

# PA228 NEUTRON ACER TENDL-2023 LIBRARY; T=0.K

## Principal cross sections

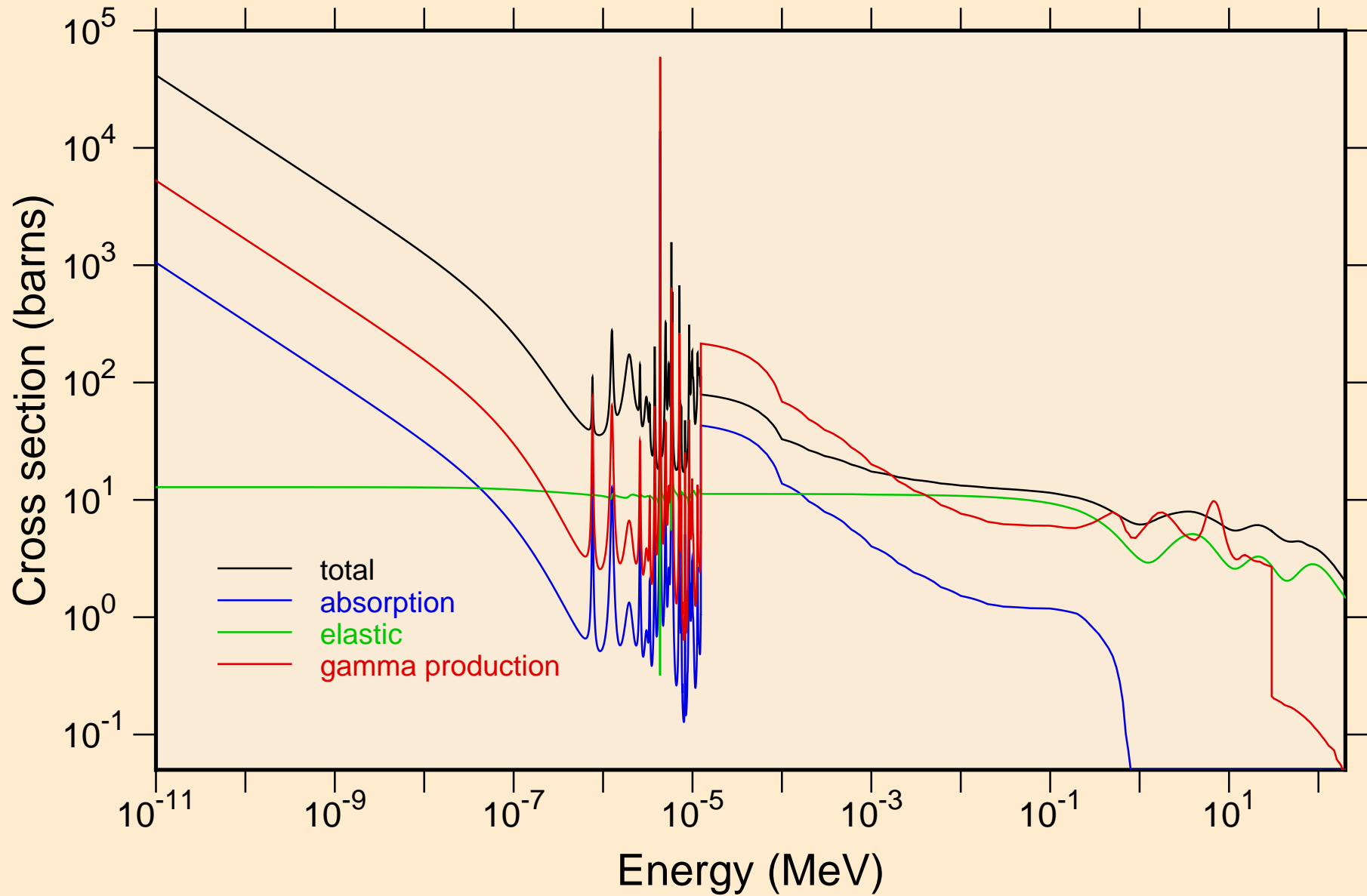

PA228 NEUTRON ACER TENDL-2023 LIBRARY; T=0.K  
resonance total cross section

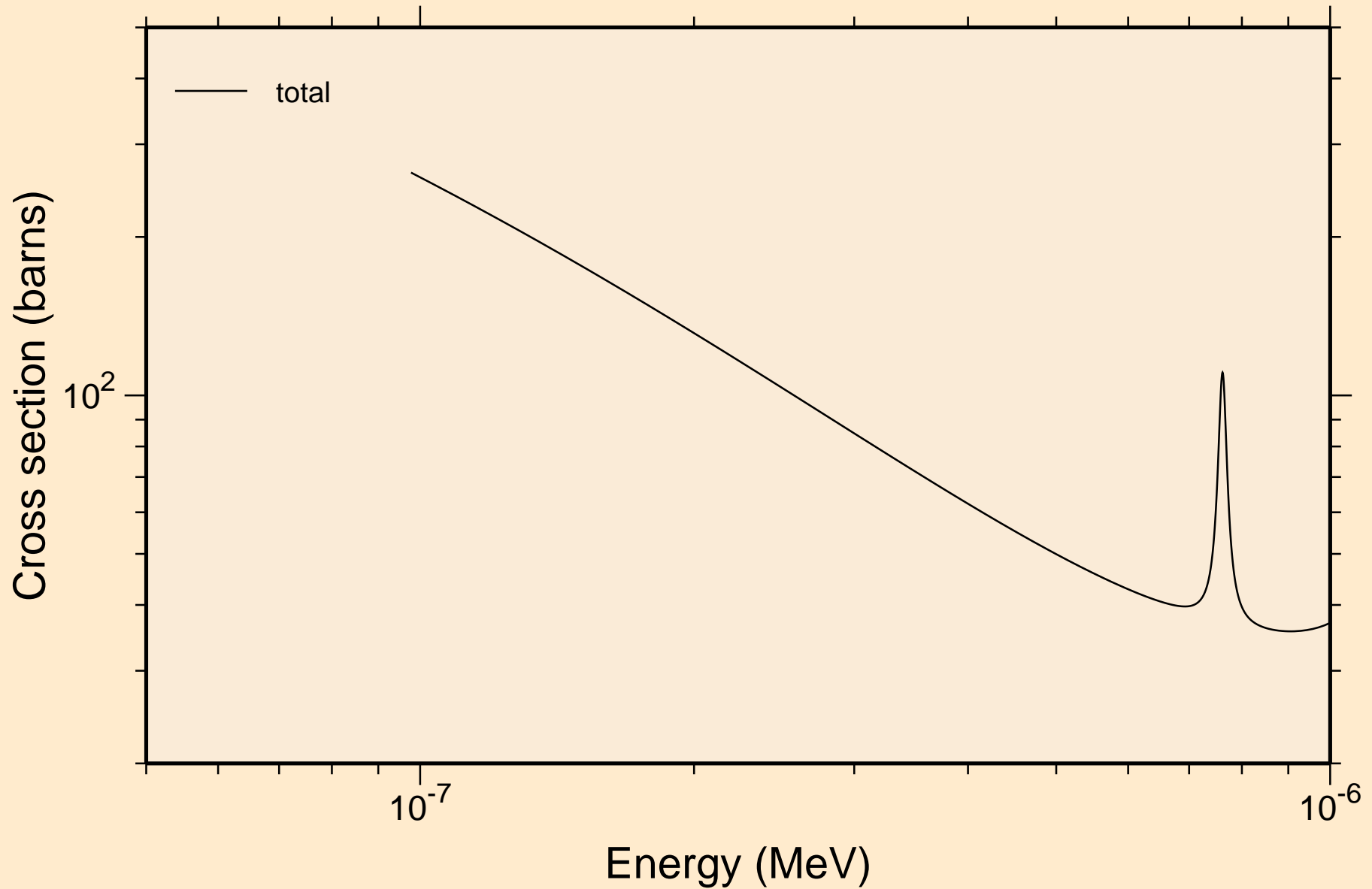

PA228 NEUTRON ACER TENDL-2023 LIBRARY; T=0.K  
resonance total cross section

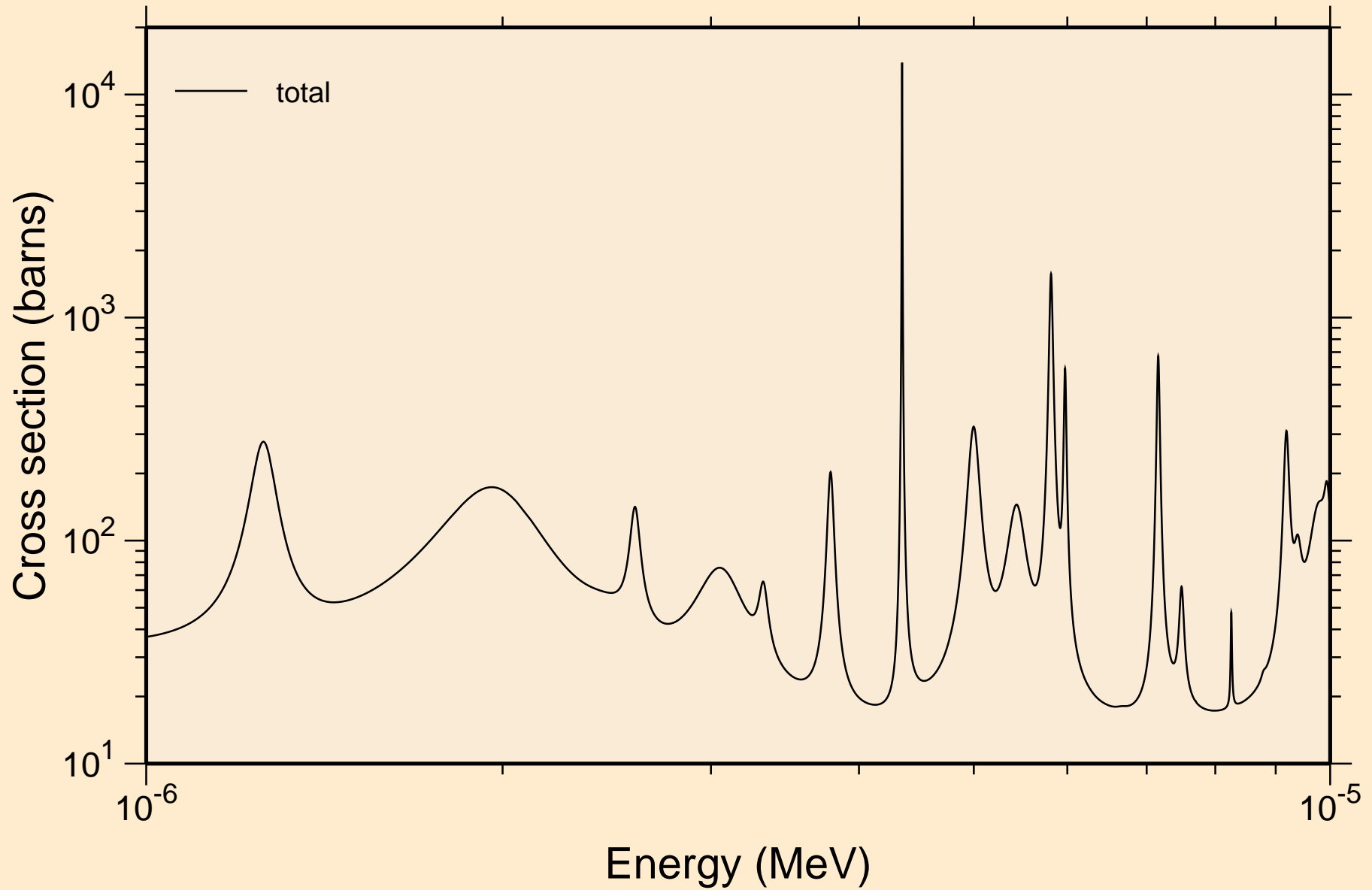

PA228 NEUTRON ACER TENDL-2023 LIBRARY; T=0.K  
resonance total cross section

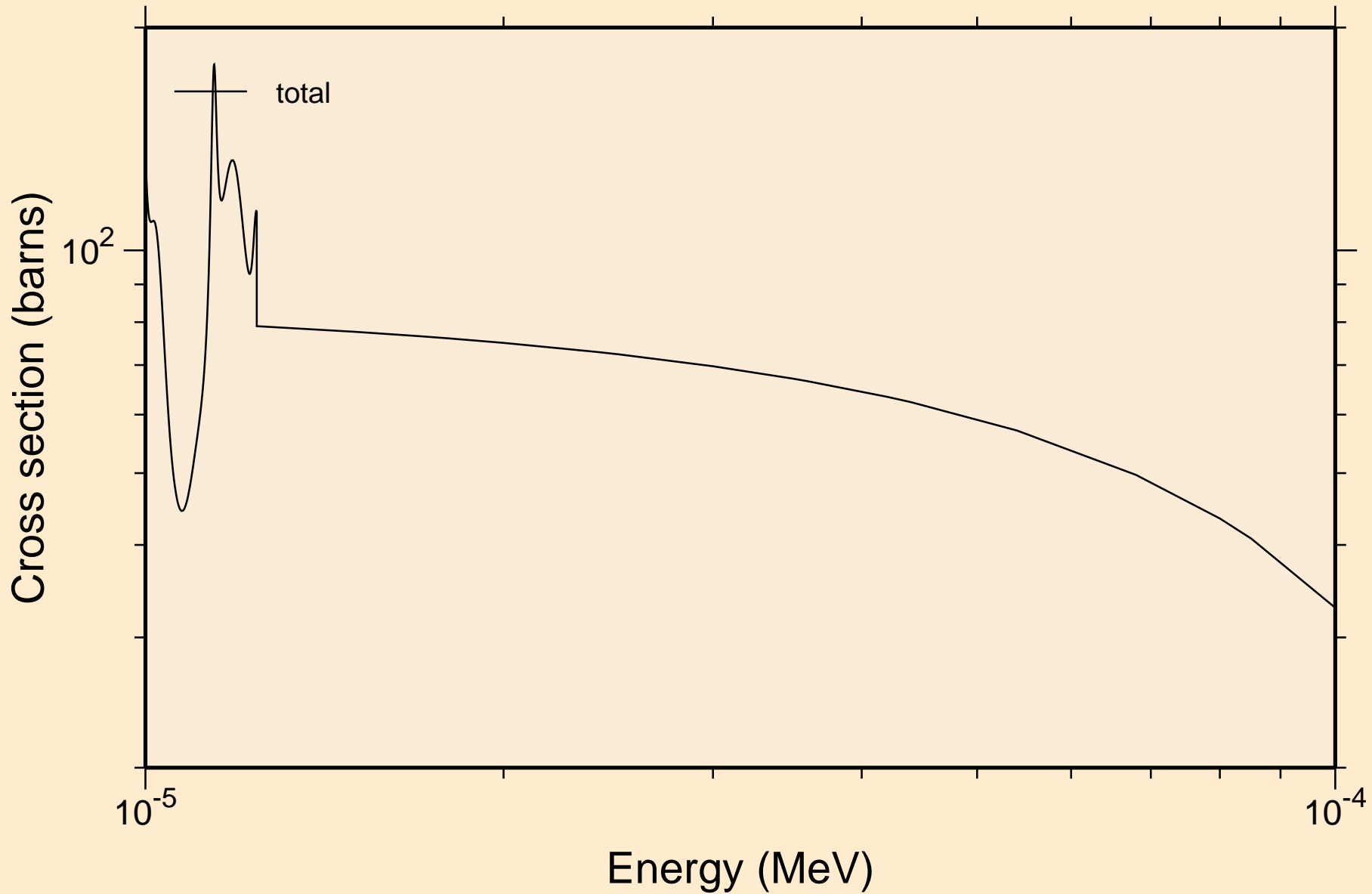

PA228 NEUTRON ACER TENDL-2023 LIBRARY; T=0.K  
resonance total cross section

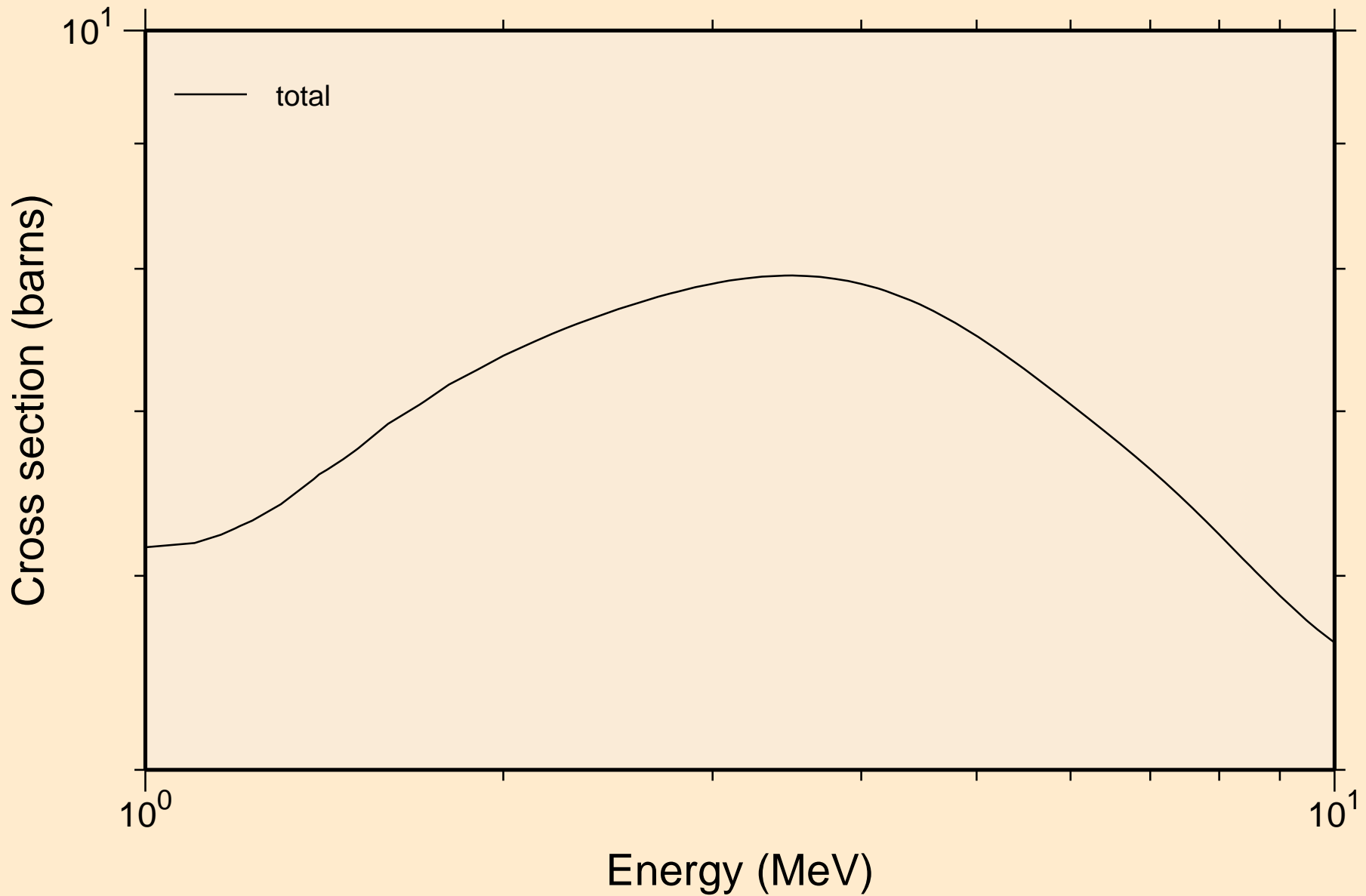

PA228 NEUTRON ACER TENDL-2023 LIBRARY; T=0.K  
resonance absorption cross sections

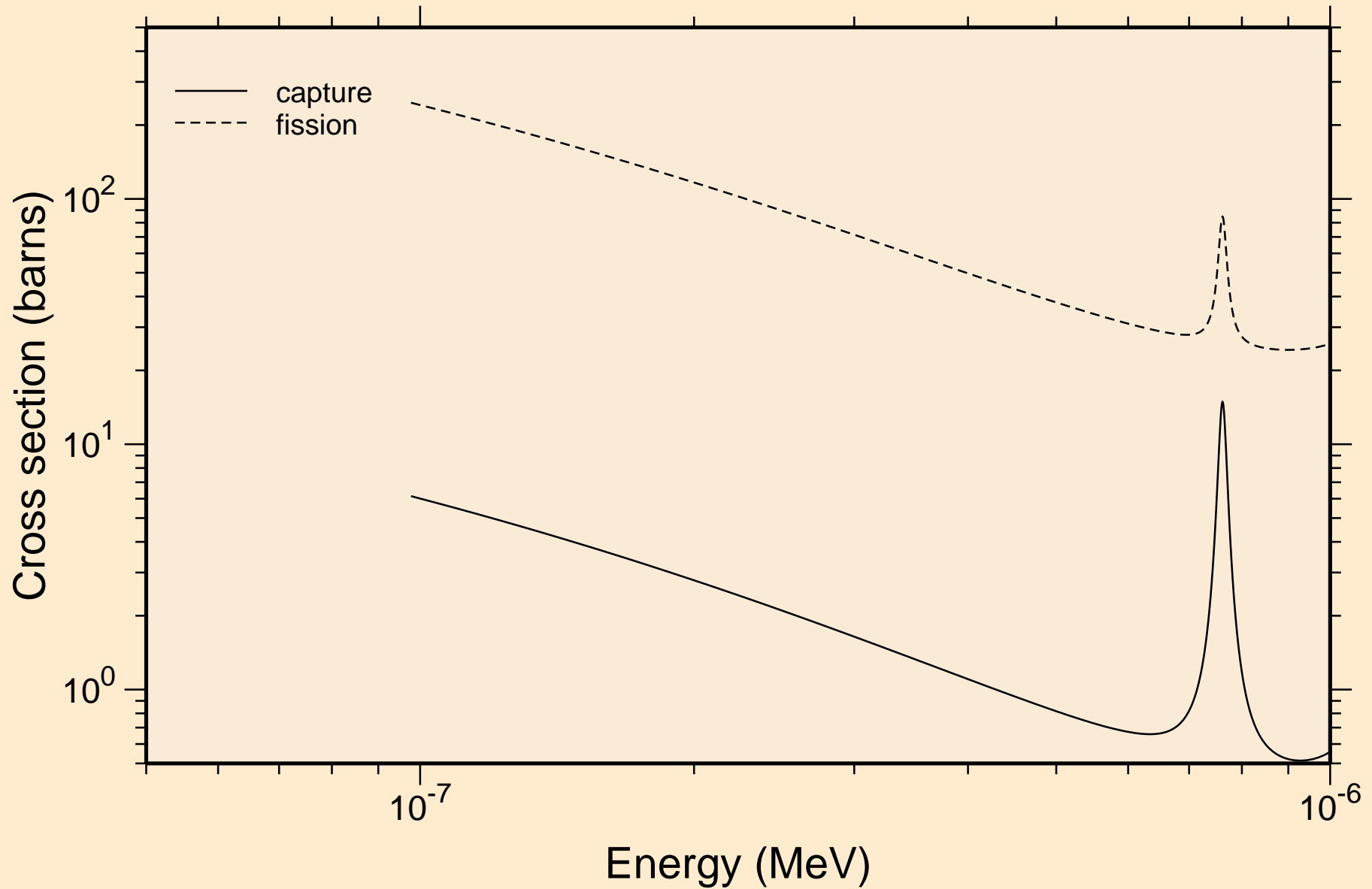

PA228 NEUTRON ACER TENDL-2023 LIBRARY; T=0.K  
resonance absorption cross sections

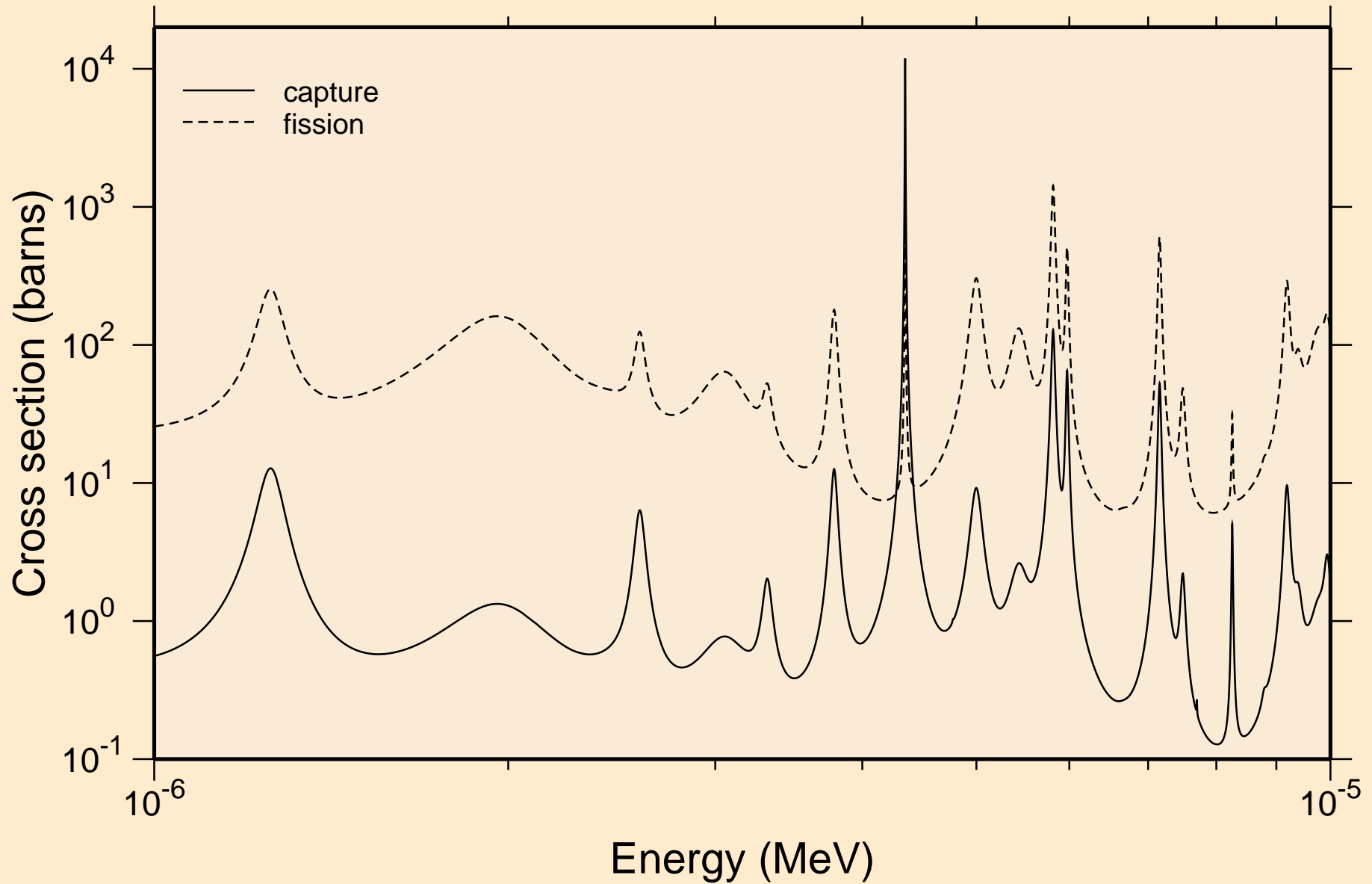

PA228 NEUTRON ACER TENDL-2023 LIBRARY; T=0.K  
resonance absorption cross sections

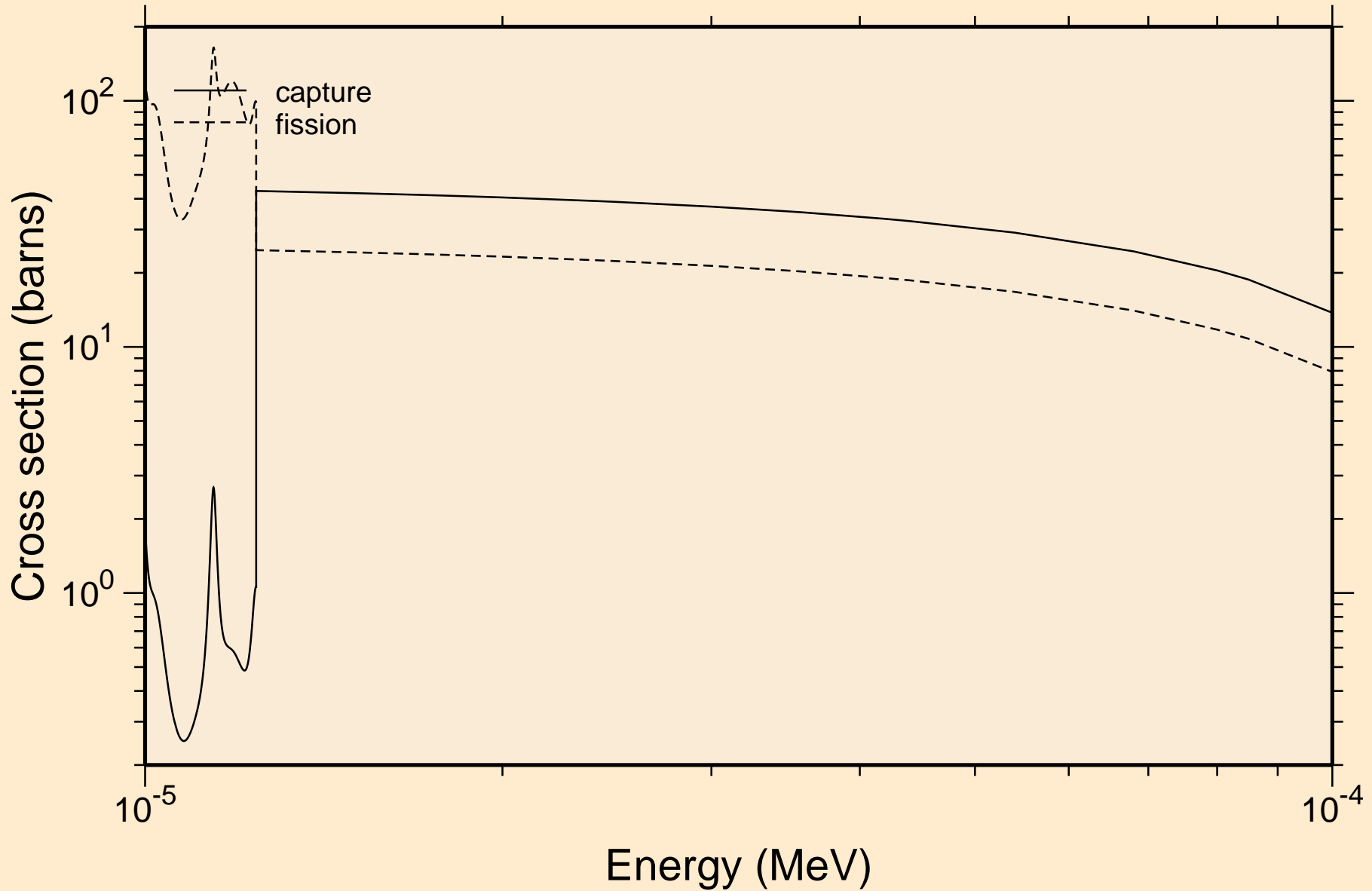



PA228 NEUTRON ACER TENDL-2023 LIBRARY; T=0.K  
resonance absorption cross sections

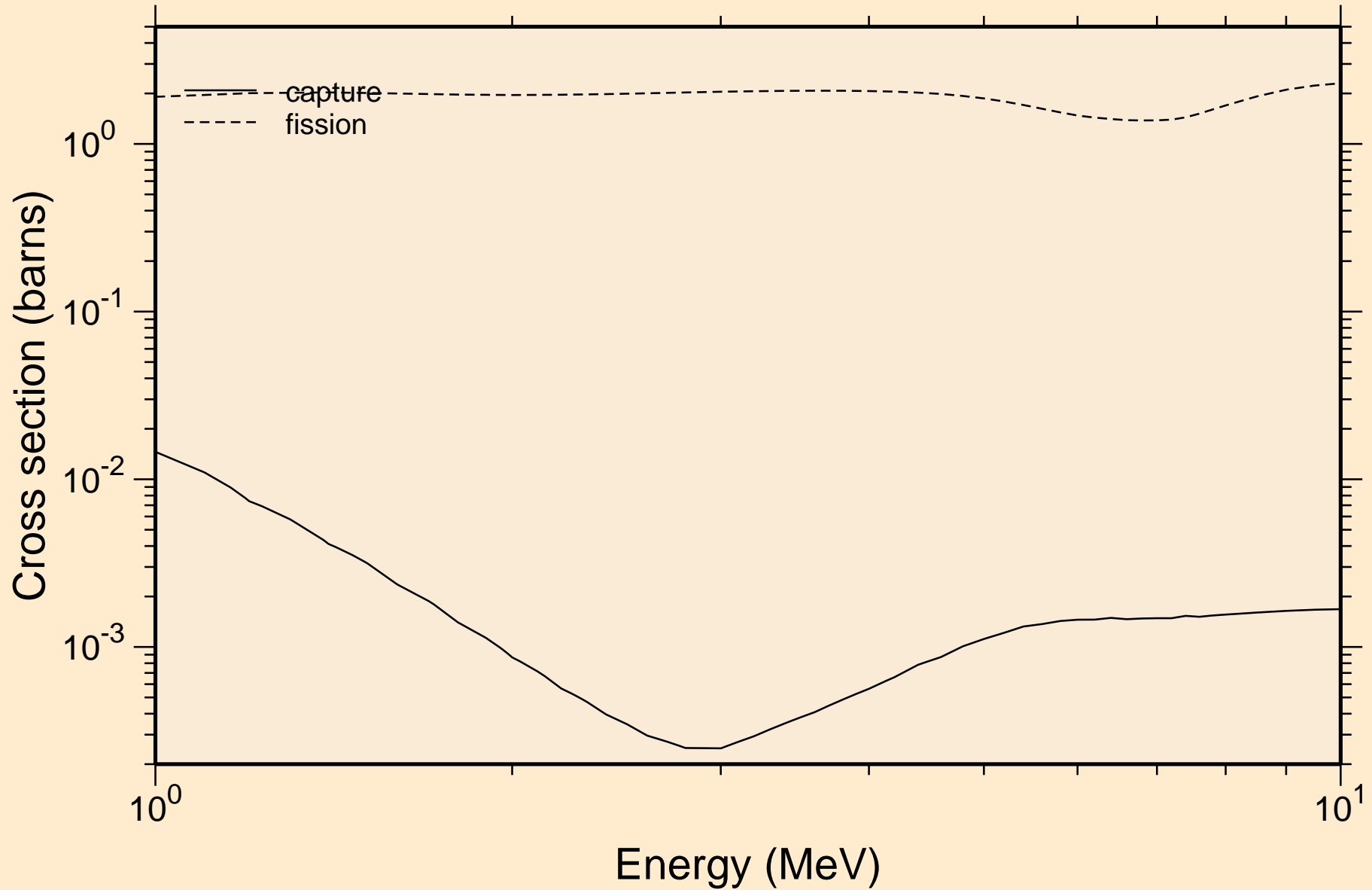

PA228 NEUTRON ACER TENDL-2023 LIBRARY; T=0.K

Heating

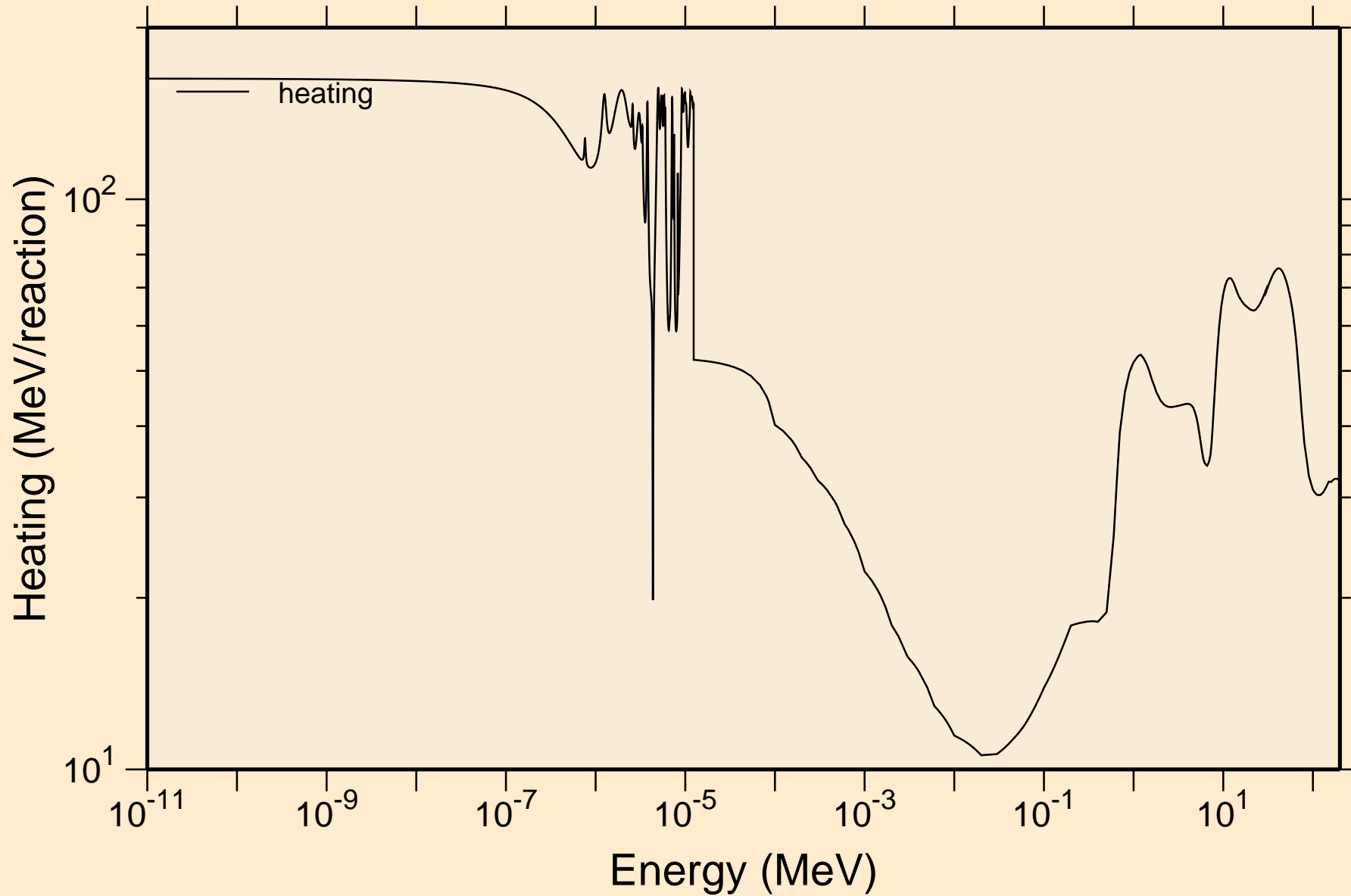

PA228 NEUTRON ACER TENDL-2023 LIBRARY; T=0.K  
Damage

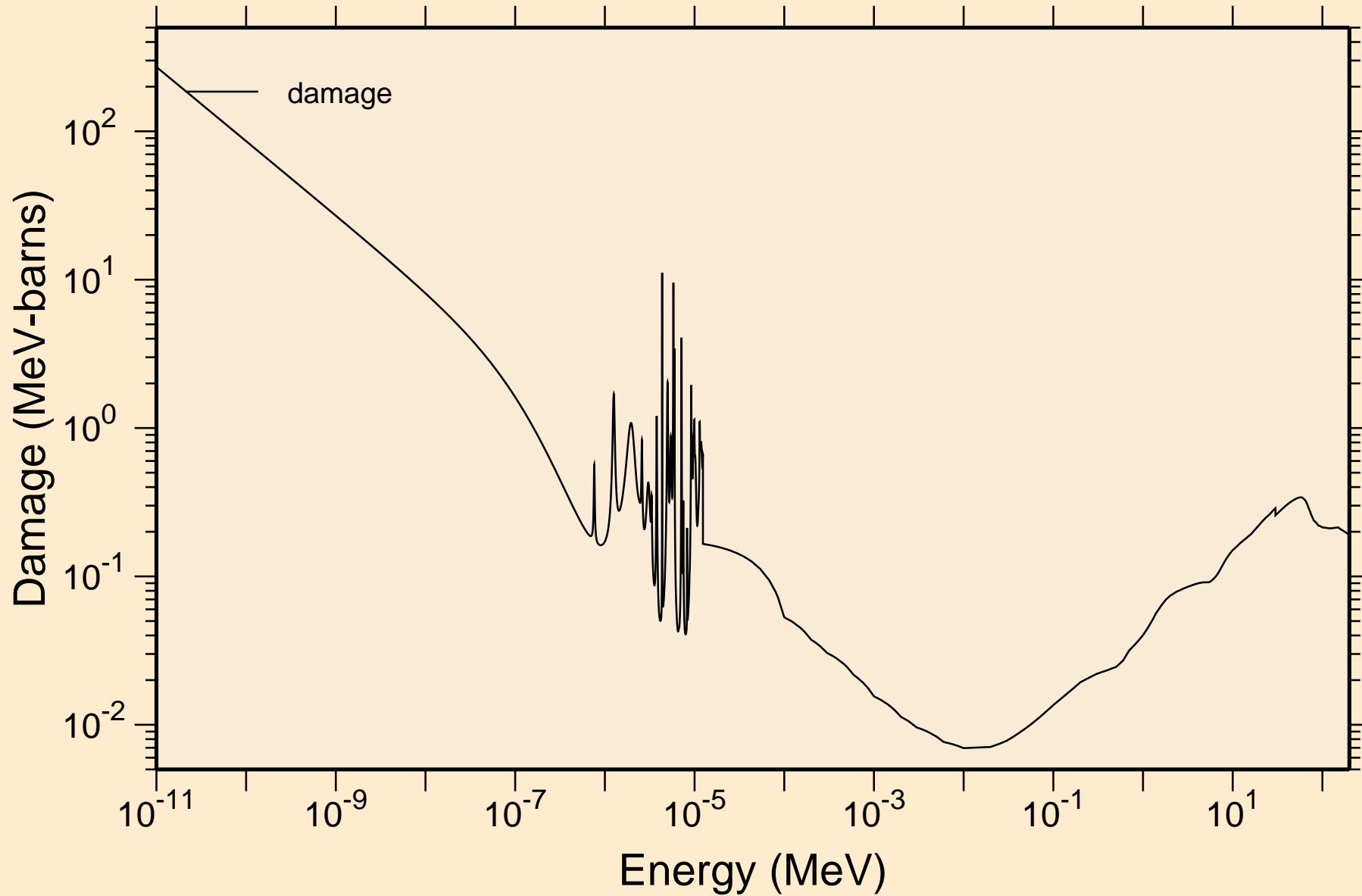

PA228 NEUTRON ACER TENDL-2023 LIBRARY; T=0.K  
Non-threshold reactions

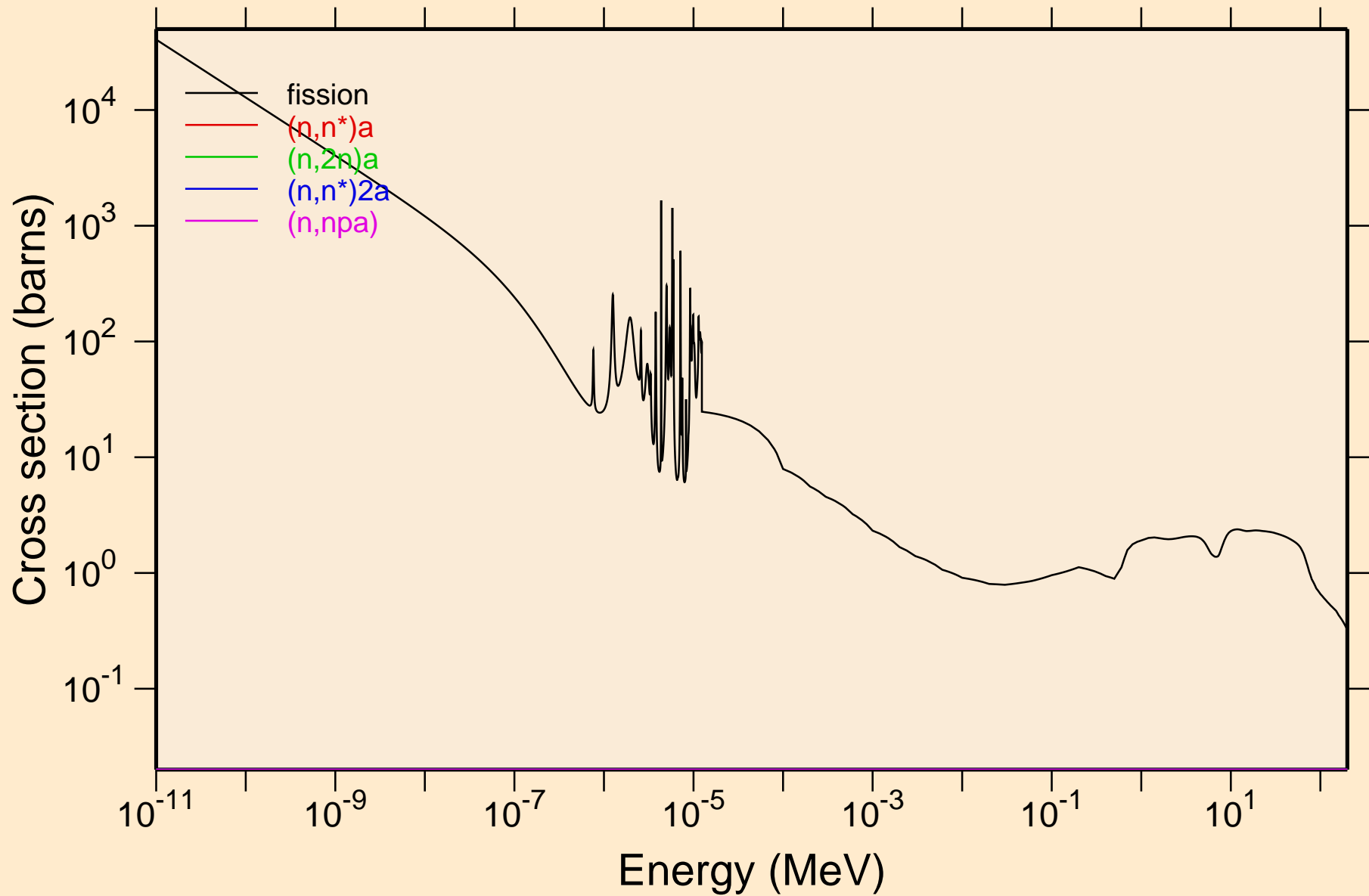

PA228 NEUTRON ACER TENDL-2023 LIBRARY; T=0.K  
Non-threshold reactions

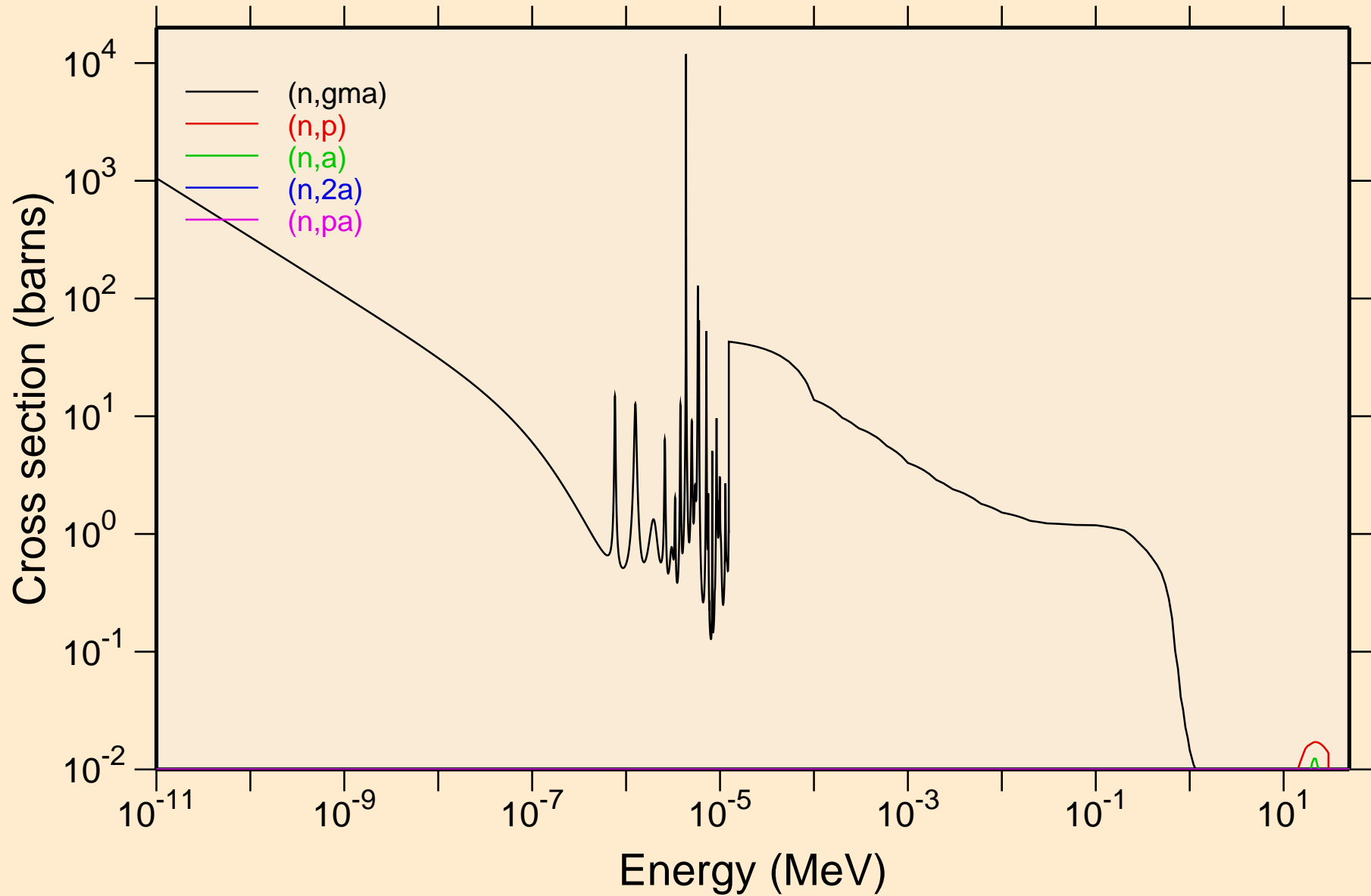

PA228 NEUTRON ACER TENDL-2023 LIBRARY; T=0.K  
Non-threshold reactions

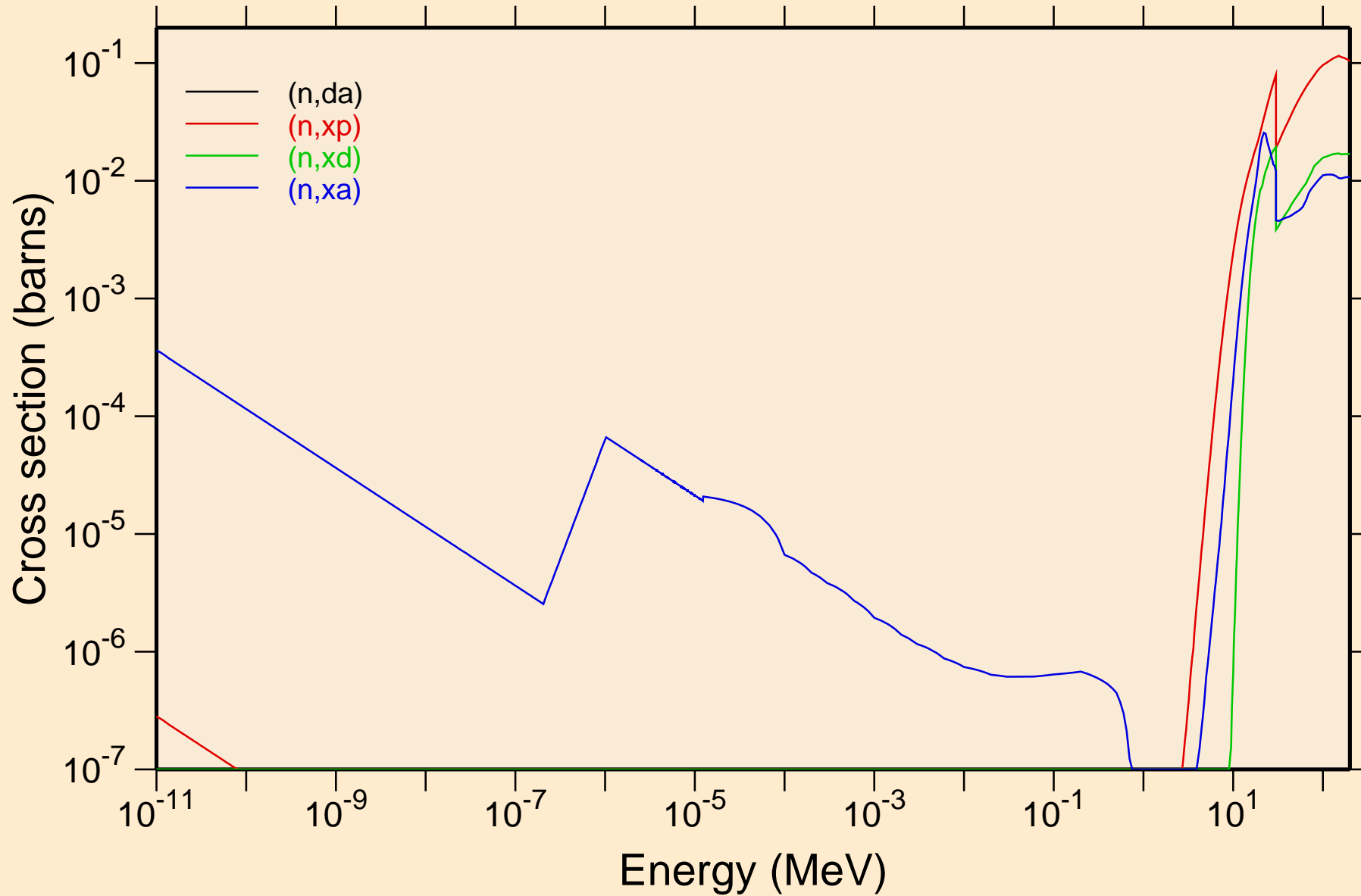

# PA228 NEUTRON ACER TENDL-2023 LIBRARY; T=0.K

## Principal cross sections

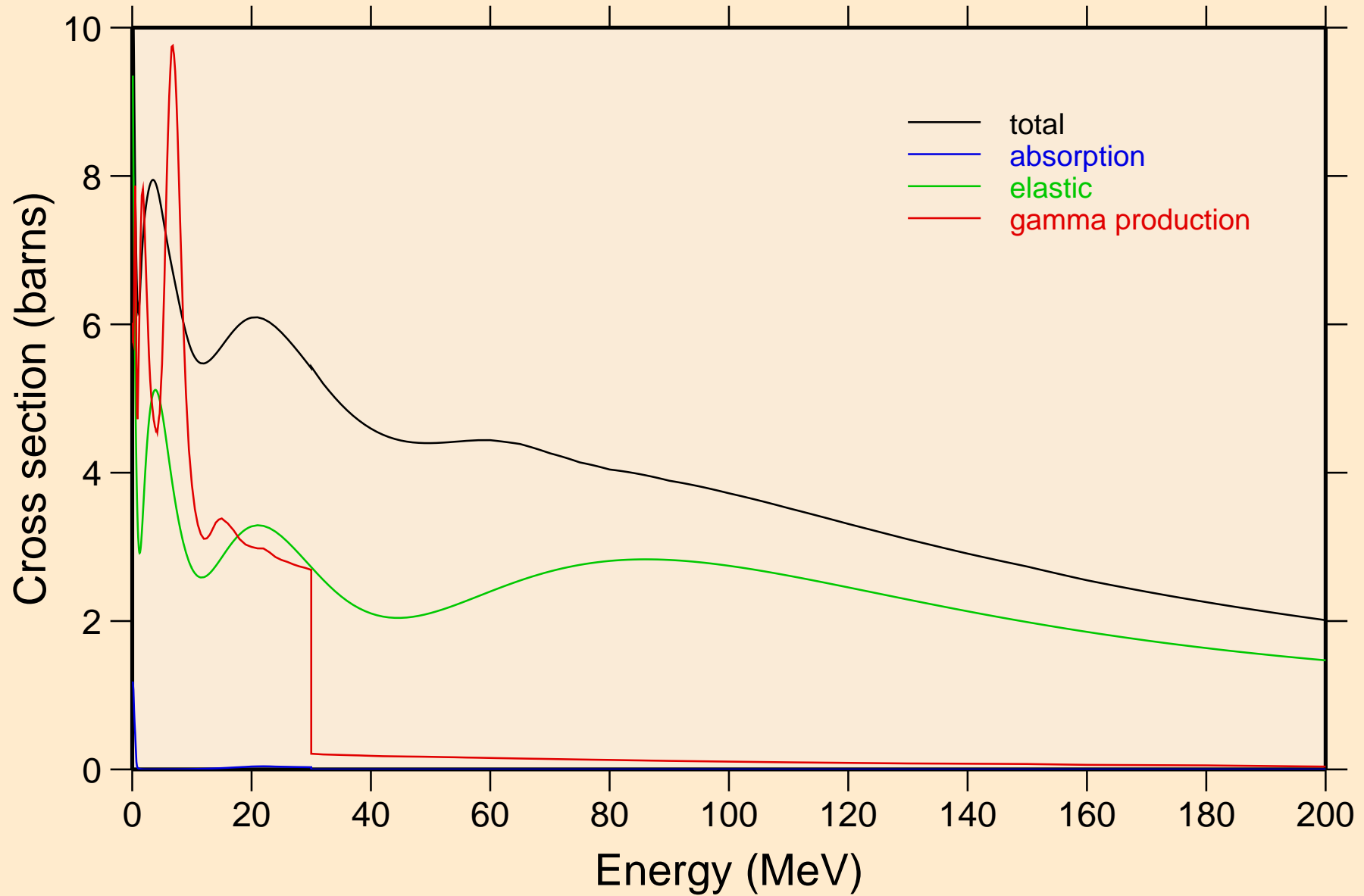

PA228 NEUTRON ACER TENDL-2023 LIBRARY; T=0.K

Heating

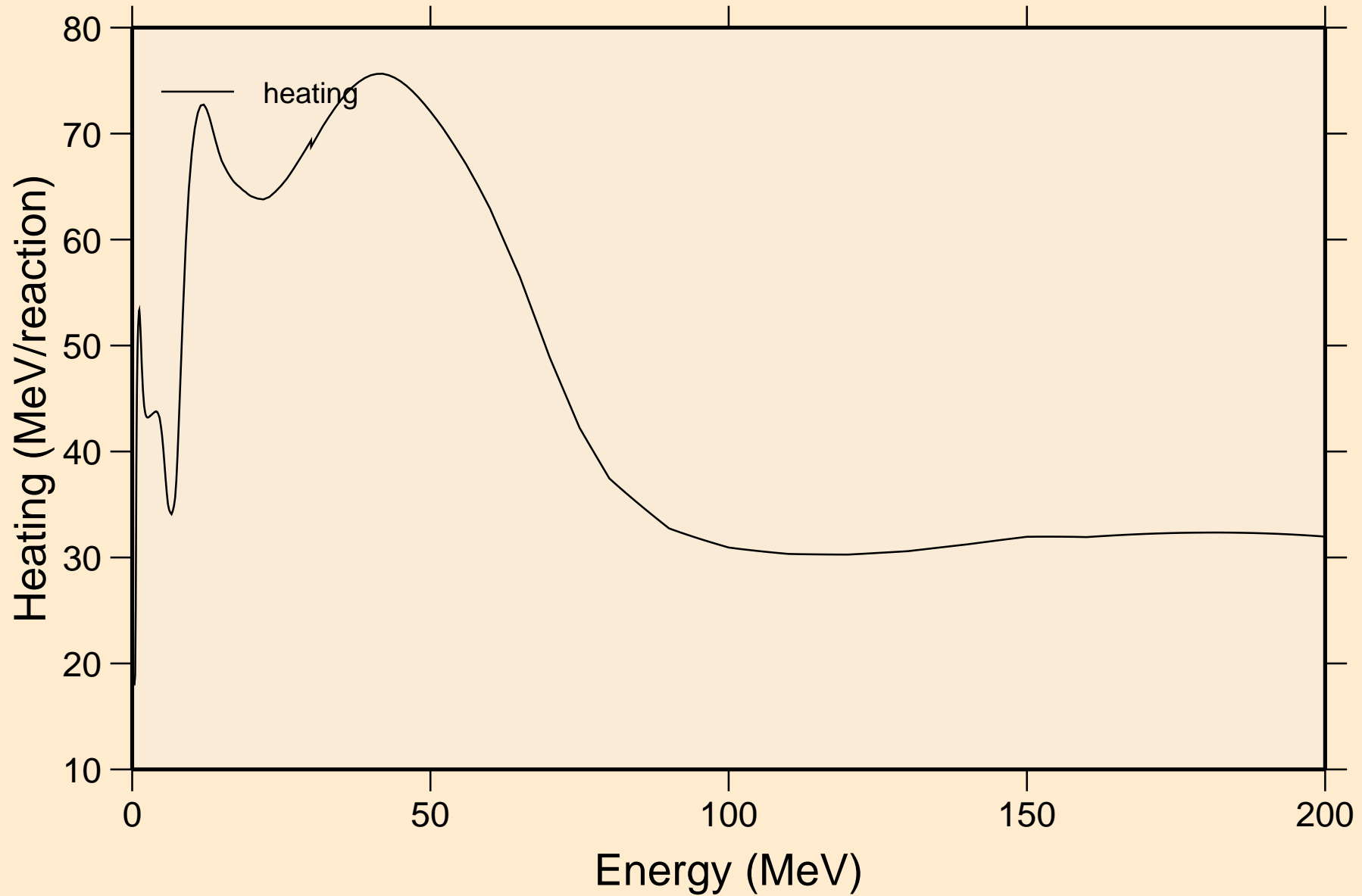



PA228 NEUTRON ACER TENDL-2023 LIBRARY; T=0.K  
Damage

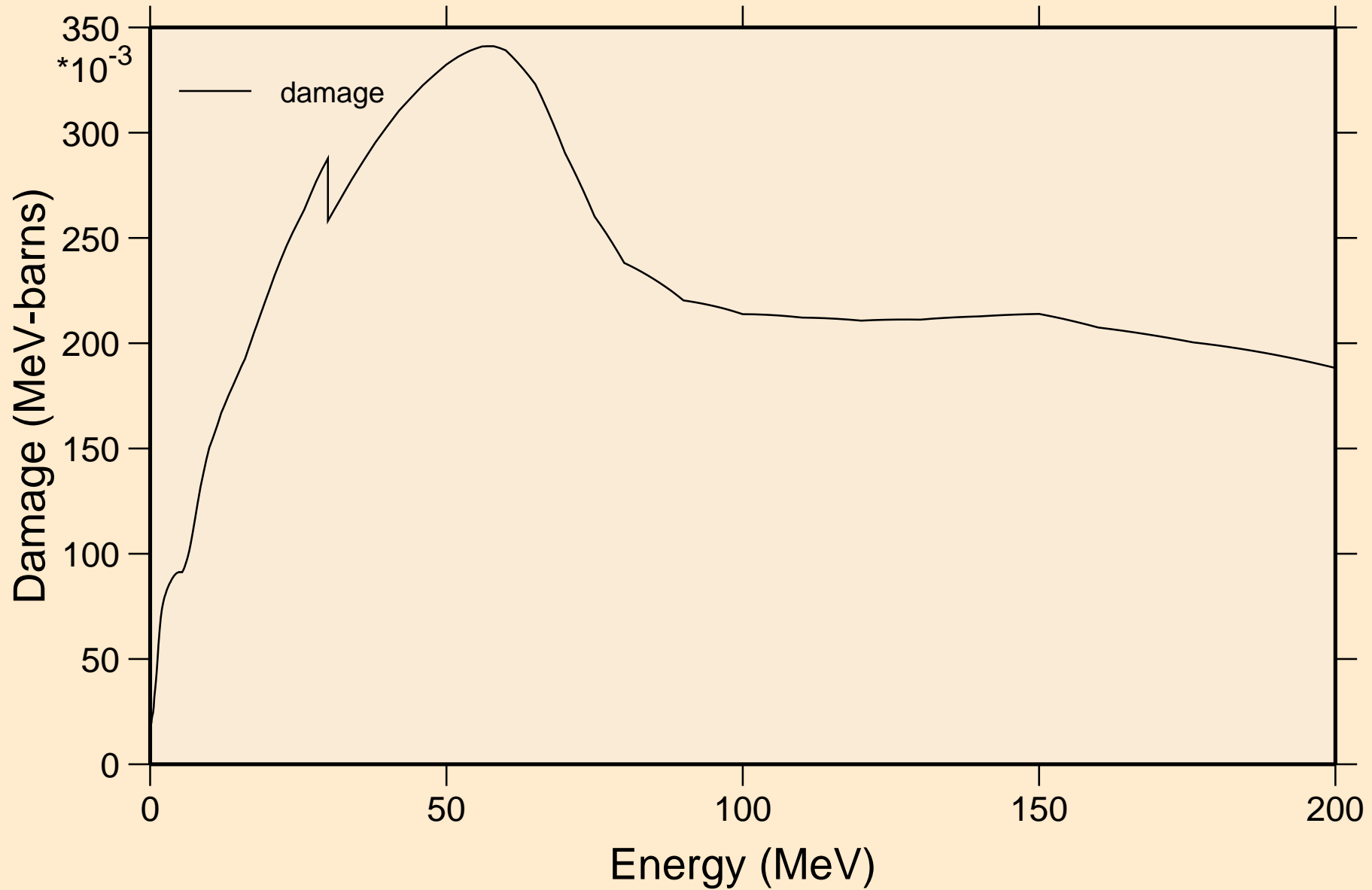

# PA228 NEUTRON ACER TENDL-2023 LIBRARY; T=0.K

## Non-threshold reactions

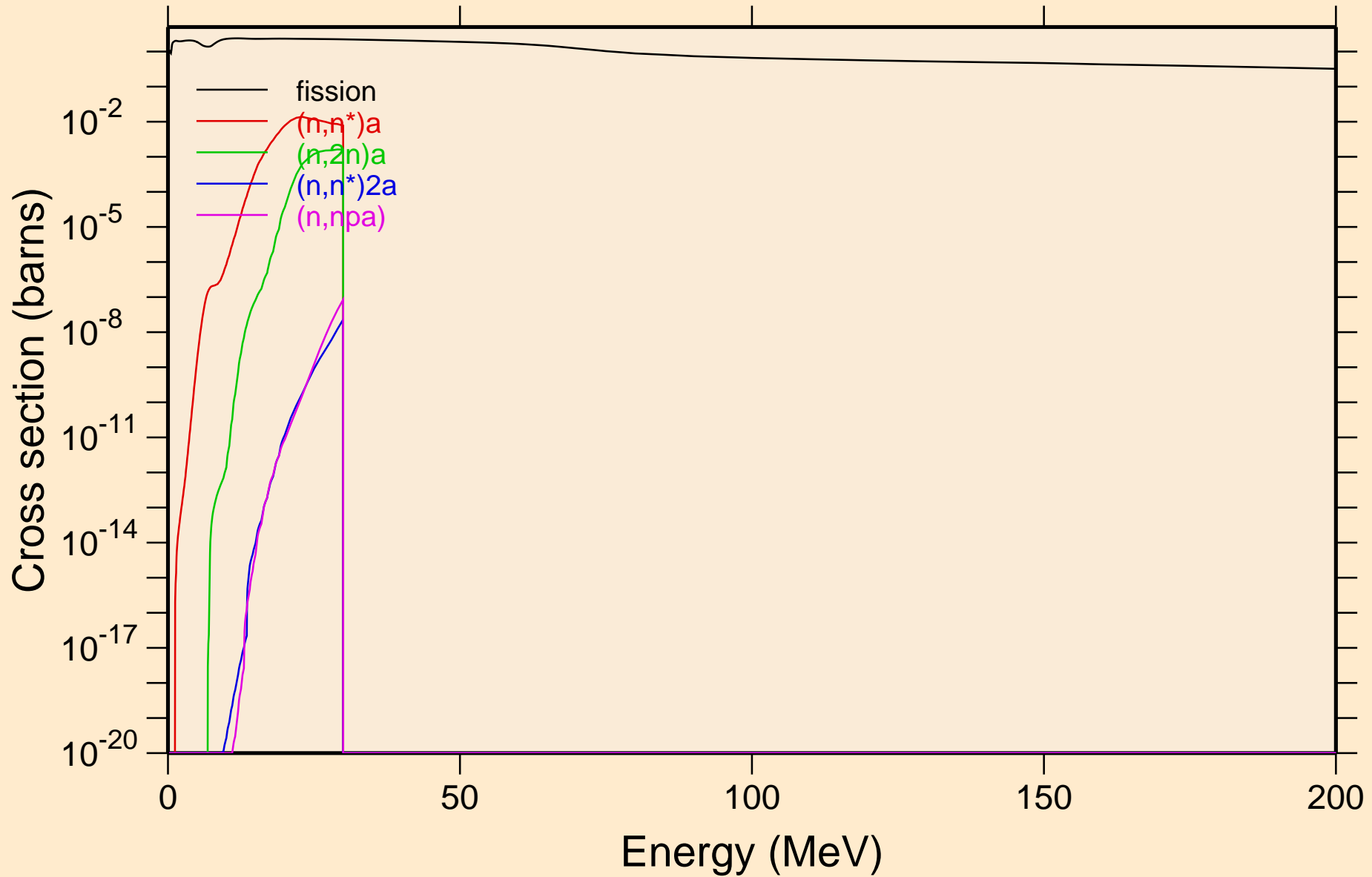

PA228 NEUTRON ACER TENDL-2023 LIBRARY; T=0.K  
Non-threshold reactions

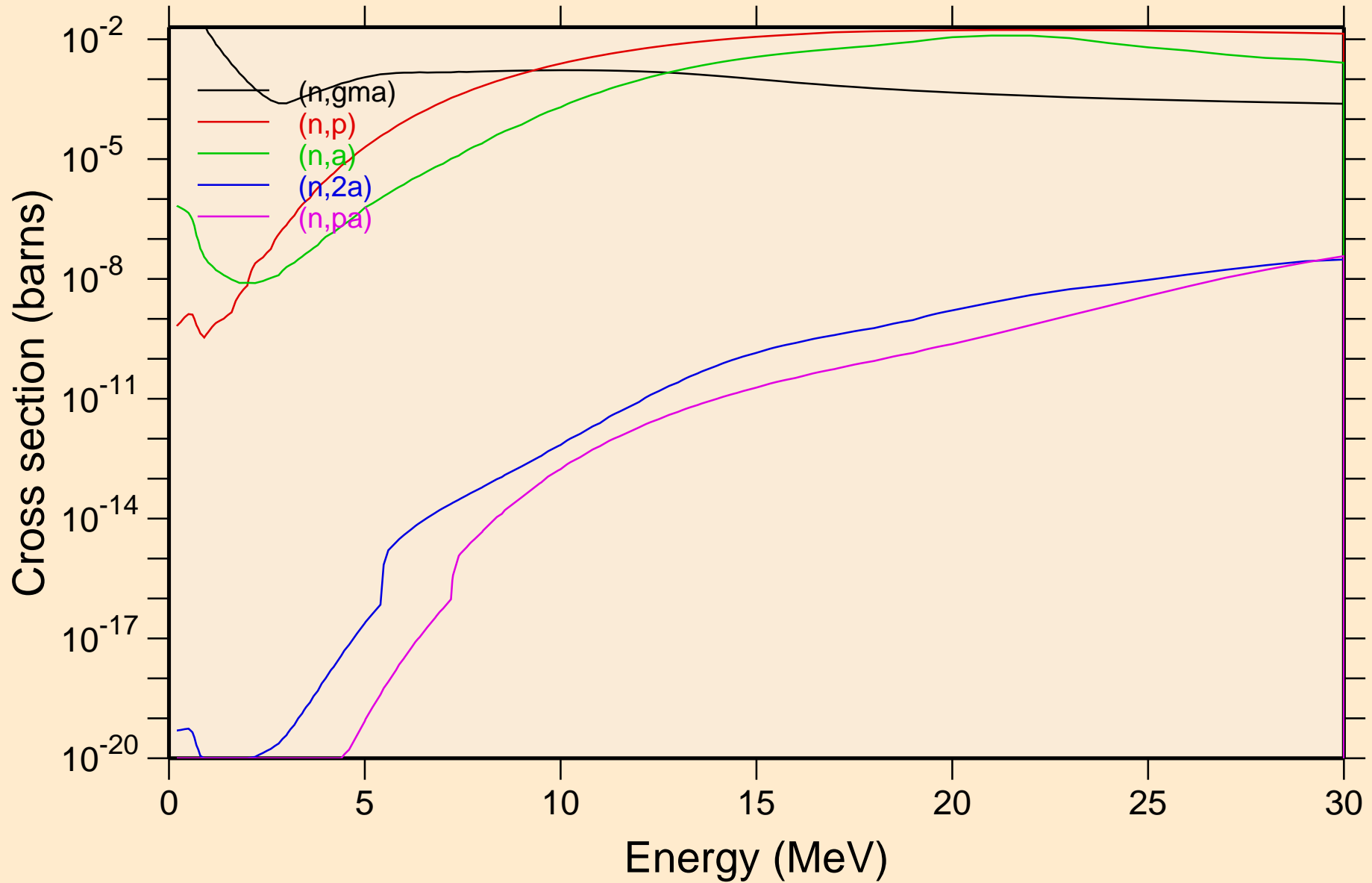

PA228 NEUTRON ACER TENDL-2023 LIBRARY; T=0.K  
Non-threshold reactions

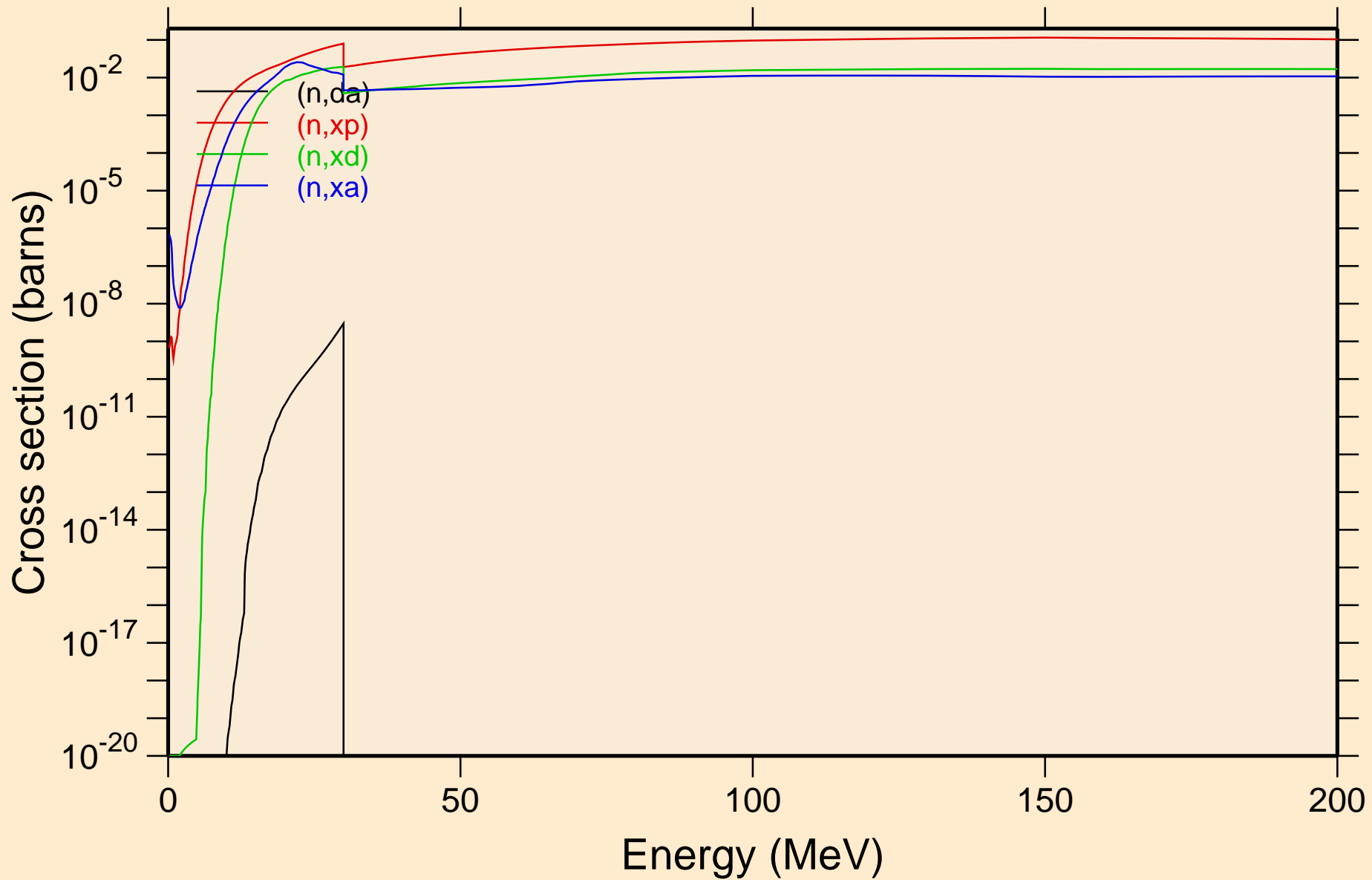

PA228 NEUTRON ACER TENDL-2023 LIBRARY; T=0.K  
Inelastic levels

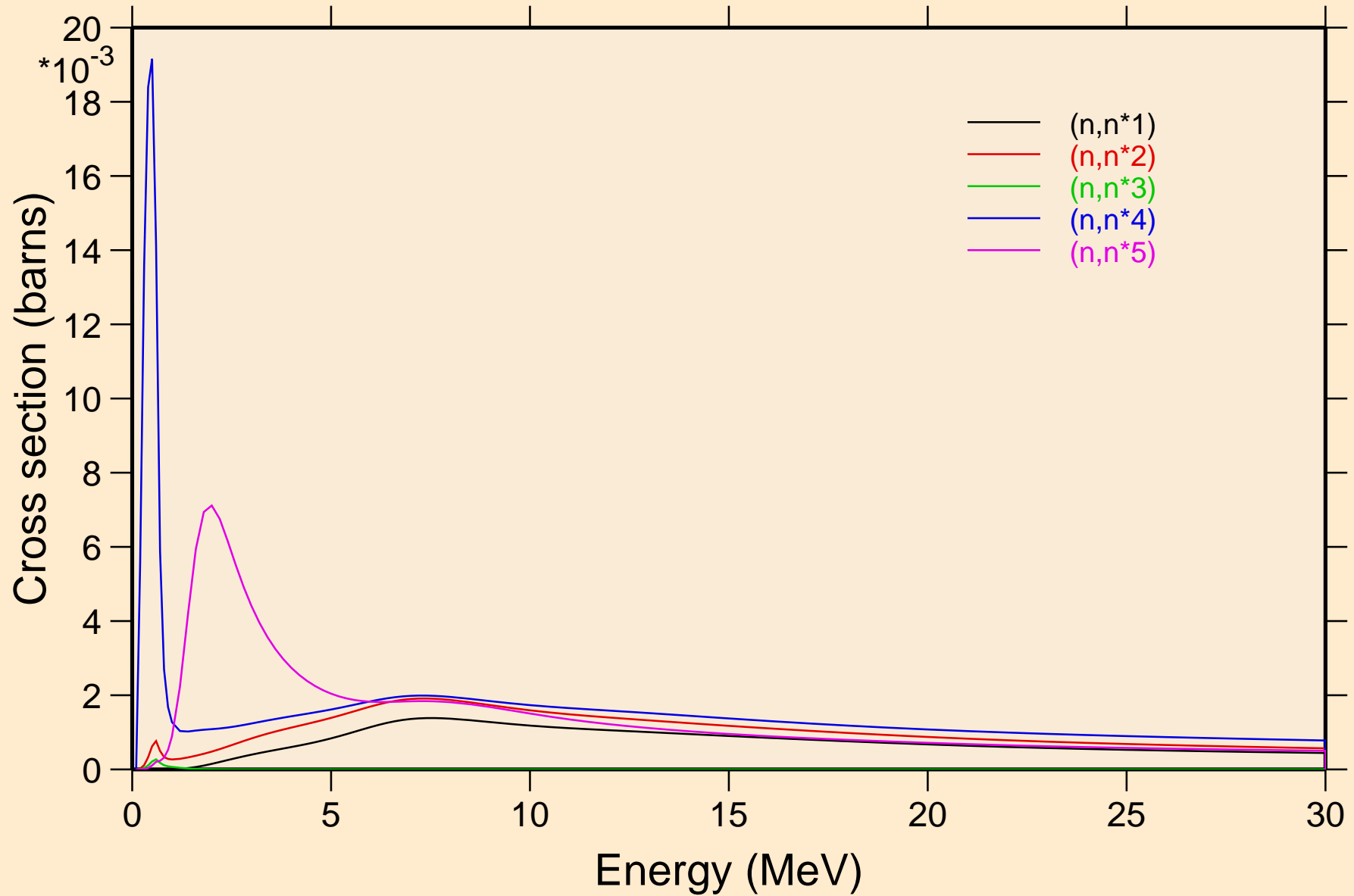

PA228 NEUTRON ACER TENDL-2023 LIBRARY; T=0.K  
Inelastic levels

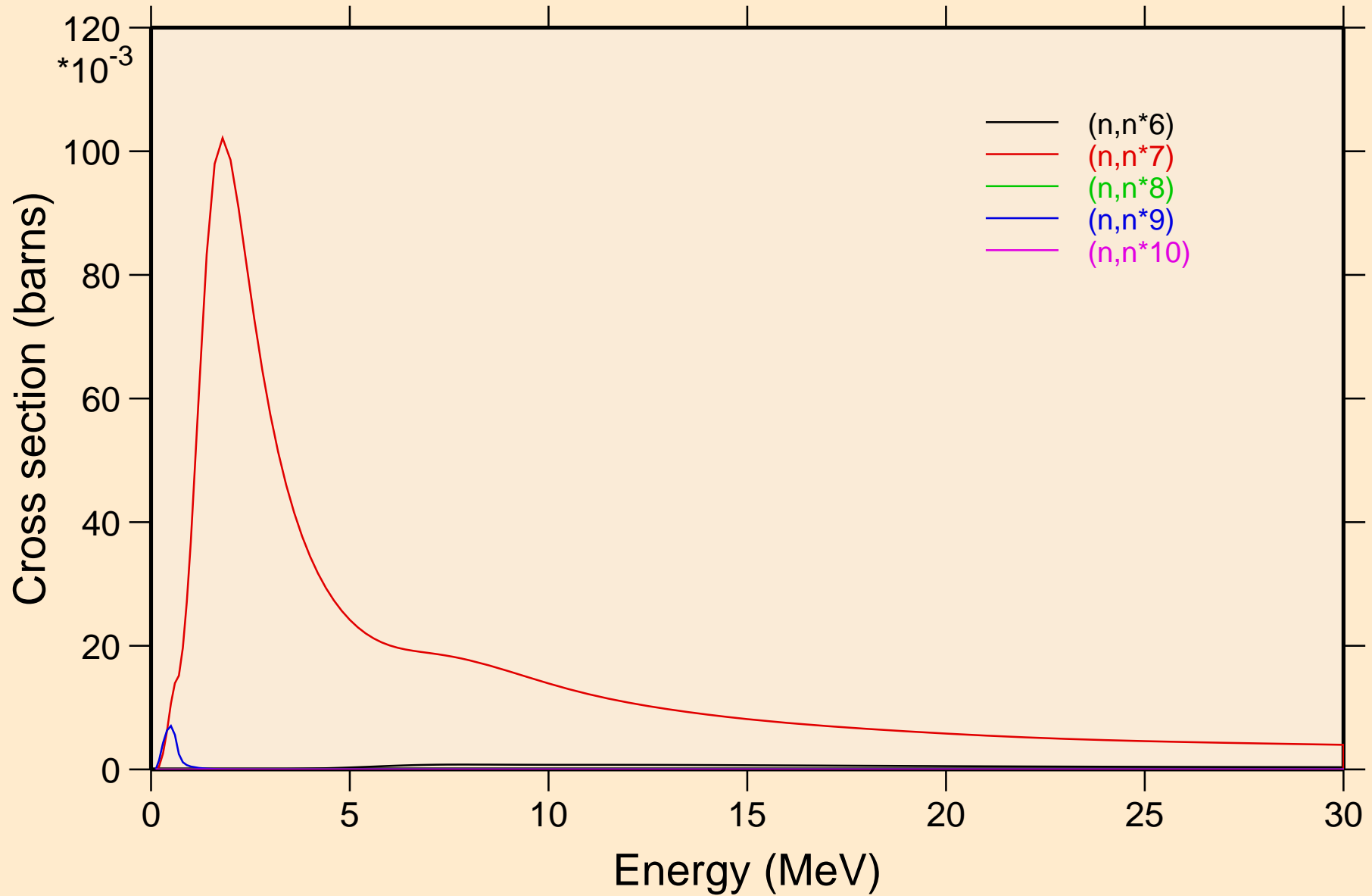

PA228 NEUTRON ACER TENDL-2023 LIBRARY; T=0.K  
Inelastic levels

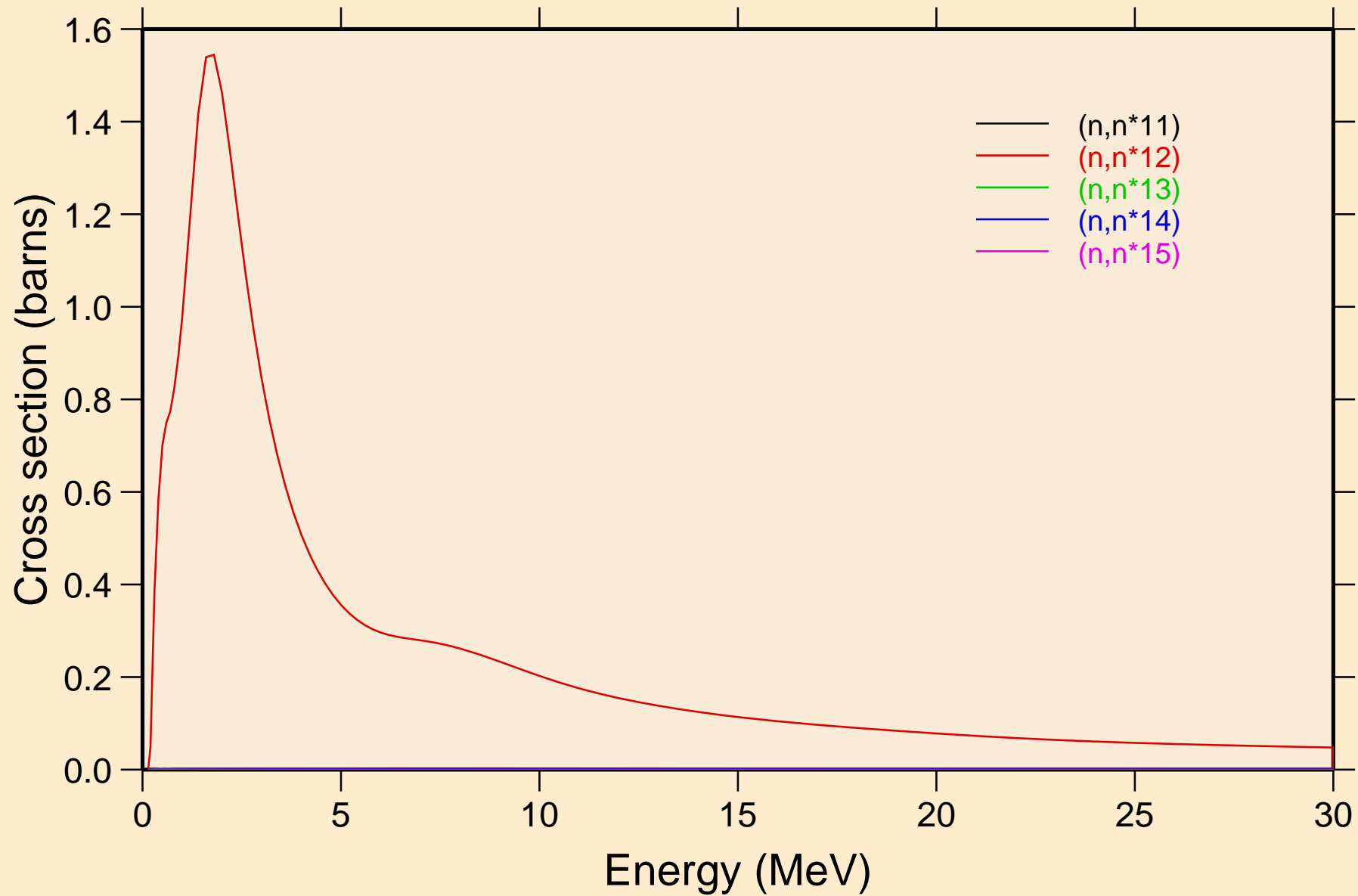

PA228 NEUTRON ACER TENDL-2023 LIBRARY; T=0.K  
Inelastic levels

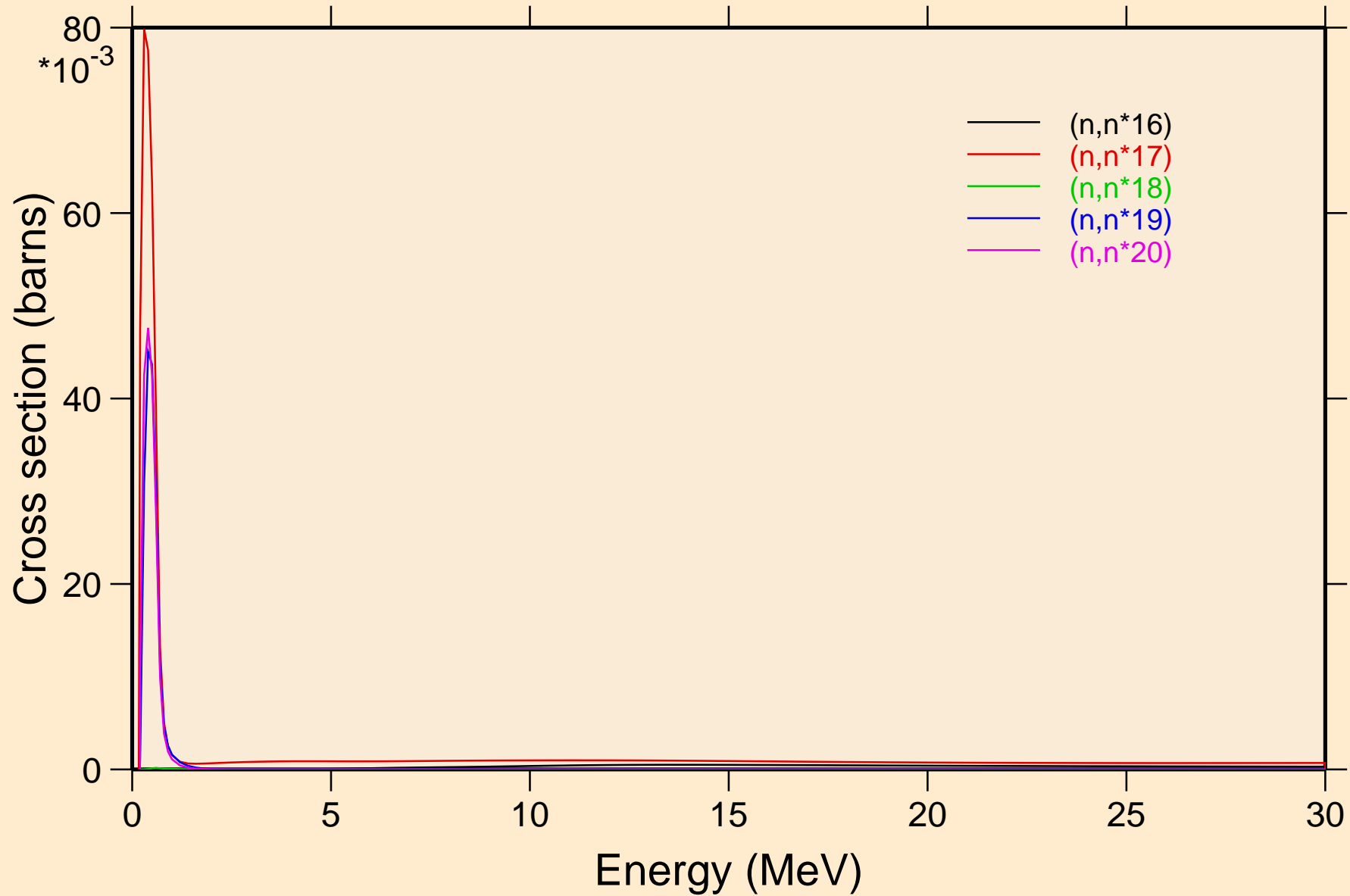



PA228 NEUTRON ACER TENDL-2023 LIBRARY; T=0.K  
Inelastic levels

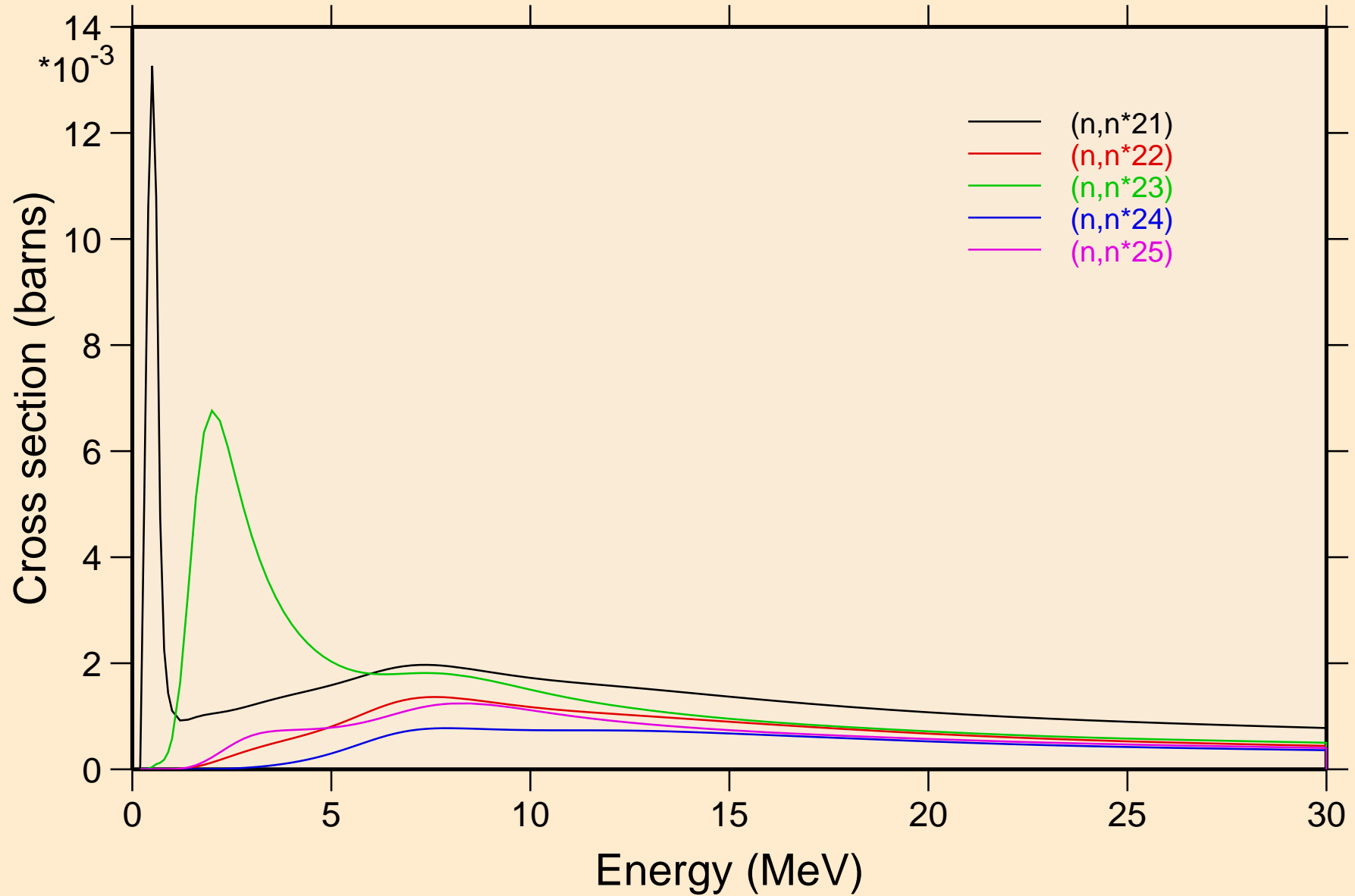

PA228 NEUTRON ACER TENDL-2023 LIBRARY; T=0.K  
Inelastic levels

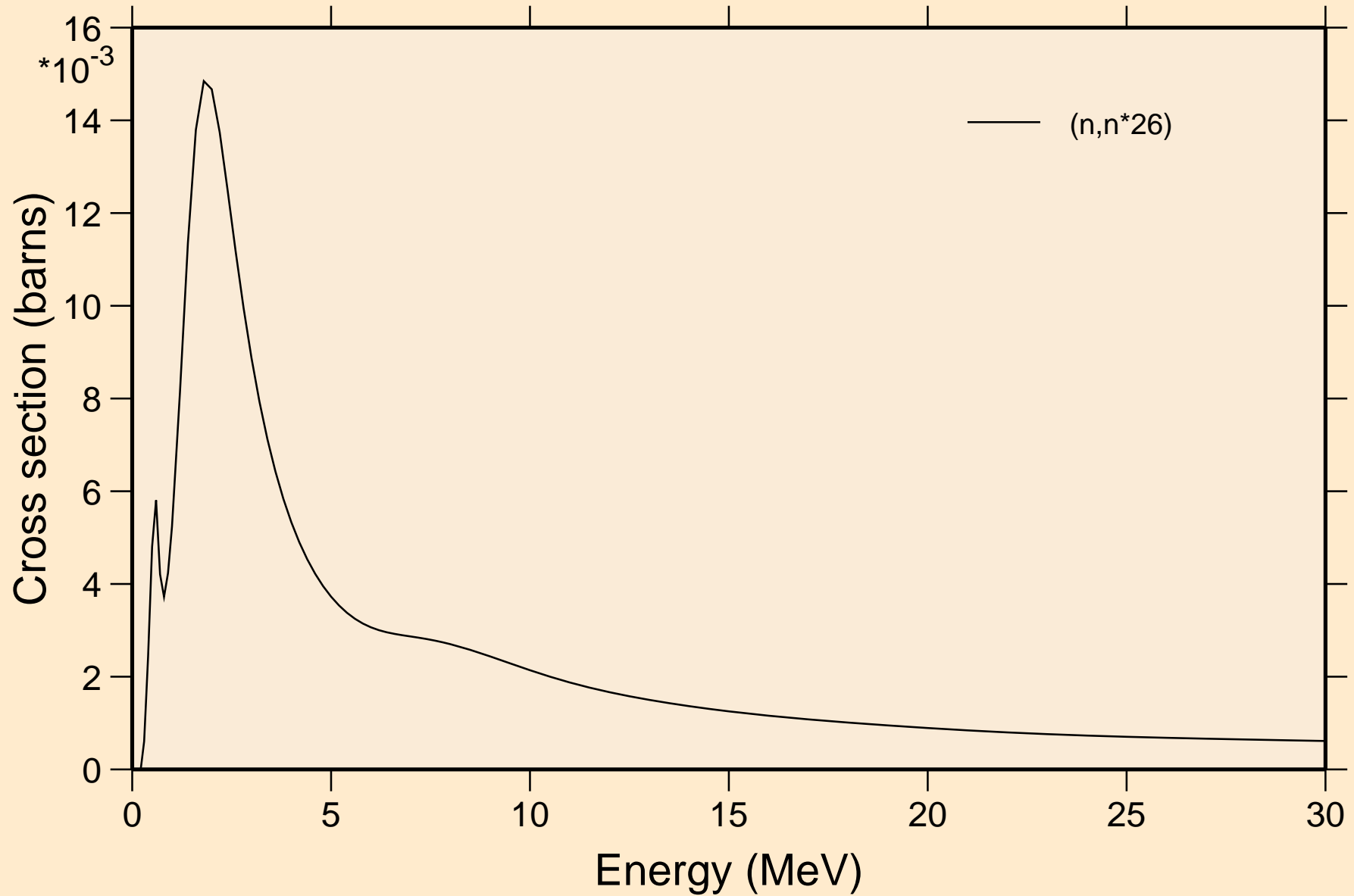

PA228 NEUTRON ACER TENDL-2023 LIBRARY; T=0.K  
Threshold reactions

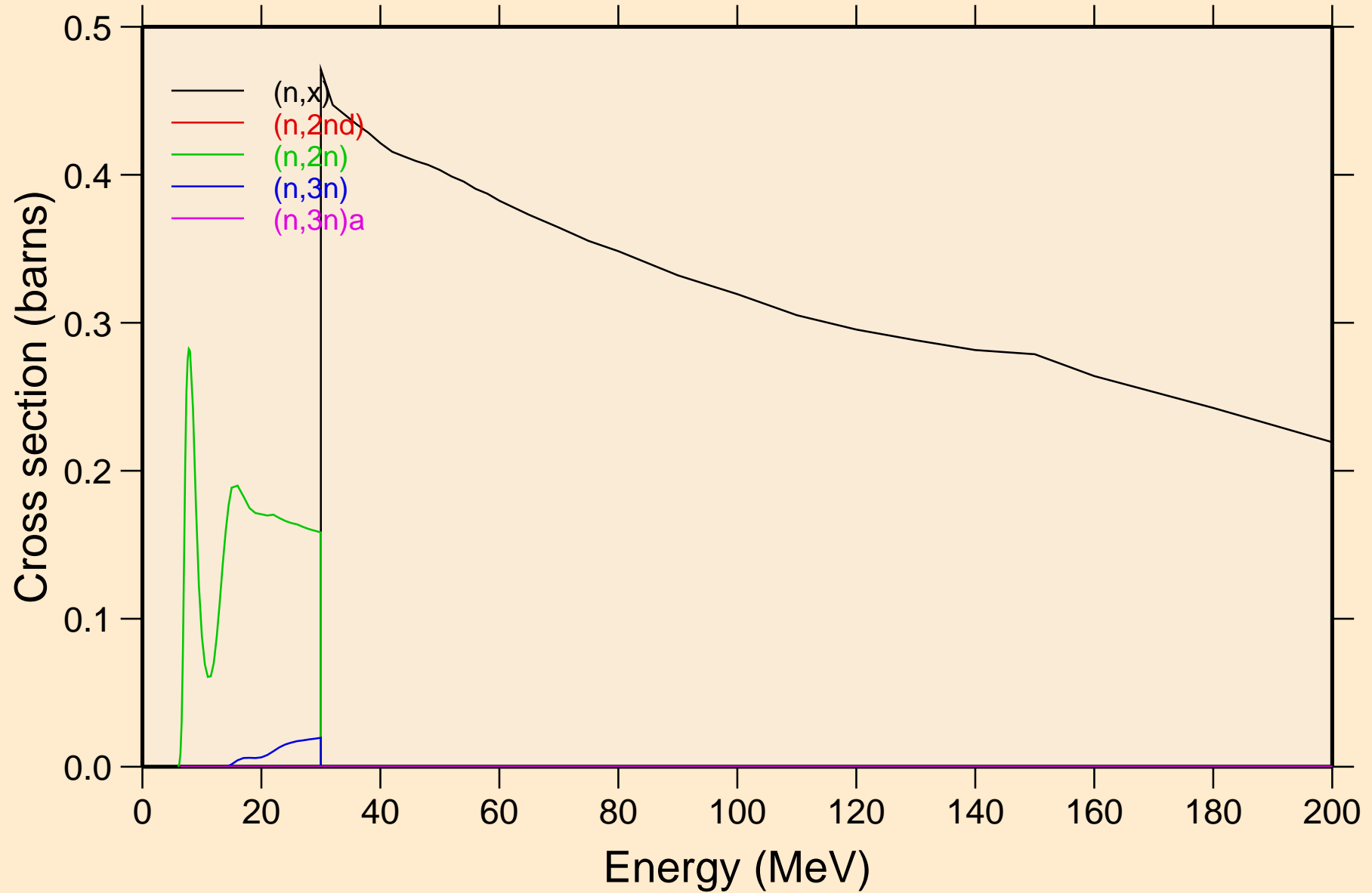

PA228 NEUTRON ACER TENDL-2023 LIBRARY; T=0.K  
Threshold reactions

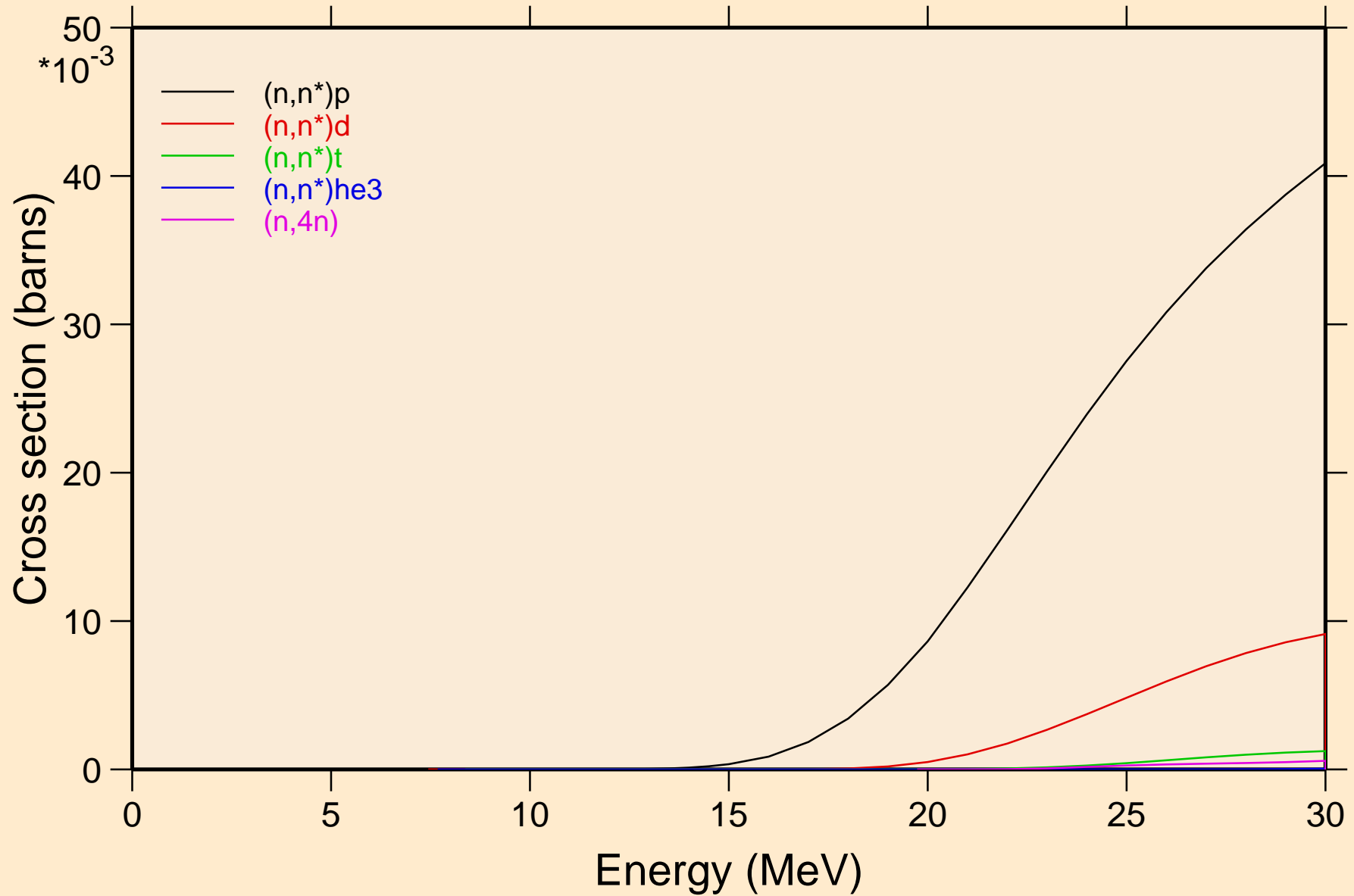

PA228 NEUTRON ACER TENDL-2023 LIBRARY; T=0.K  
Threshold reactions

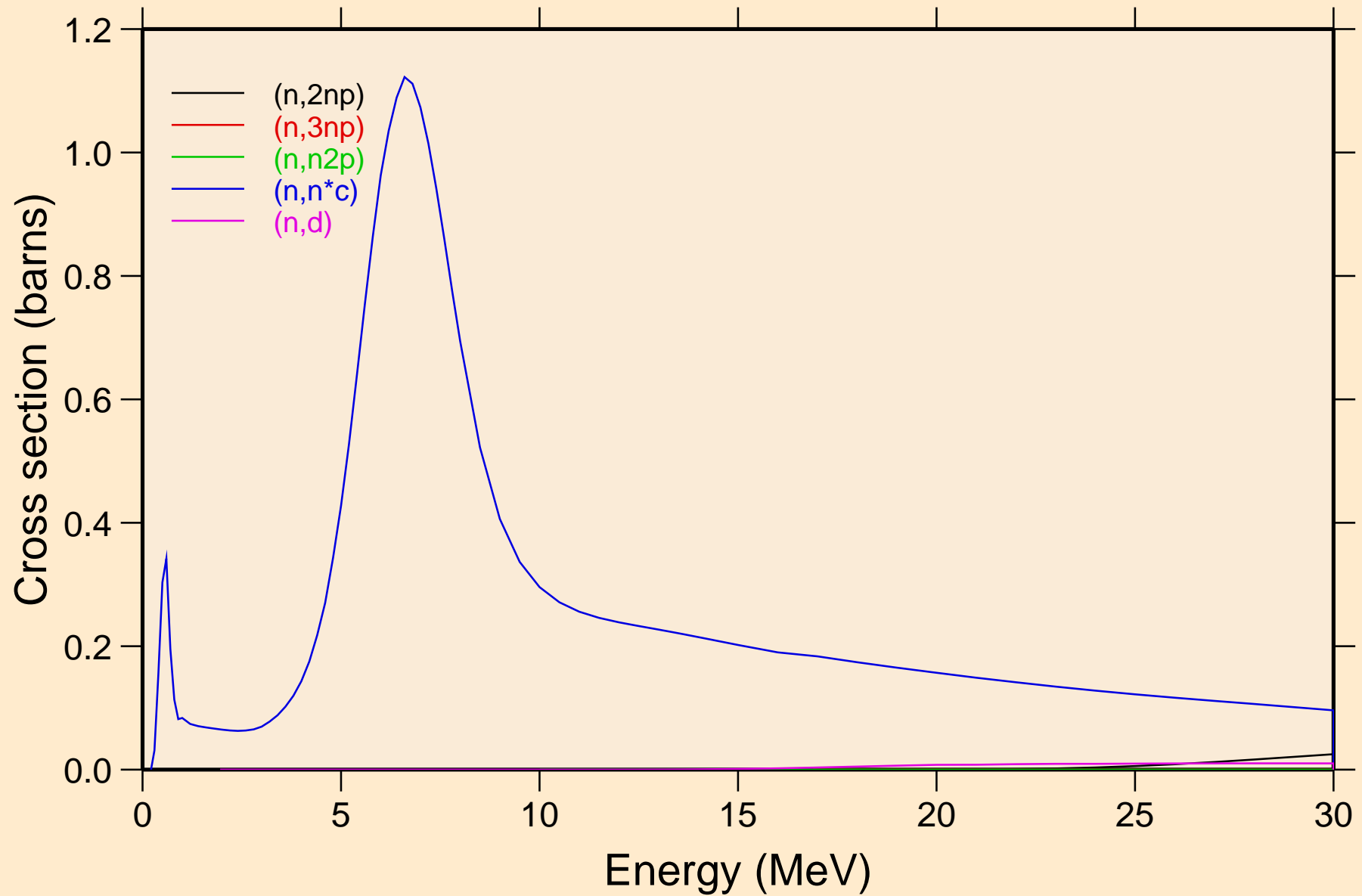

PA228 NEUTRON ACER TENDL-2023 LIBRARY; T=0.K  
Threshold reactions

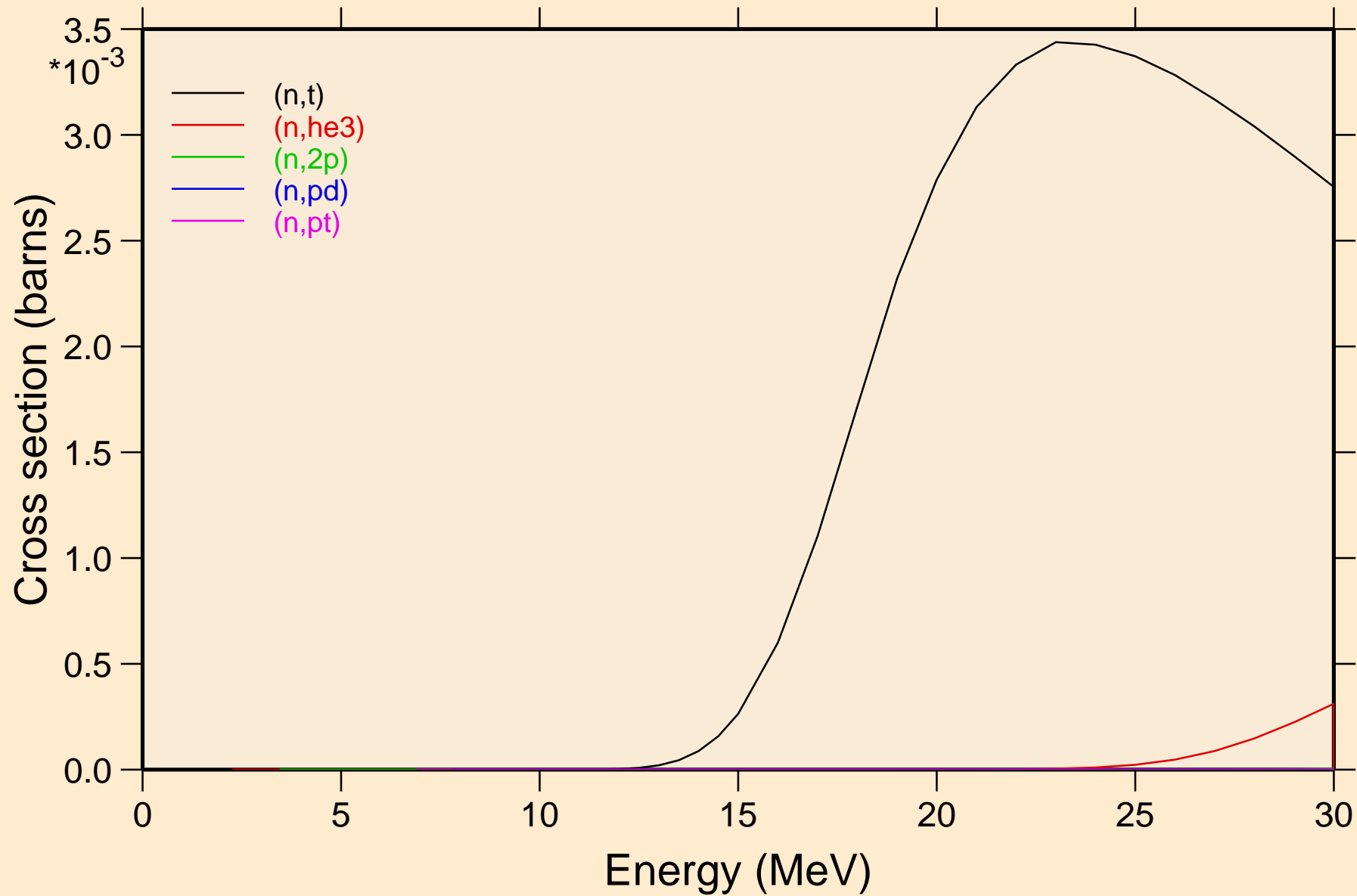

PA228 NEUTRON ACER TENDL-2023 LIBRARY; T=0.K  
Threshold reactions

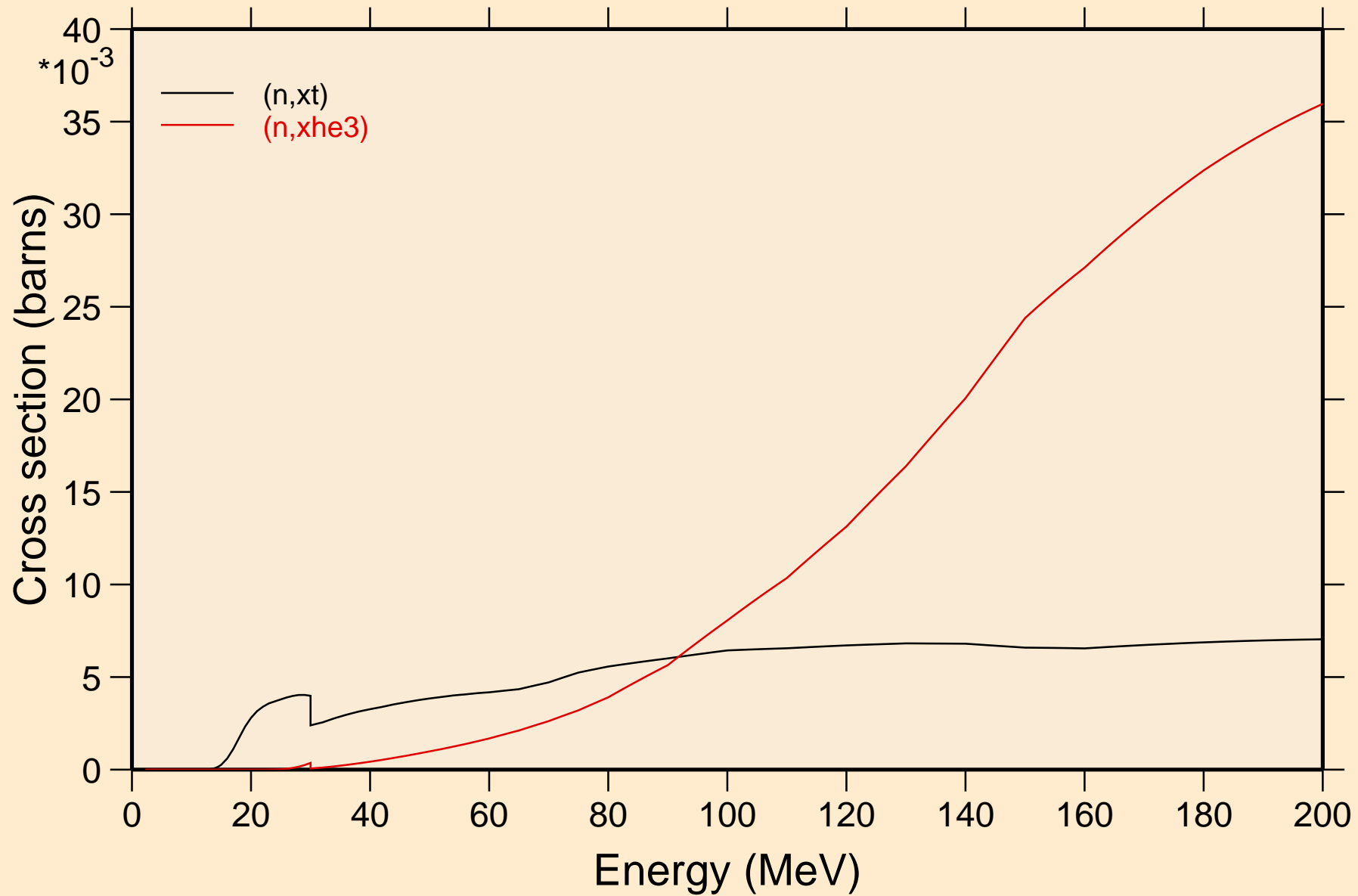

PA228 NEUTRON ACER TENDL-2023 LIBRARY; T=0.K  
angular distribution for elastic

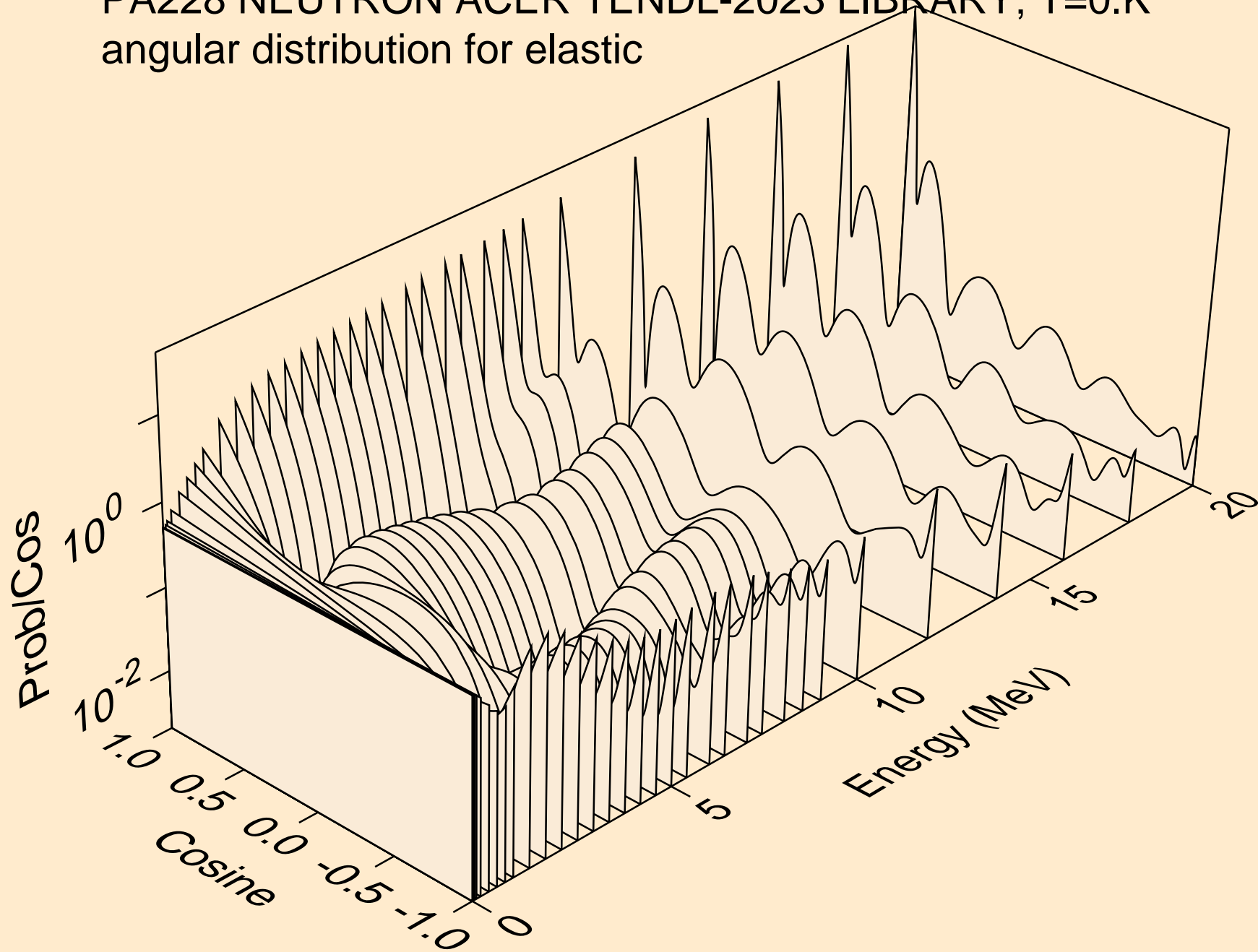



PA228 NEUTRON ACER TENDL-2023 LIBRARY; T=0.K  
angular distribution for elastic

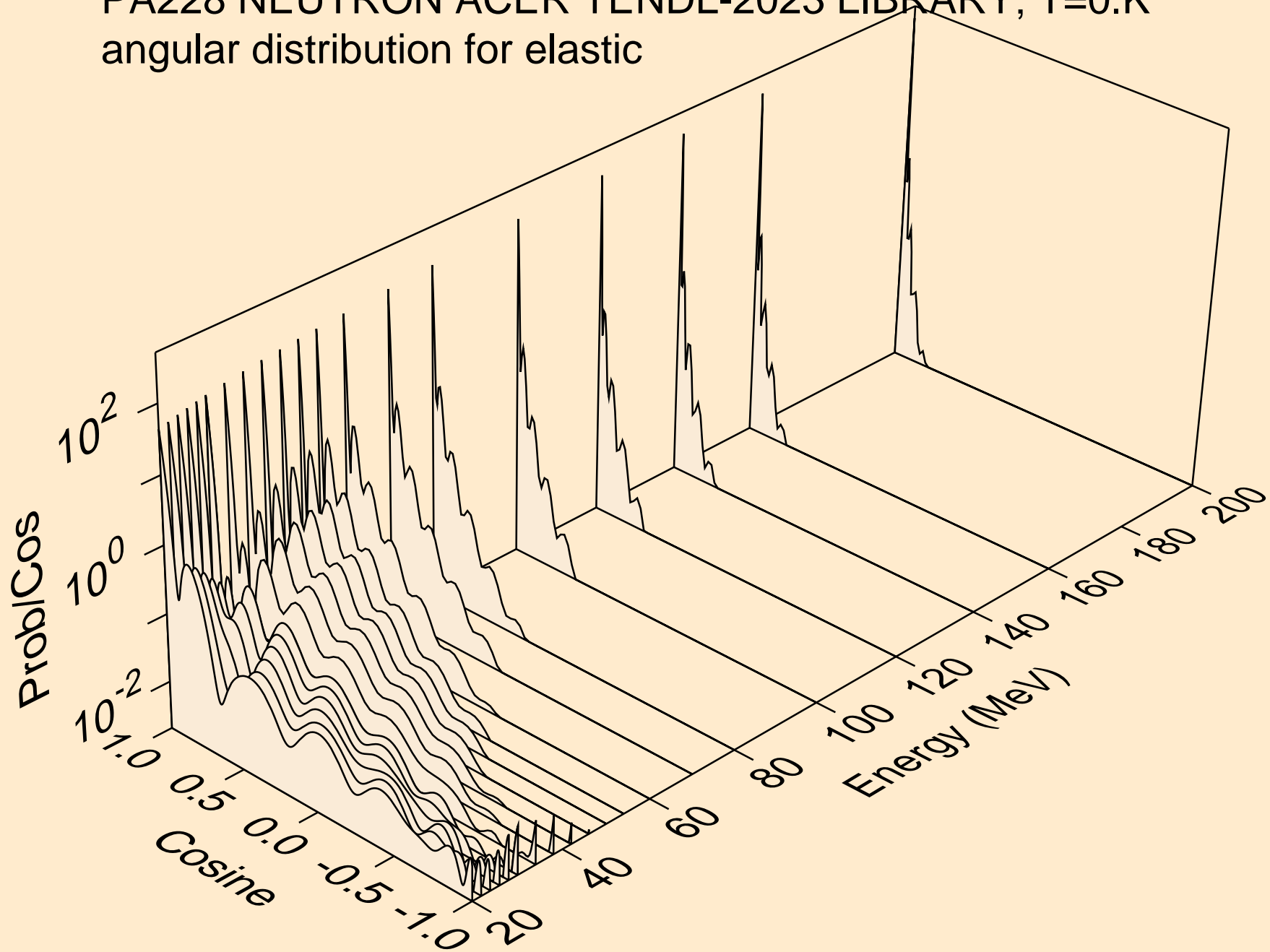

PA228 NEUTRON ACER TENDL-2023 LIBRARY; T=0.K  
angular distribution for (n,n\*1)

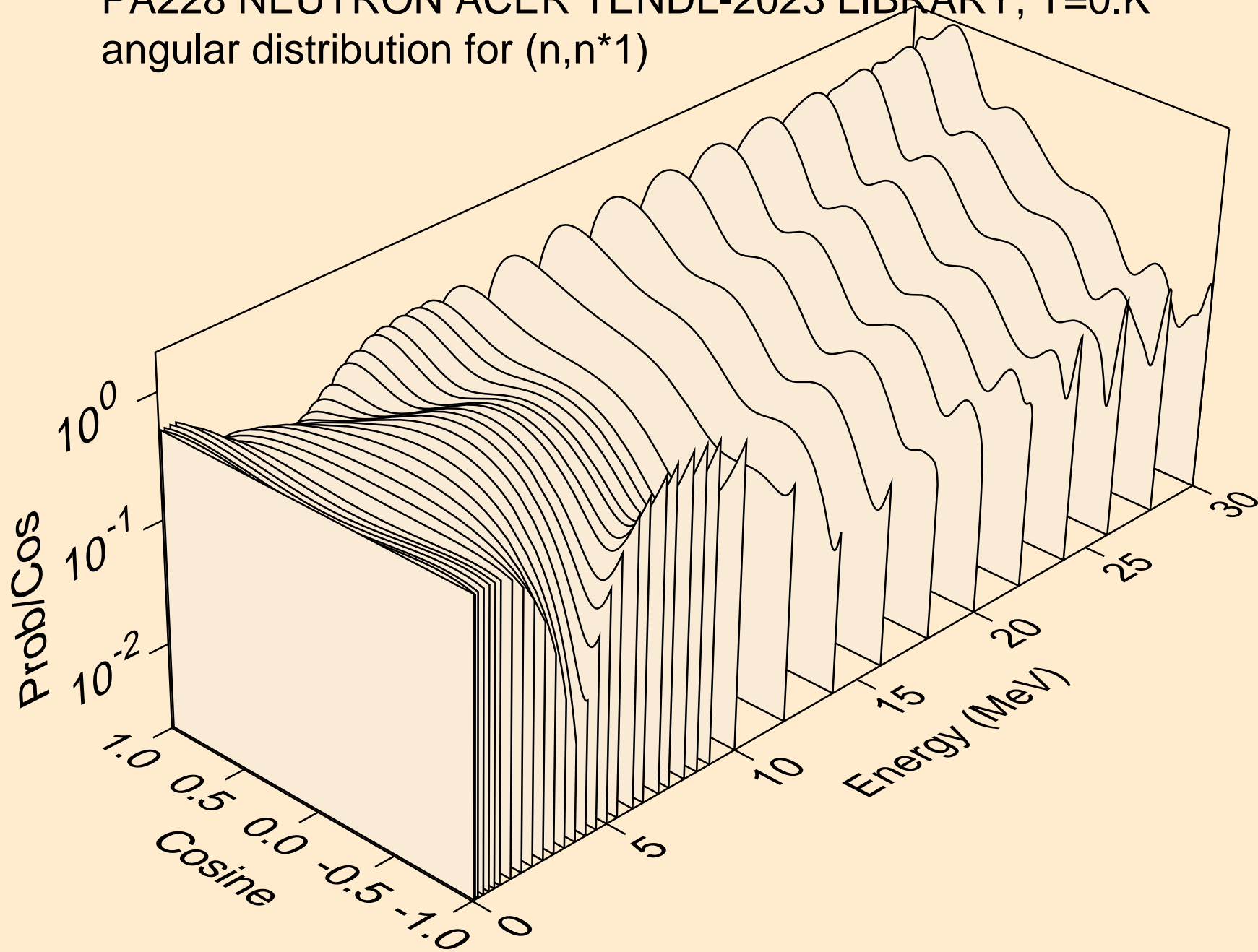

PA228 NEUTRON ACER TENDL-2023 LIBRARY; T=0.K  
angular distribution for (n,n\*2)

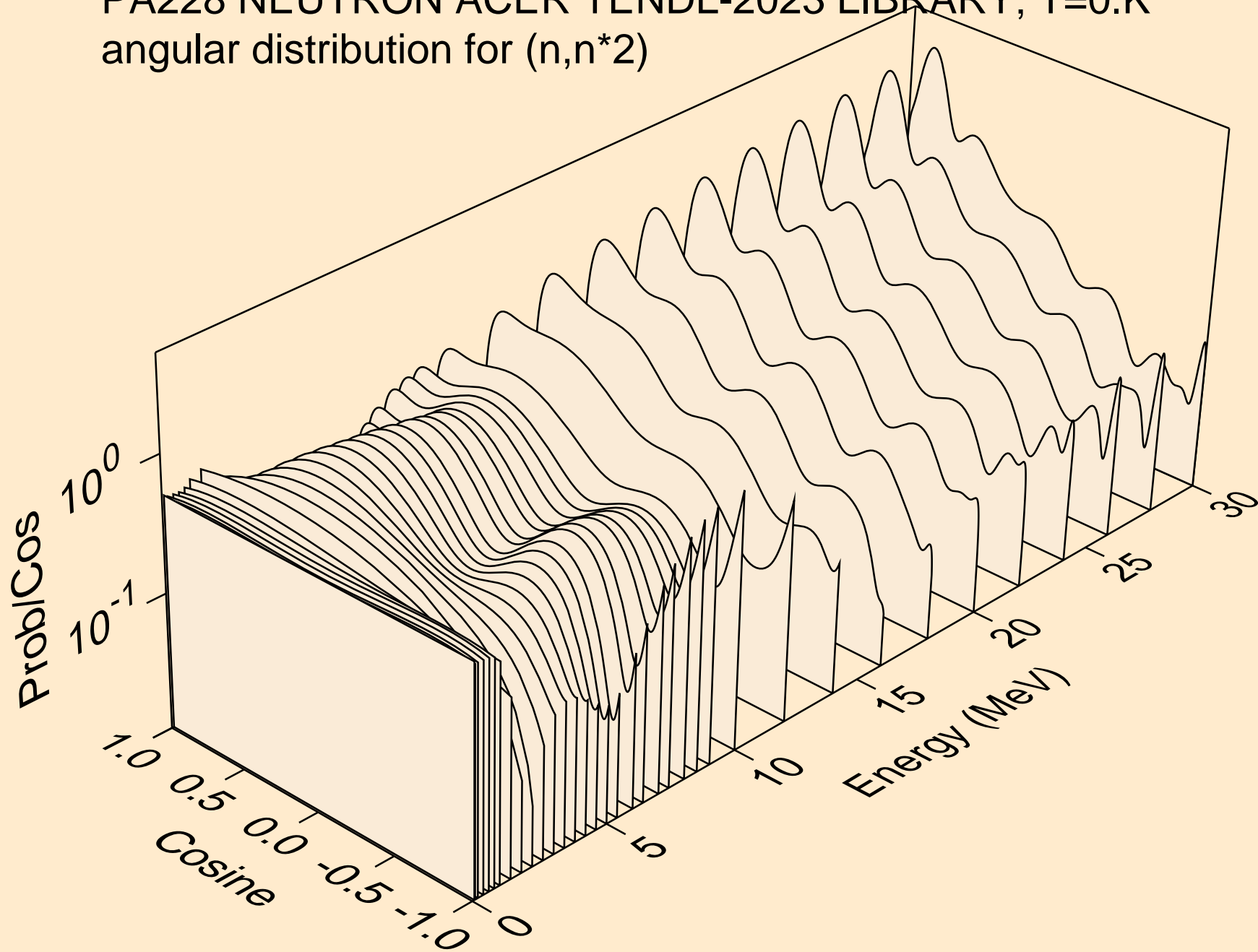

PA228 NEUTRON ACER TENDL-2023 LIBRARY; T=0.K  
angular distribution for (n,n\*3)

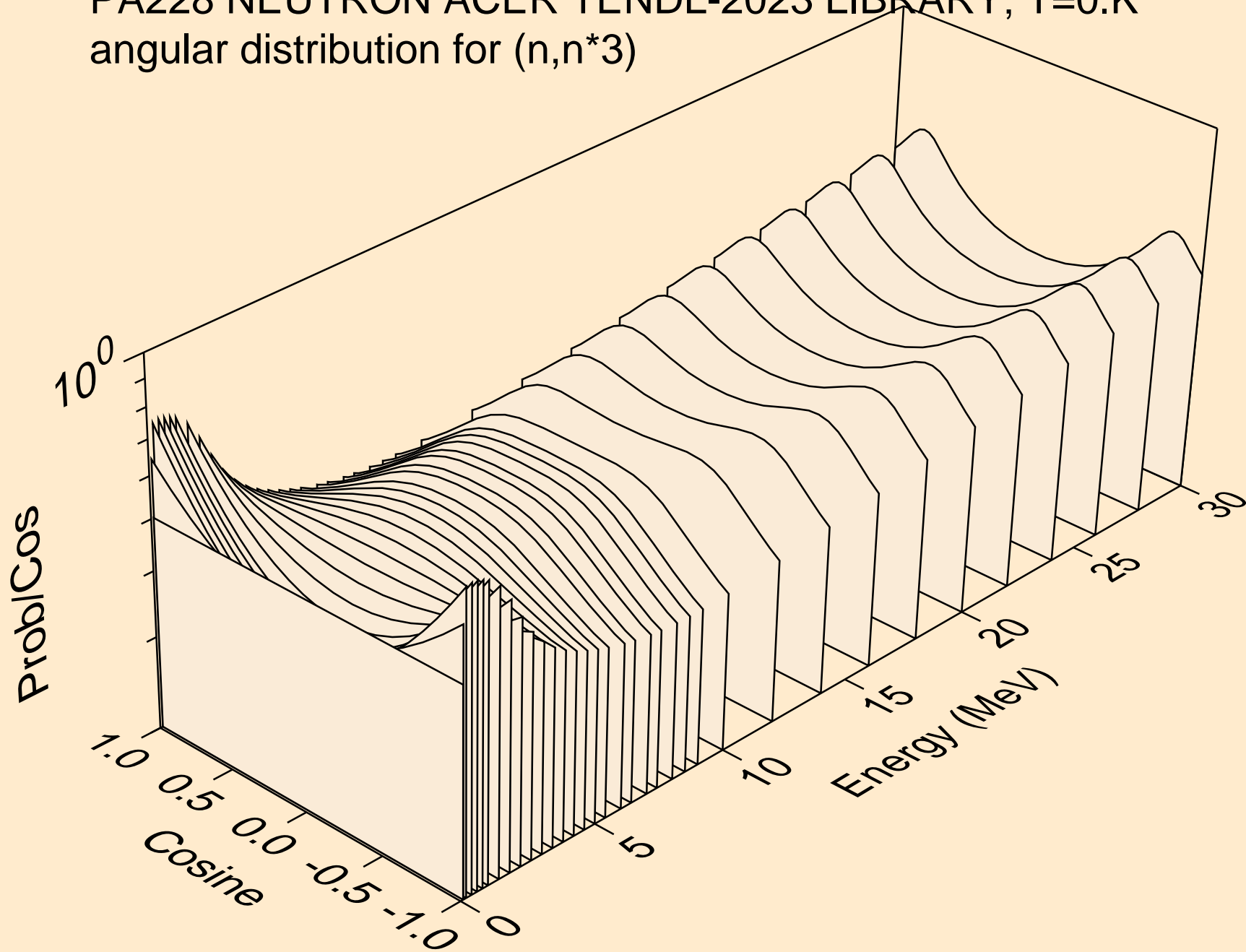

PA228 NEUTRON ACER TENDL-2023 LIBRARY; T=0.K  
angular distribution for (n,n\*4)

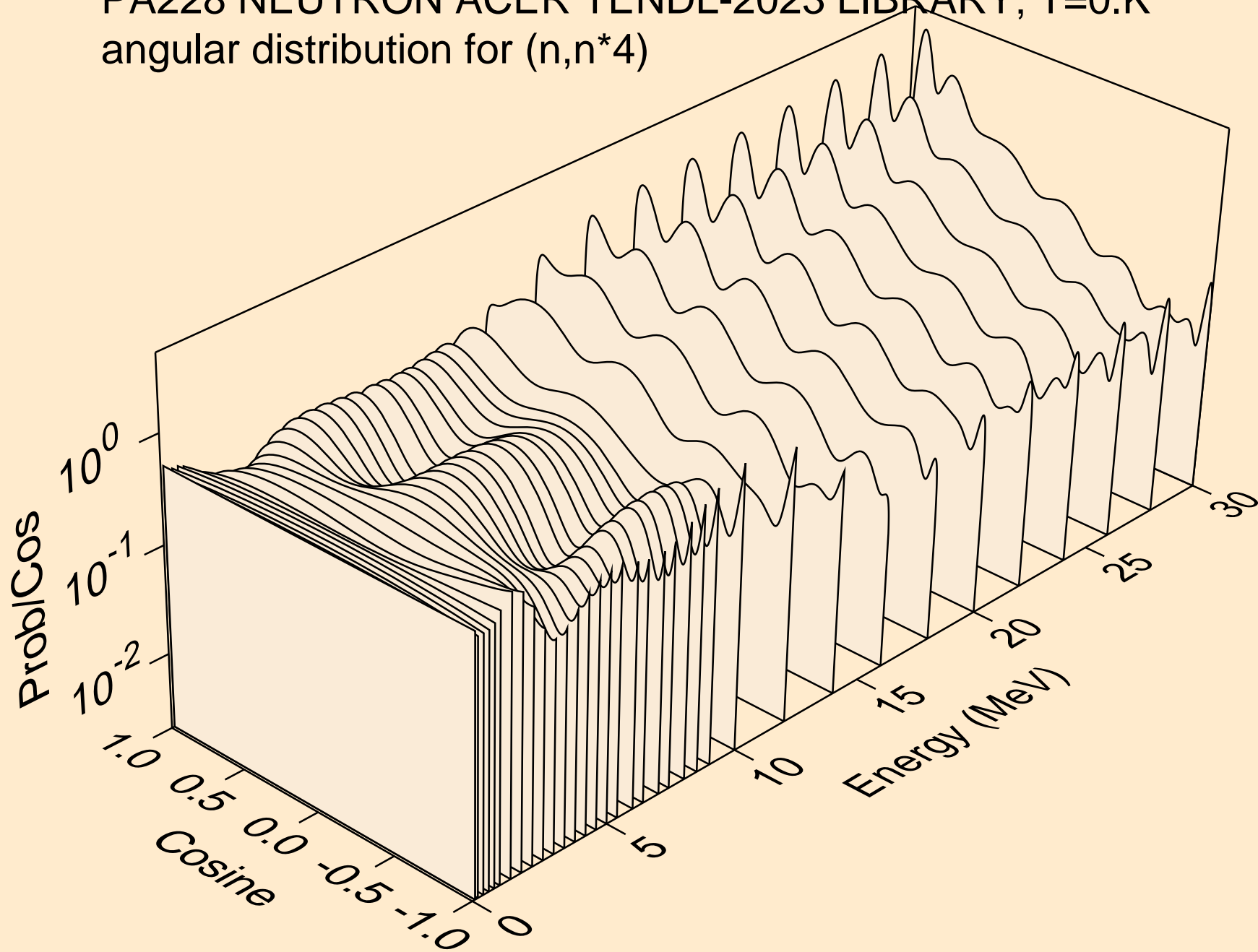

PA228 NEUTRON ACER TENDL-2023 LIBRARY; T=0.K  
angular distribution for (n,n\*5)

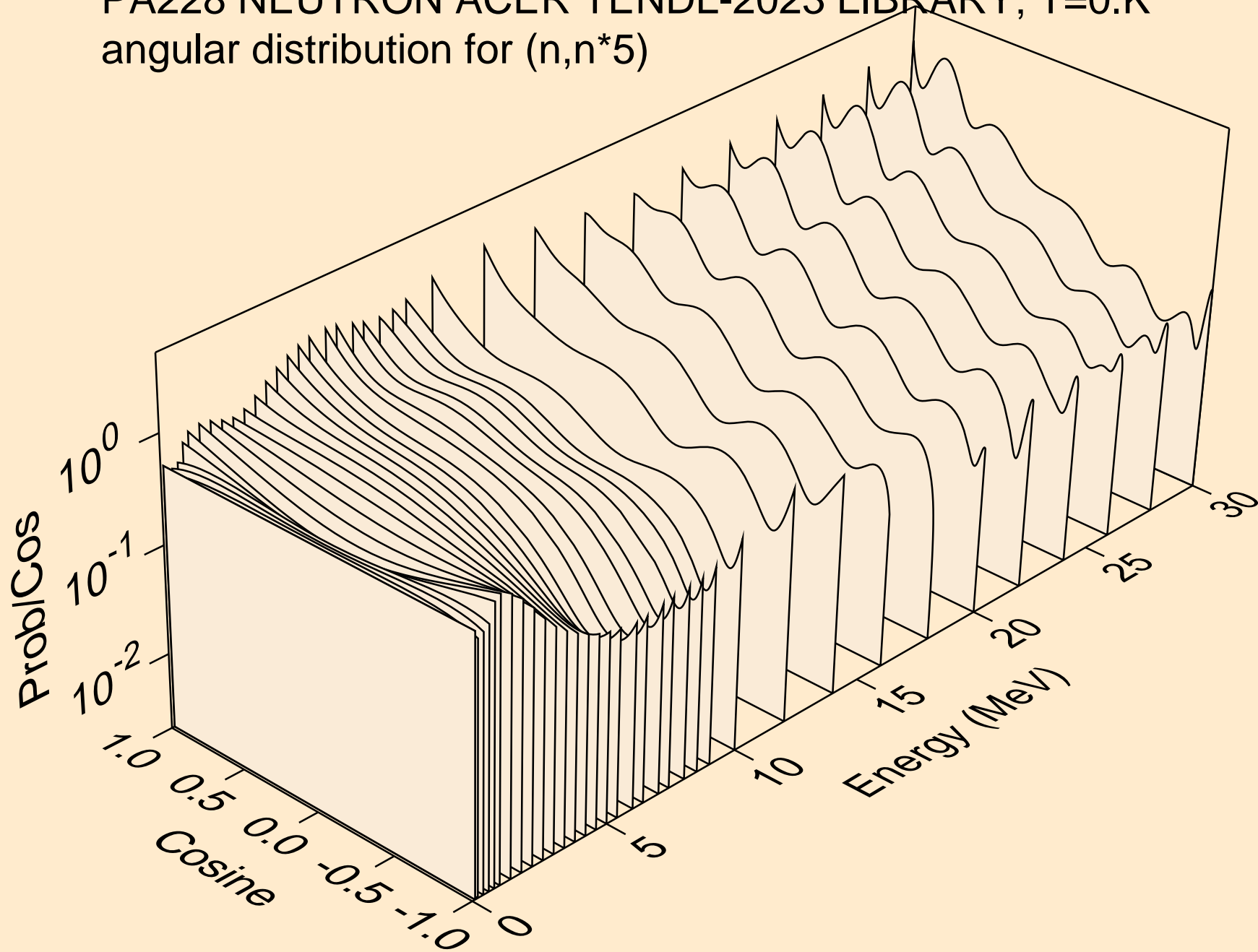

PA228 NEUTRON ACER TENDL-2023 LIBRARY; T=0.K  
angular distribution for (n,n\*6)

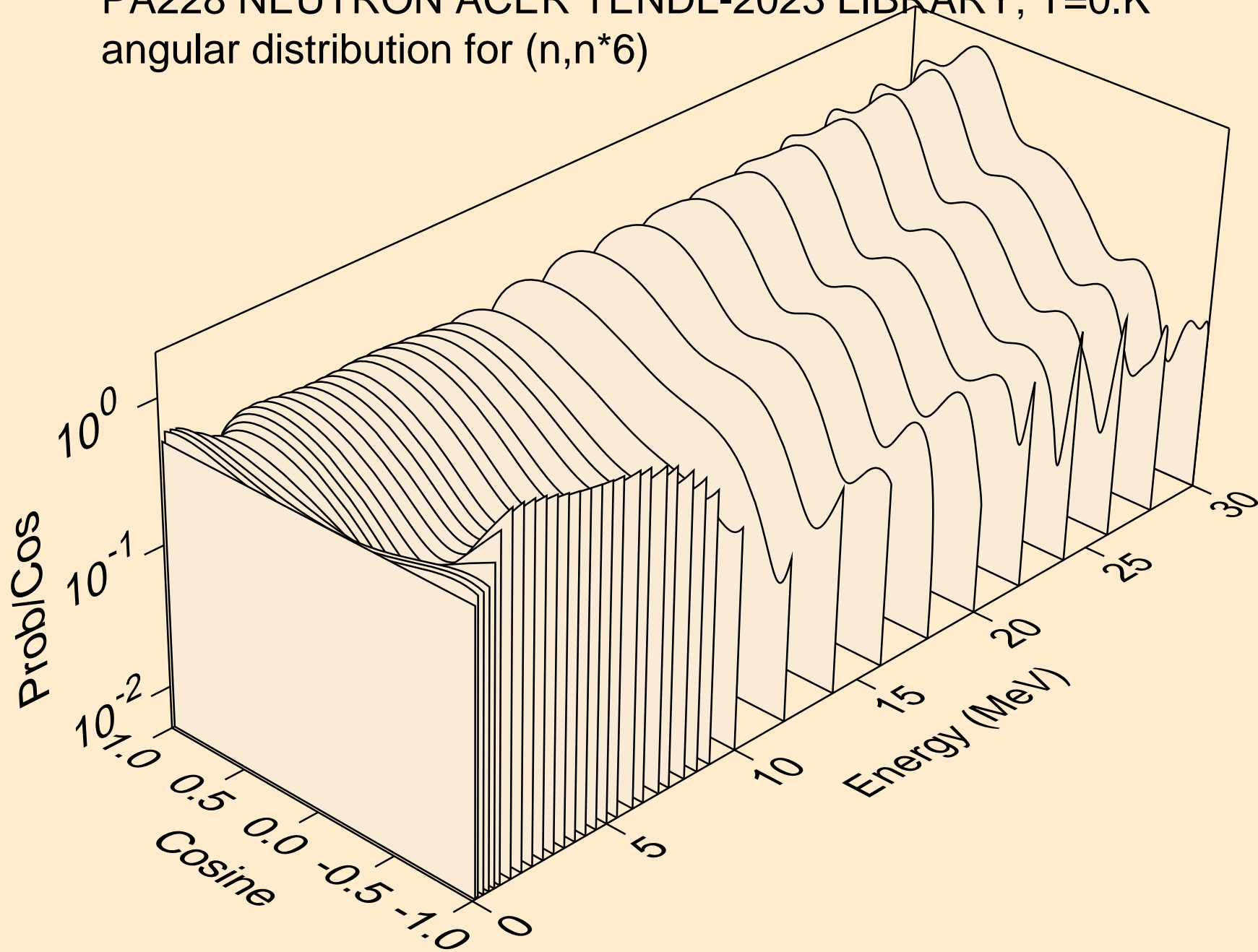

PA228 NEUTRON ACER TENDL-2023 LIBRARY; T=0.K  
angular distribution for (n,n\*7)

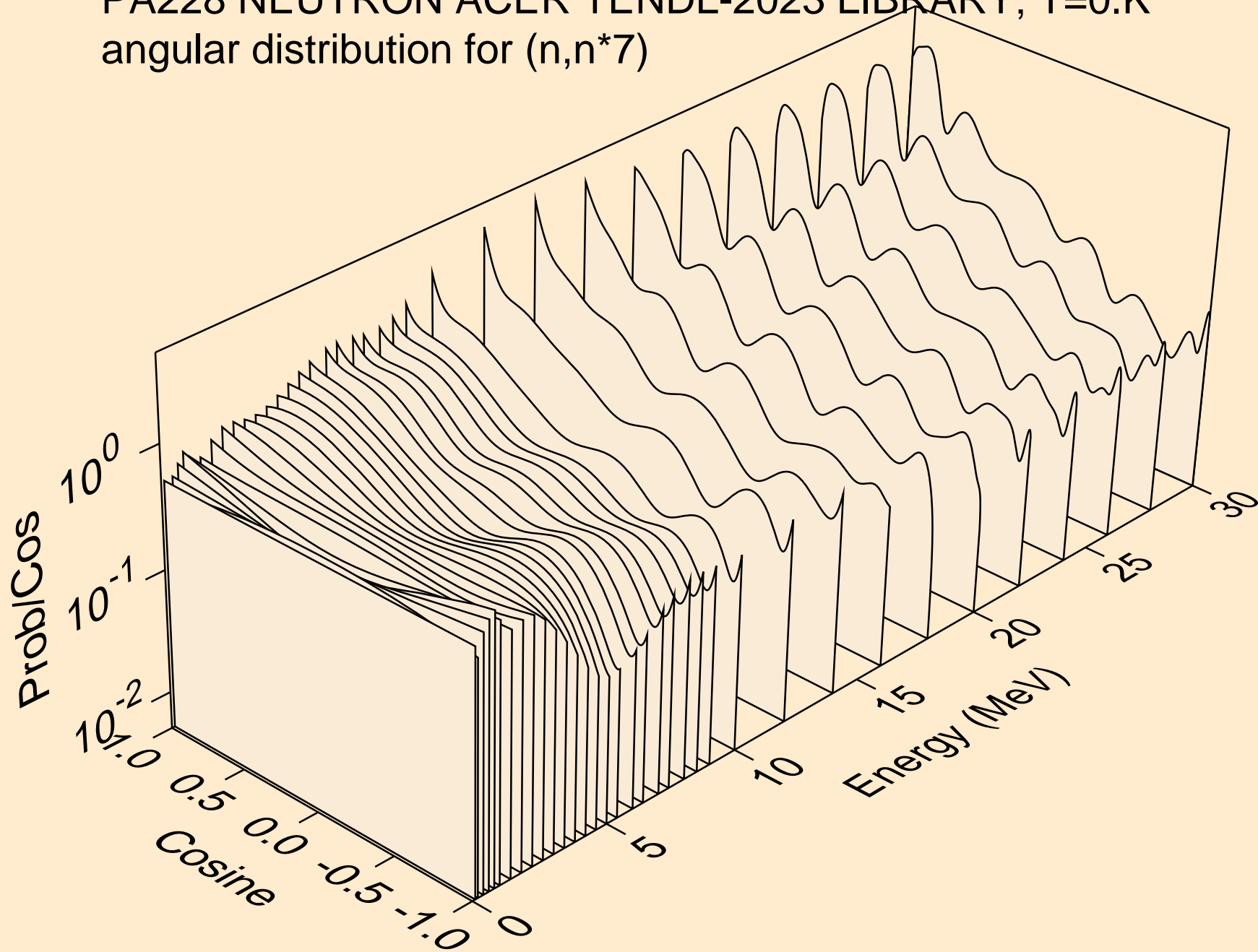



PA228 NEUTRON ACER TENDL-2023 LIBRARY; T=0.K  
angular distribution for (n,n\*8)

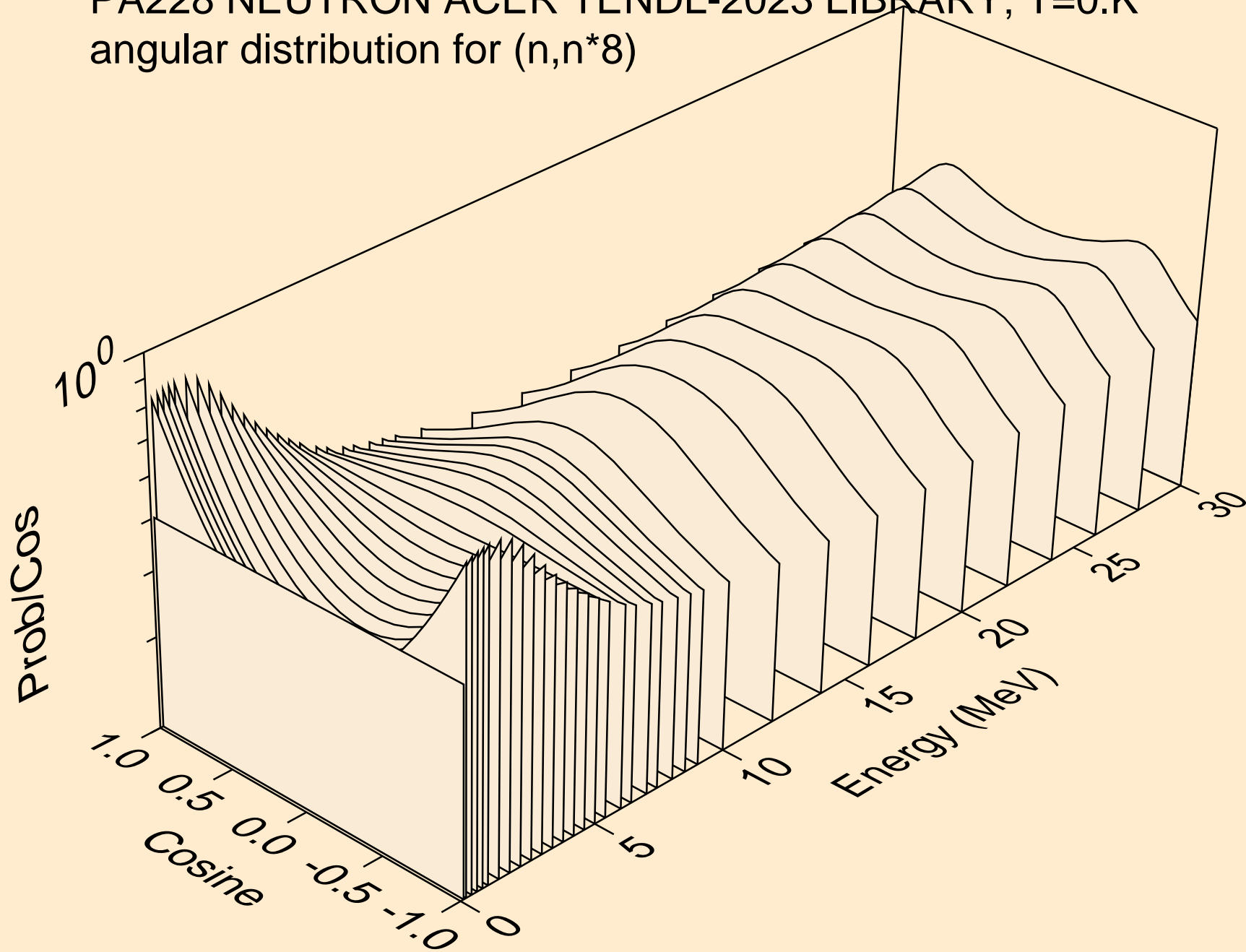

PA228 NEUTRON ACER TENDL-2023 LIBRARY; T=0.K  
angular distribution for (n,n\*9)

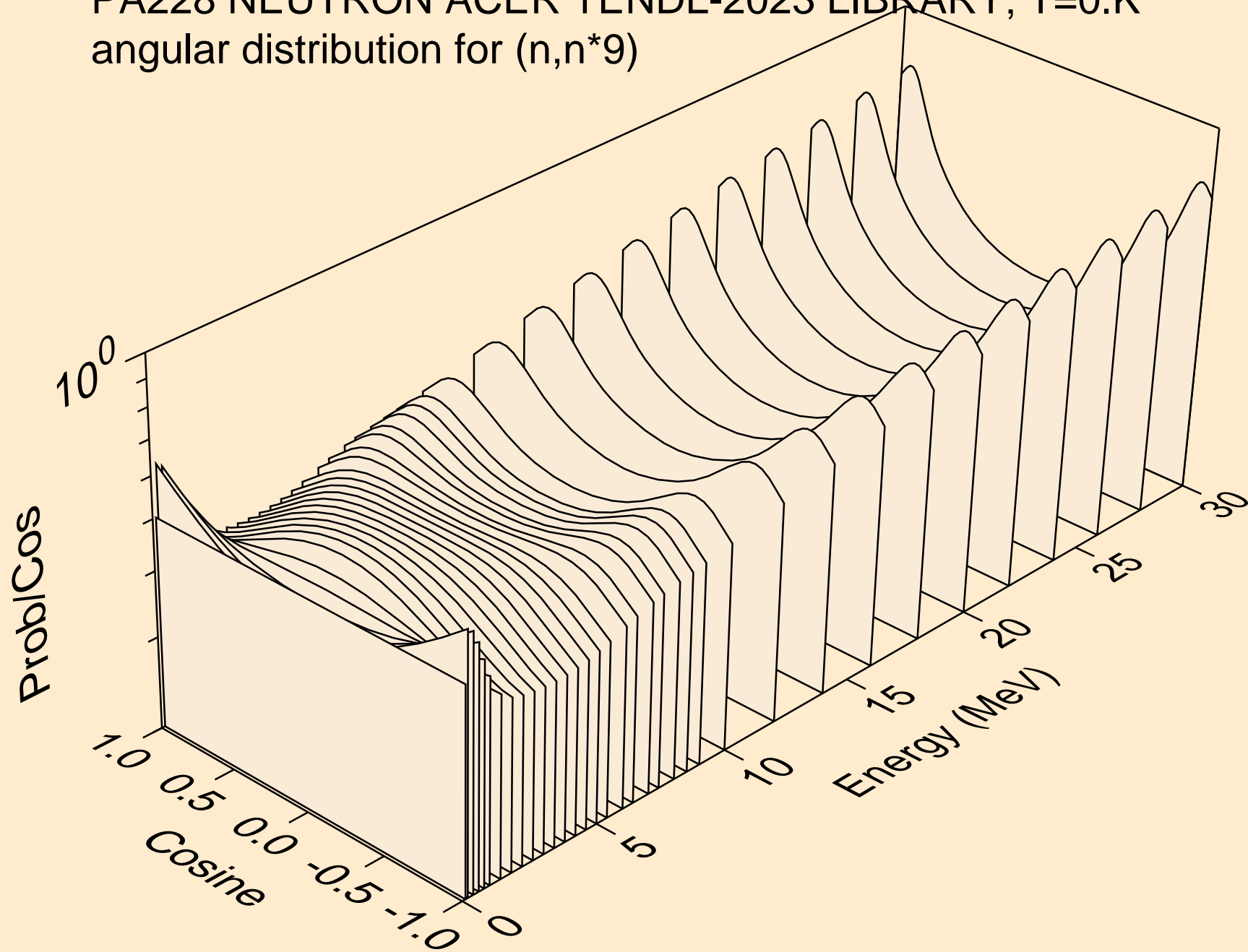

PA228 NEUTRON ACER TENDL-2023 LIBRARY; T=0.K  
angular distribution for (n,n\*10)

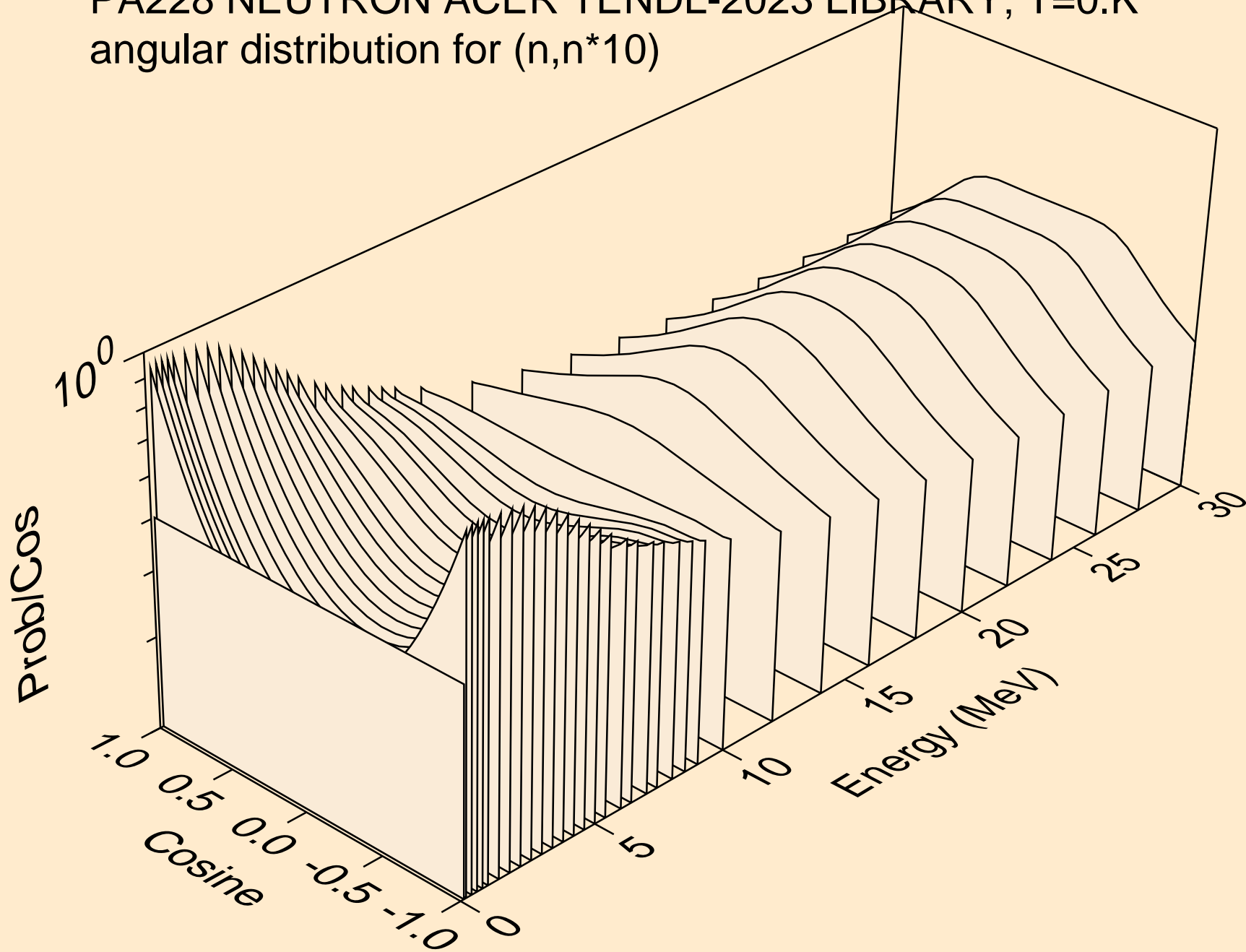

PA228 NEUTRON ACER TENDL-2023 LIBRARY; T=0.K  
angular distribution for (n,n\*11)

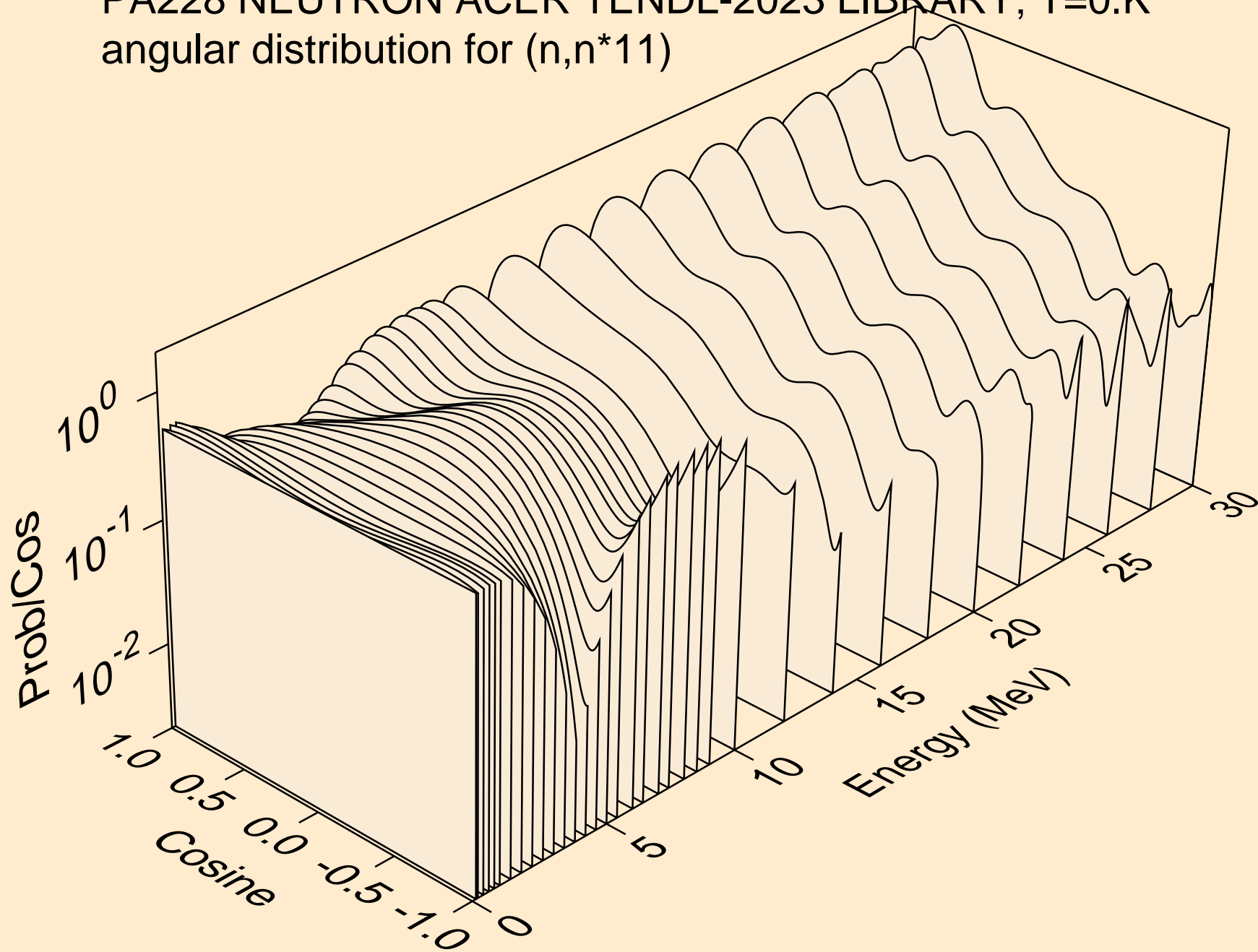

PA228 NEUTRON ACER TENDL-2023 LIBRARY; T=0.K  
angular distribution for (n,n\*12)

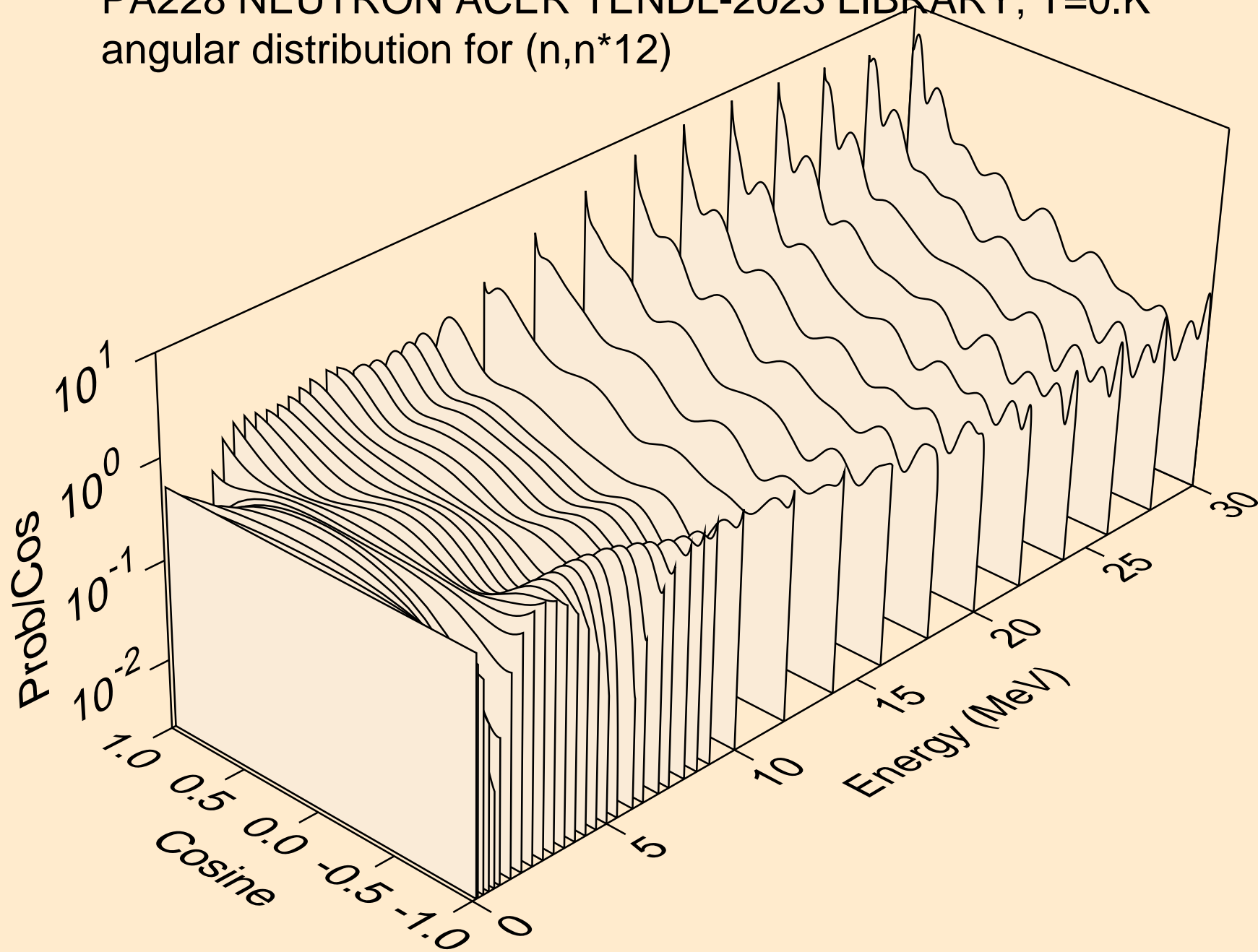

PA228 NEUTRON ACER TENDL-2023 LIBRARY; T=0.K  
angular distribution for (n,n\*13)

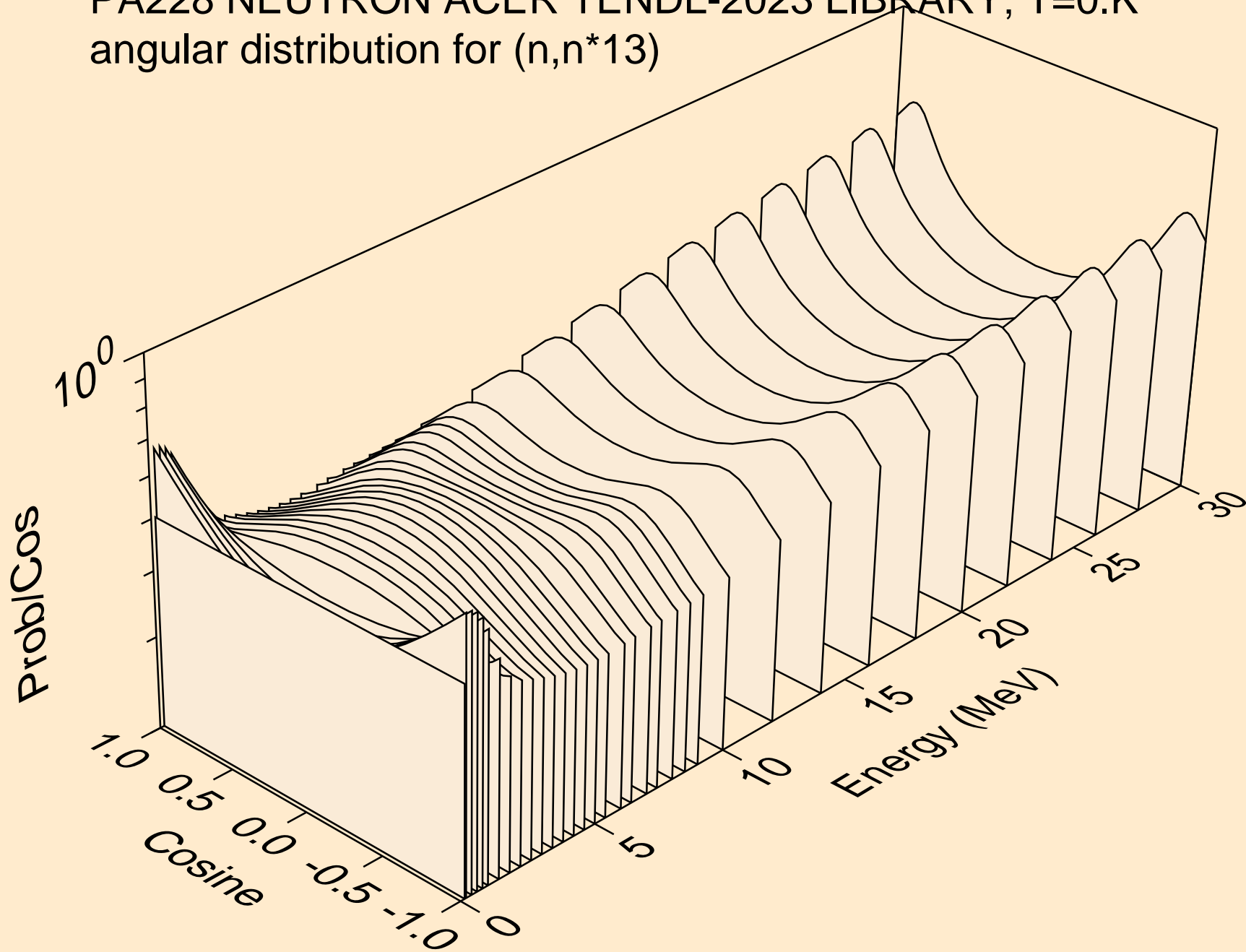

PA228 NEUTRON ACER TENDL-2023 LIBRARY; T=0.K  
angular distribution for (n,n\*14)

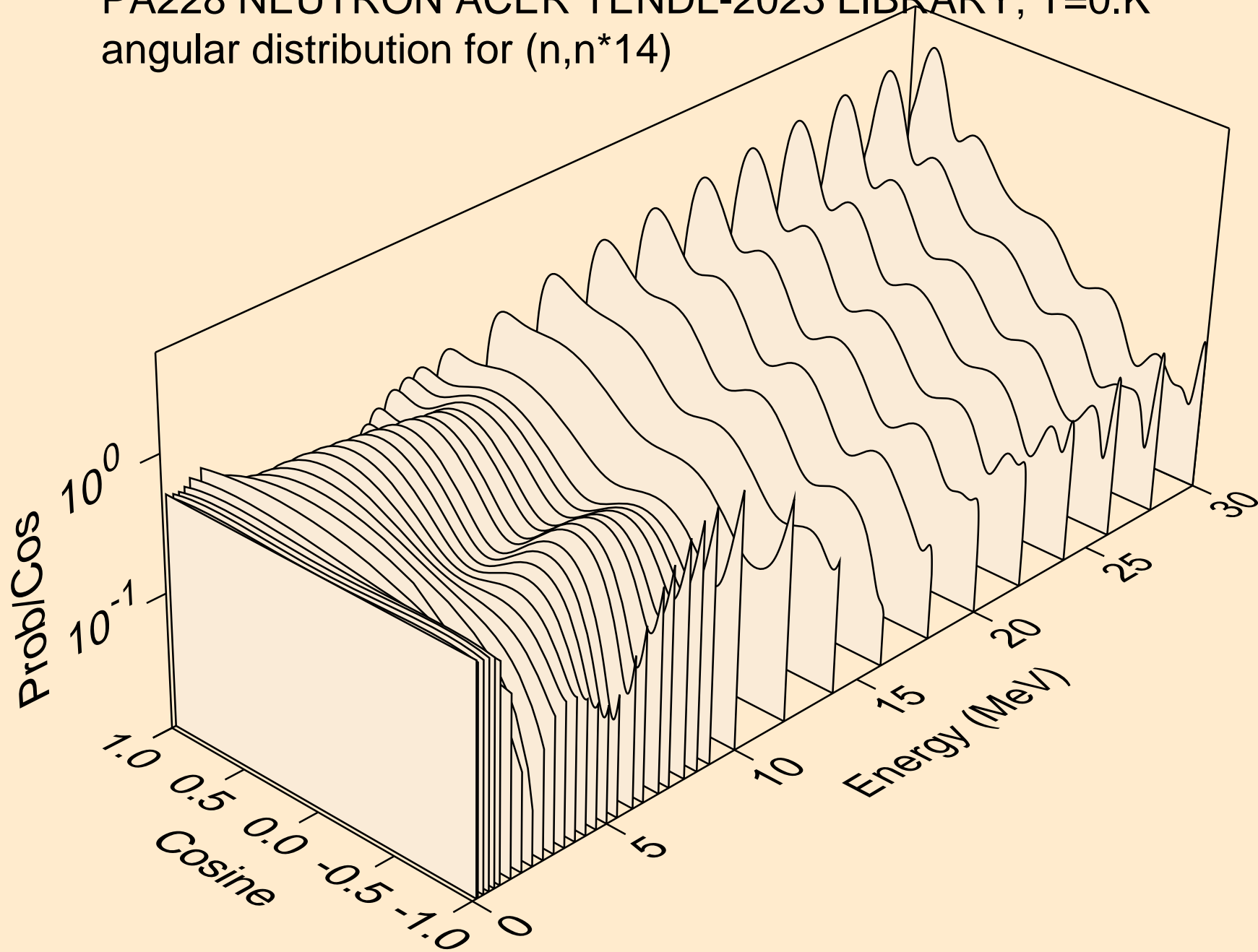

PA228 NEUTRON ACER TENDL-2023 LIBRARY; T=0.K  
angular distribution for (n,n\*15)

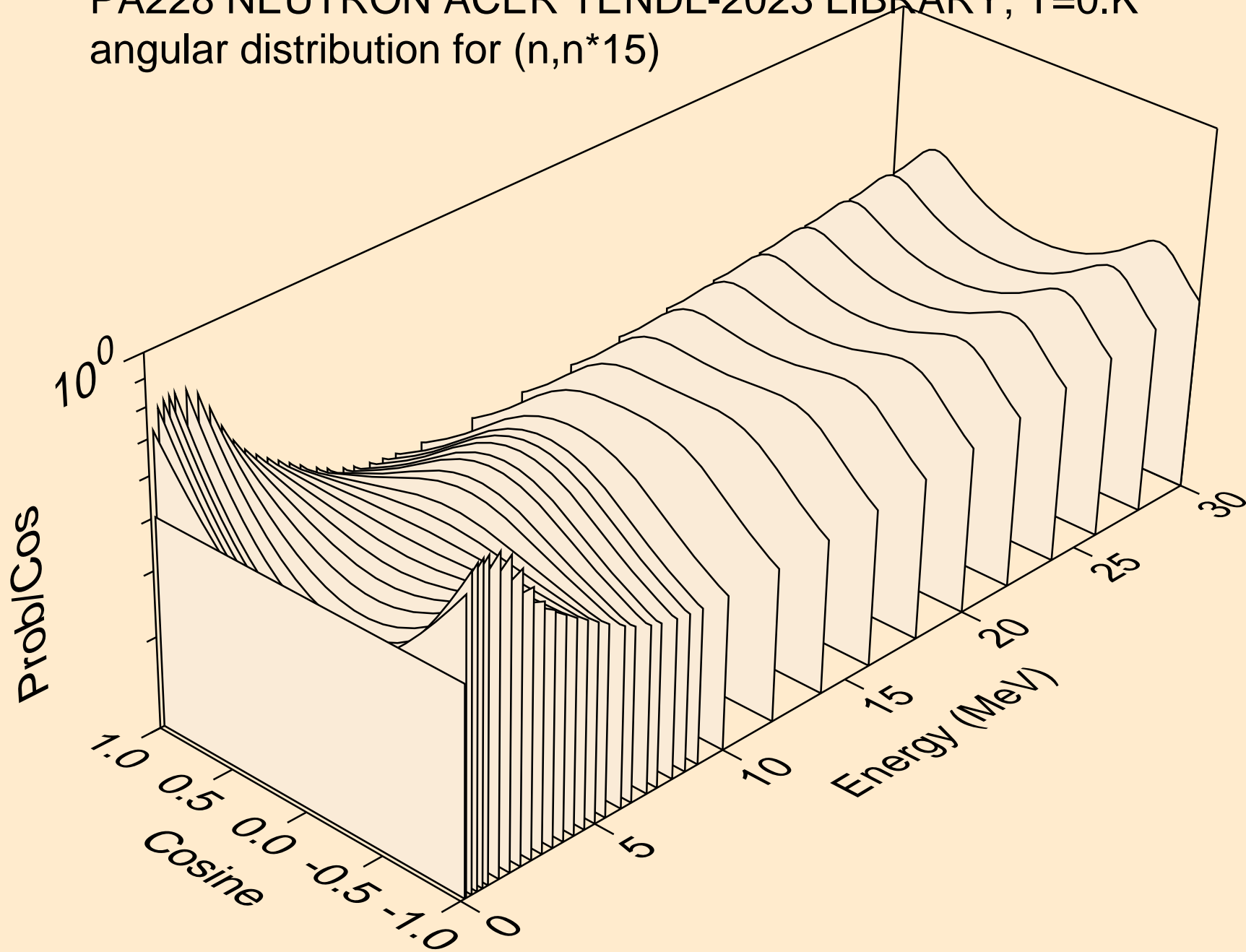



PA228 NEUTRON ACER TENDL-2023 LIBRARY; T=0.K  
angular distribution for (n,n\*16)

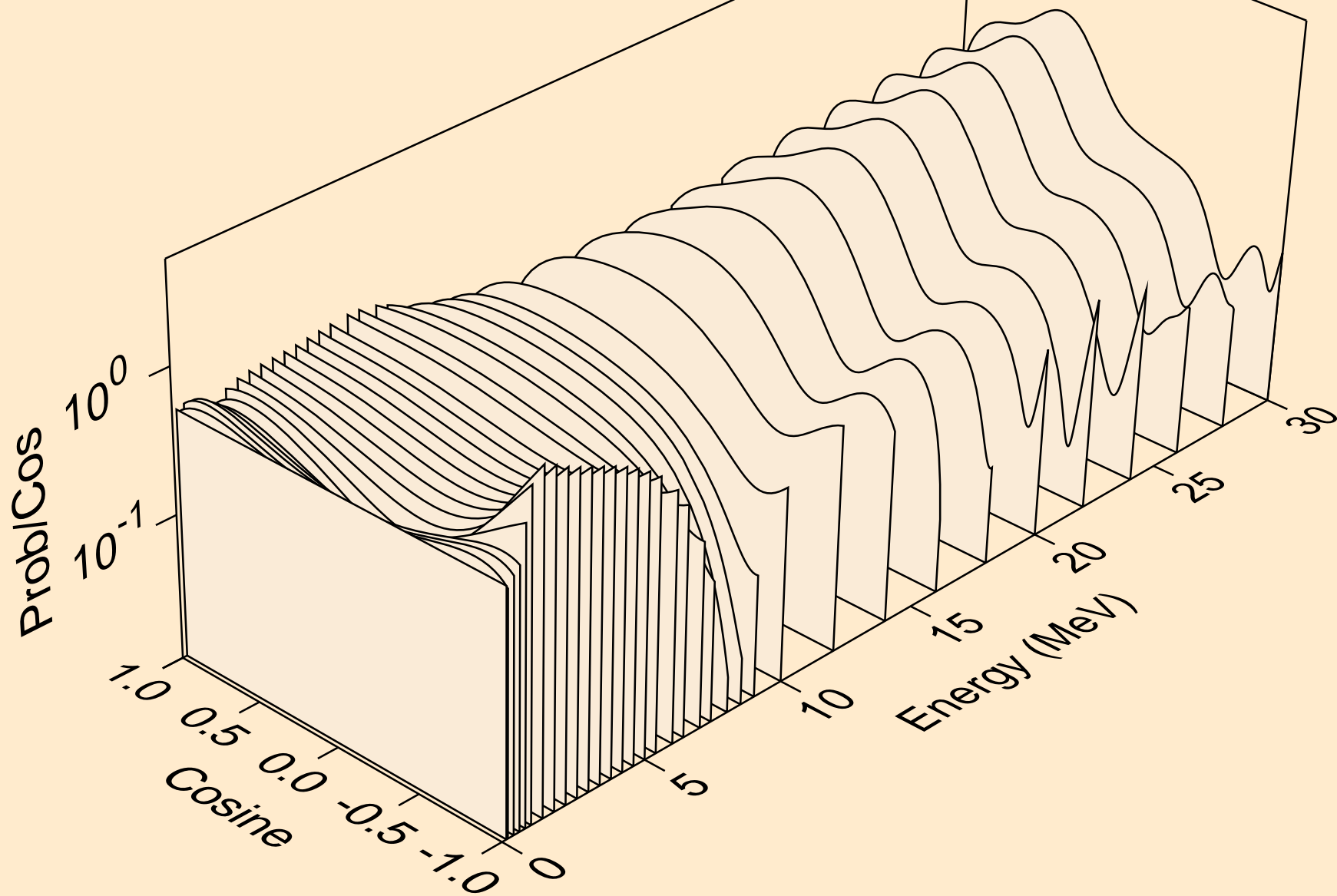

PA228 NEUTRON ACER TENDL-2023 LIBRARY; T=0.K  
angular distribution for (n,n\*17)

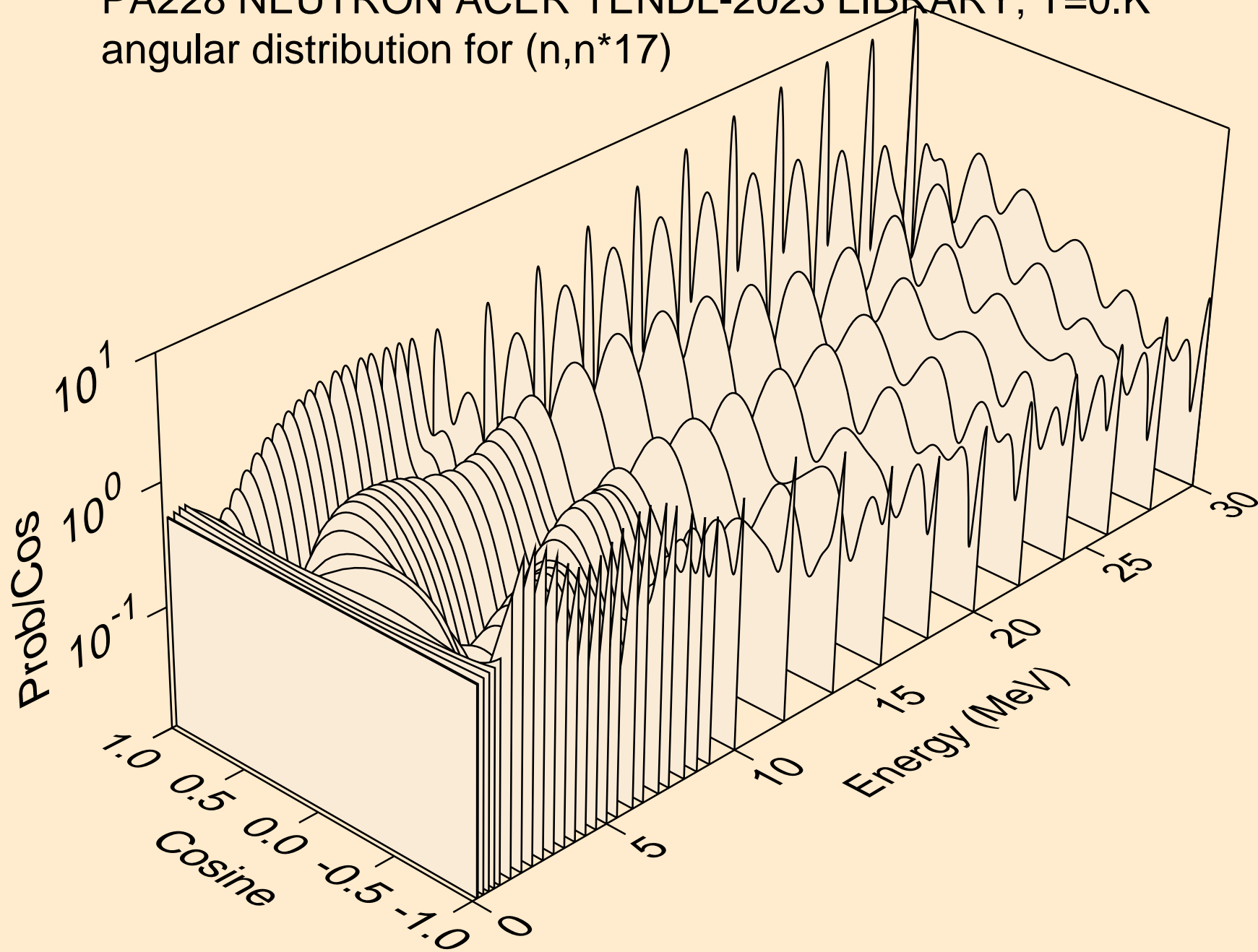

PA228 NEUTRON ACER TENDL-2023 LIBRARY; T=0.K  
angular distribution for (n,n\*18)

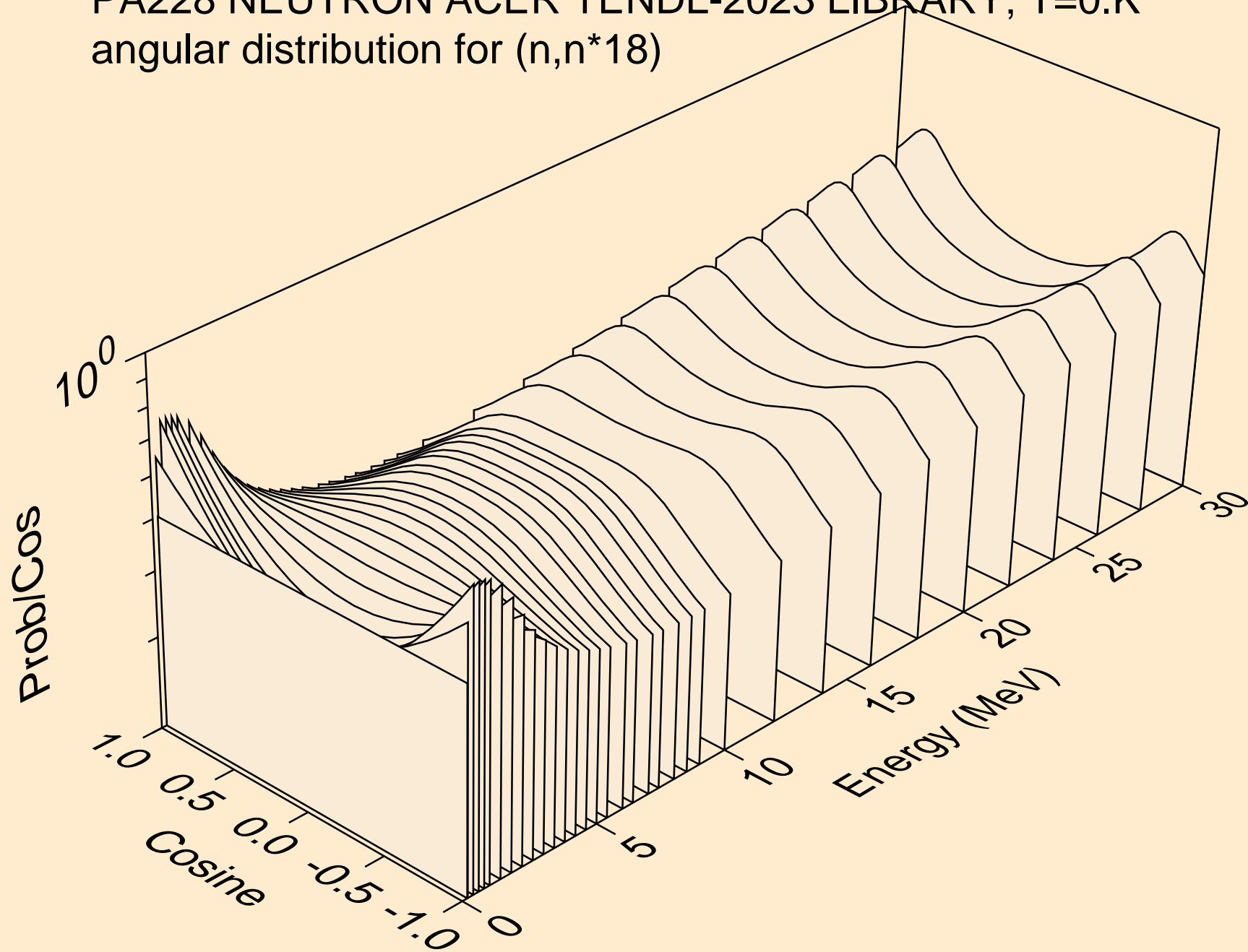

PA228 NEUTRON ACER TENDL-2023 LIBRARY; T=0.K  
angular distribution for (n,n\*19)

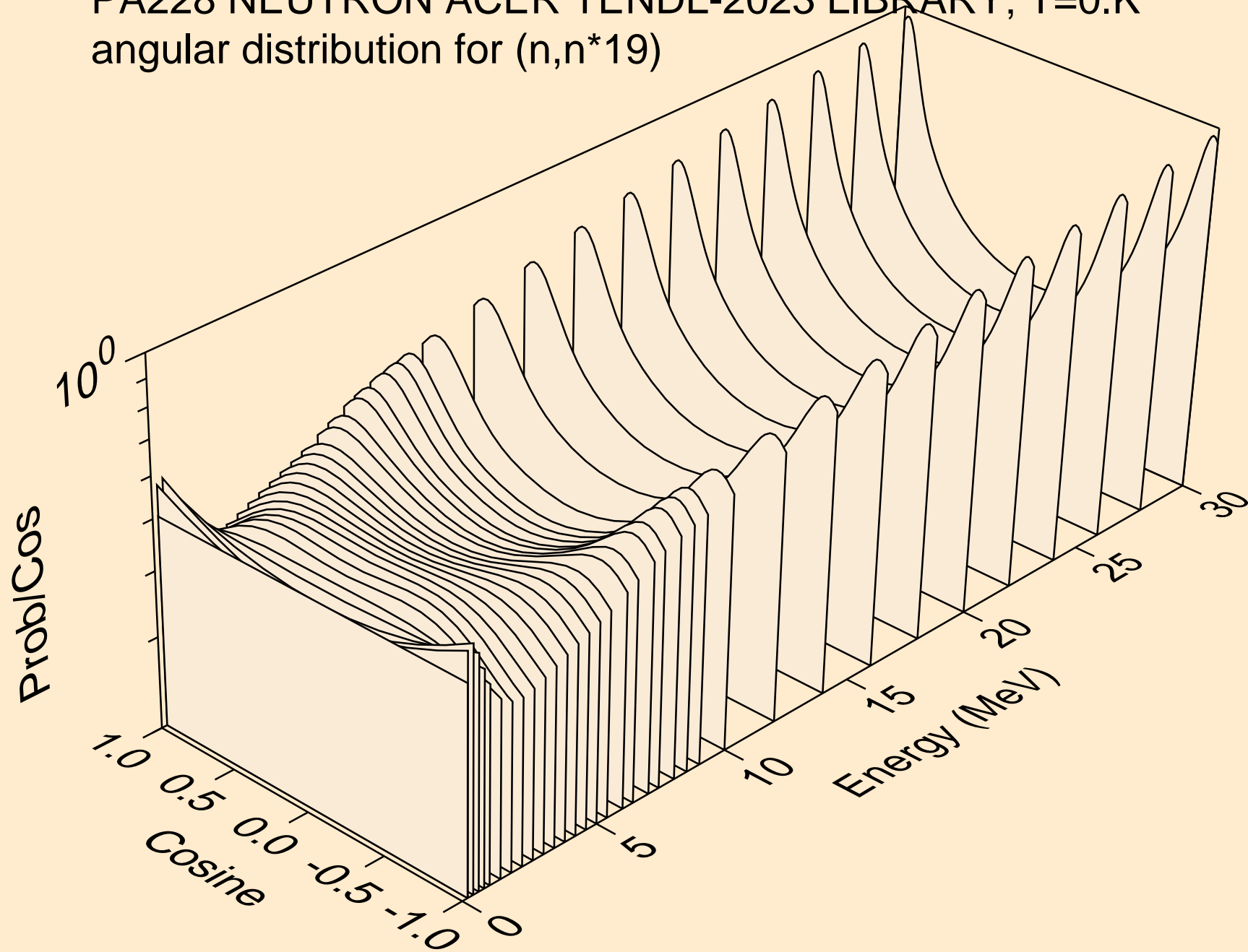

PA228 NEUTRON ACER TENDL-2023 LIBRARY; T=0.K  
angular distribution for (n,n\*20)

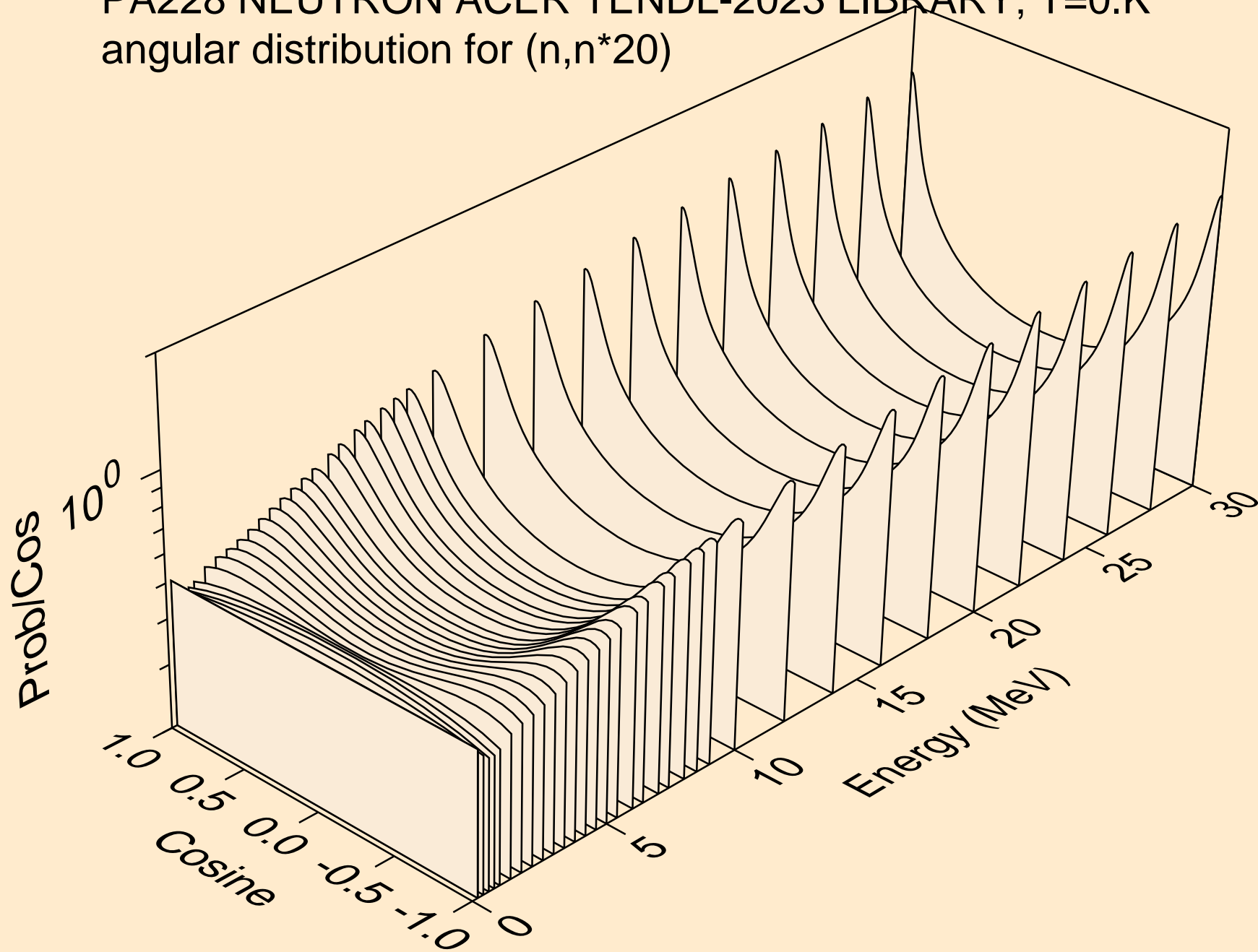

PA228 NEUTRON ACER TENDL-2023 LIBRARY; T=0.K  
angular distribution for (n,n\*21)

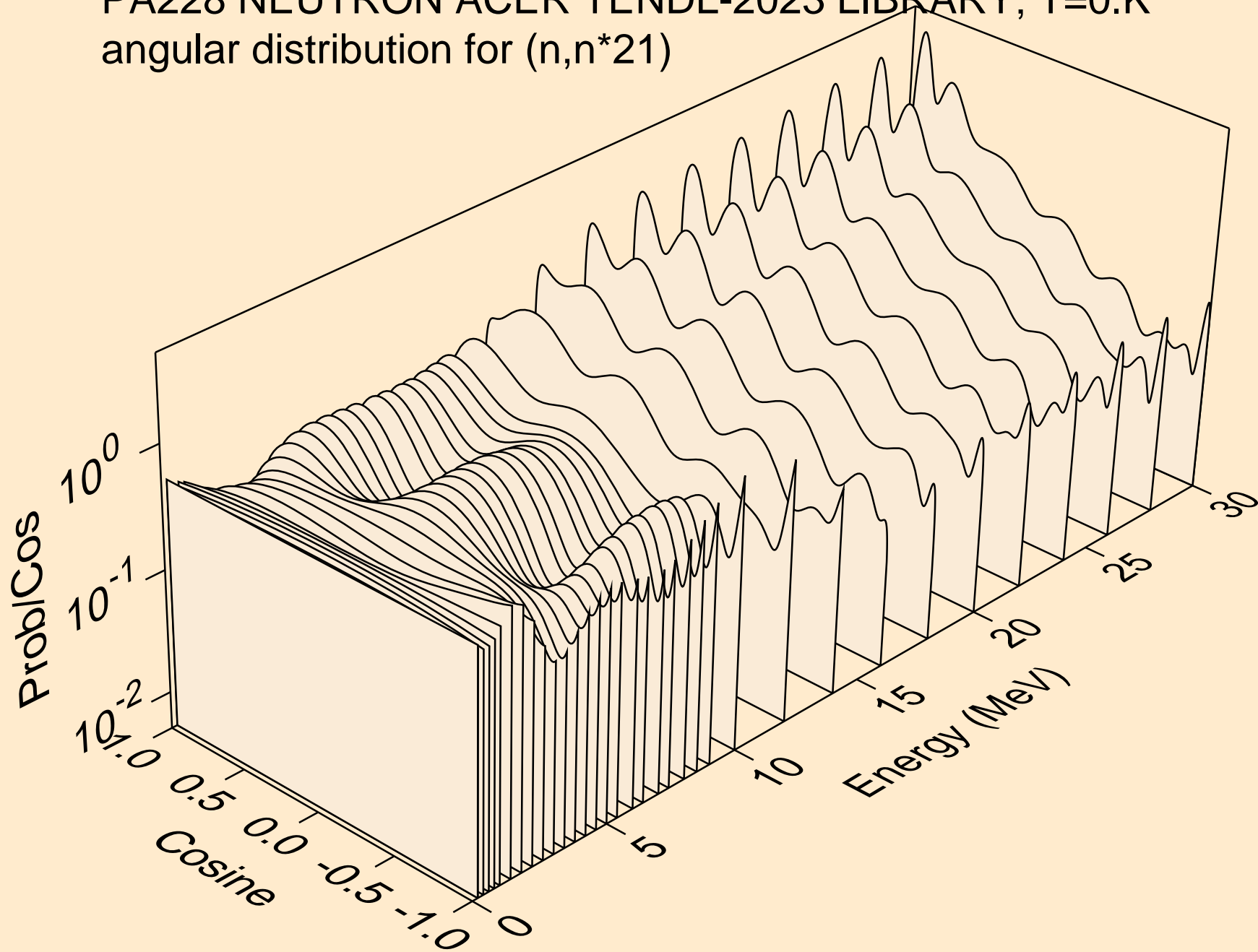

PA228 NEUTRON ACER TENDL-2023 LIBRARY; T=0.K  
angular distribution for (n,n\*22)

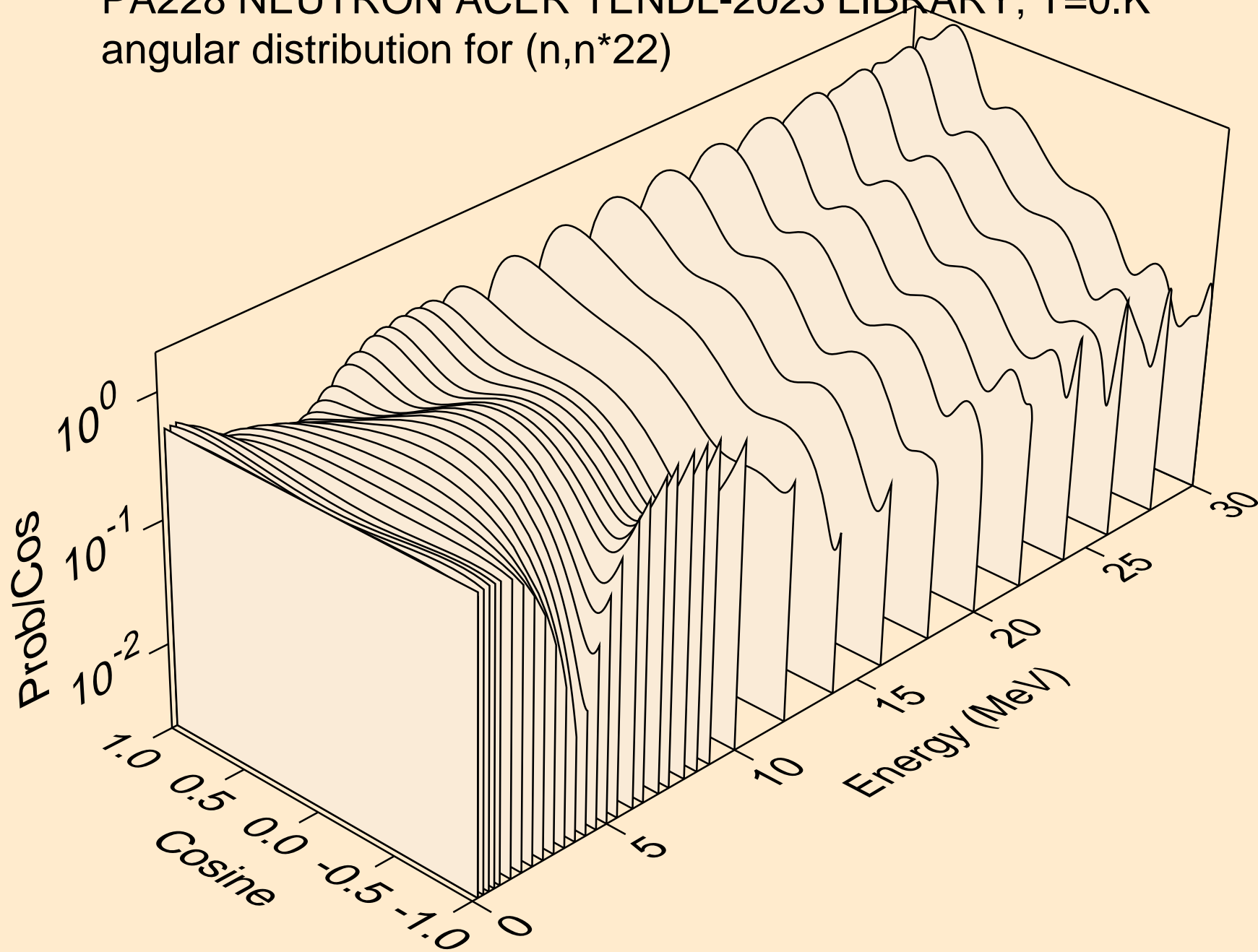

PA228 NEUTRON ACER TENDL-2023 LIBRARY; T=0.K  
angular distribution for (n,n\*23)

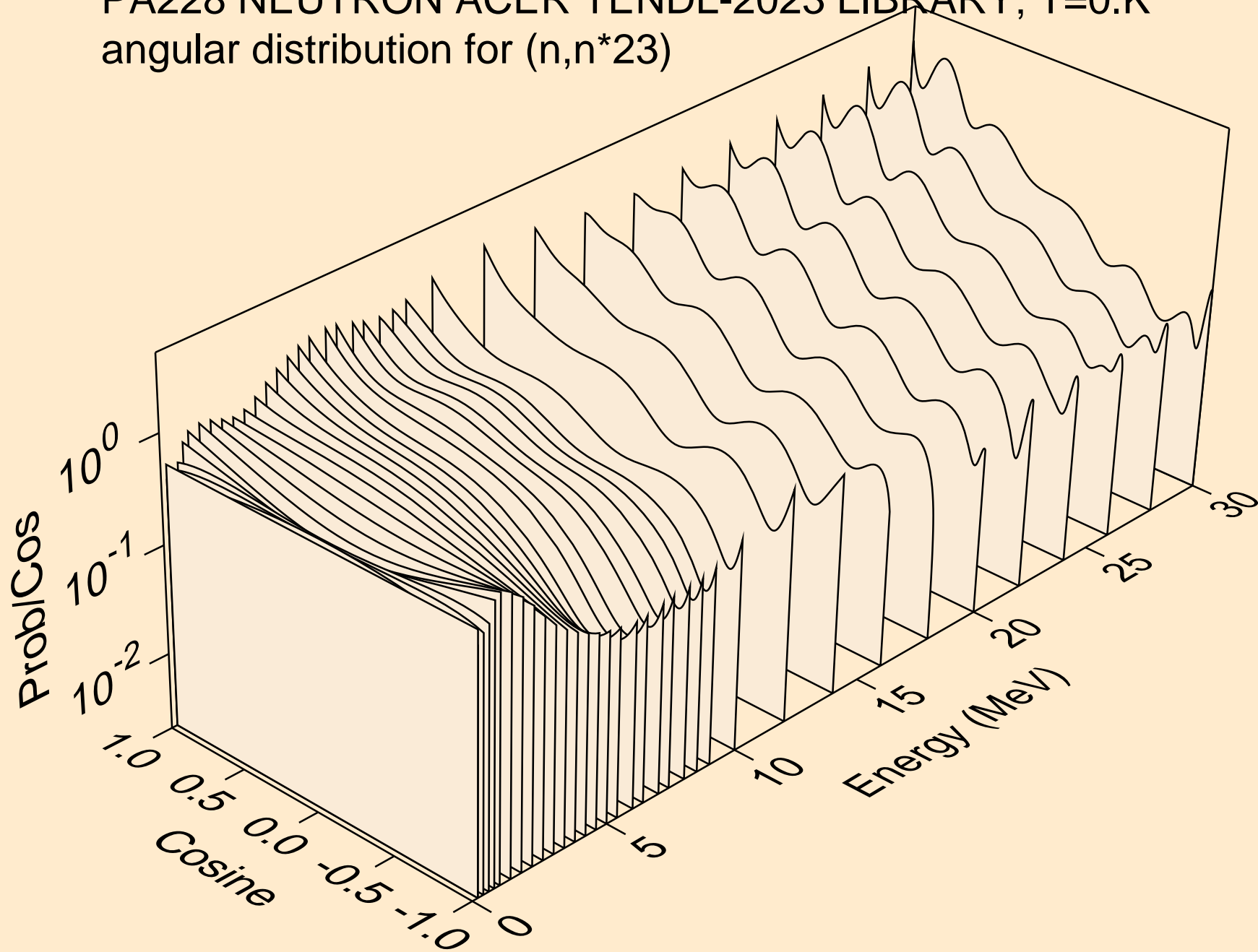



PA228 NEUTRON ACER TENDL-2023 LIBRARY; T=0.K  
angular distribution for (n,n\*24)

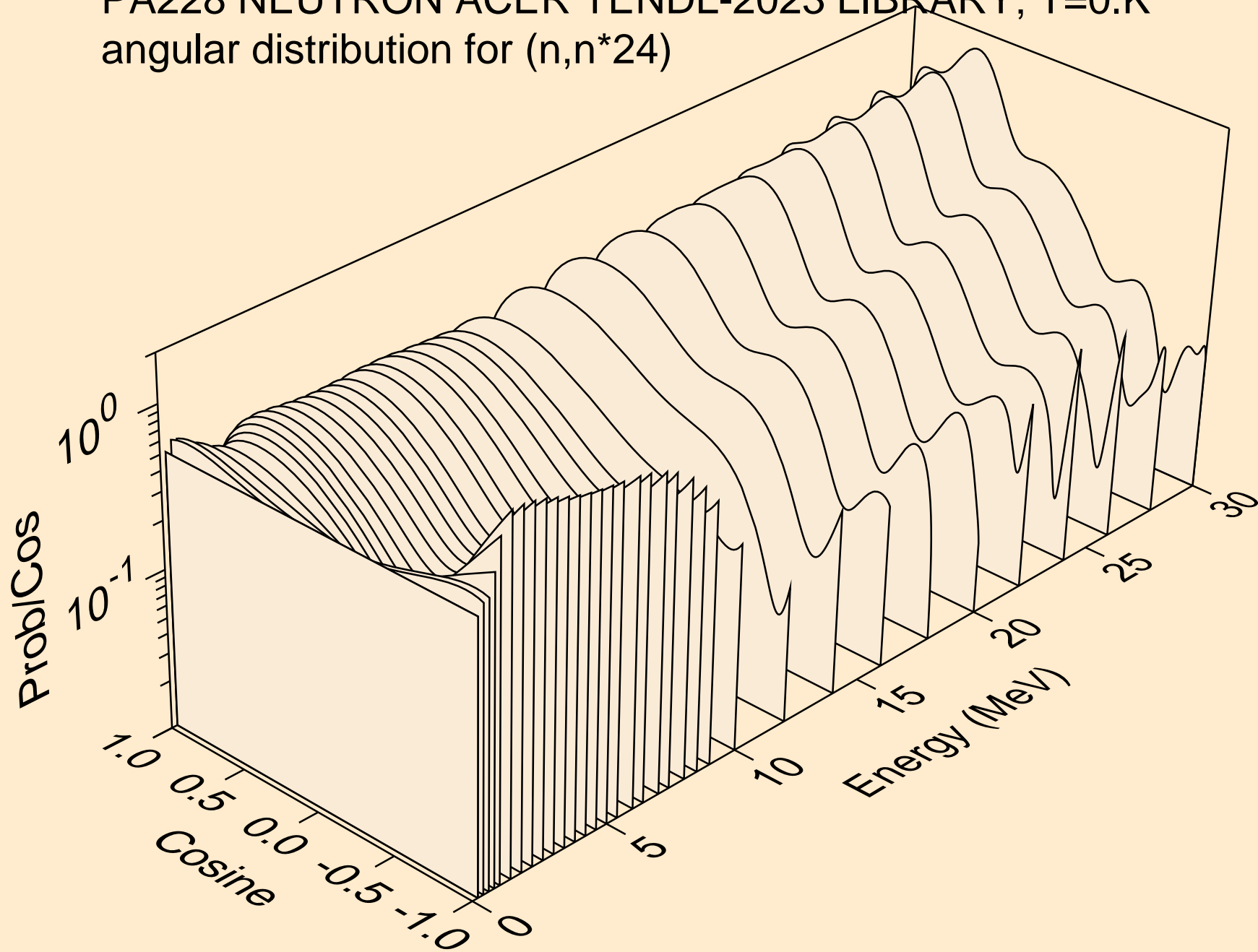

PA228 NEUTRON ACER TENDL-2023 LIBRARY; T=0.K  
angular distribution for (n,n\*25)

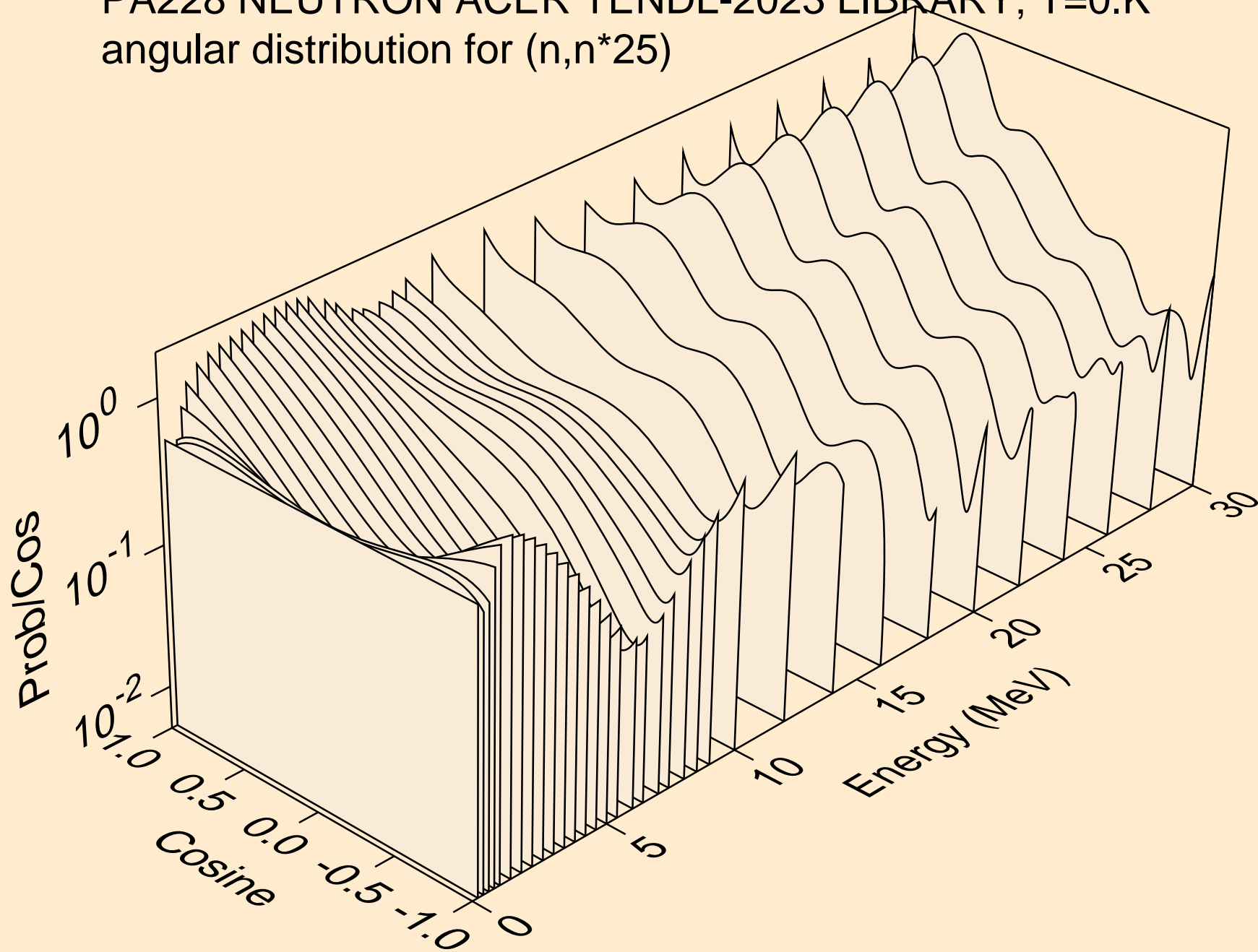

PA228 NEUTRON ACER TENDL-2023 LIBRARY; T=0.K  
angular distribution for (n,n\*26)

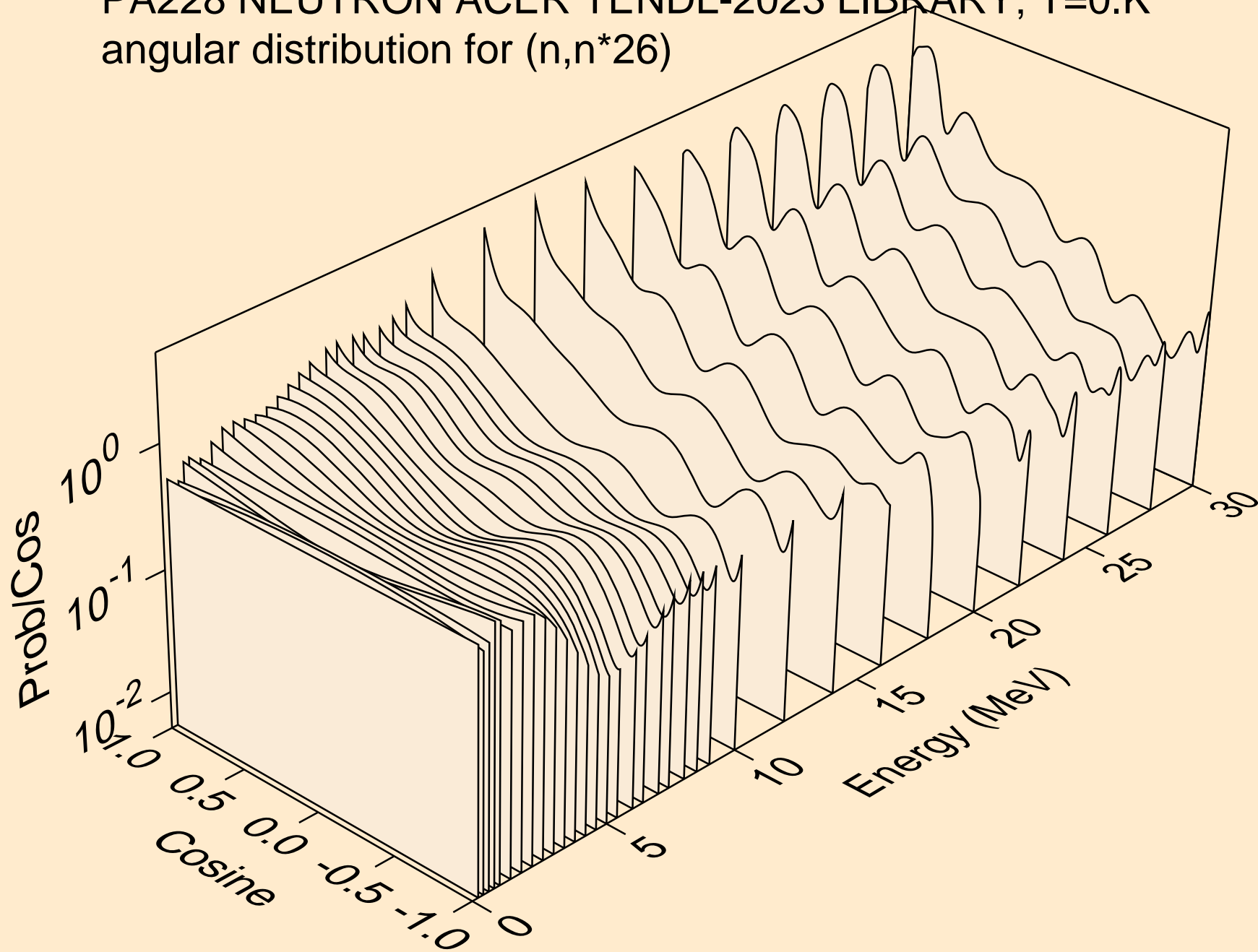

PA228 NEUTRON ACER TENDL-2023 LIBRARY; T=0.K

Total fission nubar

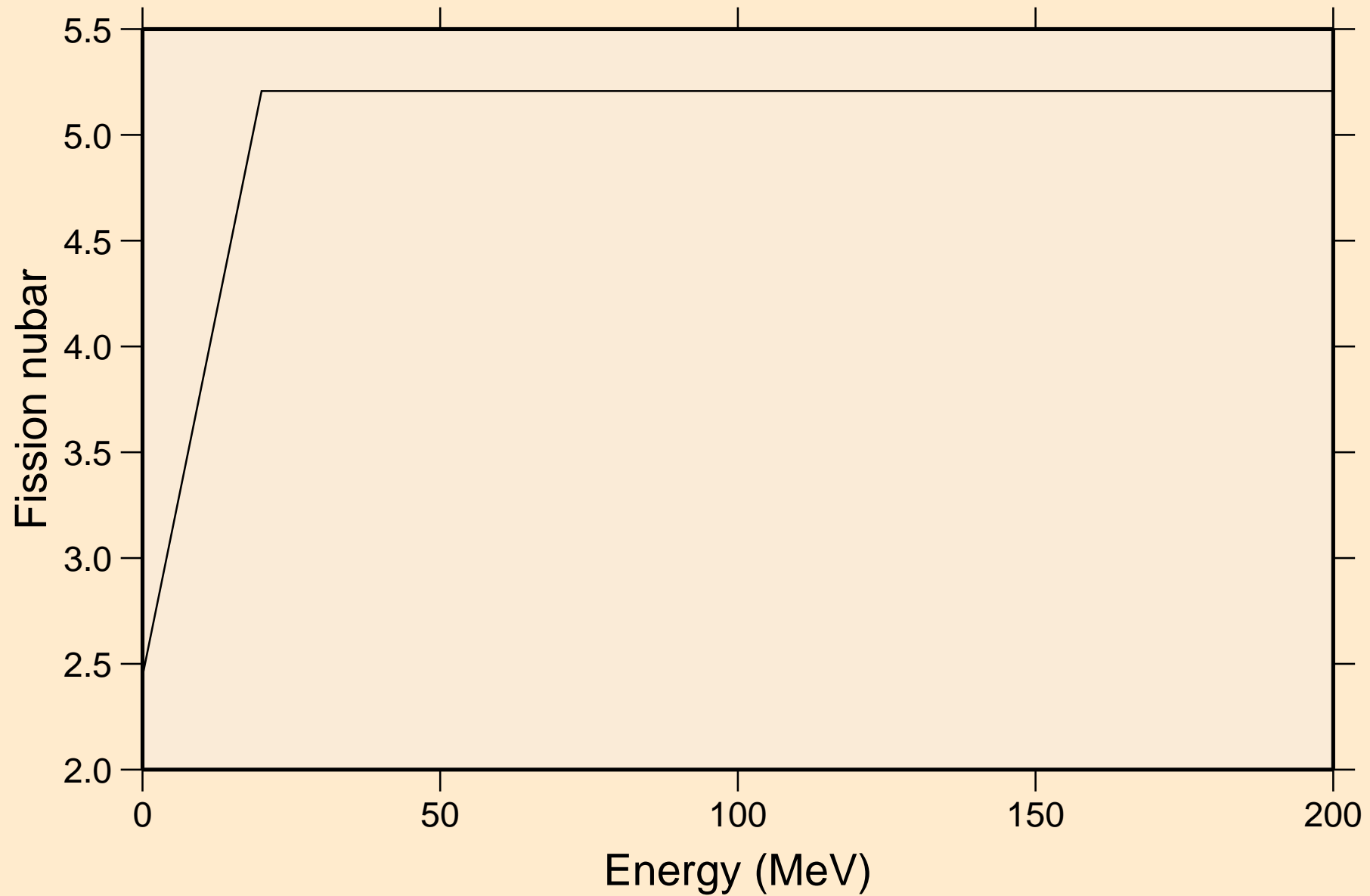

PA228 NEUTRON ACER TENDL-2023 LIBRARY; T=0.K  
Neutron emission for (n,x)

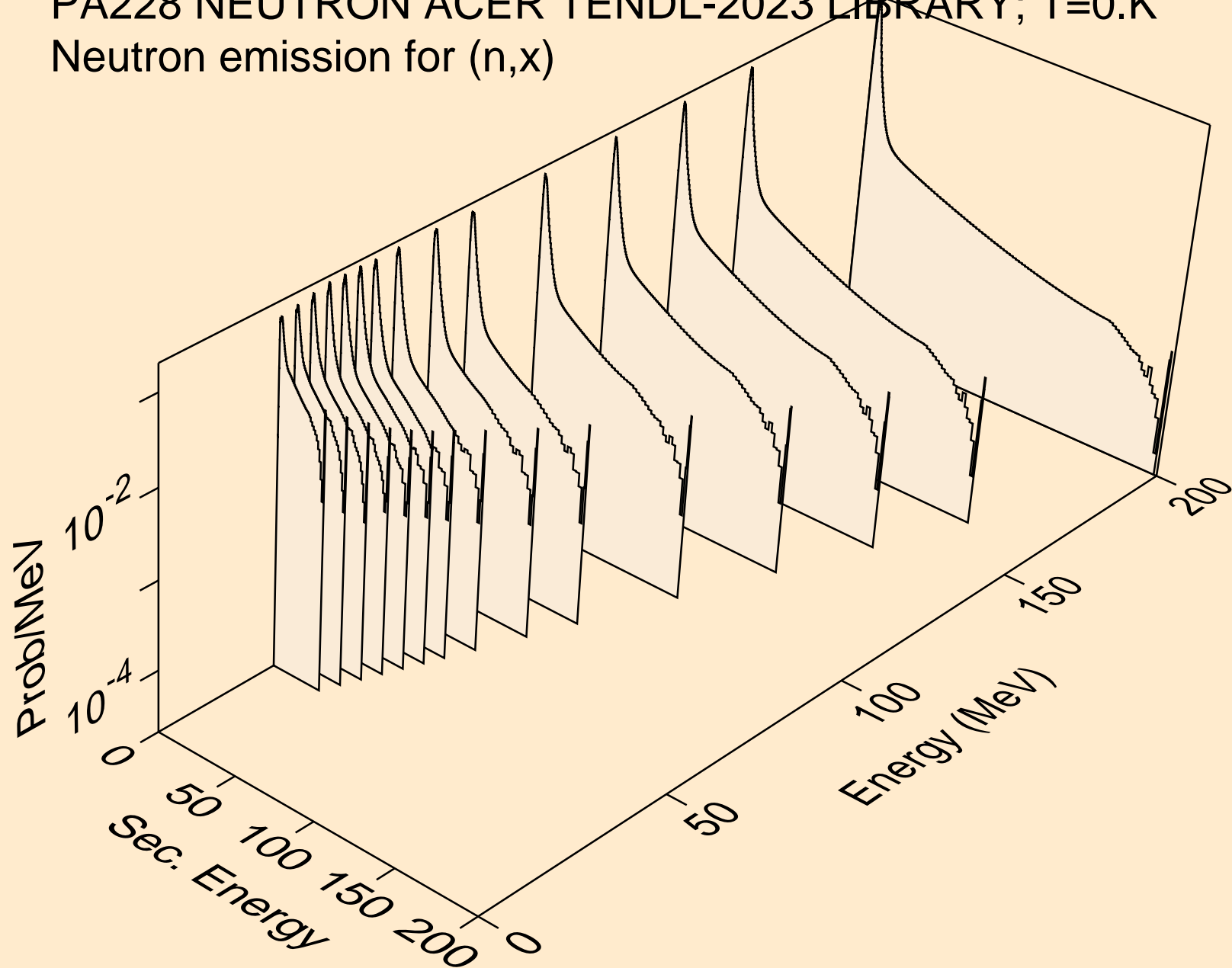

PA228 NEUTRON ACER TENDL-2023 LIBRARY; T=0.K  
Neutron emission for (n,2nd)

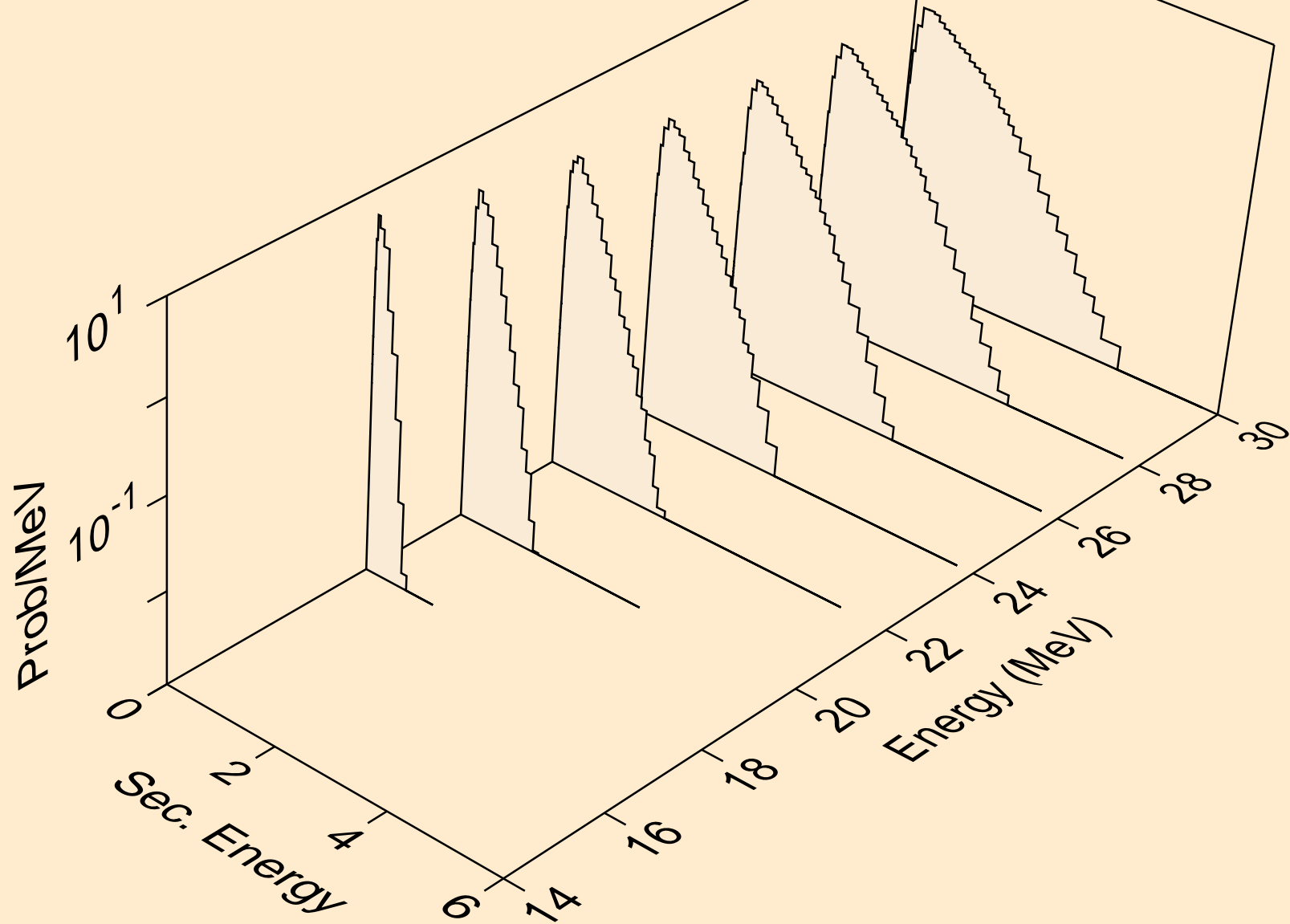

PA228 NEUTRON ACER TENDL-2023 LIBRARY; T=0.K  
Neutron emission for (n,2n)

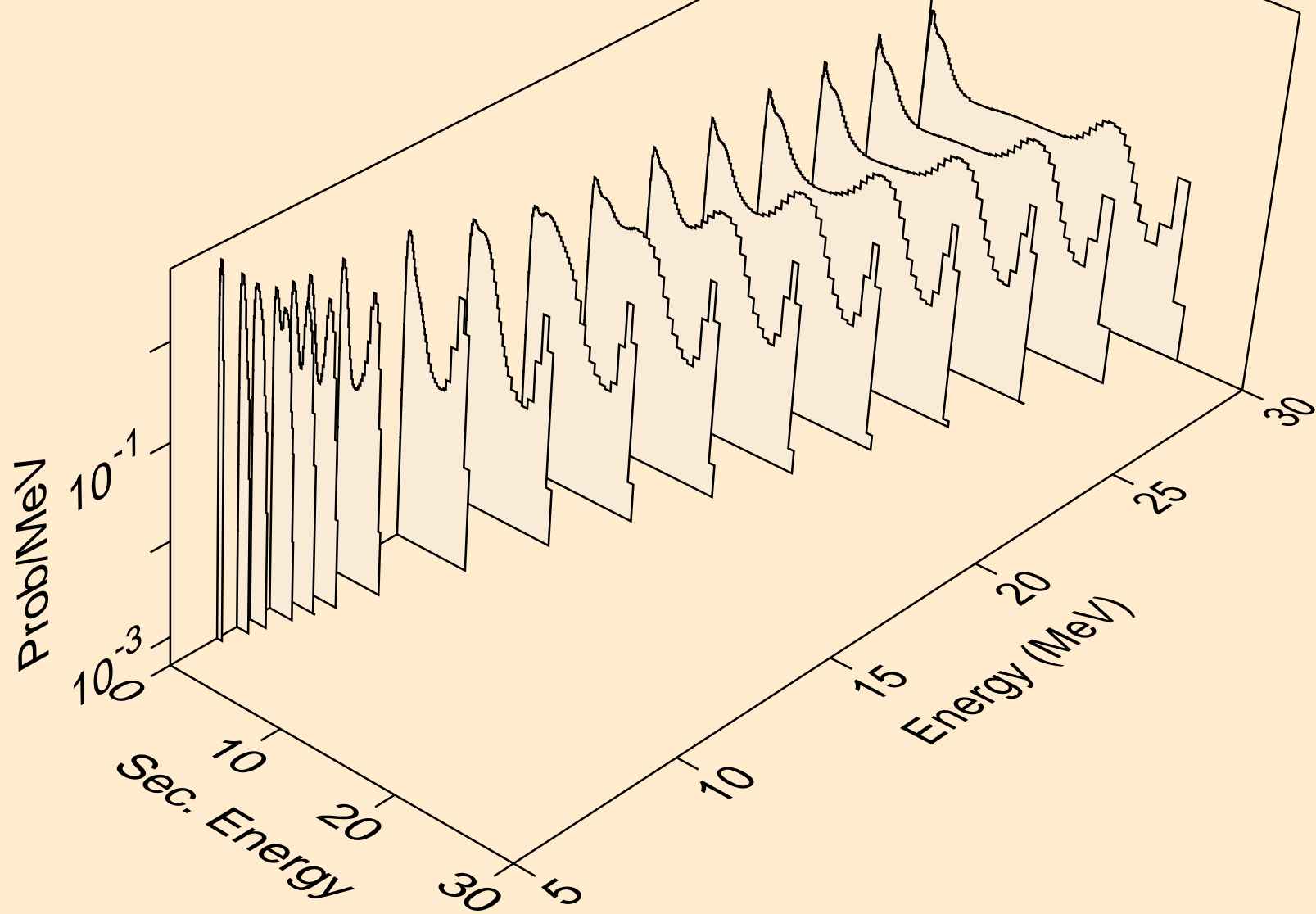

PA228 NEUTRON ACER TENDL-2023 LIBRARY; T=0.K  
Neutron emission for (n,3n)

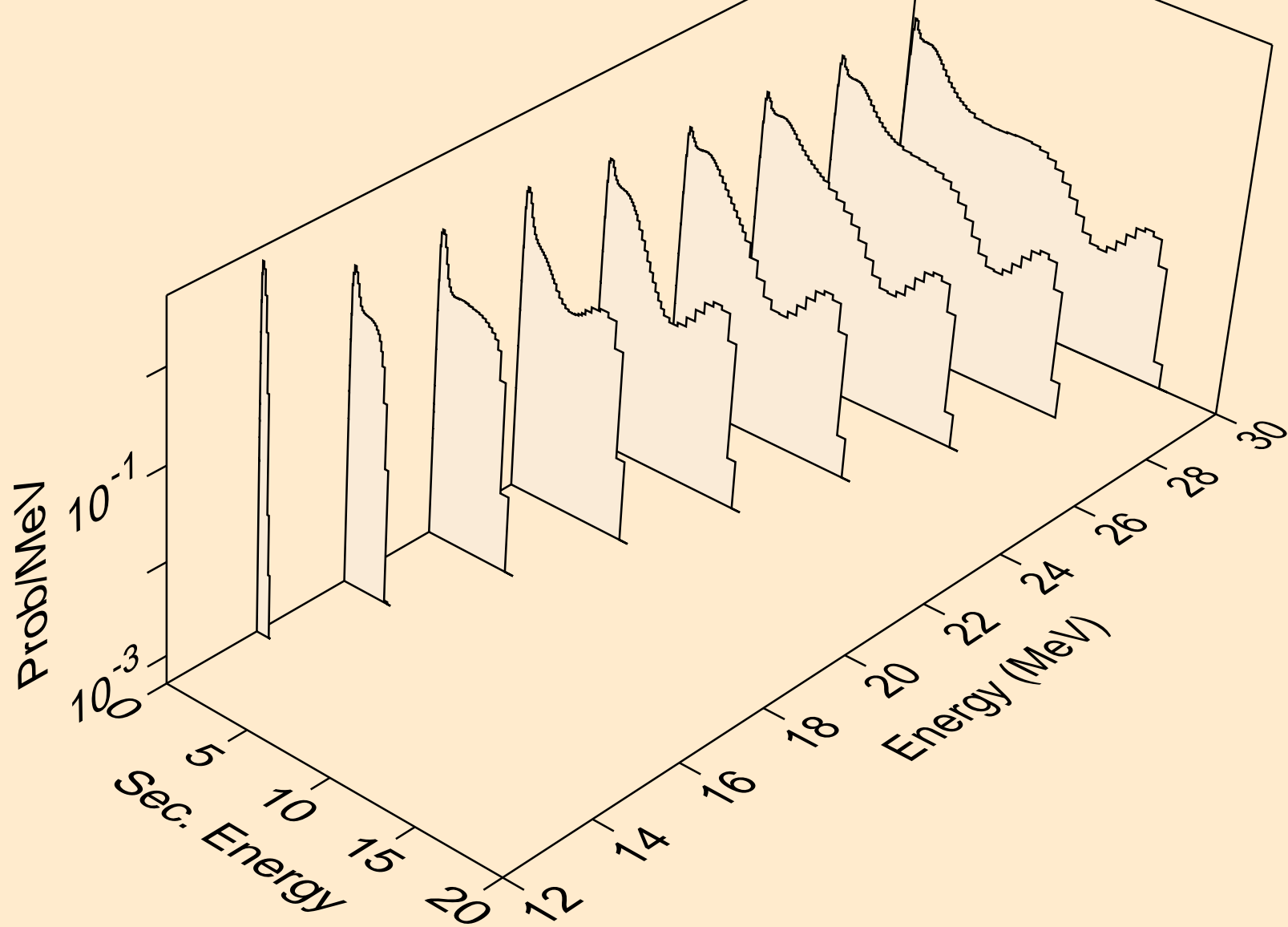



PA228 NEUTRON ACER TENDL-2023 LIBRARY; T=0.K  
Neutron emission for fission

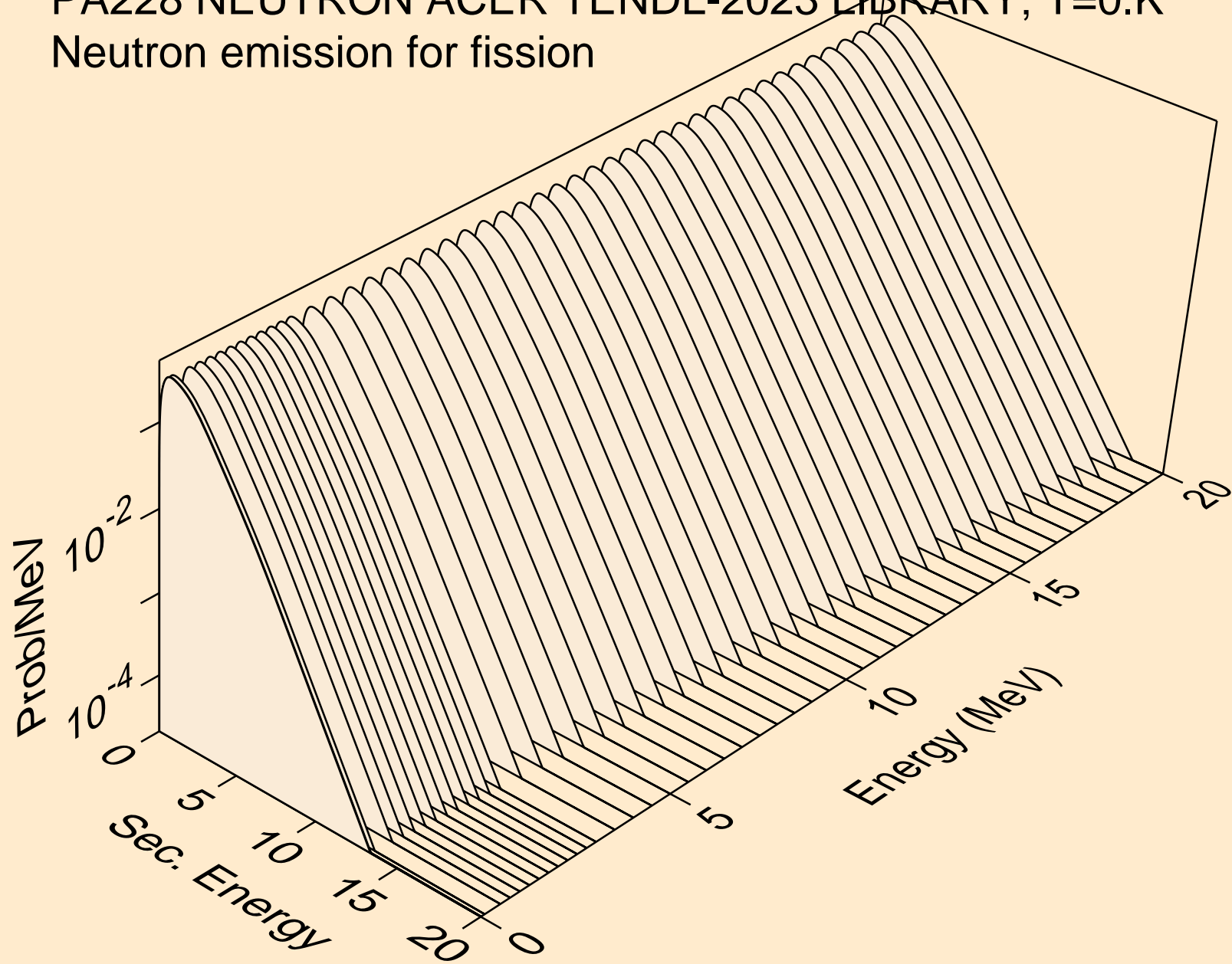

PA228 NEUTRON ACER TENDL-2023 LIBRARY; T=0.K  
Neutron emission for (n,n\*)a

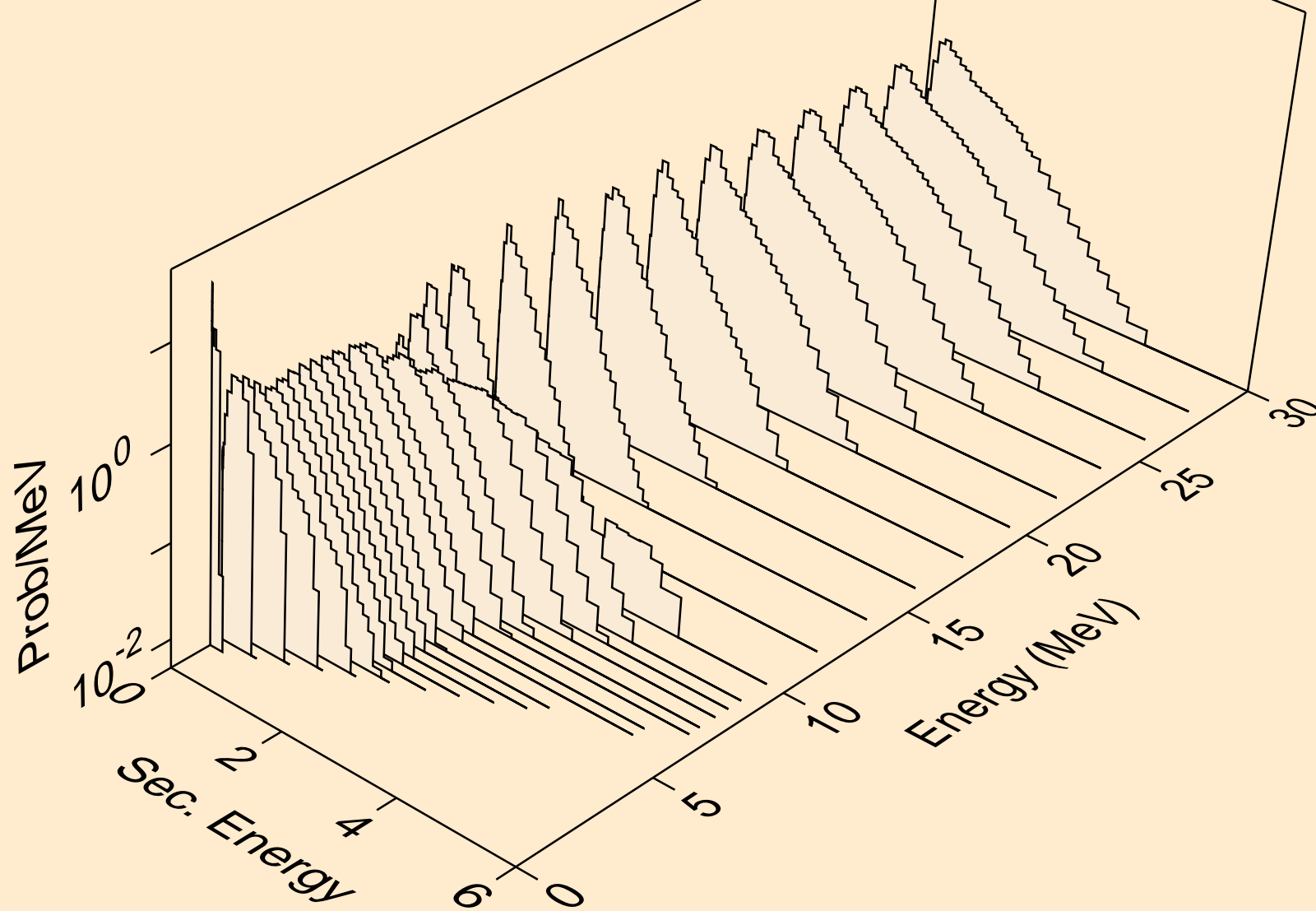

PA228 NEUTRON ACER TENDL-2023 LIBRARY; T=0.K  
Neutron emission for (n,2n)a

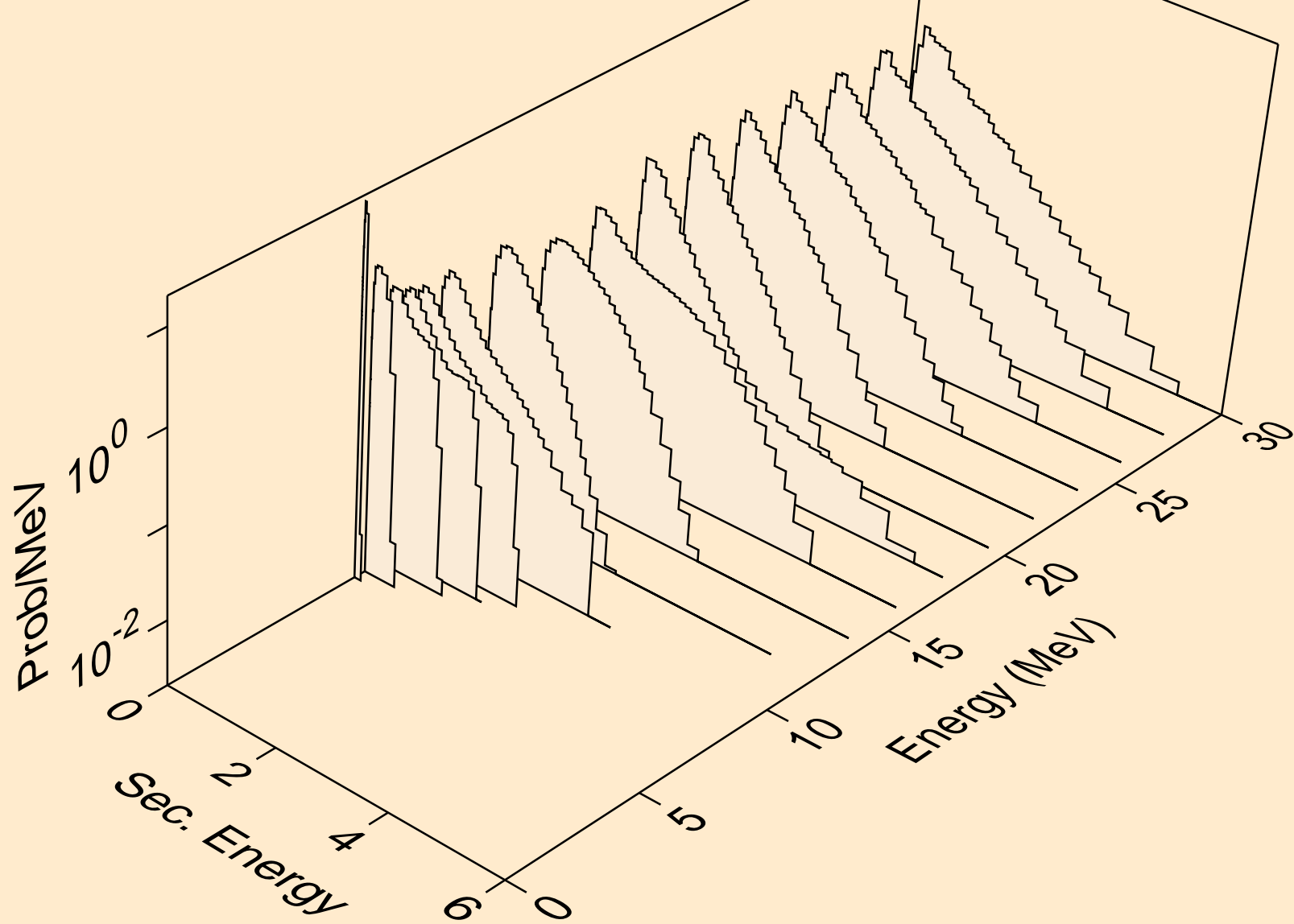

PA228 NEUTRON ACER TENDL-2023 LIBRARY; T=0.K  
Neutron emission for (n,3n)a

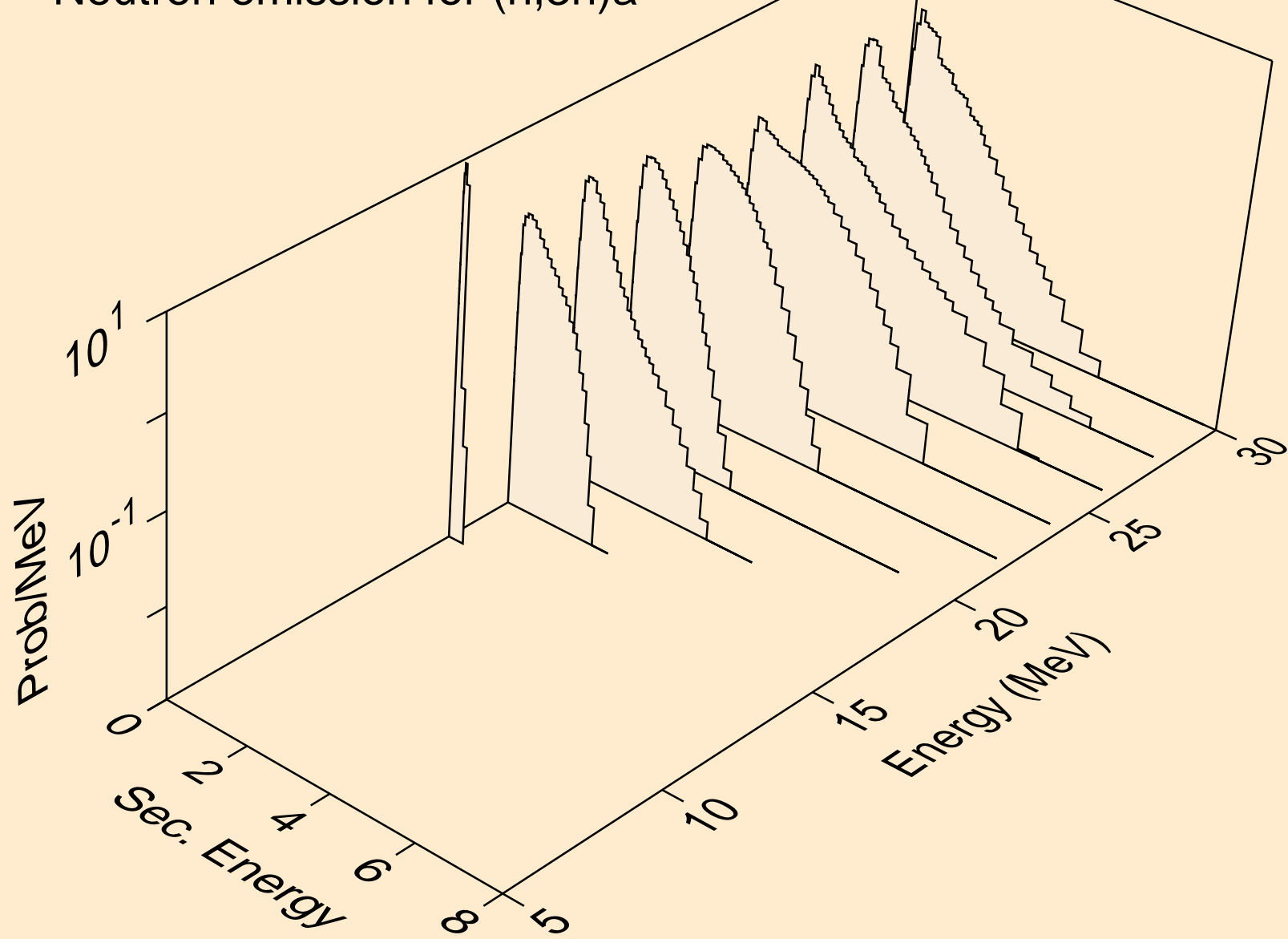

PA228 NEUTRON ACER TENDL-2023 LIBRARY; T=0.K  
Neutron emission for (n,n\*)p

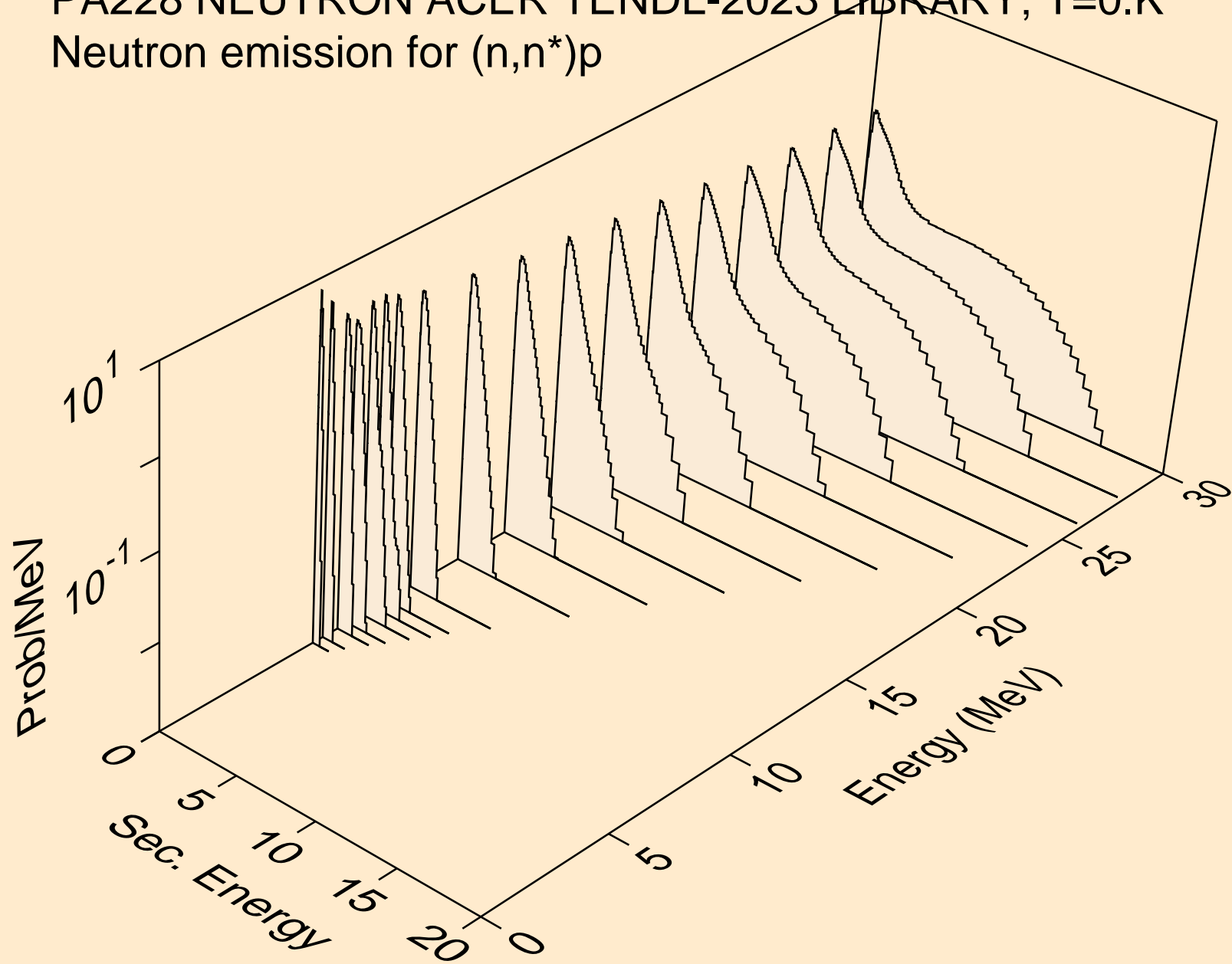

PA228 NEUTRON ACER TENDL-2023 LIBRARY; T=0.K  
Neutron emission for (n,n\*)2a

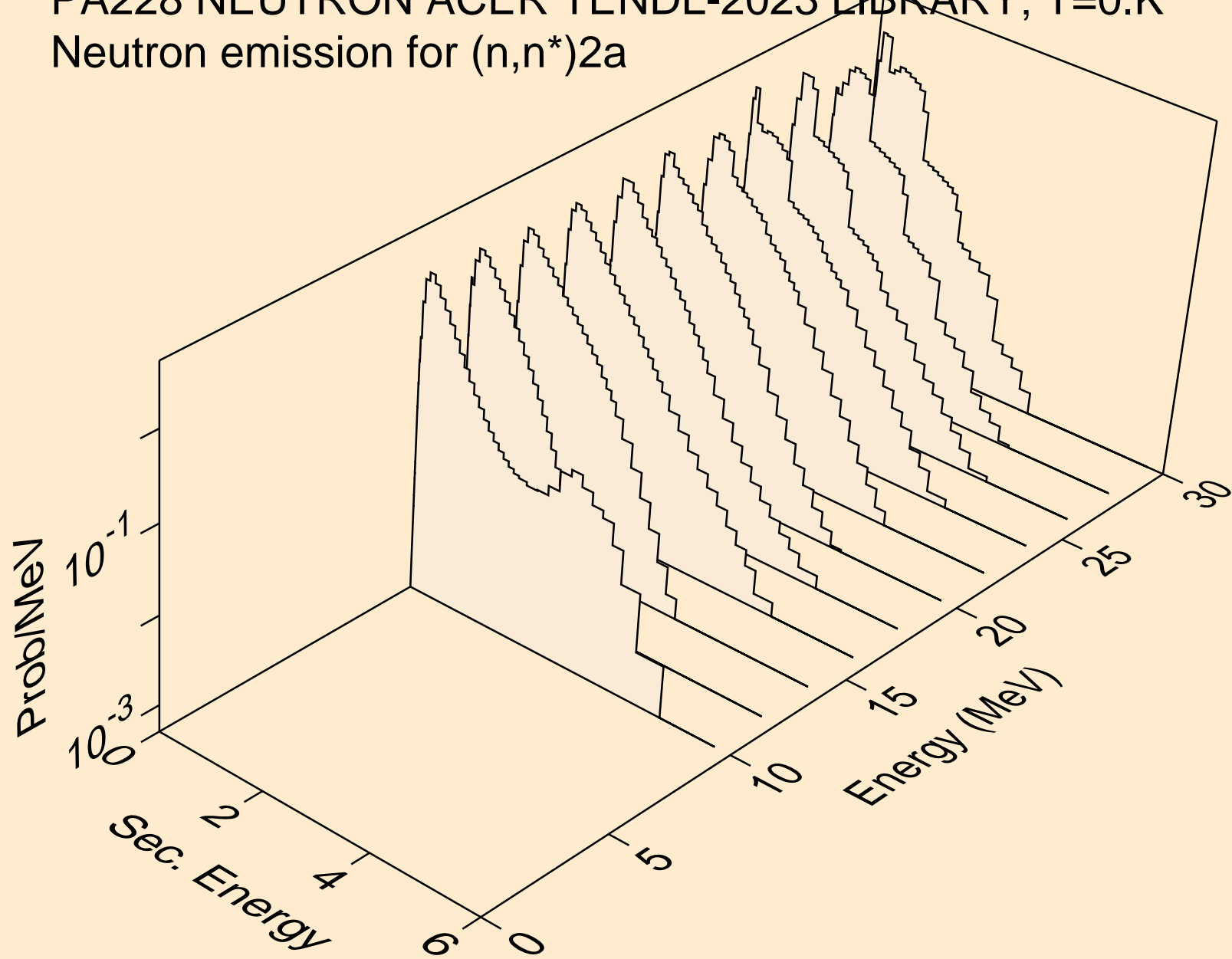

PA228 NEUTRON ACER TENDL-2023 LIBRARY; T=0.K  
Neutron emission for (n,n\*)d

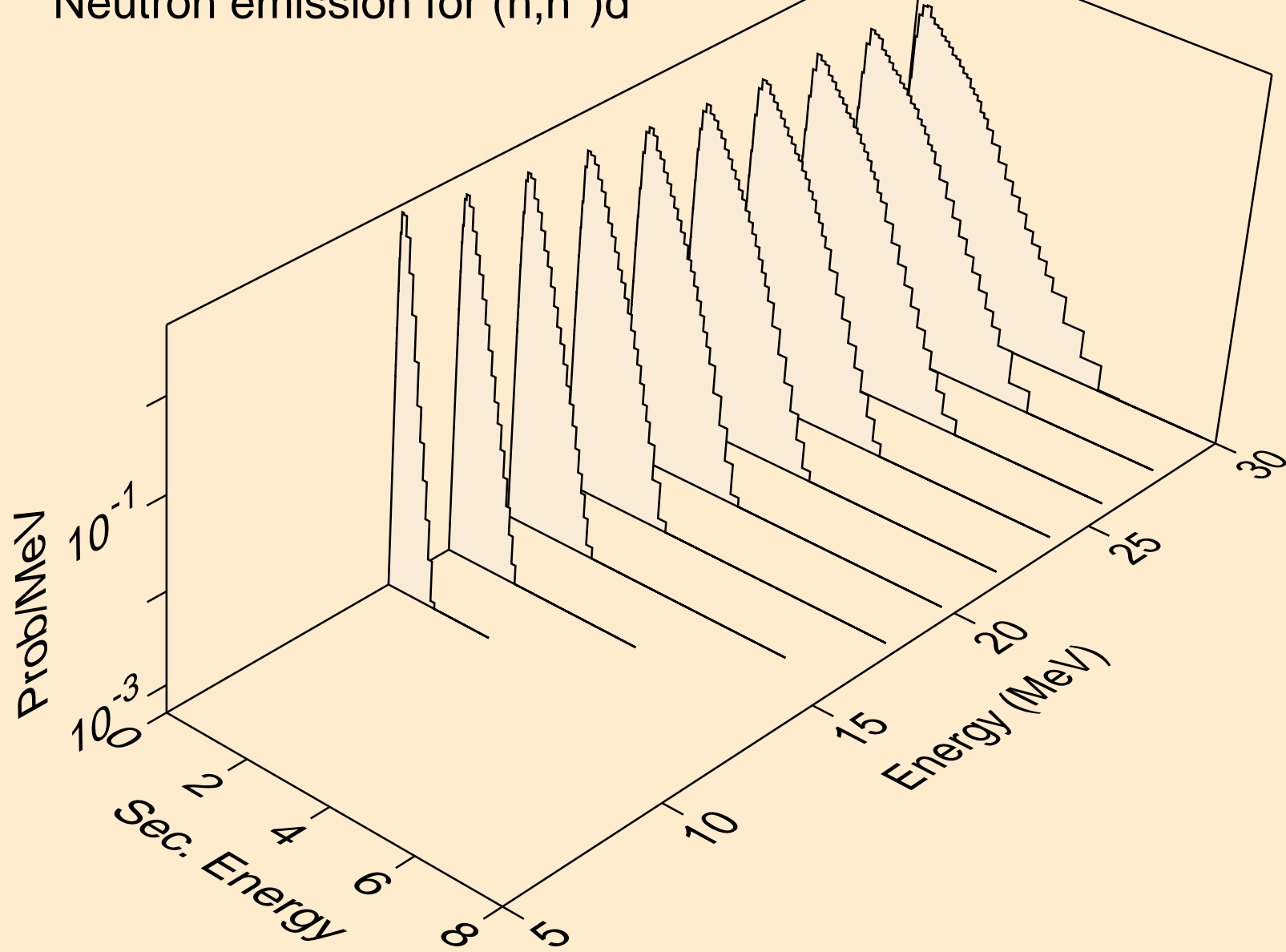

PA228 NEUTRON ACER TENDL-2023 LIBRARY; T=0.K  
Neutron emission for (n,n\*)t

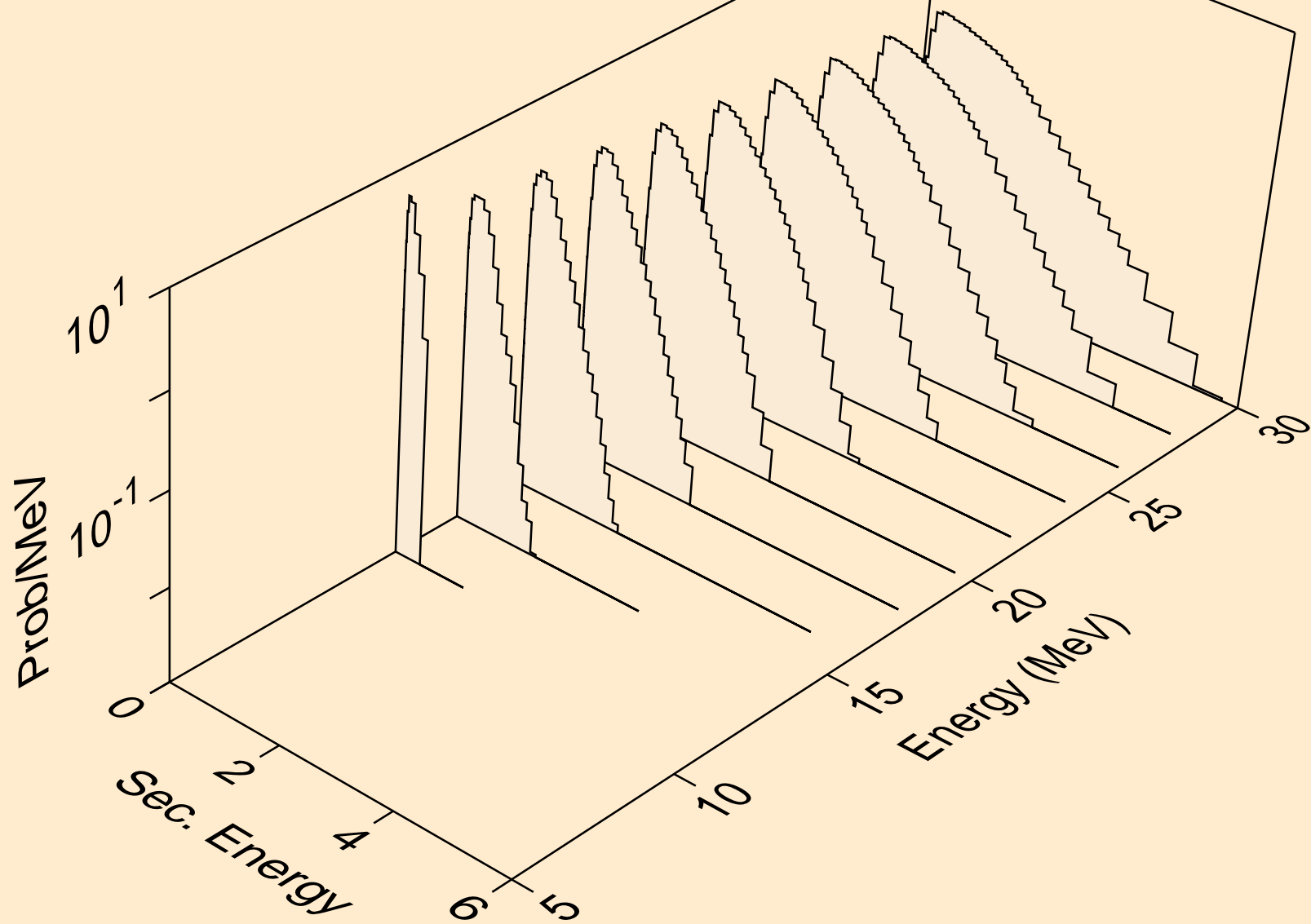



PA228 NEUTRON ACER TENDL-2023 LIBRARY; T=0.K  
Neutron emission for (n,n\*)he3

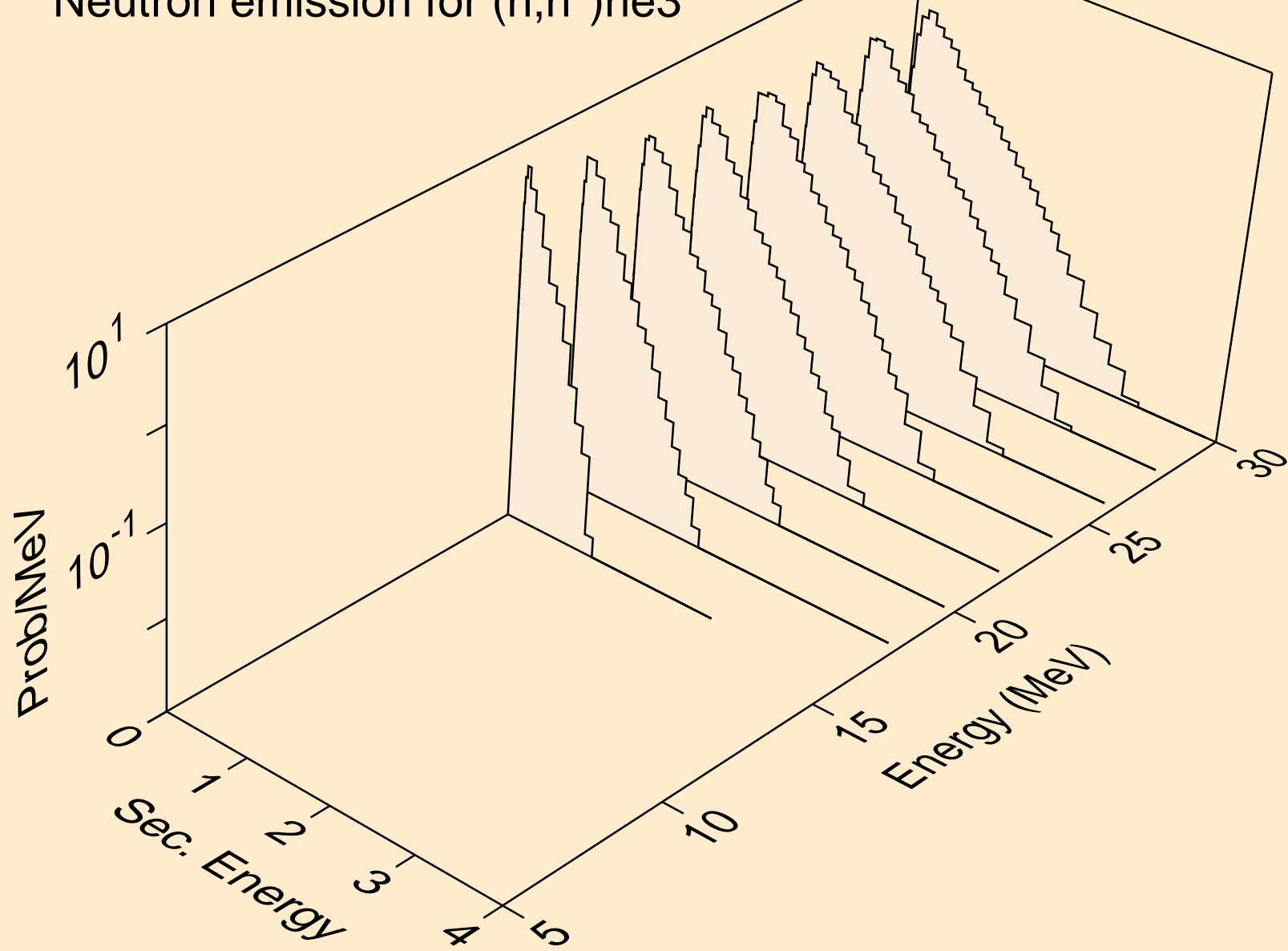

PA228 NEUTRON ACER TENDL-2023 LIBRARY; T=0.K  
Neutron emission for (n,4n)

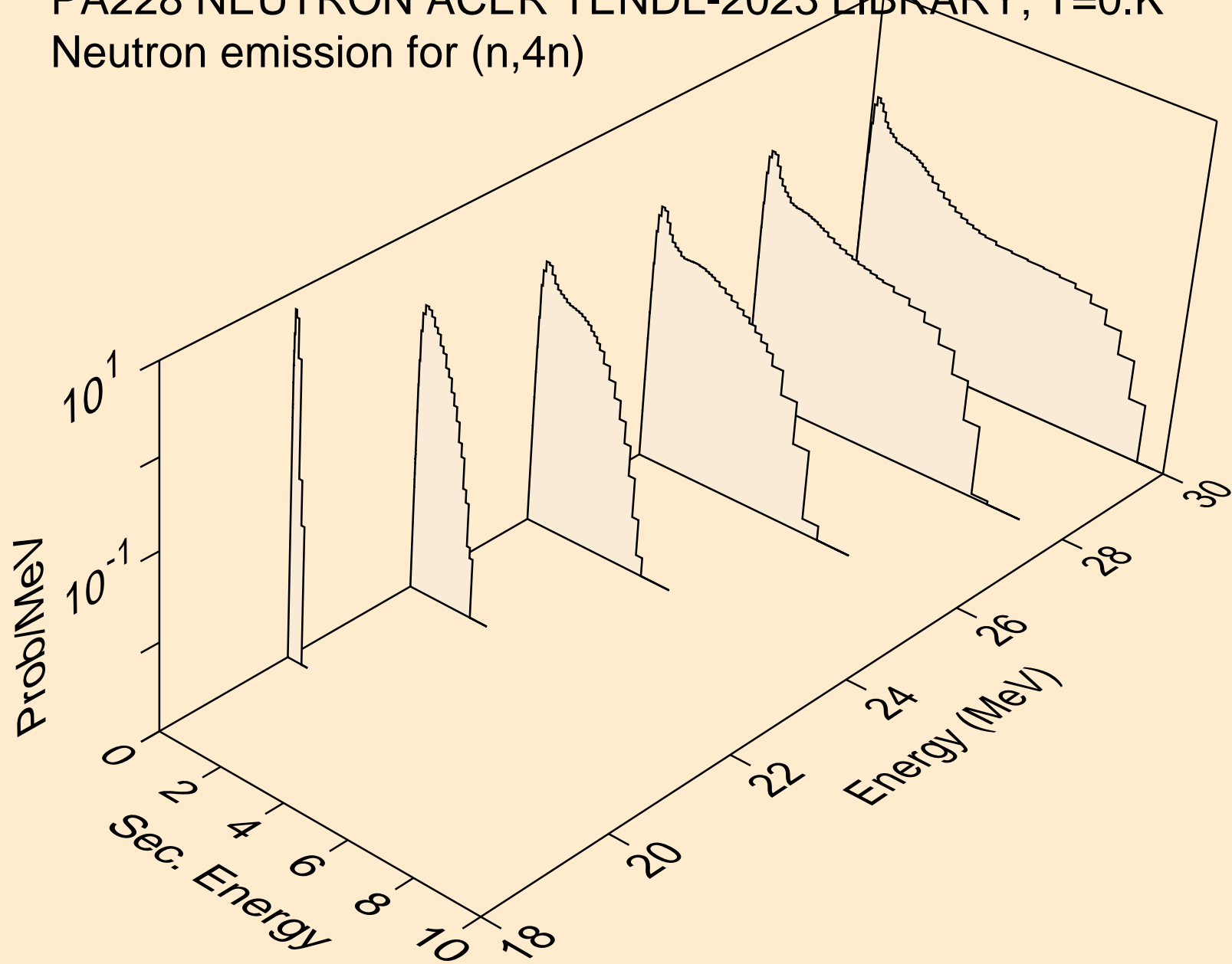

PA228 NEUTRON ACER TENDL-2023 LIBRARY; T=0.K  
Neutron emission for (n,2np)

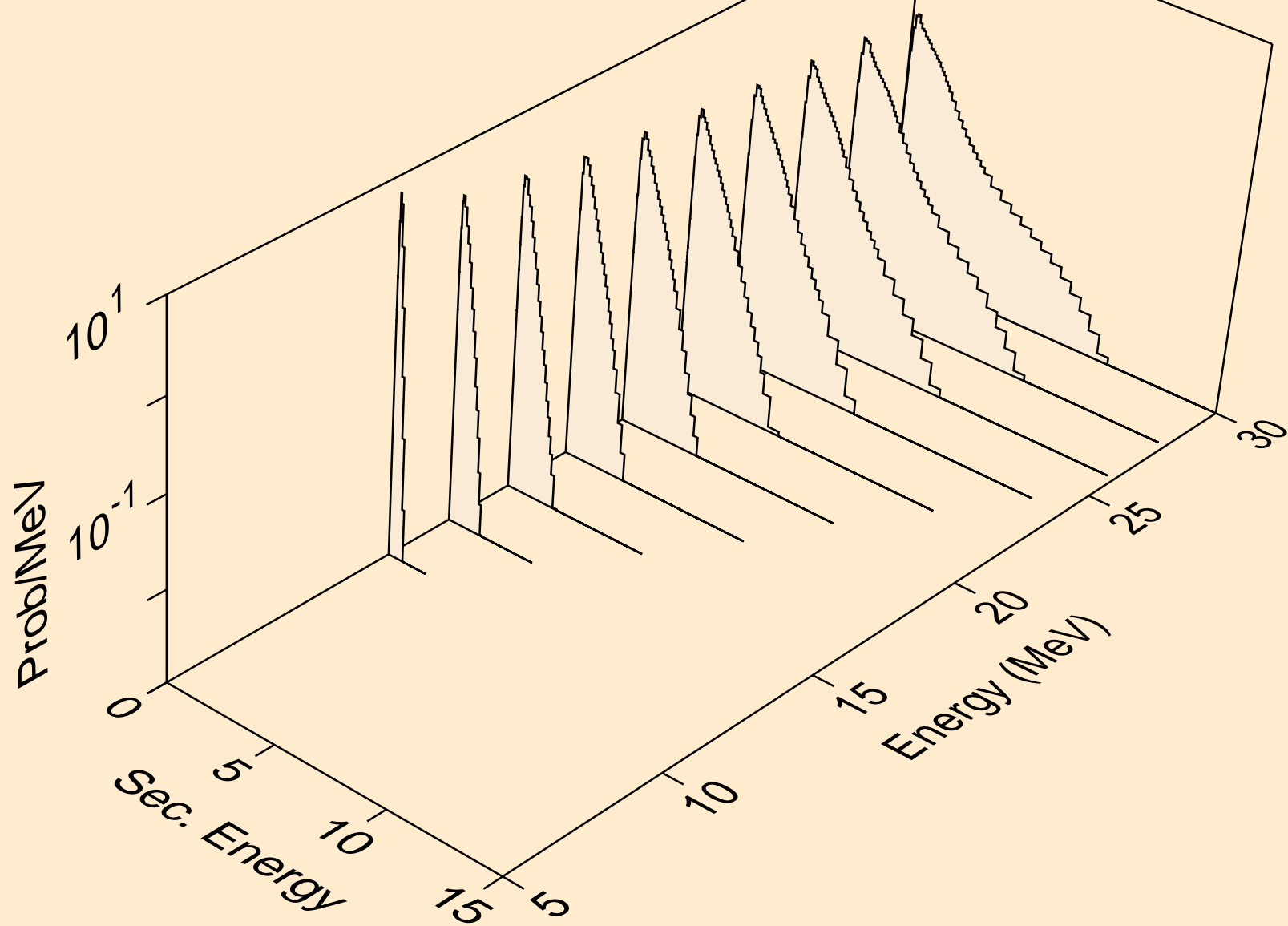

PA228 NEUTRON ACER TENDL-2023 LIBRARY; T=0.K  
Neutron emission for (n,3np)

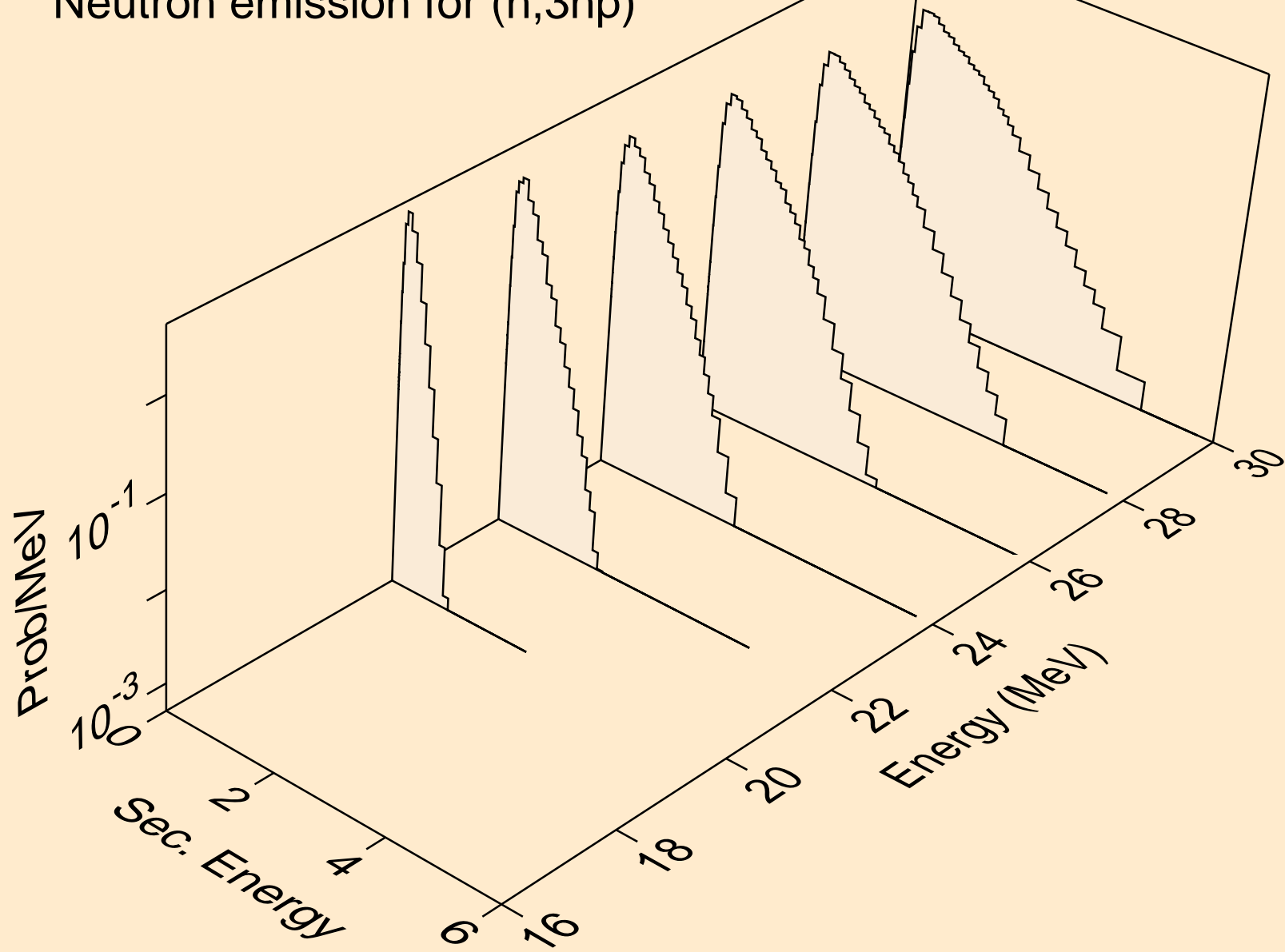

PA228 NEUTRON ACER TENDL-2023 LIBRARY; T=0.K  
Neutron emission for (n,n2p)

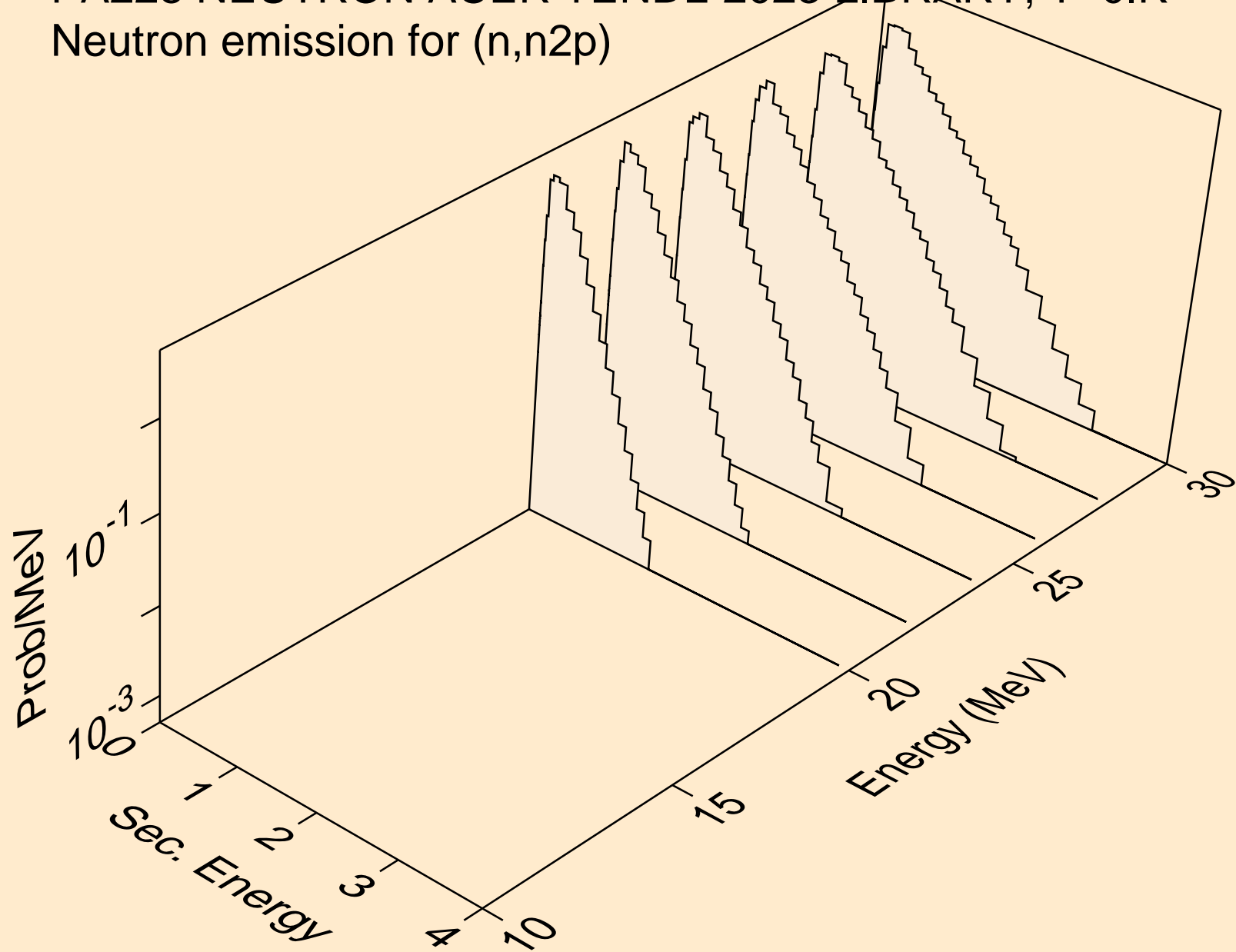

PA228 NEUTRON ACER TENDL-2023 LIBRARY; T=0.K  
Neutron emission for (n,npa)

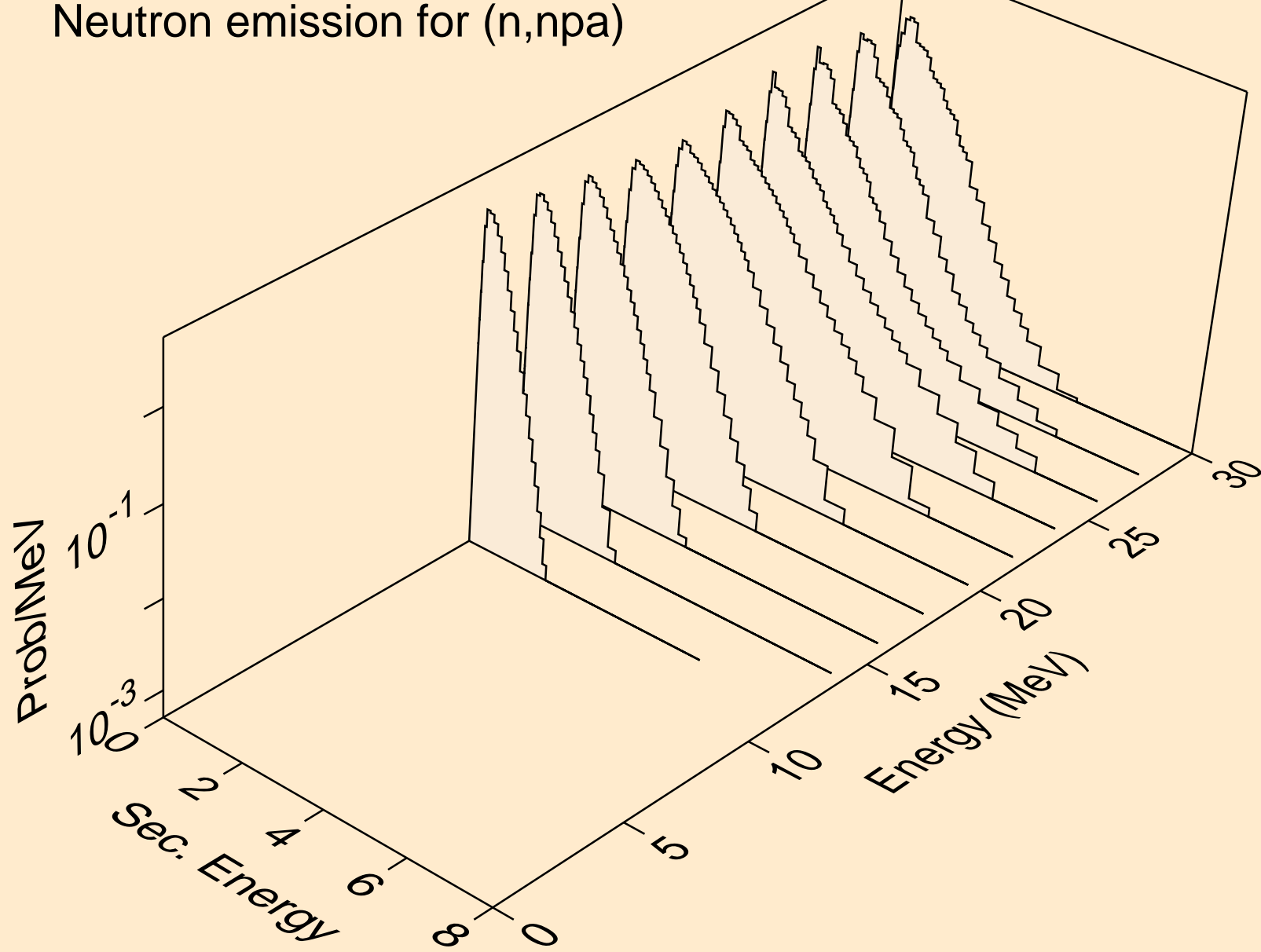

PA228 NEUTRON ACER TENDL-2023 LIBRARY; T=0.K  
Neutron emission for (n,n\*c)

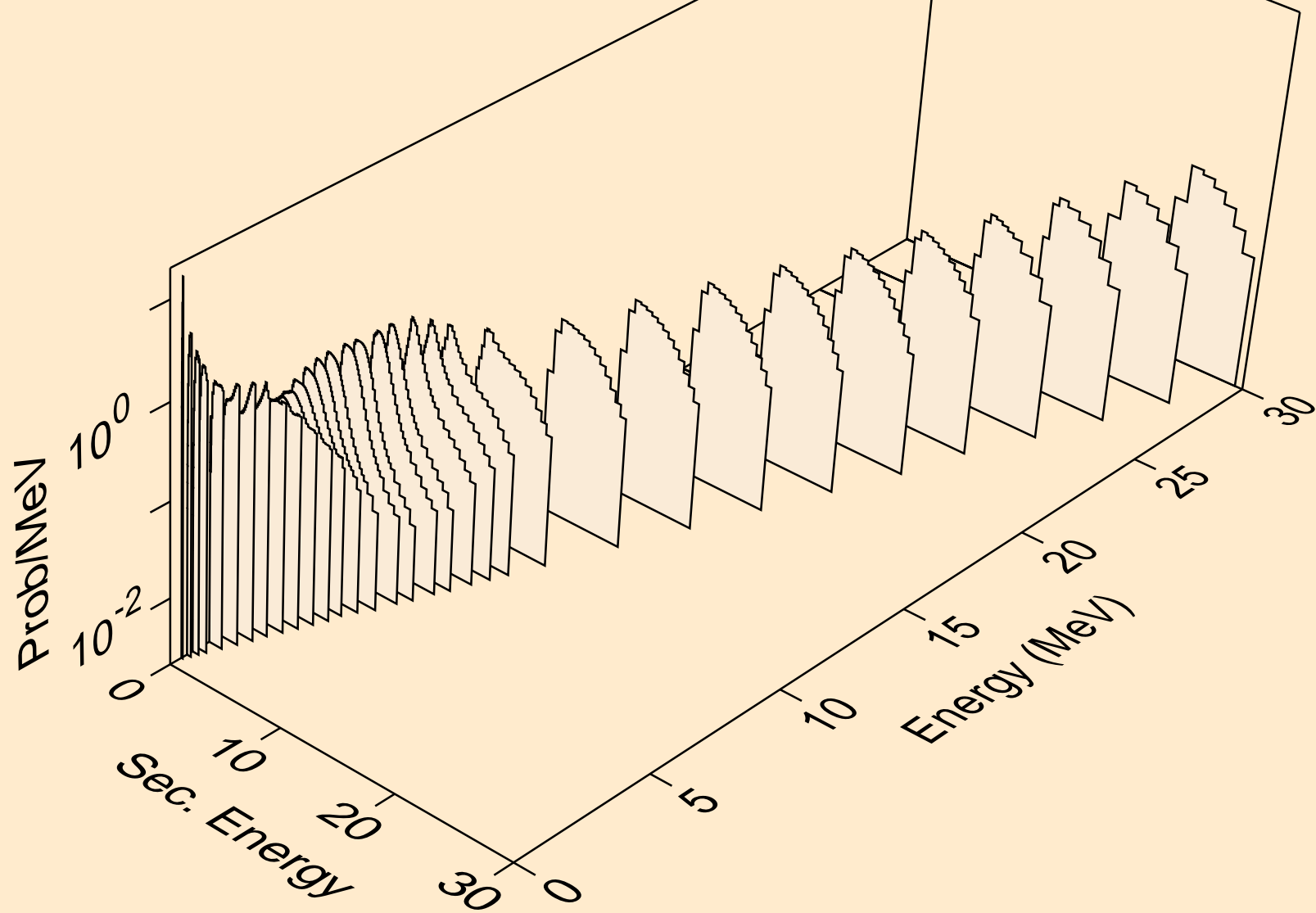

PA228 NEUTRON ACER TENDL-2023 LIBRARY; T=0.K

Delayed nubar

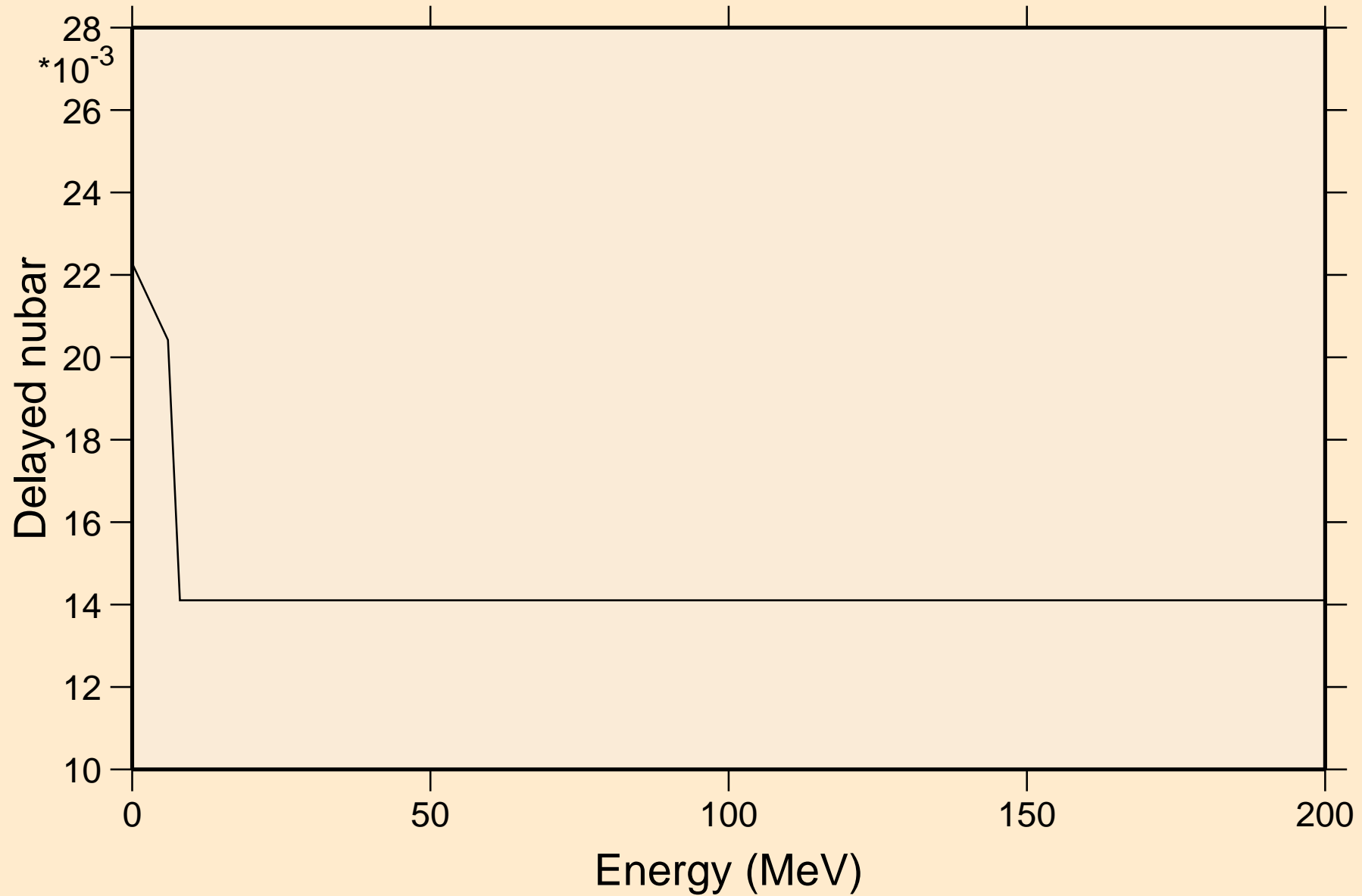



# PA228 NEUTRON ACER TENDL-2023 LIBRARY; T=0.K

## Delayed neutron spectra

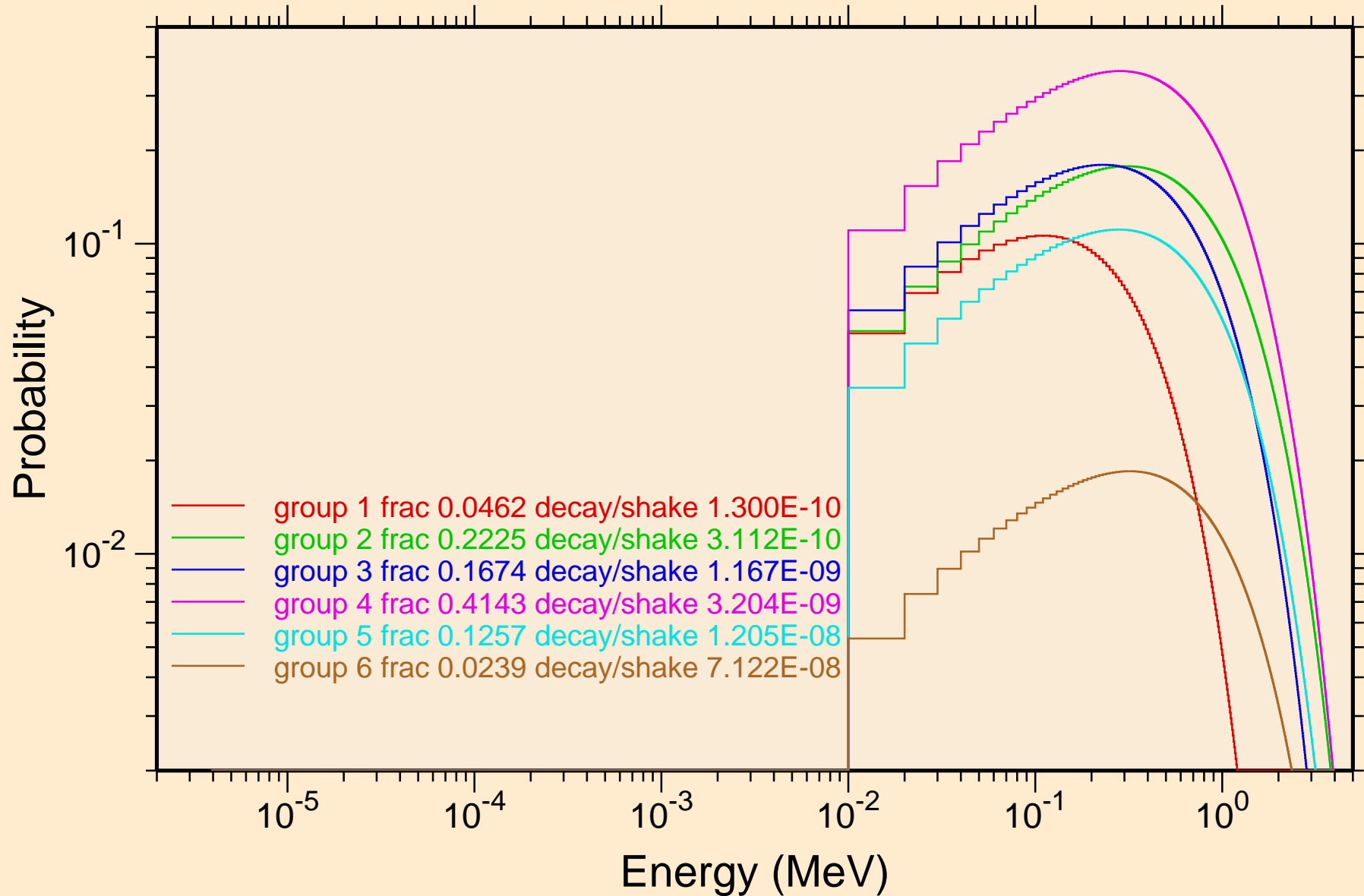

PA228 NEUTRON ACER TENDL-2023 LIBRARY; T=0.K  
Photon emission for (n,x)

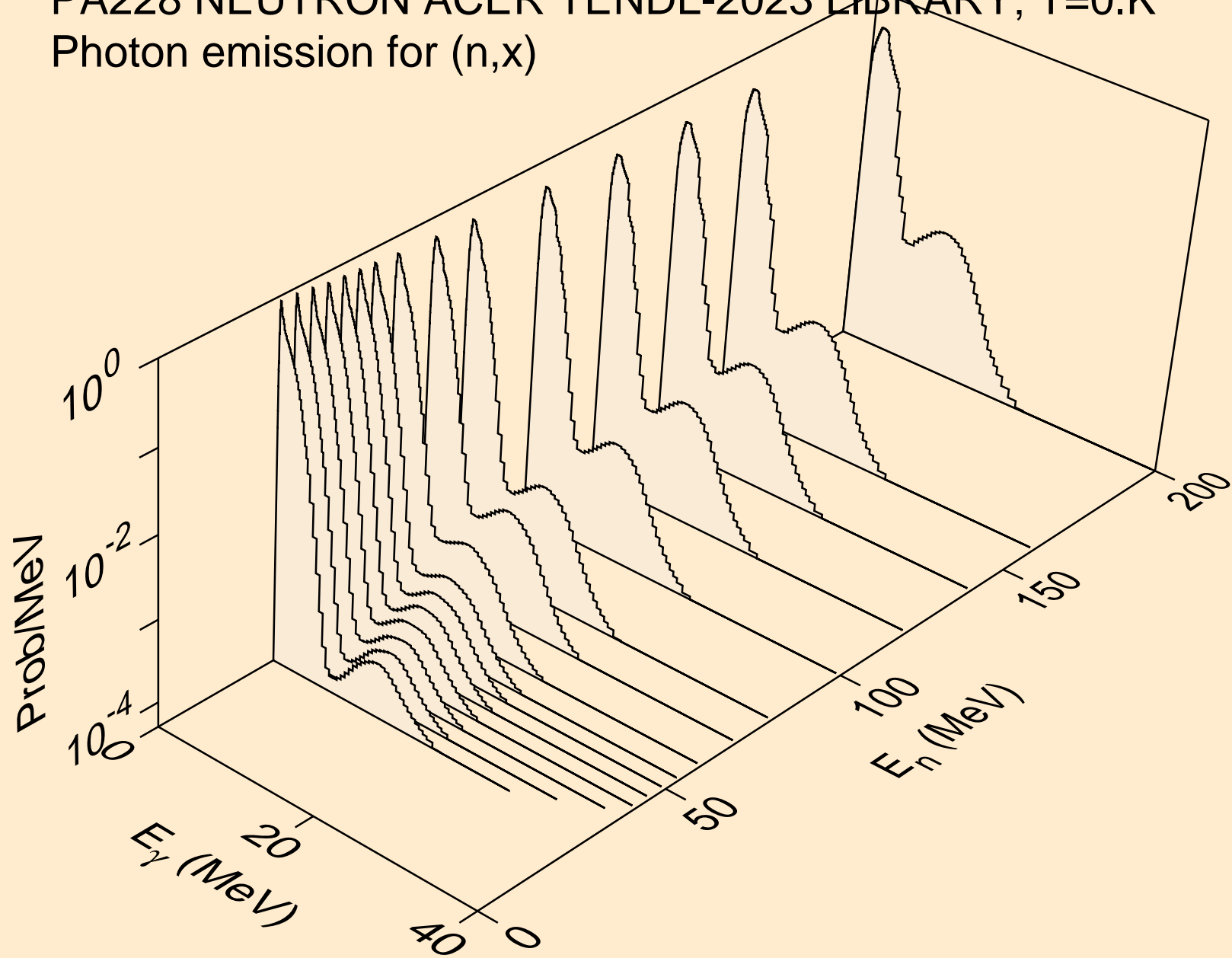

PA228 NEUTRON ACER TENDL-2023 LIBRARY; T=0.K  
Photon emission for (n,2nd)

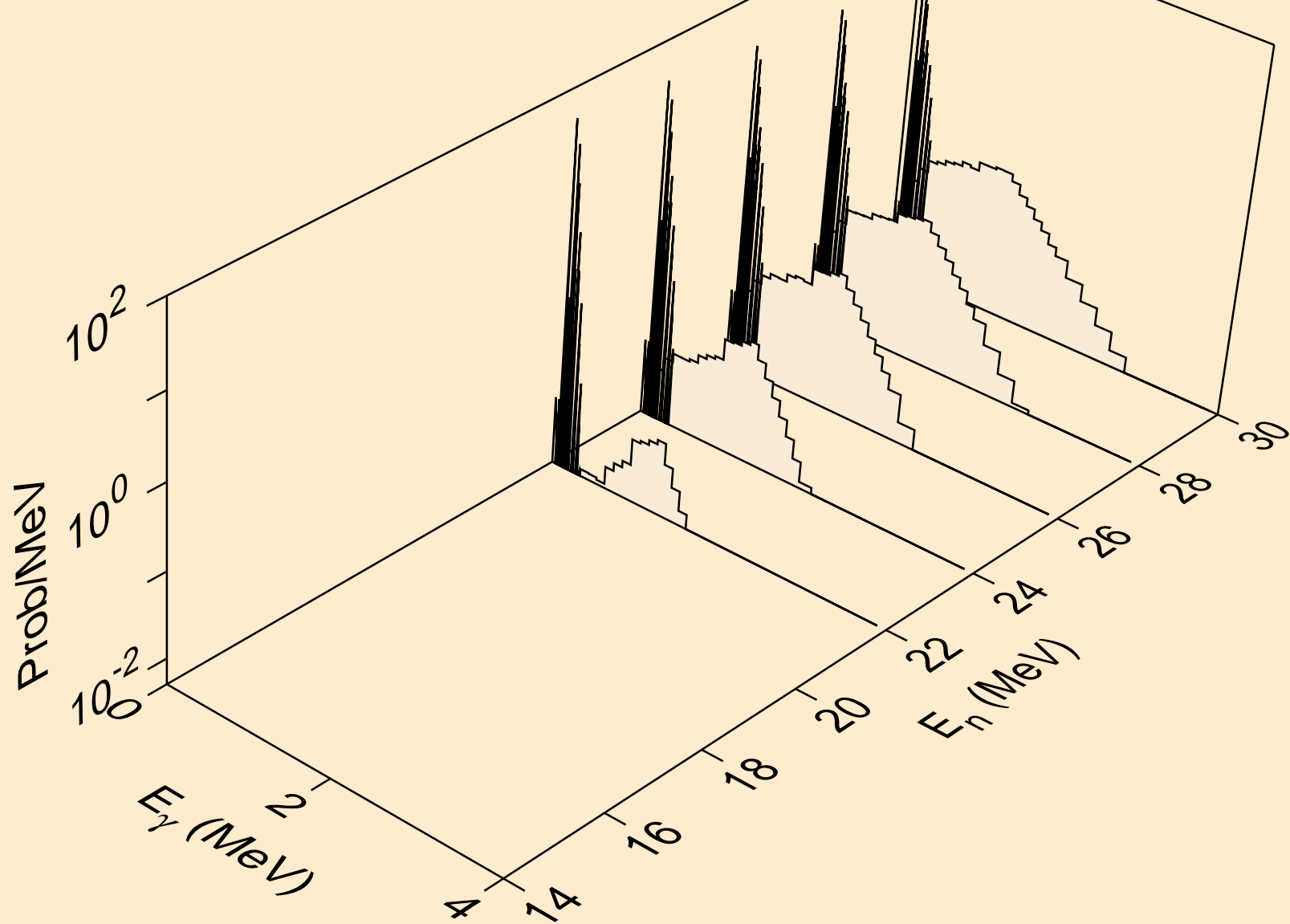

PA228 NEUTRON ACER TENDL-2023 LIBRARY; T=0.K  
Photon emission for (n,2n)

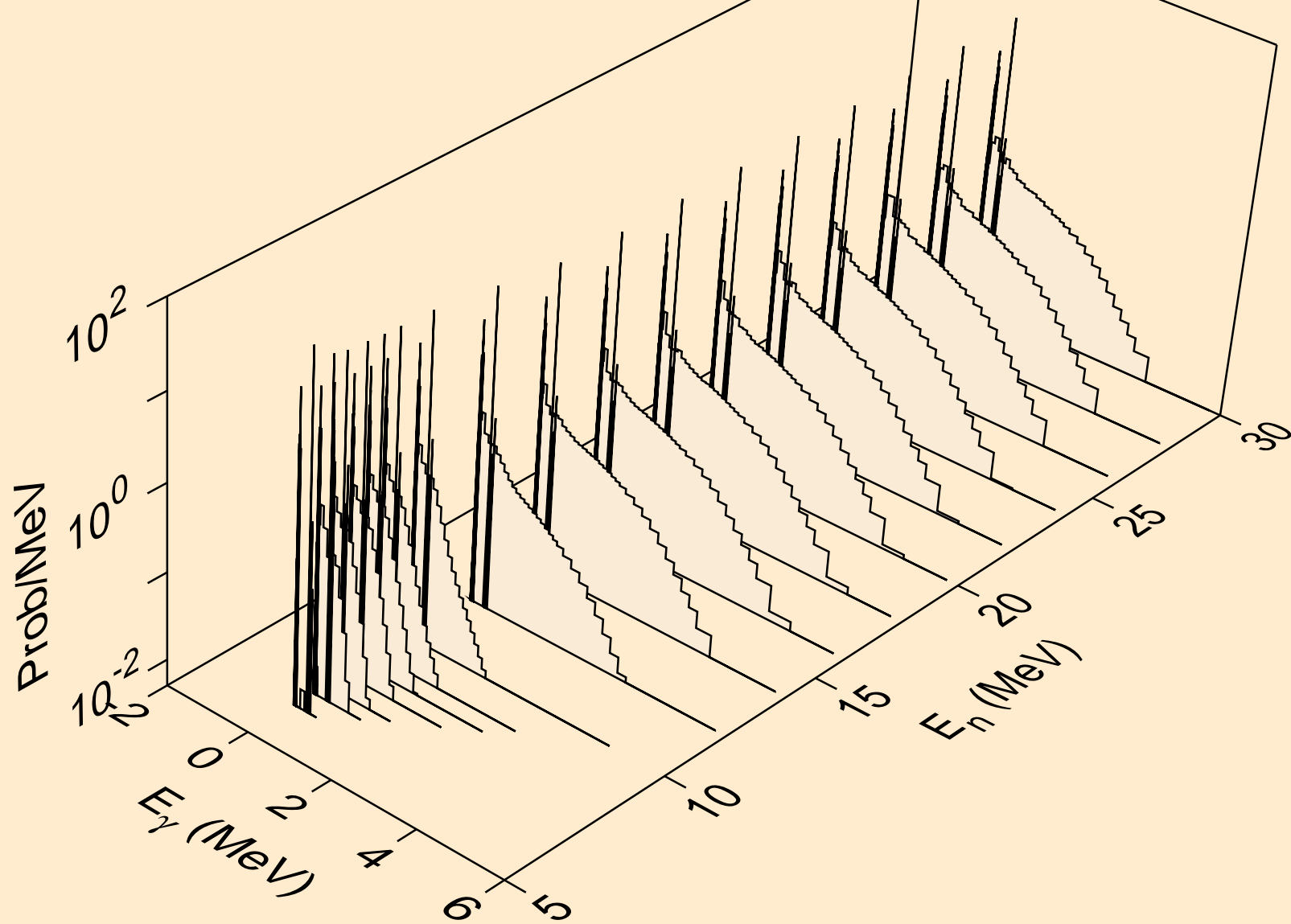

PA228 NEUTRON ACER TENDL-2023 LIBRARY; T=0.K  
Photon emission for (n,3n)

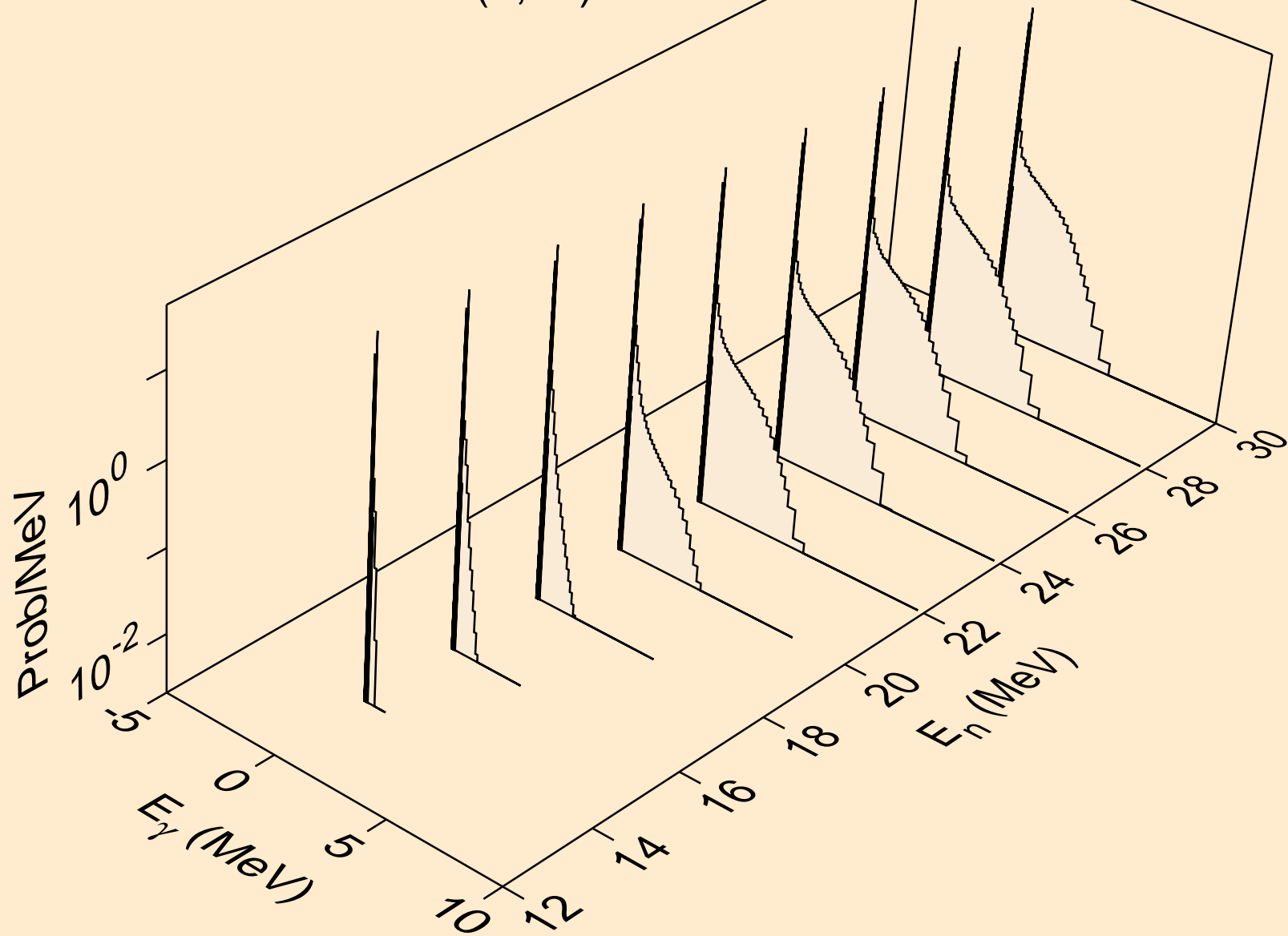

PA228 NEUTRON ACER TENDL-2023 LIBRARY; T=0.K  
Photon emission for (n,n\*)a

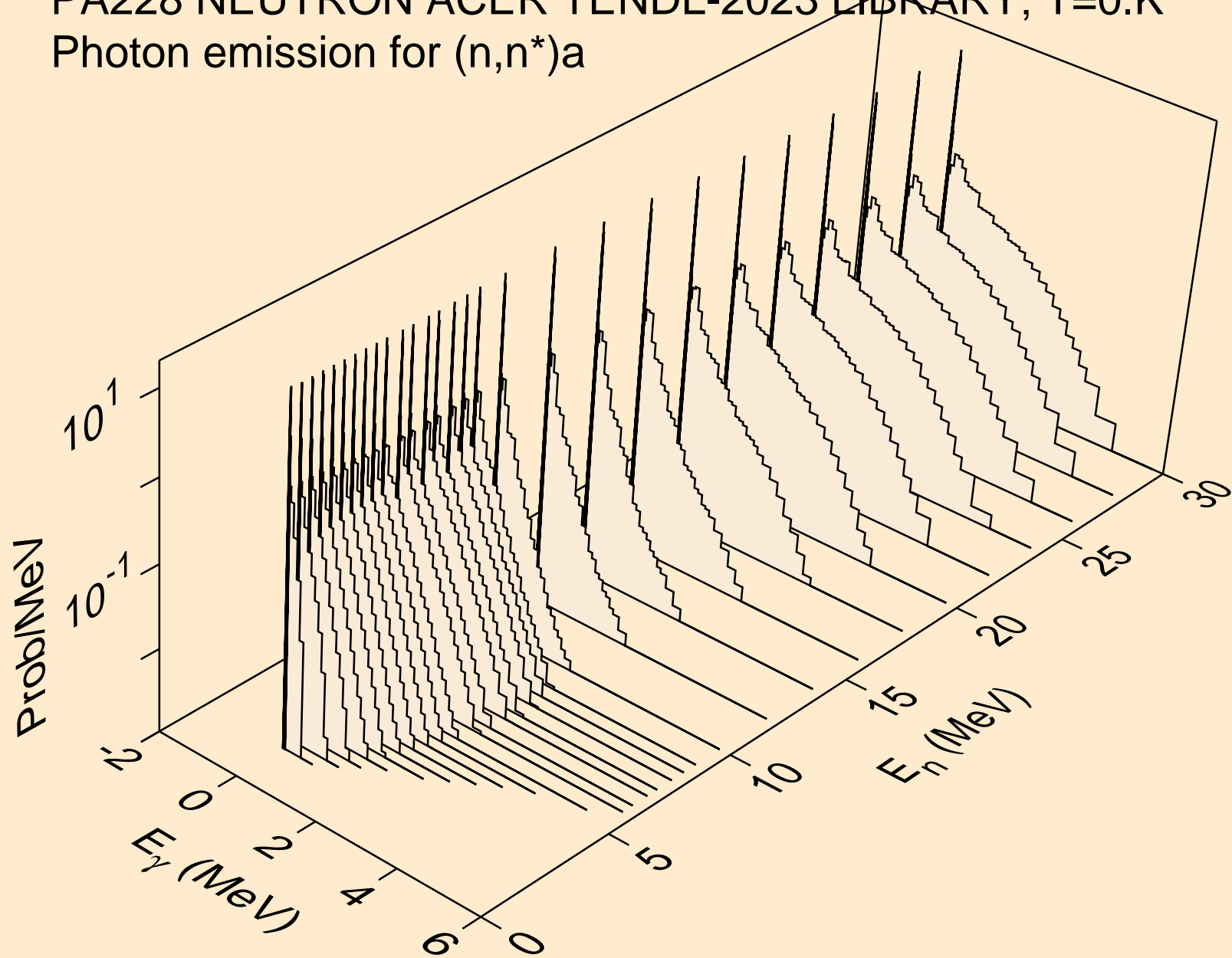

PA228 NEUTRON ACER TENDL-2023 LIBRARY; T=0.K  
Photon emission for (n,2n)a

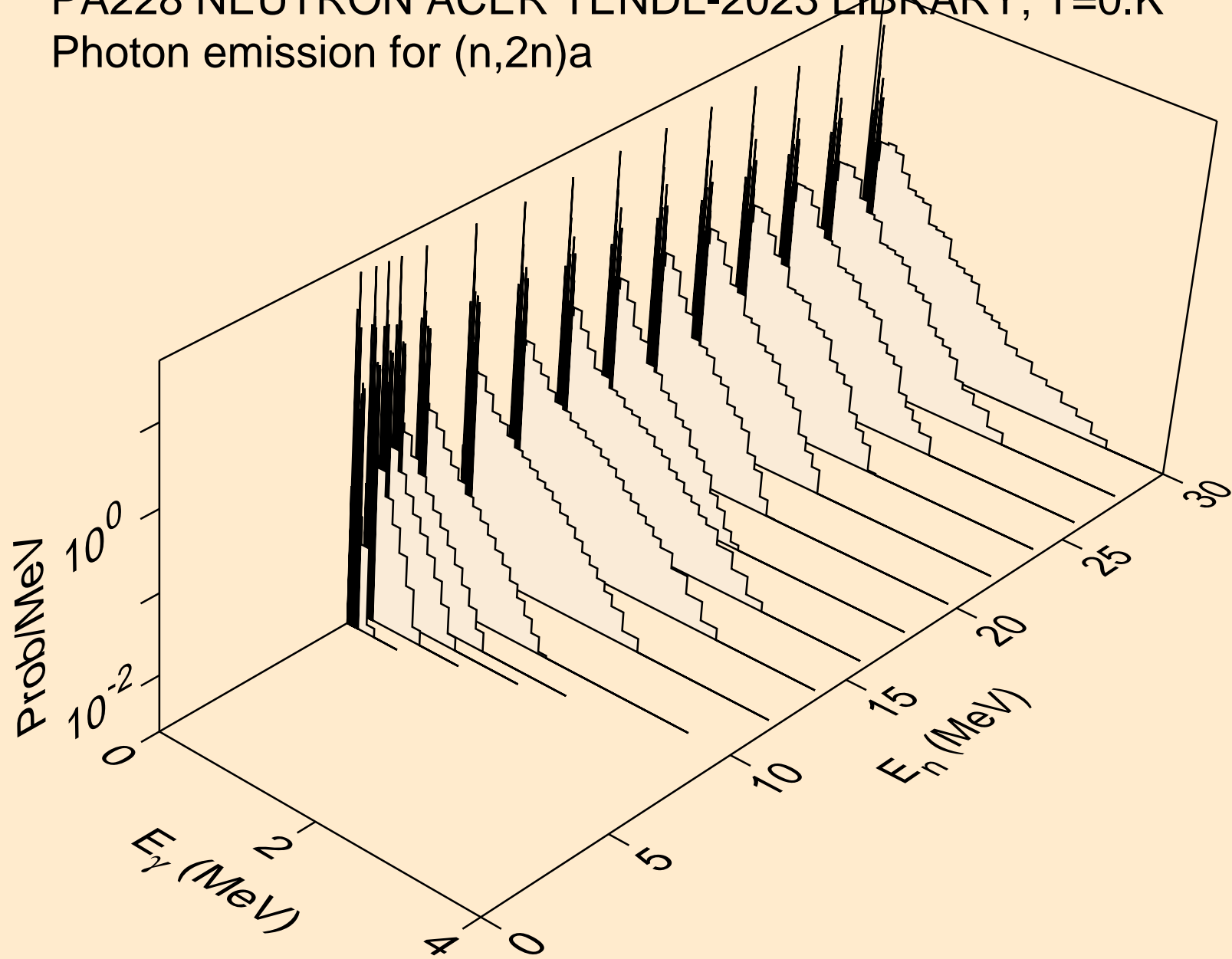

PA228 NEUTRON ACER TENDL-2023 LIBRARY; T=0.K  
Photon emission for (n,3n)a

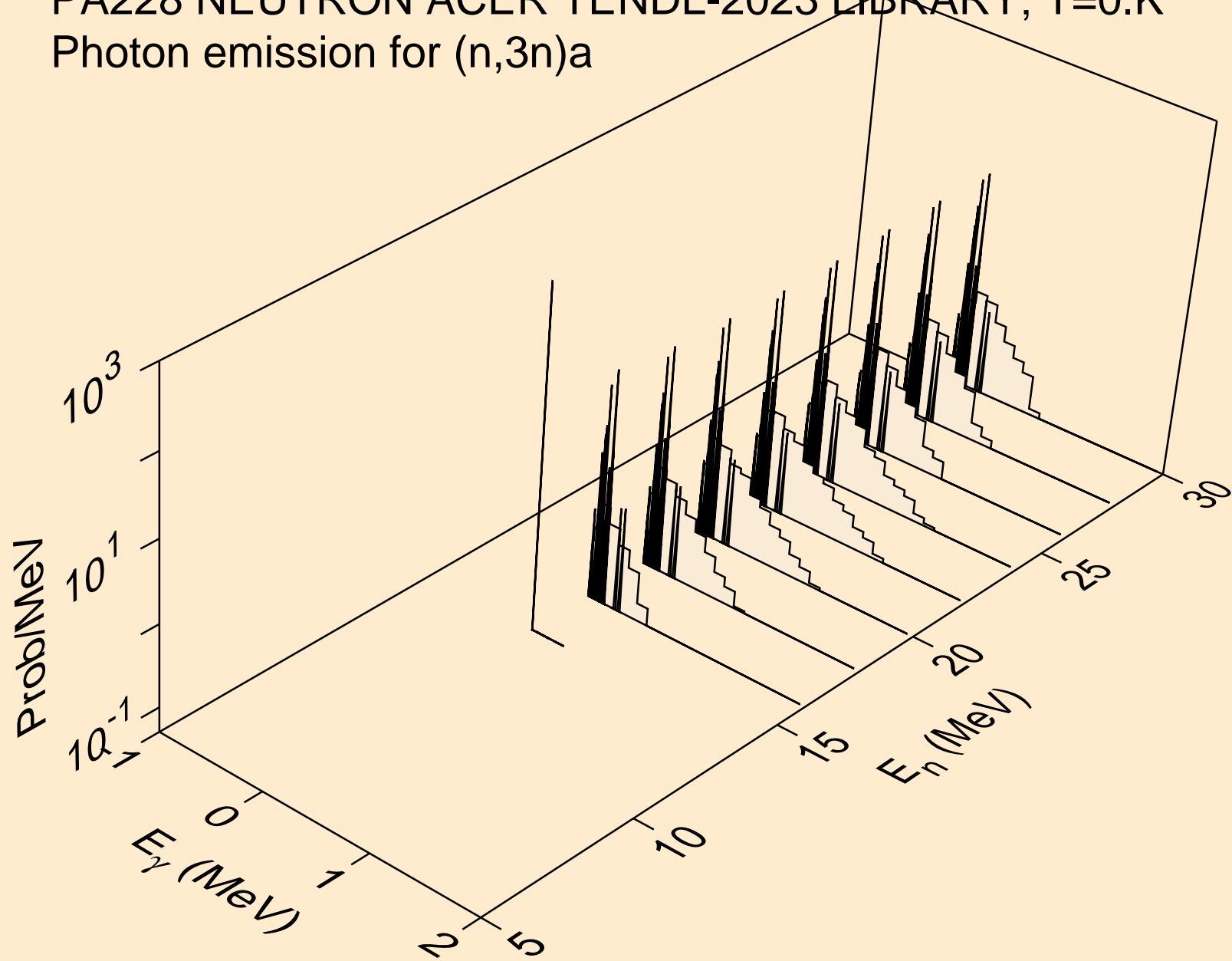



PA228 NEUTRON ACER TENDL-2023 LIBRARY; T=0.K  
Photon emission for (n,n\*)p

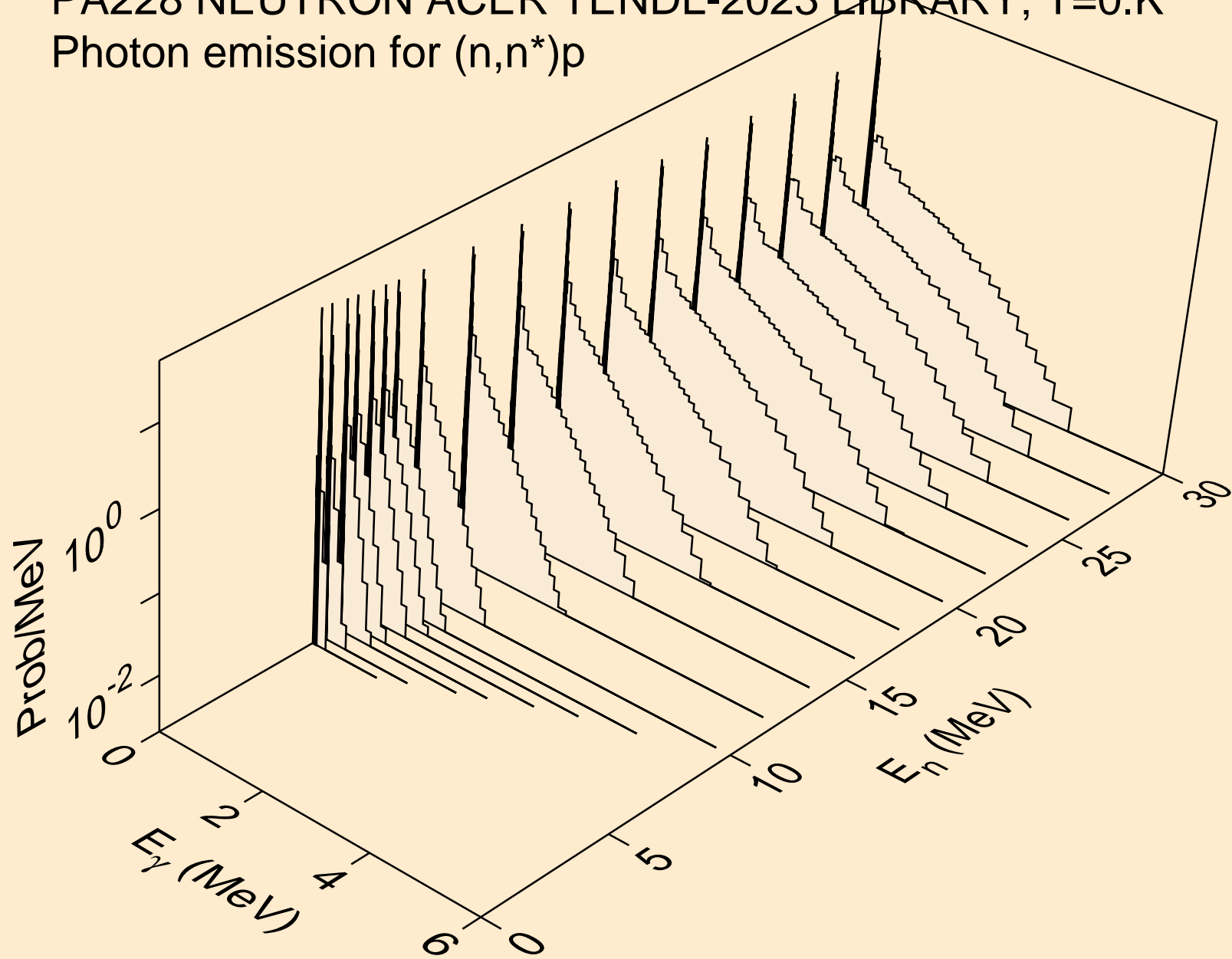

PA228 NEUTRON ACER TENDL-2023 LIBRARY; T=0.K  
Photon emission for (n,n\*)2a

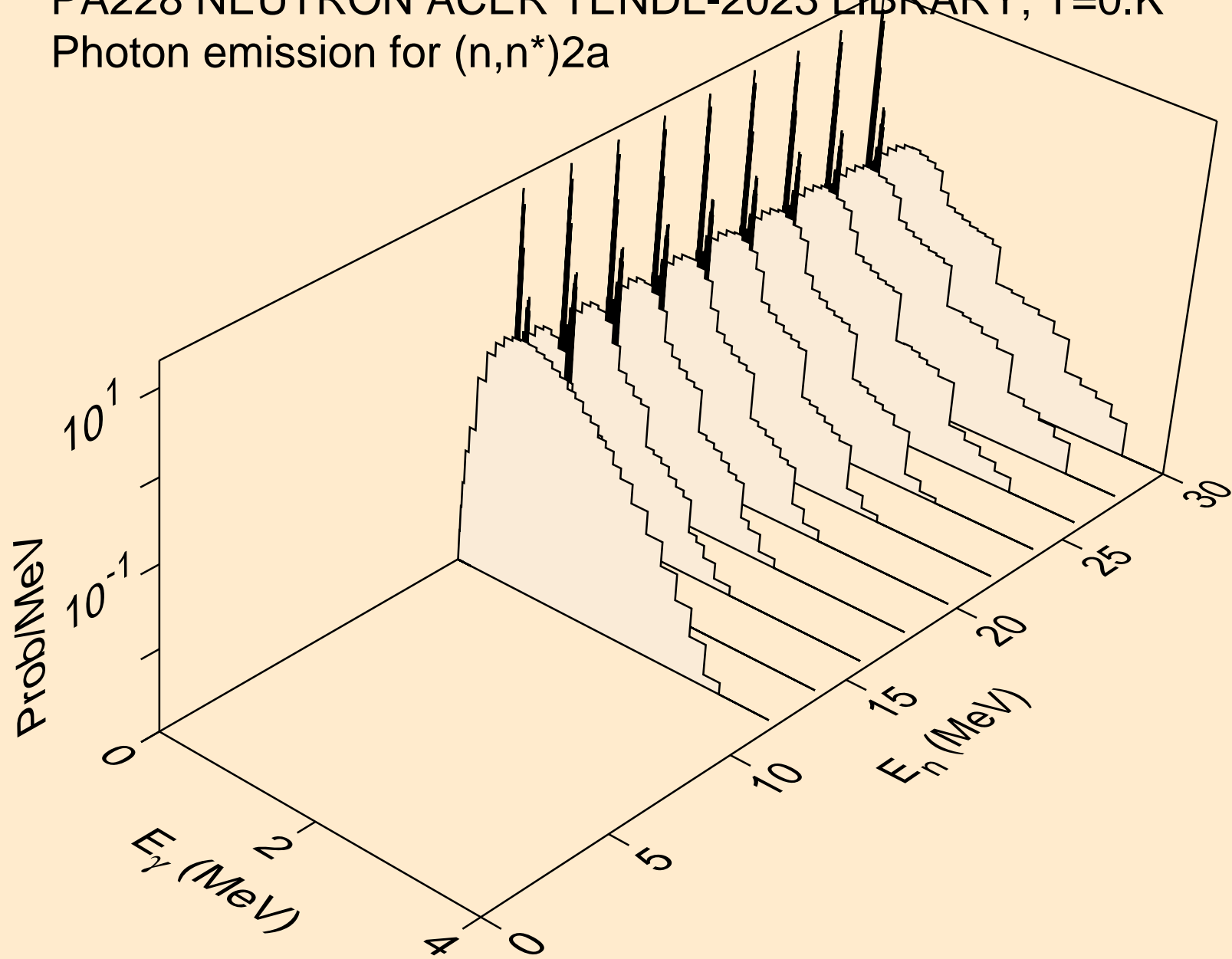

PA228 NEUTRON ACER TENDL-2023 LIBRARY; T=0.K  
Photon emission for (n,n\*)d

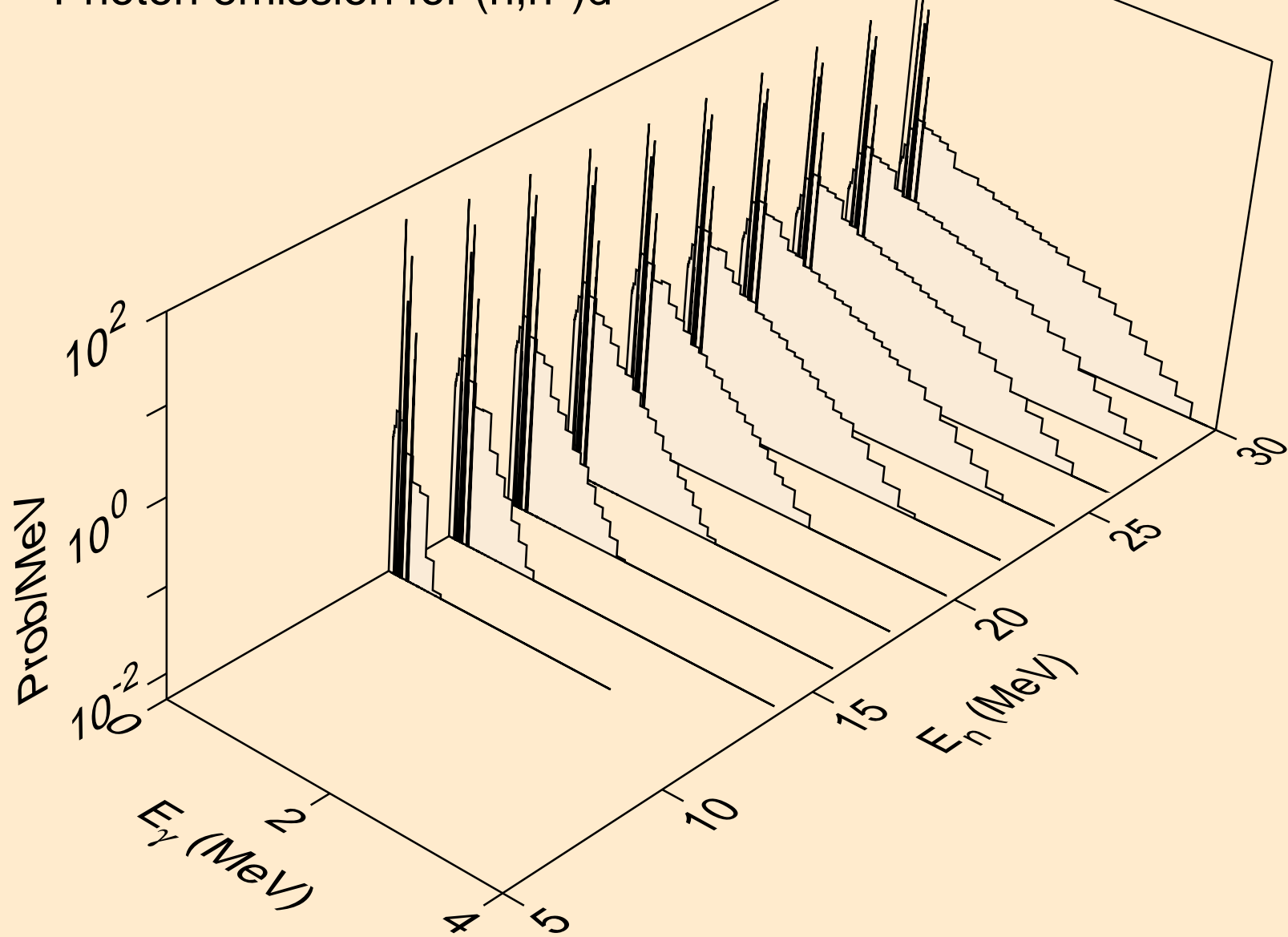

PA228 NEUTRON ACER TENDL-2023 LIBRARY; T=0.K  
Photon emission for (n,n\*)t

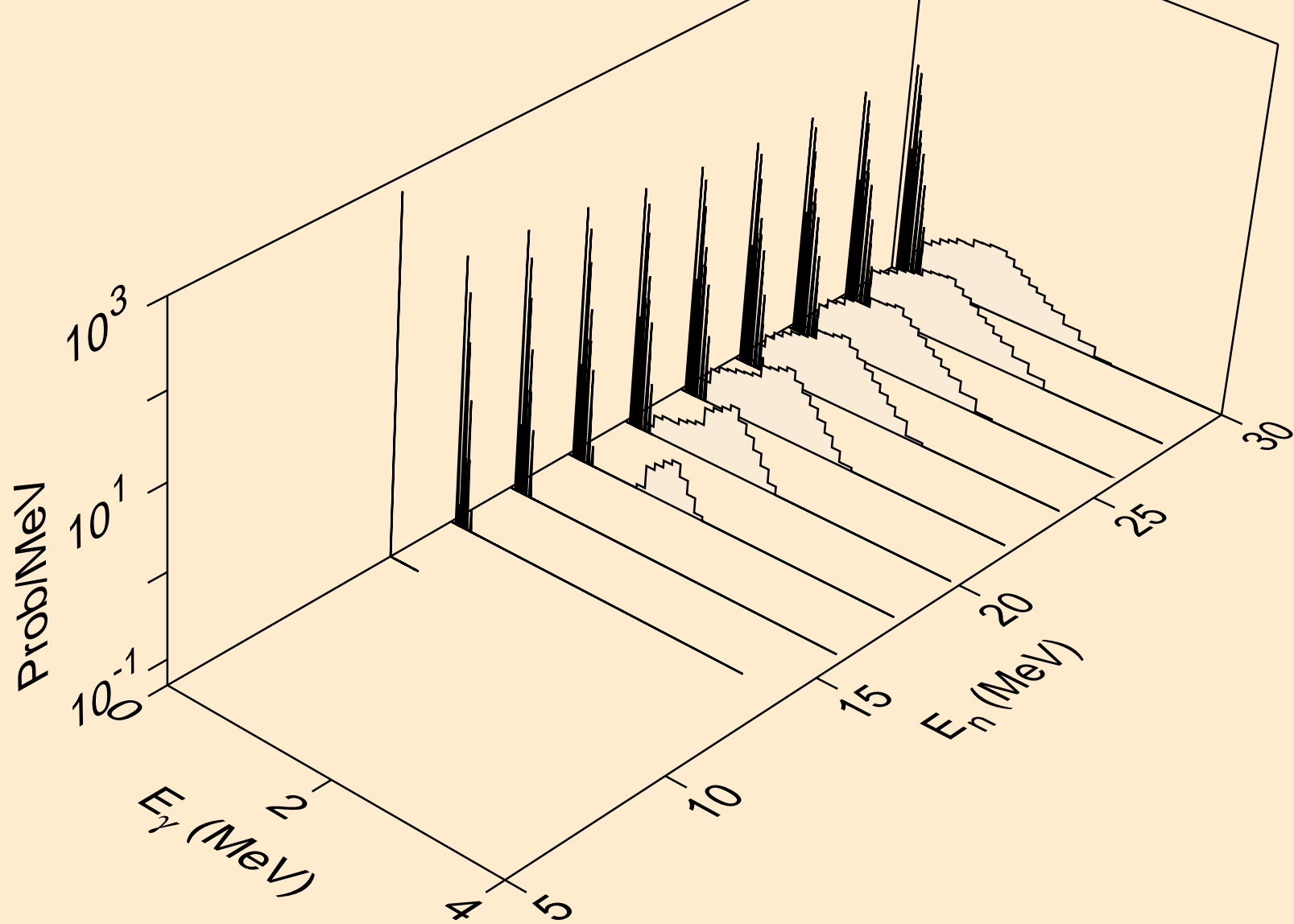

PA228 NEUTRON ACER TENDL-2023 LIBRARY; T=0.K  
Photon emission for (n,n\*)he3

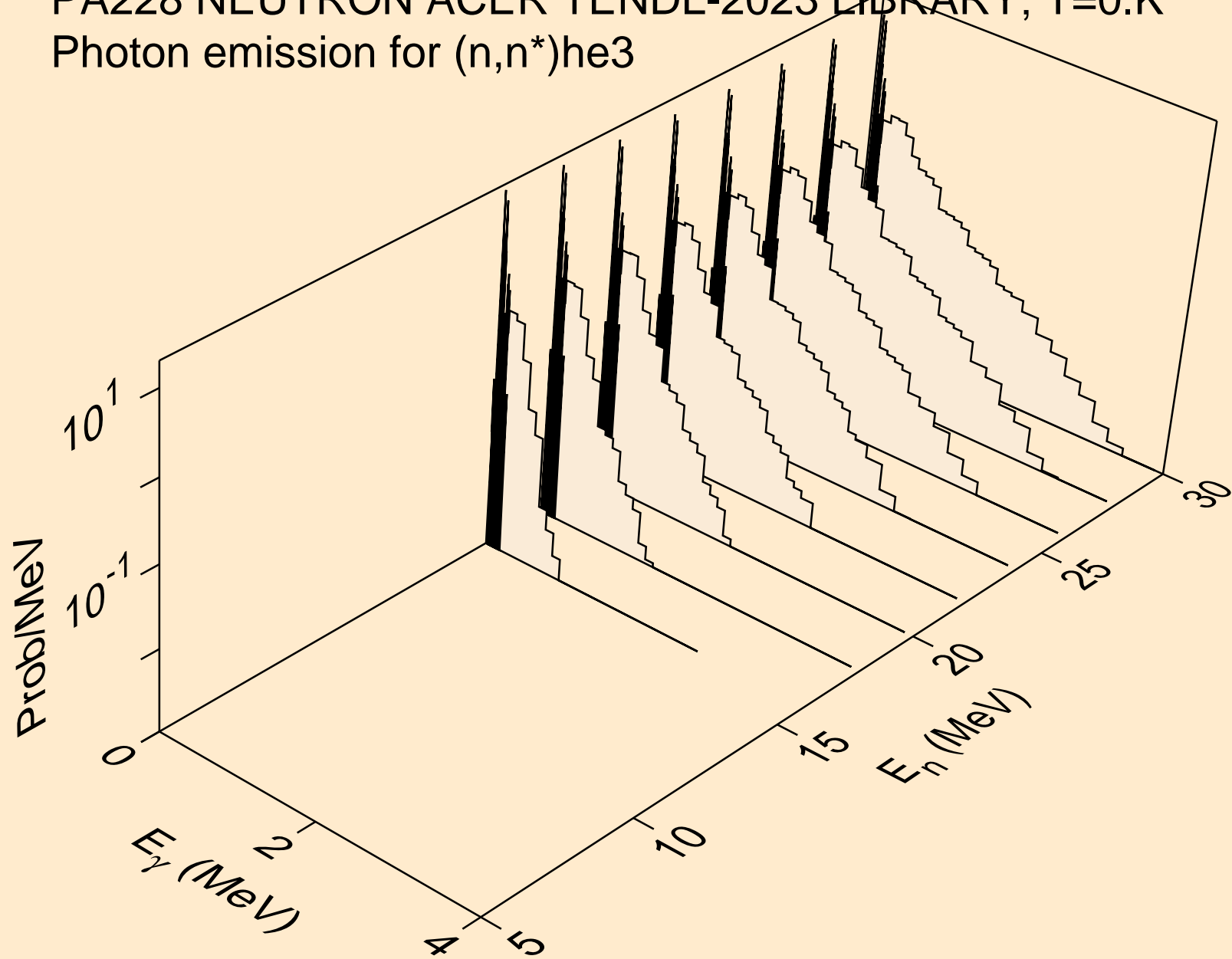

PA228 NEUTRON ACER TENDL-2023 LIBRARY; T=0.K  
Photon emission for (n,4n)

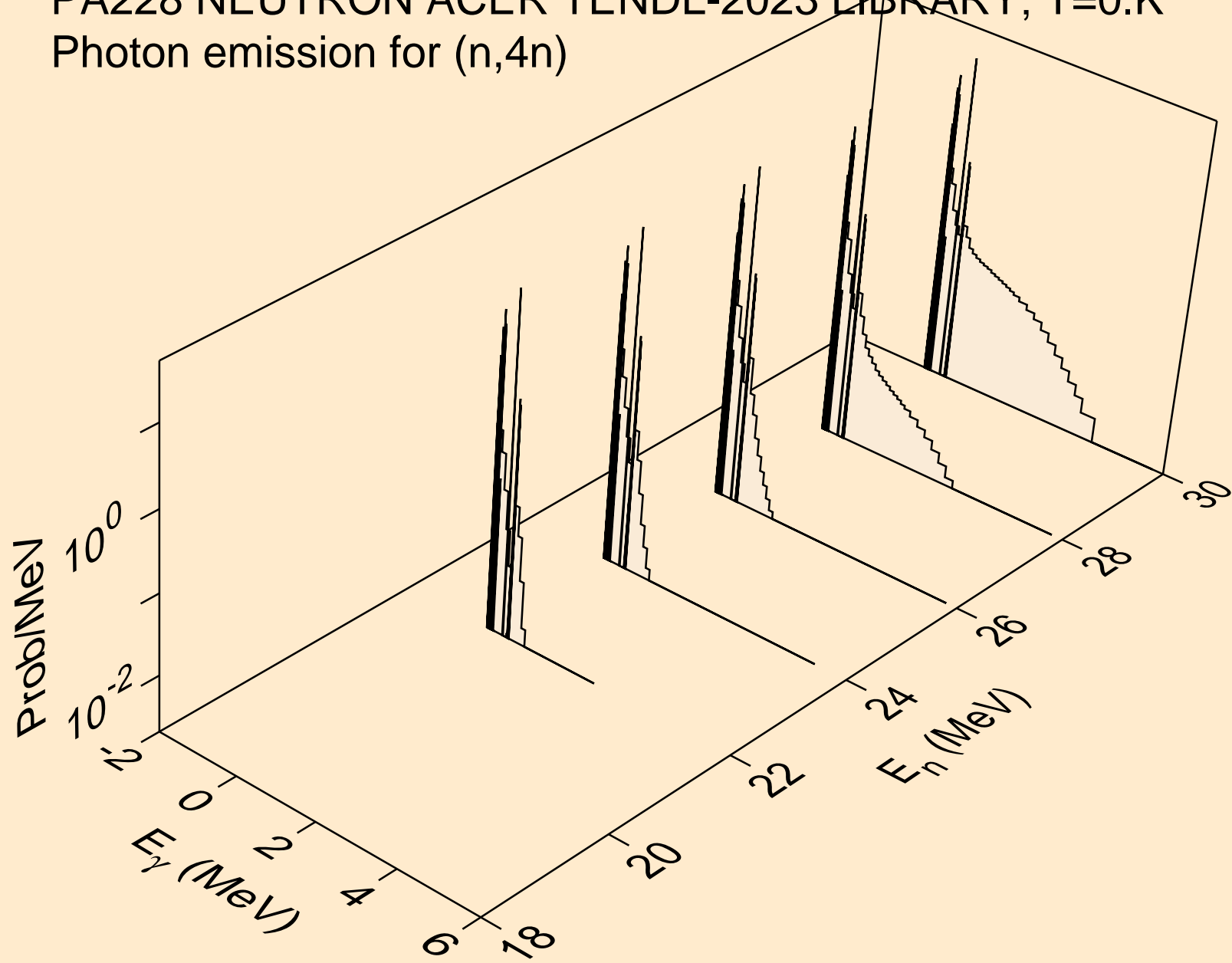

PA228 NEUTRON ACER TENDL-2023 LIBRARY; T=0.K  
Photon emission for (n,2np)

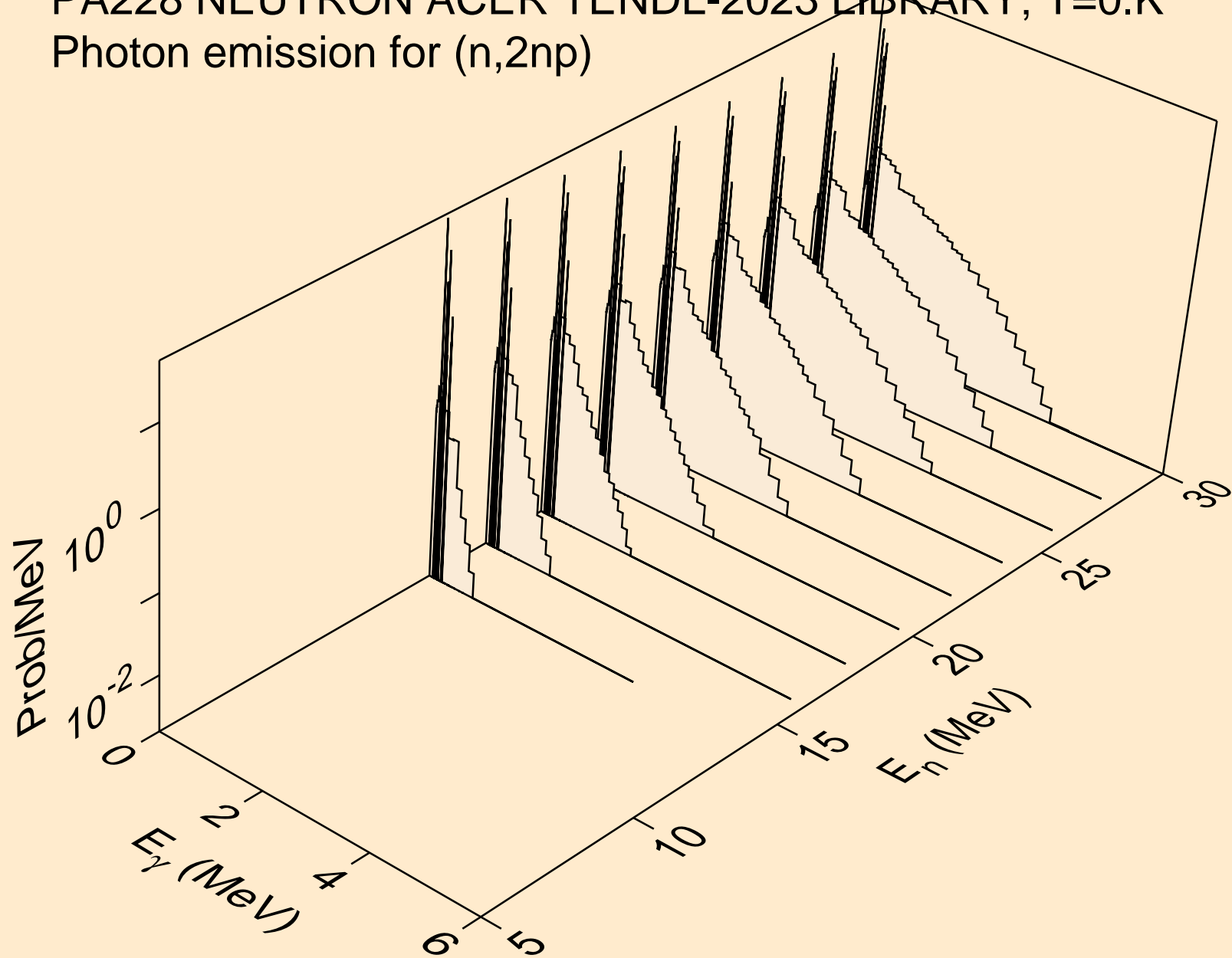

PA228 NEUTRON ACER TENDL-2023 LIBRARY; T=0.K  
Photon emission for (n,3np)

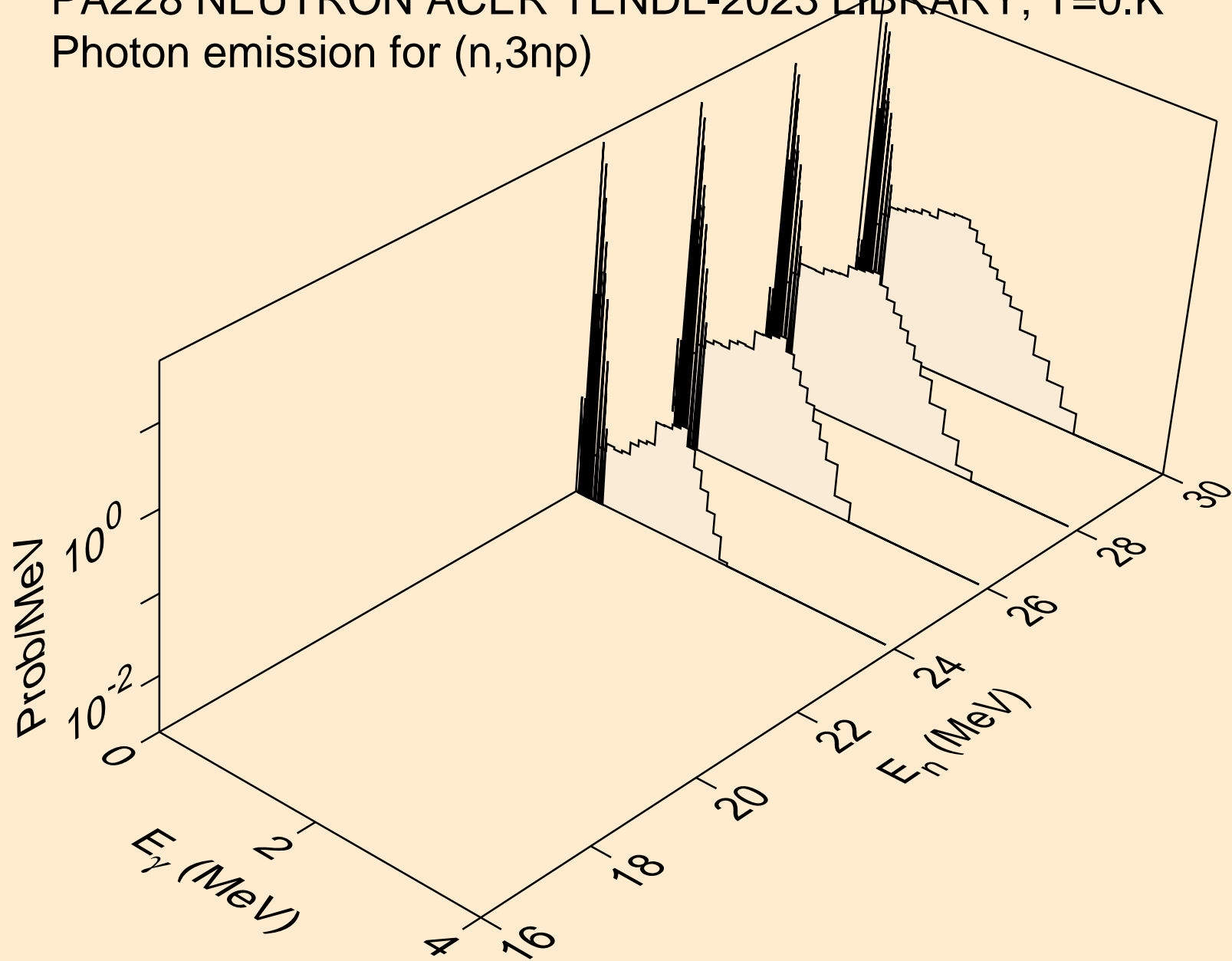



PA228 NEUTRON ACER TENDL-2023 LIBRARY; T=0.K  
Photon emission for (n,n2p)

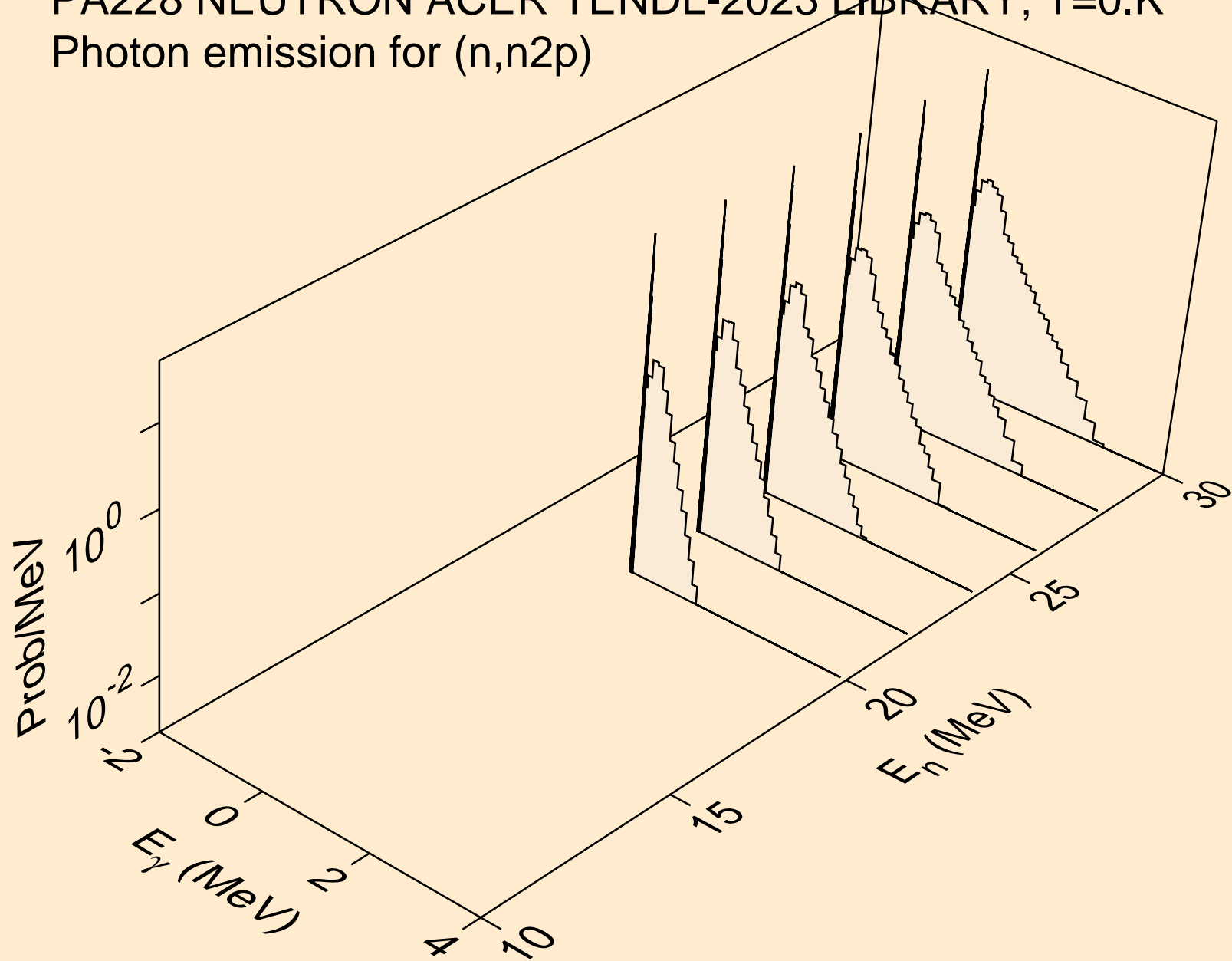

PA228 NEUTRON ACER TENDL-2023 LIBRARY; T=0.K  
Photon emission for (n,npa)

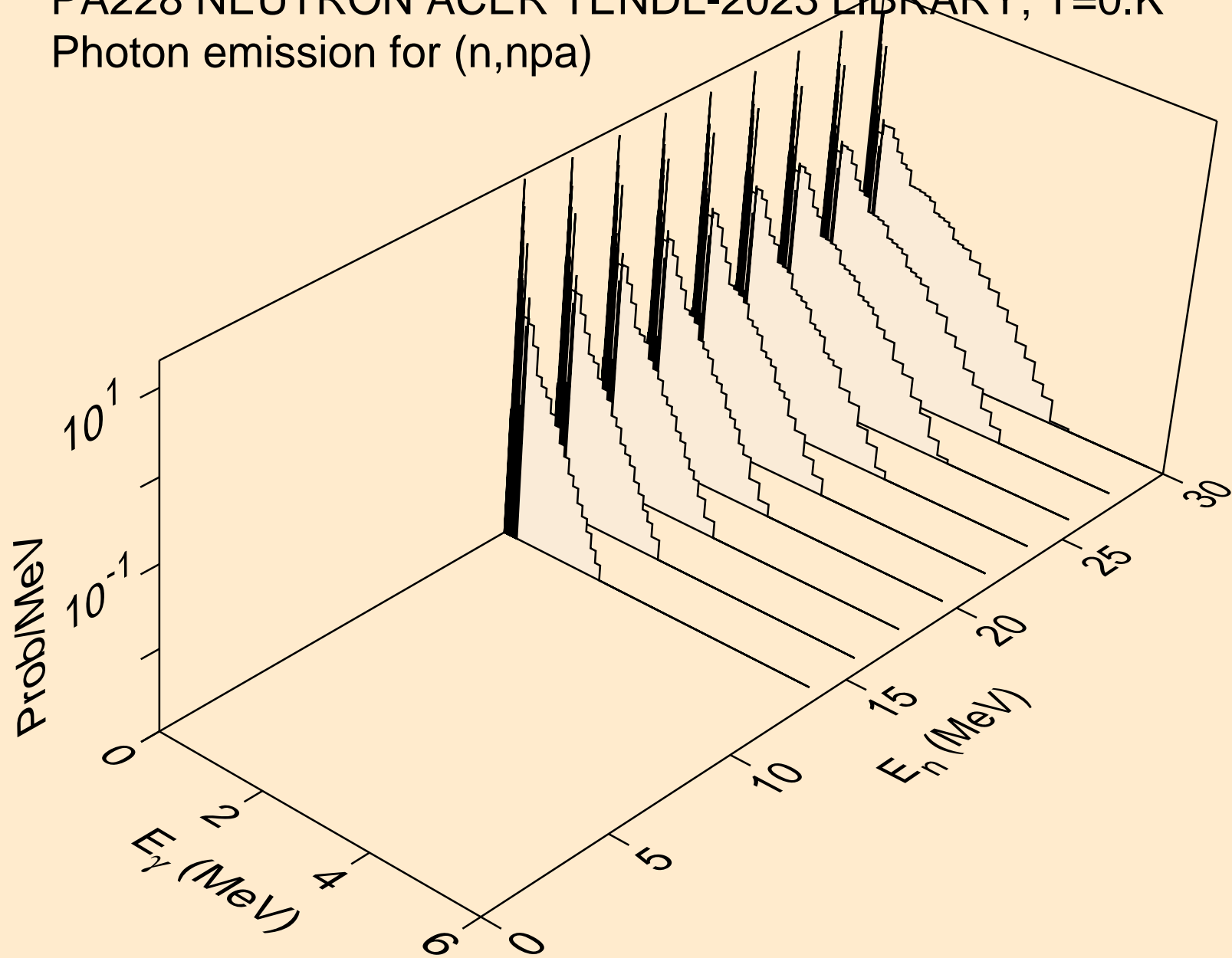

PA228 NEUTRON ACER TENDL-2023 LIBRARY; T=0.K  
Photon emission for (n,n\*c)

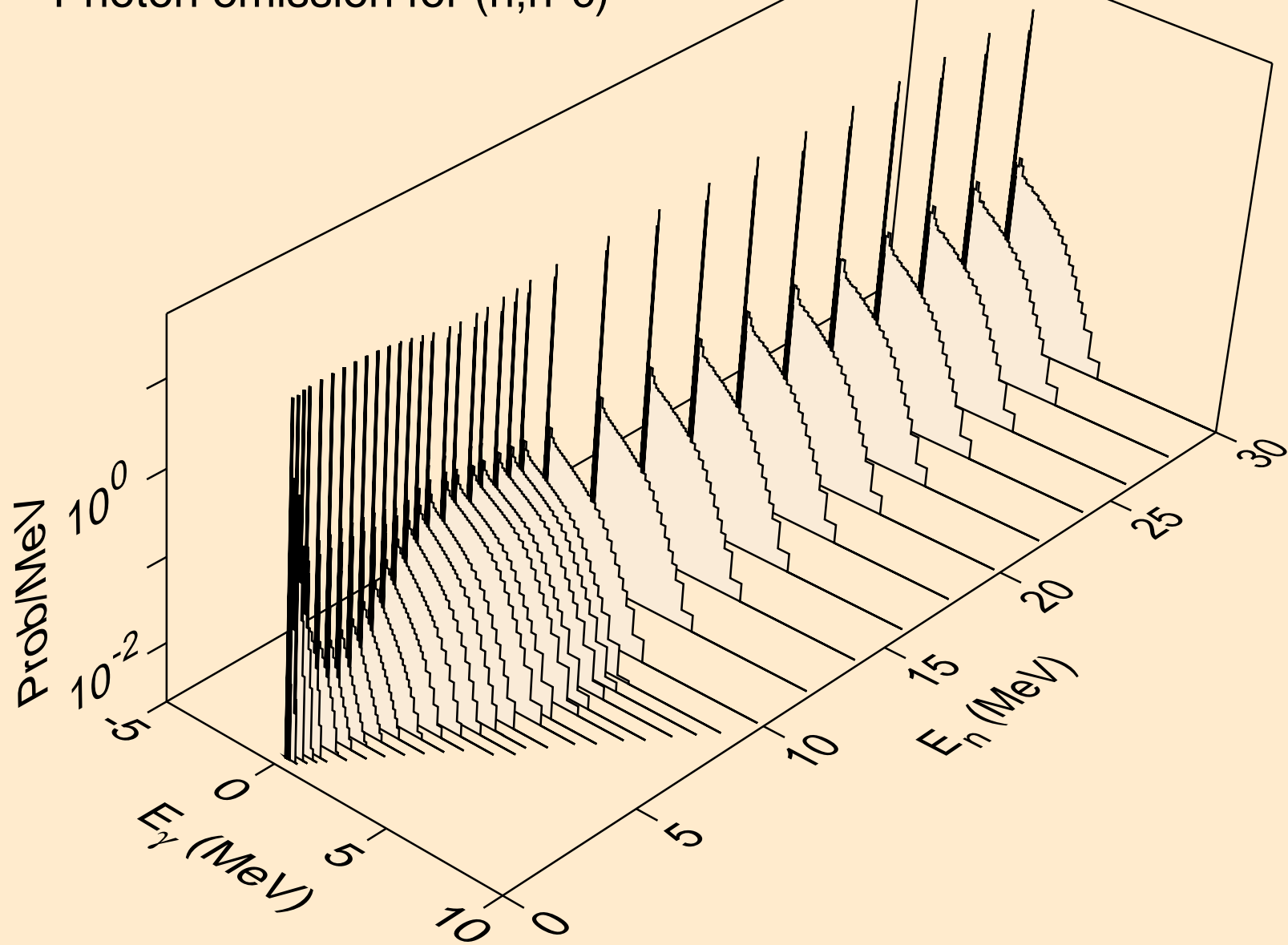

PA228 NEUTRON ACER TENDL-2023 LIBRARY; T=0.K  
Photon emission for (n,gma)

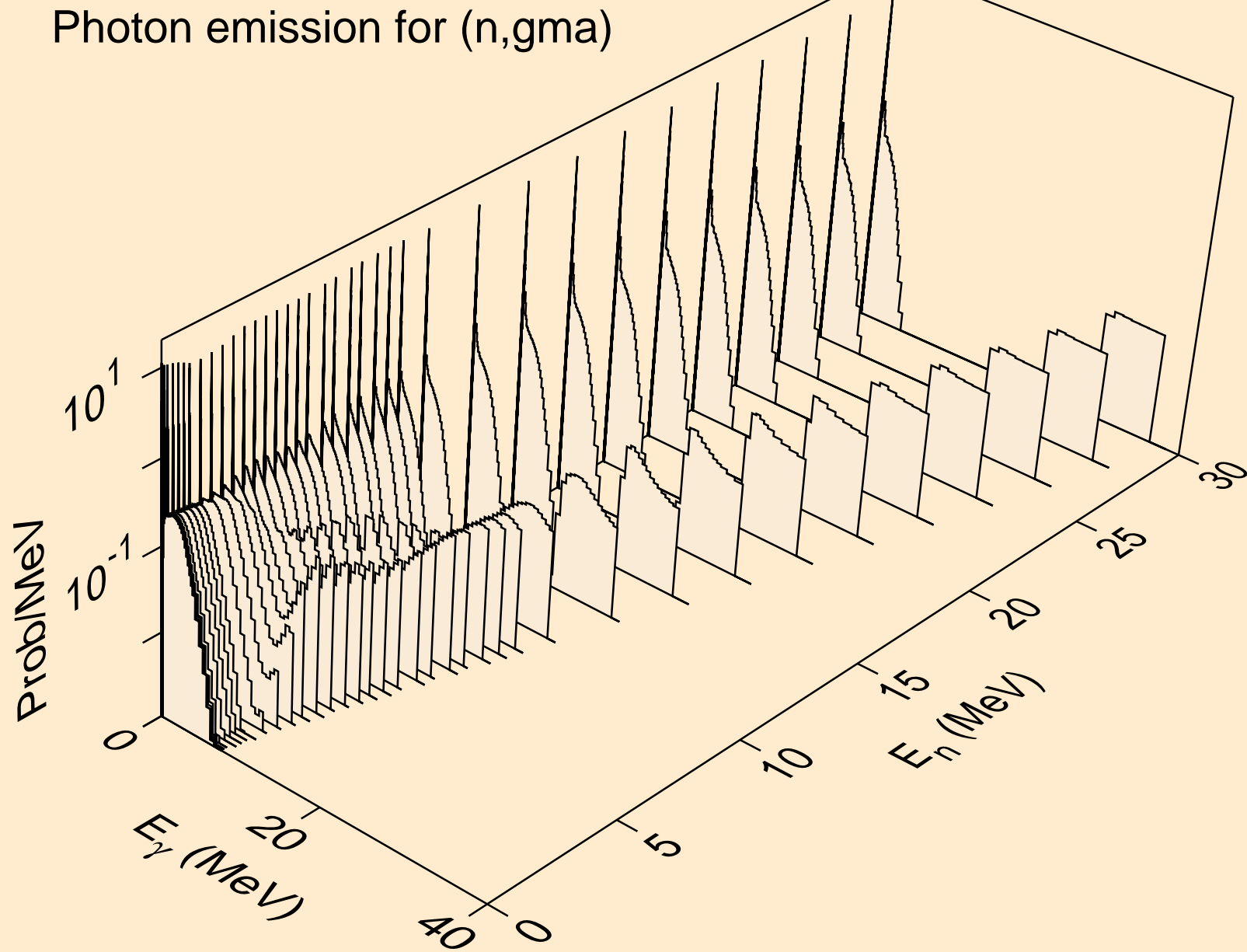

PA228 NEUTRON ACER TENDL-2023 LIBRARY; T=0.K  
Photon emission for (n,p)

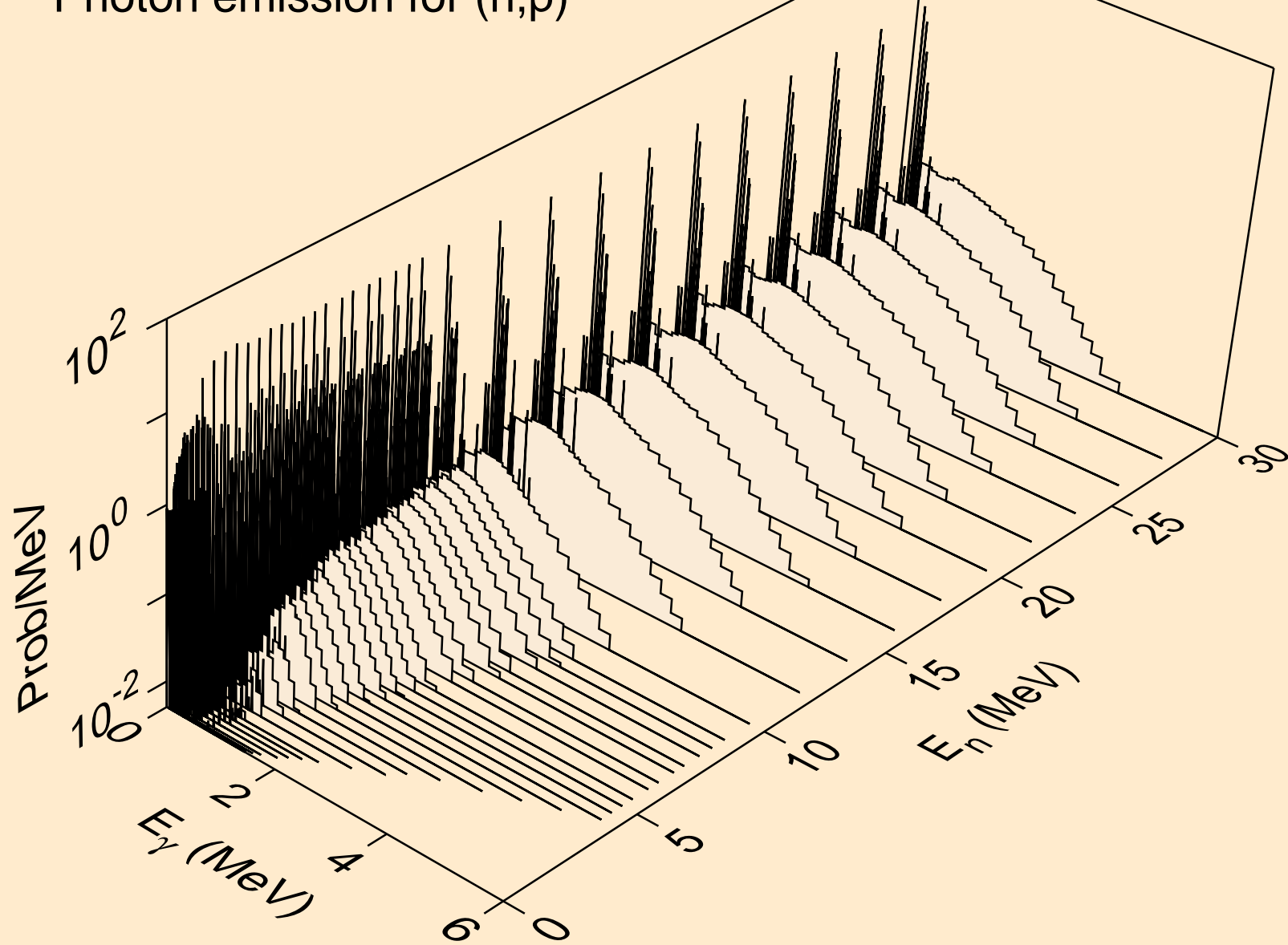

PA228 NEUTRON ACER TENDL-2023 LIBRARY; T=0.K  
Photon emission for (n,d)

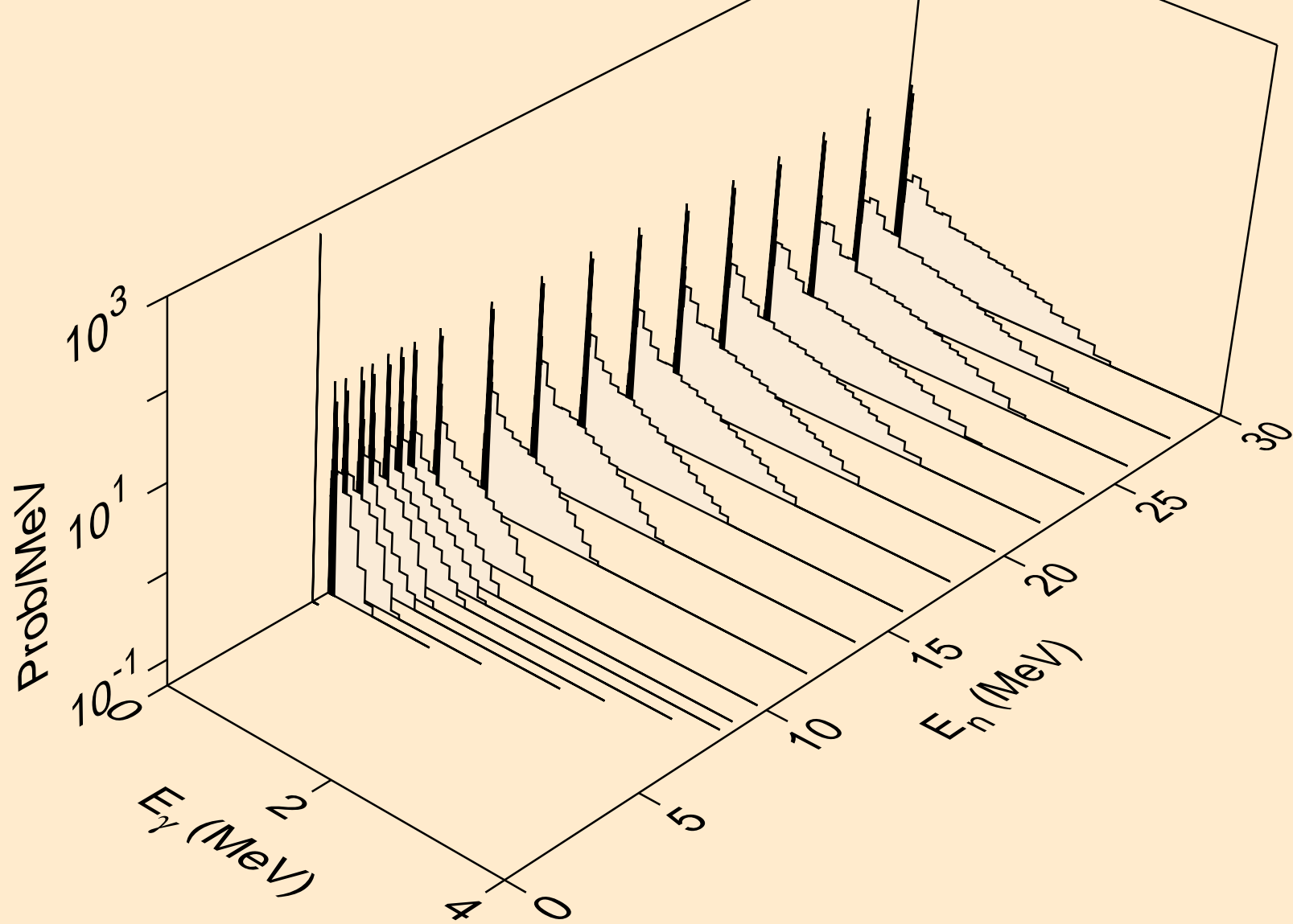

PA228 NEUTRON ACER TENDL-2023 LIBRARY; T=0.K  
Photon emission for (n,t)

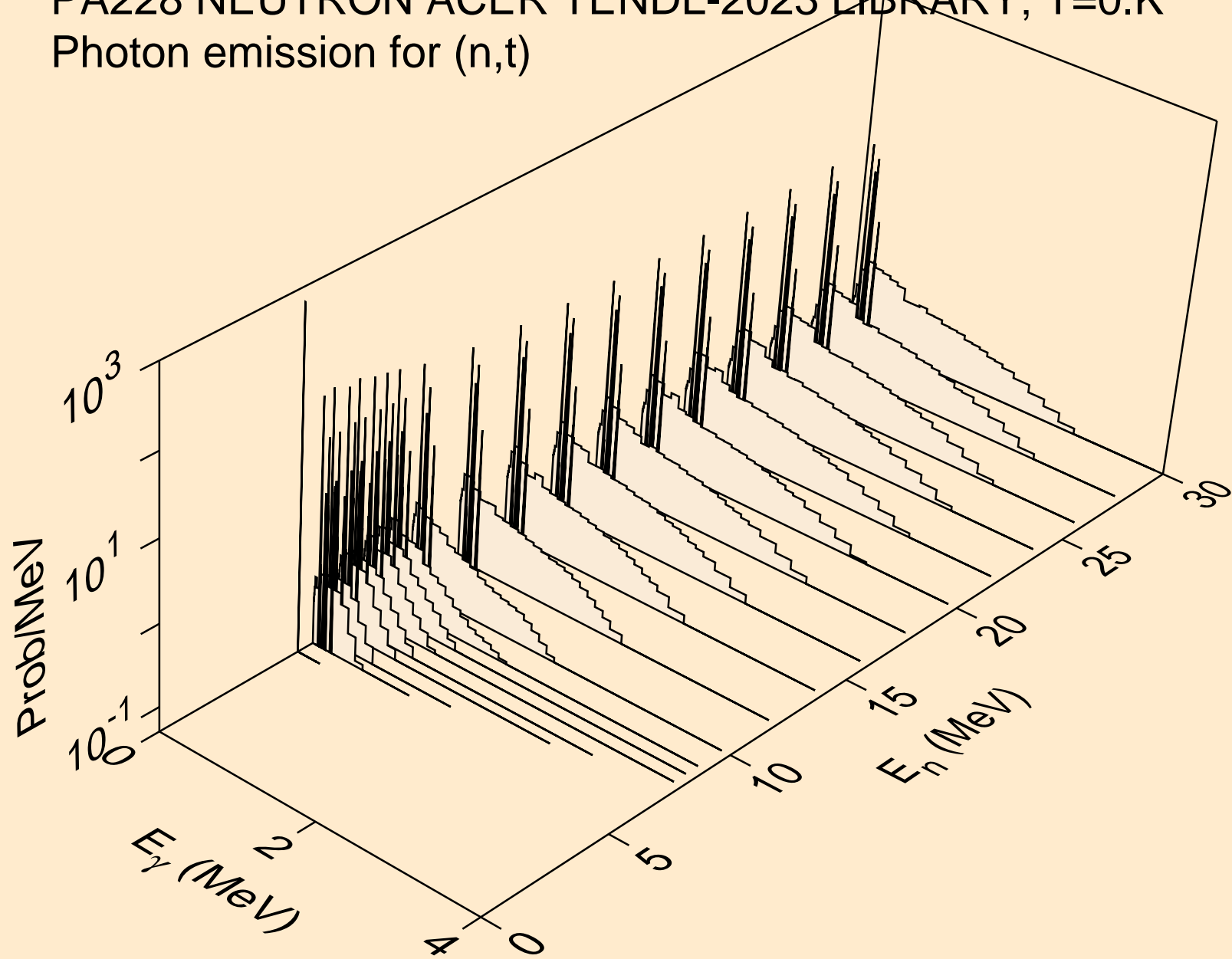

PA228 NEUTRON ACER TENDL-2023 LIBRARY; T=0.K  
Photon emission for (n,he3)

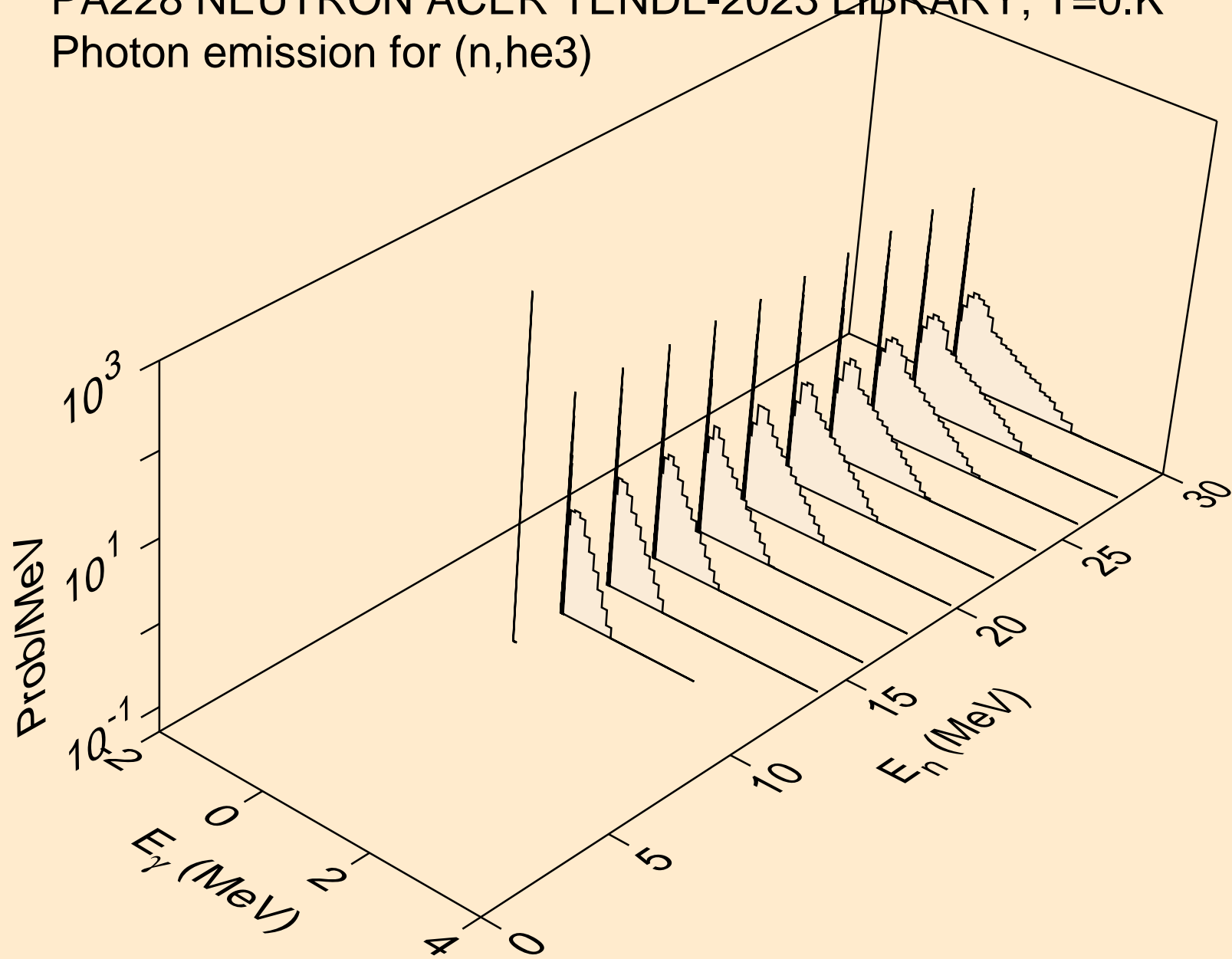



PA228 NEUTRON ACER TENDL-2023 LIBRARY; T=0.K  
Photon emission for (n,a)

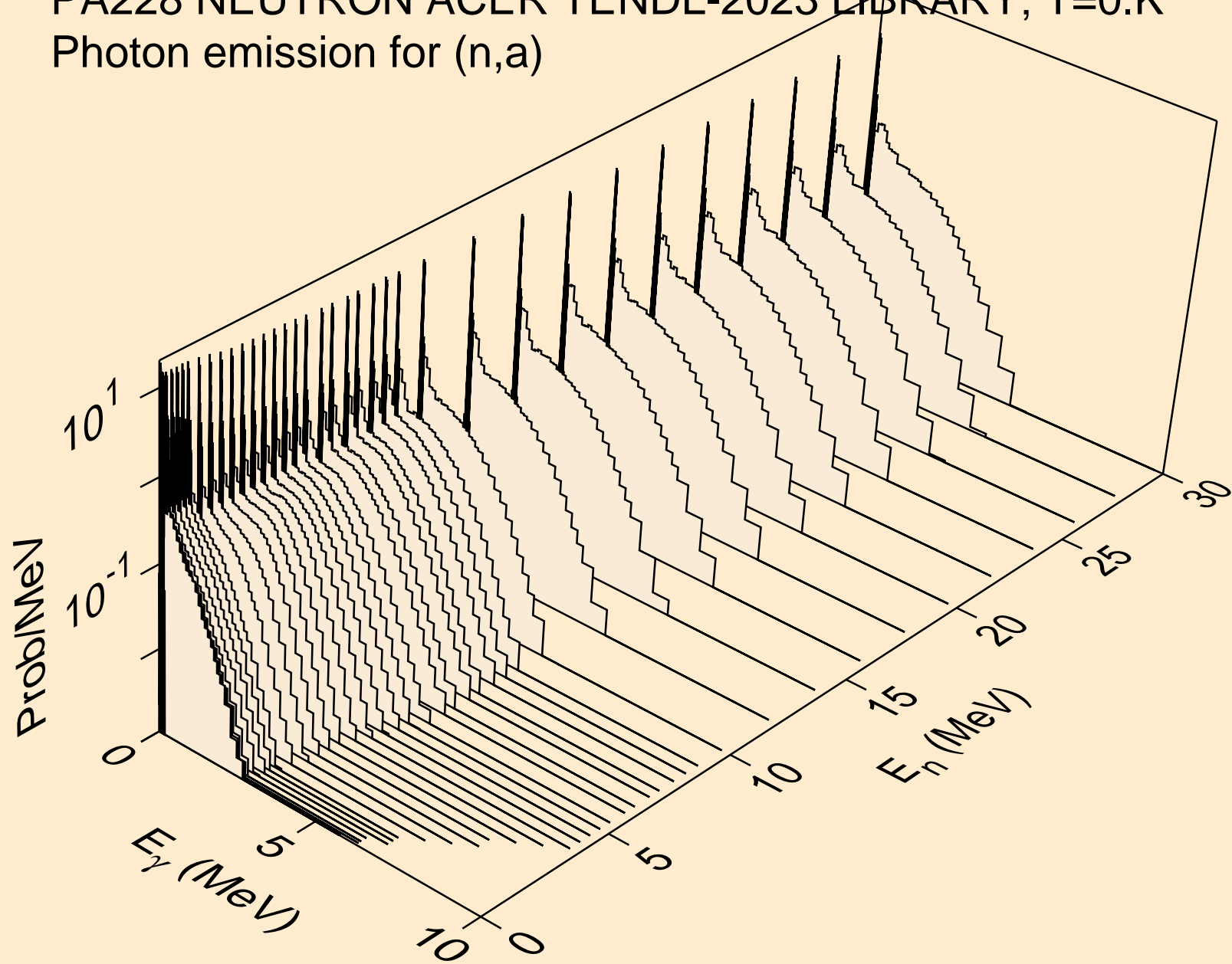

PA228 NEUTRON ACER TENDL-2023 LIBRARY; T=0.K  
Photon emission for (n,2a)

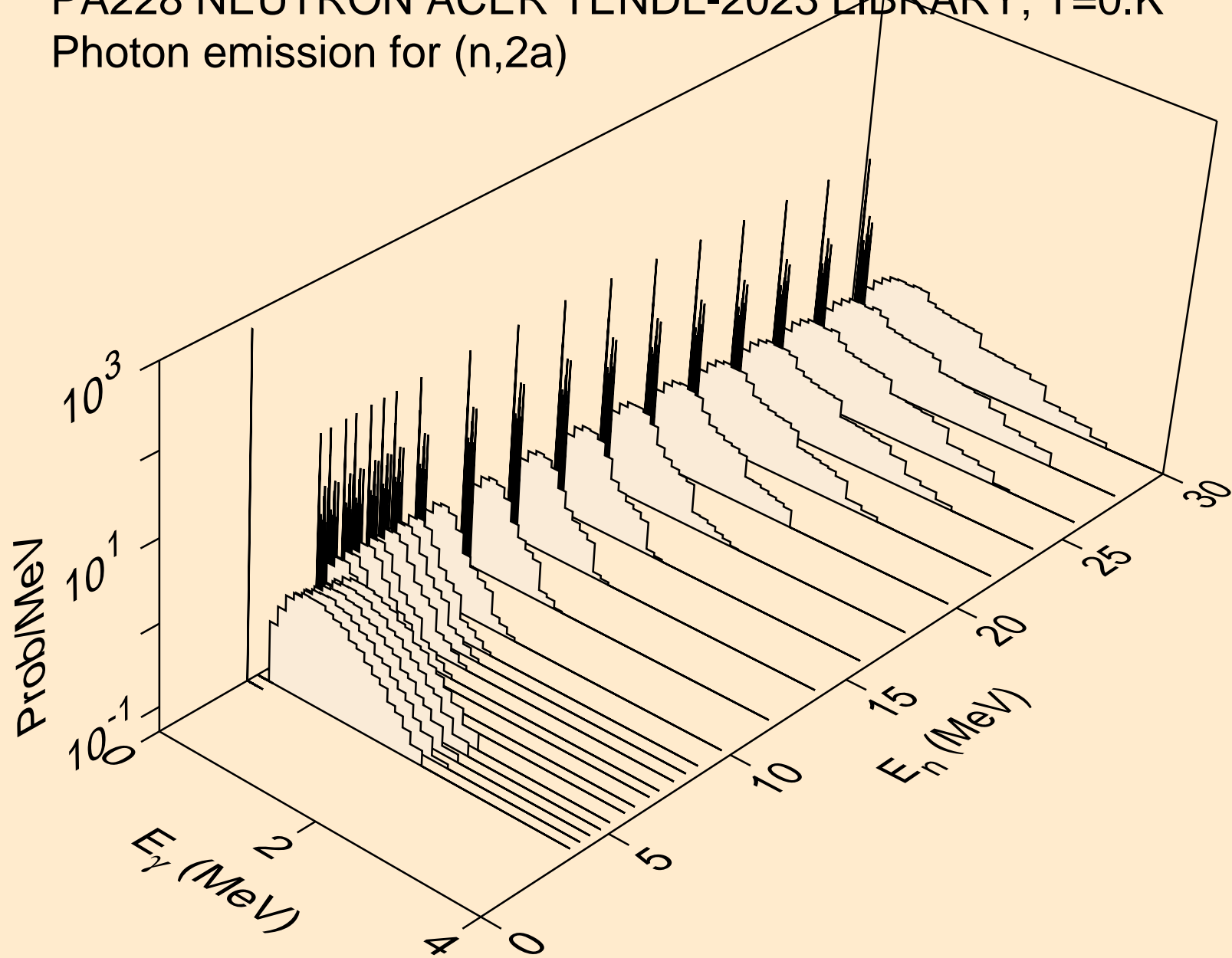

PA228 NEUTRON ACER TENDL-2023 LIBRARY; T=0.K  
Photon emission for (n,2p)

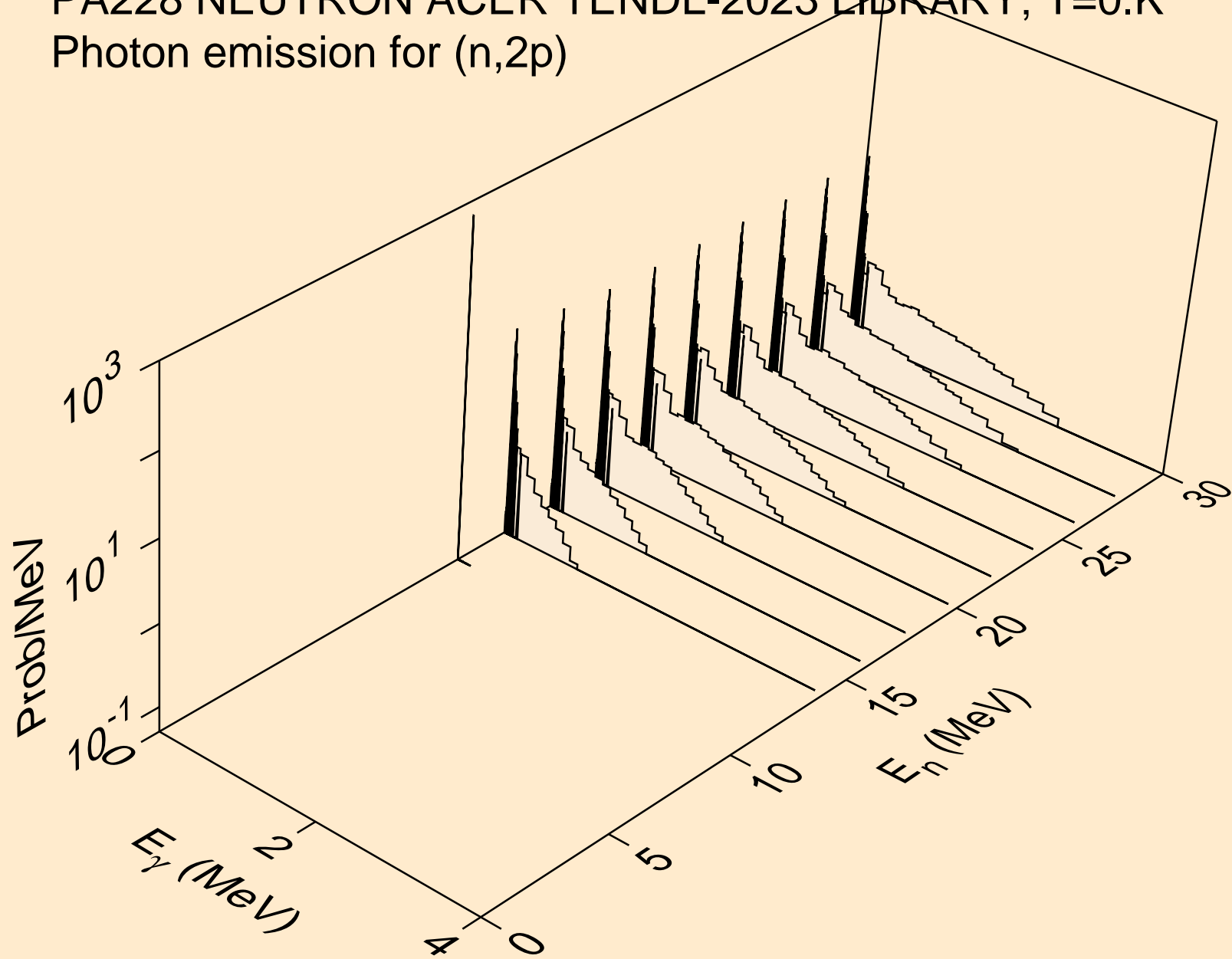

PA228 NEUTRON ACER TENDL-2023 LIBRARY; T=0.K  
Photon emission for (n,p $\alpha$ )

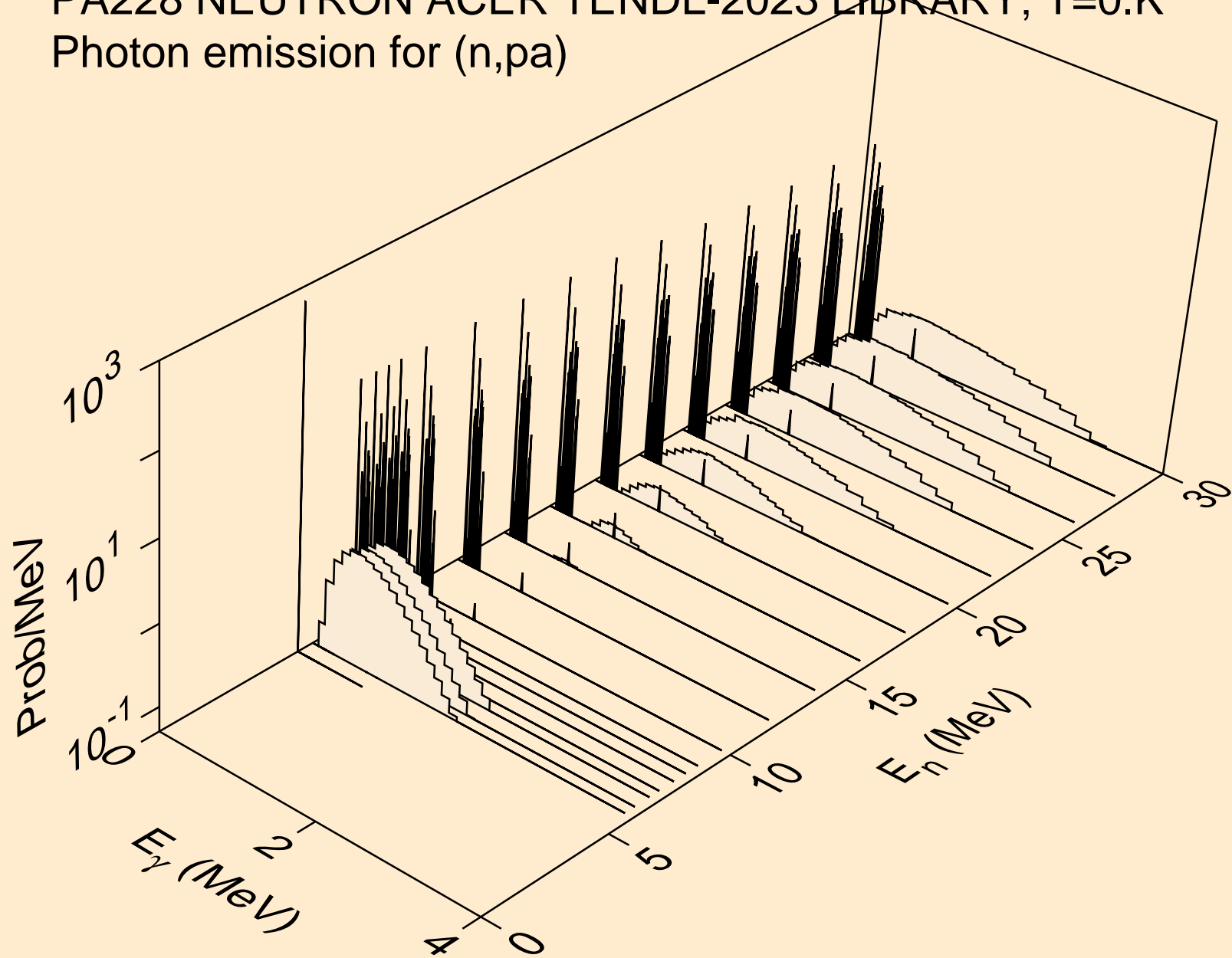

PA228 NEUTRON ACER TENDL-2023 LIBRARY; T=0.K  
Photon emission for (n,pd)

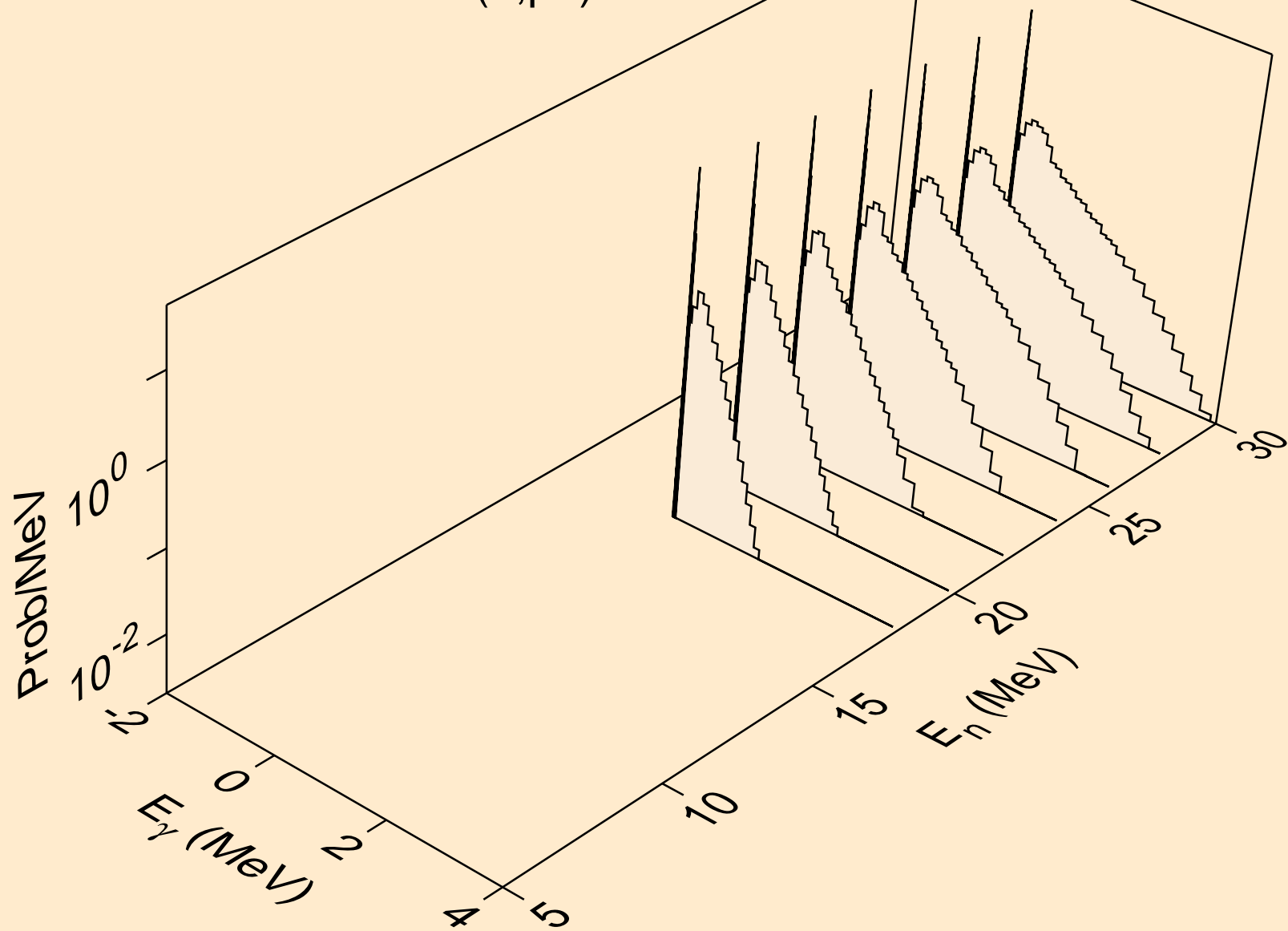

PA228 NEUTRON ACER TENDL-2023 LIBRARY; T=0.K  
Photon emission for (n,pt)

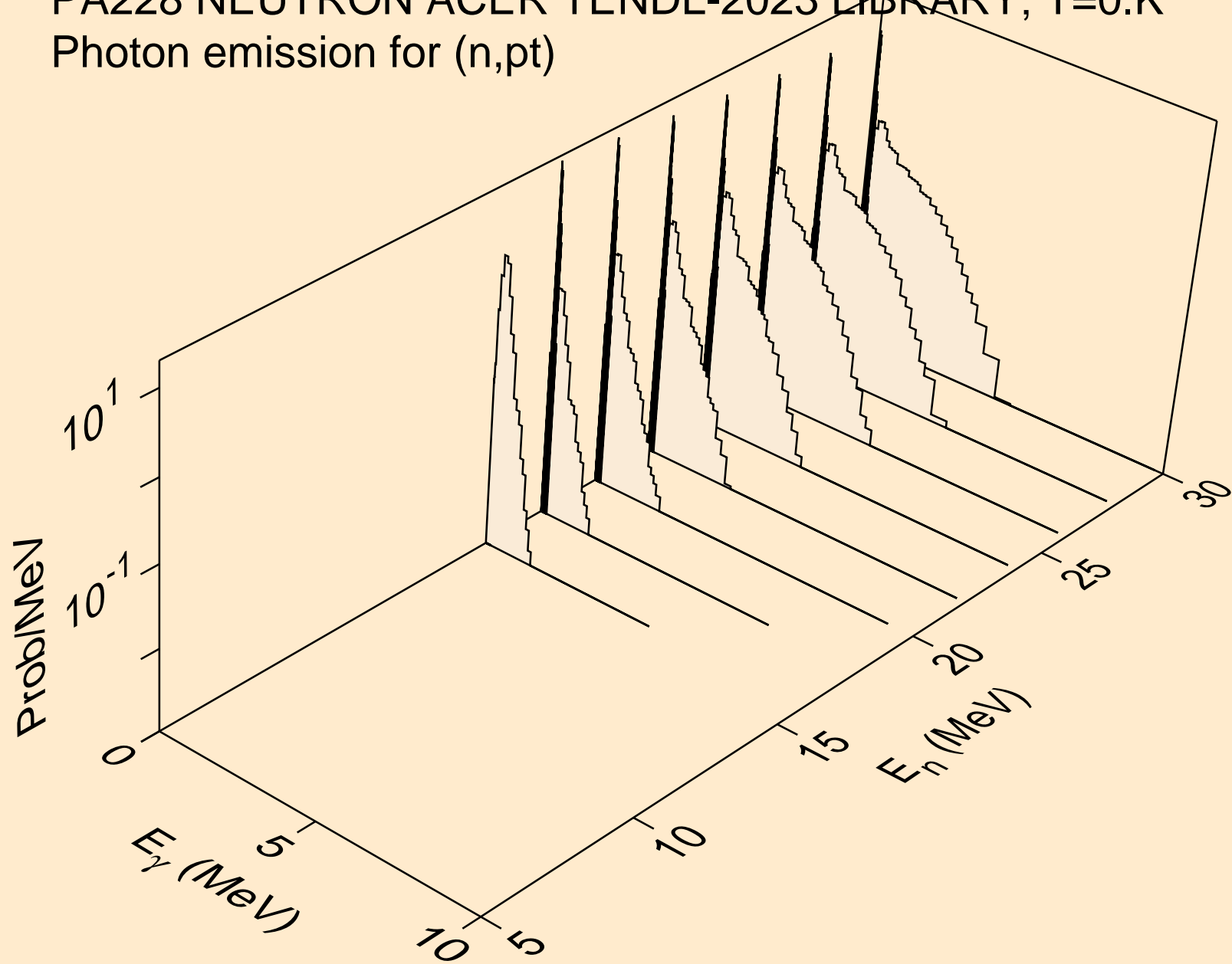

PA228 NEUTRON ACER TENDL-2023 LIBRARY; T=0.K  
Photon emission for (n,da)

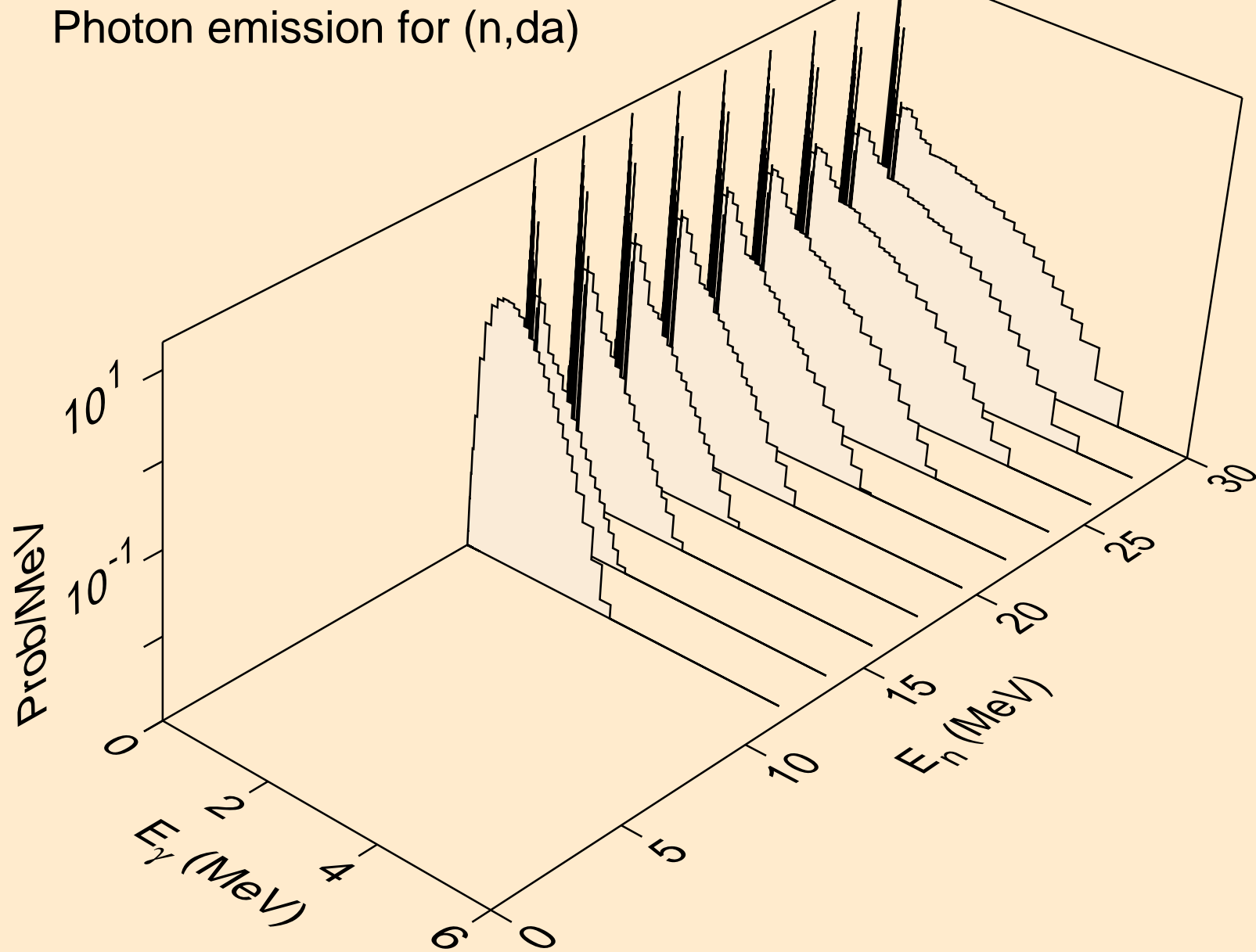

PA228 NEUTRON ACER TENDL-2023 LIBRARY; T=0.K  
thermal capture photon spectrum

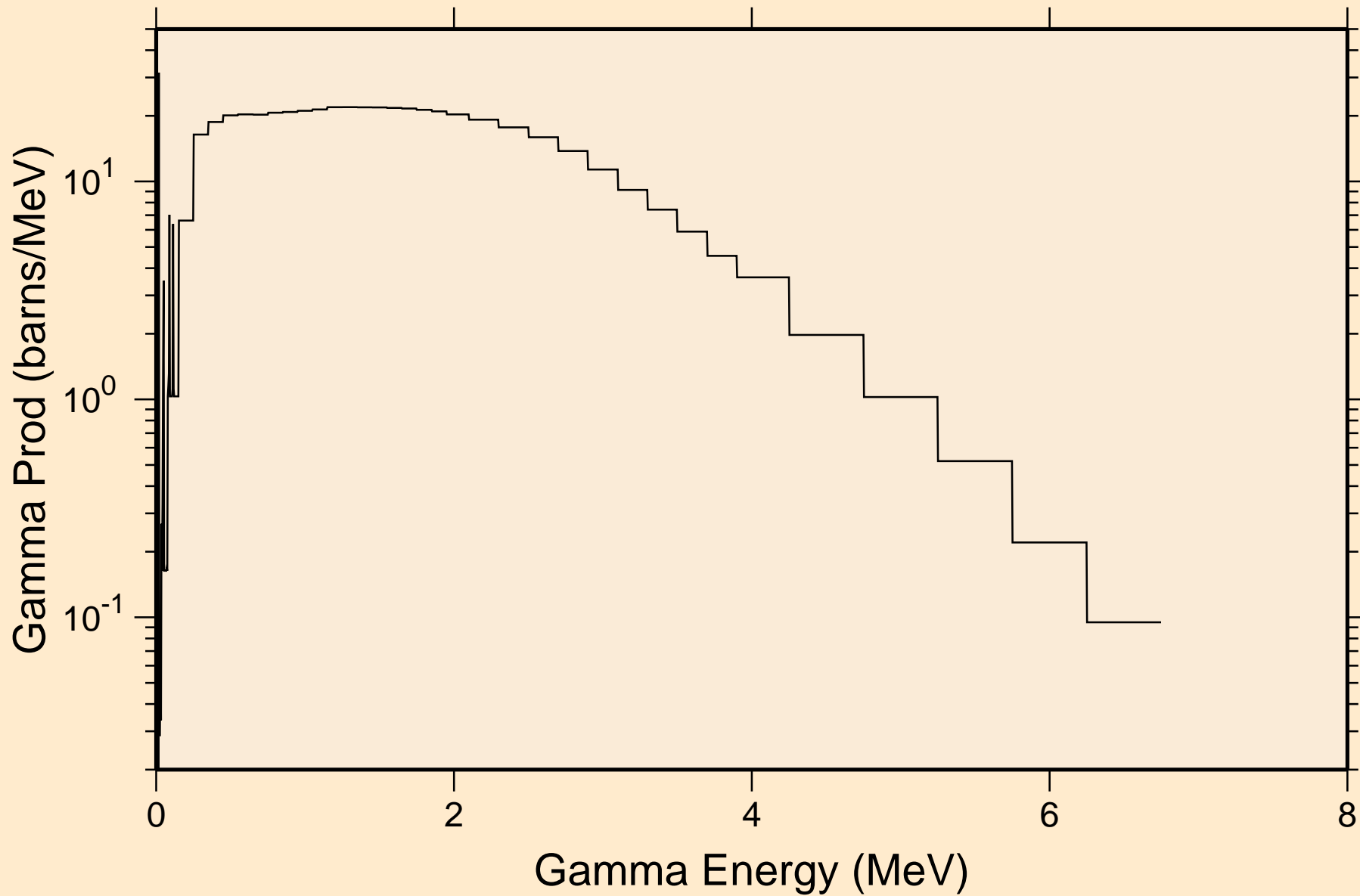



PA228 NEUTRON ACER TENDL-2023 LIBRARY; T=0.K  
14 MeV photon spectrum

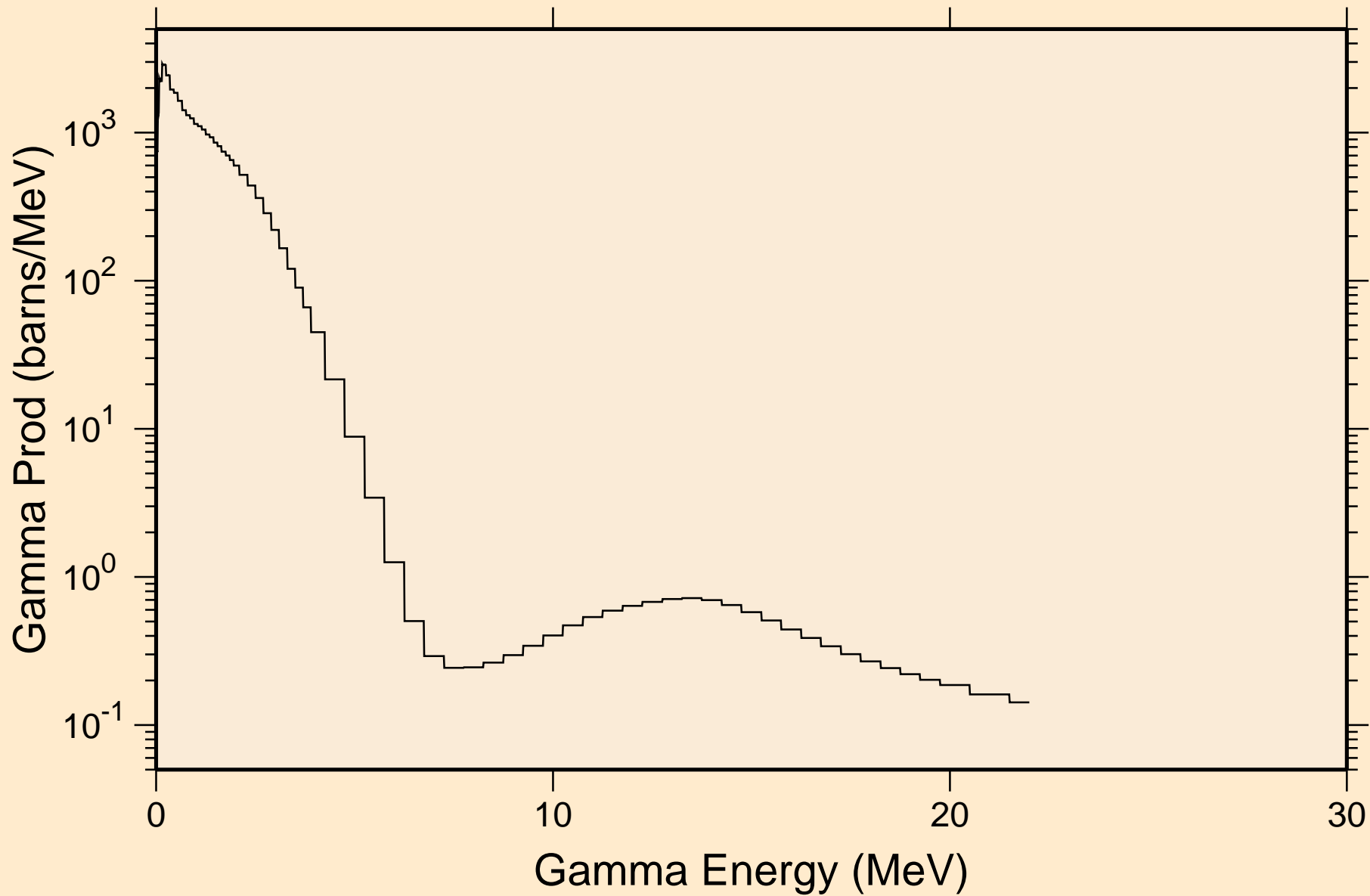

PA228 NEUTRON ACER TENDL-2023 LIBRARY; T=0.K  
Particle heating contributions

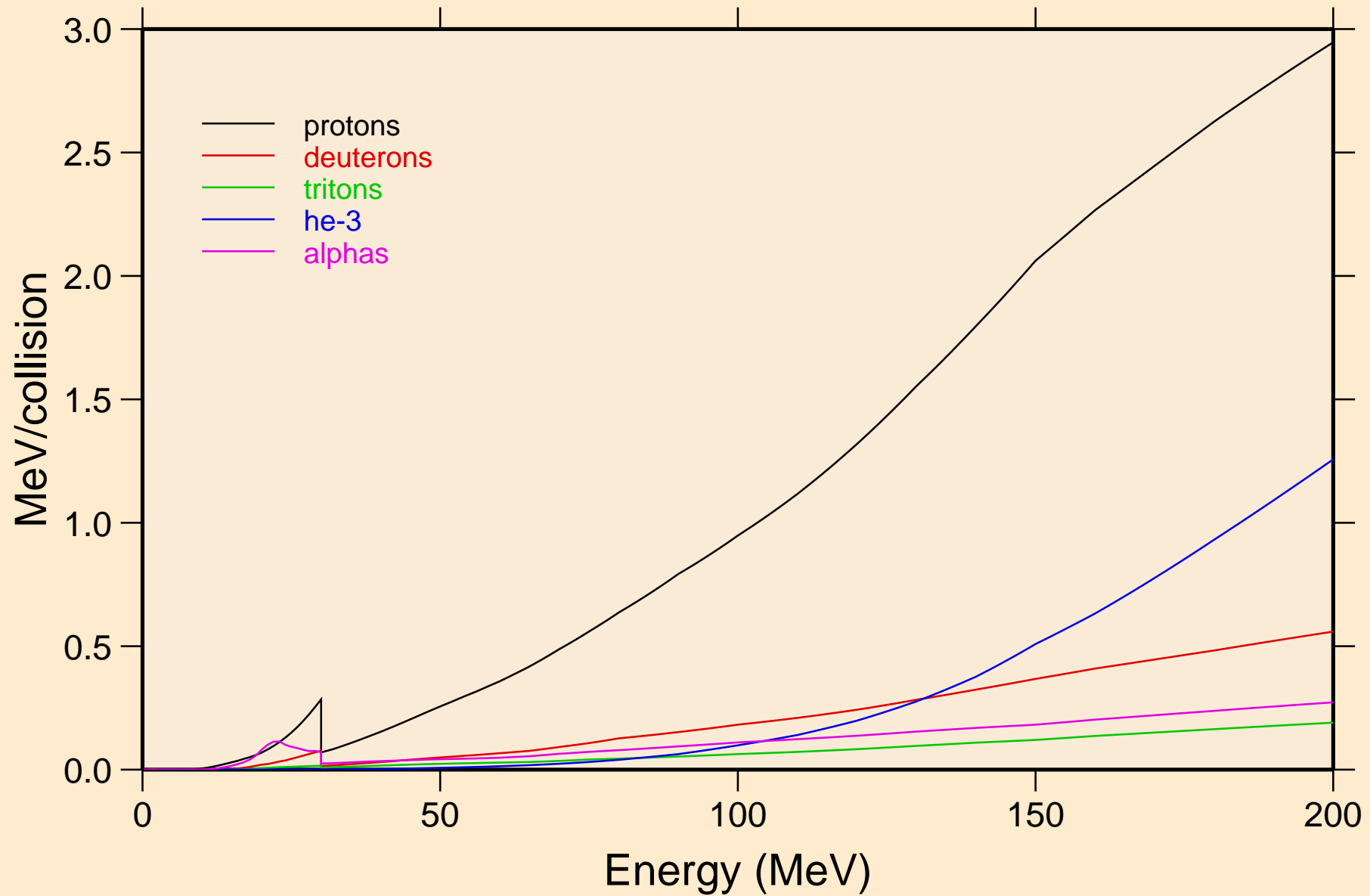

PA228 NEUTRON ACER TENDL-2023 LIBRARY; T=0.K  
Recoil Heating

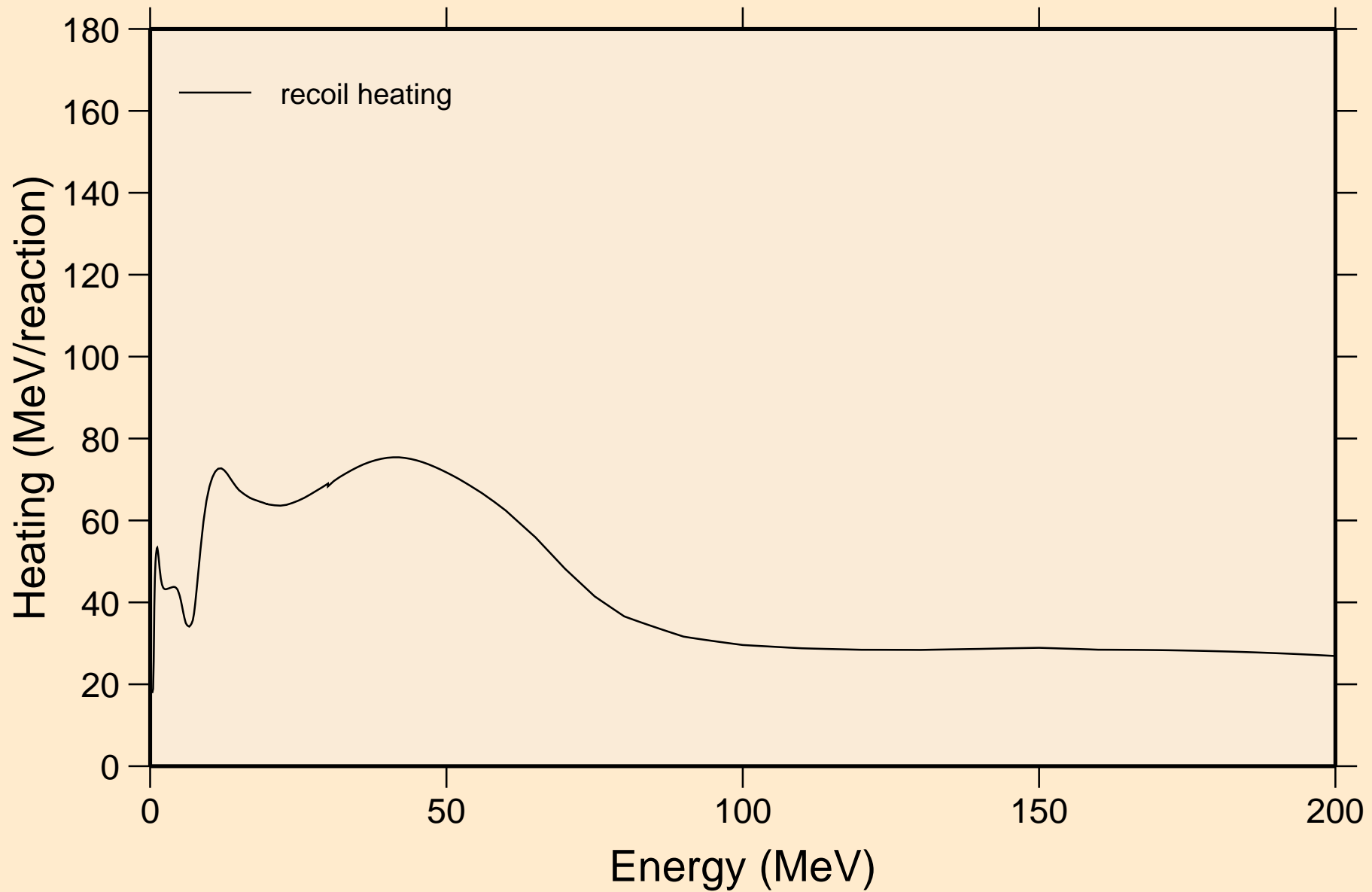

PA228 NEUTRON ACER TENDL-2023 LIBRARY; T=0.K  
Particle production cross sections

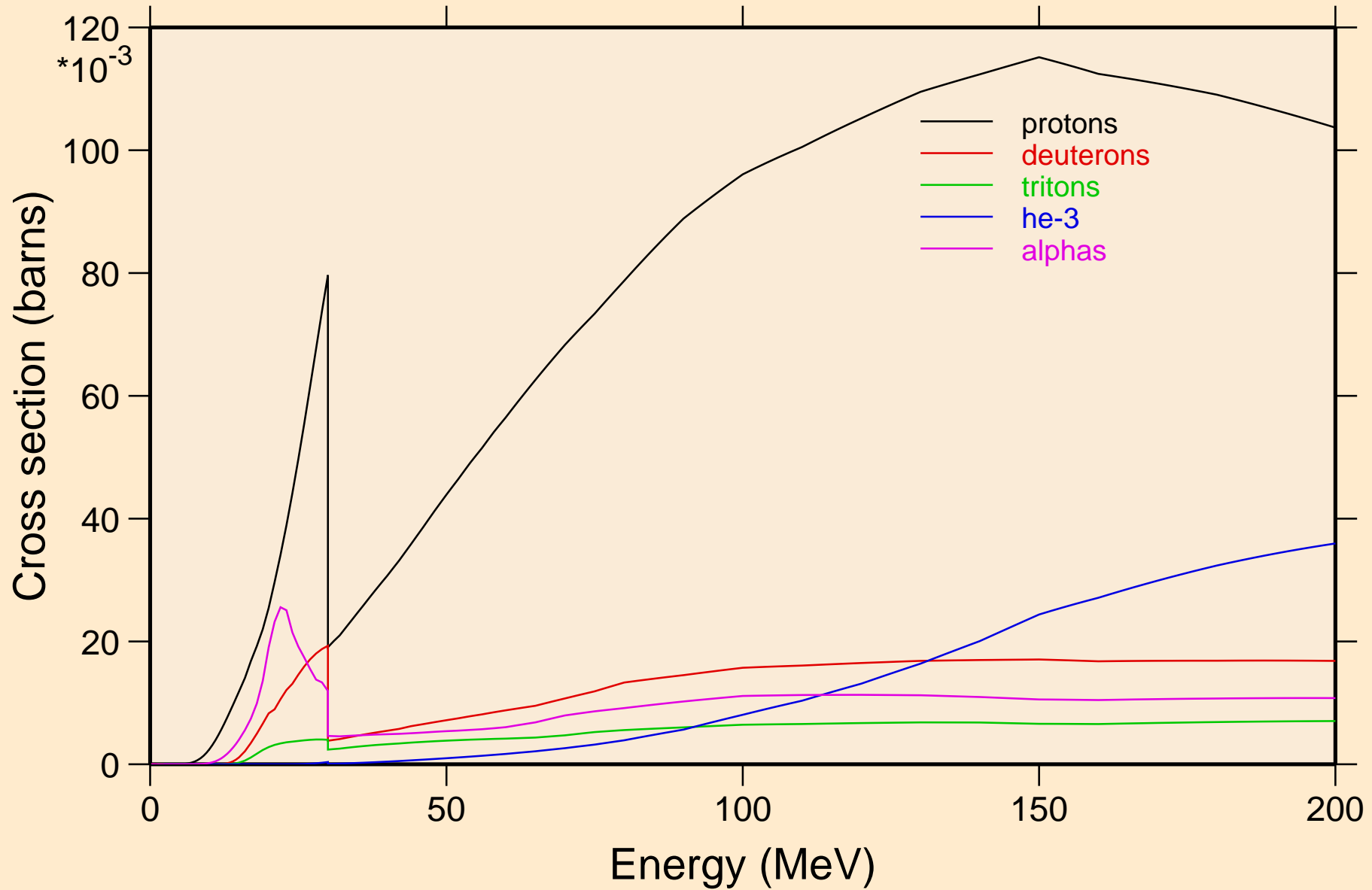

PA228 NEUTRON ACER TENDL-2023 LIBRARY; T=0.K  
protons from (n,x)

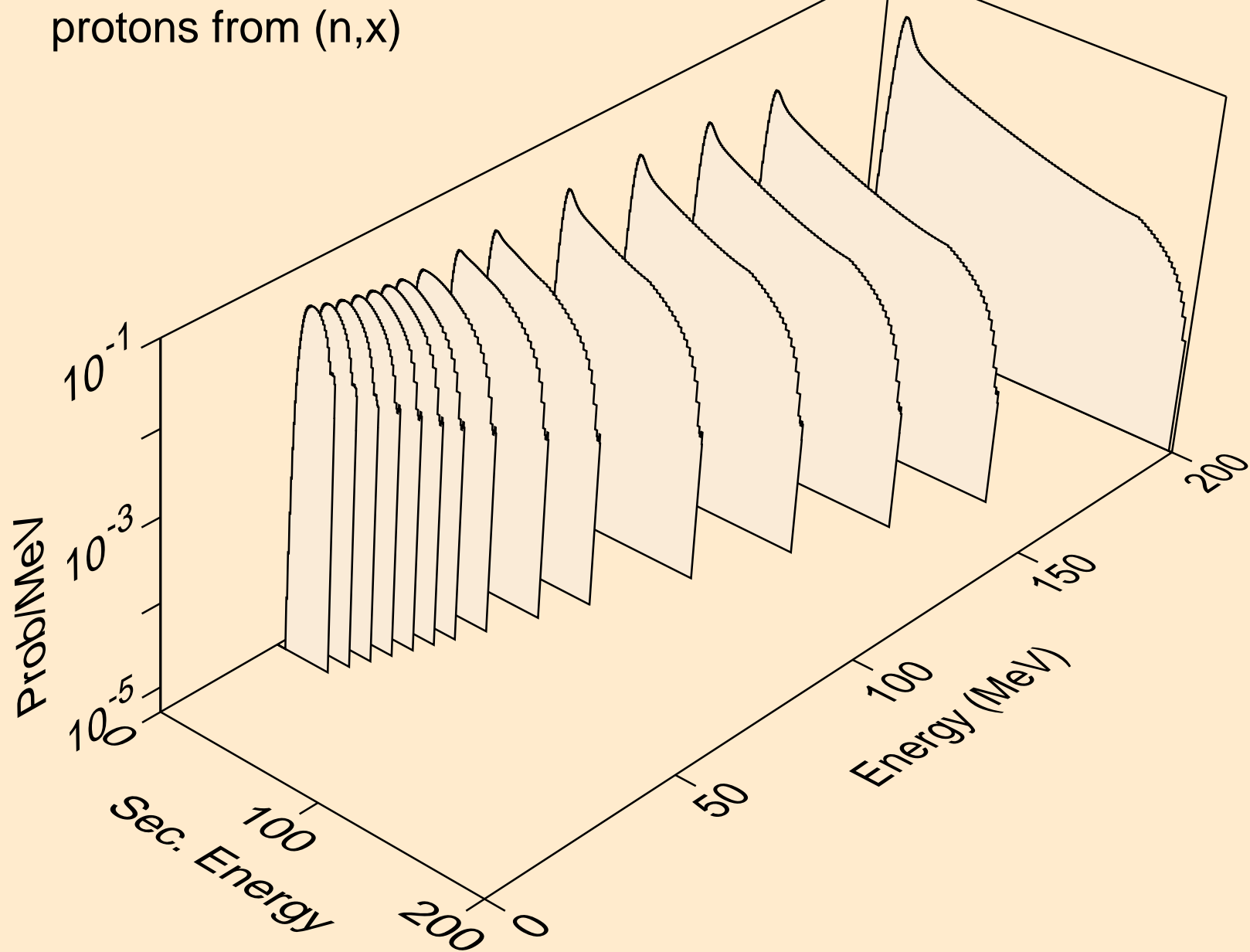

PA228 NEUTRON ACER TENDL-2023 LIBRARY; T=0.K  
protons from (n,n\*)p

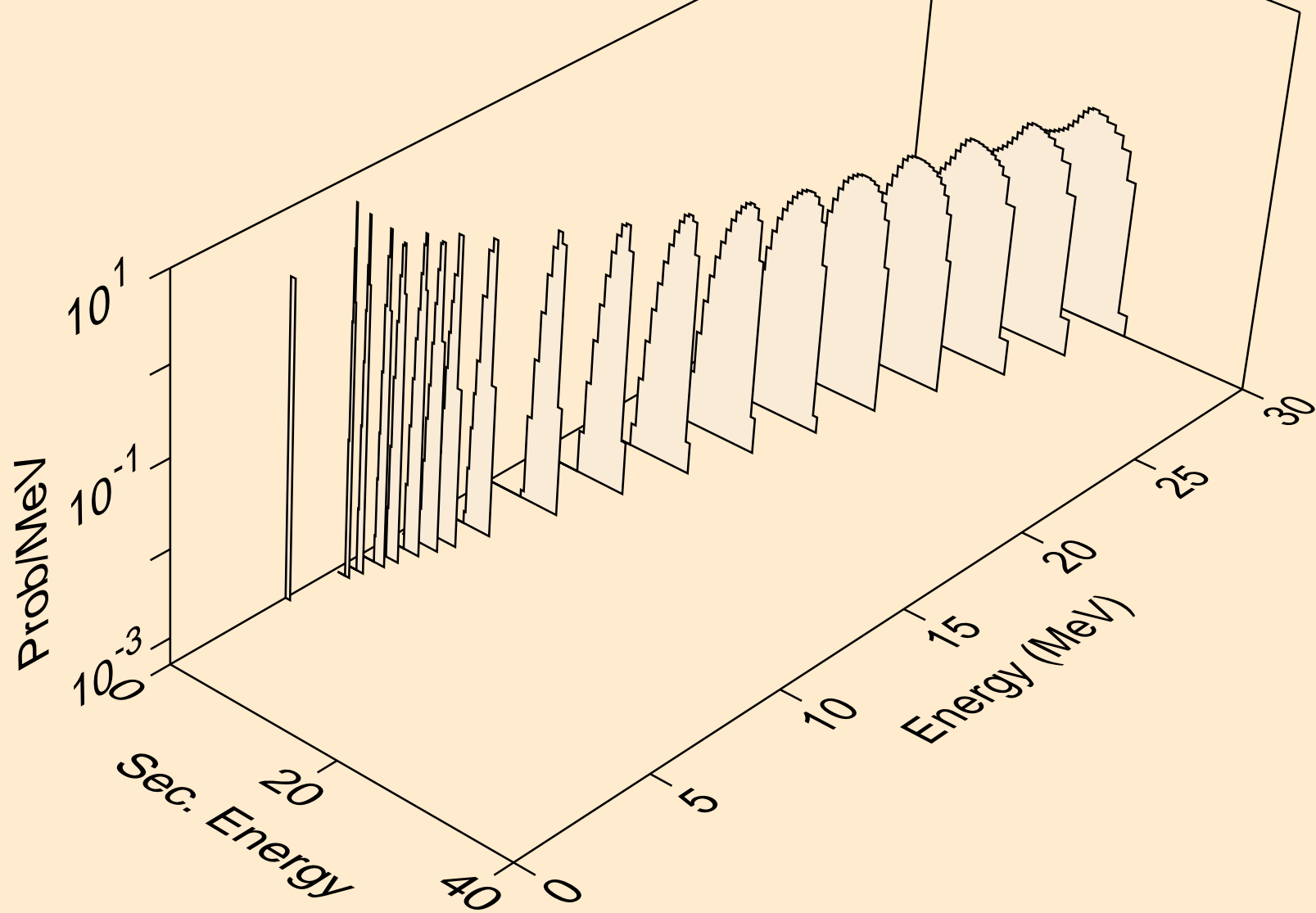

PA228 NEUTRON ACER TENDL-2023 LIBRARY; T=0.K  
protons from (n,2np)

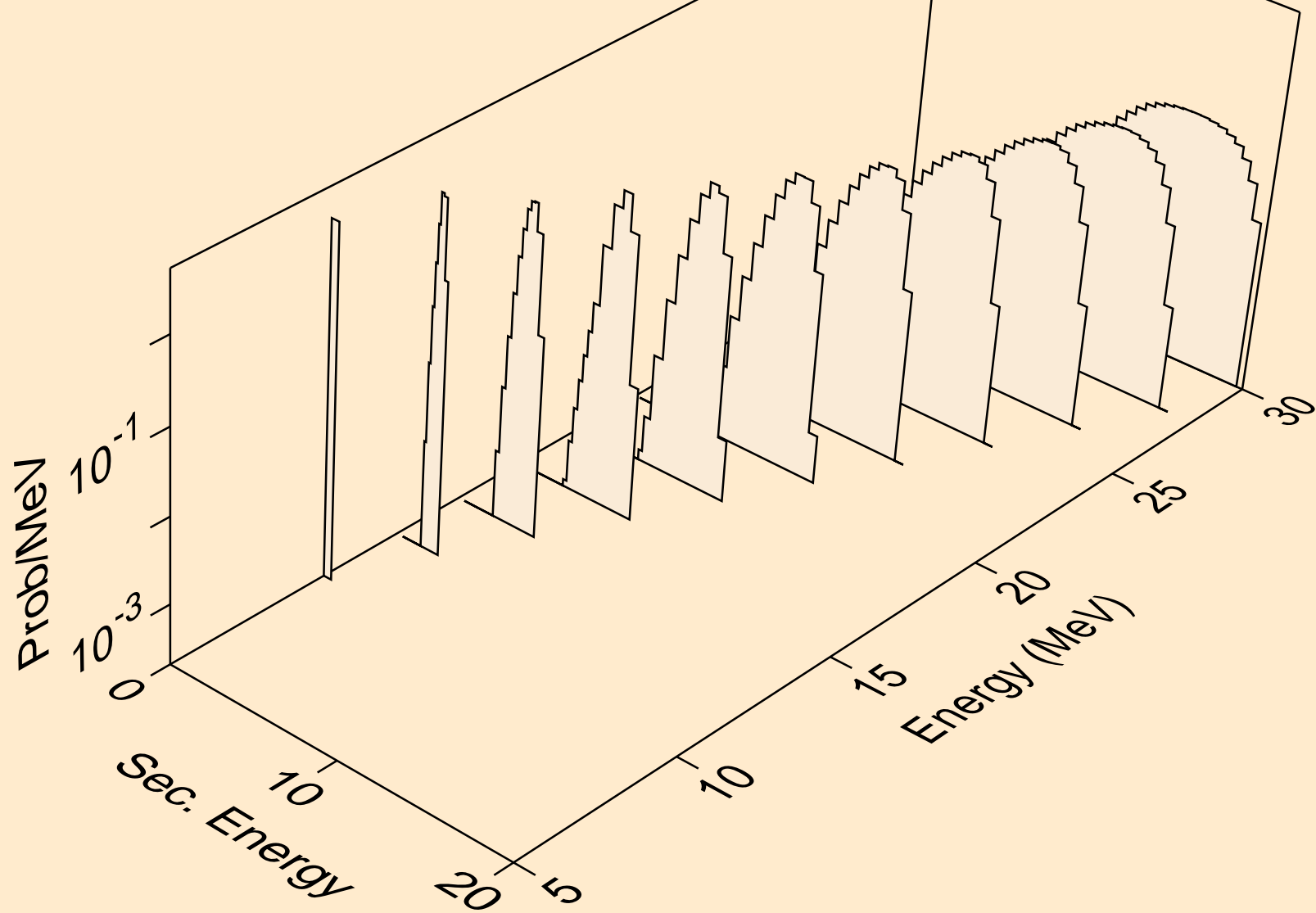

PA228 NEUTRON ACER TENDL-2023 LIBRARY; T=0.K  
protons from (n,3np)

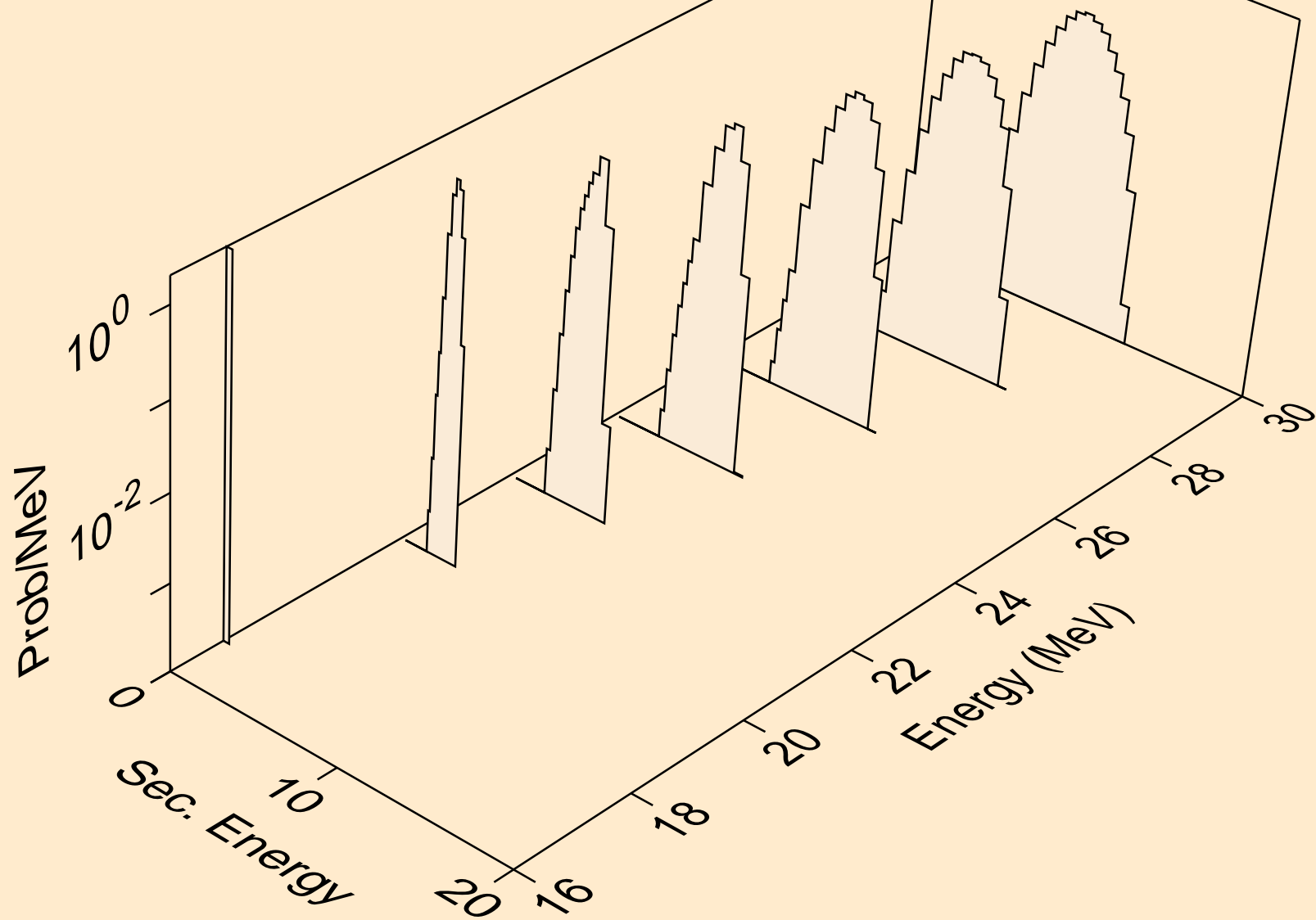



PA228 NEUTRON ACER TENDL-2023 LIBRARY; T=0.K  
protons from (n,n2p)

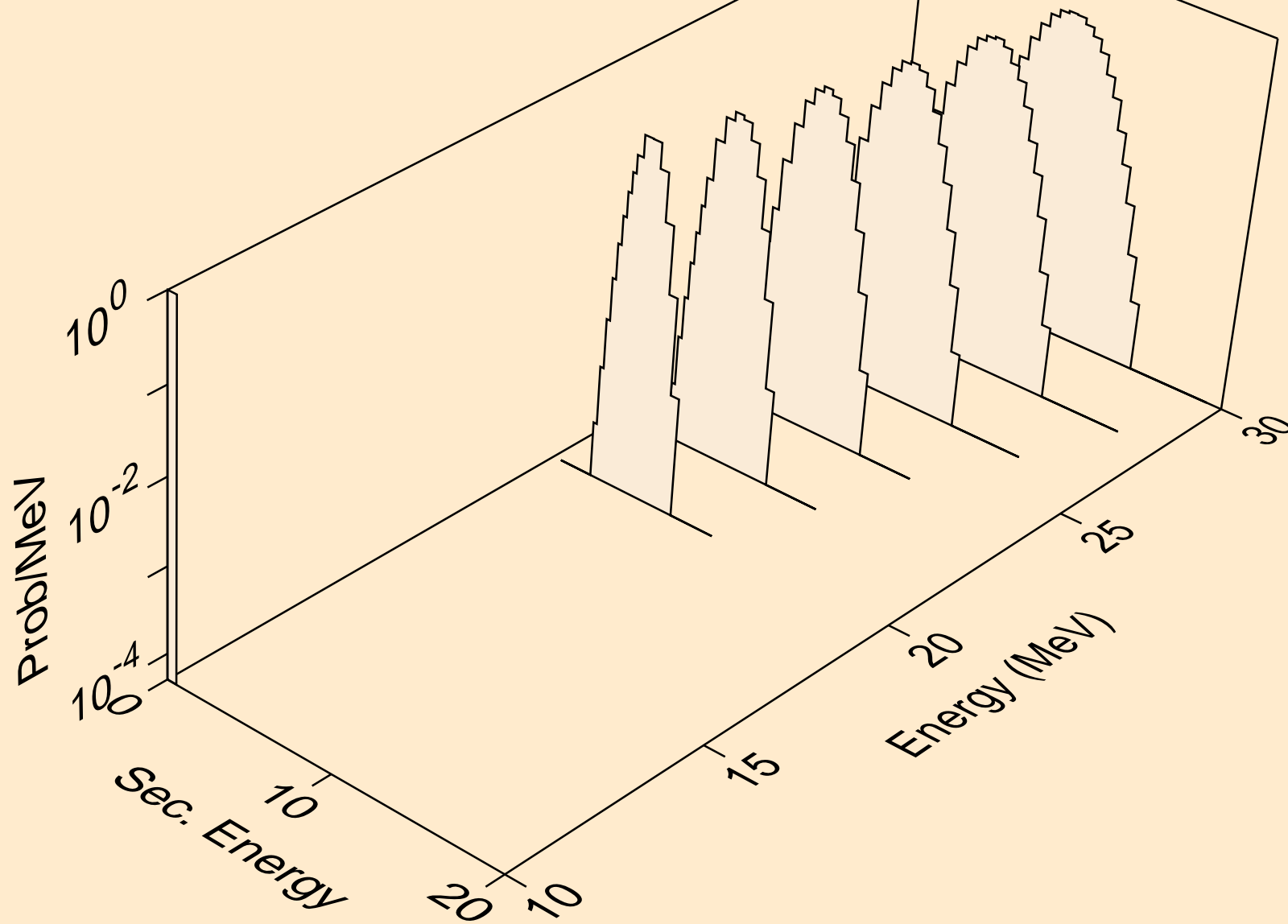

PA228 NEUTRON ACER TENDL-2023 LIBRARY; T=0.K  
protons from (n,npa)

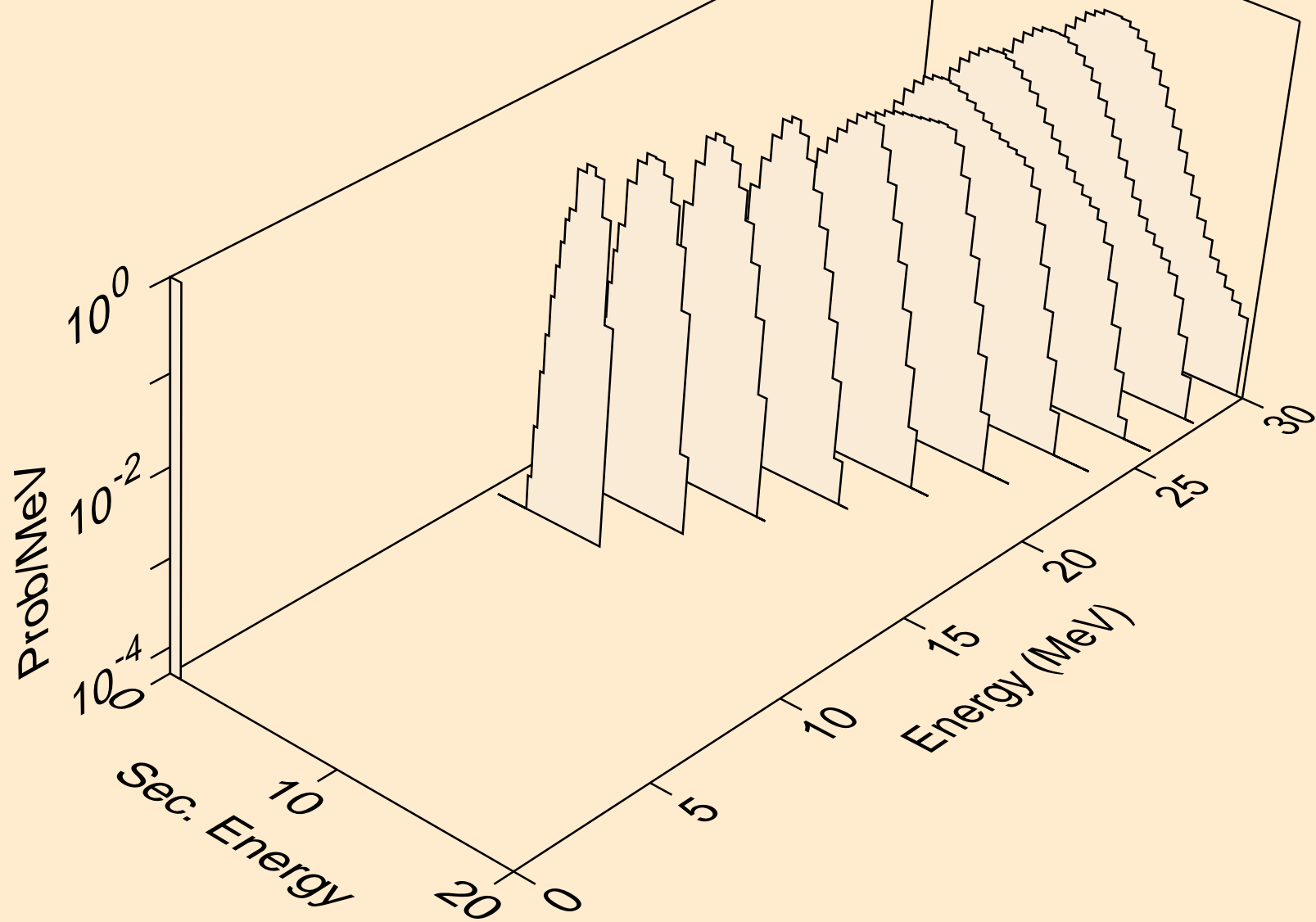

PA228 NEUTRON ACER TENDL-2023 LIBRARY; T=0.K  
protons from (n,p)

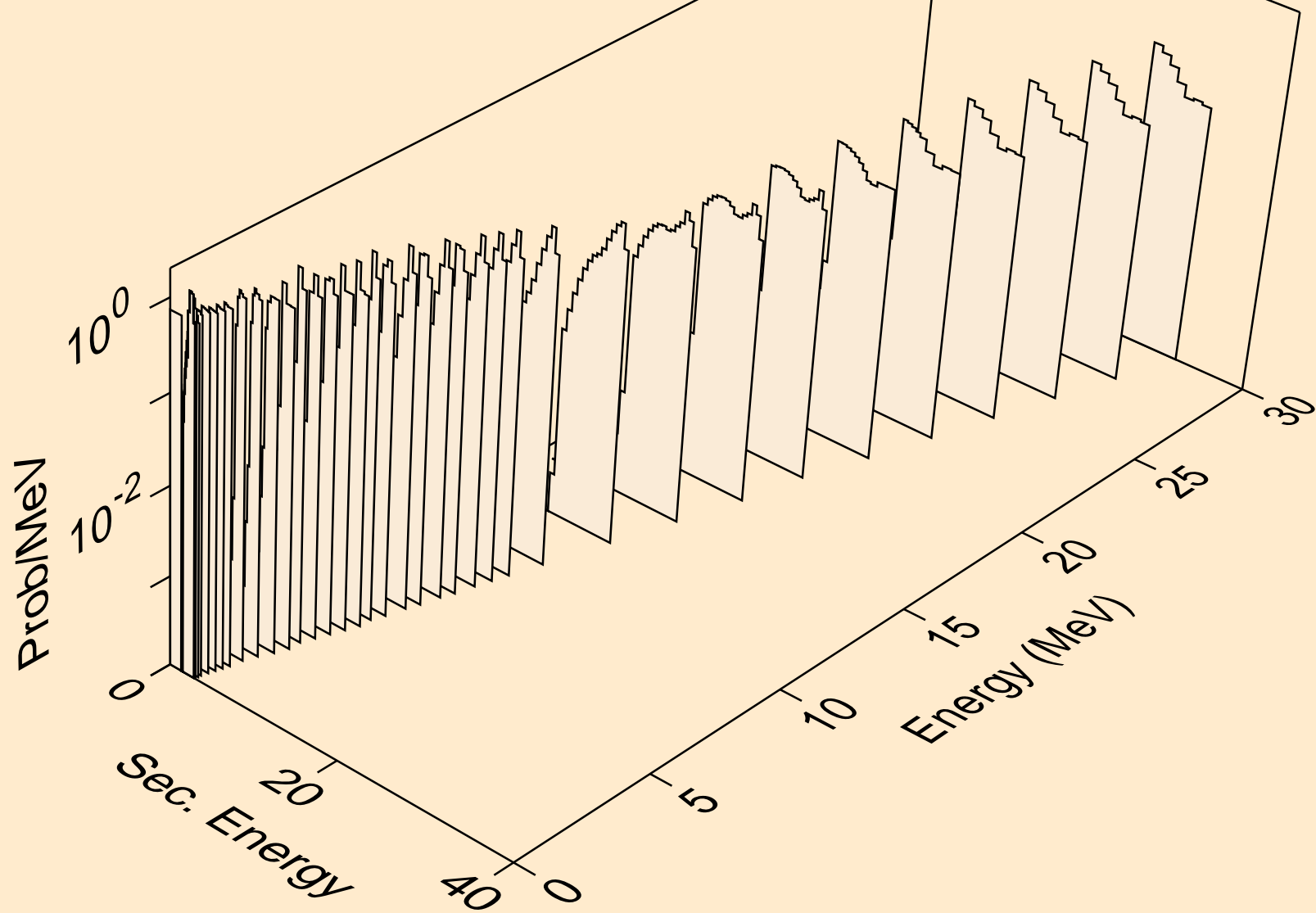

PA228 NEUTRON ACER TENDL-2023 LIBRARY; T=0.K  
protons from (n,2p)

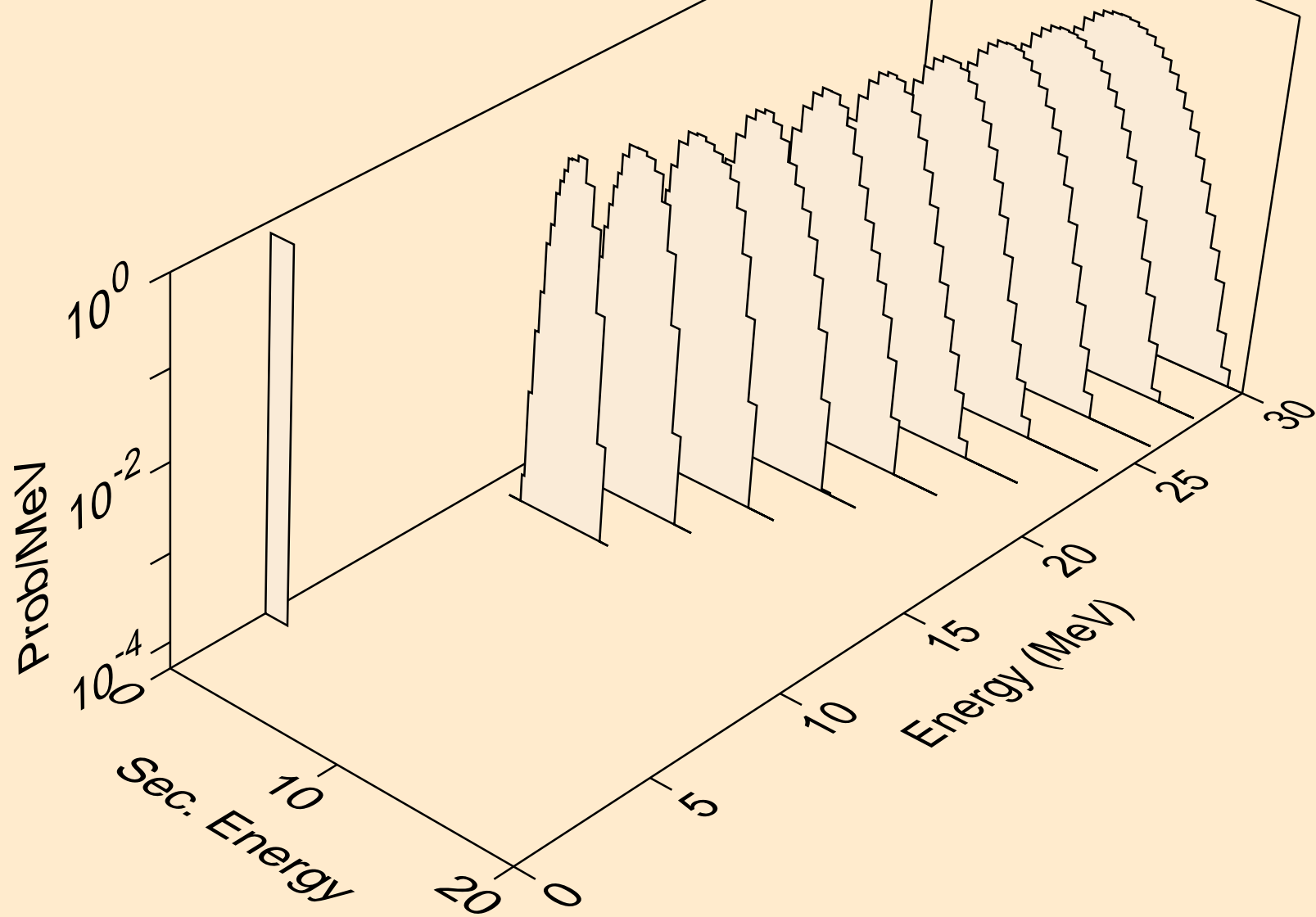

PA228 NEUTRON ACER TENDL-2023 LIBRARY; T=0.K  
protons from (n,pa)

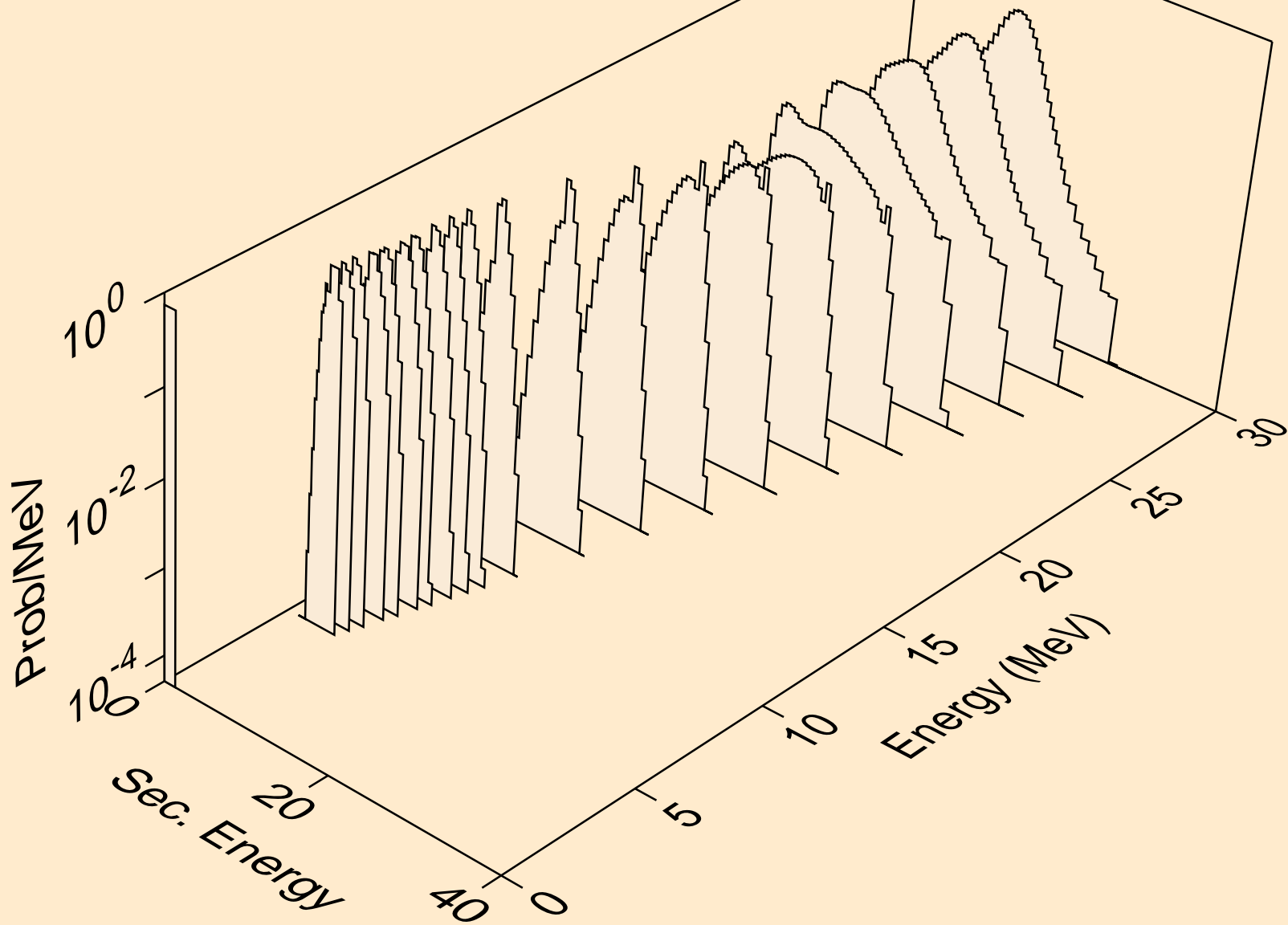

PA228 NEUTRON ACER TENDL-2023 LIBRARY; T=0.K  
protons from (n,pd)

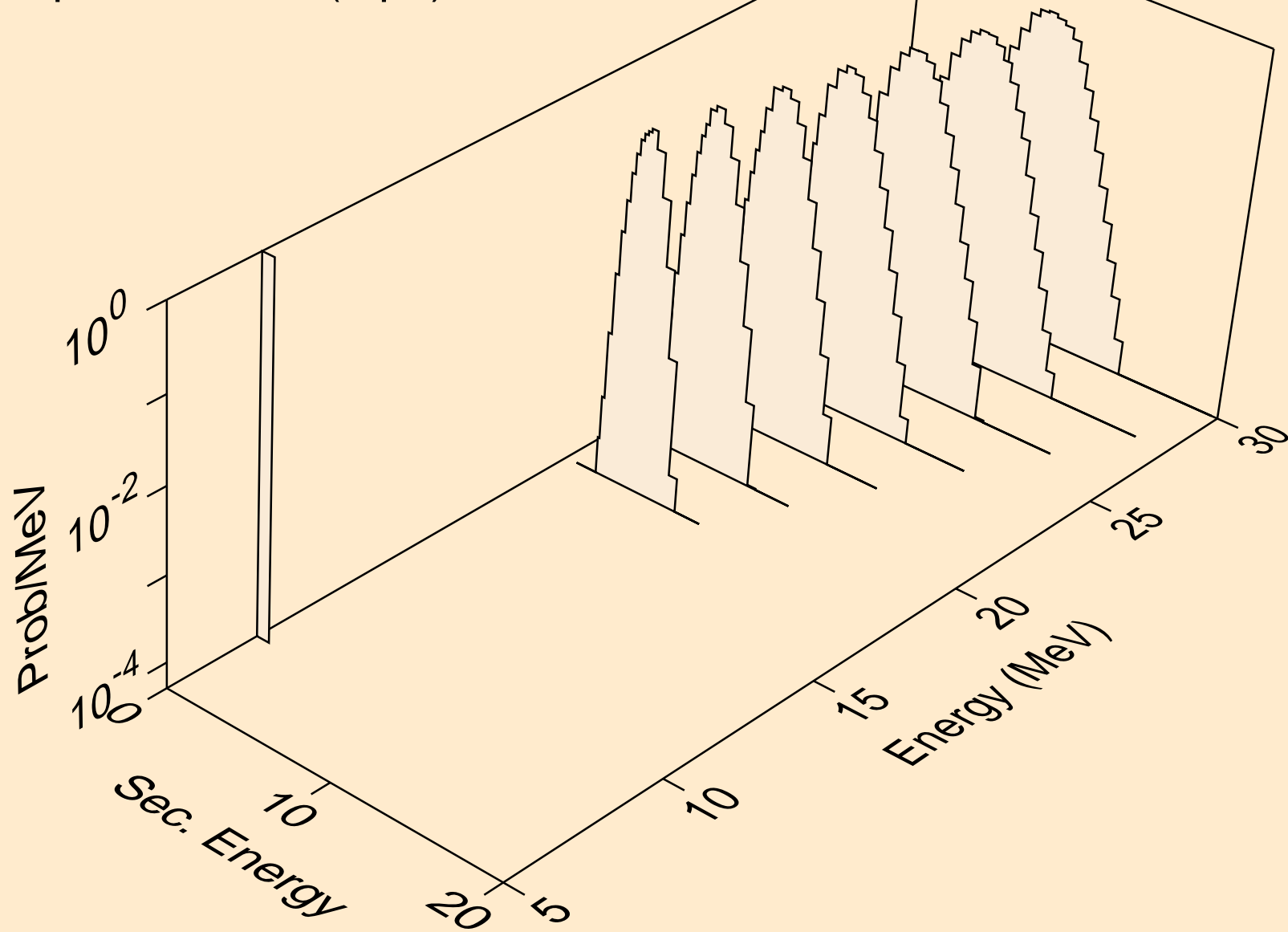

PA228 NEUTRON ACER TENDL-2023 LIBRARY; T=0.K  
protons from (n,pt)

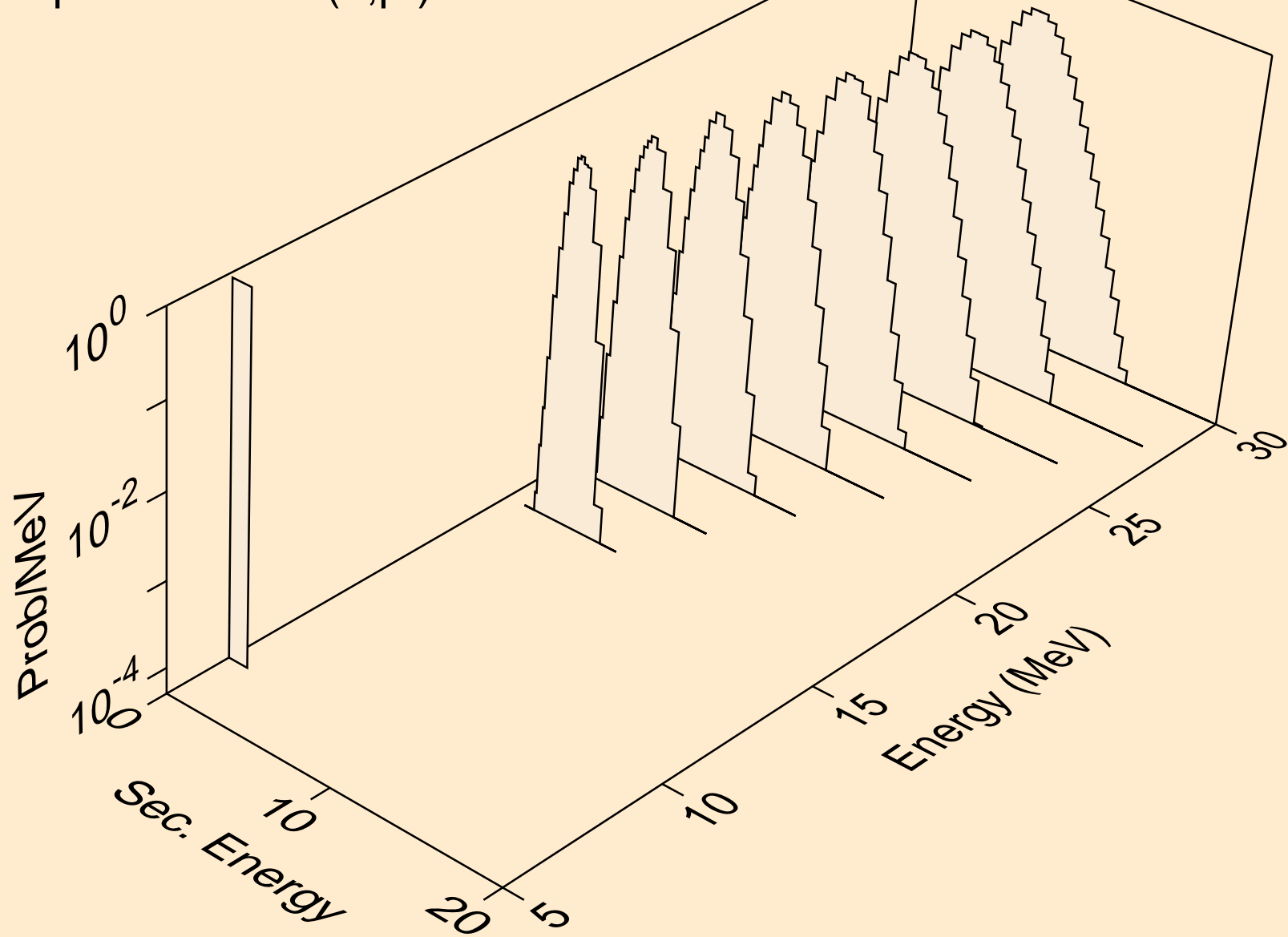

PA228 NEUTRON ACER TENDL-2023 LIBRARY; T=0.K  
deuterons from (n,x)

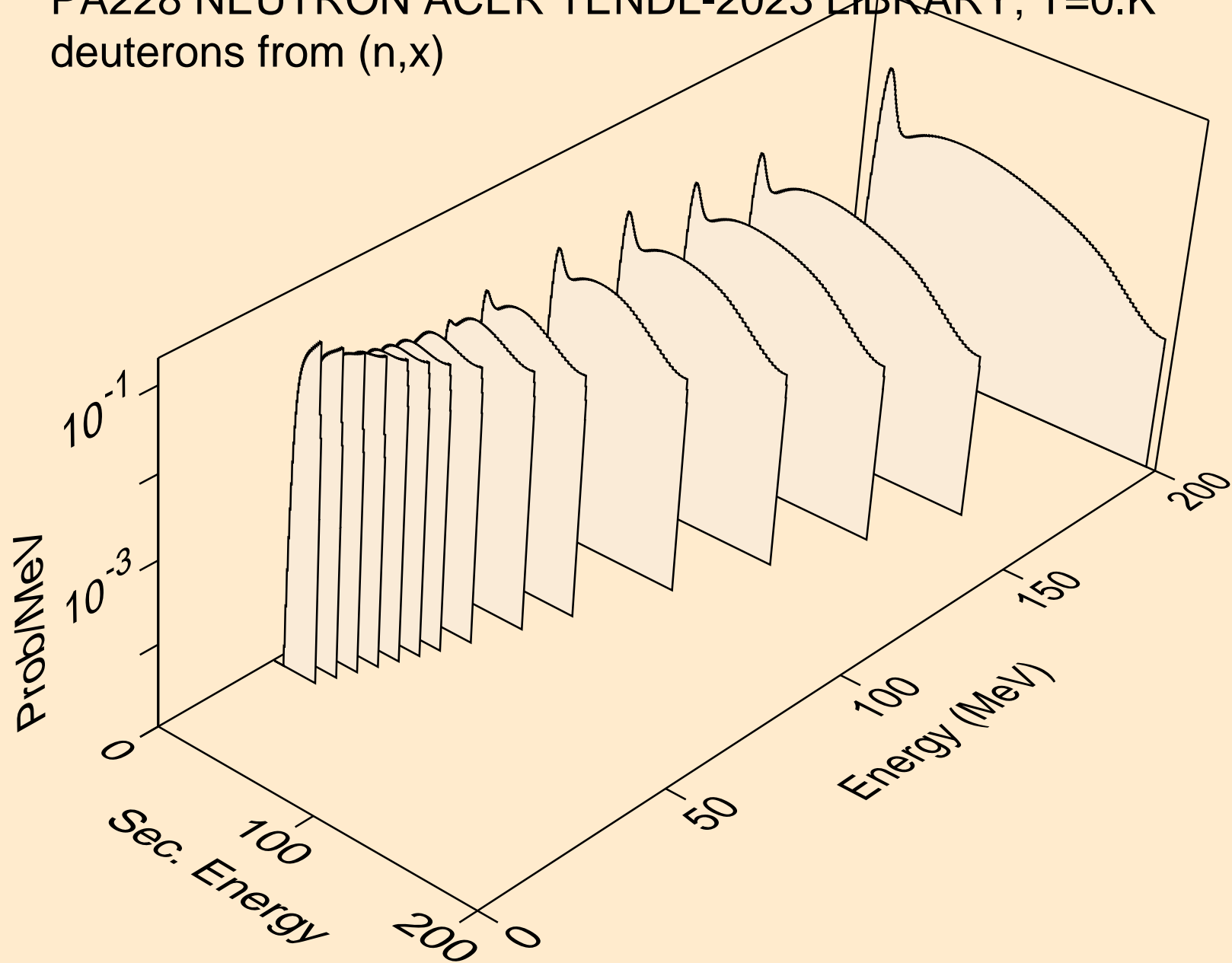



PA228 NEUTRON ACER TENDL-2023 LIBRARY; T=0.K  
deuterons from (n,2nd)

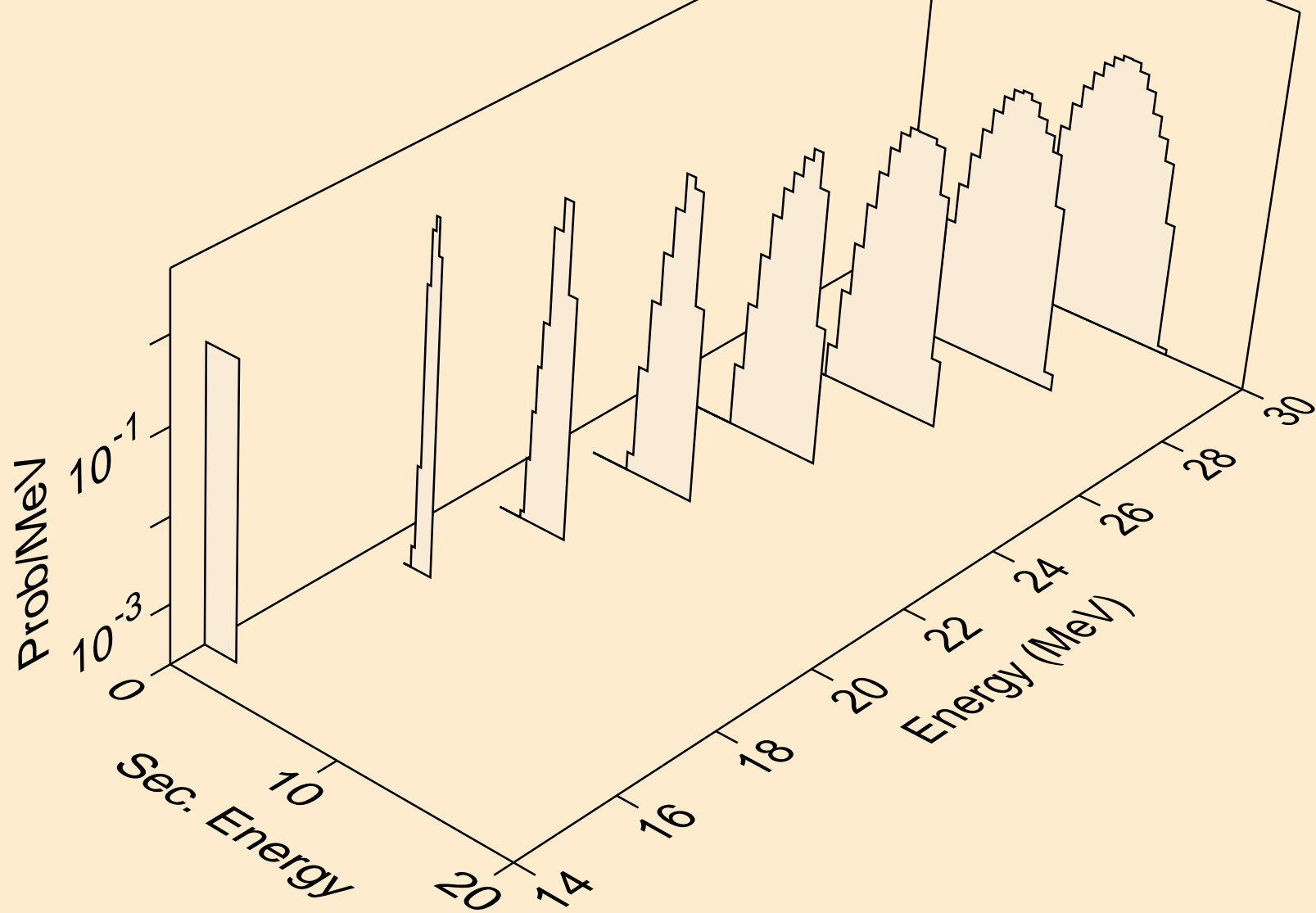

PA228 NEUTRON ACER TENDL-2023 LIBRARY; T=0.K  
deuterons from (n,n\*)d

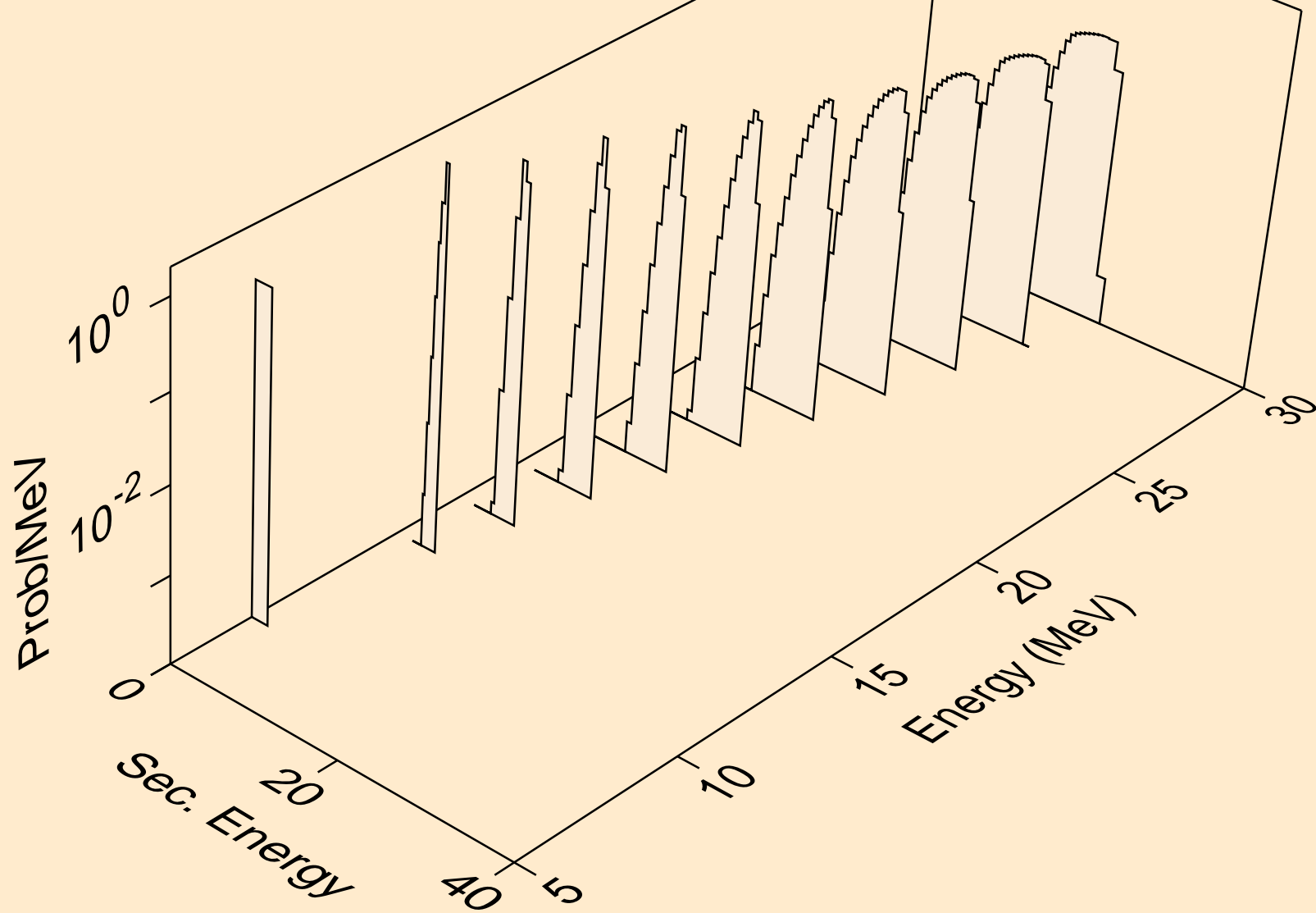

PA228 NEUTRON ACER TENDL-2023 LIBRARY; T=0.K  
deuterons from (n,d)

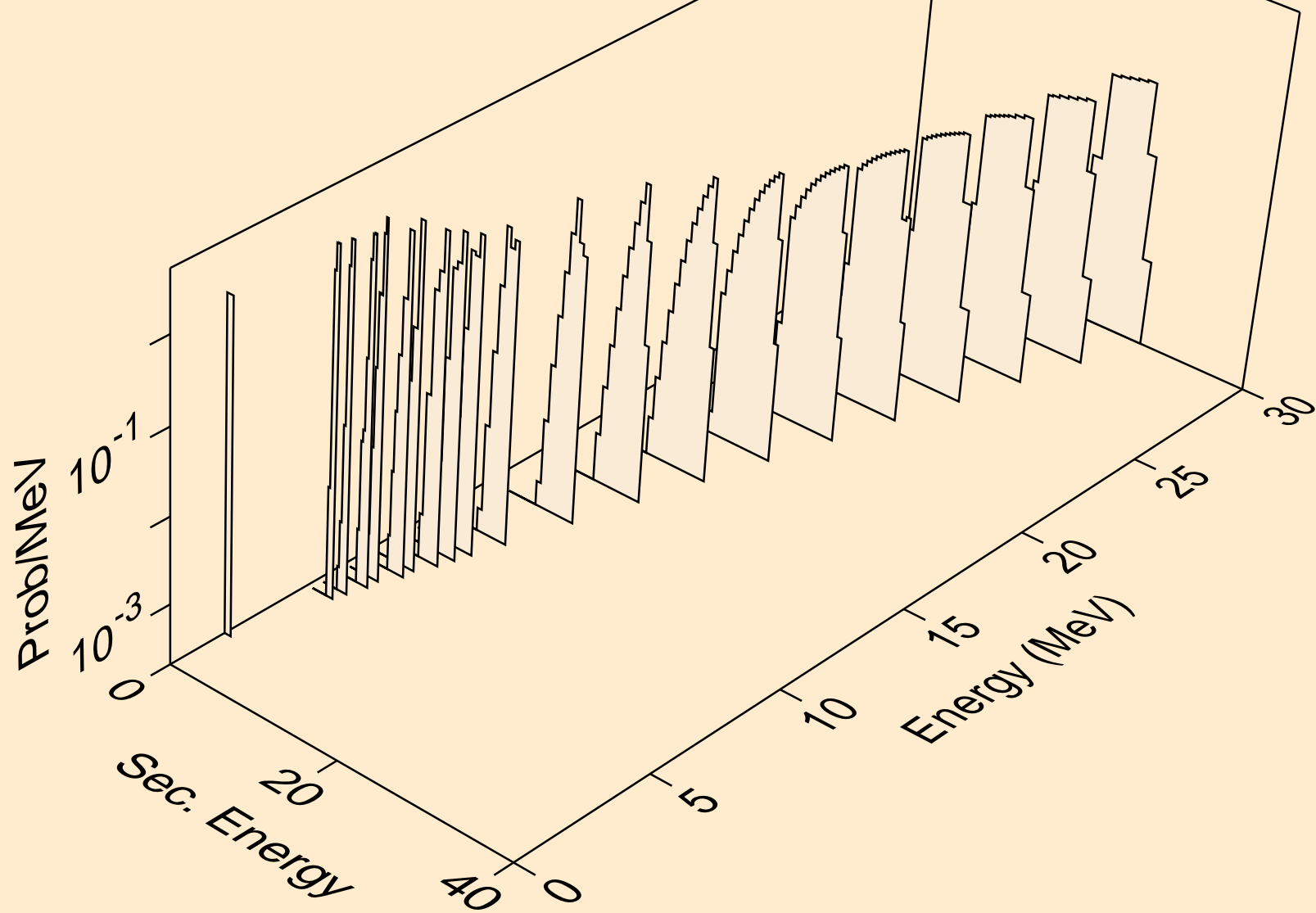

PA228 NEUTRON ACER TENDL-2023 LIBRARY; T=0.K  
deuterons from (n,pd)

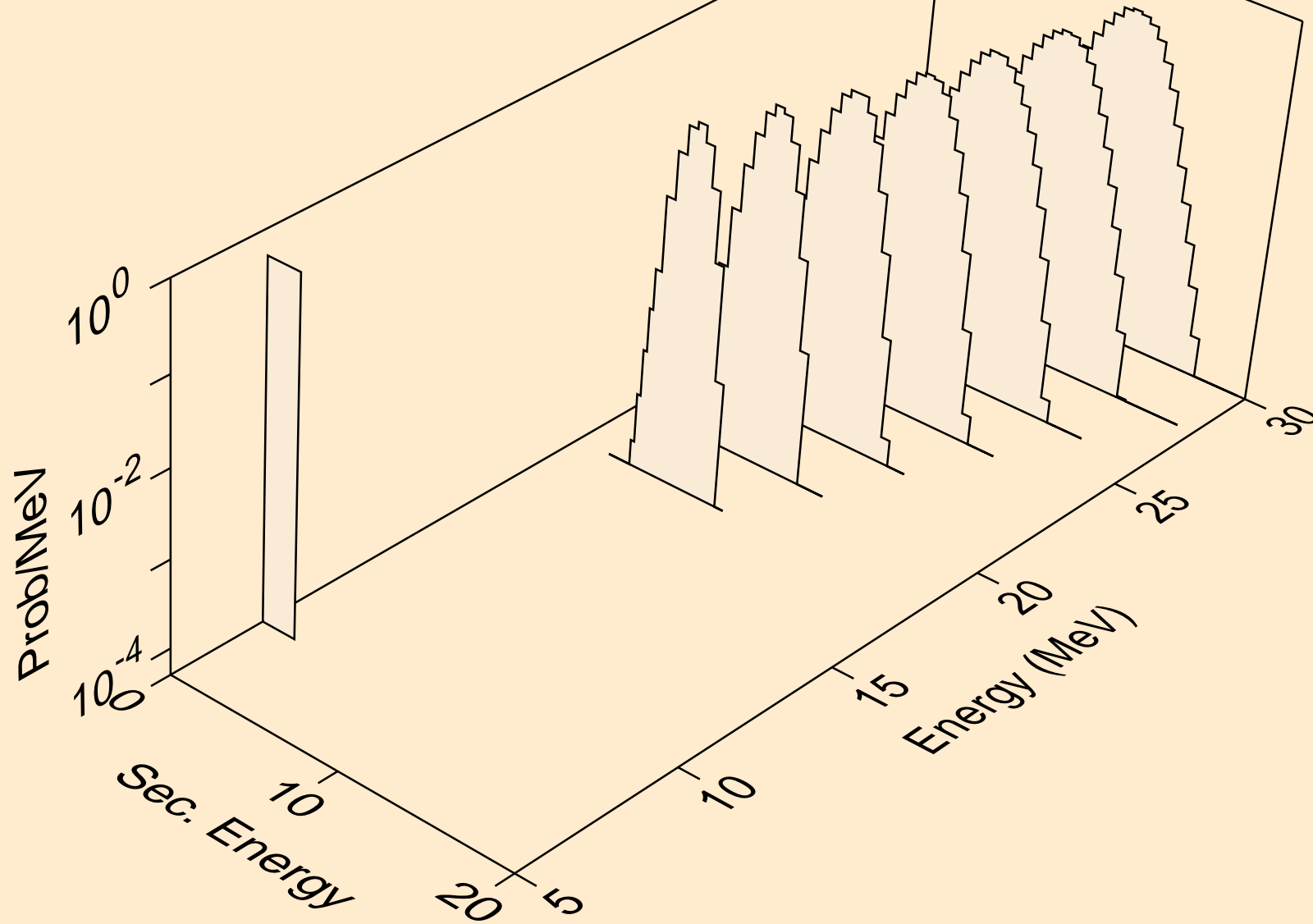

PA228 NEUTRON ACER TENDL-2023 LIBRARY; T=0.K  
deuterons from (n,da)

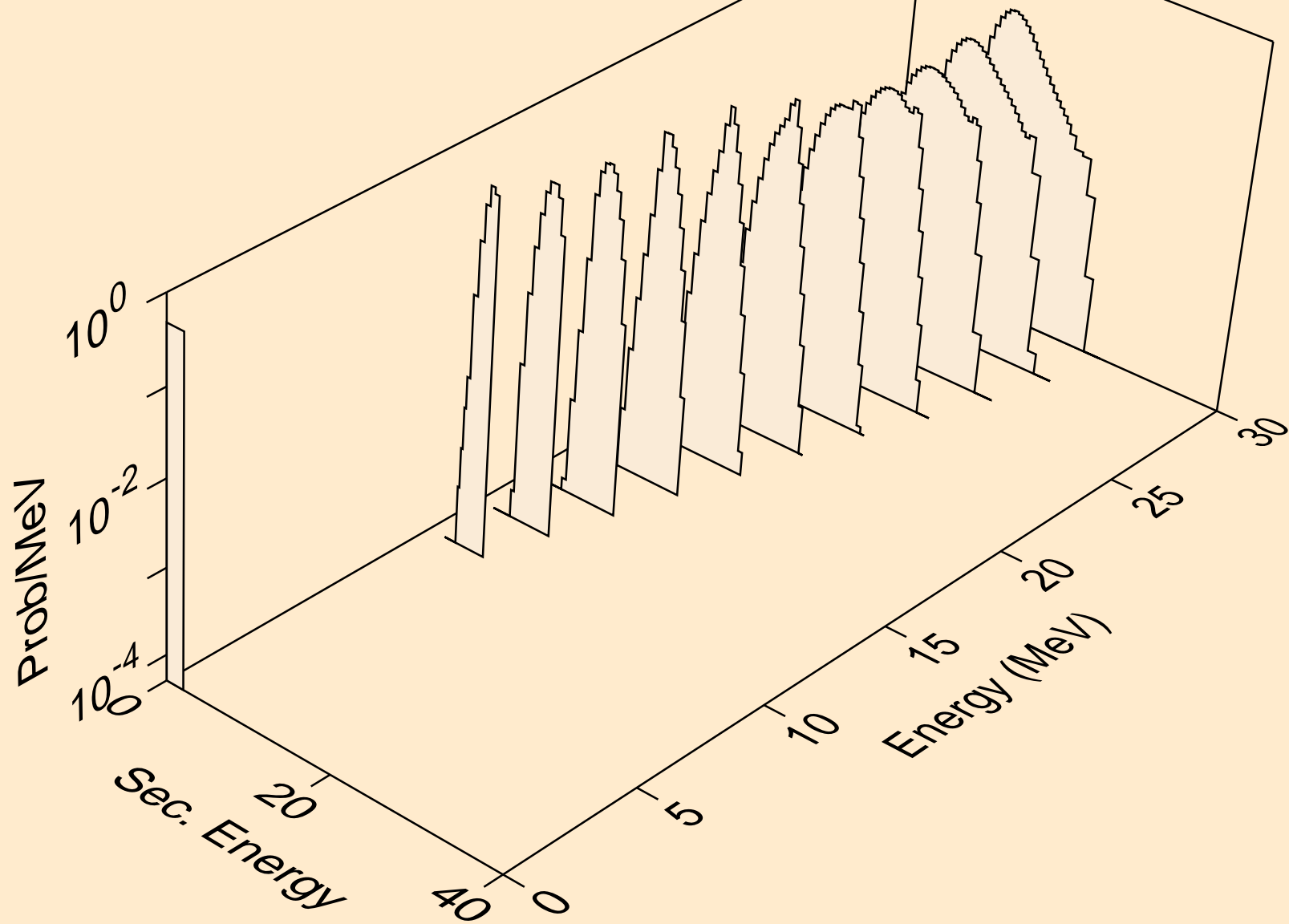

PA228 NEUTRON ACER TENDL-2023 LIBRARY; T=0.K  
tritons from (n,x)

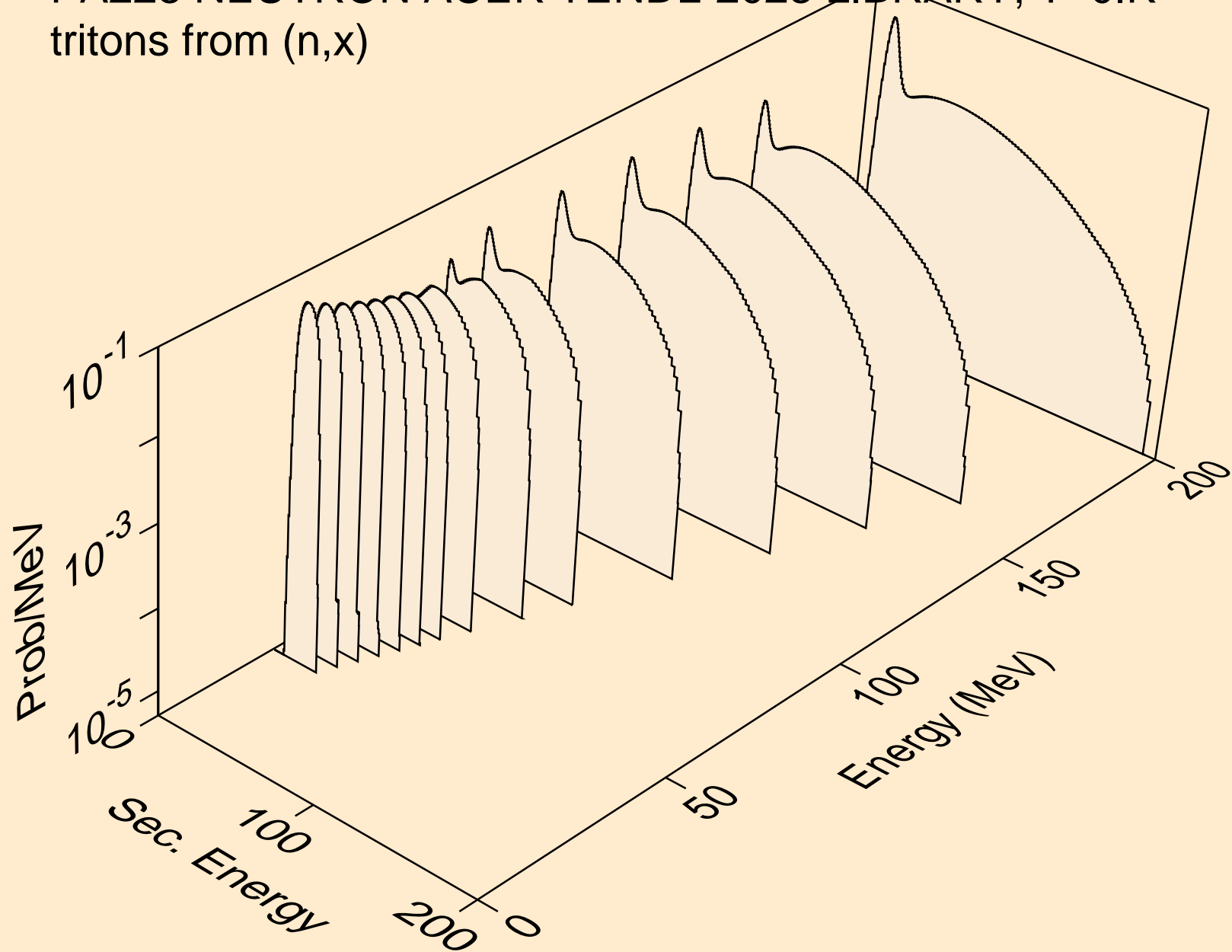

PA228 NEUTRON ACER TENDL-2023 LIBRARY; T=0.K  
tritons from (n,n\*)t

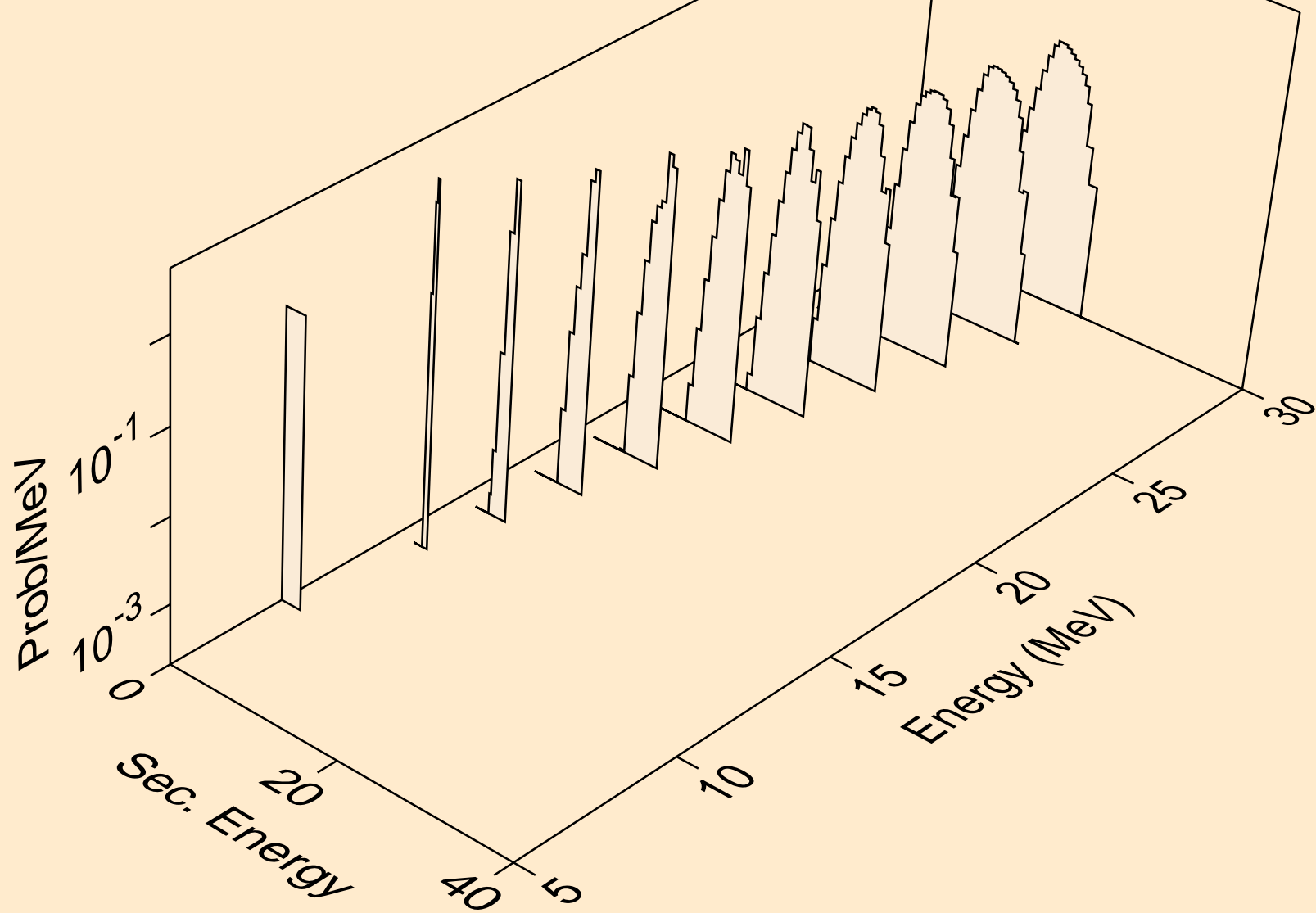

PA228 NEUTRON ACER TENDL-2023 LIBRARY; T=0.K  
tritons from (n,t)

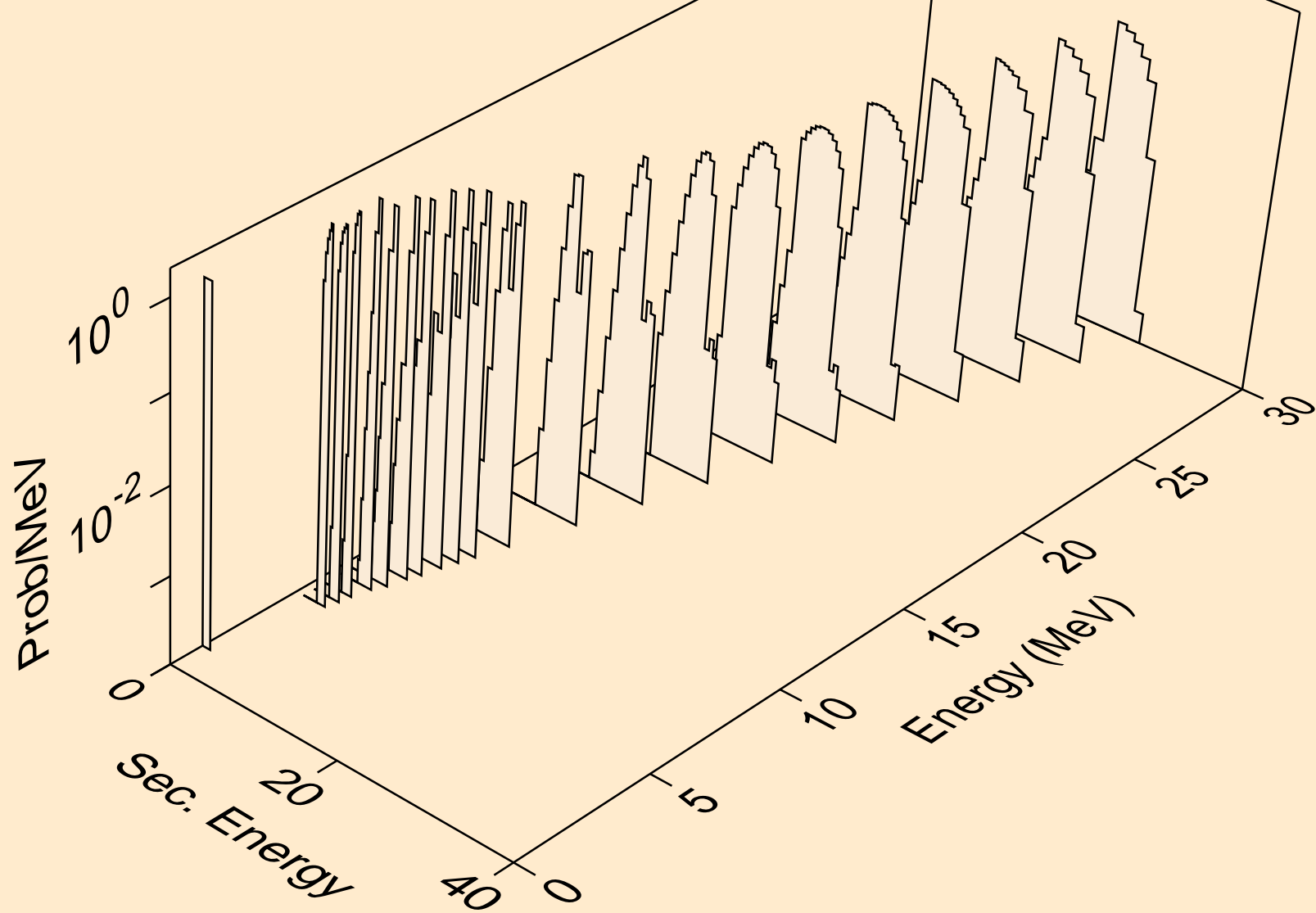



PA228 NEUTRON ACER TENDL-2023 LIBRARY; T=0.K  
tritons from (n,pt)

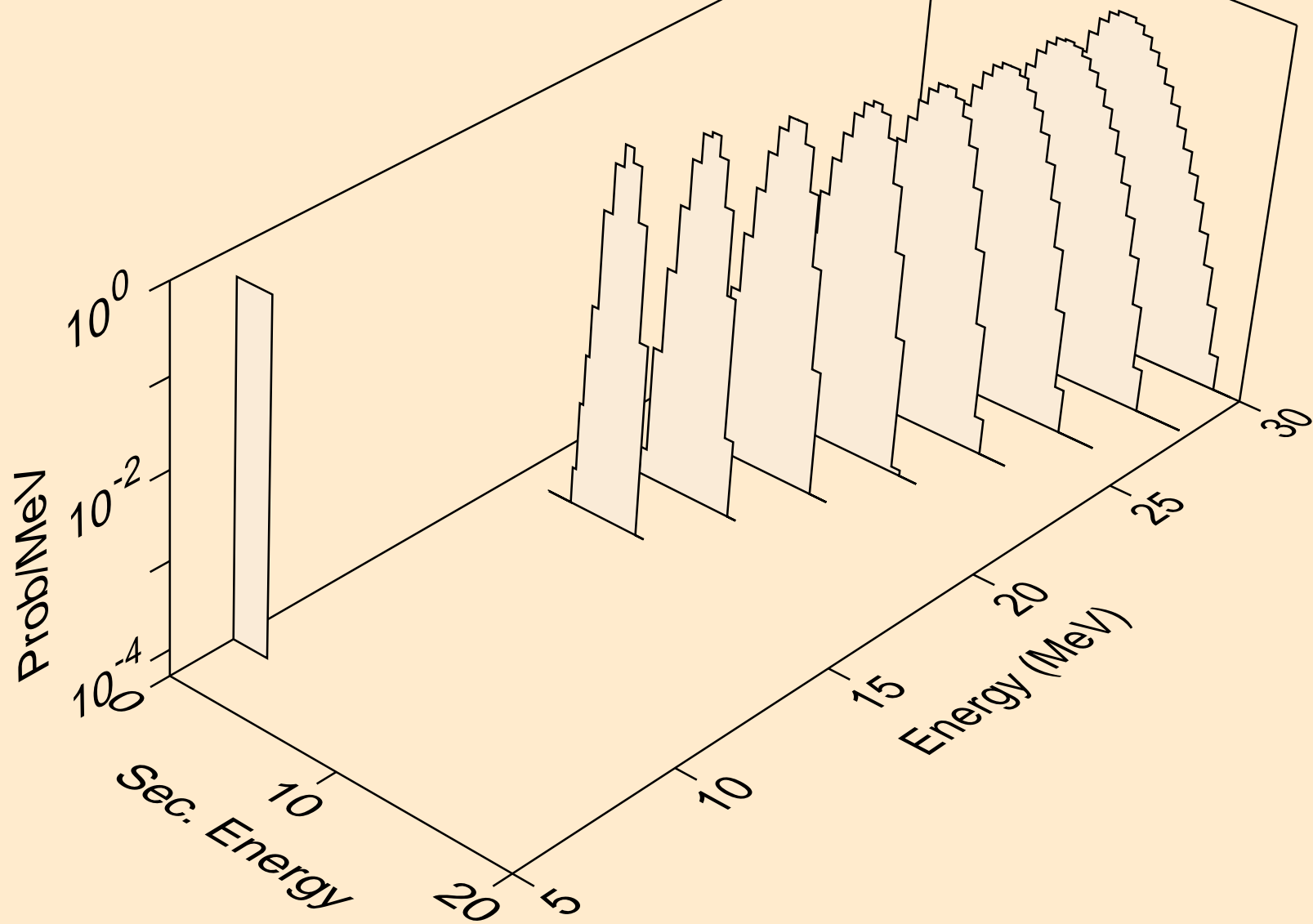

PA228 NEUTRON ACER TENDL-2023 LIBRARY; T=0.K  
he3s from (n,x)

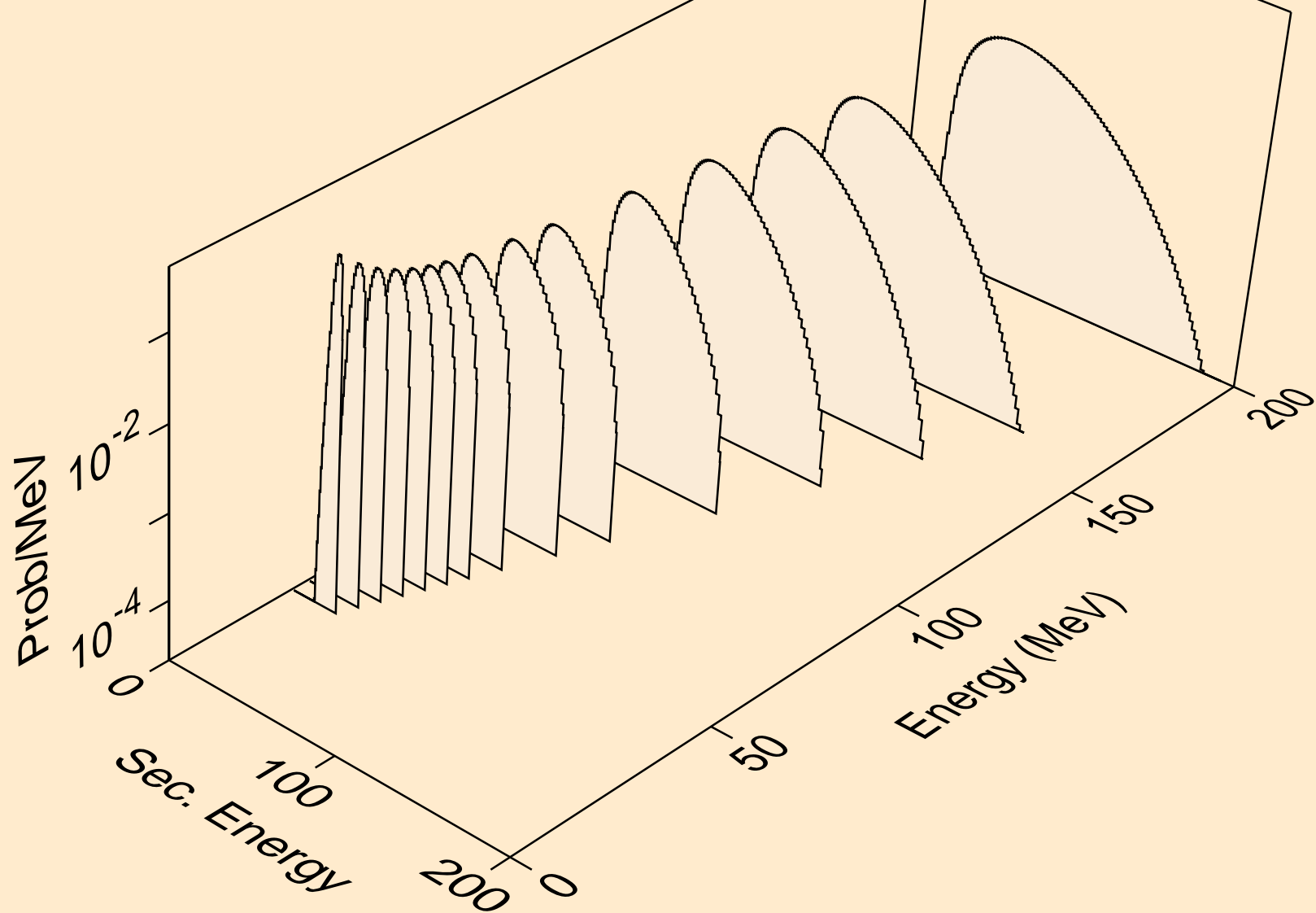

PA228 NEUTRON ACER TENDL-2023 LIBRARY; T=0.K  
he3s from (n,n\*)he3

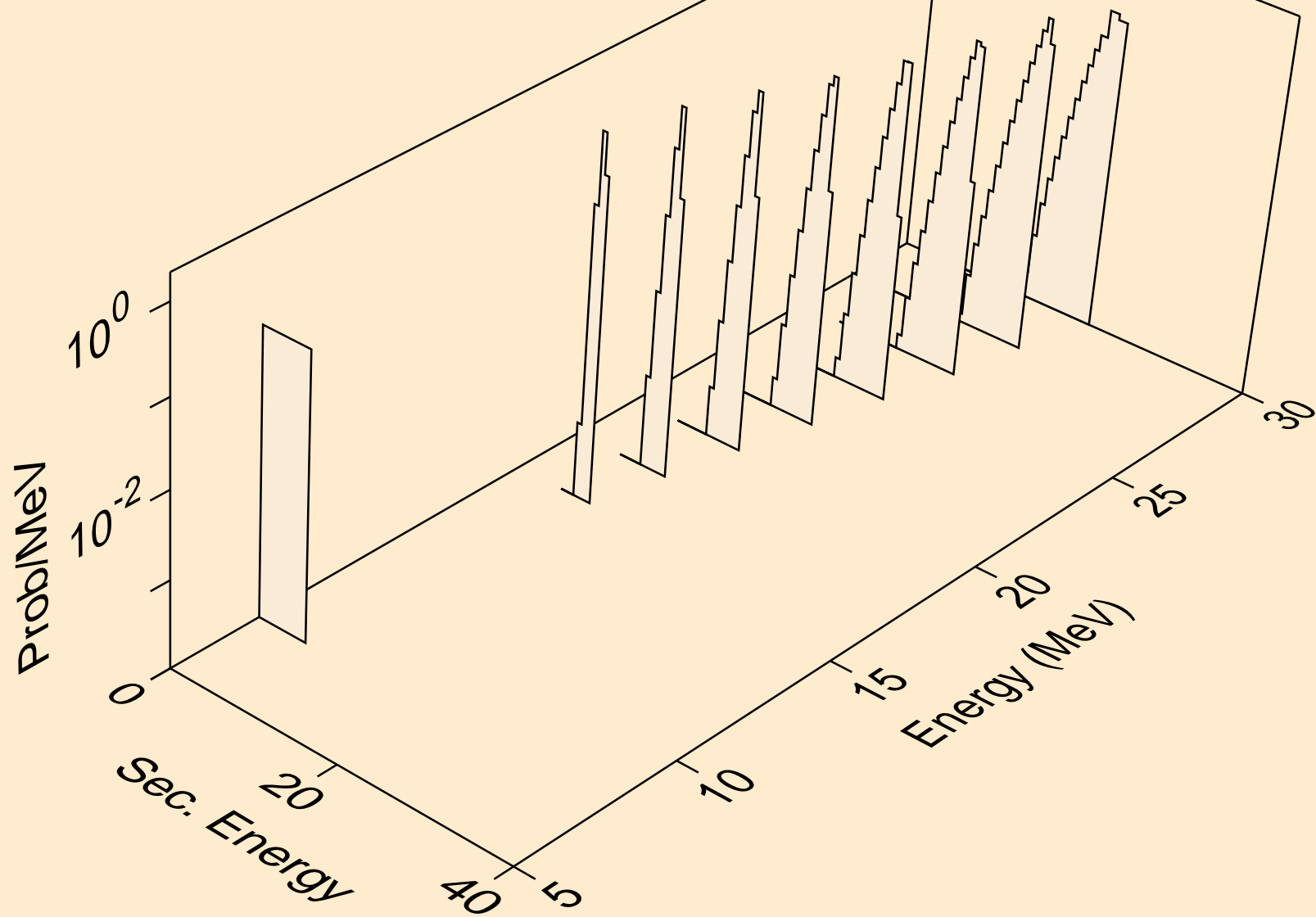

PA228 NEUTRON ACER TENDL-2023 LIBRARY; T=0.K  
he3s from (n,he3)

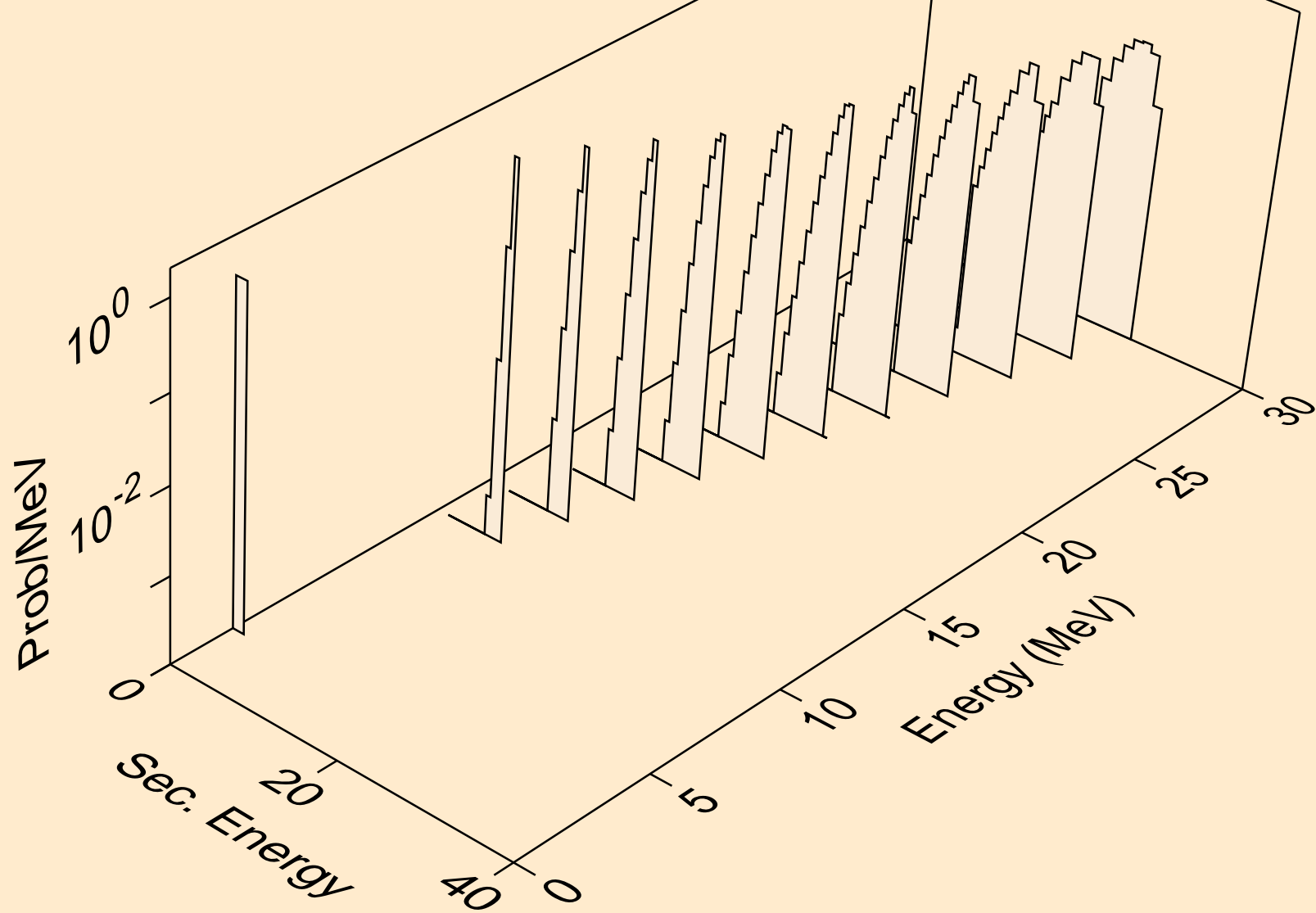

PA228 NEUTRON ACER TENDL-2023 LIBRARY; T=0.K  
alphas from (n,x)

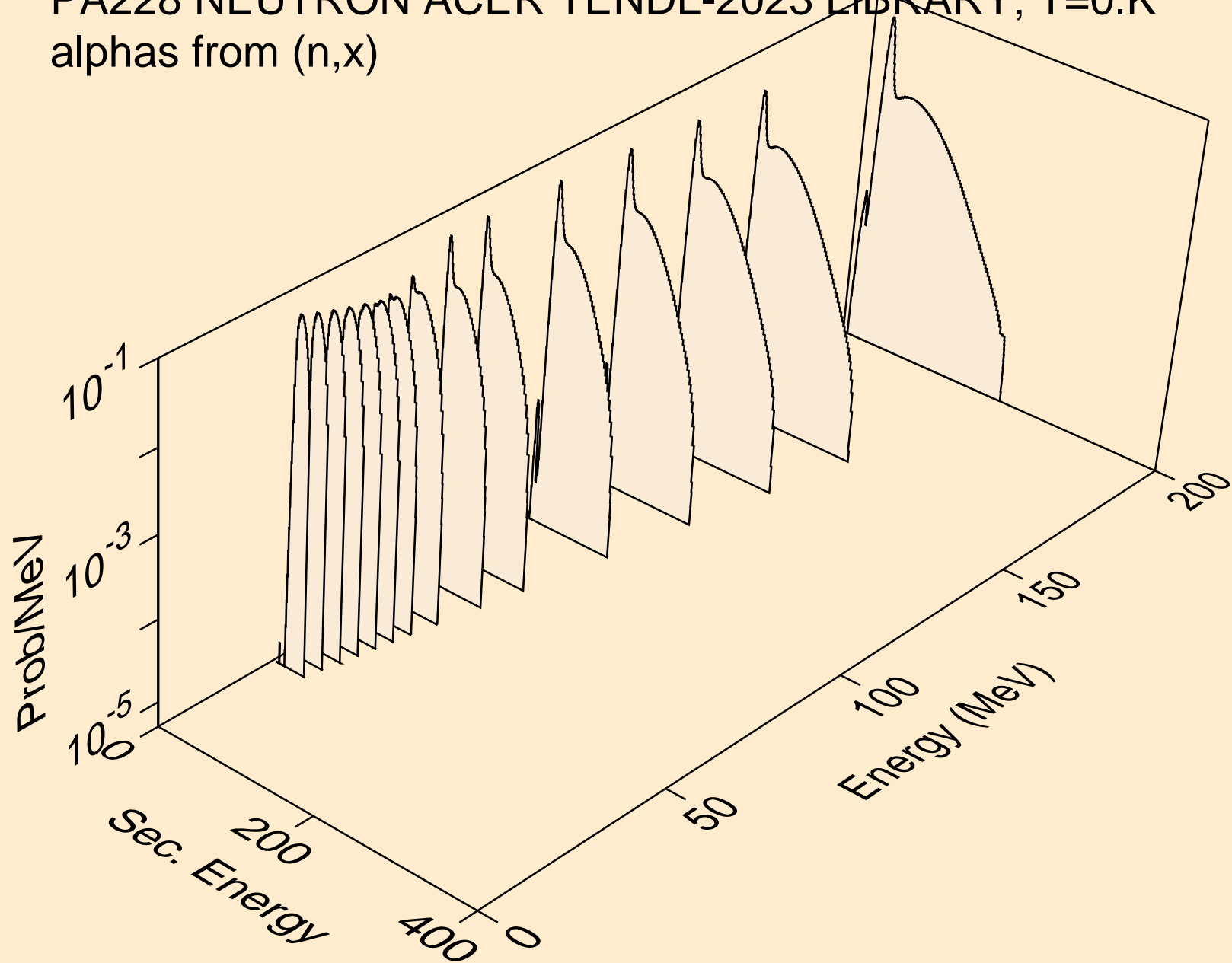

PA228 NEUTRON ACER TENDL-2023 LIBRARY; T=0.K  
alphas from (n,n\*)a

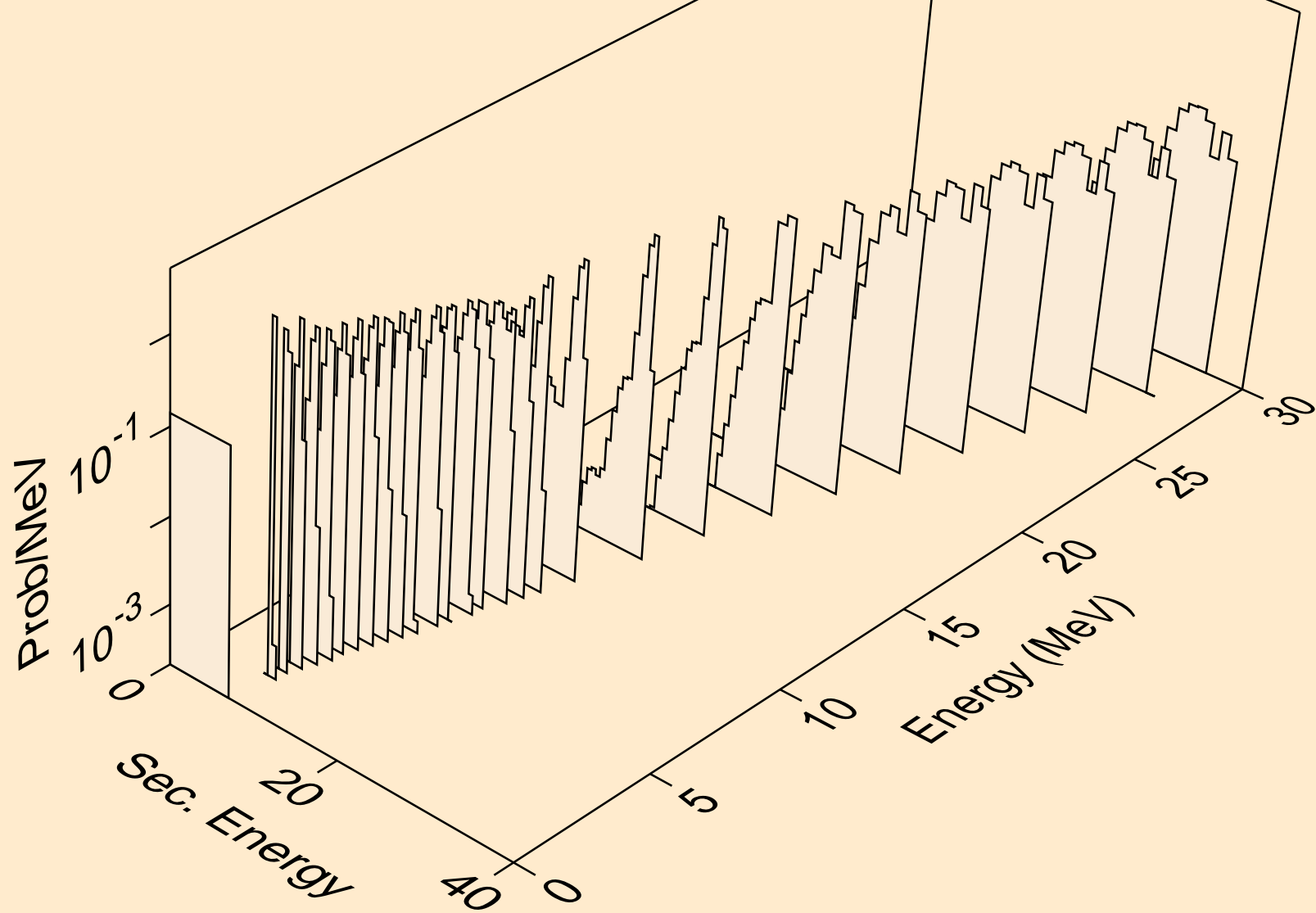

PA228 NEUTRON ACER TENDL-2023 LIBRARY; T=0.K  
alphas from (n,2n)a

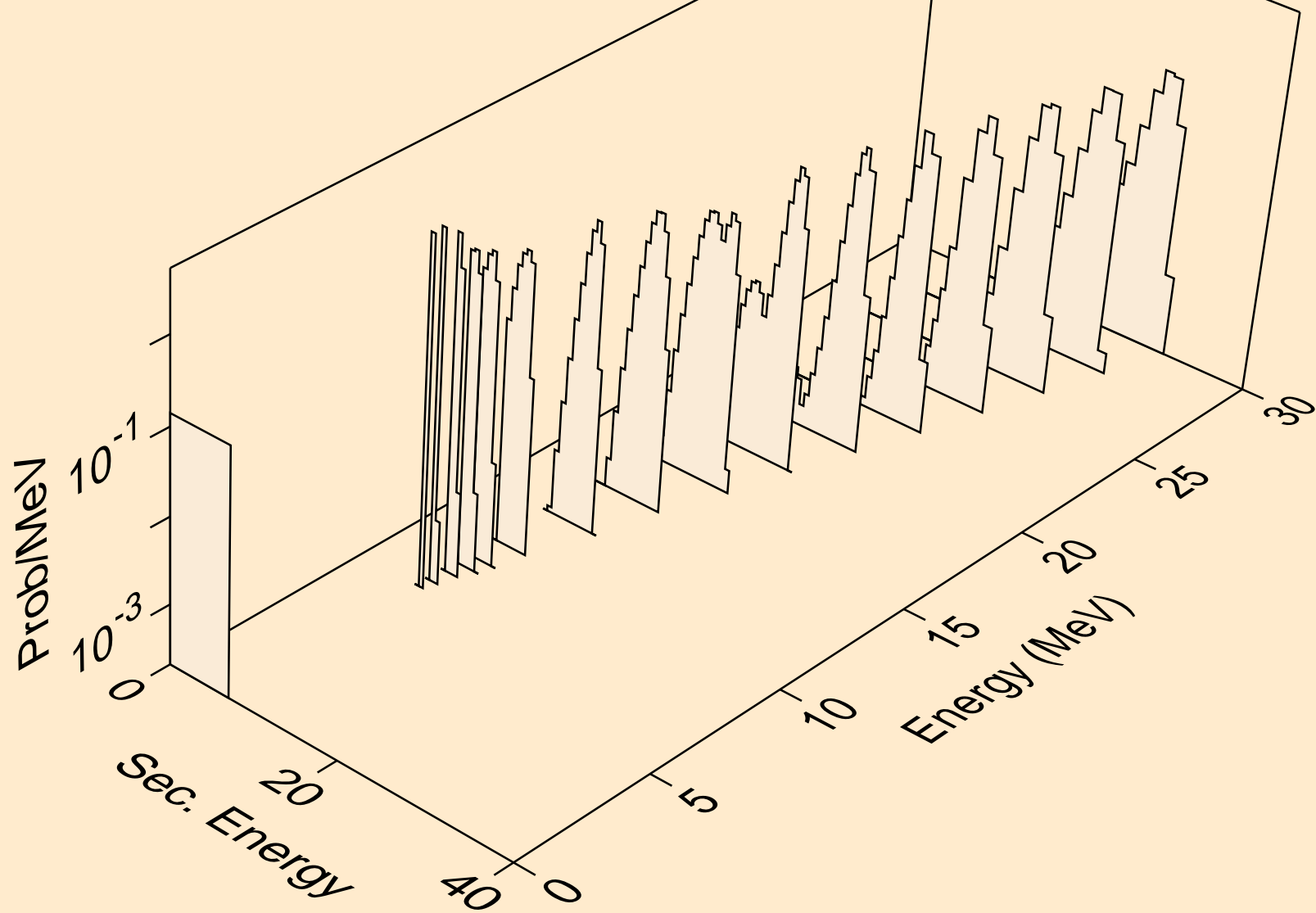

PA228 NEUTRON ACER TENDL-2023 LIBRARY; T=0.K  
alphas from (n,3n)a

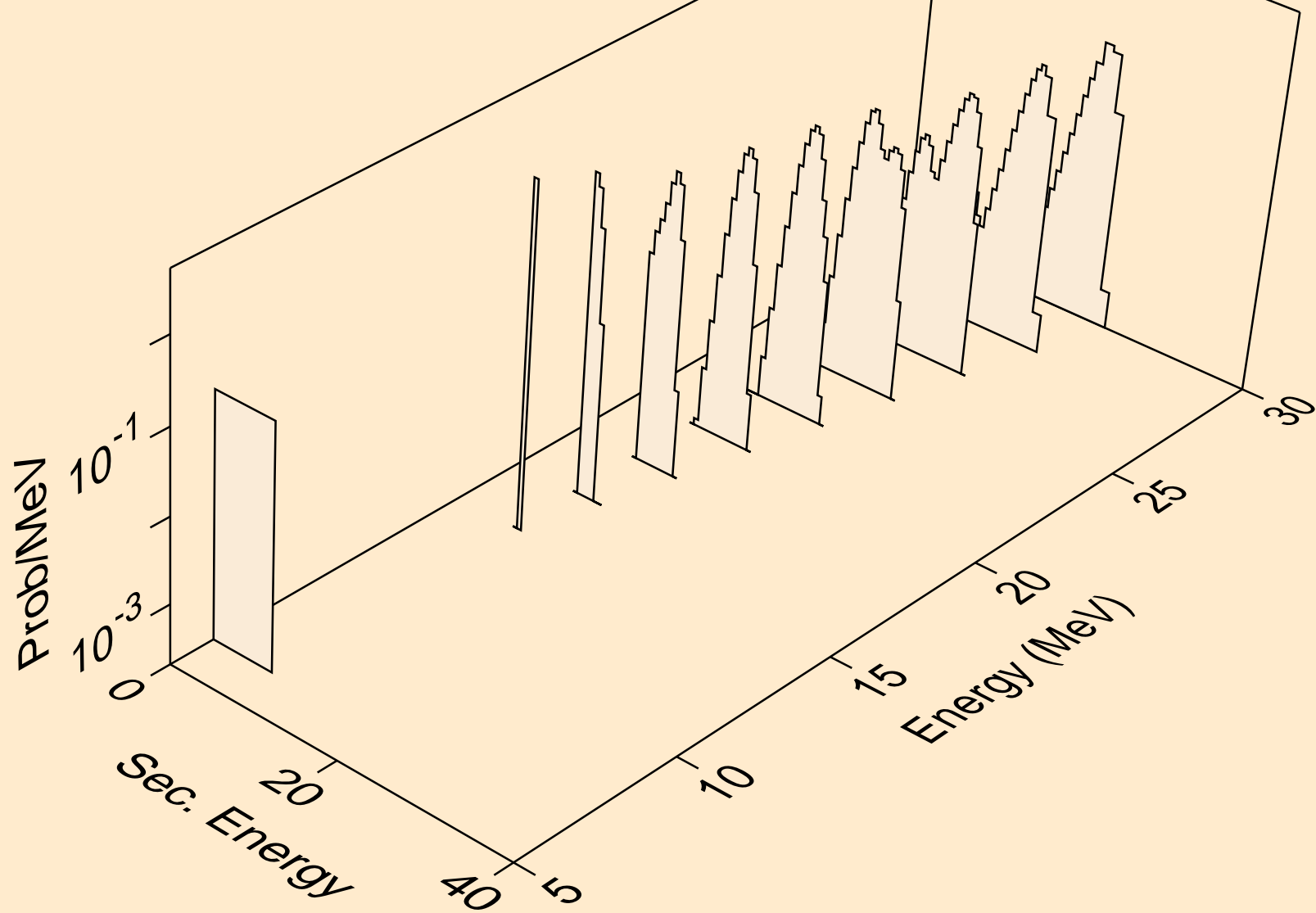



PA228 NEUTRON ACER TENDL-2023 LIBRARY; T=0.K  
alphas from (n,n\*)2a

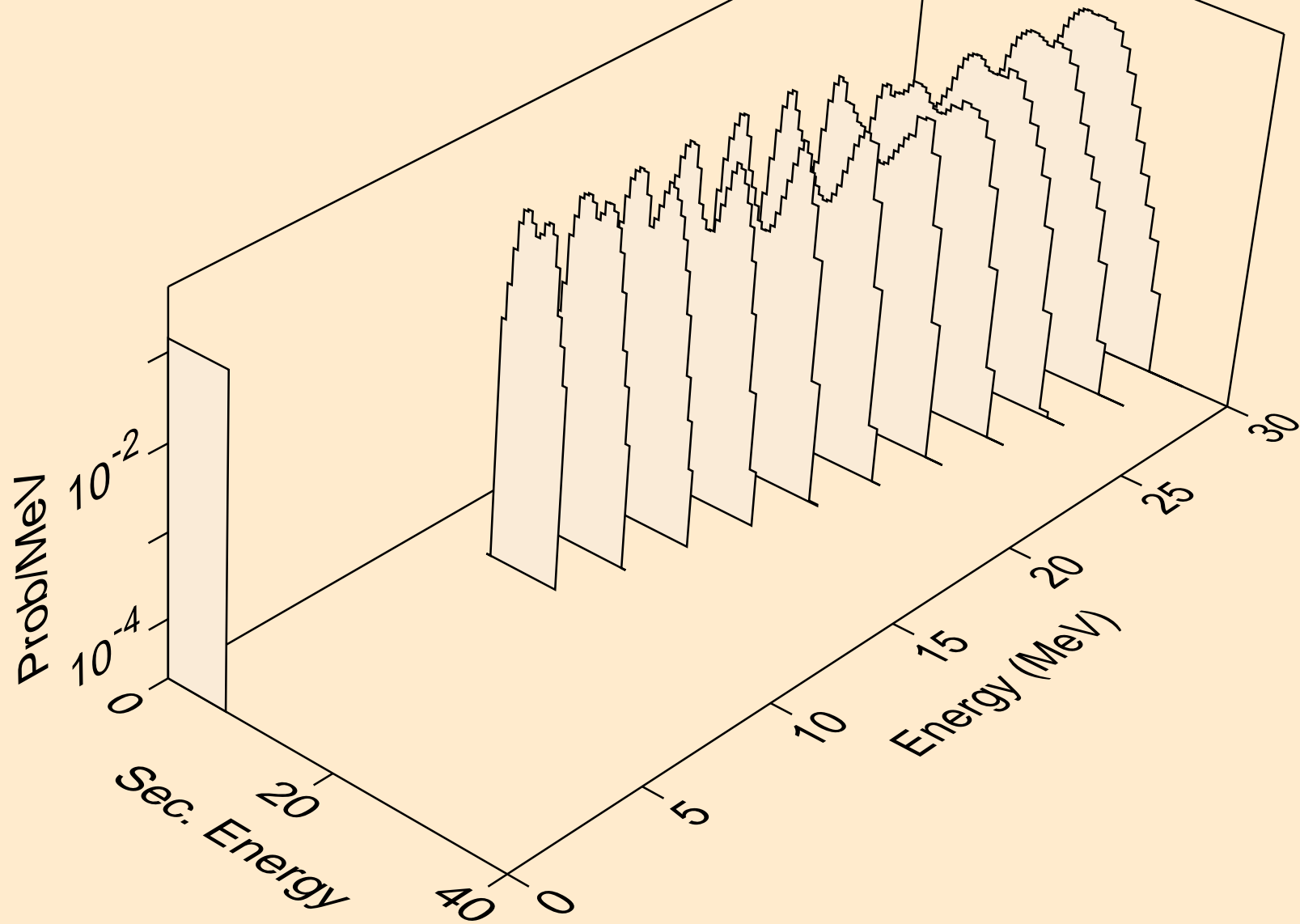

PA228 NEUTRON ACER TENDL-2023 LIBRARY; T=0.K  
alphas from (n,npa)

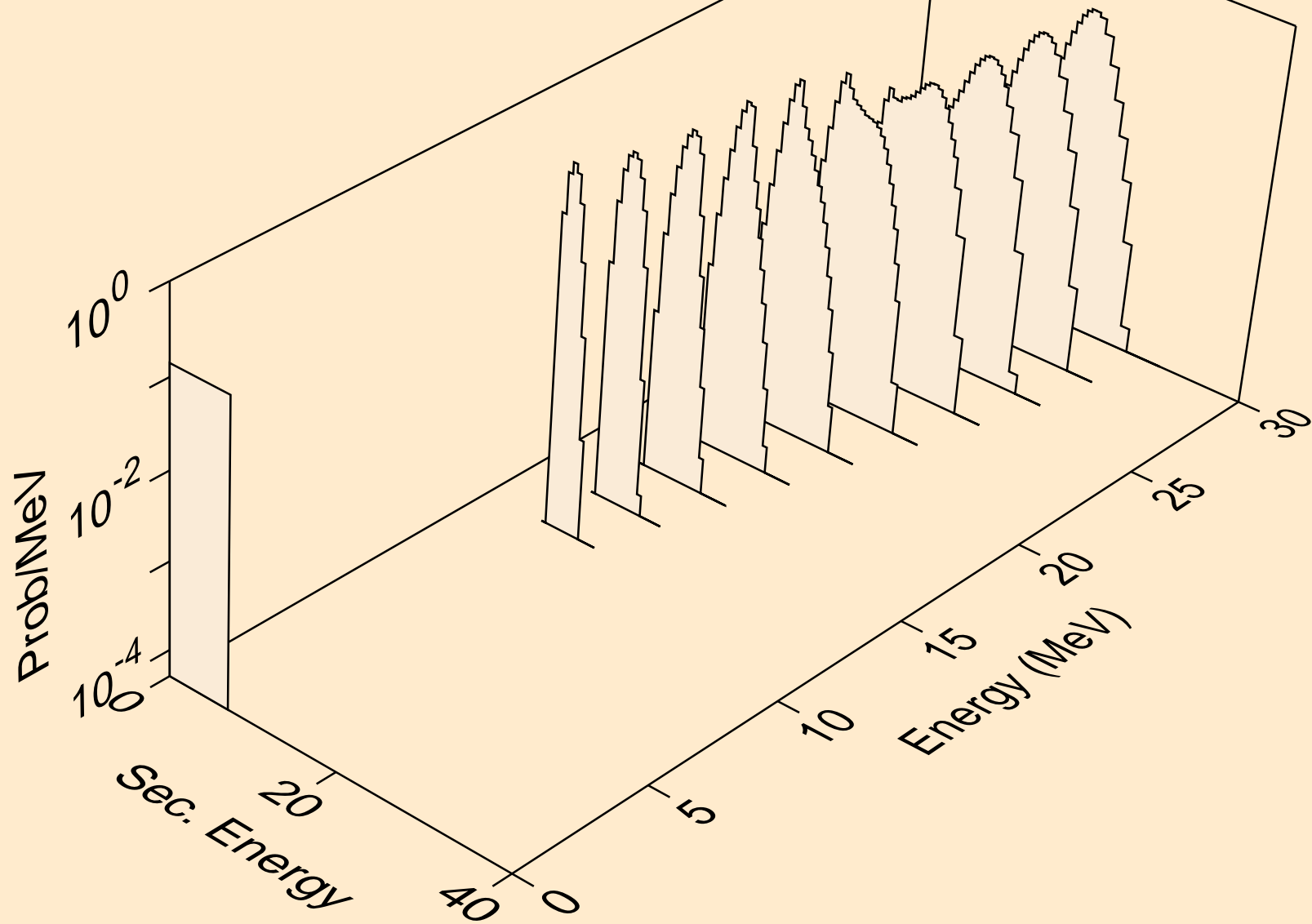

PA228 NEUTRON ACER TENDL-2023 LIBRARY; T=0.K  
alphas from (n,a)

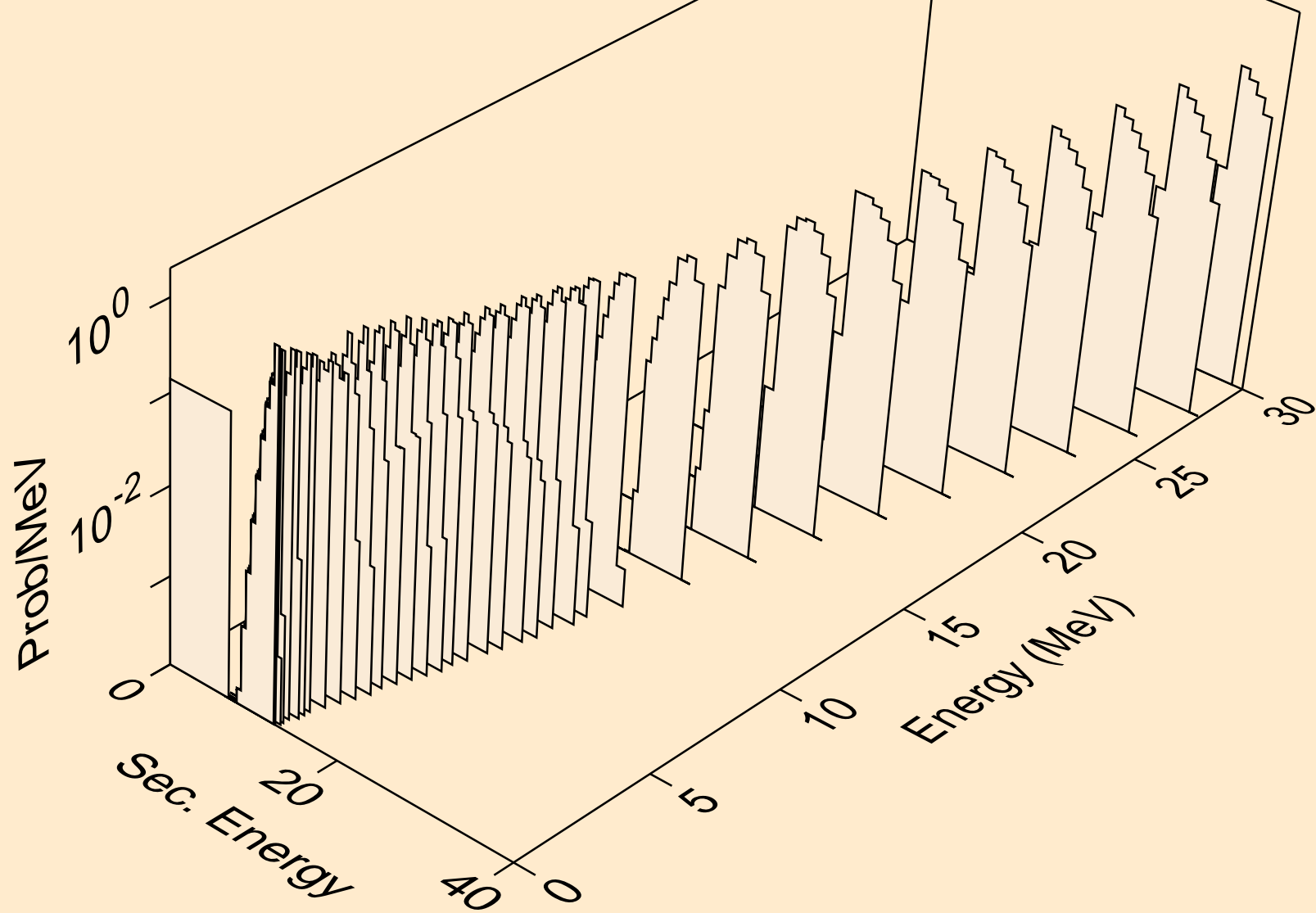

PA228 NEUTRON ACER TENDL-2023 LIBRARY; T=0.K  
alphas from (n,2a)

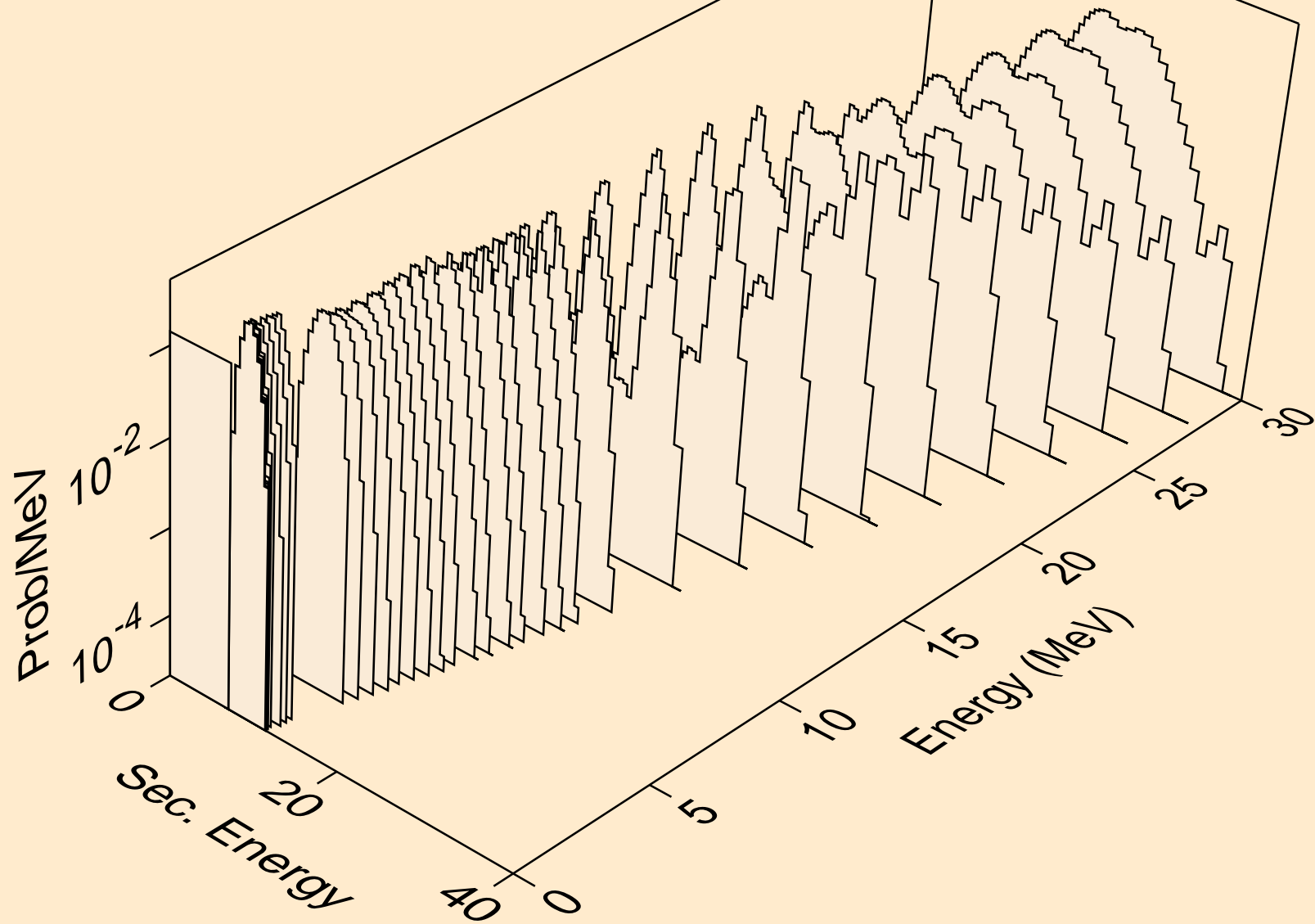

PA228 NEUTRON ACER TENDL-2023 LIBRARY; T=0.K  
alphas from (n,pa)

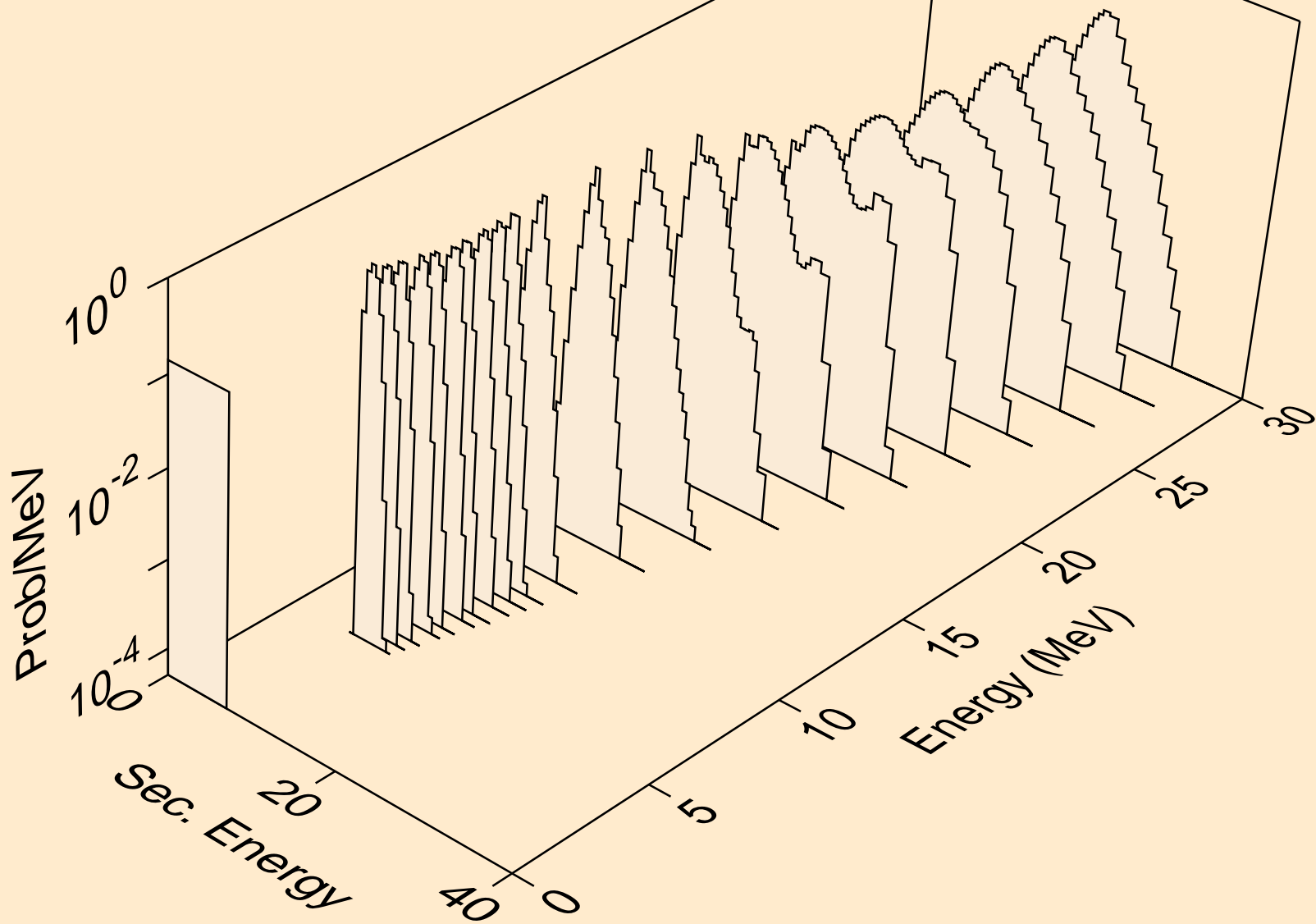

PA228 NEUTRON ACER TENDL-2023 LIBRARY; T=0.K  
alphas from (n,da)

