

PD092 NEUTRON ACER TENDL-2023 LIBRARY; T=0.K
Principal cross sections

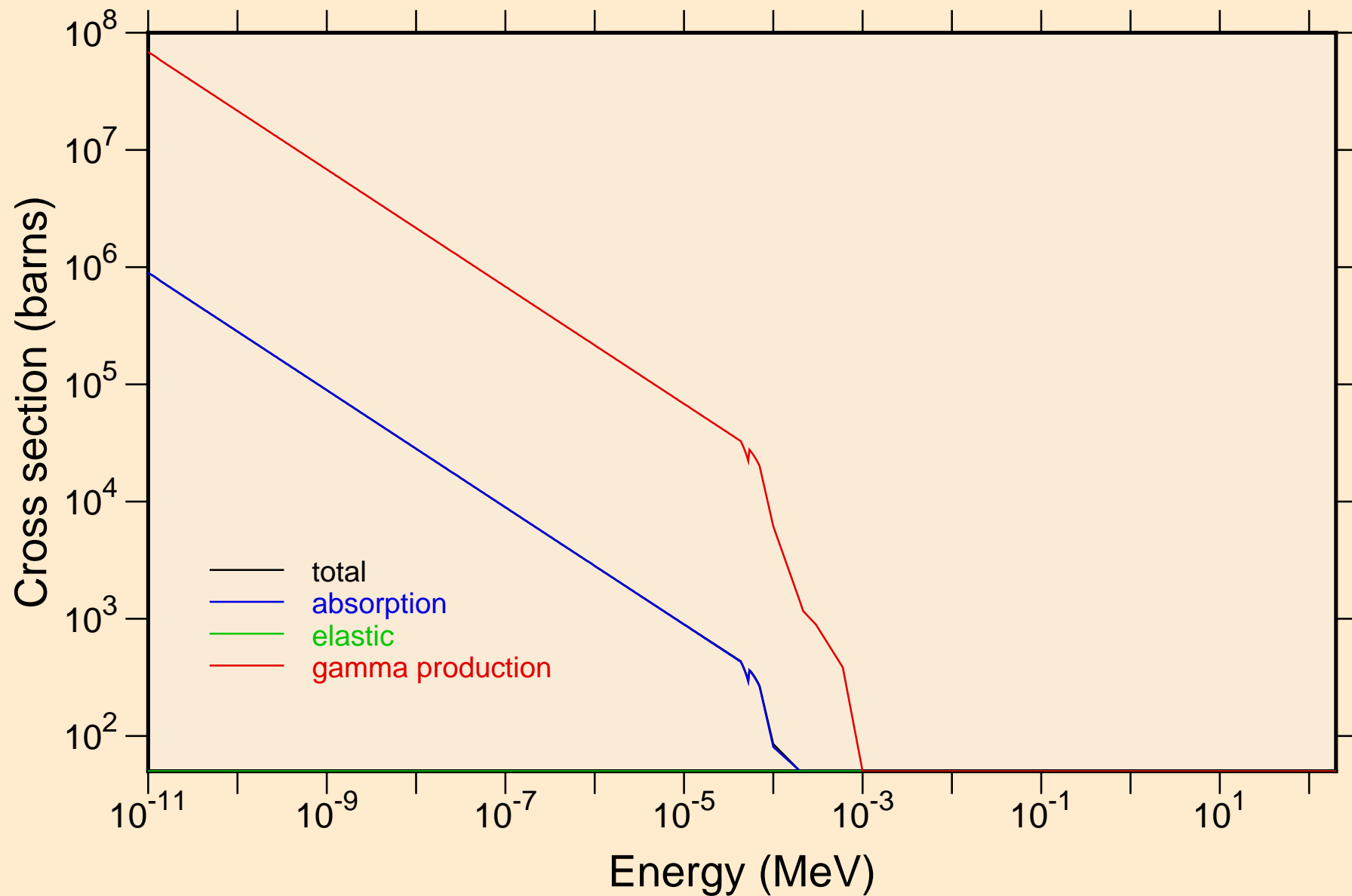

PD092 NEUTRON ACER TENDL-2023 LIBRARY; T=0.K
Heating

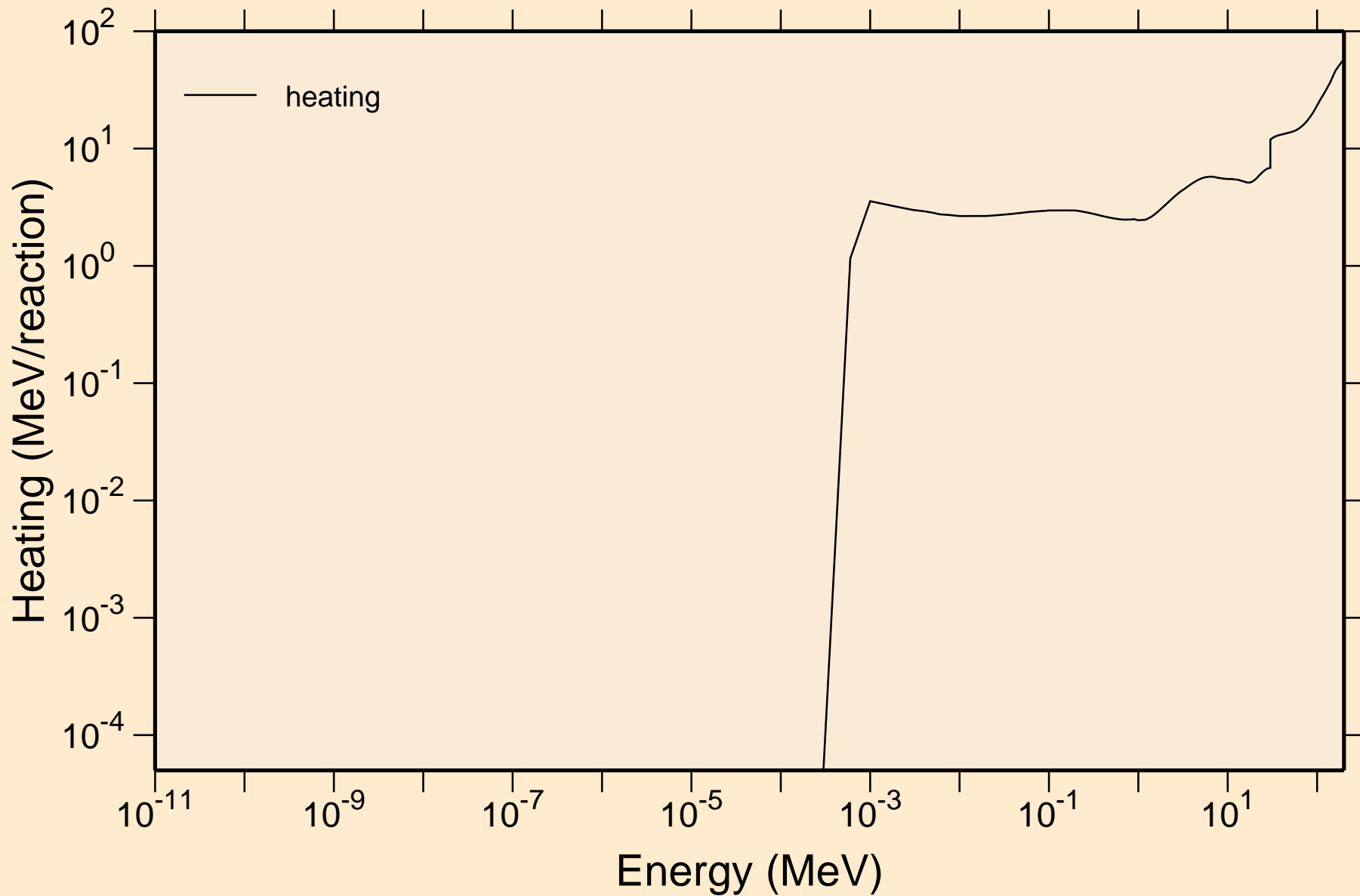

PD092 NEUTRON ACER TENDL-2023 LIBRARY; T=0.K
Damage

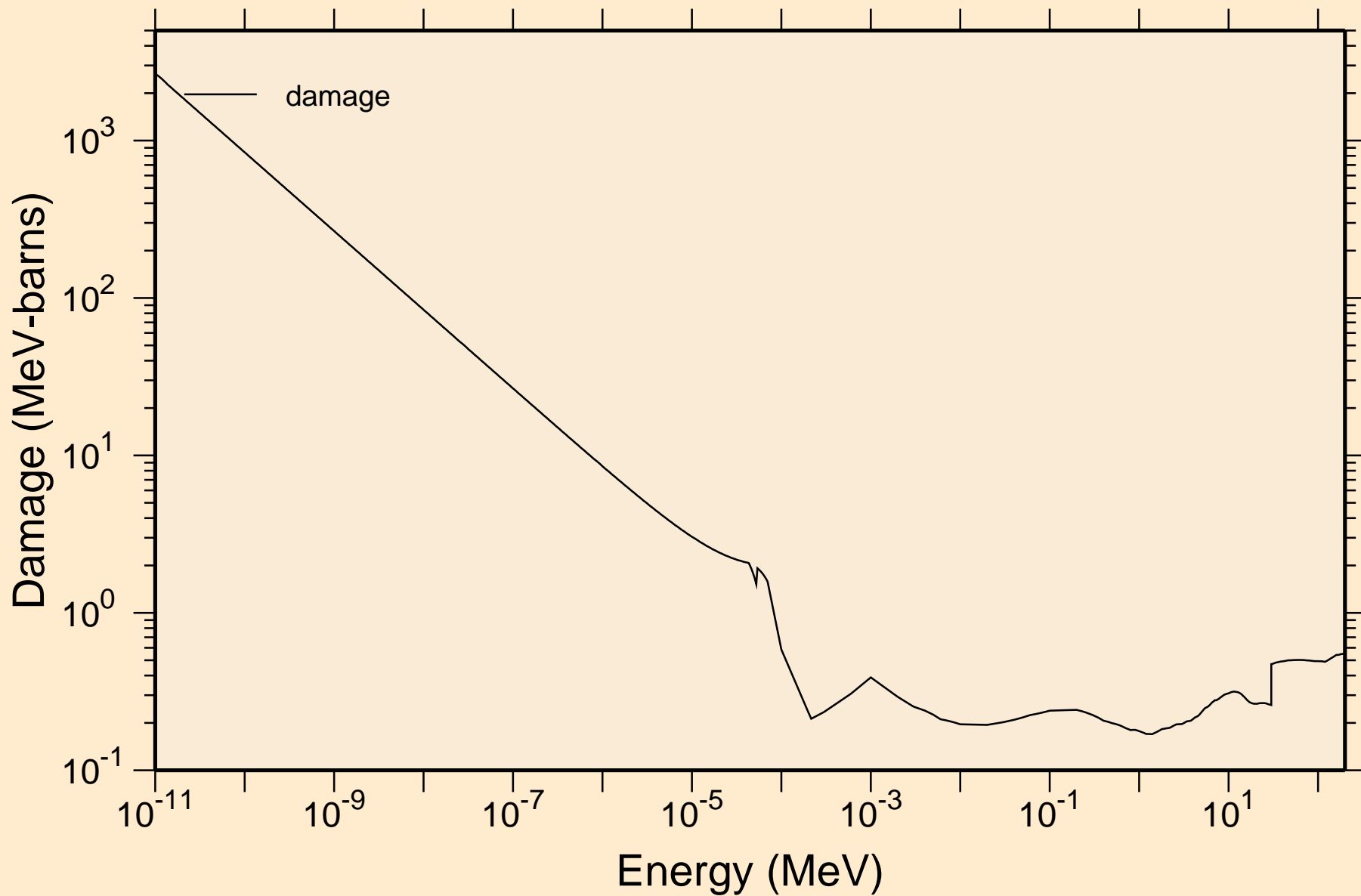

PD092 NEUTRON ACER TENDL-2023 LIBRARY; T=0.K
Non-threshold reactions

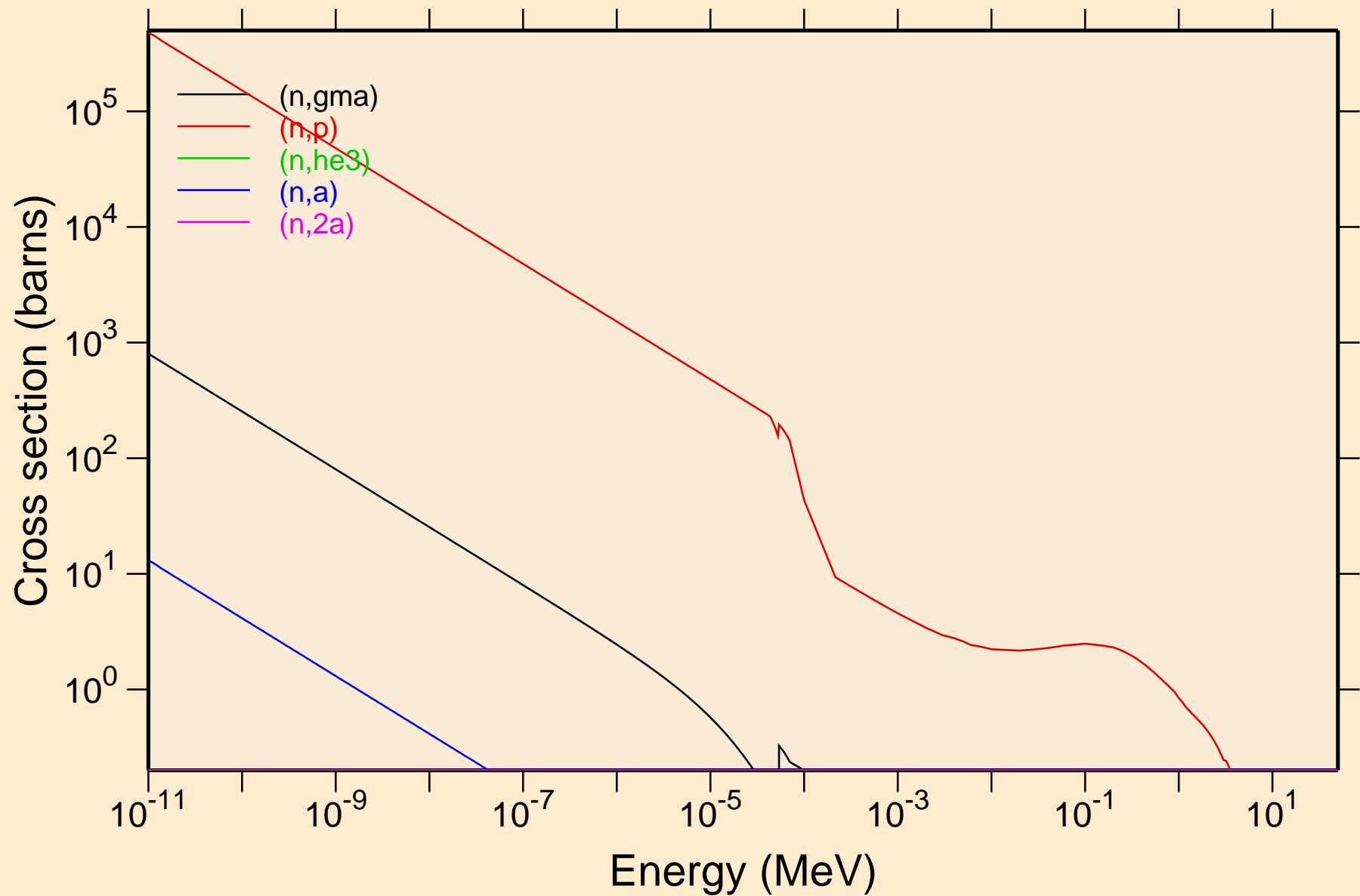

PD092 NEUTRON ACER TENDL-2023 LIBRARY; T=0.K
Non-threshold reactions

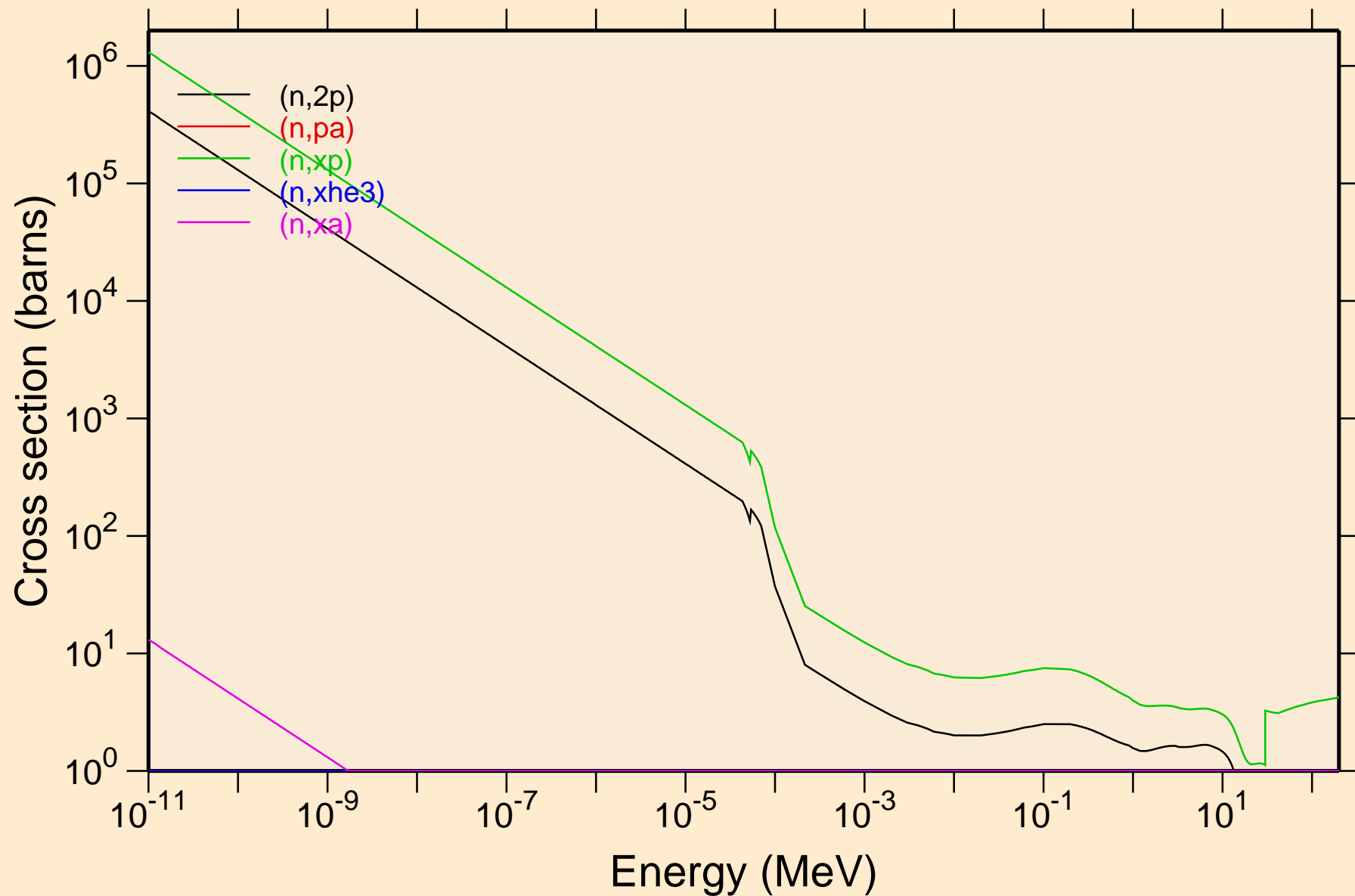

PD092 NEUTRON ACER TENDL-2023 LIBRARY; T=0.K
Principal cross sections

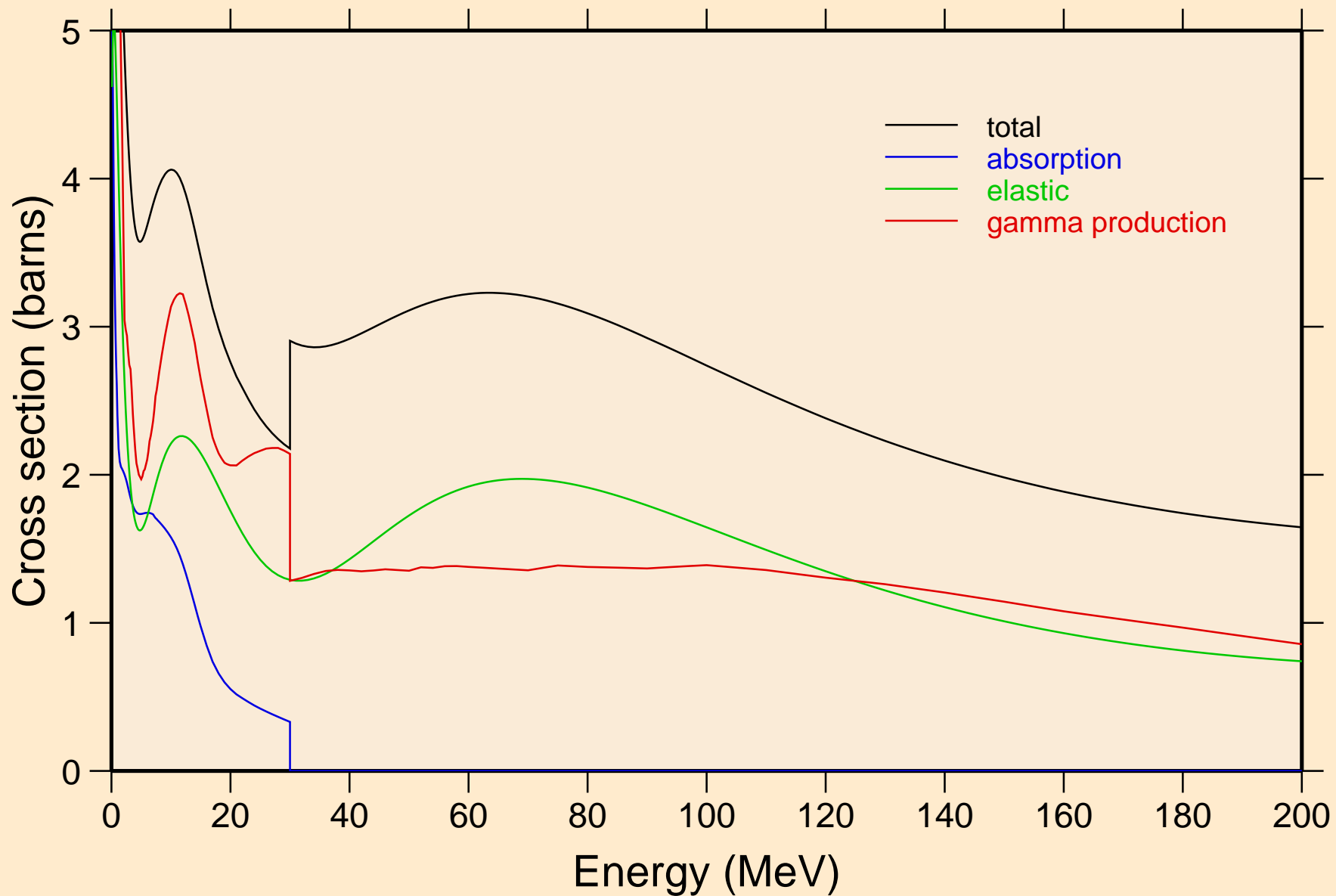

PD092 NEUTRON ACER TENDL-2023 LIBRARY; T=0.K
Heating

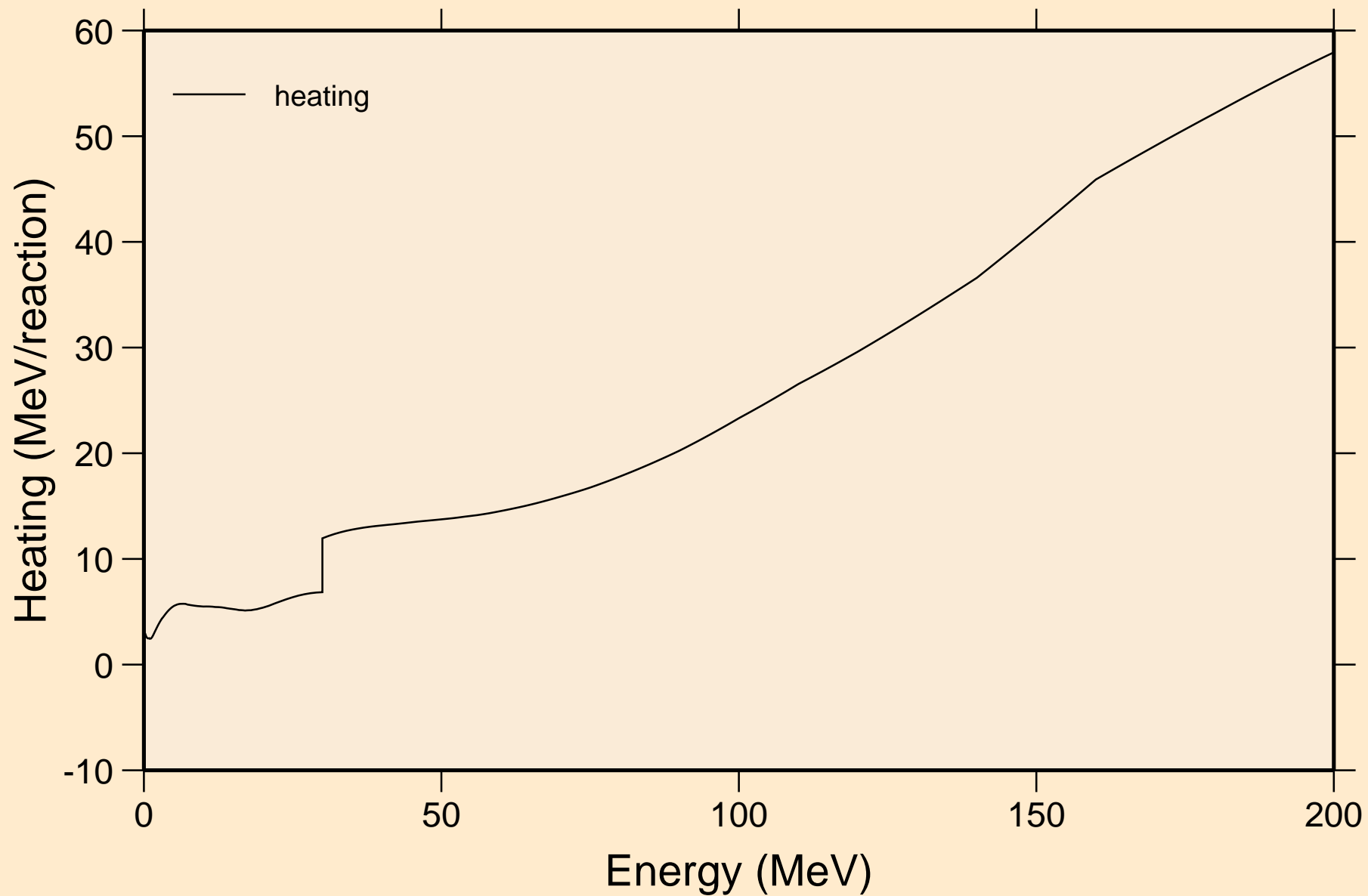

PD092 NEUTRON ACER TENDL-2023 LIBRARY; T=0.K
Damage

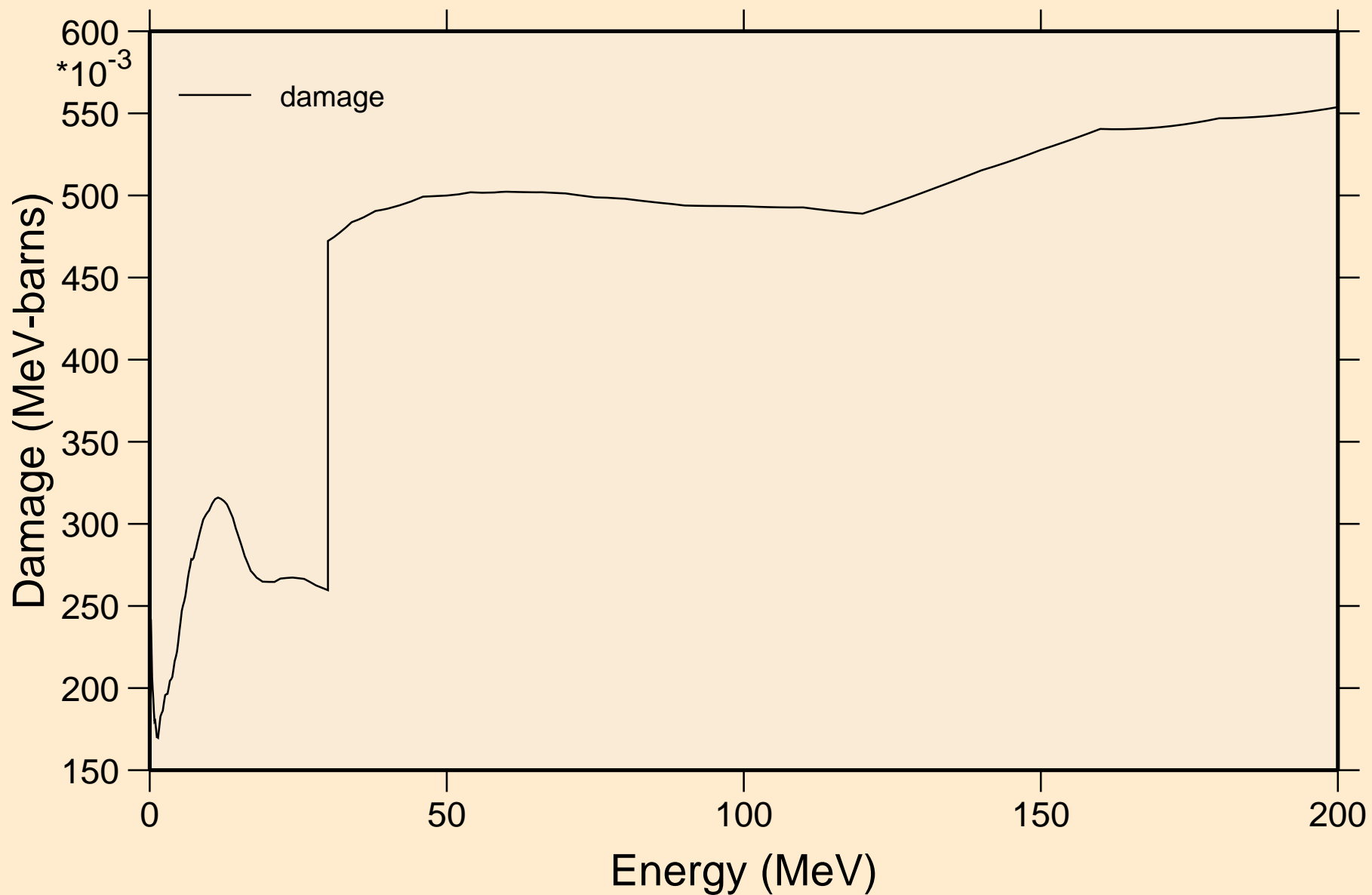

PD092 NEUTRON ACER TENDL-2023 LIBRARY; T=0.K
Non-threshold reactions

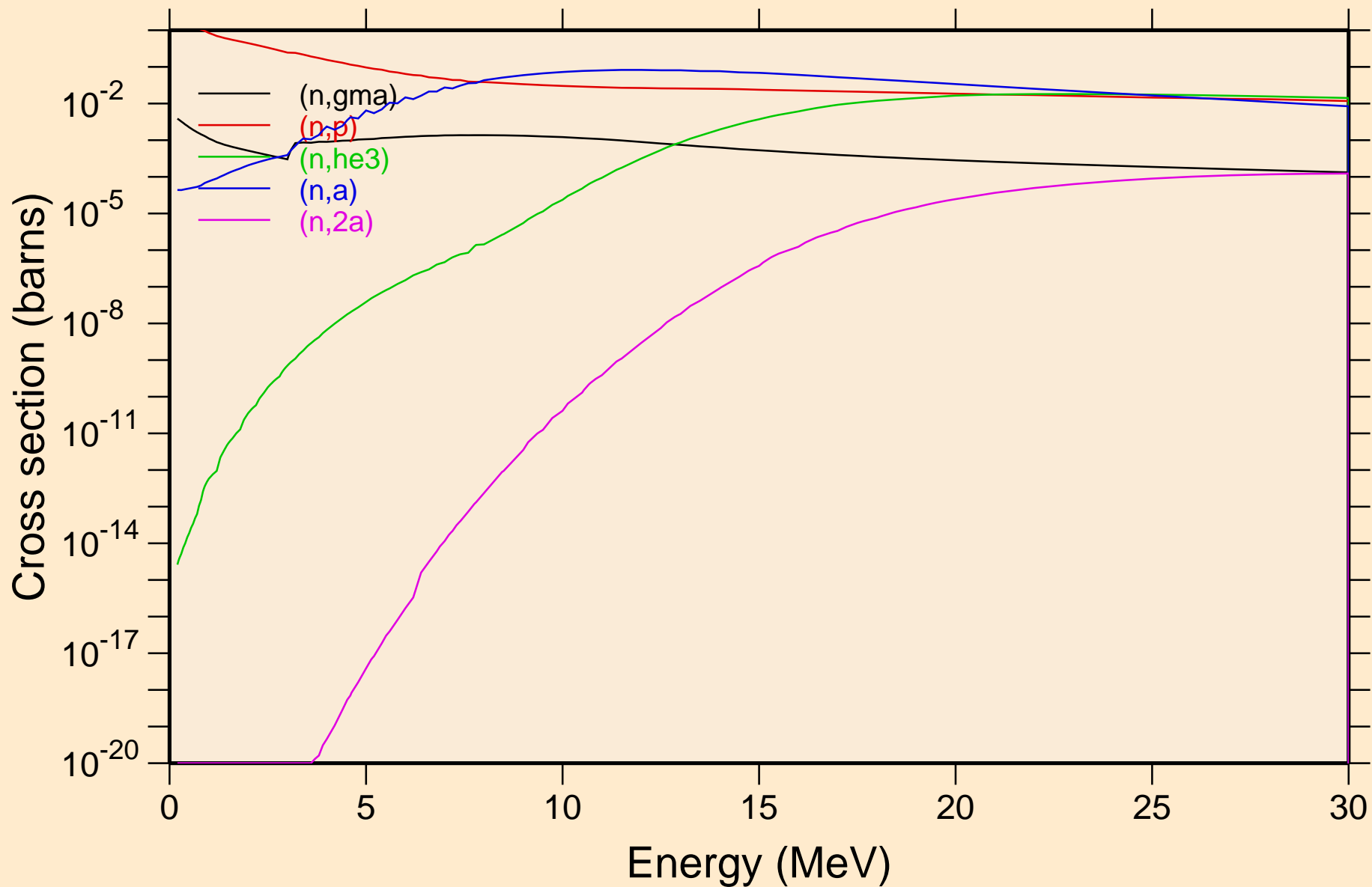

PD092 NEUTRON ACER TENDL-2023 LIBRARY; T=0.K
Non-threshold reactions

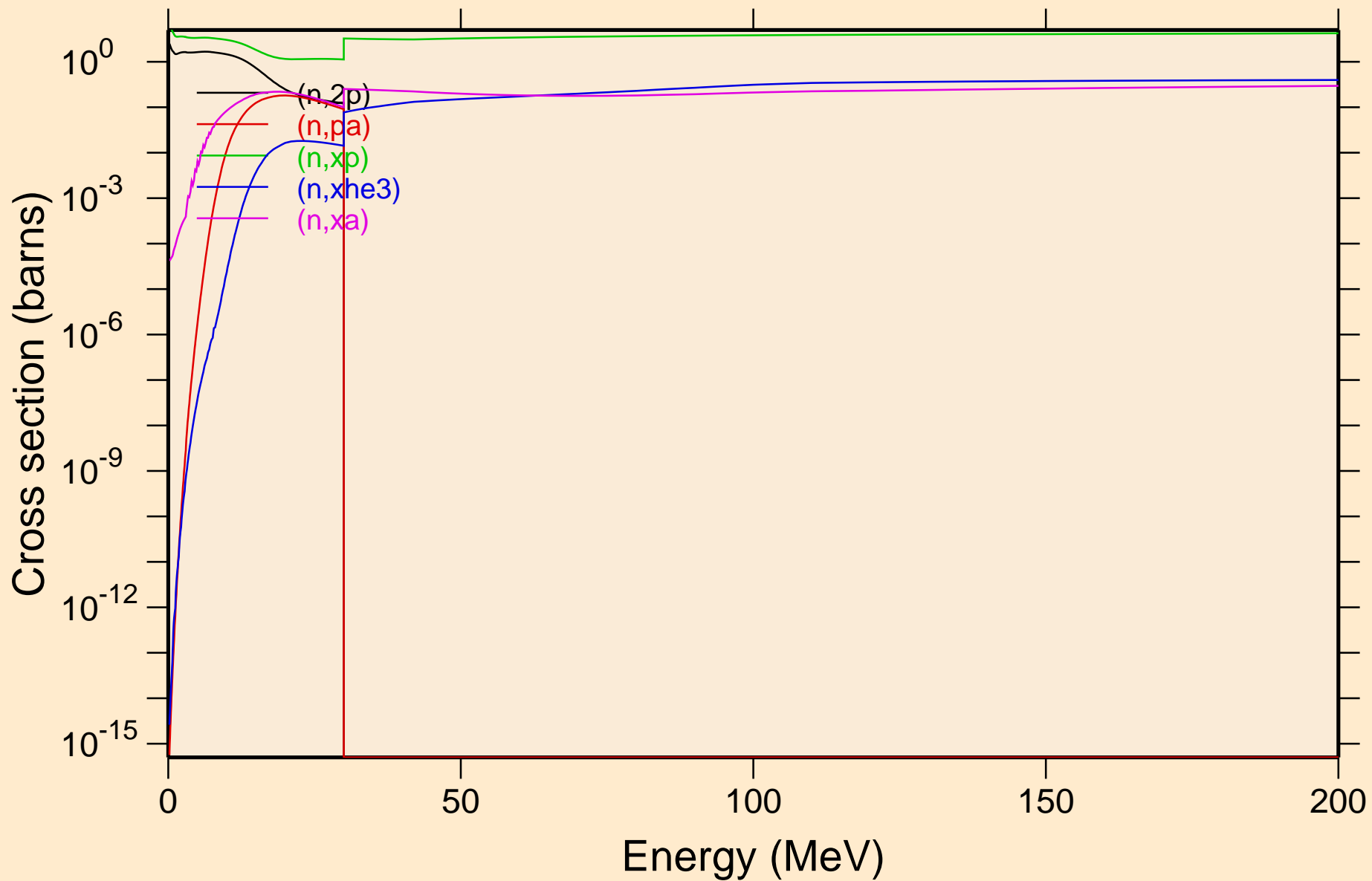

PD092 NEUTRON ACER TENDL-2023 LIBRARY; T=0.K
Inelastic levels

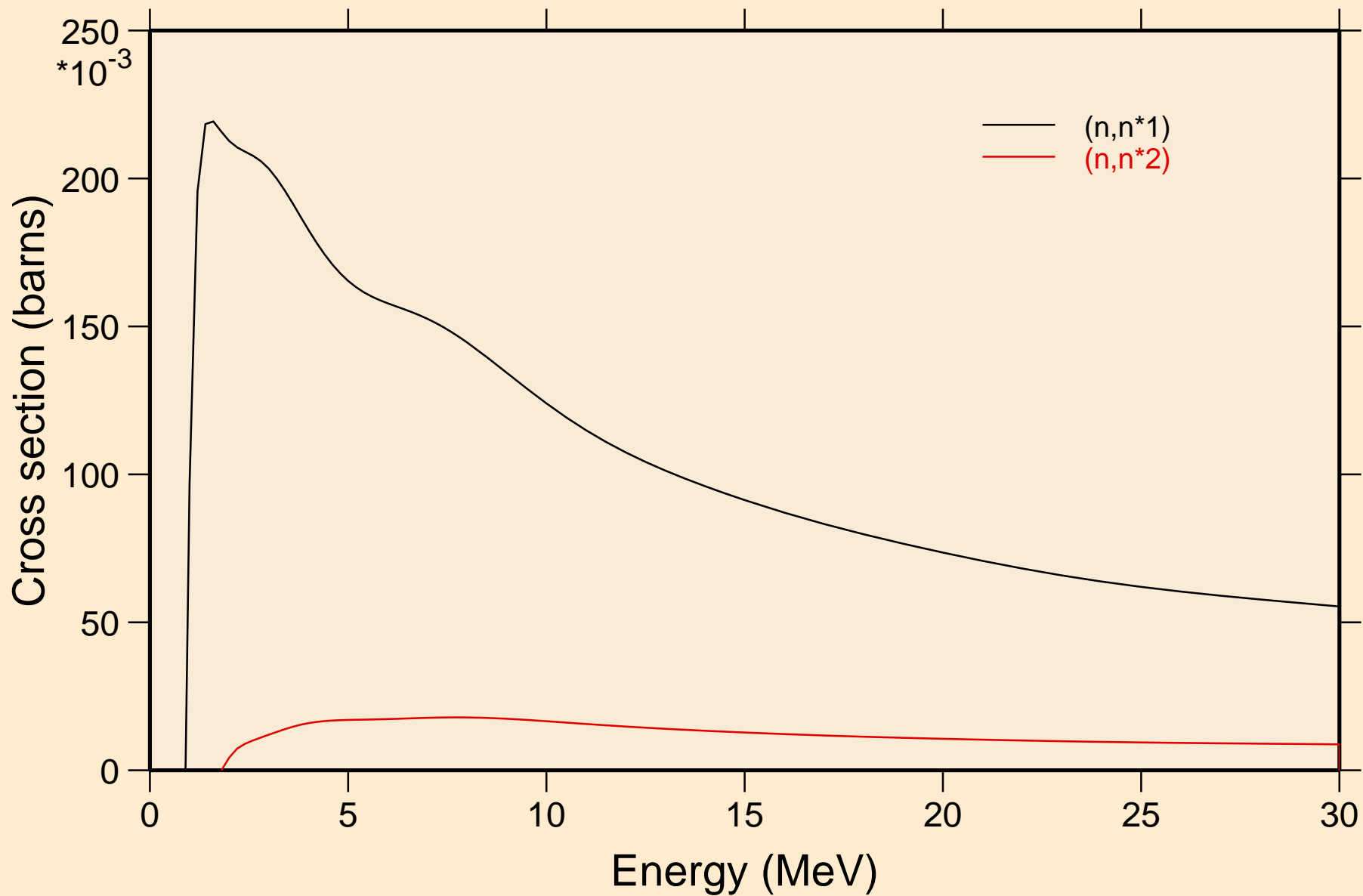

PD092 NEUTRON ACER TENDL-2023 LIBRARY; T=0.K
Threshold reactions

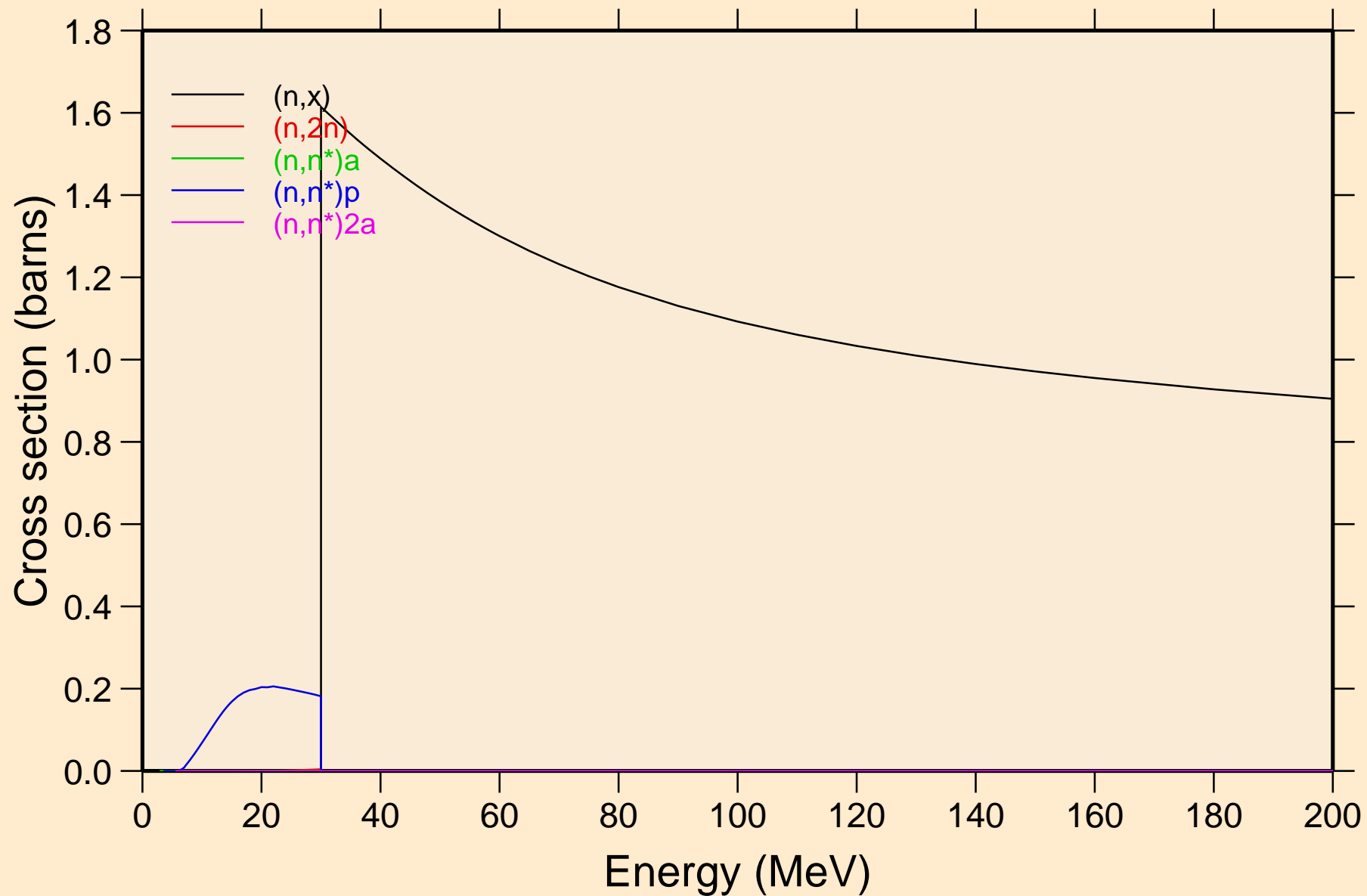

PD092 NEUTRON ACER TENDL-2023 LIBRARY; T=0.K
Threshold reactions

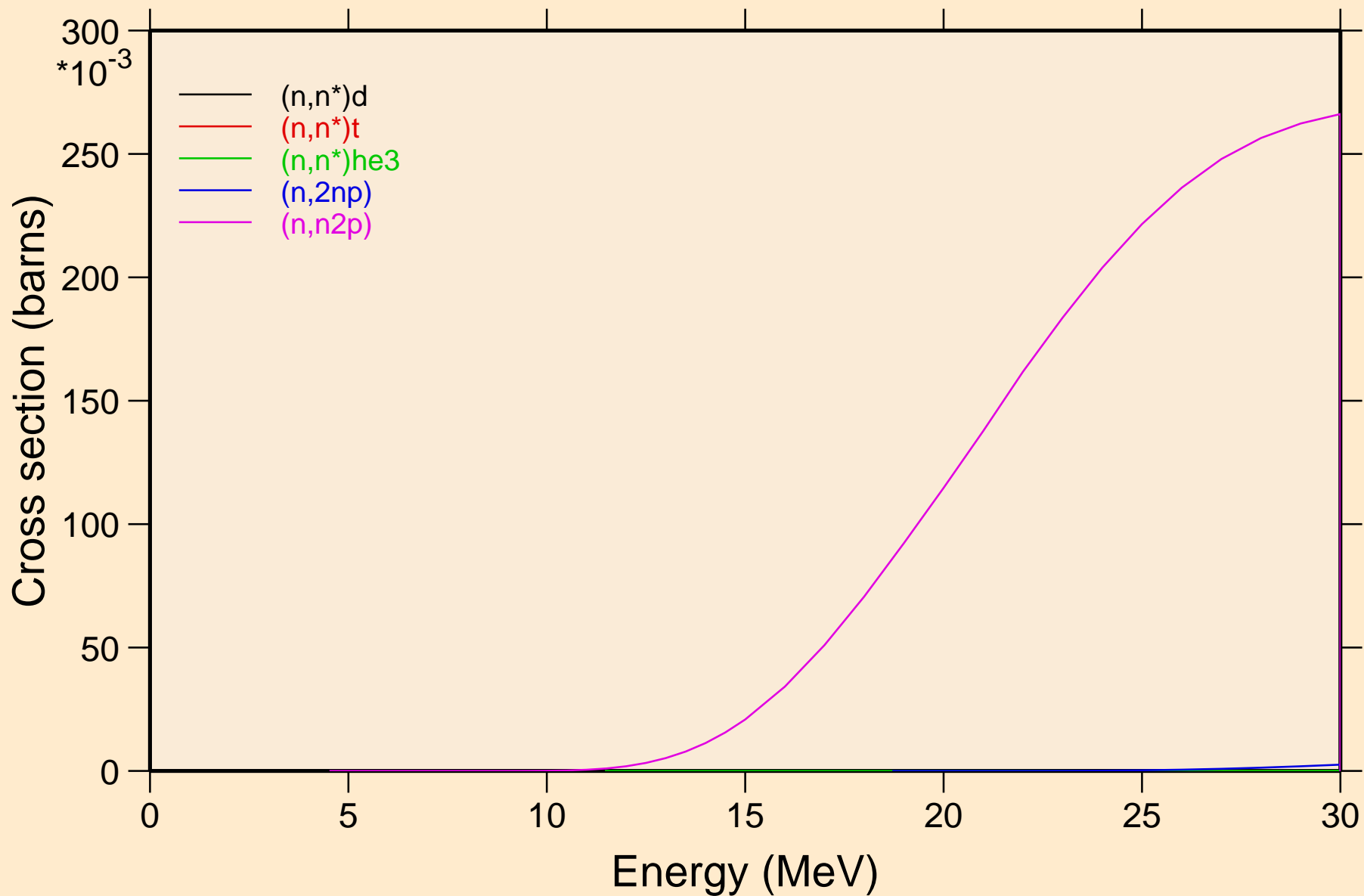

PD092 NEUTRON ACER TENDL-2023 LIBRARY; T=0.K
Threshold reactions

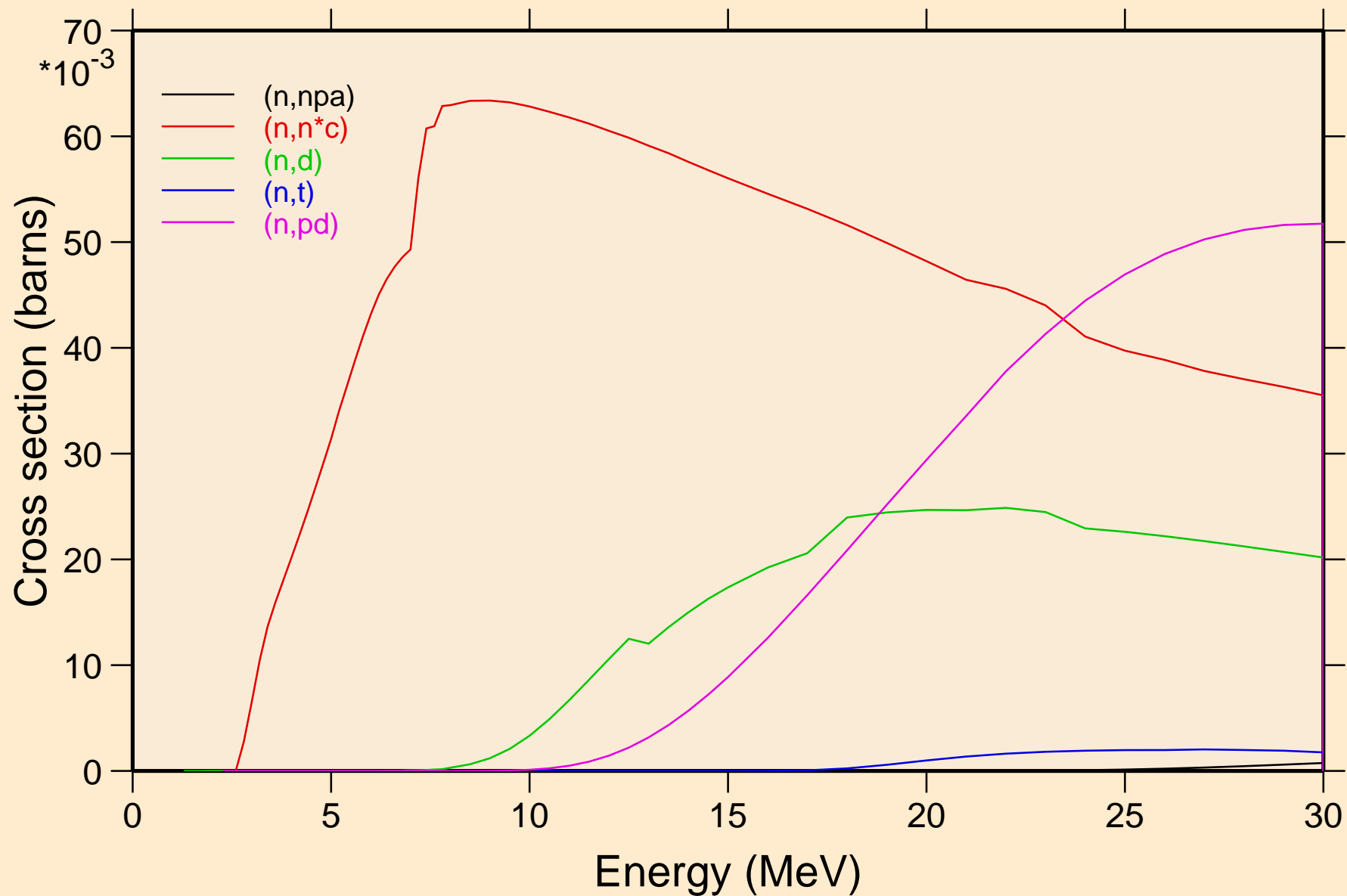

PD092 NEUTRON ACER TENDL-2023 LIBRARY; T=0.K
Threshold reactions

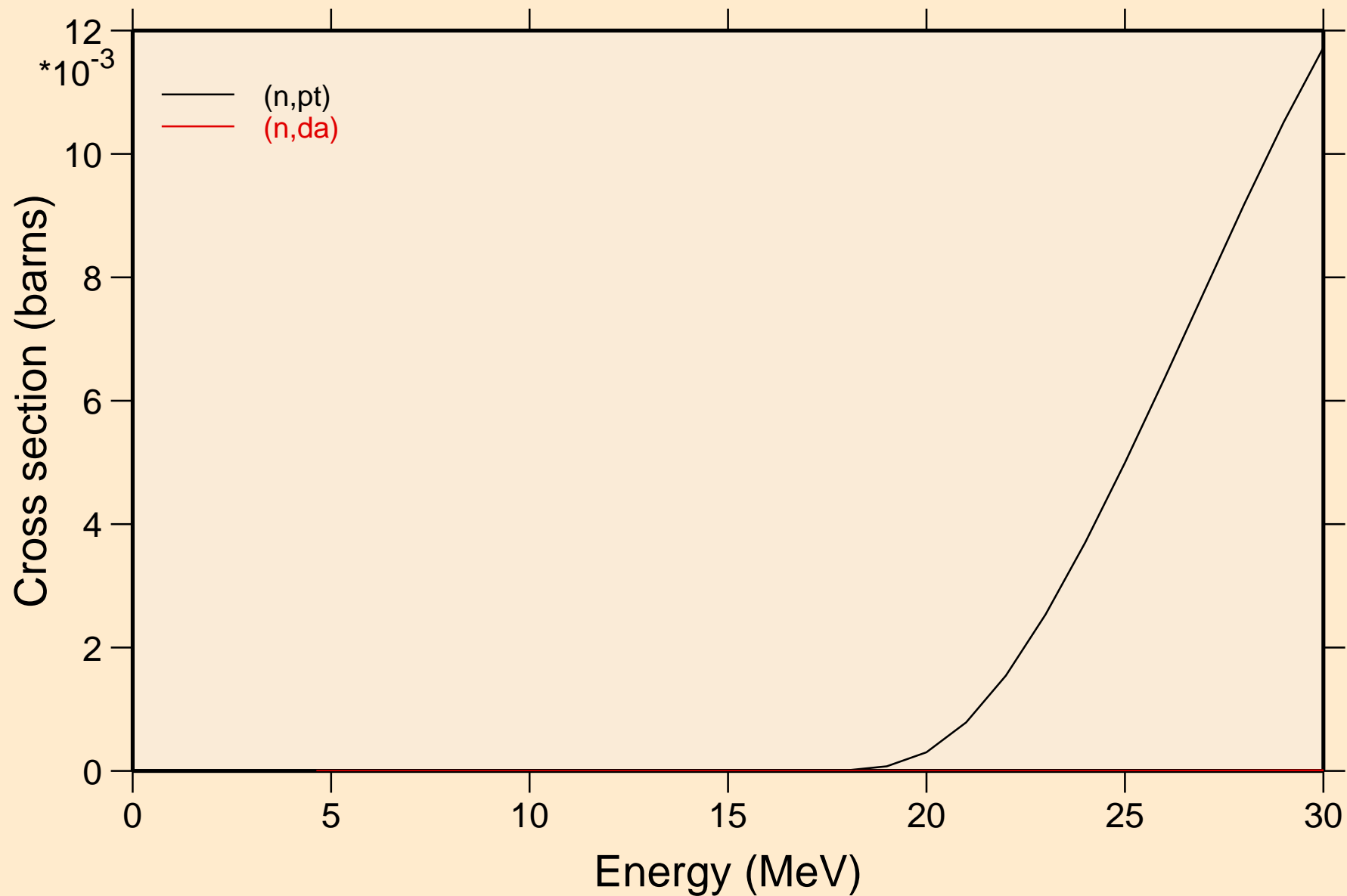

PD092 NEUTRON ACER TENDL-2023 LIBRARY; T=0.K
Threshold reactions

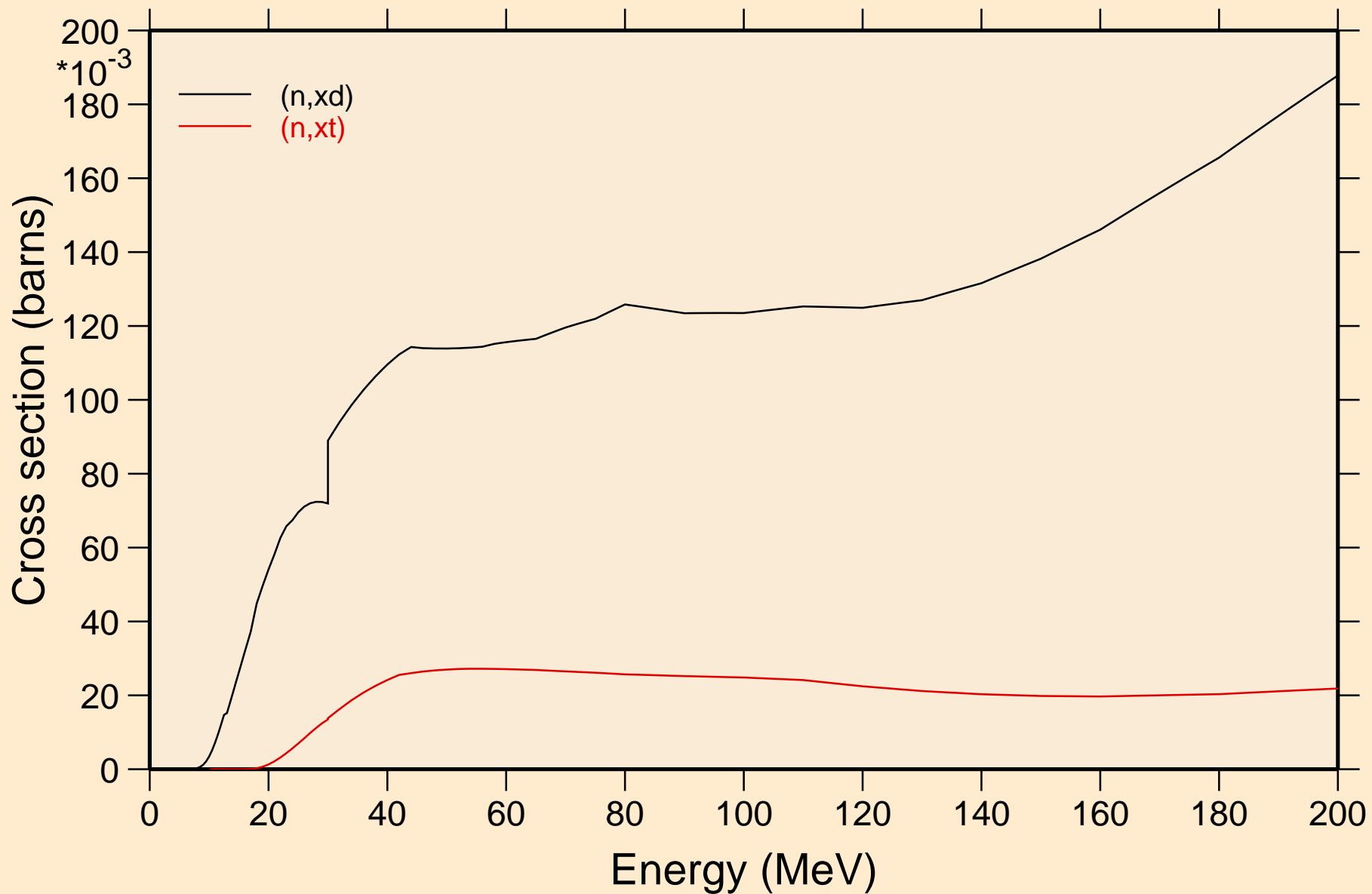

PD092 NEUTRON ACER TENDL-2023 LIBRARY; T=0.K
angular distribution for elastic

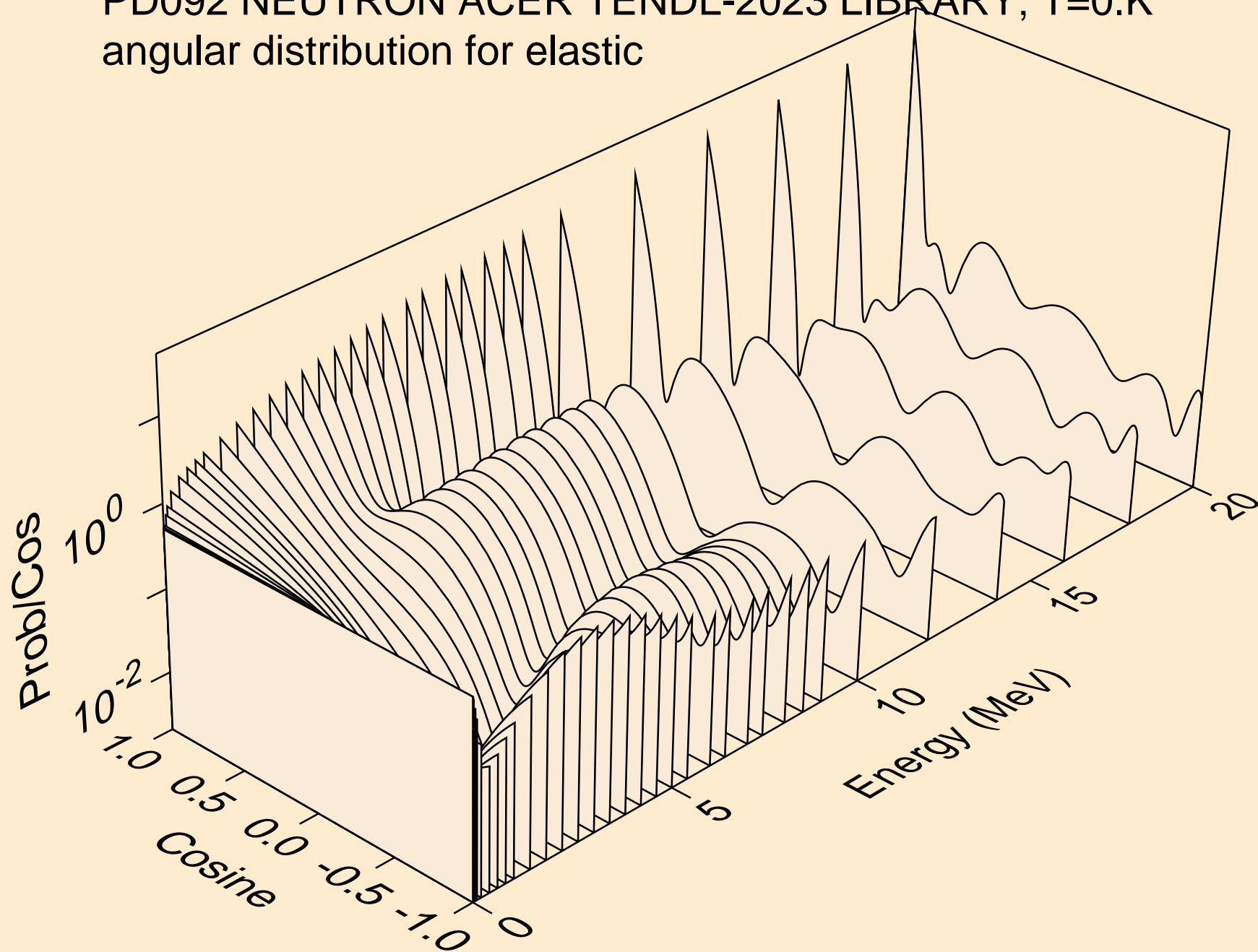

PD092 NEUTRON ACER TENDL-2023 LIBRARY; T=0.K
angular distribution for elastic

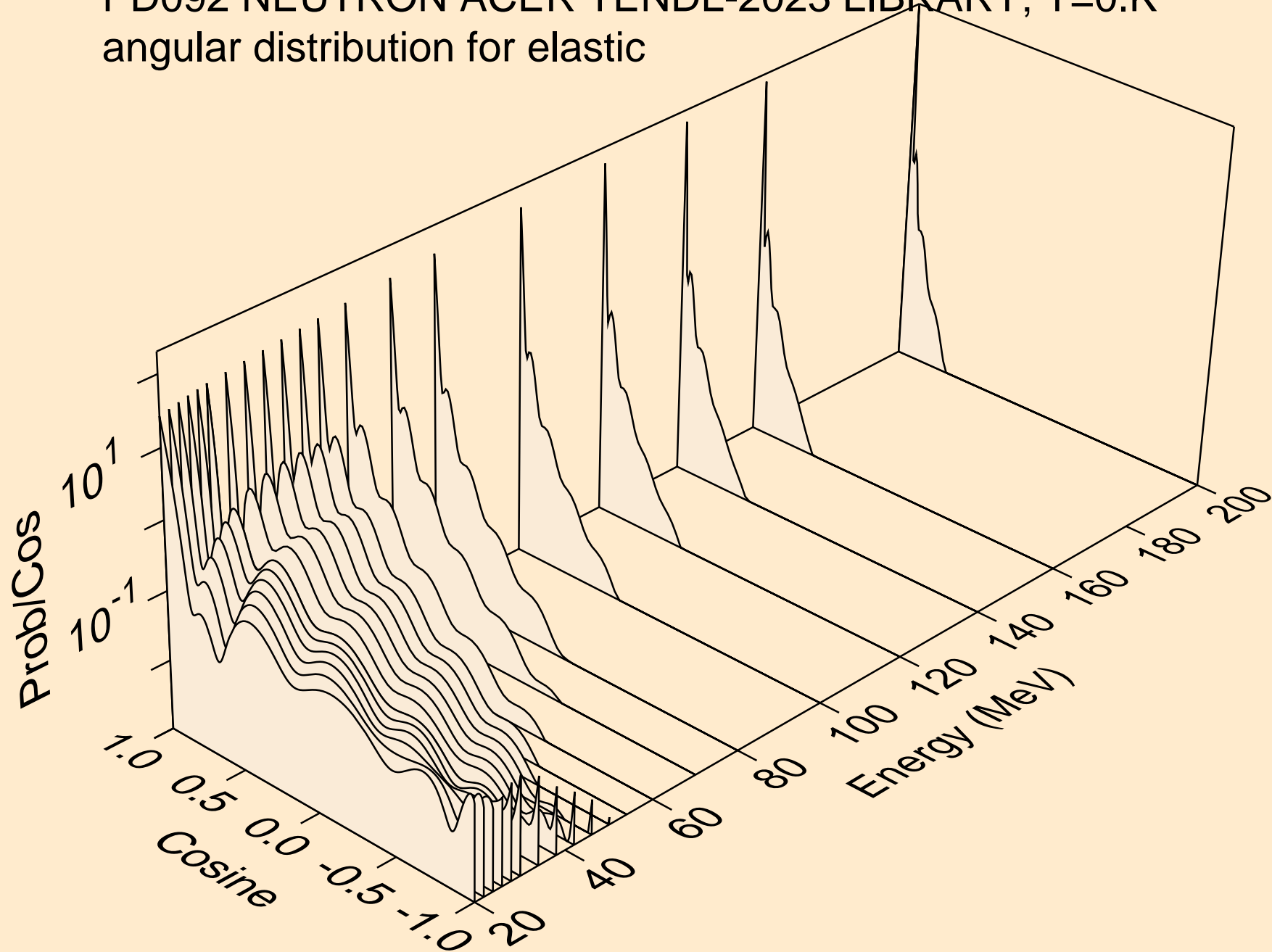

PD092 NEUTRON ACER TENDL-2023 LIBRARY; T=0.K
angular distribution for (n,n*1)

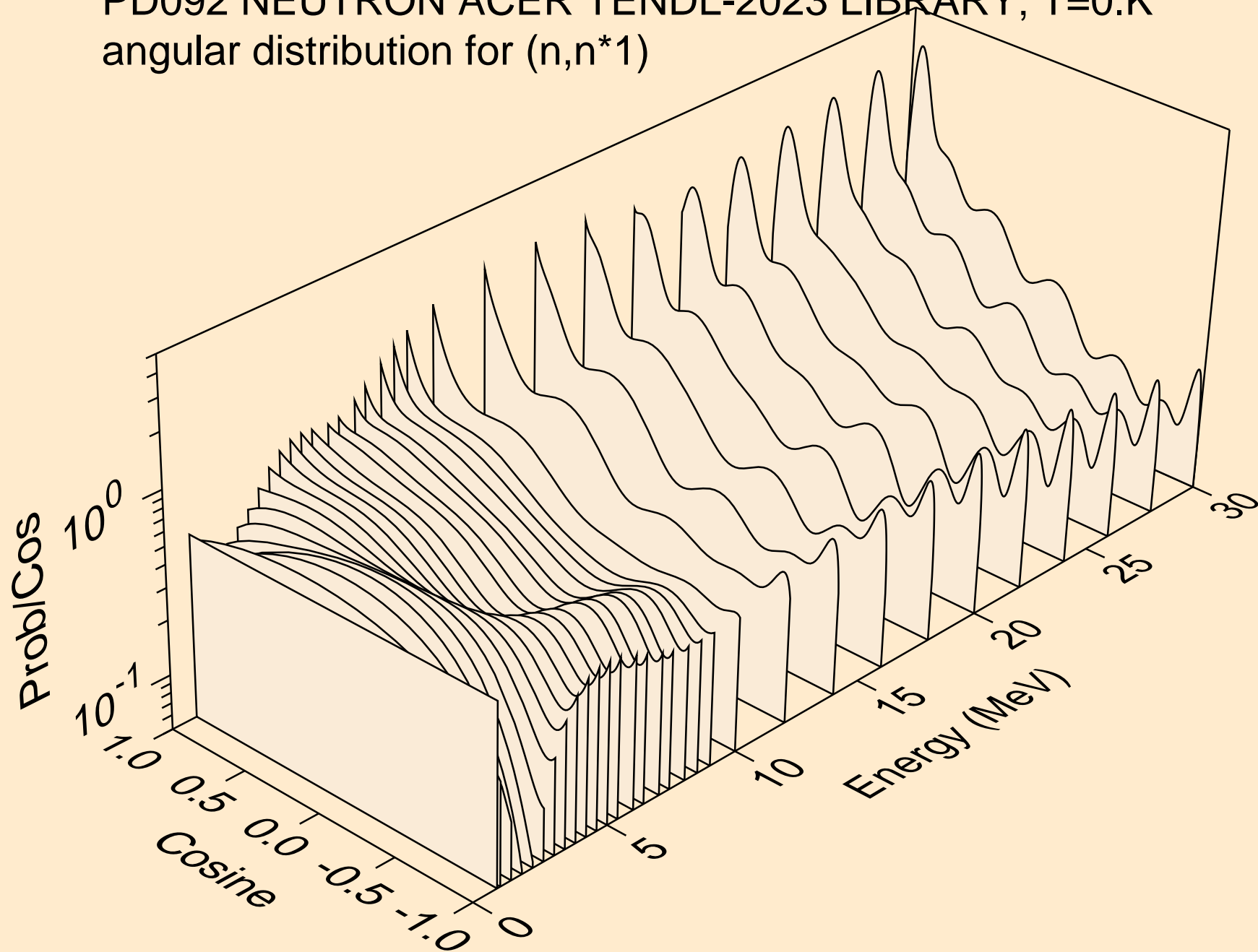

PD092 NEUTRON ACER TENDL-2023 LIBRARY; T=0.K
angular distribution for (n,n*2)

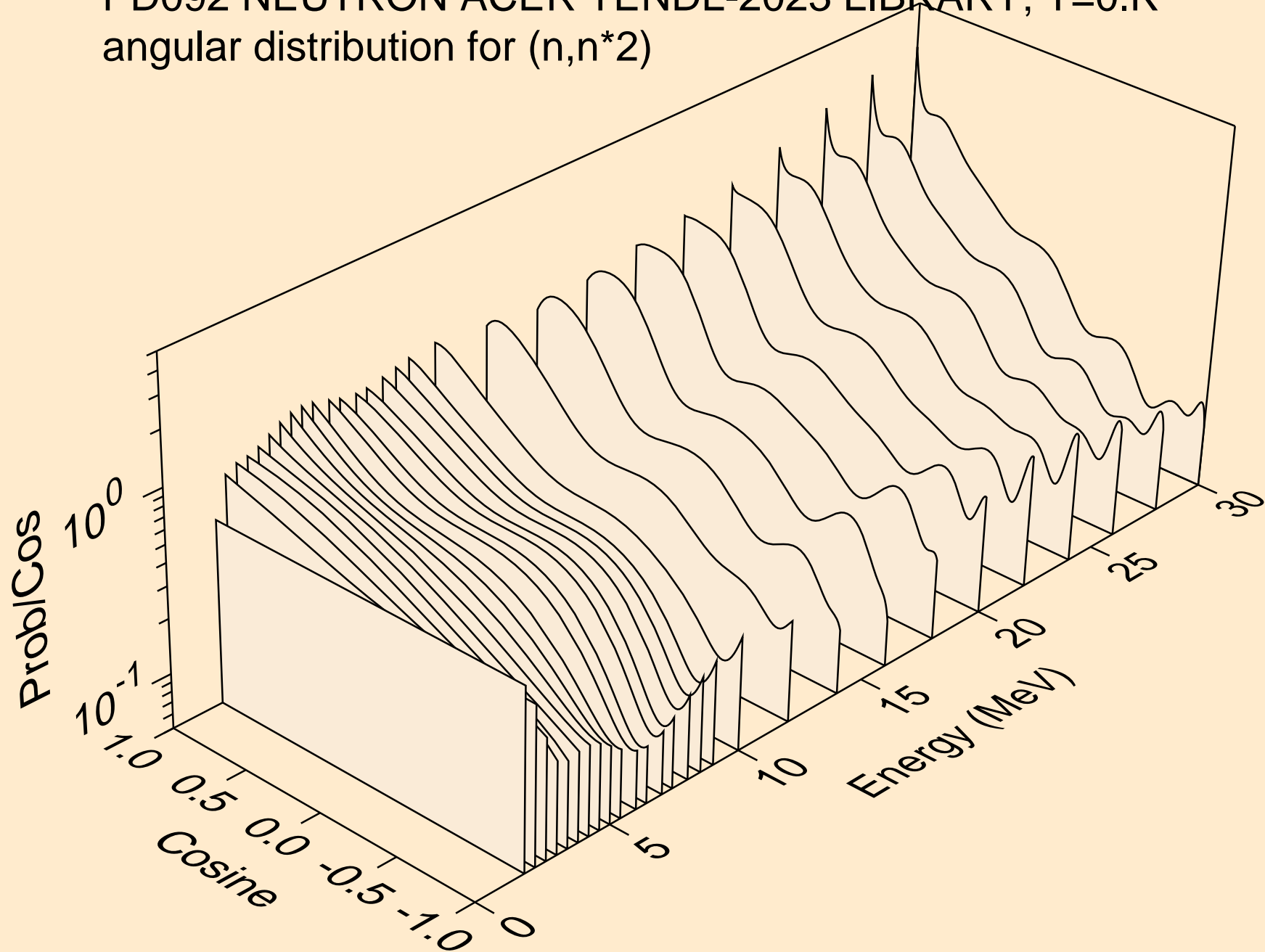

PD092 NEUTRON ACER TENDL-2023 LIBRARY; T=0.K
Neutron emission for (n,x)

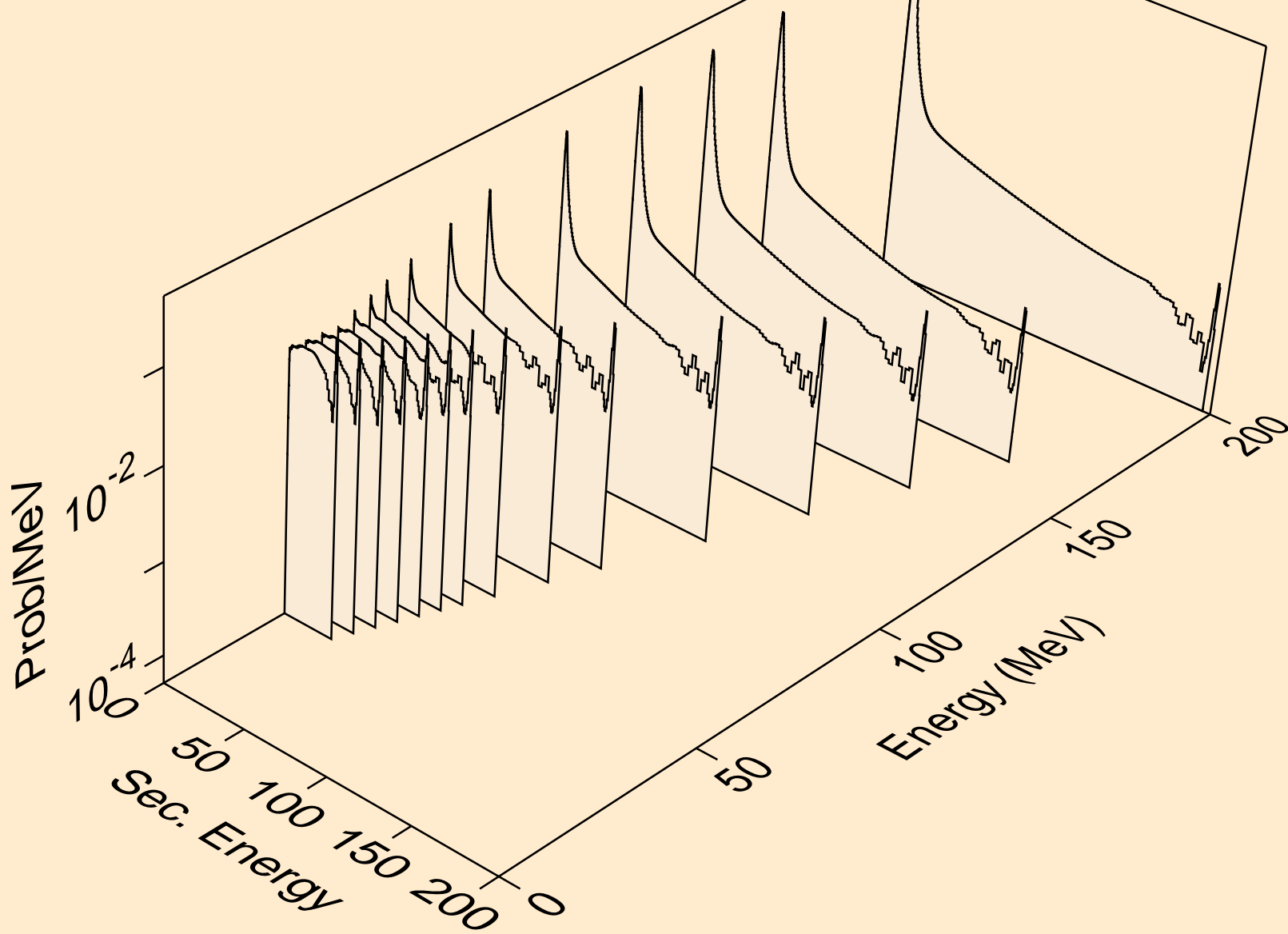

PD092 NEUTRON ACER TENDL-2023 LIBRARY; T=0.K
Neutron emission for (n,2n)

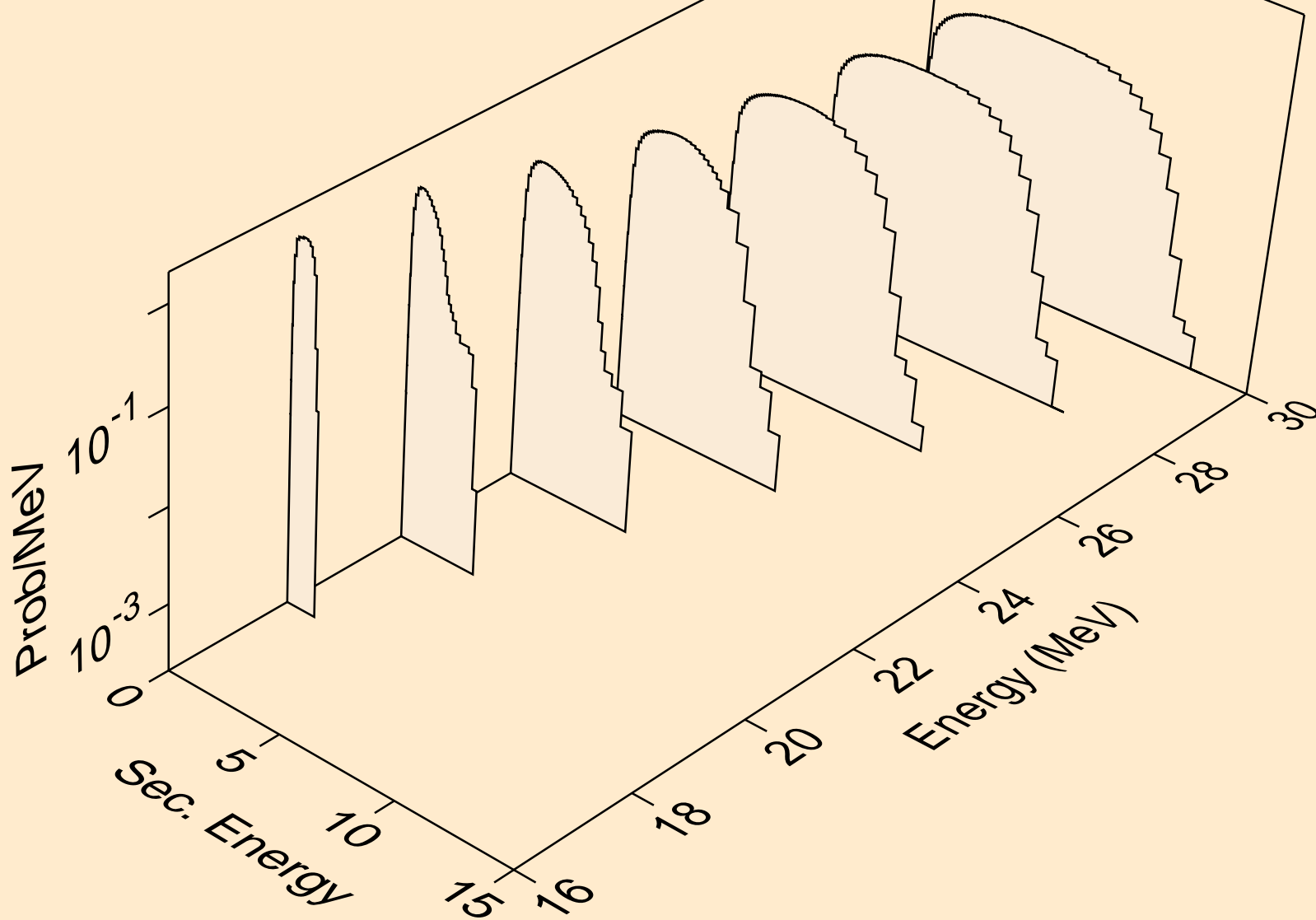

PD092 NEUTRON ACER TENDL-2023 LIBRARY; T=0.K
Neutron emission for (n,n*)a

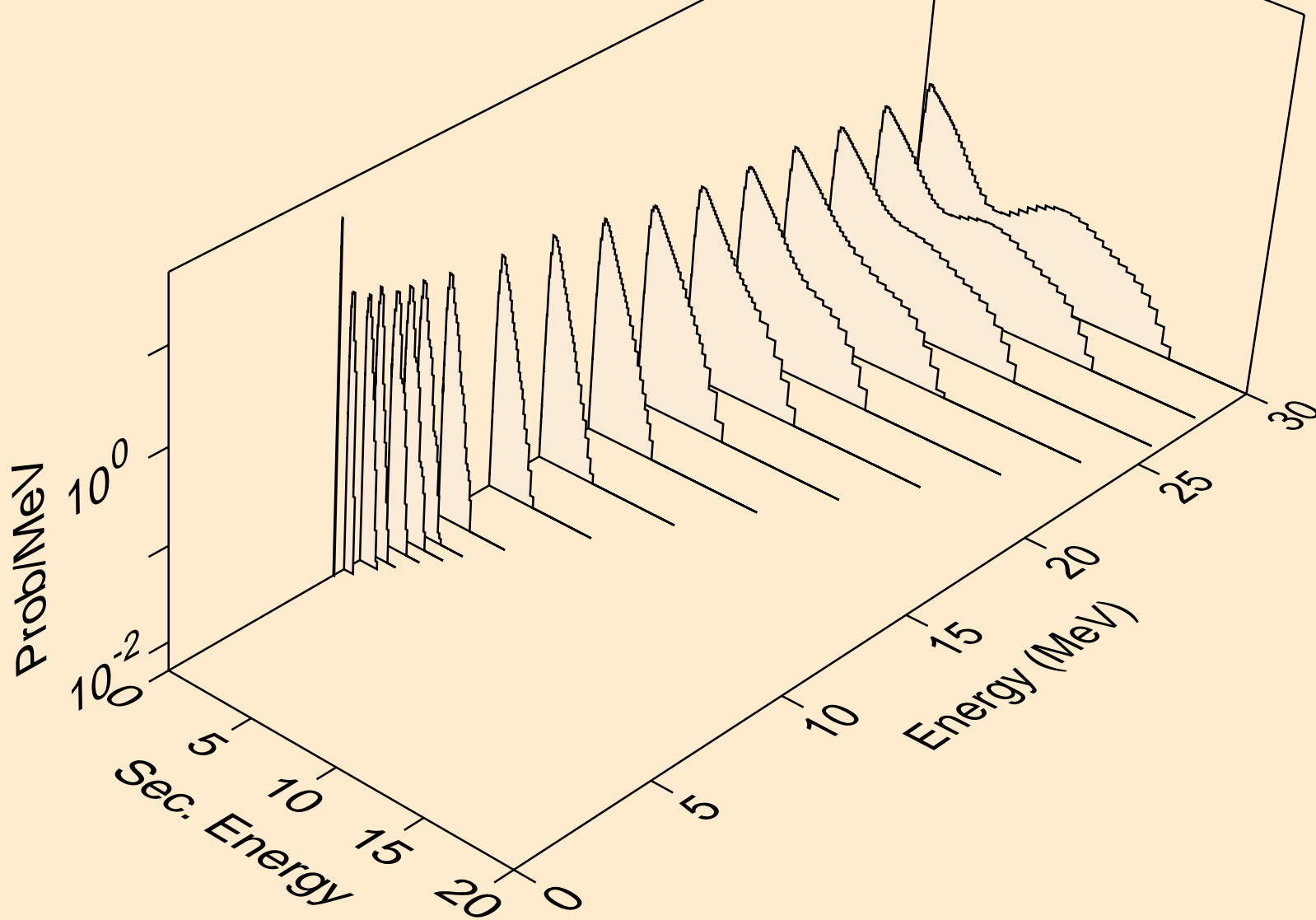

PD092 NEUTRON ACER TENDL-2023 LIBRARY; T=0.K
Neutron emission for (n,n*)p

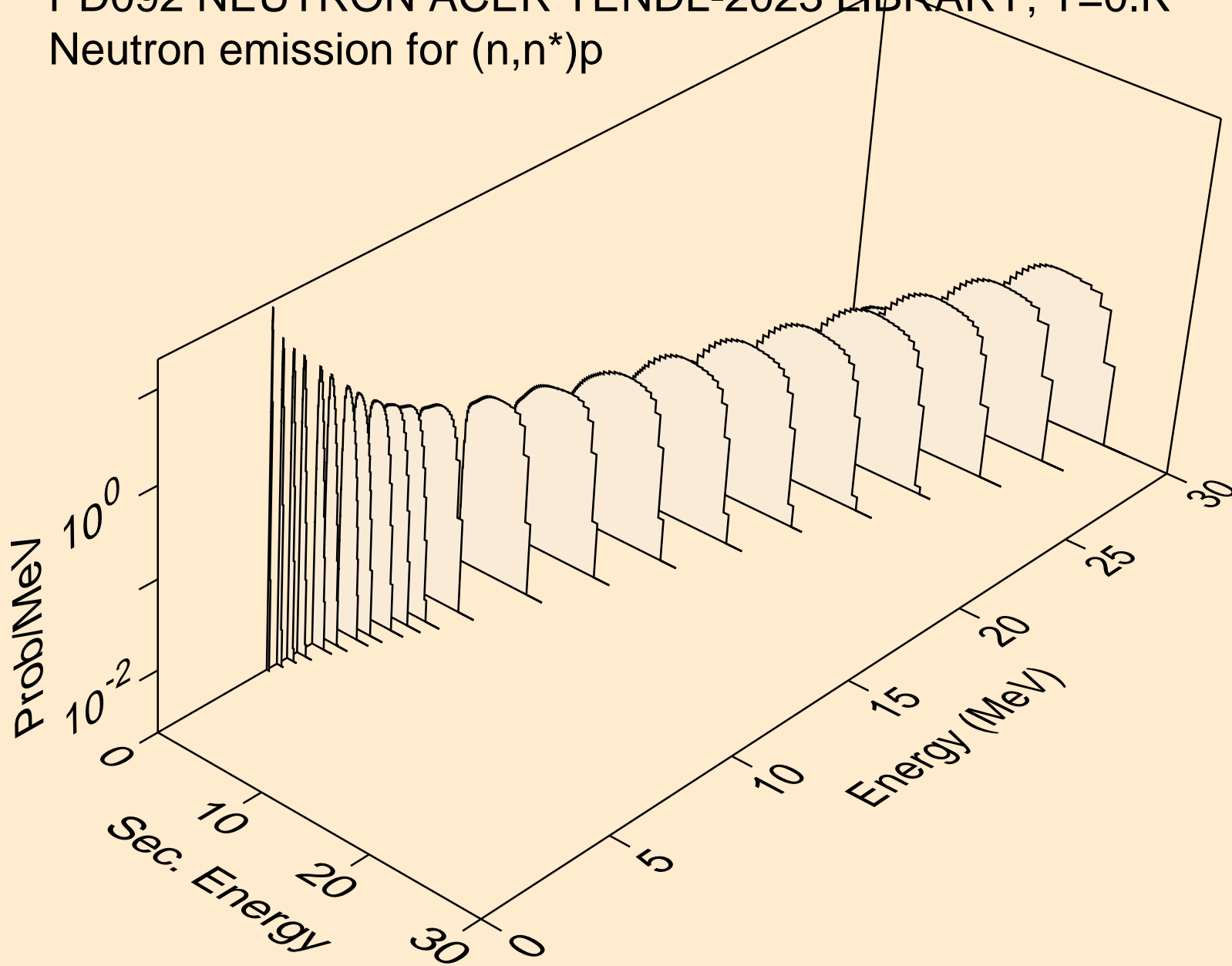

PD092 NEUTRON ACER TENDL-2023 LIBRARY; T=0.K
Neutron emission for (n,n*)2a

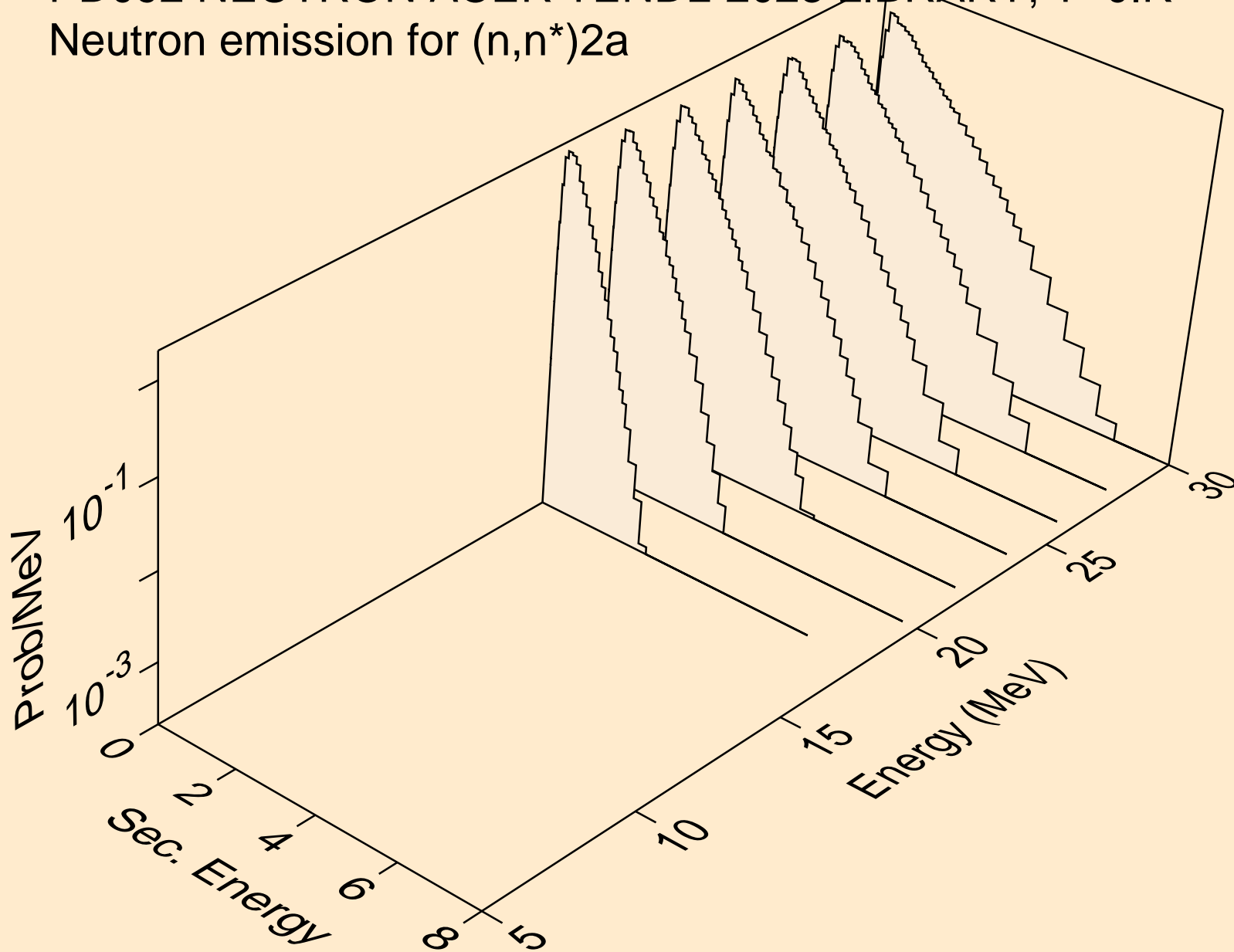

PD092 NEUTRON ACER TENDL-2023 LIBRARY; T=0.K
Neutron emission for (n,n*)d

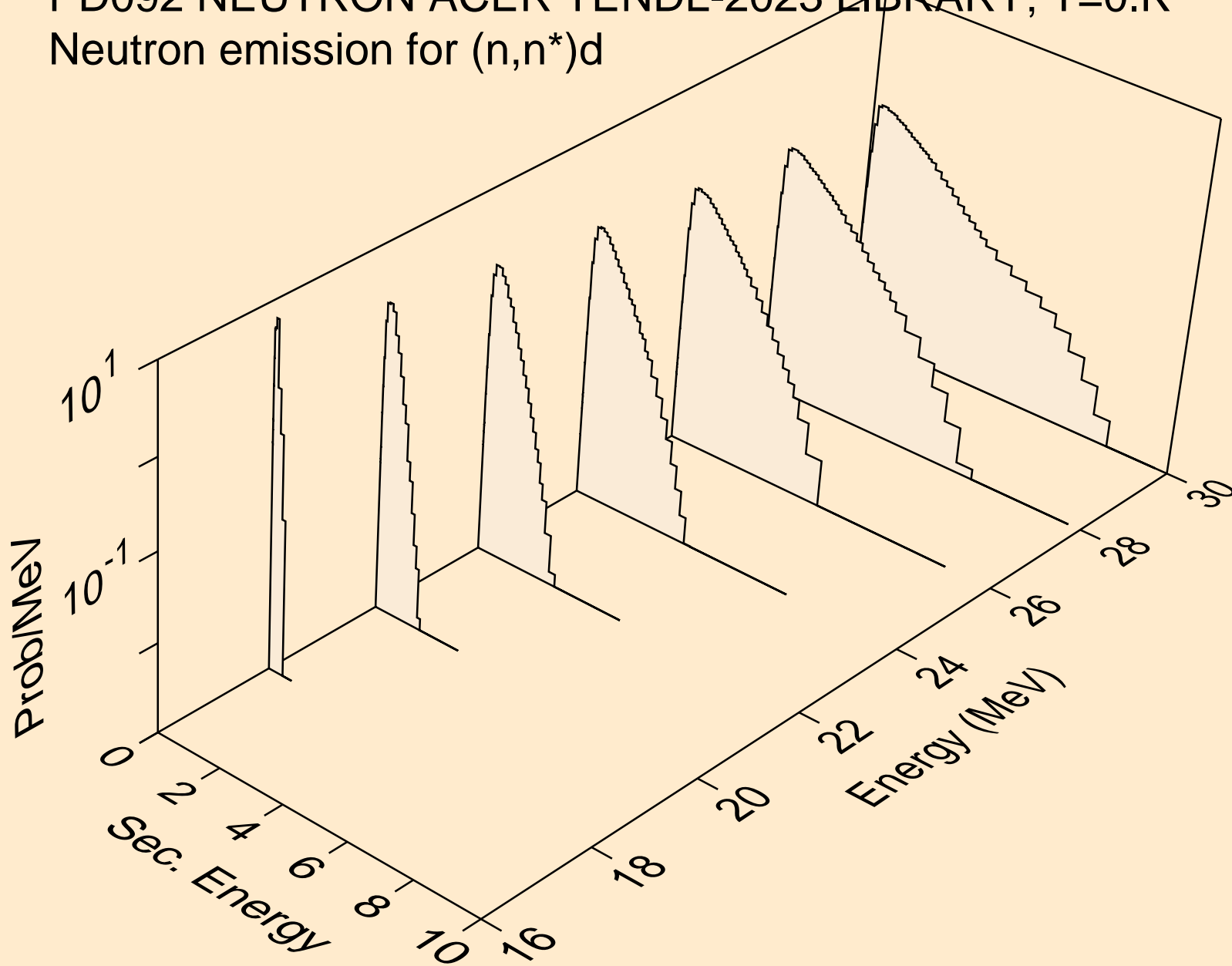

PD092 NEUTRON ACER TENDL-2023 LIBRARY; T=0.K
Neutron emission for (n,n*)t

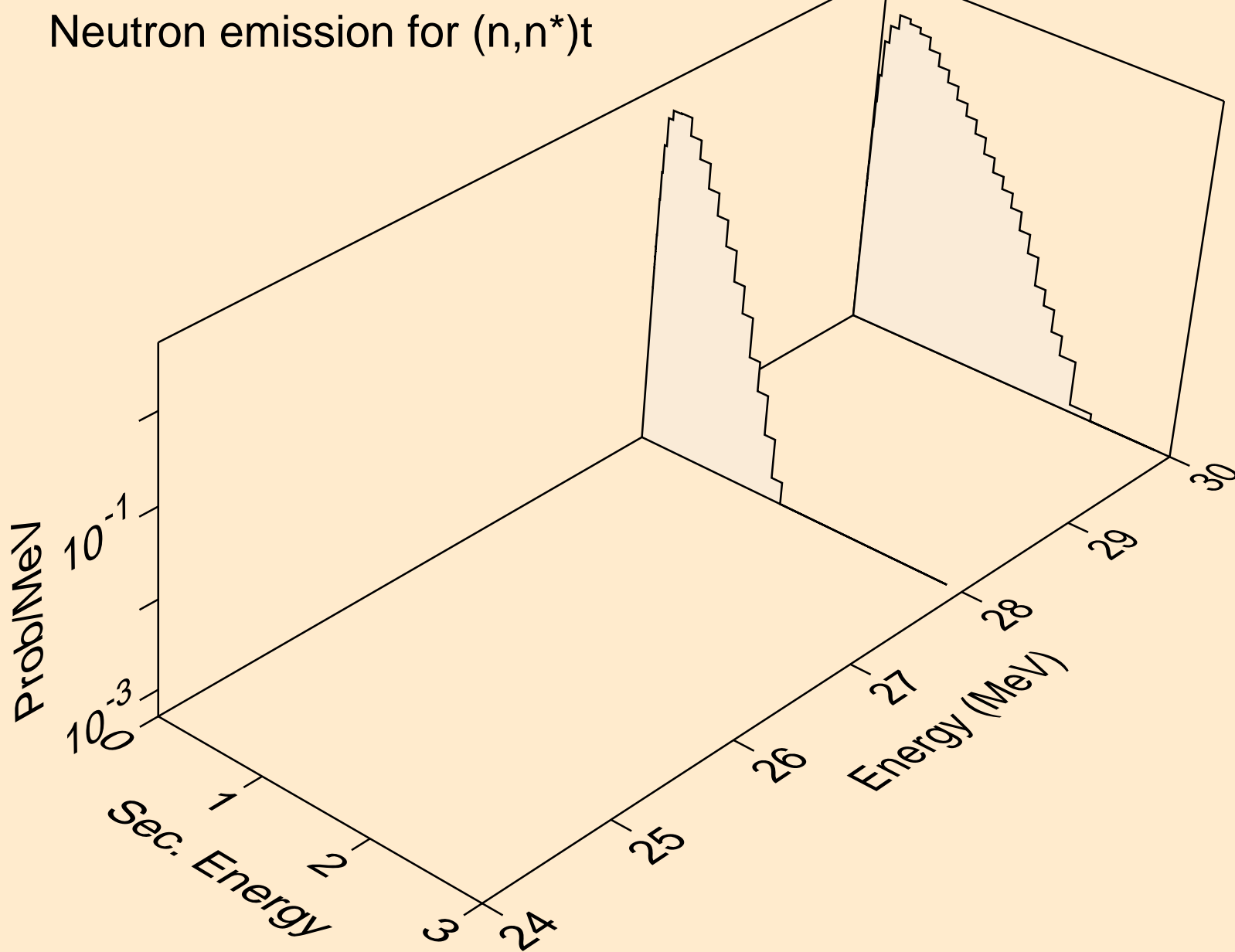

PD092 NEUTRON ACER TENDL-2023 LIBRARY; T=0.K
Neutron emission for (n,n*)he3

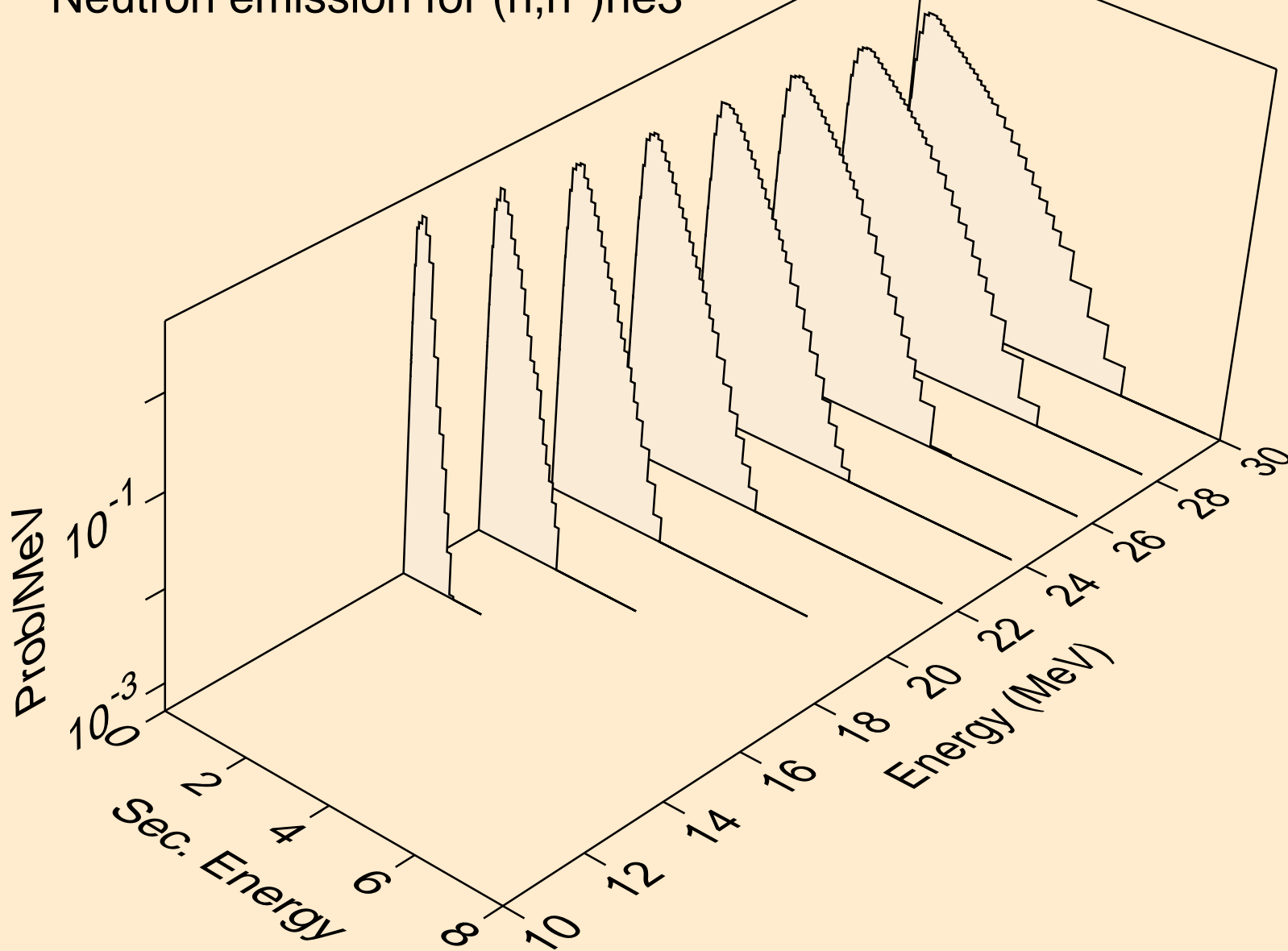

PD092 NEUTRON ACER TENDL-2023 LIBRARY; T=0.K
Neutron emission for (n,2np)

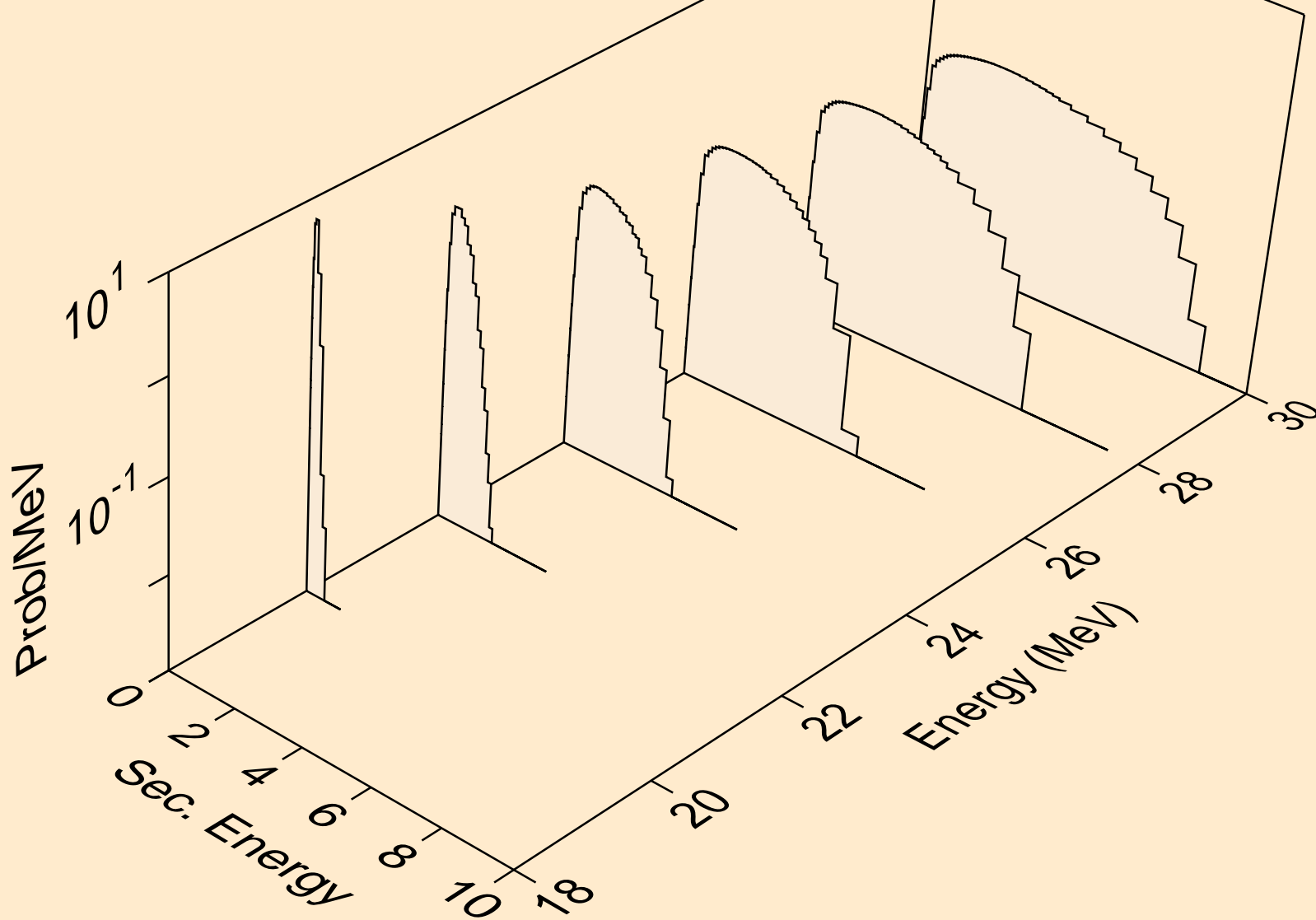

PD092 NEUTRON ACER TENDL-2023 LIBRARY; T=0.K
Neutron emission for (n,n2p)

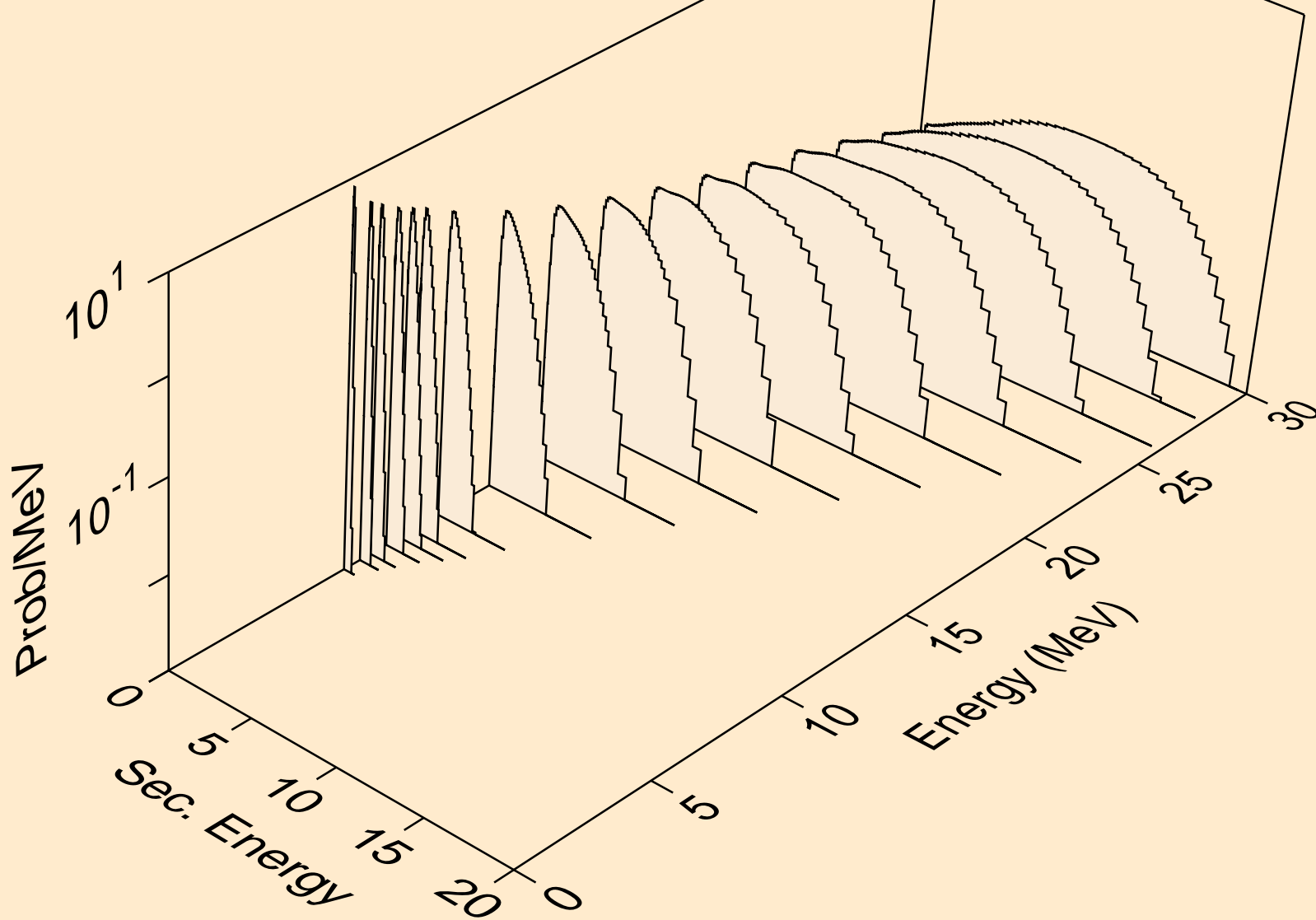

PD092 NEUTRON ACER TENDL-2023 LIBRARY; T=0.K
Neutron emission for (n,npa)

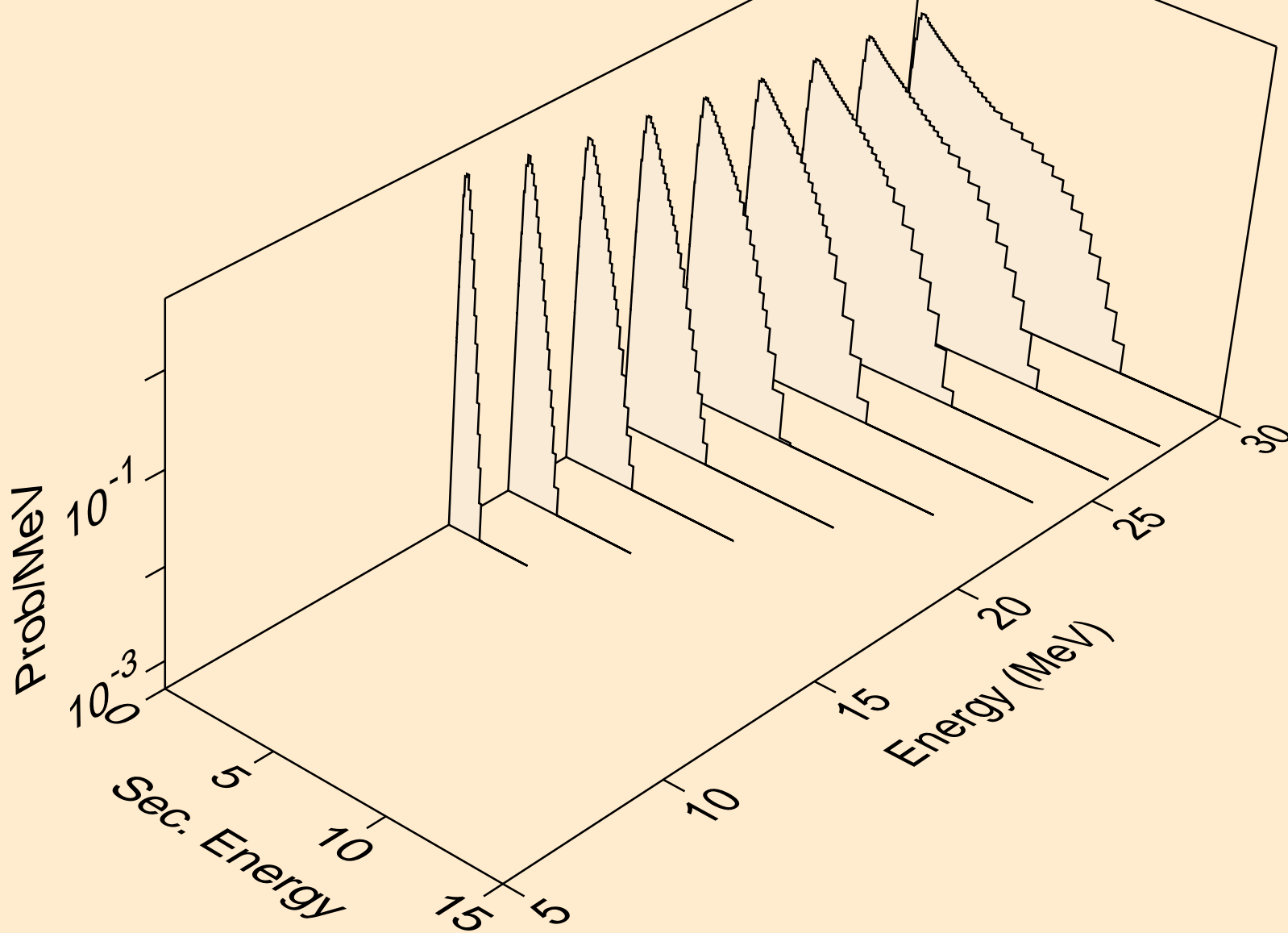

PD092 NEUTRON ACER TENDL-2023 LIBRARY; T=0.K
Neutron emission for (n,n*c)

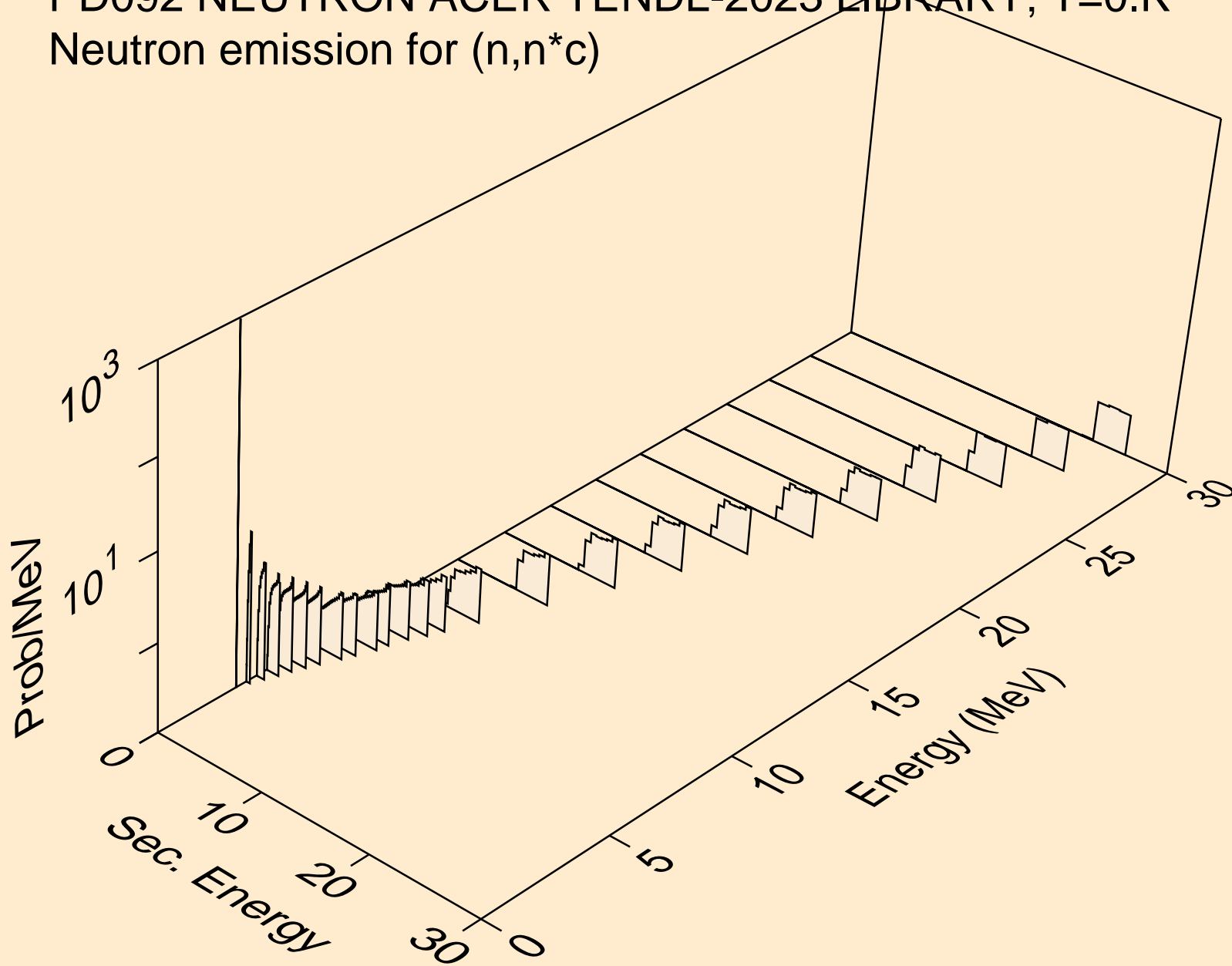

PD092 NEUTRON ACER TENDL-2023 LIBRARY; T=0.K
Photon emission for (n,x)

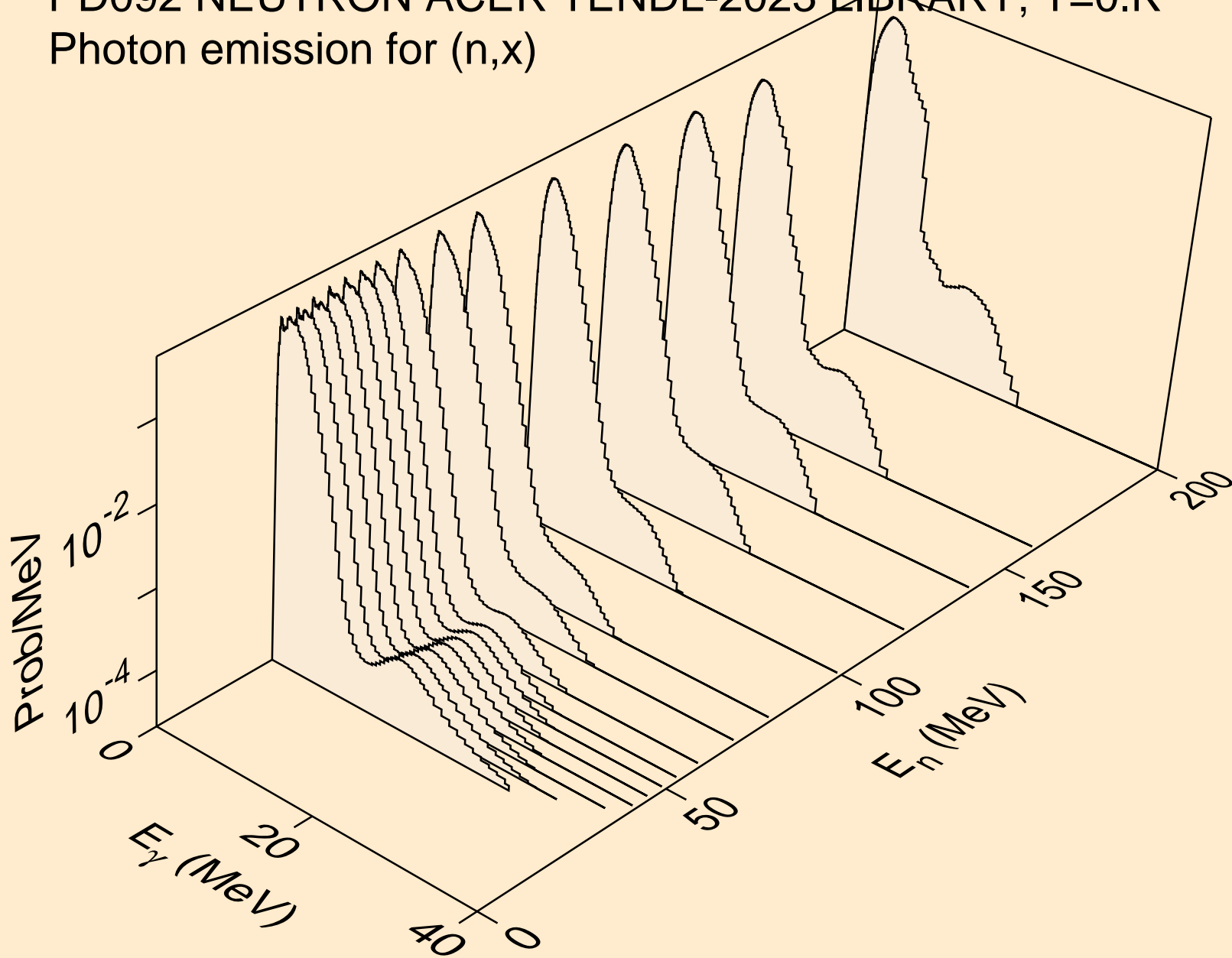

PD092 NEUTRON ACER TENDL-2023 LIBRARY; T=0.K
Photon emission for (n,2n)

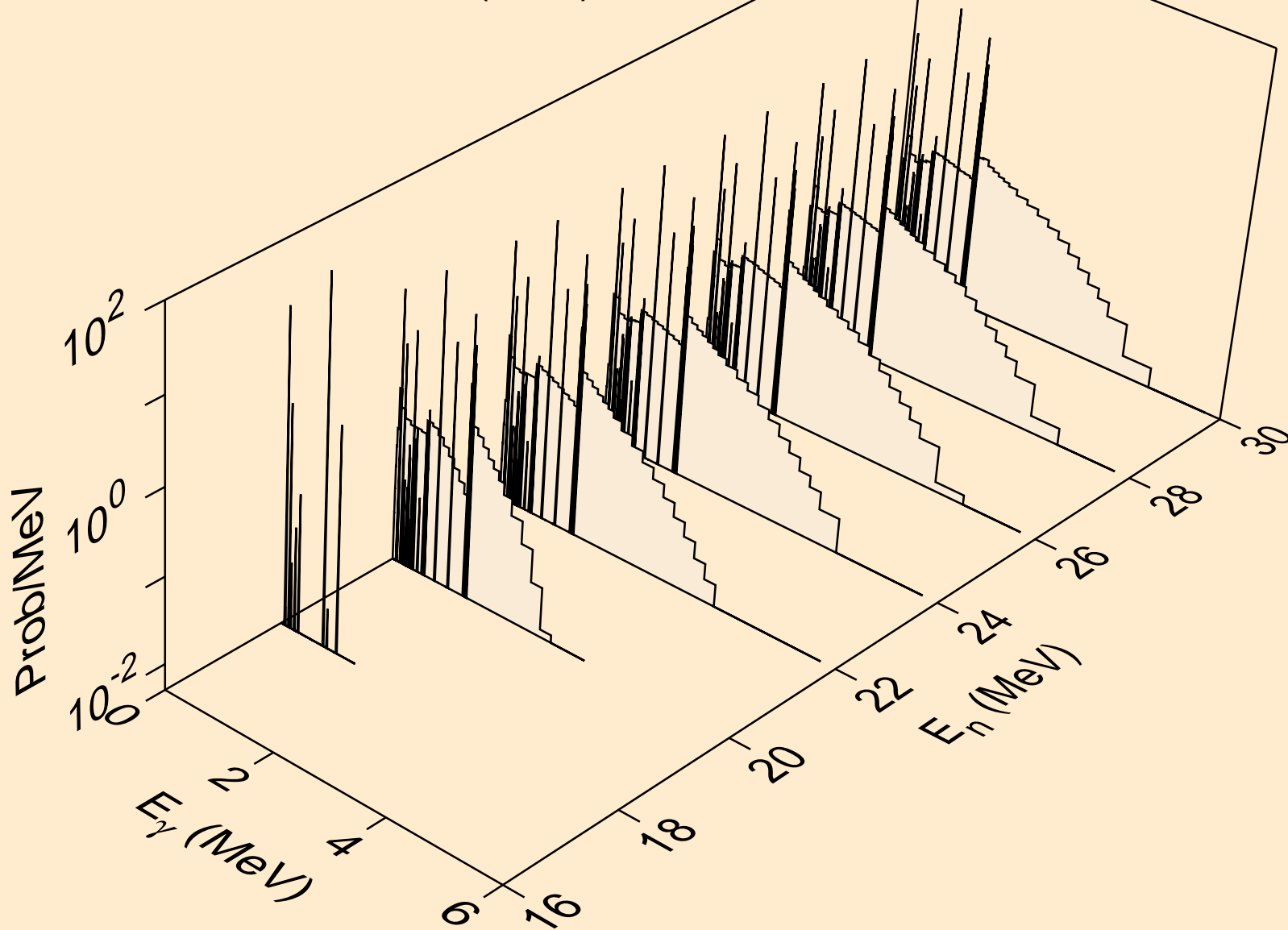

PD092 NEUTRON ACER TENDL-2023 LIBRARY; T=0.K
Photon emission for (n,n*)a

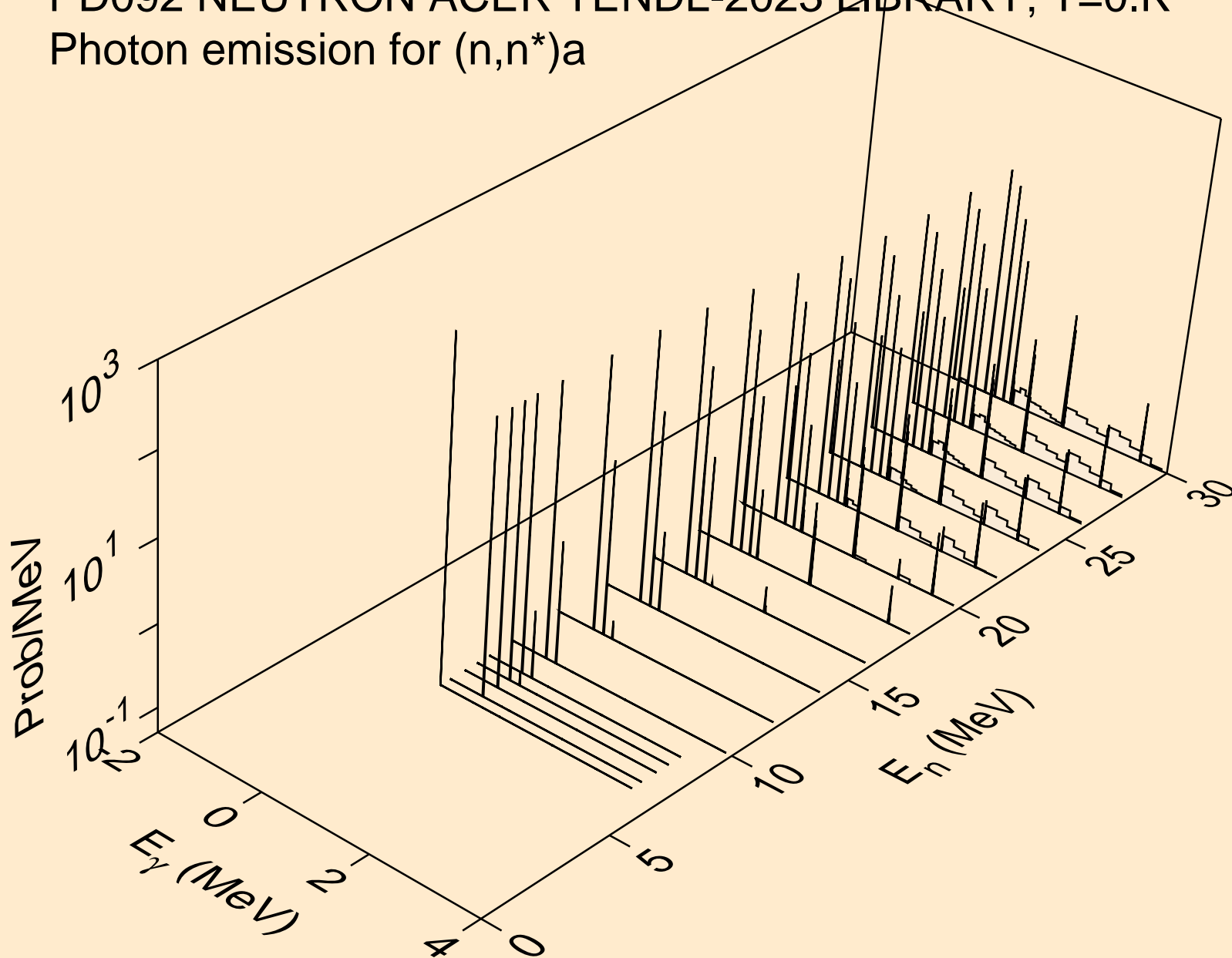

PD092 NEUTRON ACER TENDL-2023 LIBRARY; T=0.K
Photon emission for (n,n*)p

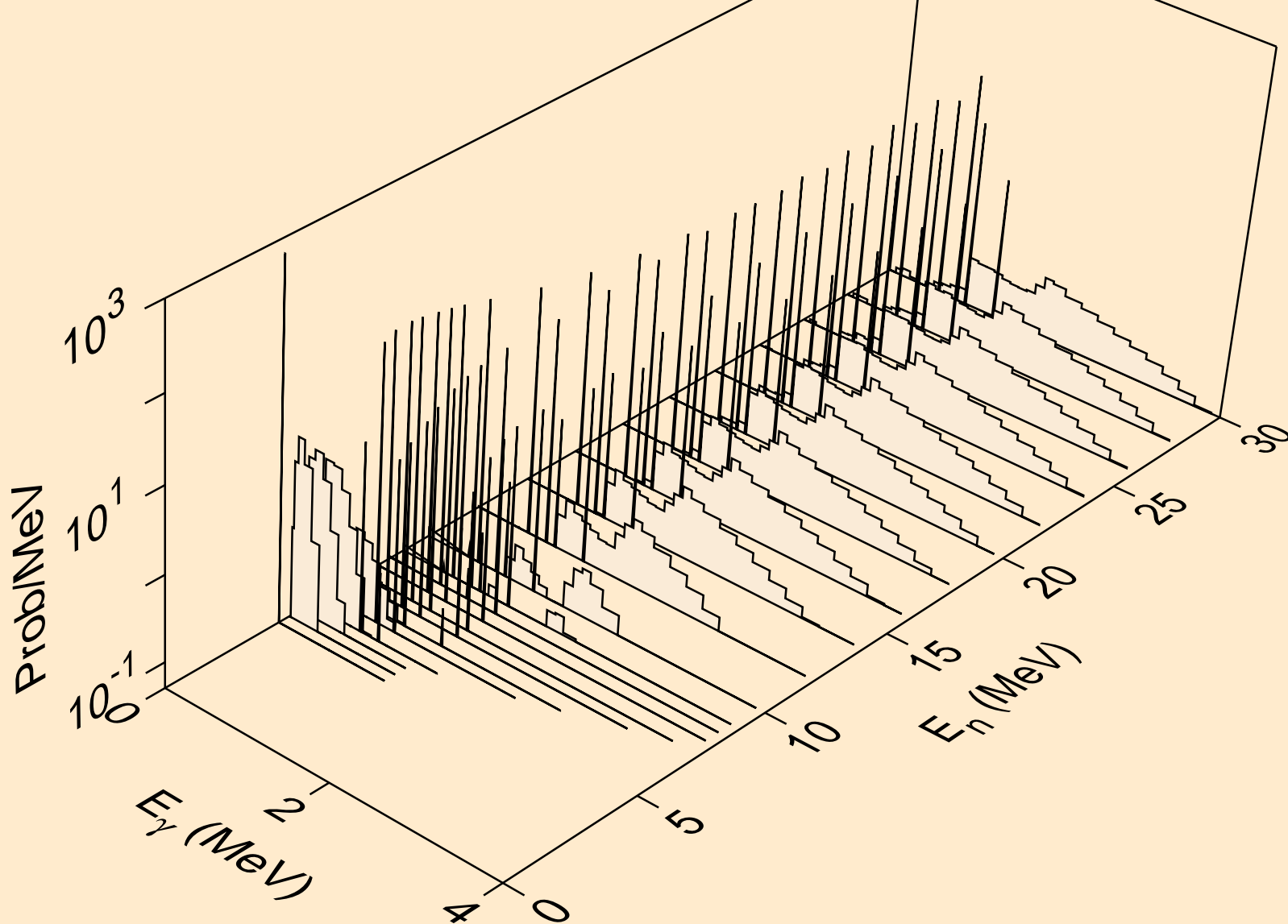

PD092 NEUTRON ACER TENDL-2023 LIBRARY; T=0.K
Photon emission for (n,n*)2a

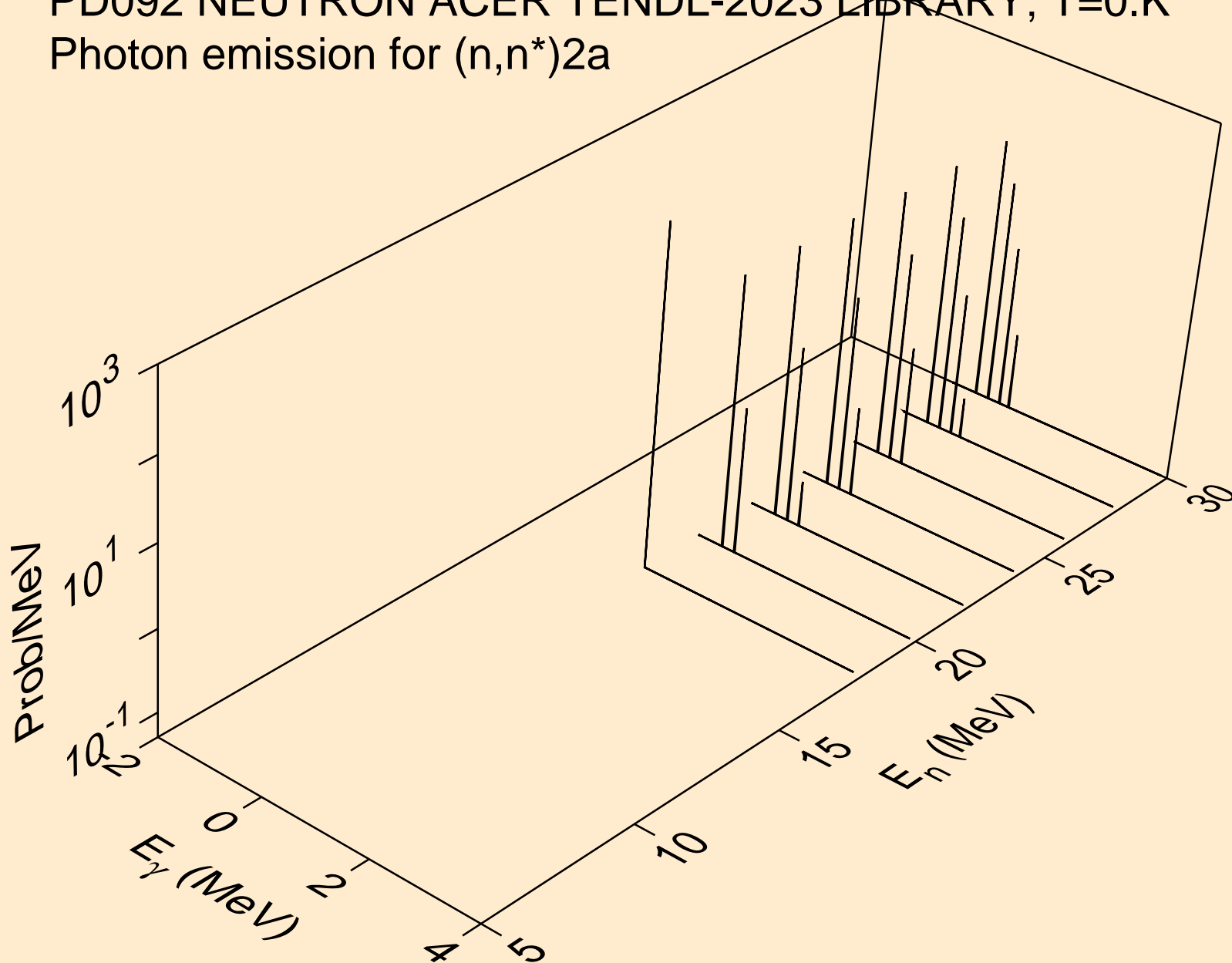

PD092 NEUTRON ACER TENDL-2023 LIBRARY; T=0.K
Photon emission for (n,n*)d

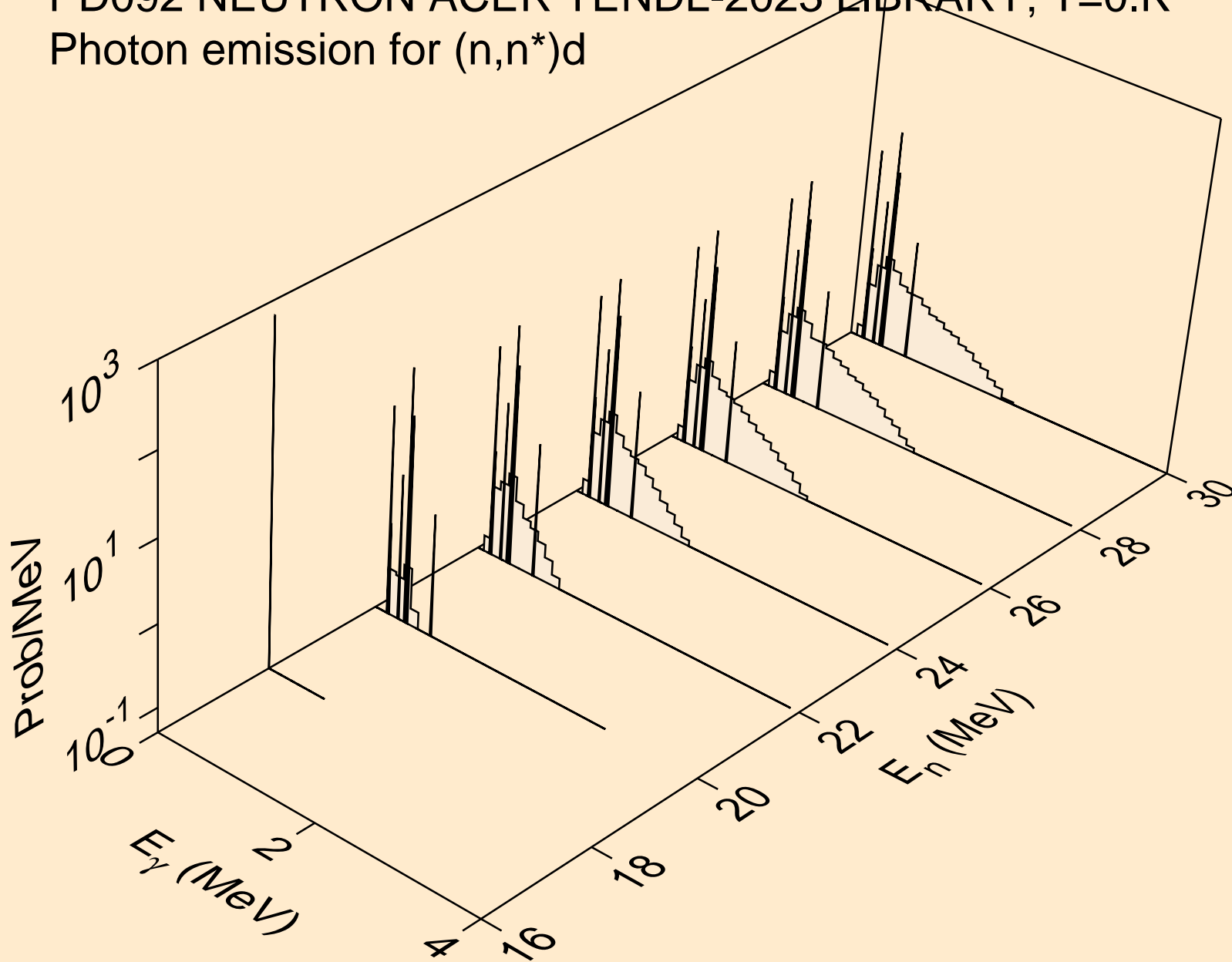

PD092 NEUTRON ACER TENDL-2023 LIBRARY; T=0.K
Photon emission for (n,n*)t

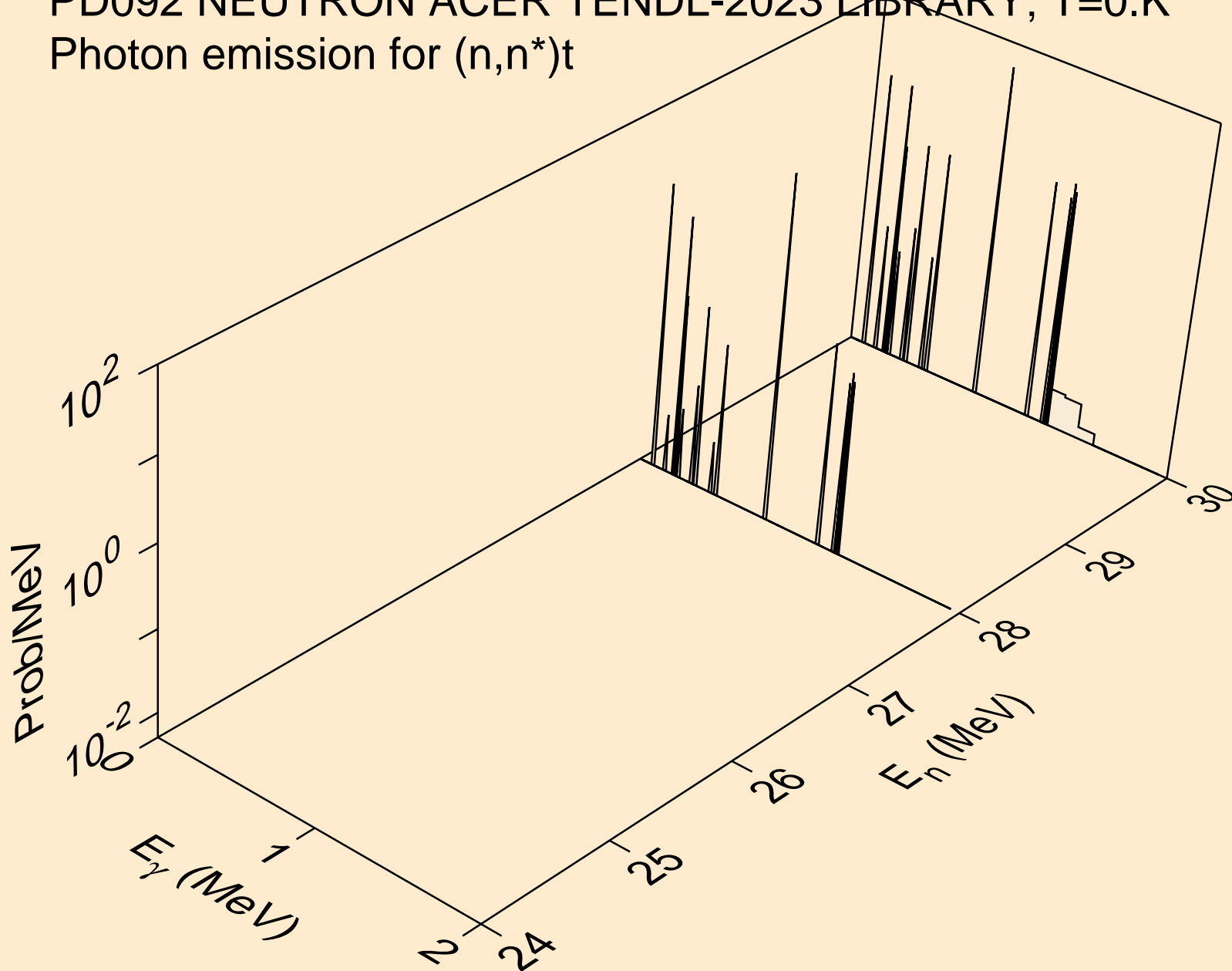

PD092 NEUTRON ACER TENDL-2023 LIBRARY; T=0.K
Photon emission for (n,n*)he3

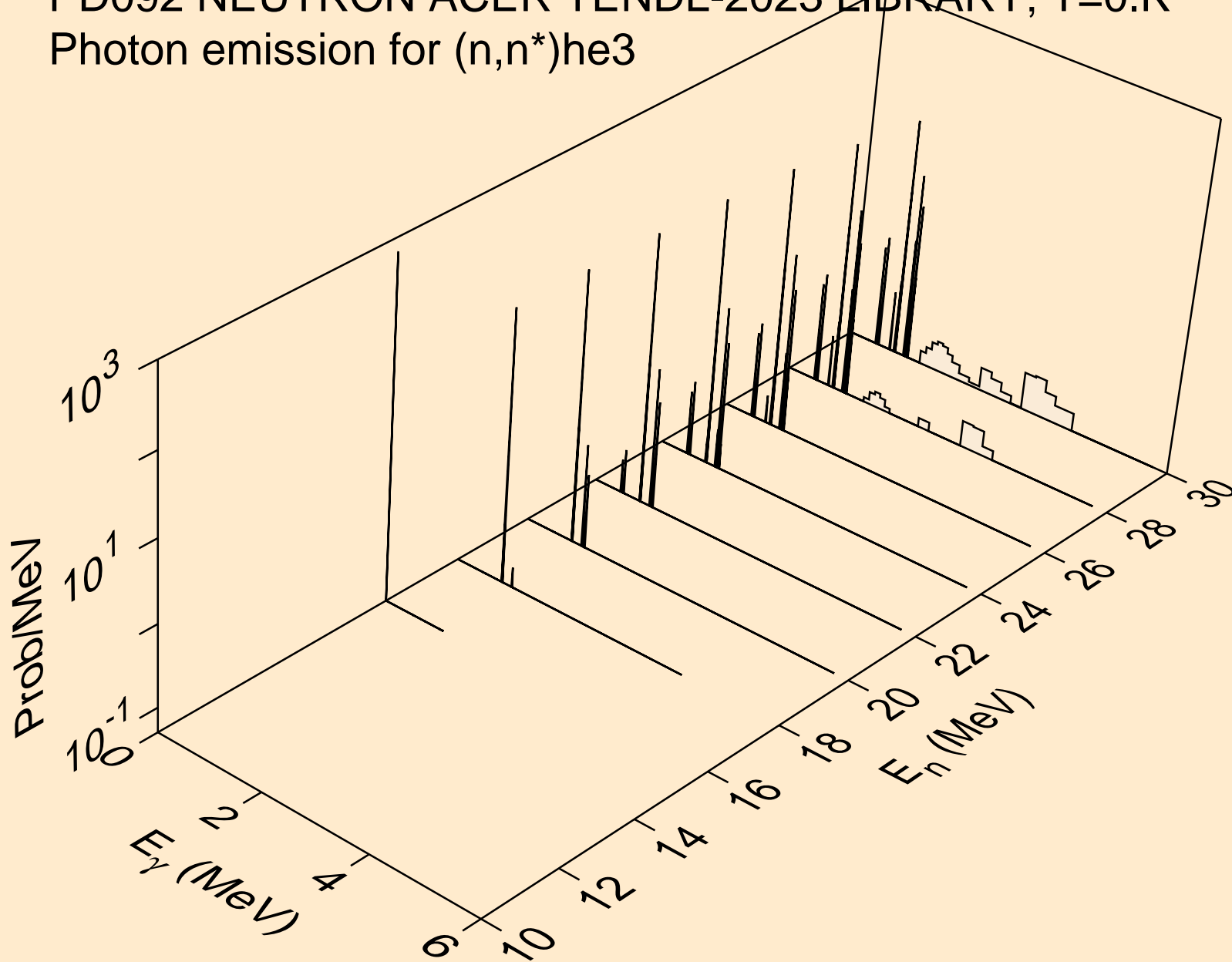

PD092 NEUTRON ACER TENDL-2023 LIBRARY; T=0.K
Photon emission for (n,2np)

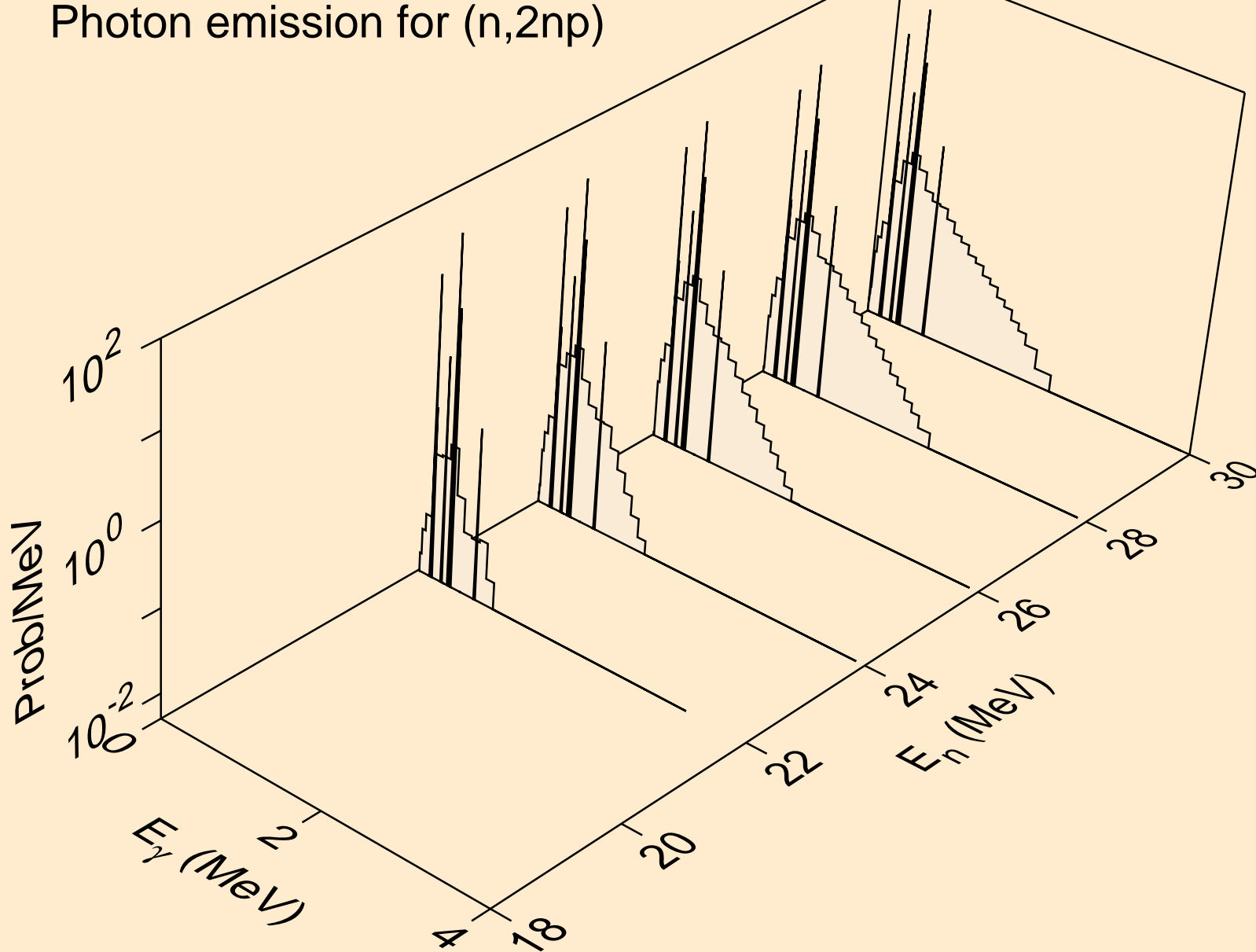

PD092 NEUTRON ACER TENDL-2023 LIBRARY; T=0.K
Photon emission for (n,n2p)

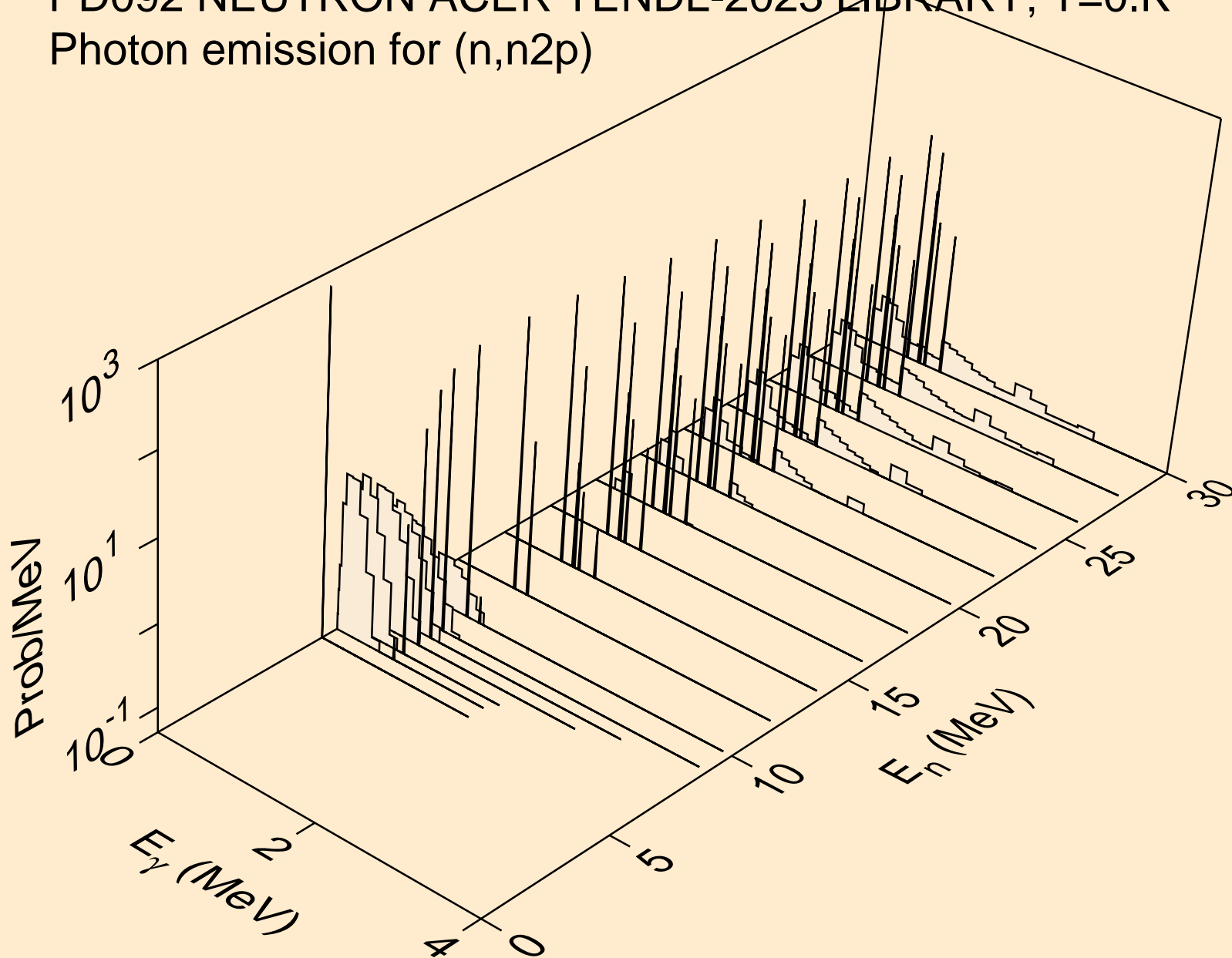

PD092 NEUTRON ACER TENDL-2023 LIBRARY; T=0.K
Photon emission for (n,npa)

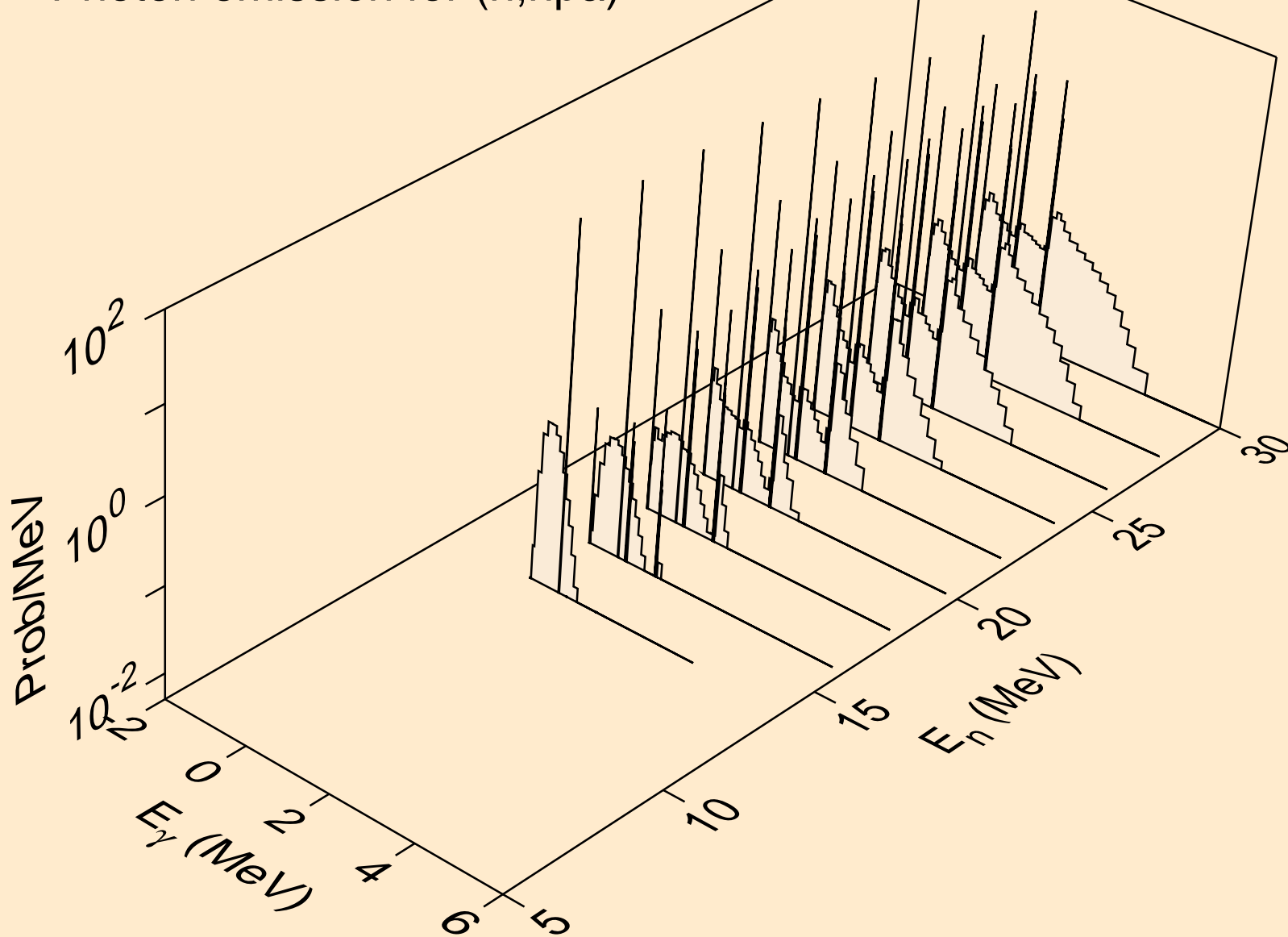

PD092 NEUTRON ACER TENDL-2023 LIBRARY; T=0.K
Photon emission for (n,n*c)

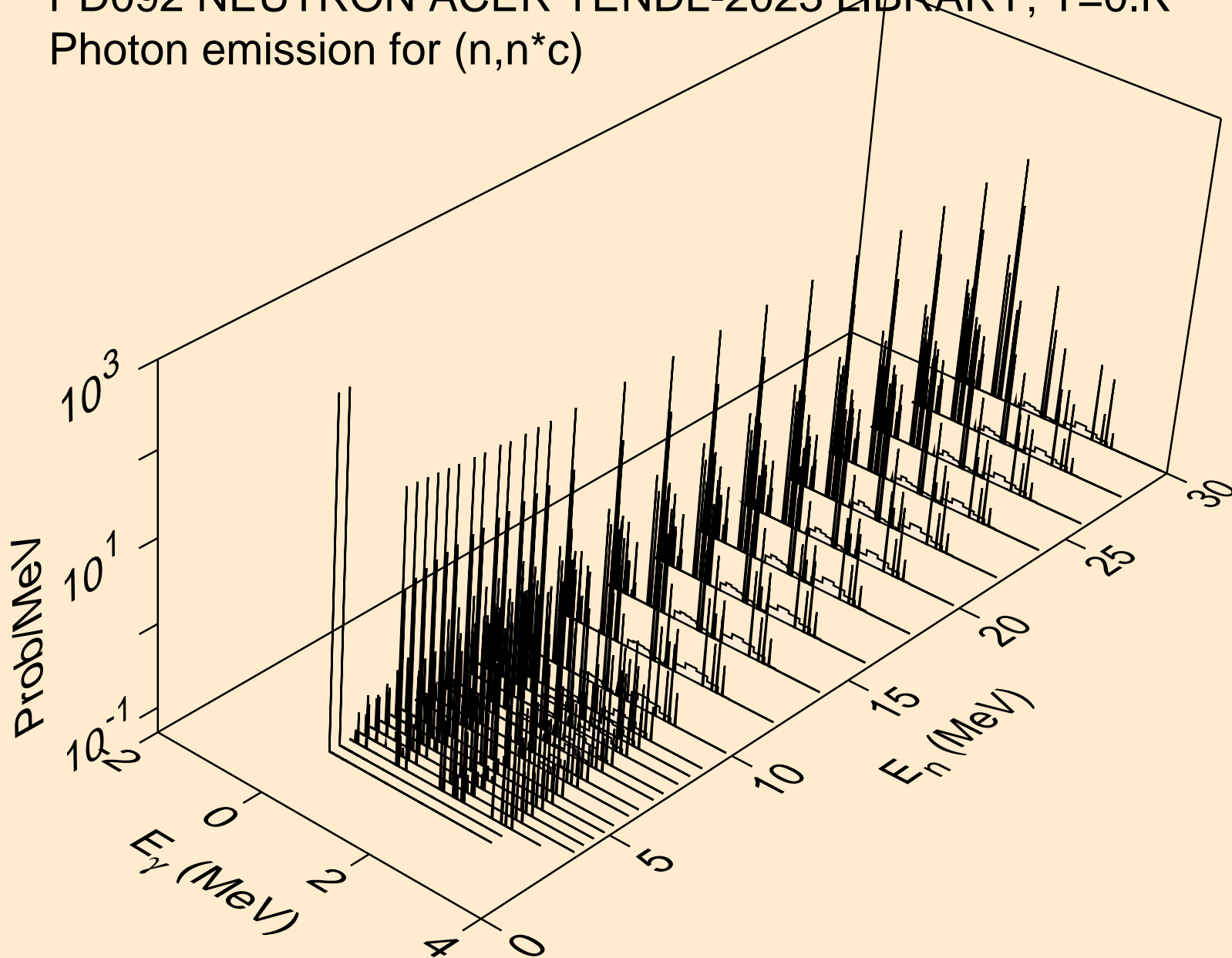

PD092 NEUTRON ACER TENDL-2023 LIBRARY; T=0.K
Photon emission for (n,gma)

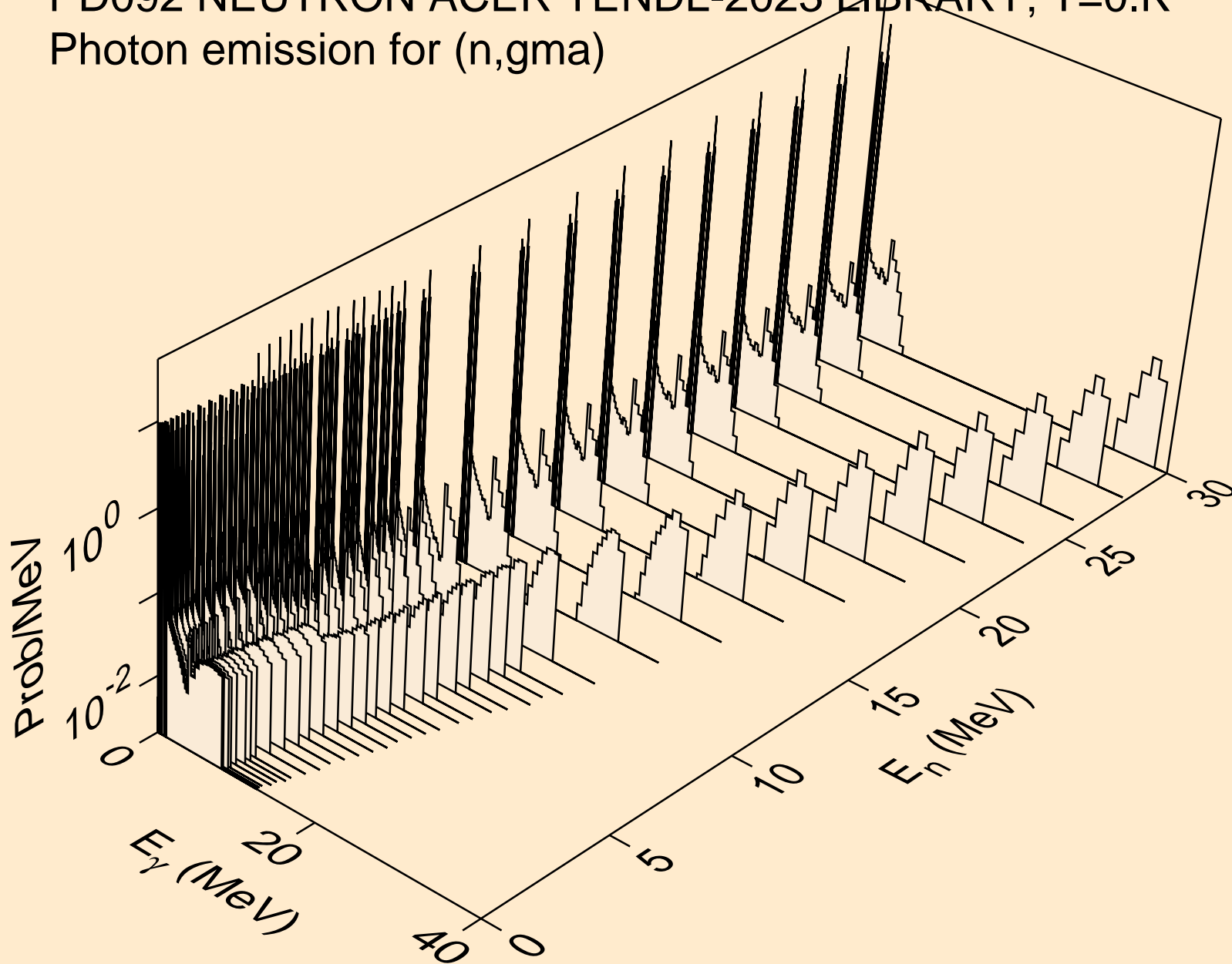

PD092 NEUTRON ACER TENDL-2023 LIBRARY; T=0.K
Photon emission for (n,p)

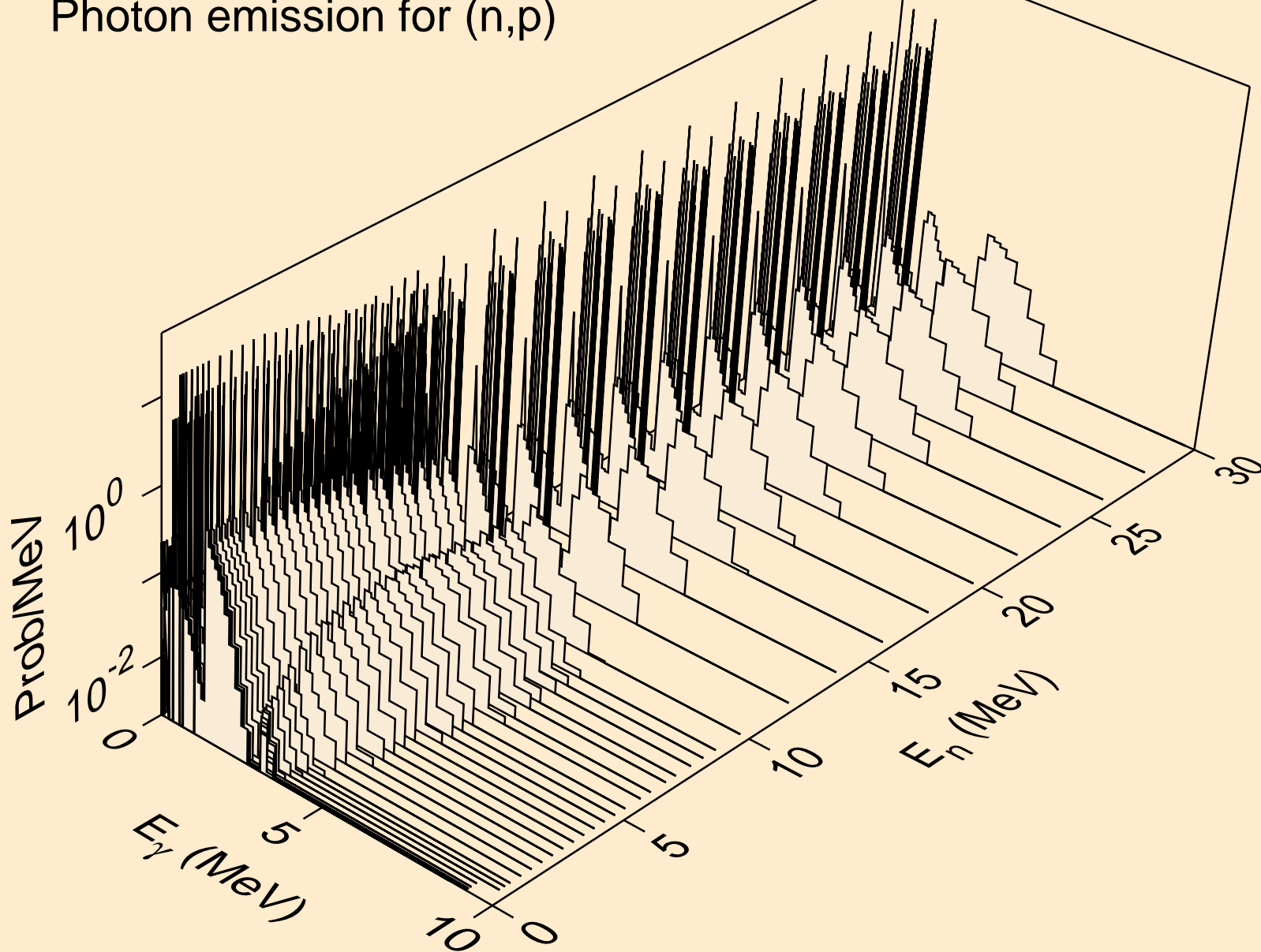

PD092 NEUTRON ACER TENDL-2023 LIBRARY; T=0.K
Photon emission for (n,d)

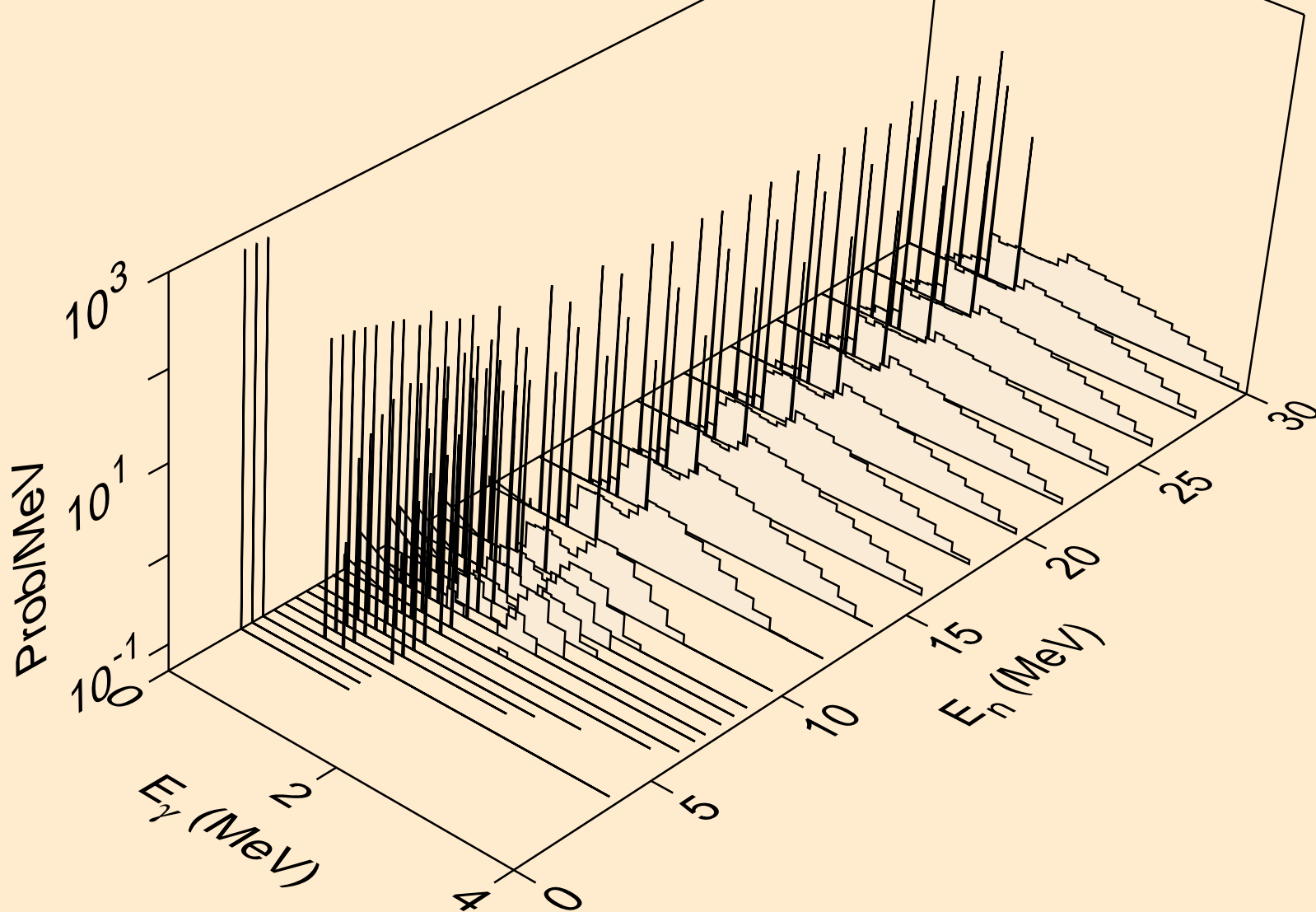

PD092 NEUTRON ACER TENDL-2023 LIBRARY; T=0.K
Photon emission for (n,t)

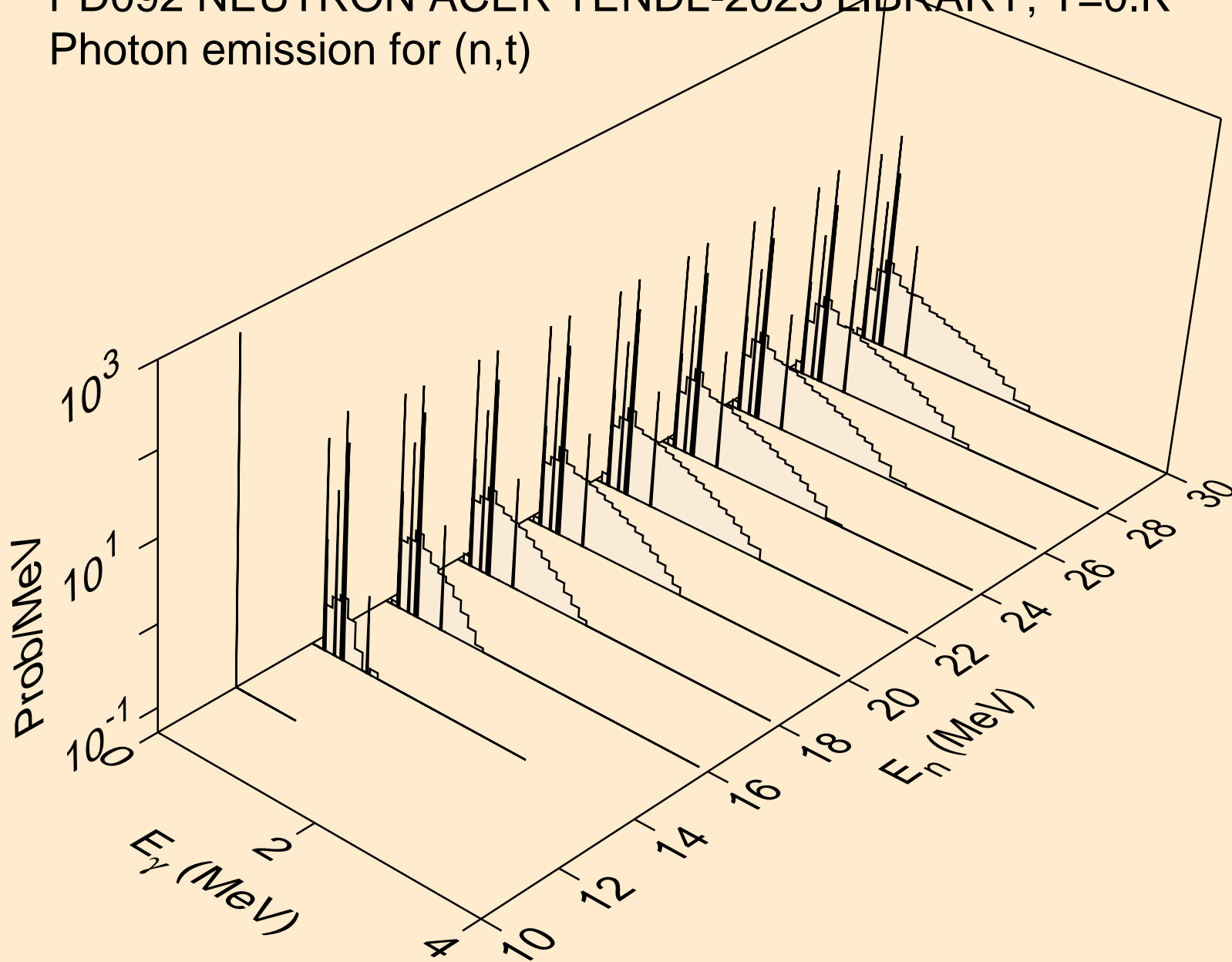

PD092 NEUTRON ACER TENDL-2023 LIBRARY; T=0.K
Photon emission for (n,he3)

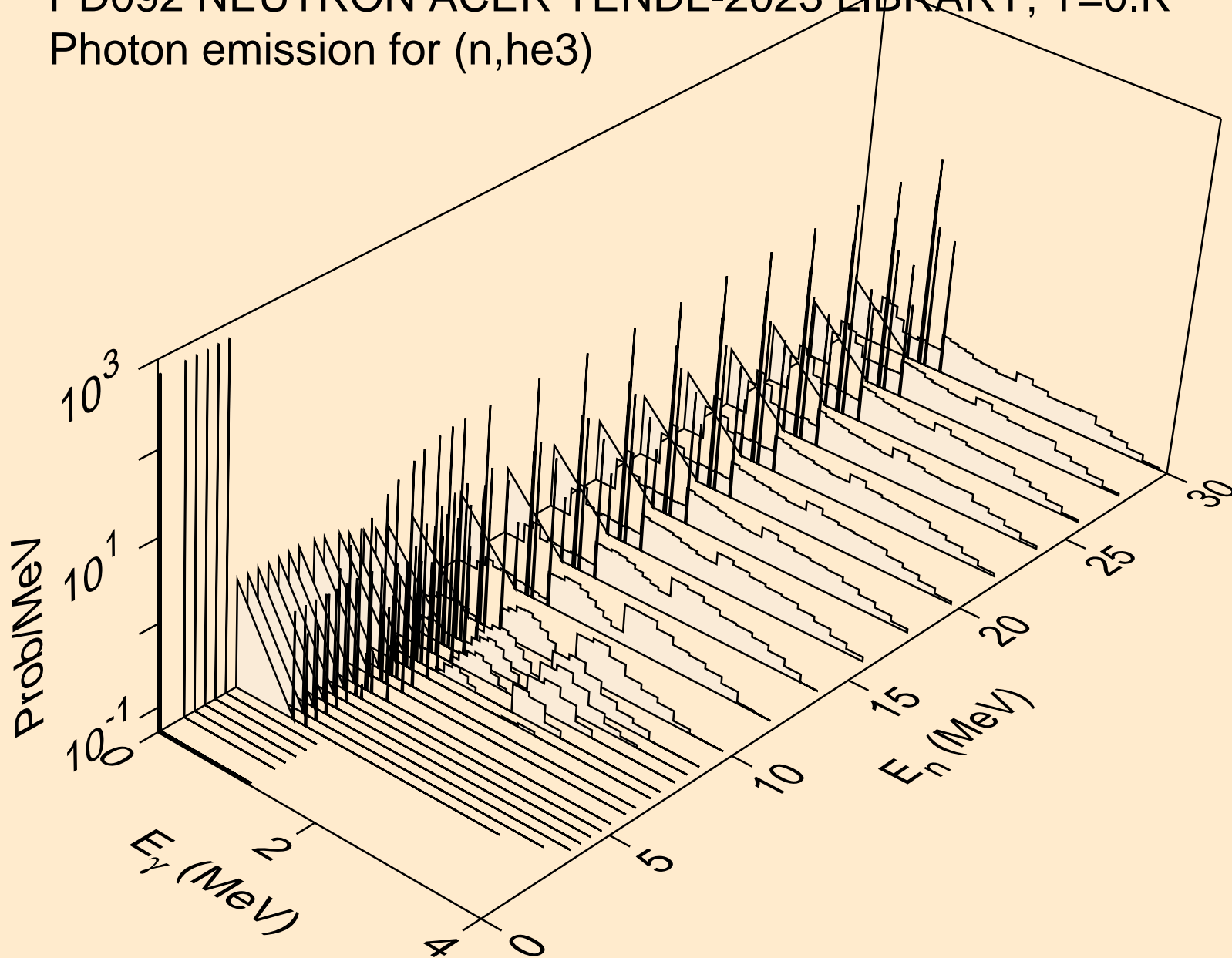

PD092 NEUTRON ACER TENDL-2023 LIBRARY; T=0.K
Photon emission for (n,a)

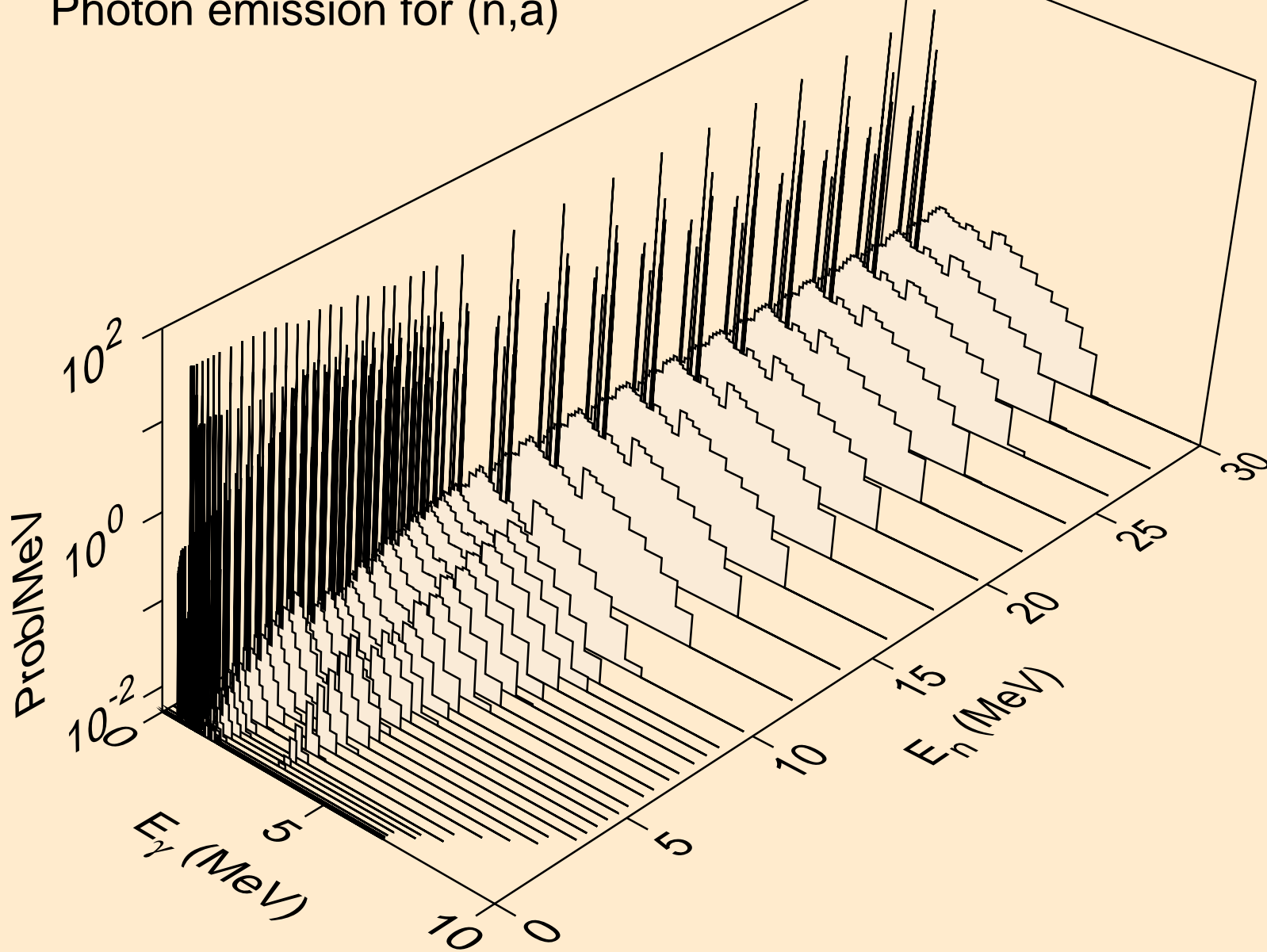

PD092 NEUTRON ACER TENDL-2023 LIBRARY; T=0.K
Photon emission for (n,2a)

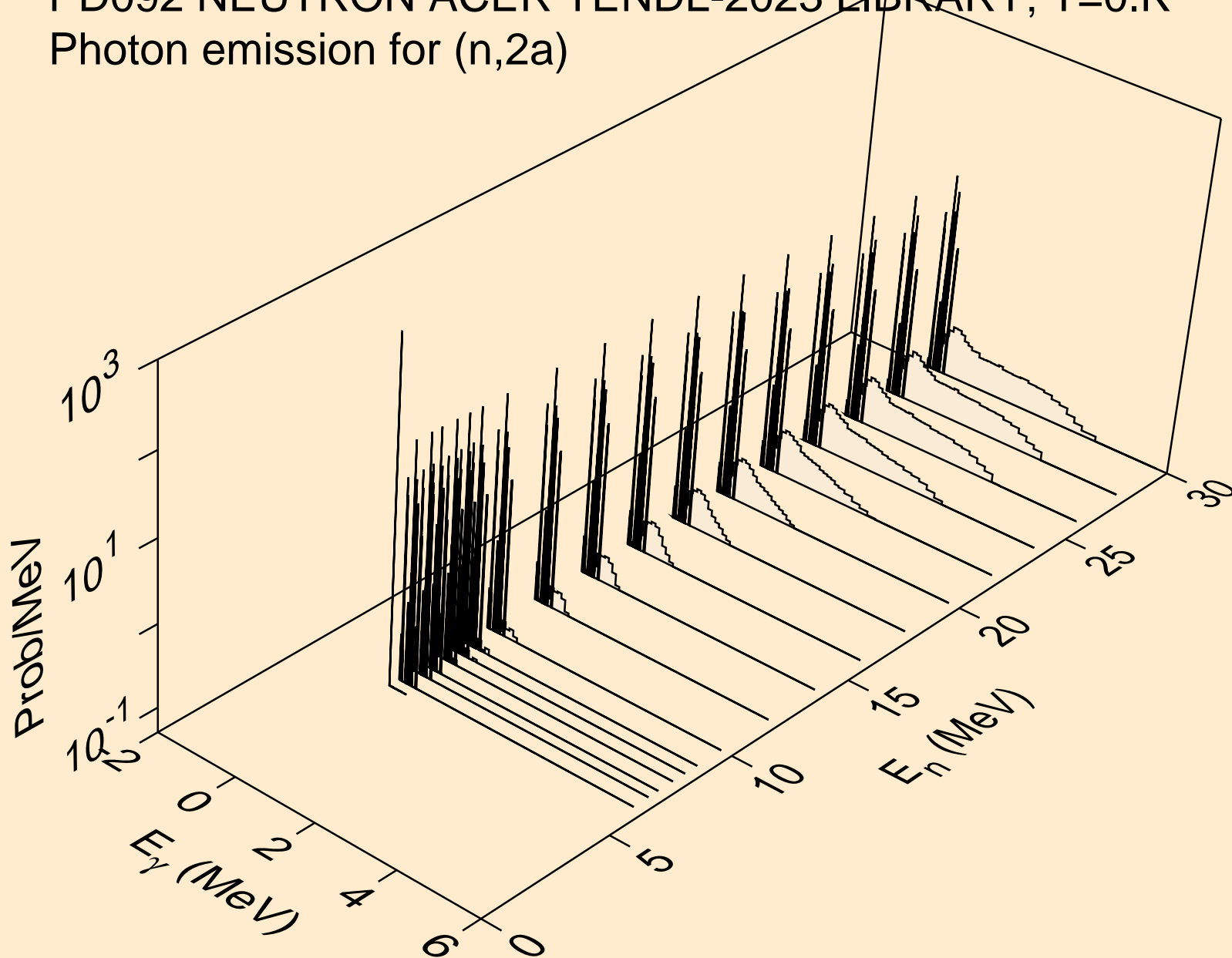

PD092 NEUTRON ACER TENDL-2023 LIBRARY; T=0.K
Photon emission for (n,2p)

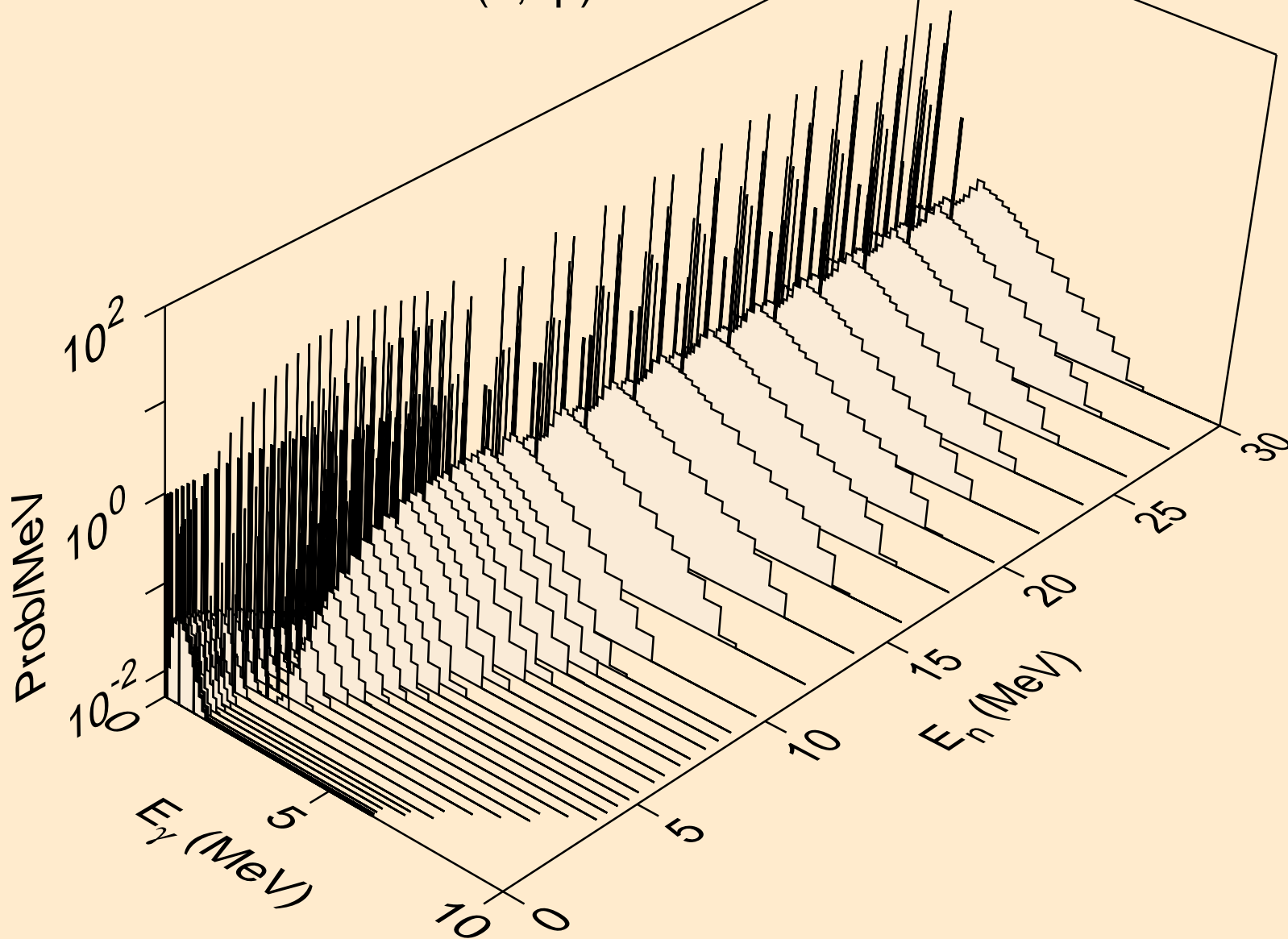

PD092 NEUTRON ACER TENDL-2023 LIBRARY; T=0.K
Photon emission for (n,p)

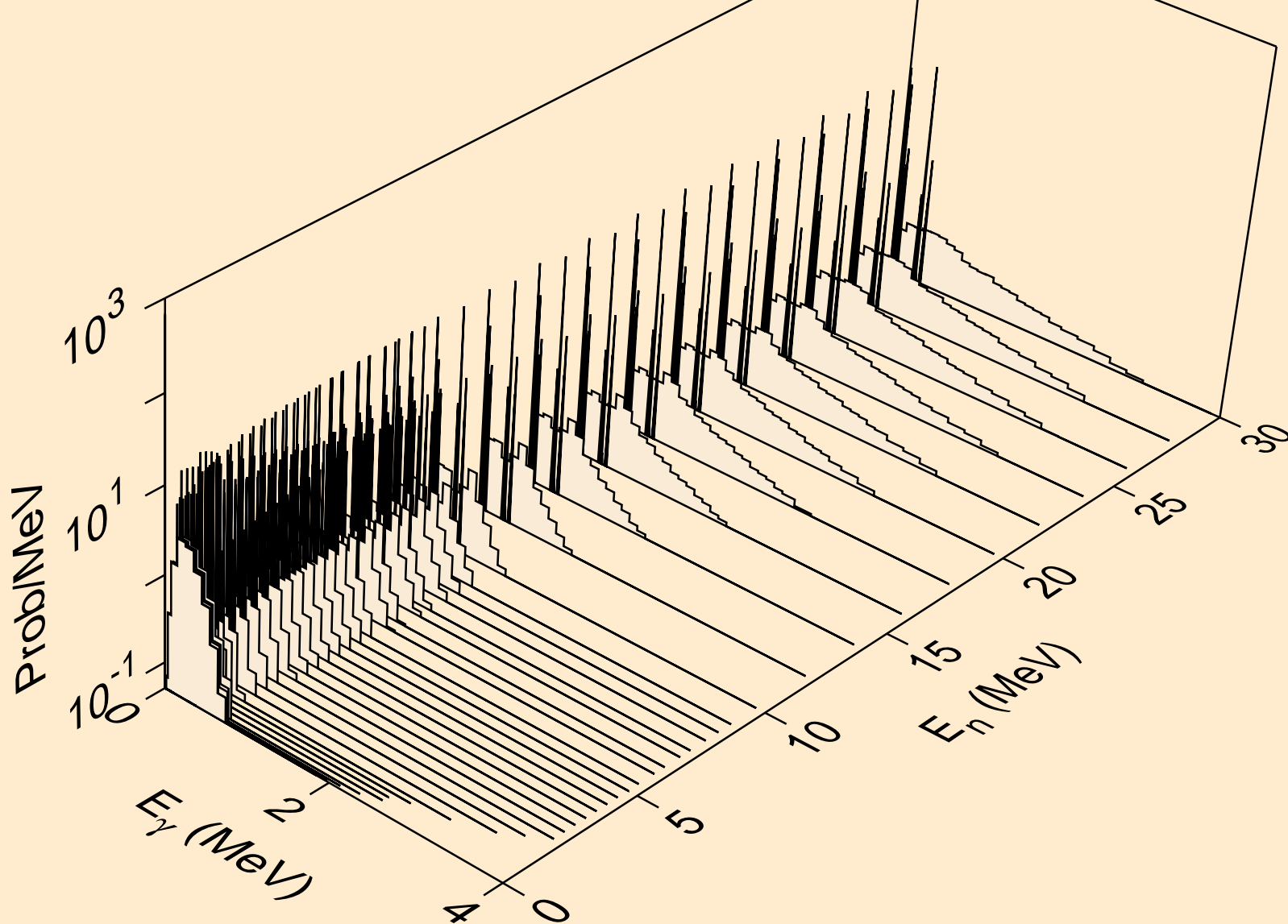

PD092 NEUTRON ACER TENDL-2023 LIBRARY; T=0.K
Photon emission for (n,pd)

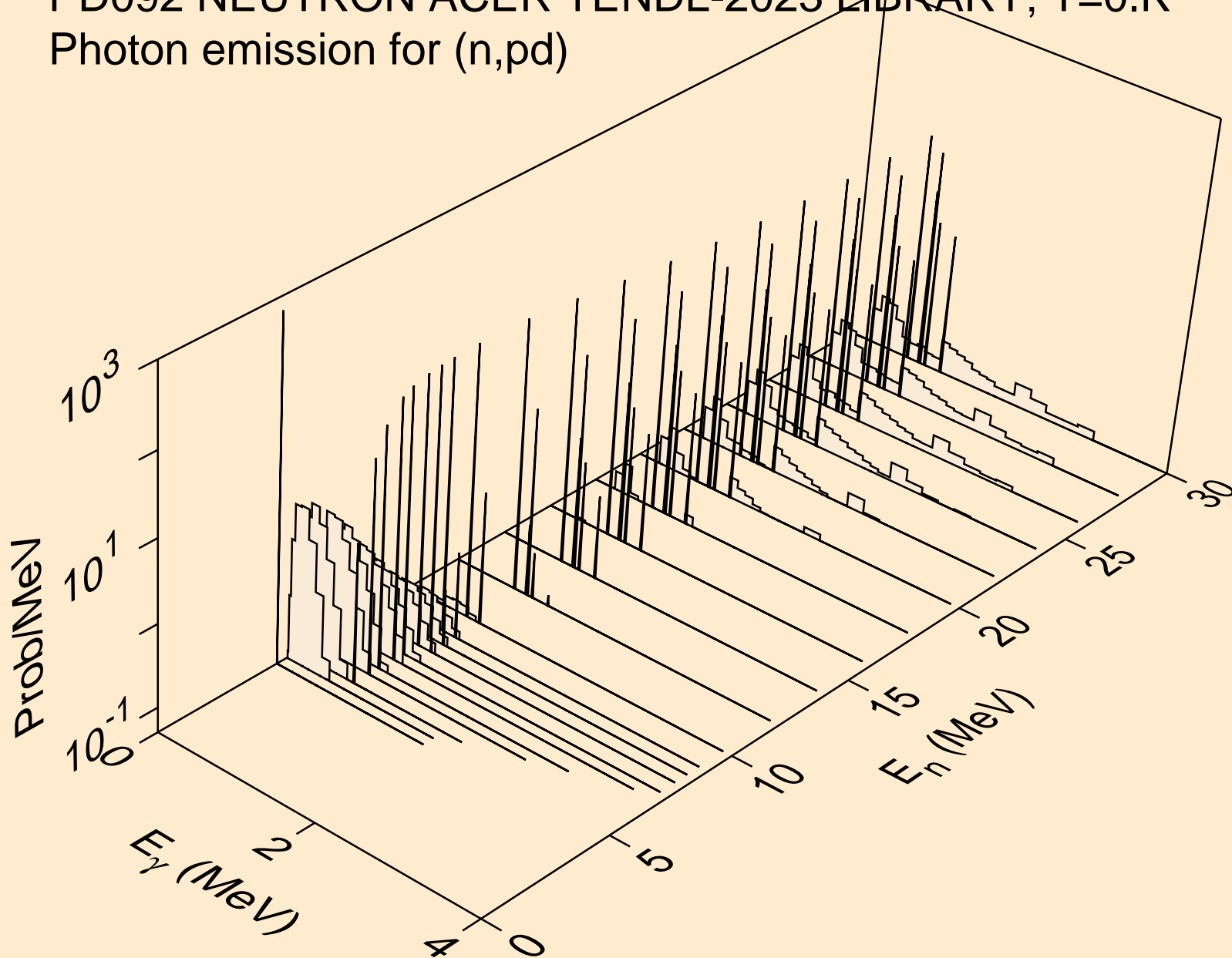

PD092 NEUTRON ACER TENDL-2023 LIBRARY; T=0.K
Photon emission for (n,pt)

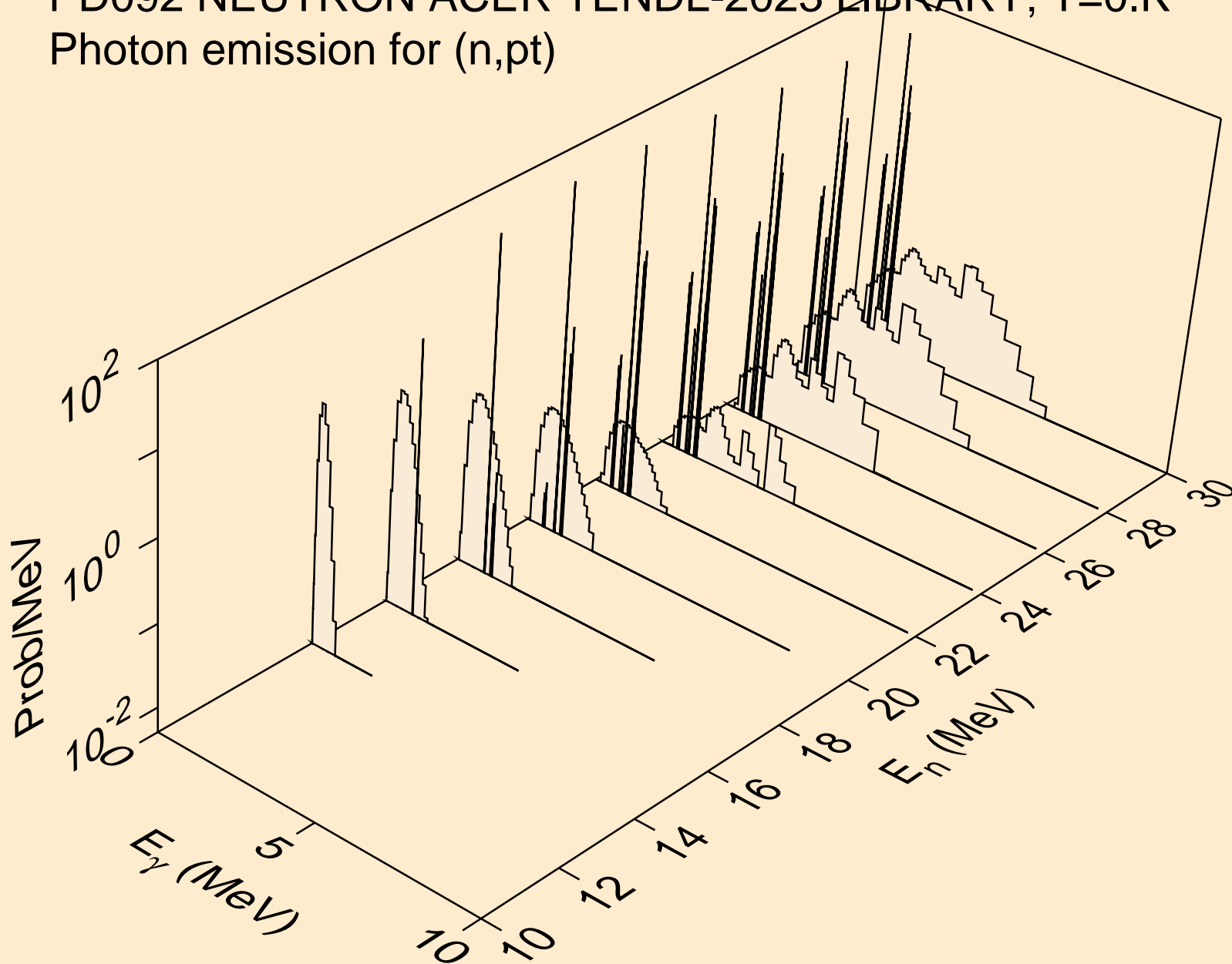

PD092 NEUTRON ACER TENDL-2023 LIBRARY; T=0.K
Photon emission for (n,da)

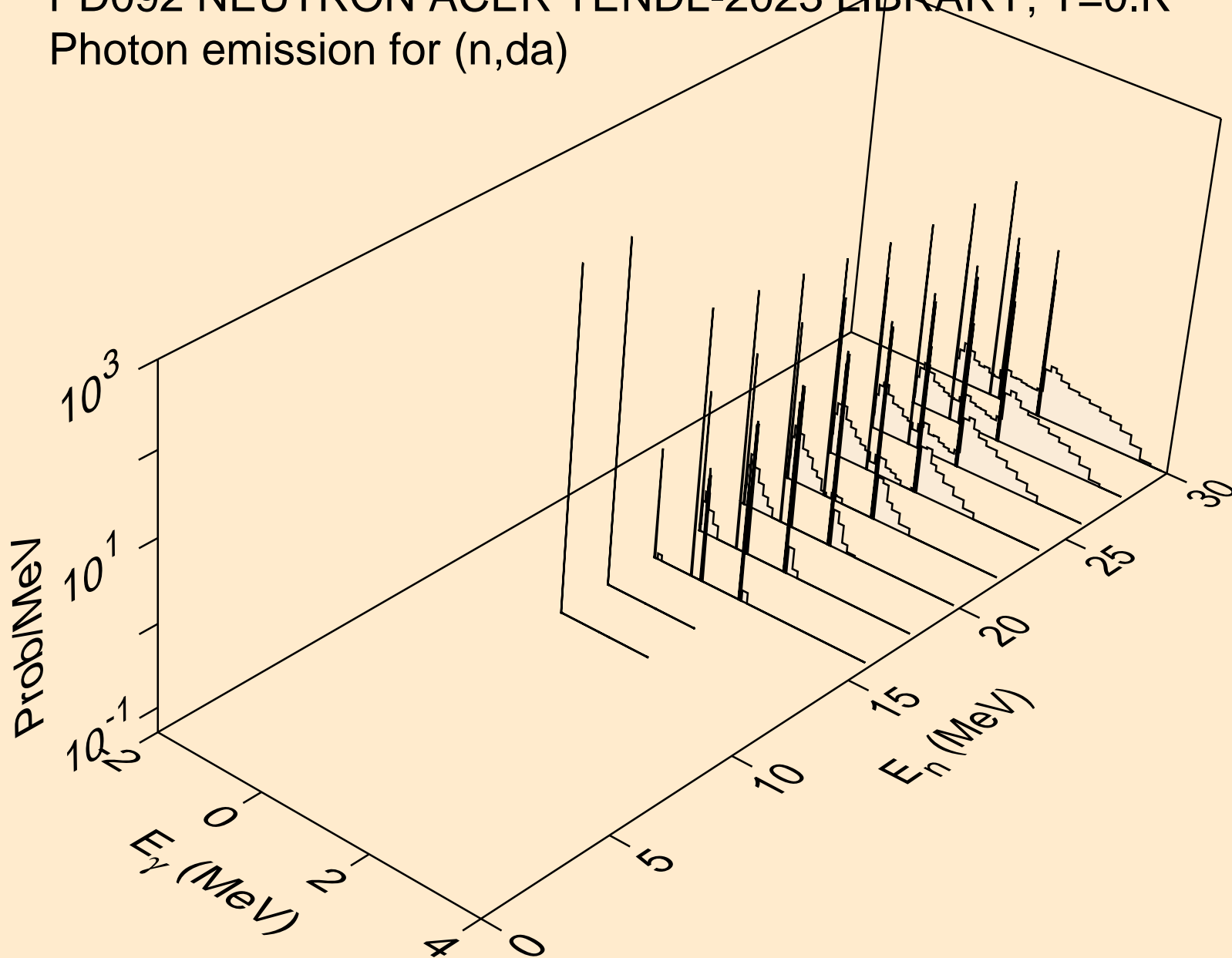

PD092 NEUTRON ACER TENDL-2023 LIBRARY; T=0.K
thermal capture photon spectrum

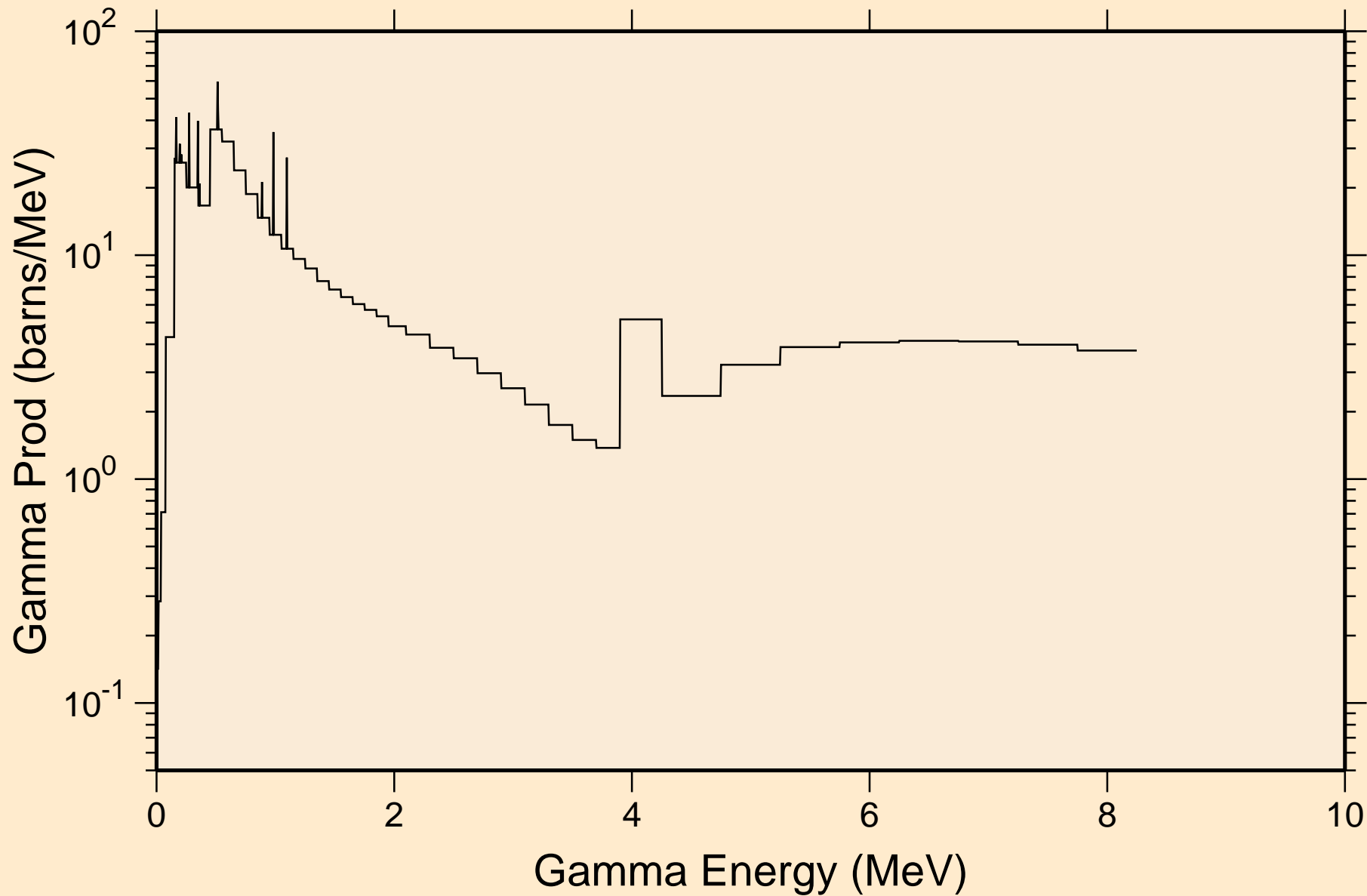

PD092 NEUTRON ACER TENDL-2023 LIBRARY; T=0.K
14 MeV photon spectrum

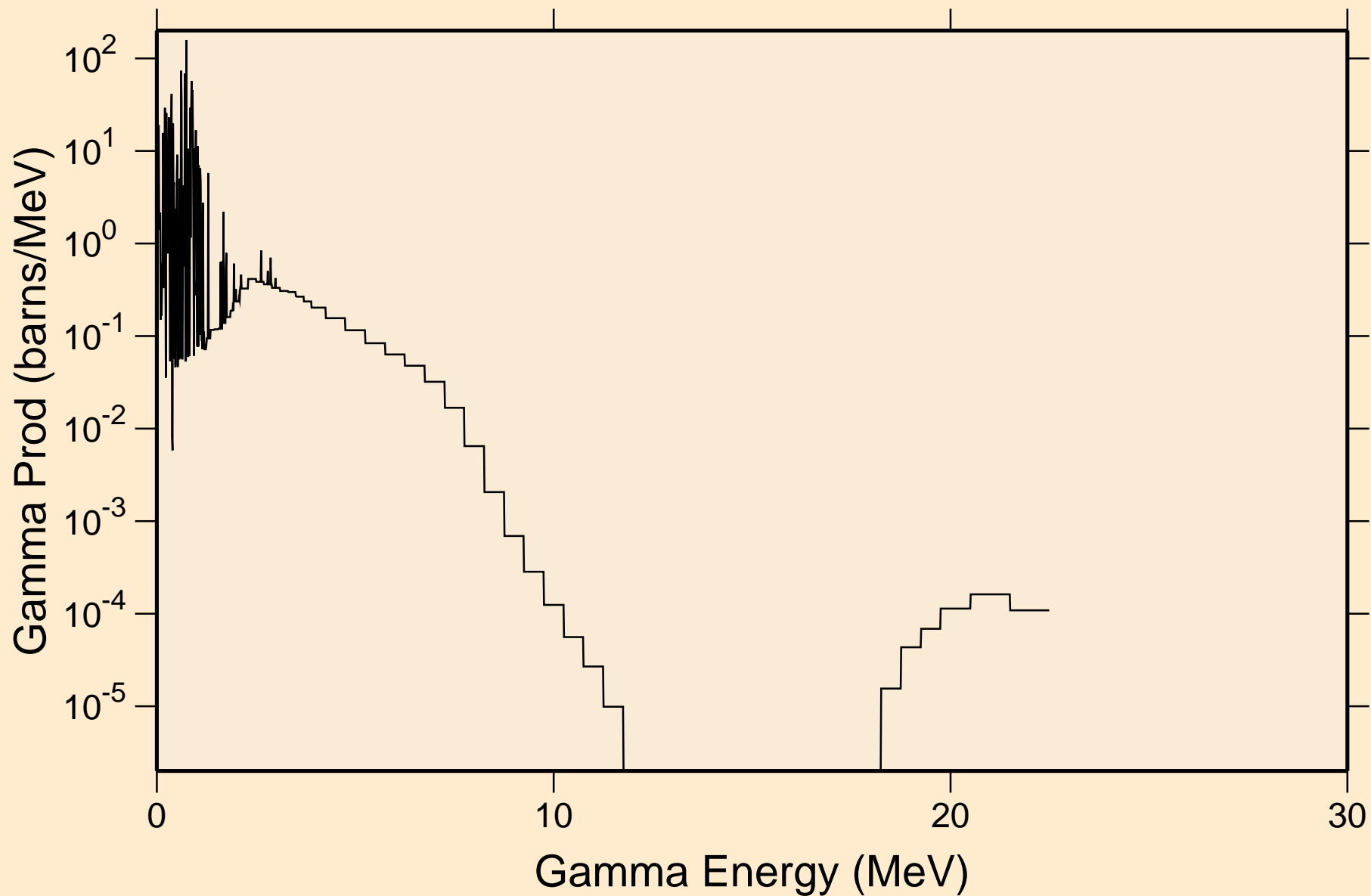

PD092 NEUTRON ACER TENDL-2023 LIBRARY; T=0.K

Particle heating contributions

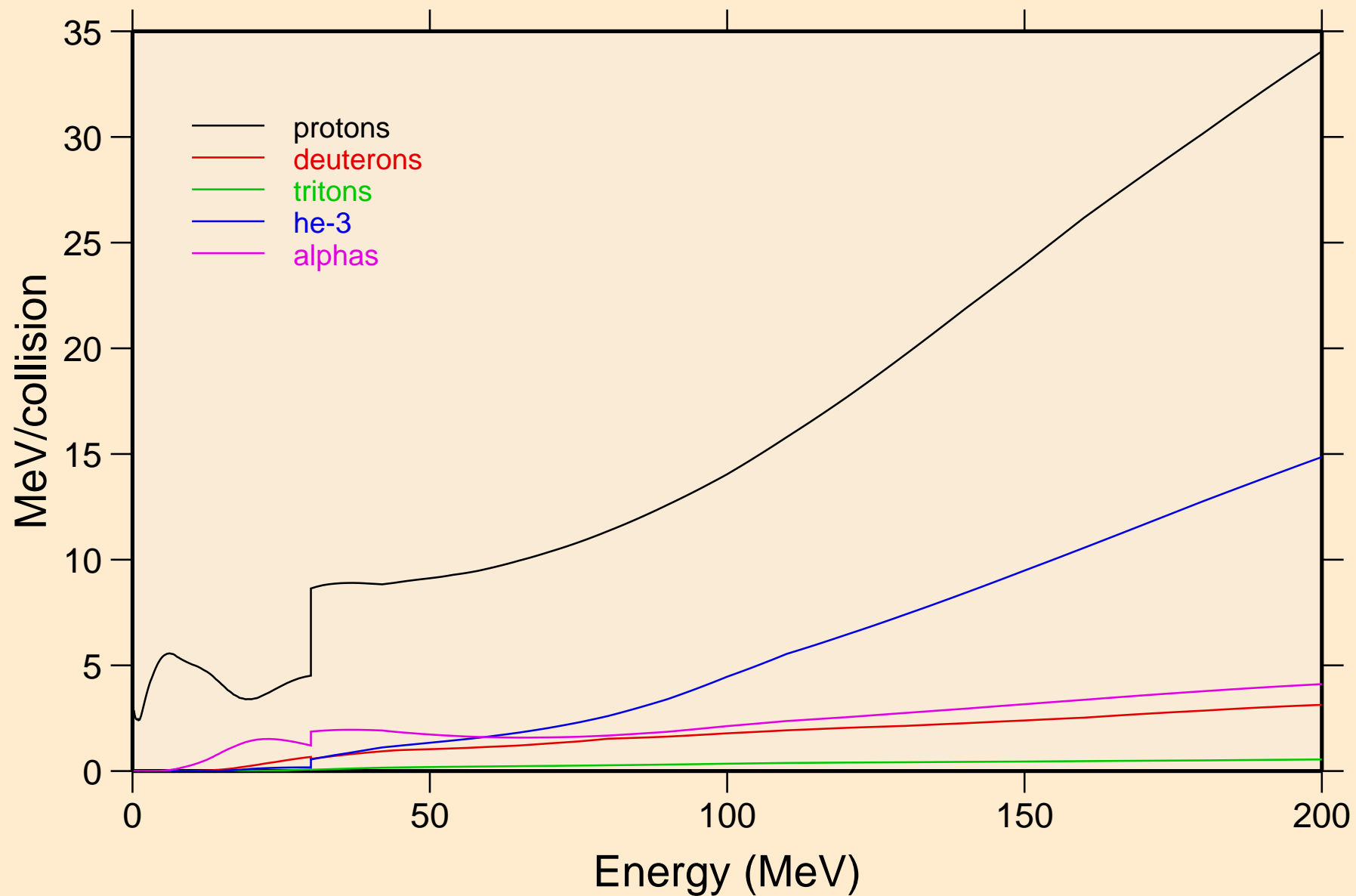

PD092 NEUTRON ACER TENDL-2023 LIBRARY; T=0.K
Recoil Heating

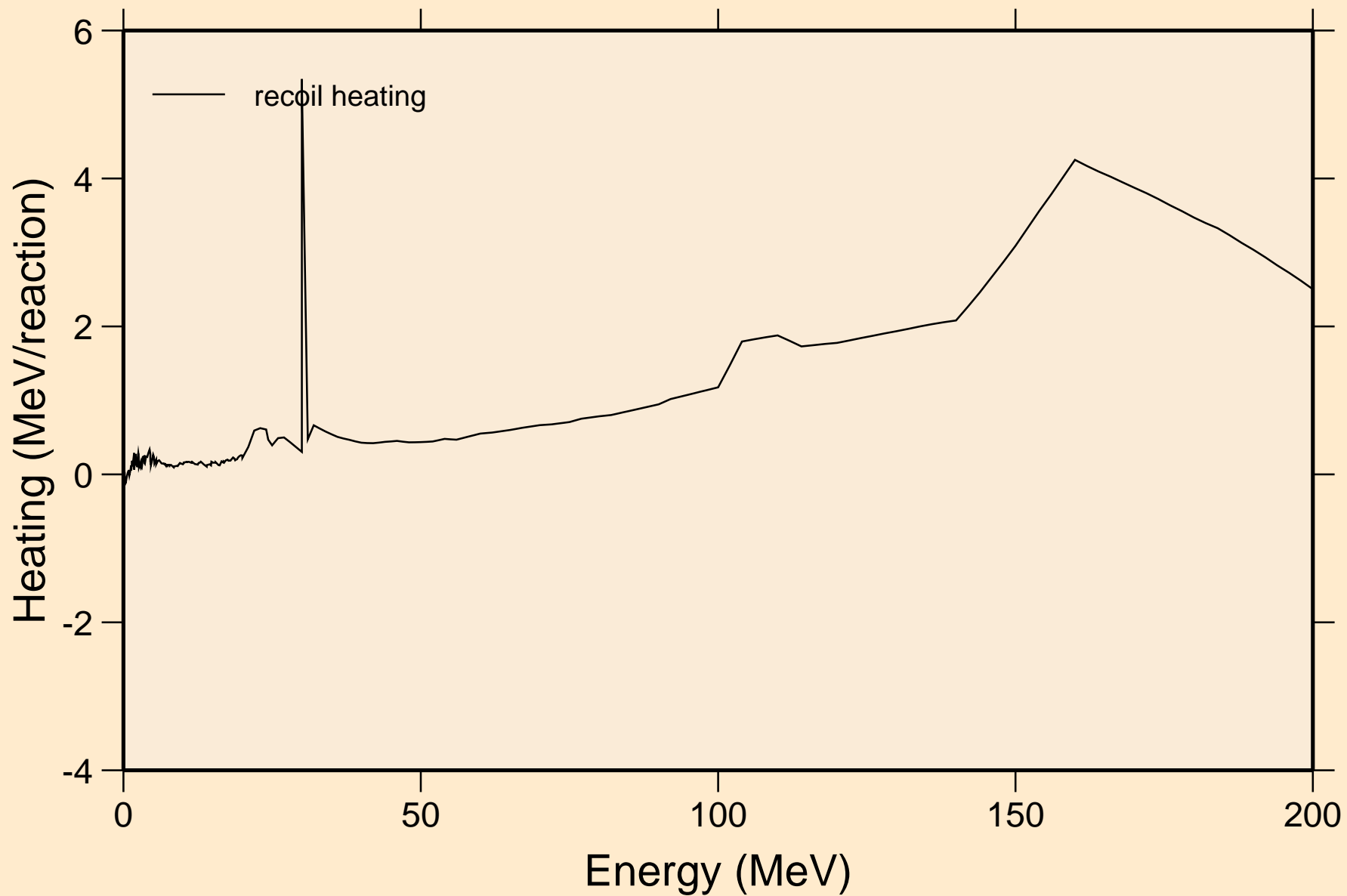

PD092 NEUTRON ACER TENDL-2023 LIBRARY; T=0.K
Particle production cross sections

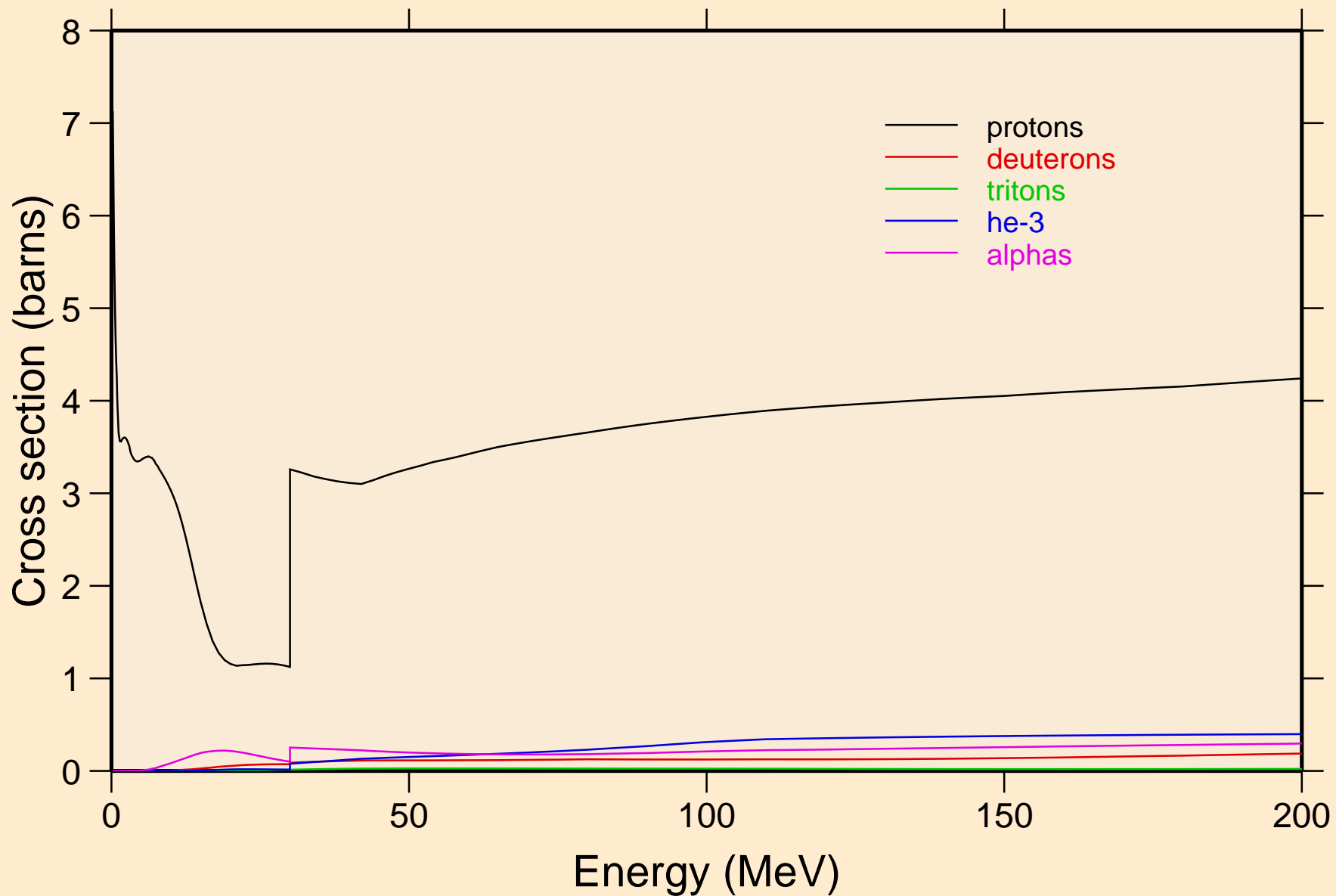

PD092 NEUTRON ACER TENDL-2023 LIBRARY; T=0.K
protons from (n,x)

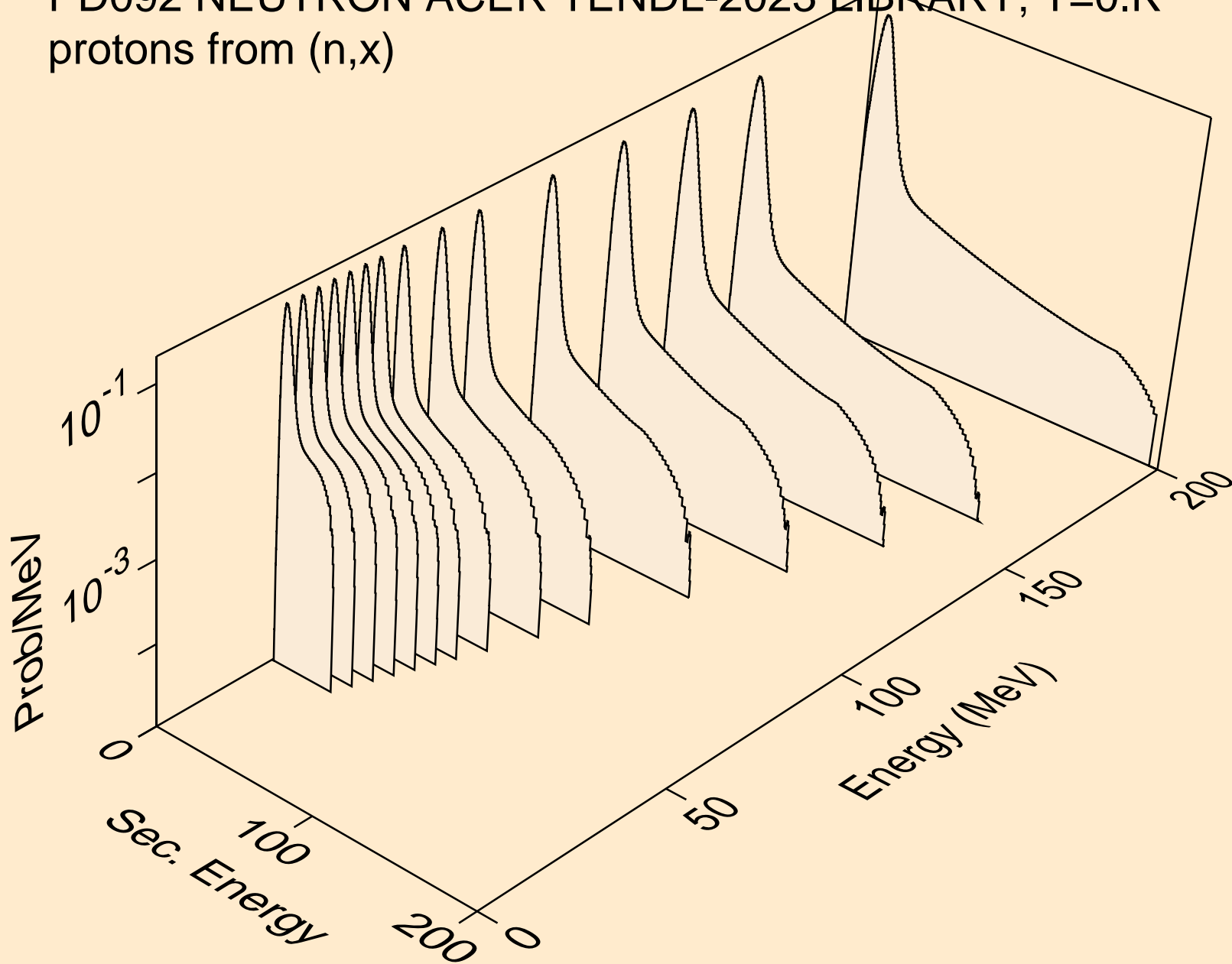

PD092 NEUTRON ACER TENDL-2023 LIBRARY; T=0.K
protons from (n,n*)p

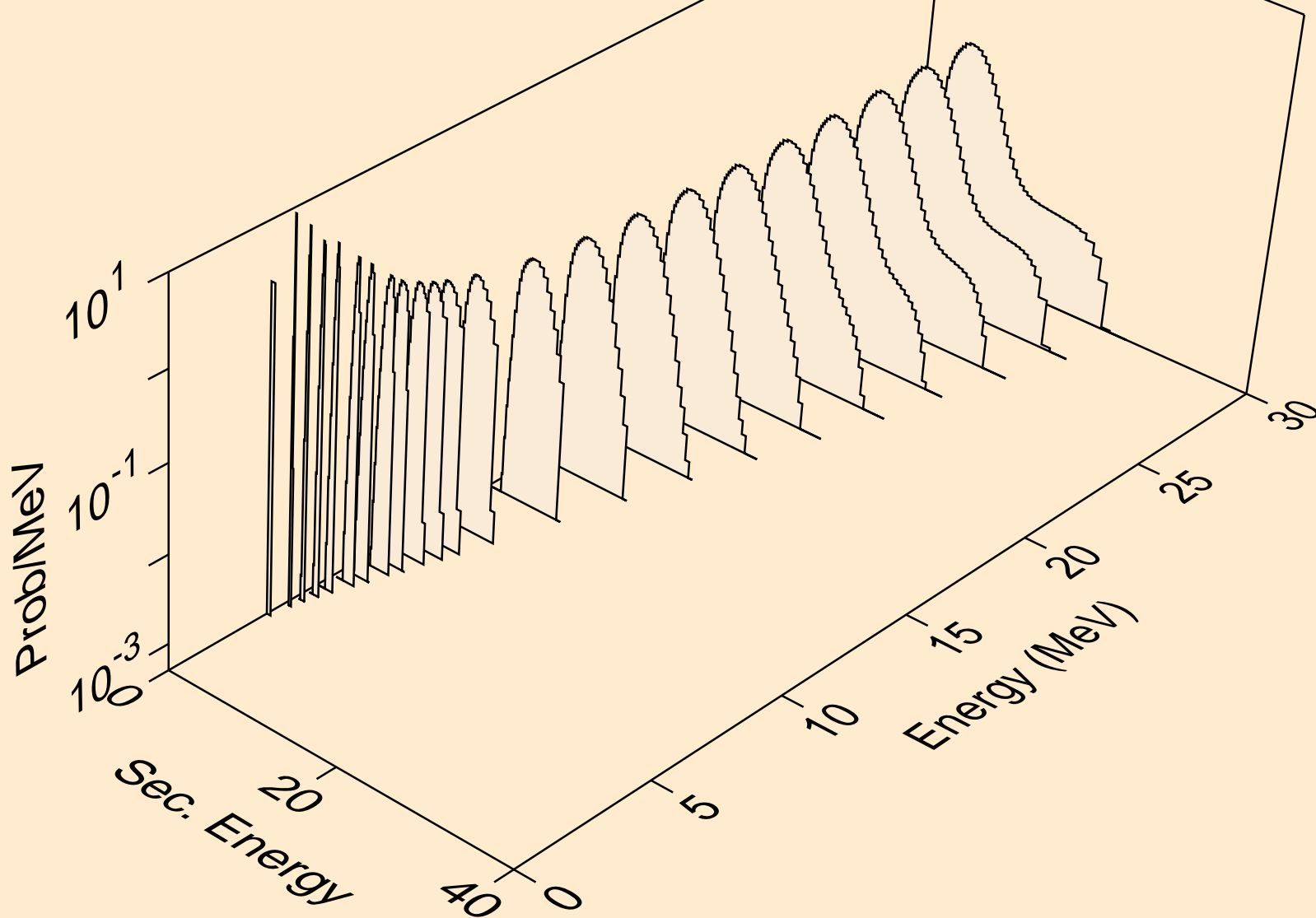

PD092 NEUTRON ACER TENDL-2023 LIBRARY; T=0.K
protons from (n,2np)

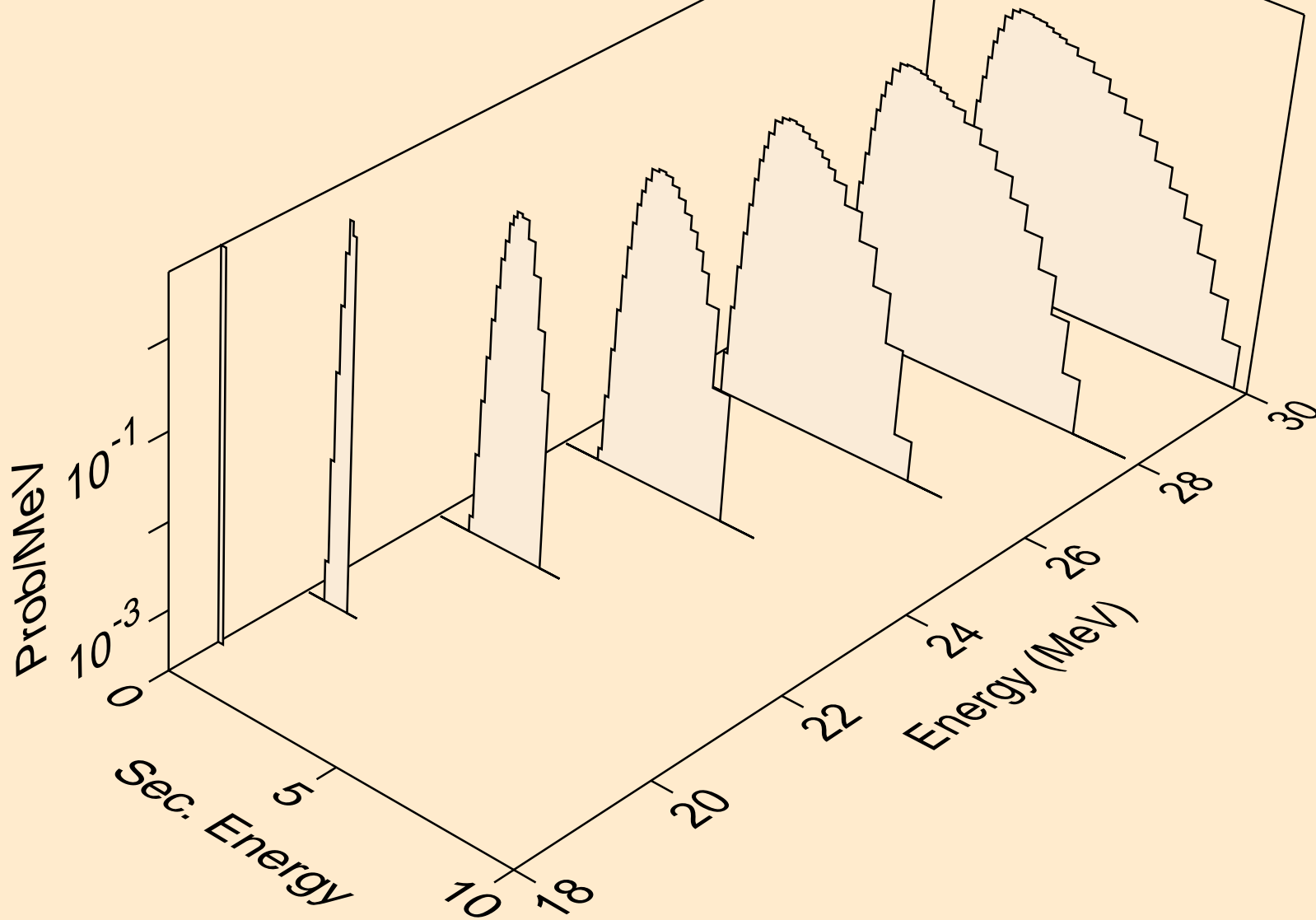

PD092 NEUTRON ACER TENDL-2023 LIBRARY; T=0.K
protons from (n,n2p)

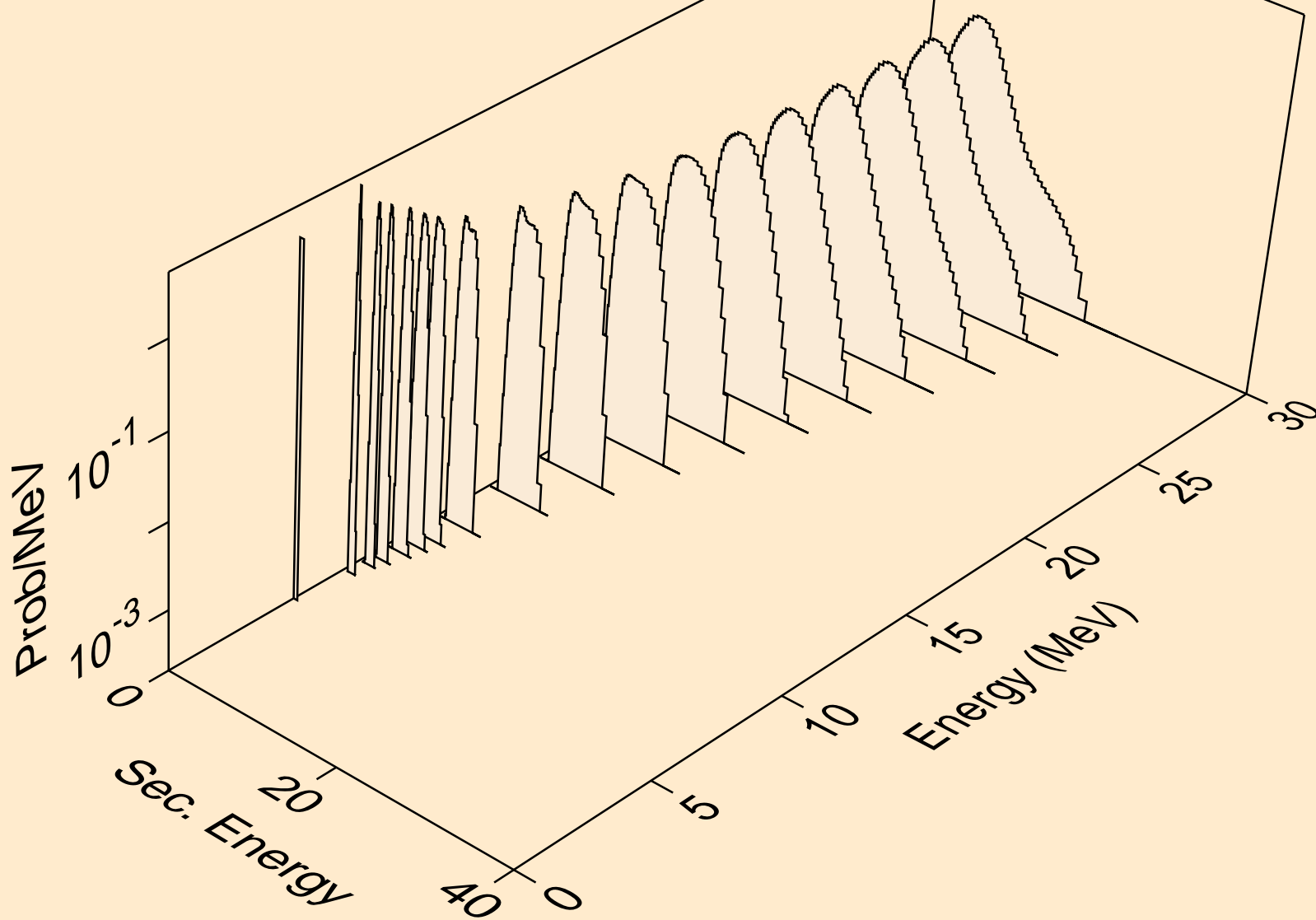

PD092 NEUTRON ACER TENDL-2023 LIBRARY; T=0.K
protons from (n,npa)

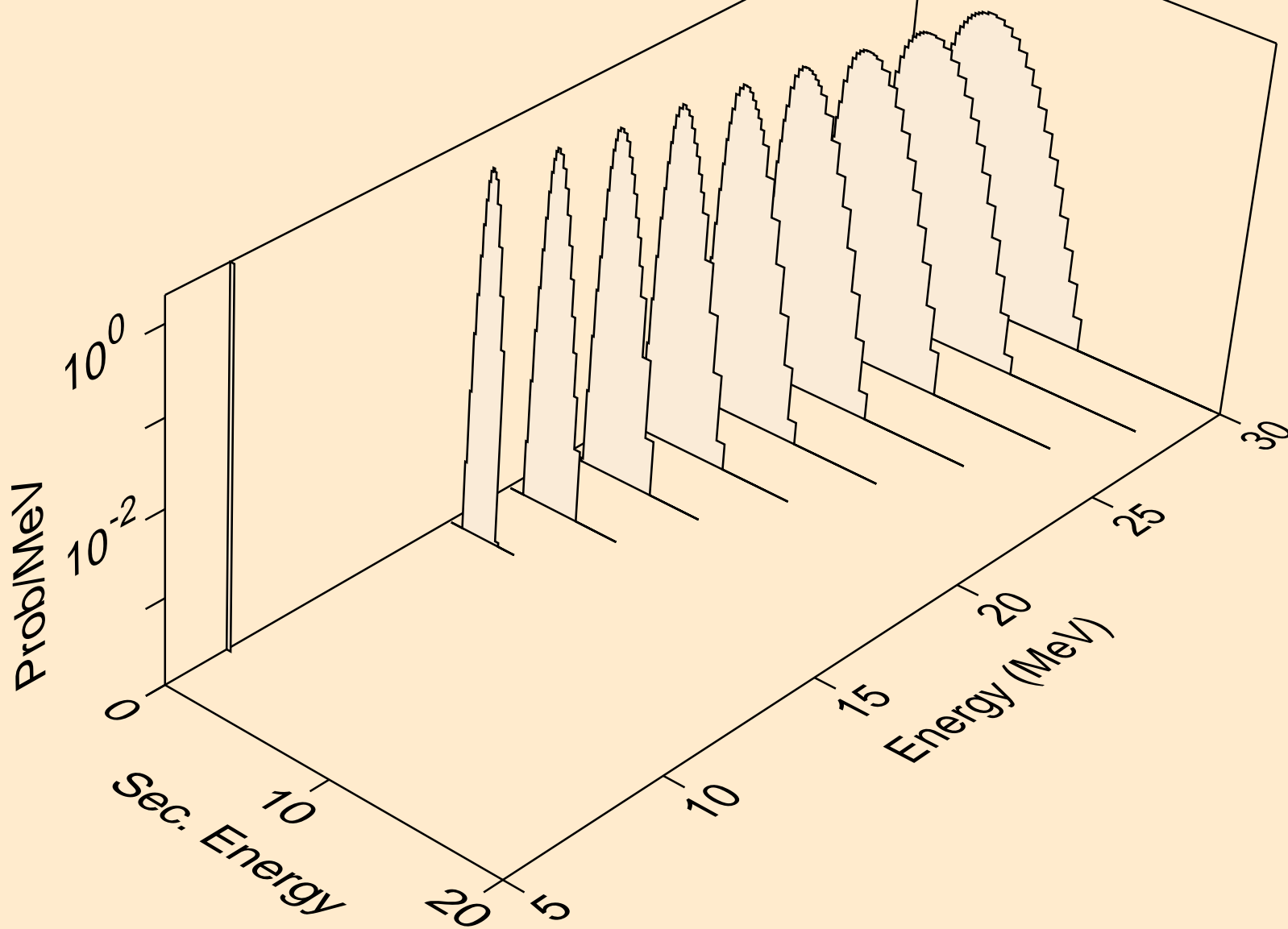

PD092 NEUTRON ACER TENDL-2023 LIBRARY; T=0.K
protons from (n,p)

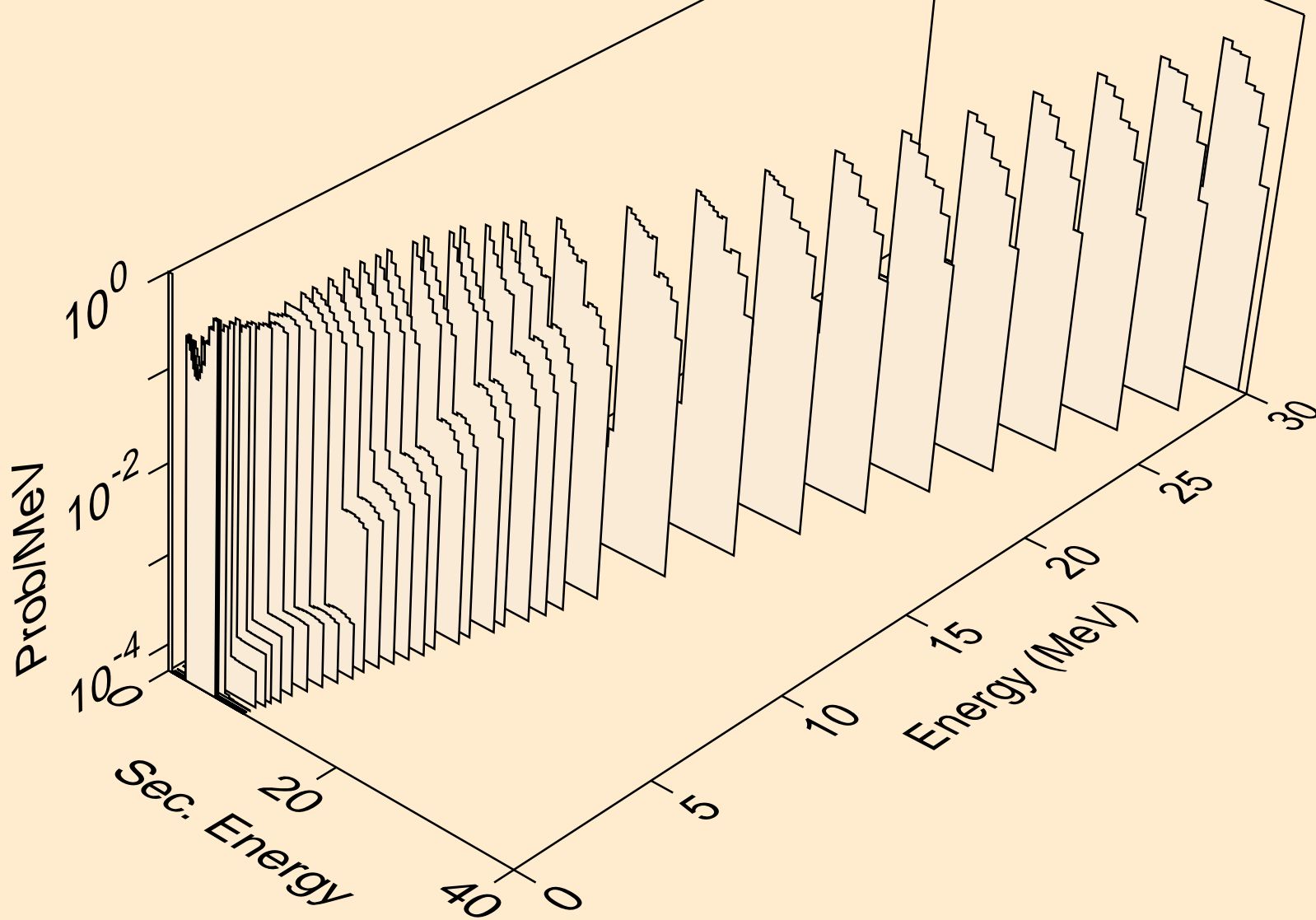

PD092 NEUTRON ACER TENDL-2023 LIBRARY; T=0.K
protons from (n,2p)

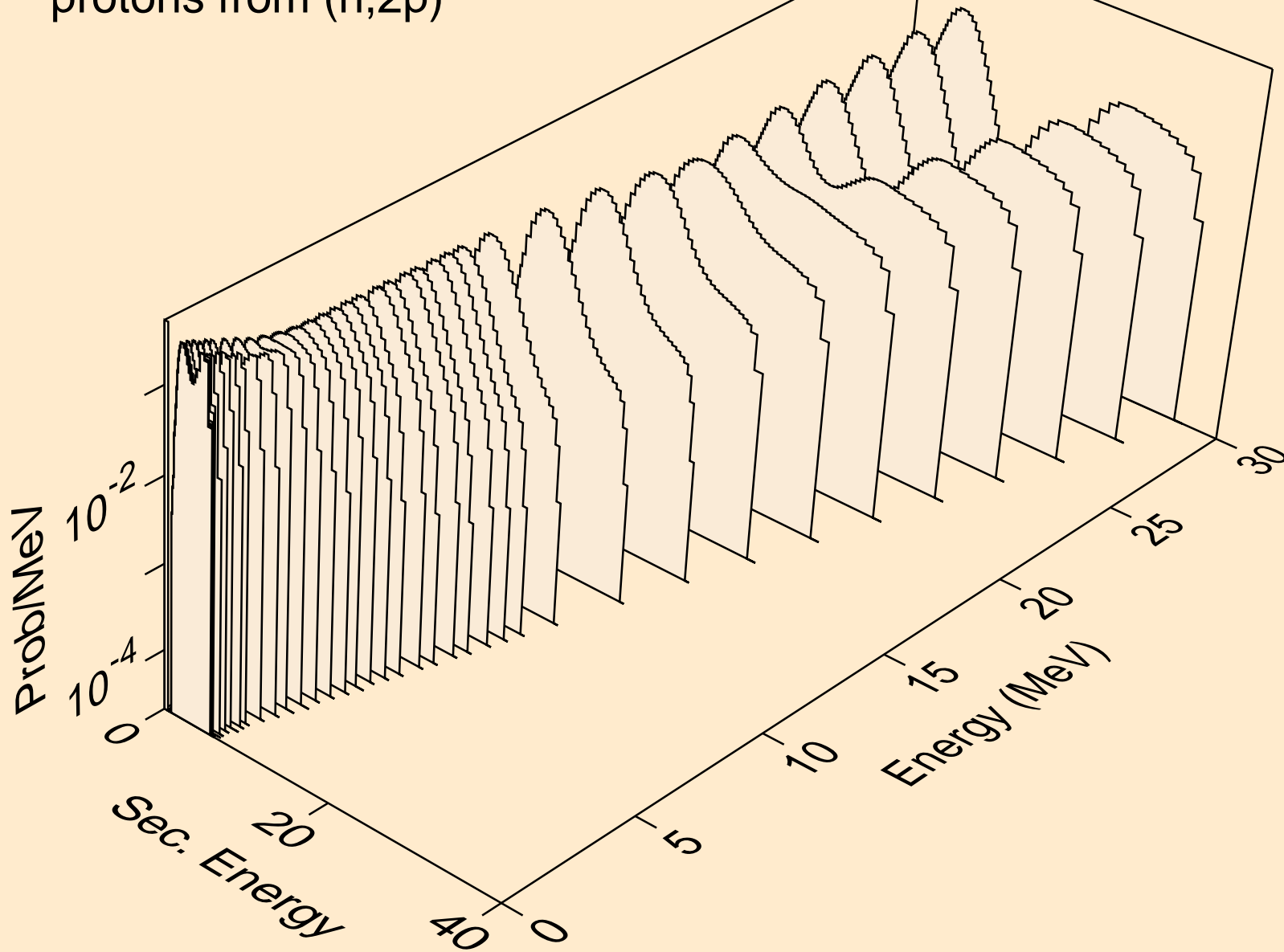

PD092 NEUTRON ACER TENDL-2023 LIBRARY; T=0.K
protons from (n,p)

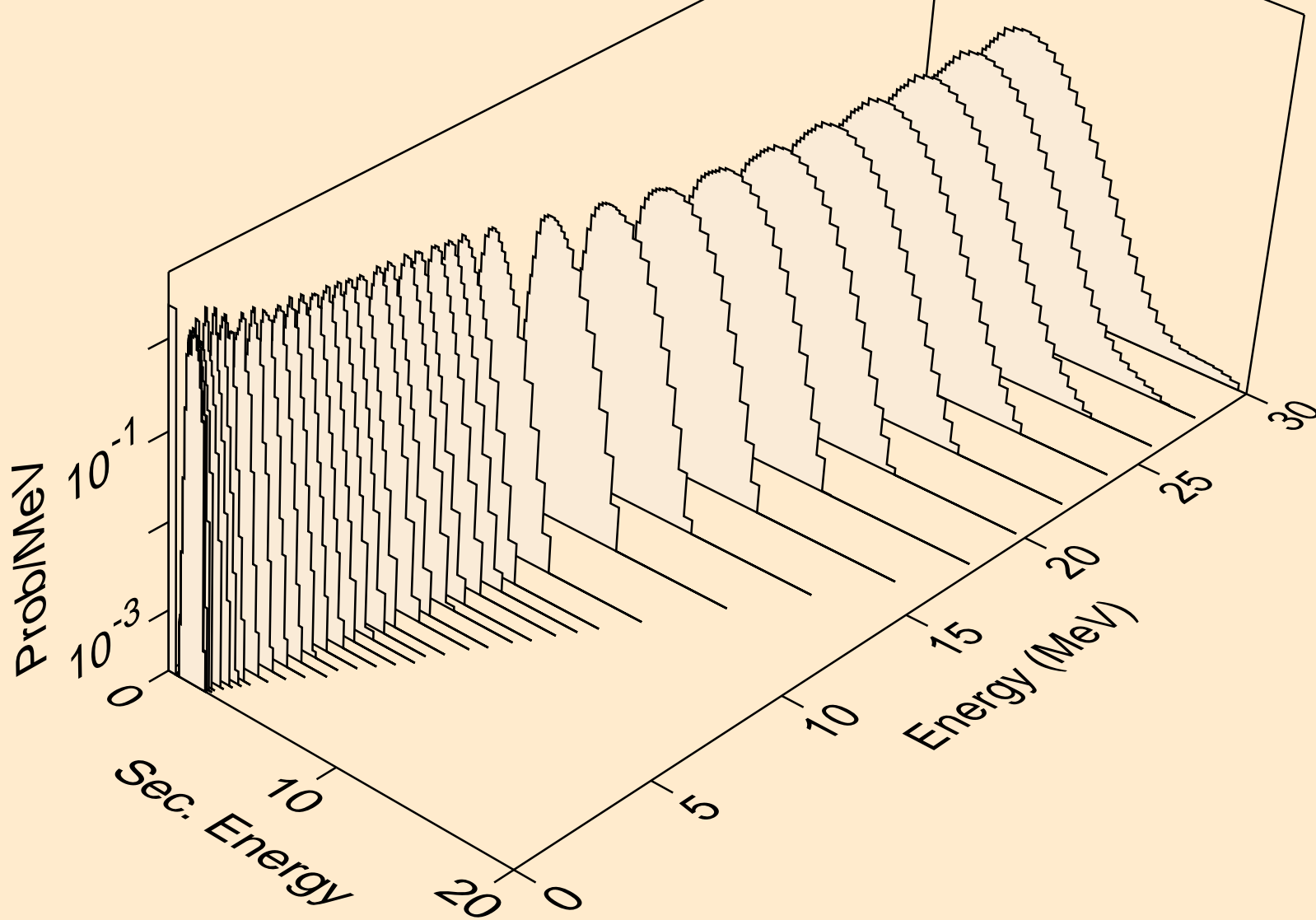

PD092 NEUTRON ACER TENDL-2023 LIBRARY; T=0.K
protons from (n,pd)

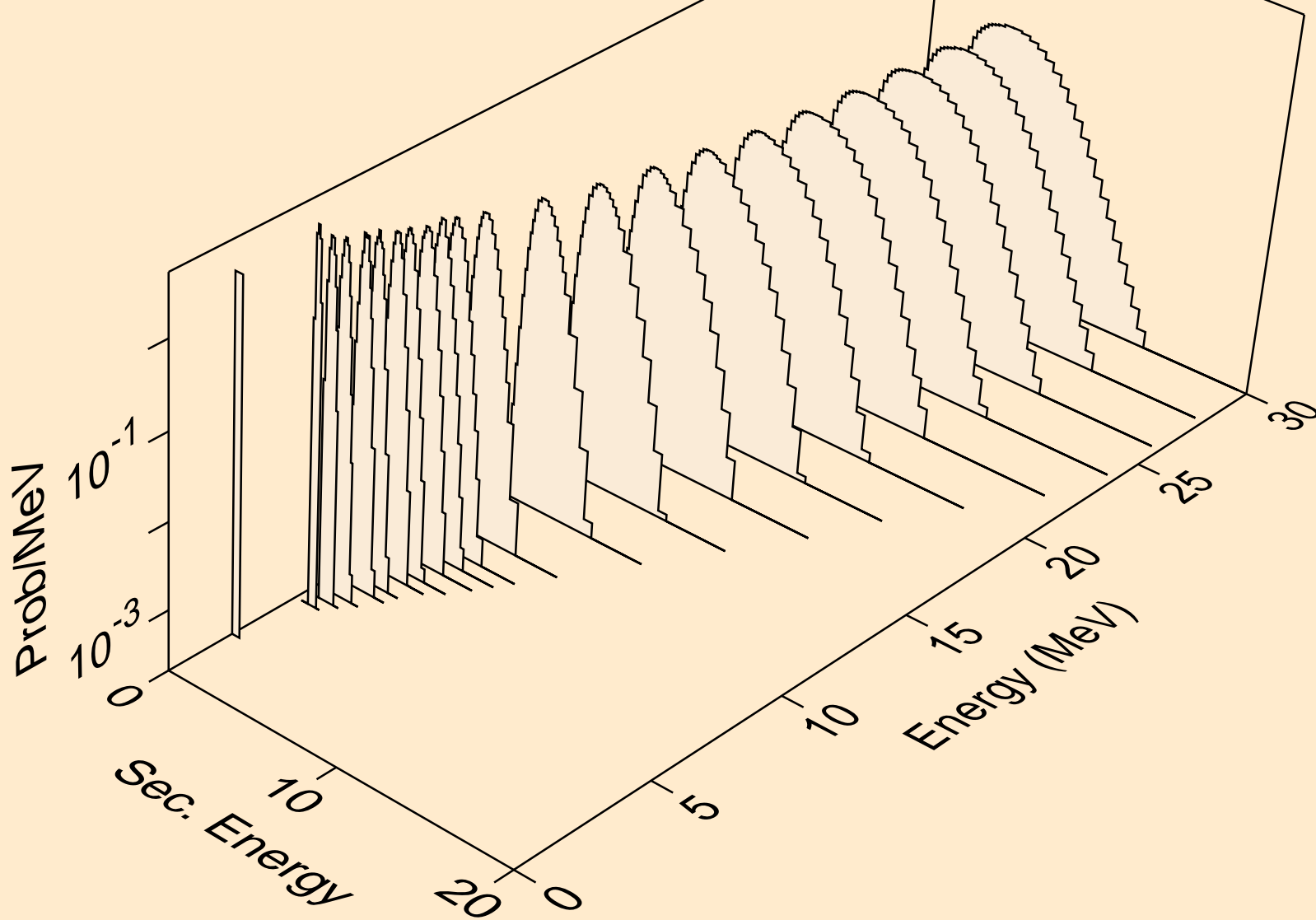

PD092 NEUTRON ACER TENDL-2023 LIBRARY; T=0.K
protons from (n,pt)

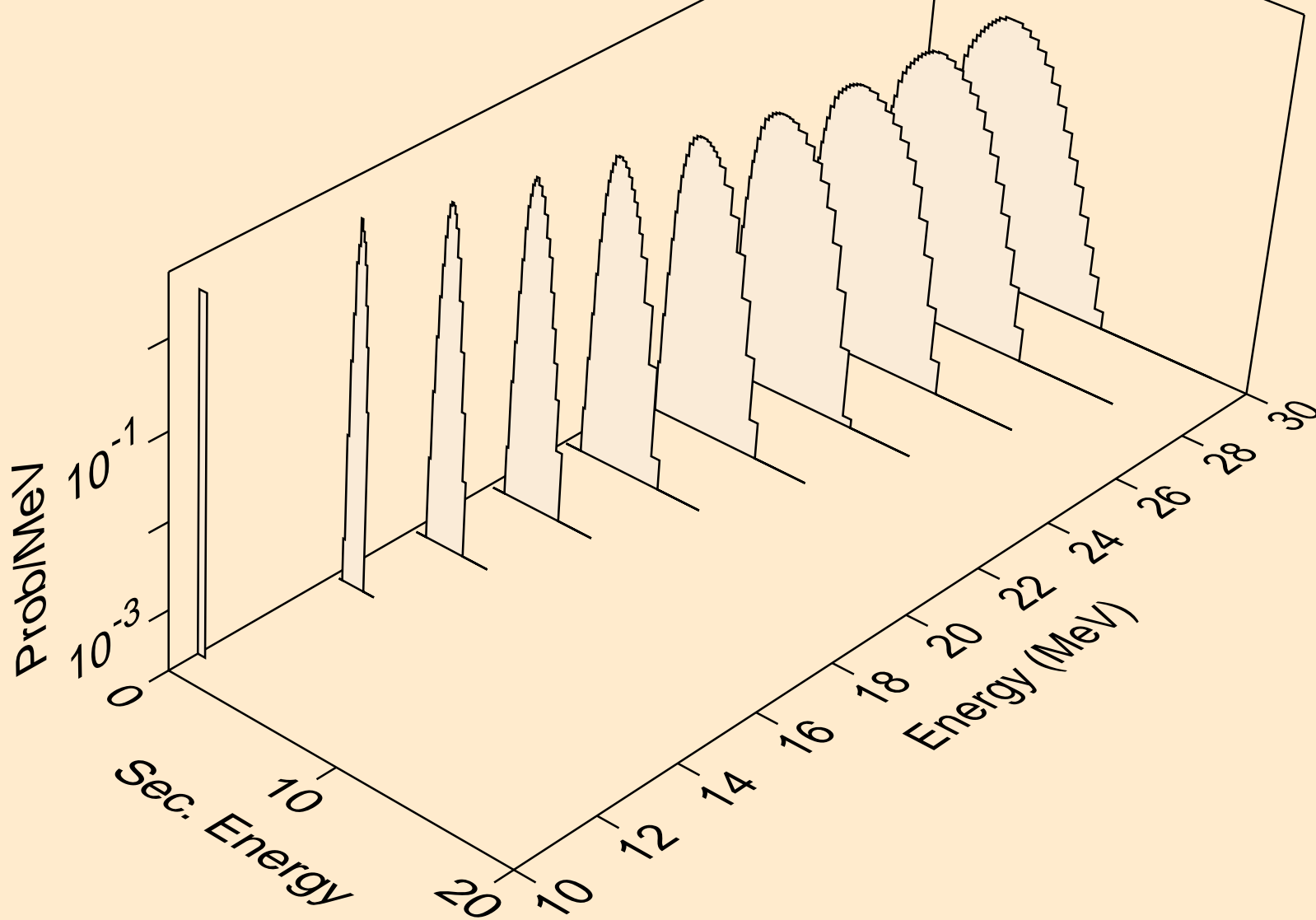

PD092 NEUTRON ACER TENDL-2023 LIBRARY; T=0.K
deuterons from (n,x)

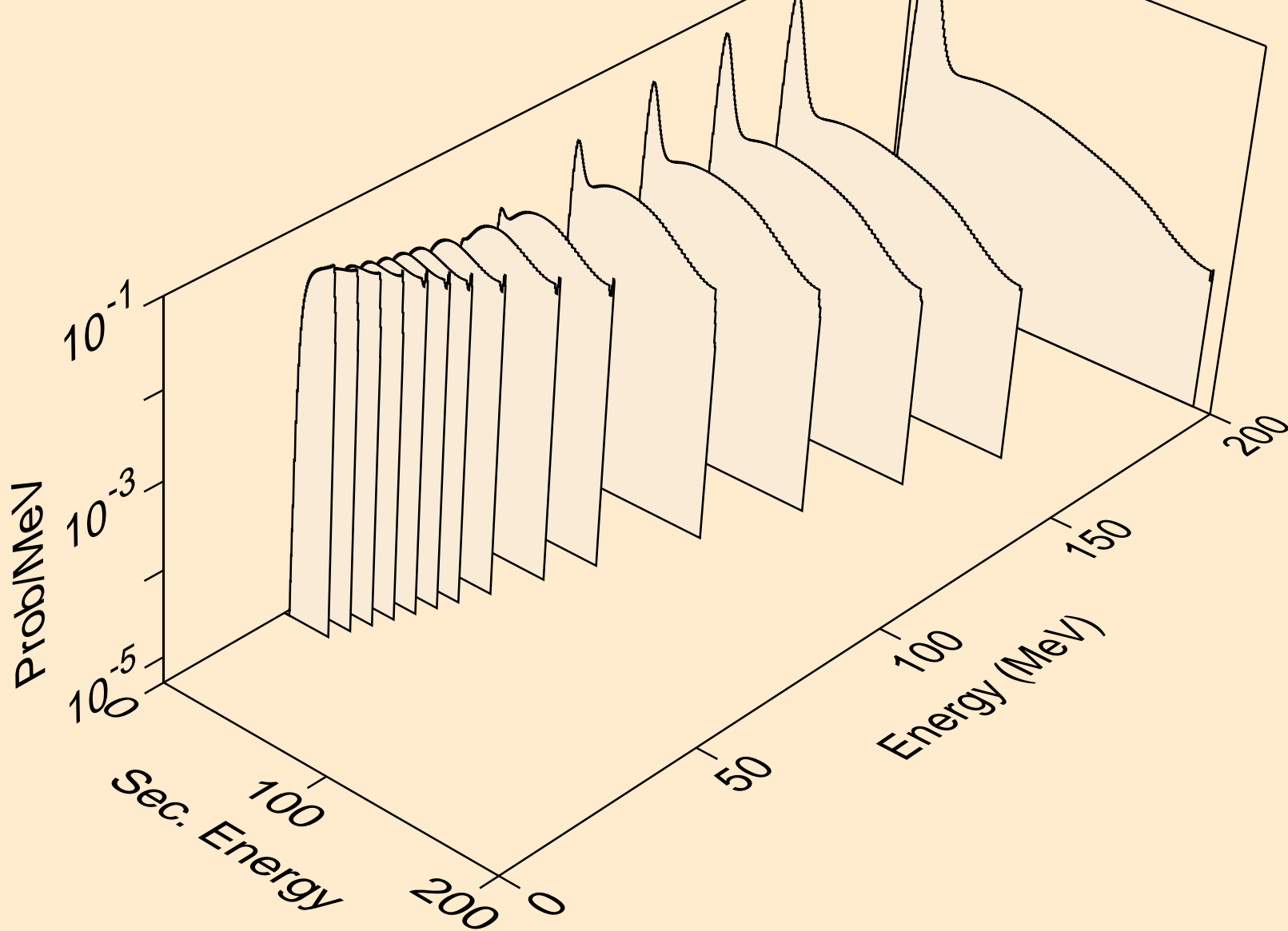

PD092 NEUTRON ACER TENDL-2023 LIBRARY; T=0.K
deuterons from (n,n*)d

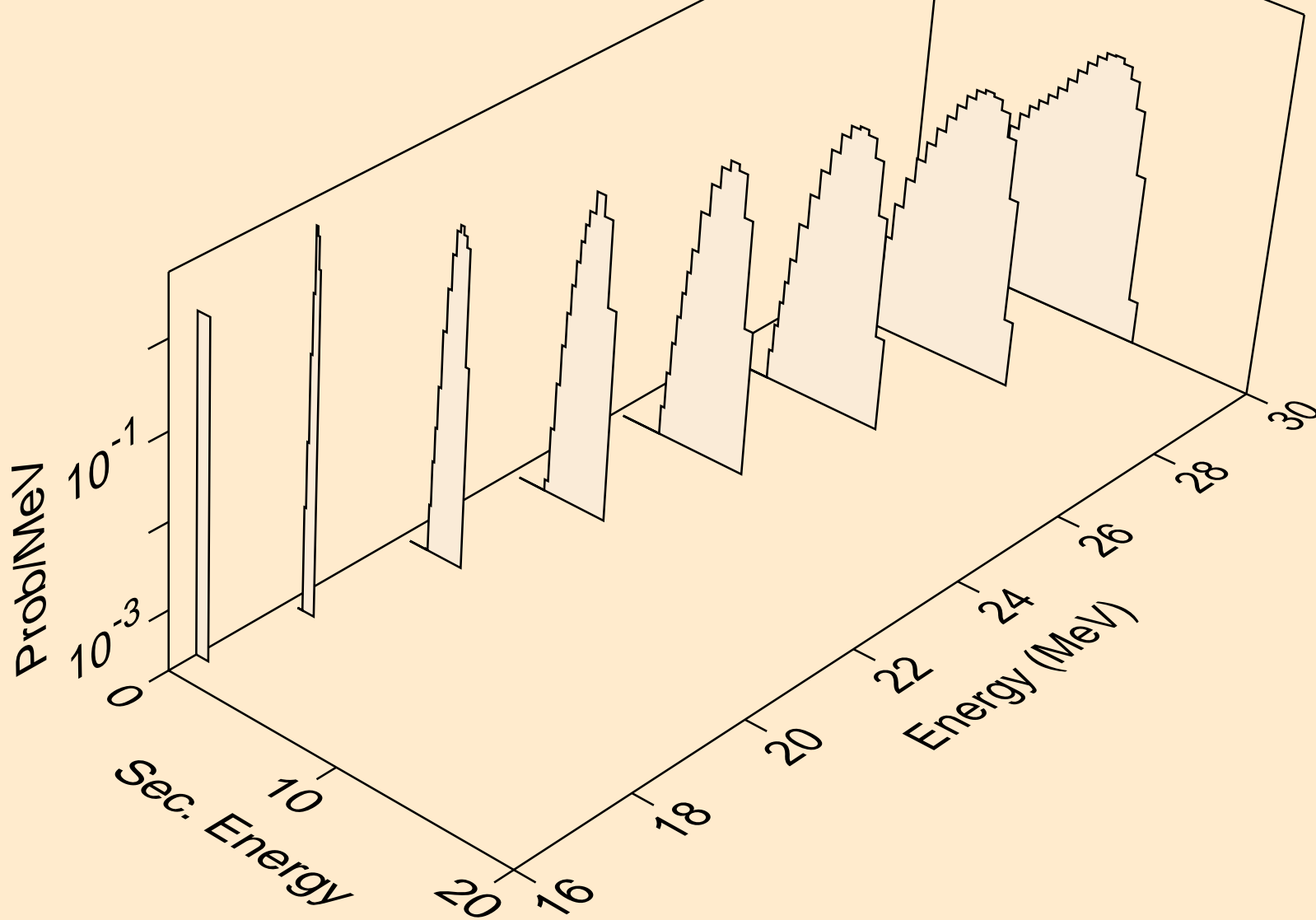

PD092 NEUTRON ACER TENDL-2023 LIBRARY; T=0.K
deuterons from (n,d)

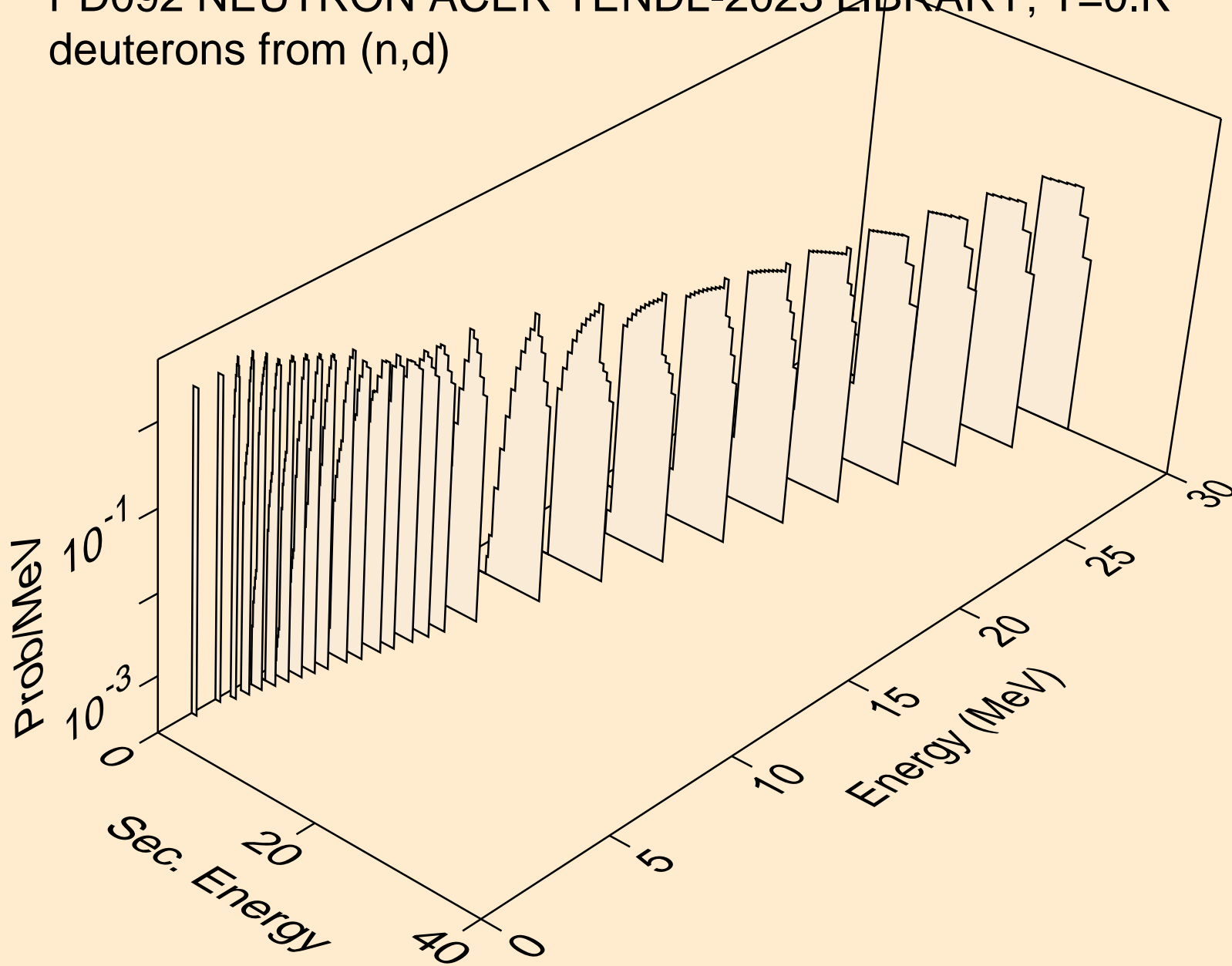

PD092 NEUTRON ACER TENDL-2023 LIBRARY; T=0.K
deuterons from (n,pd)

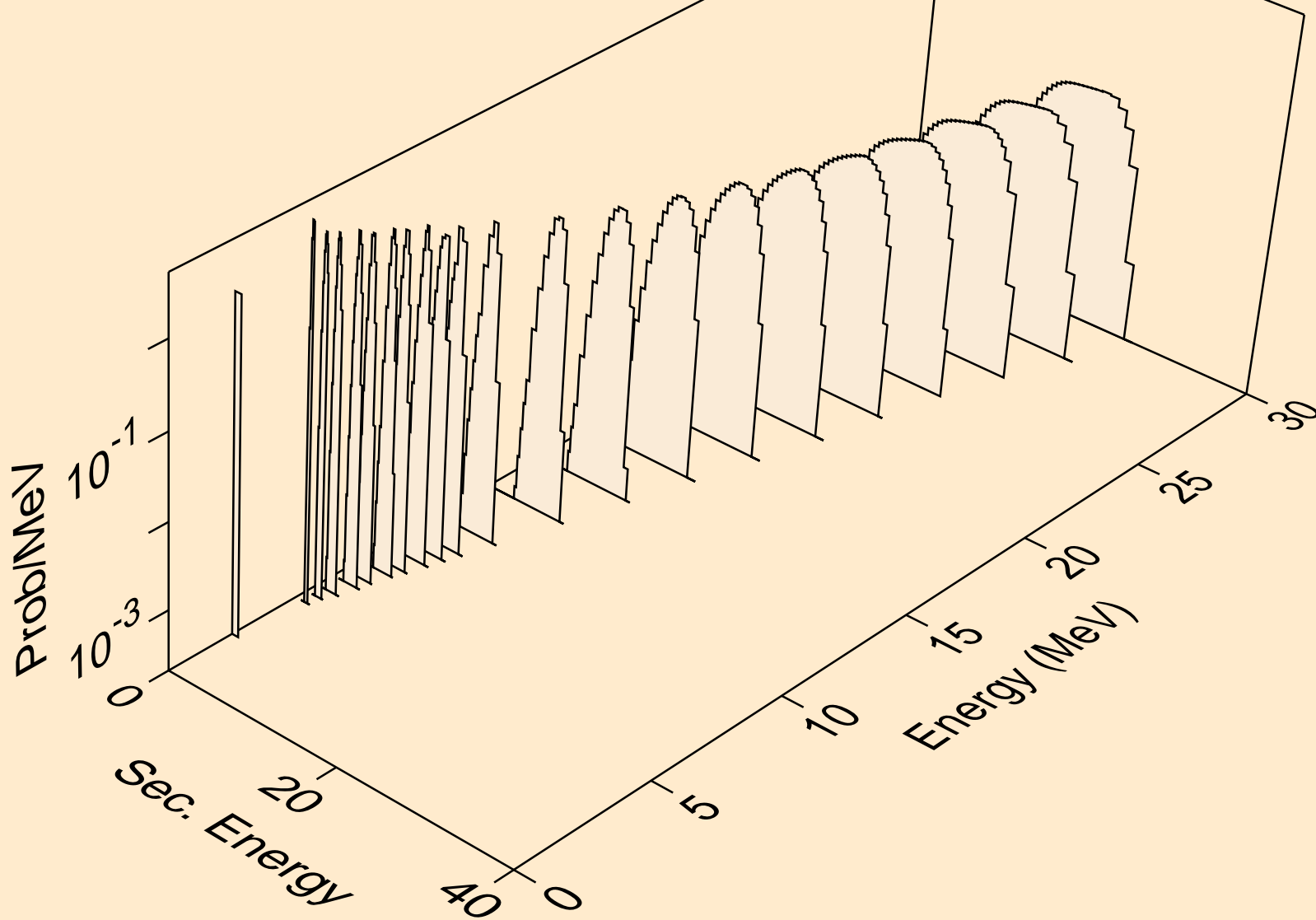

PD092 NEUTRON ACER TENDL-2023 LIBRARY; T=0.K
deuterons from (n,da)

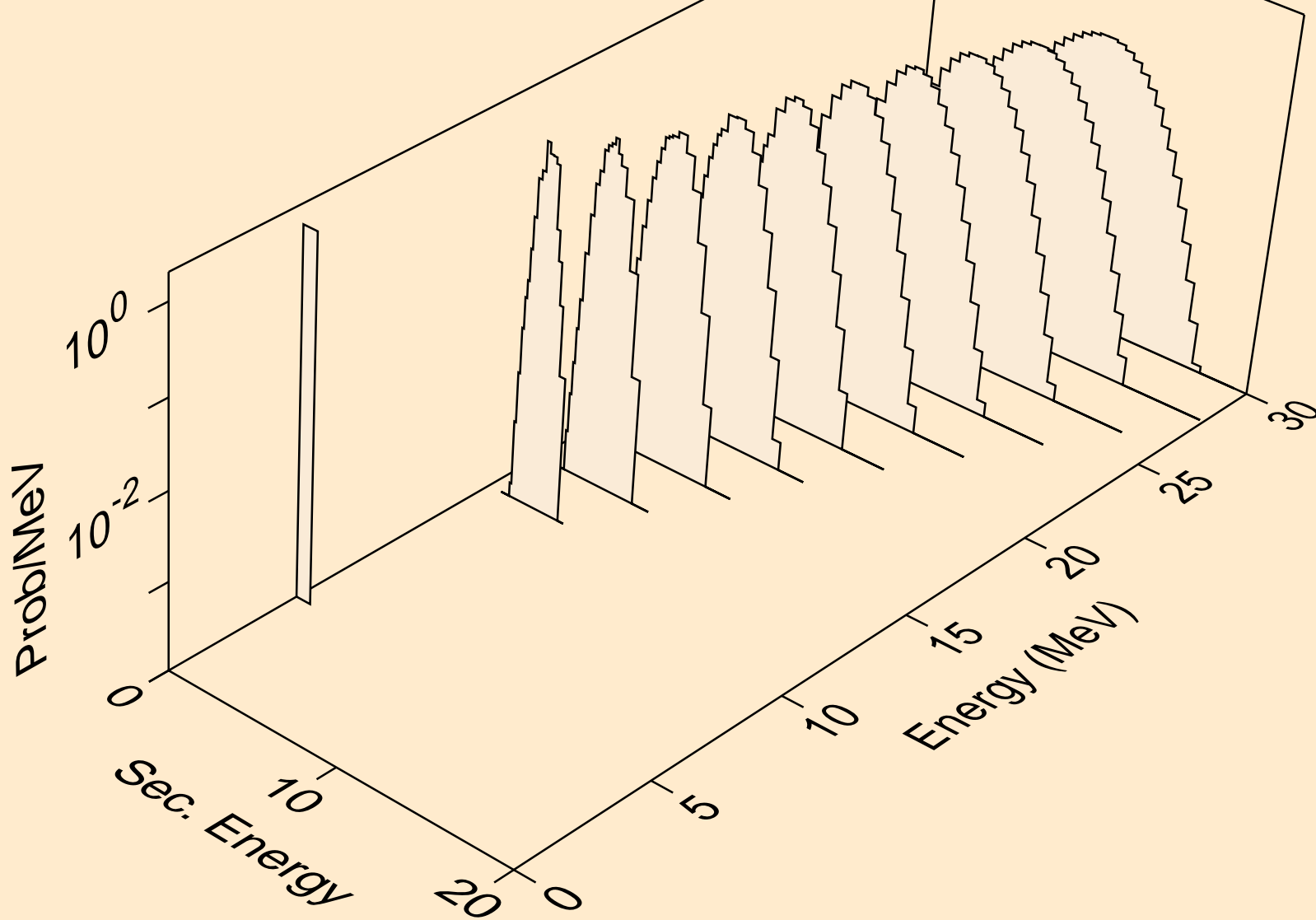

PD092 NEUTRON ACER TENDL-2023 LIBRARY; T=0.K
tritons from (n,x)

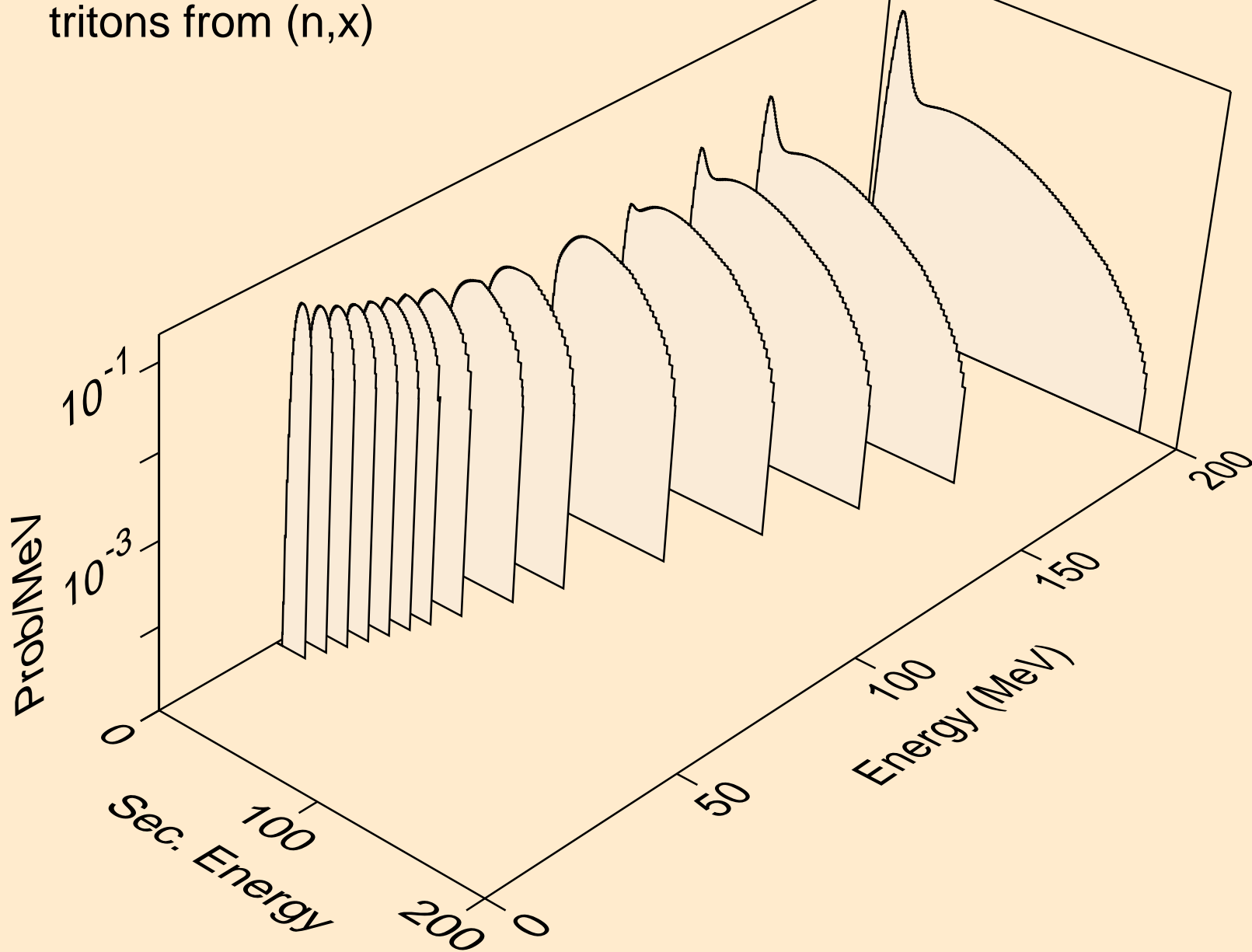

PD092 NEUTRON ACER TENDL-2023 LIBRARY; T=0.K
tritons from (n,n*)t

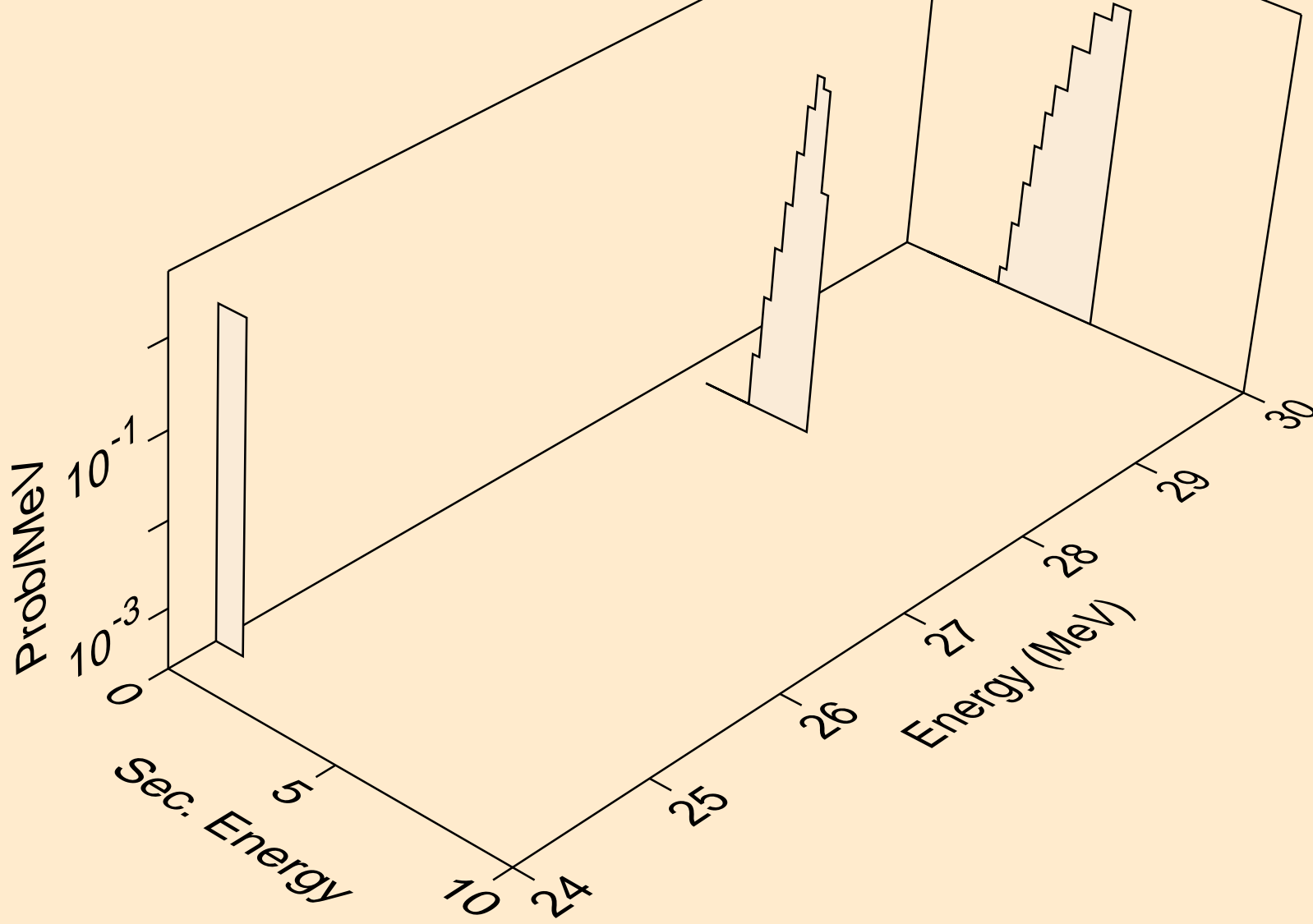

PD092 NEUTRON ACER TENDL-2023 LIBRARY; T=0.K
tritons from (n,t)

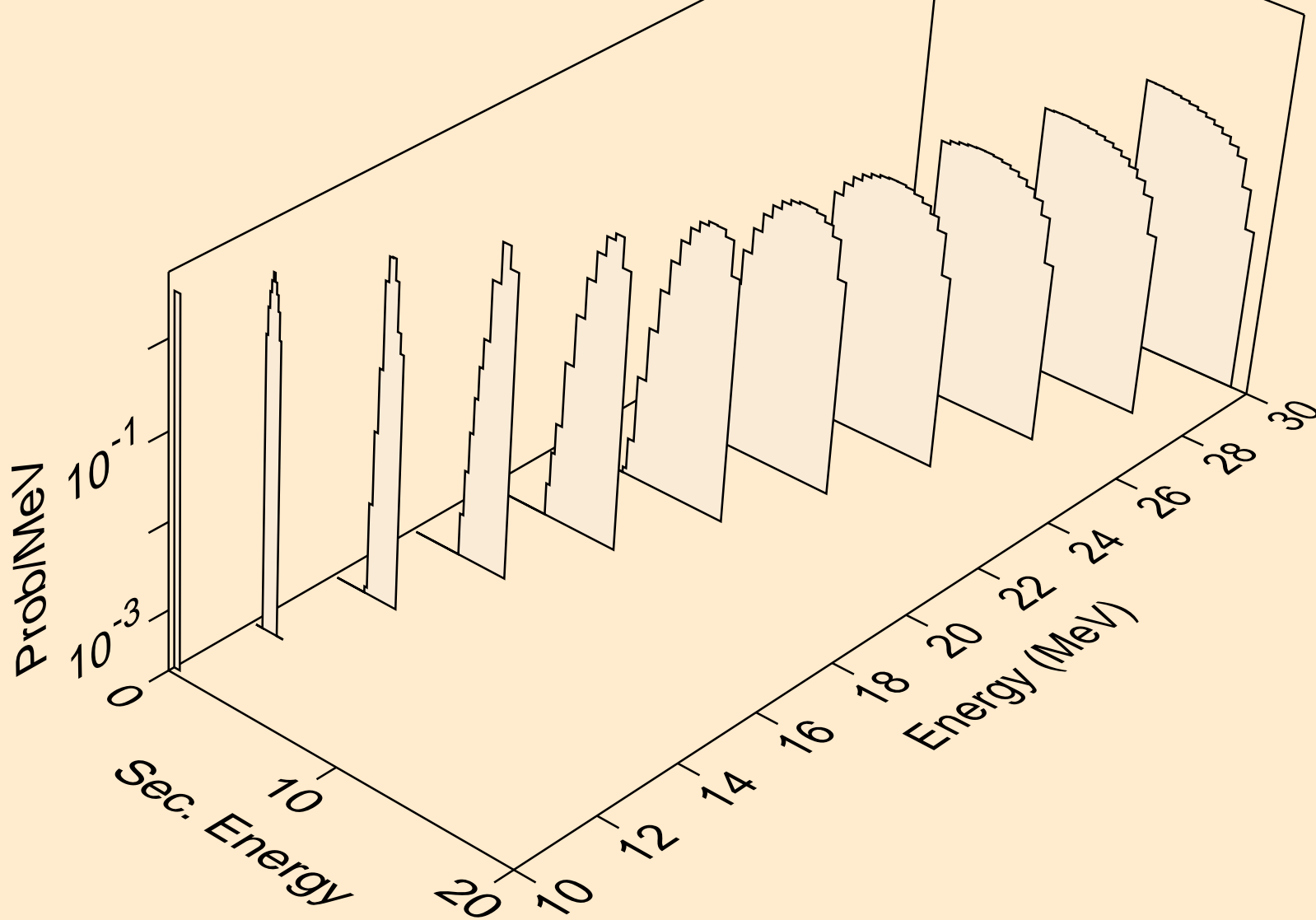

PD092 NEUTRON ACER TENDL-2023 LIBRARY; T=0.K
tritons from (n,pt)

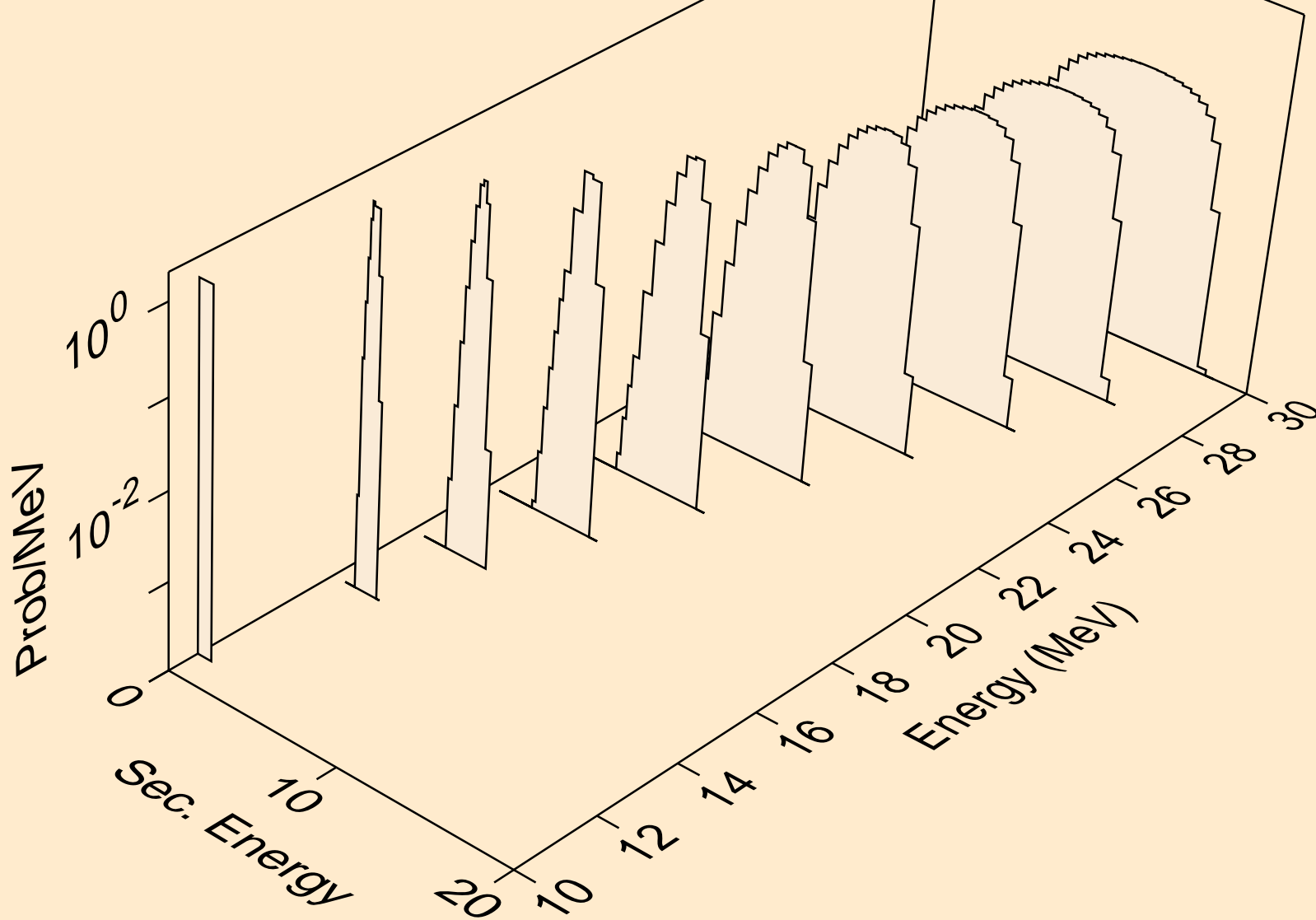

PD092 NEUTRON ACER TENDL-2023 LIBRARY; T=0.K
he3s from (n,x)

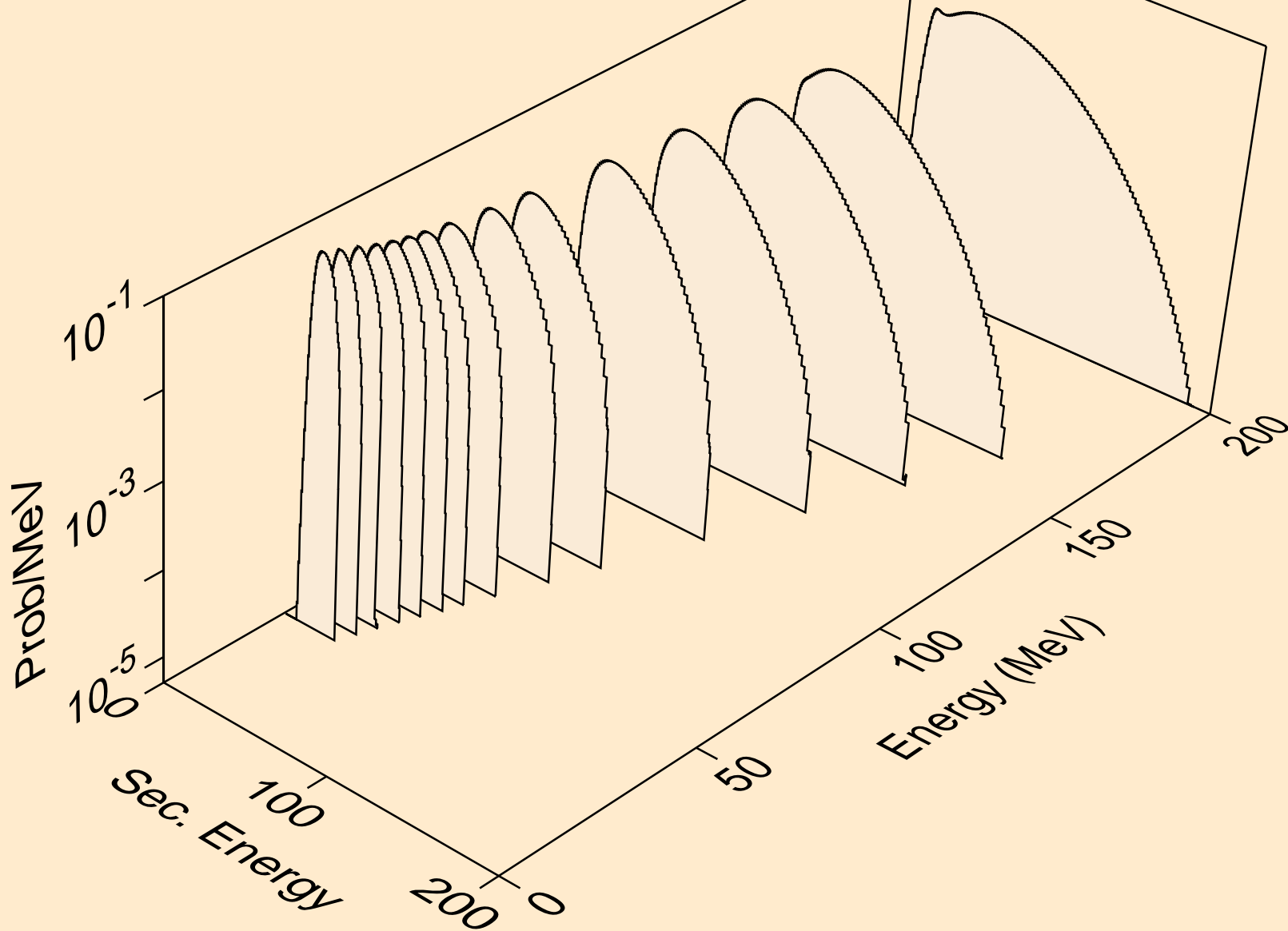

PD092 NEUTRON ACER TENDL-2023 LIBRARY; T=0.K
he3s from (n,n*)he3

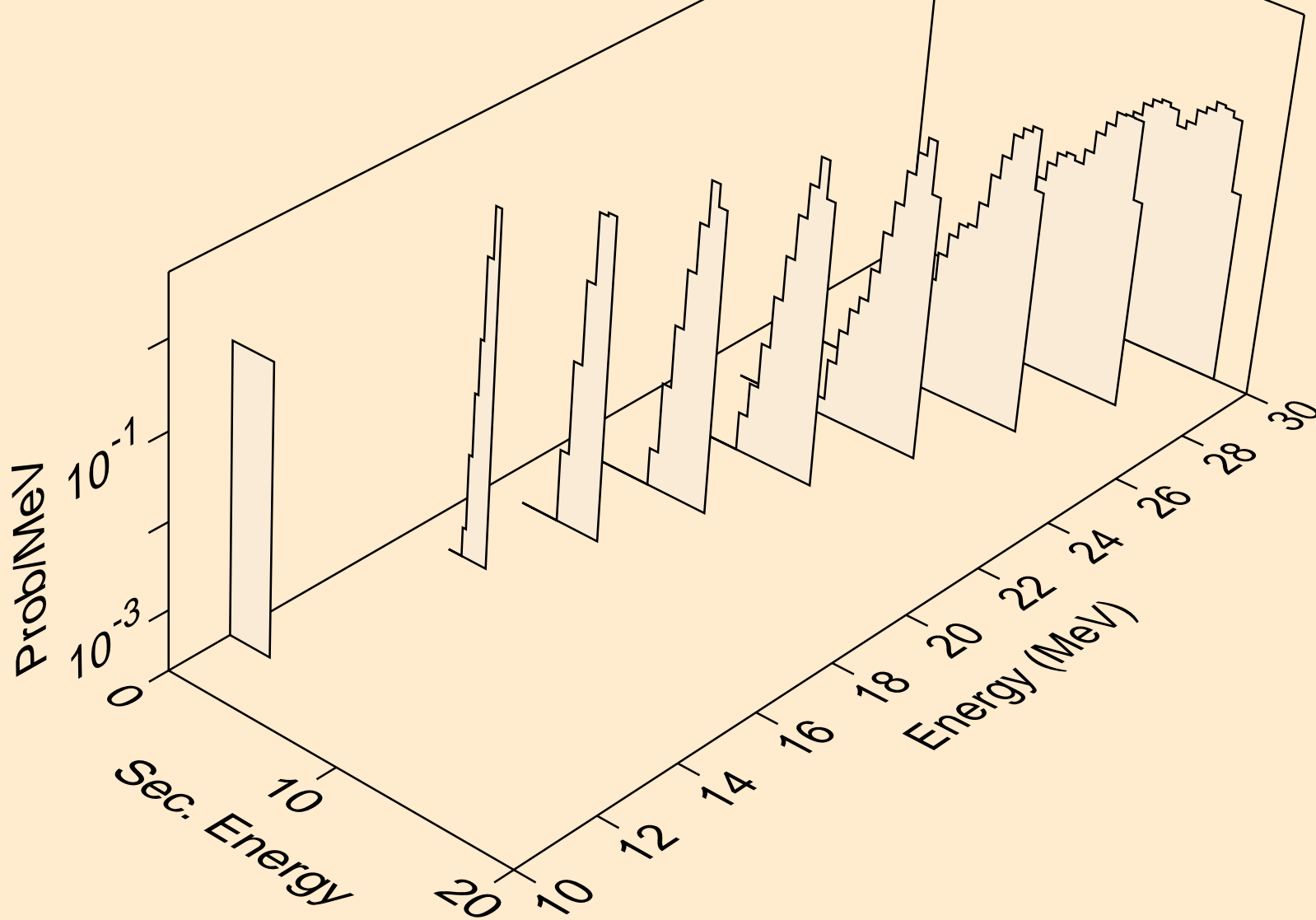

PD092 NEUTRON ACER TENDL-2023 LIBRARY; T=0.K
he3s from (n,he3)

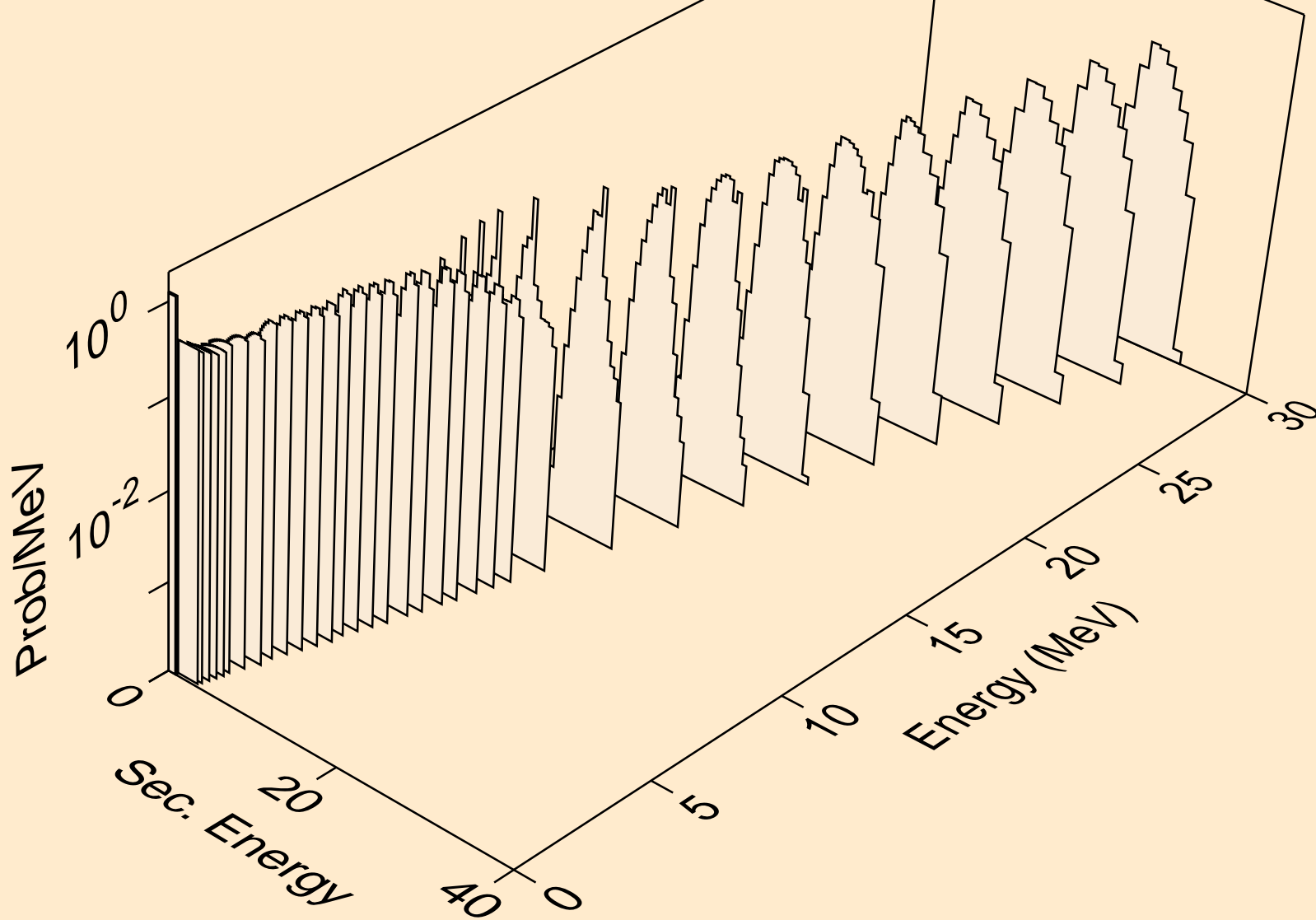

PD092 NEUTRON ACER TENDL-2023 LIBRARY; T=0.K
alphas from (n,x)

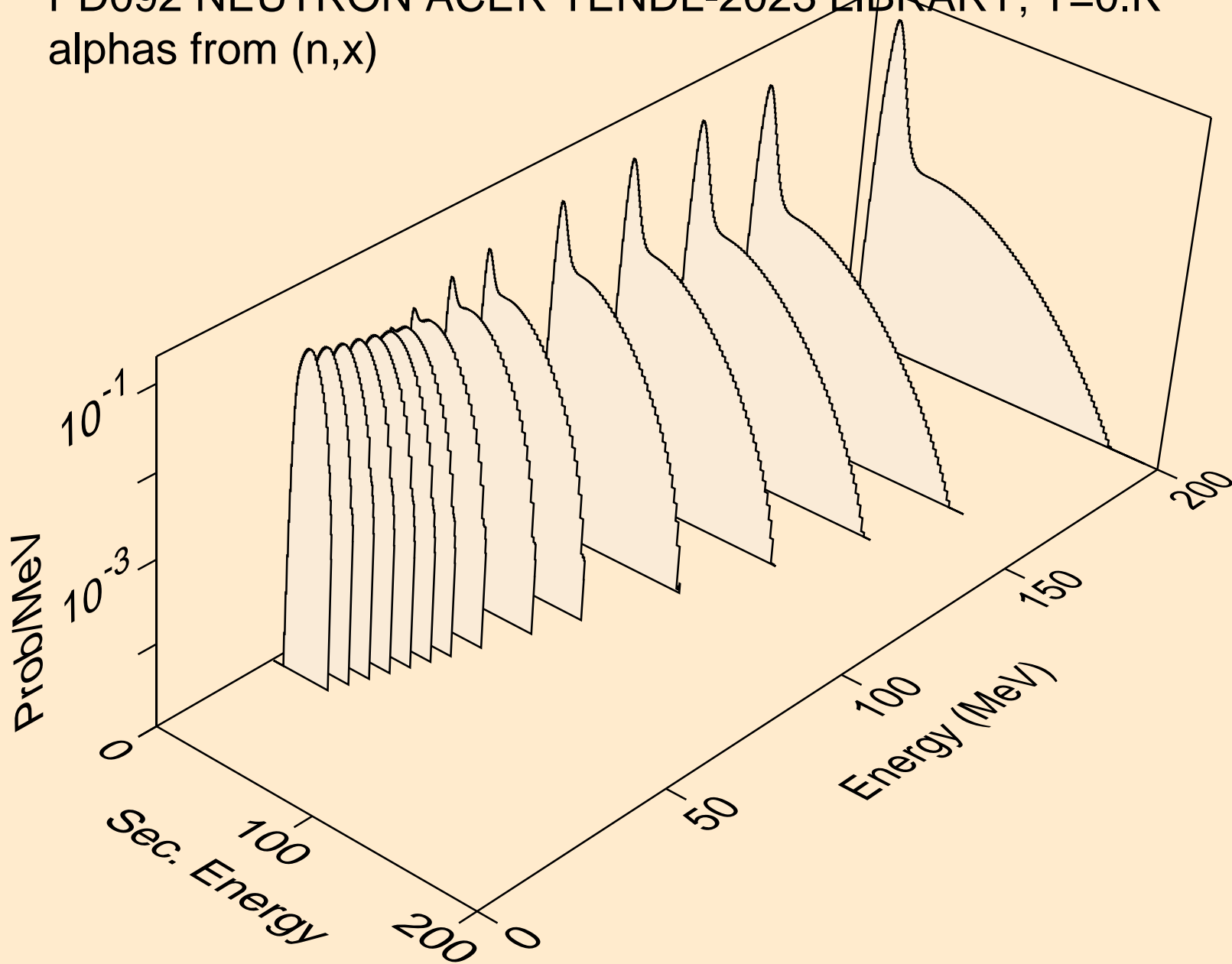

PD092 NEUTRON ACER TENDL-2023 LIBRARY; T=0.K
alphas from (n,n*)a

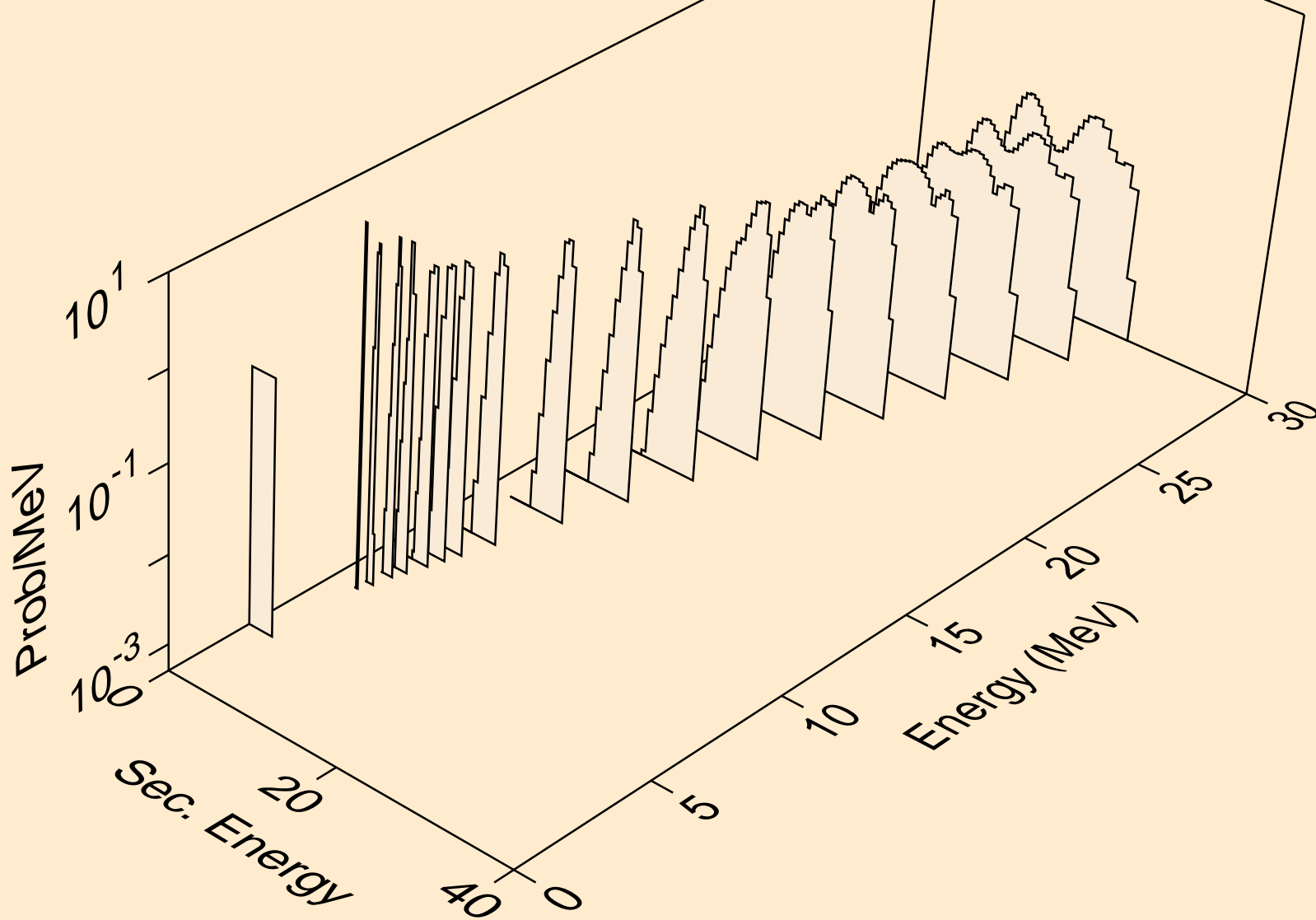

PD092 NEUTRON ACER TENDL-2023 LIBRARY; T=0.K
alphas from (n,n*)2a

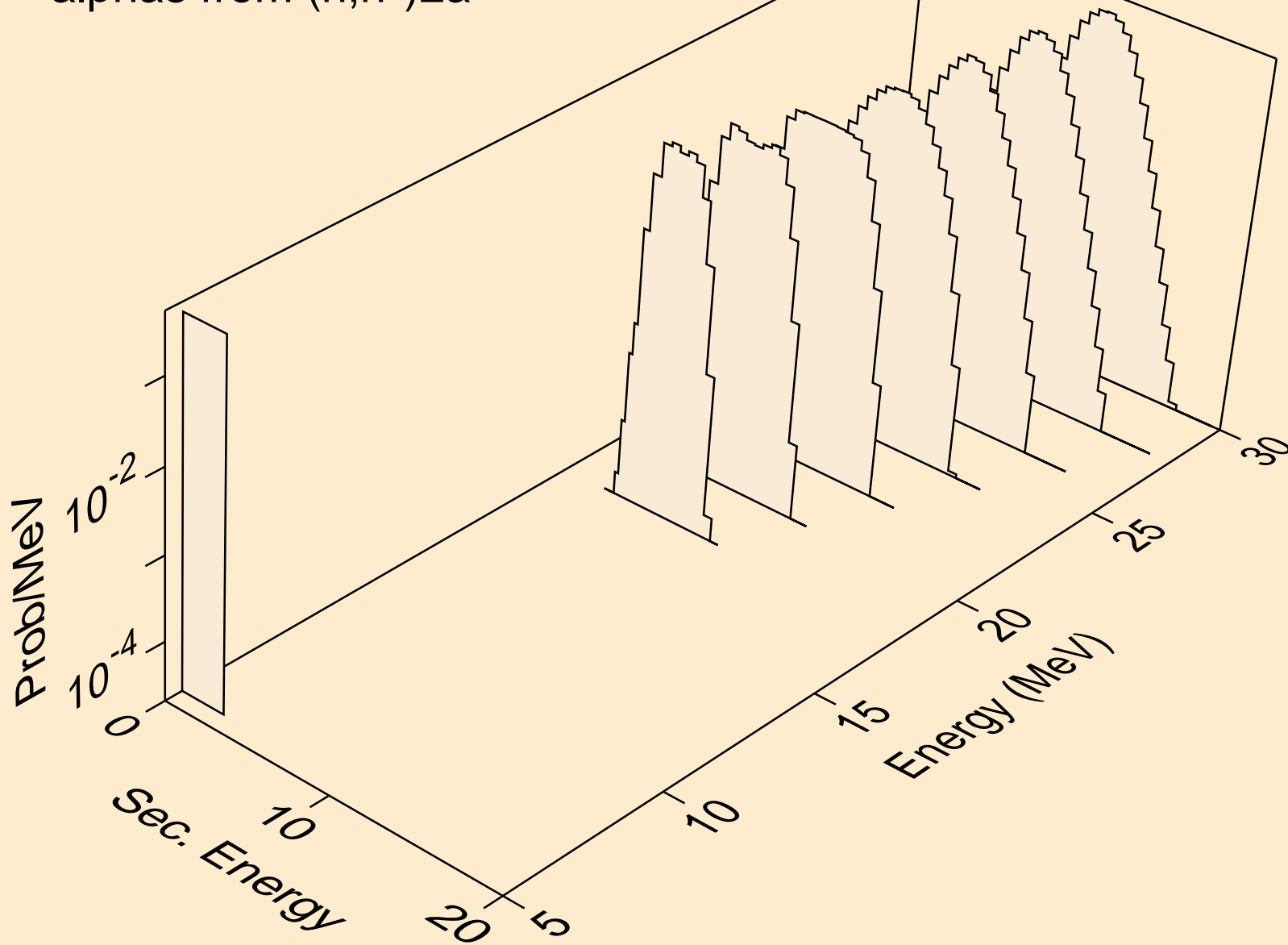

PD092 NEUTRON ACER TENDL-2023 LIBRARY; T=0.K
alphas from (n,npa)

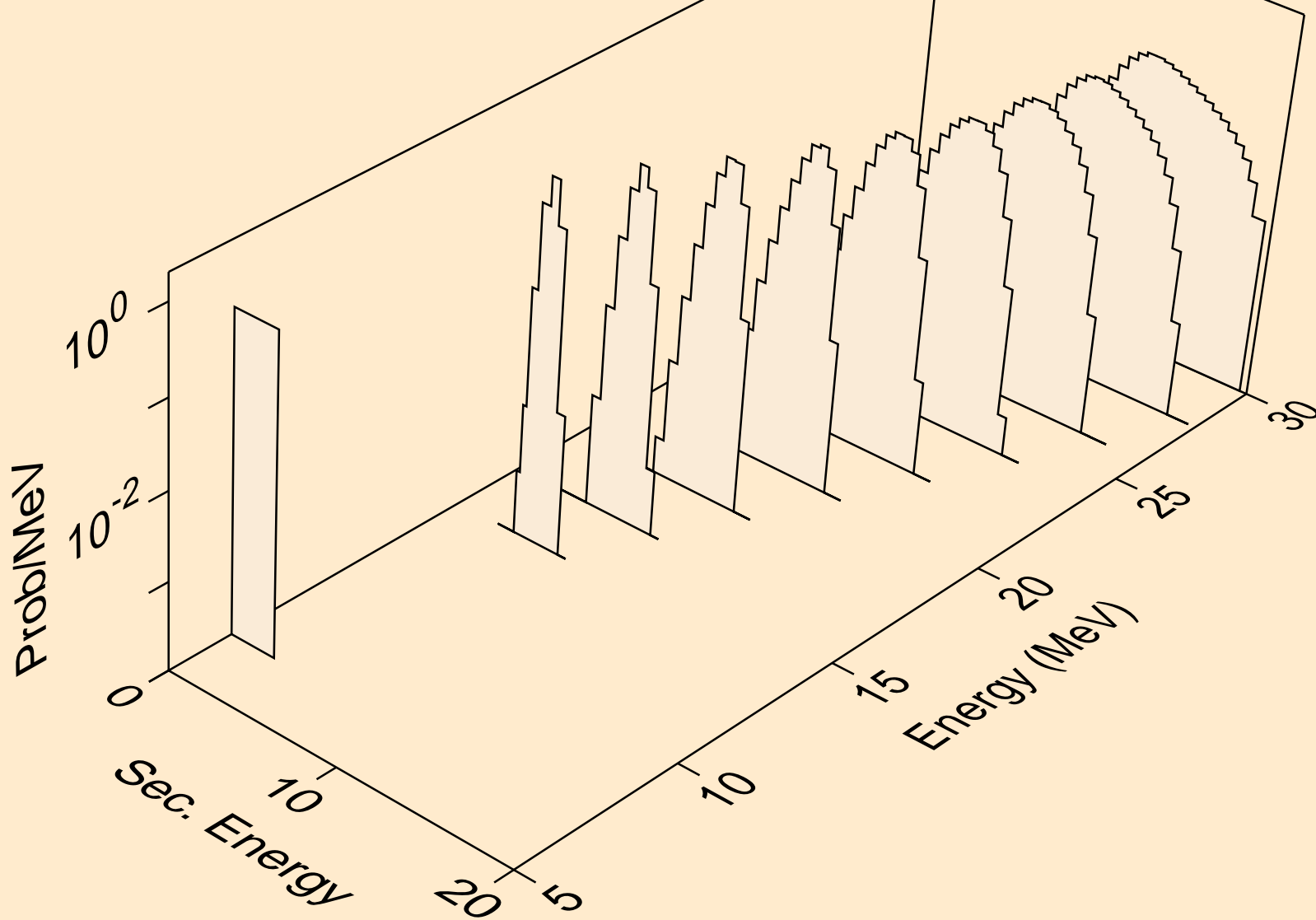

PD092 NEUTRON ACER TENDL-2023 LIBRARY; T=0.K
alphas from (n,a)

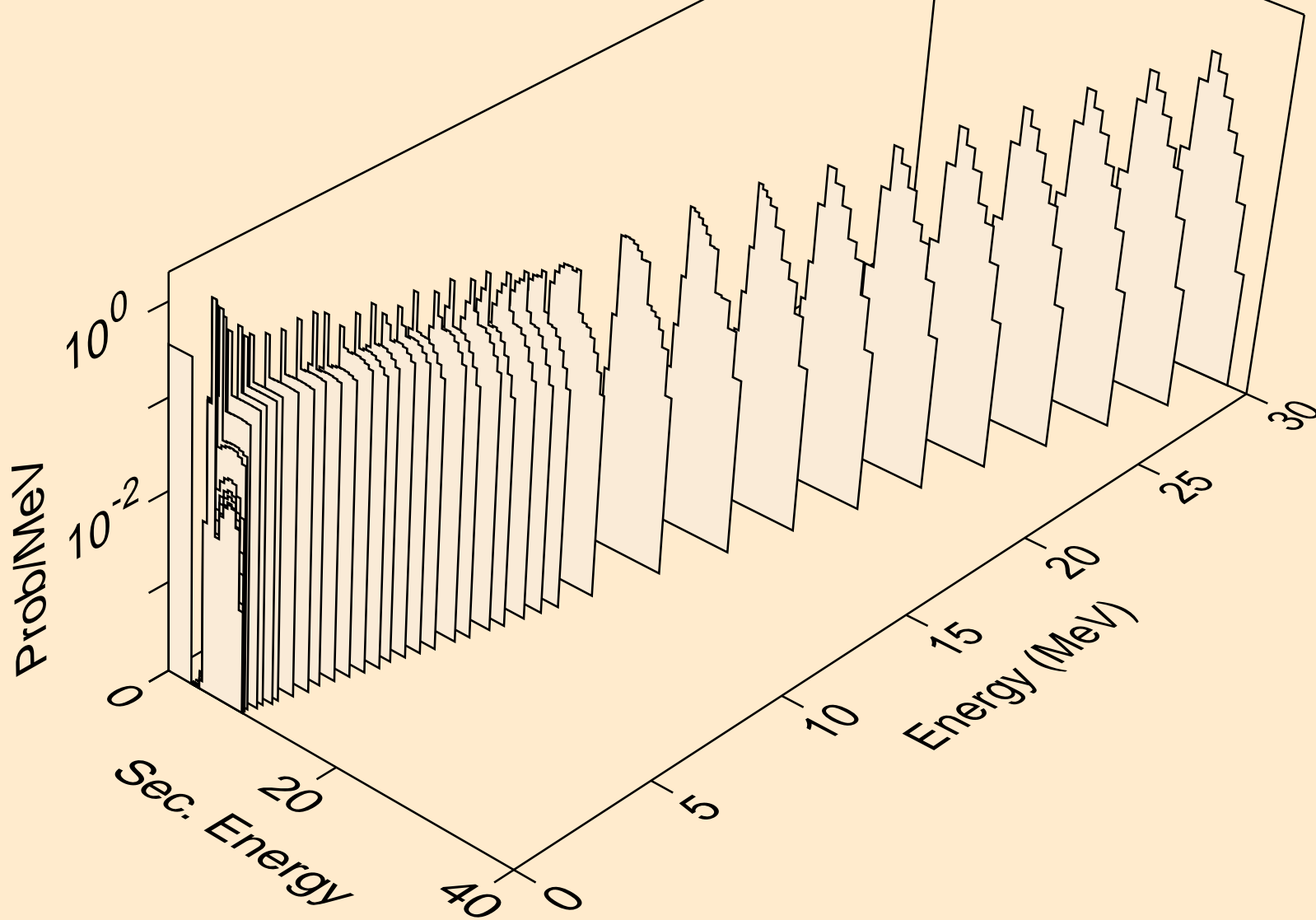

PD092 NEUTRON ACER TENDL-2023 LIBRARY; T=0.K
alphas from (n,2a)

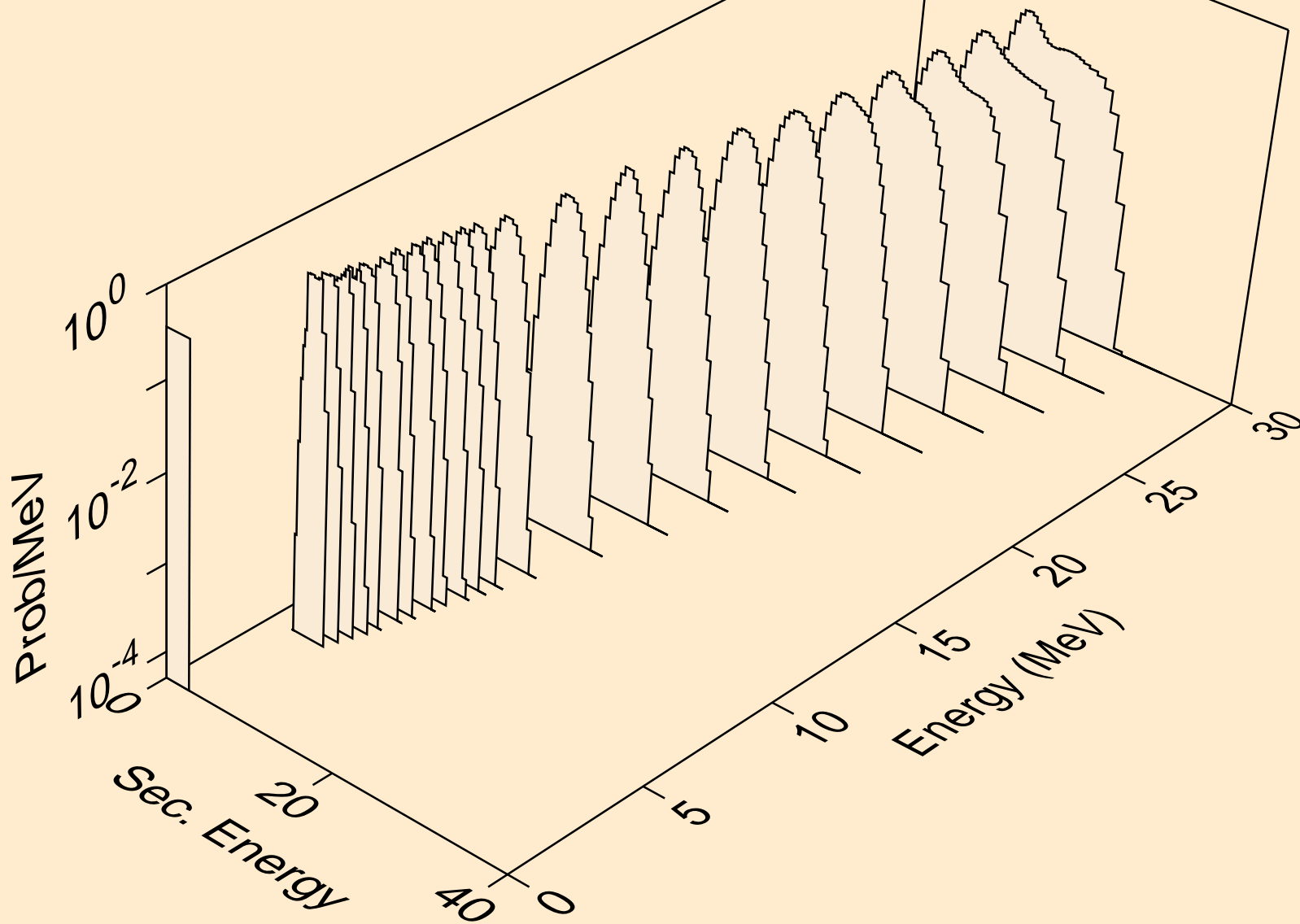

PD092 NEUTRON ACER TENDL-2023 LIBRARY; T=0.K
alphas from (n,pa)

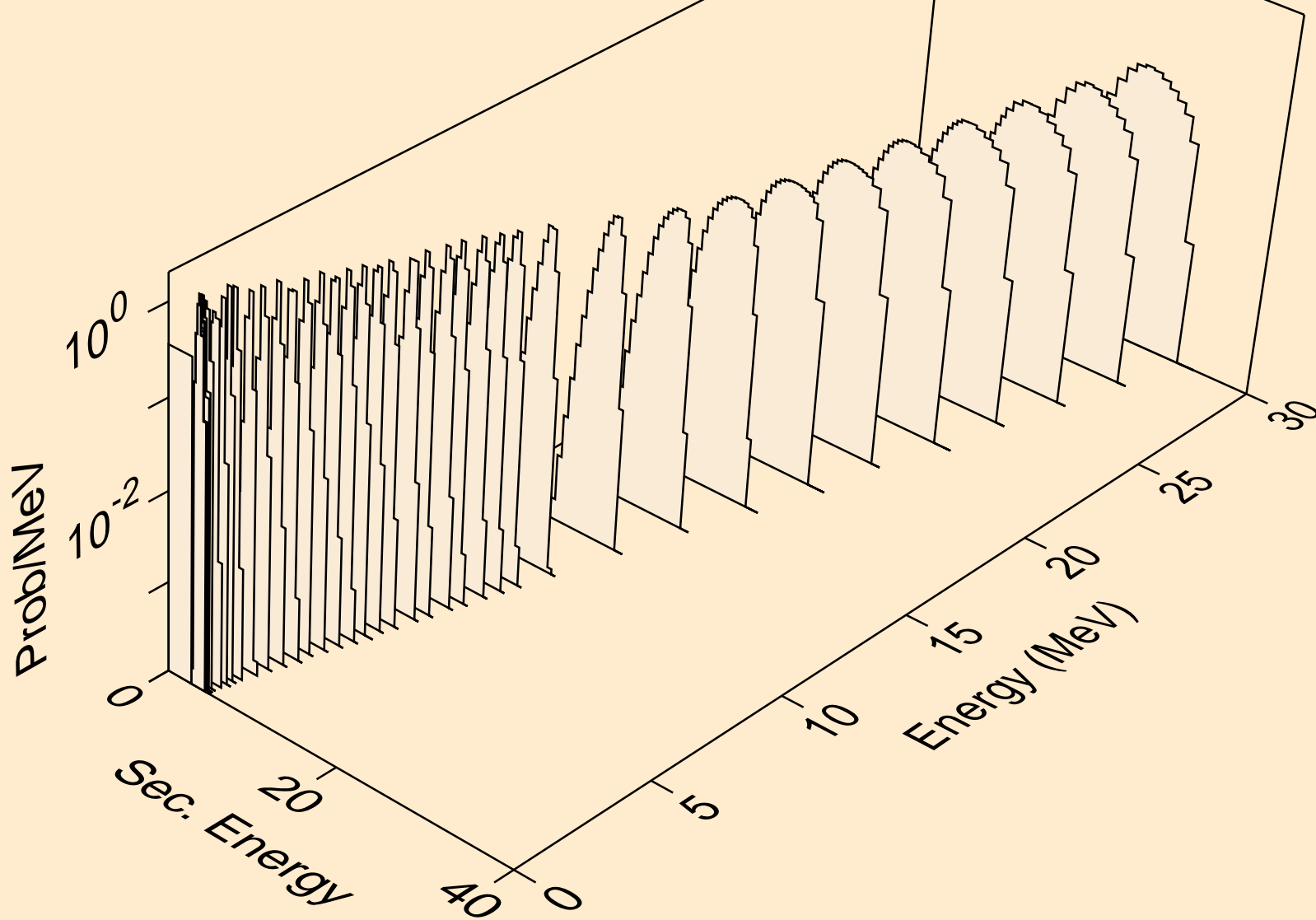

PD092 NEUTRON ACER TENDL-2023 LIBRARY; T=0.K
alphas from (n,da)

