

PM143 NEUTRON ACER TENDL-2023 LIBRARY; T=0.K
Principal cross sections

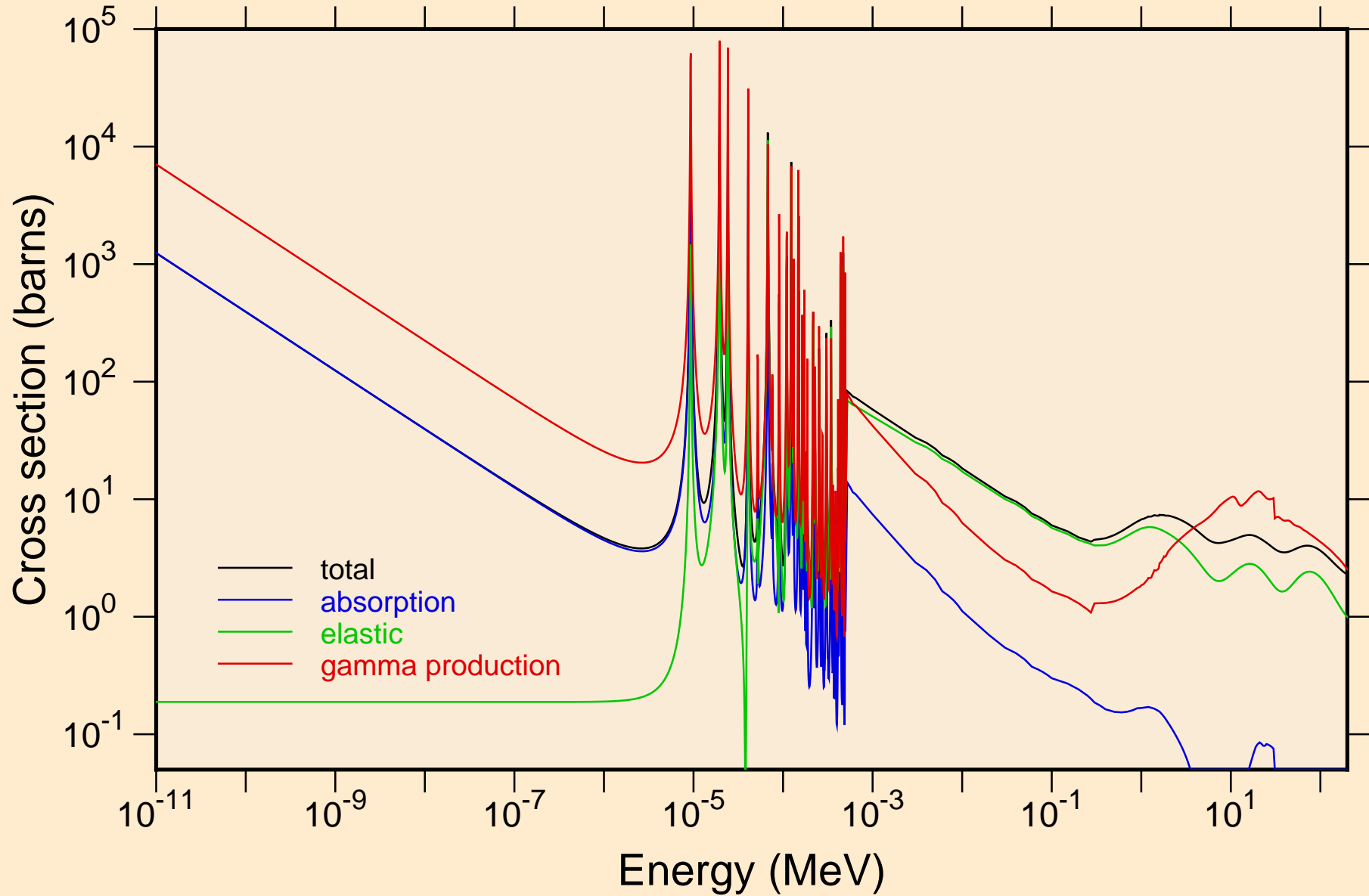

PM143 NEUTRON ACER TENDL-2023 LIBRARY; T=0.K
resonance total cross section

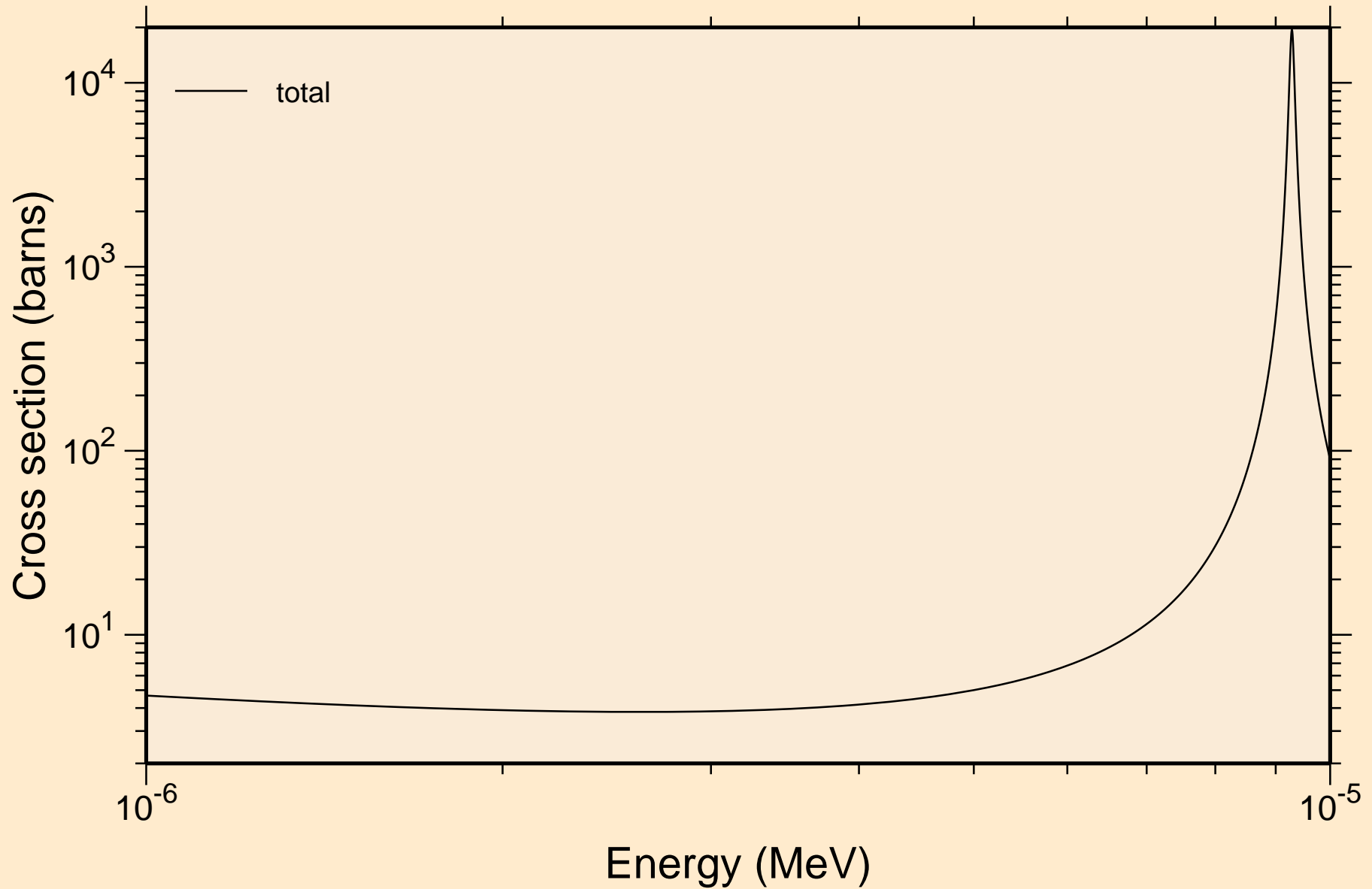

PM143 NEUTRON ACER TENDL-2023 LIBRARY; T=0.K
resonance total cross section

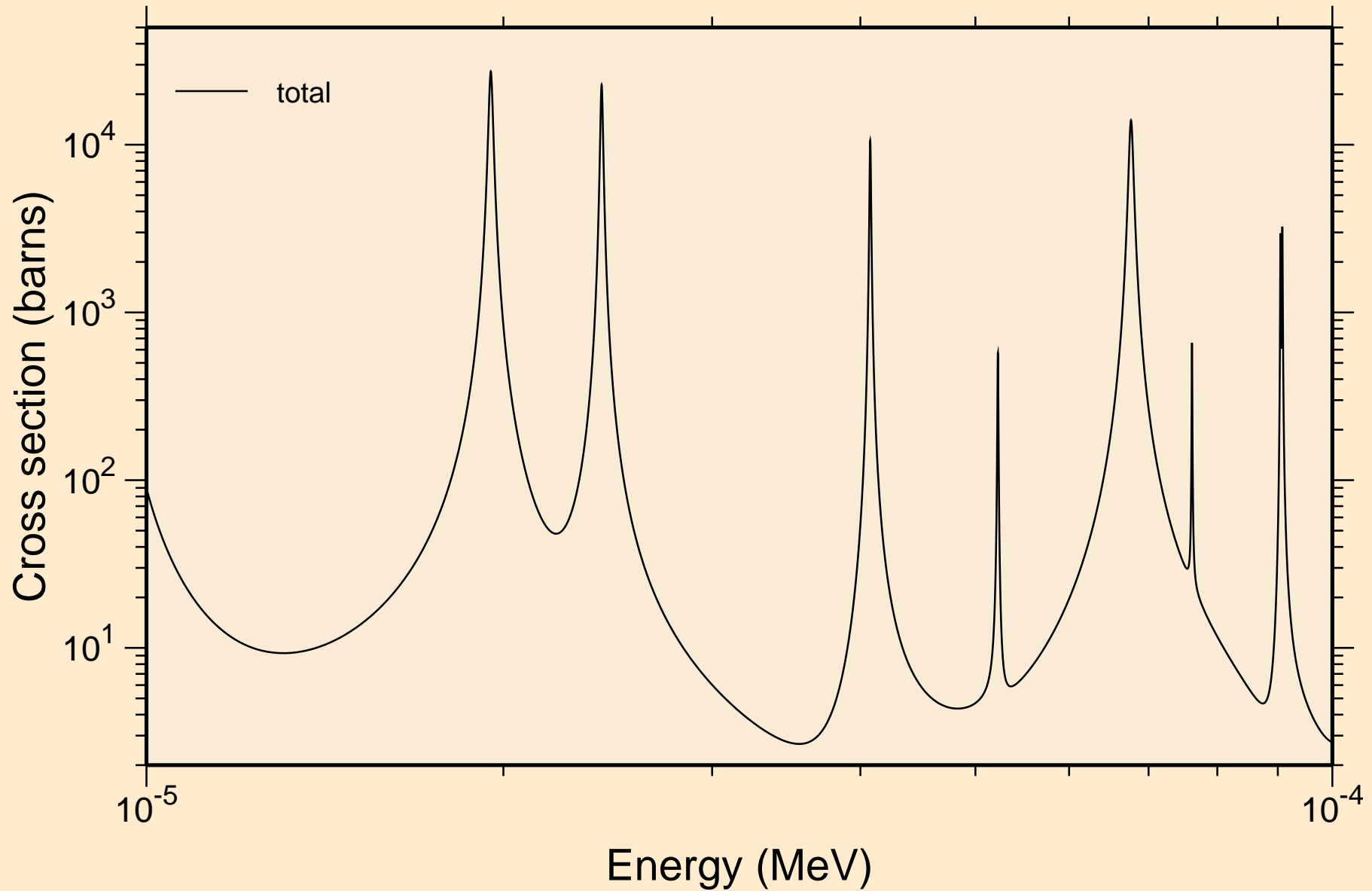

PM143 NEUTRON ACER TENDL-2023 LIBRARY; T=0.K
resonance total cross section

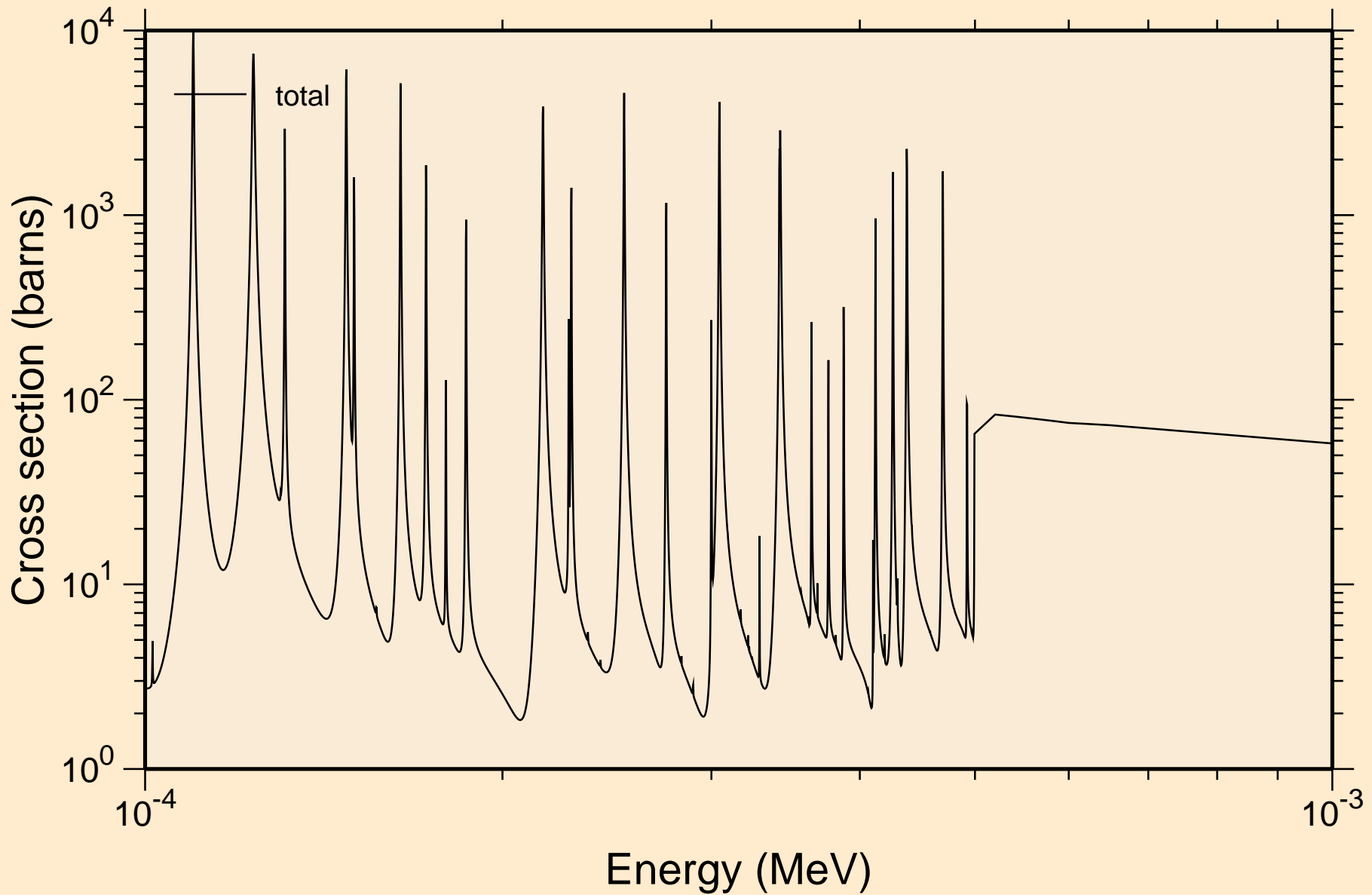

PM143 NEUTRON ACER TENDL-2023 LIBRARY; T=0.K
resonance total cross section

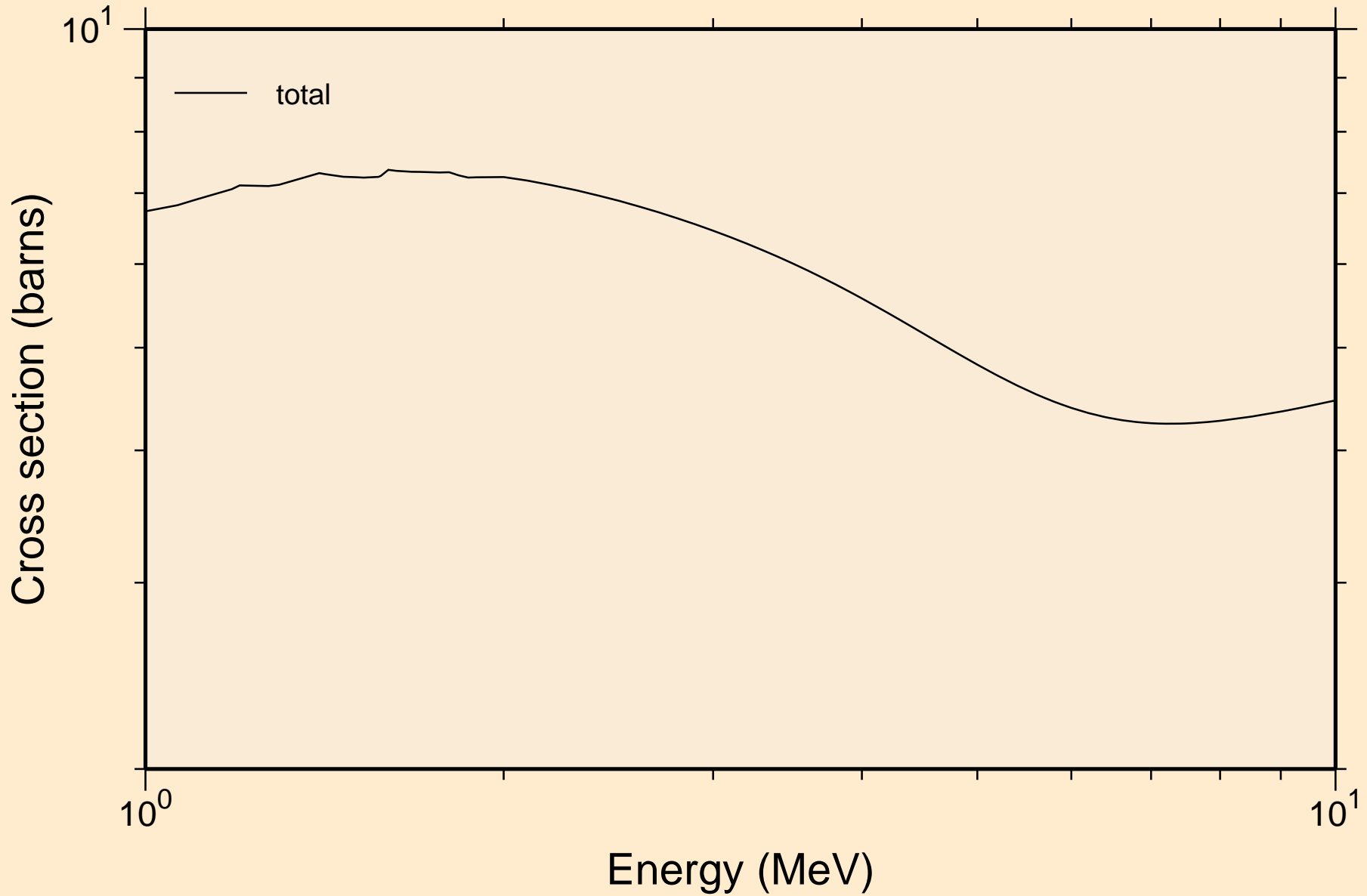

PM143 NEUTRON ACER TENDL-2023 LIBRARY; T=0.K
resonance absorption cross sections

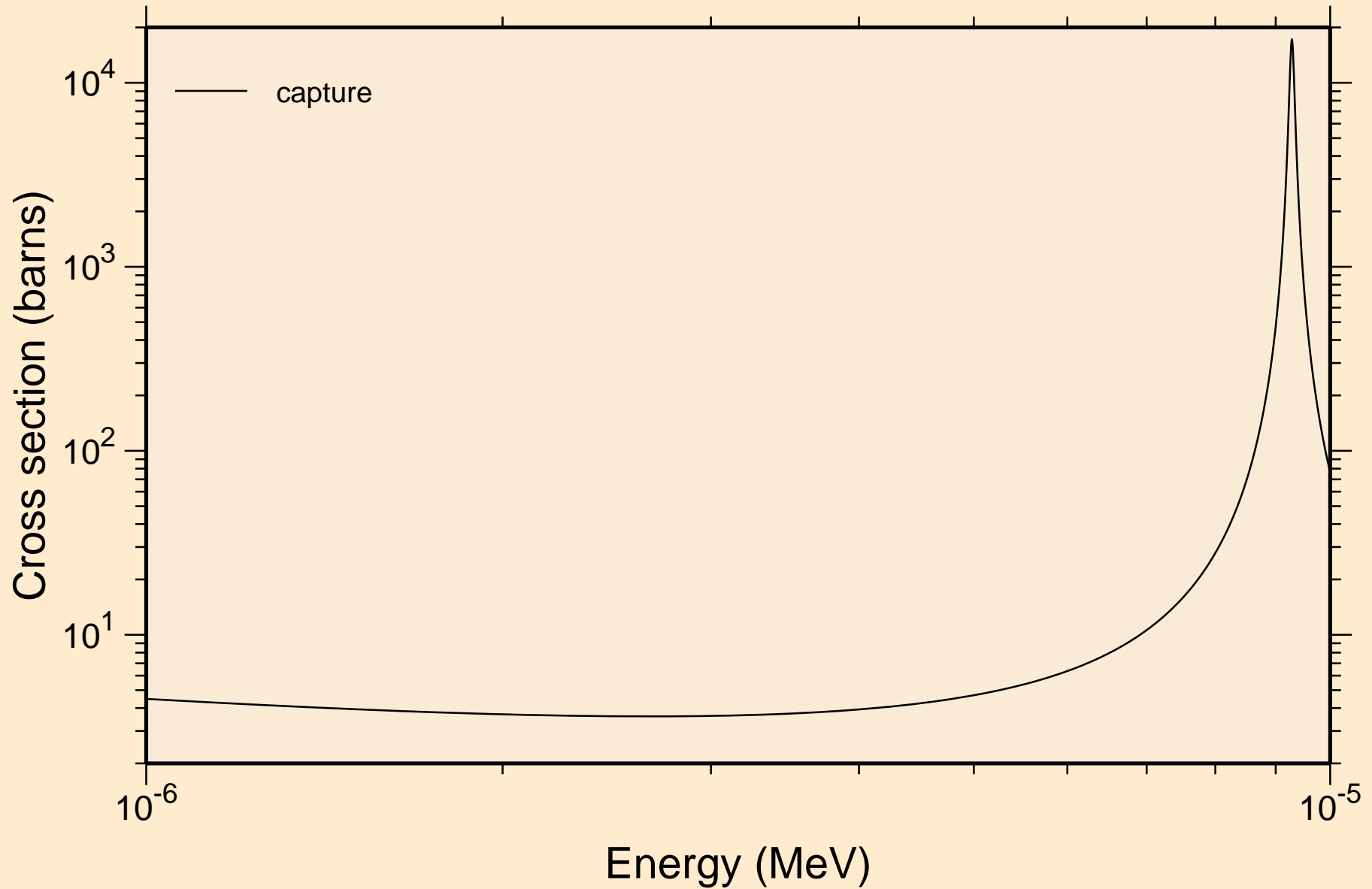

PM143 NEUTRON ACER TENDL-2023 LIBRARY; T=0.K
resonance absorption cross sections

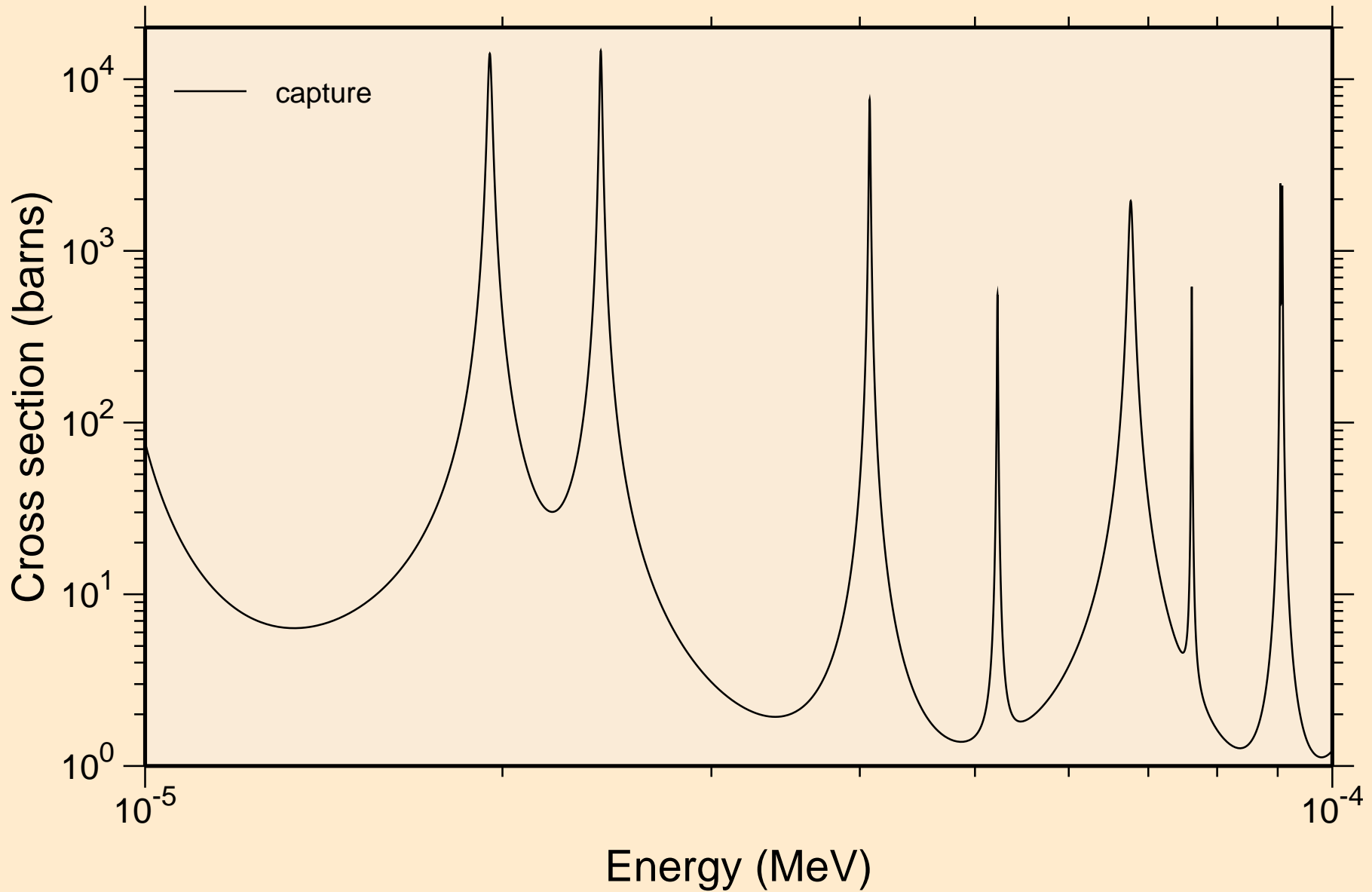

PM143 NEUTRON ACER TENDL-2023 LIBRARY; T=0.K
resonance absorption cross sections

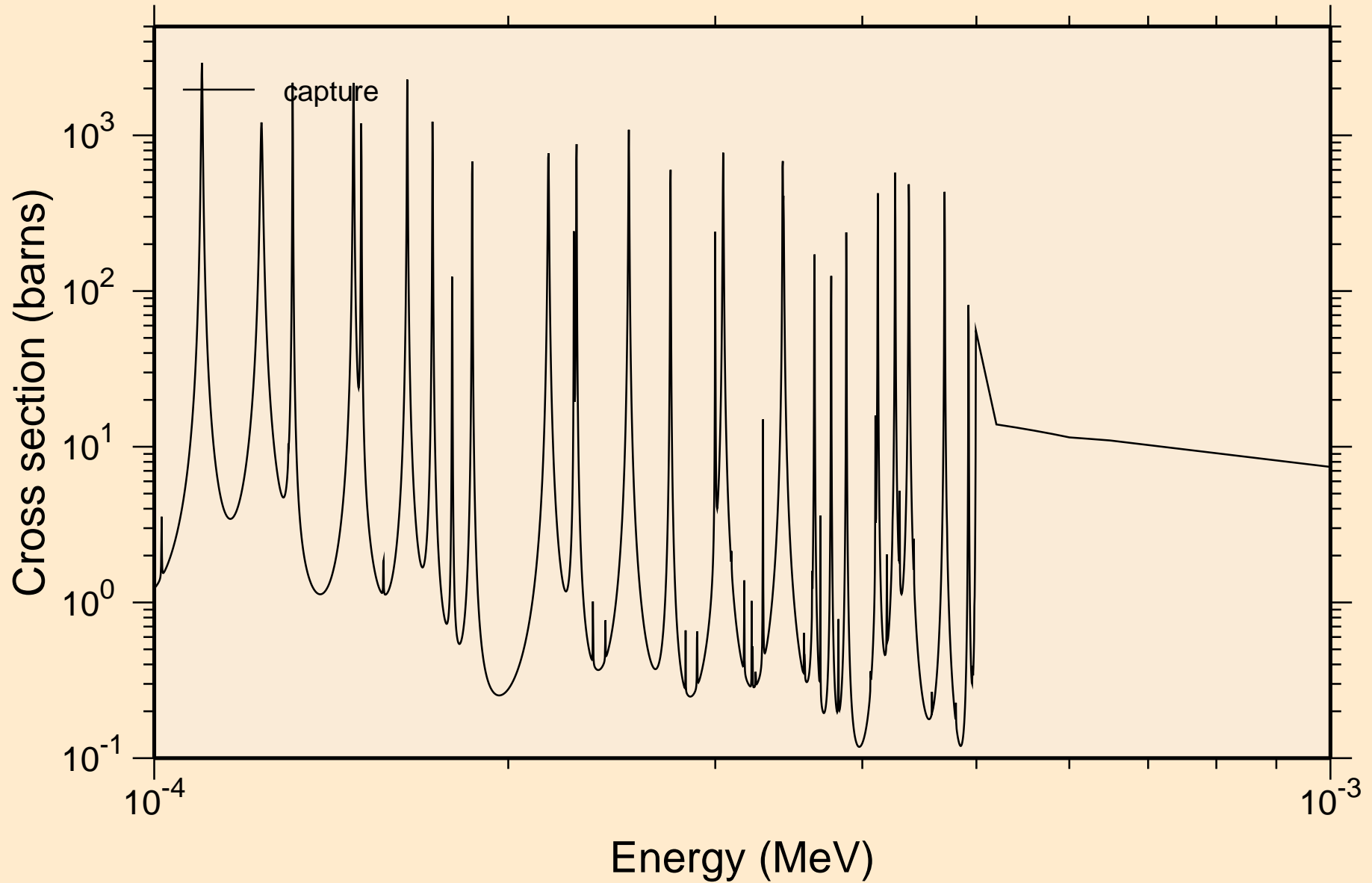

PM143 NEUTRON ACER TENDL-2023 LIBRARY; T=0.K
resonance absorption cross sections

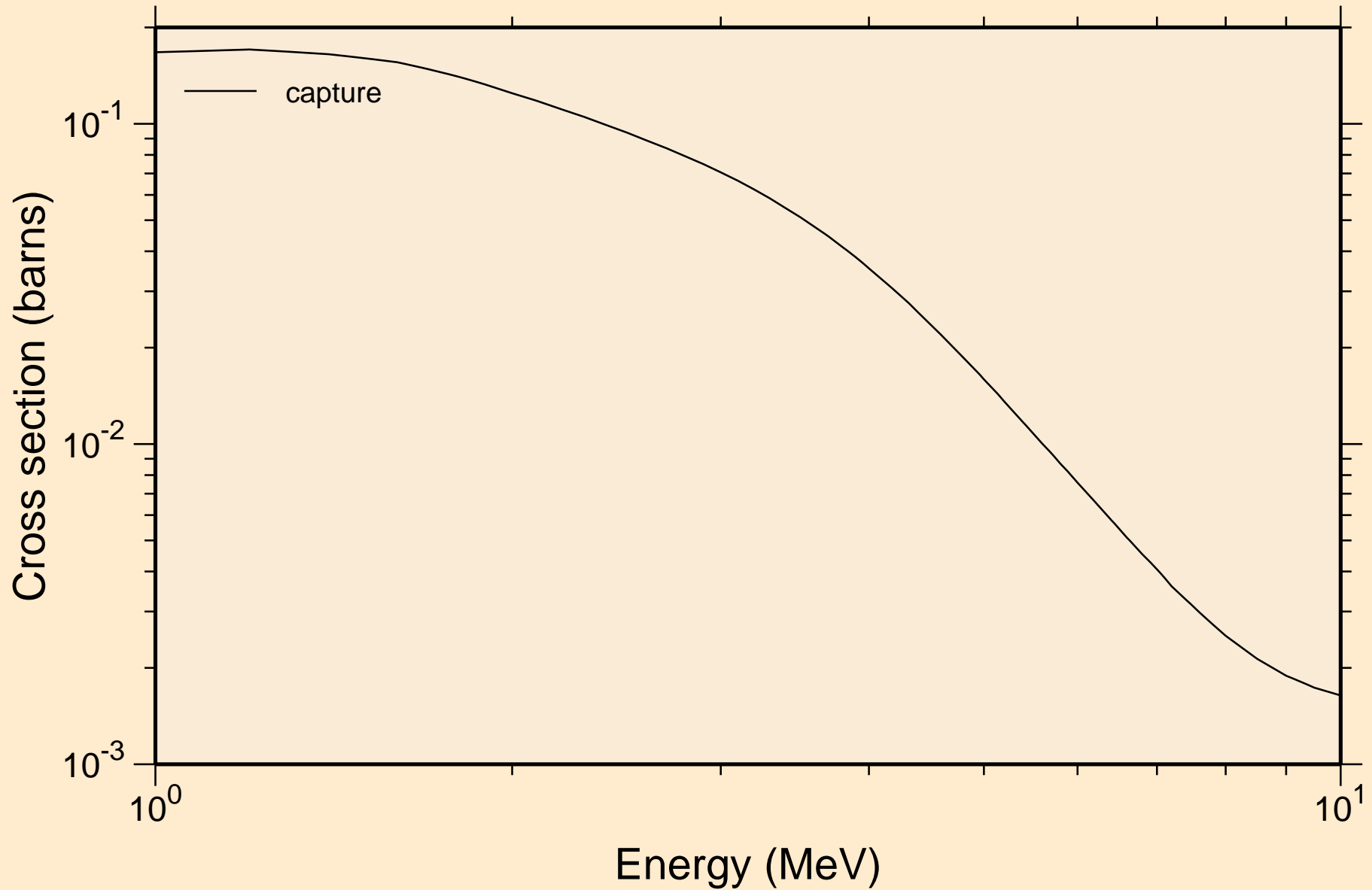

PM143 NEUTRON ACER TENDL-2023 LIBRARY; T=0.K
Heating

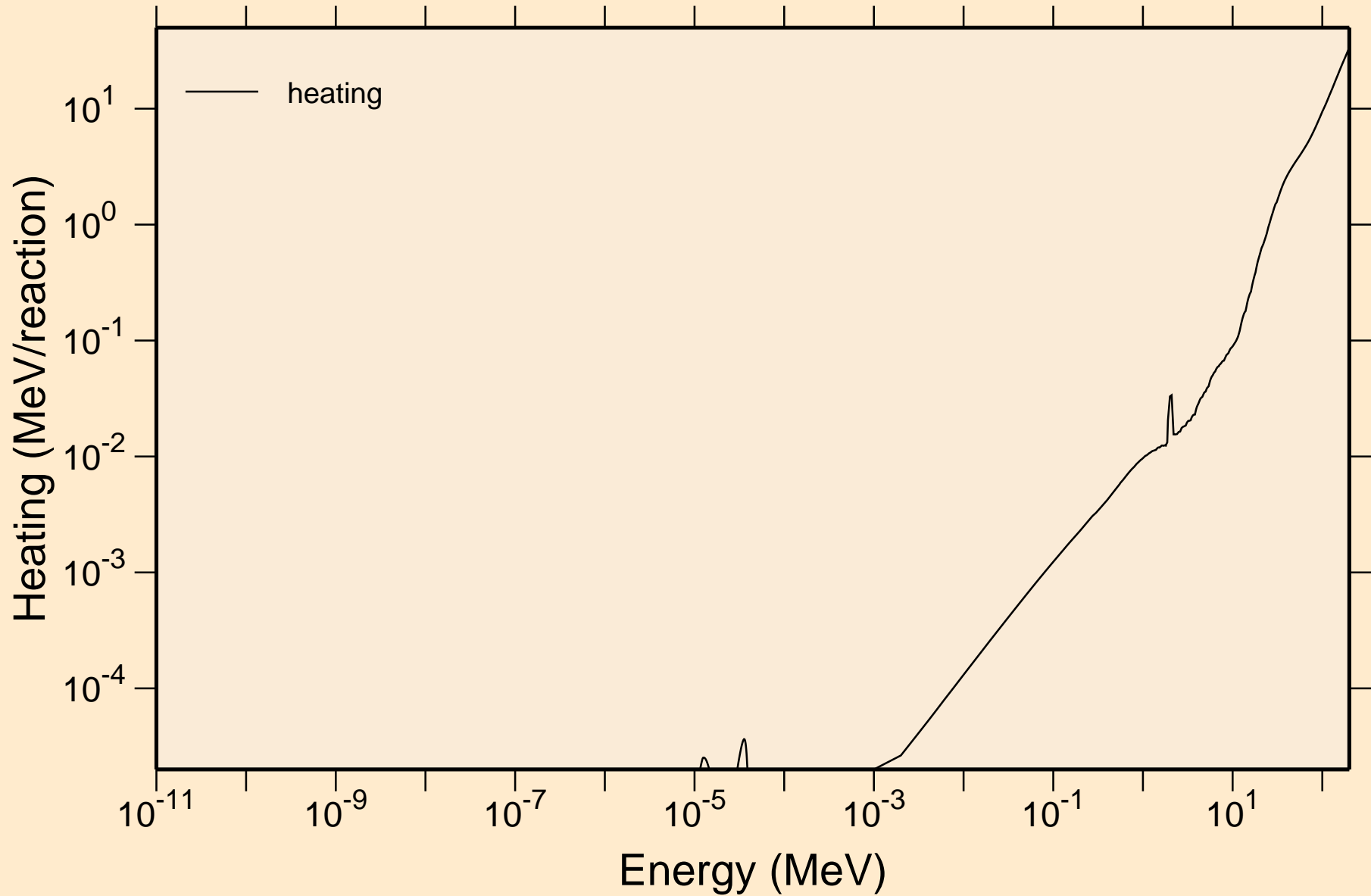

PM143 NEUTRON ACER TENDL-2023 LIBRARY; T=0.K
Damage

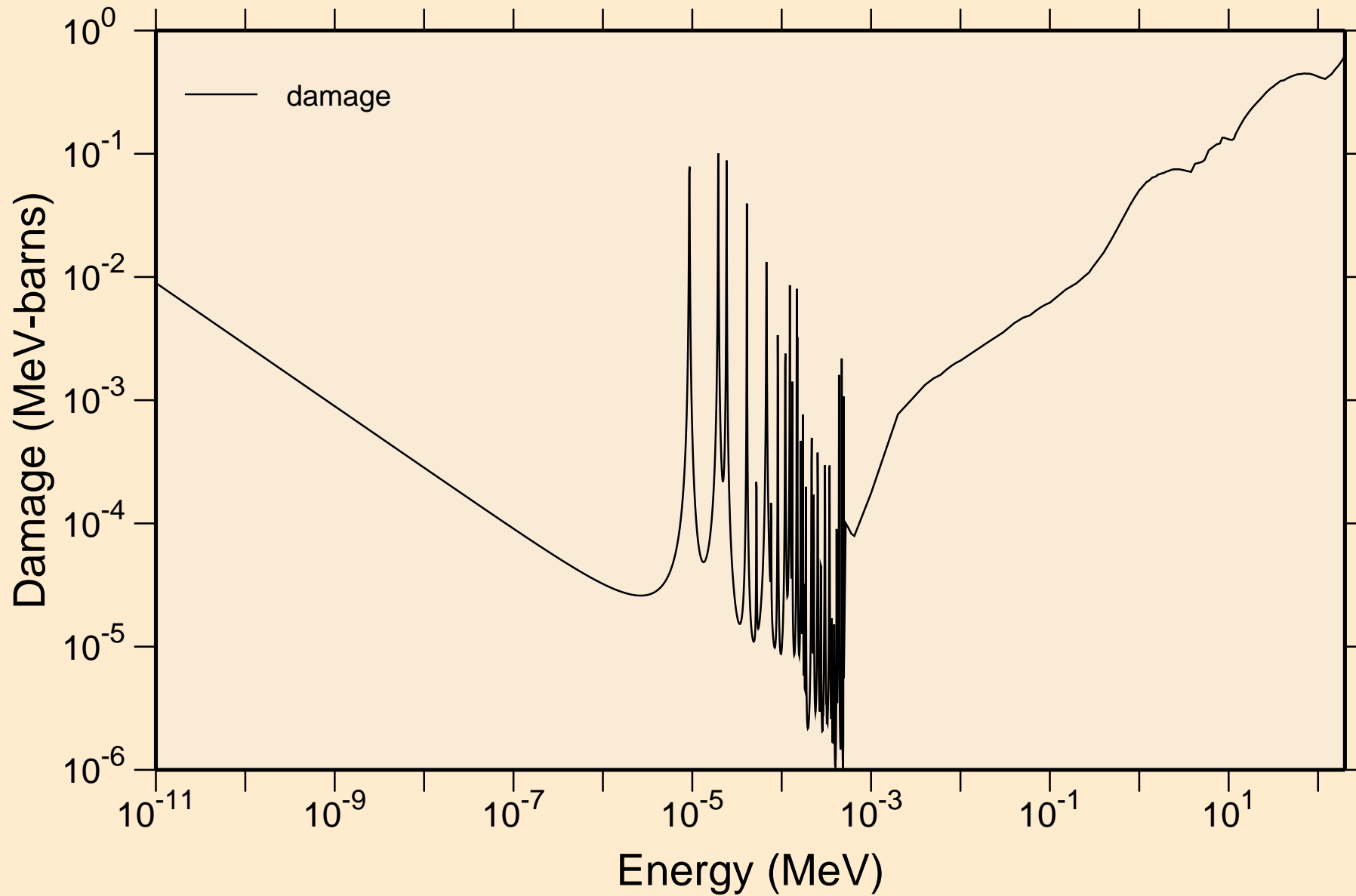

PM143 NEUTRON ACER TENDL-2023 LIBRARY; T=0.K
Non-threshold reactions

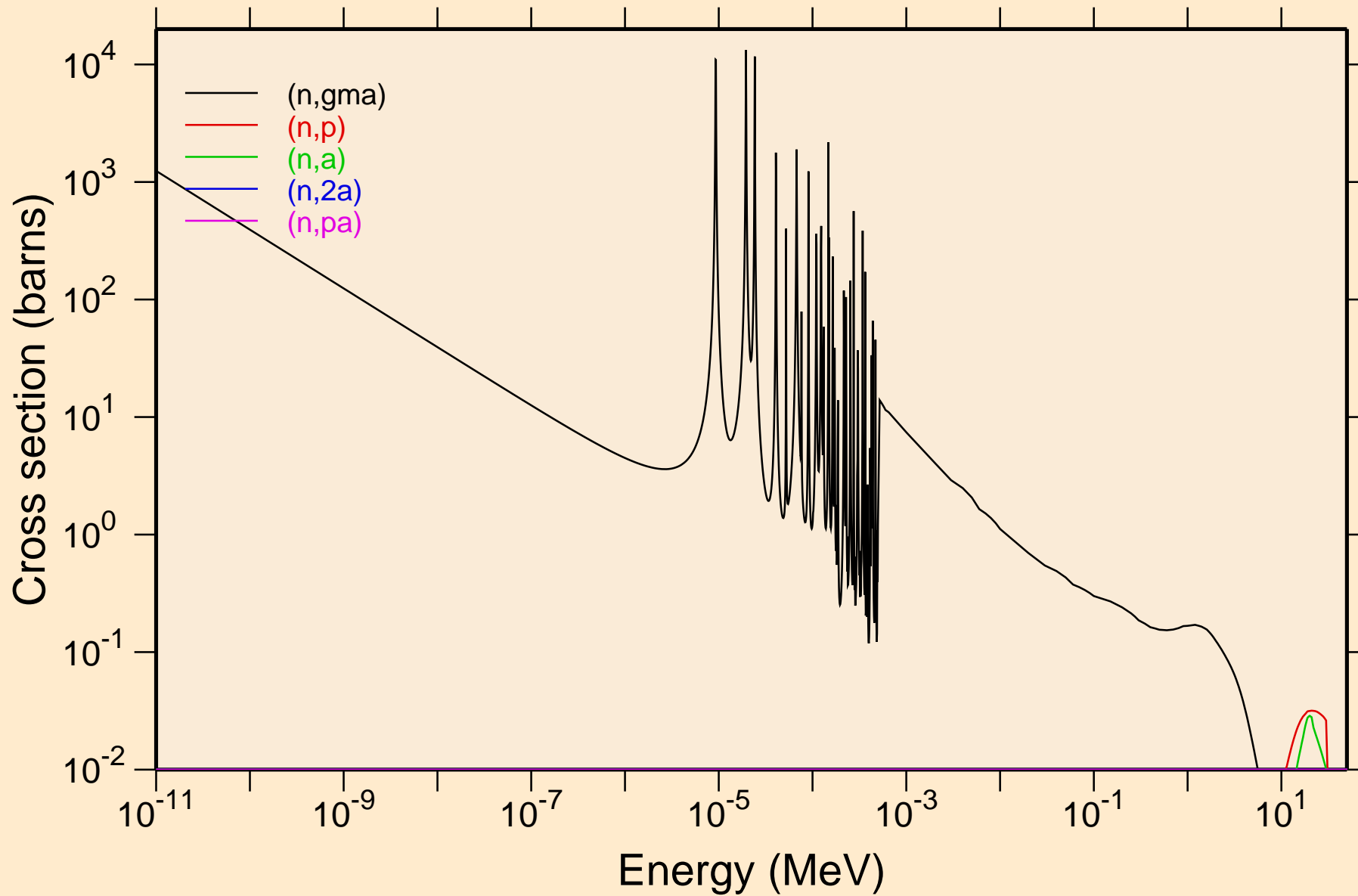

PM143 NEUTRON ACER TENDL-2023 LIBRARY; T=0.K
Non-threshold reactions

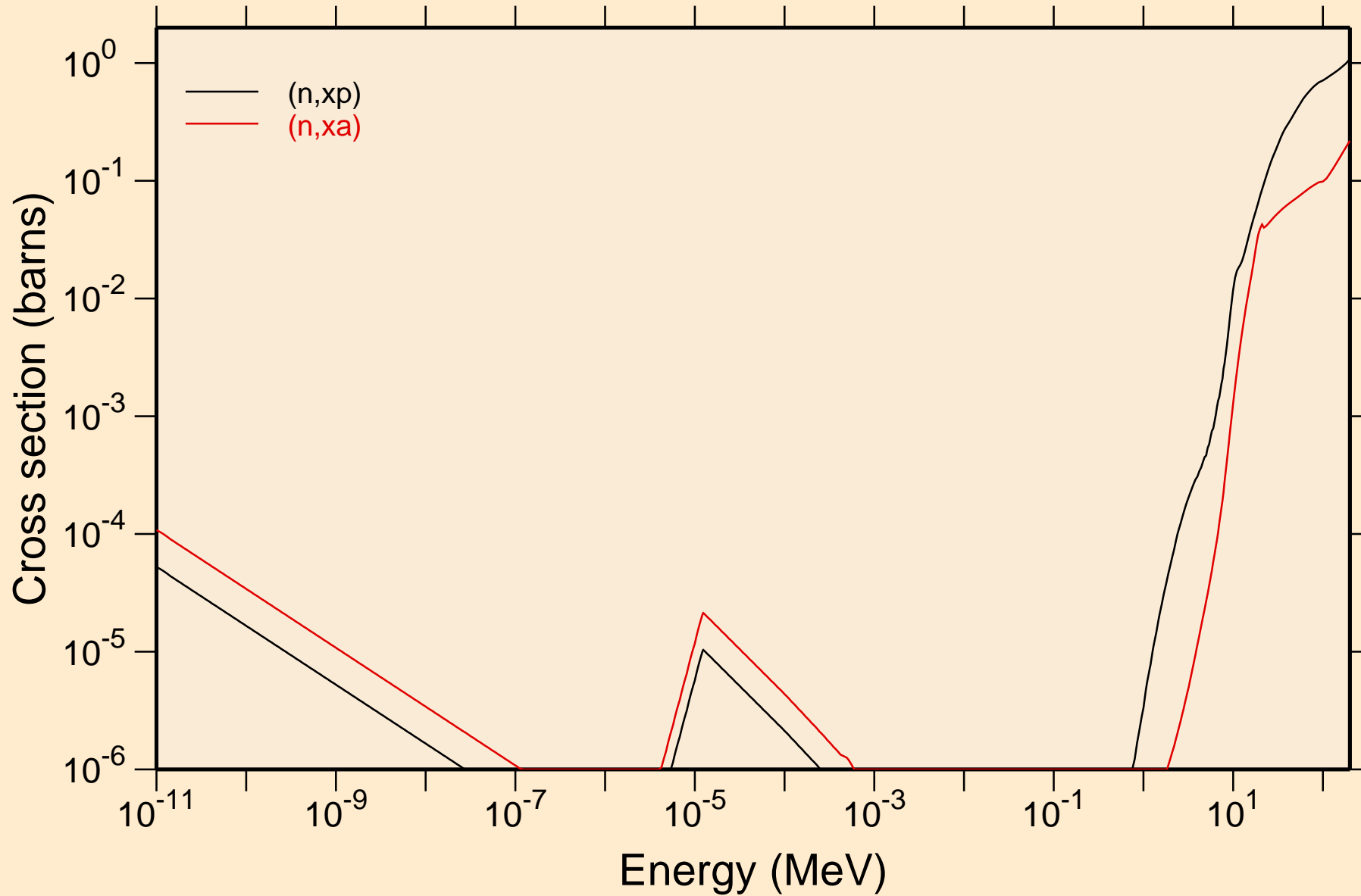

PM143 NEUTRON ACER TENDL-2023 LIBRARY; T=0.K

Principal cross sections

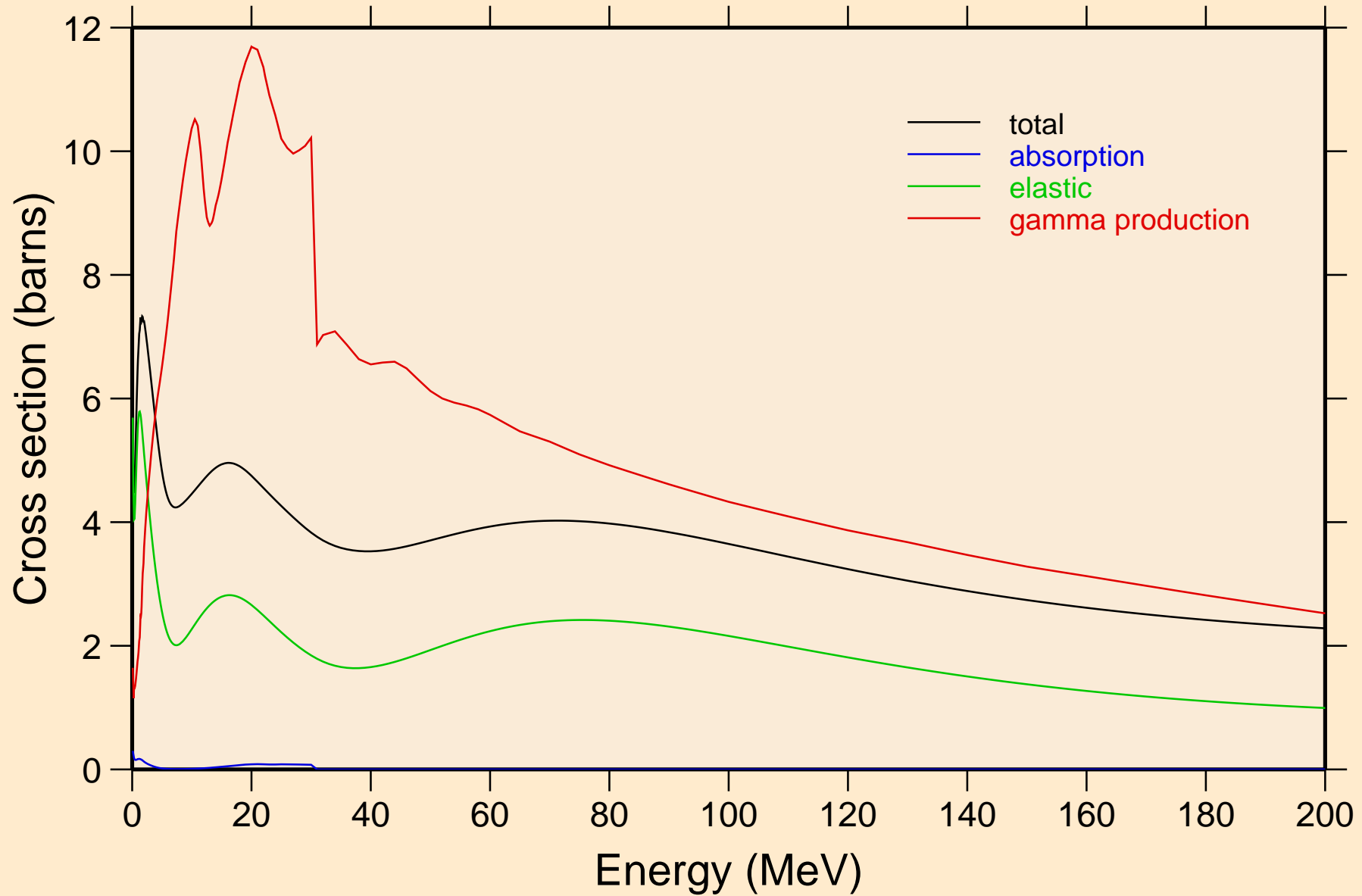

PM143 NEUTRON ACER TENDL-2023 LIBRARY; T=0.K

Heating

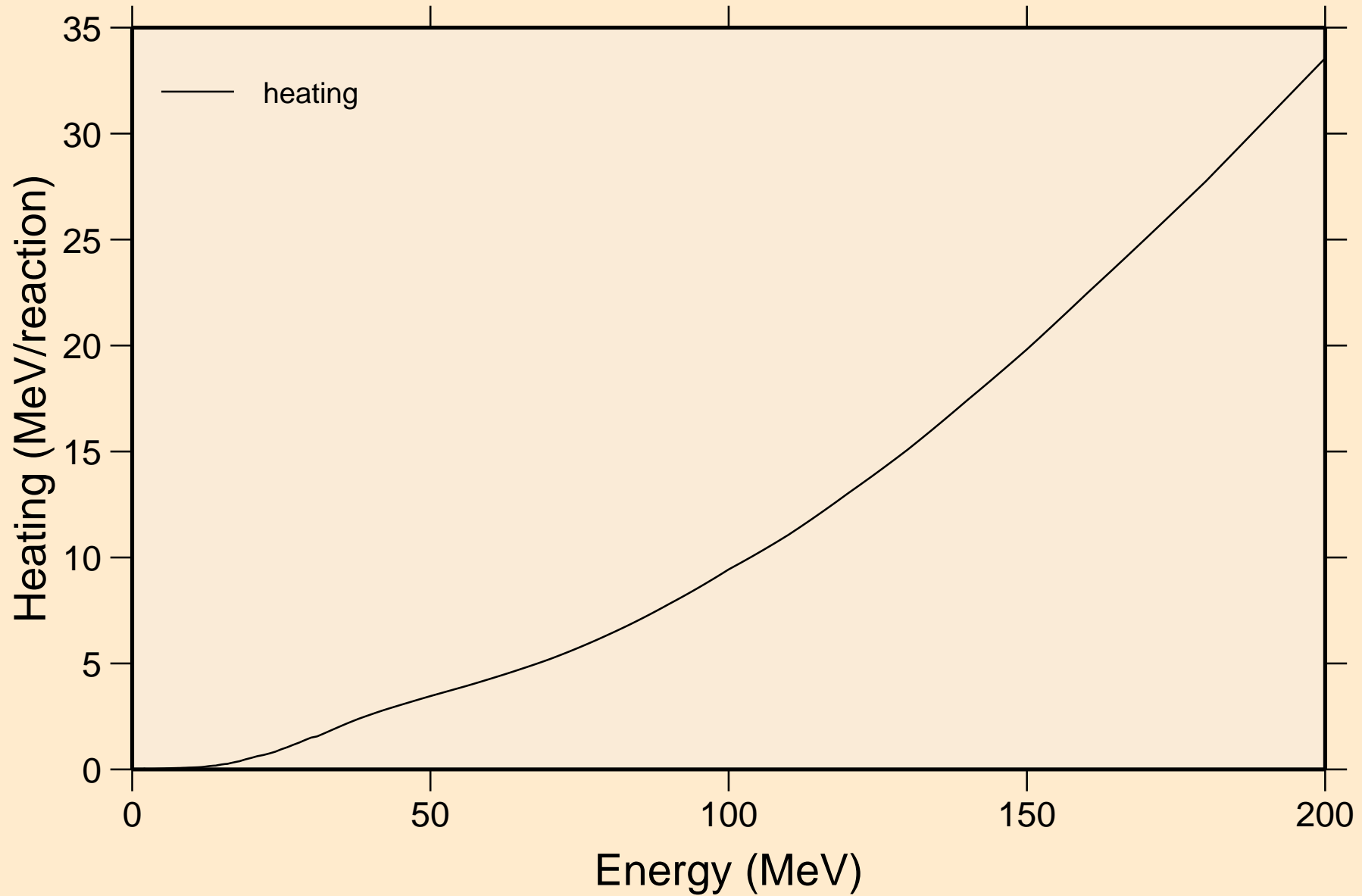

PM143 NEUTRON ACER TENDL-2023 LIBRARY; T=0.K
Damage

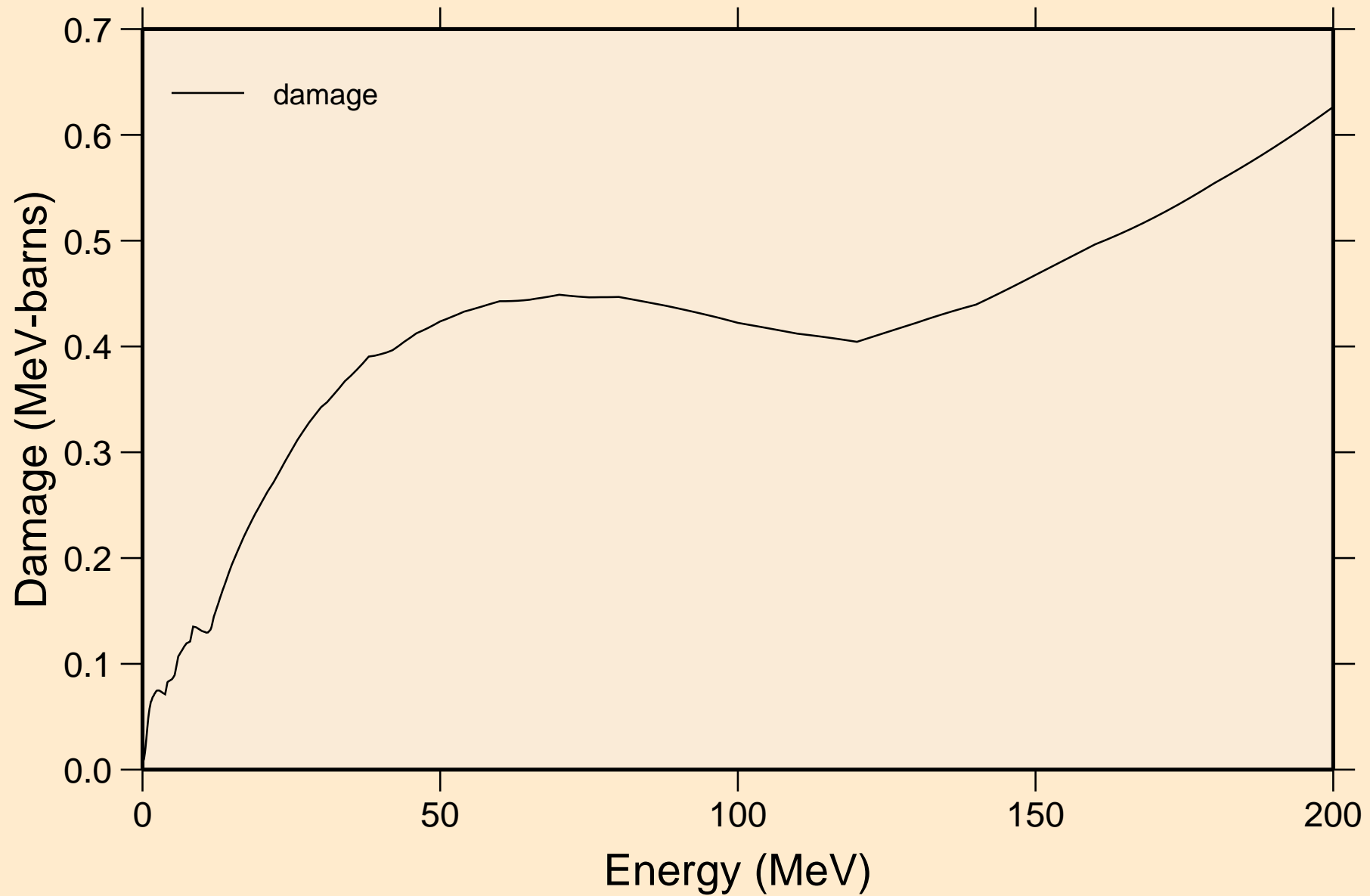

PM143 NEUTRON ACER TENDL-2023 LIBRARY; T=0.K
Non-threshold reactions

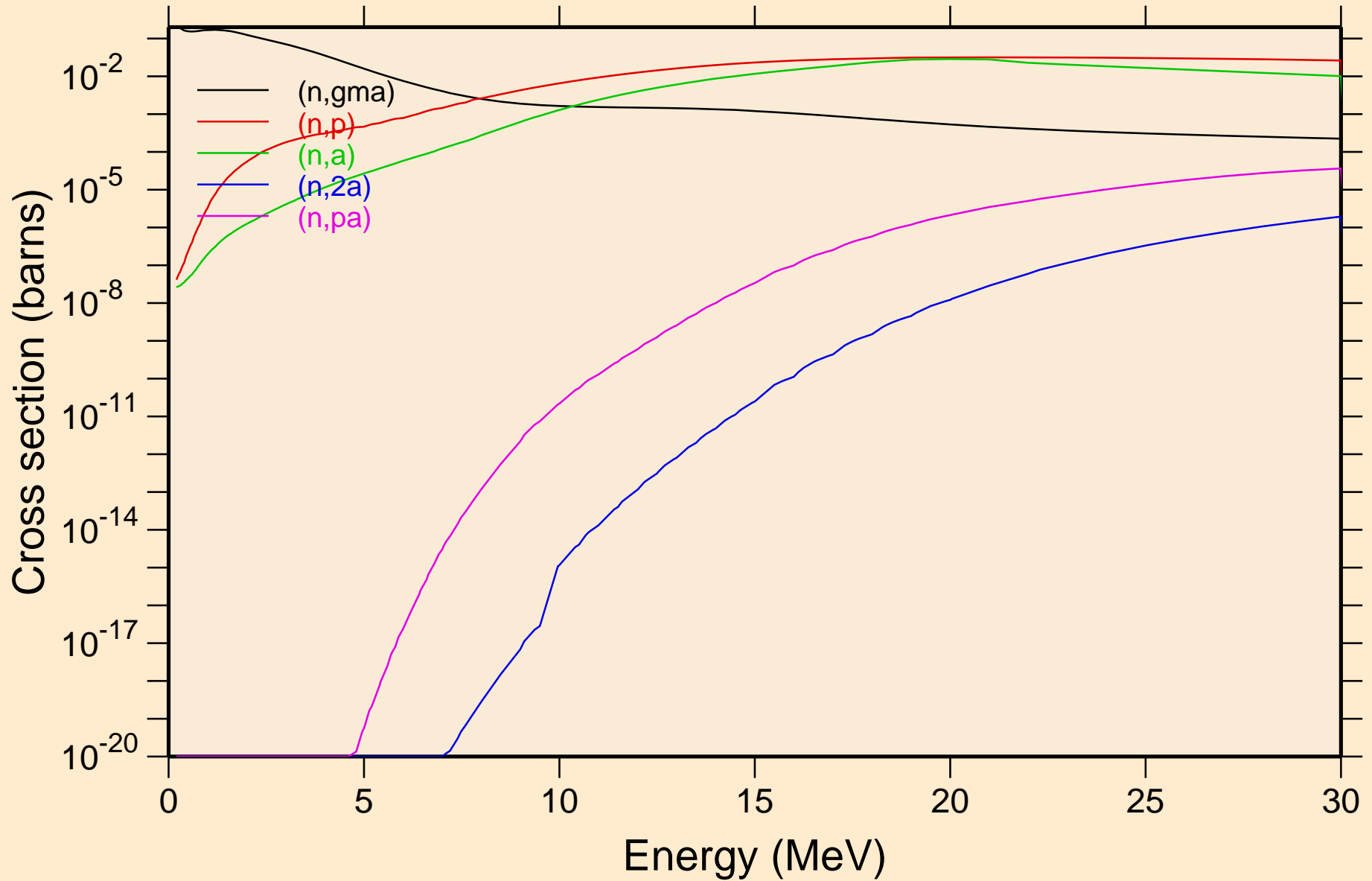

PM143 NEUTRON ACER TENDL-2023 LIBRARY; T=0.K
Non-threshold reactions

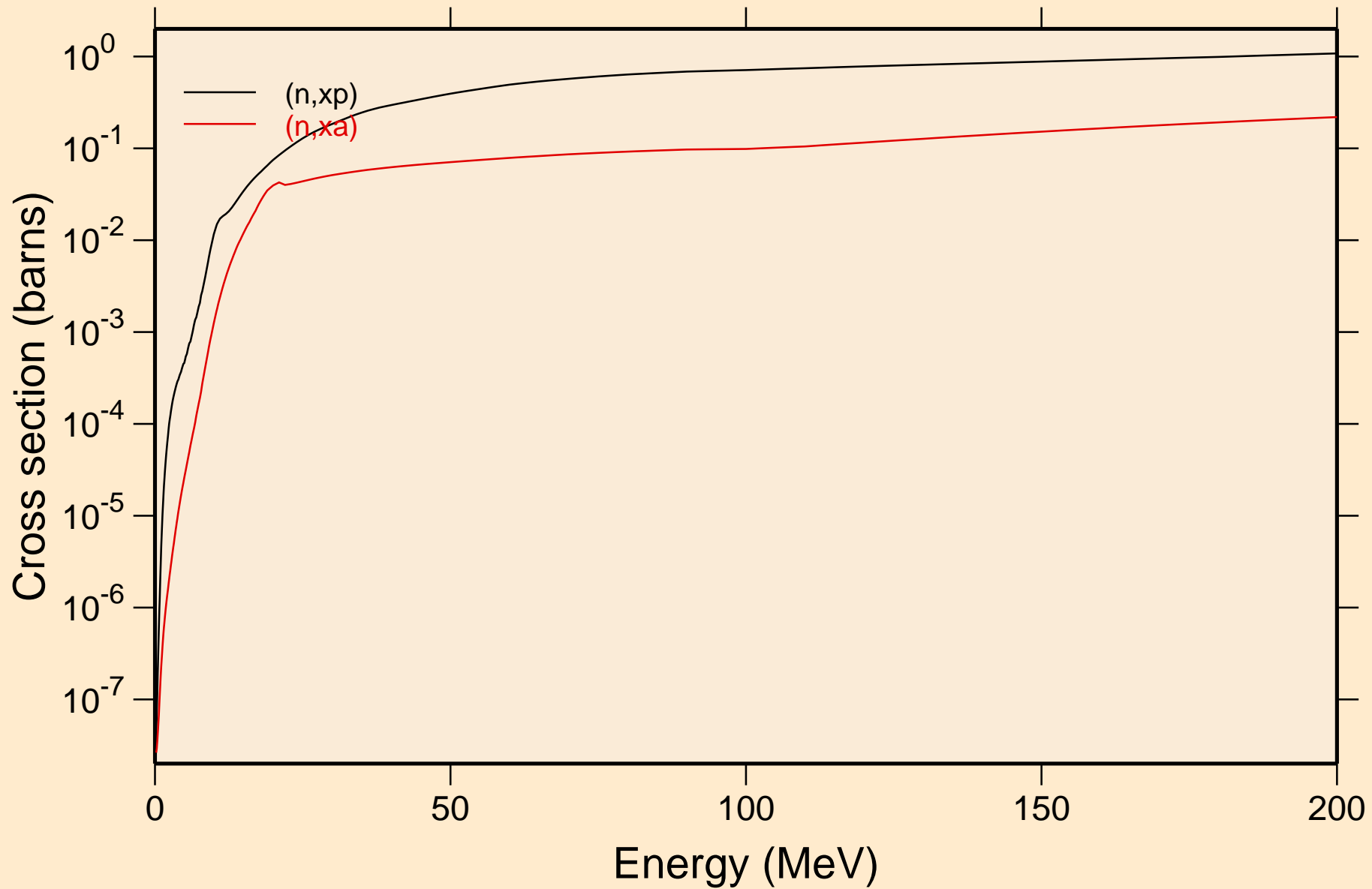

PM143 NEUTRON ACER TENDL-2023 LIBRARY; T=0.K
Inelastic levels

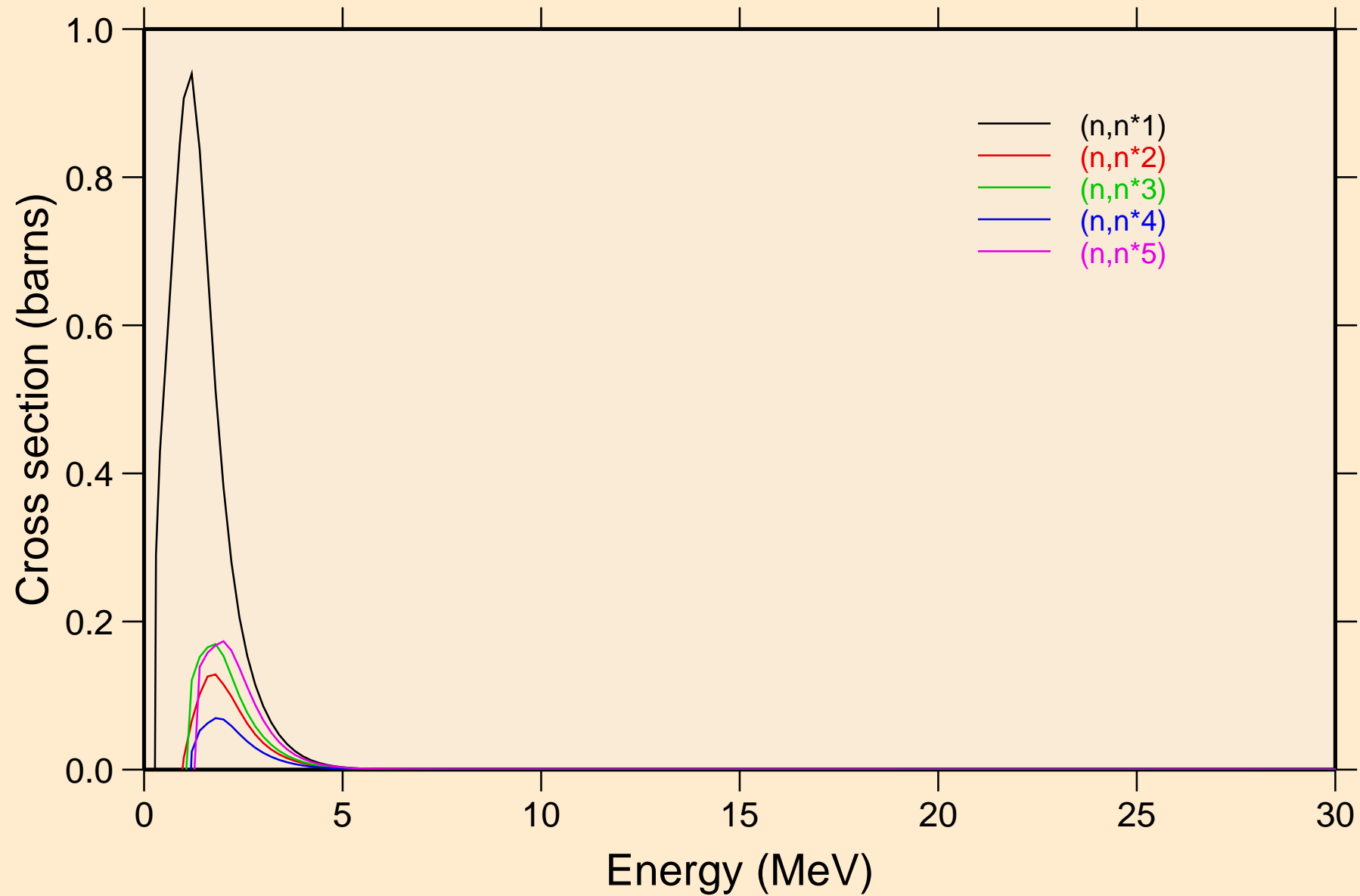

PM143 NEUTRON ACER TENDL-2023 LIBRARY; T=0.K
Inelastic levels

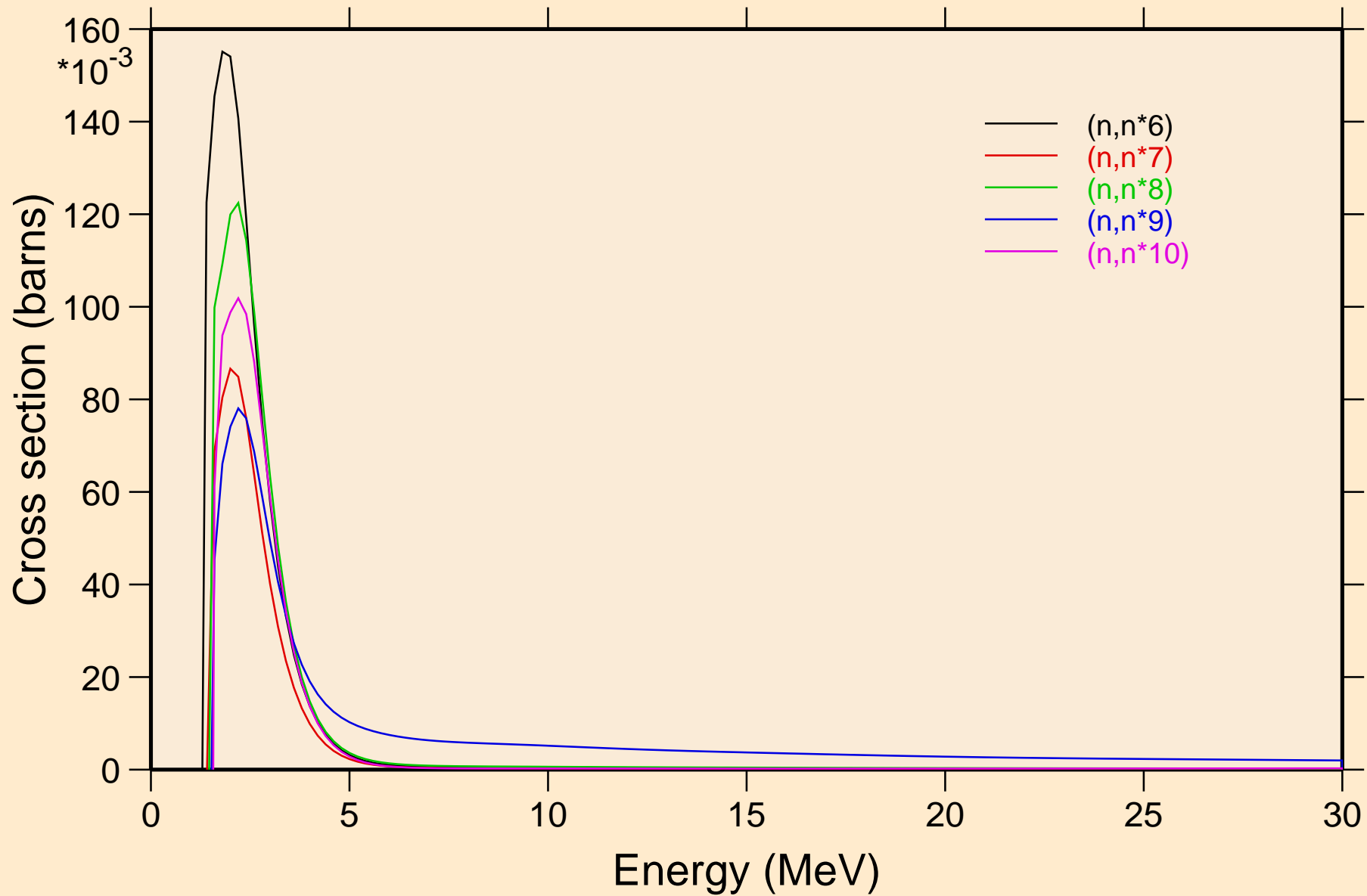

PM143 NEUTRON ACER TENDL-2023 LIBRARY; T=0.K
Inelastic levels

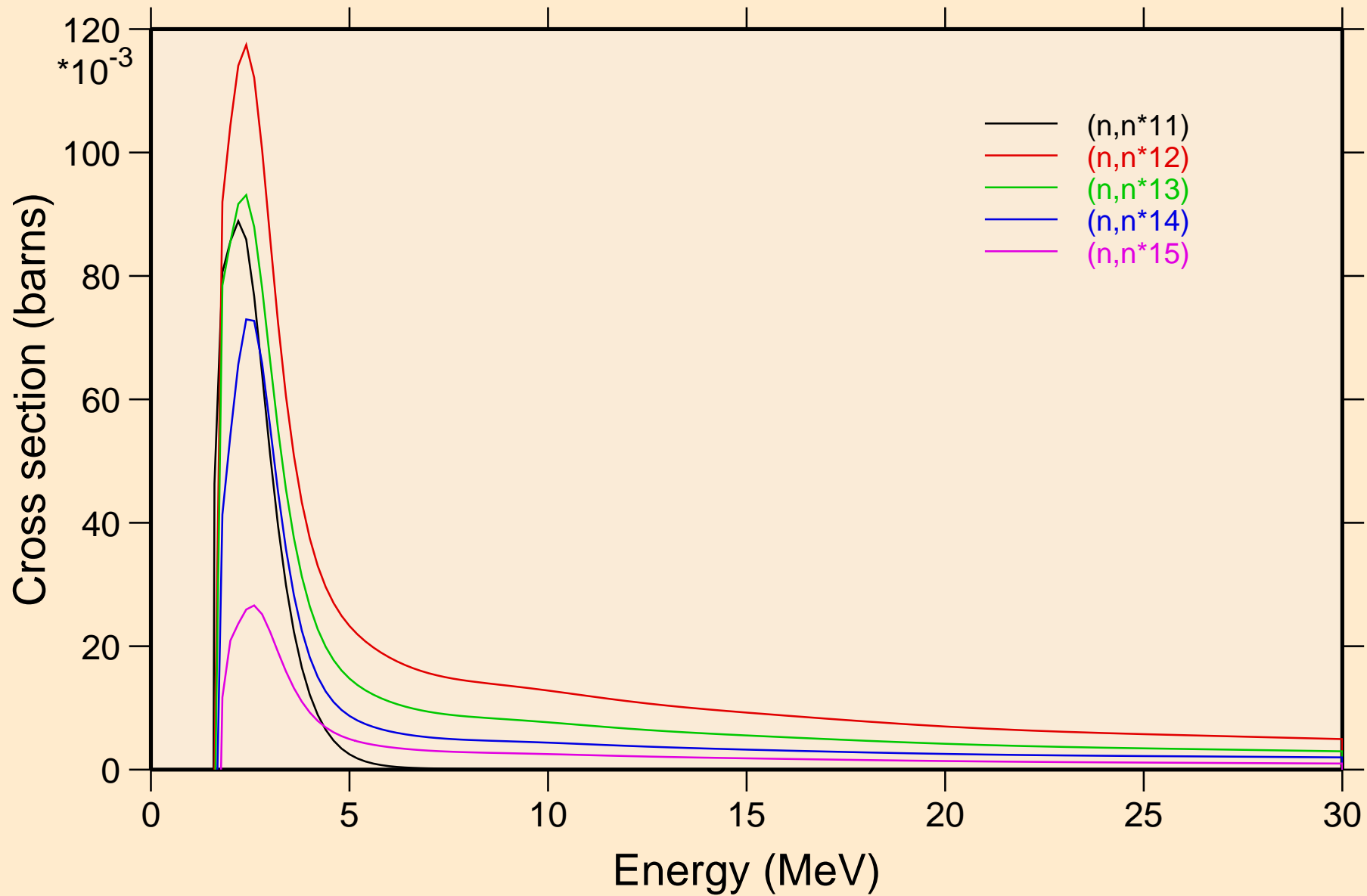

PM143 NEUTRON ACER TENDL-2023 LIBRARY; T=0.K
Inelastic levels

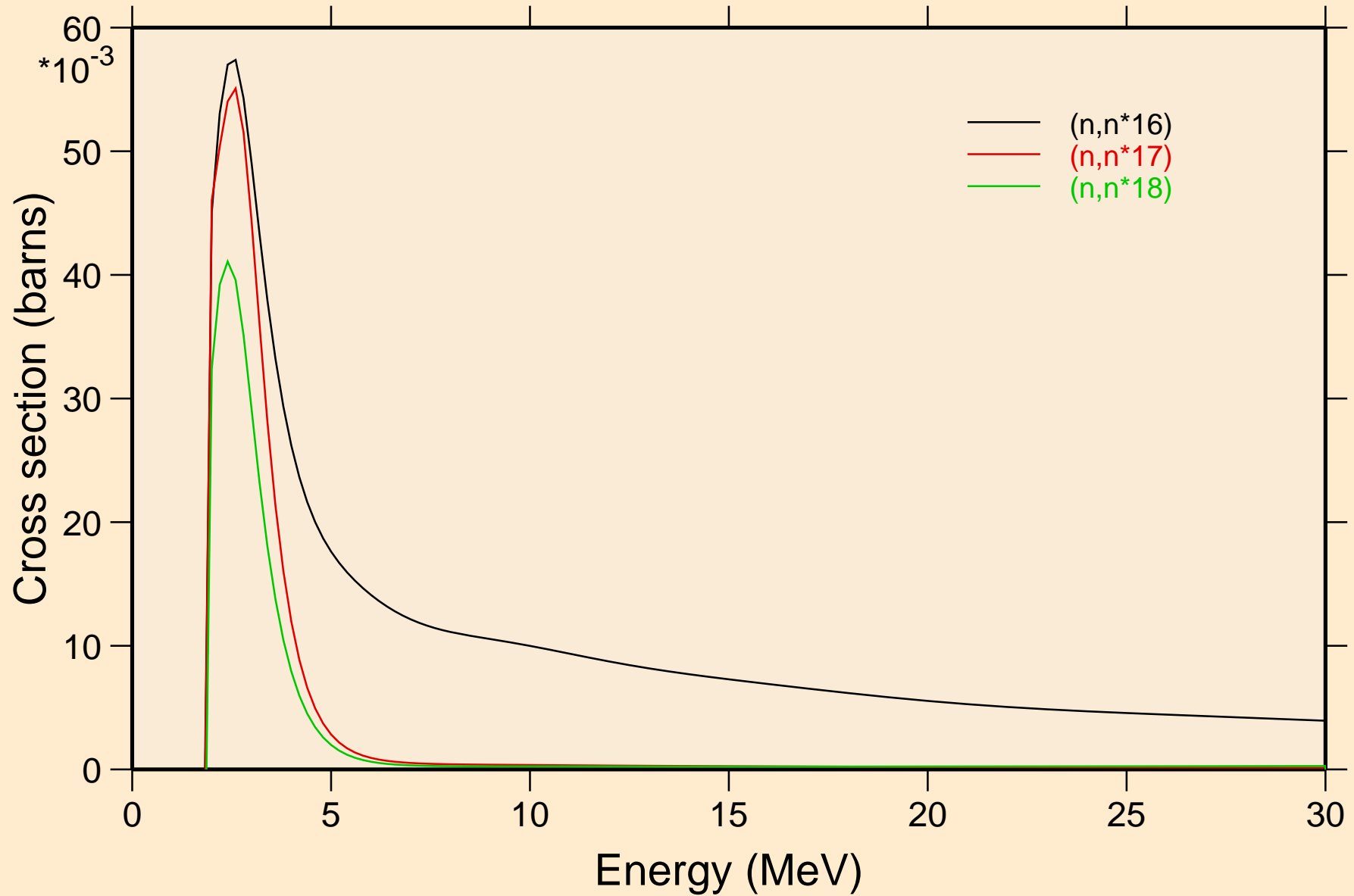

PM143 NEUTRON ACER TENDL-2023 LIBRARY; T=0.K
Threshold reactions

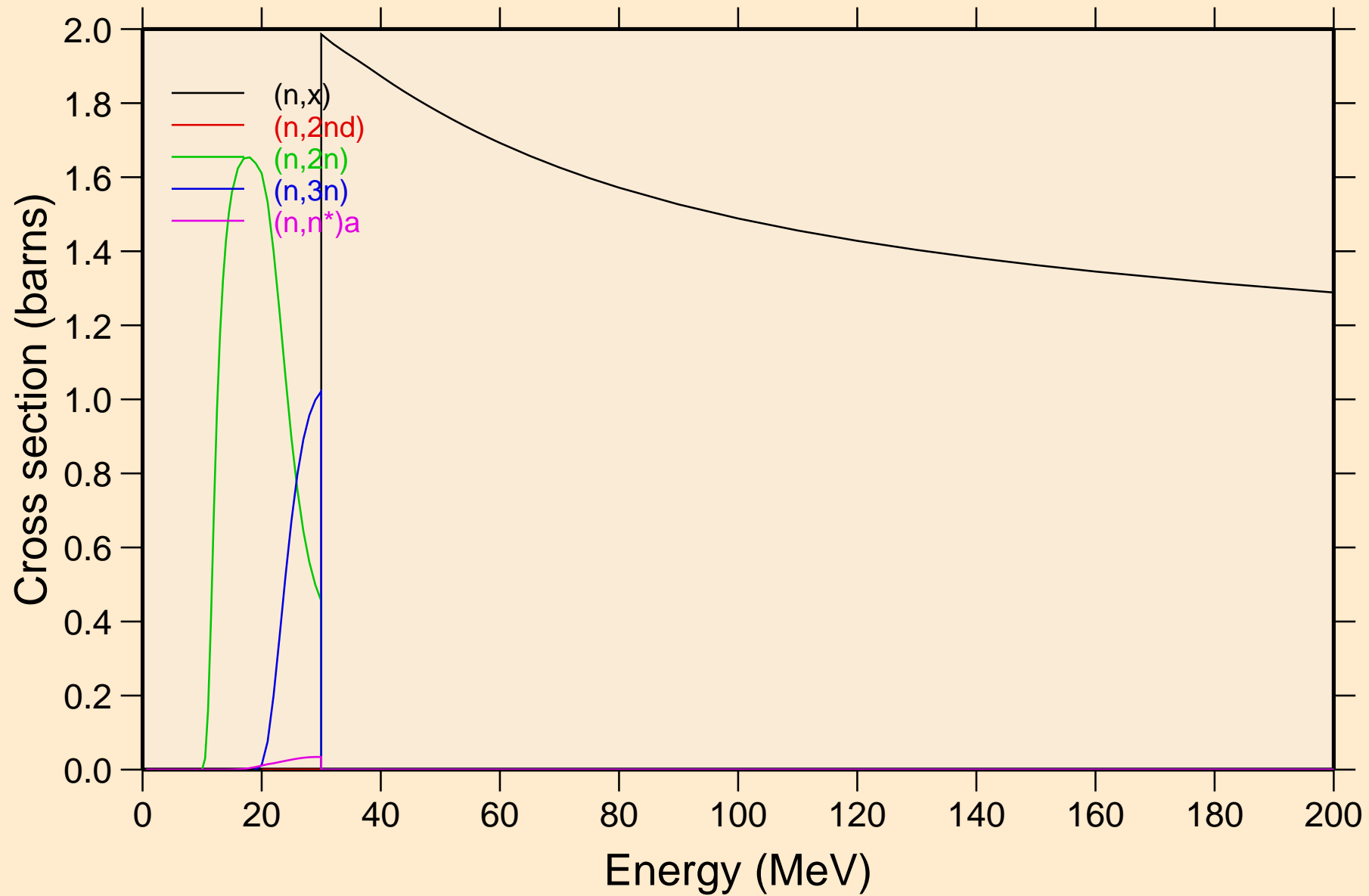

PM143 NEUTRON ACER TENDL-2023 LIBRARY; T=0.K
Threshold reactions

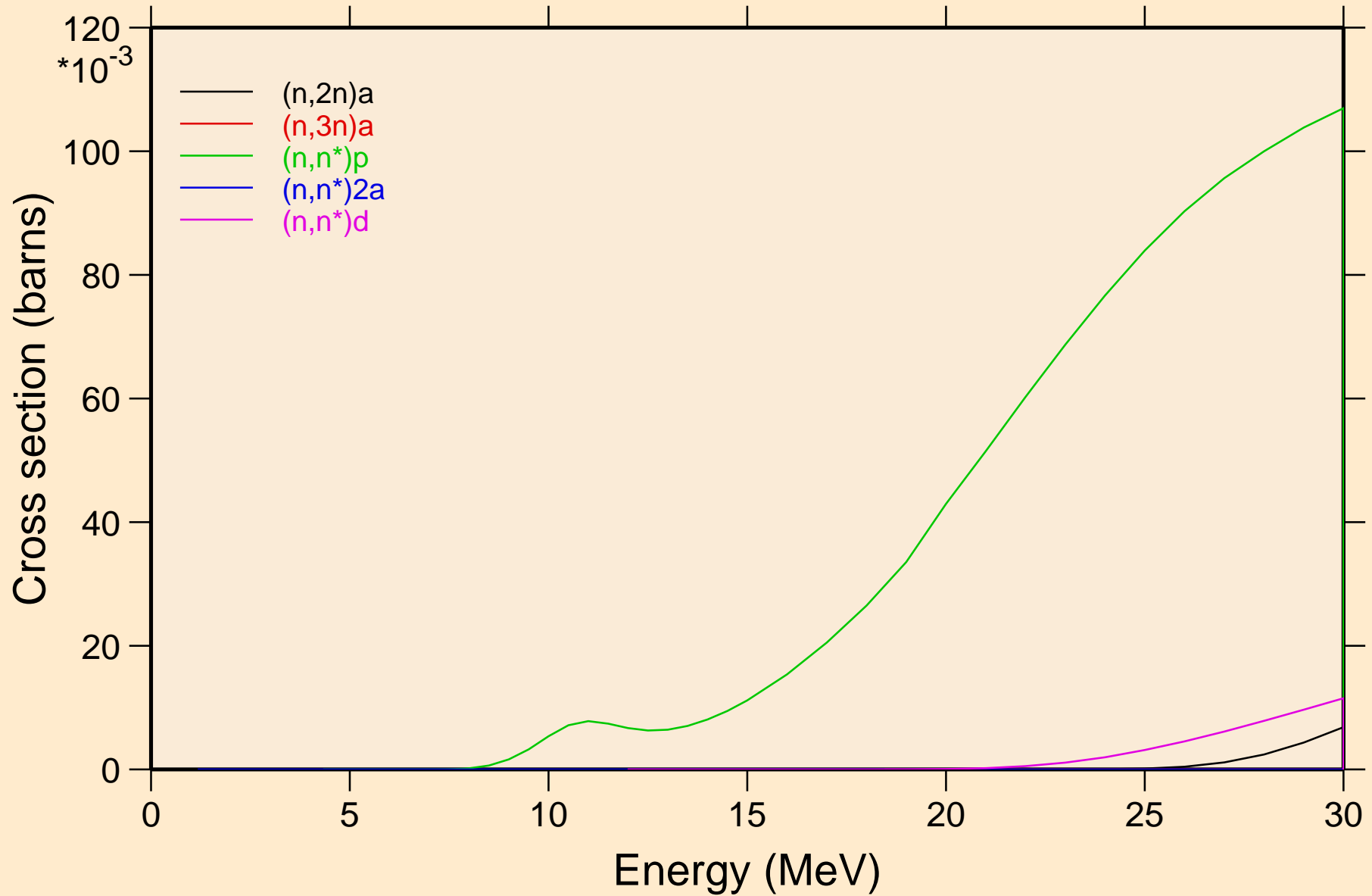

PM143 NEUTRON ACER TENDL-2023 LIBRARY; T=0.K
Threshold reactions

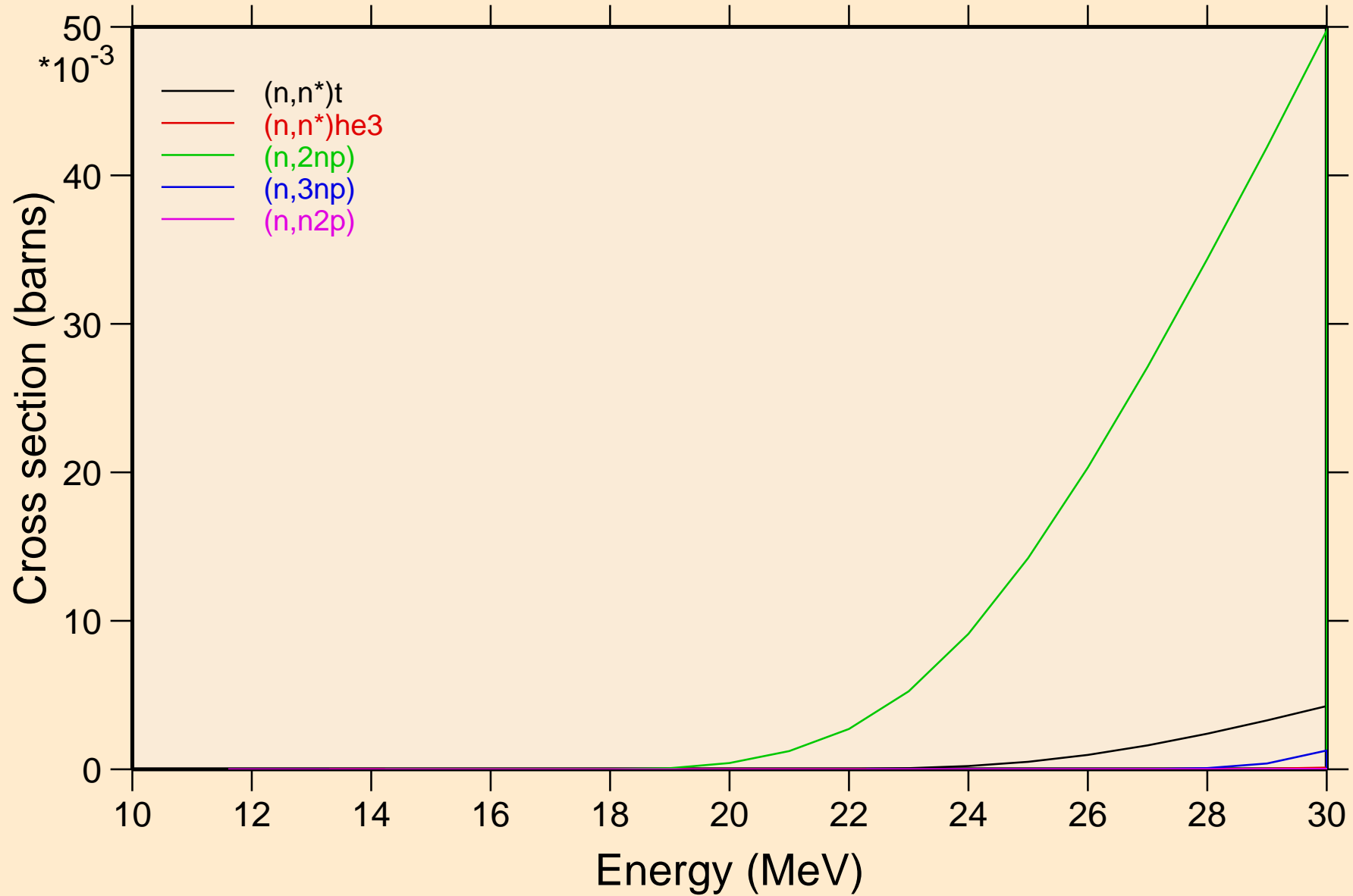

PM143 NEUTRON ACER TENDL-2023 LIBRARY; T=0.K
Threshold reactions

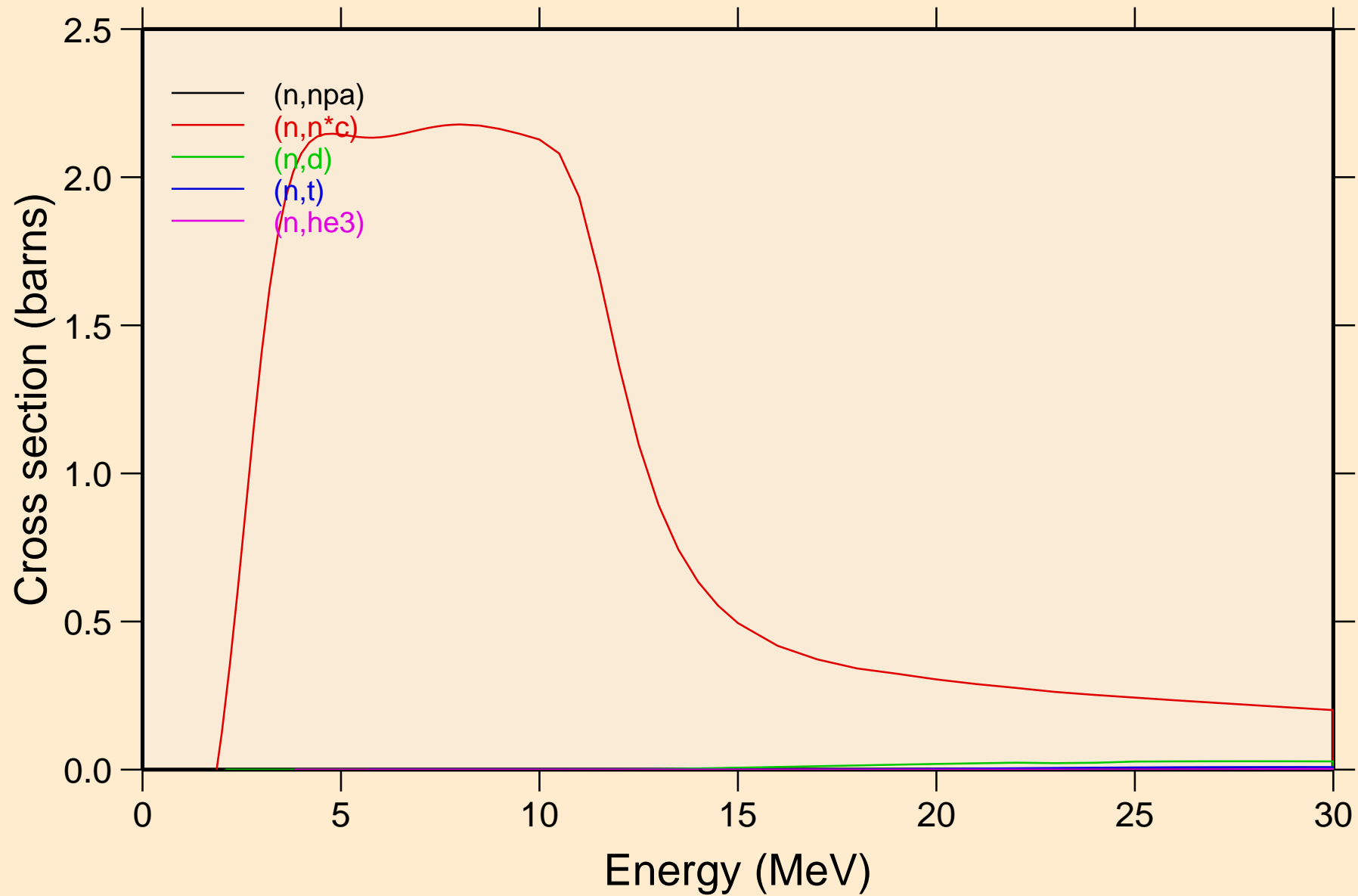

PM143 NEUTRON ACER TENDL-2023 LIBRARY; T=0.K
Threshold reactions

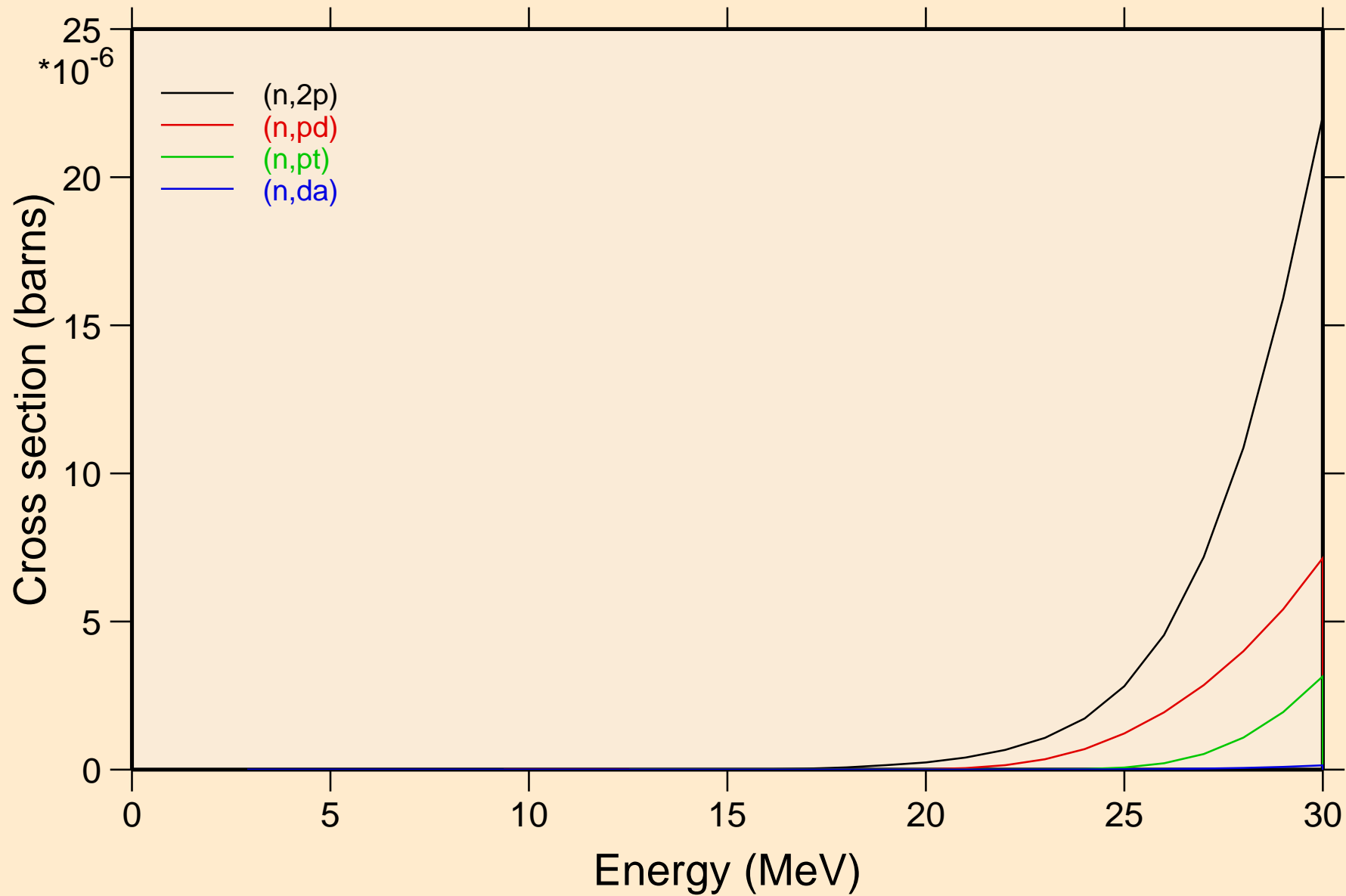

PM143 NEUTRON ACER TENDL-2023 LIBRARY; T=0.K
Threshold reactions

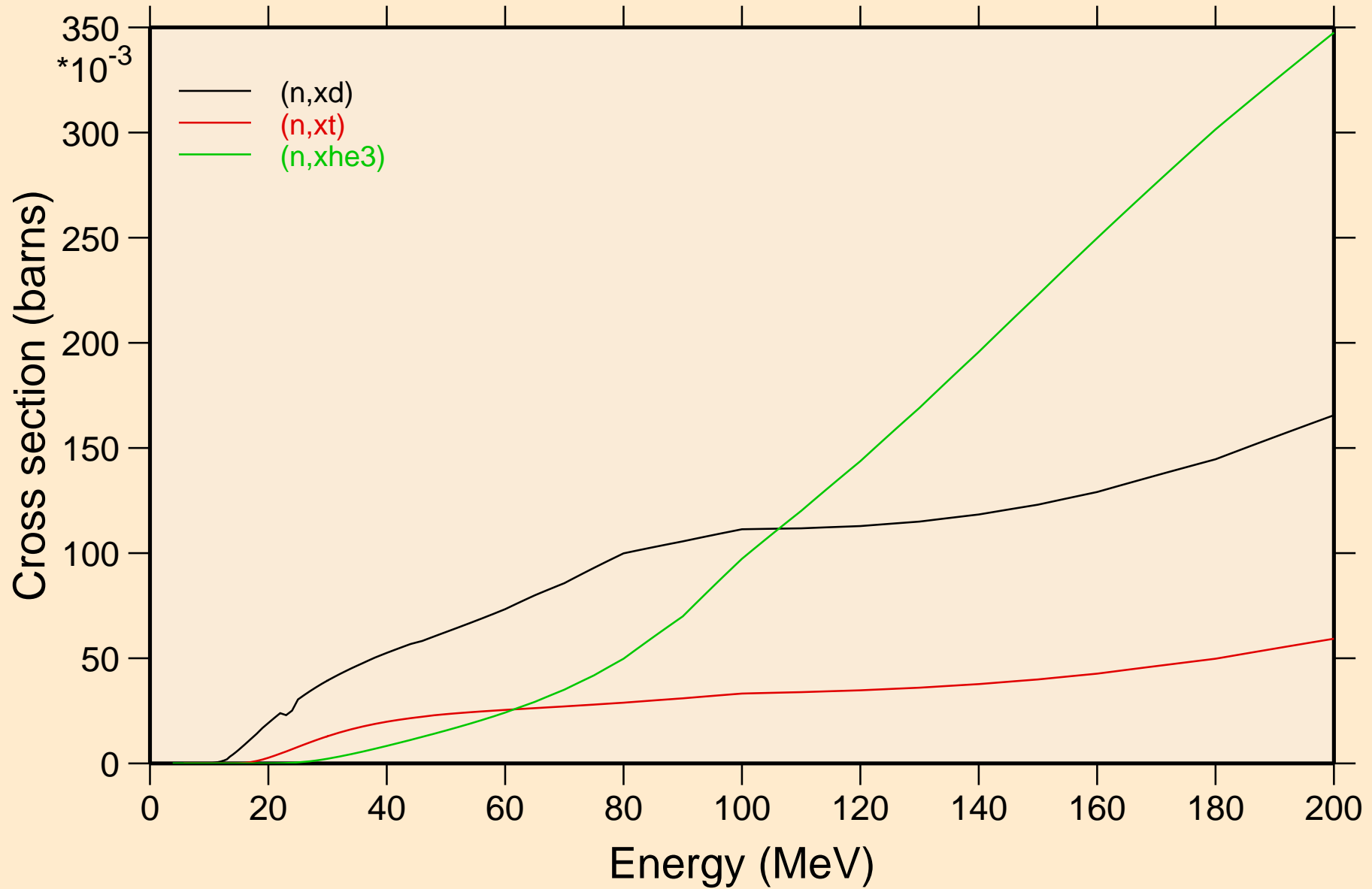

PM143 NEUTRON ACER TENDL-2023 LIBRARY; T=0.K
angular distribution for elastic

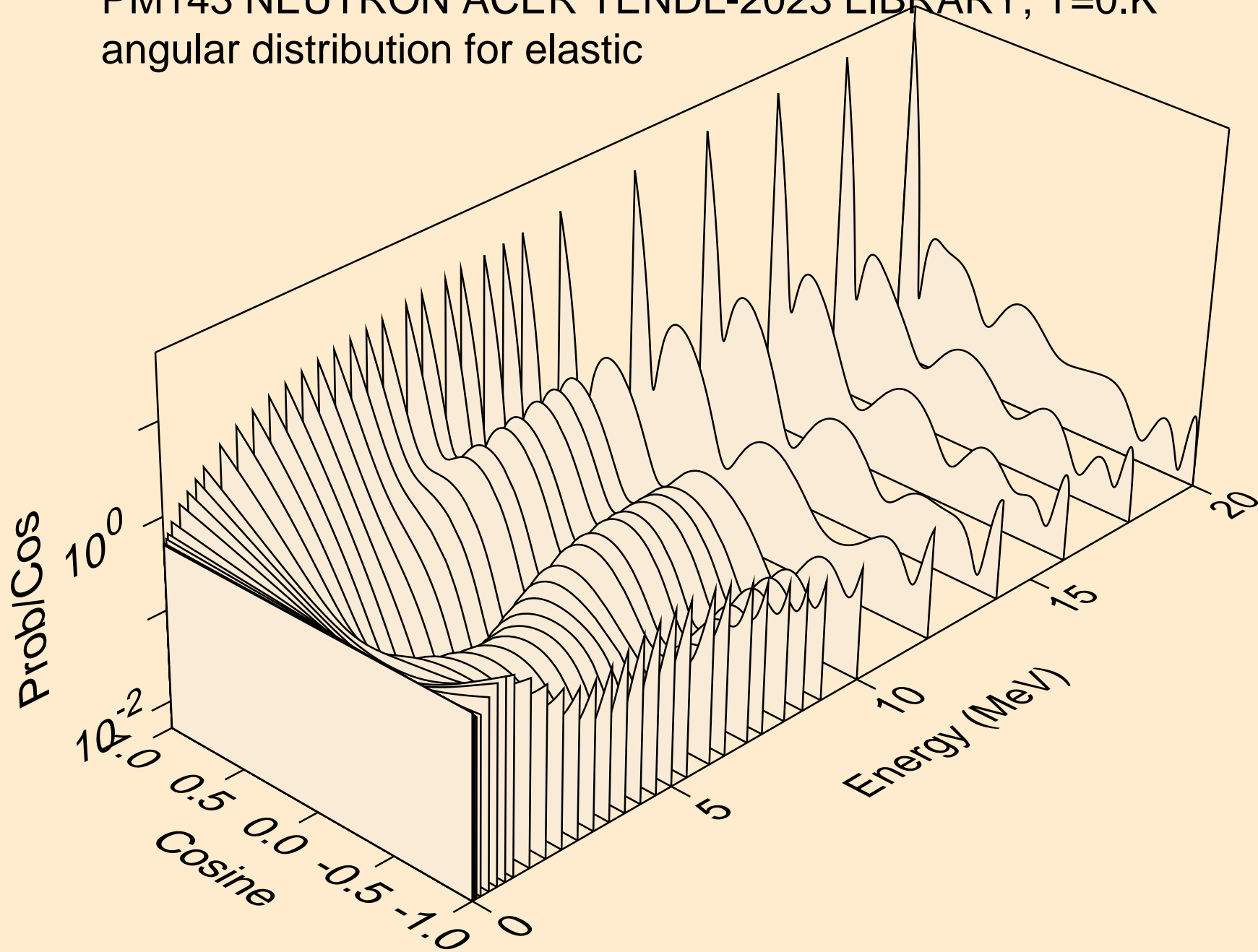

PM143 NEUTRON ACER TENDL-2023 LIBRARY; T=0.K
angular distribution for elastic

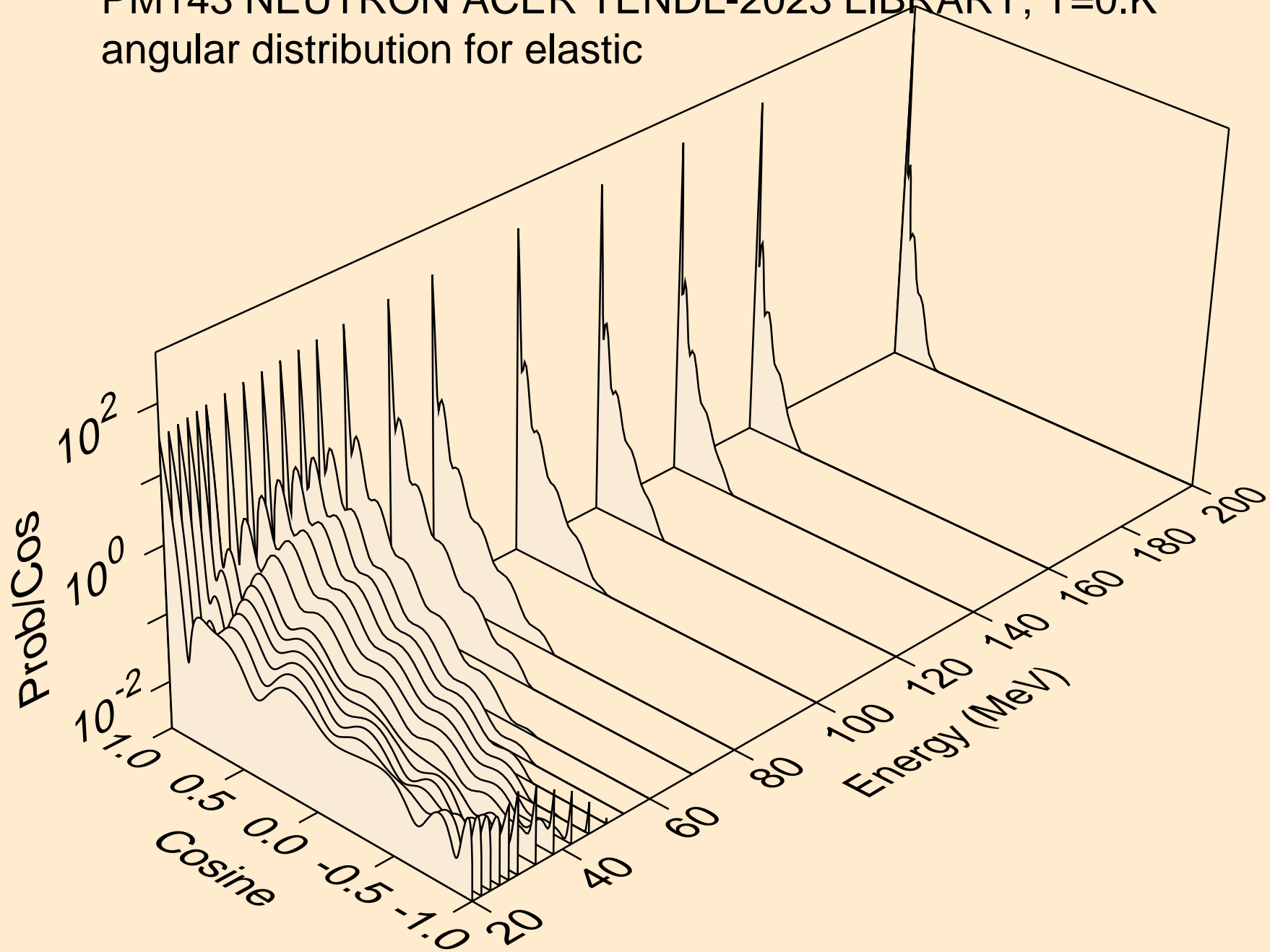

PM143 NEUTRON ACER TENDL-2023 LIBRARY; T=0.K
angular distribution for (n,n*1)

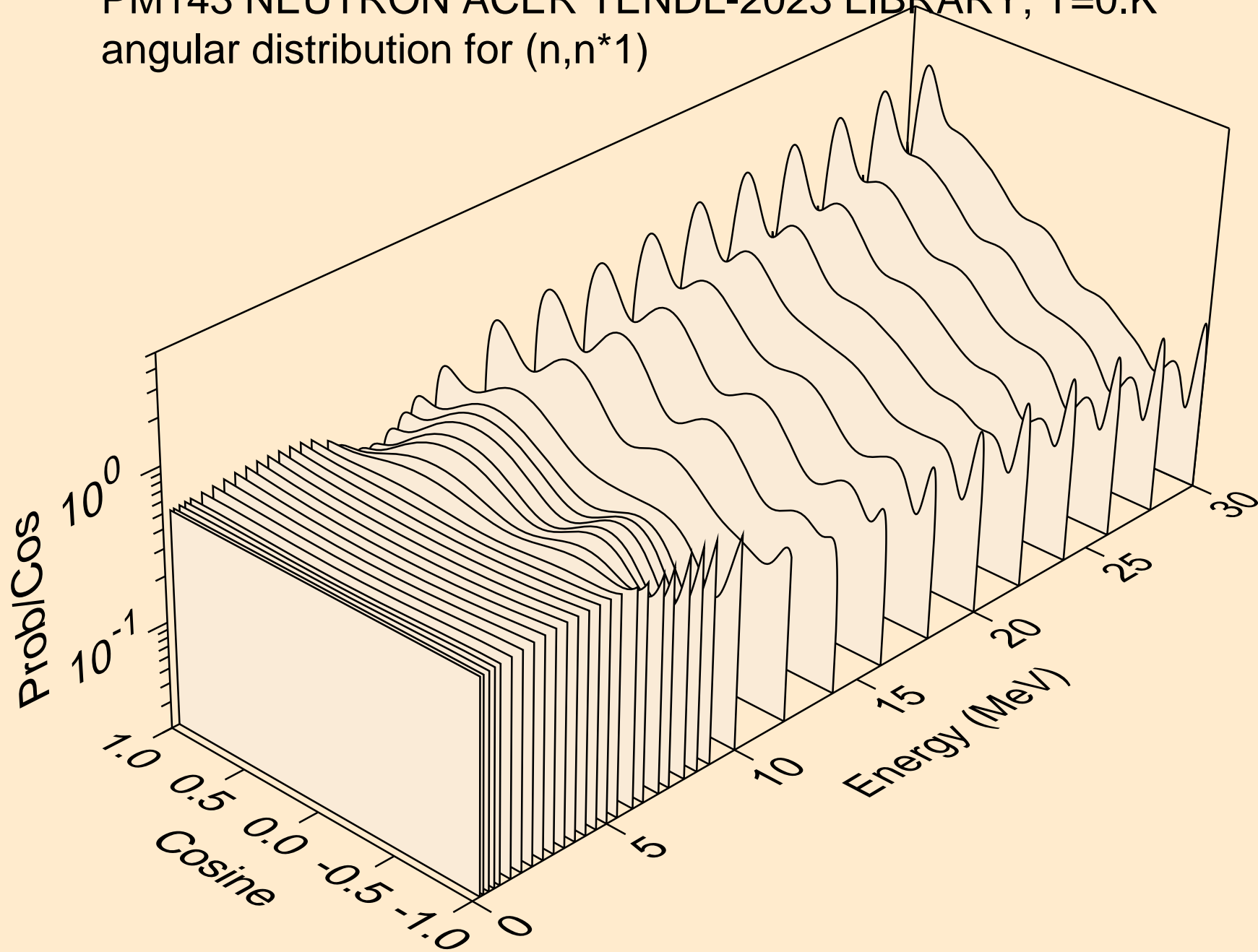

PM143 NEUTRON ACER TENDL-2023 LIBRARY; T=0.K
angular distribution for (n,n*2)

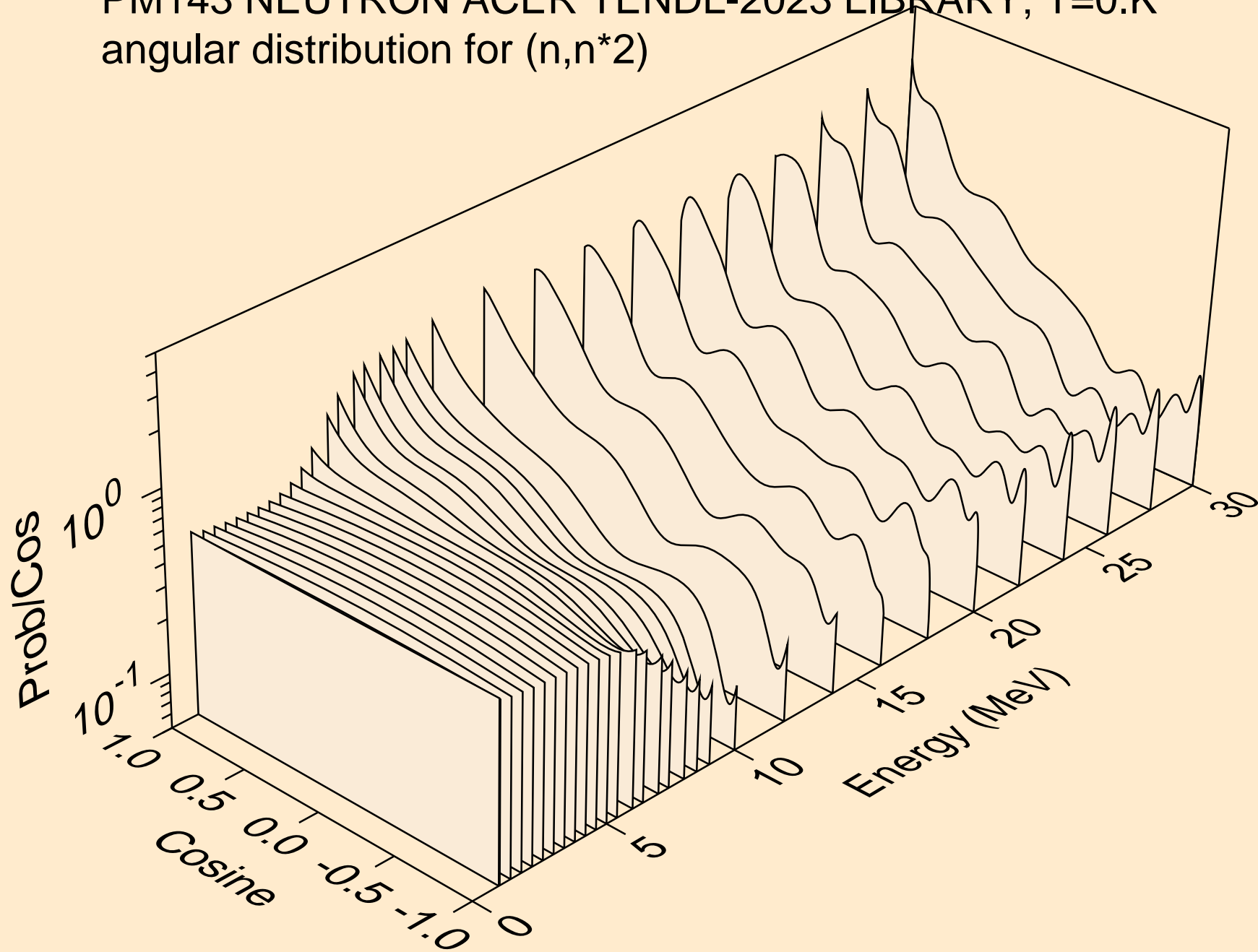

PM143 NEUTRON ACER TENDL-2023 LIBRARY; T=0.K
angular distribution for (n,n*3)

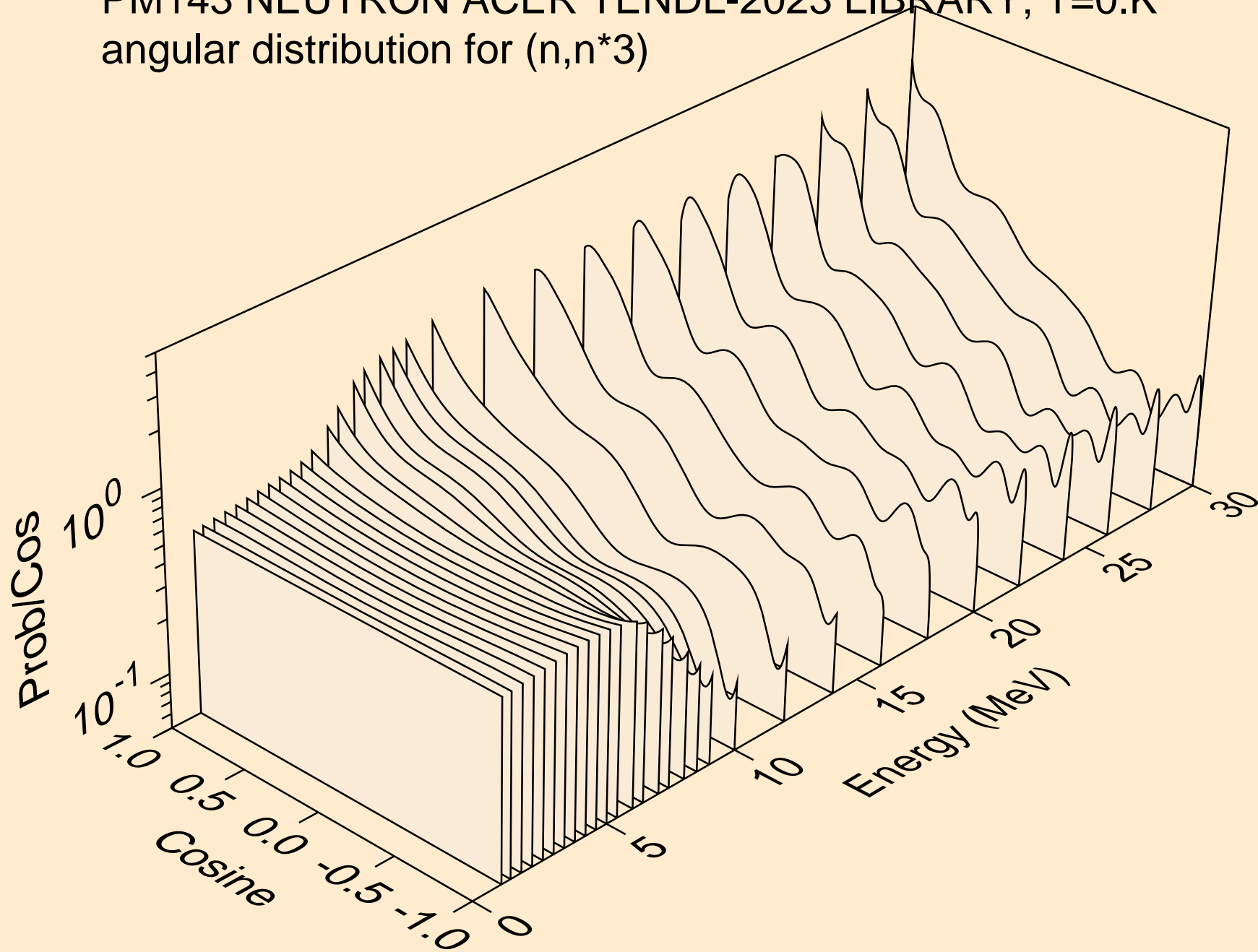

PM143 NEUTRON ACER TENDL-2023 LIBRARY; T=0.K
angular distribution for (n,n*4)

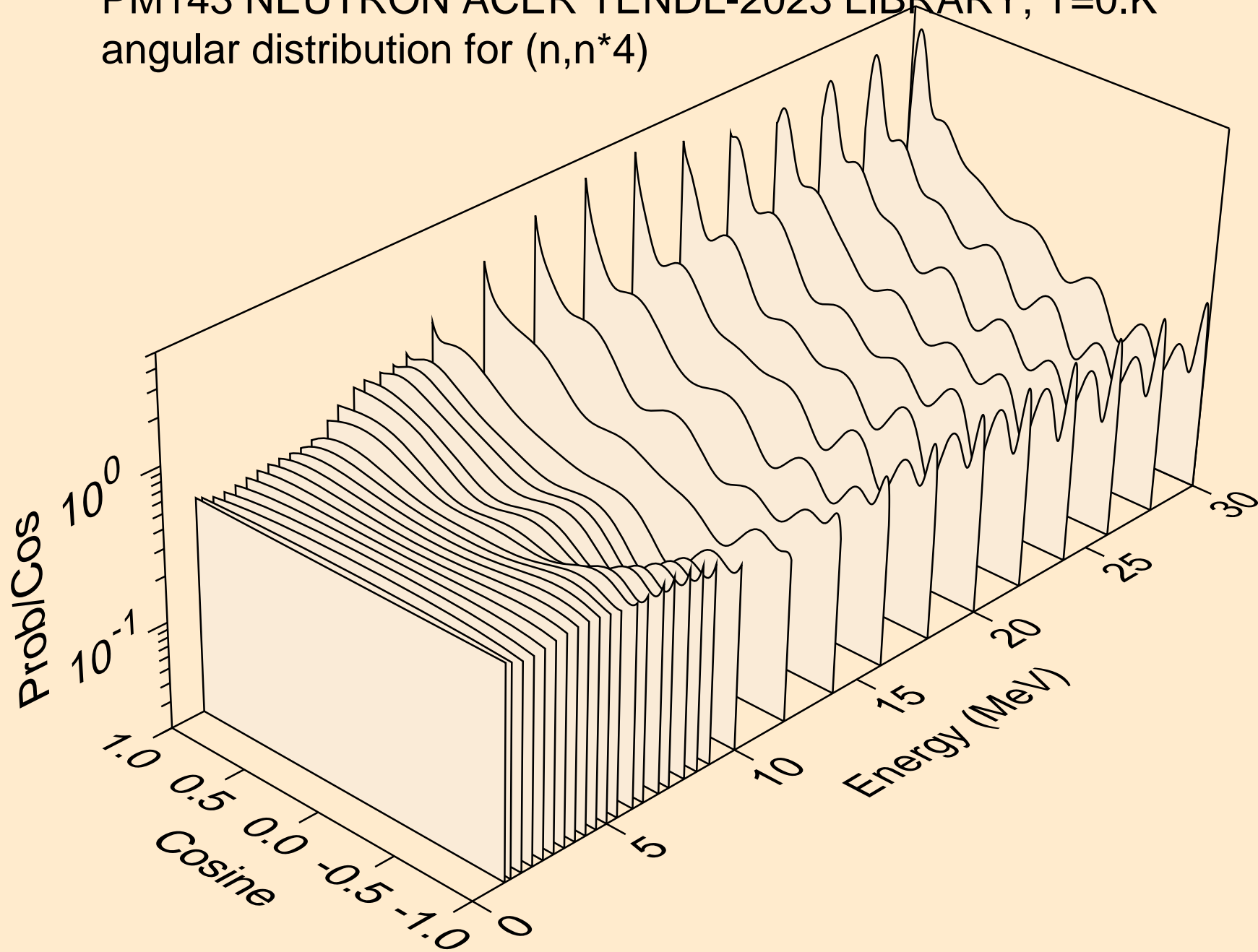

PM143 NEUTRON ACER TENDL-2023 LIBRARY; T=0.K
angular distribution for (n,n*5)

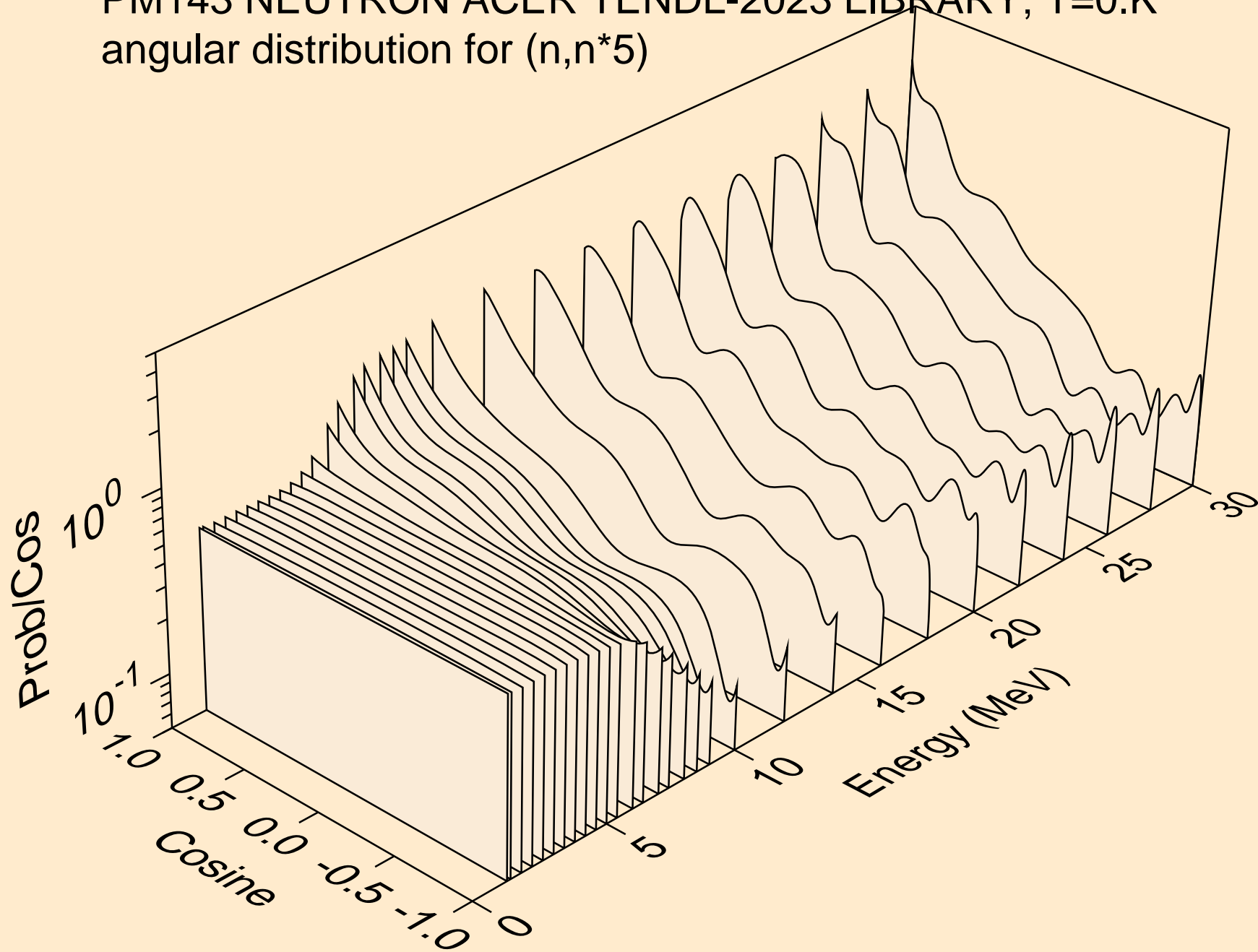

PM143 NEUTRON ACER TENDL-2023 LIBRARY; T=0.K
angular distribution for (n,n*6)

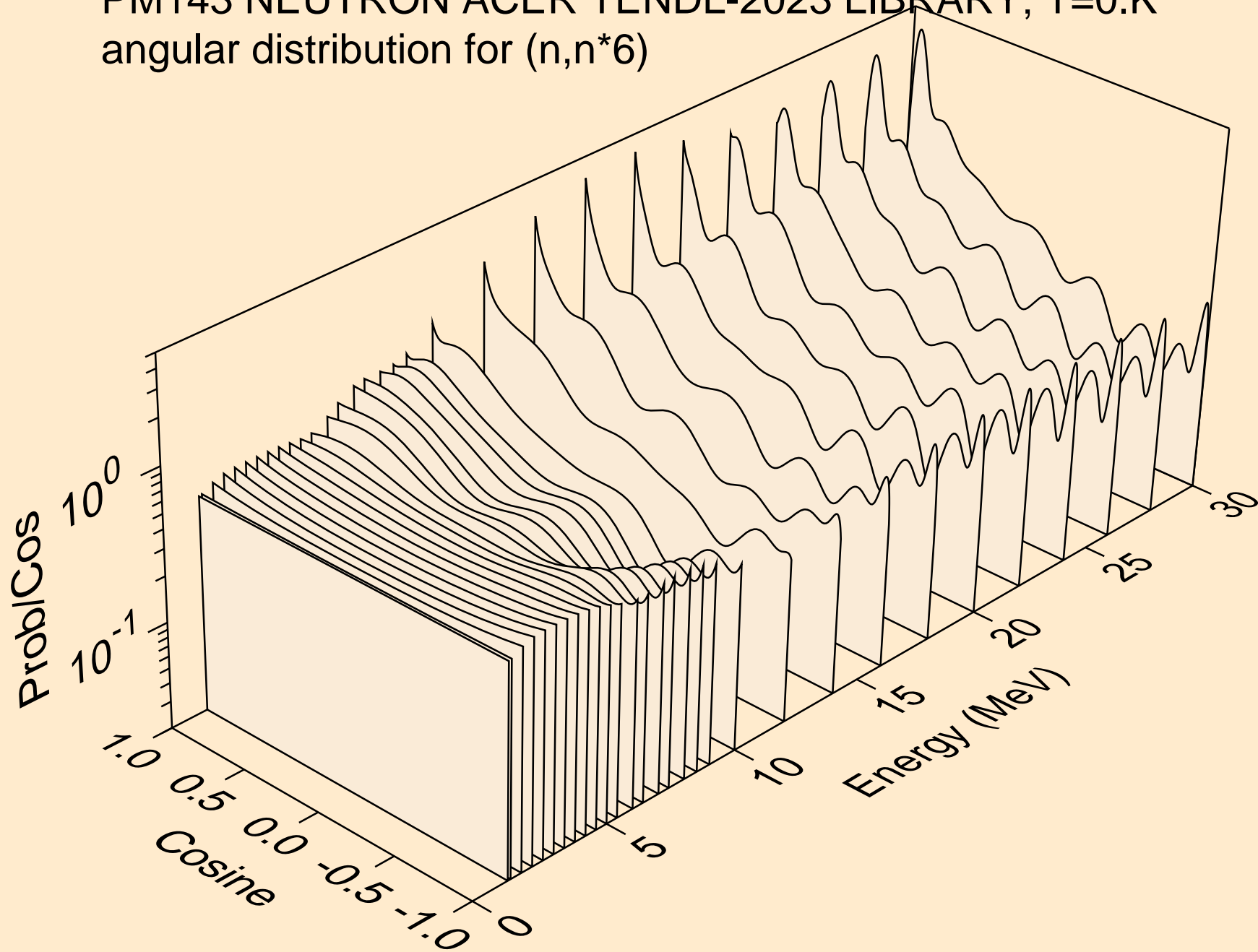

PM143 NEUTRON ACER TENDL-2023 LIBRARY; T=0.K
angular distribution for (n,n*7)

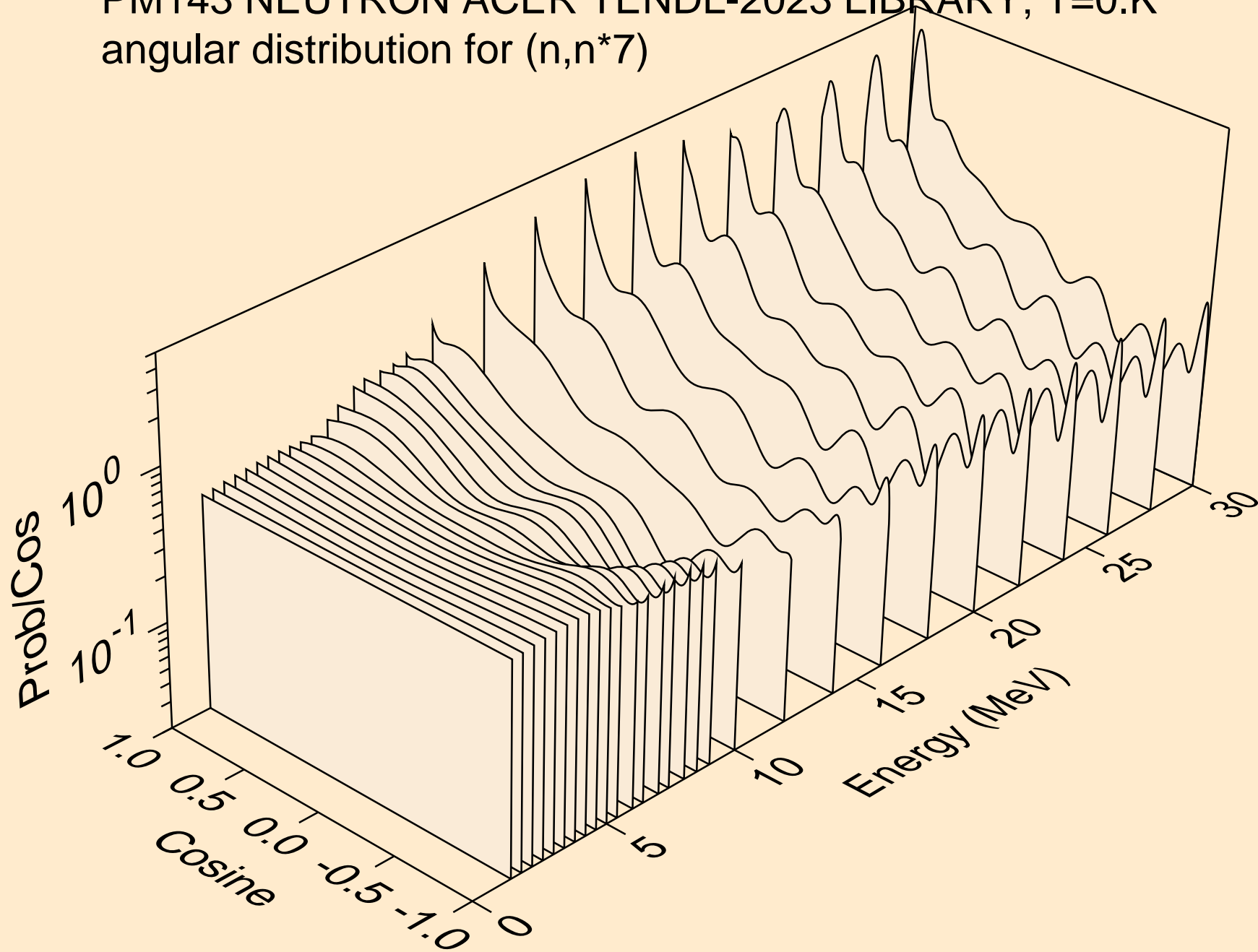

PM143 NEUTRON ACER TENDL-2023 LIBRARY; T=0.K
angular distribution for (n,n*8)

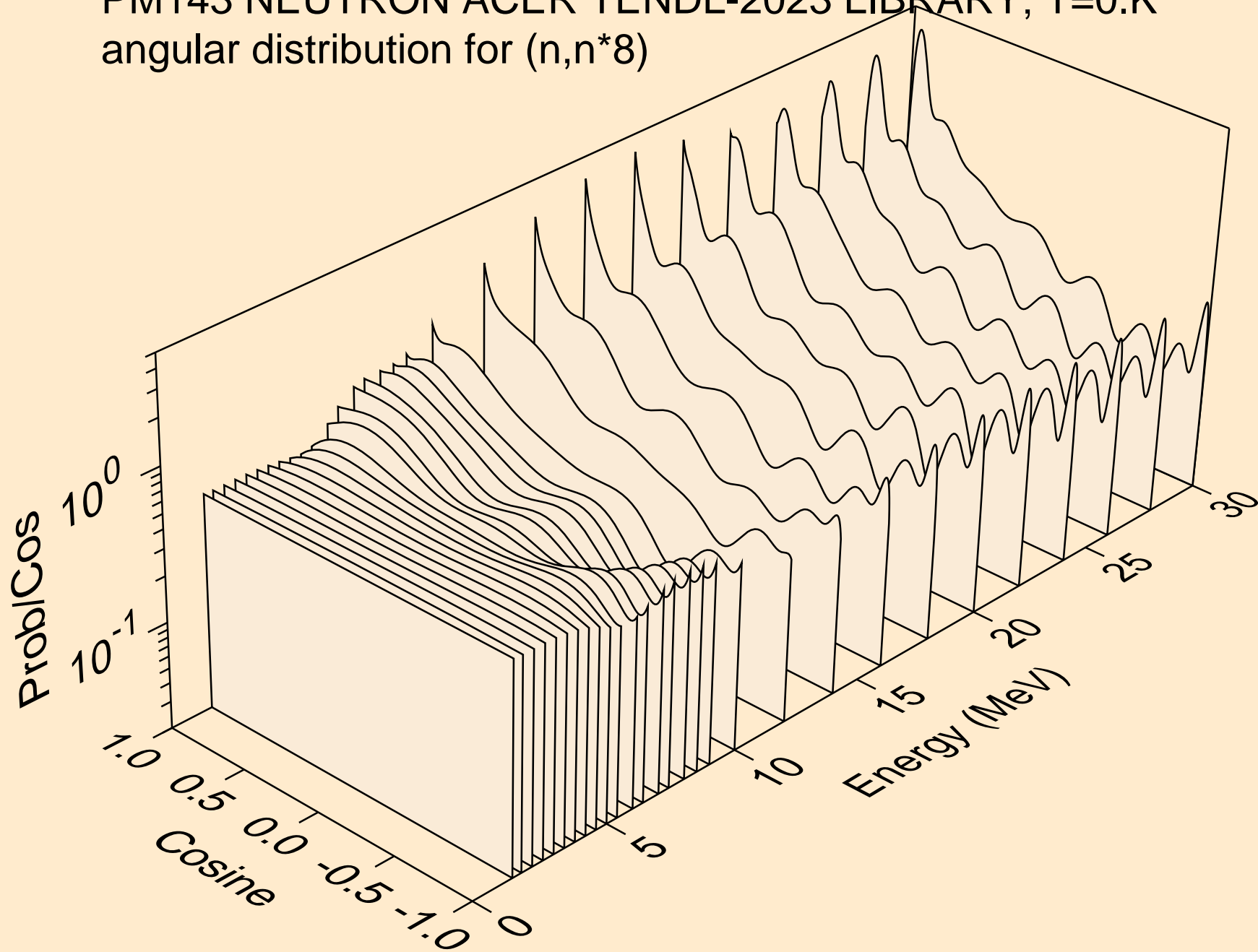

PM143 NEUTRON ACER TENDL-2023 LIBRARY; T=0.K
angular distribution for (n,n*9)

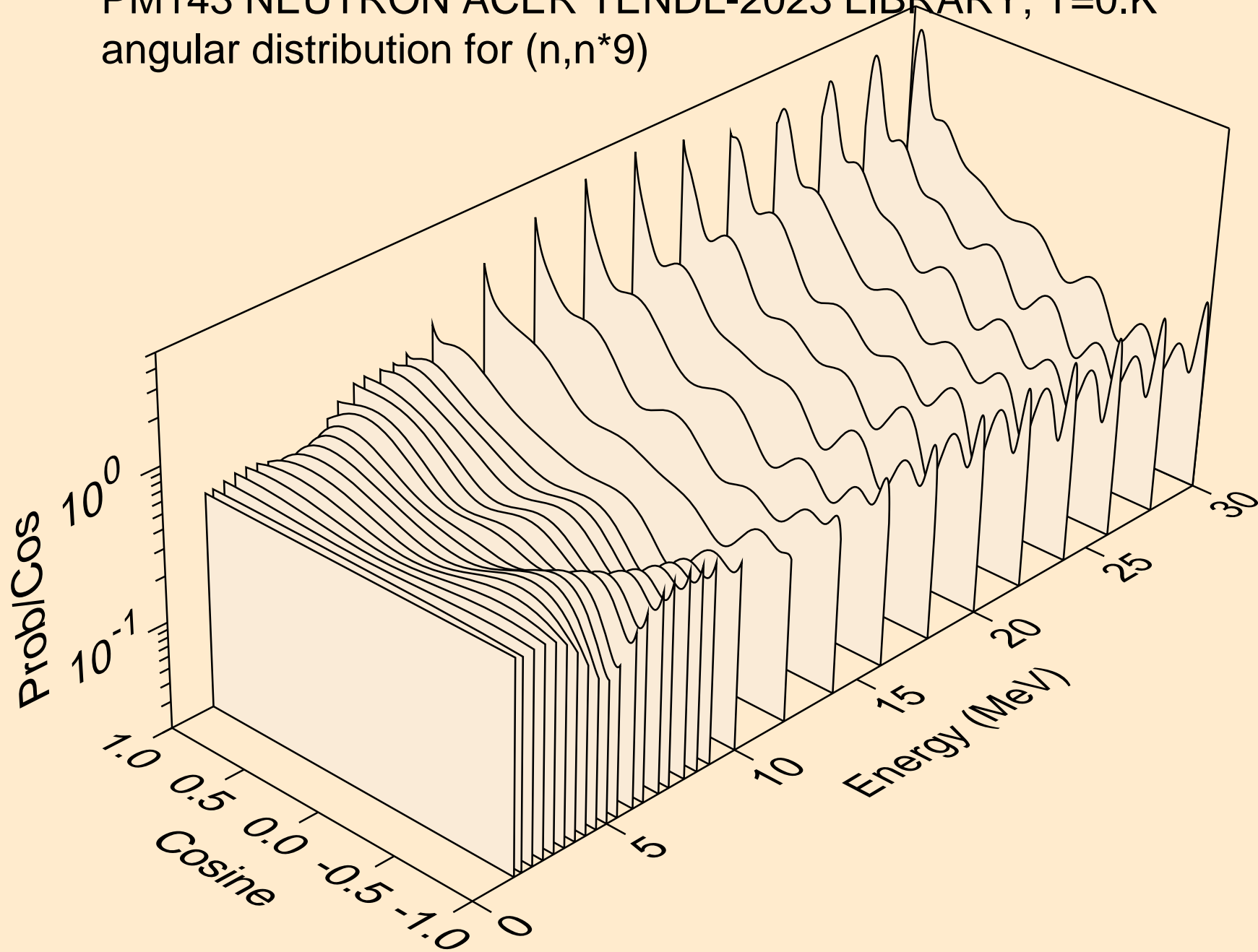

PM143 NEUTRON ACER TENDL-2023 LIBRARY; T=0.K
angular distribution for (n,n*10)

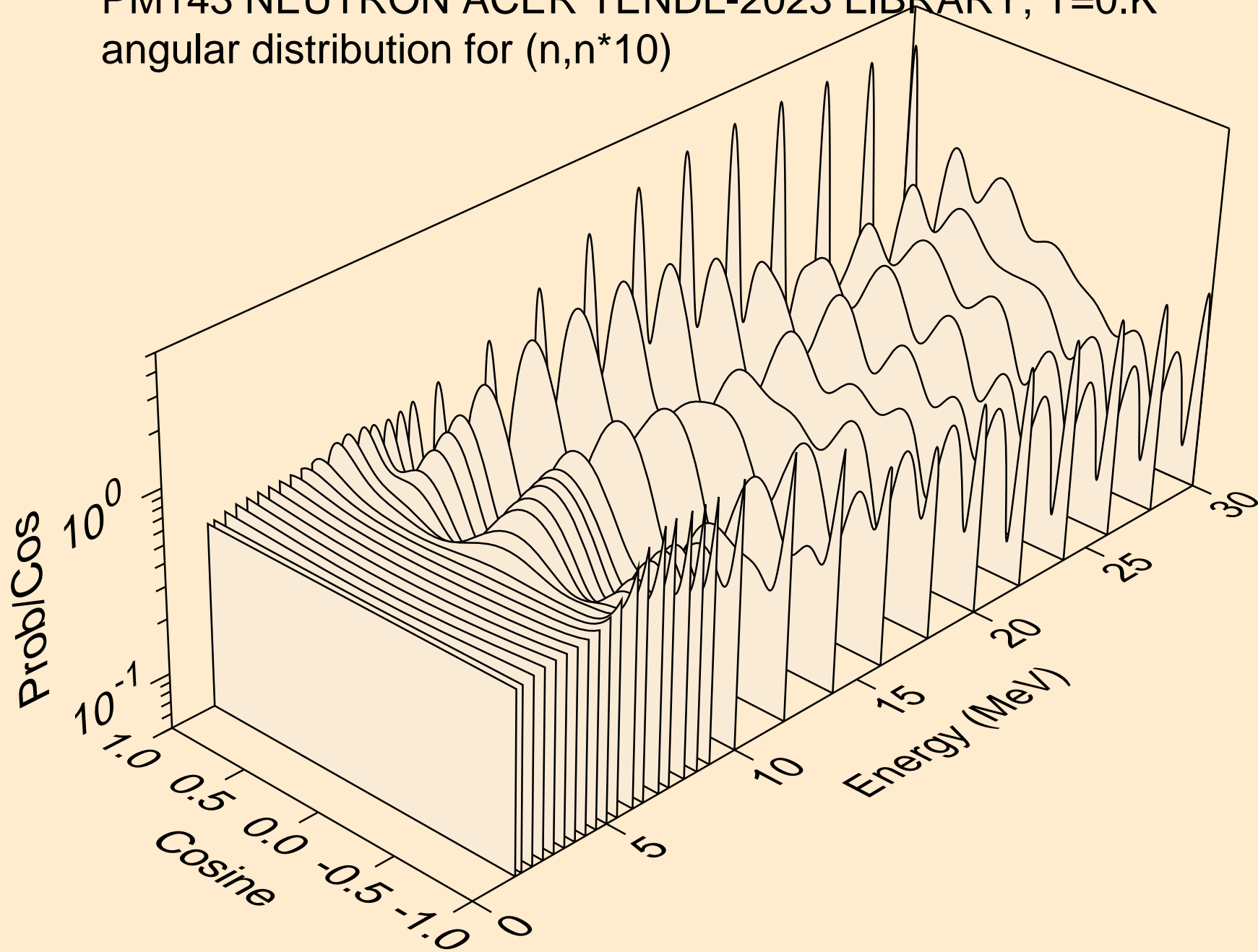

PM143 NEUTRON ACER TENDL-2023 LIBRARY; T=0.K
angular distribution for (n,n*11)

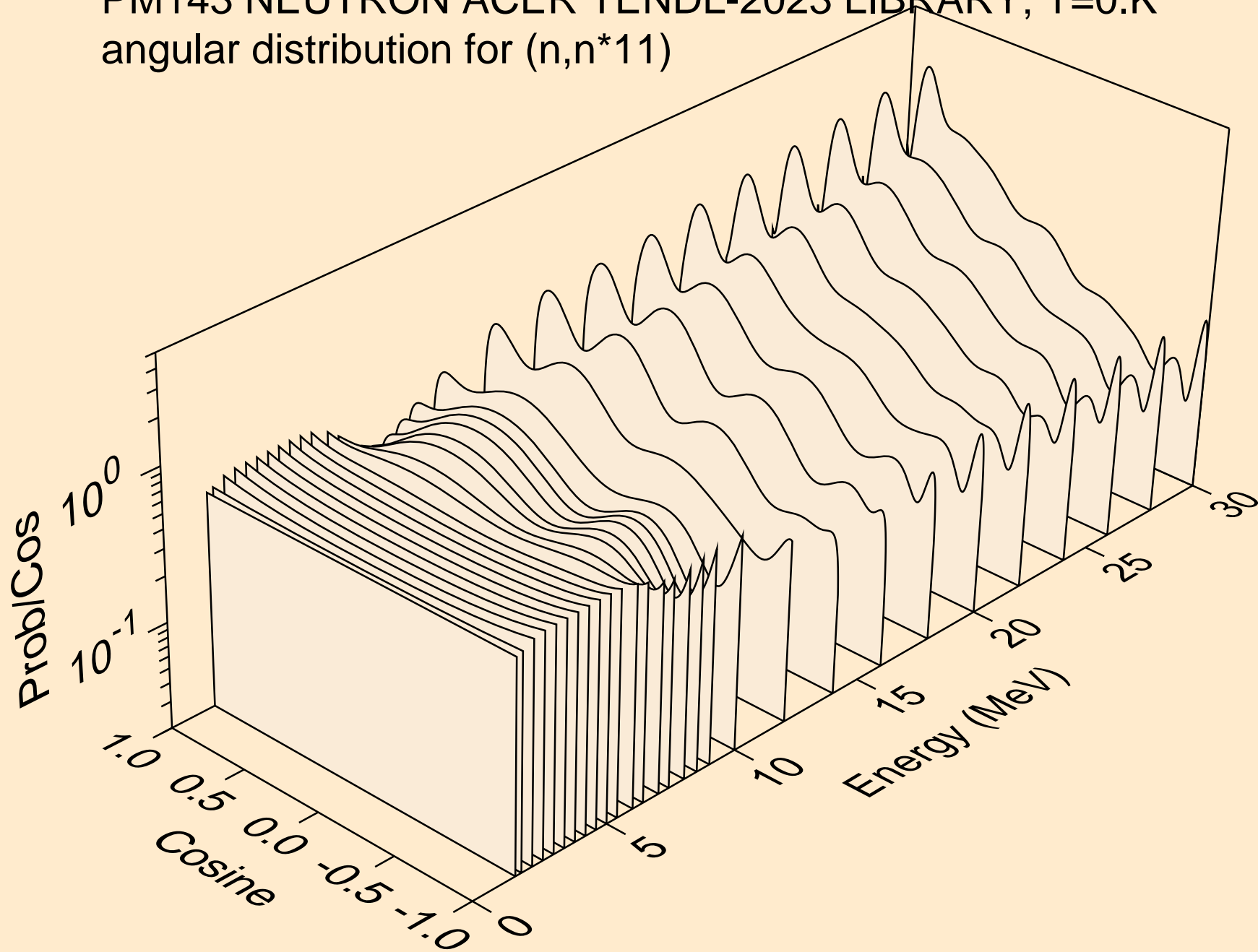

PM143 NEUTRON ACER TENDL-2023 LIBRARY; T=0.K
angular distribution for (n,n*12)

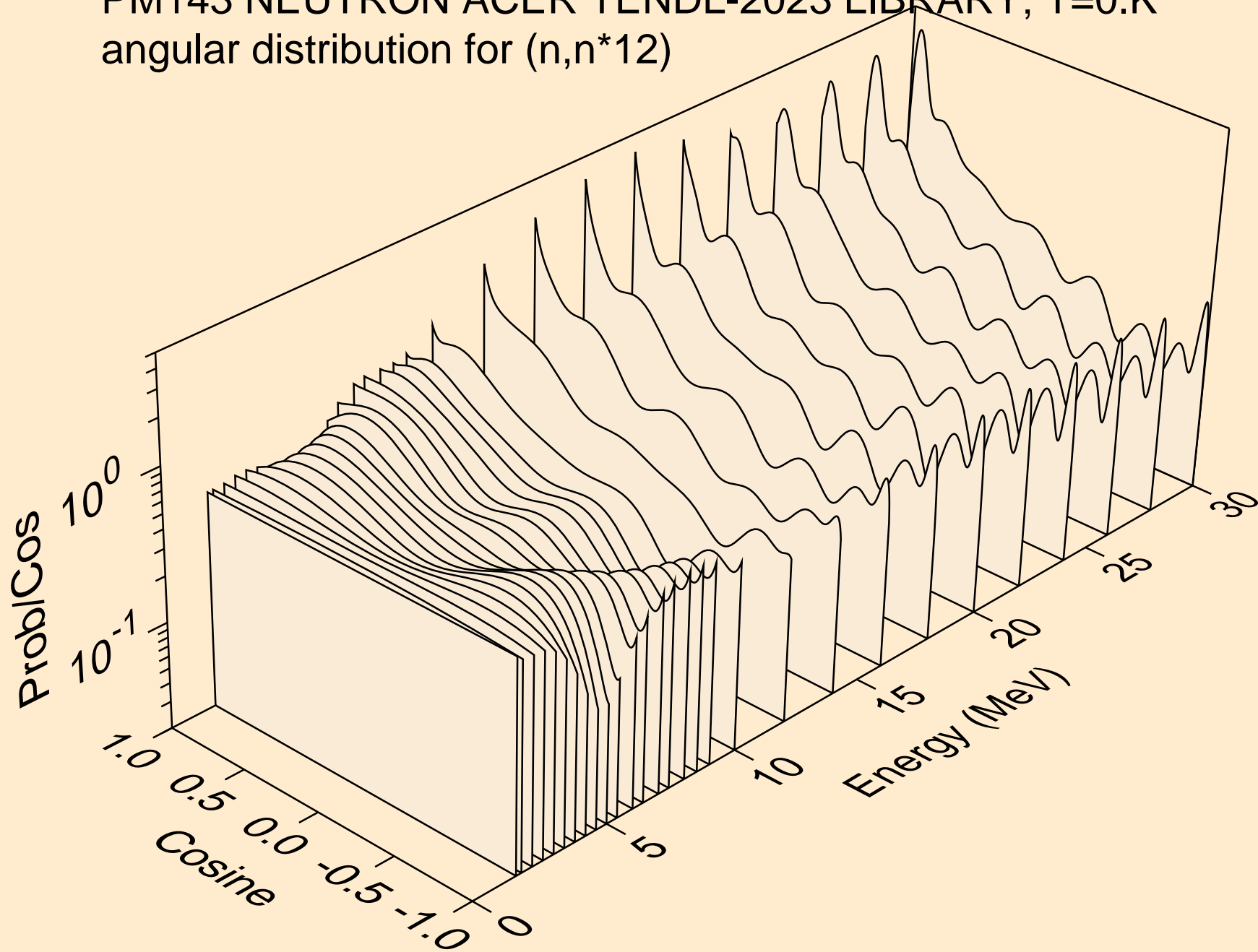

PM143 NEUTRON ACER TENDL-2023 LIBRARY; T=0.K
angular distribution for (n,n*13)

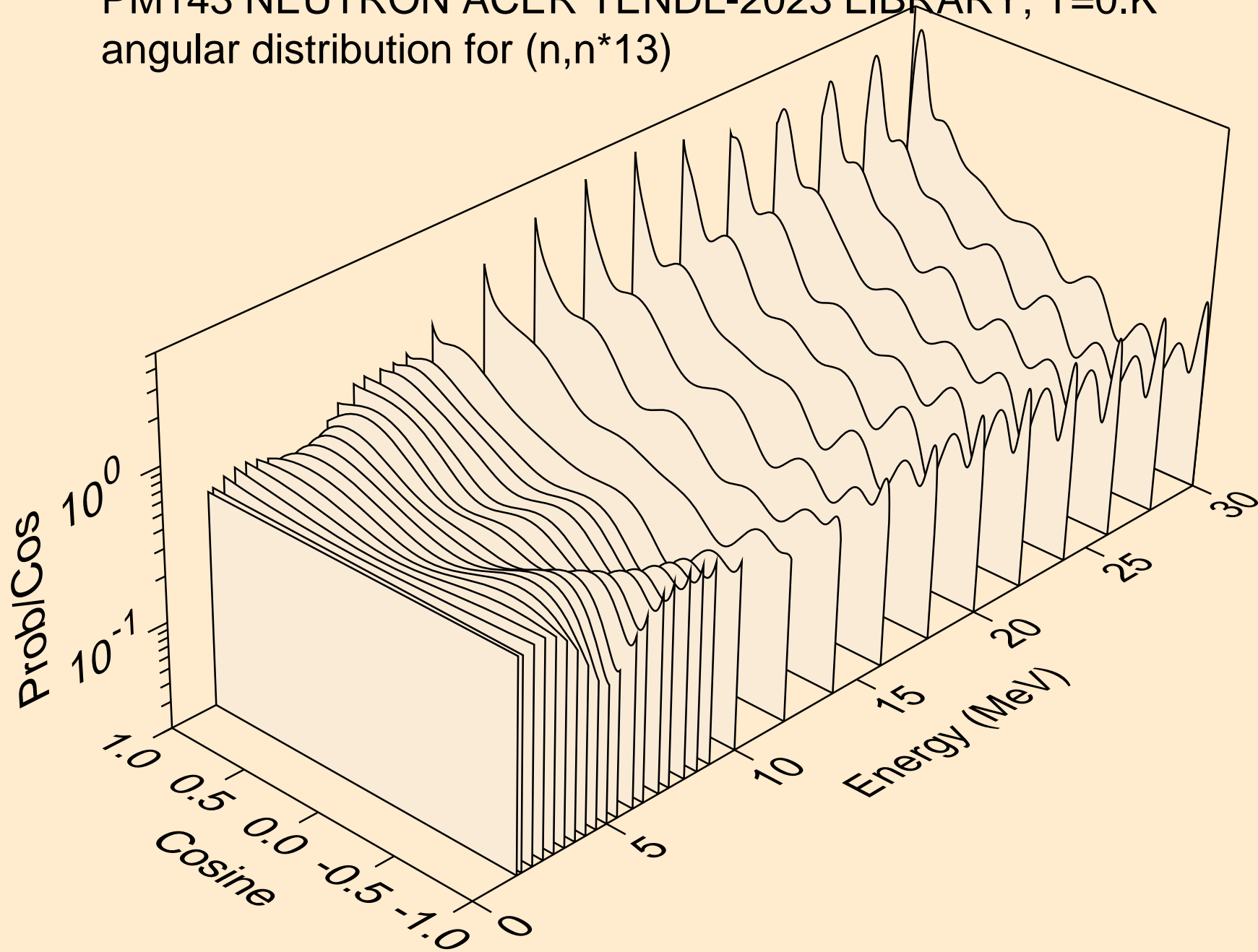

PM143 NEUTRON ACER TENDL-2023 LIBRARY; T=0.K
angular distribution for (n,n*14)

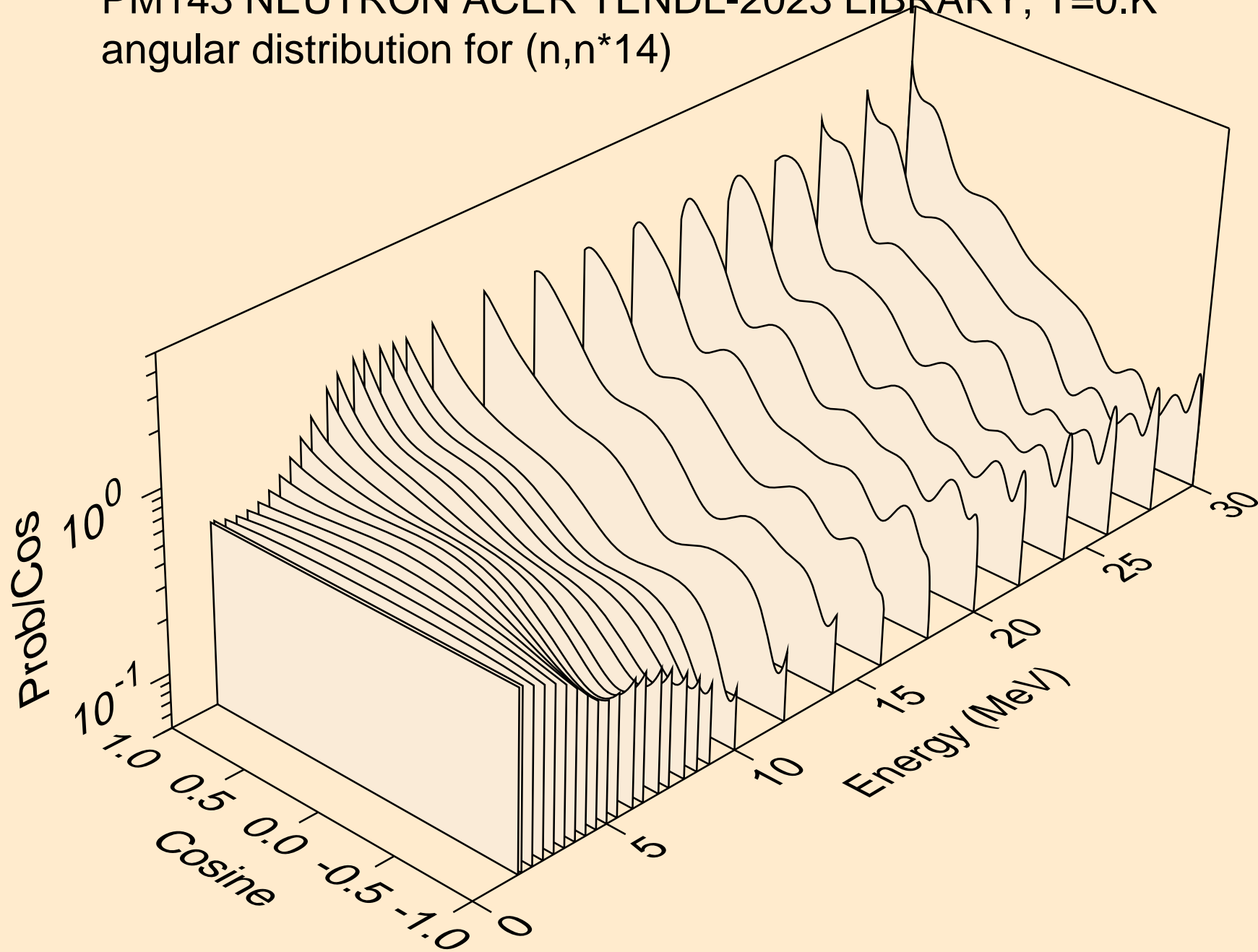

PM143 NEUTRON ACER TENDL-2023 LIBRARY; T=0.K
angular distribution for (n,n*15)

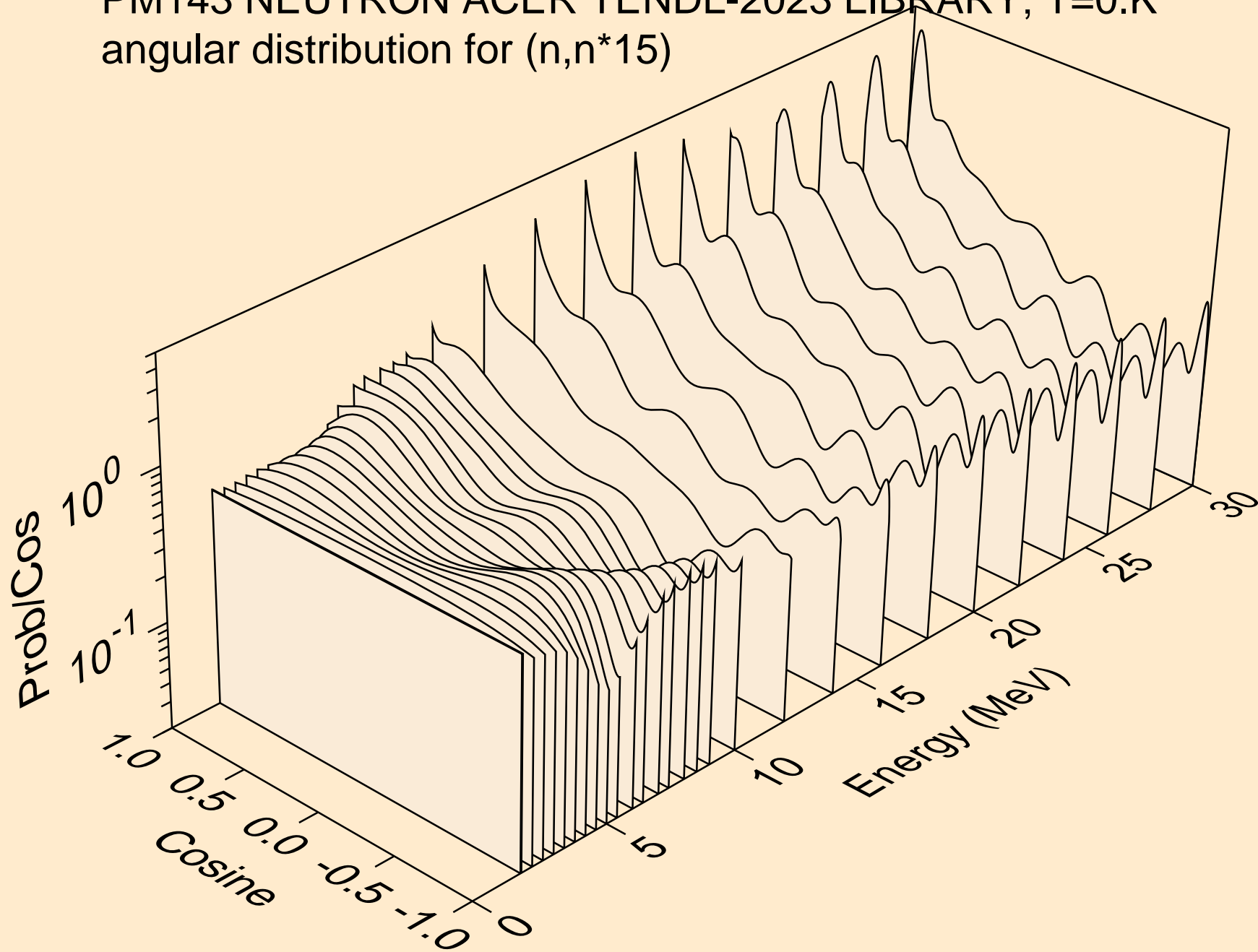

PM143 NEUTRON ACER TENDL-2023 LIBRARY; T=0.K
angular distribution for (n,n*16)

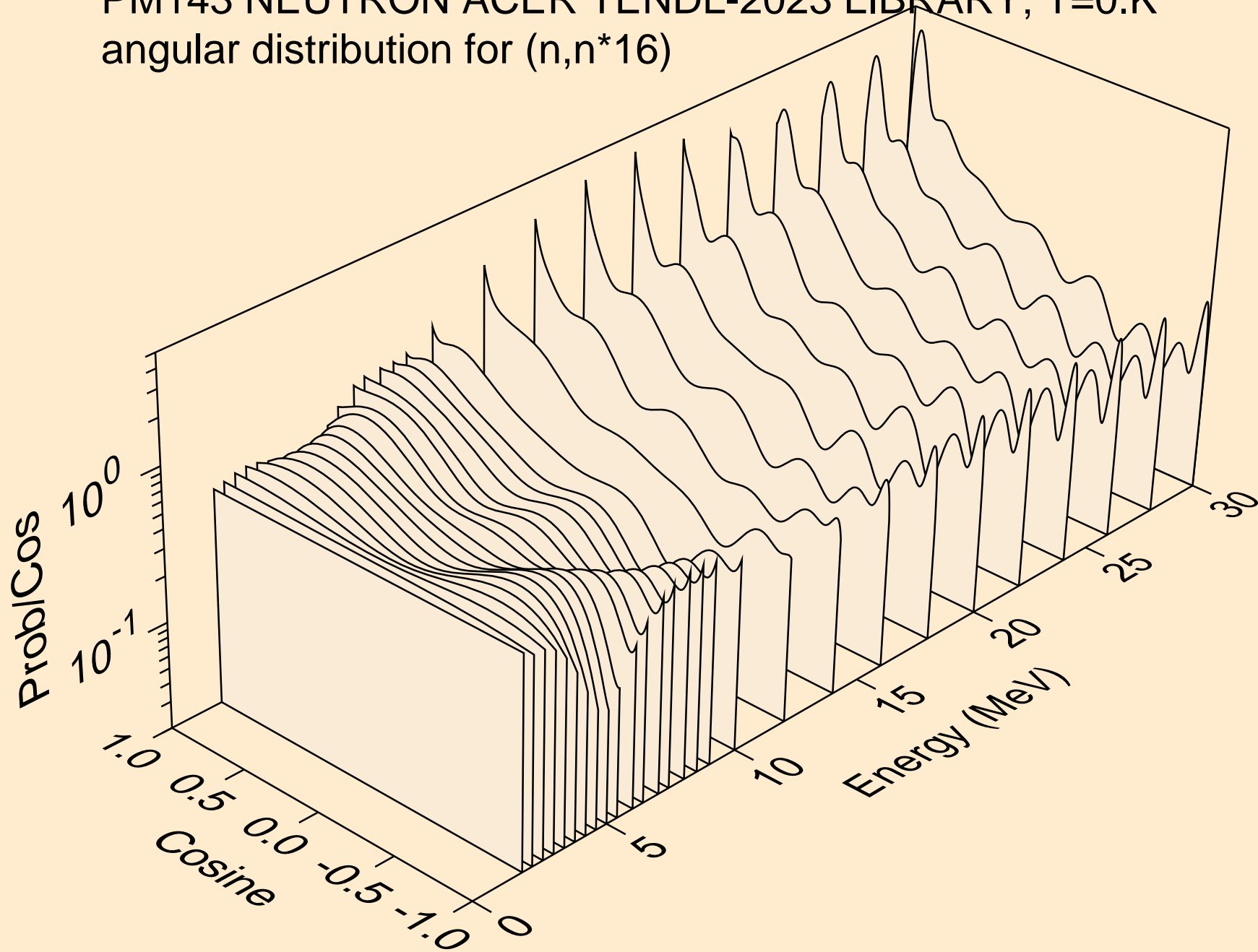

PM143 NEUTRON ACER TENDL-2023 LIBRARY; T=0.K
angular distribution for (n,n*17)

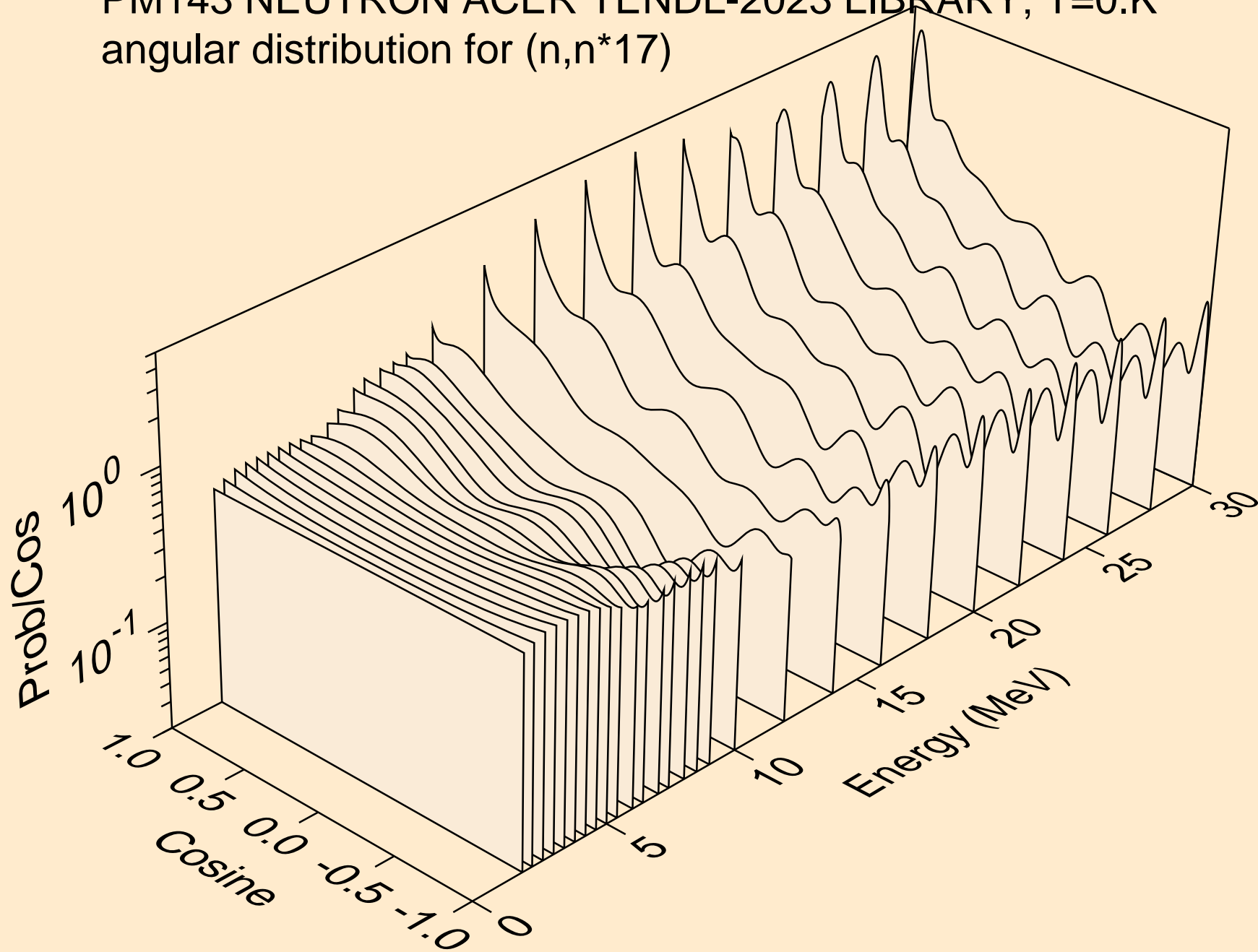

PM143 NEUTRON ACER TENDL-2023 LIBRARY; T=0.K
angular distribution for (n,n*18)

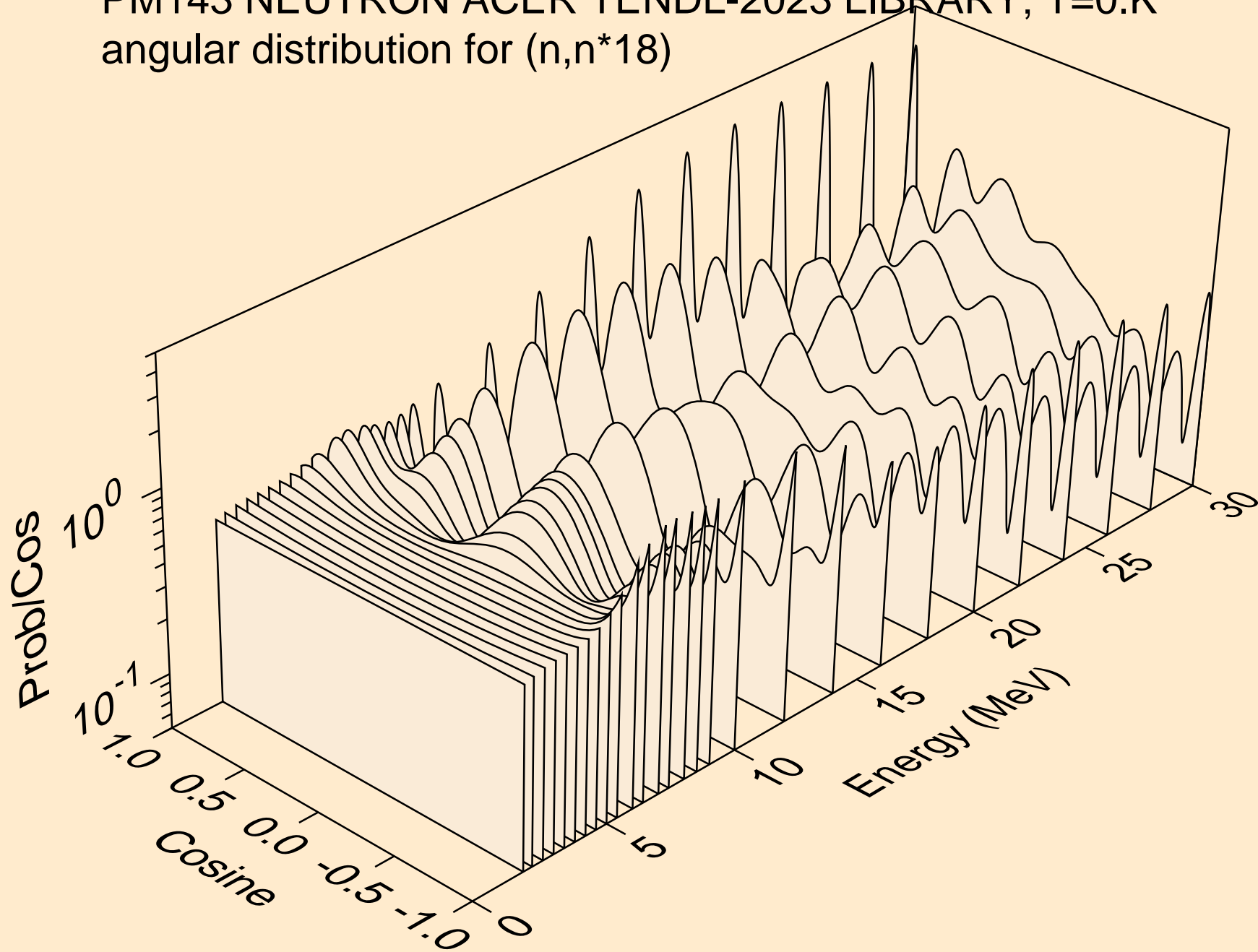

PM143 NEUTRON ACER TENDL-2023 LIBRARY; T=0.K
Neutron emission for (n,x)

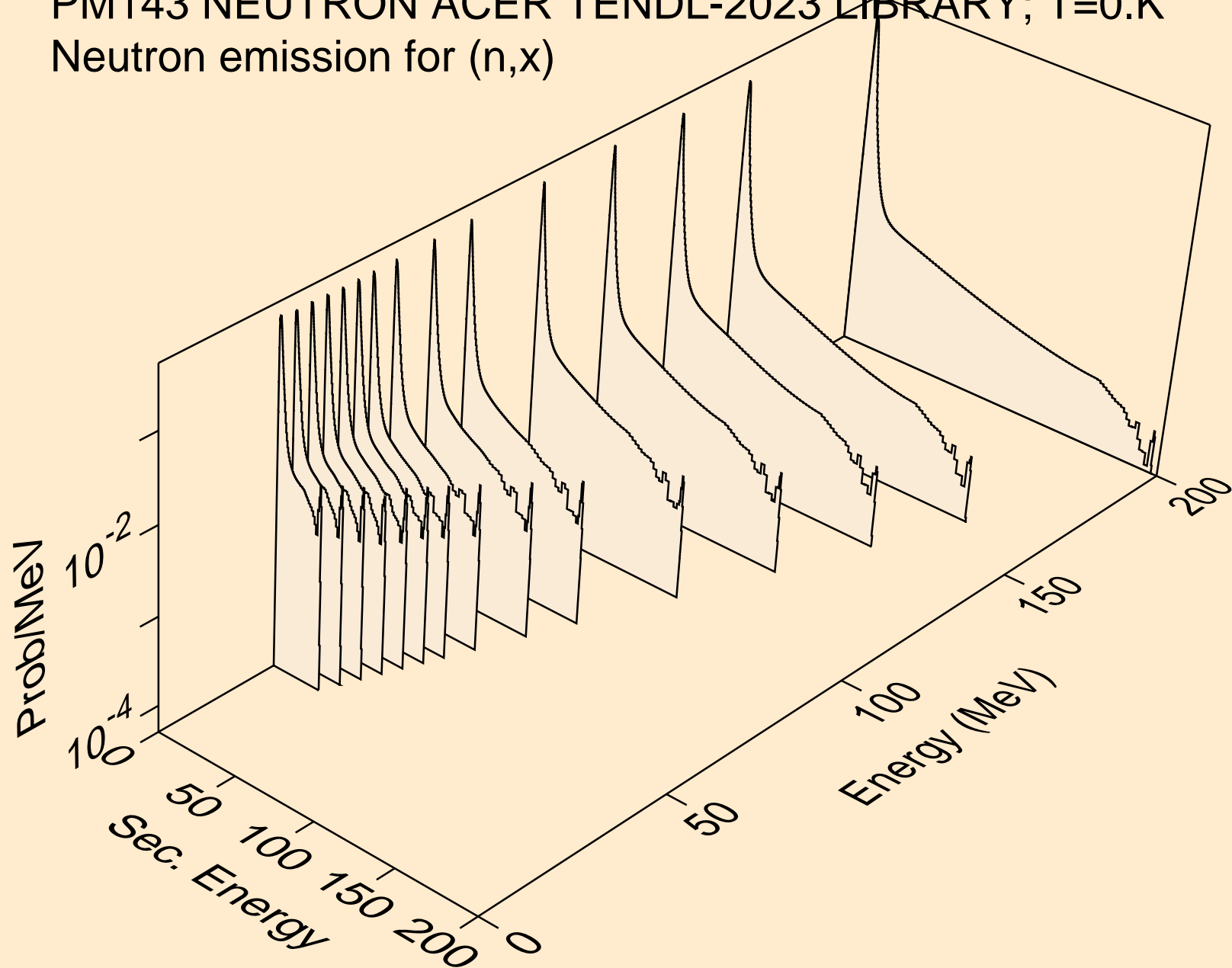

PM143 NEUTRON ACER TENDL-2023 LIBRARY; T=0.K
Neutron emission for (n,2nd)

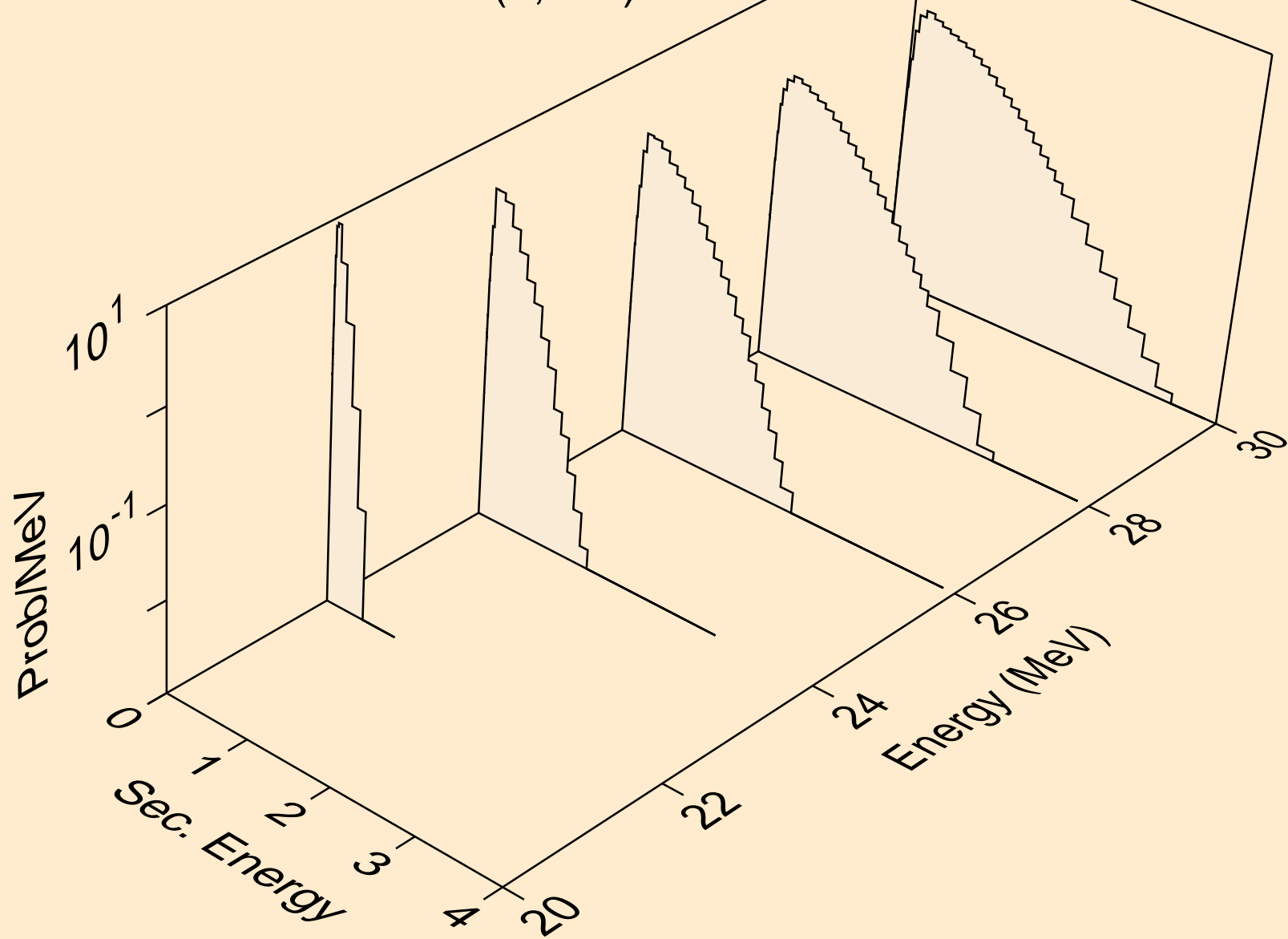

PM143 NEUTRON ACER TENDL-2023 LIBRARY; T=0.K
Neutron emission for (n,2n)

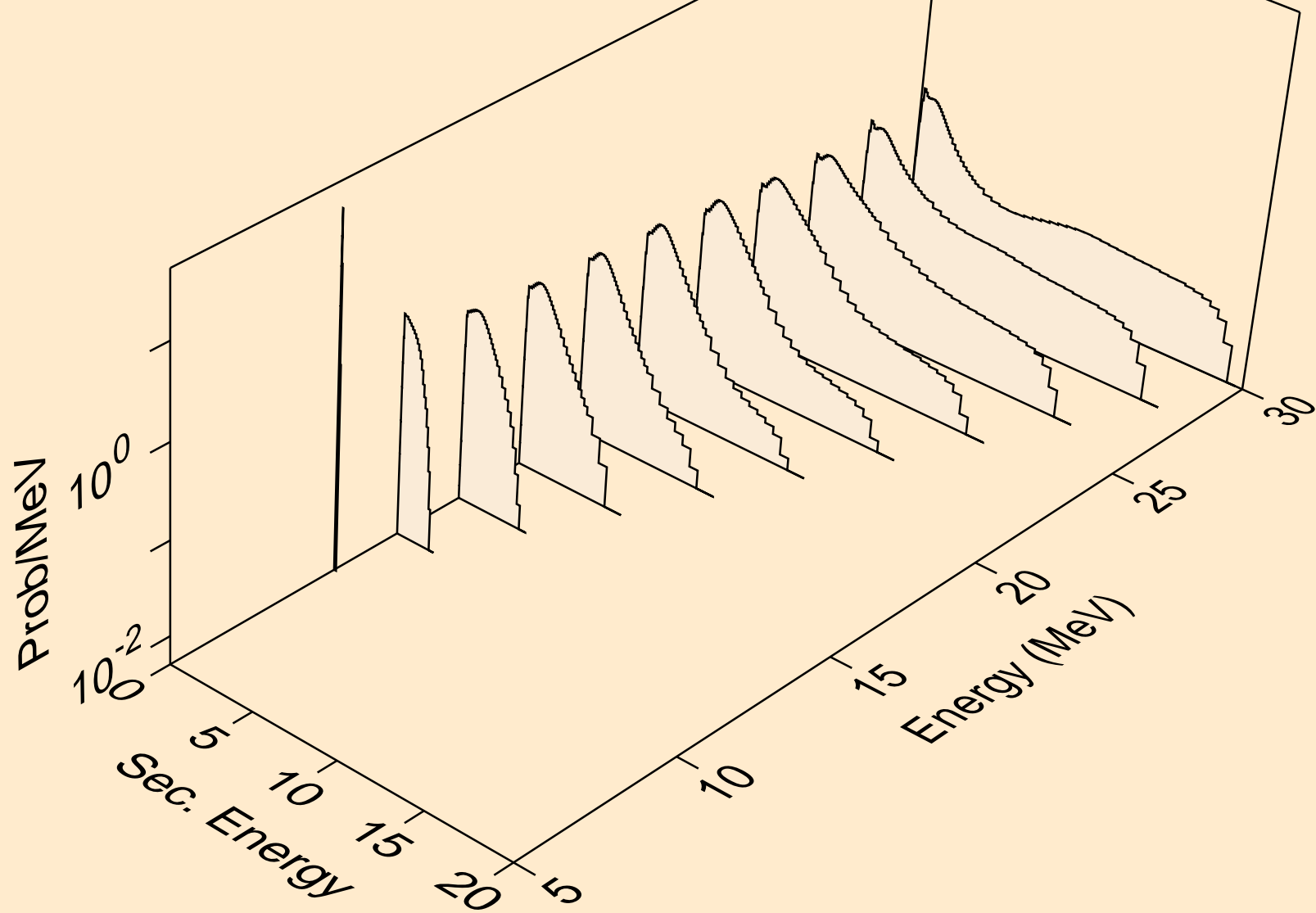

PM143 NEUTRON ACER TENDL-2023 LIBRARY; T=0.K
Neutron emission for (n,3n)

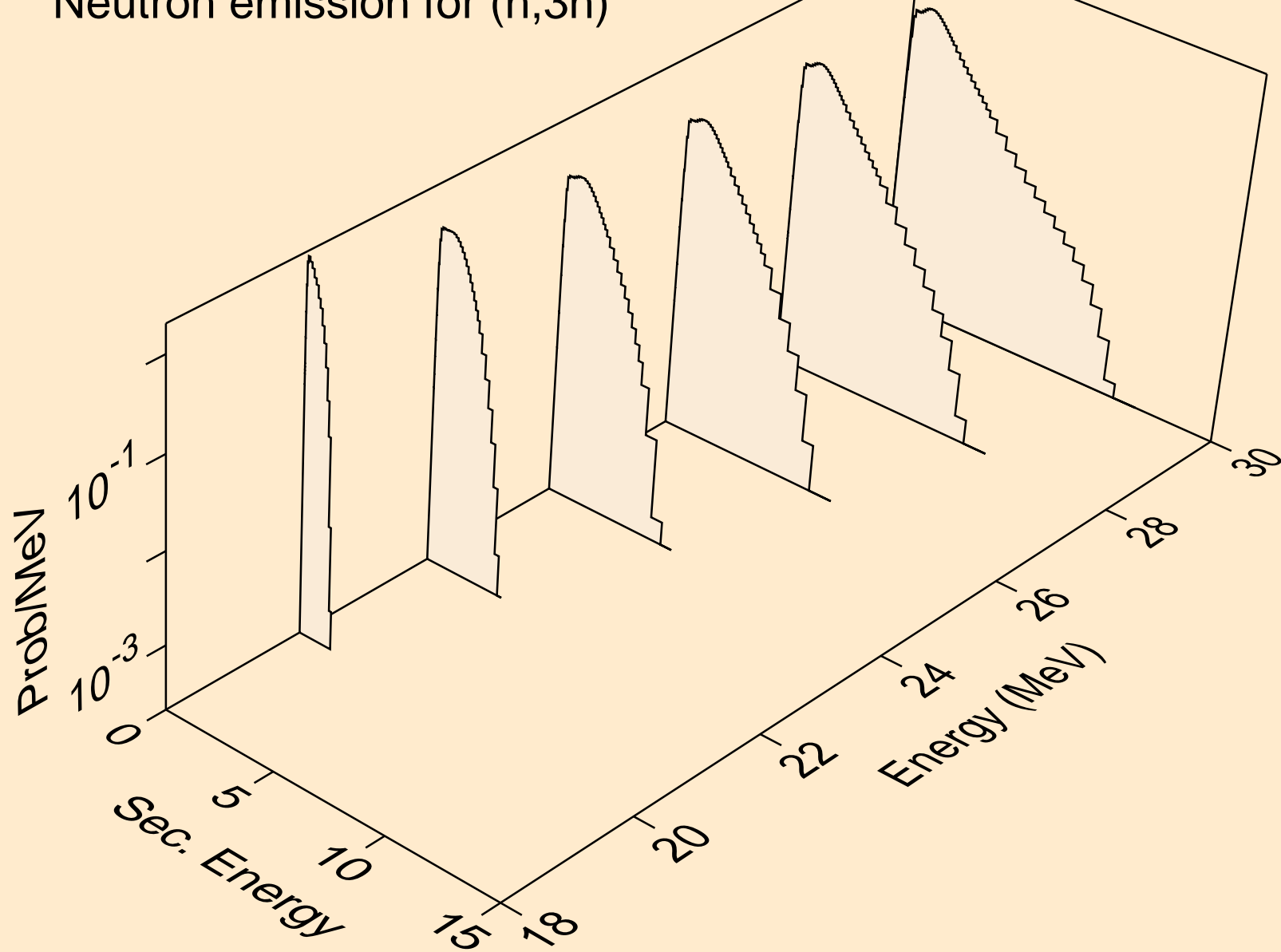

PM143 NEUTRON ACER TENDL-2023 LIBRARY; T=0.K
Neutron emission for (n,n*)a

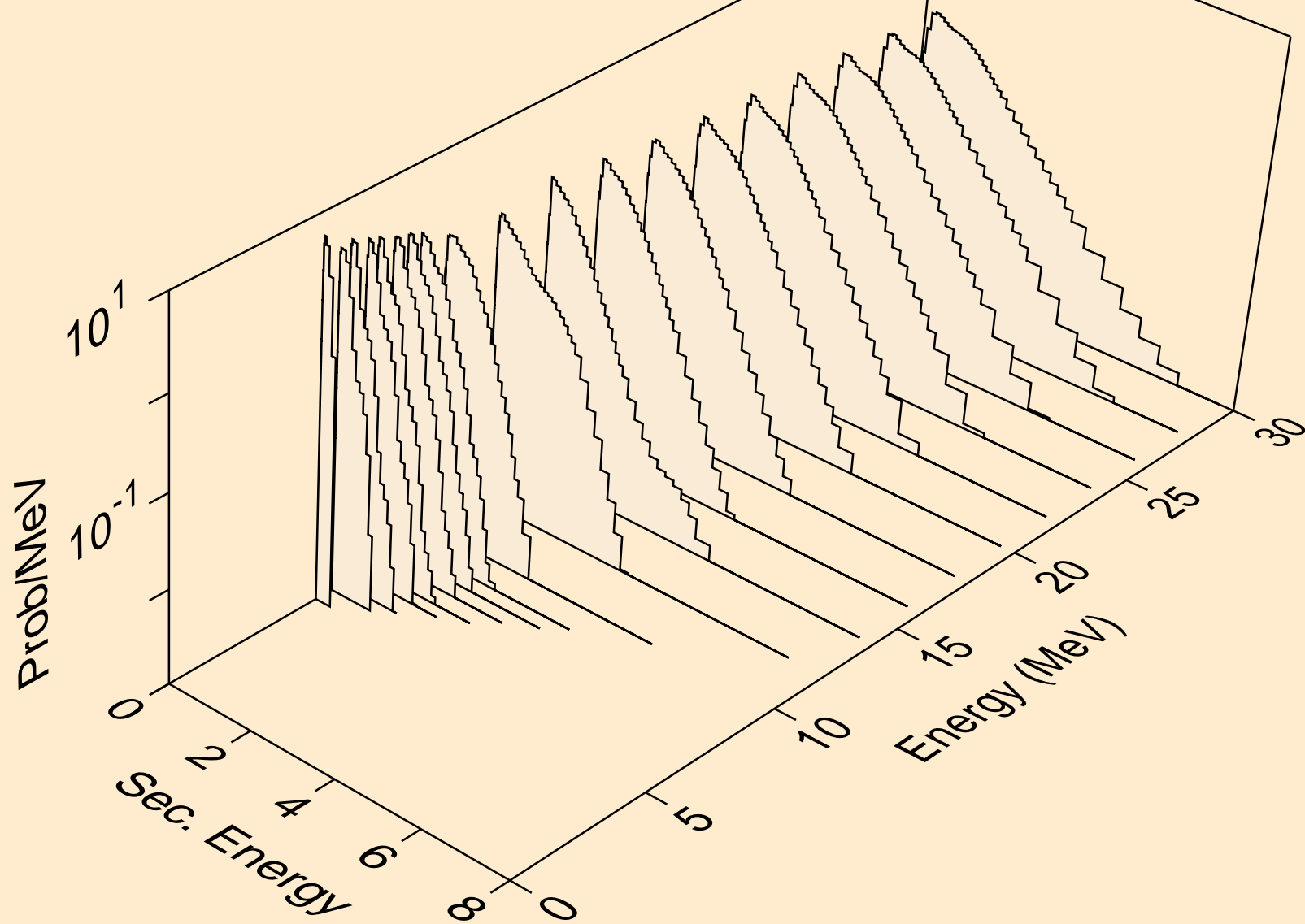

PM143 NEUTRON ACER TENDL-2023 LIBRARY; T=0.K
Neutron emission for (n,2n)a

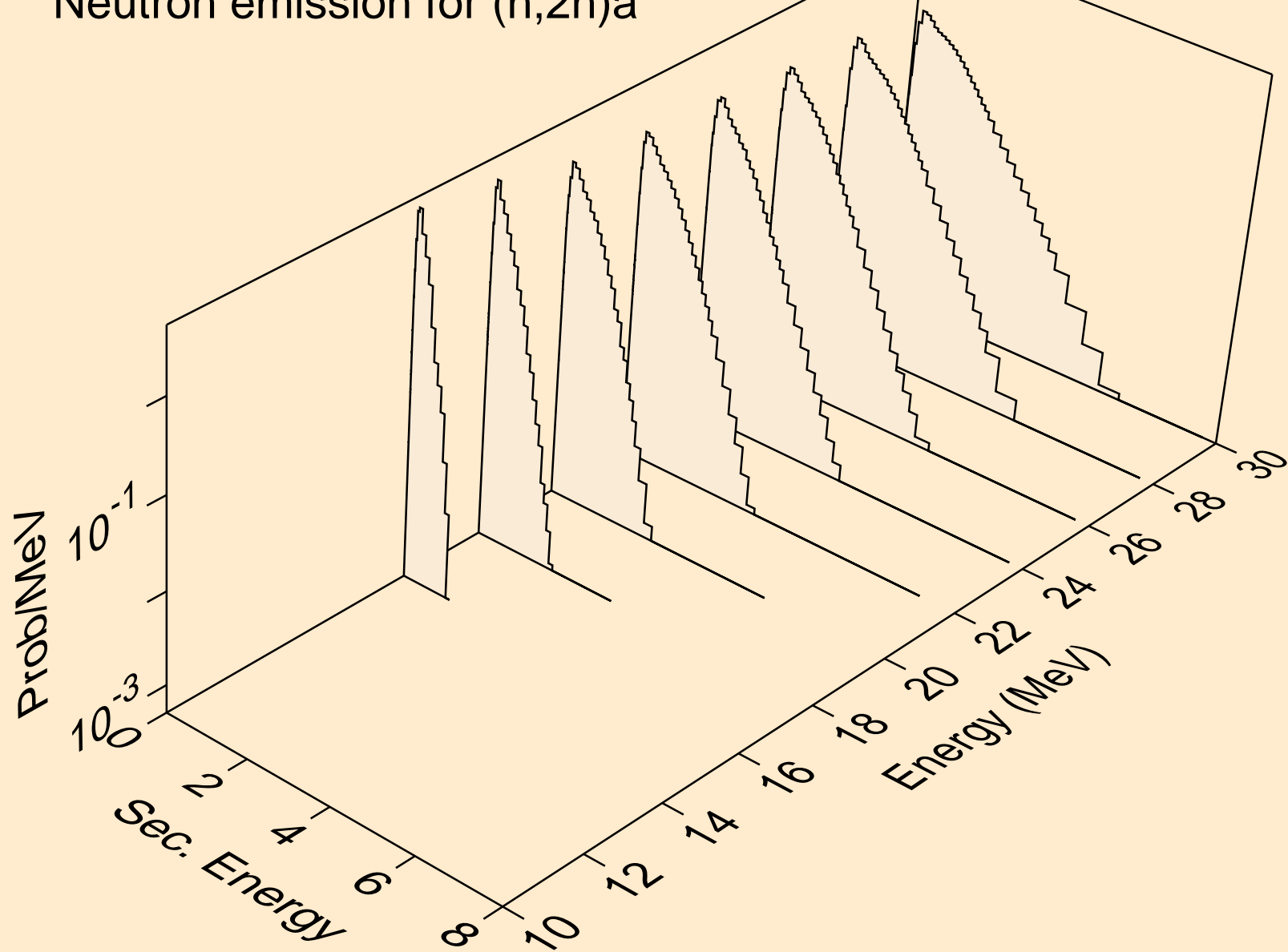

PM143 NEUTRON ACER TENDL-2023 LIBRARY; T=0.K
Neutron emission for (n,3n)a

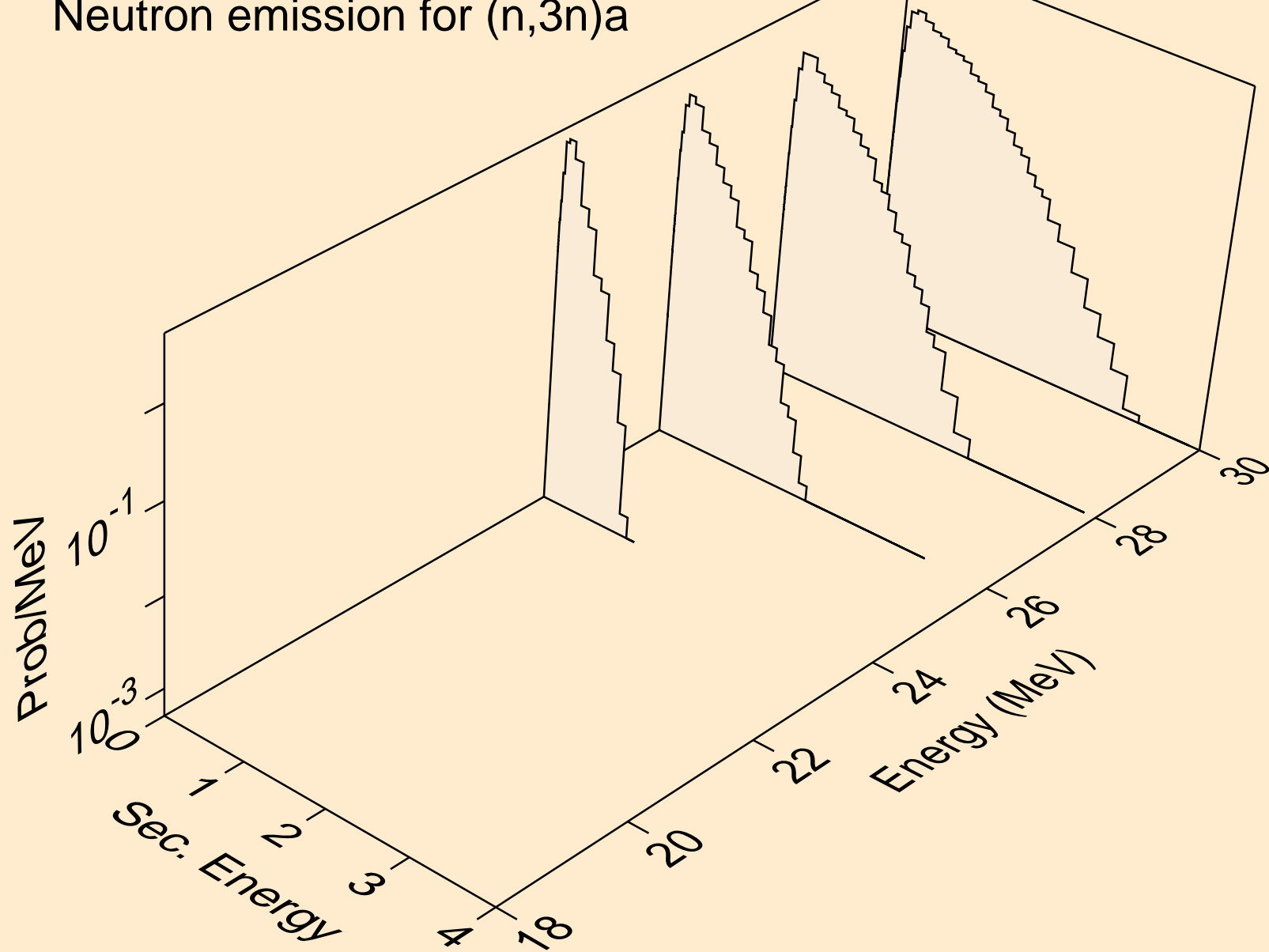

PM143 NEUTRON ACER TENDL-2023 LIBRARY; T=0.K
Neutron emission for (n,n*)p

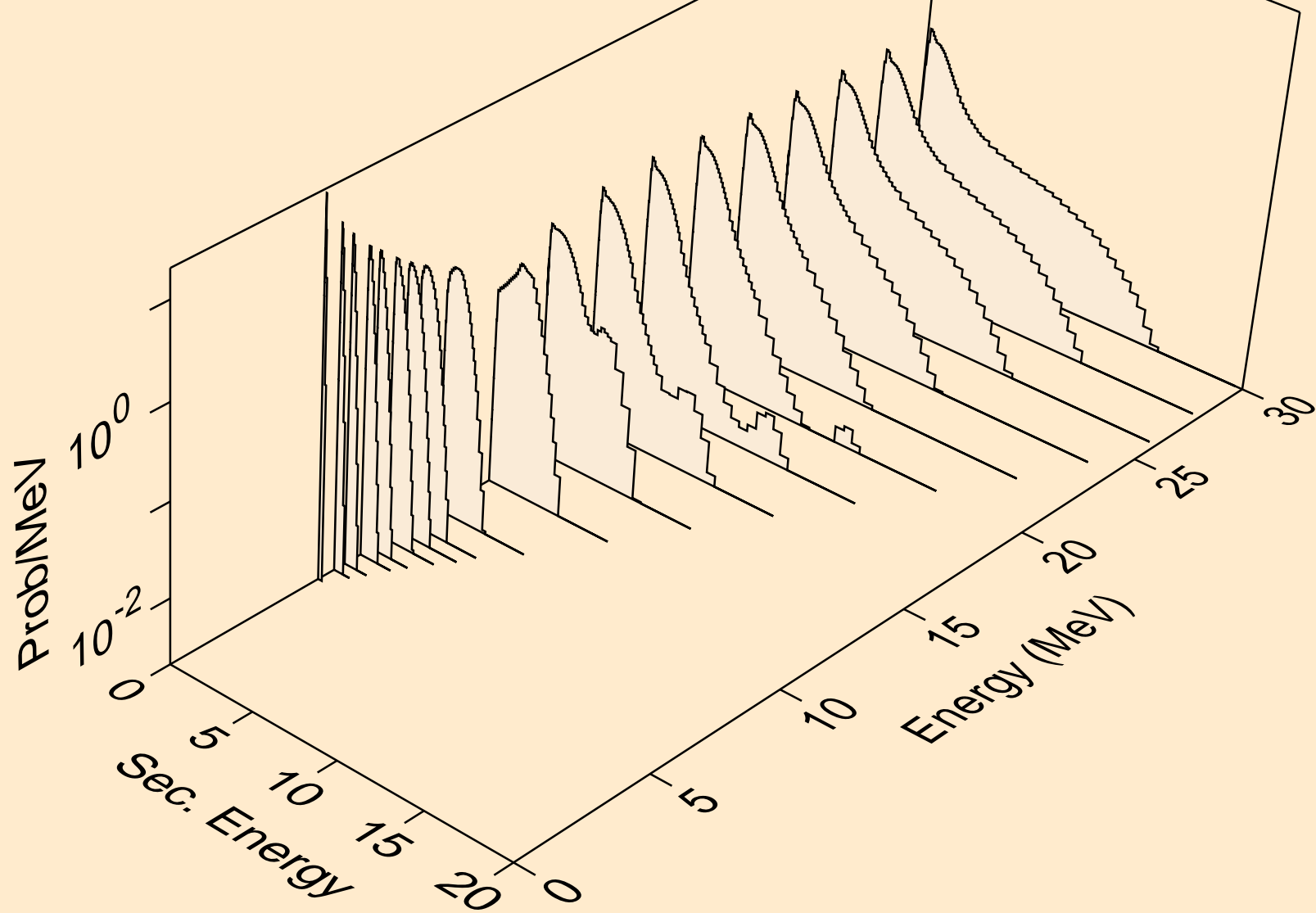

PM143 NEUTRON ACER TENDL-2023 LIBRARY; T=0.K
Neutron emission for (n,n*)2a

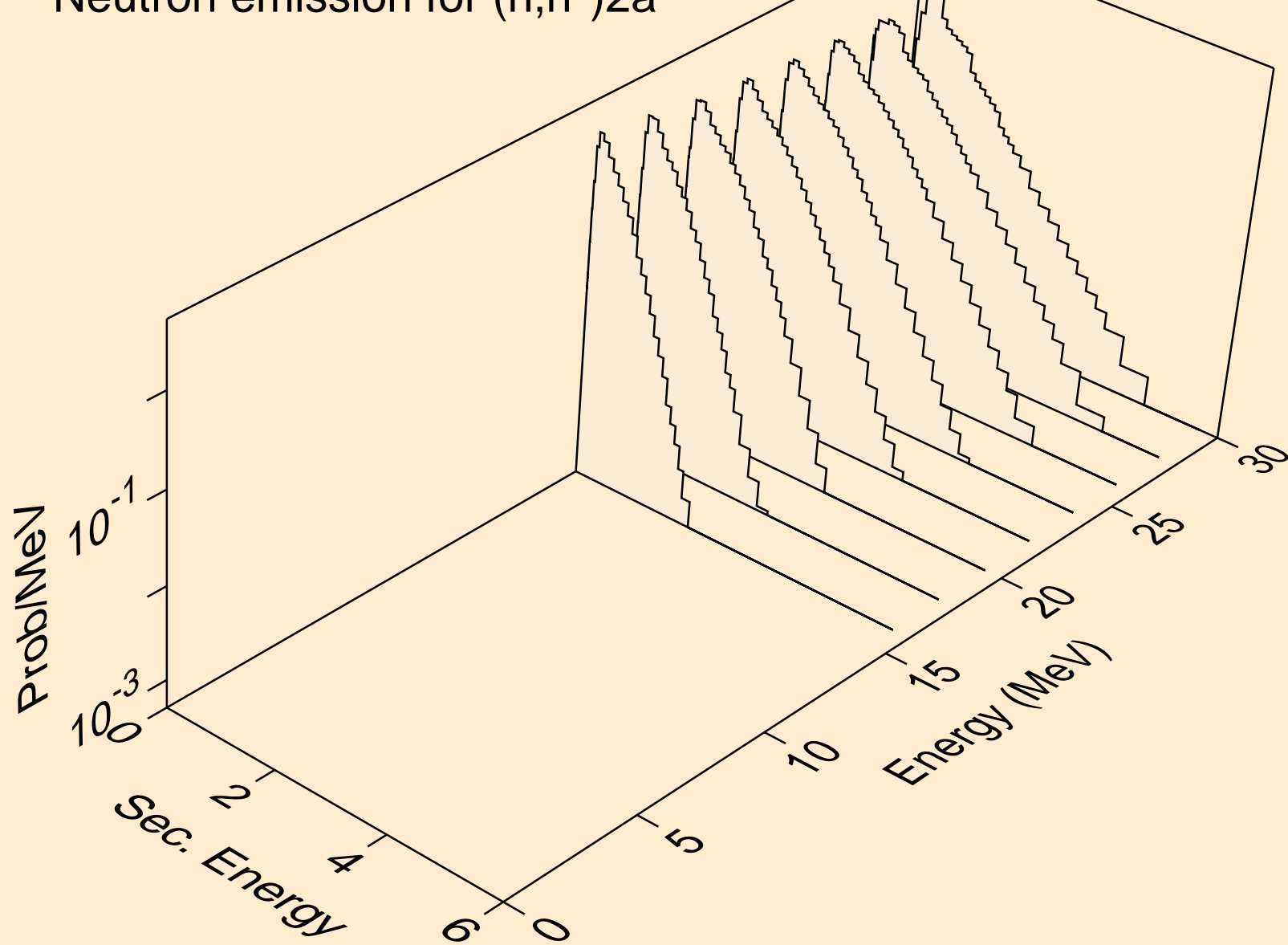

PM143 NEUTRON ACER TENDL-2023 LIBRARY; T=0.K
Neutron emission for (n,n*)d

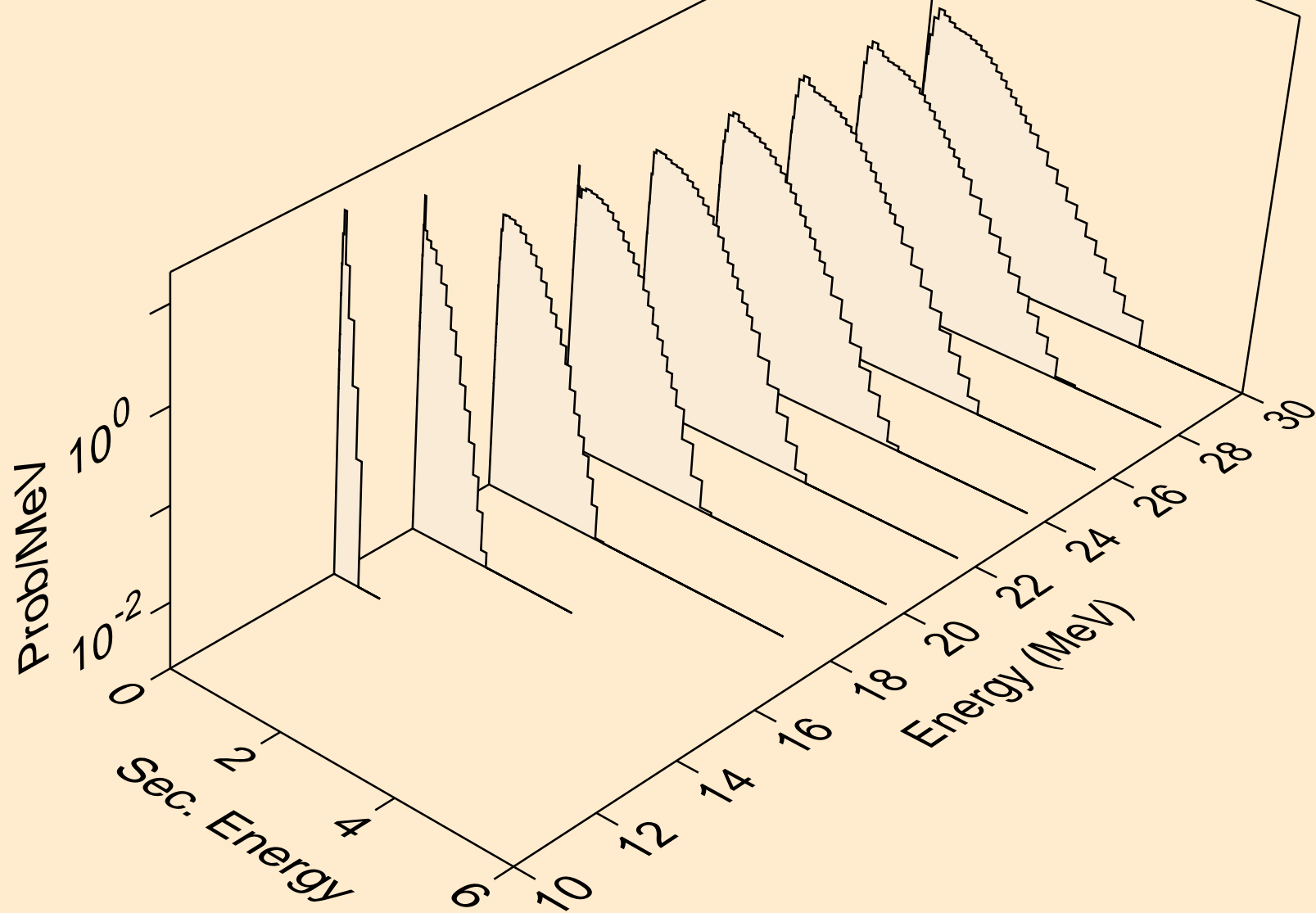

PM143 NEUTRON ACER TENDL-2023 LIBRARY; T=0.K
Neutron emission for (n,n*)t

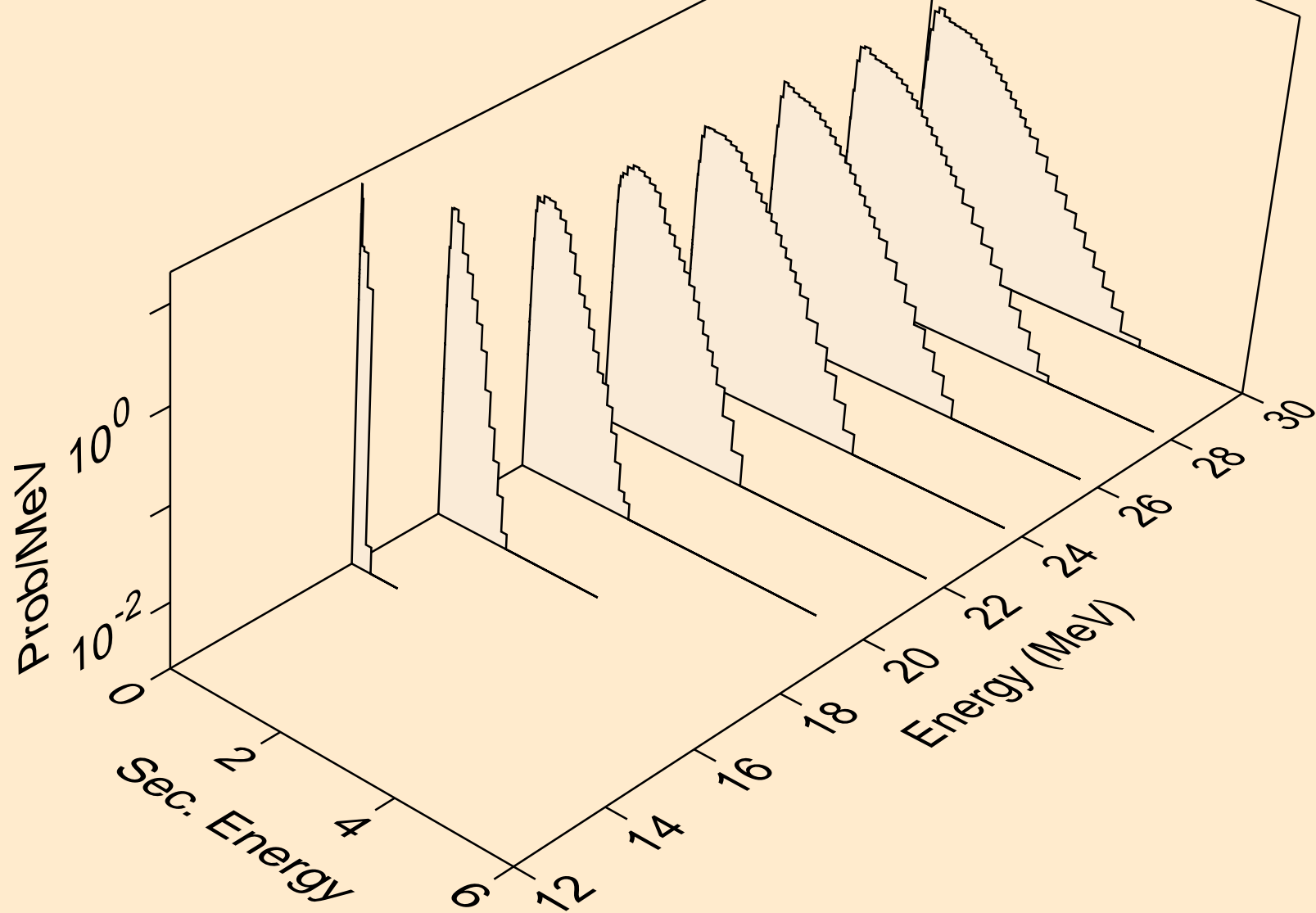

PM143 NEUTRON ACER TENDL-2023 LIBRARY; T=0.K
Neutron emission for (n,n*)he3

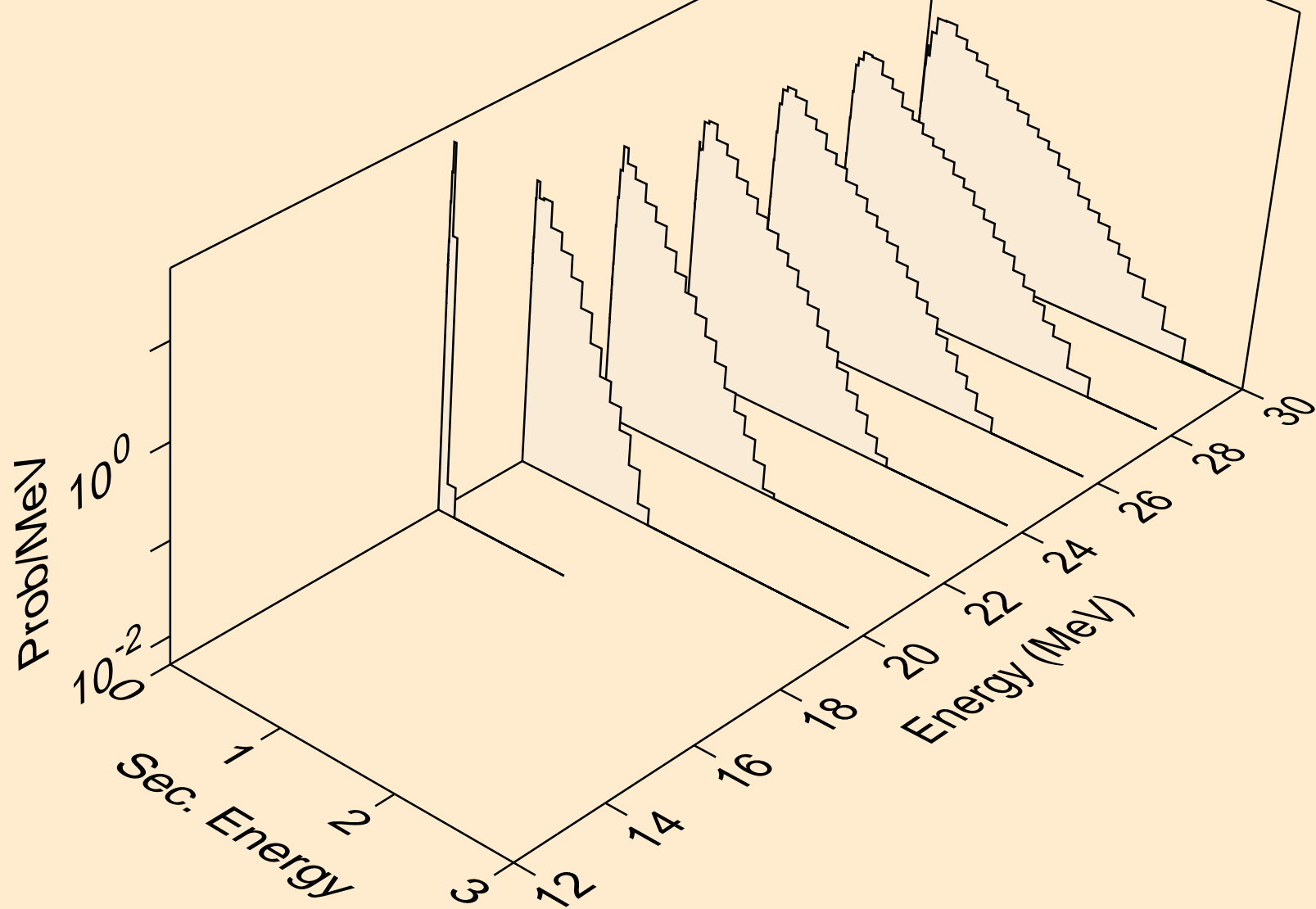

PM143 NEUTRON ACER TENDL-2023 LIBRARY; T=0.K
Neutron emission for (n,2np)

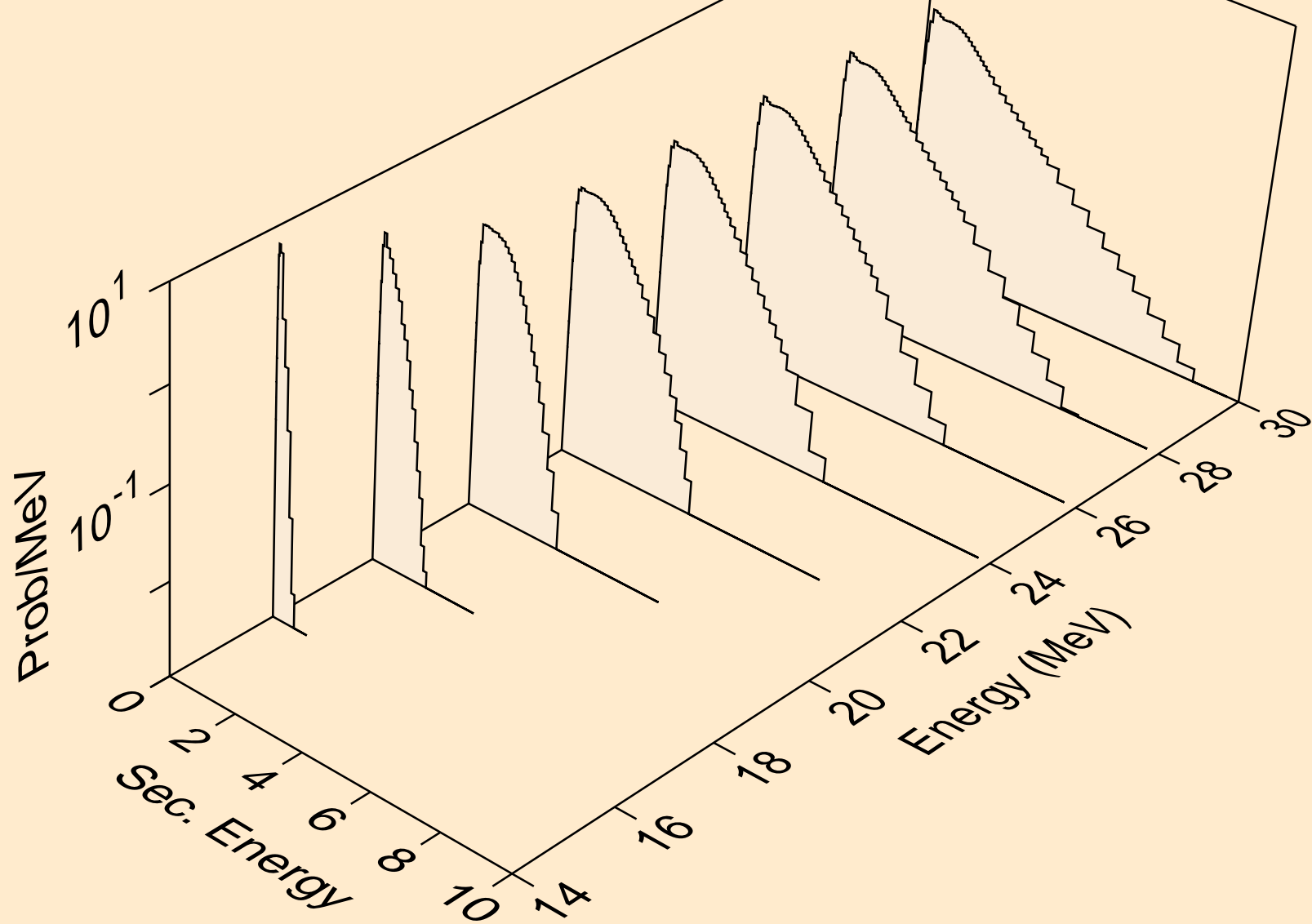

PM143 NEUTRON ACER TENDL-2023 LIBRARY; T=0.K
Neutron emission for (n,3np)

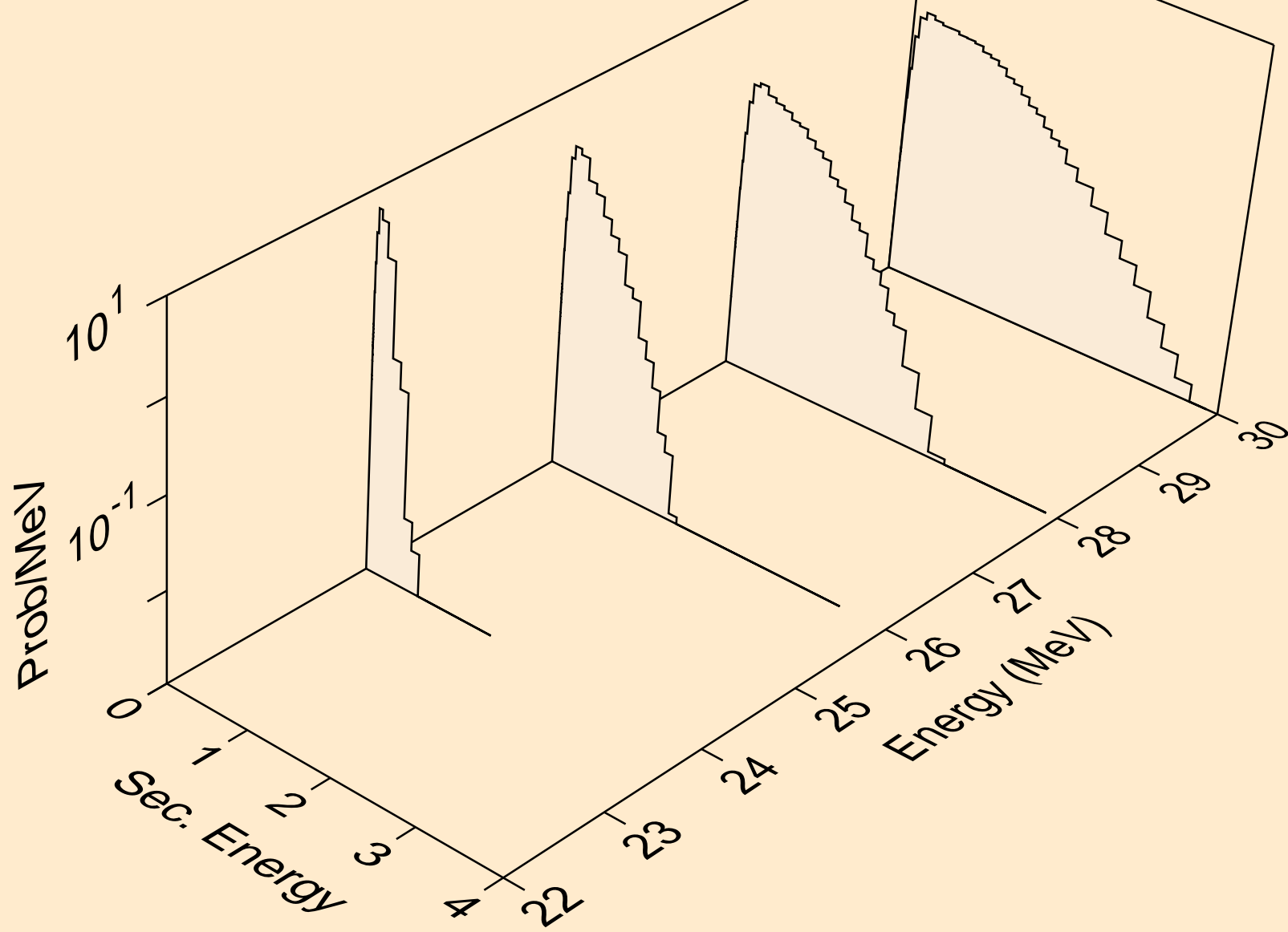

PM143 NEUTRON ACER TENDL-2023 LIBRARY; T=0.K
Neutron emission for (n,n2p)

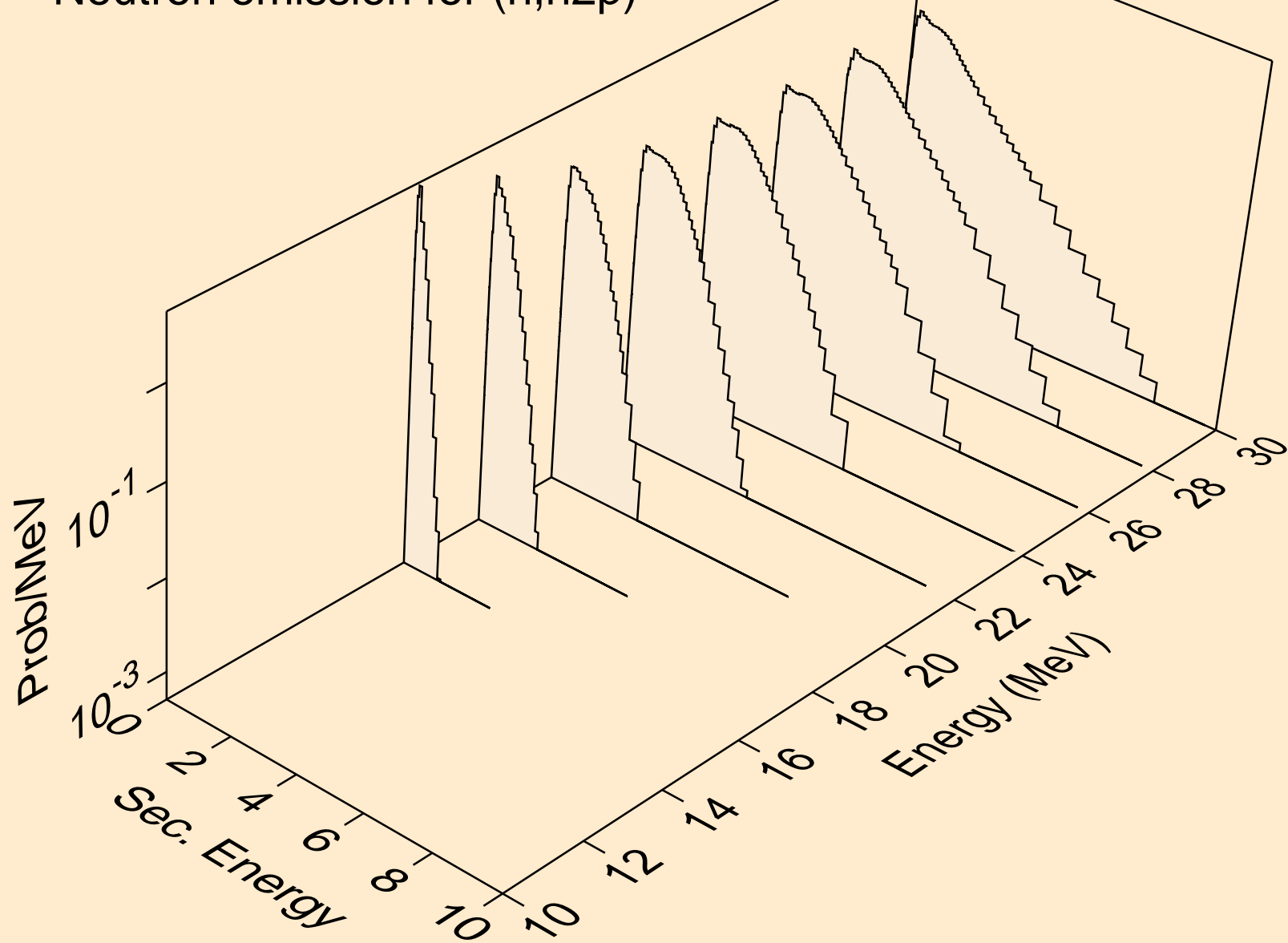

PM143 NEUTRON ACER TENDL-2023 LIBRARY; T=0.K
Neutron emission for (n,npa)

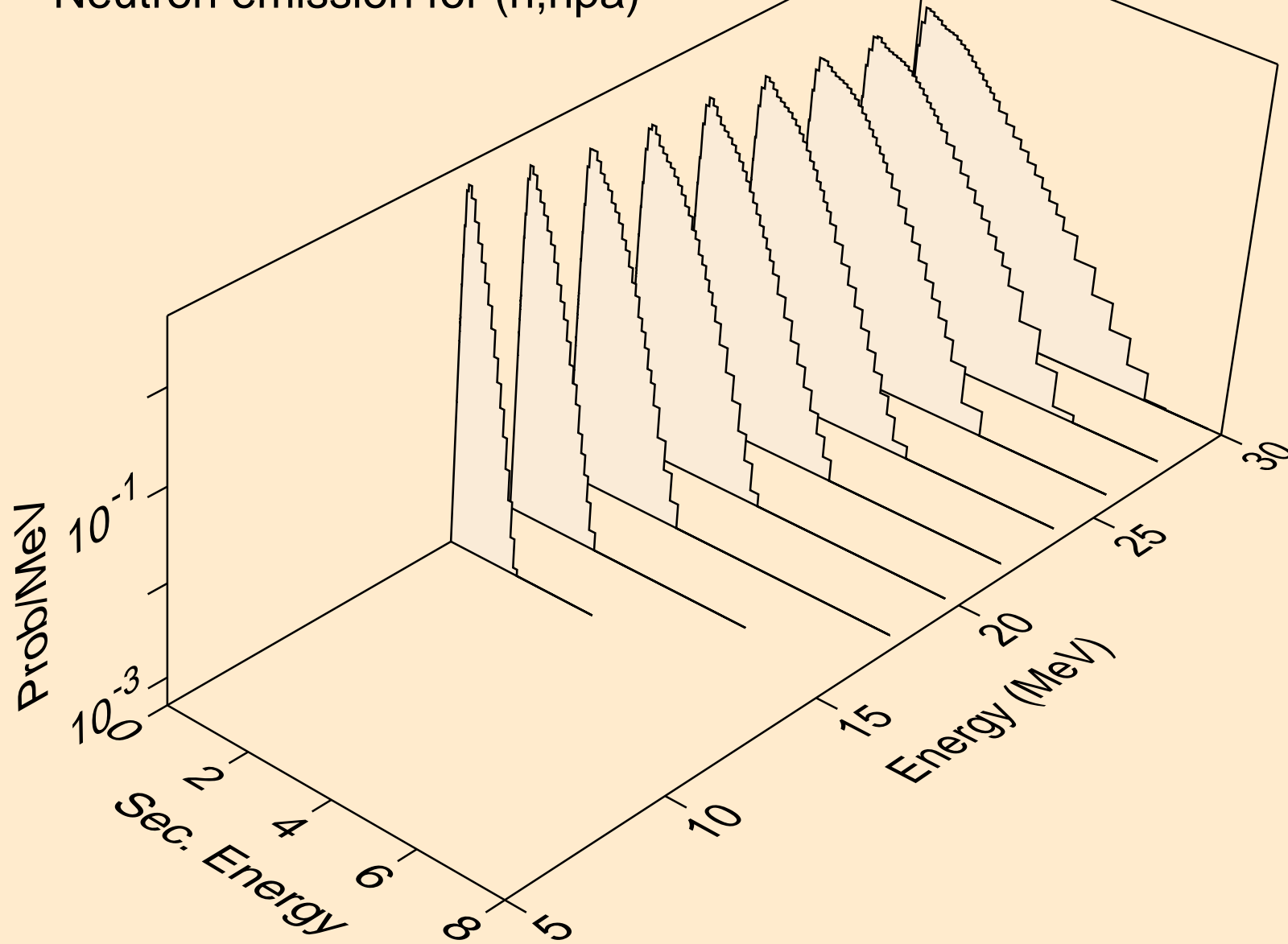

PM143 NEUTRON ACER TENDL-2023 LIBRARY; T=0.K
Neutron emission for (n,n*c)

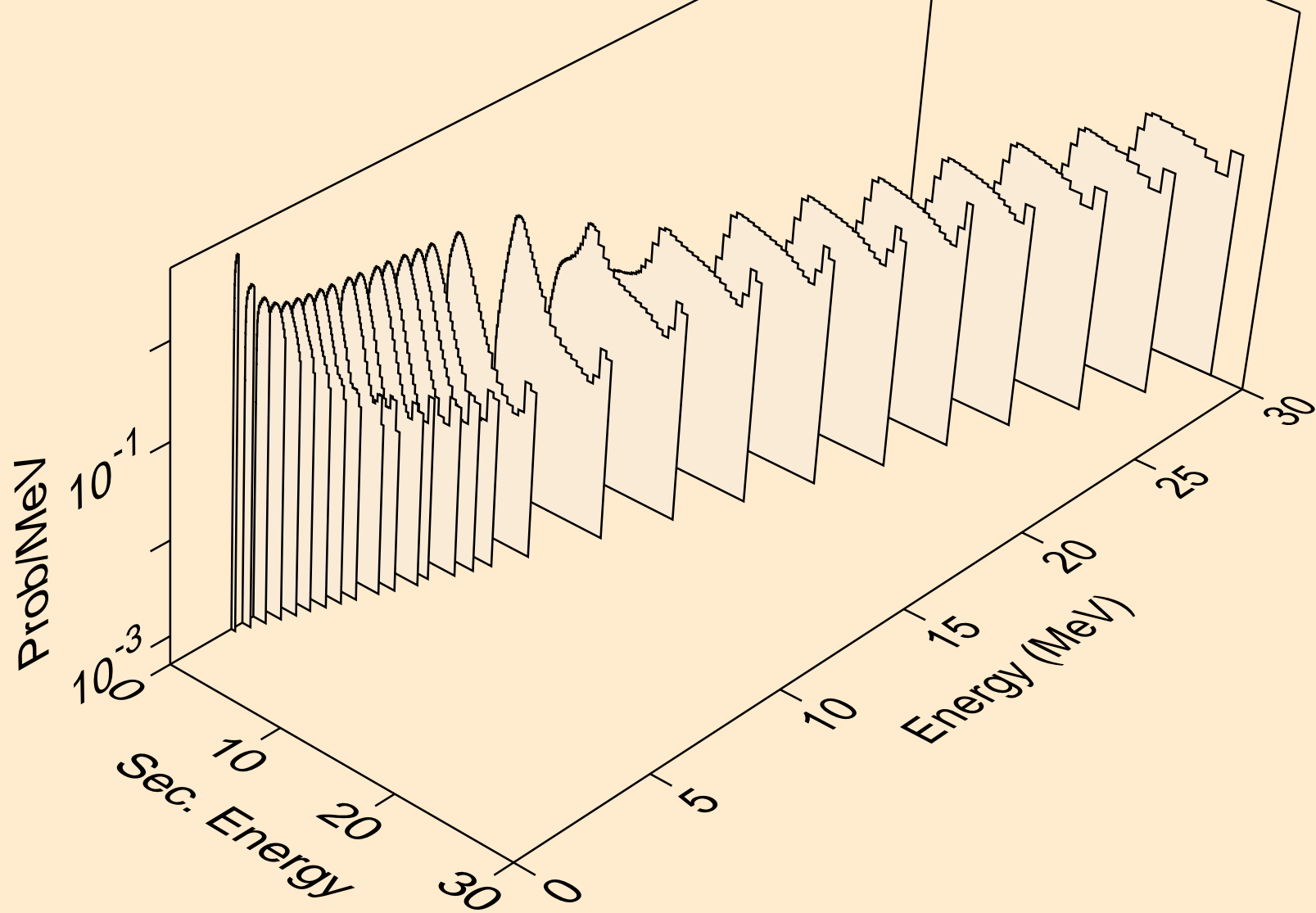

PM143 NEUTRON ACER TENDL-2023 LIBRARY; T=0.K
Photon emission for (n,x)

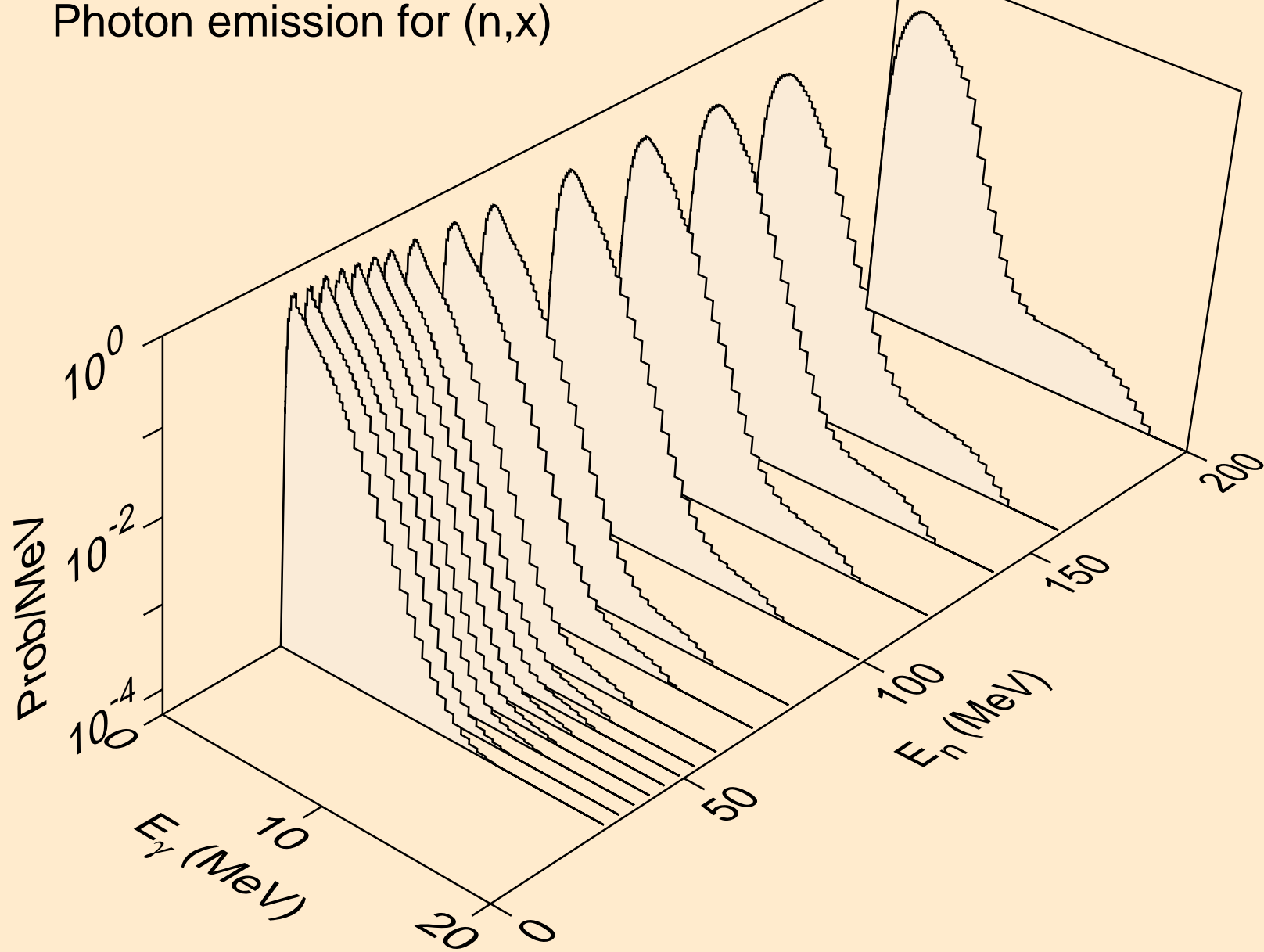

PM143 NEUTRON ACER TENDL-2023 LIBRARY; T=0.K
Photon emission for (n,2nd)

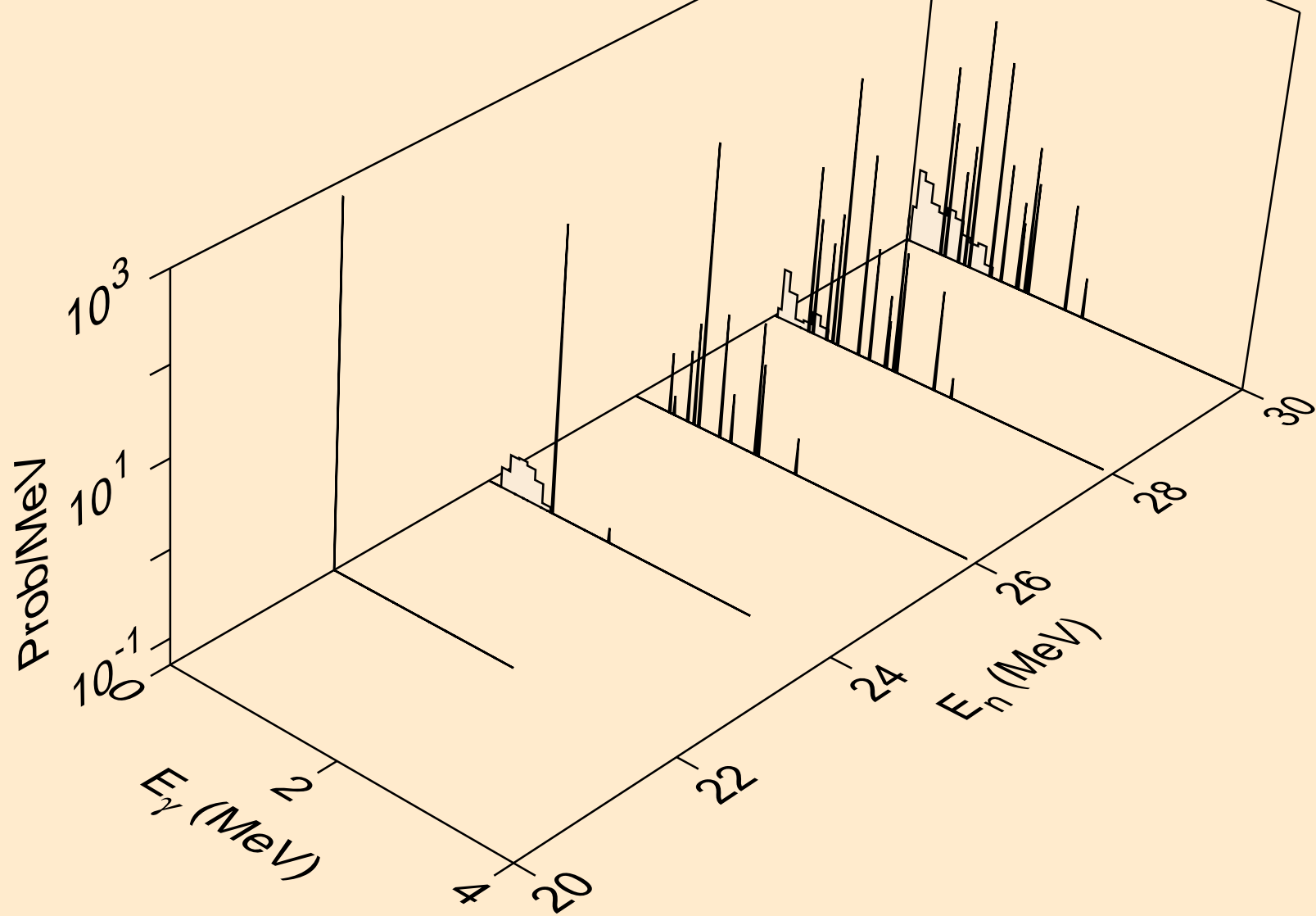

PM143 NEUTRON ACER TENDL-2023 LIBRARY; T=0.K
Photon emission for (n,2n)

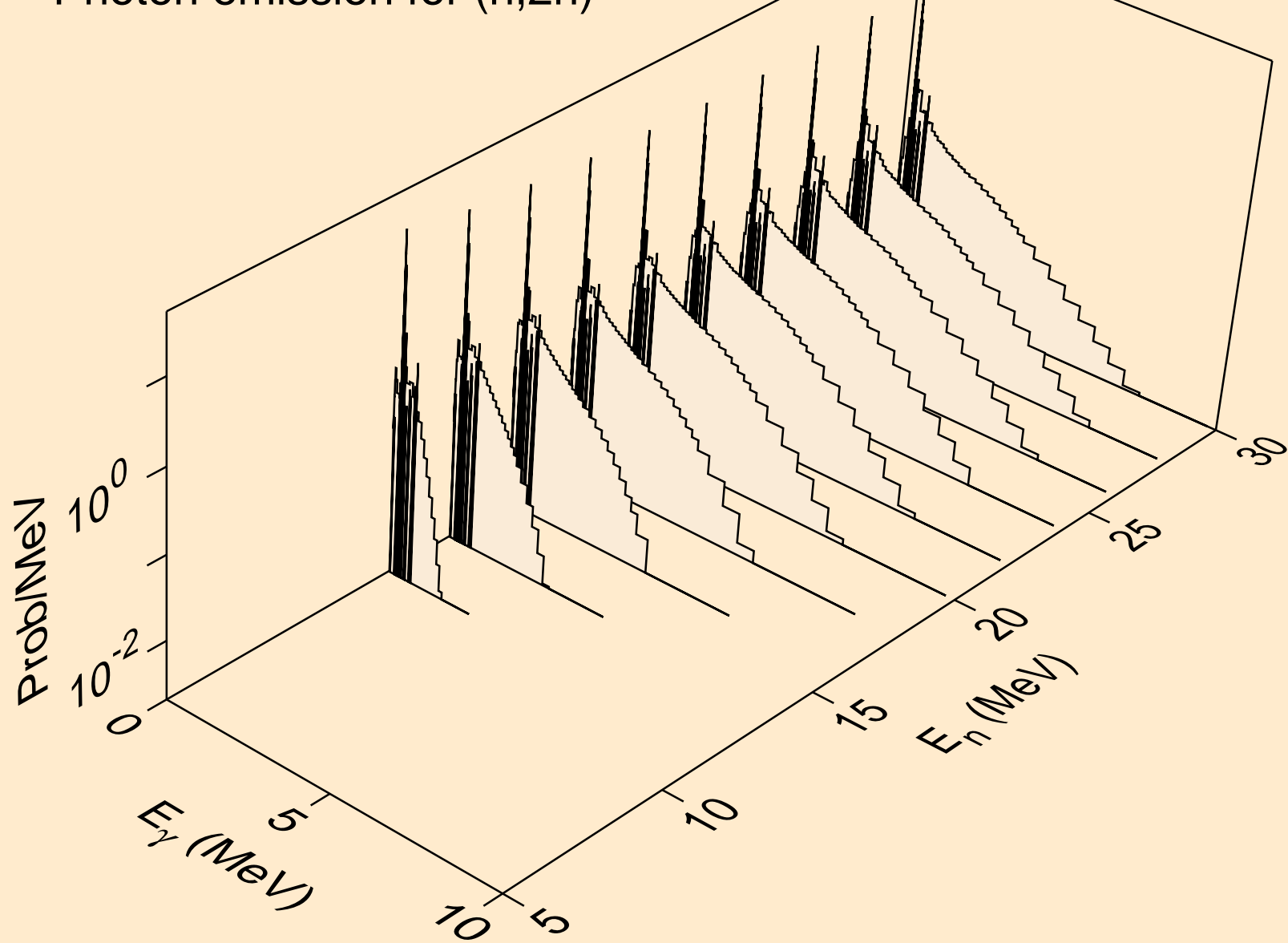

PM143 NEUTRON ACER TENDL-2023 LIBRARY; T=0.K
Photon emission for (n,3n)

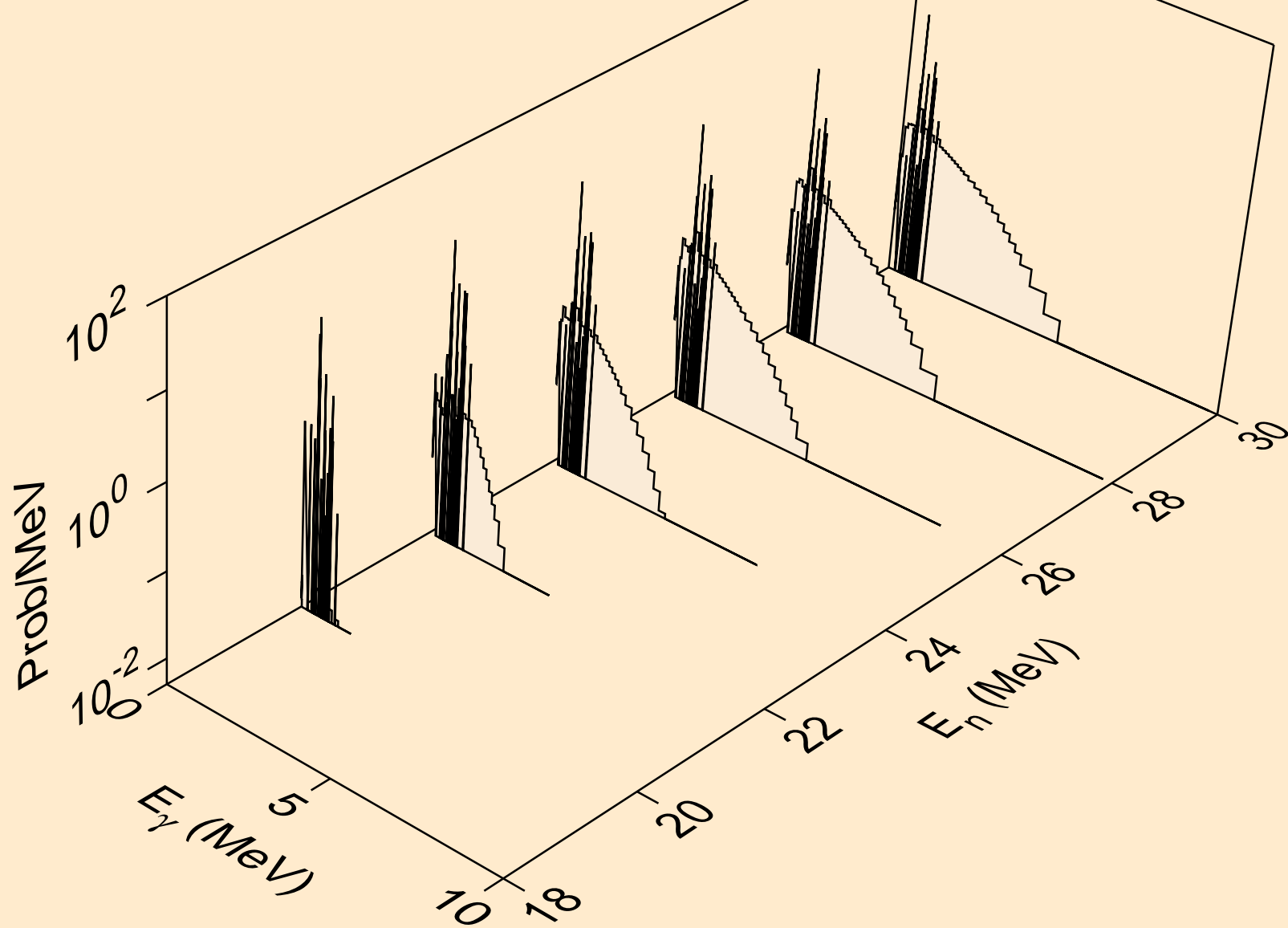

PM143 NEUTRON ACER TENDL-2023 LIBRARY; T=0.K
Photon emission for (n,n*)a

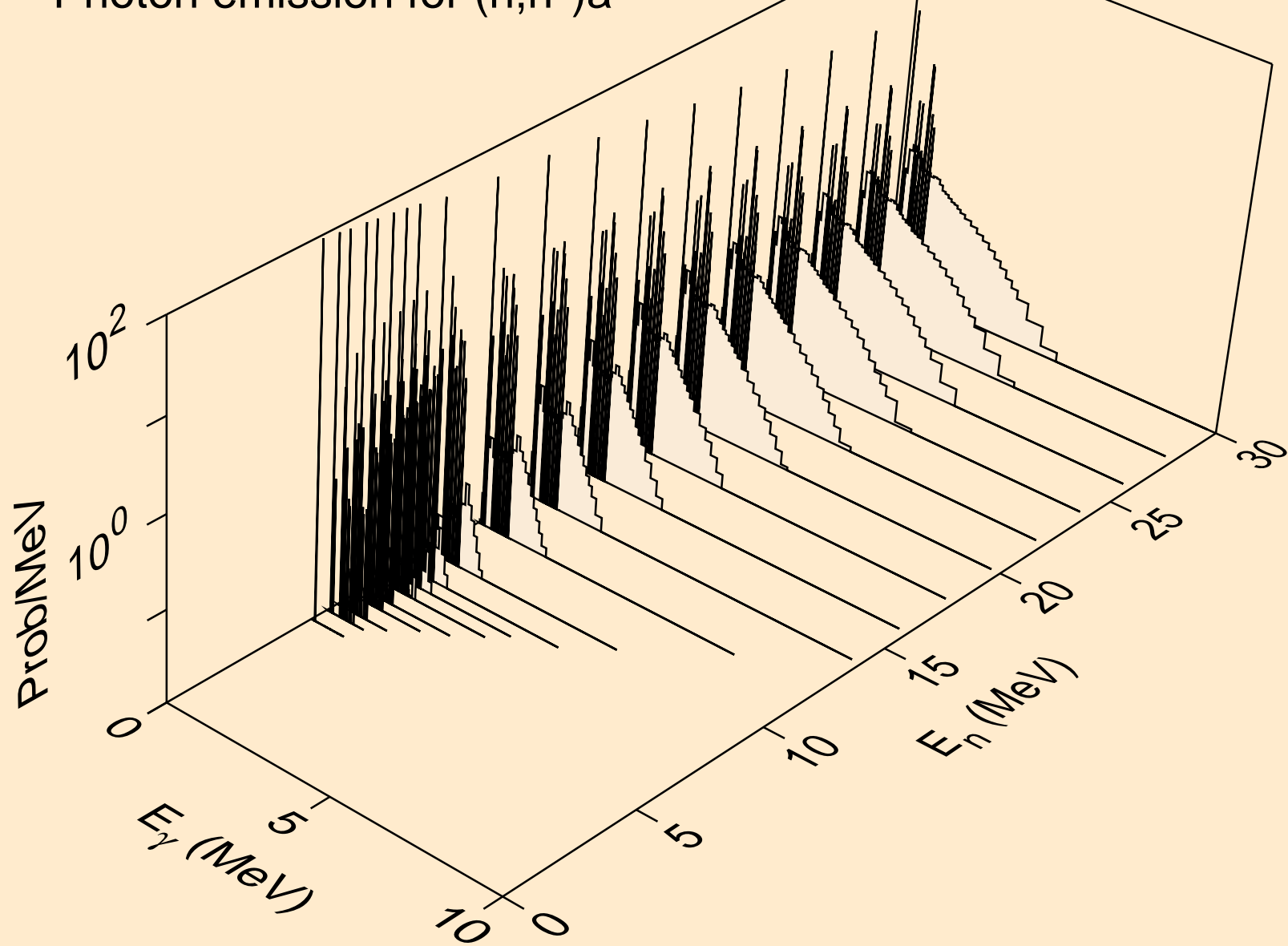

PM143 NEUTRON ACER TENDL-2023 LIBRARY; T=0.K
Photon emission for (n,2n)a

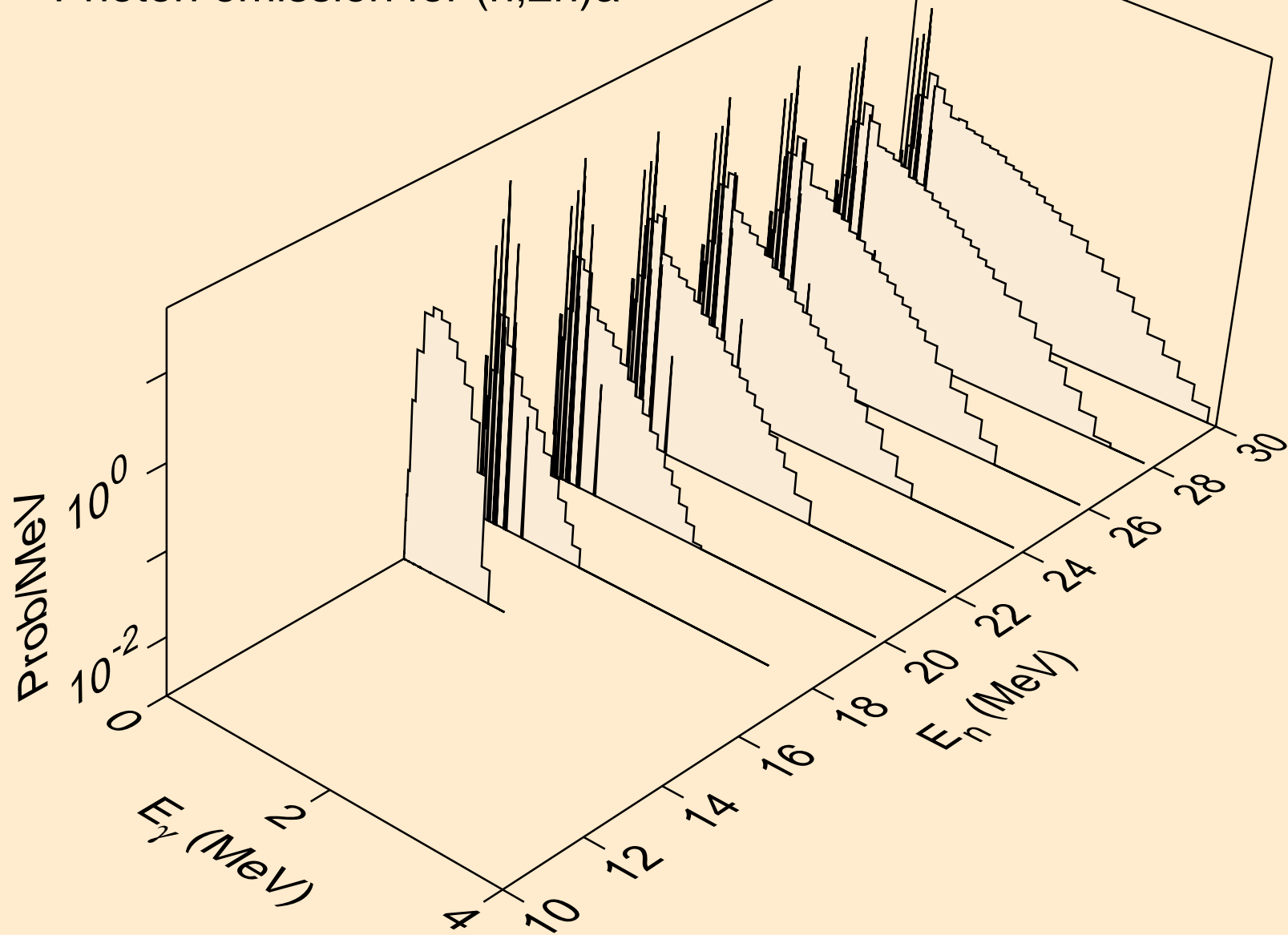

PM143 NEUTRON ACER TENDL-2023 LIBRARY; T=0.K
Photon emission for (n,3n)a

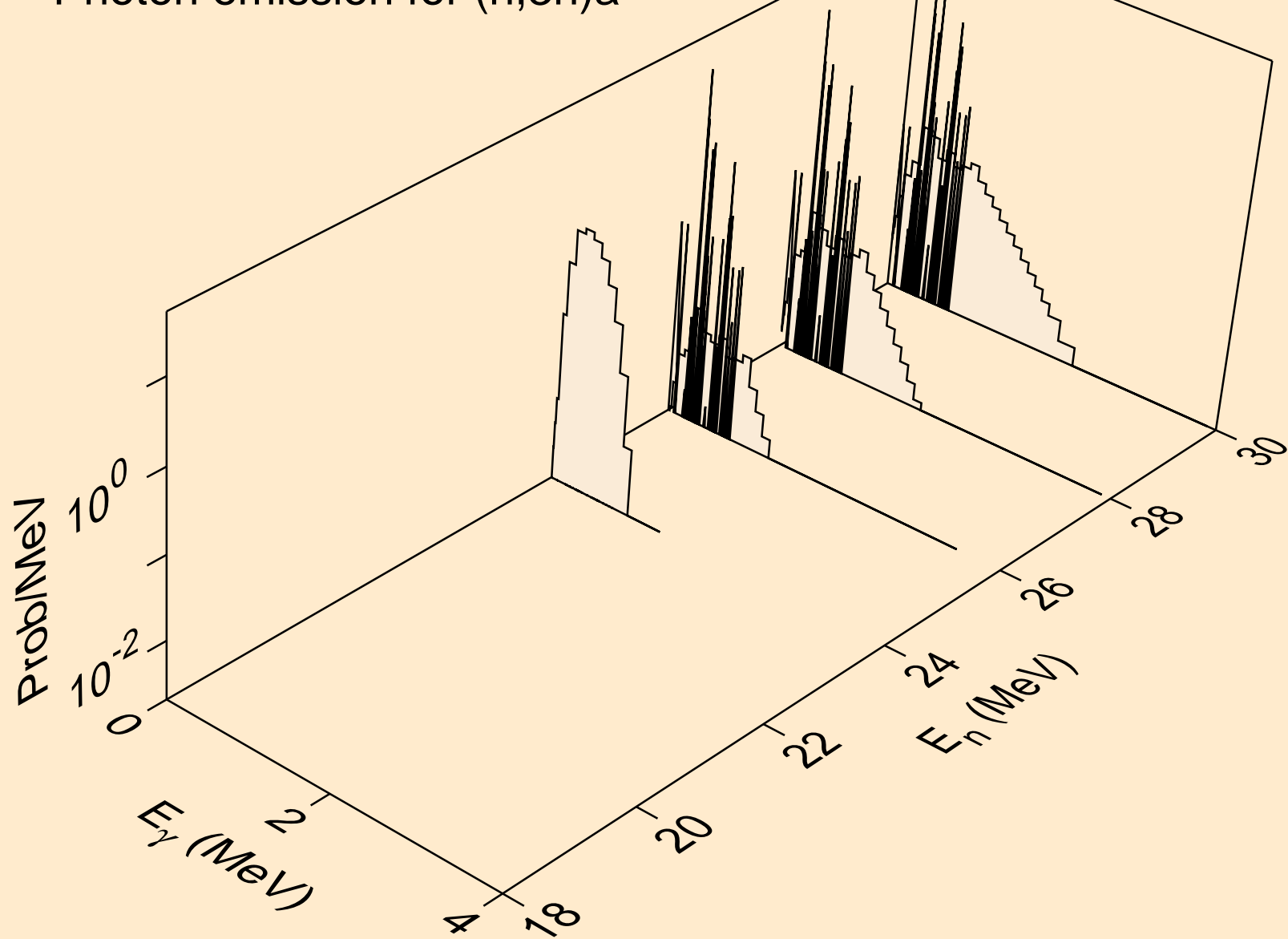

PM143 NEUTRON ACER TENDL-2023 LIBRARY; T=0.K
Photon emission for (n,n*)p

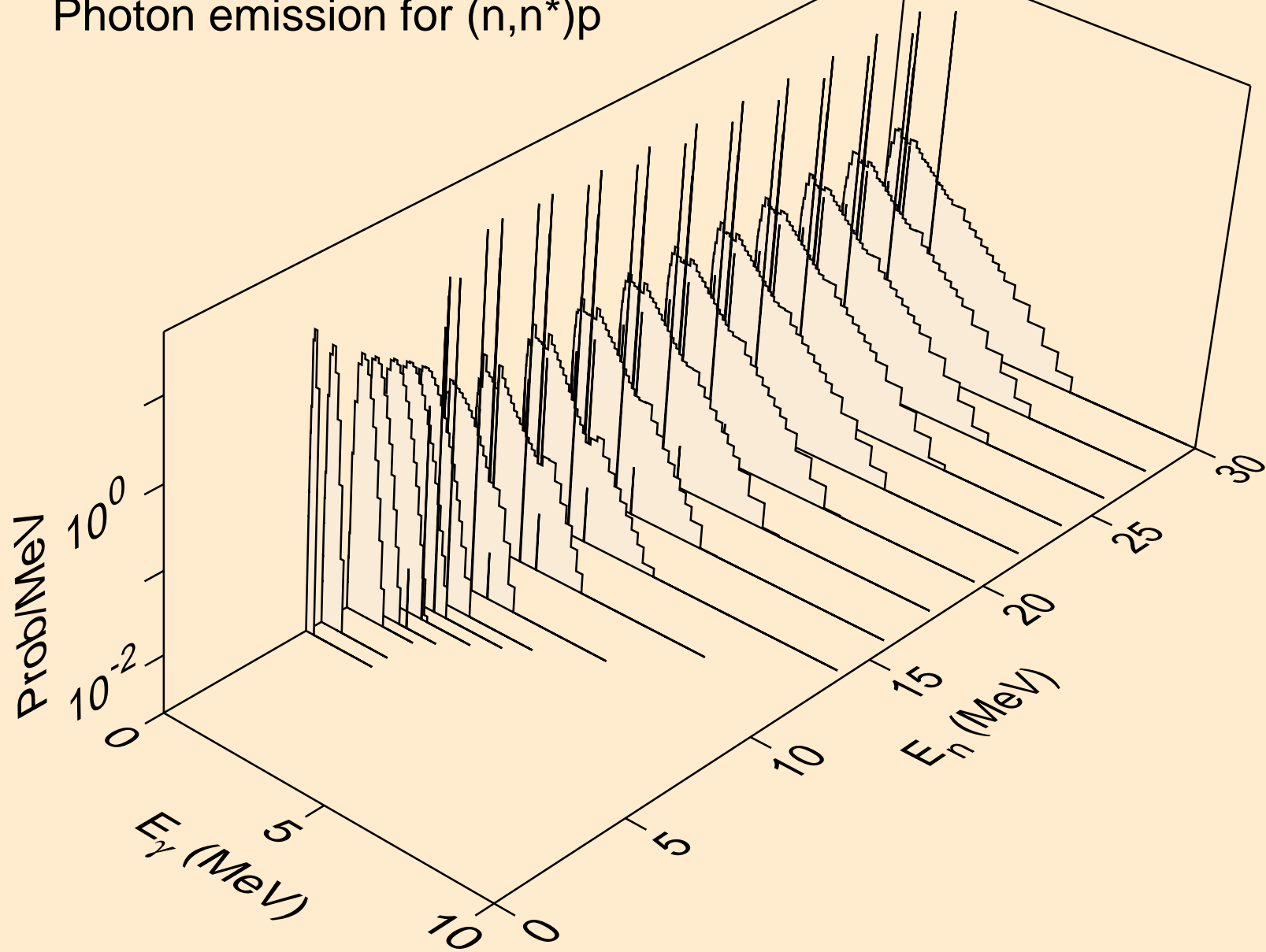

PM143 NEUTRON ACER TENDL-2023 LIBRARY; T=0.K
Photon emission for (n,n*)2a

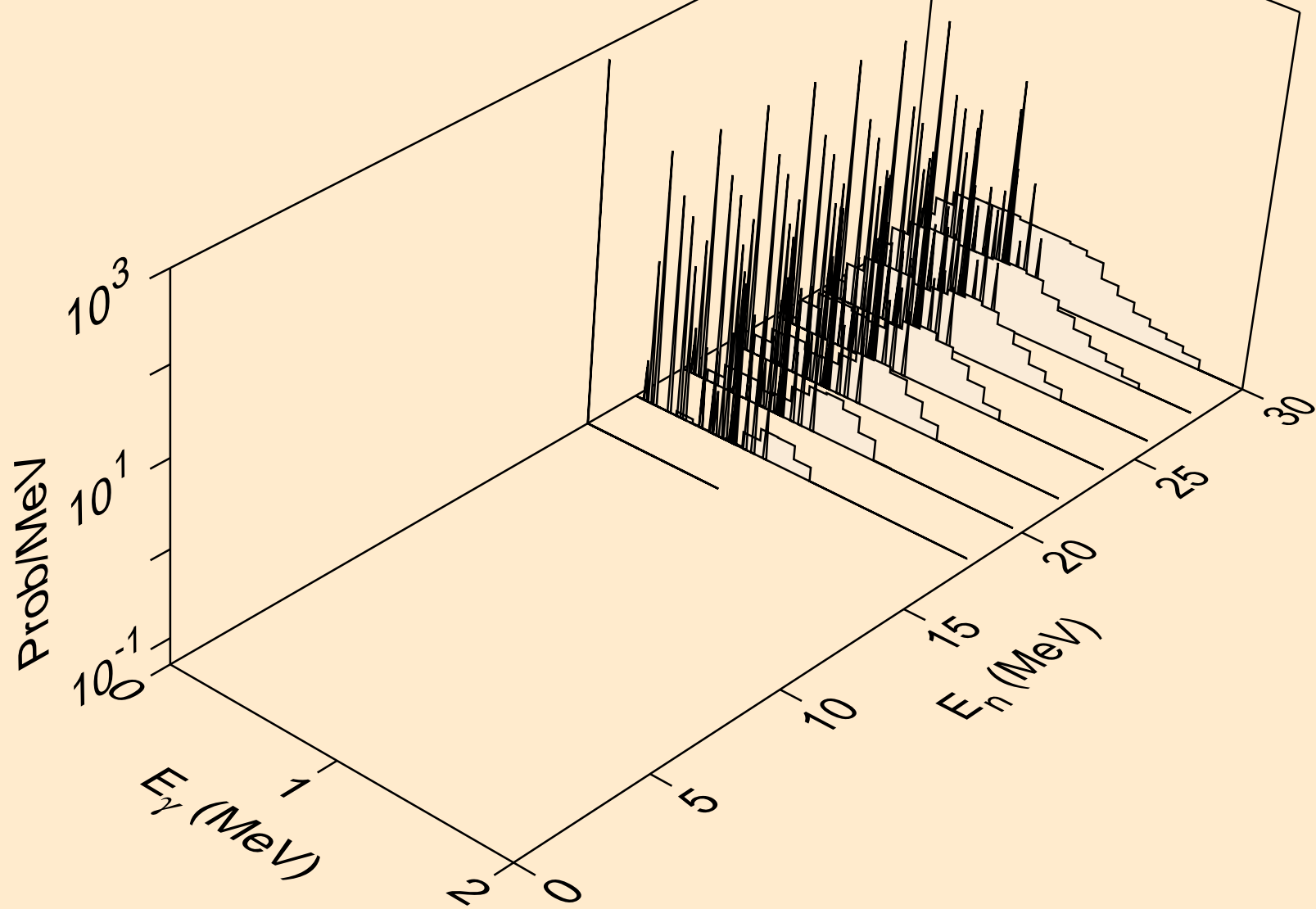

PM143 NEUTRON ACER TENDL-2023 LIBRARY; T=0.K
Photon emission for (n,n*)d

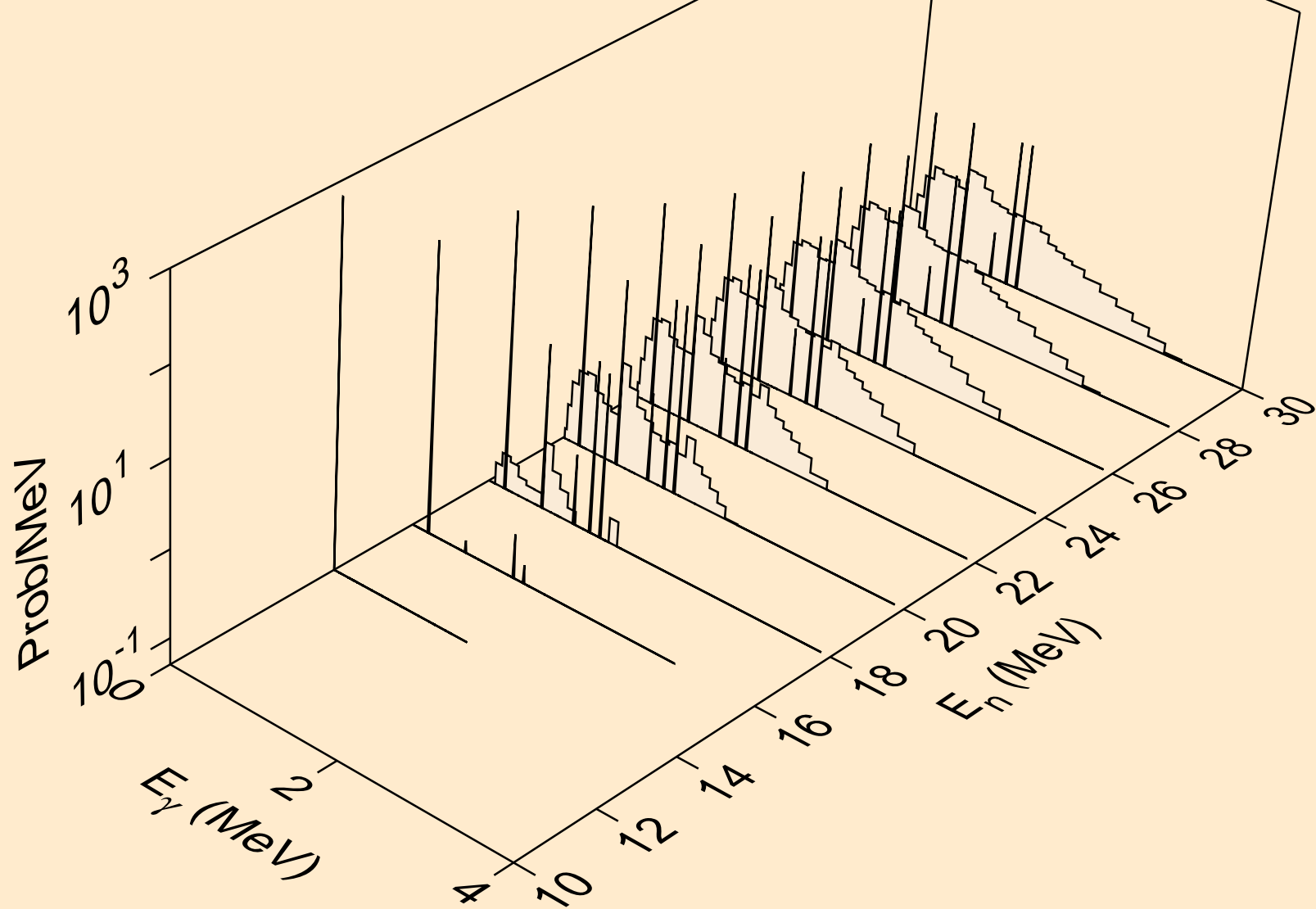

PM143 NEUTRON ACER TENDL-2023 LIBRARY; T=0.K
Photon emission for (n,n*)t

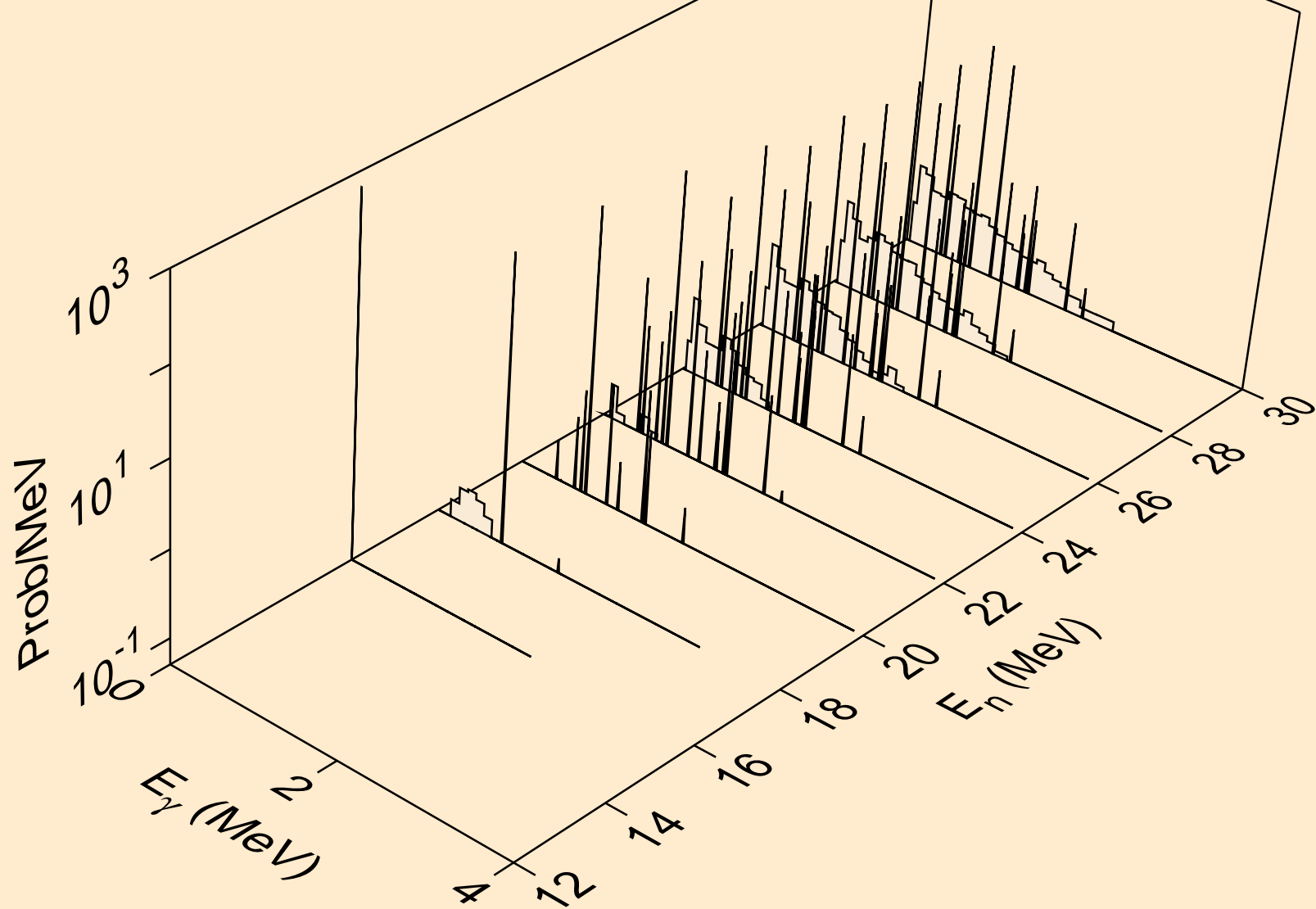

PM143 NEUTRON ACER TENDL-2023 LIBRARY; T=0.K
Photon emission for (n,n*)he3

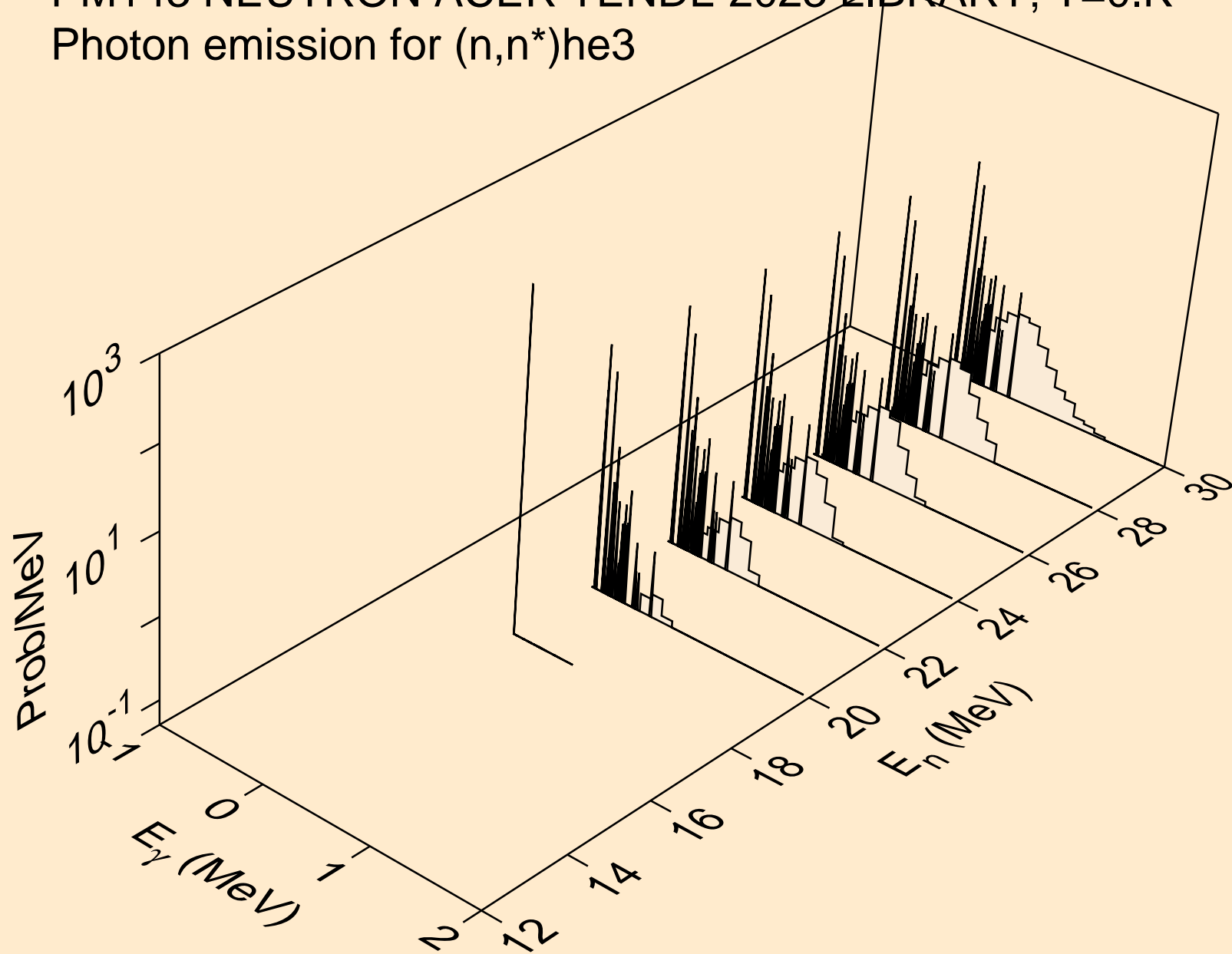

PM143 NEUTRON ACER TENDL-2023 LIBRARY; T=0.K
Photon emission for (n,2np)

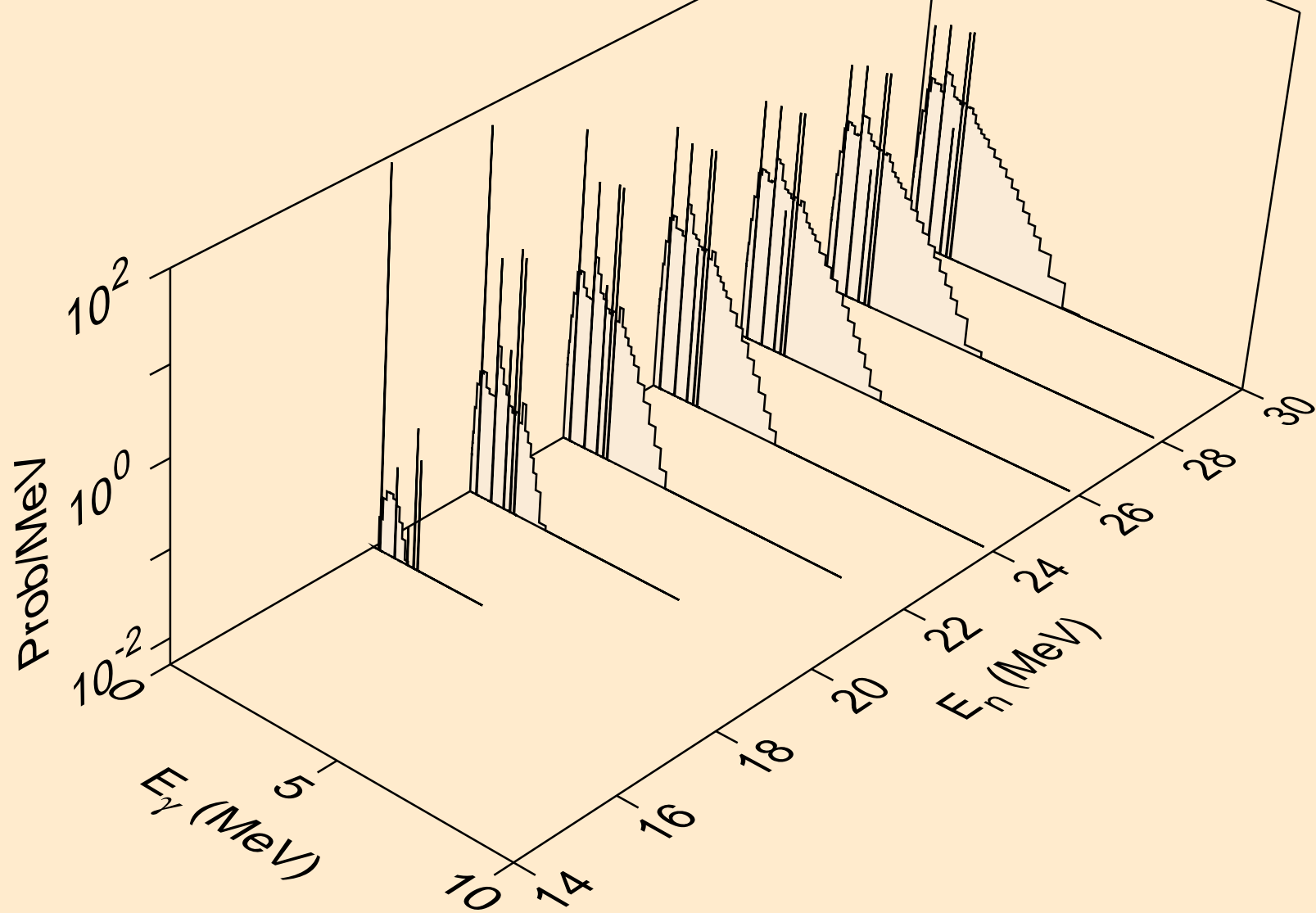

PM143 NEUTRON ACER TENDL-2023 LIBRARY; T=0.K
Photon emission for (n,3np)

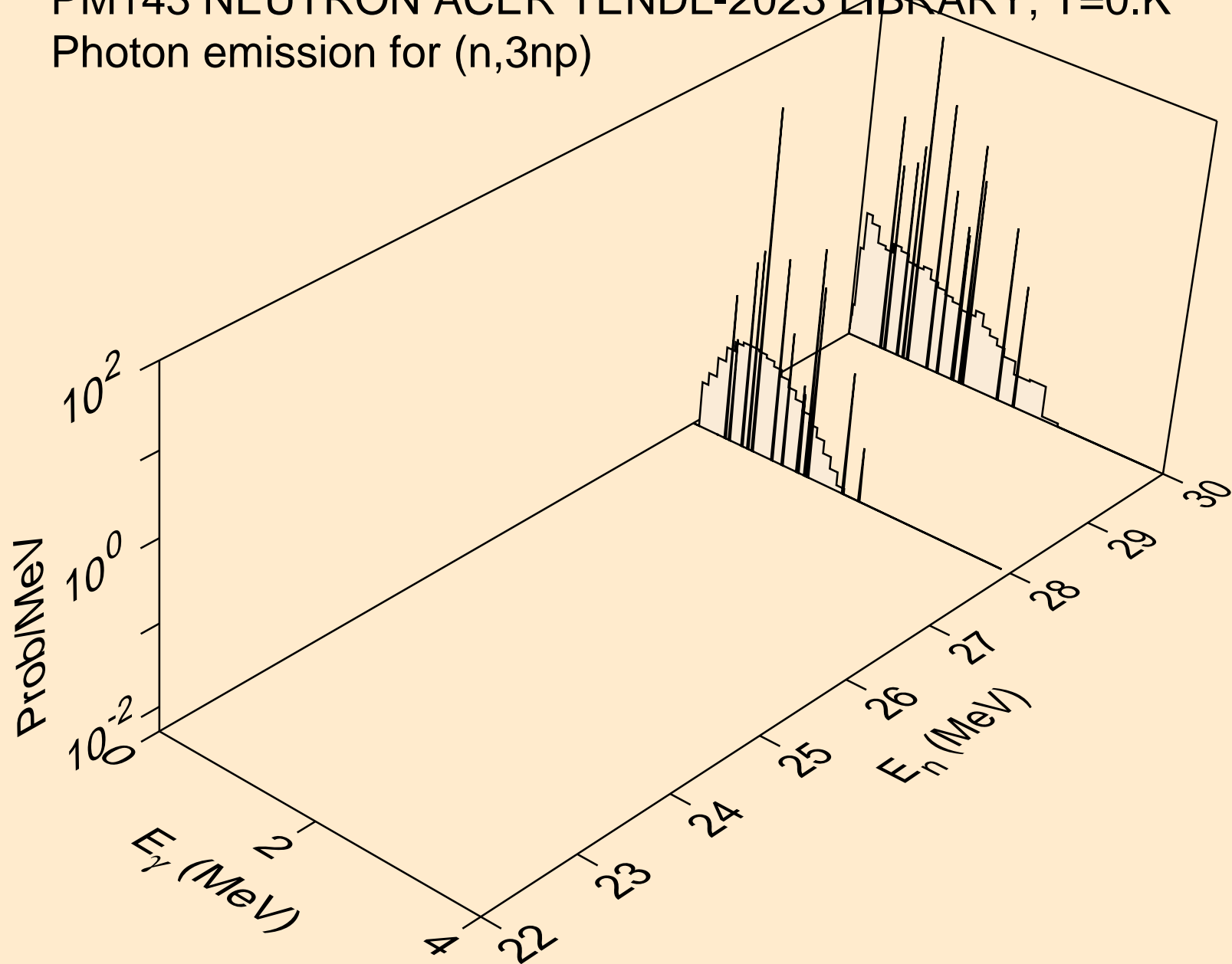

PM143 NEUTRON ACER TENDL-2023 LIBRARY; T=0.K
Photon emission for (n,n2p)

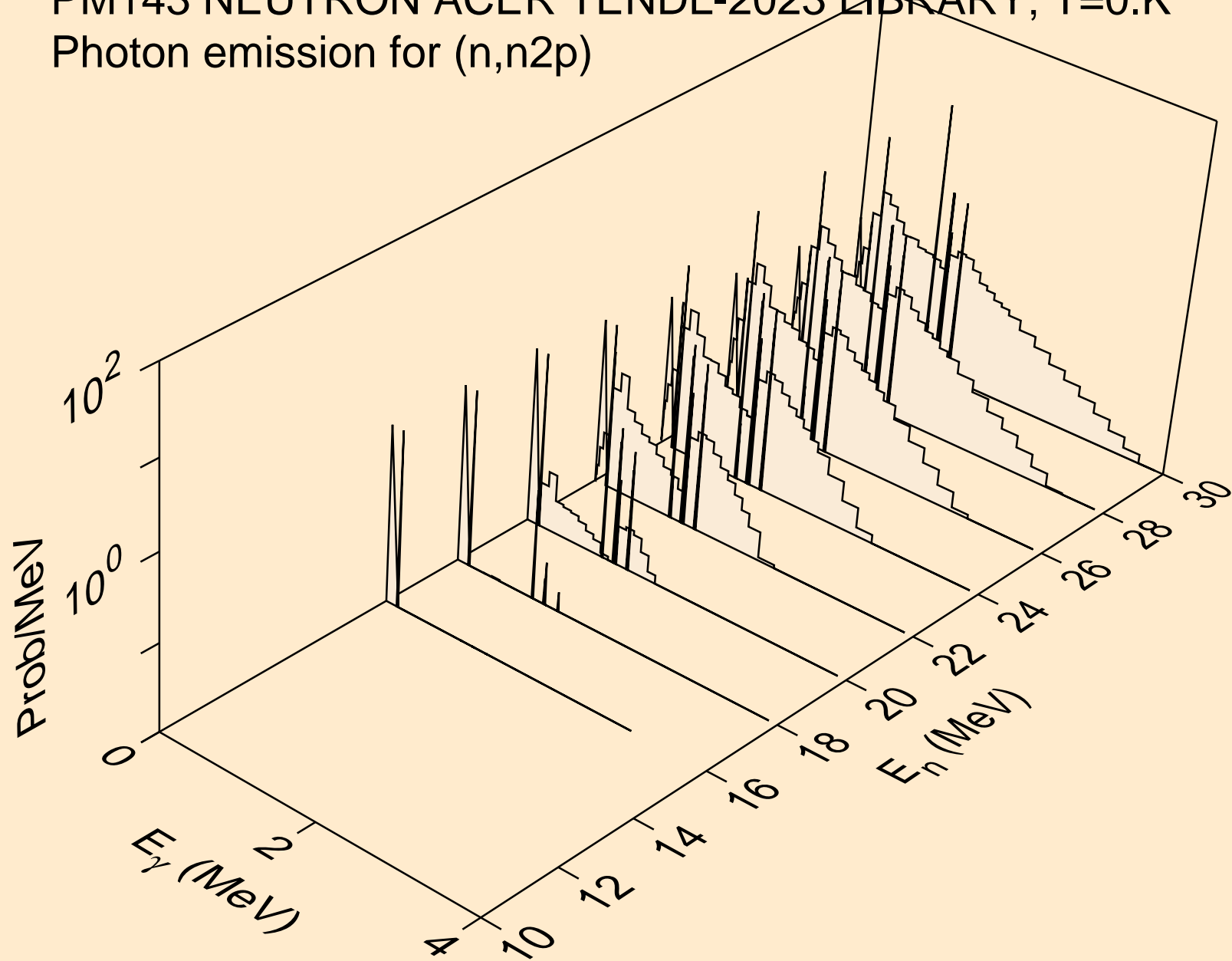

PM143 NEUTRON ACER TENDL-2023 LIBRARY; T=0.K
Photon emission for (n,npa)

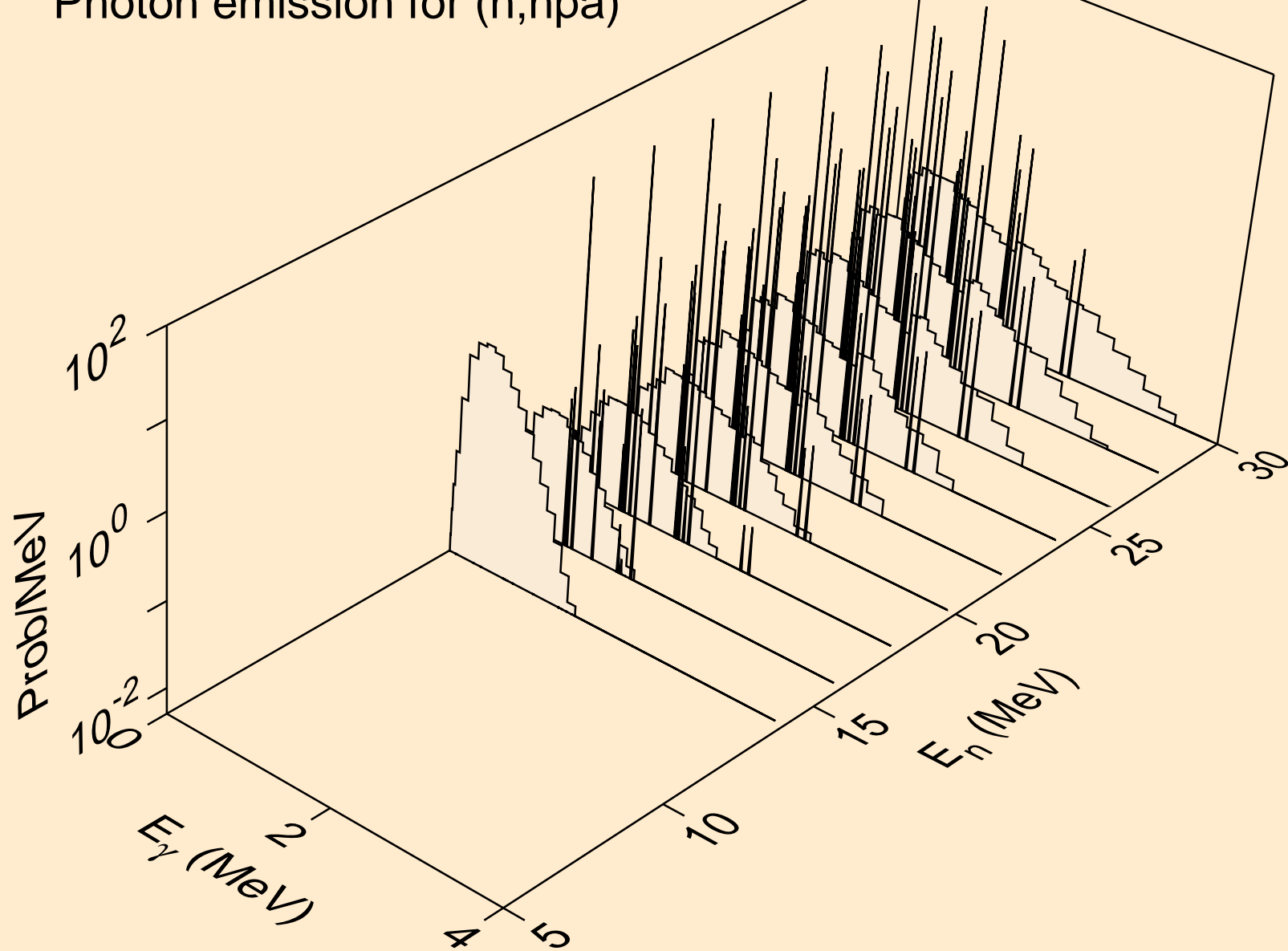

PM143 NEUTRON ACER TENDL-2023 LIBRARY; T=0.K
Photon emission for (n,n*c)

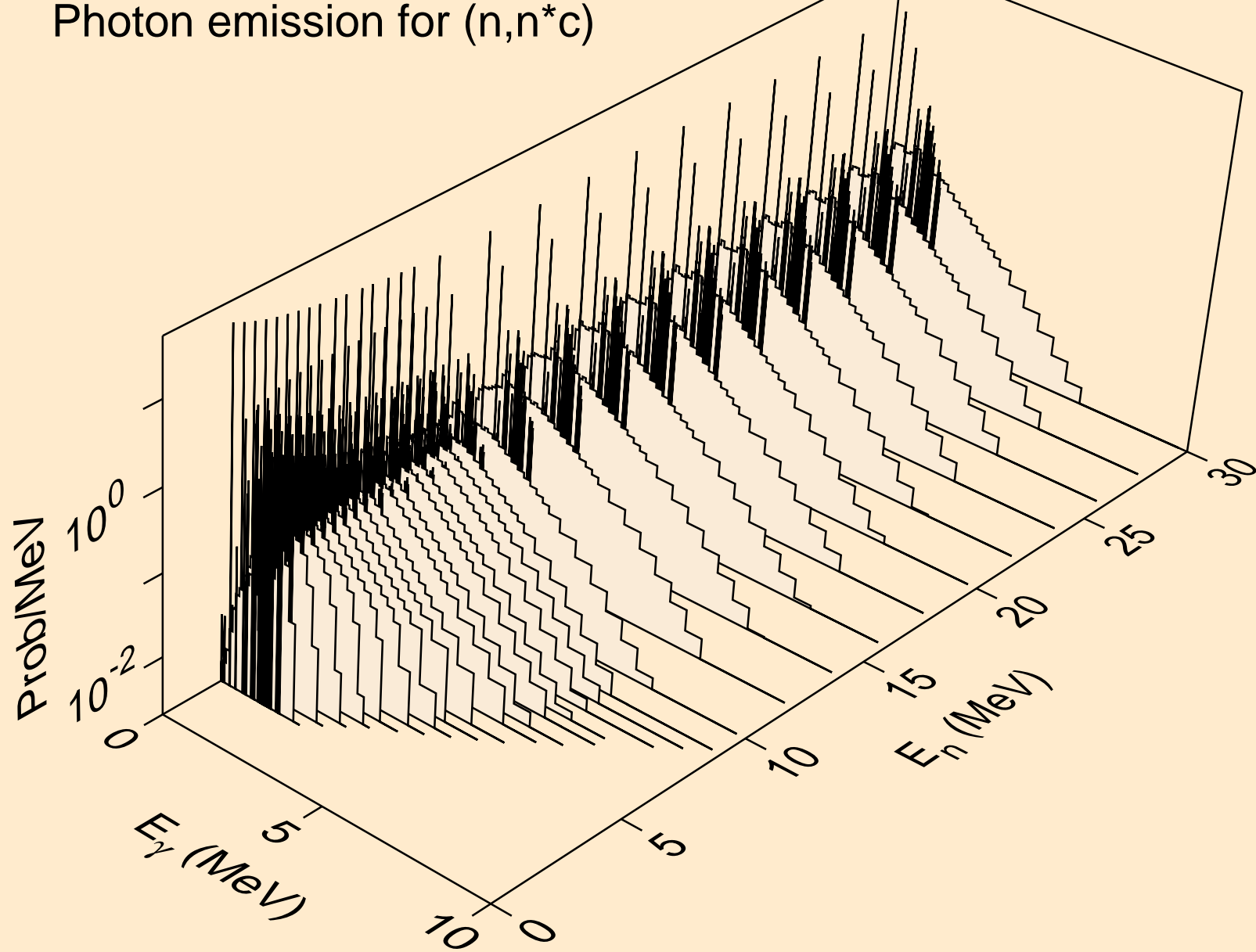

PM143 NEUTRON ACER TENDL-2023 LIBRARY; T=0.K
Photon emission for (n,gma)

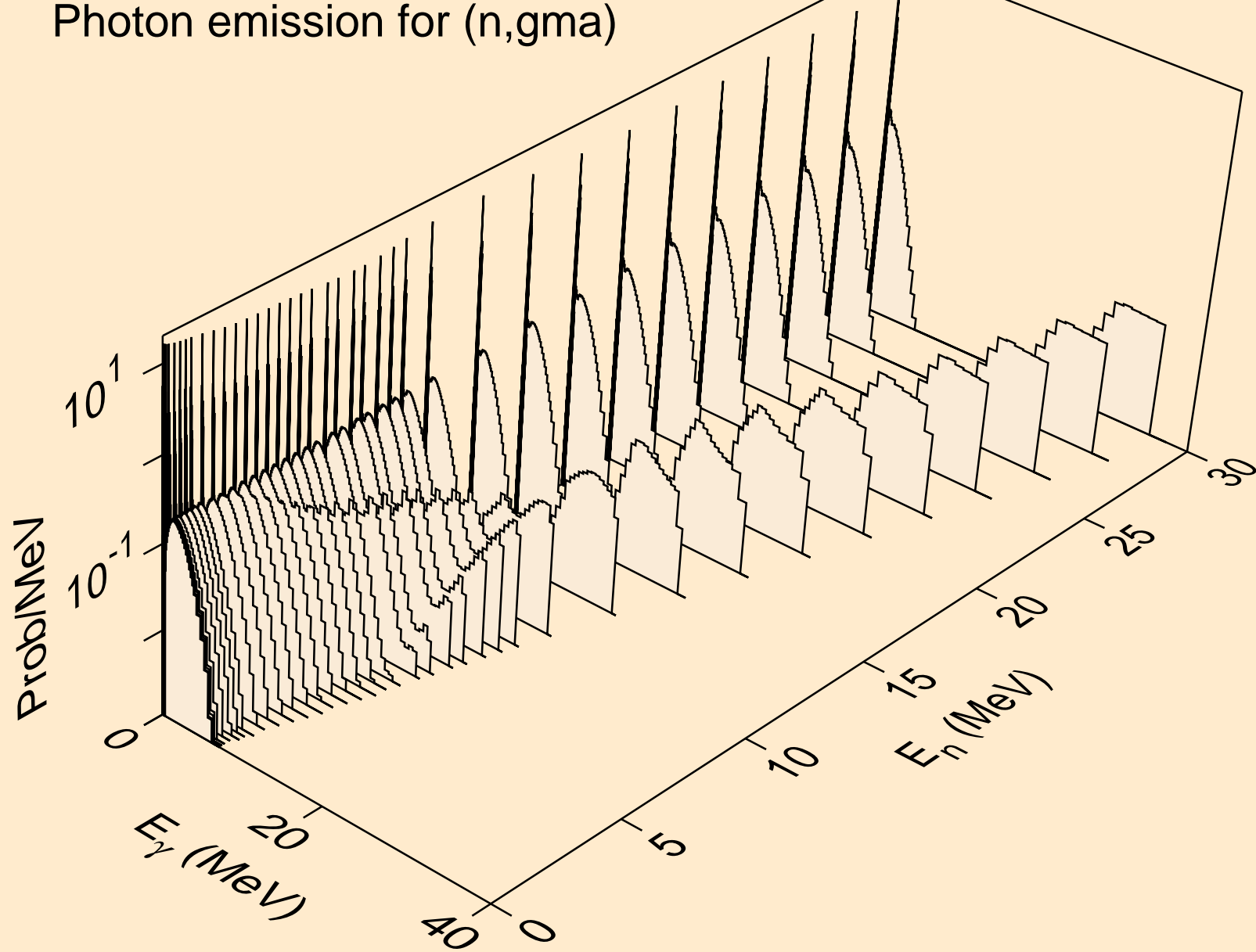

PM143 NEUTRON ACER TENDL-2023 LIBRARY; T=0.K
Photon emission for (n,p)

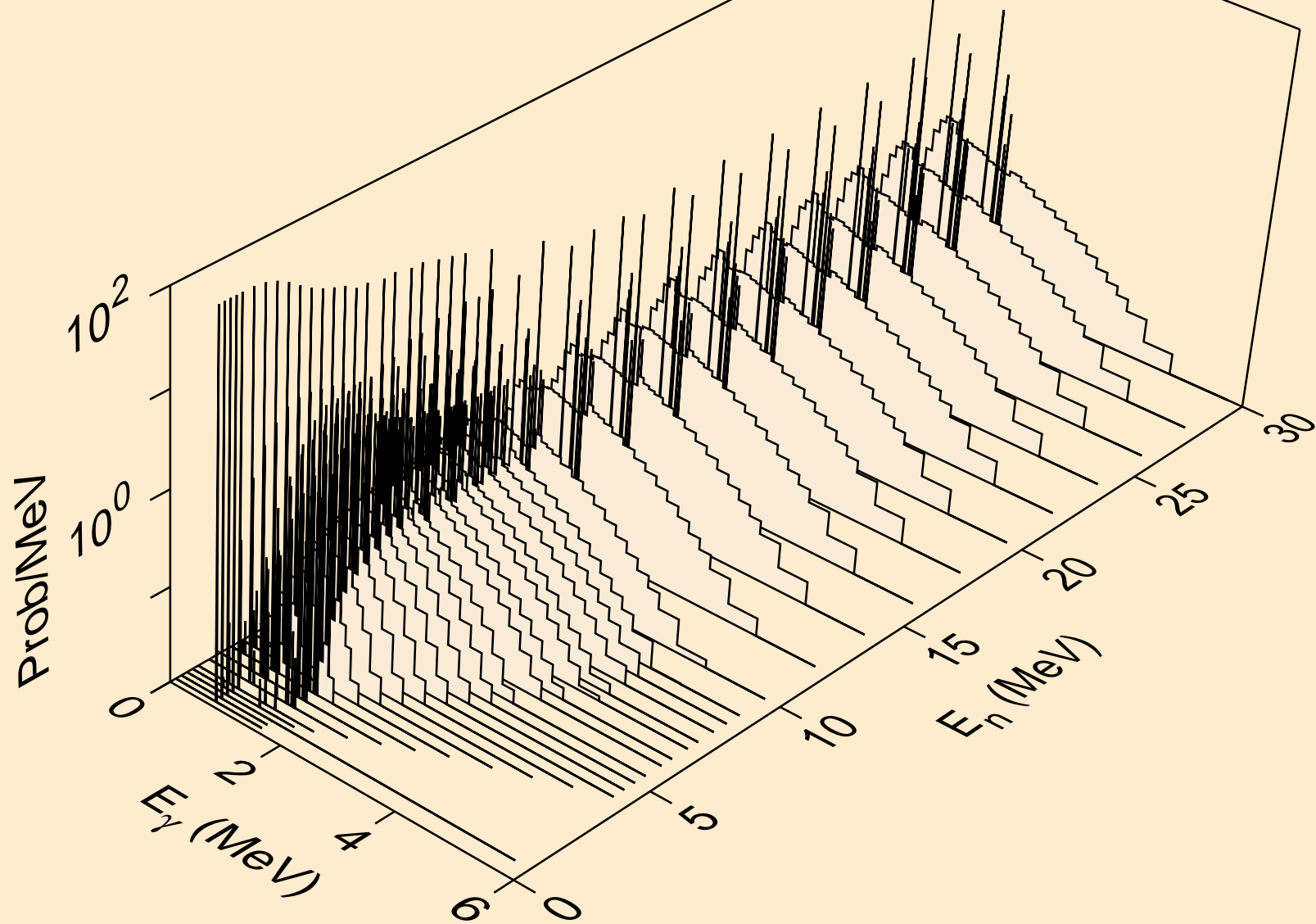

PM143 NEUTRON ACER TENDL-2023 LIBRARY; T=0.K
Photon emission for (n,d)

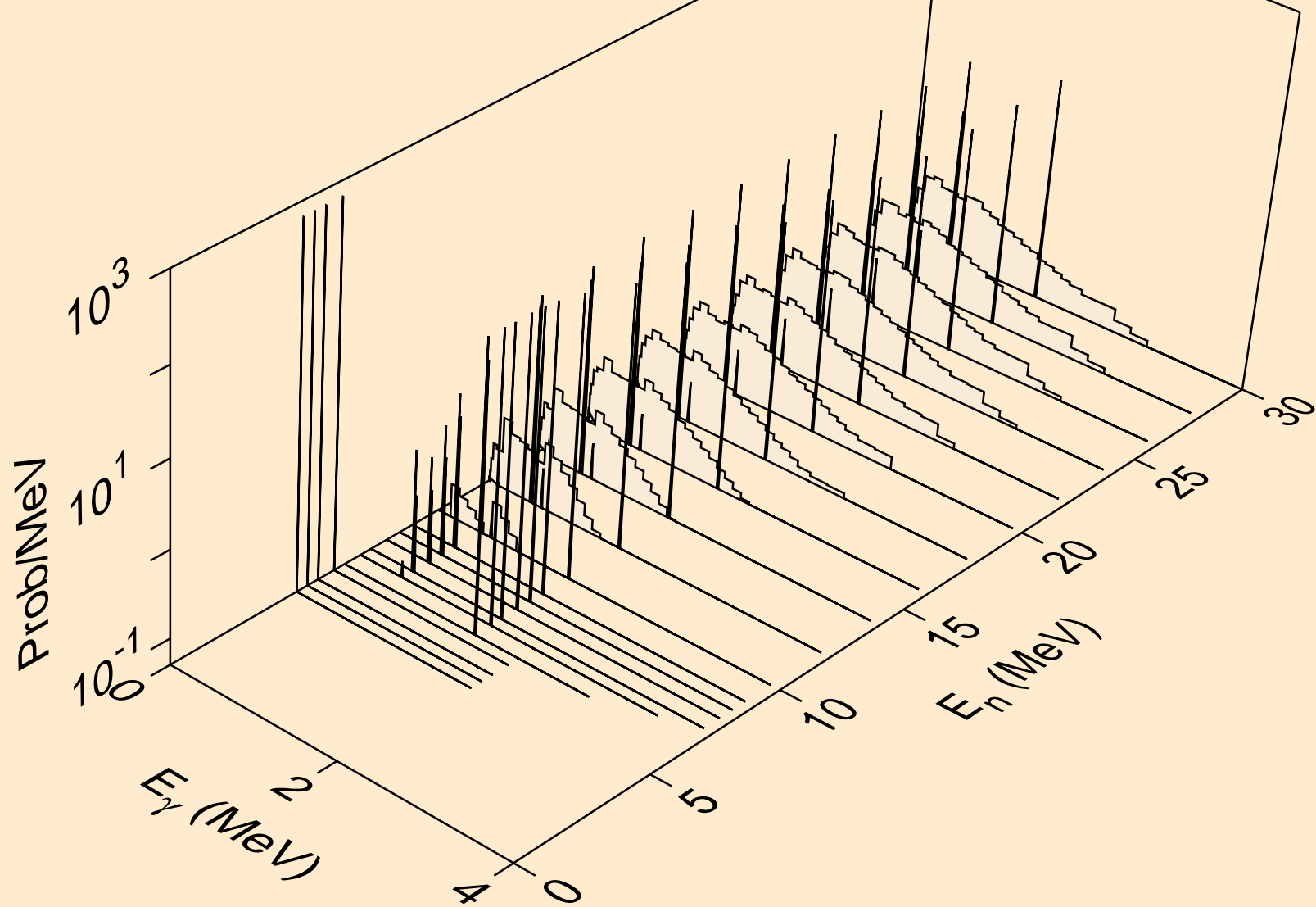

PM143 NEUTRON ACER TENDL-2023 LIBRARY; T=0.K
Photon emission for (n,t)

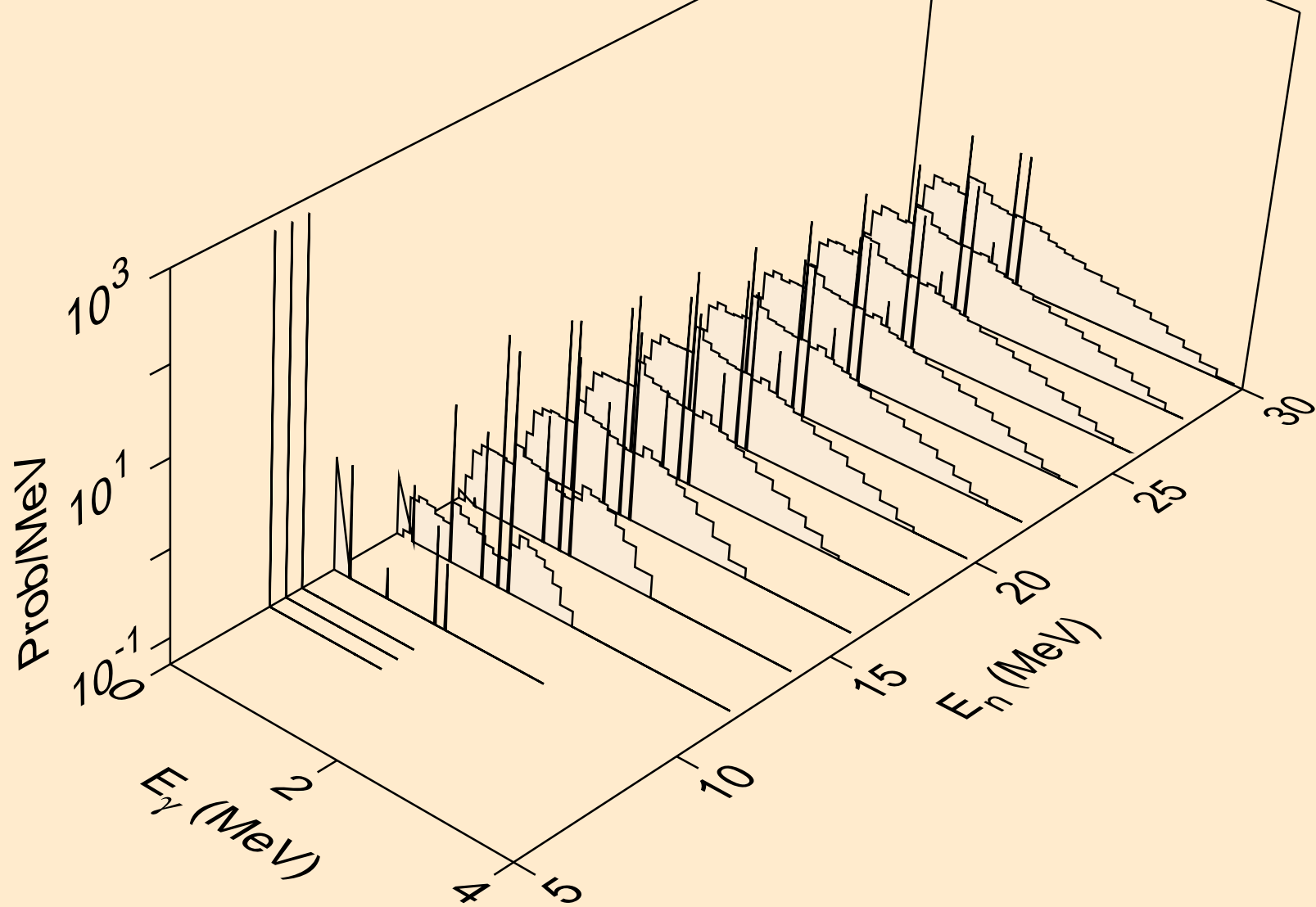

PM143 NEUTRON ACER TENDL-2023 LIBRARY; T=0.K
Photon emission for (n,he3)

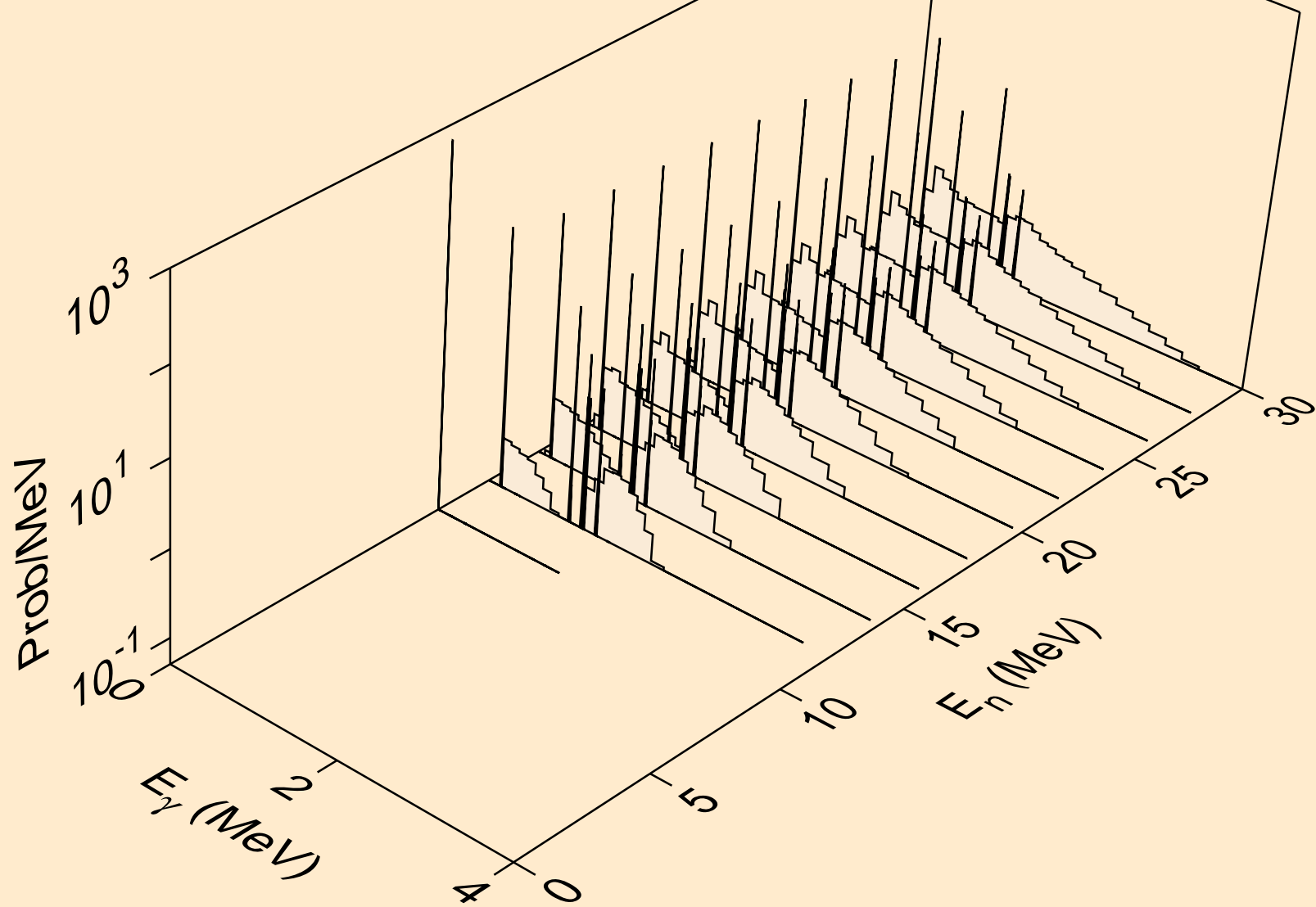

PM143 NEUTRON ACER TENDL-2023 LIBRARY; T=0.K
Photon emission for (n,a)

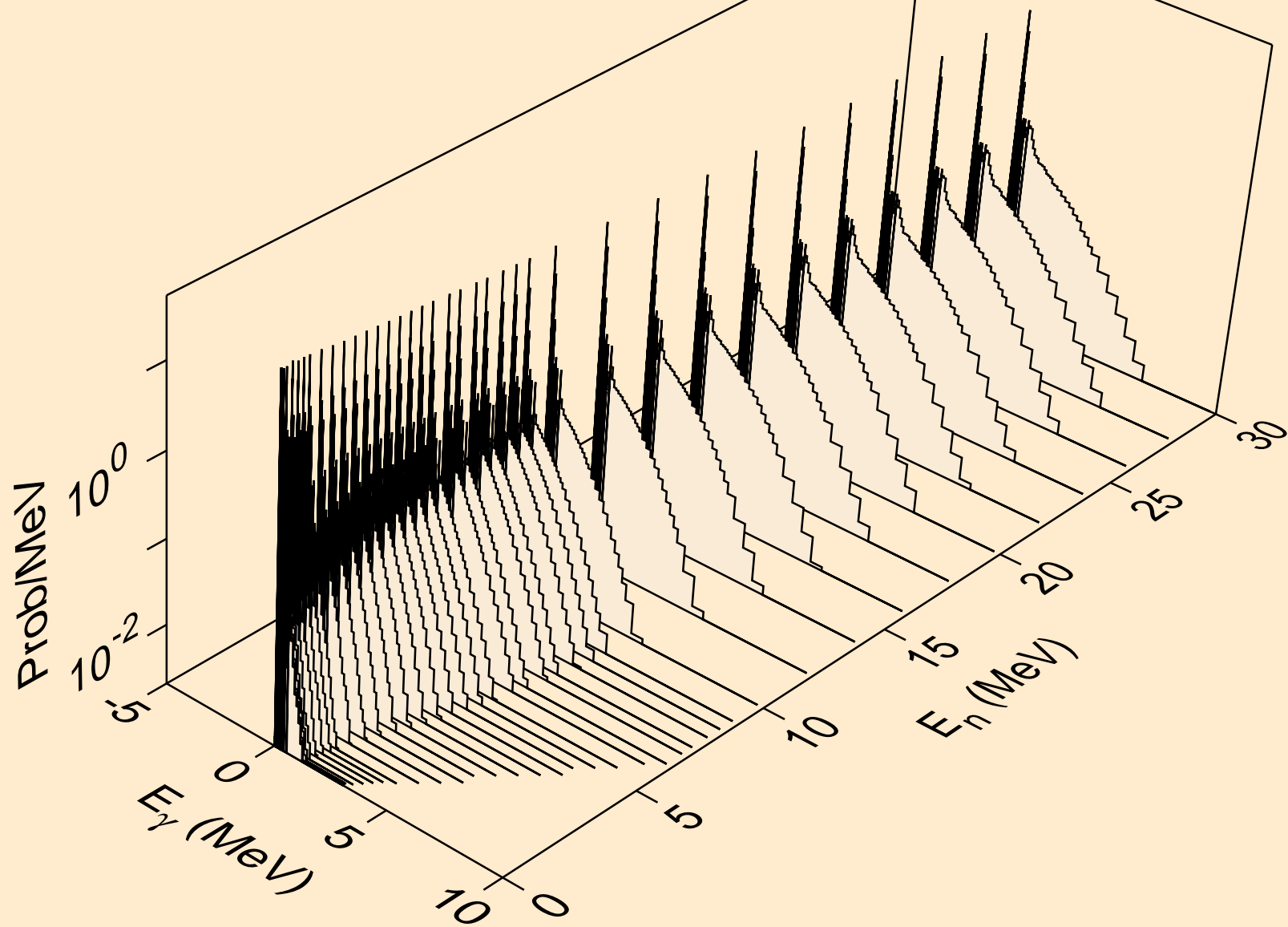

PM143 NEUTRON ACER TENDL-2023 LIBRARY; T=0.K
Photon emission for (n,2a)

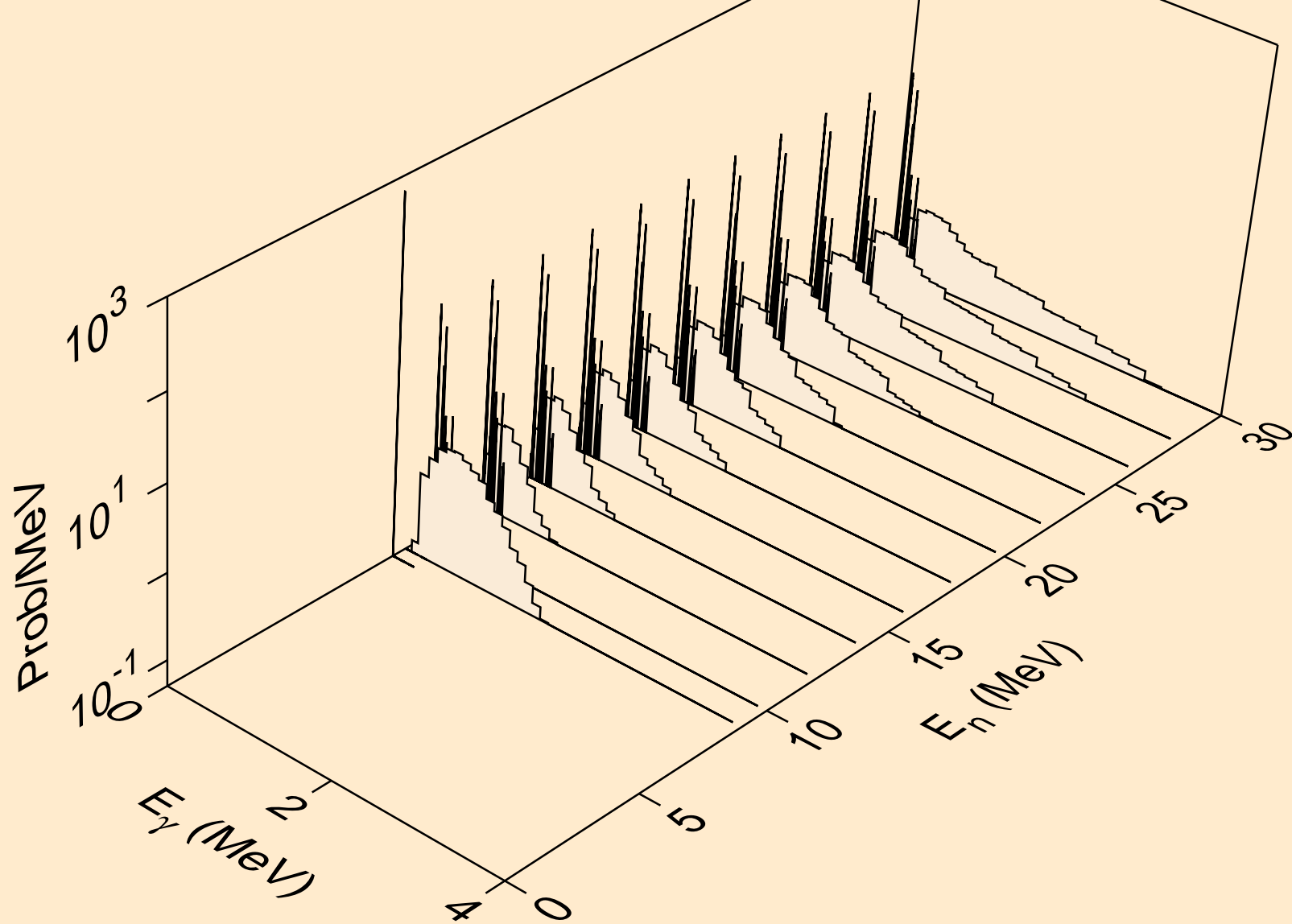

PM143 NEUTRON ACER TENDL-2023 LIBRARY; T=0.K
Photon emission for (n,2p)

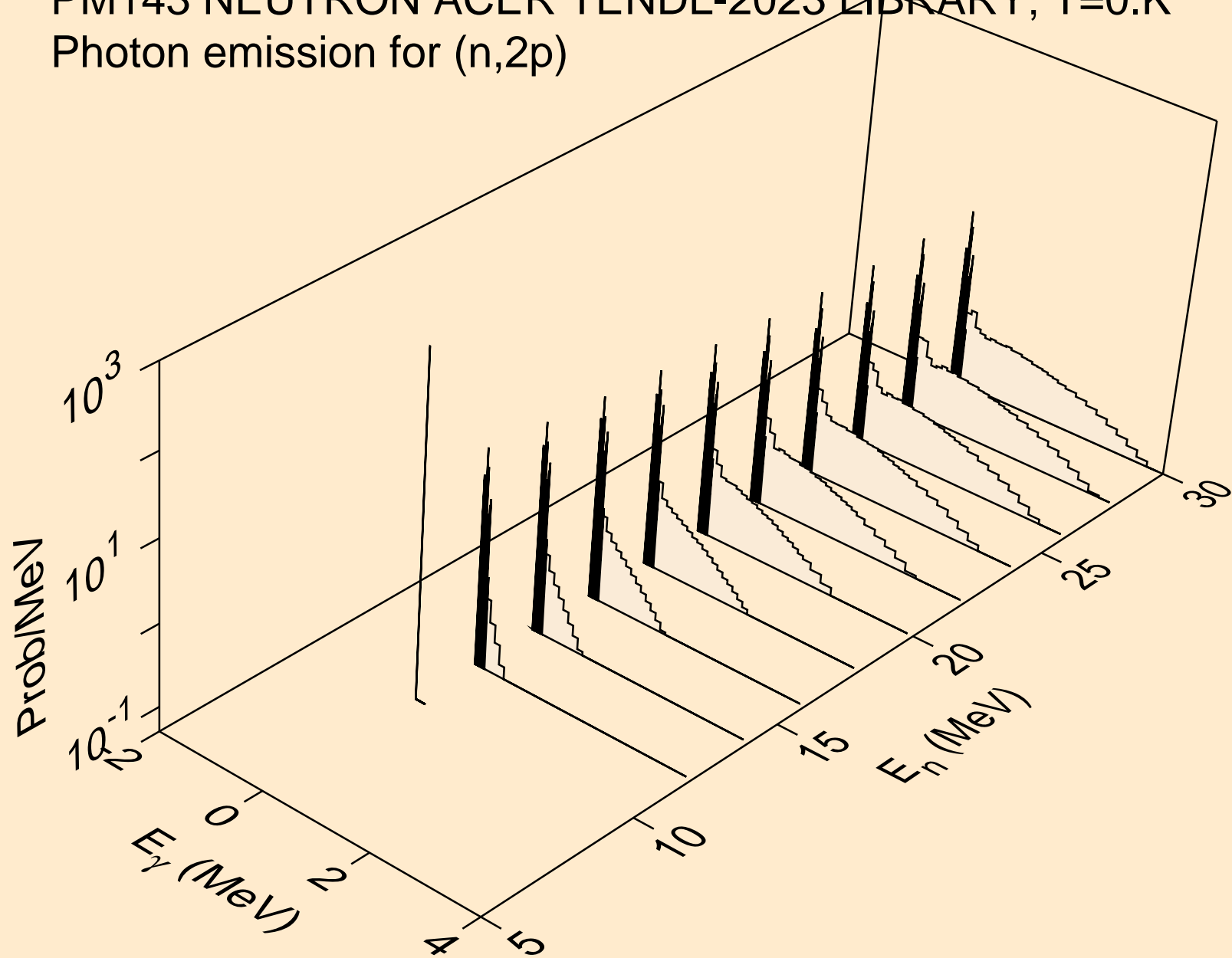

PM143 NEUTRON ACER TENDL-2023 LIBRARY; T=0.K
Photon emission for (n,p α)

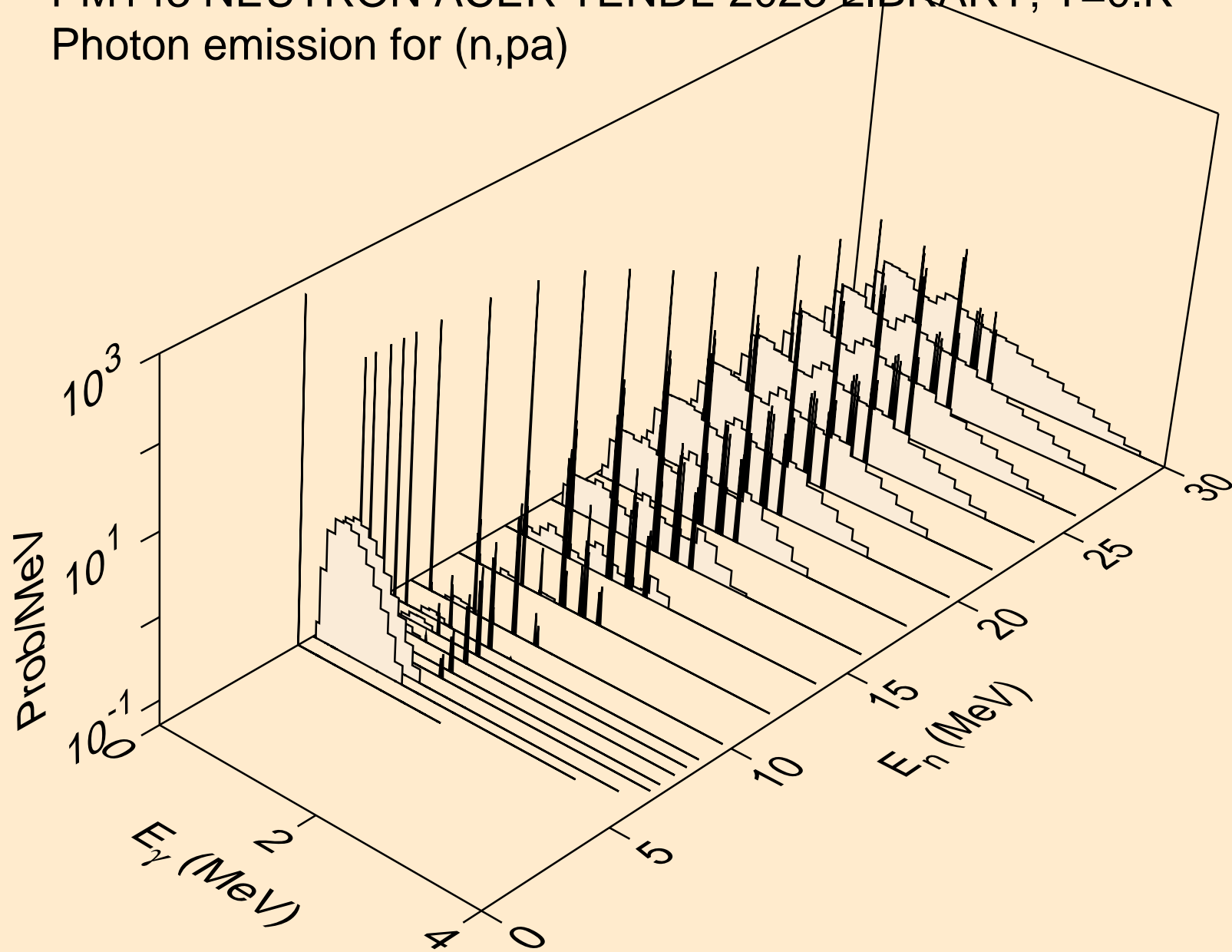

PM143 NEUTRON ACER TENDL-2023 LIBRARY; T=0.K
Photon emission for (n,pd)

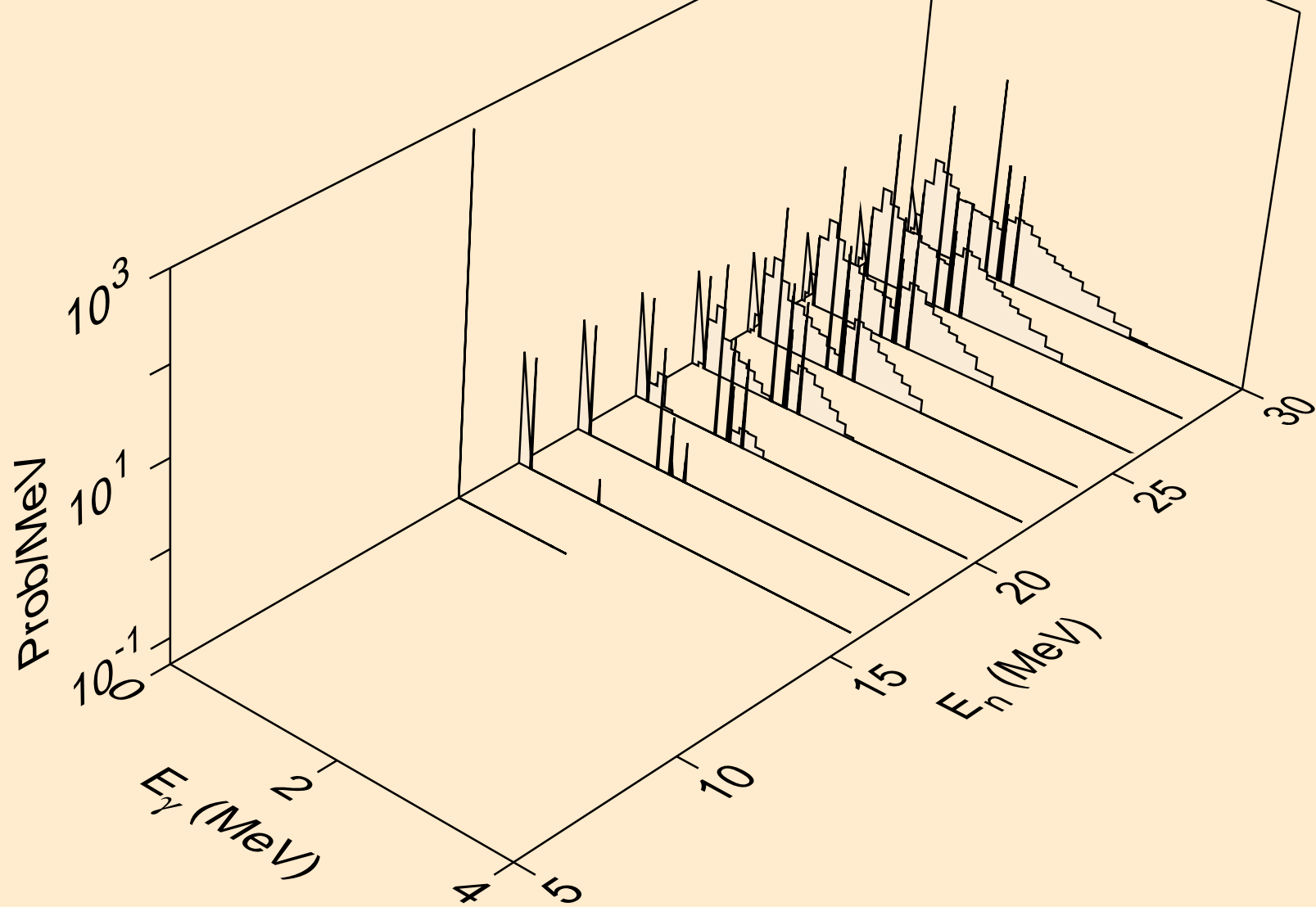

PM143 NEUTRON ACER TENDL-2023 LIBRARY; T=0.K
Photon emission for (n,pt)

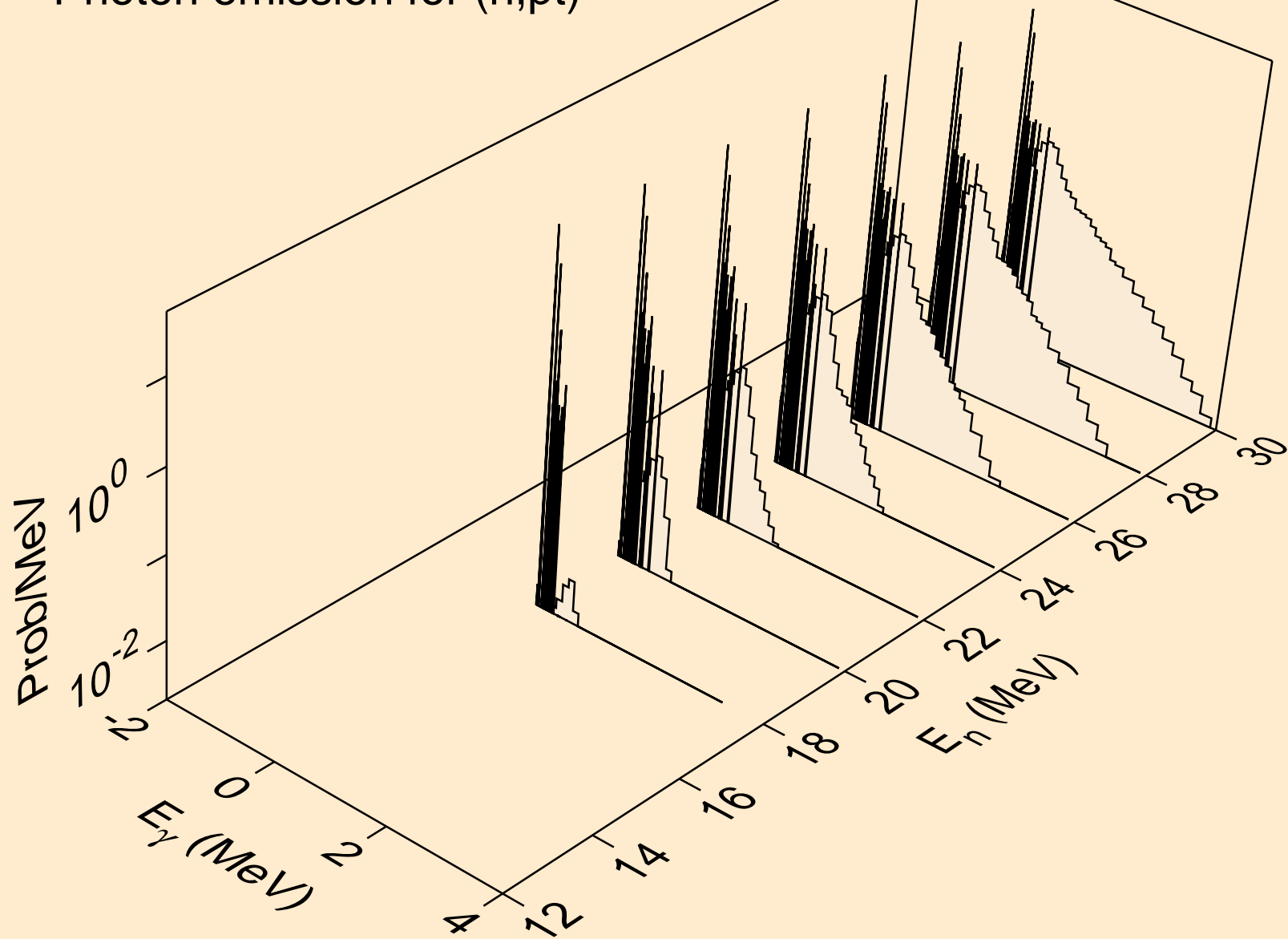

PM143 NEUTRON ACER TENDL-2023 LIBRARY; T=0.K
Photon emission for (n,da)

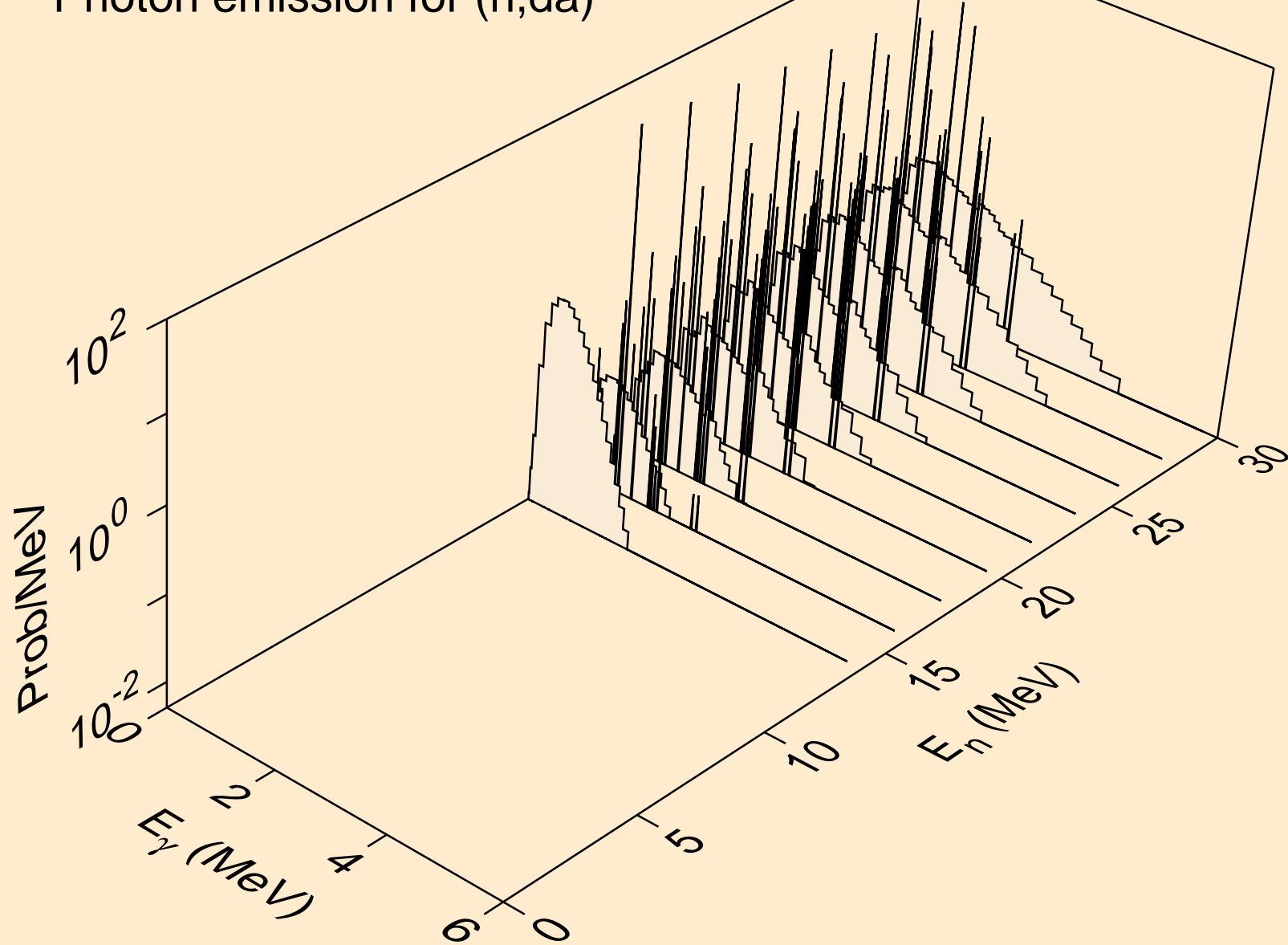

PM143 NEUTRON ACER TENDL-2023 LIBRARY; T=0.K
thermal capture photon spectrum

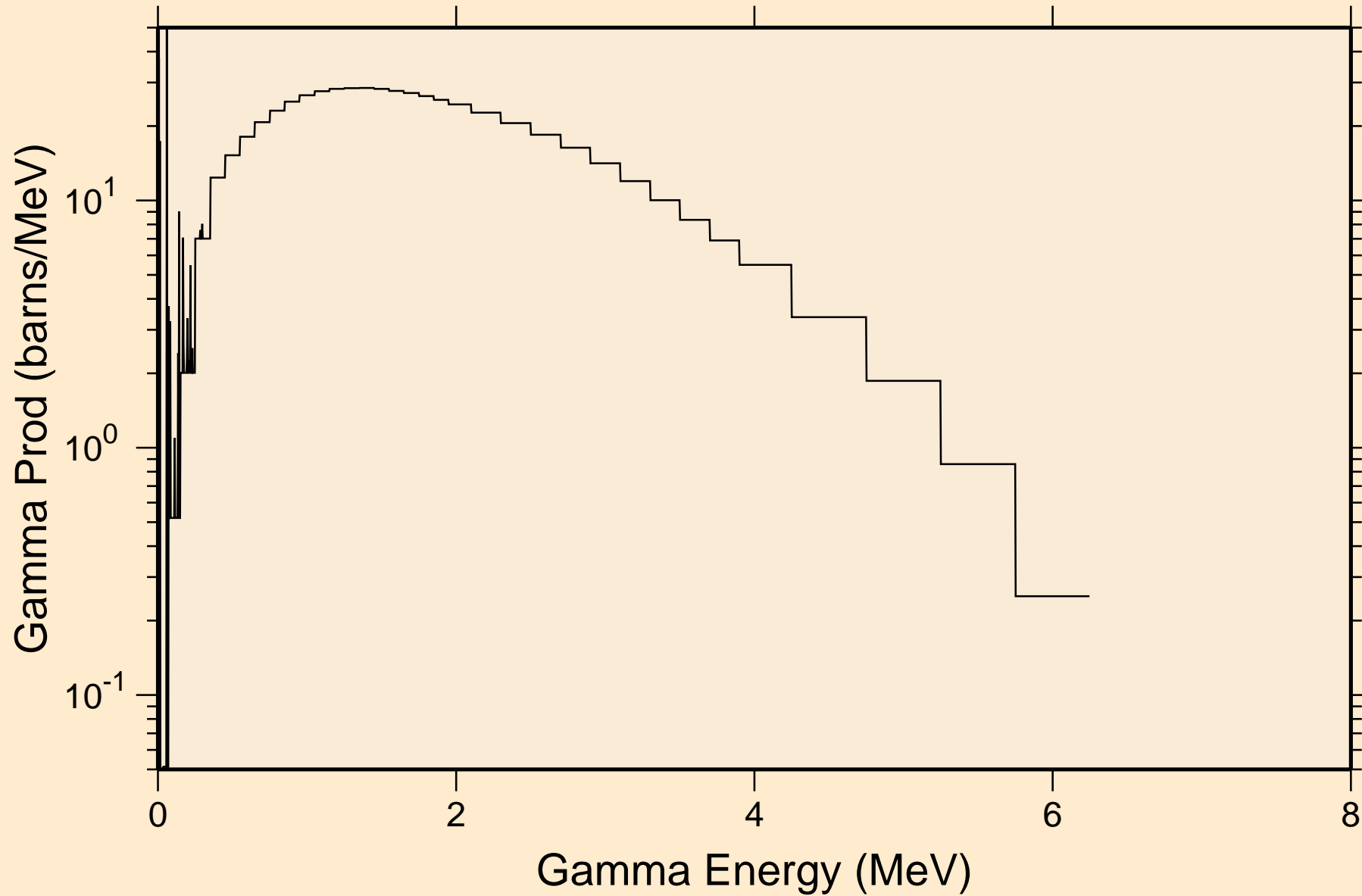

PM143 NEUTRON ACER TENDL-2023 LIBRARY; T=0.K
14 MeV photon spectrum

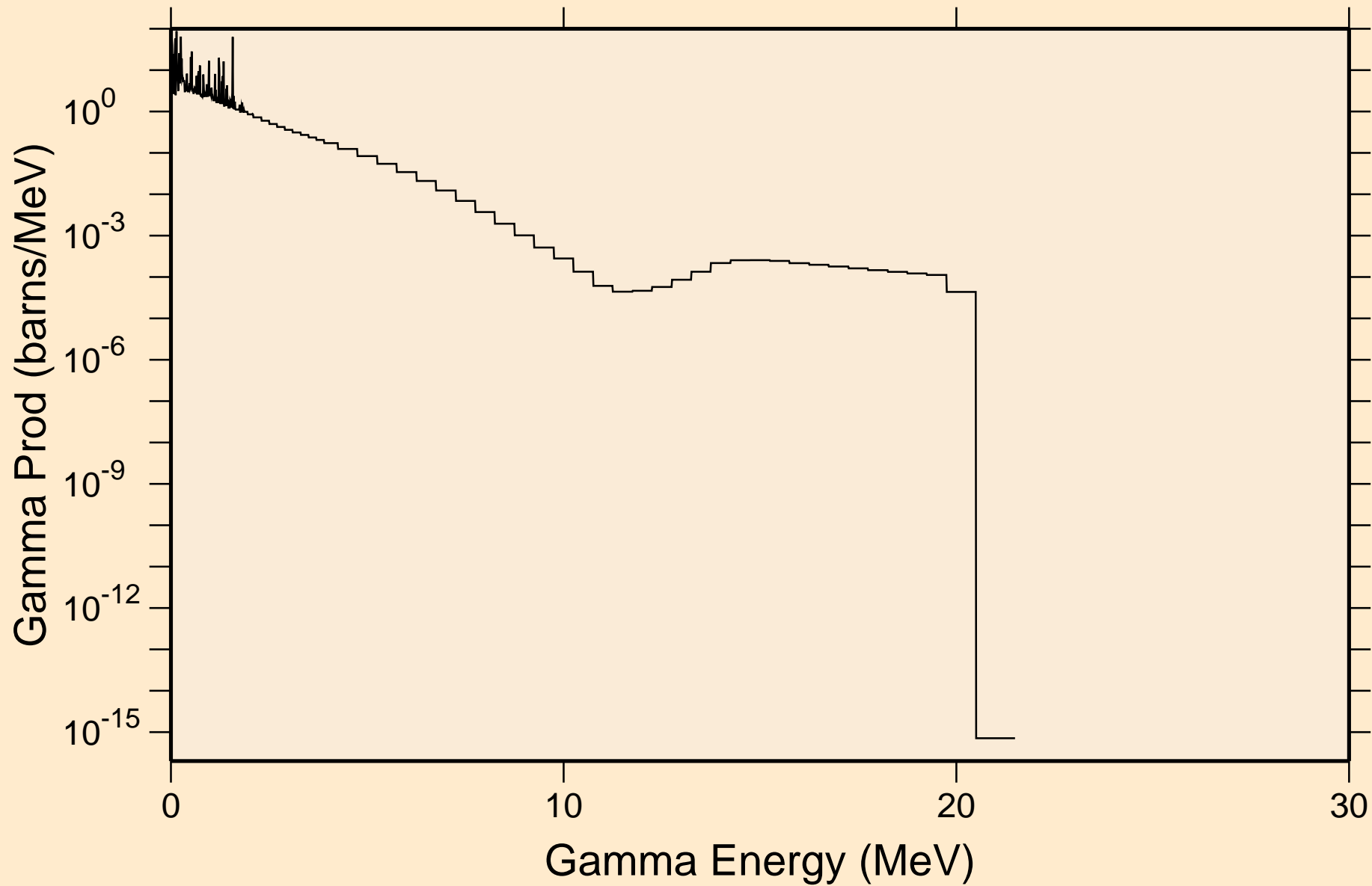

PM143 NEUTRON ACER TENDL-2023 LIBRARY; T=0.K

Particle heating contributions

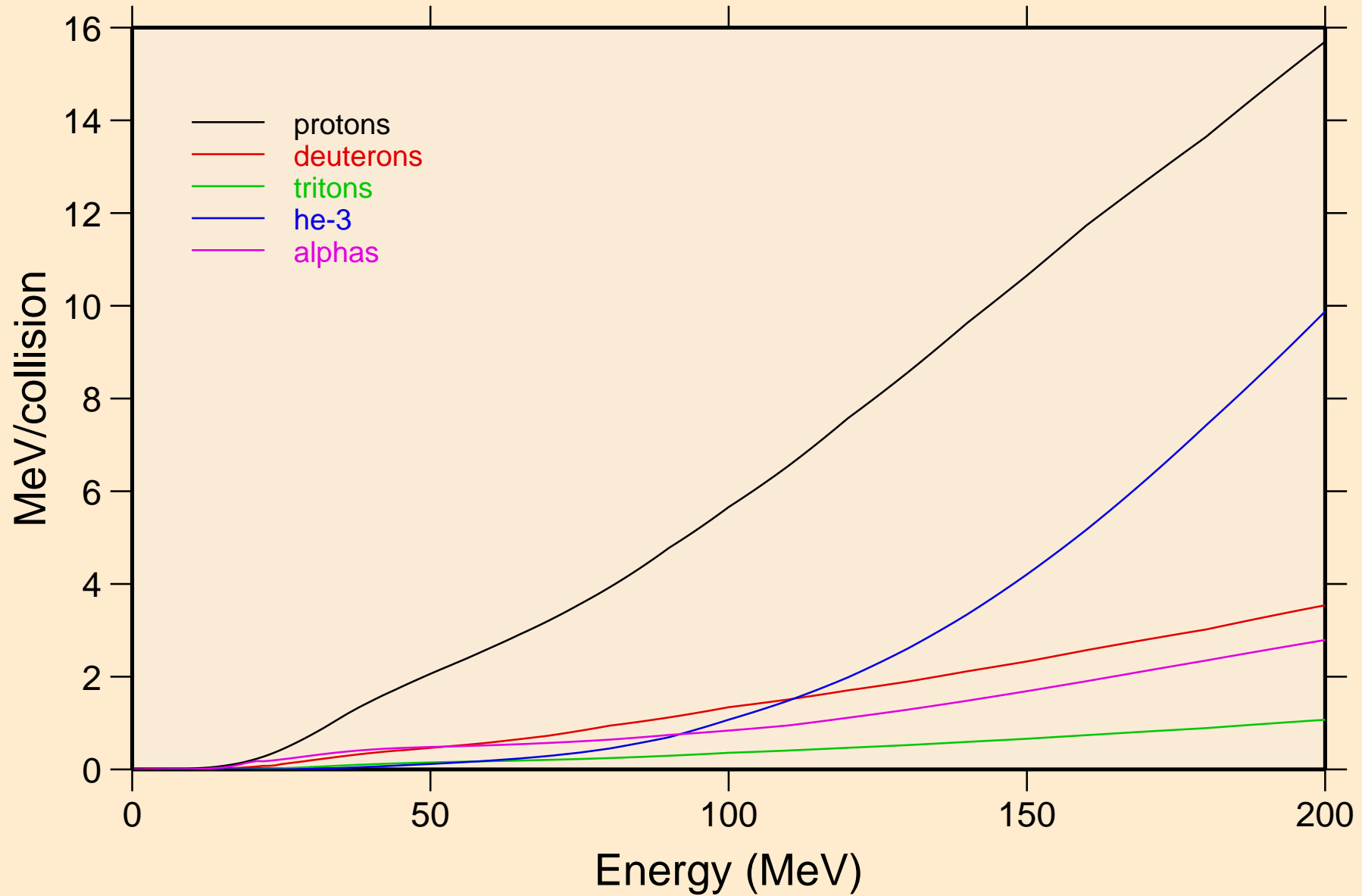

PM143 NEUTRON ACER TENDL-2023 LIBRARY; T=0.K
Recoil Heating

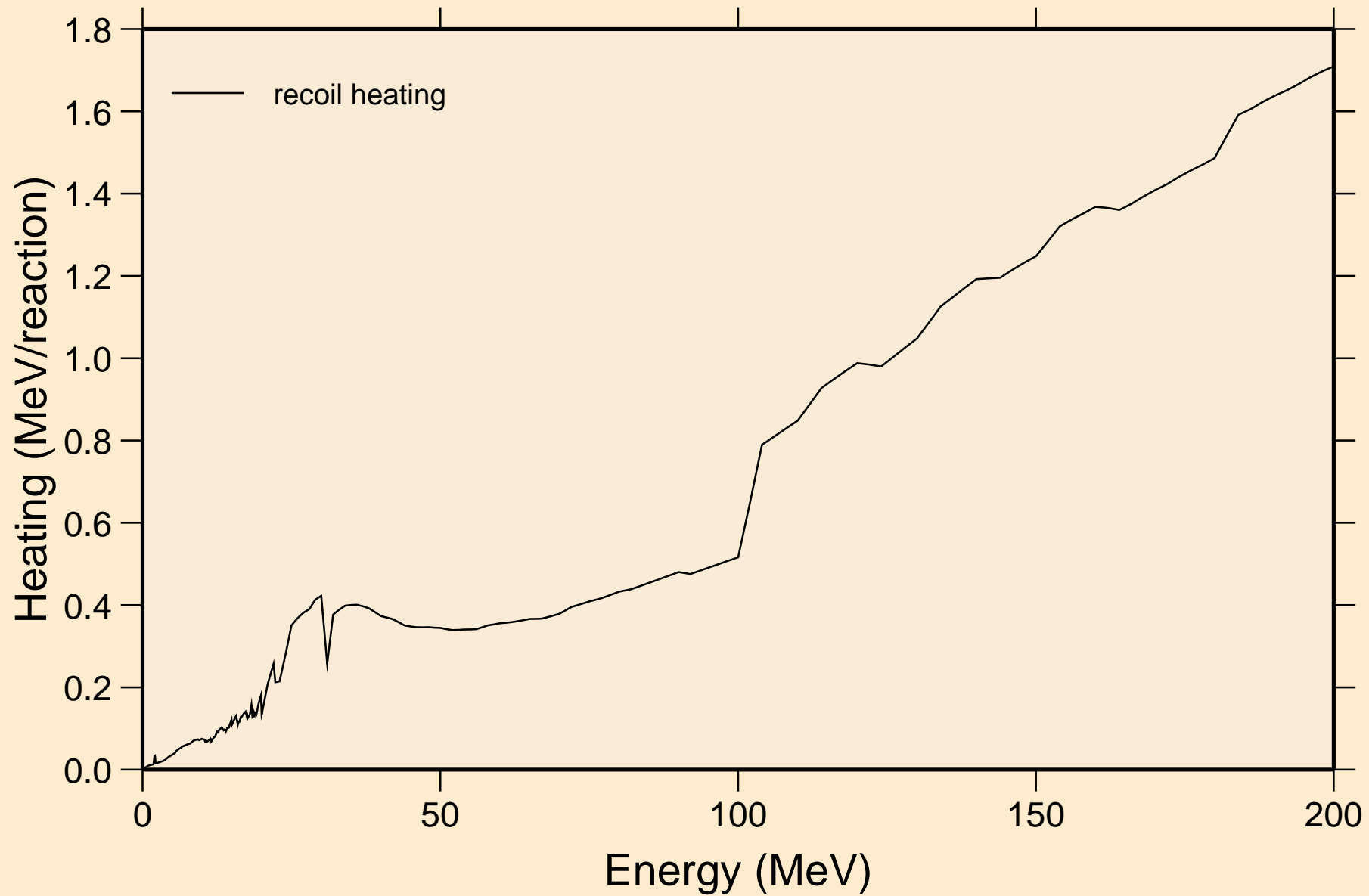

PM143 NEUTRON ACER TENDL-2023 LIBRARY; T=0.K
Particle production cross sections

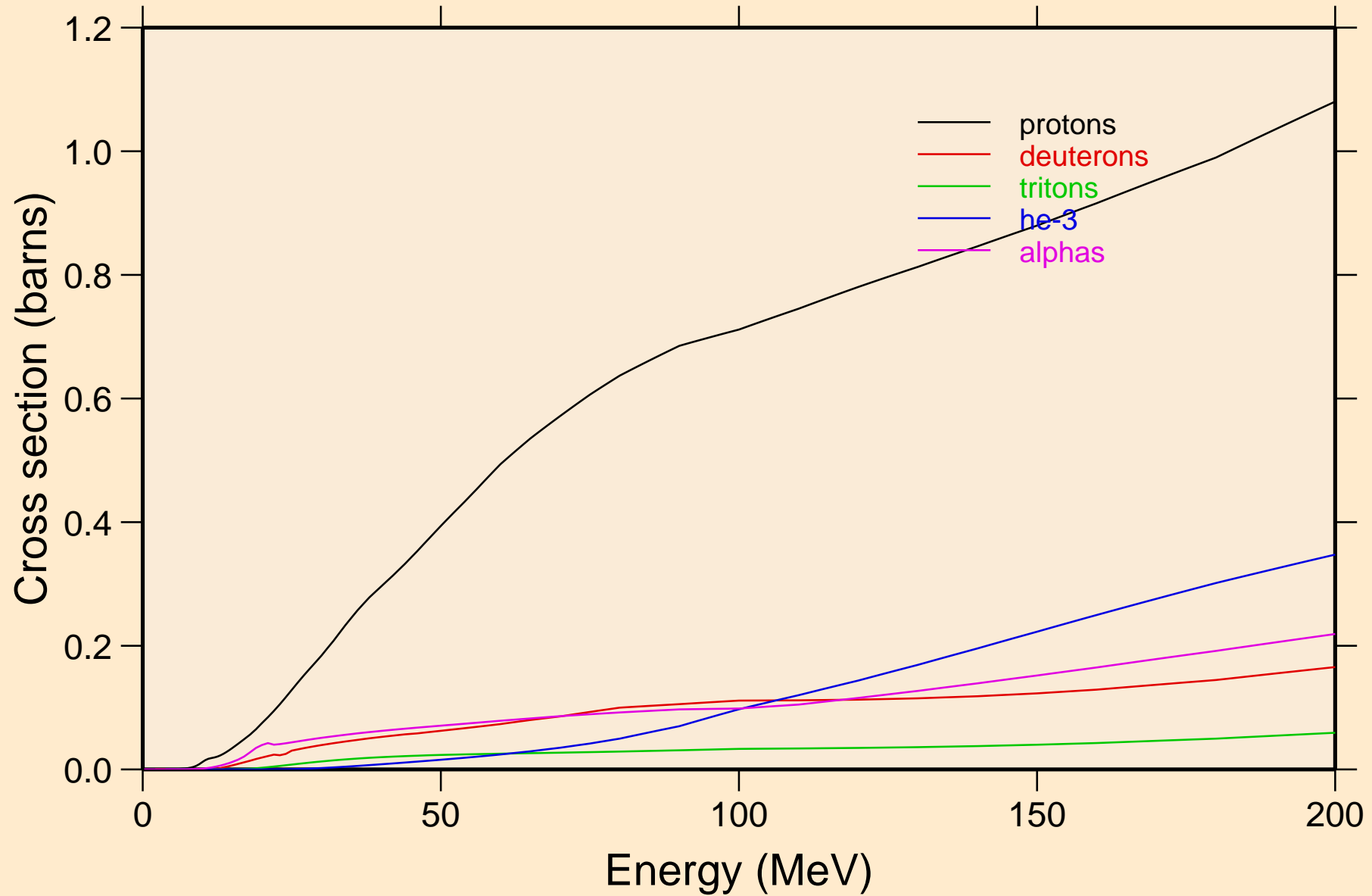

PM143 NEUTRON ACER TENDL-2023 LIBRARY; T=0.K
protons from (n,x)

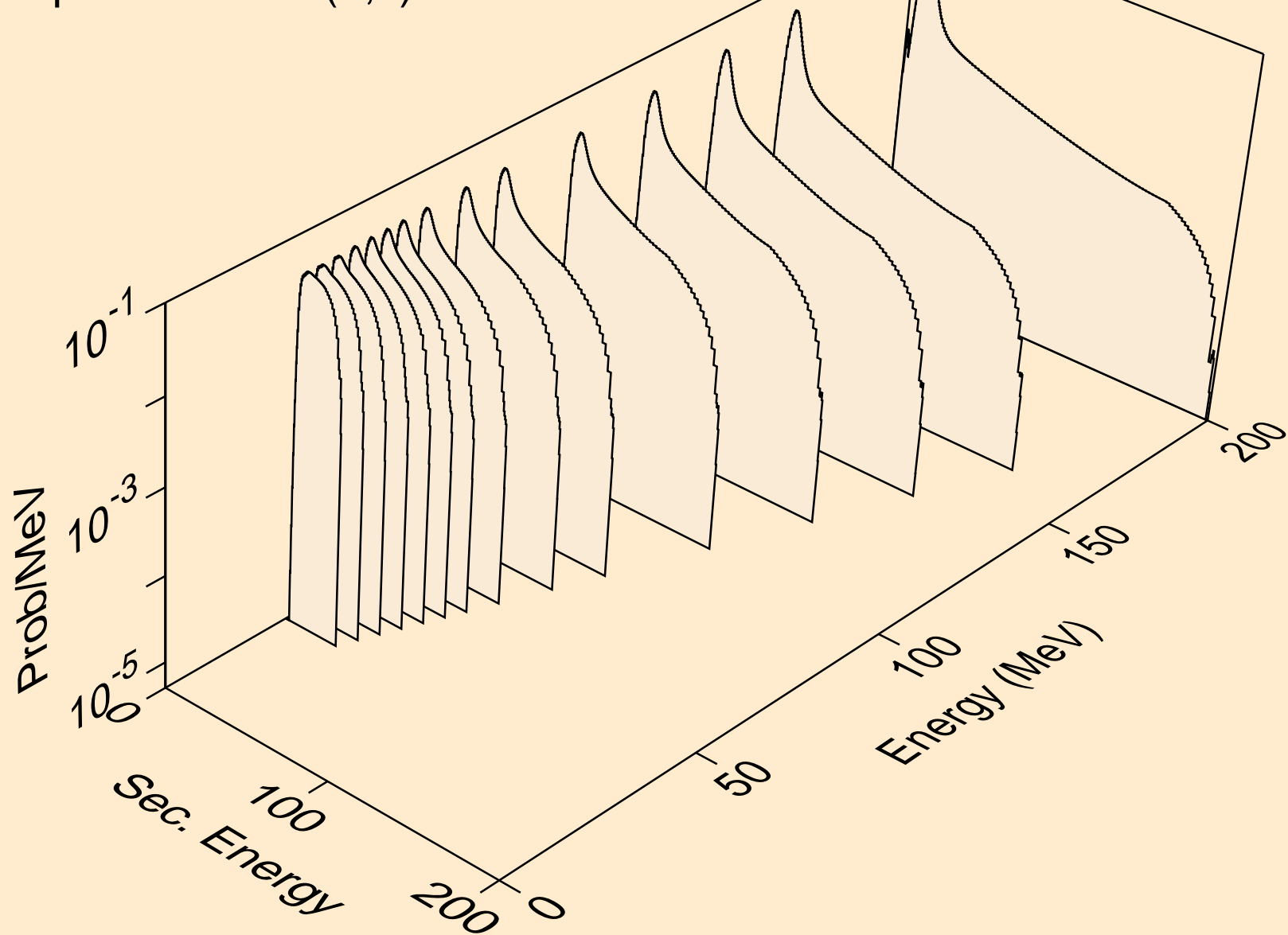

PM143 NEUTRON ACER TENDL-2023 LIBRARY; T=0.K
protons from (n,n*)p

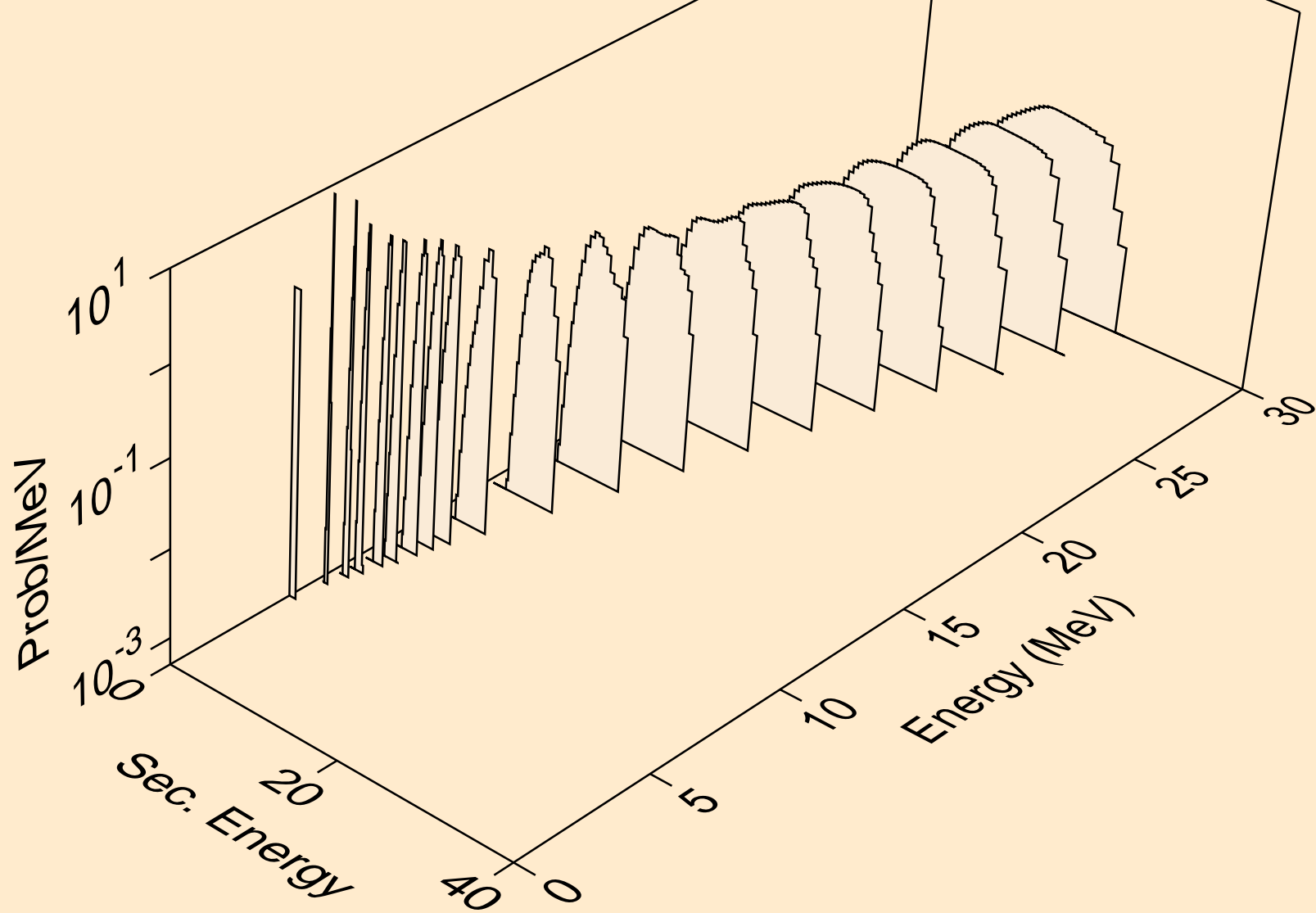

PM143 NEUTRON ACER TENDL-2023 LIBRARY; T=0.K
protons from (n,2np)

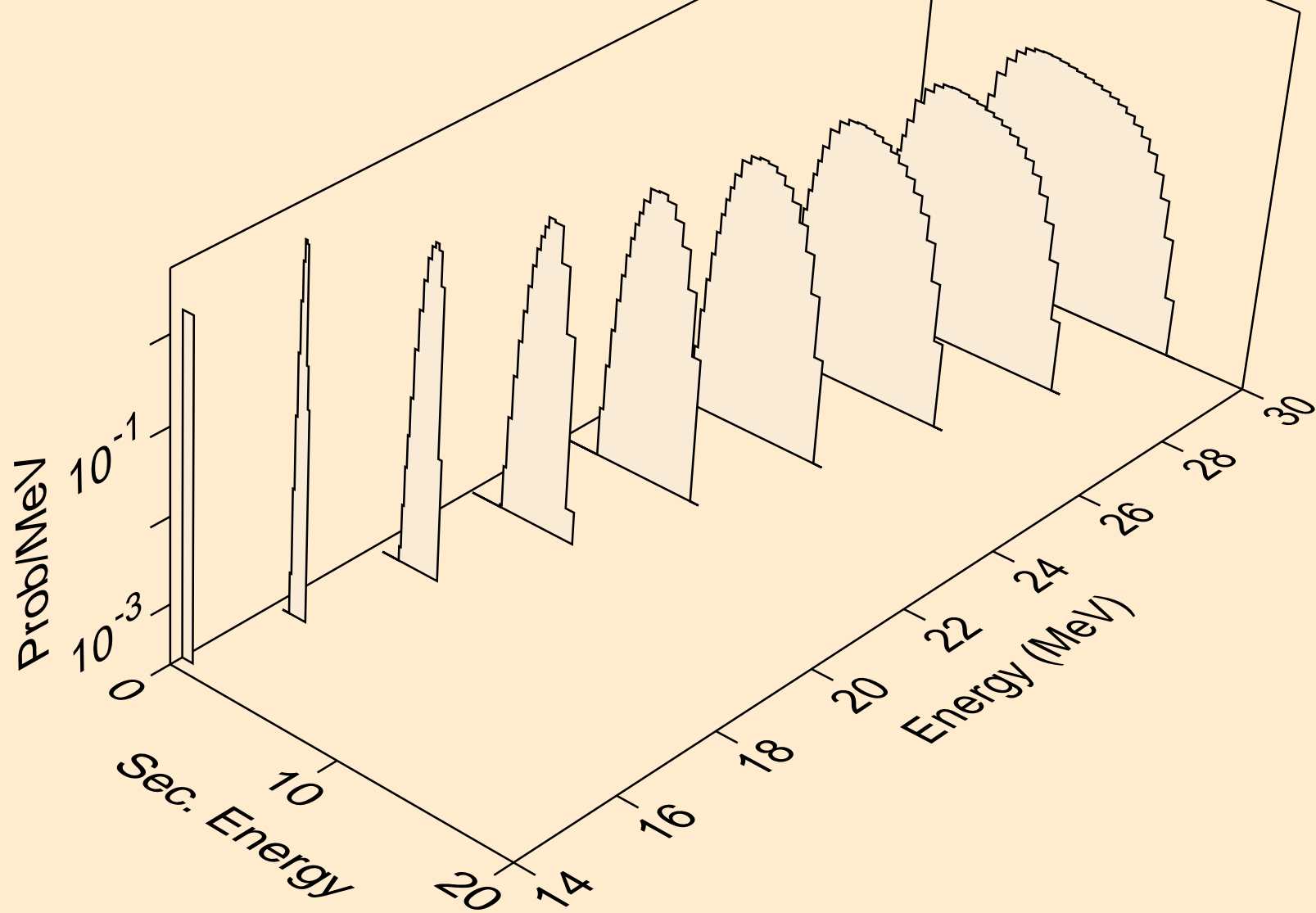

PM143 NEUTRON ACER TENDL-2023 LIBRARY; T=0.K
protons from (n,3np)

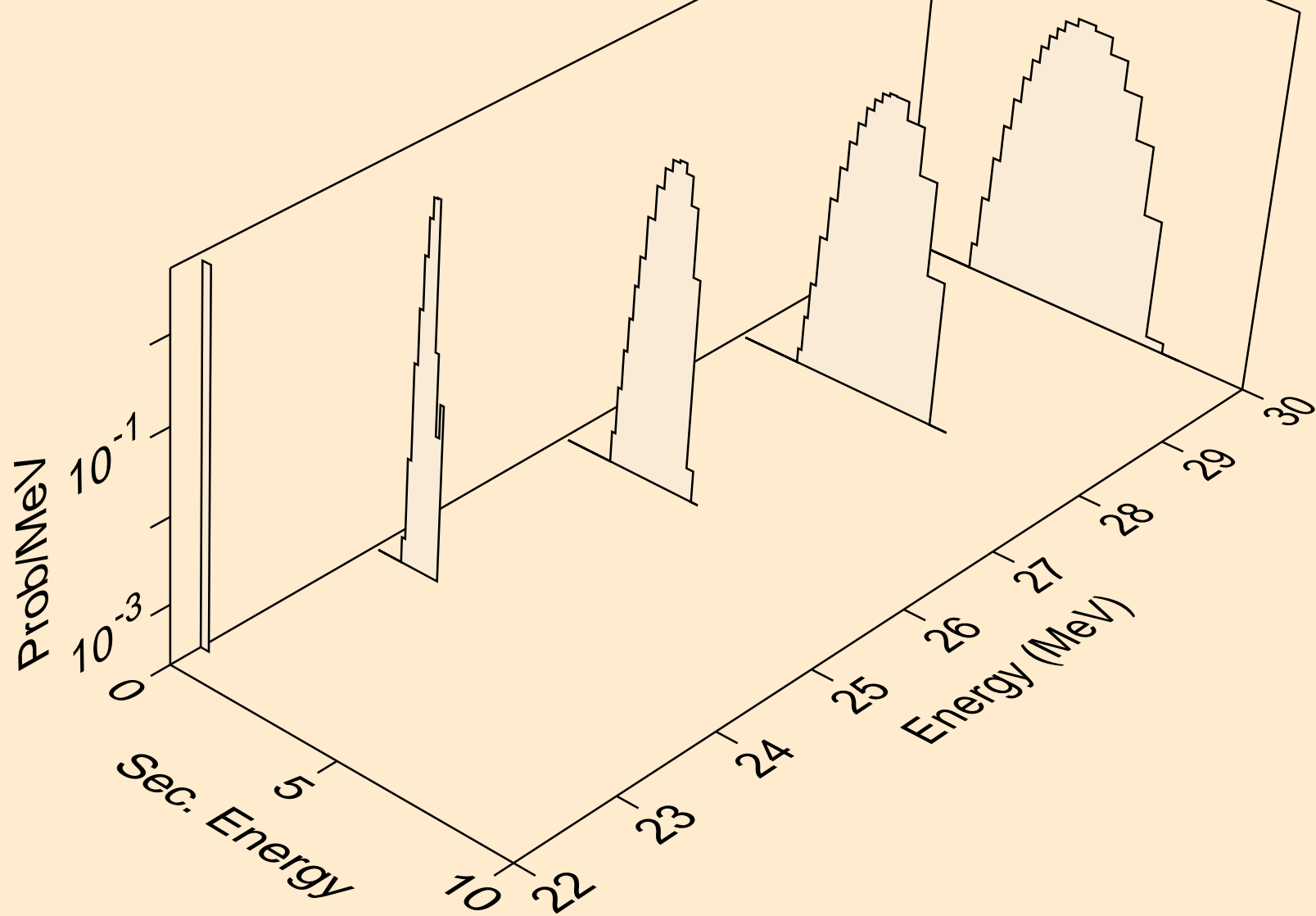

PM143 NEUTRON ACER TENDL-2023 LIBRARY; T=0.K
protons from (n,n2p)

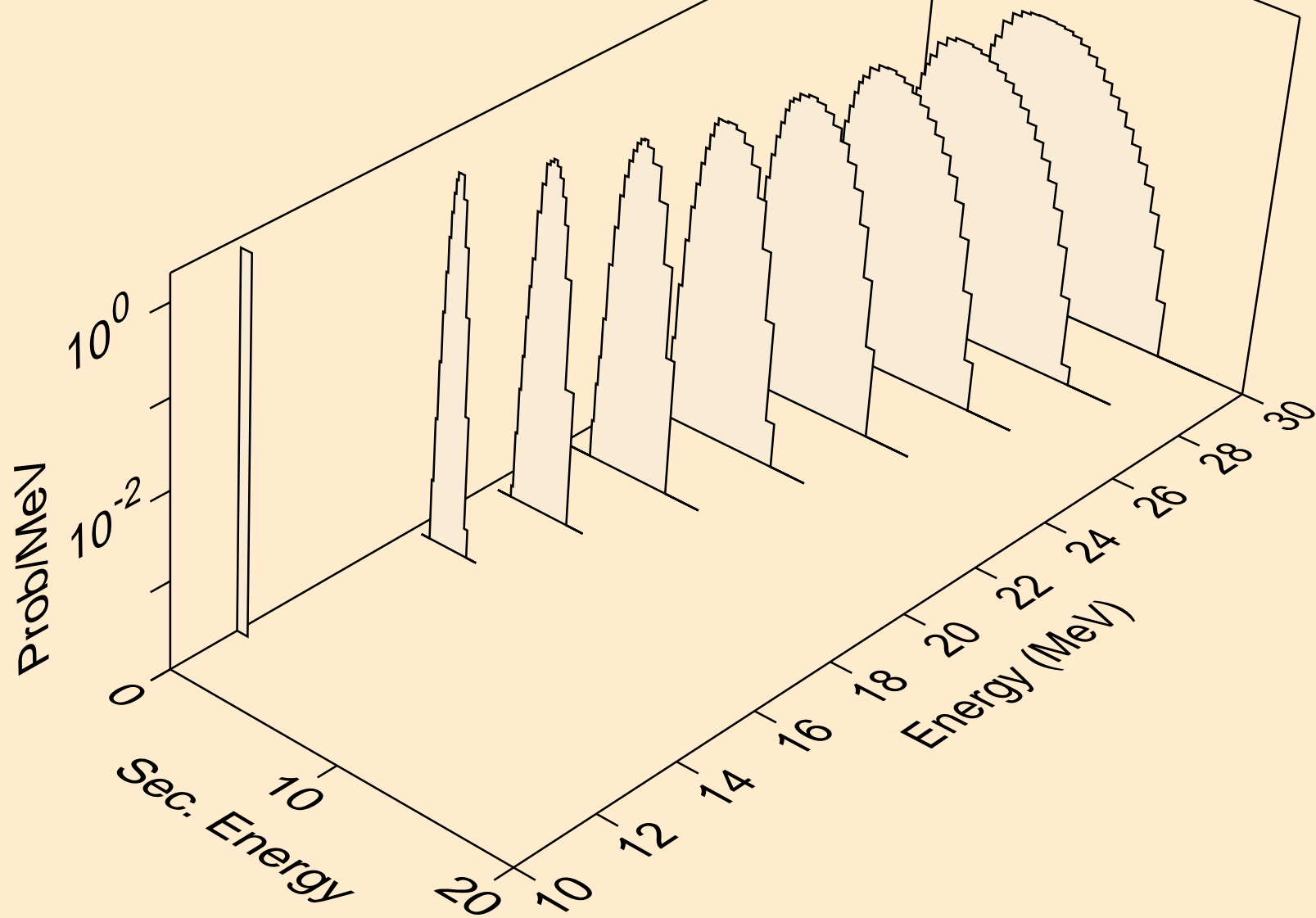

PM143 NEUTRON ACER TENDL-2023 LIBRARY; T=0.K
protons from (n,npa)

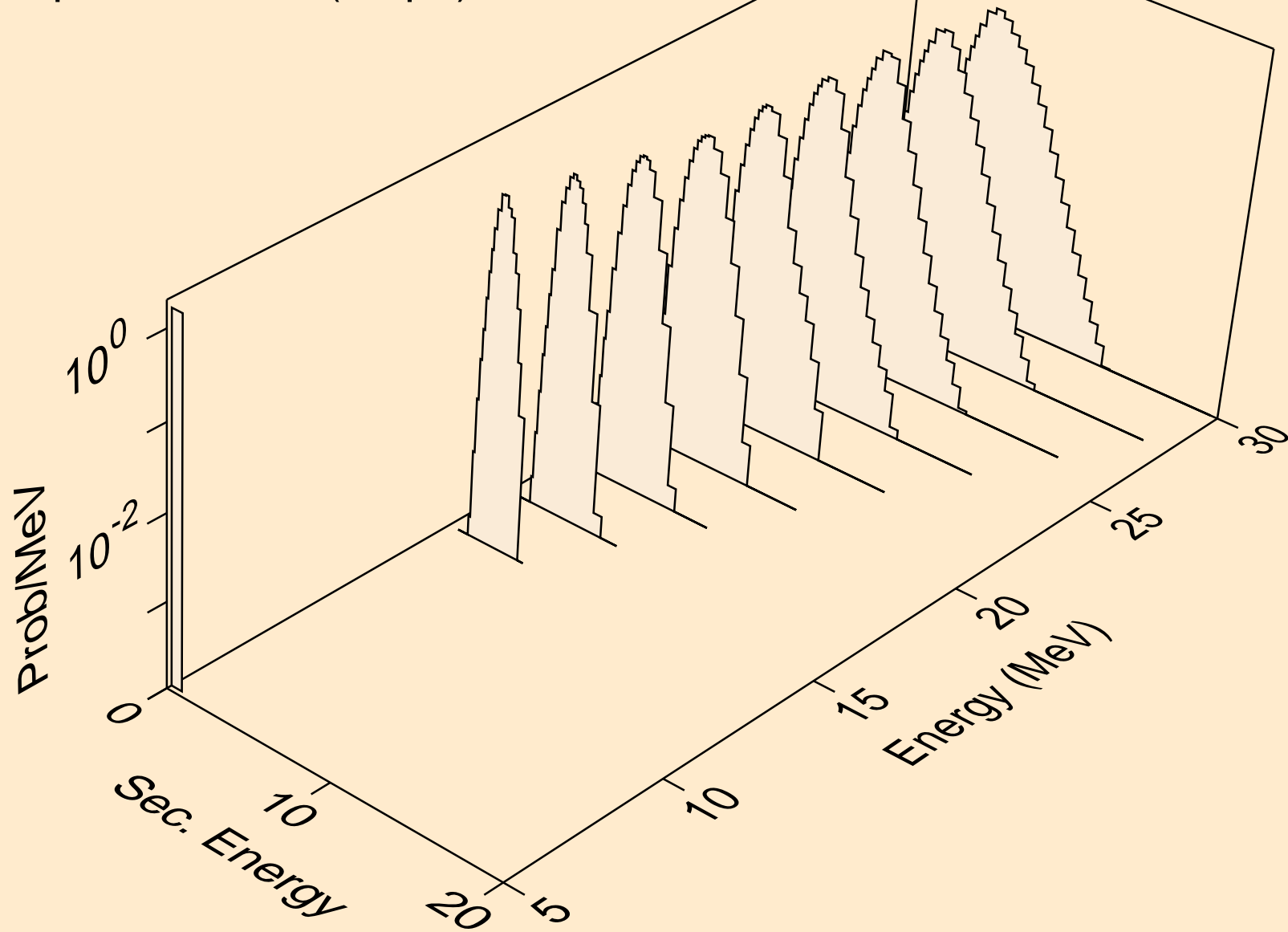

PM143 NEUTRON ACER TENDL-2023 LIBRARY; T=0.K
protons from (n,p)

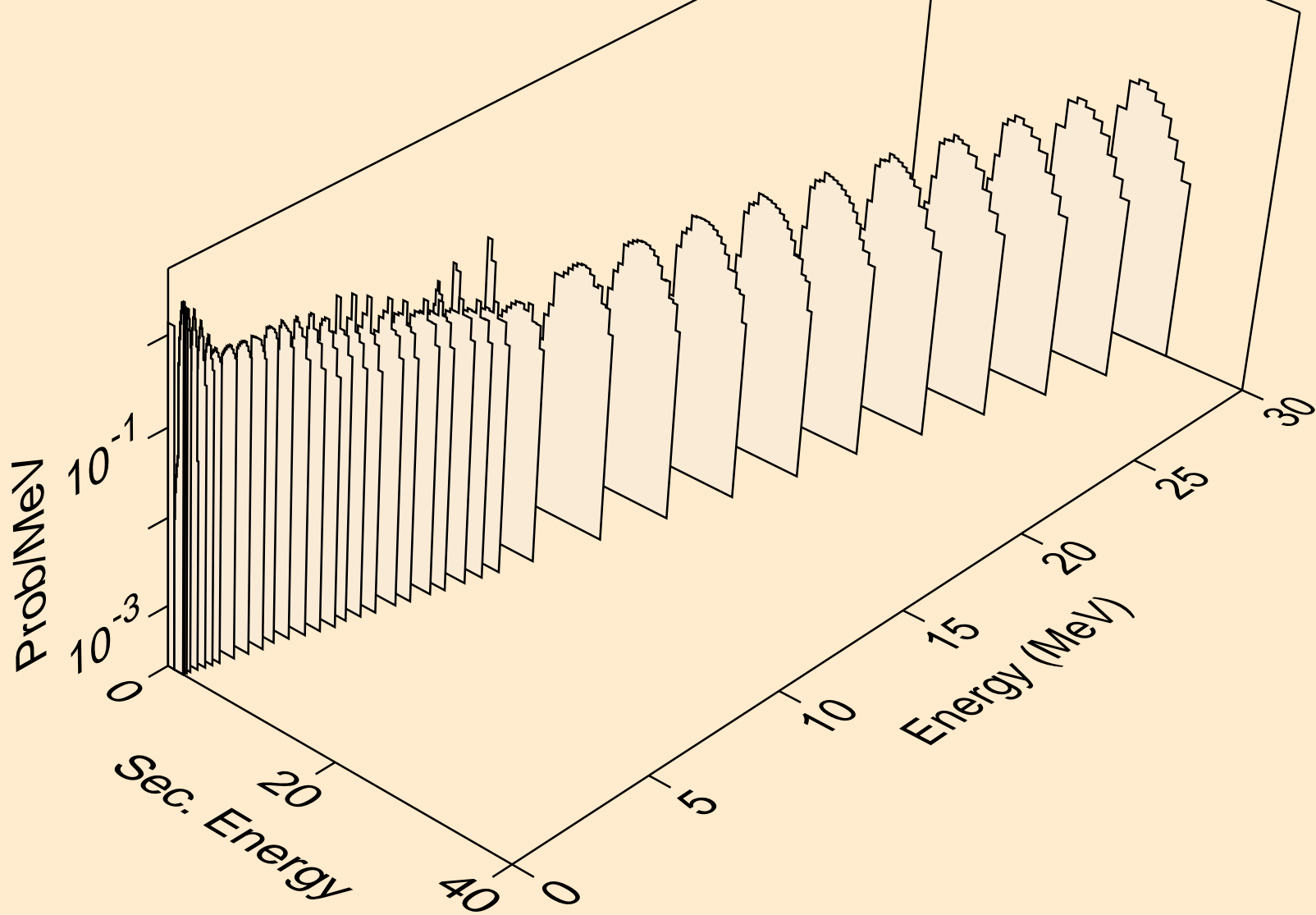

PM143 NEUTRON ACER TENDL-2023 LIBRARY; T=0.K
protons from (n,2p)

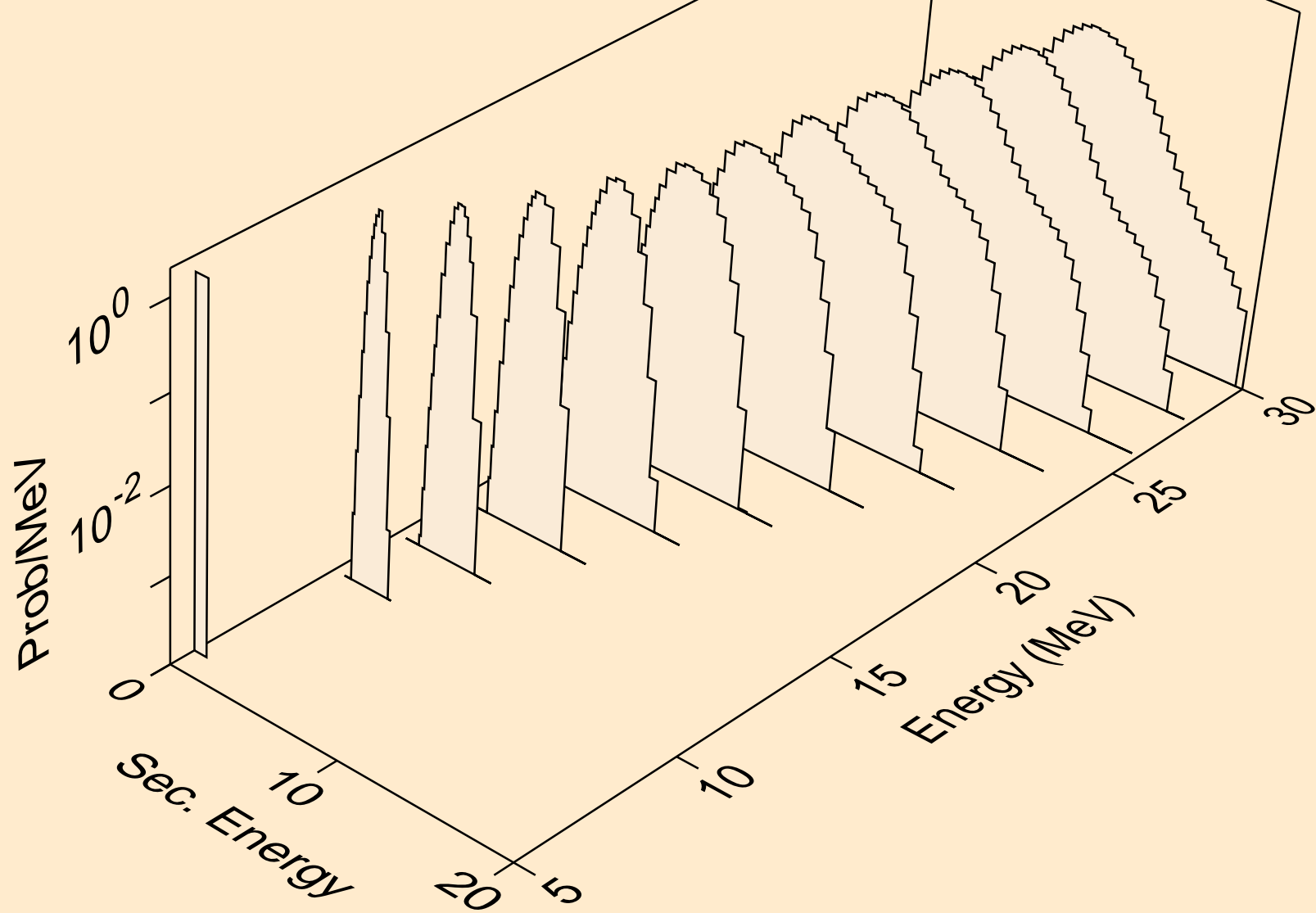

PM143 NEUTRON ACER TENDL-2023 LIBRARY; T=0.K
protons from (n,pa)

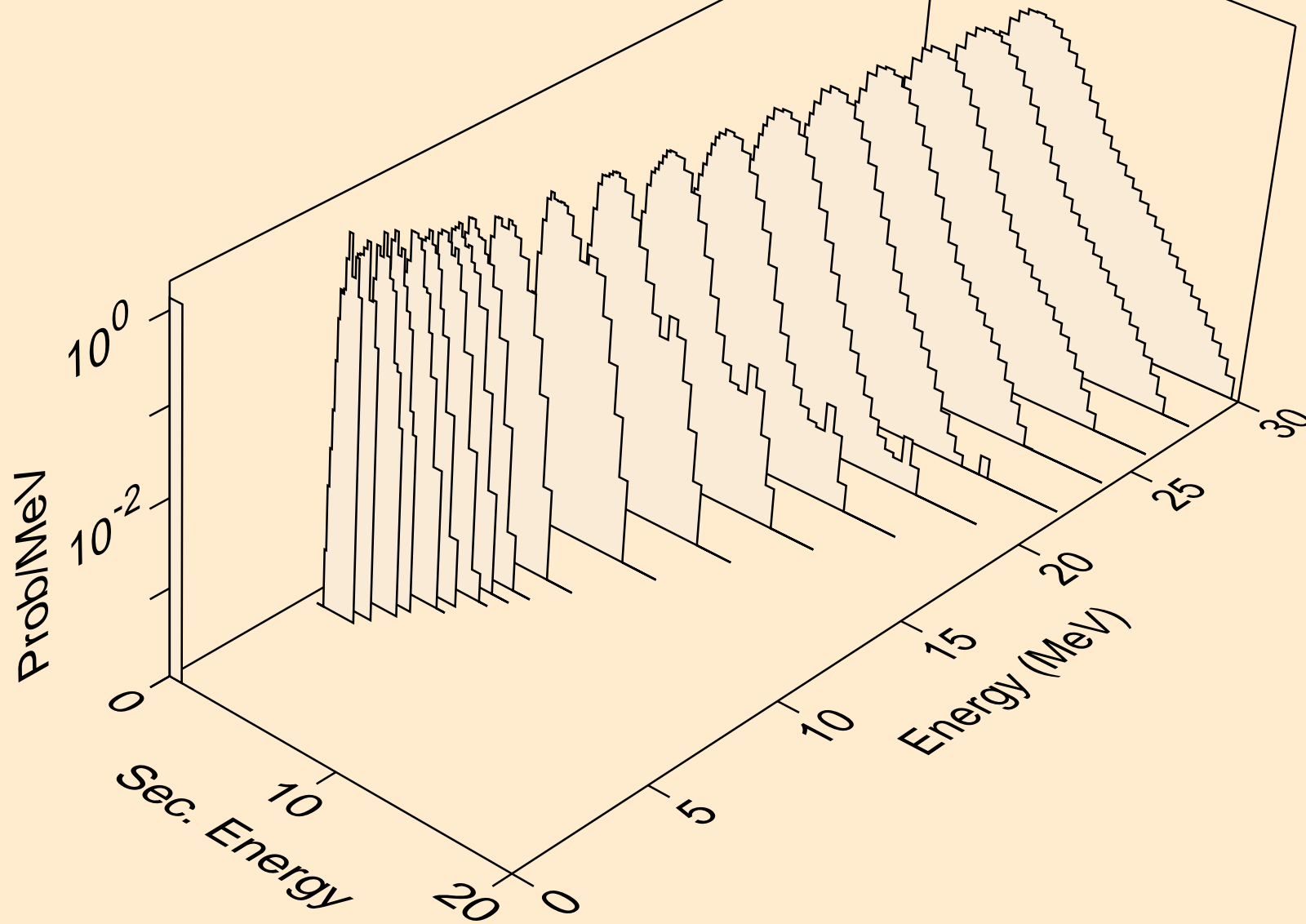

PM143 NEUTRON ACER TENDL-2023 LIBRARY; T=0.K
protons from (n,pd)

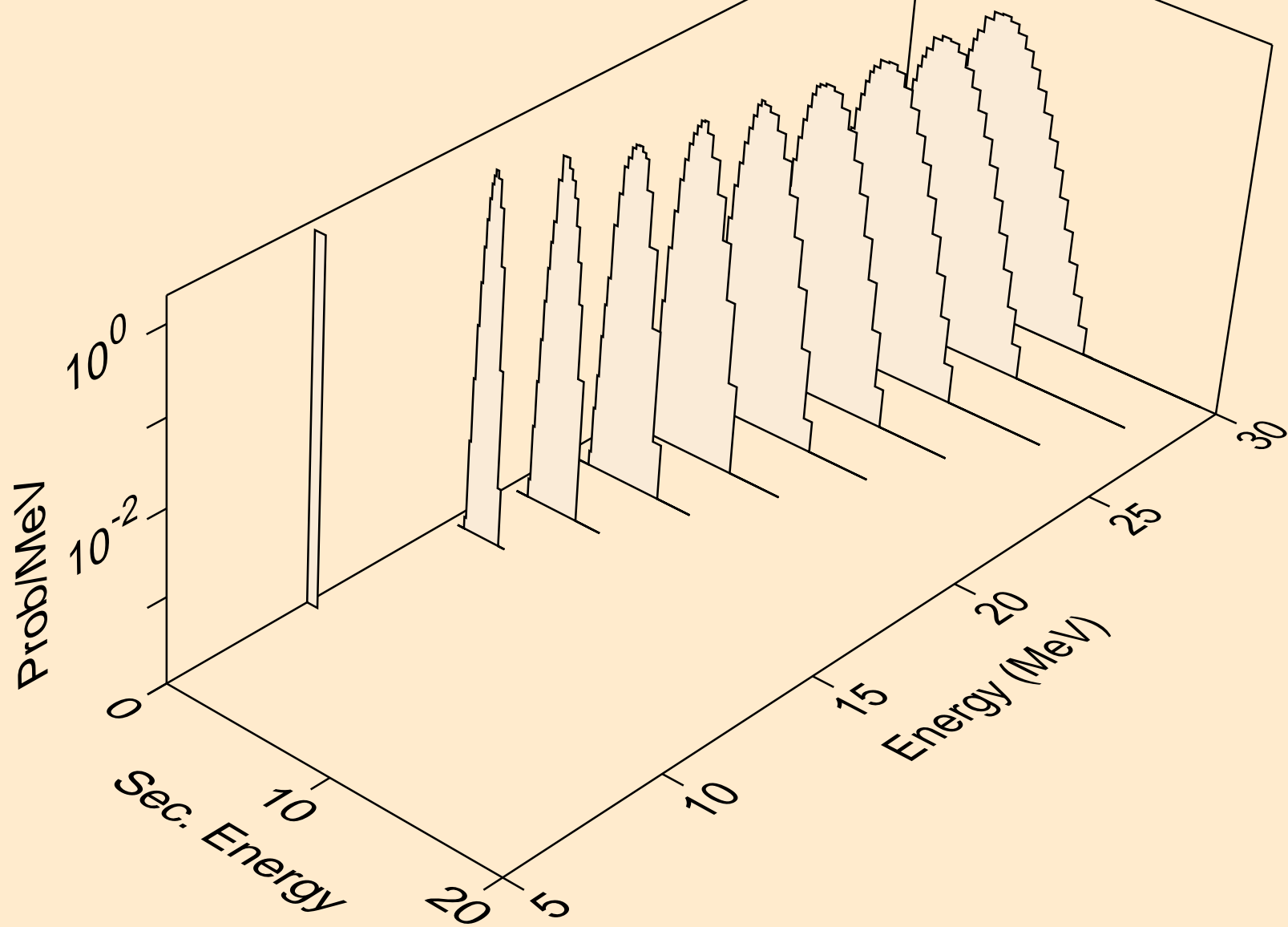

PM143 NEUTRON ACER TENDL-2023 LIBRARY; T=0.K
protons from (n,pt)

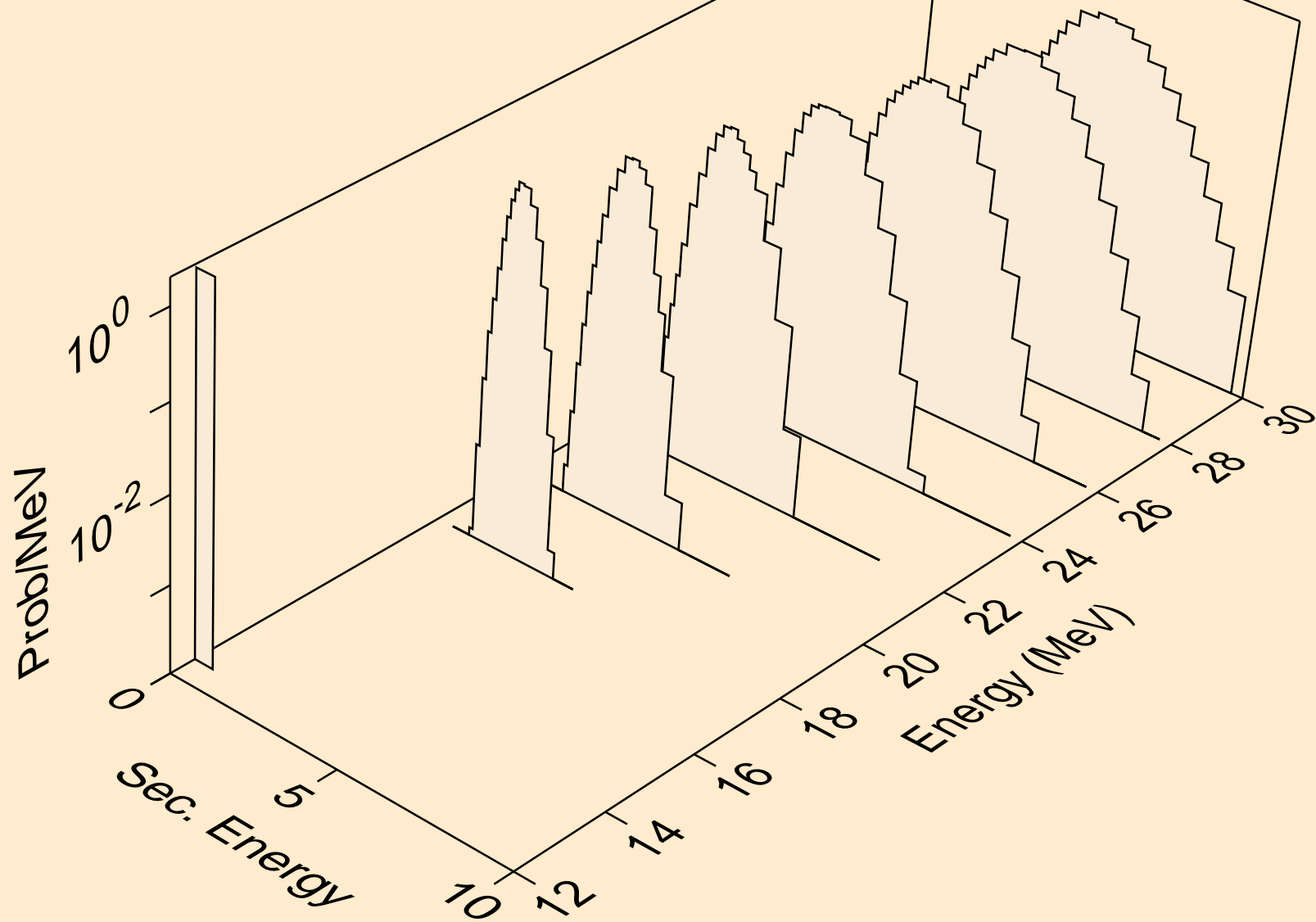

PM143 NEUTRON ACER TENDL-2023 LIBRARY; T=0.K
deuterons from (n,x)

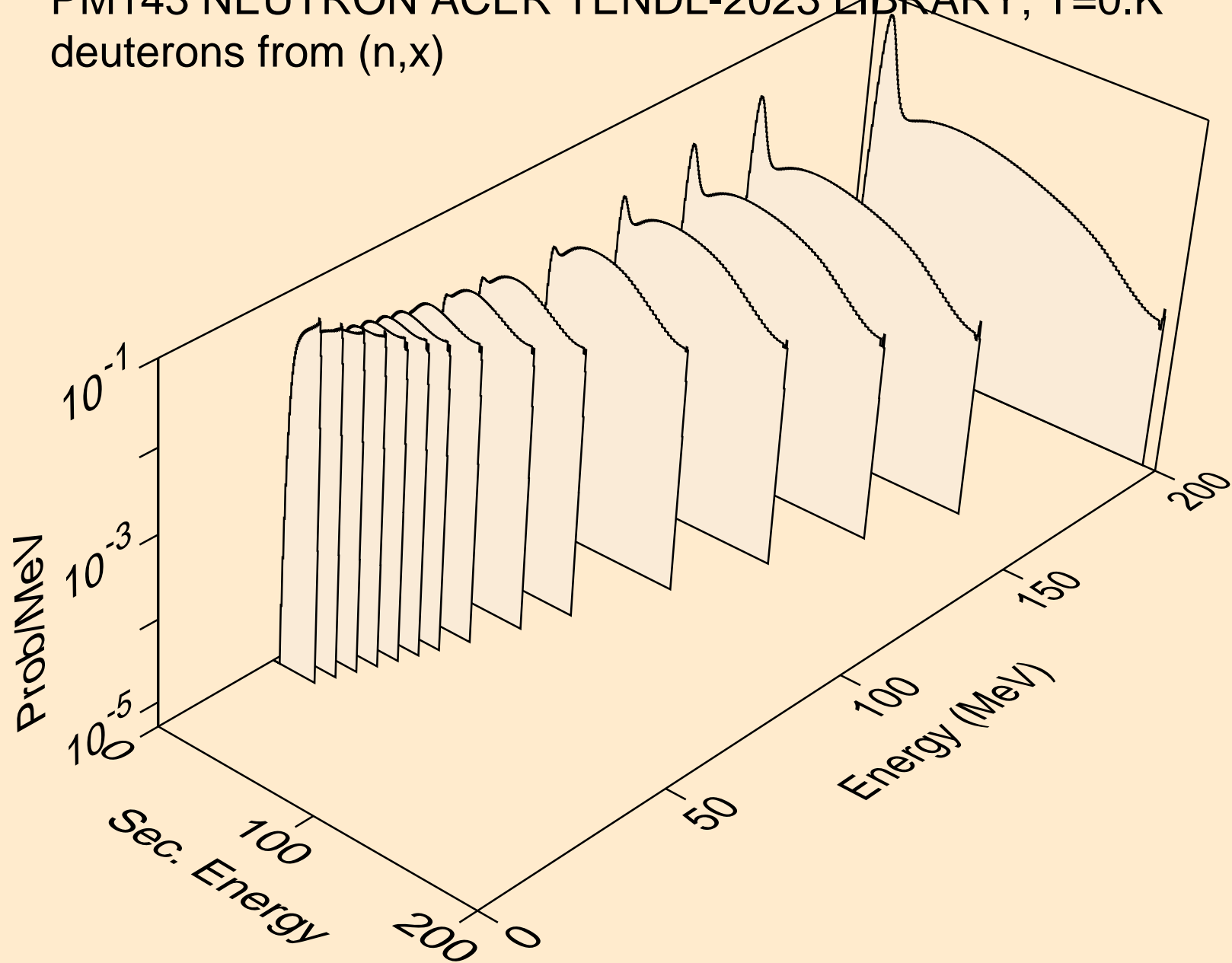

PM143 NEUTRON ACER TENDL-2023 LIBRARY; T=0.K
deuterons from (n,2nd)

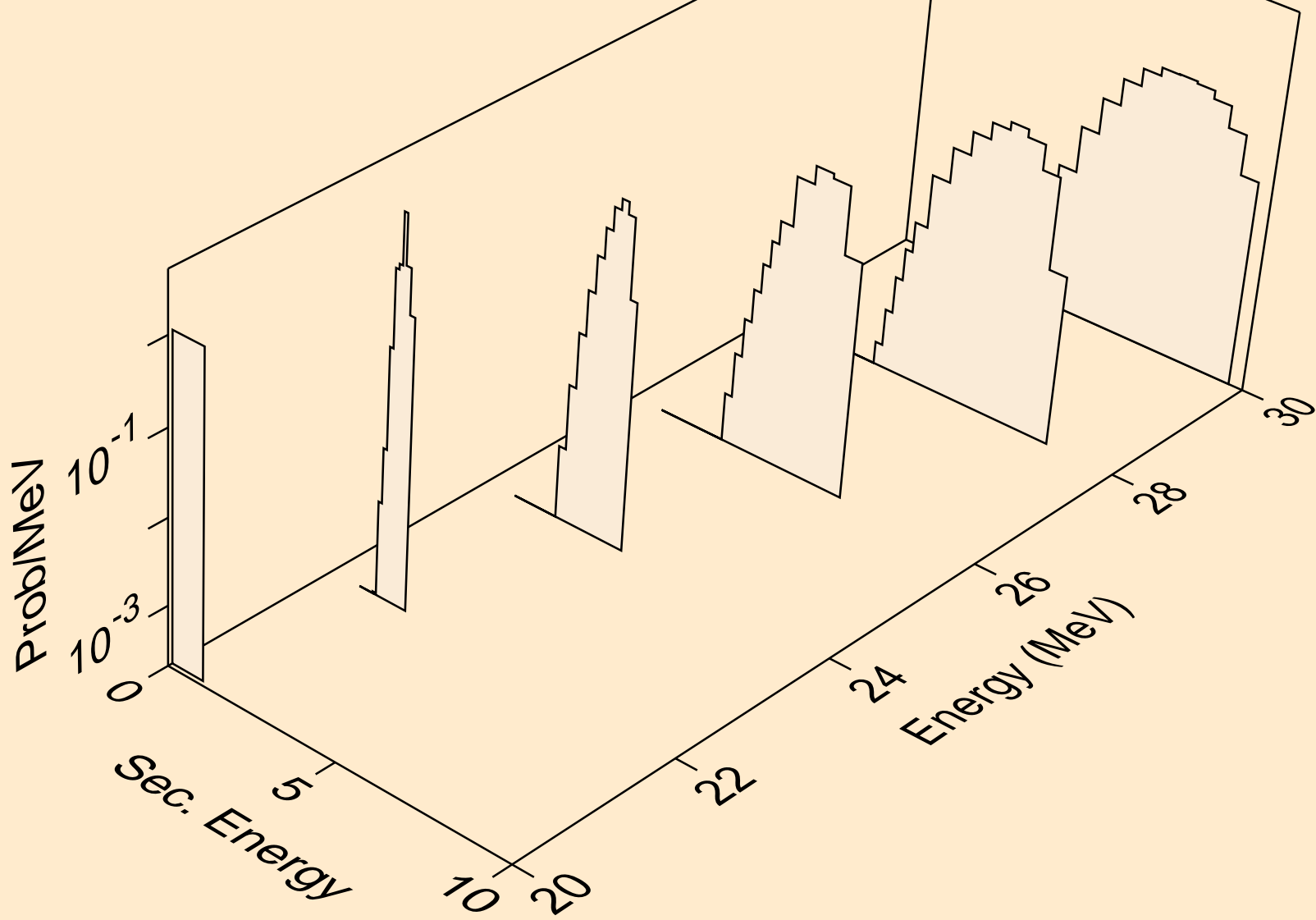

PM143 NEUTRON ACER TENDL-2023 LIBRARY; T=0.K
deuterons from (n,n*)d

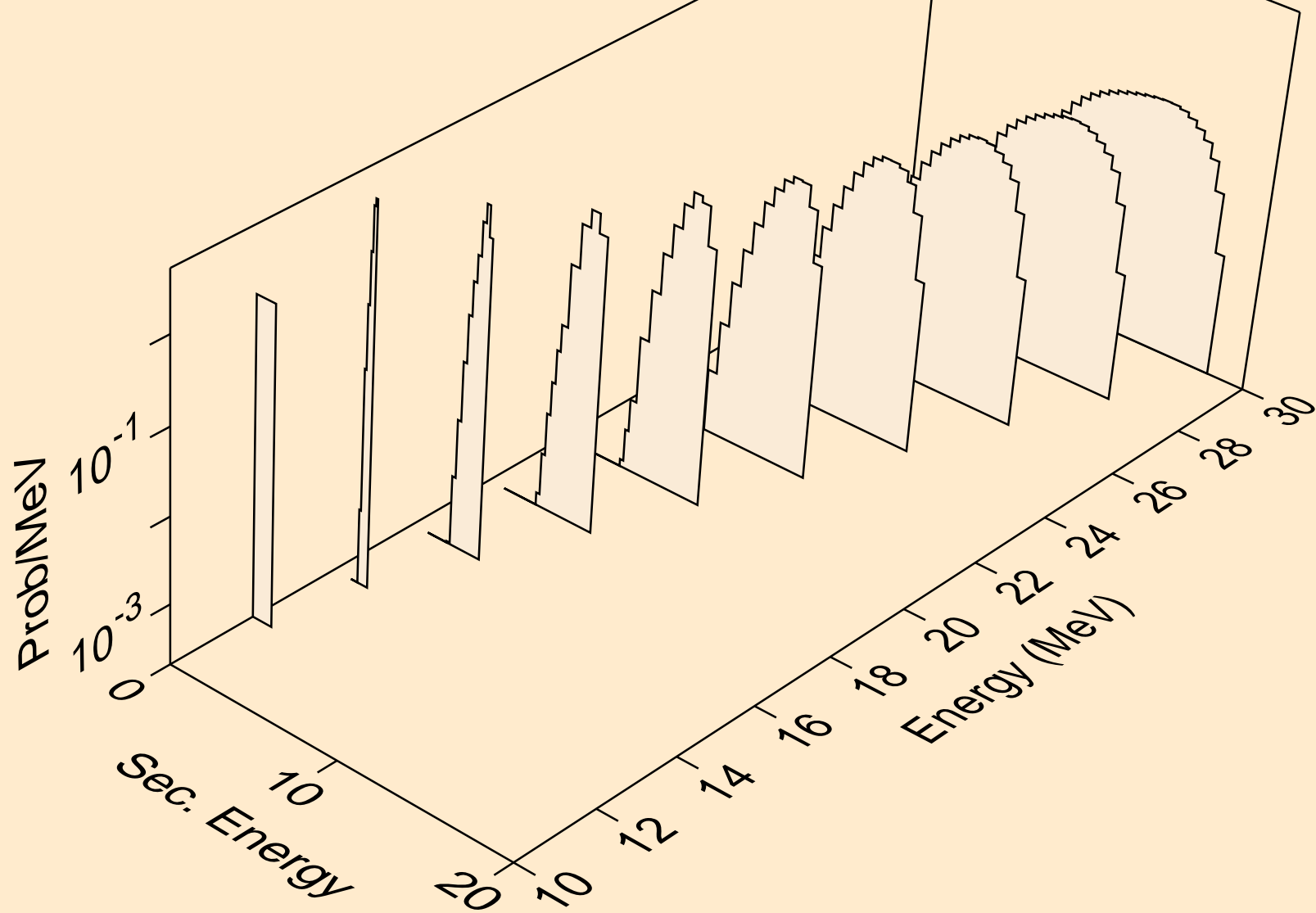

PM143 NEUTRON ACER TENDL-2023 LIBRARY; T=0.K
deuterons from (n,d)

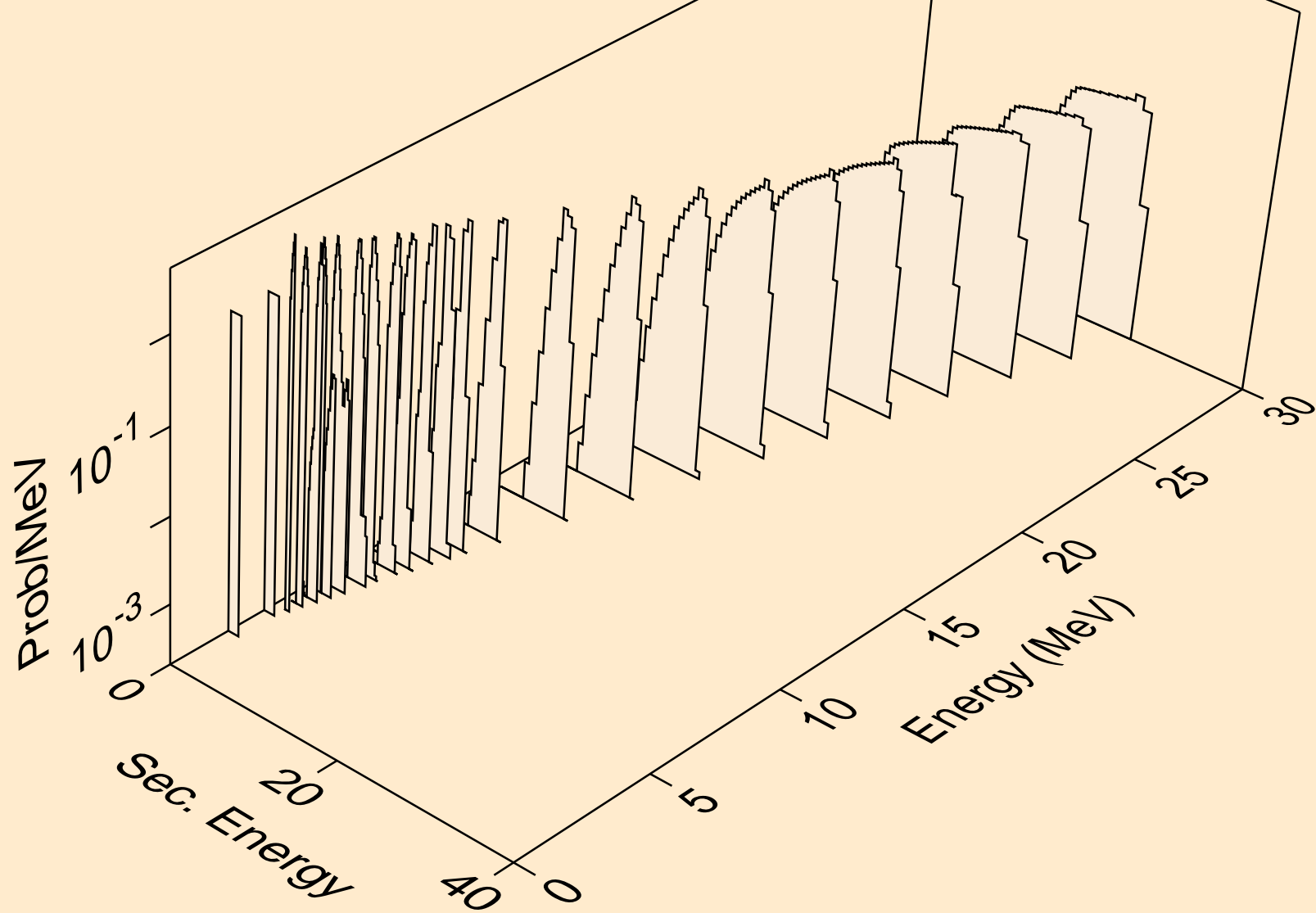

PM143 NEUTRON ACER TENDL-2023 LIBRARY; T=0.K
deuterons from (n,pd)

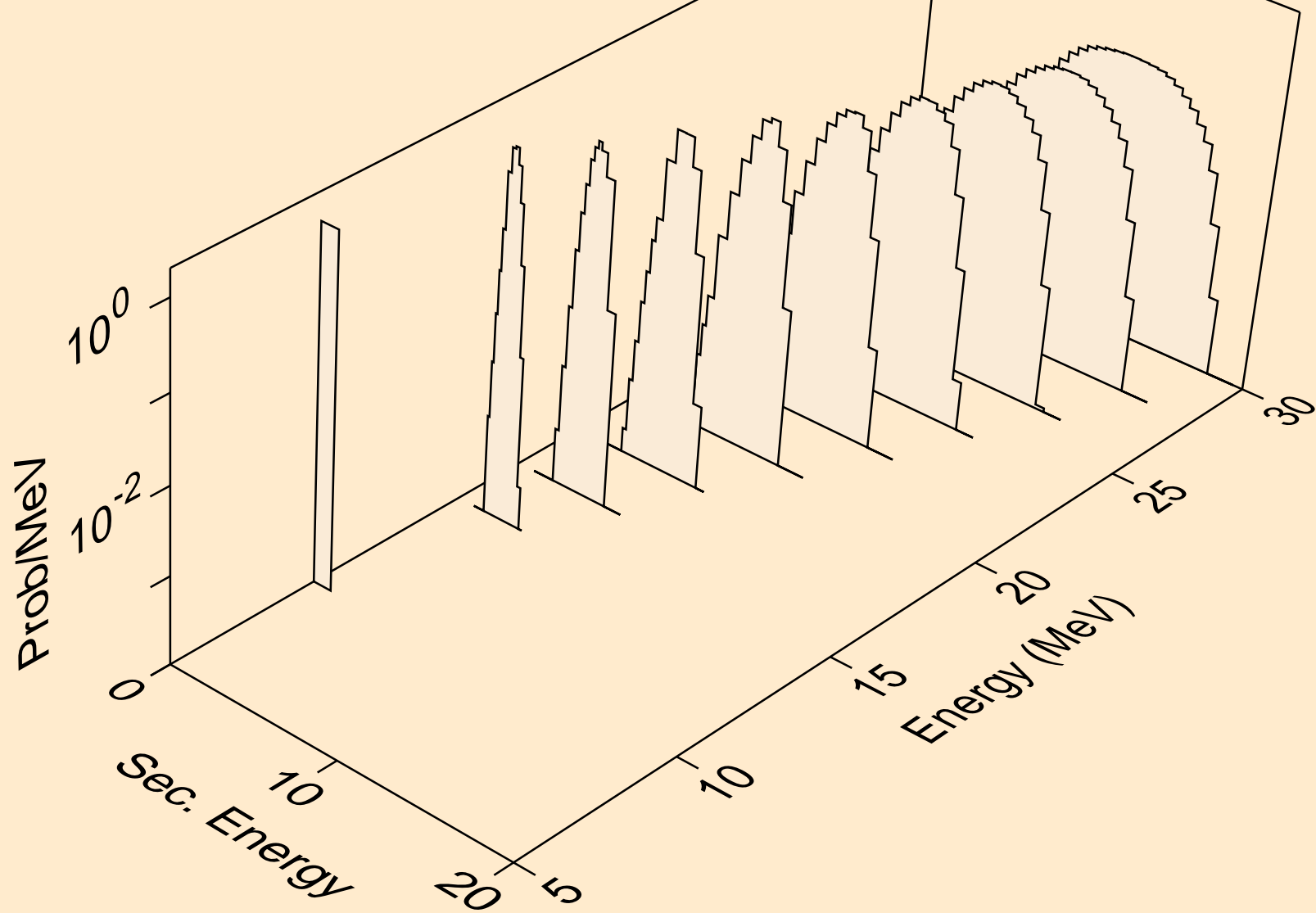

PM143 NEUTRON ACER TENDL-2023 LIBRARY; T=0.K
deuterons from (n,da)

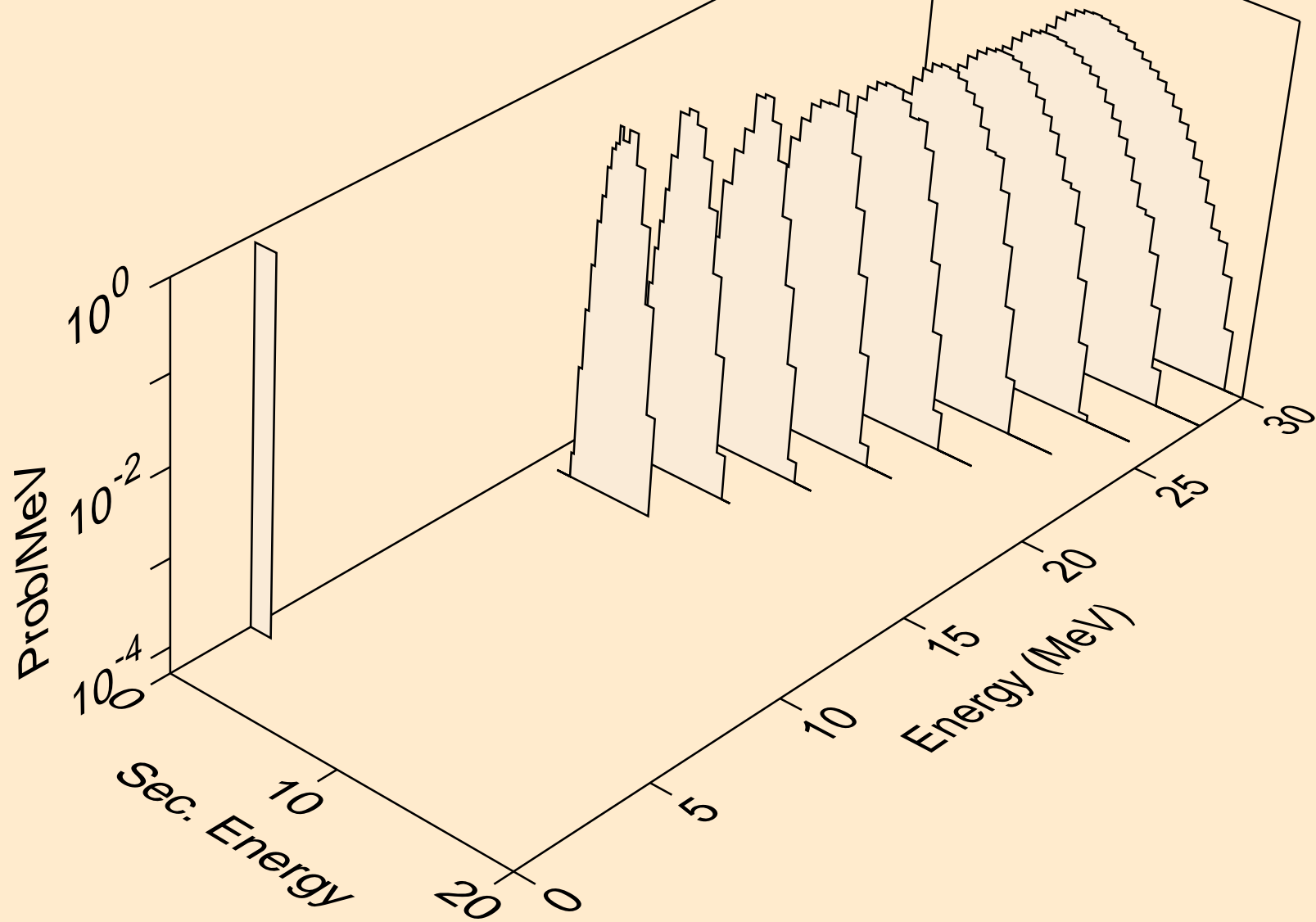

PM143 NEUTRON ACER TENDL-2023 LIBRARY; T=0.K
tritons from (n,x)

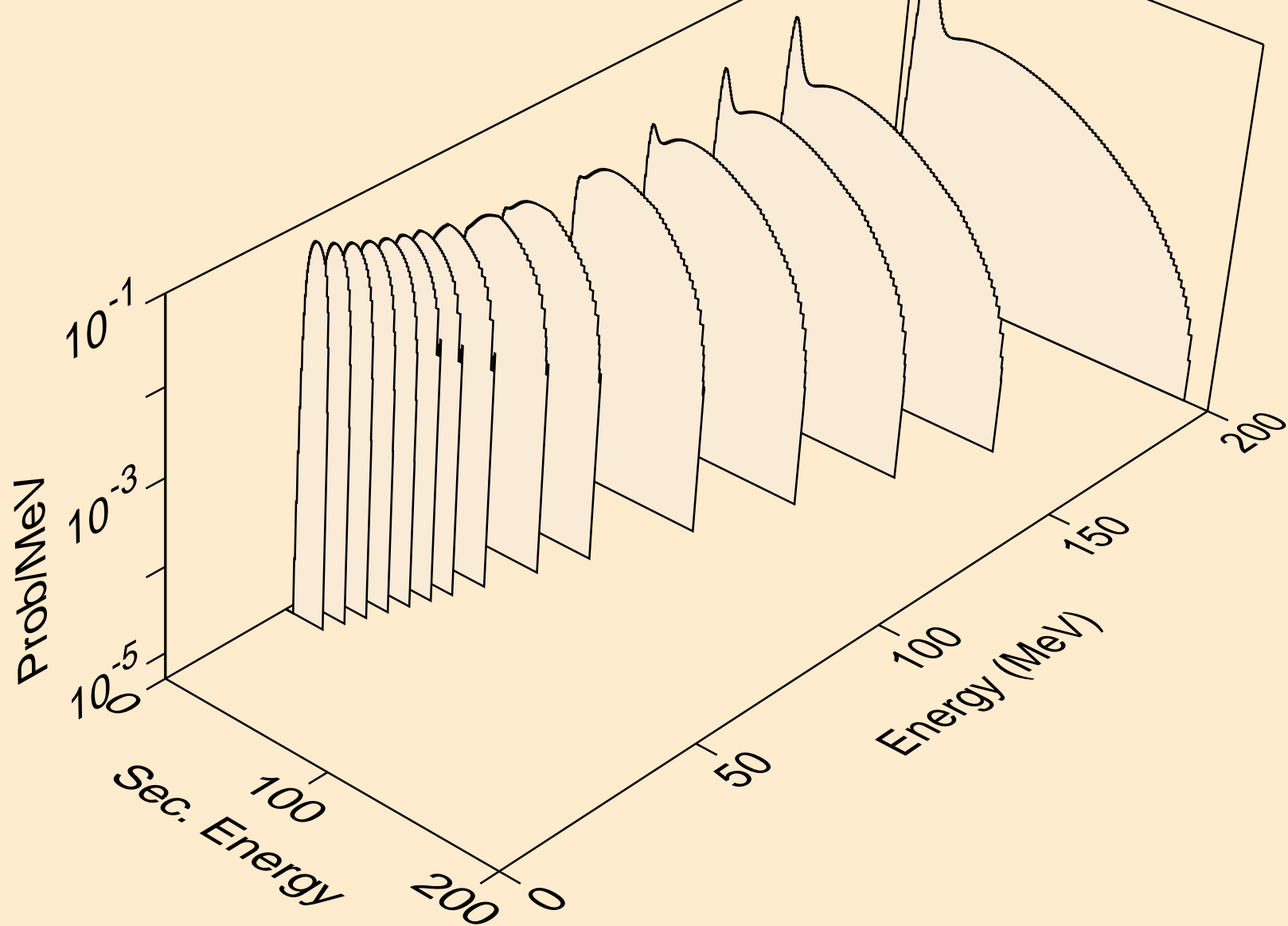

PM143 NEUTRON ACER TENDL-2023 LIBRARY; T=0.K
tritons from (n,n*)t

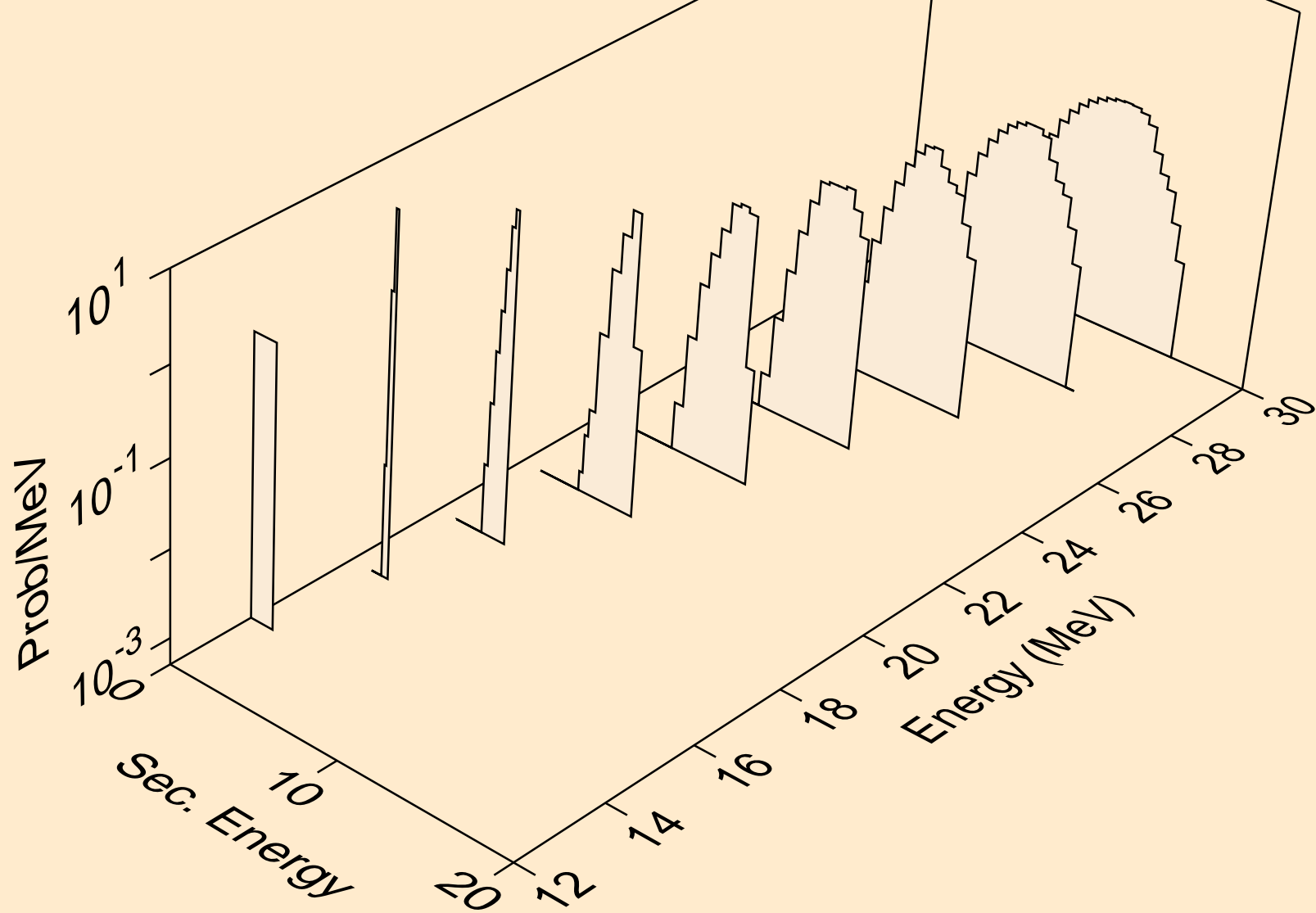

PM143 NEUTRON ACER TENDL-2023 LIBRARY; T=0.K
tritons from (n,t)

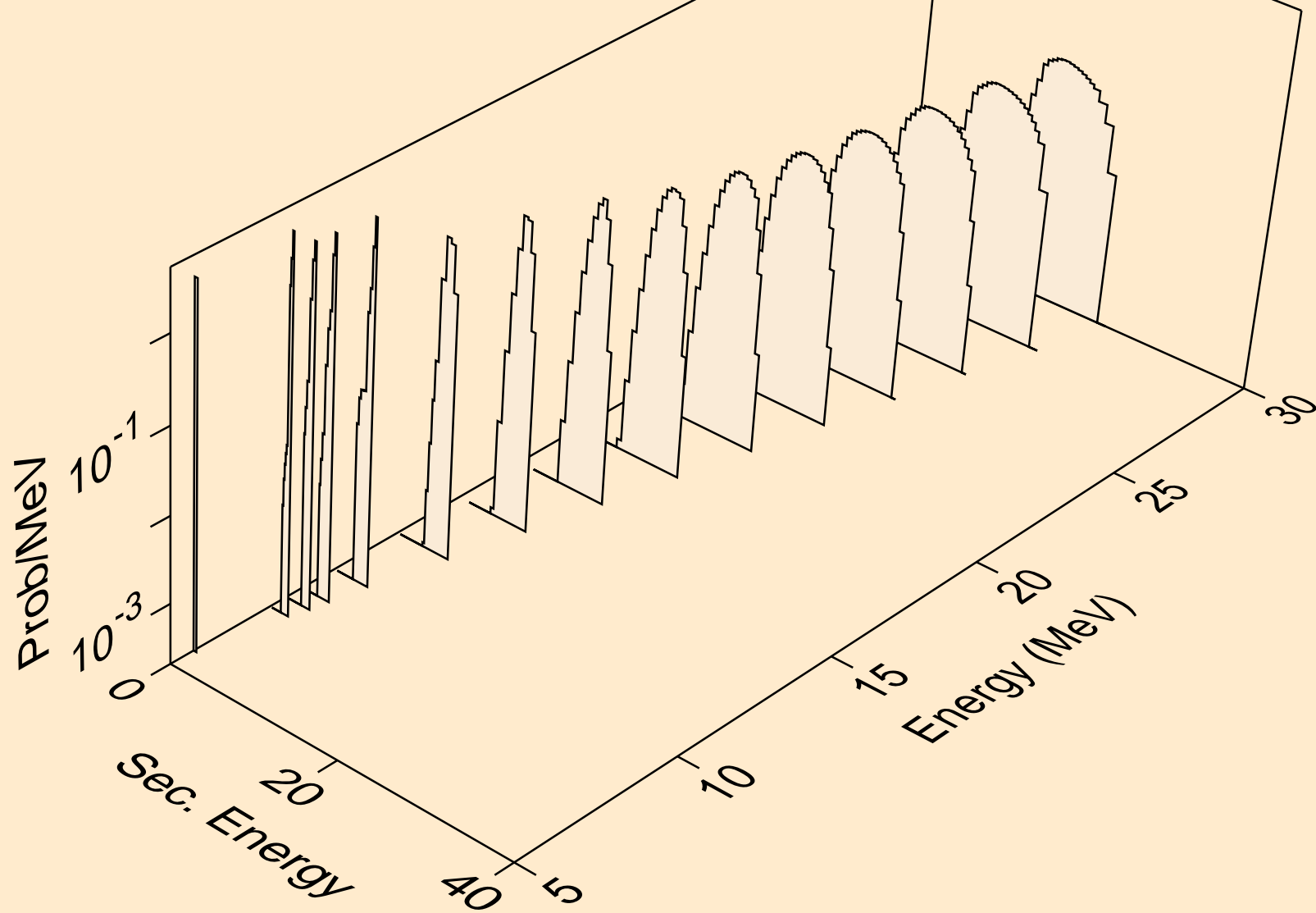

PM143 NEUTRON ACER TENDL-2023 LIBRARY; T=0.K
tritons from (n,pt)

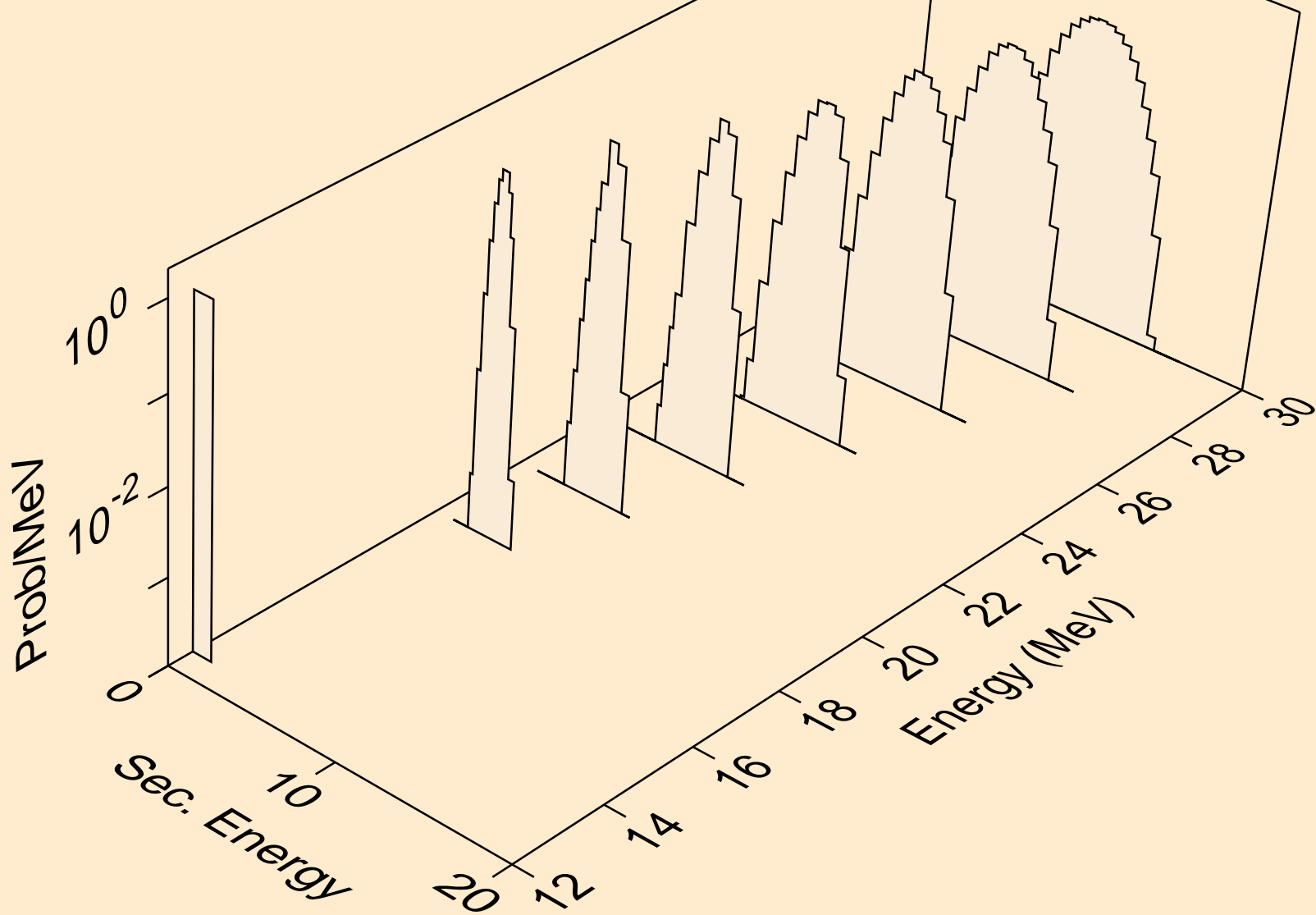

PM143 NEUTRON ACER TENDL-2023 LIBRARY; T=0.K
he3s from (n,x)

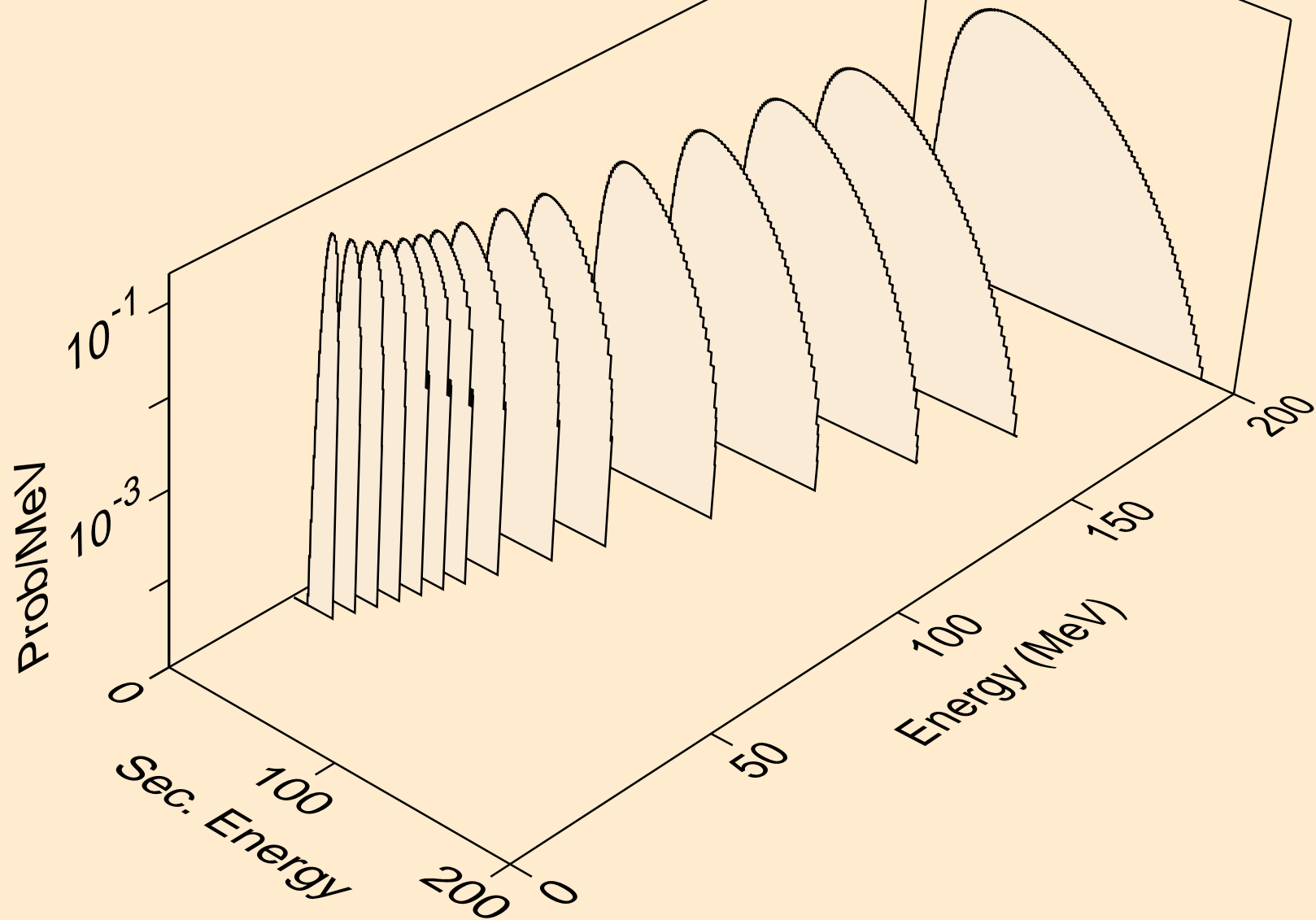

PM143 NEUTRON ACER TENDL-2023 LIBRARY; T=0.K
he3s from (n,n*)he3

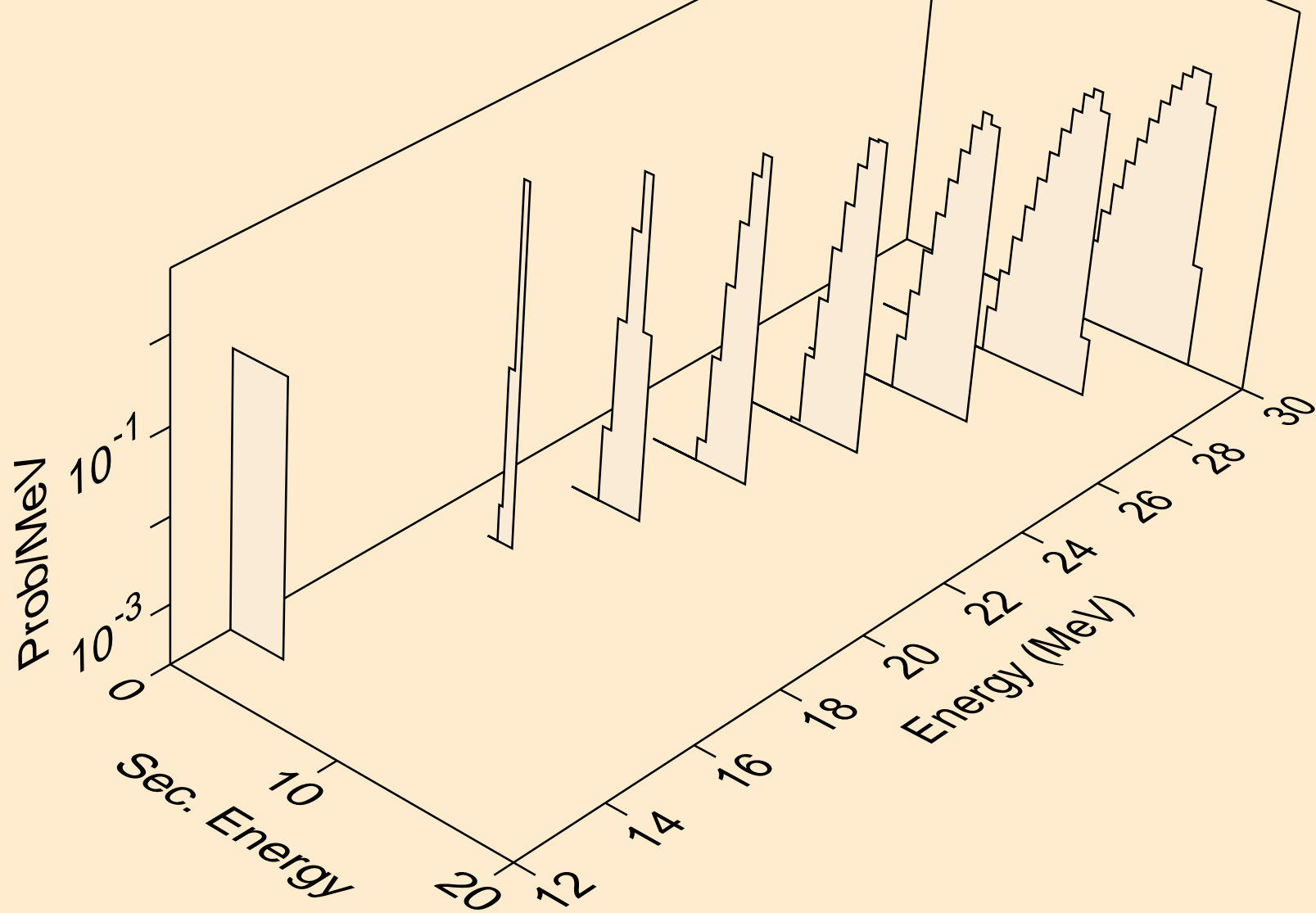

PM143 NEUTRON ACER TENDL-2023 LIBRARY; T=0.K
he3s from (n,he3)

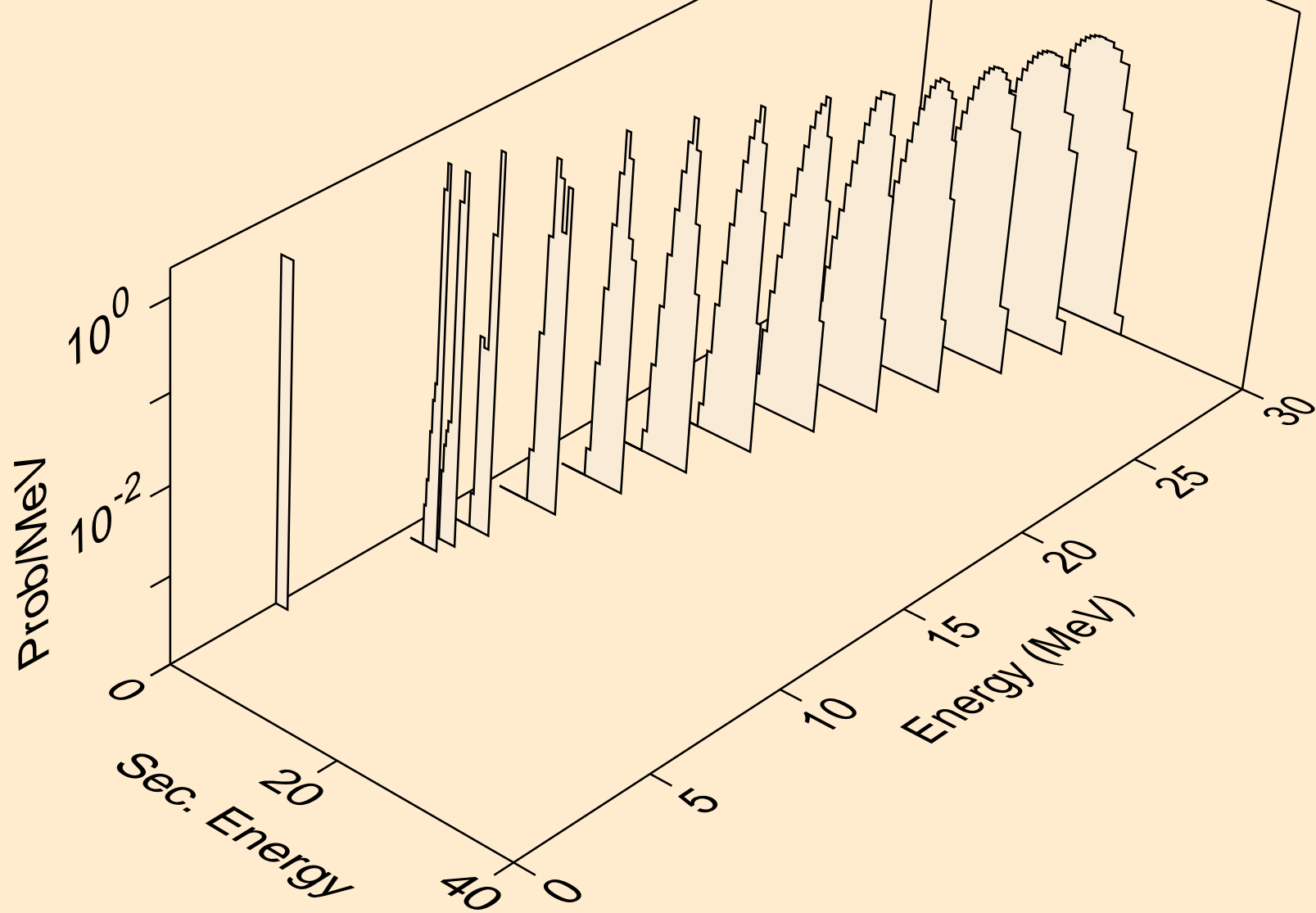

PM143 NEUTRON ACER TENDL-2023 LIBRARY; T=0.K
alphas from (n,x)

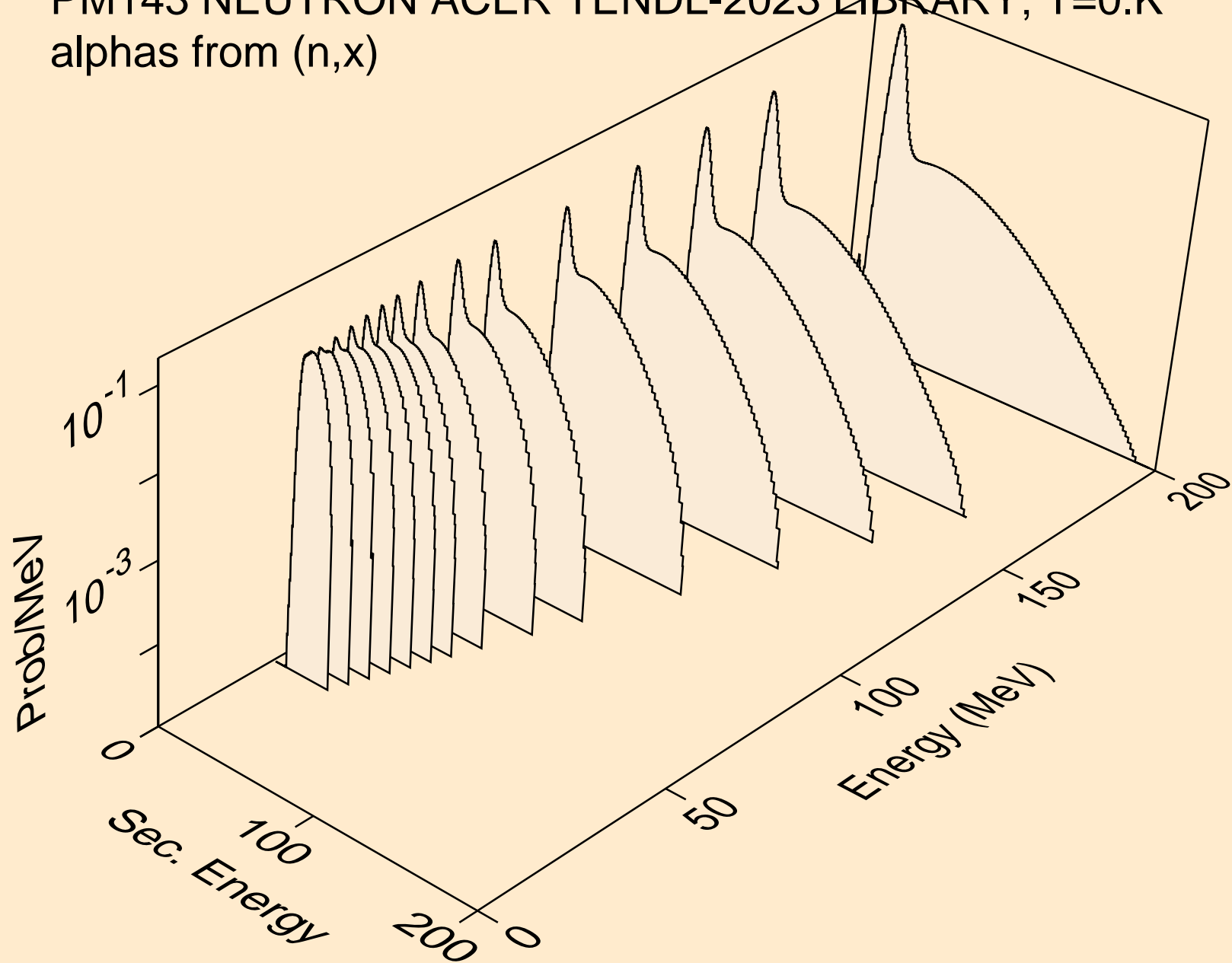

PM143 NEUTRON ACER TENDL-2023 LIBRARY; T=0.K
alphas from (n,n*)a

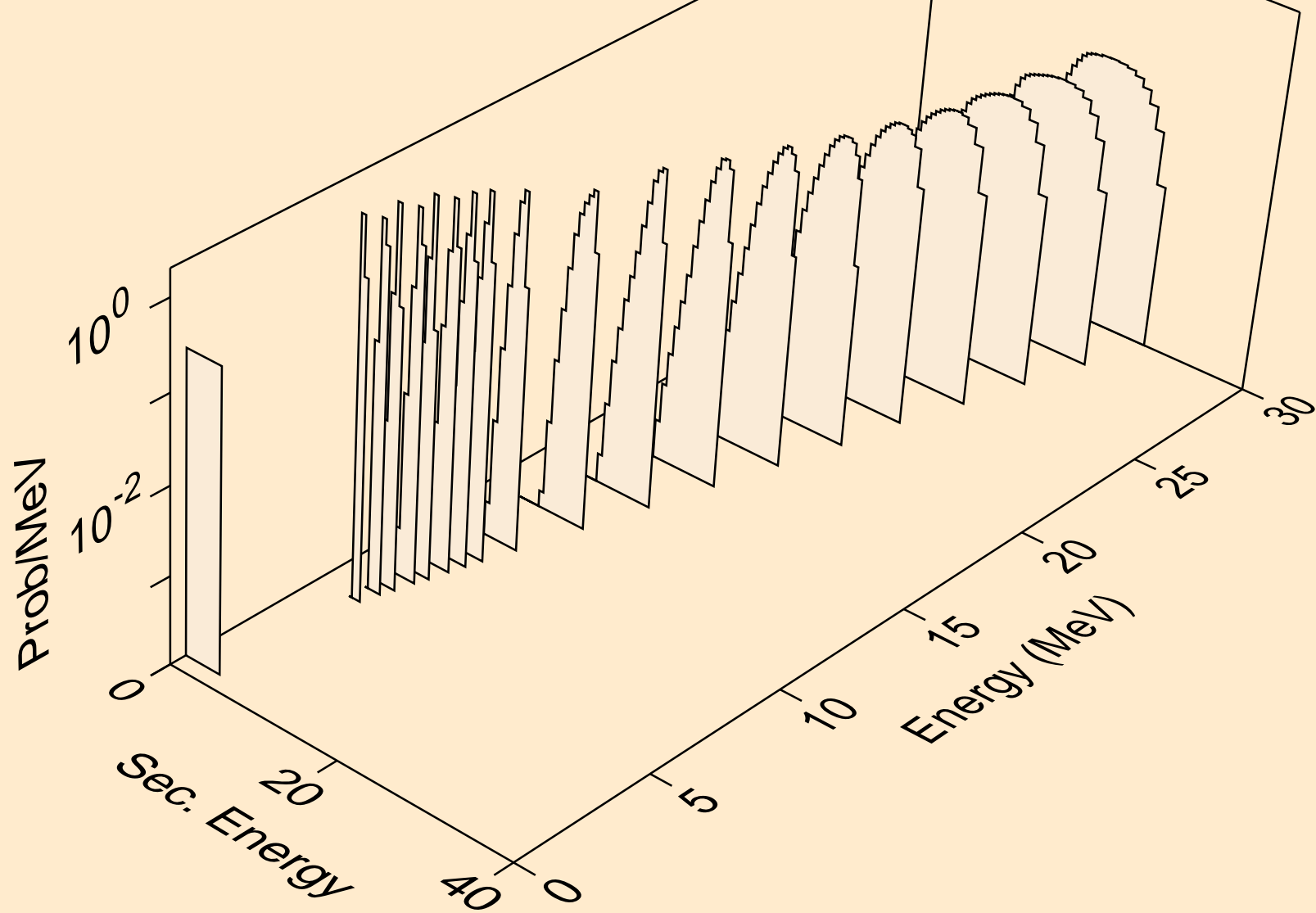

PM143 NEUTRON ACER TENDL-2023 LIBRARY; T=0.K
alphas from (n,2n)a

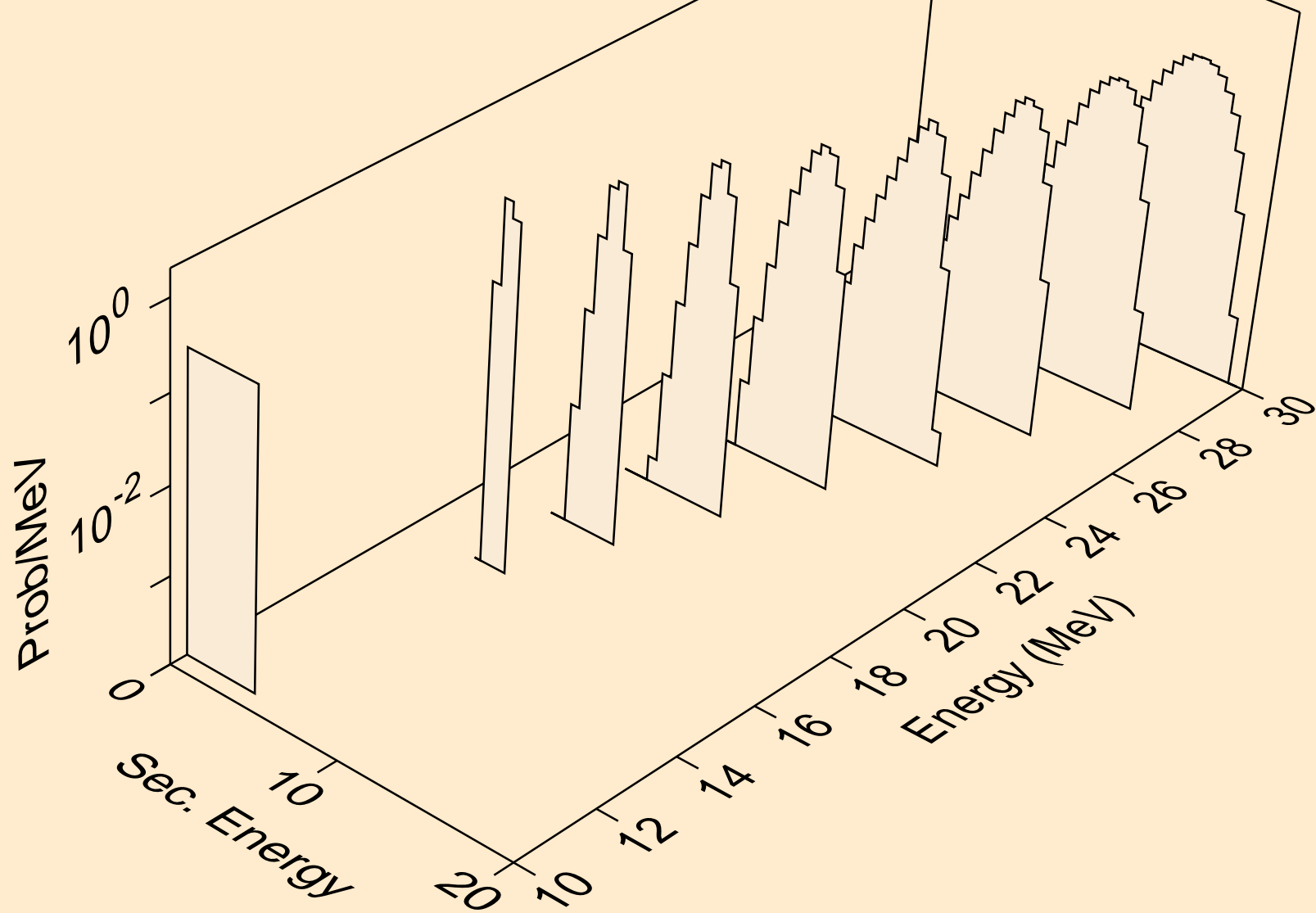

PM143 NEUTRON ACER TENDL-2023 LIBRARY; T=0.K
alphas from (n,3n)a

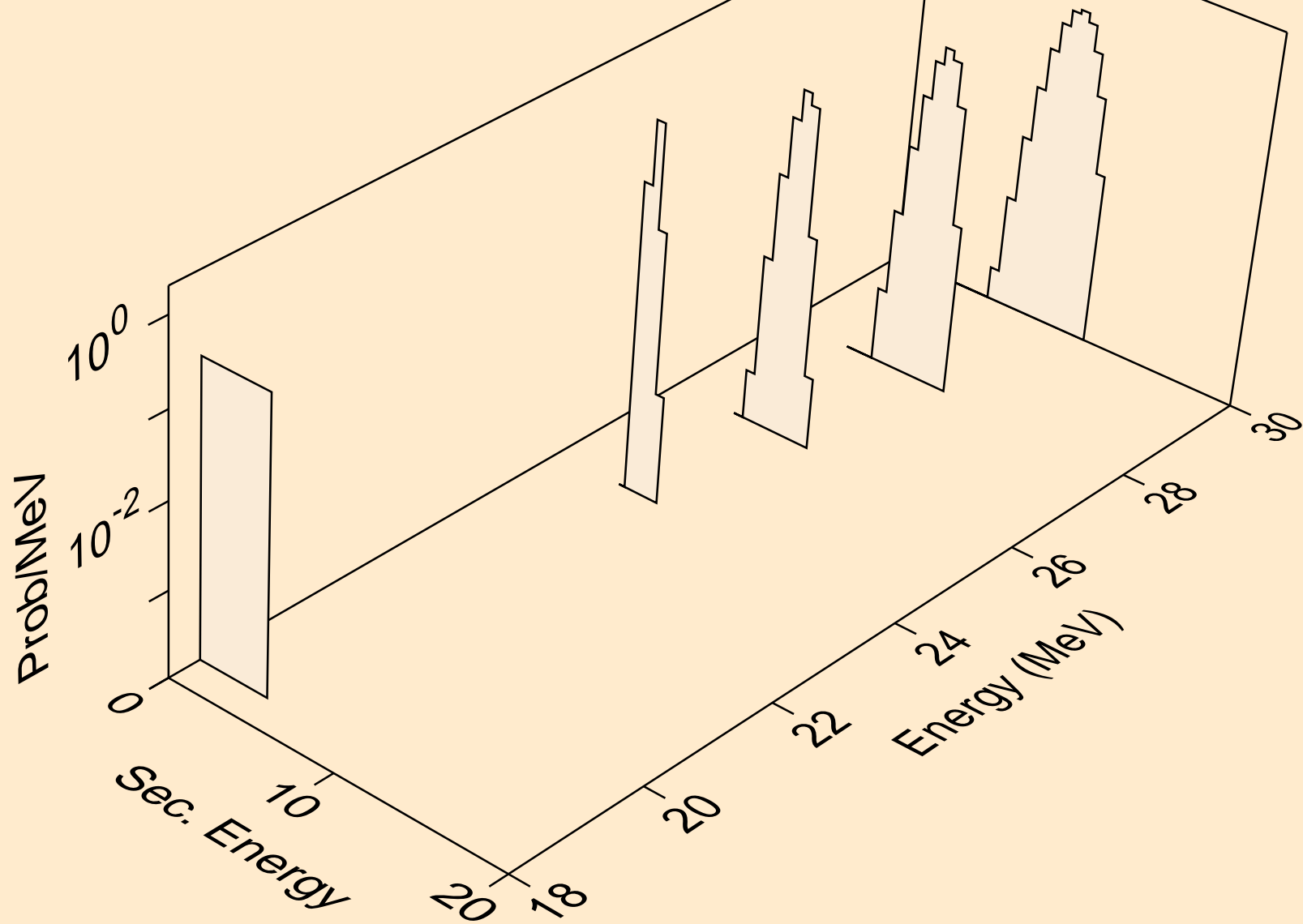

PM143 NEUTRON ACER TENDL-2023 LIBRARY; T=0.K
alphas from (n,n*)2a

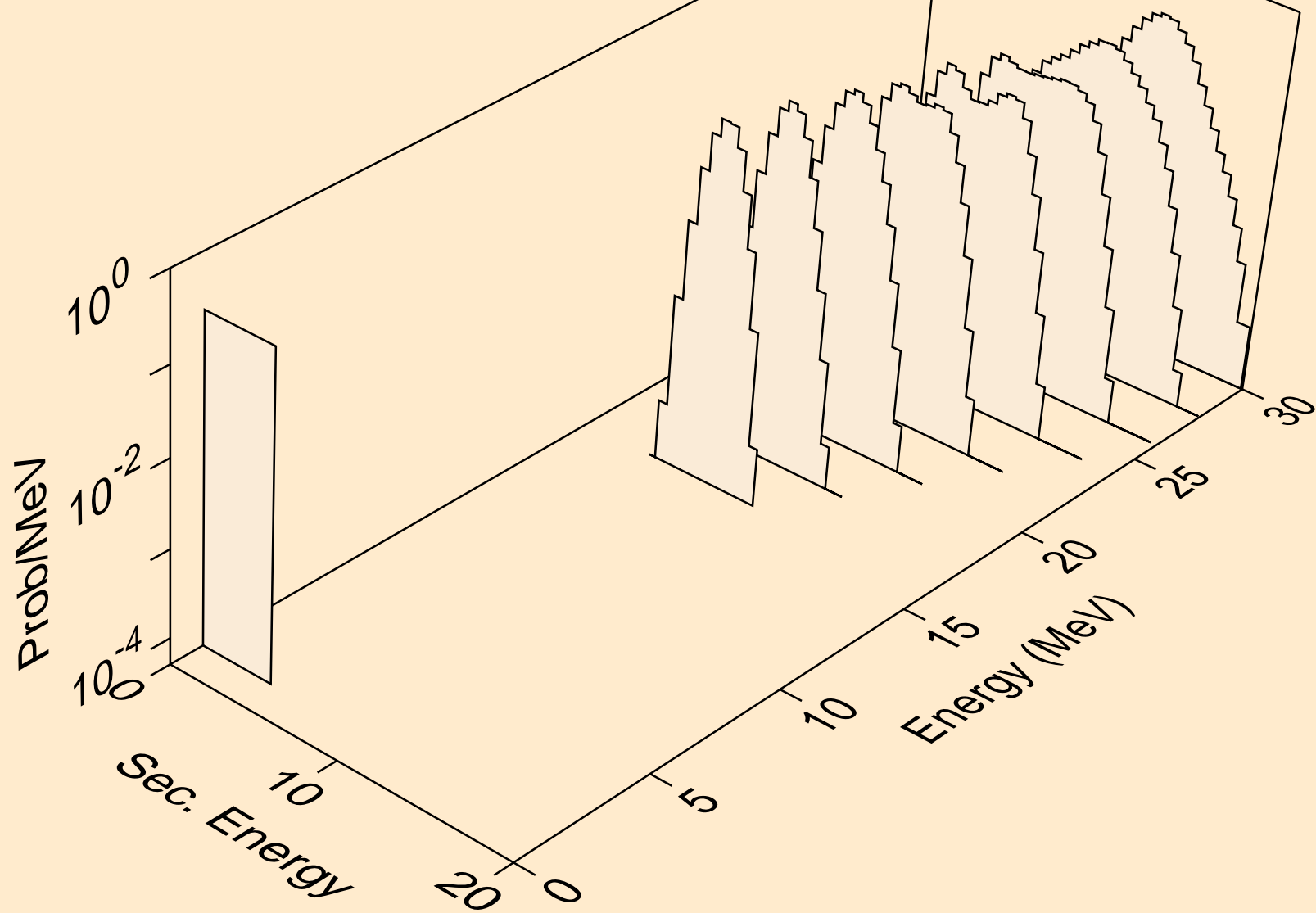

PM143 NEUTRON ACER TENDL-2023 LIBRARY; T=0.K
alphas from (n,npa)

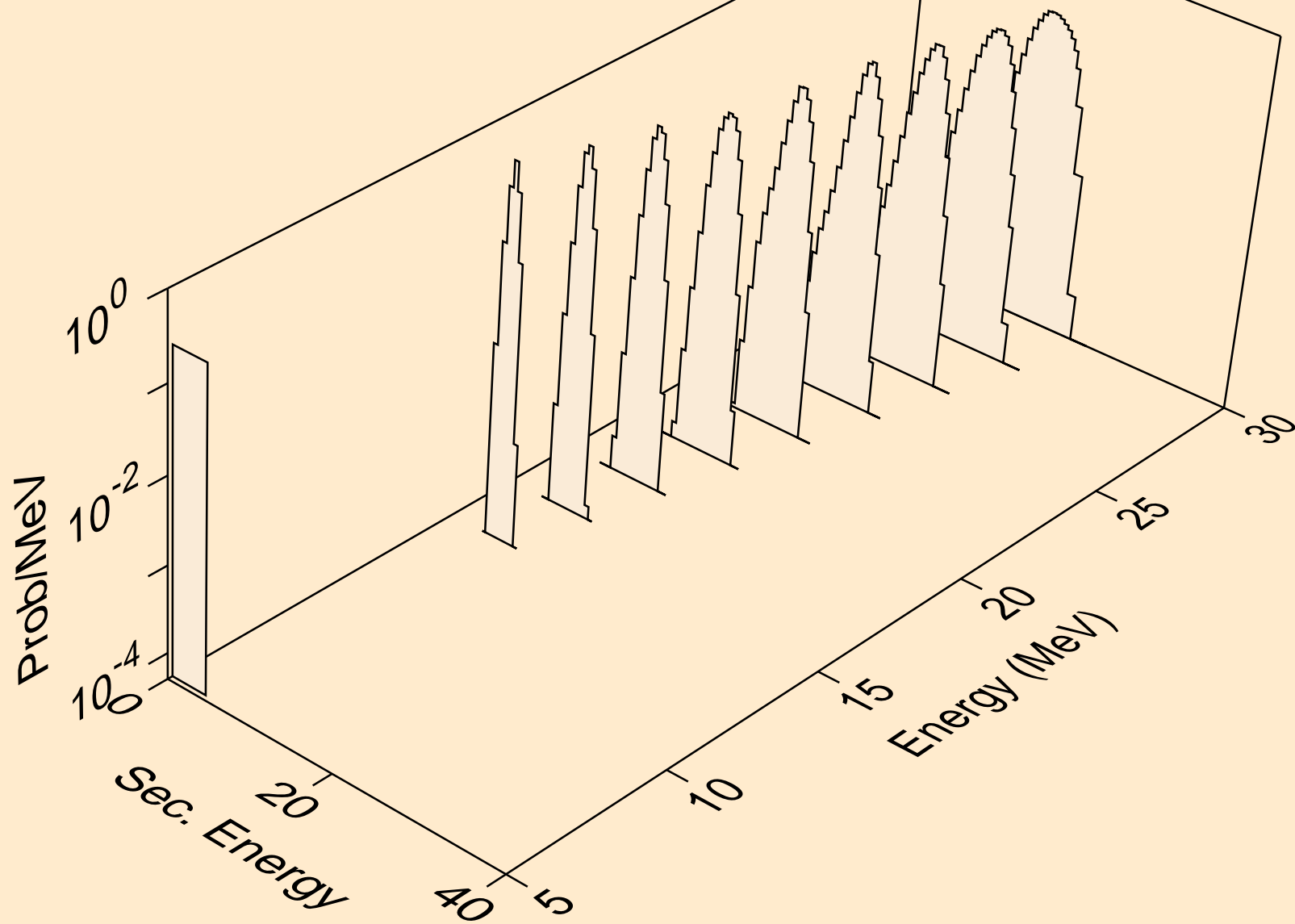

PM143 NEUTRON ACER TENDL-2023 LIBRARY; T=0.K
alphas from (n,a)

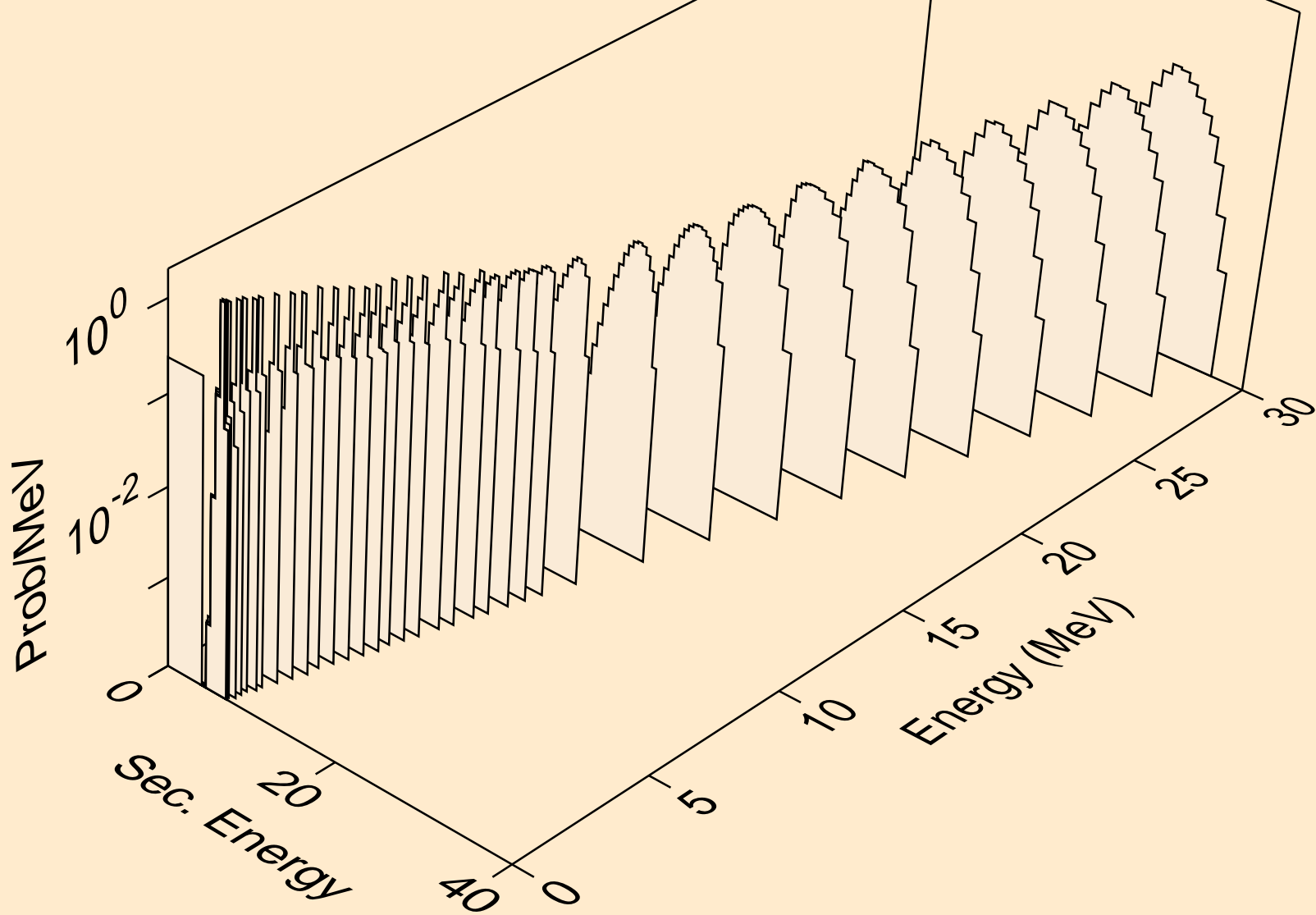

PM143 NEUTRON ACER TENDL-2023 LIBRARY; T=0.K
alphas from (n,2a)

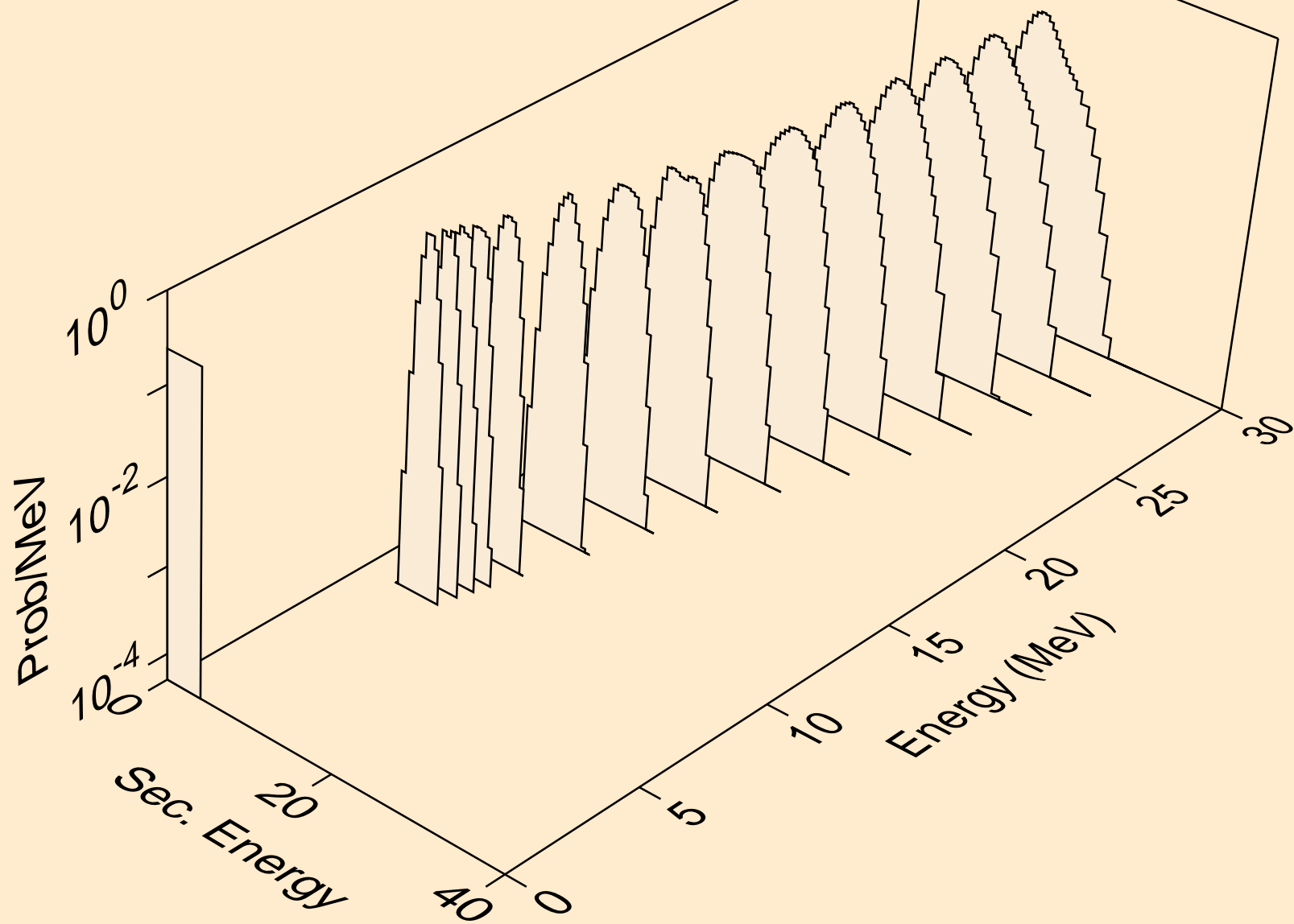

PM143 NEUTRON ACER TENDL-2023 LIBRARY; T=0.K
alphas from (n,pa)

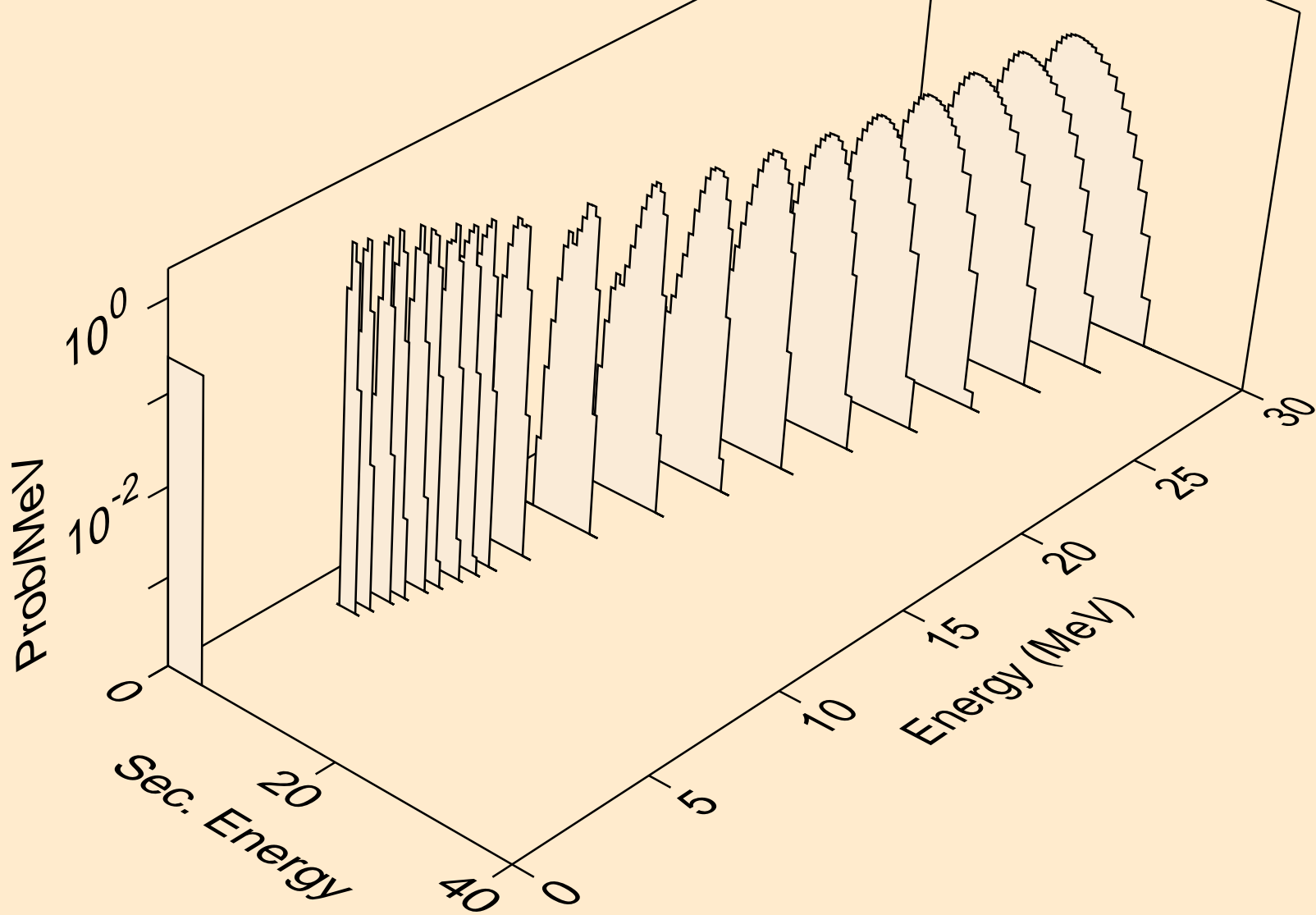

PM143 NEUTRON ACER TENDL-2023 LIBRARY; T=0.K
alphas from (n,da)

