

PO202 NEUTRON ACER TENDL-2023 LIBRARY; T=0.K

Principal cross sections

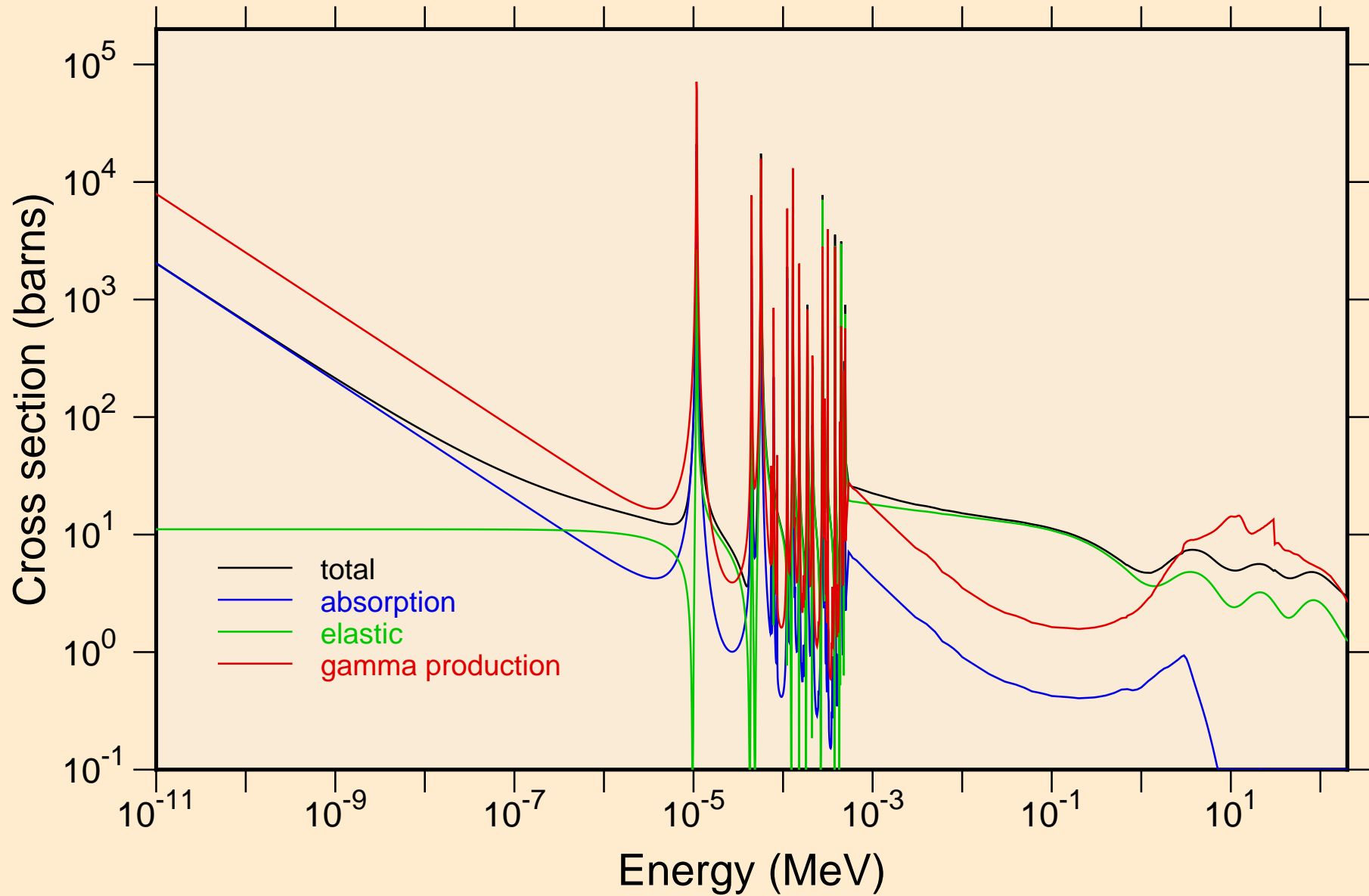

PO202 NEUTRON ACER TENDL-2023 LIBRARY; T=0.K
resonance total cross section

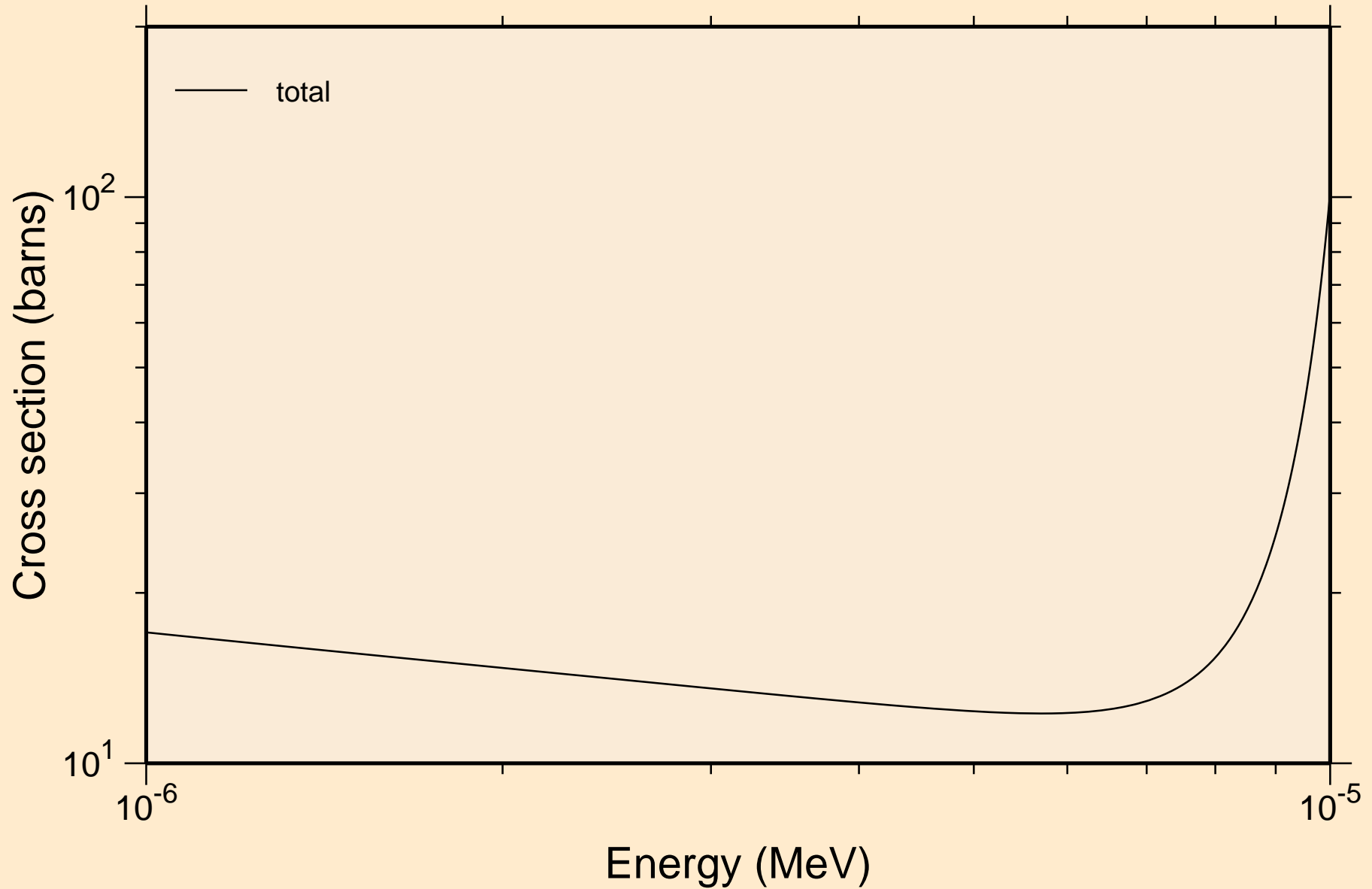

PO202 NEUTRON ACER TENDL-2023 LIBRARY; T=0.K
resonance total cross section

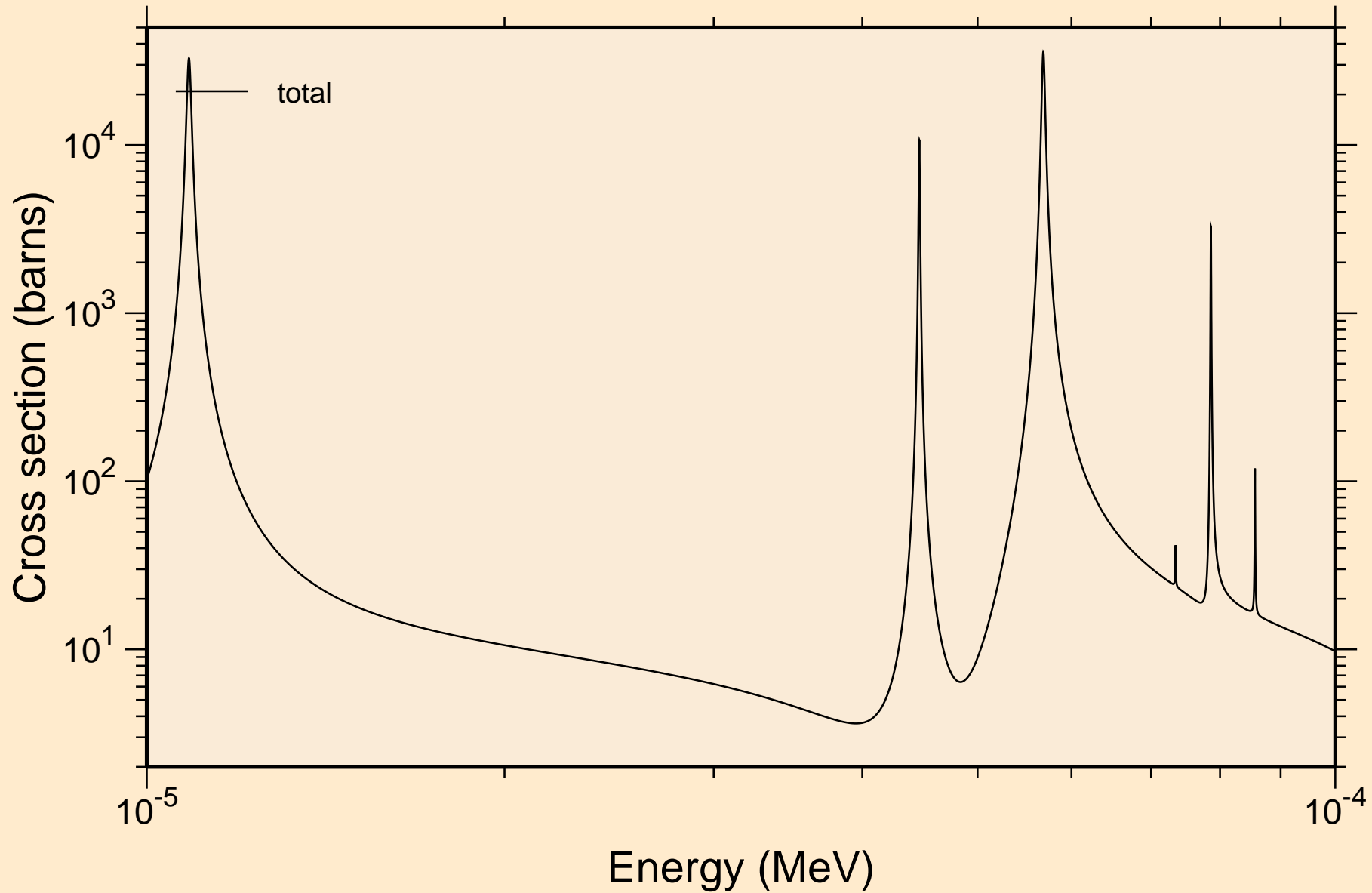

PO202 NEUTRON ACER TENDL-2023 LIBRARY; T=0.K
resonance total cross section

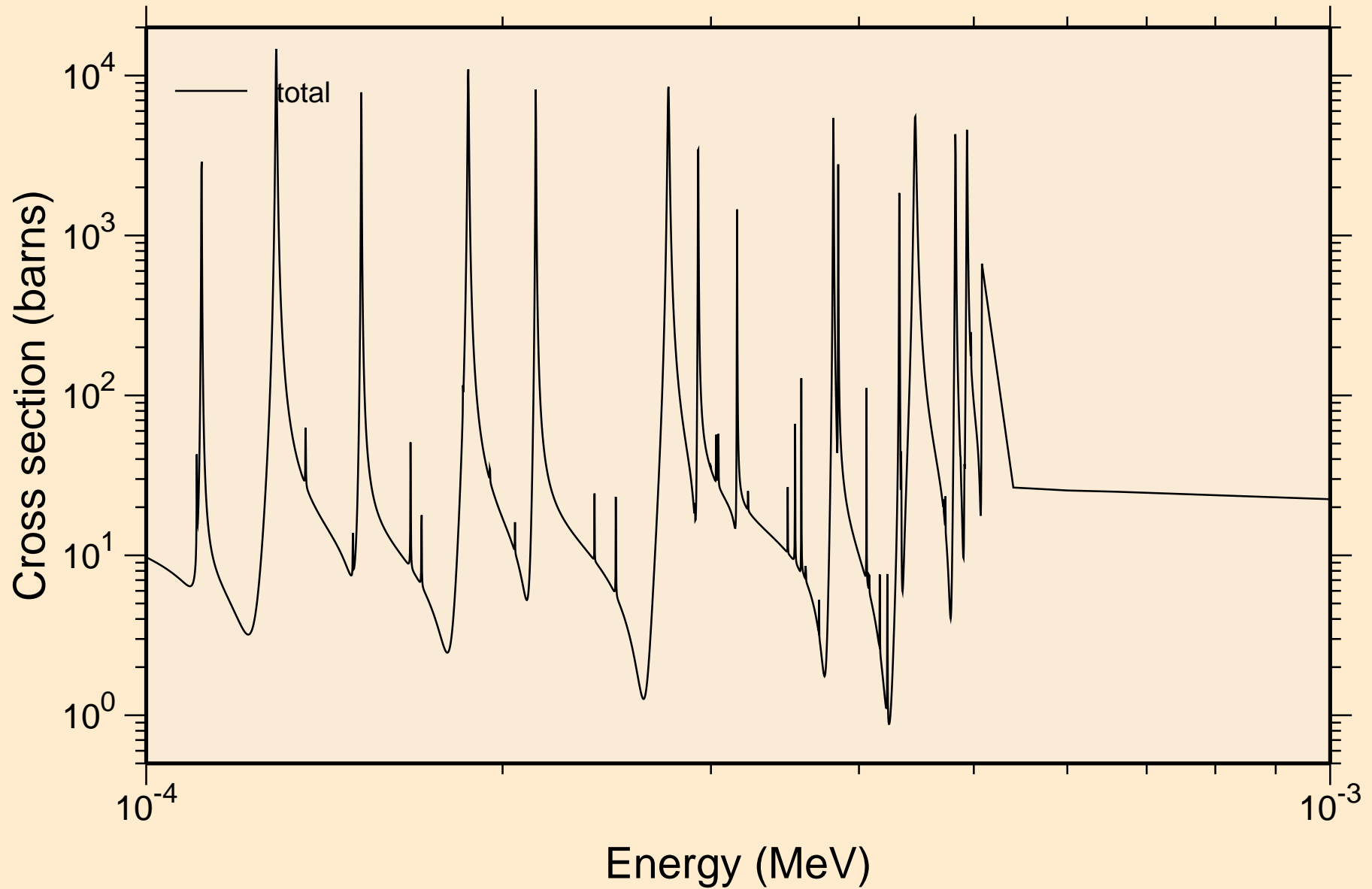

PO202 NEUTRON ACER TENDL-2023 LIBRARY; T=0.K
resonance total cross section

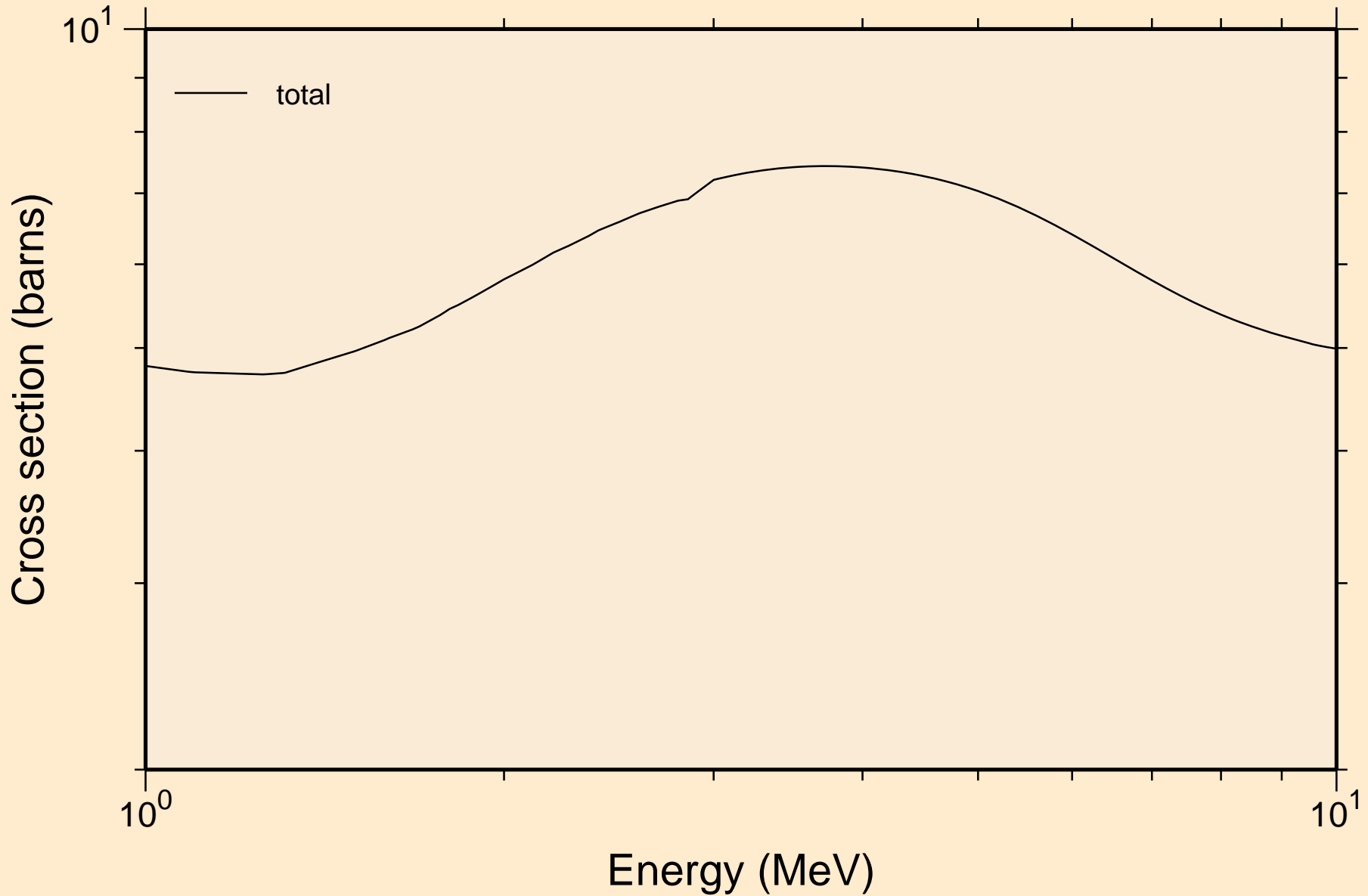

PO202 NEUTRON ACER TENDL-2023 LIBRARY; T=0.K
resonance absorption cross sections

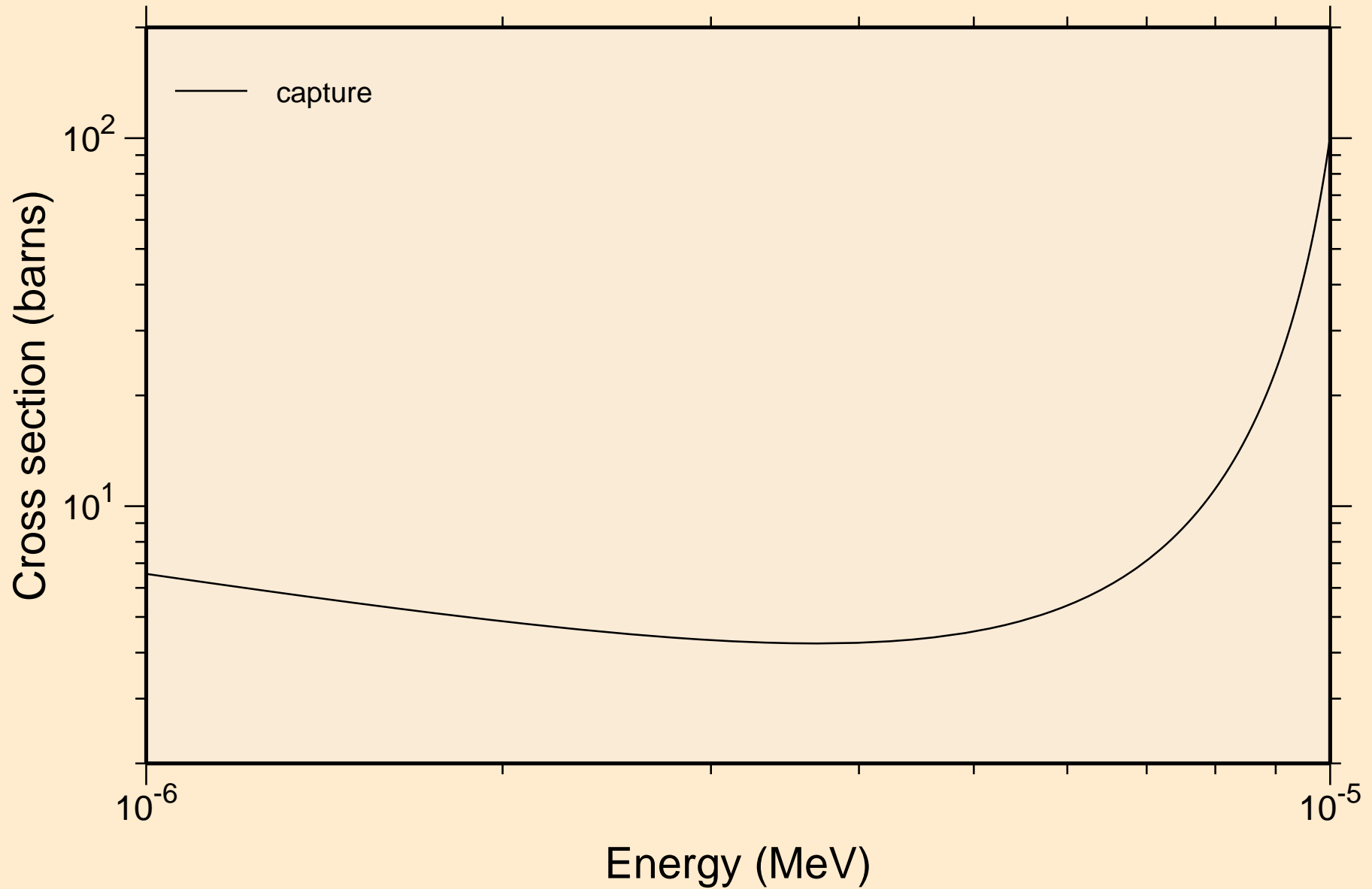

PO202 NEUTRON ACER TENDL-2023 LIBRARY; T=0.K
resonance absorption cross sections

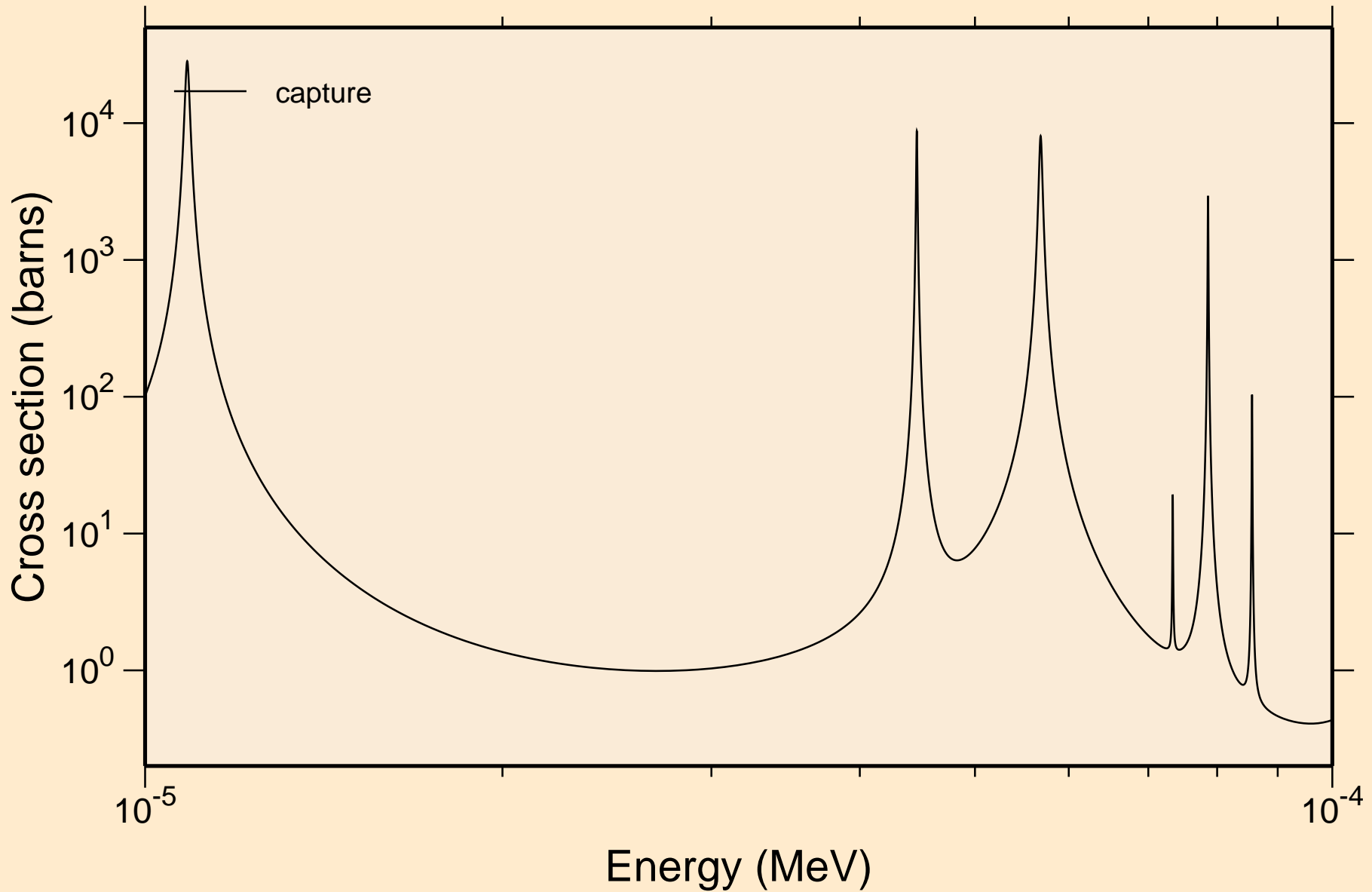

PO202 NEUTRON ACER TENDL-2023 LIBRARY; T=0.K
resonance absorption cross sections

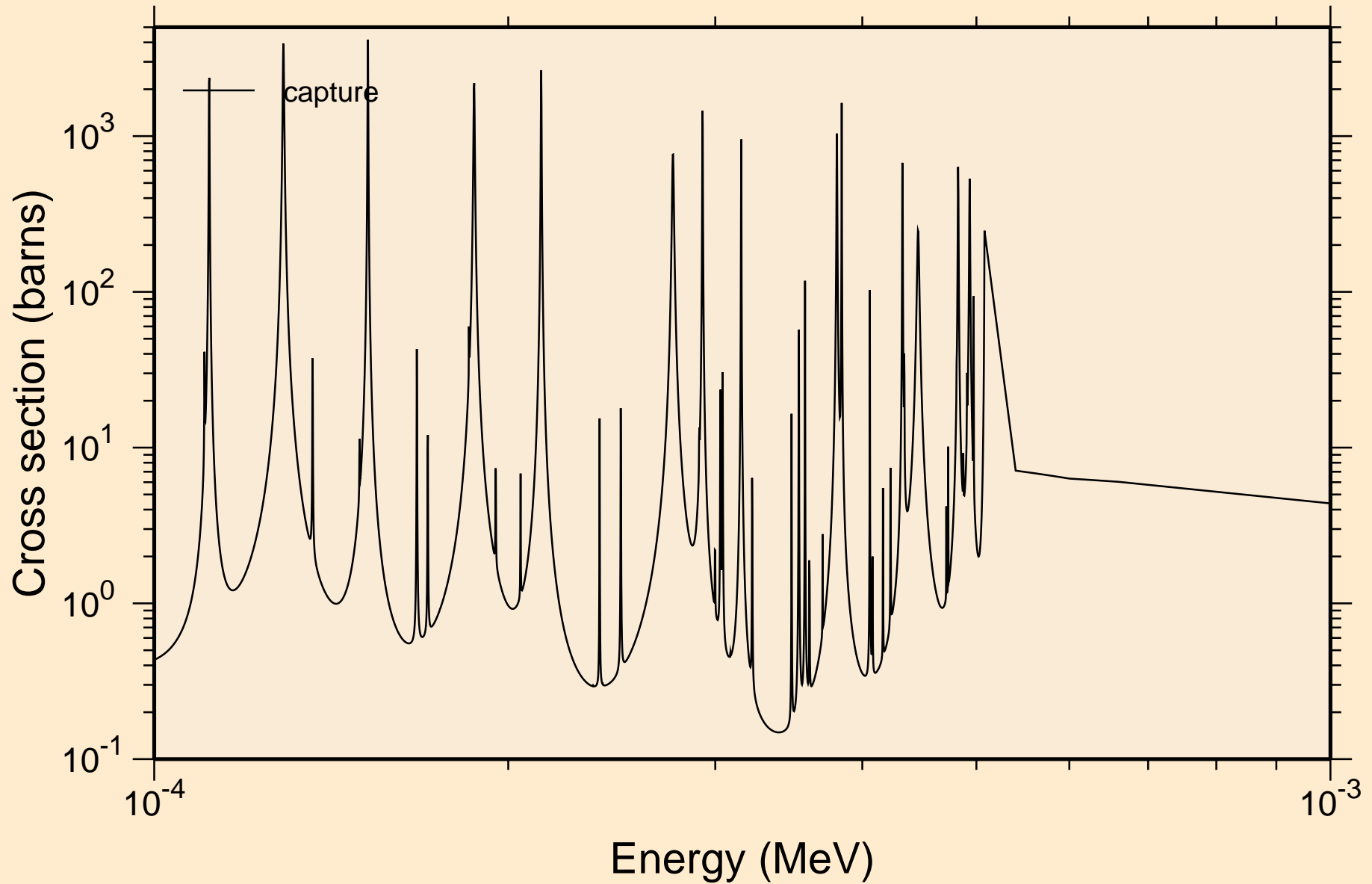

PO202 NEUTRON ACER TENDL-2023 LIBRARY; T=0.K
resonance absorption cross sections

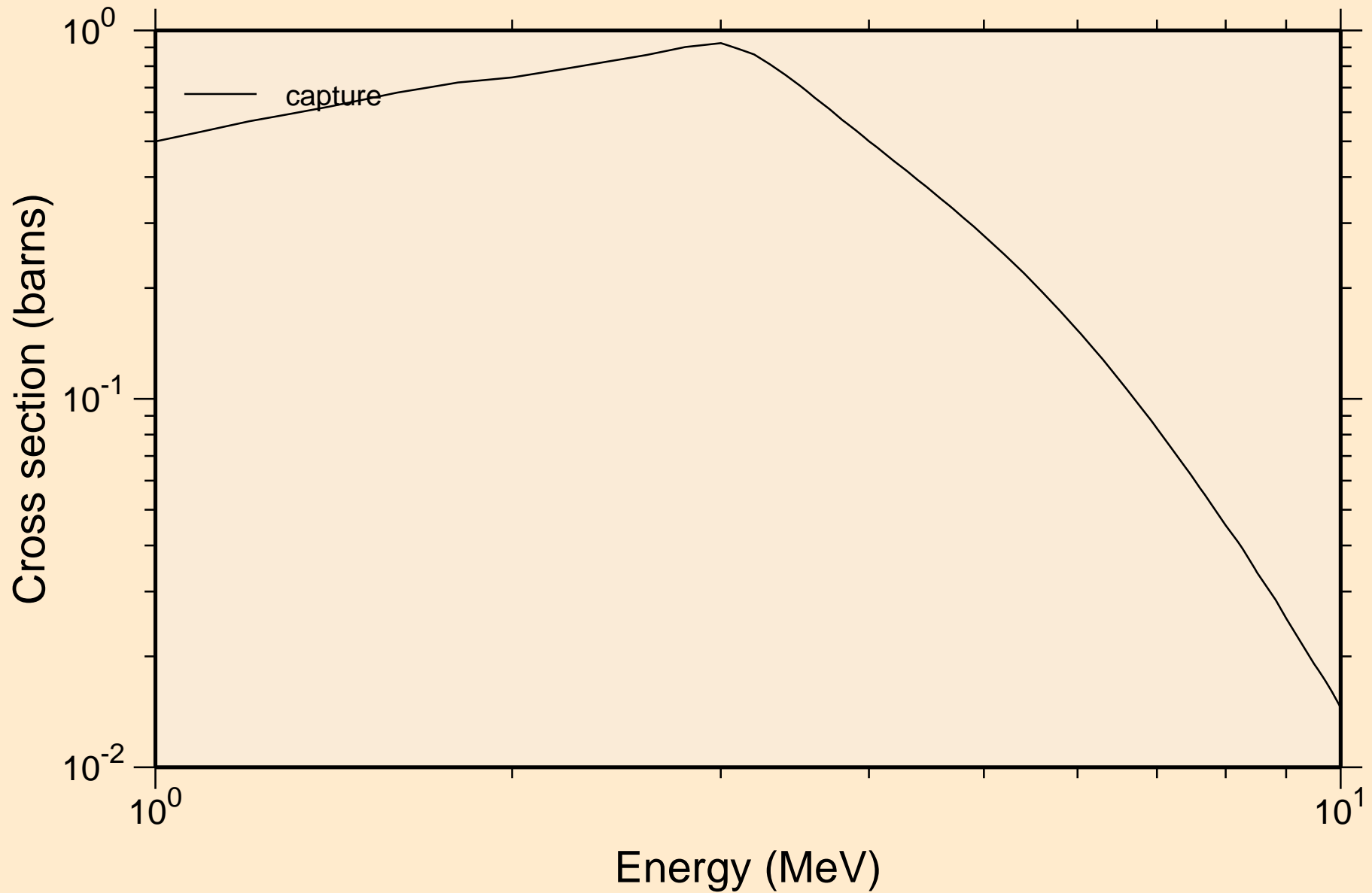

PO202 NEUTRON ACER TENDL-2023 LIBRARY; T=0.K
Heating

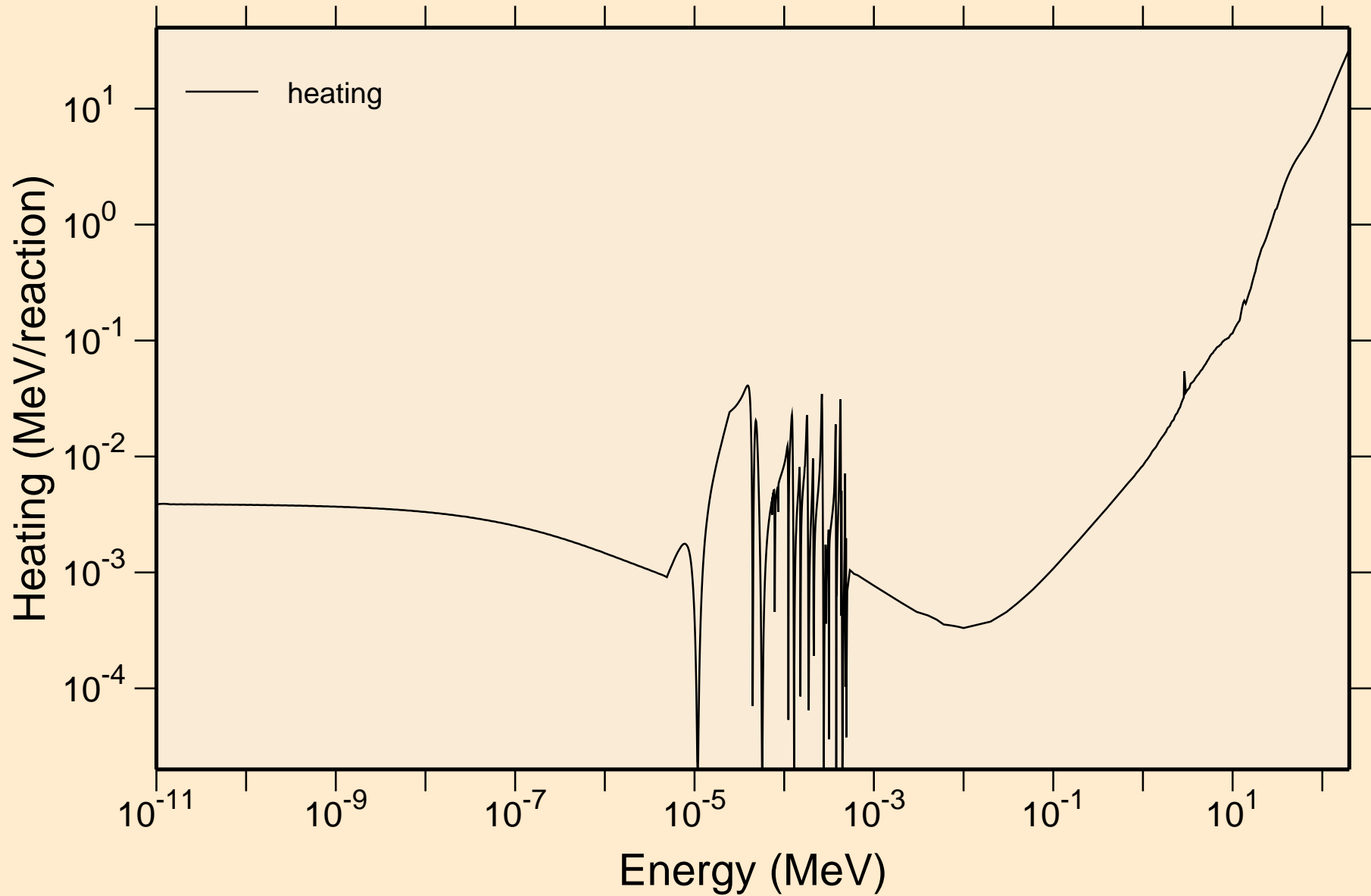

PO202 NEUTRON ACER TENDL-2023 LIBRARY; T=0.K
Damage

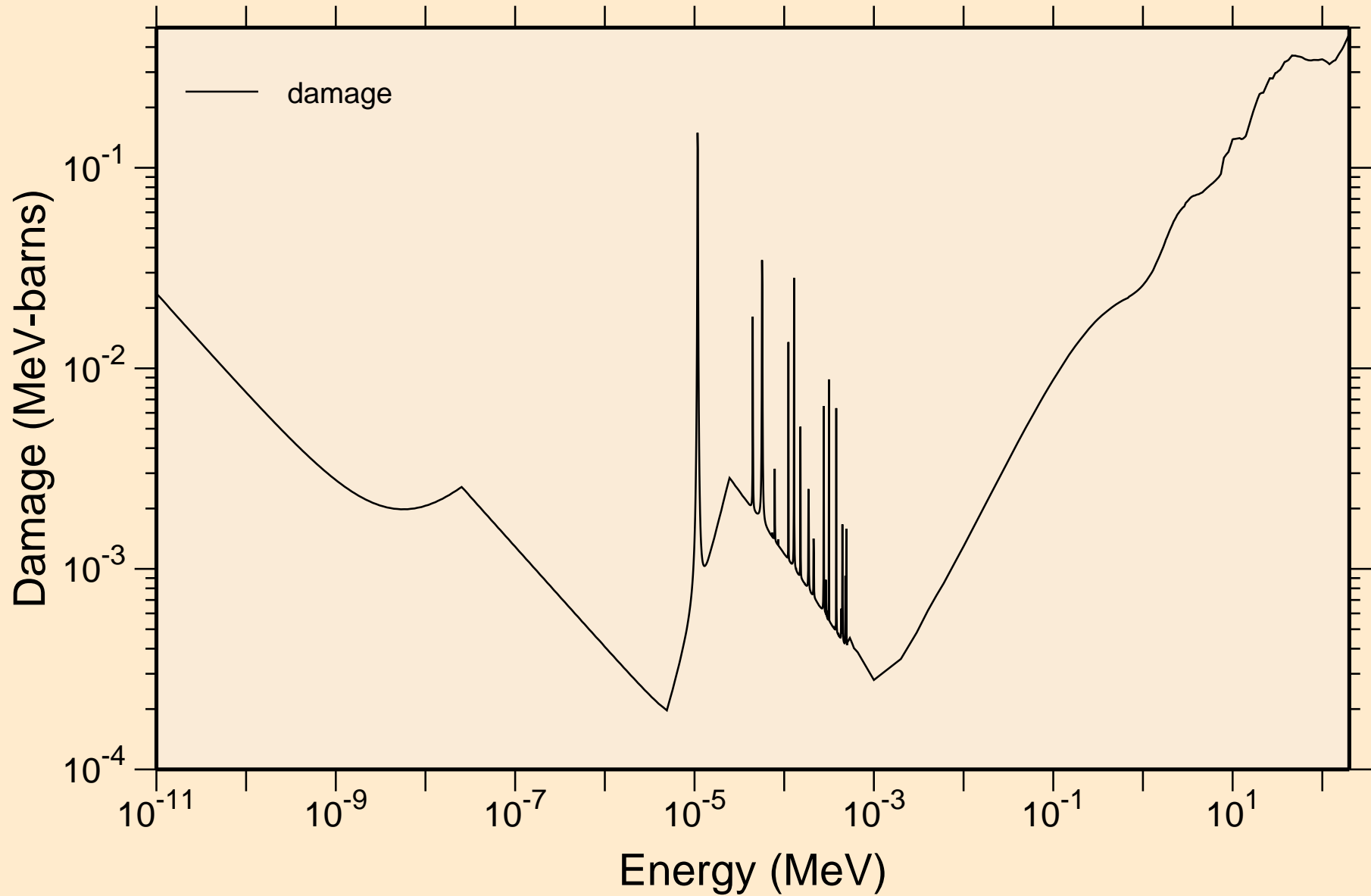

PO202 NEUTRON ACER TENDL-2023 LIBRARY; T=0.K
Non-threshold reactions

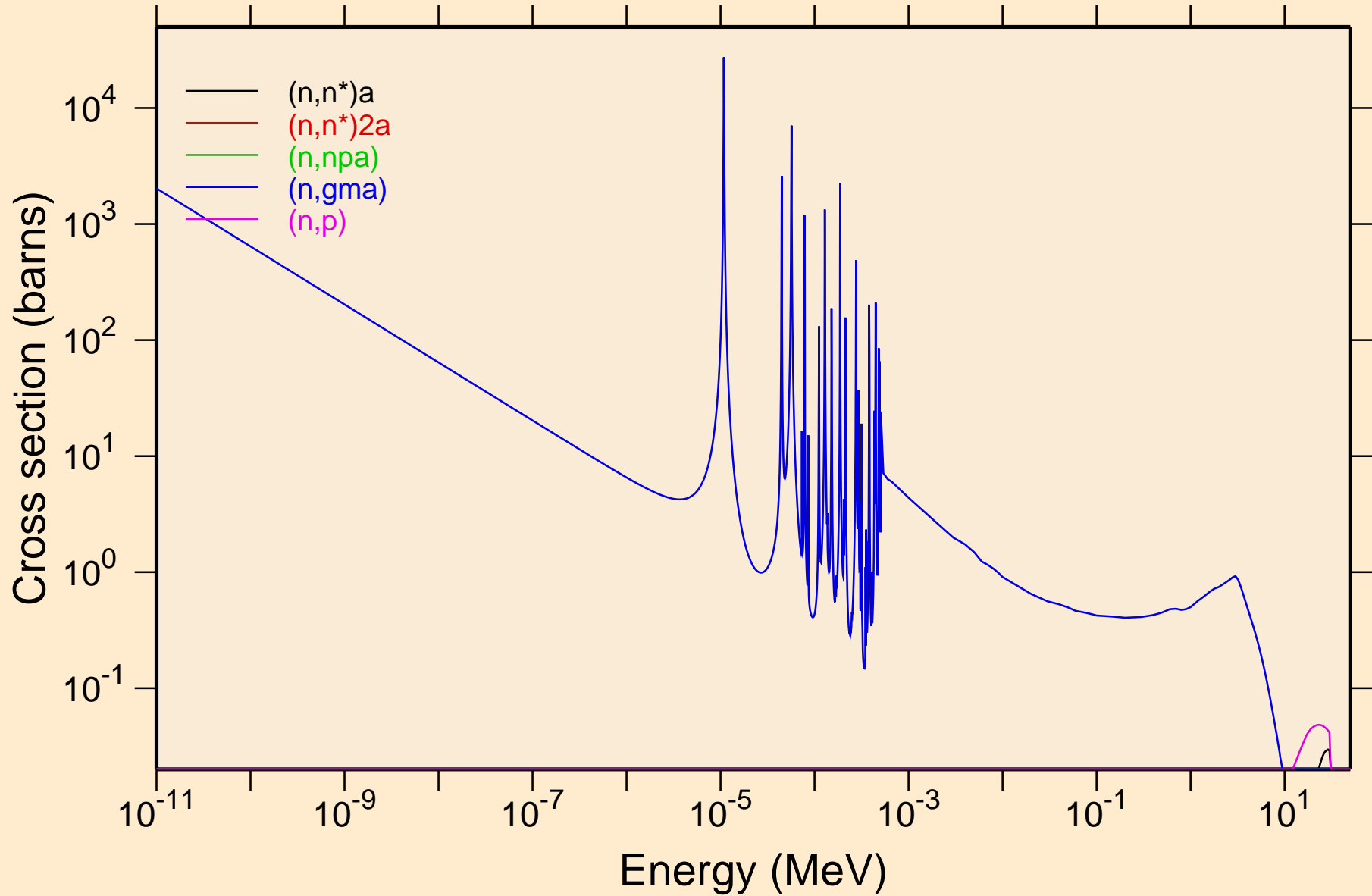

PO202 NEUTRON ACER TENDL-2023 LIBRARY; T=0.K
Non-threshold reactions

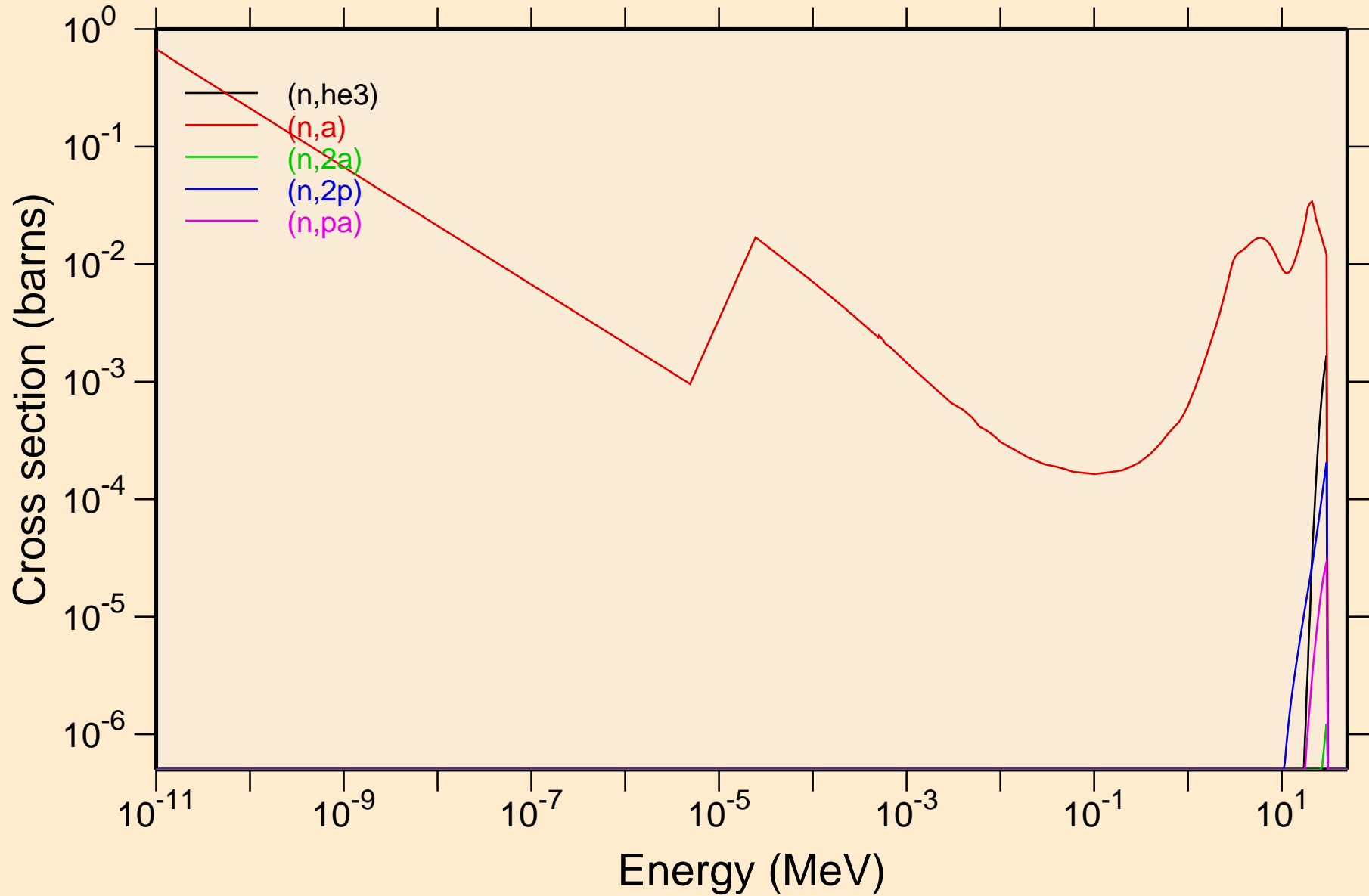

PO202 NEUTRON ACER TENDL-2023 LIBRARY; T=0.K
Non-threshold reactions

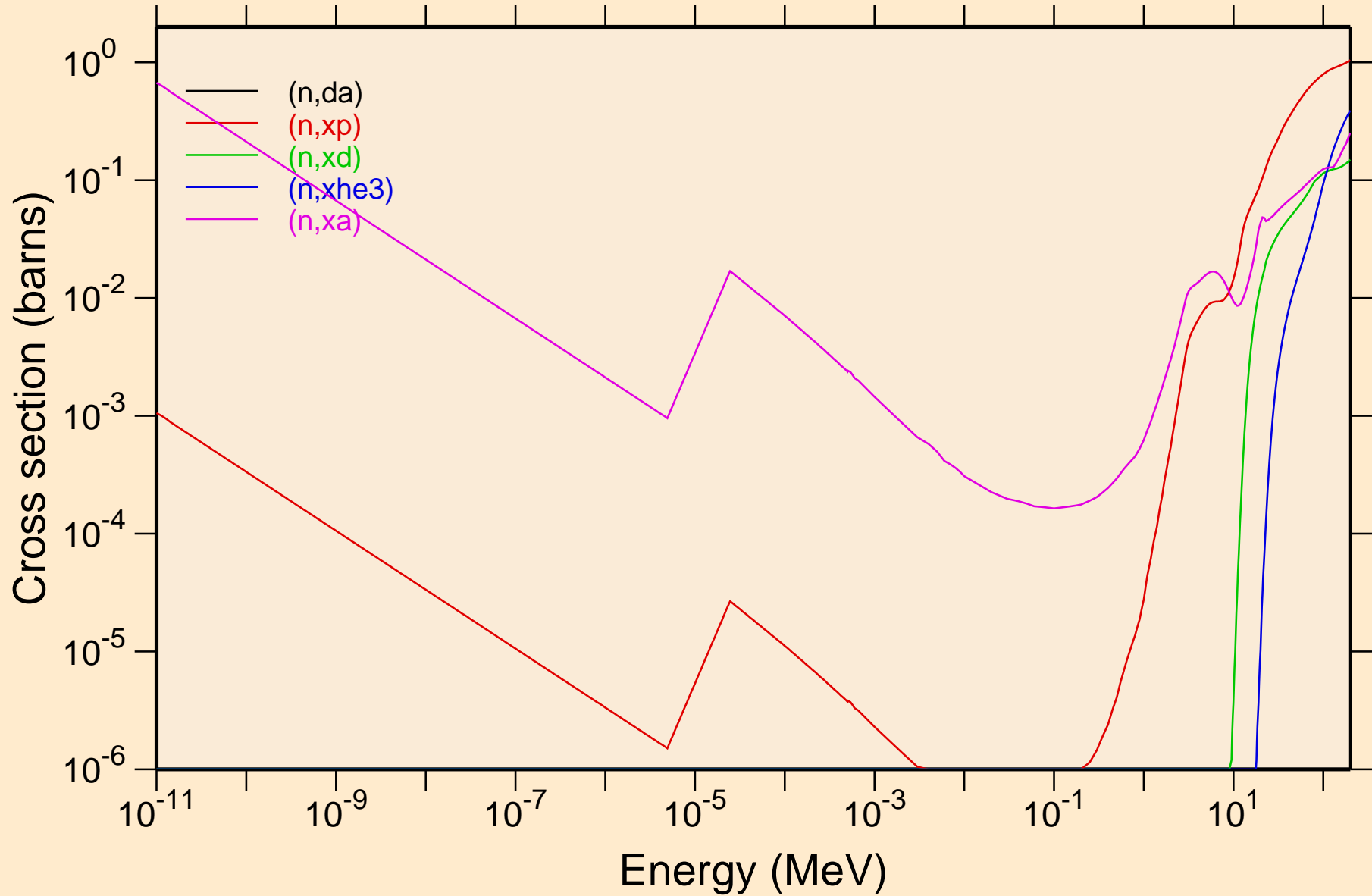

PO202 NEUTRON ACER TENDL-2023 LIBRARY; T=0.K

Principal cross sections

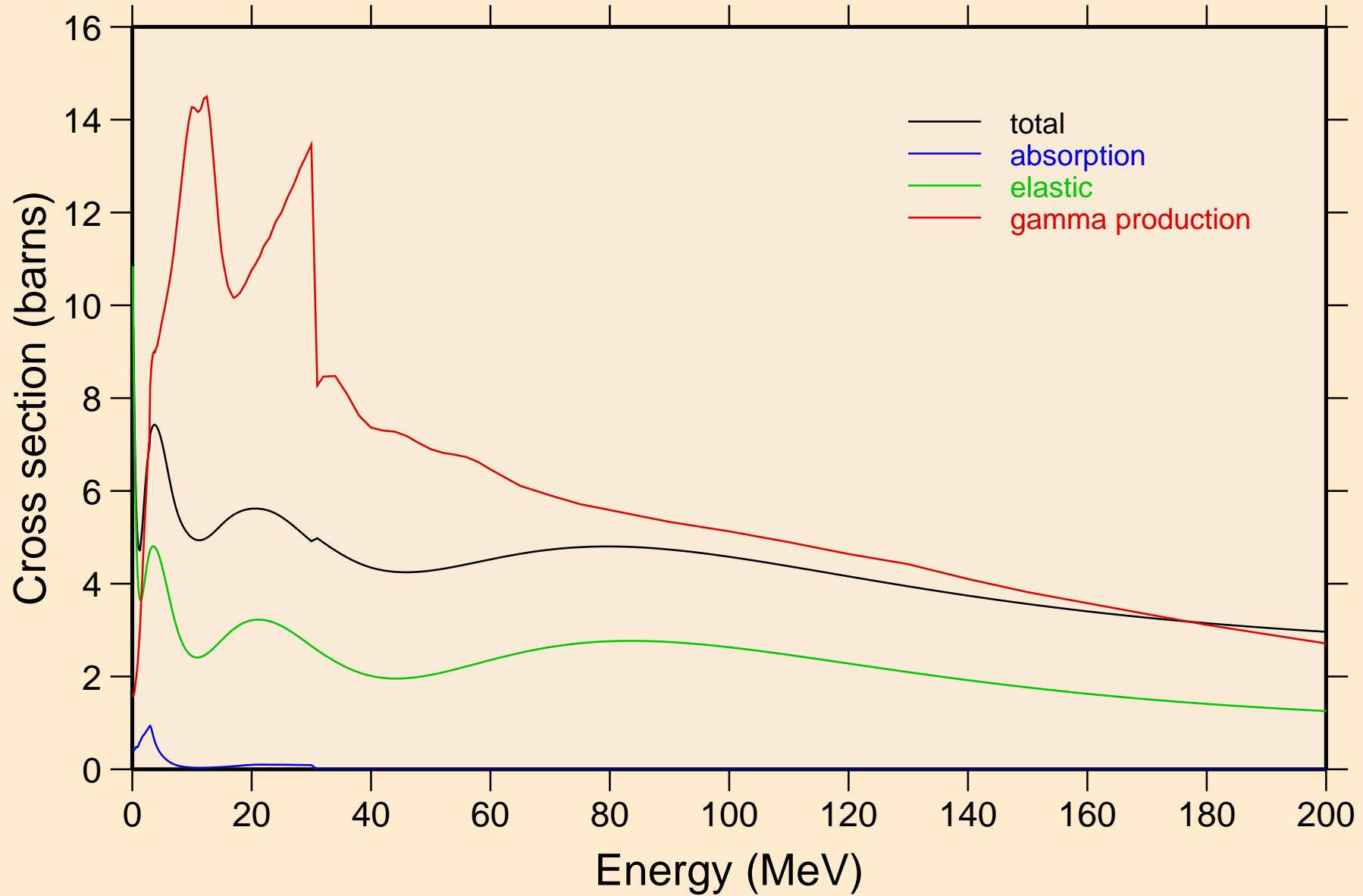

PO202 NEUTRON ACER TENDL-2023 LIBRARY; T=0.K

Heating

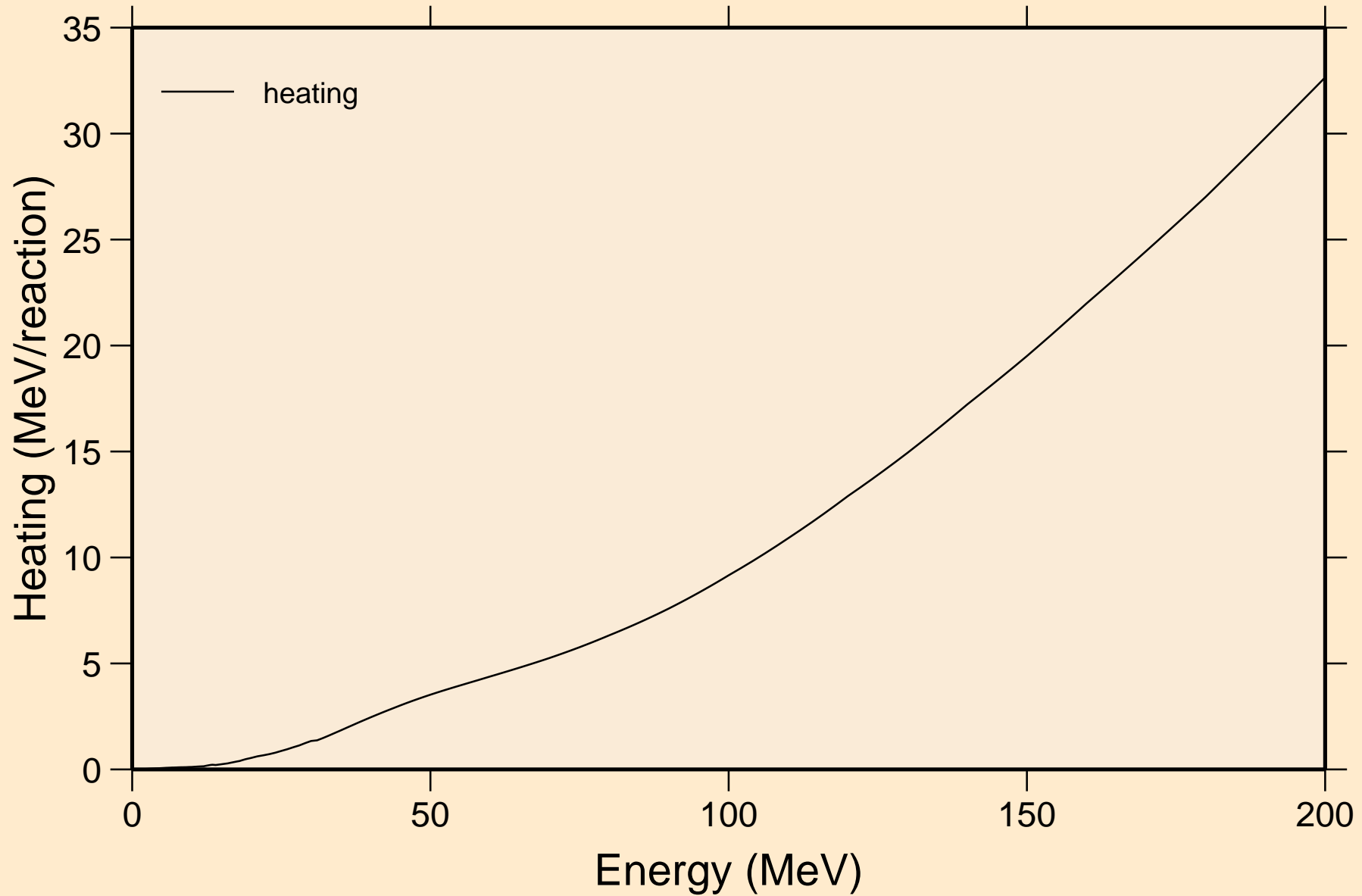

PO202 NEUTRON ACER TENDL-2023 LIBRARY; T=0.K
Damage

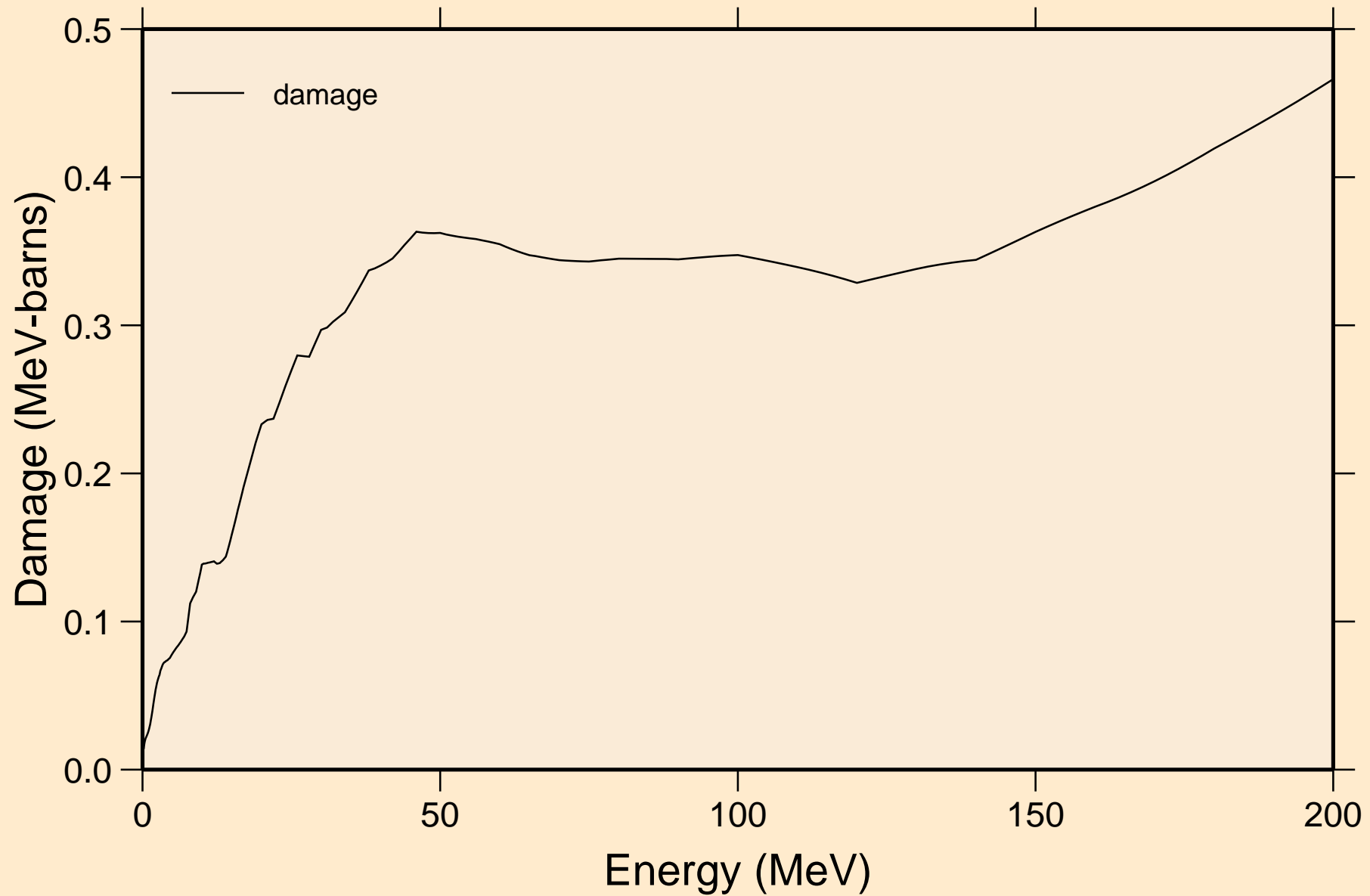

PO202 NEUTRON ACER TENDL-2023 LIBRARY; T=0.K
Non-threshold reactions

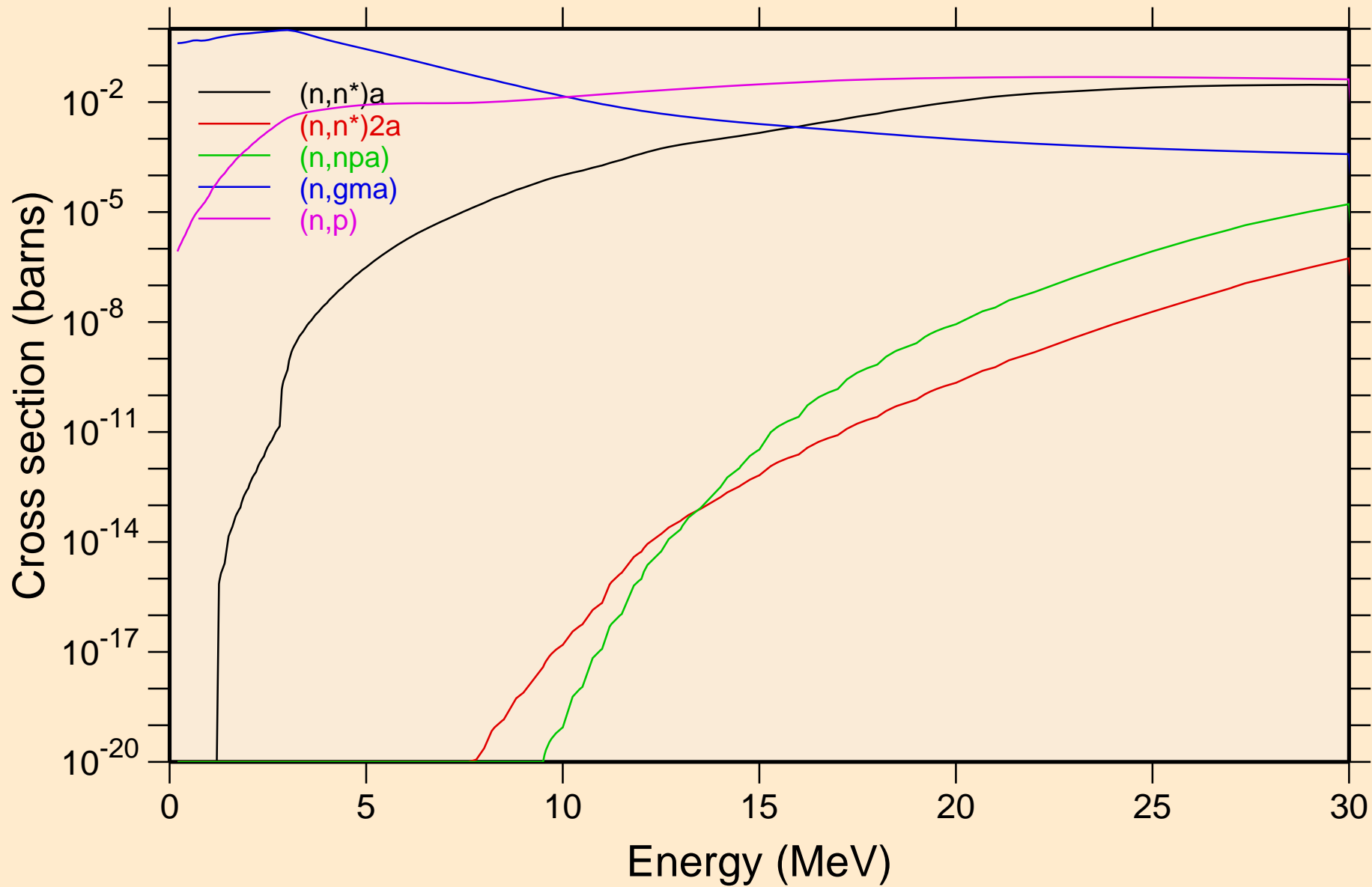

PO202 NEUTRON ACER TENDL-2023 LIBRARY; T=0.K
Non-threshold reactions

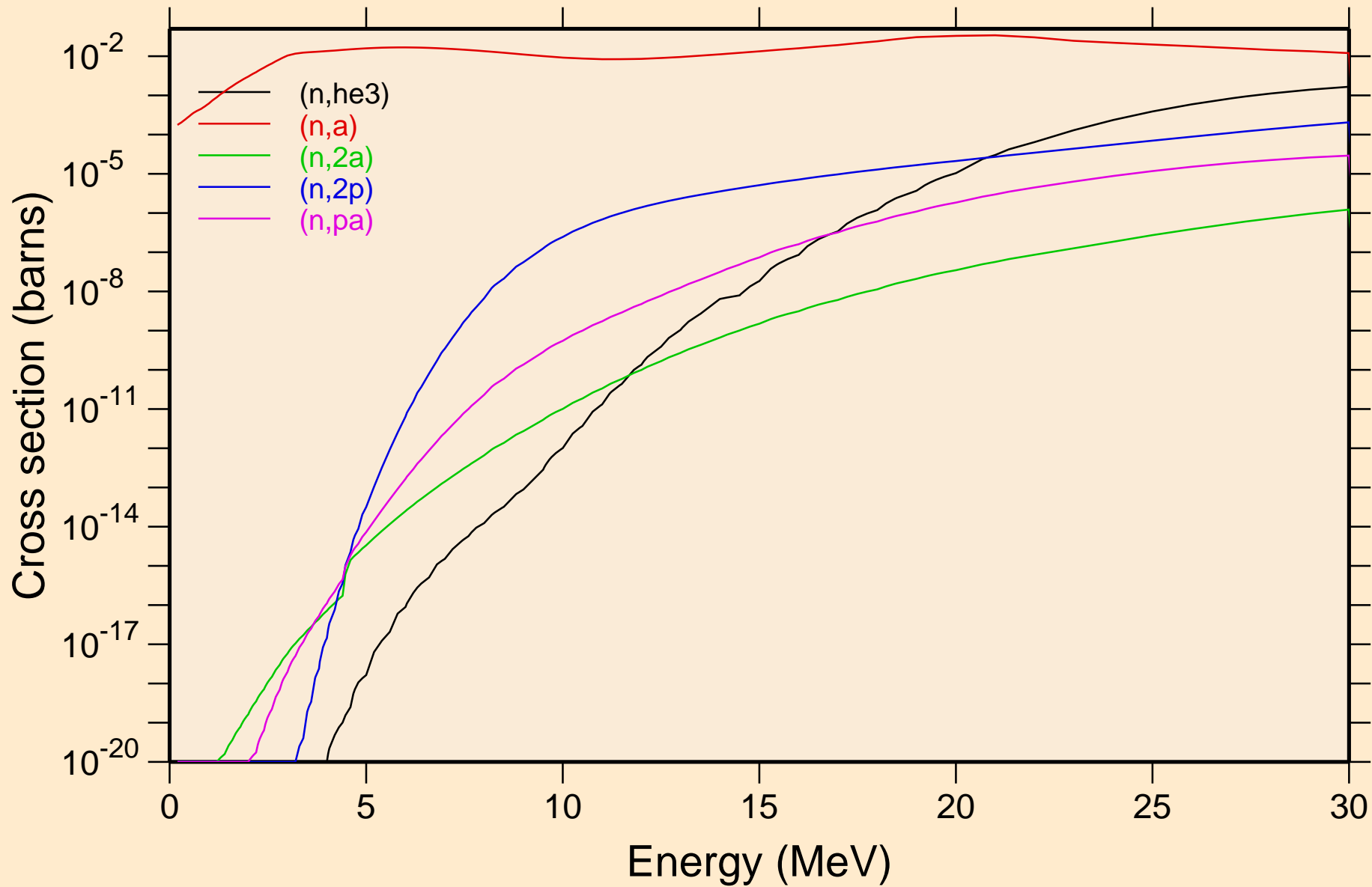

PO202 NEUTRON ACER TENDL-2023 LIBRARY; T=0.K
Non-threshold reactions

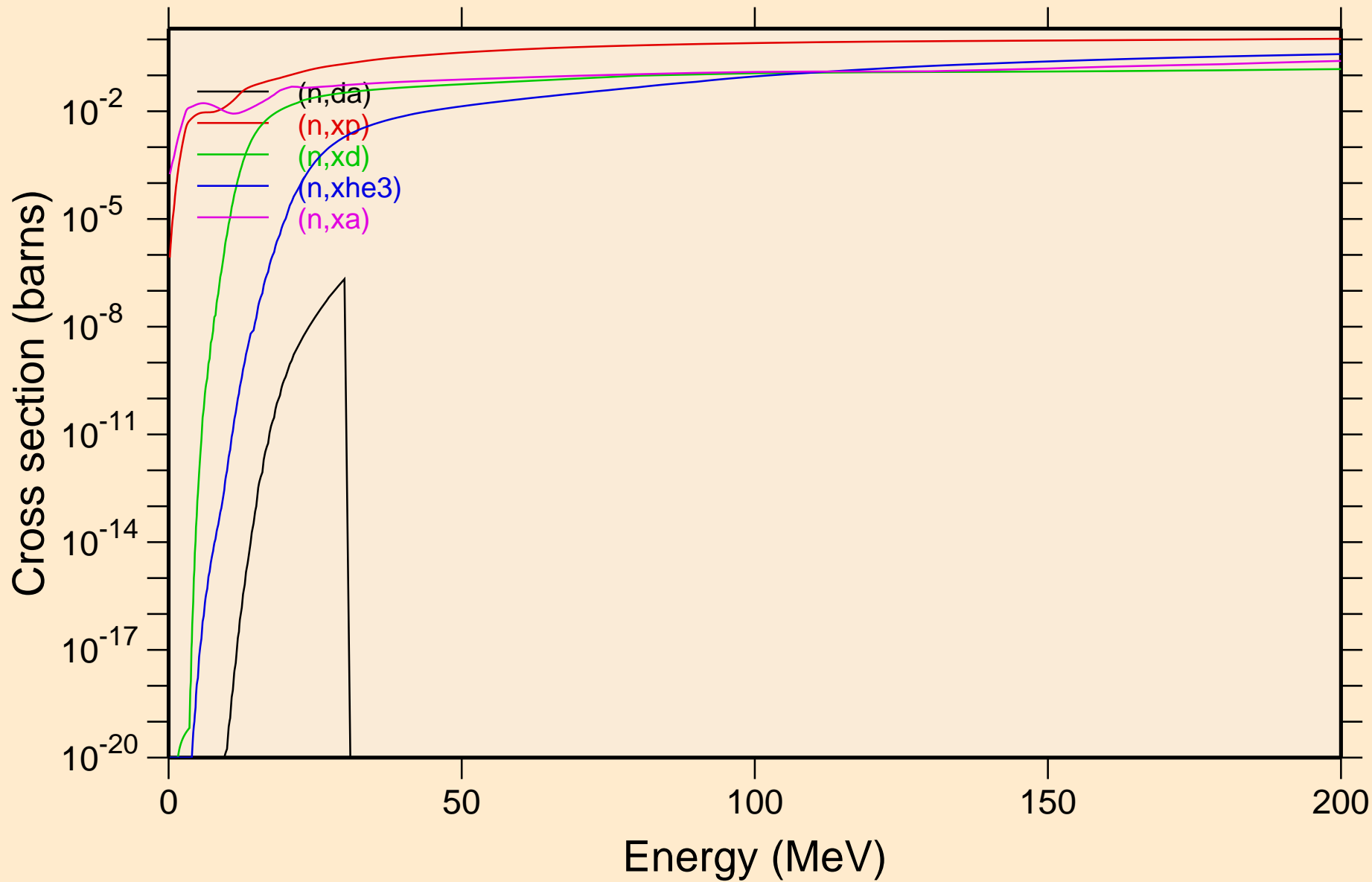

PO202 NEUTRON ACER TENDL-2023 LIBRARY; T=0.K
Inelastic levels

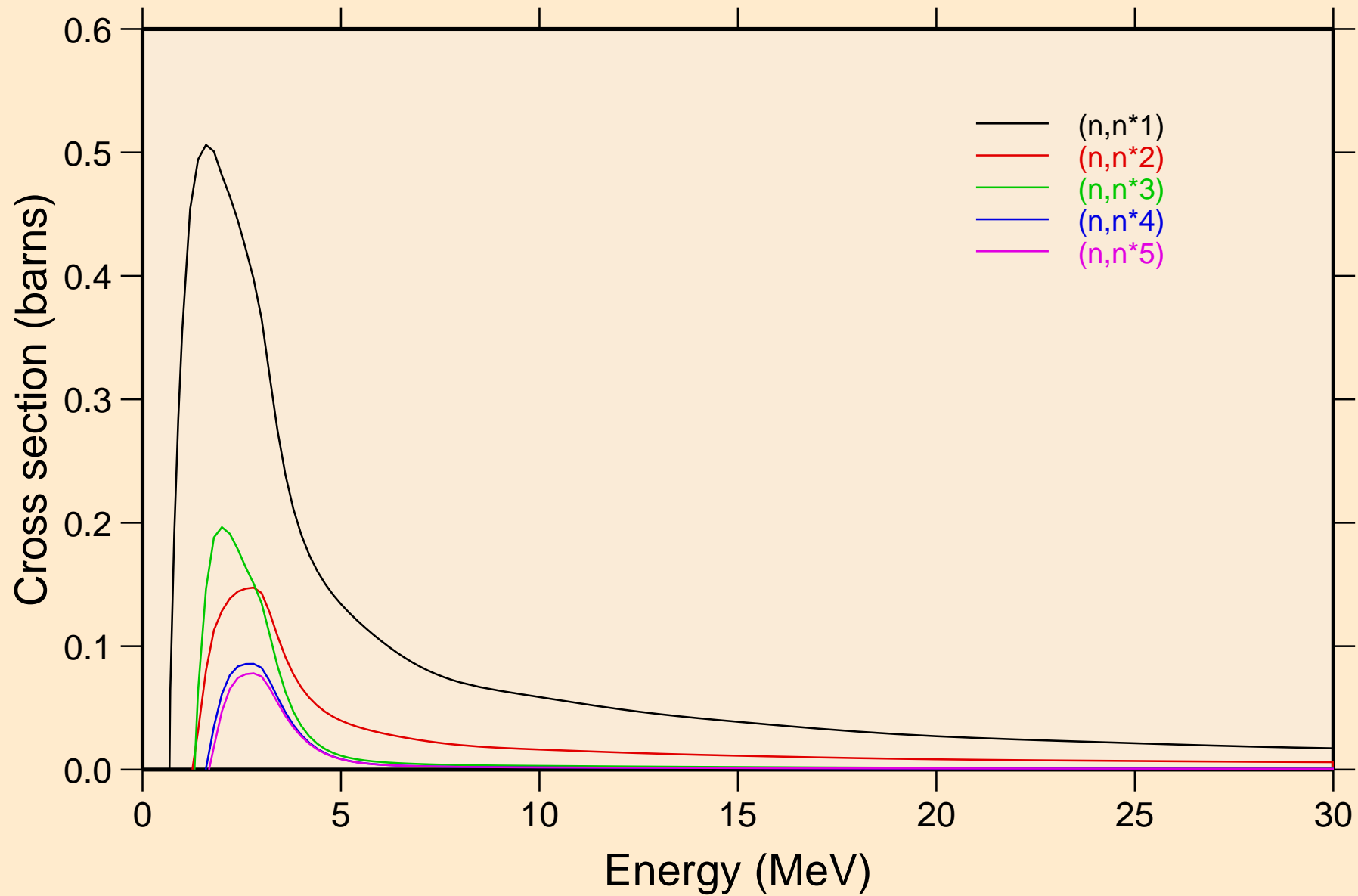

PO202 NEUTRON ACER TENDL-2023 LIBRARY; T=0.K
Inelastic levels

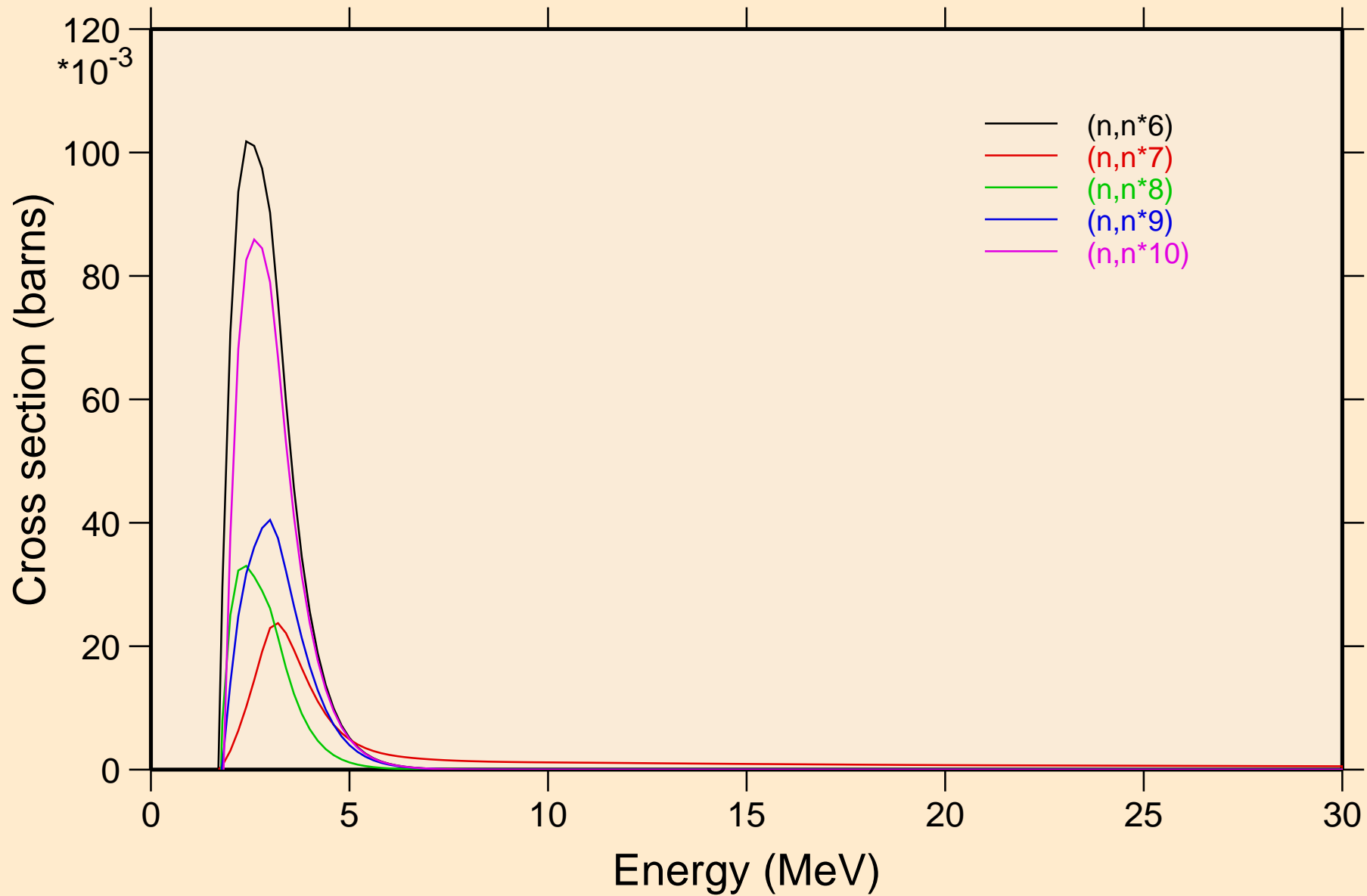

PO202 NEUTRON ACER TENDL-2023 LIBRARY; T=0.K
Inelastic levels

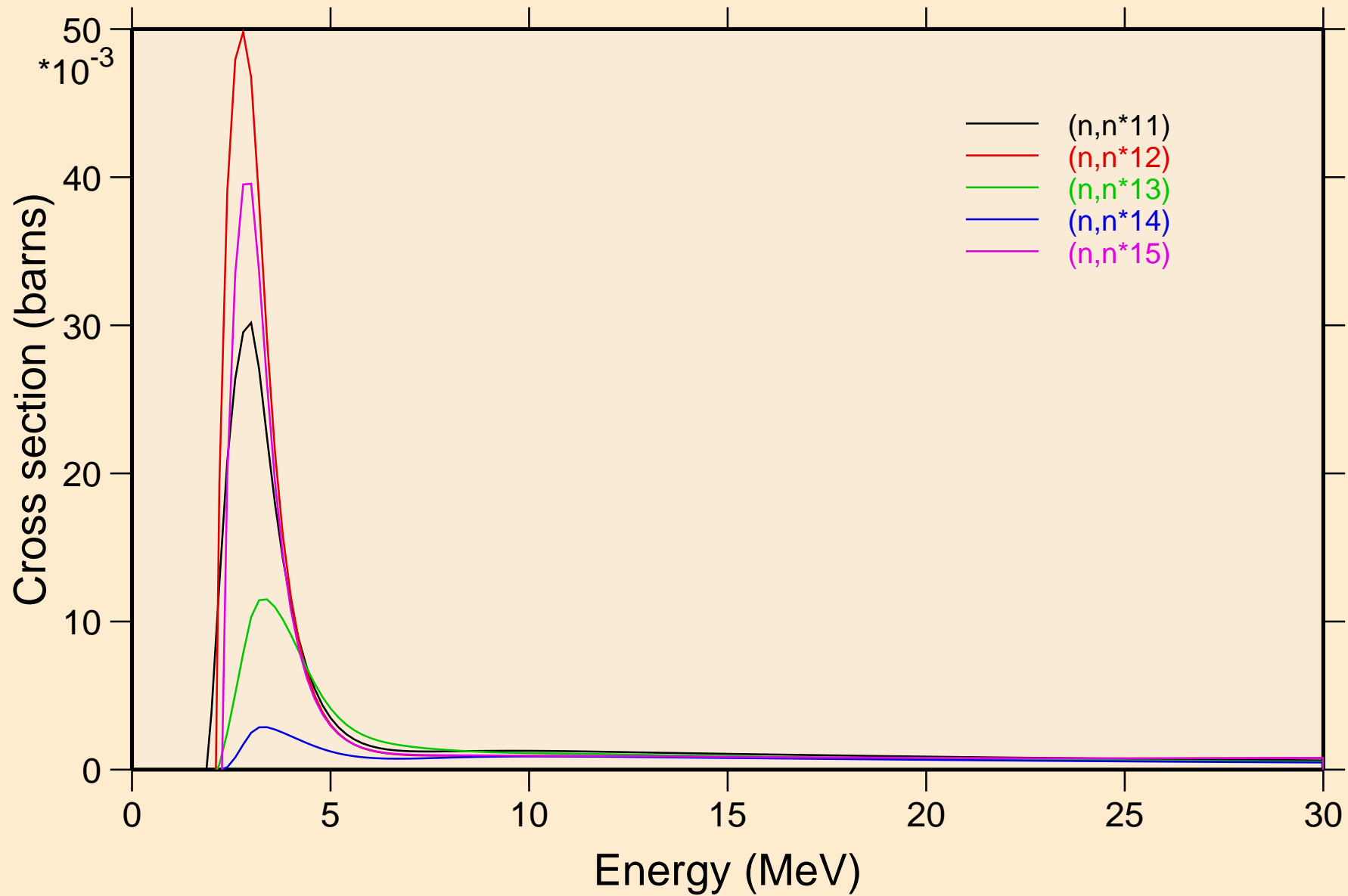

PO202 NEUTRON ACER TENDL-2023 LIBRARY; T=0.K
Inelastic levels

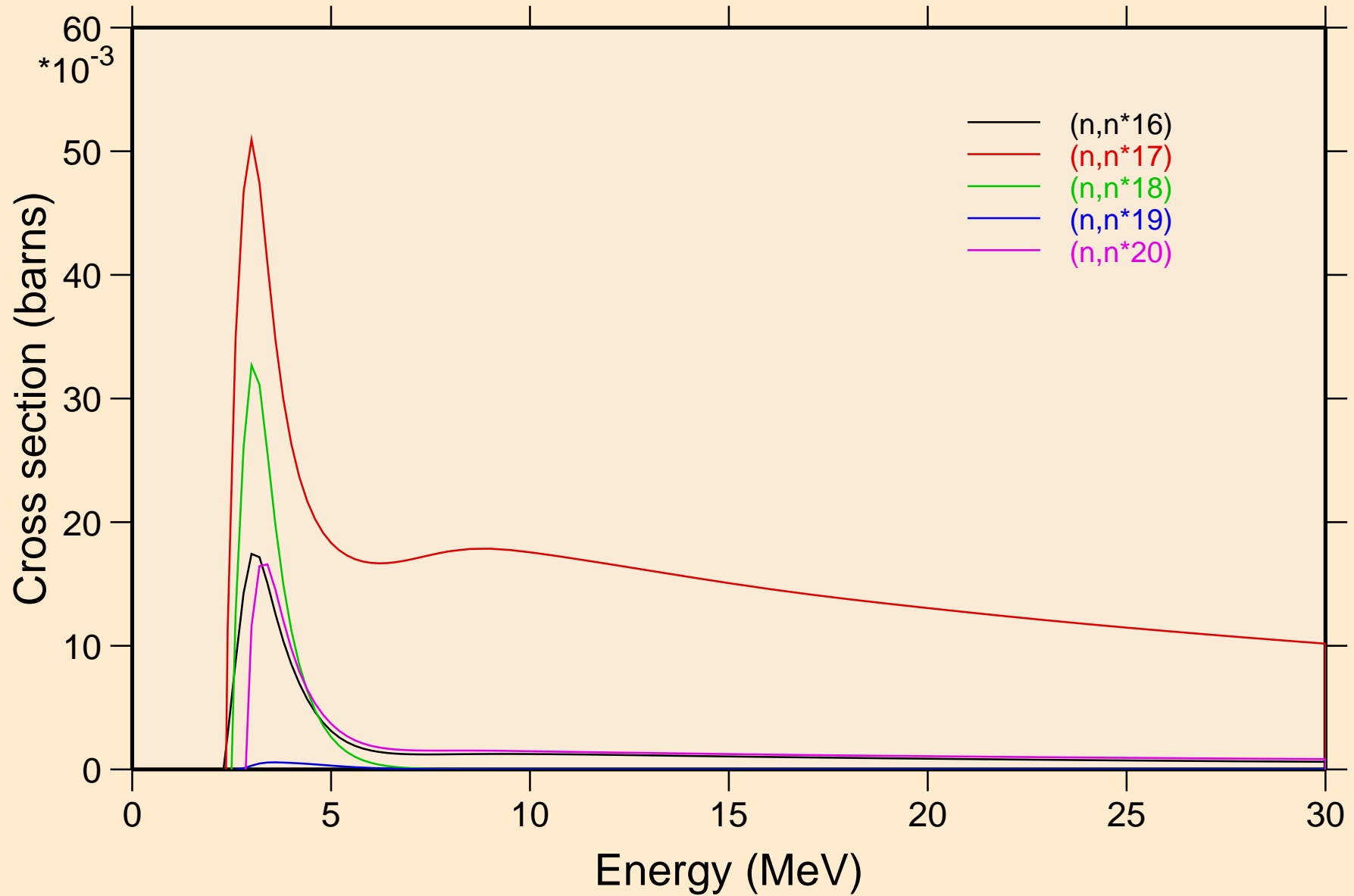

PO202 NEUTRON ACER TENDL-2023 LIBRARY; T=0.K
Threshold reactions

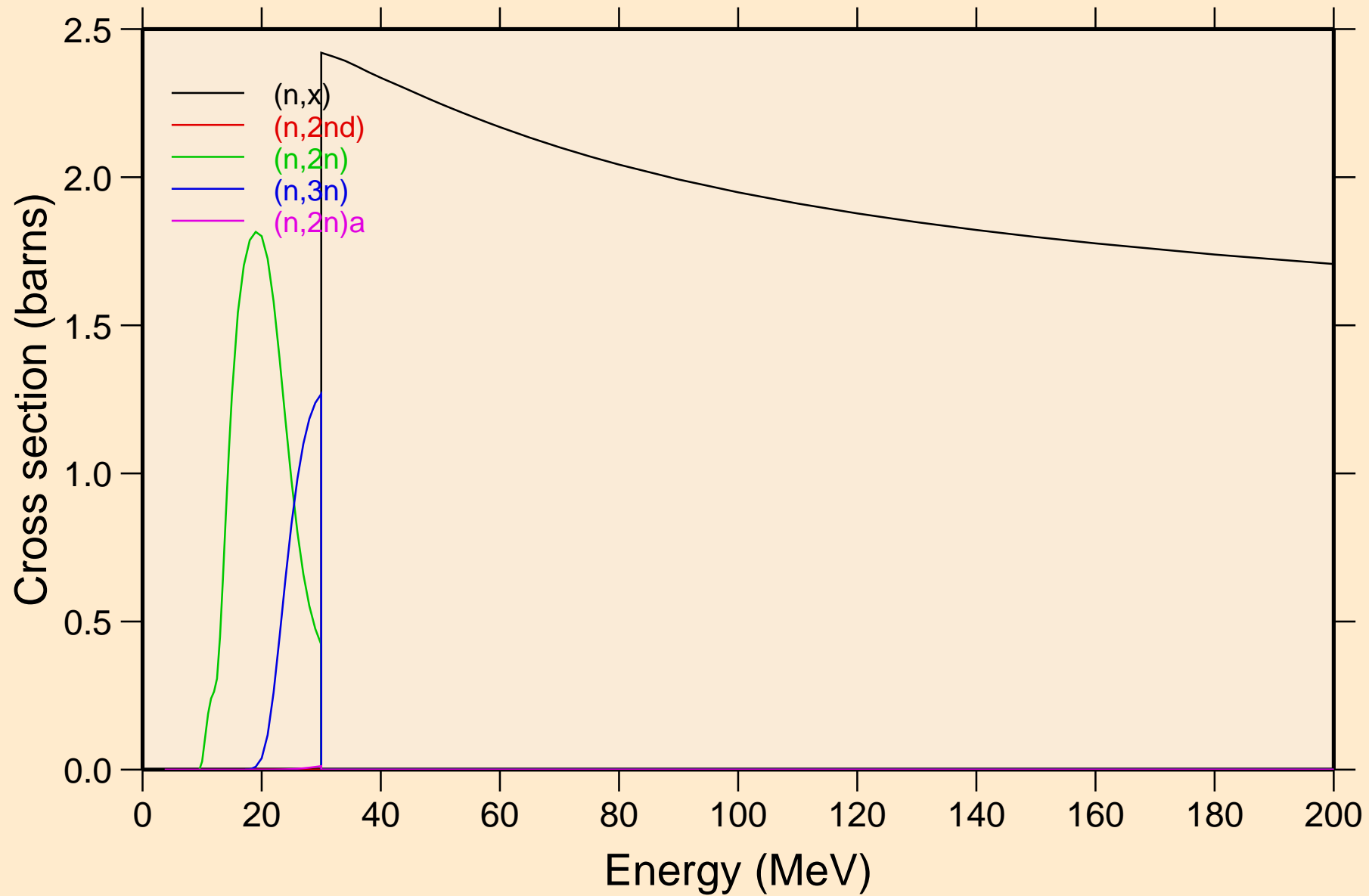

PO202 NEUTRON ACER TENDL-2023 LIBRARY; T=0.K
Threshold reactions

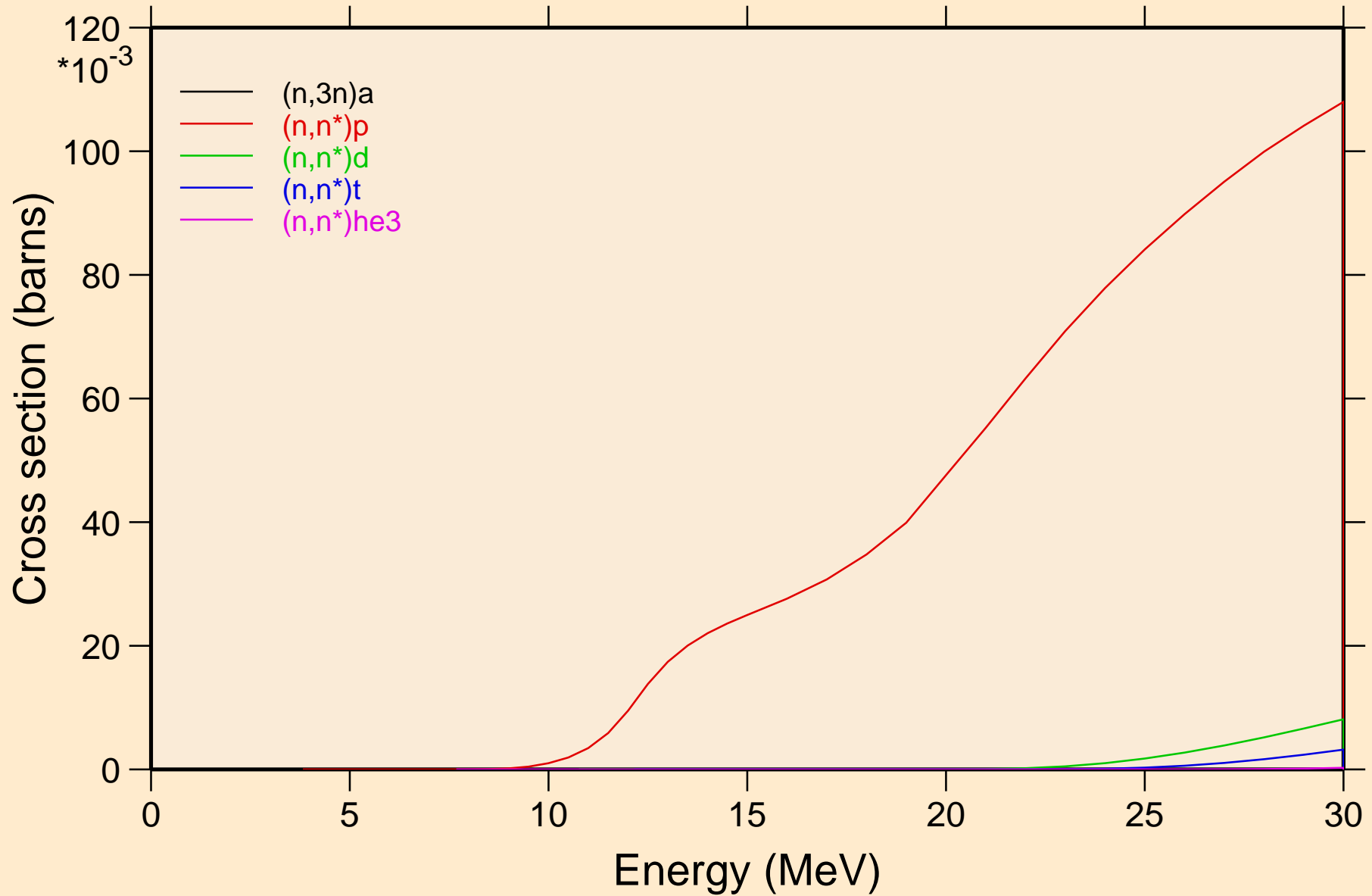

PO202 NEUTRON ACER TENDL-2023 LIBRARY; T=0.K
Threshold reactions

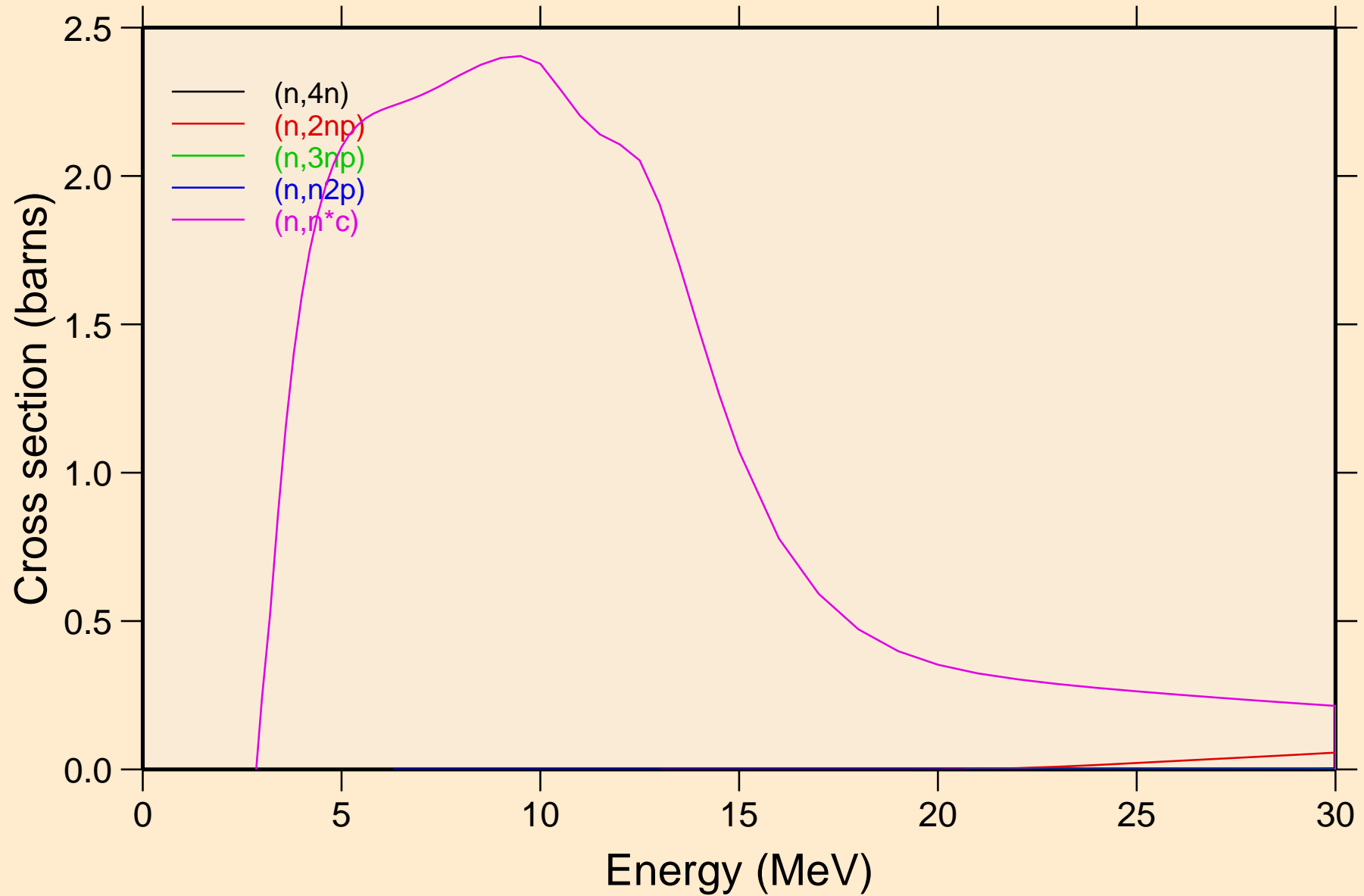

PO202 NEUTRON ACER TENDL-2023 LIBRARY; T=0.K
Threshold reactions

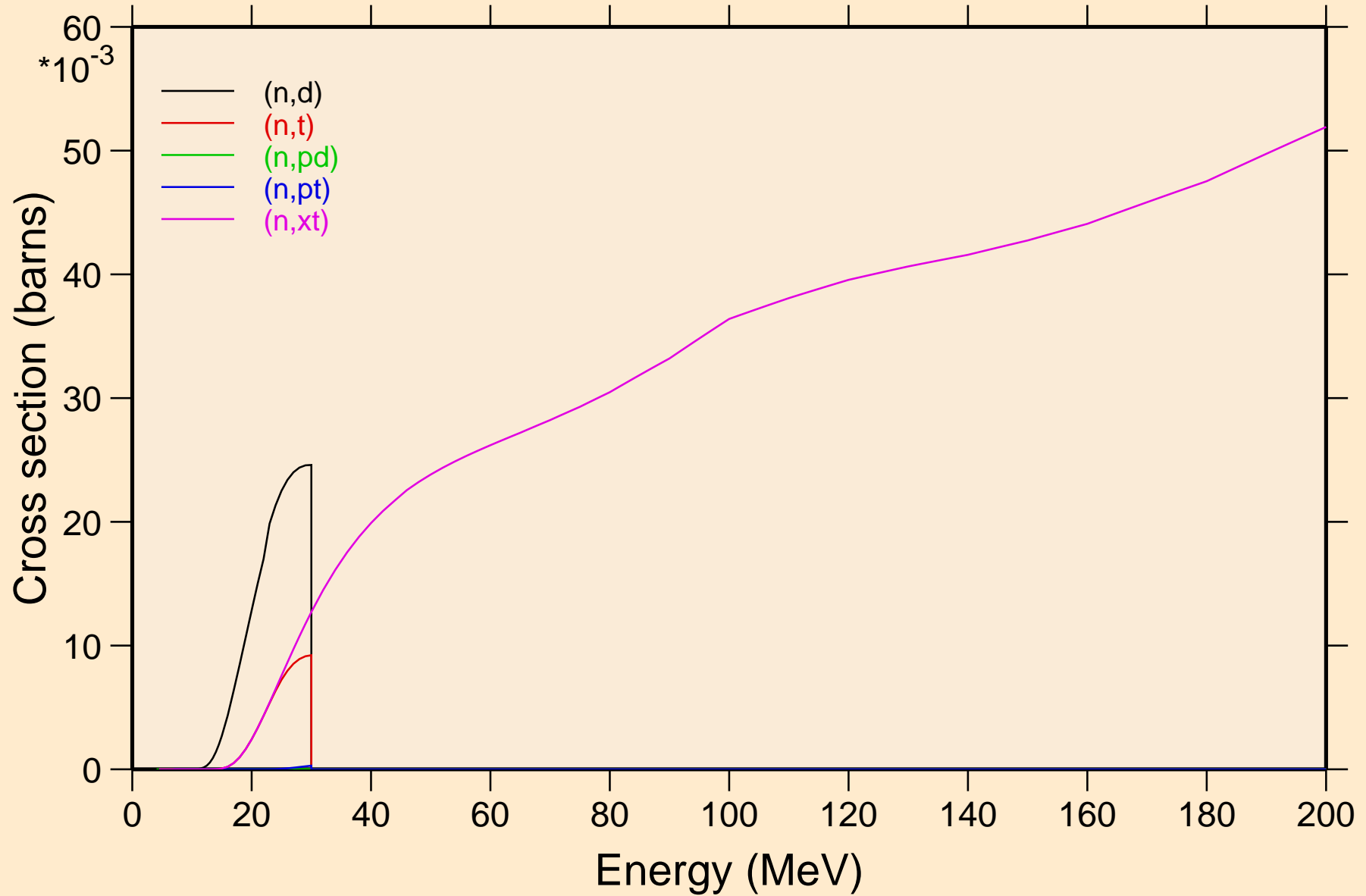

PO202 NEUTRON ACER TENDL-2023 LIBRARY; T=0.K
angular distribution for elastic

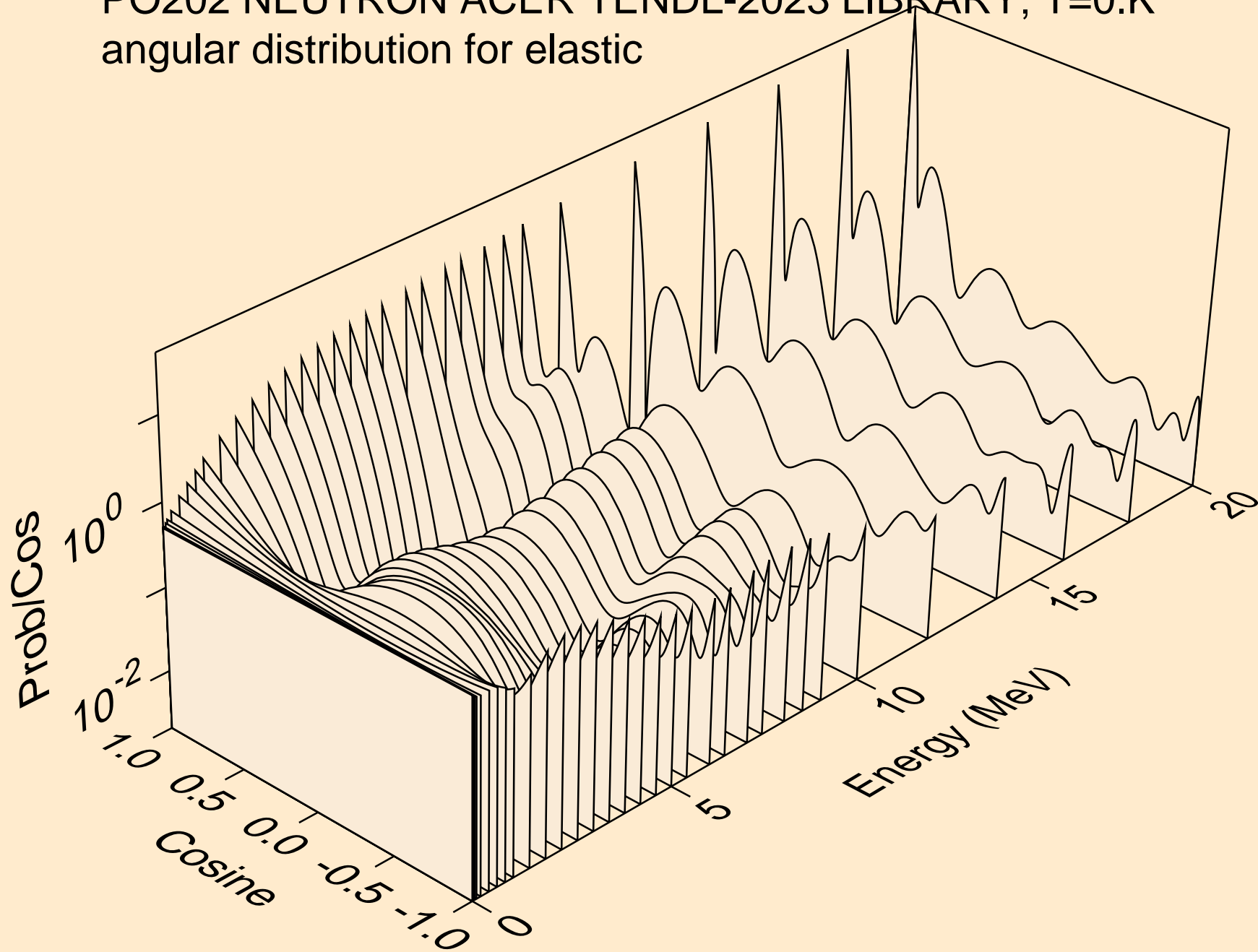

PO202 NEUTRON ACER TENDL-2023 LIBRARY; T=0.K
angular distribution for elastic

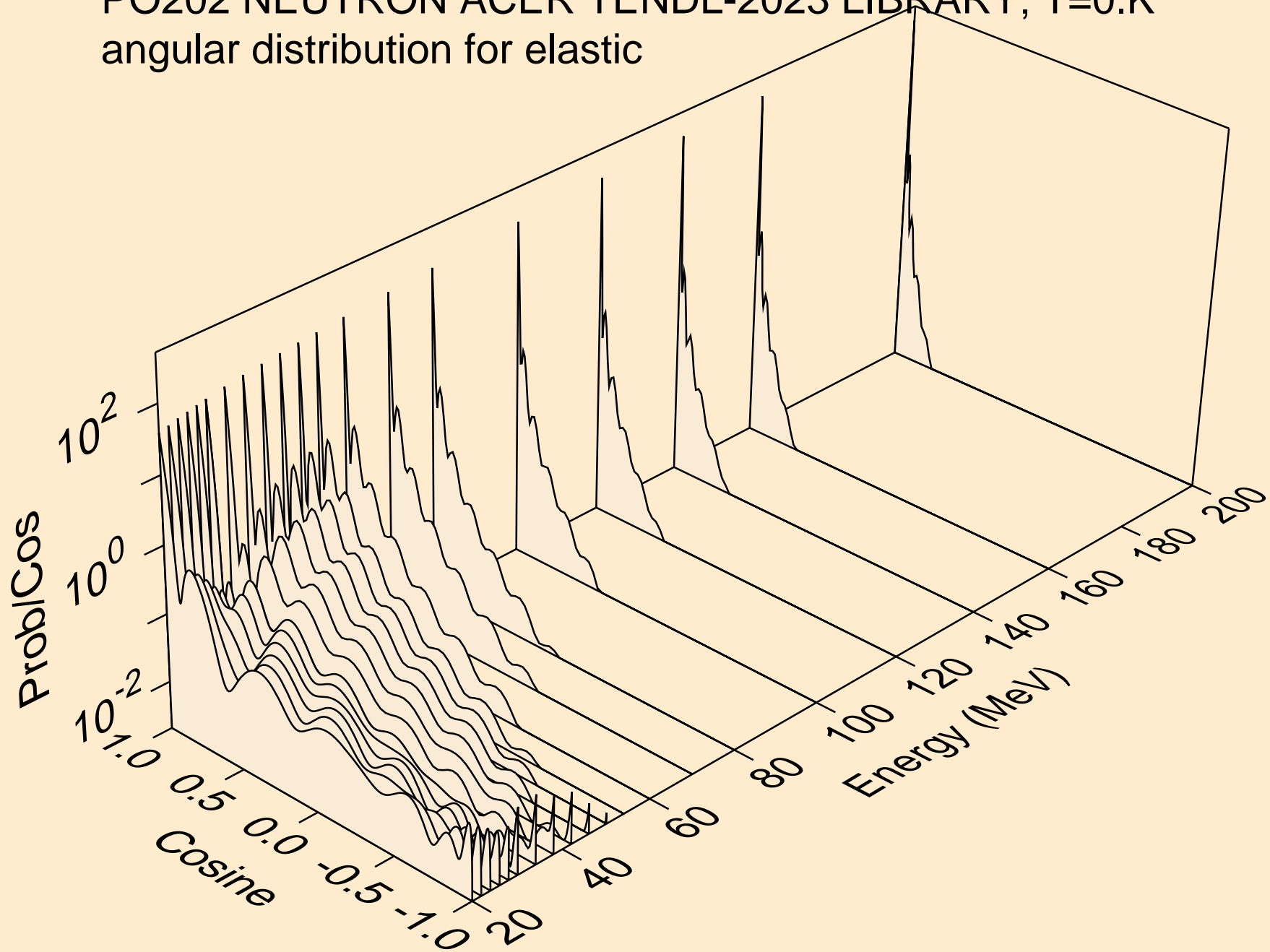

PO202 NEUTRON ACER TENDL-2023 LIBRARY; T=0.K
angular distribution for (n,n*1)

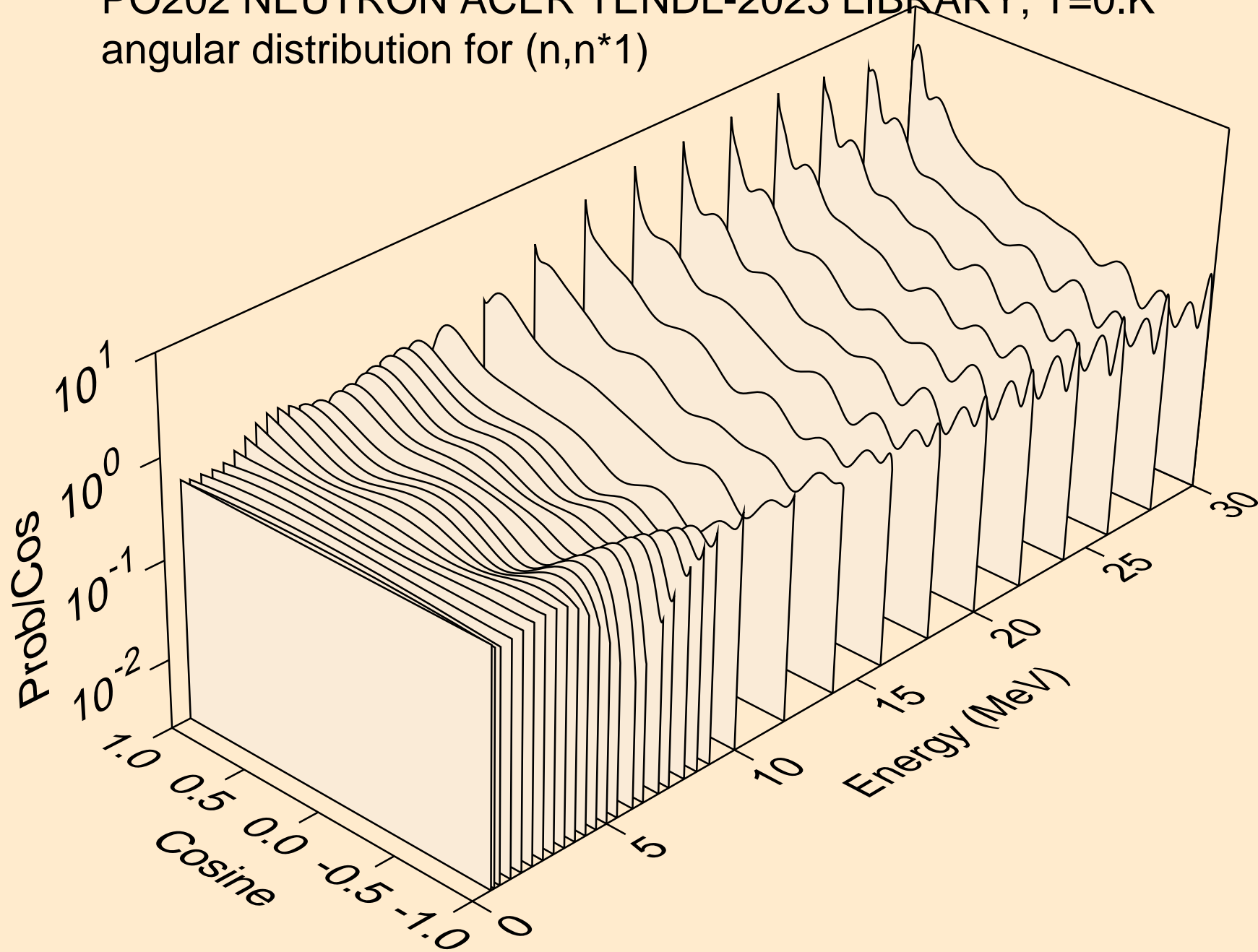

PO202 NEUTRON ACER TENDL-2023 LIBRARY; T=0.K
angular distribution for (n,n*2)

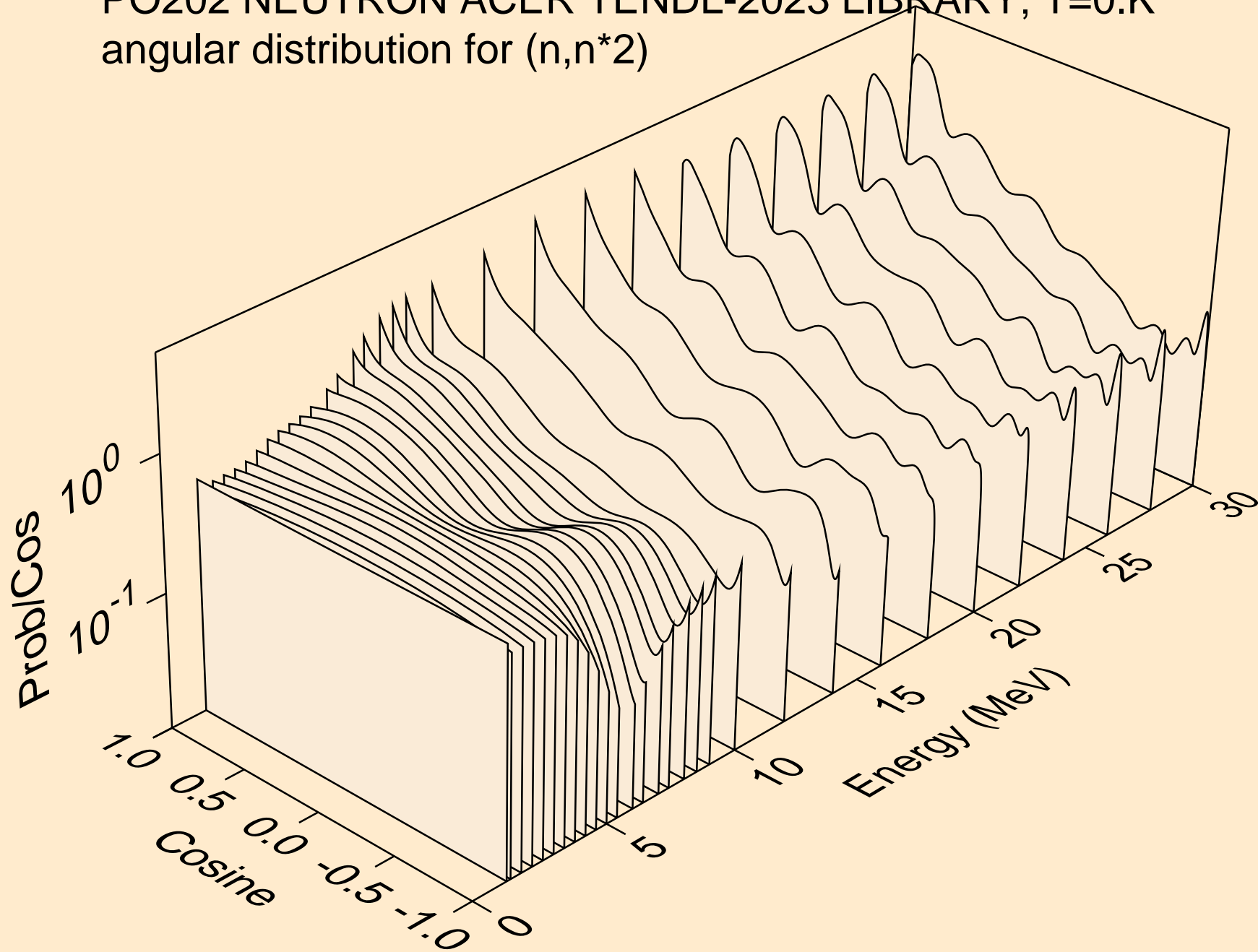

PO202 NEUTRON ACER TENDL-2023 LIBRARY; T=0.K
angular distribution for (n,n*3)

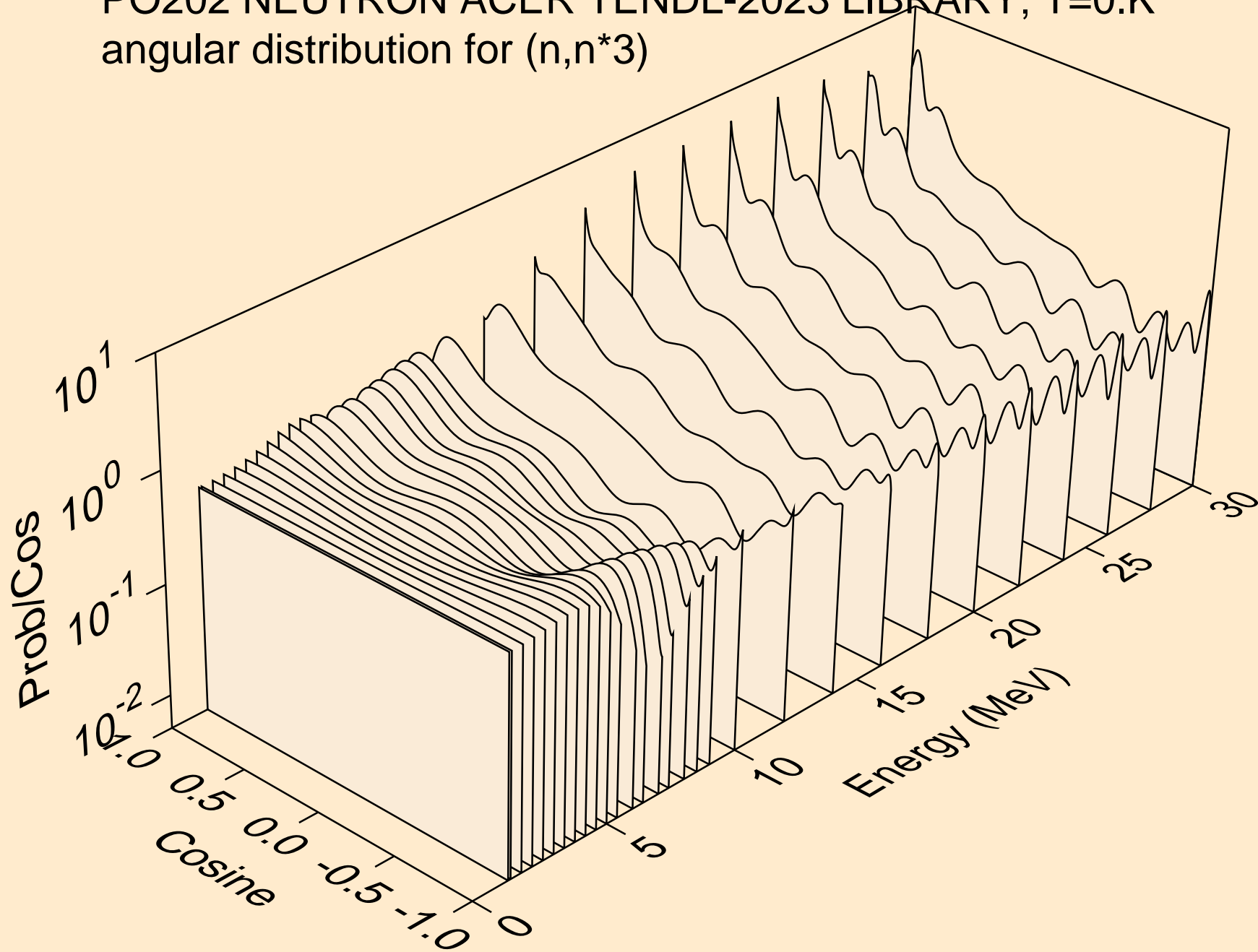

PO202 NEUTRON ACER TENDL-2023 LIBRARY; T=0.K
angular distribution for (n,n*4)

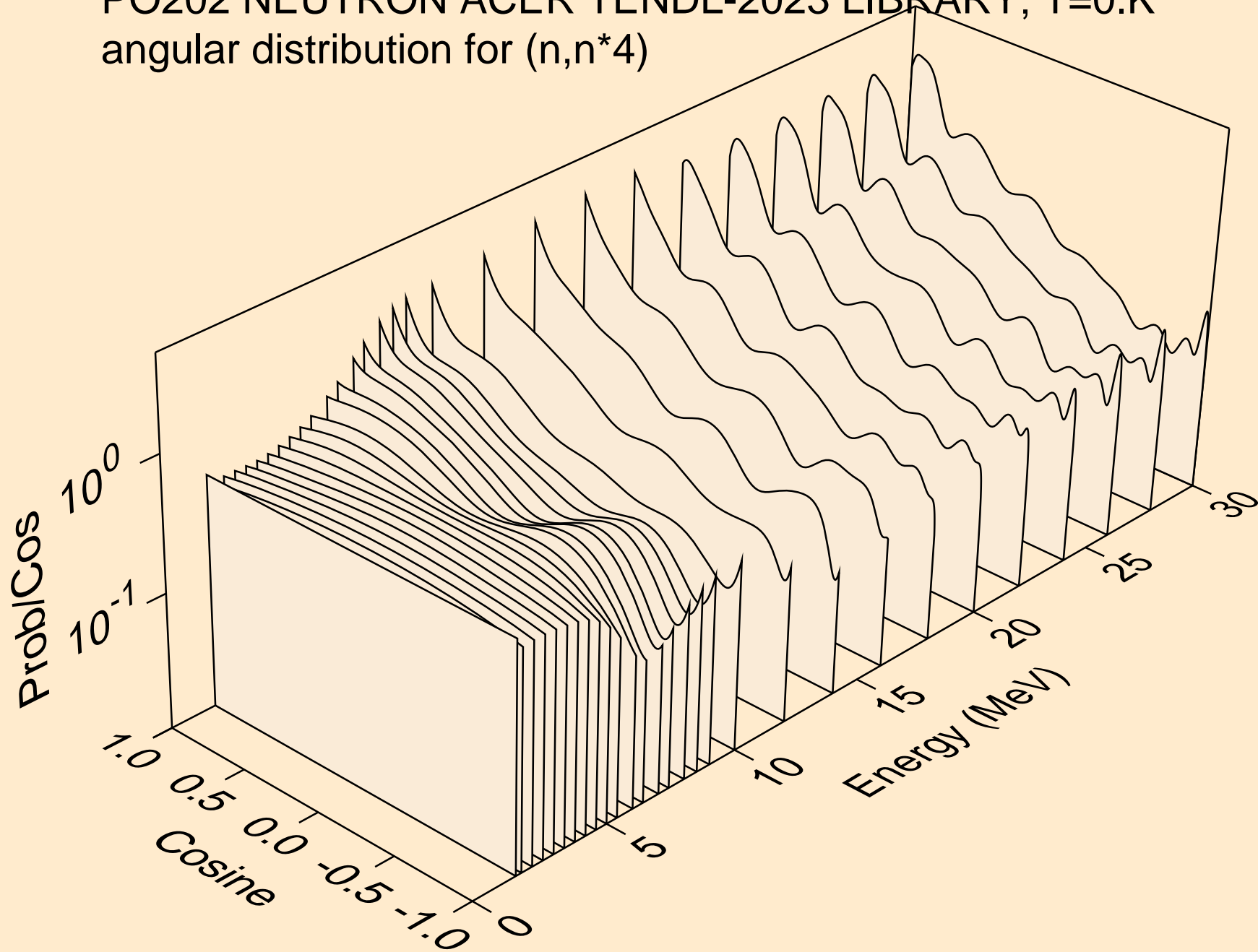

PO202 NEUTRON ACER TENDL-2023 LIBRARY; T=0.K
angular distribution for (n,n*5)

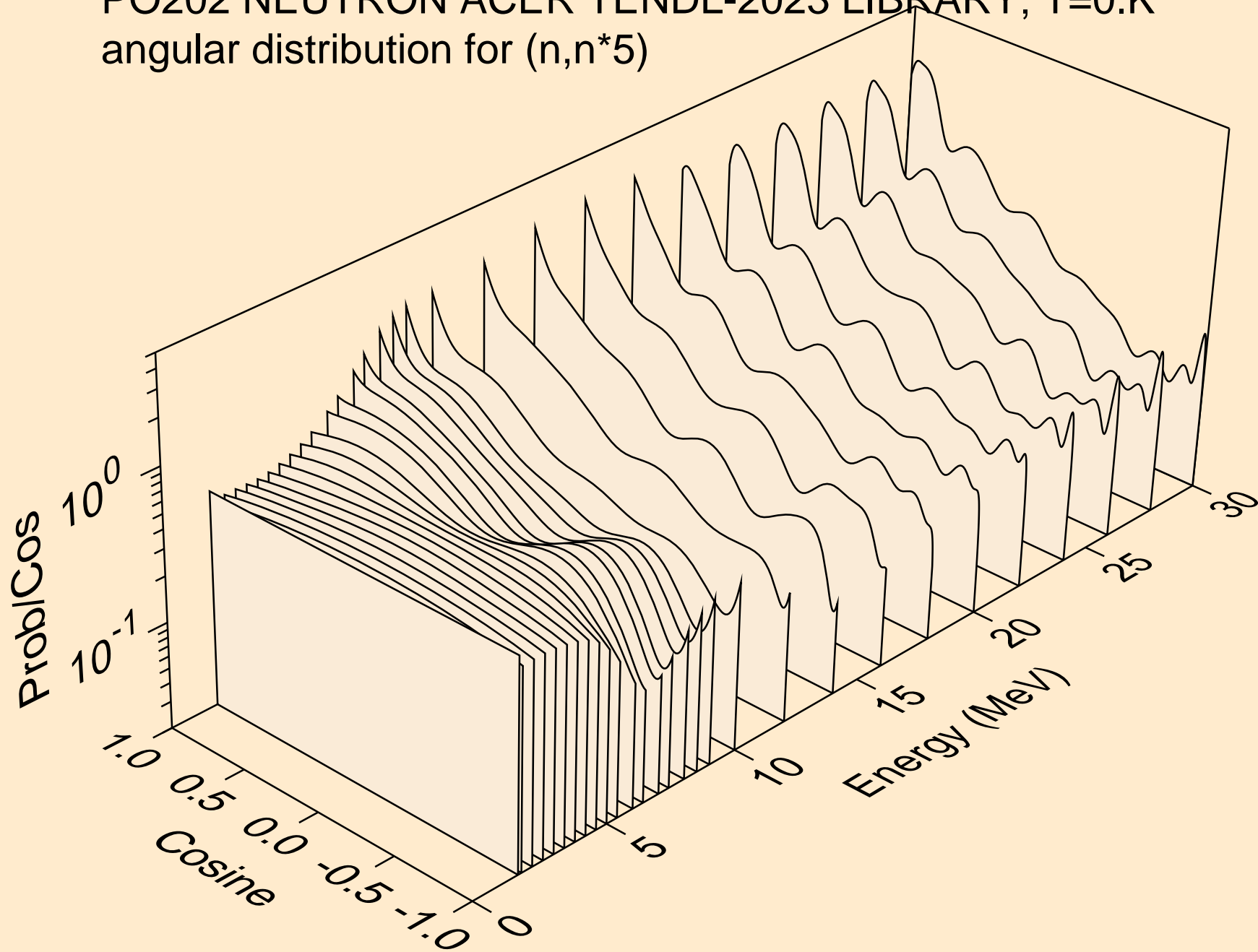

PO202 NEUTRON ACER TENDL-2023 LIBRARY; T=0.K
angular distribution for (n,n*6)

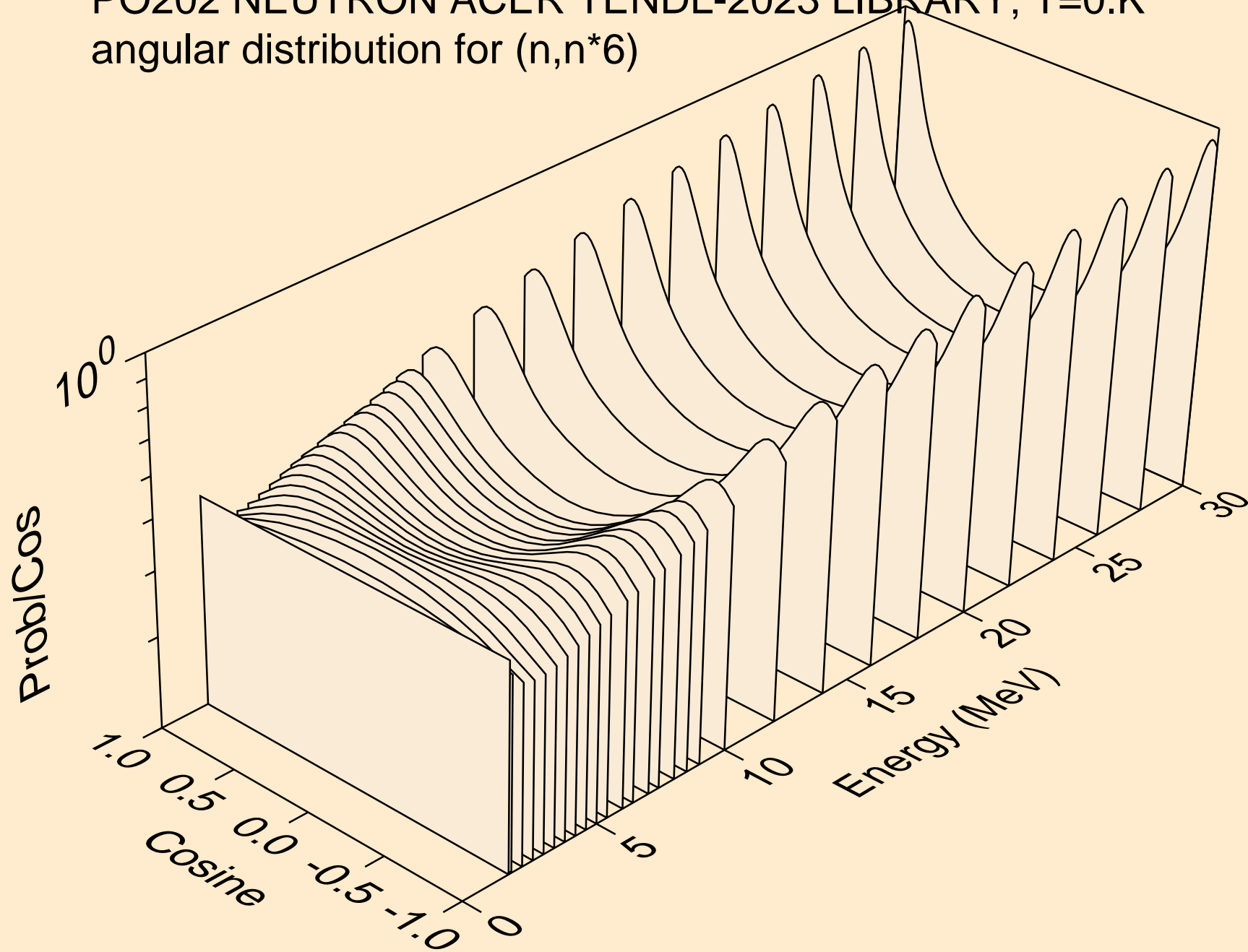

PO202 NEUTRON ACER TENDL-2023 LIBRARY; T=0.K
angular distribution for (n,n*7)

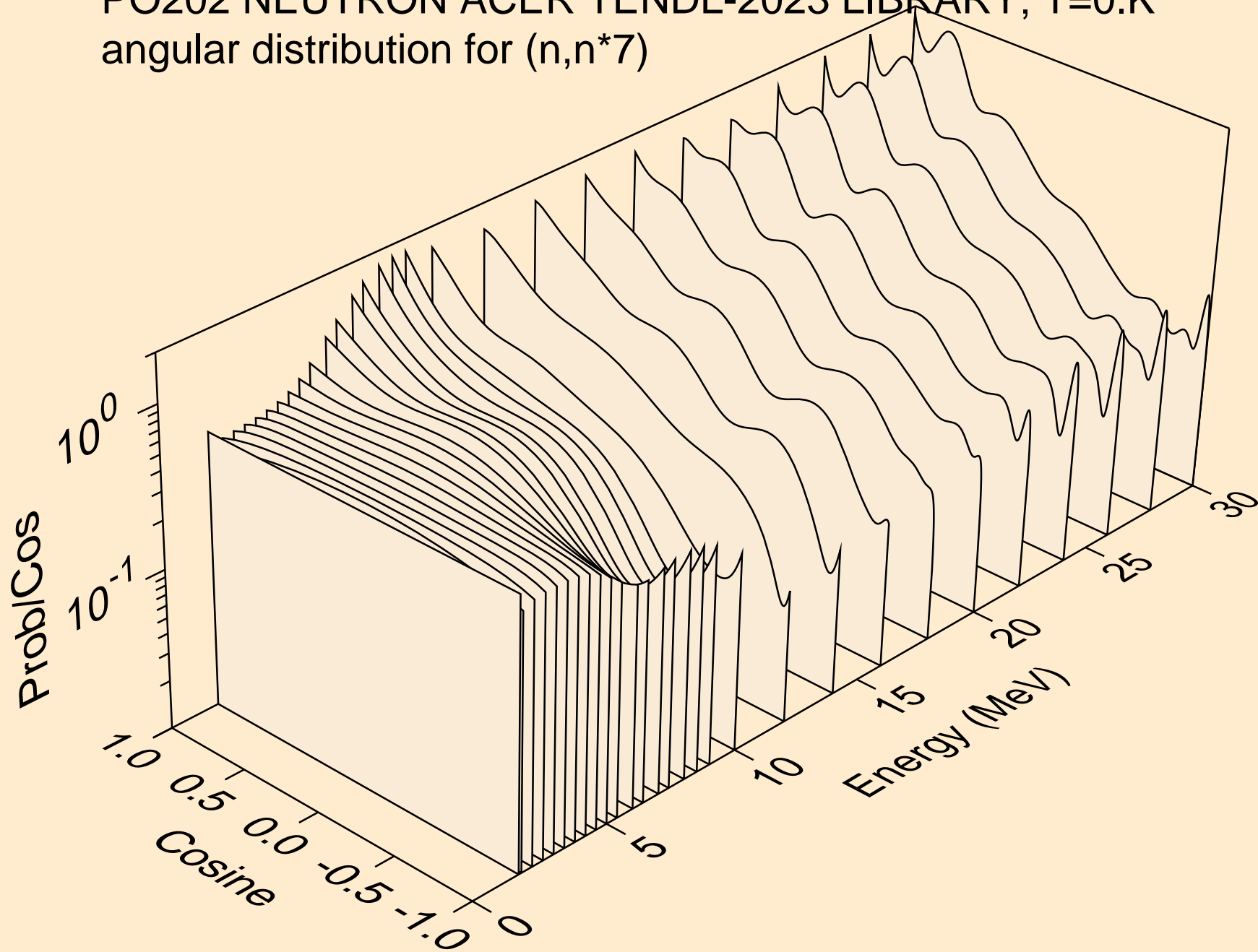

PO202 NEUTRON ACER TENDL-2023 LIBRARY; T=0.K
angular distribution for (n,n*8)

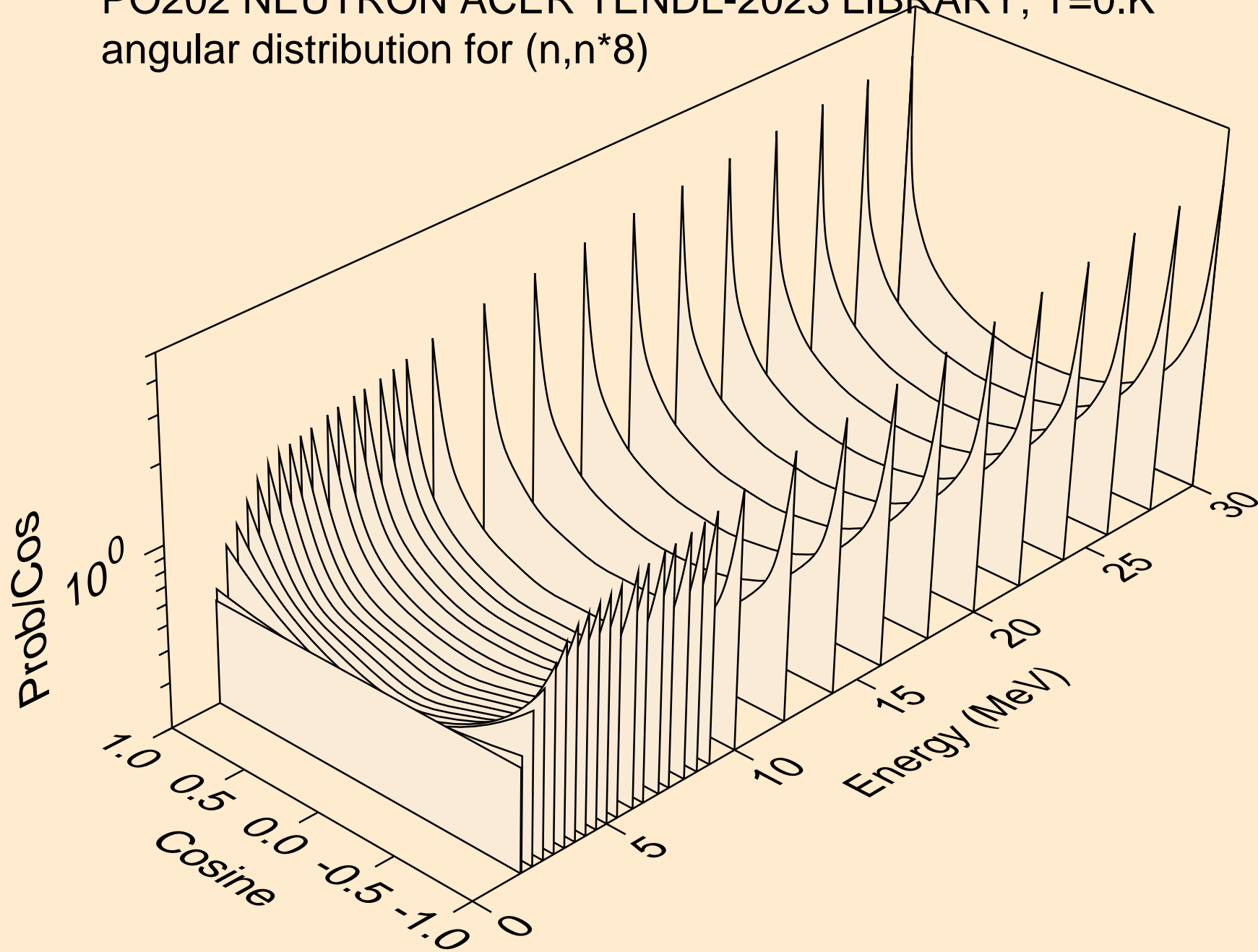

PO202 NEUTRON ACER TENDL-2023 LIBRARY; T=0.K
angular distribution for (n,n*9)

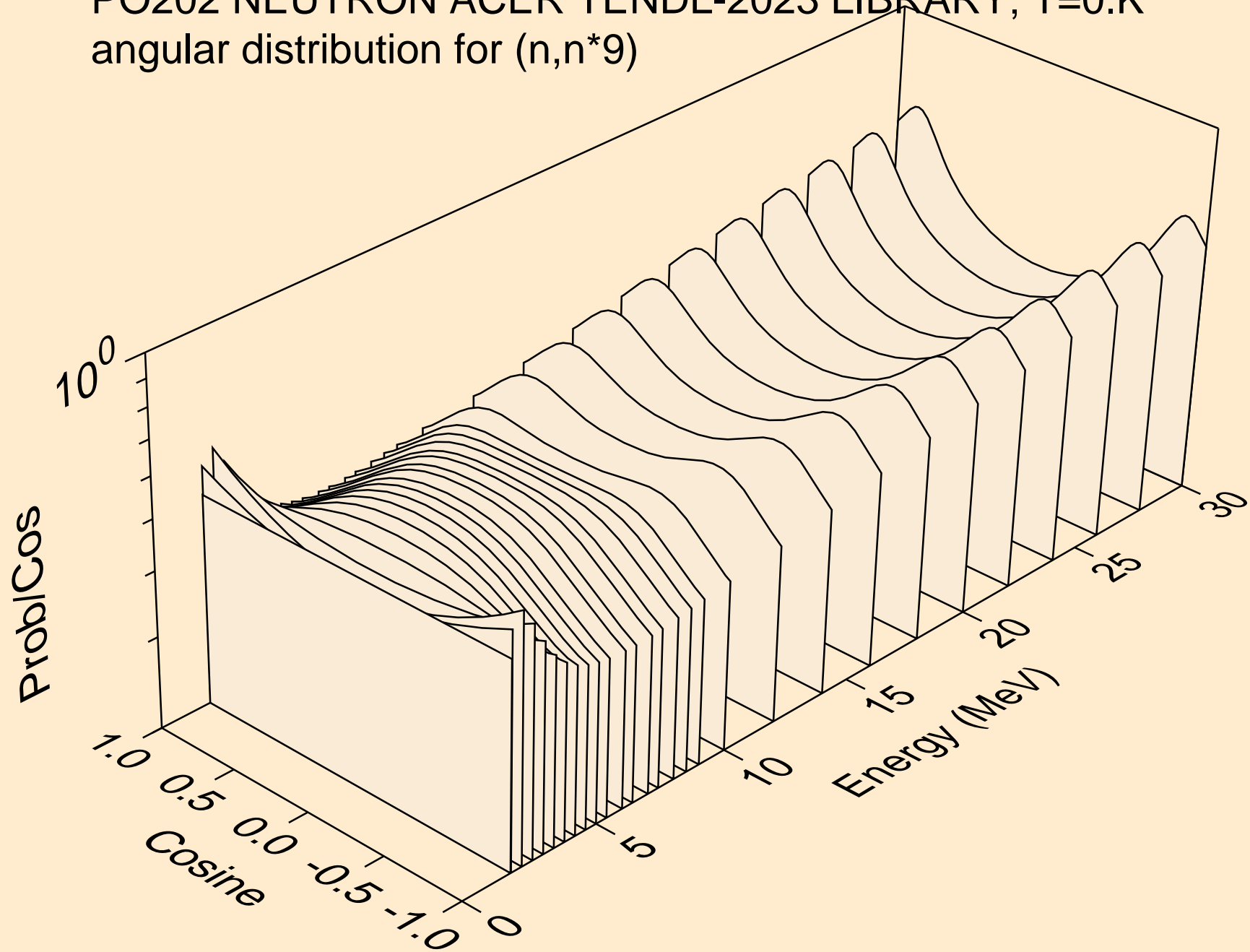

PO202 NEUTRON ACER TENDL-2023 LIBRARY; T=0.K
angular distribution for (n,n*10)

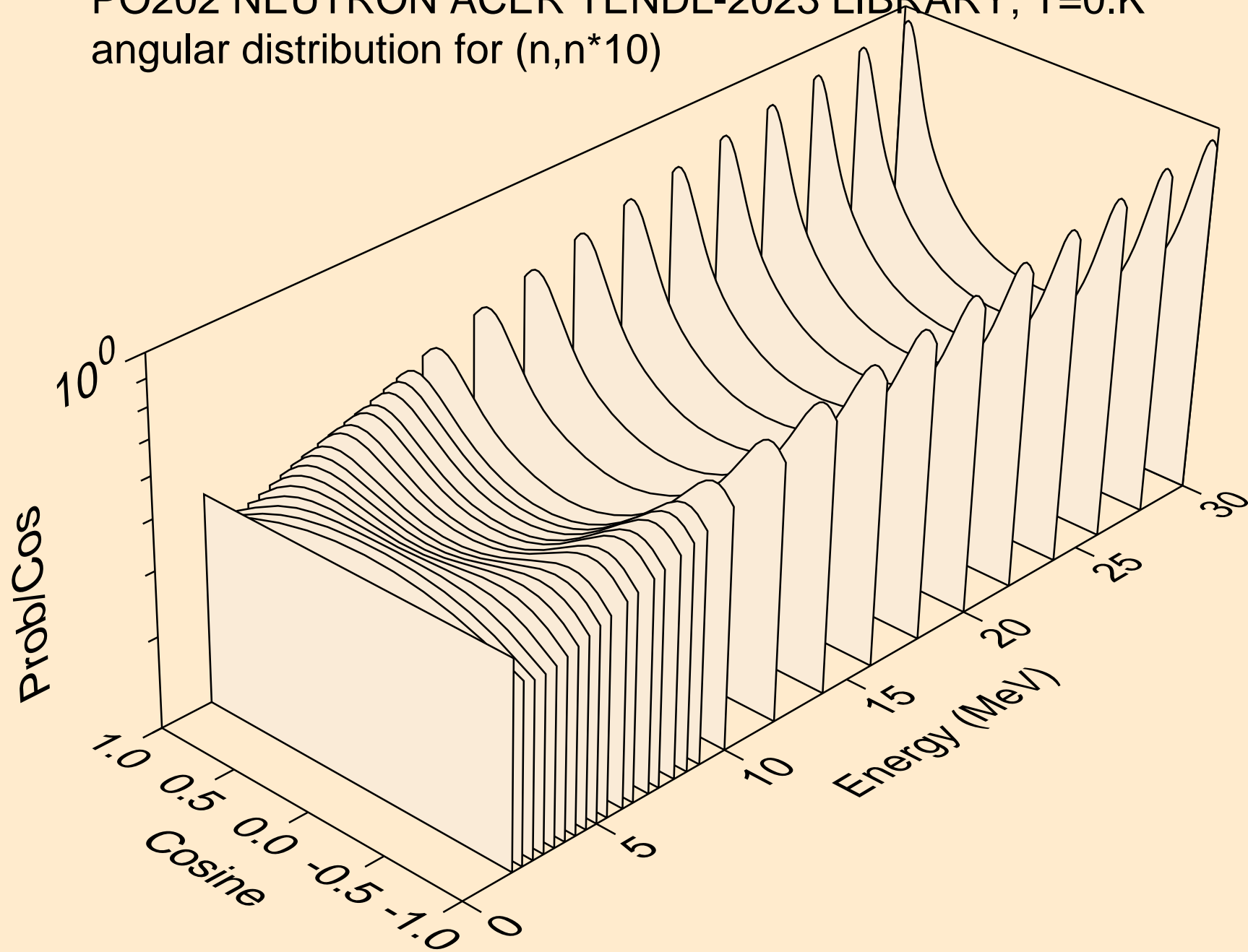

PO202 NEUTRON ACER TENDL-2023 LIBRARY; T=0.K
angular distribution for (n,n*11)

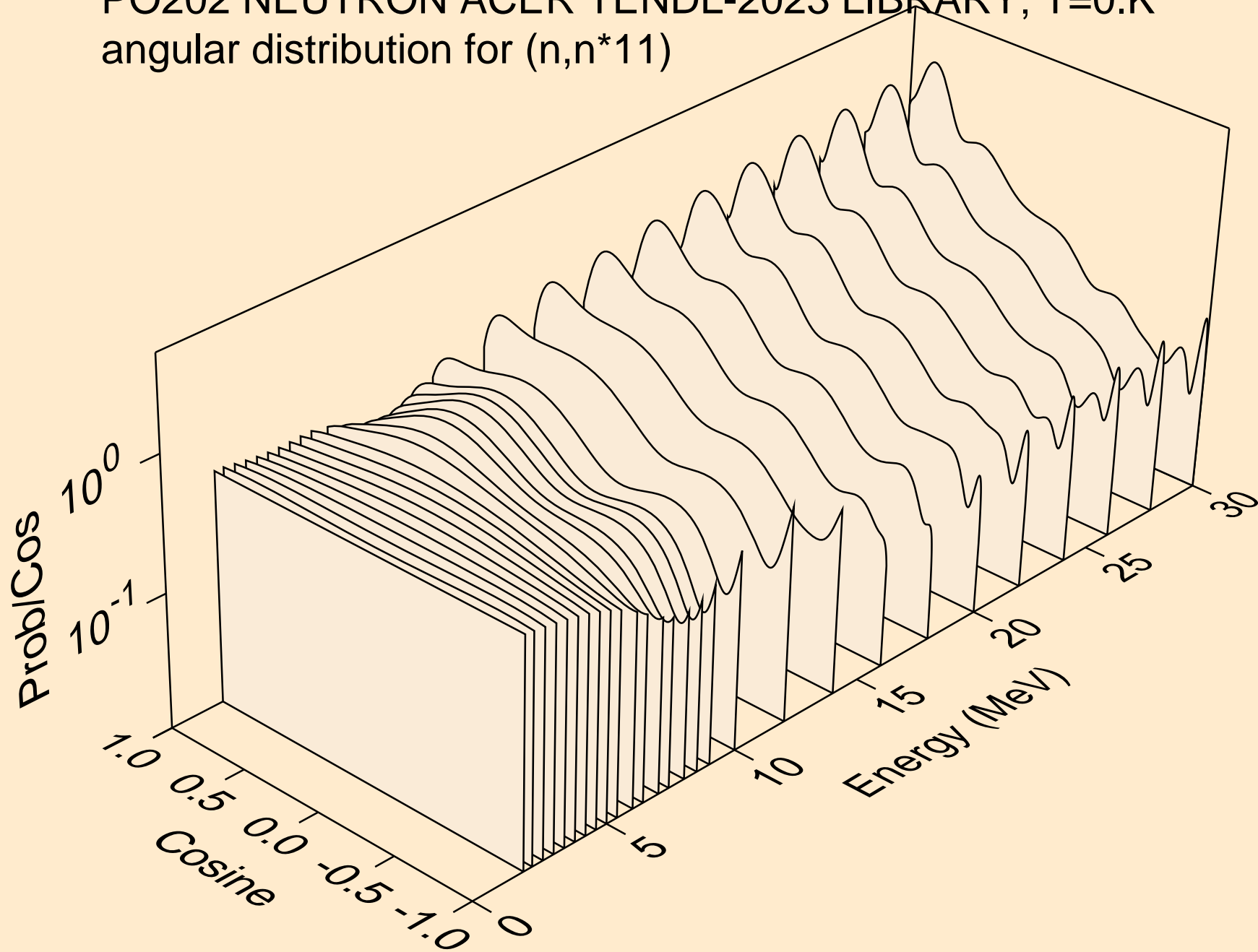

PO202 NEUTRON ACER TENDL-2023 LIBRARY; T=0.K
angular distribution for (n,n*12)

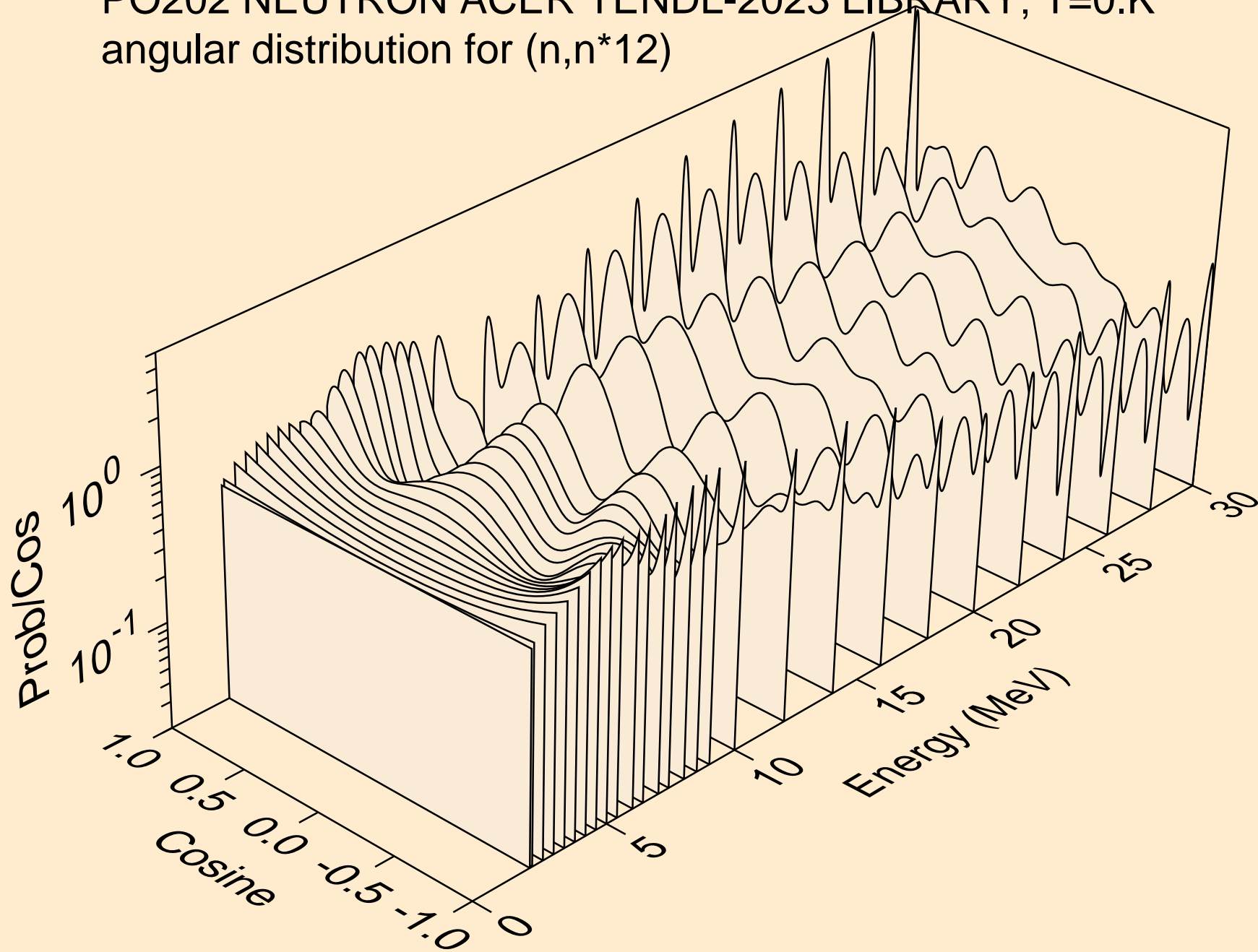

PO202 NEUTRON ACER TENDL-2023 LIBRARY; T=0.K
angular distribution for (n,n*13)

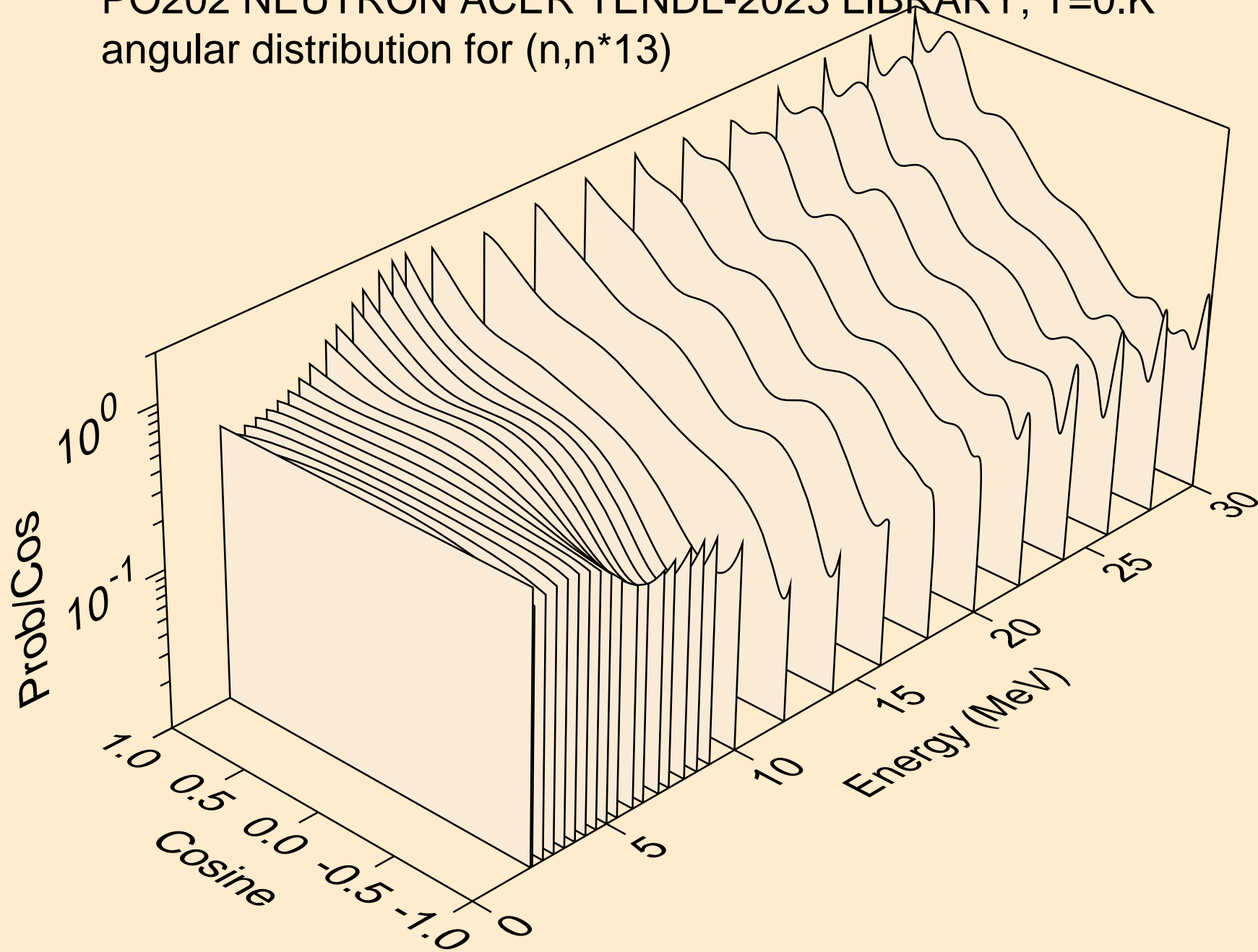

PO202 NEUTRON ACER TENDL-2023 LIBRARY; T=0.K
angular distribution for (n,n*14)

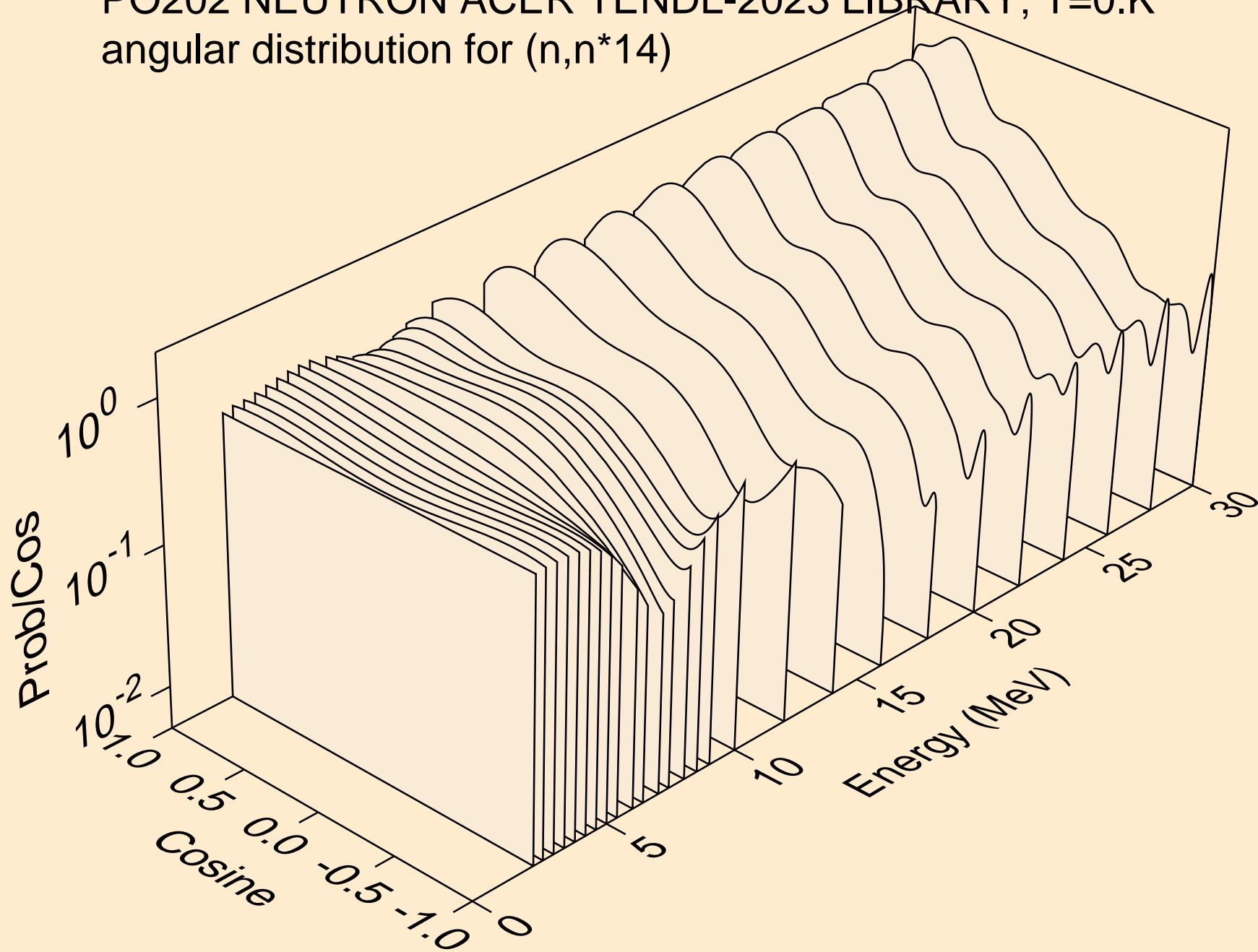

PO202 NEUTRON ACER TENDL-2023 LIBRARY; T=0.K
angular distribution for (n,n*15)

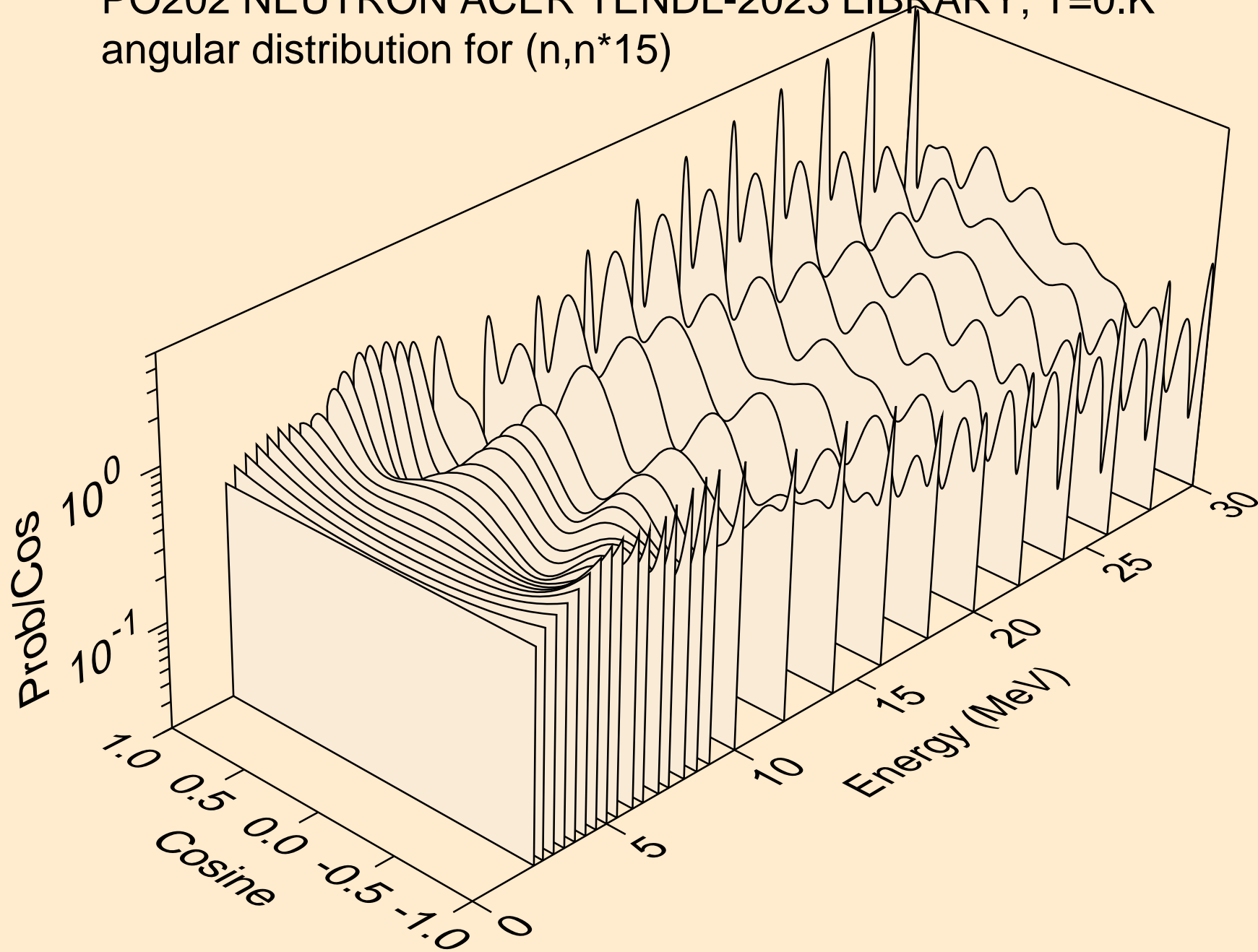

PO202 NEUTRON ACER TENDL-2023 LIBRARY; T=0.K
angular distribution for (n,n*16)

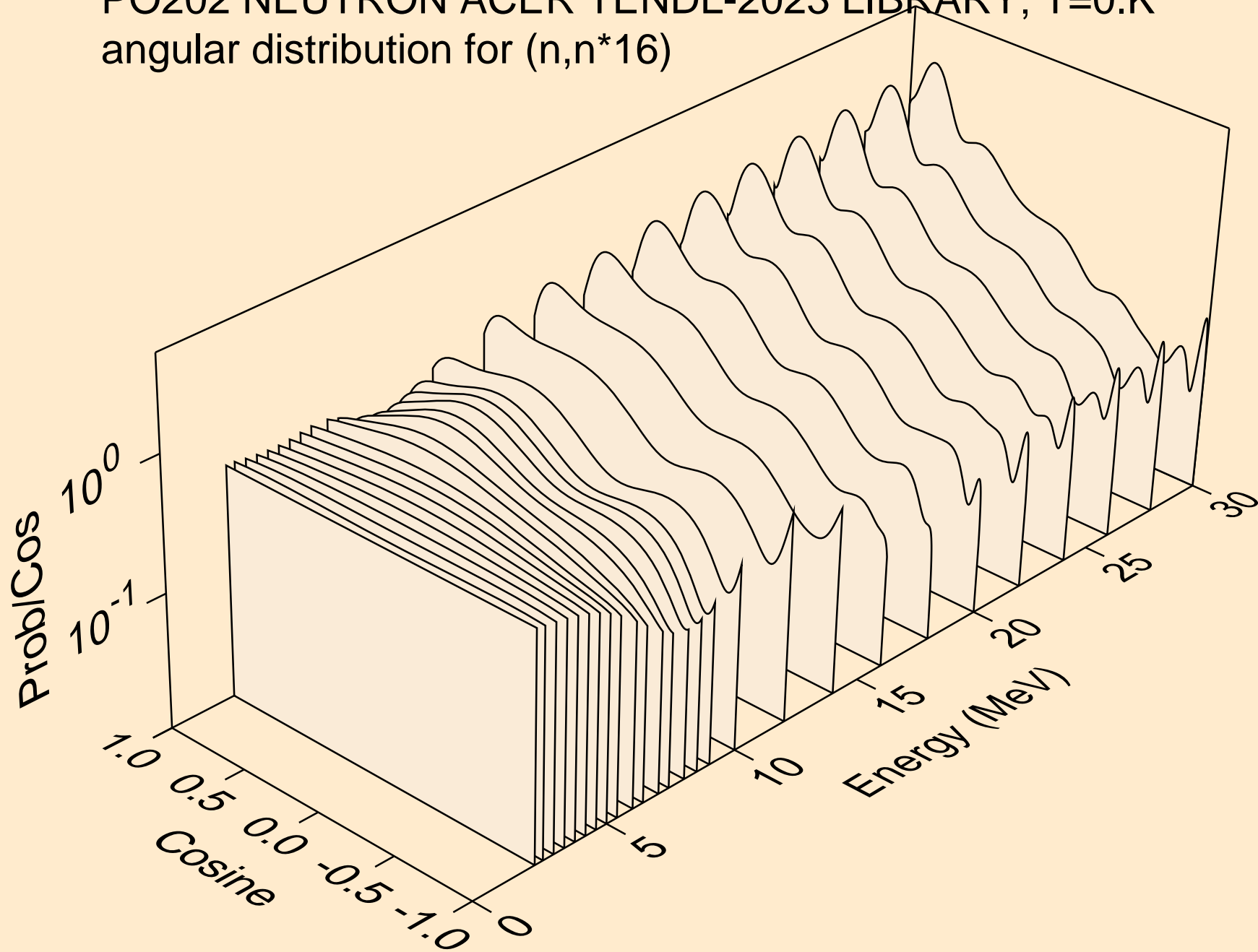

PO202 NEUTRON ACER TENDL-2023 LIBRARY; T=0.K
angular distribution for (n,n*17)

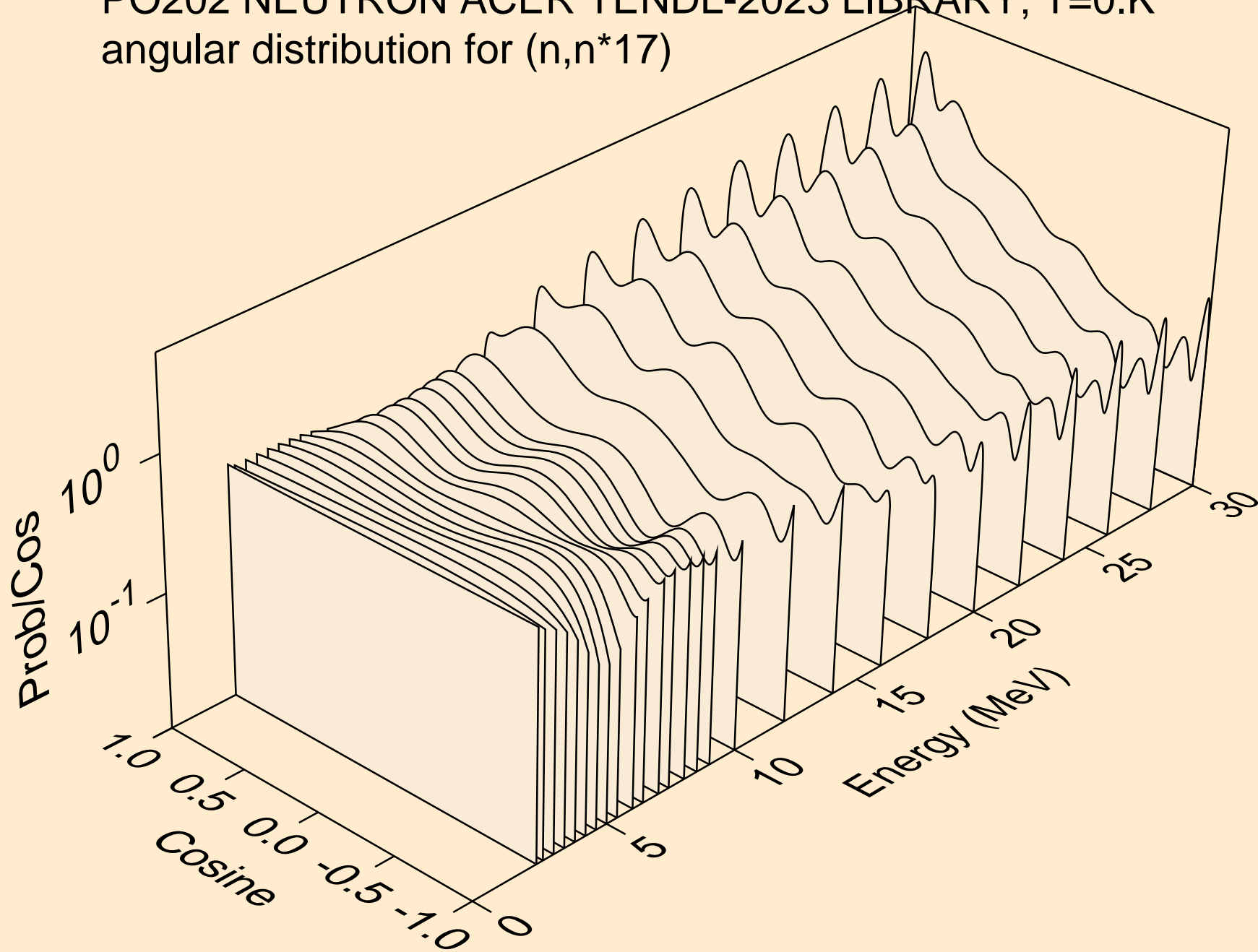

PO202 NEUTRON ACER TENDL-2023 LIBRARY; T=0.K
angular distribution for (n,n*18)

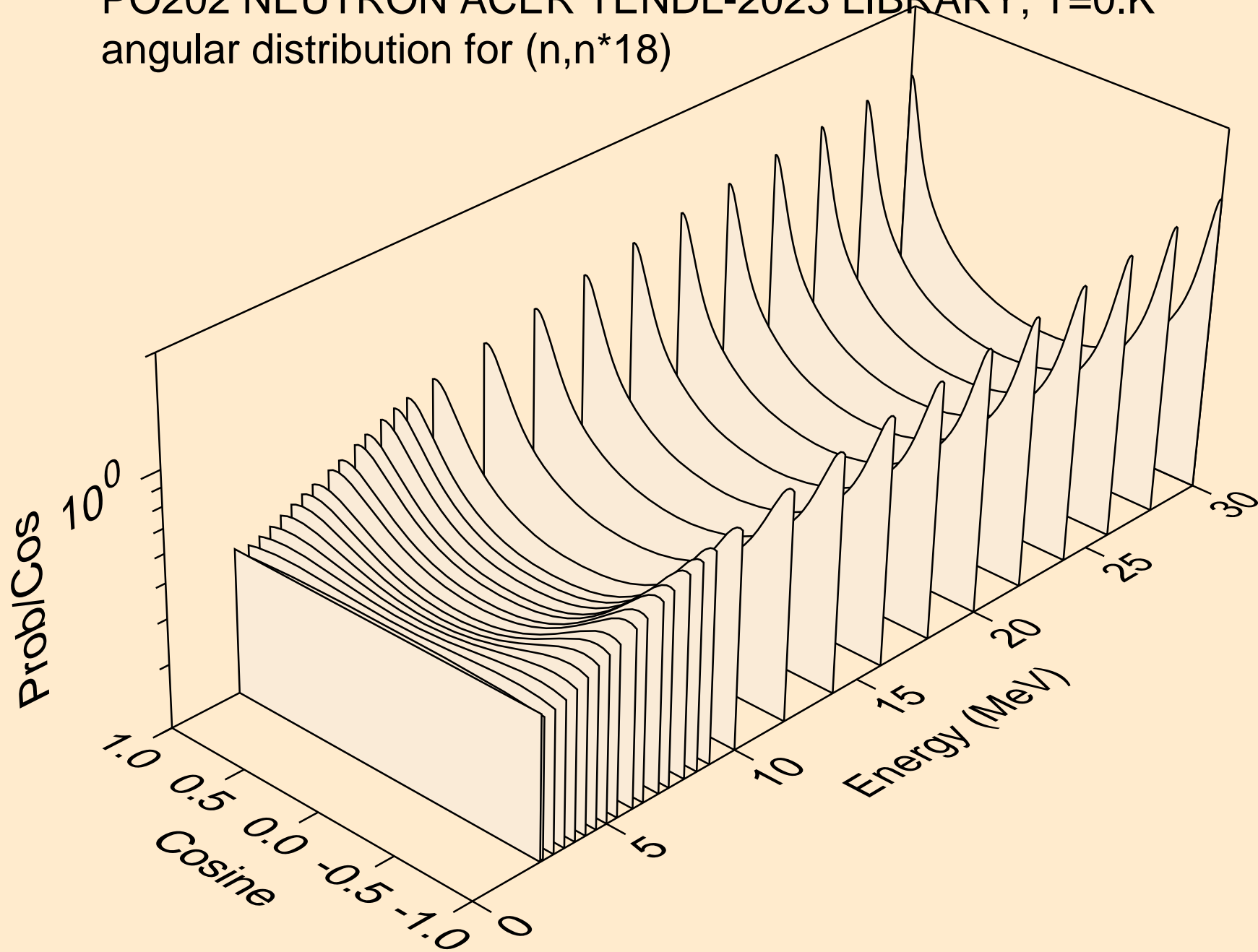

PO202 NEUTRON ACER TENDL-2023 LIBRARY; T=0.K
angular distribution for (n,n*19)

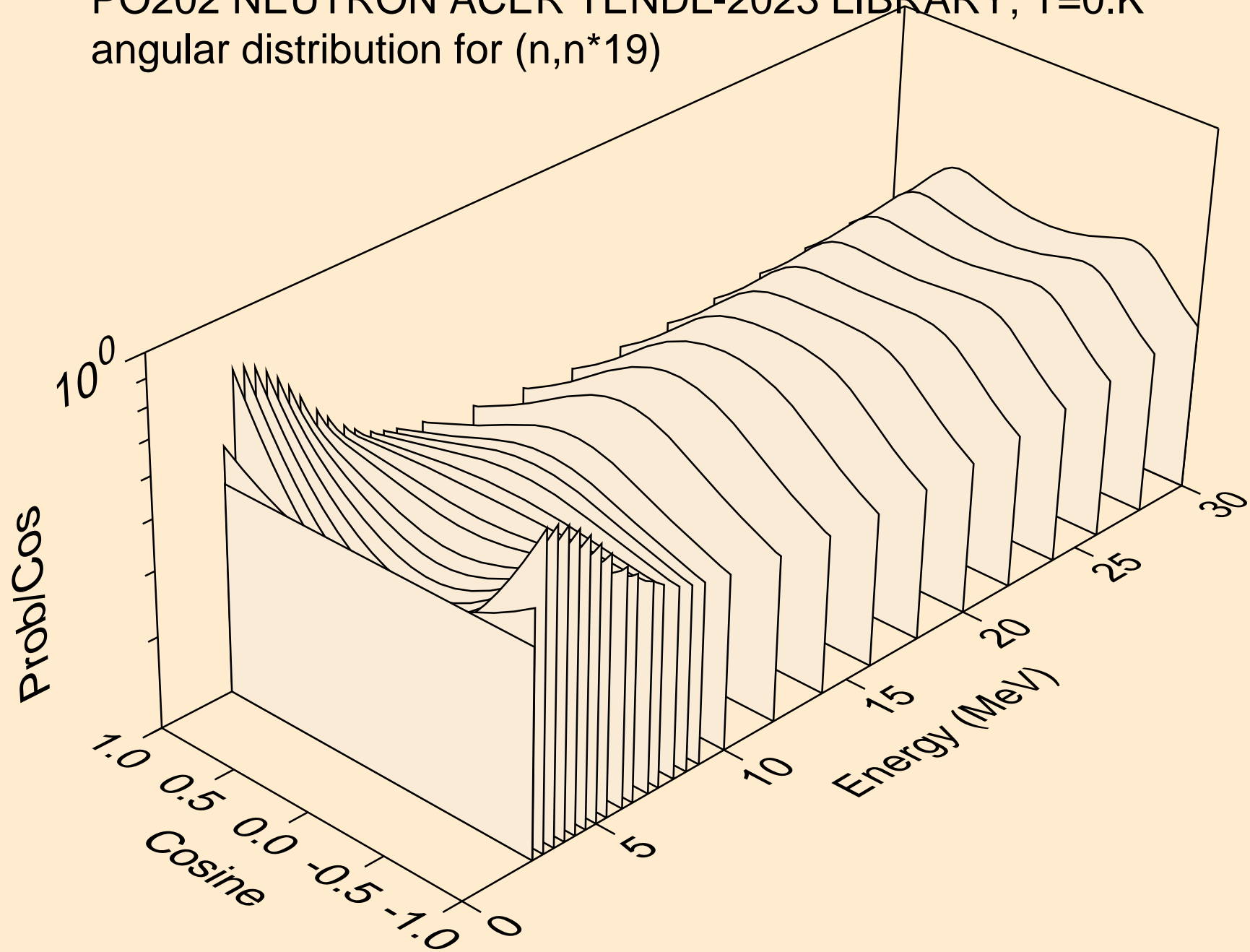

PO202 NEUTRON ACER TENDL-2023 LIBRARY; T=0.K
angular distribution for (n,n*20)

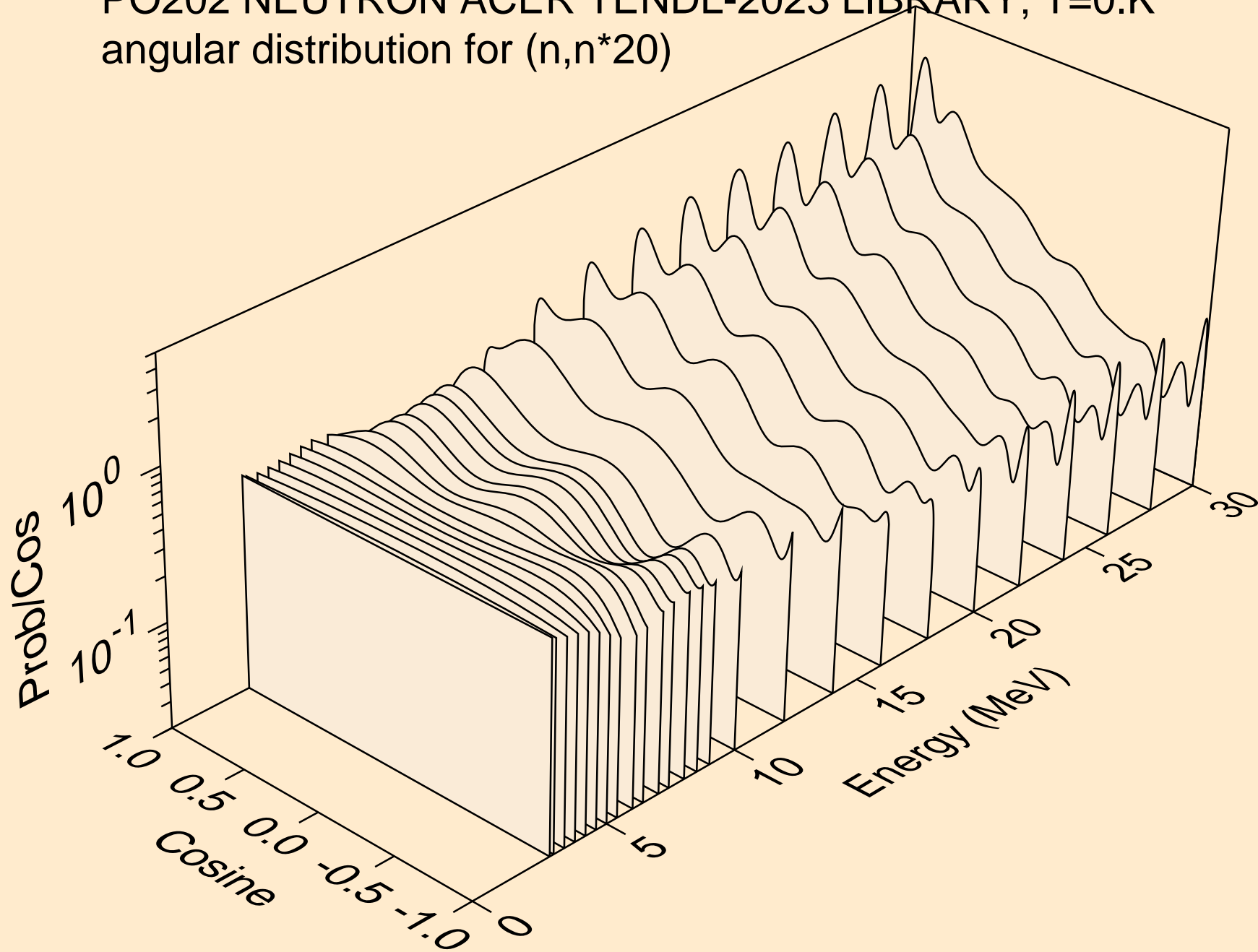

PO202 NEUTRON ACER TENDL-2023 LIBRARY; T=0.K
Neutron emission for (n,x)

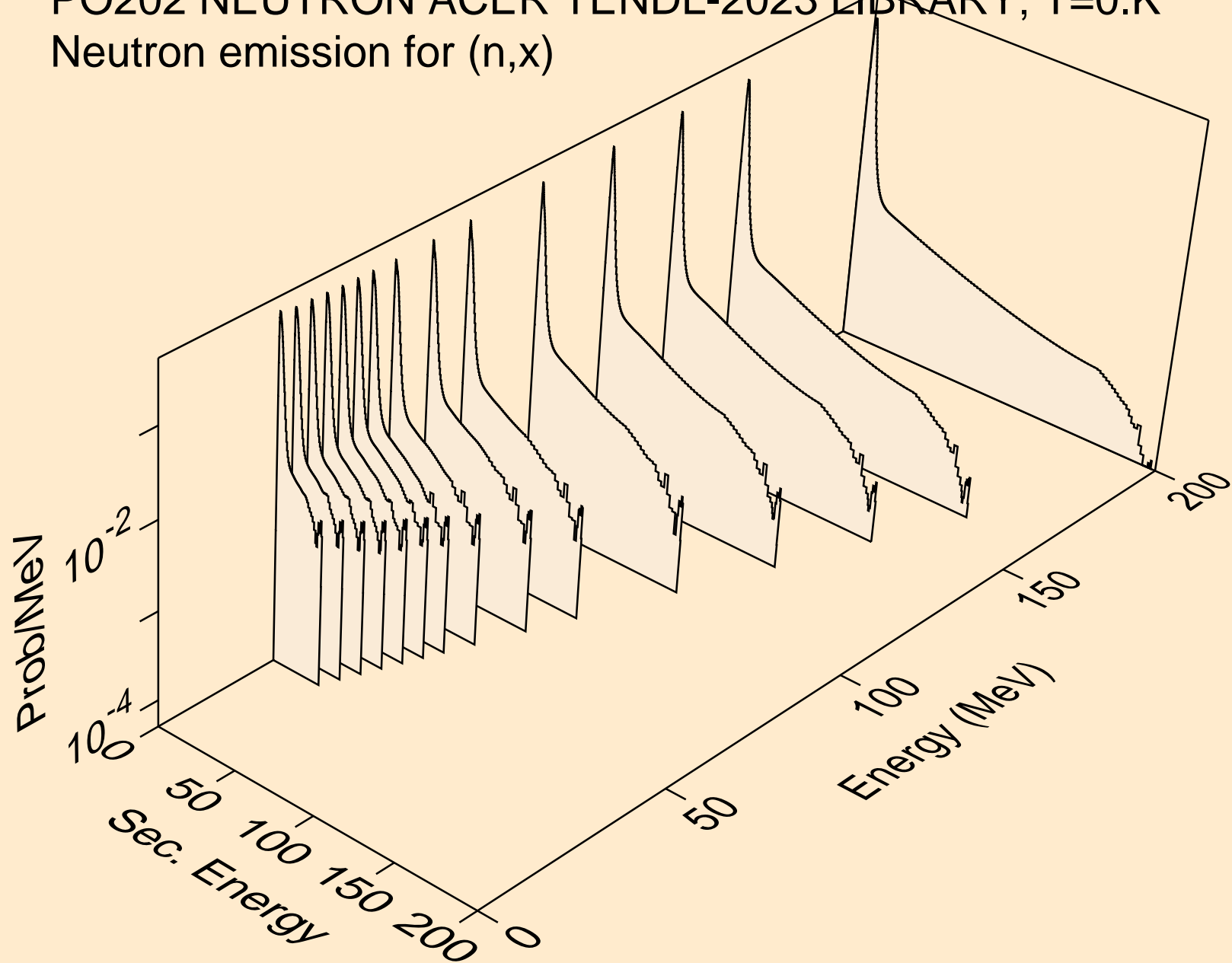

PO202 NEUTRON ACER TENDL-2023 LIBRARY; T=0.K
Neutron emission for (n,2nd)

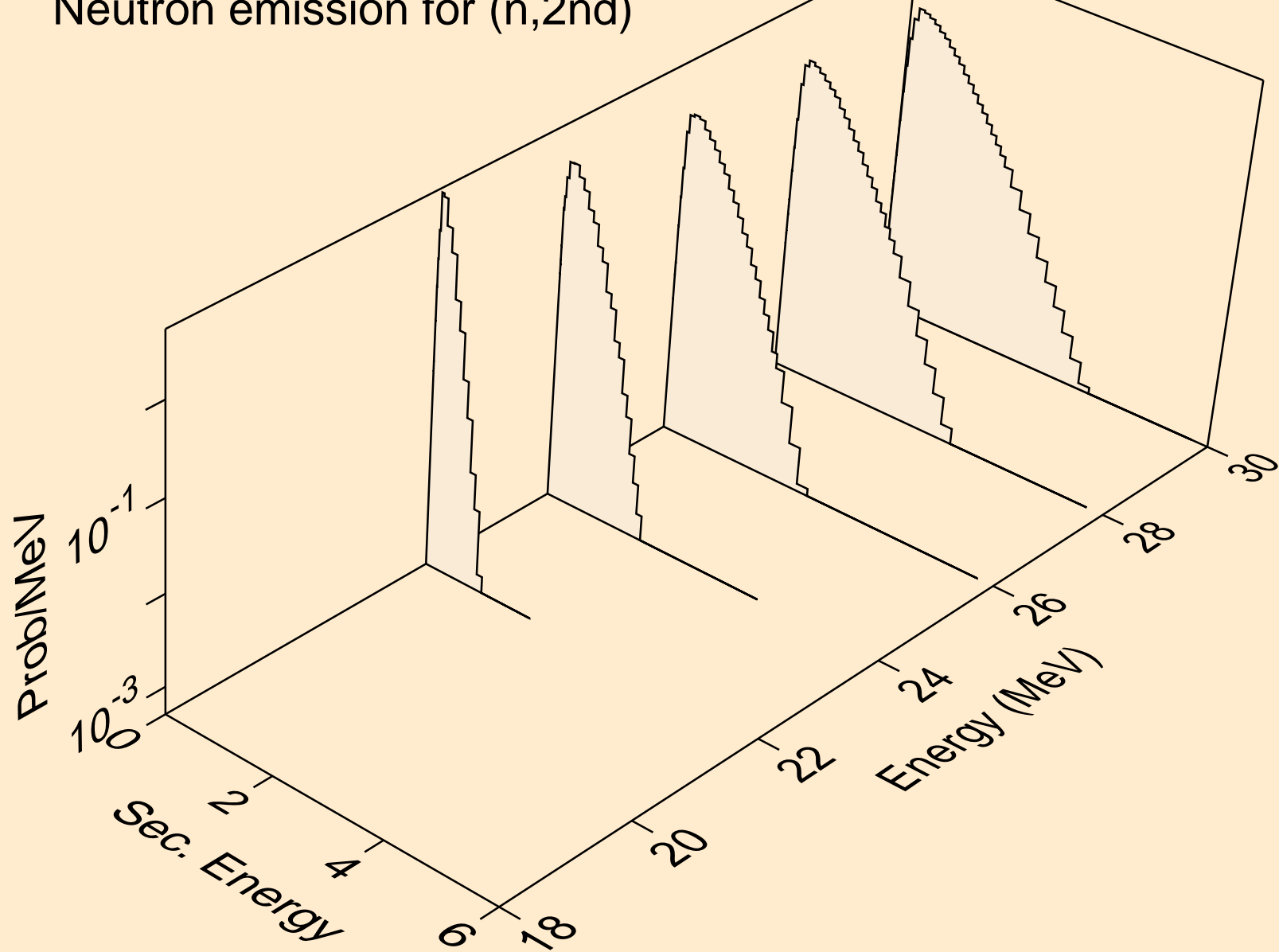

PO202 NEUTRON ACER TENDL-2023 LIBRARY; T=0.K
Neutron emission for (n,2n)

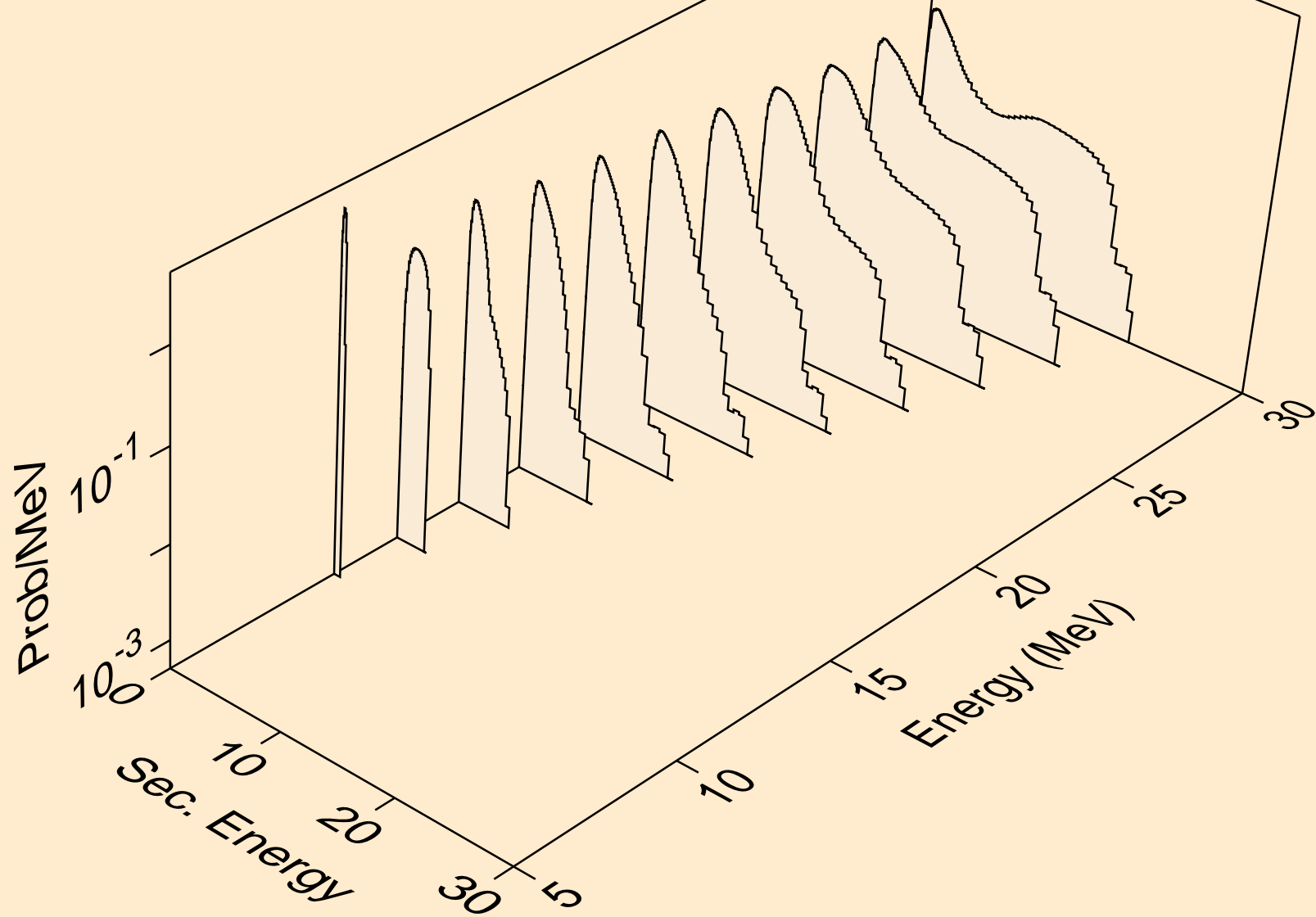

PO202 NEUTRON ACER TENDL-2023 LIBRARY; T=0.K
Neutron emission for (n,3n)

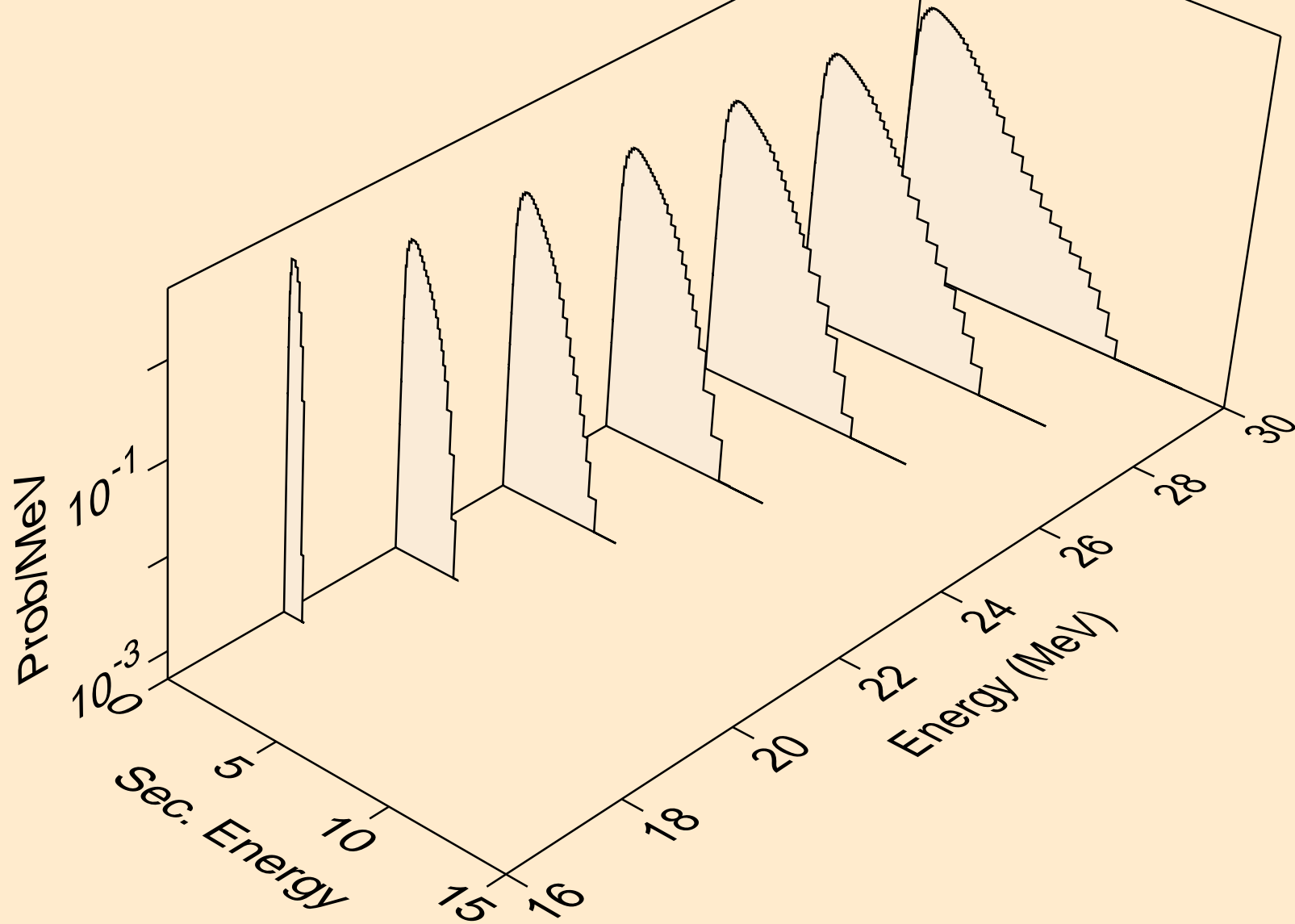

PO202 NEUTRON ACER TENDL-2023 LIBRARY; T=0.K
Neutron emission for (n,n*)a

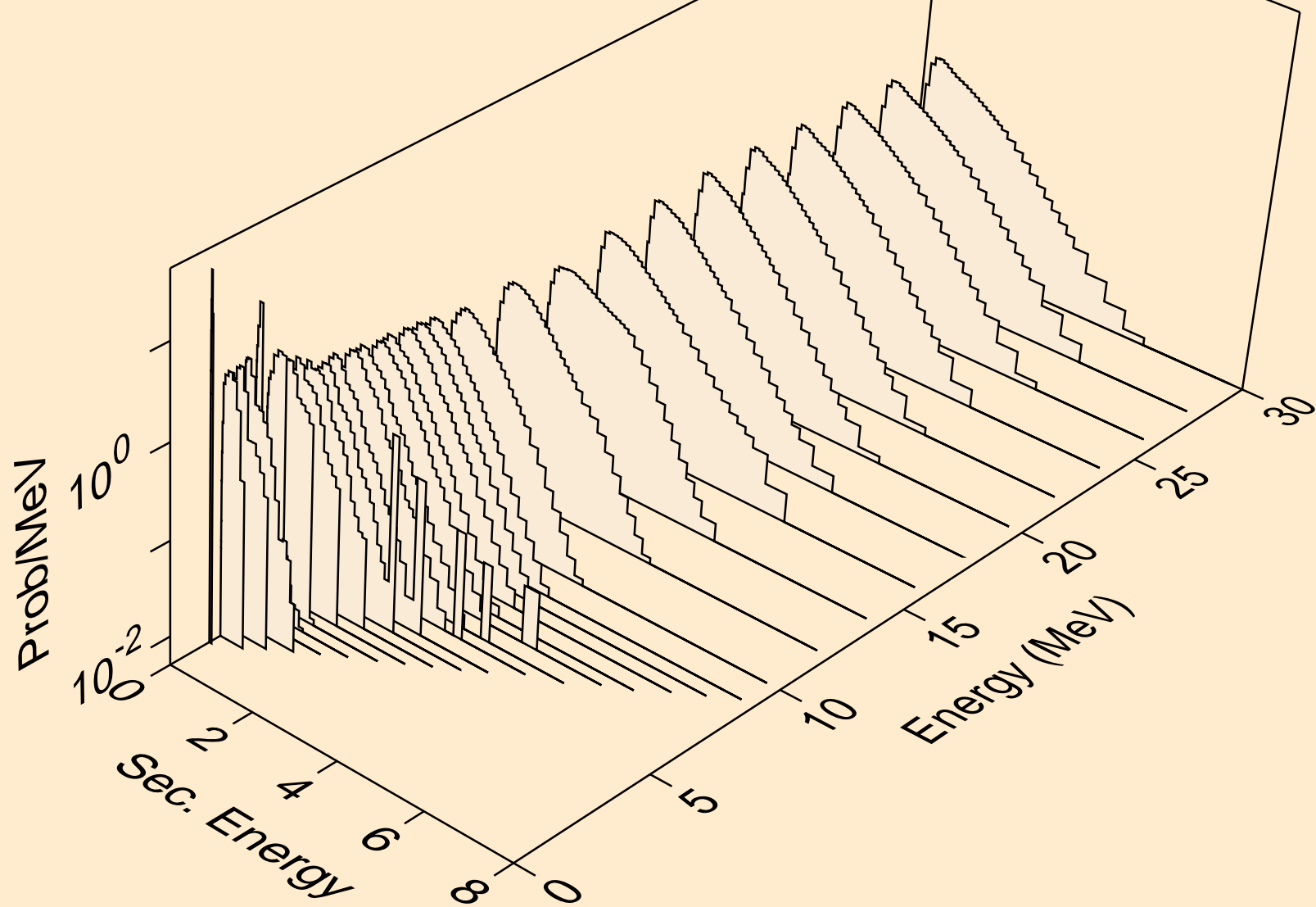

PO202 NEUTRON ACER TENDL-2023 LIBRARY; T=0.K
Neutron emission for (n,2n)a

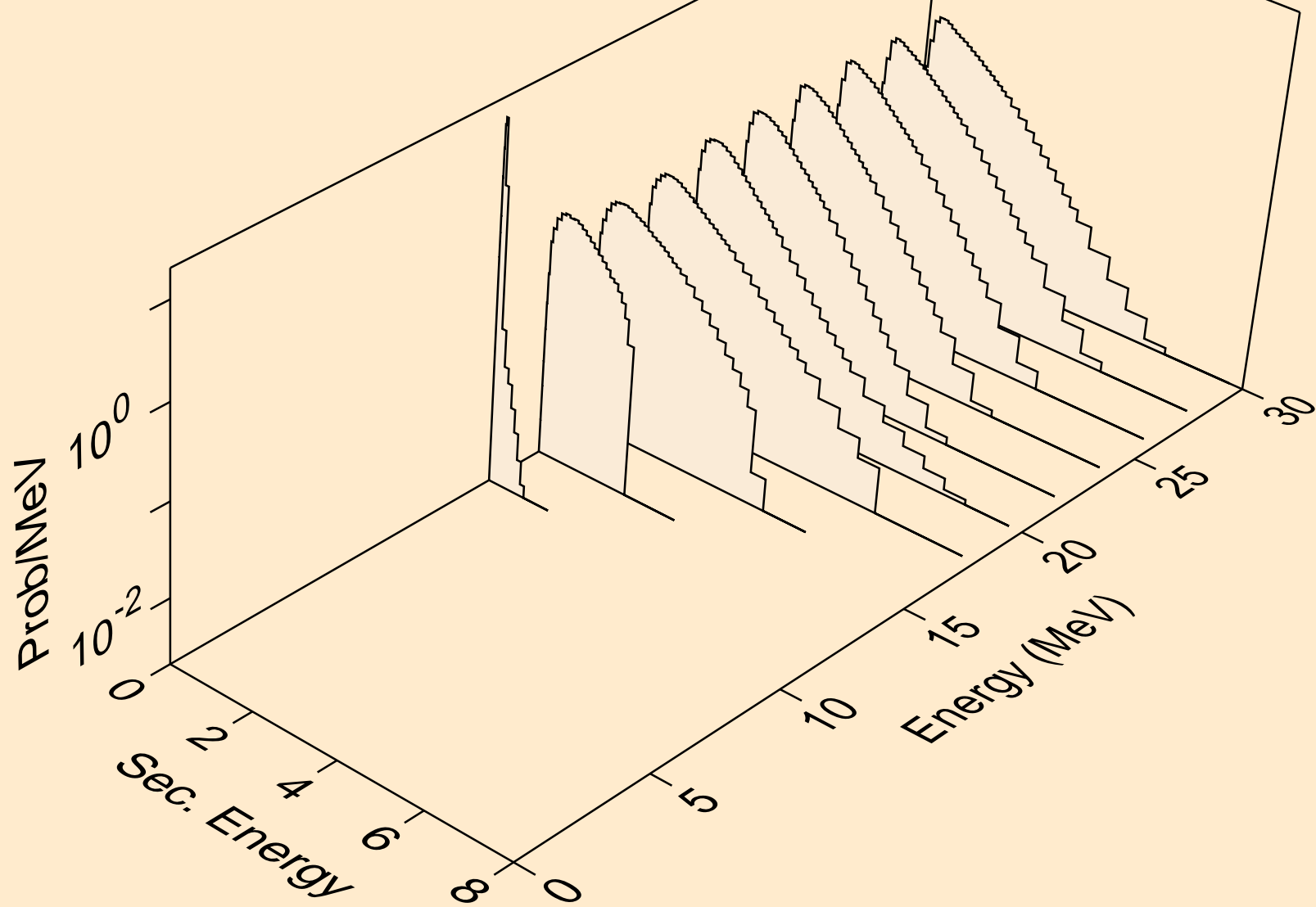

PO202 NEUTRON ACER TENDL-2023 LIBRARY; T=0.K
Neutron emission for (n,3n)a

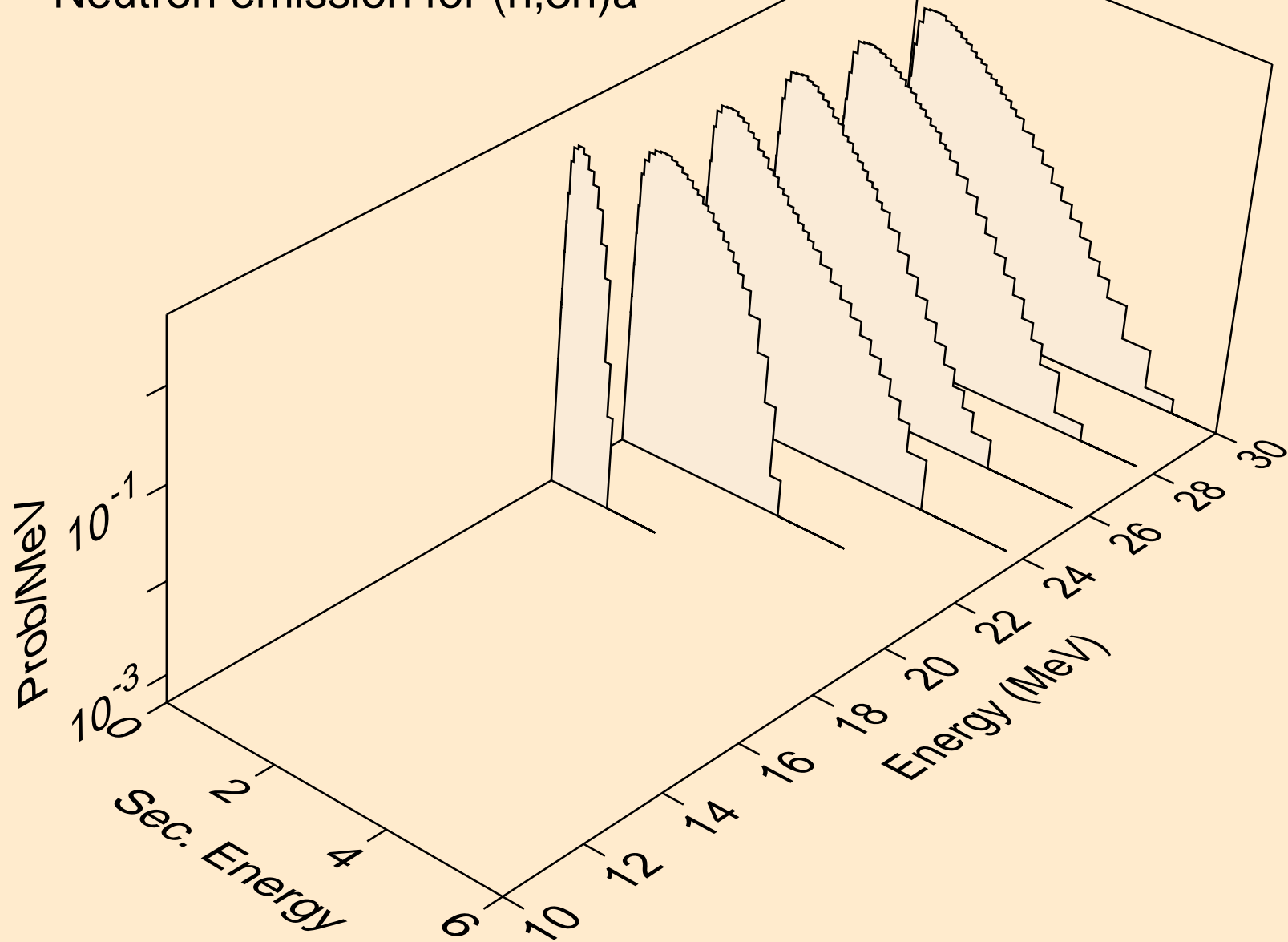

PO202 NEUTRON ACER TENDL-2023 LIBRARY; T=0.K
Neutron emission for (n,n*)p

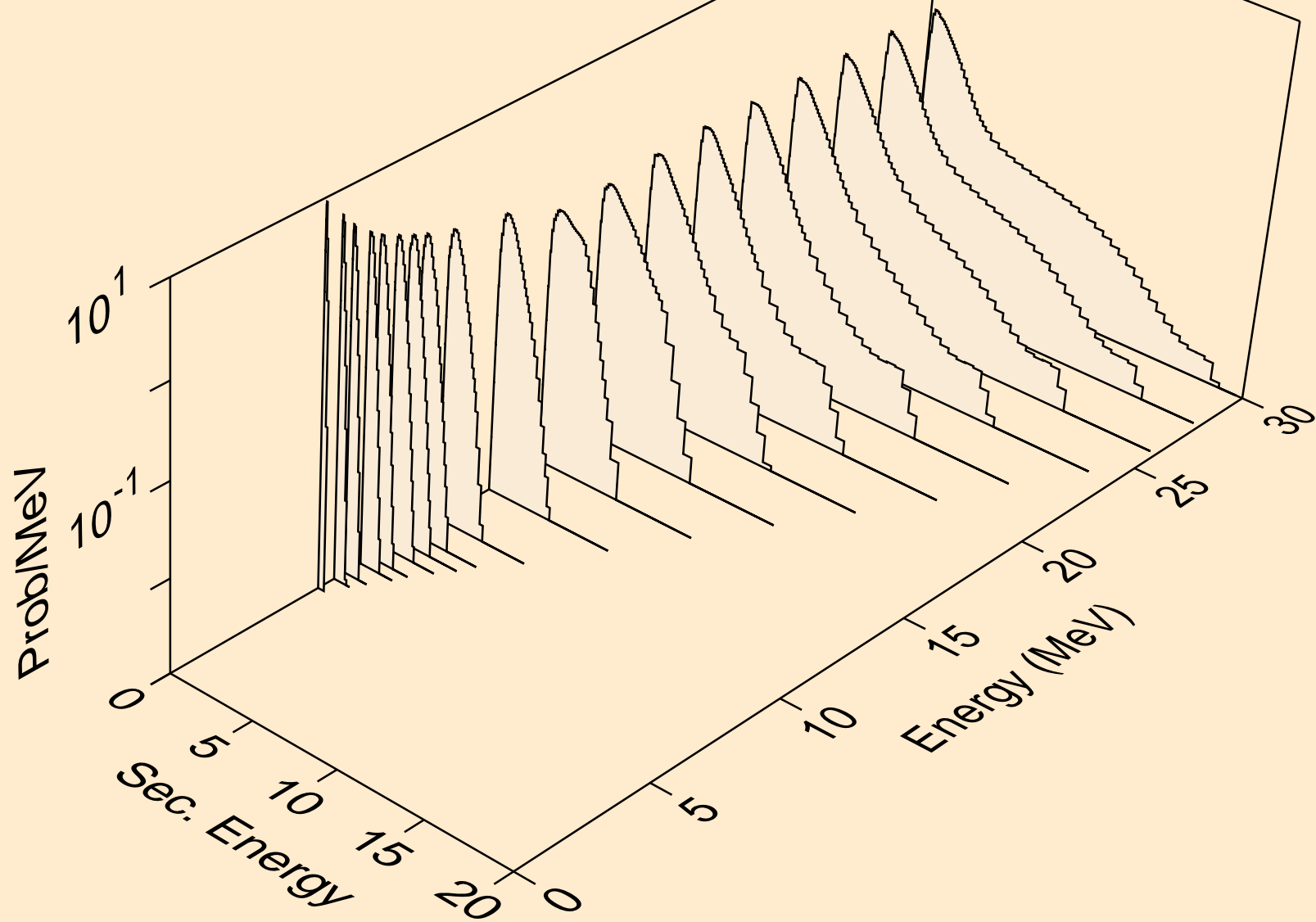

PO202 NEUTRON ACER TENDL-2023 LIBRARY; T=0.K
Neutron emission for (n,n*)2a

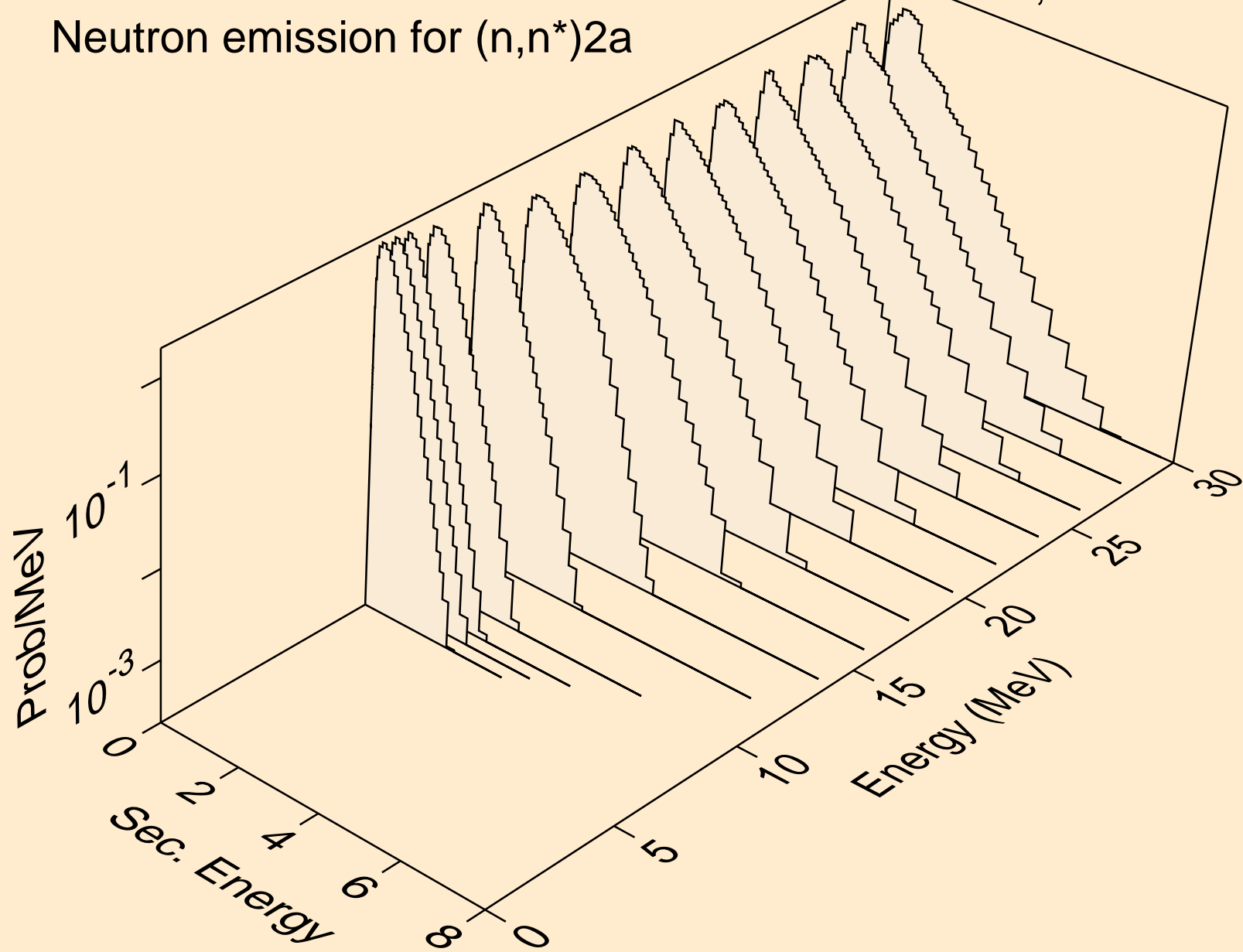

PO202 NEUTRON ACER TENDL-2023 LIBRARY; T=0.K
Neutron emission for (n,n*)d

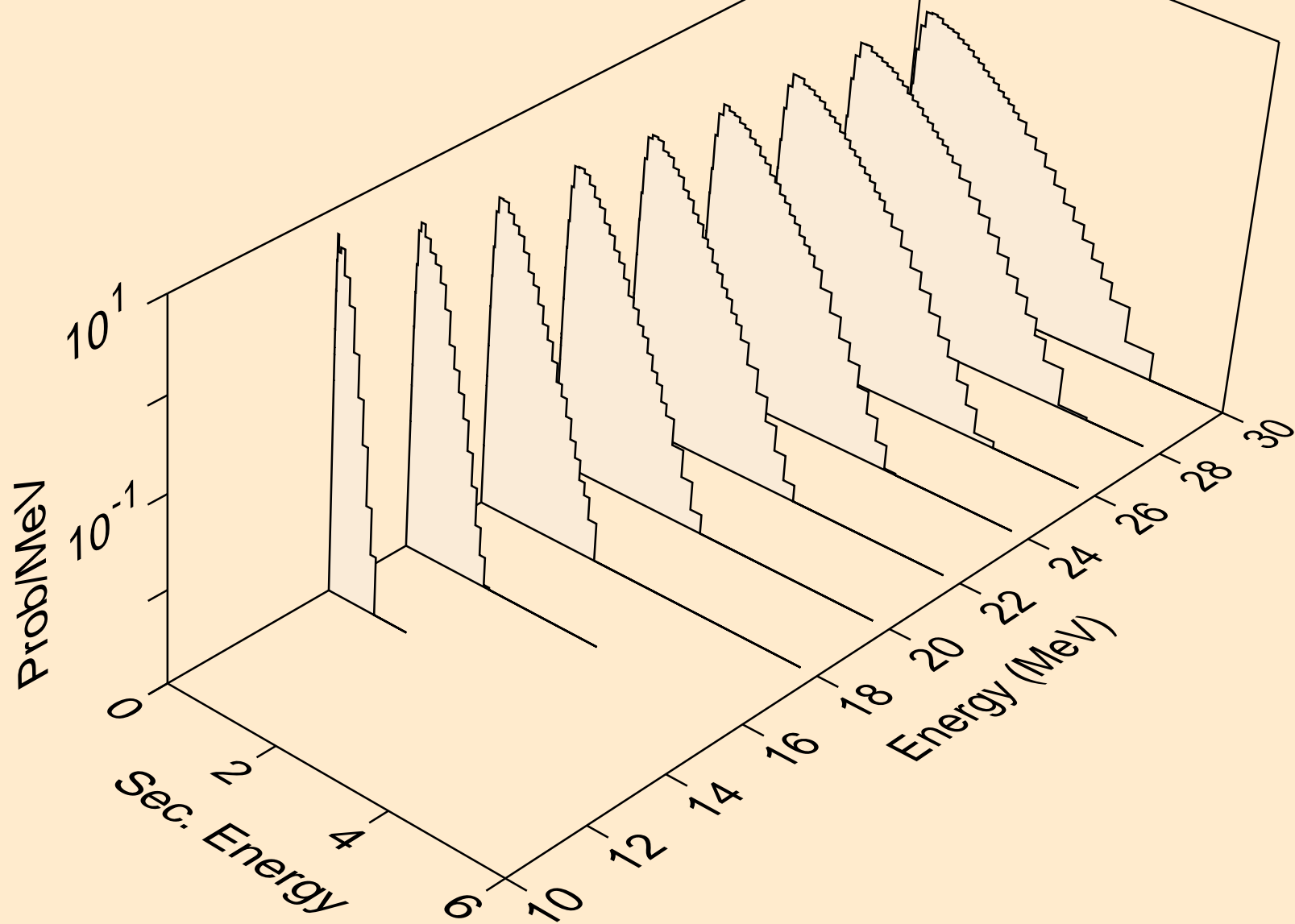

PO202 NEUTRON ACER TENDL-2023 LIBRARY; T=0.K
Neutron emission for (n,n*)t

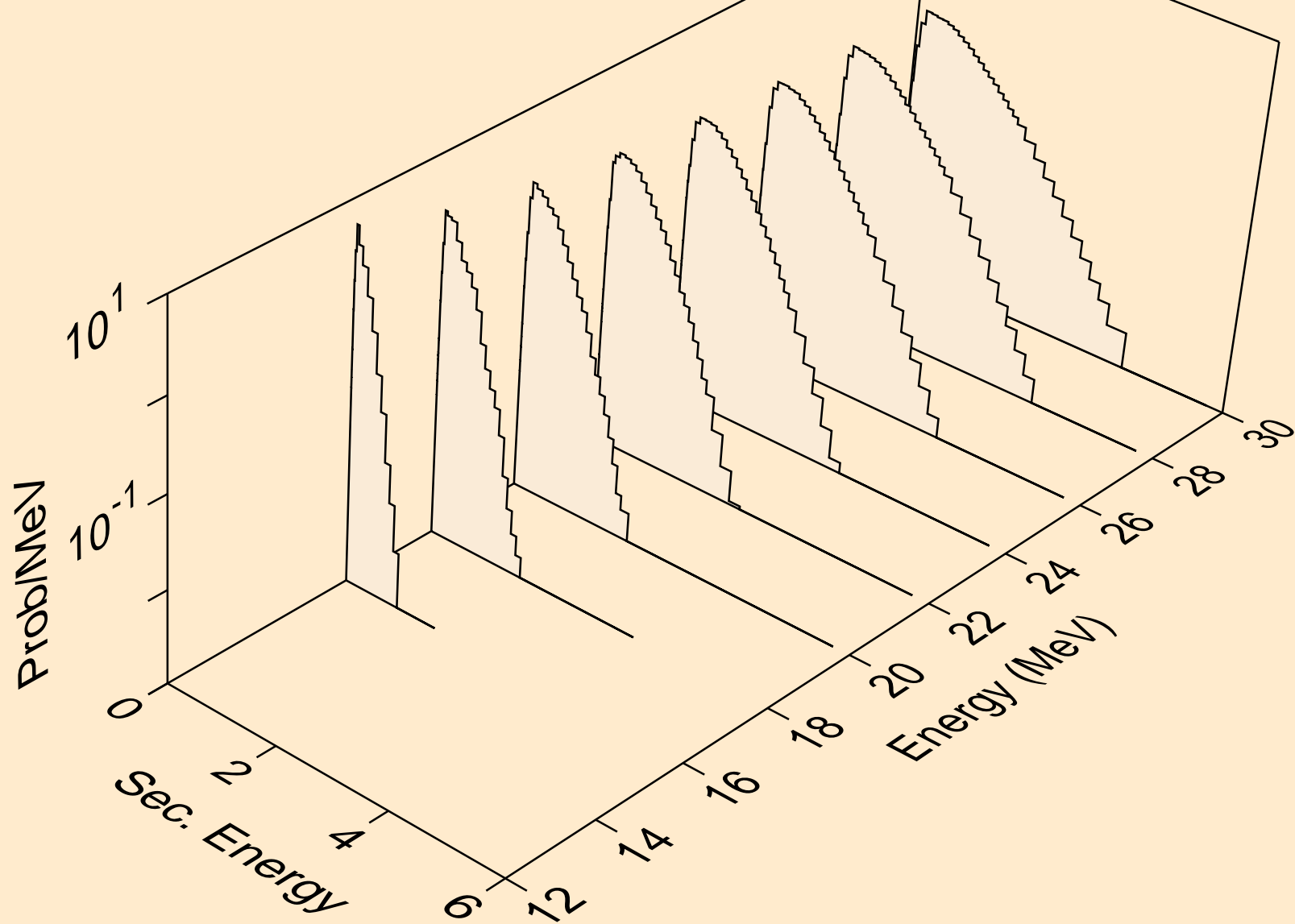

PO202 NEUTRON ACER TENDL-2023 LIBRARY; T=0.K
Neutron emission for (n,n*)he3

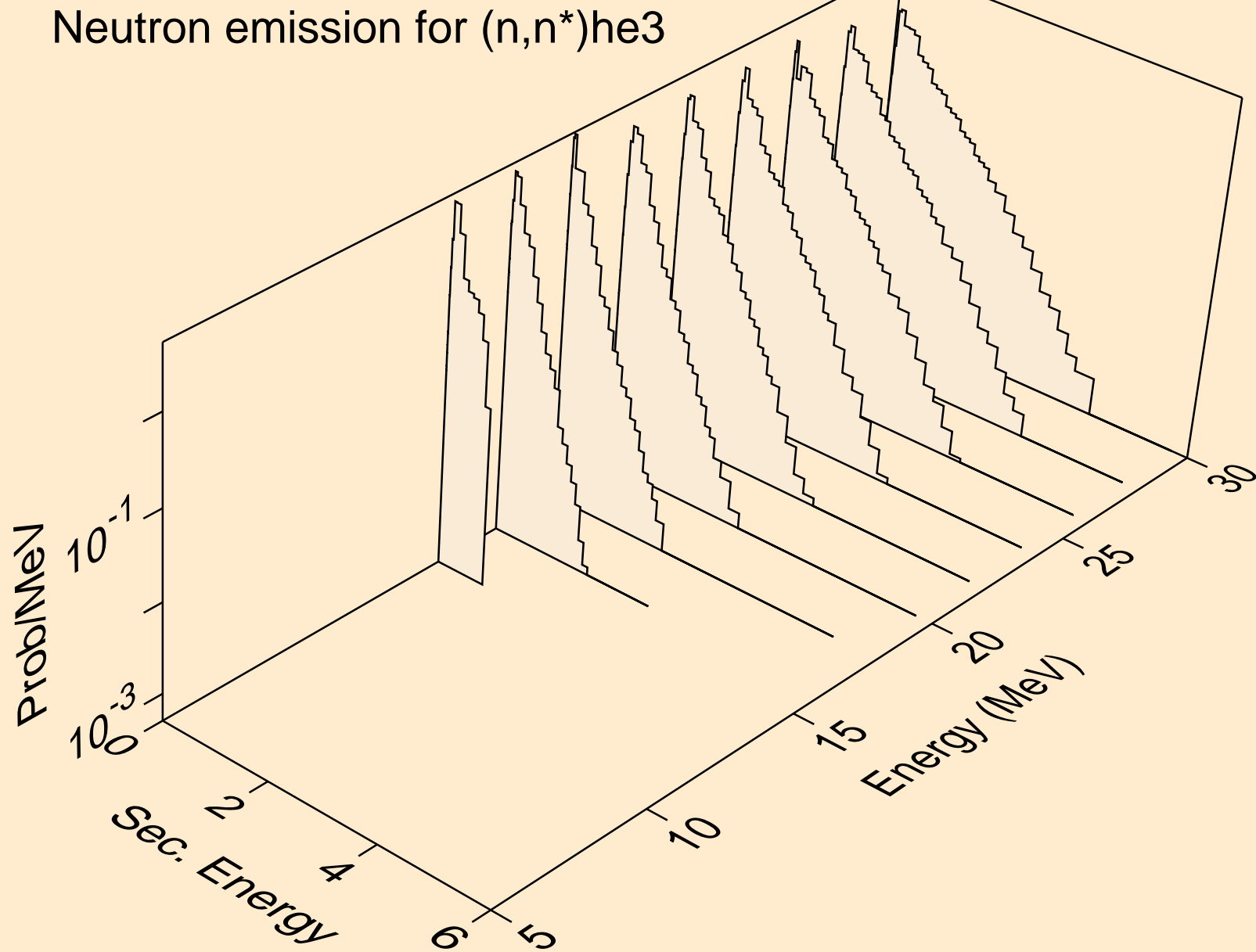

PO202 NEUTRON ACER TENDL-2023 LIBRARY; T=0.K
Neutron emission for (n,4n)

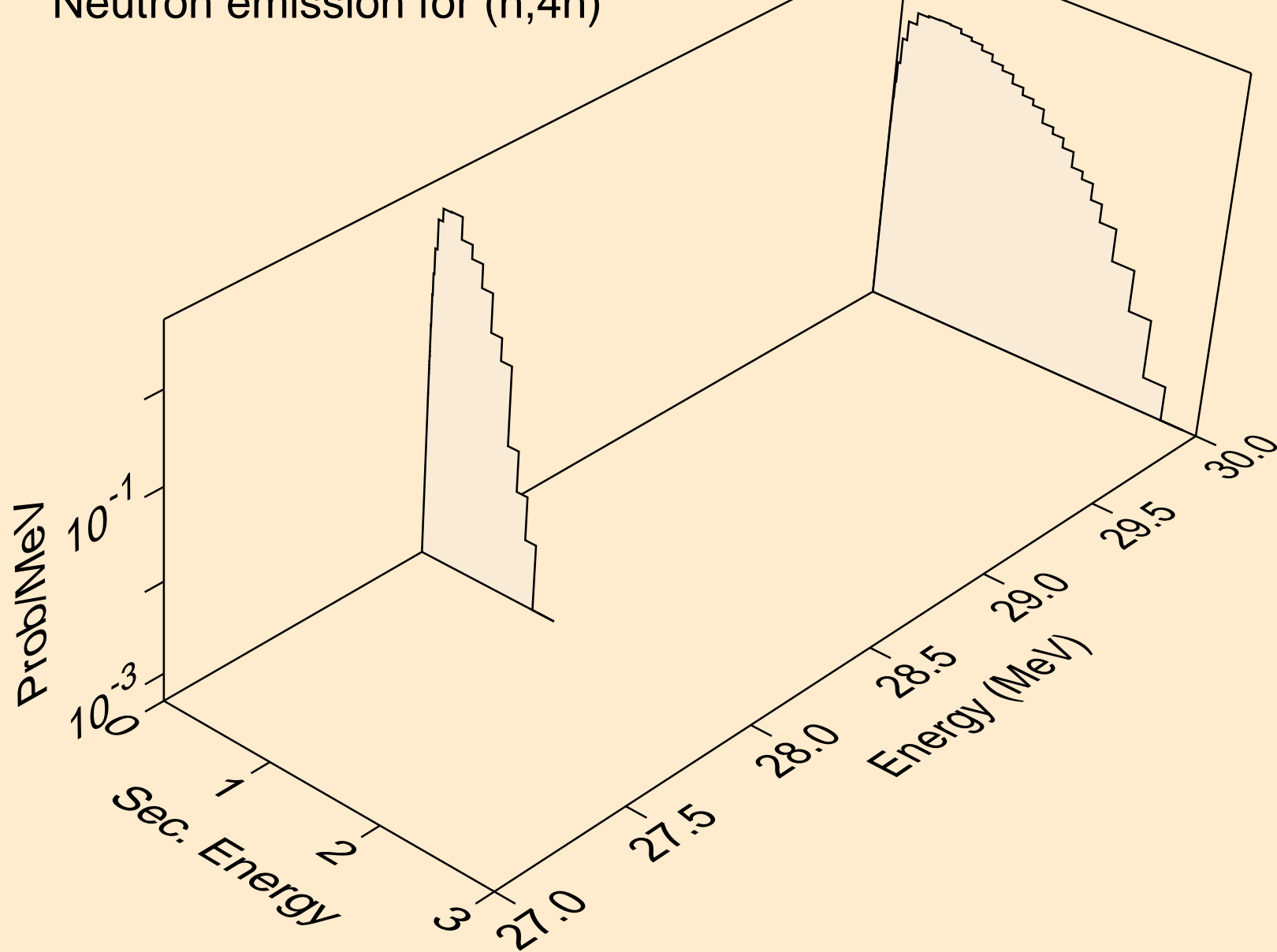

PO202 NEUTRON ACER TENDL-2023 LIBRARY; T=0.K
Neutron emission for (n,2np)

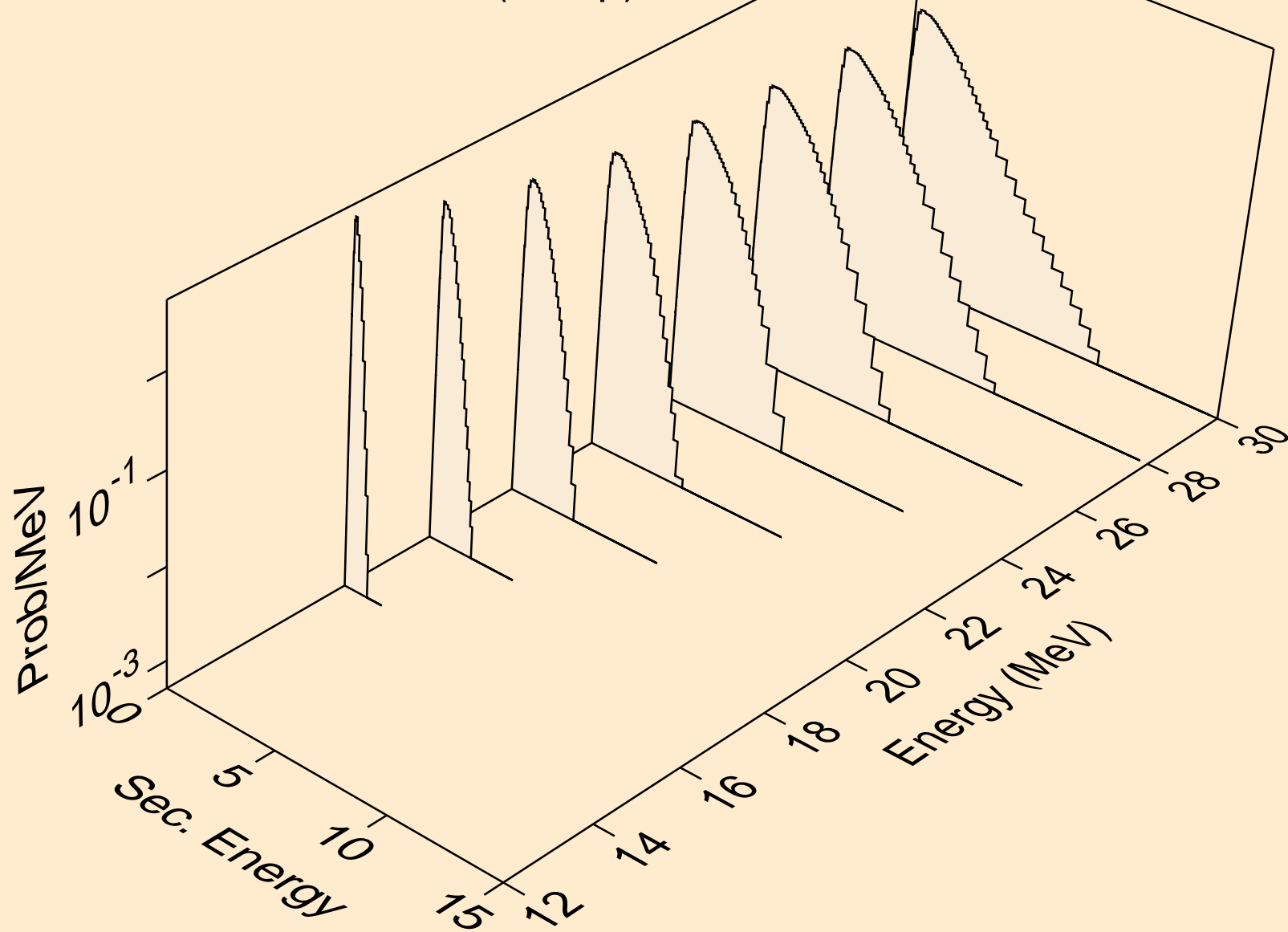

PO202 NEUTRON ACER TENDL-2023 LIBRARY; T=0.K
Neutron emission for (n,3np)

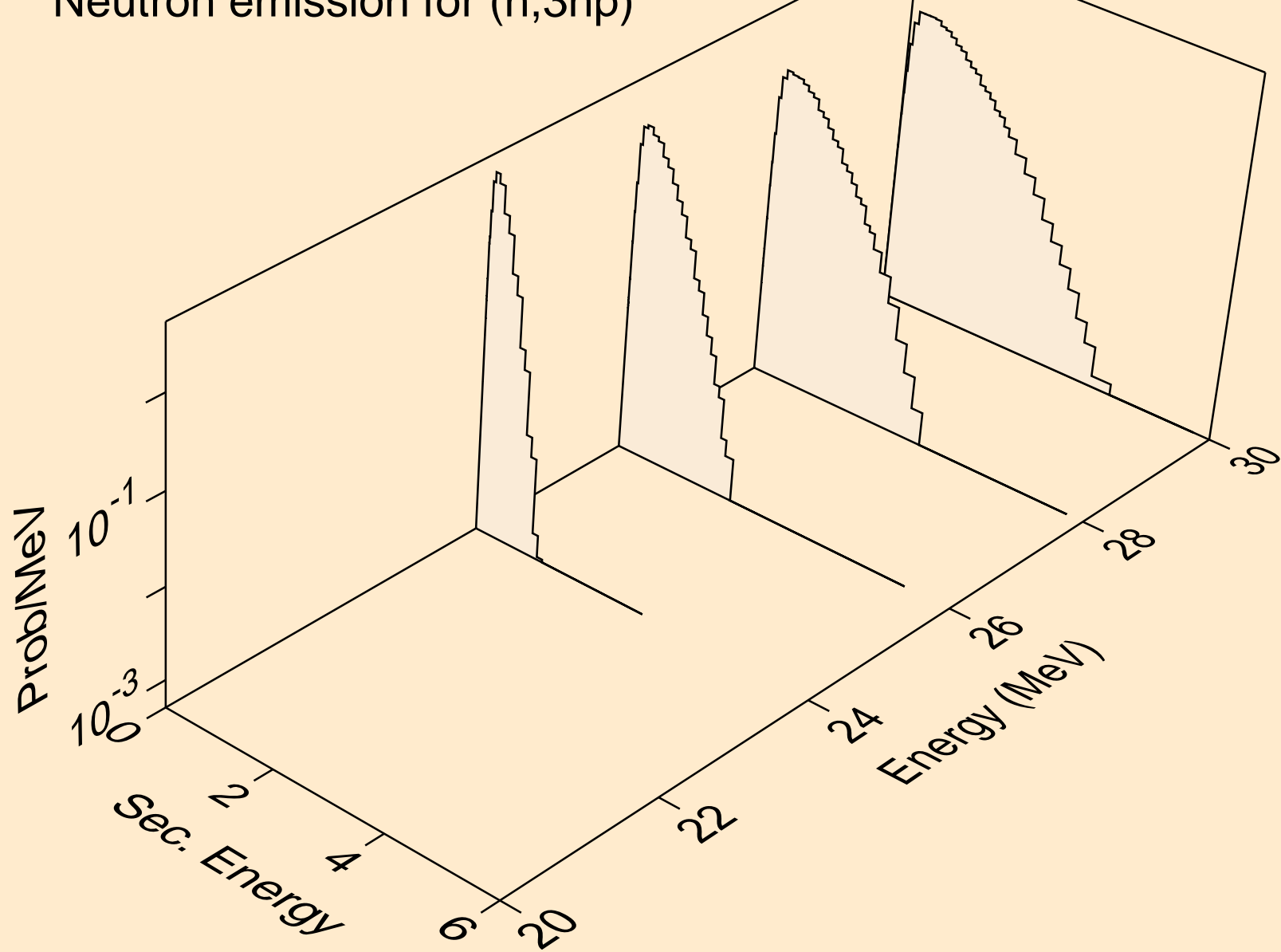

PO202 NEUTRON ACER TENDL-2023 LIBRARY; T=0.K
Neutron emission for (n,n2p)

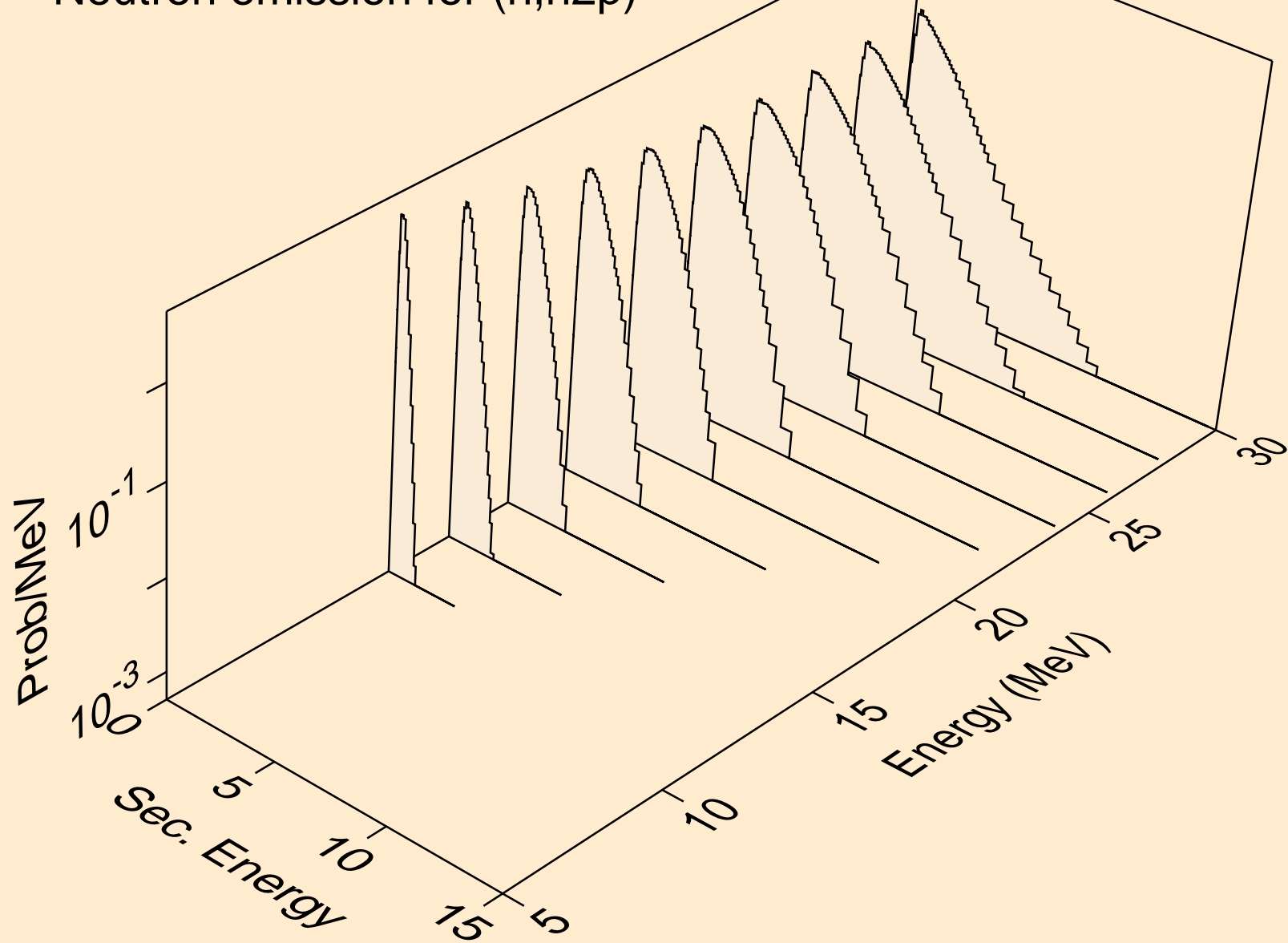

PO202 NEUTRON ACER TENDL-2023 LIBRARY; T=0.K
Neutron emission for (n,npa)

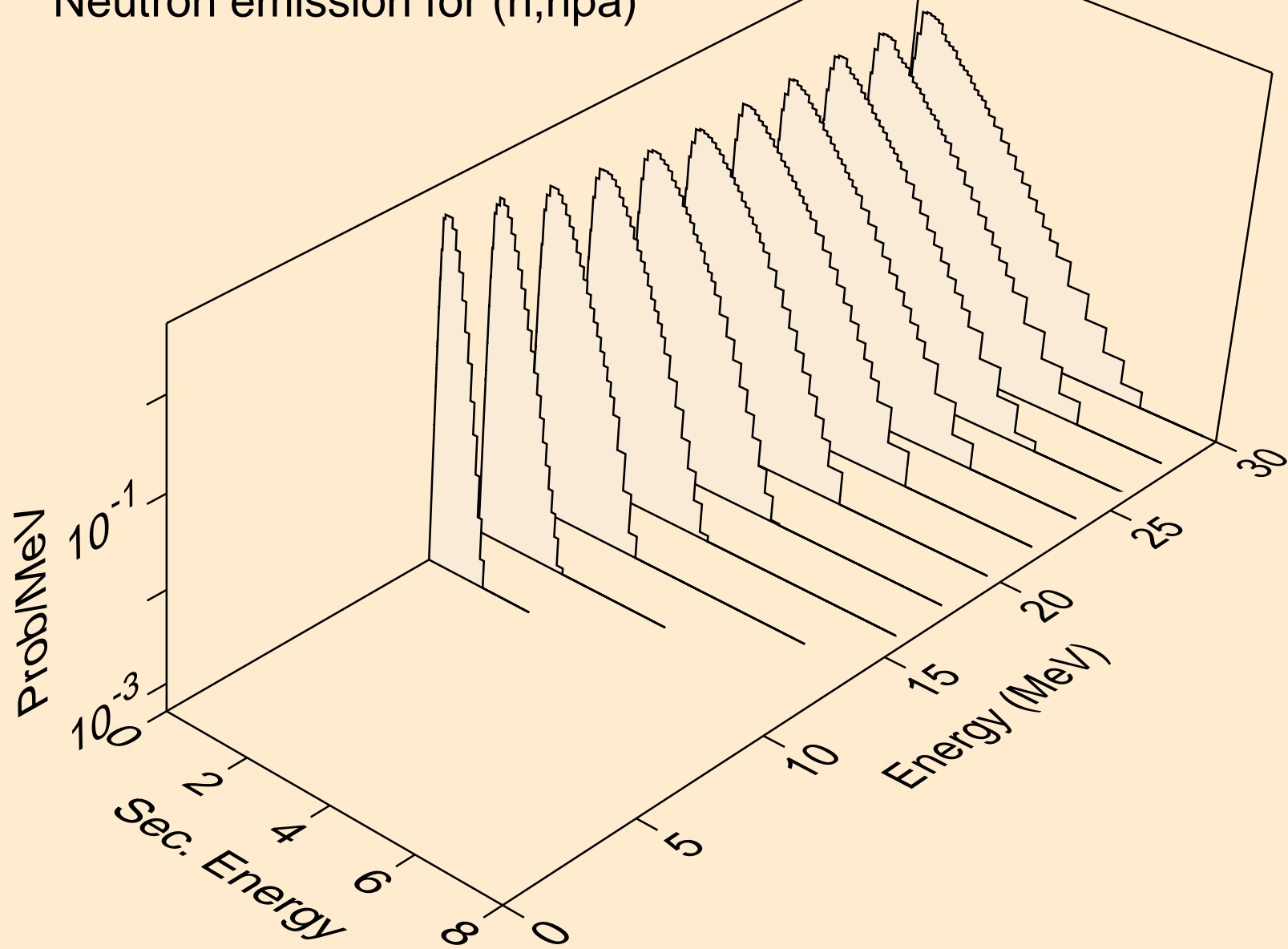

PO202 NEUTRON ACER TENDL-2023 LIBRARY; T=0.K
Neutron emission for (n,n*c)

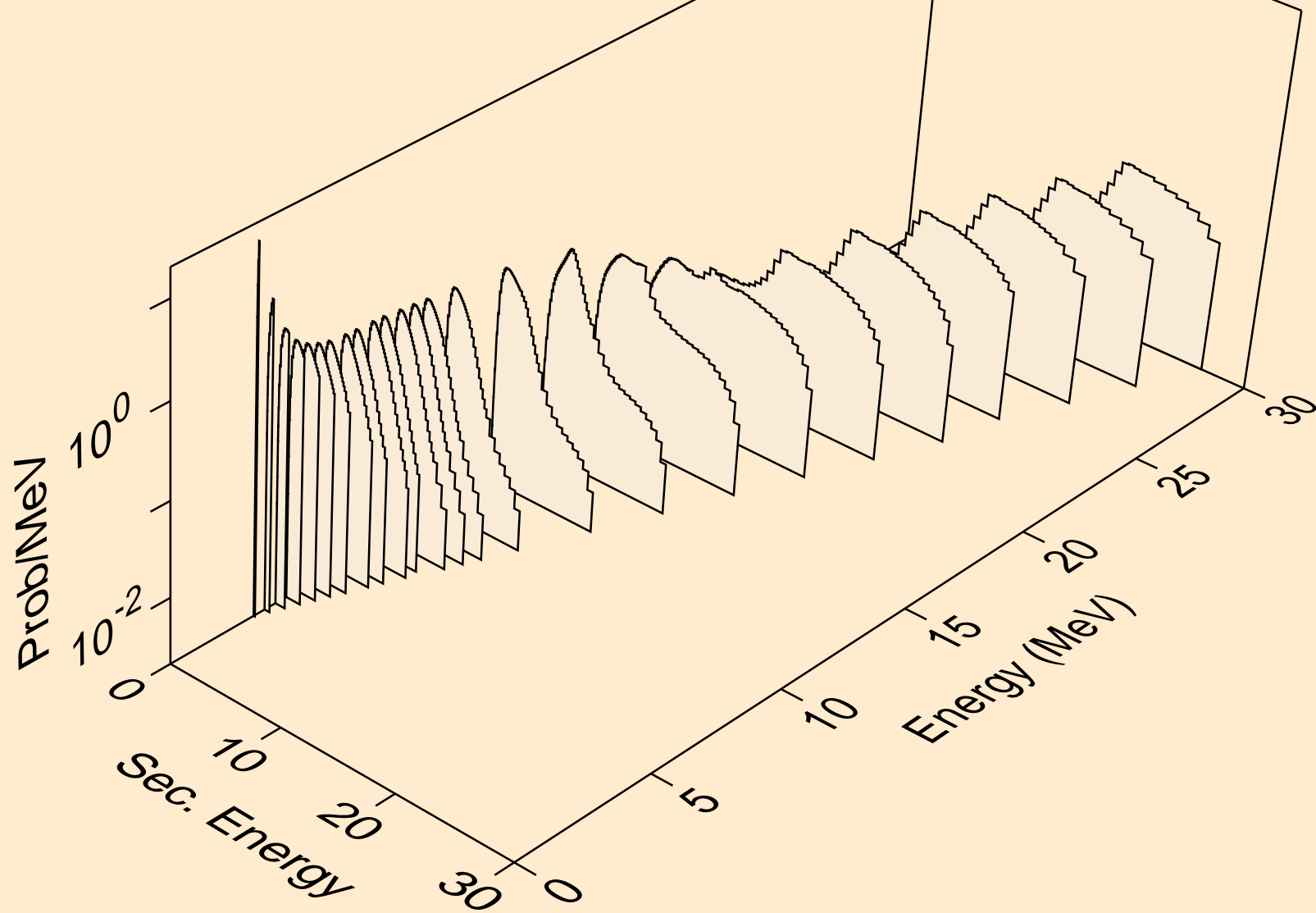

PO202 NEUTRON ACER TENDL-2023 LIBRARY; T=0.K
Photon emission for (n,x)

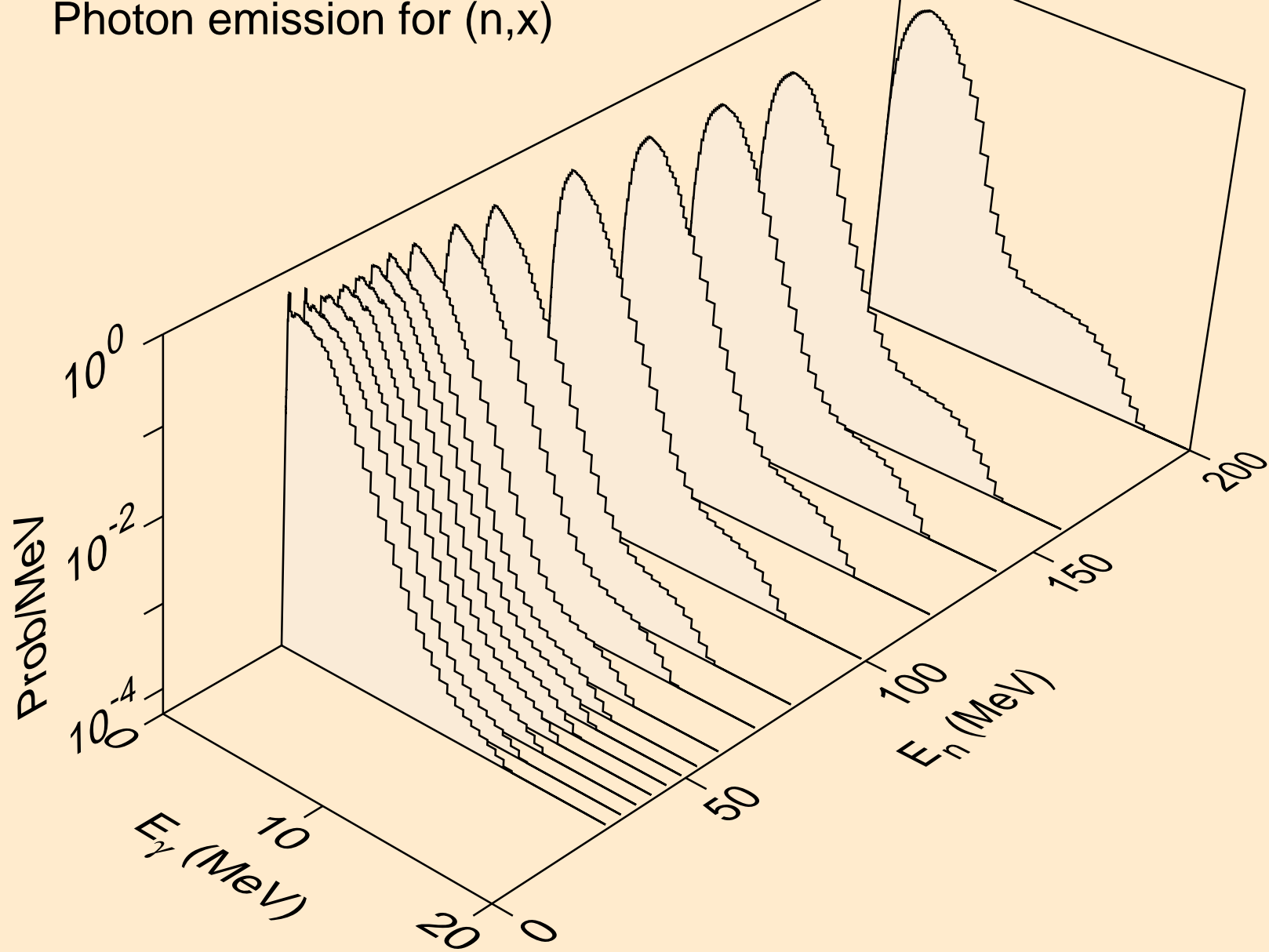

PO202 NEUTRON ACER TENDL-2023 LIBRARY; T=0.K
Photon emission for (n,2nd)

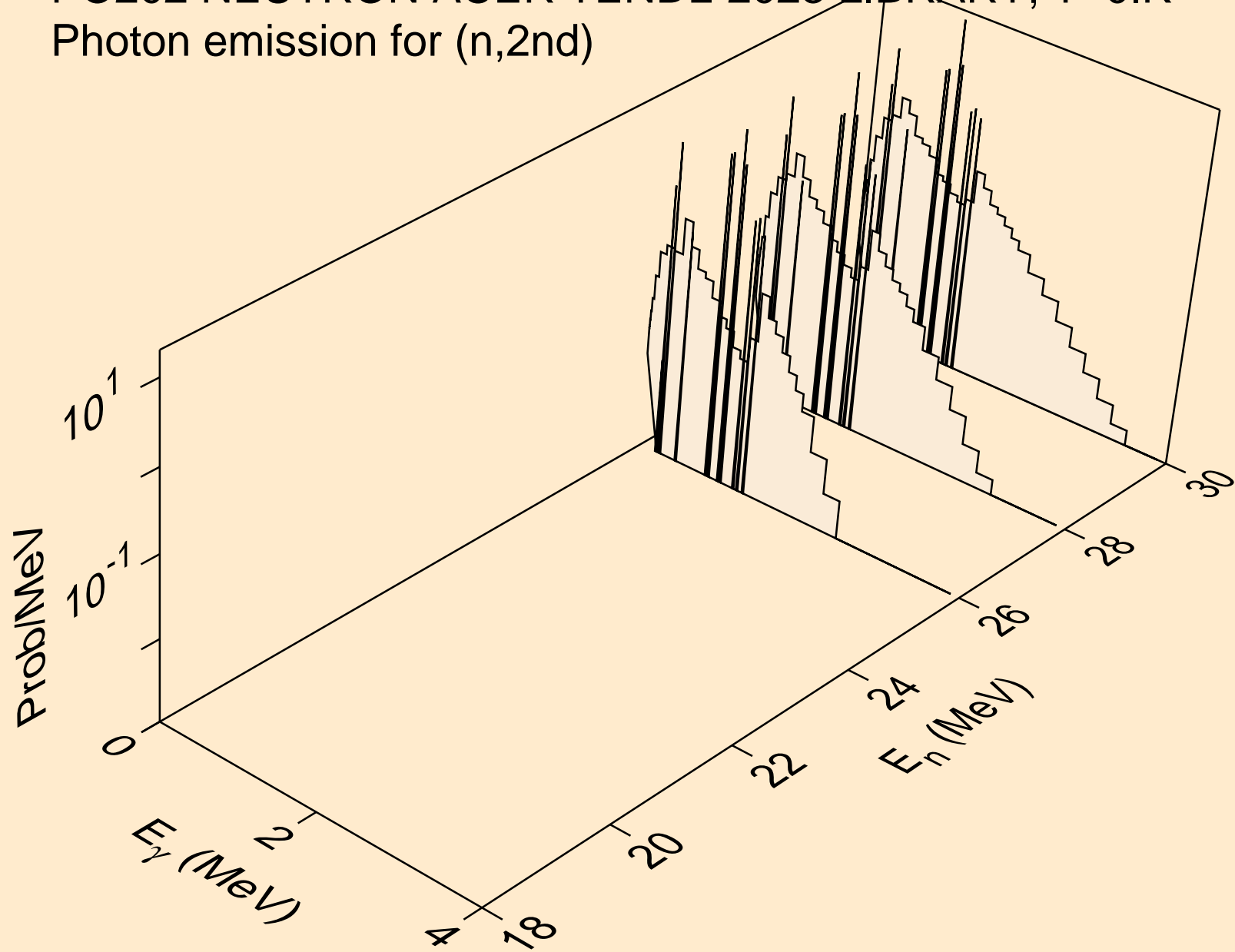

PO202 NEUTRON ACER TENDL-2023 LIBRARY; T=0.K
Photon emission for (n,2n)

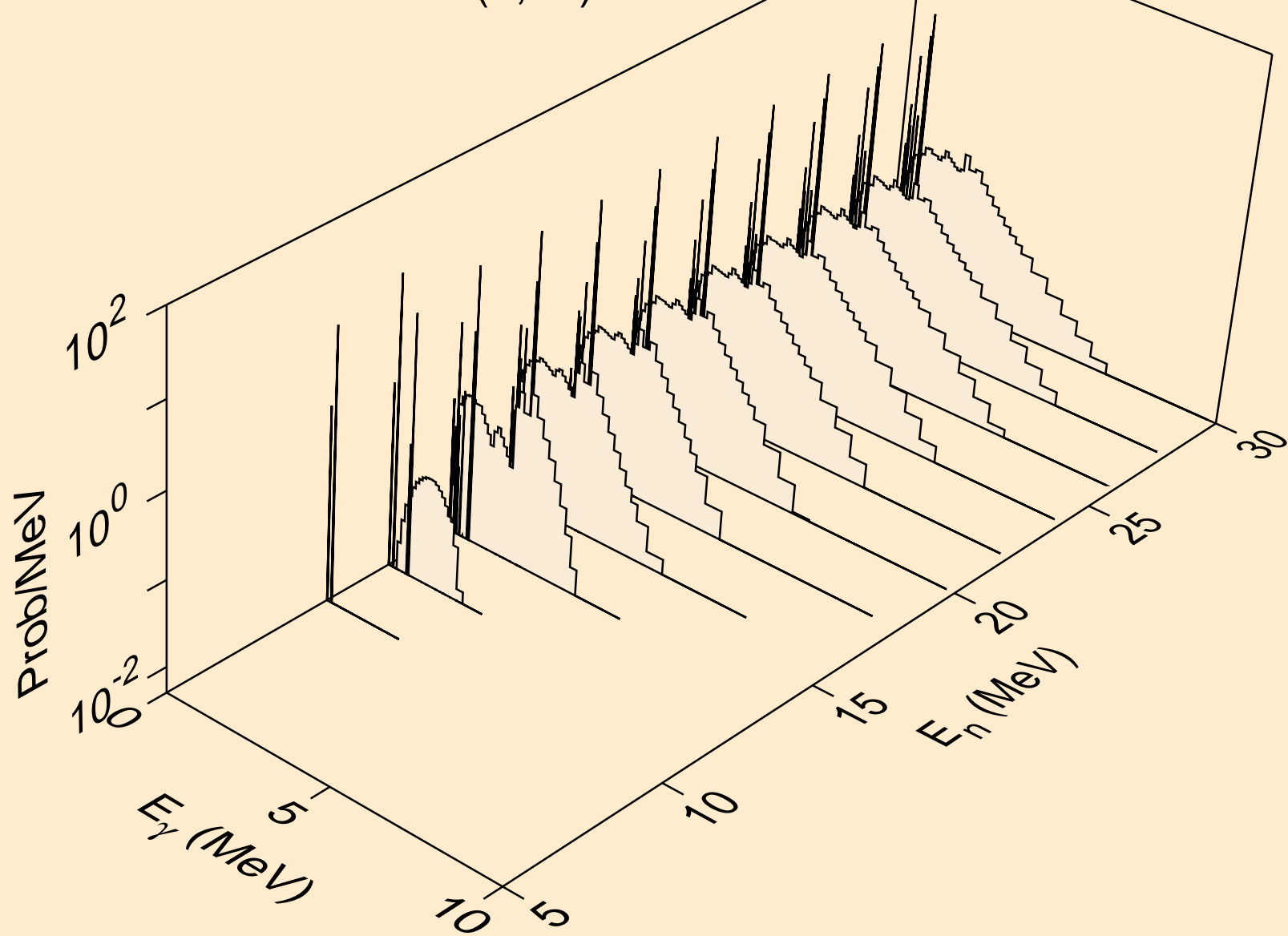

PO202 NEUTRON ACER TENDL-2023 LIBRARY; T=0.K
Photon emission for (n,3n)

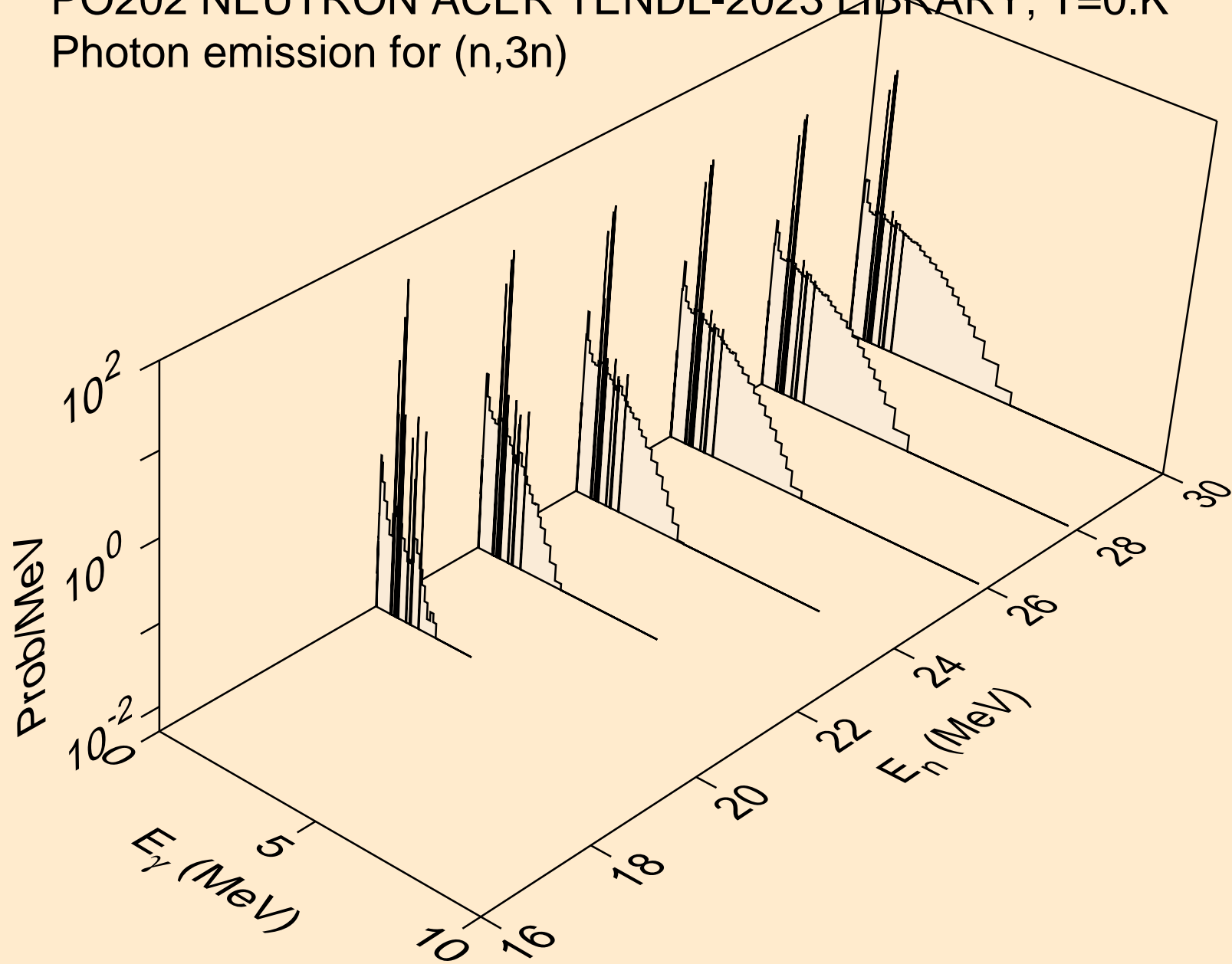

PO202 NEUTRON ACER TENDL-2023 LIBRARY; T=0.K
Photon emission for (n,n*)a

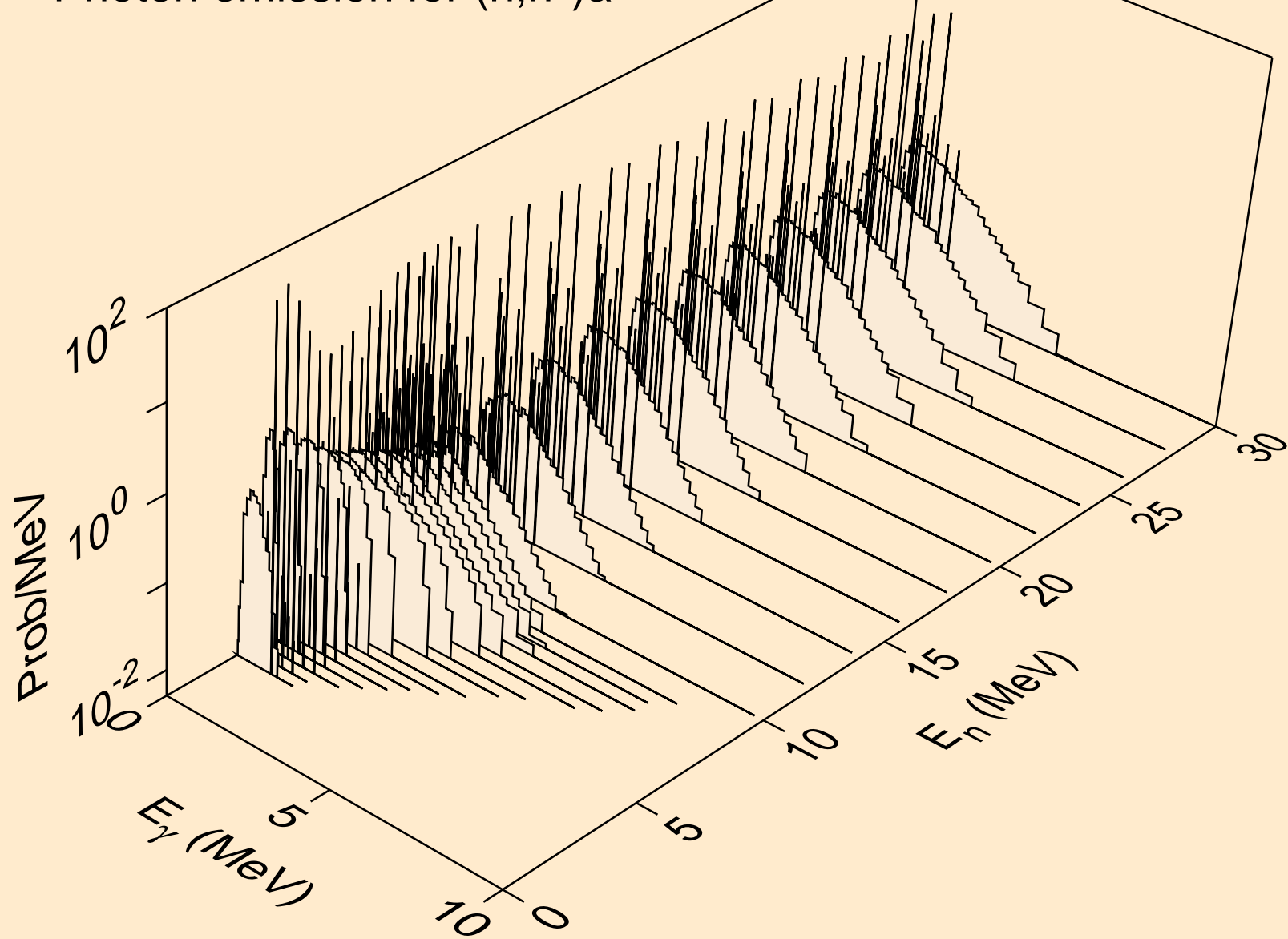

PO202 NEUTRON ACER TENDL-2023 LIBRARY; T=0.K
Photon emission for (n,2n)a

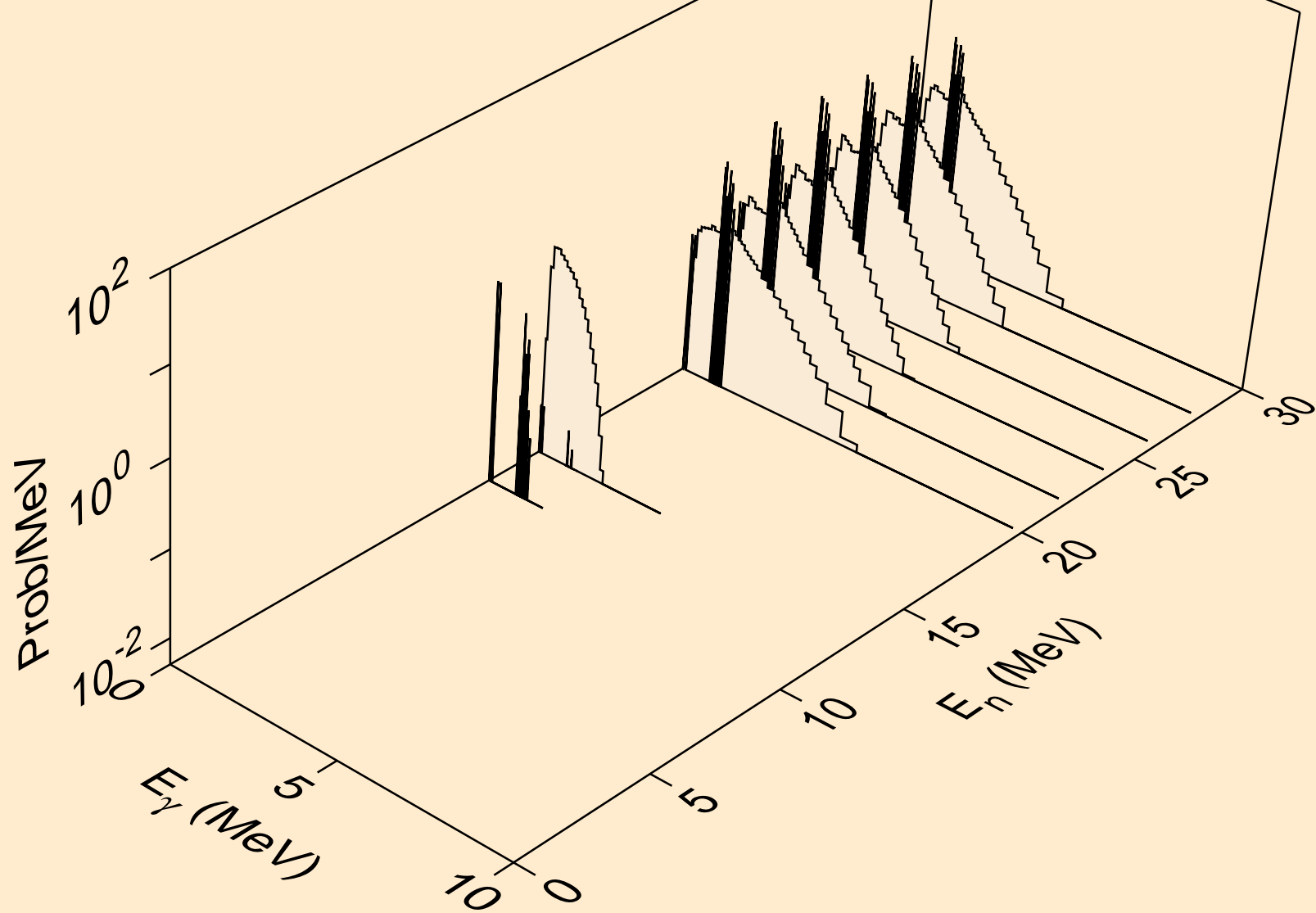

PO202 NEUTRON ACER TENDL-2023 LIBRARY; T=0.K
Photon emission for (n,3n)a

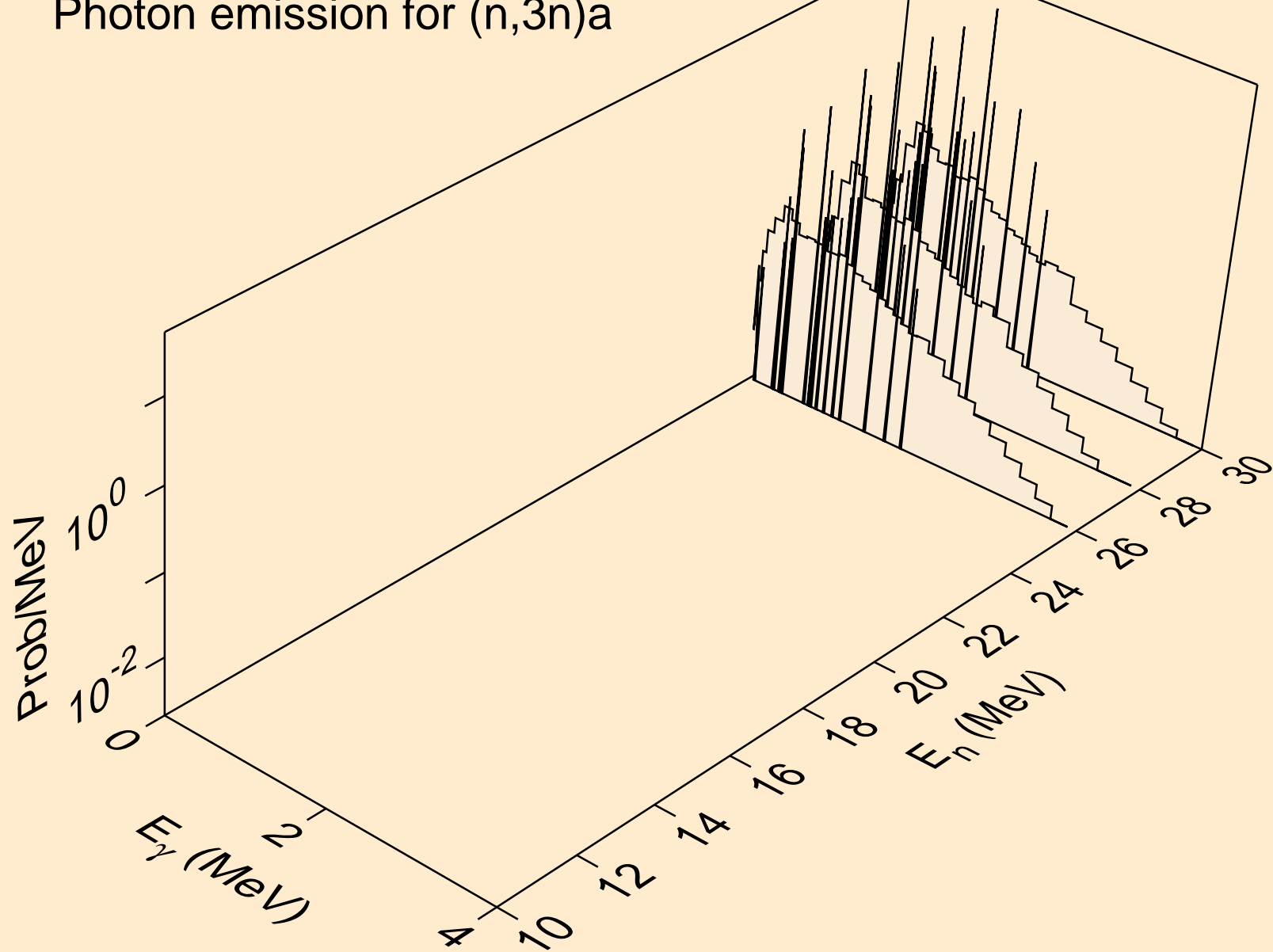

PO202 NEUTRON ACER TENDL-2023 LIBRARY; T=0.K
Photon emission for (n,n*)p

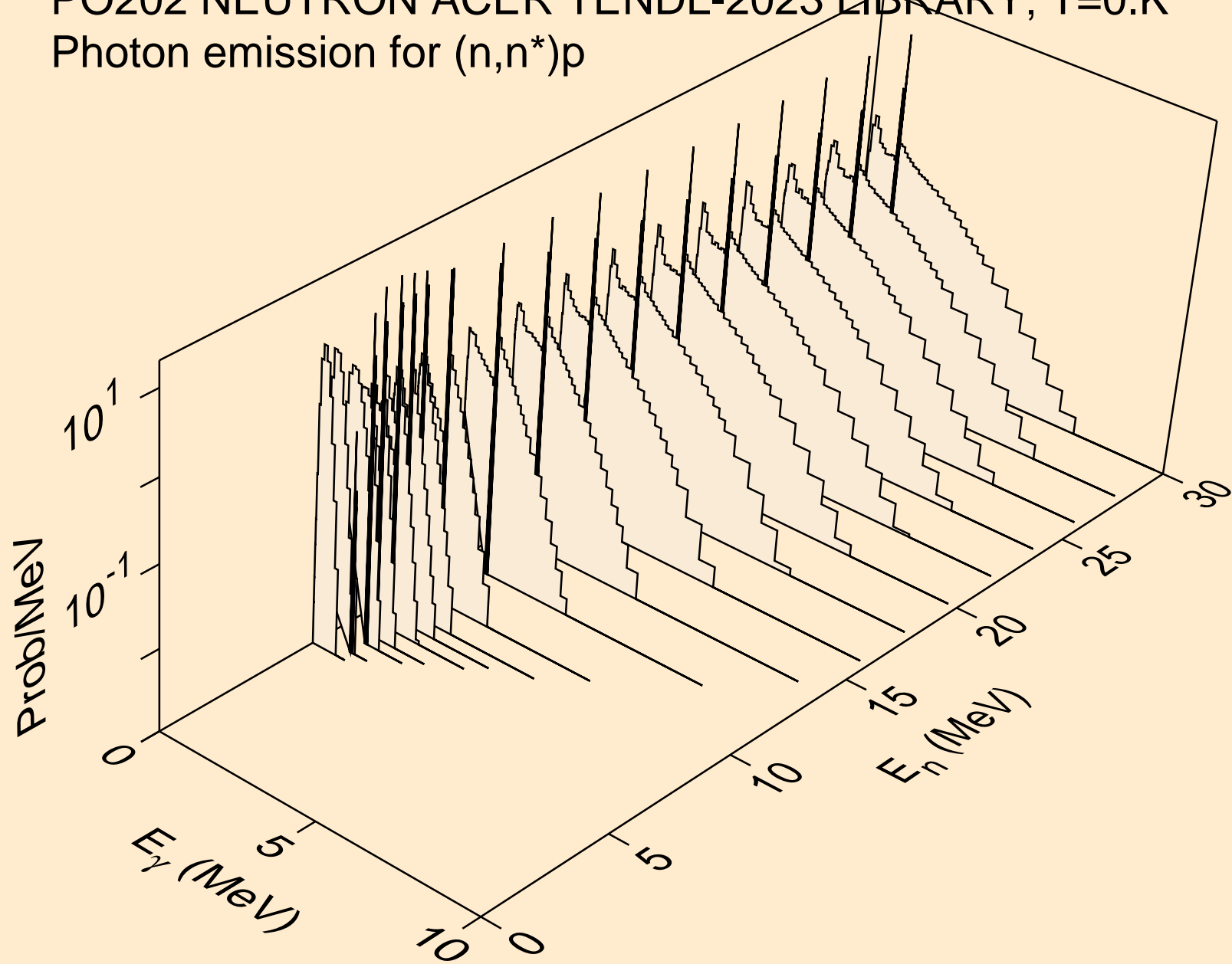

PO202 NEUTRON ACER TENDL-2023 LIBRARY; T=0.K
Photon emission for (n,n*)2a

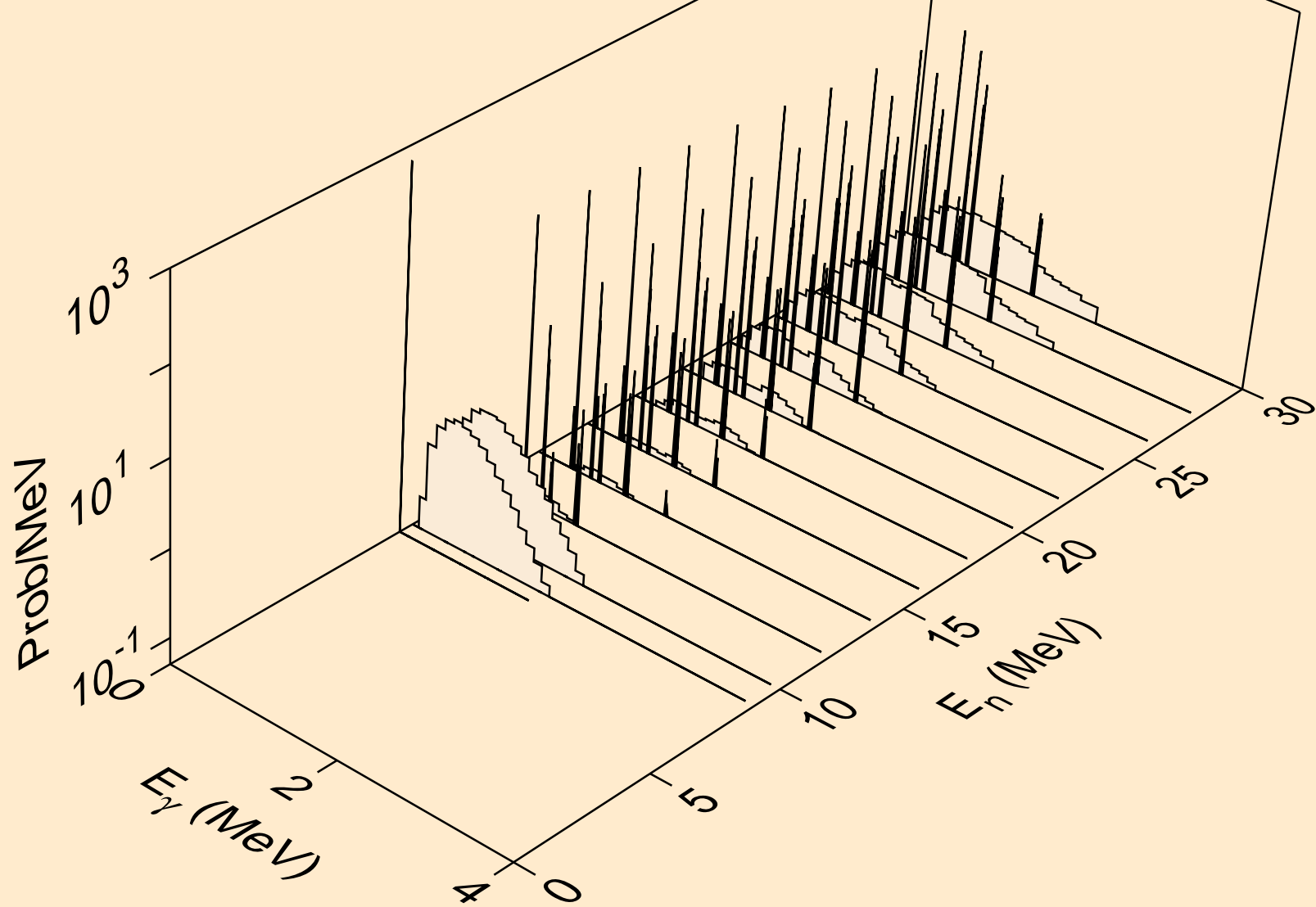

PO202 NEUTRON ACER TENDL-2023 LIBRARY; T=0.K
Photon emission for (n,n*)d

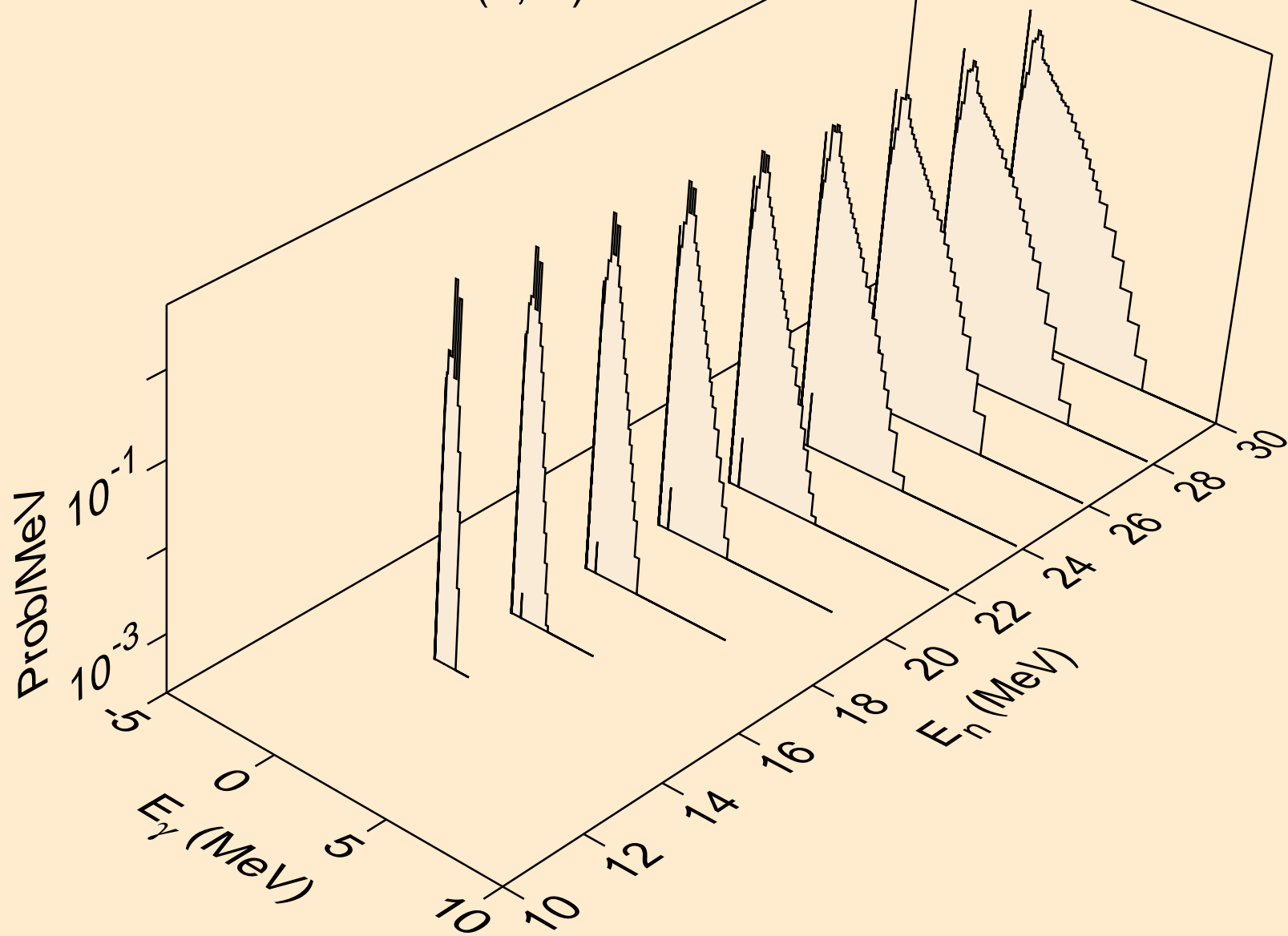

PO202 NEUTRON ACER TENDL-2023 LIBRARY; T=0.K
Photon emission for (n,n*)t

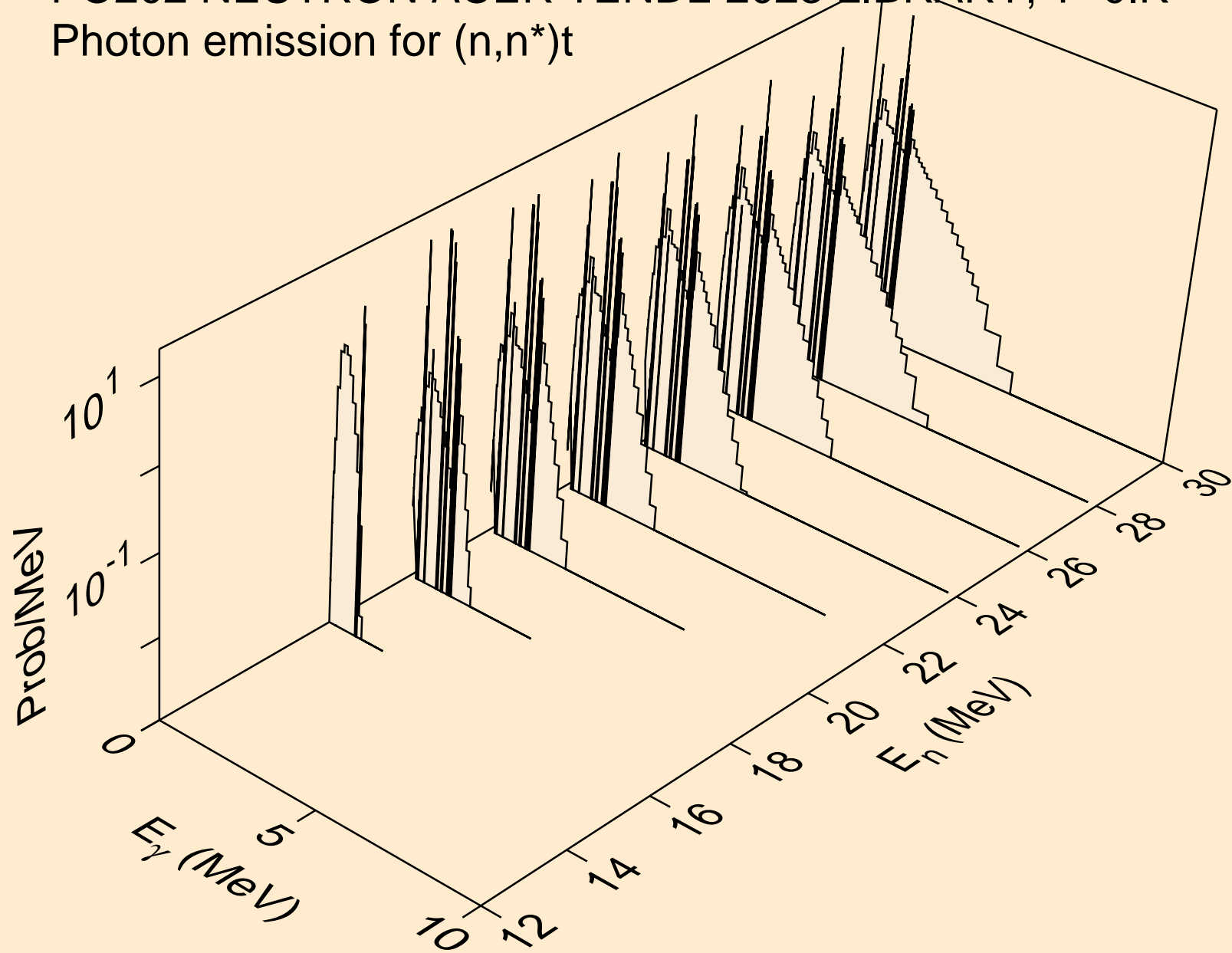

PO202 NEUTRON ACER TENDL-2023 LIBRARY; T=0.K
Photon emission for (n,n*)he3

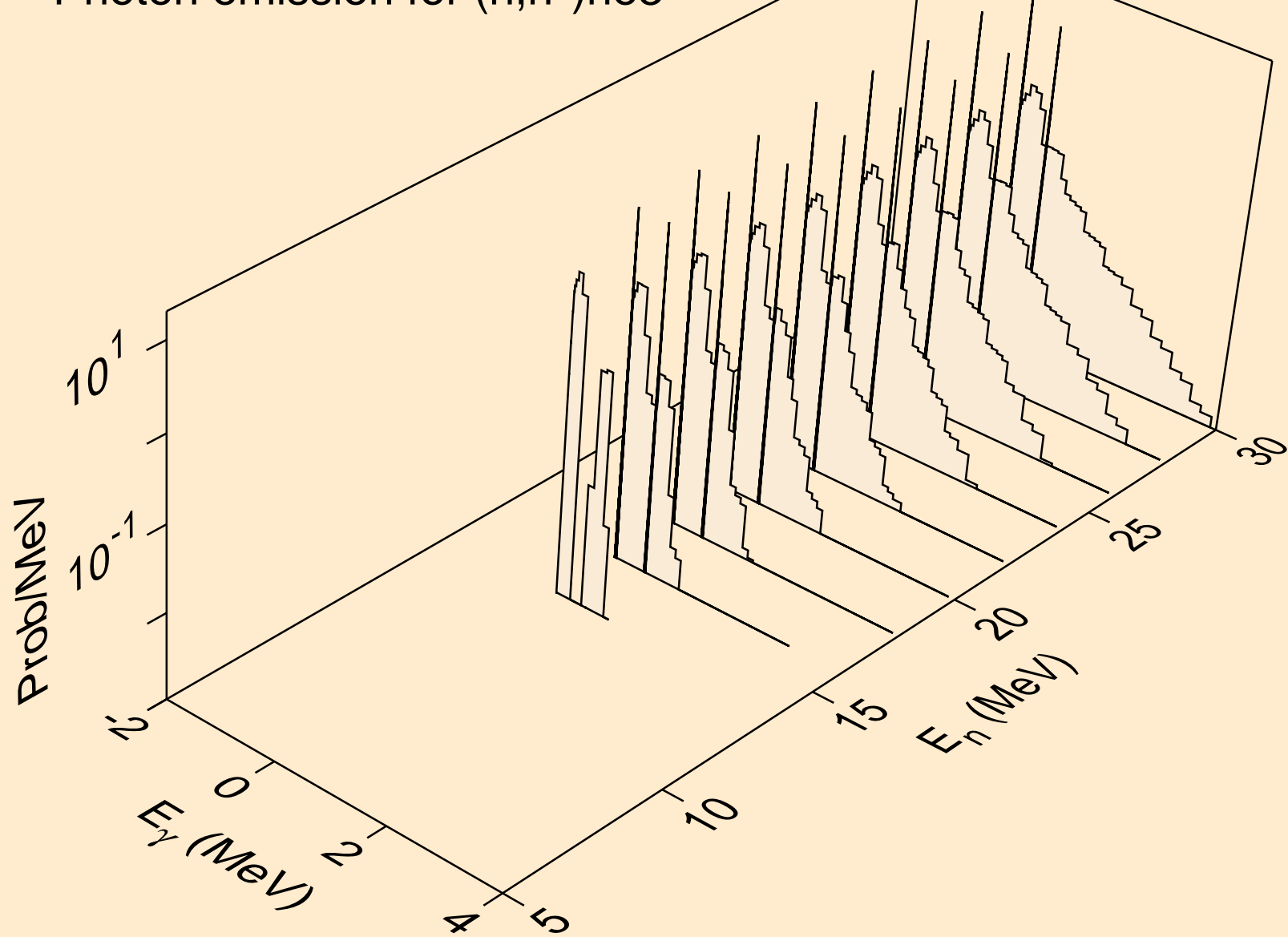

PO202 NEUTRON ACER TENDL-2023 LIBRARY; T=0.K
Photon emission for (n,4n)

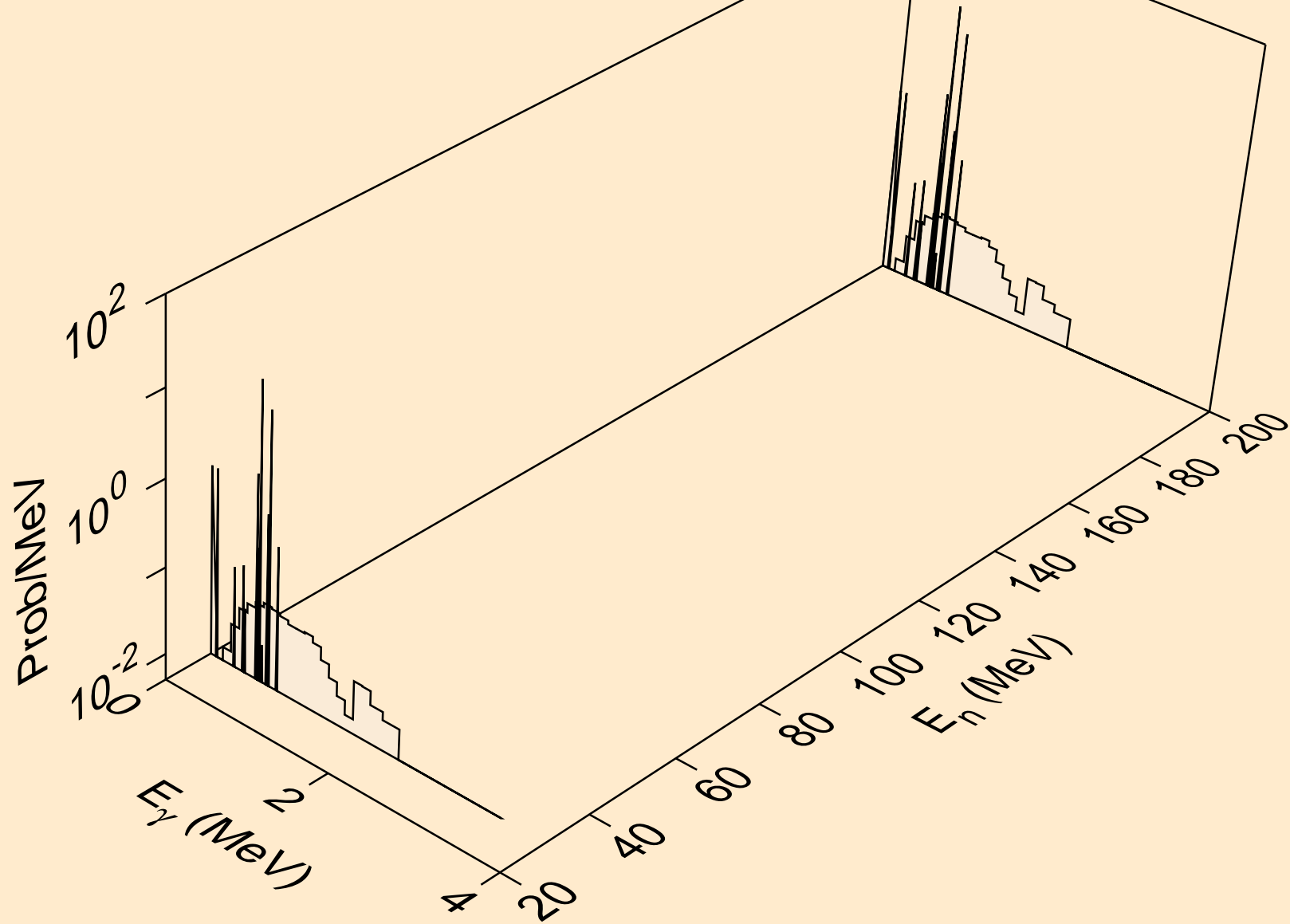

PO202 NEUTRON ACER TENDL-2023 LIBRARY; T=0.K
Photon emission for (n,2np)

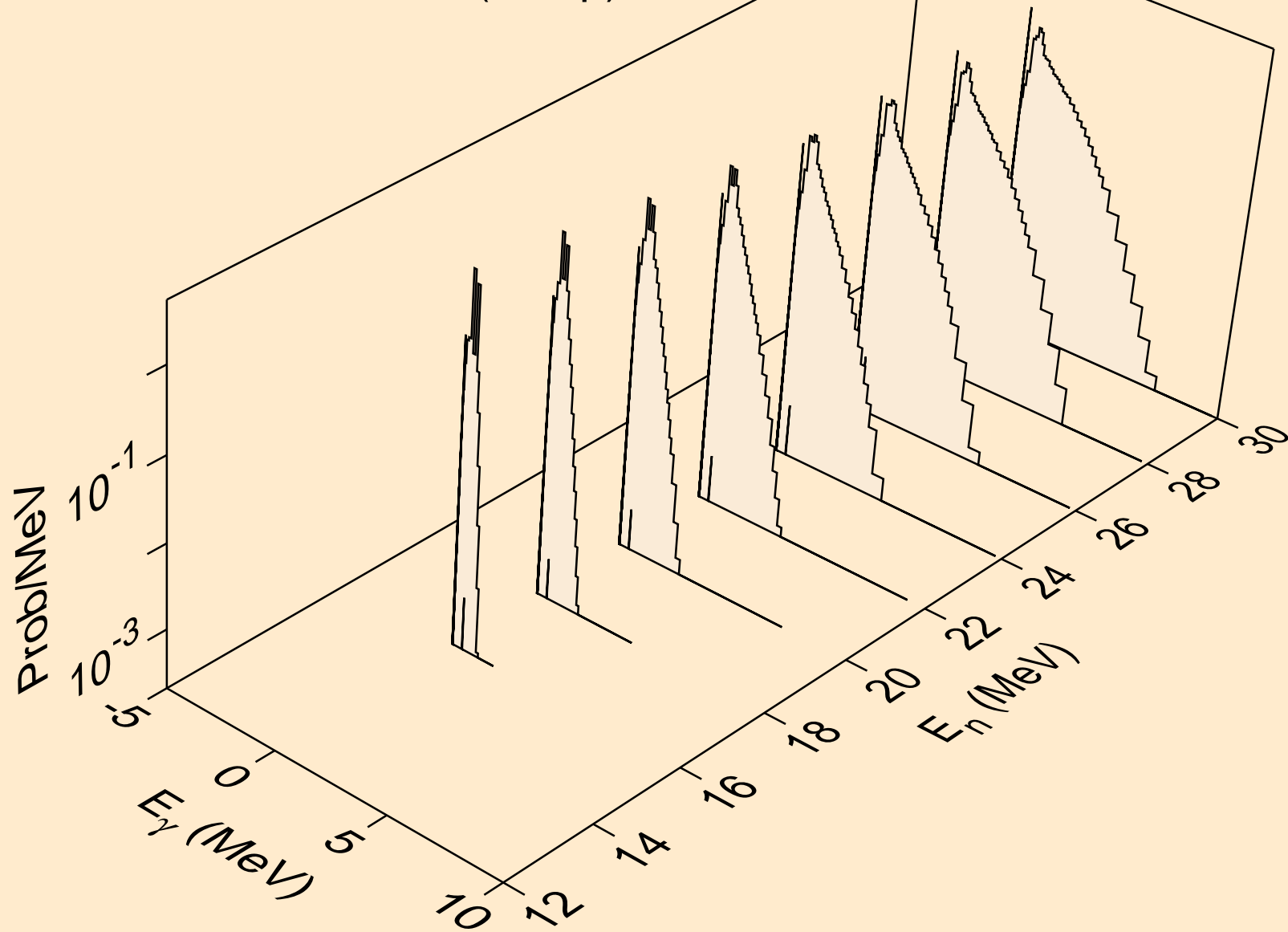

PO202 NEUTRON ACER TENDL-2023 LIBRARY; T=0.K
Photon emission for (n,3np)

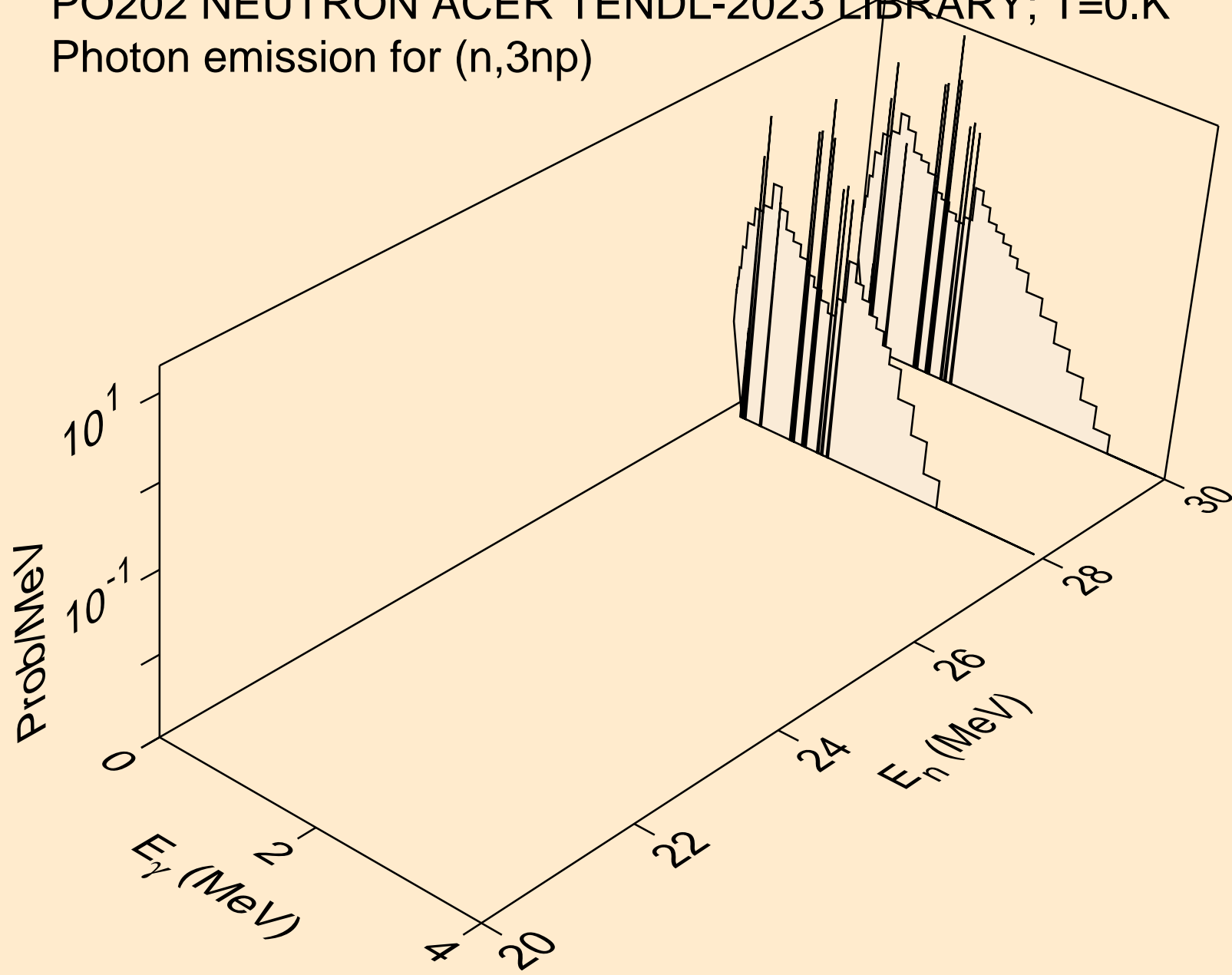

PO202 NEUTRON ACER TENDL-2023 LIBRARY; T=0.K
Photon emission for (n,n2p)

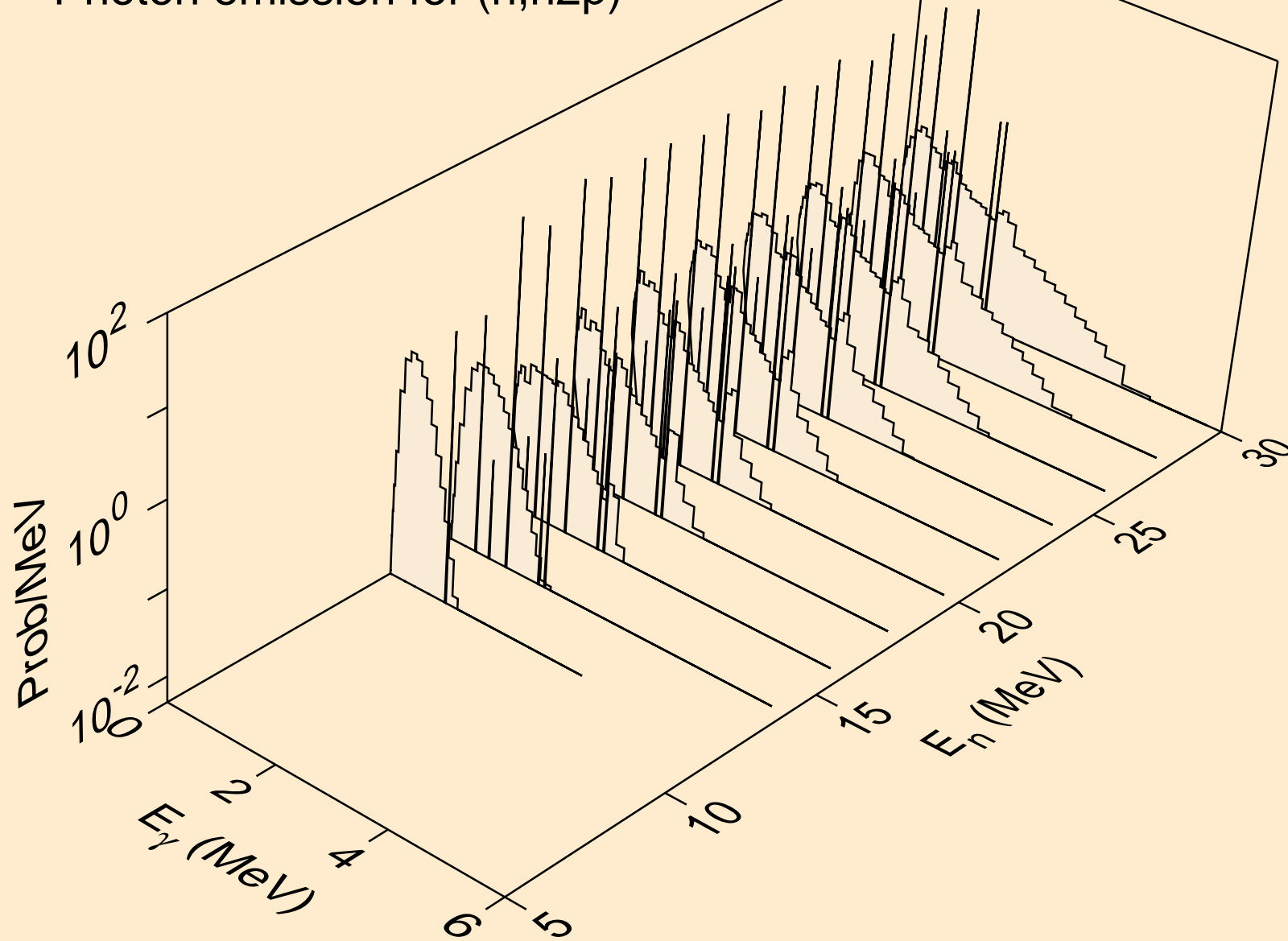

PO202 NEUTRON ACER TENDL-2023 LIBRARY; T=0.K
Photon emission for (n,npa)

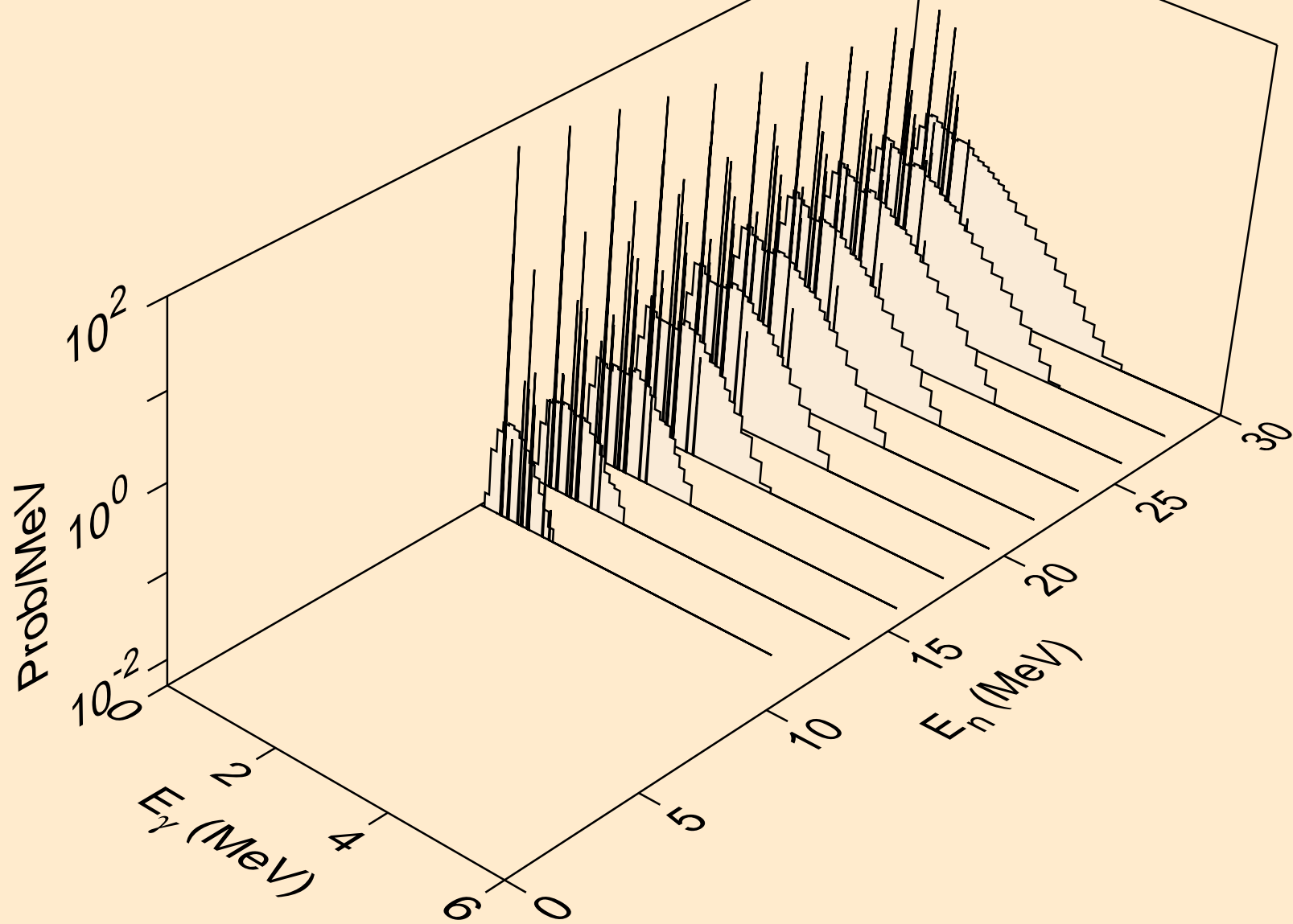

PO202 NEUTRON ACER TENDL-2023 LIBRARY; T=0.K
Photon emission for (n,n*c)

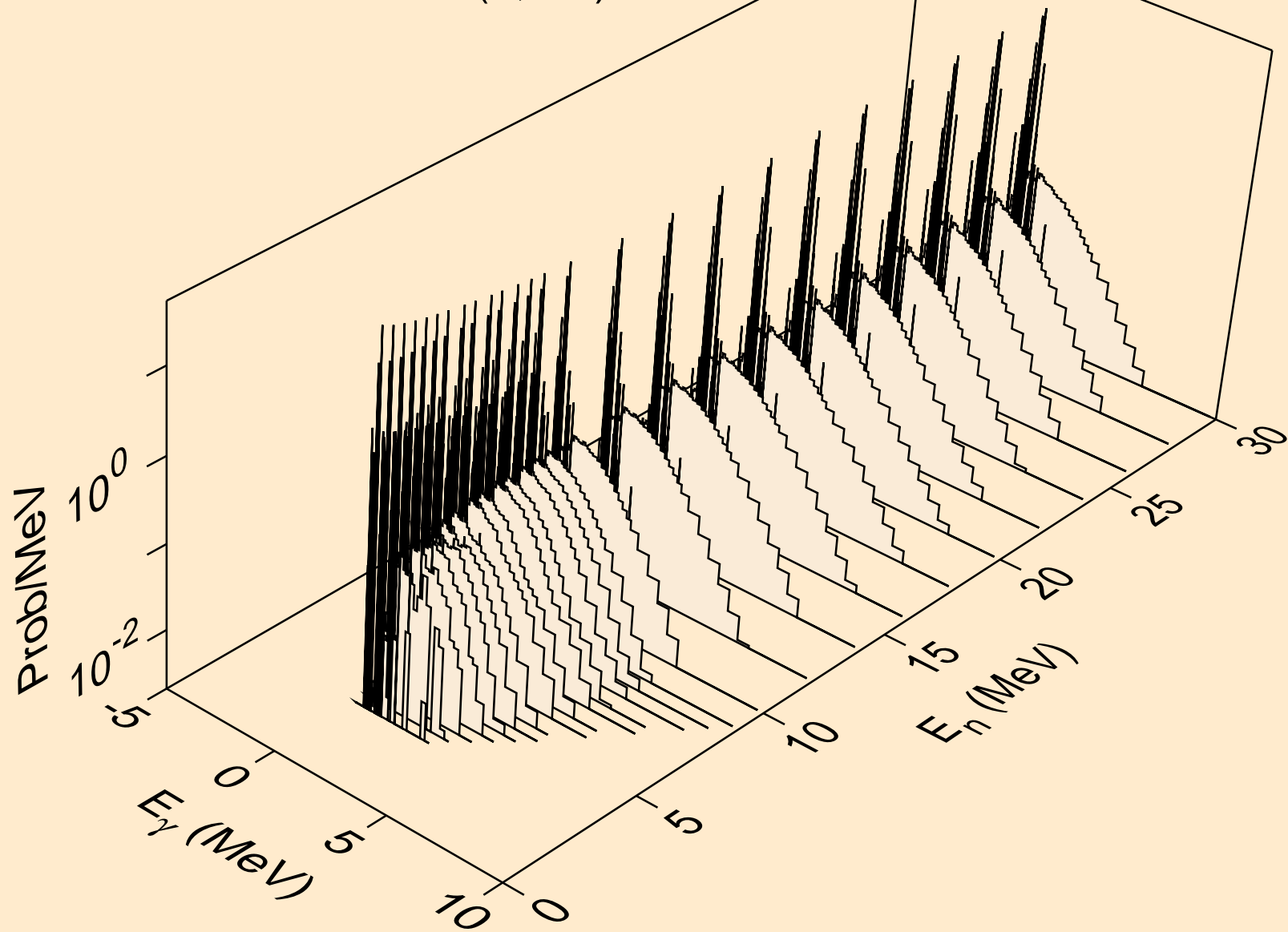

PO202 NEUTRON ACER TENDL-2023 LIBRARY; T=0.K
Photon emission for (n,gma)

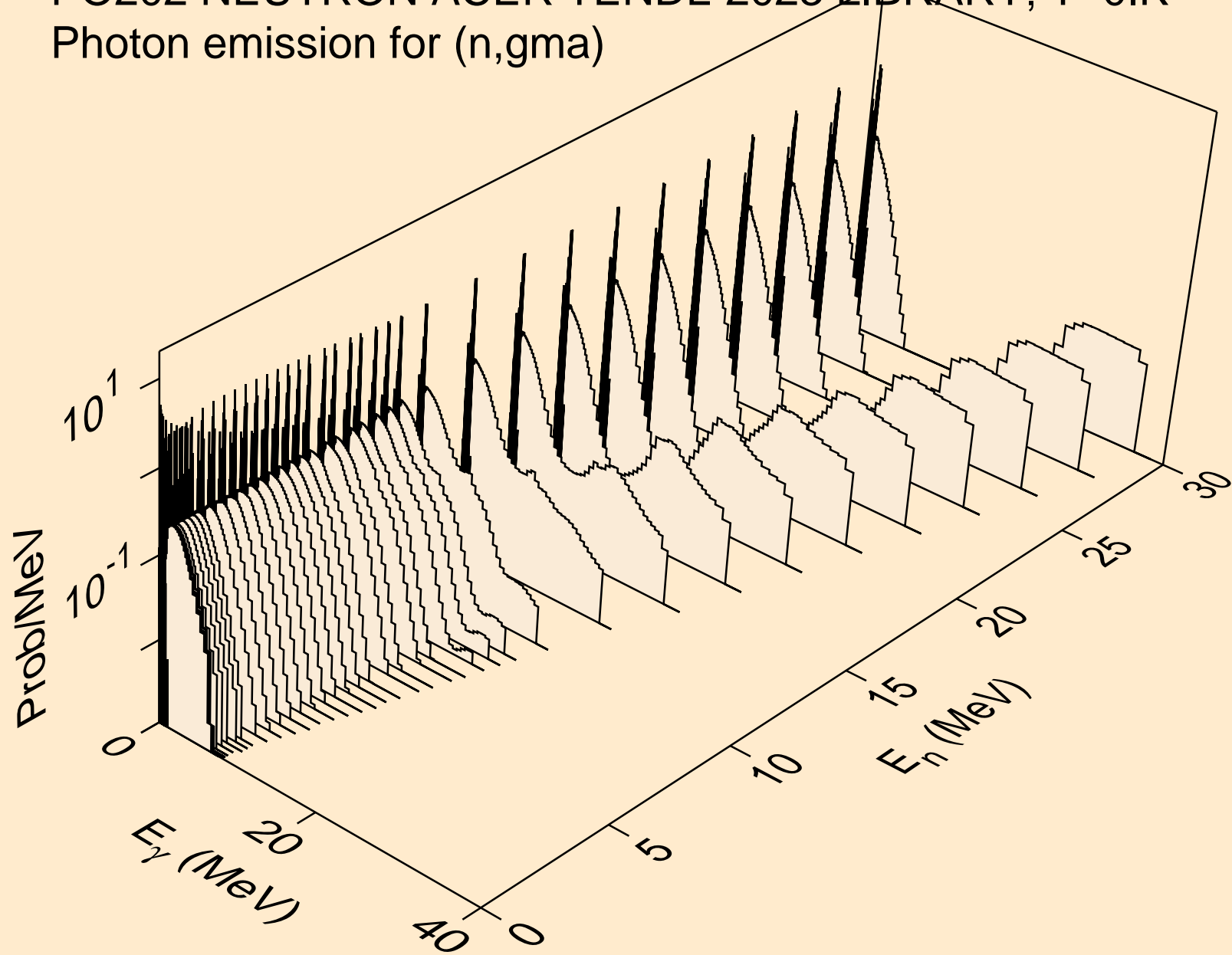

PO202 NEUTRON ACER TENDL-2023 LIBRARY; T=0.K
Photon emission for (n,p)

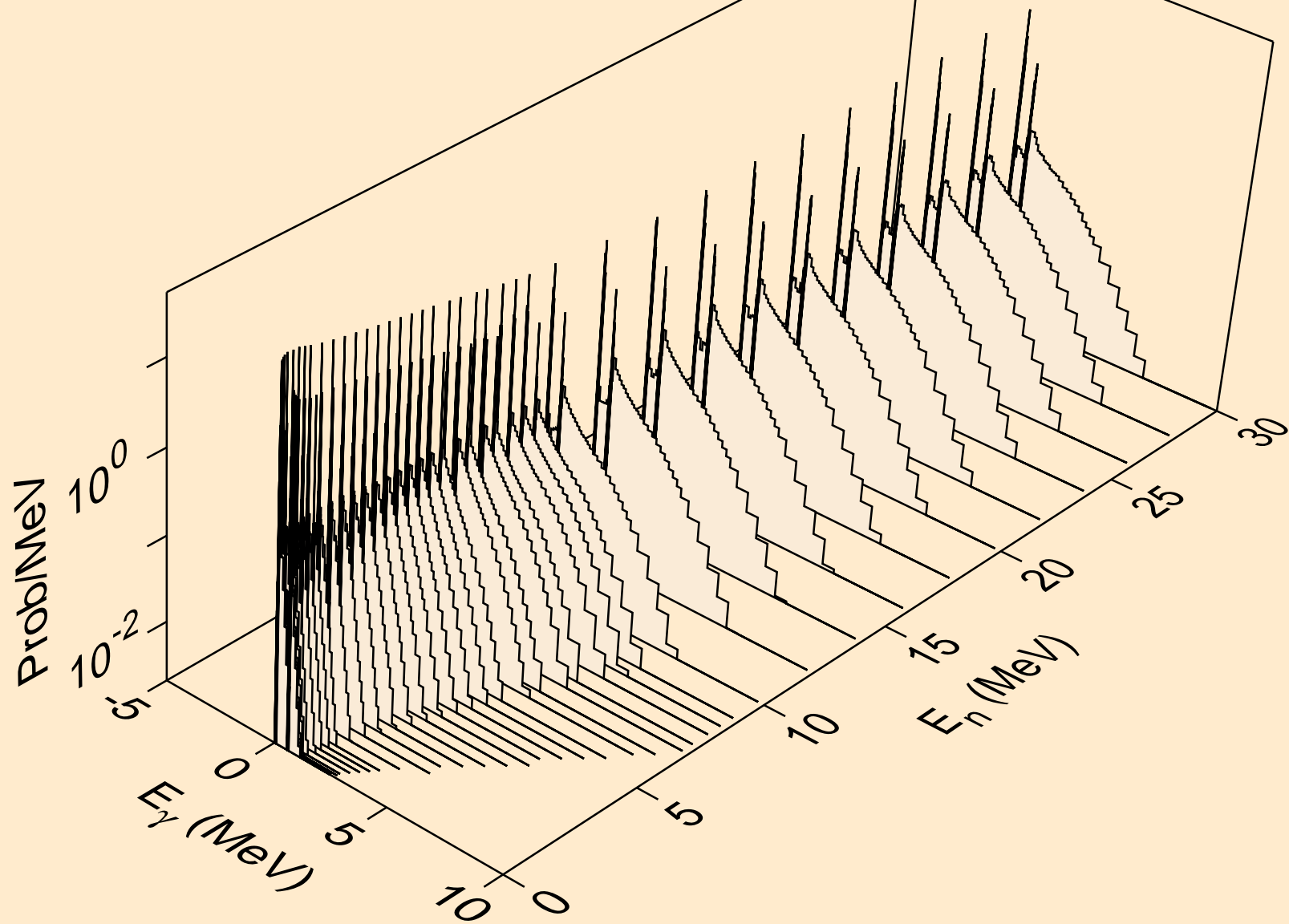

PO202 NEUTRON ACER TENDL-2023 LIBRARY; T=0.K
Photon emission for (n,d)

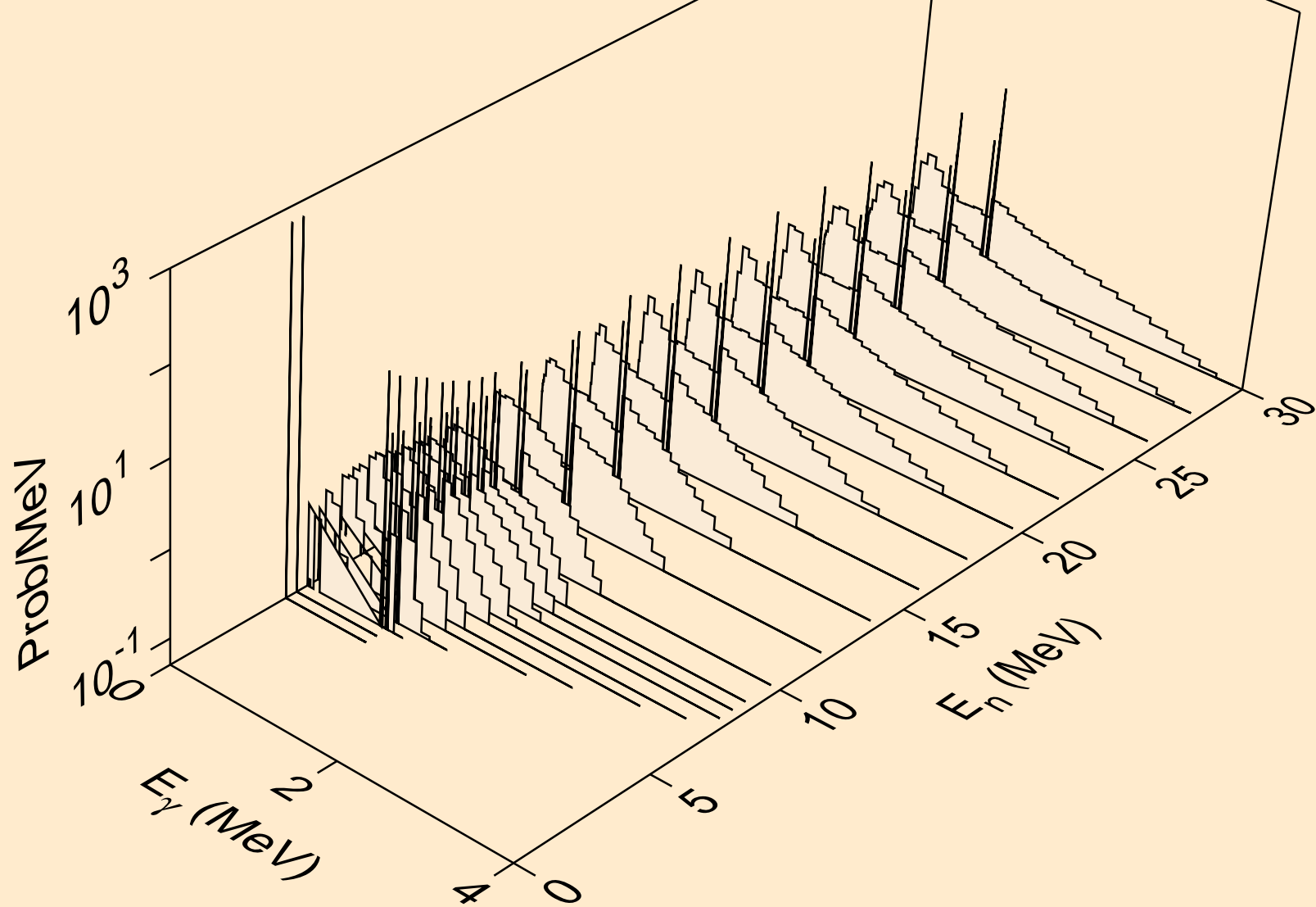

PO202 NEUTRON ACER TENDL-2023 LIBRARY; T=0.K
Photon emission for (n,t)

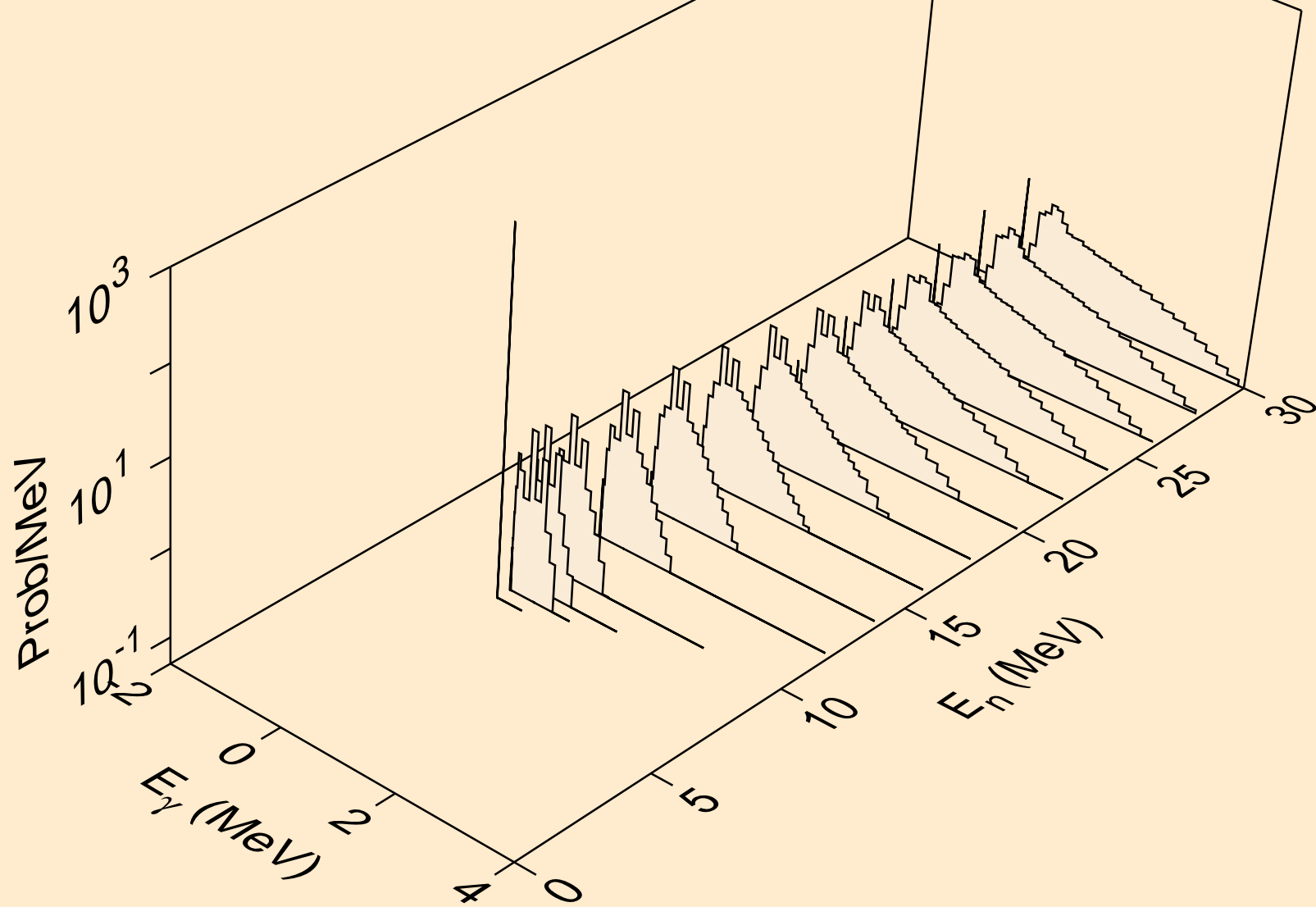

PO202 NEUTRON ACER TENDL-2023 LIBRARY; T=0.K
Photon emission for (n,he3)

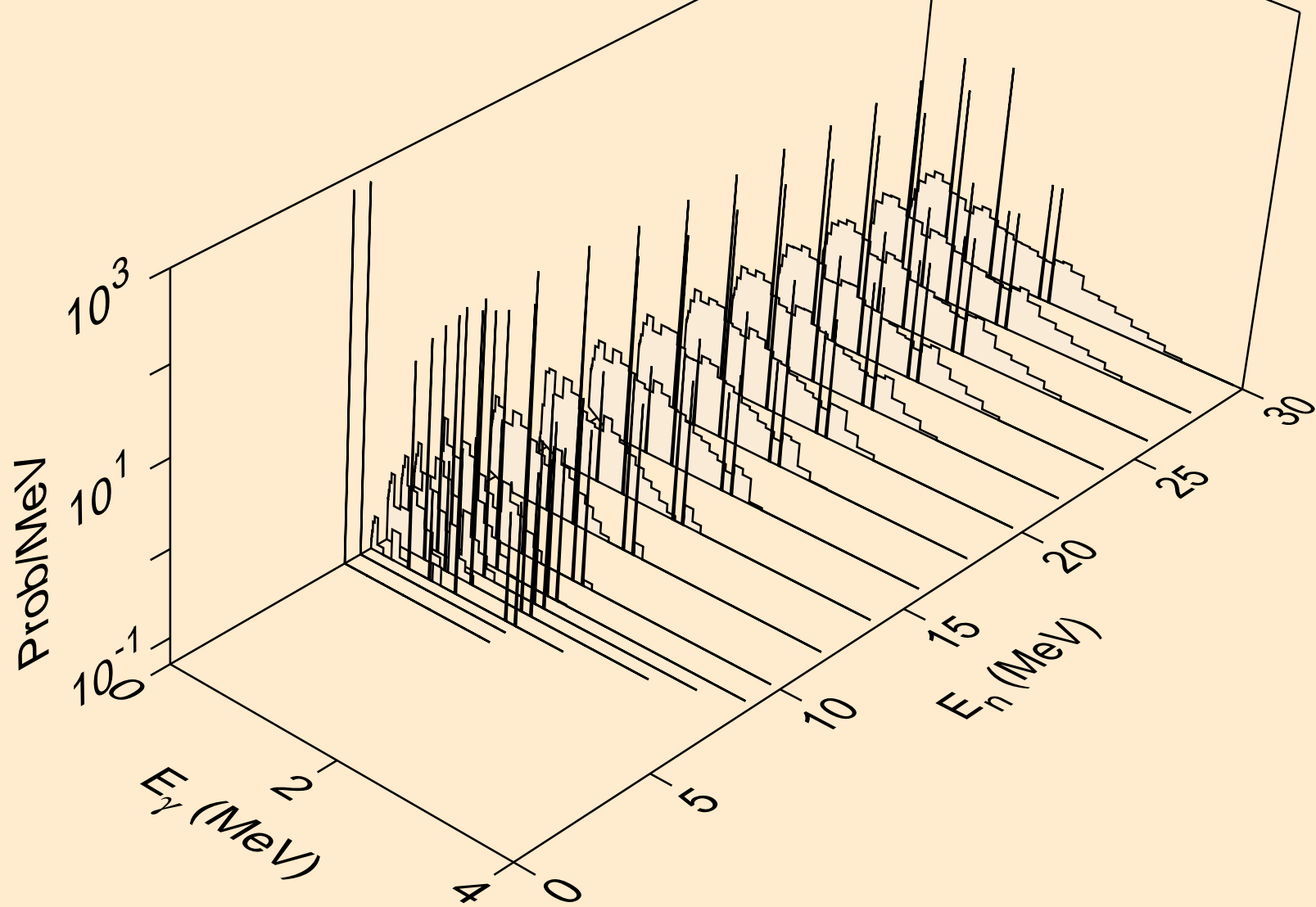

PO202 NEUTRON ACER TENDL-2023 LIBRARY; T=0.K
Photon emission for (n,a)

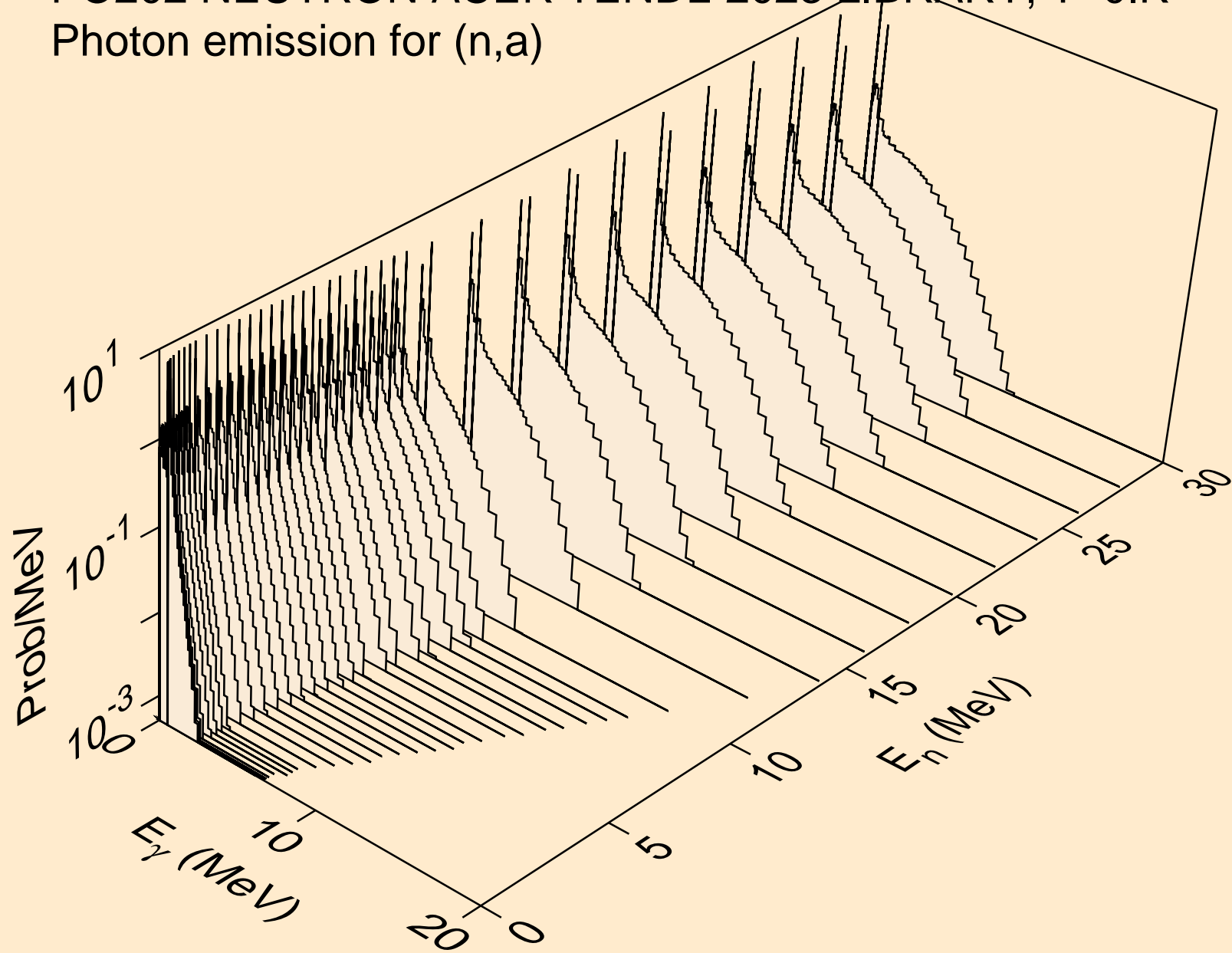

PO202 NEUTRON ACER TENDL-2023 LIBRARY; T=0.K
Photon emission for (n,2a)

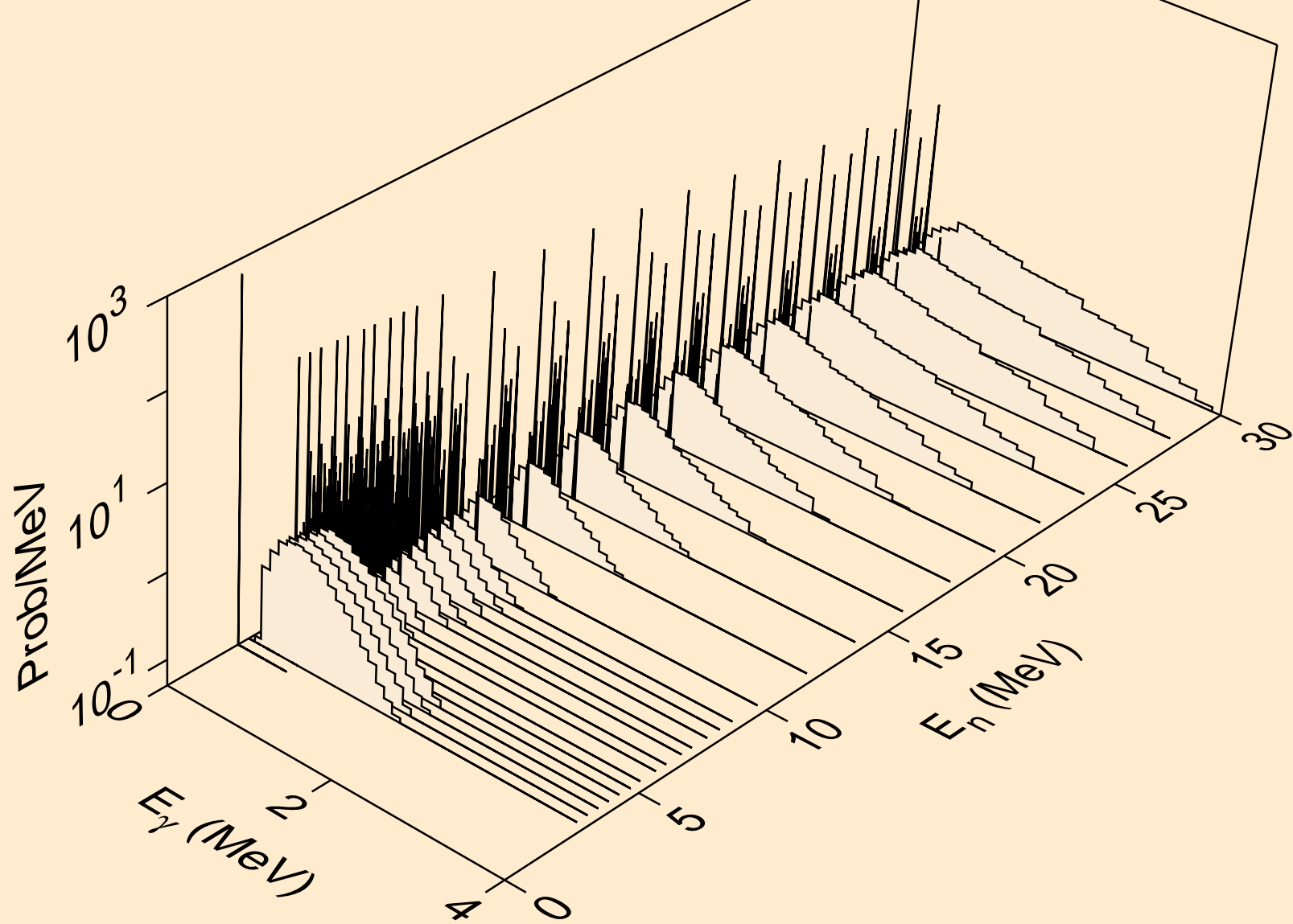

PO202 NEUTRON ACER TENDL-2023 LIBRARY; T=0.K
Photon emission for (n,2p)

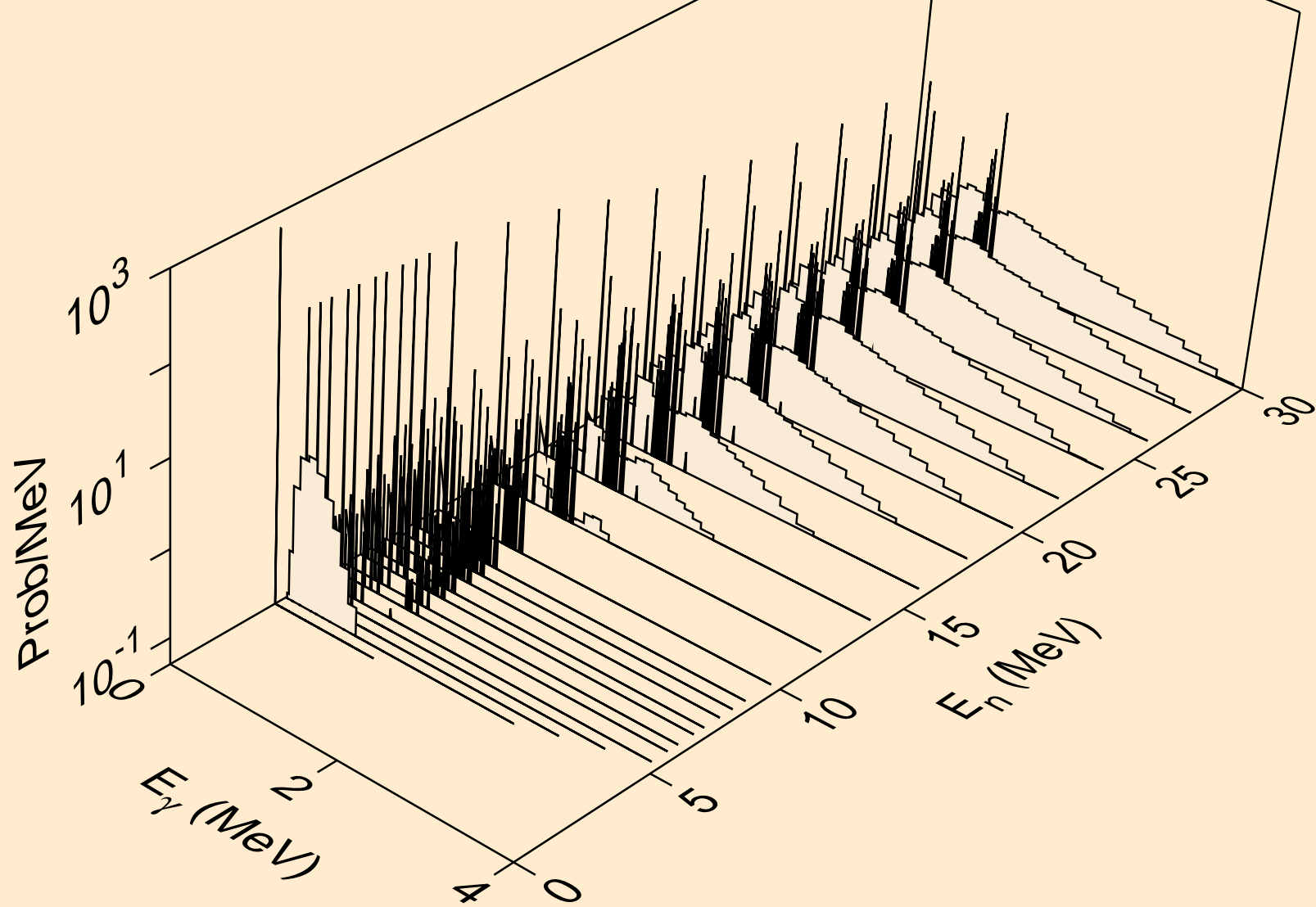

PO202 NEUTRON ACER TENDL-2023 LIBRARY; T=0.K
Photon emission for (n,p α)

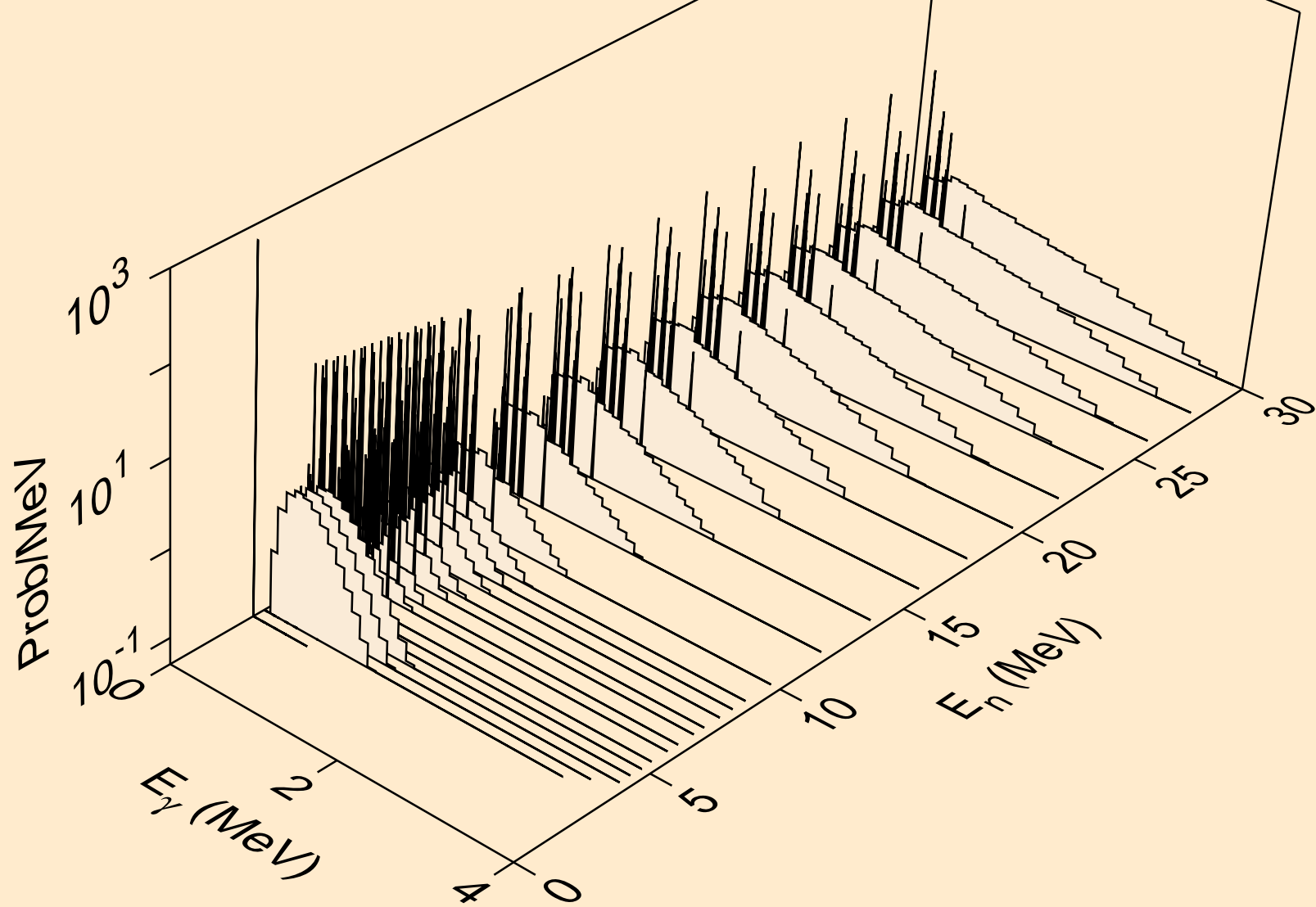

PO202 NEUTRON ACER TENDL-2023 LIBRARY; T=0.K
Photon emission for (n,pd)

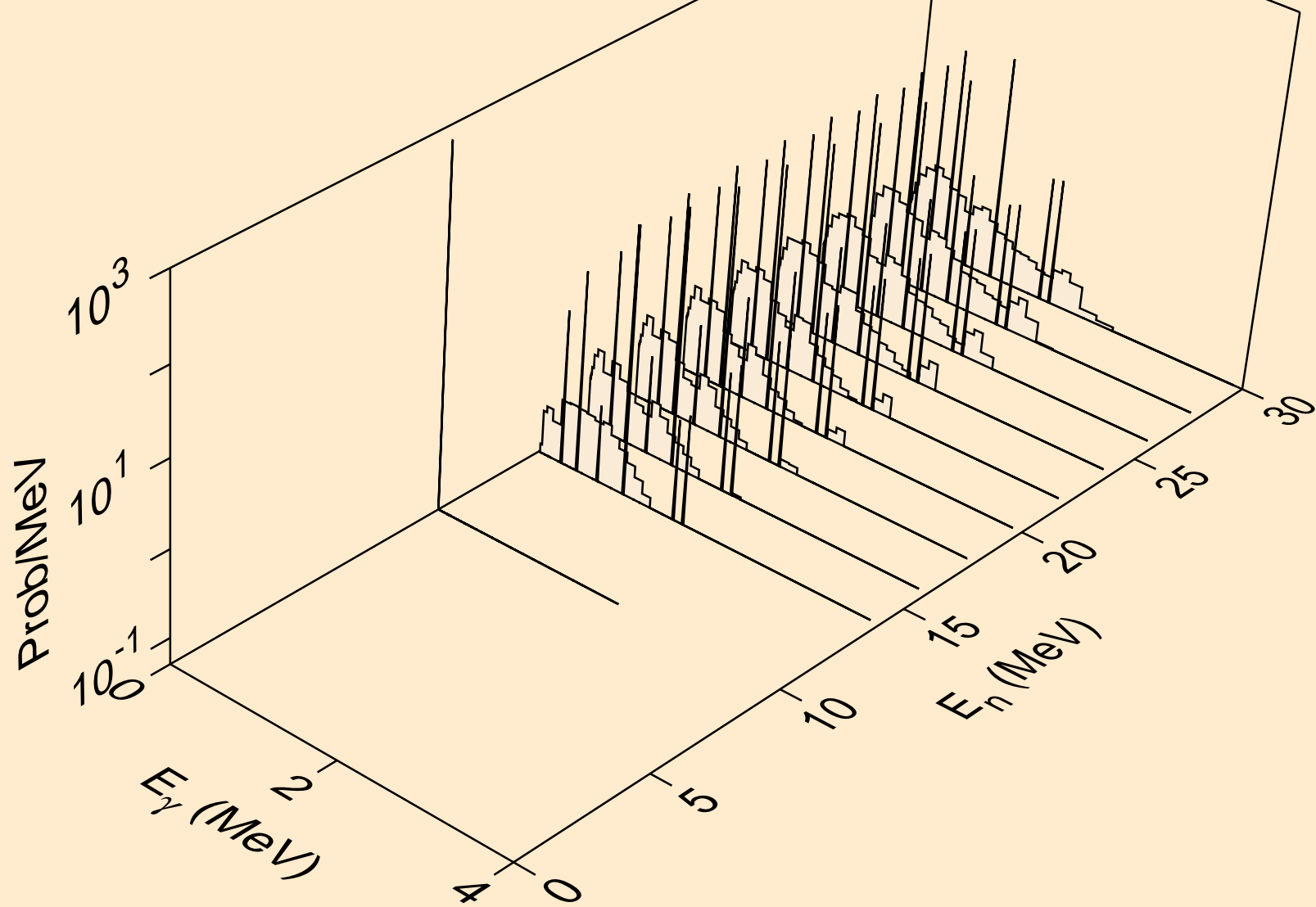

PO202 NEUTRON ACER TENDL-2023 LIBRARY; T=0.K
Photon emission for (n,pt)

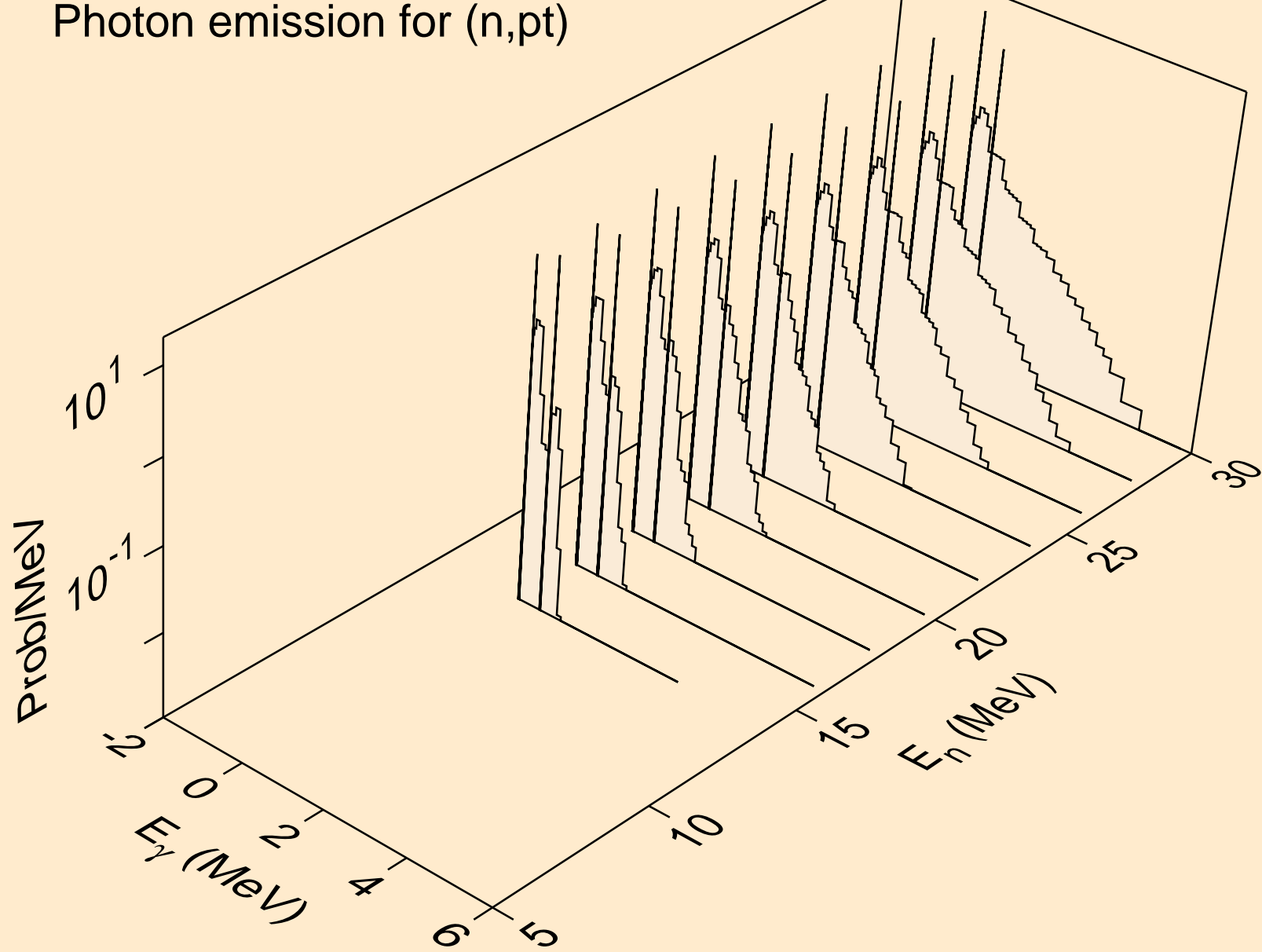

PO202 NEUTRON ACER TENDL-2023 LIBRARY; T=0.K
Photon emission for (n,da)

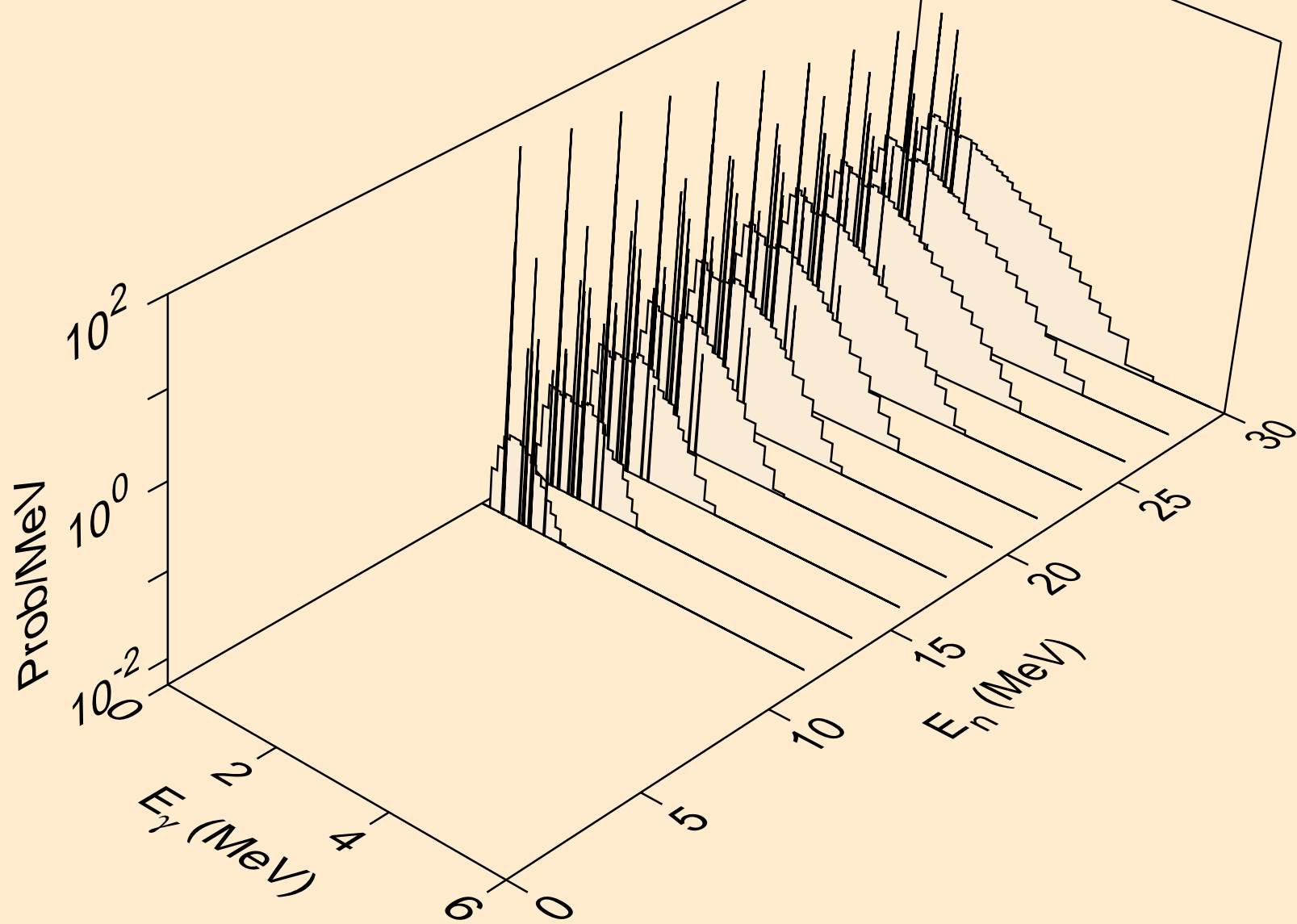

PO202 NEUTRON ACER TENDL-2023 LIBRARY; T=0.K
thermal capture photon spectrum

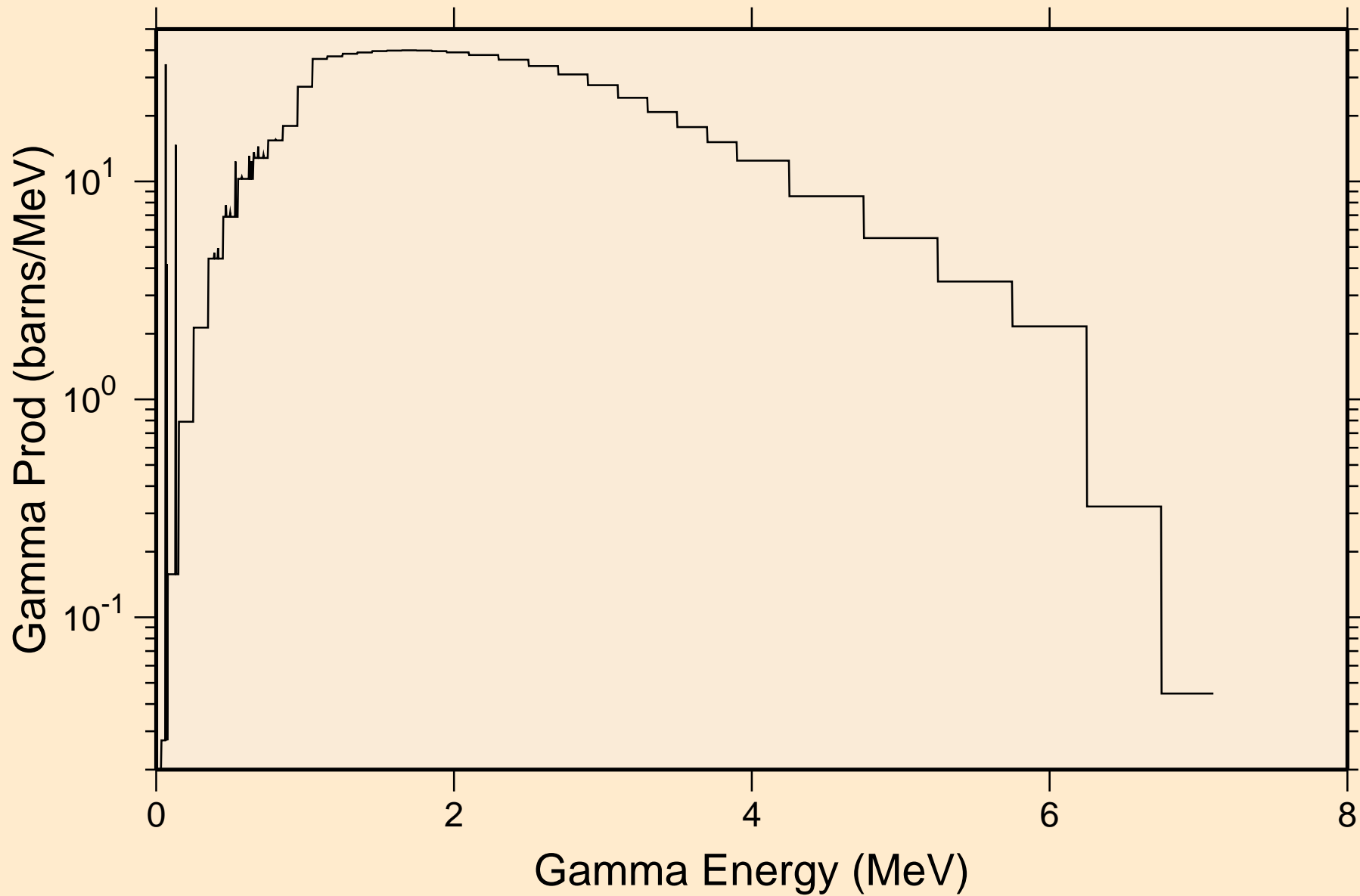

PO202 NEUTRON ACER TENDL-2023 LIBRARY; T=0.K
14 MeV photon spectrum

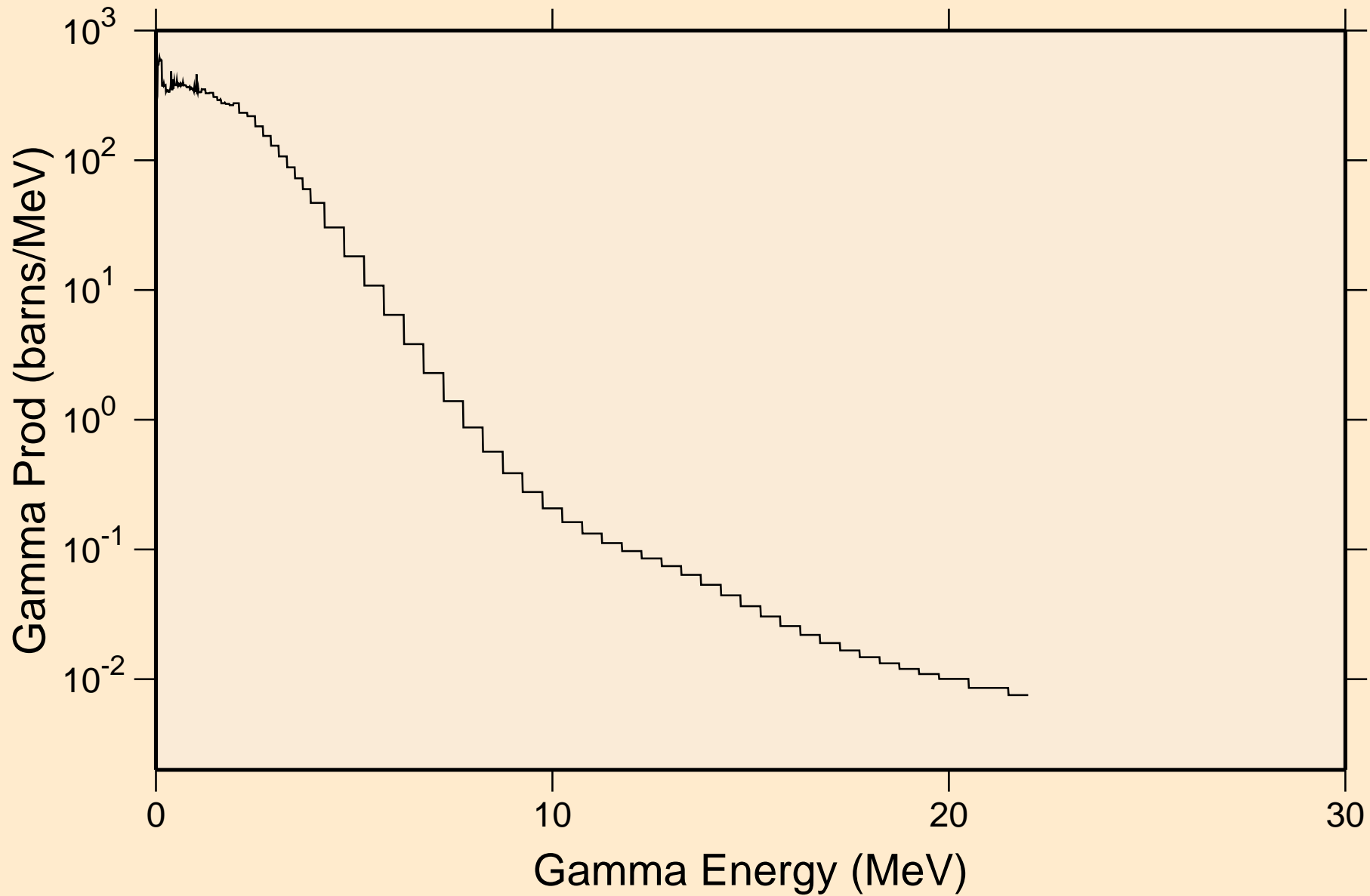

PO202 NEUTRON ACER TENDL-2023 LIBRARY; T=0.K

Particle heating contributions

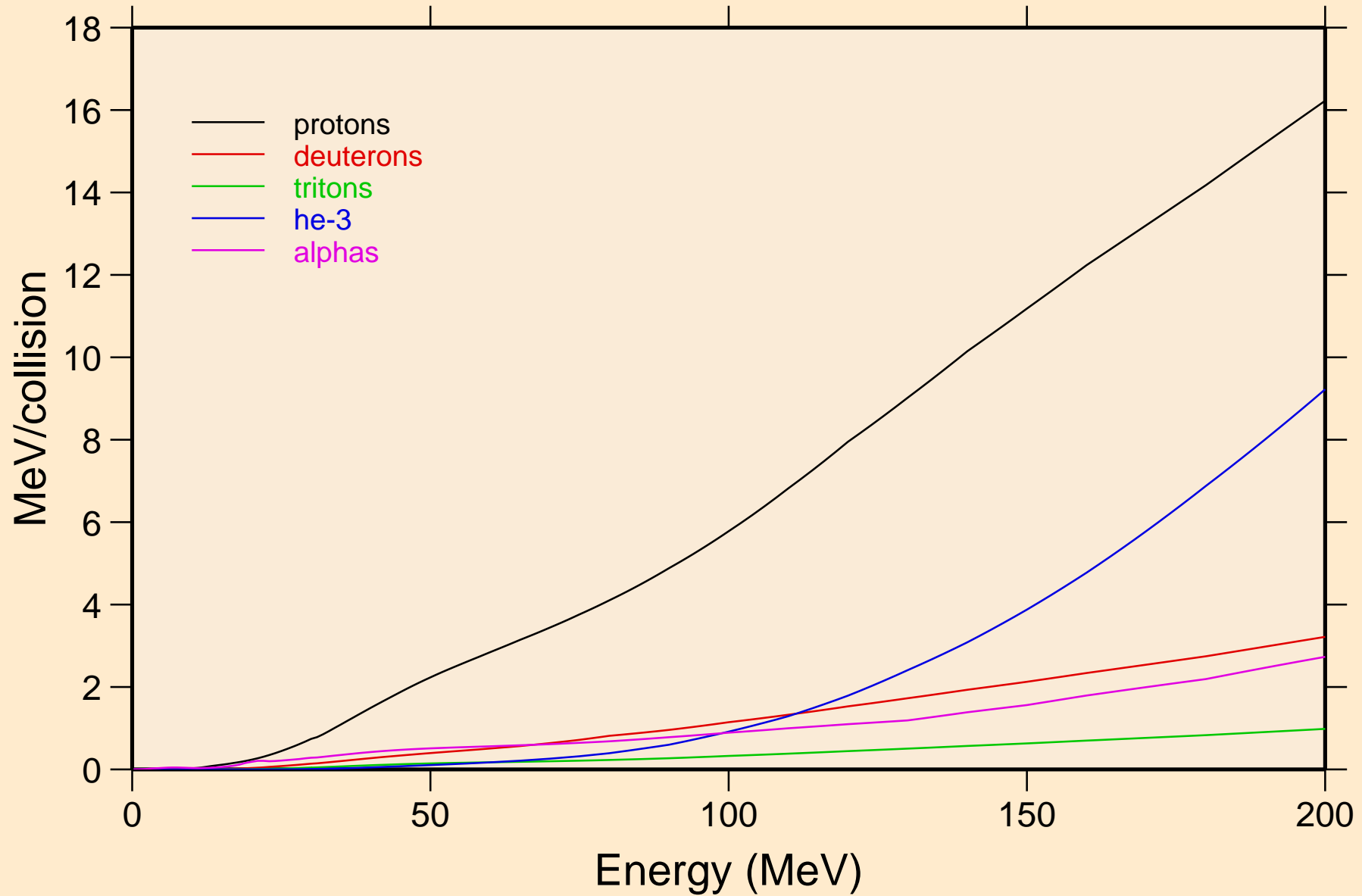

PO202 NEUTRON ACER TENDL-2023 LIBRARY; T=0.K
Recoil Heating

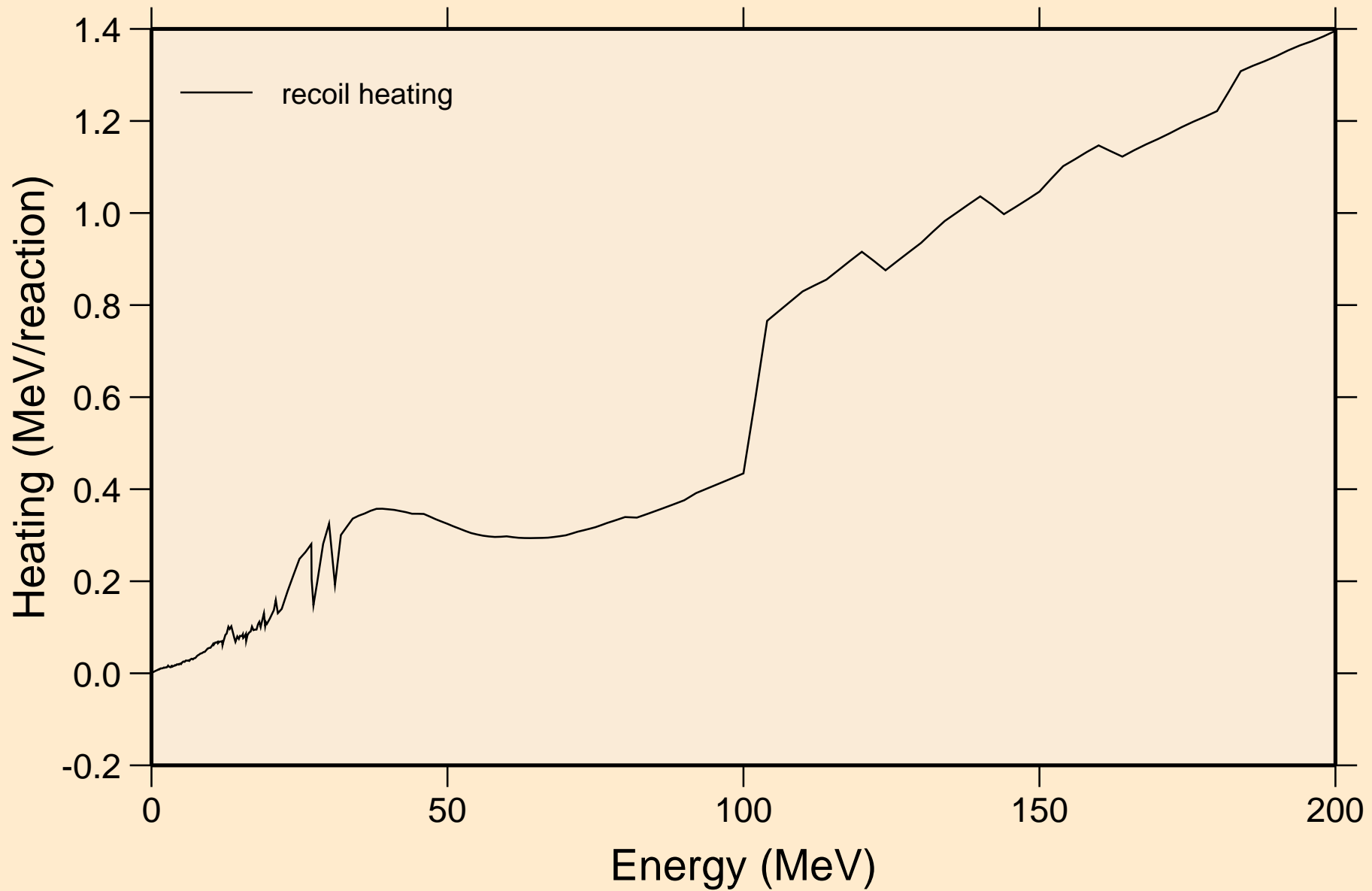

PO202 NEUTRON ACER TENDL-2023 LIBRARY; T=0.K
Particle production cross sections

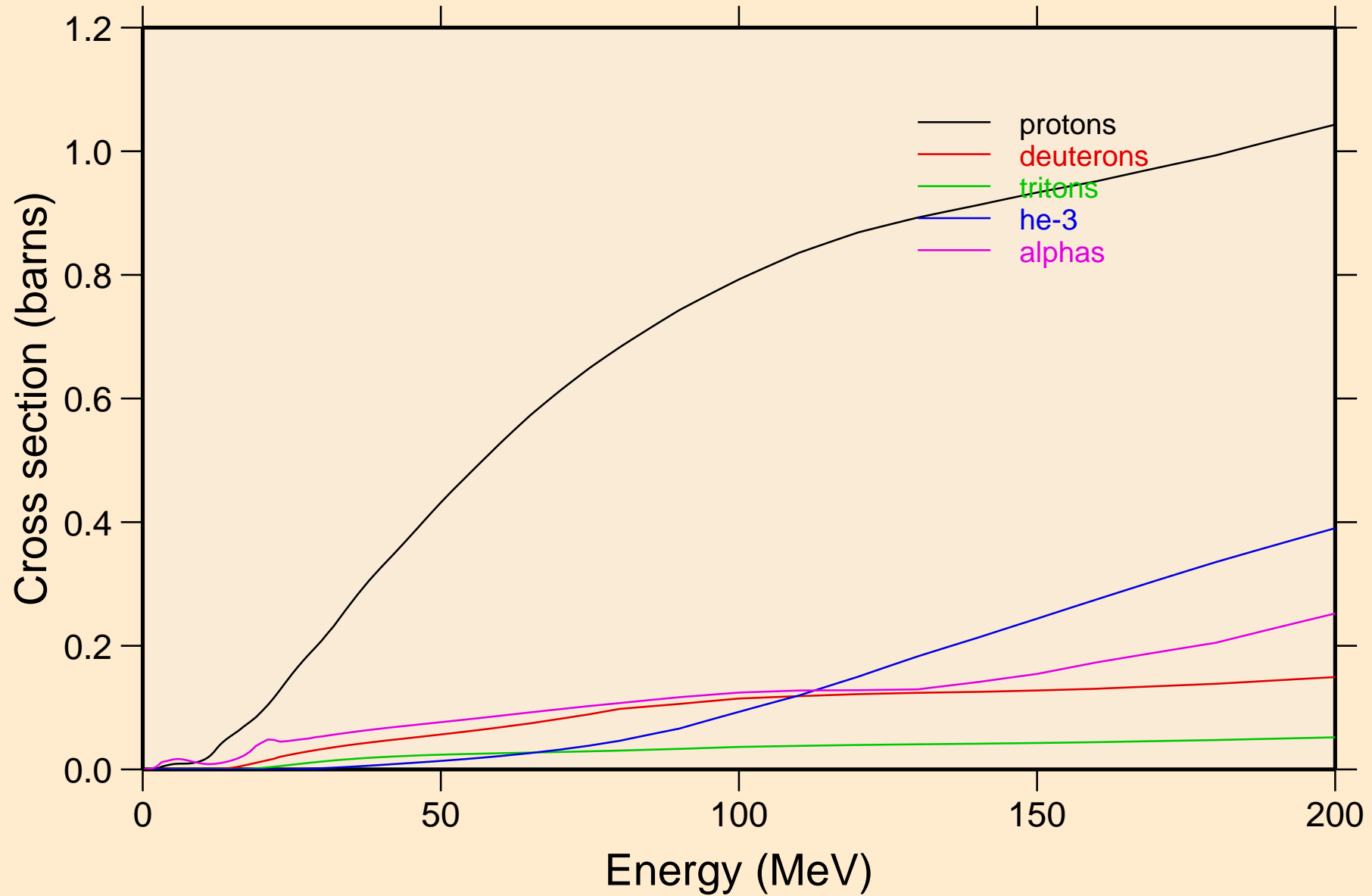

PO202 NEUTRON ACER TENDL-2023 LIBRARY; T=0.K
protons from (n,x)

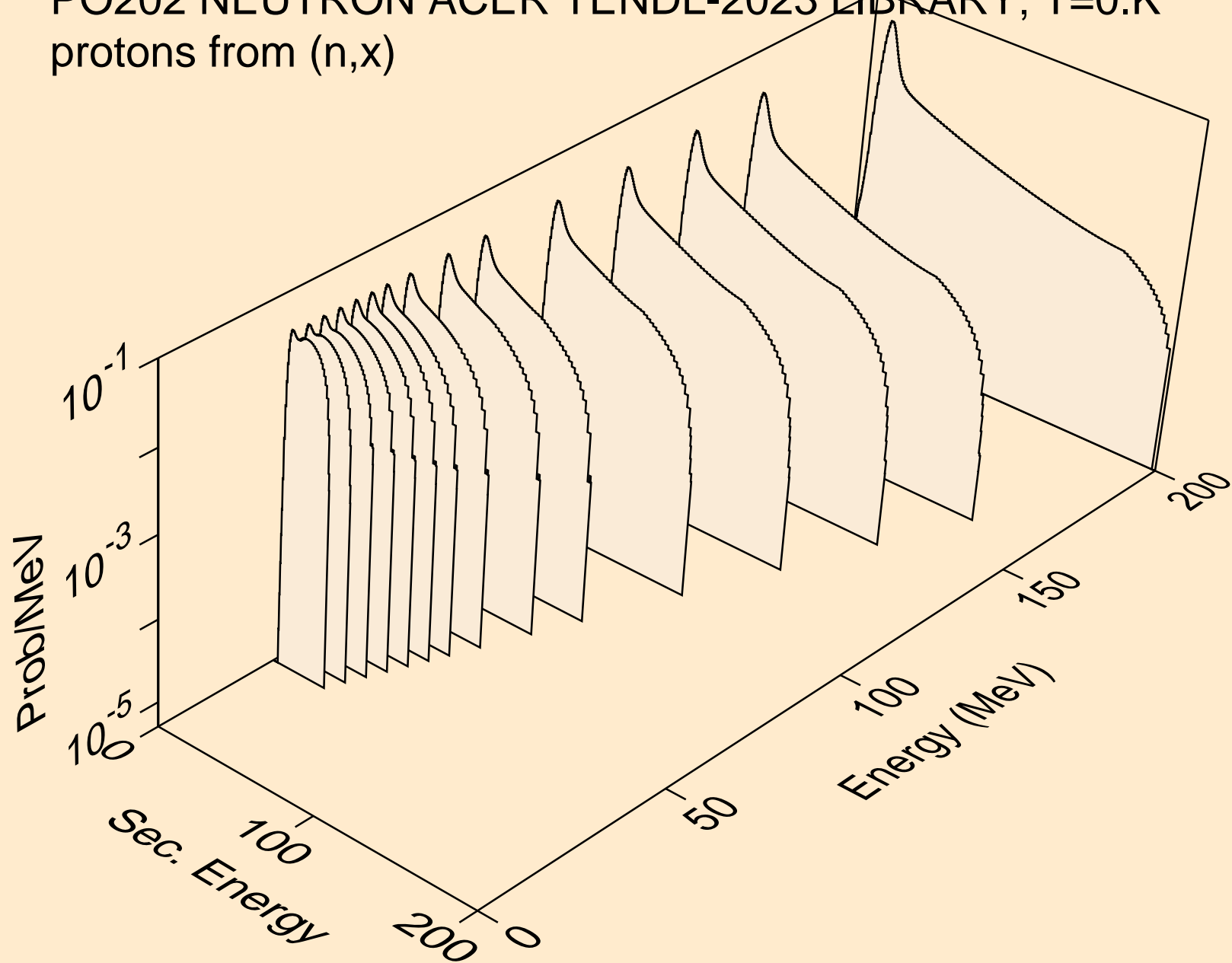

PO202 NEUTRON ACER TENDL-2023 LIBRARY; T=0.K
protons from (n,n*)p

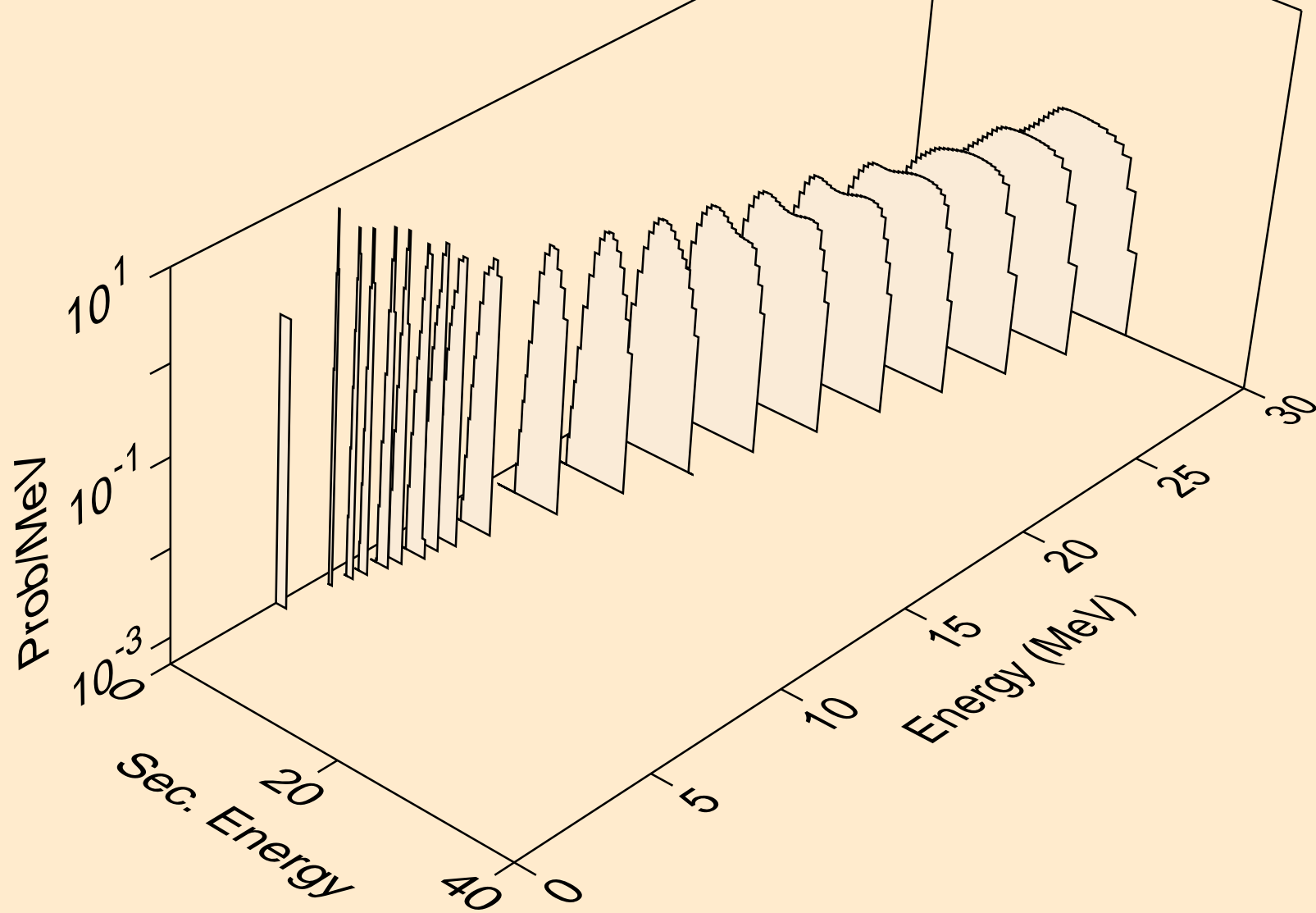

PO202 NEUTRON ACER TENDL-2023 LIBRARY; T=0.K
protons from (n,2np)

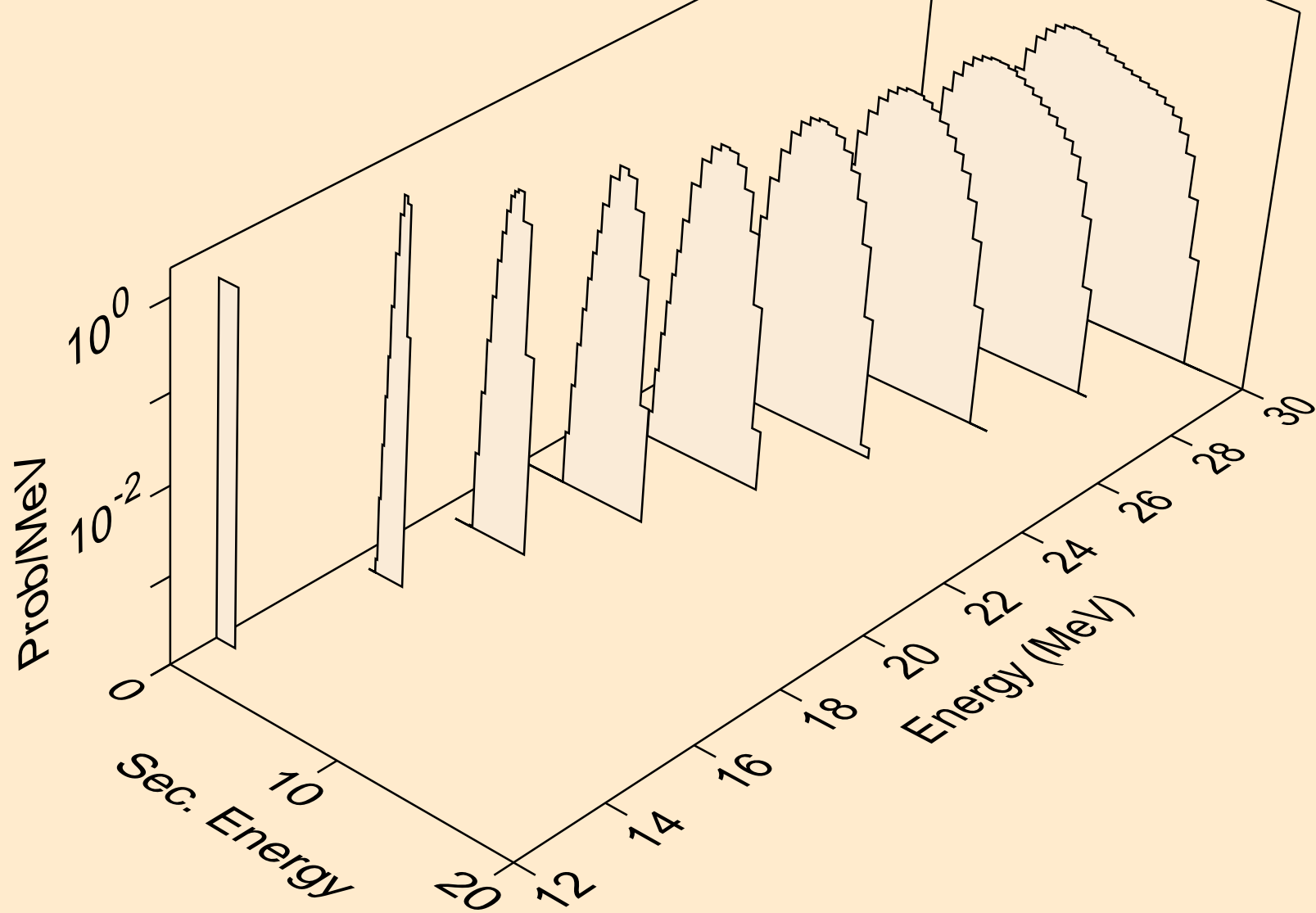

PO202 NEUTRON ACER TENDL-2023 LIBRARY; T=0.K
protons from (n,3np)

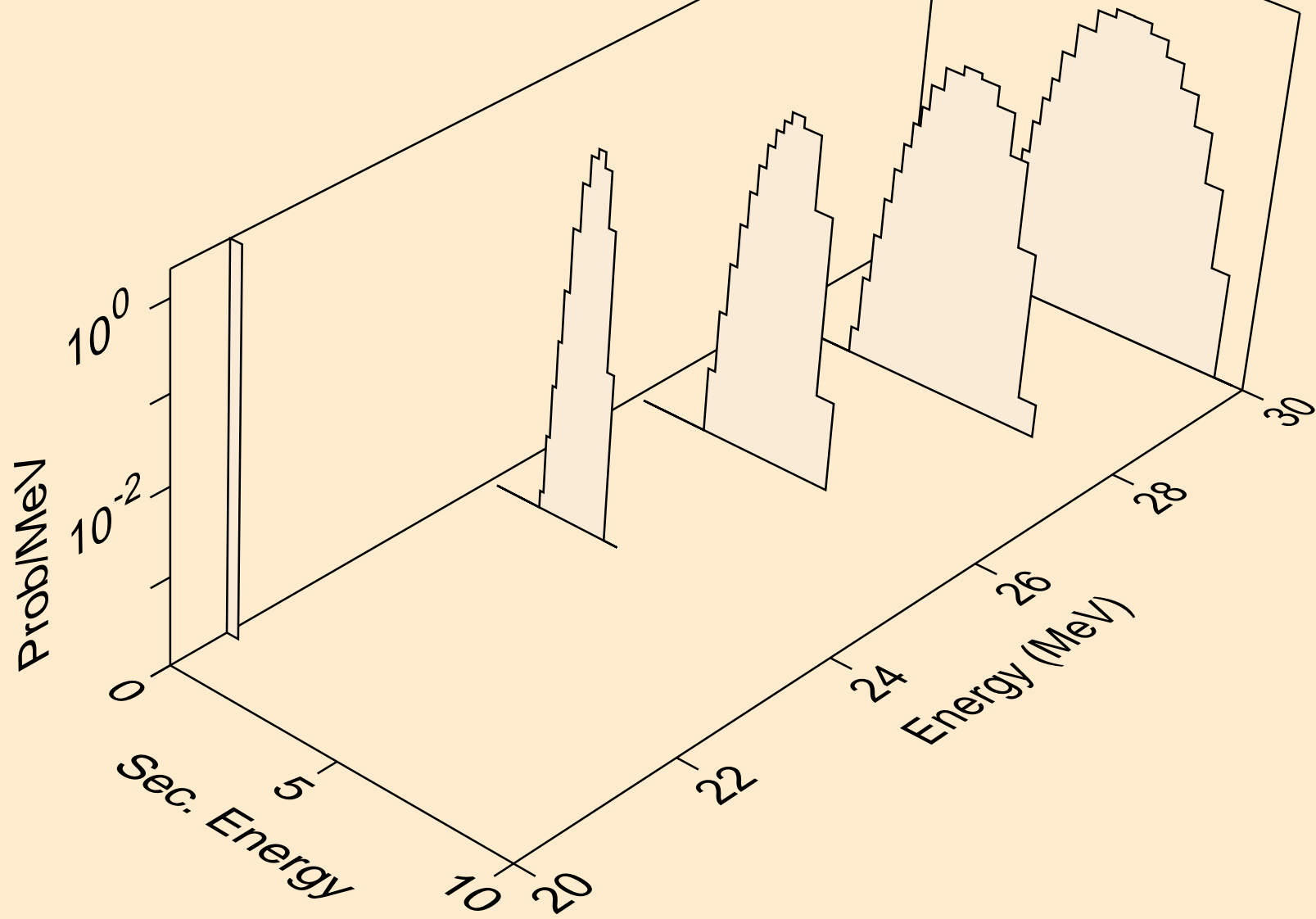

PO202 NEUTRON ACER TENDL-2023 LIBRARY; T=0.K
protons from (n,n2p)

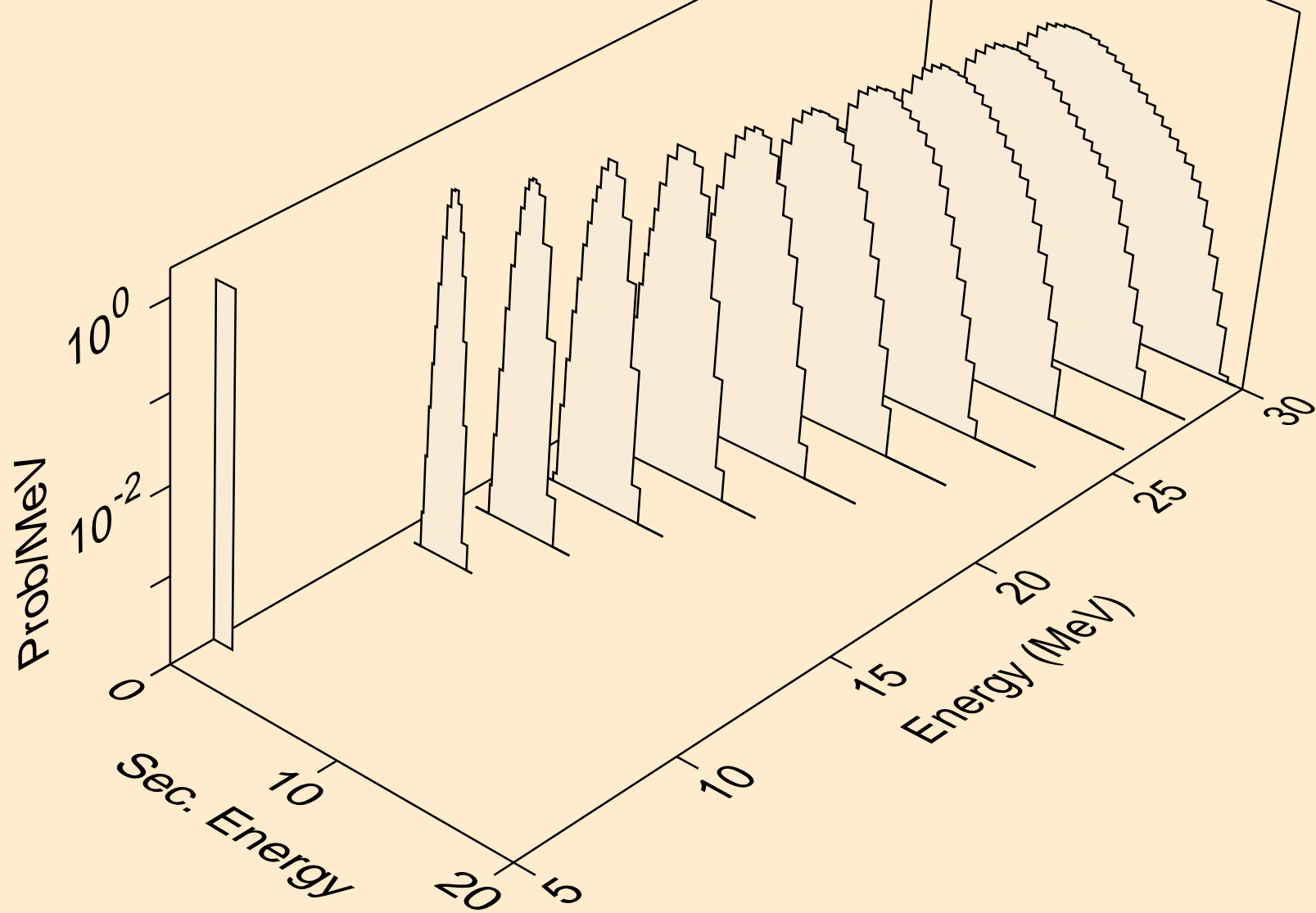

PO202 NEUTRON ACER TENDL-2023 LIBRARY; T=0.K
protons from (n,npa)

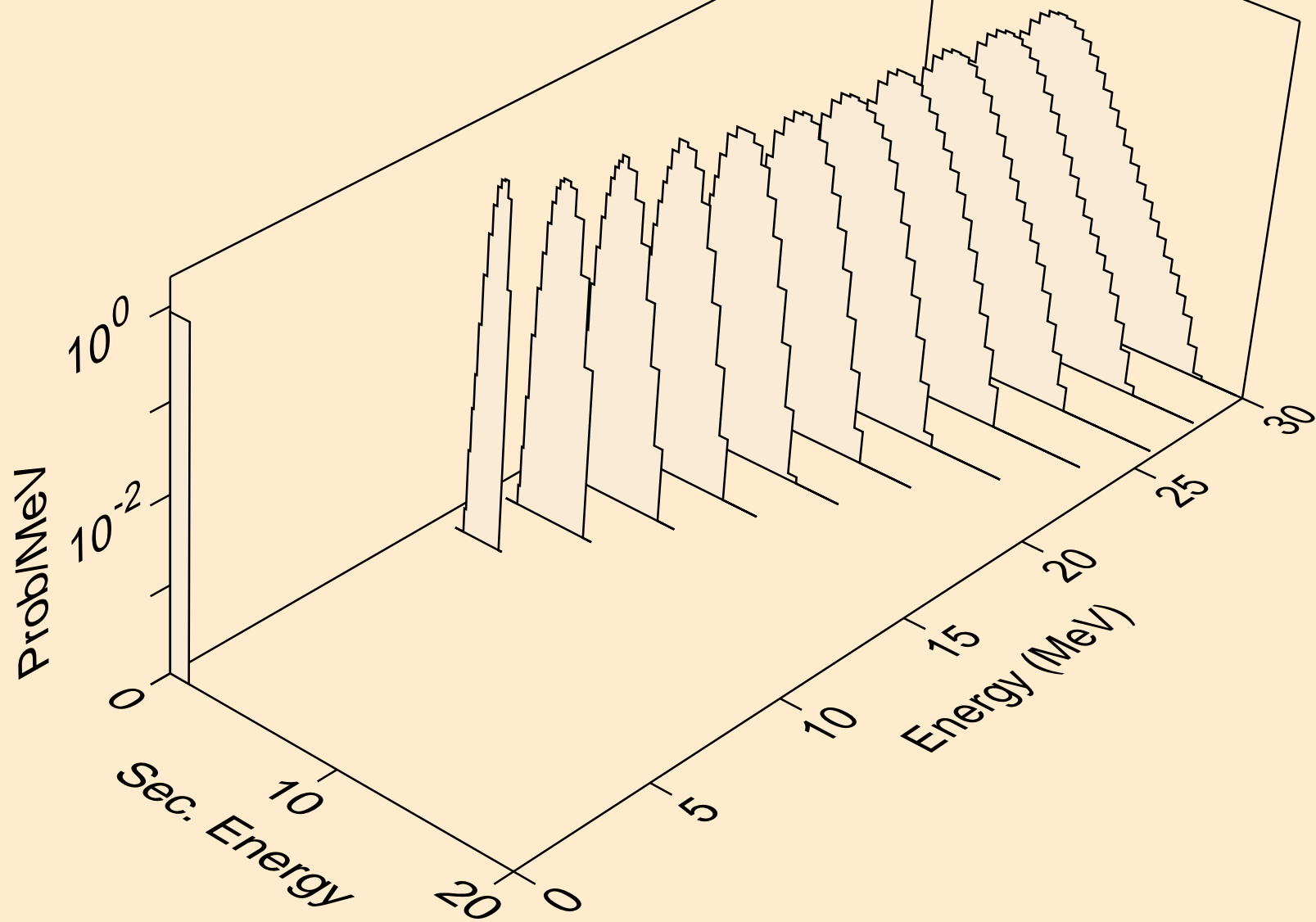

PO202 NEUTRON ACER TENDL-2023 LIBRARY; T=0.K
protons from (n,p)

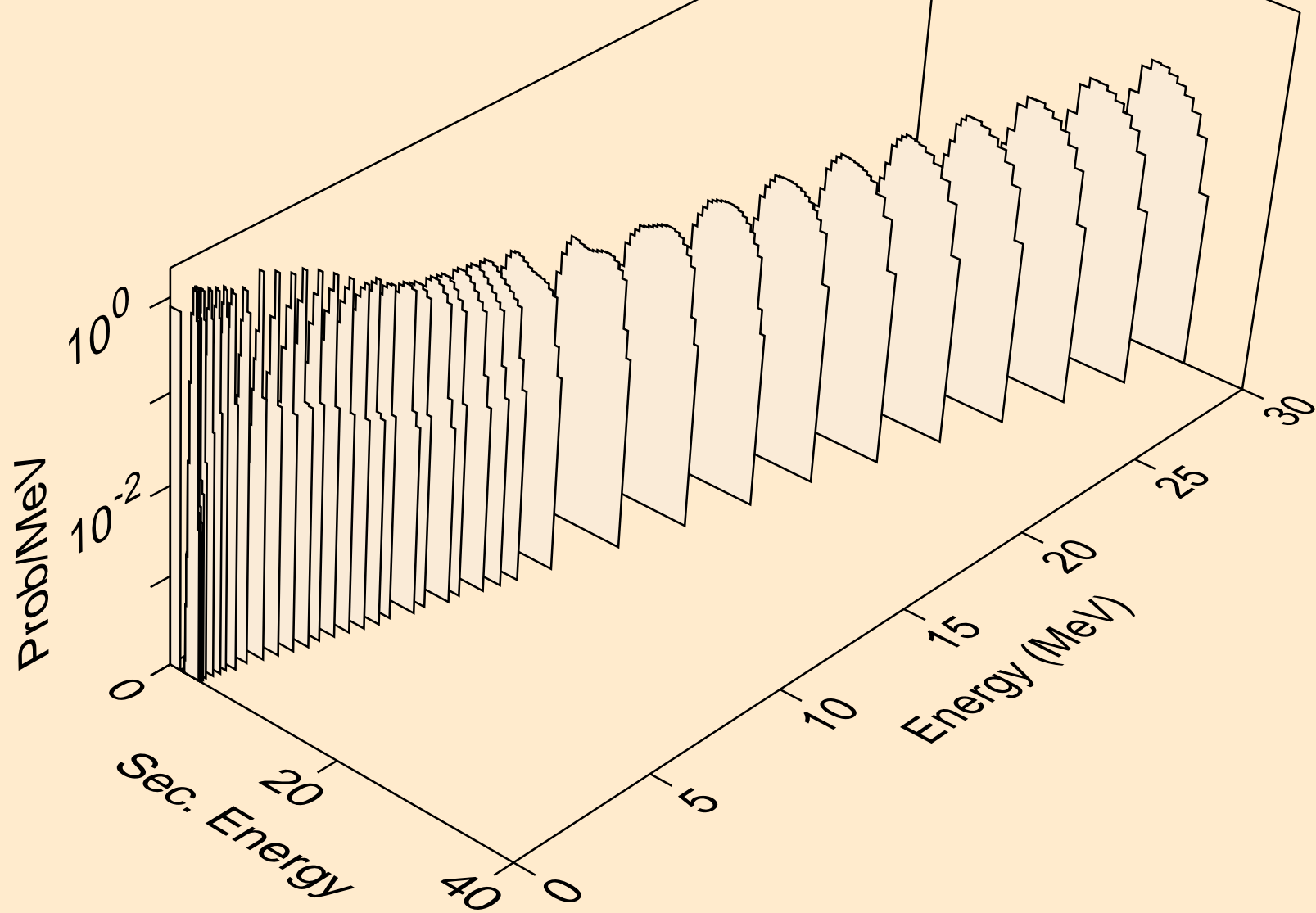

PO202 NEUTRON ACER TENDL-2023 LIBRARY; T=0.K
protons from (n,2p)

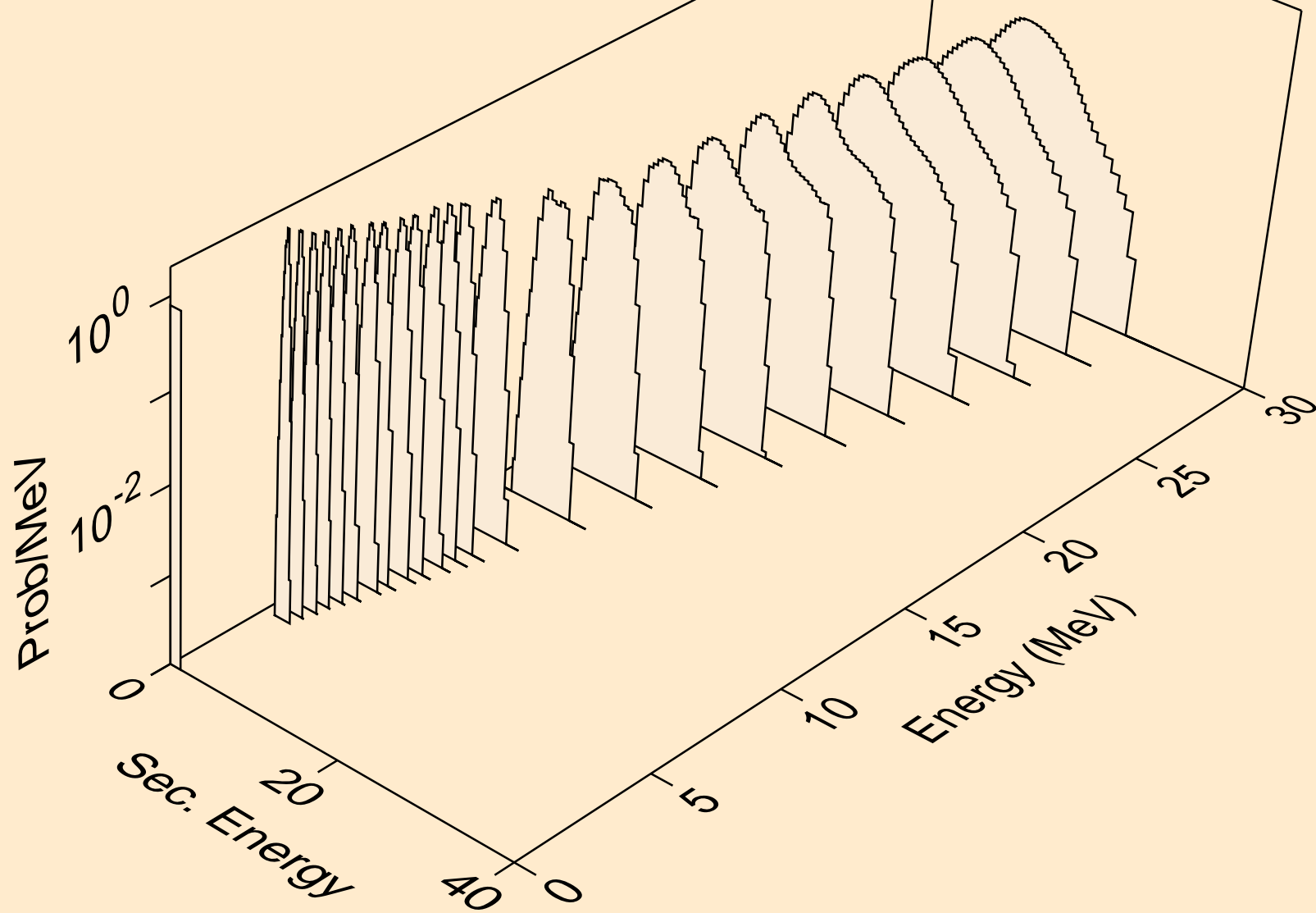

PO202 NEUTRON ACER TENDL-2023 LIBRARY; T=0.K
protons from (n,p)

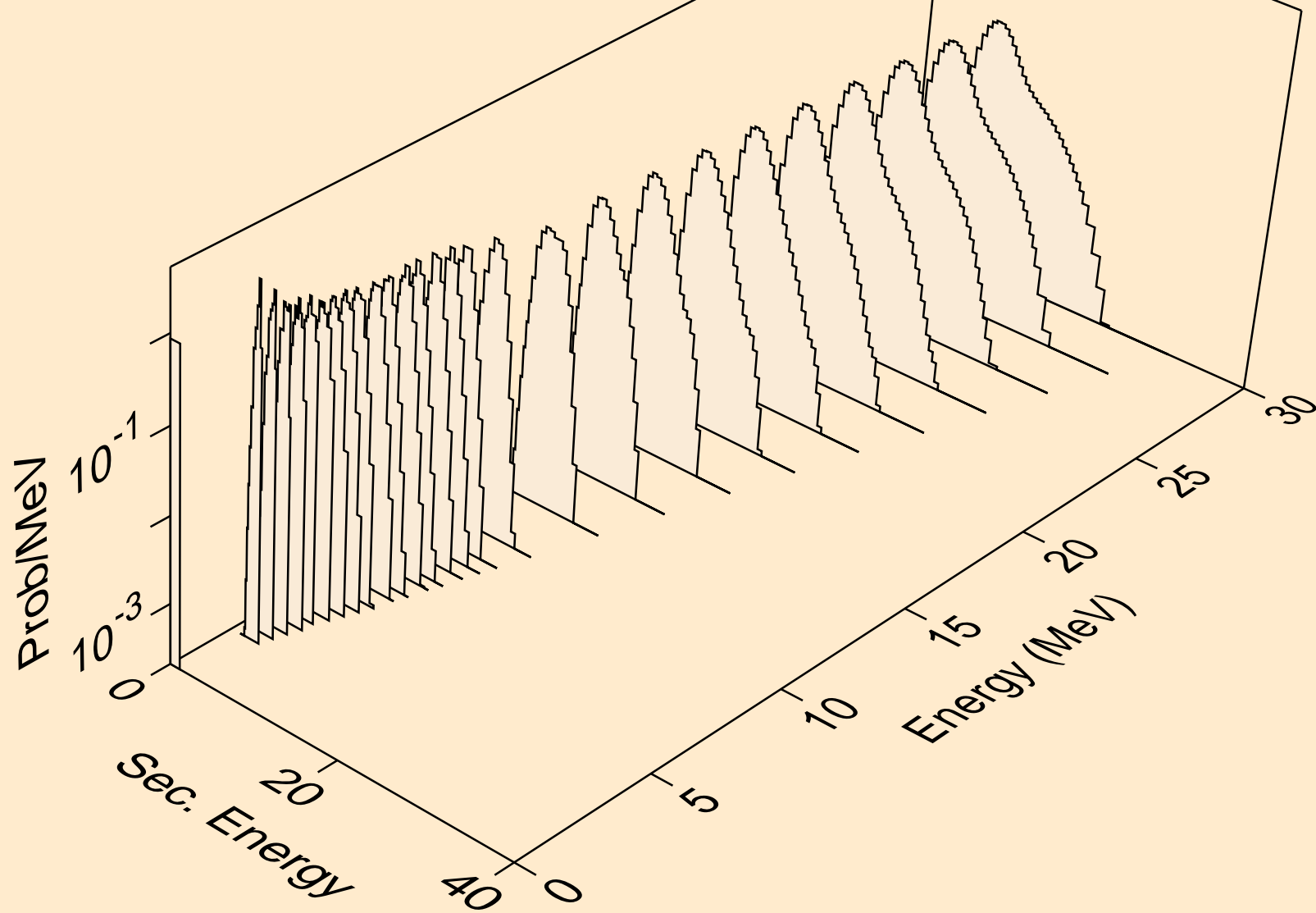

PO202 NEUTRON ACER TENDL-2023 LIBRARY; T=0.K
protons from (n,pd)

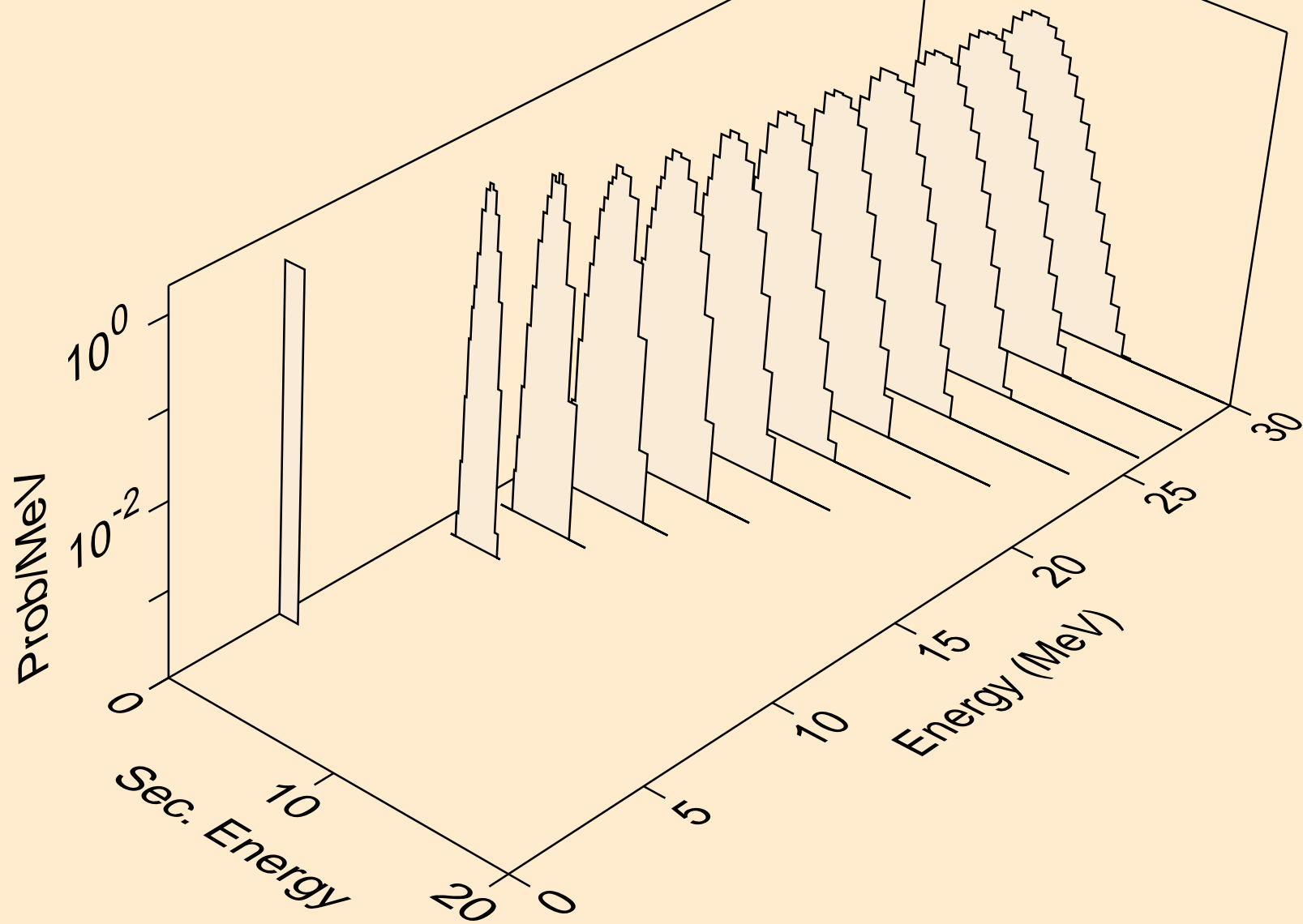

PO202 NEUTRON ACER TENDL-2023 LIBRARY; T=0.K
protons from (n,pt)

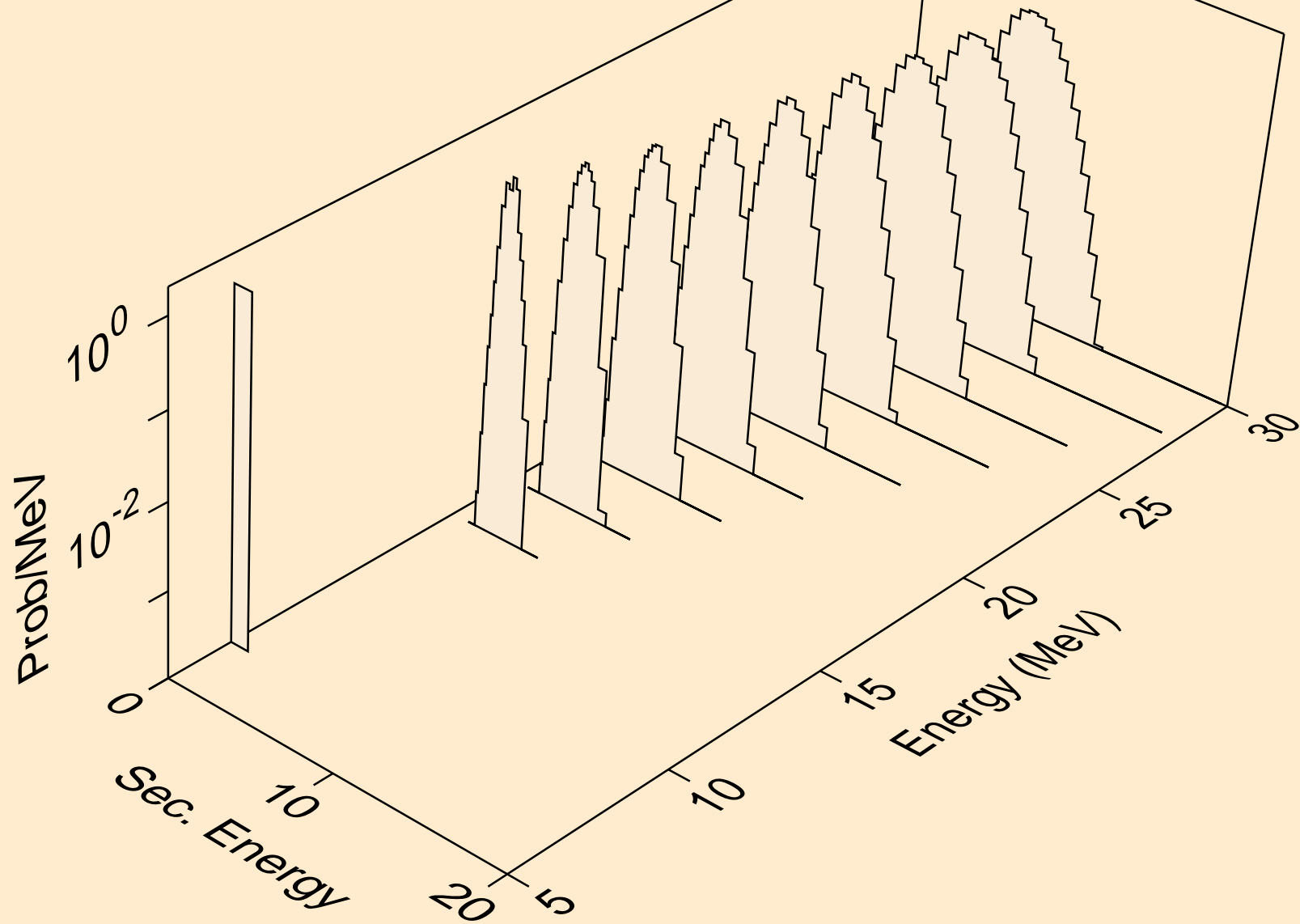

PO202 NEUTRON ACER TENDL-2023 LIBRARY; T=0.K
deuterons from (n,x)

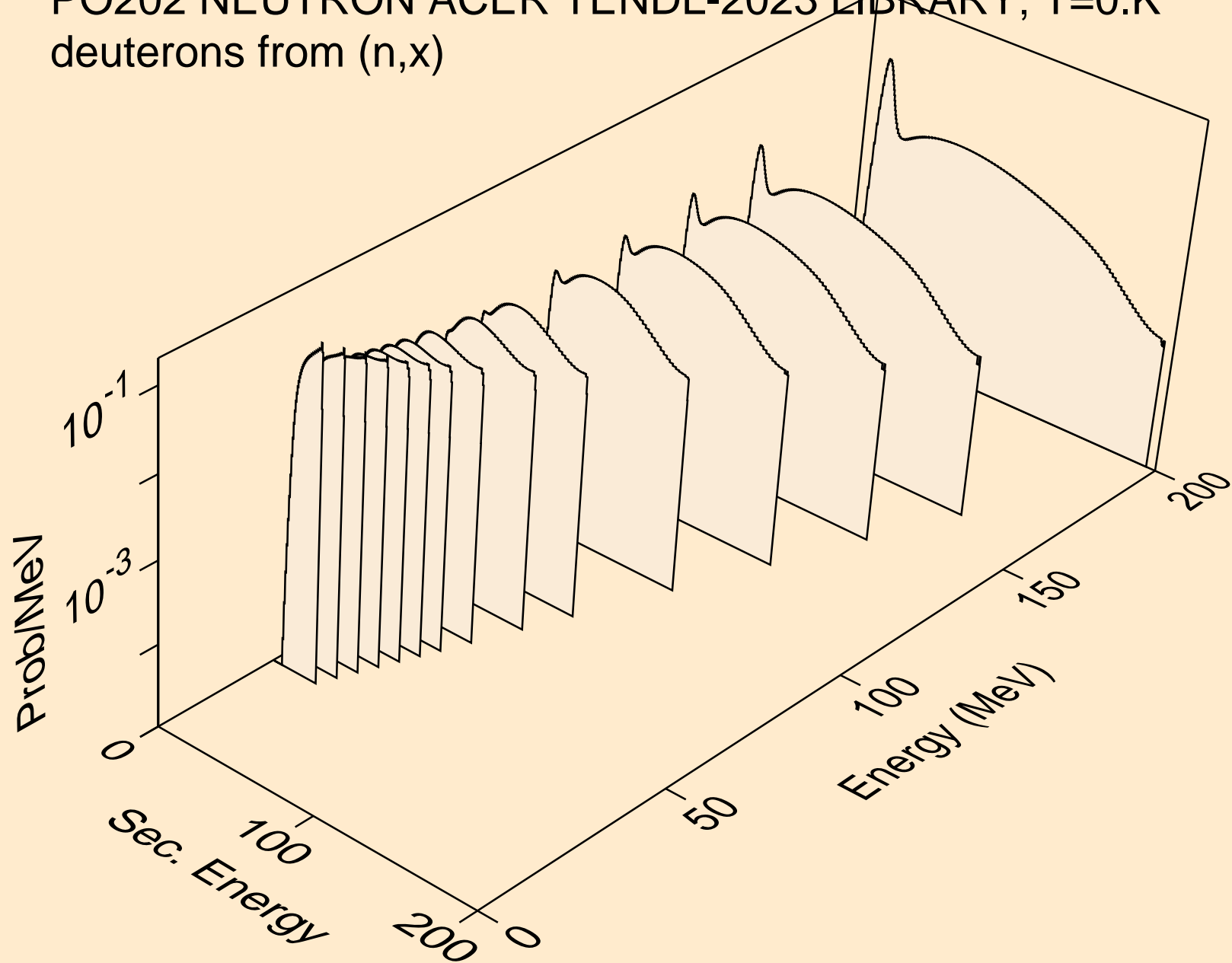

PO202 NEUTRON ACER TENDL-2023 LIBRARY; T=0.K
deuterons from (n,2nd)

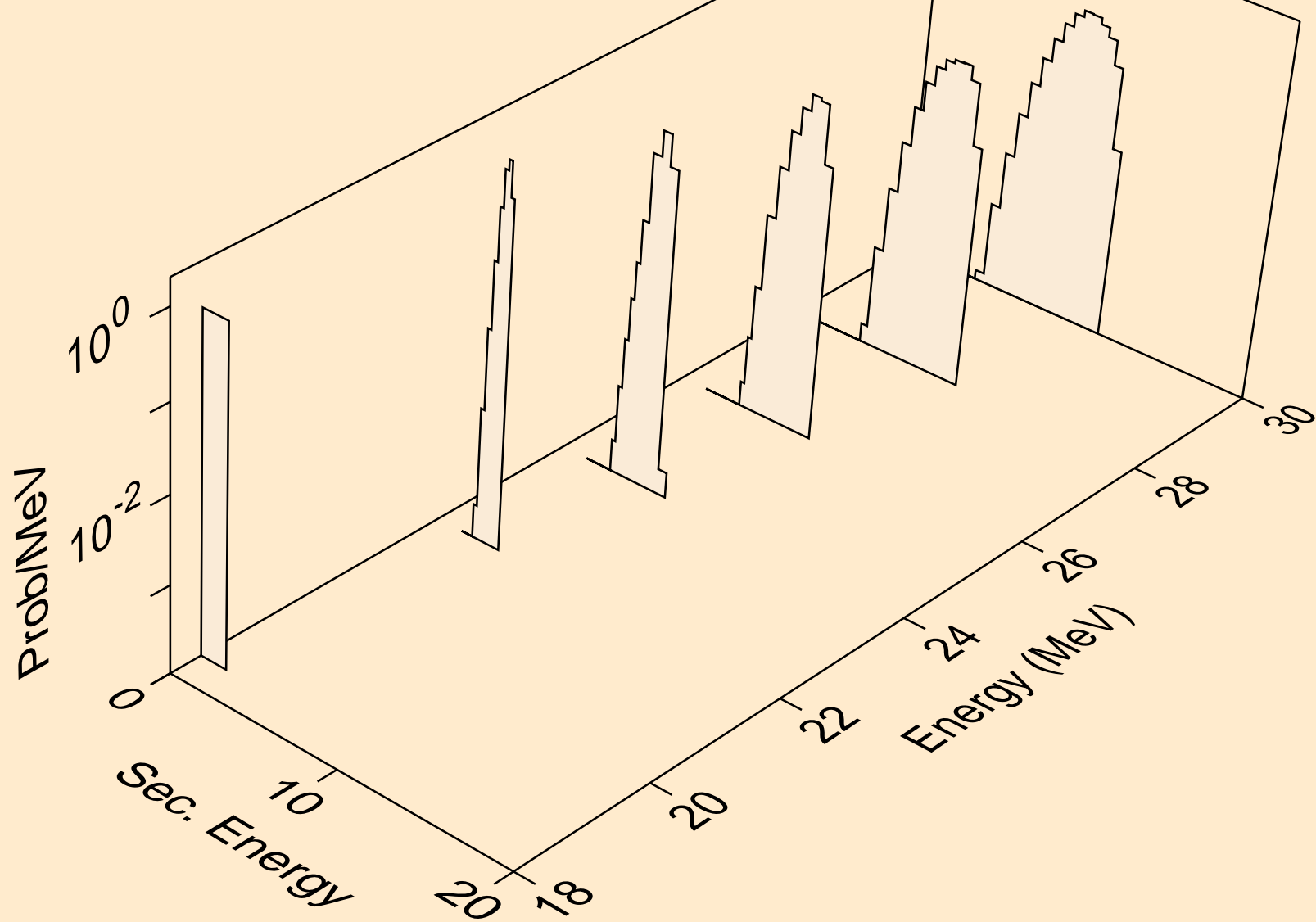

PO202 NEUTRON ACER TENDL-2023 LIBRARY; T=0.K
deuterons from (n,n*)d

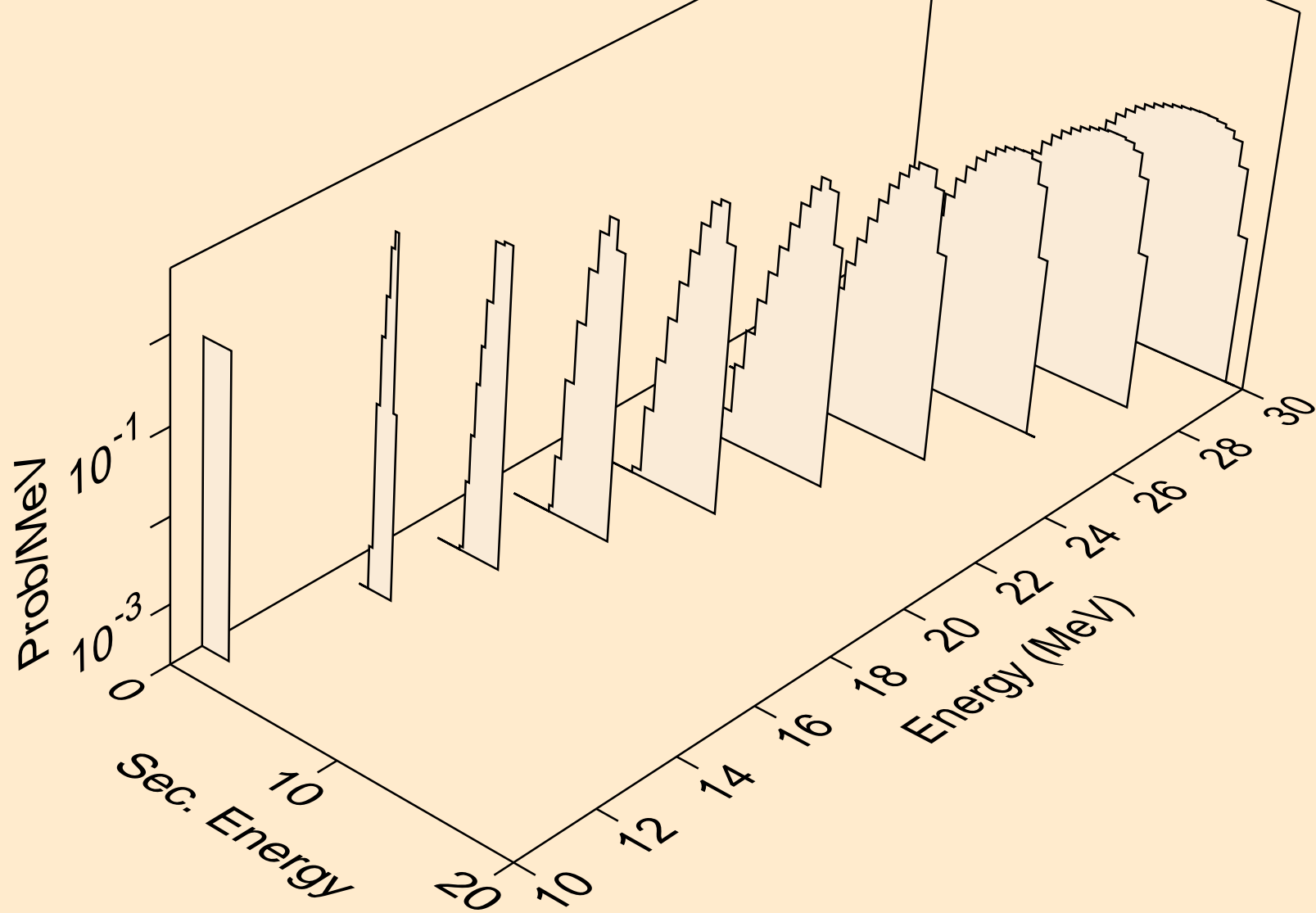

PO202 NEUTRON ACER TENDL-2023 LIBRARY; T=0.K
deuterons from (n,d)

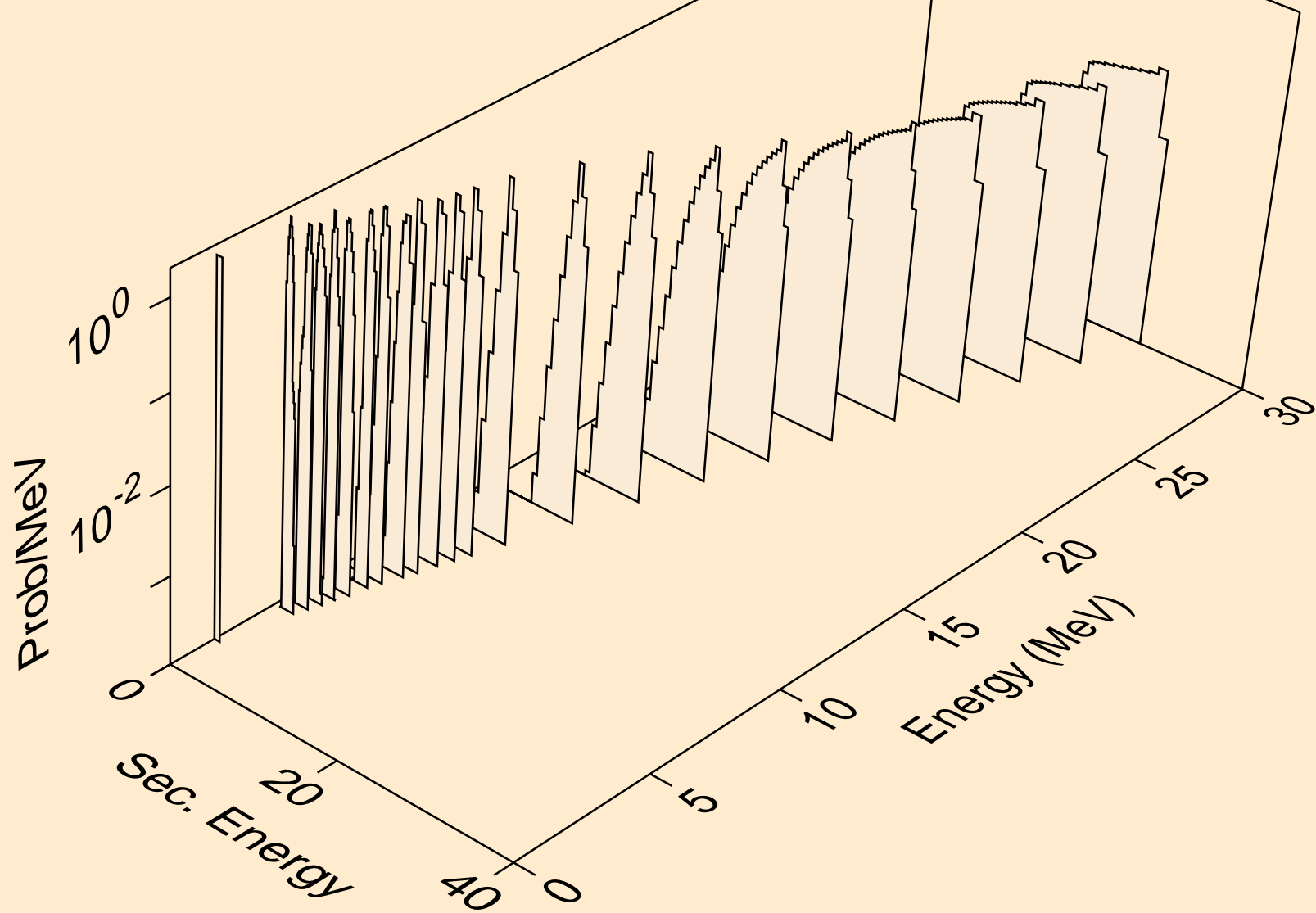

PO202 NEUTRON ACER TENDL-2023 LIBRARY; T=0.K
deuterons from (n,pd)

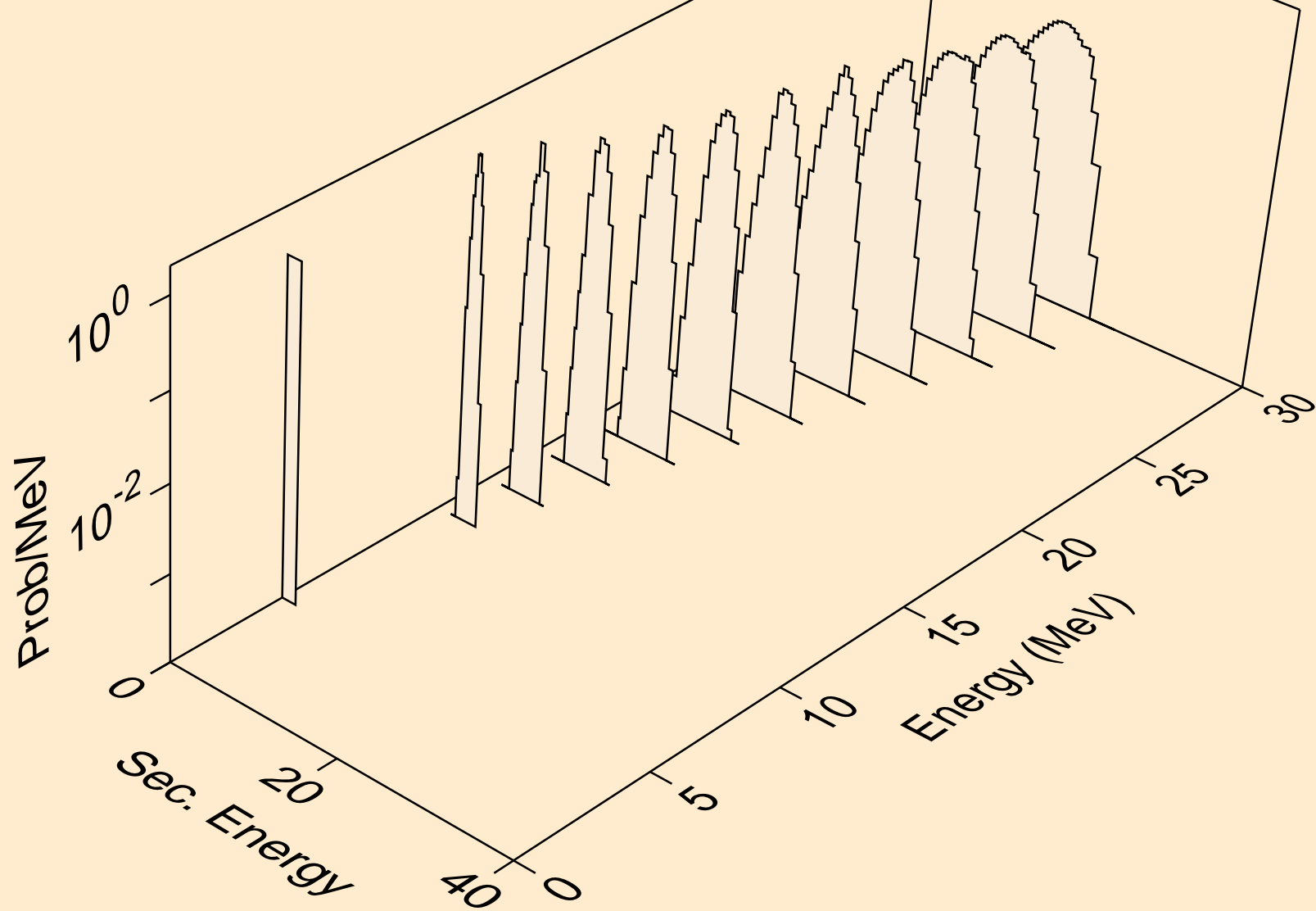

PO202 NEUTRON ACER TENDL-2023 LIBRARY; T=0.K
deuterons from (n,da)

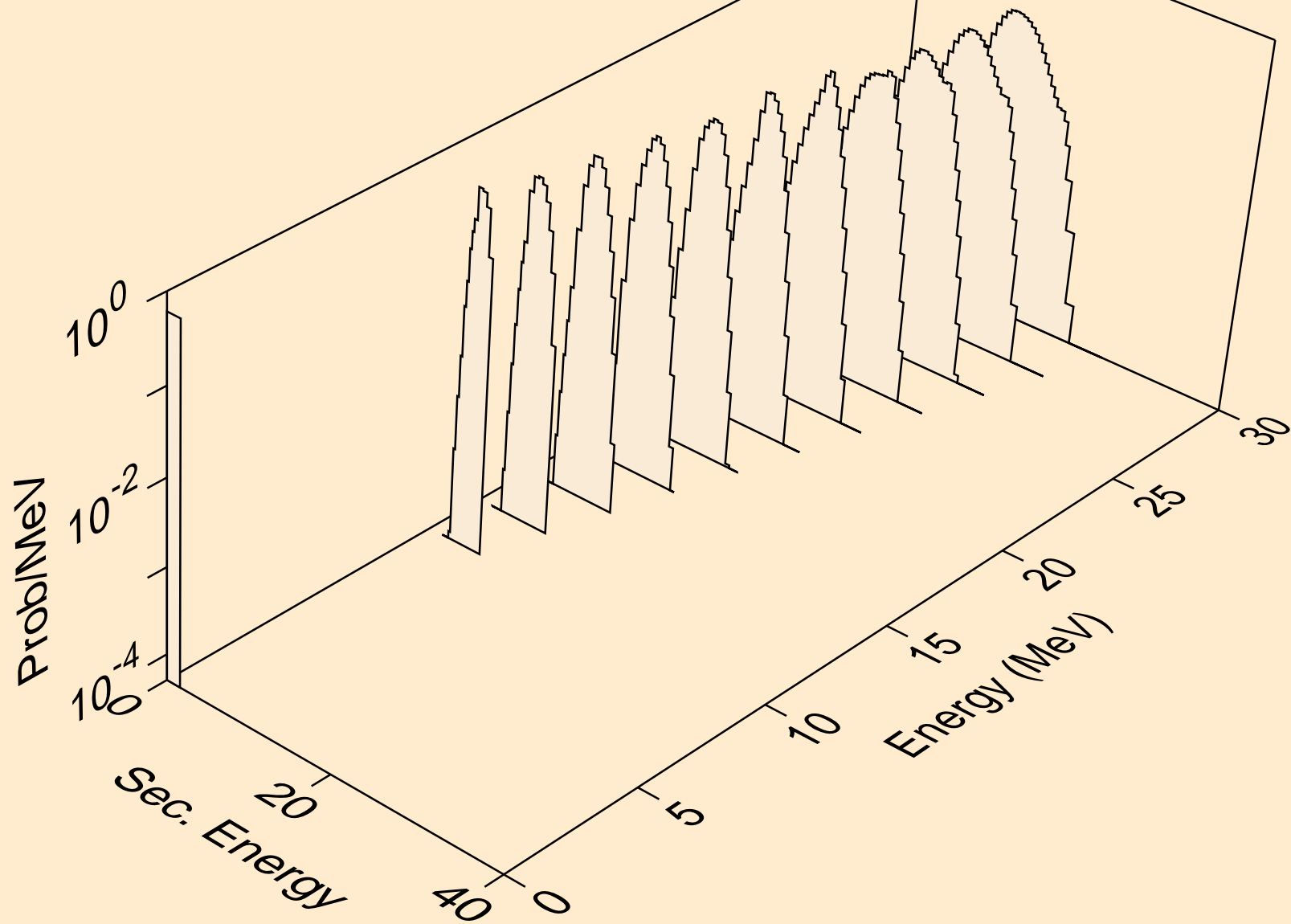

PO202 NEUTRON ACER TENDL-2023 LIBRARY; T=0.K
tritons from (n,x)

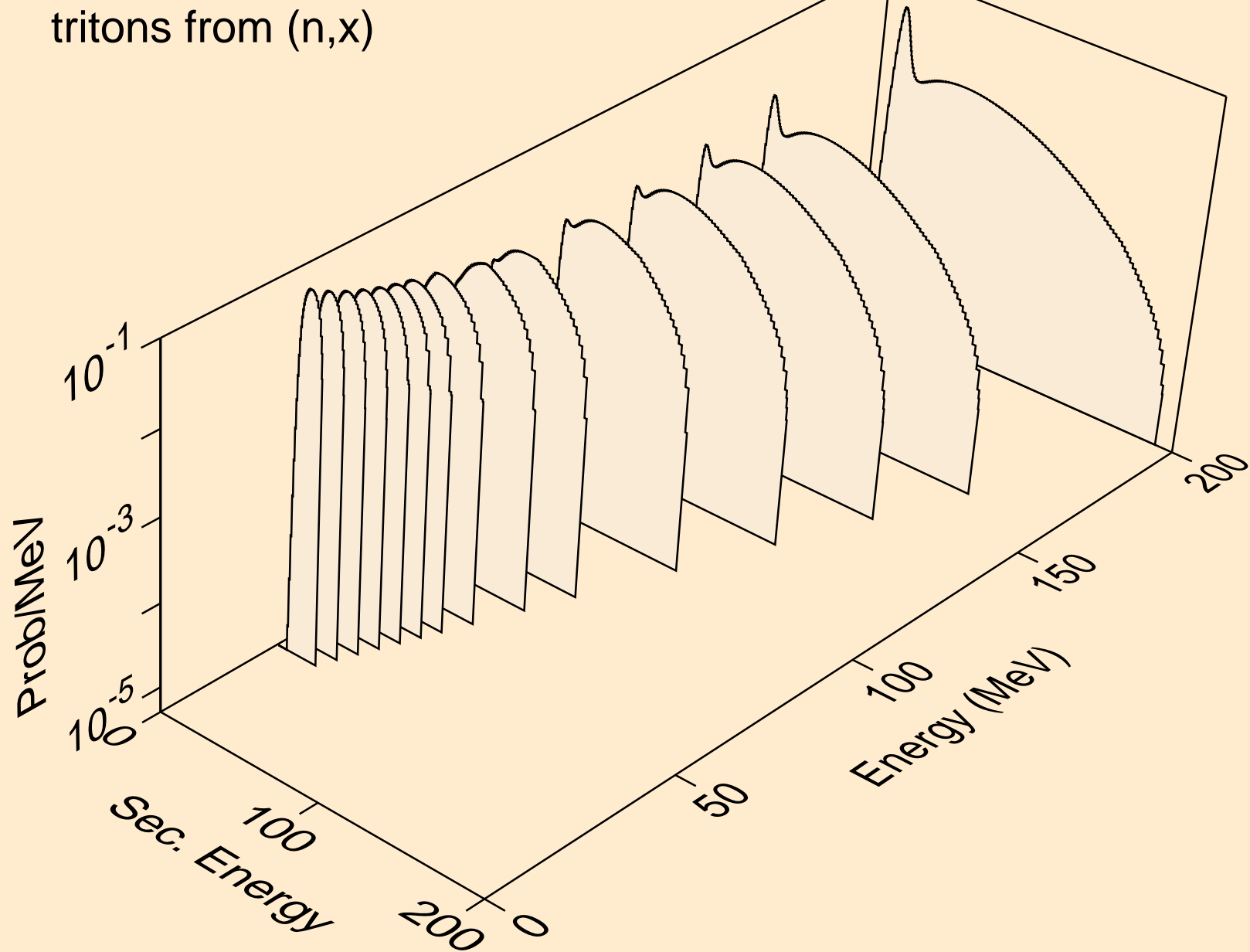

PO202 NEUTRON ACER TENDL-2023 LIBRARY; T=0.K
tritons from (n,n*)t

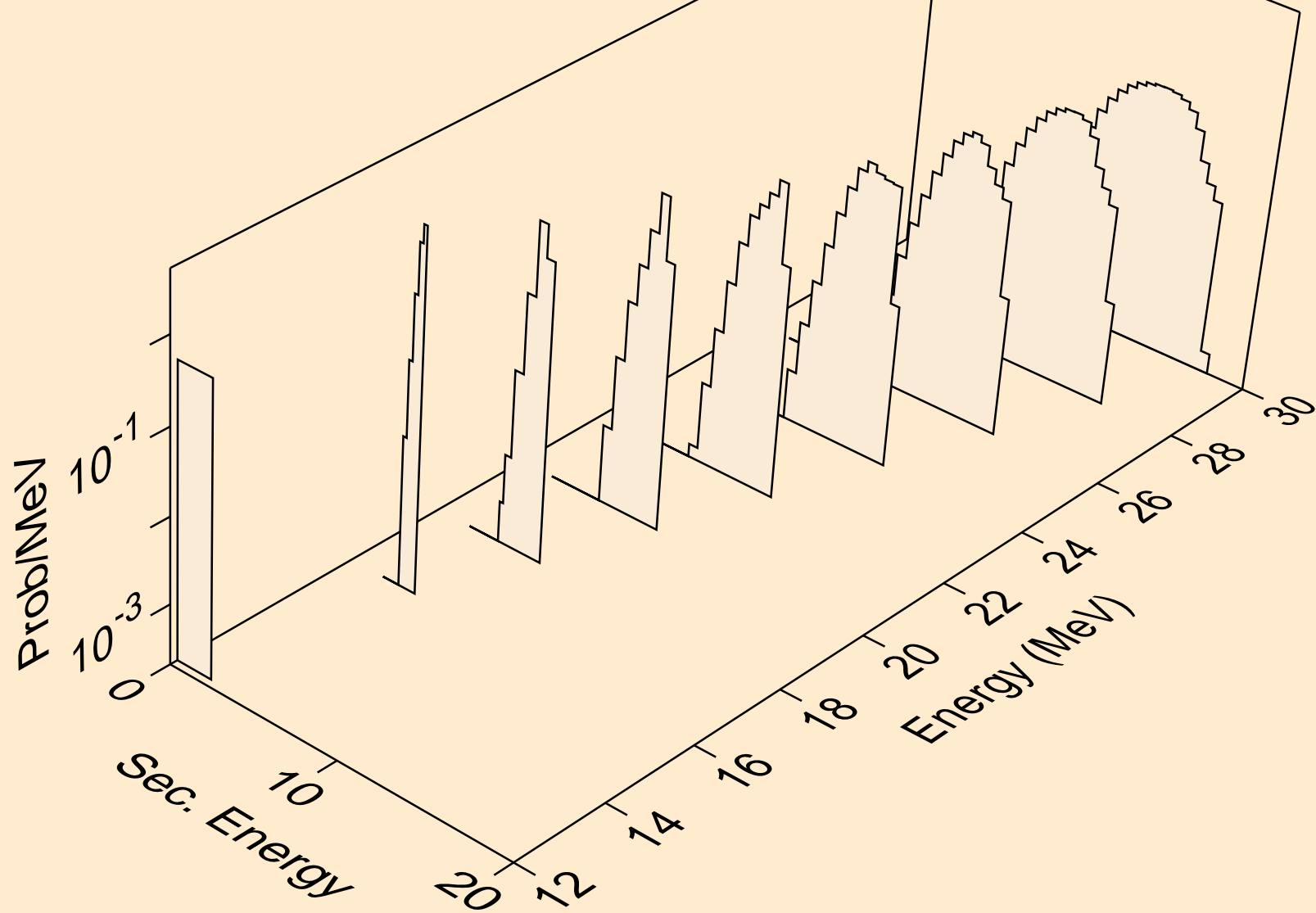

PO202 NEUTRON ACER TENDL-2023 LIBRARY; T=0.K
tritons from (n,t)

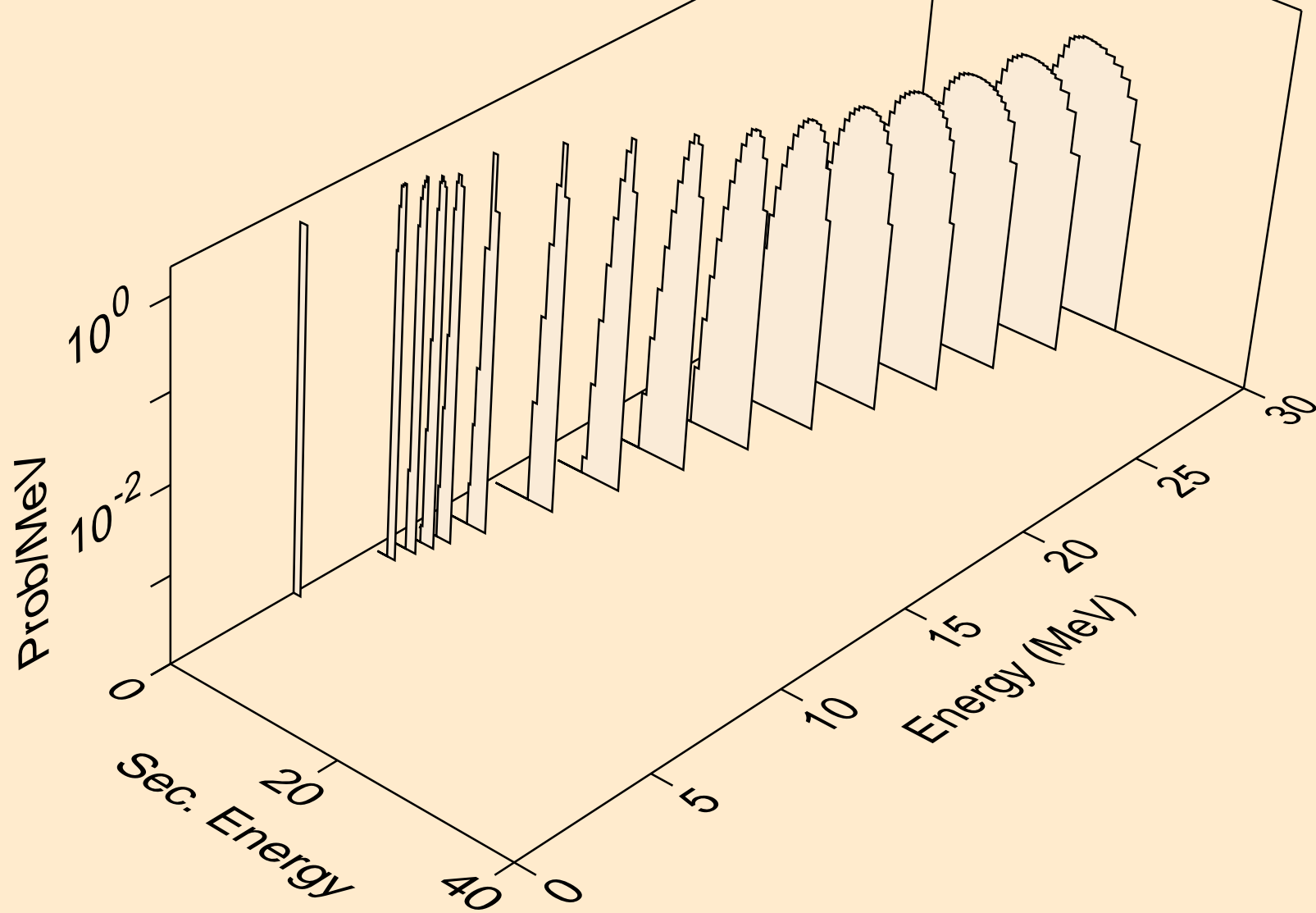

PO202 NEUTRON ACER TENDL-2023 LIBRARY; T=0.K
tritons from (n,pt)

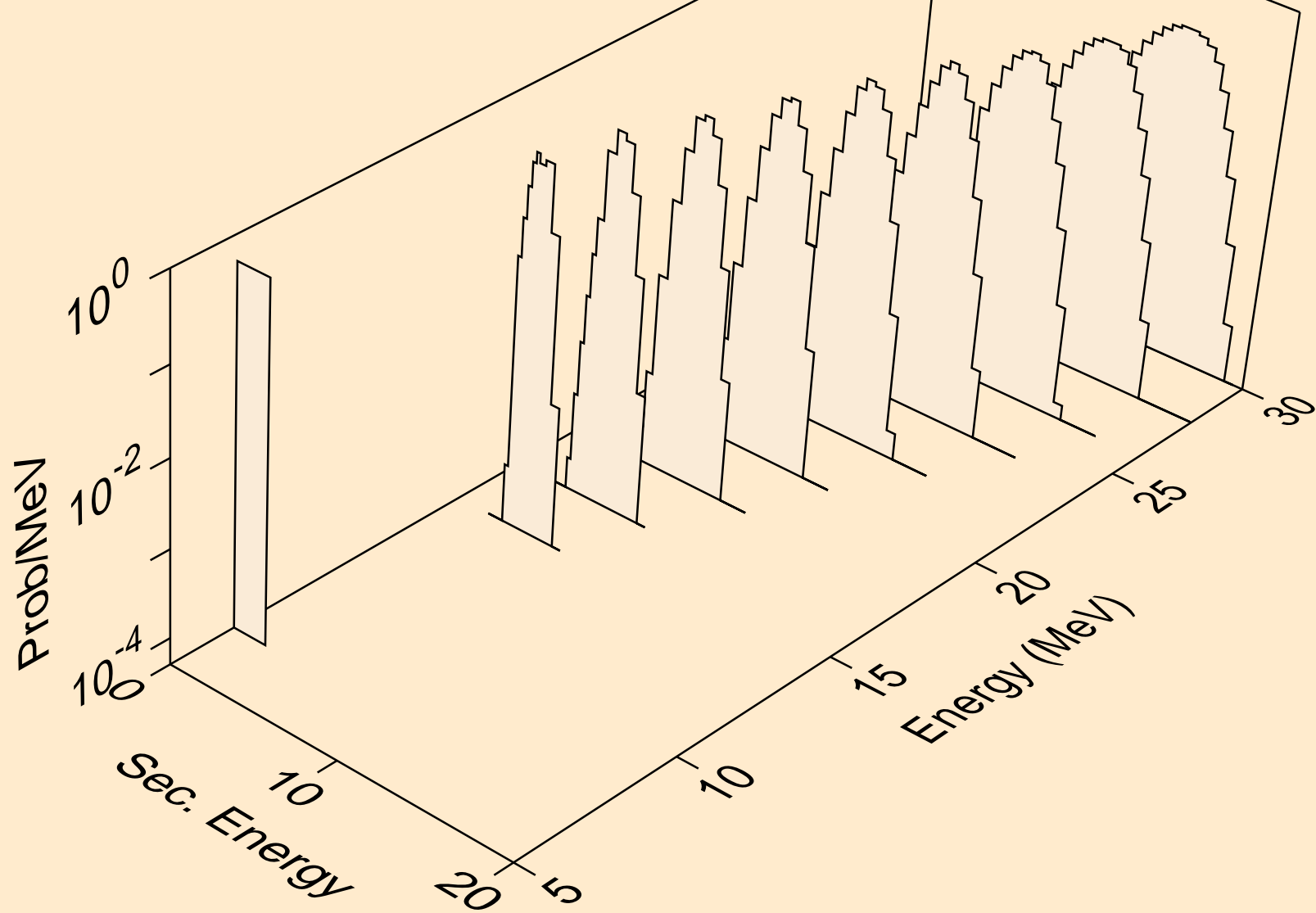

PO202 NEUTRON ACER TENDL-2023 LIBRARY; T=0.K
he3s from (n,x)

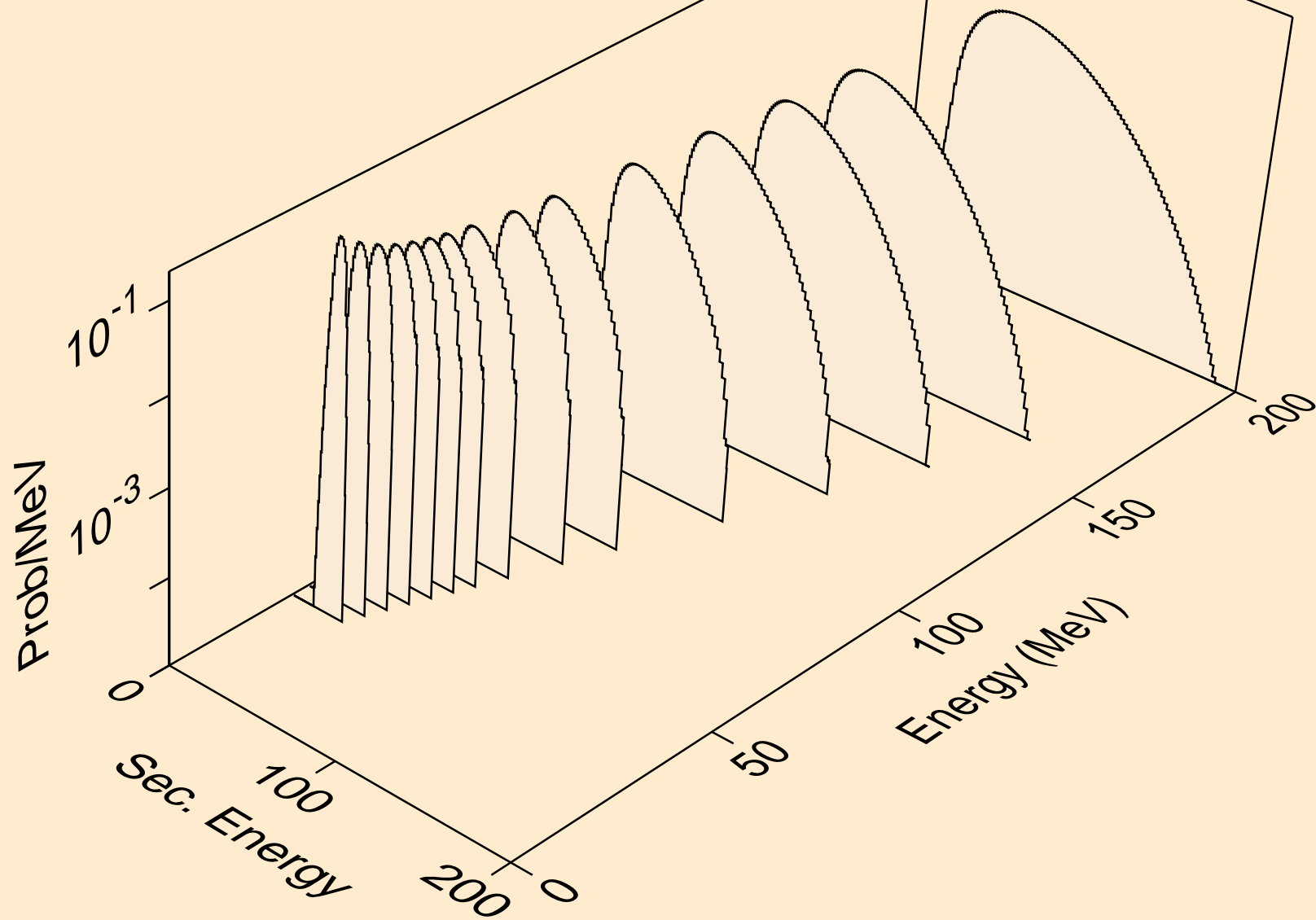

PO202 NEUTRON ACER TENDL-2023 LIBRARY; T=0.K
he3s from (n,n*)he3

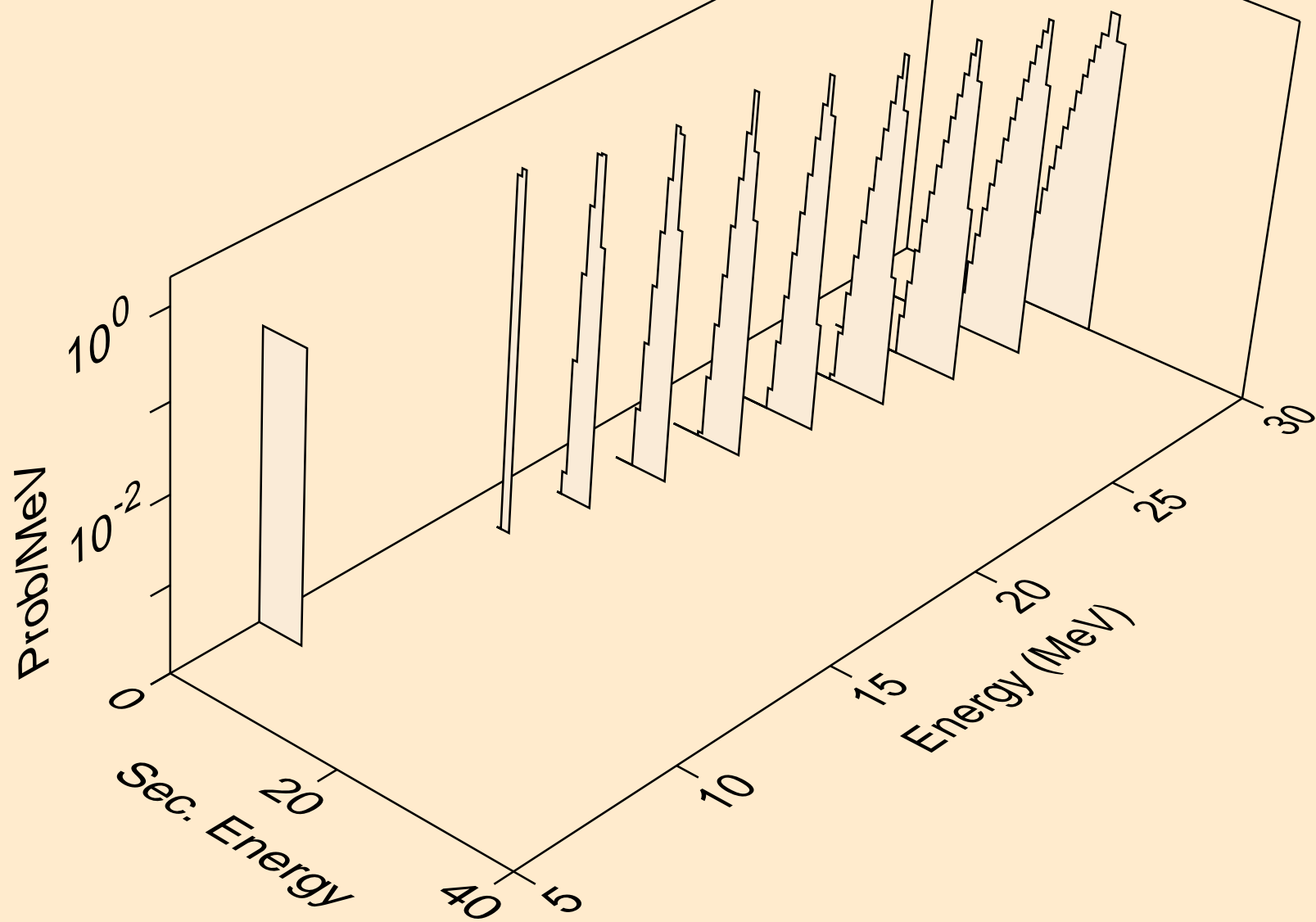

PO202 NEUTRON ACER TENDL-2023 LIBRARY; T=0.K
he3s from (n,he3)

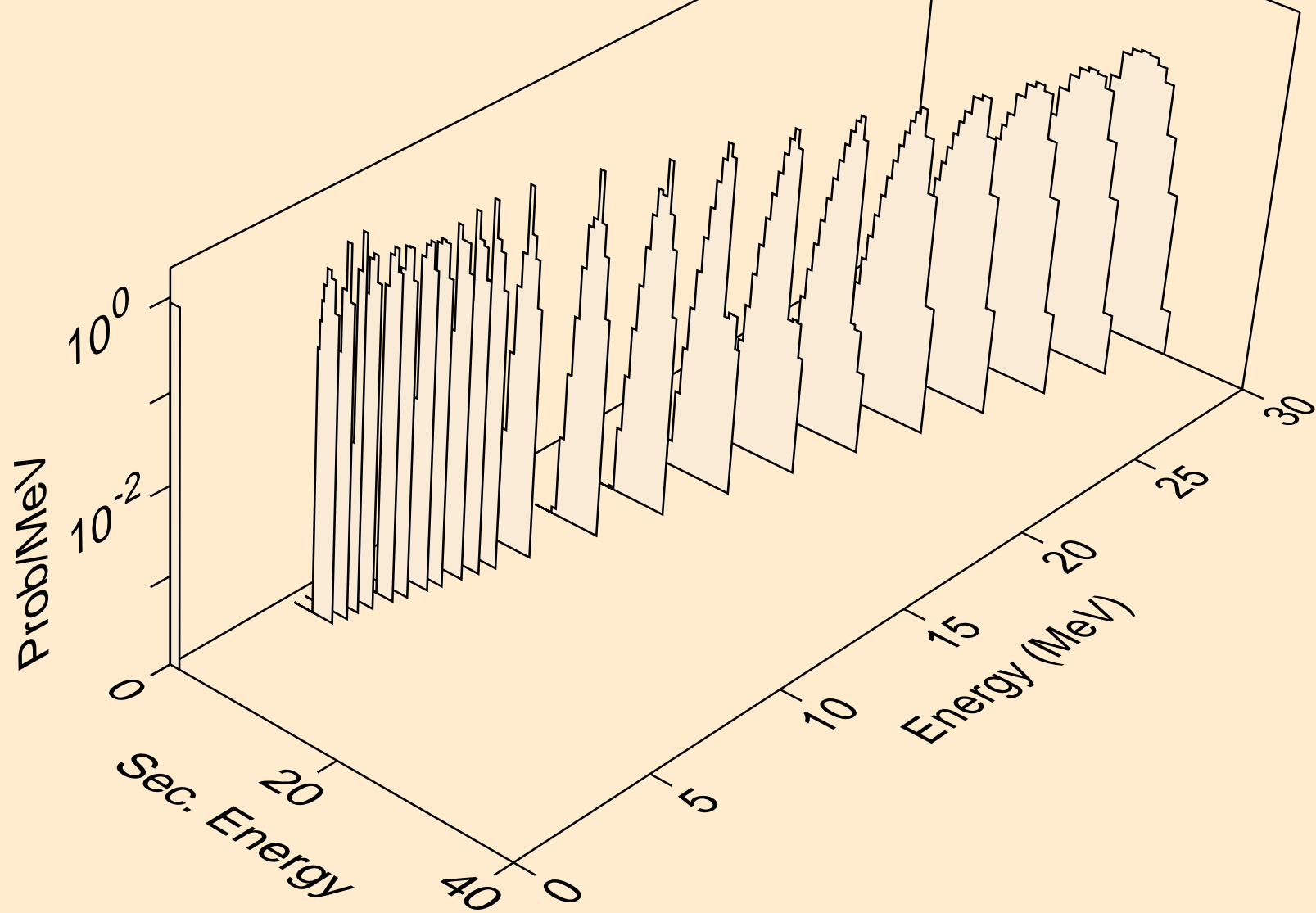

PO202 NEUTRON ACER TENDL-2023 LIBRARY; T=0.K
alphas from (n,x)

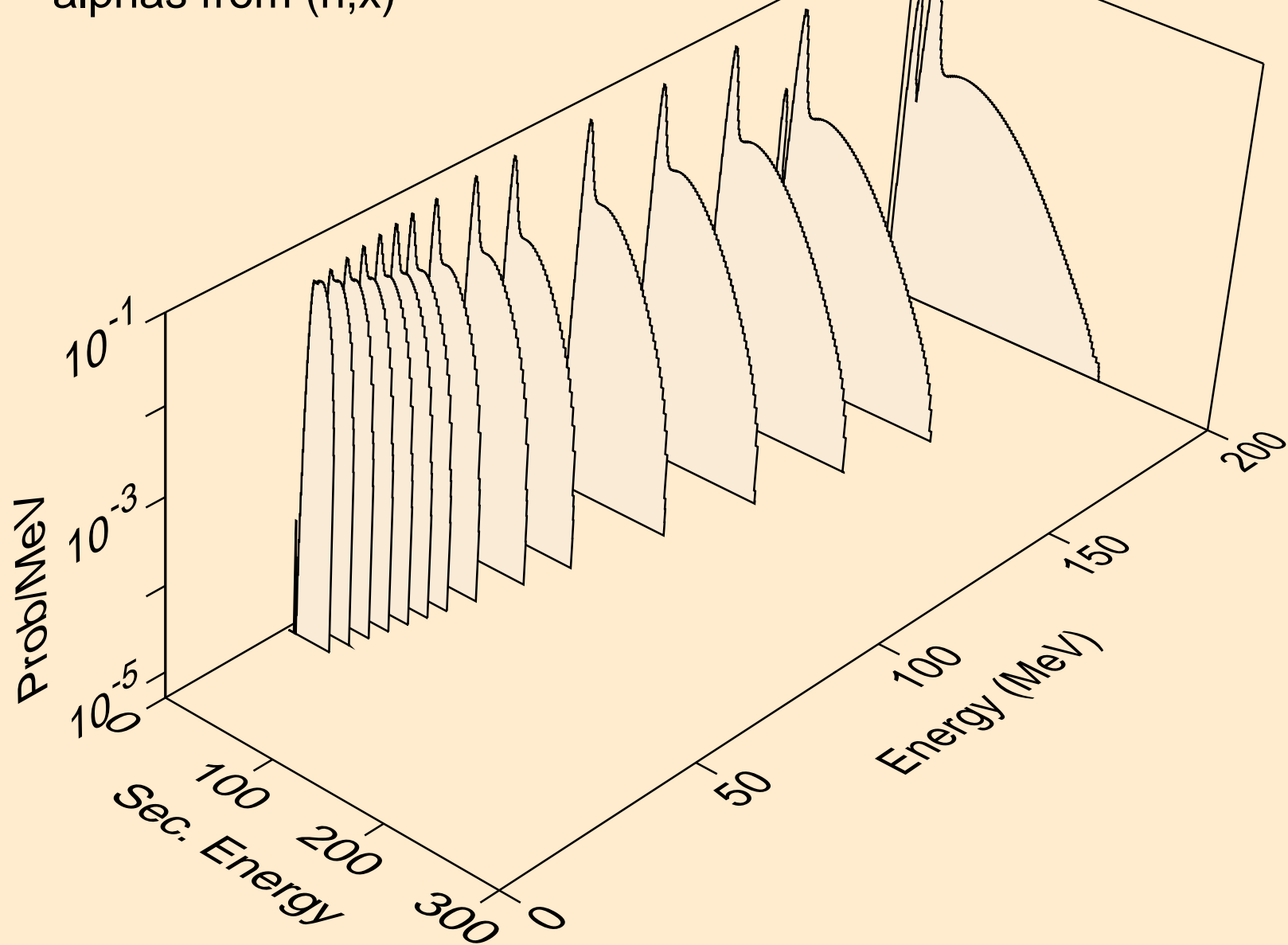

PO202 NEUTRON ACER TENDL-2023 LIBRARY; T=0.K
alphas from (n,n*)a

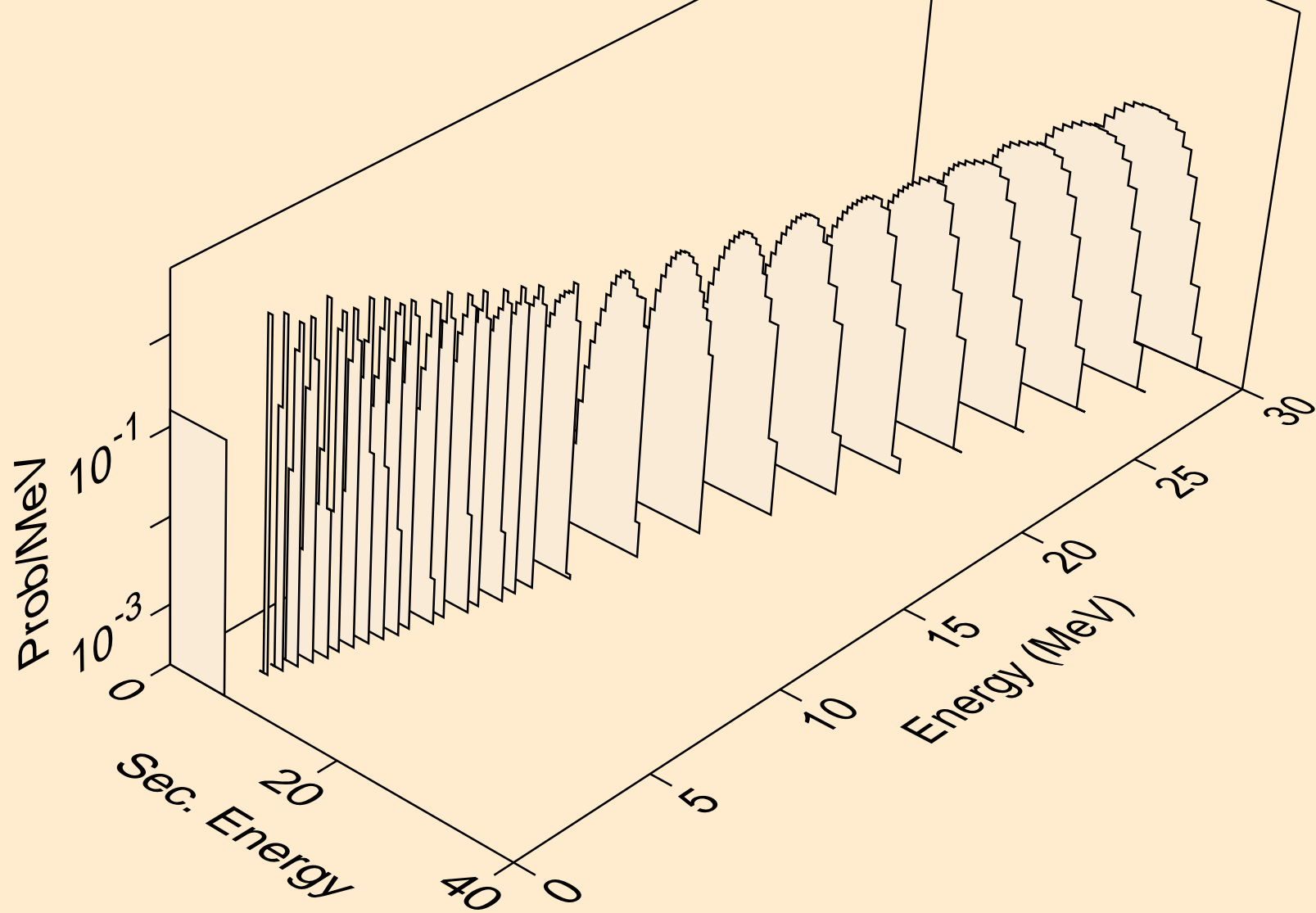

PO202 NEUTRON ACER TENDL-2023 LIBRARY; T=0.K
alphas from (n,2n)a

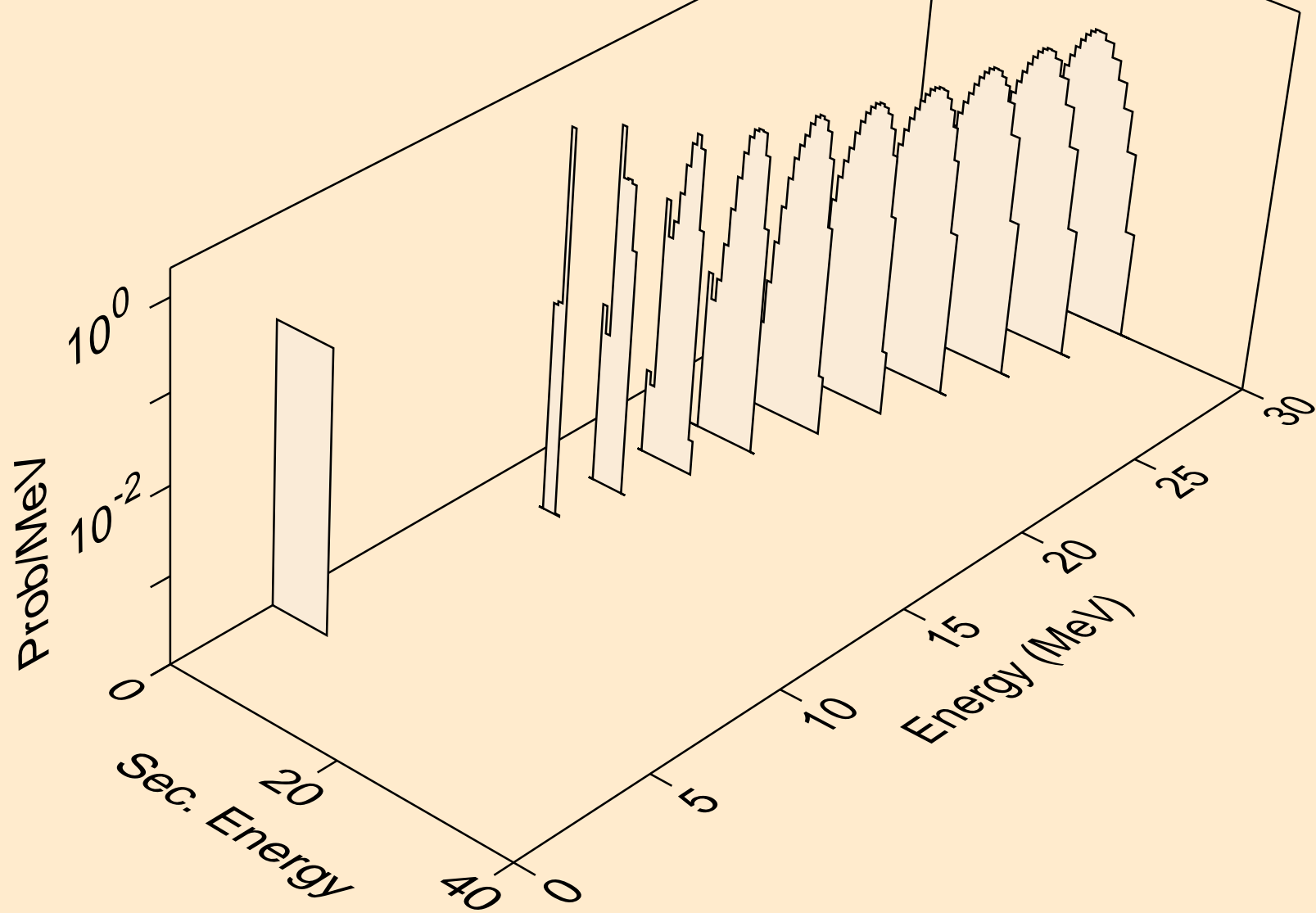

PO202 NEUTRON ACER TENDL-2023 LIBRARY; T=0.K
alphas from (n,3n)a

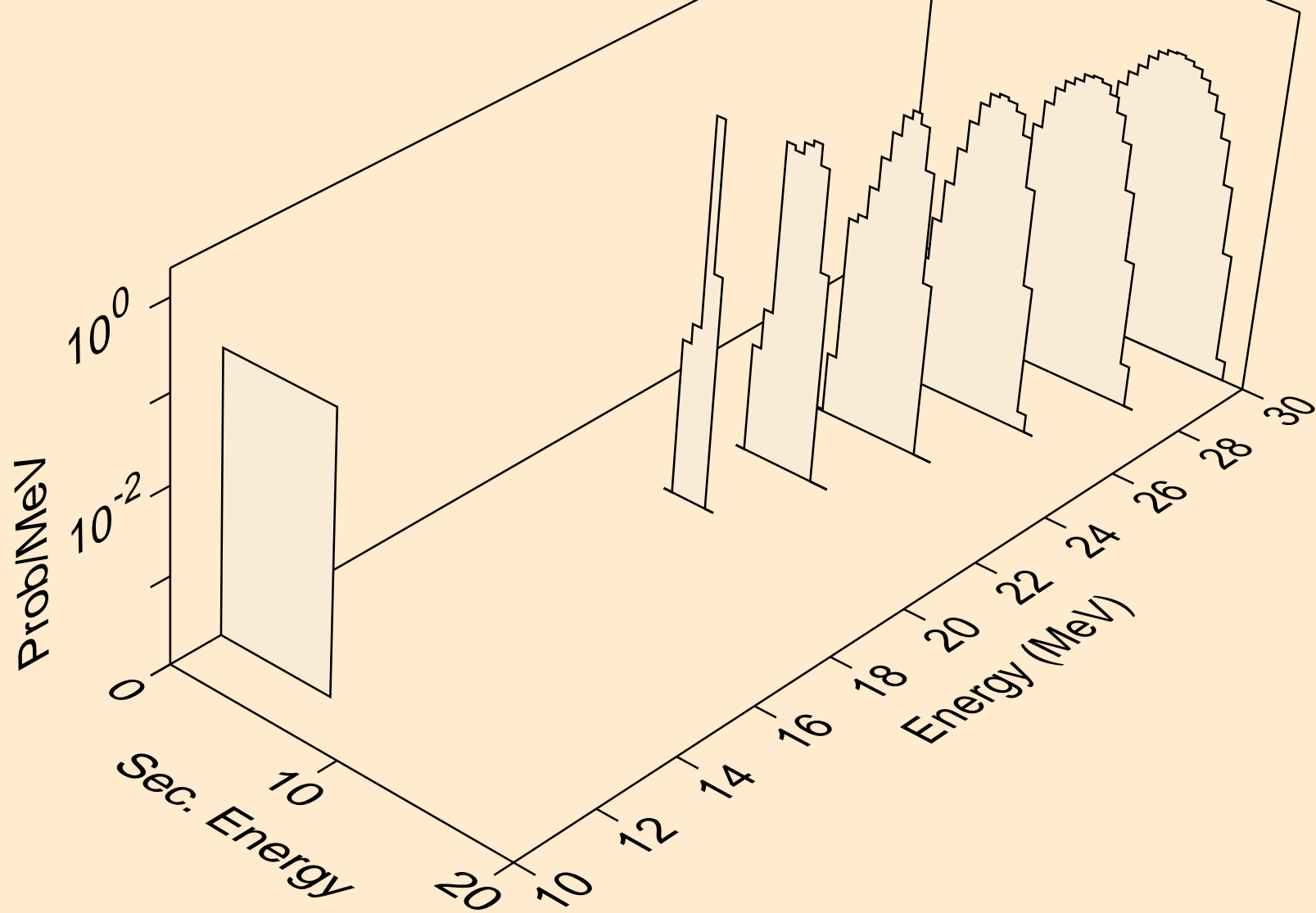

PO202 NEUTRON ACER TENDL-2023 LIBRARY; T=0.K
alphas from (n,n*)2a

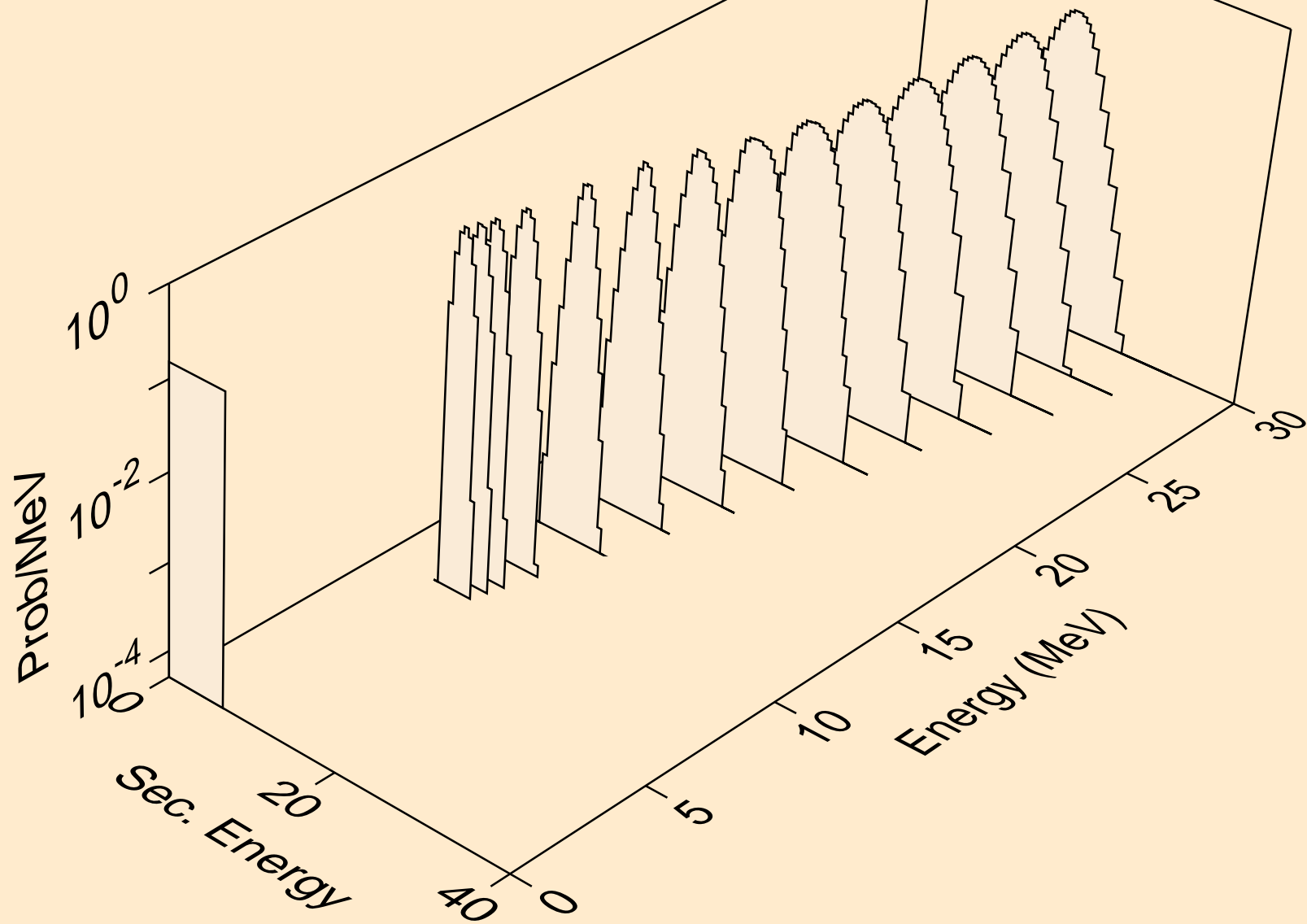

PO202 NEUTRON ACER TENDL-2023 LIBRARY; T=0.K
alphas from (n,npa)

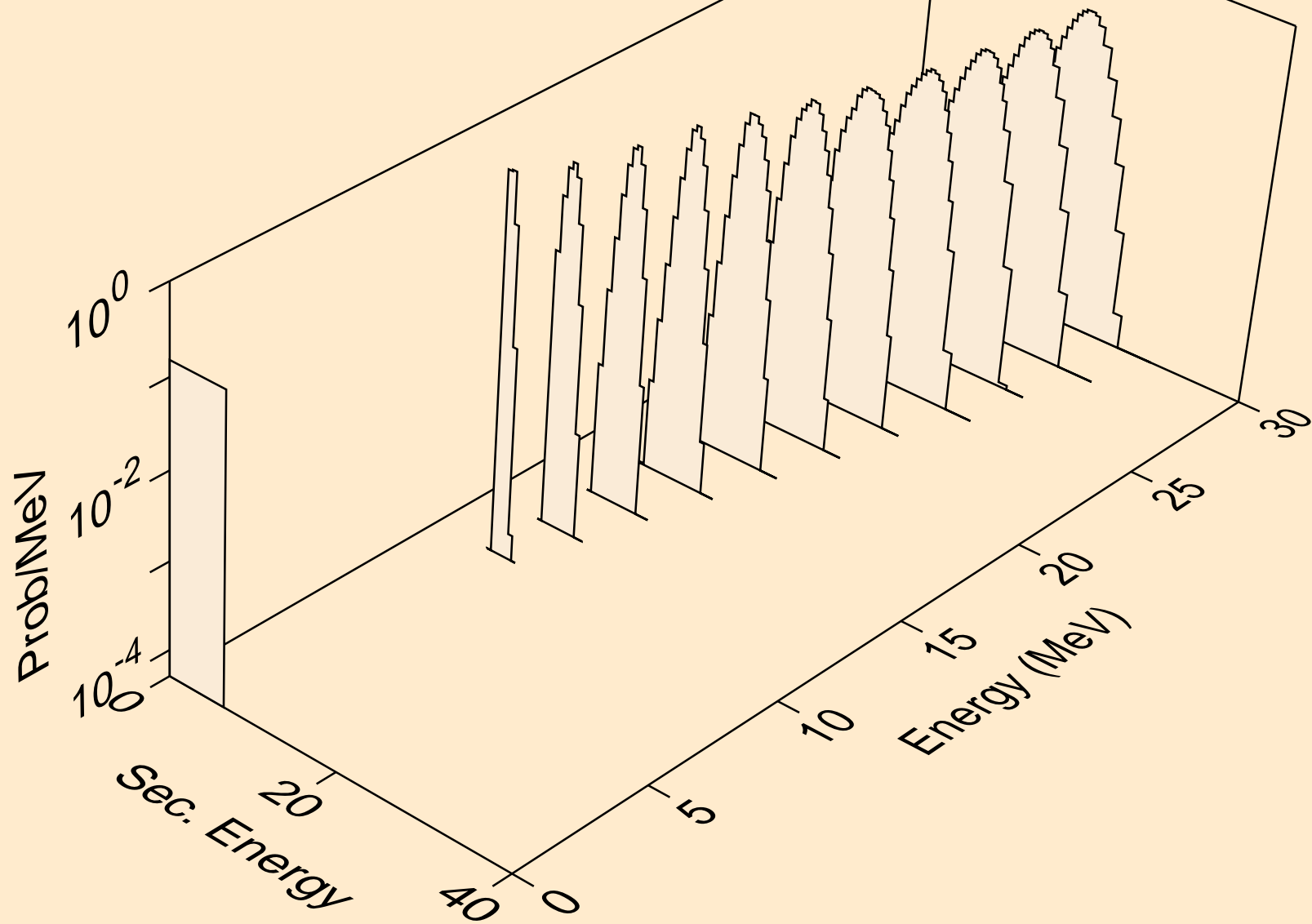

PO202 NEUTRON ACER TENDL-2023 LIBRARY; T=0.K
alphas from (n,a)

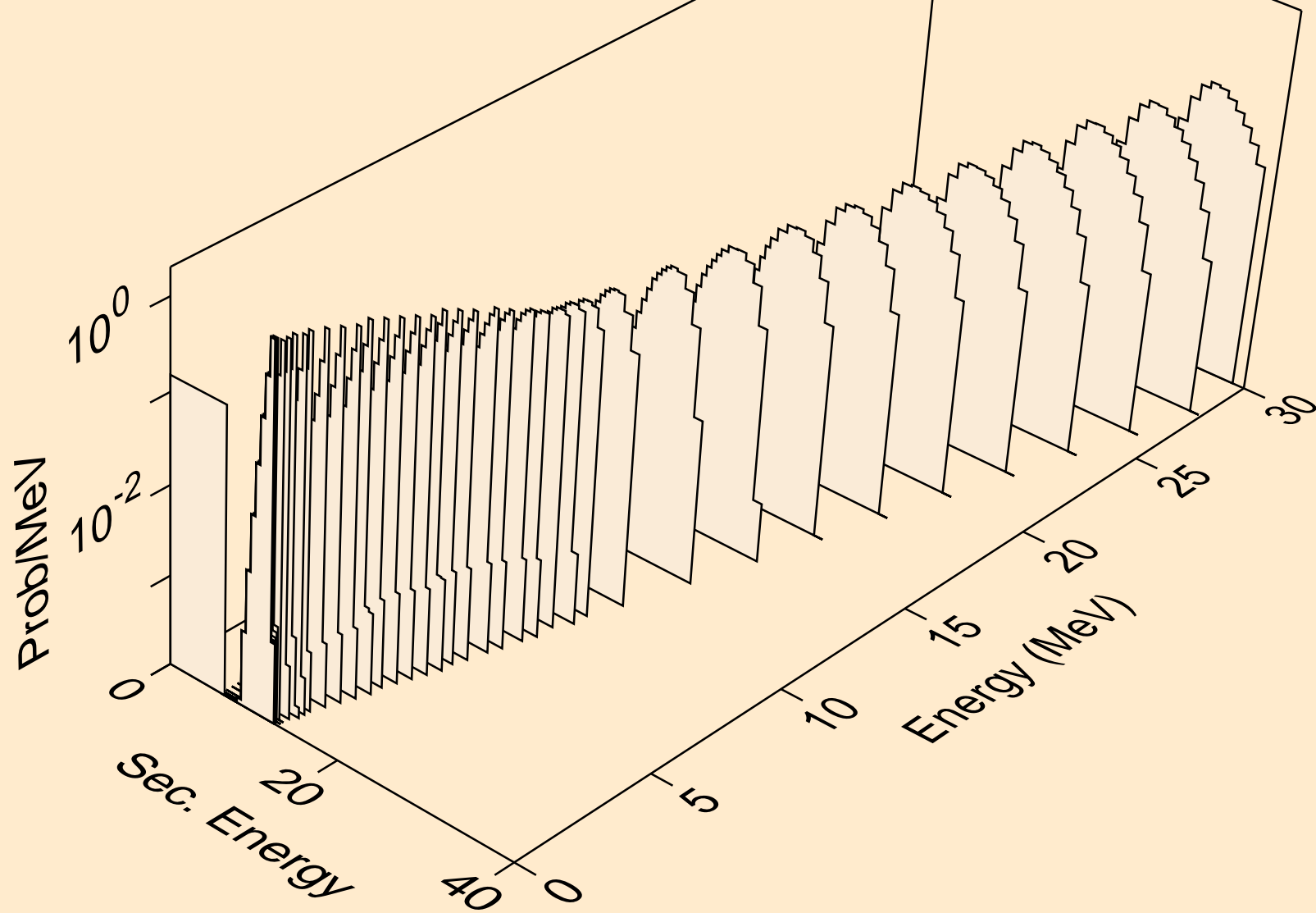

PO202 NEUTRON ACER TENDL-2023 LIBRARY; T=0.K
alphas from (n,2a)

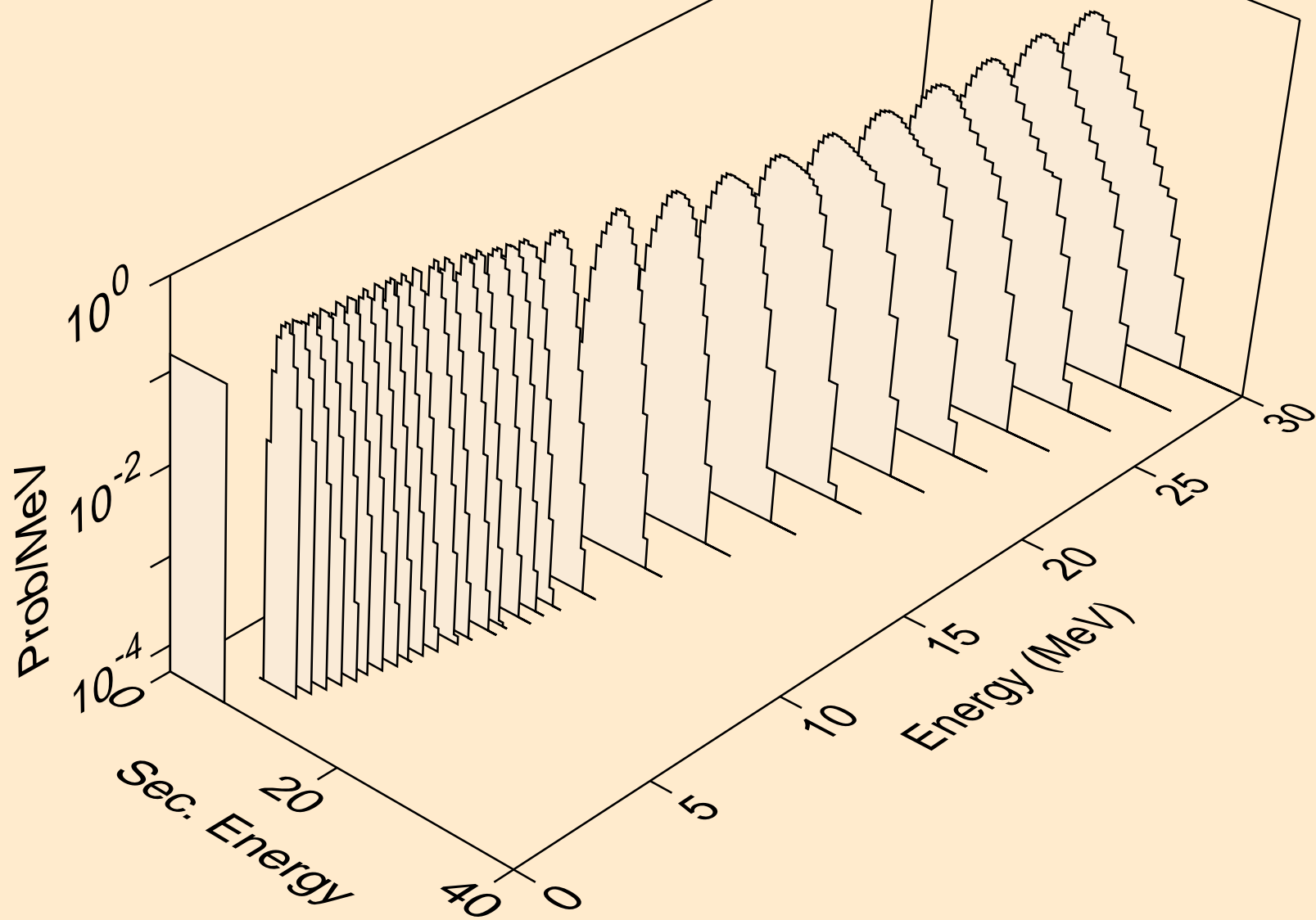

PO202 NEUTRON ACER TENDL-2023 LIBRARY; T=0.K
alphas from (n,pa)

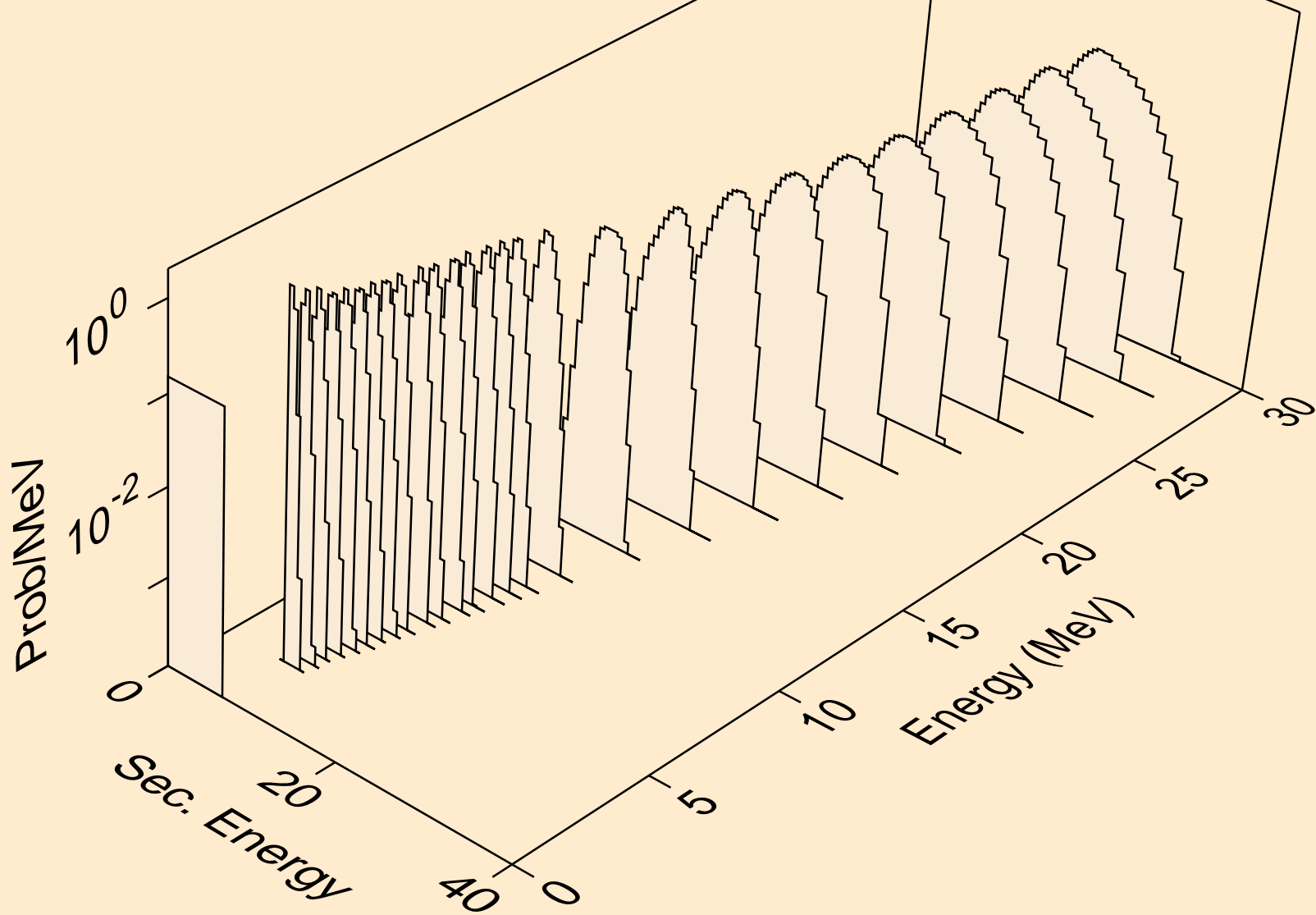

PO202 NEUTRON ACER TENDL-2023 LIBRARY; T=0.K
alphas from (n,da)

