

PO203 NEUTRON ACER TENDL-2023 LIBRARY; T=0.K
Principal cross sections

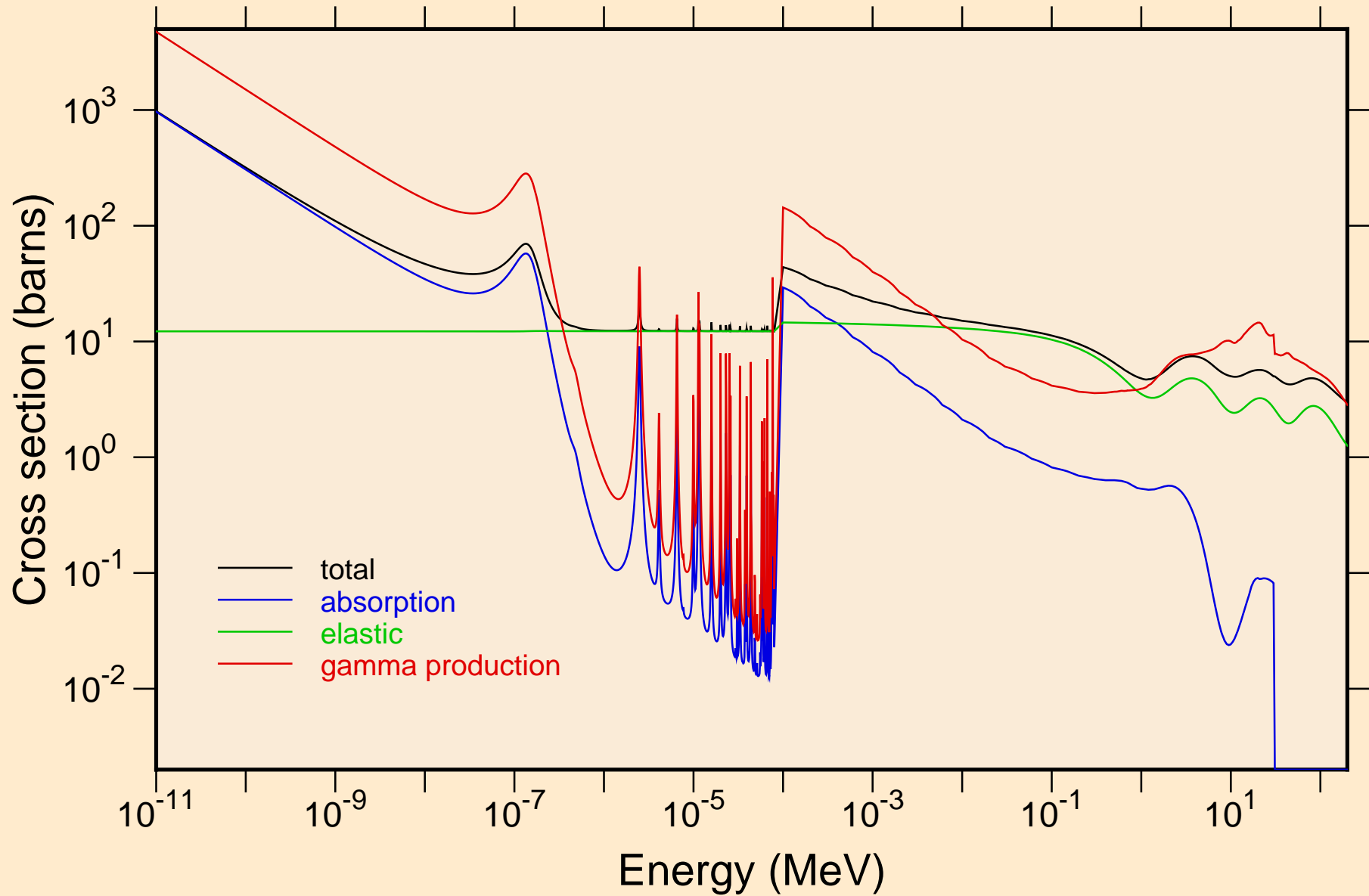

PO203 NEUTRON ACER TENDL-2023 LIBRARY; T=0.K
resonance total cross section

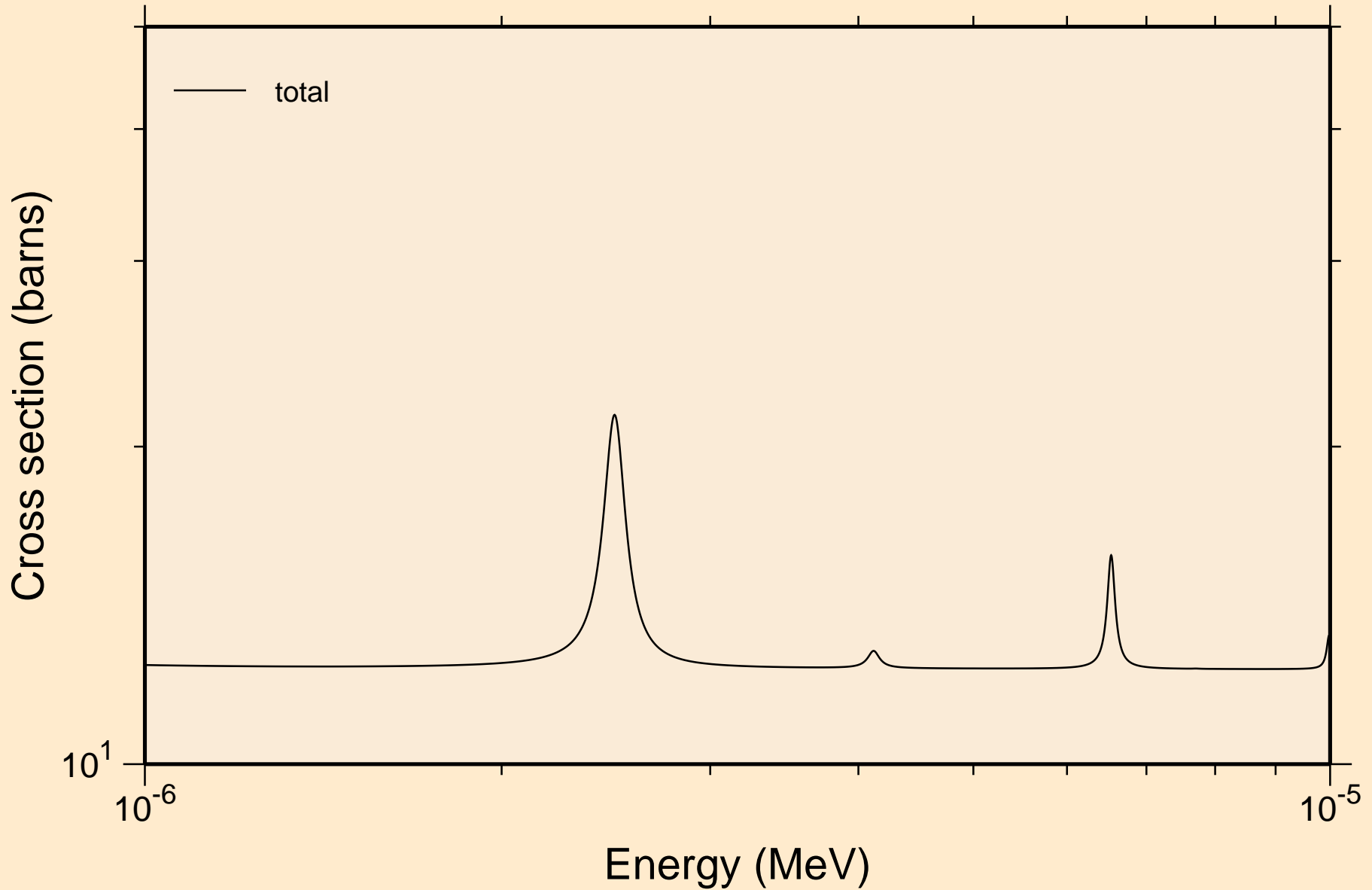

PO203 NEUTRON ACER TENDL-2023 LIBRARY; T=0.K
resonance total cross section

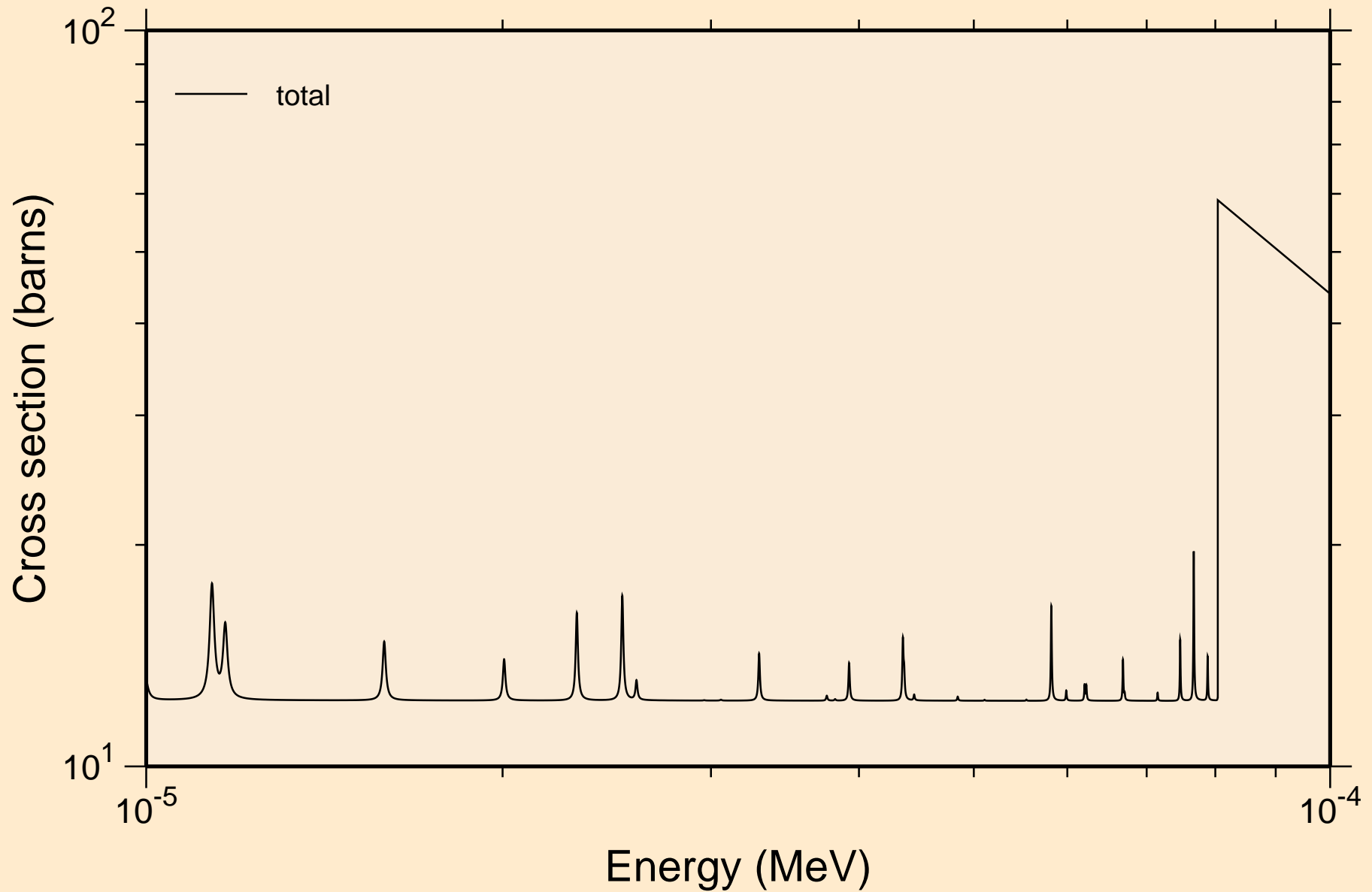

PO203 NEUTRON ACER TENDL-2023 LIBRARY; T=0.K
resonance total cross section

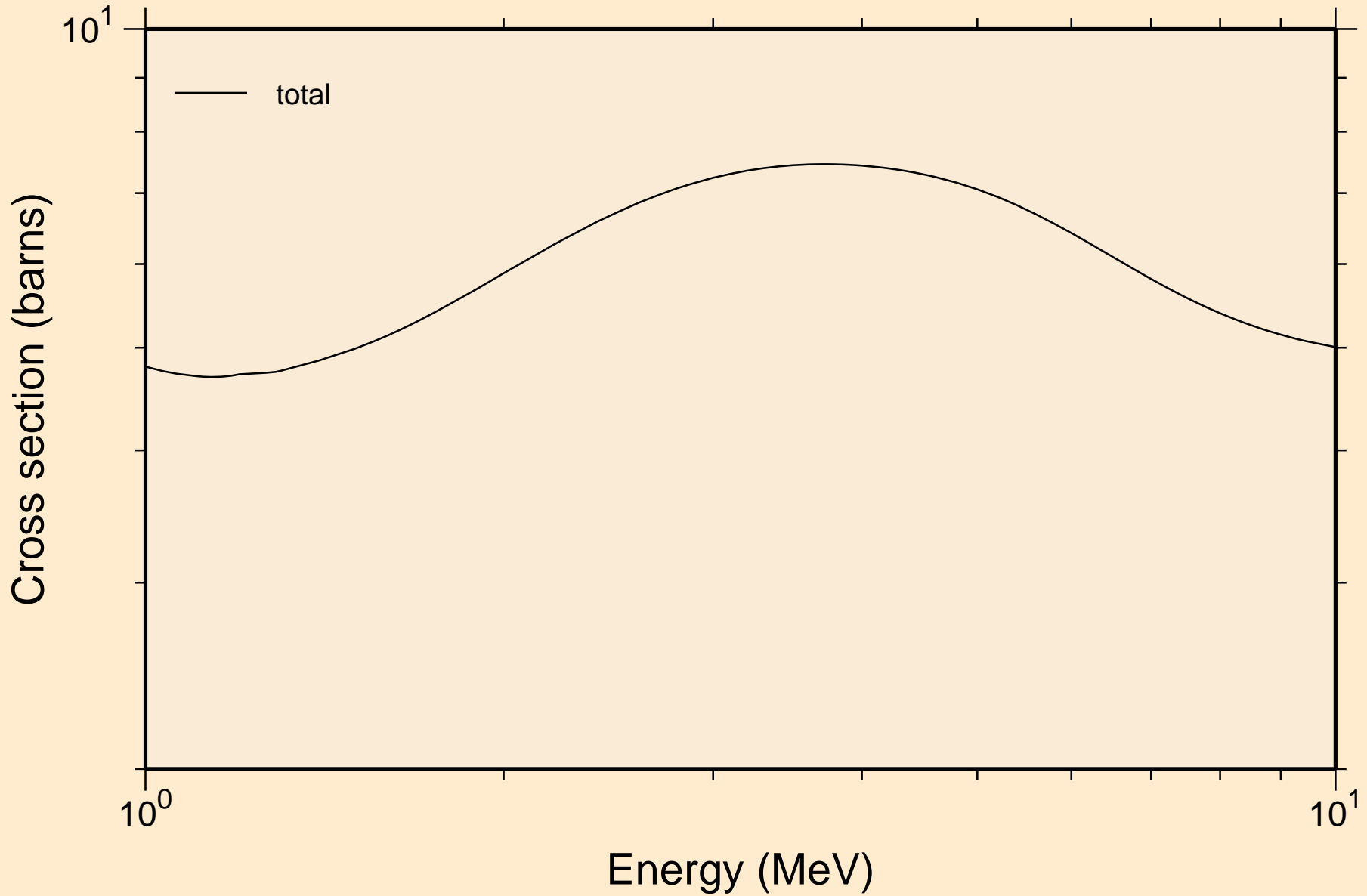

PO203 NEUTRON ACER TENDL-2023 LIBRARY; T=0.K
resonance absorption cross sections

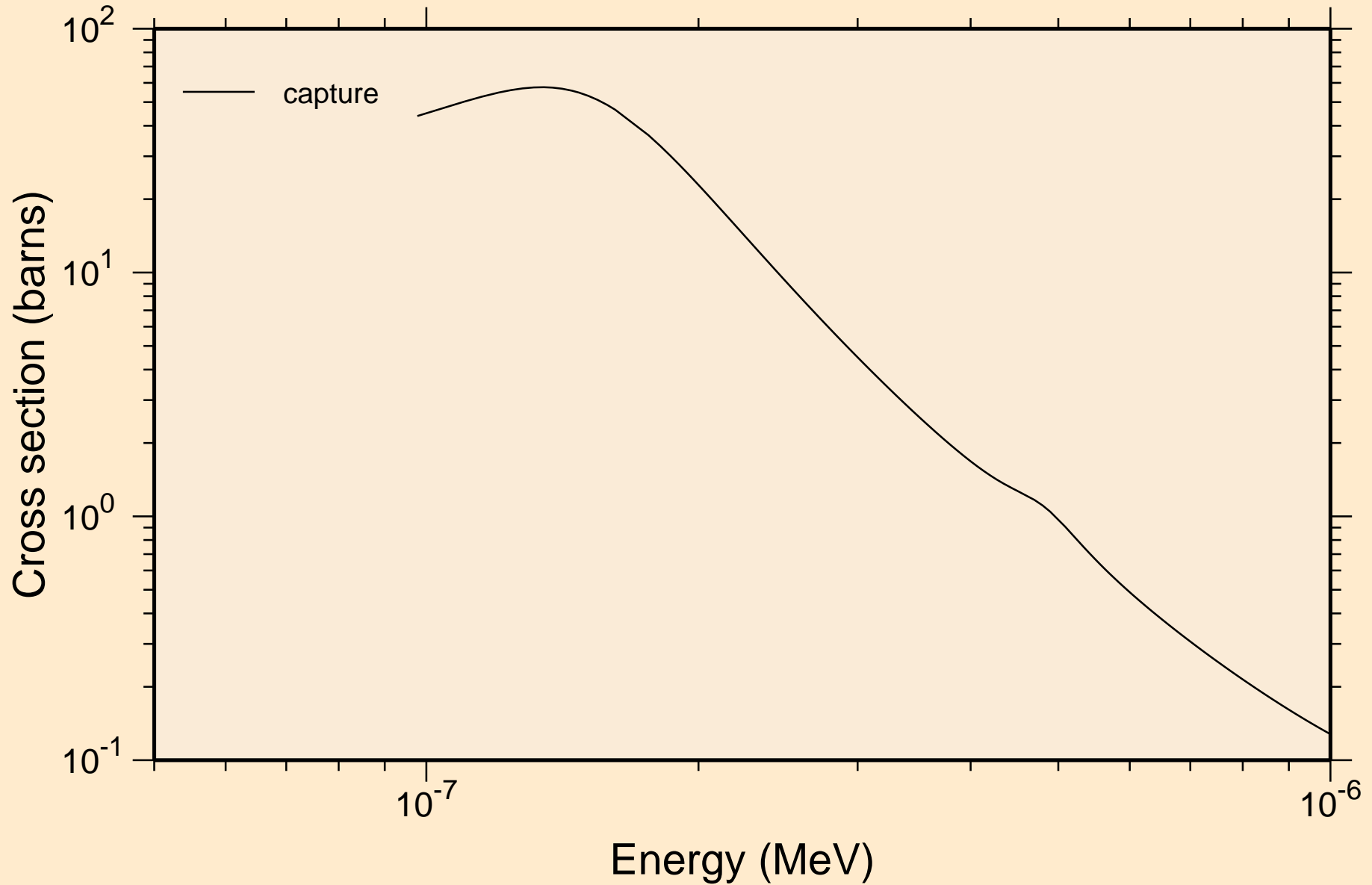

PO203 NEUTRON ACER TENDL-2023 LIBRARY; T=0.K
resonance absorption cross sections

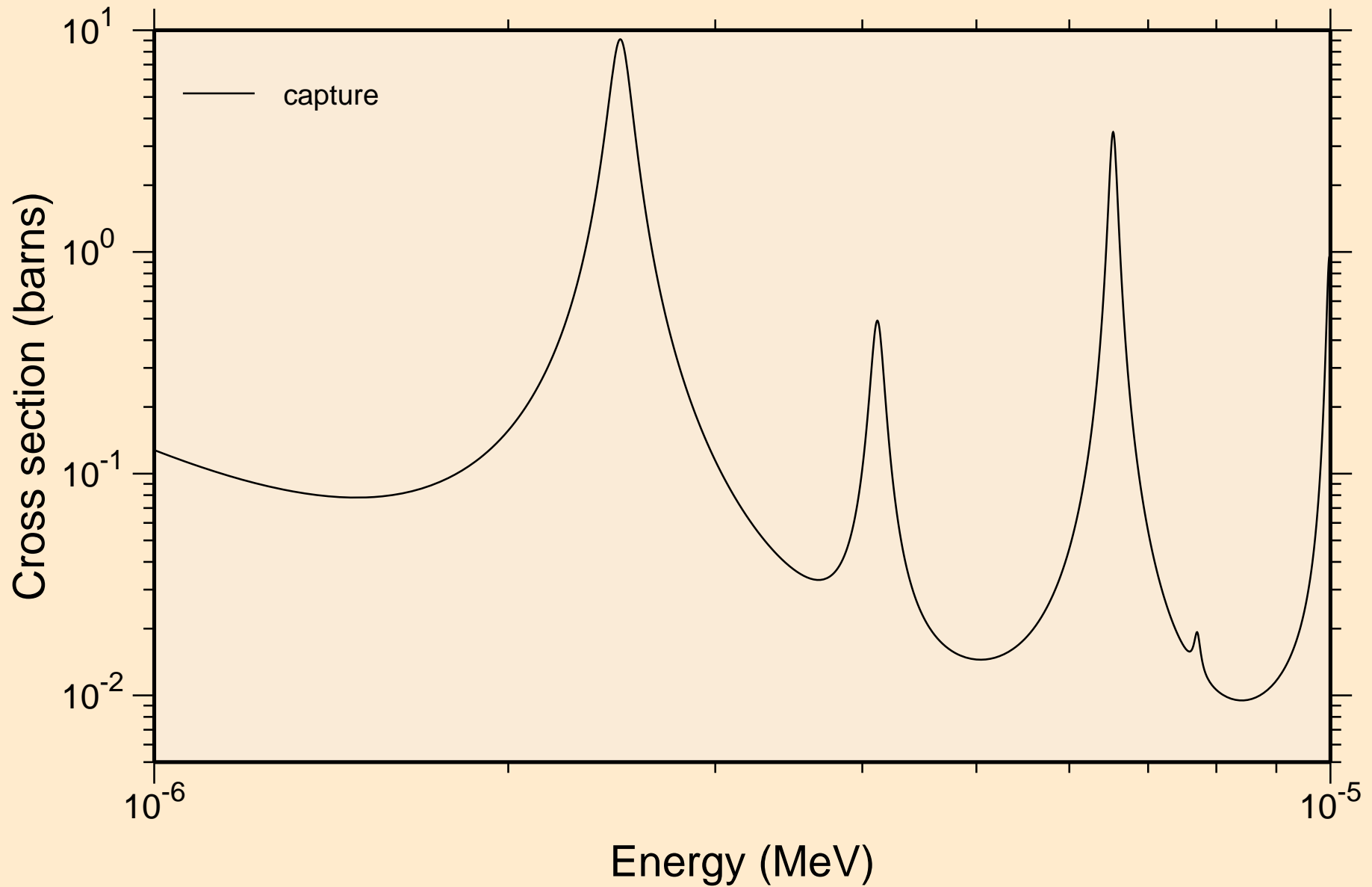

PO203 NEUTRON ACER TENDL-2023 LIBRARY; T=0.K
resonance absorption cross sections

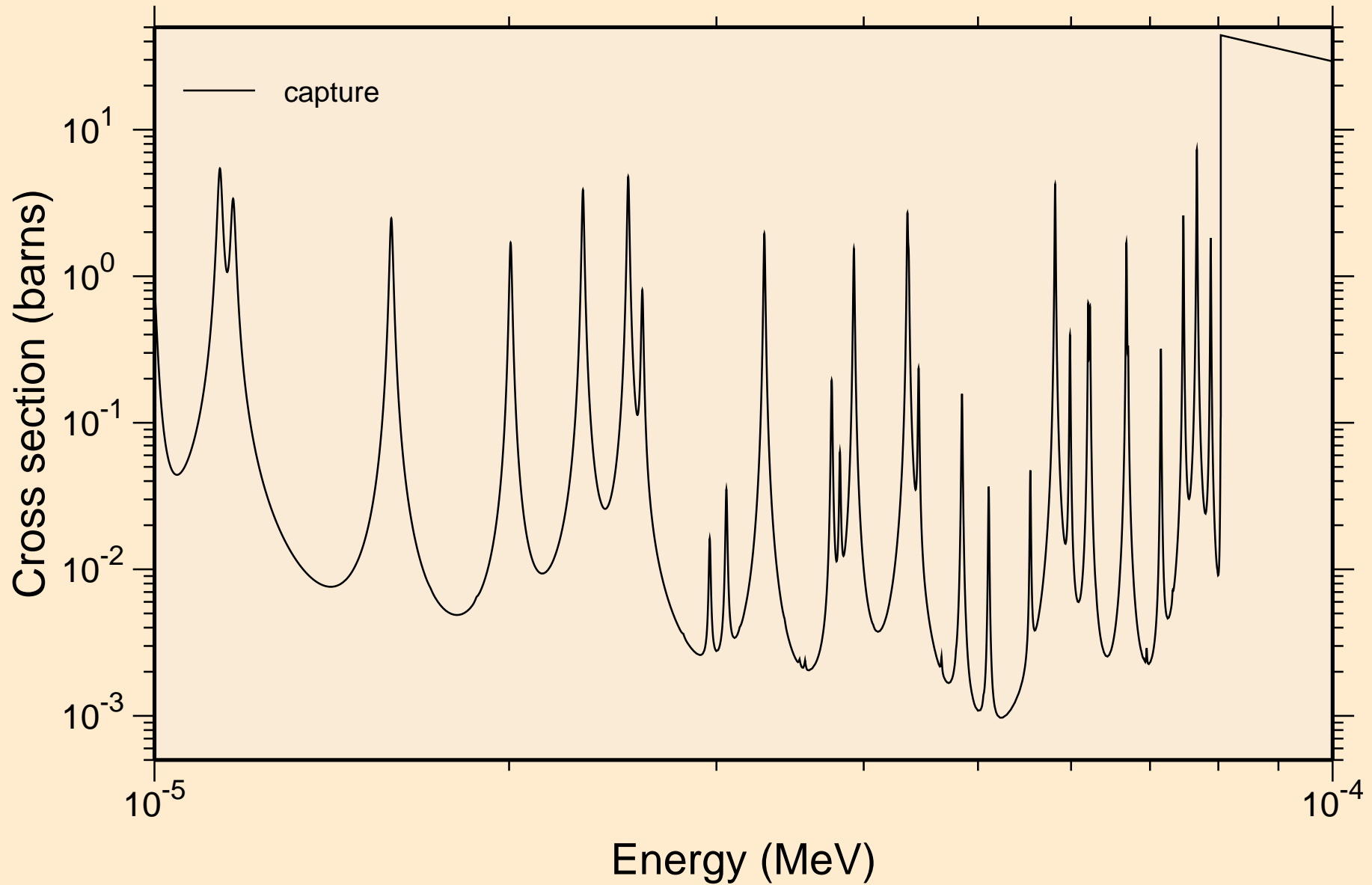

PO203 NEUTRON ACER TENDL-2023 LIBRARY; T=0.K
resonance absorption cross sections

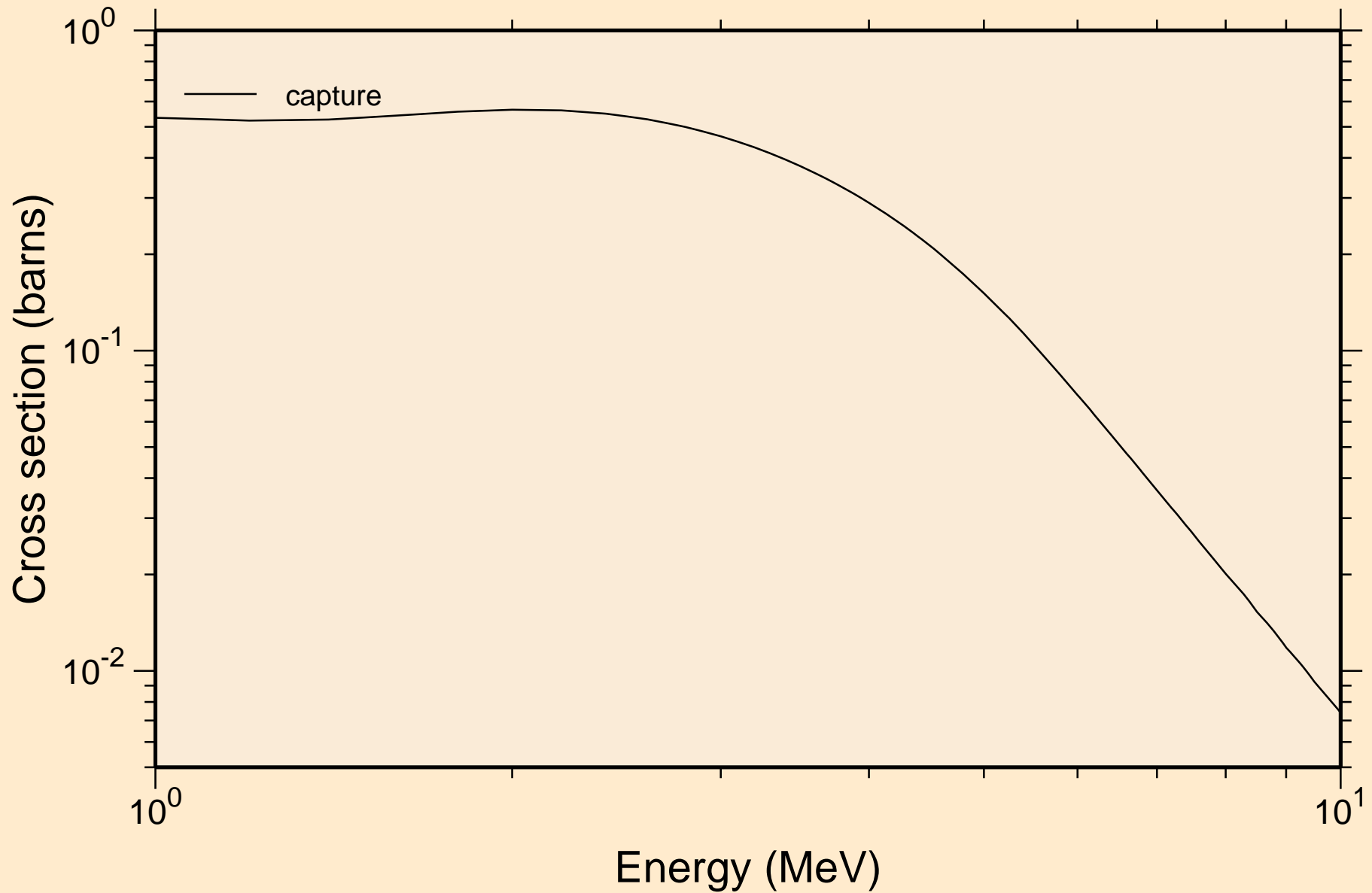

PO203 NEUTRON ACER TENDL-2023 LIBRARY; T=0.K
Heating

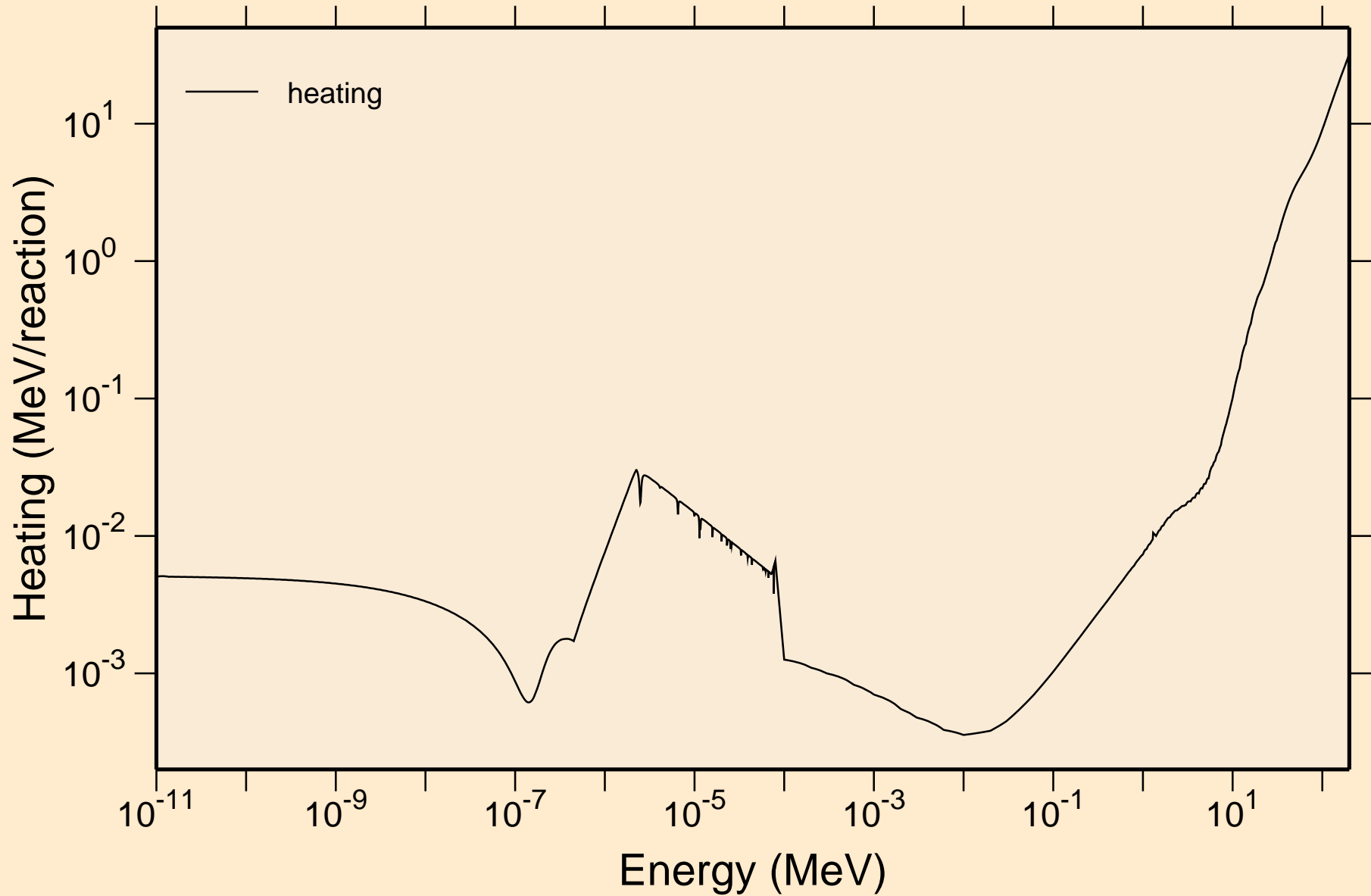

PO203 NEUTRON ACER TENDL-2023 LIBRARY; T=0.K
Damage

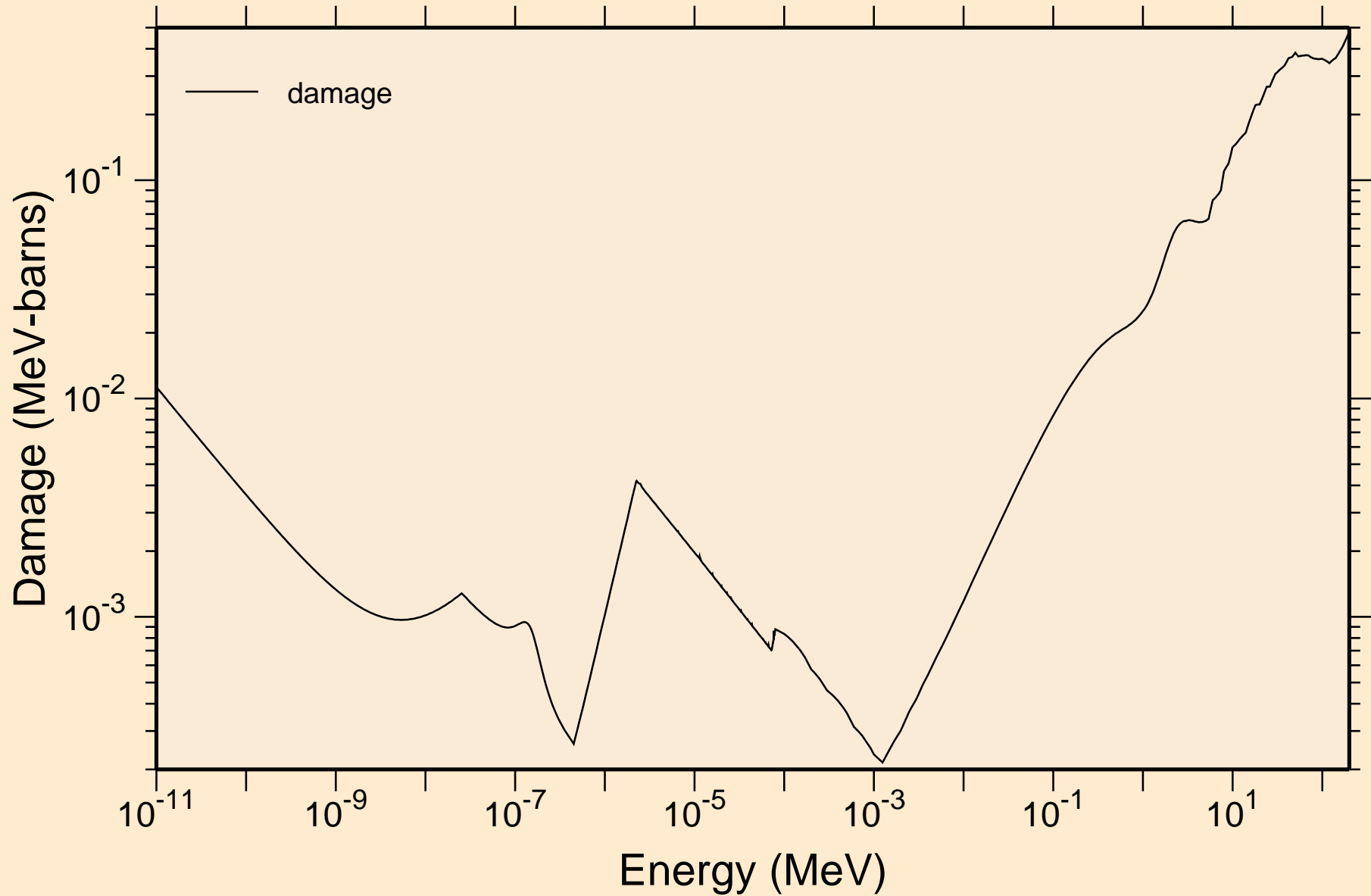

PO203 NEUTRON ACER TENDL-2023 LIBRARY; T=0.K
Non-threshold reactions

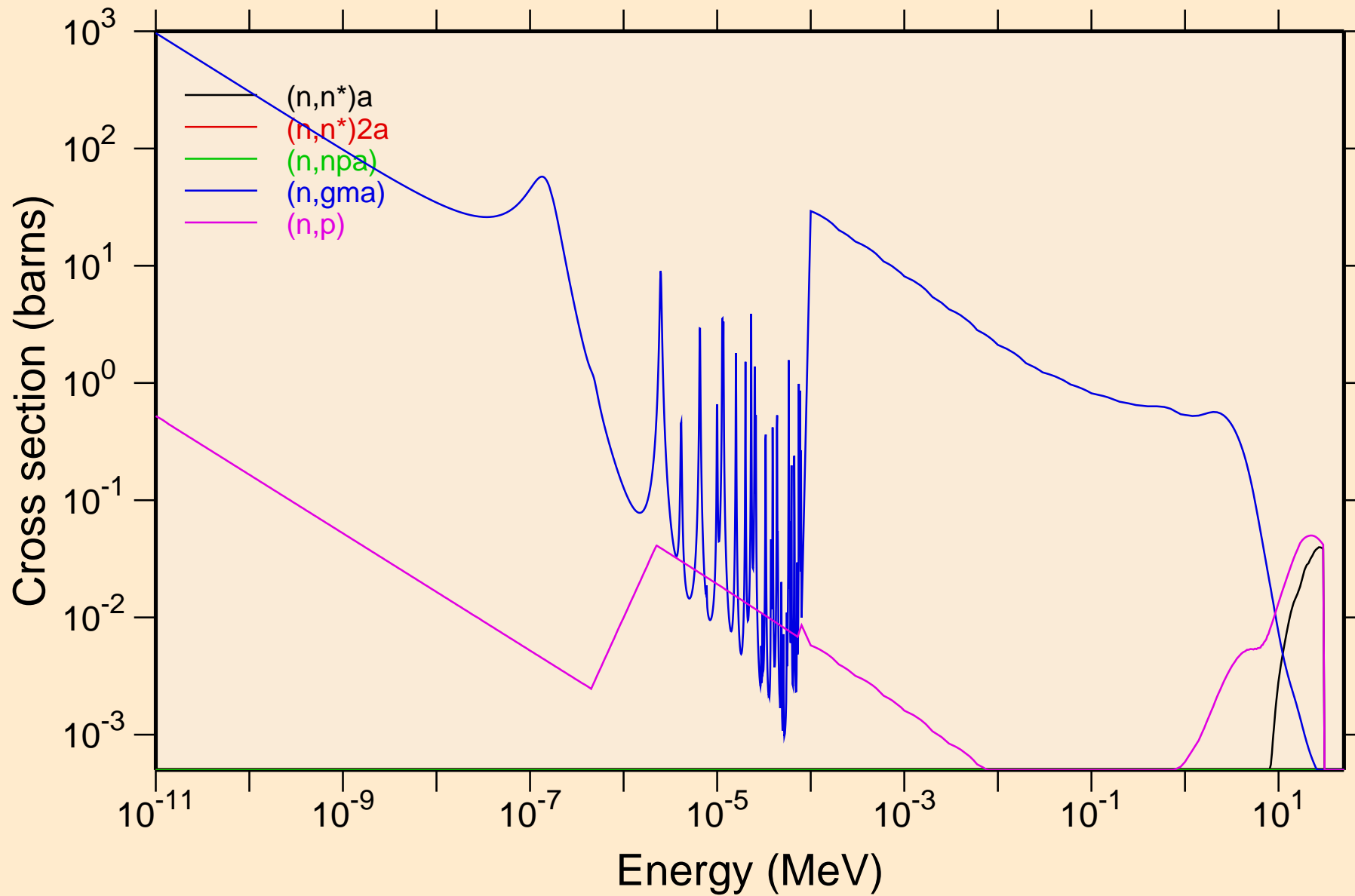

PO203 NEUTRON ACER TENDL-2023 LIBRARY; T=0.K
Non-threshold reactions

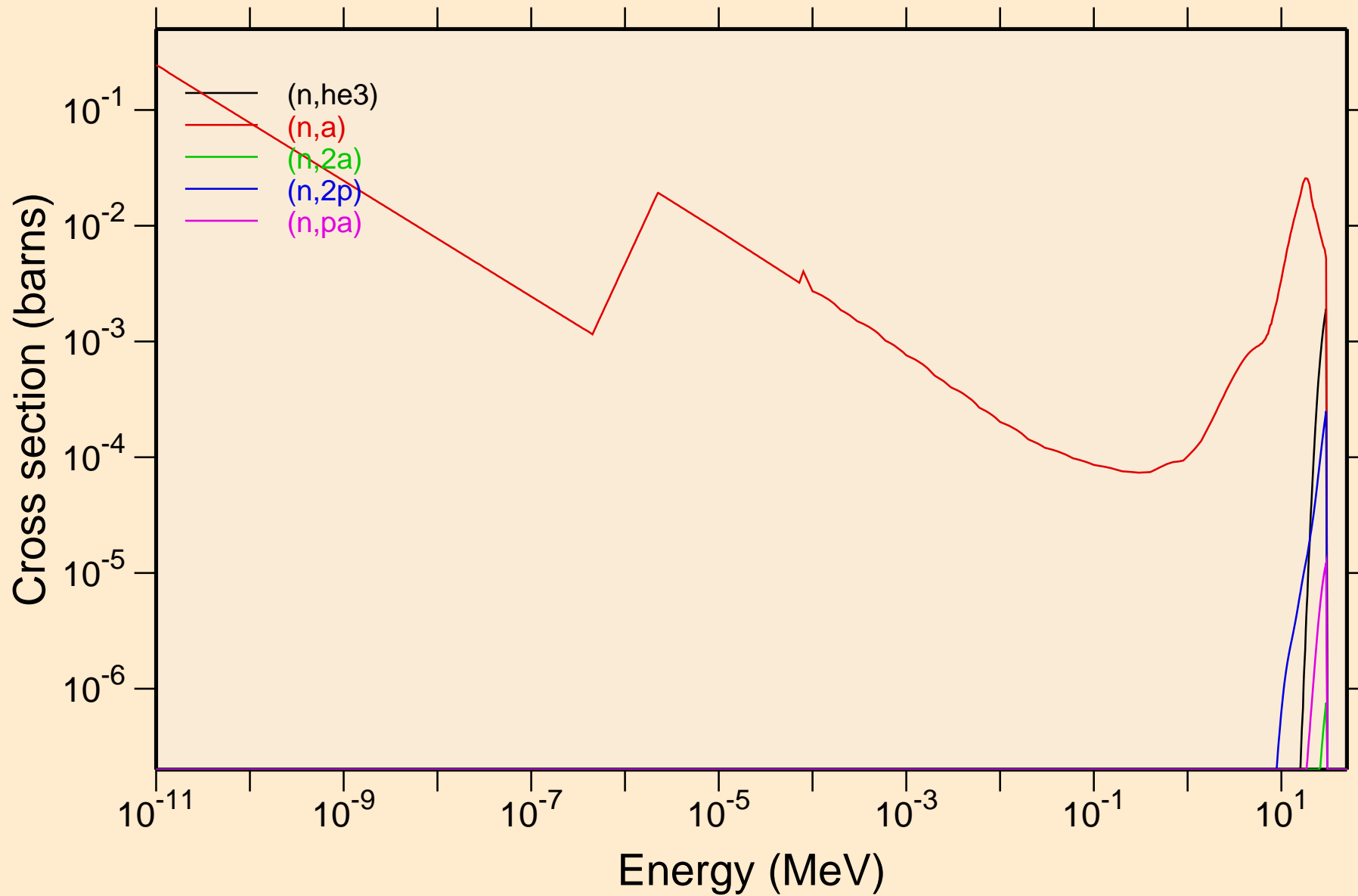

PO203 NEUTRON ACER TENDL-2023 LIBRARY; T=0.K
Non-threshold reactions

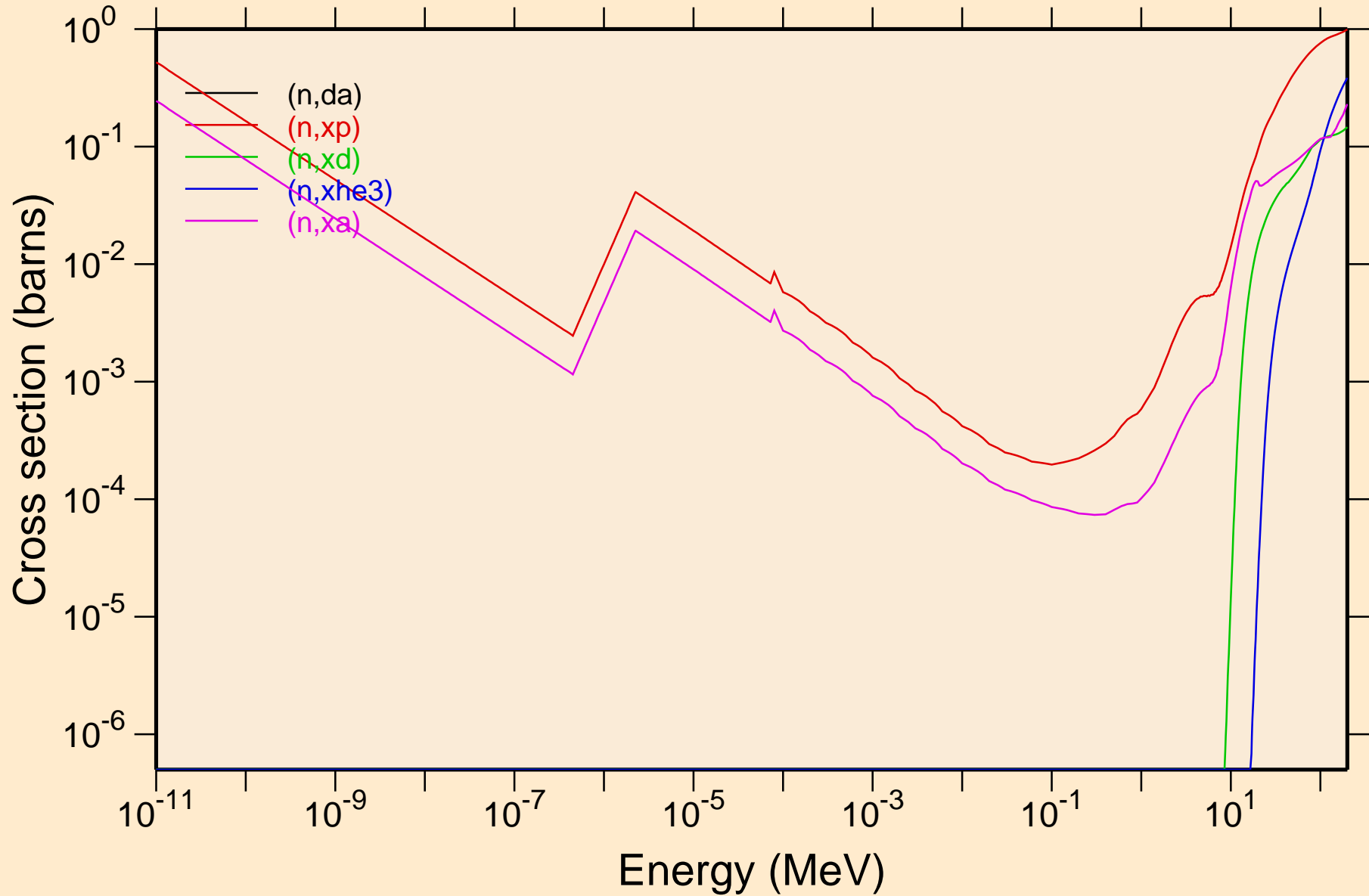

PO203 NEUTRON ACER TENDL-2023 LIBRARY; T=0.K

Principal cross sections

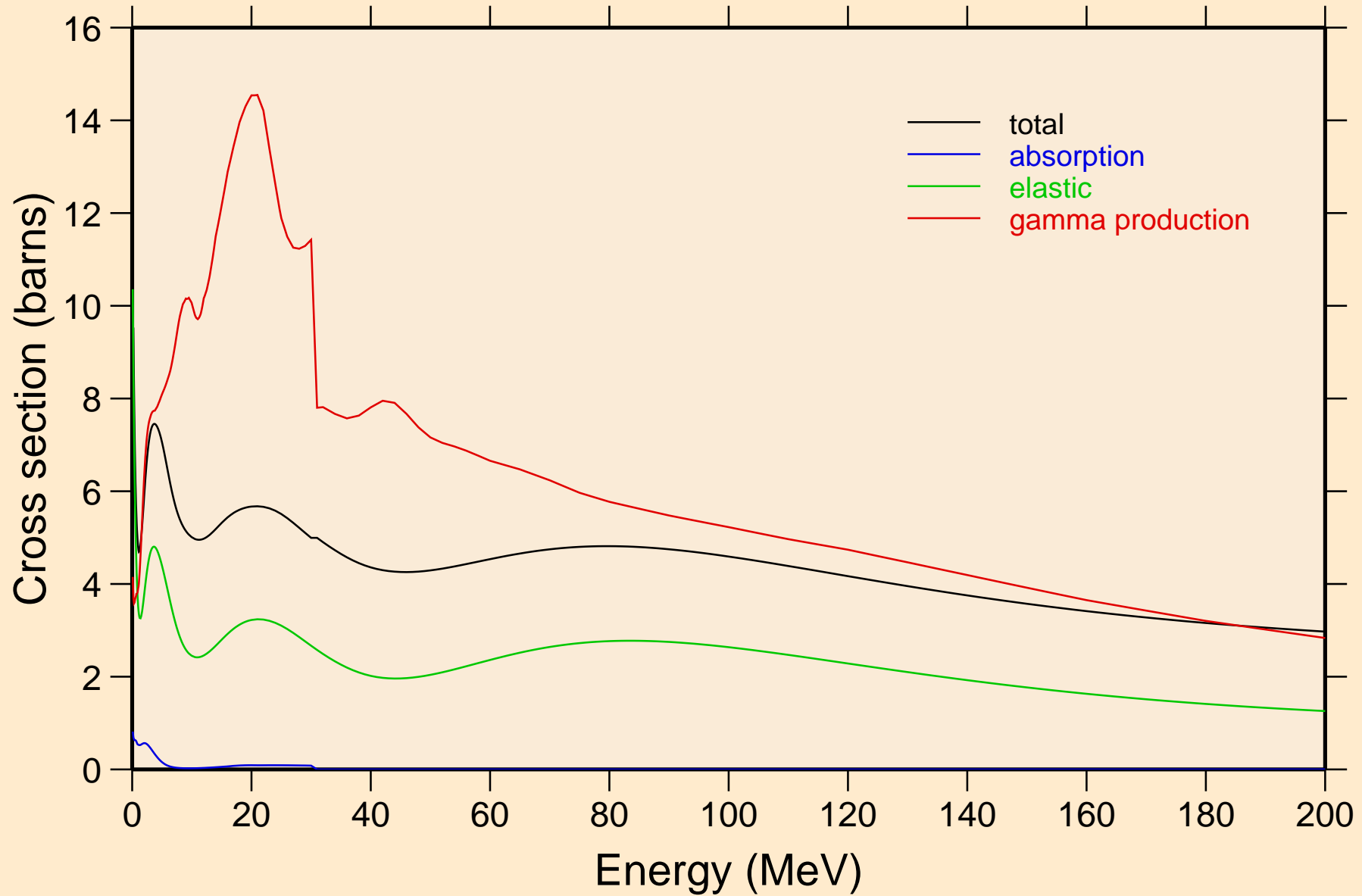

PO203 NEUTRON ACER TENDL-2023 LIBRARY; T=0.K

Heating

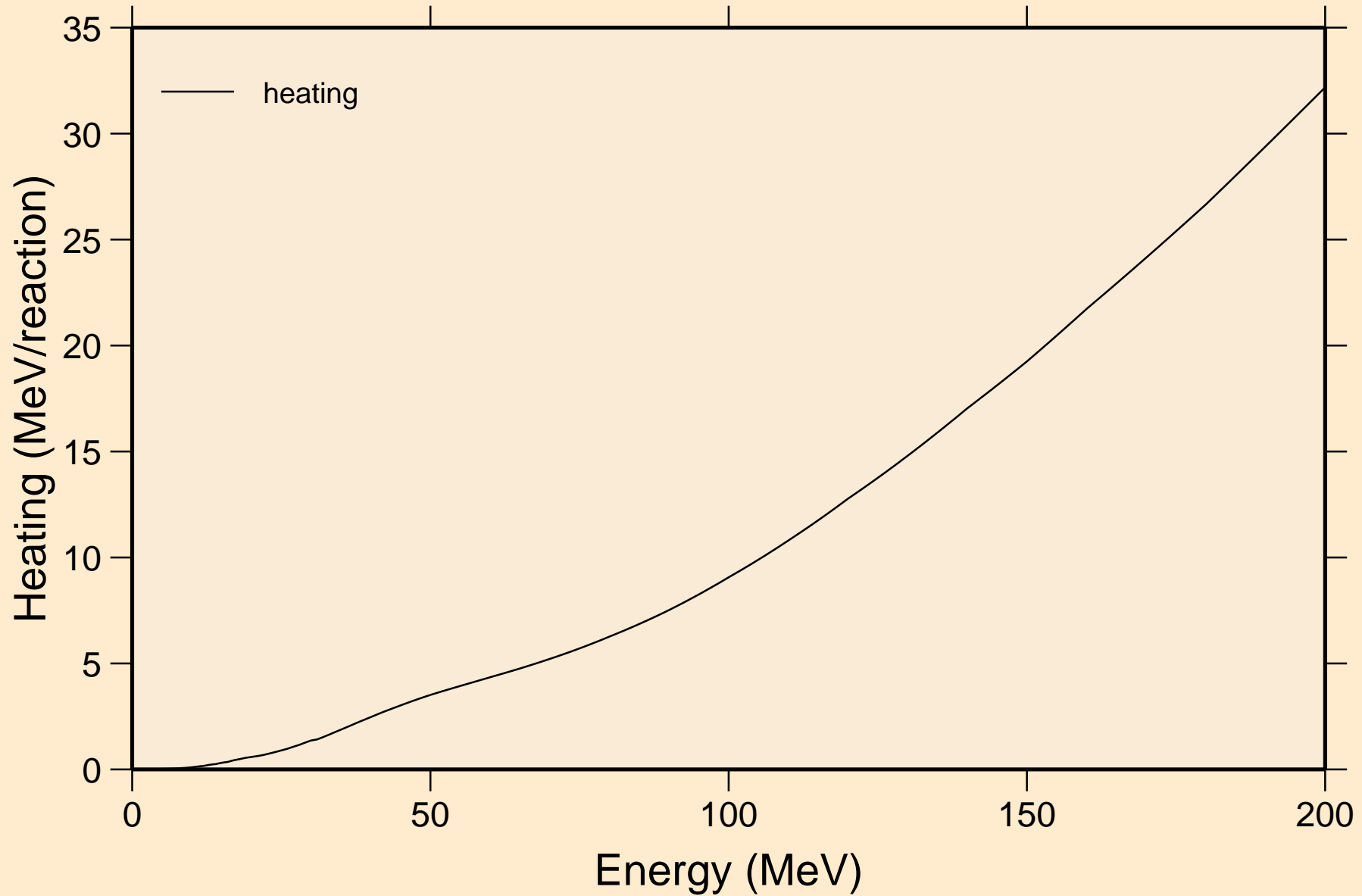

PO203 NEUTRON ACER TENDL-2023 LIBRARY; T=0.K
Damage

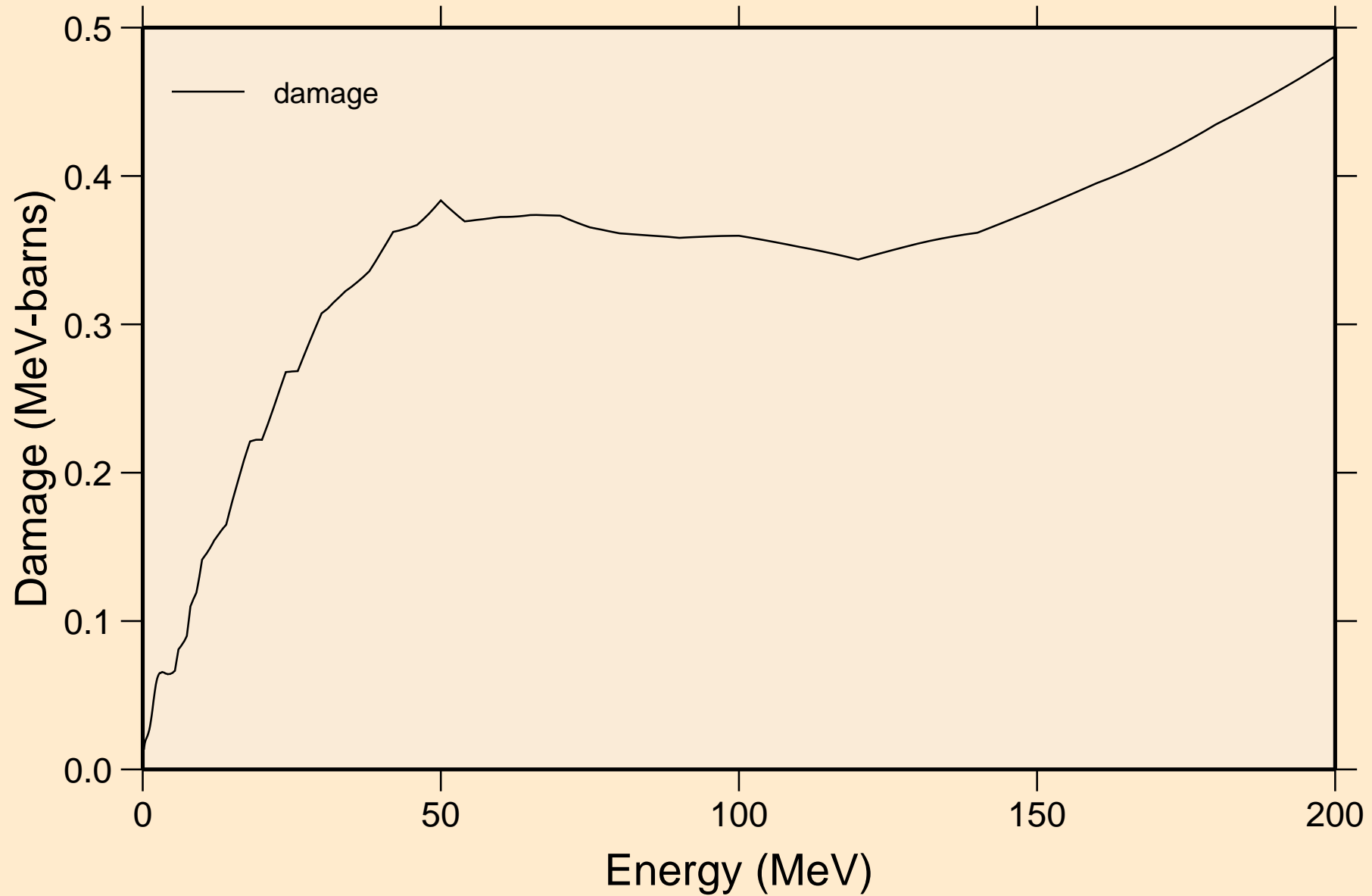

PO203 NEUTRON ACER TENDL-2023 LIBRARY; T=0.K
Non-threshold reactions

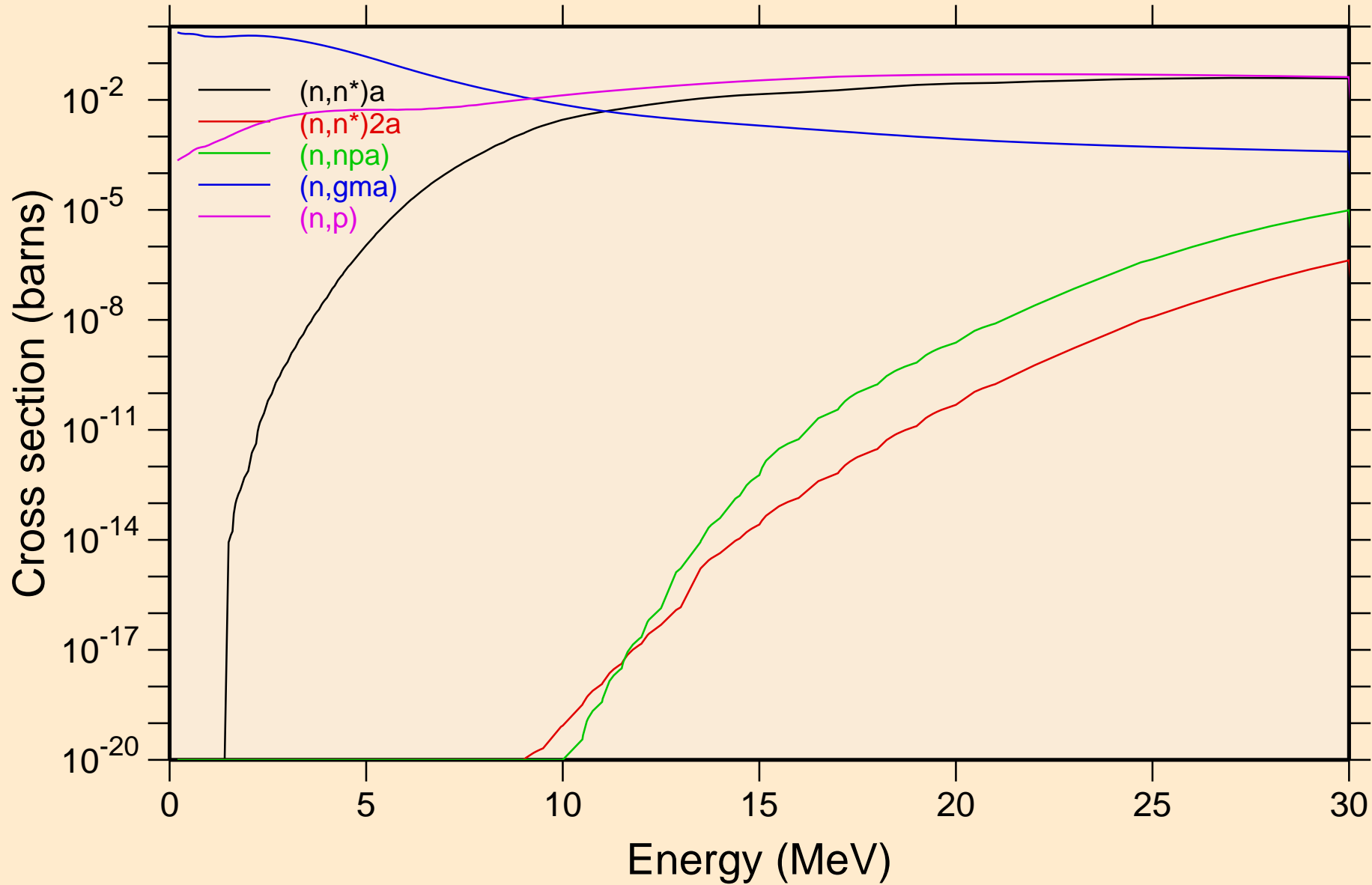

PO203 NEUTRON ACER TENDL-2023 LIBRARY; T=0.K
Non-threshold reactions

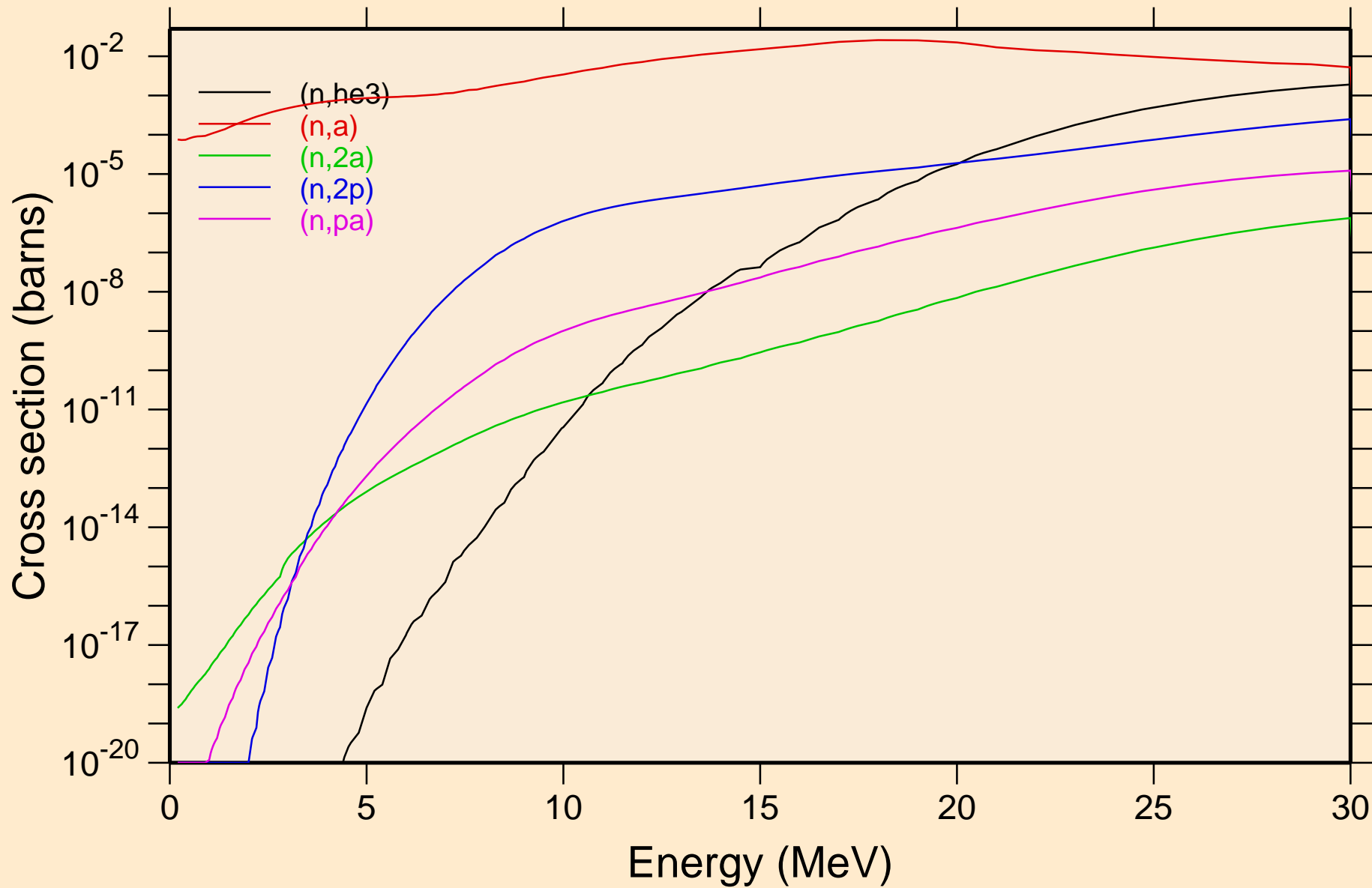

PO203 NEUTRON ACER TENDL-2023 LIBRARY; T=0.K
Non-threshold reactions

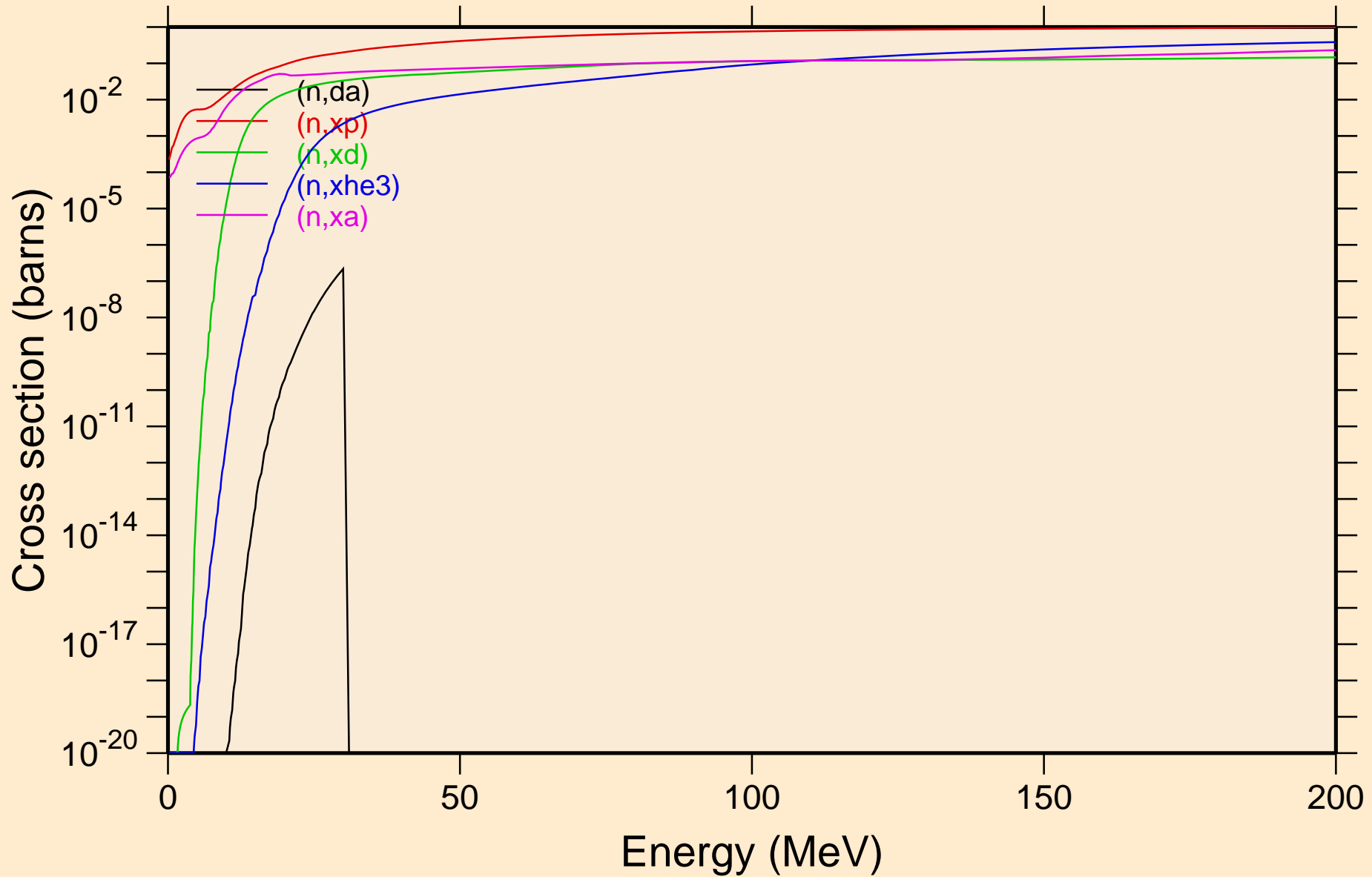

PO203 NEUTRON ACER TENDL-2023 LIBRARY; T=0.K
Inelastic levels

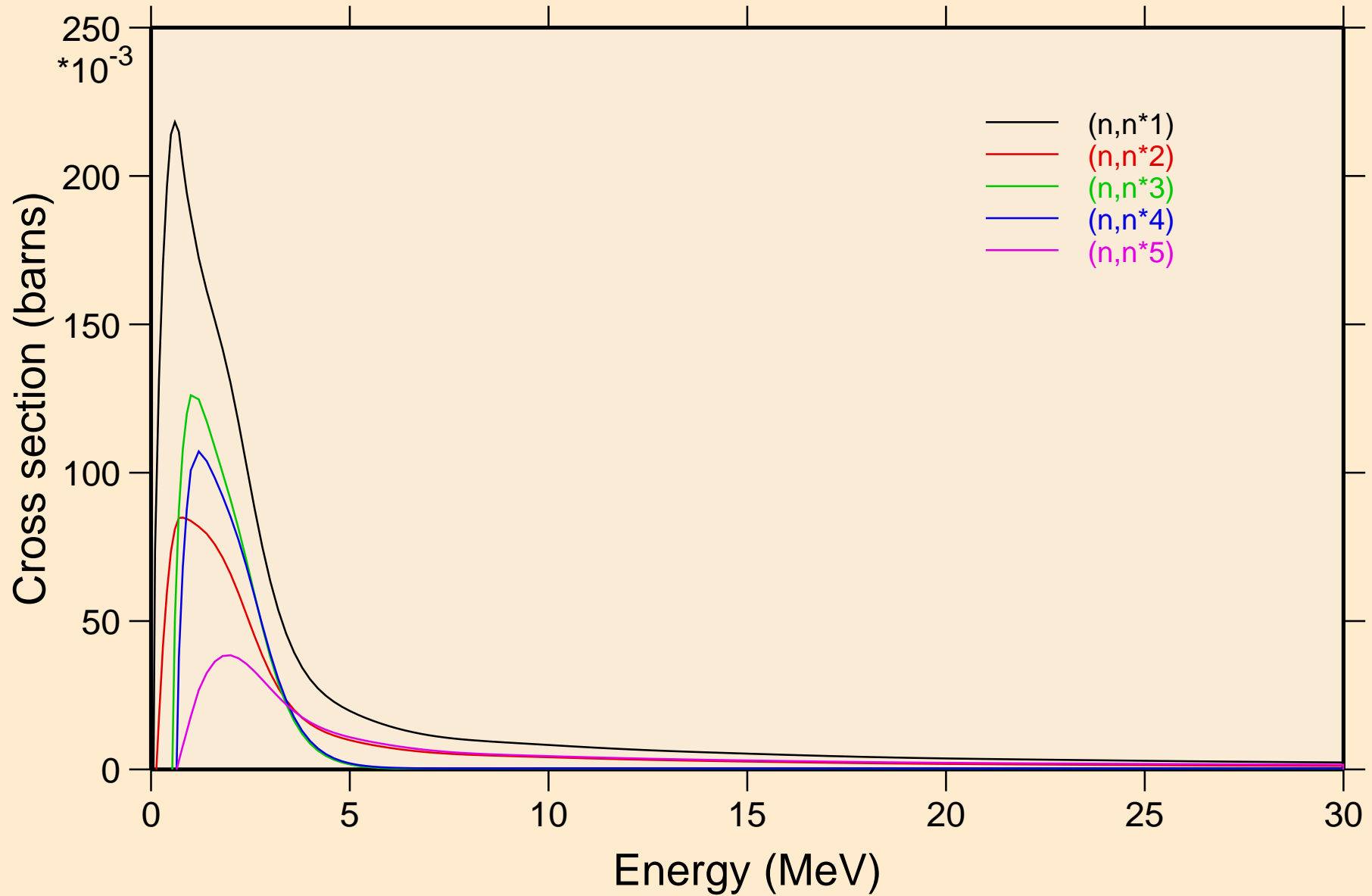

PO203 NEUTRON ACER TENDL-2023 LIBRARY; T=0.K
Inelastic levels

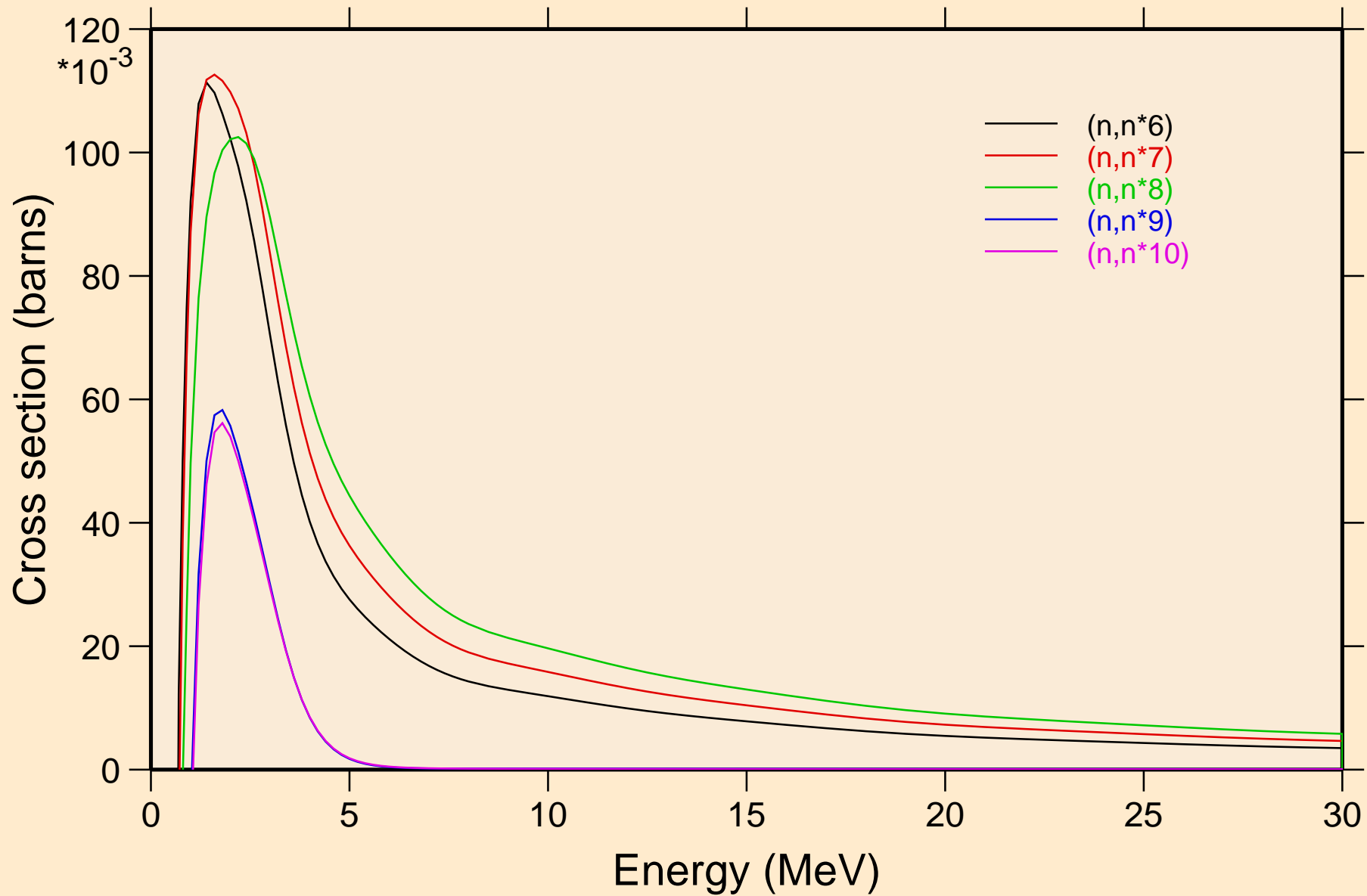

PO203 NEUTRON ACER TENDL-2023 LIBRARY; T=0.K
Inelastic levels

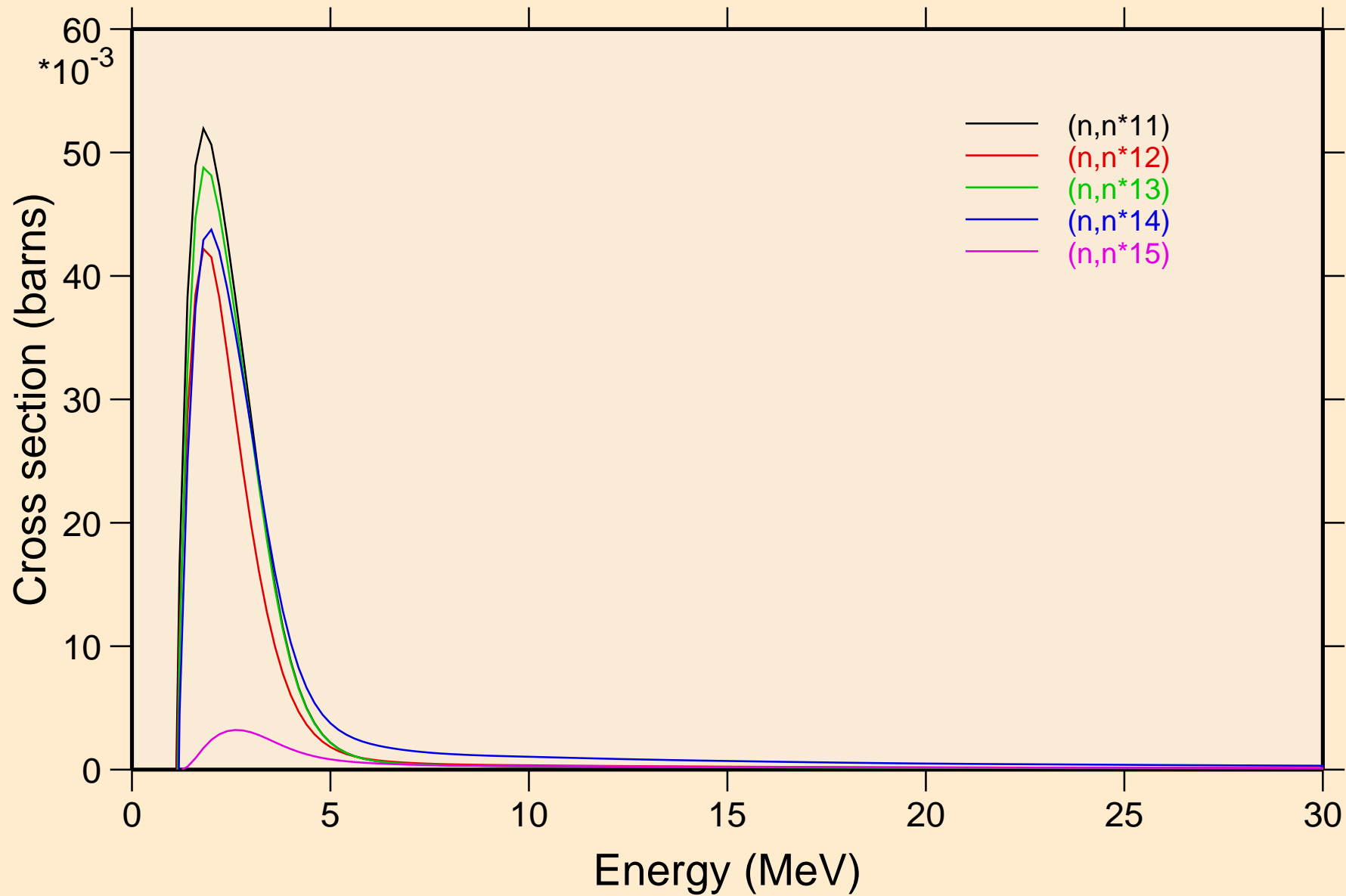

PO203 NEUTRON ACER TENDL-2023 LIBRARY; T=0.K
Inelastic levels

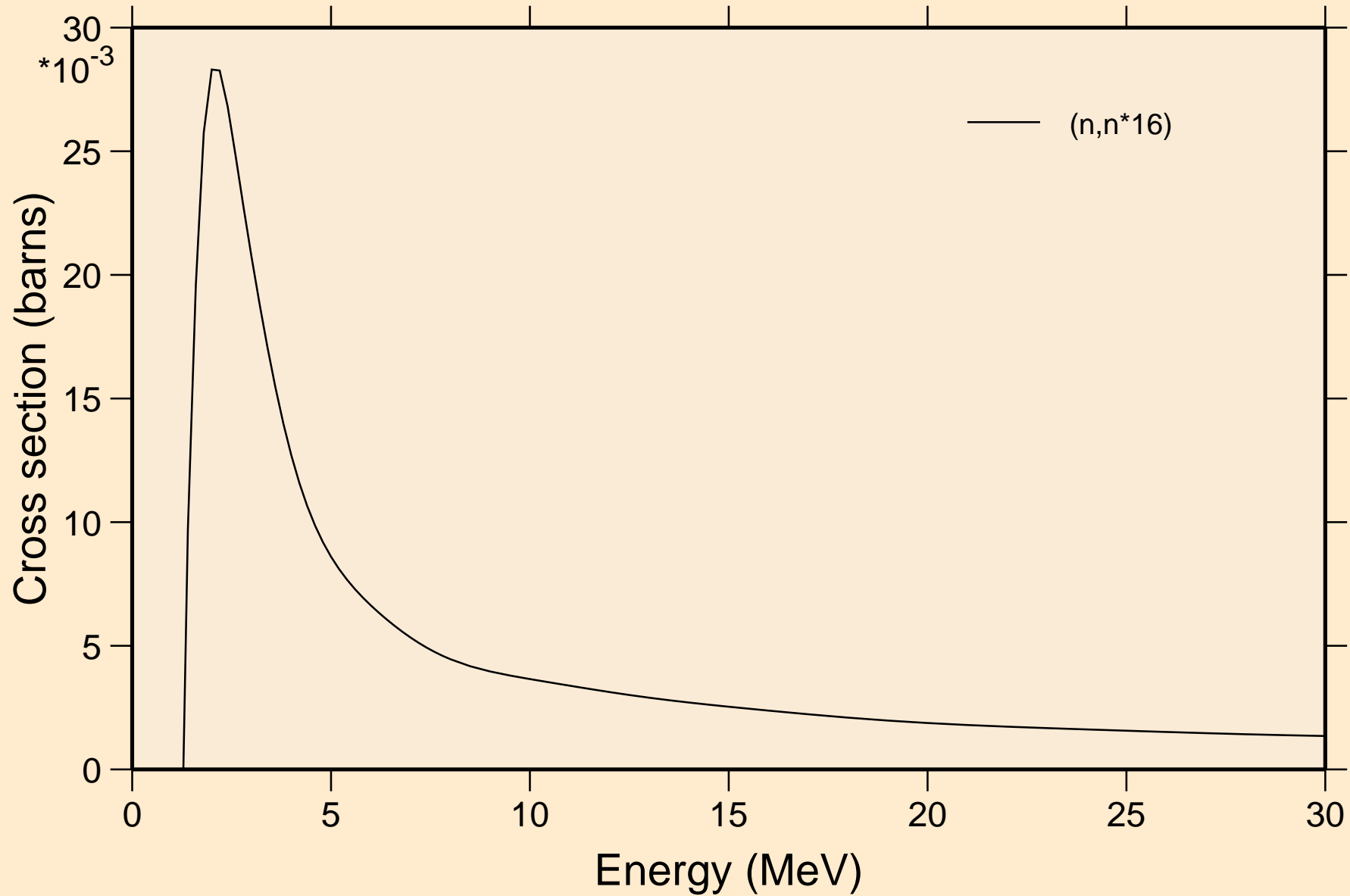

PO203 NEUTRON ACER TENDL-2023 LIBRARY; T=0.K
Threshold reactions

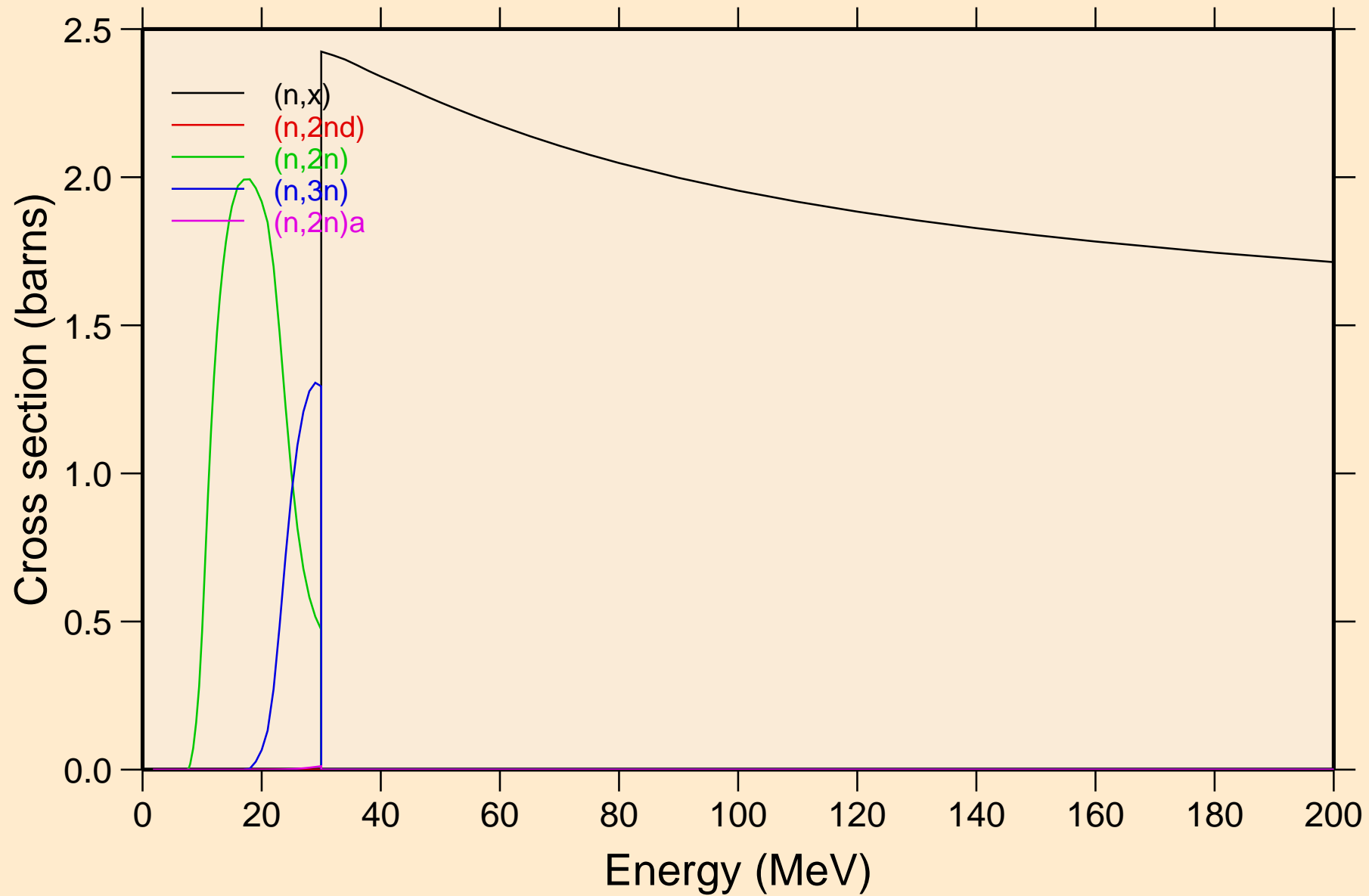

PO203 NEUTRON ACER TENDL-2023 LIBRARY; T=0.K
Threshold reactions

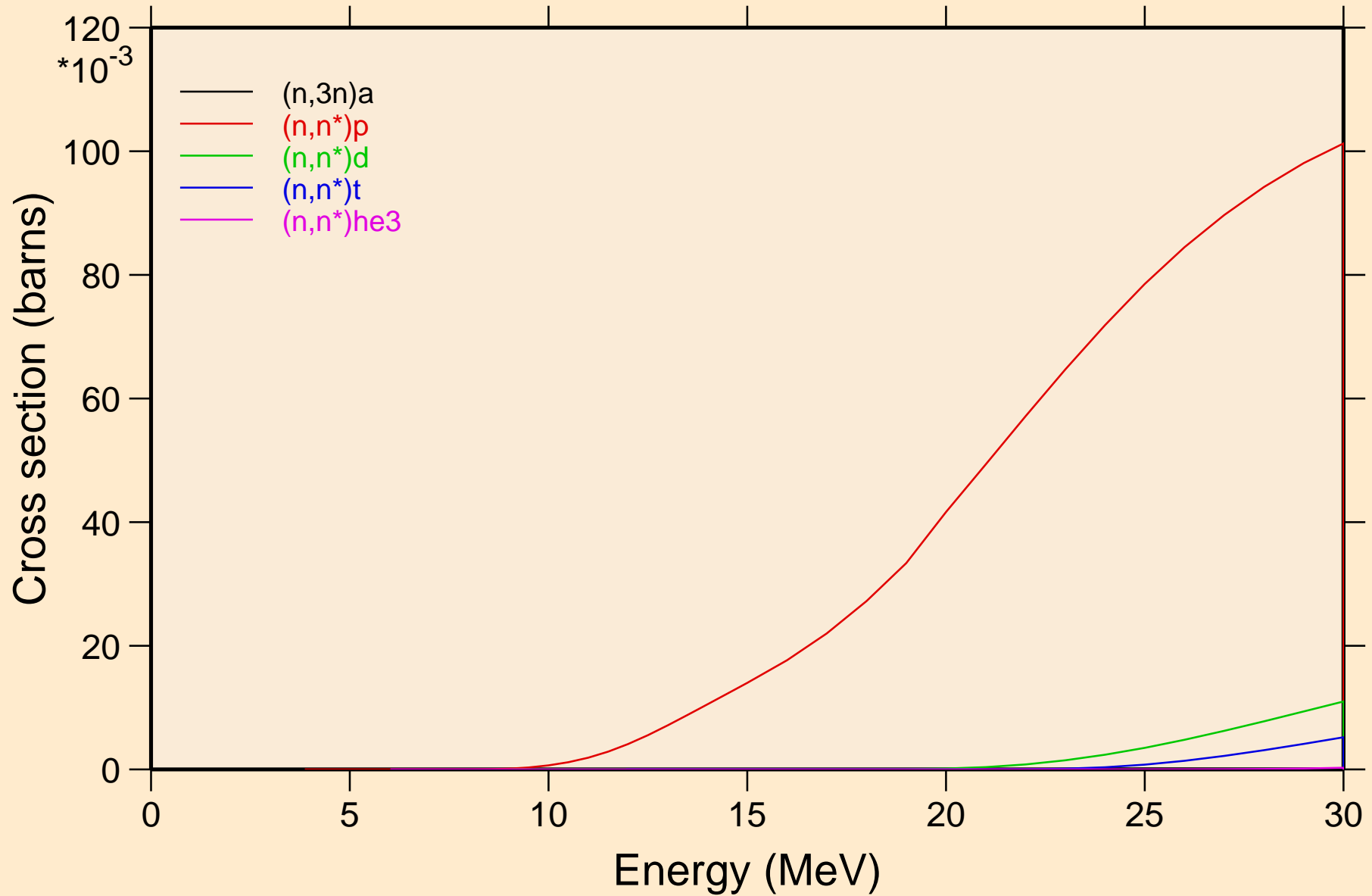

PO203 NEUTRON ACER TENDL-2023 LIBRARY; T=0.K
Threshold reactions

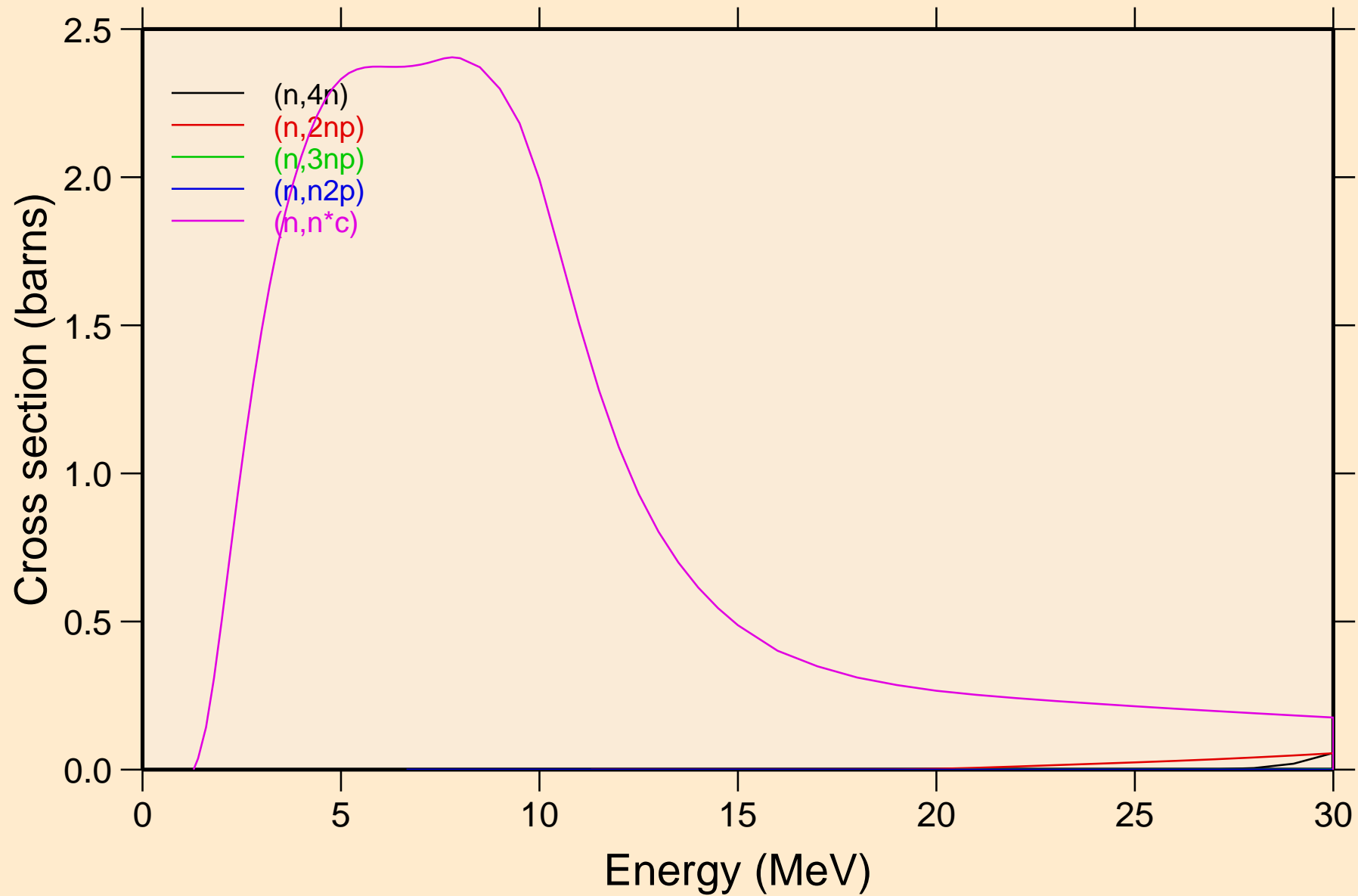

PO203 NEUTRON ACER TENDL-2023 LIBRARY; T=0.K
Threshold reactions

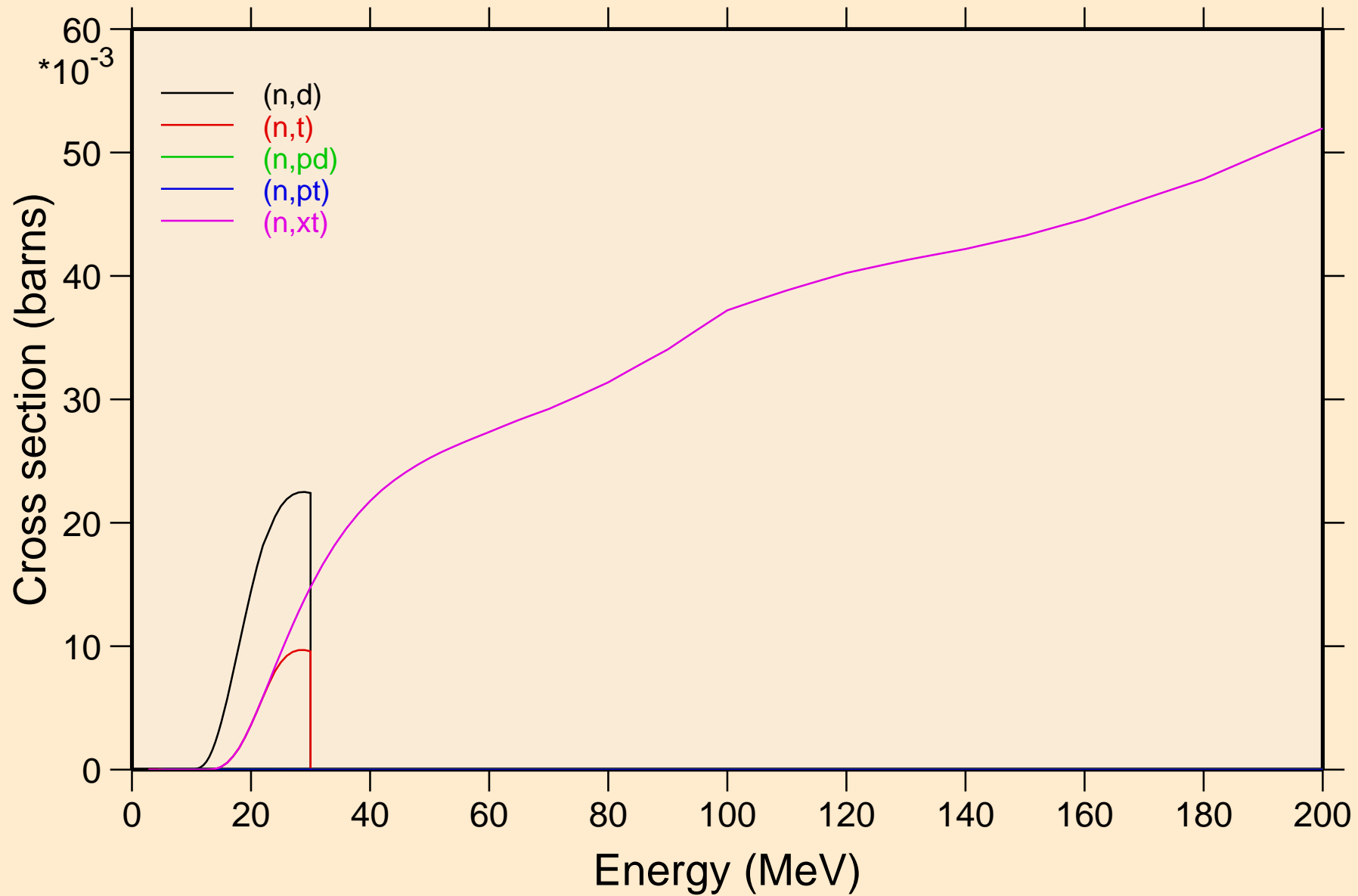

PO203 NEUTRON ACER TENDL-2023 LIBRARY; T=0.K
angular distribution for elastic

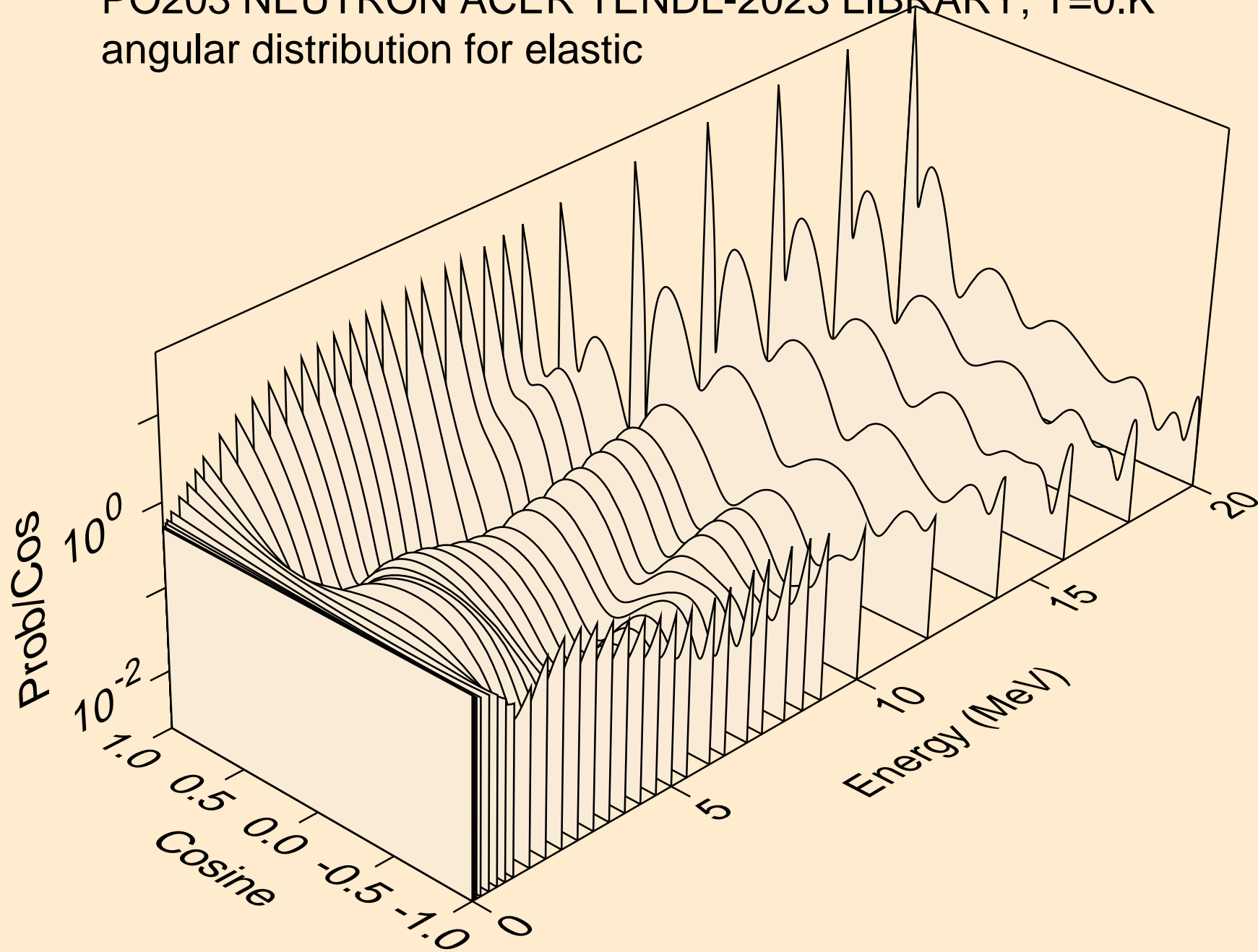

PO203 NEUTRON ACER TENDL-2023 LIBRARY; T=0.K
angular distribution for elastic

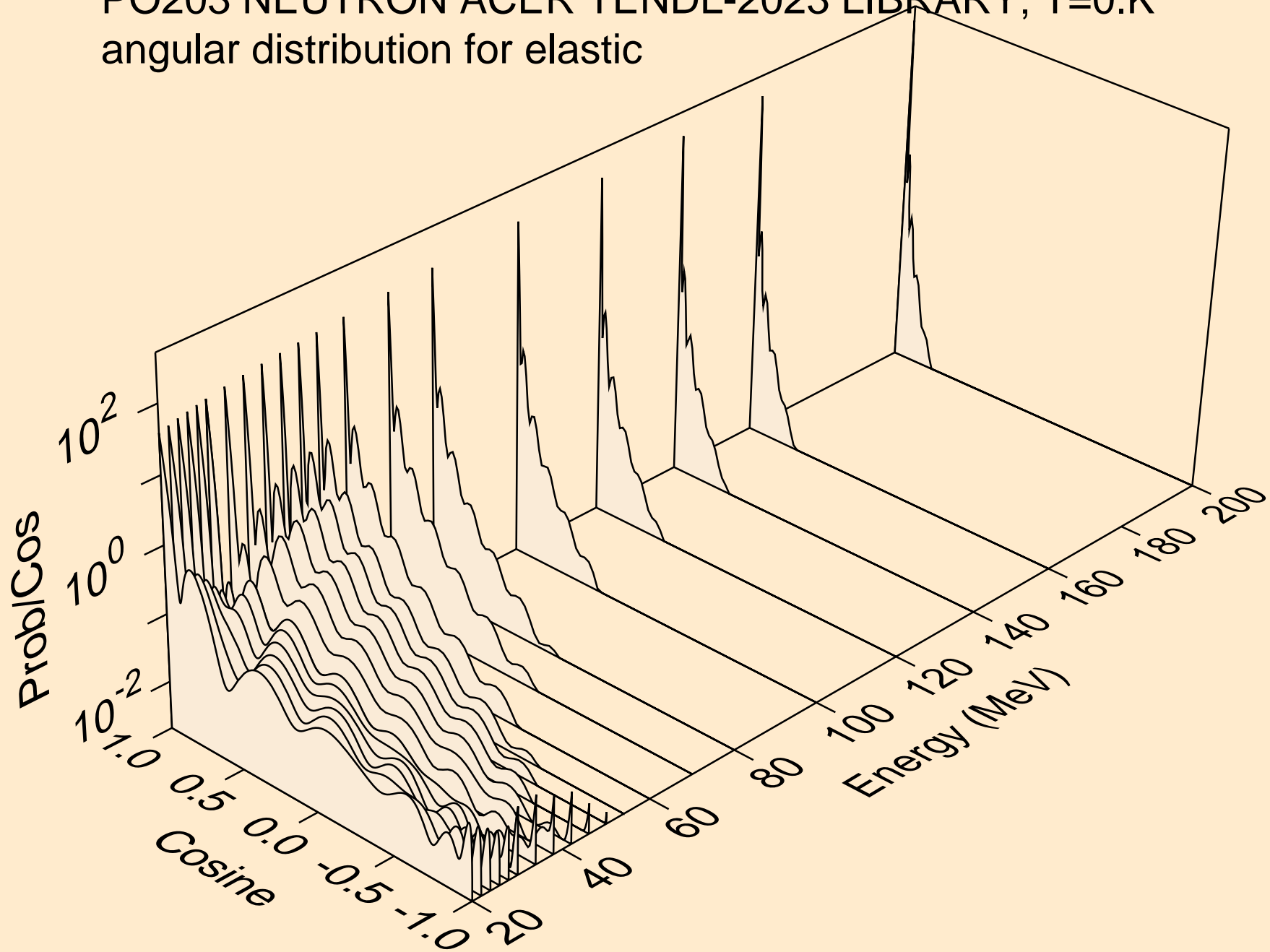

PO203 NEUTRON ACER TENDL-2023 LIBRARY; T=0.K
angular distribution for (n,n*1)

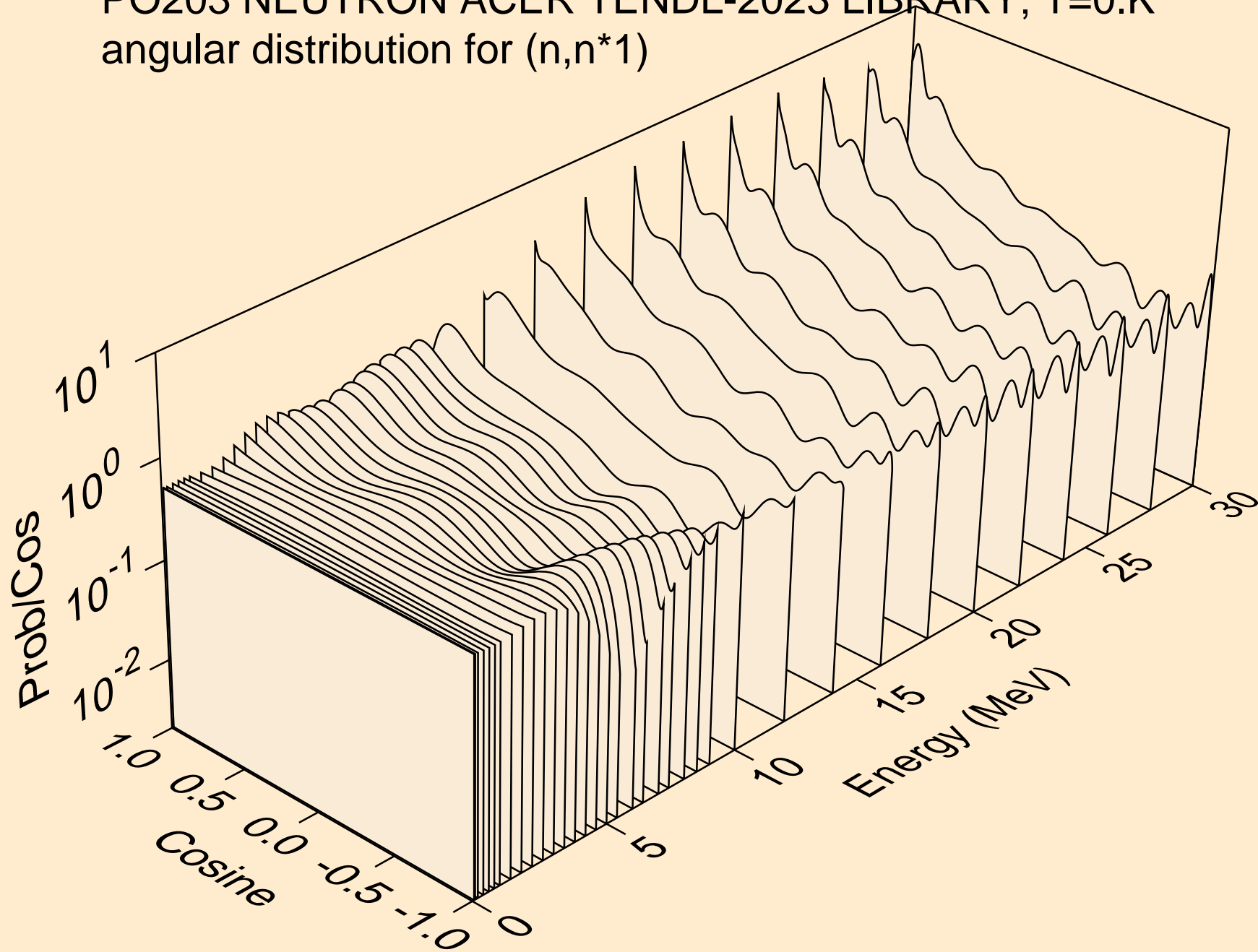

PO203 NEUTRON ACER TENDL-2023 LIBRARY; T=0.K
angular distribution for (n,n*2)

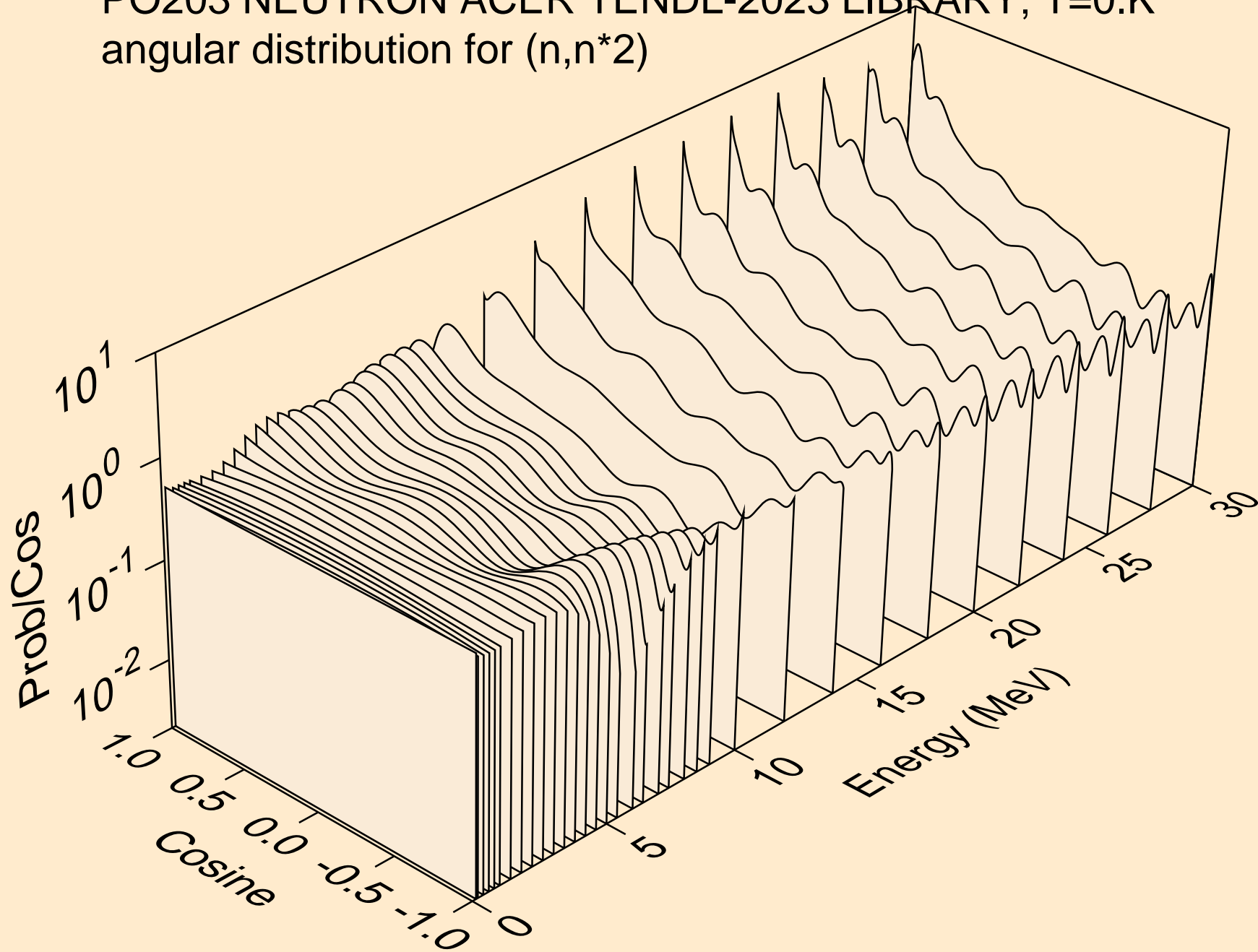

PO203 NEUTRON ACER TENDL-2023 LIBRARY; T=0.K
angular distribution for (n,n*3)

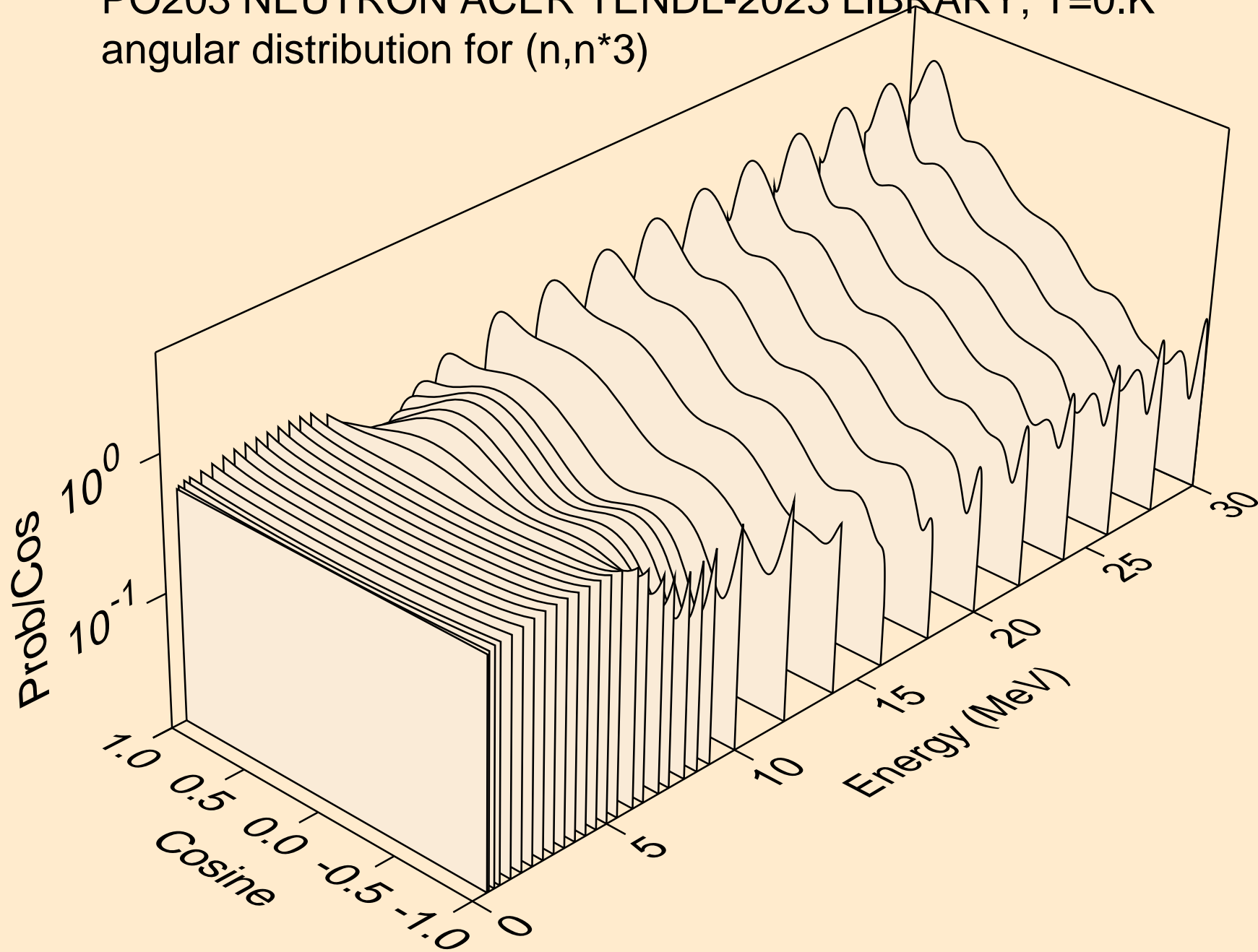

PO203 NEUTRON ACER TENDL-2023 LIBRARY; T=0.K
angular distribution for (n,n*4)

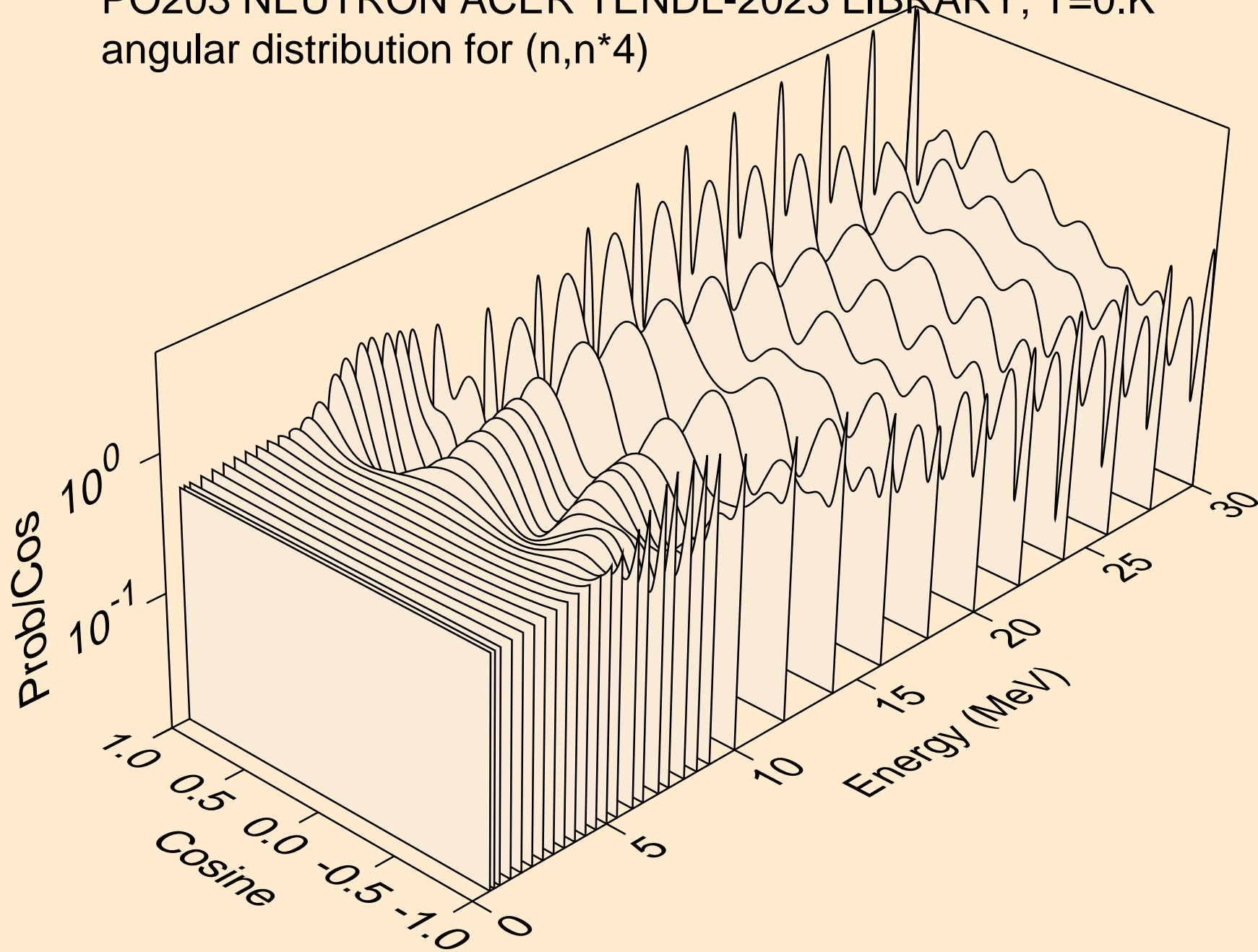

PO203 NEUTRON ACER TENDL-2023 LIBRARY; T=0.K
angular distribution for (n,n*5)

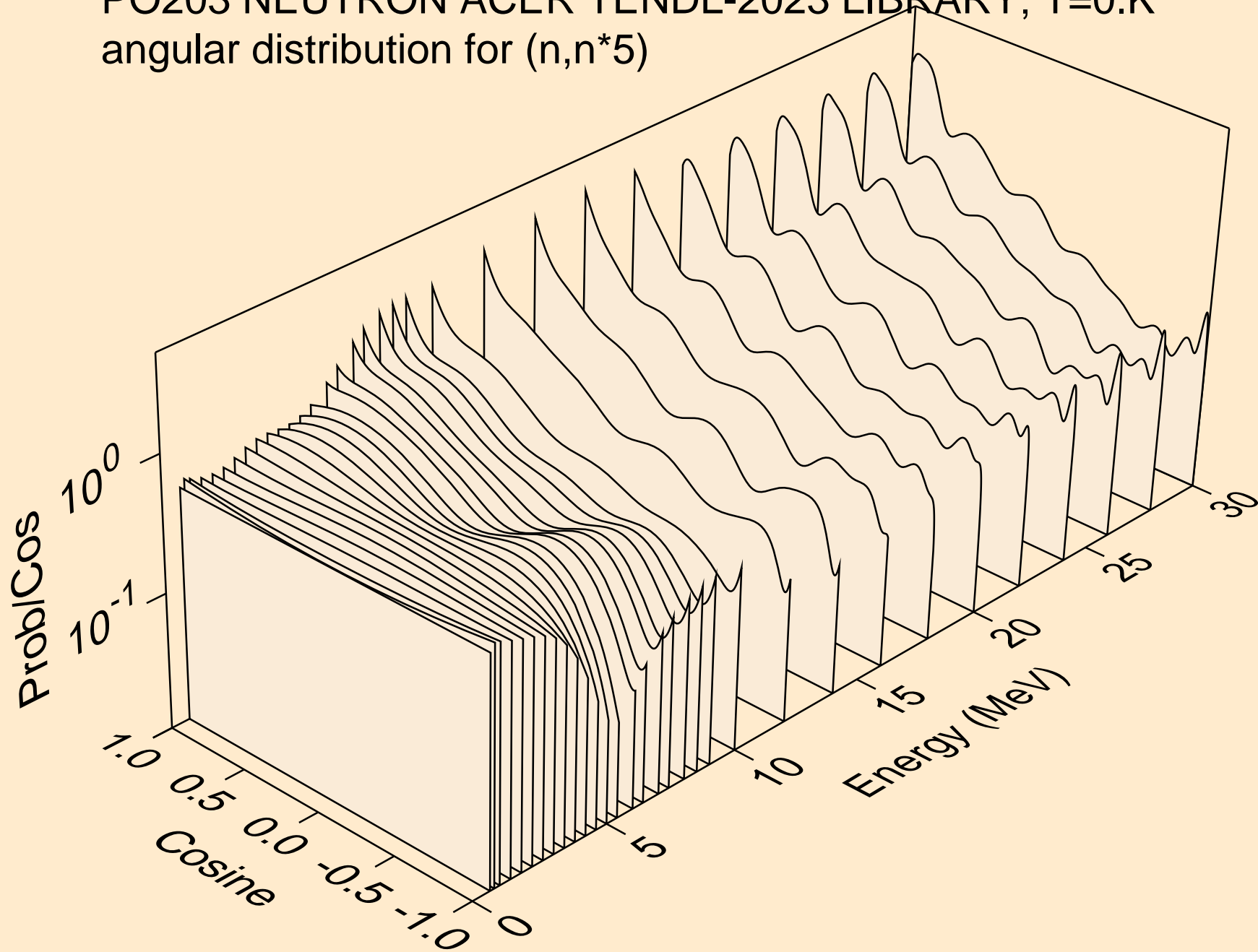

PO203 NEUTRON ACER TENDL-2023 LIBRARY; T=0.K
angular distribution for (n,n*6)

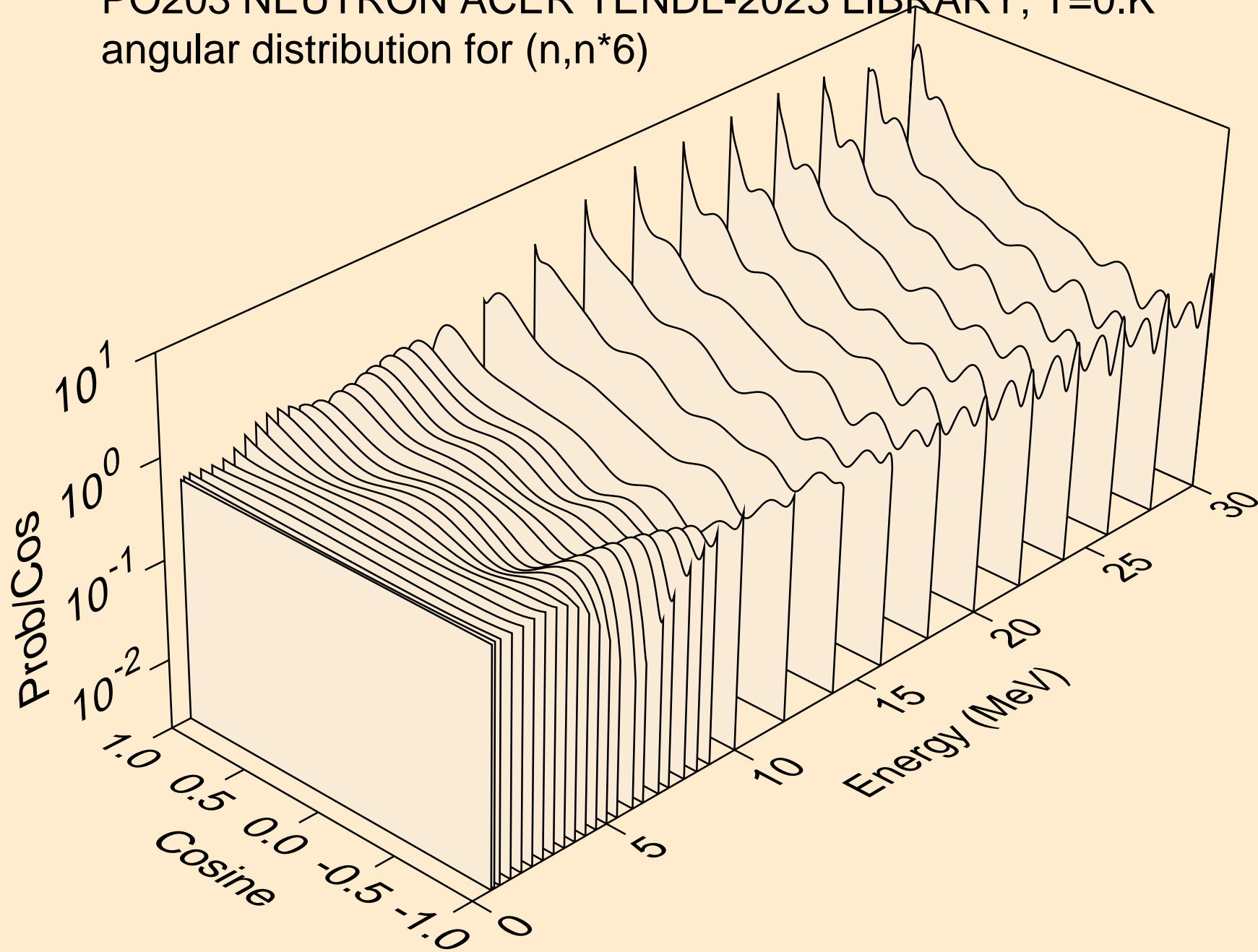

PO203 NEUTRON ACER TENDL-2023 LIBRARY; T=0.K
angular distribution for (n,n*7)

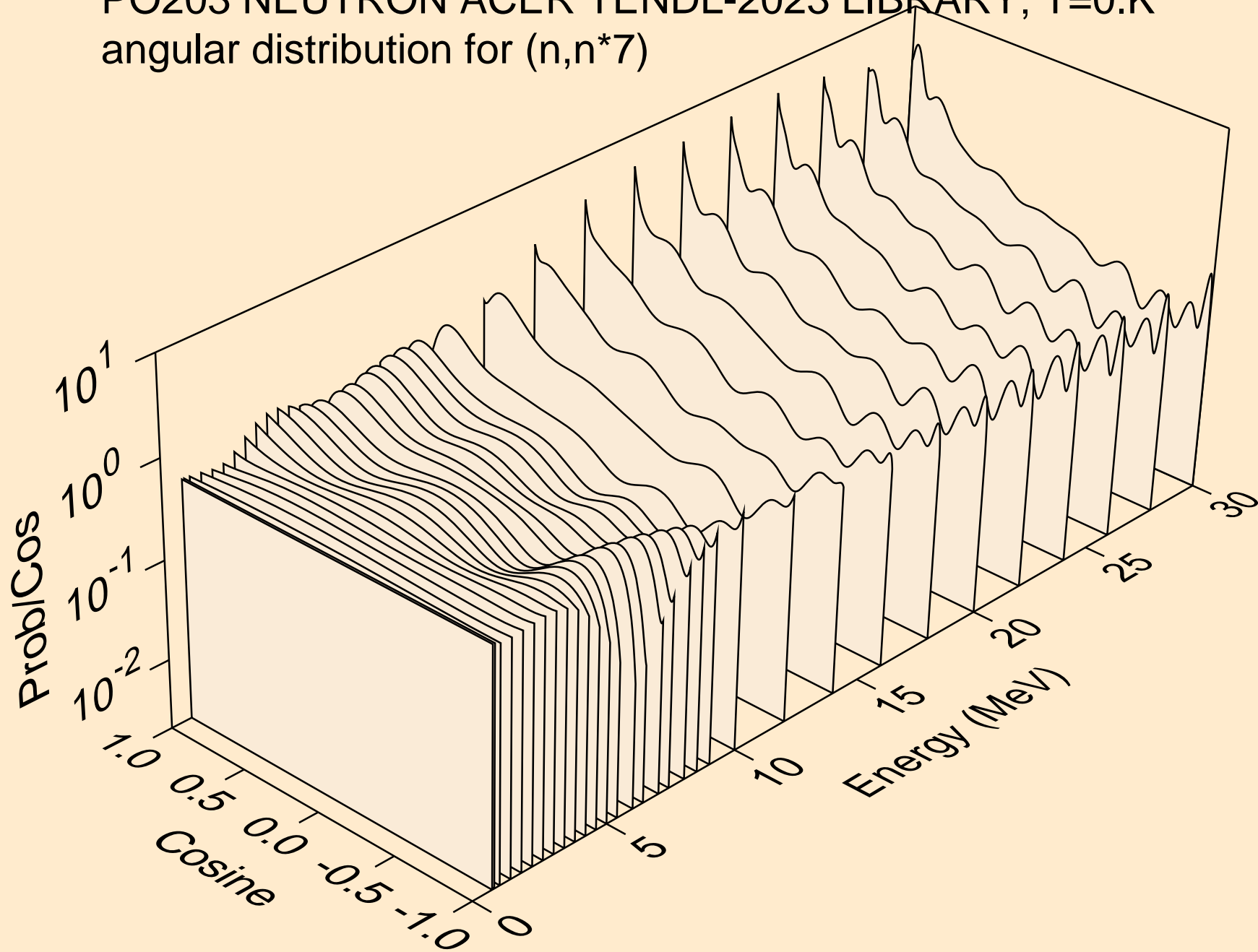

PO203 NEUTRON ACER TENDL-2023 LIBRARY; T=0.K
angular distribution for (n,n*8)

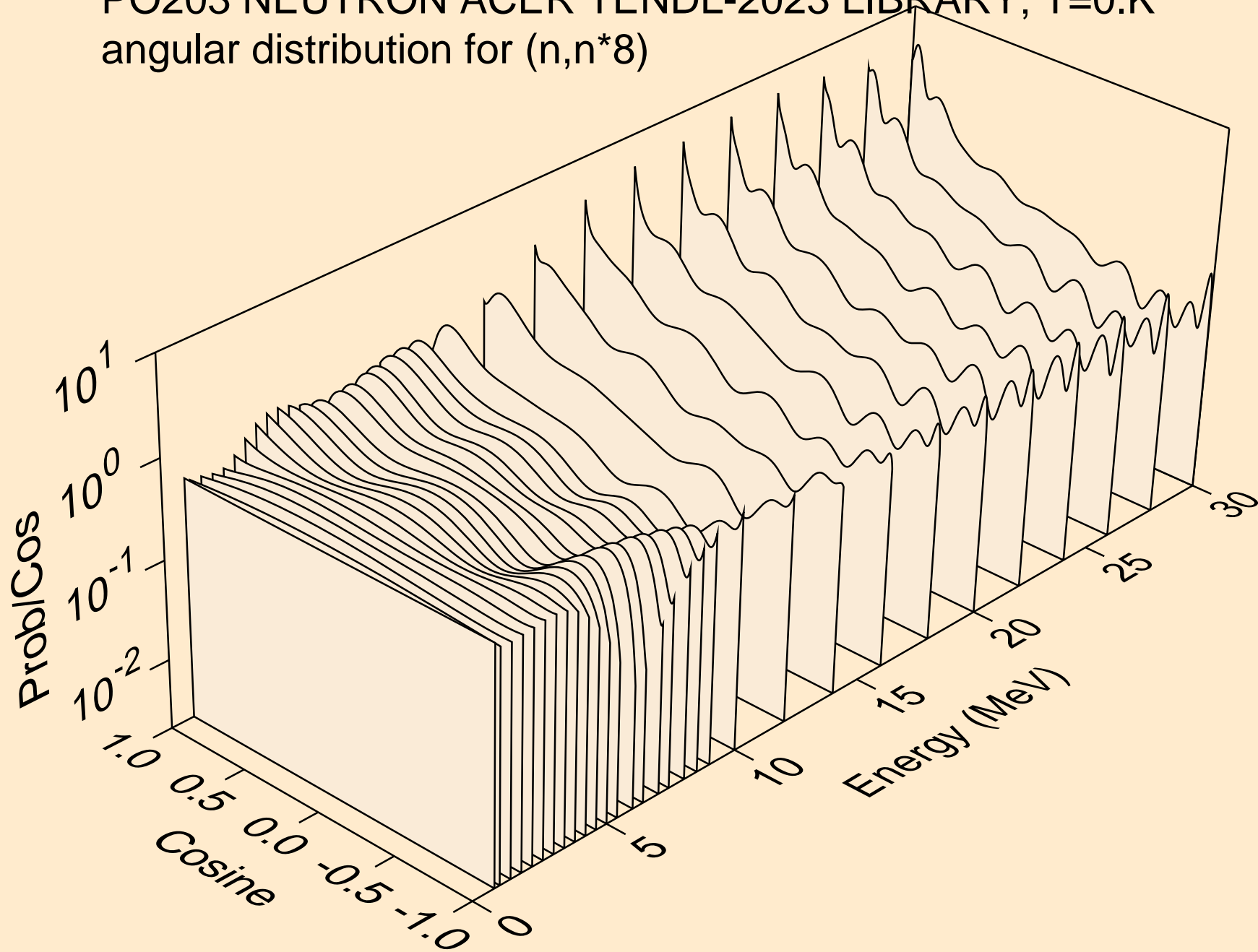

PO203 NEUTRON ACER TENDL-2023 LIBRARY; T=0.K
angular distribution for (n,n*9)

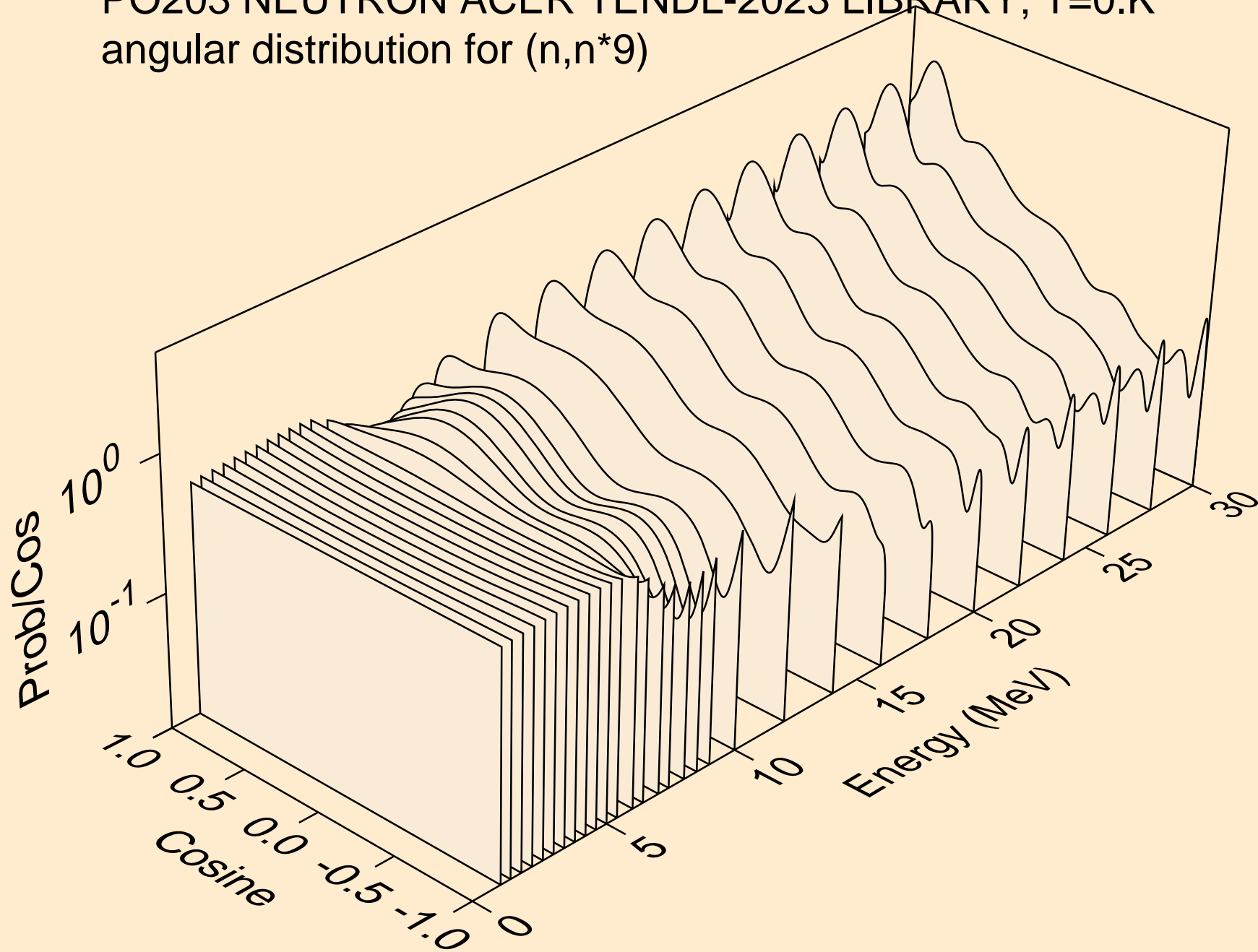

PO203 NEUTRON ACER TENDL-2023 LIBRARY; T=0.K
angular distribution for (n,n*10)

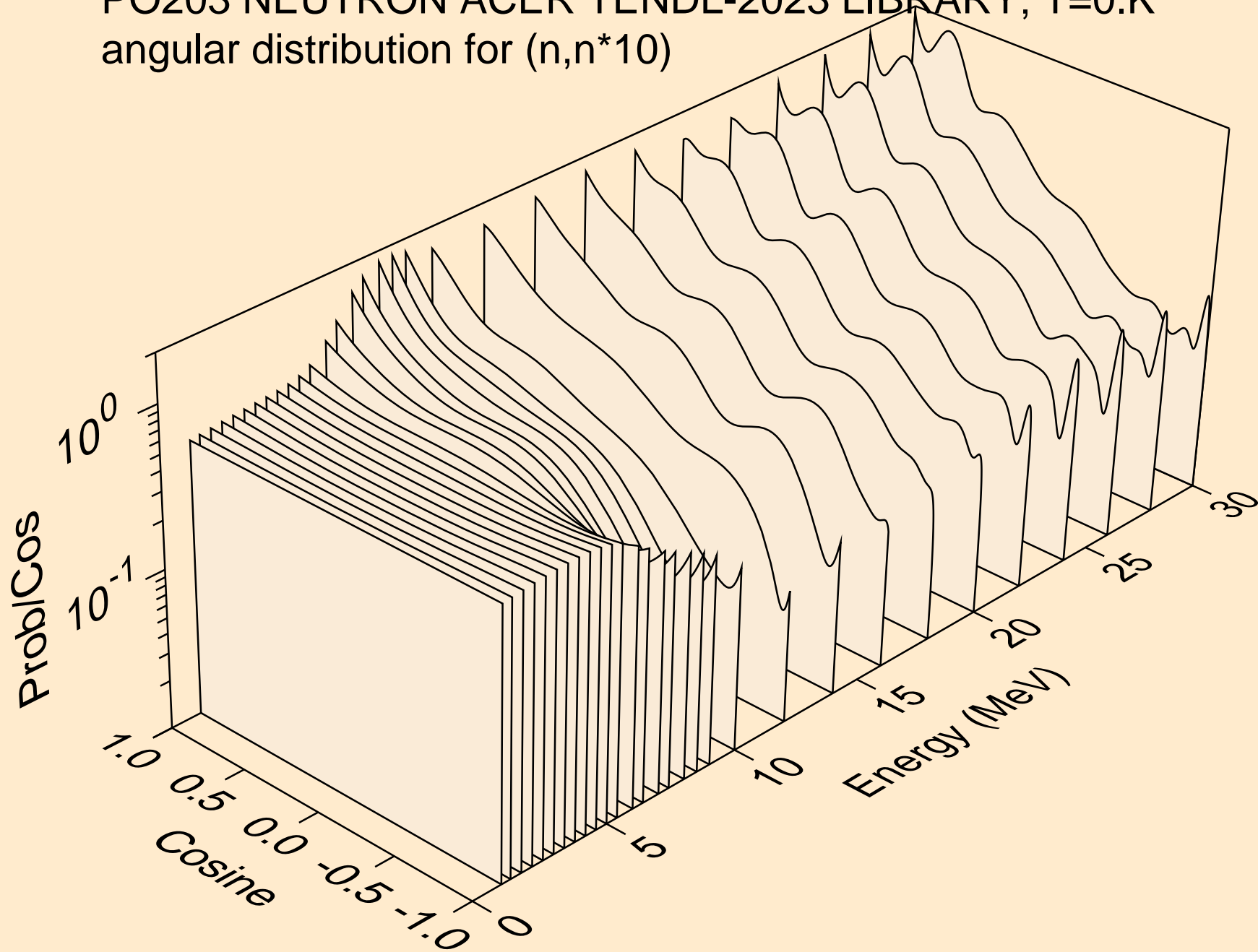

PO203 NEUTRON ACER TENDL-2023 LIBRARY; T=0.K
angular distribution for (n,n*11)

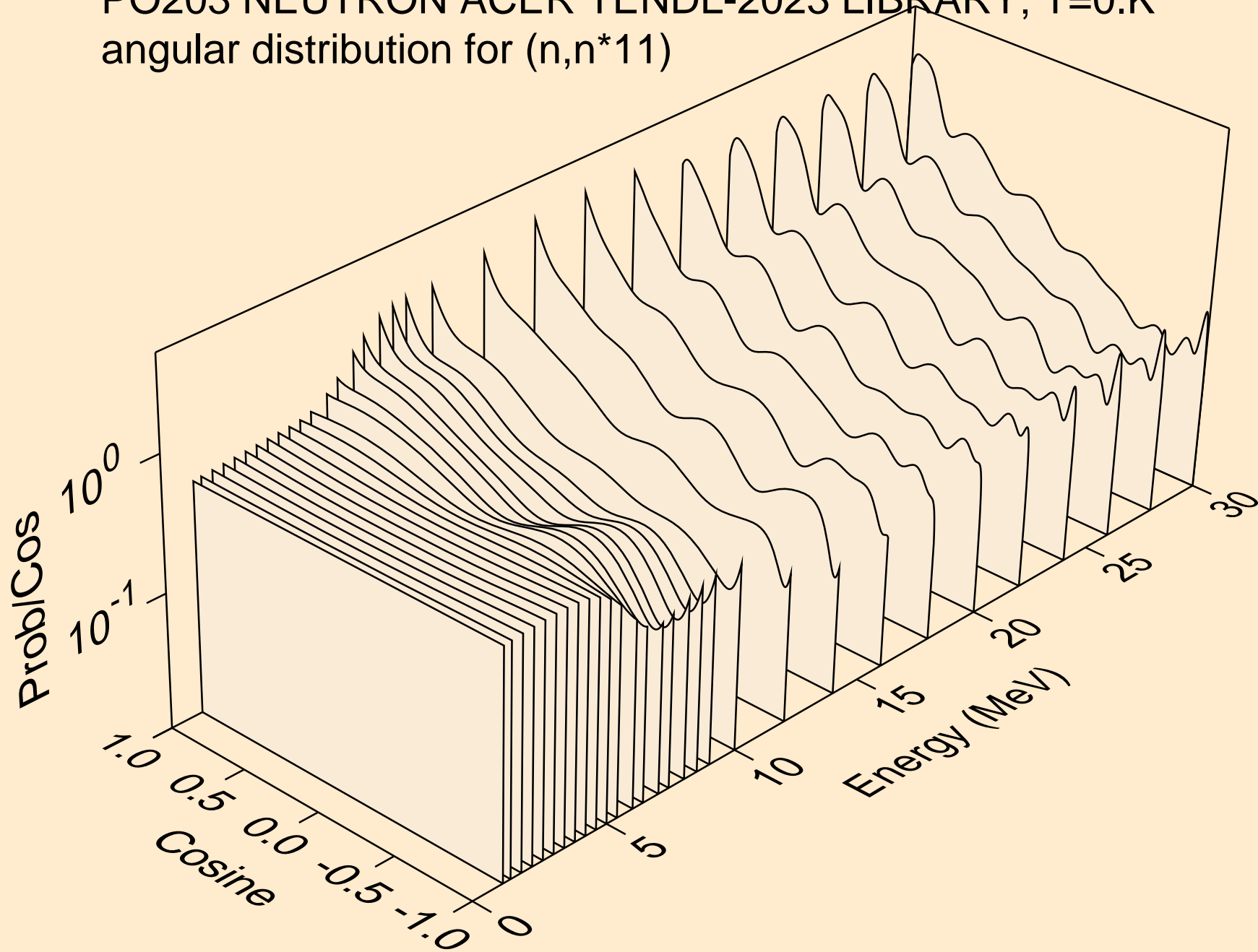

PO203 NEUTRON ACER TENDL-2023 LIBRARY; T=0.K
angular distribution for (n,n*12)

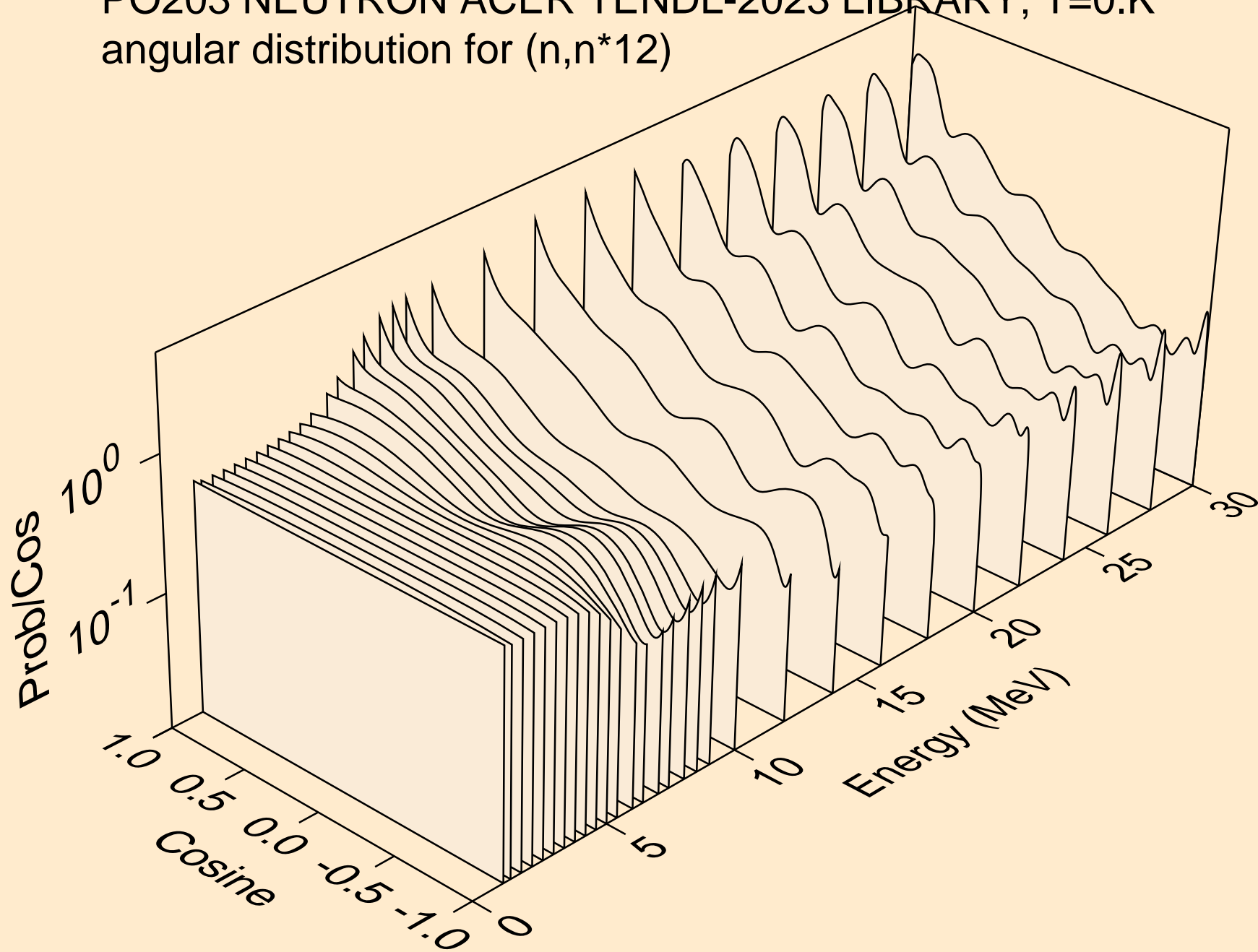

PO203 NEUTRON ACER TENDL-2023 LIBRARY; T=0.K
angular distribution for (n,n*13)

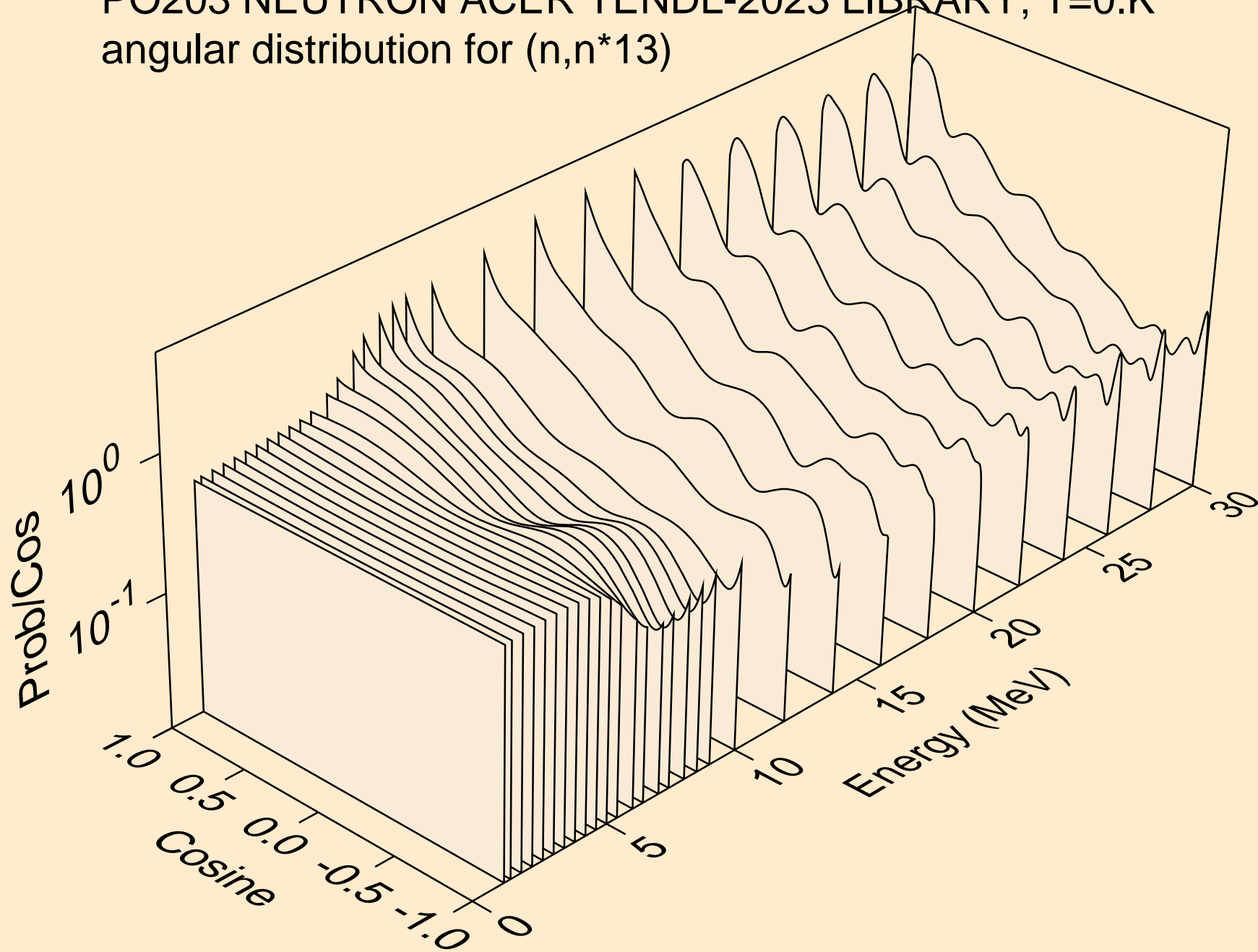

PO203 NEUTRON ACER TENDL-2023 LIBRARY; T=0.K
angular distribution for (n,n*14)

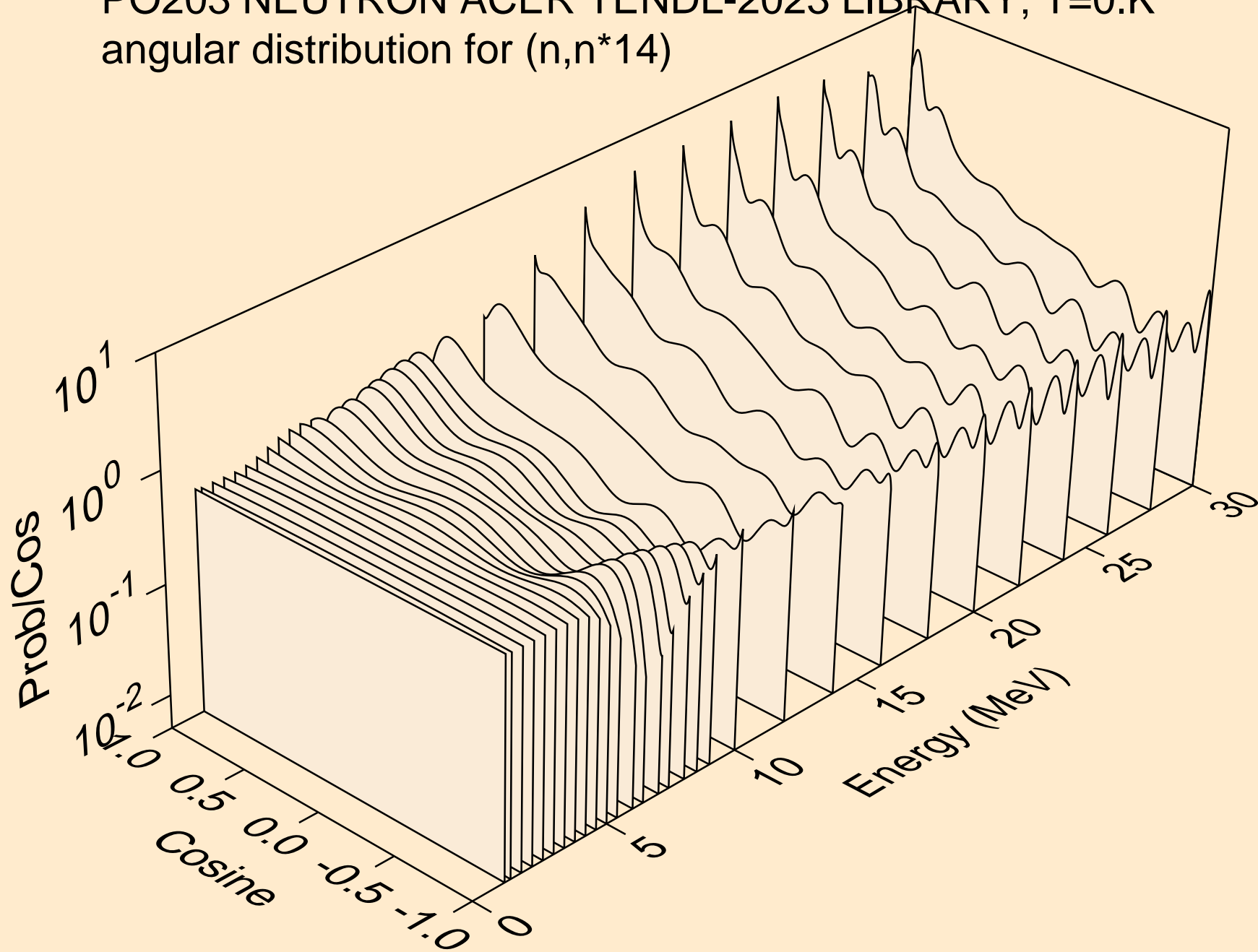

PO203 NEUTRON ACER TENDL-2023 LIBRARY; T=0.K
angular distribution for (n,n*15)

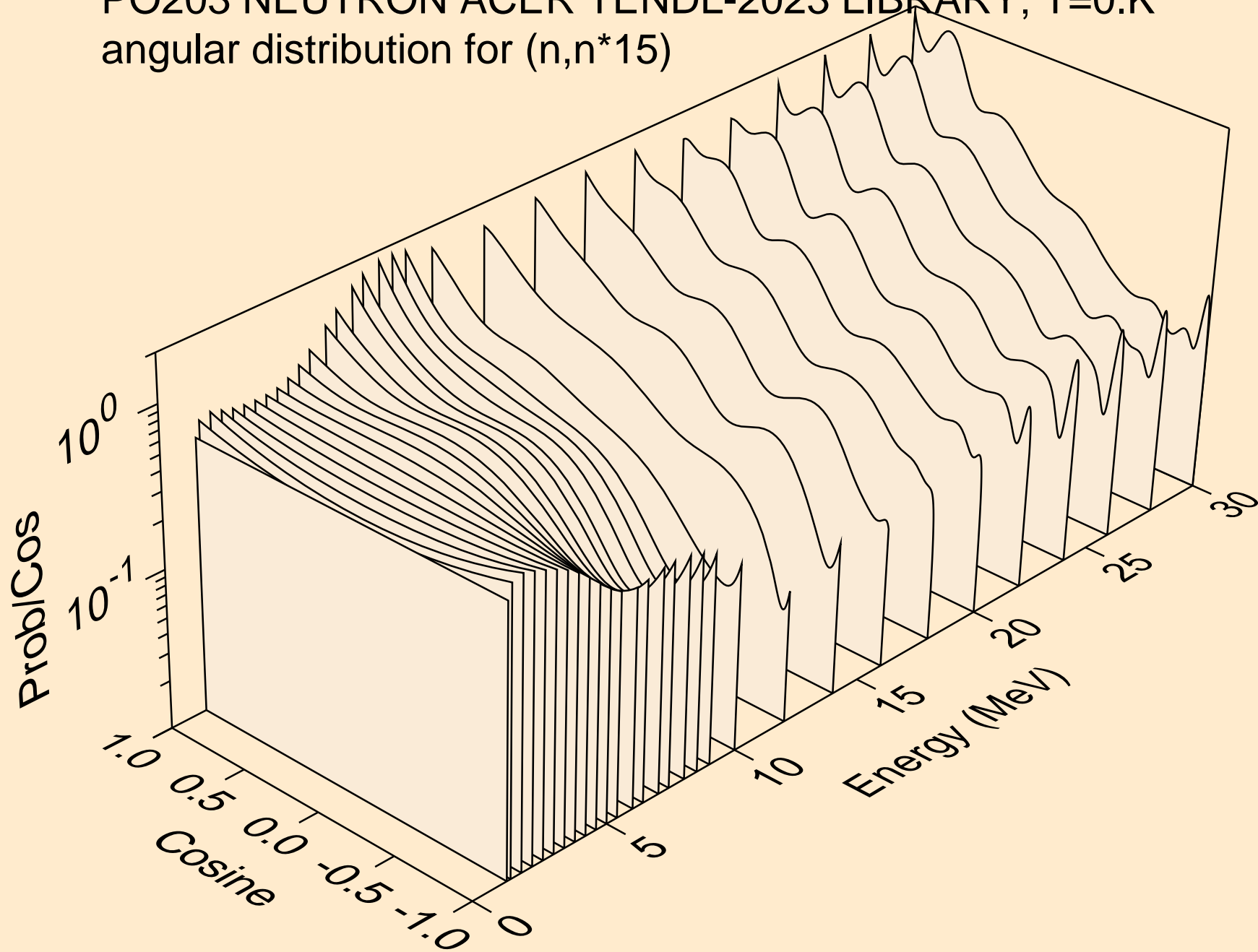

PO203 NEUTRON ACER TENDL-2023 LIBRARY; T=0.K
angular distribution for (n,n*16)

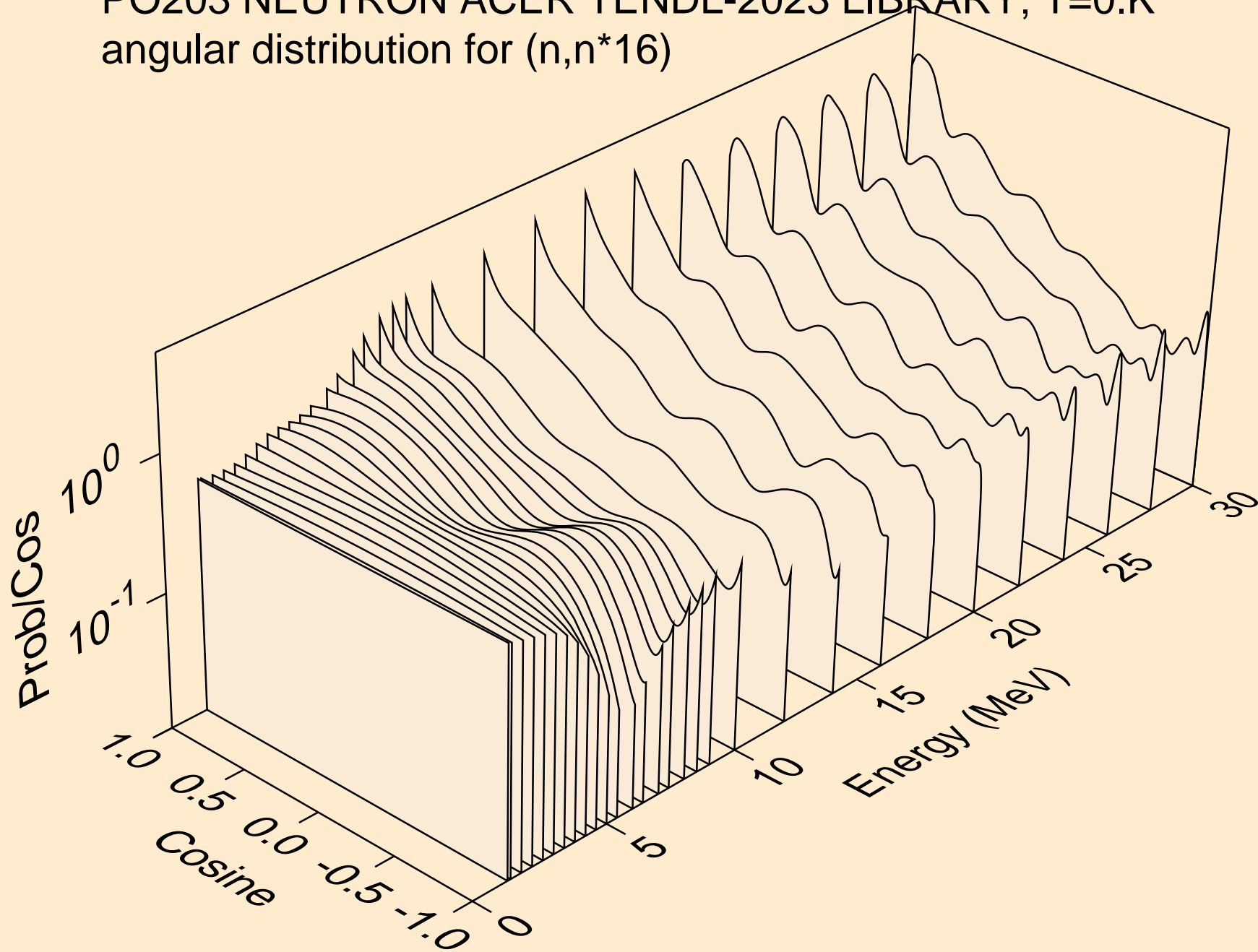

PO203 NEUTRON ACER TENDL-2023 LIBRARY; T=0.K
Neutron emission for (n,x)

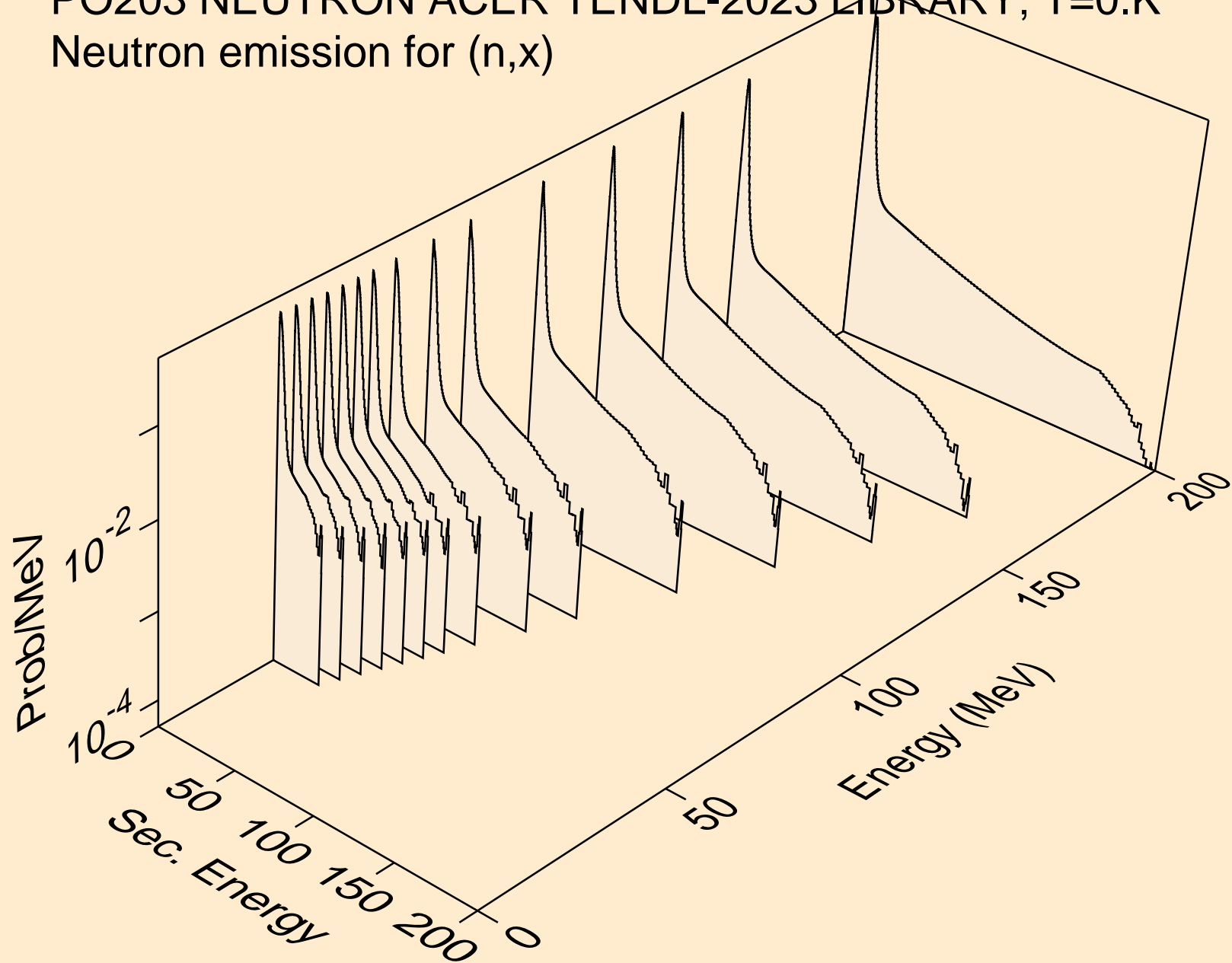

PO203 NEUTRON ACER TENDL-2023 LIBRARY; T=0.K
Neutron emission for (n,2nd)

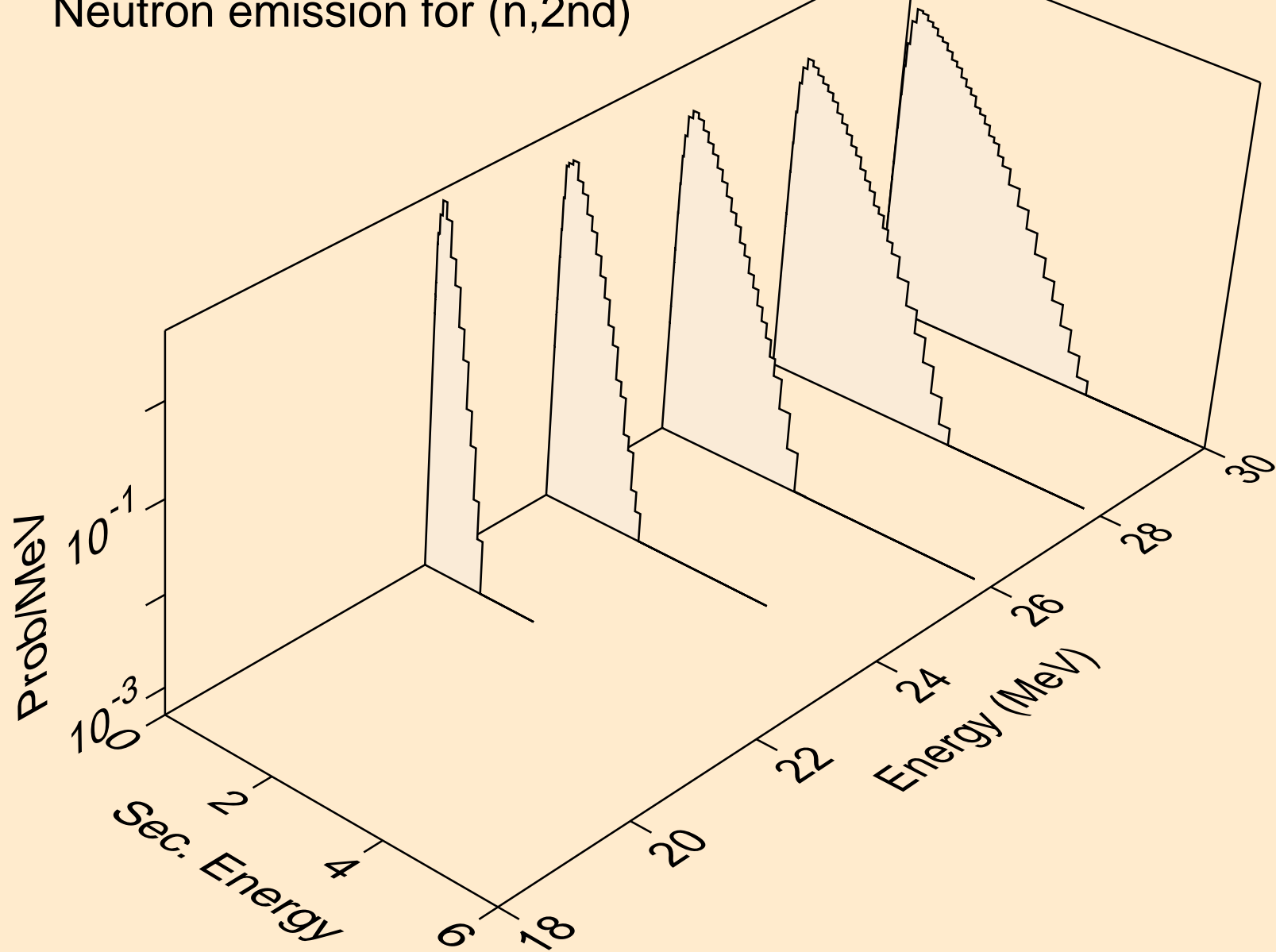

PO203 NEUTRON ACER TENDL-2023 LIBRARY; T=0.K
Neutron emission for (n,2n)

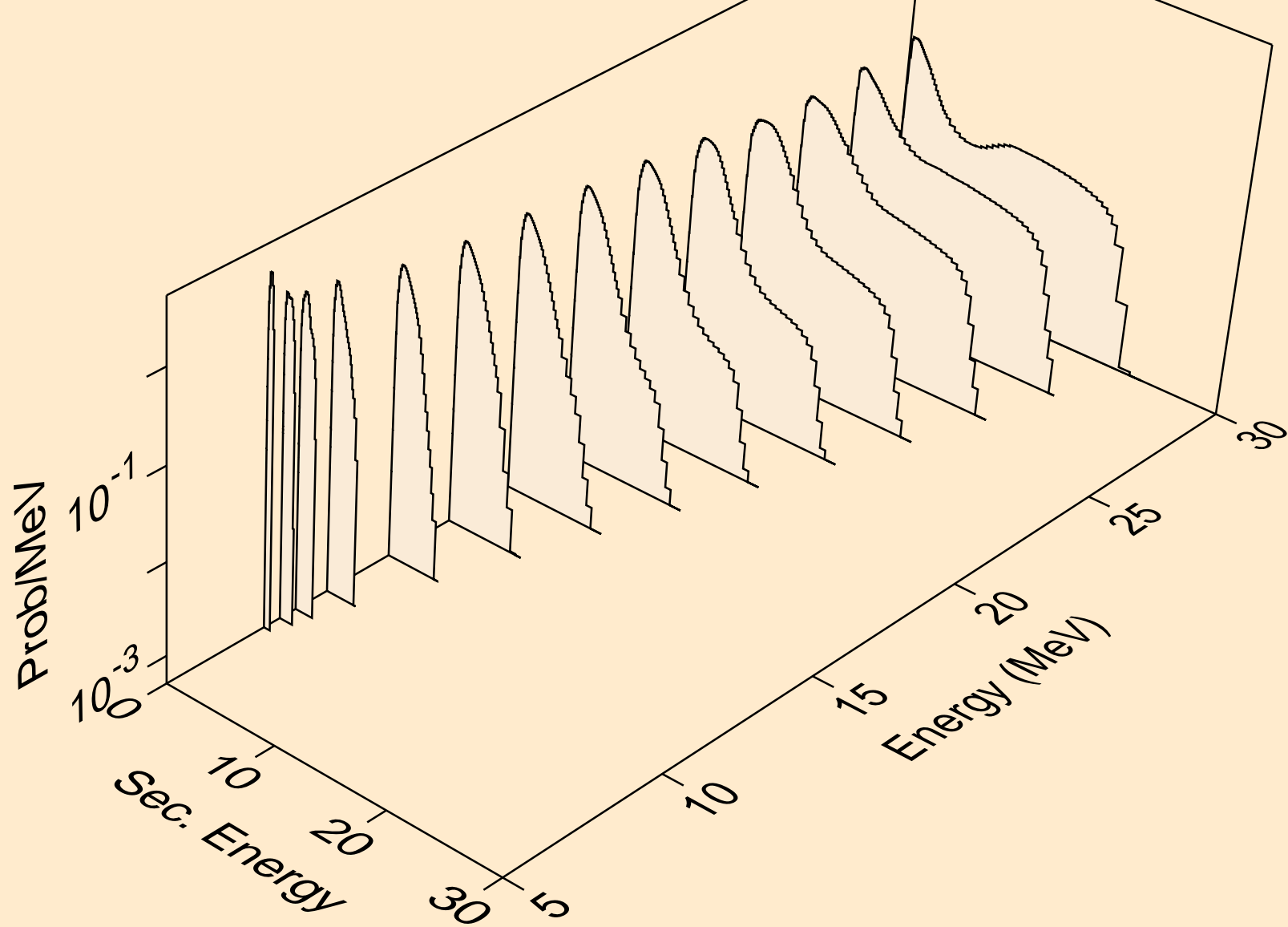

PO203 NEUTRON ACER TENDL-2023 LIBRARY; T=0.K
Neutron emission for (n,3n)

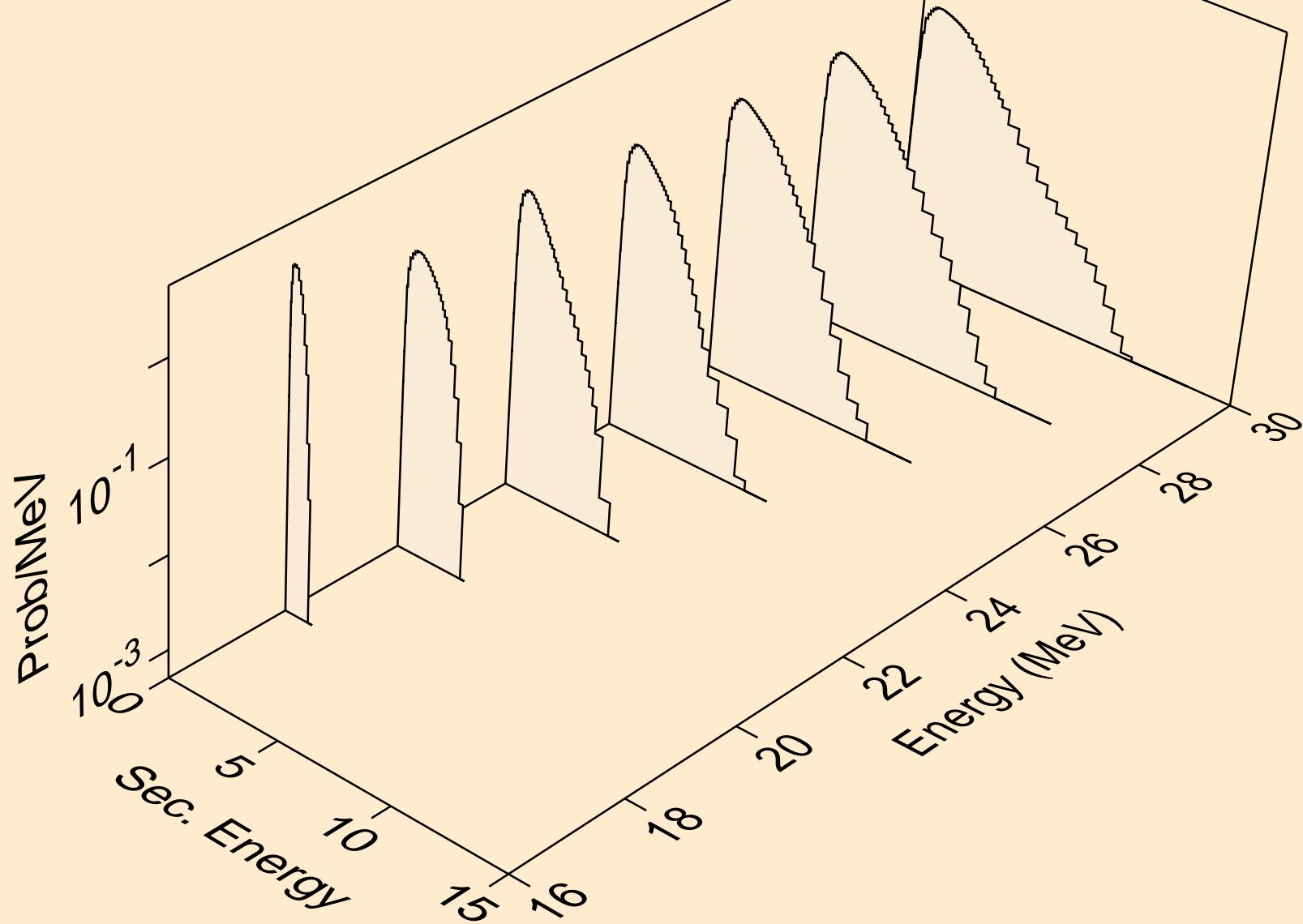

PO203 NEUTRON ACER TENDL-2023 LIBRARY; T=0.K
Neutron emission for (n,n*)a

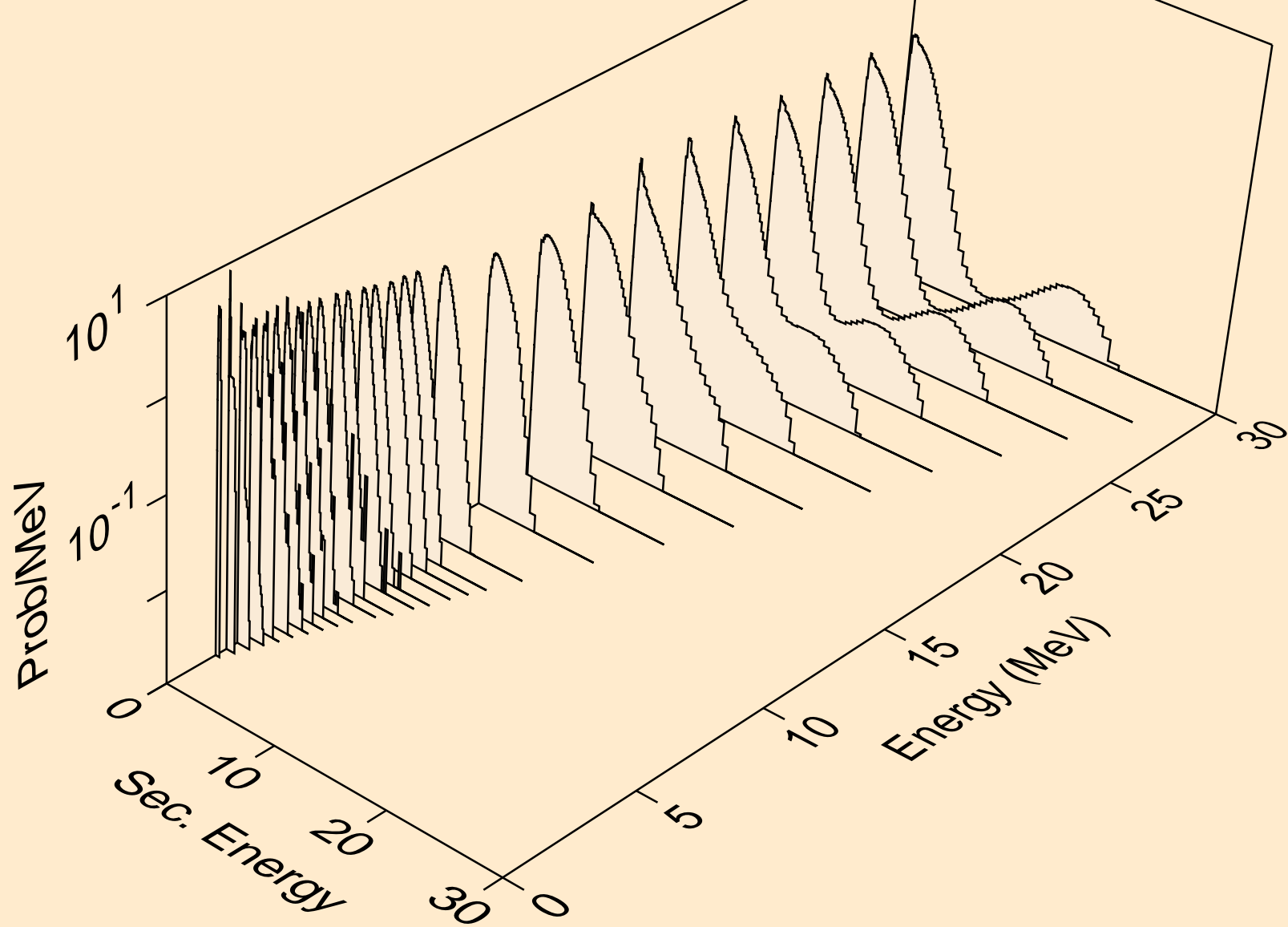

PO203 NEUTRON ACER TENDL-2023 LIBRARY; T=0.K
Neutron emission for (n,2n)a

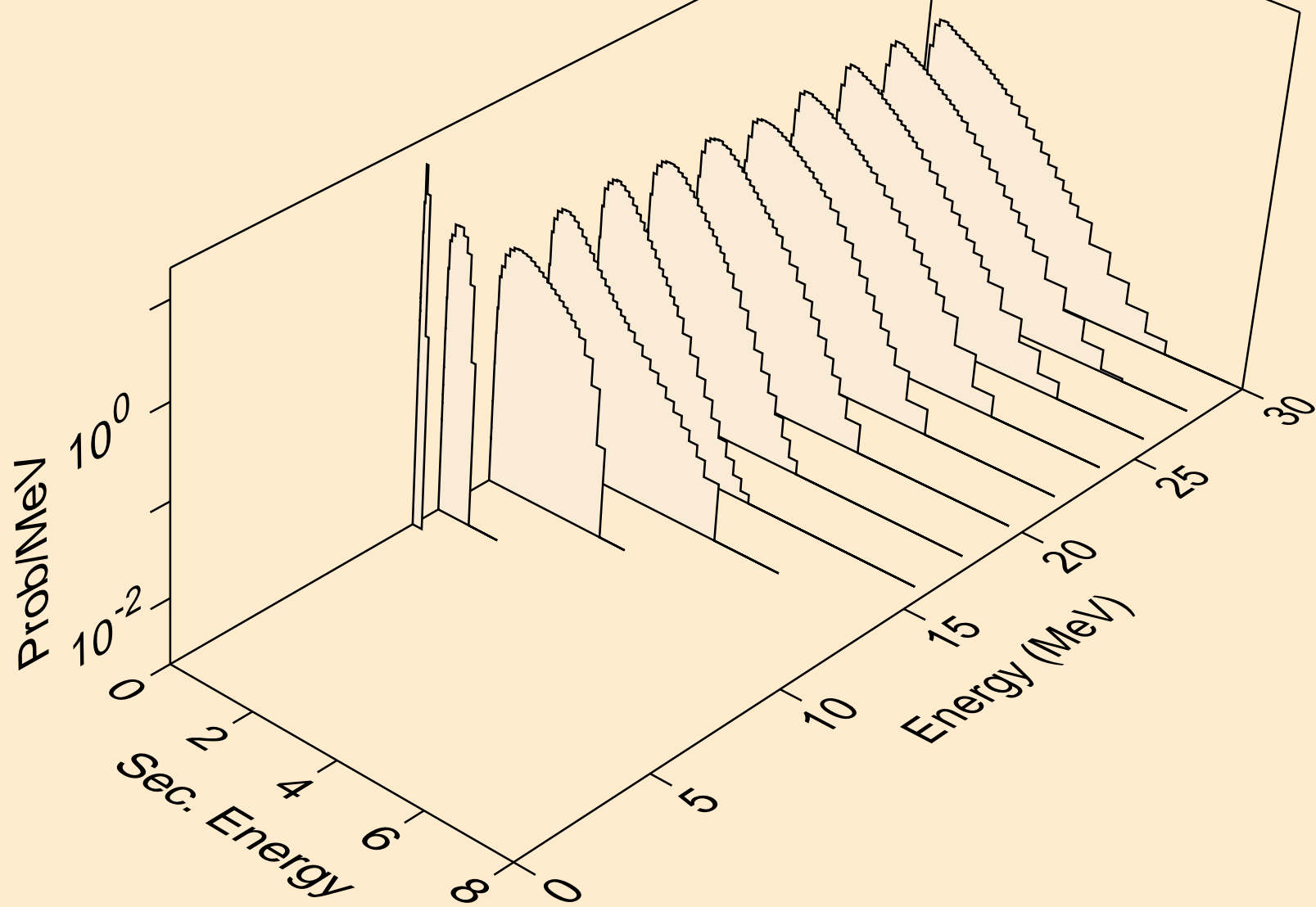

PO203 NEUTRON ACER TENDL-2023 LIBRARY; T=0.K
Neutron emission for (n,3n)a

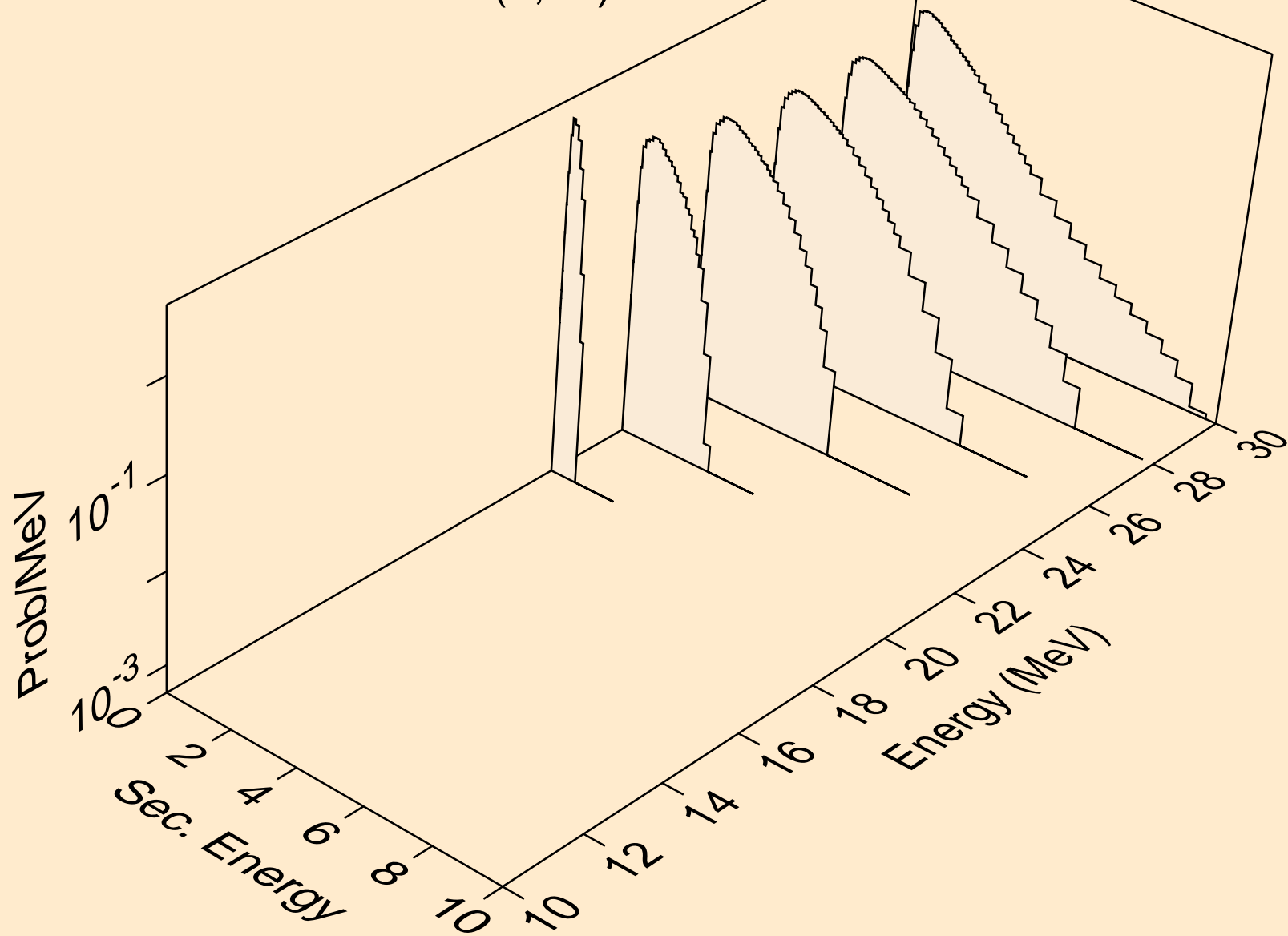

PO203 NEUTRON ACER TENDL-2023 LIBRARY; T=0.K
Neutron emission for (n,n*)p

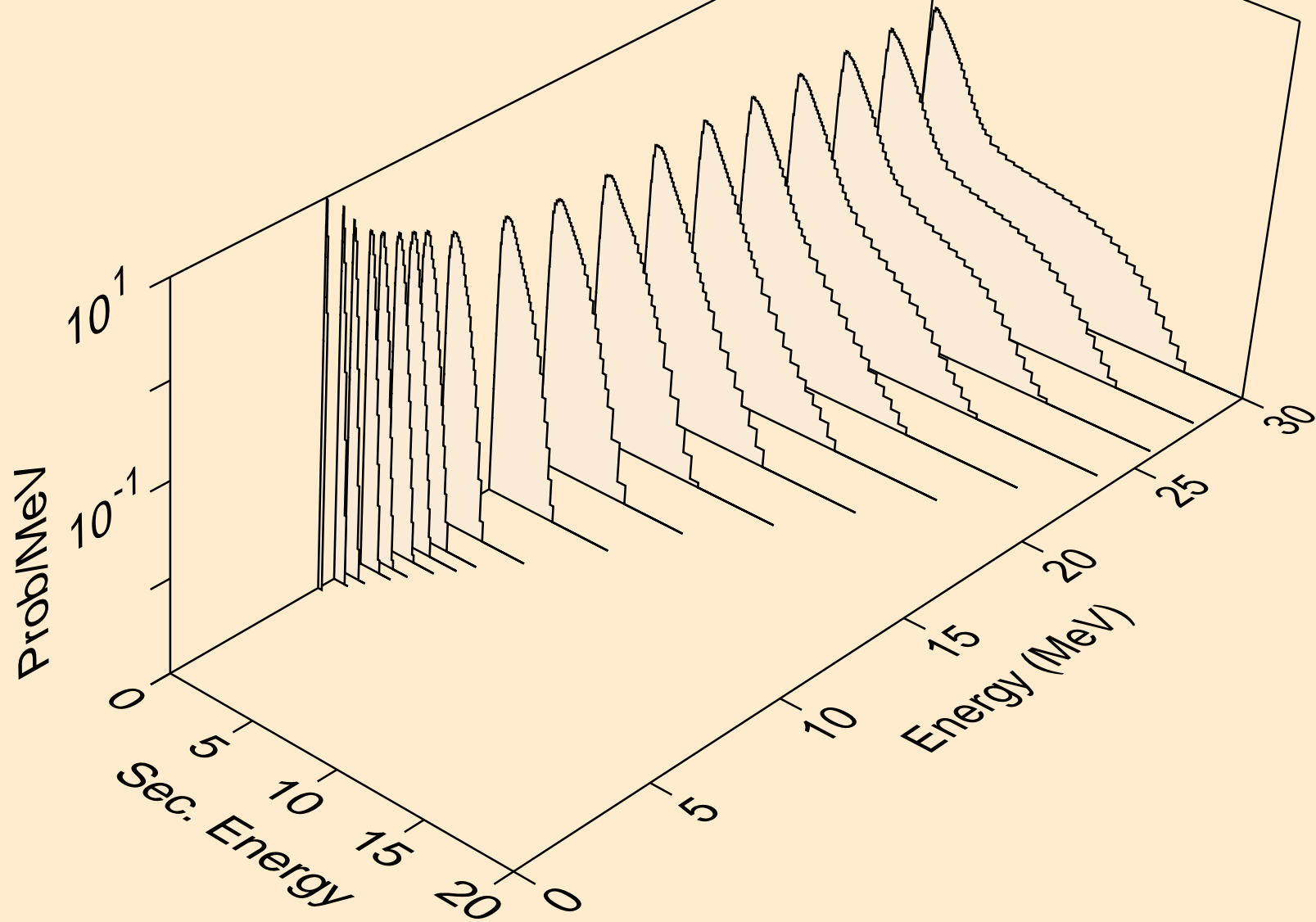

PO203 NEUTRON ACER TENDL-2023 LIBRARY; T=0.K
Neutron emission for (n,n*)2a

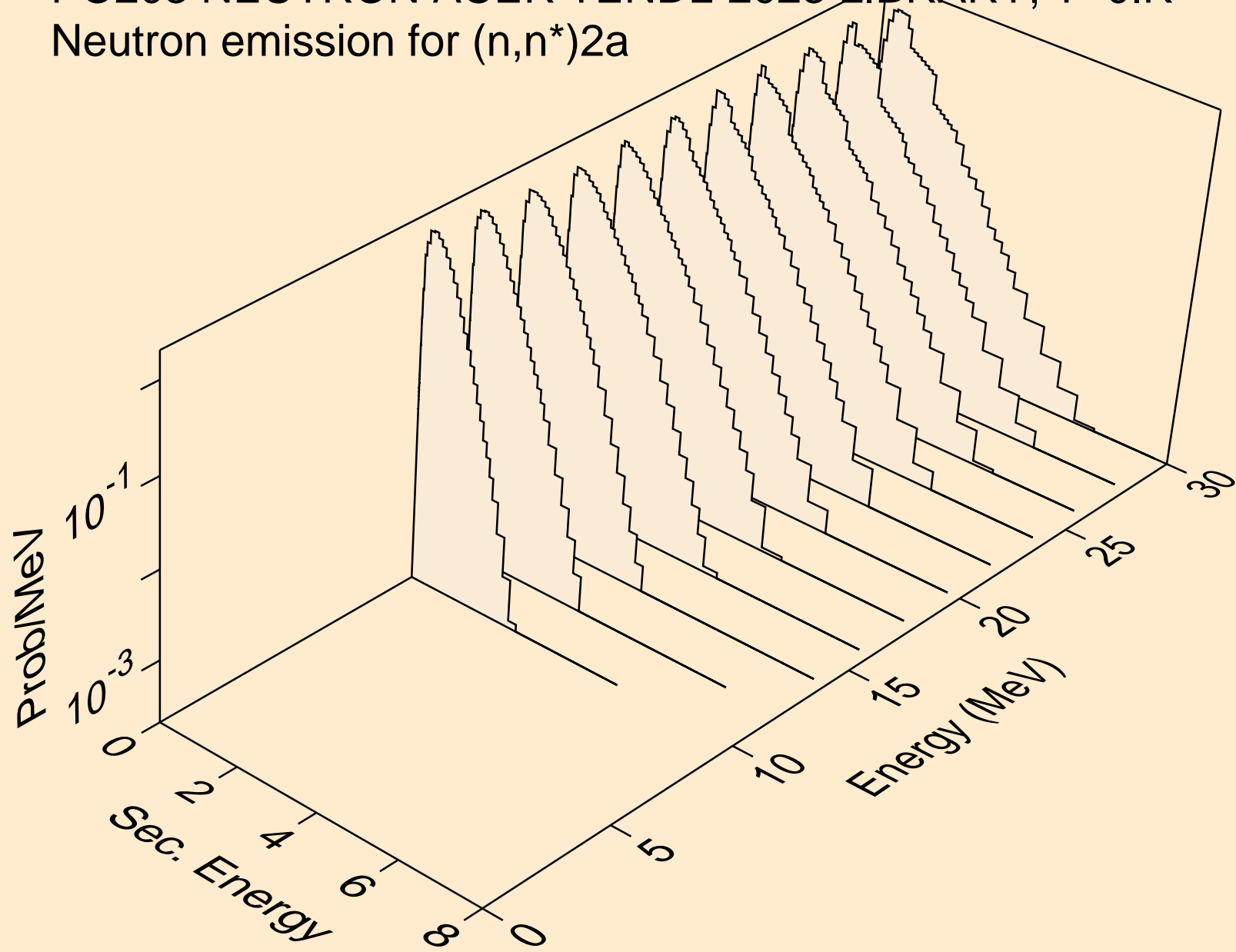

PO203 NEUTRON ACER TENDL-2023 LIBRARY; T=0.K
Neutron emission for (n,n*)d

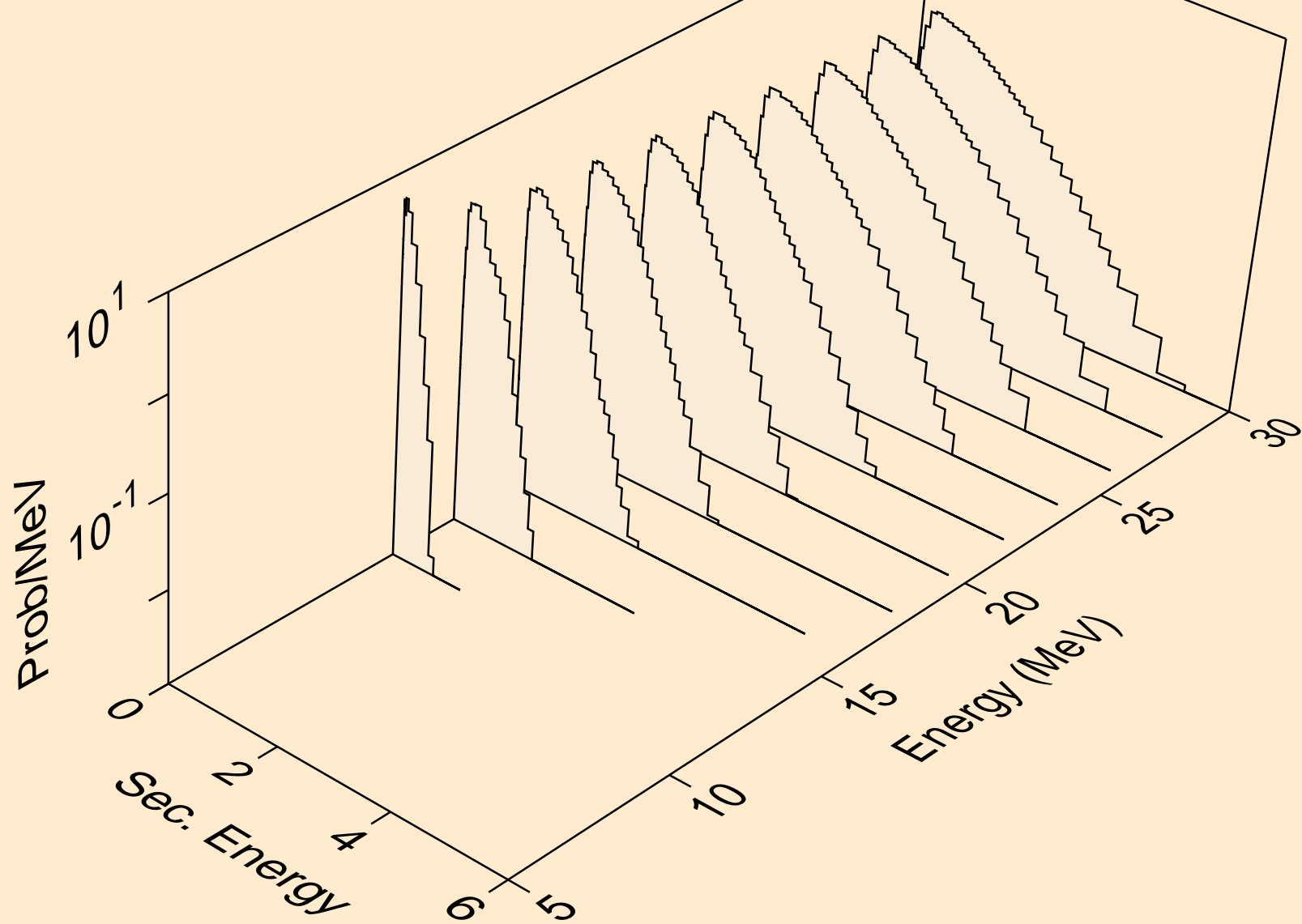

PO203 NEUTRON ACER TENDL-2023 LIBRARY; T=0.K
Neutron emission for (n,n*)t

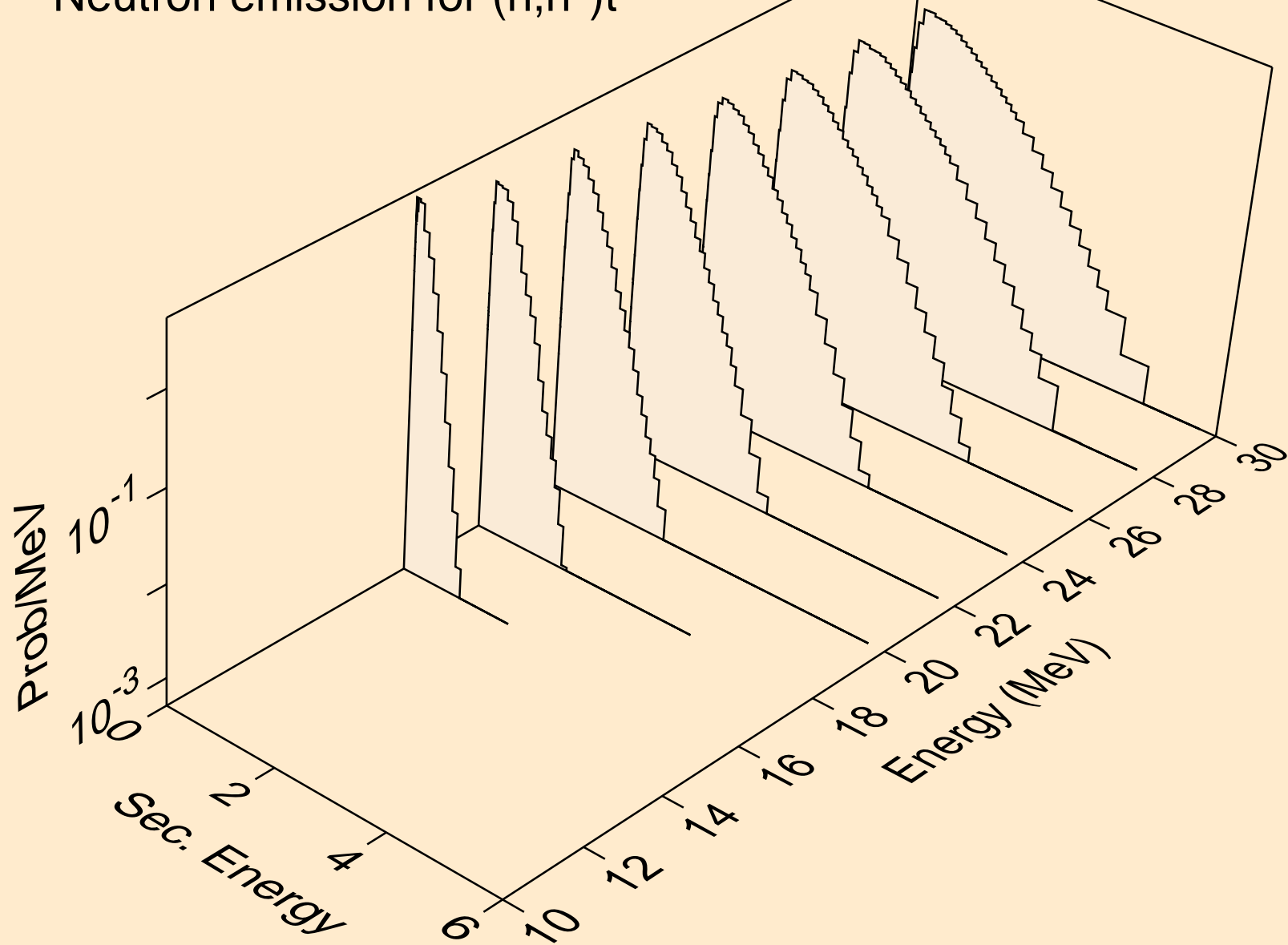

PO203 NEUTRON ACER TENDL-2023 LIBRARY; T=0.K
Neutron emission for (n,n*)he3

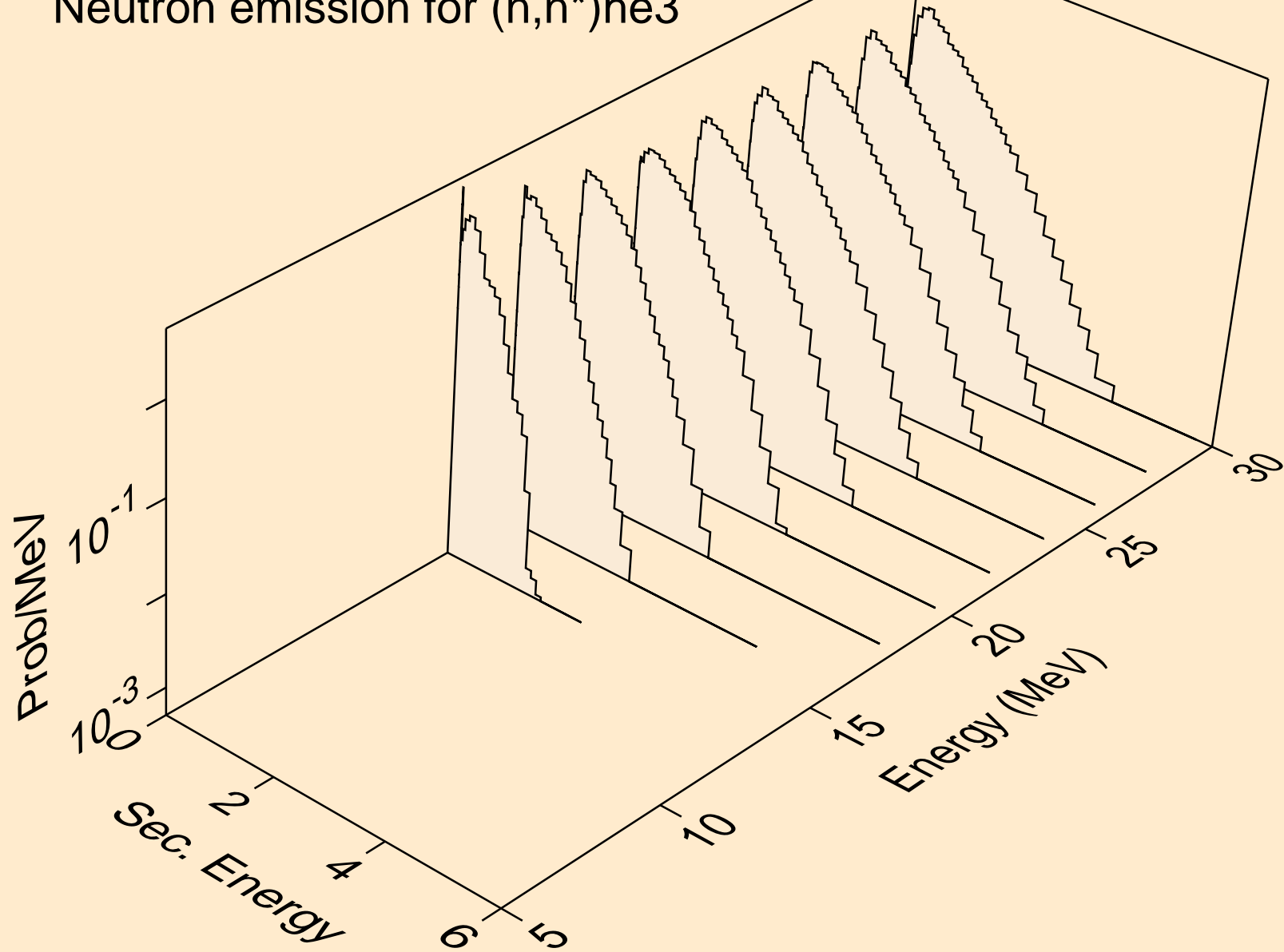

PO203 NEUTRON ACER TENDL-2023 LIBRARY; T=0.K
Neutron emission for (n,4n)

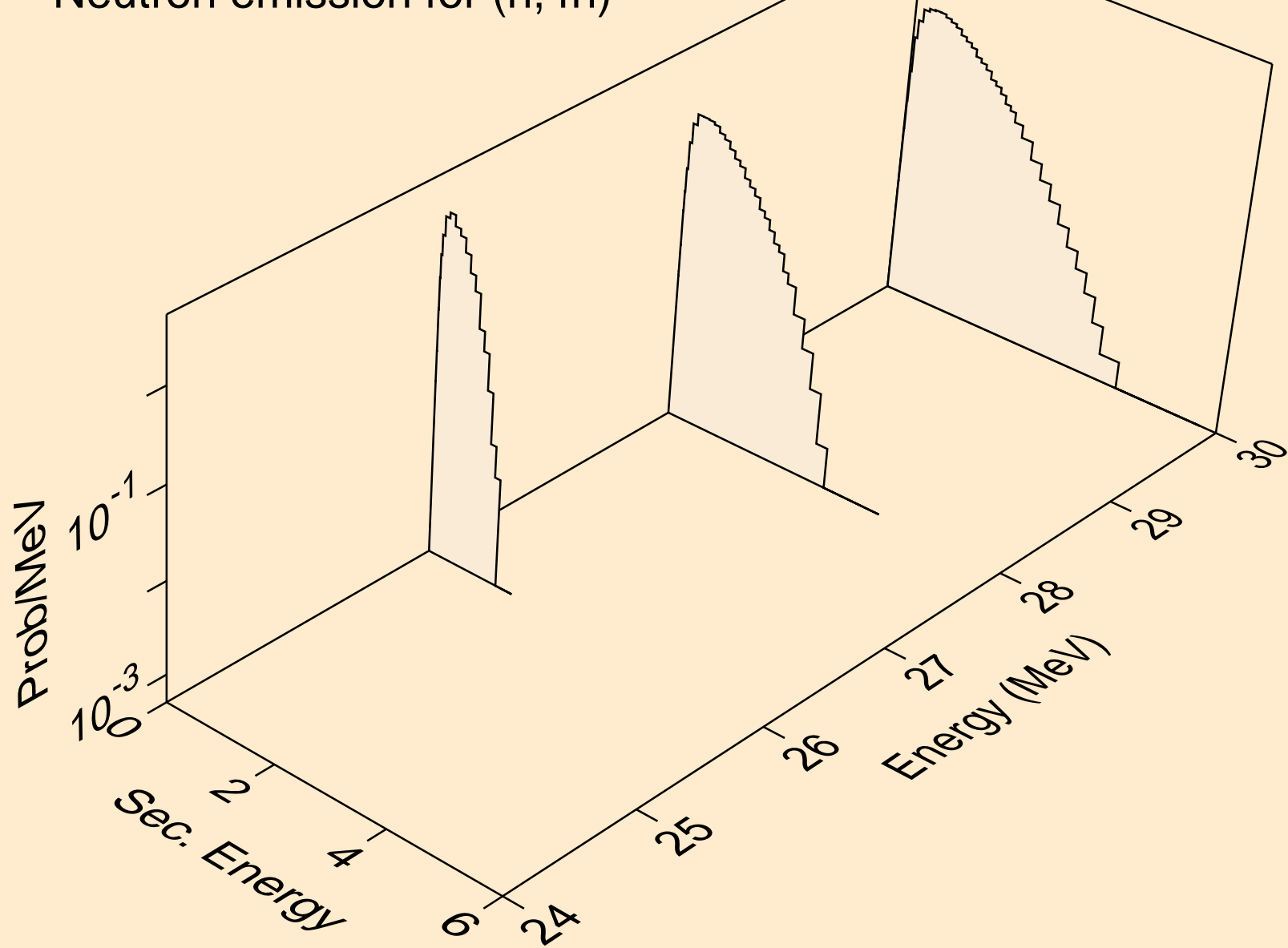

PO203 NEUTRON ACER TENDL-2023 LIBRARY; T=0.K
Neutron emission for (n,2np)

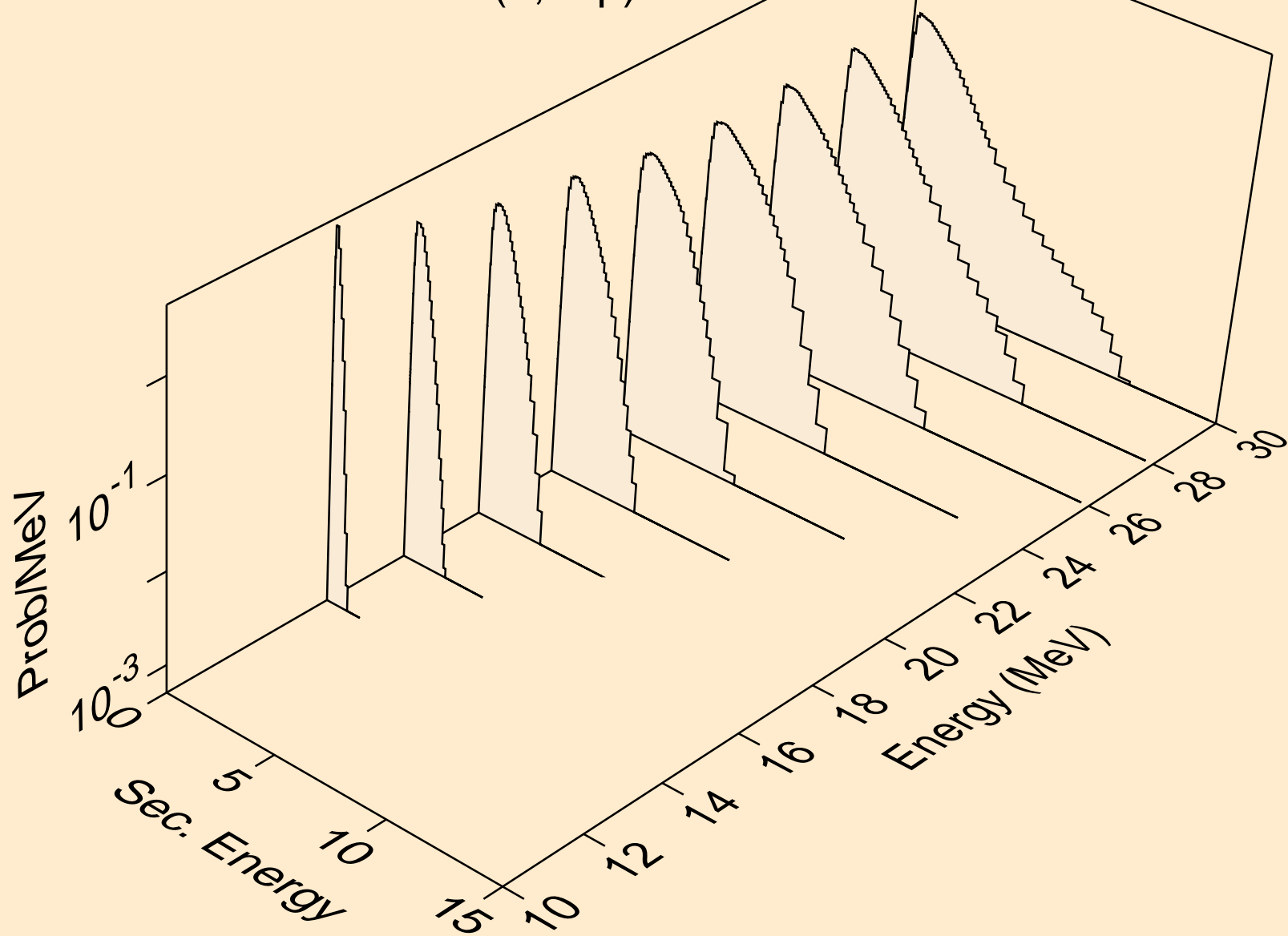

PO203 NEUTRON ACER TENDL-2023 LIBRARY; T=0.K
Neutron emission for (n,3np)

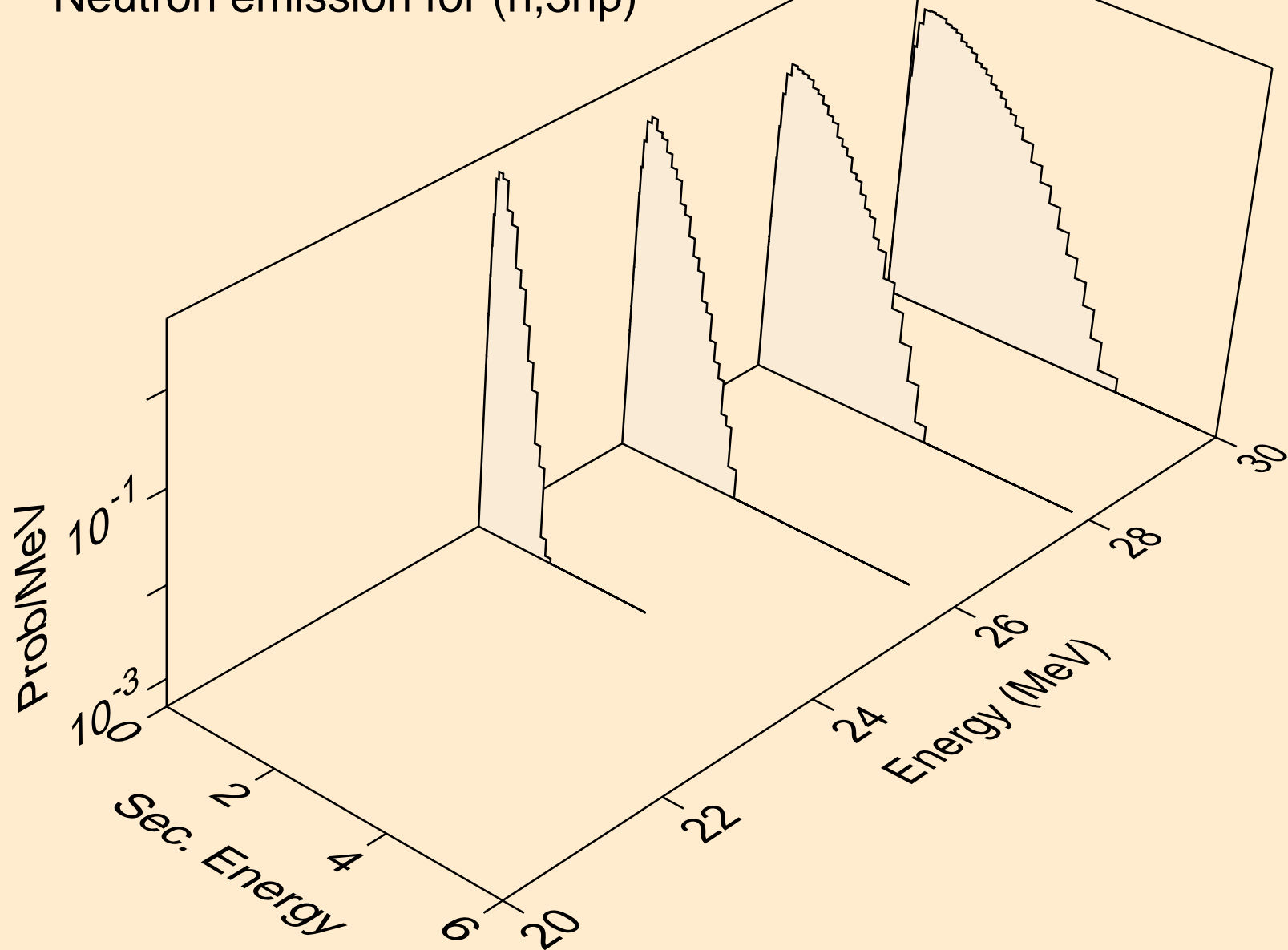

PO203 NEUTRON ACER TENDL-2023 LIBRARY; T=0.K
Neutron emission for (n,n2p)

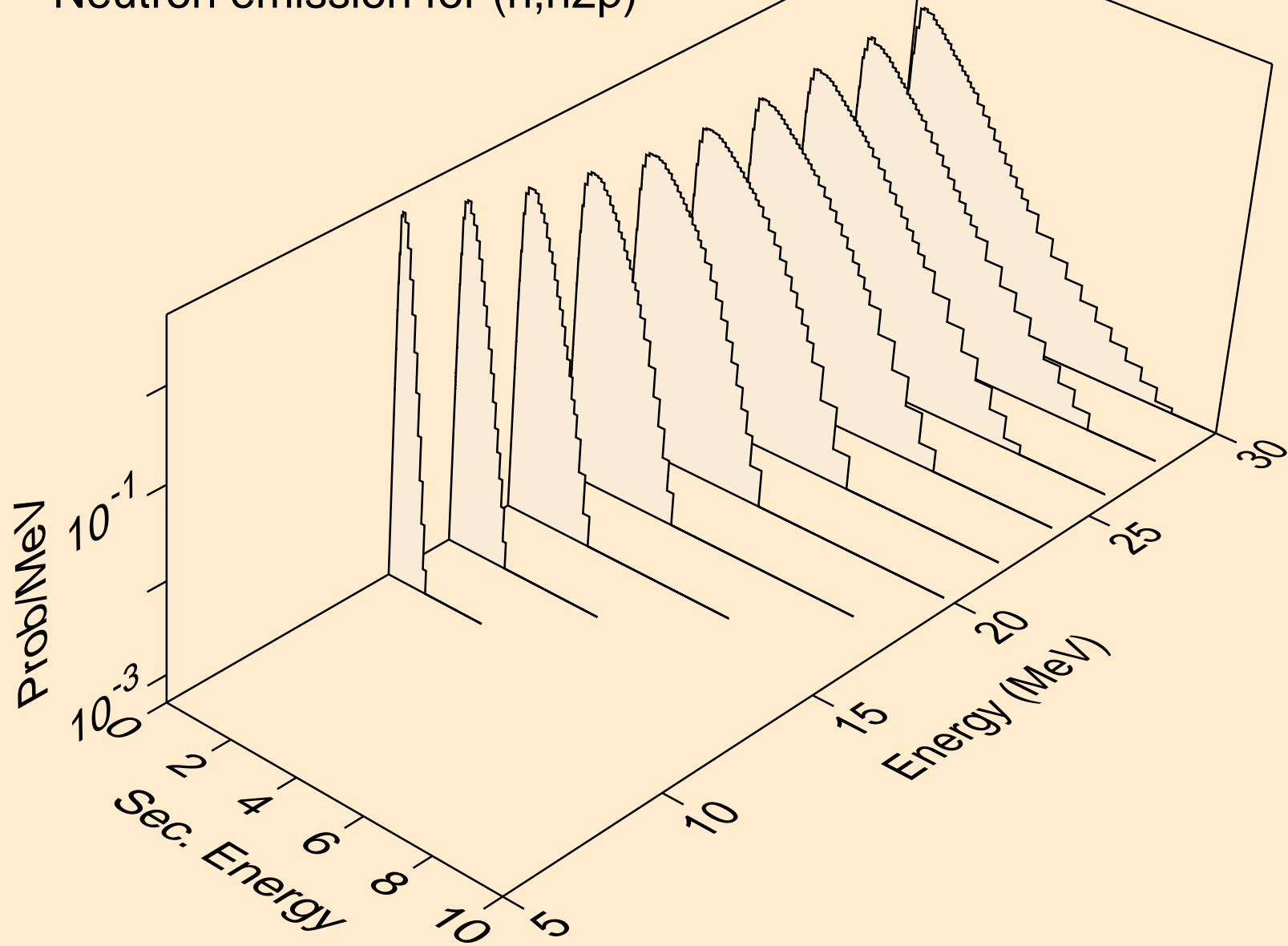

PO203 NEUTRON ACER TENDL-2023 LIBRARY; T=0.K
Neutron emission for (n,npa)

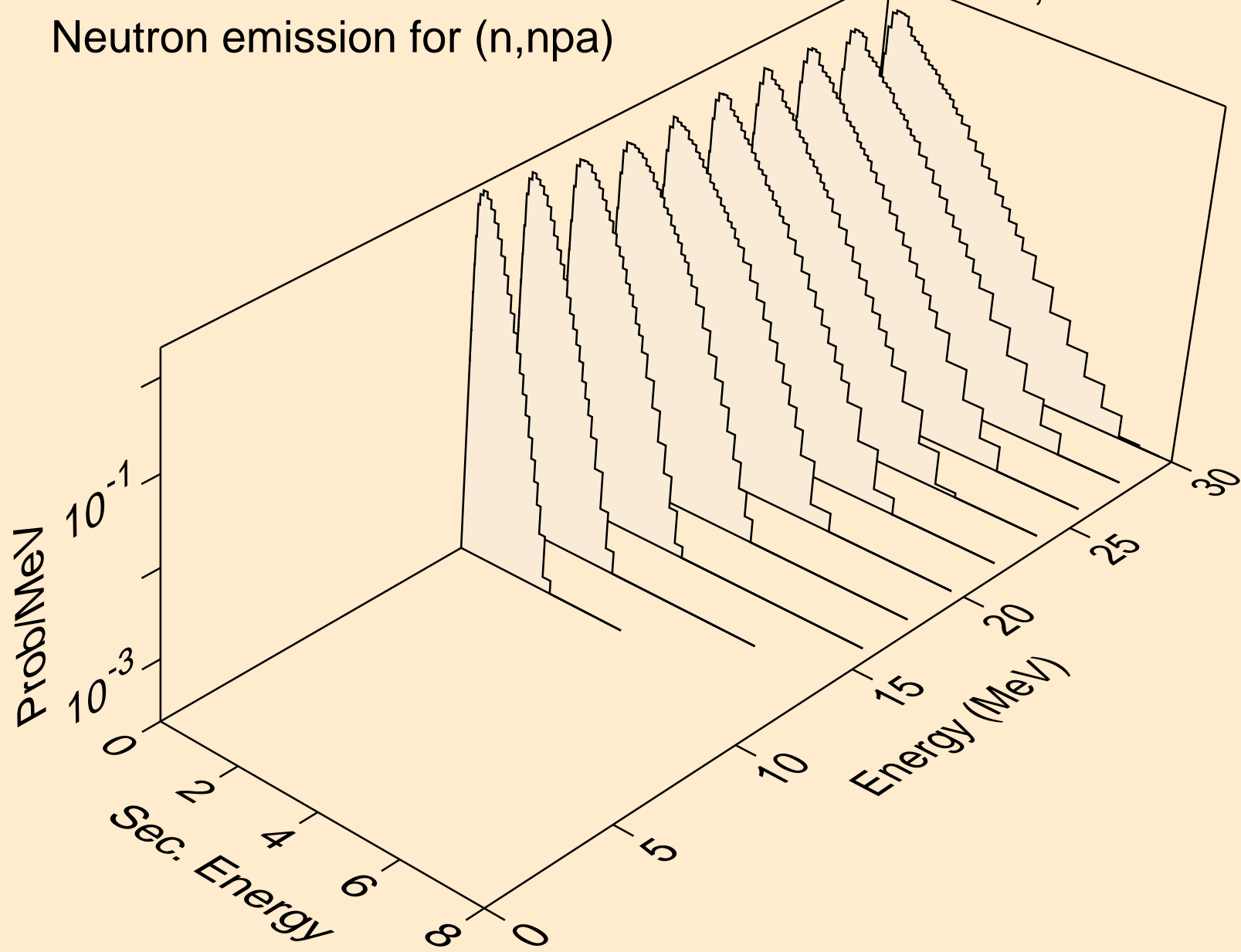

PO203 NEUTRON ACER TENDL-2023 LIBRARY; T=0.K
Neutron emission for (n,n*c)

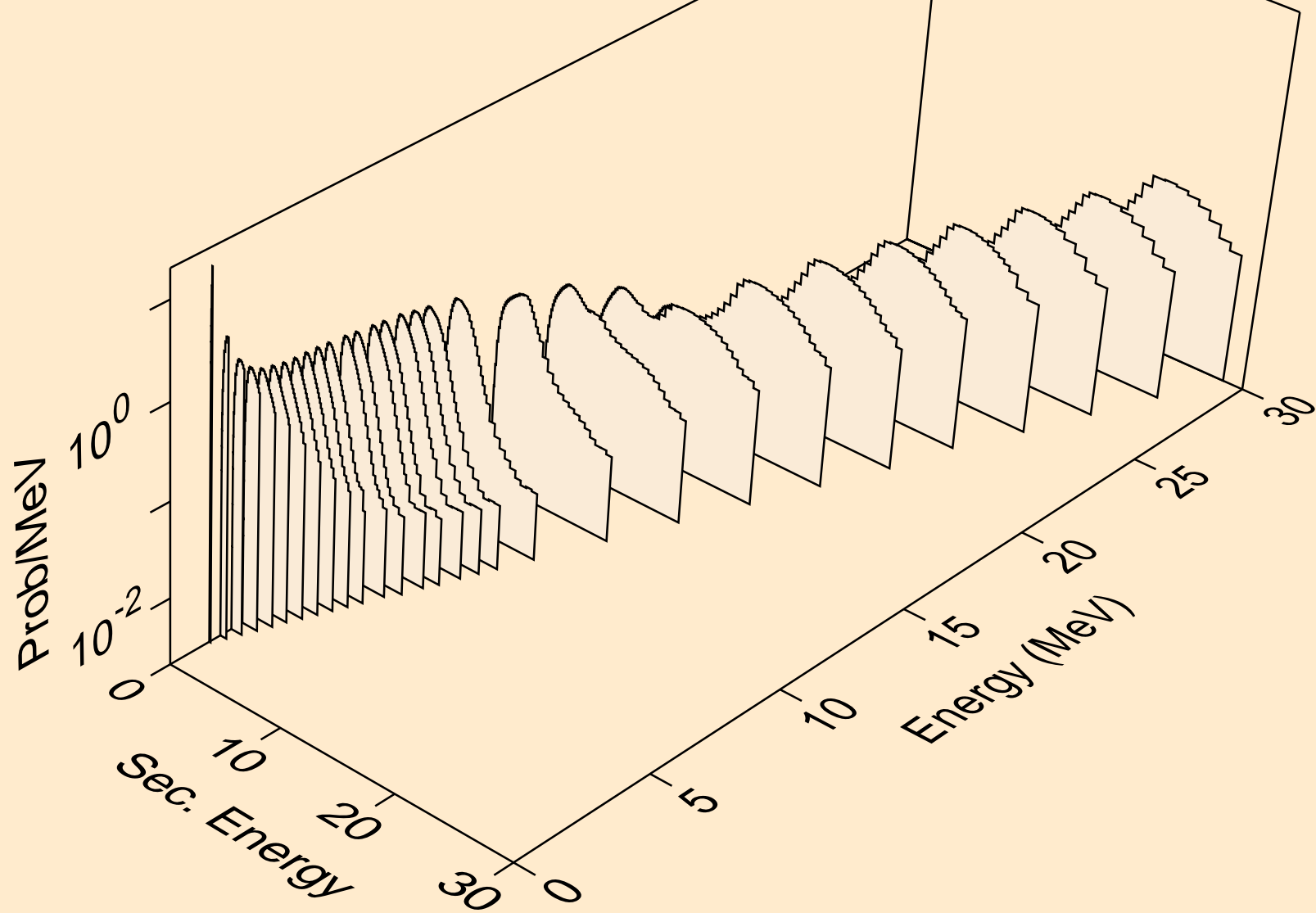

PO203 NEUTRON ACER TENDL-2023 LIBRARY; T=0.K
Photon emission for (n,x)

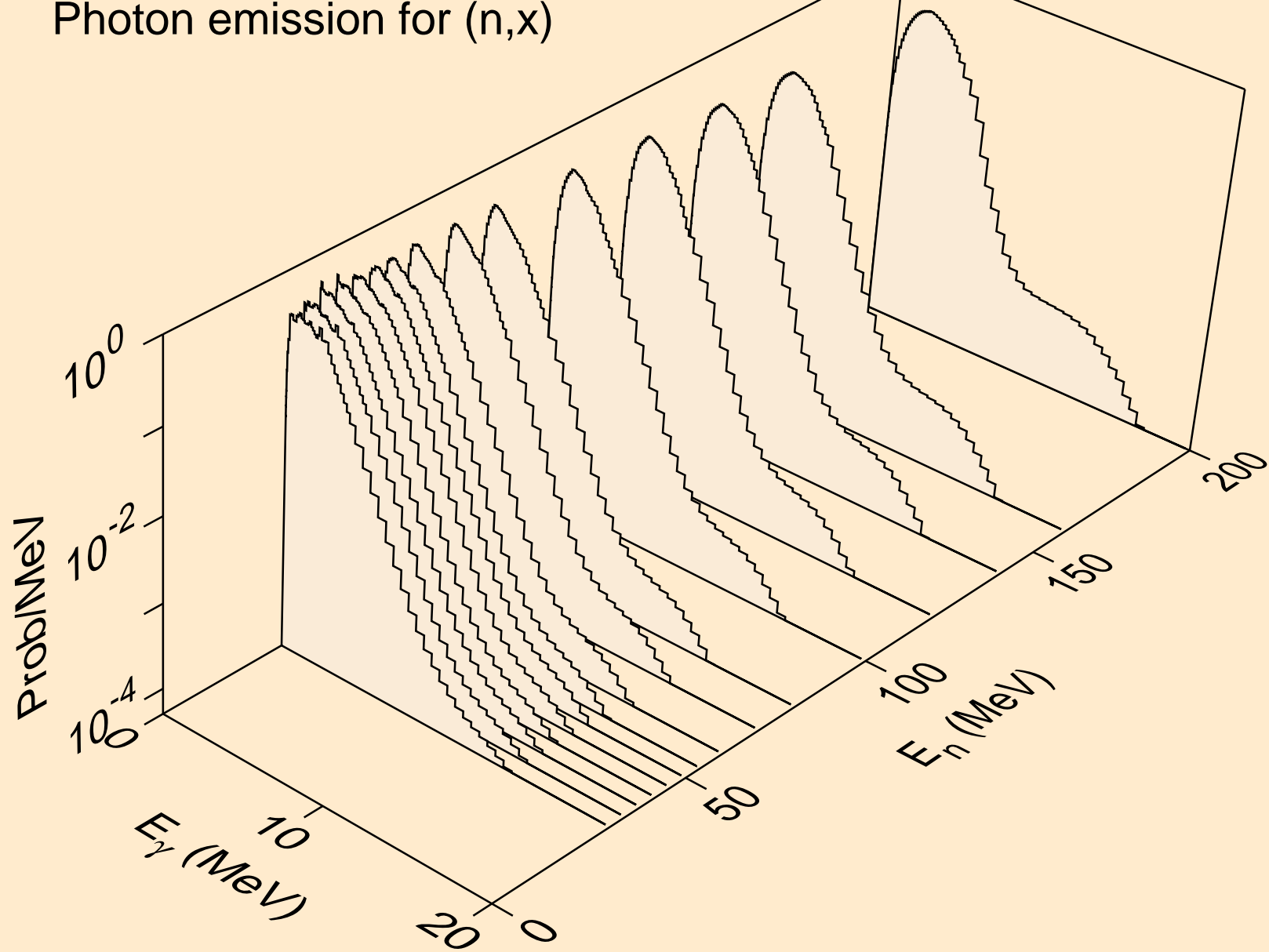

PO203 NEUTRON ACER TENDL-2023 LIBRARY; T=0.K
Photon emission for (n,2nd)

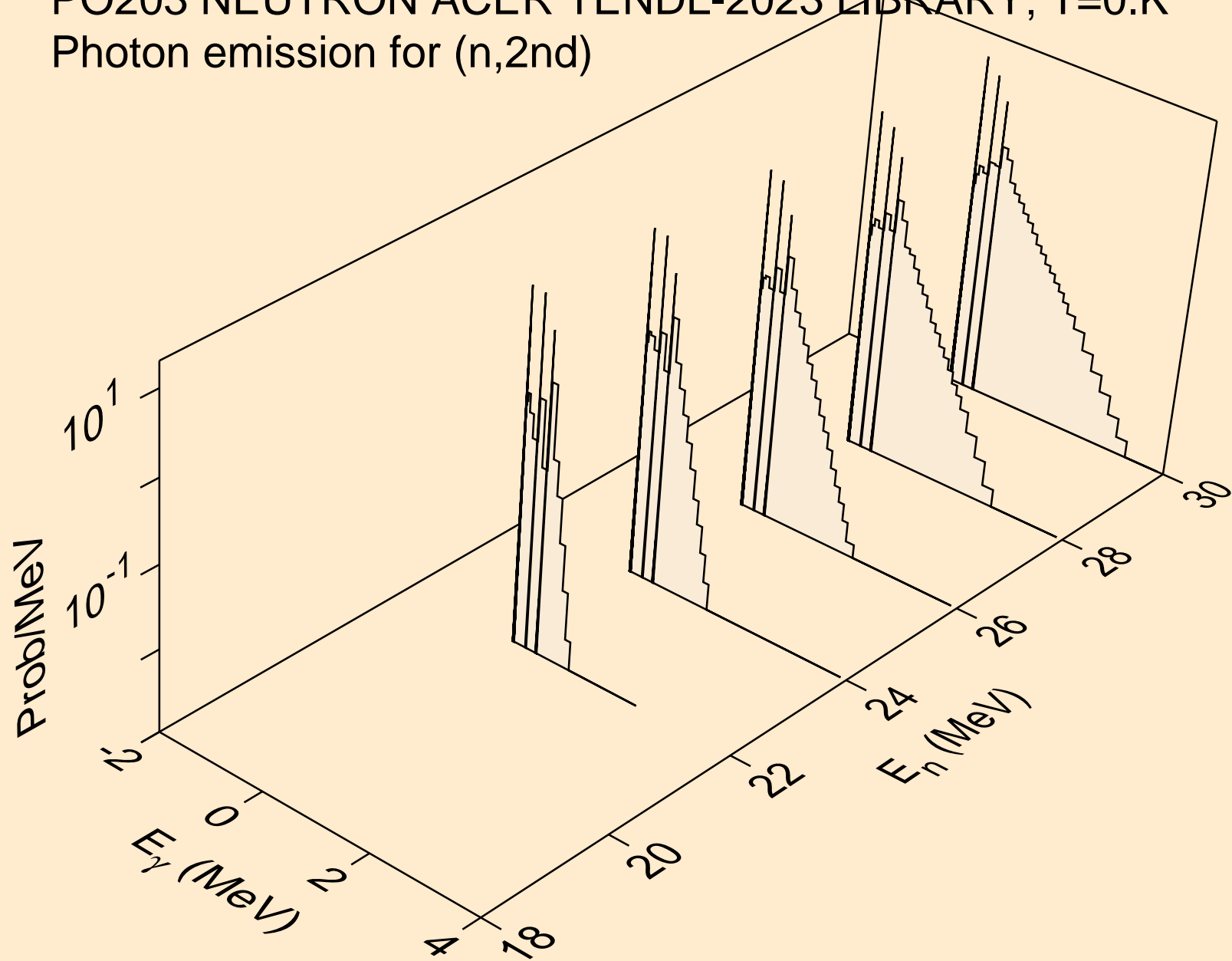

PO203 NEUTRON ACER TENDL-2023 LIBRARY; T=0.K
Photon emission for (n,2n)

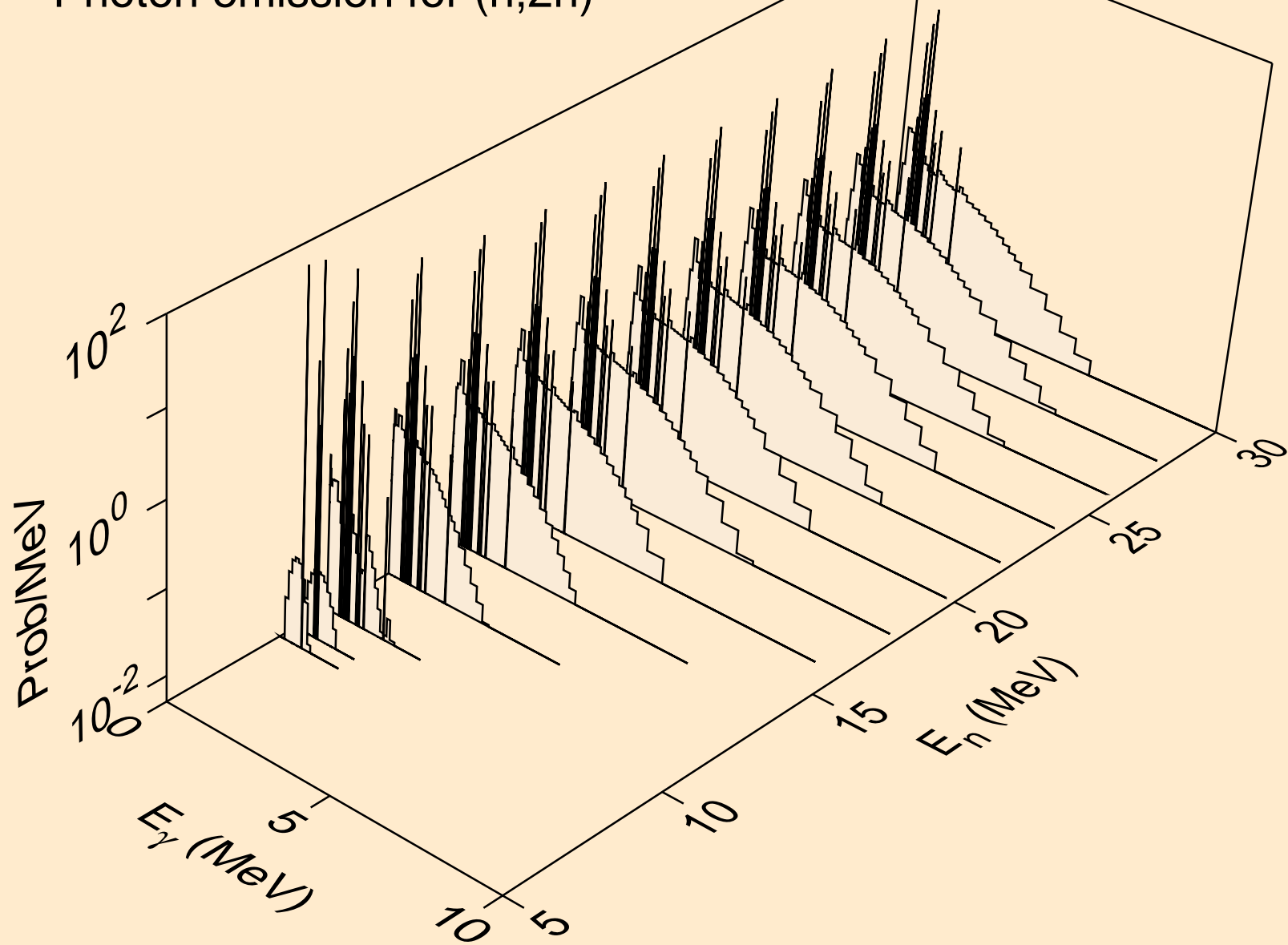

PO203 NEUTRON ACER TENDL-2023 LIBRARY; T=0.K
Photon emission for (n,3n)

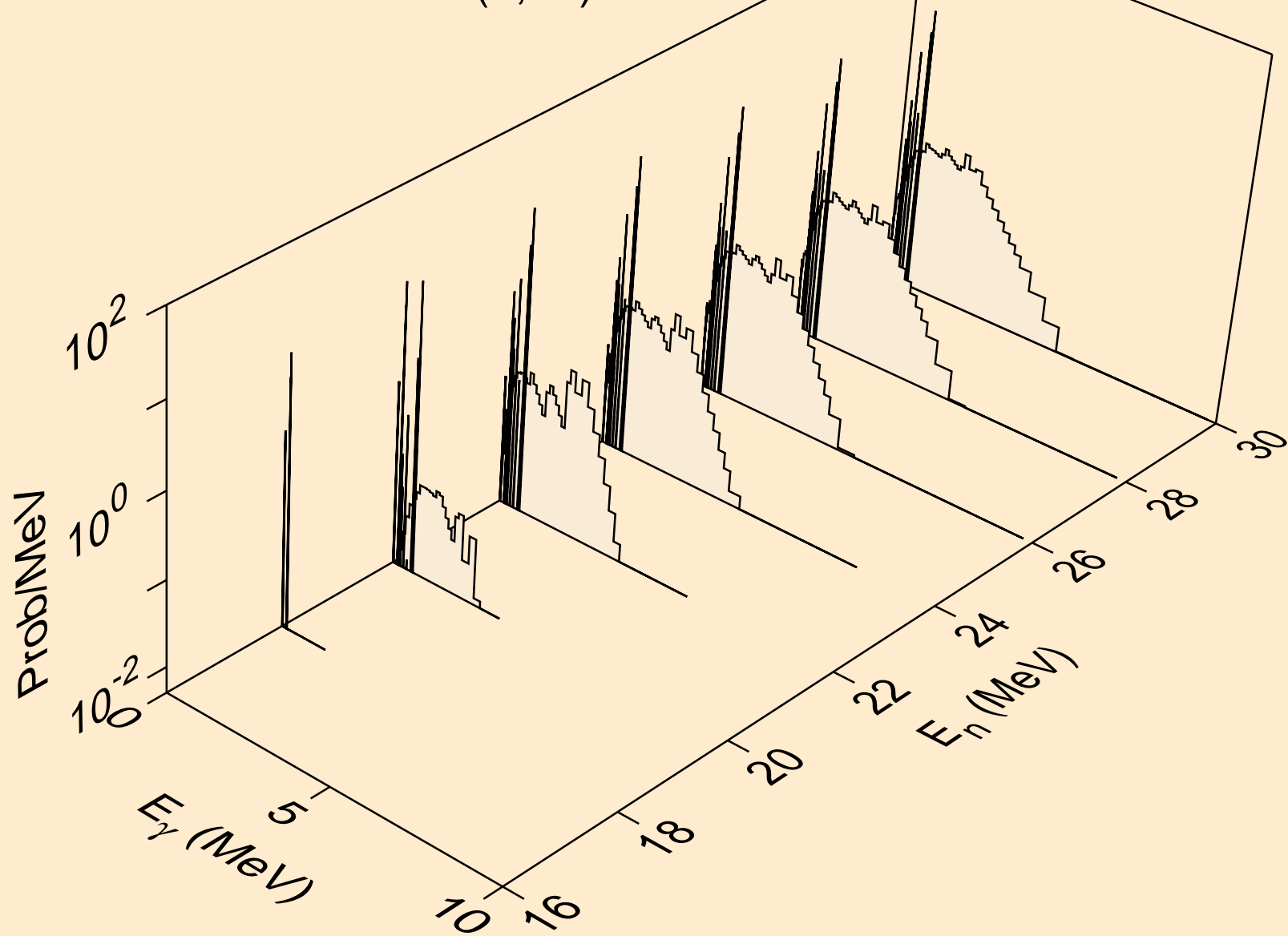

PO203 NEUTRON ACER TENDL-2023 LIBRARY; T=0.K
Photon emission for (n,n*)a

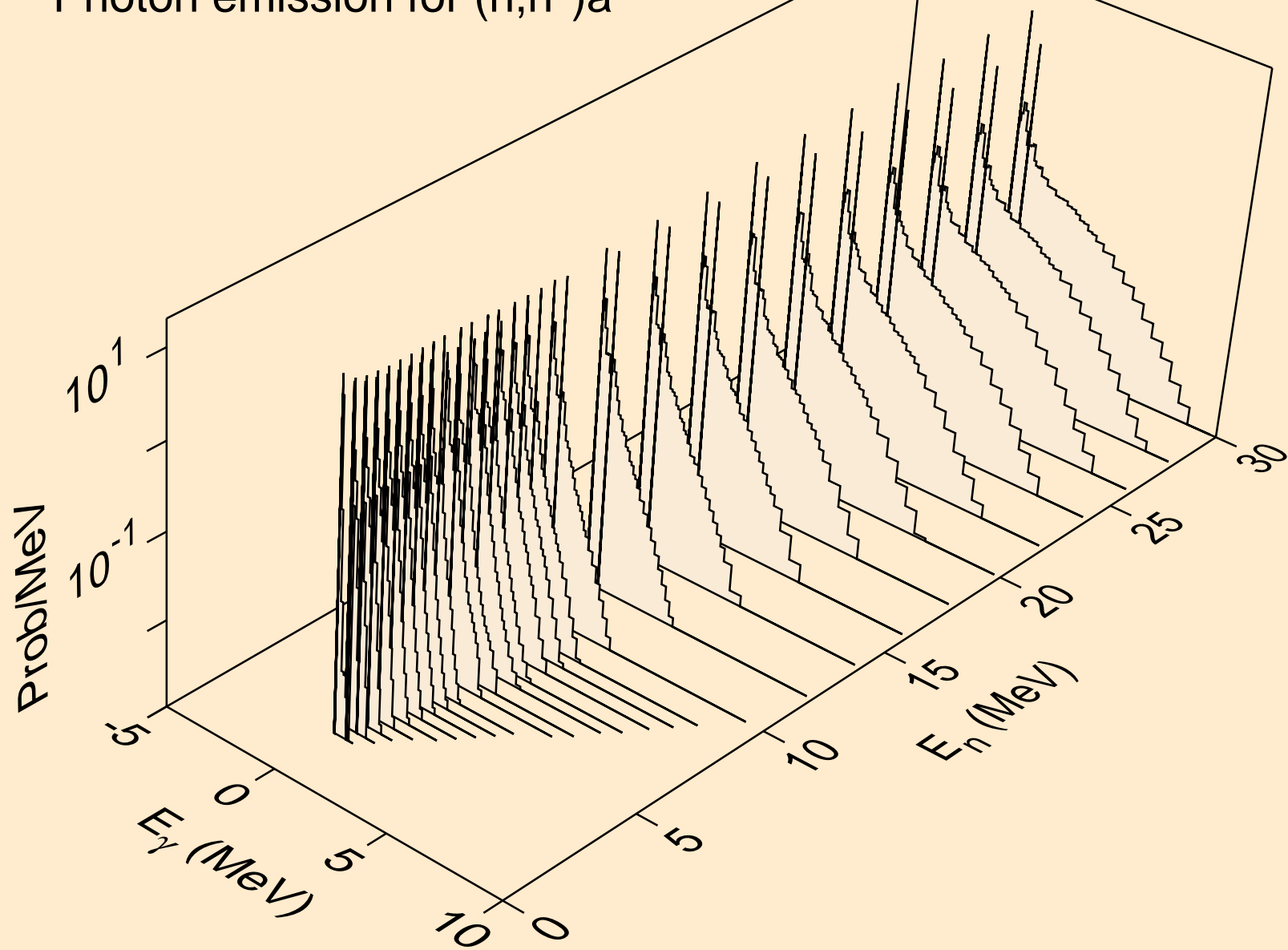

PO203 NEUTRON ACER TENDL-2023 LIBRARY; T=0.K
Photon emission for (n,2n)a

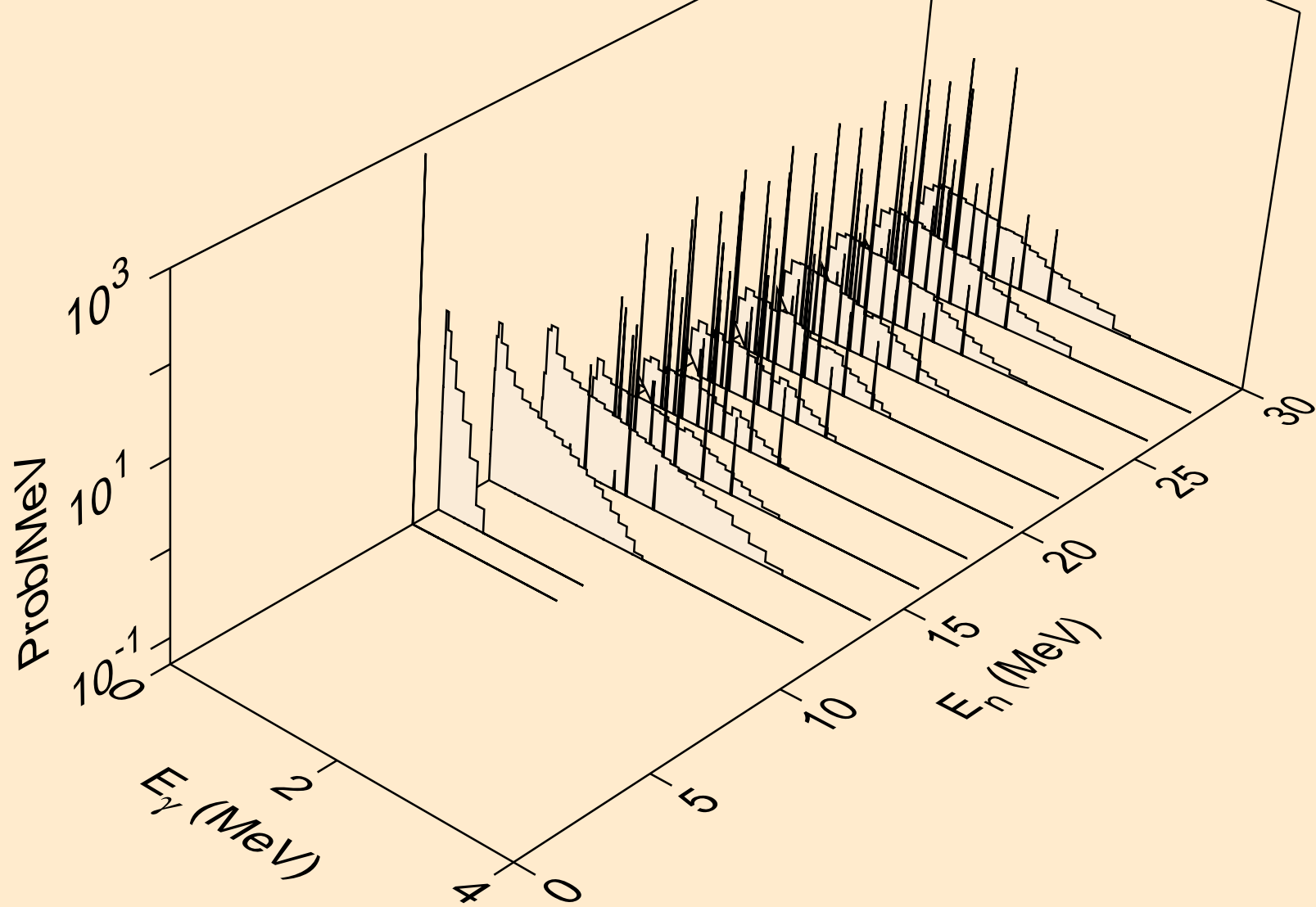

PO203 NEUTRON ACER TENDL-2023 LIBRARY; T=0.K
Photon emission for (n,3n)a

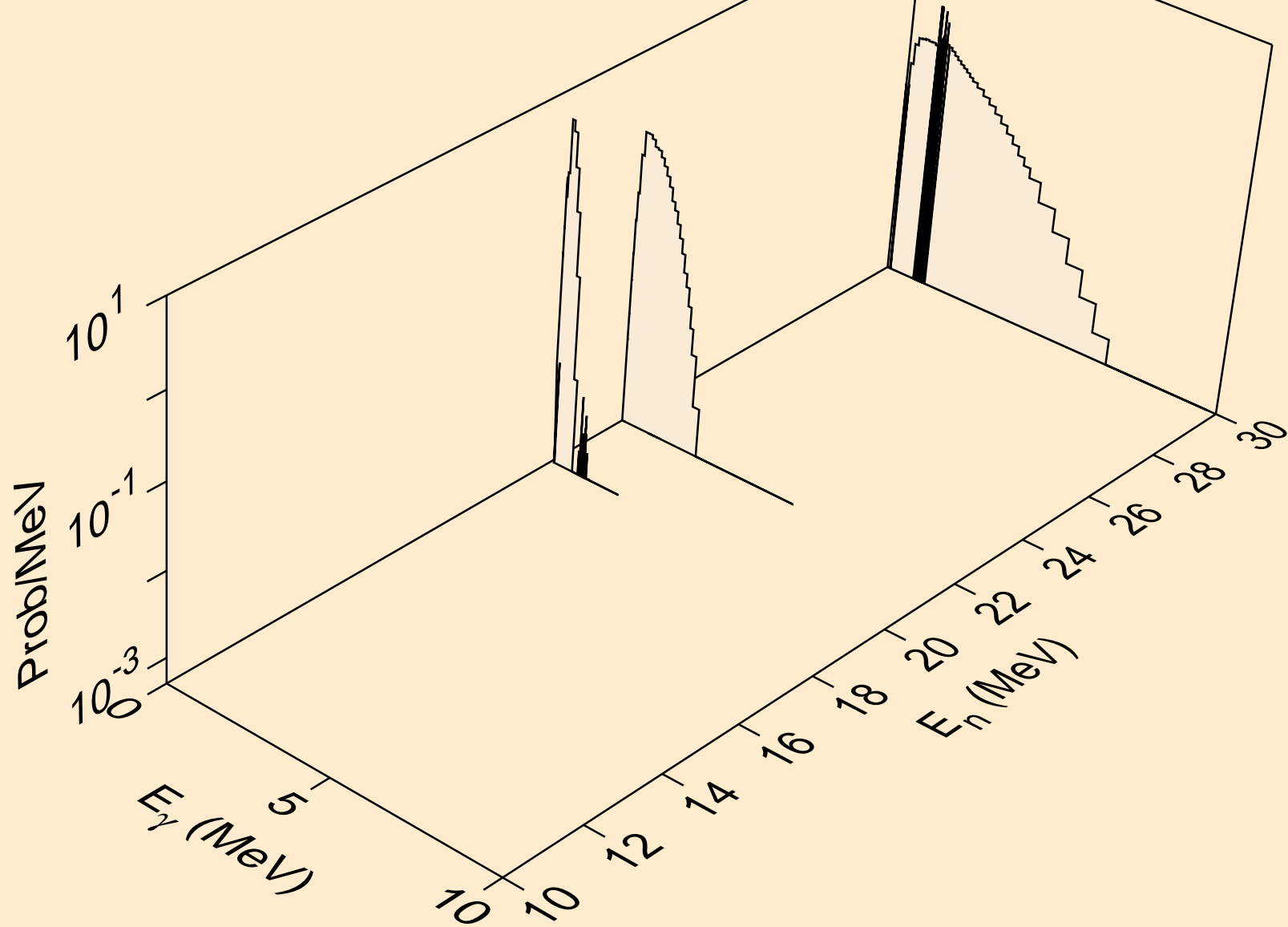

PO203 NEUTRON ACER TENDL-2023 LIBRARY; T=0.K
Photon emission for (n,n*)p

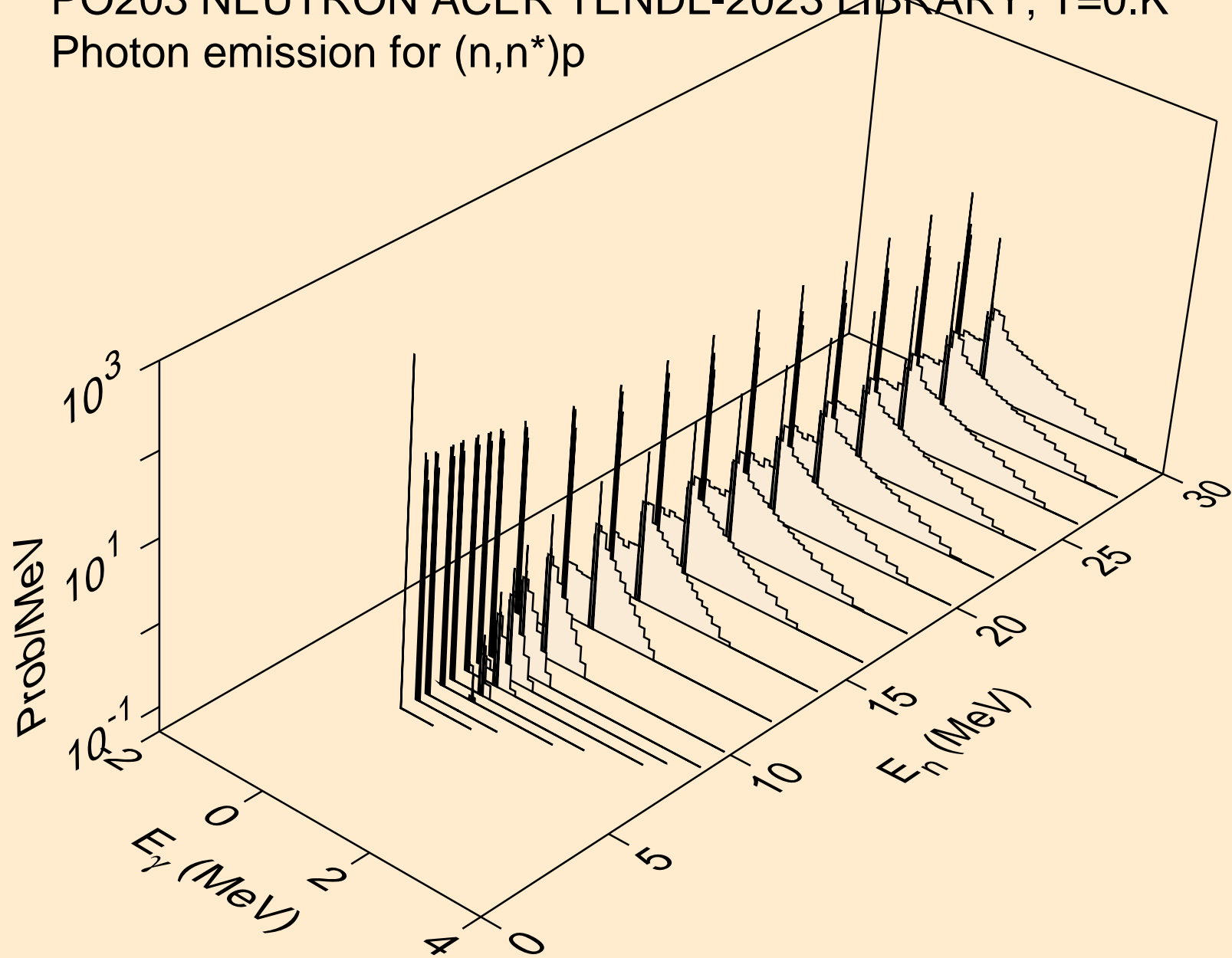

PO203 NEUTRON ACER TENDL-2023 LIBRARY; T=0.K
Photon emission for (n,n*)2a

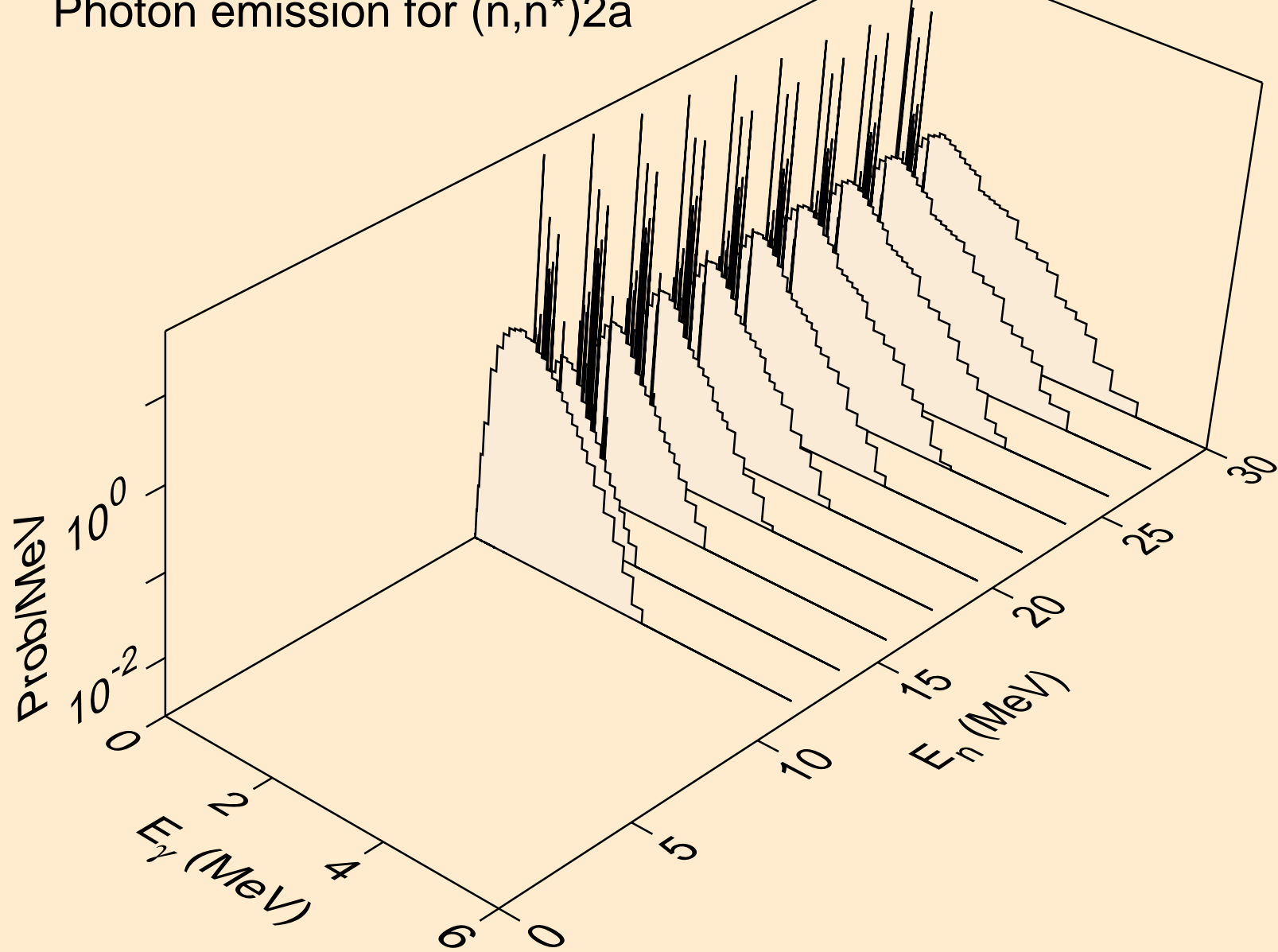

PO203 NEUTRON ACER TENDL-2023 LIBRARY; T=0.K
Photon emission for (n,n*)d

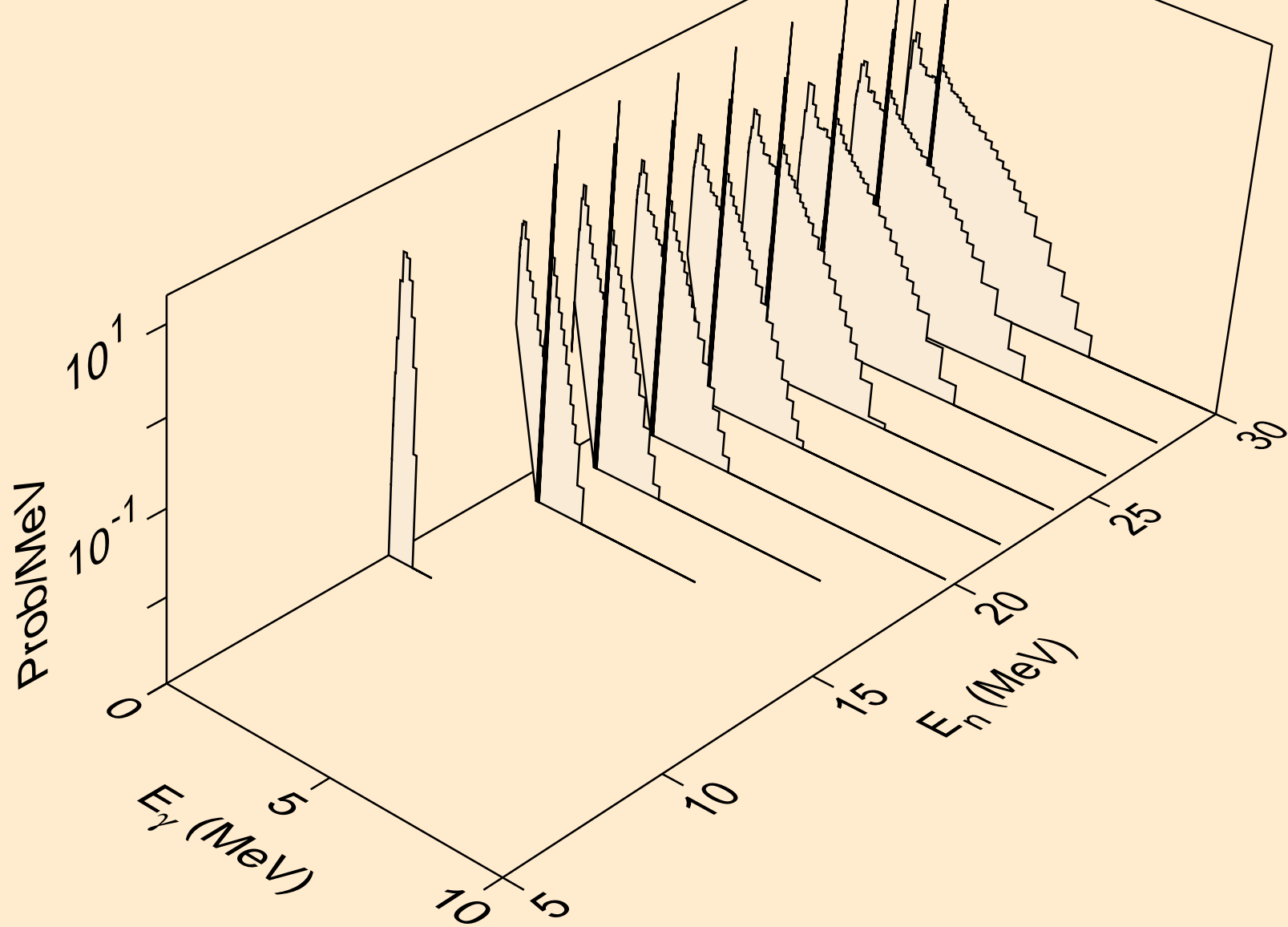

PO203 NEUTRON ACER TENDL-2023 LIBRARY; T=0.K
Photon emission for (n,n*)t

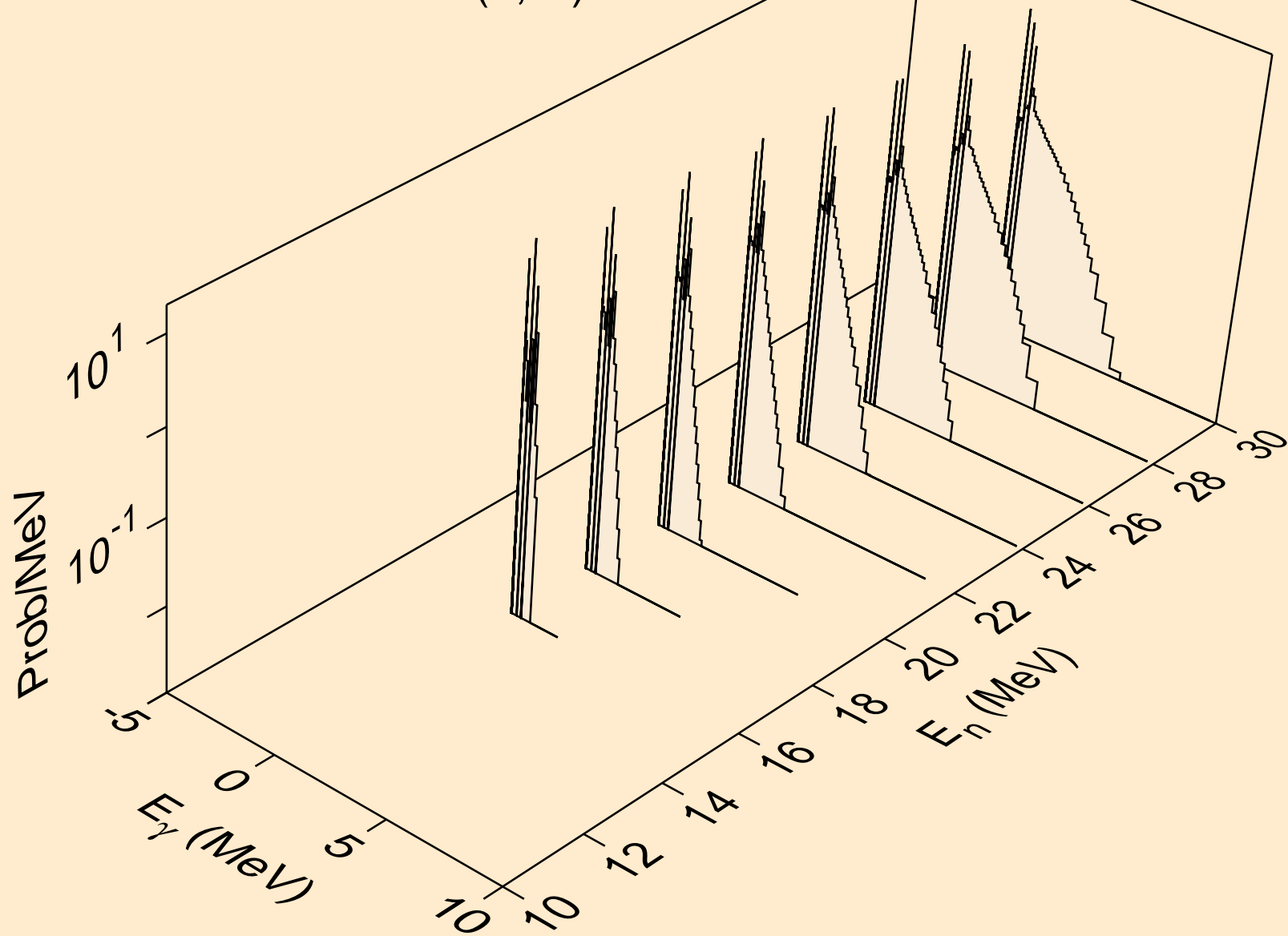

PO203 NEUTRON ACER TENDL-2023 LIBRARY; T=0.K
Photon emission for (n,n*)he3

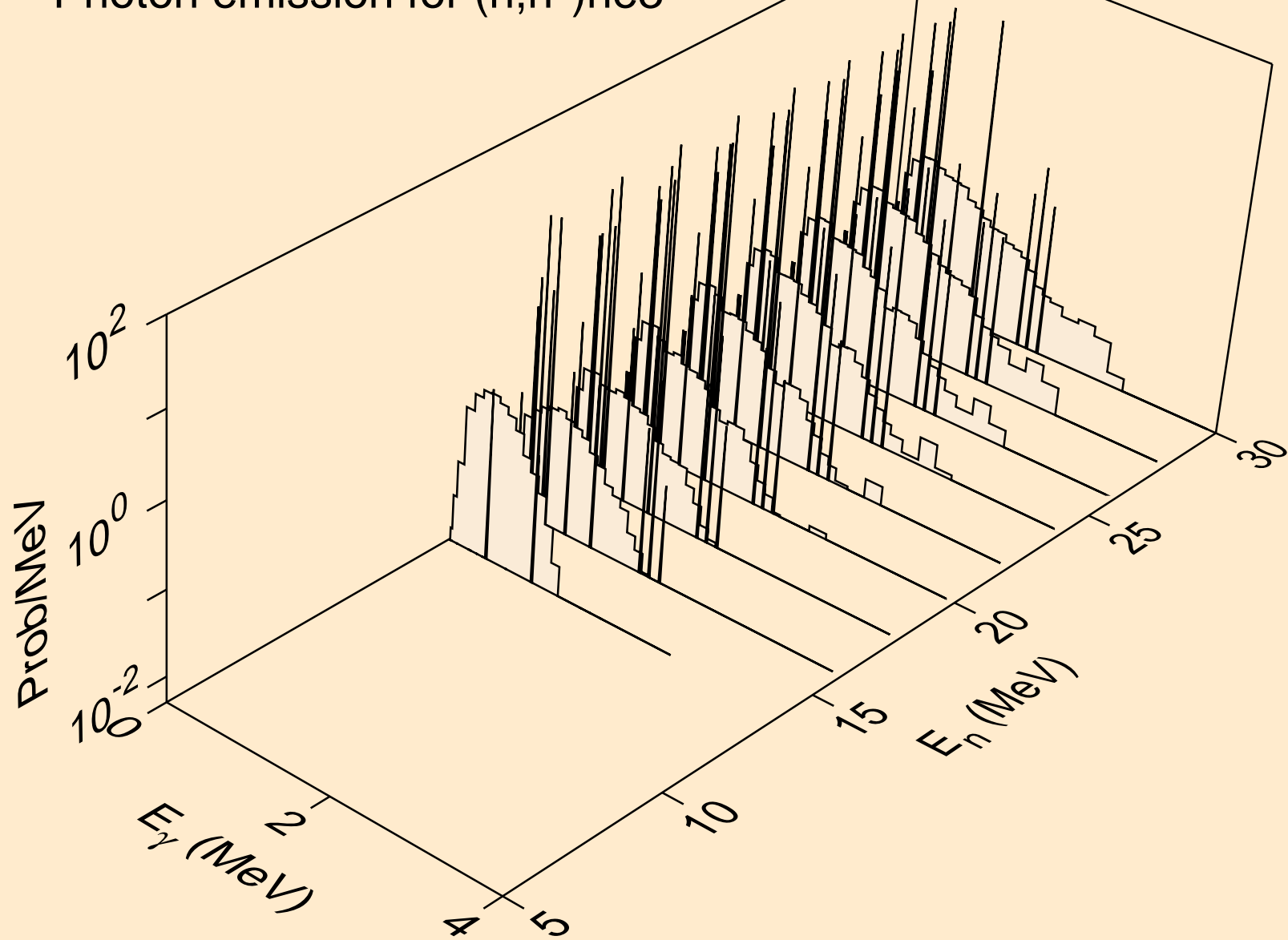

PO203 NEUTRON ACER TENDL-2023 LIBRARY; T=0.K
Photon emission for (n,4n)

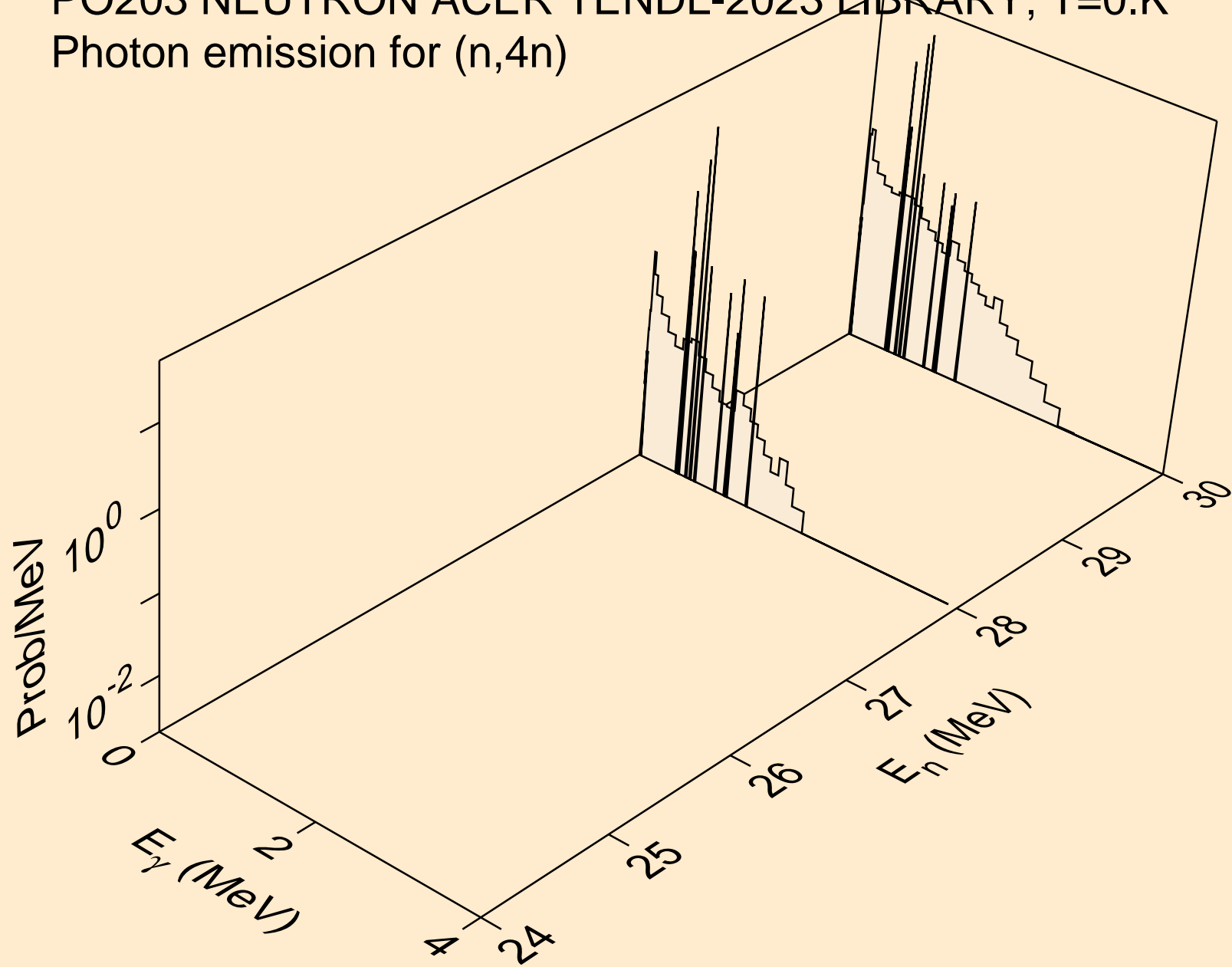

PO203 NEUTRON ACER TENDL-2023 LIBRARY; T=0.K
Photon emission for (n,2np)

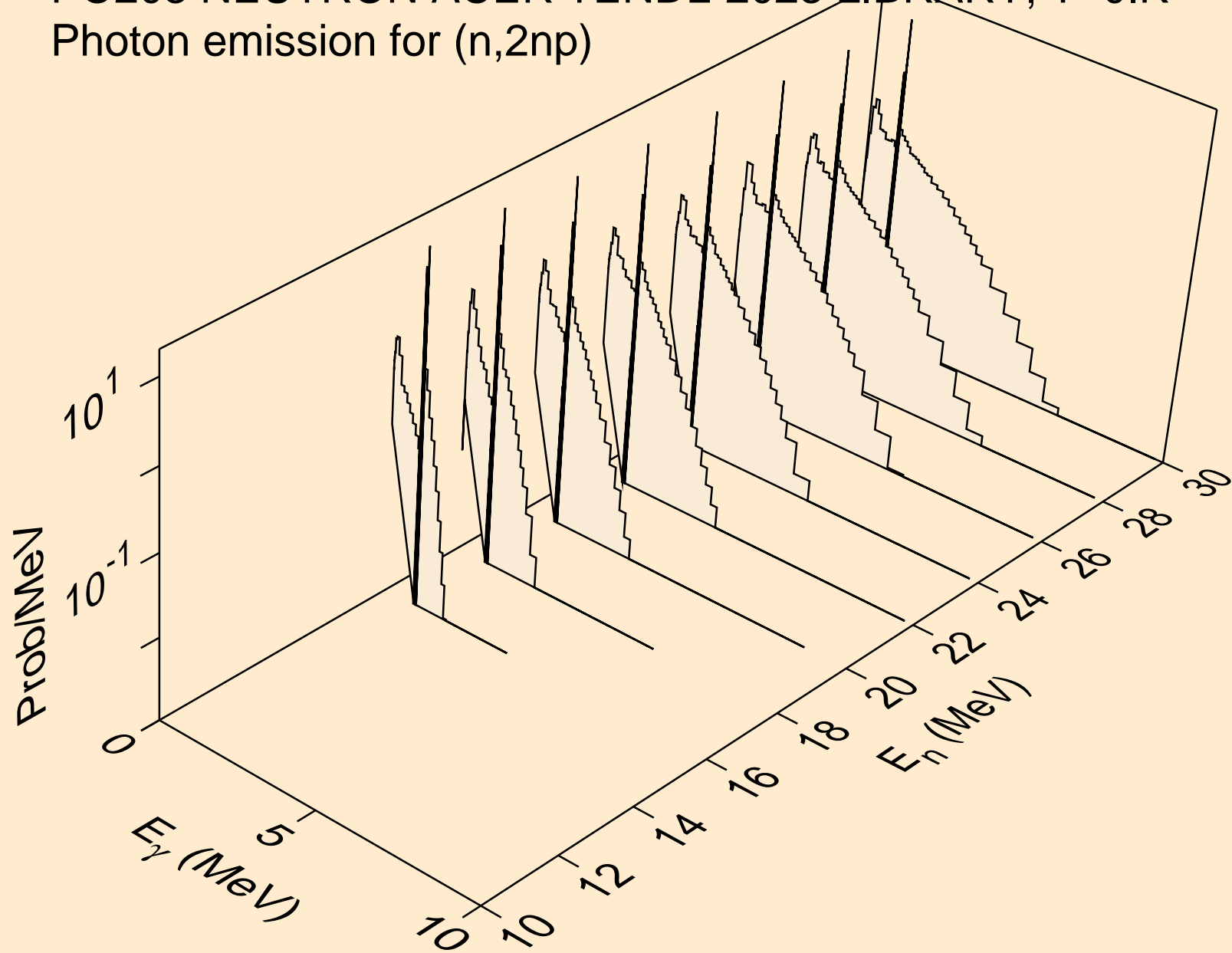

PO203 NEUTRON ACER TENDL-2023 LIBRARY; T=0.K
Photon emission for (n,3np)

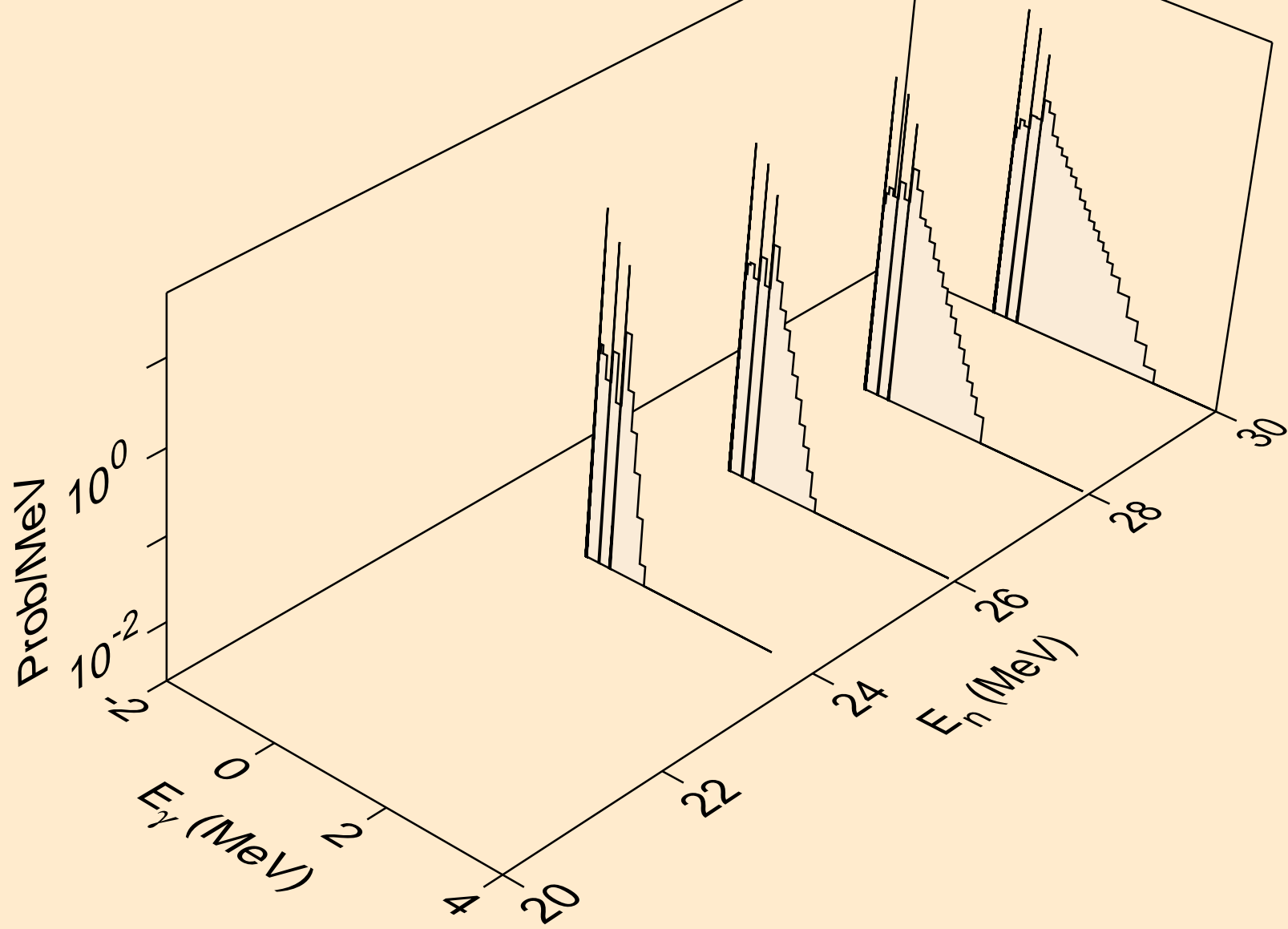

PO203 NEUTRON ACER TENDL-2023 LIBRARY; T=0.K
Photon emission for (n,n2p)

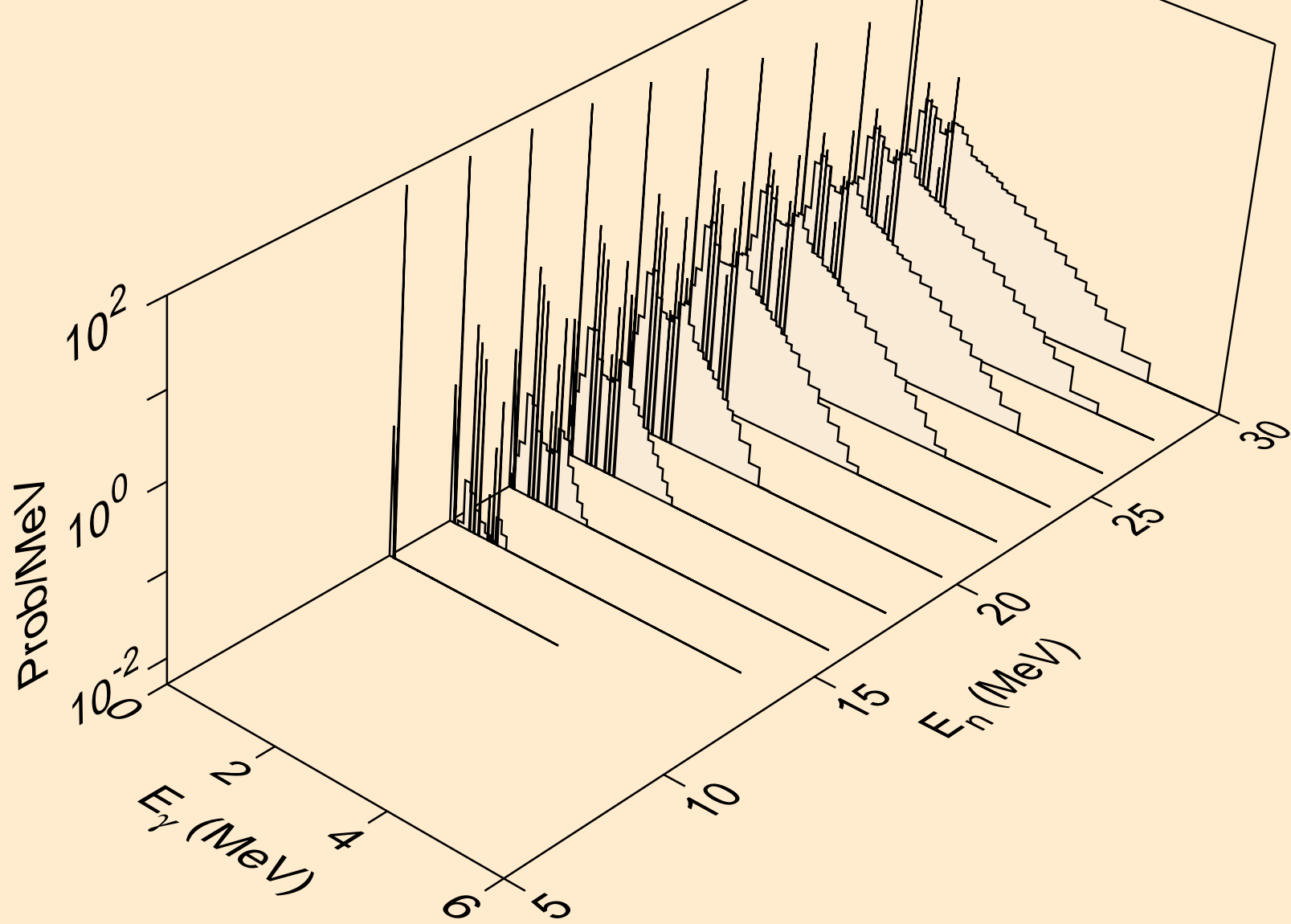

PO203 NEUTRON ACER TENDL-2023 LIBRARY; T=0.K
Photon emission for (n,npa)

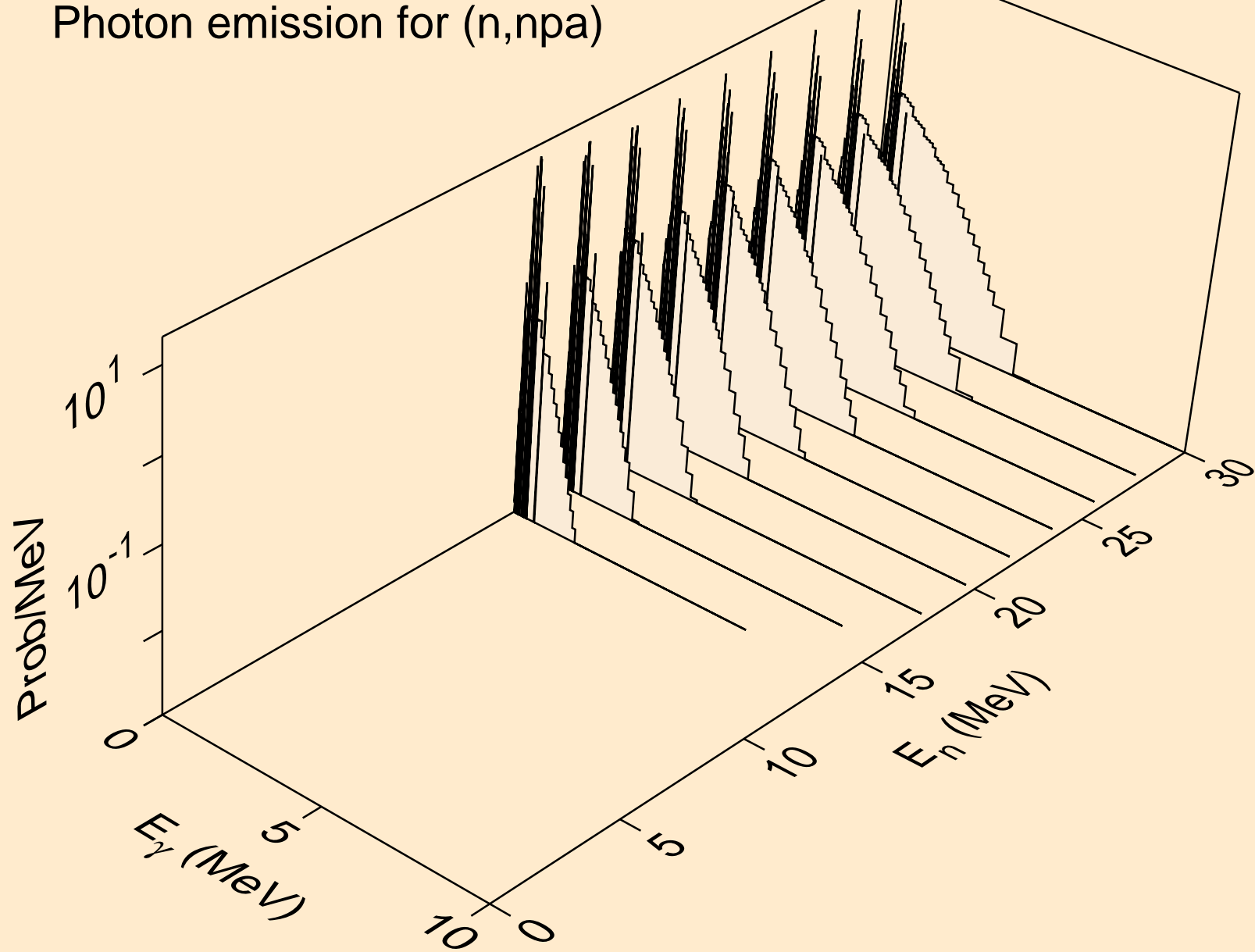

PO203 NEUTRON ACER TENDL-2023 LIBRARY; T=0.K
Photon emission for (n,n*c)

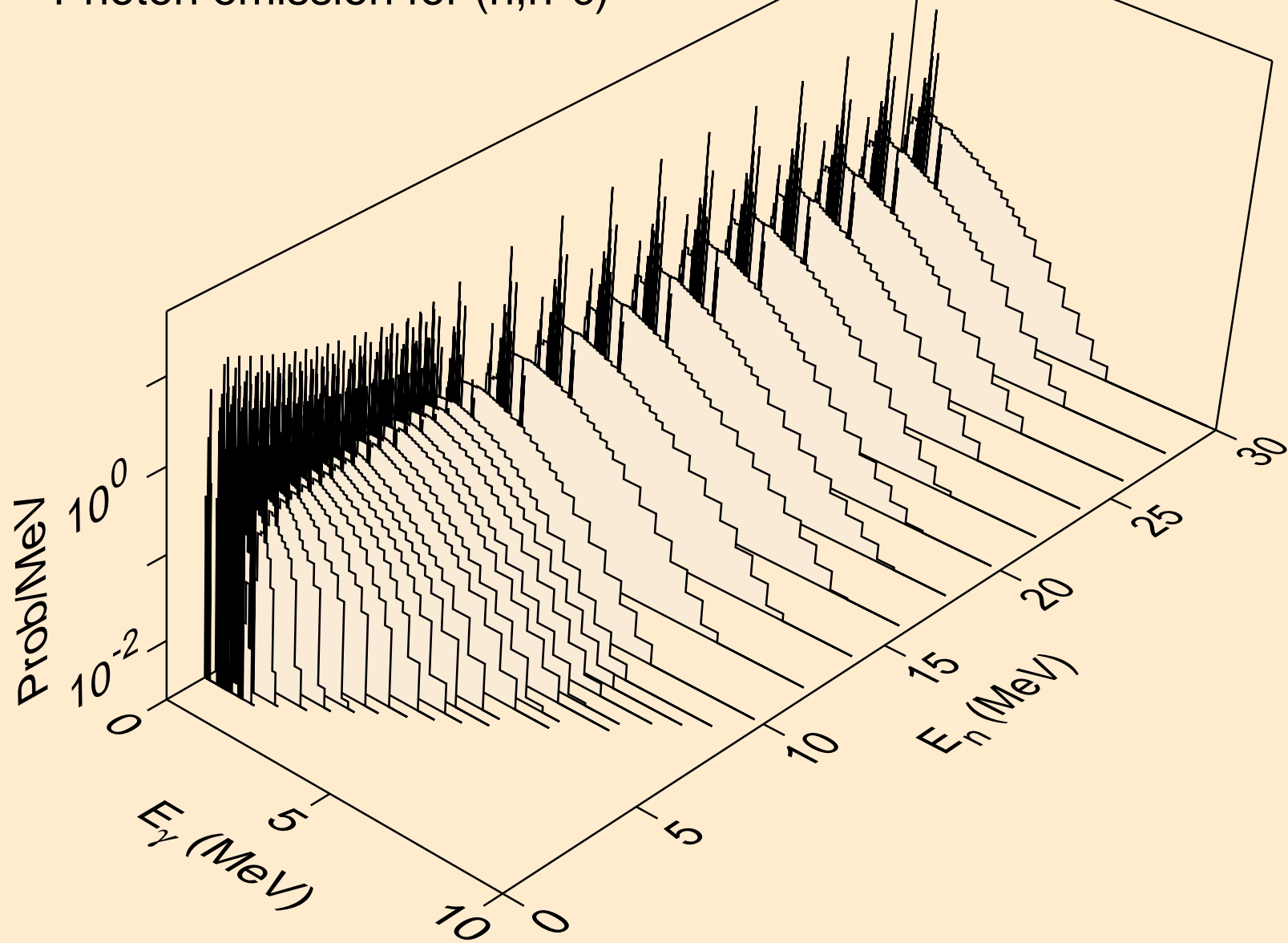

PO203 NEUTRON ACER TENDL-2023 LIBRARY; T=0.K
Photon emission for (n,gma)

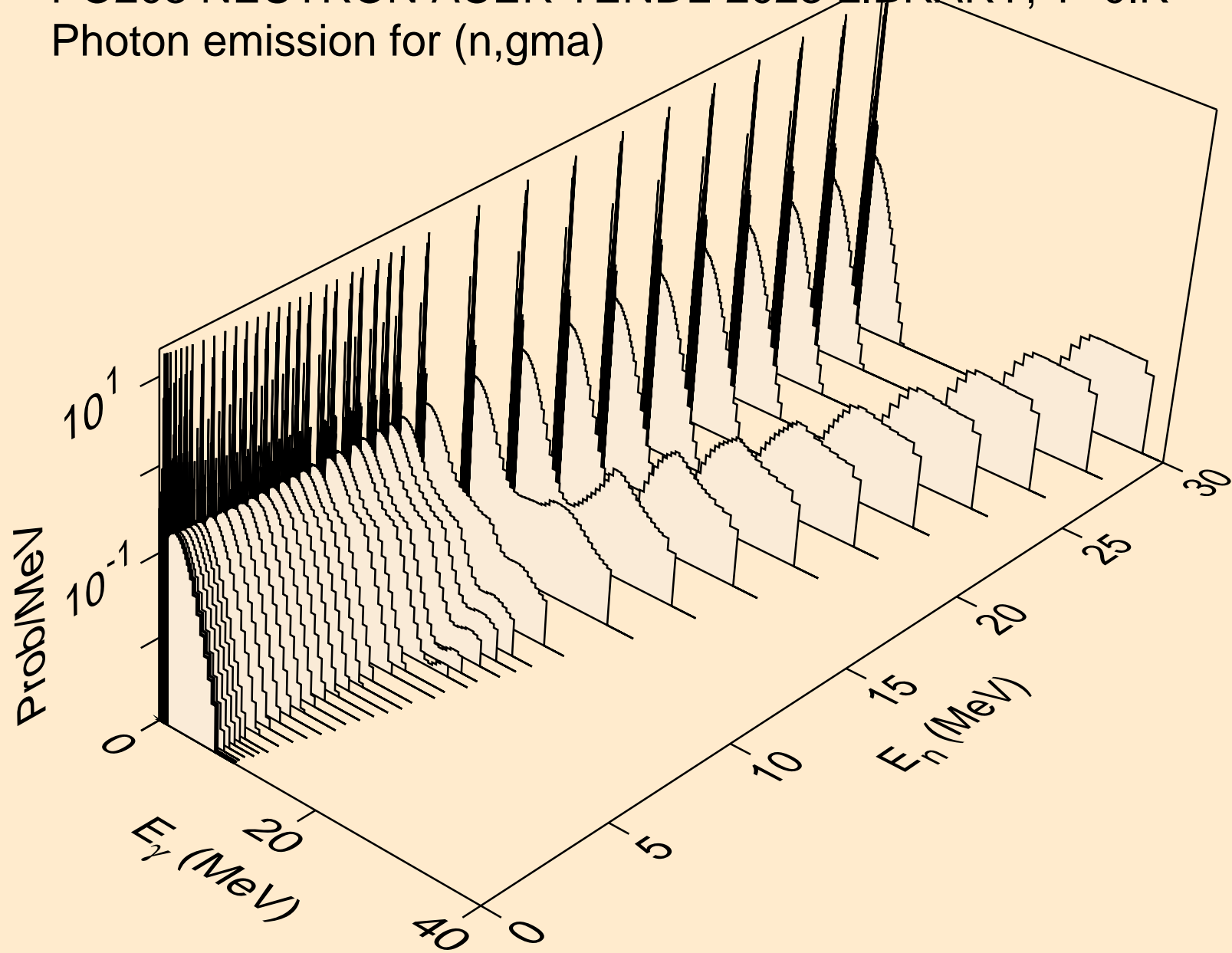

PO203 NEUTRON ACER TENDL-2023 LIBRARY; T=0.K
Photon emission for (n,p)

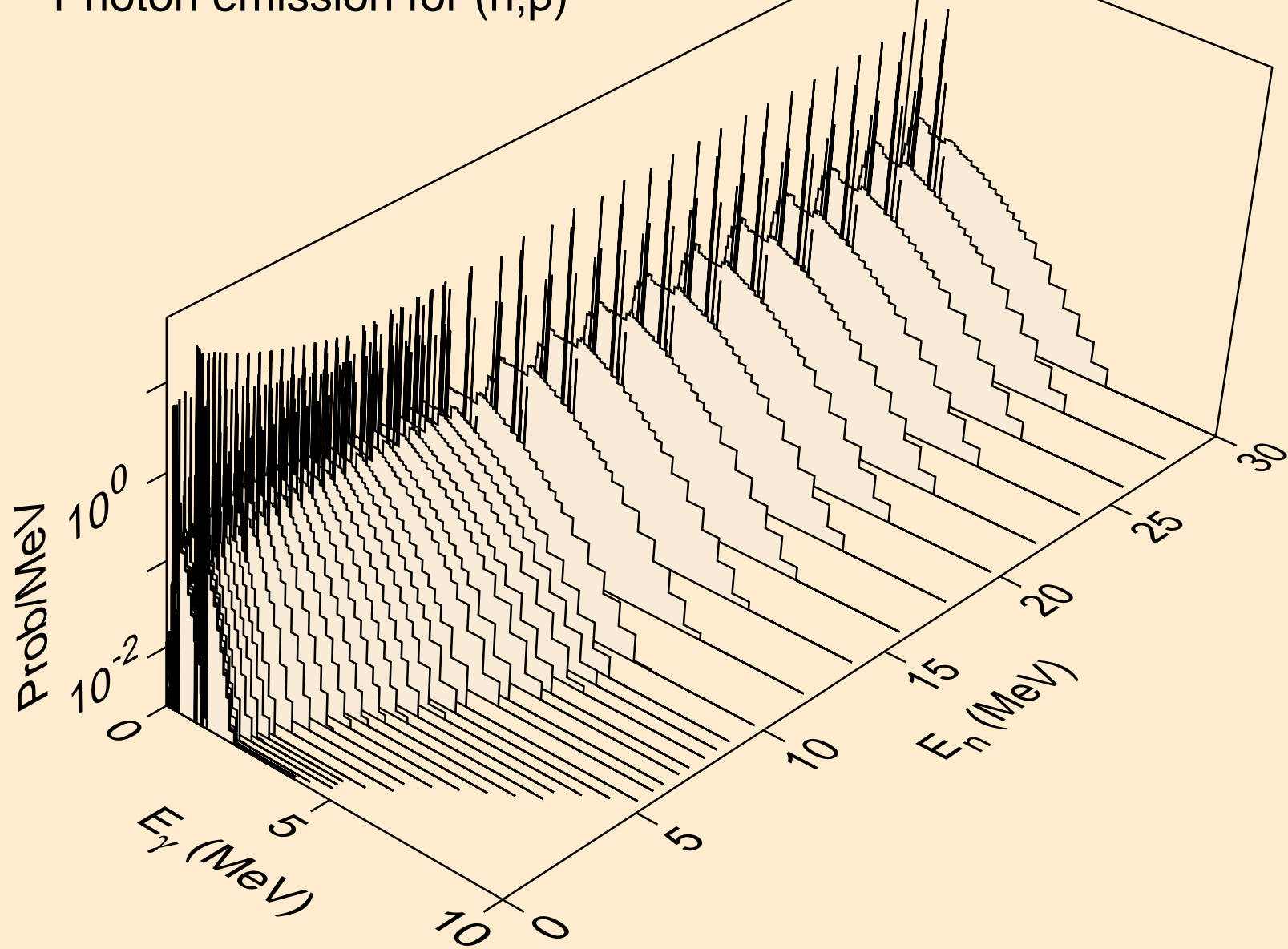

PO203 NEUTRON ACER TENDL-2023 LIBRARY; T=0.K
Photon emission for (n,d)

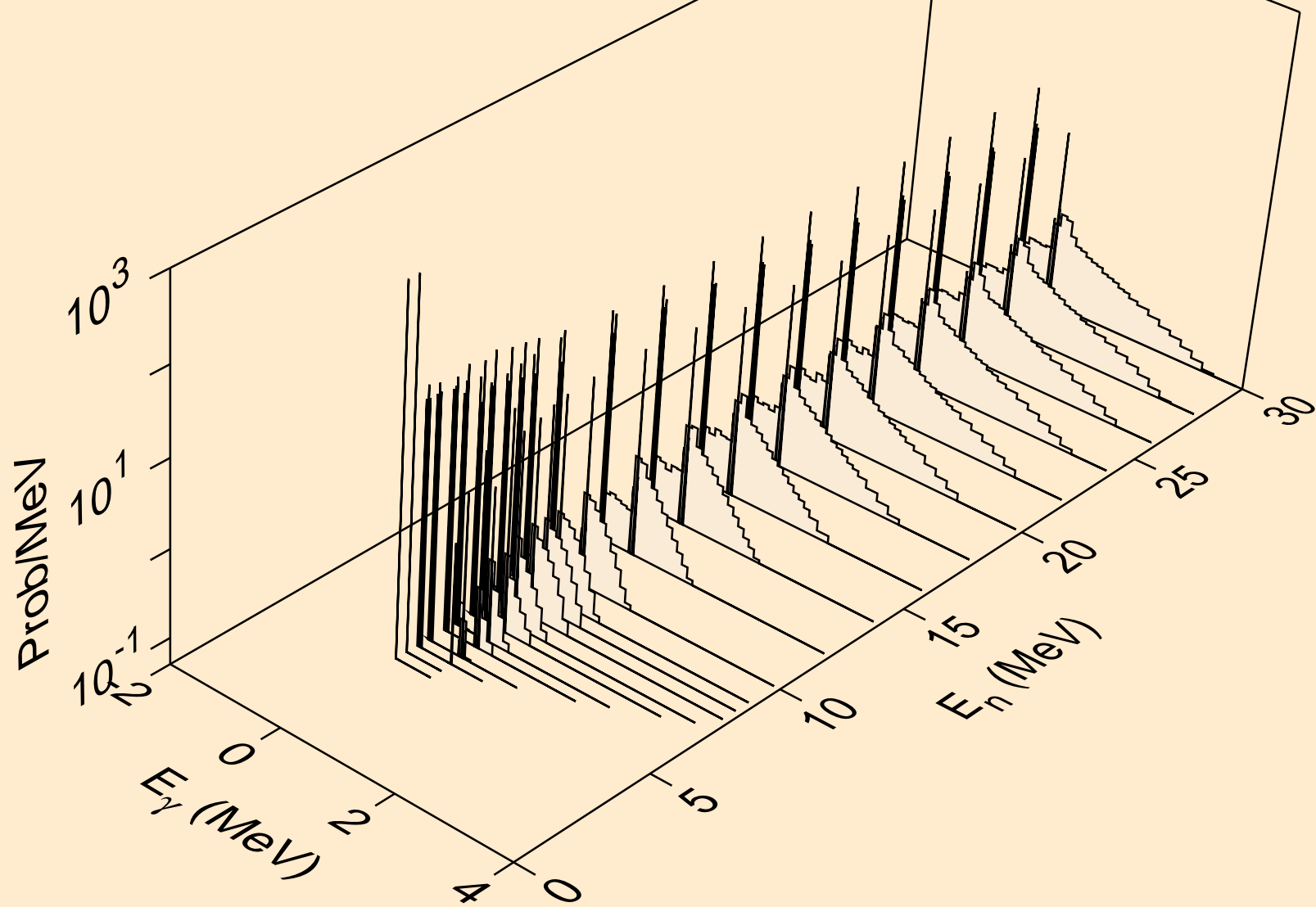

PO203 NEUTRON ACER TENDL-2023 LIBRARY; T=0.K
Photon emission for (n,t)

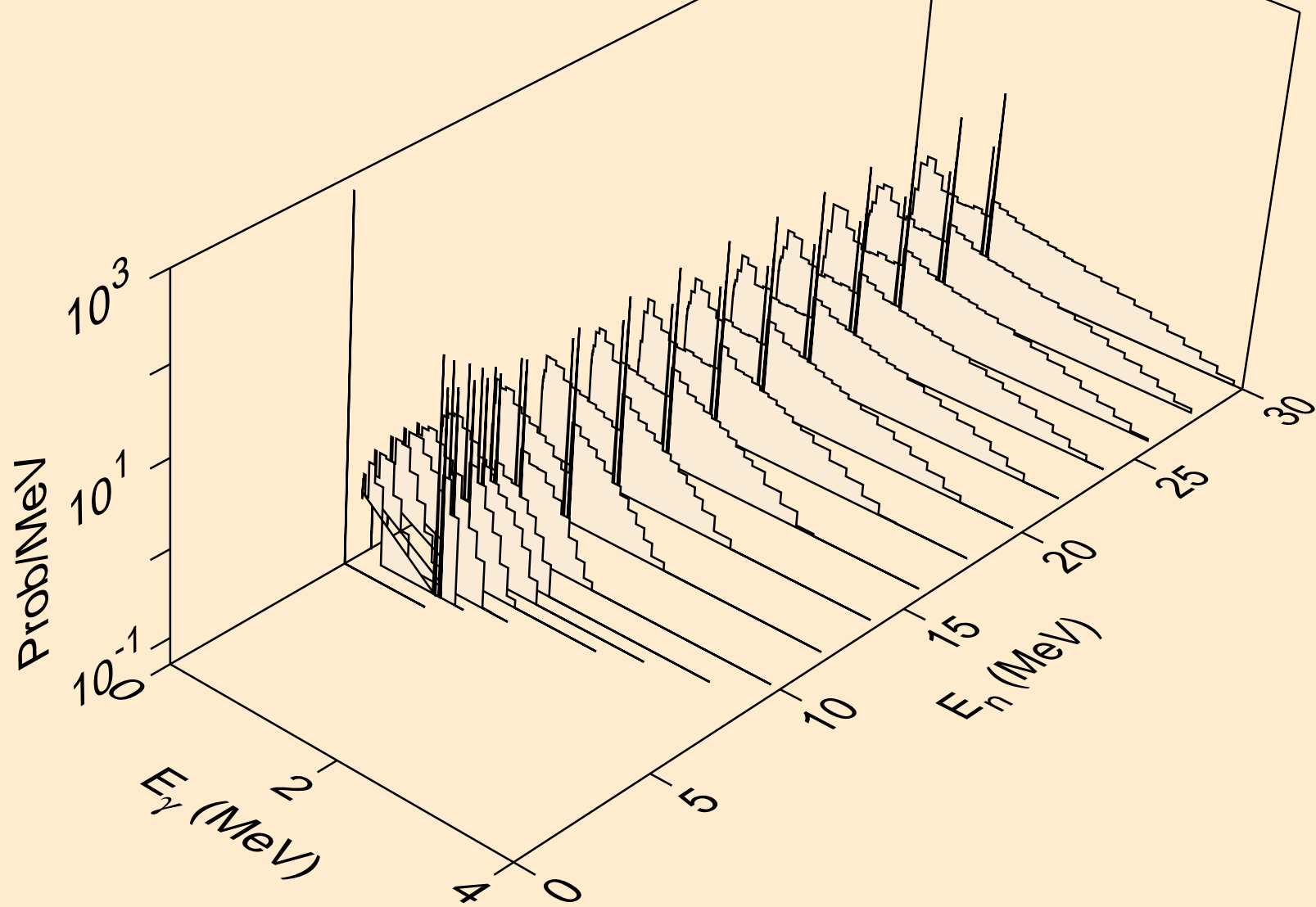

PO203 NEUTRON ACER TENDL-2023 LIBRARY; T=0.K
Photon emission for (n,he3)

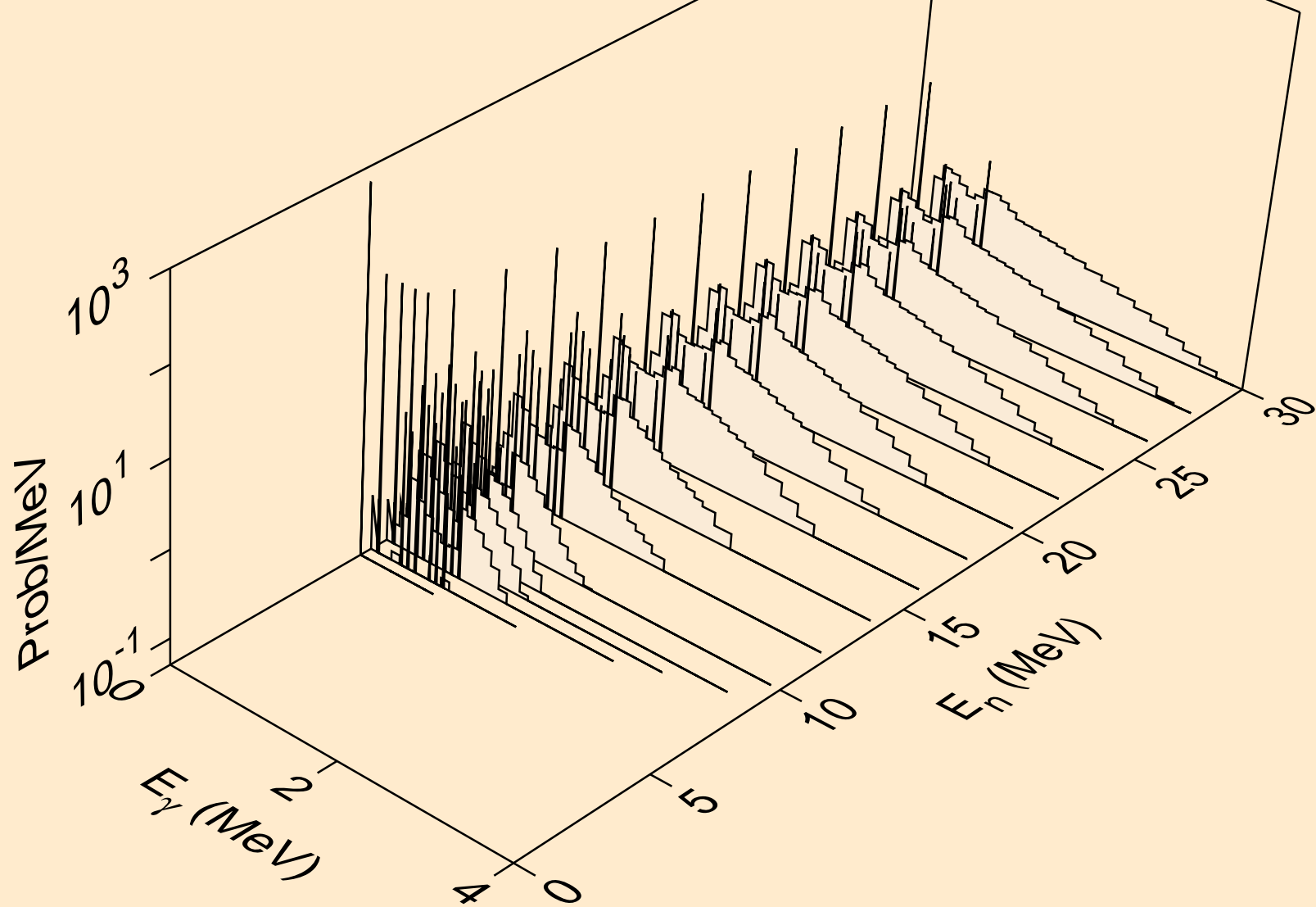

PO203 NEUTRON ACER TENDL-2023 LIBRARY; T=0.K
Photon emission for (n,a)

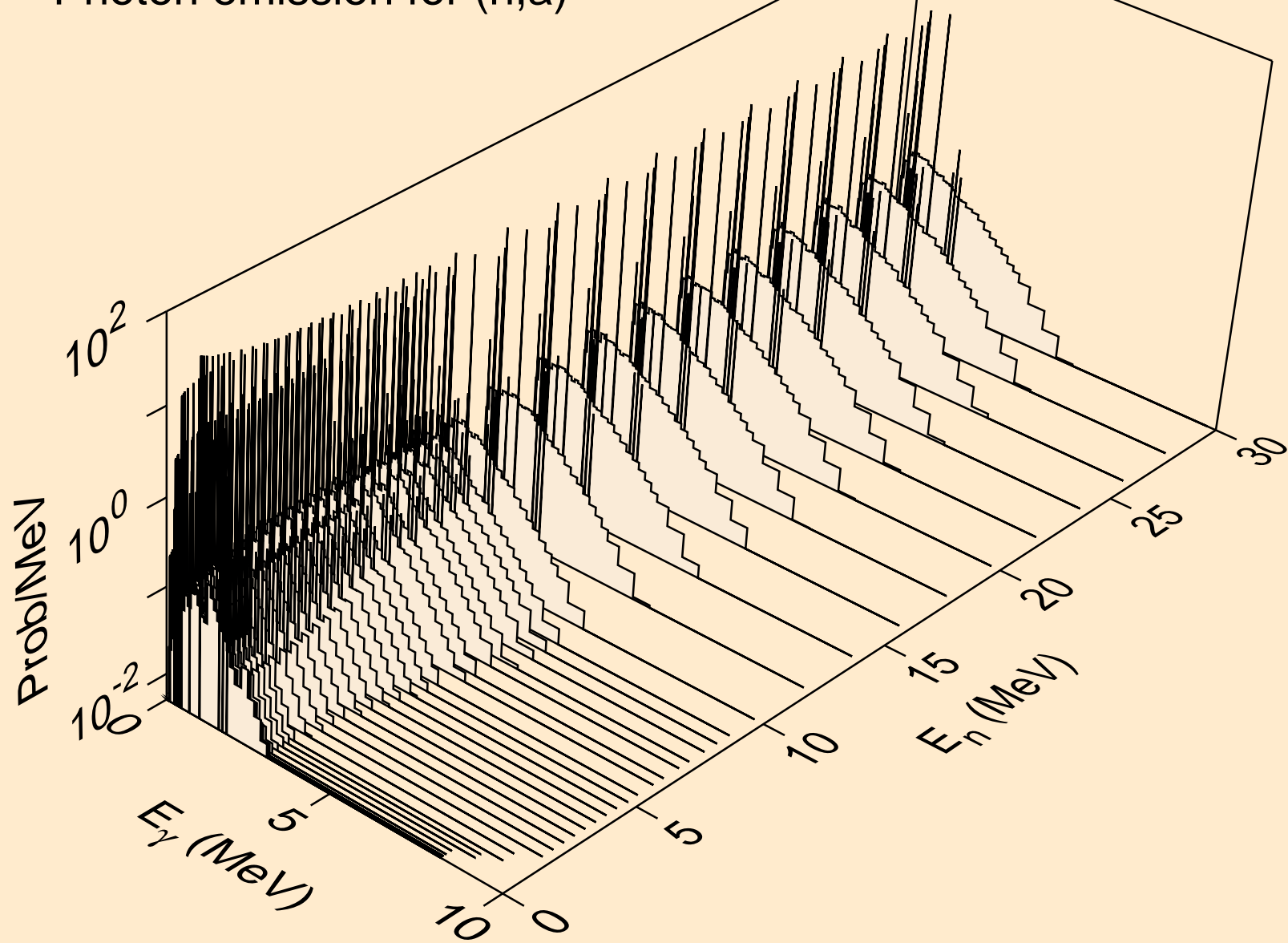

PO203 NEUTRON ACER TENDL-2023 LIBRARY; T=0.K
Photon emission for (n,2a)

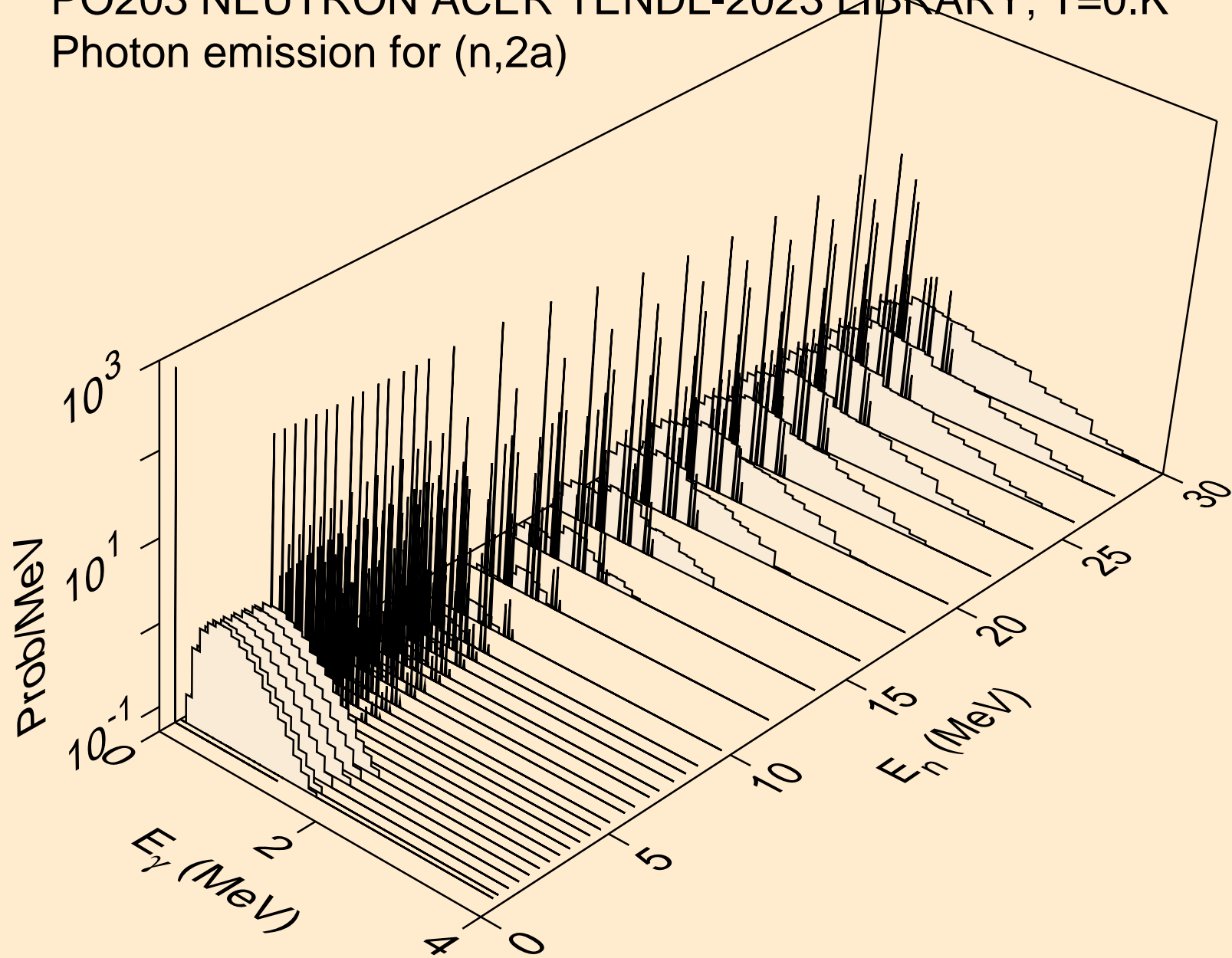

PO203 NEUTRON ACER TENDL-2023 LIBRARY; T=0.K
Photon emission for (n,2p)

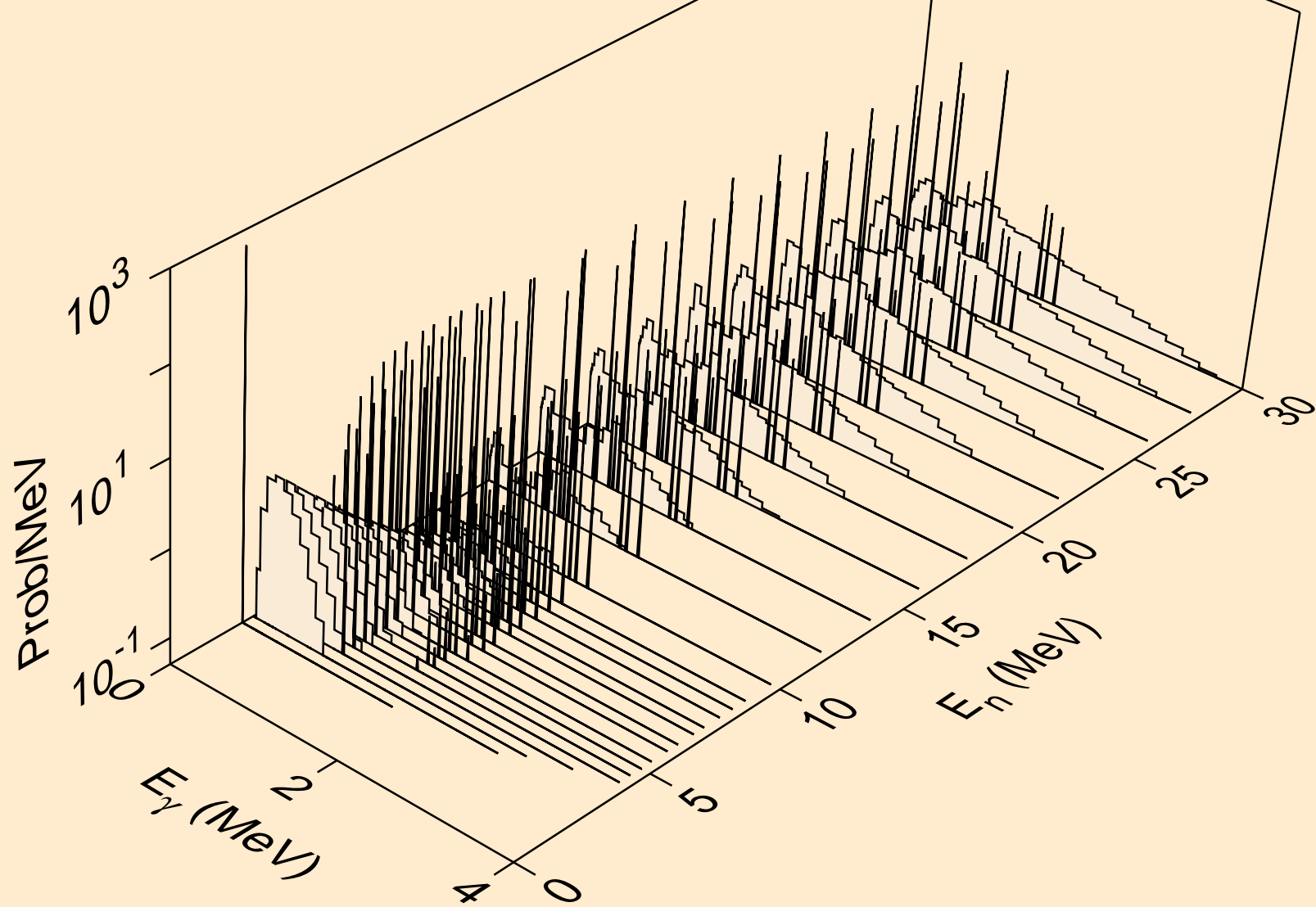

PO203 NEUTRON ACER TENDL-2023 LIBRARY; T=0.K
Photon emission for (n,p α)

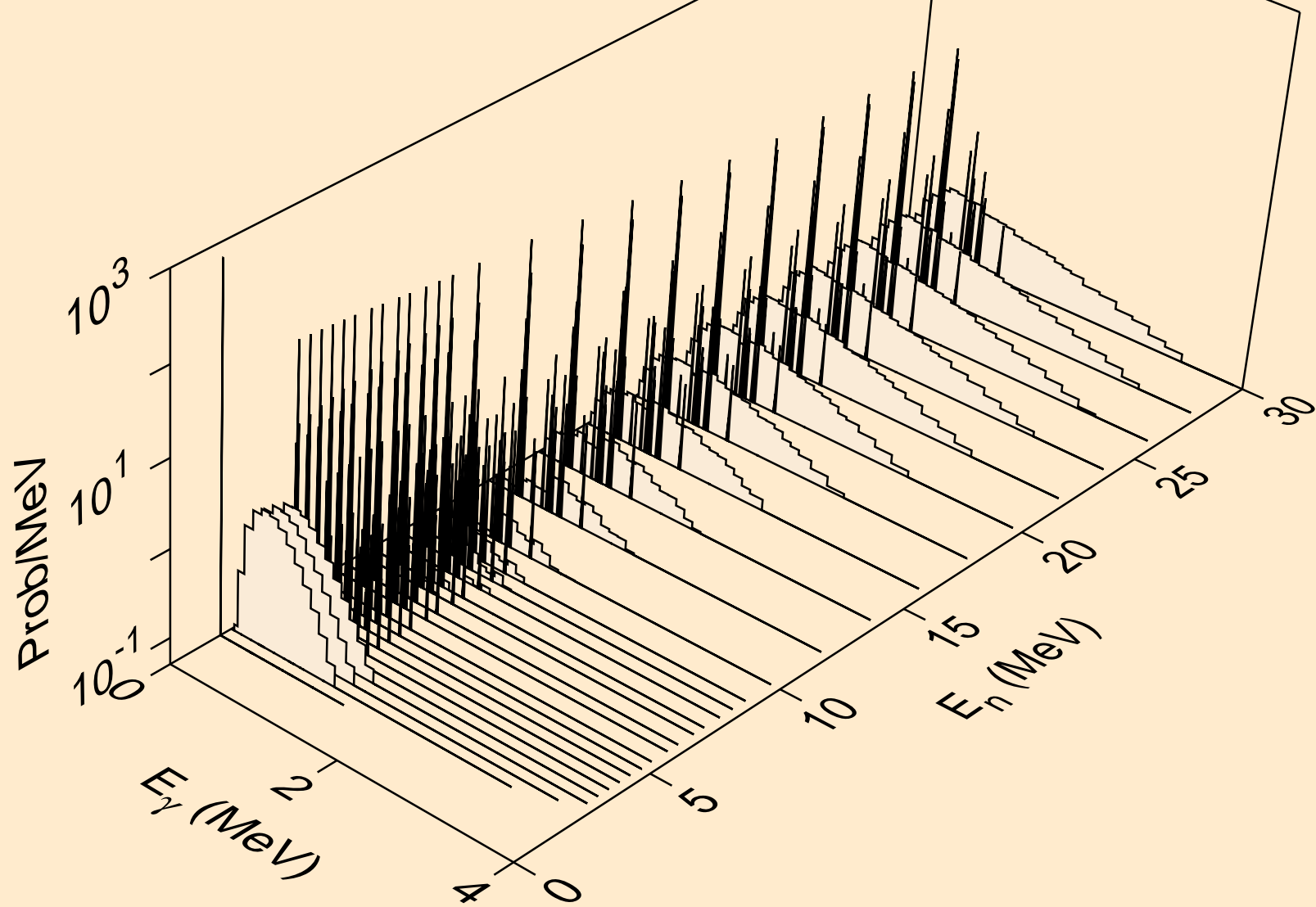

PO203 NEUTRON ACER TENDL-2023 LIBRARY; T=0.K
Photon emission for (n,pd)

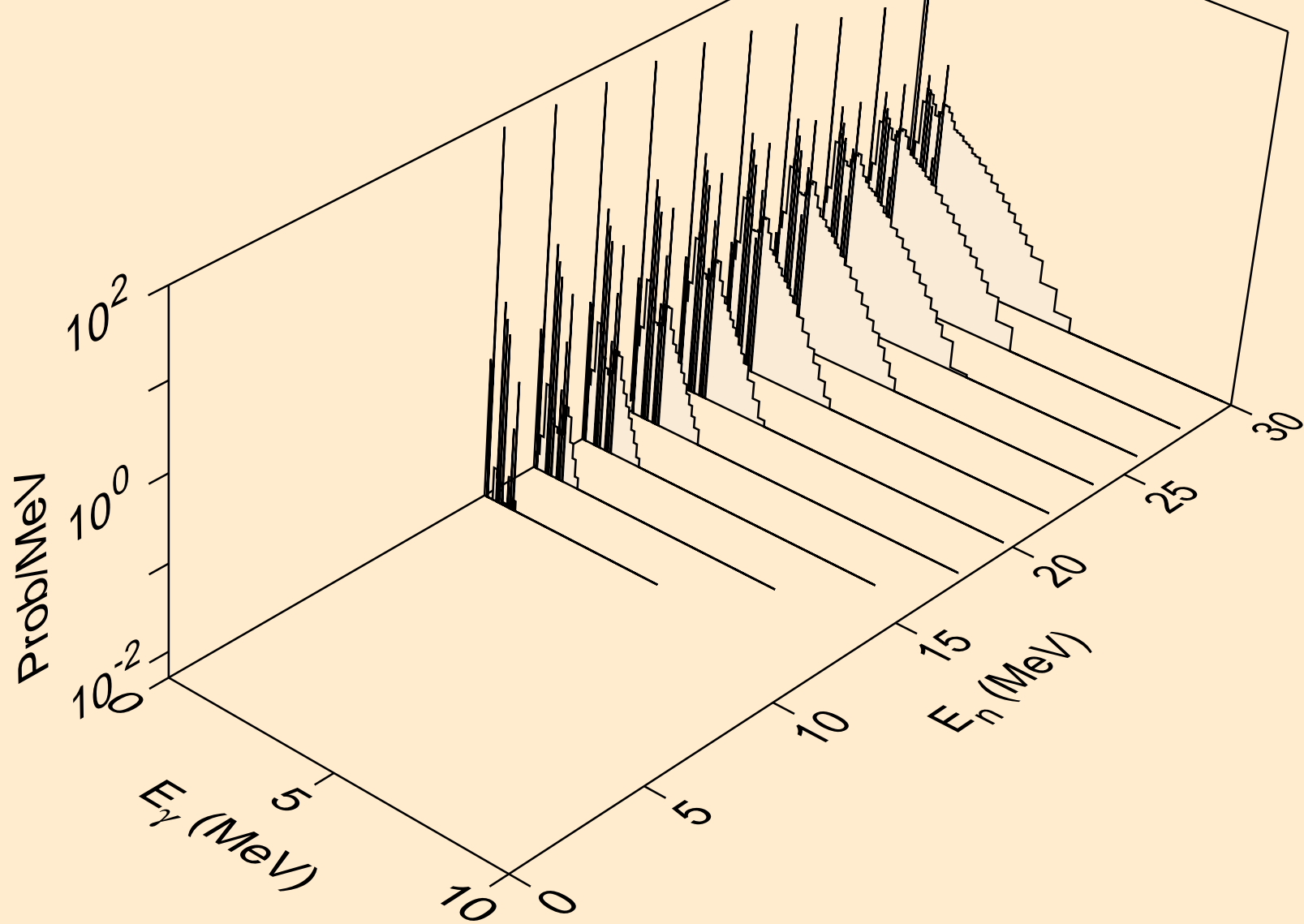

PO203 NEUTRON ACER TENDL-2023 LIBRARY; T=0.K
Photon emission for (n,pt)

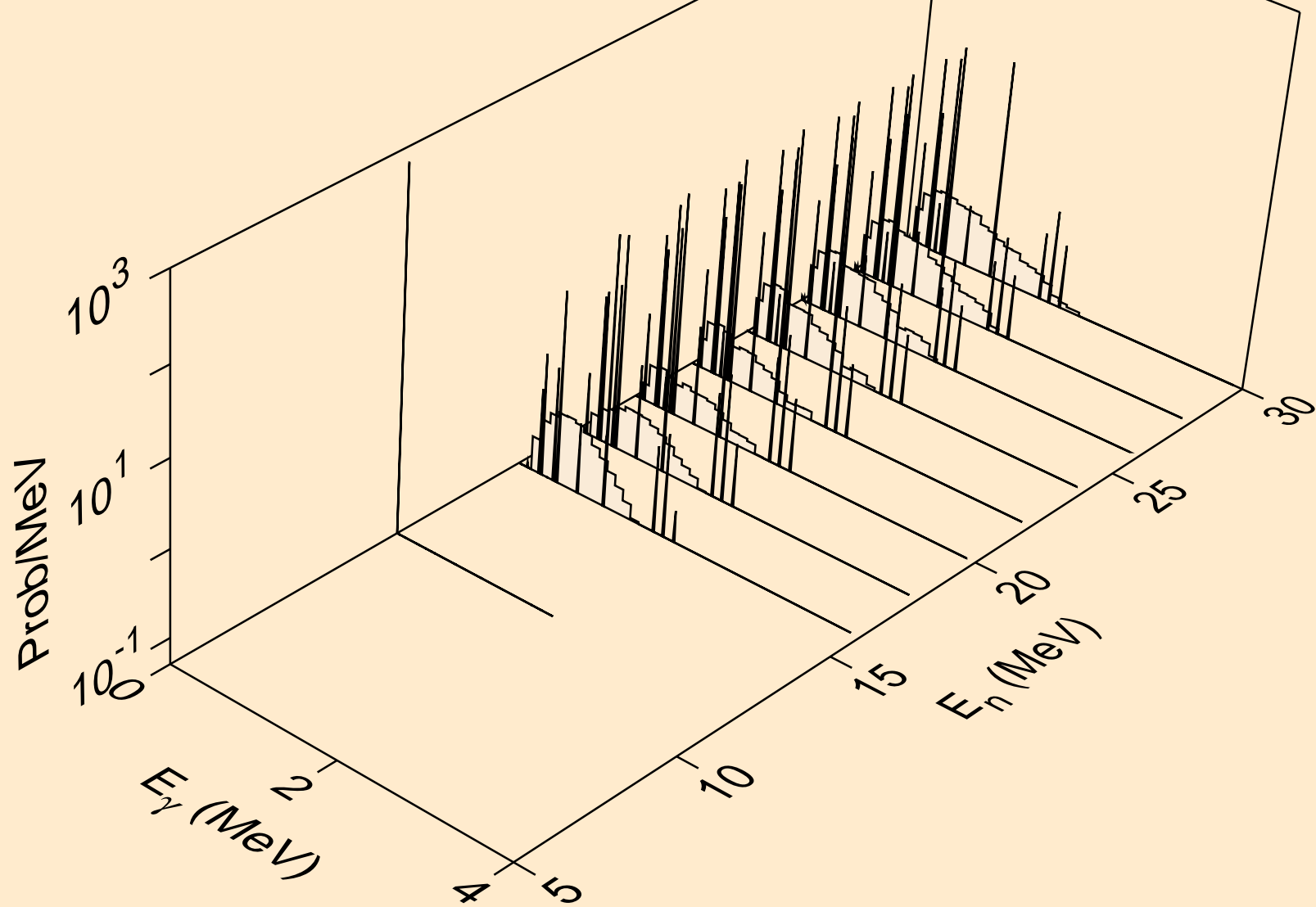

PO203 NEUTRON ACER TENDL-2023 LIBRARY; T=0.K
Photon emission for (n,da)

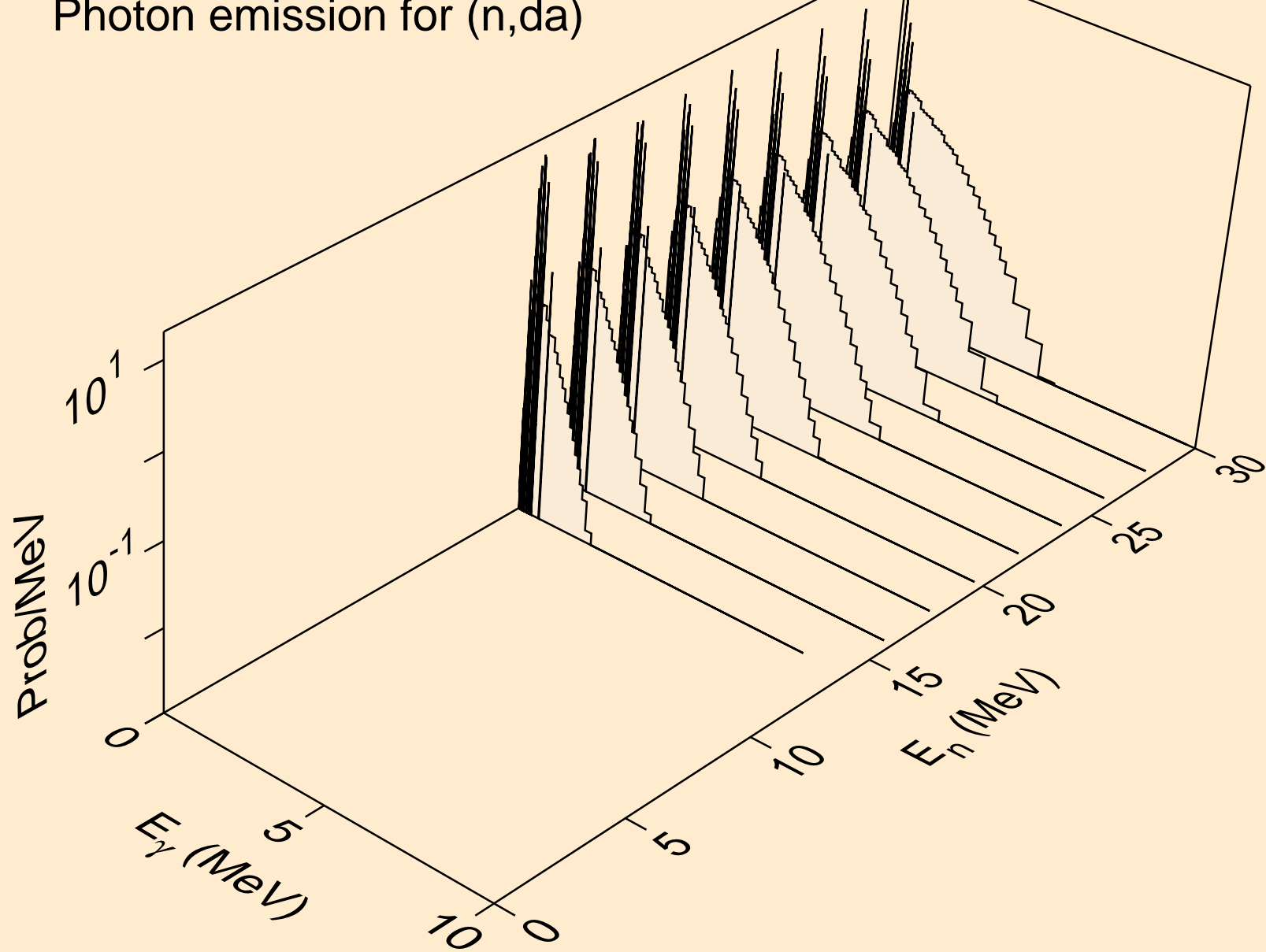

PO203 NEUTRON ACER TENDL-2023 LIBRARY; T=0.K
thermal capture photon spectrum

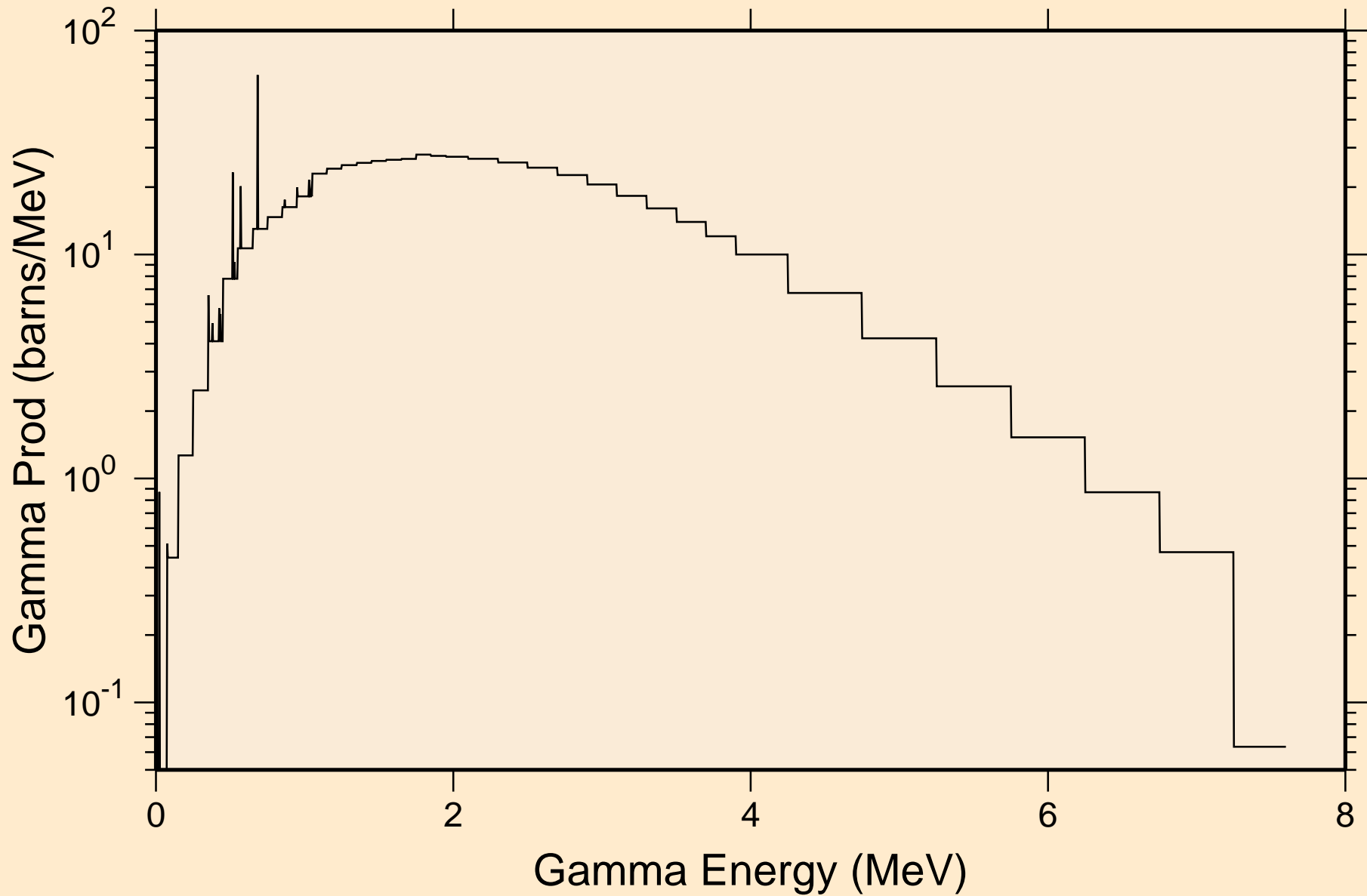

PO203 NEUTRON ACER TENDL-2023 LIBRARY; T=0.K
14 MeV photon spectrum

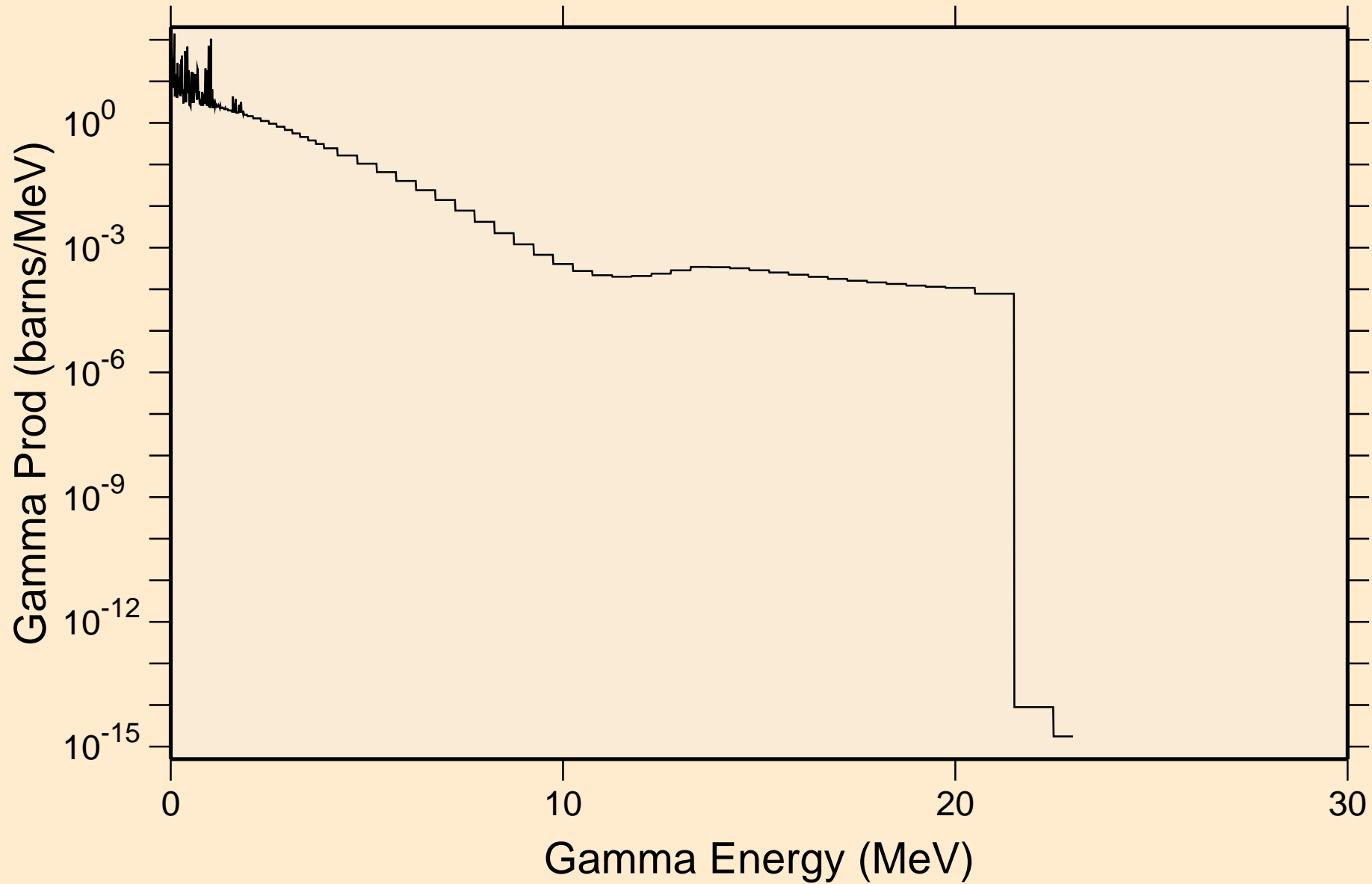

PO203 NEUTRON ACER TENDL-2023 LIBRARY; T=0.K
Particle heating contributions

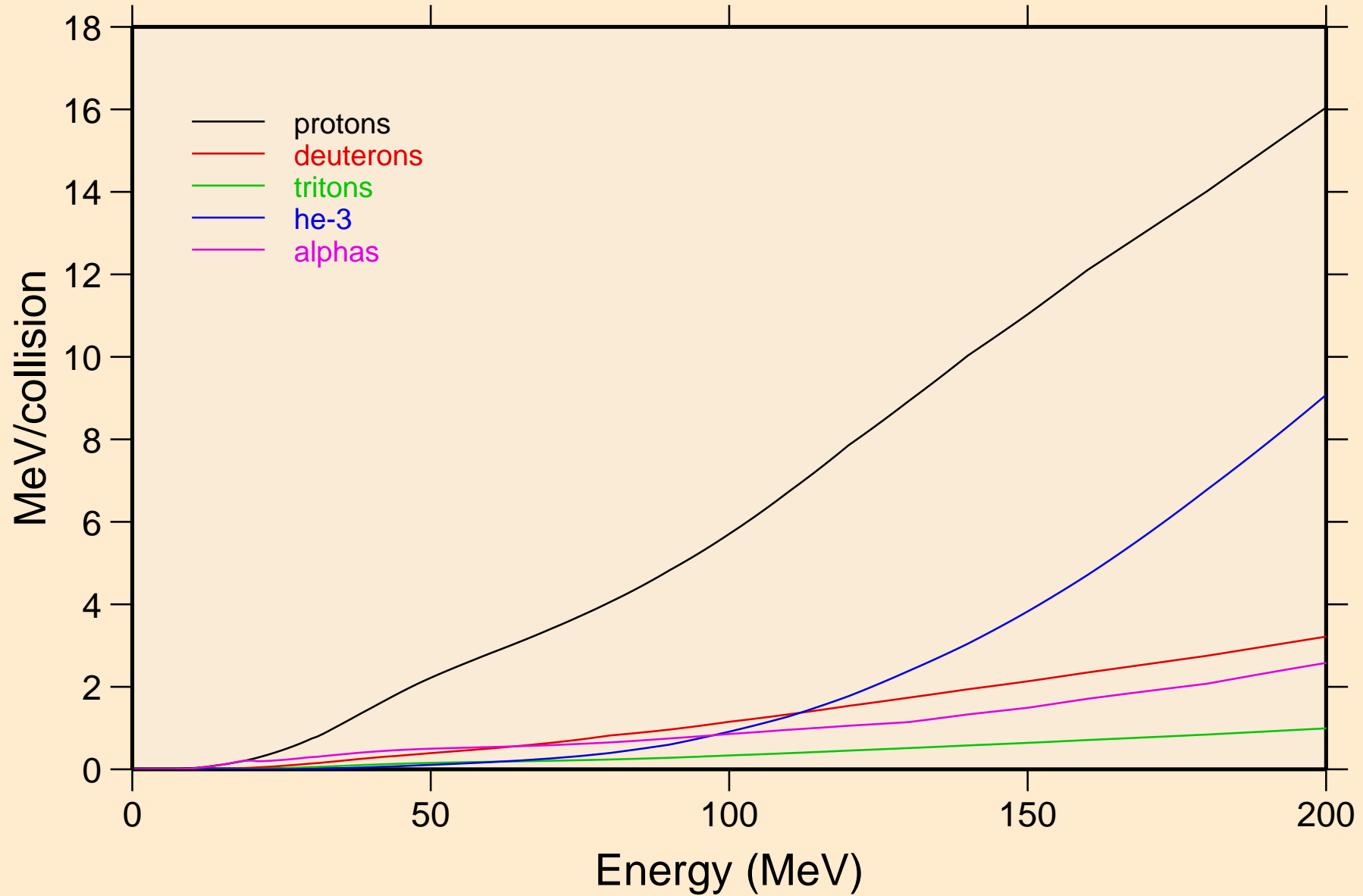

PO203 NEUTRON ACER TENDL-2023 LIBRARY; T=0.K
Recoil Heating

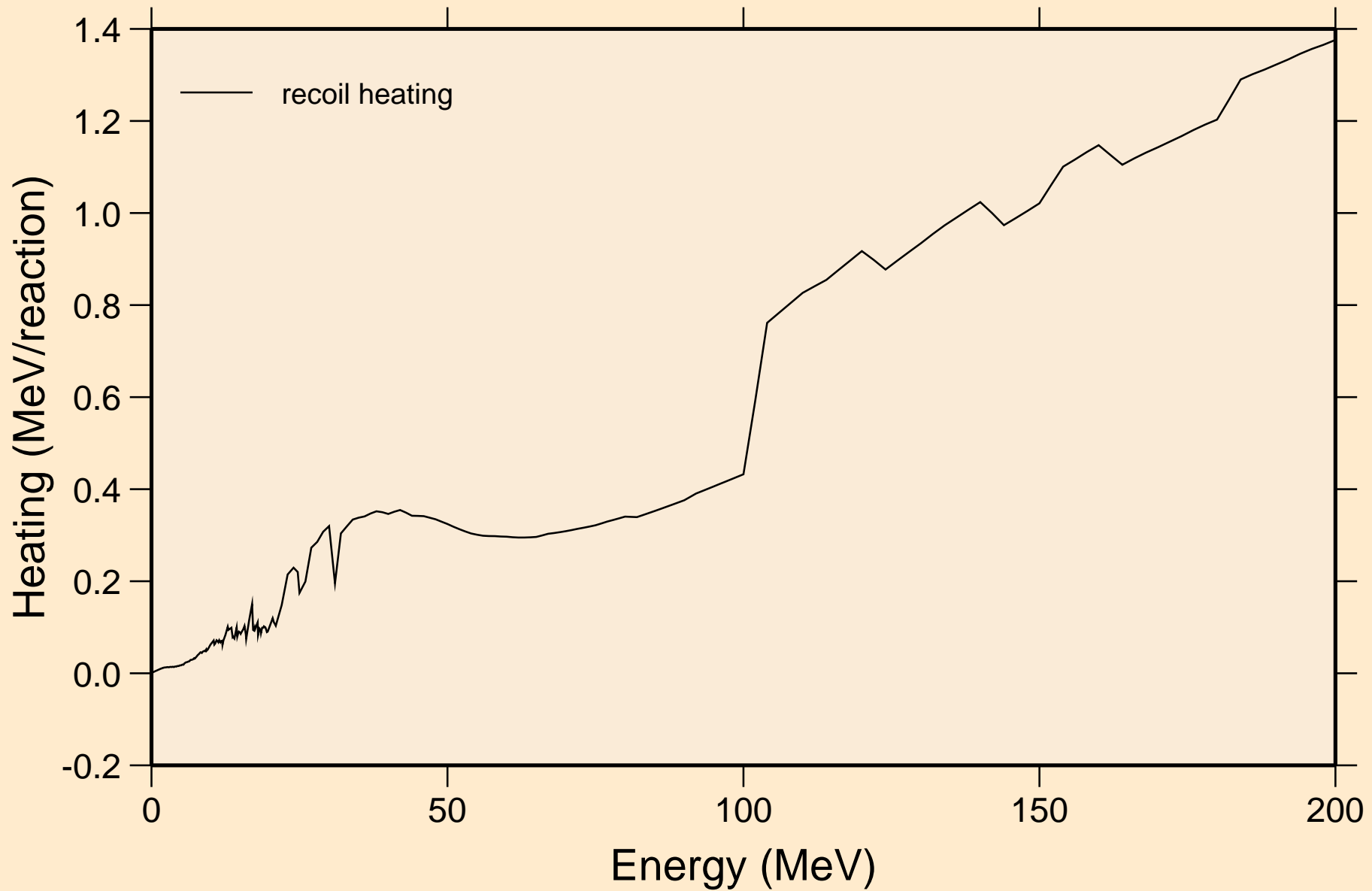

PO203 NEUTRON ACER TENDL-2023 LIBRARY; T=0.K
Particle production cross sections

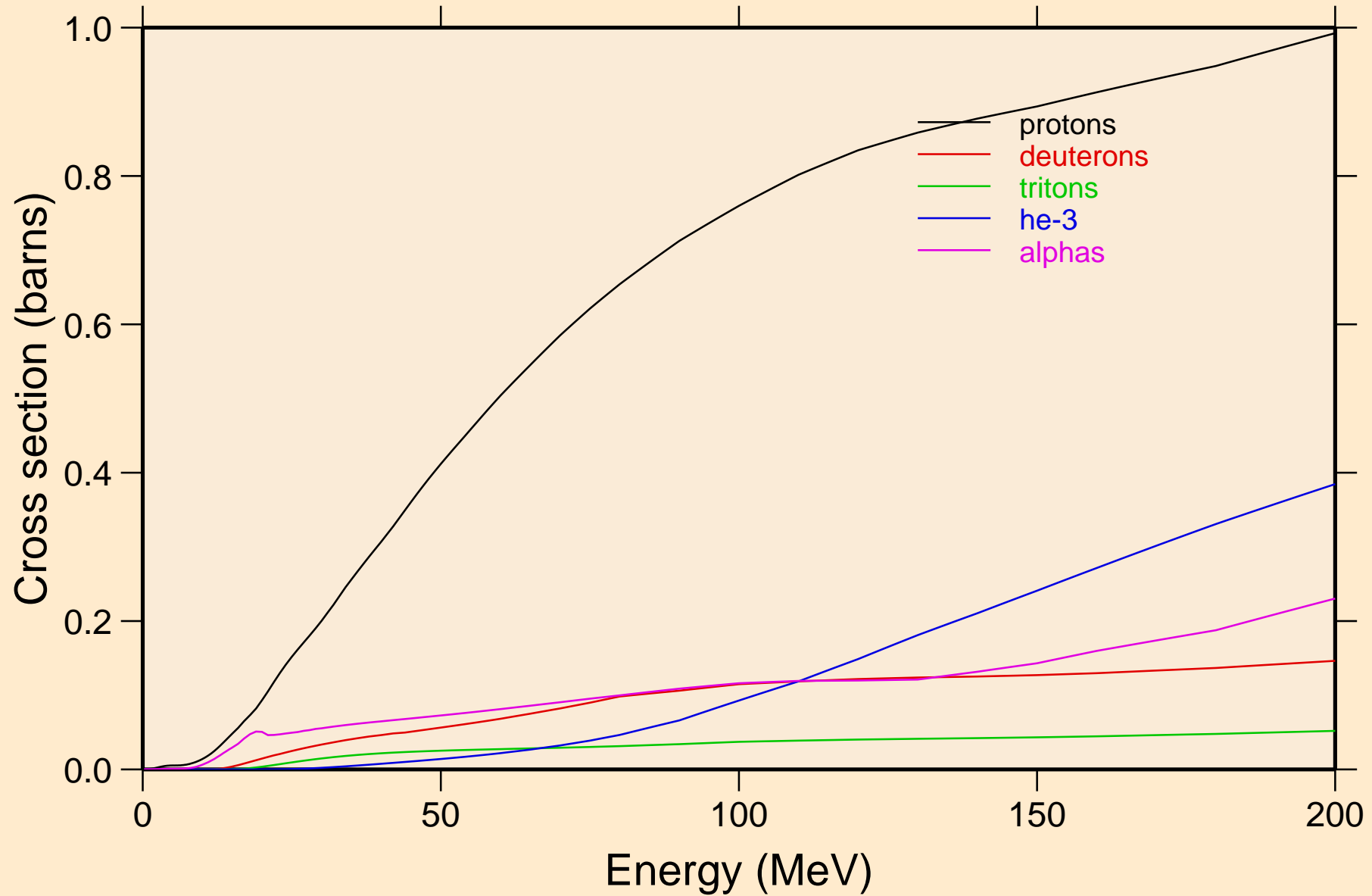

PO203 NEUTRON ACER TENDL-2023 LIBRARY; T=0.K
protons from (n,x)

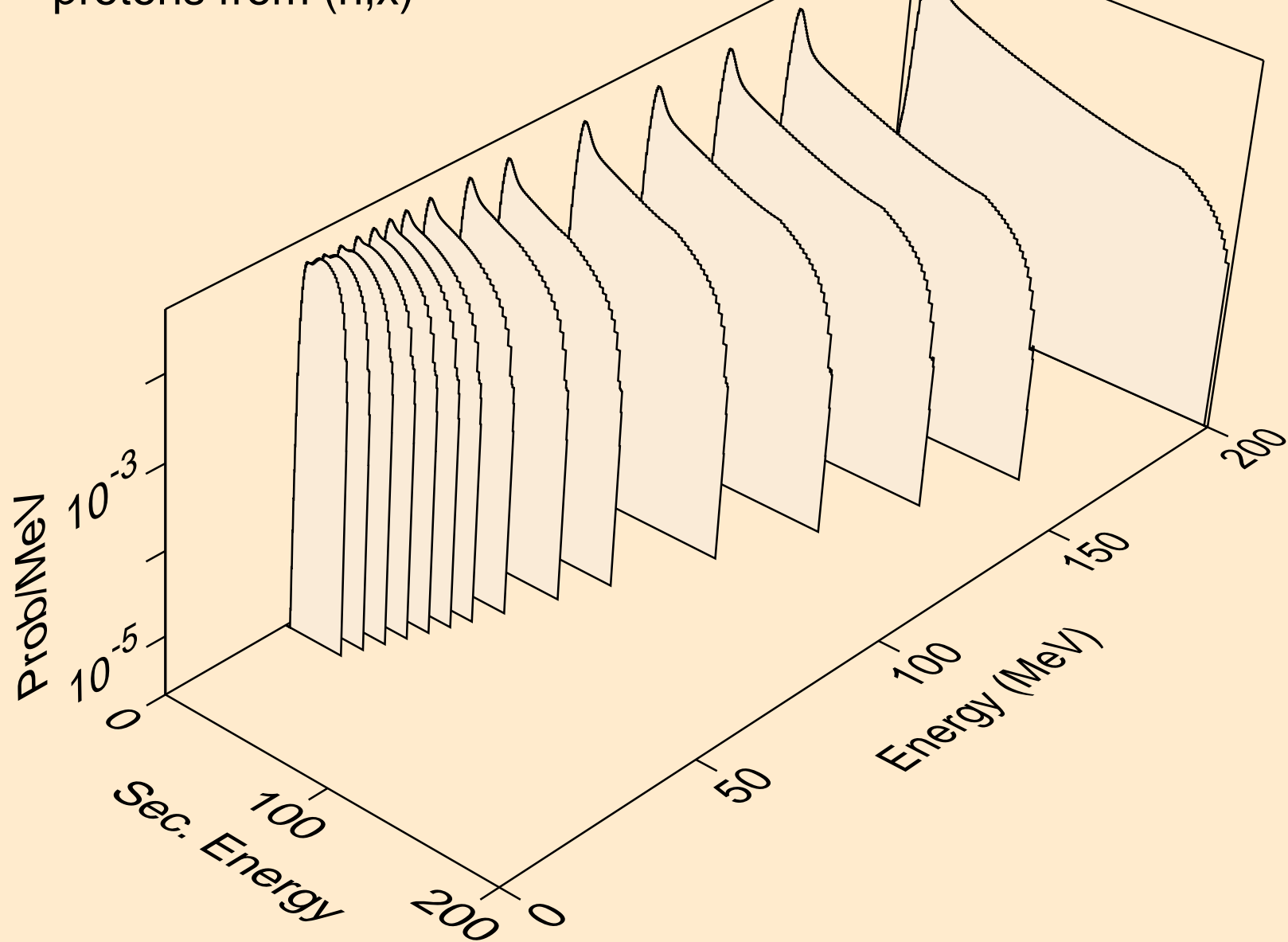

PO203 NEUTRON ACER TENDL-2023 LIBRARY; T=0.K
protons from (n,n*)p

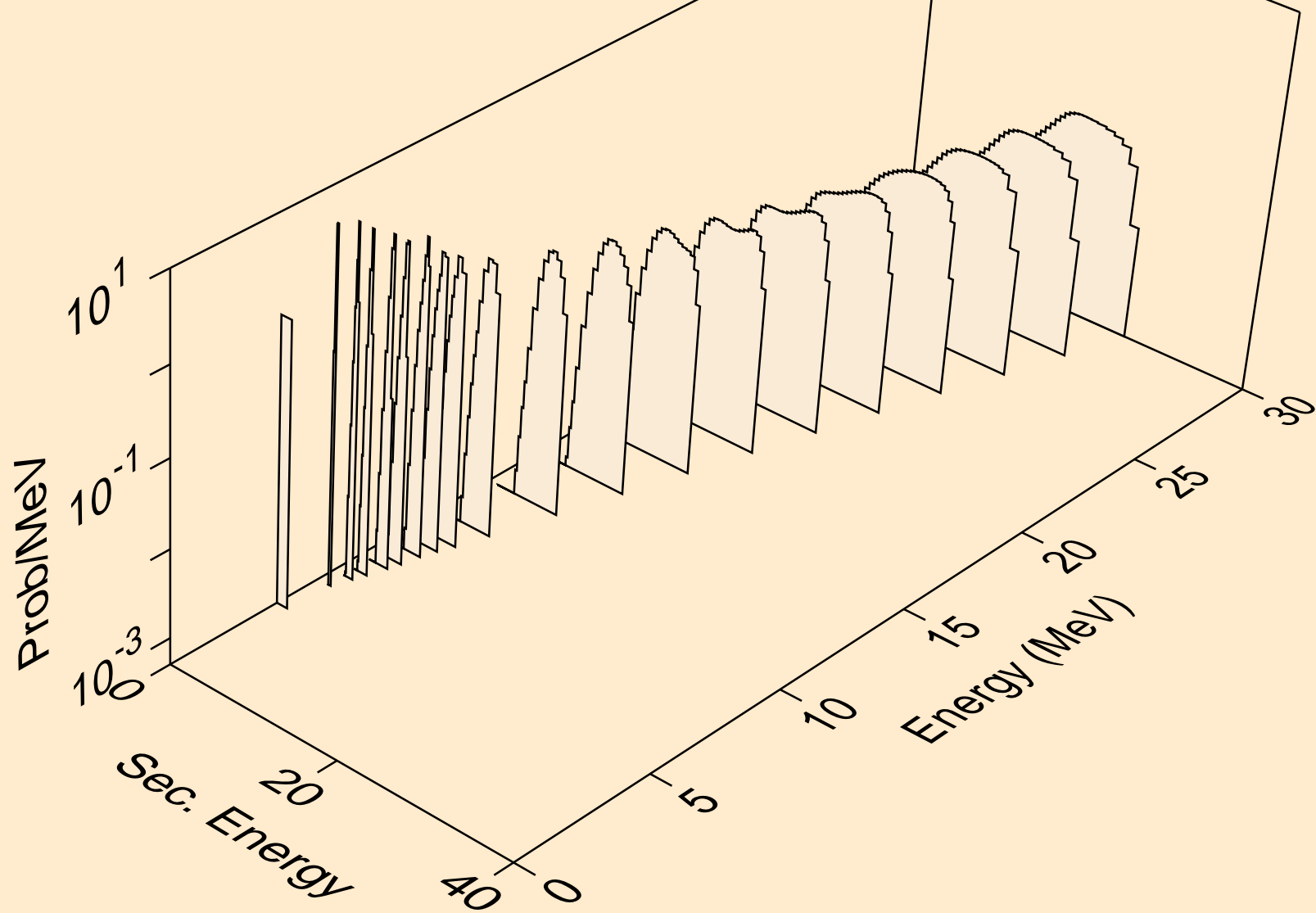

PO203 NEUTRON ACER TENDL-2023 LIBRARY; T=0.K
protons from (n,2np)

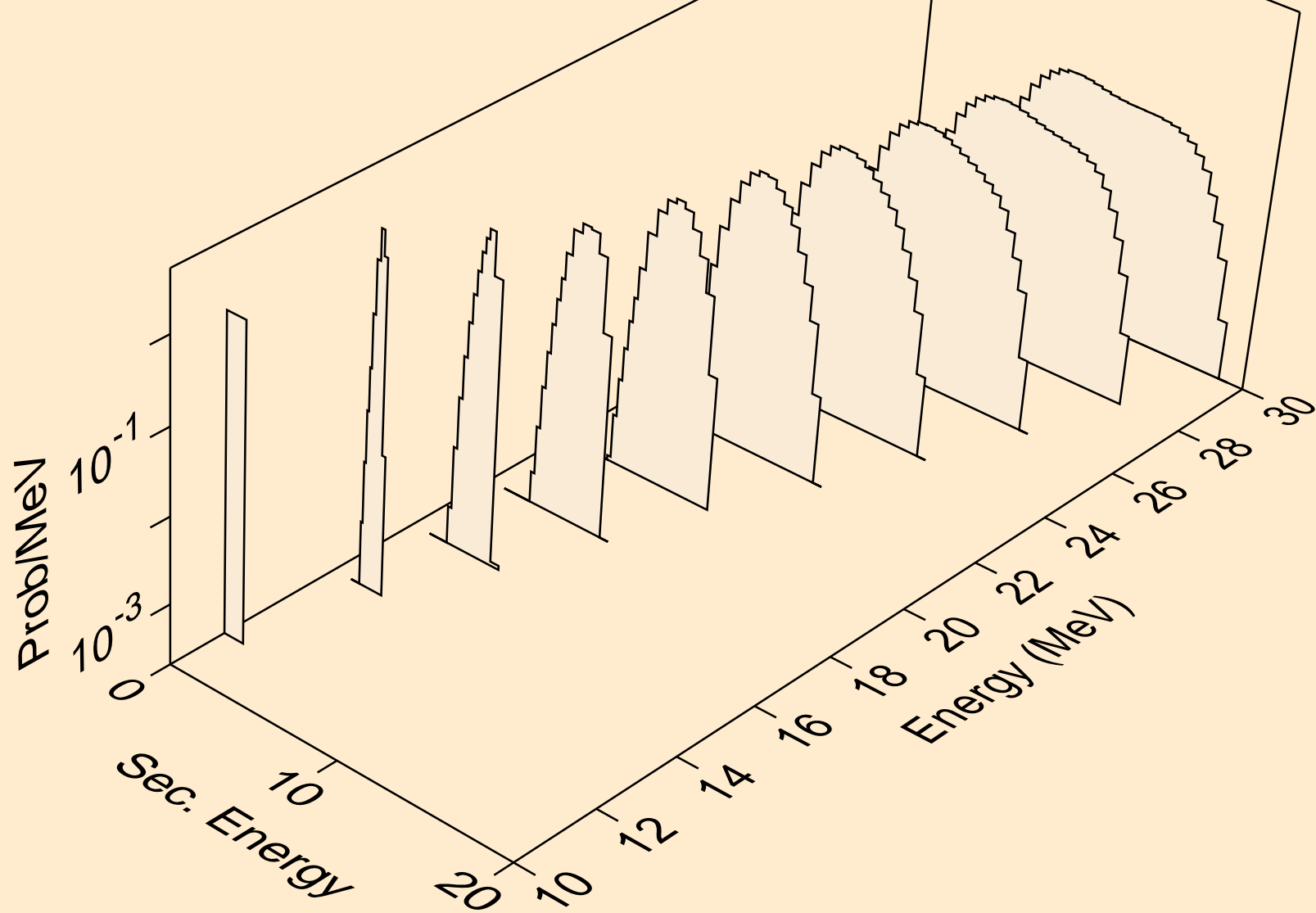

PO203 NEUTRON ACER TENDL-2023 LIBRARY; T=0.K
protons from (n,3np)

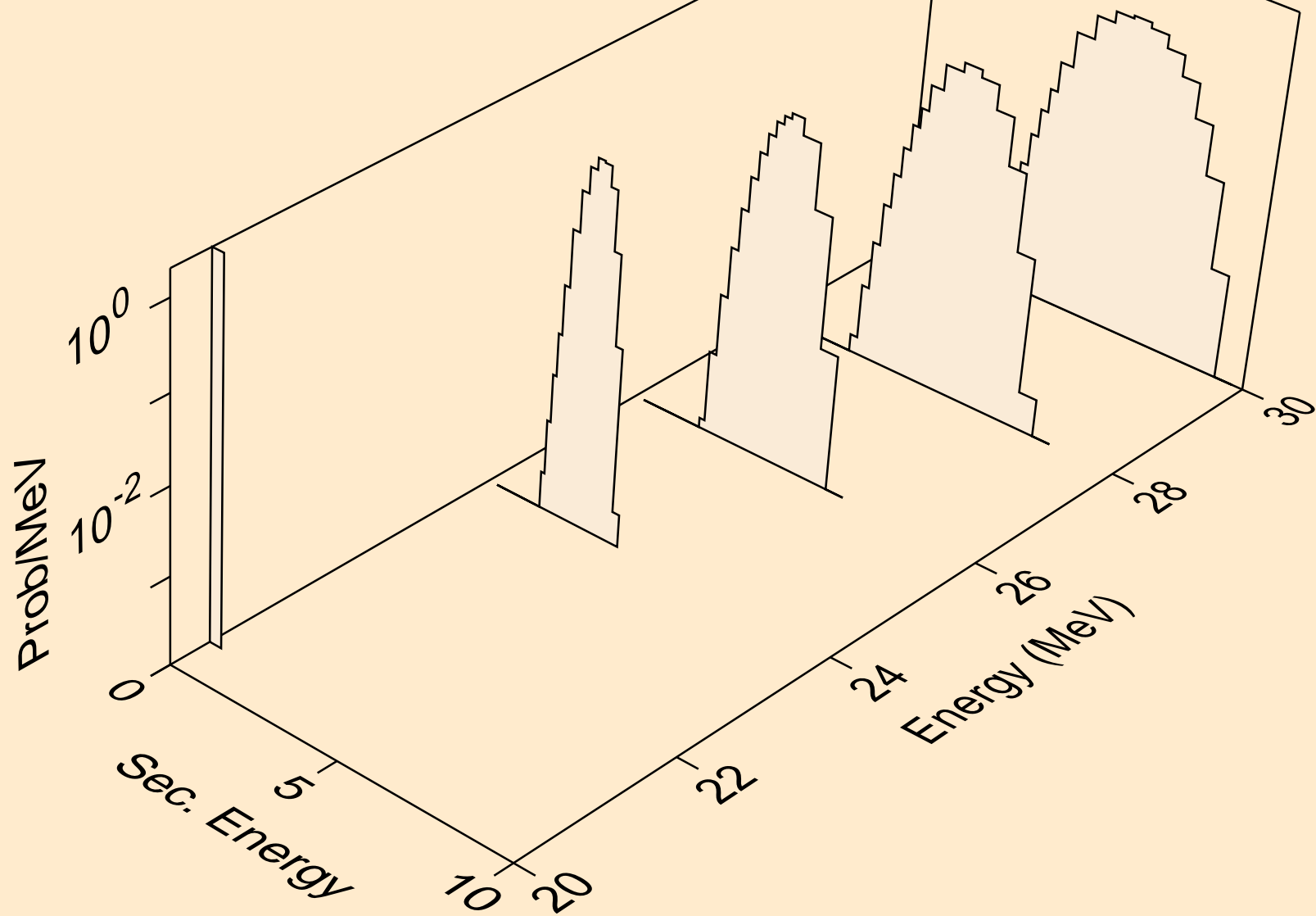

PO203 NEUTRON ACER TENDL-2023 LIBRARY; T=0.K
protons from (n,n2p)

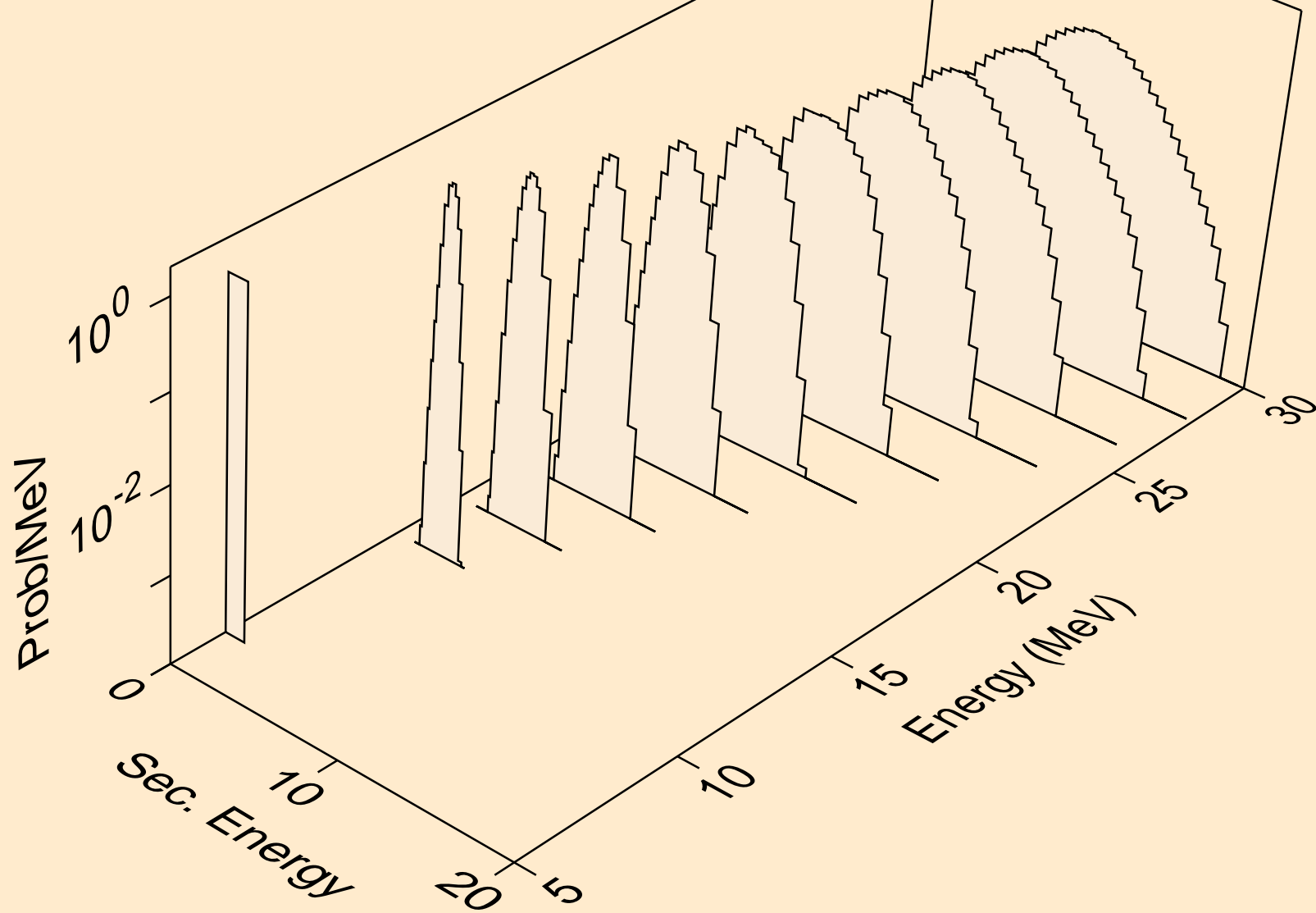

PO203 NEUTRON ACER TENDL-2023 LIBRARY; T=0.K
protons from (n,npa)

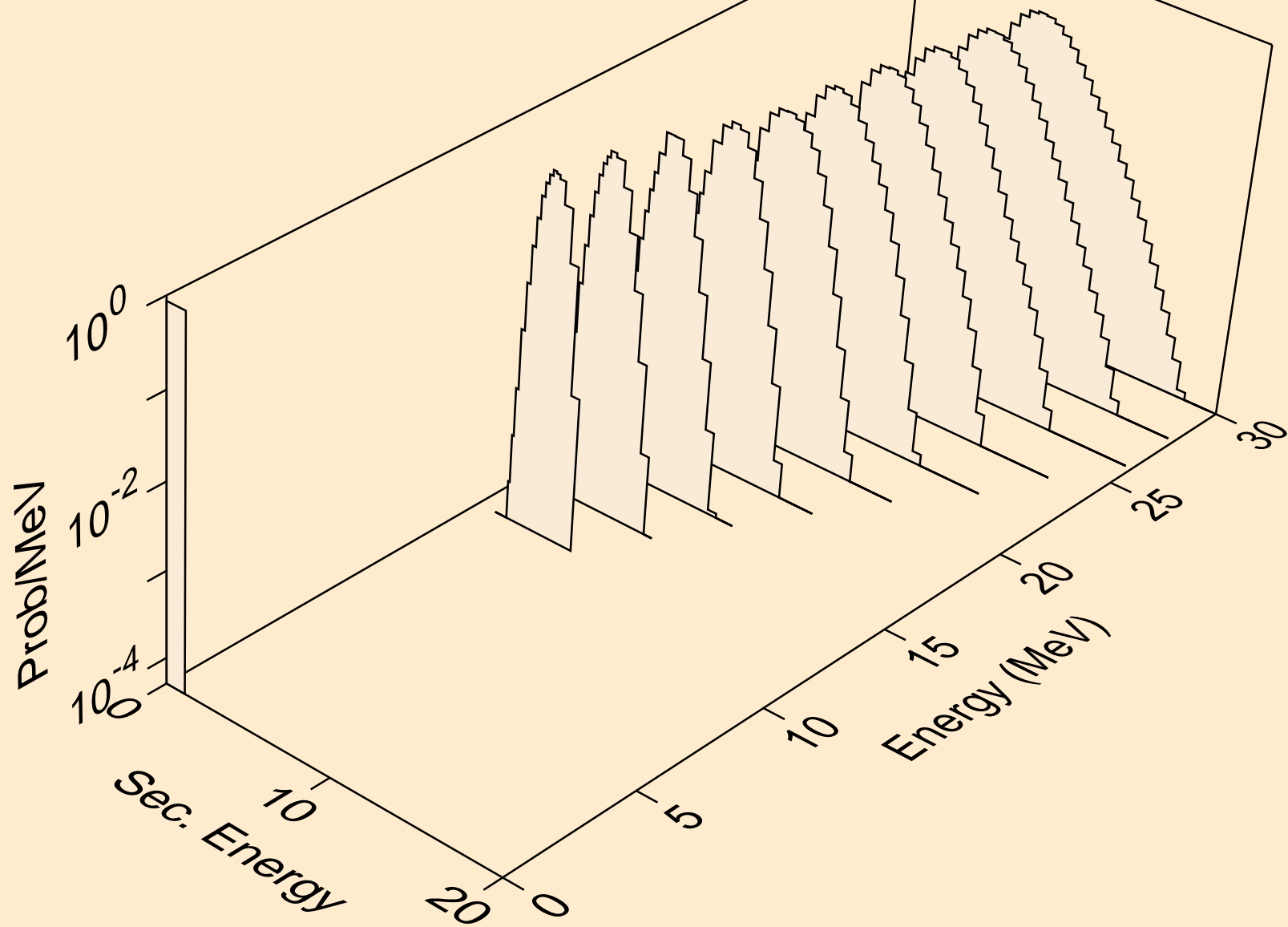

PO203 NEUTRON ACER TENDL-2023 LIBRARY; T=0.K
protons from (n,p)

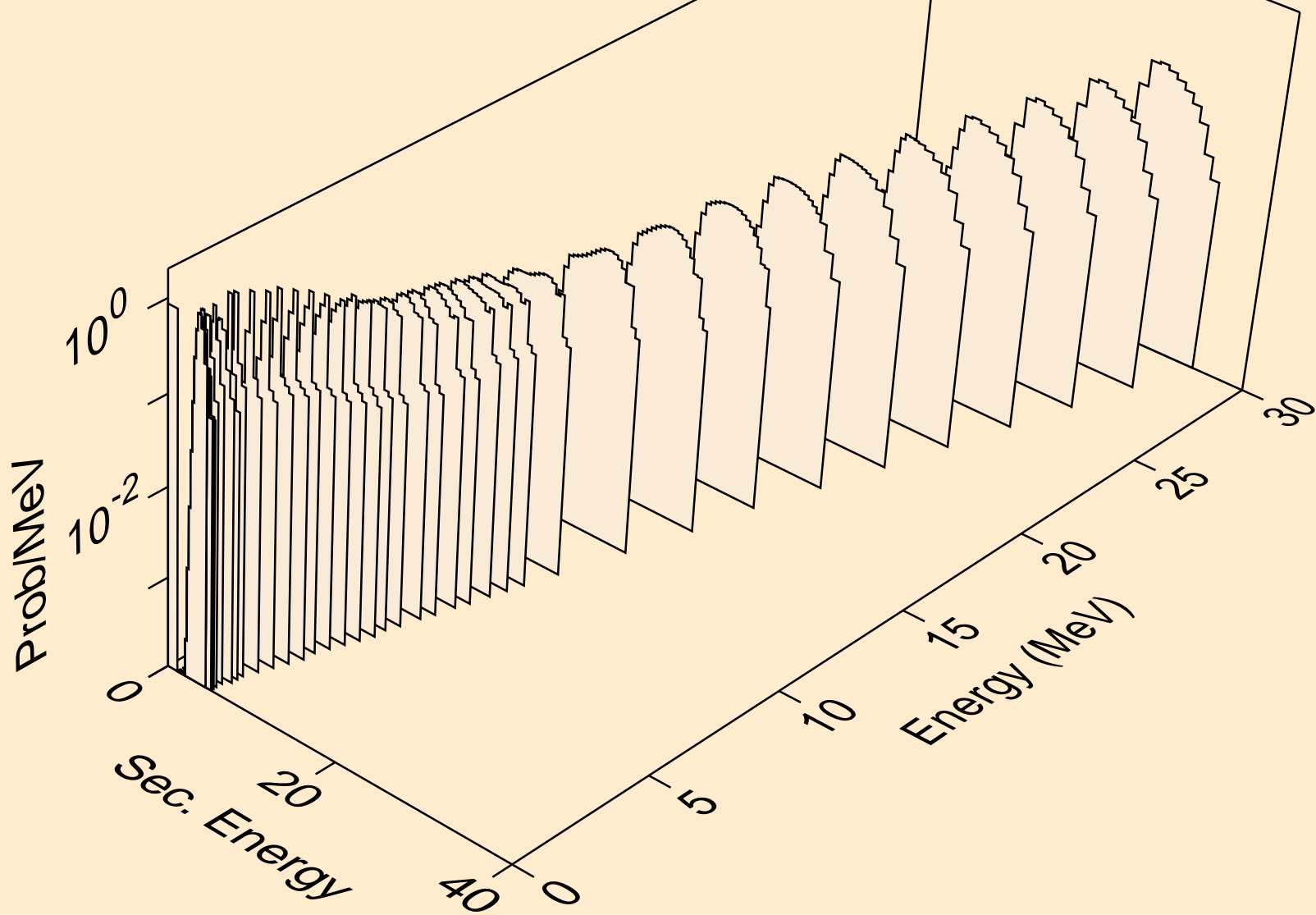

PO203 NEUTRON ACER TENDL-2023 LIBRARY; T=0.K
protons from (n,2p)

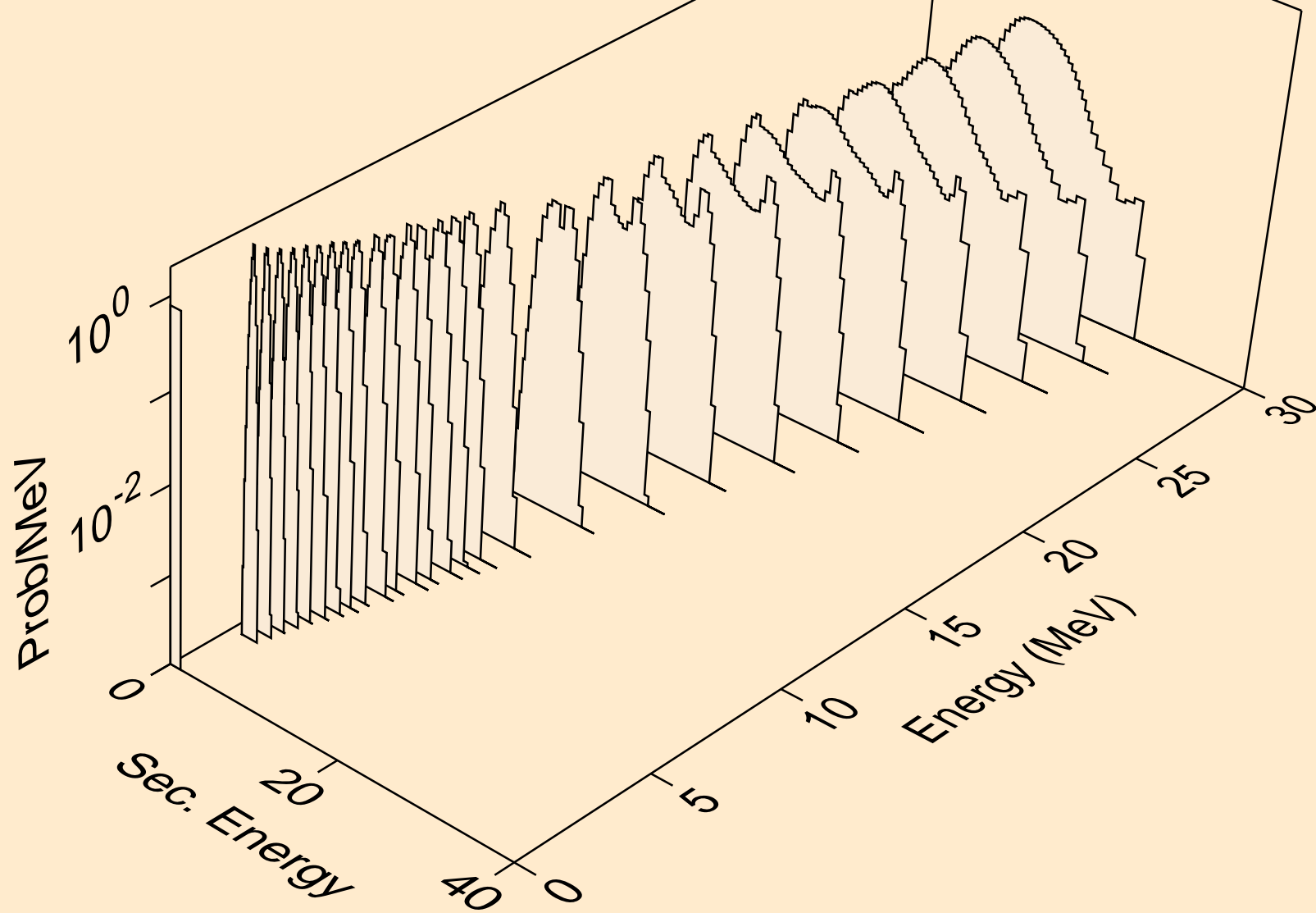

PO203 NEUTRON ACER TENDL-2023 LIBRARY; T=0.K
protons from (n,p)

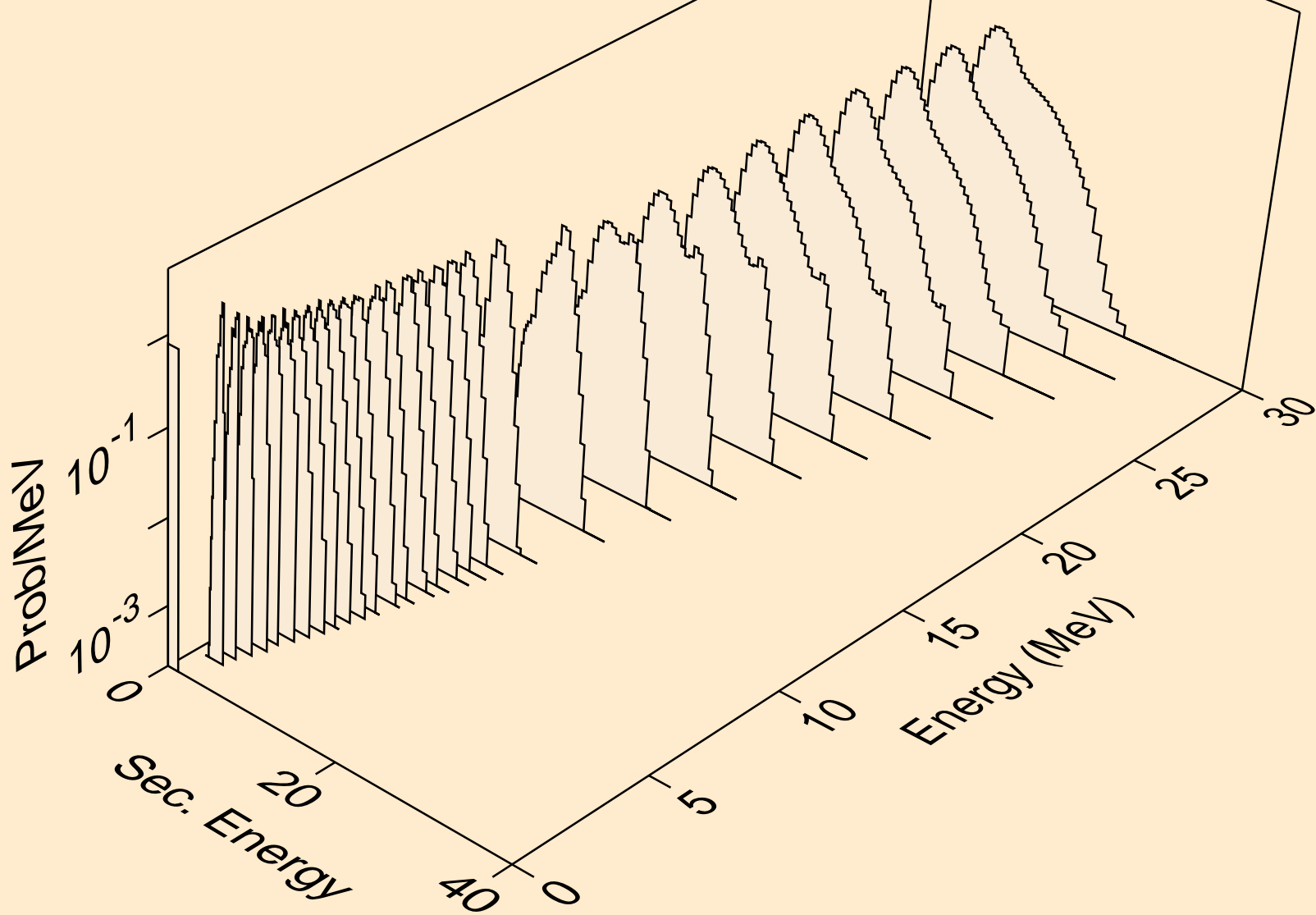

PO203 NEUTRON ACER TENDL-2023 LIBRARY; T=0.K
protons from (n,pd)

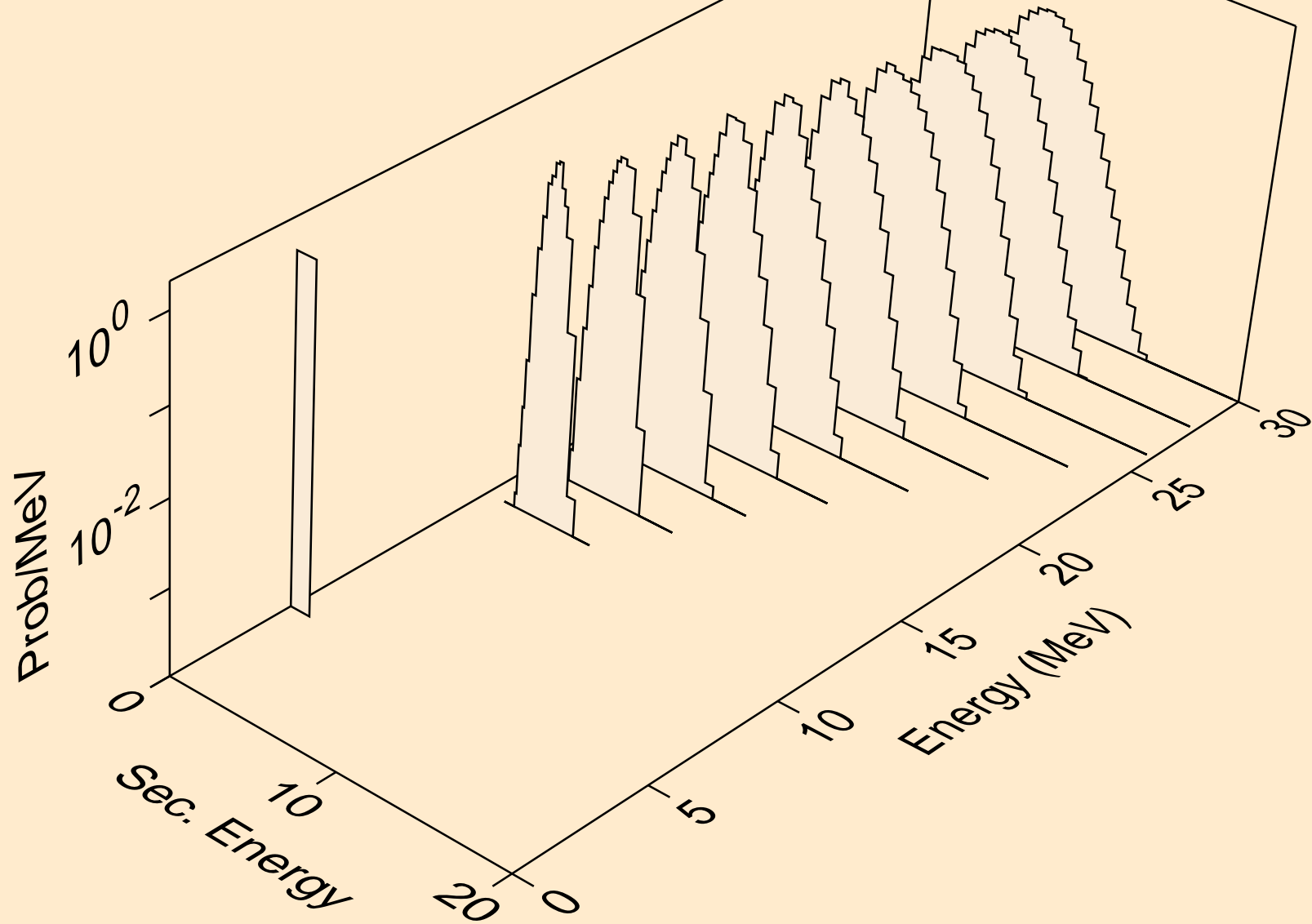

PO203 NEUTRON ACER TENDL-2023 LIBRARY; T=0.K
protons from (n,pt)

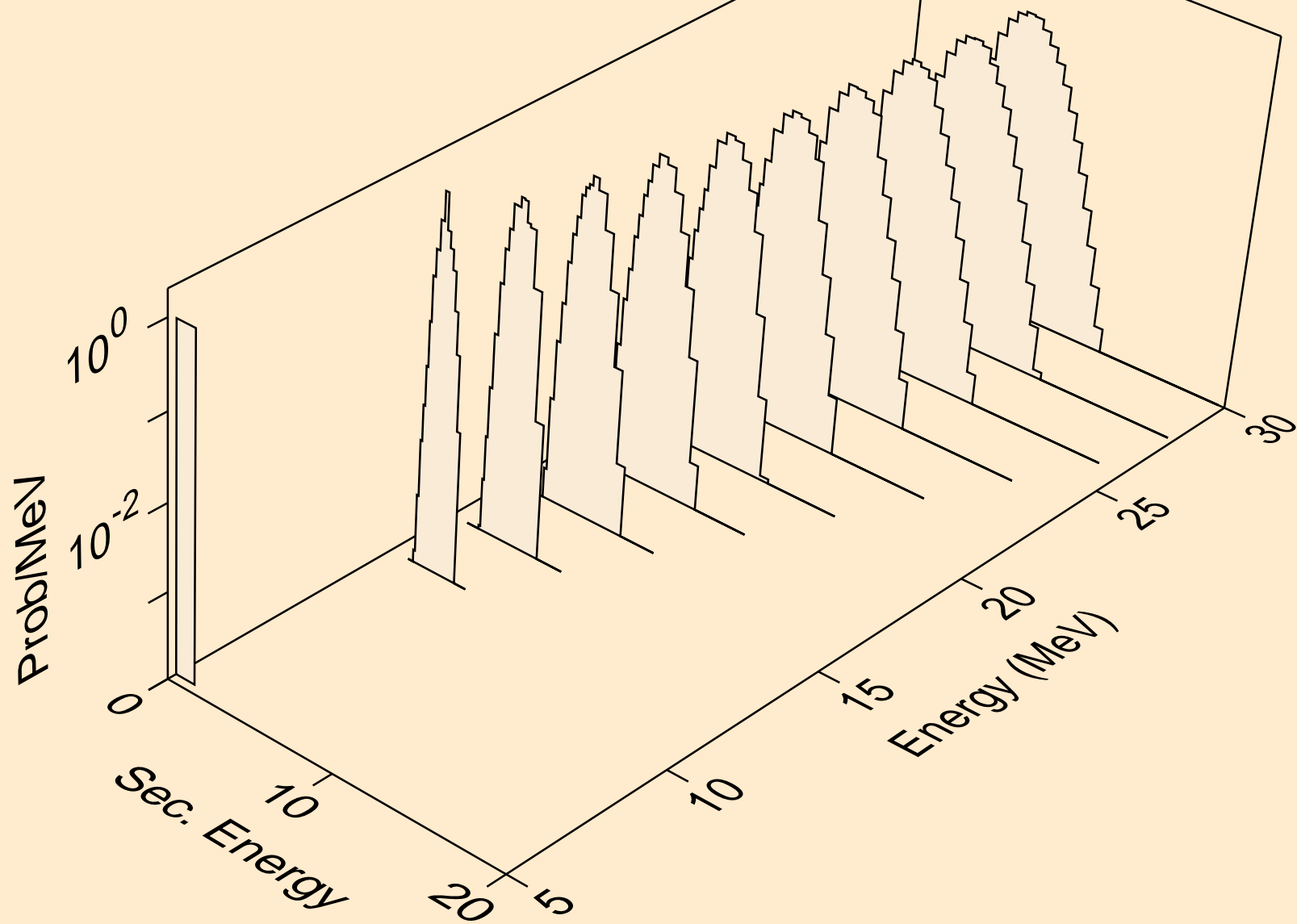

PO203 NEUTRON ACER TENDL-2023 LIBRARY; T=0.K
deuterons from (n,x)

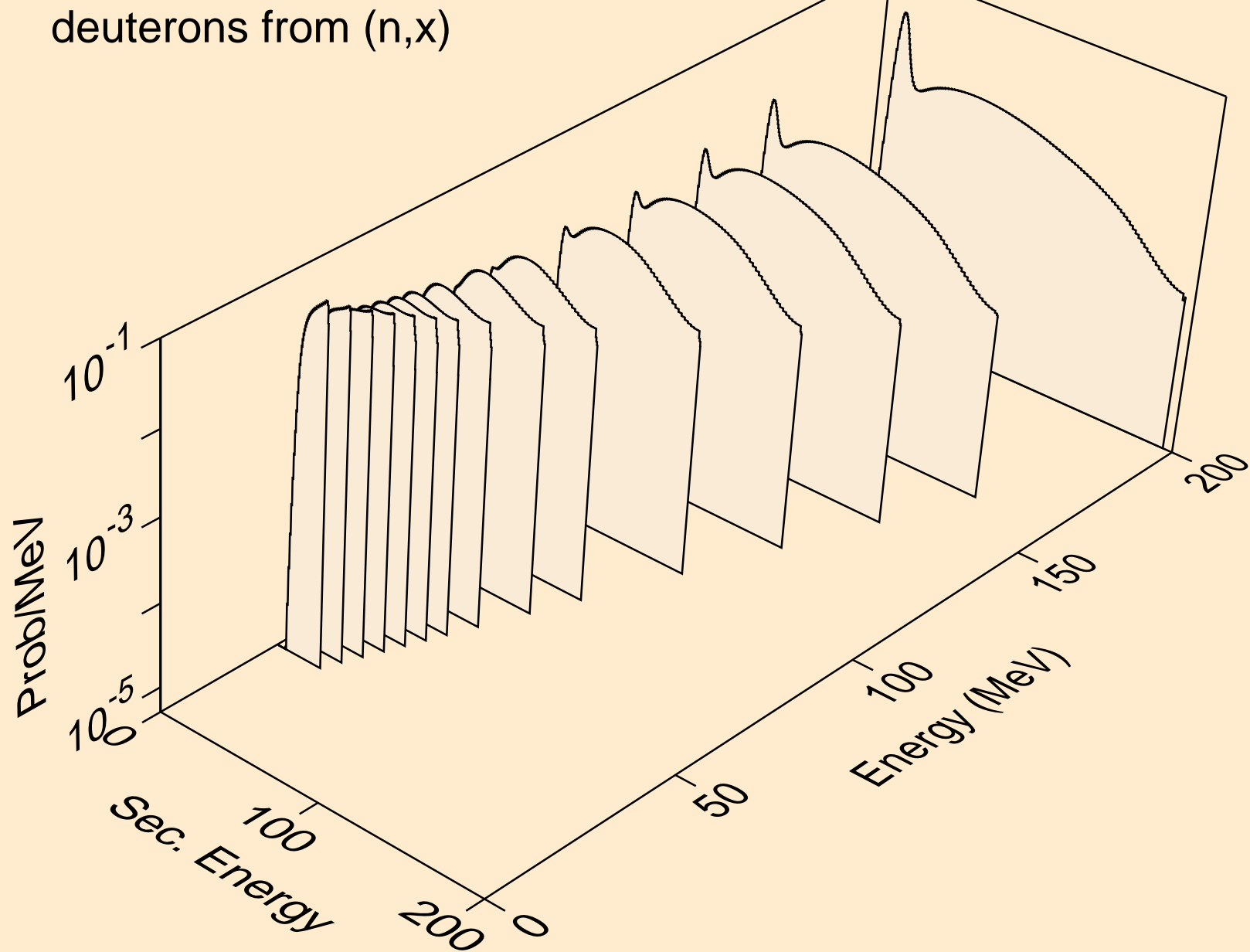

PO203 NEUTRON ACER TENDL-2023 LIBRARY; T=0.K
deuterons from (n,2nd)

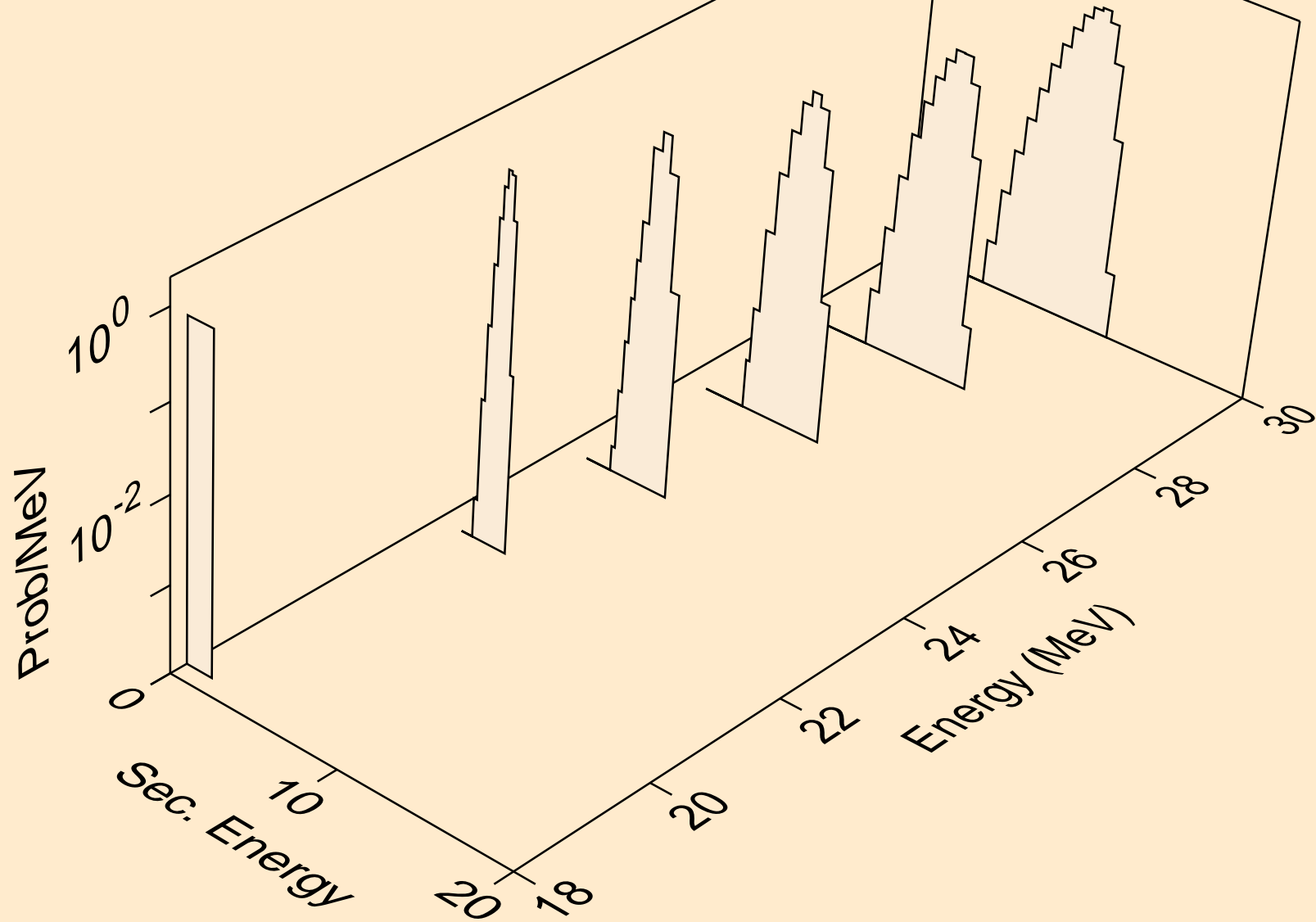

PO203 NEUTRON ACER TENDL-2023 LIBRARY; T=0.K
deuterons from (n,n*)d

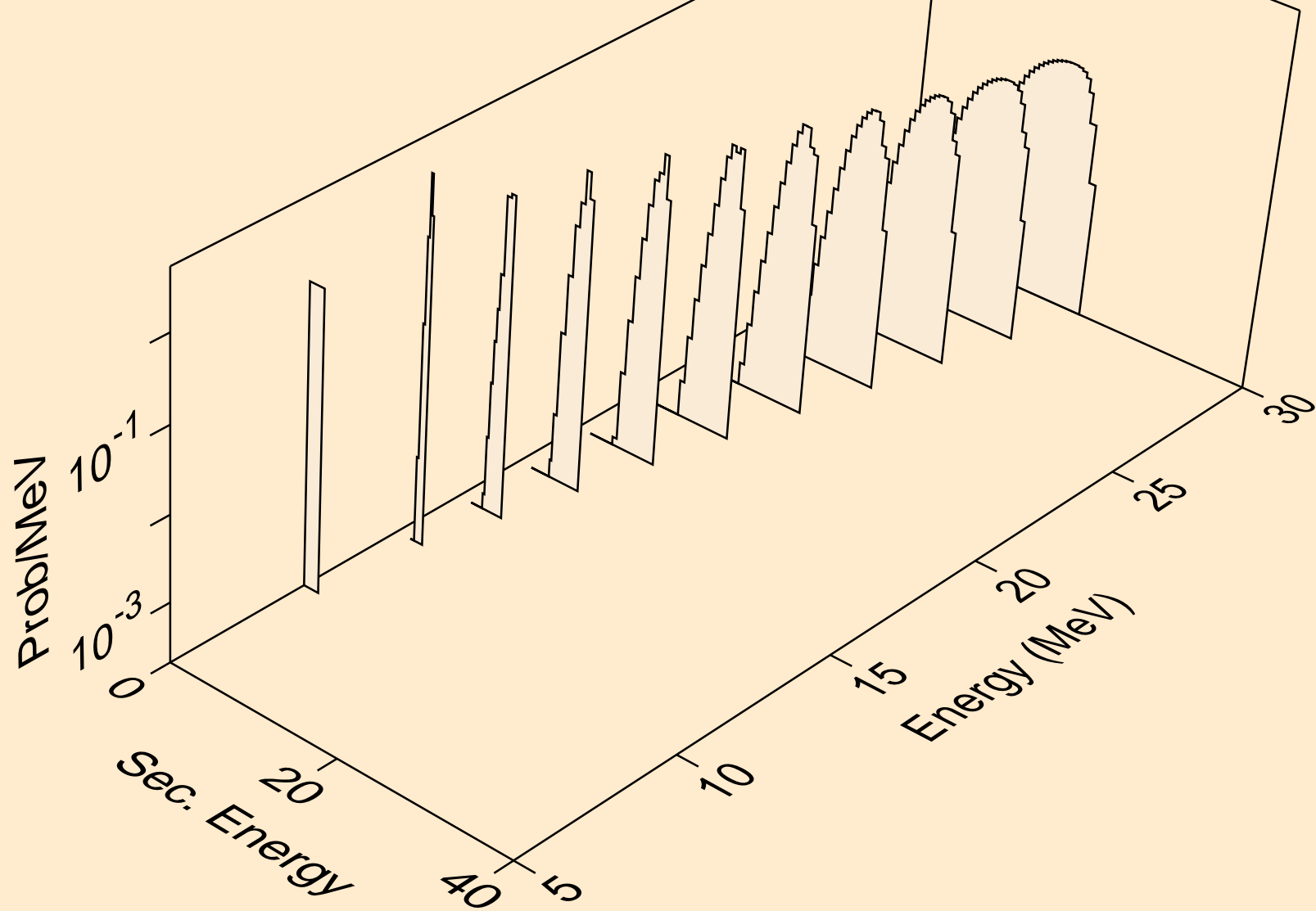

PO203 NEUTRON ACER TENDL-2023 LIBRARY; T=0.K
deuterons from (n,d)

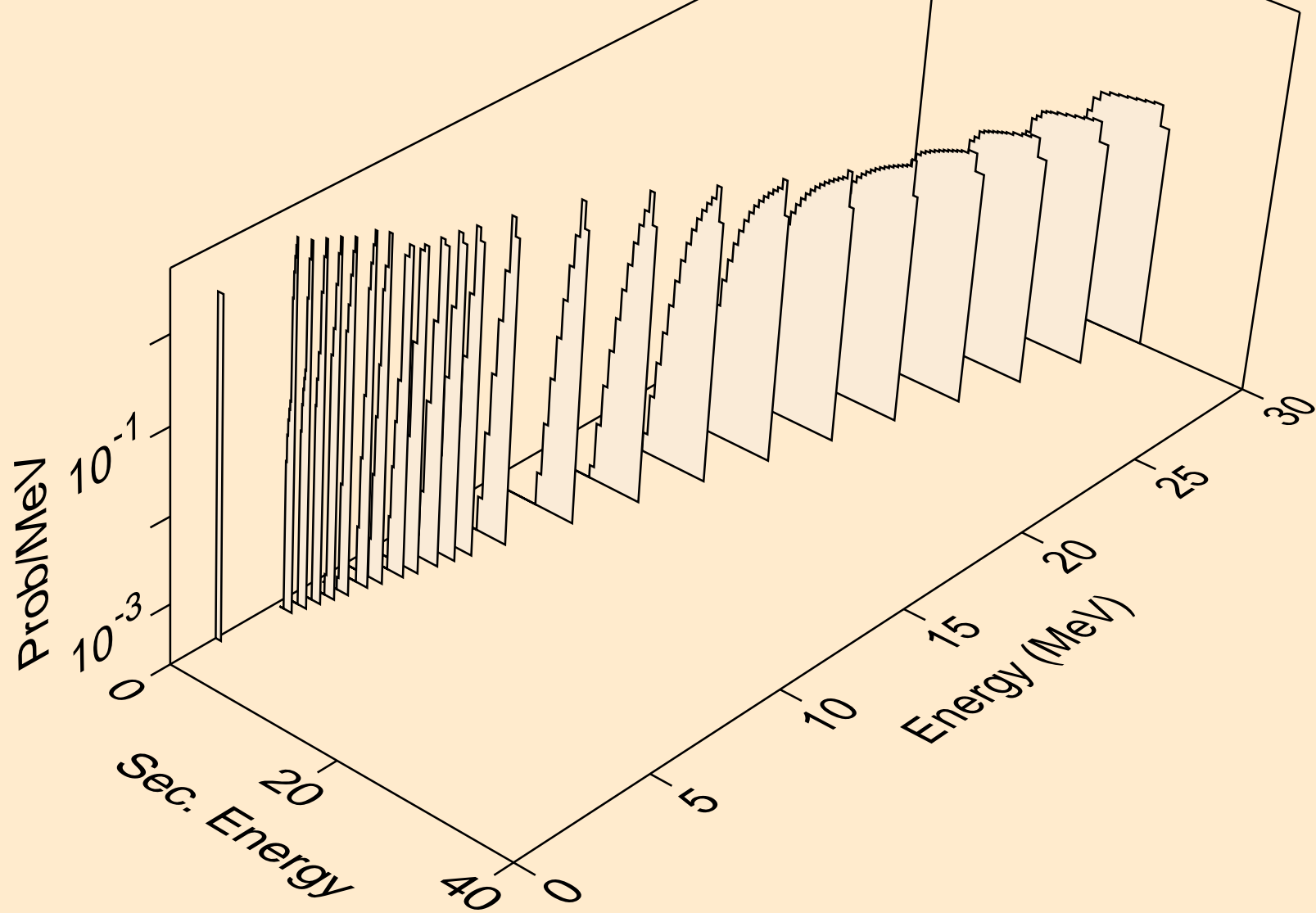

PO203 NEUTRON ACER TENDL-2023 LIBRARY; T=0.K
deuterons from (n,pd)

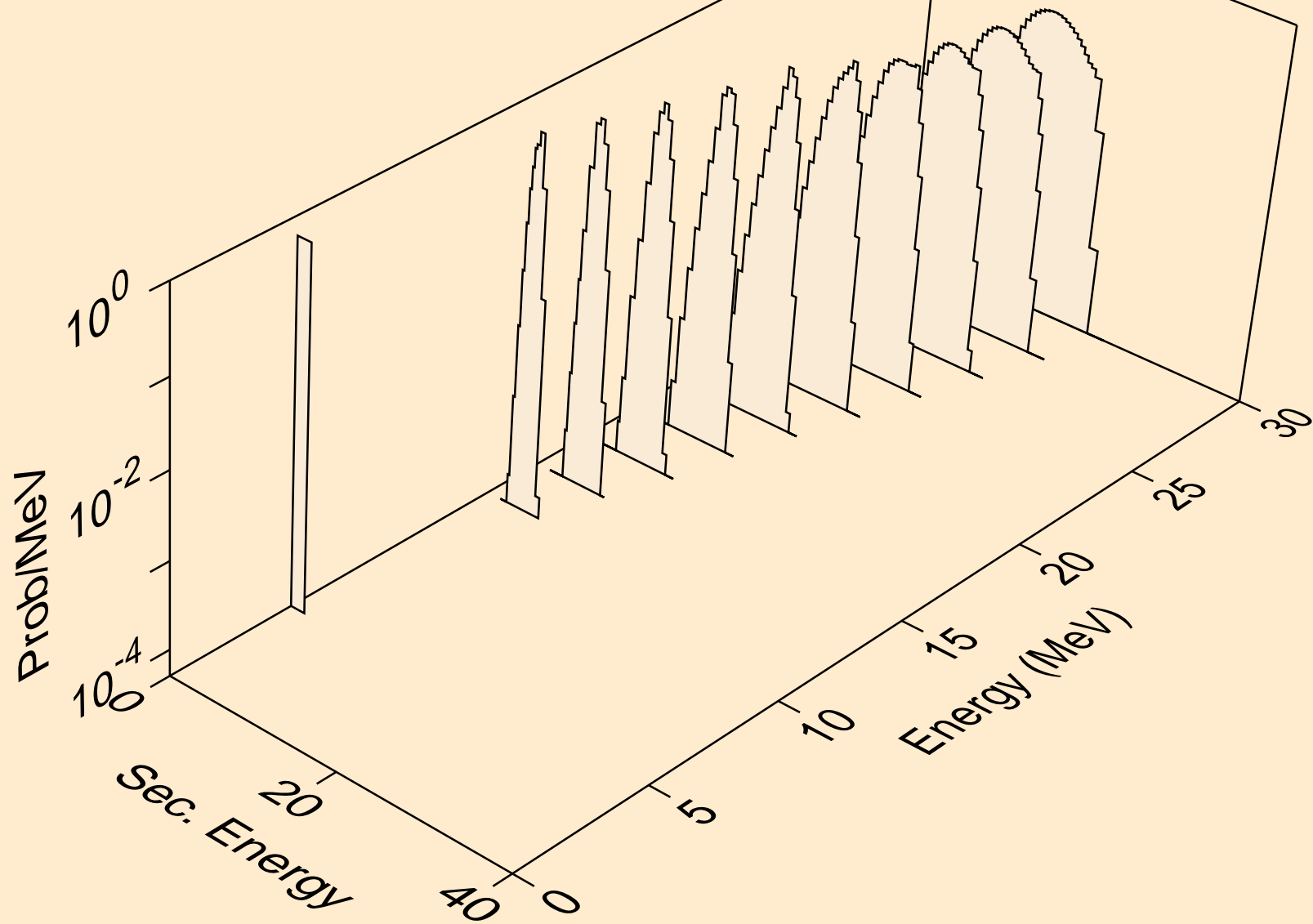

PO203 NEUTRON ACER TENDL-2023 LIBRARY; T=0.K
deuterons from (n,da)

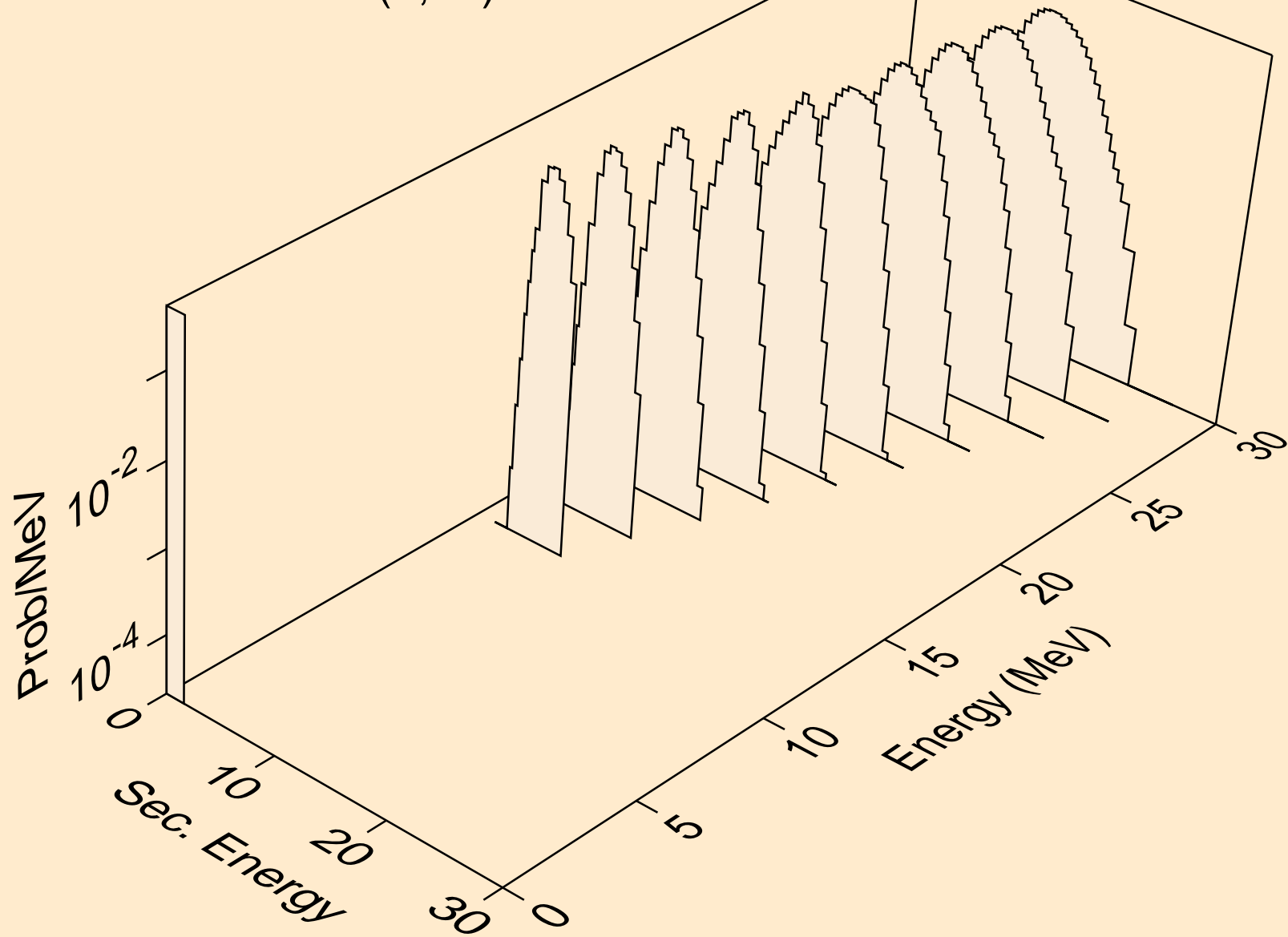

PO203 NEUTRON ACER TENDL-2023 LIBRARY; T=0.K
tritons from (n,x)

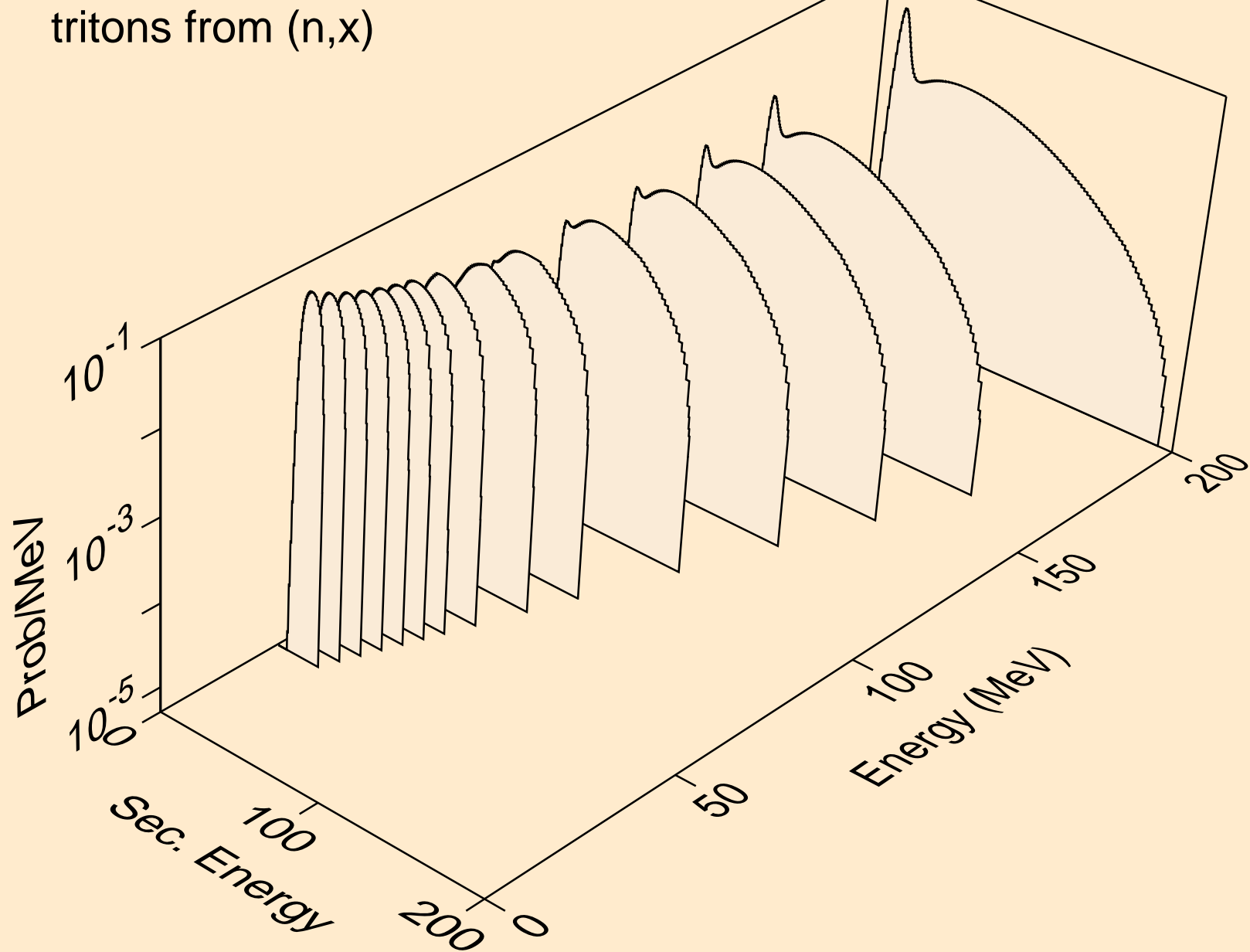

PO203 NEUTRON ACER TENDL-2023 LIBRARY; T=0.K
tritons from (n,n*)t

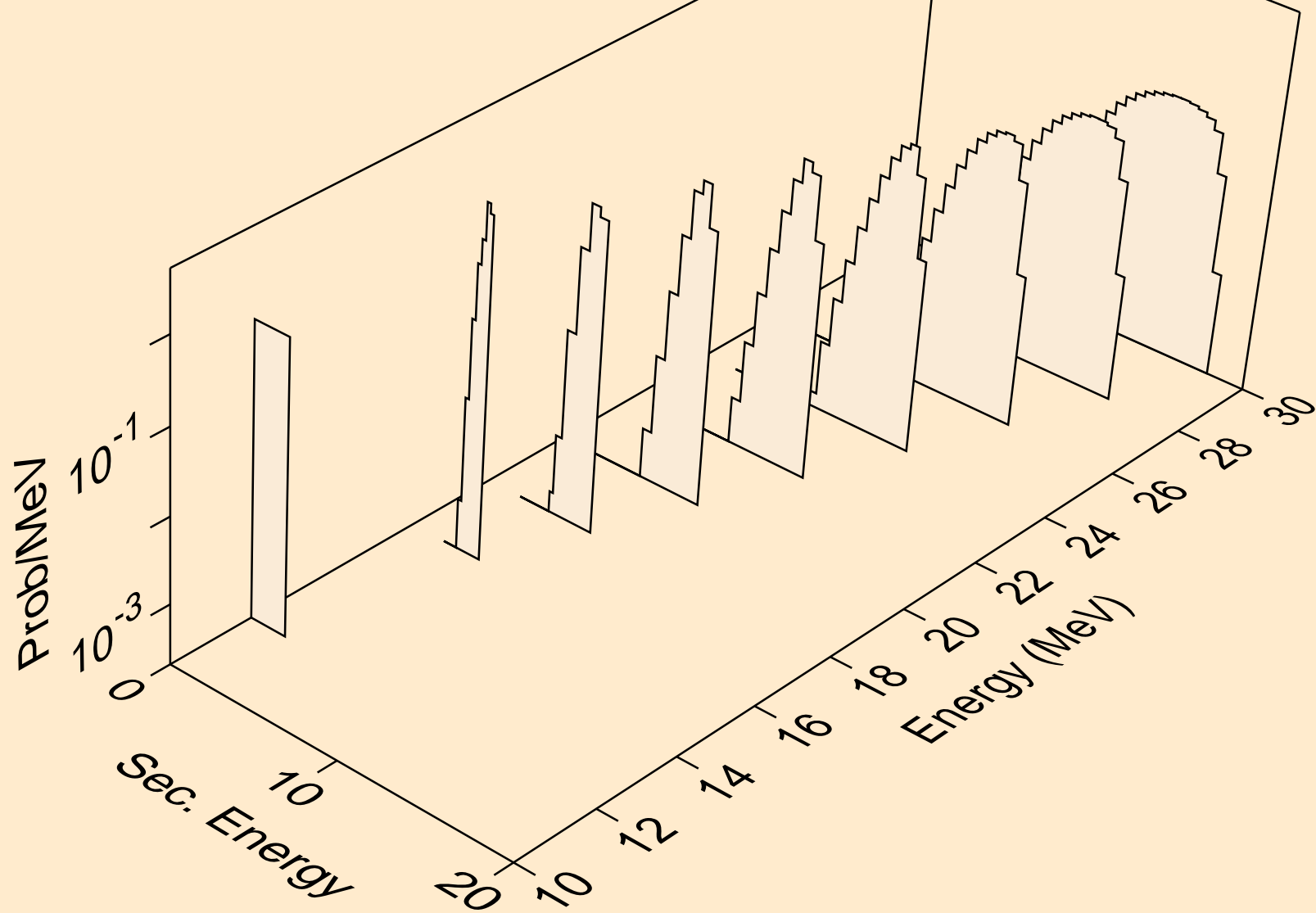

PO203 NEUTRON ACER TENDL-2023 LIBRARY; T=0.K
tritons from (n,t)

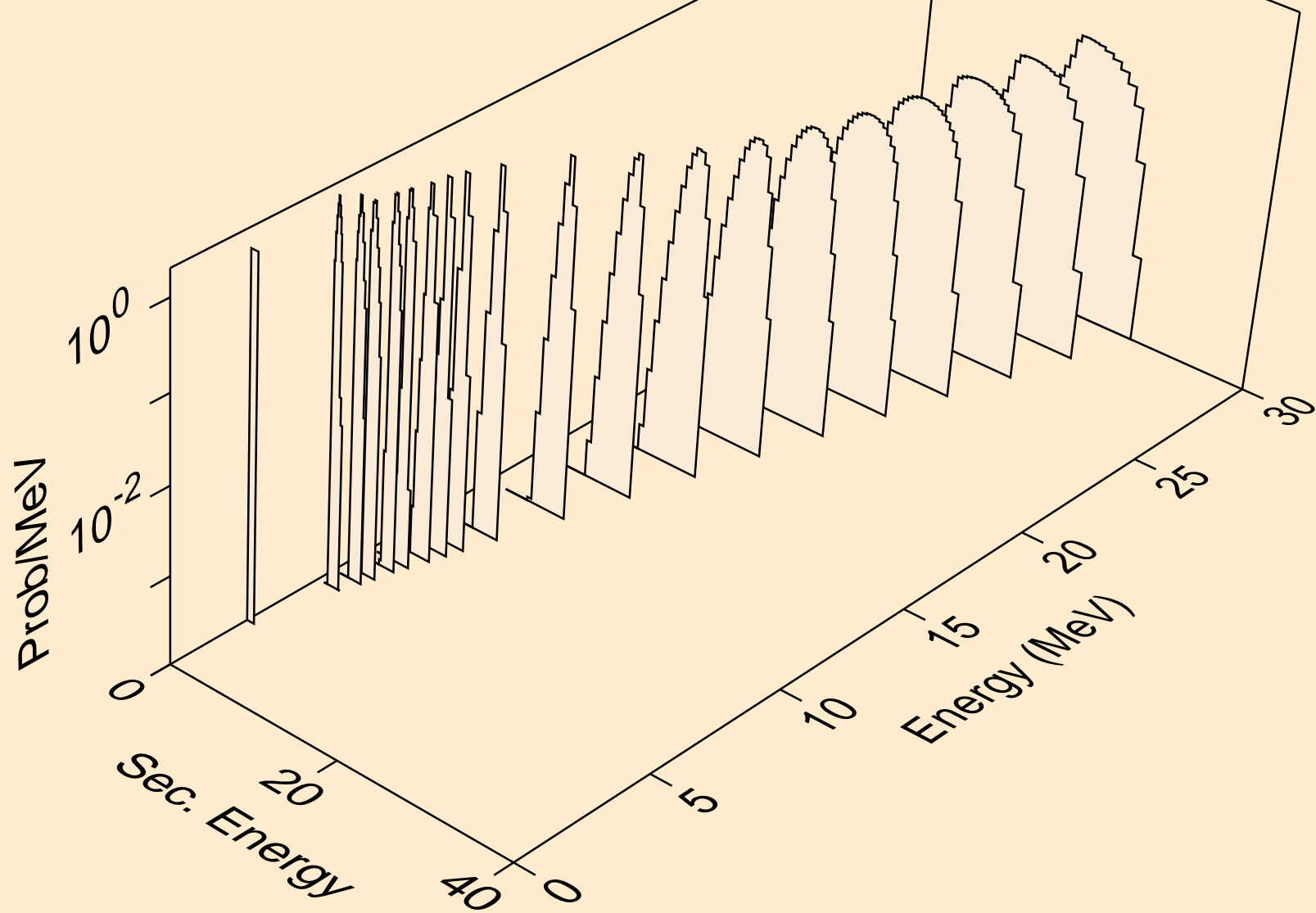

PO203 NEUTRON ACER TENDL-2023 LIBRARY; T=0.K
tritons from (n,pt)

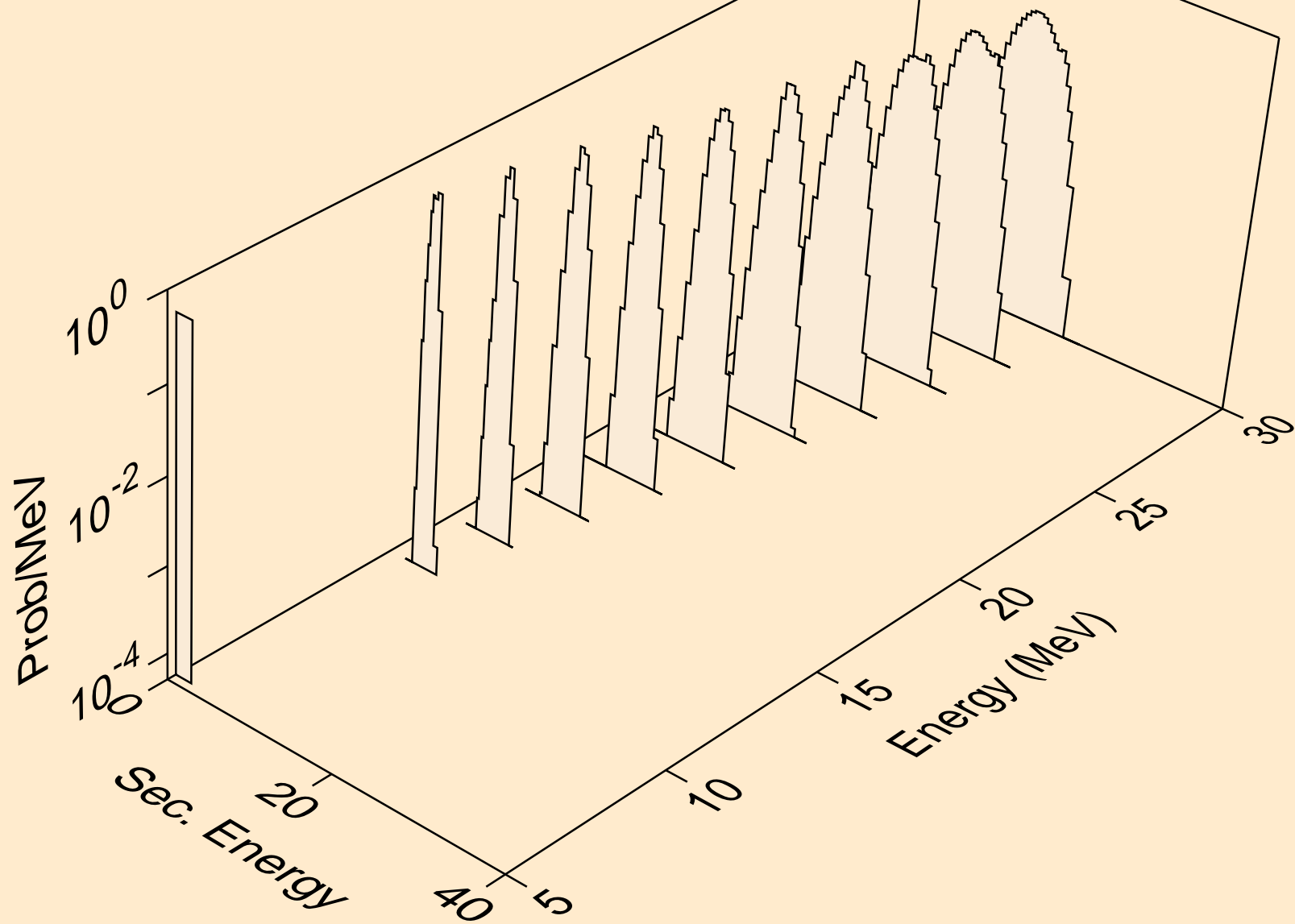

PO203 NEUTRON ACER TENDL-2023 LIBRARY; T=0.K
he3s from (n,x)

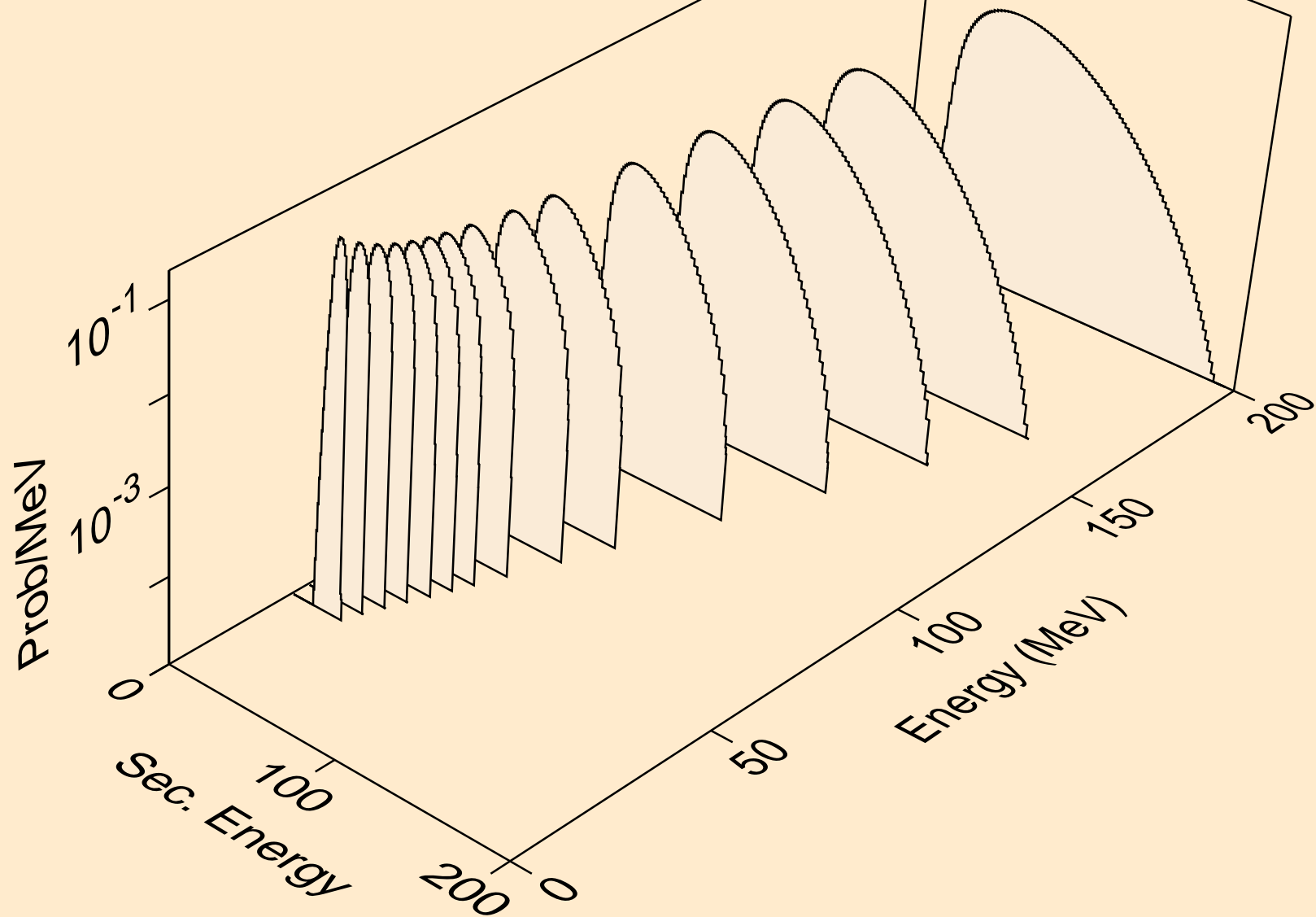

PO203 NEUTRON ACER TENDL-2023 LIBRARY; T=0.K
he3s from (n,n*)he3

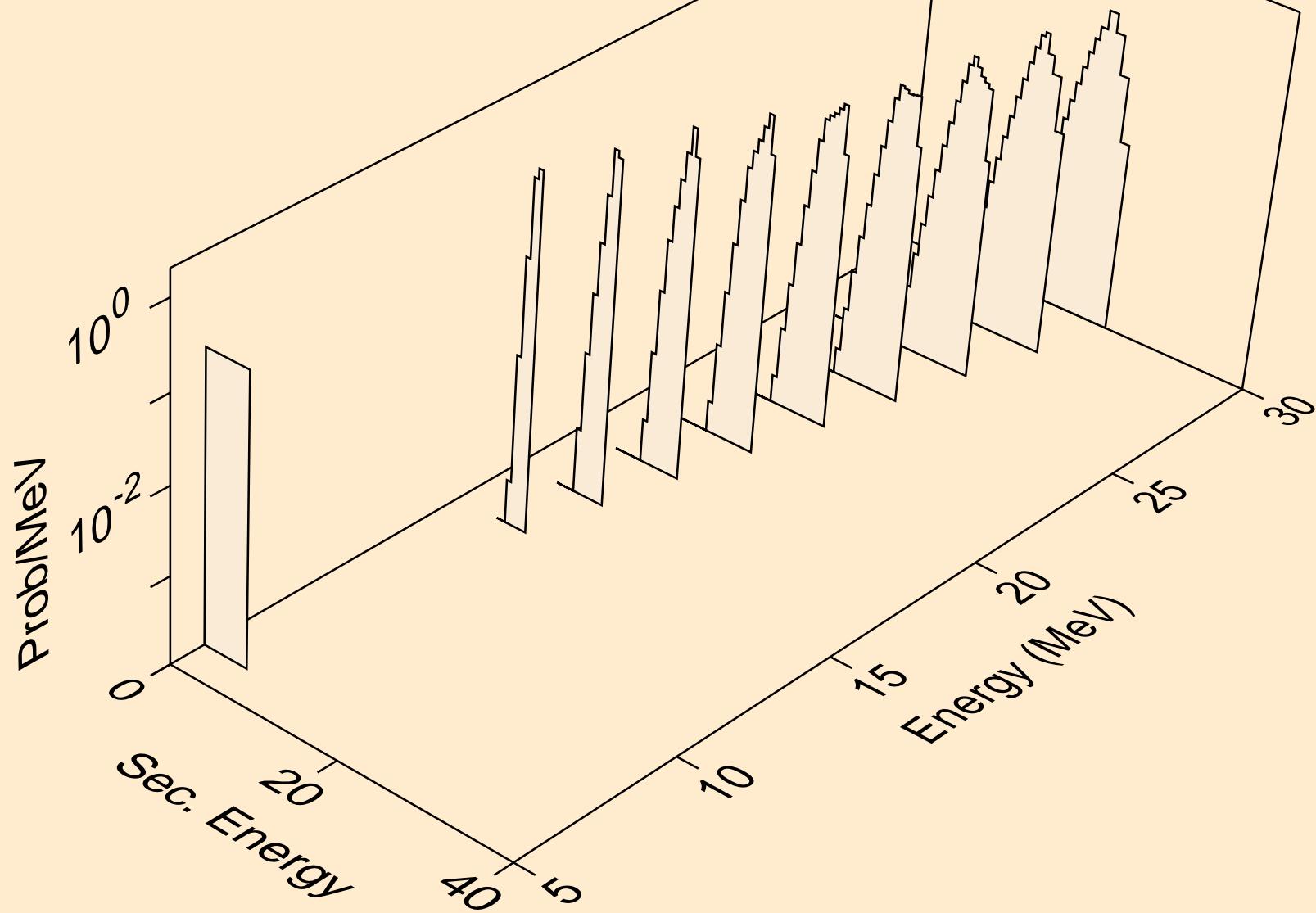

PO203 NEUTRON ACER TENDL-2023 LIBRARY; T=0.K
he3s from (n,he3)

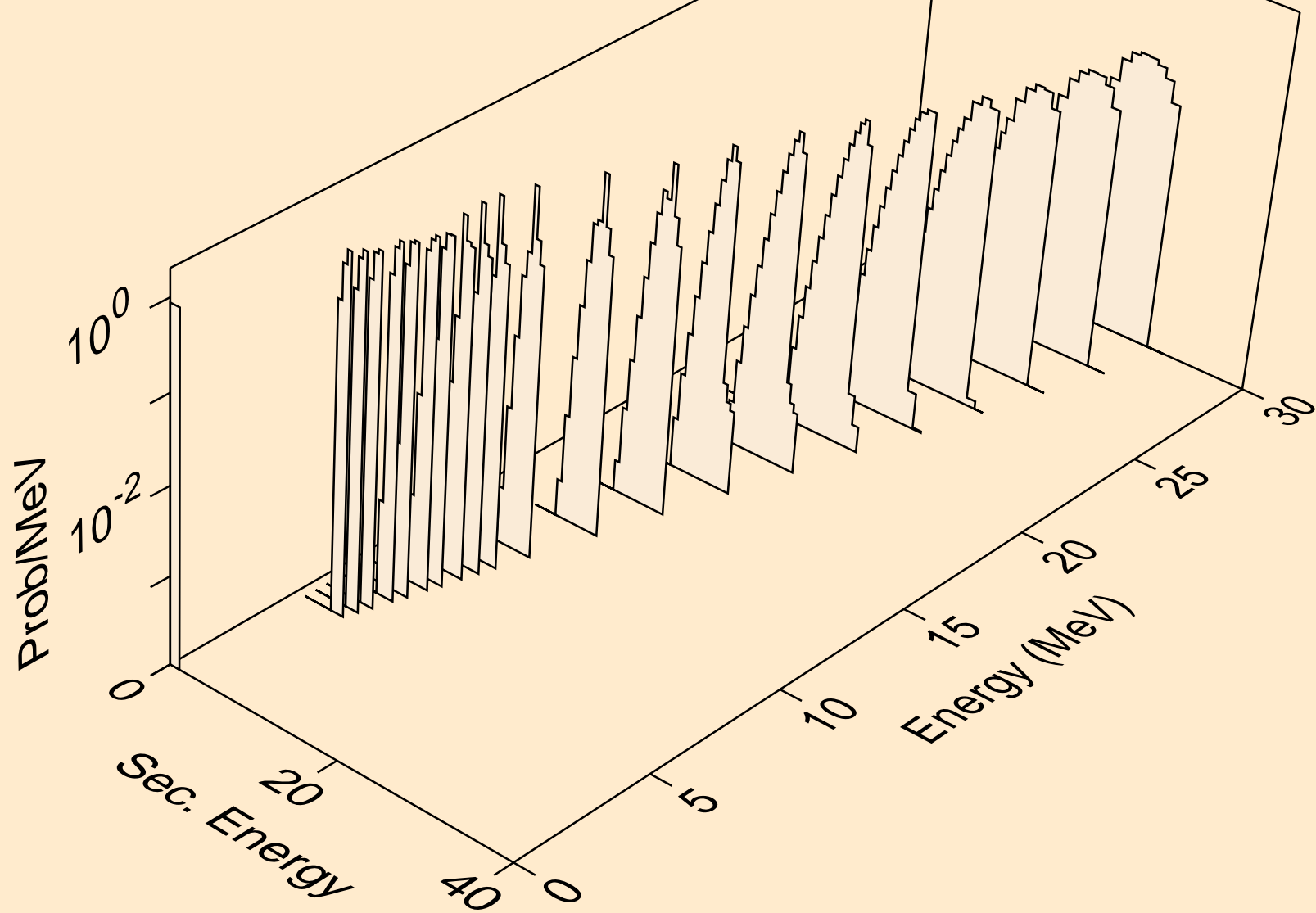

PO203 NEUTRON ACER TENDL-2023 LIBRARY; T=0.K
alphas from (n,x)

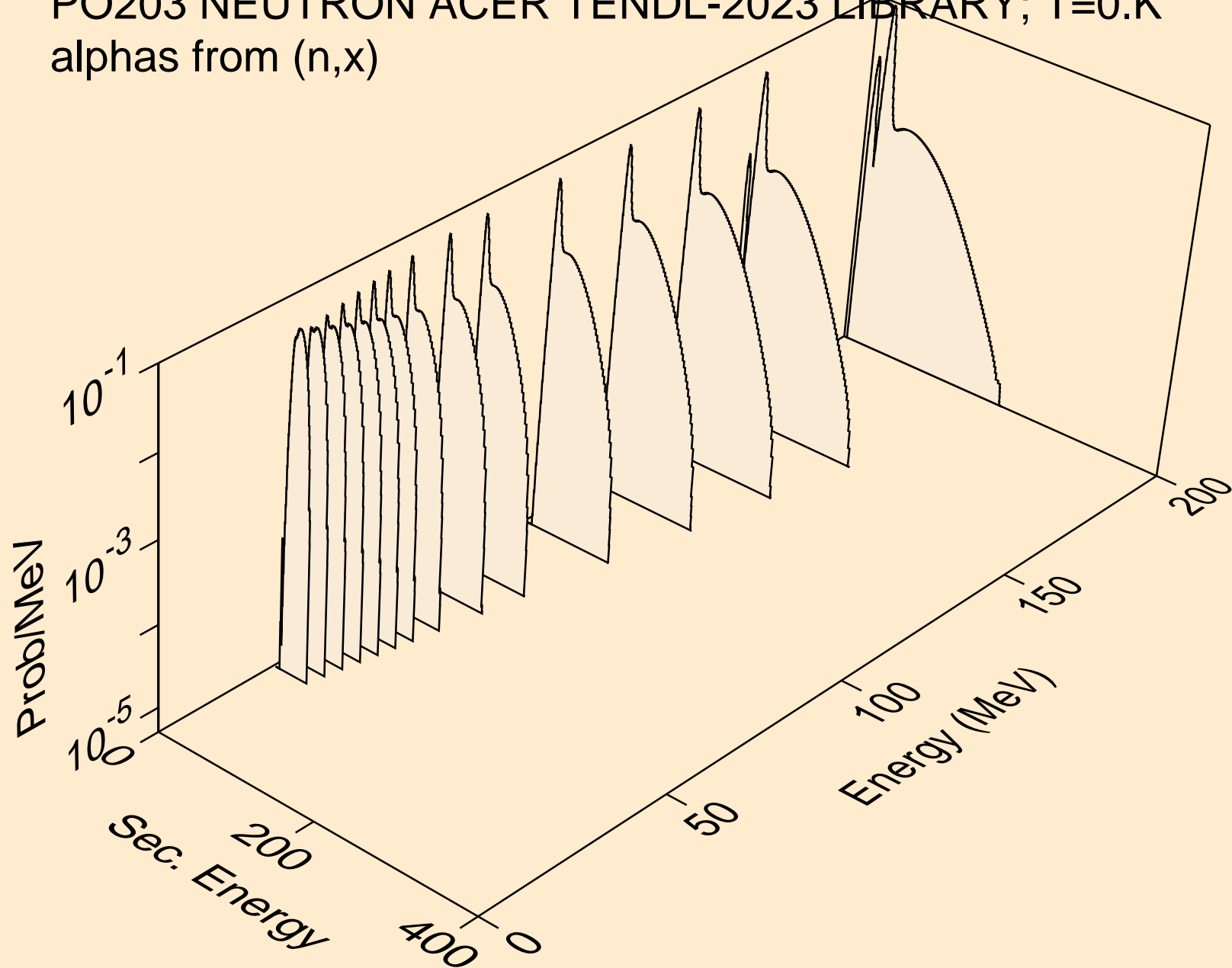

PO203 NEUTRON ACER TENDL-2023 LIBRARY; T=0.K
alphas from (n,n*)a

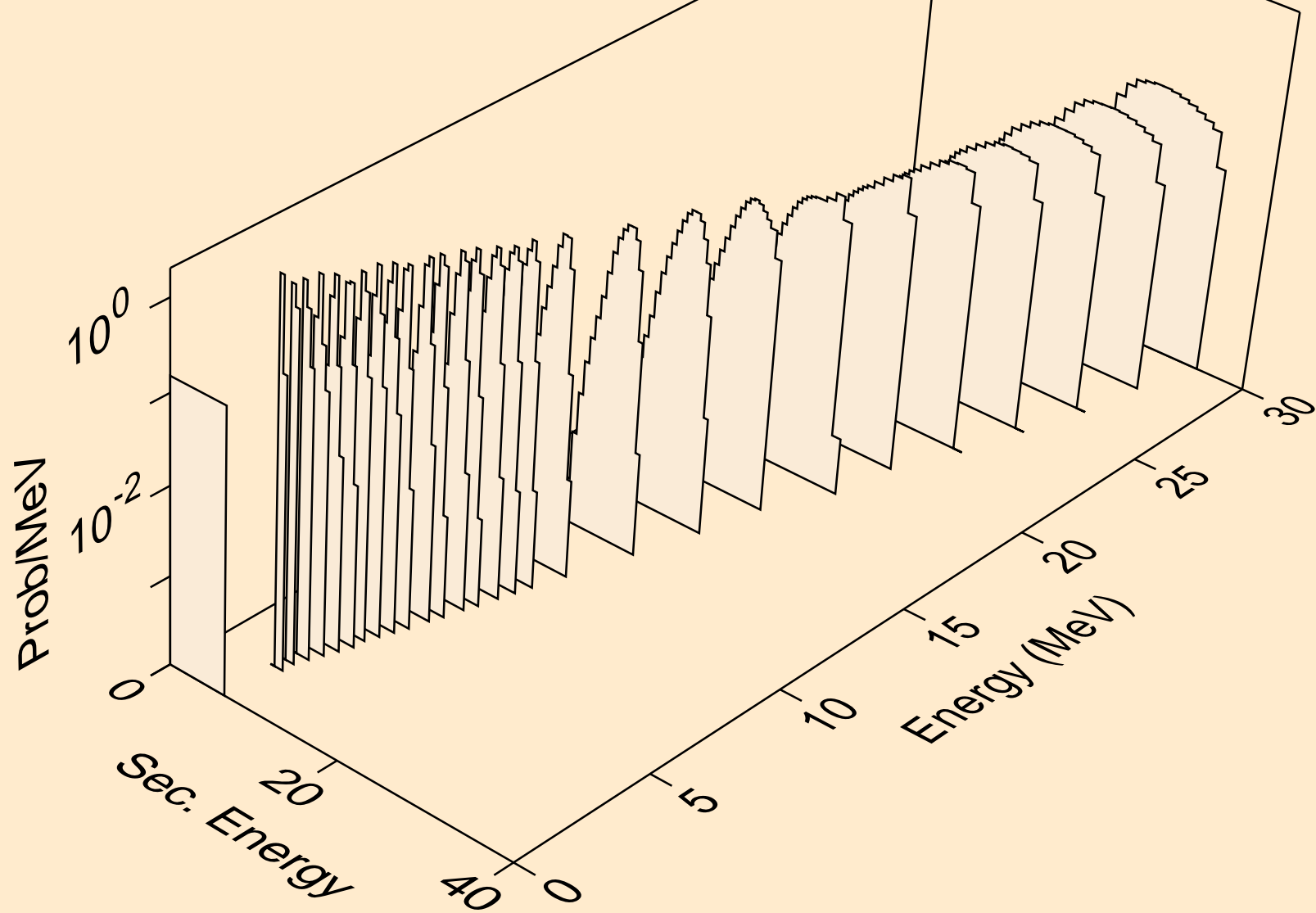

PO203 NEUTRON ACER TENDL-2023 LIBRARY; T=0.K
alphas from (n,2n)a

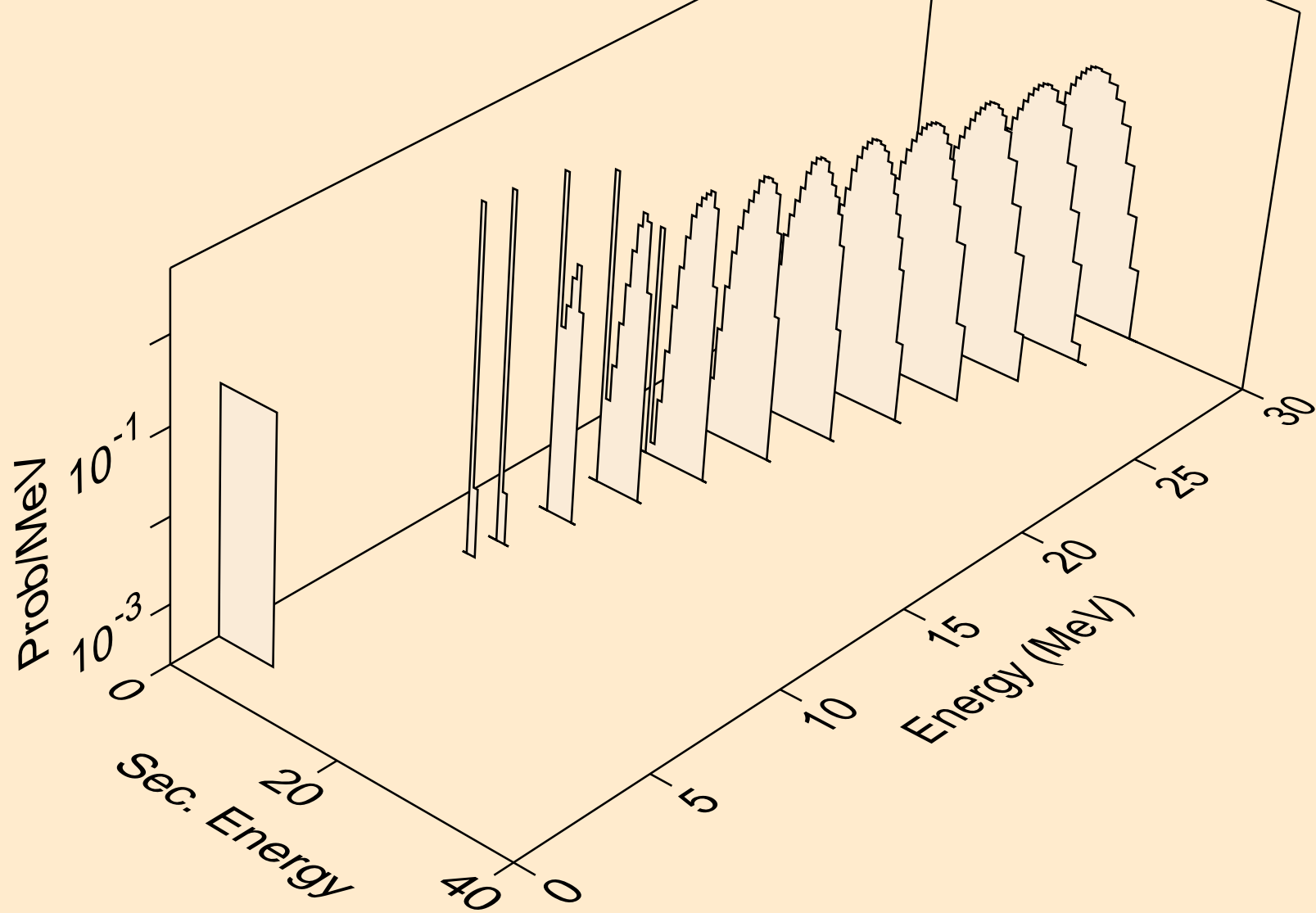

PO203 NEUTRON ACER TENDL-2023 LIBRARY; T=0.K
alphas from (n,3n)a

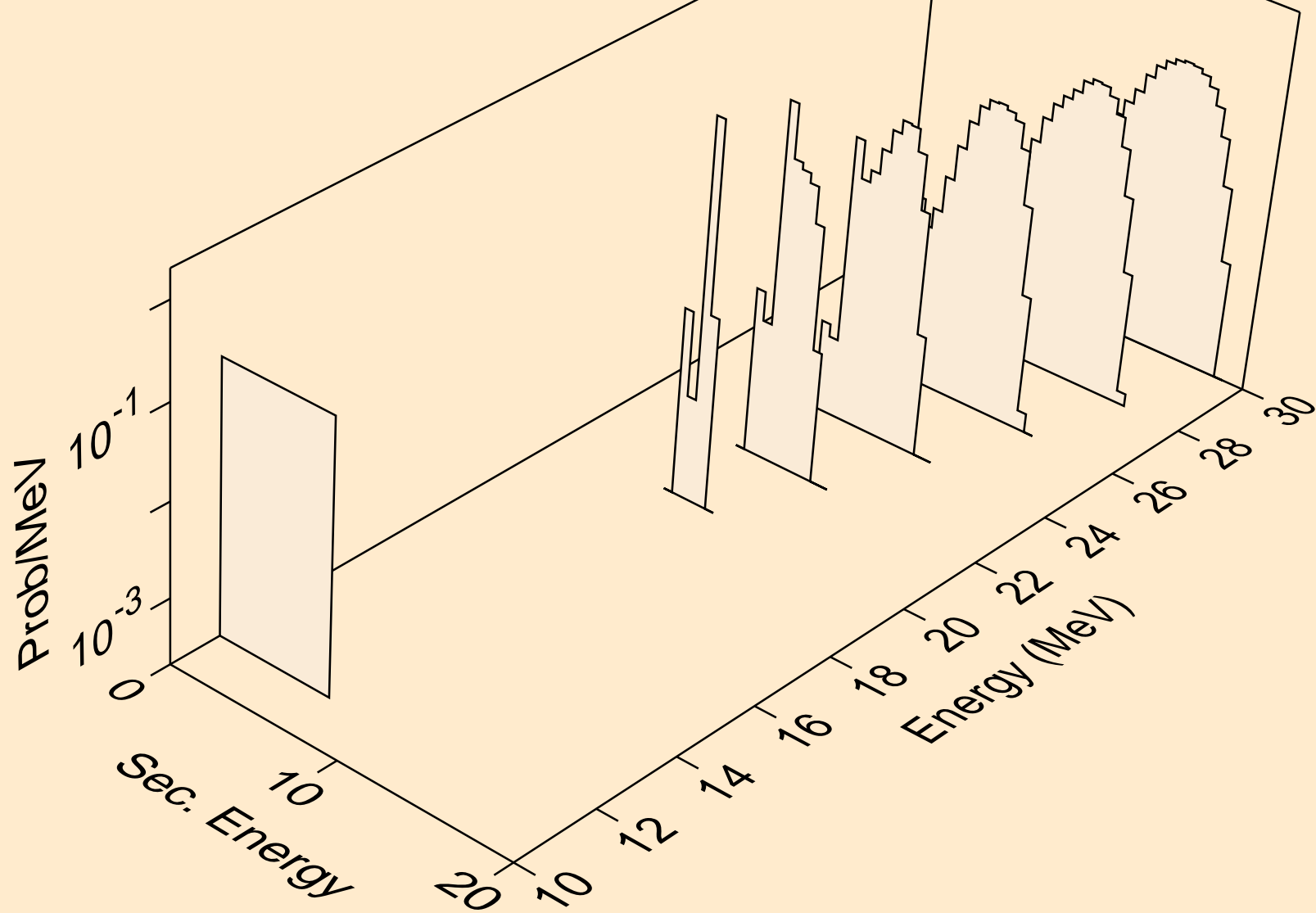

PO203 NEUTRON ACER TENDL-2023 LIBRARY; T=0.K
alphas from (n,n*)2a

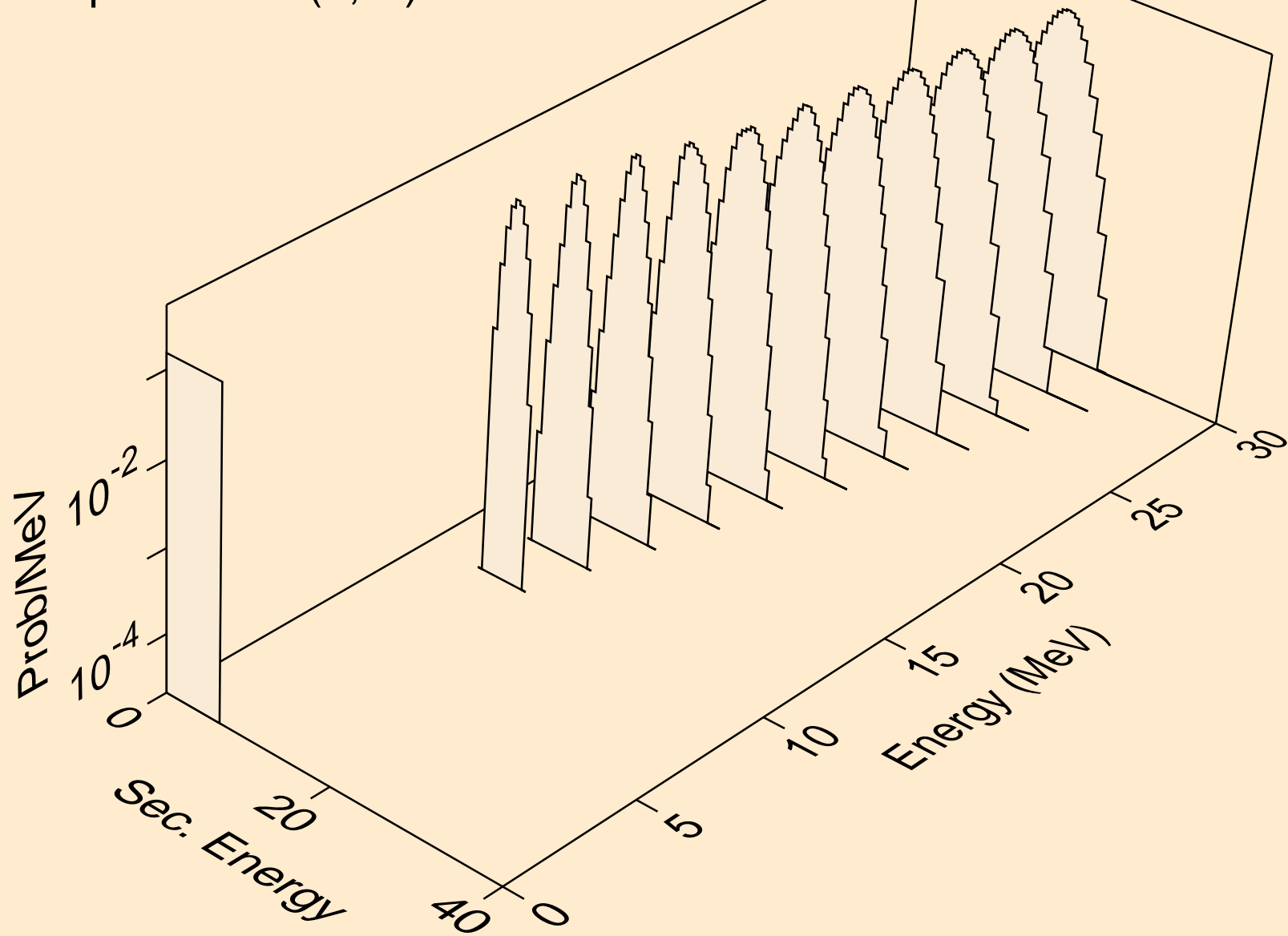

PO203 NEUTRON ACER TENDL-2023 LIBRARY; T=0.K
alphas from (n,npa)

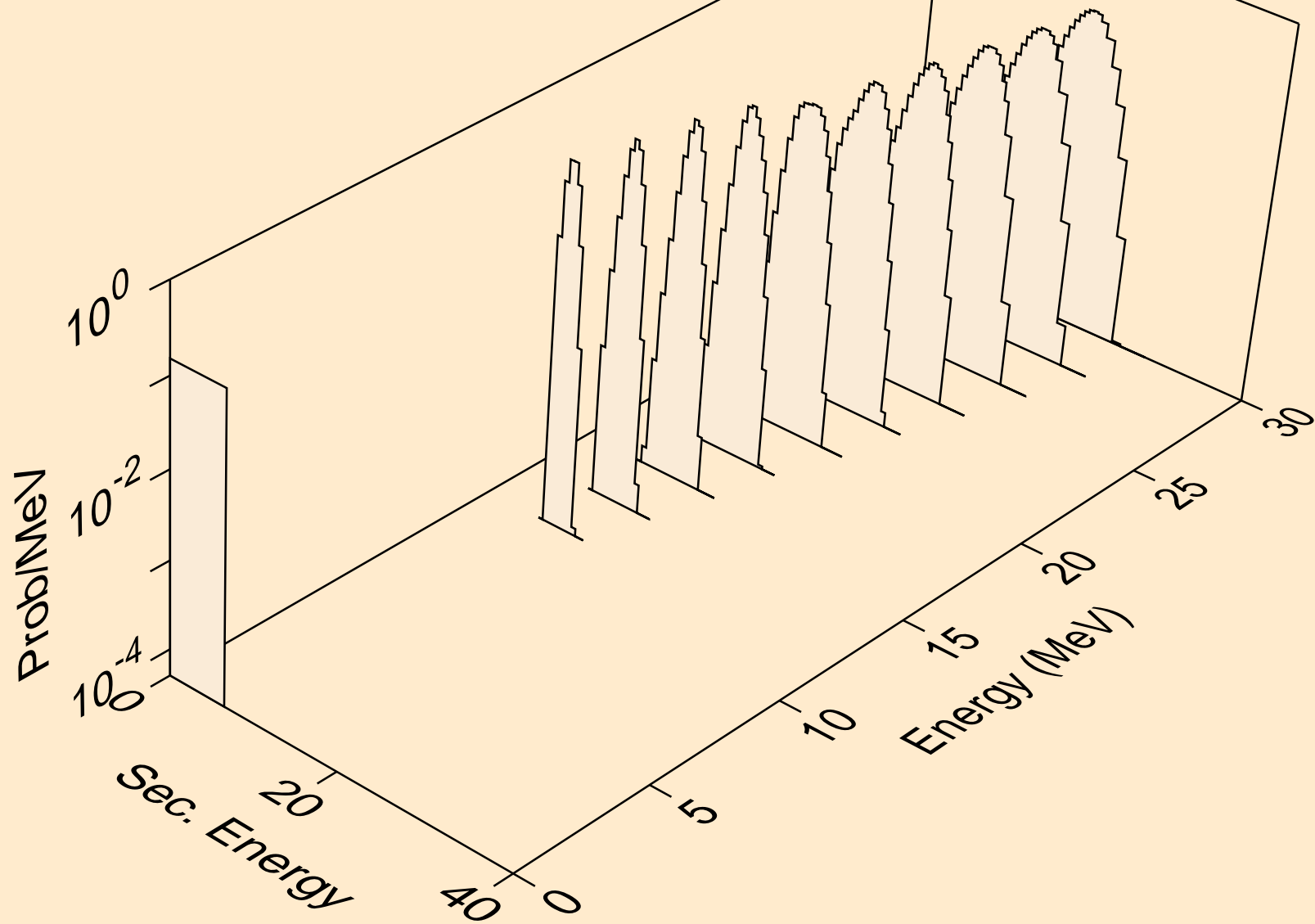

PO203 NEUTRON ACER TENDL-2023 LIBRARY; T=0.K
alphas from (n,a)

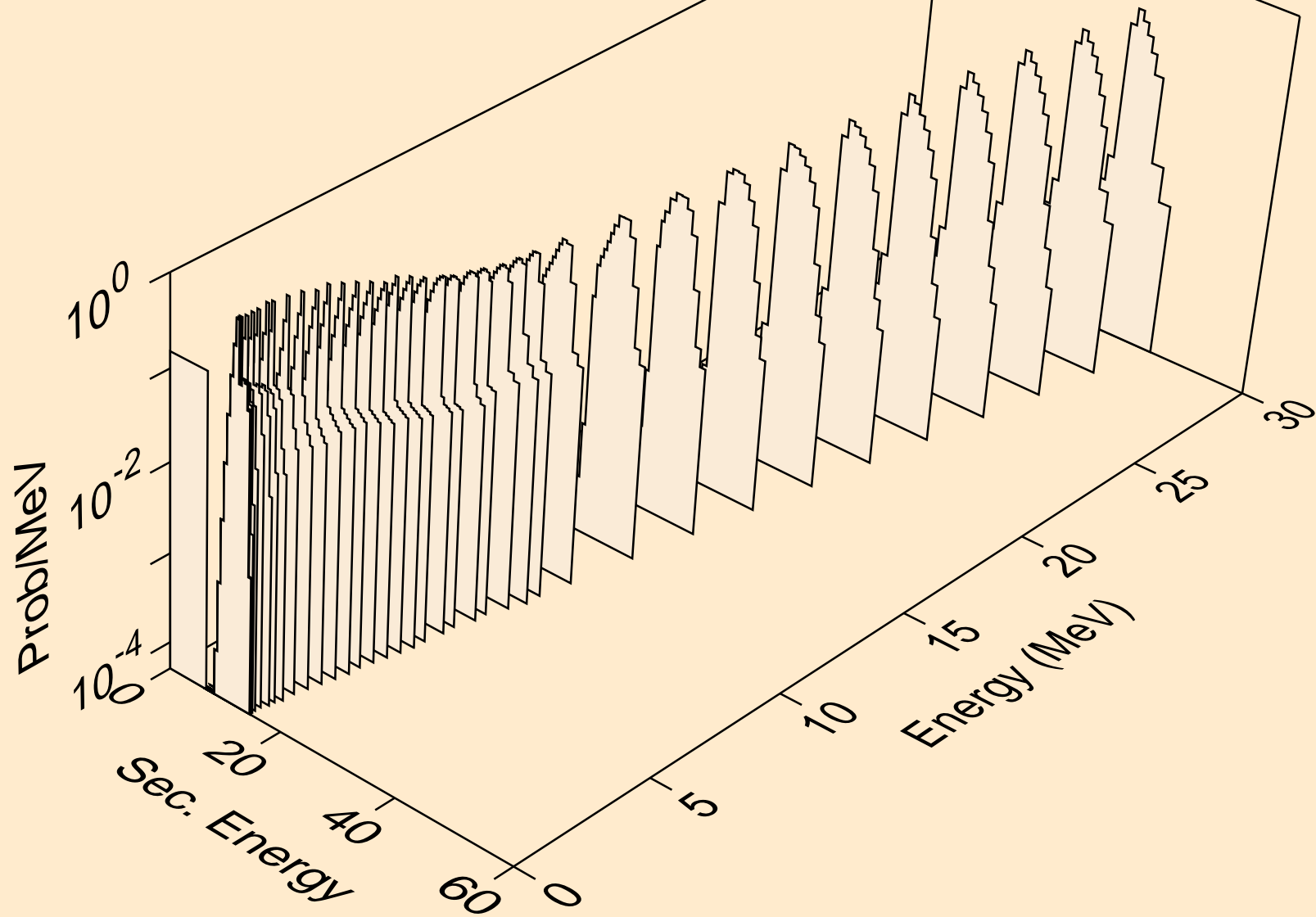

PO203 NEUTRON ACER TENDL-2023 LIBRARY; T=0.K
alphas from (n,2a)

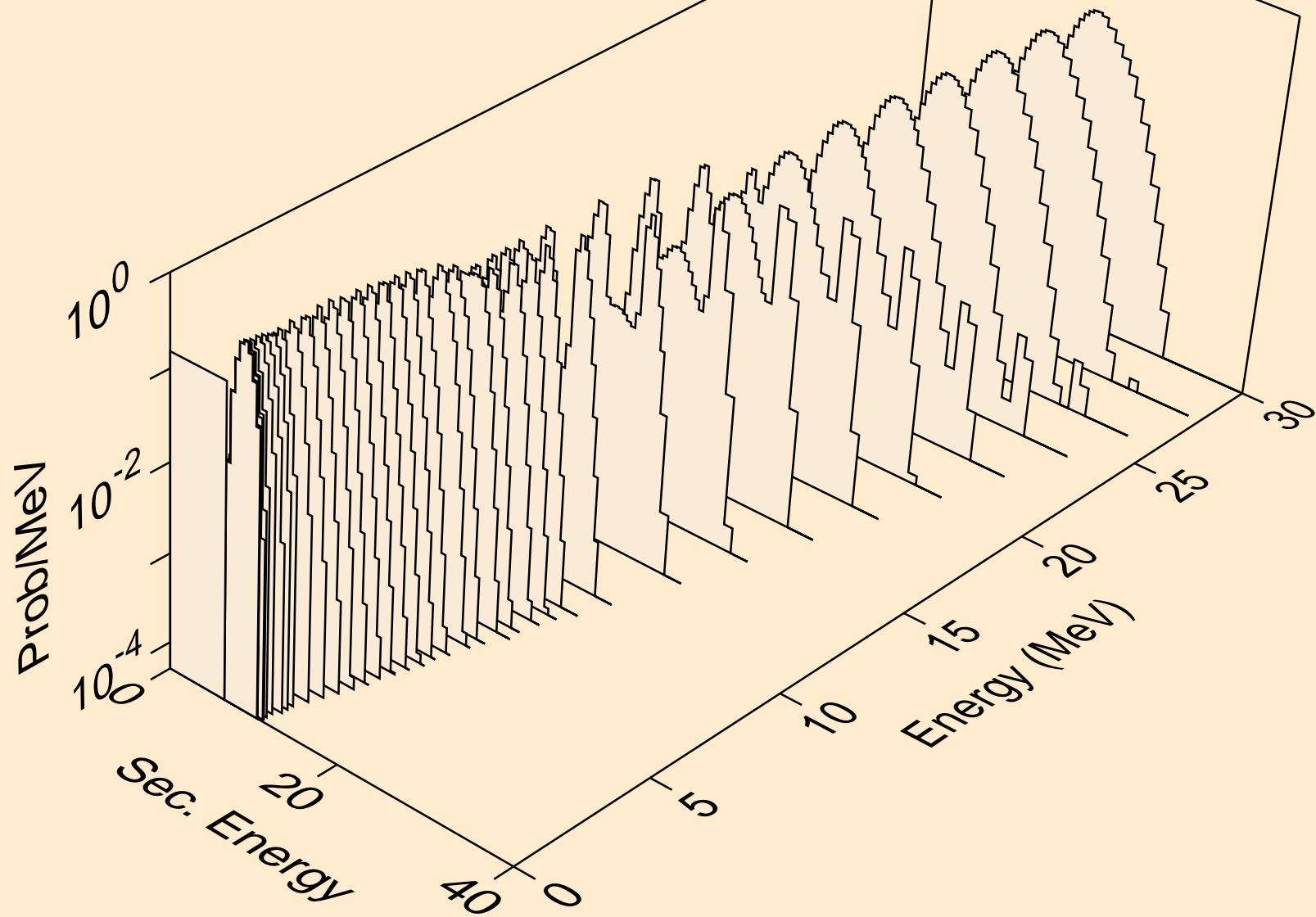

PO203 NEUTRON ACER TENDL-2023 LIBRARY; T=0.K
alphas from (n,pa)

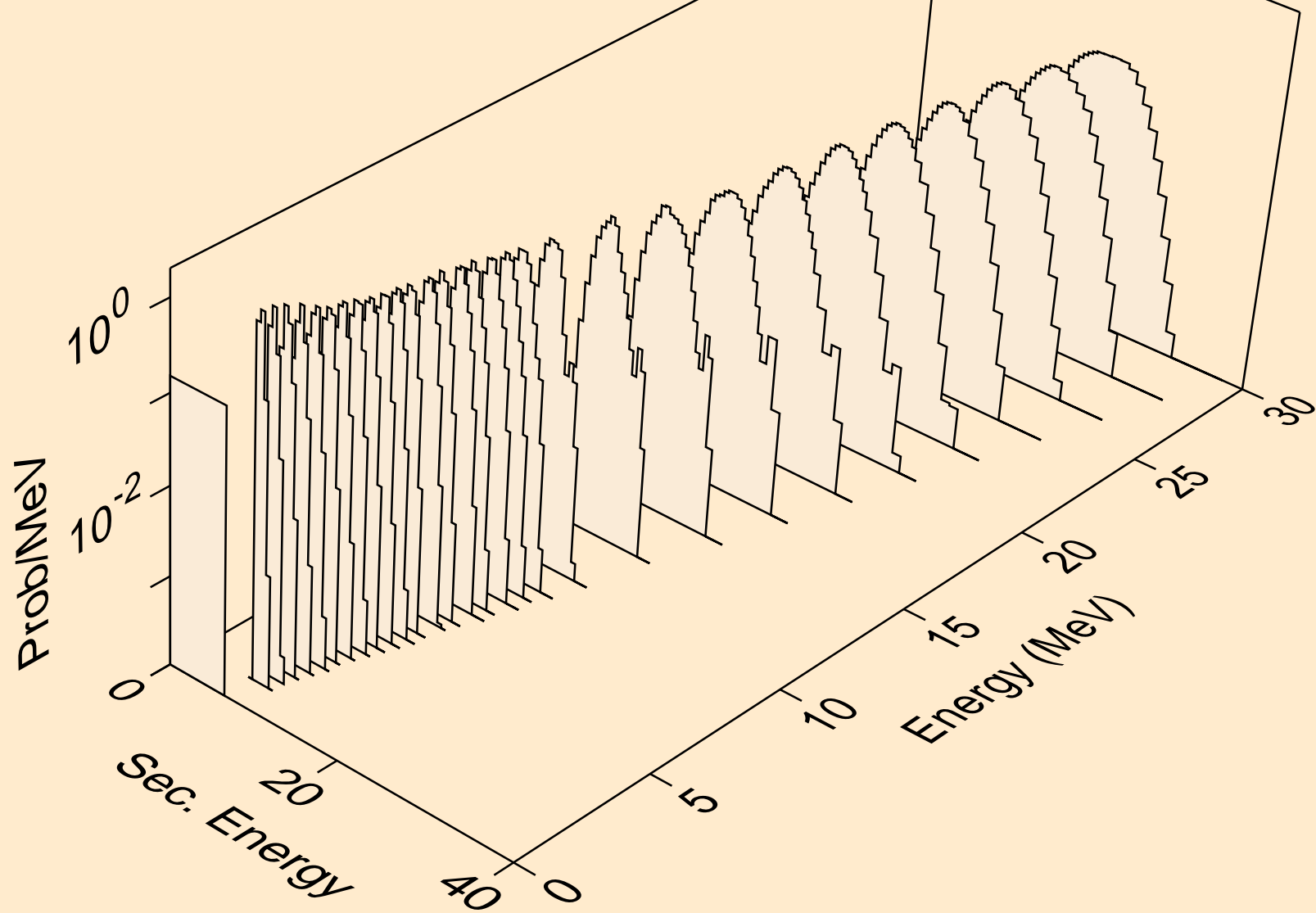

PO203 NEUTRON ACER TENDL-2023 LIBRARY; T=0.K
alphas from (n,da)

