

# PR142M NEUTRON ACER TENDL-2023 LIBRARY; T=0.K

## Principal cross sections

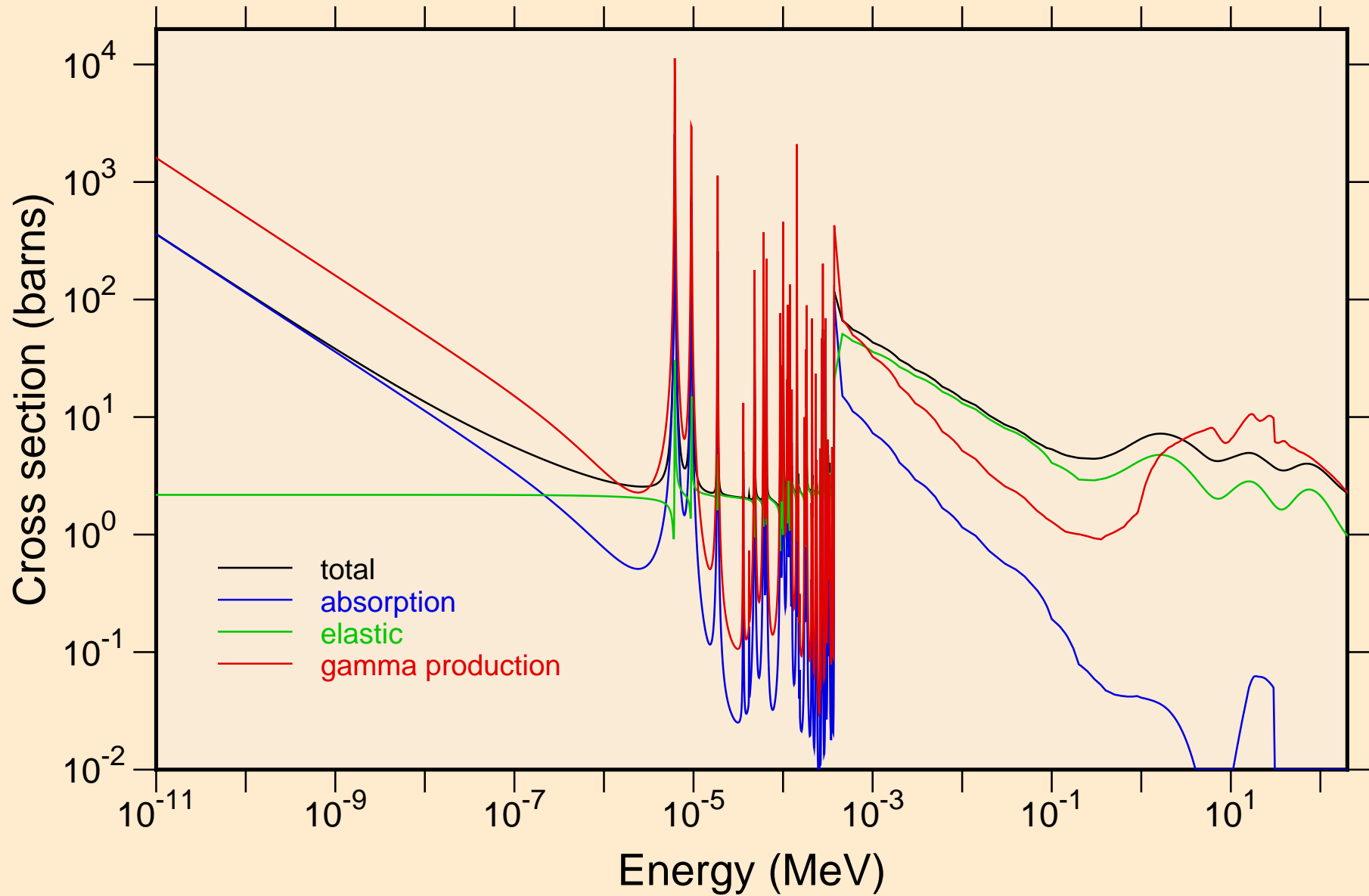

PR142M NEUTRON ACER TENDL-2023 LIBRARY; T=0.K  
resonance total cross section

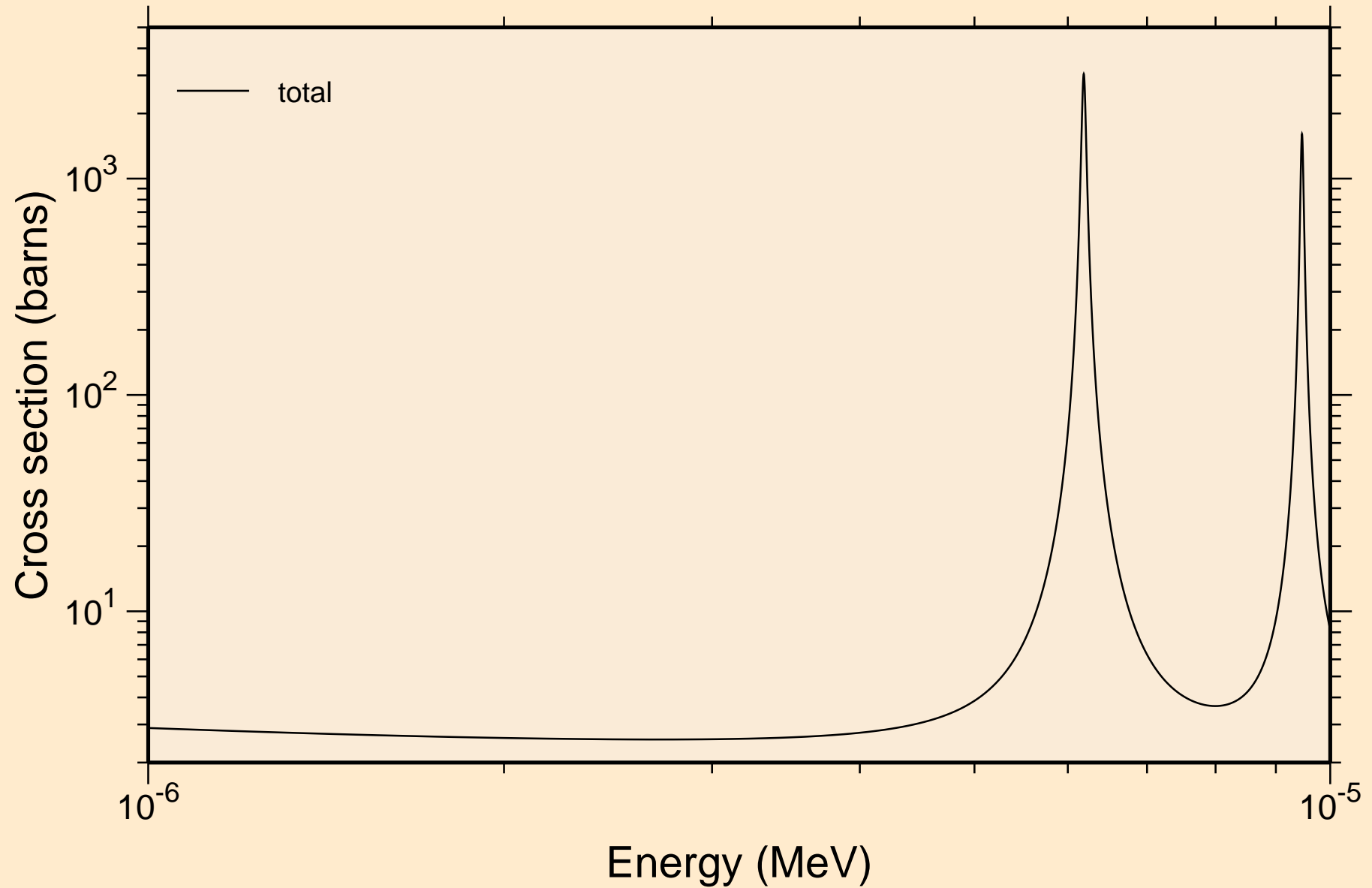

PR142M NEUTRON ACER TENDL-2023 LIBRARY; T=0.K  
resonance total cross section

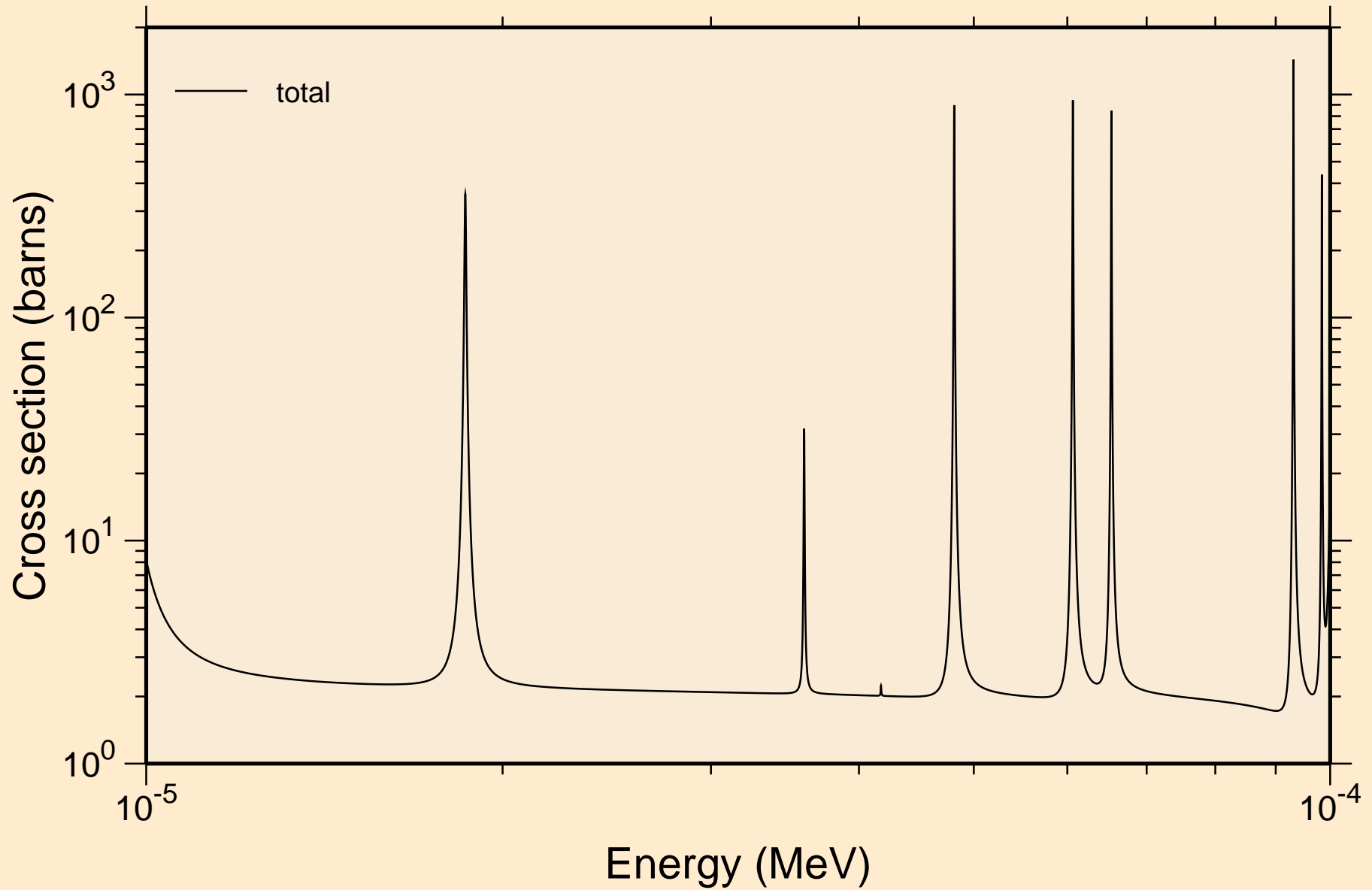

PR142M NEUTRON ACER TENDL-2023 LIBRARY; T=0.K  
resonance total cross section

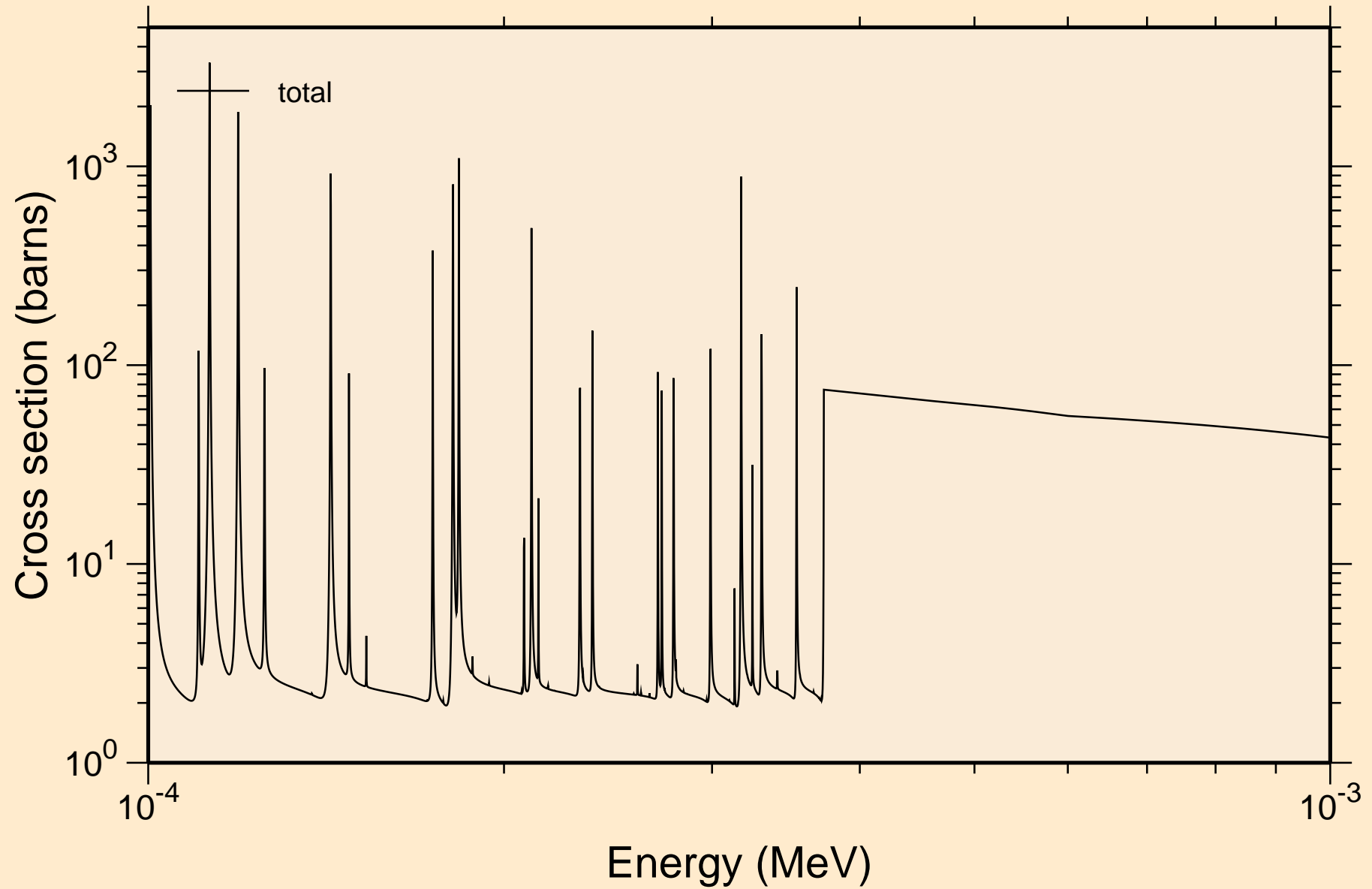

PR142M NEUTRON ACER TENDL-2023 LIBRARY; T=0.K  
resonance total cross section

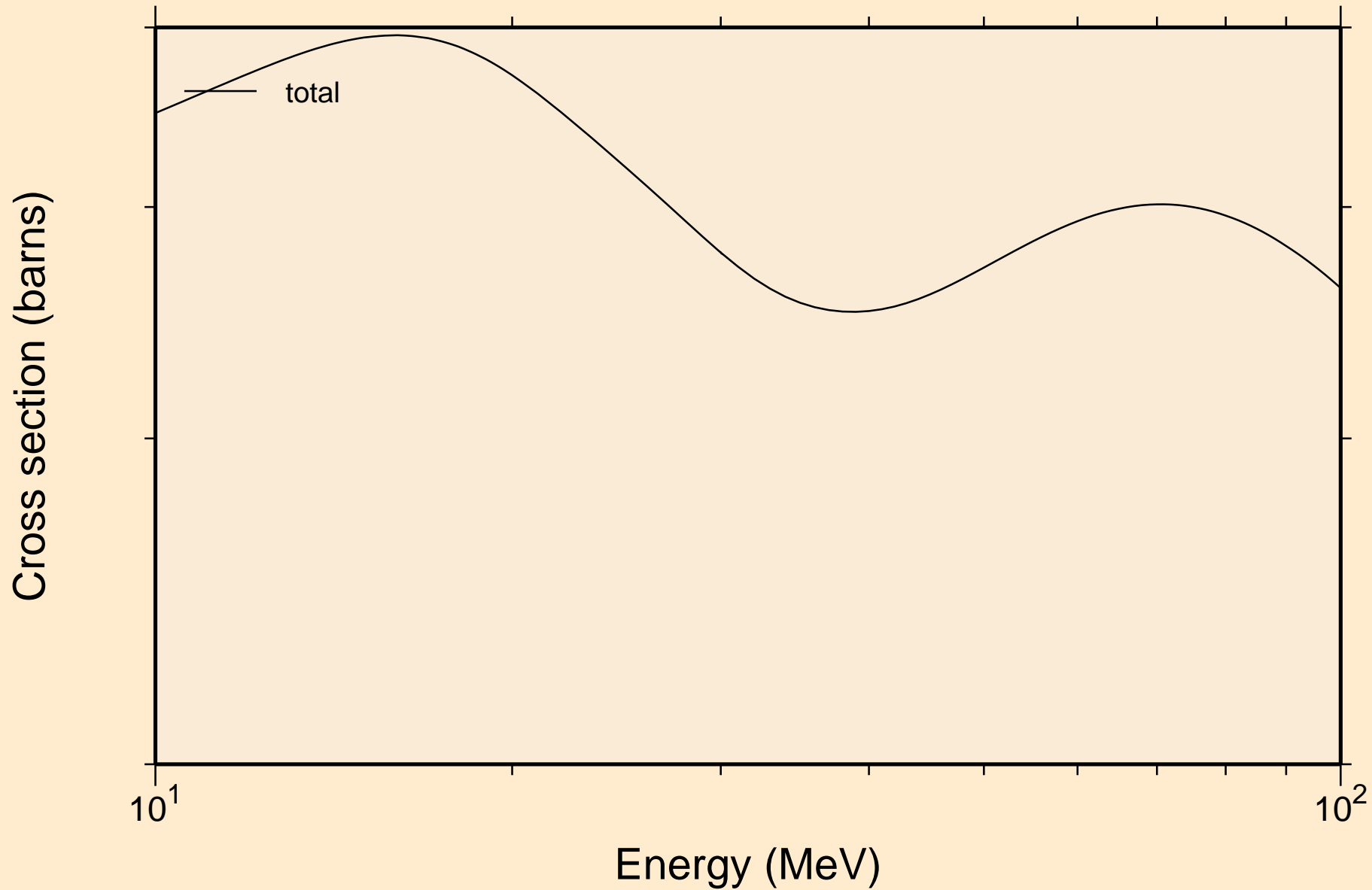

PR142M NEUTRON ACER TENDL-2023 LIBRARY; T=0.K  
resonance absorption cross sections

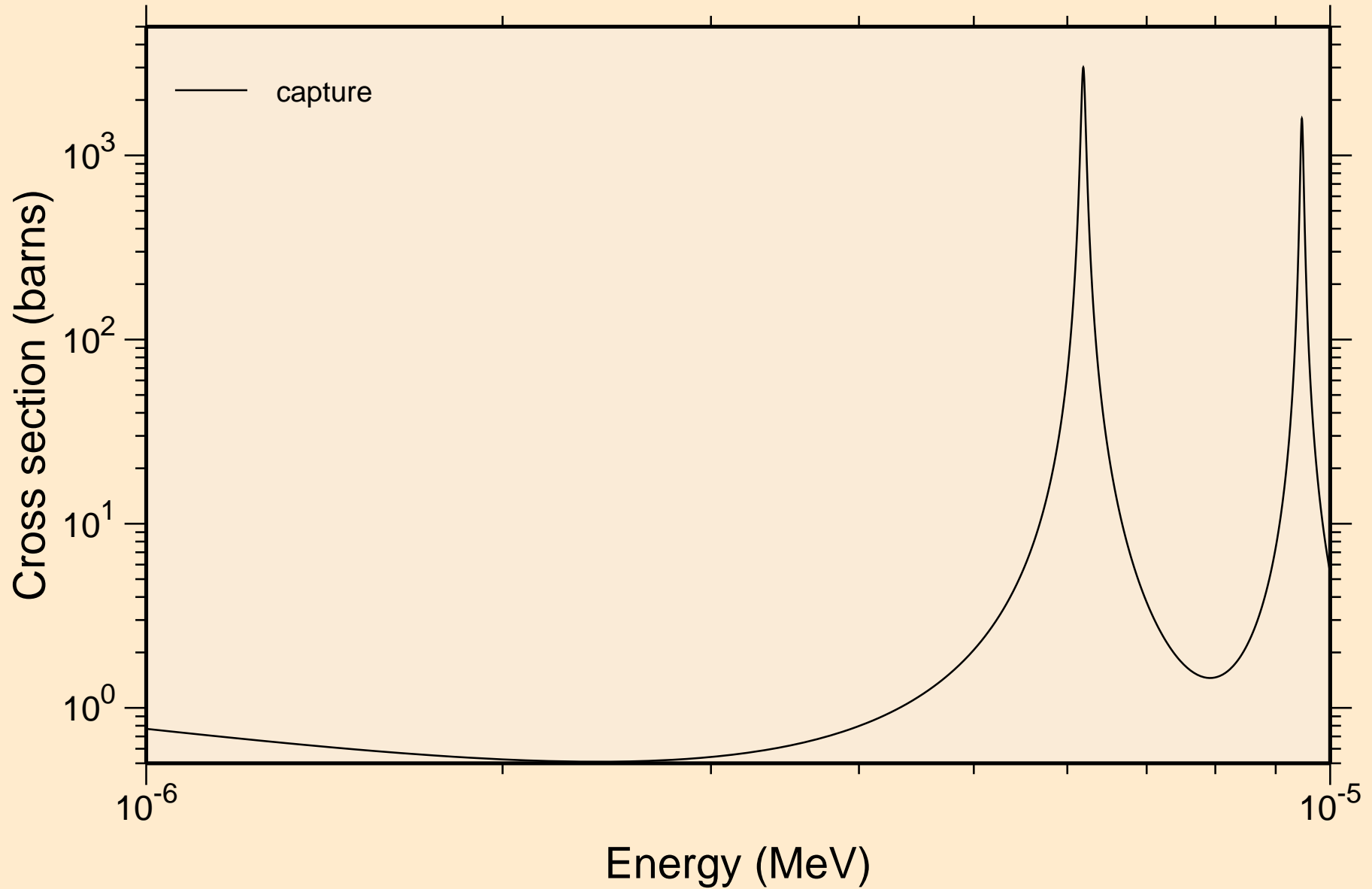

PR142M NEUTRON ACER TENDL-2023 LIBRARY; T=0.K  
resonance absorption cross sections

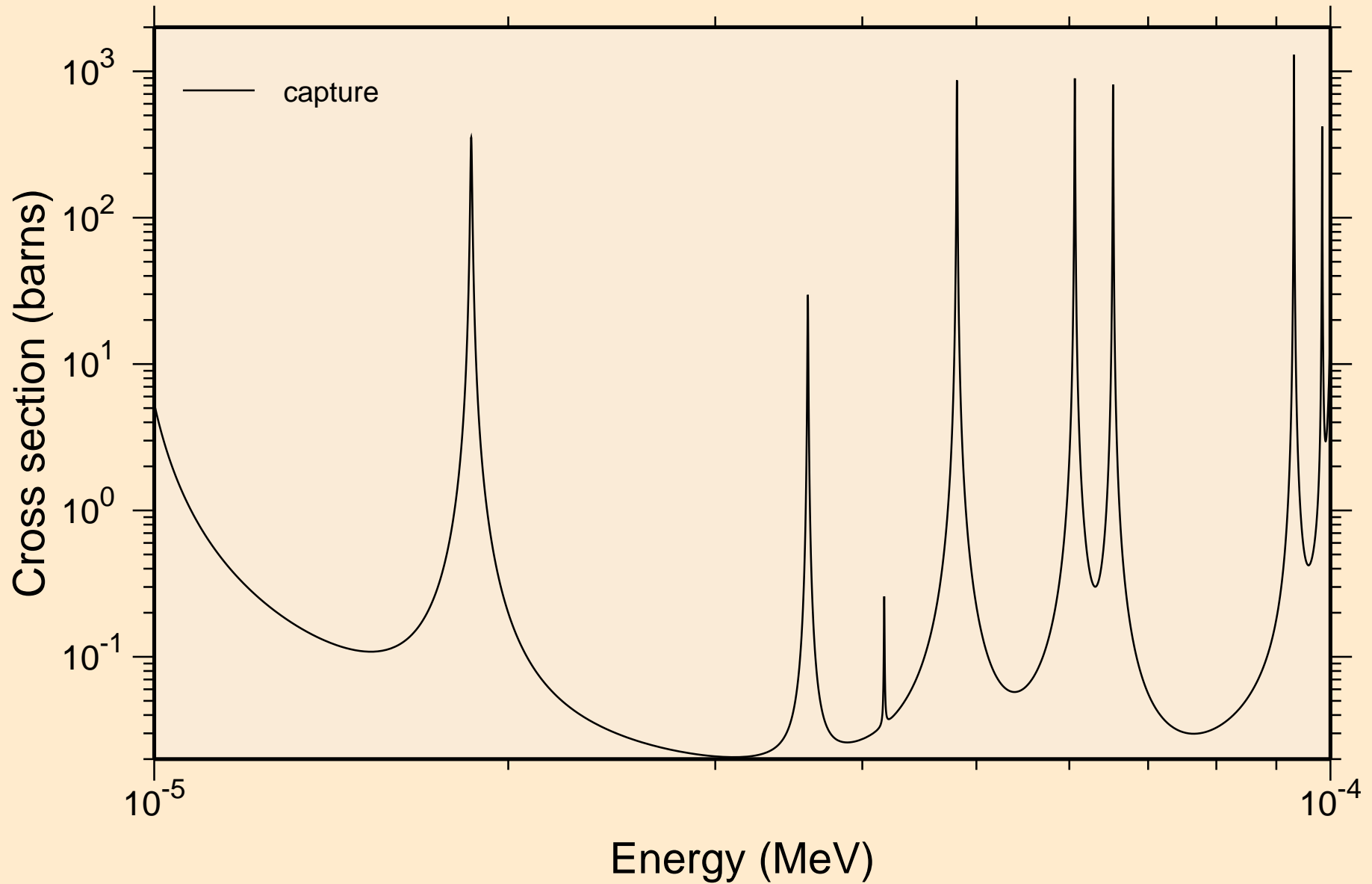

PR142M NEUTRON ACER TENDL-2023 LIBRARY; T=0.K  
resonance absorption cross sections

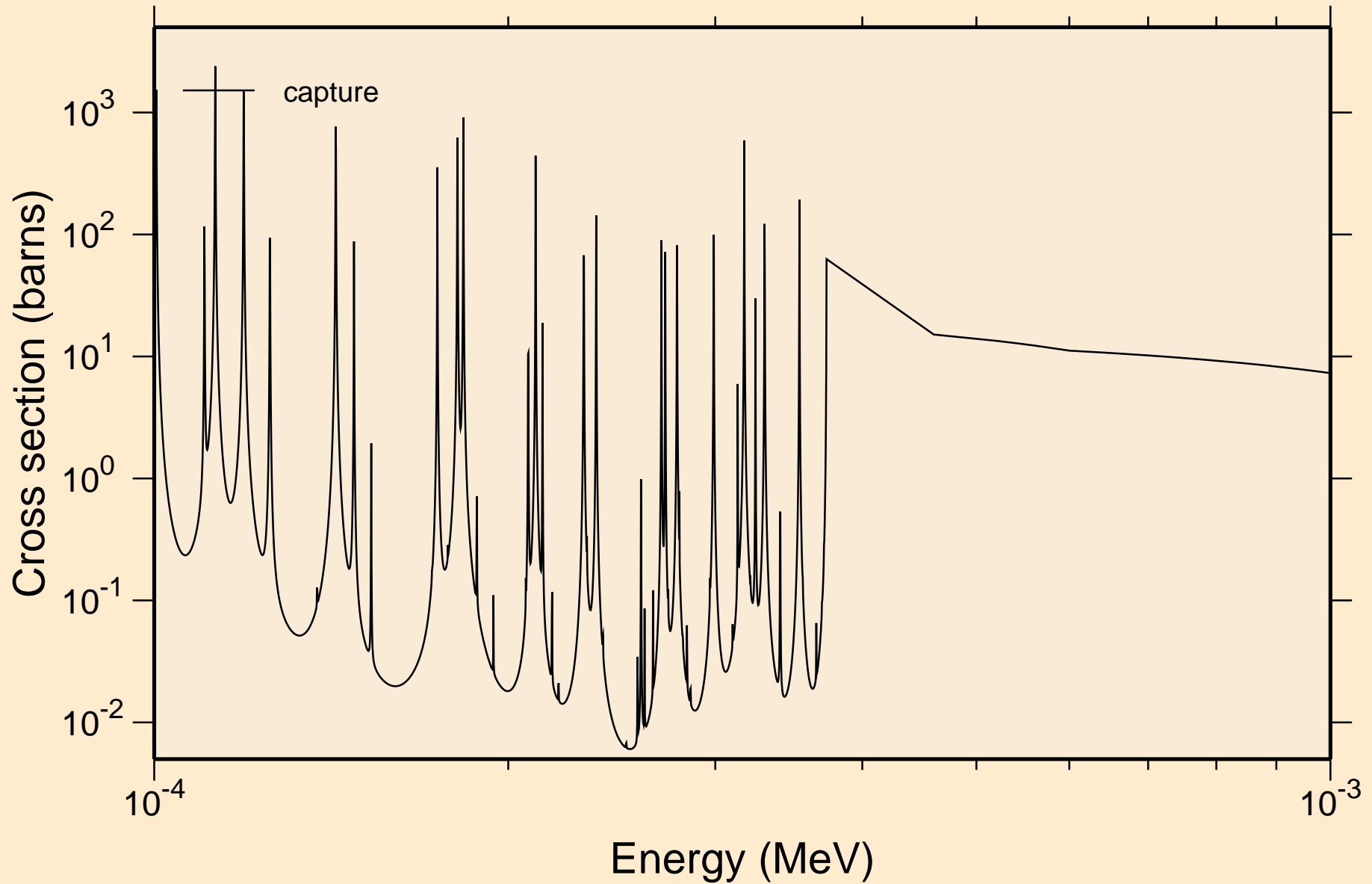



PR142M NEUTRON ACER TENDL-2023 LIBRARY; T=0.K  
resonance absorption cross sections

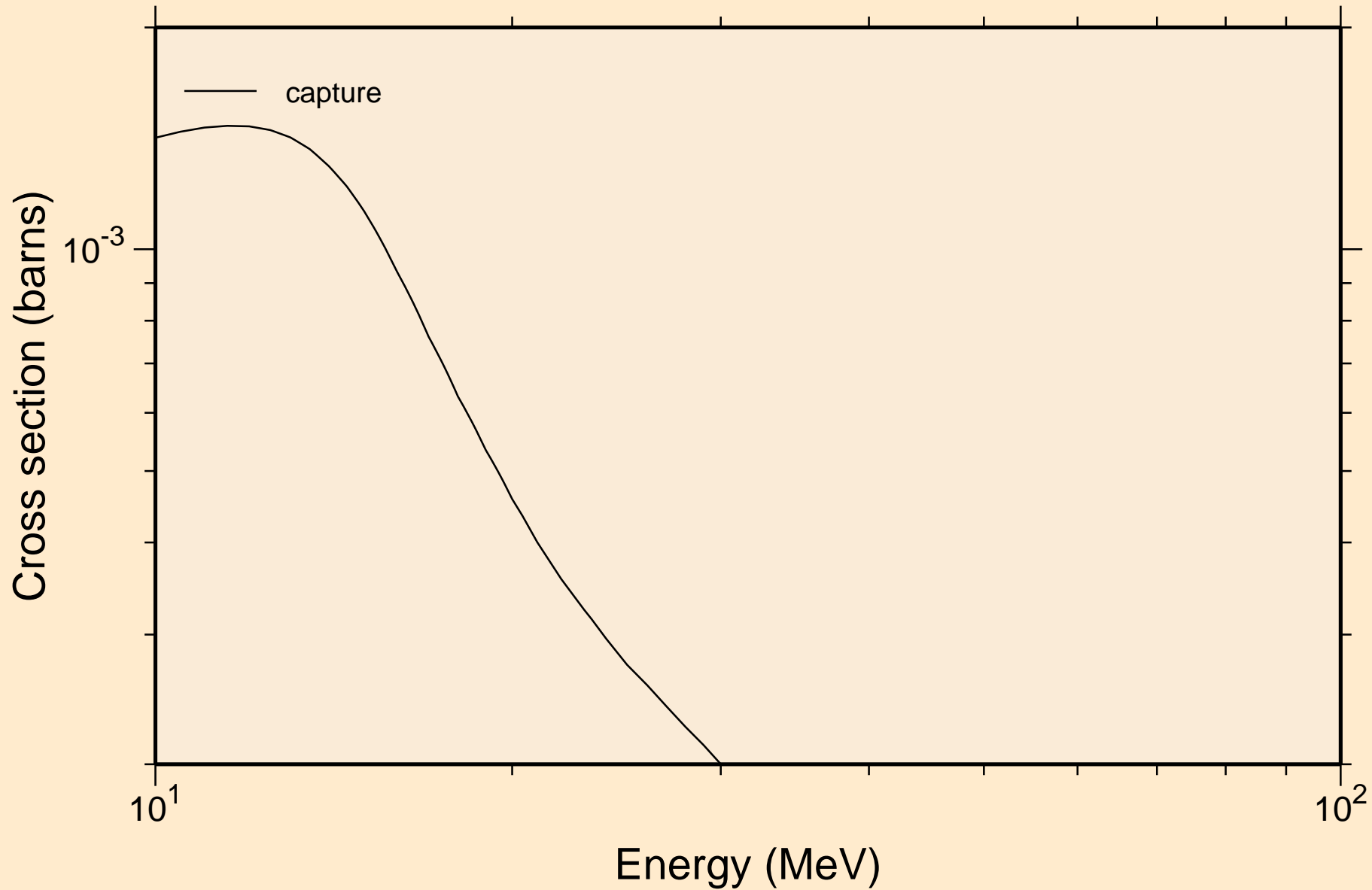

PR142M NEUTRON ACER TENDL-2023 LIBRARY; T=0.K  
Heating

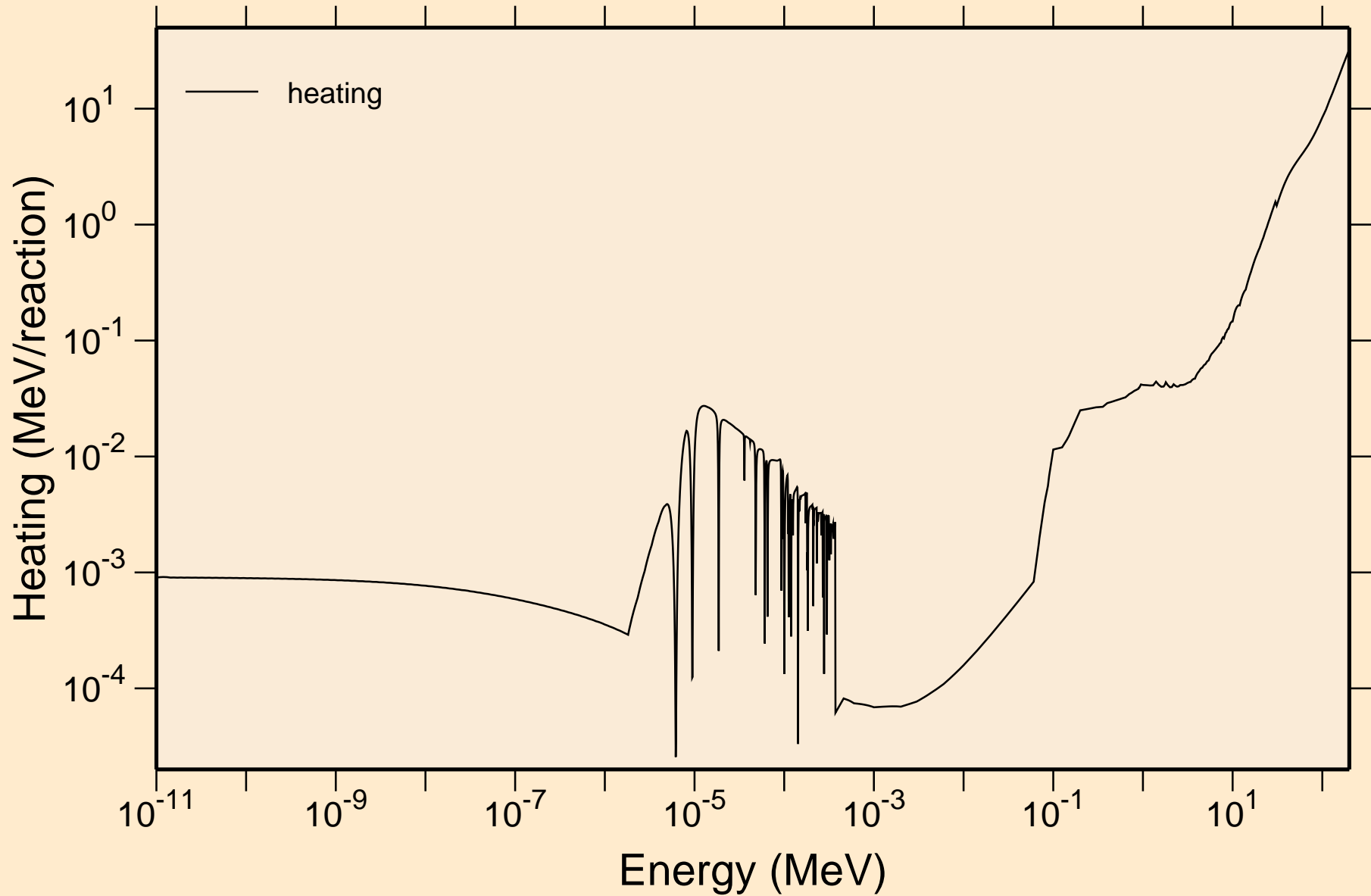

PR142M NEUTRON ACER TENDL-2023 LIBRARY; T=0.K  
Damage

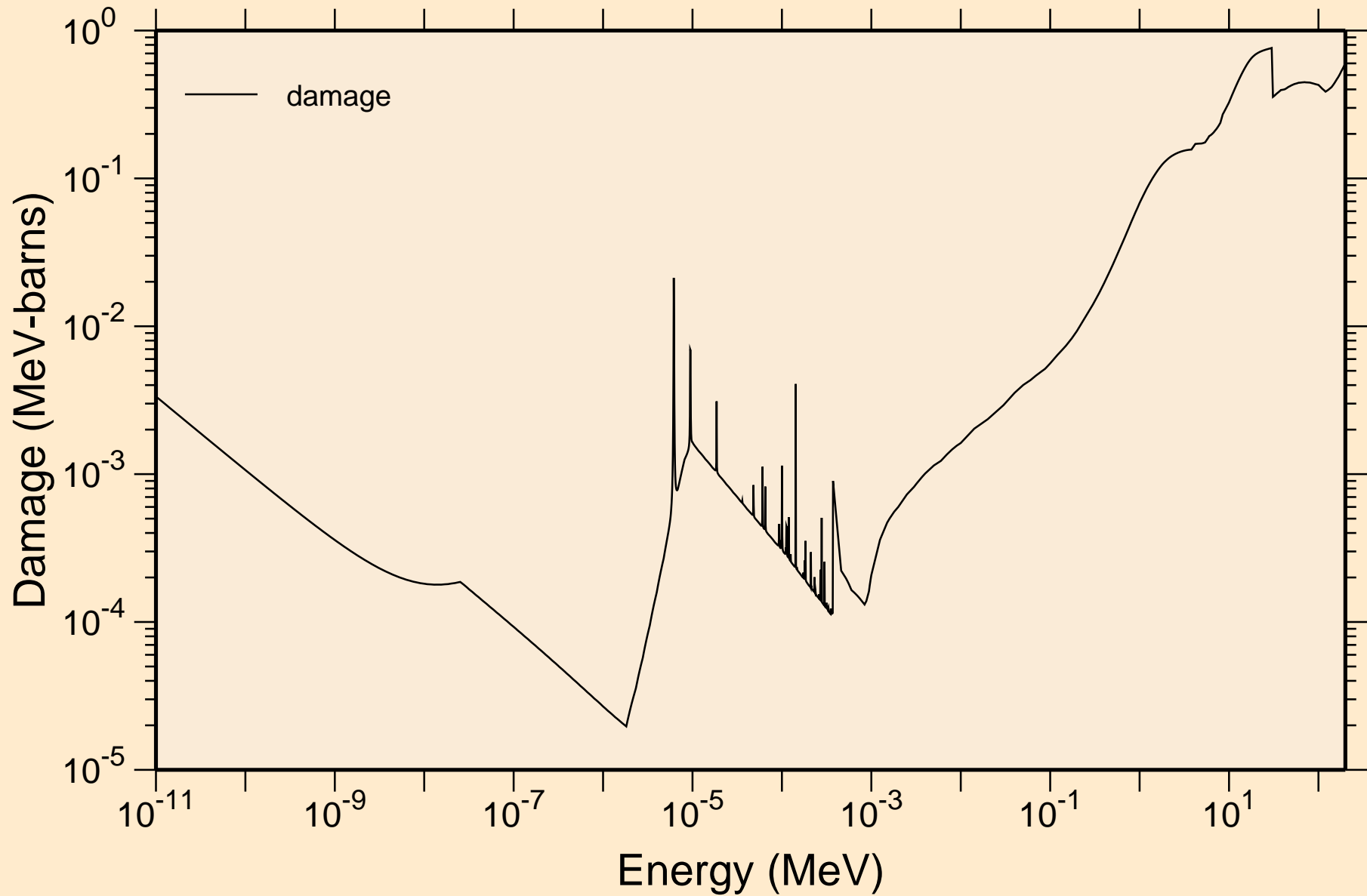

PR142M NEUTRON ACER TENDL-2023 LIBRARY; T=0.K  
Non-threshold reactions

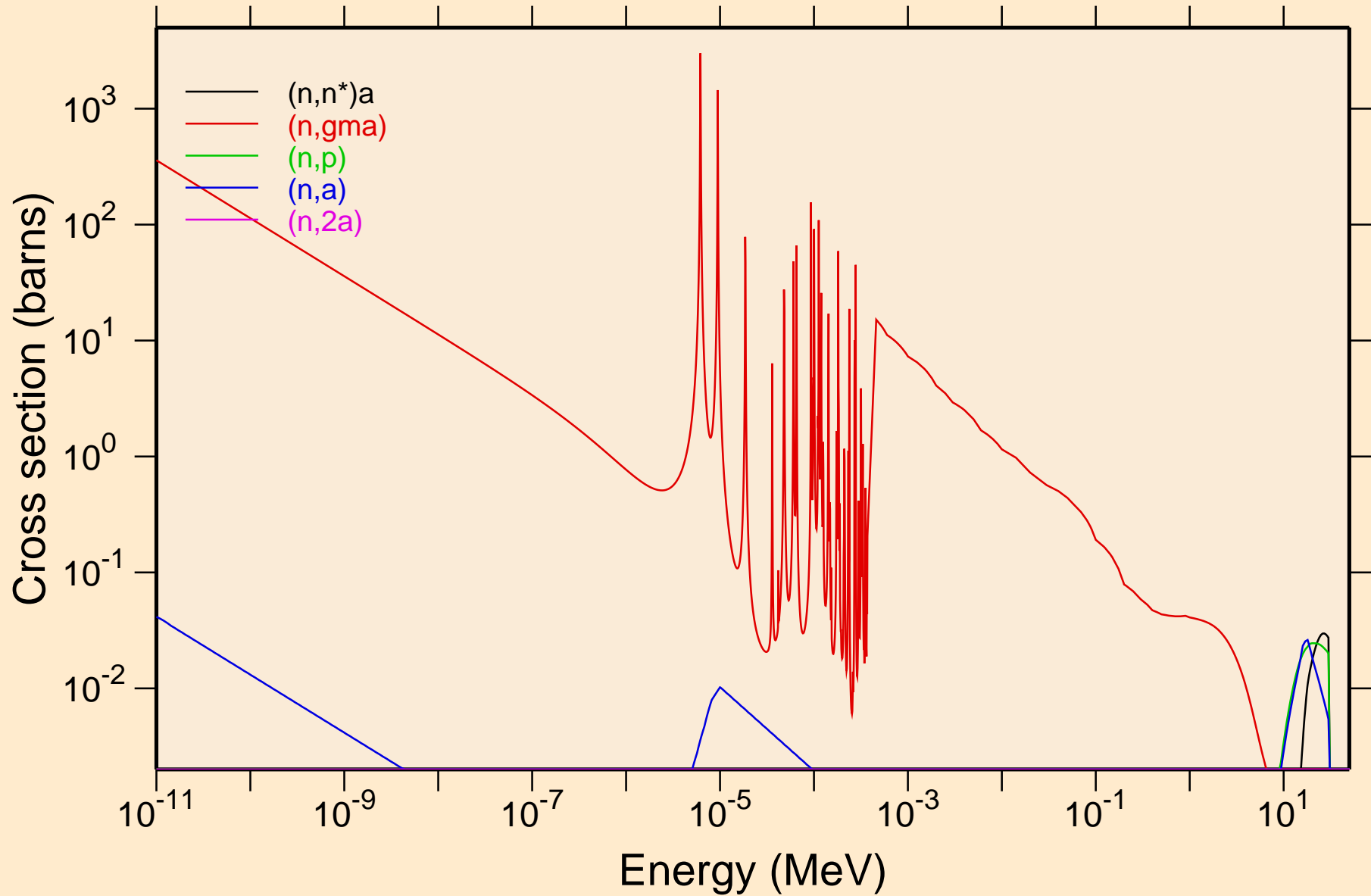

PR142M NEUTRON ACER TENDL-2023 LIBRARY; T=0.K  
Non-threshold reactions

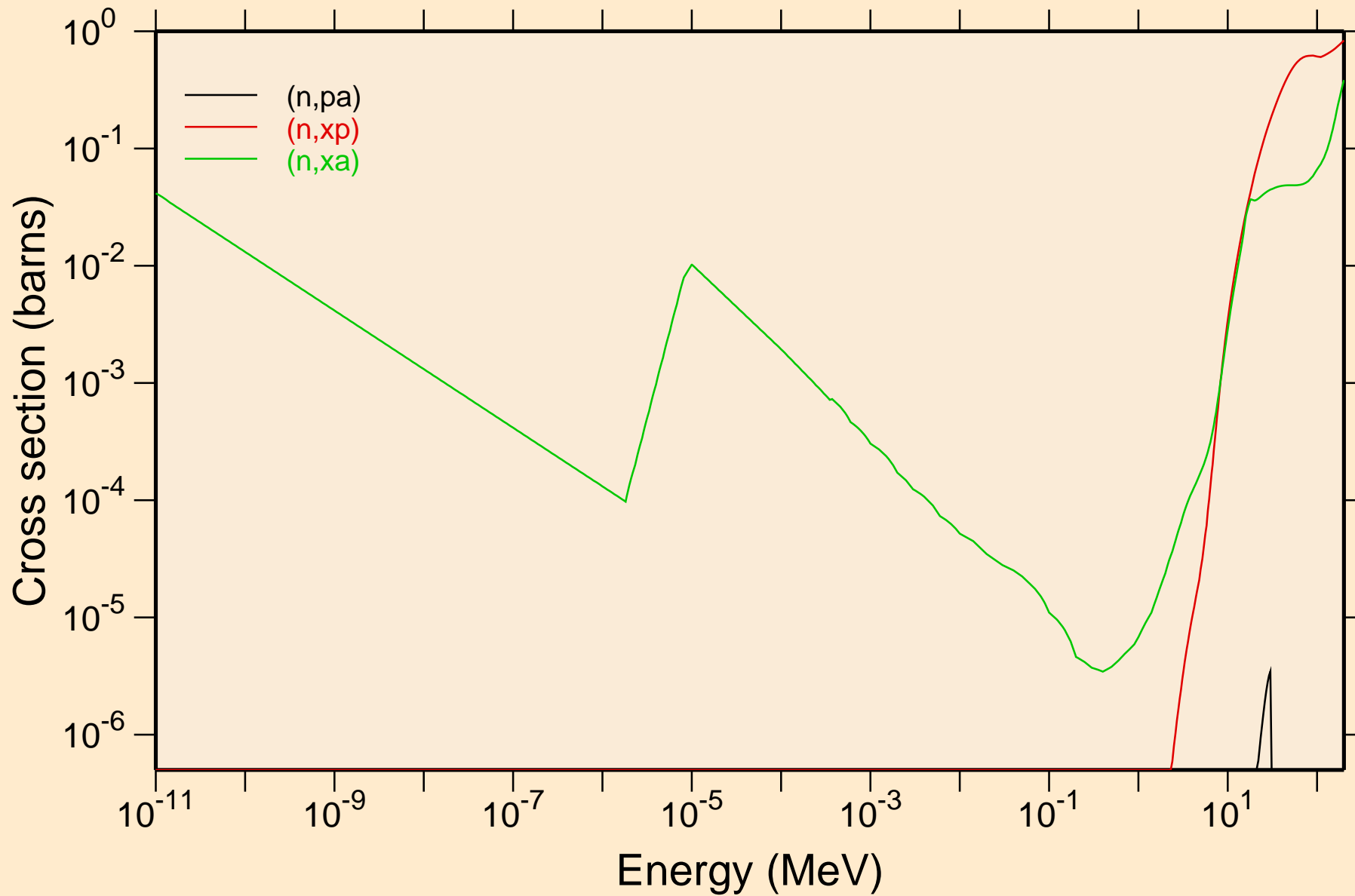

PR142M NEUTRON ACER TENDL-2023 LIBRARY; T=0.K  
Principal cross sections

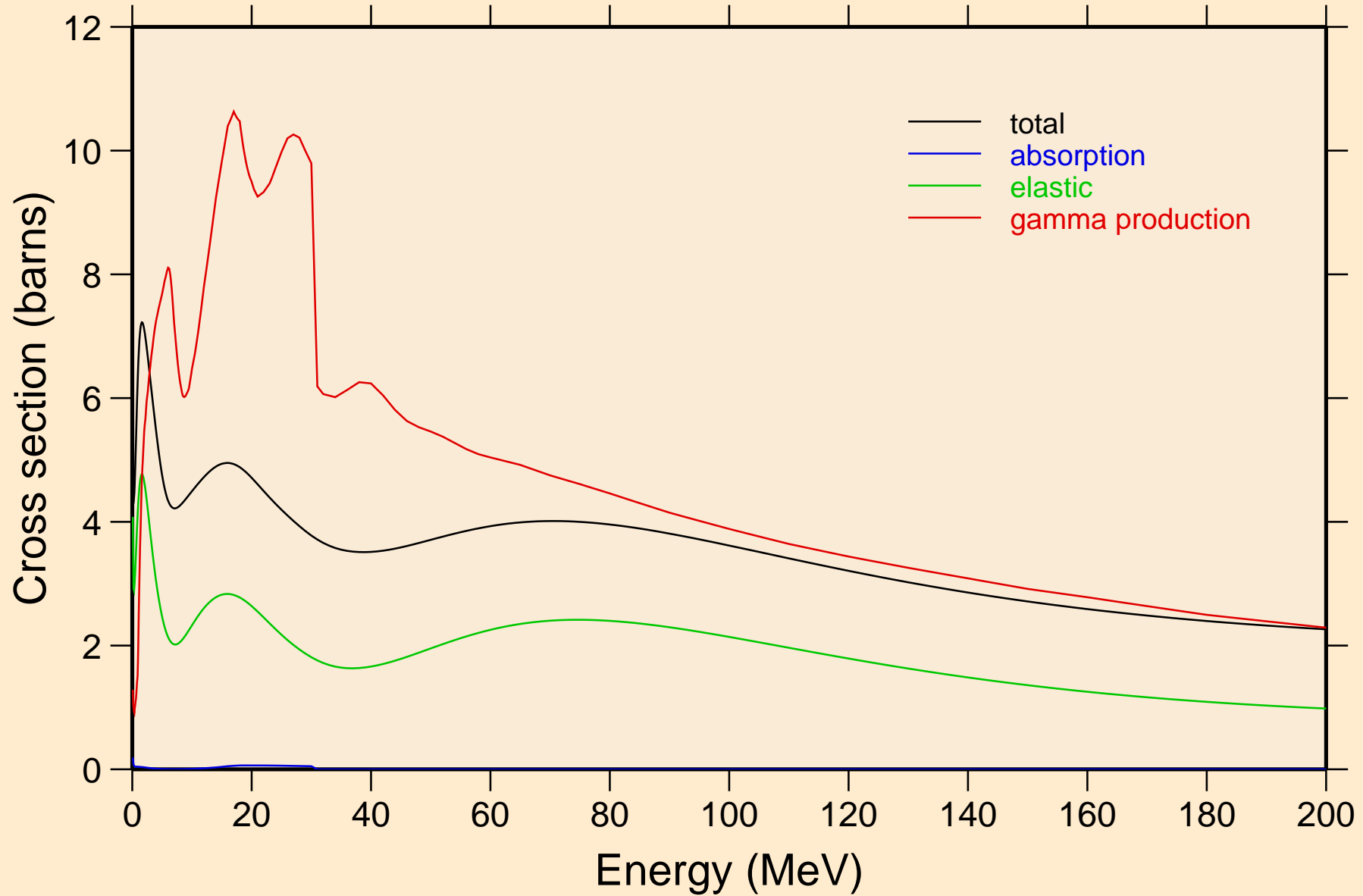

# PR142M NEUTRON ACER TENDL-2023 LIBRARY; T=0.K

## Heating

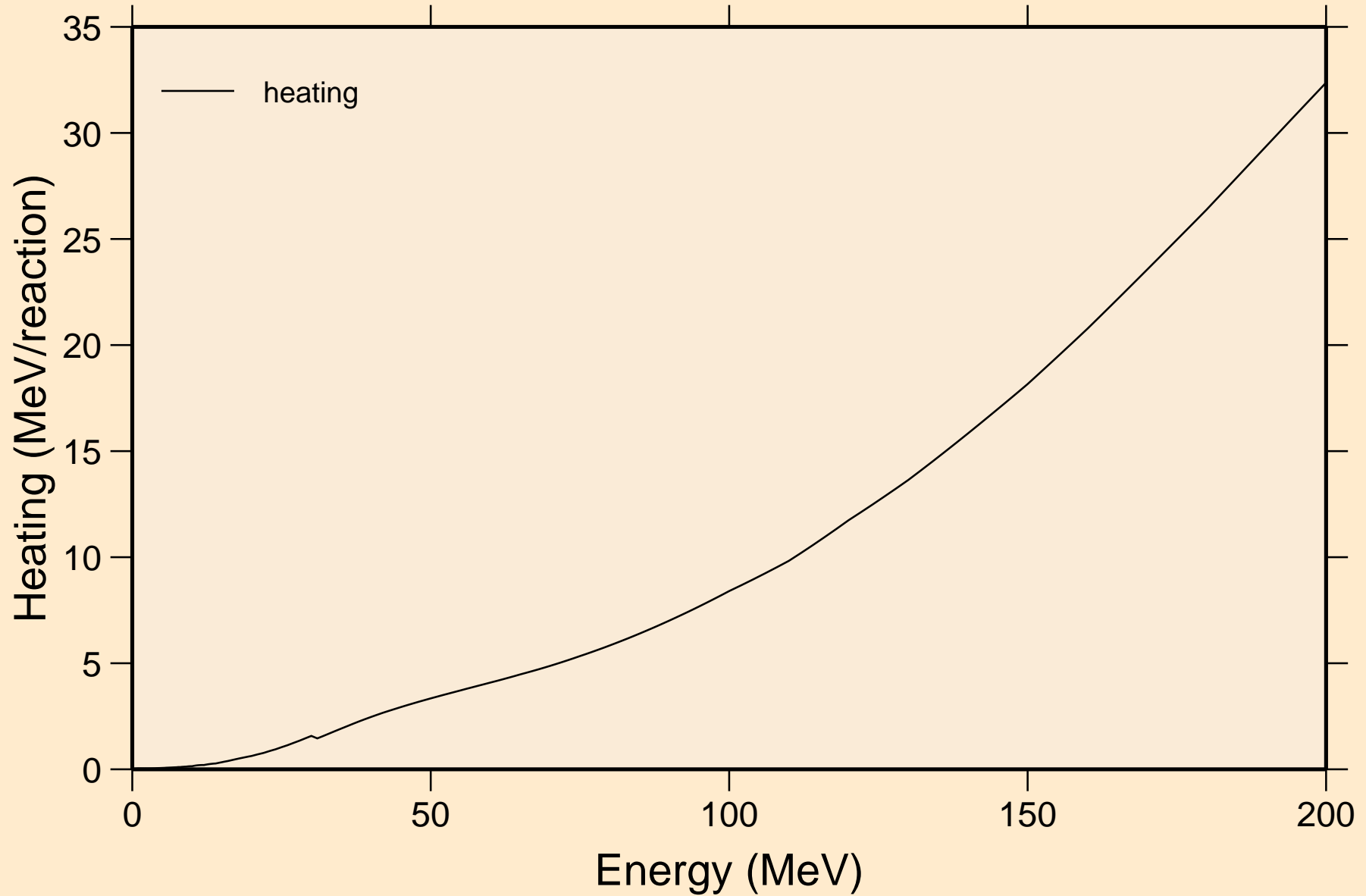

# PR142M NEUTRON ACER TENDL-2023 LIBRARY; T=0.K

## Damage

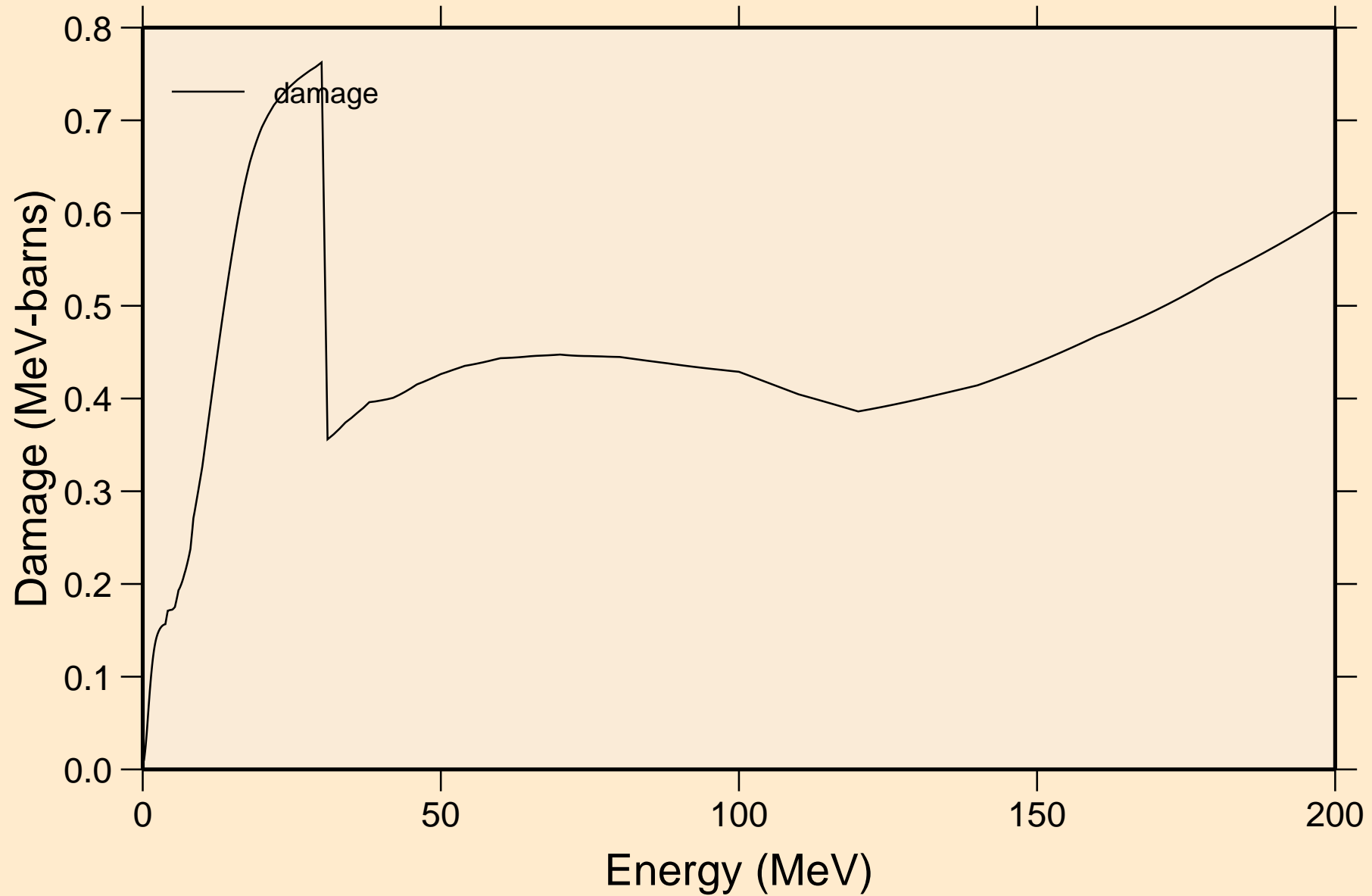



PR142M NEUTRON ACER TENDL-2023 LIBRARY; T=0.K  
Non-threshold reactions

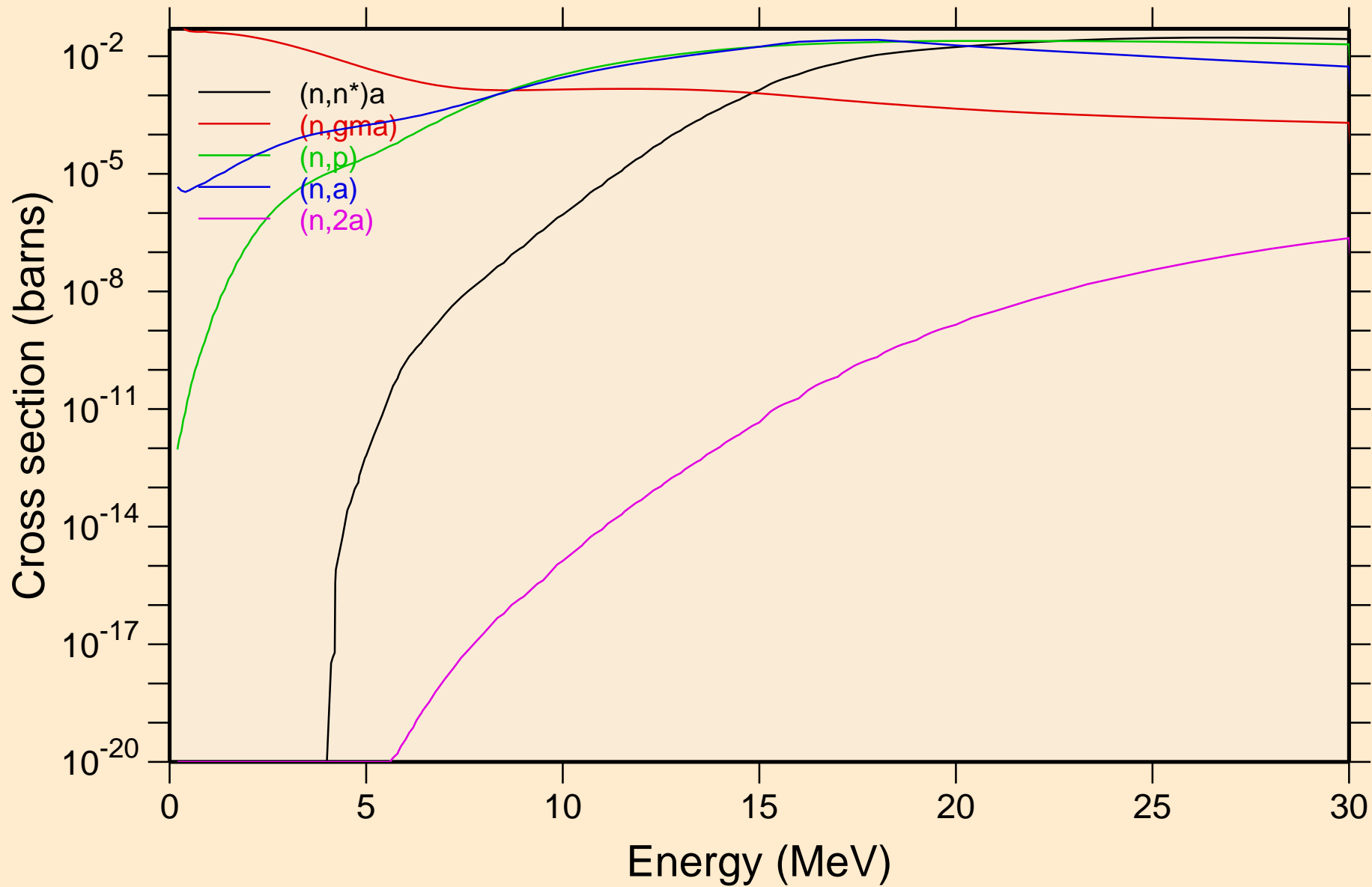

PR142M NEUTRON ACER TENDL-2023 LIBRARY; T=0.K  
Non-threshold reactions

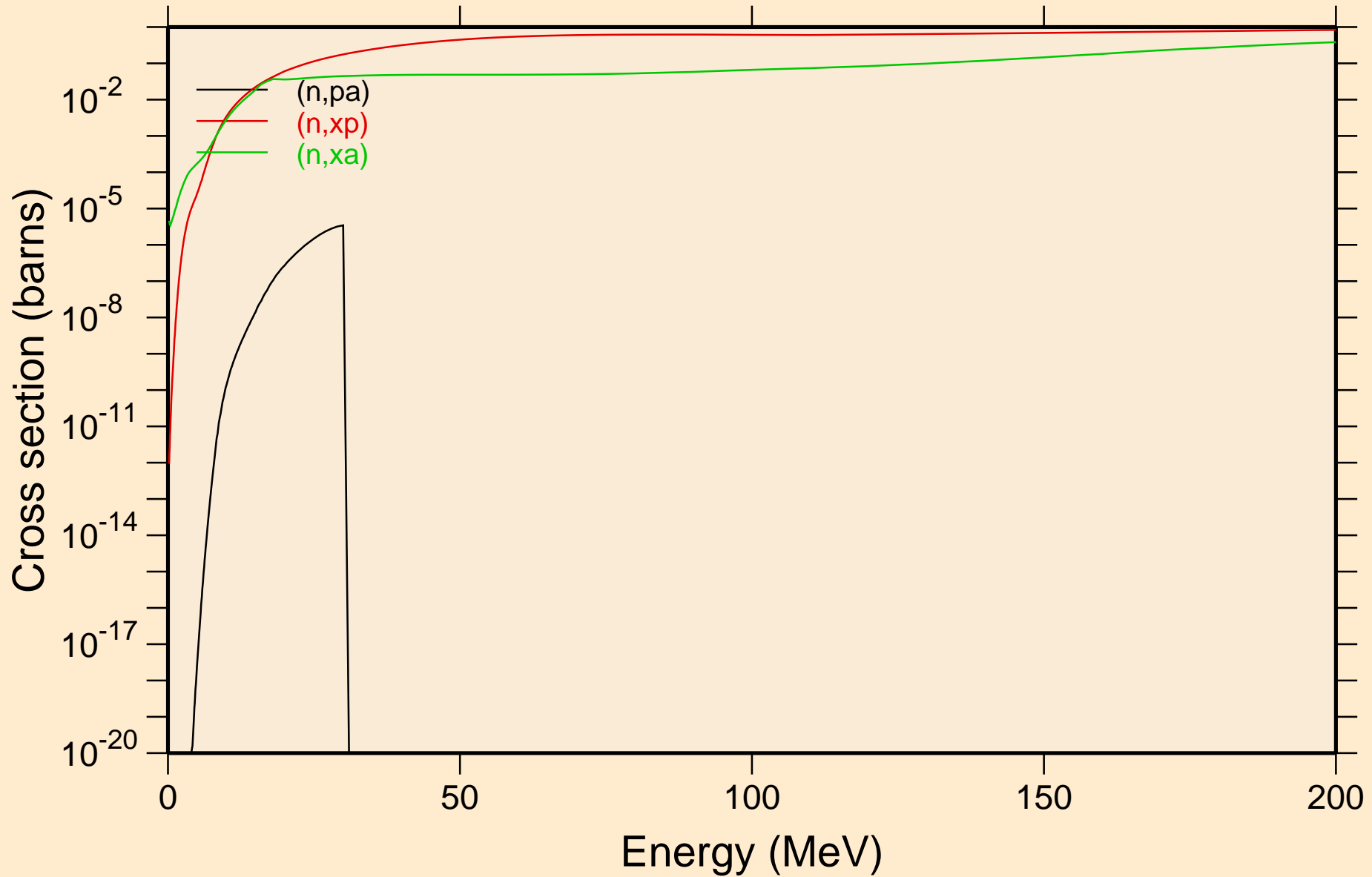

PR142M NEUTRON ACER TENDL-2023 LIBRARY; T=0.K  
Inelastic levels

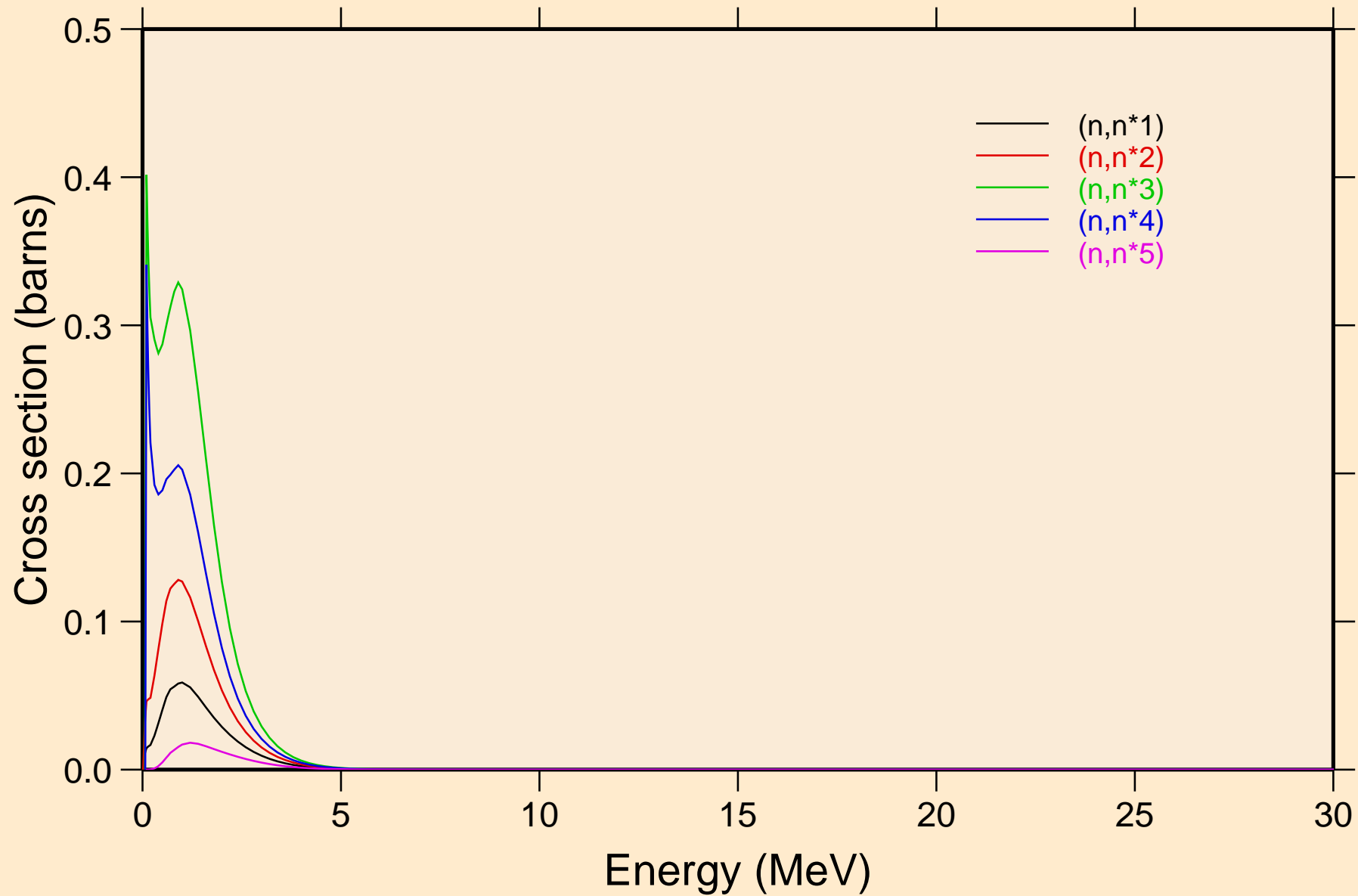

PR142M NEUTRON ACER TENDL-2023 LIBRARY; T=0.K  
Inelastic levels

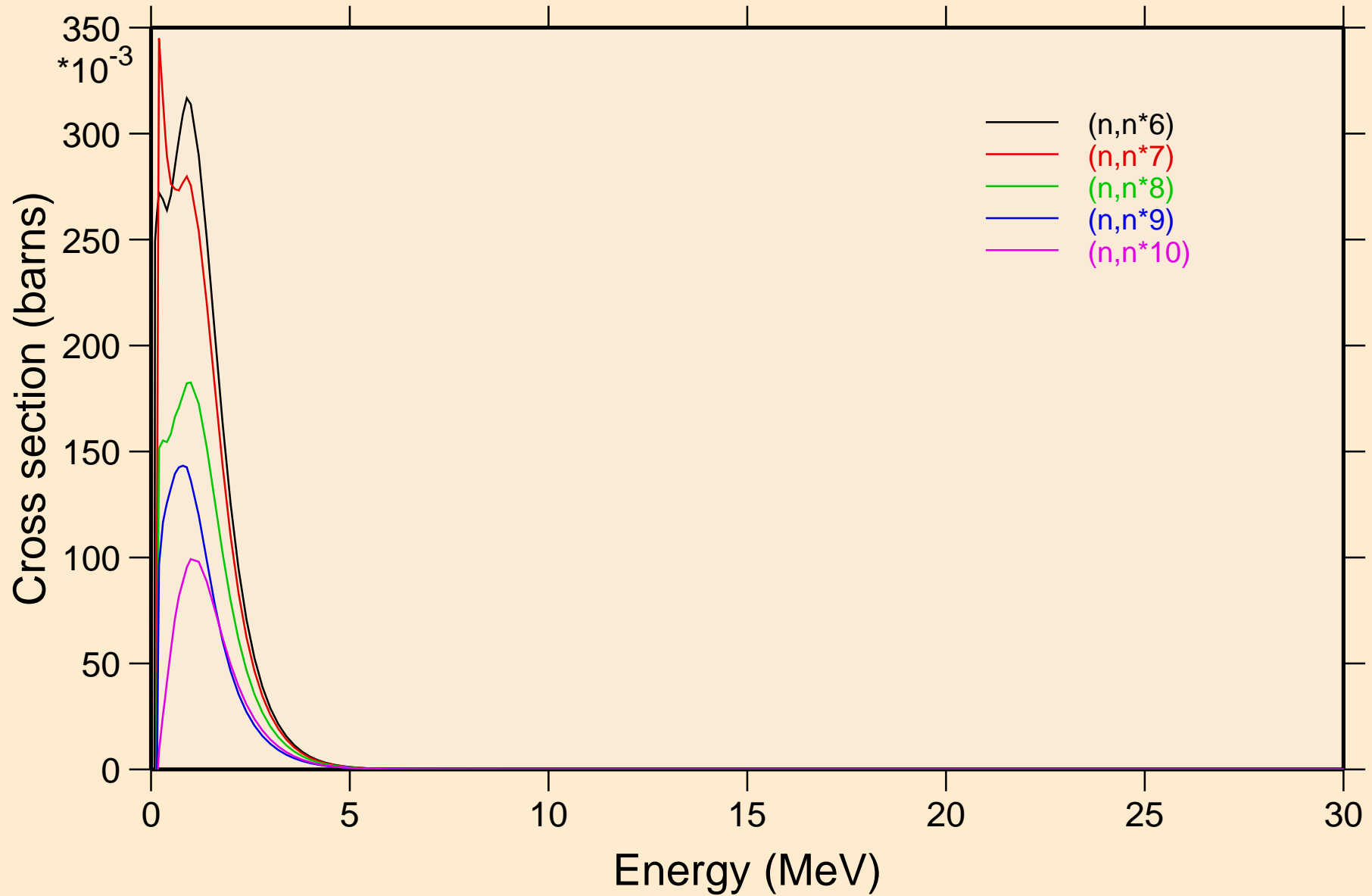

PR142M NEUTRON ACER TENDL-2023 LIBRARY; T=0.K  
Inelastic levels

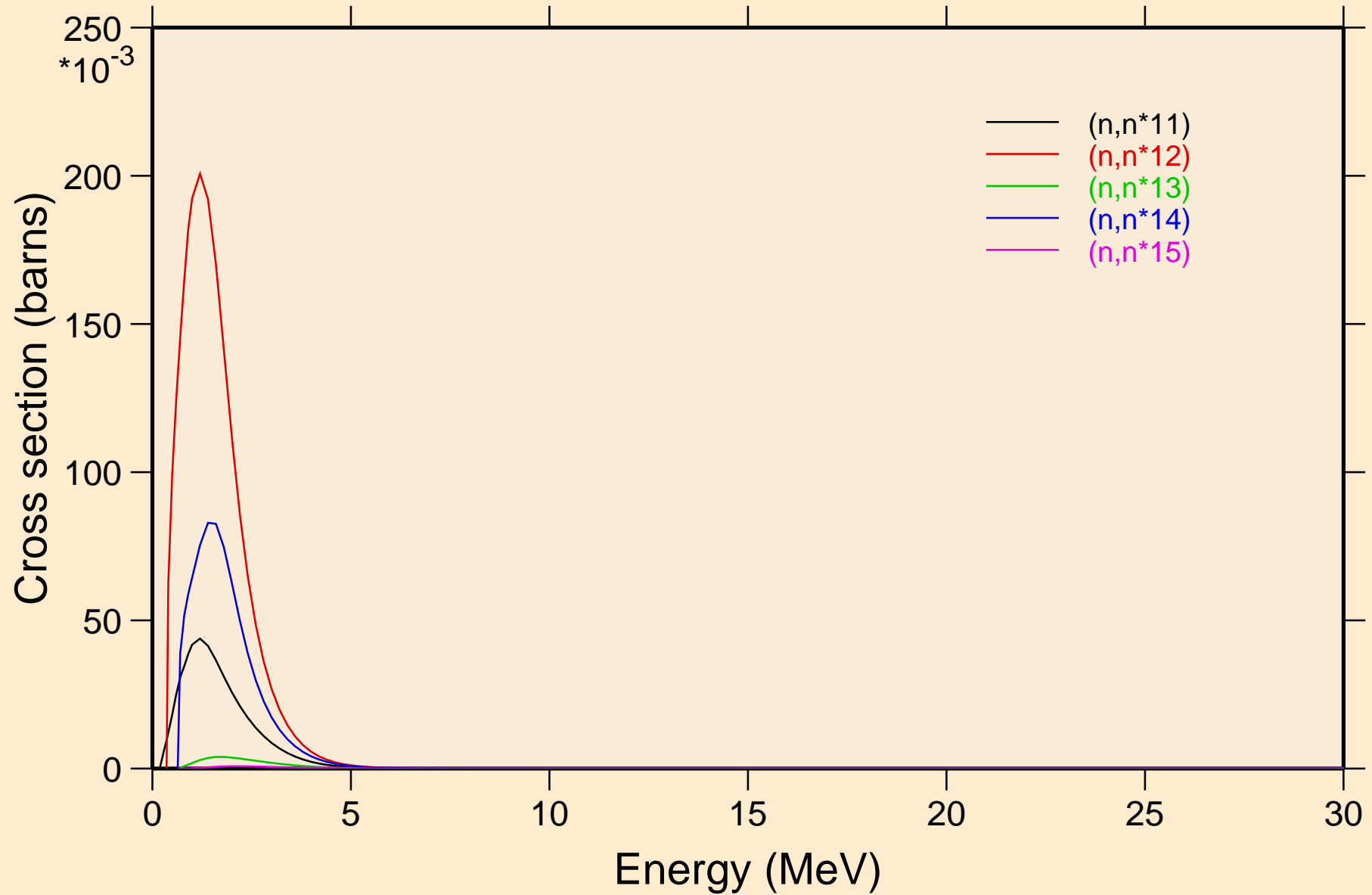

PR142M NEUTRON ACER TENDL-2023 LIBRARY; T=0.K  
Inelastic levels

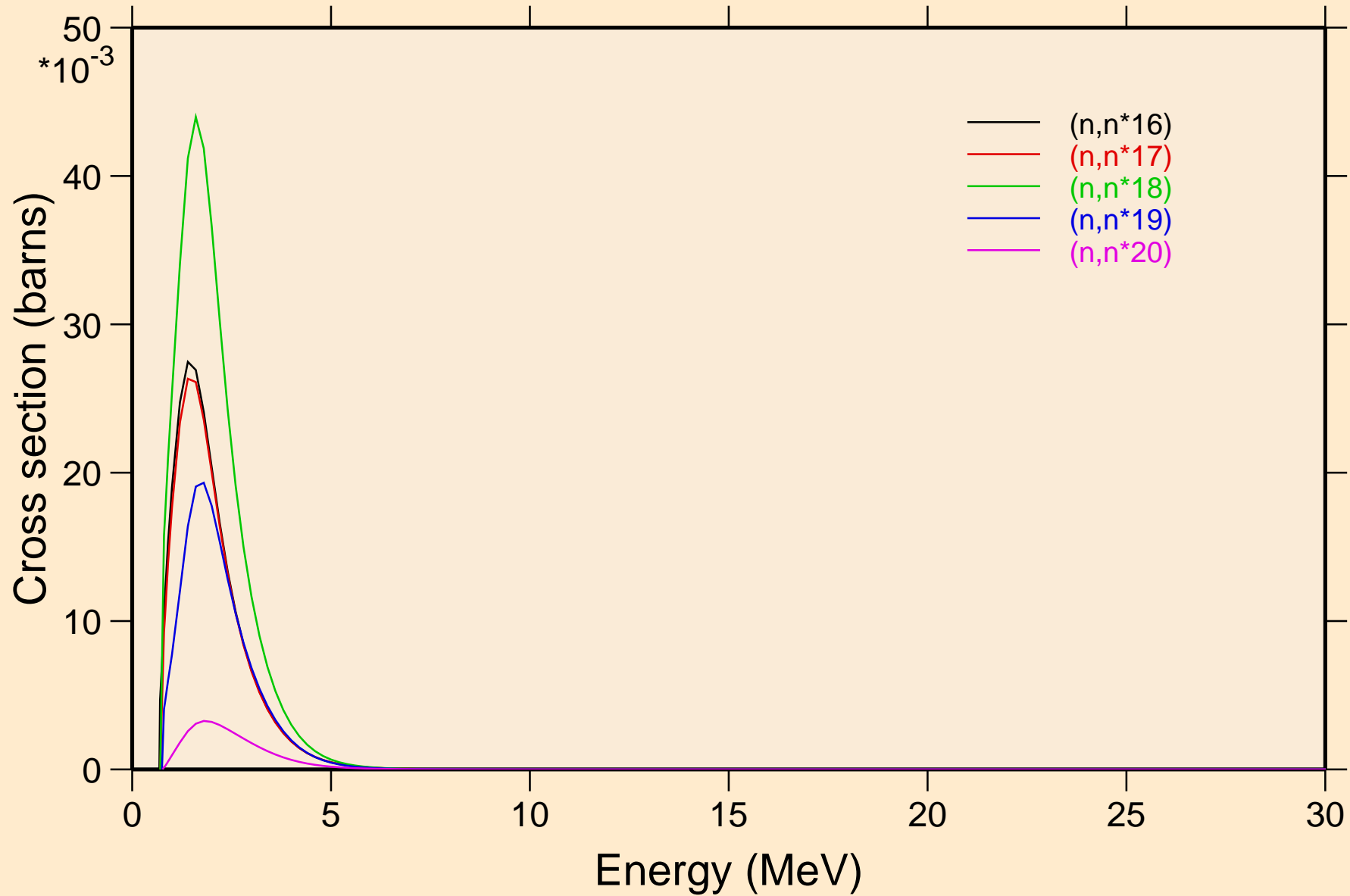

PR142M NEUTRON ACER TENDL-2023 LIBRARY; T=0.K  
Inelastic levels

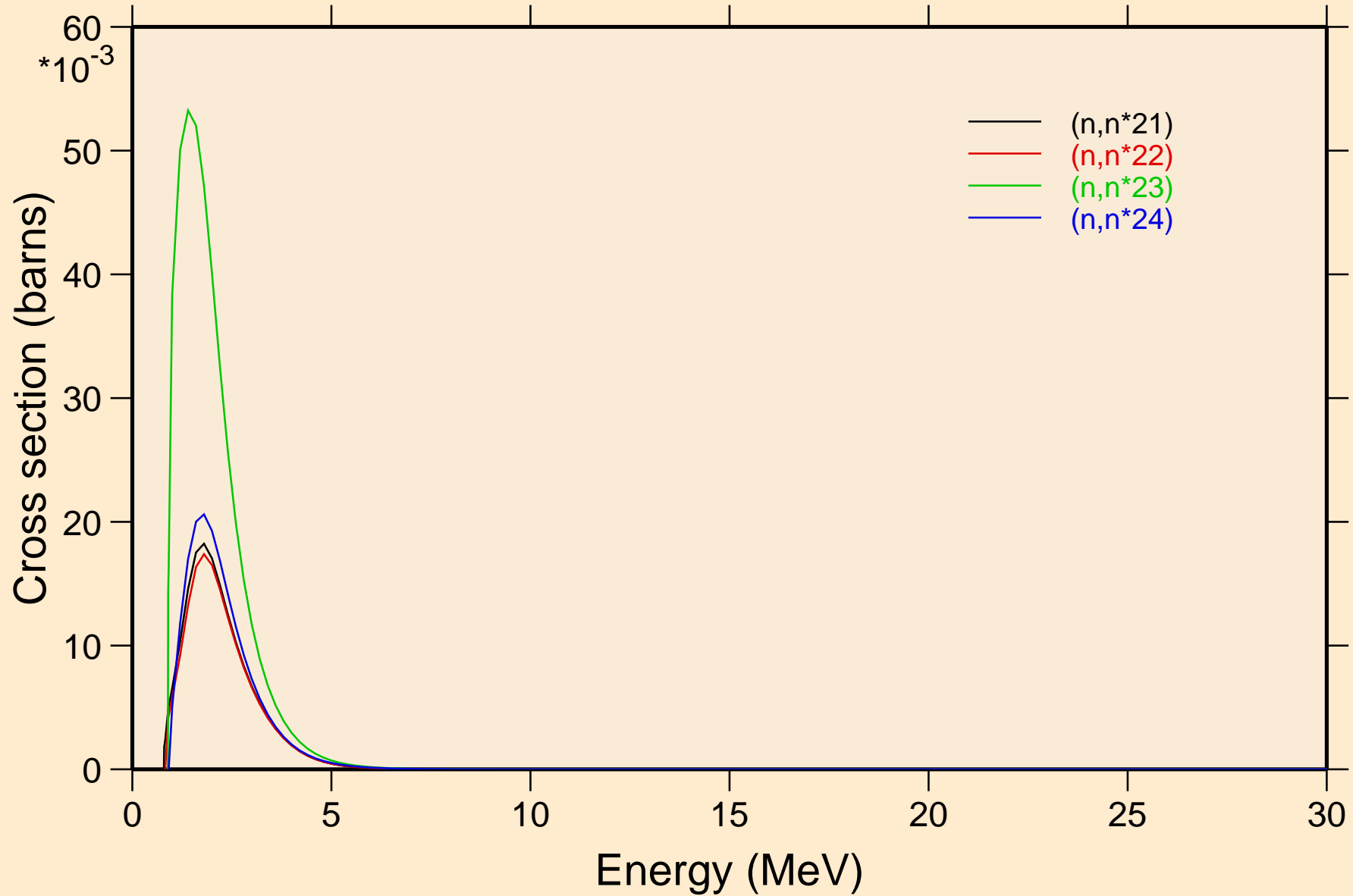

PR142M NEUTRON ACER TENDL-2023 LIBRARY; T=0.K  
Threshold reactions

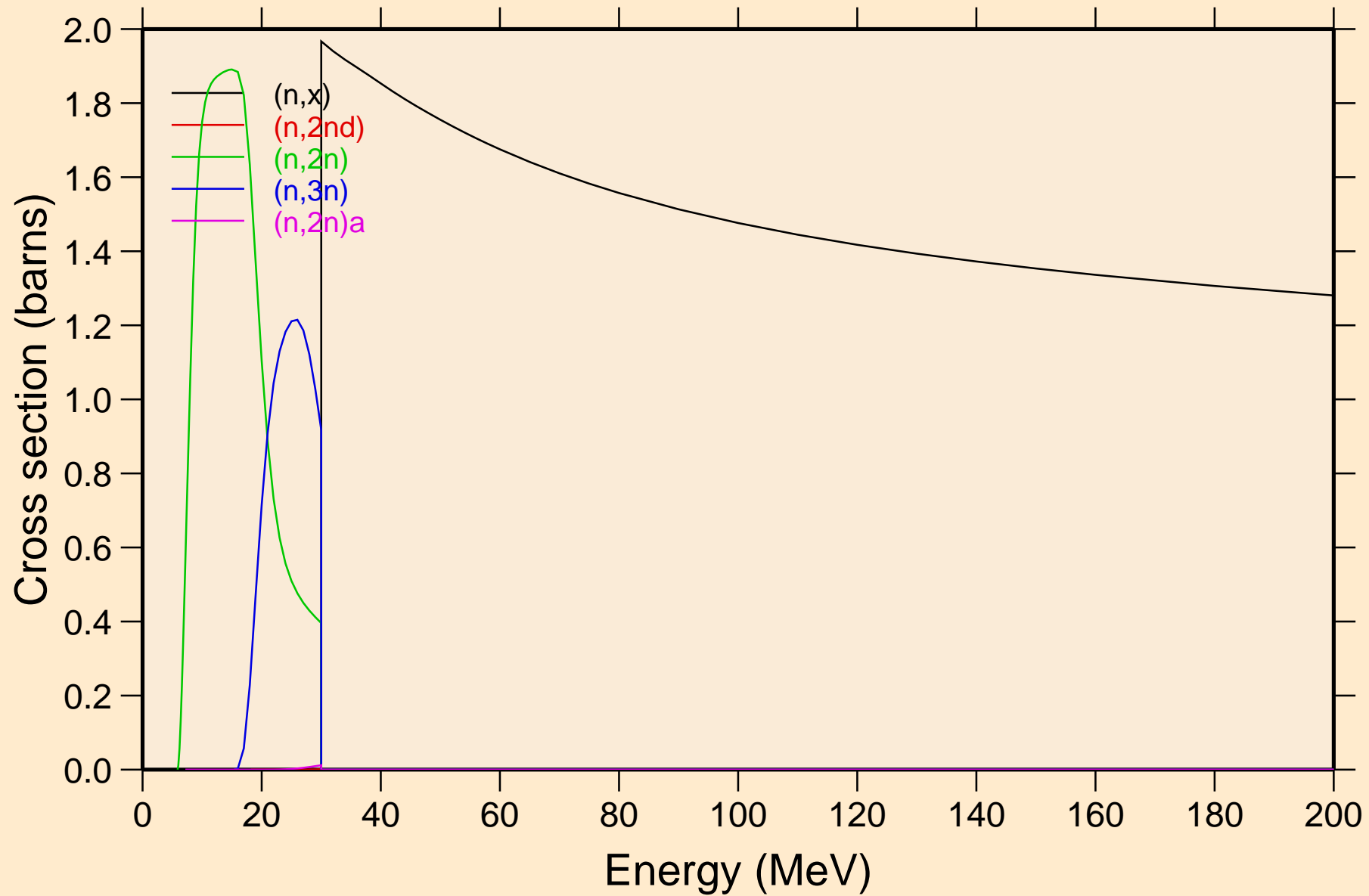



PR142M NEUTRON ACER TENDL-2023 LIBRARY; T=0.K  
Threshold reactions

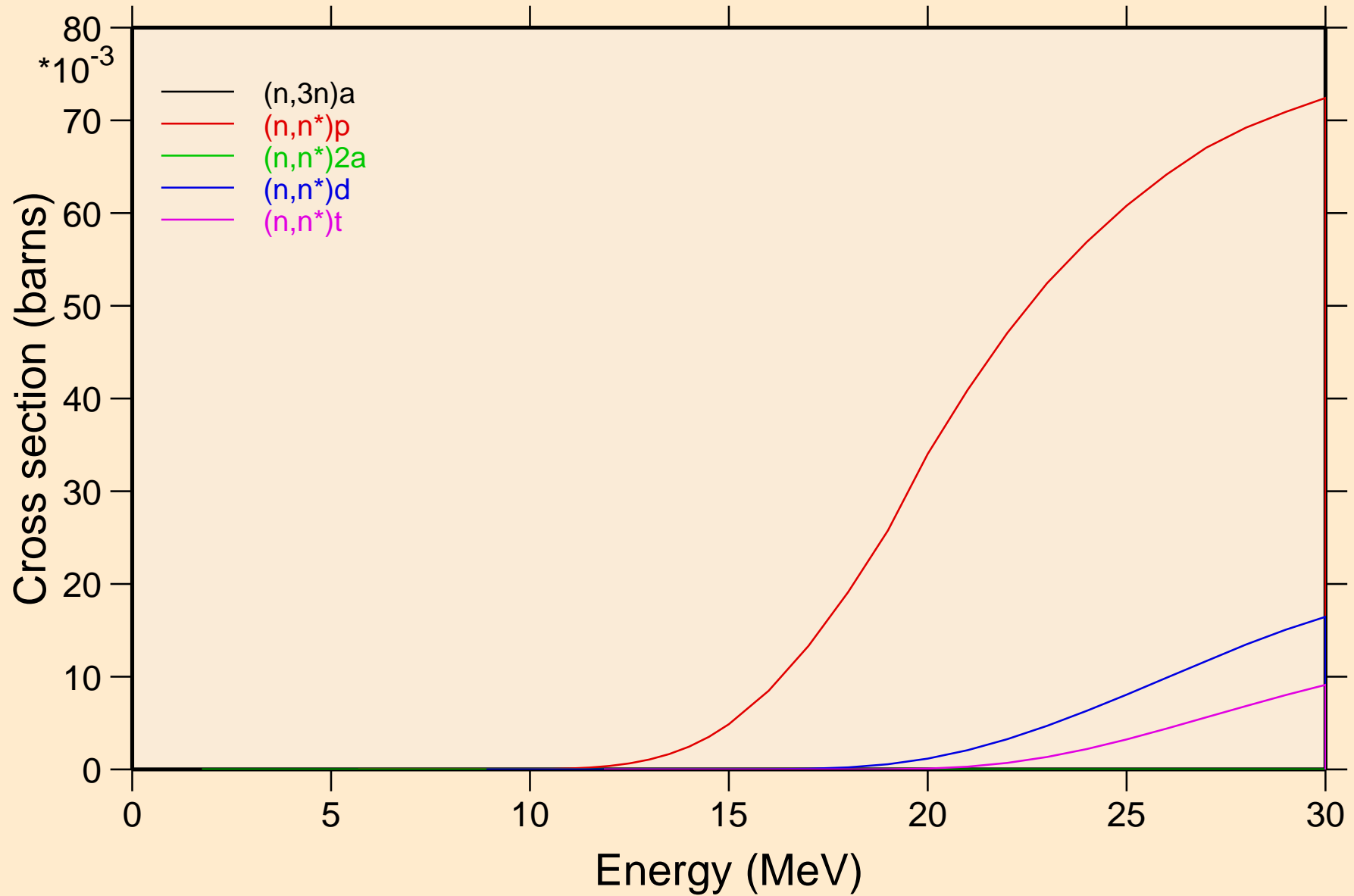

PR142M NEUTRON ACER TENDL-2023 LIBRARY; T=0.K  
Threshold reactions

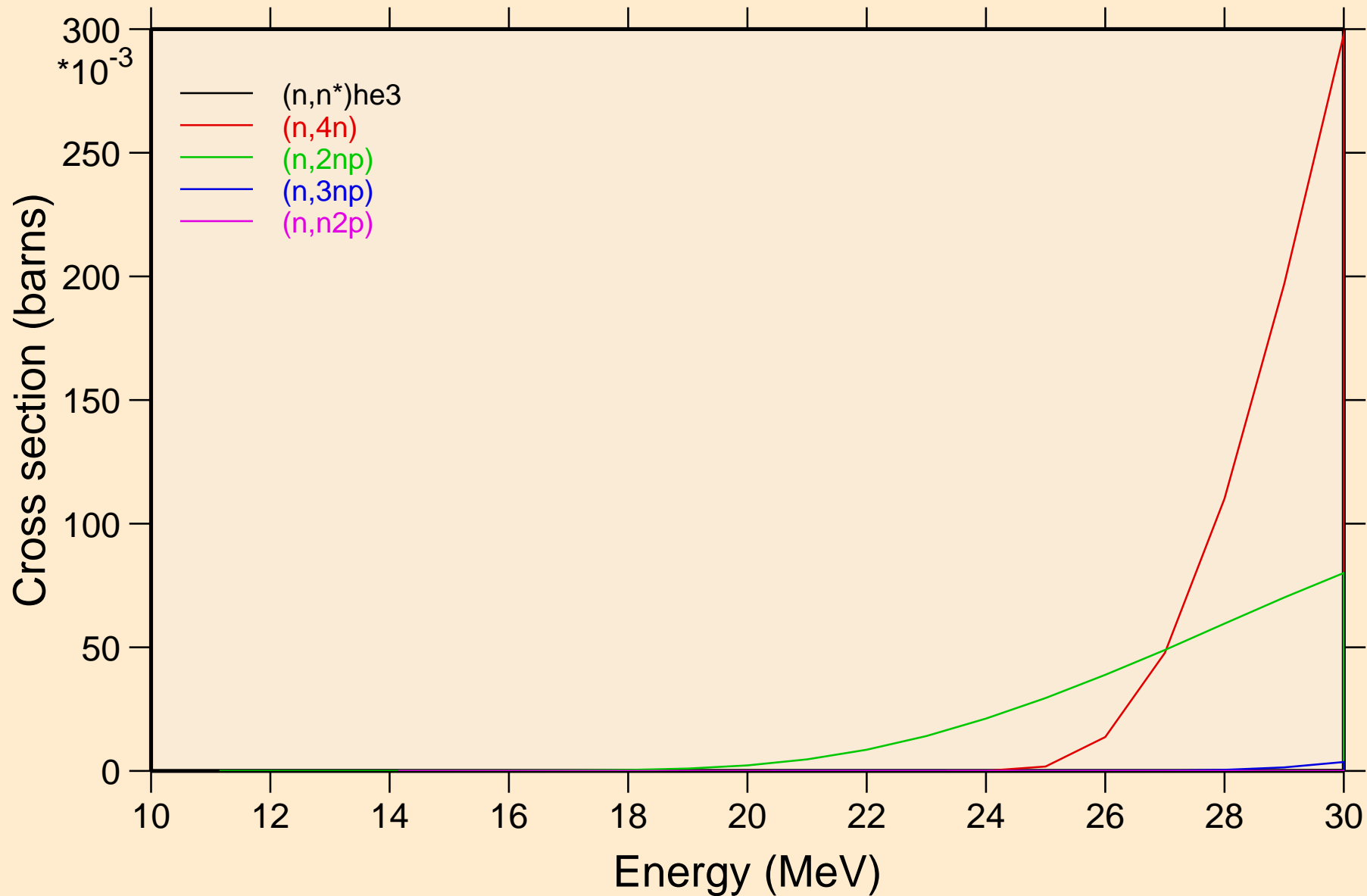

PR142M NEUTRON ACER TENDL-2023 LIBRARY; T=0.K  
Threshold reactions

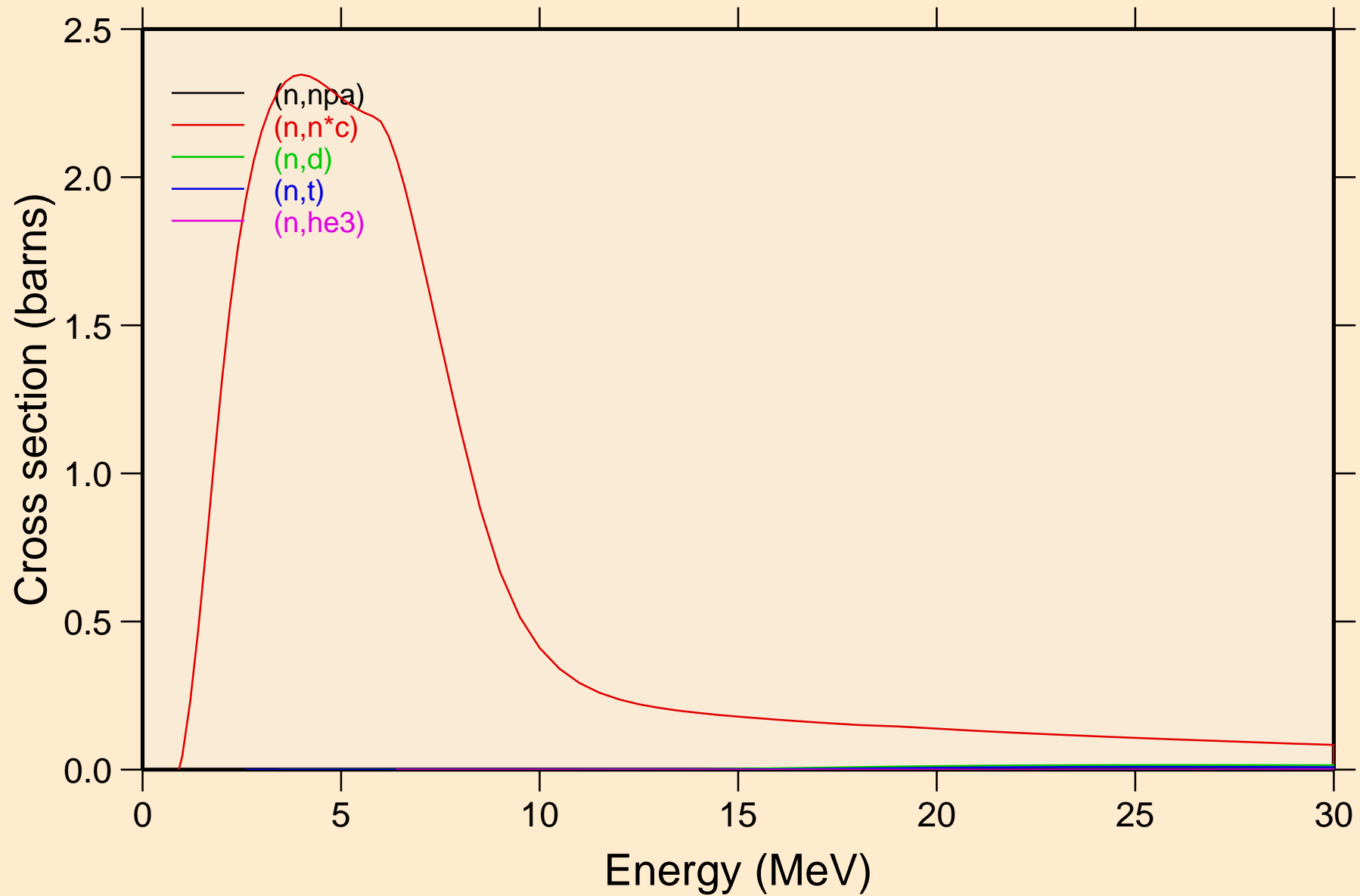

PR142M NEUTRON ACER TENDL-2023 LIBRARY; T=0.K  
Threshold reactions

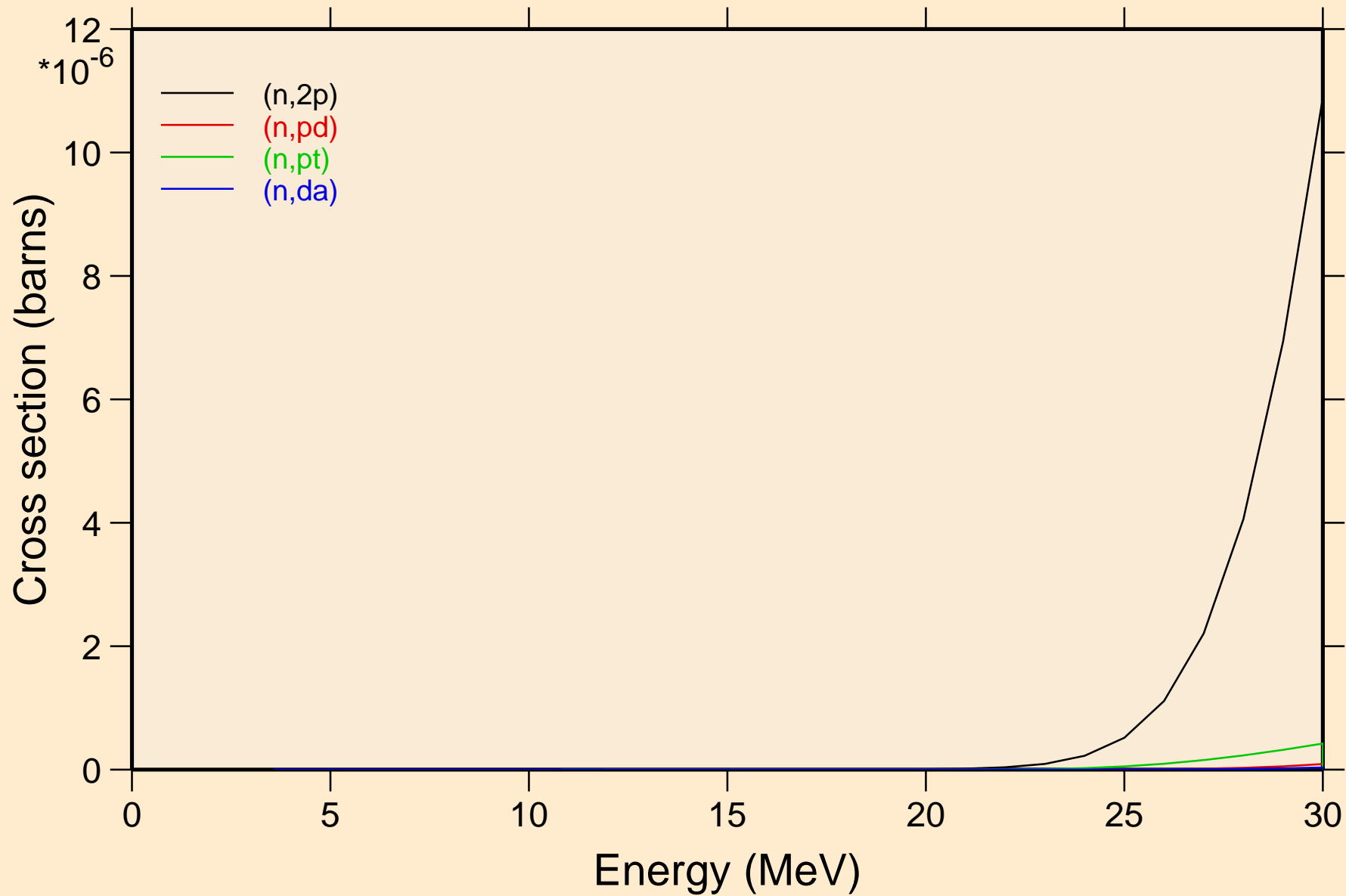

PR142M NEUTRON ACER TENDL-2023 LIBRARY; T=0.K  
Threshold reactions

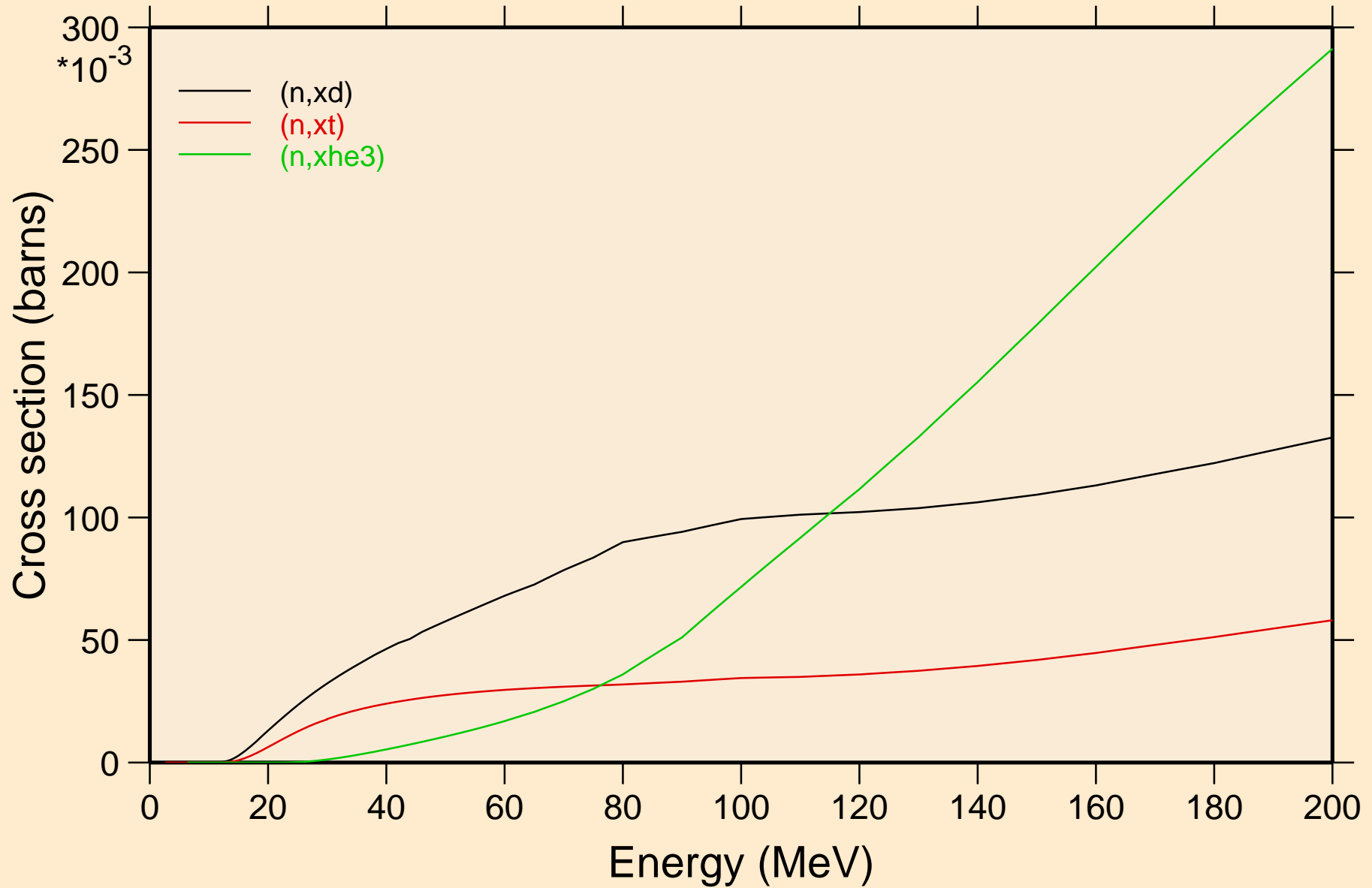

PR142M NEUTRON ACER TENDL-2023 LIBRARY; T=0.K  
angular distribution for elastic

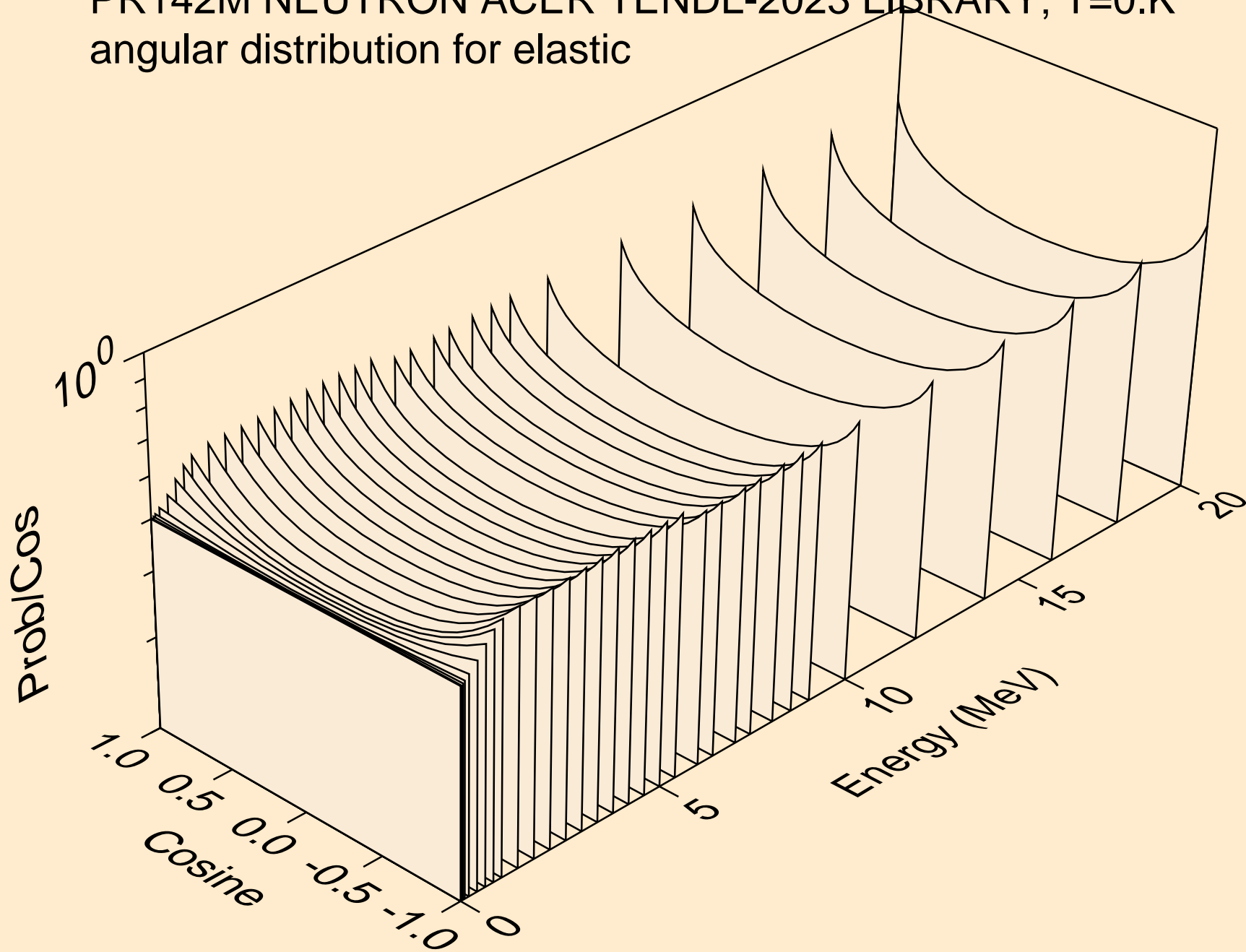

PR142M NEUTRON ACER TENDL-2023 LIBRARY; T=0.K  
angular distribution for elastic

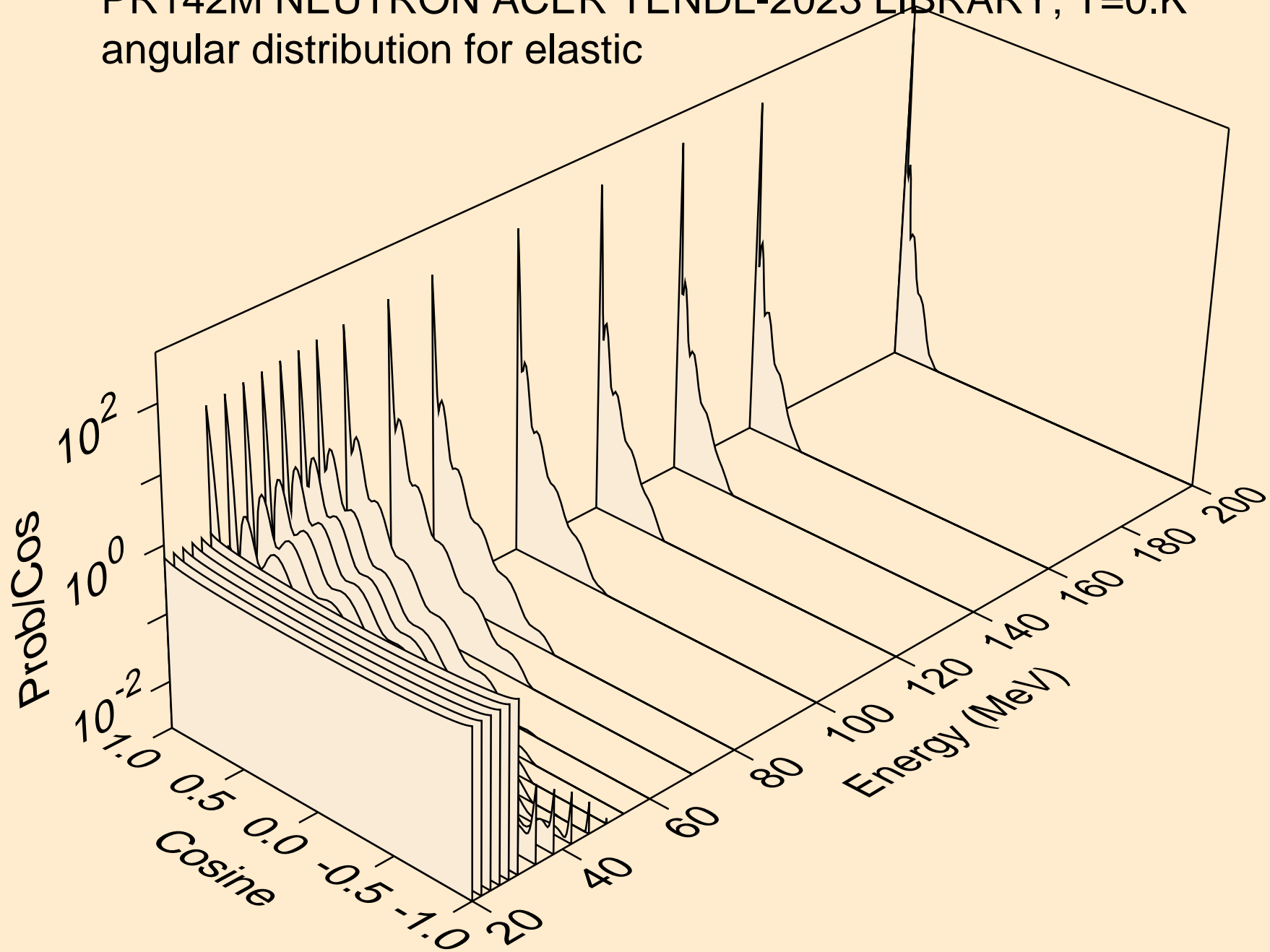

PR142M NEUTRON ACER TENDL-2023 LIBRARY; T=0.K  
angular distribution for (n,n\*1)

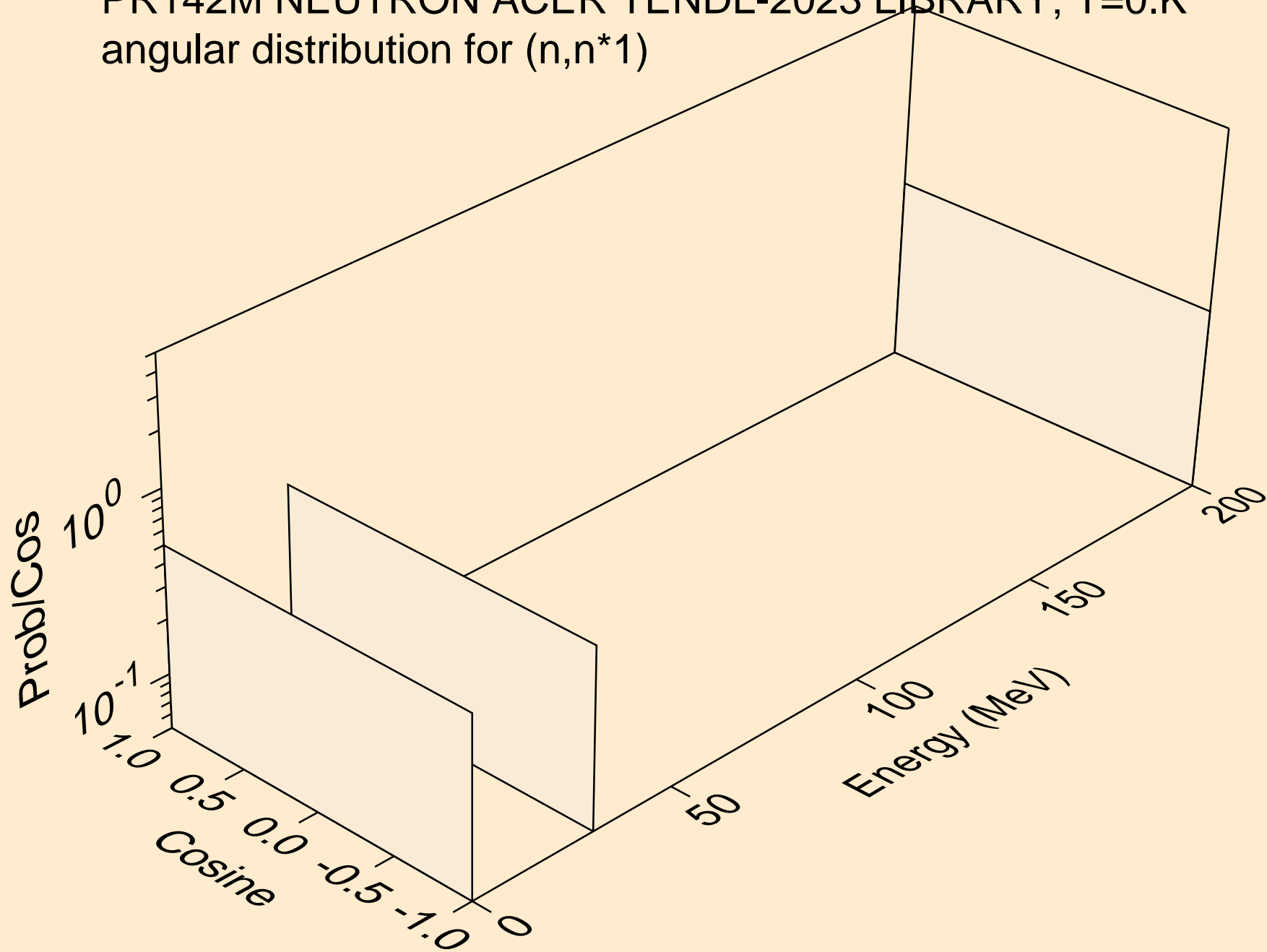



PR142M NEUTRON ACER TENDL-2023 LIBRARY; T=0.K  
angular distribution for (n,n\*2)

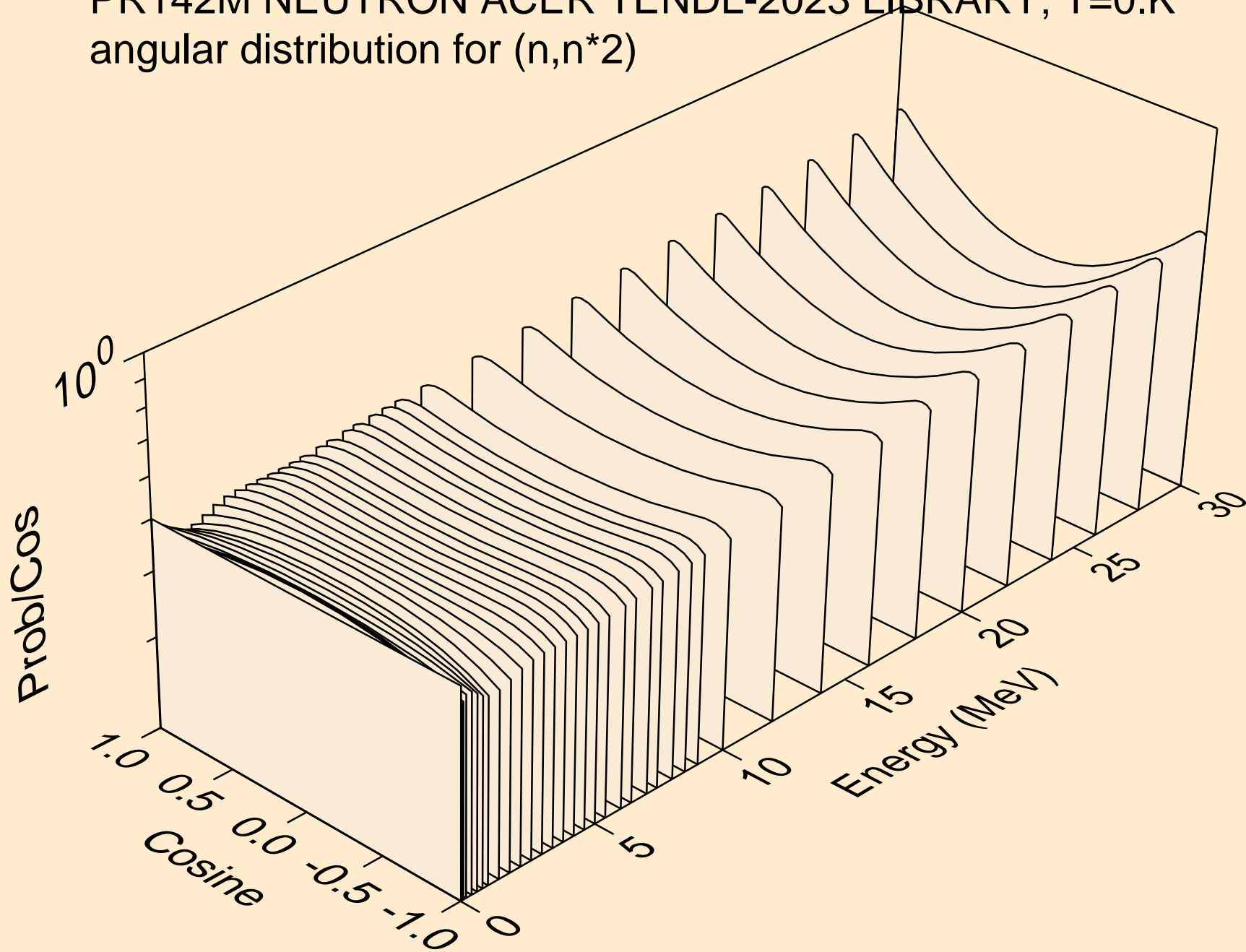

PR142M NEUTRON ACER TENDL-2023 LIBRARY; T=0.K  
angular distribution for (n,n\*3)

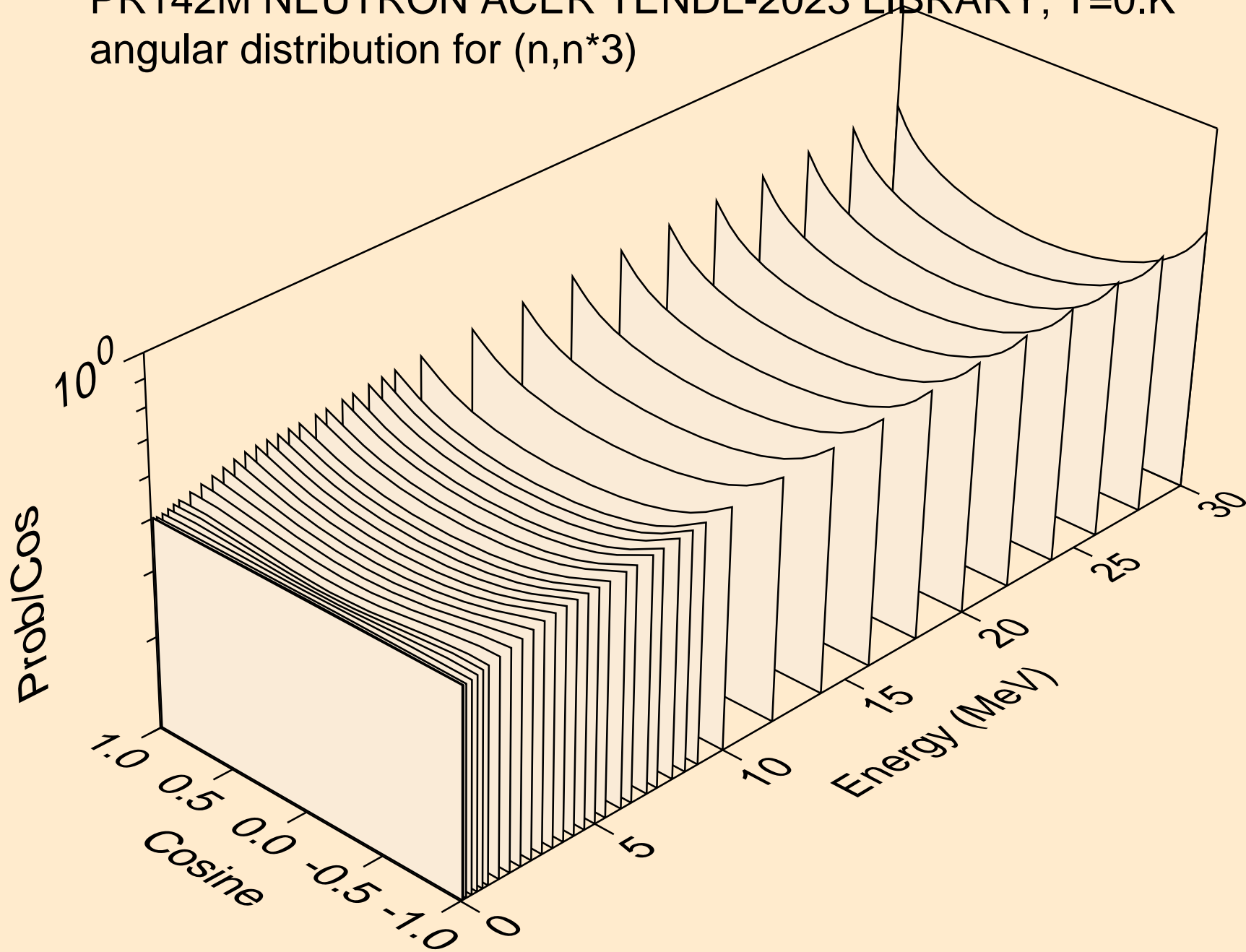

PR142M NEUTRON ACER TENDL-2023 LIBRARY; T=0.K  
angular distribution for (n,n\*4)

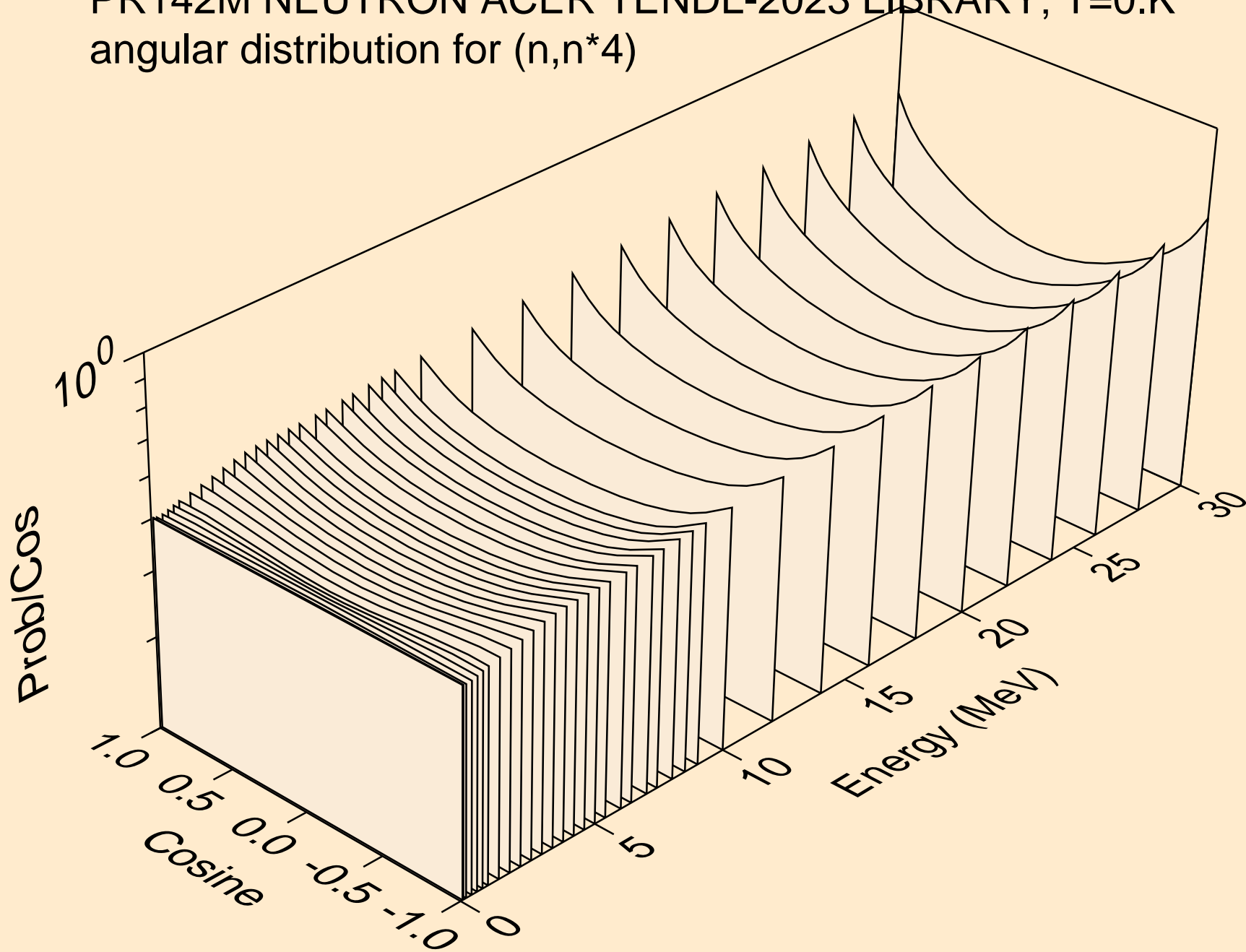

PR142M NEUTRON ACER TENDL-2023 LIBRARY; T=0.K  
angular distribution for (n,n\*5)

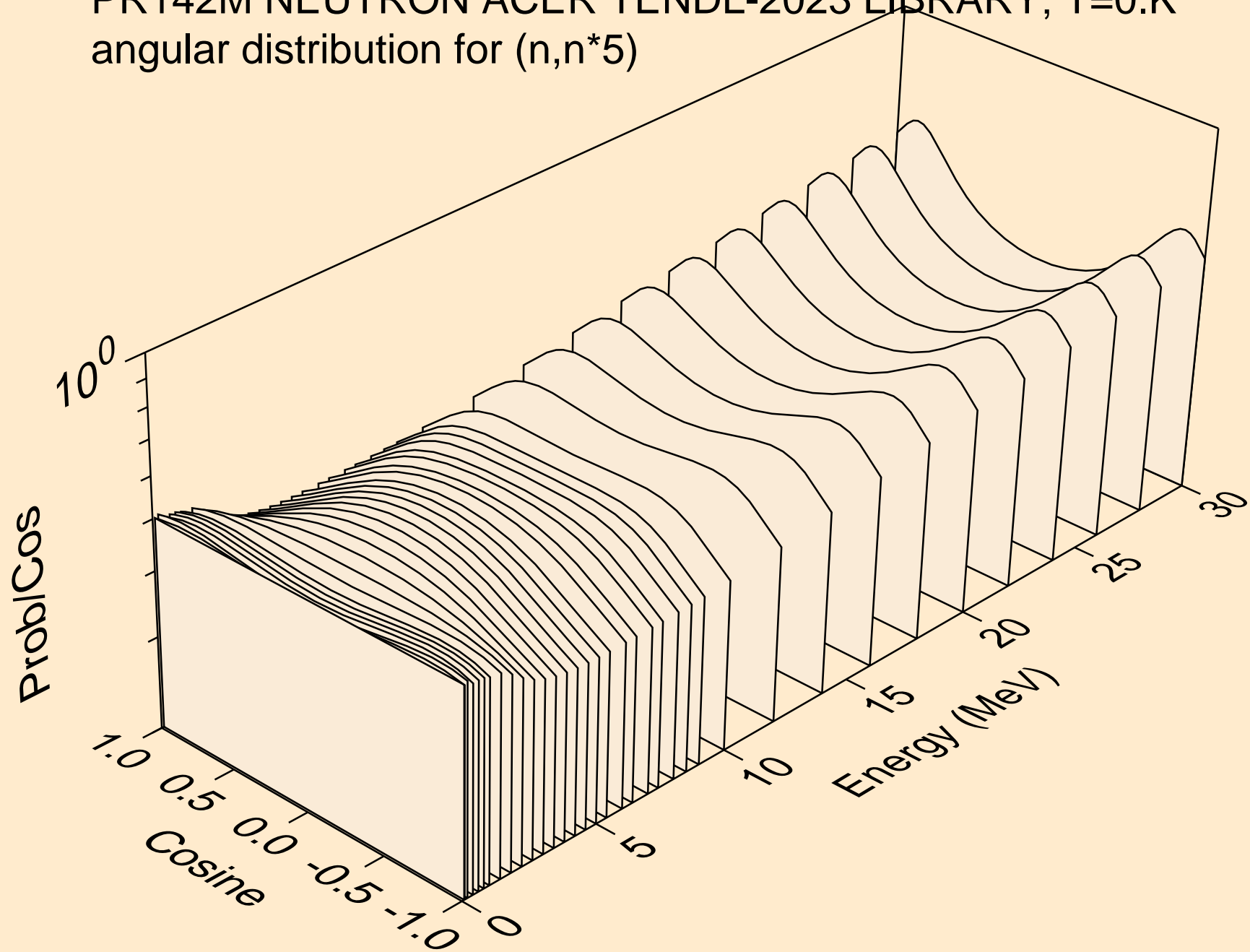

PR142M NEUTRON ACER TENDL-2023 LIBRARY; T=0.K  
angular distribution for (n,n\*6)

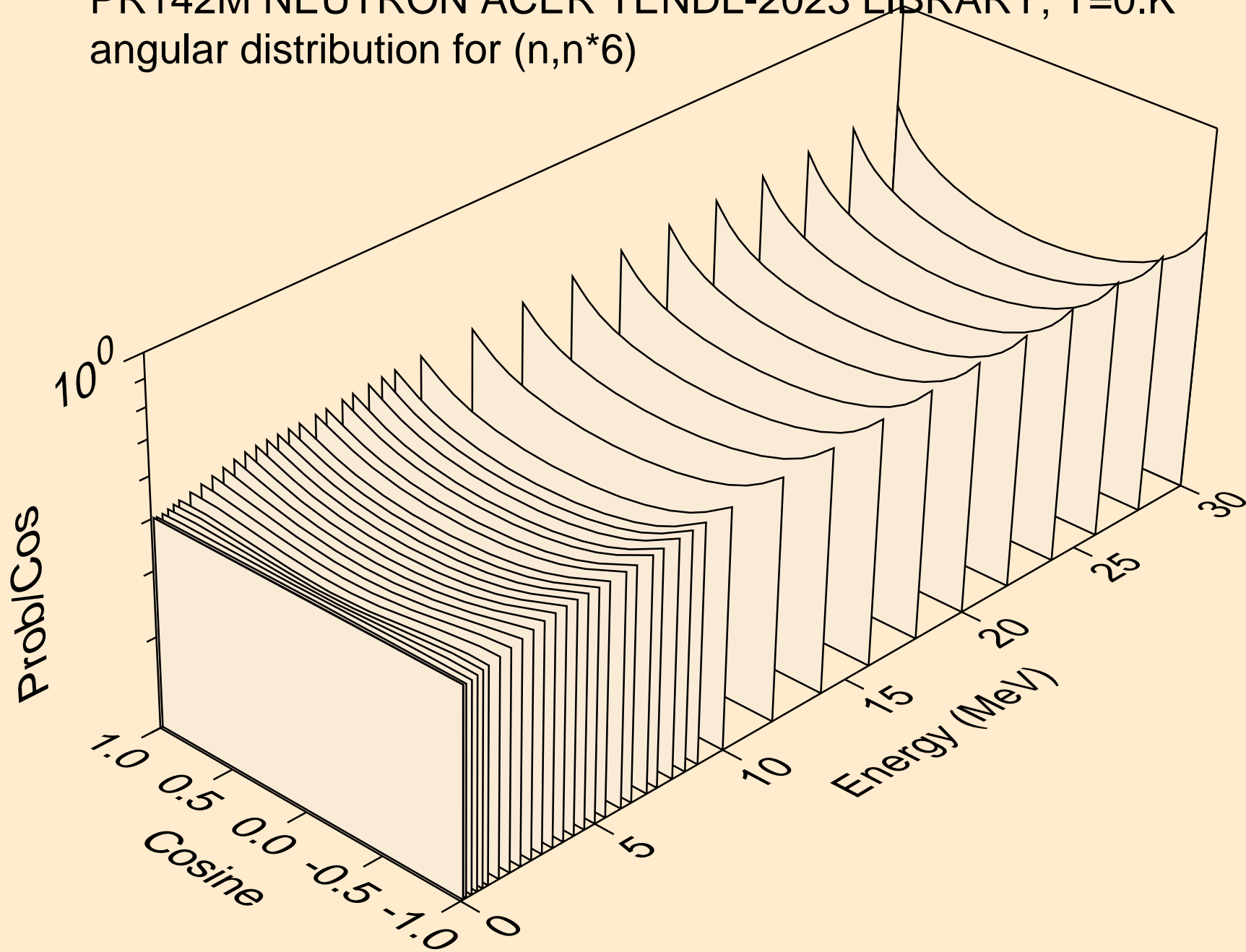

PR142M NEUTRON ACER TENDL-2023 LIBRARY; T=0.K  
angular distribution for (n,n\*7)

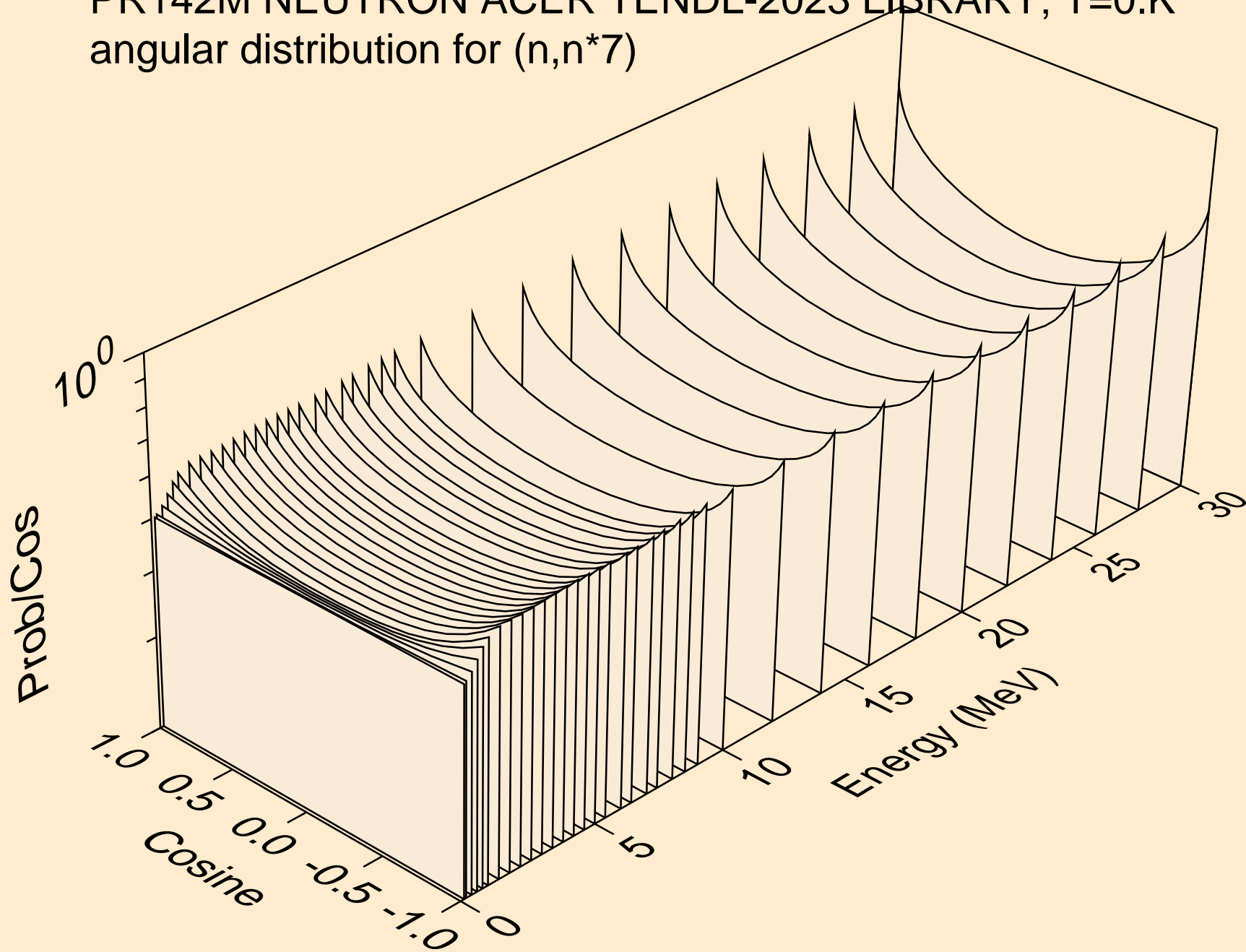

PR142M NEUTRON ACER TENDL-2023 LIBRARY; T=0.K  
angular distribution for (n,n\*8)

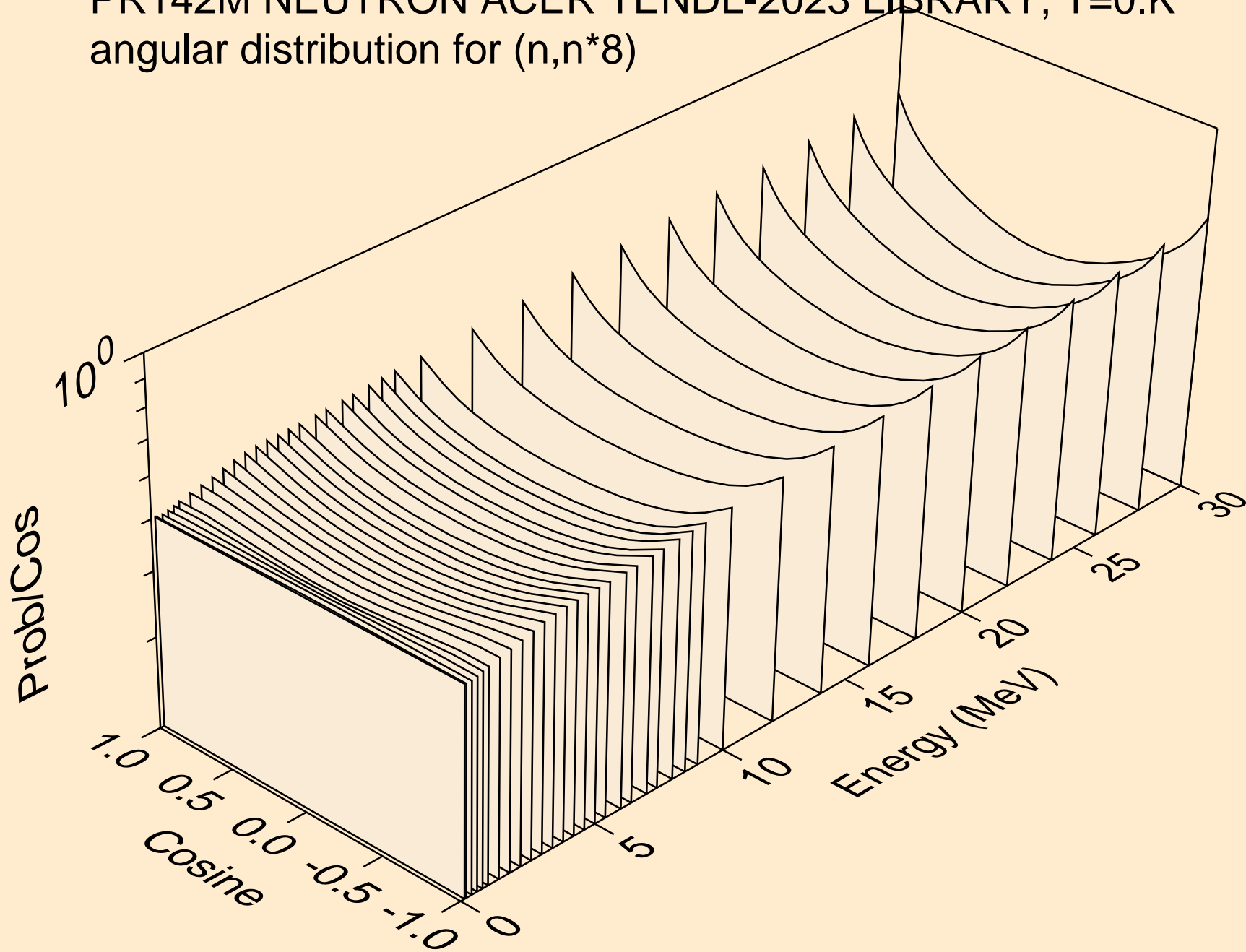

PR142M NEUTRON ACER TENDL-2023 LIBRARY; T=0.K  
angular distribution for (n,n\*9)

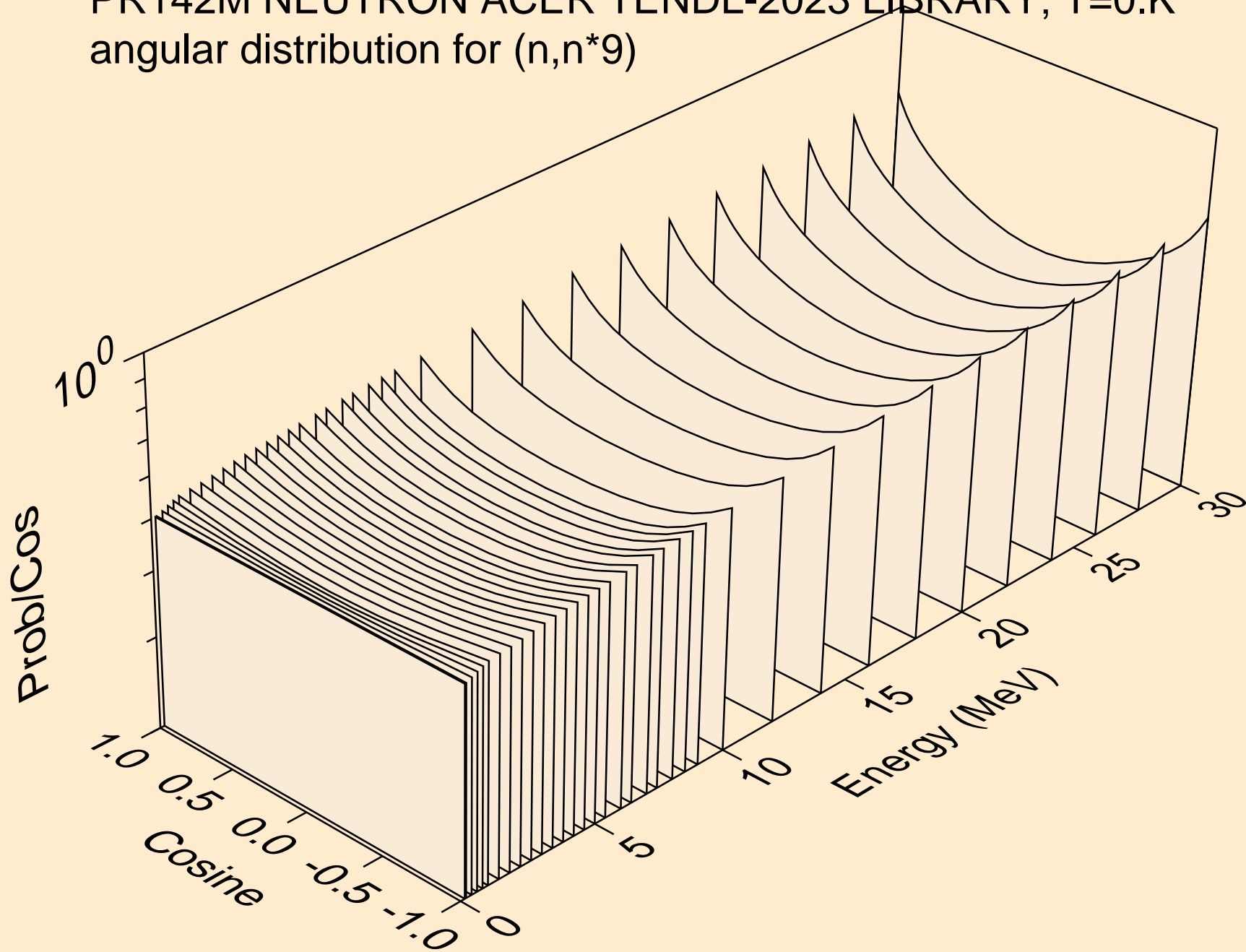



PR142M NEUTRON ACER TENDL-2023 LIBRARY; T=0.K  
angular distribution for (n,n\*10)

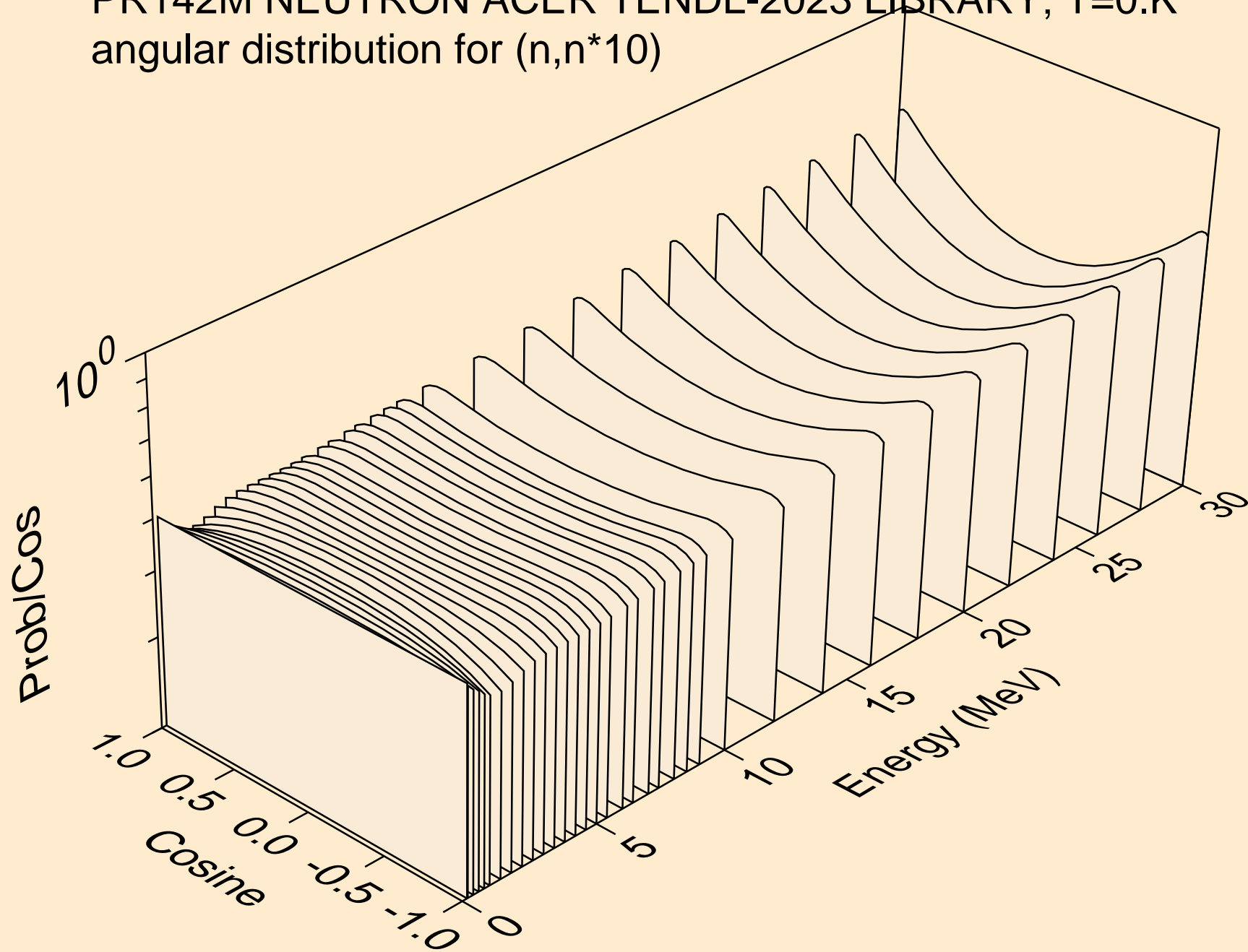

PR142M NEUTRON ACER TENDL-2023 LIBRARY; T=0.K  
angular distribution for (n,n\*11)

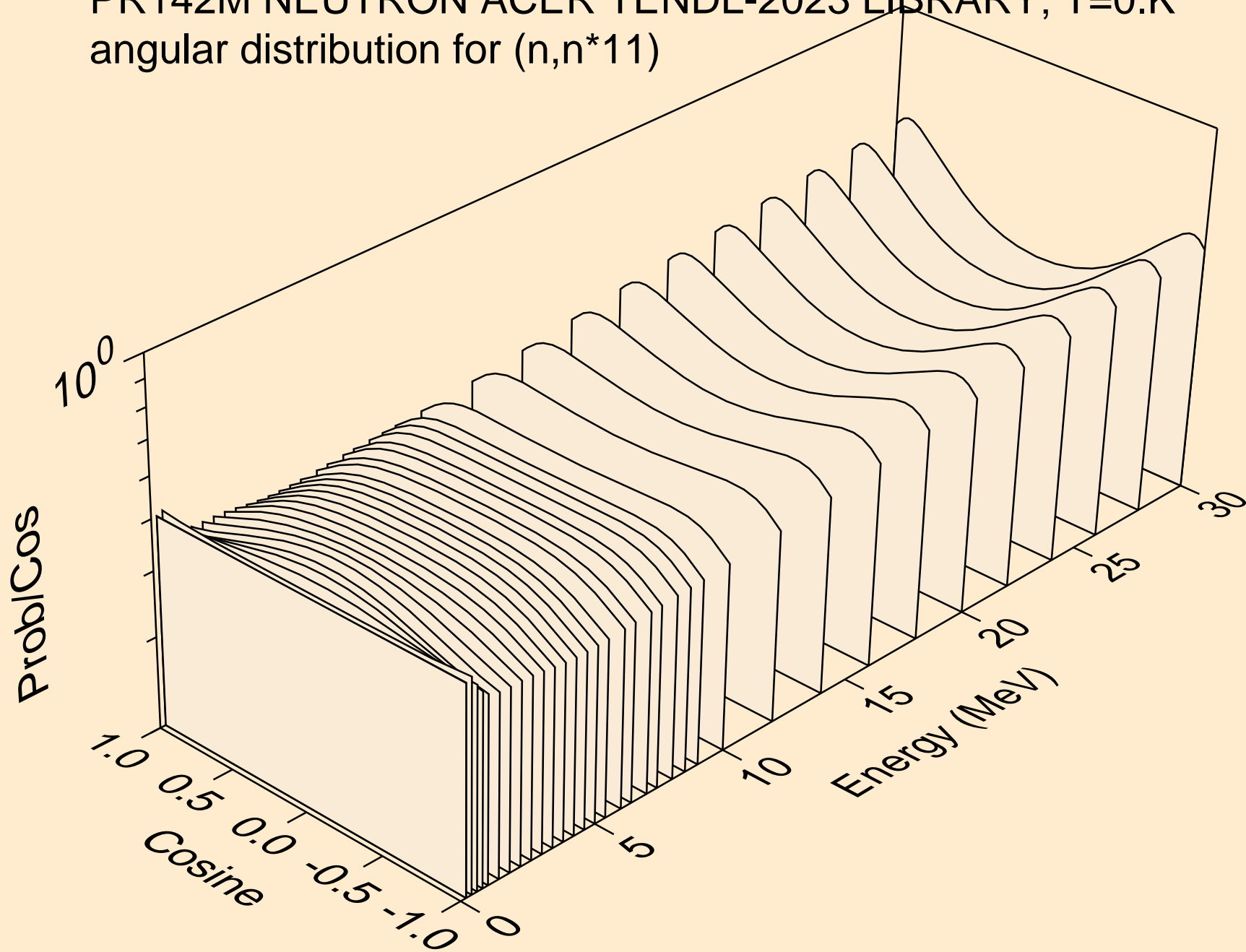

PR142M NEUTRON ACER TENDL-2023 LIBRARY; T=0.K  
angular distribution for (n,n\*12)

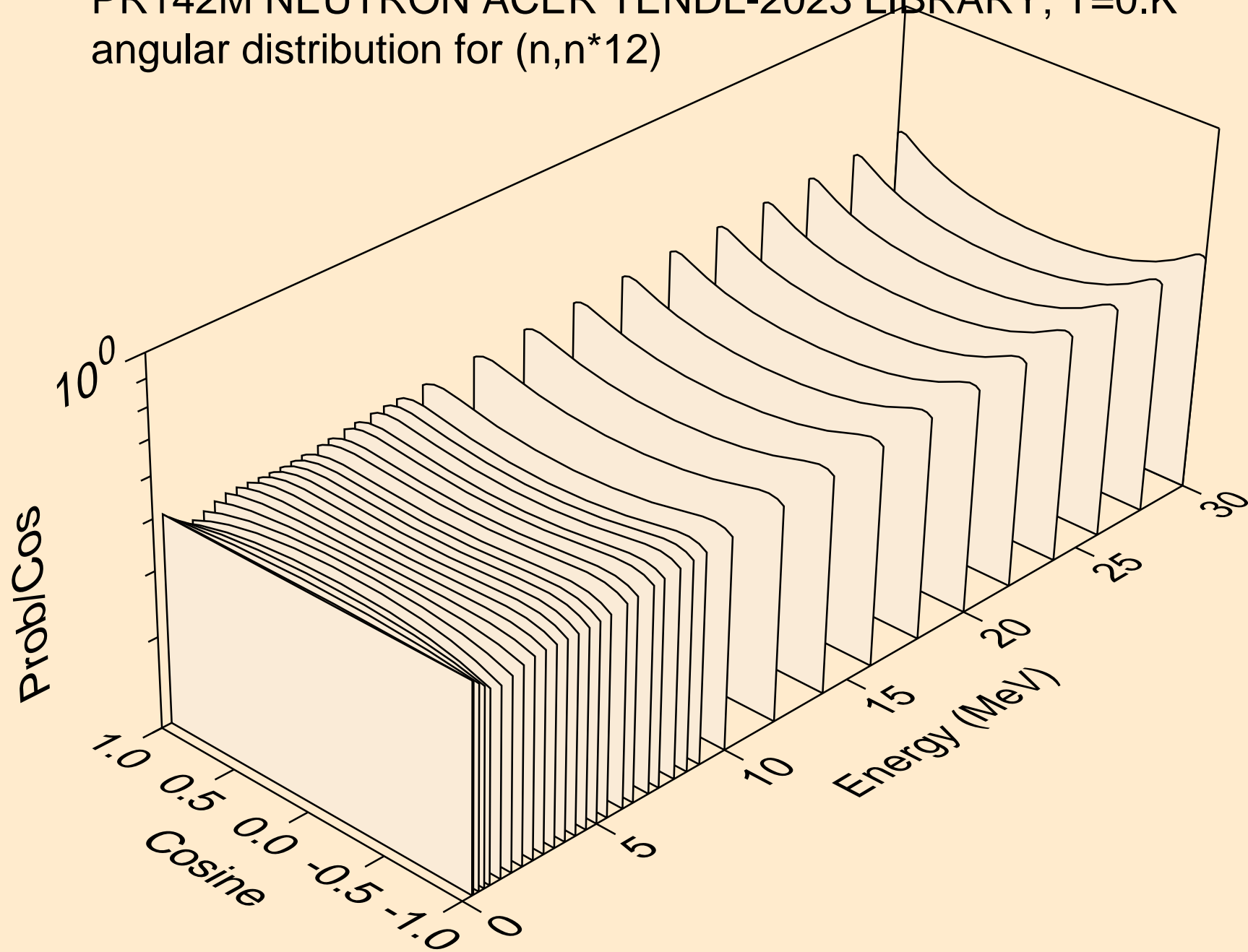

PR142M NEUTRON ACER TENDL-2023 LIBRARY; T=0.K  
angular distribution for (n,n\*13)

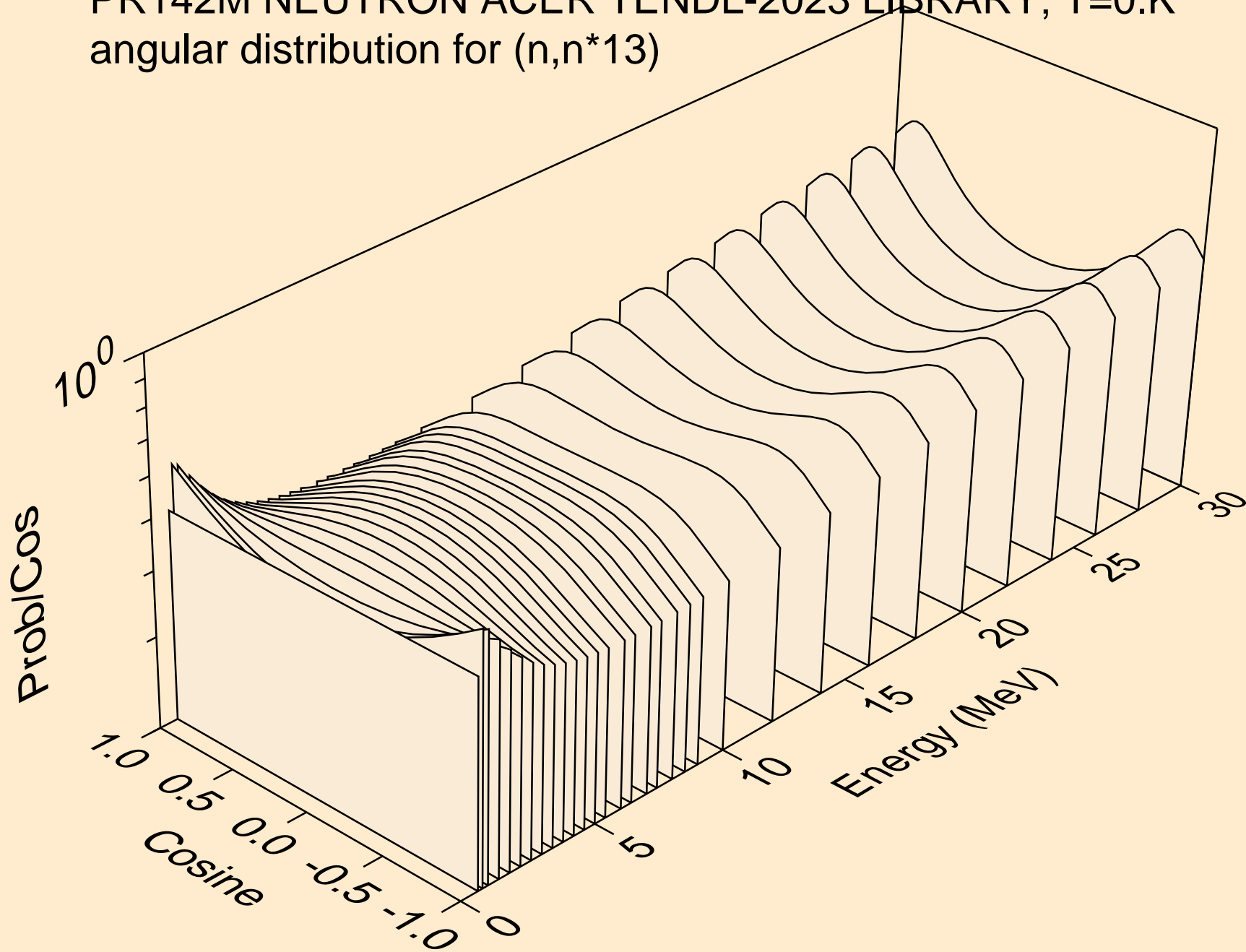

PR142M NEUTRON ACER TENDL-2023 LIBRARY; T=0.K  
angular distribution for (n,n\*14)

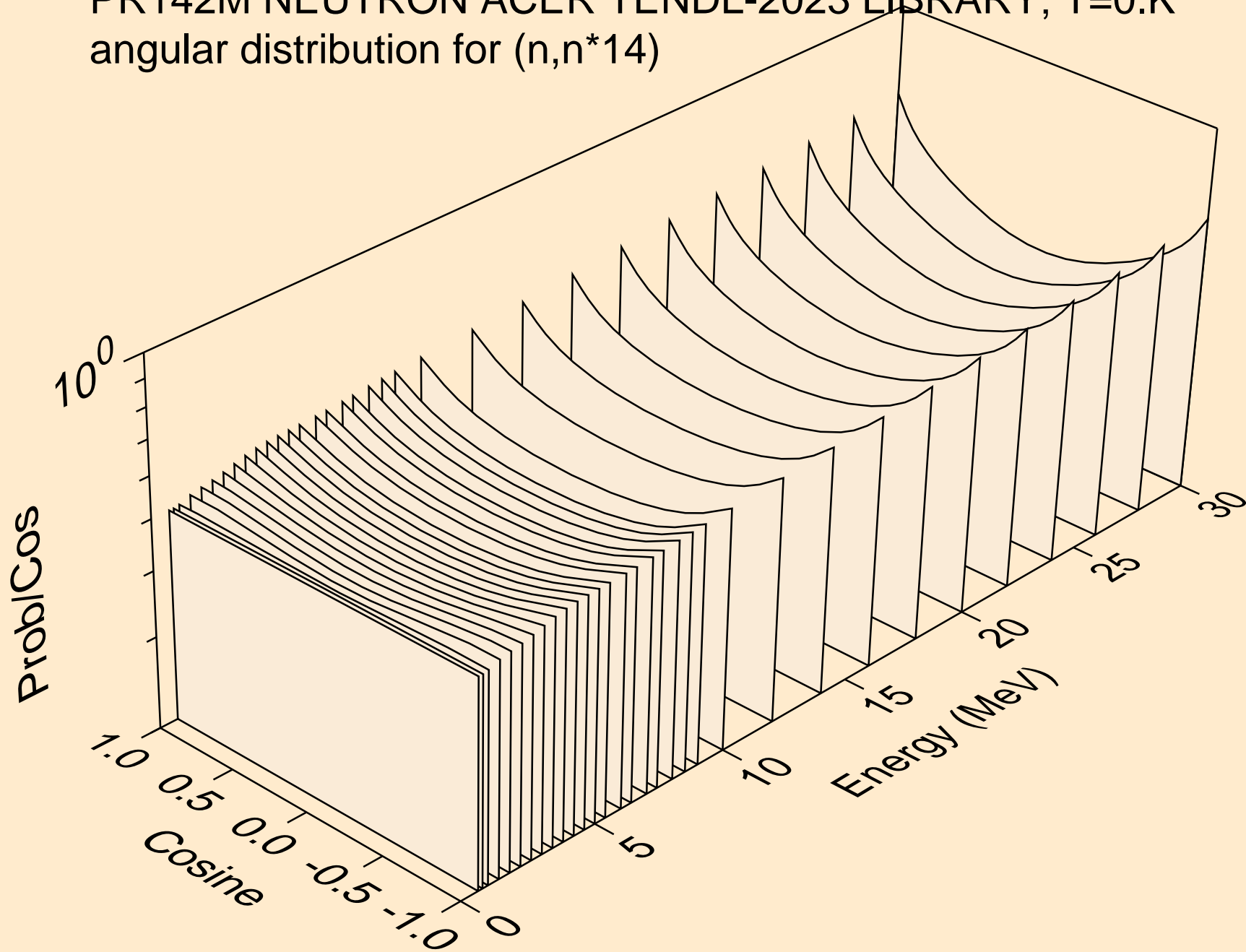

PR142M NEUTRON ACER TENDL-2023 LIBRARY; T=0.K  
angular distribution for (n,n\*15)

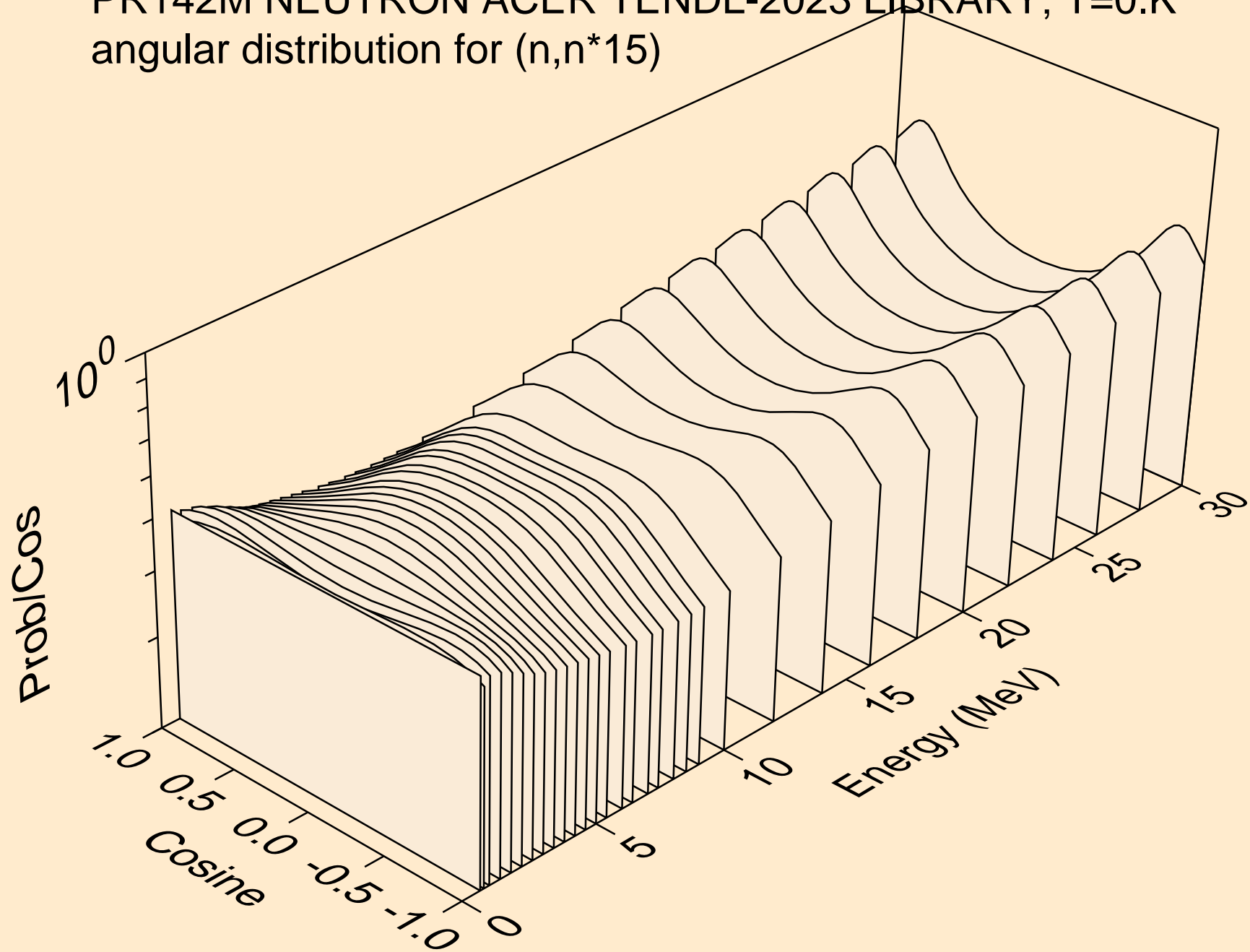

PR142M NEUTRON ACER TENDL-2023 LIBRARY; T=0.K  
angular distribution for (n,n\*16)

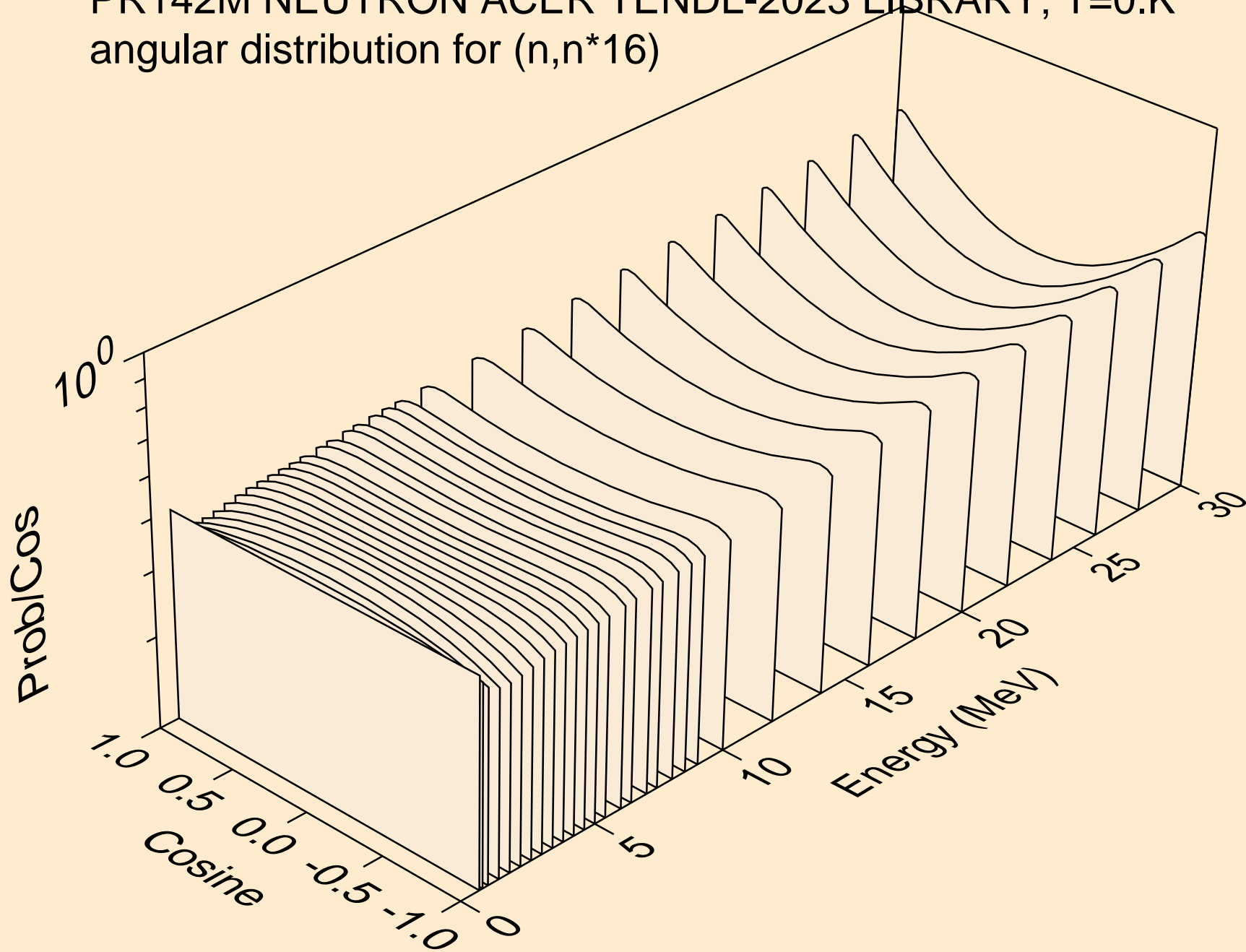

PR142M NEUTRON ACER TENDL-2023 LIBRARY; T=0.K  
angular distribution for (n,n\*17)

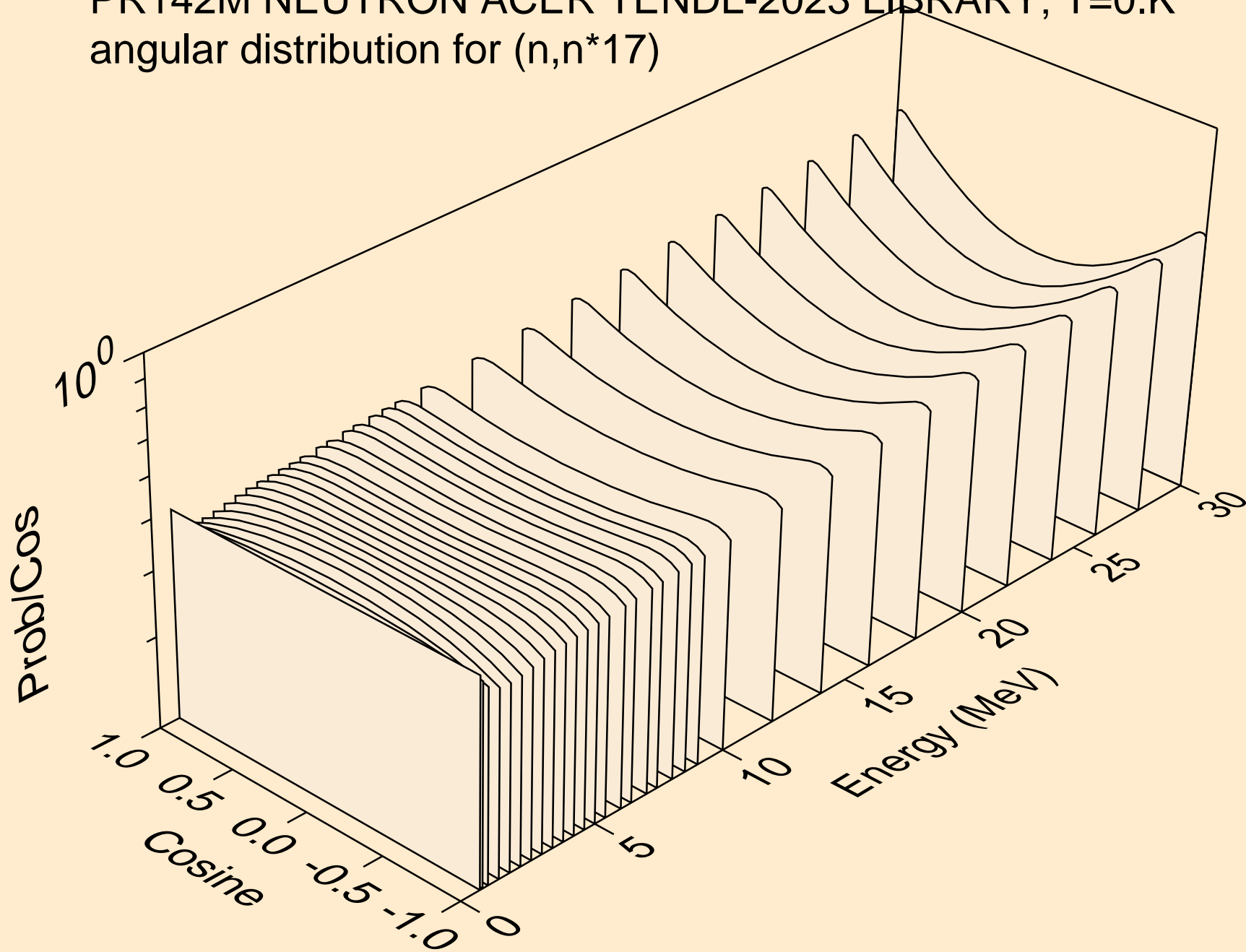



PR142M NEUTRON ACER TENDL-2023 LIBRARY; T=0.K  
angular distribution for (n,n\*18)

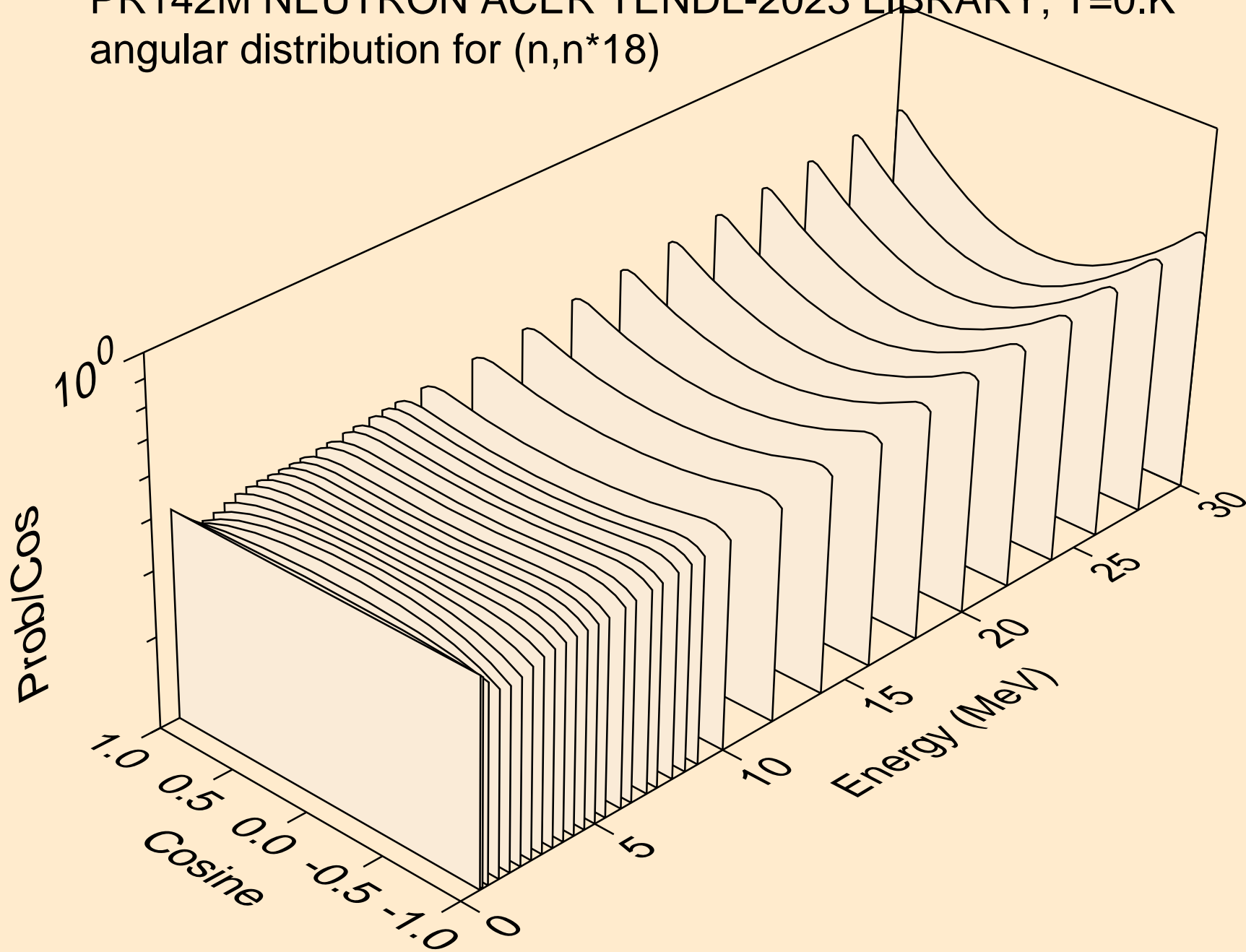

PR142M NEUTRON ACER TENDL-2023 LIBRARY; T=0.K  
angular distribution for (n,n\*19)

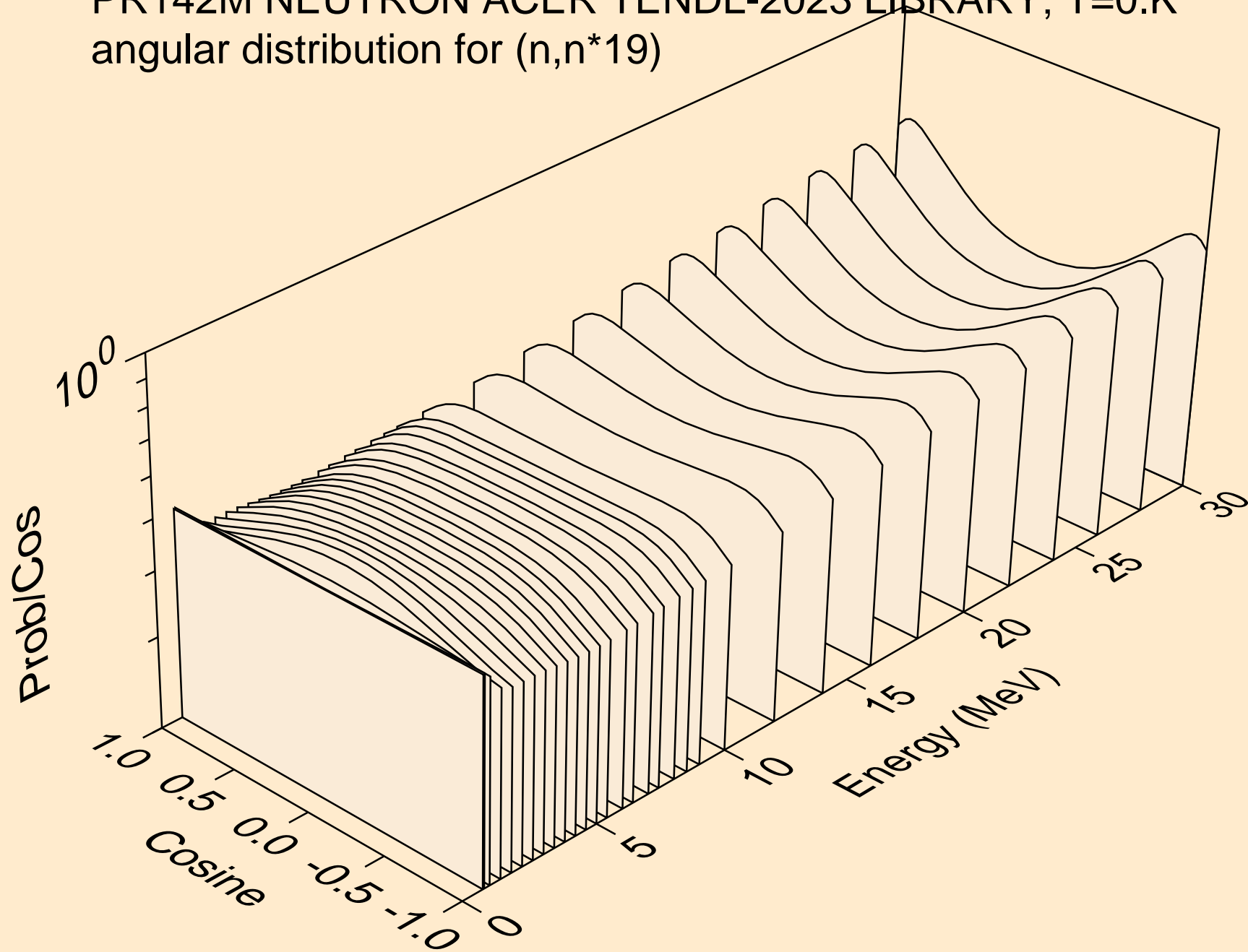

PR142M NEUTRON ACER TENDL-2023 LIBRARY; T=0.K  
angular distribution for (n,n\*20)

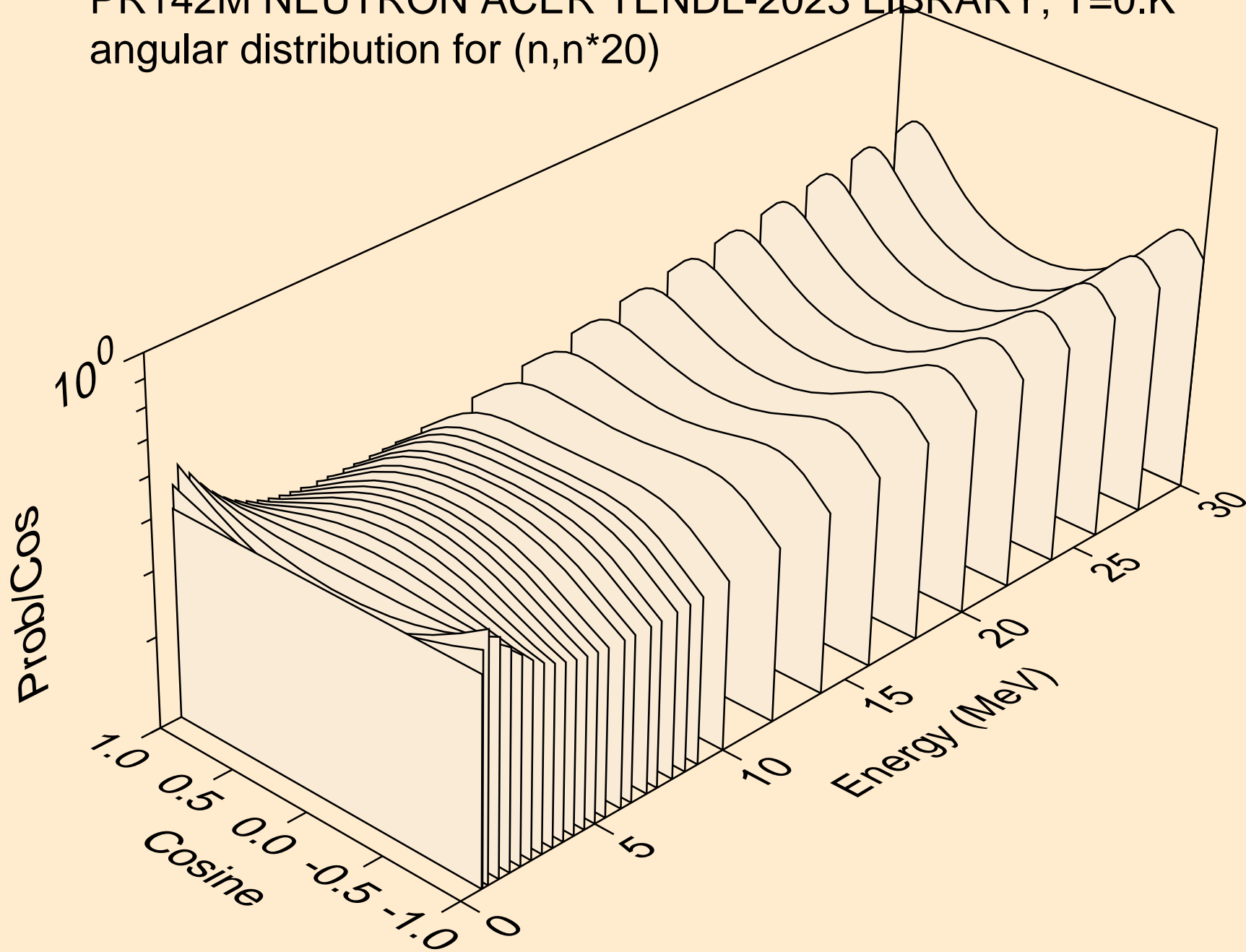

PR142M NEUTRON ACER TENDL-2023 LIBRARY; T=0.K  
angular distribution for (n,n\*21)

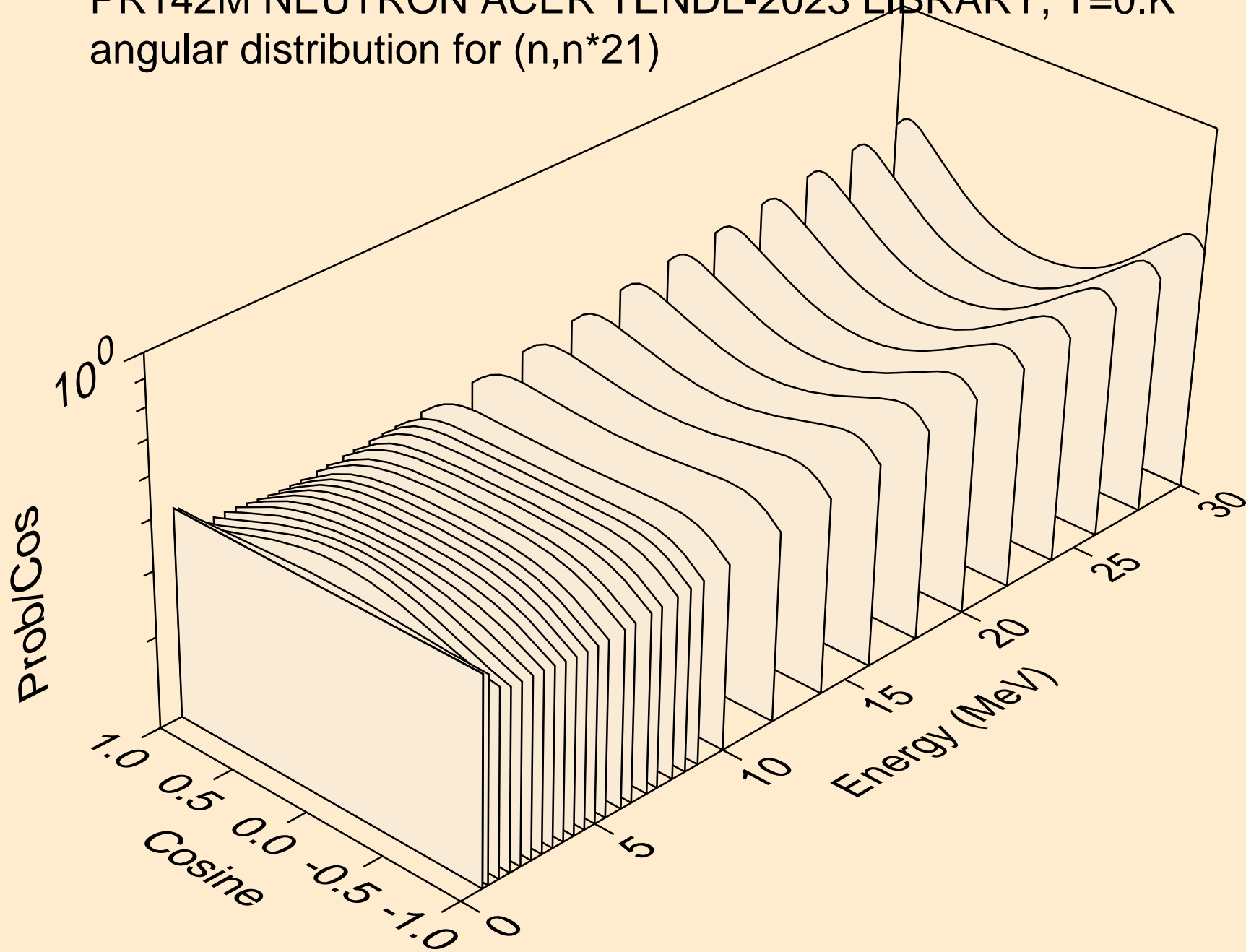

PR142M NEUTRON ACER TENDL-2023 LIBRARY; T=0.K  
angular distribution for (n,n\*22)

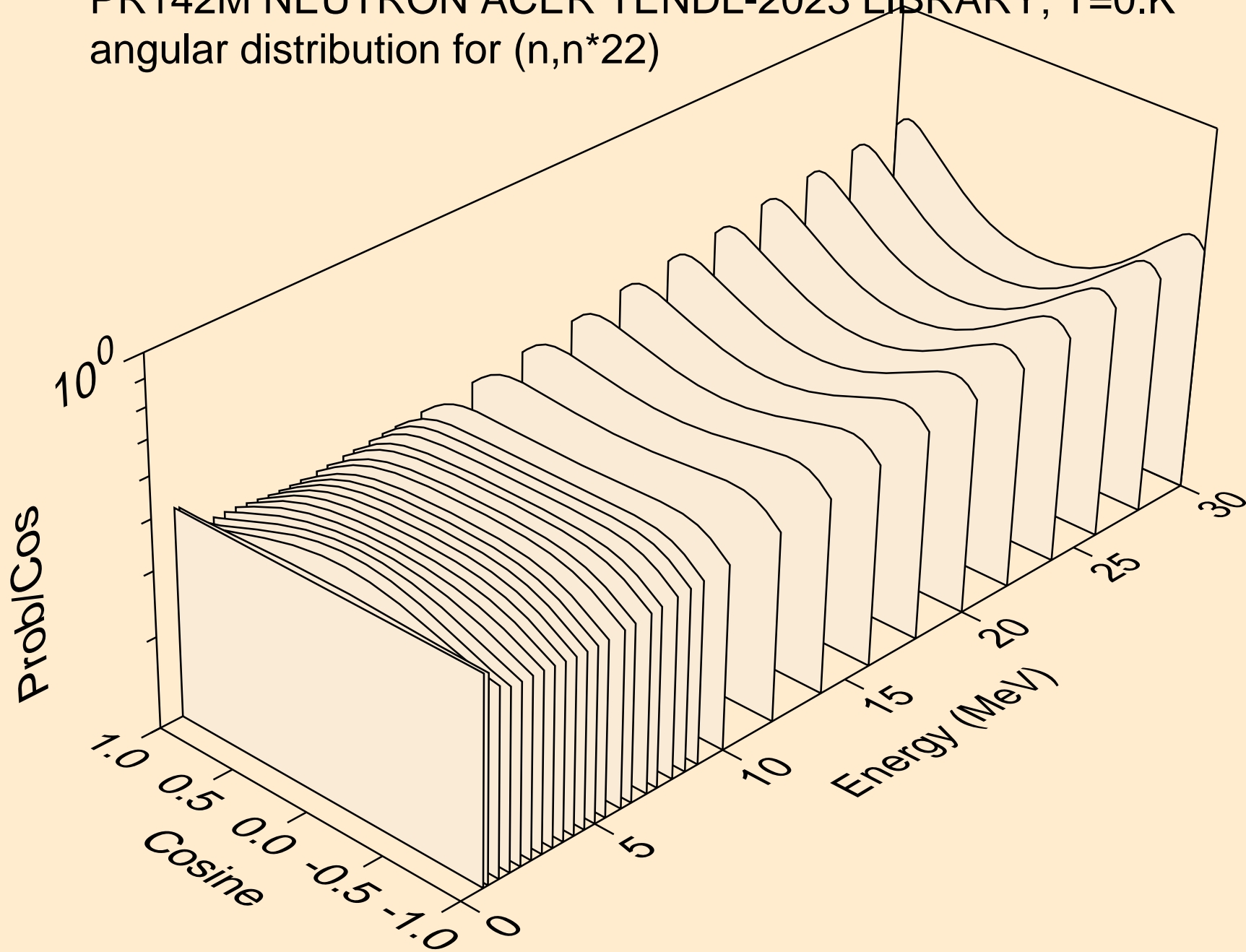

PR142M NEUTRON ACER TENDL-2023 LIBRARY; T=0.K  
angular distribution for (n,n\*23)

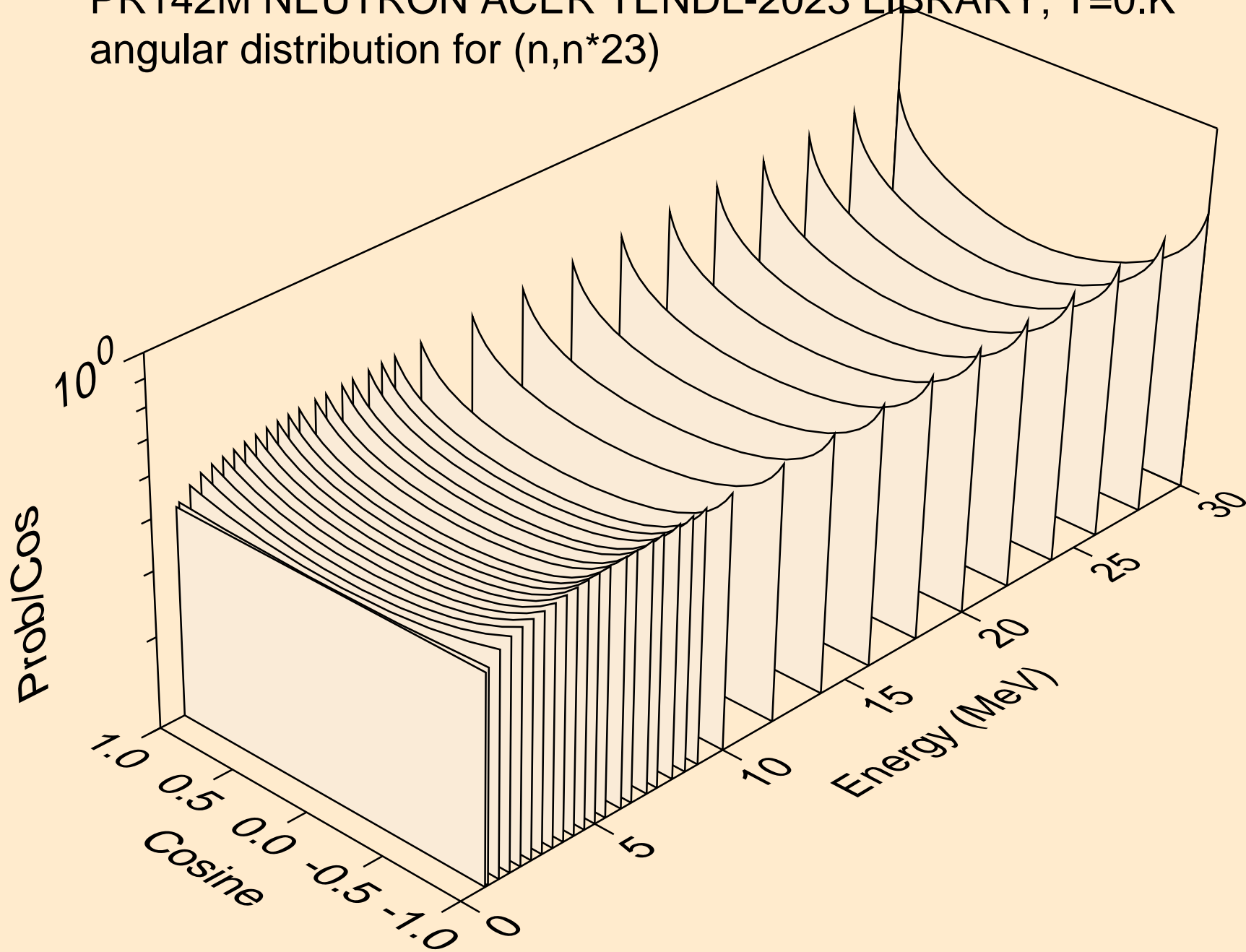

PR142M NEUTRON ACER TENDL-2023 LIBRARY; T=0.K  
angular distribution for (n,n\*24)

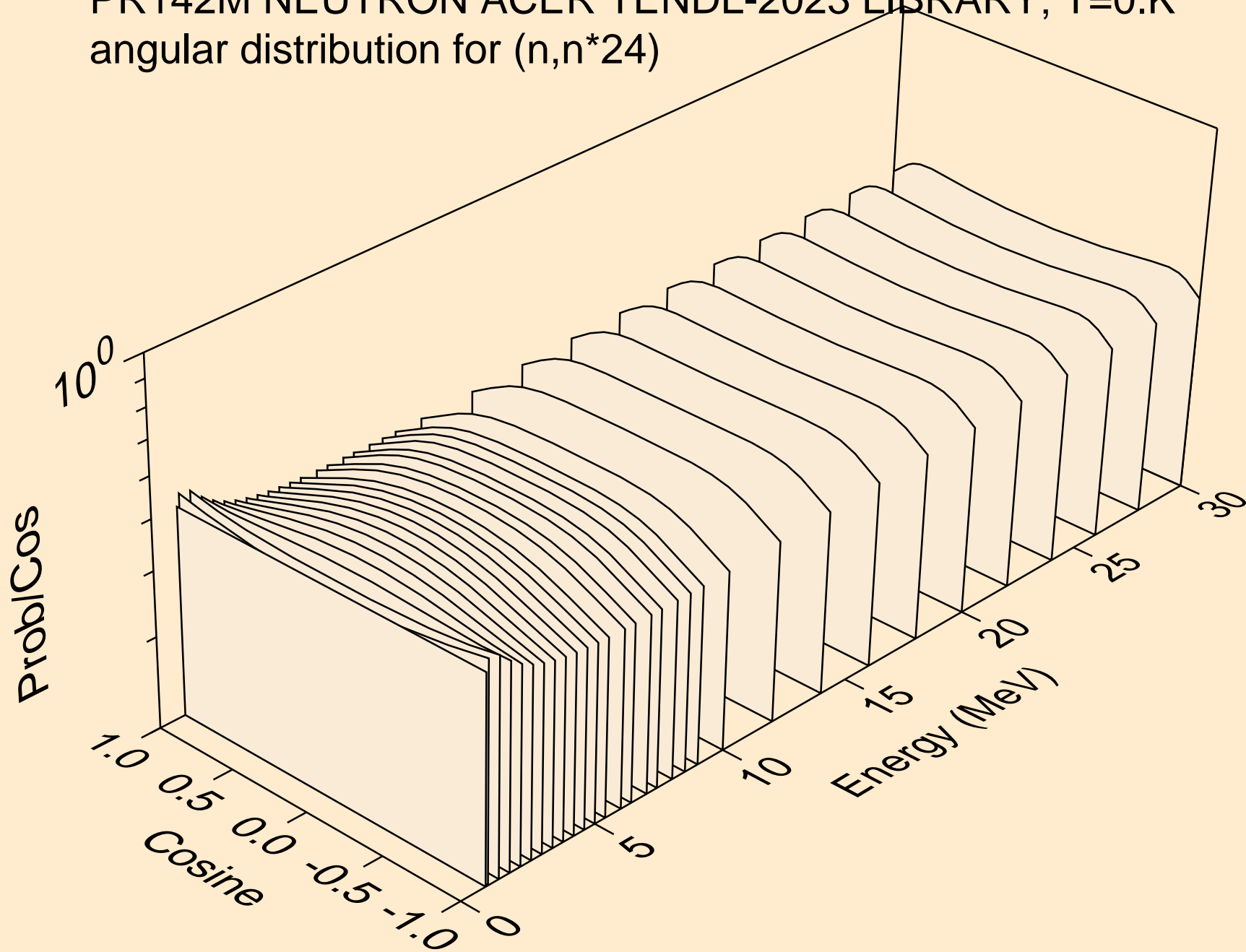

PR142M NEUTRON ACER TENDL-2023 LIBRARY; T=0.K  
Neutron emission for (n,x)

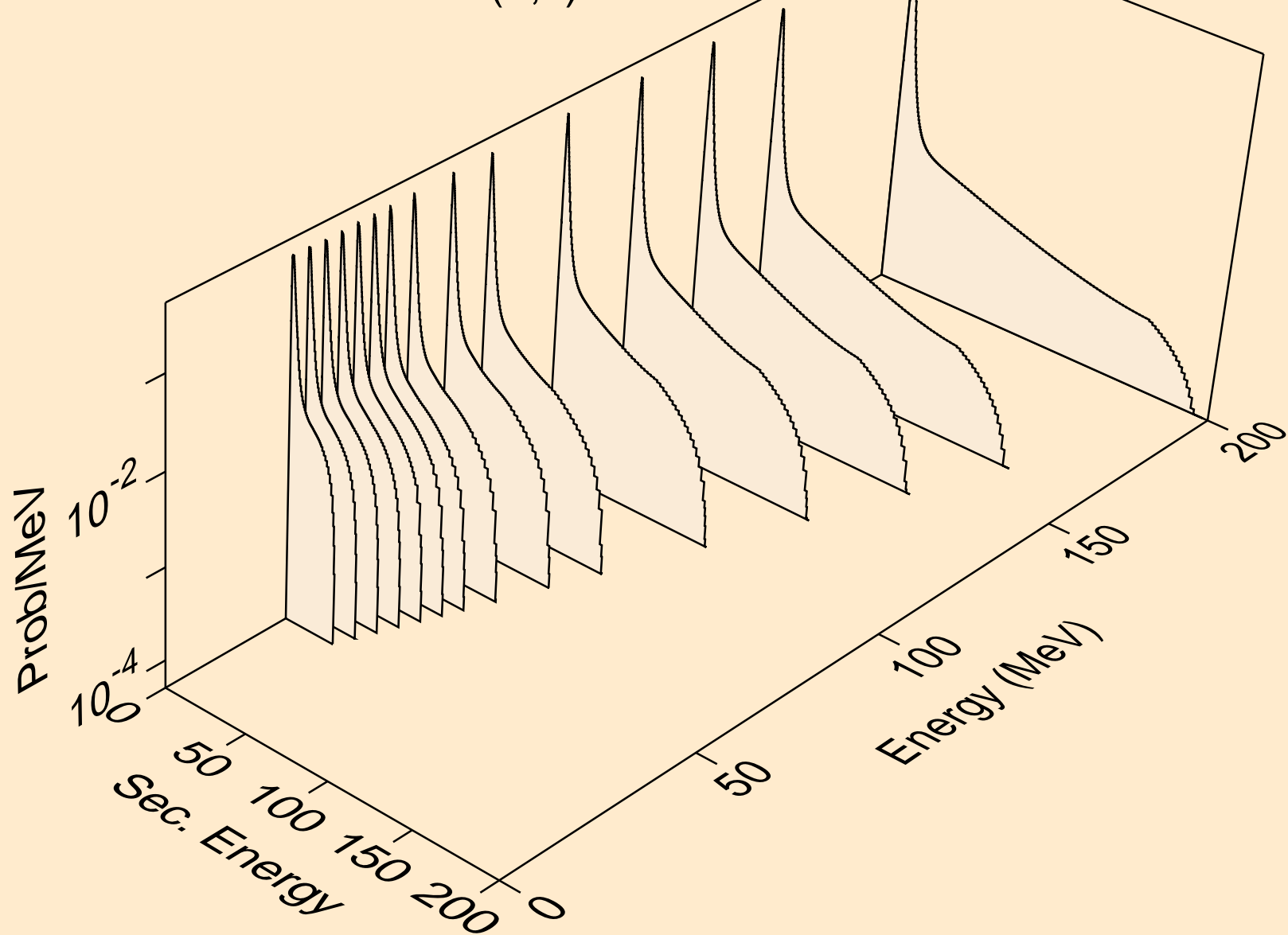



PR142M NEUTRON ACER TENDL-2023 LIBRARY; T=0.K  
Neutron emission for (n,2nd)

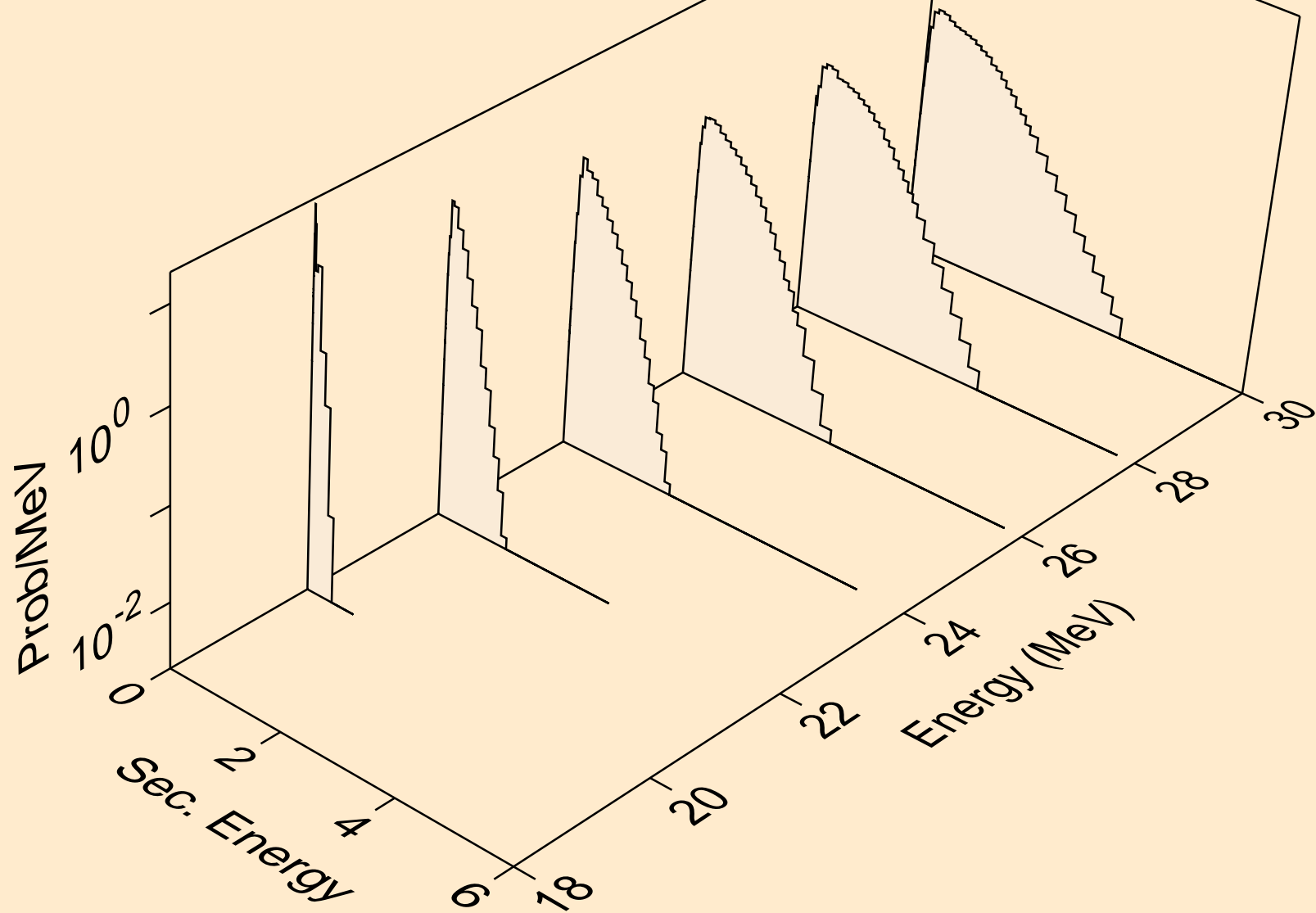

PR142M NEUTRON ACER TENDL-2023 LIBRARY; T=0.K  
Neutron emission for (n,2n)

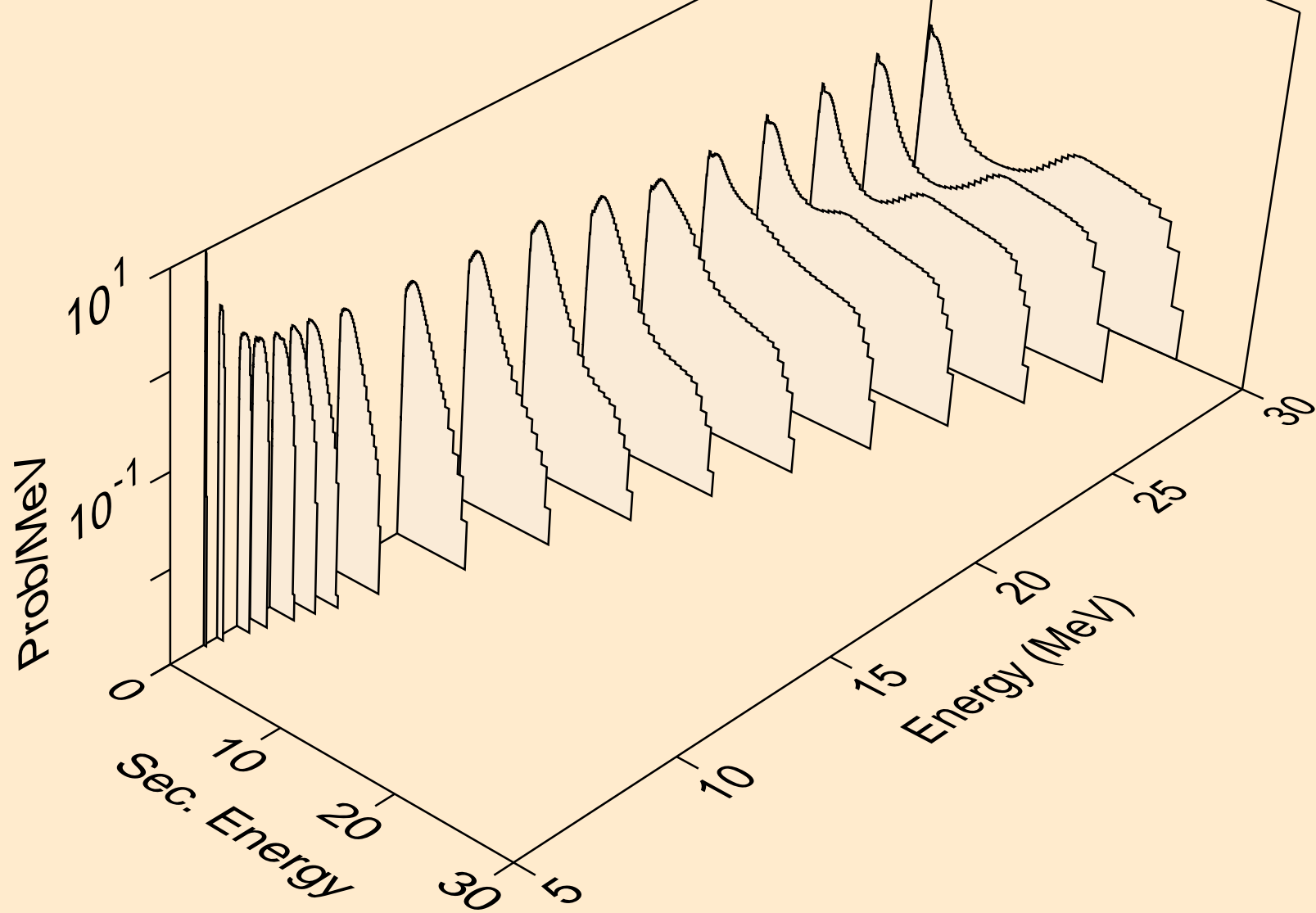

PR142M NEUTRON ACER TENDL-2023 LIBRARY; T=0.K  
Neutron emission for (n,3n)

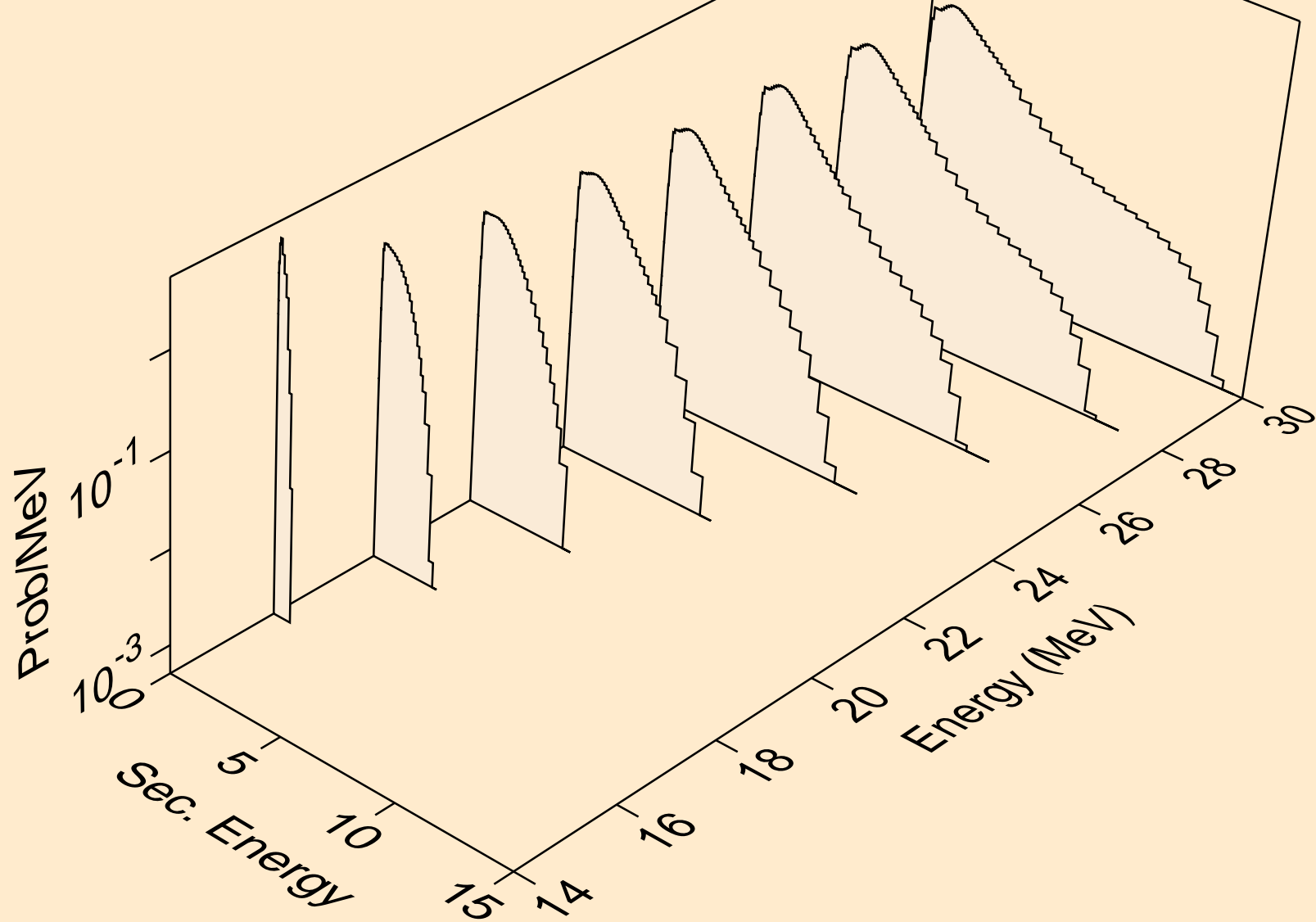

PR142M NEUTRON ACER TENDL-2023 LIBRARY; T=0.K  
Neutron emission for (n,n\*)a

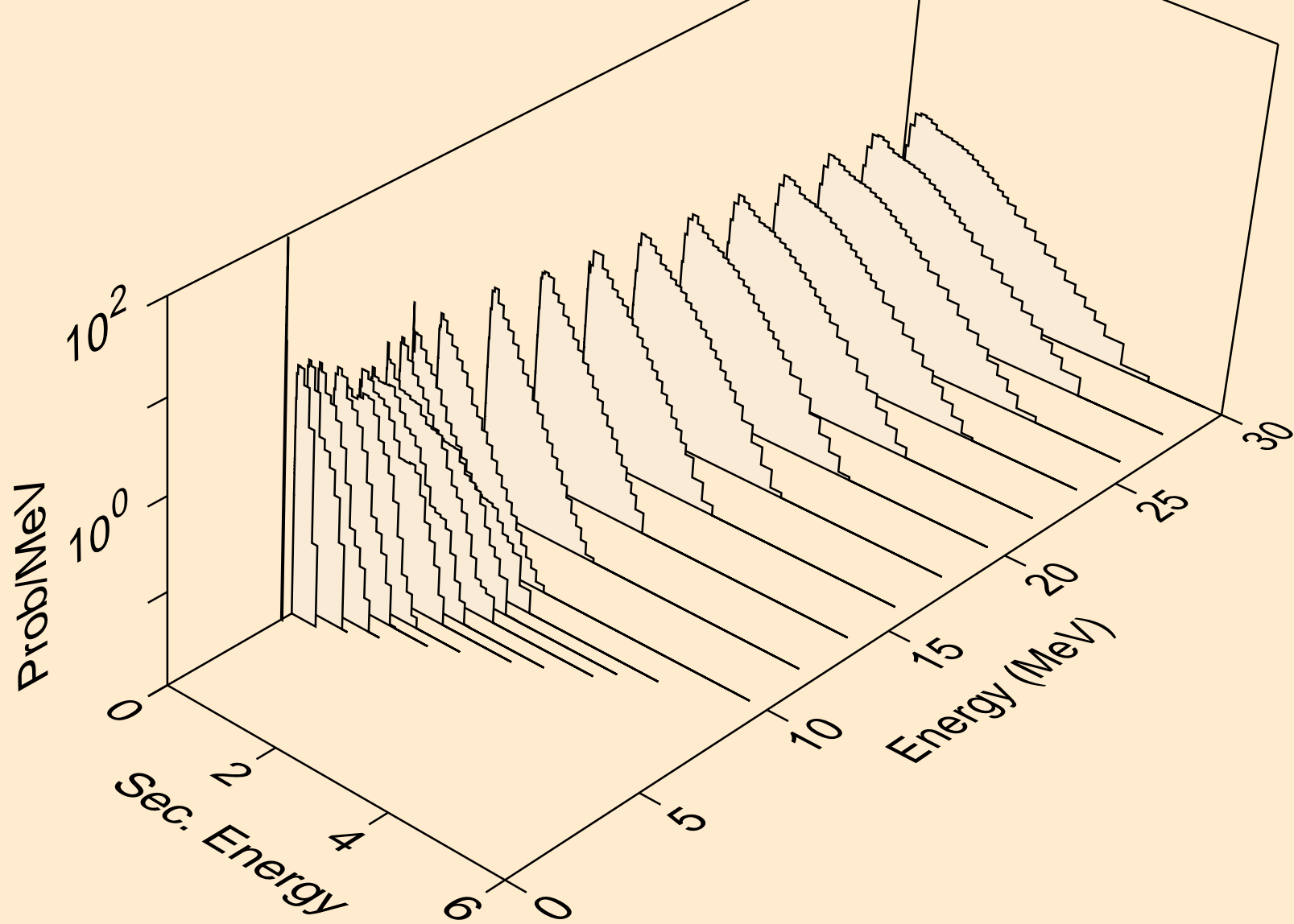

PR142M NEUTRON ACER TENDL-2023 LIBRARY; T=0.K  
Neutron emission for (n,2n)a

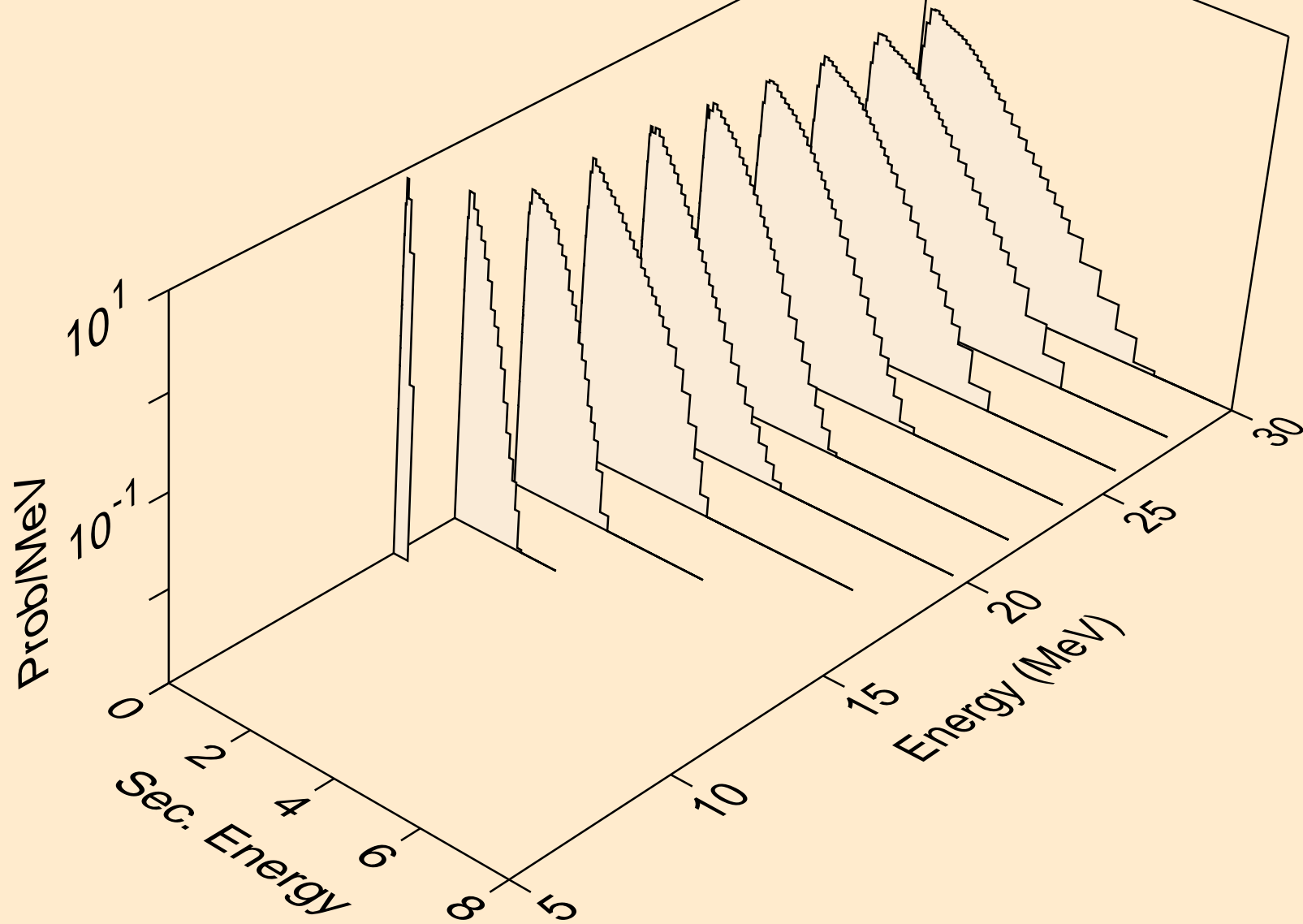

PR142M NEUTRON ACER TENDL-2023 LIBRARY; T=0.K  
Neutron emission for (n,3n)a

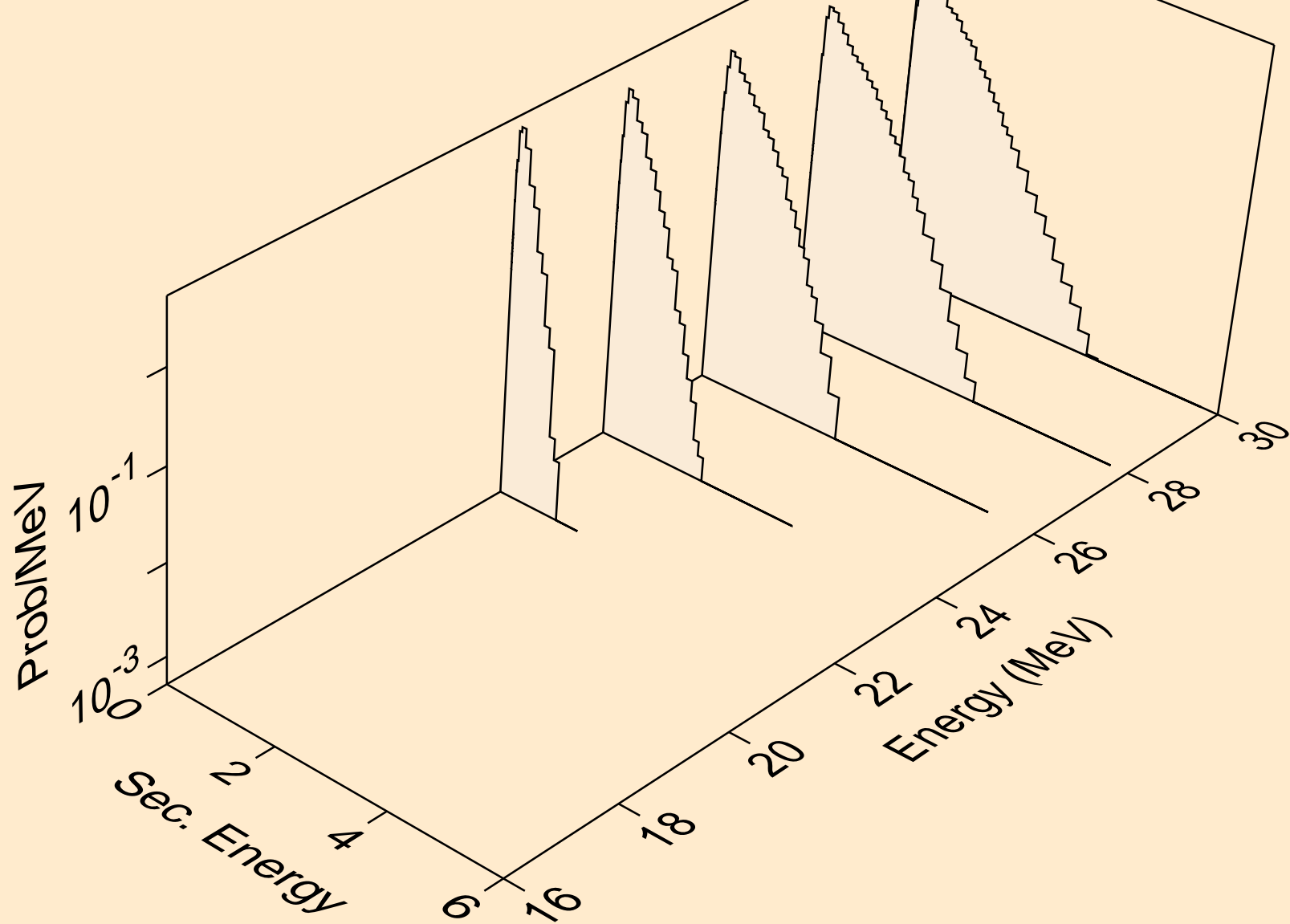

PR142M NEUTRON ACER TENDL-2023 LIBRARY; T=0.K  
Neutron emission for (n,n\*)p

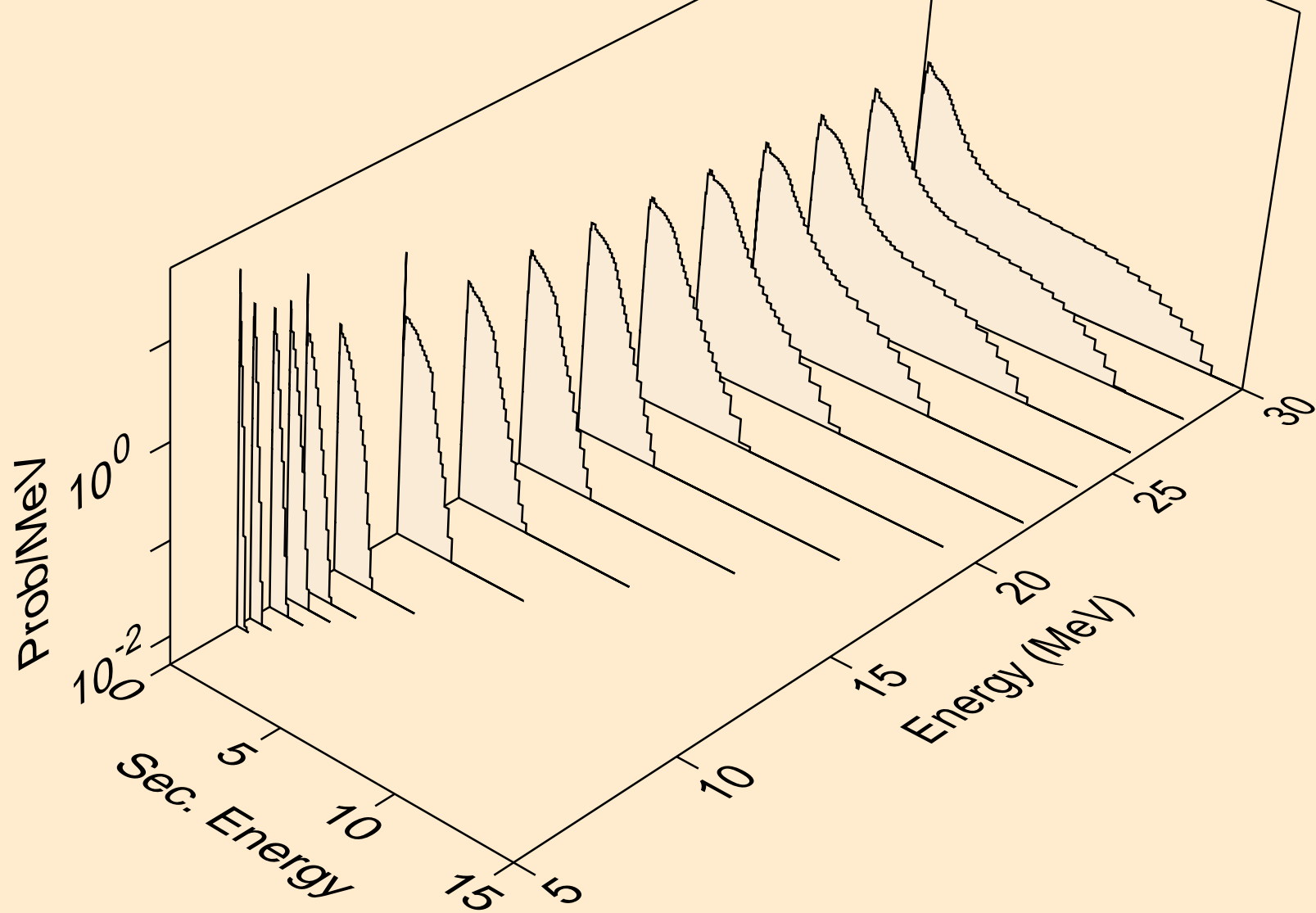

PR142M NEUTRON ACER TENDL-2023 LIBRARY; T=0.K  
Neutron emission for (n,n\*)2a

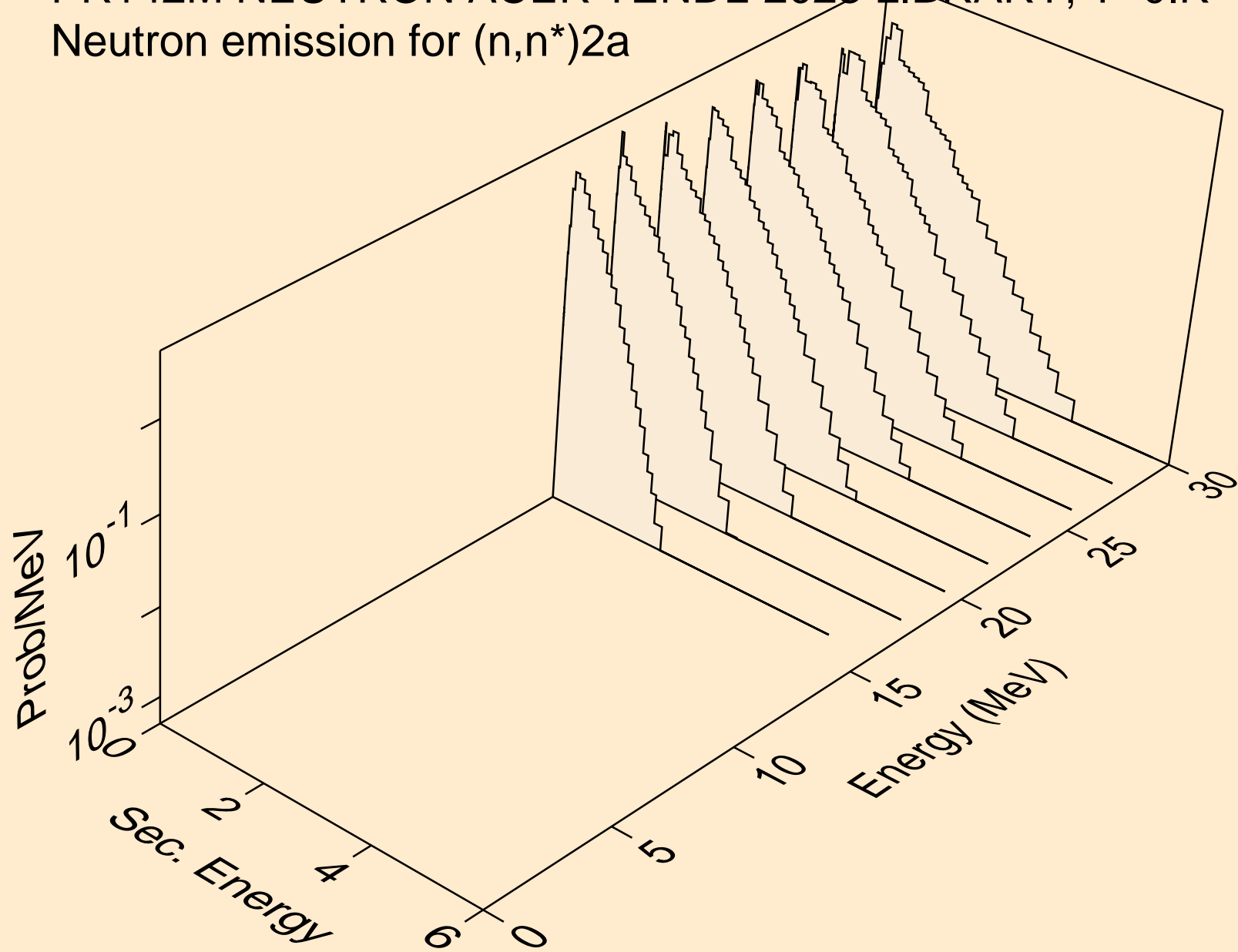



PR142M NEUTRON ACER TENDL-2023 LIBRARY; T=0.K  
Neutron emission for (n,n\*)d

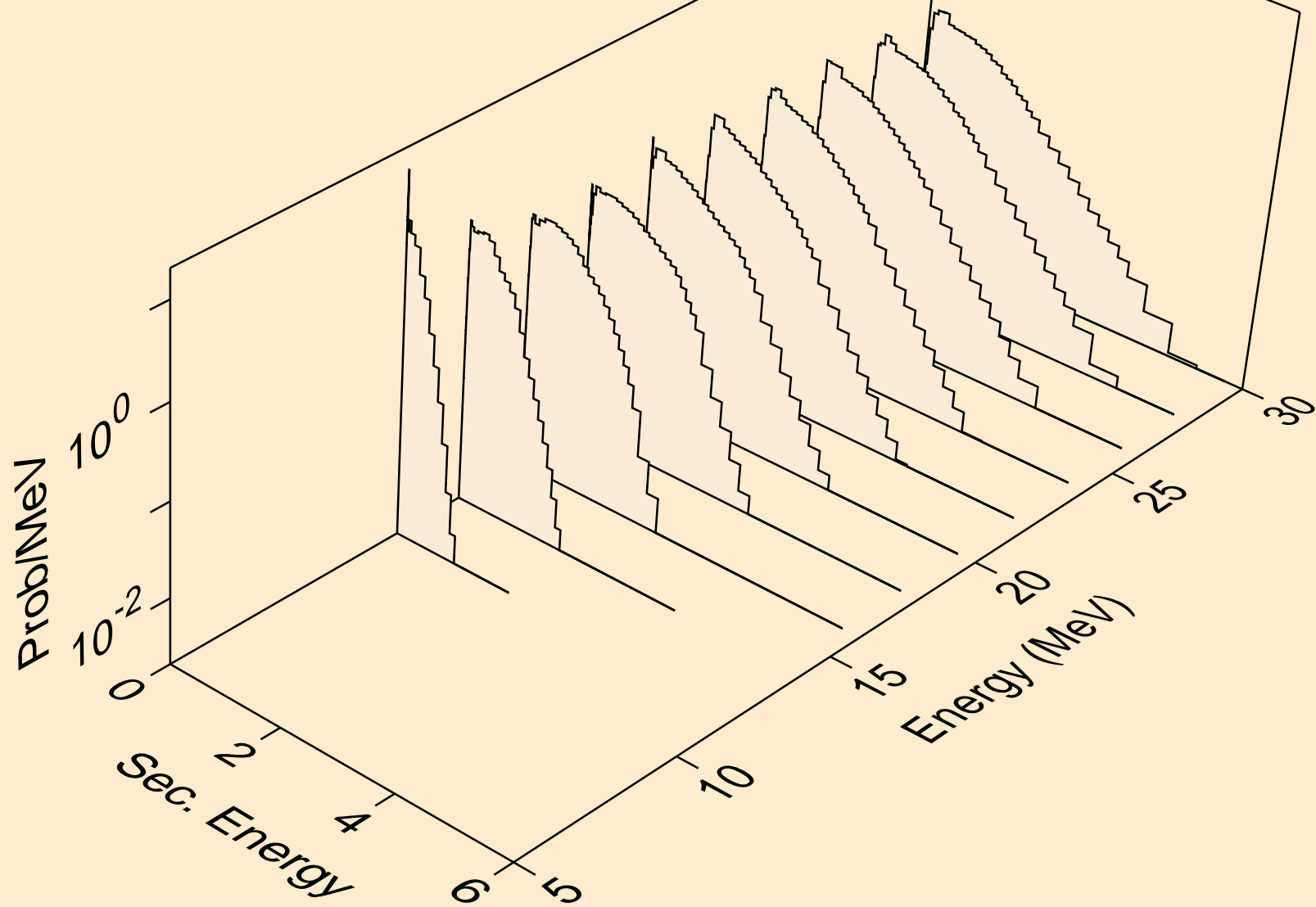

PR142M NEUTRON ACER TENDL-2023 LIBRARY; T=0.K  
Neutron emission for (n,n\*)t

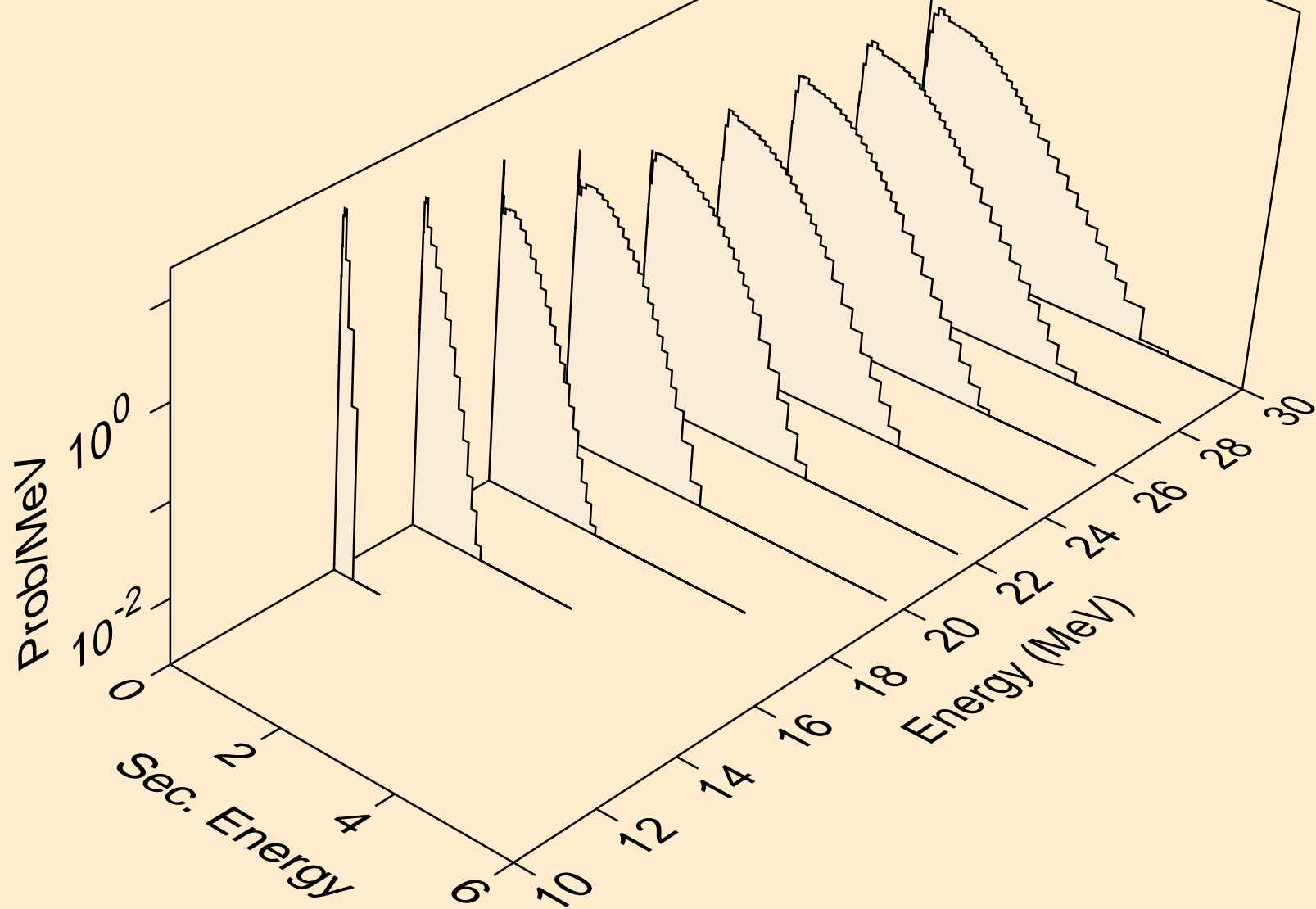

PR142M NEUTRON ACER TENDL-2023 LIBRARY; T=0.K  
Neutron emission for (n,n\*)he3

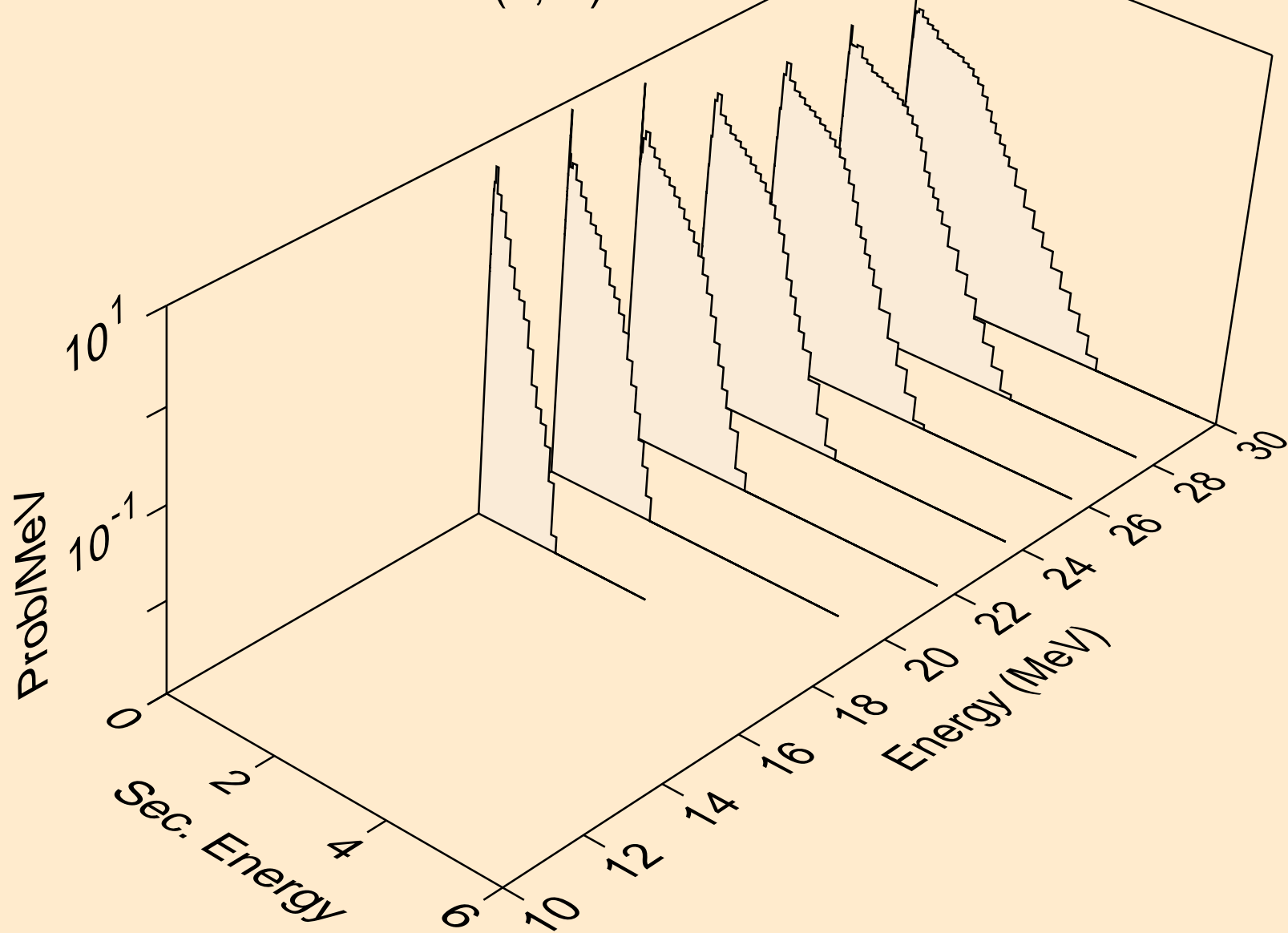

PR142M NEUTRON ACER TENDL-2023 LIBRARY; T=0.K  
Neutron emission for (n,4n)

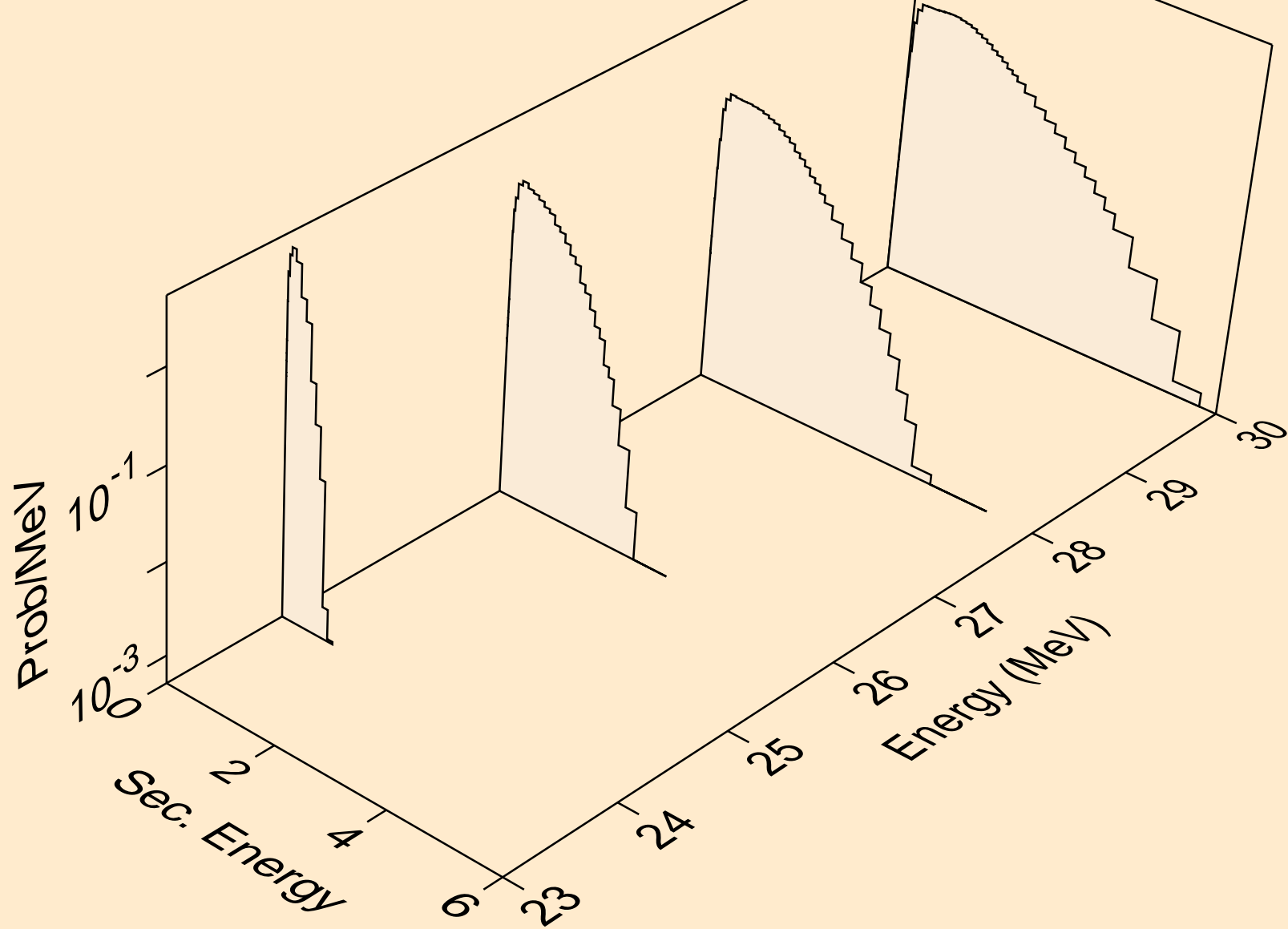

PR142M NEUTRON ACER TENDL-2023 LIBRARY; T=0.K  
Neutron emission for (n,2np)

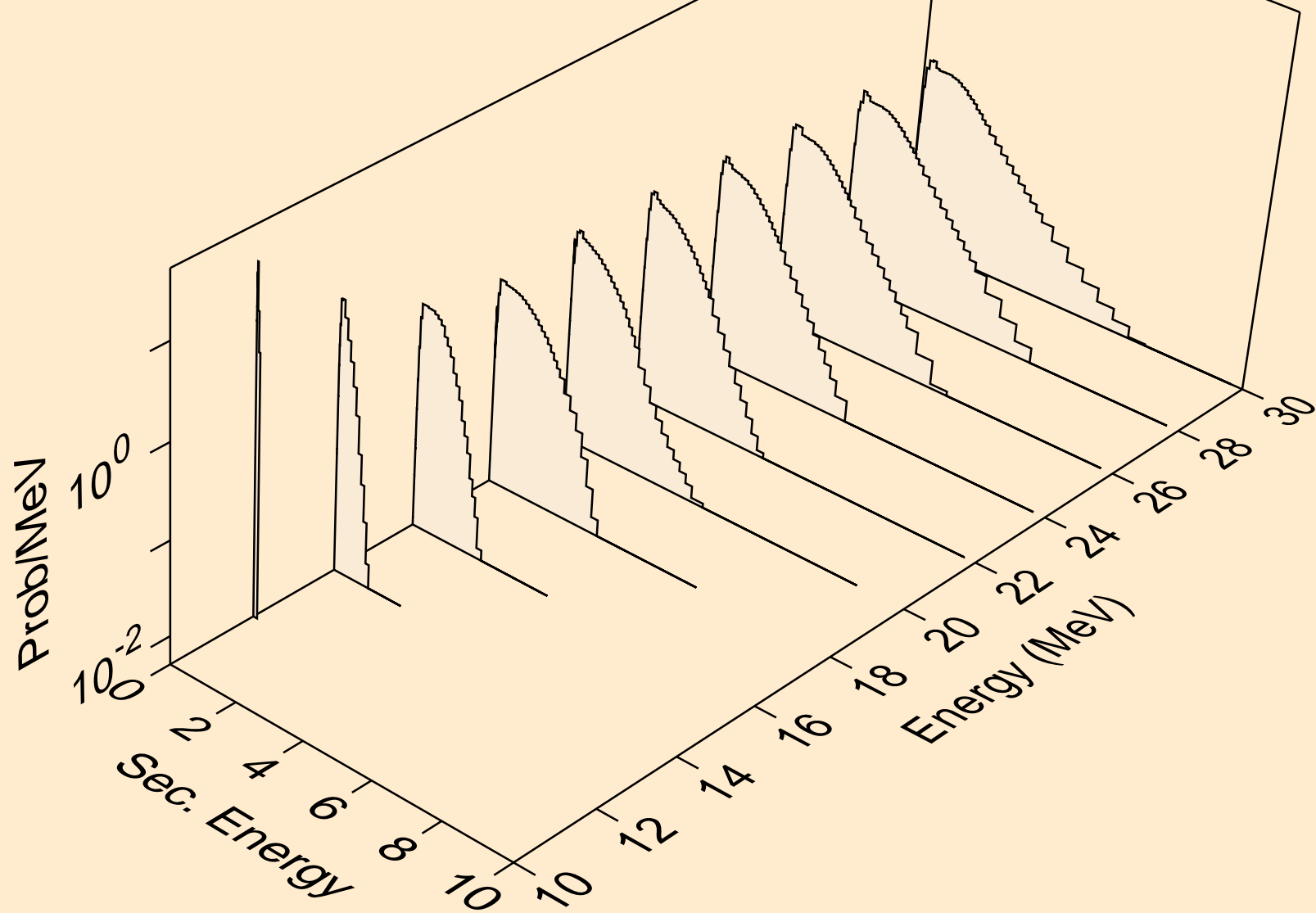

PR142M NEUTRON ACER TENDL-2023 LIBRARY; T=0.K  
Neutron emission for (n,3np)

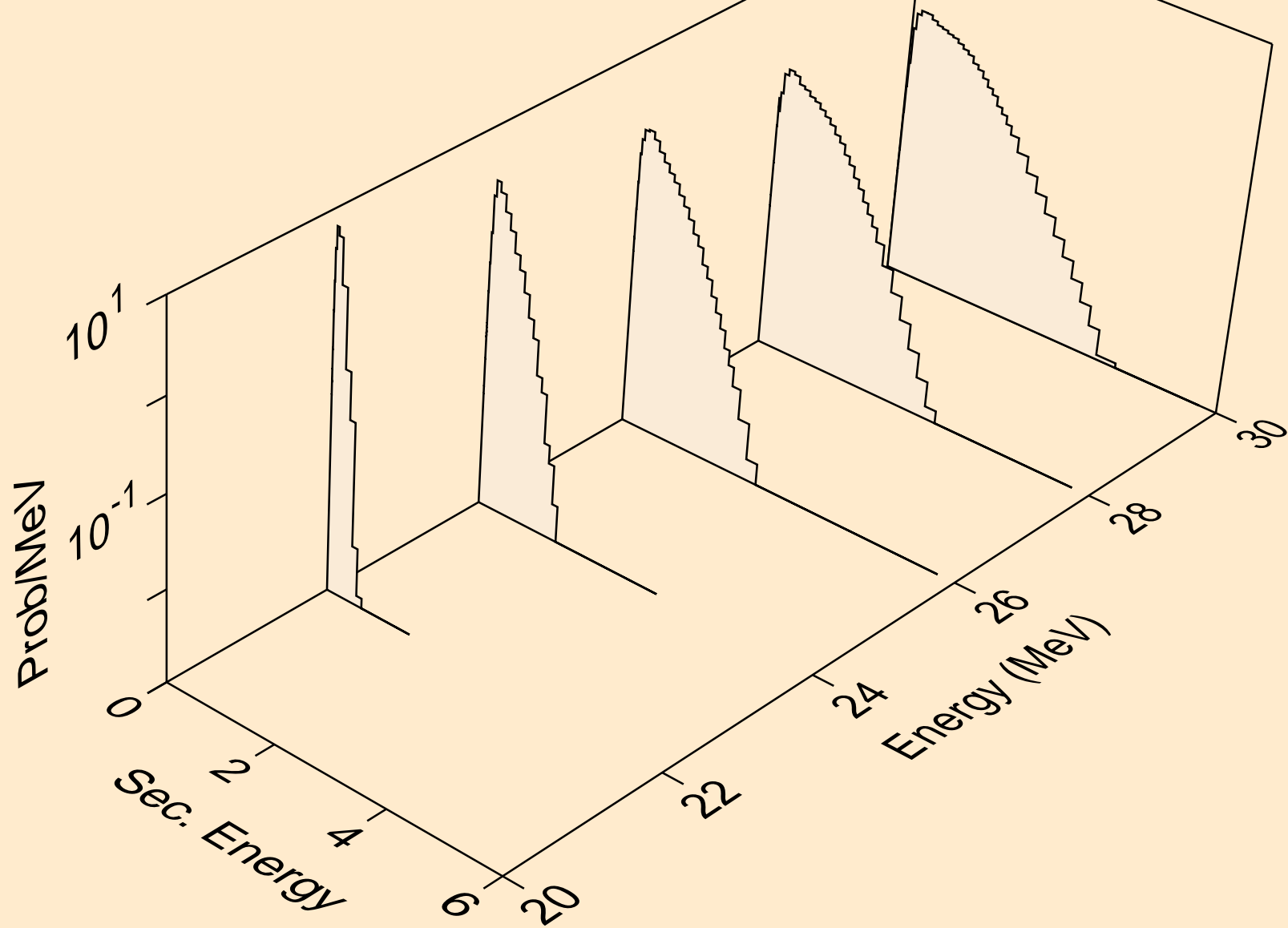

PR142M NEUTRON ACER TENDL-2023 LIBRARY; T=0.K  
Neutron emission for (n,n2p)

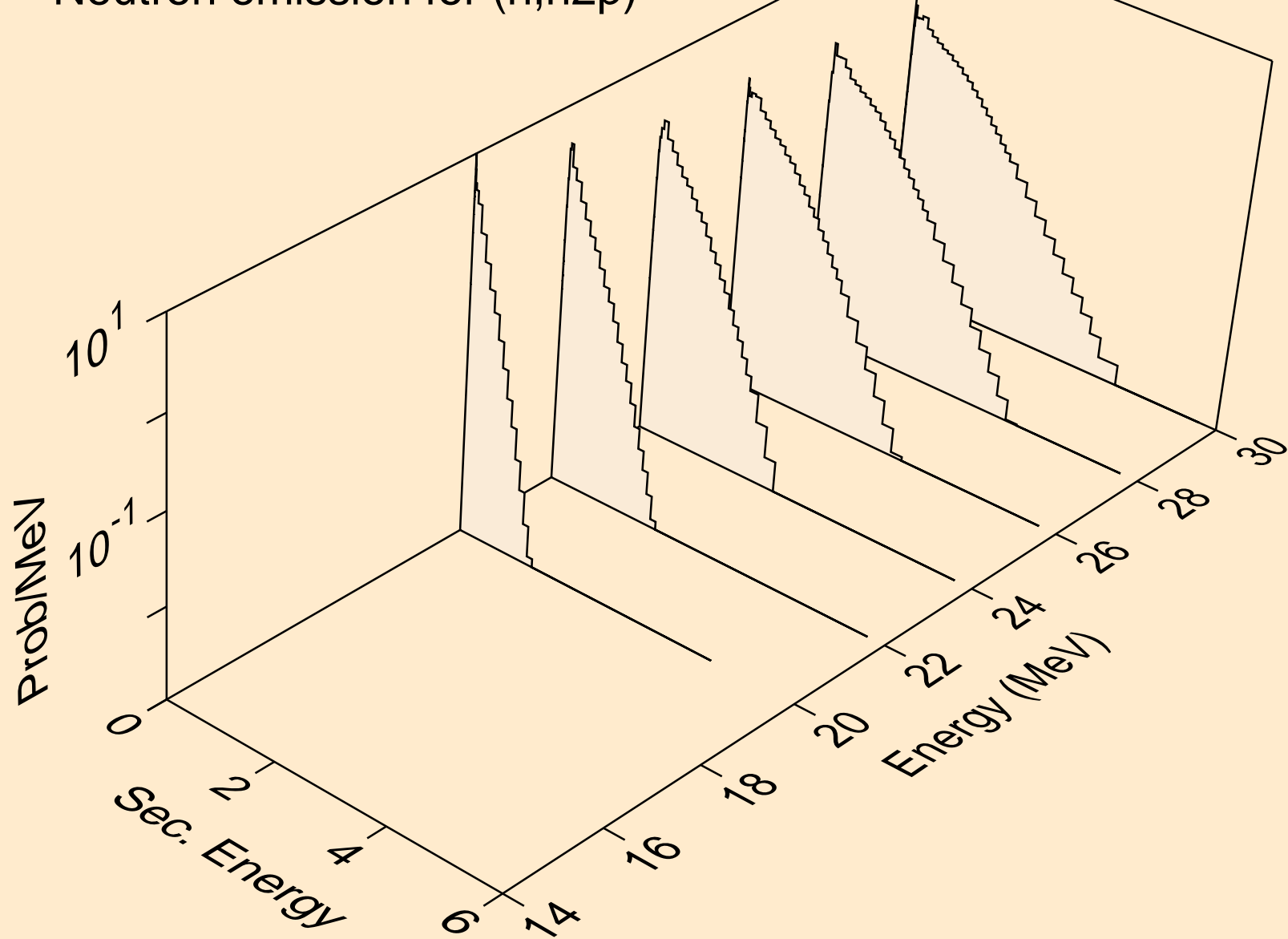

PR142M NEUTRON ACER TENDL-2023 LIBRARY; T=0.K  
Neutron emission for (n,npa)

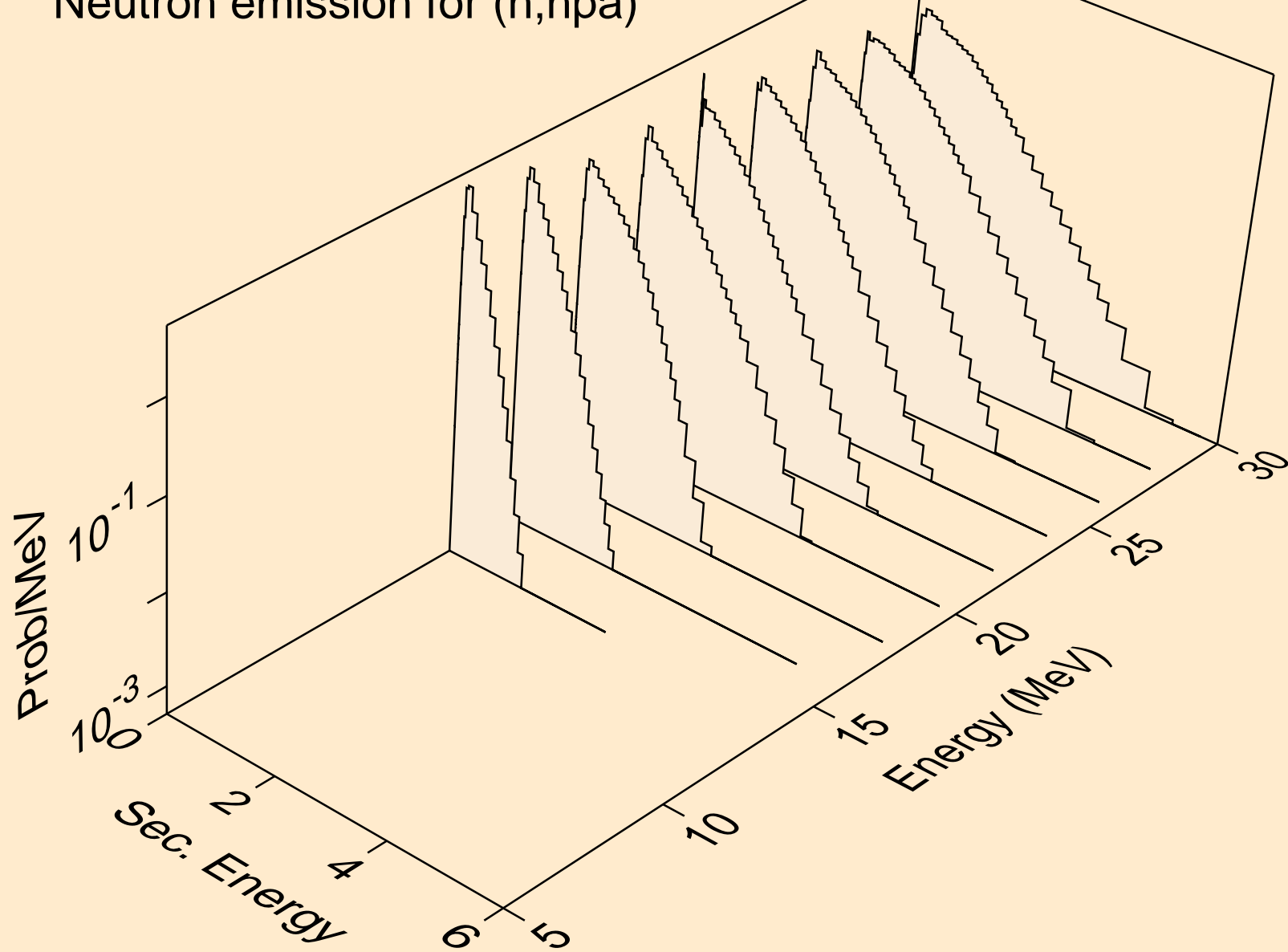



PR142M NEUTRON ACER TENDL-2023 LIBRARY; T=0.K  
Neutron emission for (n,n\*c)

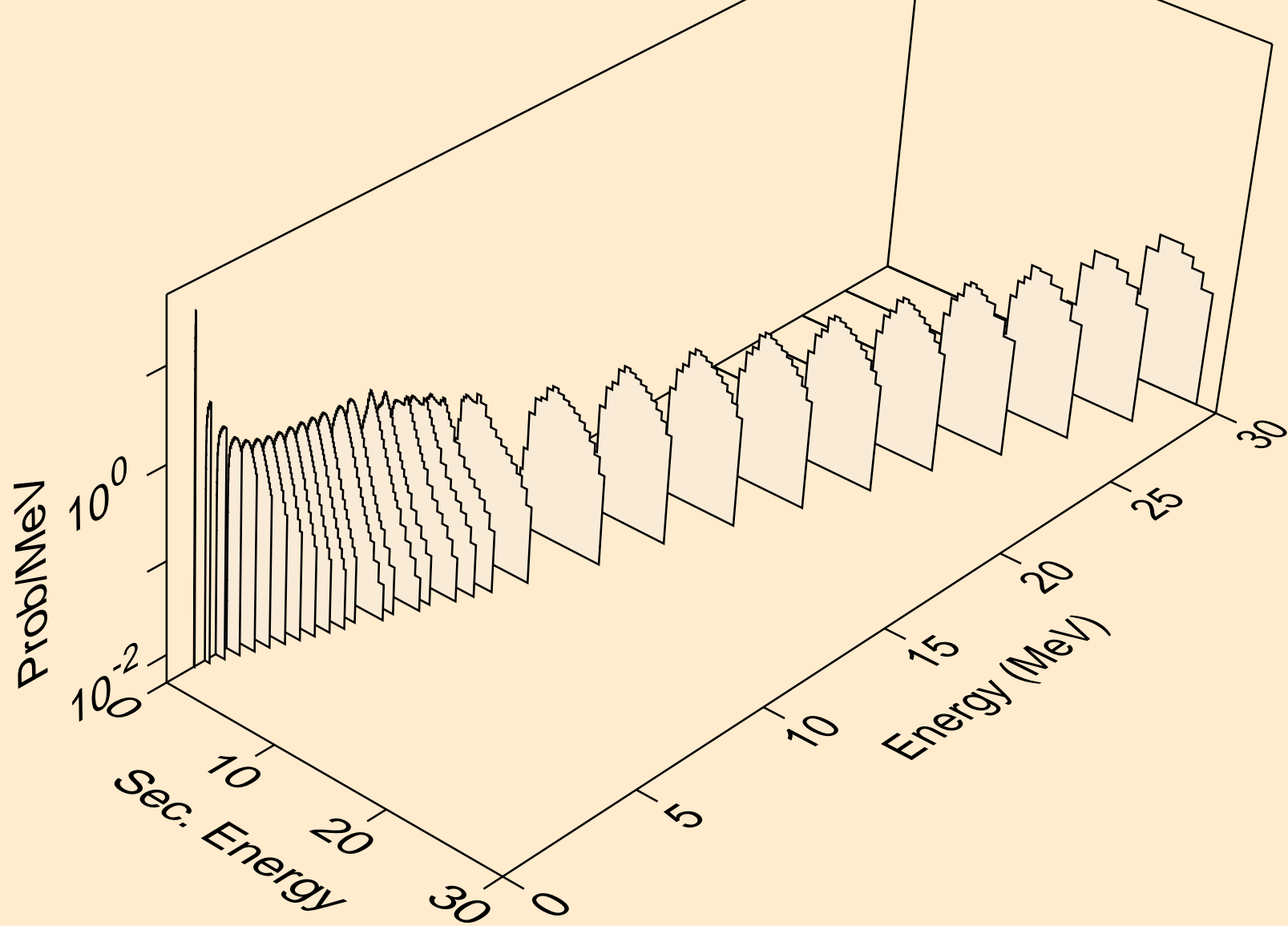

PR142M NEUTRON ACER TENDL-2023 LIBRARY; T=0.K  
Photon emission for (n,x)

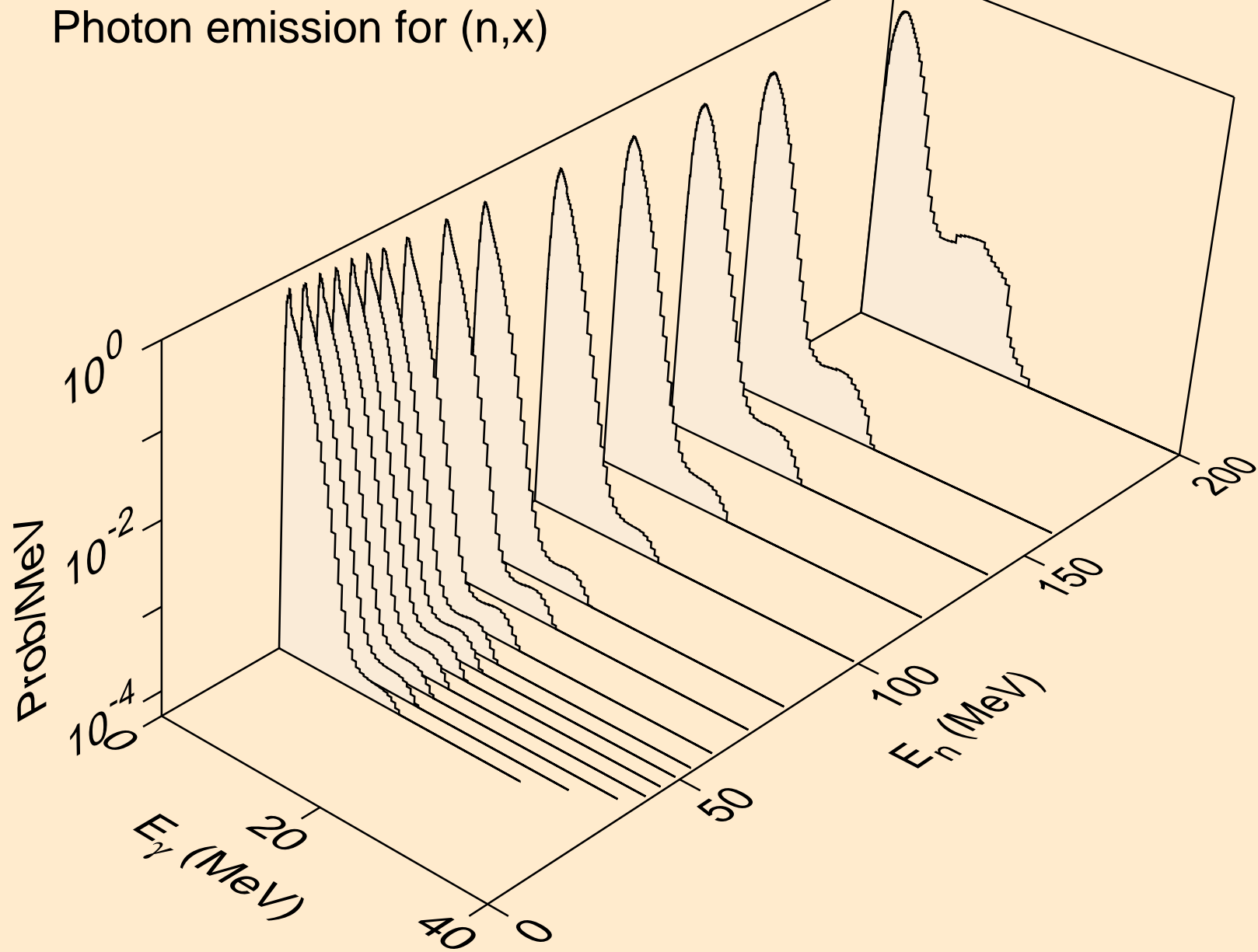

PR142M NEUTRON ACER TENDL-2023 LIBRARY; T=0.K  
Photon emission for (n,2nd)

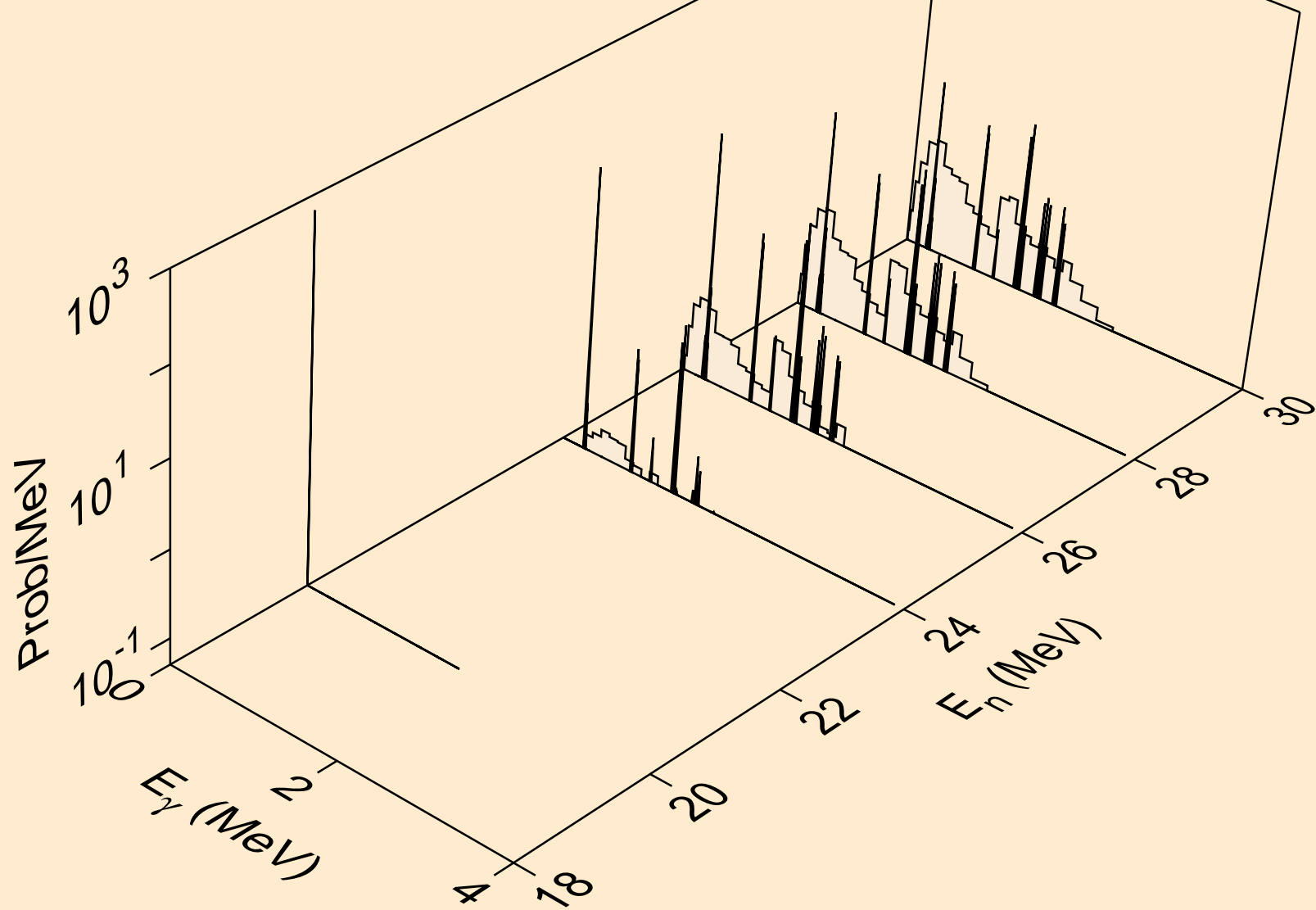

PR142M NEUTRON ACER TENDL-2023 LIBRARY; T=0.K  
Photon emission for (n,2n)

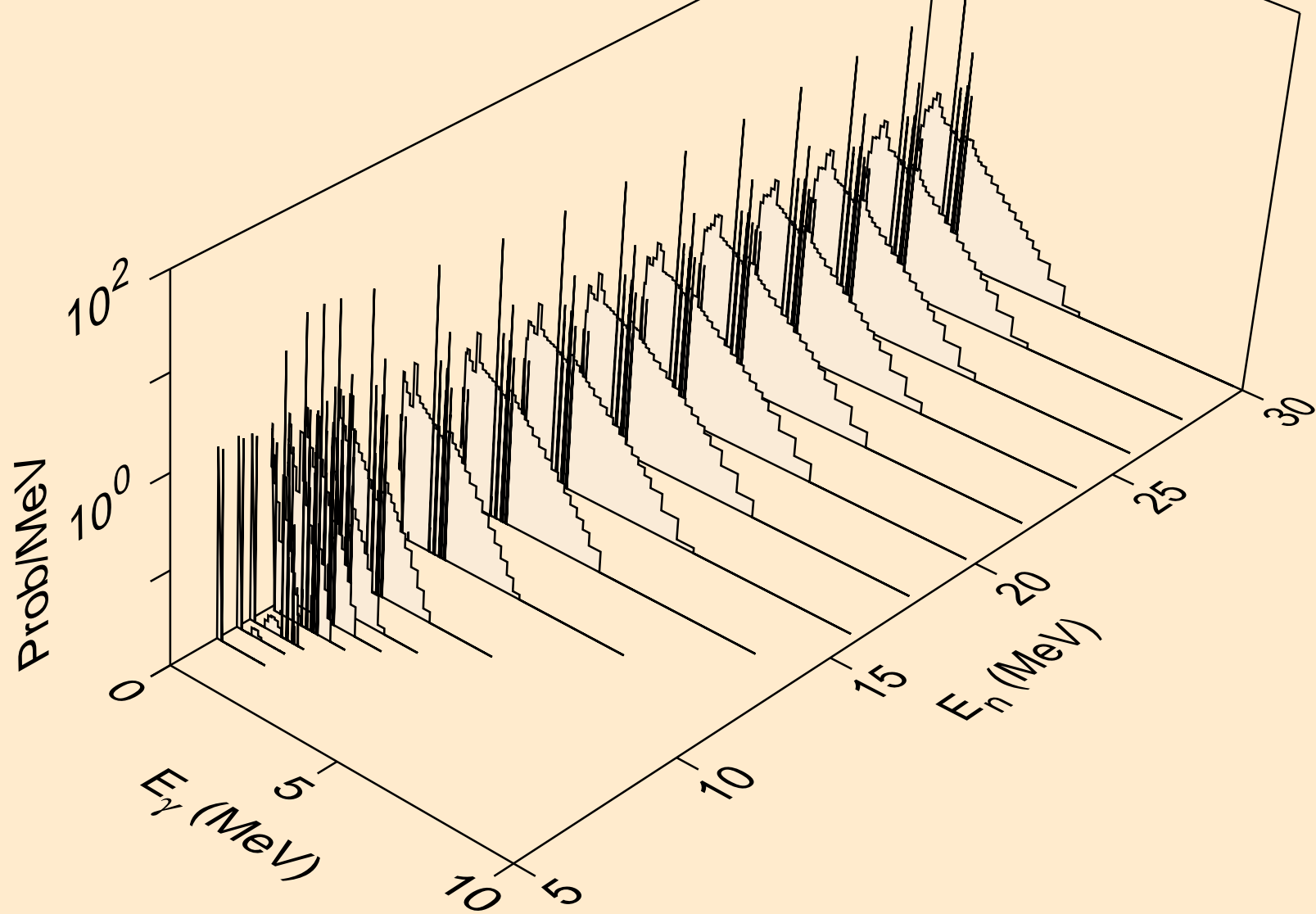

PR142M NEUTRON ACER TENDL-2023 LIBRARY; T=0.K  
Photon emission for (n,3n)

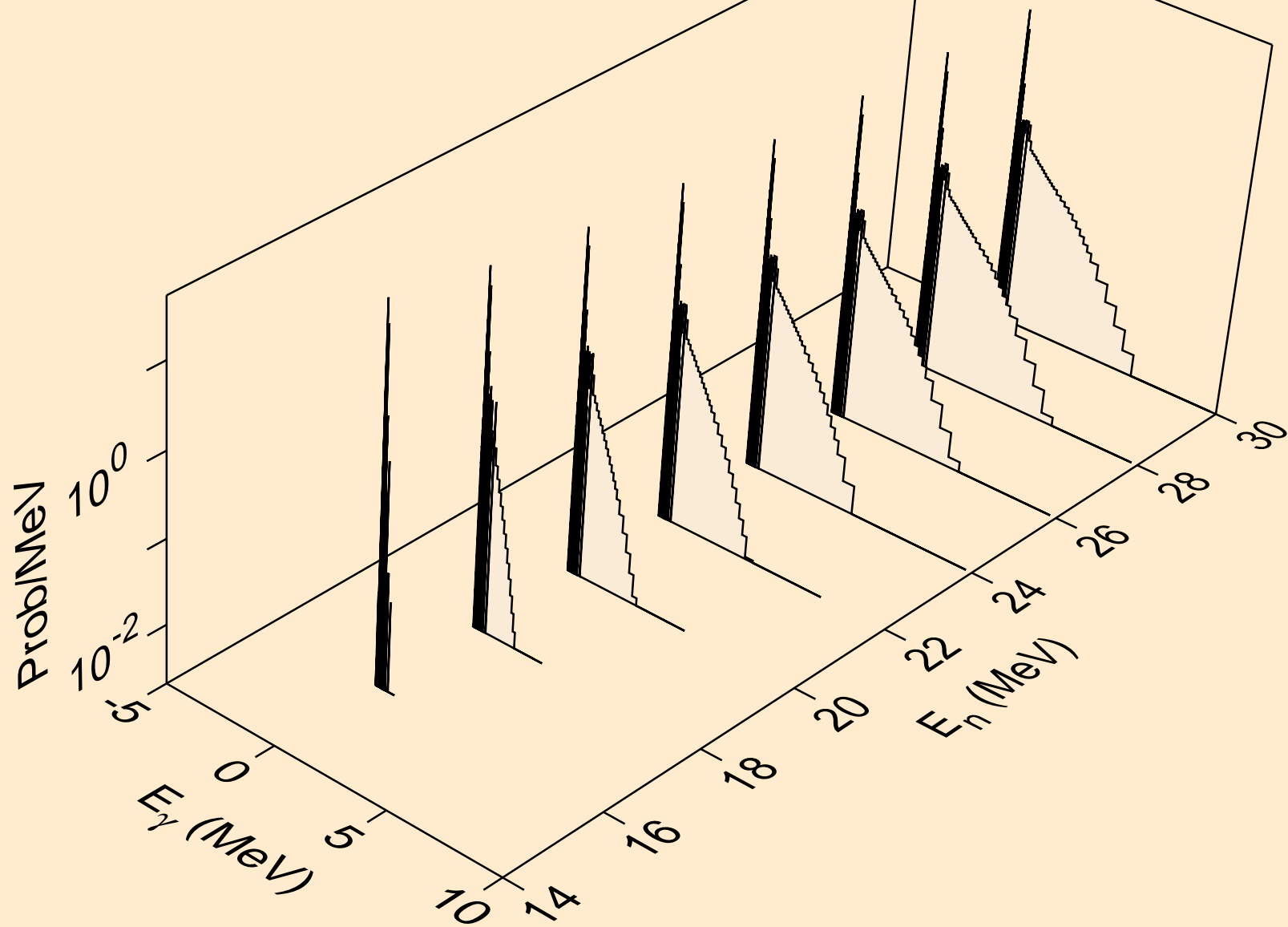

PR142M NEUTRON ACER TENDL-2023 LIBRARY; T=0.K  
Photon emission for (n,n\*)a

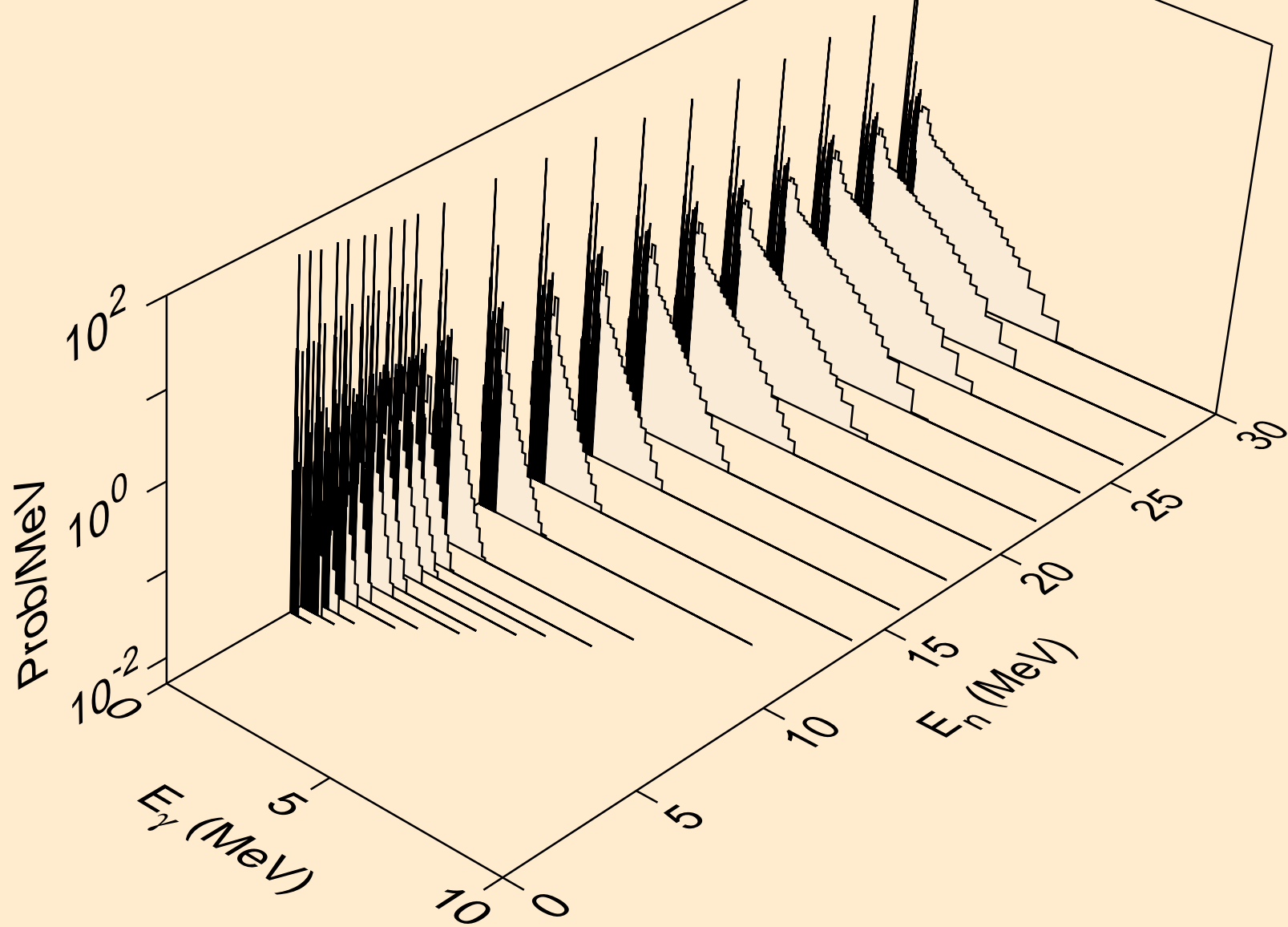

PR142M NEUTRON ACER TENDL-2023 LIBRARY; T=0.K  
Photon emission for (n,2n)a

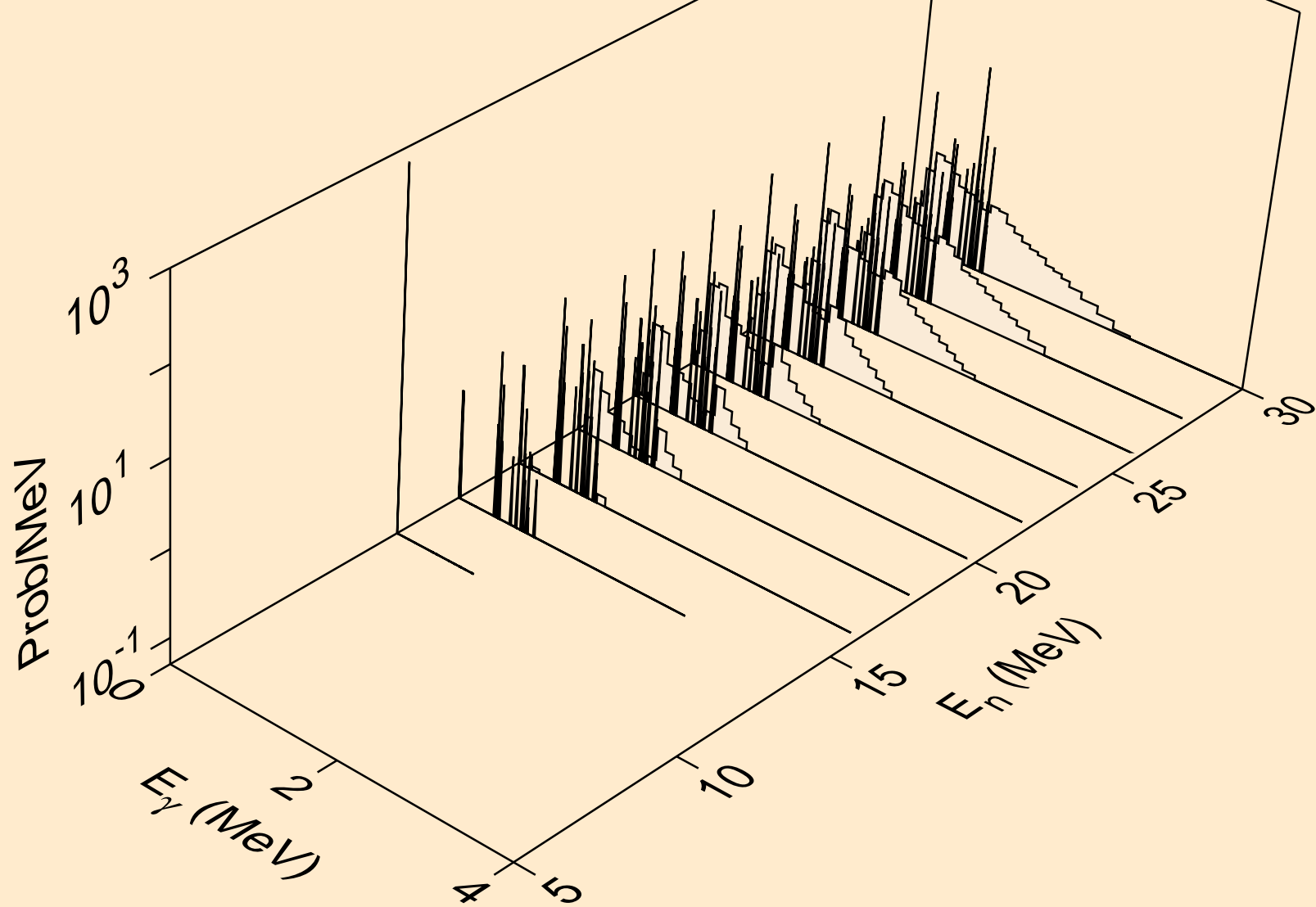

PR142M NEUTRON ACER TENDL-2023 LIBRARY; T=0.K  
Photon emission for (n,3n)a

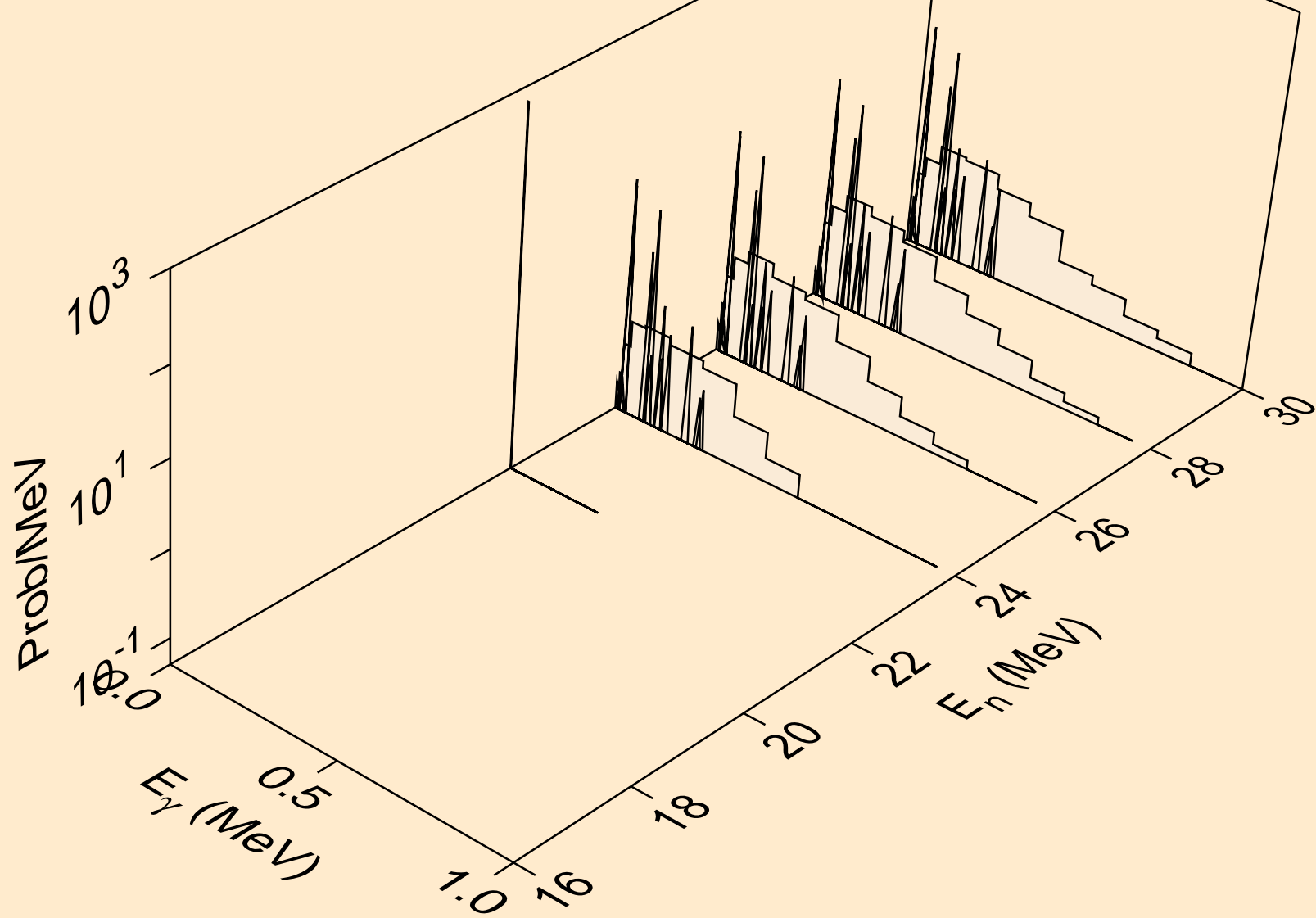



PR142M NEUTRON ACER TENDL-2023 LIBRARY; T=0.K  
Photon emission for (n,n\*)p

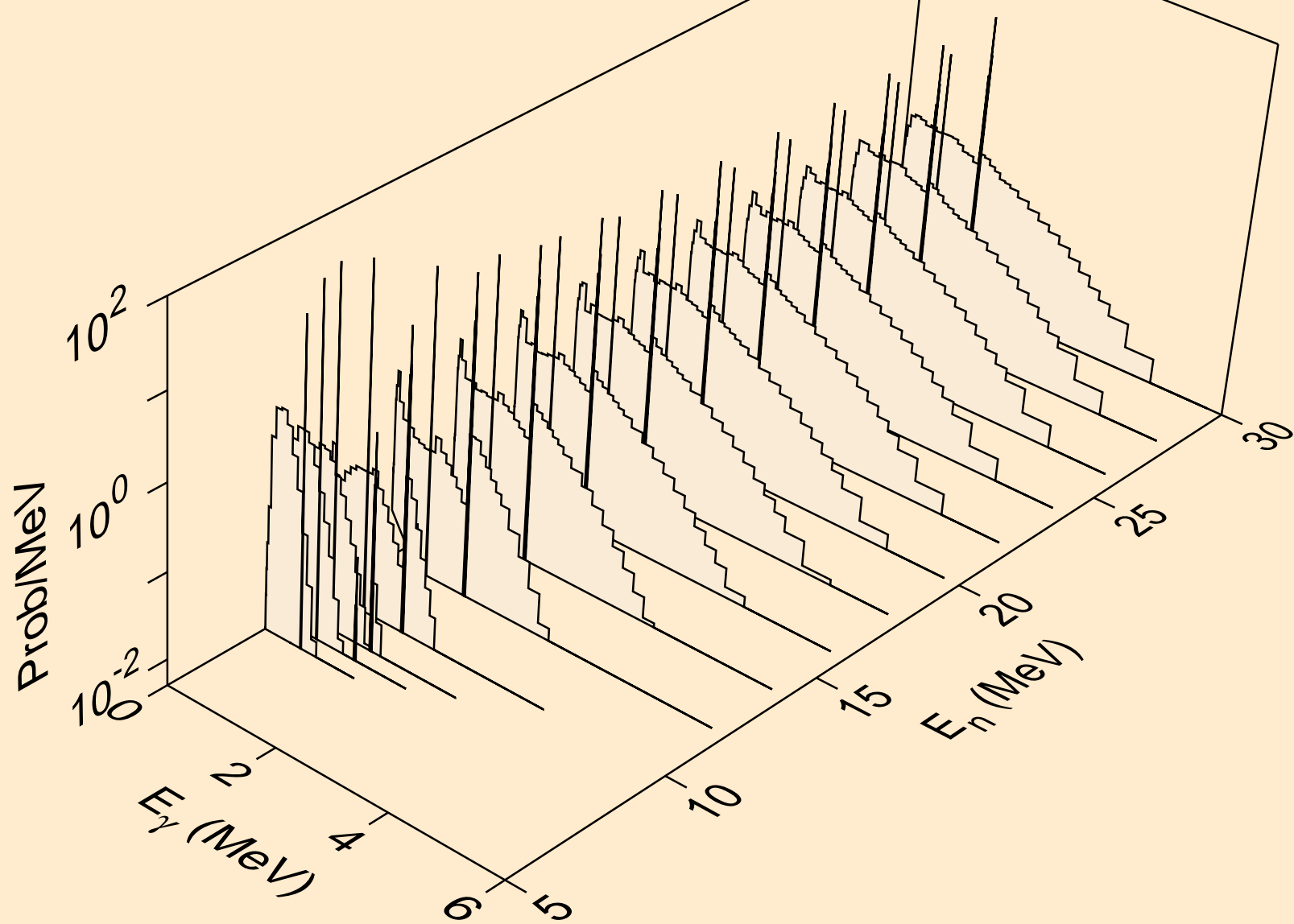

PR142M NEUTRON ACER TENDL-2023 LIBRARY; T=0.K  
Photon emission for (n,n\*)2a

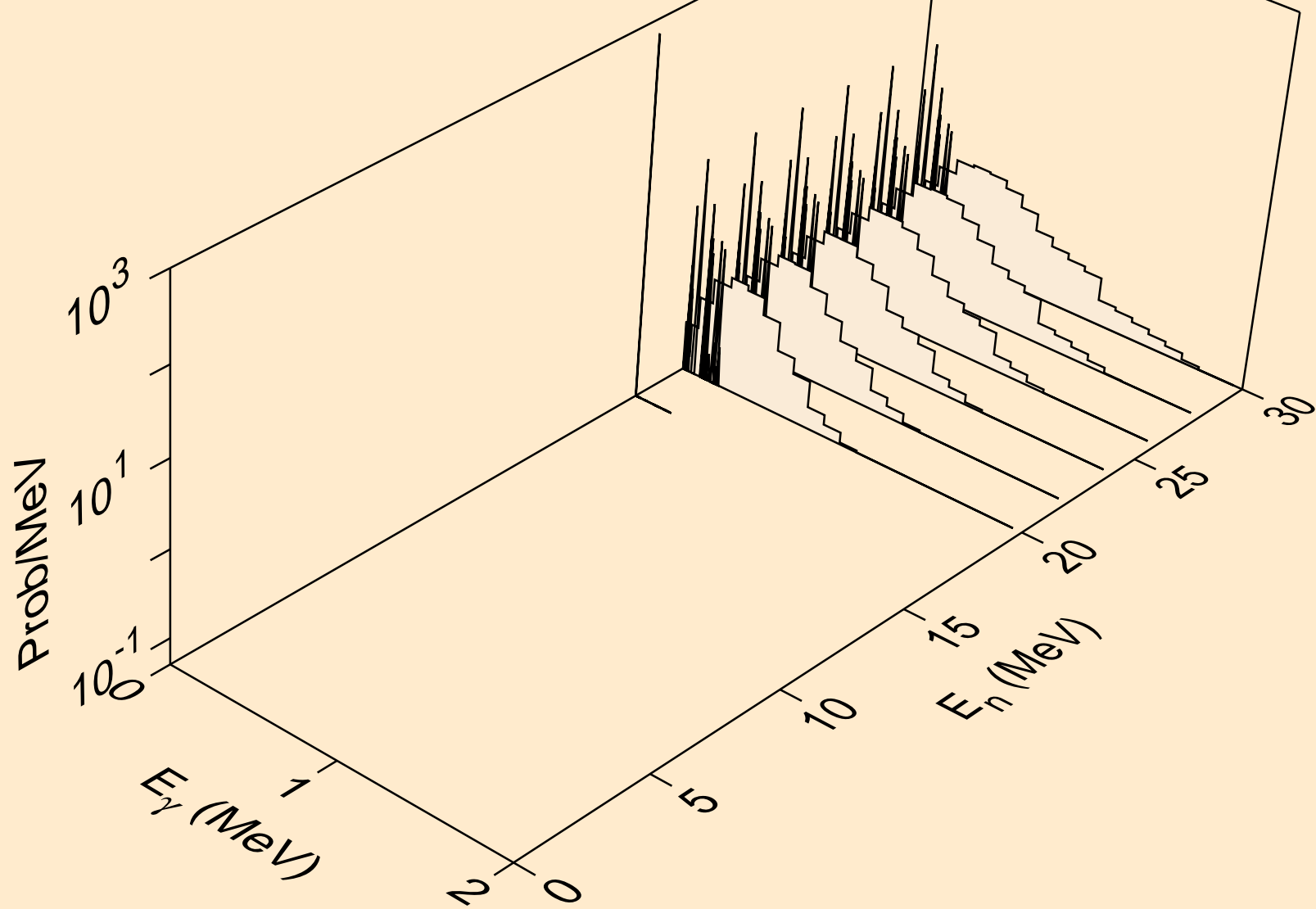

PR142M NEUTRON ACER TENDL-2023 LIBRARY; T=0.K  
Photon emission for (n,n\*)d

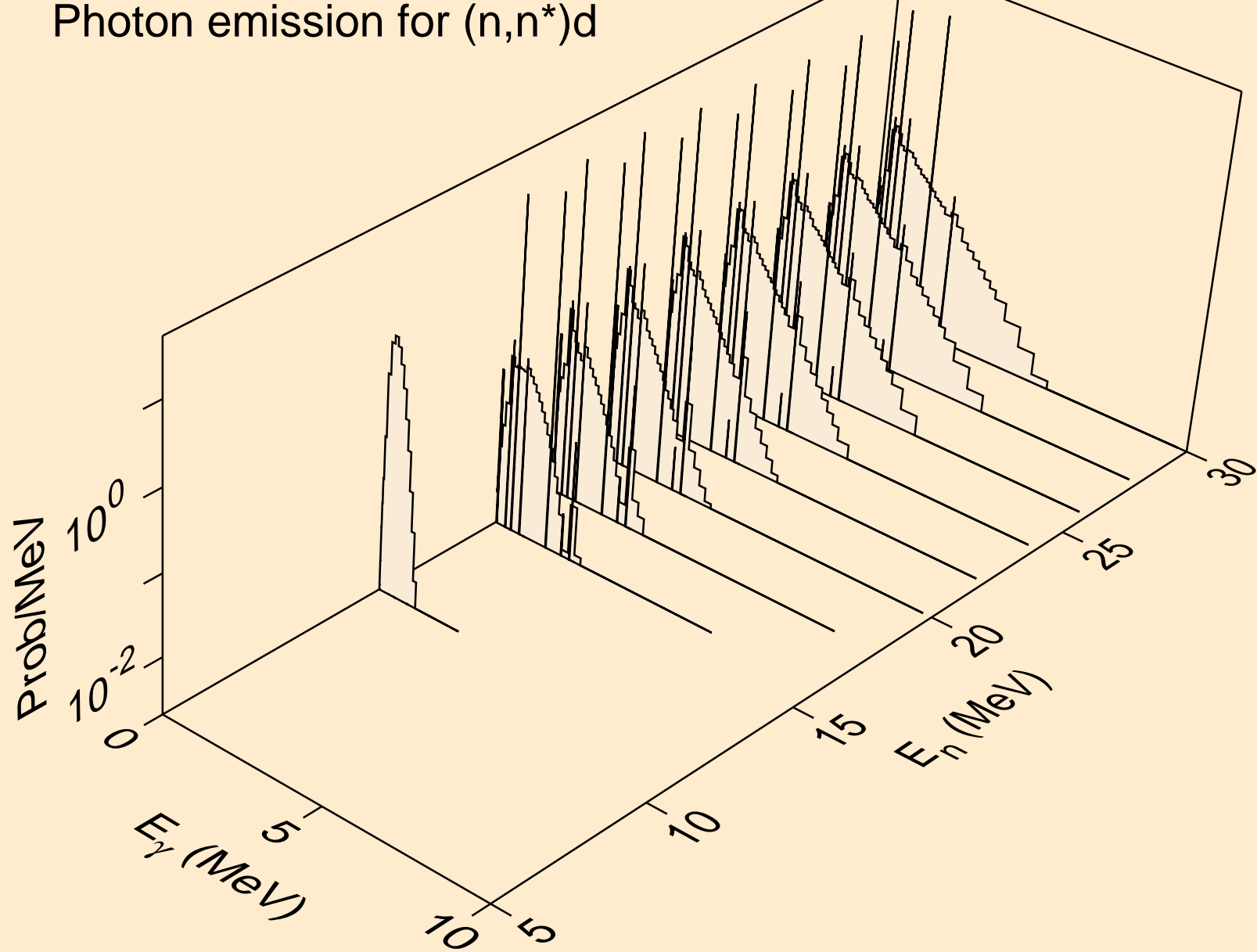

PR142M NEUTRON ACER TENDL-2023 LIBRARY; T=0.K  
Photon emission for (n,n\*)t

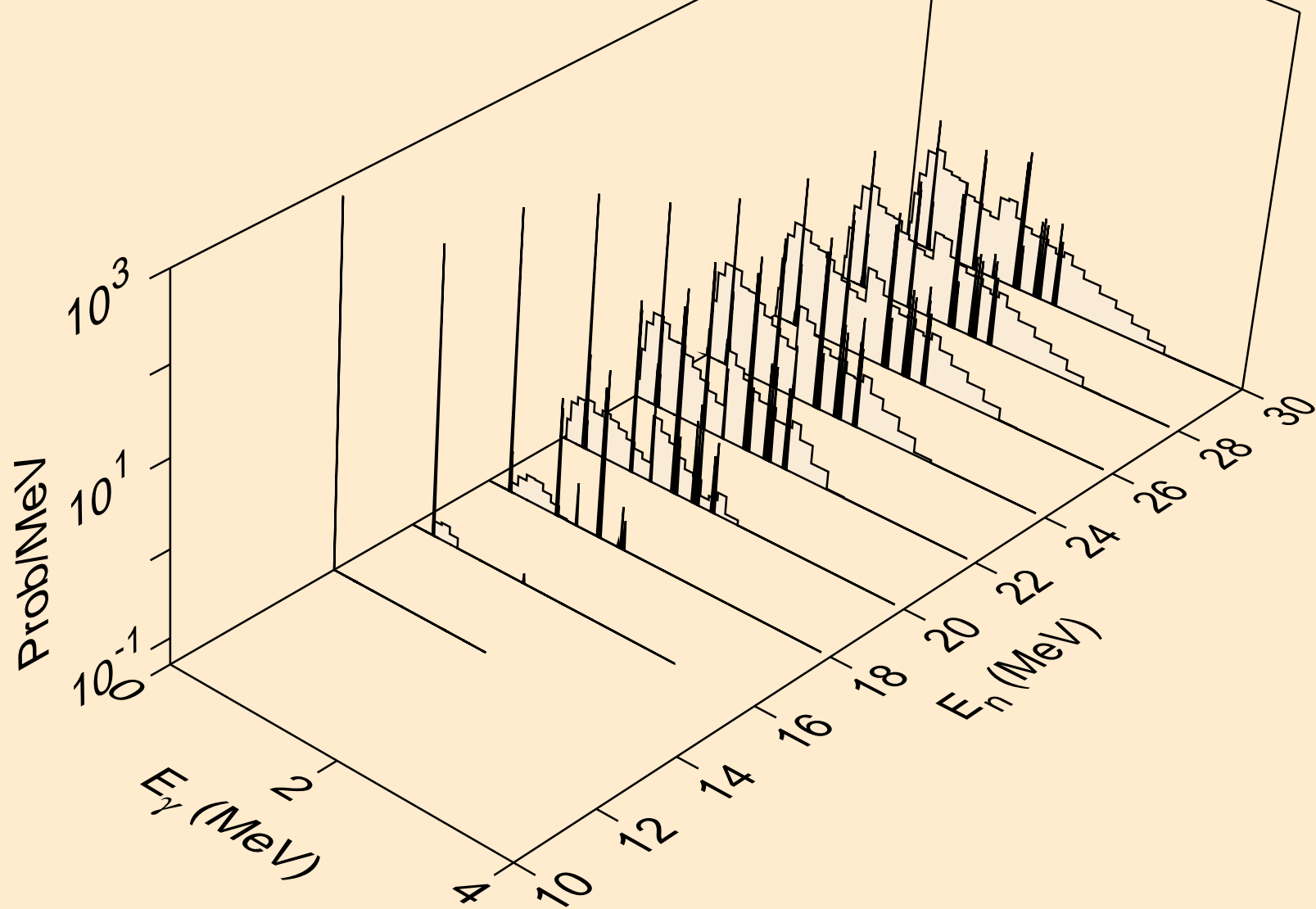

PR142M NEUTRON ACER TENDL-2023 LIBRARY; T=0.K  
Photon emission for (n,n\*)he3

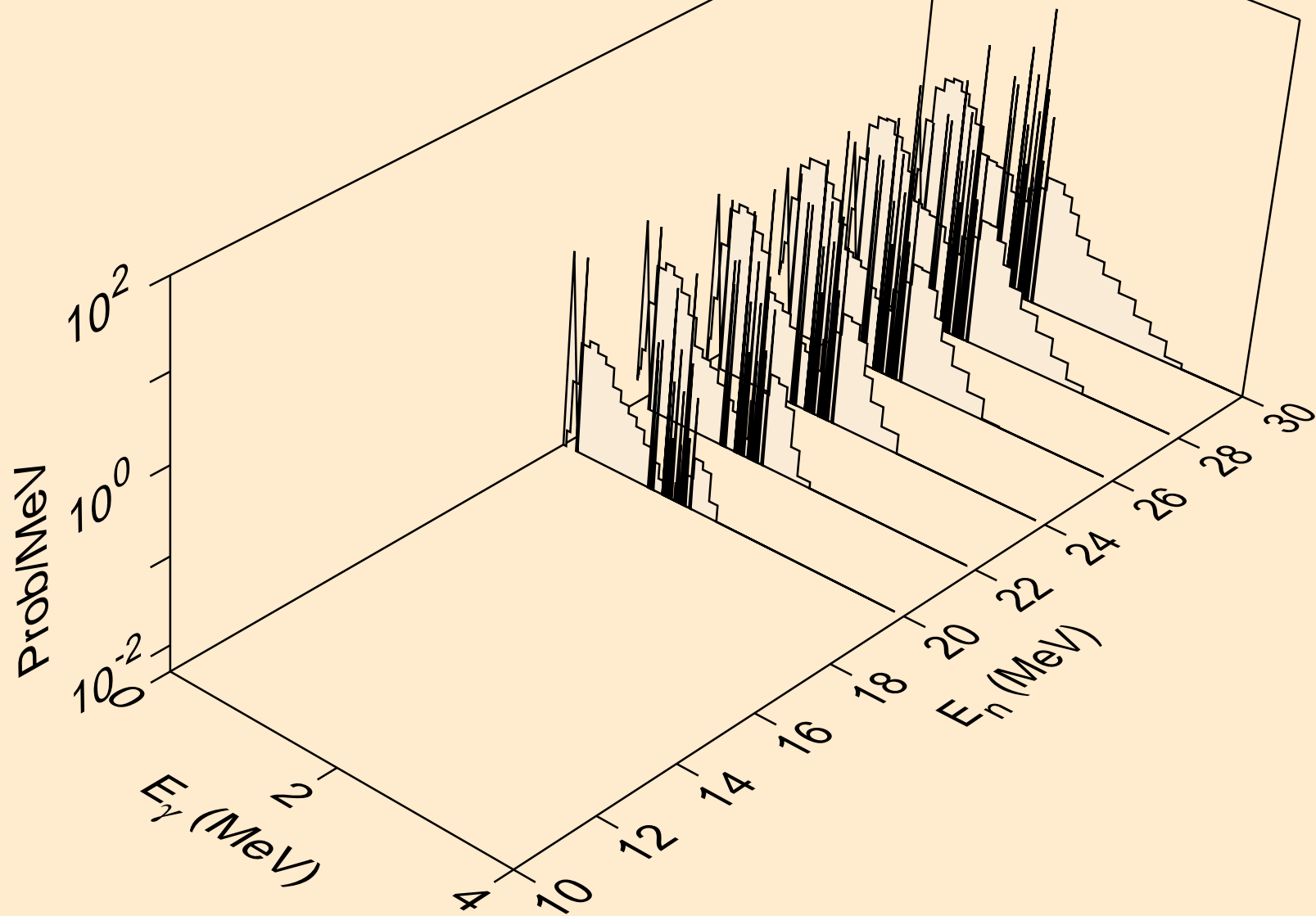

PR142M NEUTRON ACER TENDL-2023 LIBRARY; T=0.K  
Photon emission for (n,4n)

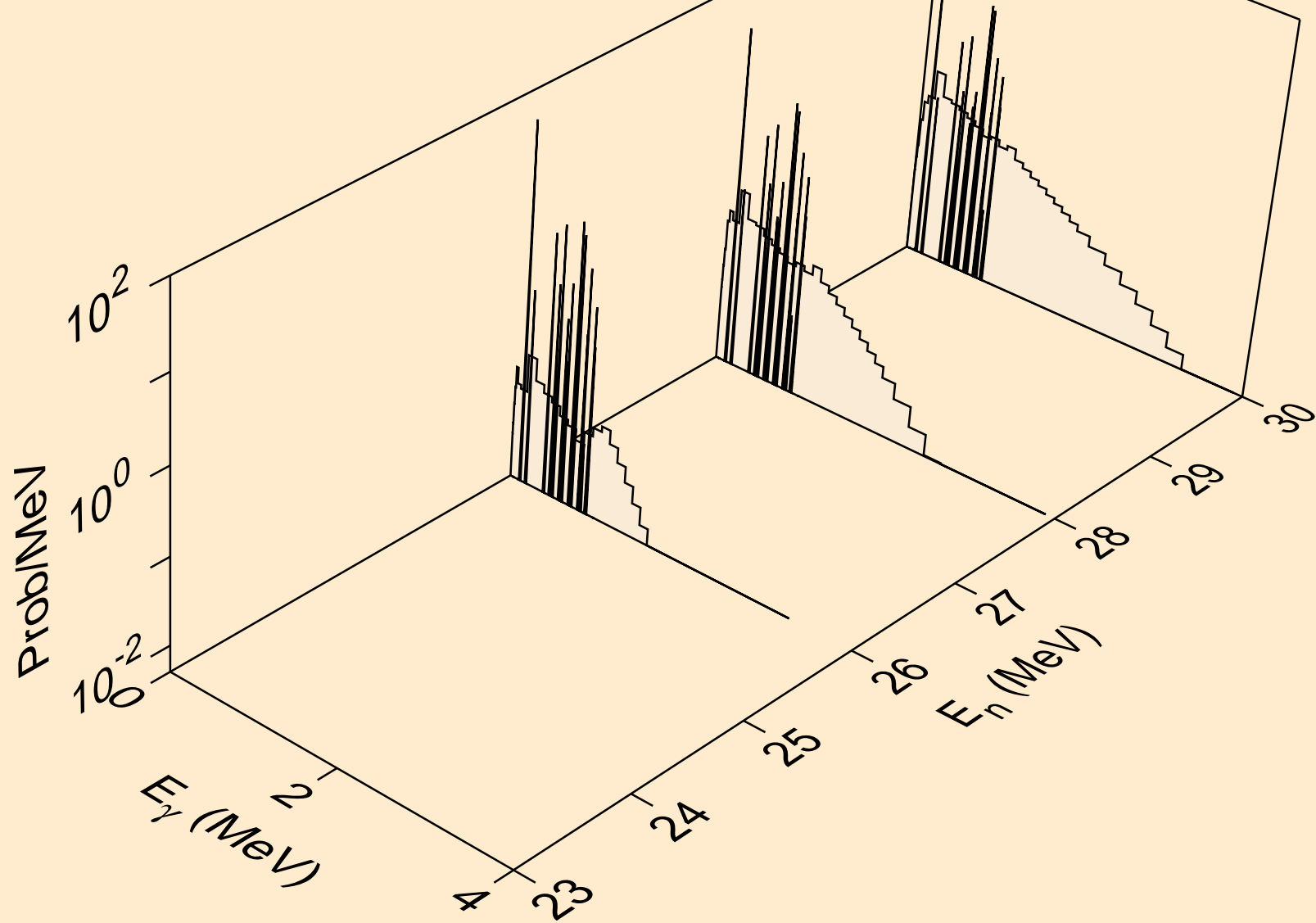

PR142M NEUTRON ACER TENDL-2023 LIBRARY; T=0.K  
Photon emission for (n,2np)

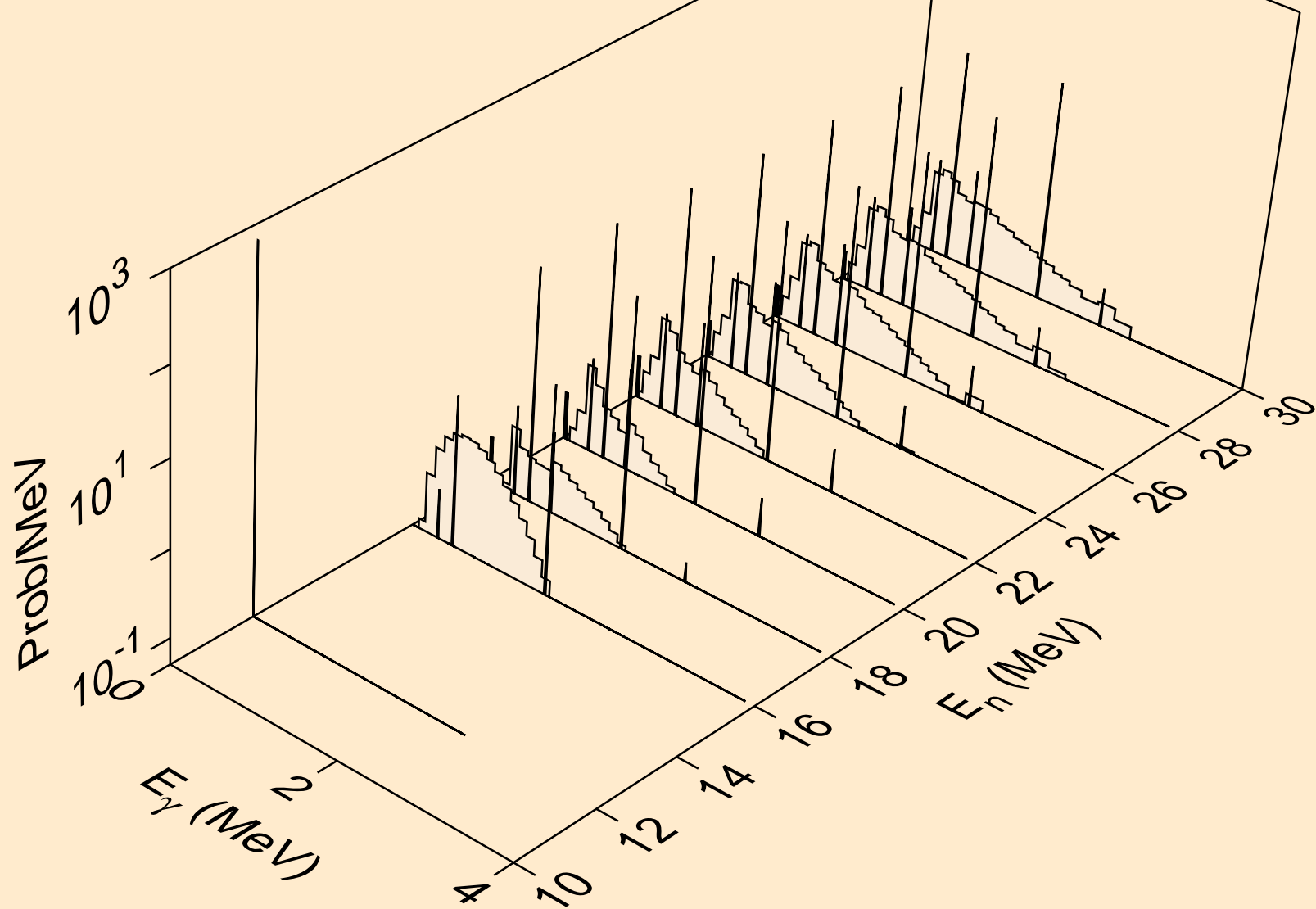

PR142M NEUTRON ACER TENDL-2023 LIBRARY; T=0.K  
Photon emission for (n,3np)

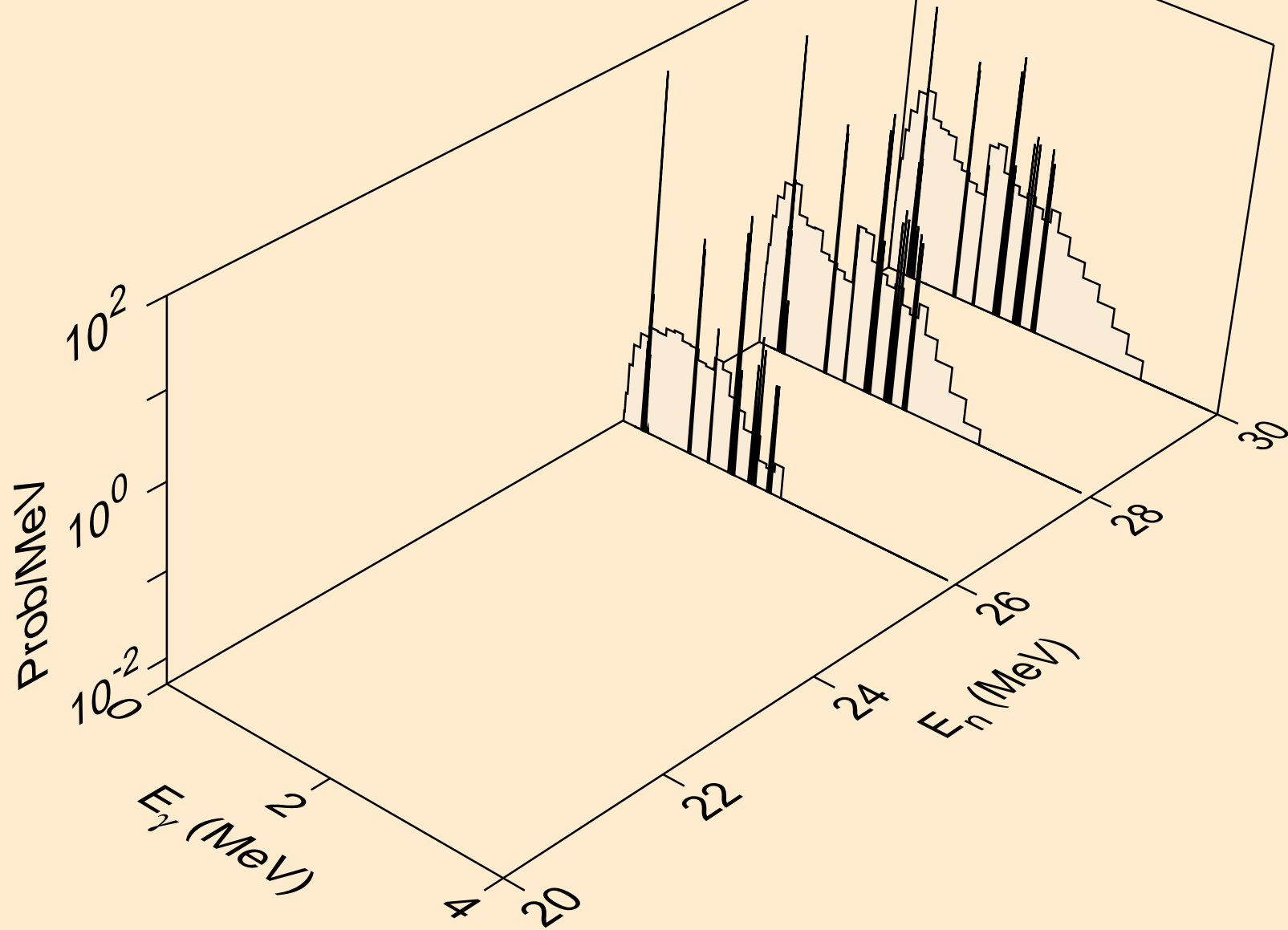



PR142M NEUTRON ACER TENDL-2023 LIBRARY; T=0.K  
Photon emission for (n,n2p)

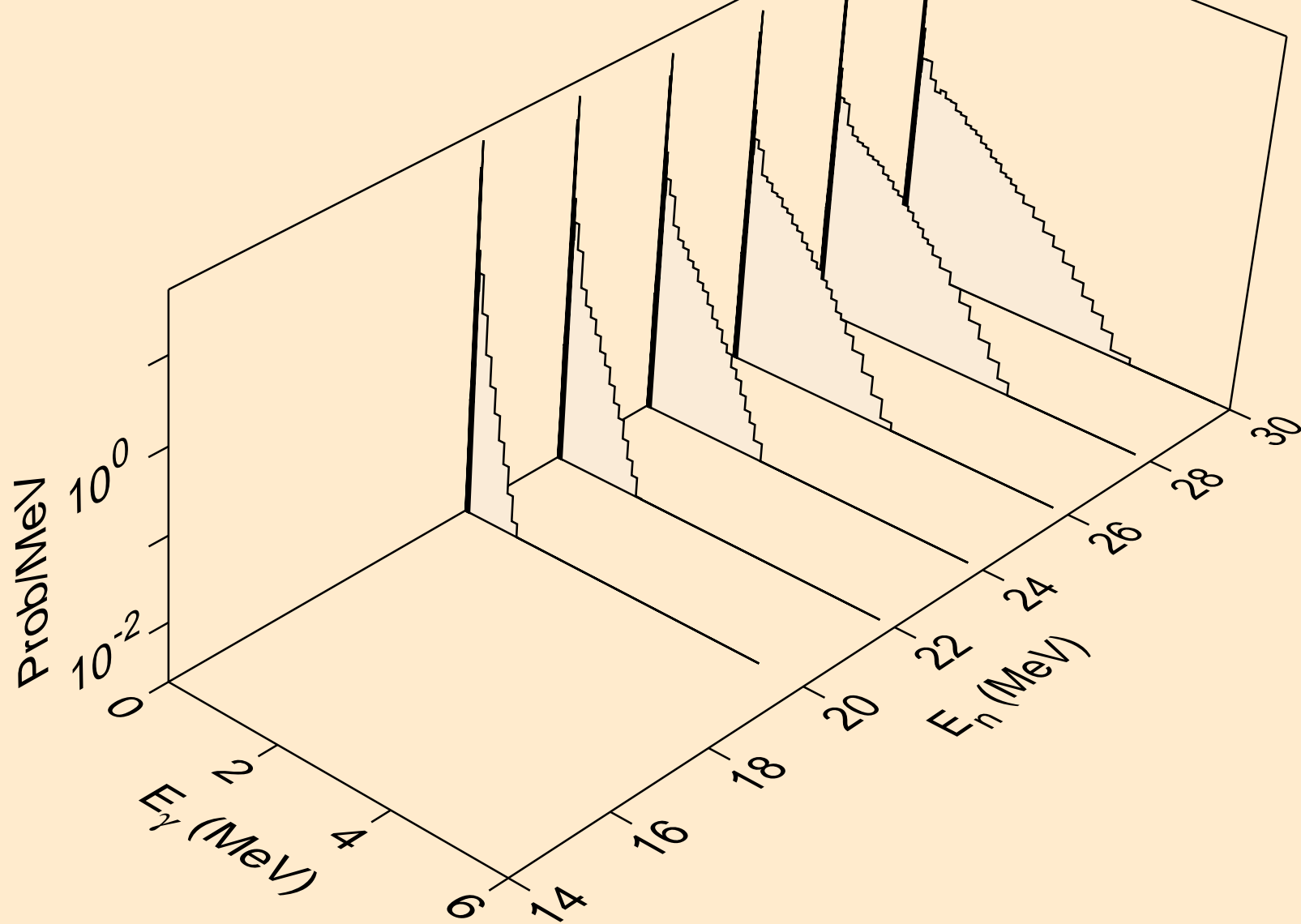

PR142M NEUTRON ACER TENDL-2023 LIBRARY; T=0.K  
Photon emission for (n,npa)

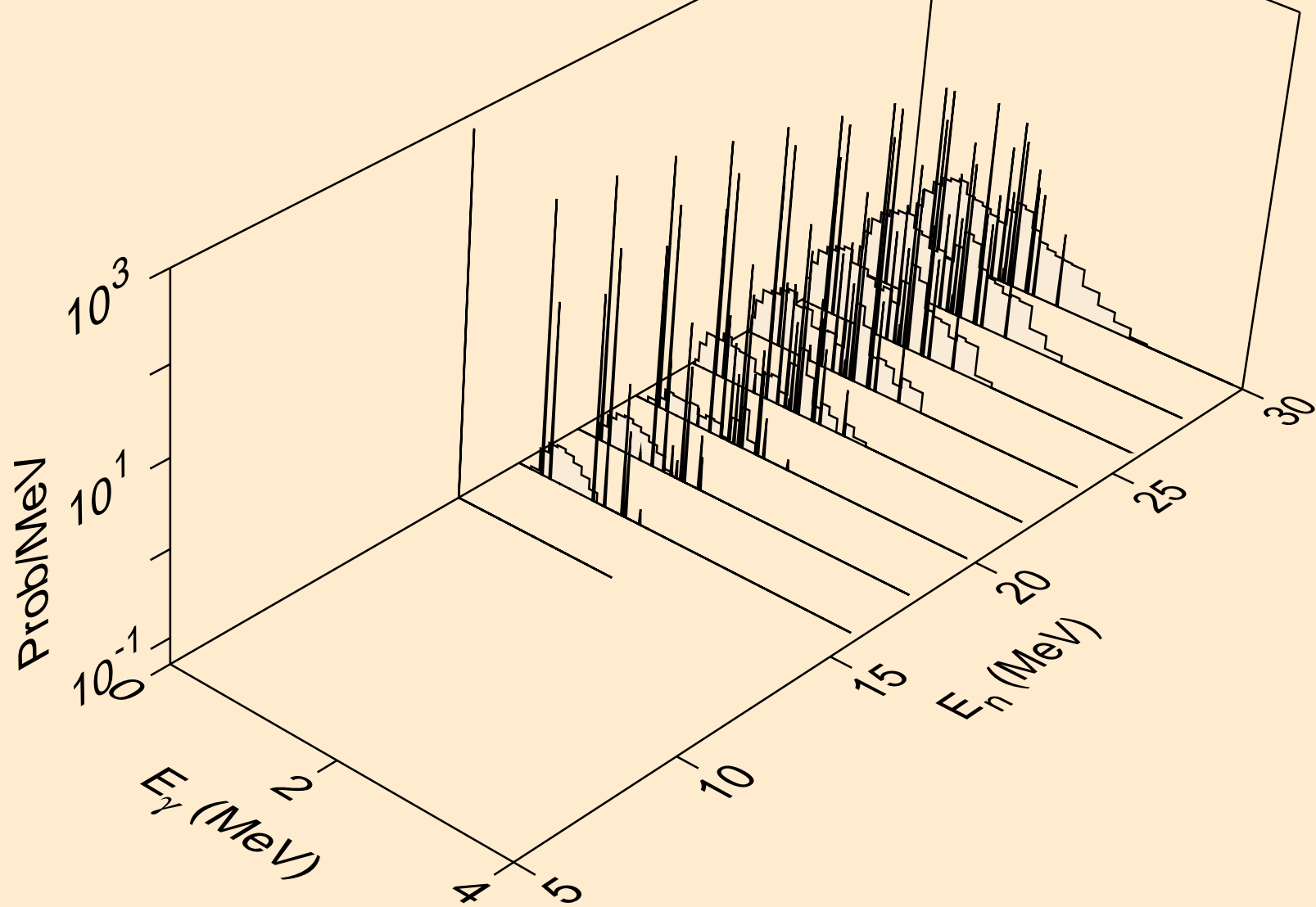

PR142M NEUTRON ACER TENDL-2023 LIBRARY; T=0.K  
Photon emission for (n,n\*2)

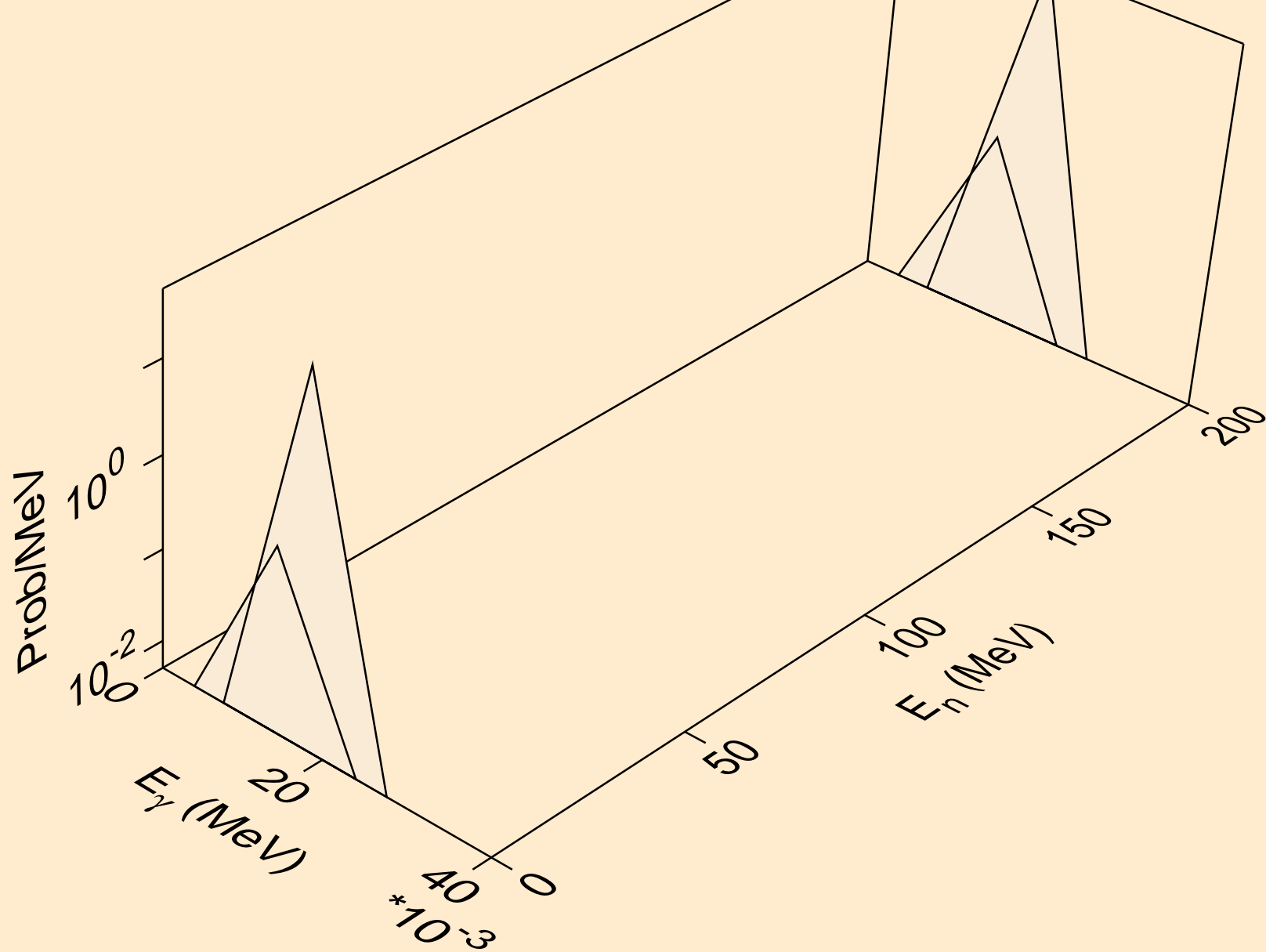

PR142M NEUTRON ACER TENDL-2023 LIBRARY; T=0.K  
Photon emission for (n,n\*3)

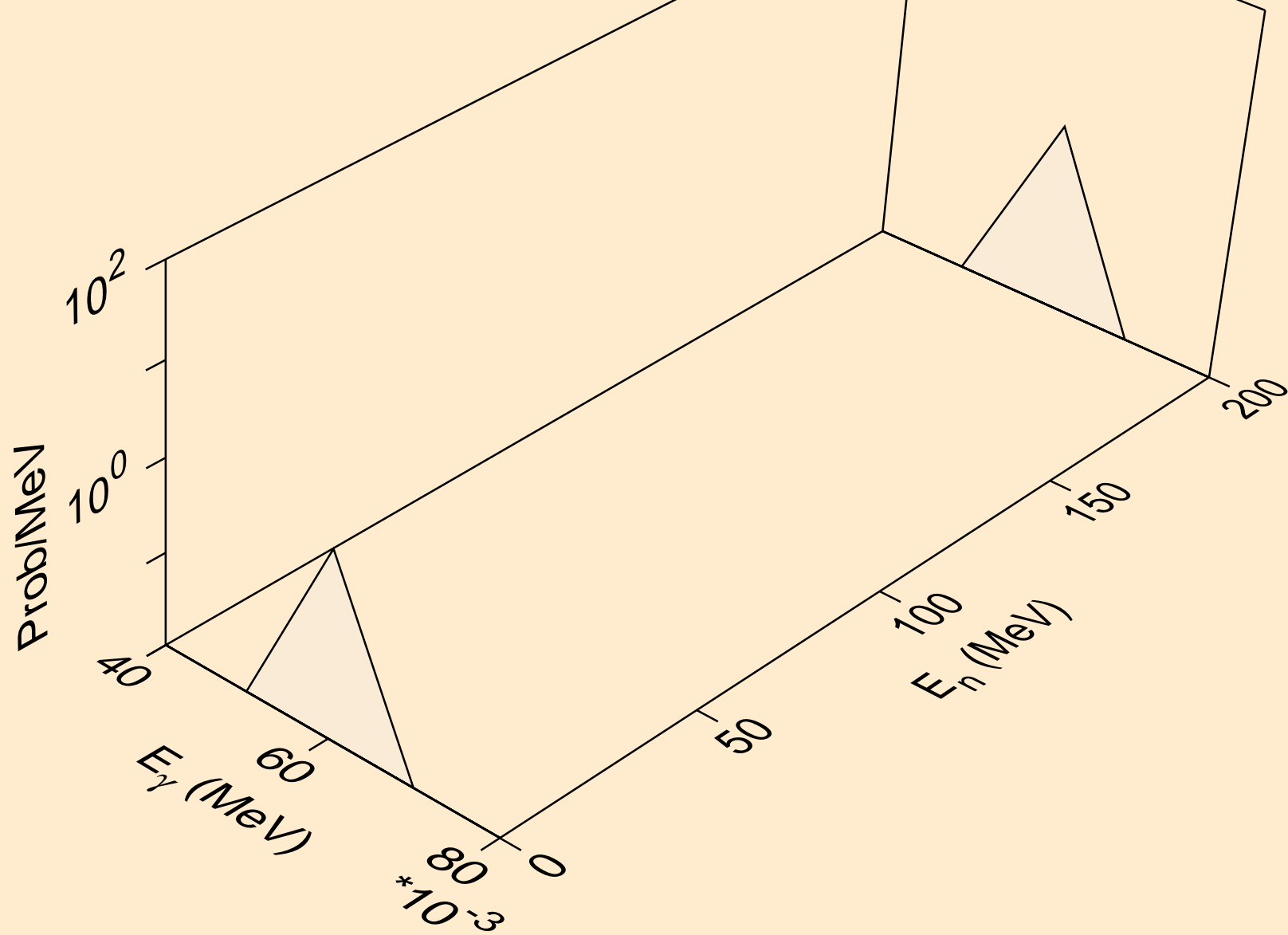

PR142M NEUTRON ACER TENDL-2023 LIBRARY; T=0.K  
Photon emission for (n,n\*4)

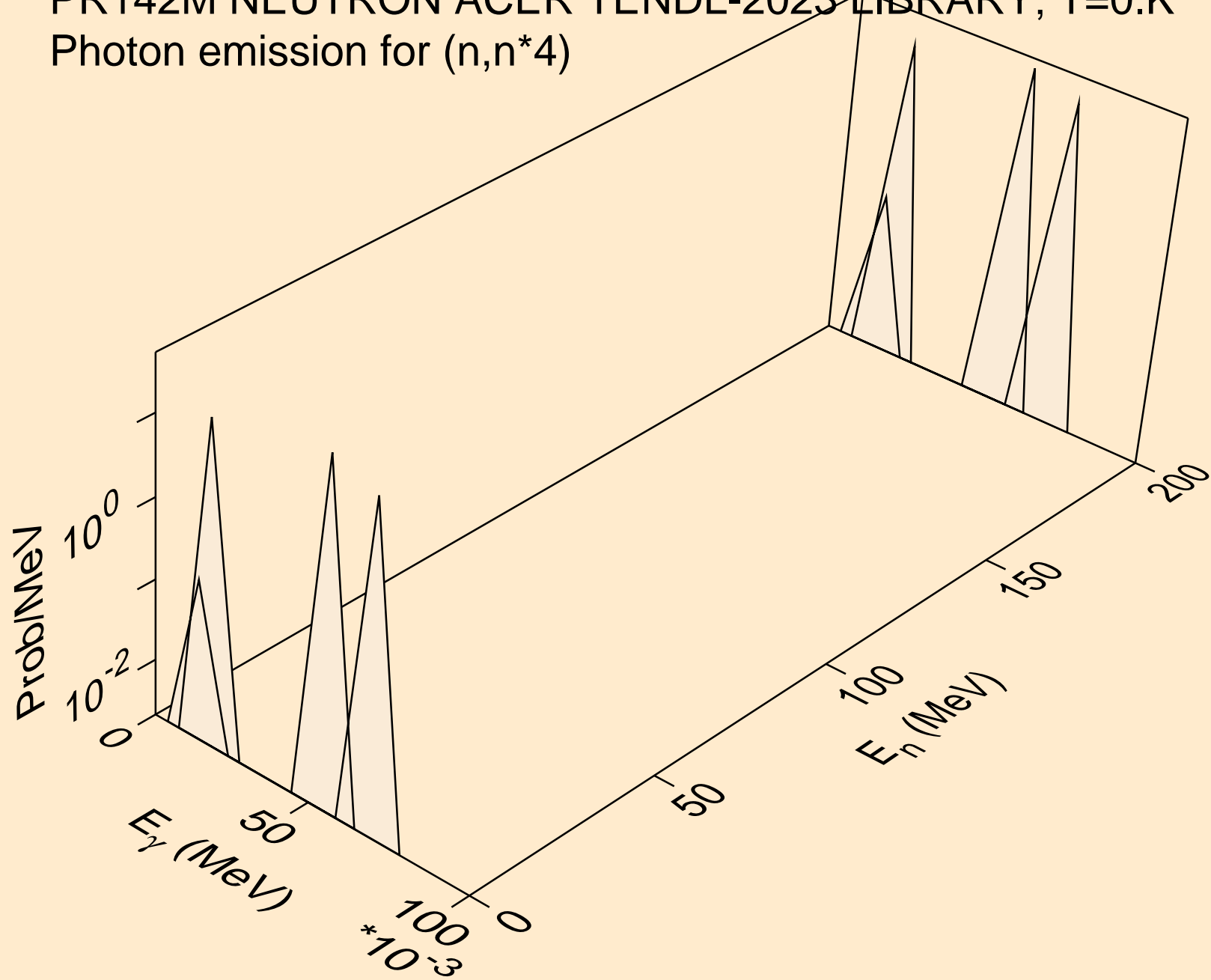

PR142M NEUTRON ACER TENDL-2023 LIBRARY; T=0.K  
Photon emission for (n,n\*5)

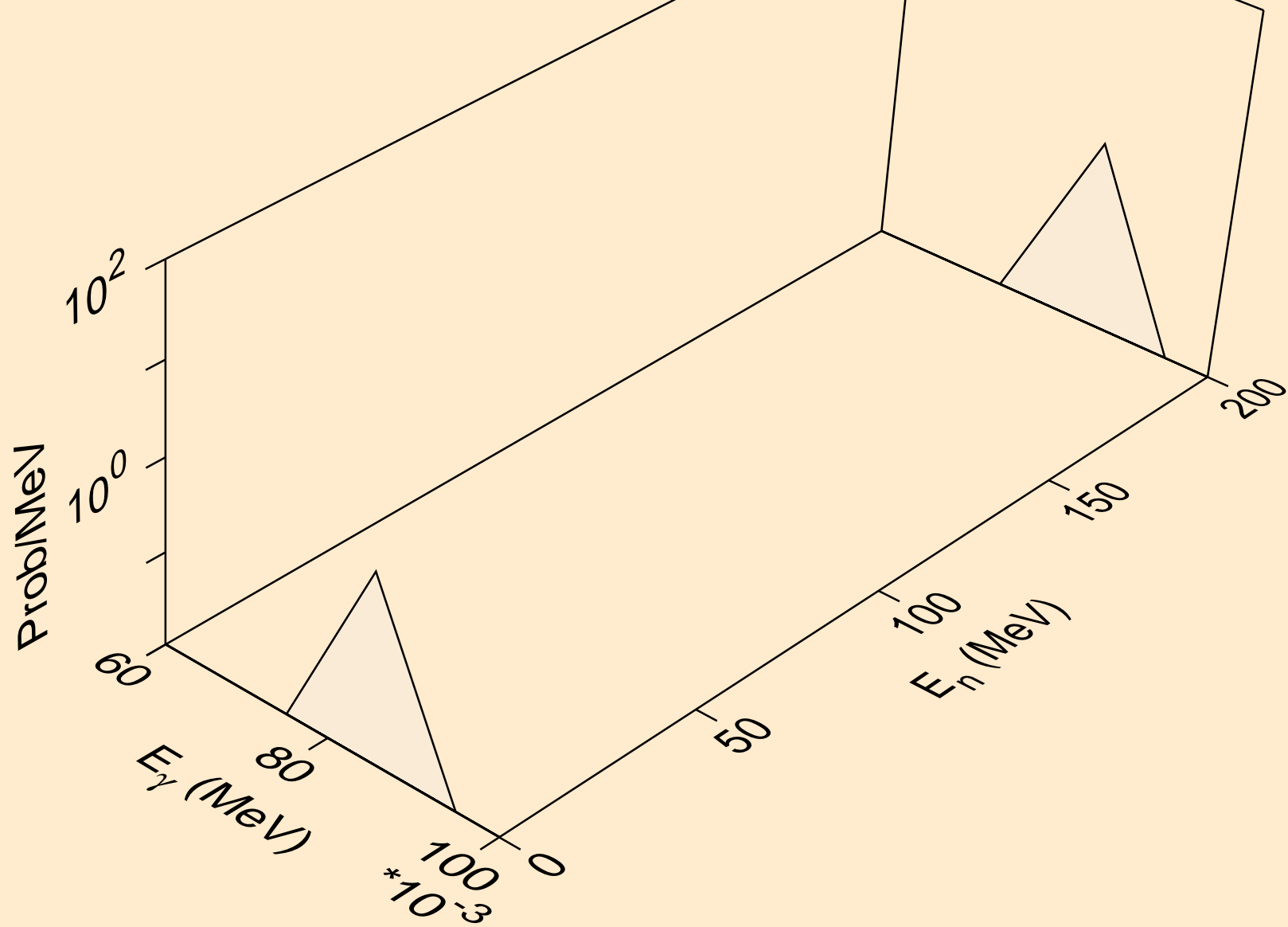

PR142M NEUTRON ACER TENDL-2023 LIBRARY; T=0.K  
Photon emission for (n,n\*6)

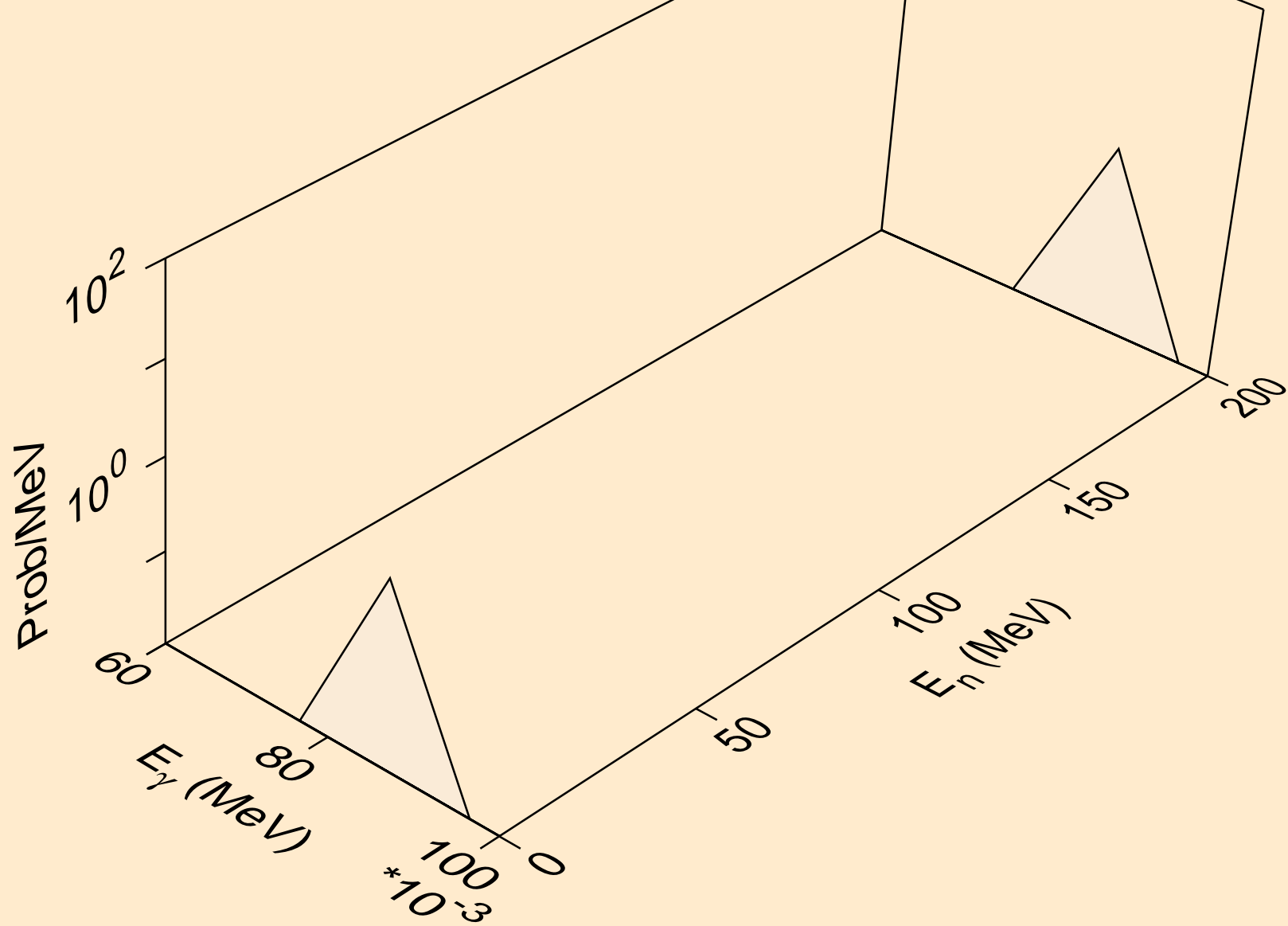

PR142M NEUTRON ACER TENDL-2023 LIBRARY; T=0.K  
Photon emission for (n,n\*7)

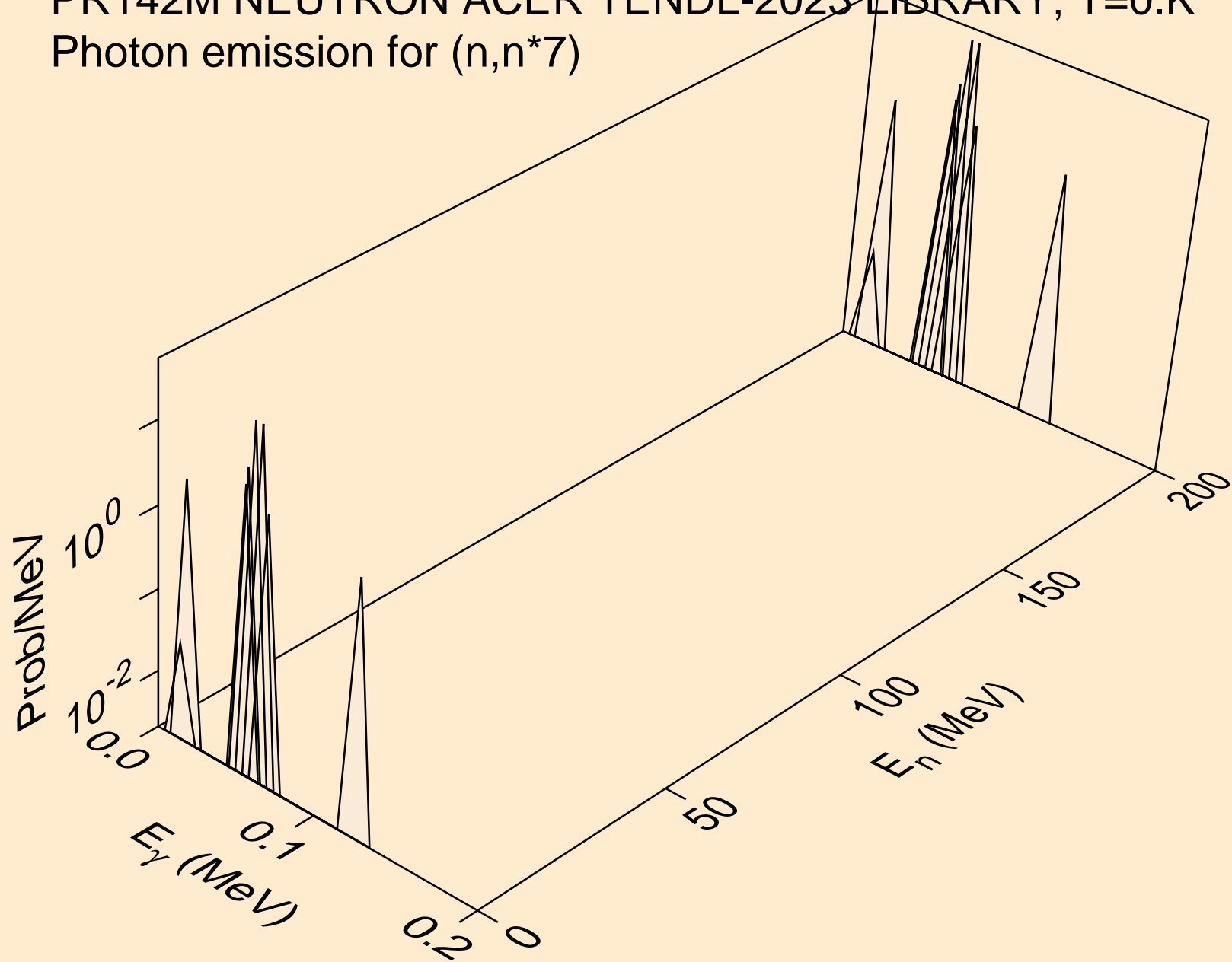



PR142M NEUTRON ACER TENDL-2023 LIBRARY; T=0.K  
Photon emission for (n,n\*8)

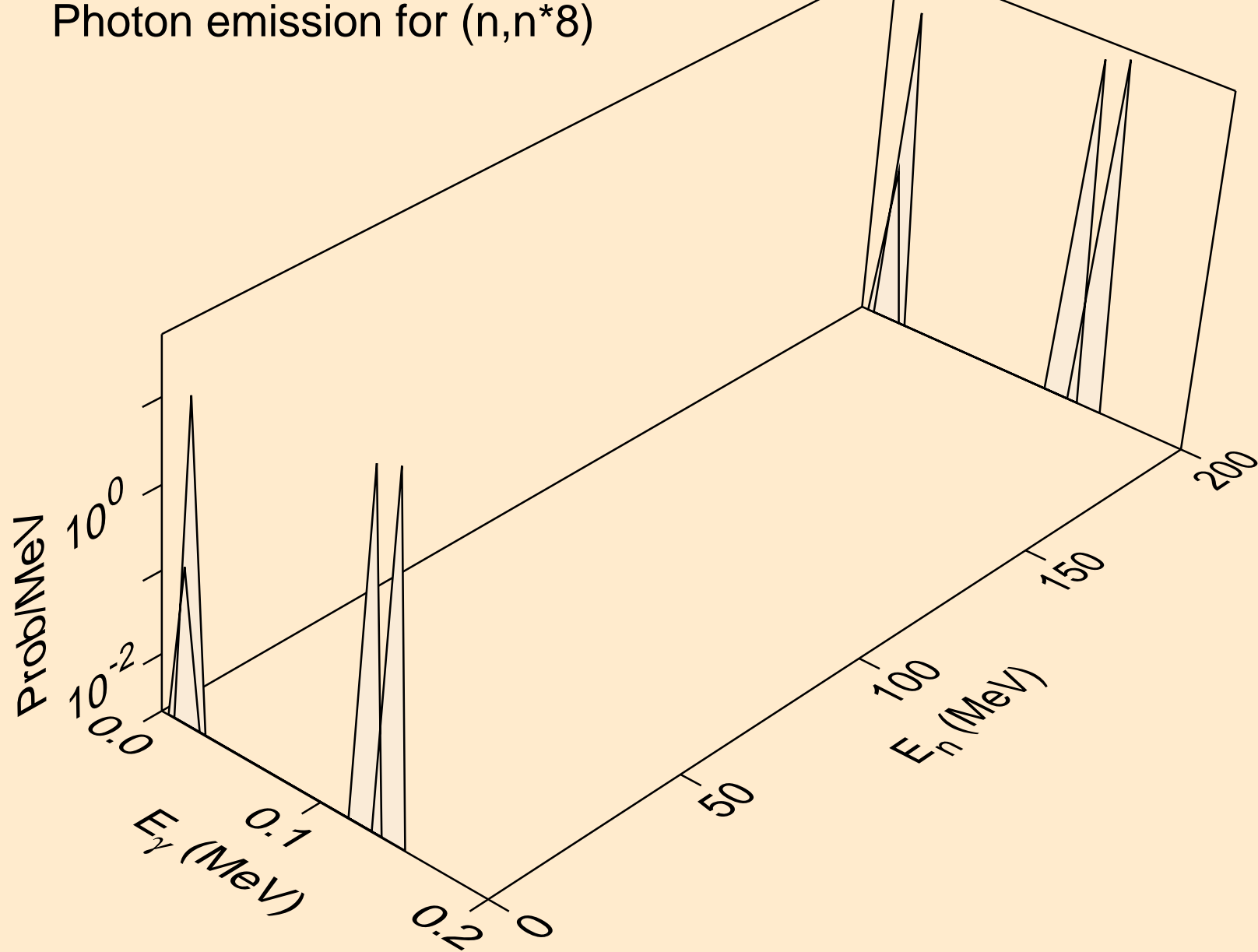

PR142M NEUTRON ACER TENDL-2023 LIBRARY; T=0.K  
Photon emission for (n,n\*9)

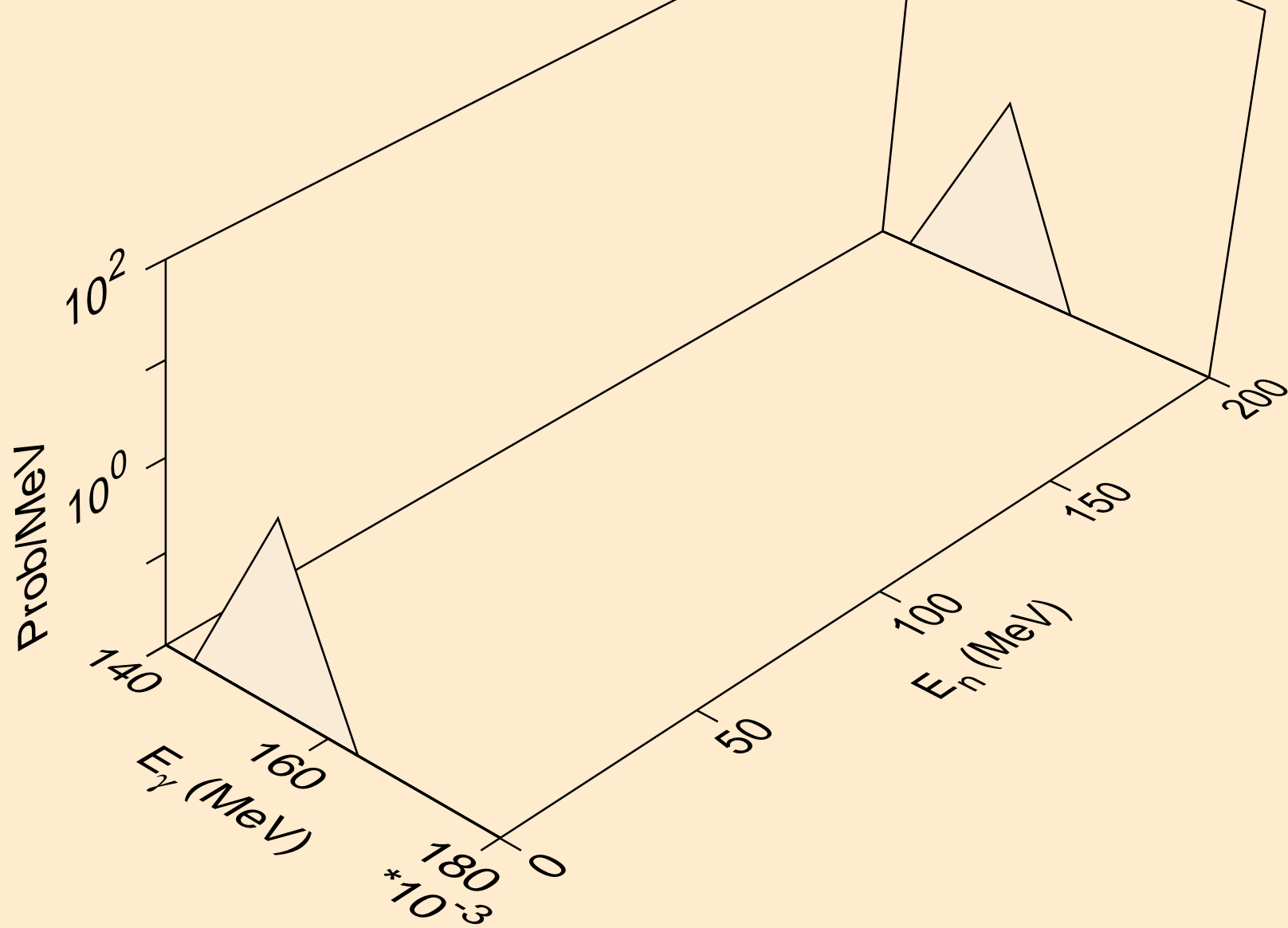

PR142M NEUTRON ACER TENDL-2023 LIBRARY; T=0.K  
Photon emission for (n,n\*10)

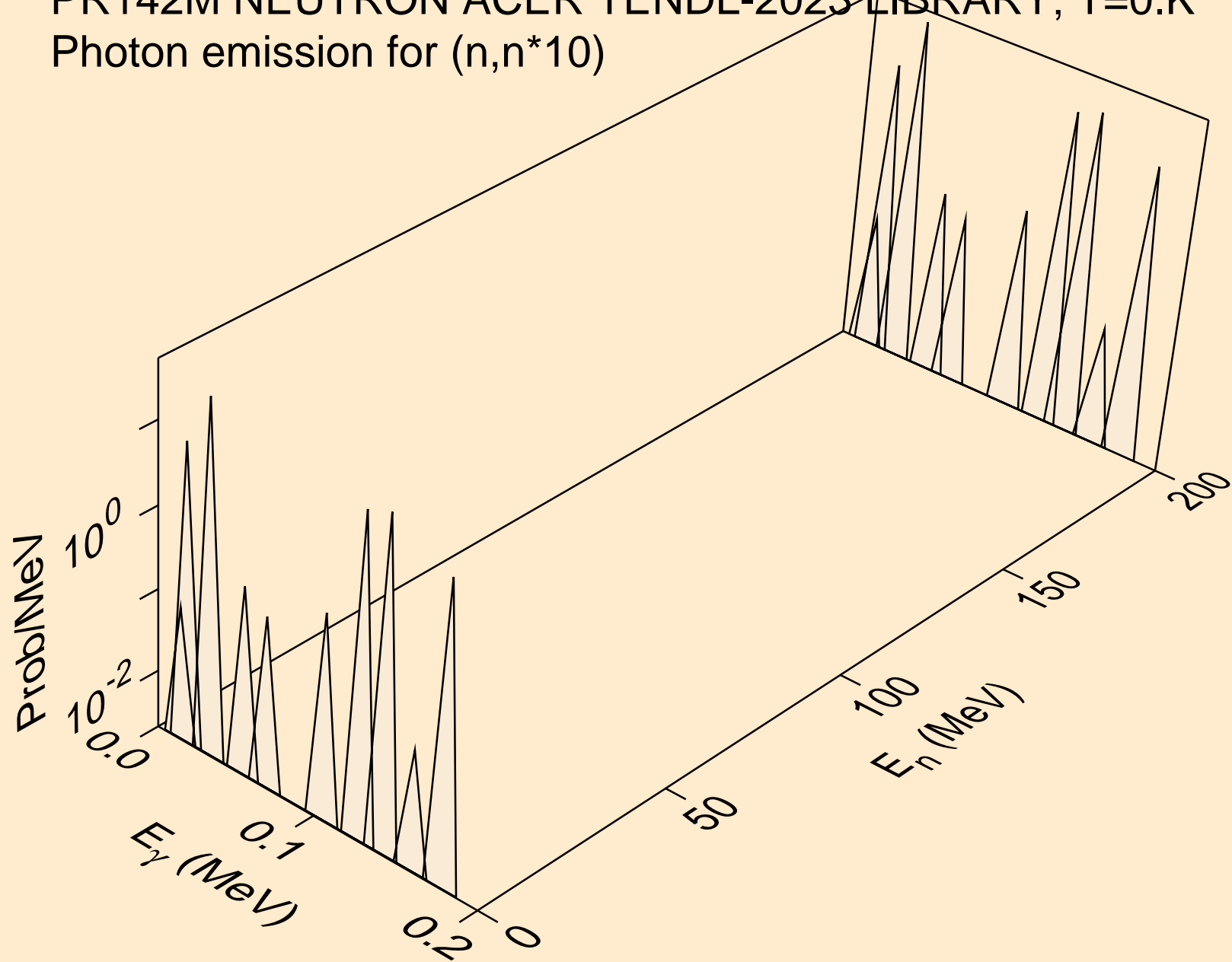

PR142M NEUTRON ACER TENDL-2023 LIBRARY; T=0.K  
Photon emission for (n,n\*11)

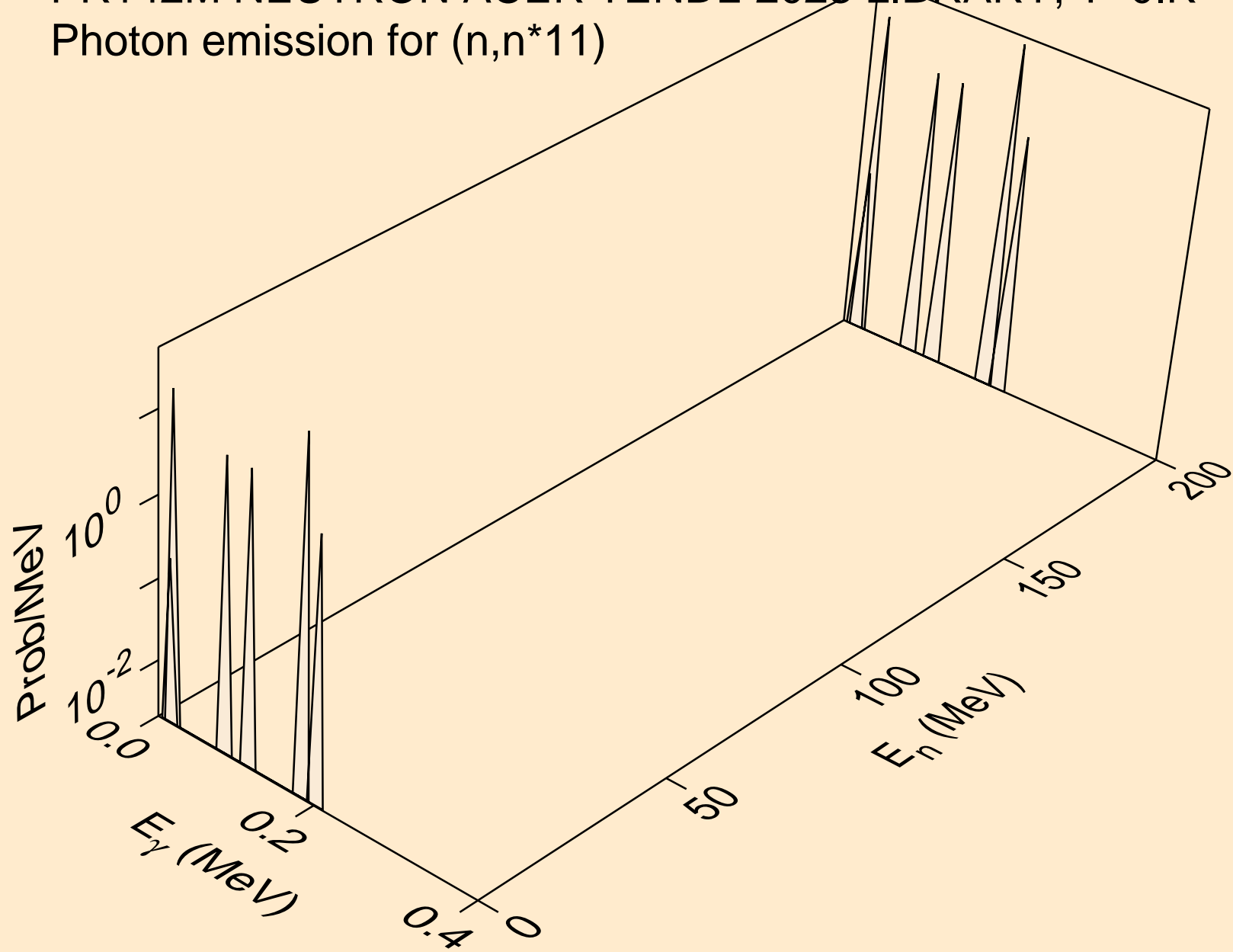

PR142M NEUTRON ACER TENDL-2023 LIBRARY; T=0.K  
Photon emission for (n,n\*12)

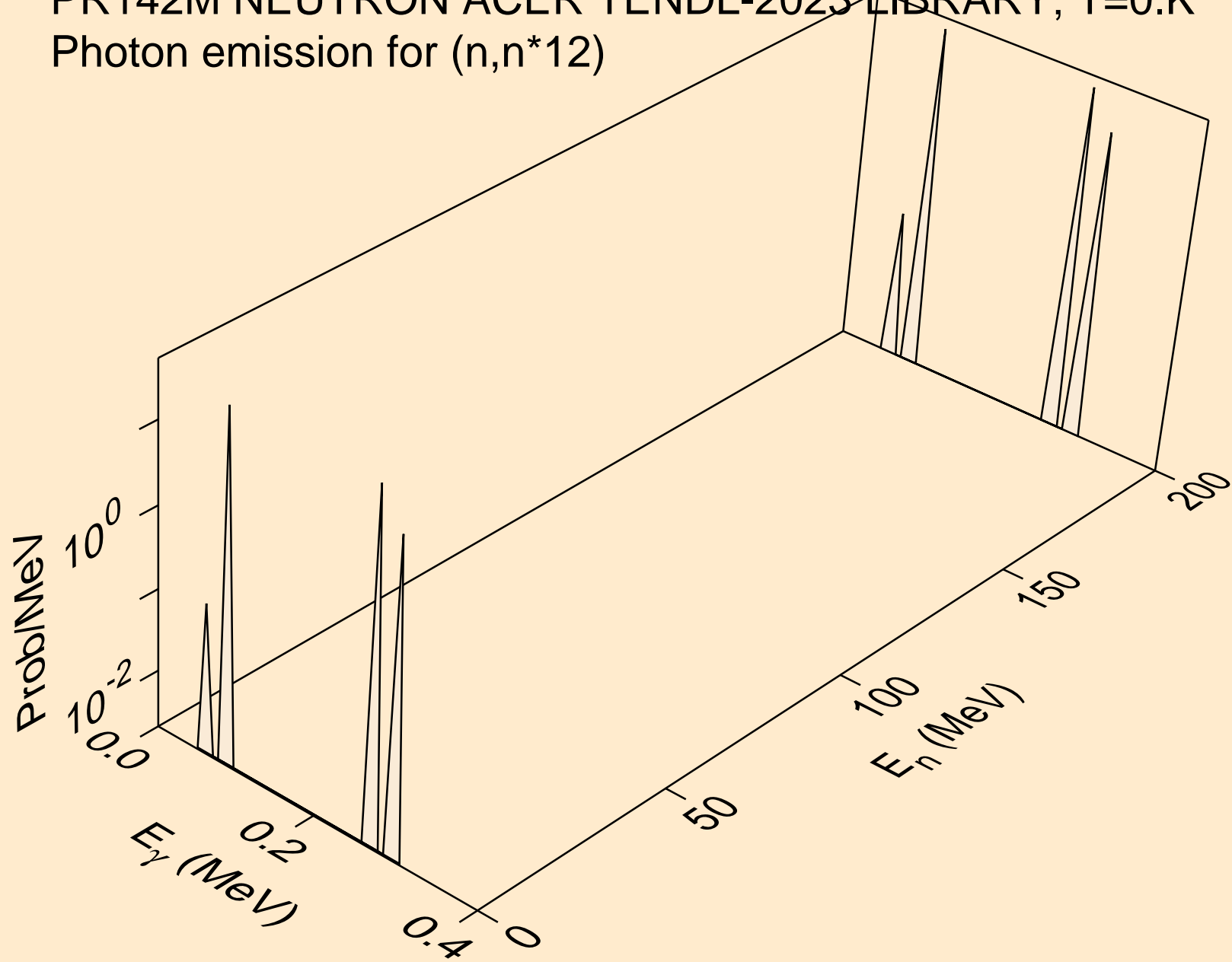

PR142M NEUTRON ACER TENDL-2023 LIBRARY; T=0.K  
Photon emission for (n,n\*13)

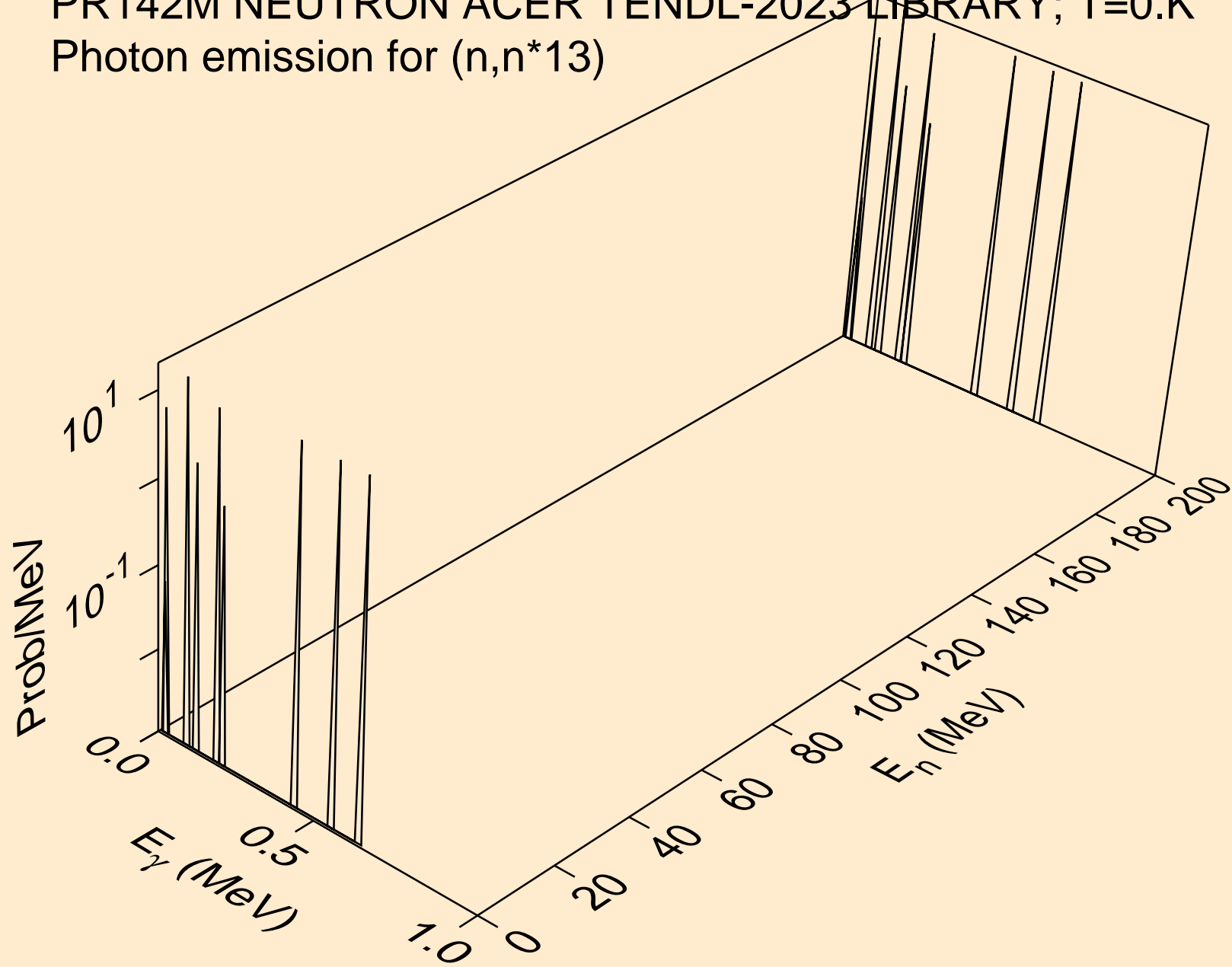

PR142M NEUTRON ACER TENDL-2023 LIBRARY; T=0.K  
Photon emission for (n,n\*14)

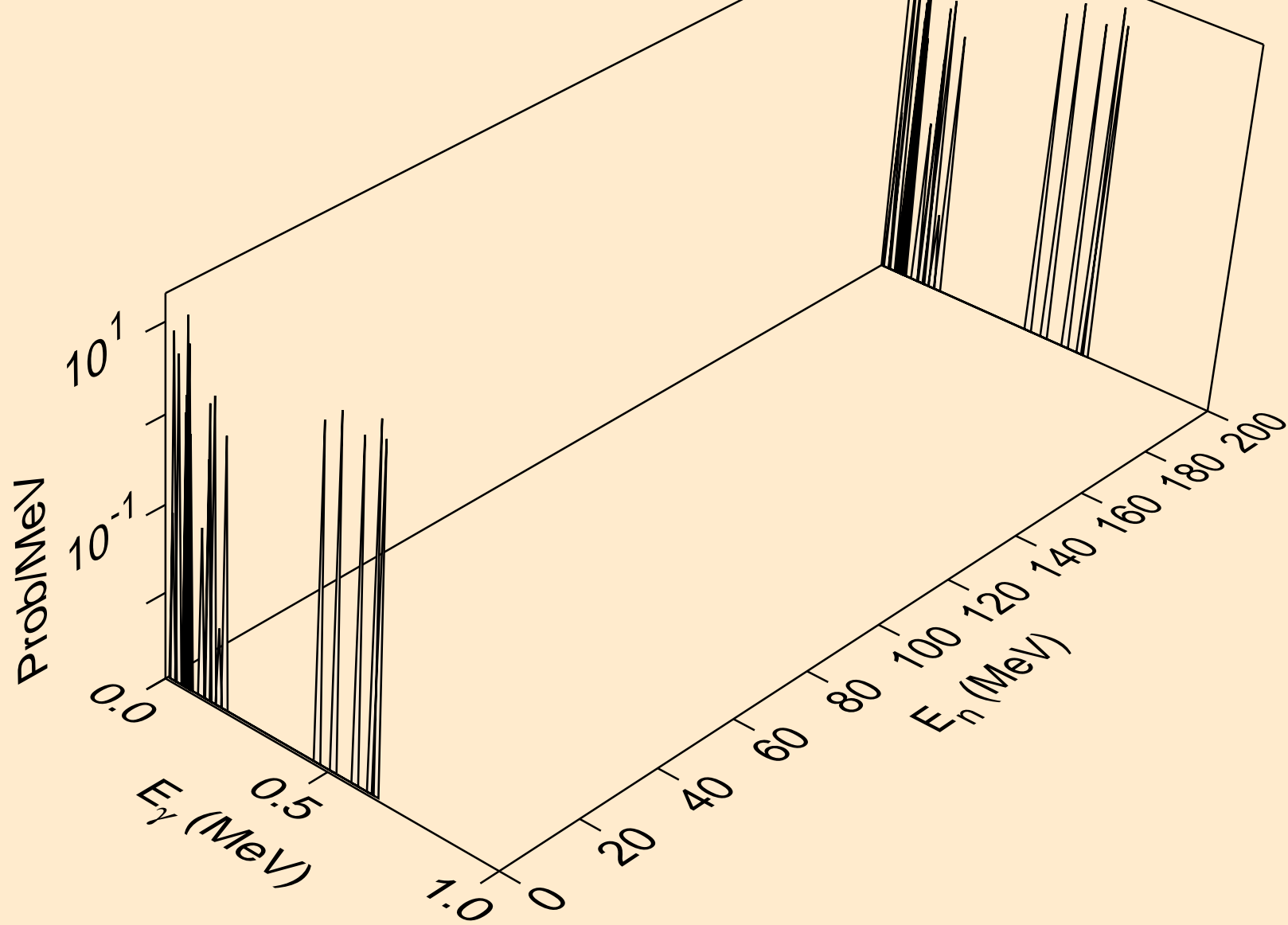

PR142M NEUTRON ACER TENDL-2023 LIBRARY; T=0.K  
Photon emission for (n,n\*15)

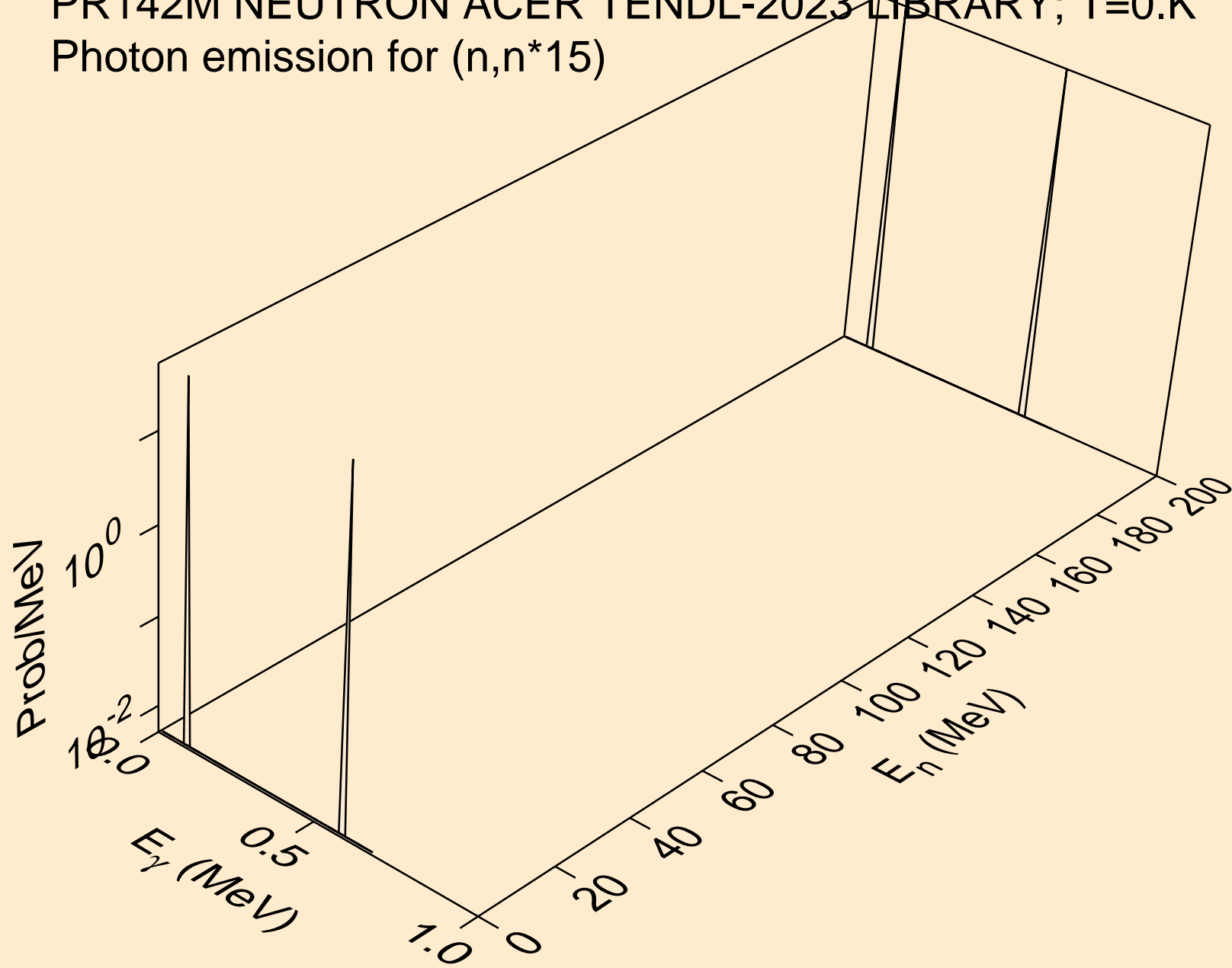



PR142M NEUTRON ACER TENDL-2023 LIBRARY; T=0.K  
Photon emission for (n,n\*16)

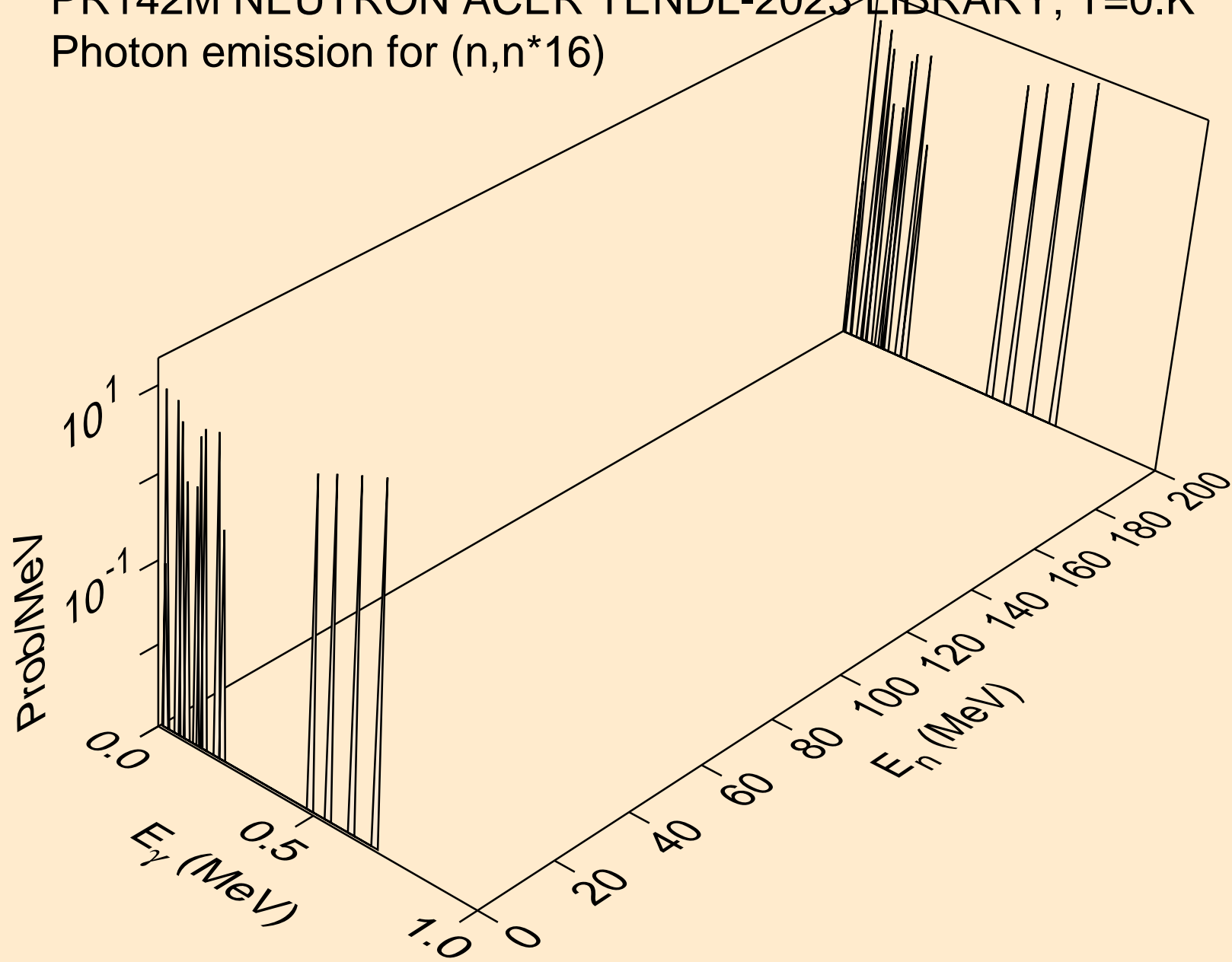

PR142M NEUTRON ACER TENDL-2023 LIBRARY; T=0.K  
Photon emission for (n,n\*17)

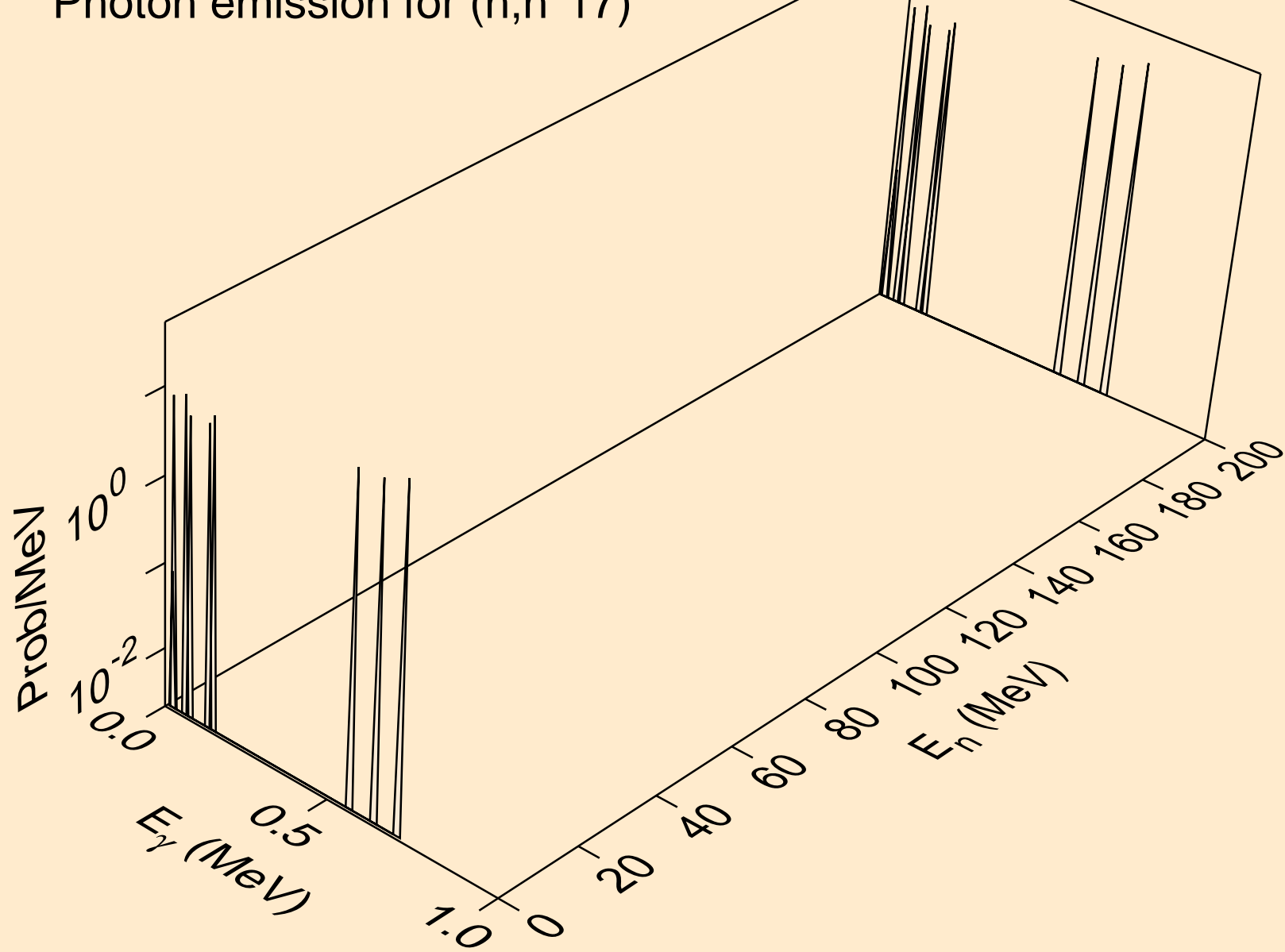

PR142M NEUTRON ACER TENDL-2023 LIBRARY; T=0.K  
Photon emission for (n,n\*18)

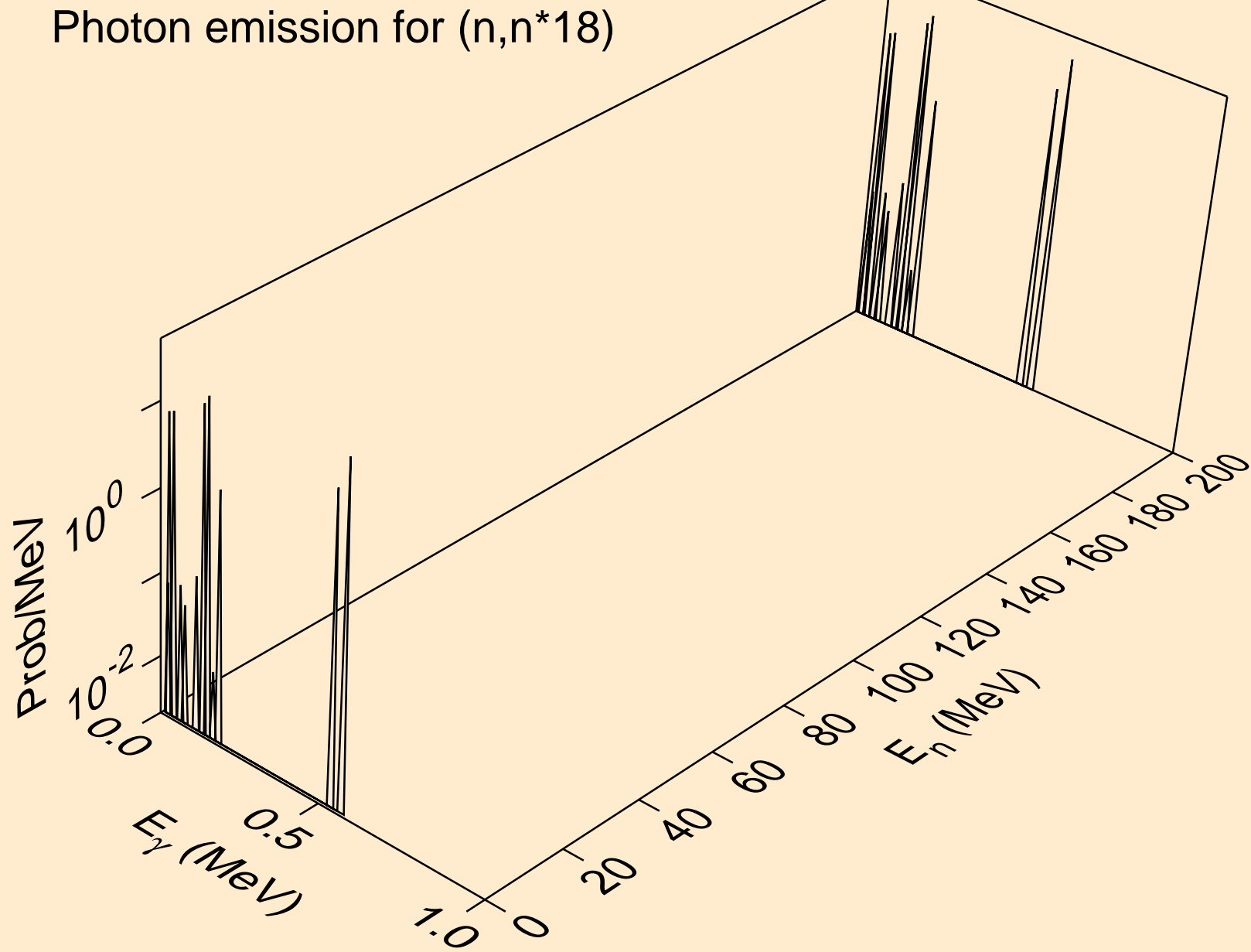

PR142M NEUTRON ACER TENDL-2023 LIBRARY; T=0.K  
Photon emission for (n,n\*19)

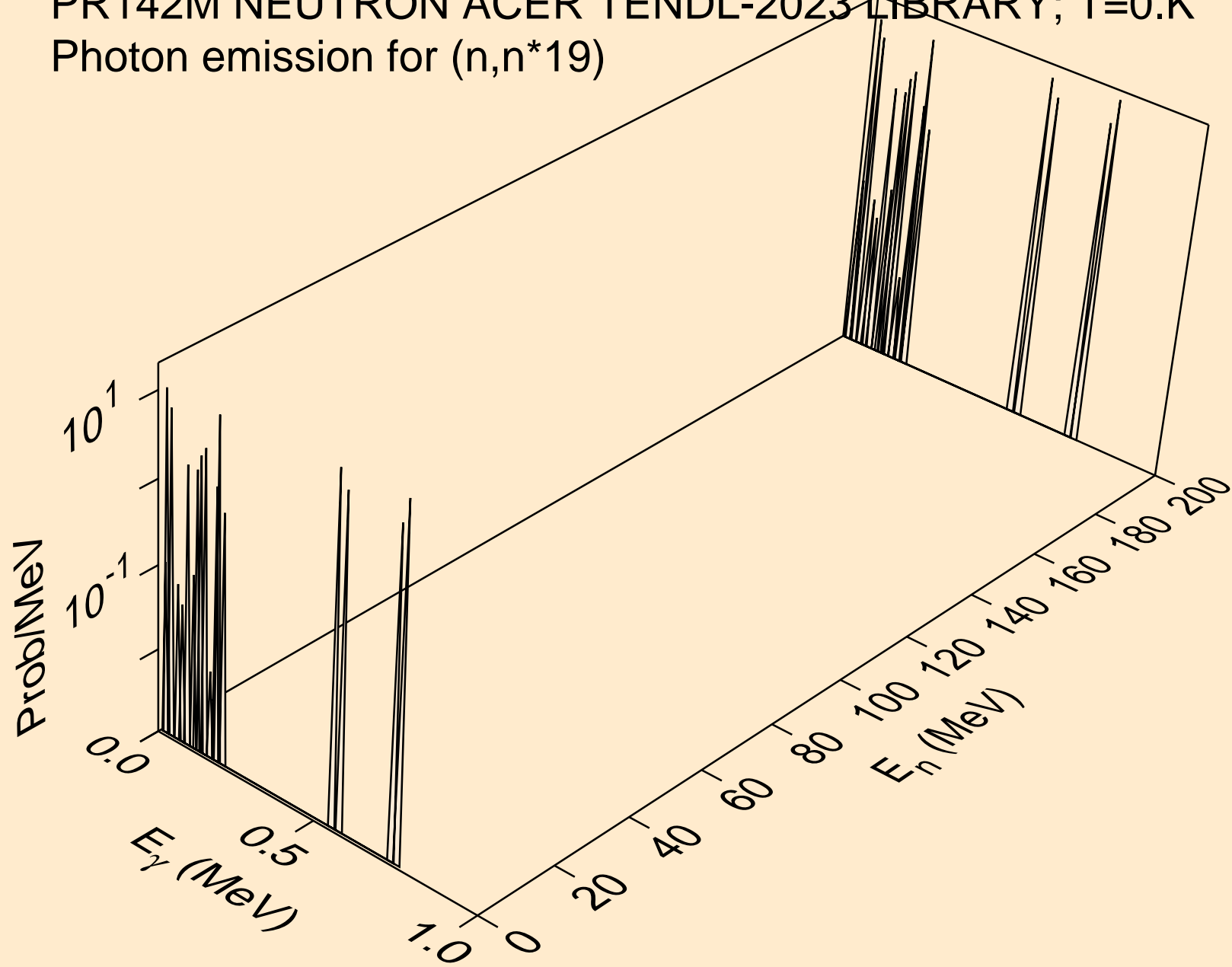

PR142M NEUTRON ACER TENDL-2023 LIBRARY; T=0.K  
Photon emission for (n,n\*20)

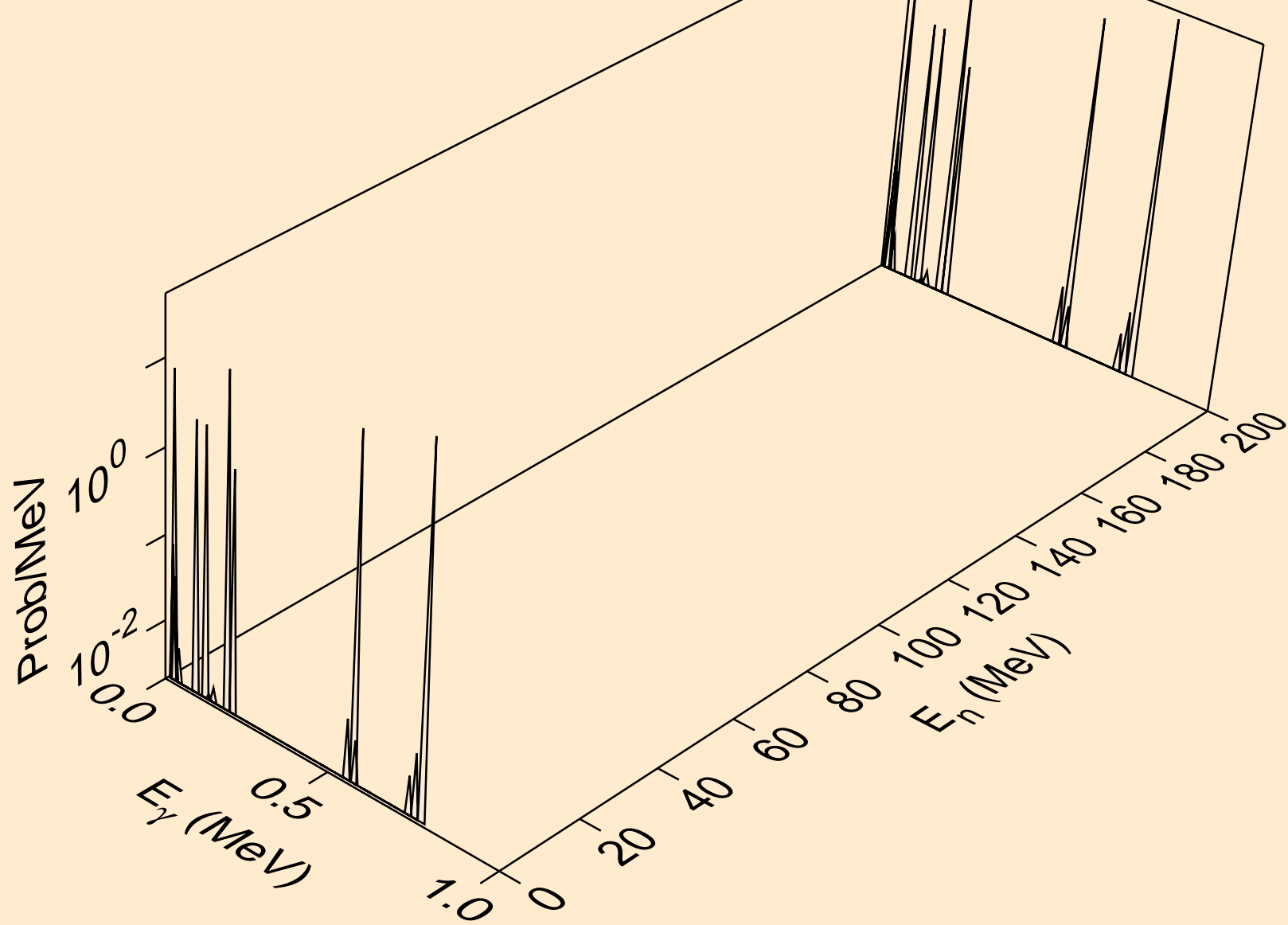

PR142M NEUTRON ACER TENDL-2023 LIBRARY; T=0.K  
Photon emission for (n,n\*21)

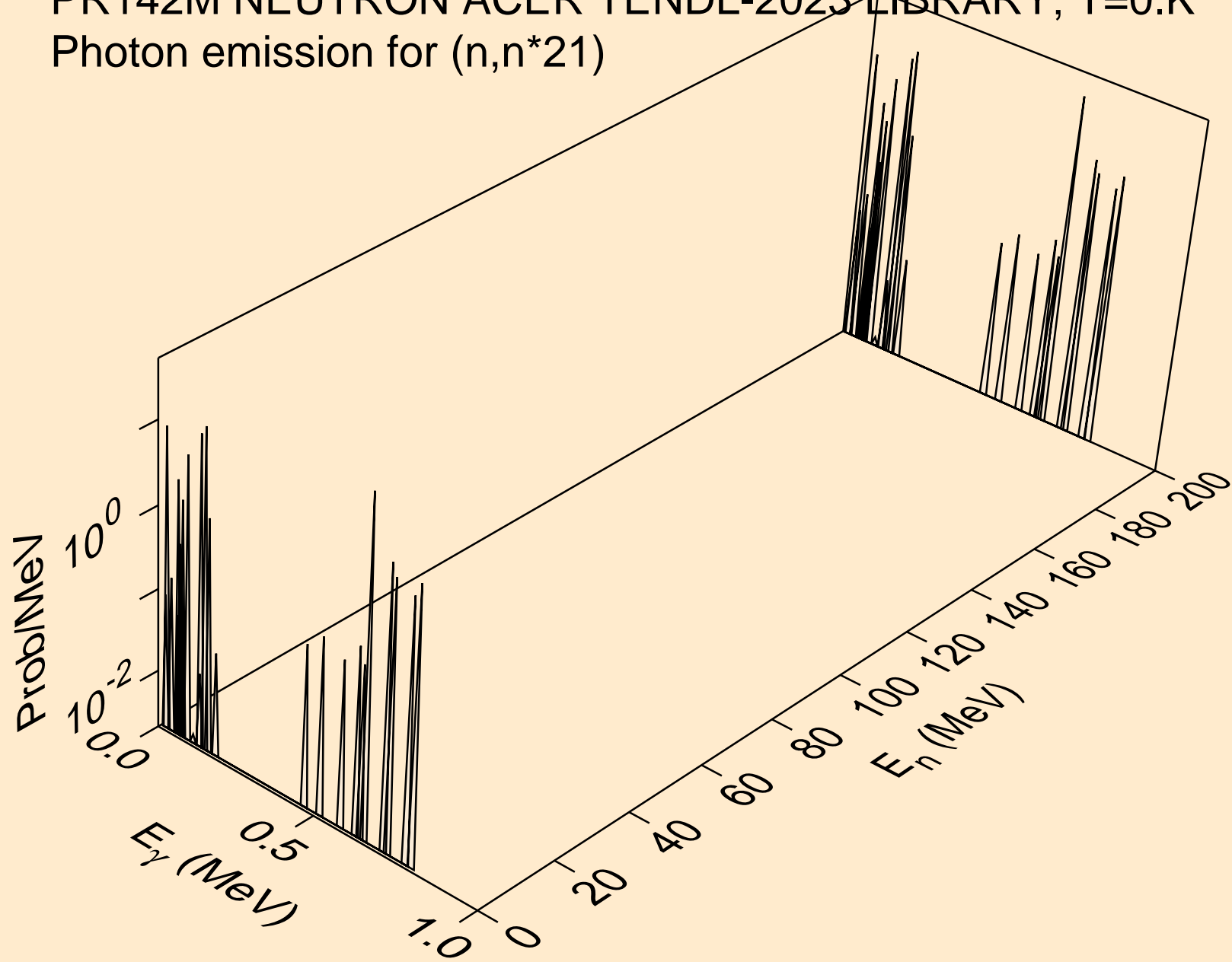

PR142M NEUTRON ACER TENDL-2023 LIBRARY; T=0.K  
Photon emission for (n,n\*22)

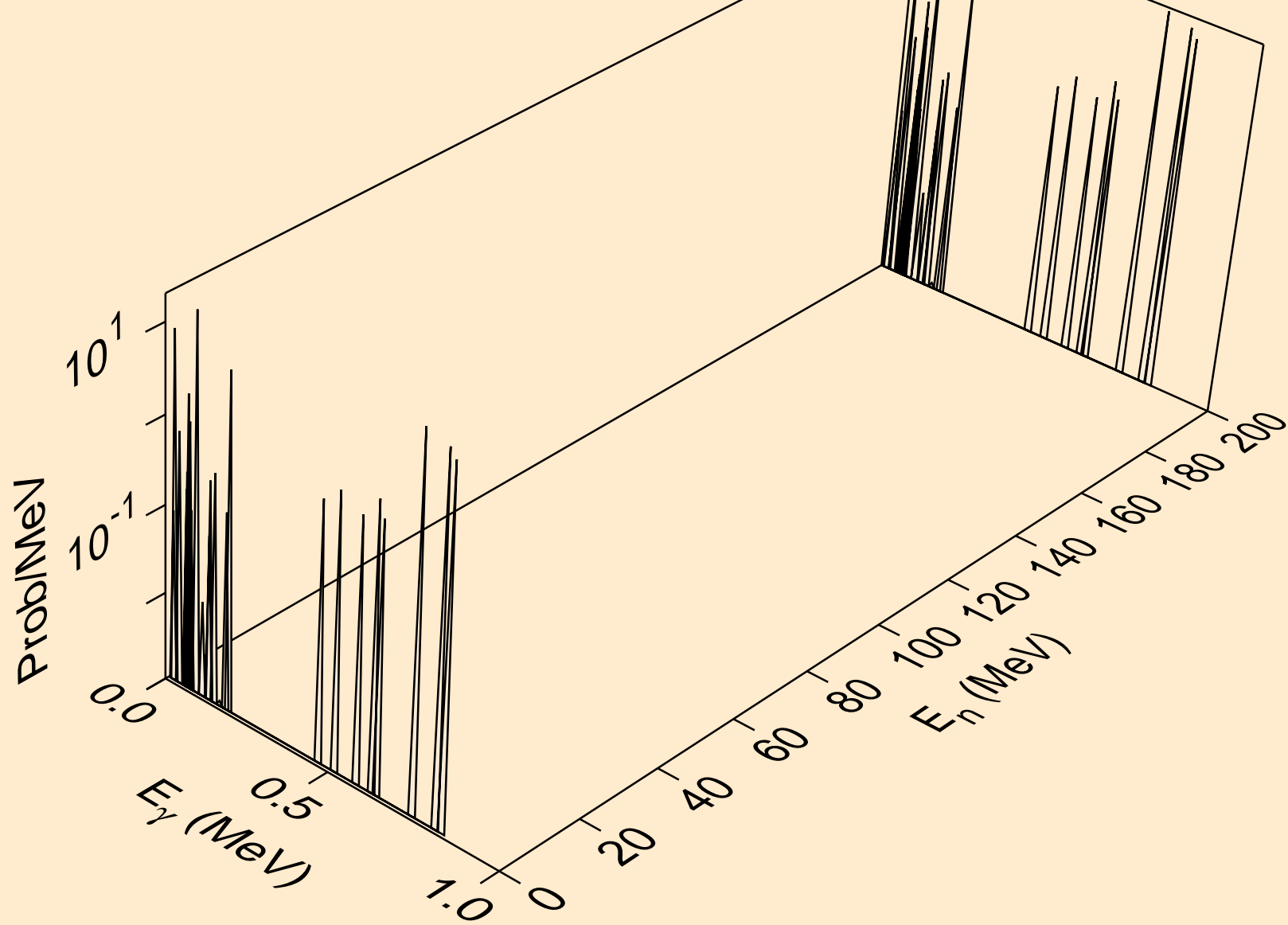

PR142M NEUTRON ACER TENDL-2023 LIBRARY; T=0.K  
Photon emission for (n,n\*23)

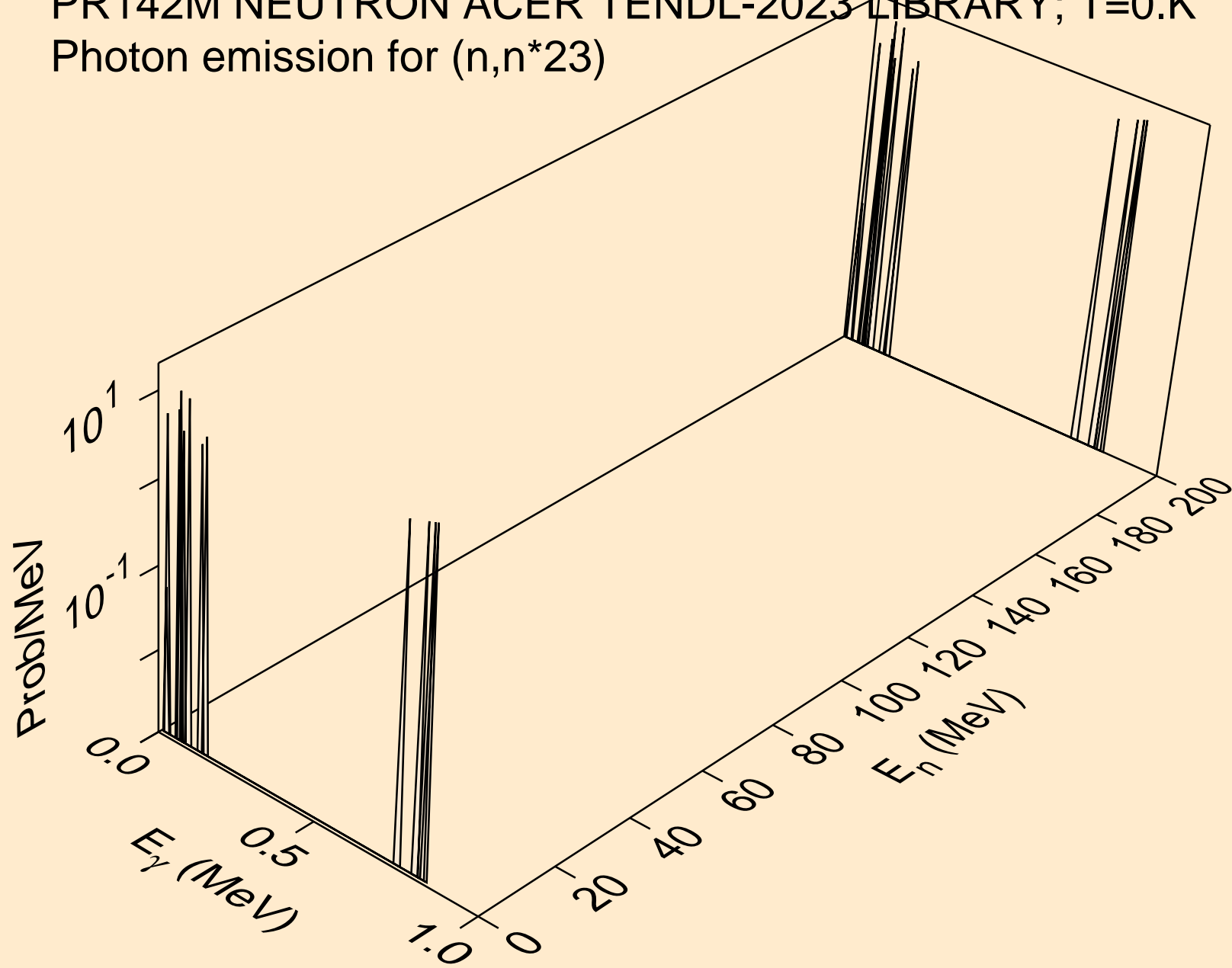



PR142M NEUTRON ACER TENDL-2023 LIBRARY; T=0.K  
Photon emission for (n,n\*24)

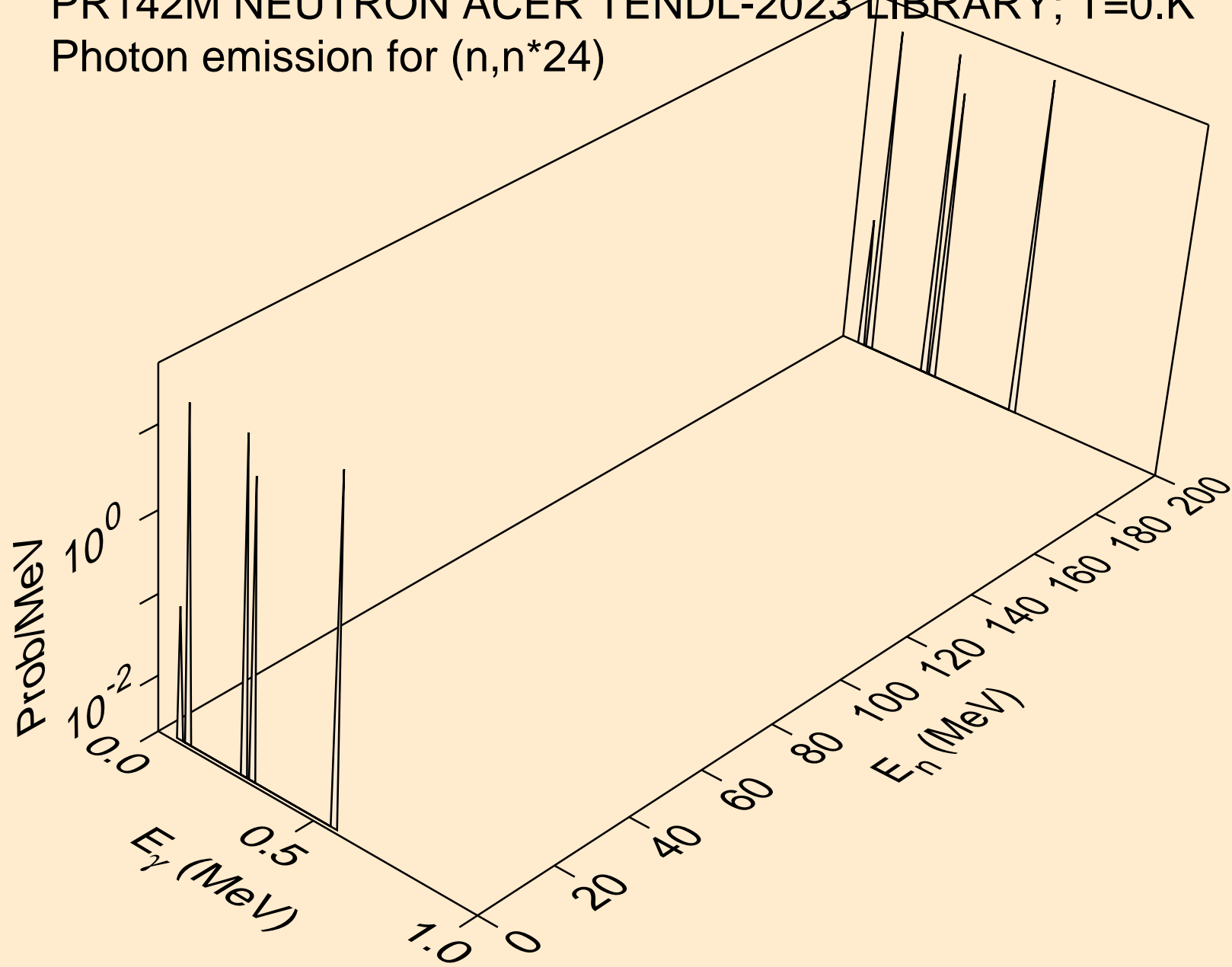

PR142M NEUTRON ACER TENDL-2023 LIBRARY; T=0.K  
Photon emission for (n,n\*c)

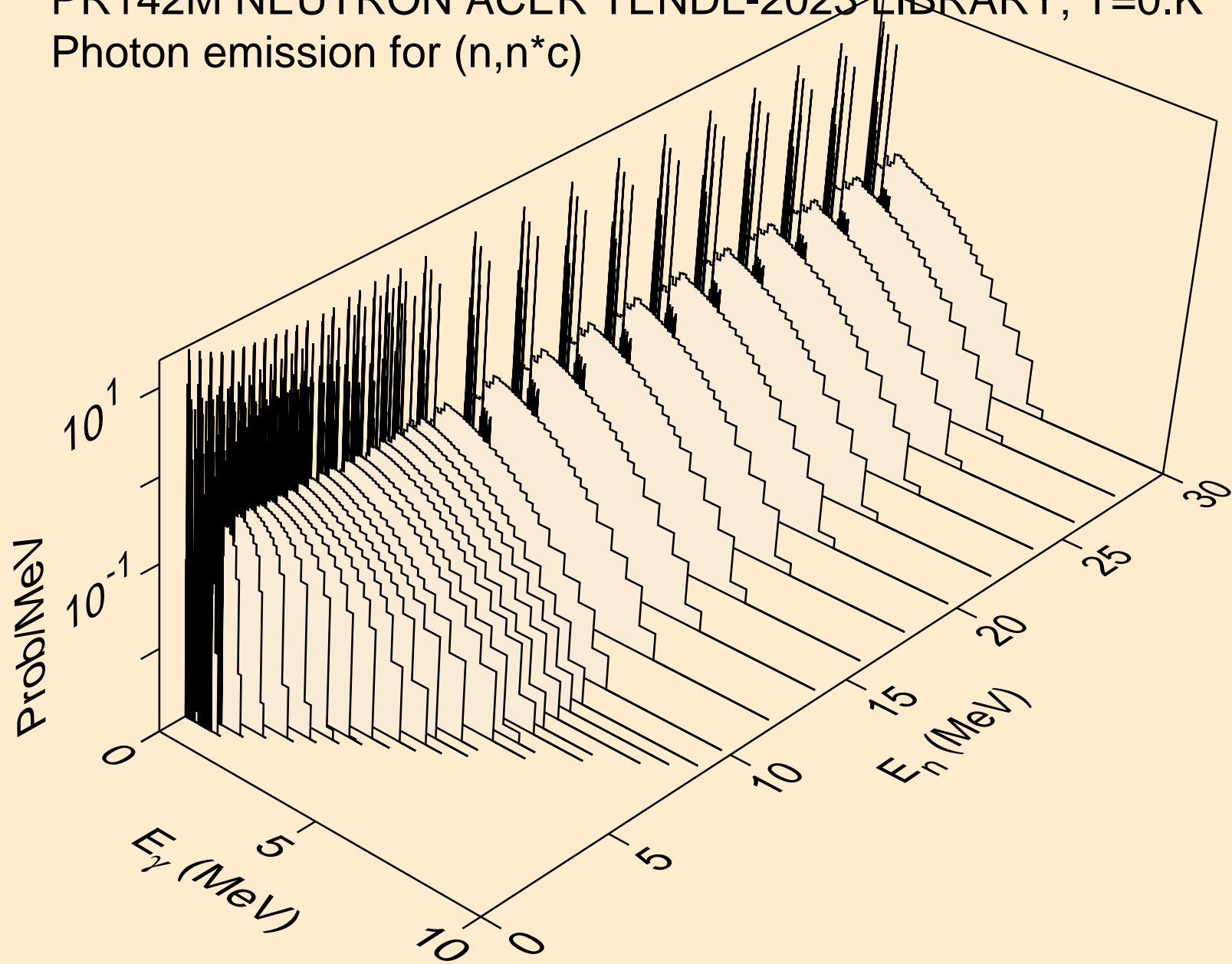

PR142M NEUTRON ACER TENDL-2023 LIBRARY; T=0.K  
Photon emission for (n,gma)

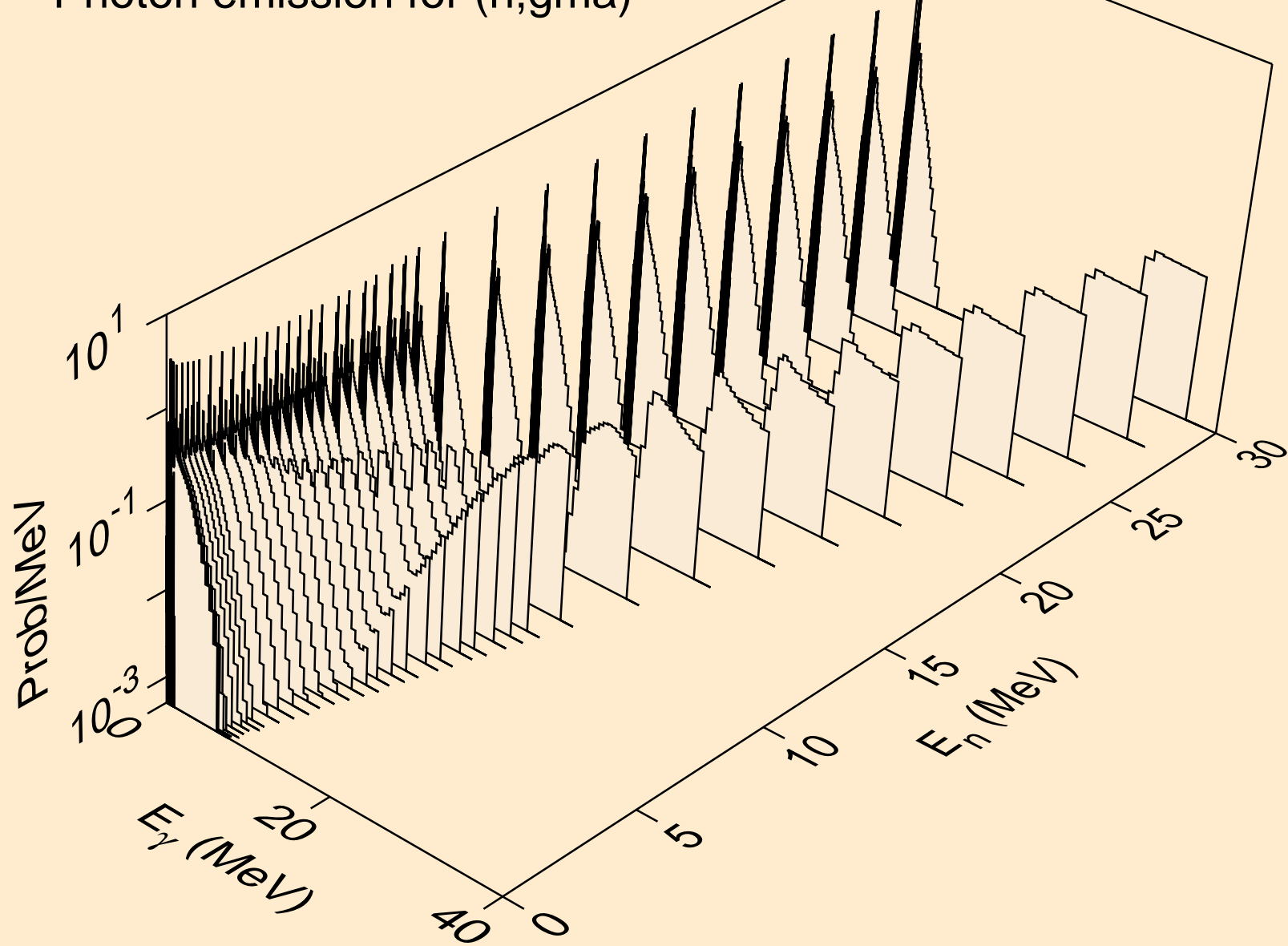

PR142M NEUTRON ACER TENDL-2023 LIBRARY; T=0.K  
Photon emission for (n,p)

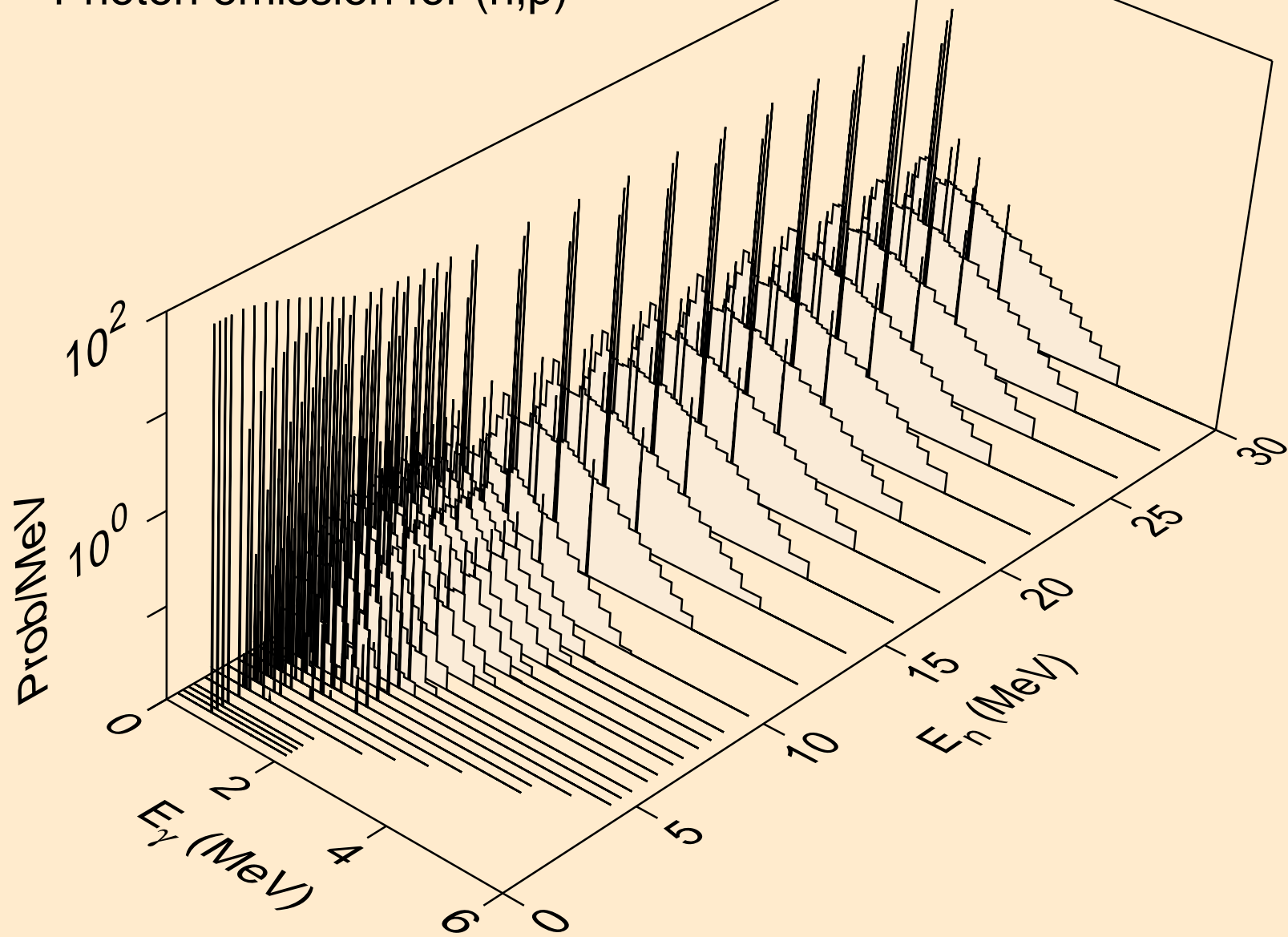

PR142M NEUTRON ACER TENDL-2023 LIBRARY; T=0.K  
Photon emission for (n,d)

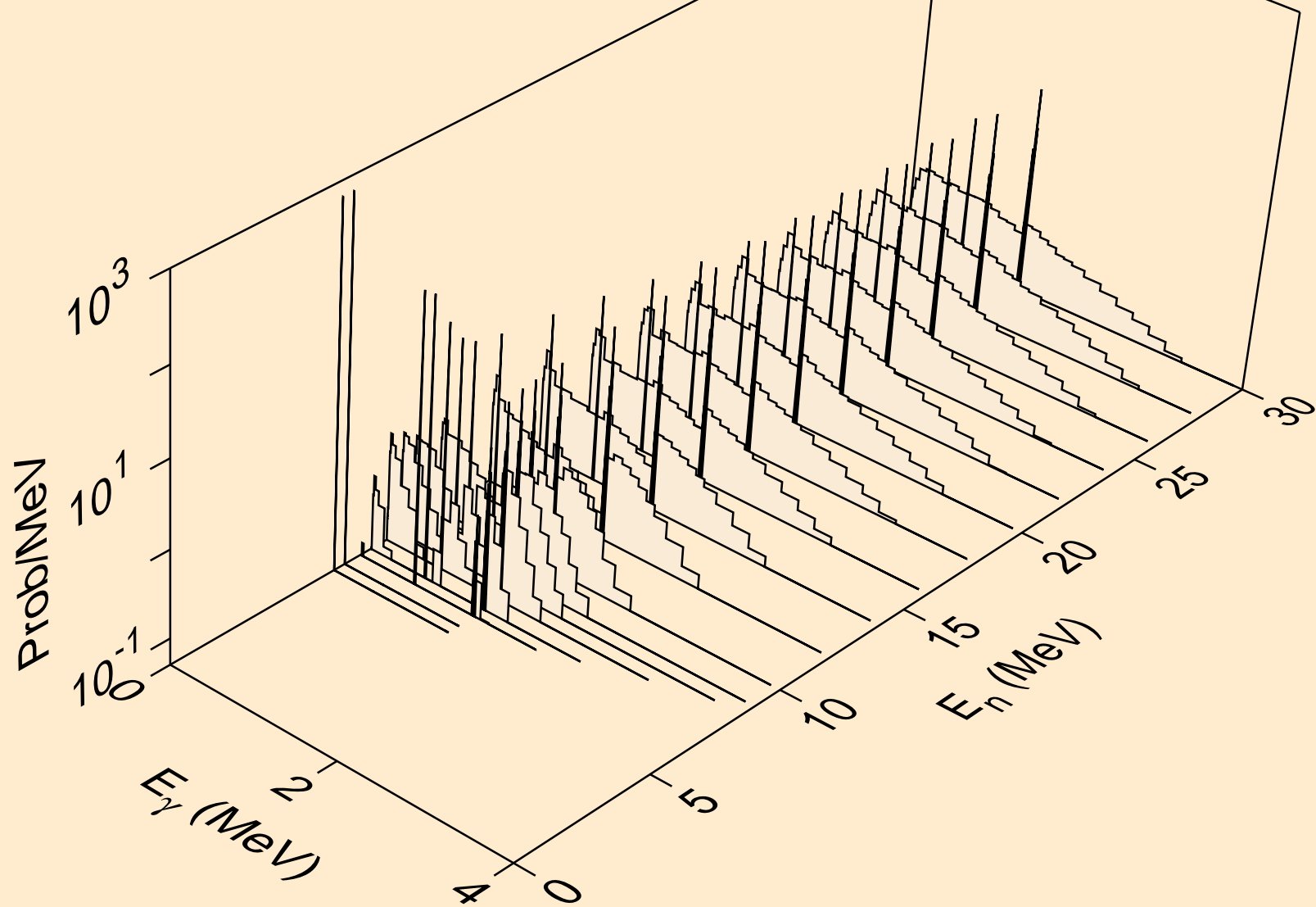

PR142M NEUTRON ACER TENDL-2023 LIBRARY; T=0.K  
Photon emission for (n,t)

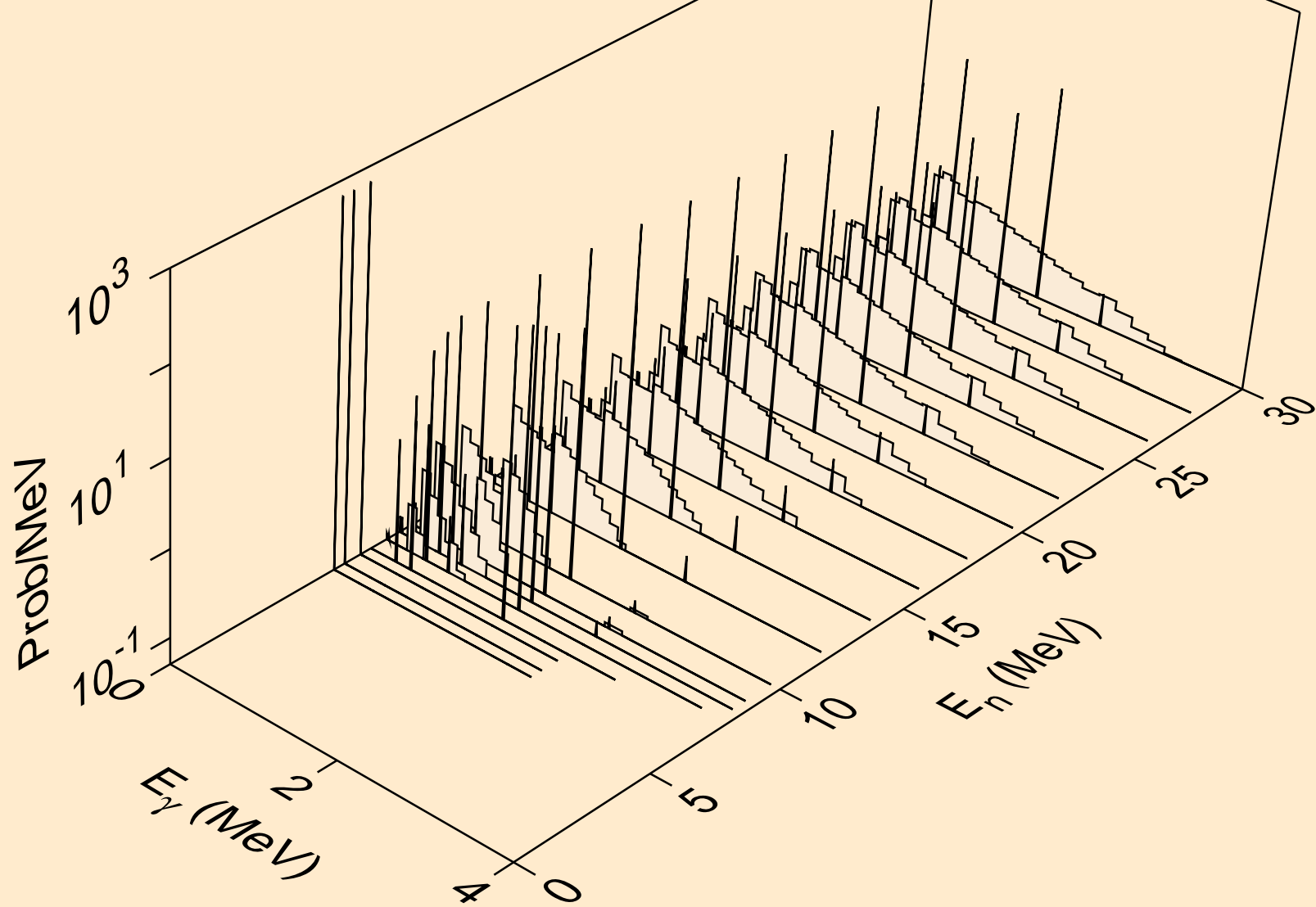

PR142M NEUTRON ACER TENDL-2023 LIBRARY; T=0.K  
Photon emission for (n,he3)

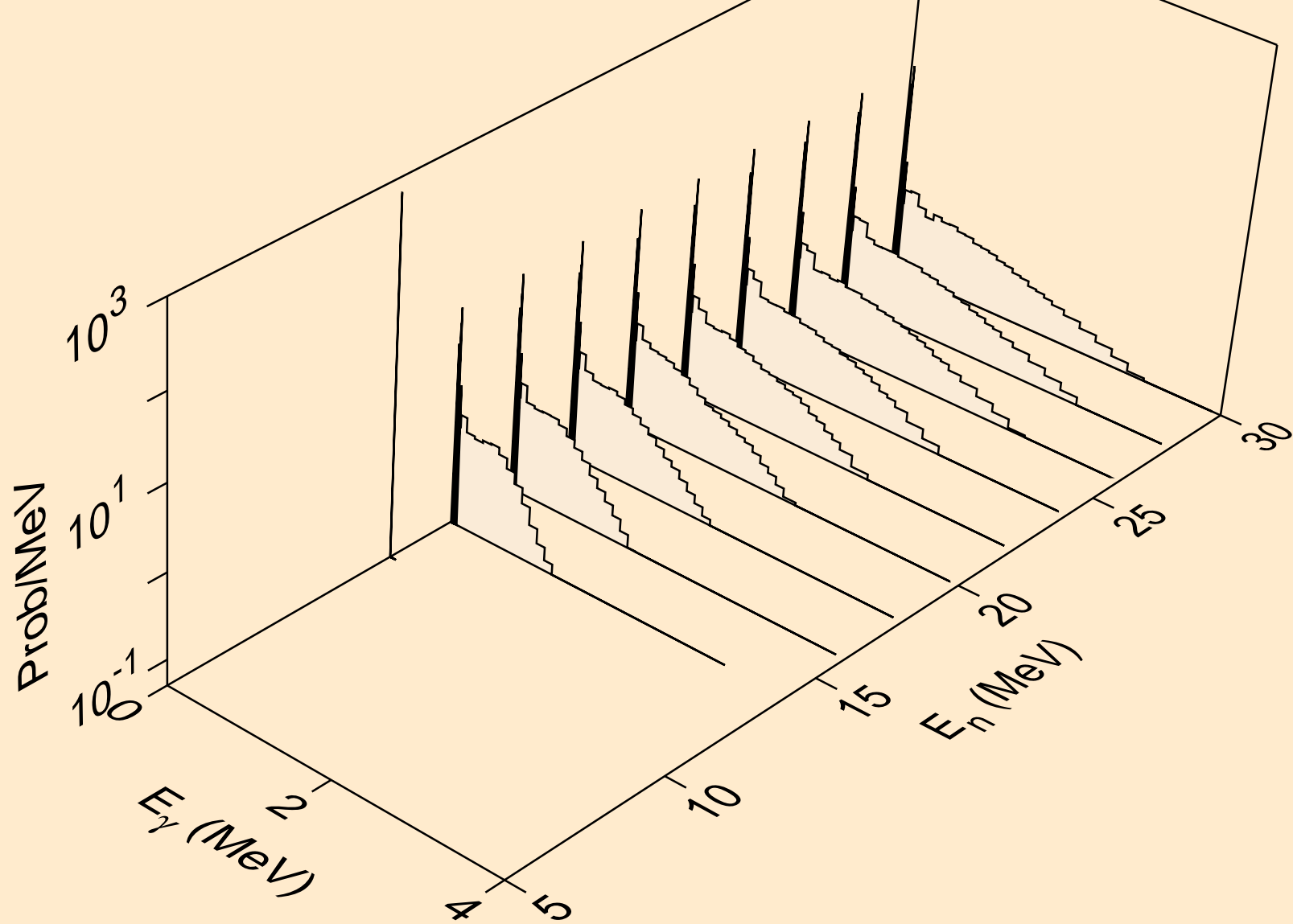

PR142M NEUTRON ACER TENDL-2023 LIBRARY; T=0.K  
Photon emission for (n,a)

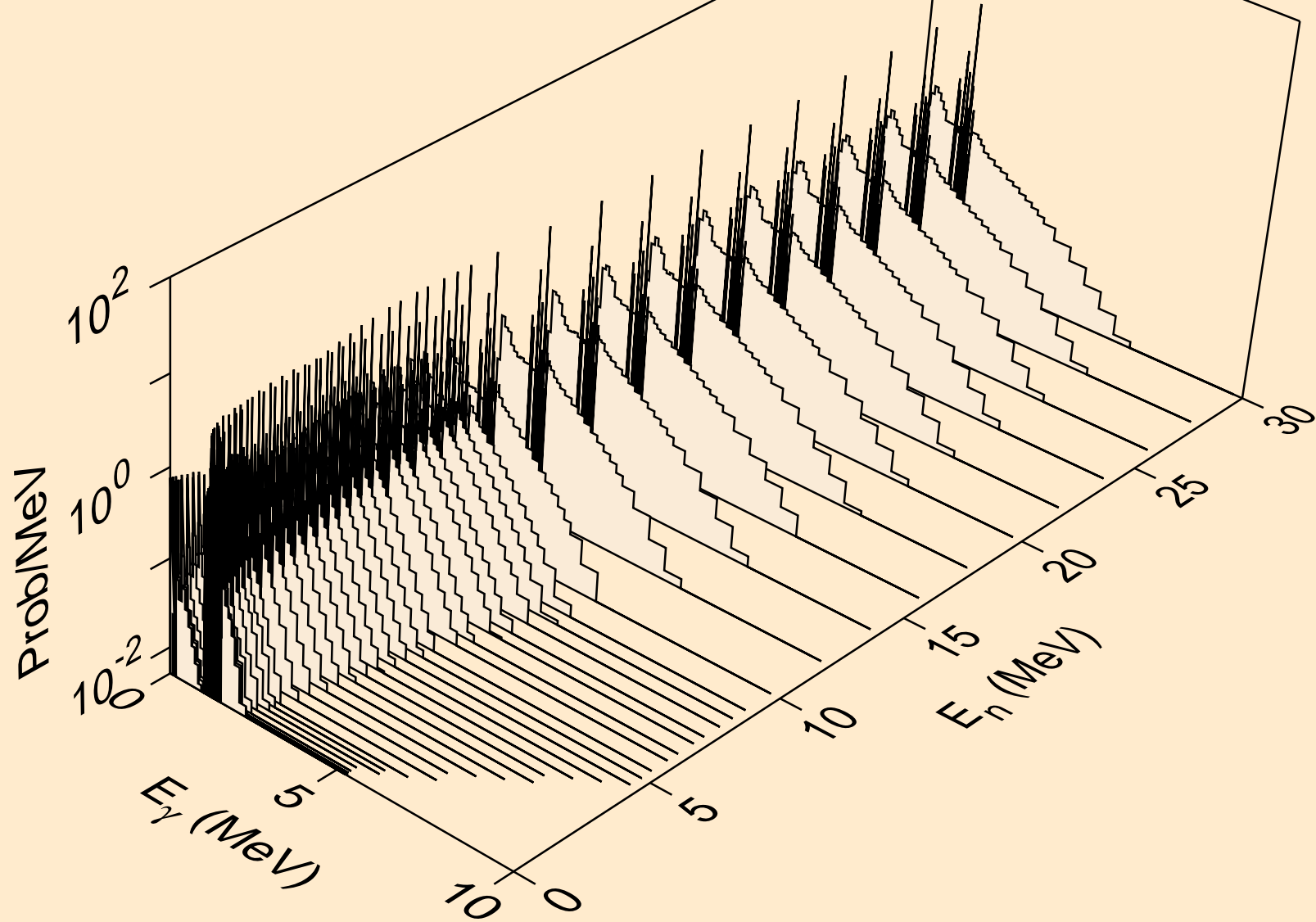



PR142M NEUTRON ACER TENDL-2023 LIBRARY; T=0.K  
Photon emission for (n,2a)

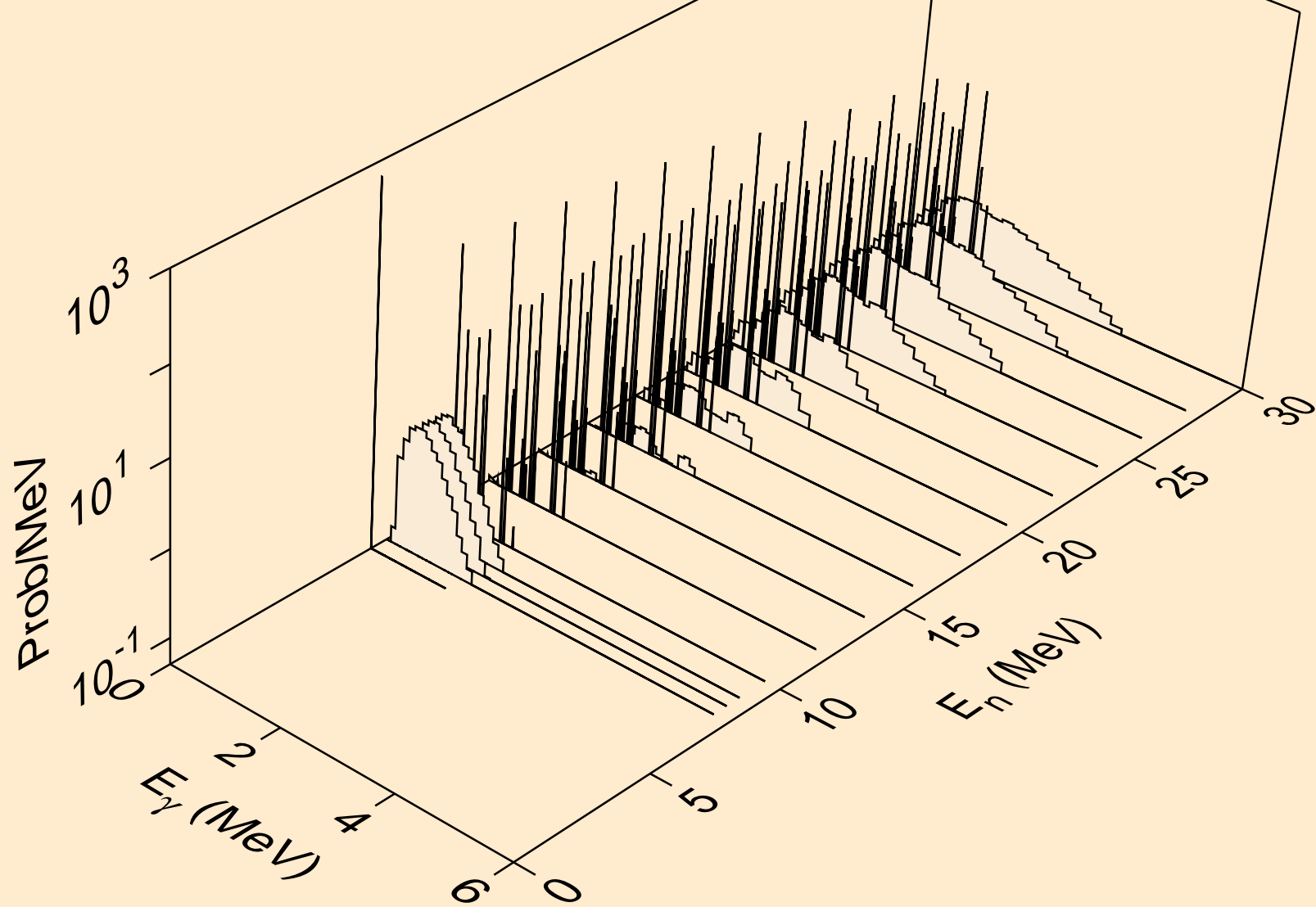

PR142M NEUTRON ACER TENDL-2023 LIBRARY; T=0.K  
Photon emission for (n,2p)

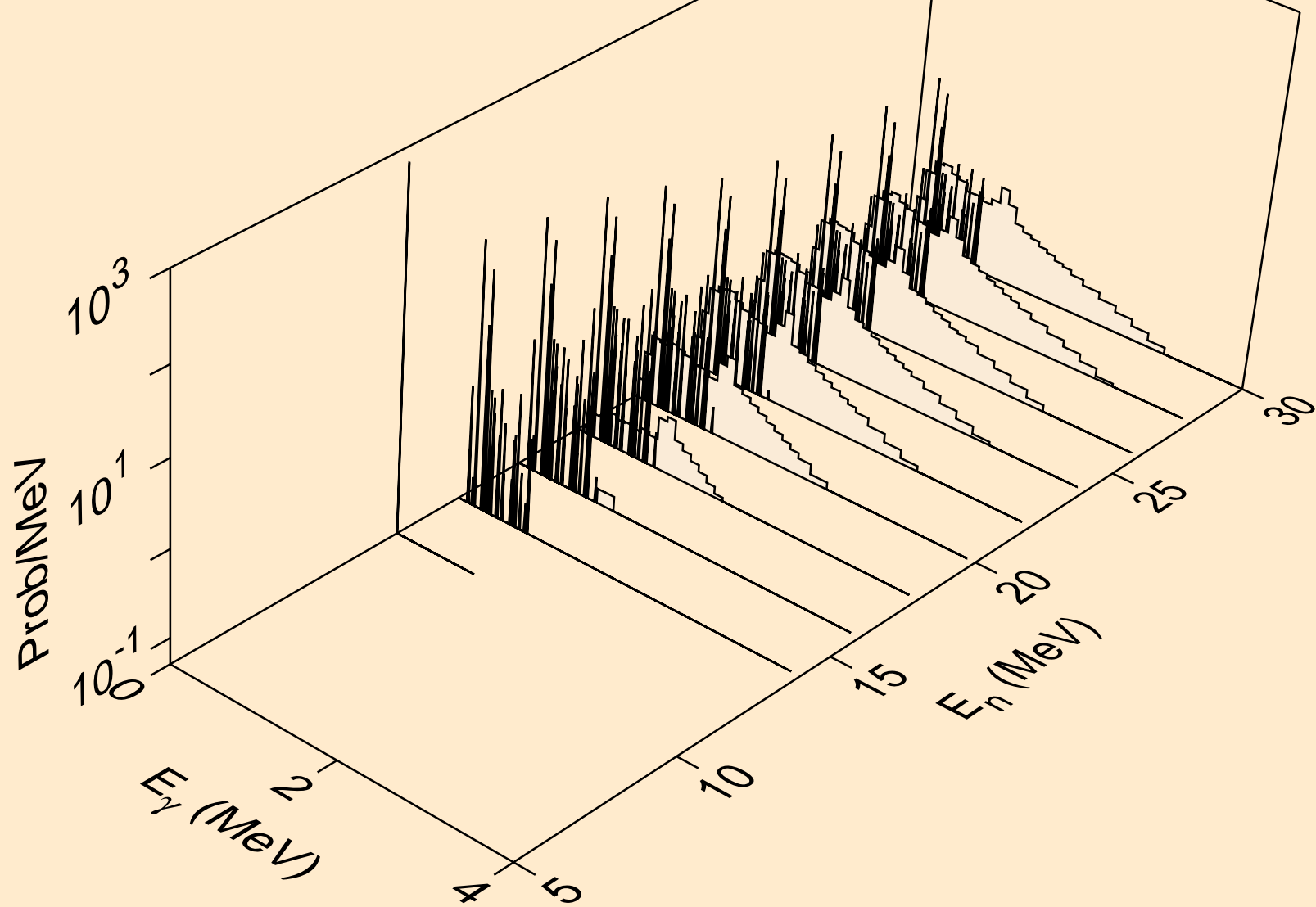

PR142M NEUTRON ACER TENDL-2023 LIBRARY; T=0.K  
Photon emission for (n,p)

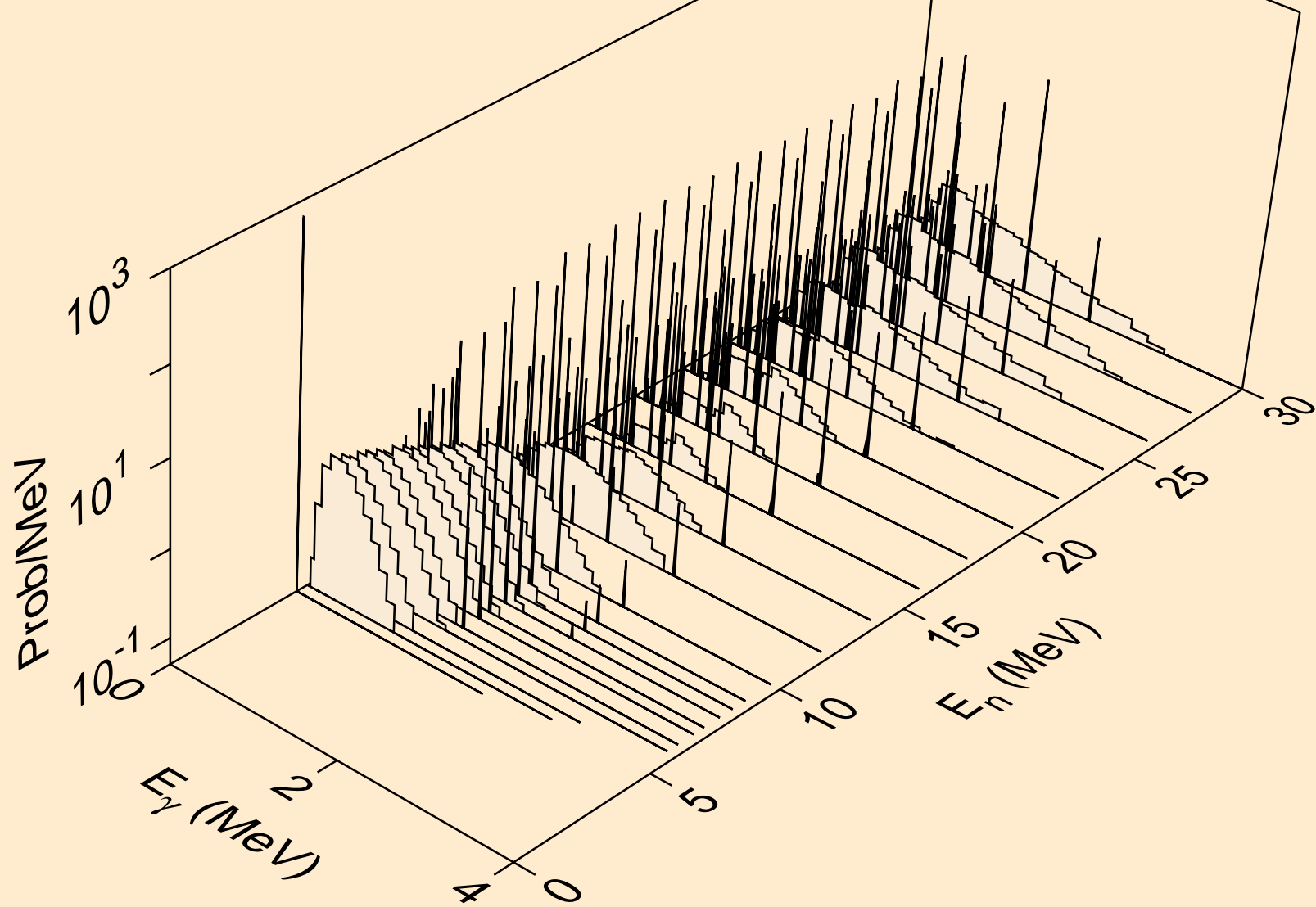

PR142M NEUTRON ACER TENDL-2023 LIBRARY; T=0.K  
Photon emission for (n,pd)

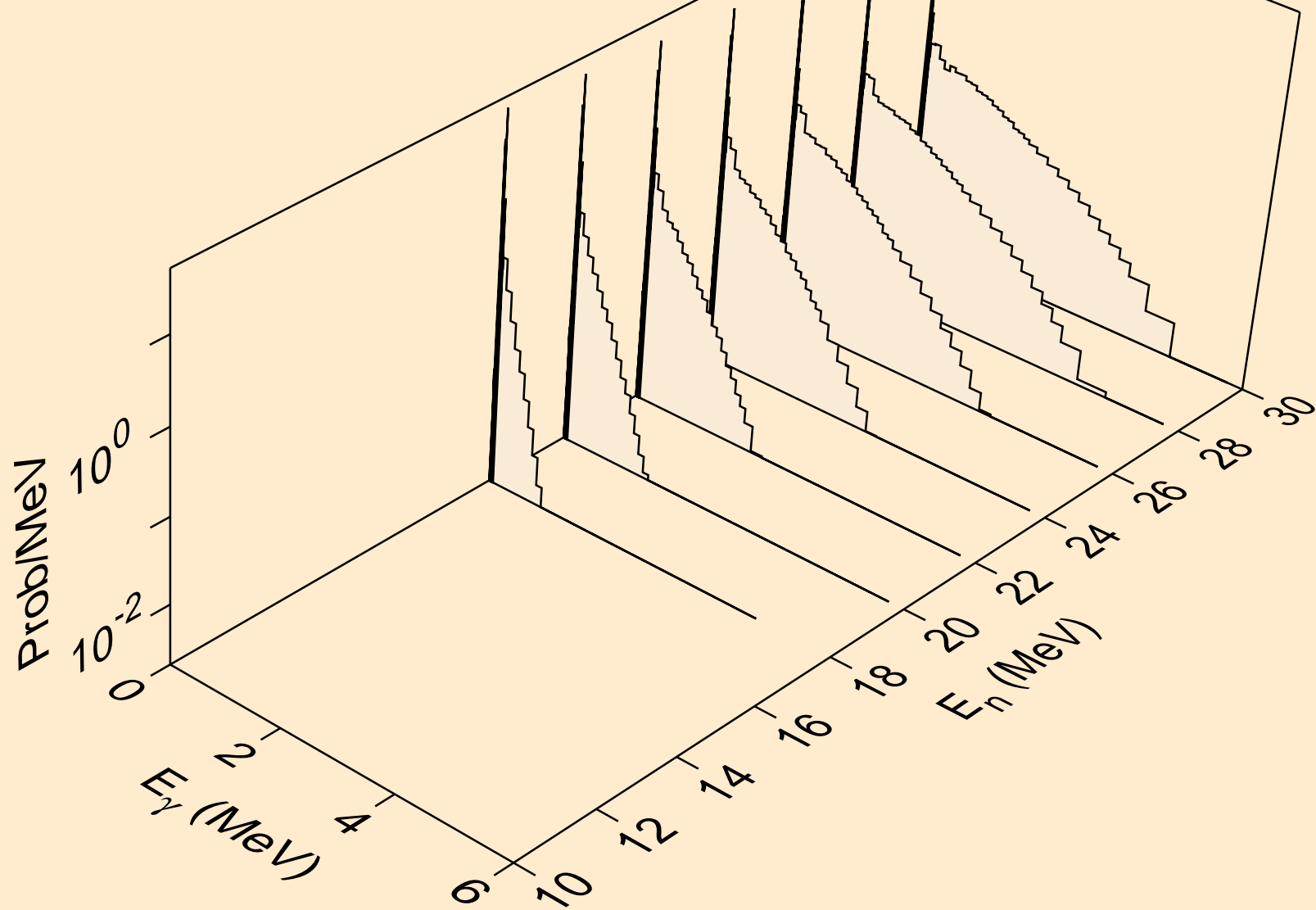

PR142M NEUTRON ACER TENDL-2023 LIBRARY; T=0.K  
Photon emission for (n,pt)

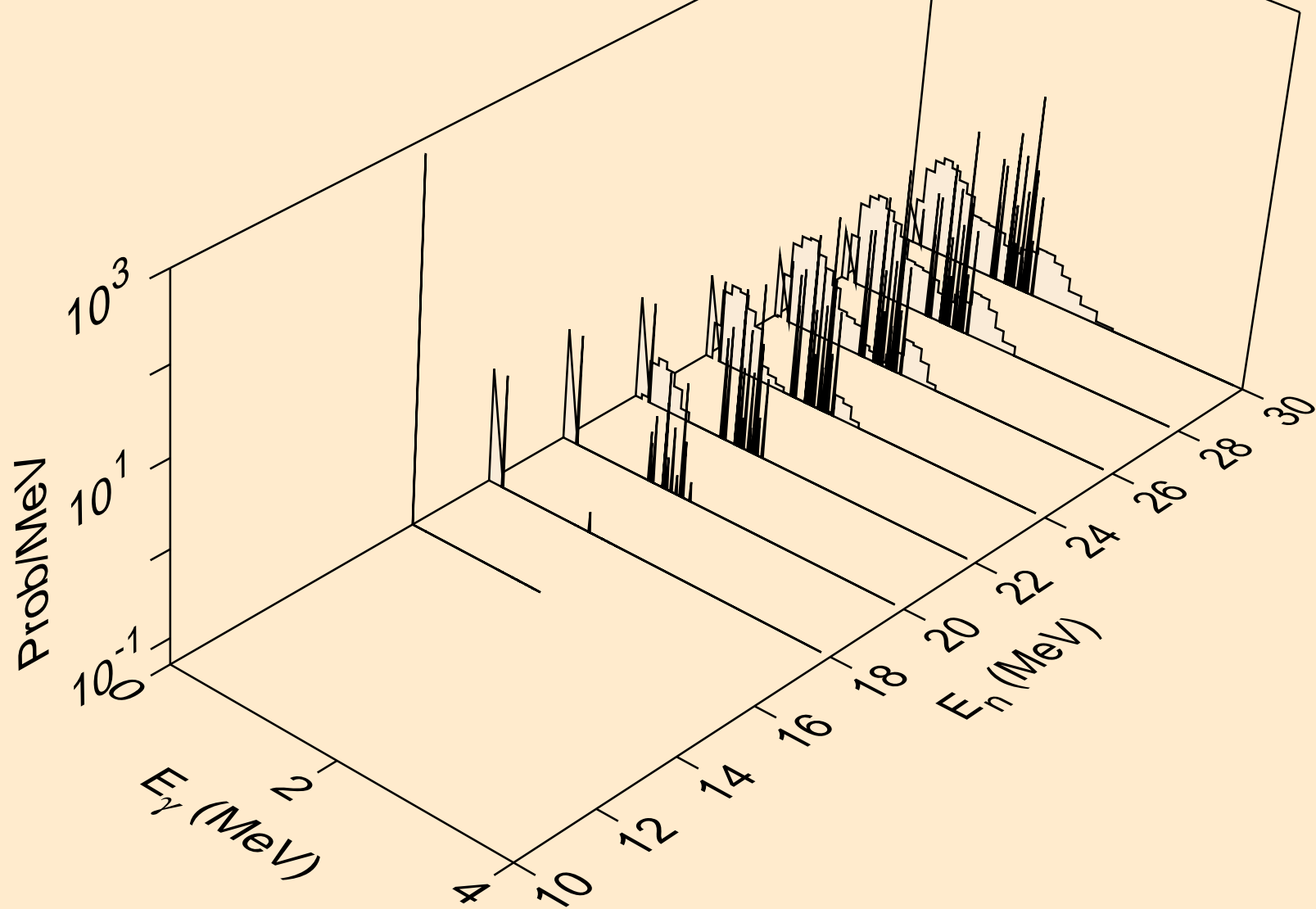

PR142M NEUTRON ACER TENDL-2023 LIBRARY; T=0.K  
Photon emission for (n,da)

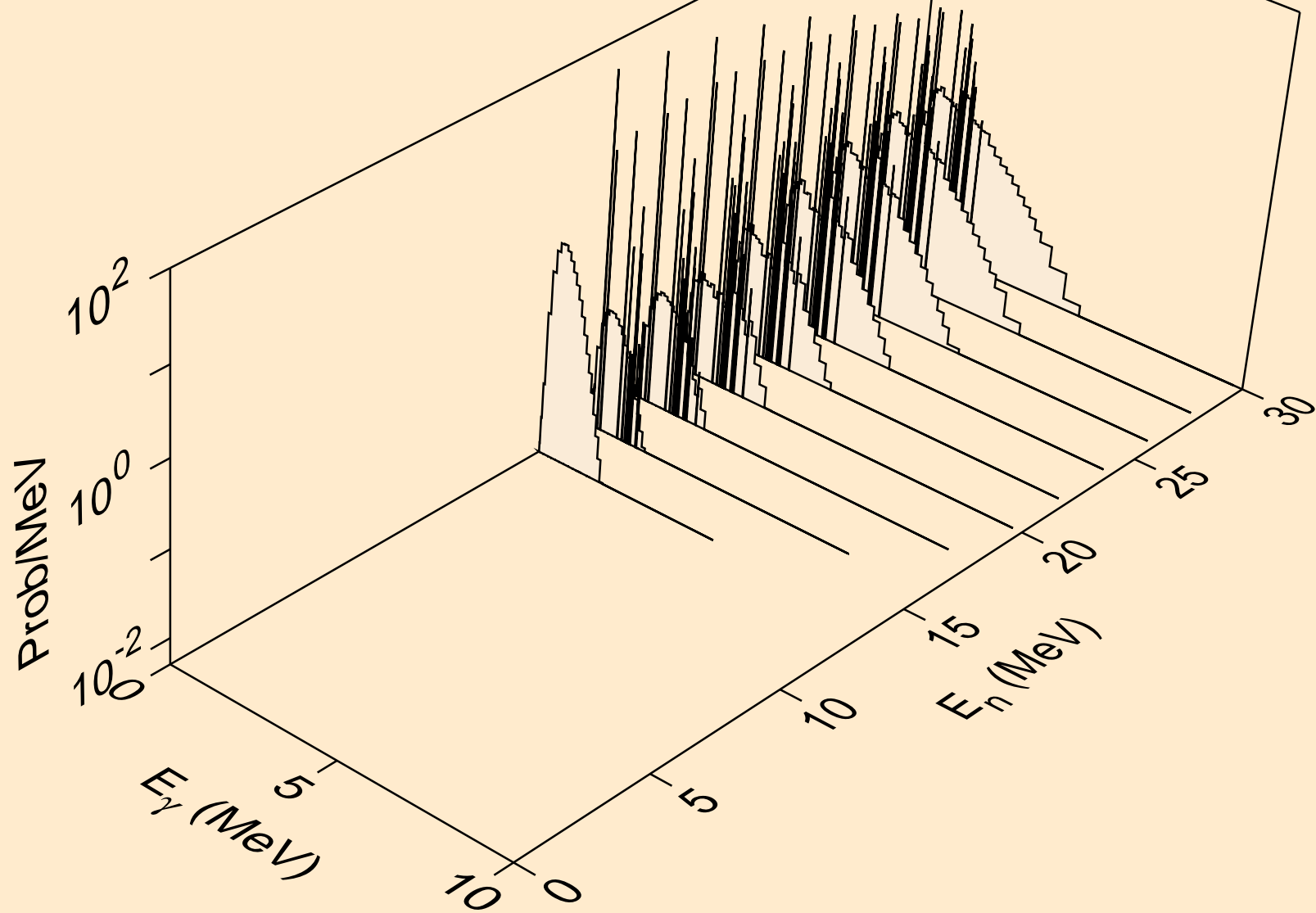

PR142M NEUTRON ACER TENDL-2023 LIBRARY; T=0.K  
thermal capture photon spectrum

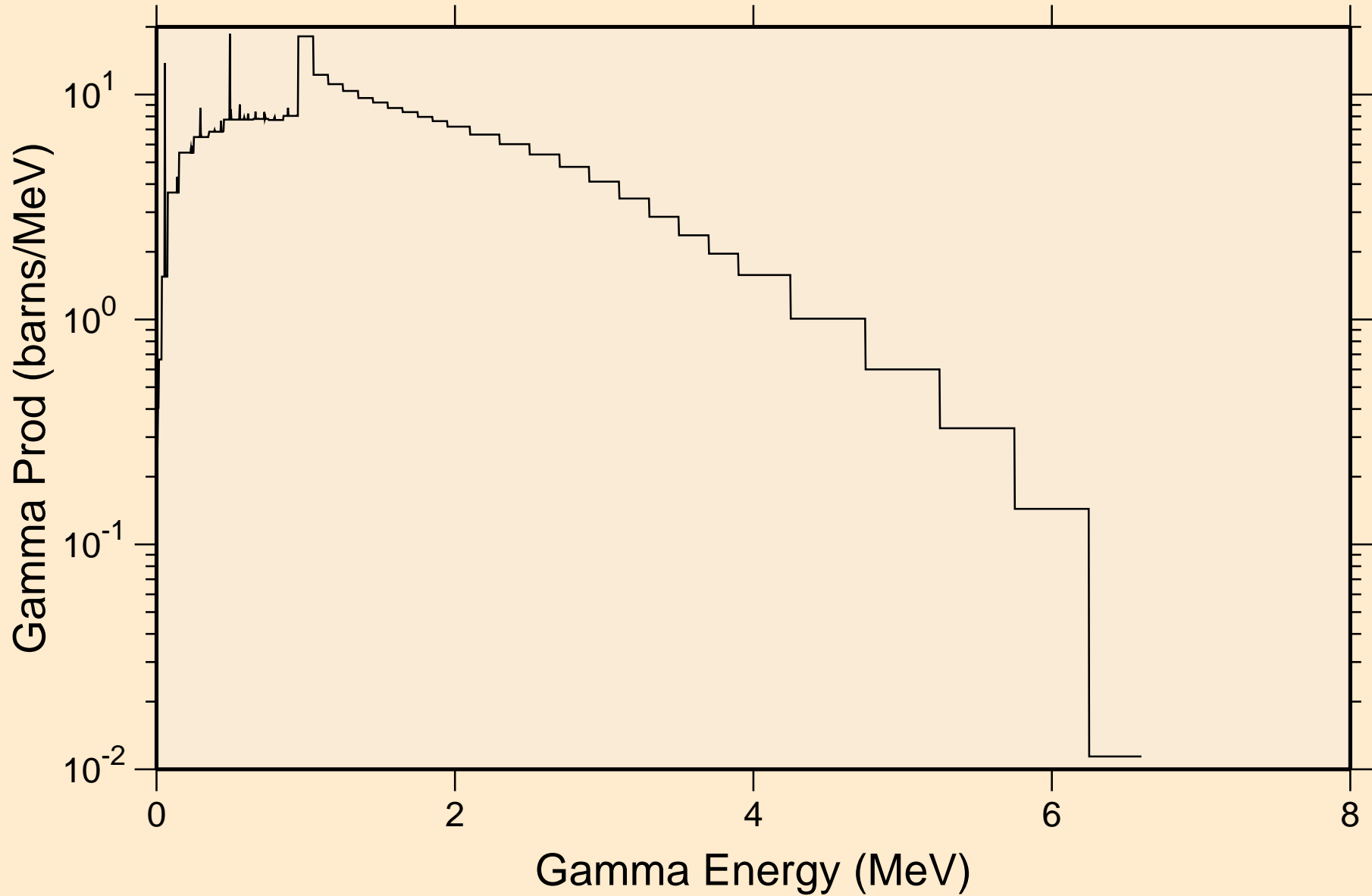

PR142M NEUTRON ACER TENDL-2023 LIBRARY; T=0.K  
14 MeV photon spectrum

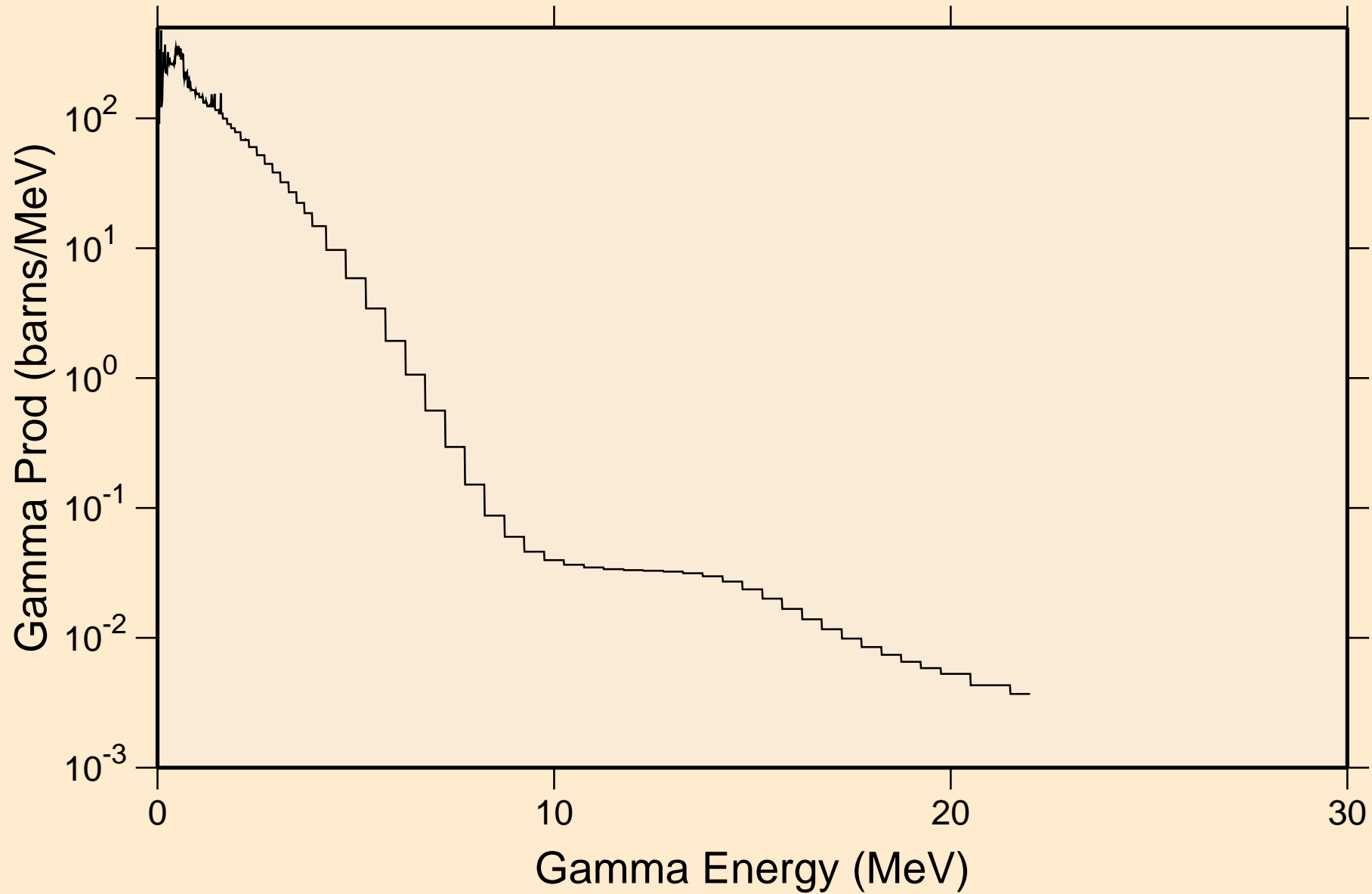



PR142M NEUTRON ACER TENDL-2023 LIBRARY; T=0.K  
Particle heating contributions

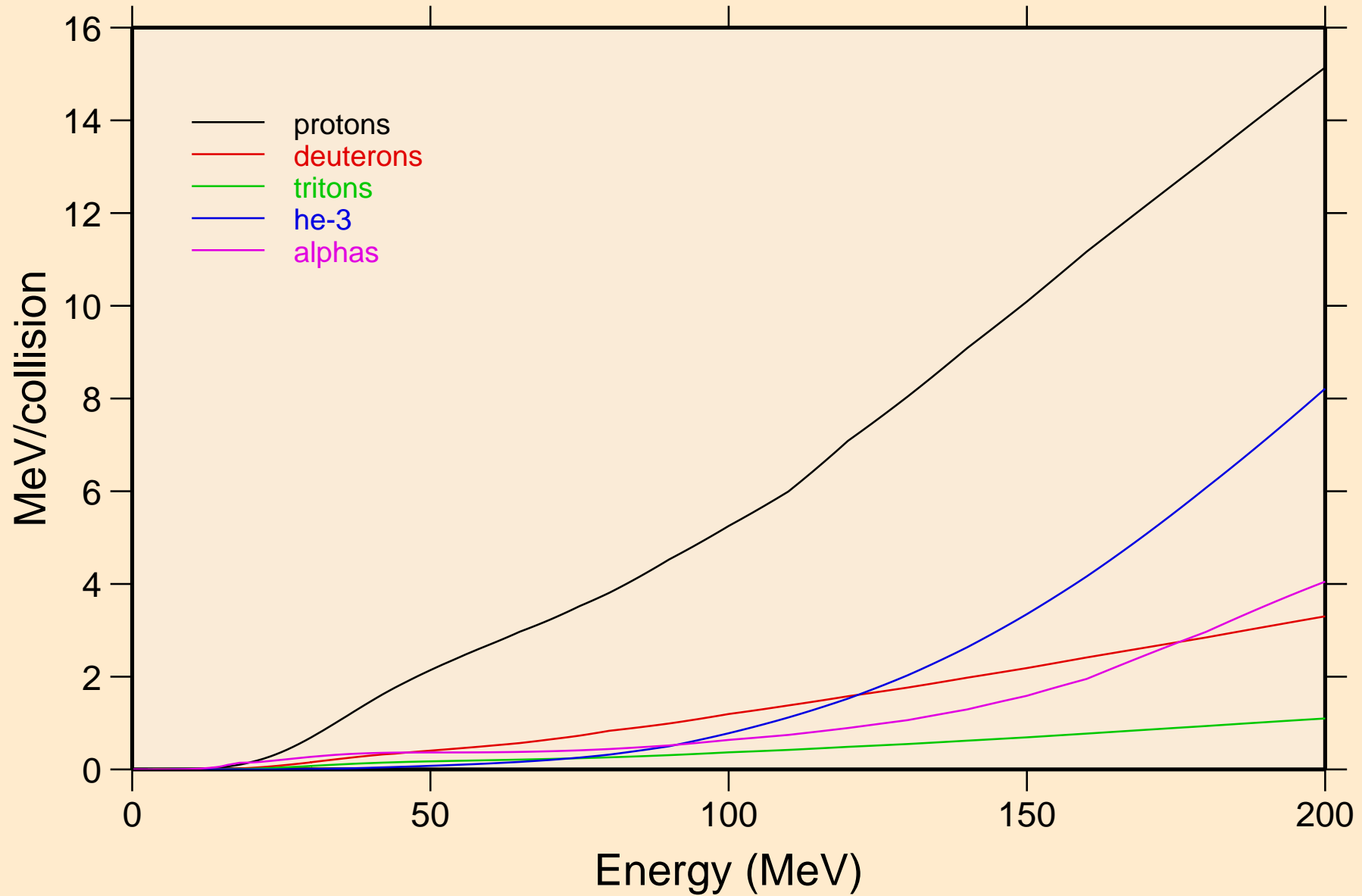

PR142M NEUTRON ACER TENDL-2023 LIBRARY; T=0.K  
Recoil Heating

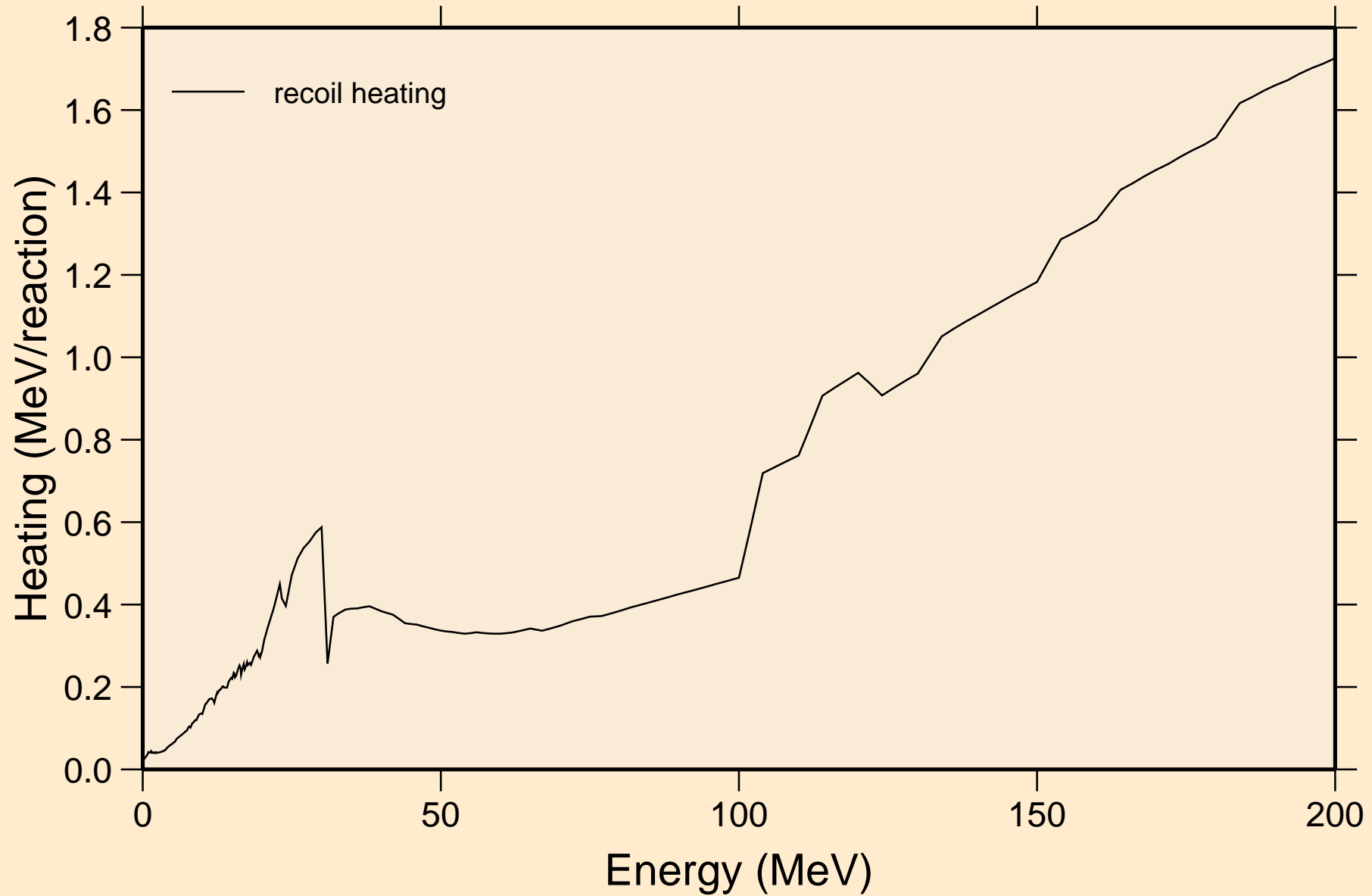

PR142M NEUTRON ACER TENDL-2023 LIBRARY; T=0.K  
Particle production cross sections

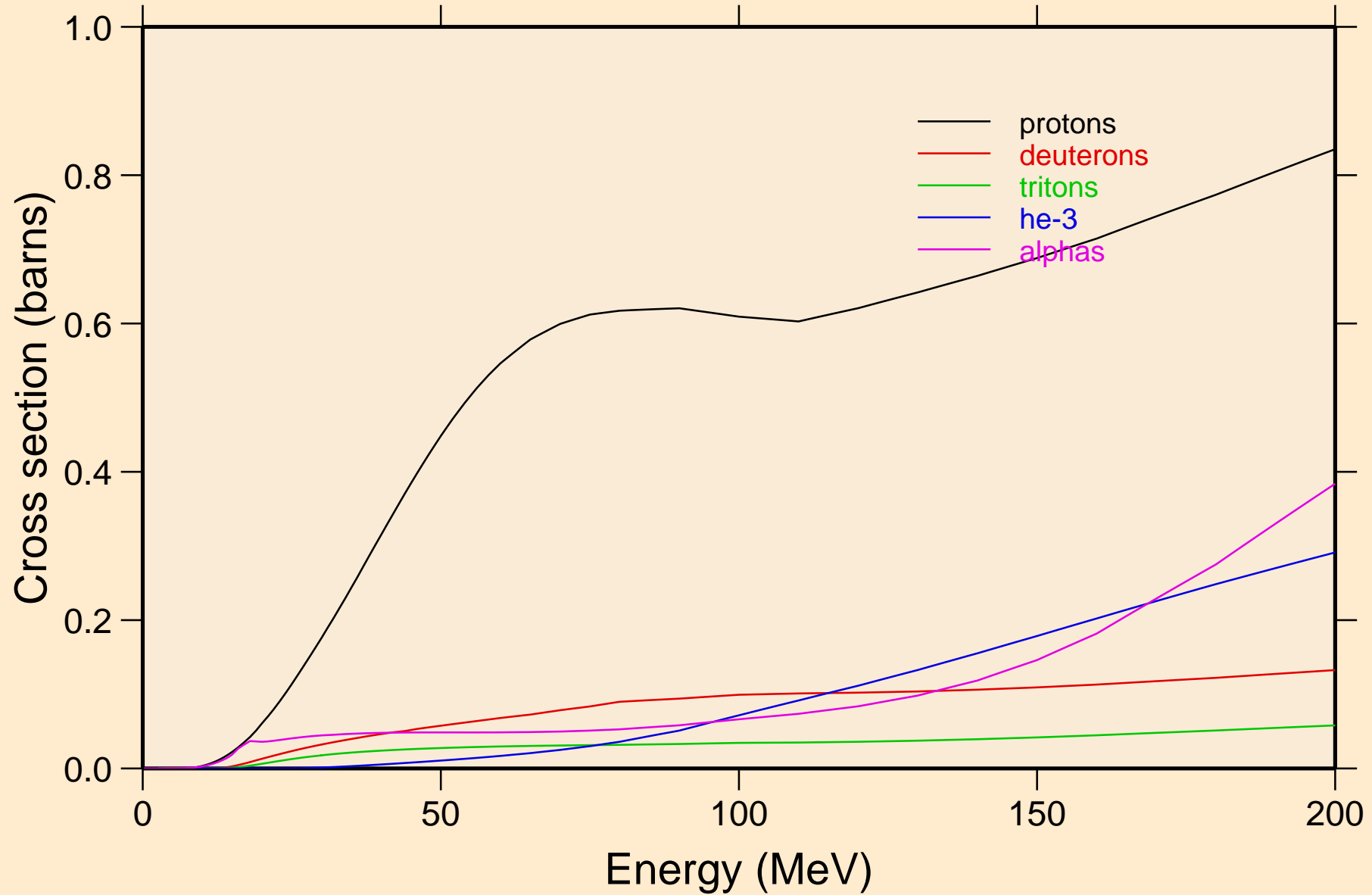

PR142M NEUTRON ACER TENDL-2023 LIBRARY; T=0.K  
protons from (n,x)

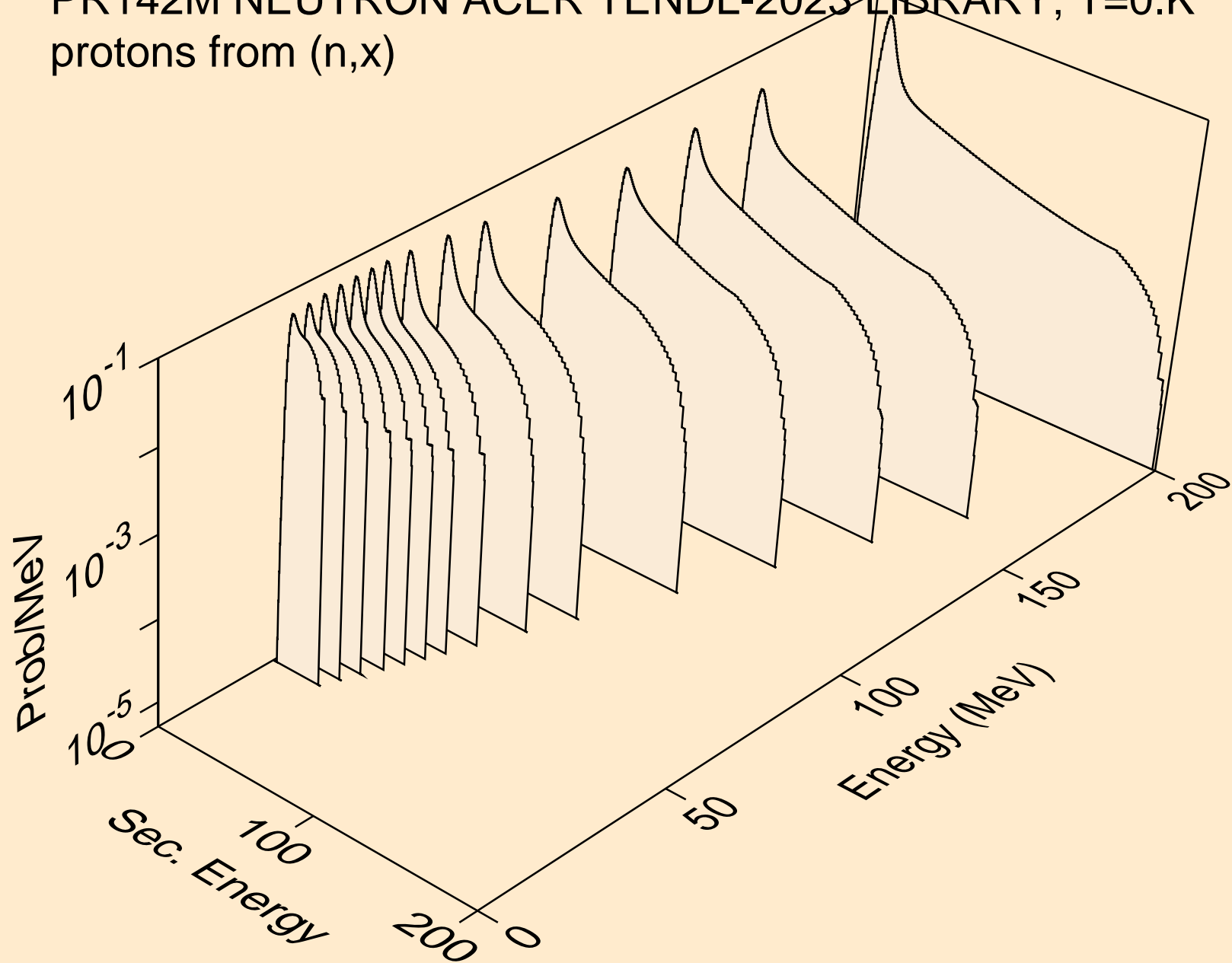

PR142M NEUTRON ACER TENDL-2023 LIBRARY; T=0.K  
protons from (n,n\*)p

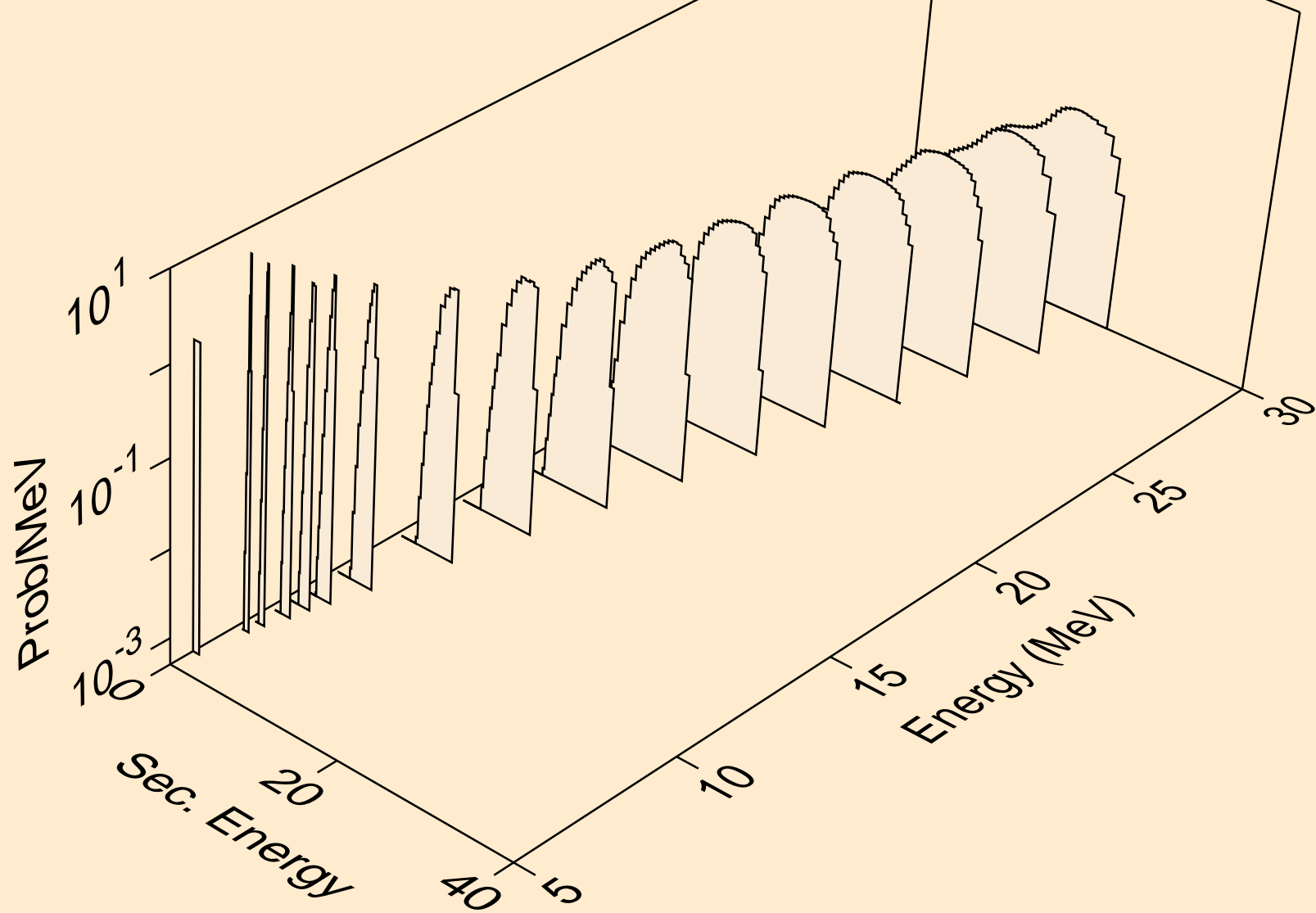

PR142M NEUTRON ACER TENDL-2023 LIBRARY; T=0.K  
protons from (n,2np)

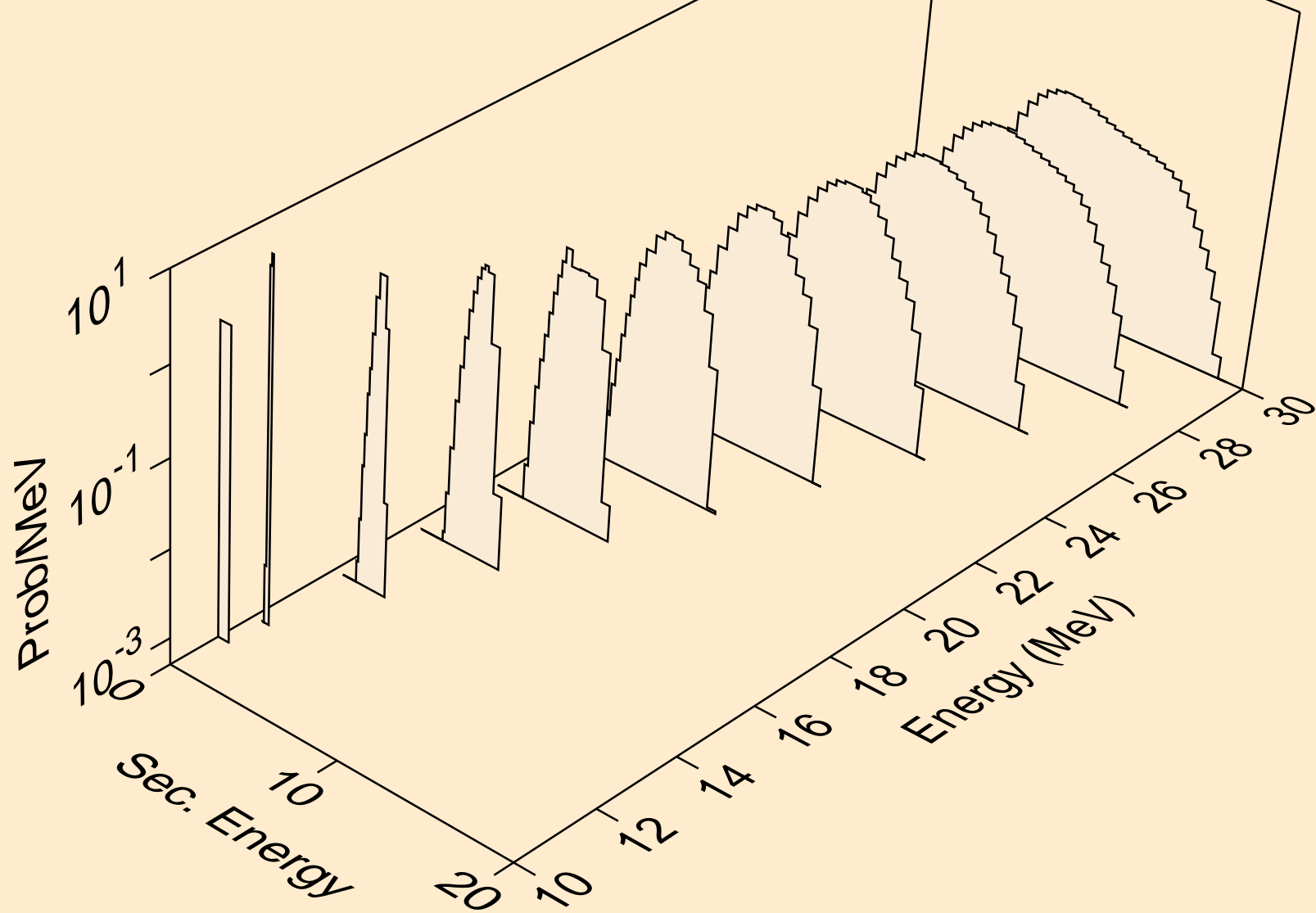

PR142M NEUTRON ACER TENDL-2023 LIBRARY; T=0.K  
protons from (n,3np)

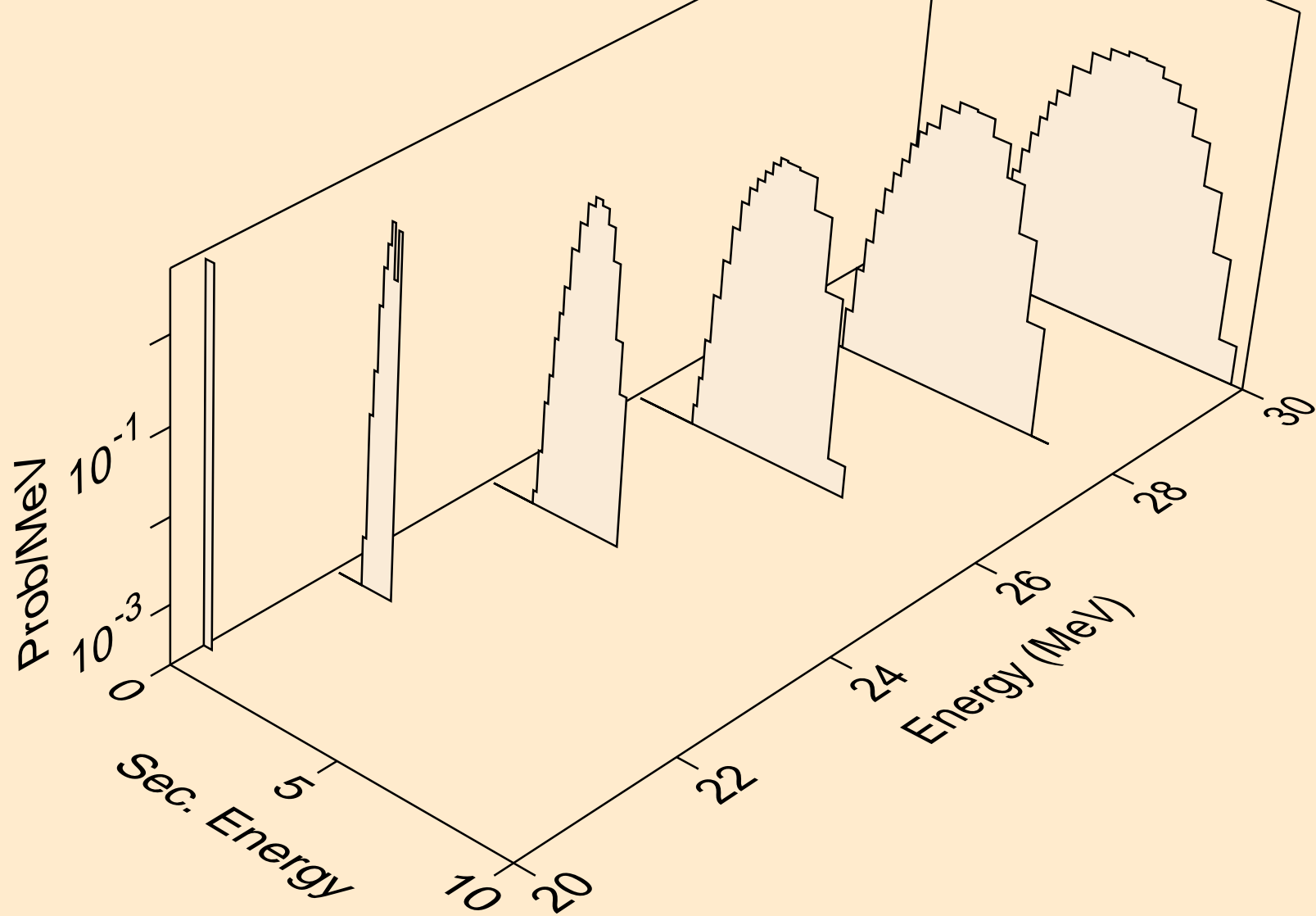

PR142M NEUTRON ACER TENDL-2023 LIBRARY; T=0.K  
protons from (n,n2p)

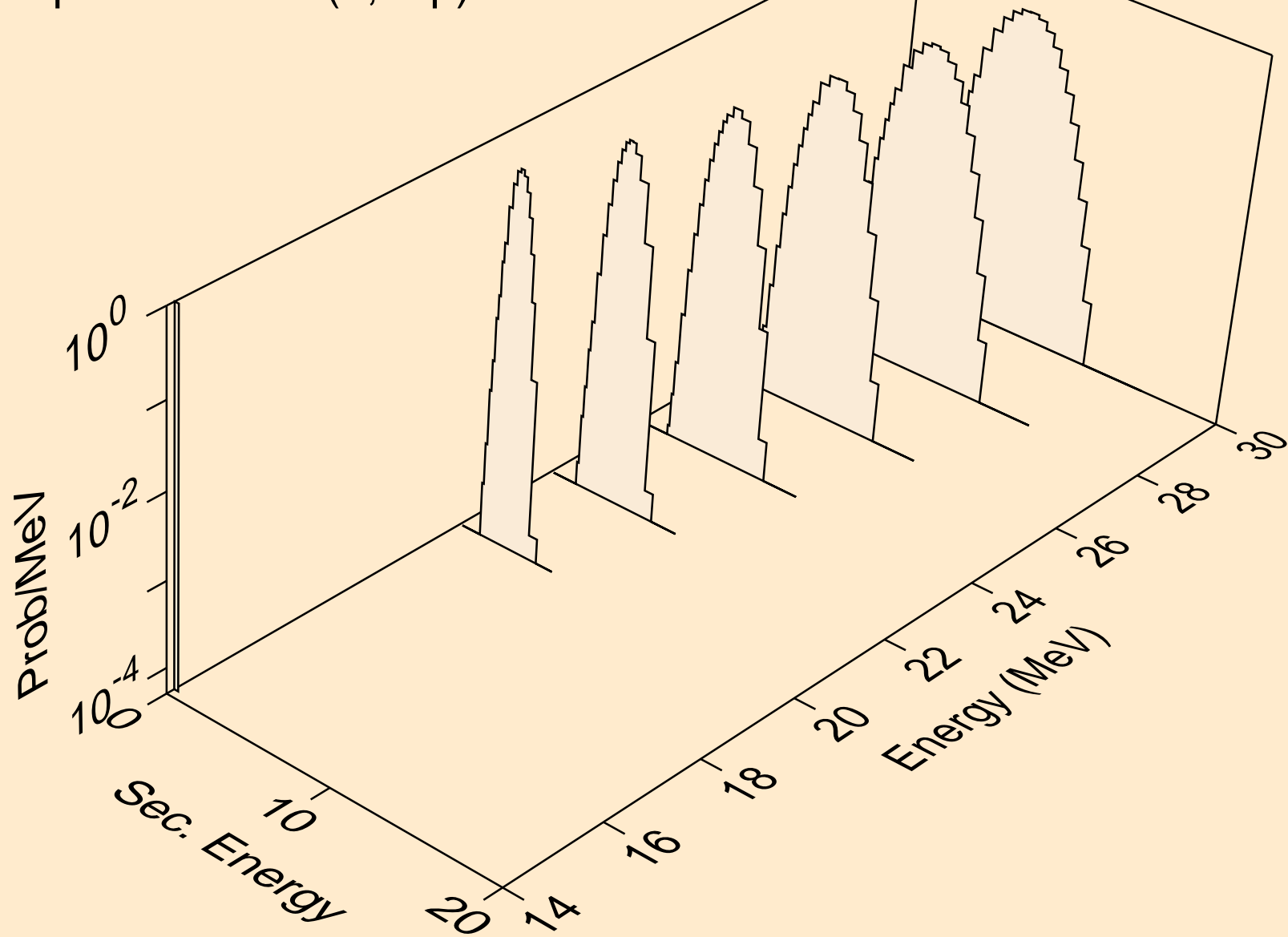



PR142M NEUTRON ACER TENDL-2023 LIBRARY; T=0.K  
protons from (n,npa)

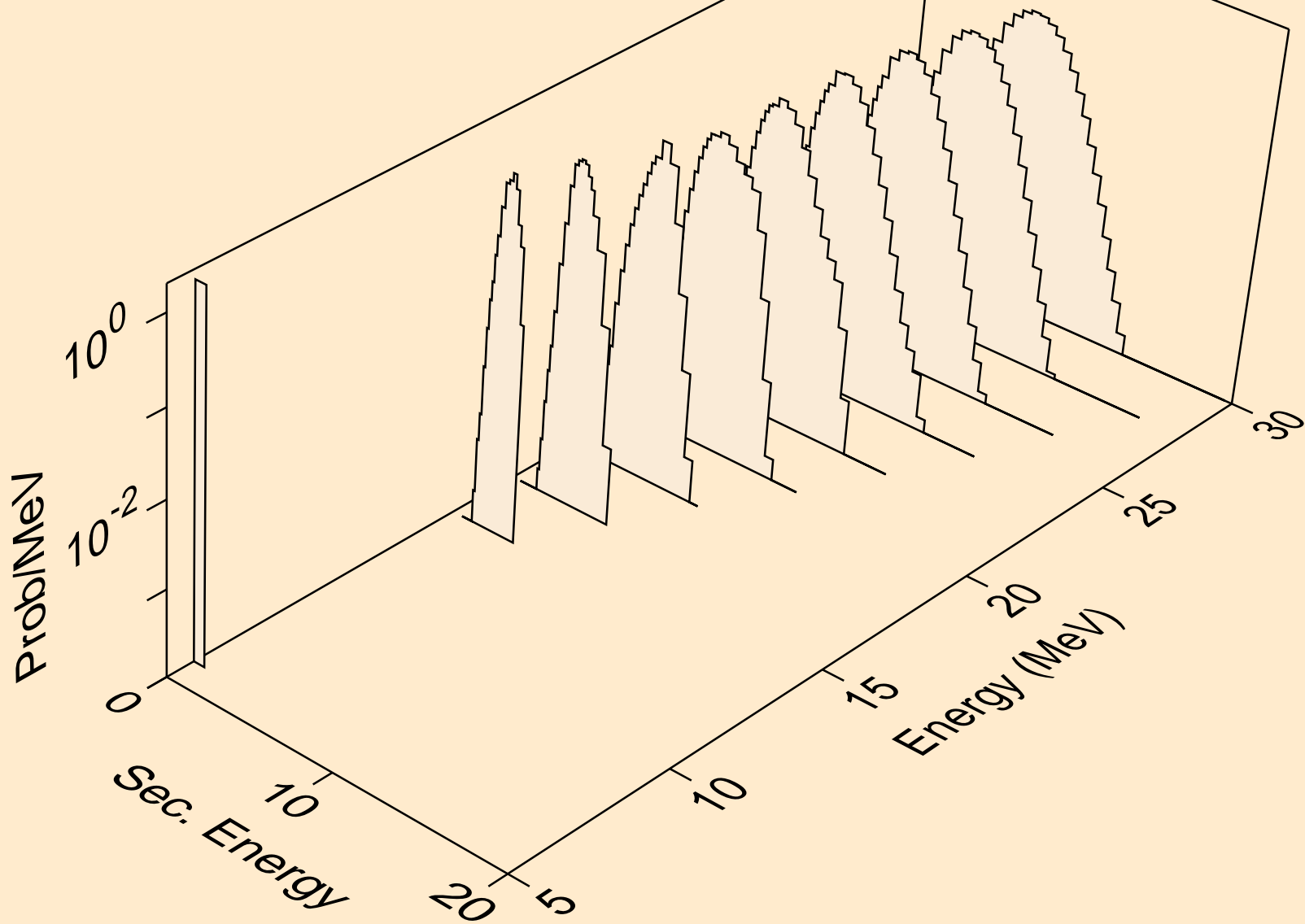

PR142M NEUTRON ACER TENDL-2023 LIBRARY; T=0.K  
protons from (n,p)

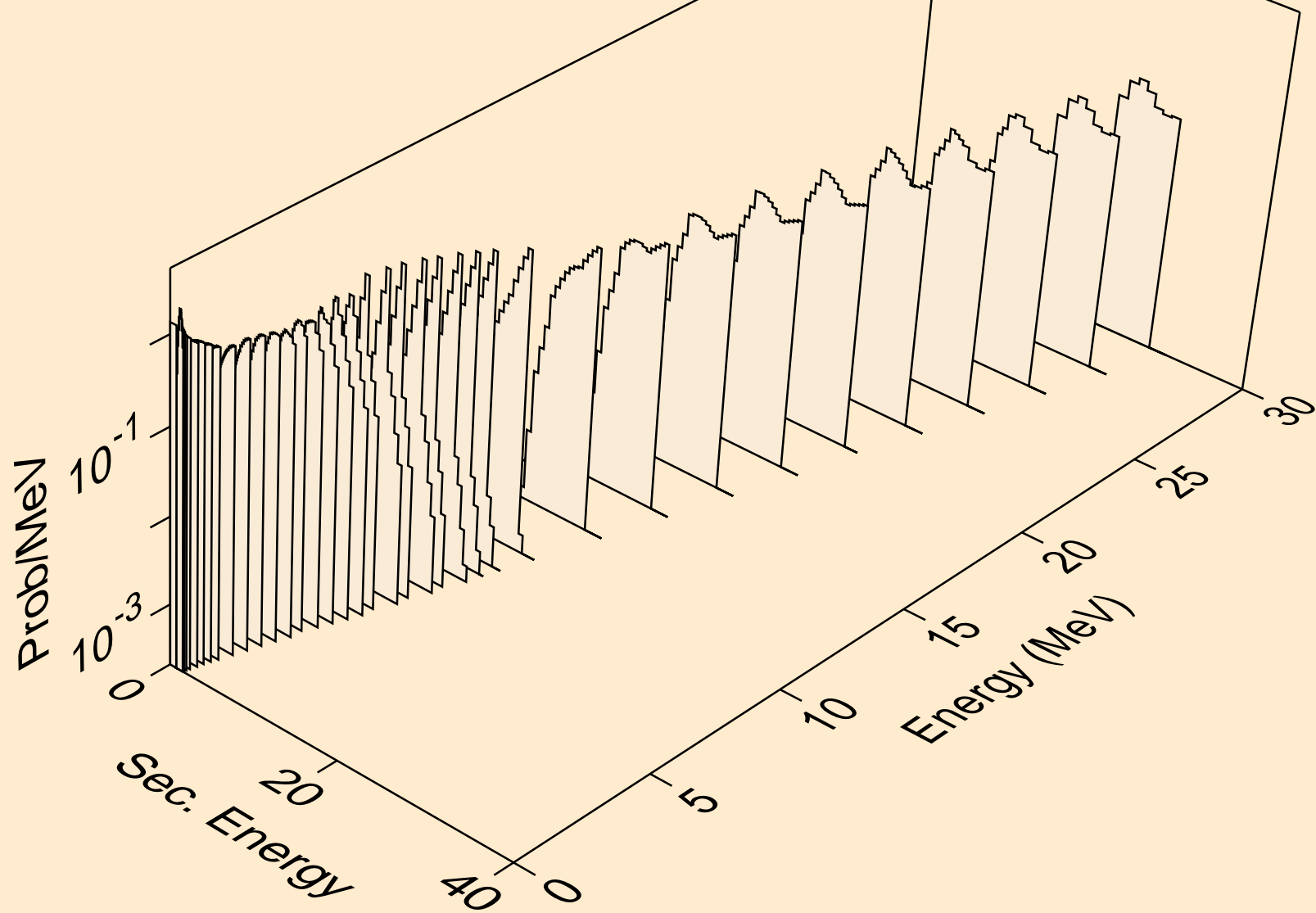

PR142M NEUTRON ACER TENDL-2023 LIBRARY; T=0.K  
protons from (n,2p)

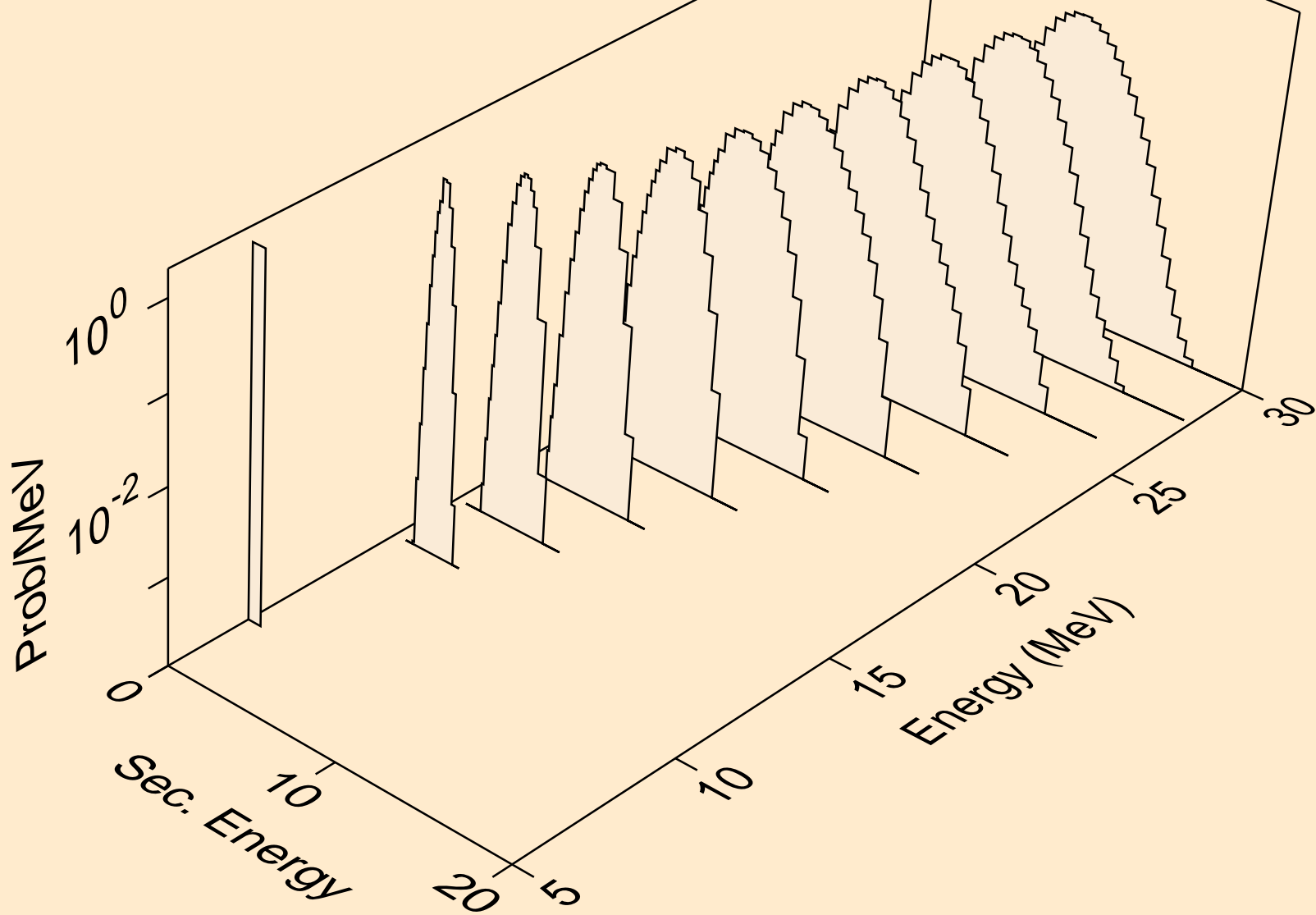

PR142M NEUTRON ACER TENDL-2023 LIBRARY; T=0.K  
protons from (n,p)

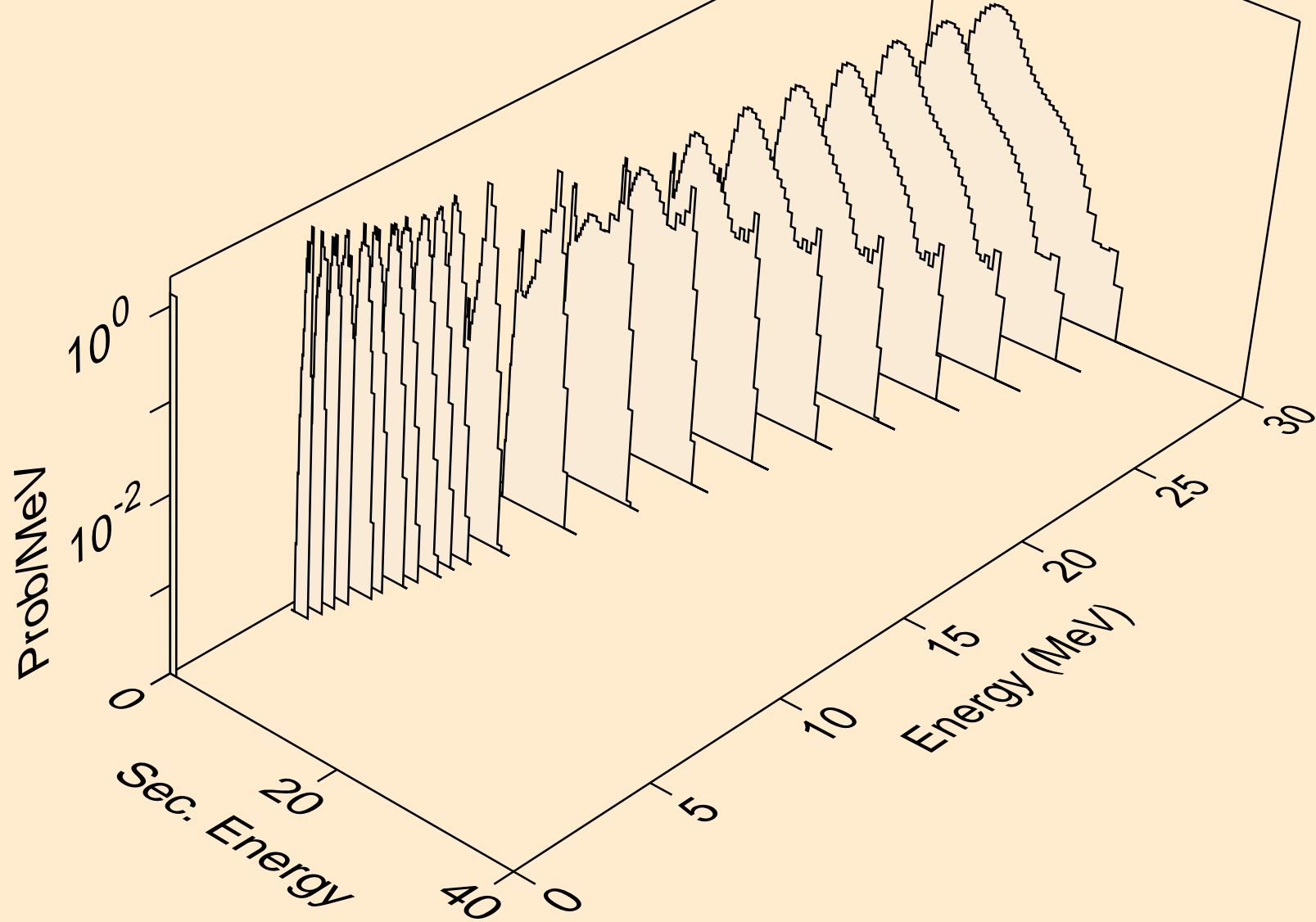

PR142M NEUTRON ACER TENDL-2023 LIBRARY; T=0.K  
protons from (n,pd)

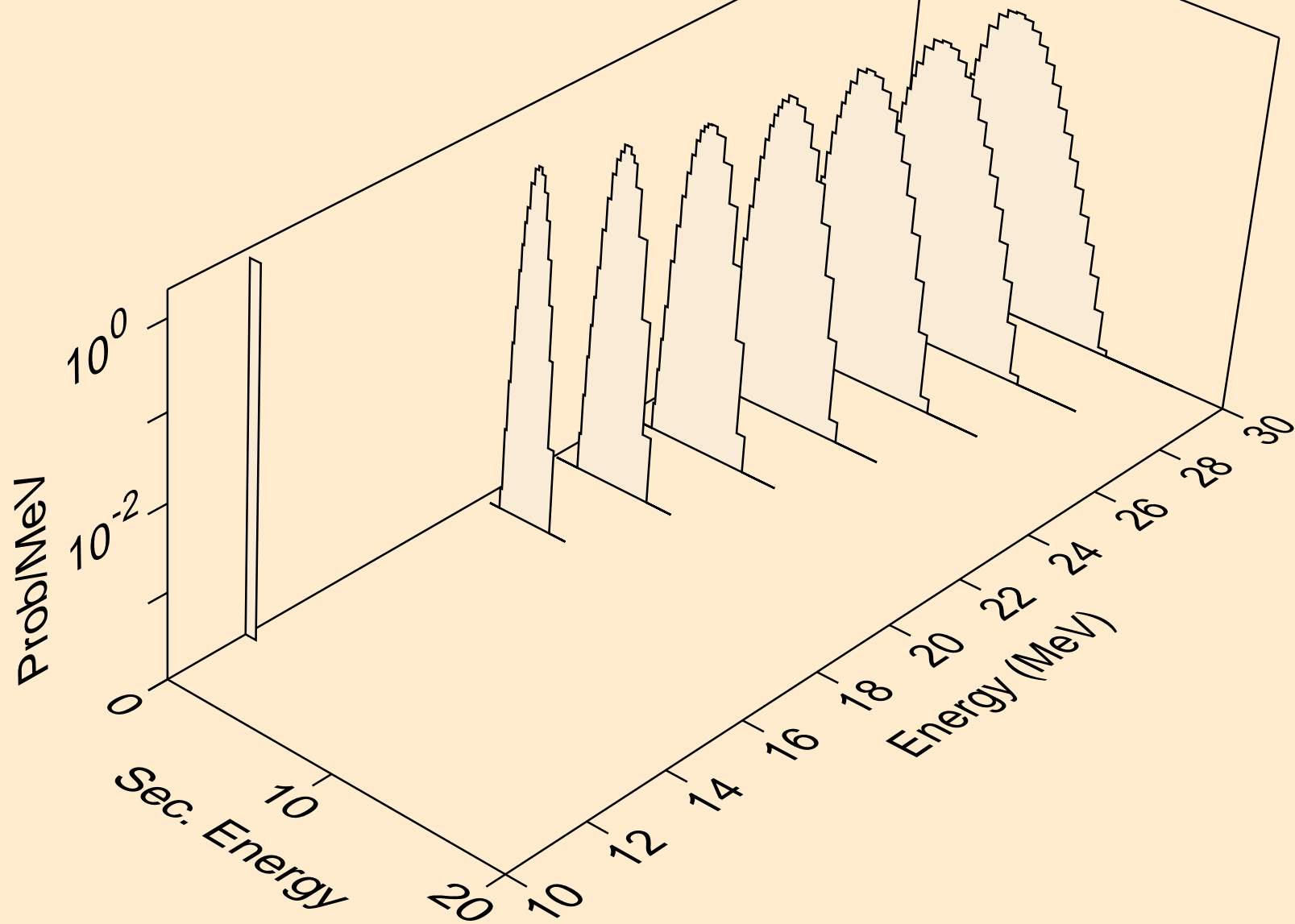

PR142M NEUTRON ACER TENDL-2023 LIBRARY; T=0.K  
protons from (n,pt)

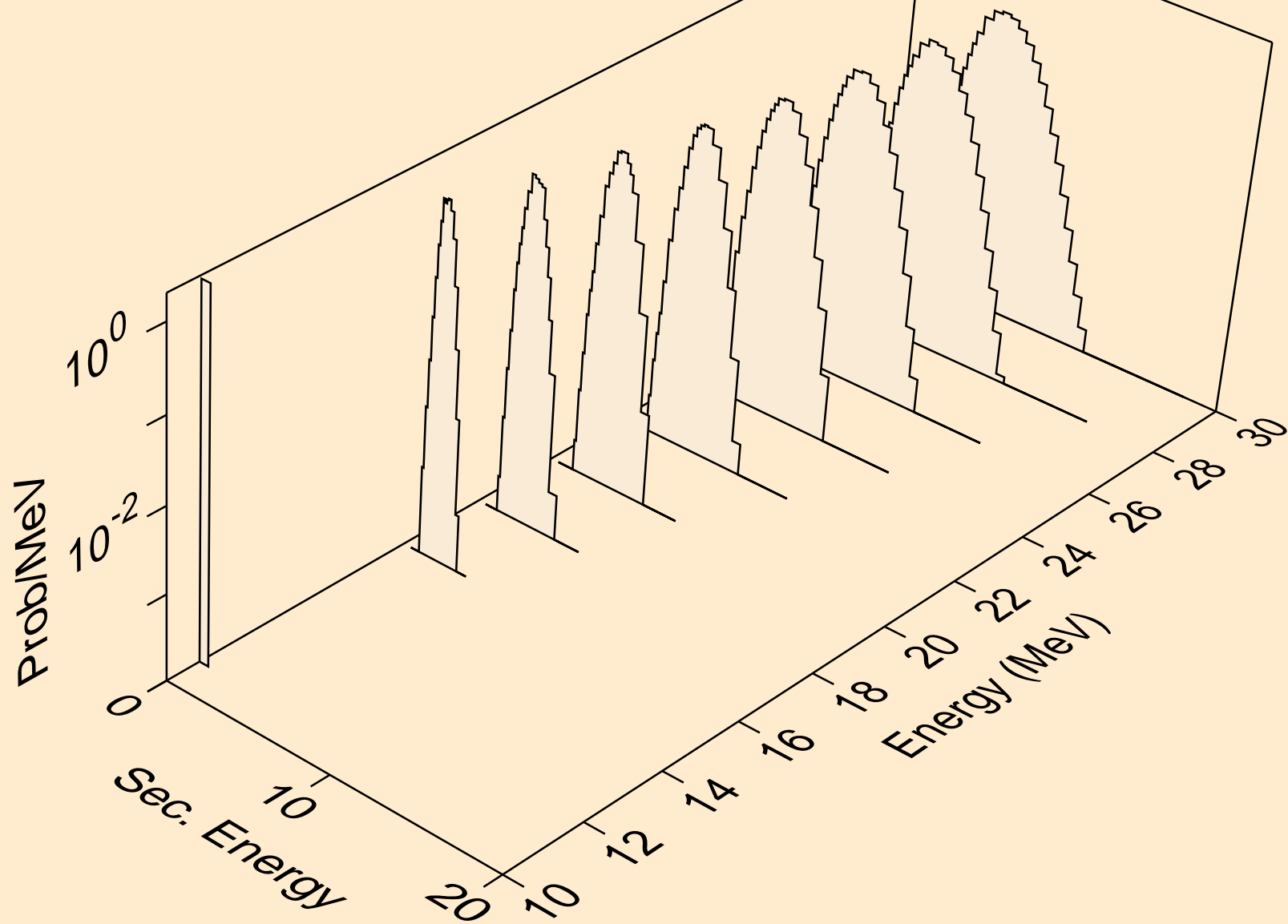

PR142M NEUTRON ACER TENDL-2023 LIBRARY; T=0.K  
deuterons from (n,x)

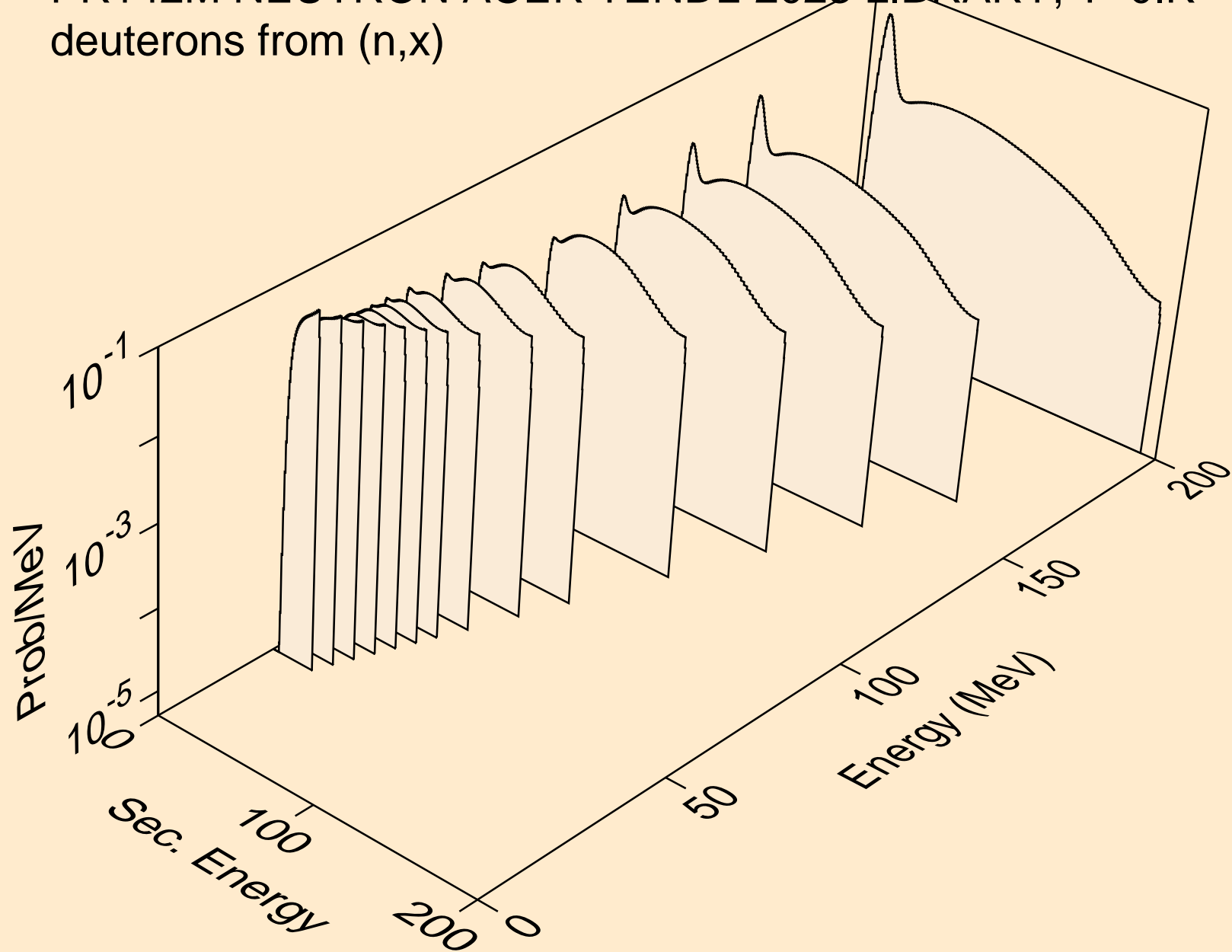

PR142M NEUTRON ACER TENDL-2023 LIBRARY; T=0.K  
deuterons from (n,2nd)

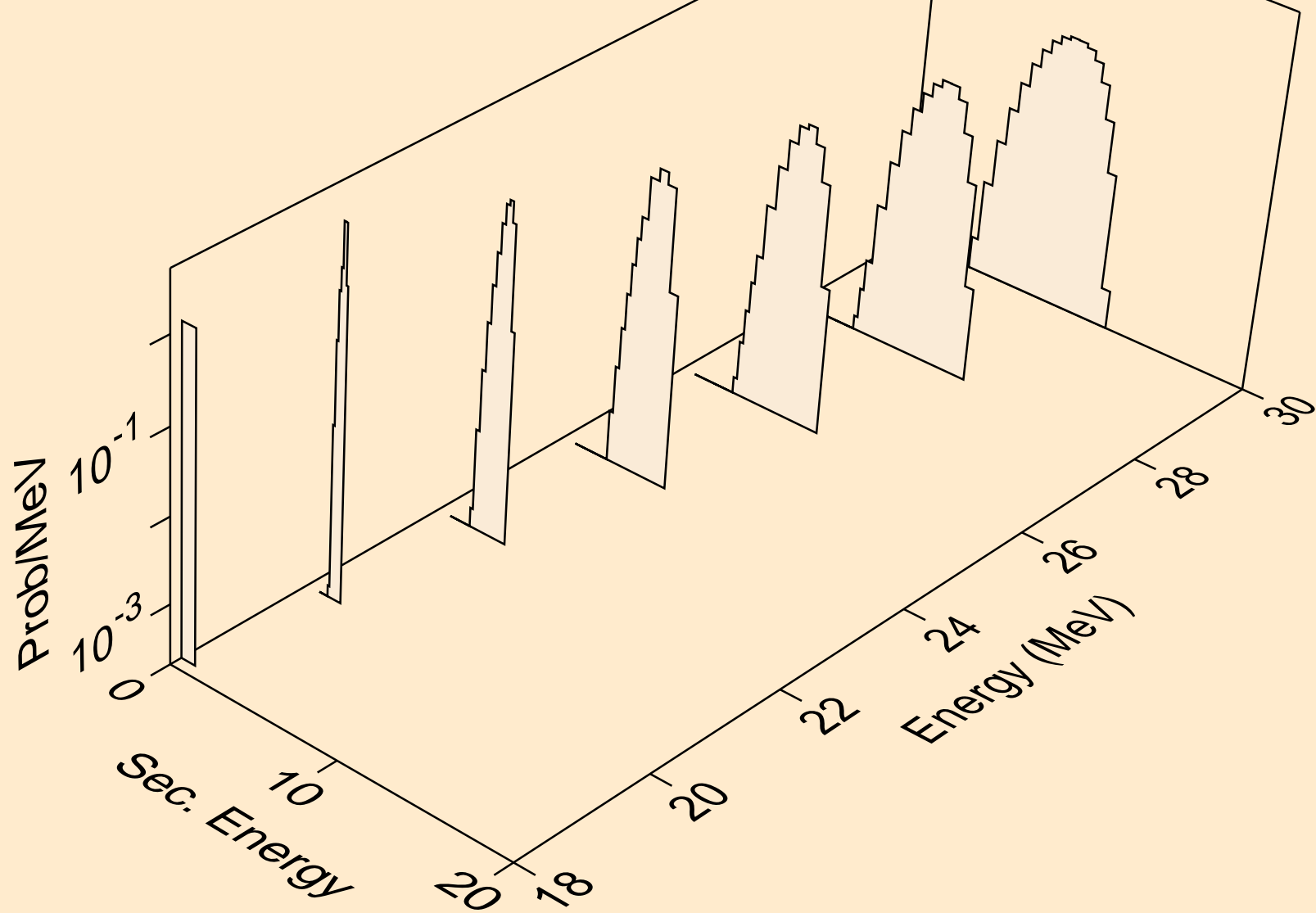



PR142M NEUTRON ACER TENDL-2023 LIBRARY; T=0.K  
deuterons from (n,n\*)d

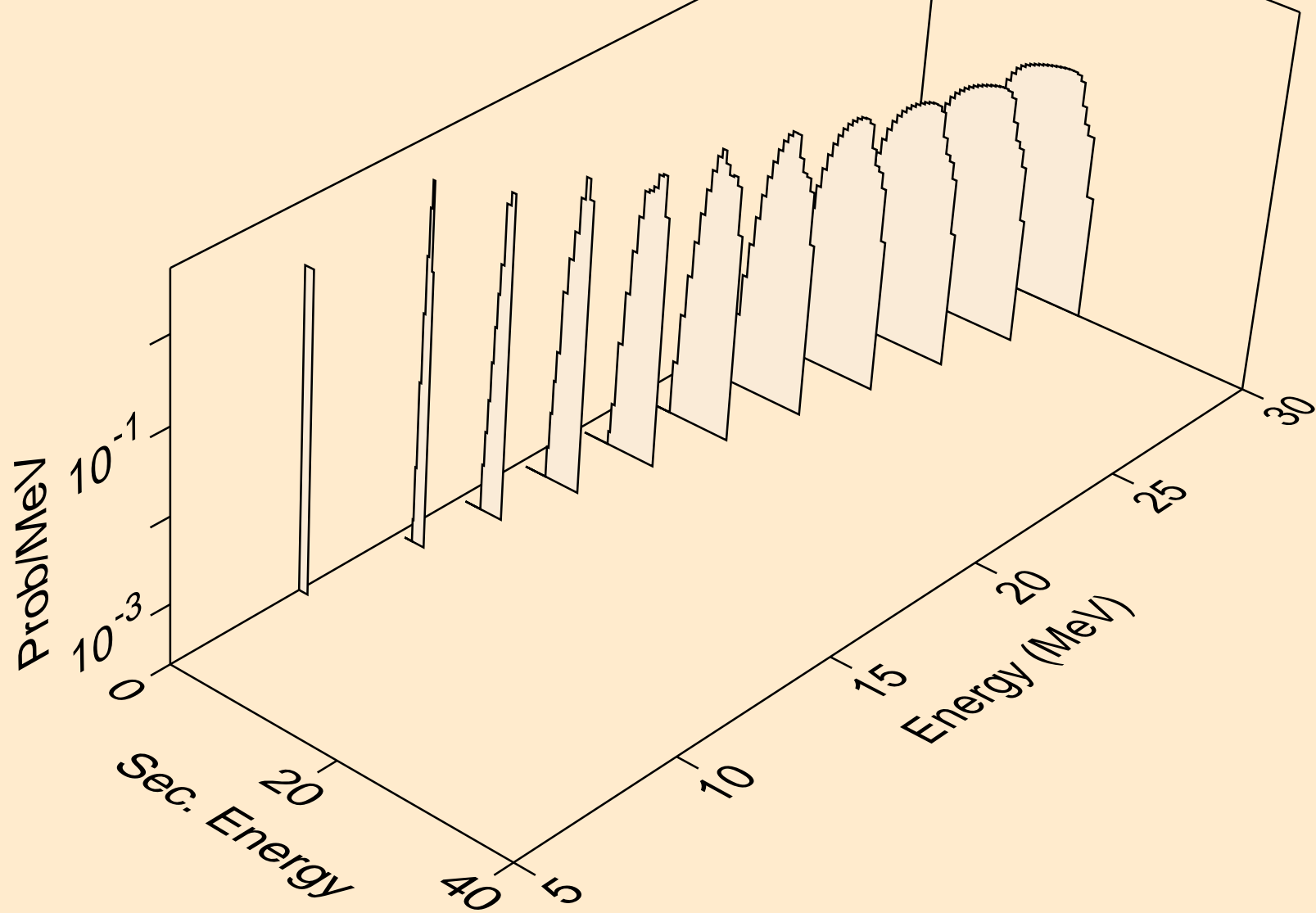

PR142M NEUTRON ACER TENDL-2023 LIBRARY; T=0.K  
deuterons from (n,d)

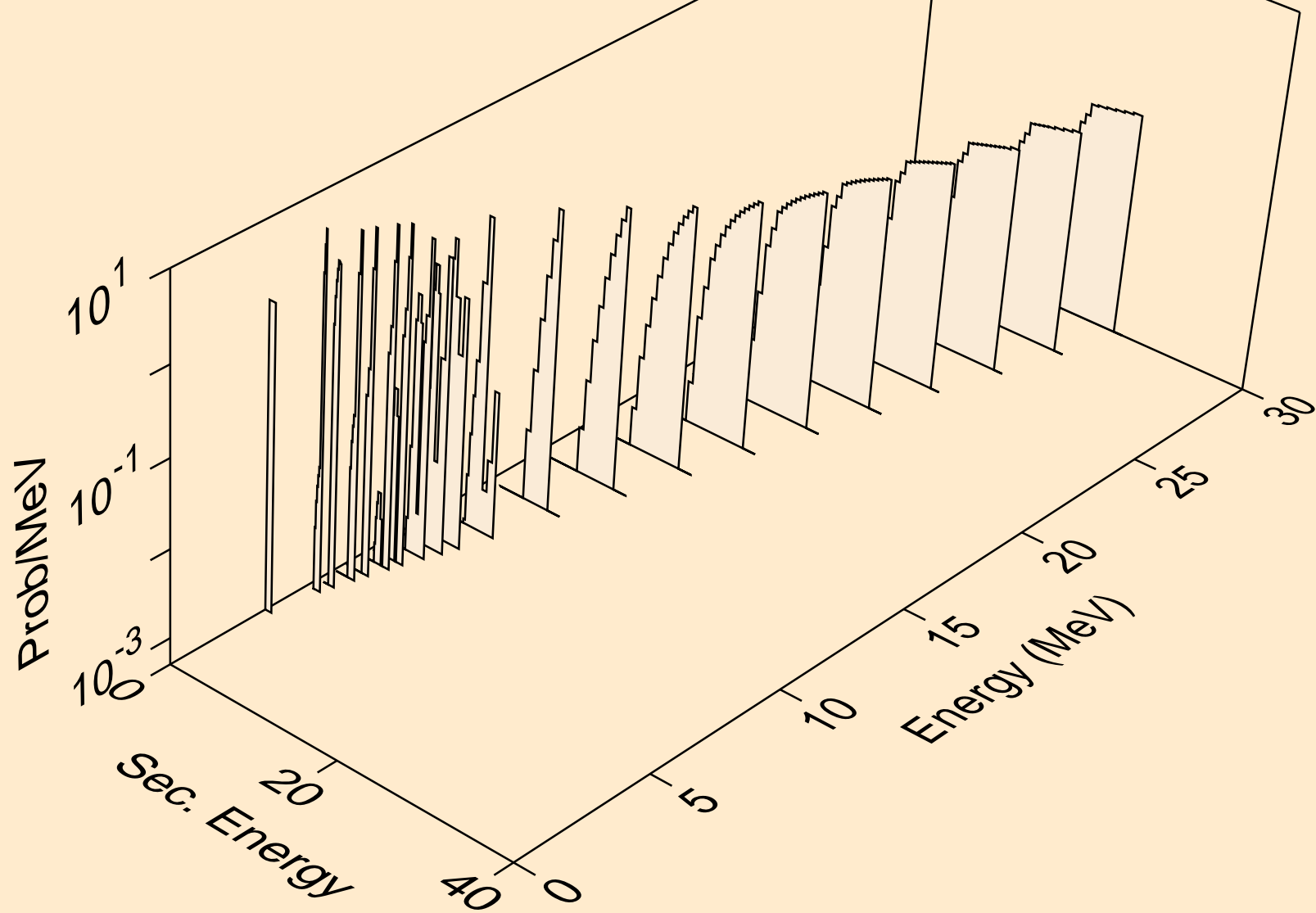

PR142M NEUTRON ACER TENDL-2023 LIBRARY; T=0.K  
deuterons from (n,pd)

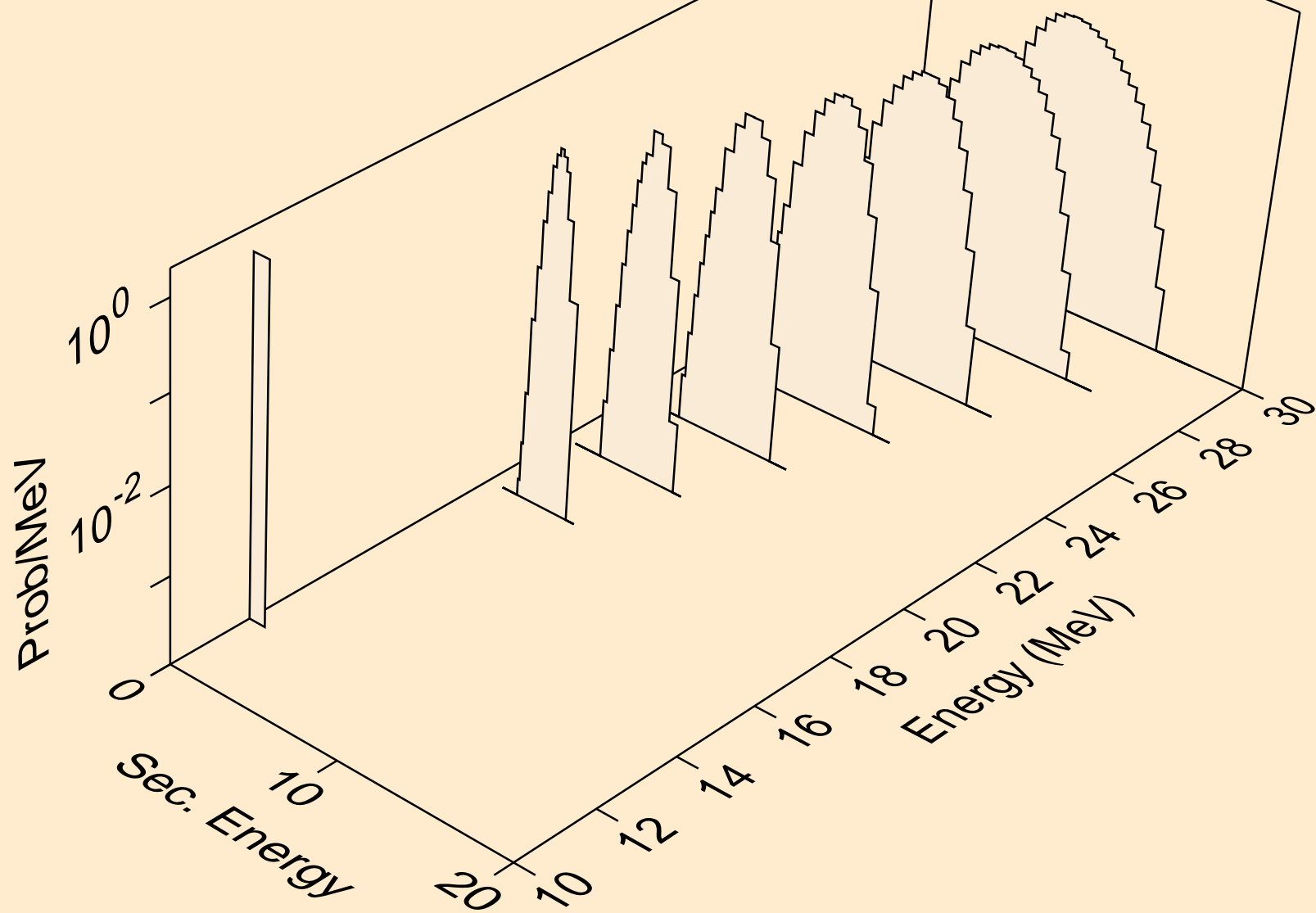

PR142M NEUTRON ACER TENDL-2023 LIBRARY; T=0.K  
deuterons from (n,da)

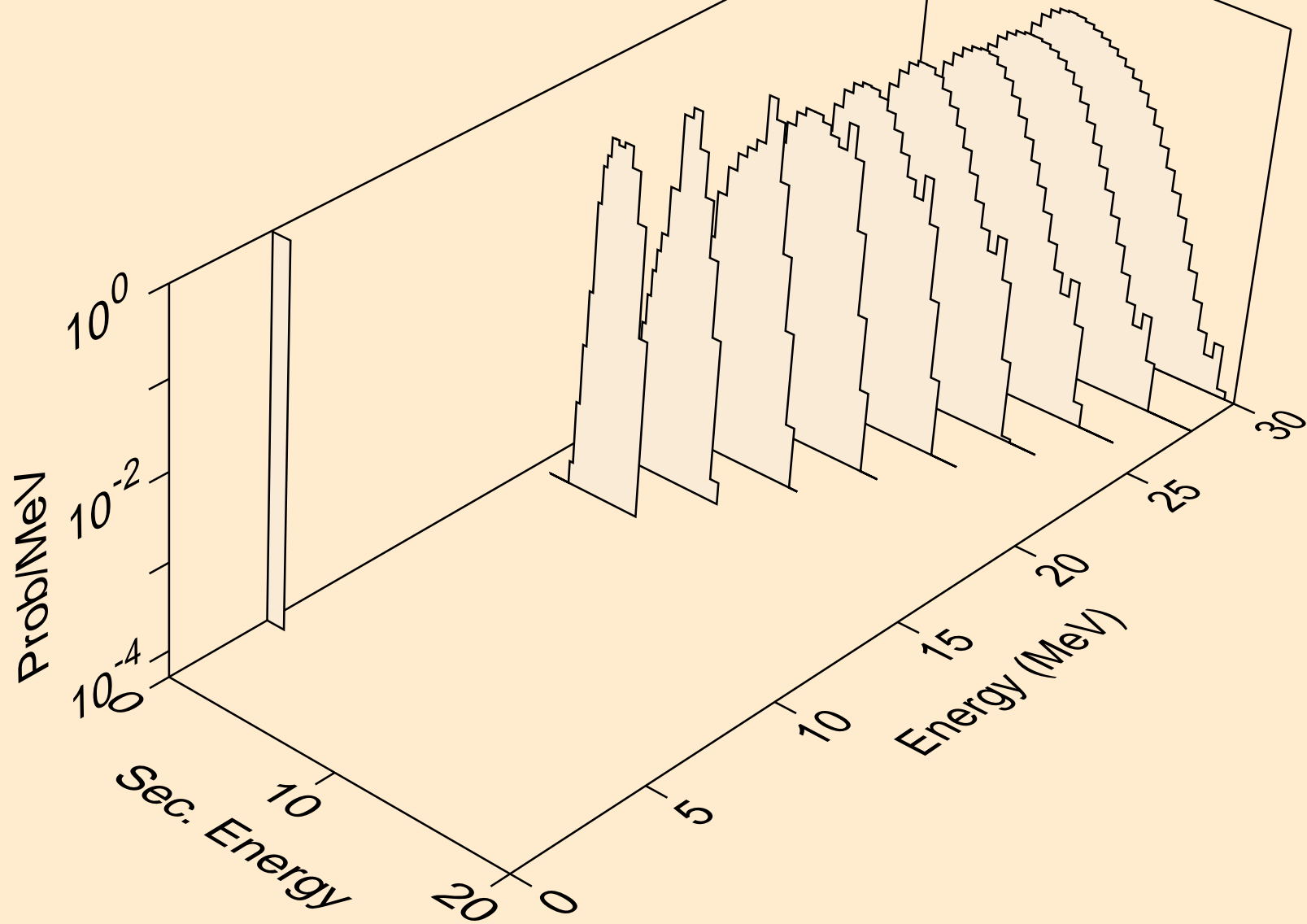

PR142M NEUTRON ACER TENDL-2023 LIBRARY; T=0.K  
tritons from (n,x)

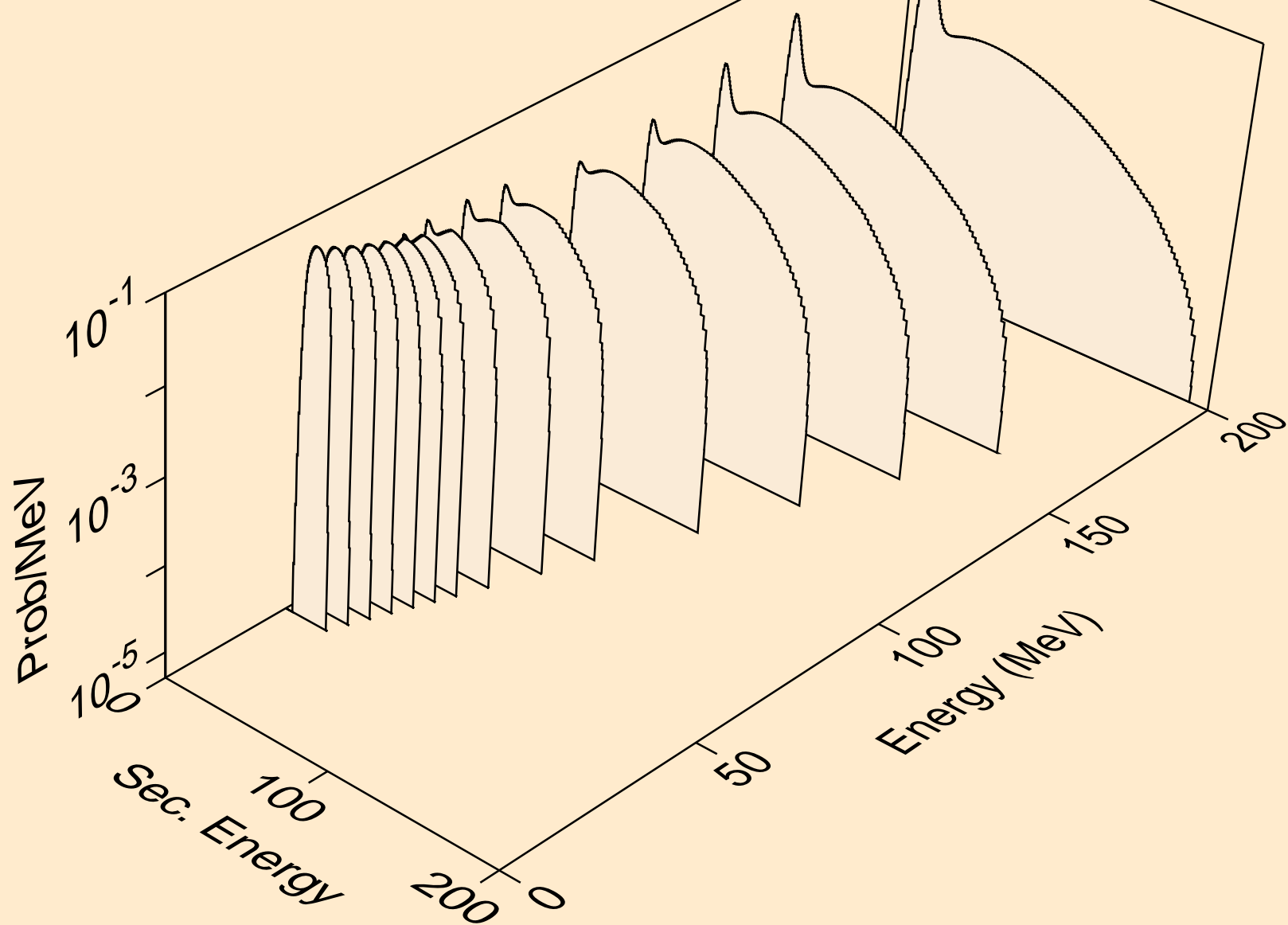

PR142M NEUTRON ACER TENDL-2023 LIBRARY; T=0.K  
tritons from (n,n\*)t

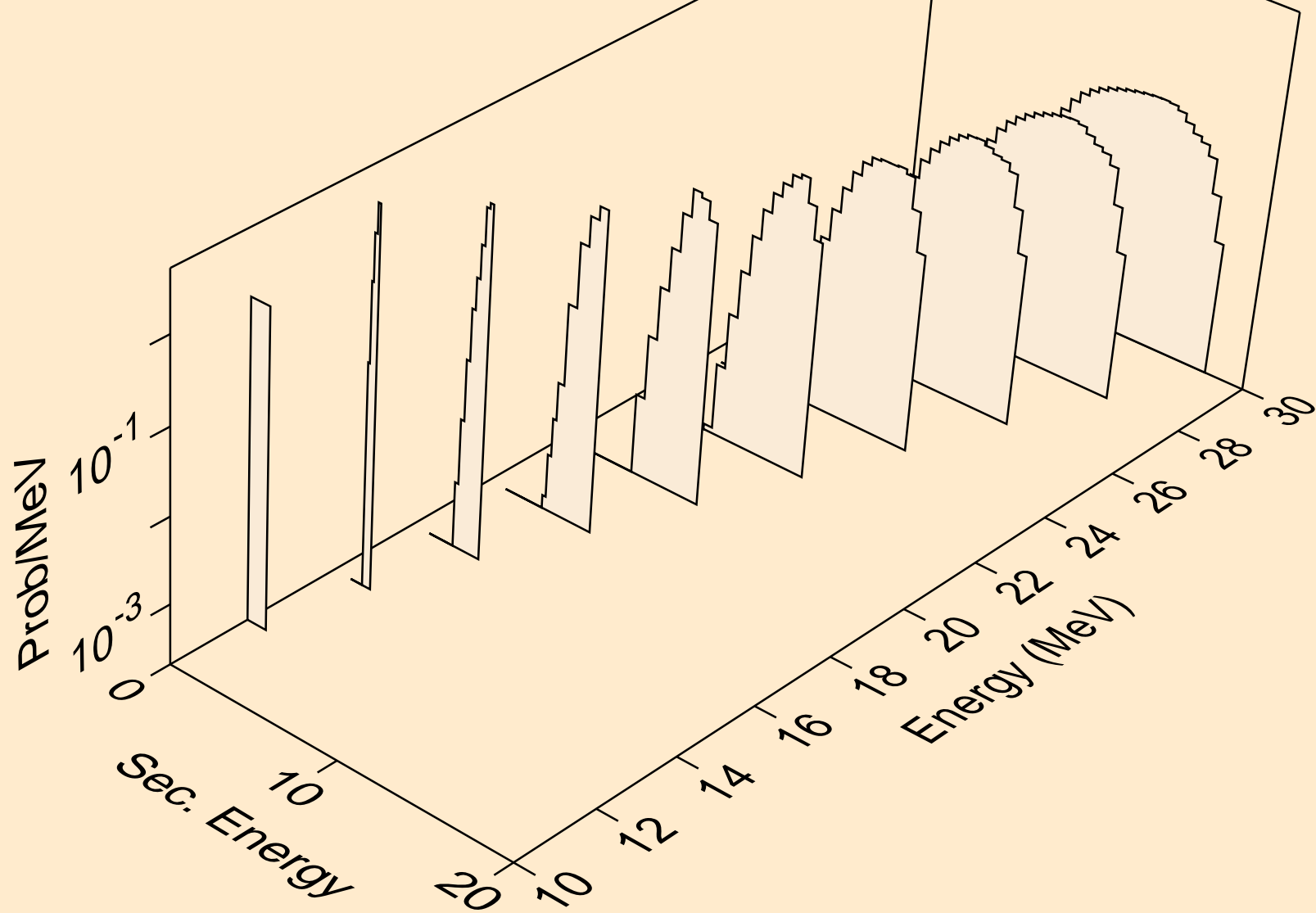

PR142M NEUTRON ACER TENDL-2023 LIBRARY; T=0.K  
tritons from (n,t)

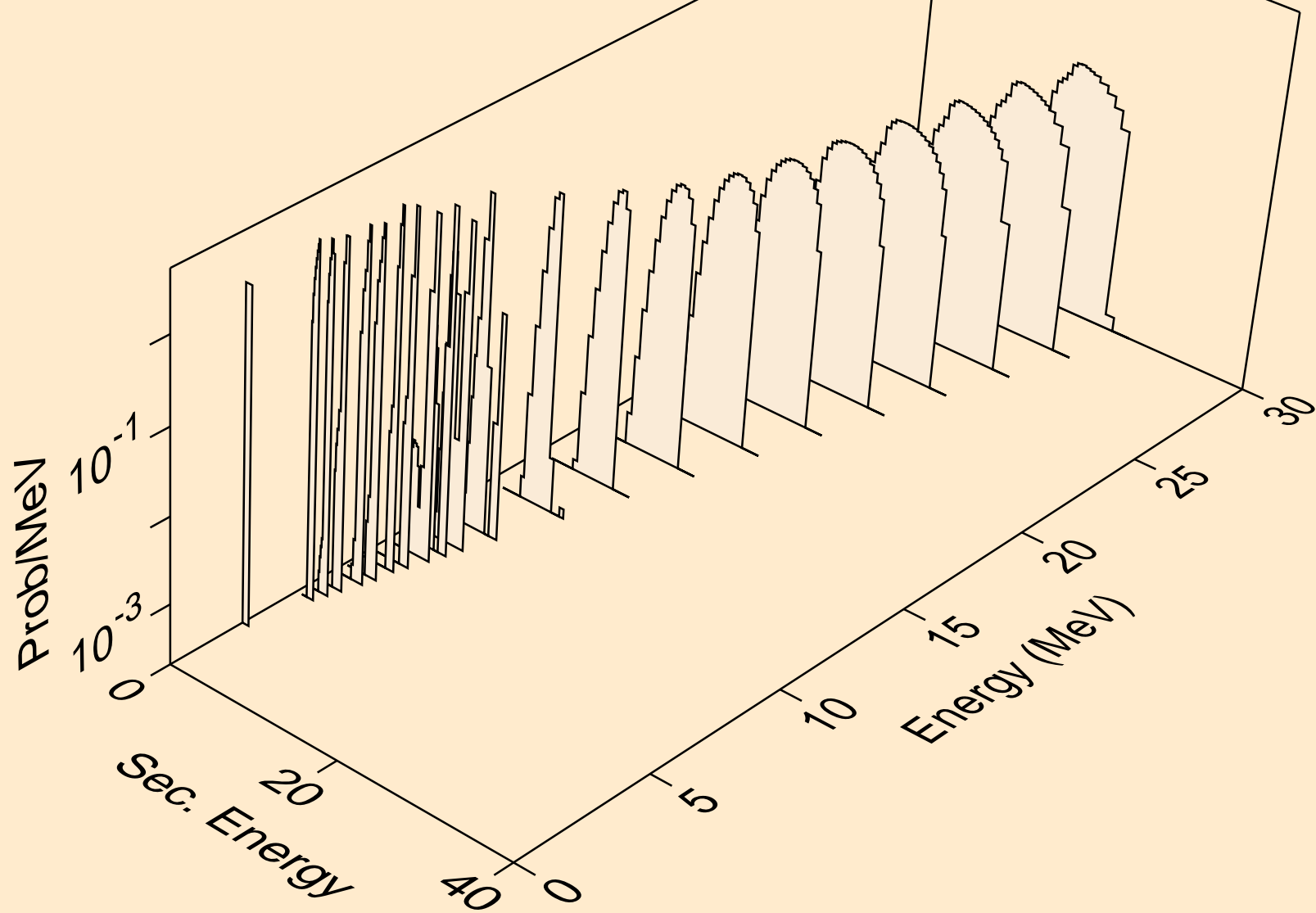

PR142M NEUTRON ACER TENDL-2023 LIBRARY; T=0.K  
tritons from (n,pt)

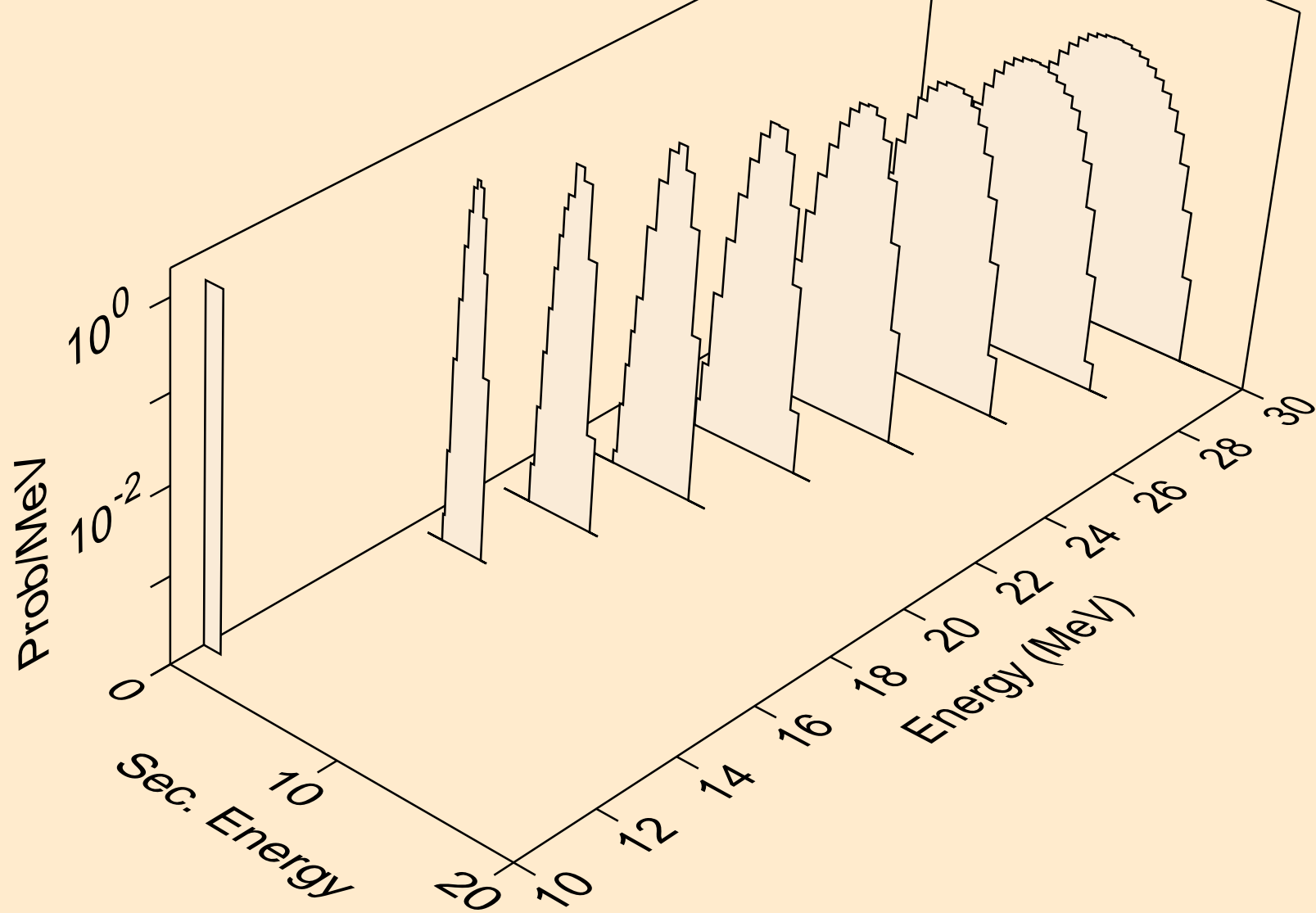



PR142M NEUTRON ACER TENDL-2023 LIBRARY; T=0.K  
he3s from (n,x)

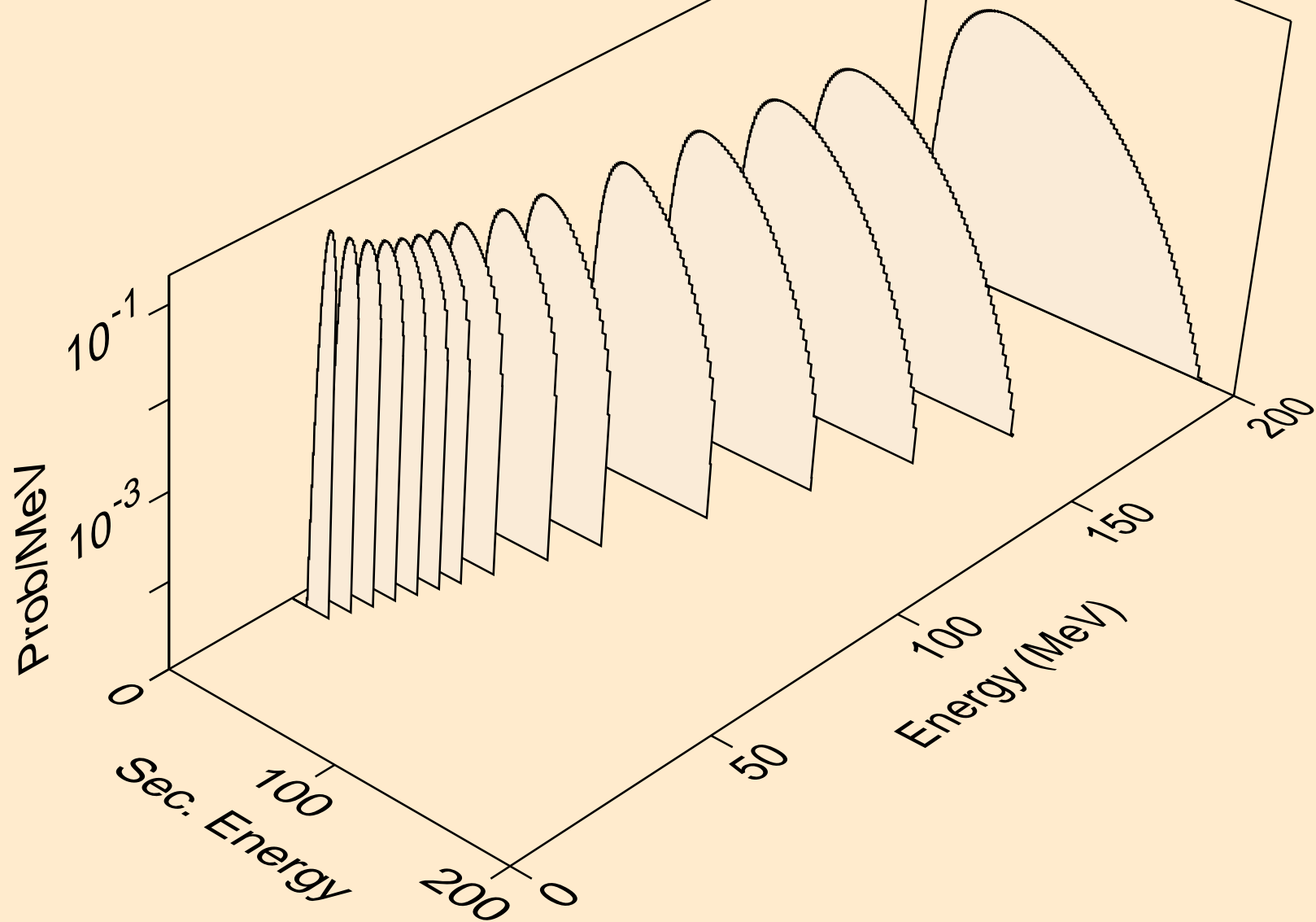

PR142M NEUTRON ACER TENDL-2023 LIBRARY; T=0.K  
he3s from (n,n\*)he3

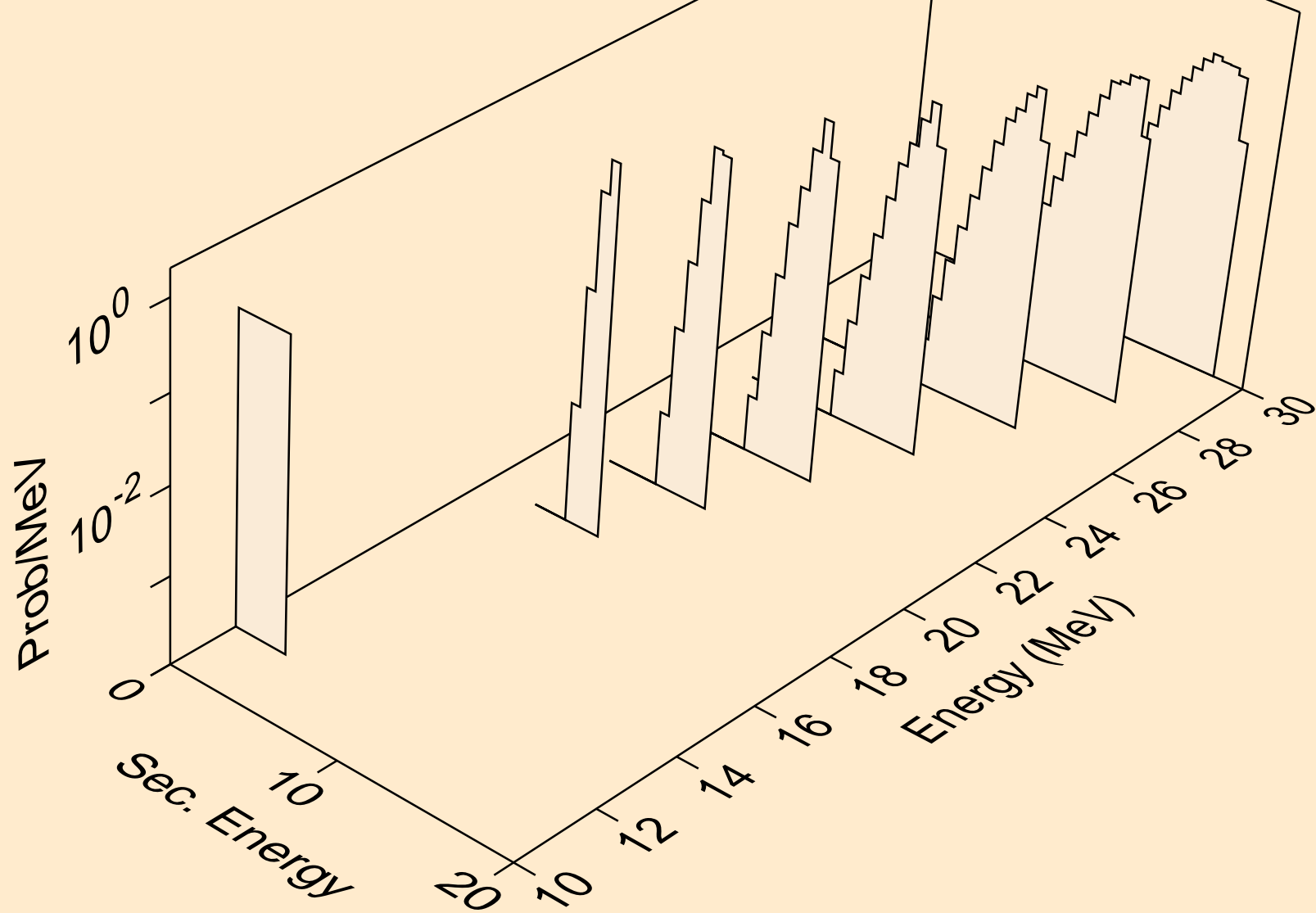

PR142M NEUTRON ACER TENDL-2023 LIBRARY; T=0.K  
he3s from (n,he3)

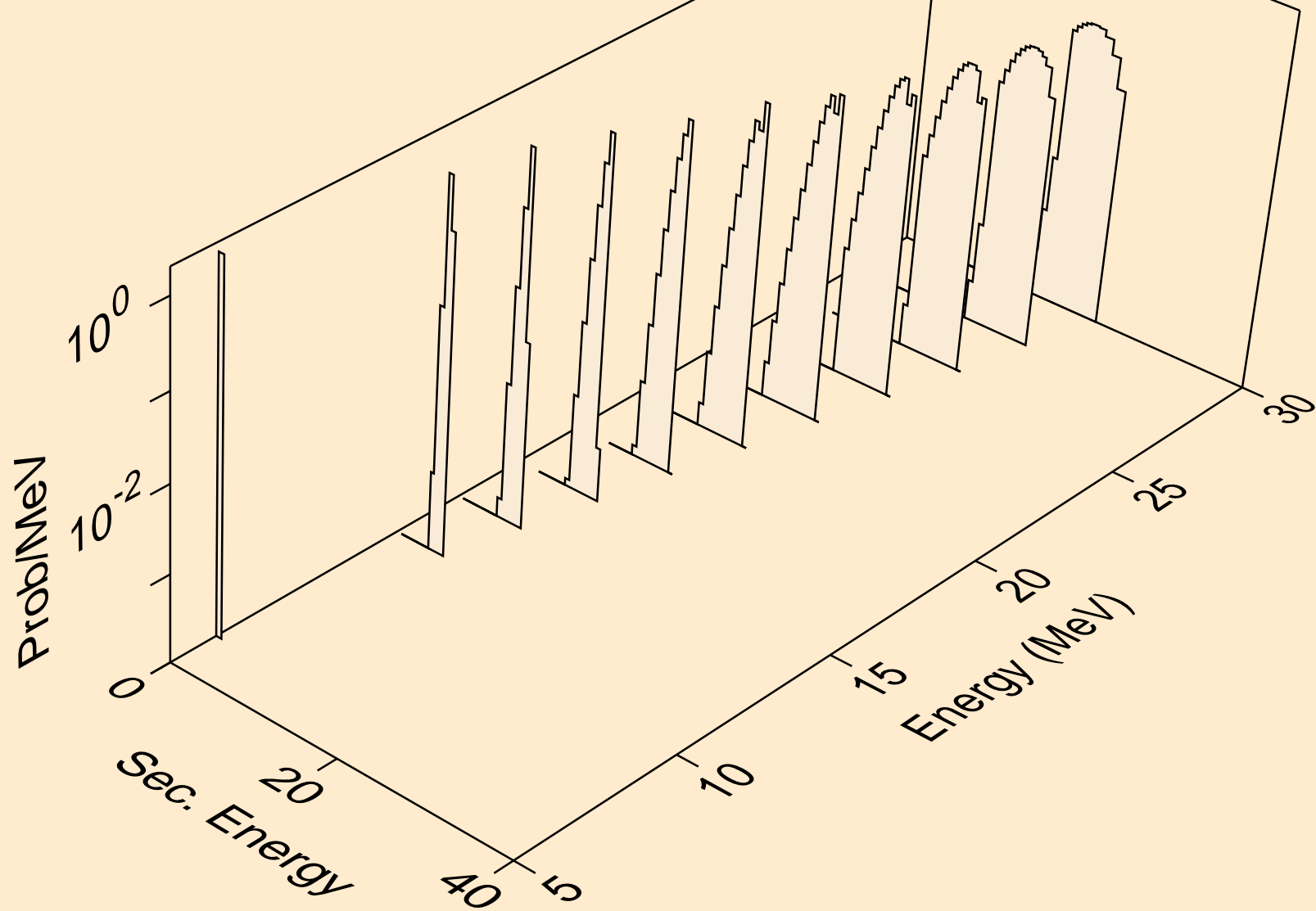

PR142M NEUTRON ACER TENDL-2023 LIBRARY; T=0.K  
alphas from (n,x)

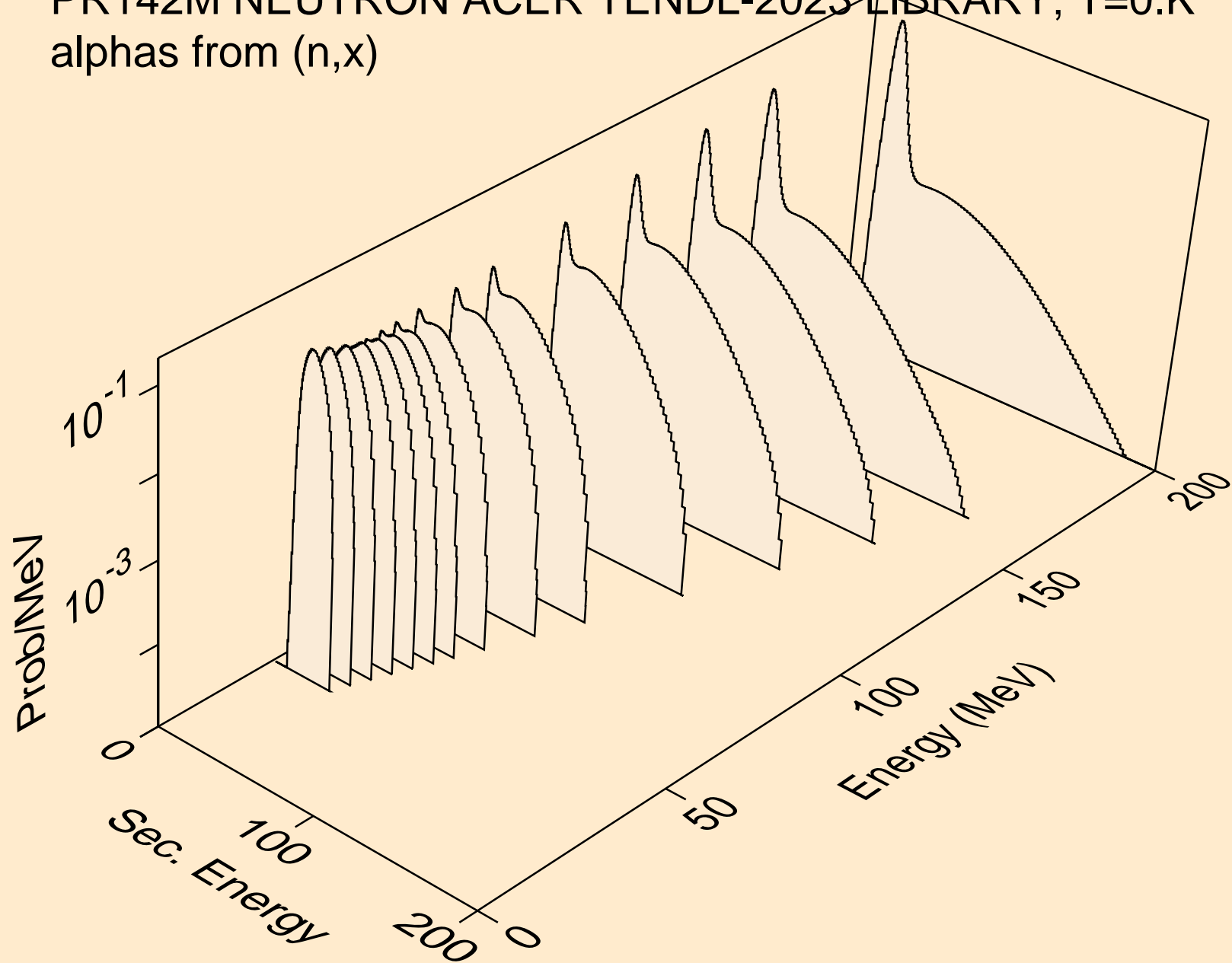

PR142M NEUTRON ACER TENDL-2023 LIBRARY; T=0.K  
alphas from (n,n\*)a

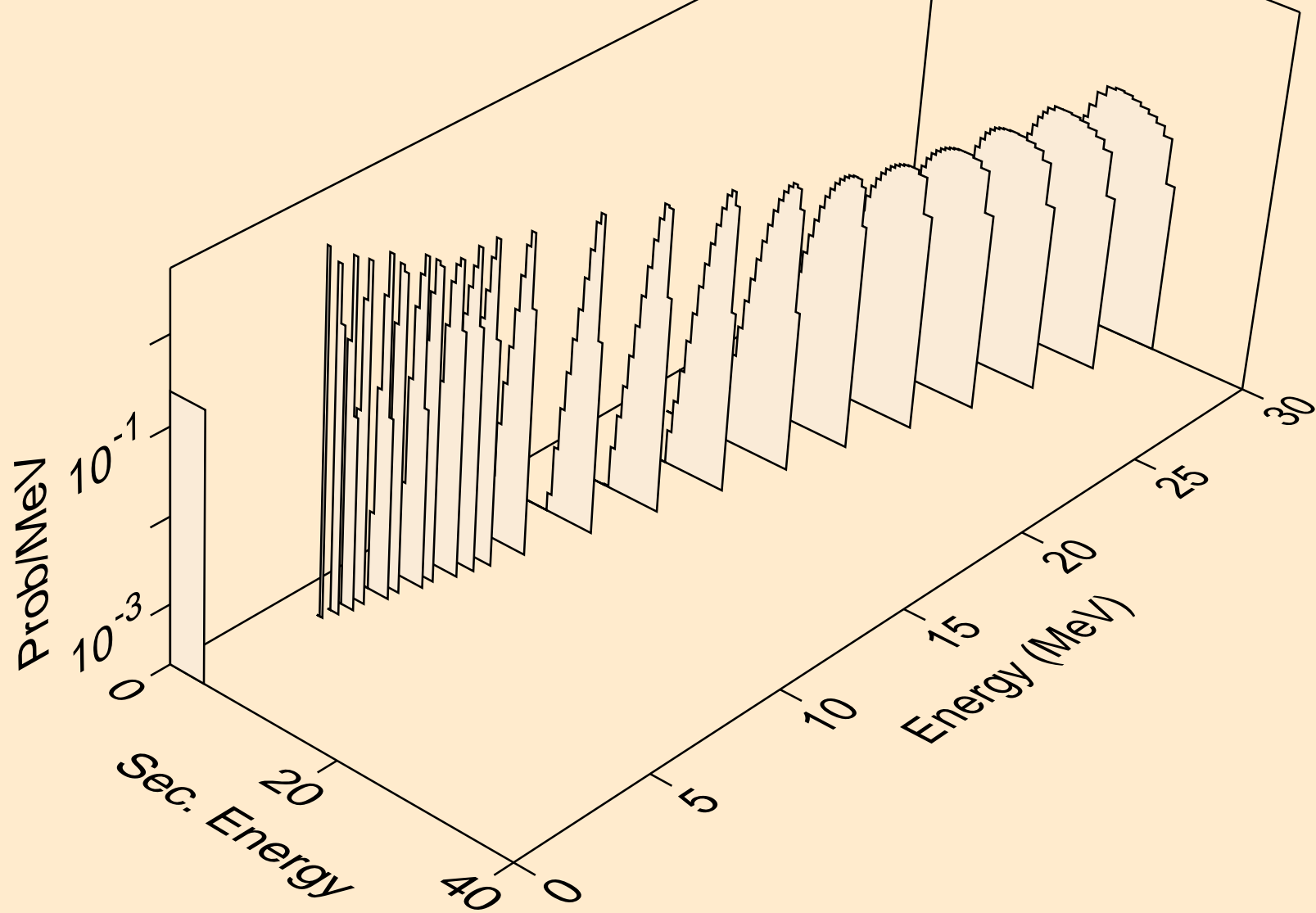

PR142M NEUTRON ACER TENDL-2023 LIBRARY; T=0.K  
alphas from (n,2n)a

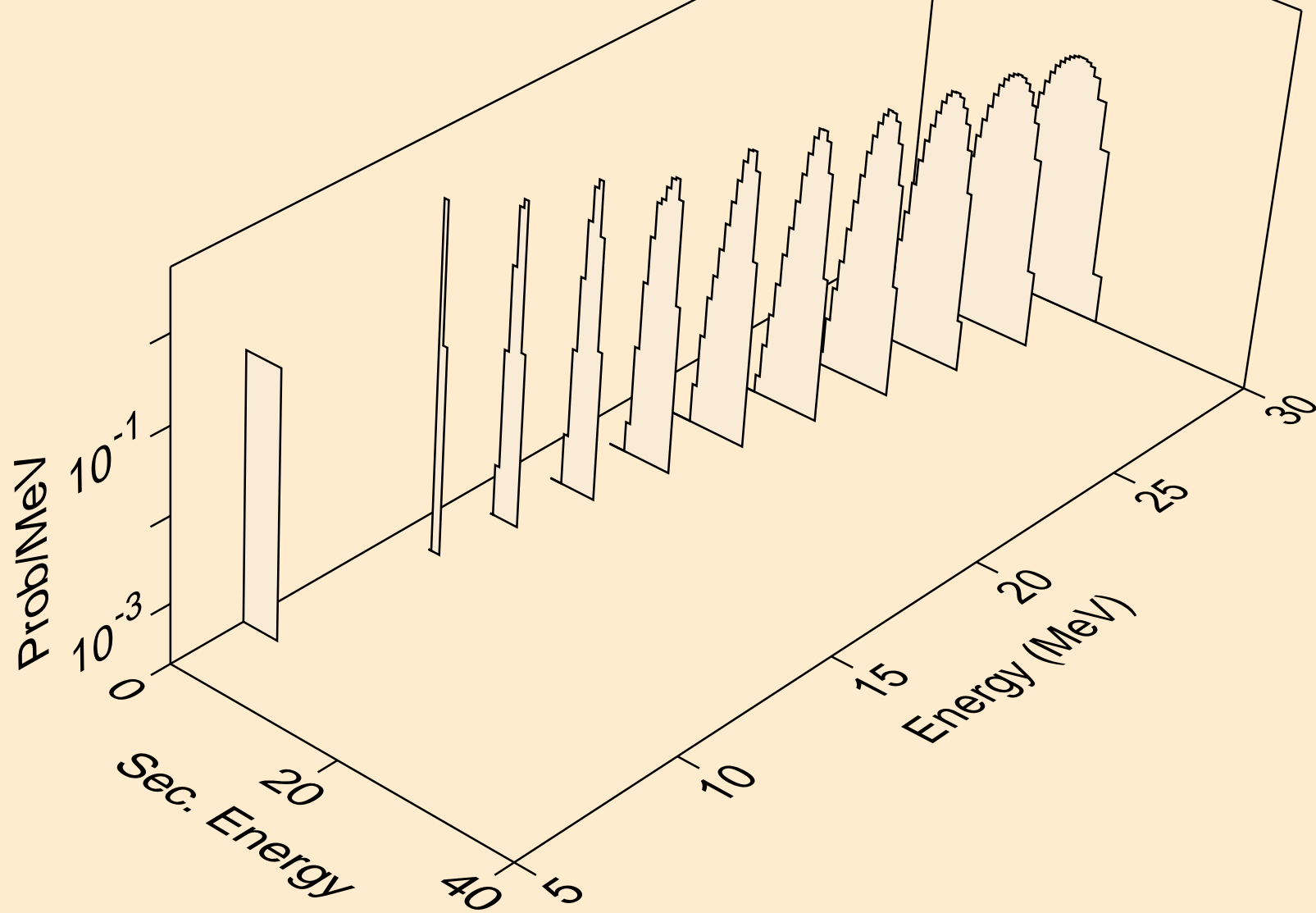

PR142M NEUTRON ACER TENDL-2023 LIBRARY; T=0.K  
alphas from (n,3n)a

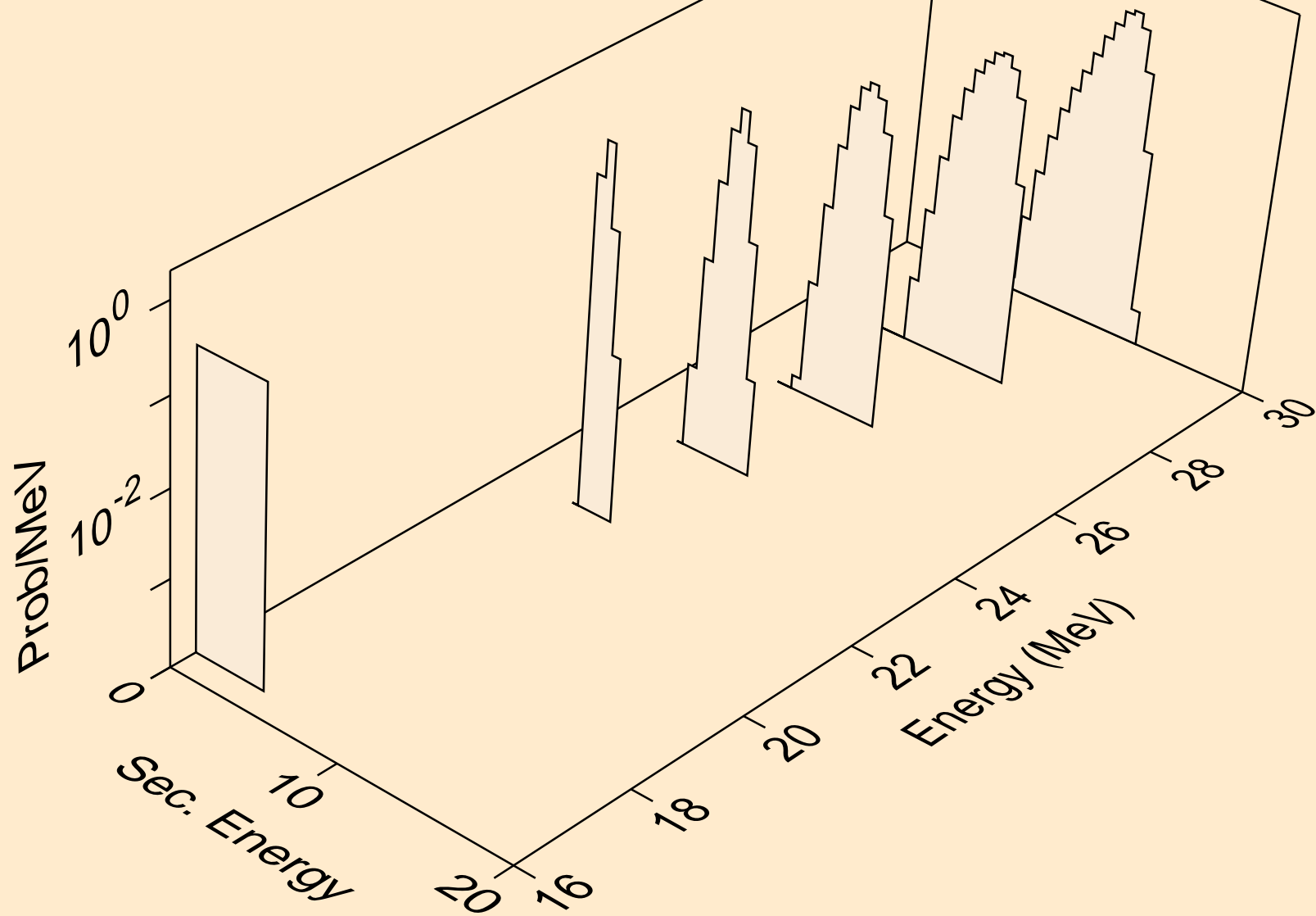

PR142M NEUTRON ACER TENDL-2023 LIBRARY; T=0.K  
alphas from (n,n\*)2a

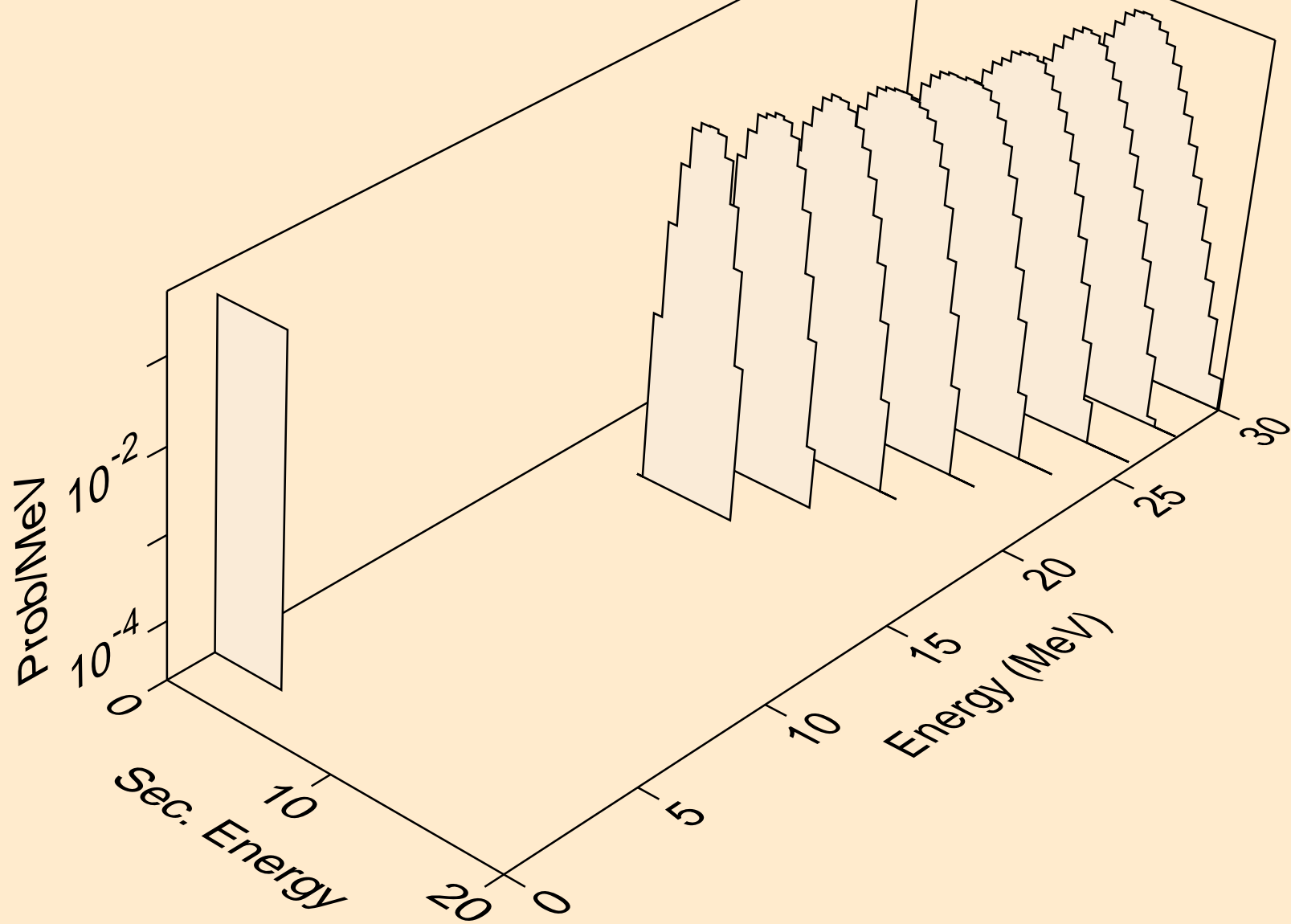



PR142M NEUTRON ACER TENDL-2023 LIBRARY; T=0.K  
alphas from (n,npa)

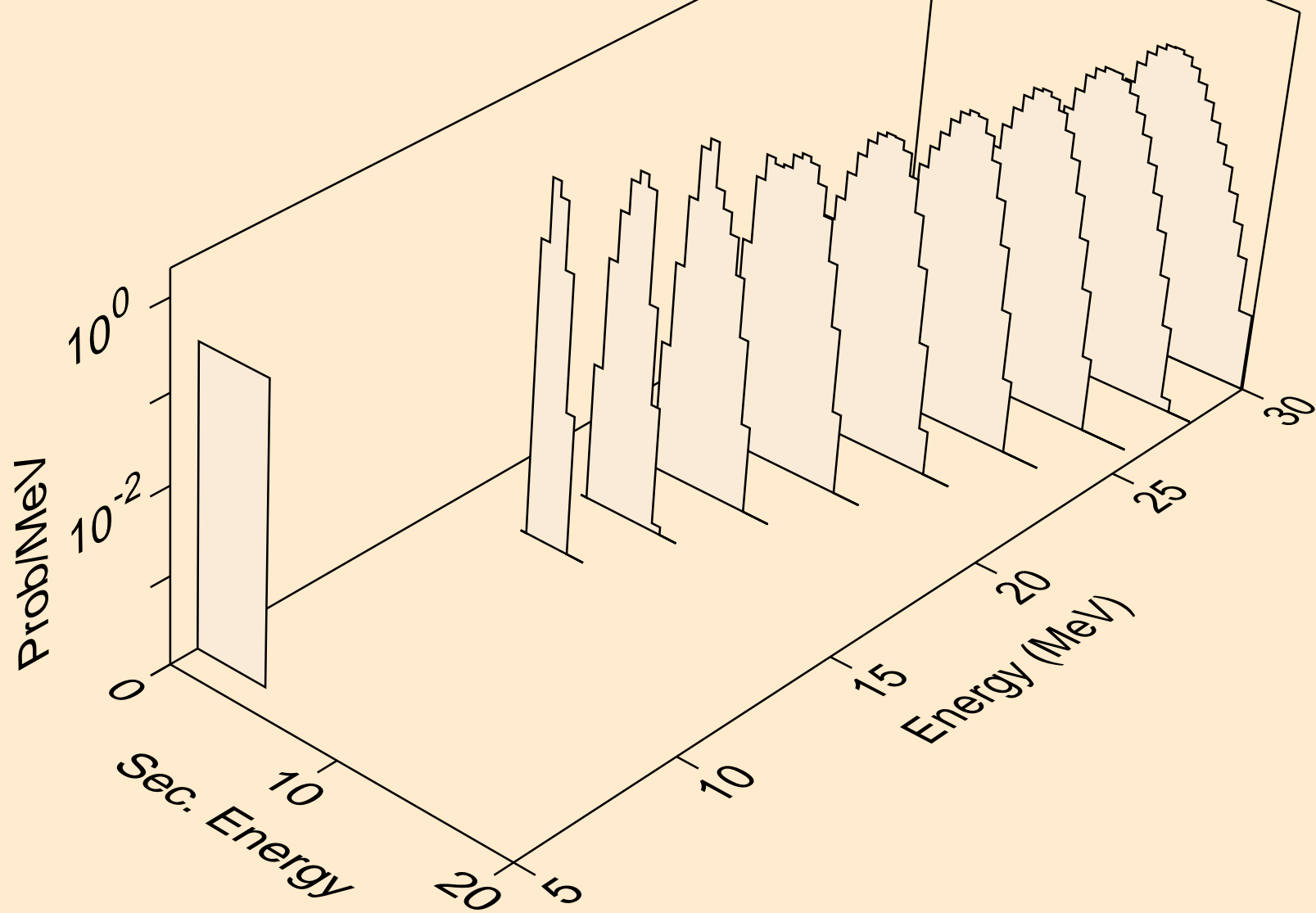

PR142M NEUTRON ACER TENDL-2023 LIBRARY; T=0.K  
alphas from (n,a)

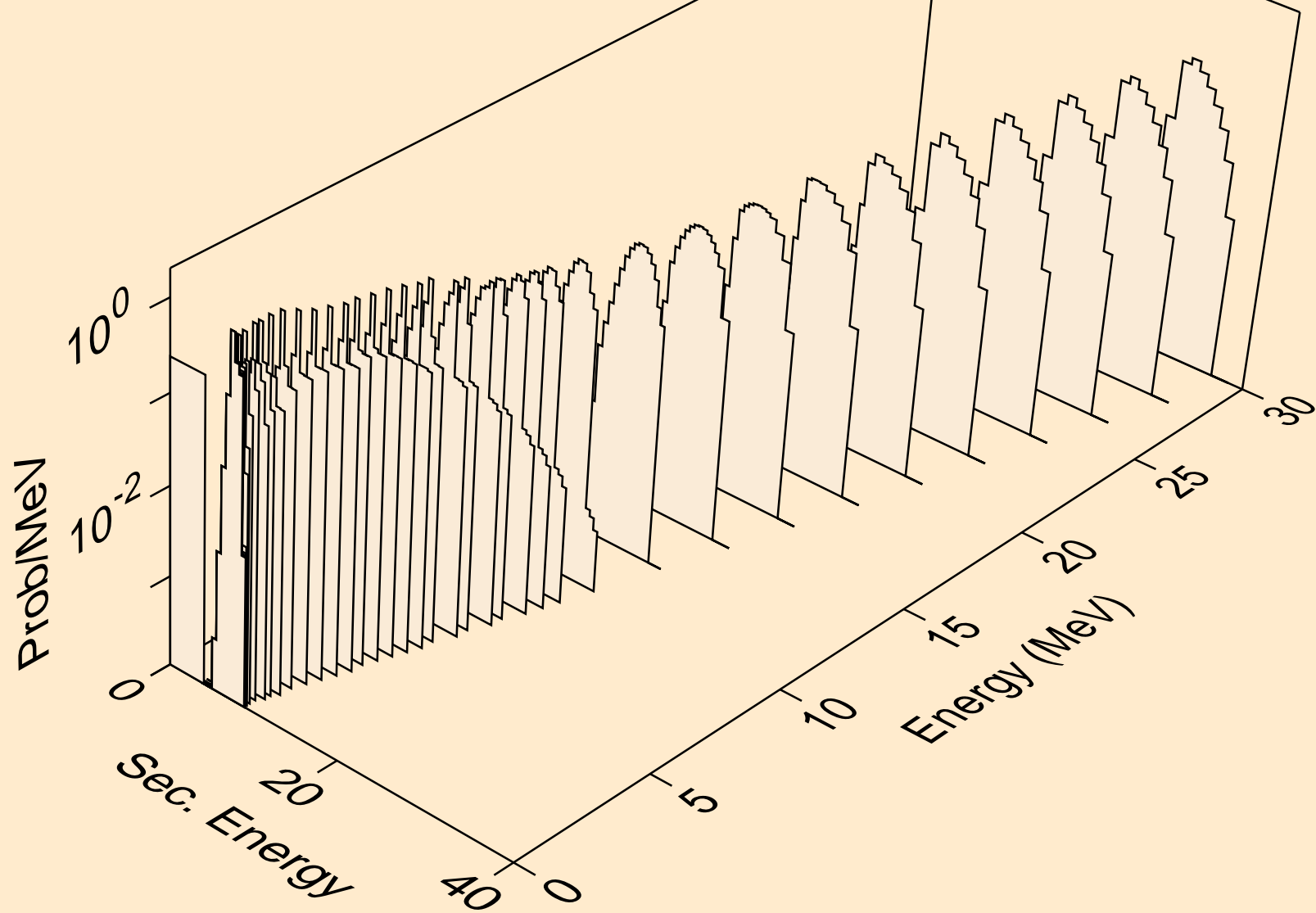

PR142M NEUTRON ACER TENDL-2023 LIBRARY; T=0.K  
alphas from (n,2a)

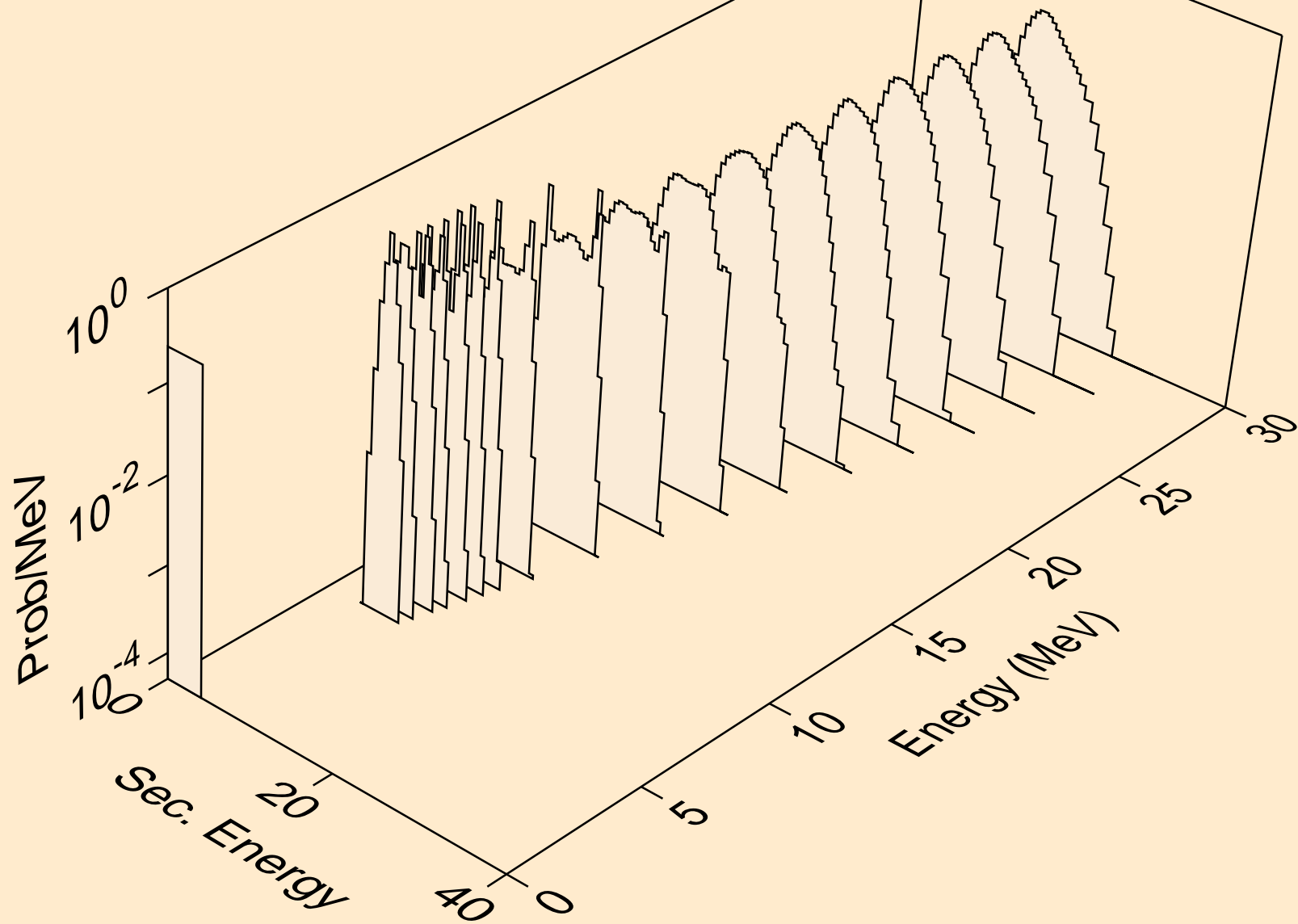

PR142M NEUTRON ACER TENDL-2023 LIBRARY; T=0.K  
alphas from (n,pa)

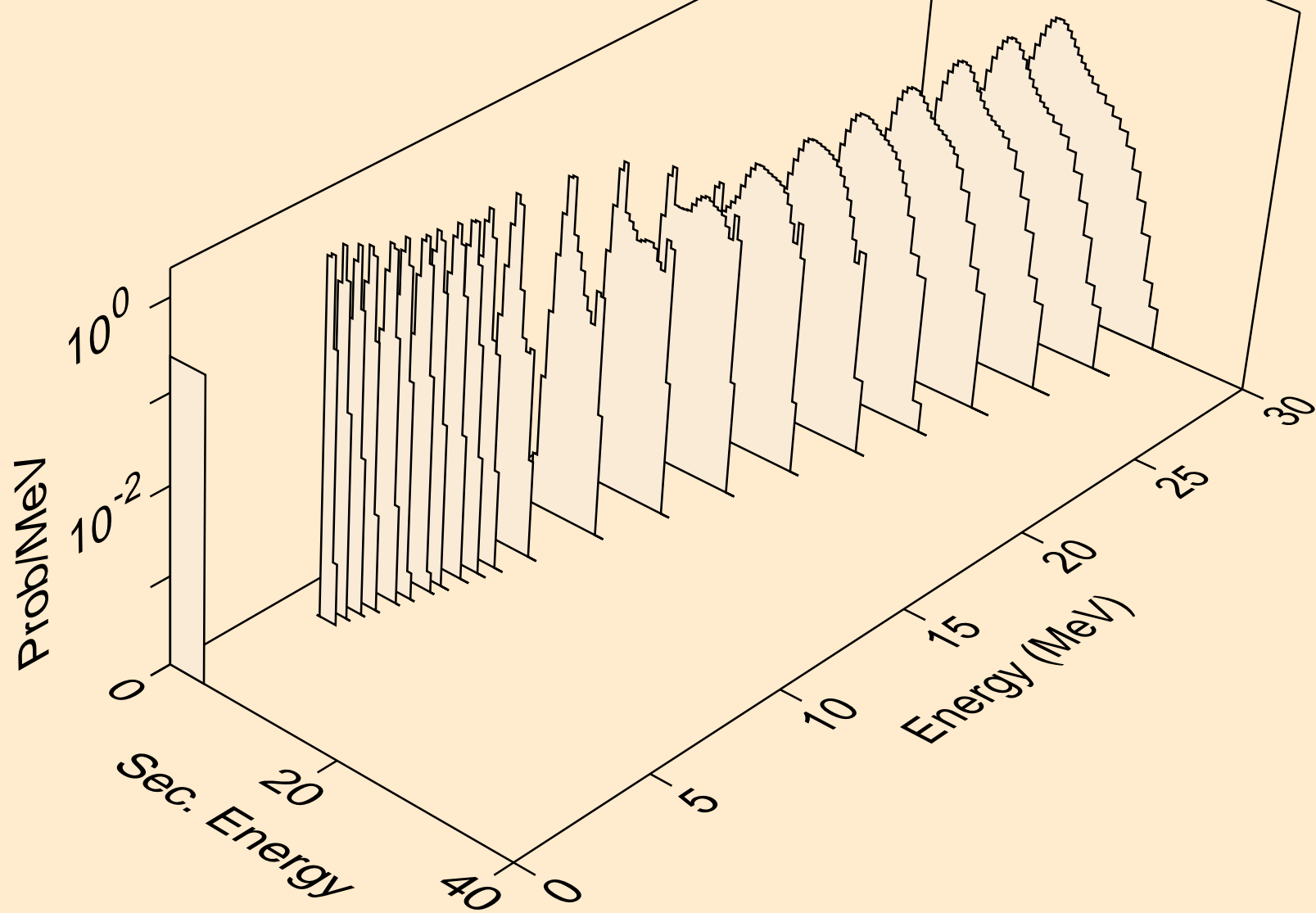

PR142M NEUTRON ACER TENDL-2023 LIBRARY; T=0.K  
alphas from (n,da)

