

PR150 NEUTRON ACER TENDL-2023 LIBRARY; T=0.K
Principal cross sections

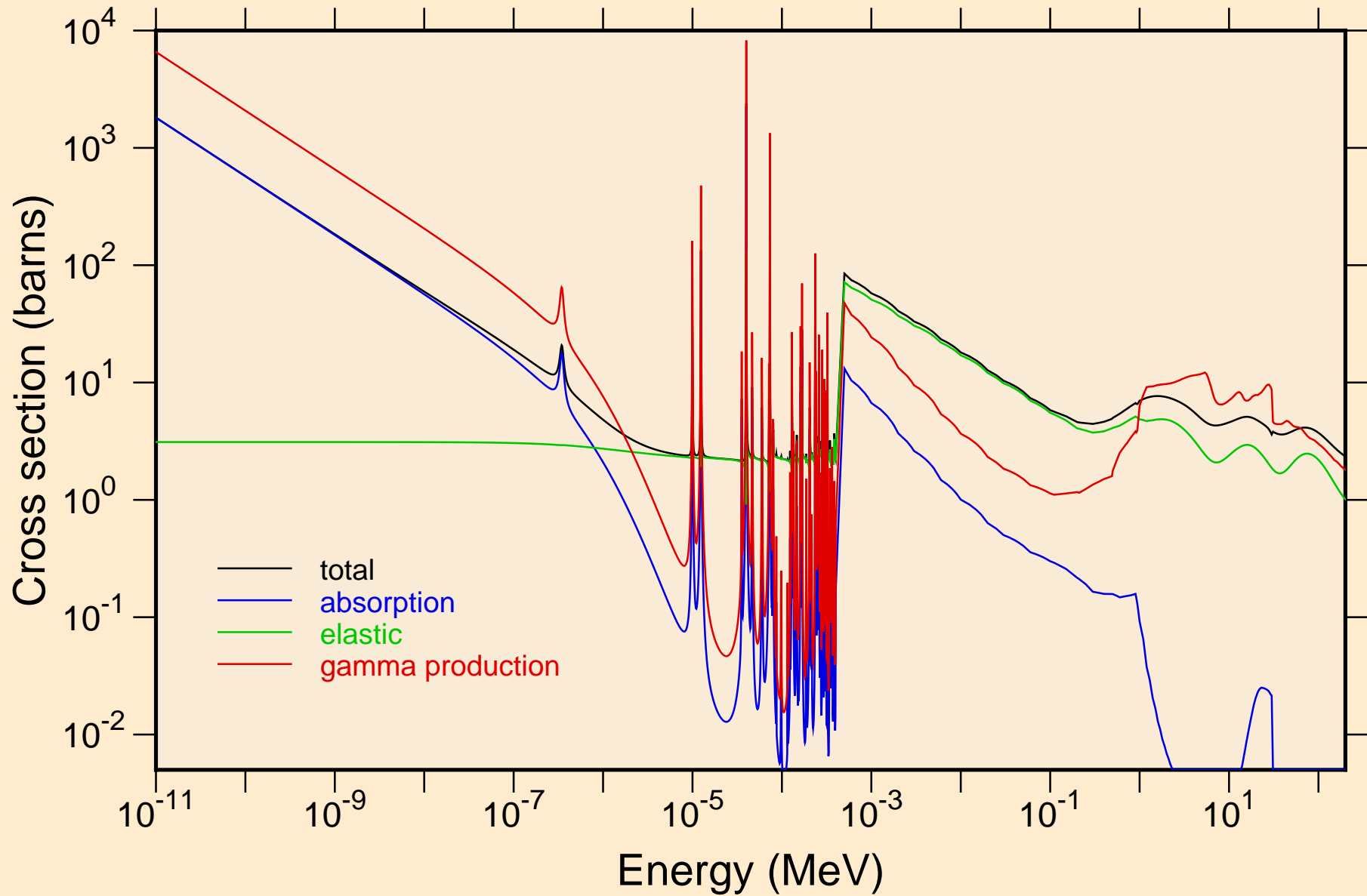

PR150 NEUTRON ACER TENDL-2023 LIBRARY; T=0.K
resonance total cross section

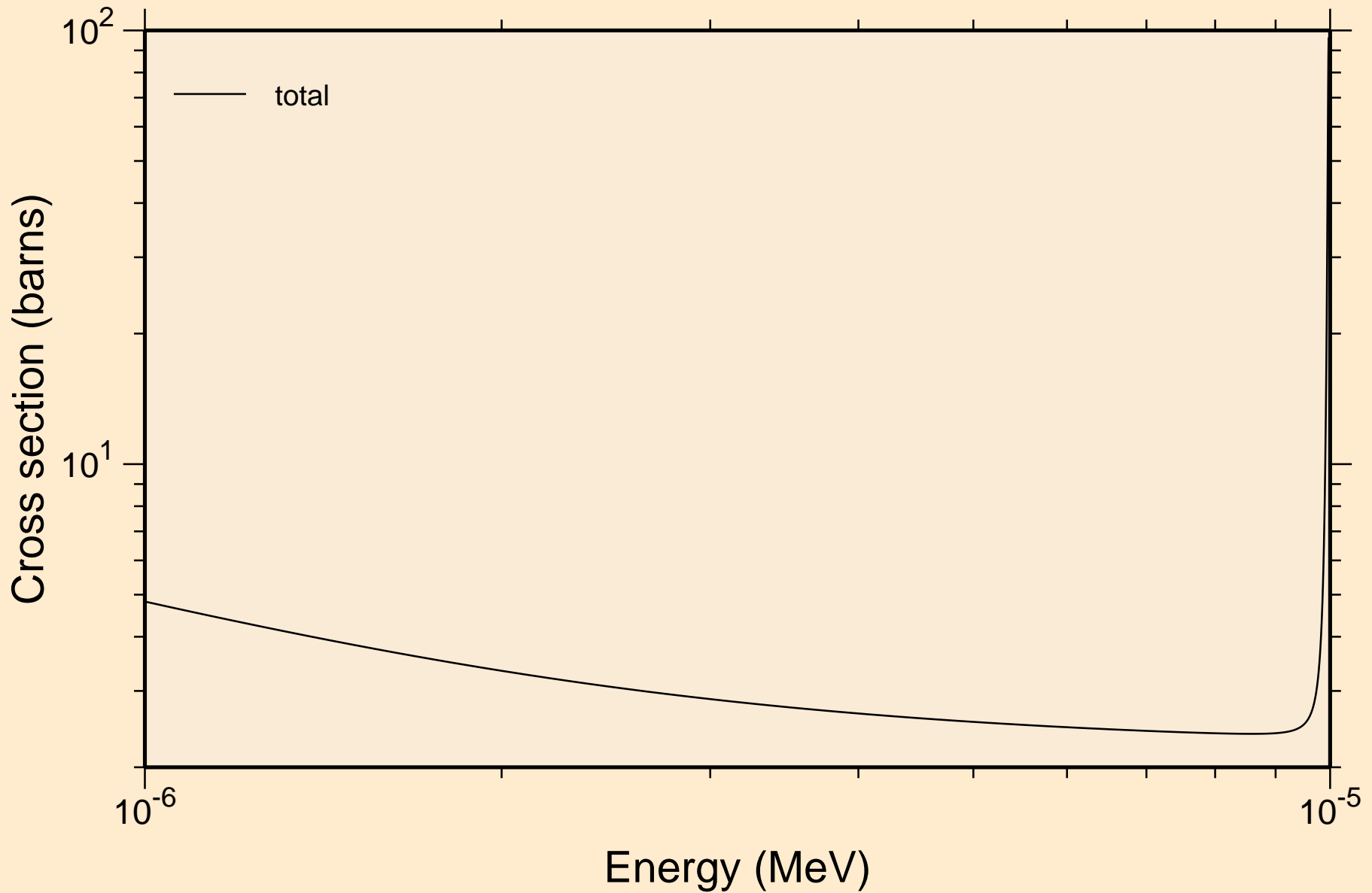

PR150 NEUTRON ACER TENDL-2023 LIBRARY; T=0.K
resonance total cross section

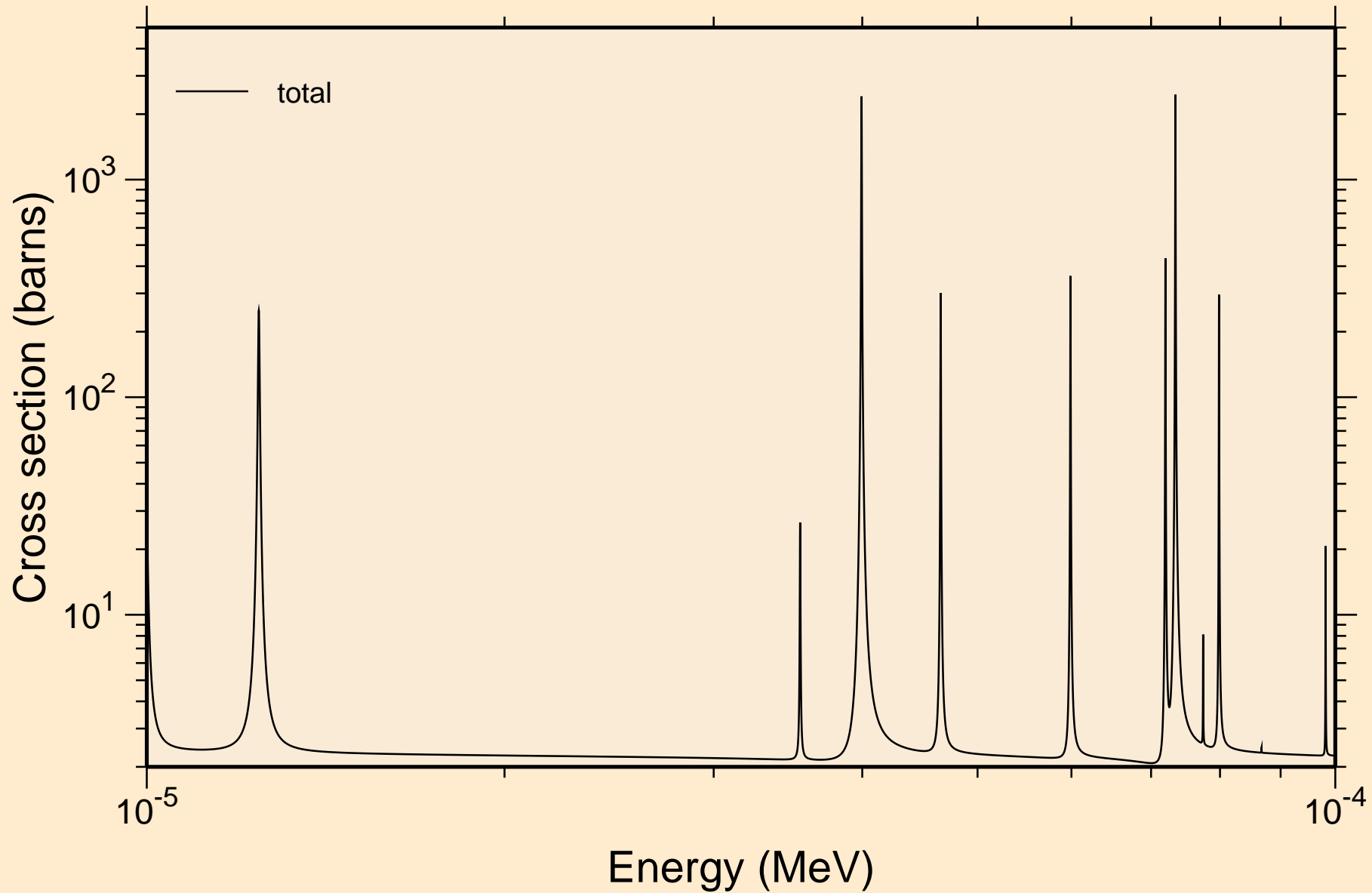

PR150 NEUTRON ACER TENDL-2023 LIBRARY; T=0.K
resonance total cross section

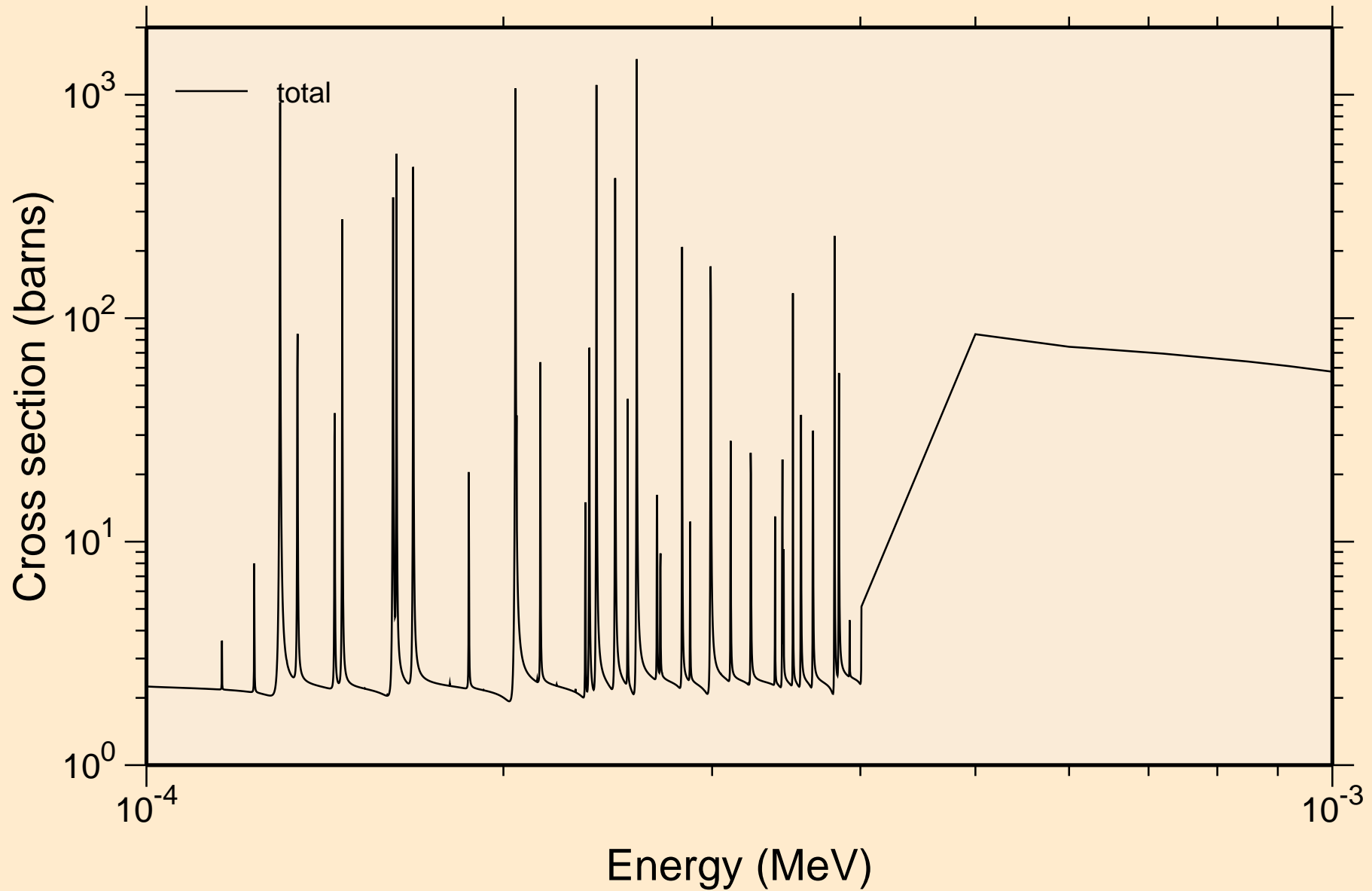

PR150 NEUTRON ACER TENDL-2023 LIBRARY; T=0.K
resonance total cross section

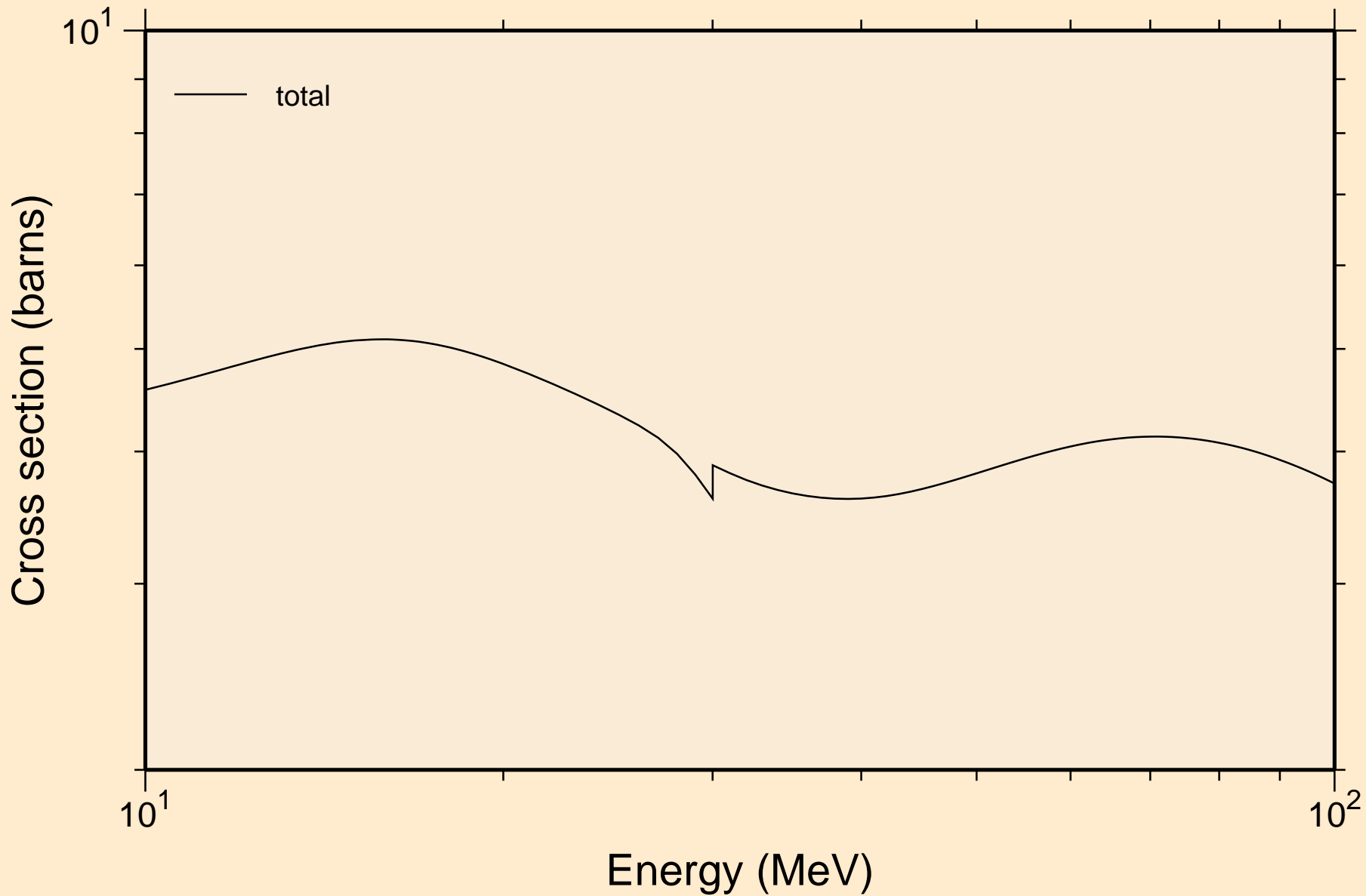

PR150 NEUTRON ACER TENDL-2023 LIBRARY; T=0.K
resonance absorption cross sections

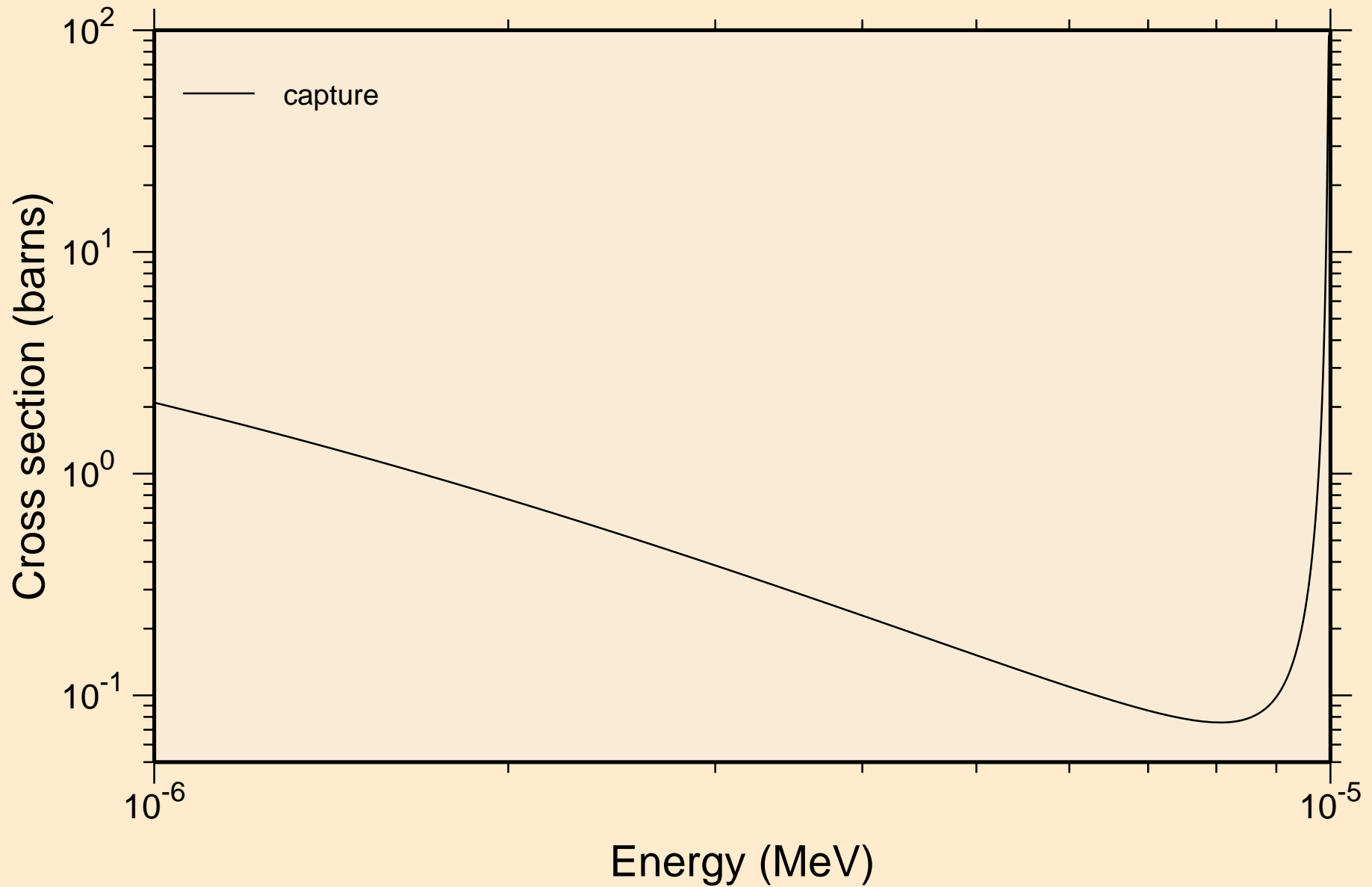

PR150 NEUTRON ACER TENDL-2023 LIBRARY; T=0.K
resonance absorption cross sections

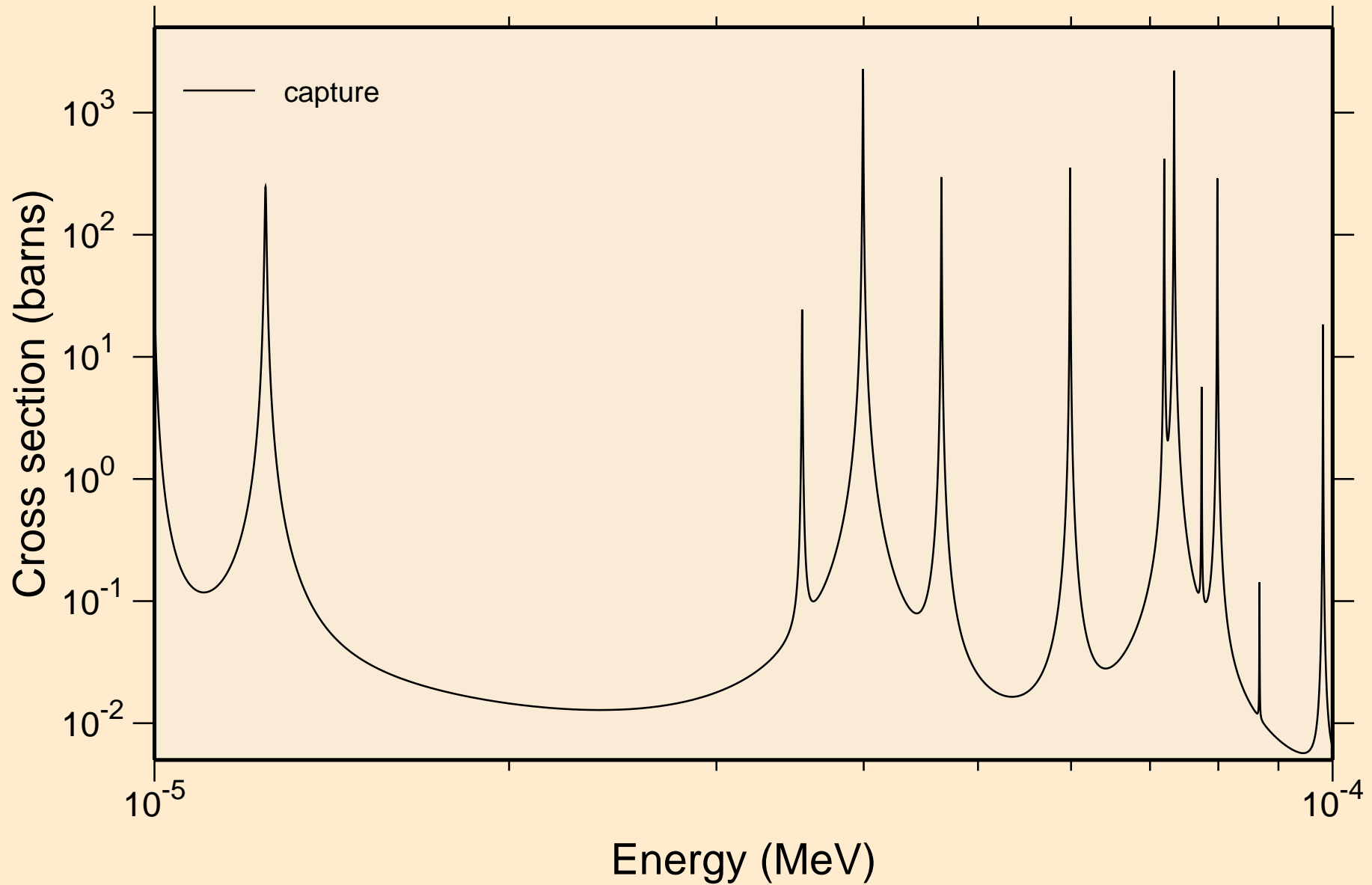

PR150 NEUTRON ACER TENDL-2023 LIBRARY; T=0.K
resonance absorption cross sections

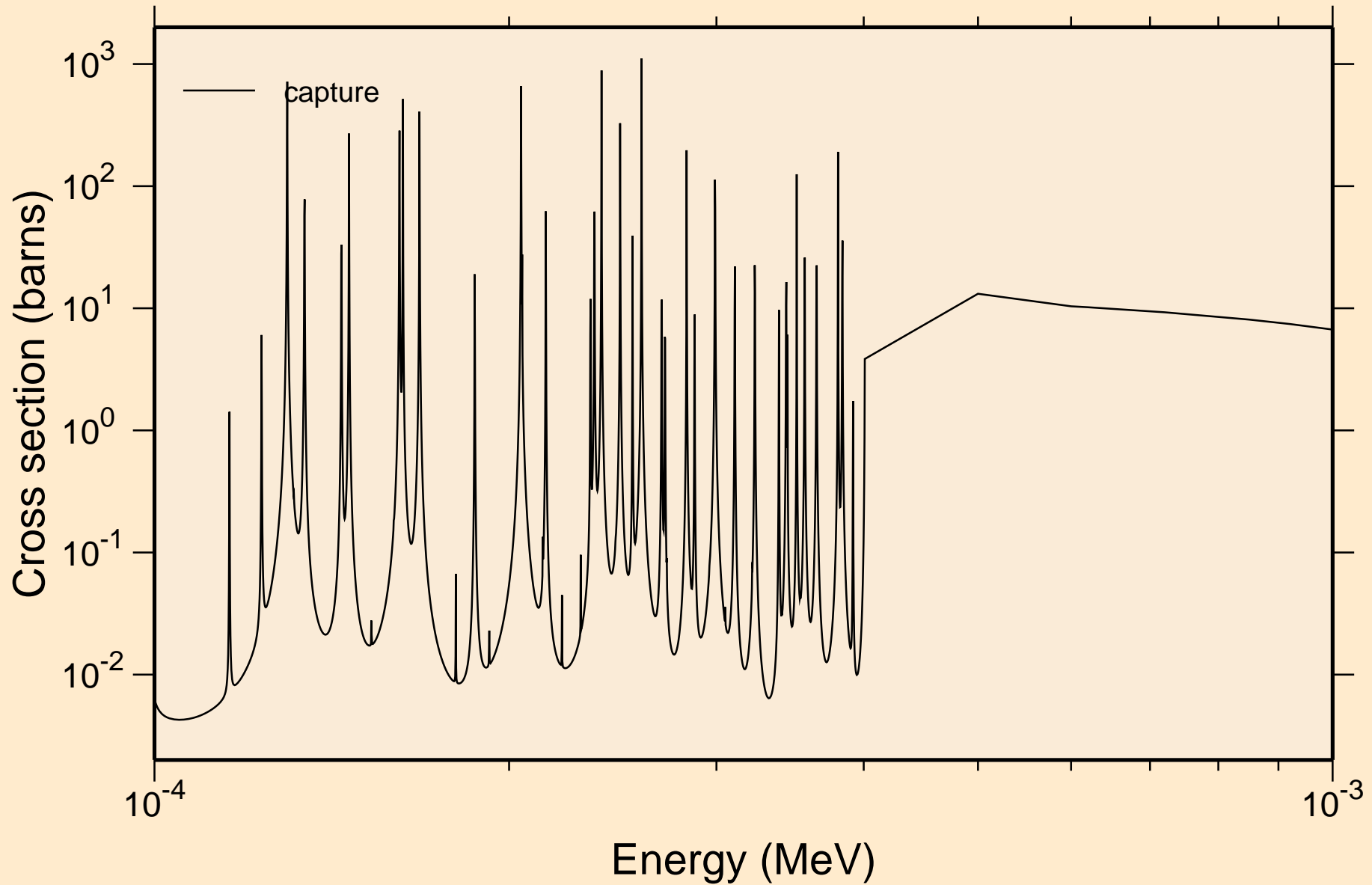

PR150 NEUTRON ACER TENDL-2023 LIBRARY; T=0.K
resonance absorption cross sections

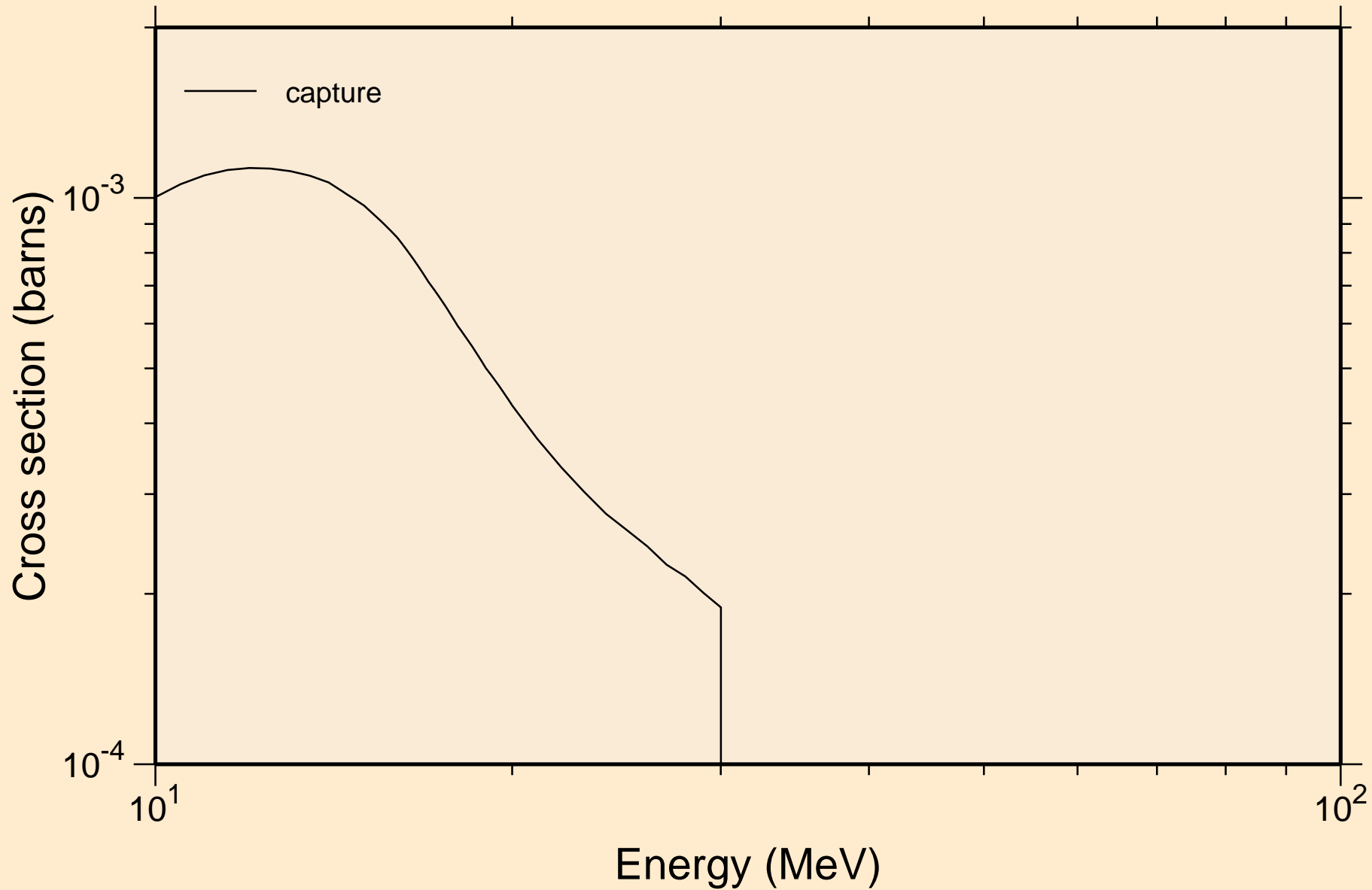

PR150 NEUTRON ACER TENDL-2023 LIBRARY; T=0.K
Heating

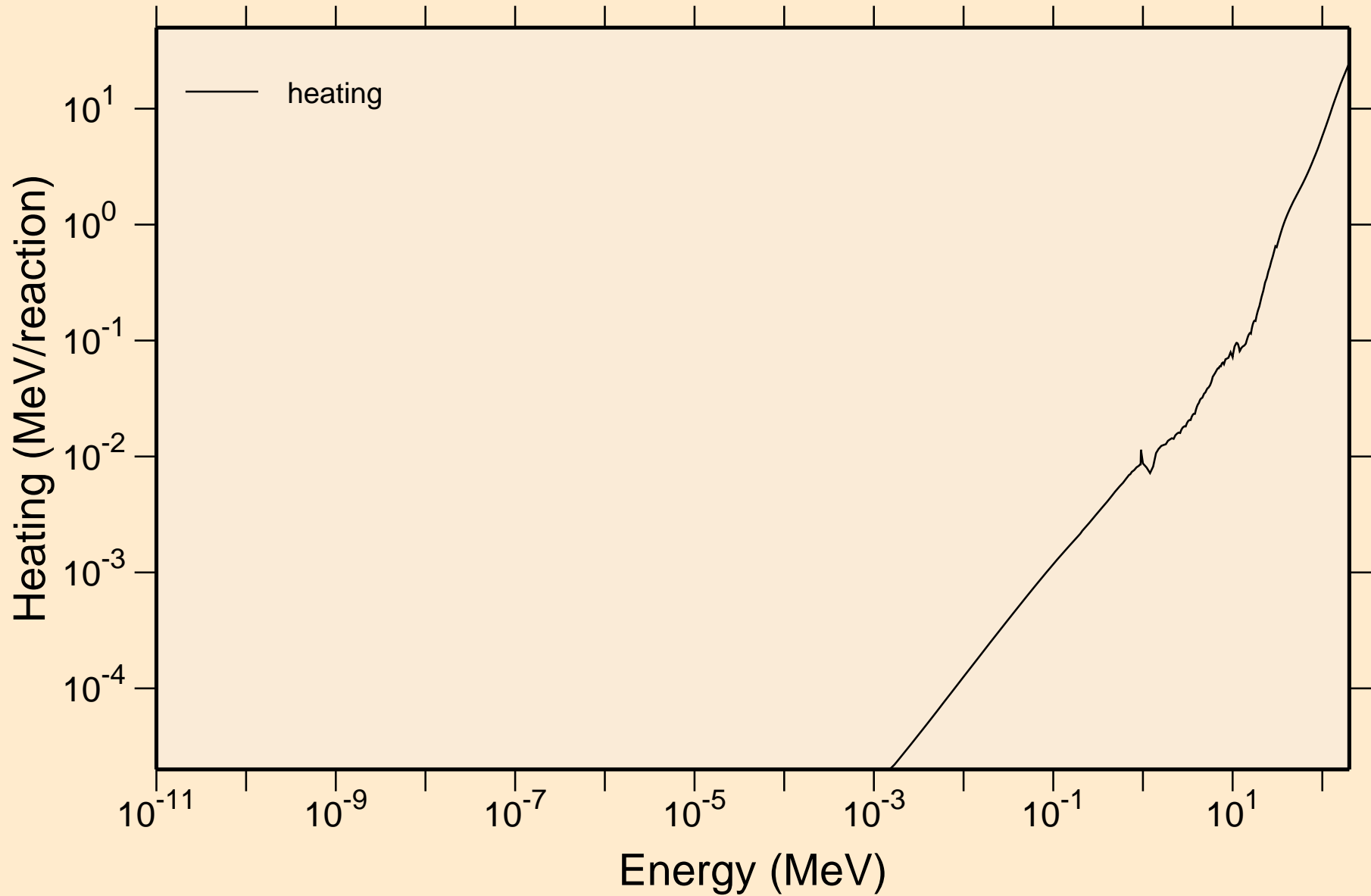

PR150 NEUTRON ACER TENDL-2023 LIBRARY; T=0.K

Damage

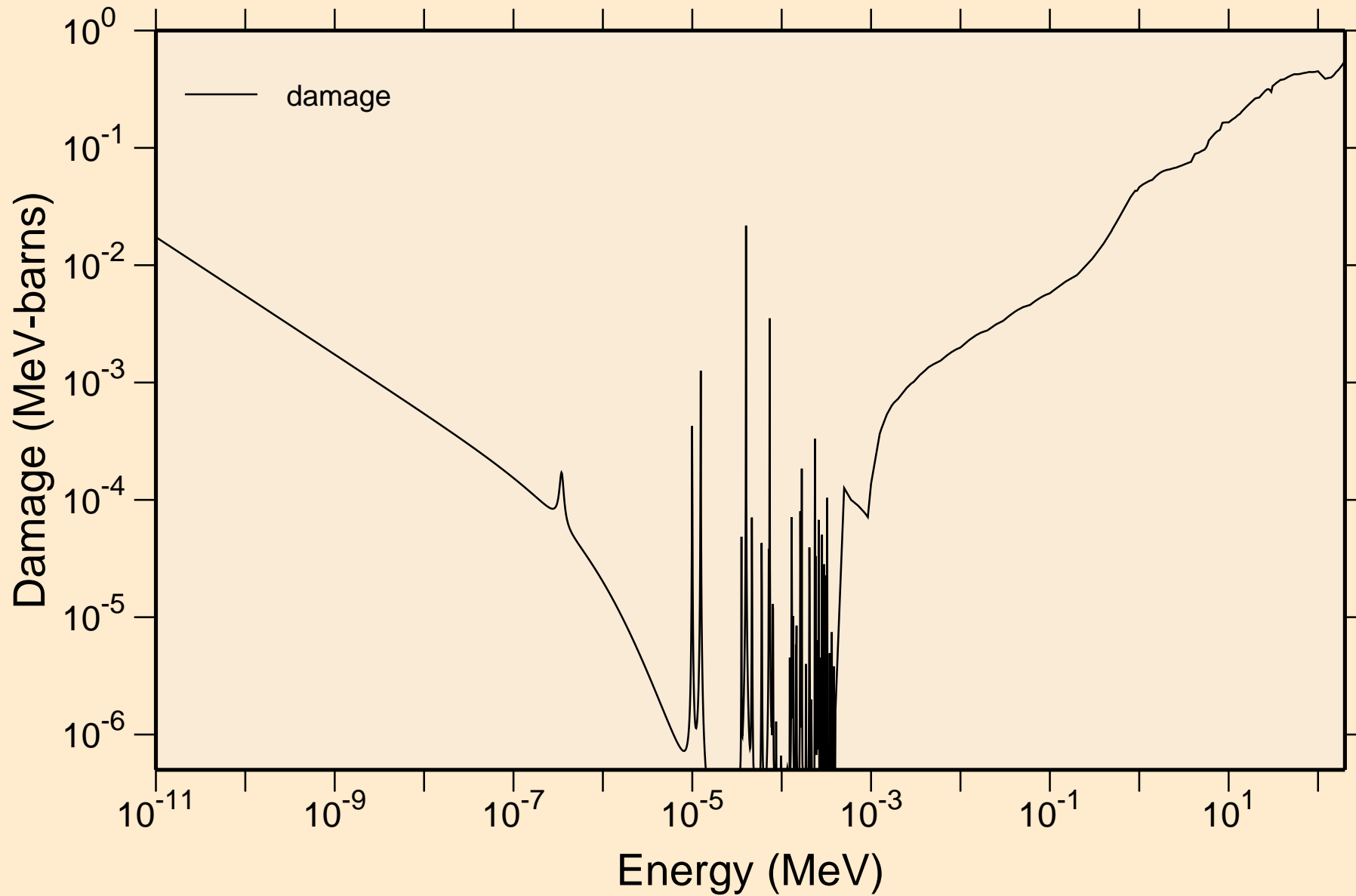

PR150 NEUTRON ACER TENDL-2023 LIBRARY; T=0.K
Non-threshold reactions

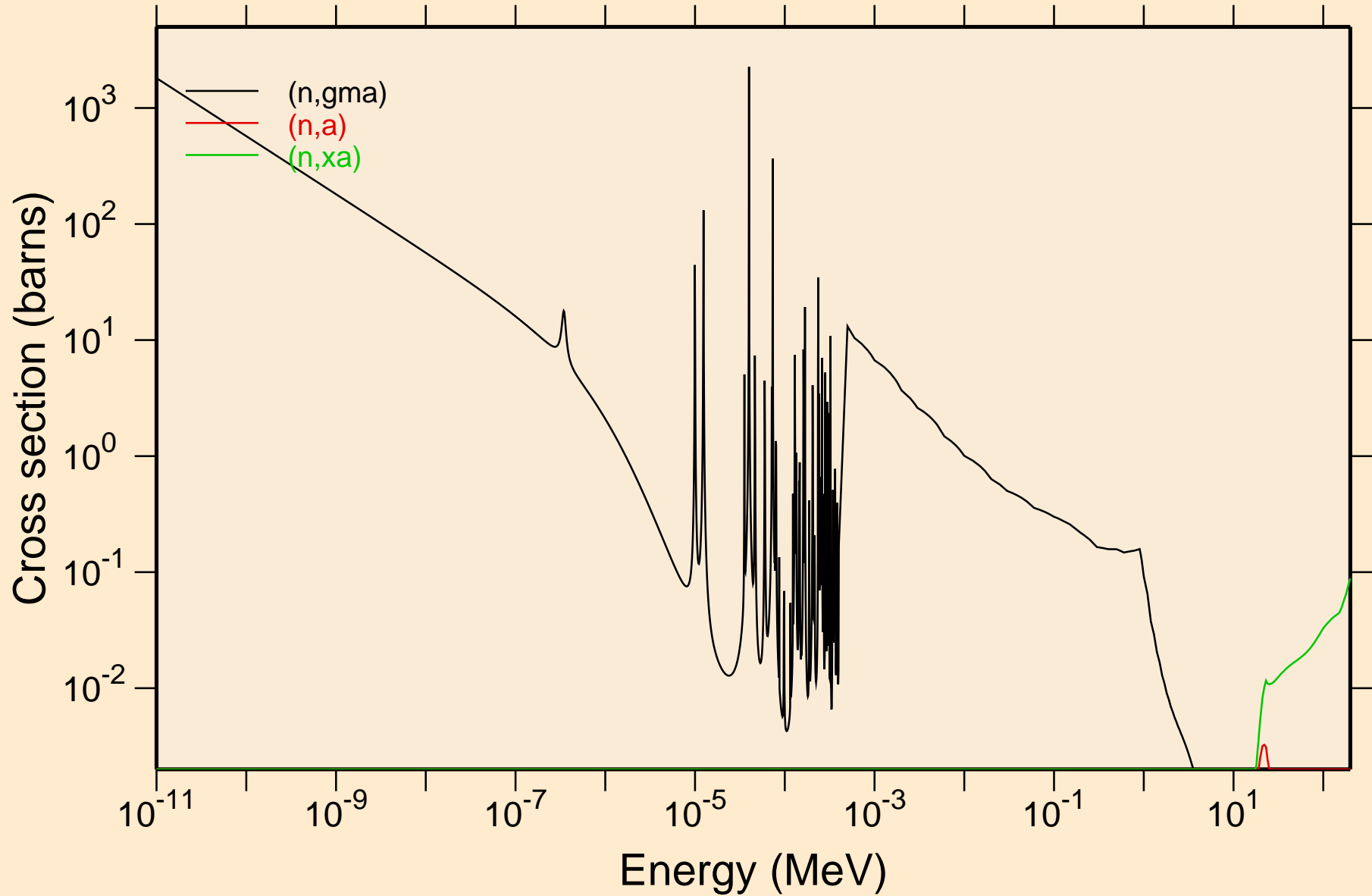

PR150 NEUTRON ACER TENDL-2023 LIBRARY; T=0.K

Principal cross sections

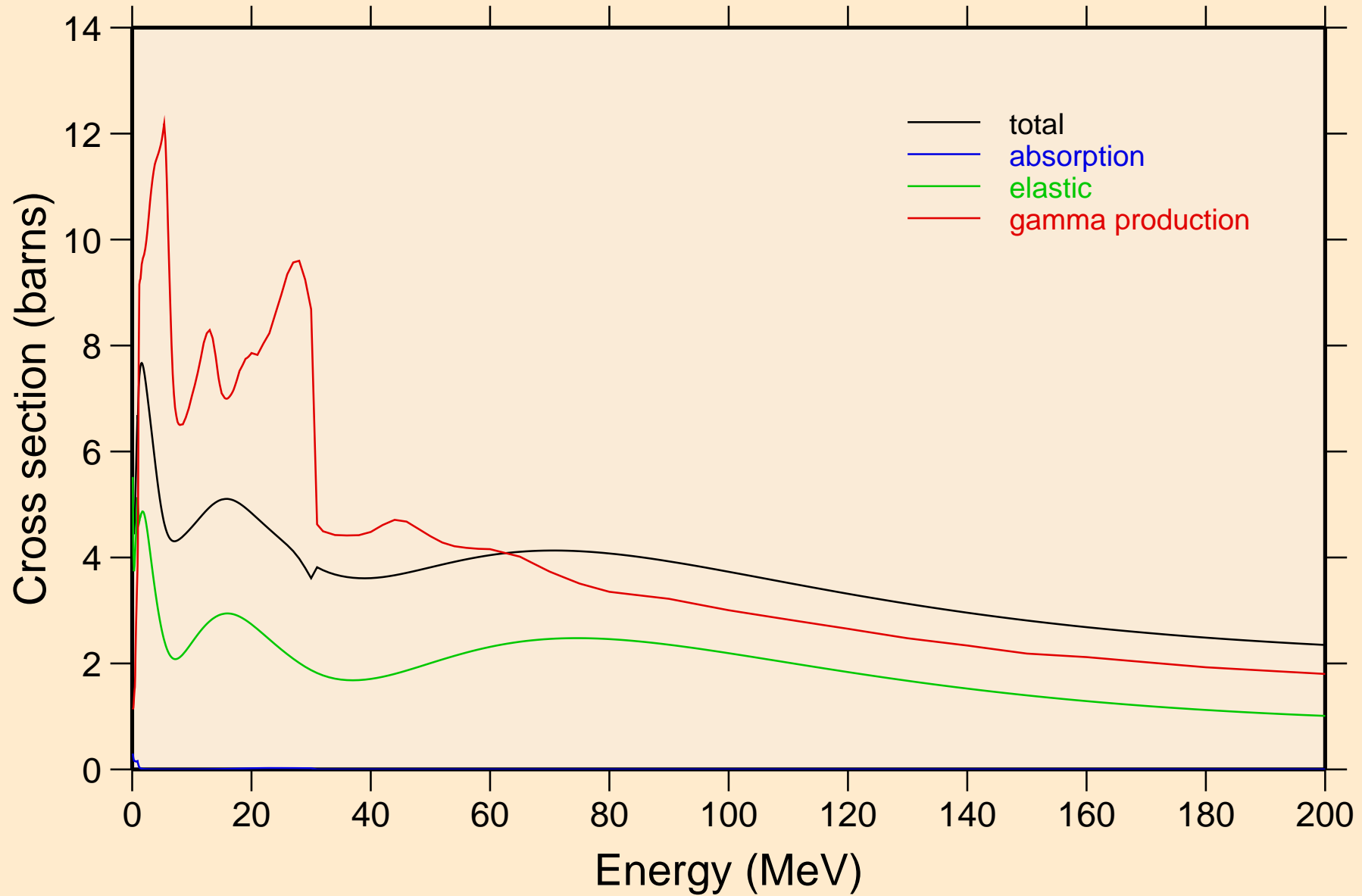

PR150 NEUTRON ACER TENDL-2023 LIBRARY; T=0.K

Heating

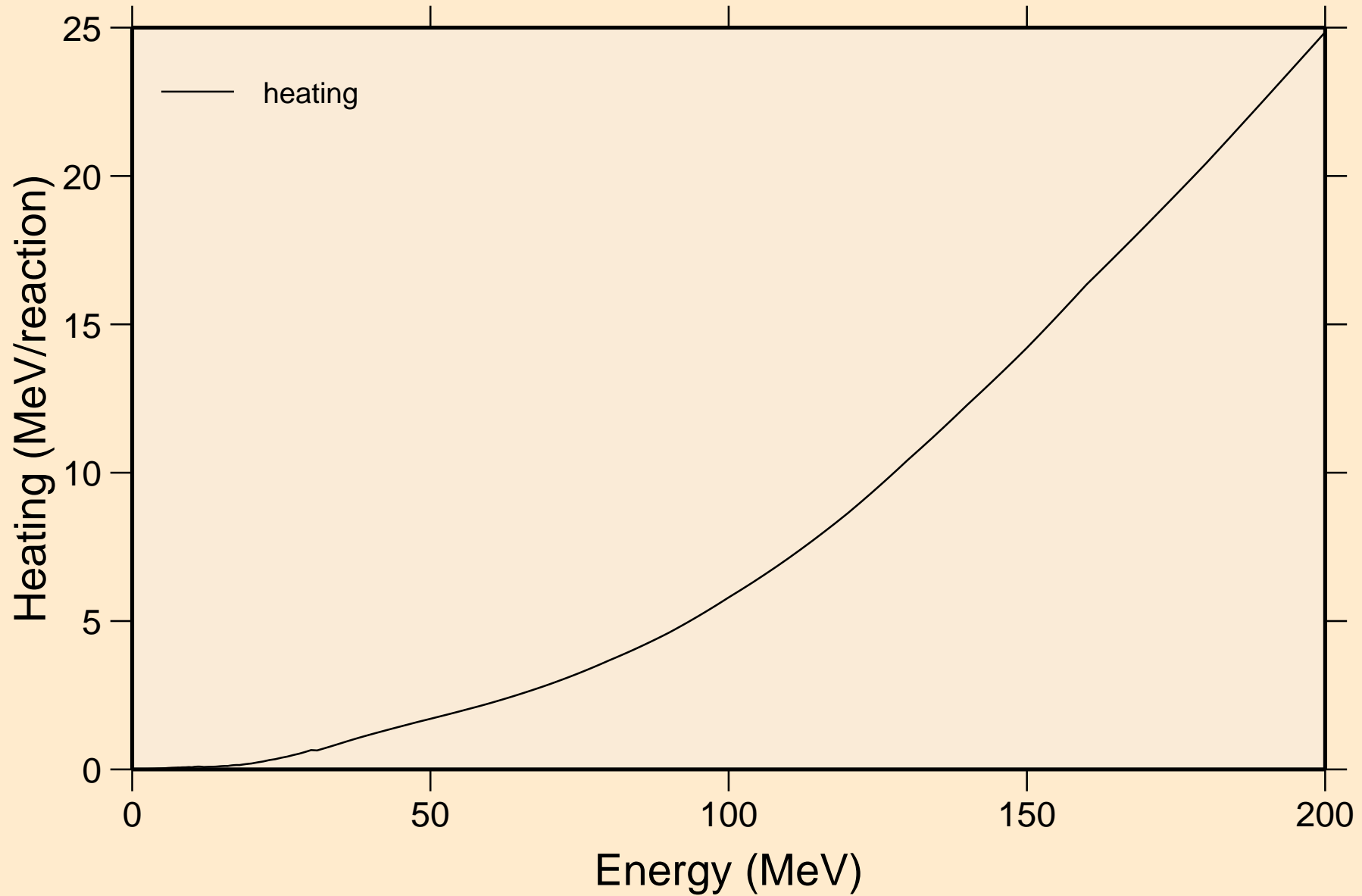

PR150 NEUTRON ACER TENDL-2023 LIBRARY; T=0.K
Damage

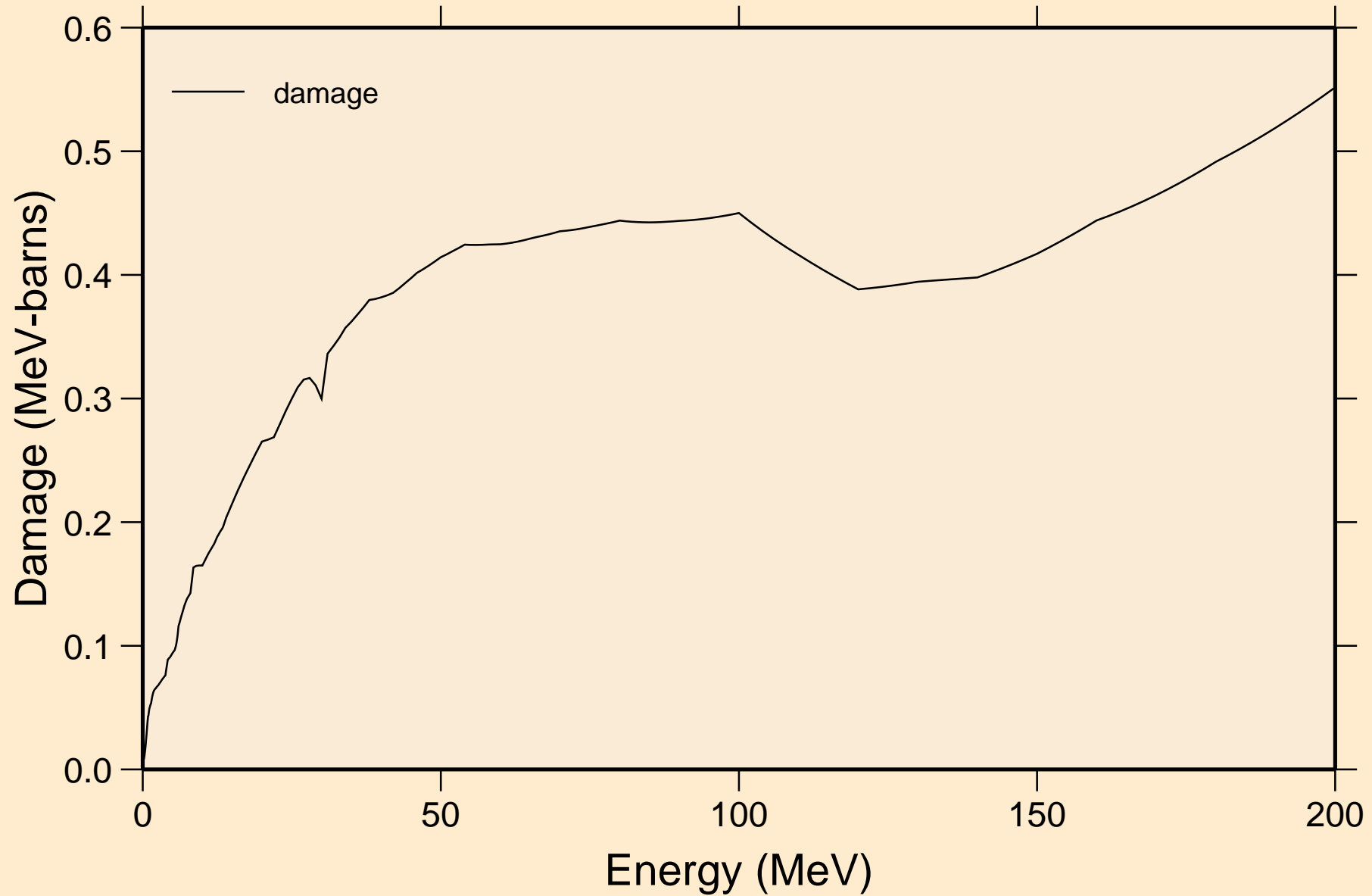

PR150 NEUTRON ACER TENDL-2023 LIBRARY; T=0.K
Non-threshold reactions

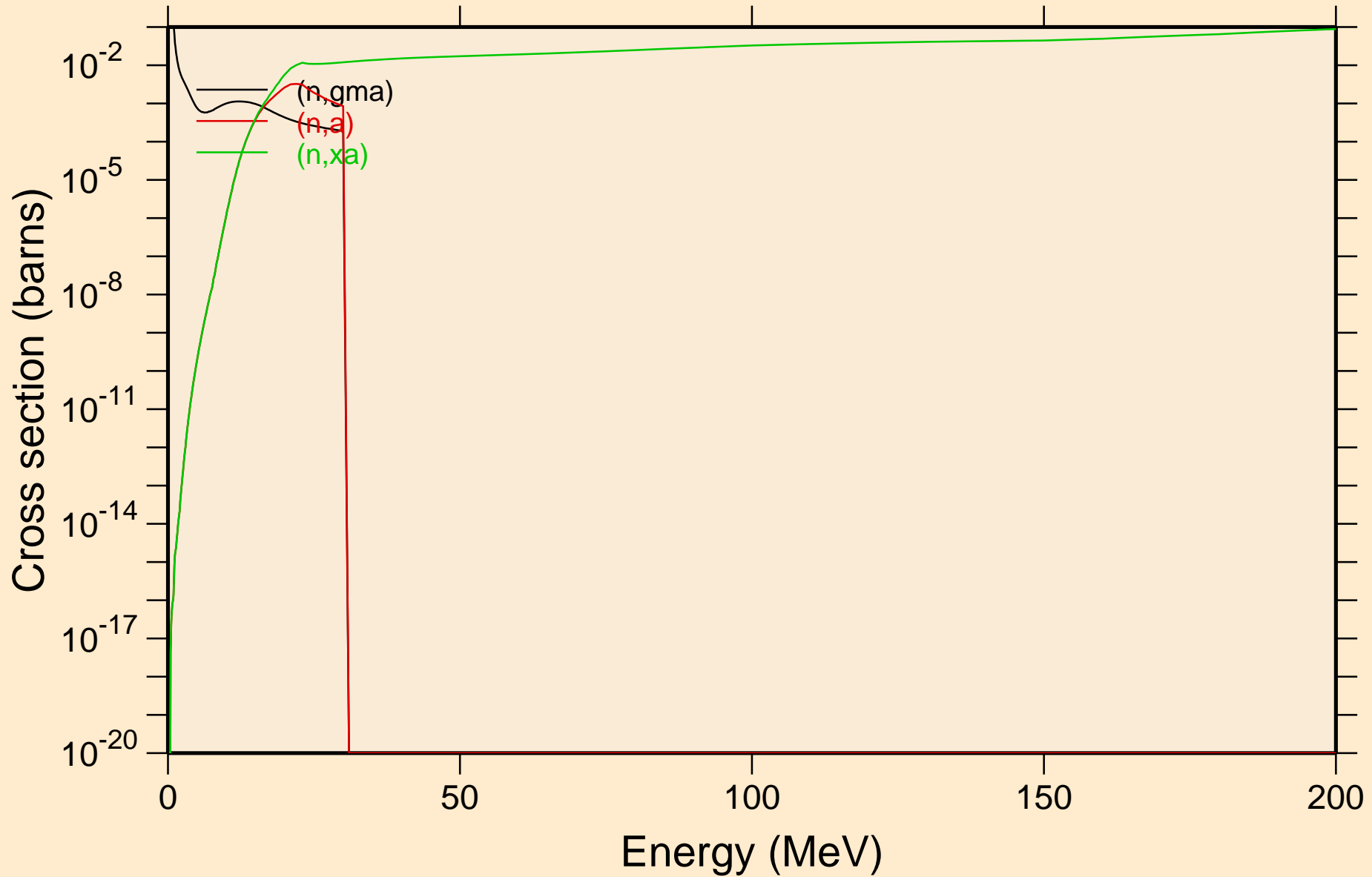

PR150 NEUTRON ACER TENDL-2023 LIBRARY; T=0.K
Inelastic levels

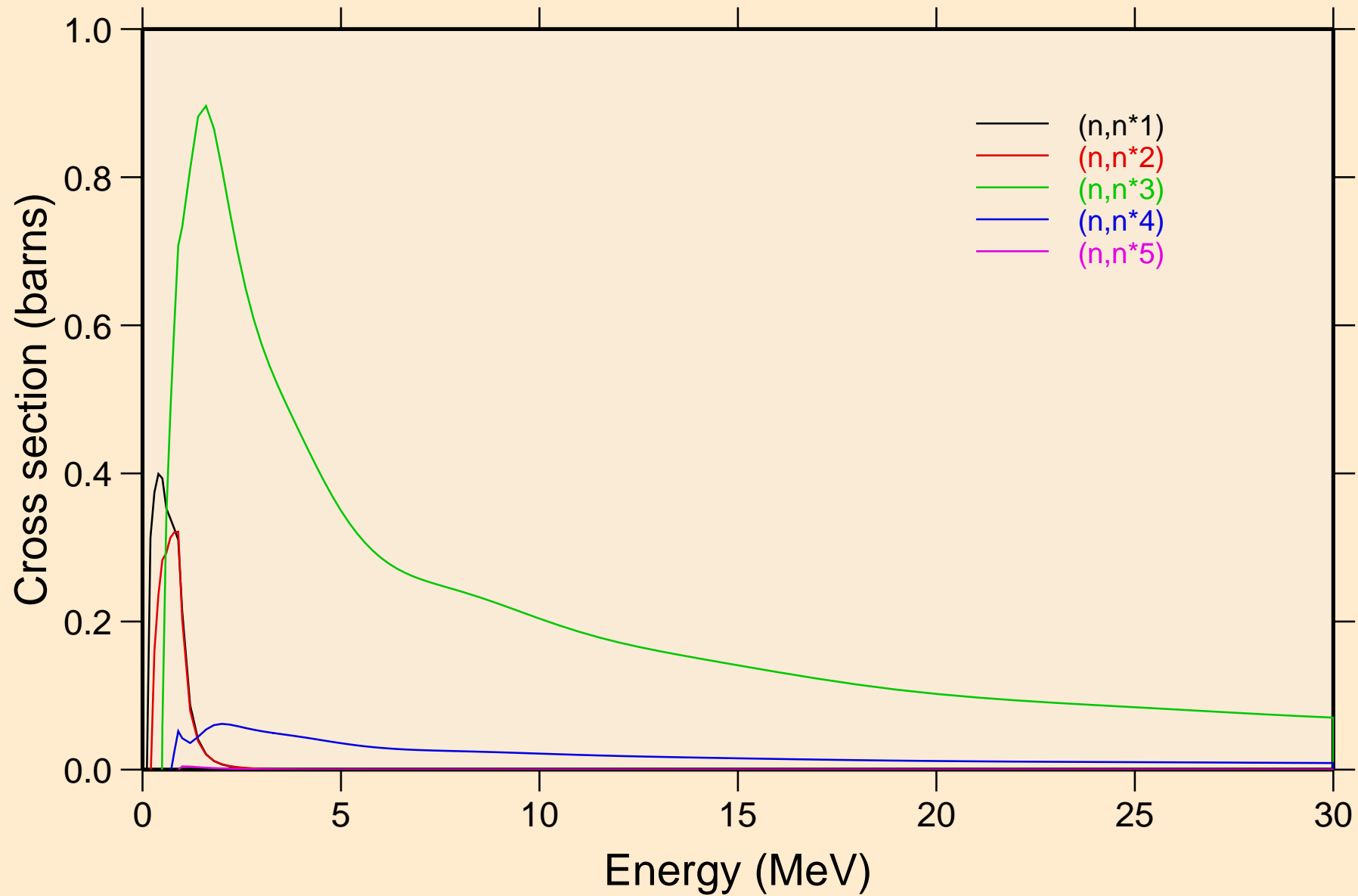

PR150 NEUTRON ACER TENDL-2023 LIBRARY; T=0.K
Inelastic levels

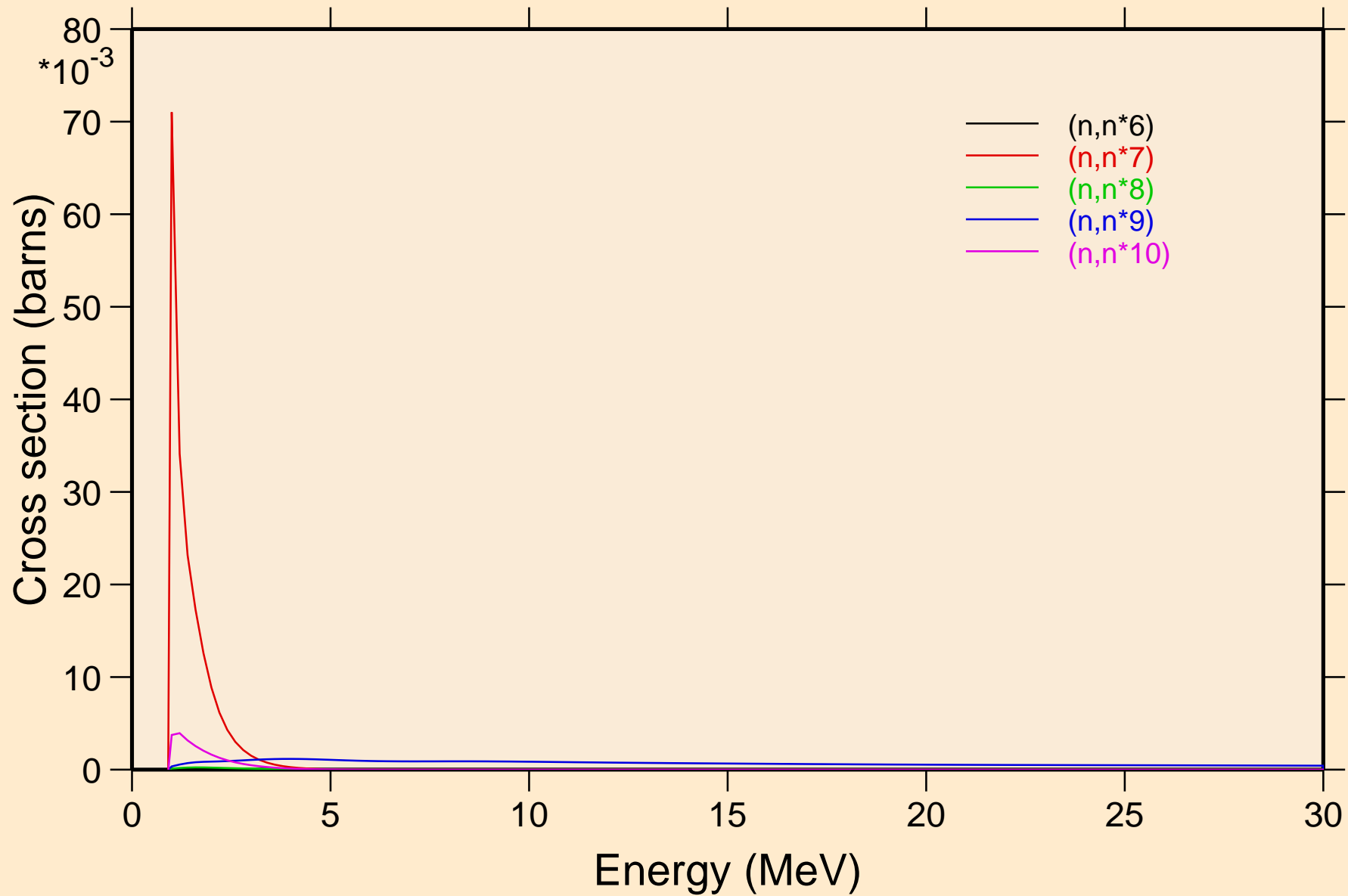

PR150 NEUTRON ACER TENDL-2023 LIBRARY; T=0.K
Inelastic levels

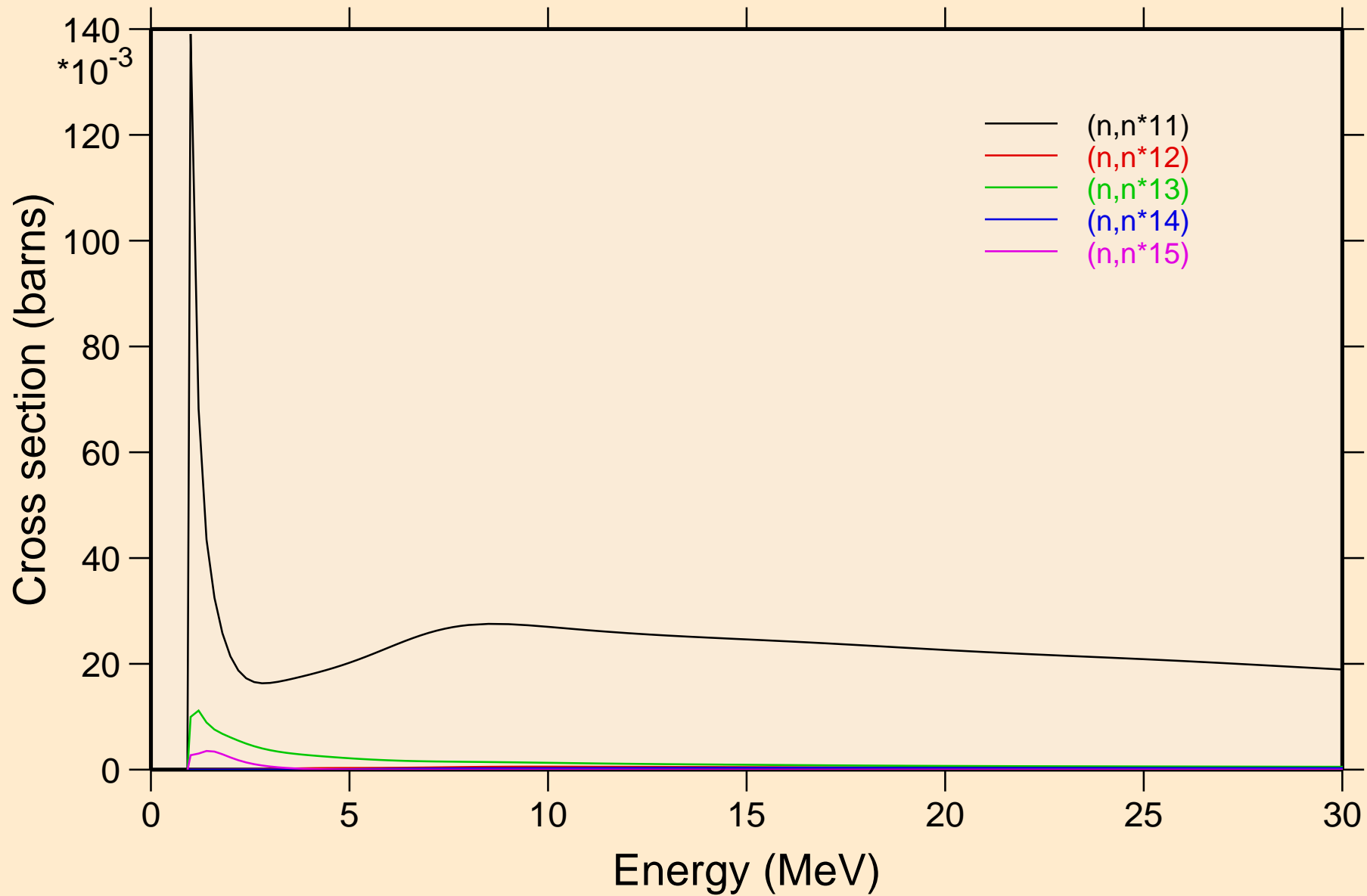

PR150 NEUTRON ACER TENDL-2023 LIBRARY; T=0.K
Inelastic levels

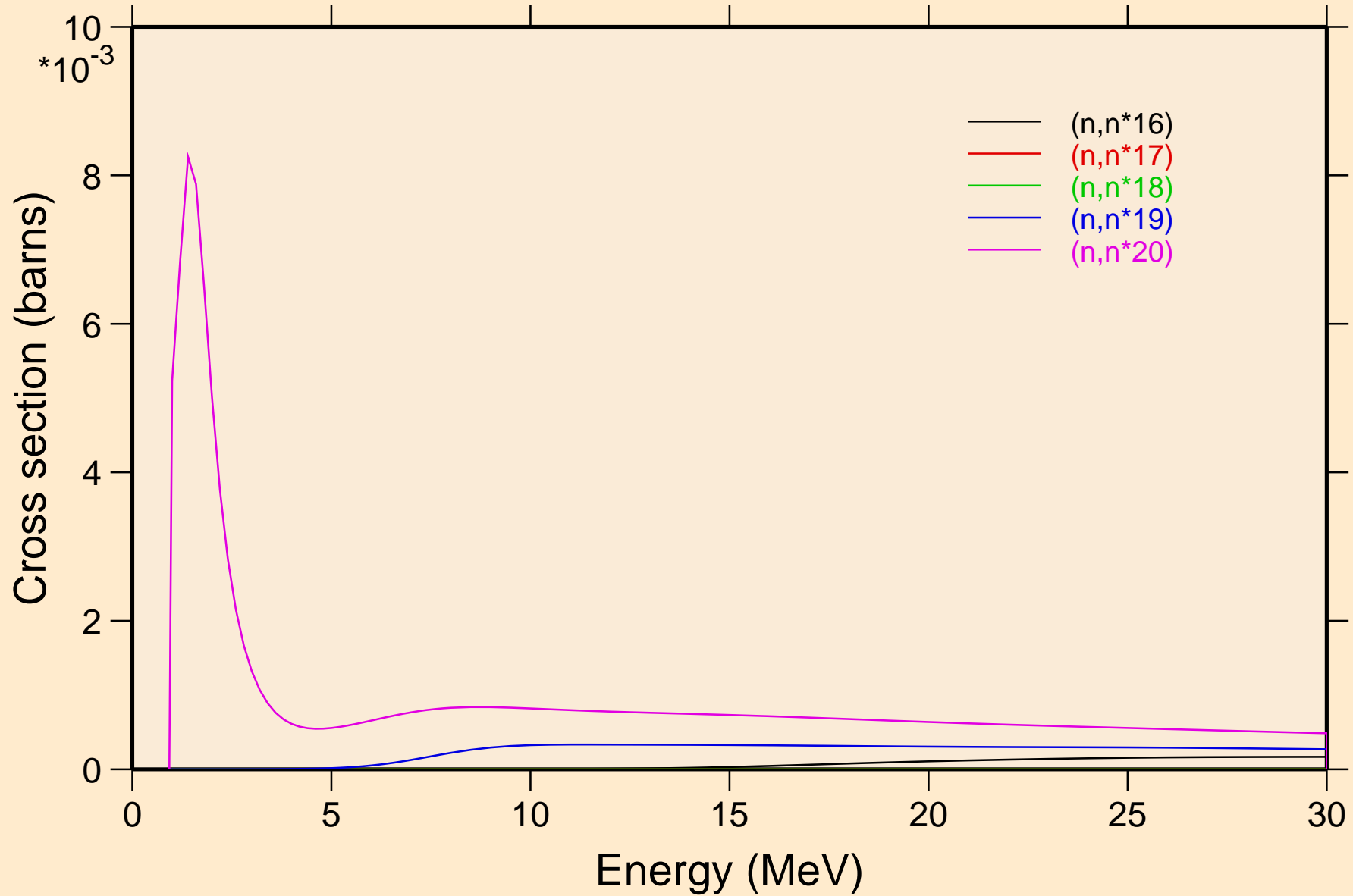

PR150 NEUTRON ACER TENDL-2023 LIBRARY; T=0.K
Inelastic levels

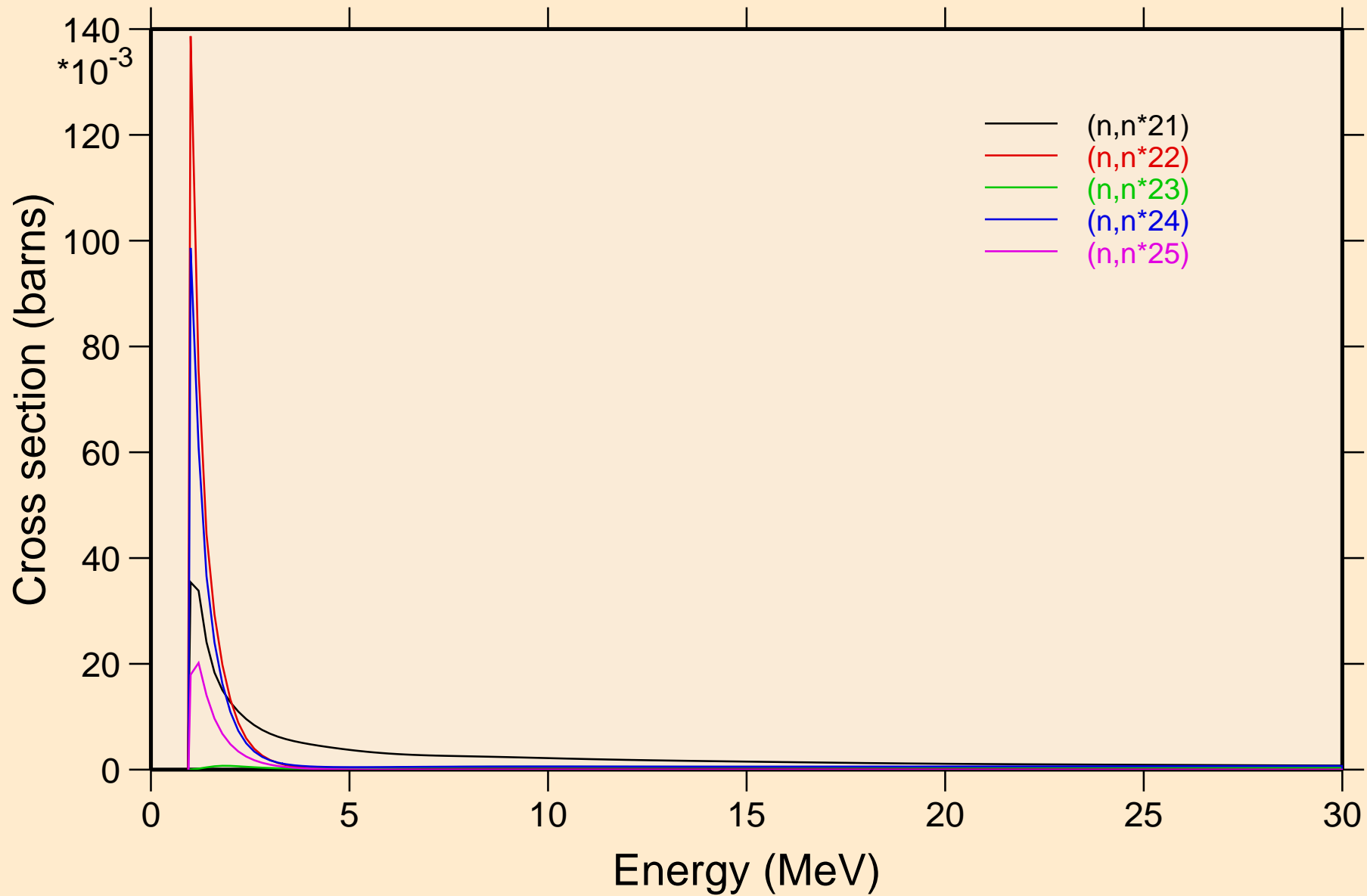

PR150 NEUTRON ACER TENDL-2023 LIBRARY; T=0.K
Threshold reactions

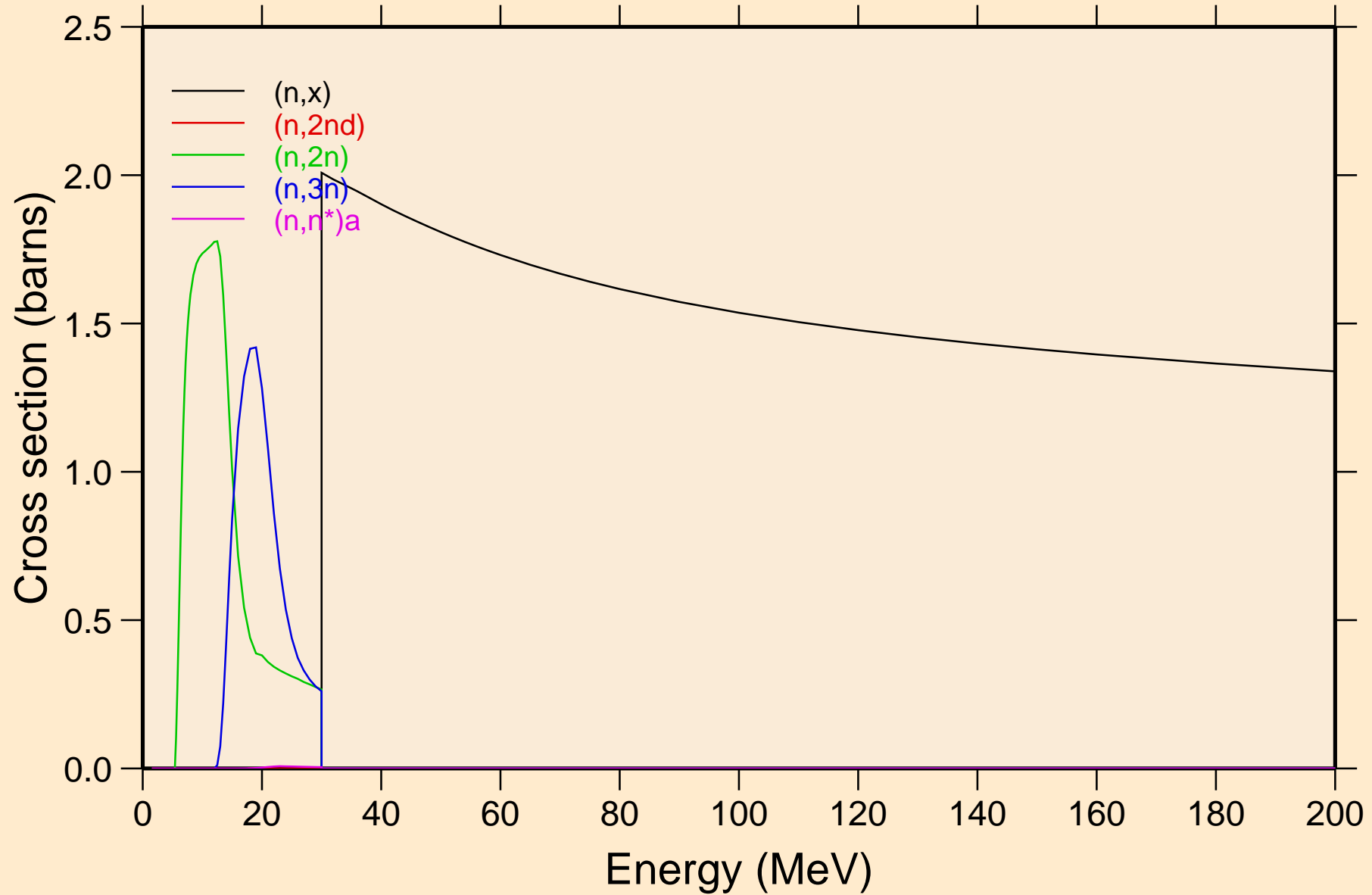

PR150 NEUTRON ACER TENDL-2023 LIBRARY; T=0.K
Threshold reactions

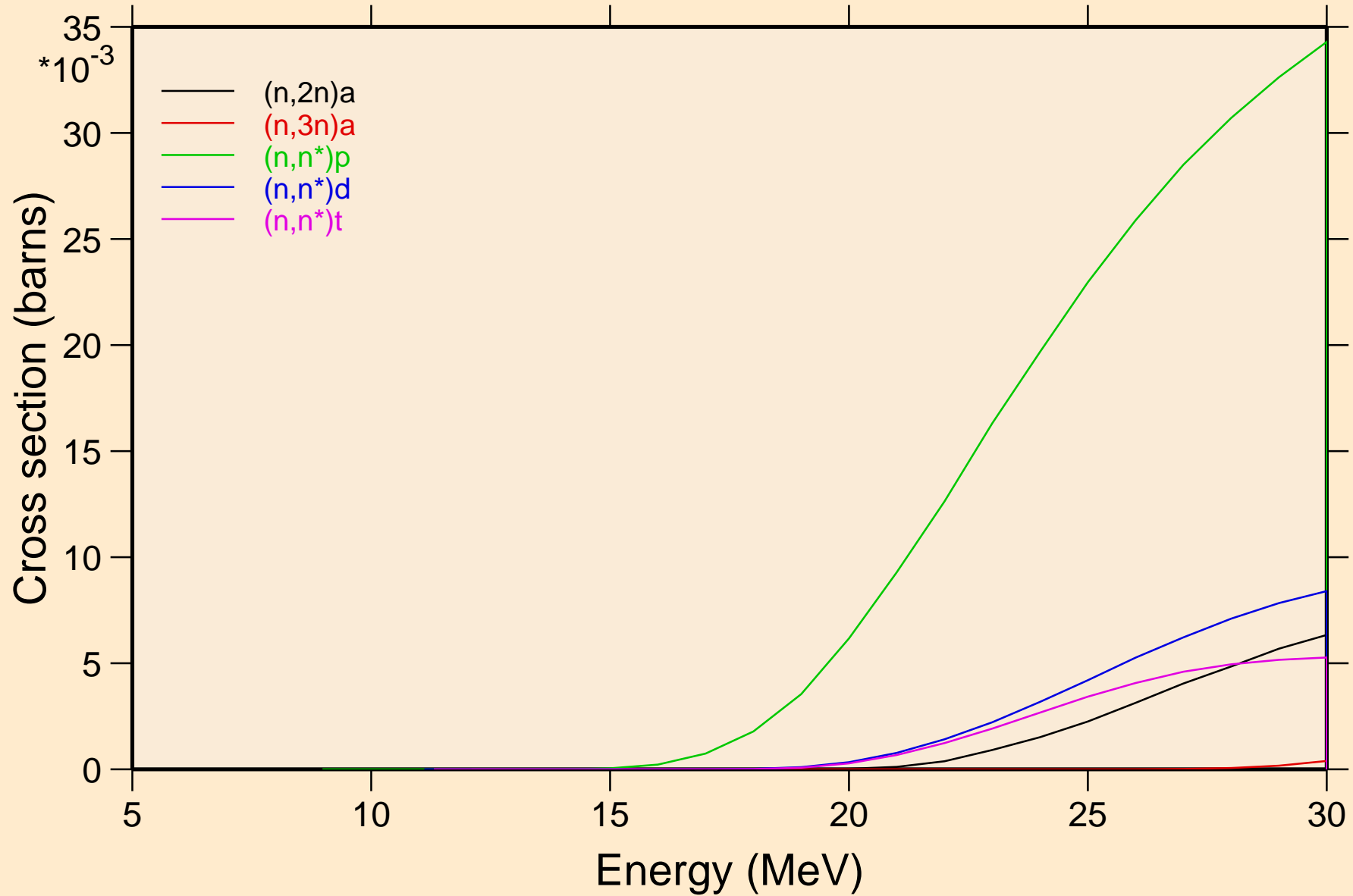

PR150 NEUTRON ACER TENDL-2023 LIBRARY; T=0.K
Threshold reactions

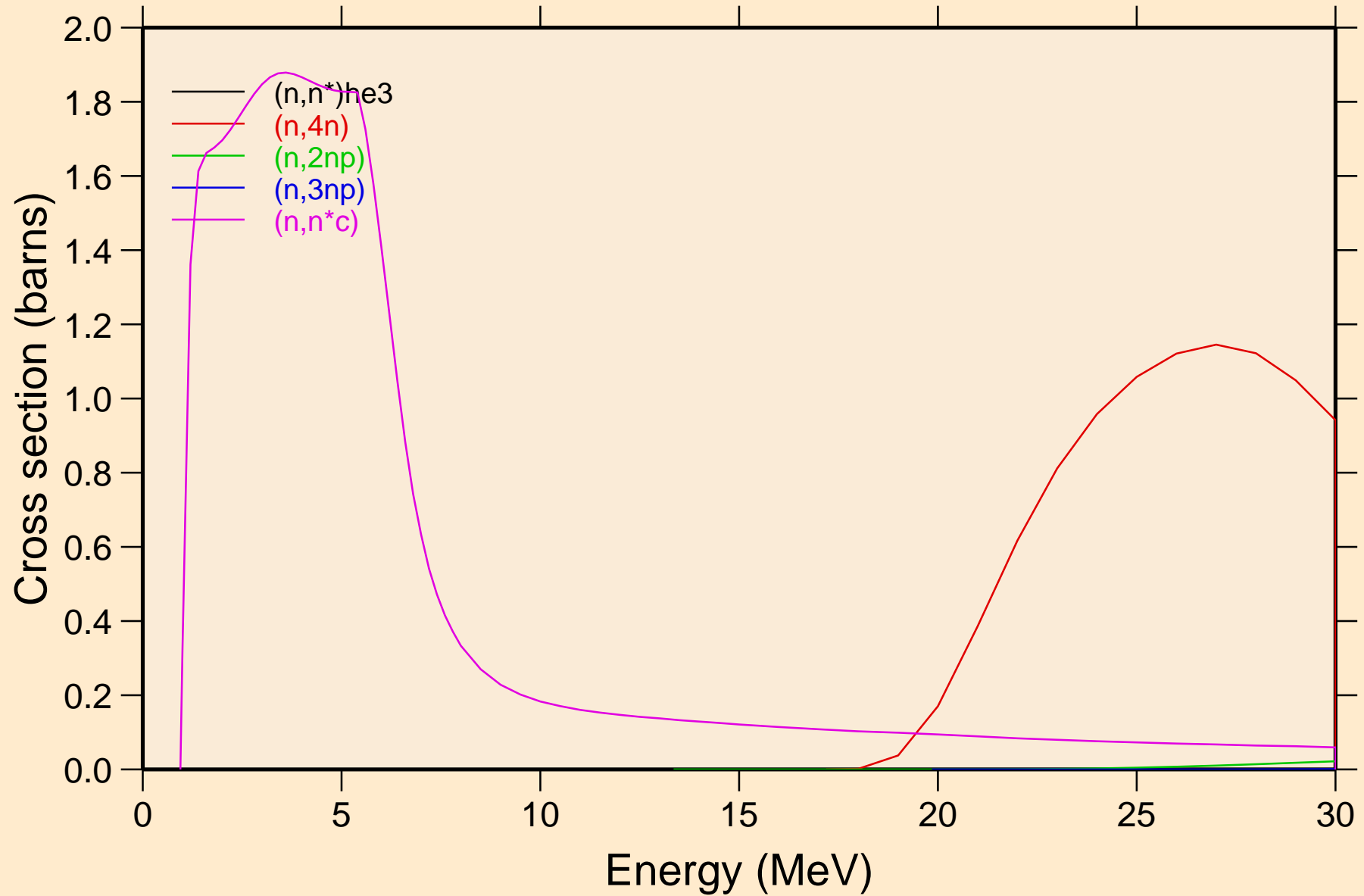

PR150 NEUTRON ACER TENDL-2023 LIBRARY; T=0.K
Threshold reactions

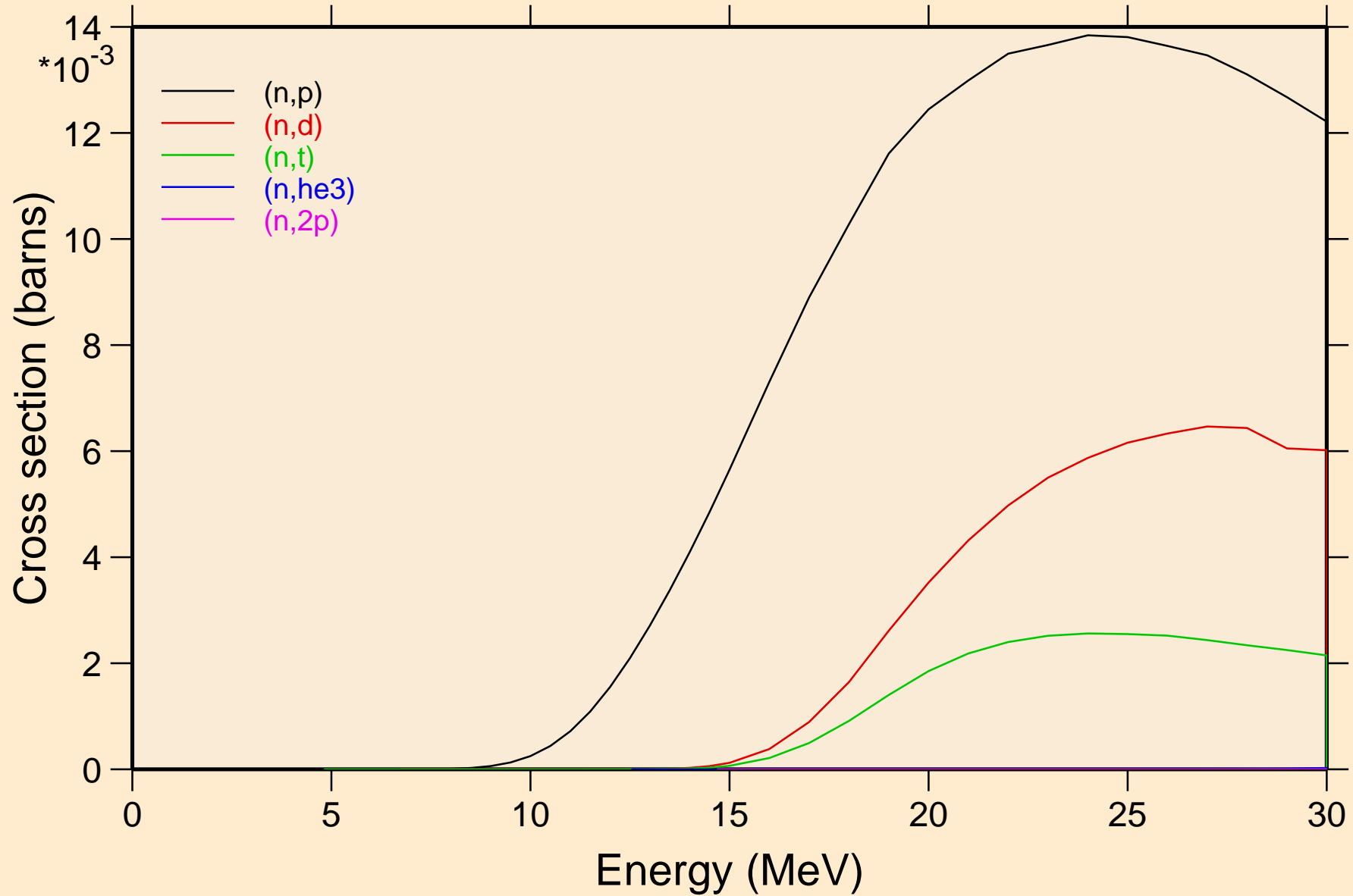

PR150 NEUTRON ACER TENDL-2023 LIBRARY; T=0.K
Threshold reactions

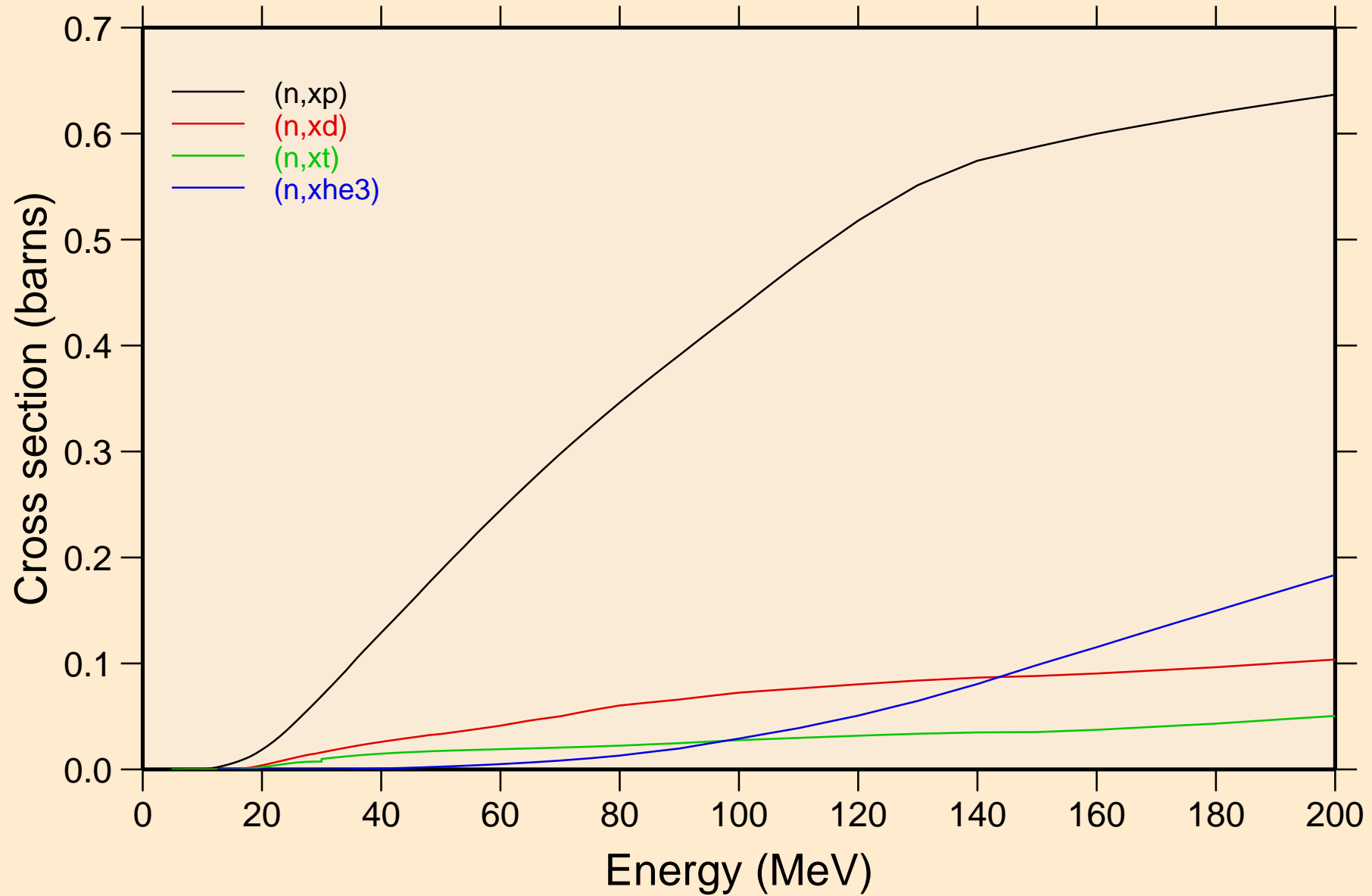

PR150 NEUTRON ACER TENDL-2023 LIBRARY; T=0.K
angular distribution for elastic

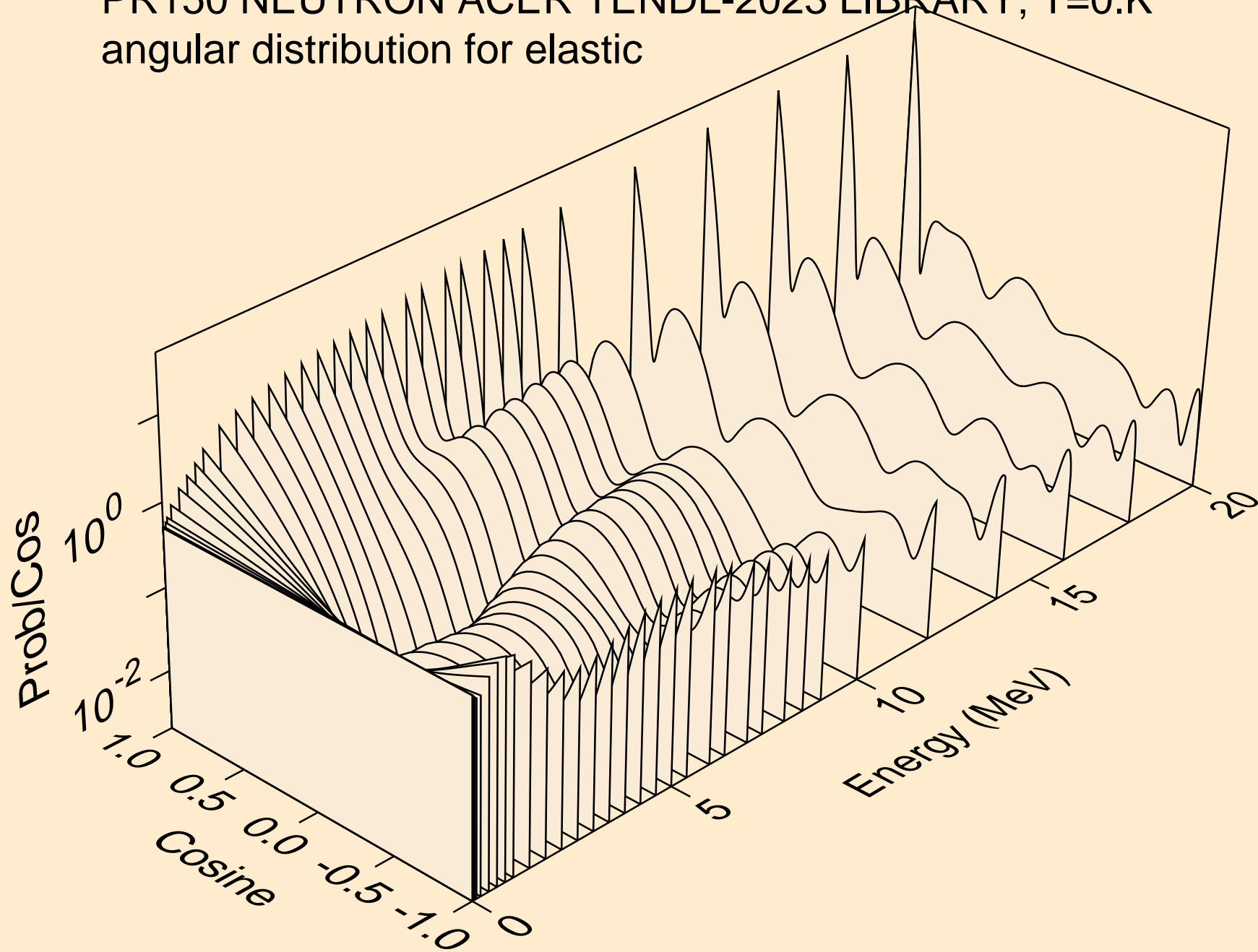

PR150 NEUTRON ACER TENDL-2023 LIBRARY; T=0.K
angular distribution for elastic

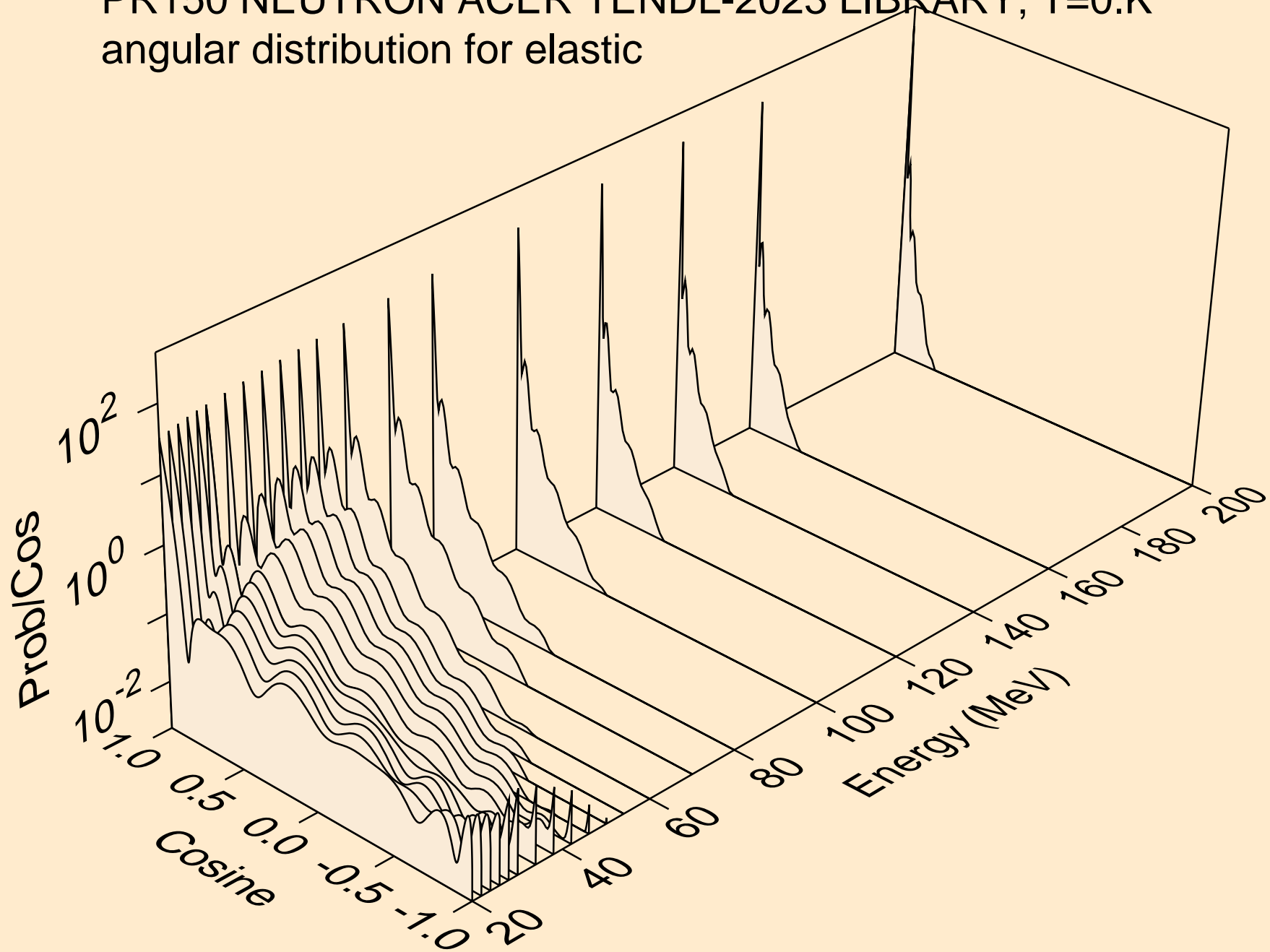

PR150 NEUTRON ACER TENDL-2023 LIBRARY; T=0.K
angular distribution for (n,n*1)

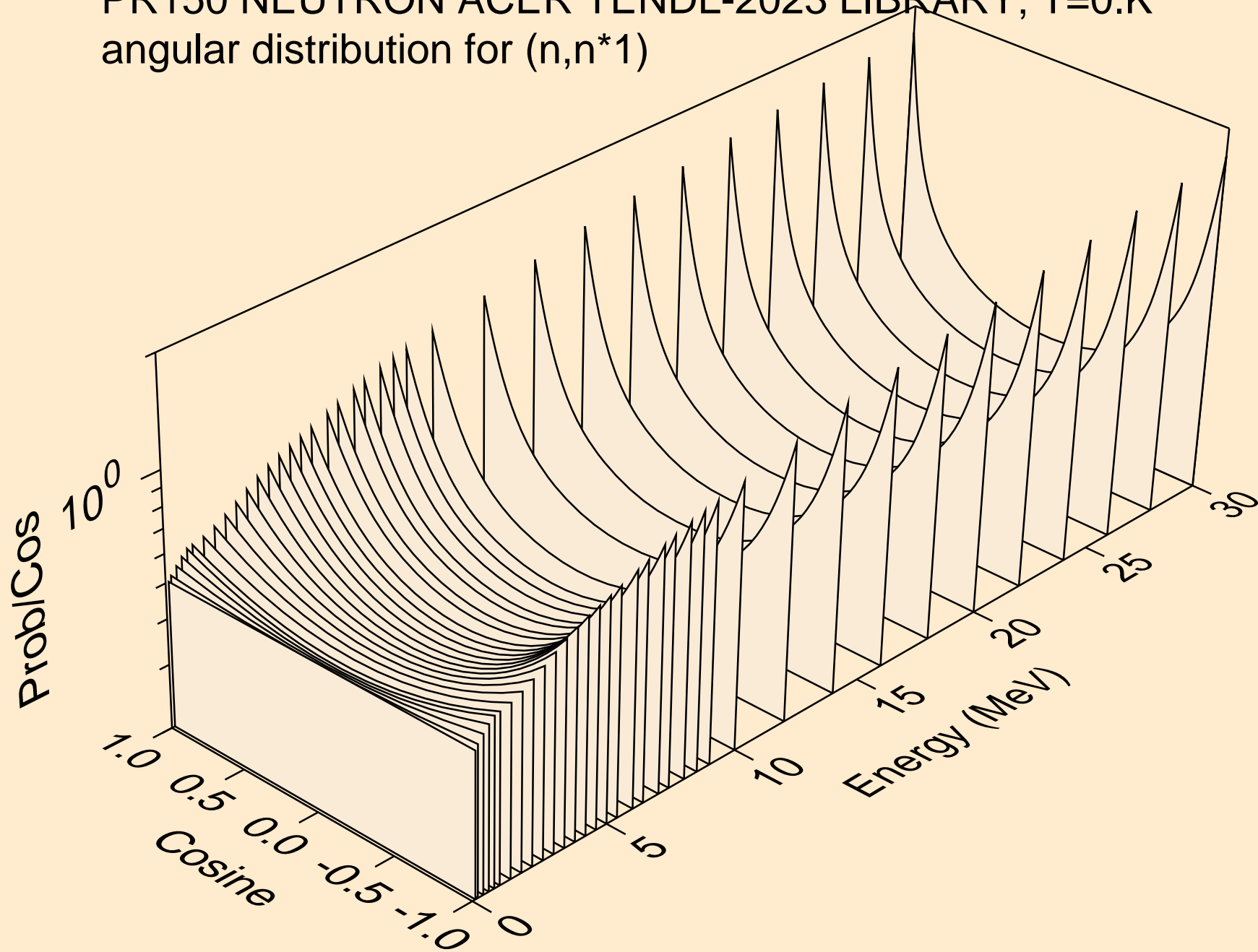

PR150 NEUTRON ACER TENDL-2023 LIBRARY; T=0.K
angular distribution for (n,n*2)

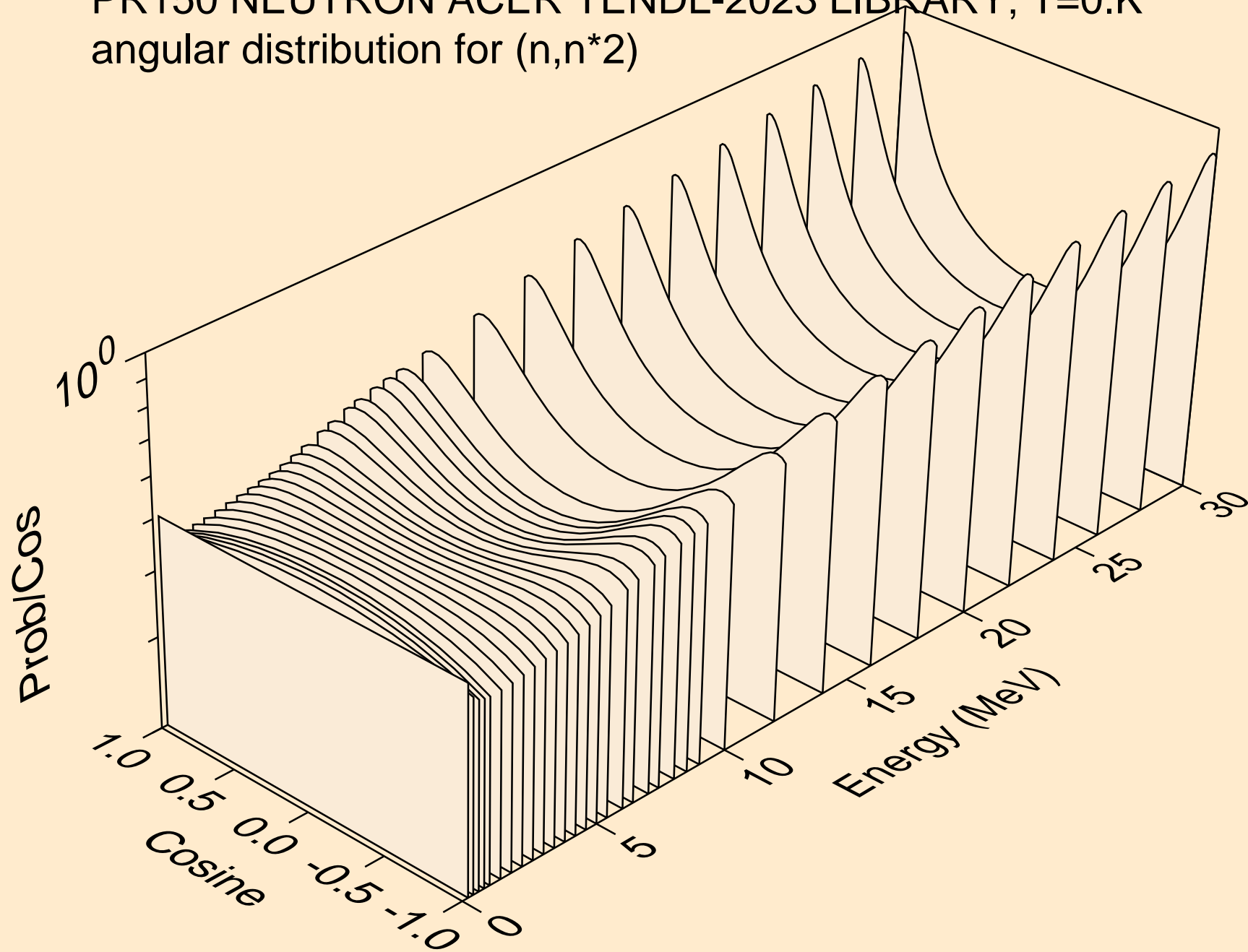

PR150 NEUTRON ACER TENDL-2023 LIBRARY; T=0.K
angular distribution for (n,n*3)

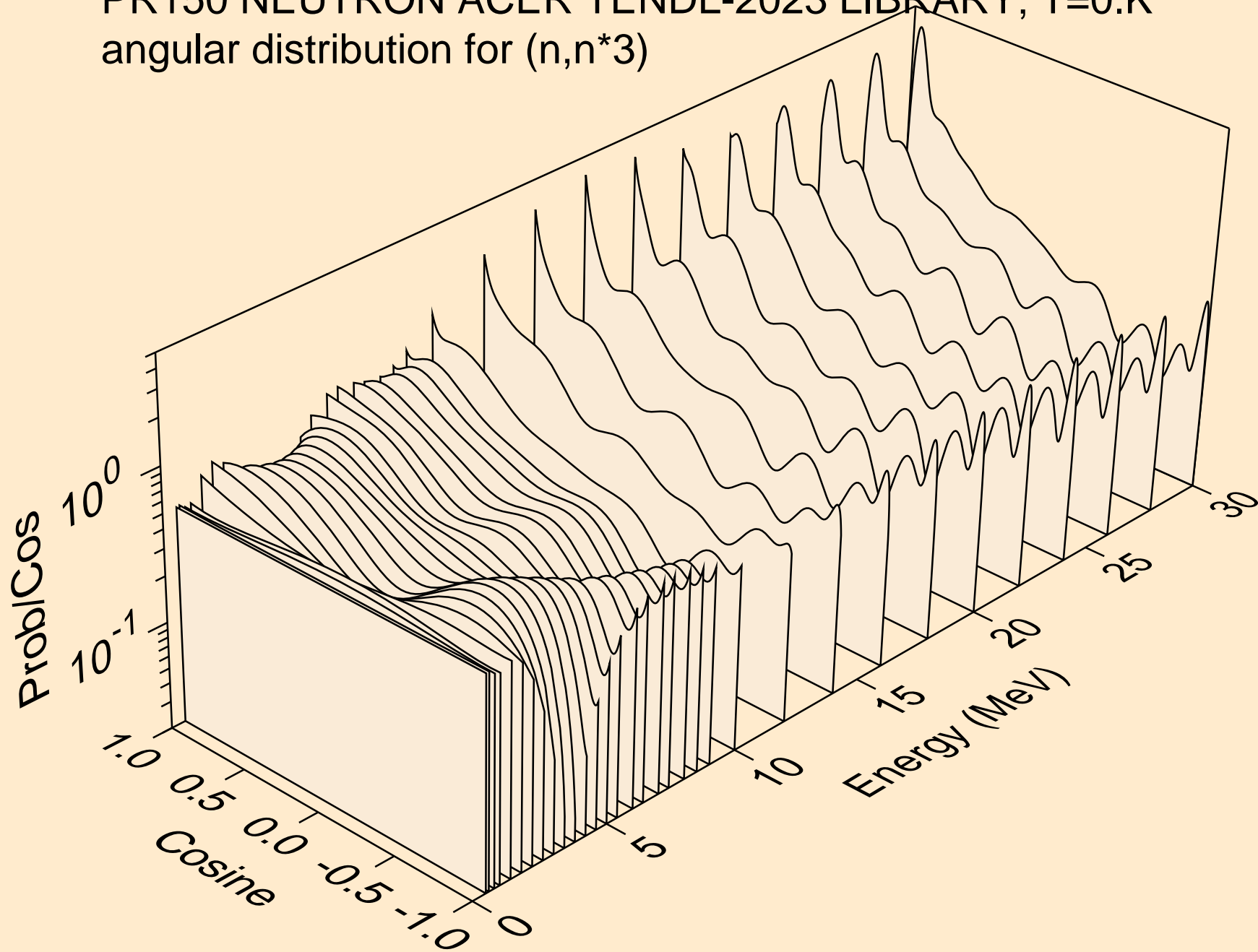

PR150 NEUTRON ACER TENDL-2023 LIBRARY; T=0.K
angular distribution for (n,n*4)

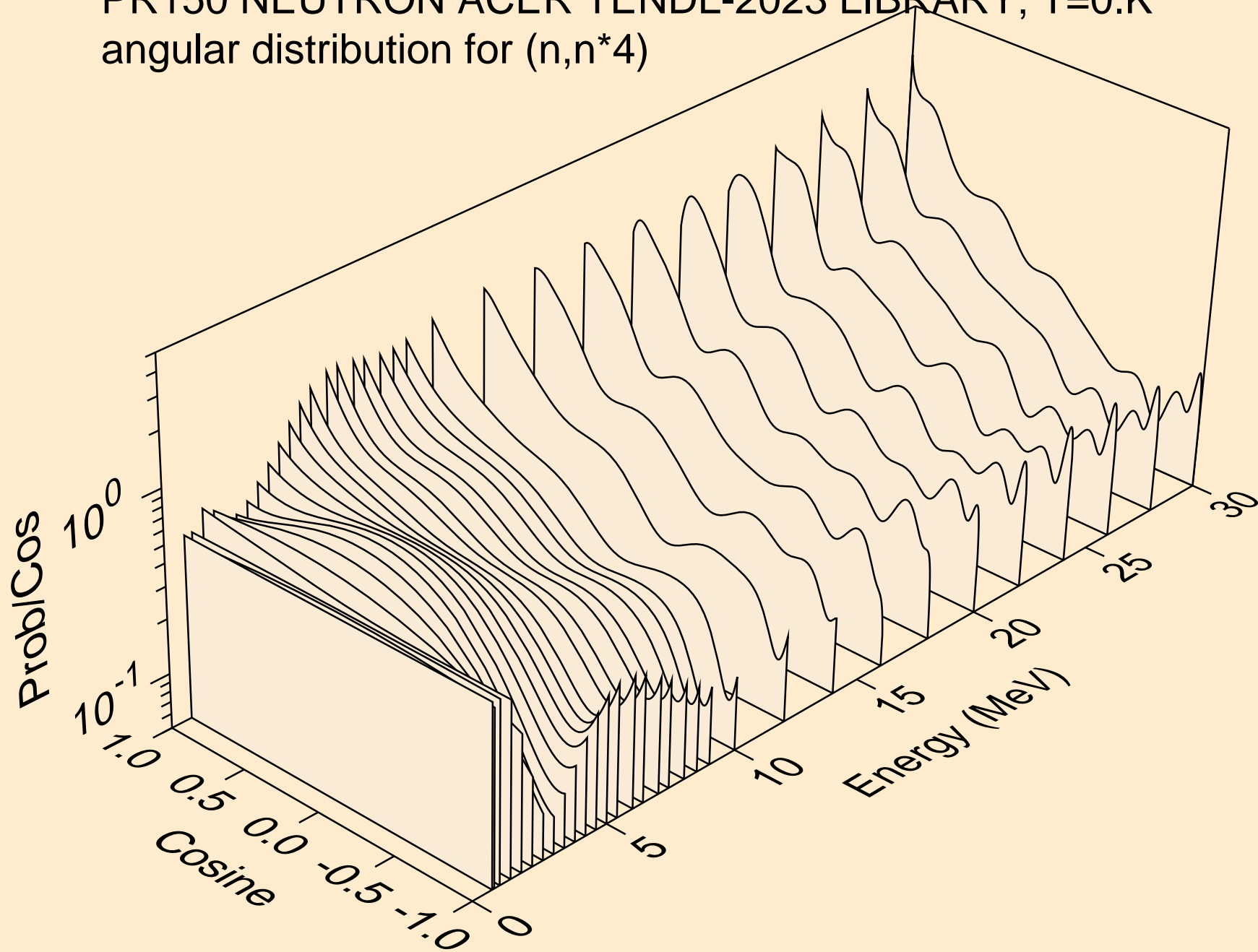

PR150 NEUTRON ACER TENDL-2023 LIBRARY; T=0.K
angular distribution for (n,n*5)

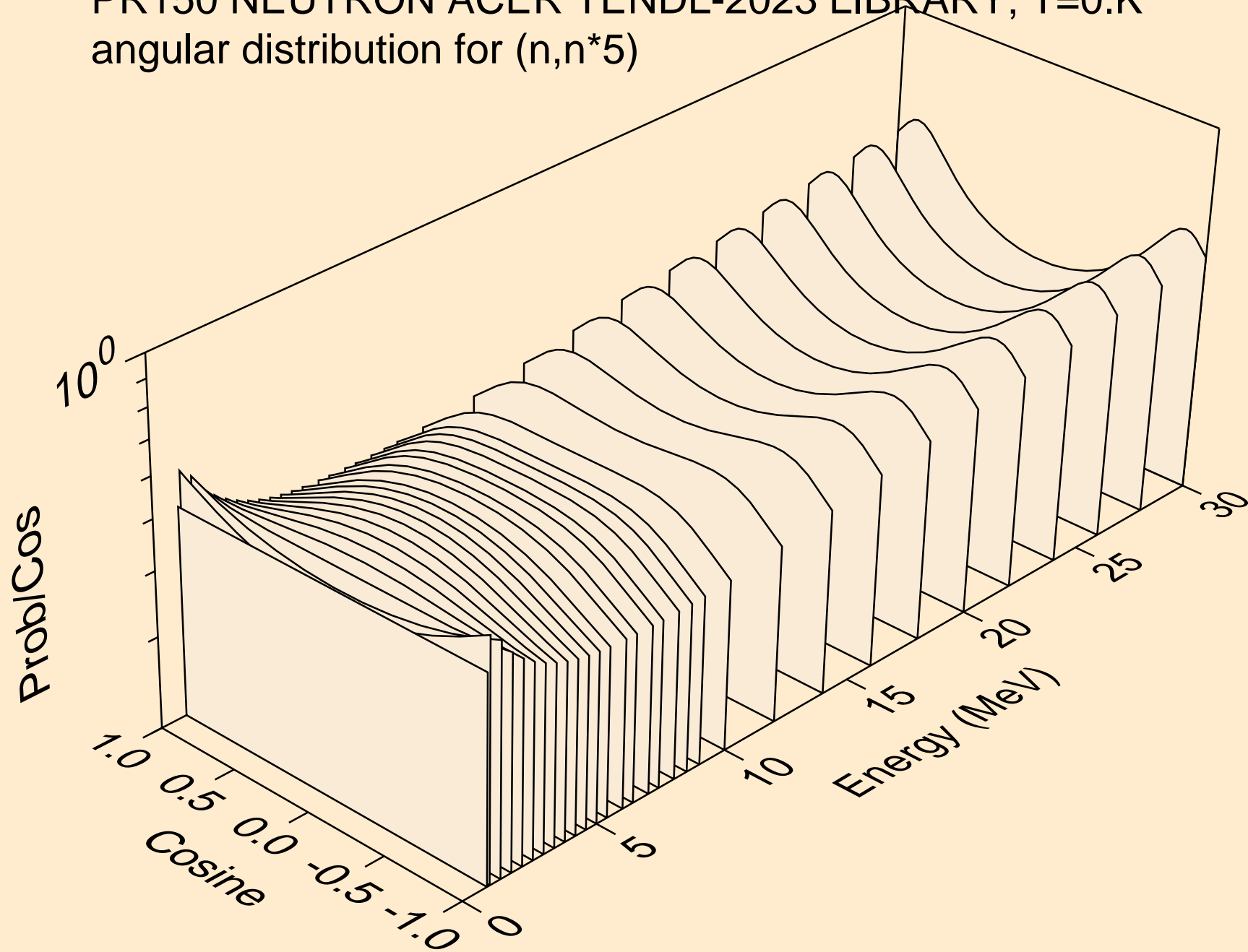

PR150 NEUTRON ACER TENDL-2023 LIBRARY; T=0.K
angular distribution for (n,n*6)

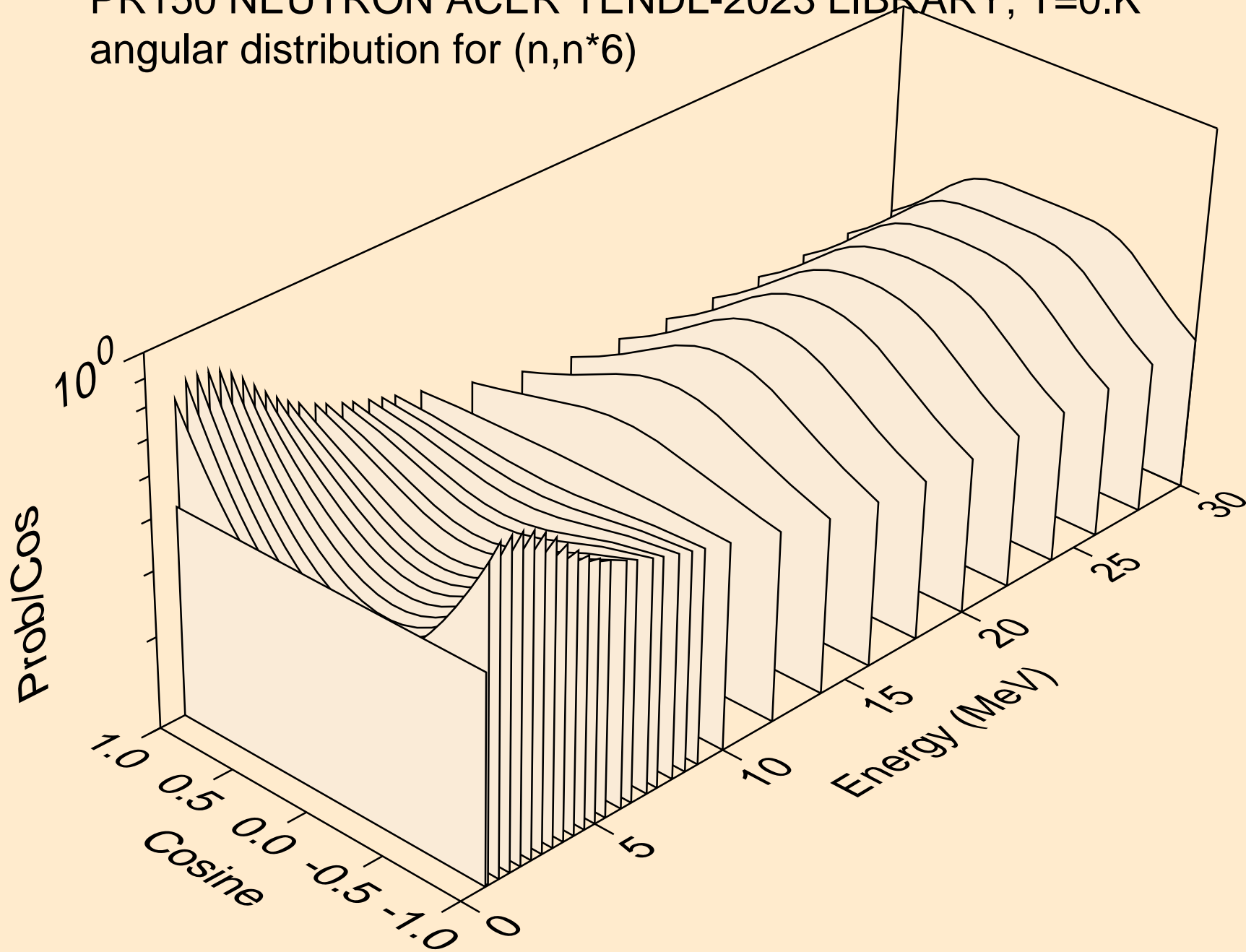

PR150 NEUTRON ACER TENDL-2023 LIBRARY; T=0.K
angular distribution for (n,n*7)

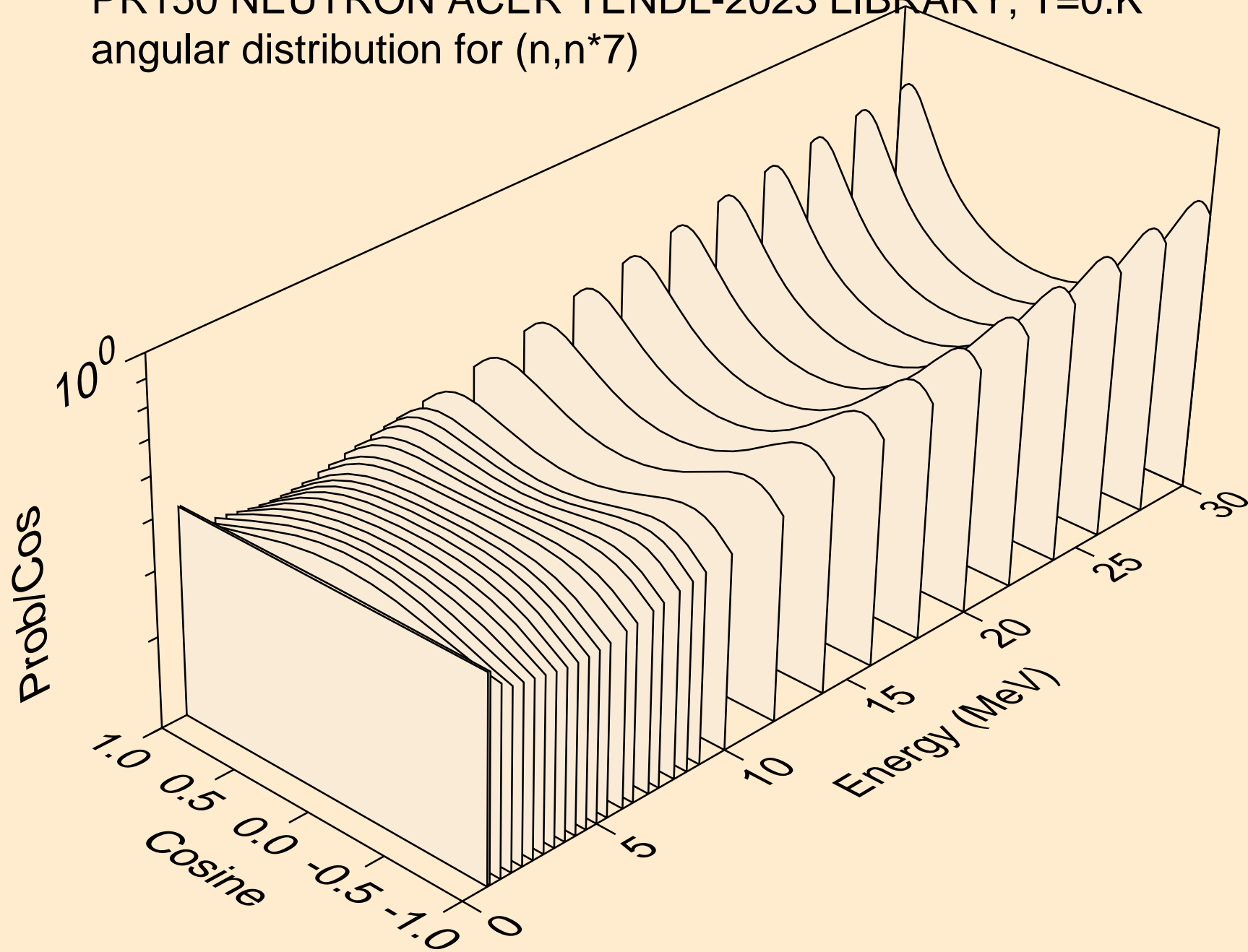

PR150 NEUTRON ACER TENDL-2023 LIBRARY; T=0.K
angular distribution for (n,n*8)

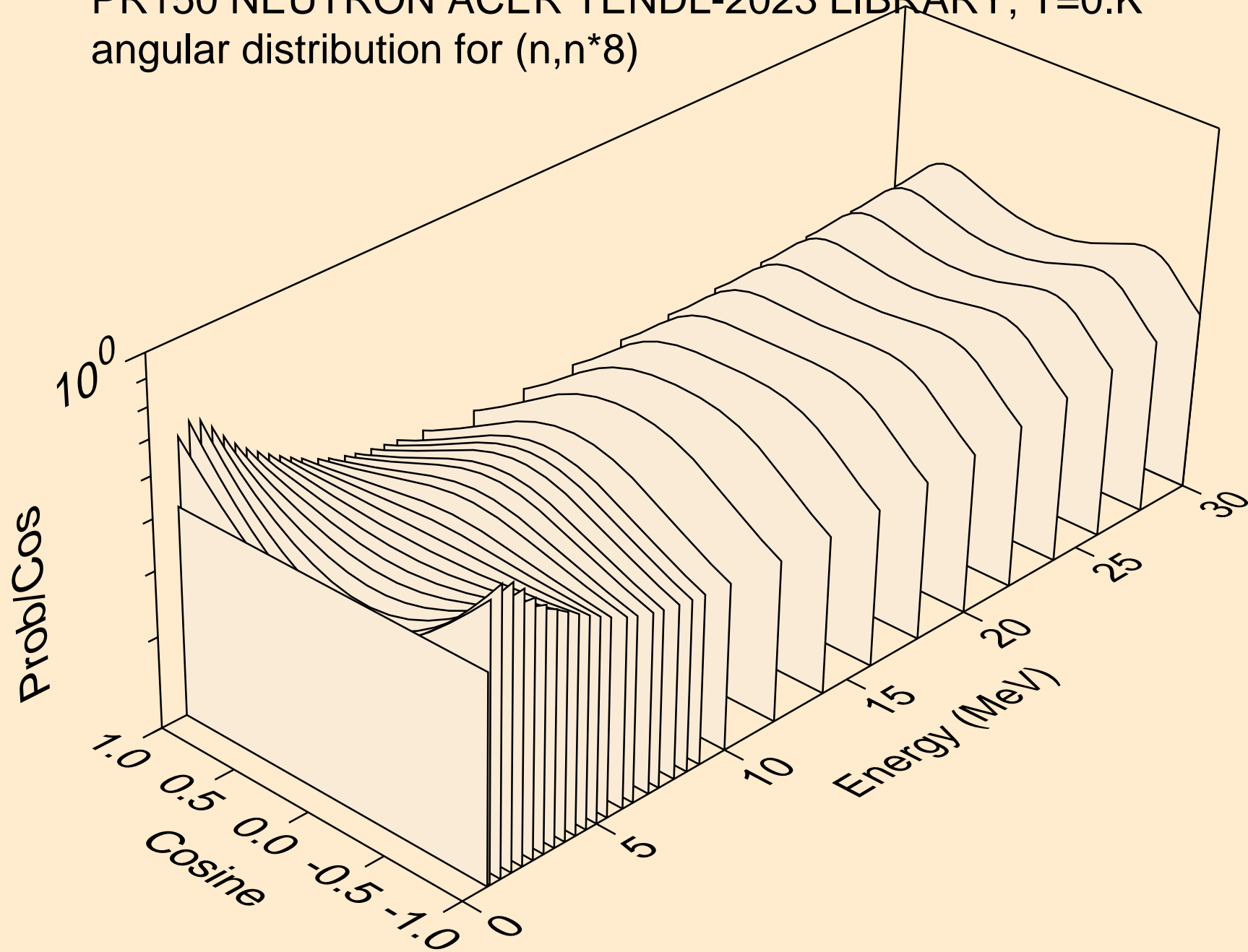

PR150 NEUTRON ACER TENDL-2023 LIBRARY; T=0.K
angular distribution for (n,n*9)

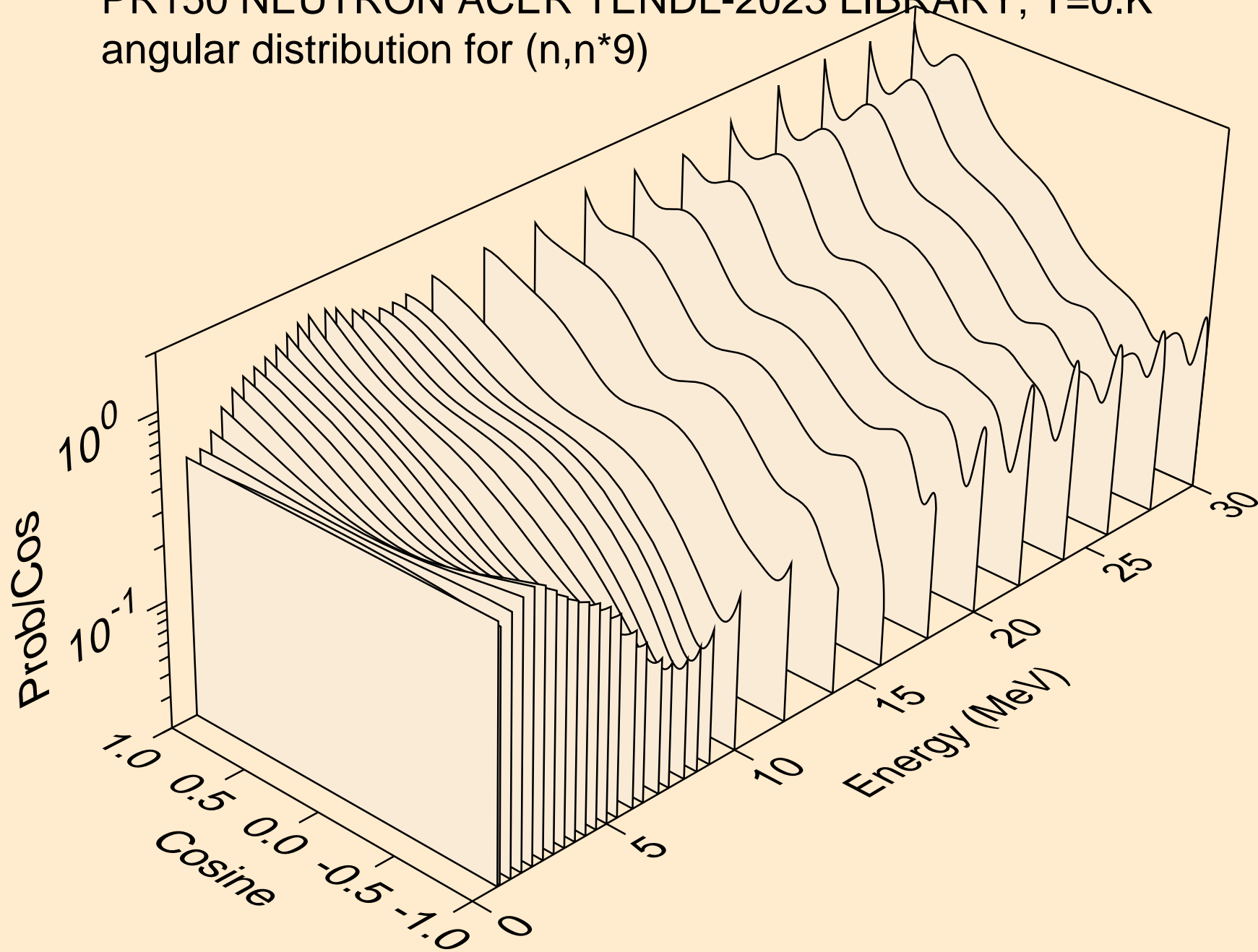

PR150 NEUTRON ACER TENDL-2023 LIBRARY; T=0.K
angular distribution for (n,n*10)

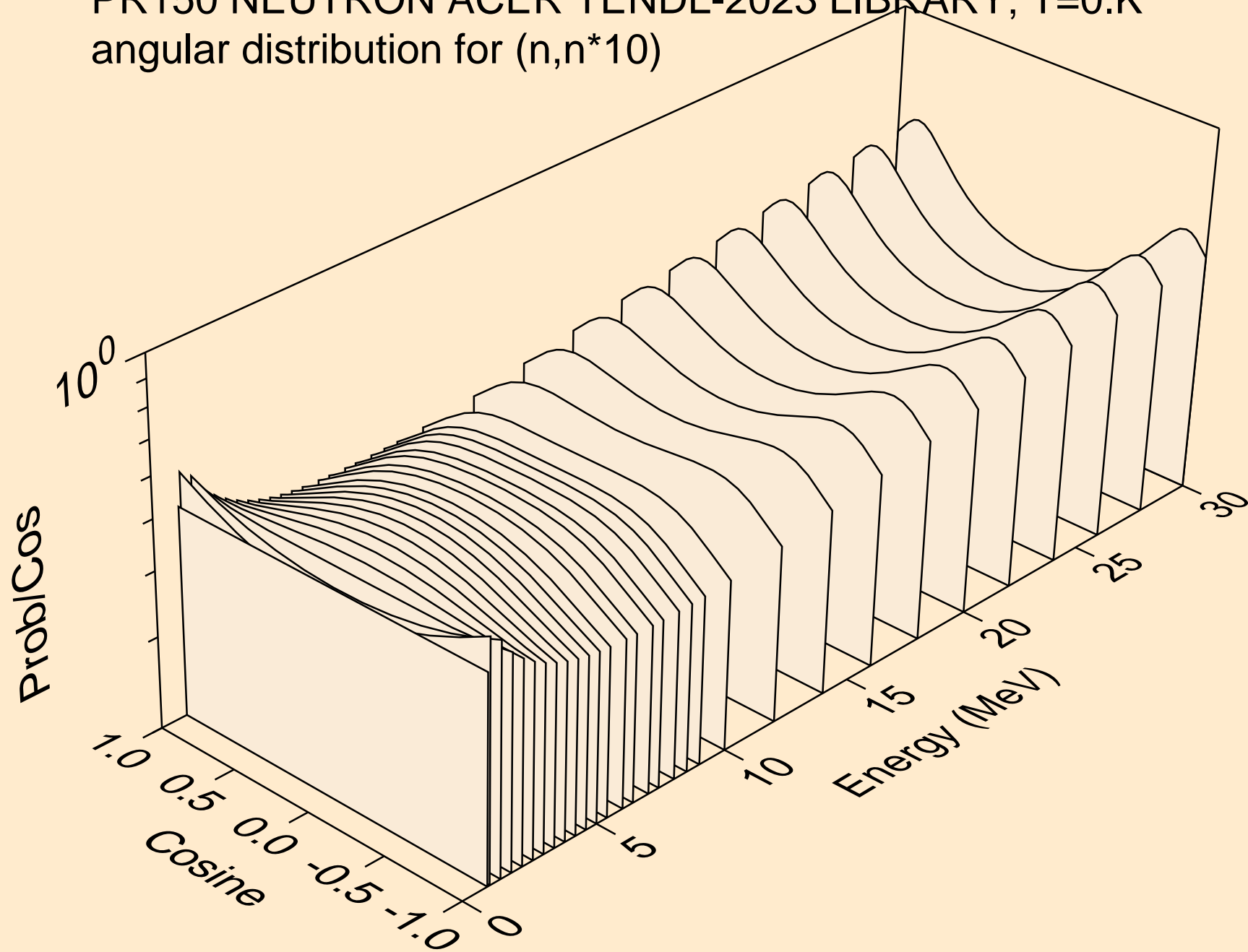

PR150 NEUTRON ACER TENDL-2023 LIBRARY; T=0.K
angular distribution for (n,n*11)

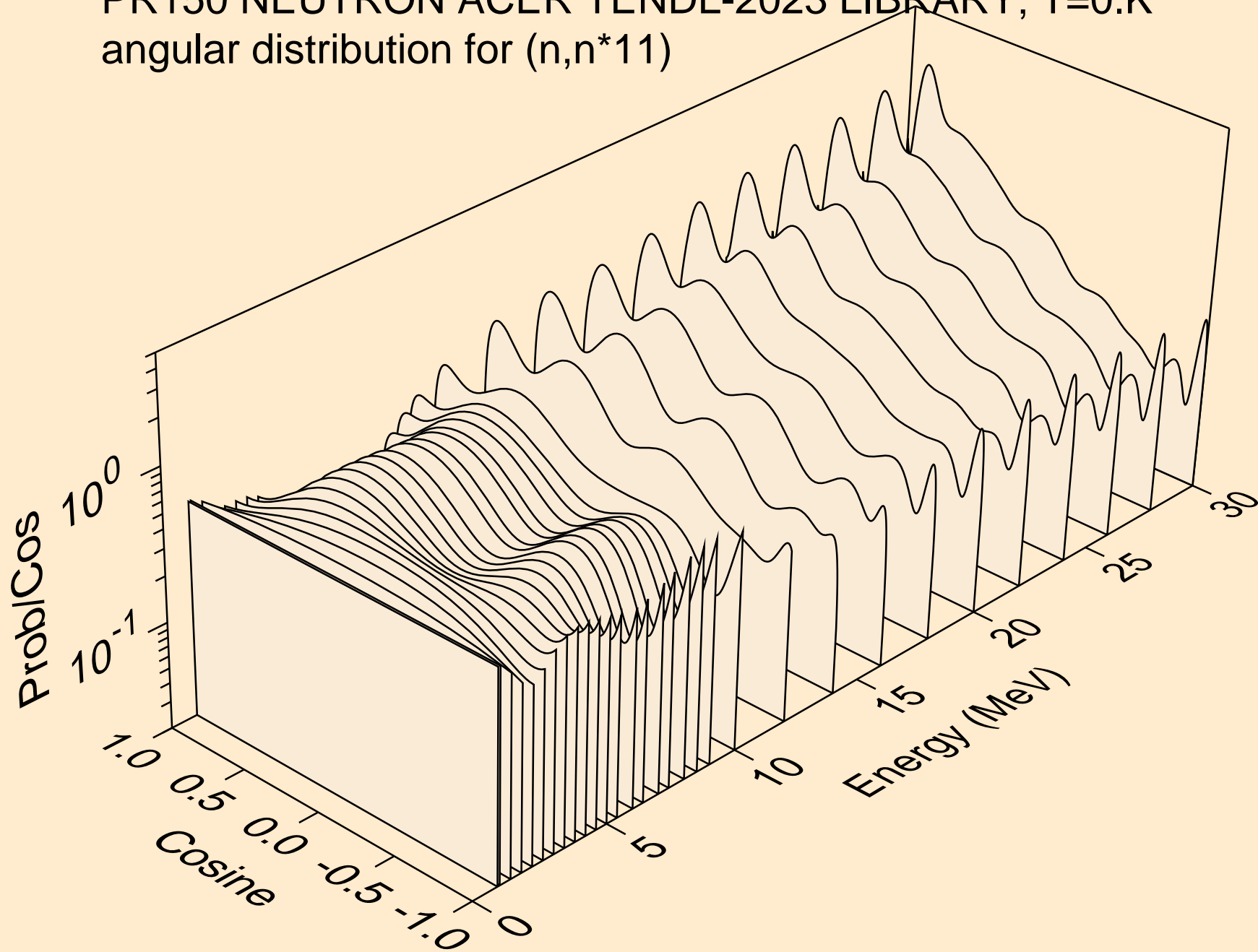

PR150 NEUTRON ACER TENDL-2023 LIBRARY; T=0.K
angular distribution for (n,n*12)

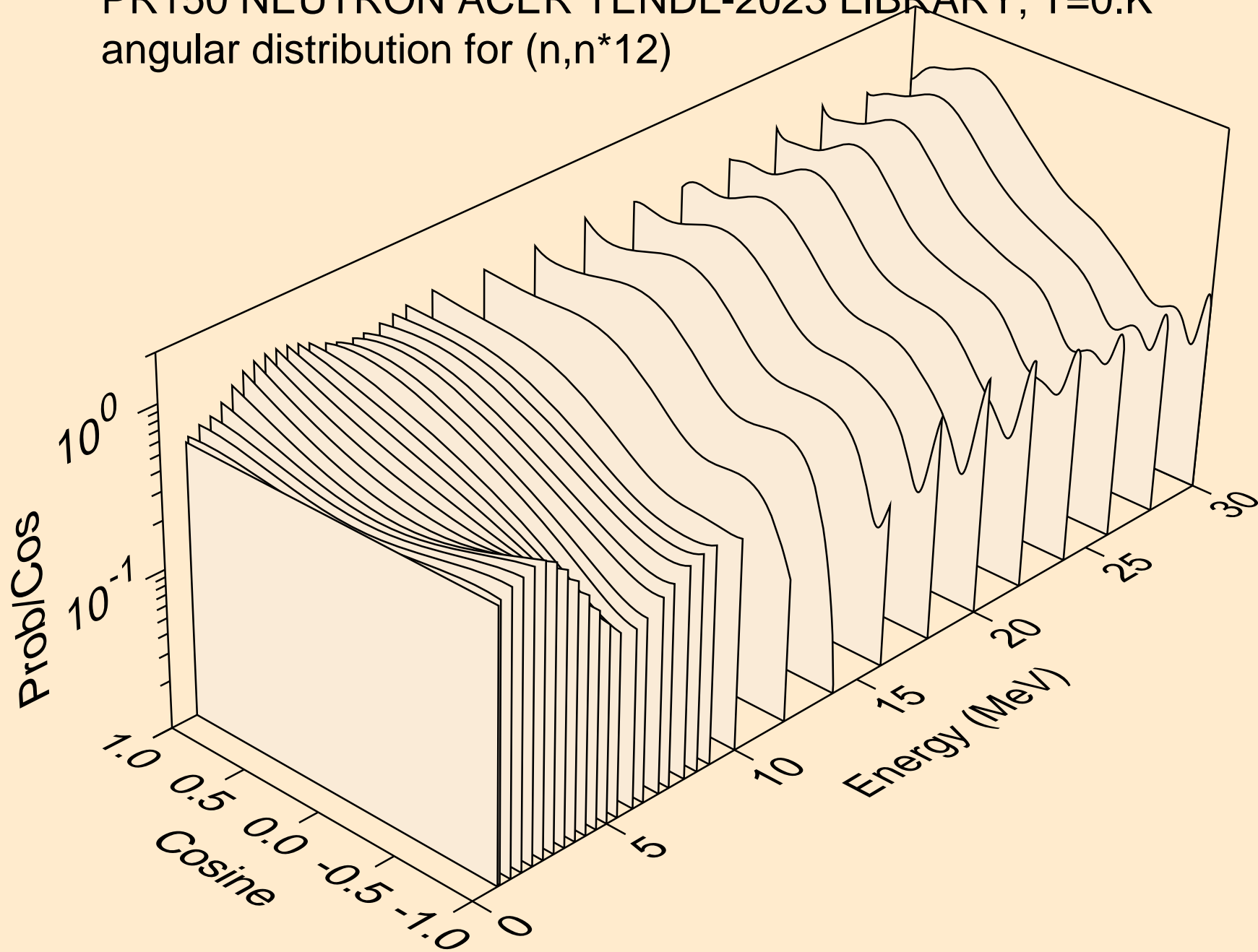

PR150 NEUTRON ACER TENDL-2023 LIBRARY; T=0.K
angular distribution for (n,n*13)

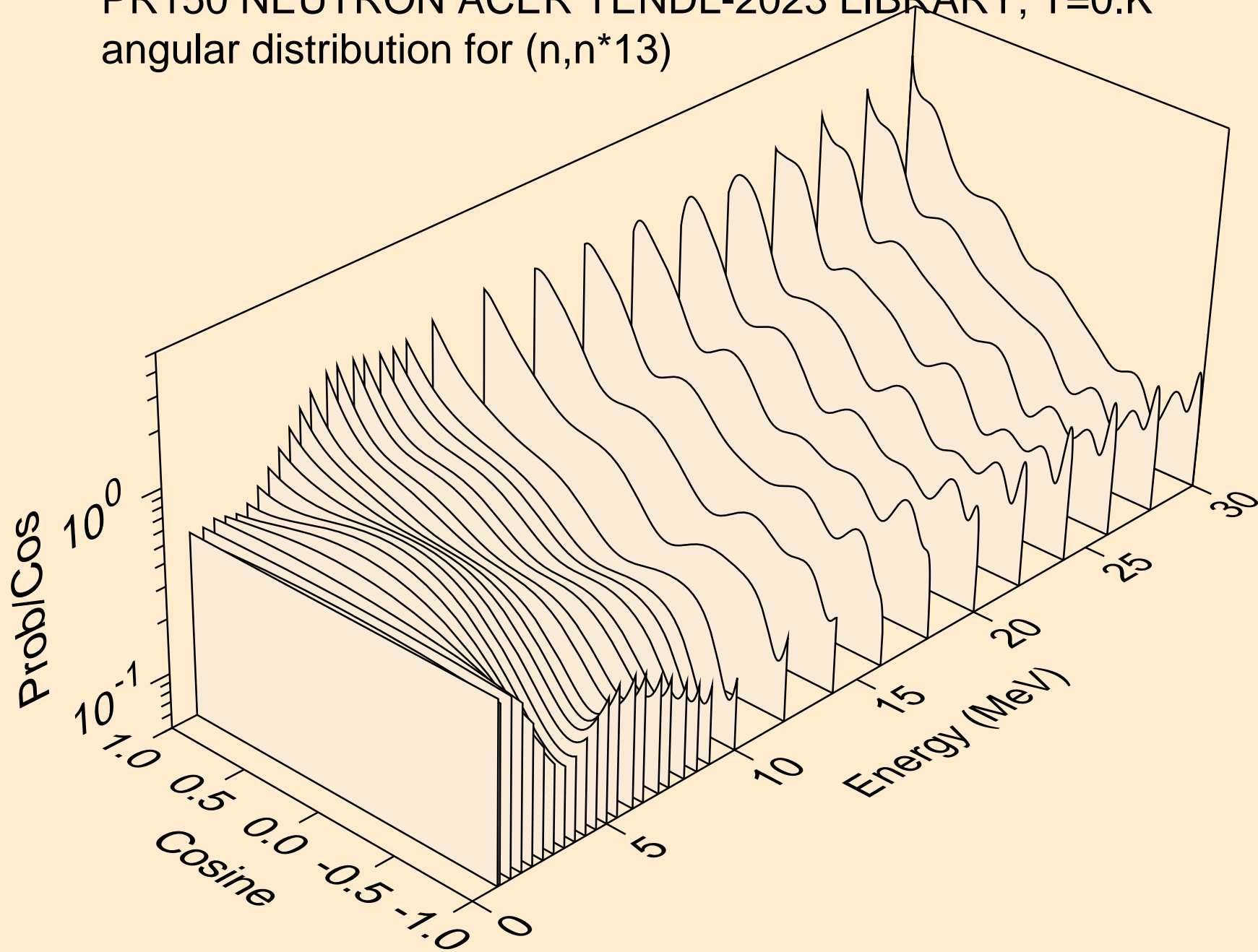

PR150 NEUTRON ACER TENDL-2023 LIBRARY; T=0.K
angular distribution for (n,n*14)

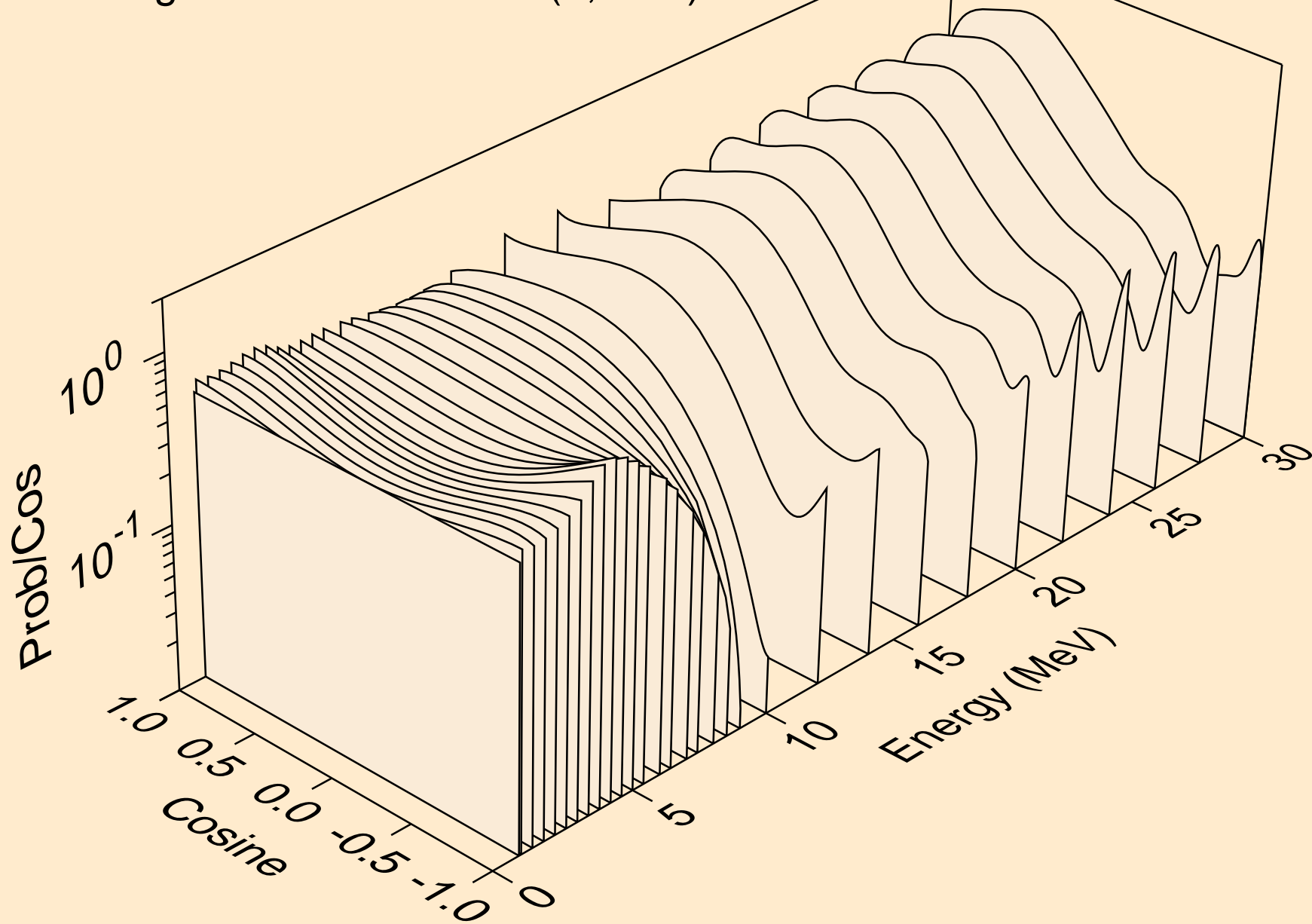

PR150 NEUTRON ACER TENDL-2023 LIBRARY; T=0.K
angular distribution for (n,n*15)

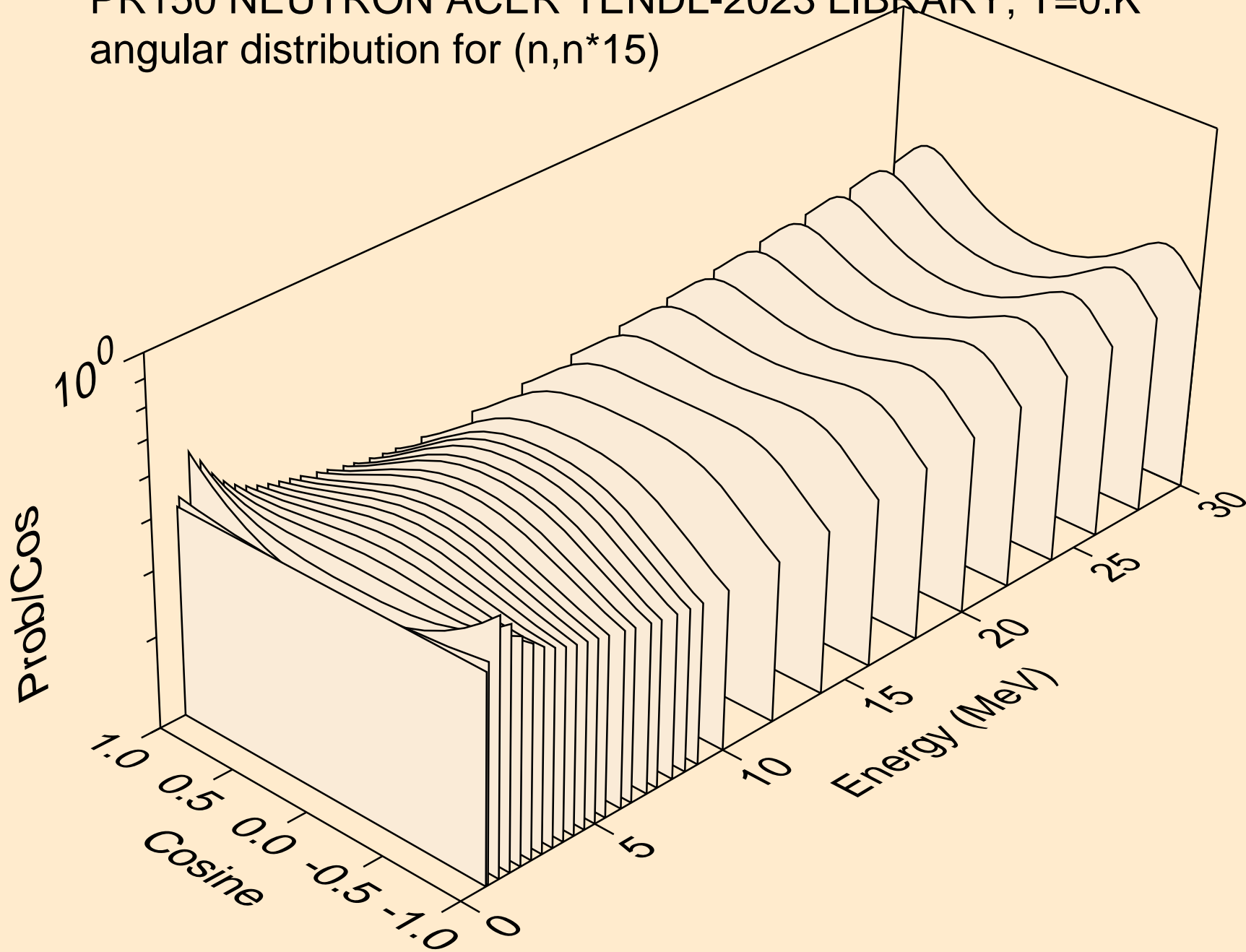

PR150 NEUTRON ACER TENDL-2023 LIBRARY; T=0.K
angular distribution for (n,n*16)

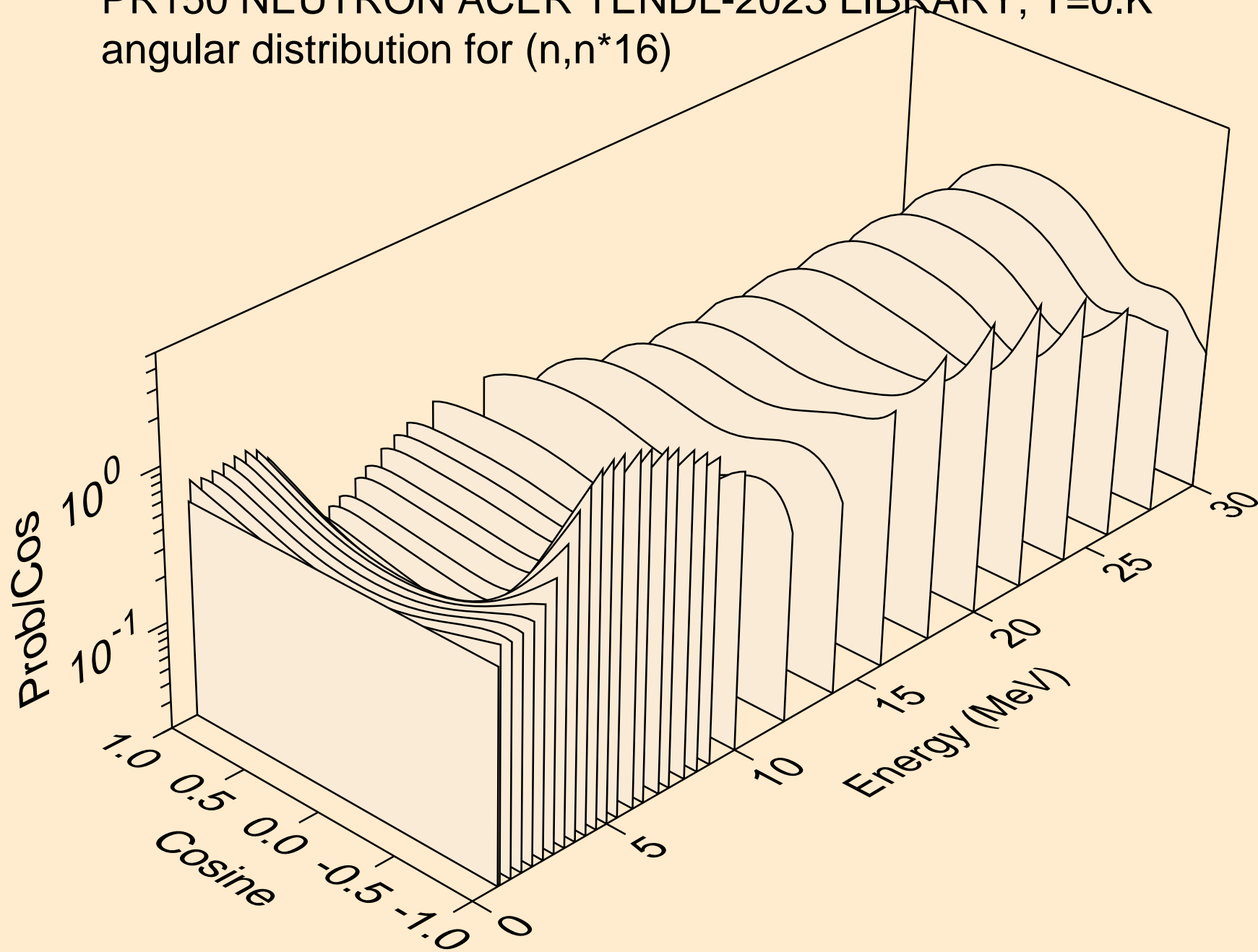

PR150 NEUTRON ACER TENDL-2023 LIBRARY; T=0.K
angular distribution for (n,n*17)

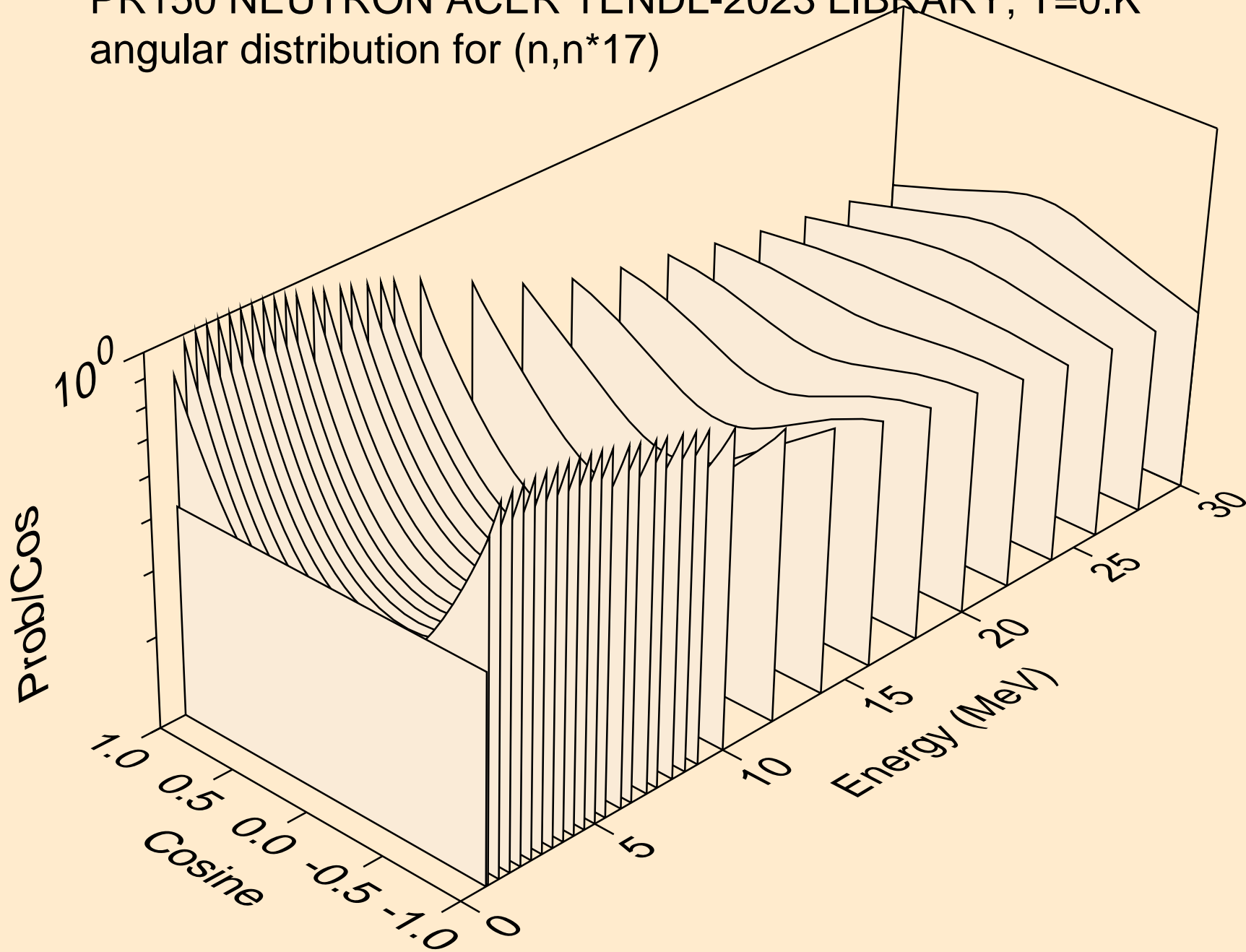

PR150 NEUTRON ACER TENDL-2023 LIBRARY; T=0.K
angular distribution for (n,n*18)

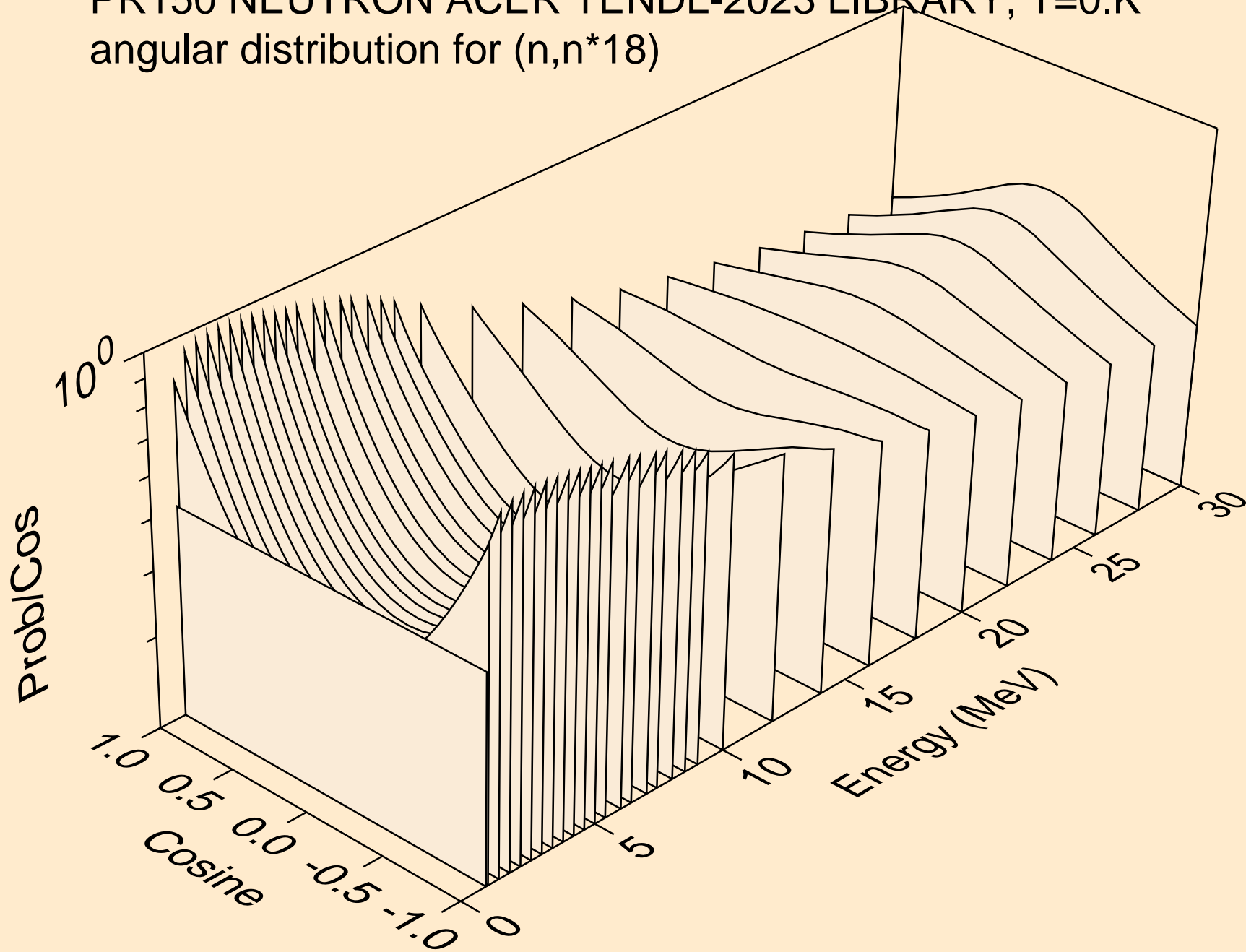

PR150 NEUTRON ACER TENDL-2023 LIBRARY; T=0.K
angular distribution for (n,n*19)

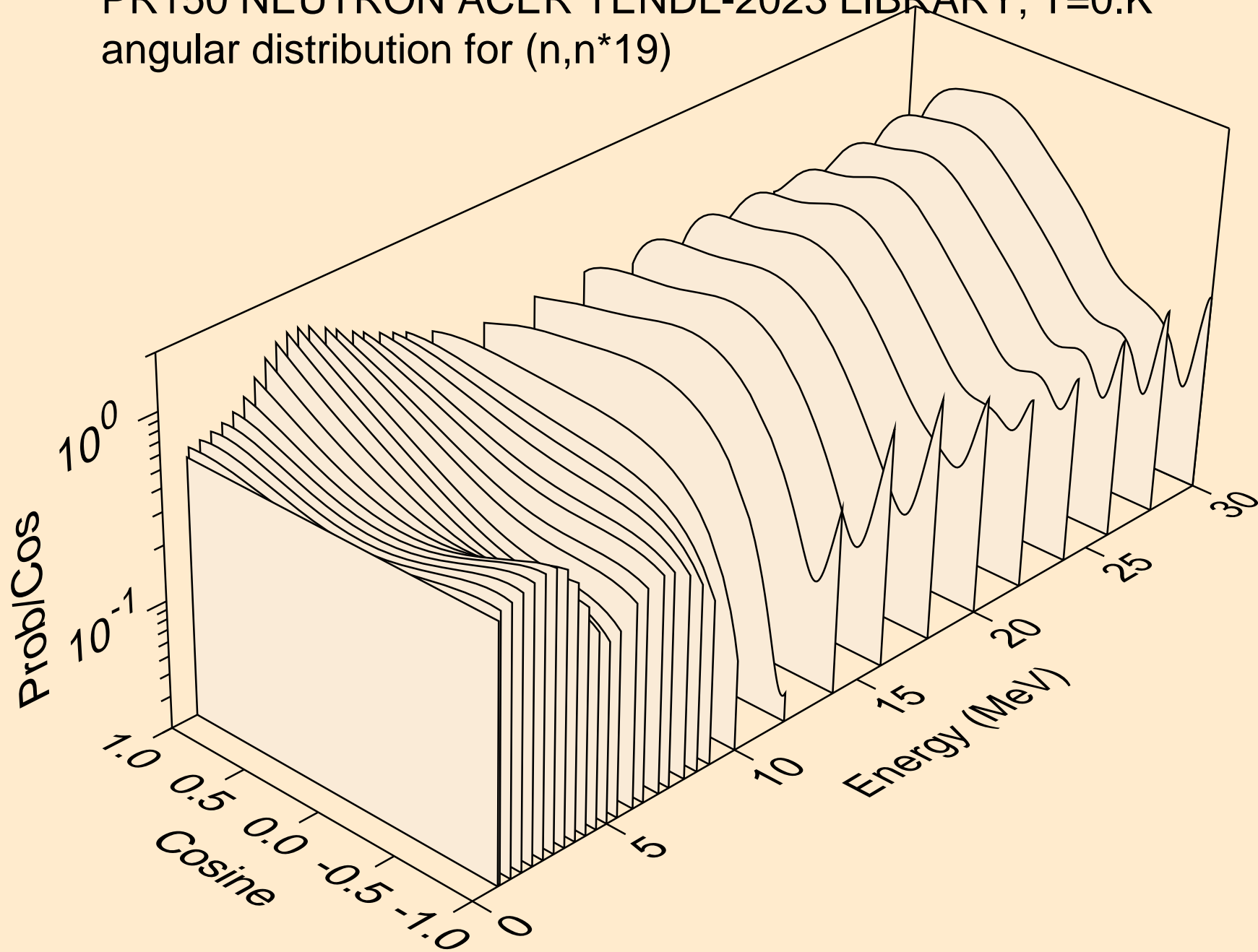

PR150 NEUTRON ACER TENDL-2023 LIBRARY; T=0.K
angular distribution for (n,n*20)

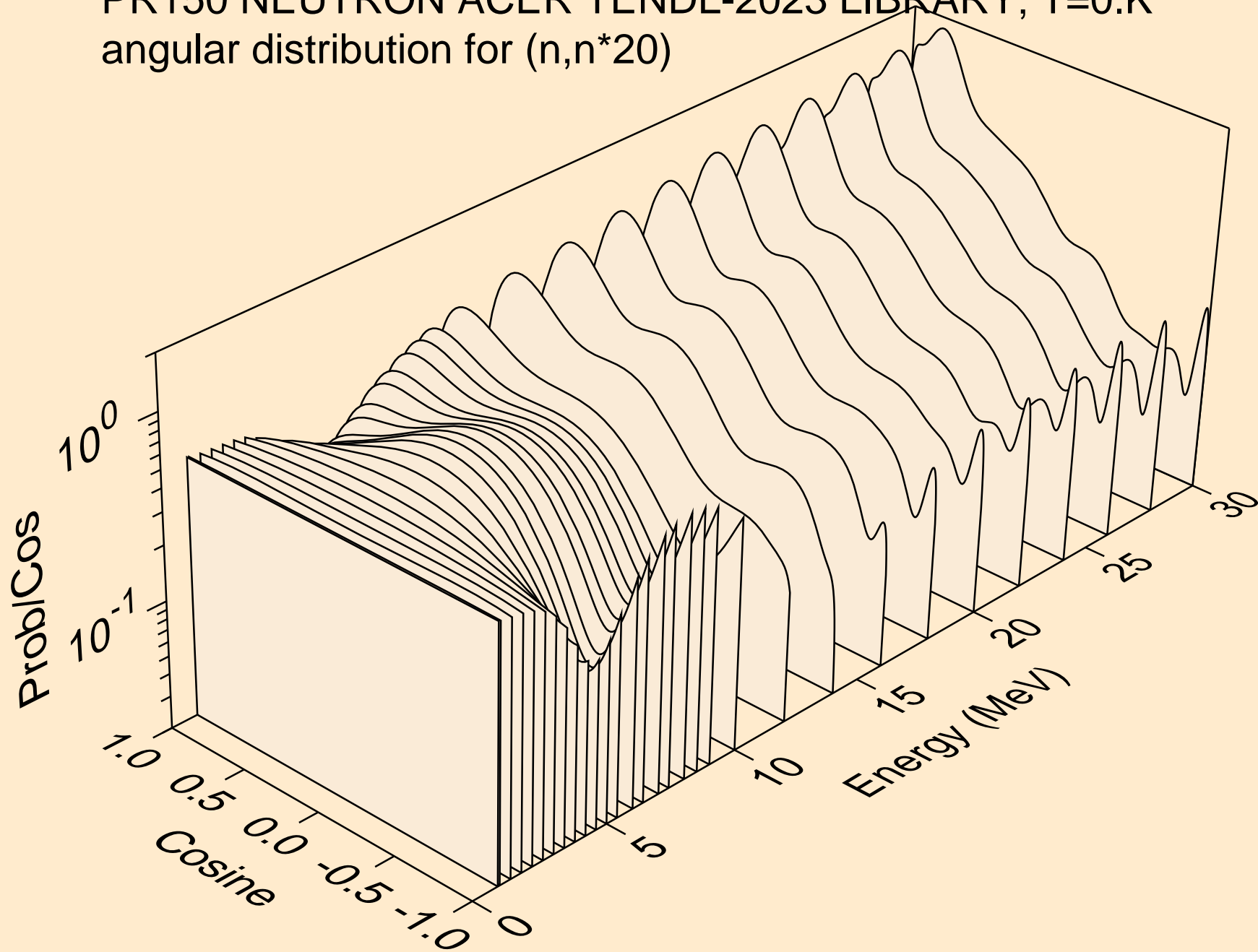

PR150 NEUTRON ACER TENDL-2023 LIBRARY; T=0.K
angular distribution for (n,n*21)

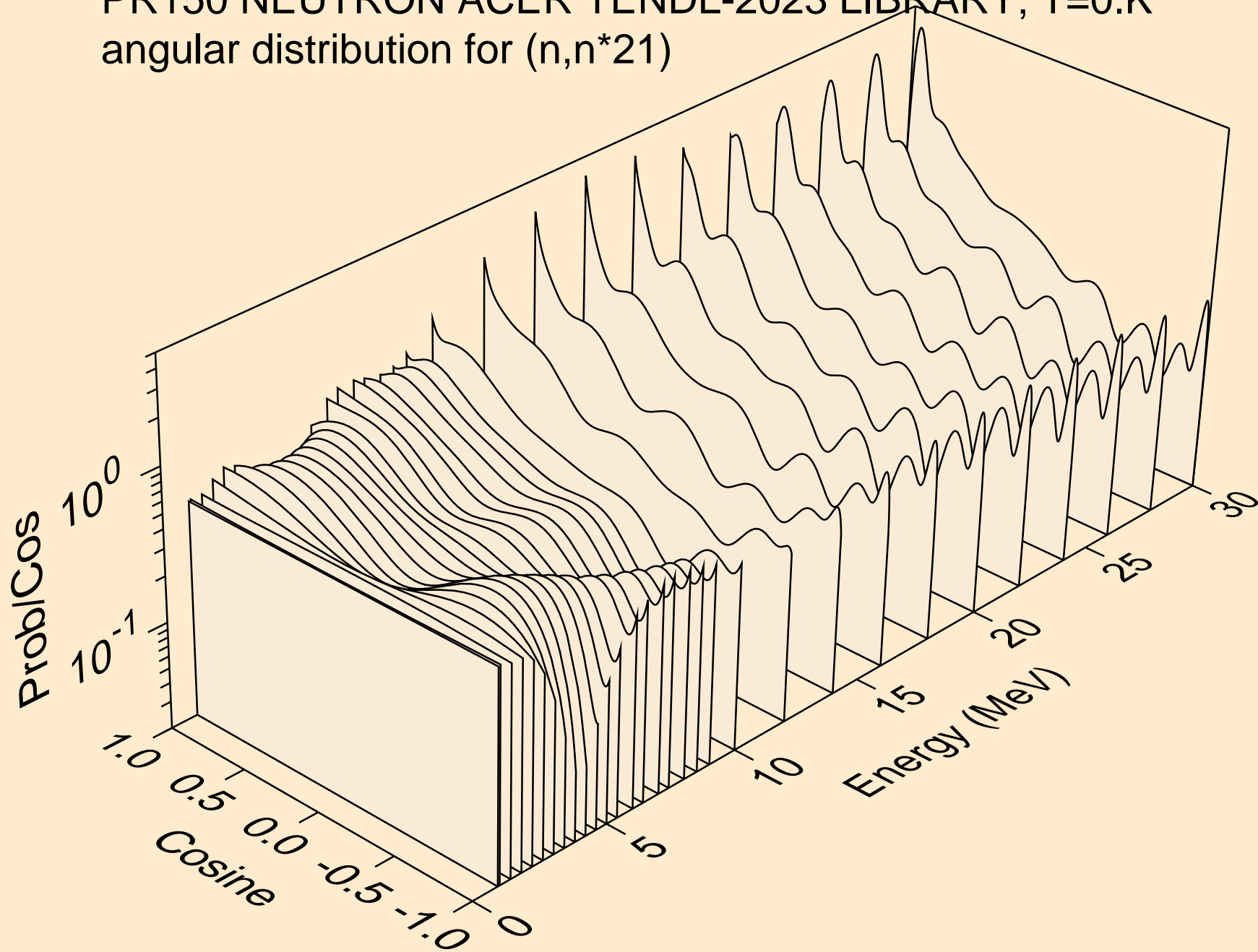

PR150 NEUTRON ACER TENDL-2023 LIBRARY; T=0.K
angular distribution for (n,n*22)

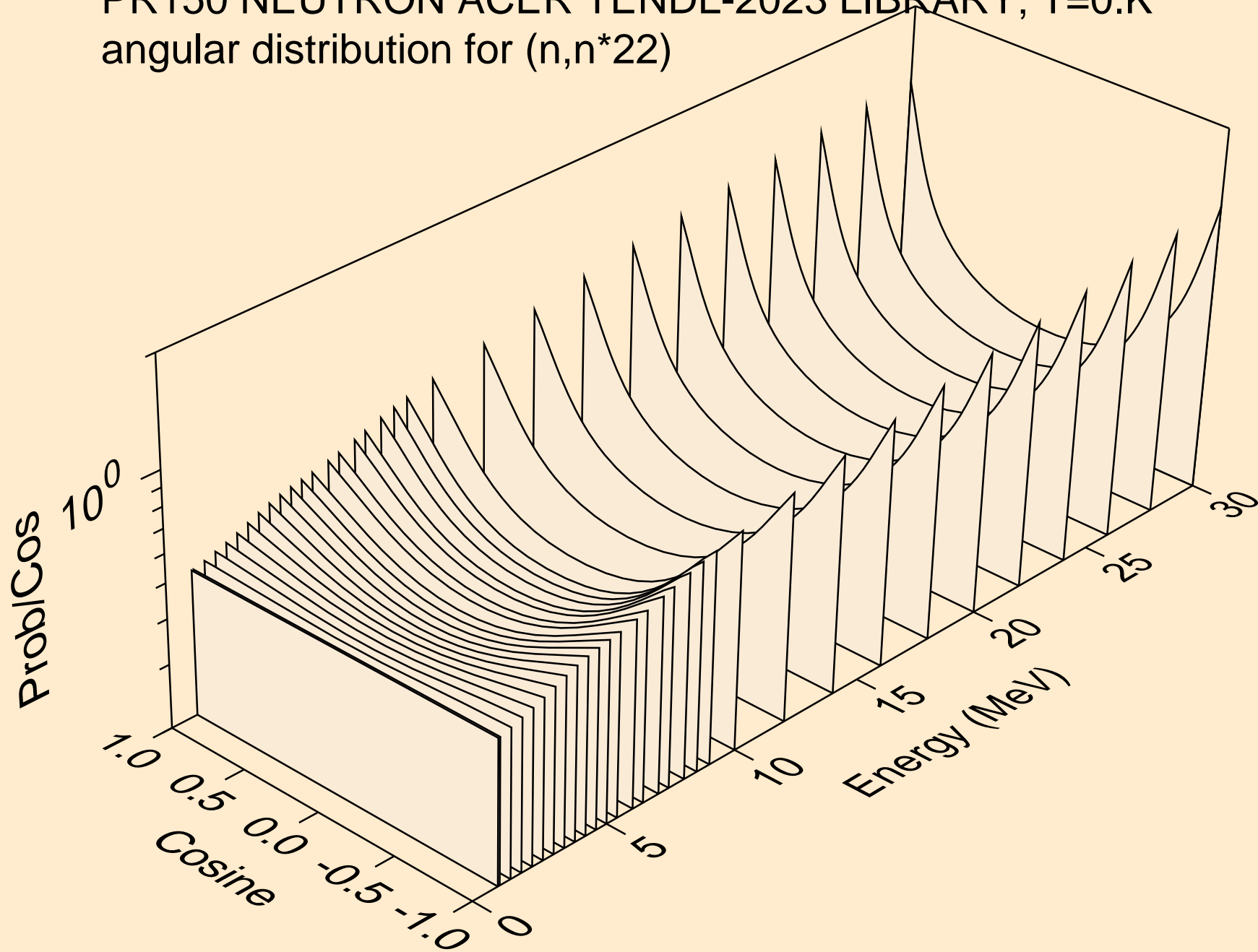

PR150 NEUTRON ACER TENDL-2023 LIBRARY; T=0.K
angular distribution for (n,n*23)

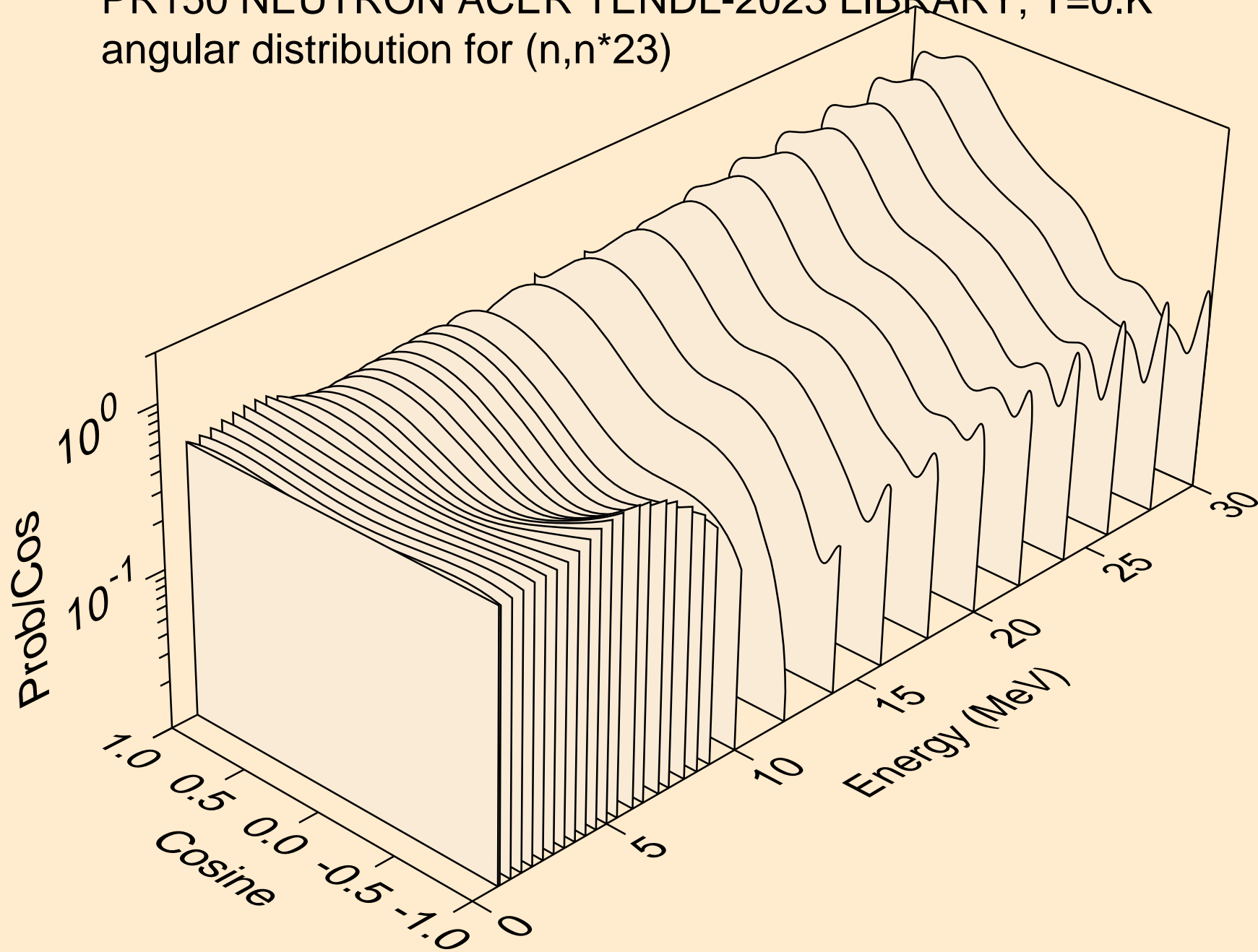

PR150 NEUTRON ACER TENDL-2023 LIBRARY; T=0.K
angular distribution for (n,n*24)

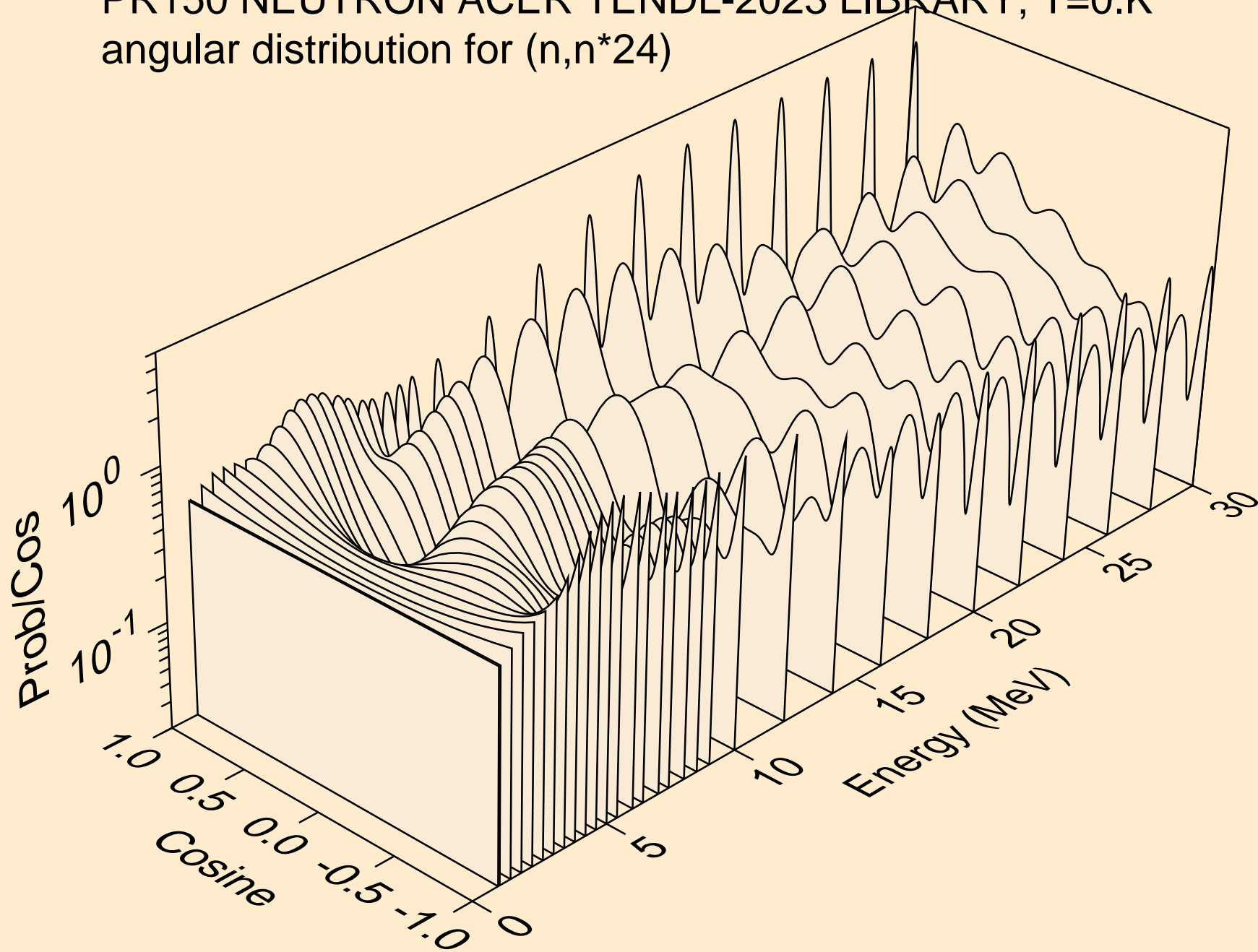

PR150 NEUTRON ACER TENDL-2023 LIBRARY; T=0.K
angular distribution for (n,n*25)

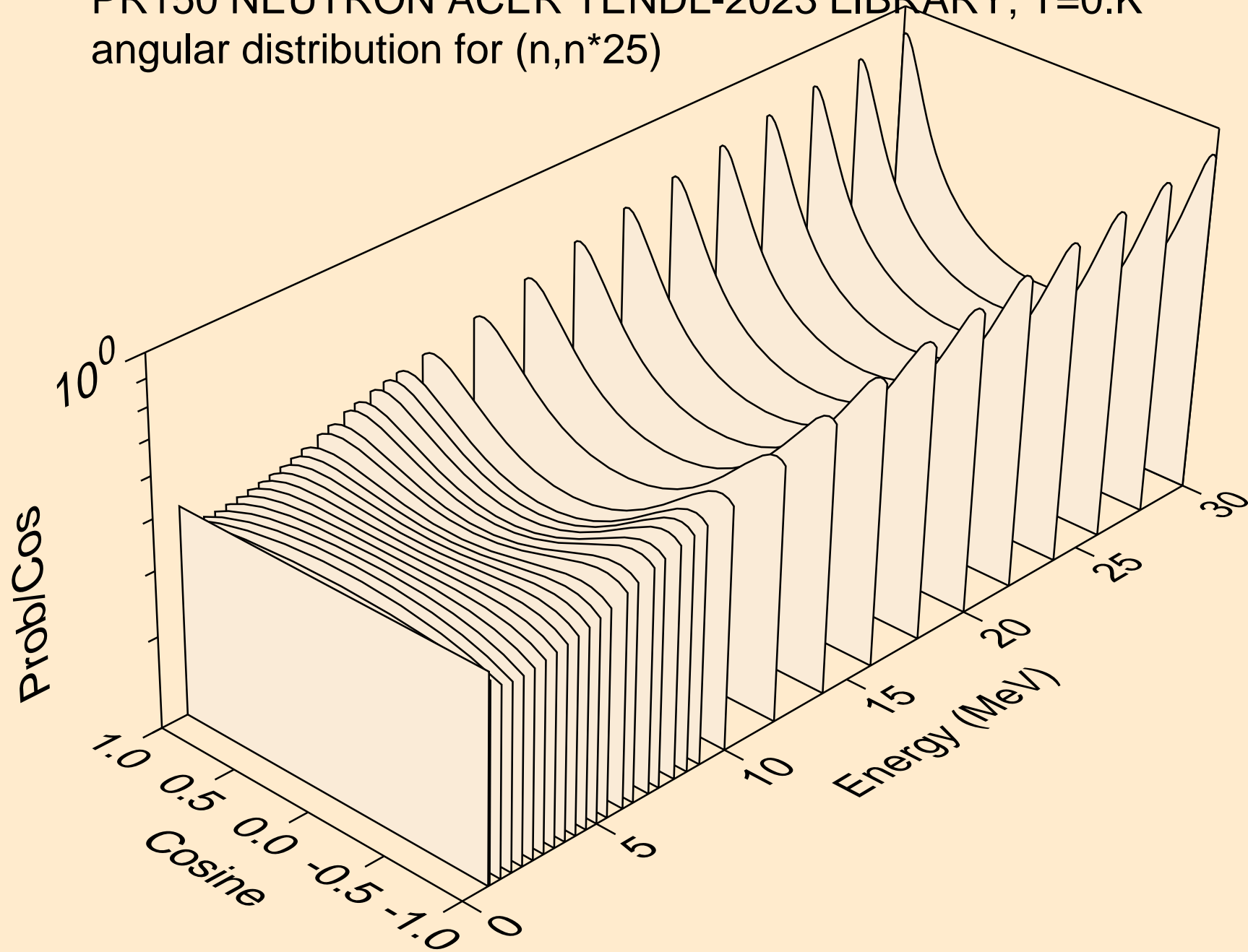

PR150 NEUTRON ACER TENDL-2023 LIBRARY; T=0.K
Neutron emission for (n,x)

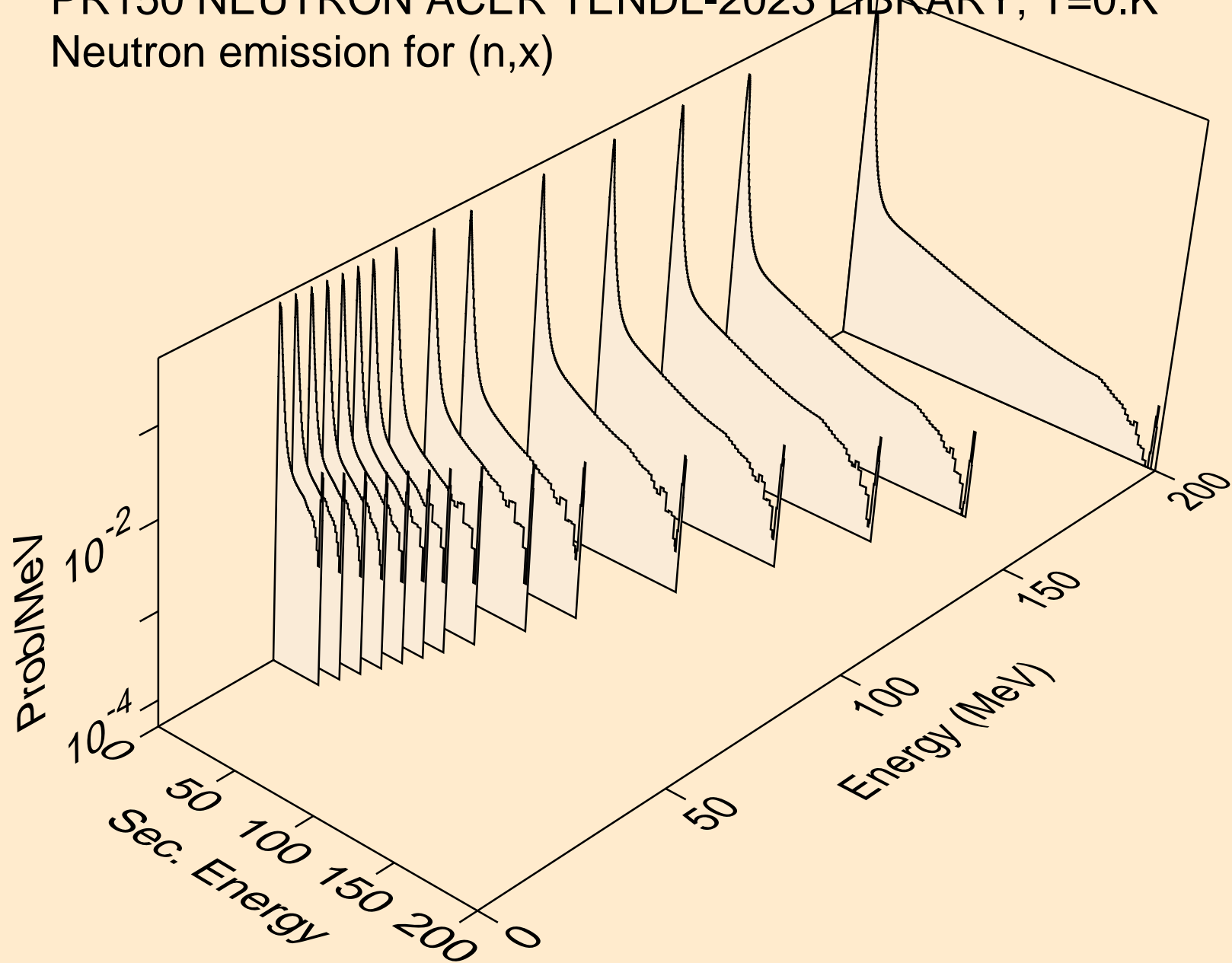

PR150 NEUTRON ACER TENDL-2023 LIBRARY; T=0.K
Neutron emission for (n,2nd)

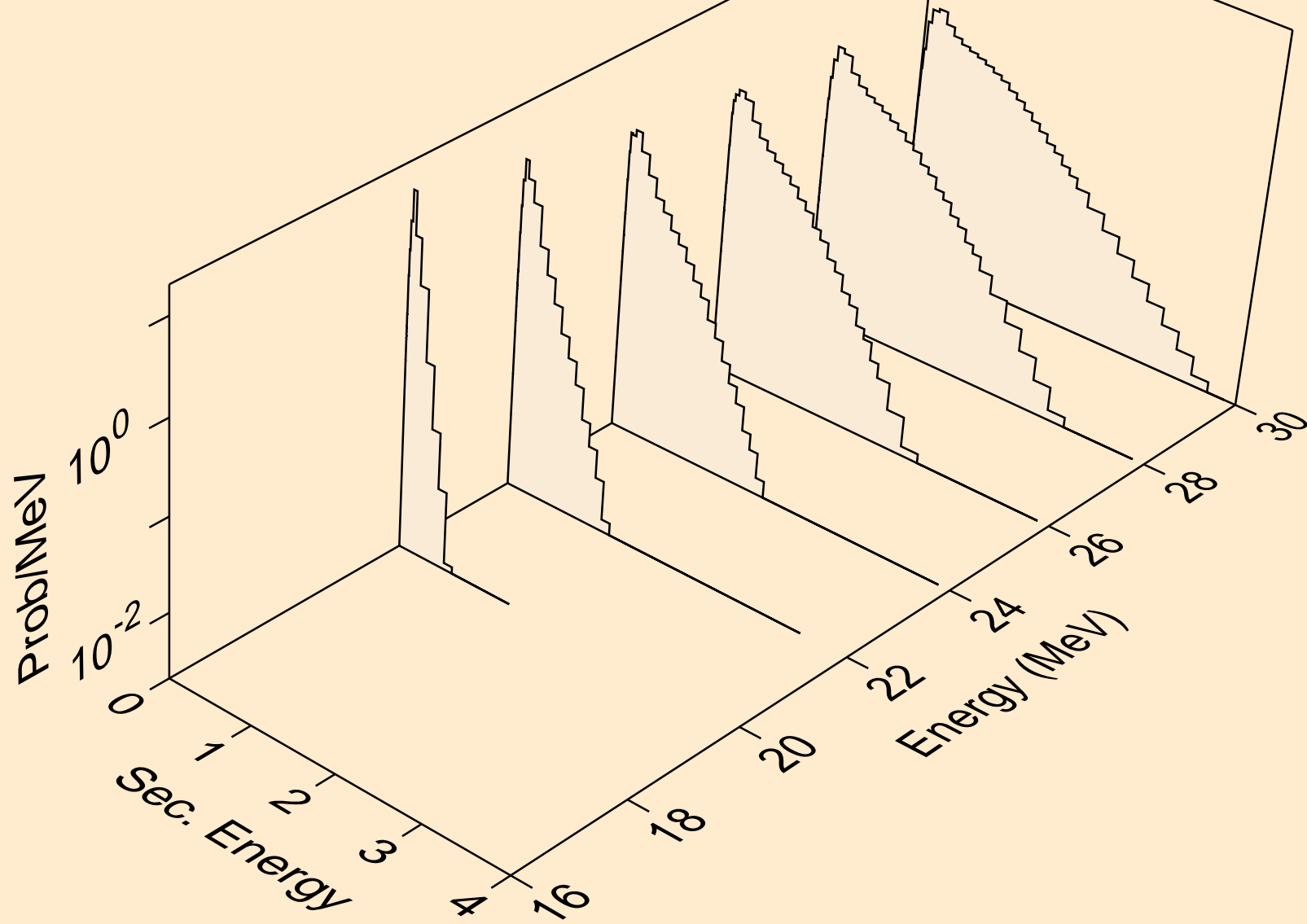

PR150 NEUTRON ACER TENDL-2023 LIBRARY; T=0.K
Neutron emission for (n,2n)

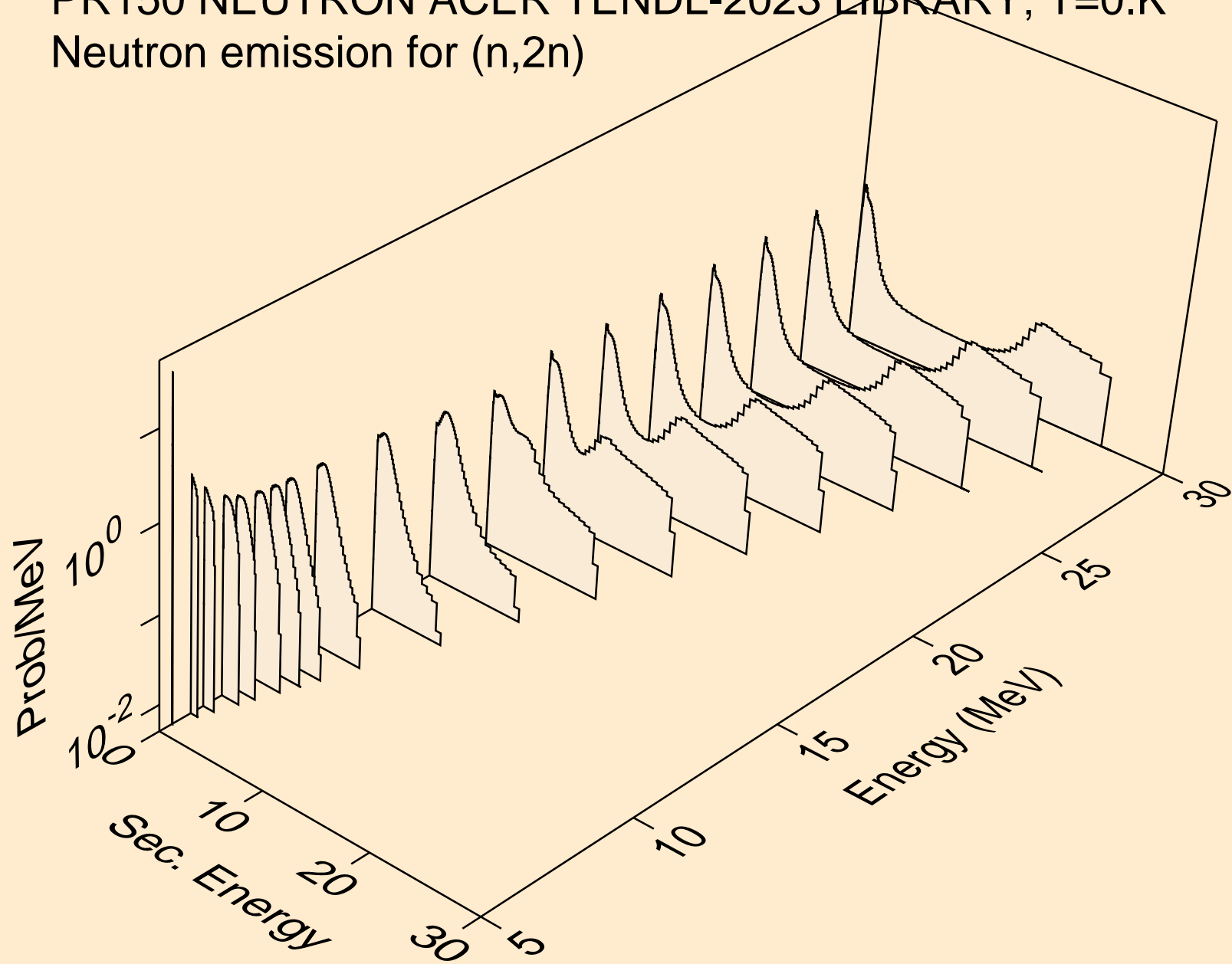

PR150 NEUTRON ACER TENDL-2023 LIBRARY; T=0.K
Neutron emission for (n,3n)

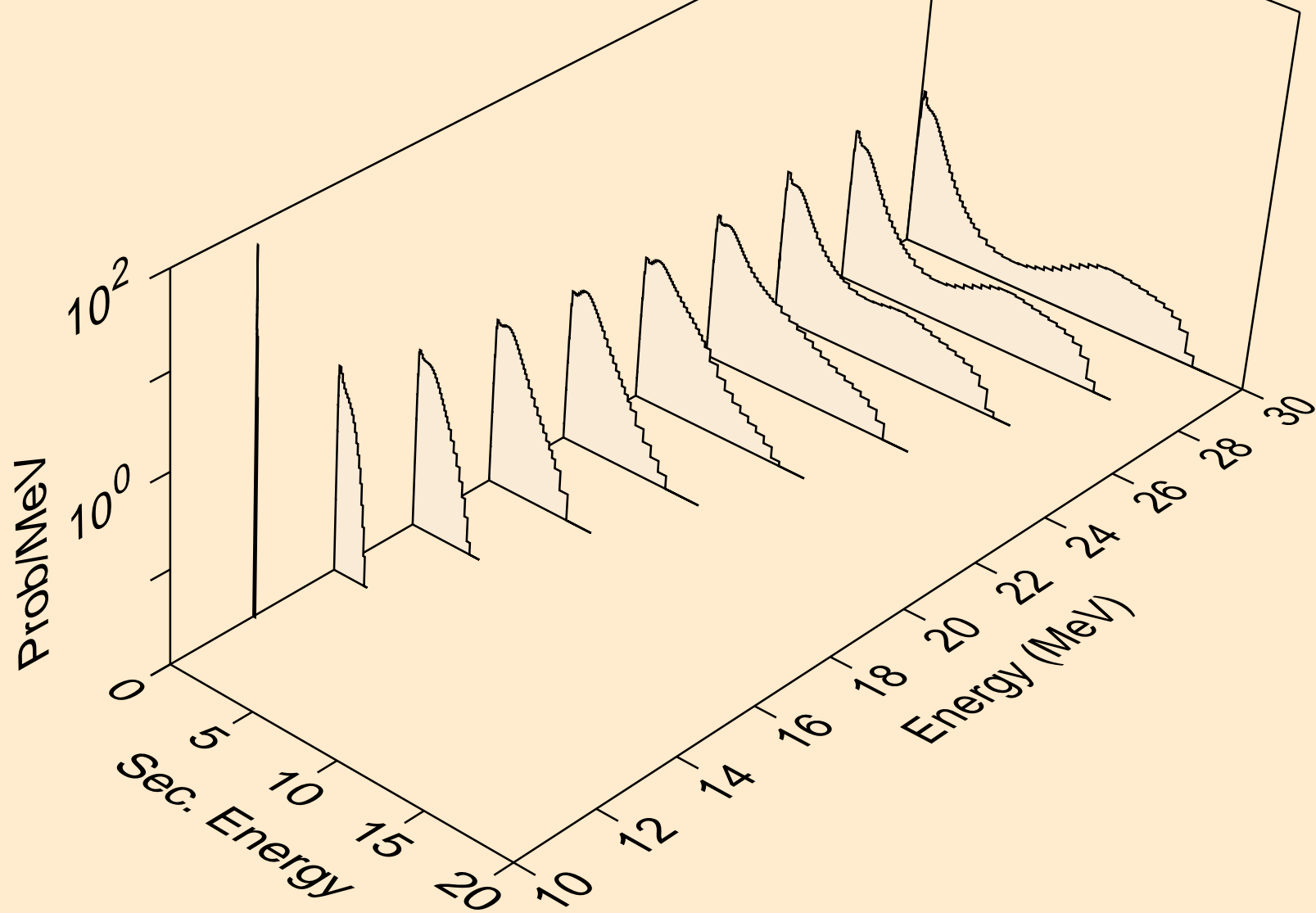

PR150 NEUTRON ACER TENDL-2023 LIBRARY; T=0.K
Neutron emission for (n,n*)a

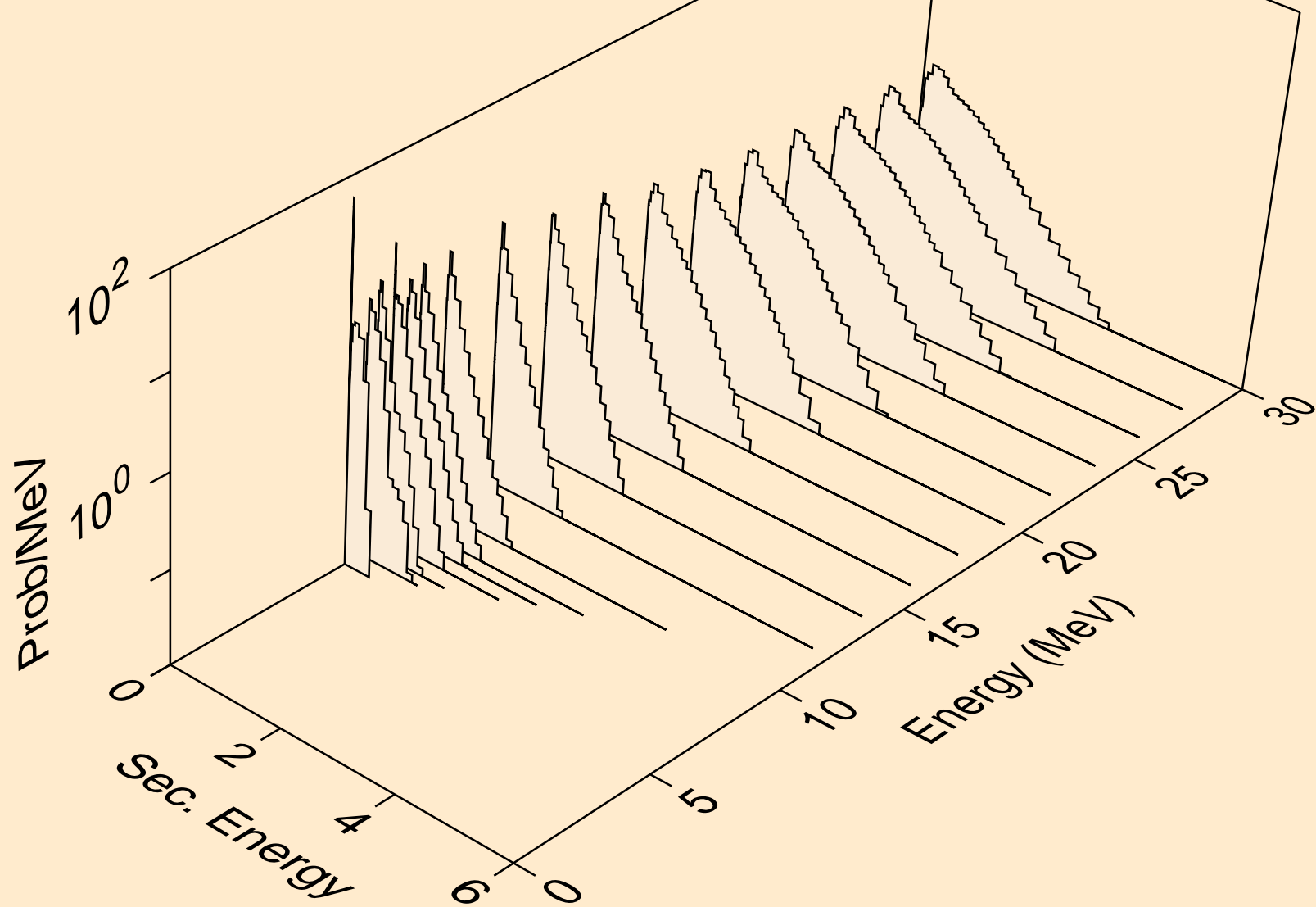

PR150 NEUTRON ACER TENDL-2023 LIBRARY; T=0.K
Neutron emission for (n,2n)a

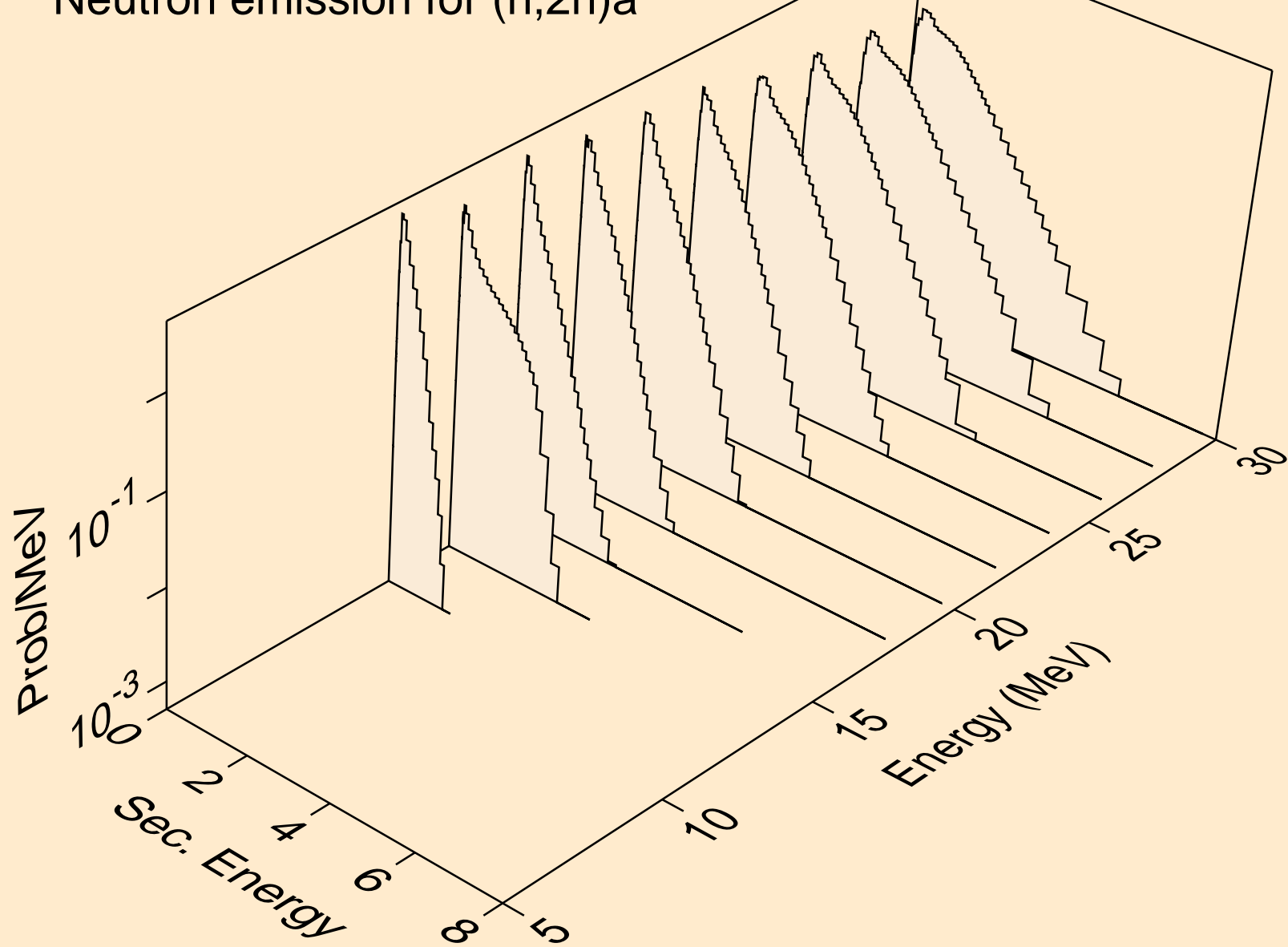

PR150 NEUTRON ACER TENDL-2023 LIBRARY; T=0.K
Neutron emission for (n,3n)a

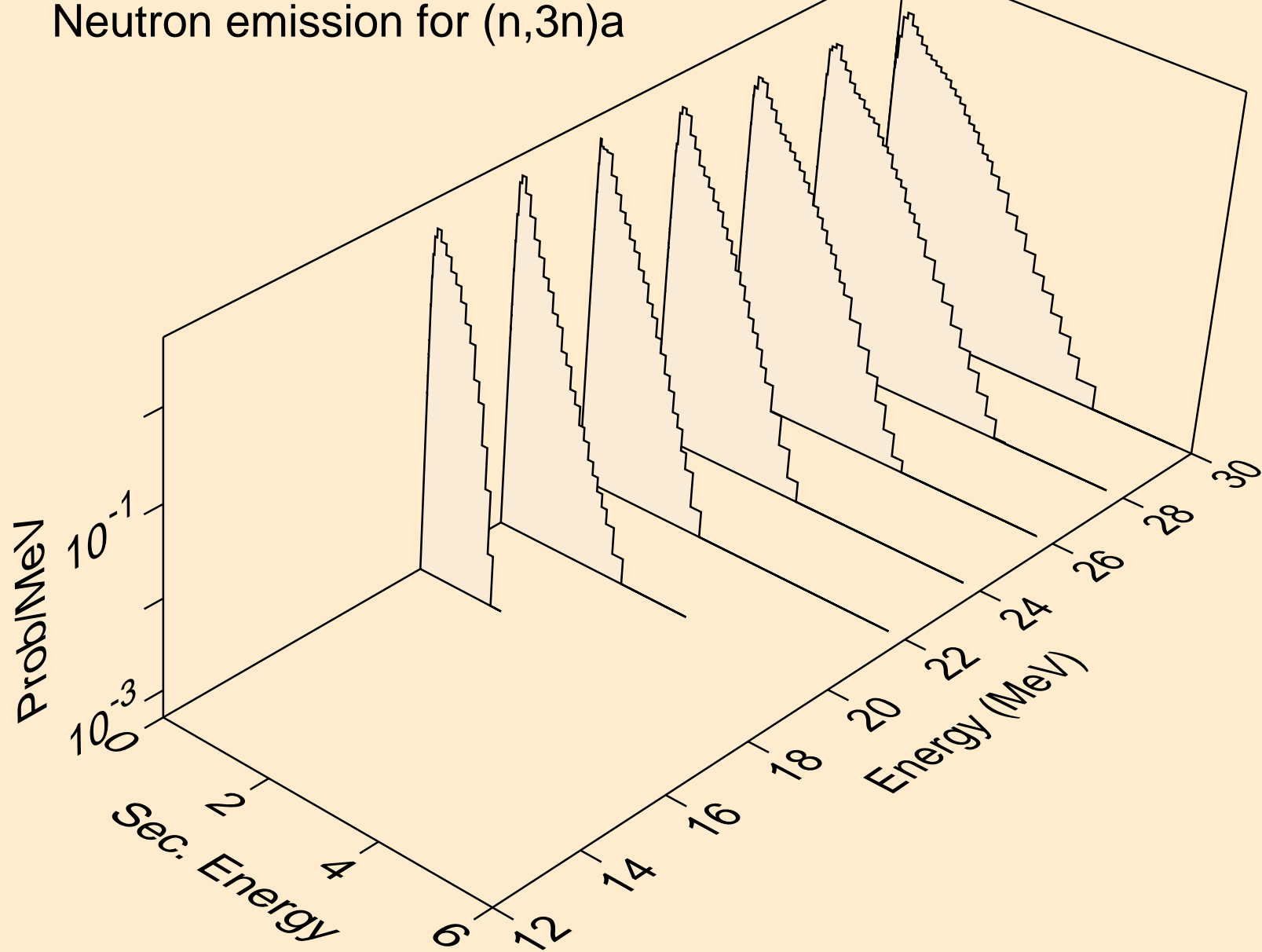

PR150 NEUTRON ACER TENDL-2023 LIBRARY; T=0.K
Neutron emission for (n,n*)p

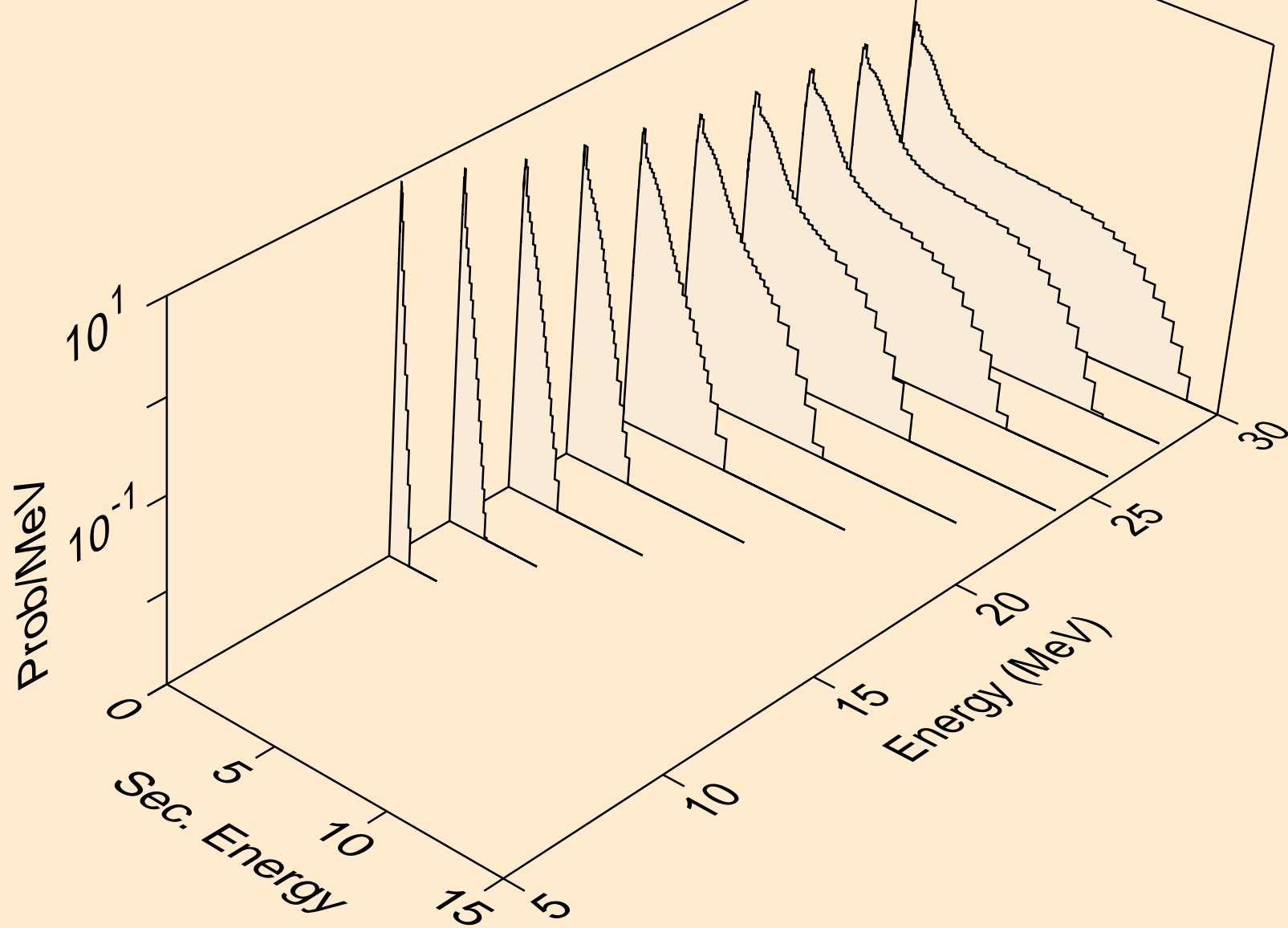

PR150 NEUTRON ACER TENDL-2023 LIBRARY; T=0.K
Neutron emission for (n,n*)d

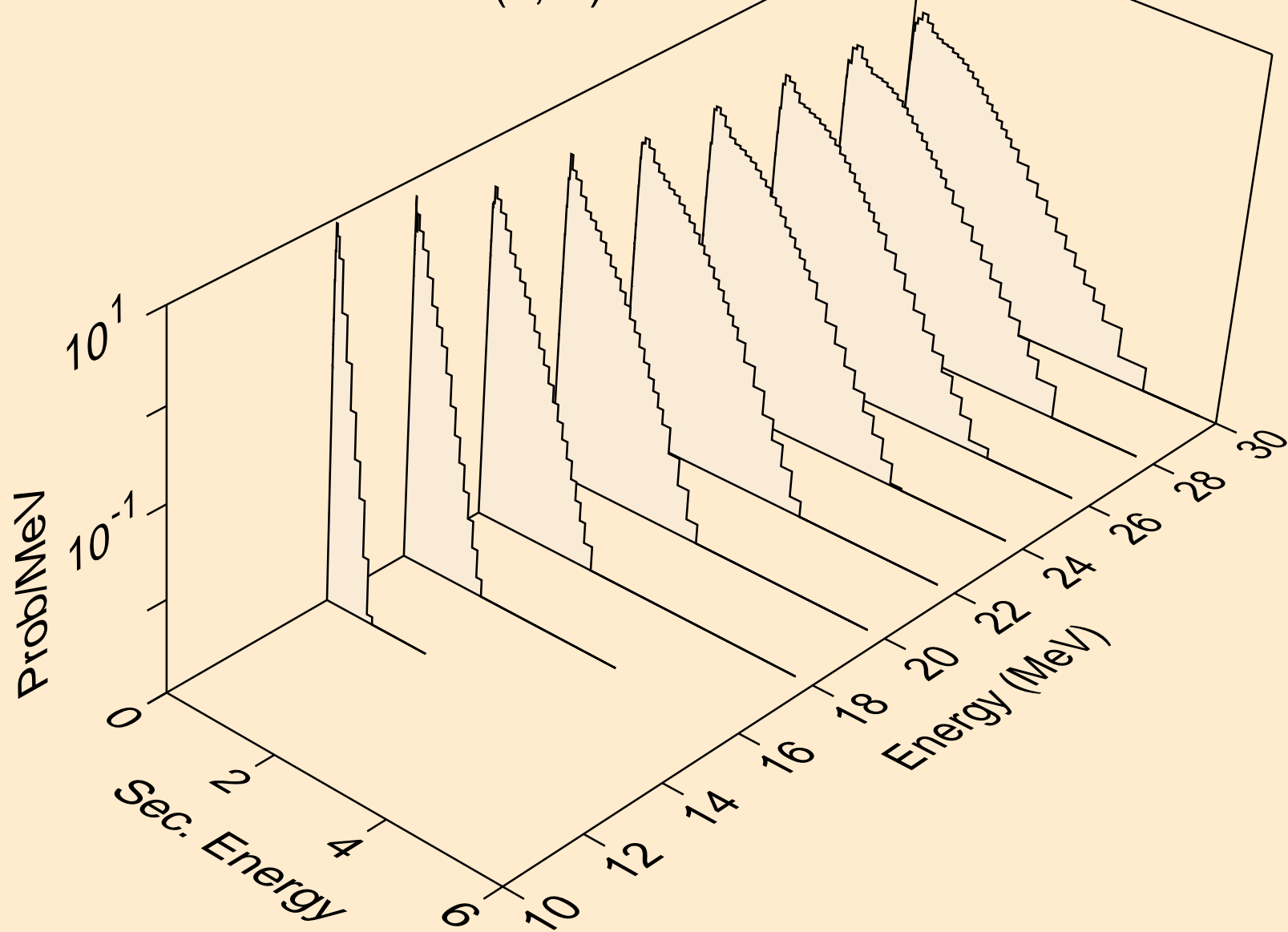

PR150 NEUTRON ACER TENDL-2023 LIBRARY; T=0.K
Neutron emission for (n,n*)t

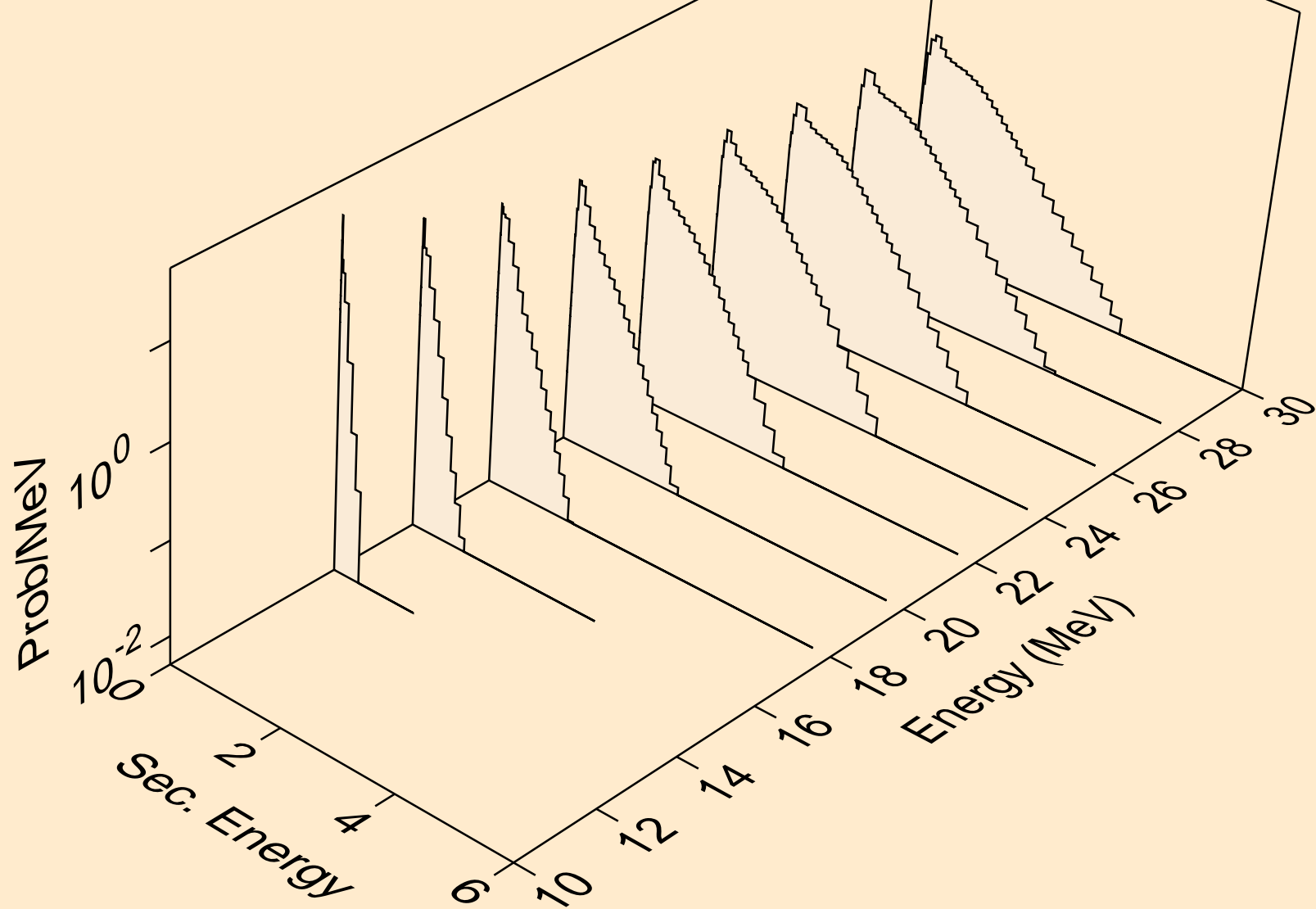

PR150 NEUTRON ACER TENDL-2023 LIBRARY; T=0.K
Neutron emission for (n,n*)he3

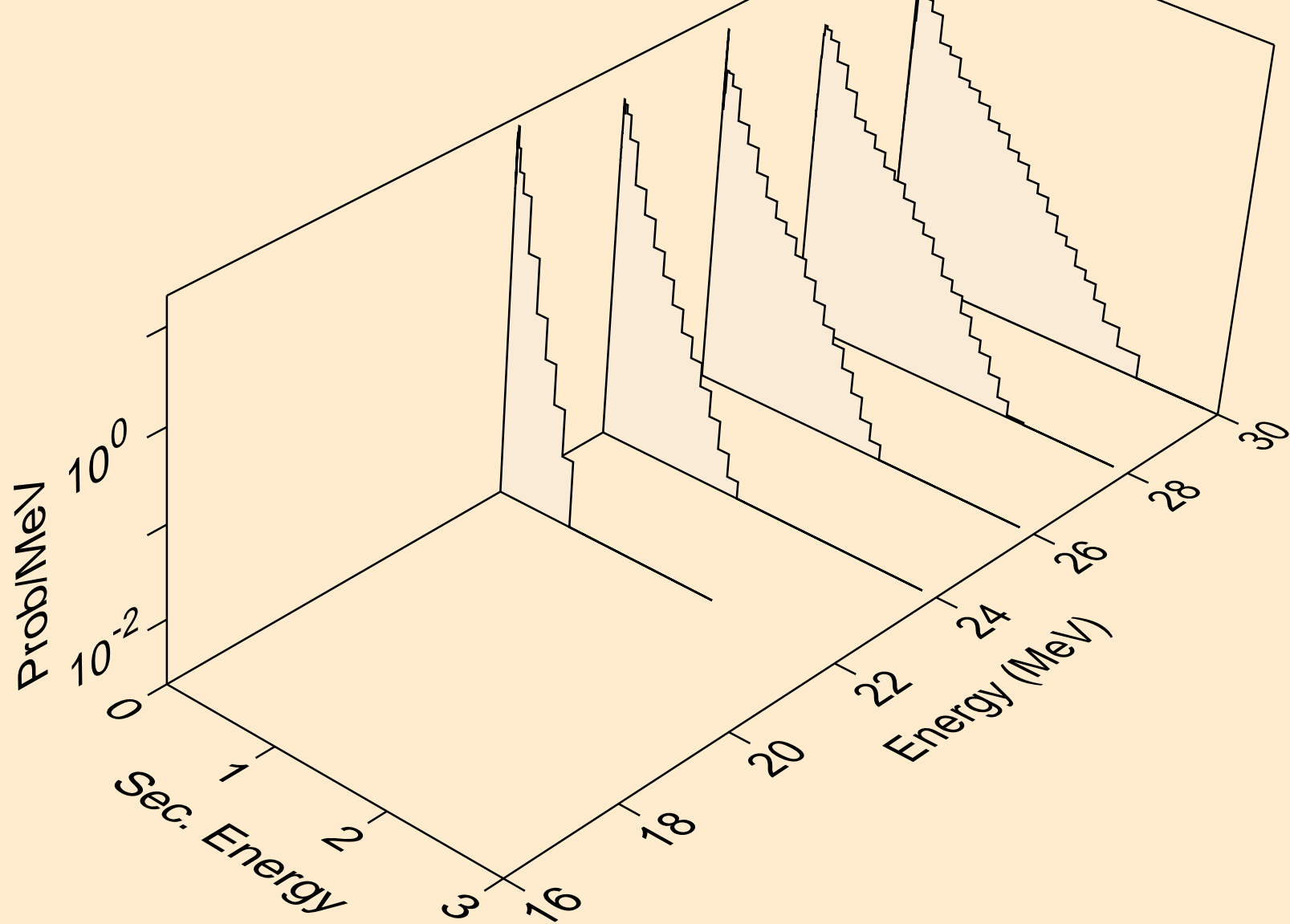

PR150 NEUTRON ACER TENDL-2023 LIBRARY; T=0.K
Neutron emission for (n,4n)

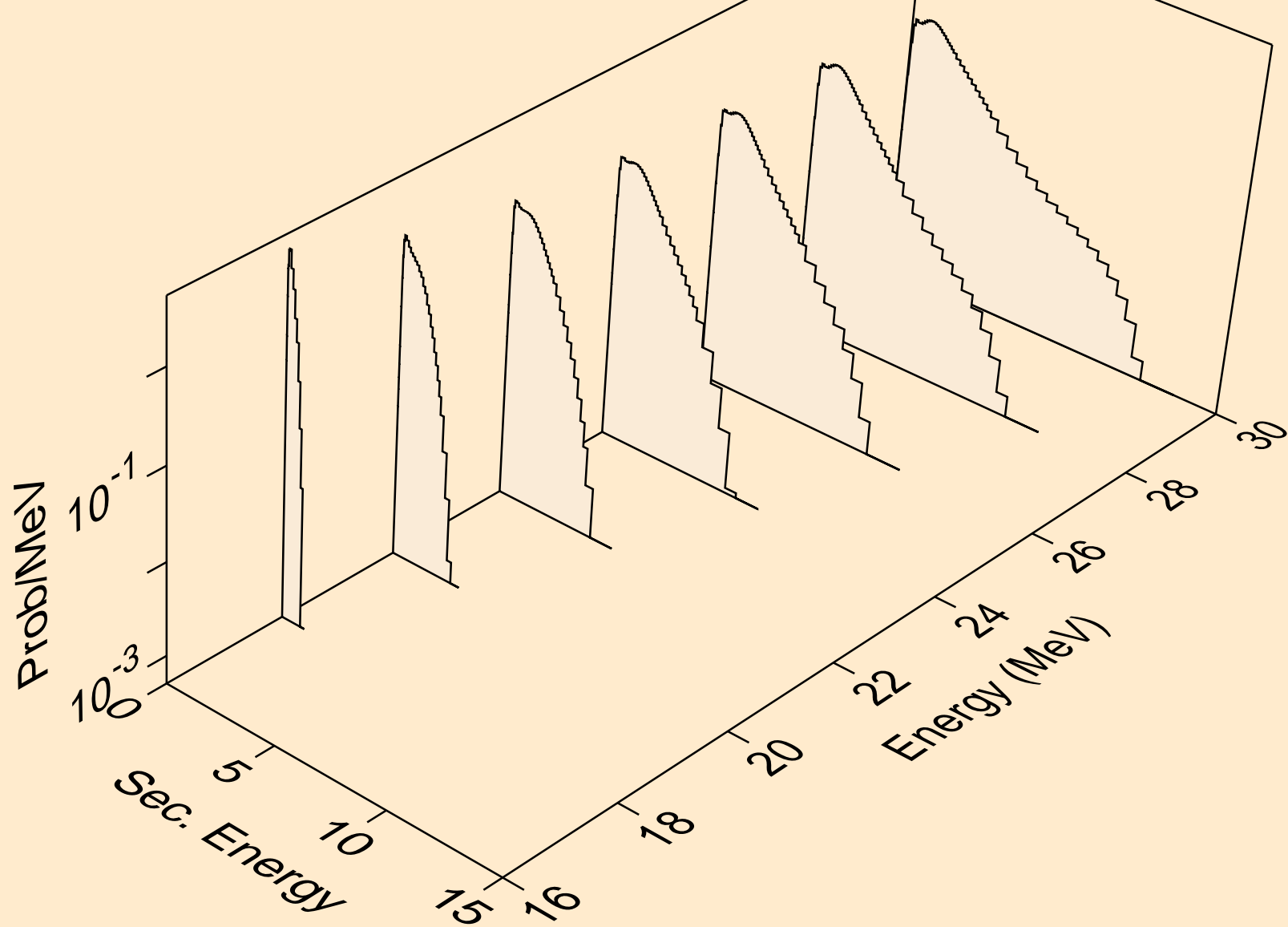

PR150 NEUTRON ACER TENDL-2023 LIBRARY; T=0.K
Neutron emission for (n,2np)

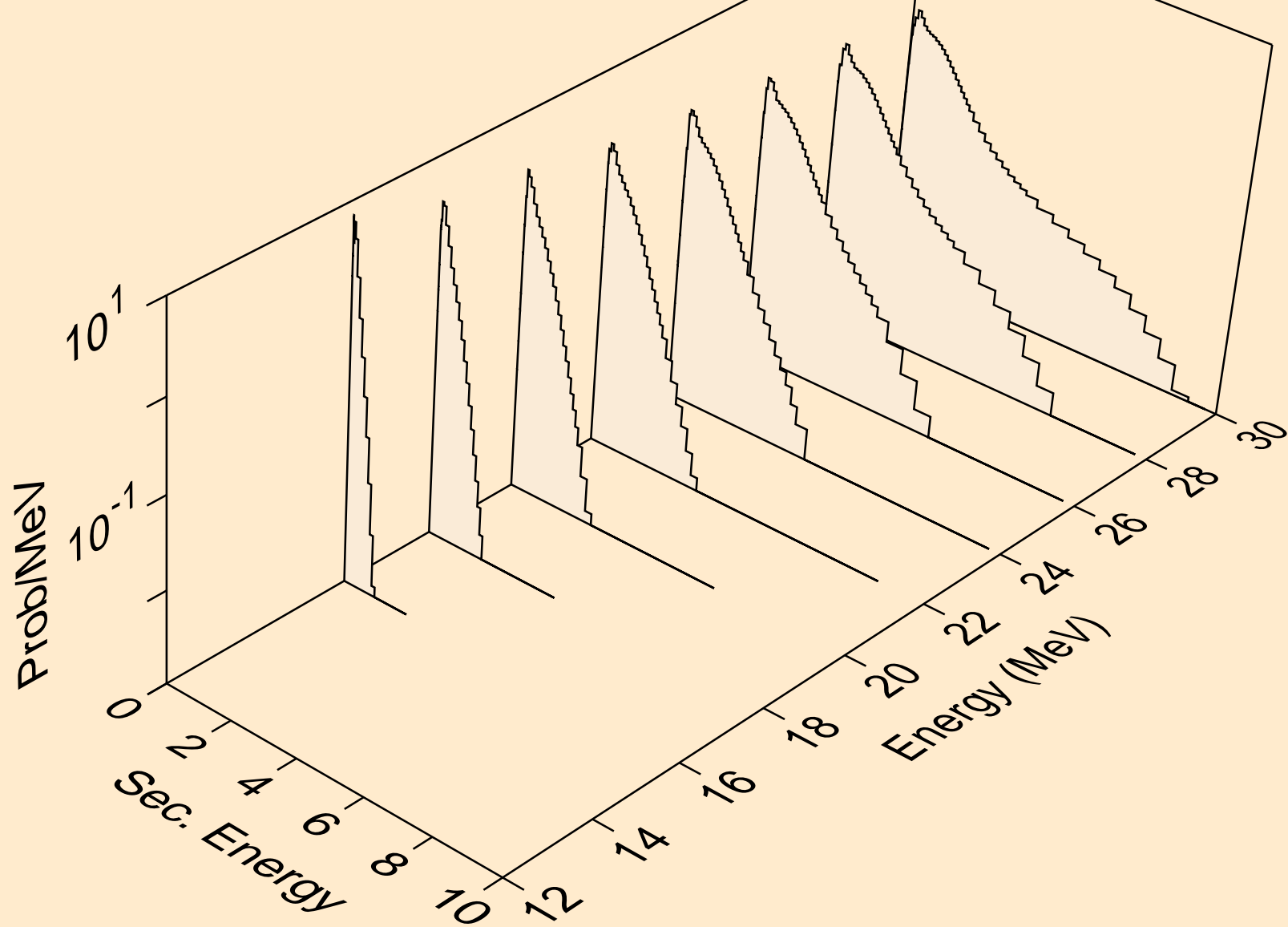

PR150 NEUTRON ACER TENDL-2023 LIBRARY; T=0.K
Neutron emission for (n,3np)

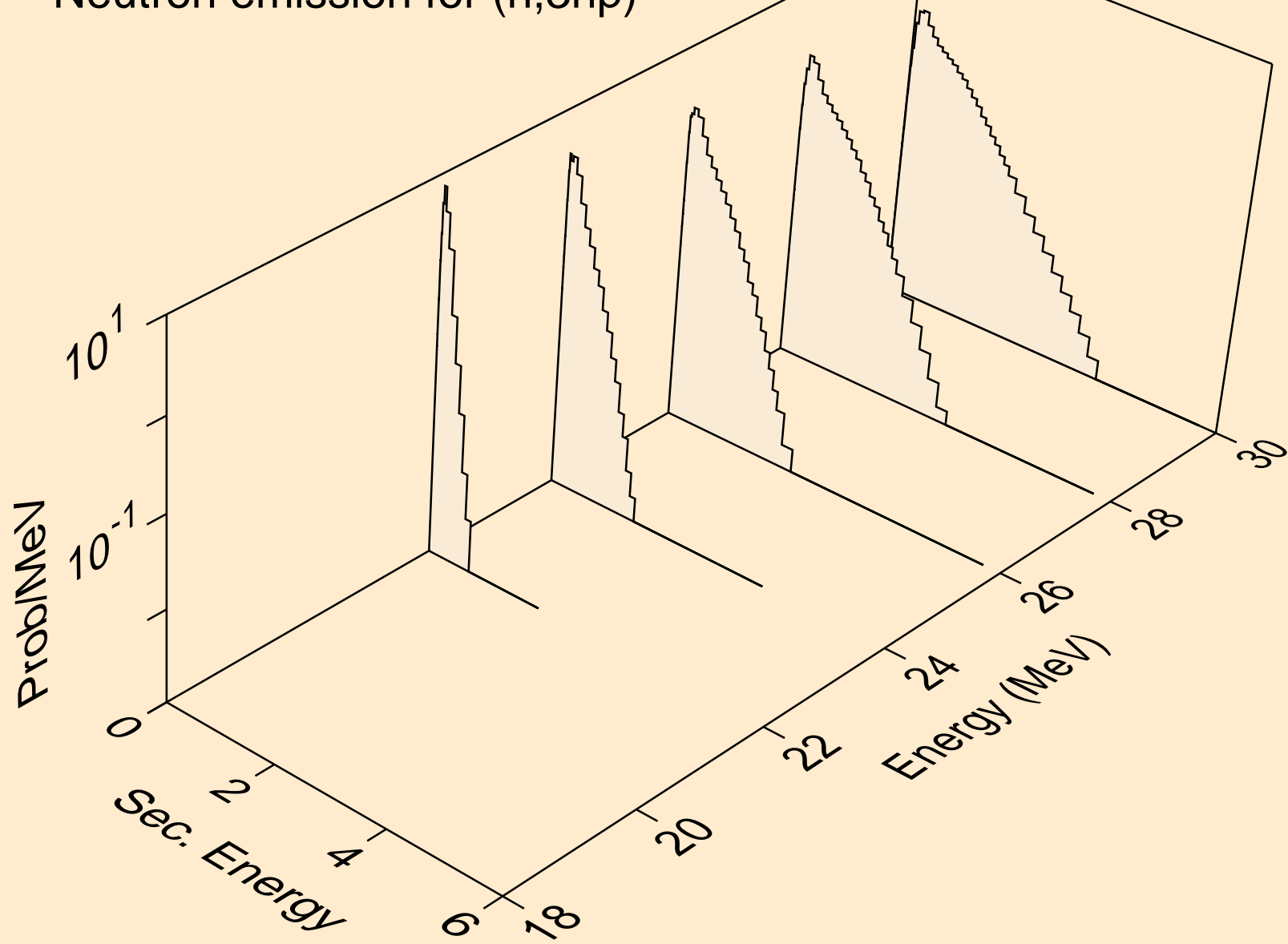

PR150 NEUTRON ACER TENDL-2023 LIBRARY; T=0.K
Neutron emission for (n,n*c)

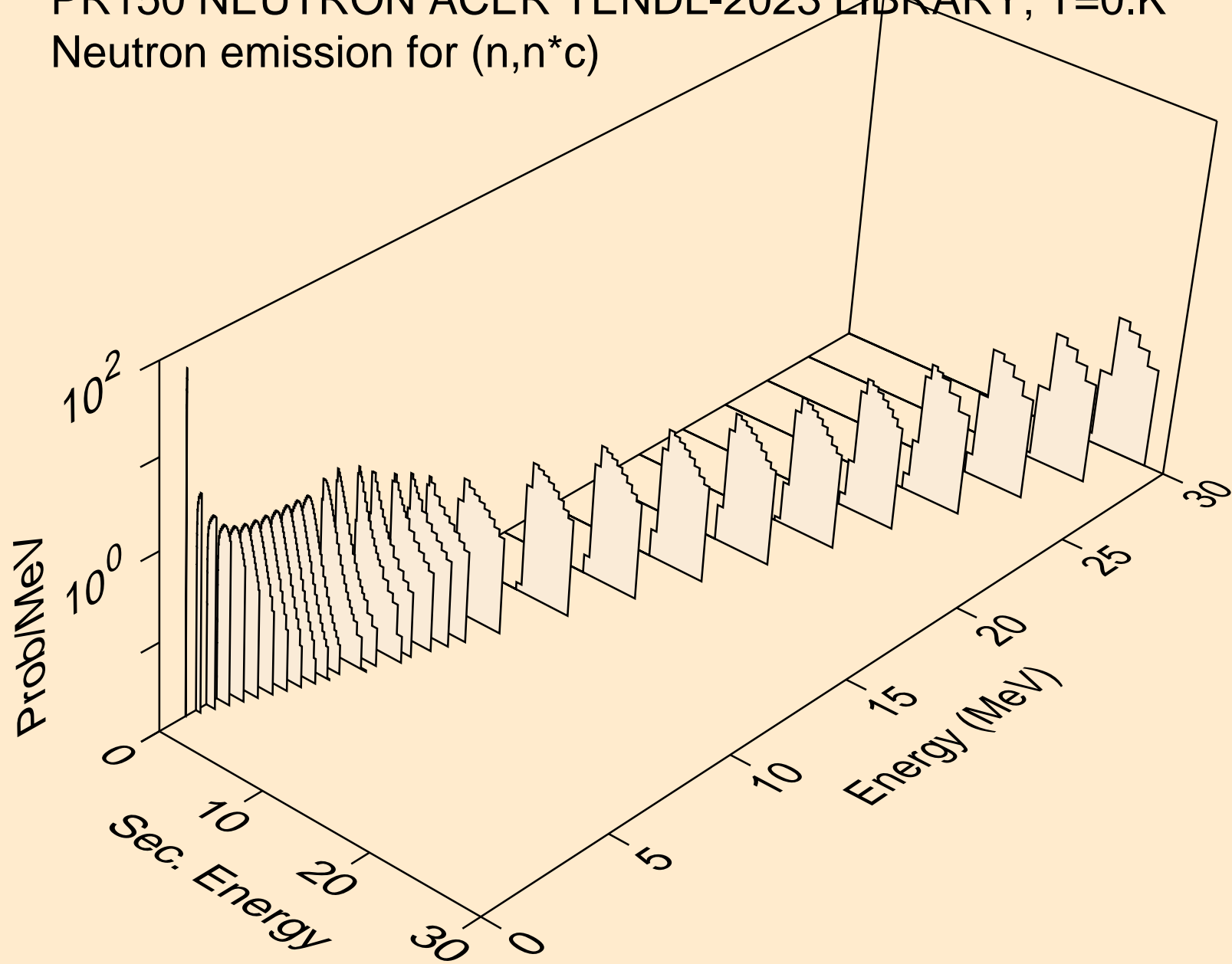

PR150 NEUTRON ACER TENDL-2023 LIBRARY; T=0.K
Photon emission for (n,x)

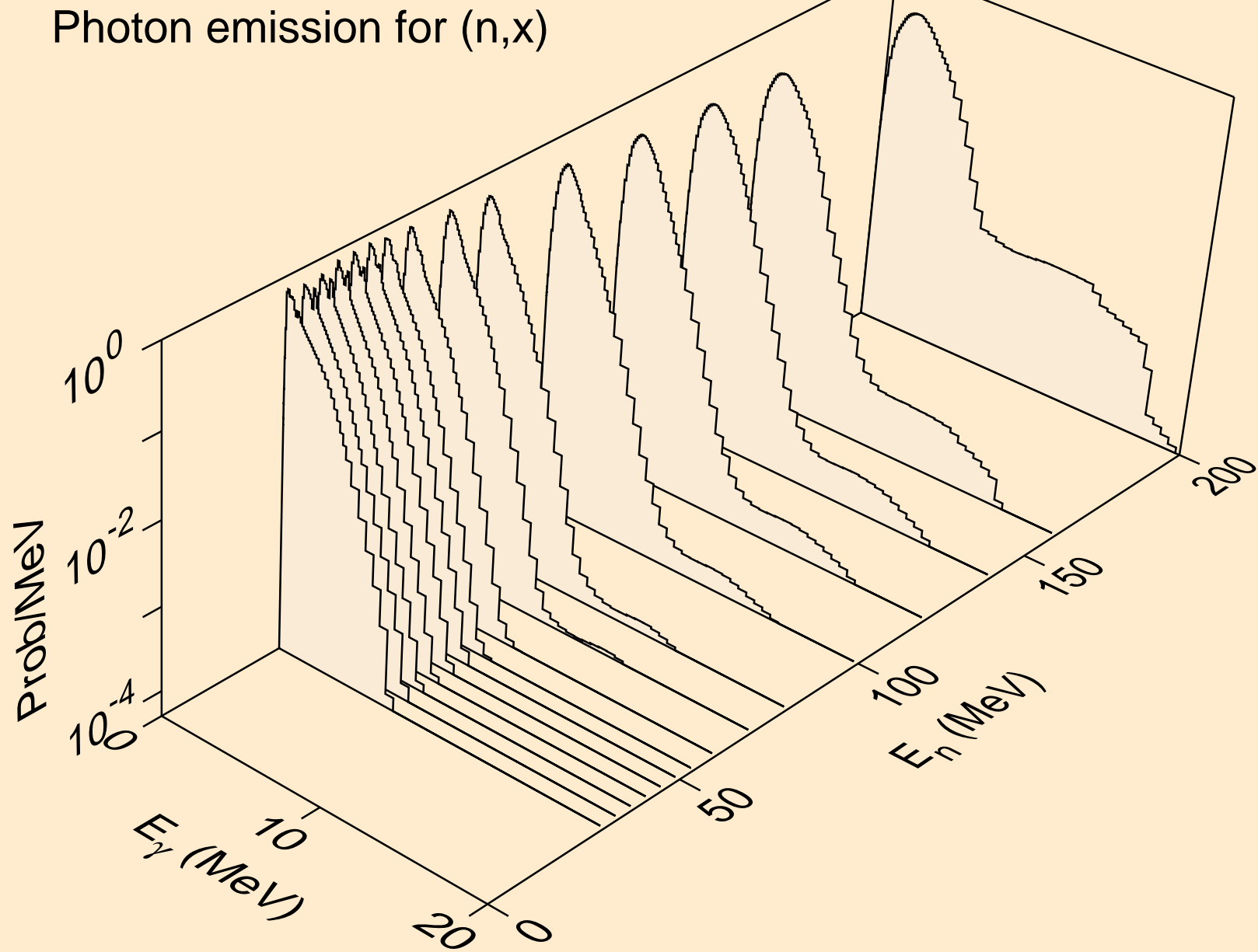

PR150 NEUTRON ACER TENDL-2023 LIBRARY; T=0.K
Photon emission for (n,2nd)

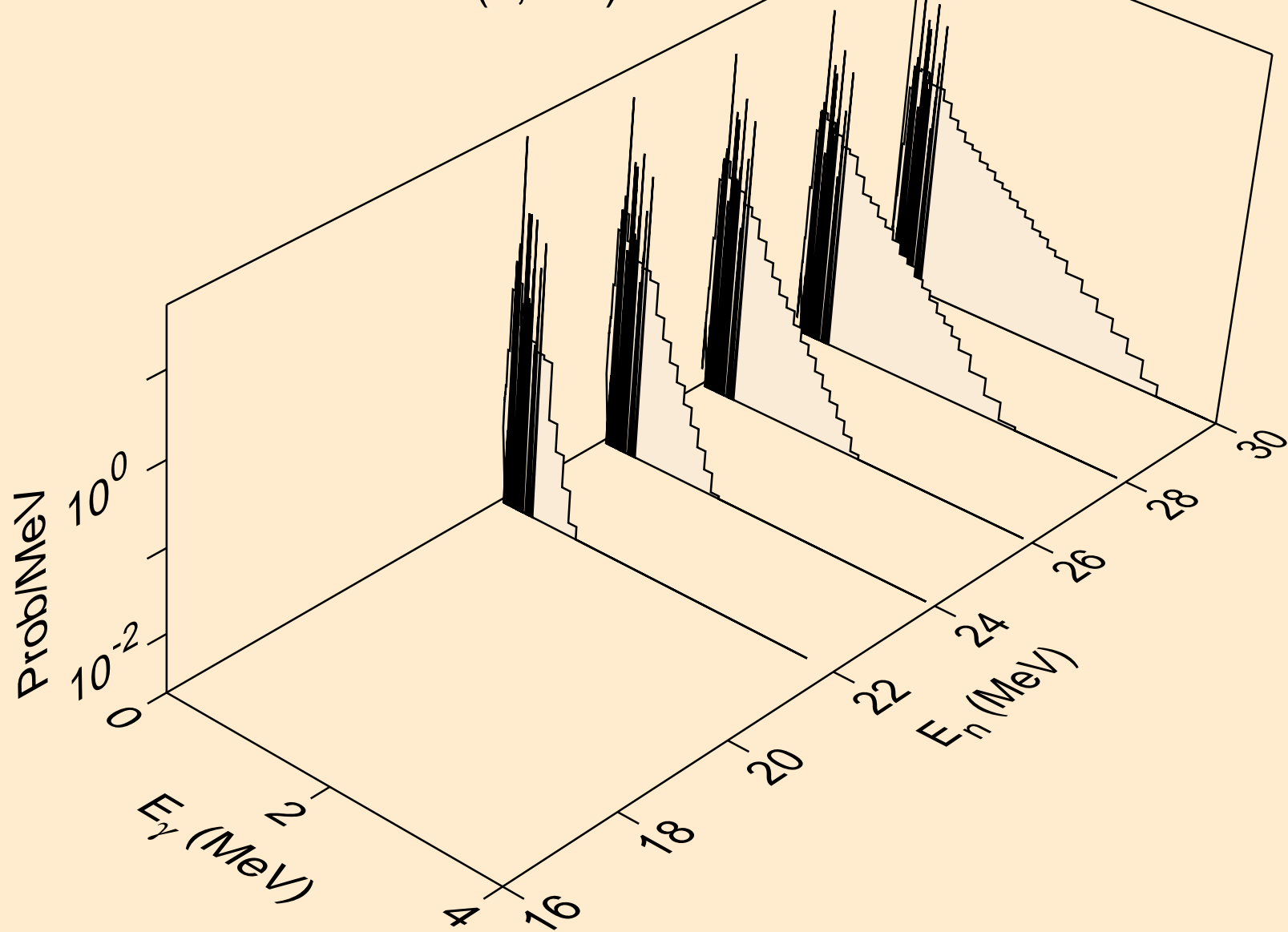

PR150 NEUTRON ACER TENDL-2023 LIBRARY; T=0.K
Photon emission for (n,2n)

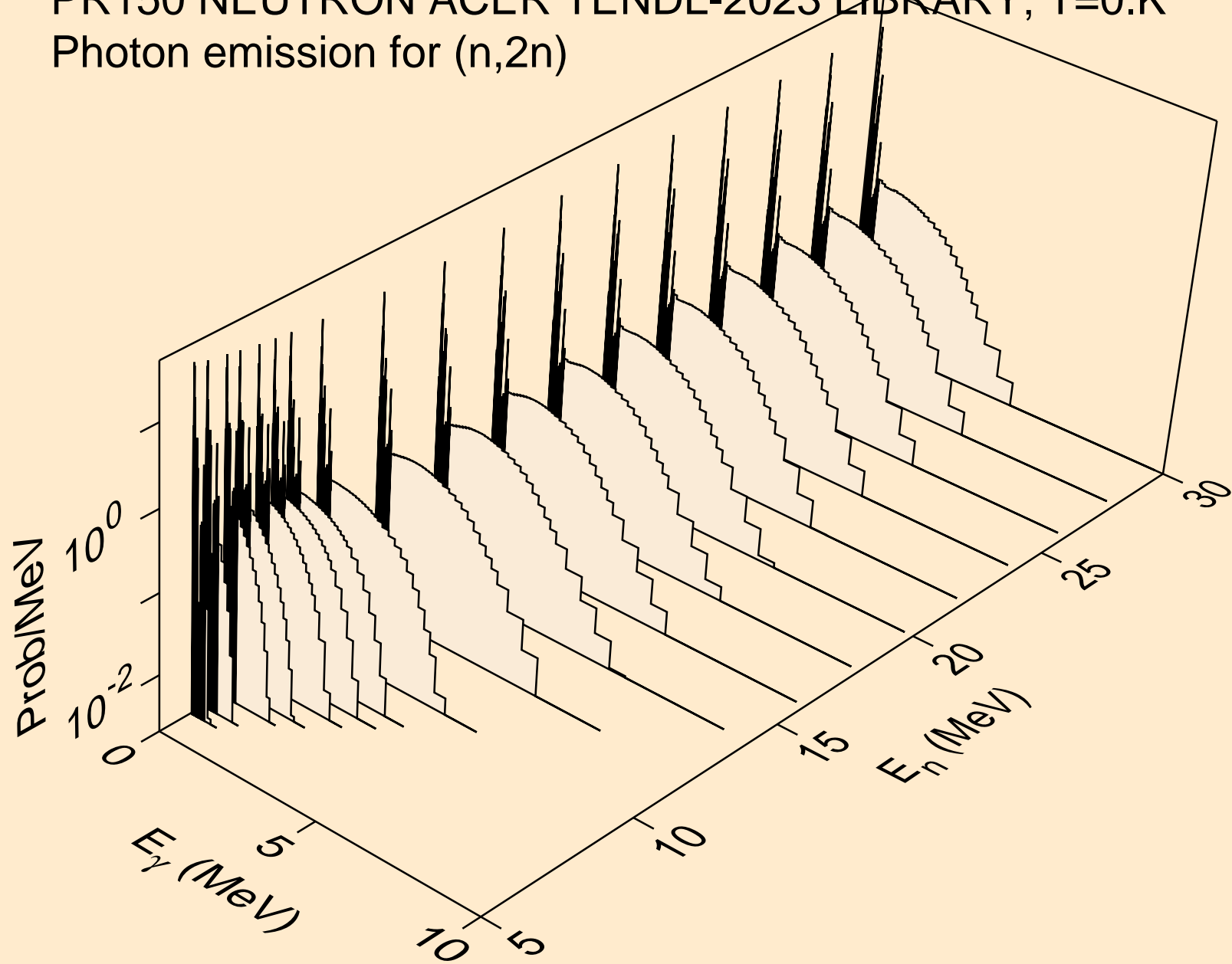

PR150 NEUTRON ACER TENDL-2023 LIBRARY; T=0.K
Photon emission for (n,3n)

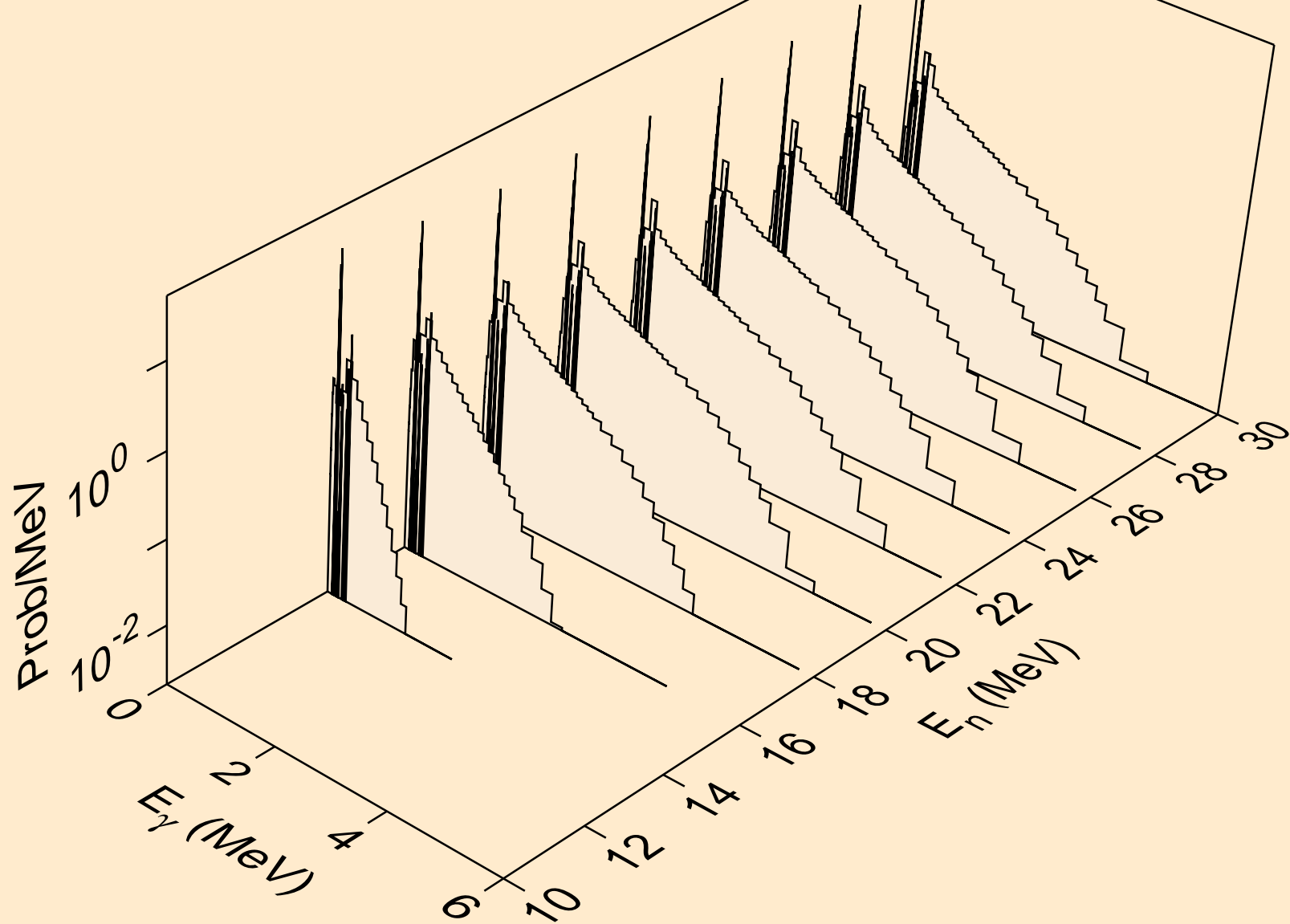

PR150 NEUTRON ACER TENDL-2023 LIBRARY; T=0.K
Photon emission for (n,n*)a

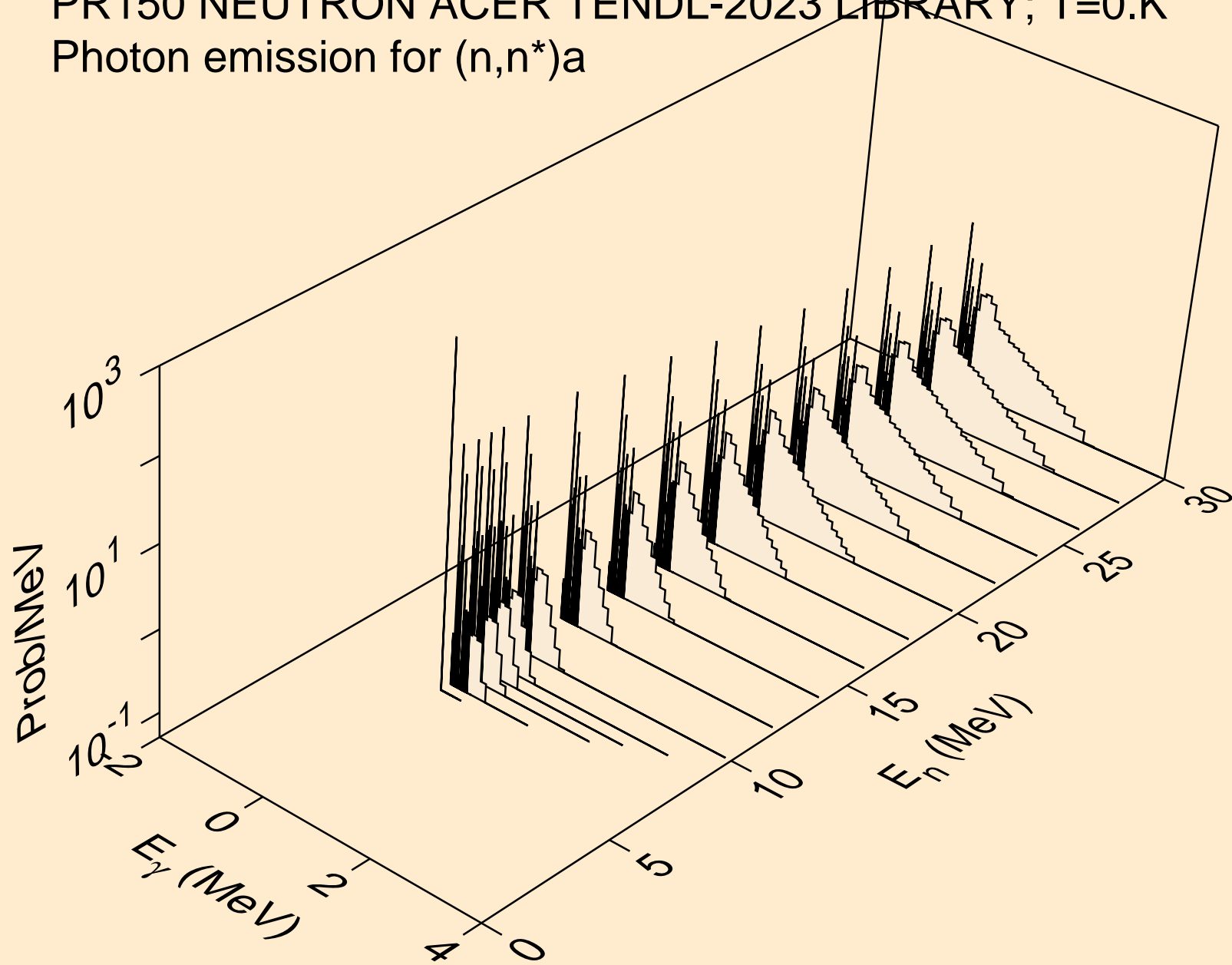

PR150 NEUTRON ACER TENDL-2023 LIBRARY; T=0.K
Photon emission for (n,2n)a

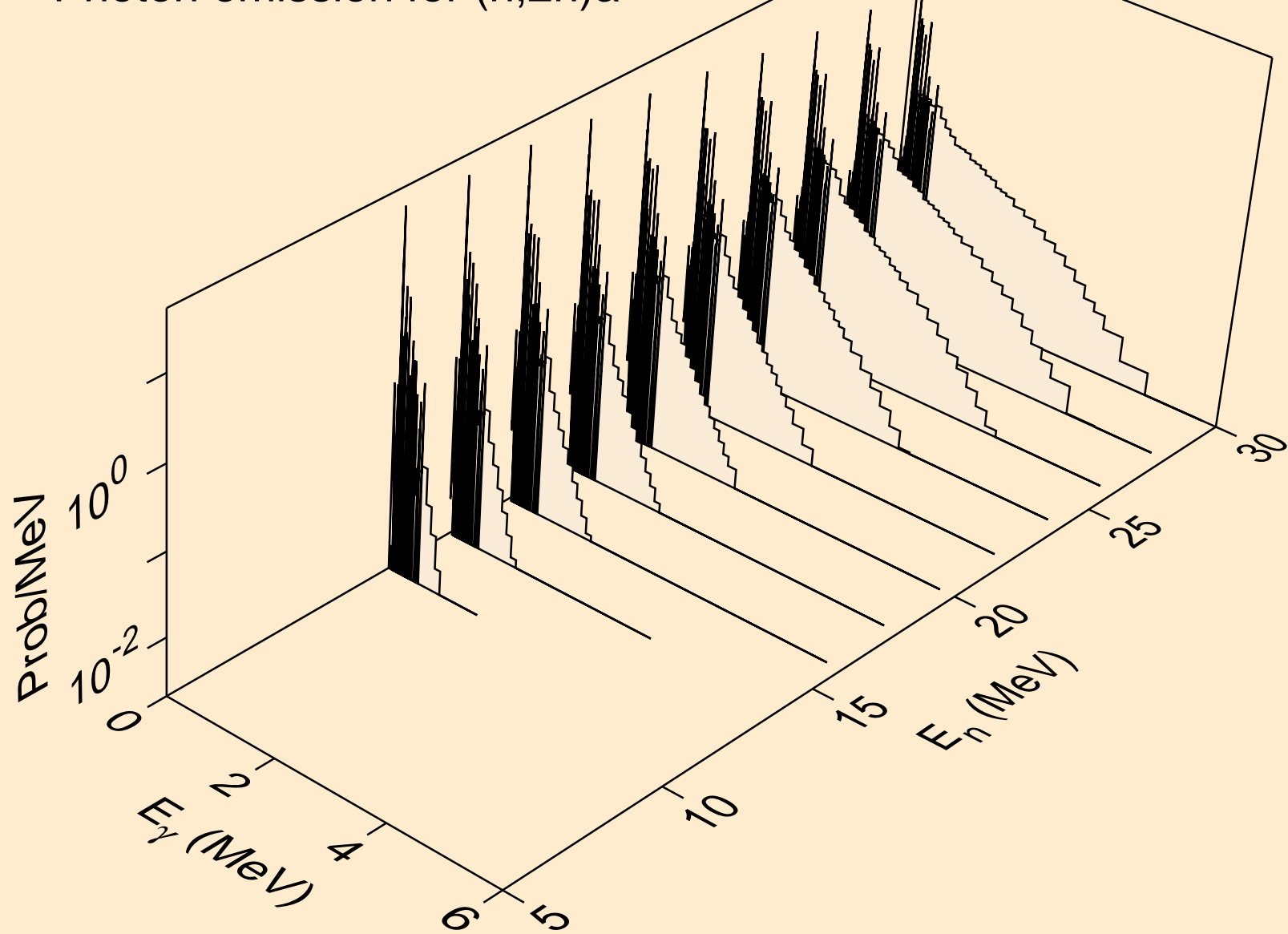

PR150 NEUTRON ACER TENDL-2023 LIBRARY; T=0.K
Photon emission for (n,3n)a

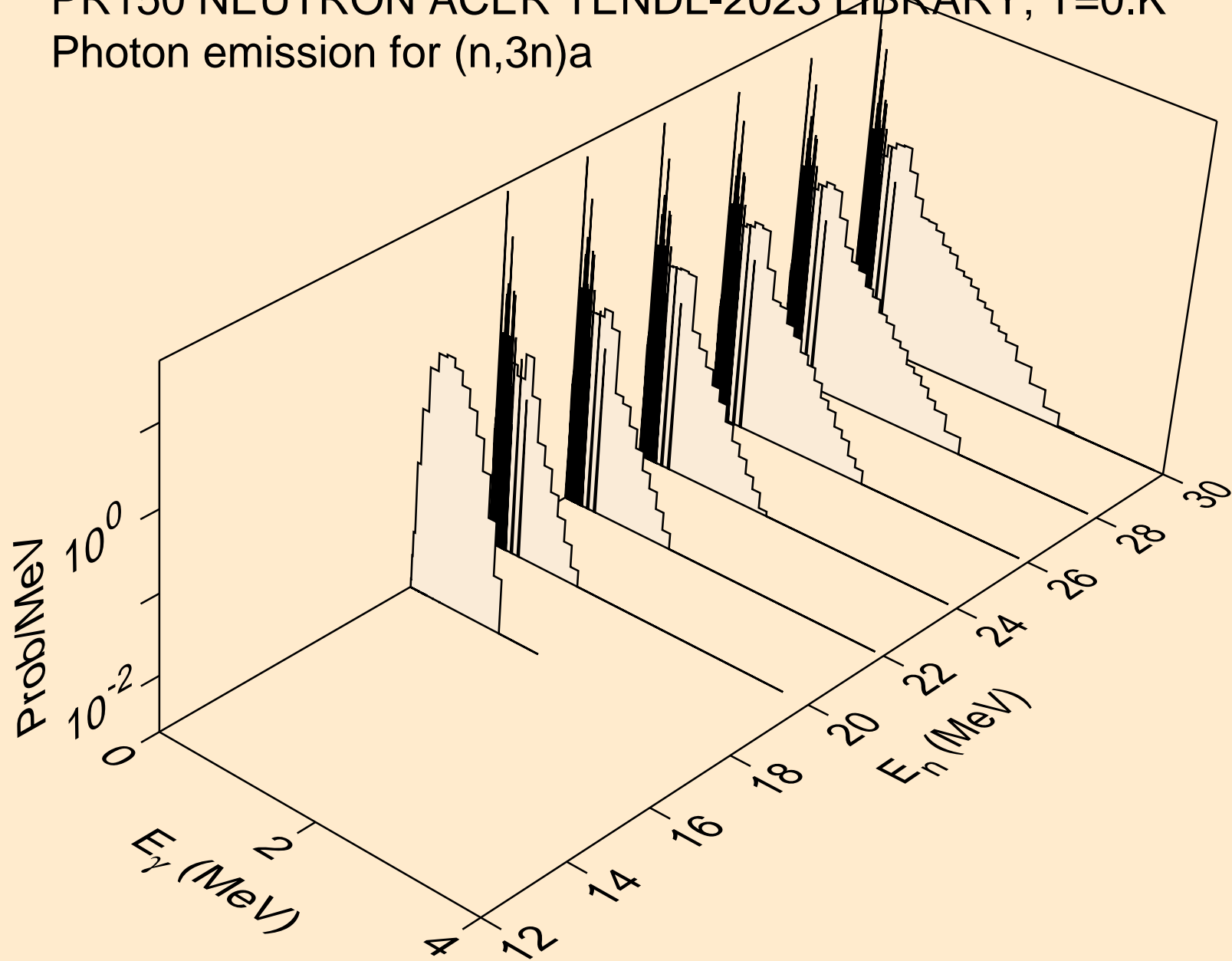

PR150 NEUTRON ACER TENDL-2023 LIBRARY; T=0.K
Photon emission for (n,n*)p

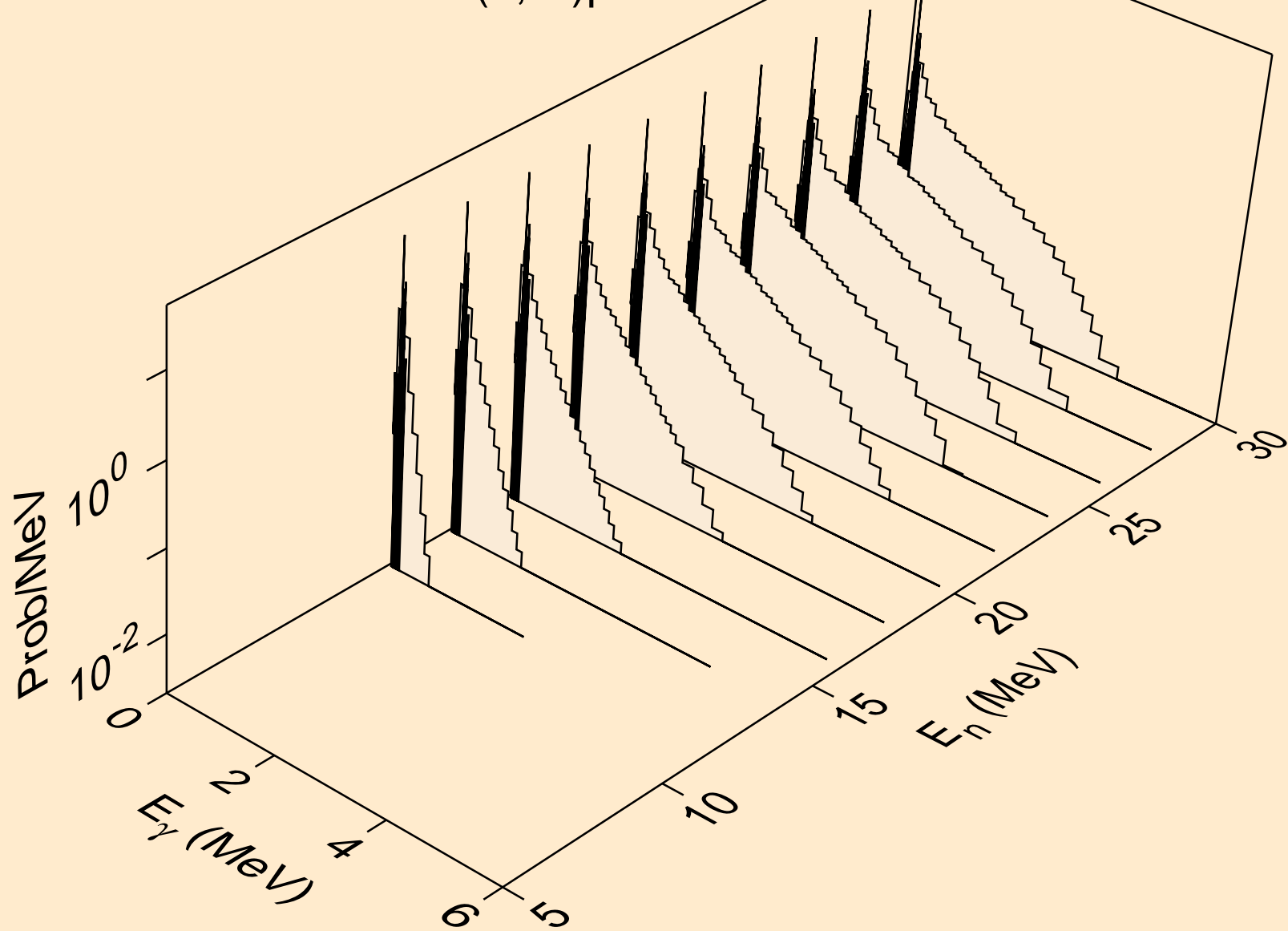

PR150 NEUTRON ACER TENDL-2023 LIBRARY; T=0.K
Photon emission for (n,n*)d

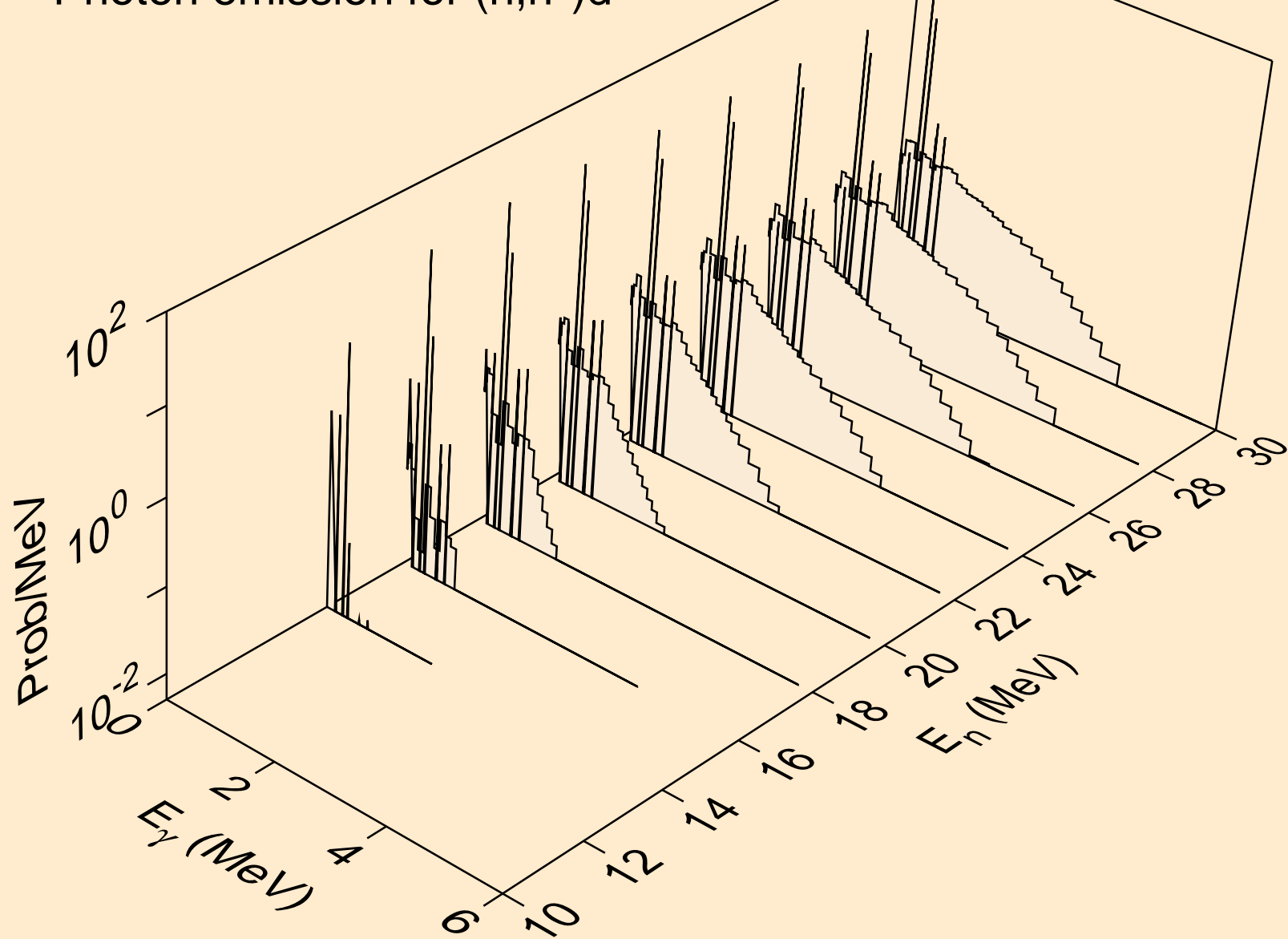

PR150 NEUTRON ACER TENDL-2023 LIBRARY; T=0.K
Photon emission for (n,n*)t

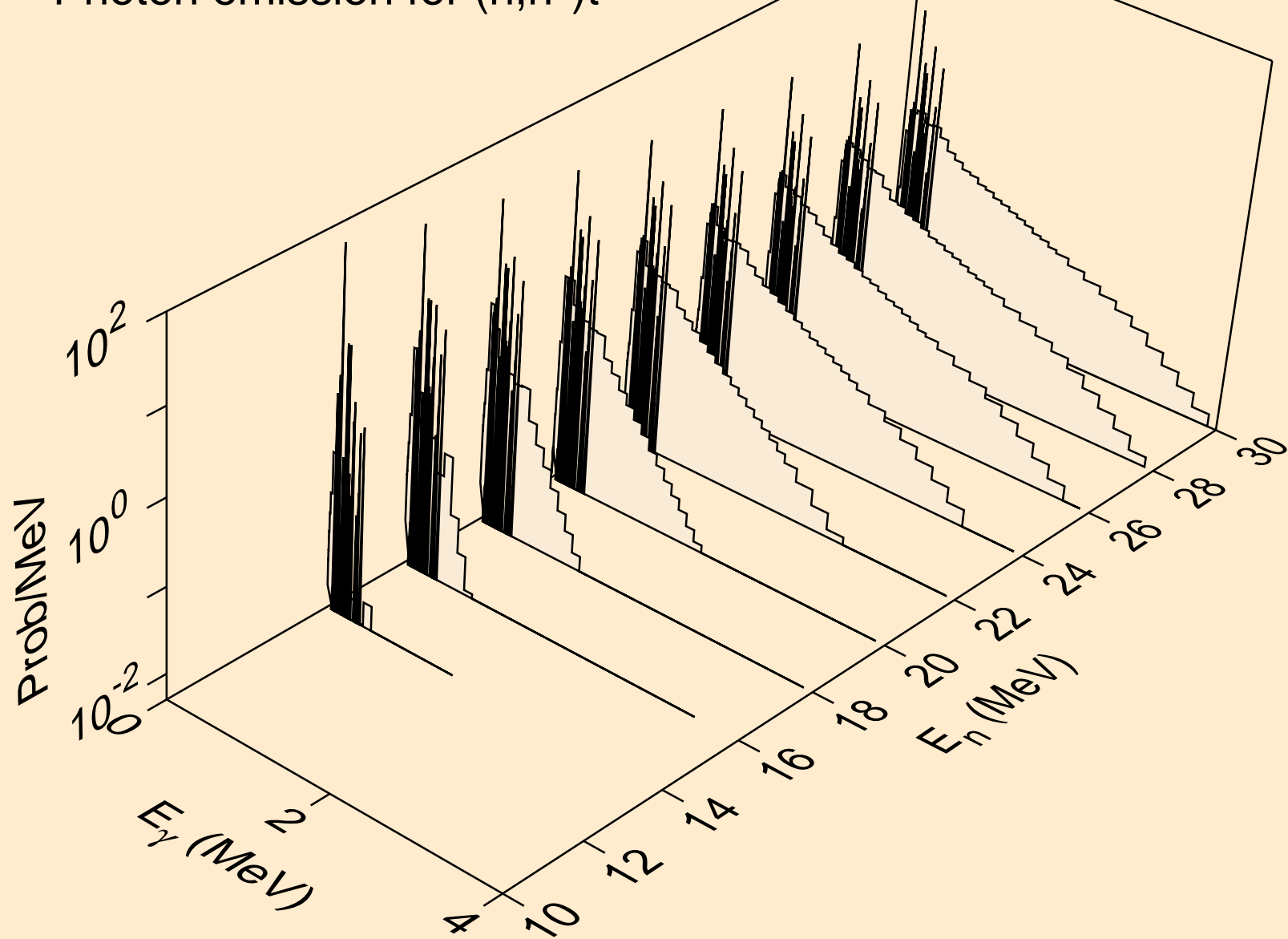

PR150 NEUTRON ACER TENDL-2023 LIBRARY; T=0.K
Photon emission for (n,n*)he3

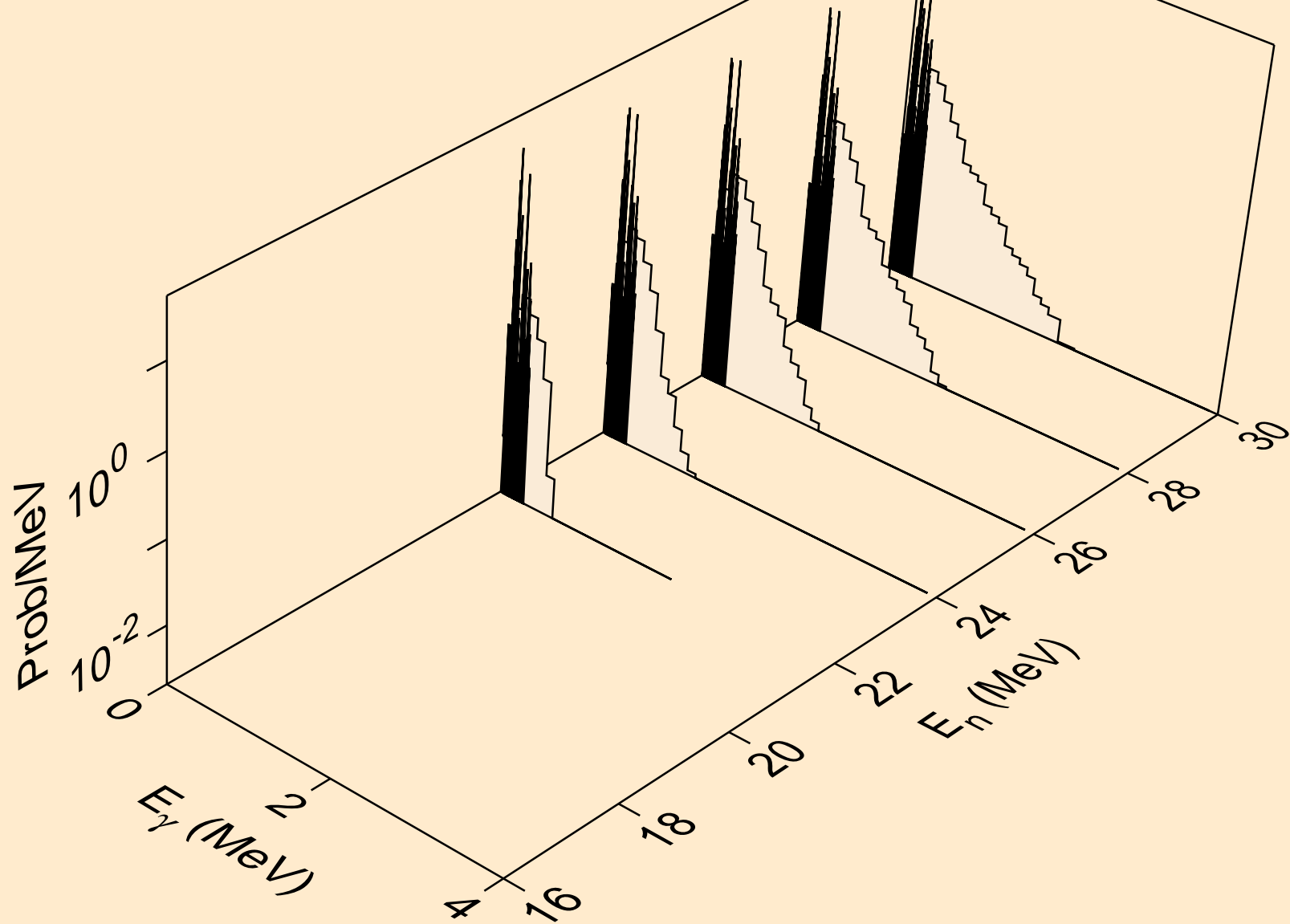

PR150 NEUTRON ACER TENDL-2023 LIBRARY; T=0.K
Photon emission for (n,4n)

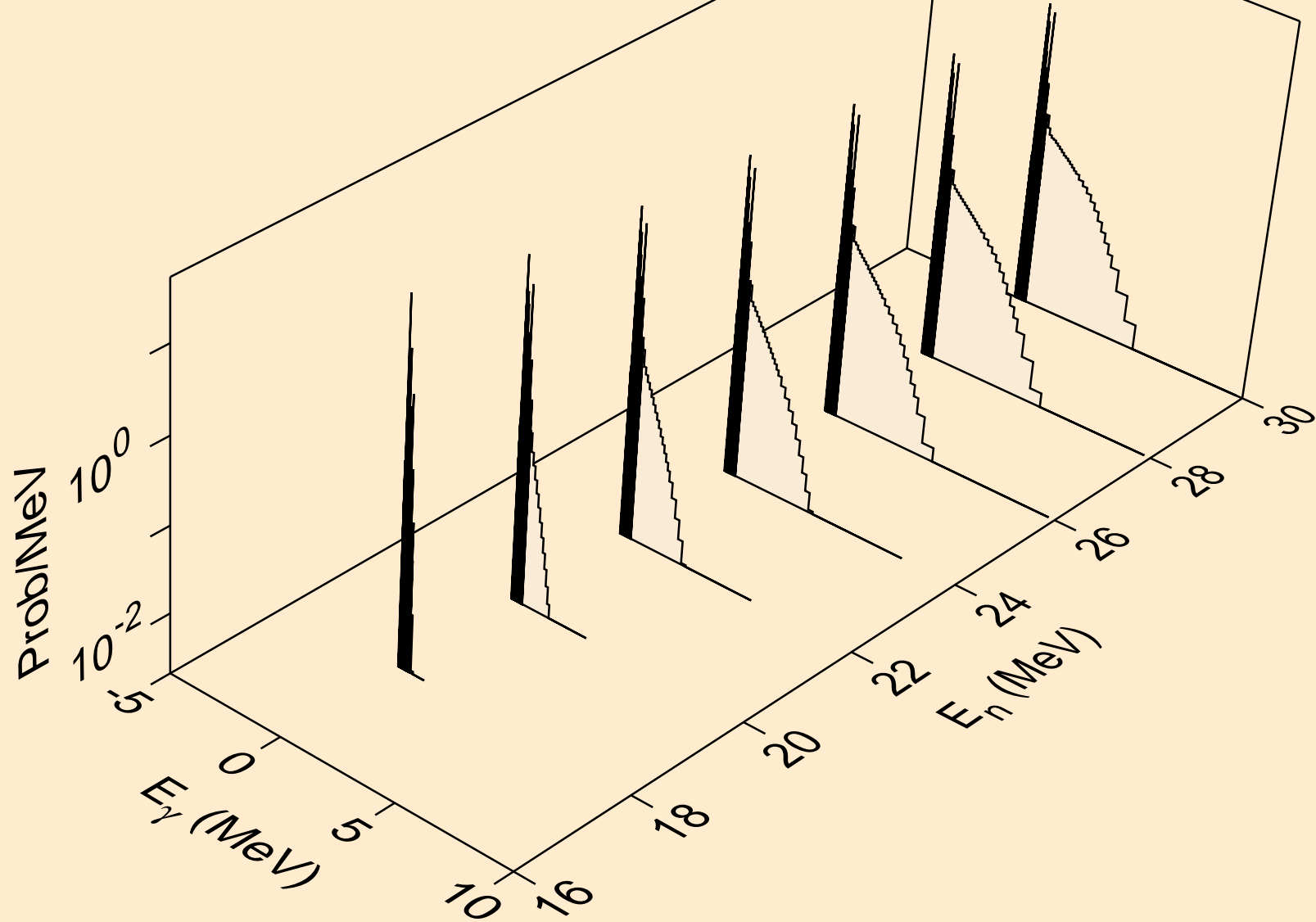

PR150 NEUTRON ACER TENDL-2023 LIBRARY; T=0.K
Photon emission for (n,2np)

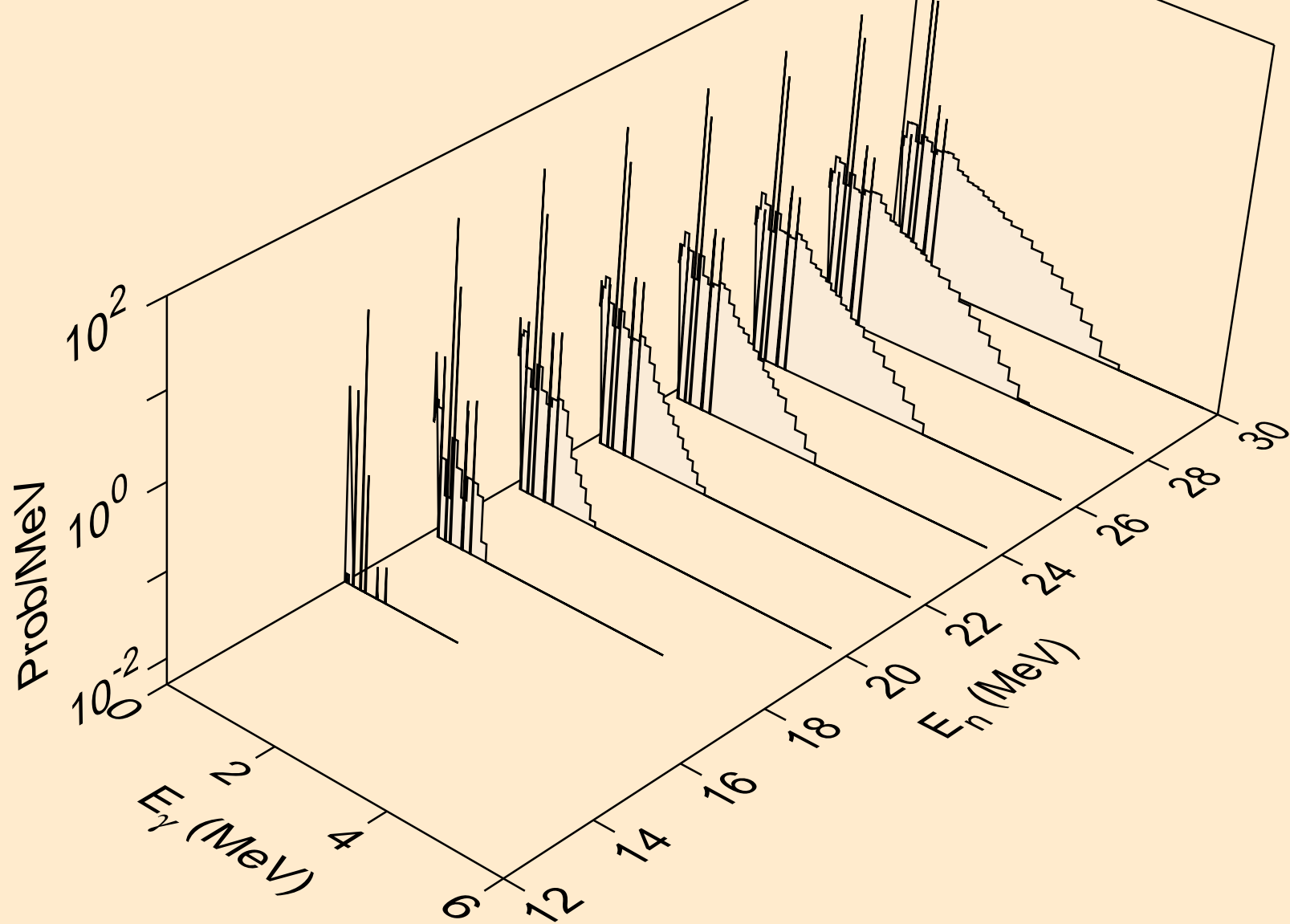

PR150 NEUTRON ACER TENDL-2023 LIBRARY; T=0.K
Photon emission for (n,3np)

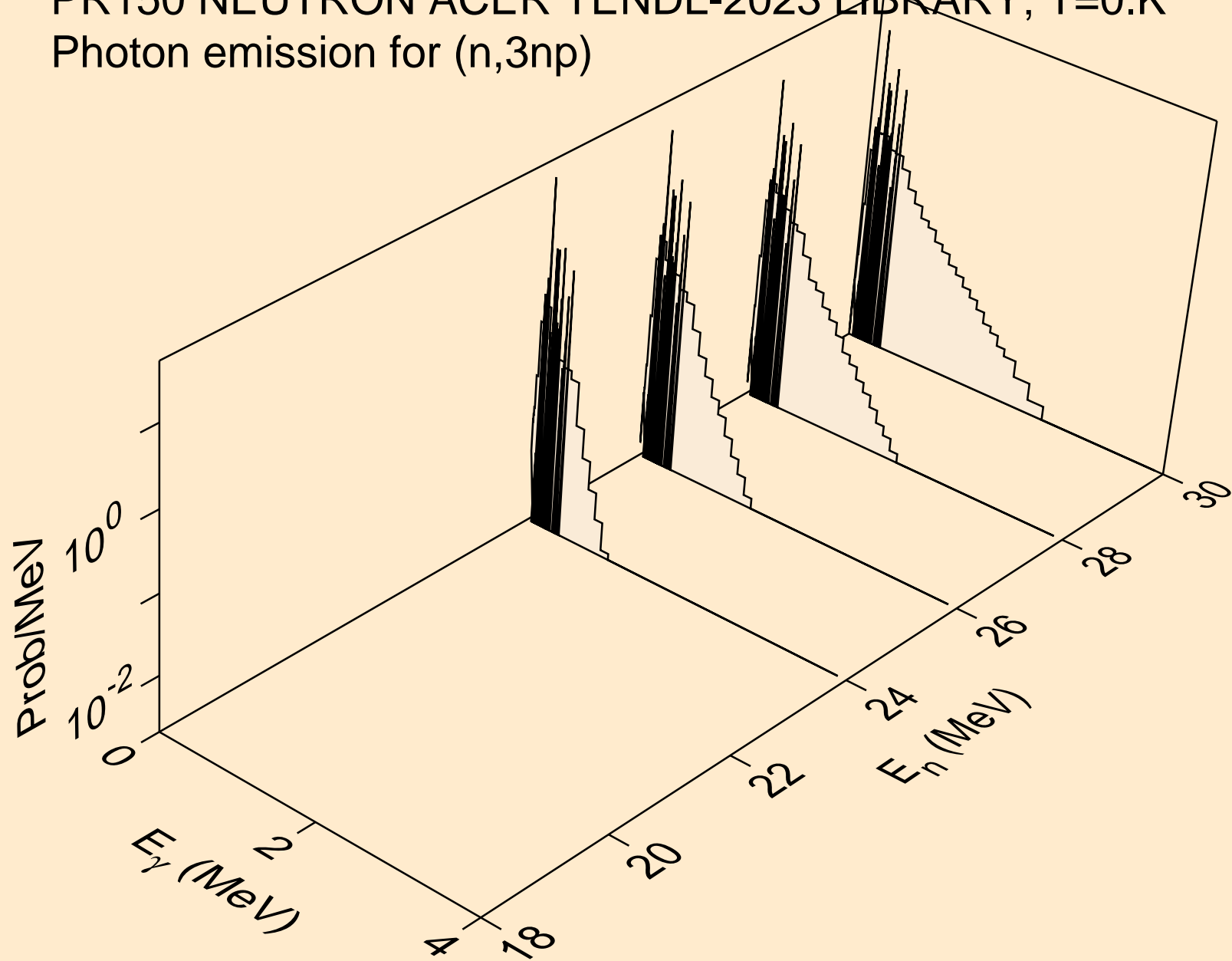

PR150 NEUTRON ACER TENDL-2023 LIBRARY; T=0.K
Photon emission for (n,n*c)

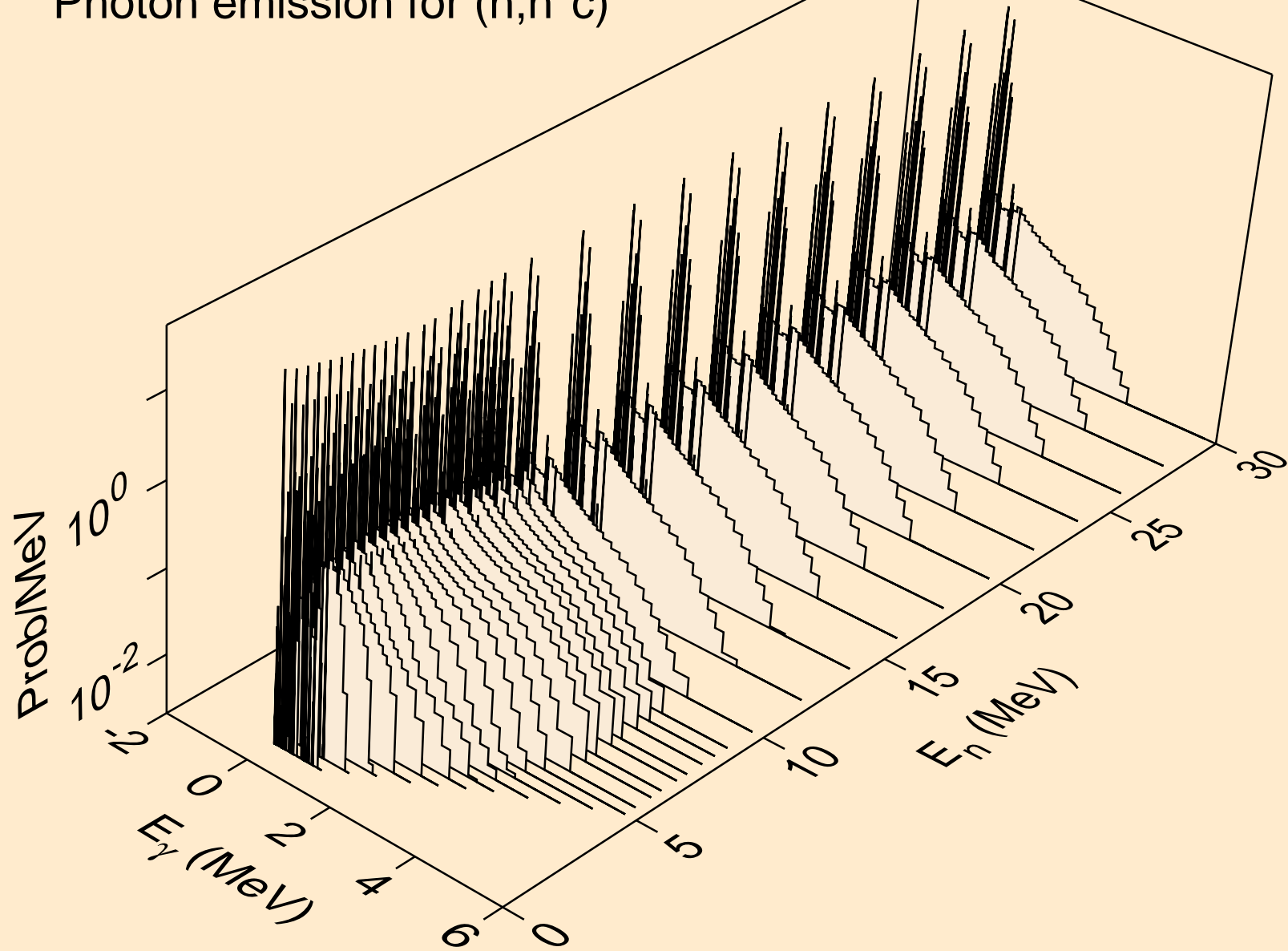

PR150 NEUTRON ACER TENDL-2023 LIBRARY; T=0.K
Photon emission for (n,gma)

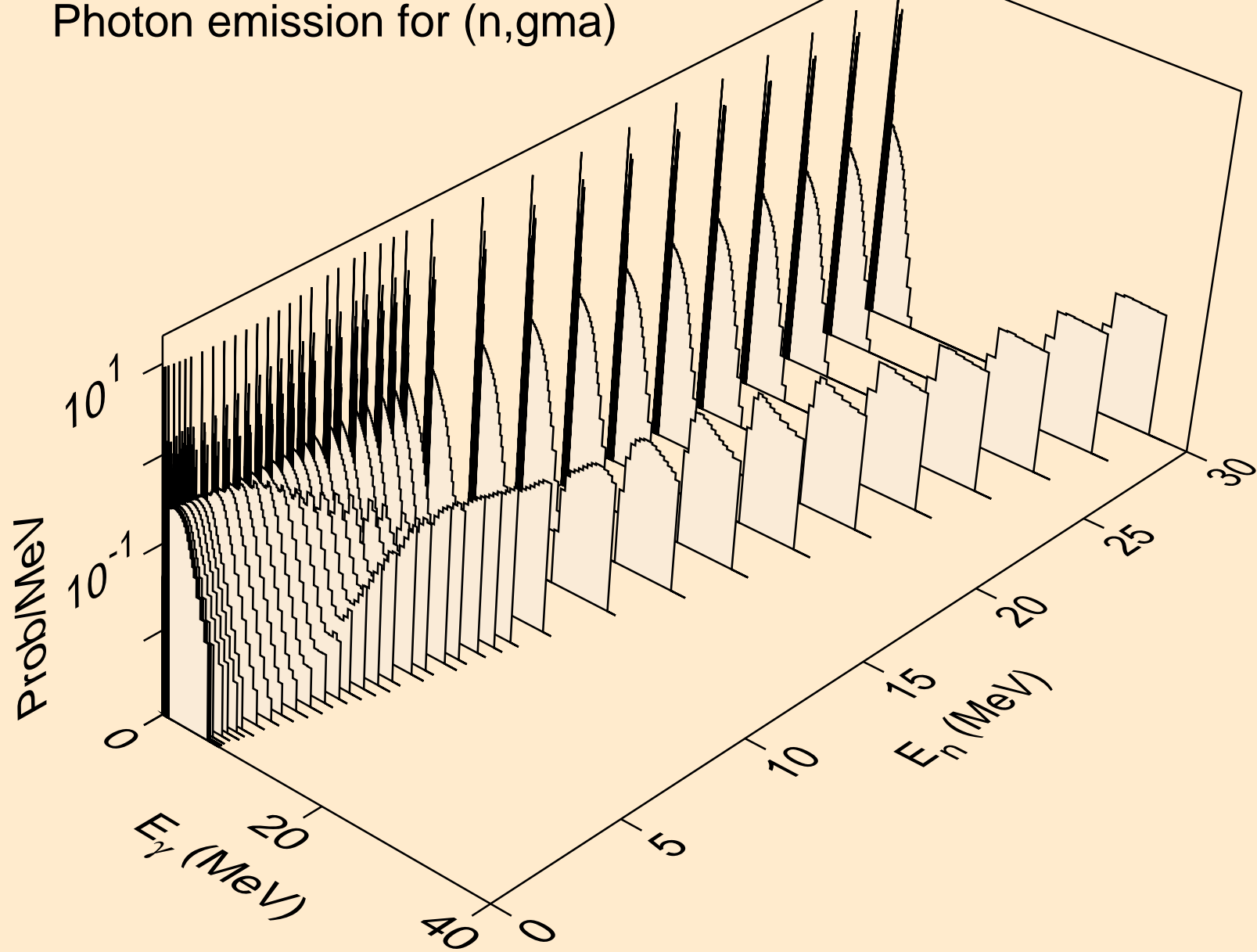

PR150 NEUTRON ACER TENDL-2023 LIBRARY; T=0.K
Photon emission for (n,p)

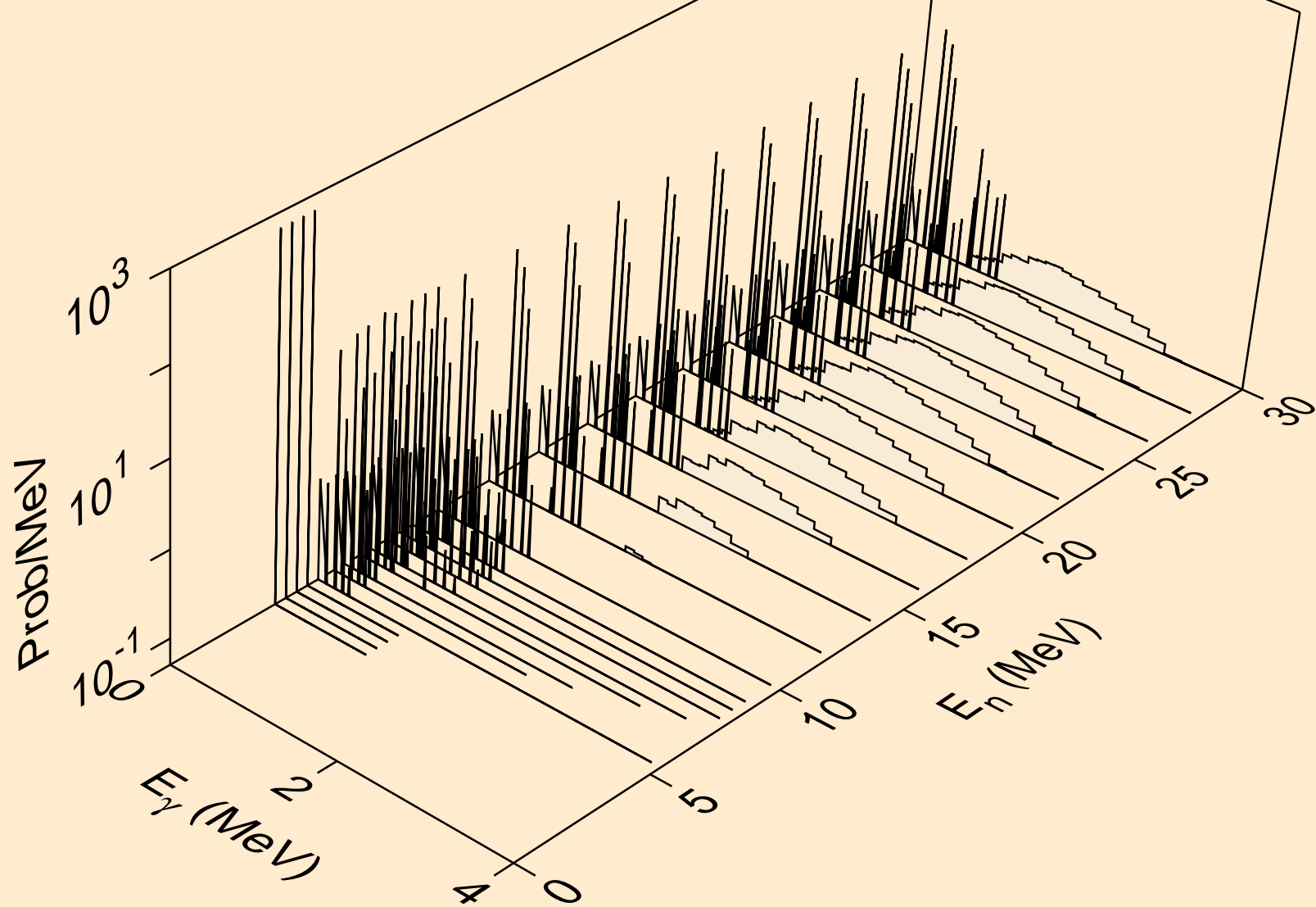

PR150 NEUTRON ACER TENDL-2023 LIBRARY; T=0.K
Photon emission for (n,d)

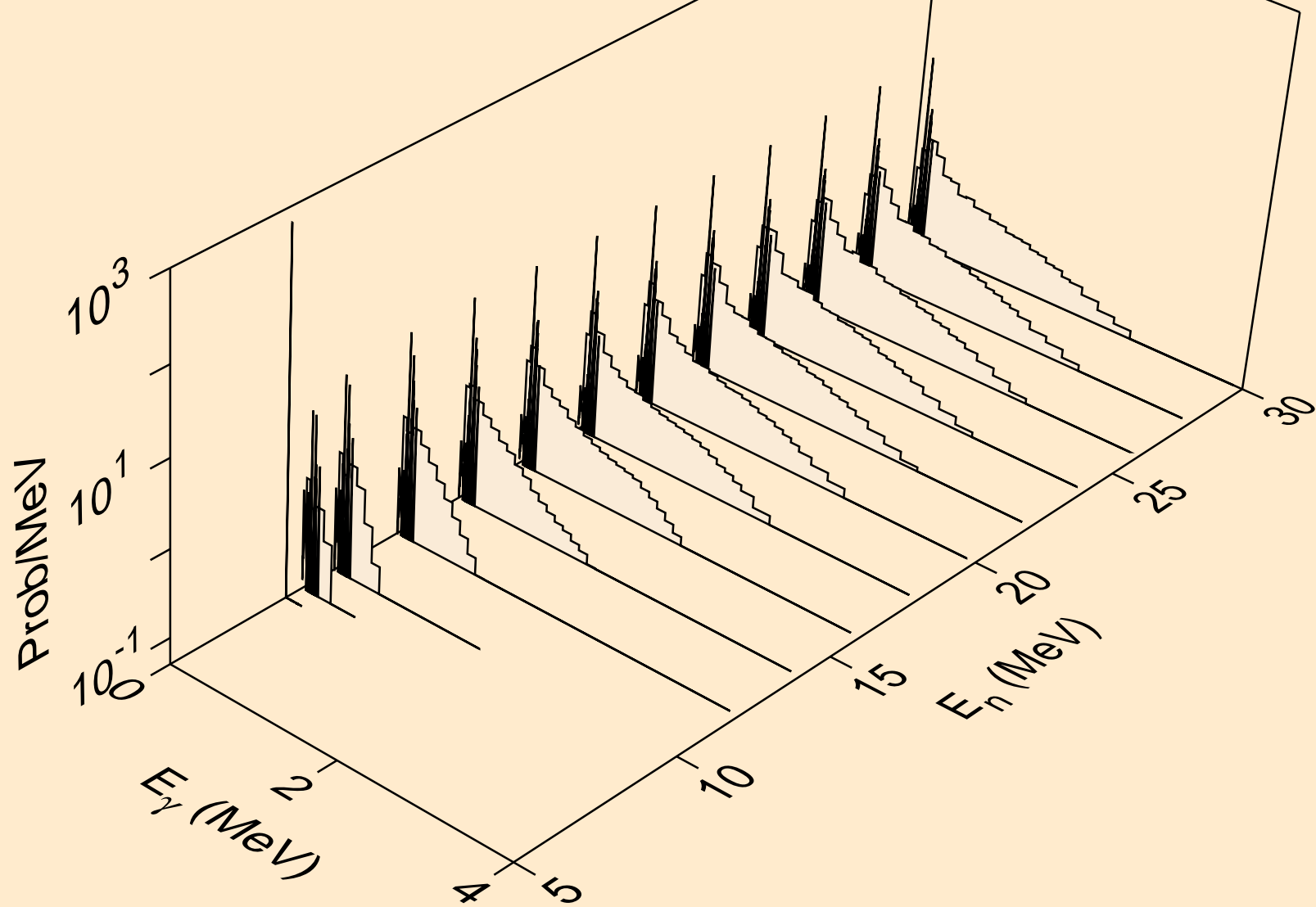

PR150 NEUTRON ACER TENDL-2023 LIBRARY; T=0.K
Photon emission for (n,t)

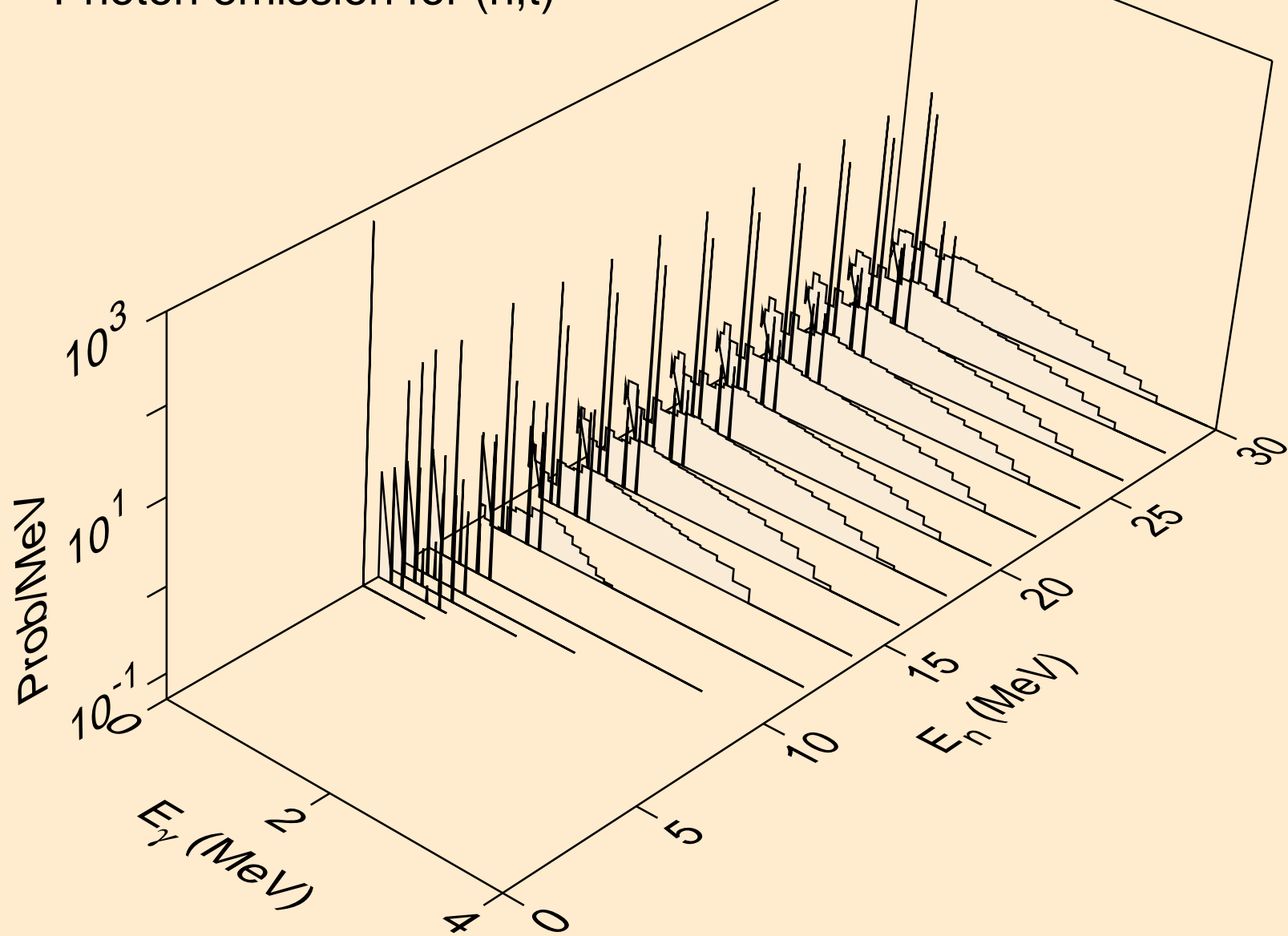

PR150 NEUTRON ACER TENDL-2023 LIBRARY; T=0.K
Photon emission for (n,he3)

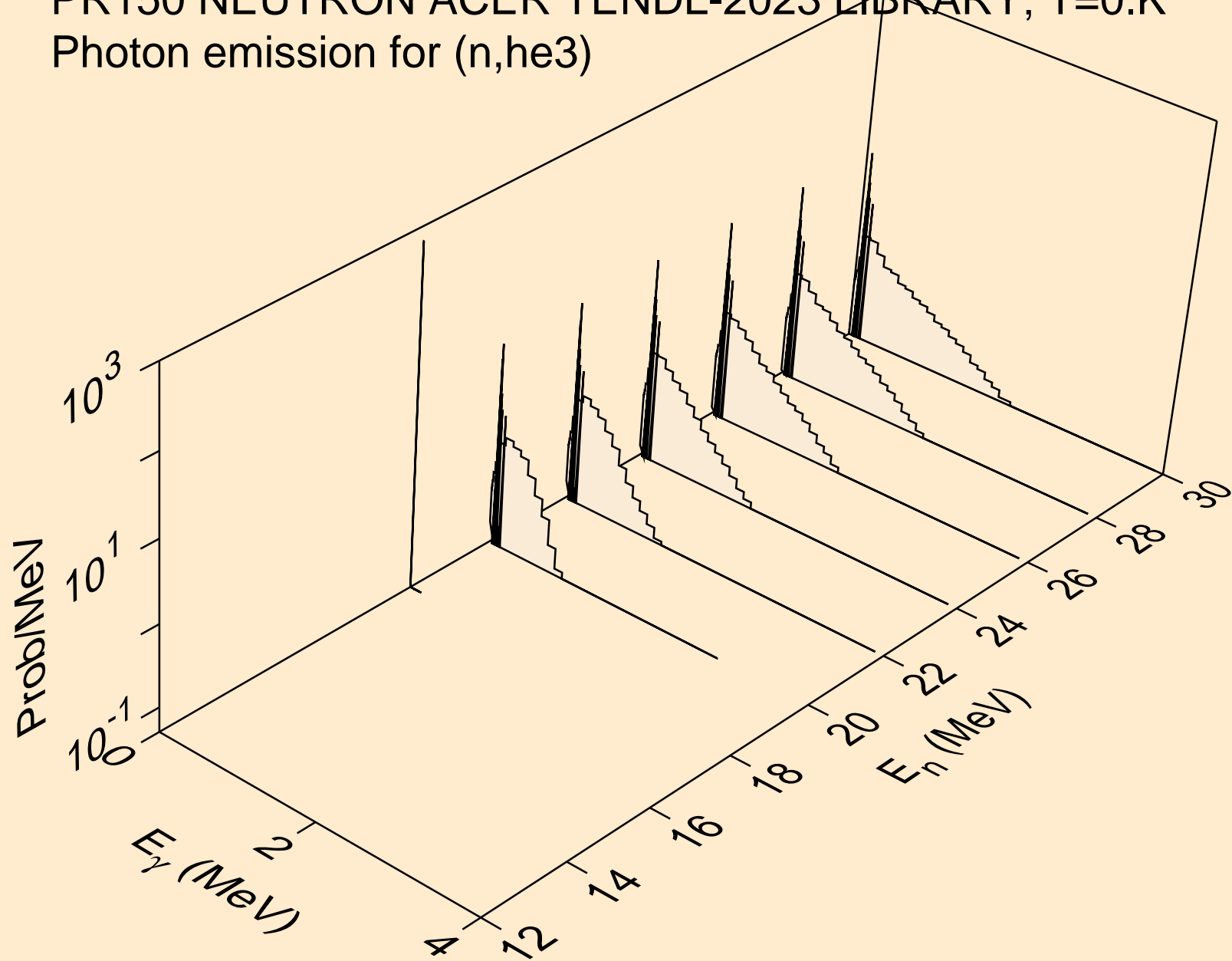

PR150 NEUTRON ACER TENDL-2023 LIBRARY; T=0.K
Photon emission for (n,a)

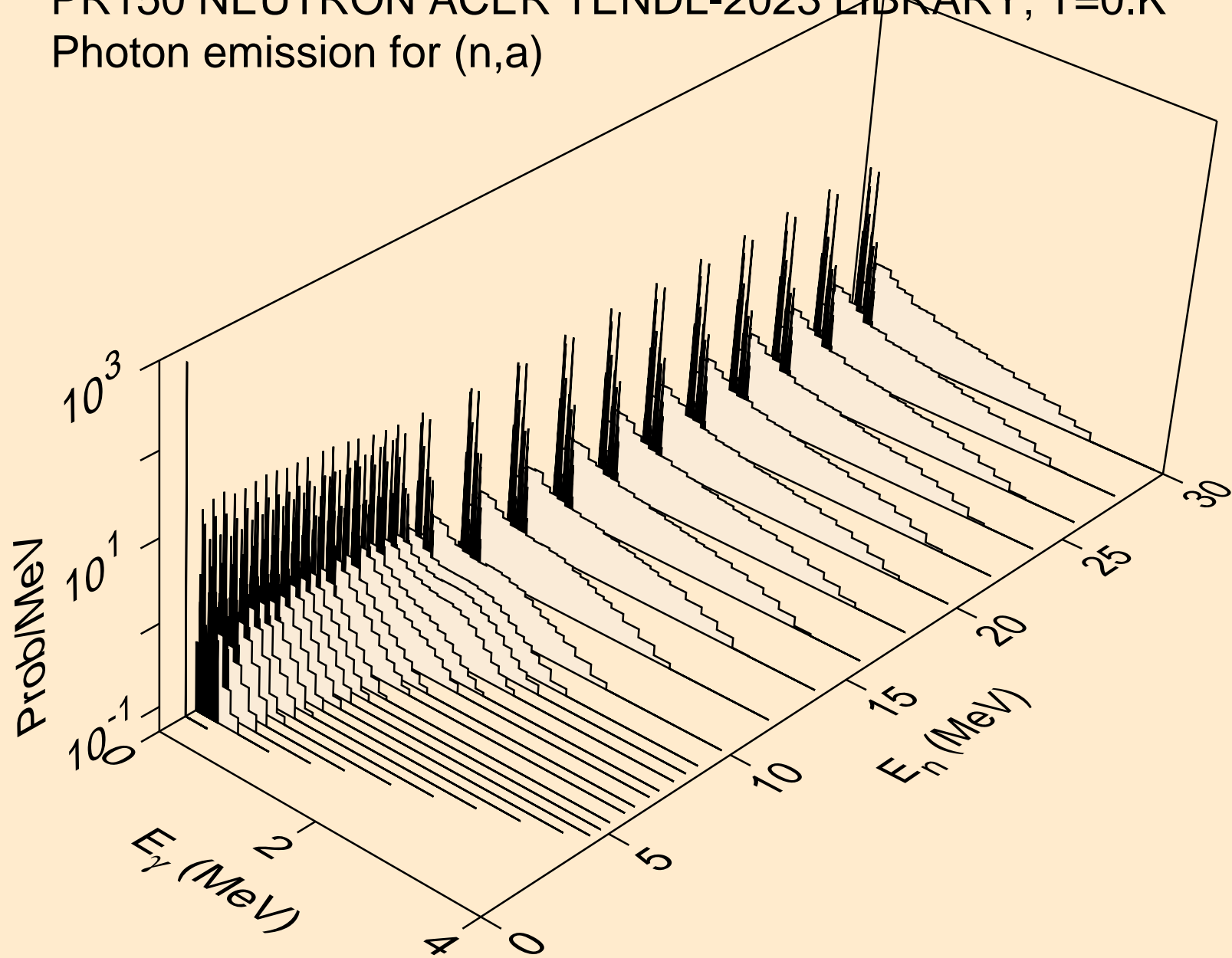

PR150 NEUTRON ACER TENDL-2023 LIBRARY; T=0.K
Photon emission for (n,2p)

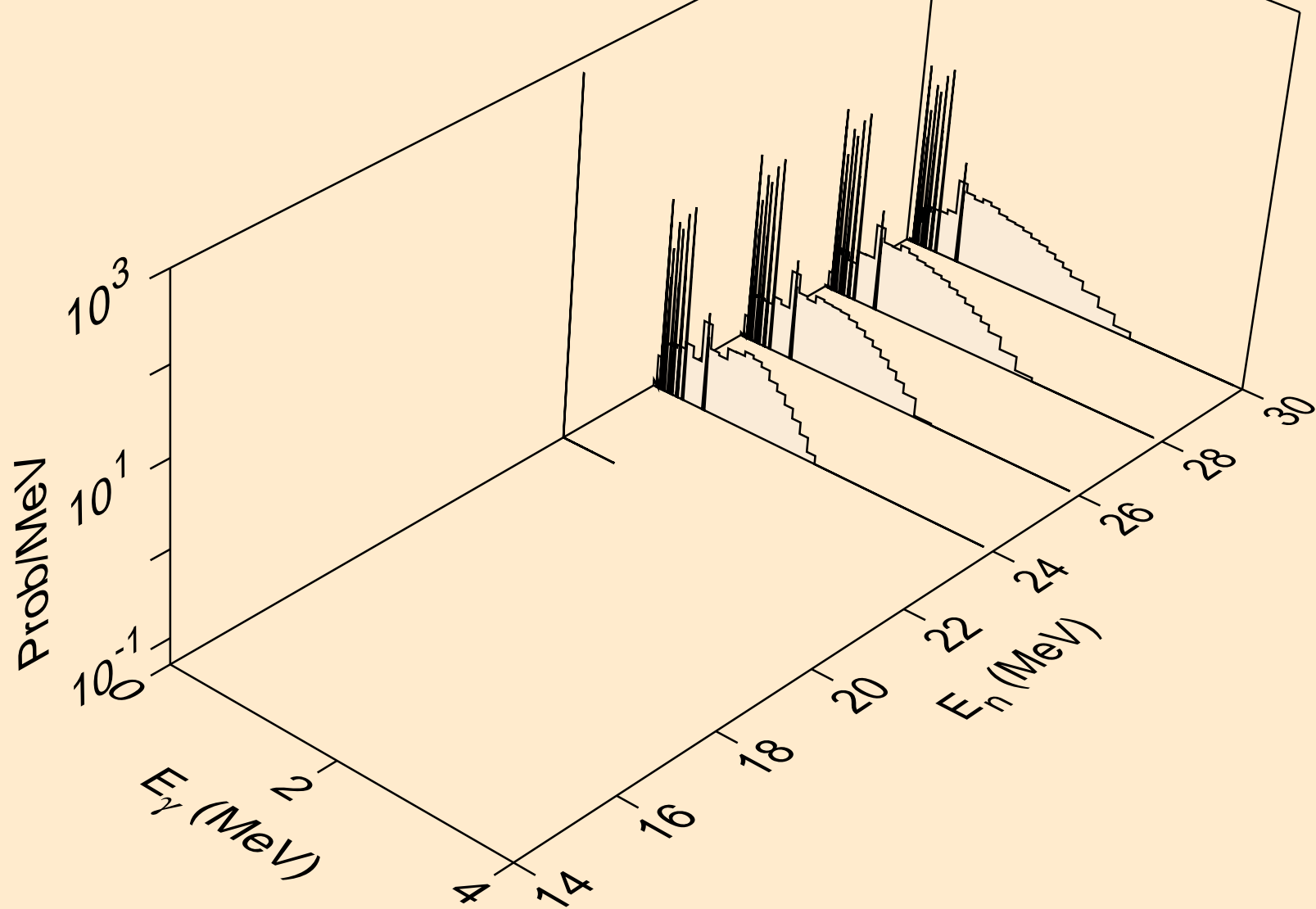

PR150 NEUTRON ACER TENDL-2023 LIBRARY; T=0.K
thermal capture photon spectrum

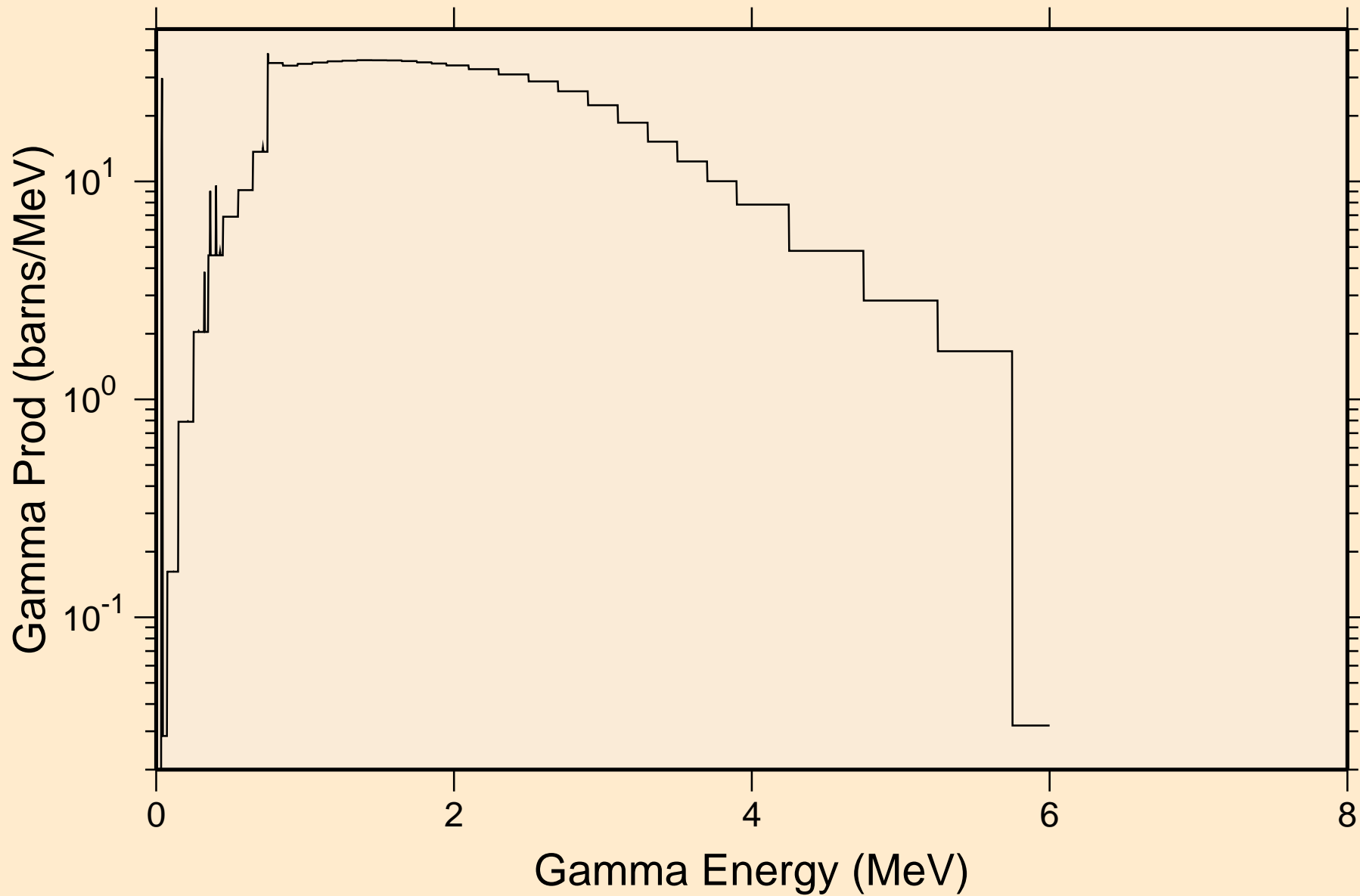

PR150 NEUTRON ACER TENDL-2023 LIBRARY; T=0.K
14 MeV photon spectrum

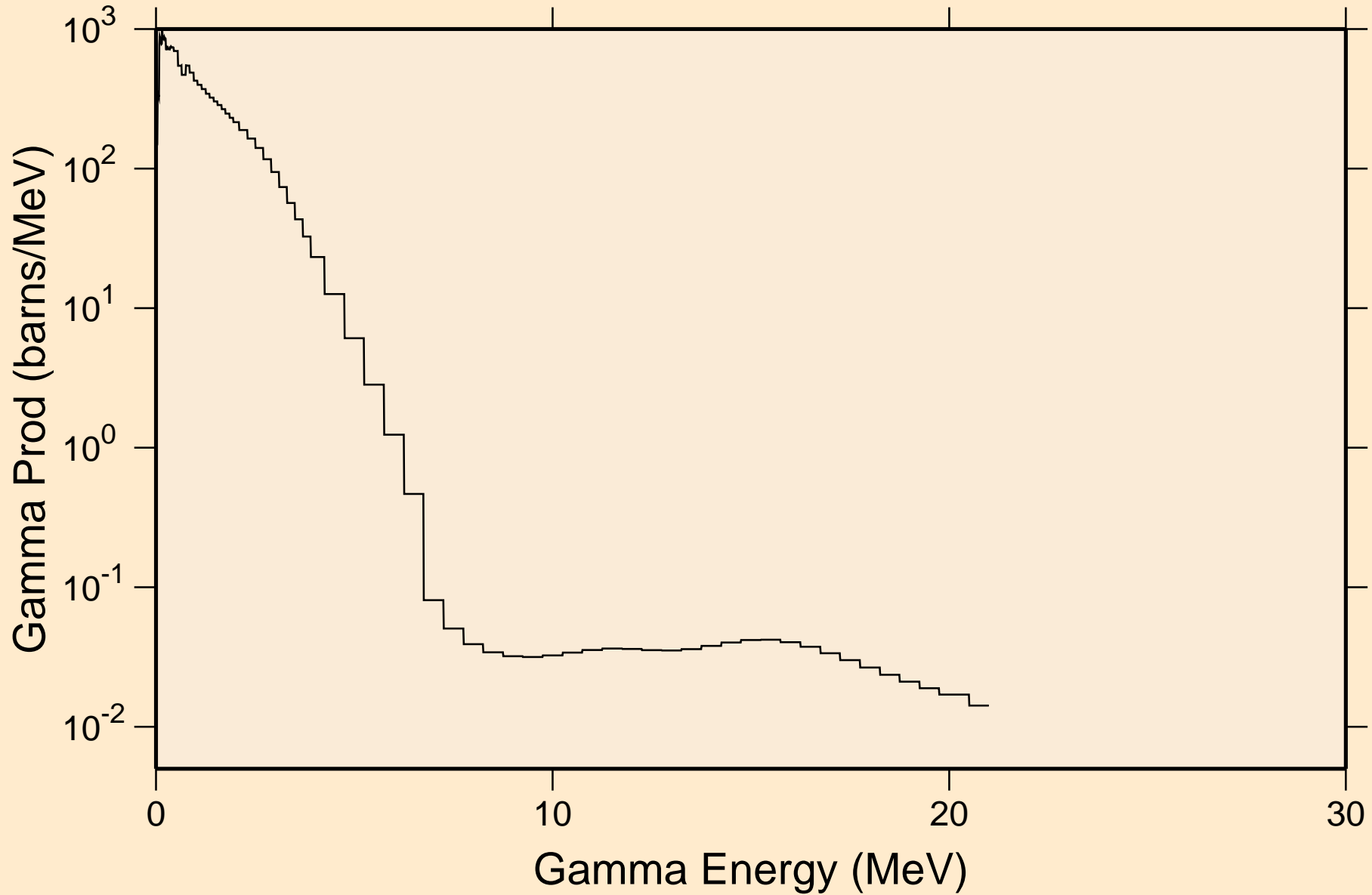

PR150 NEUTRON ACER TENDL-2023 LIBRARY; T=0.K
Particle heating contributions

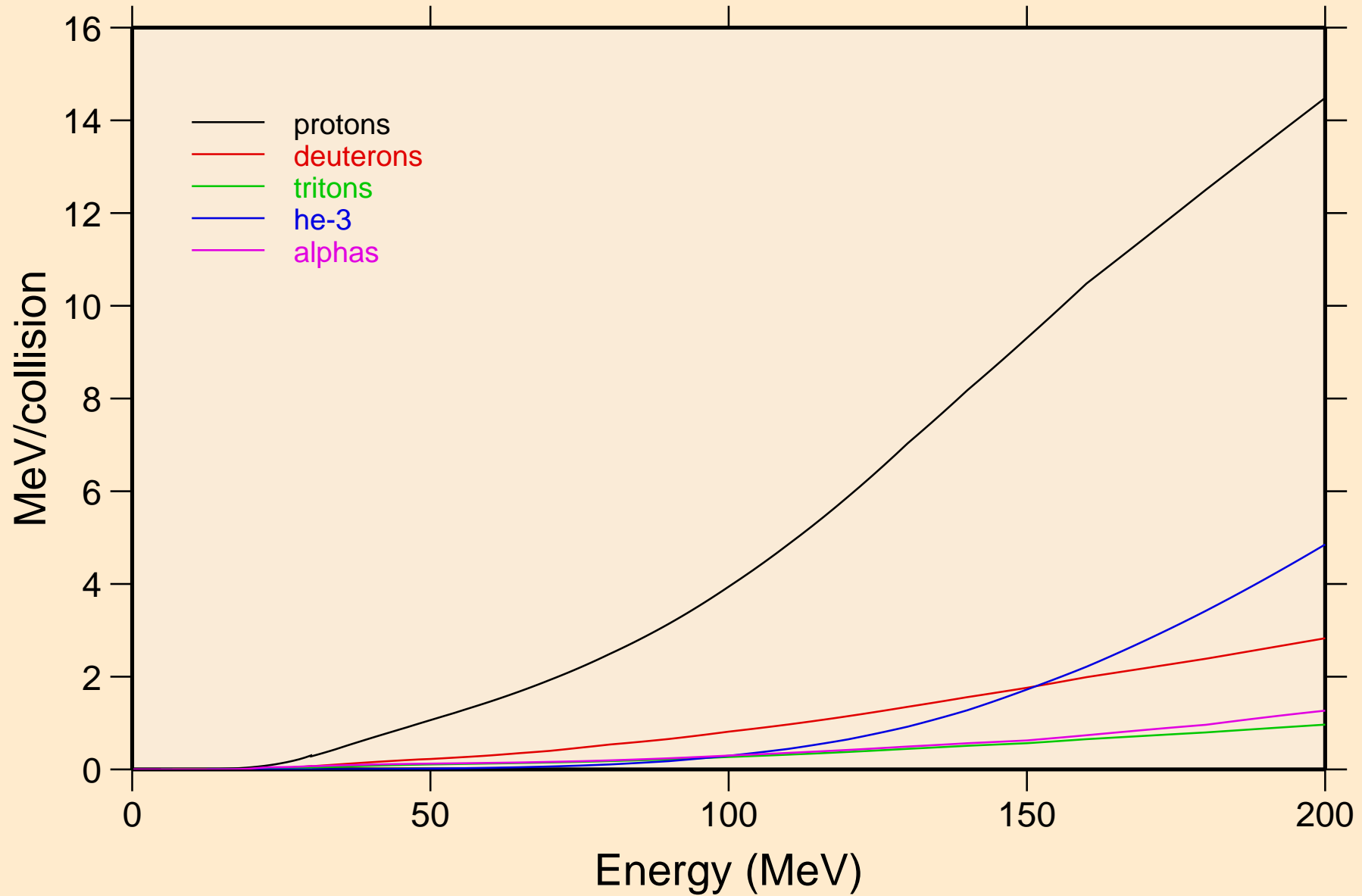

PR150 NEUTRON ACER TENDL-2023 LIBRARY; T=0.K
Recoil Heating

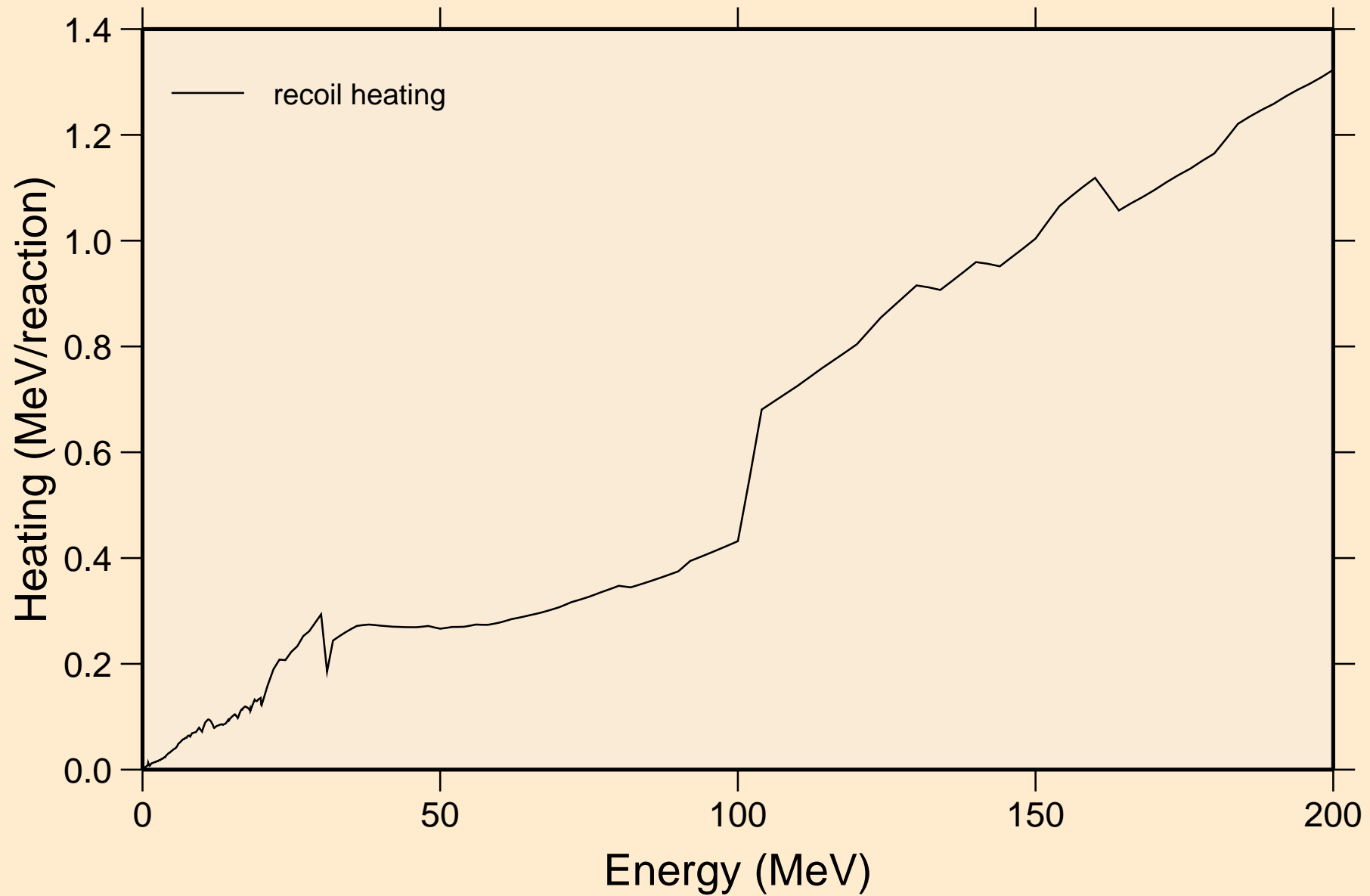

PR150 NEUTRON ACER TENDL-2023 LIBRARY; T=0.K
Particle production cross sections

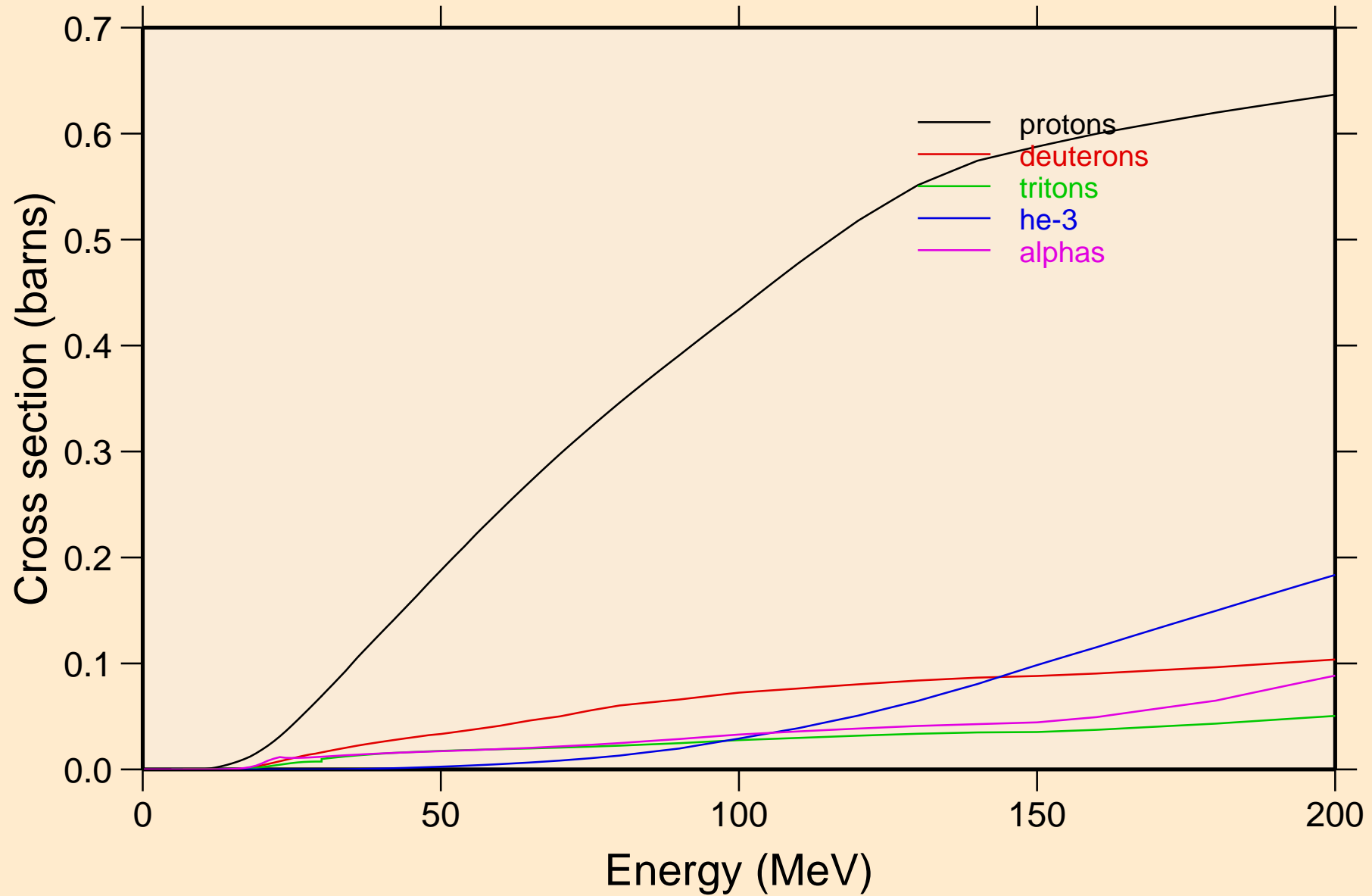

PR150 NEUTRON ACER TENDL-2023 LIBRARY; T=0.K
protons from (n,x)

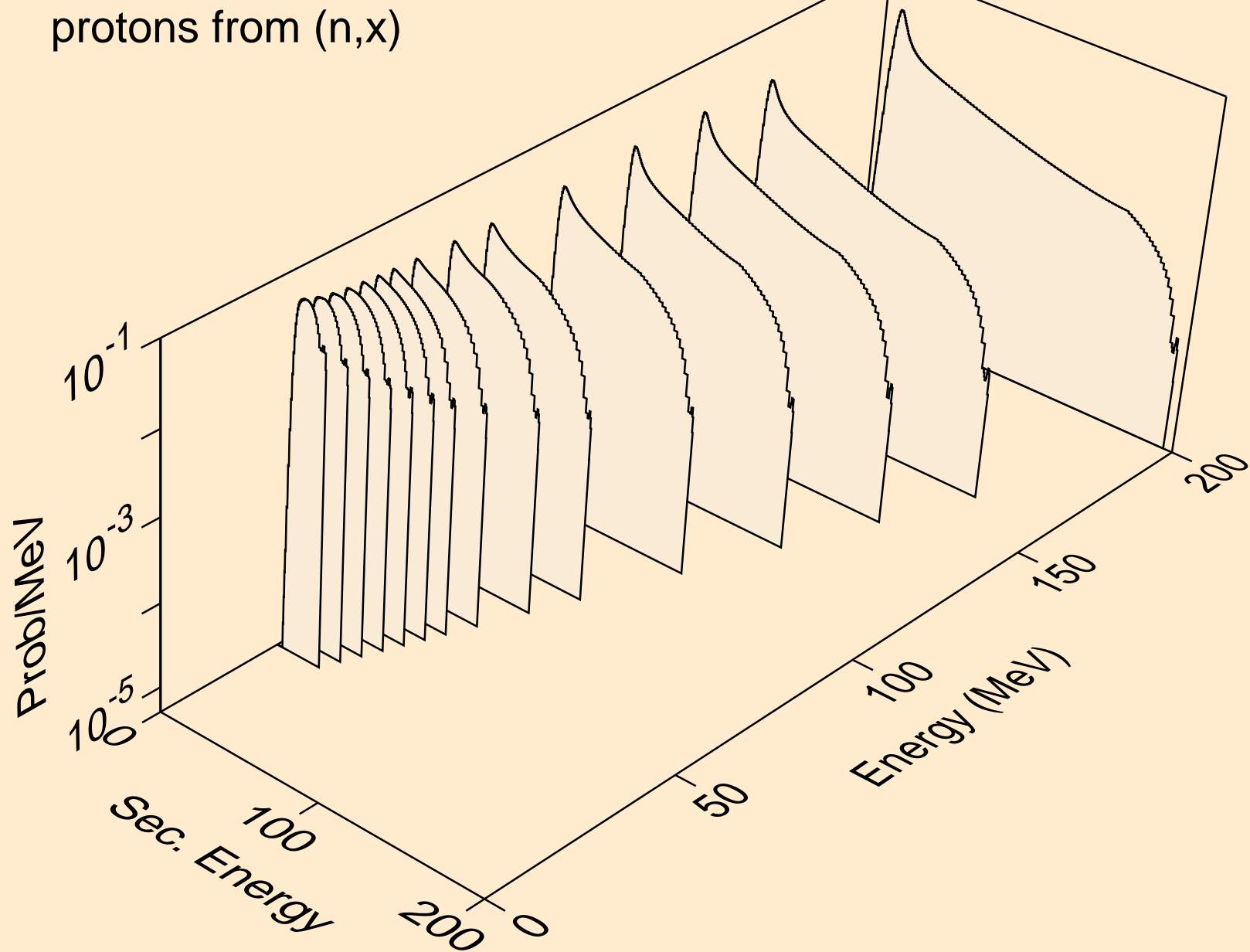

PR150 NEUTRON ACER TENDL-2023 LIBRARY; T=0.K
protons from (n,n*)p

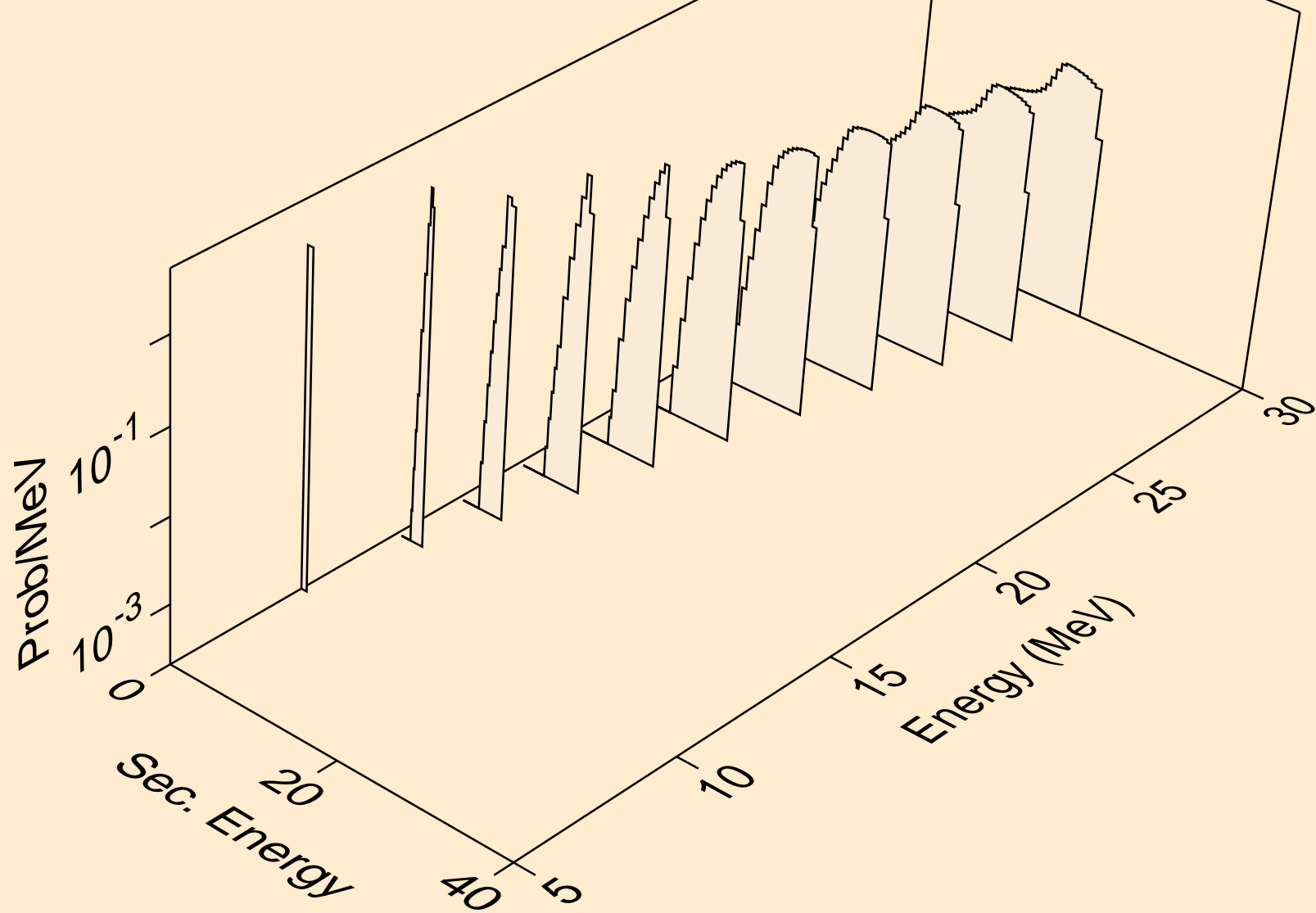

PR150 NEUTRON ACER TENDL-2023 LIBRARY; T=0.K
protons from (n,2np)

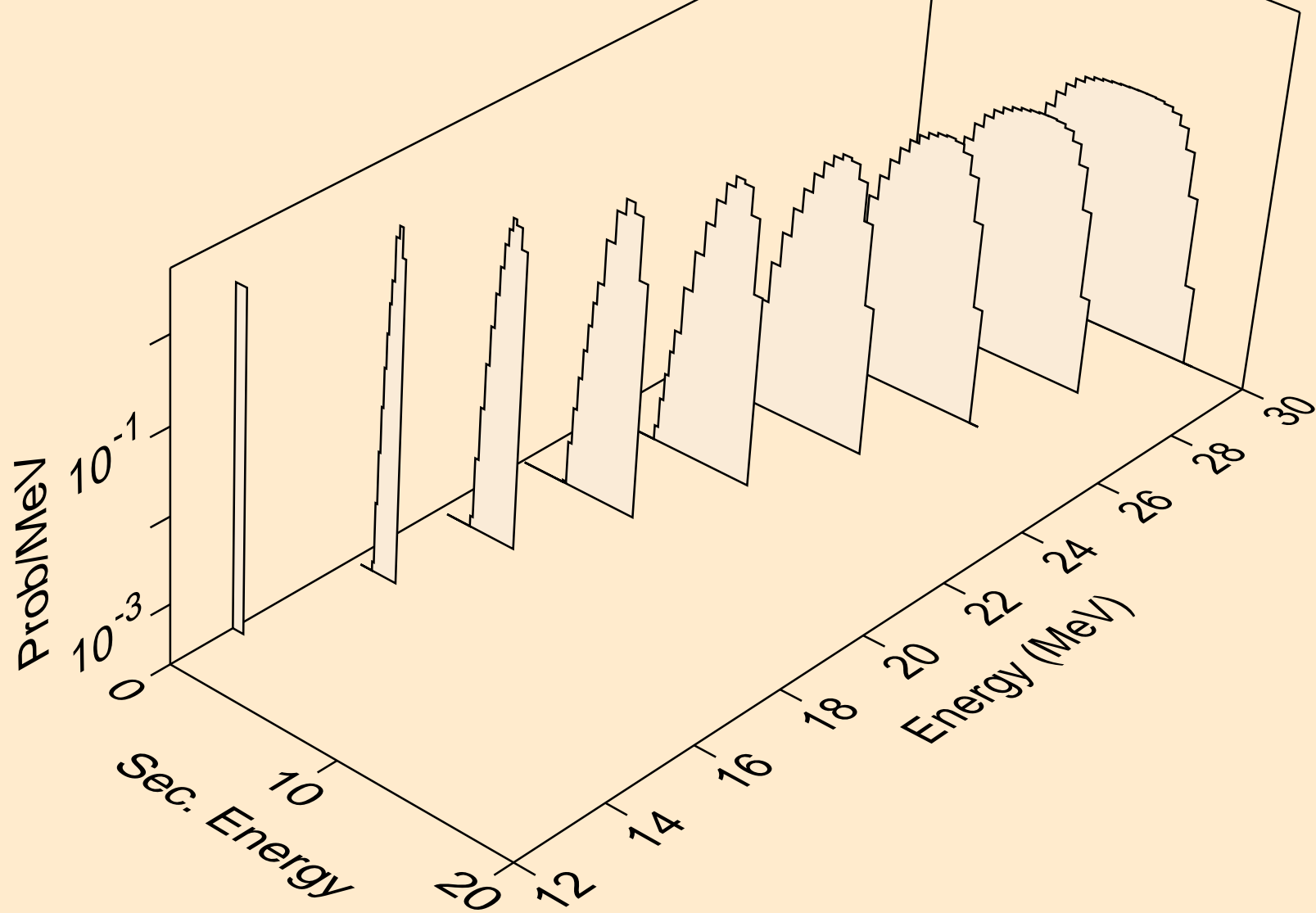

PR150 NEUTRON ACER TENDL-2023 LIBRARY; T=0.K
protons from (n,3np)

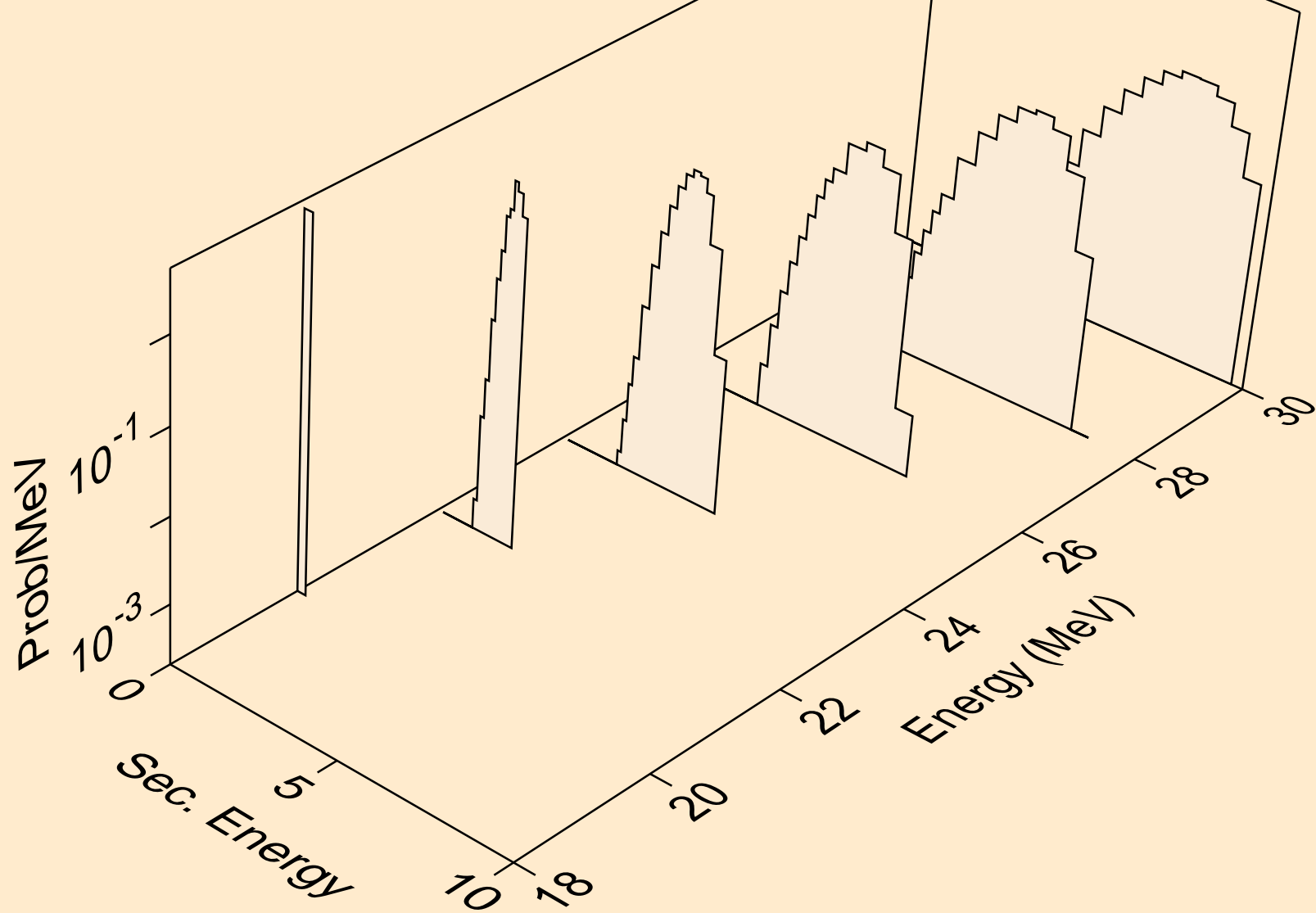

PR150 NEUTRON ACER TENDL-2023 LIBRARY; T=0.K
protons from (n,p)

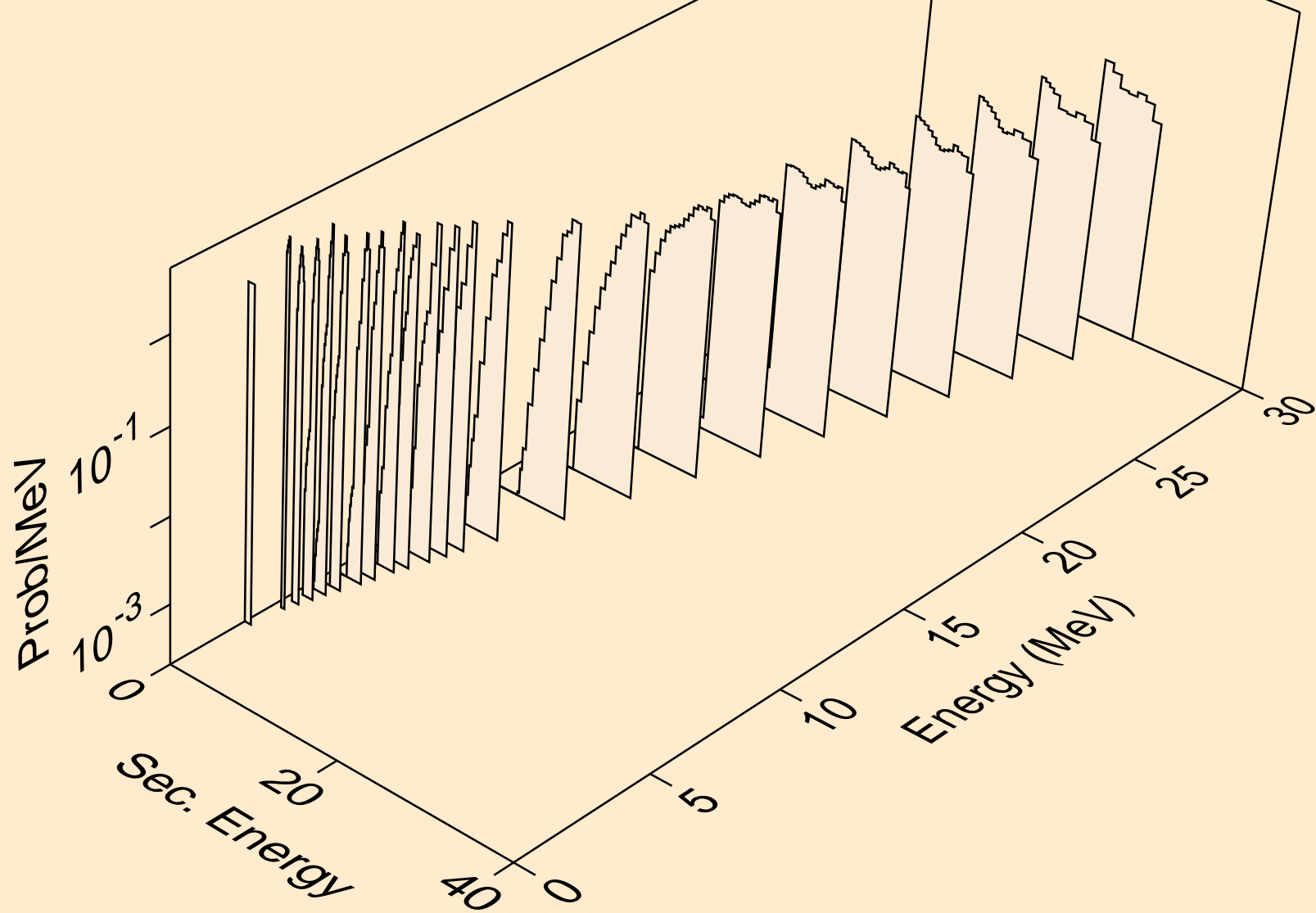

PR150 NEUTRON ACER TENDL-2023 LIBRARY; T=0.K
protons from (n,2p)

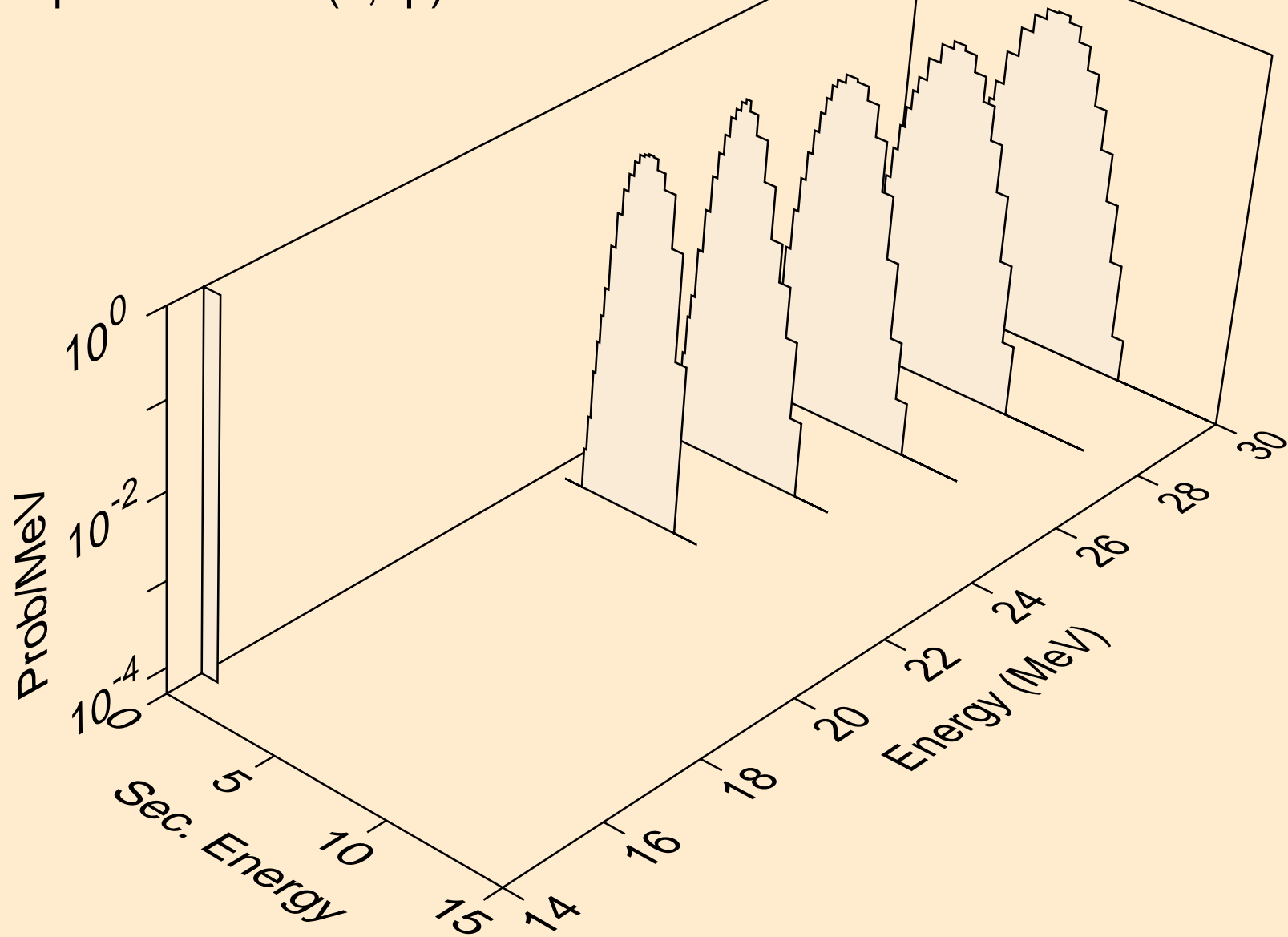

PR150 NEUTRON ACER TENDL-2023 LIBRARY; T=0.K
deuterons from (n,x)

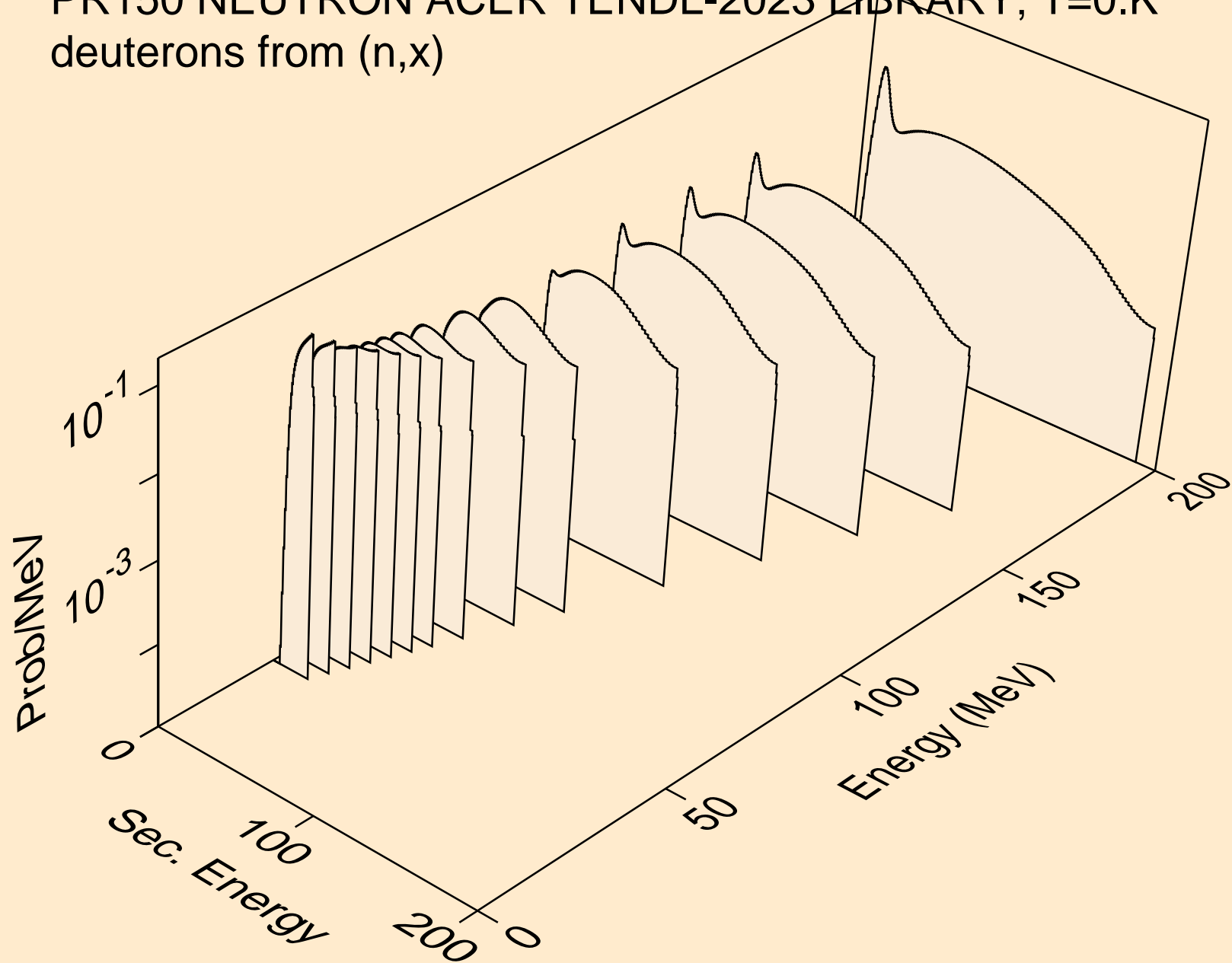

PR150 NEUTRON ACER TENDL-2023 LIBRARY; T=0.K
deuterons from (n,2nd)

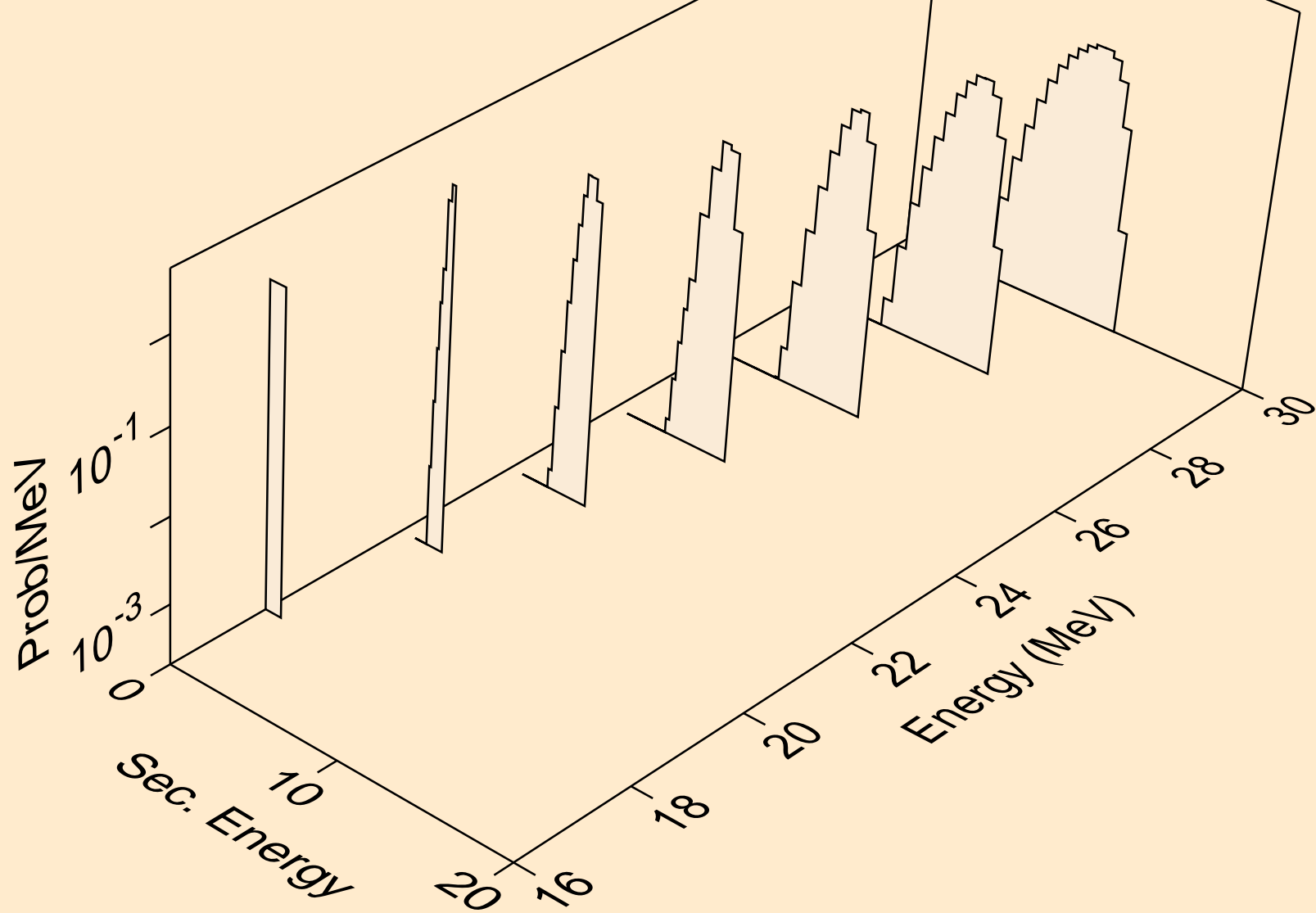

PR150 NEUTRON ACER TENDL-2023 LIBRARY; T=0.K
deuterons from (n,n*)d

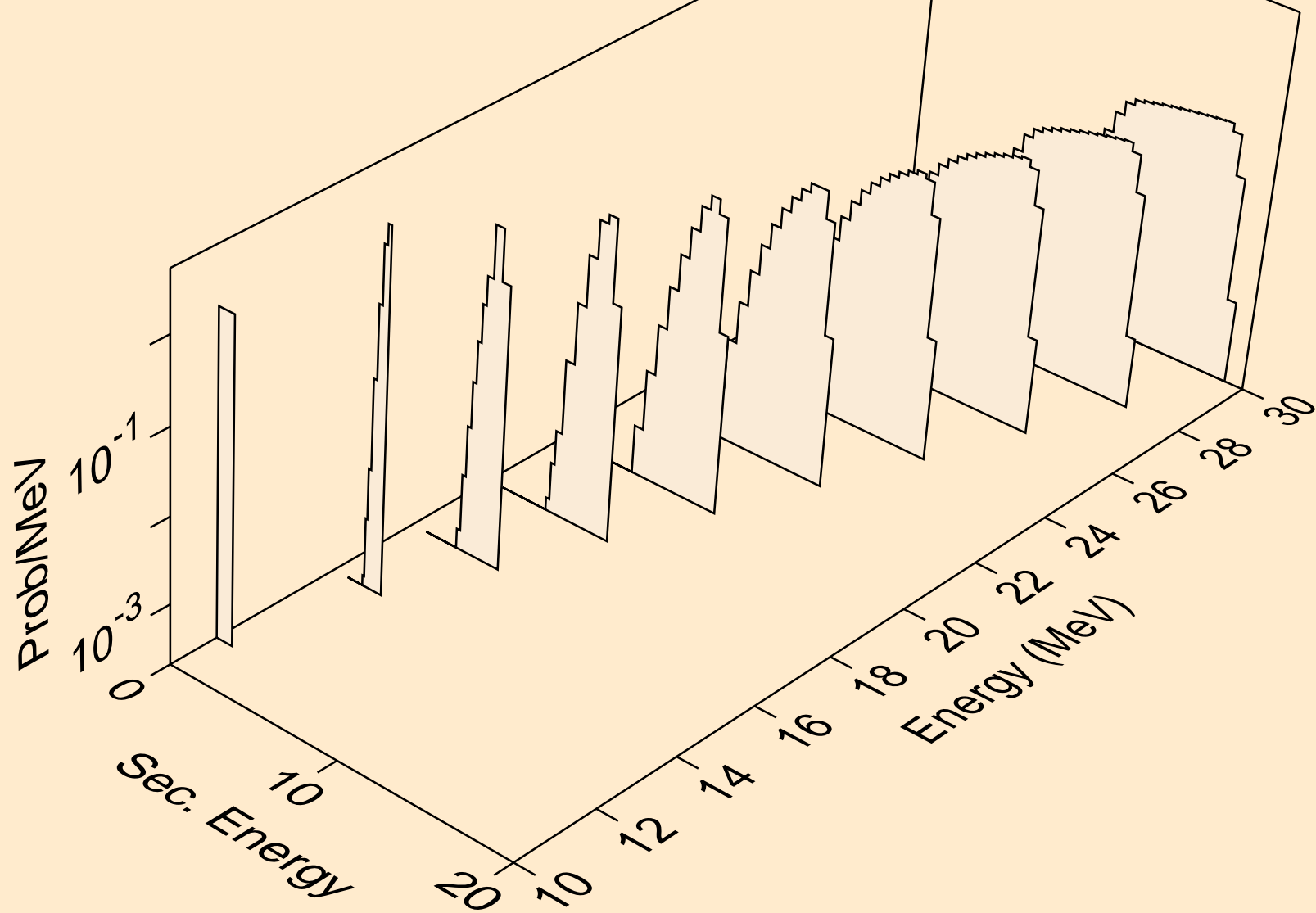

PR150 NEUTRON ACER TENDL-2023 LIBRARY; T=0.K
deuterons from (n,d)

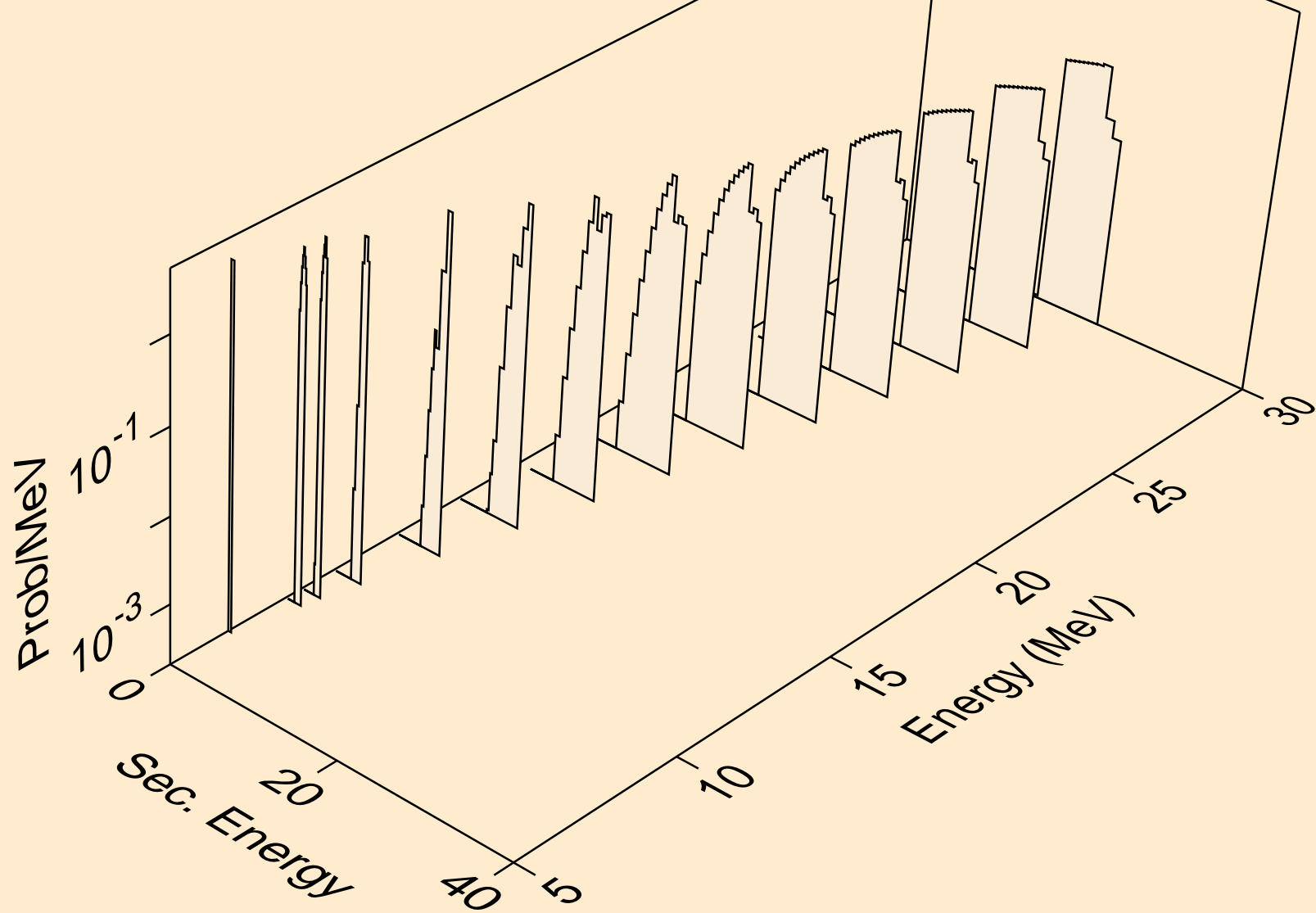

PR150 NEUTRON ACER TENDL-2023 LIBRARY; T=0.K
tritons from (n,x)

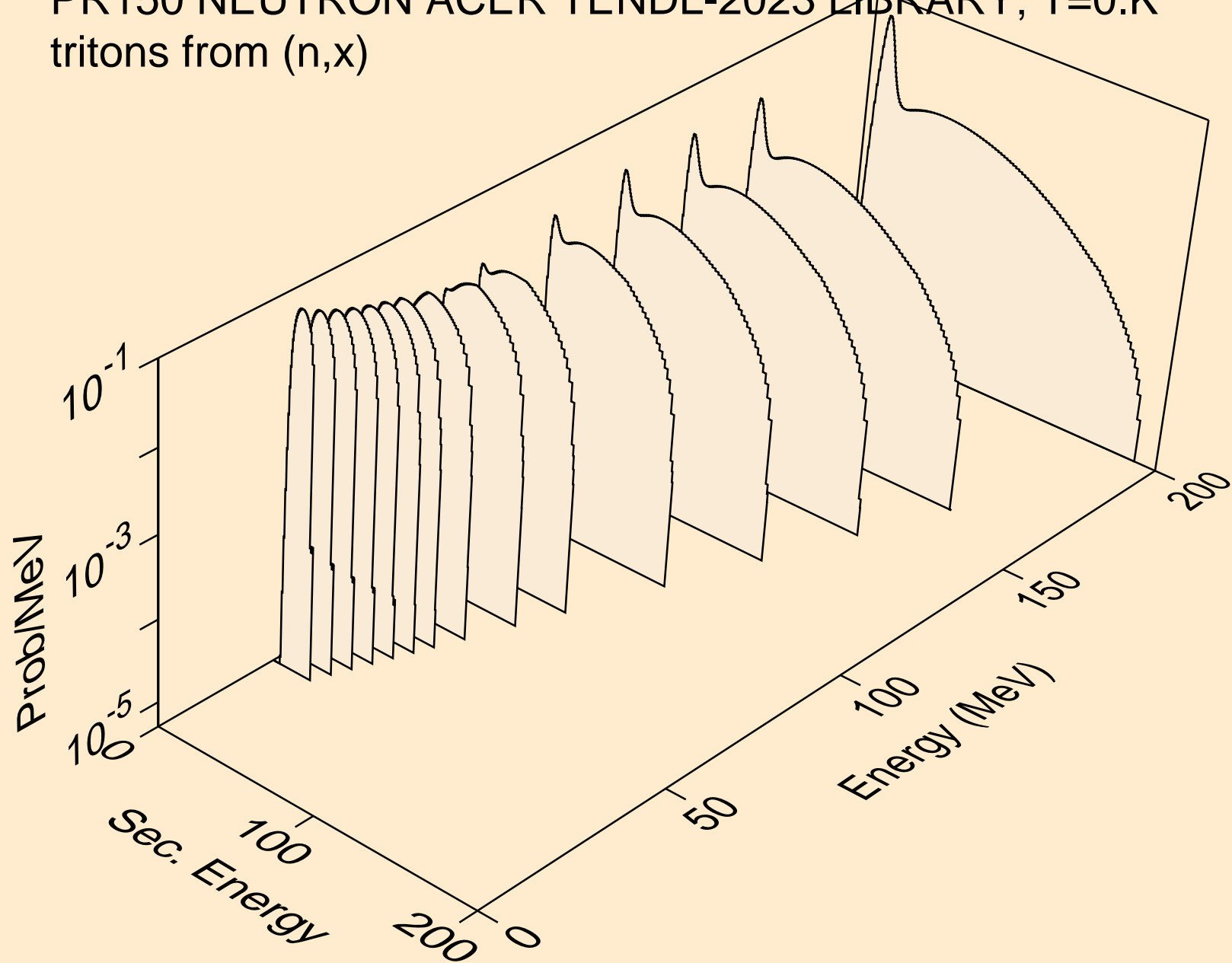

PR150 NEUTRON ACER TENDL-2023 LIBRARY; T=0.K
tritons from (n,n*)t

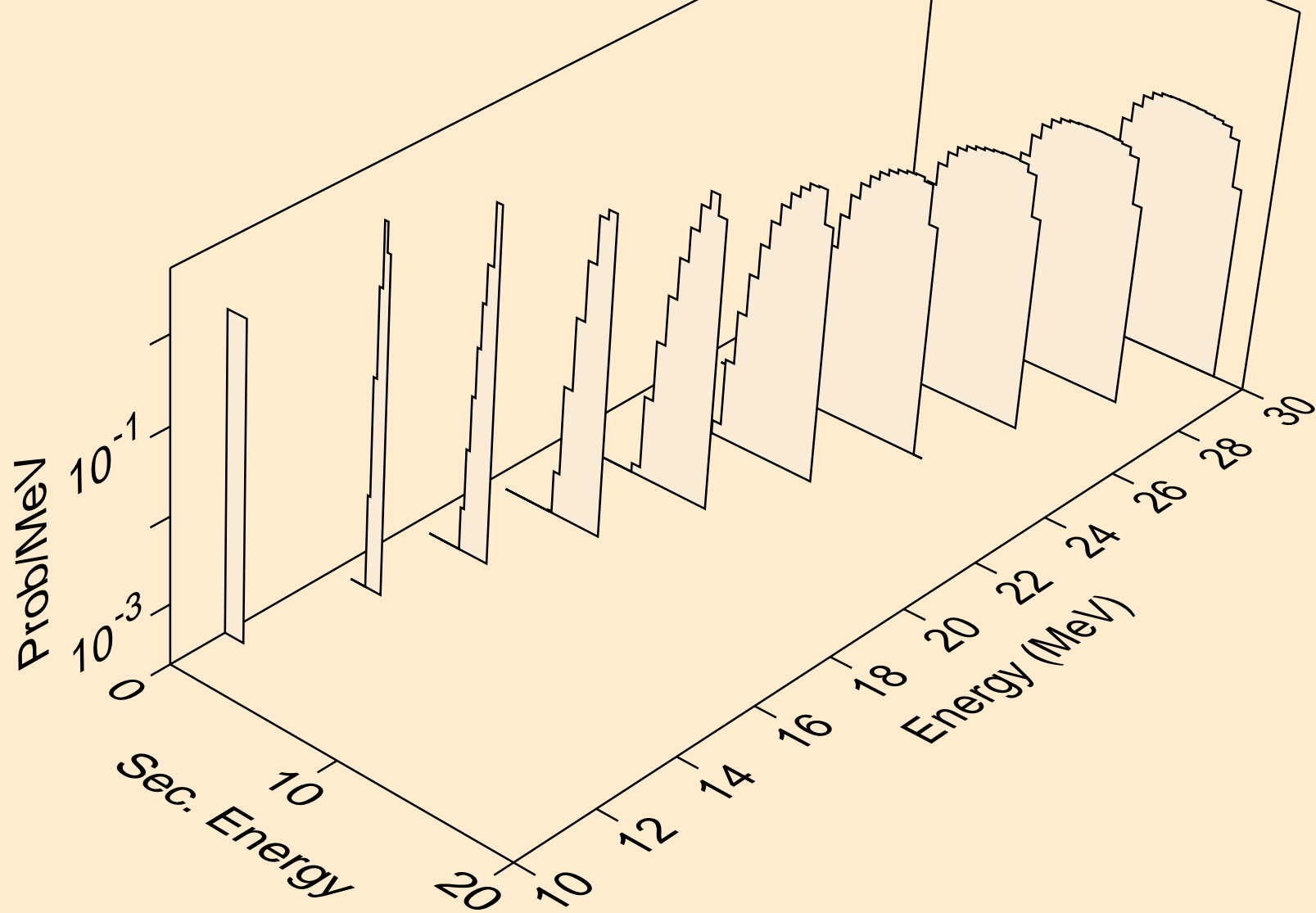

PR150 NEUTRON ACER TENDL-2023 LIBRARY; T=0.K
tritons from (n,t)

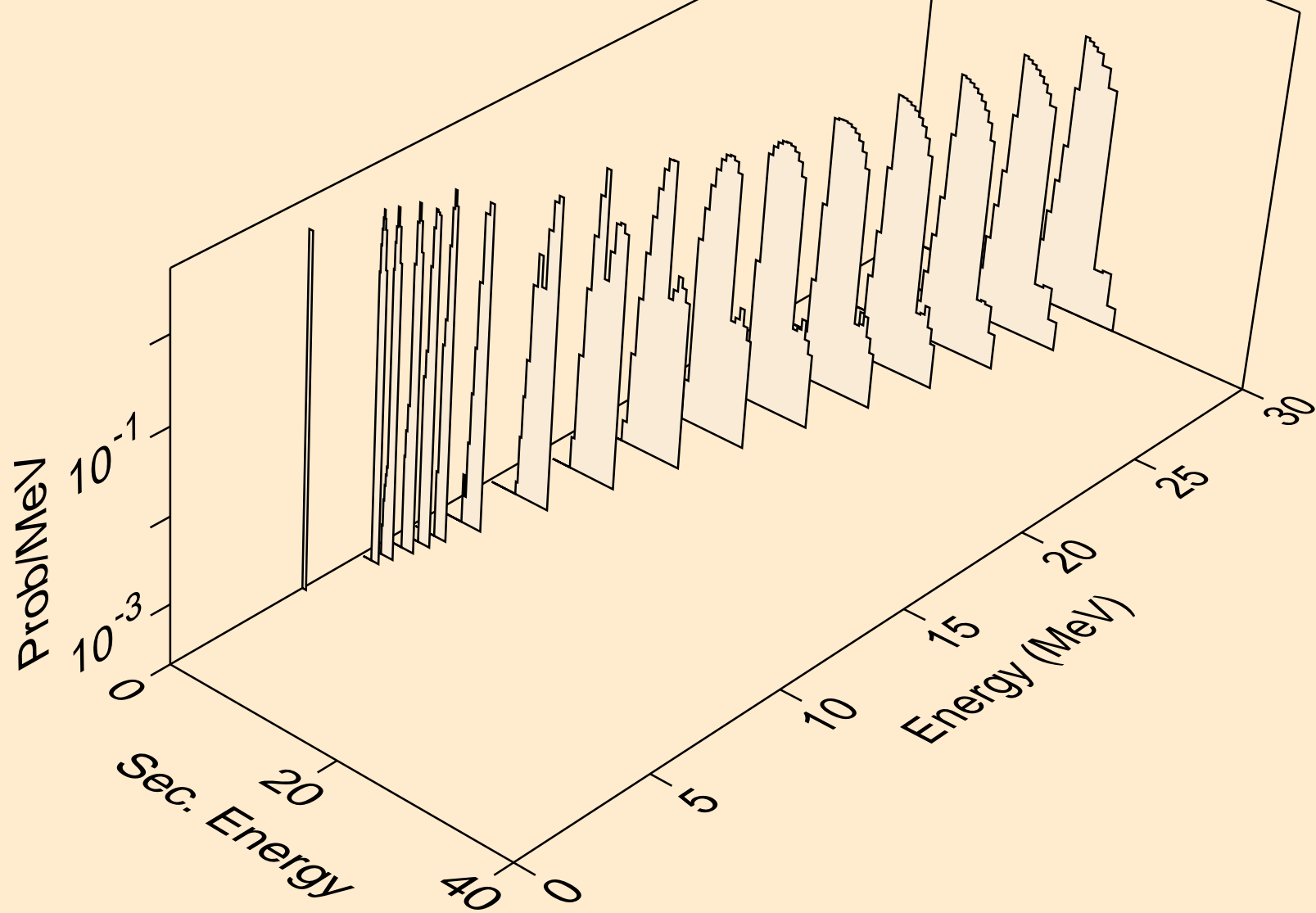

PR150 NEUTRON ACER TENDL-2023 LIBRARY; T=0.K
he3s from (n,x)

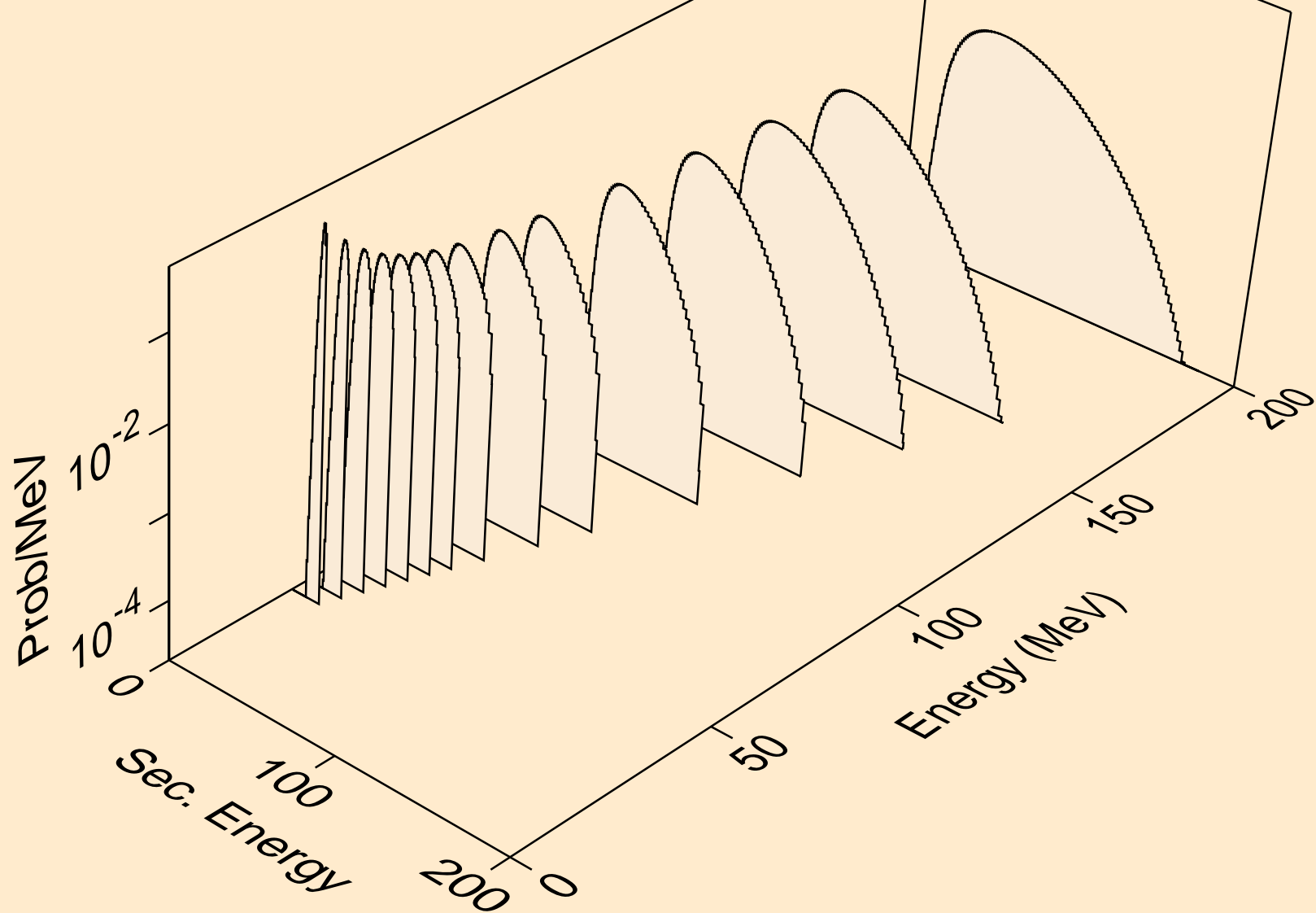

PR150 NEUTRON ACER TENDL-2023 LIBRARY; T=0.K
he3s from (n,n*)he3

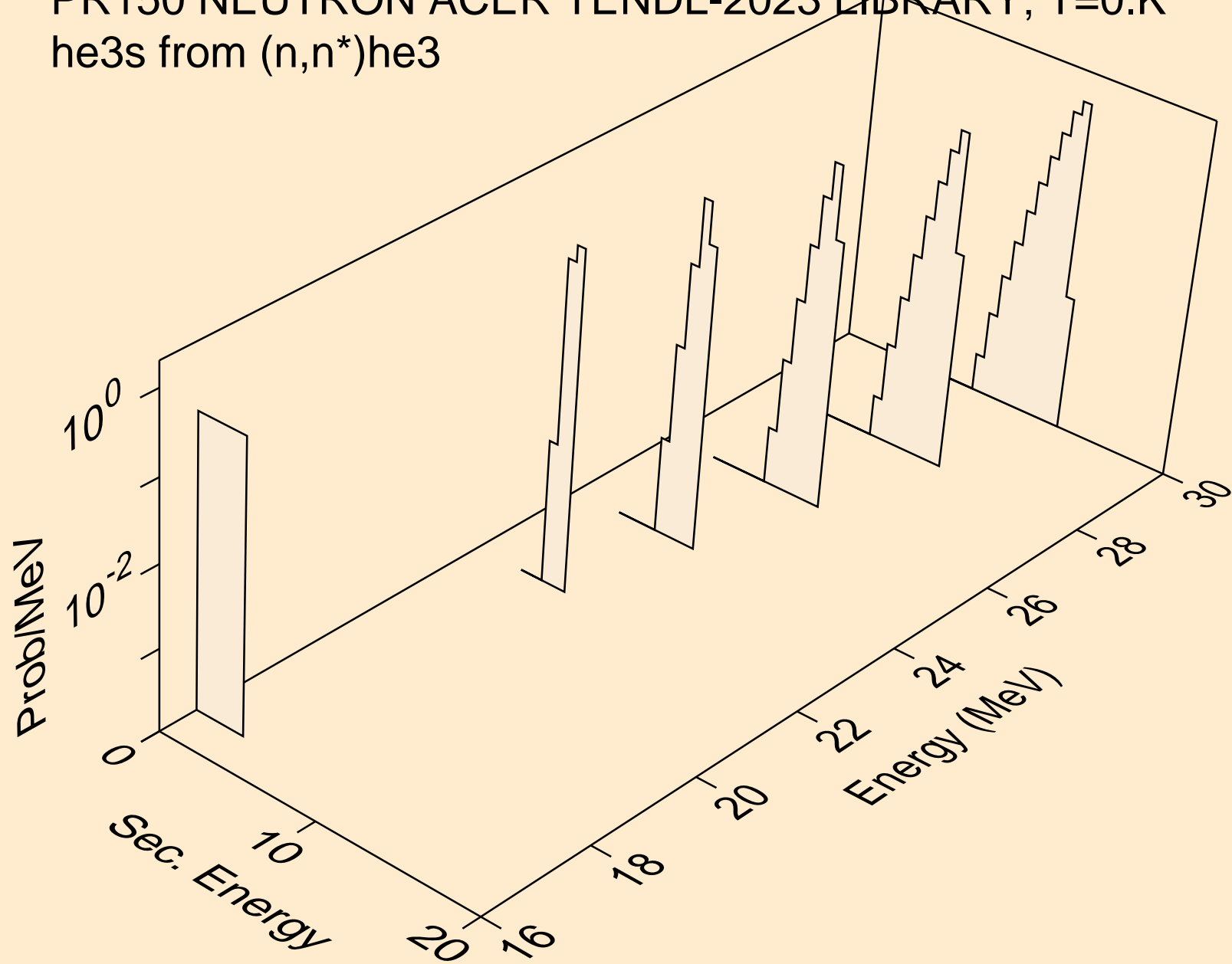

PR150 NEUTRON ACER TENDL-2023 LIBRARY; T=0.K
he3s from (n,he3)

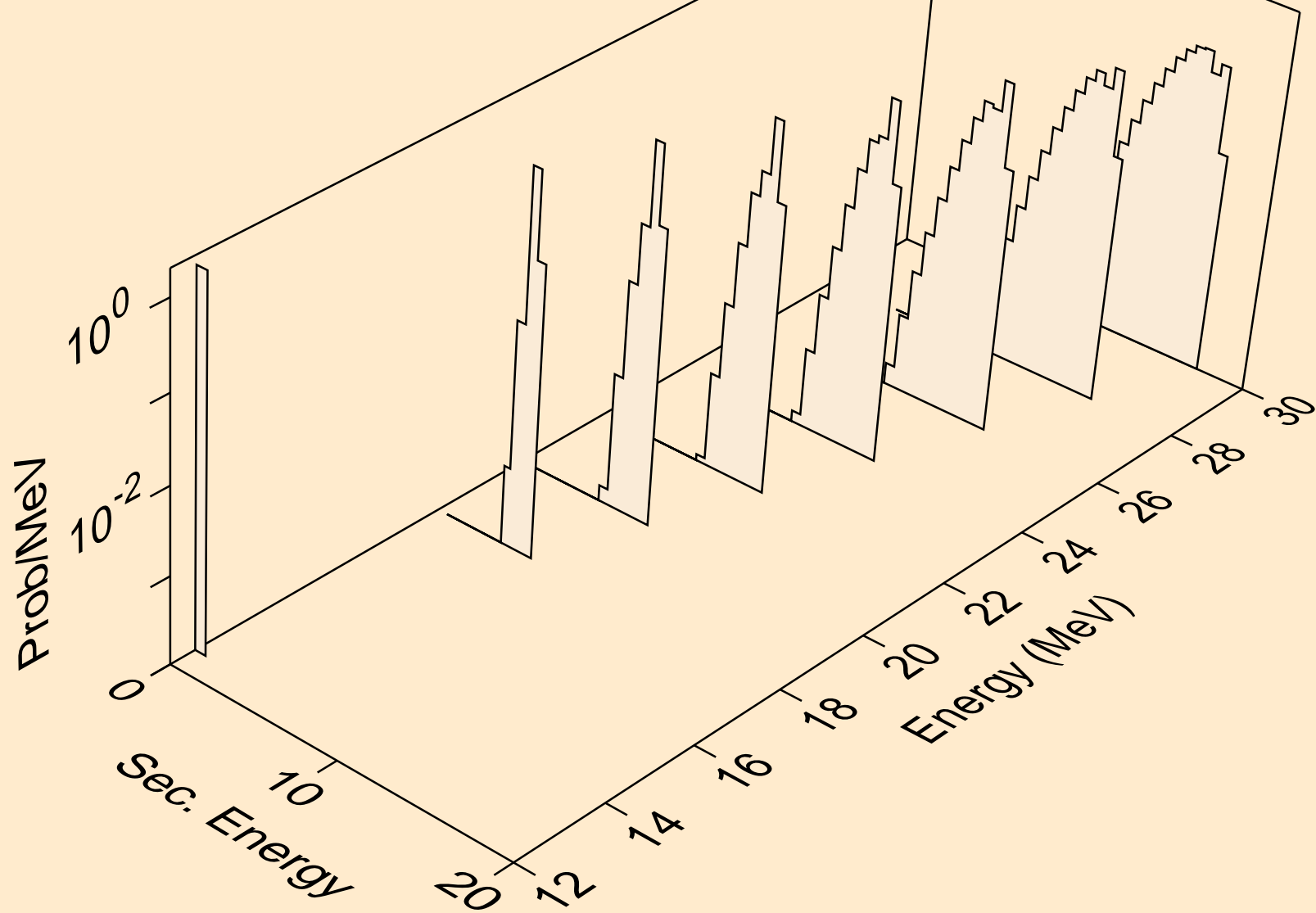

PR150 NEUTRON ACER TENDL-2023 LIBRARY; T=0.K
alphas from (n,x)

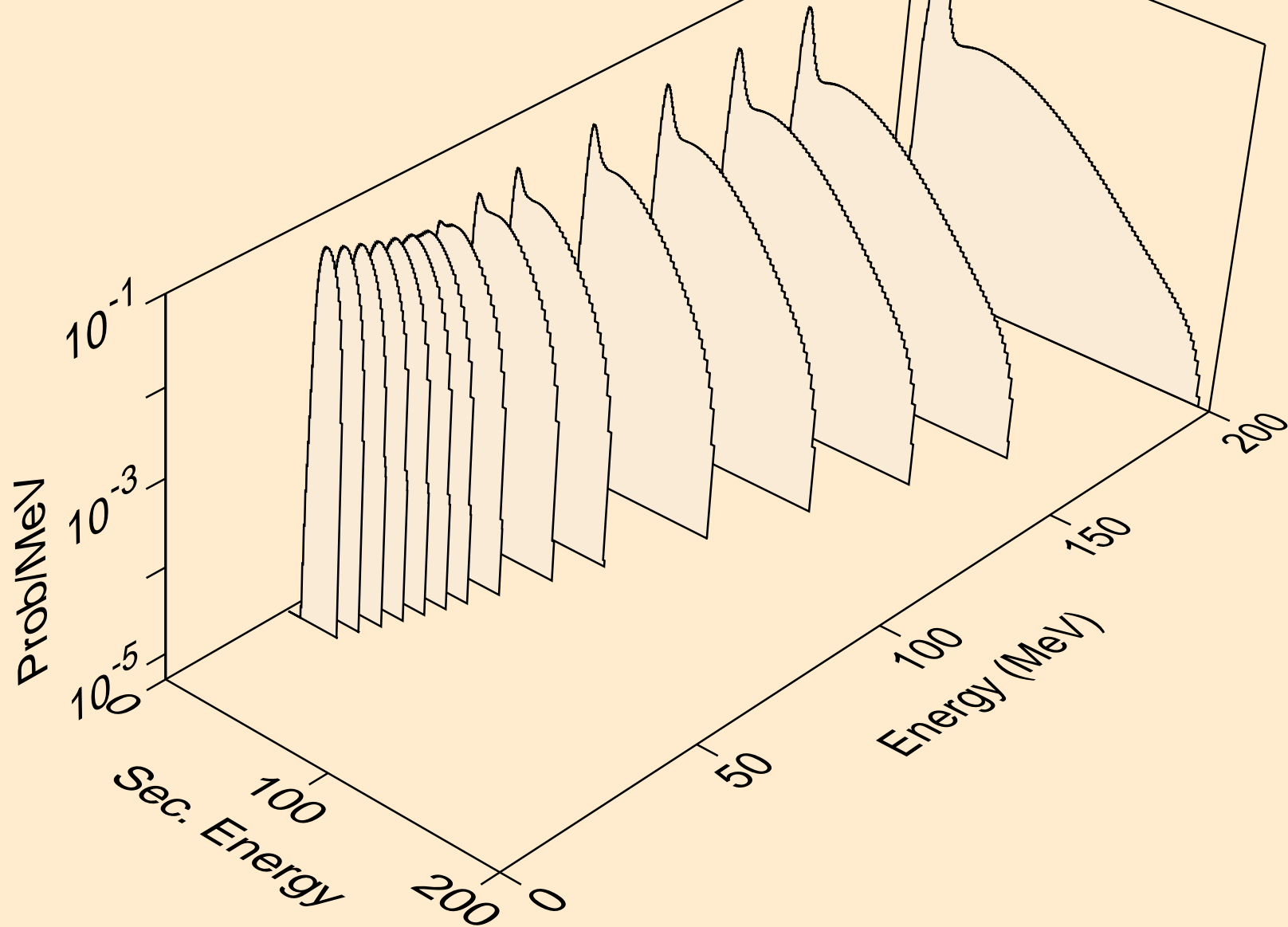

PR150 NEUTRON ACER TENDL-2023 LIBRARY; T=0.K
alphas from (n,n*)a

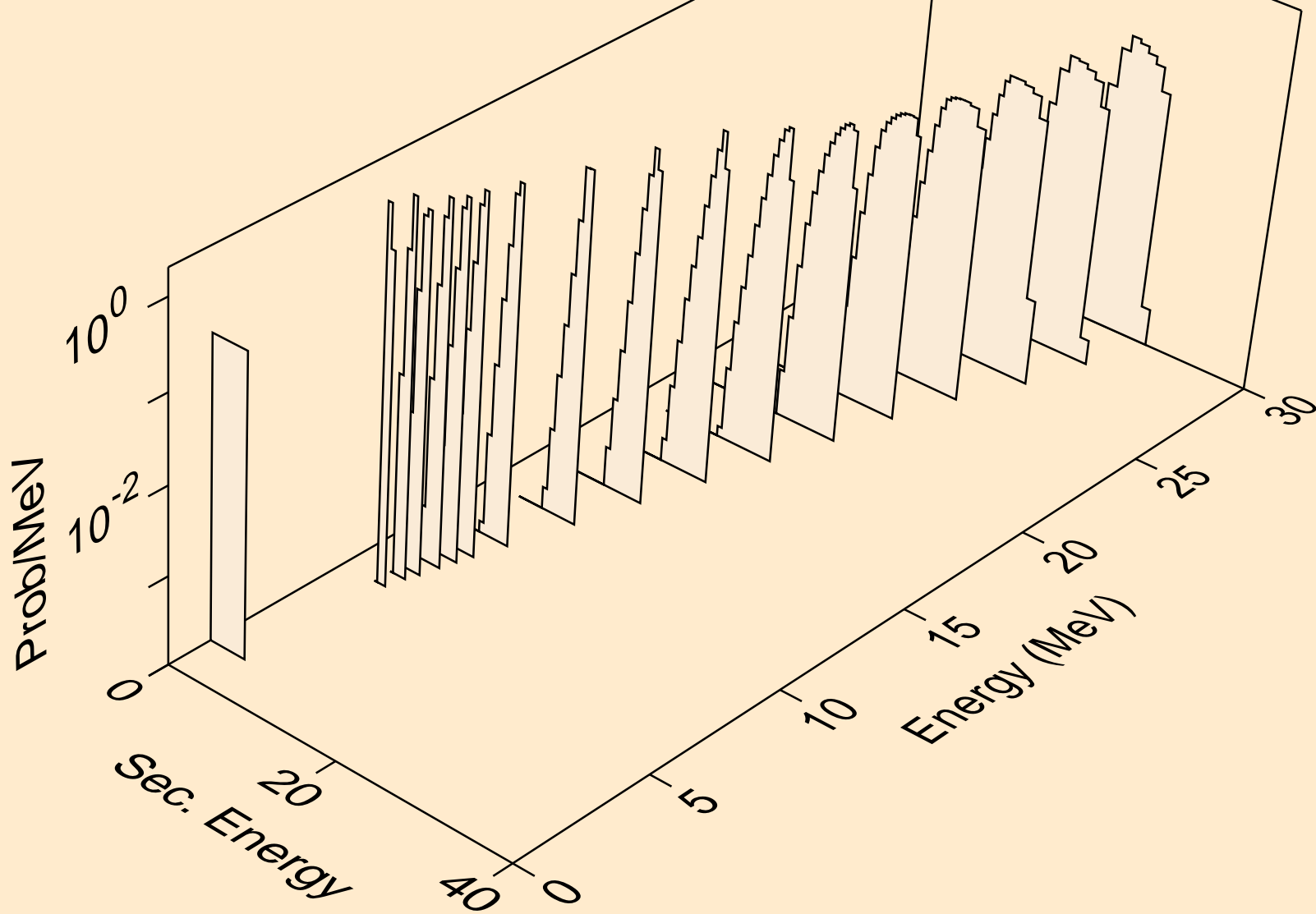

PR150 NEUTRON ACER TENDL-2023 LIBRARY; T=0.K
alphas from (n,2n)a

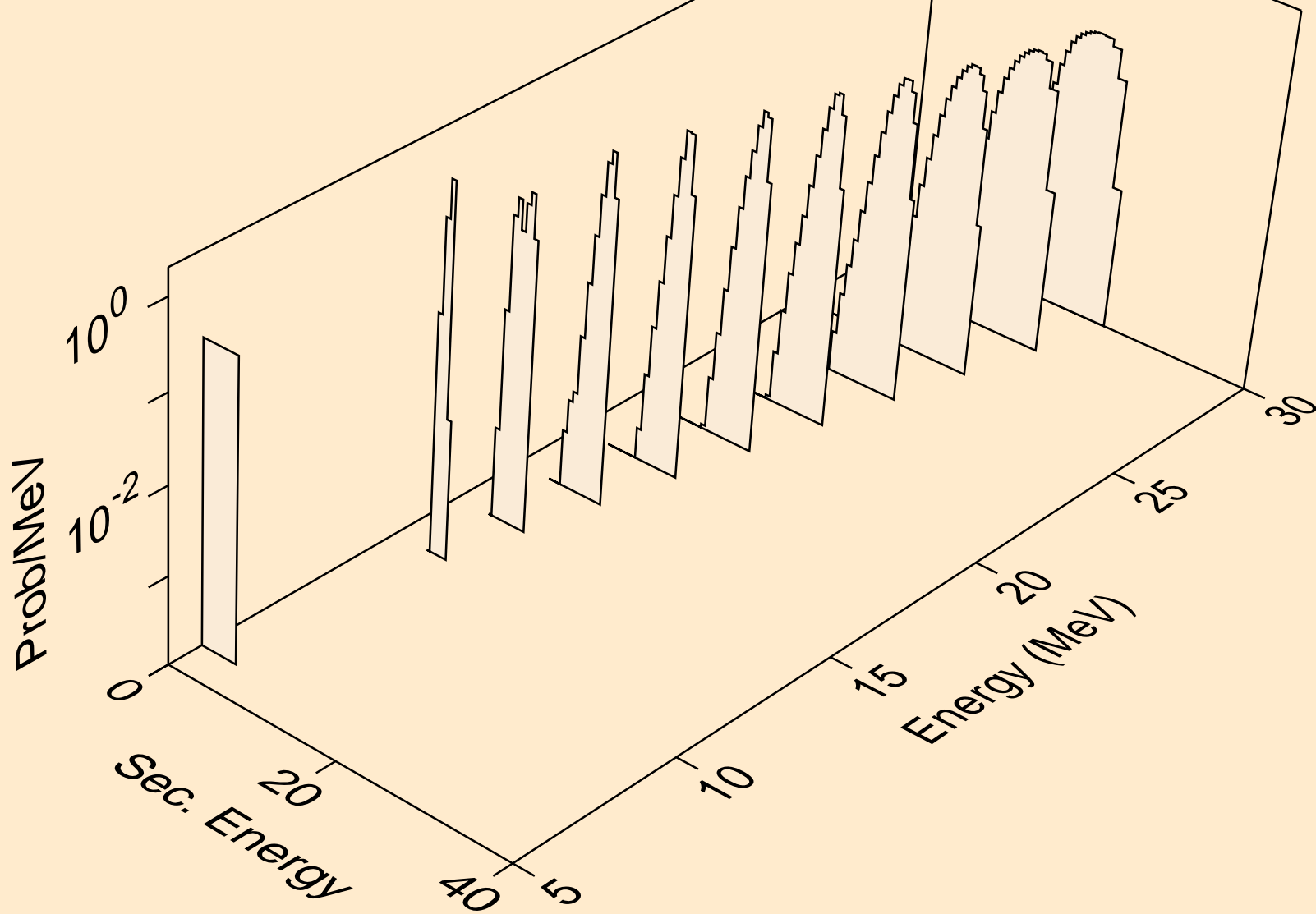

PR150 NEUTRON ACER TENDL-2023 LIBRARY; T=0.K
alphas from (n,3n)a

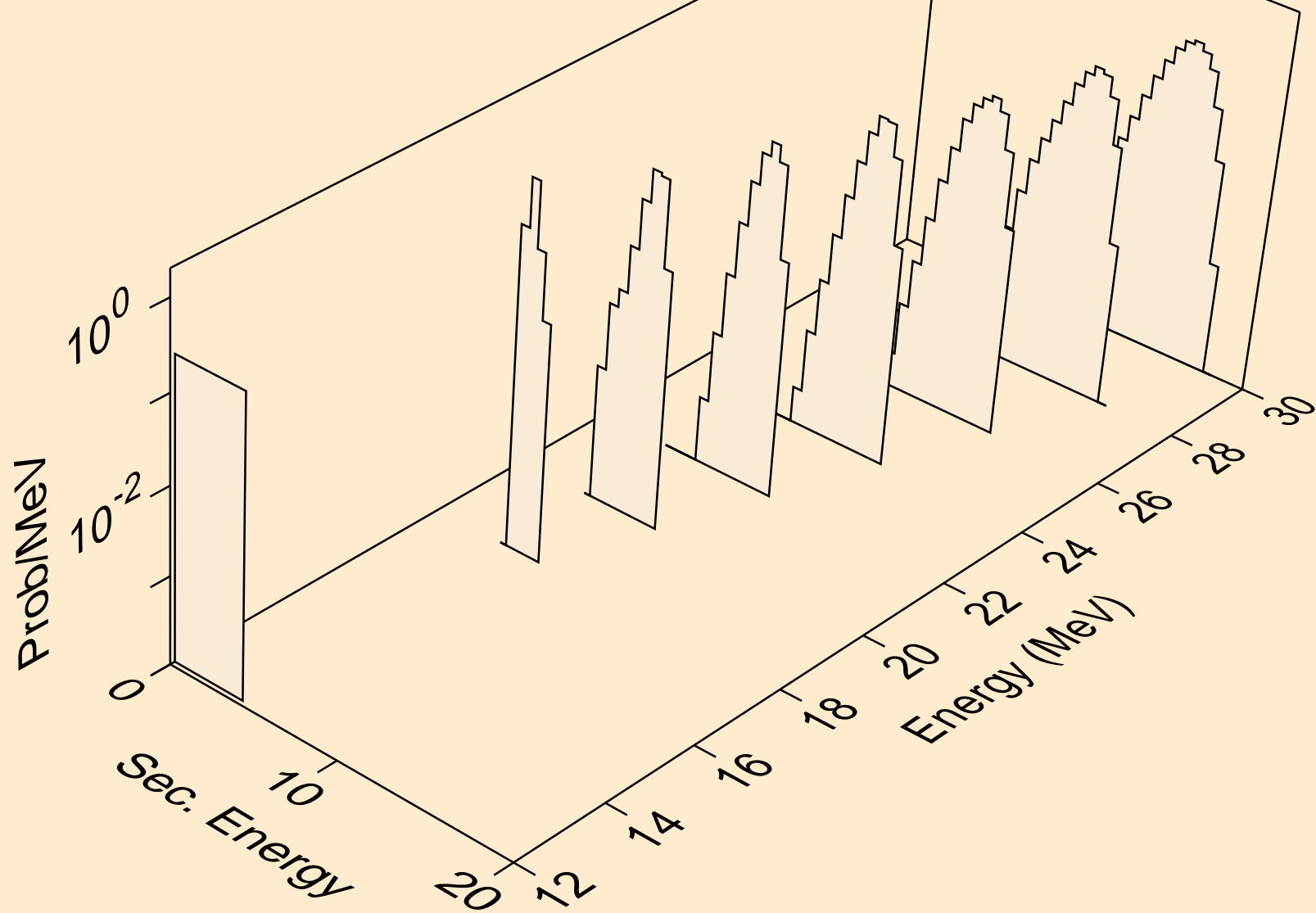

PR150 NEUTRON ACER TENDL-2023 LIBRARY; T=0.K
alphas from (n,a)

