

# PT193 NEUTRON ACER TENDL-2023 LIBRARY; T=0.K

## Principal cross sections

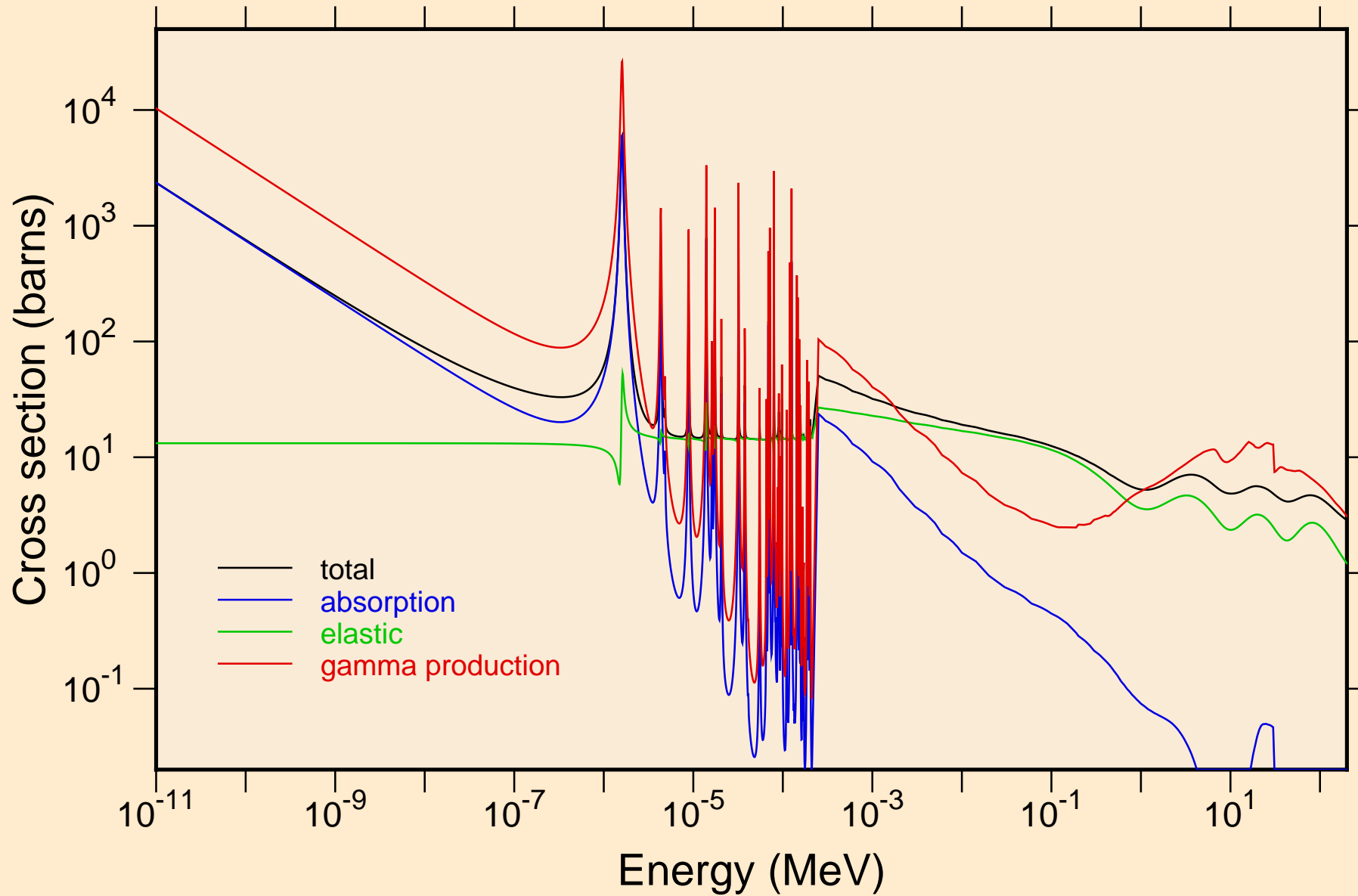

PT193 NEUTRON ACER TENDL-2023 LIBRARY; T=0.K  
resonance total cross section

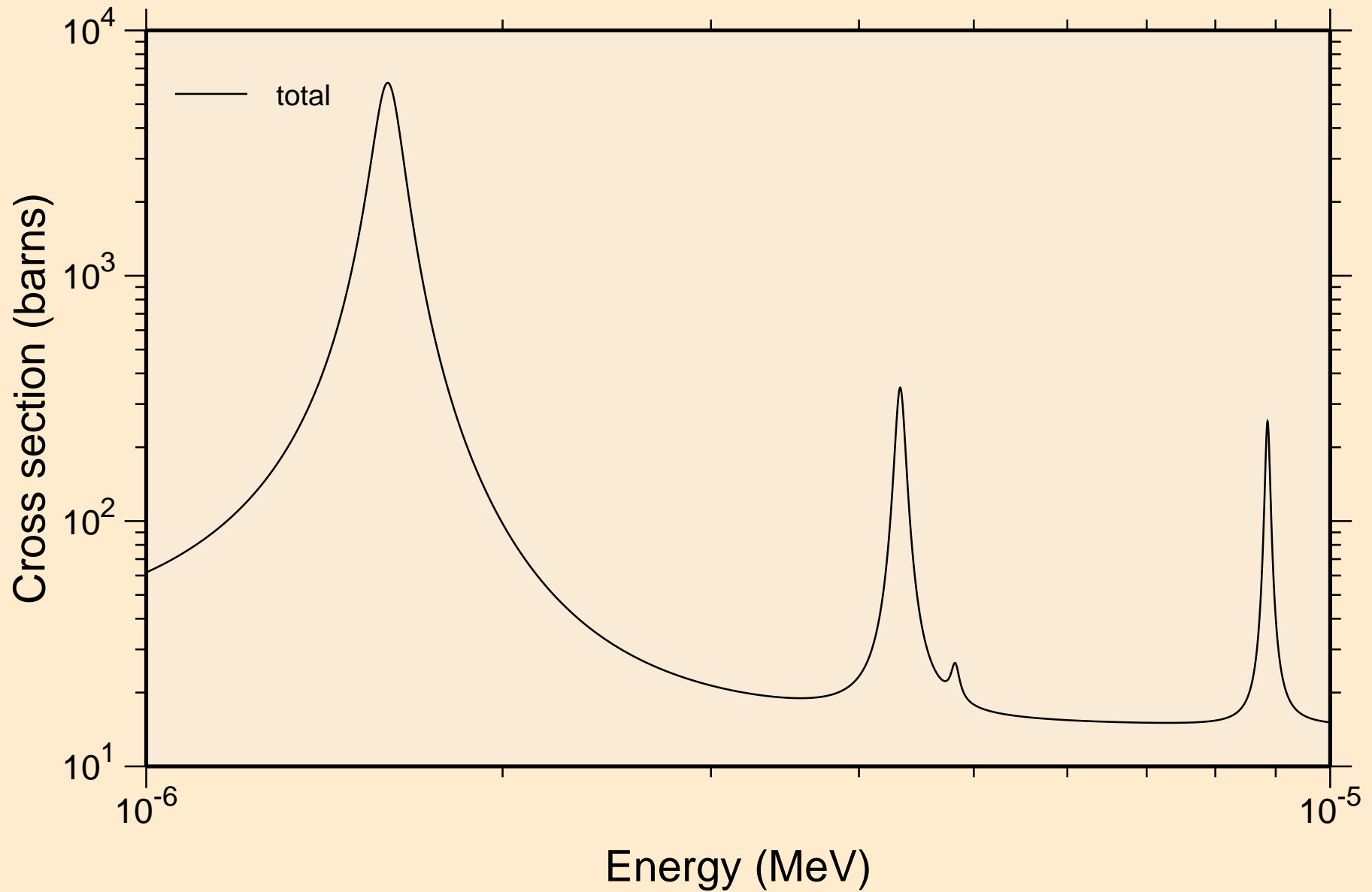

PT193 NEUTRON ACER TENDL-2023 LIBRARY; T=0.K  
resonance total cross section

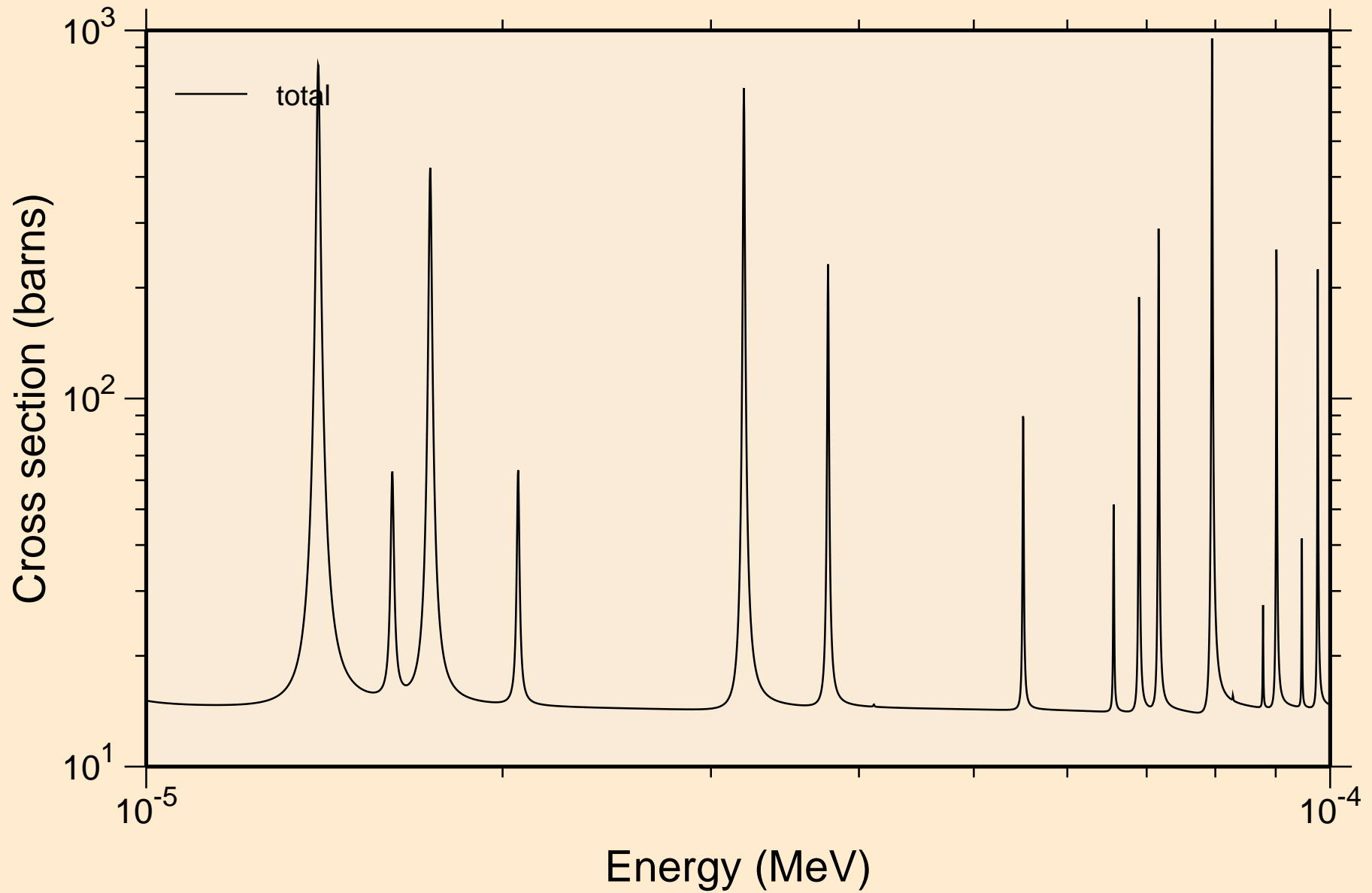

PT193 NEUTRON ACER TENDL-2023 LIBRARY; T=0.K  
resonance total cross section

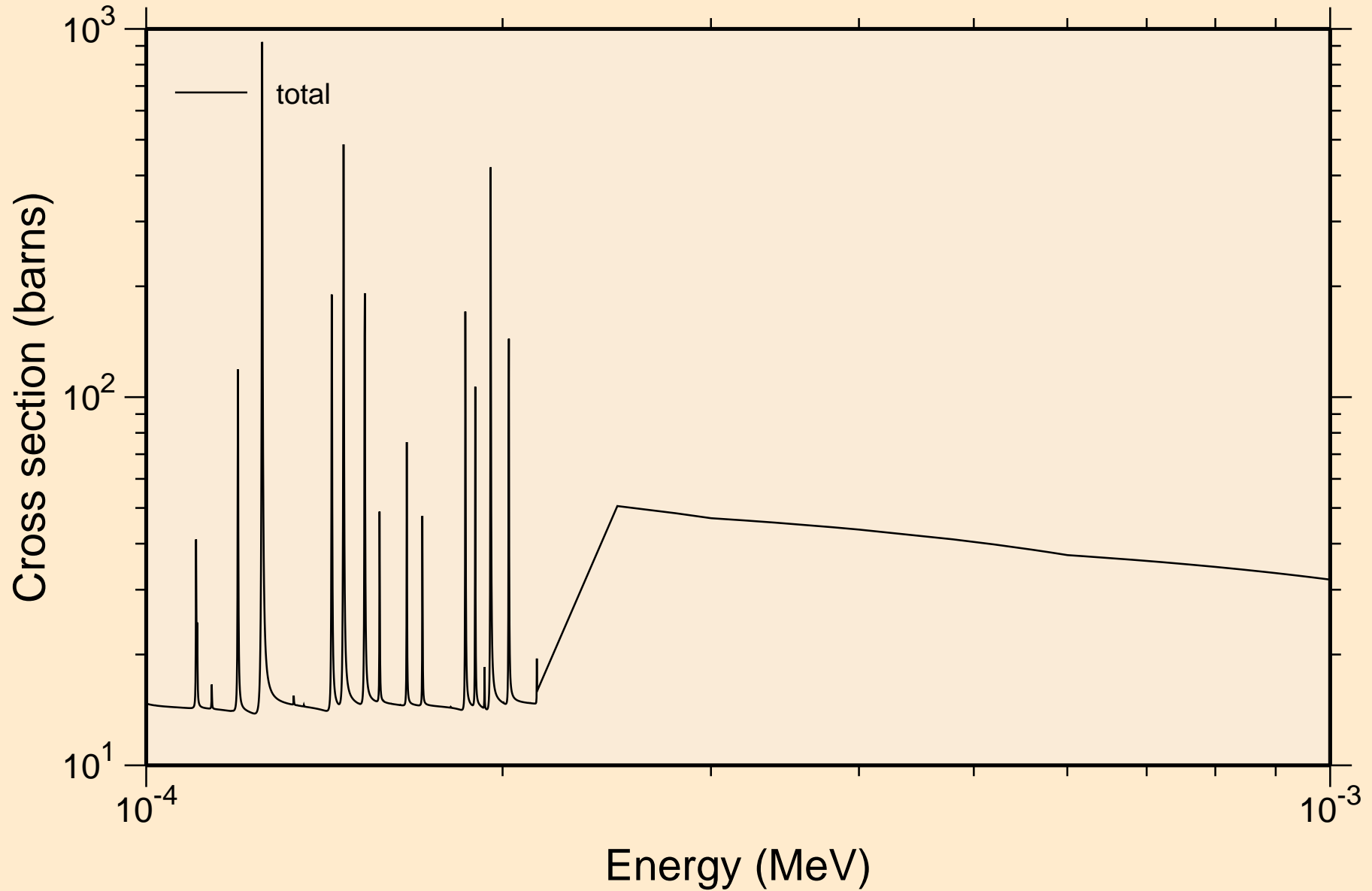

PT193 NEUTRON ACER TENDL-2023 LIBRARY; T=0.K  
resonance total cross section

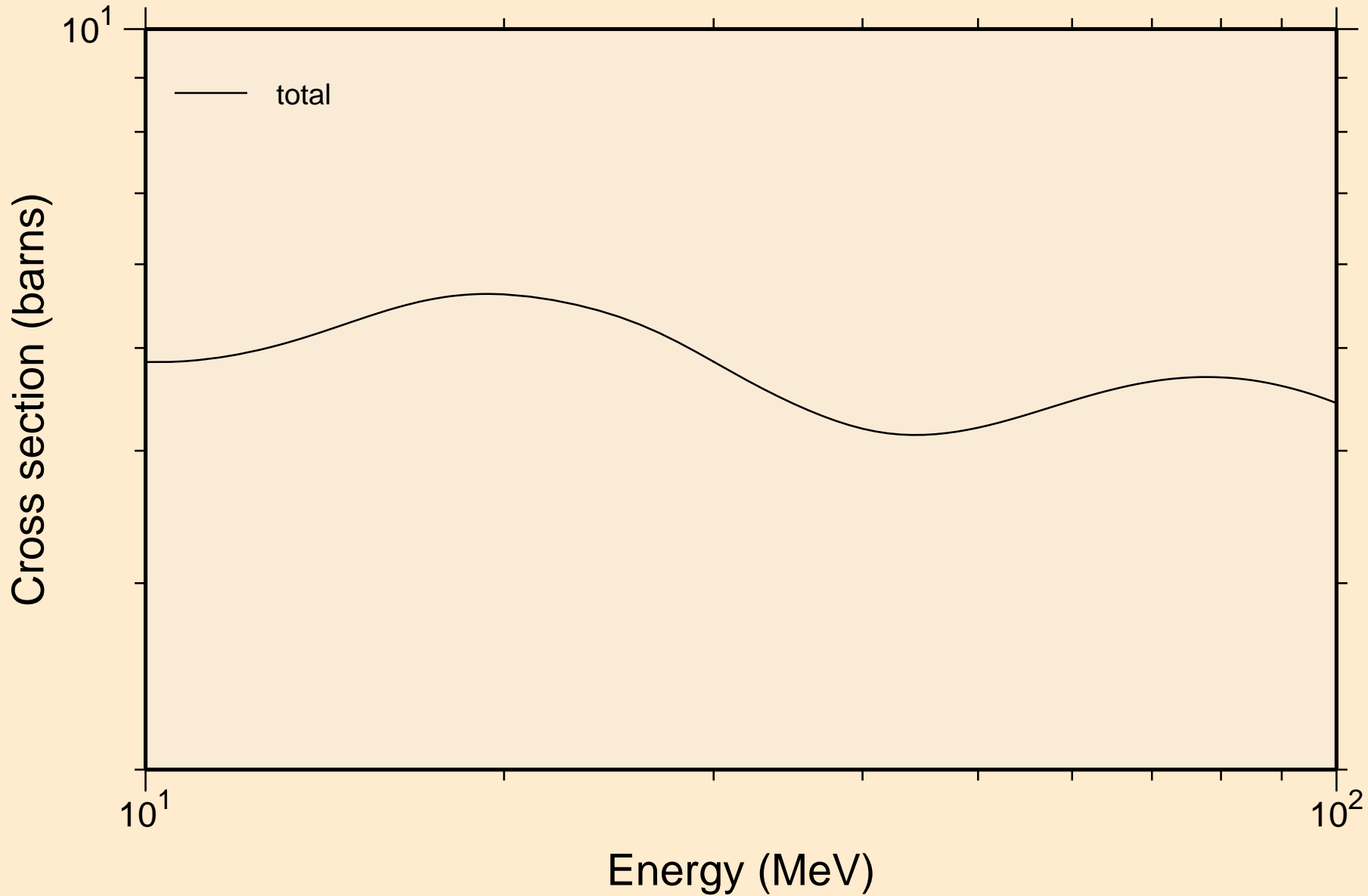

PT193 NEUTRON ACER TENDL-2023 LIBRARY; T=0.K  
resonance absorption cross sections

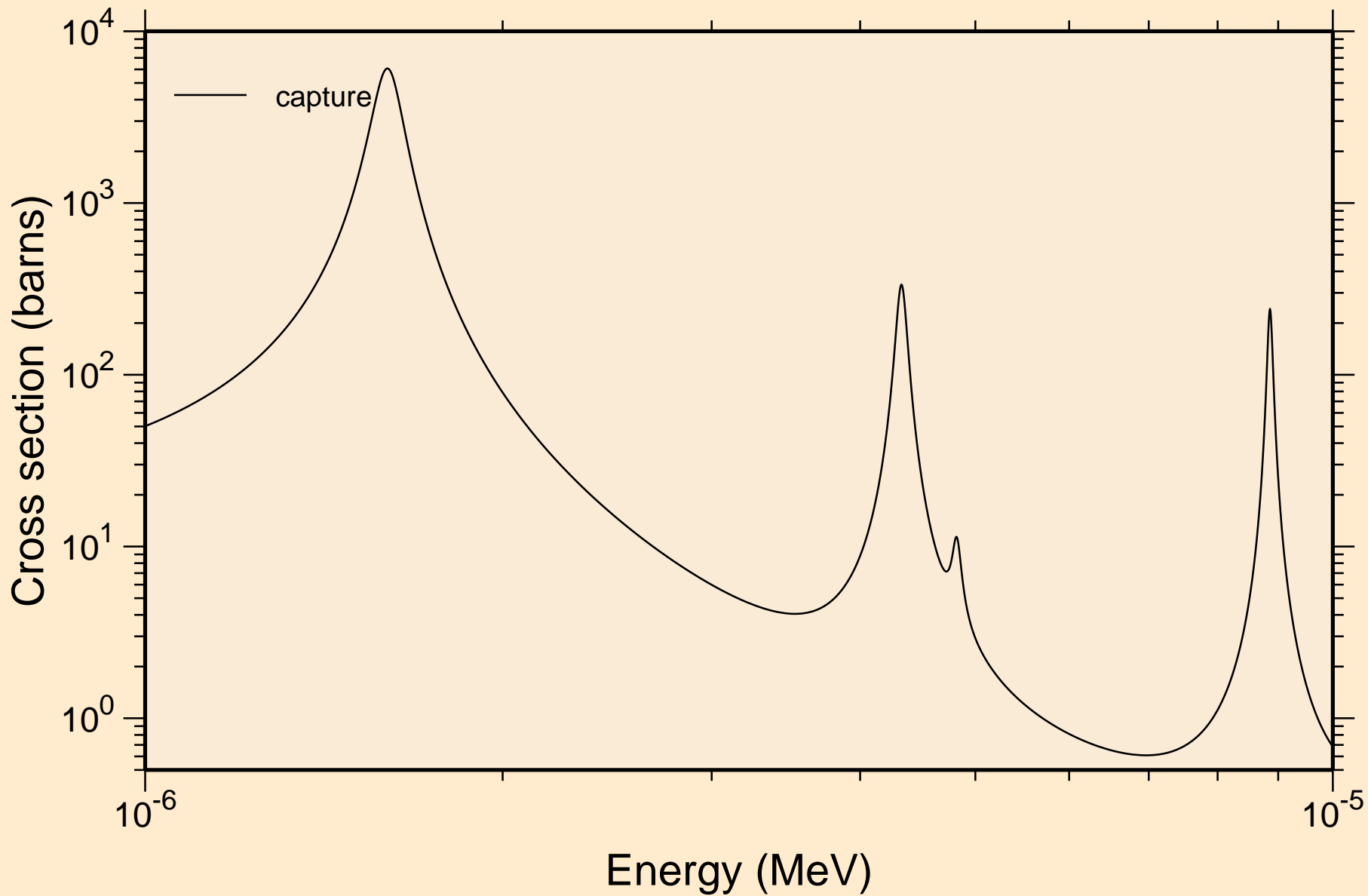

PT193 NEUTRON ACER TENDL-2023 LIBRARY; T=0.K  
resonance absorption cross sections

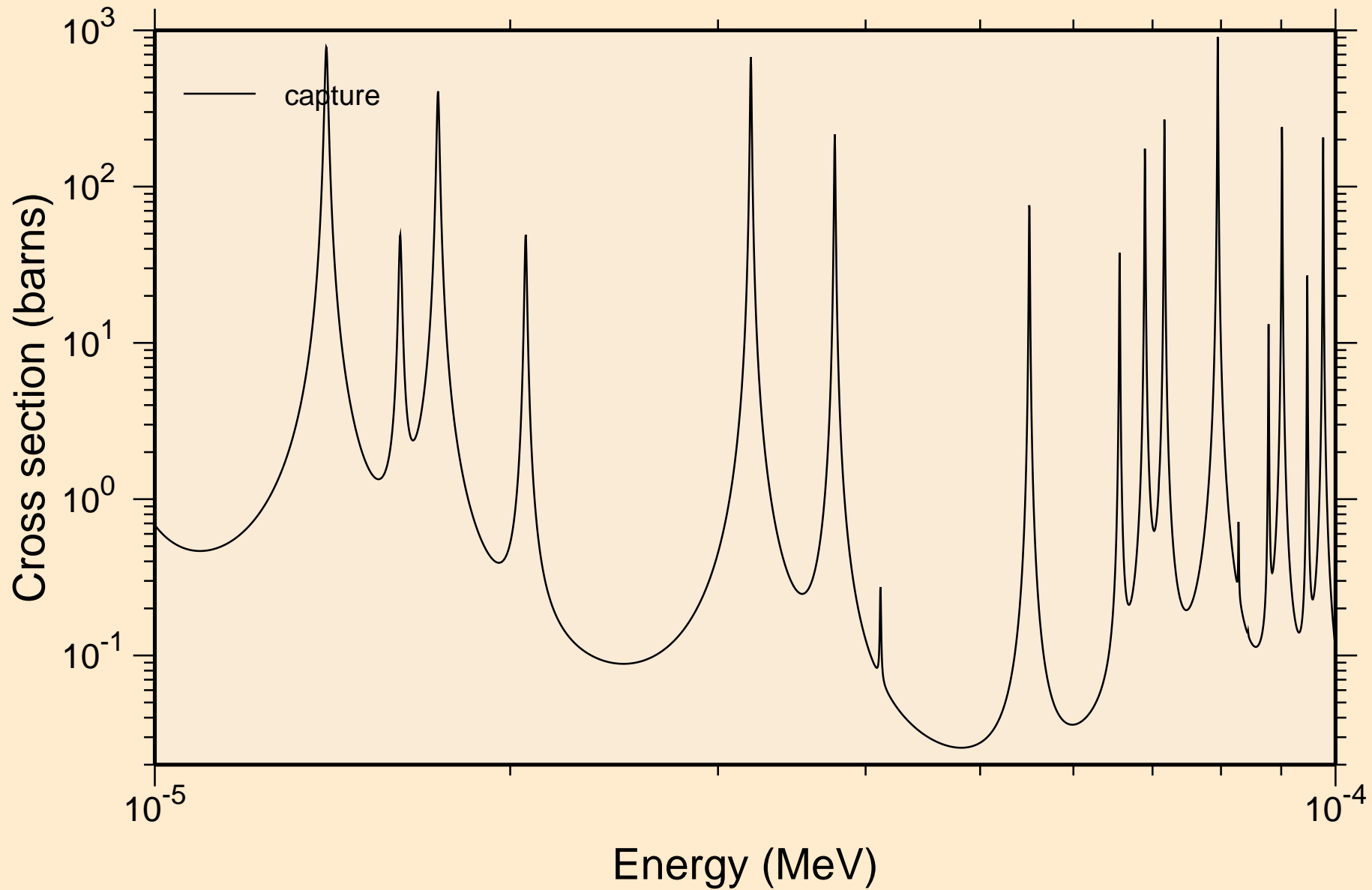

PT193 NEUTRON ACER TENDL-2023 LIBRARY; T=0.K  
resonance absorption cross sections

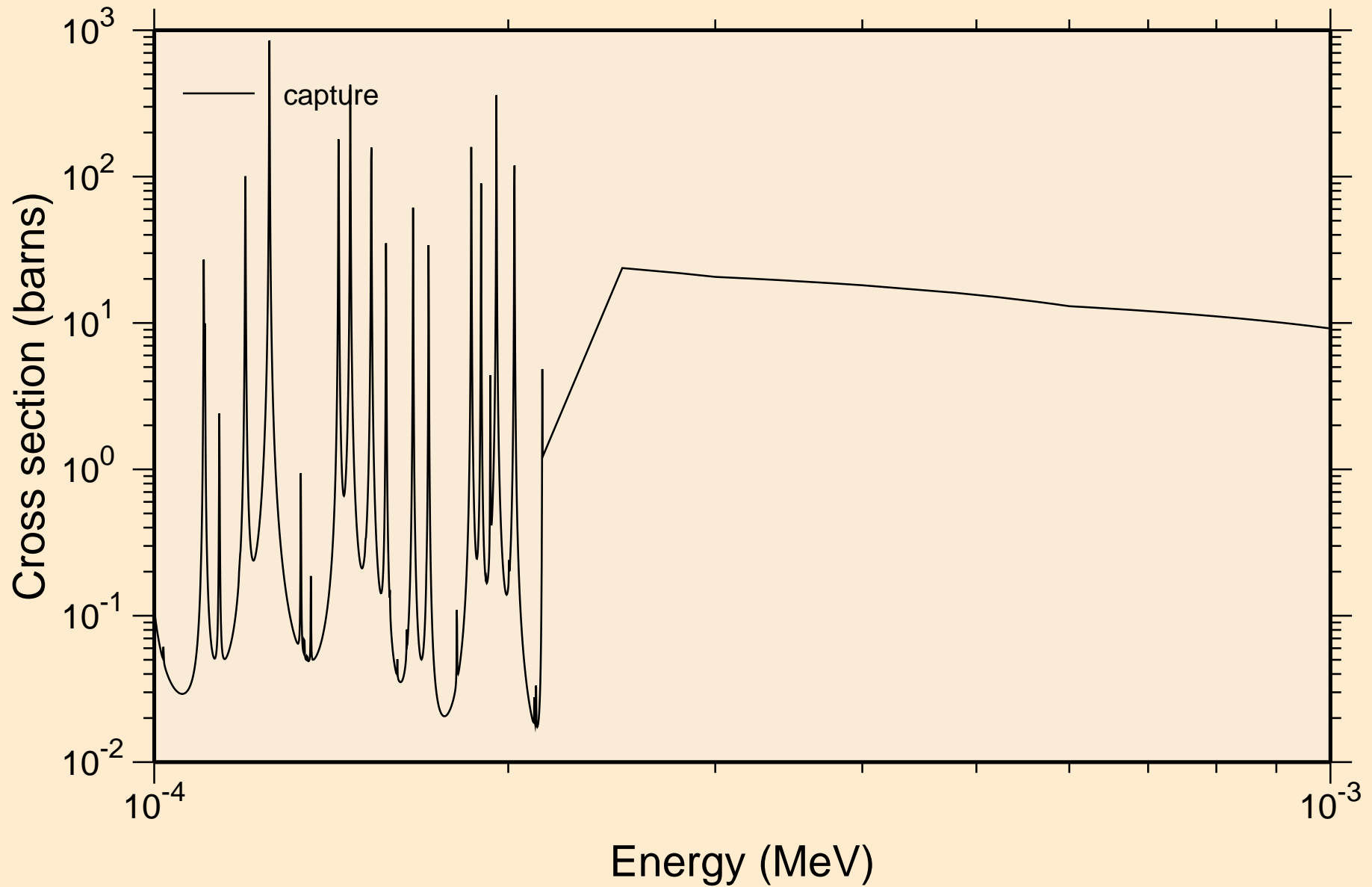



PT193 NEUTRON ACER TENDL-2023 LIBRARY; T=0.K  
resonance absorption cross sections

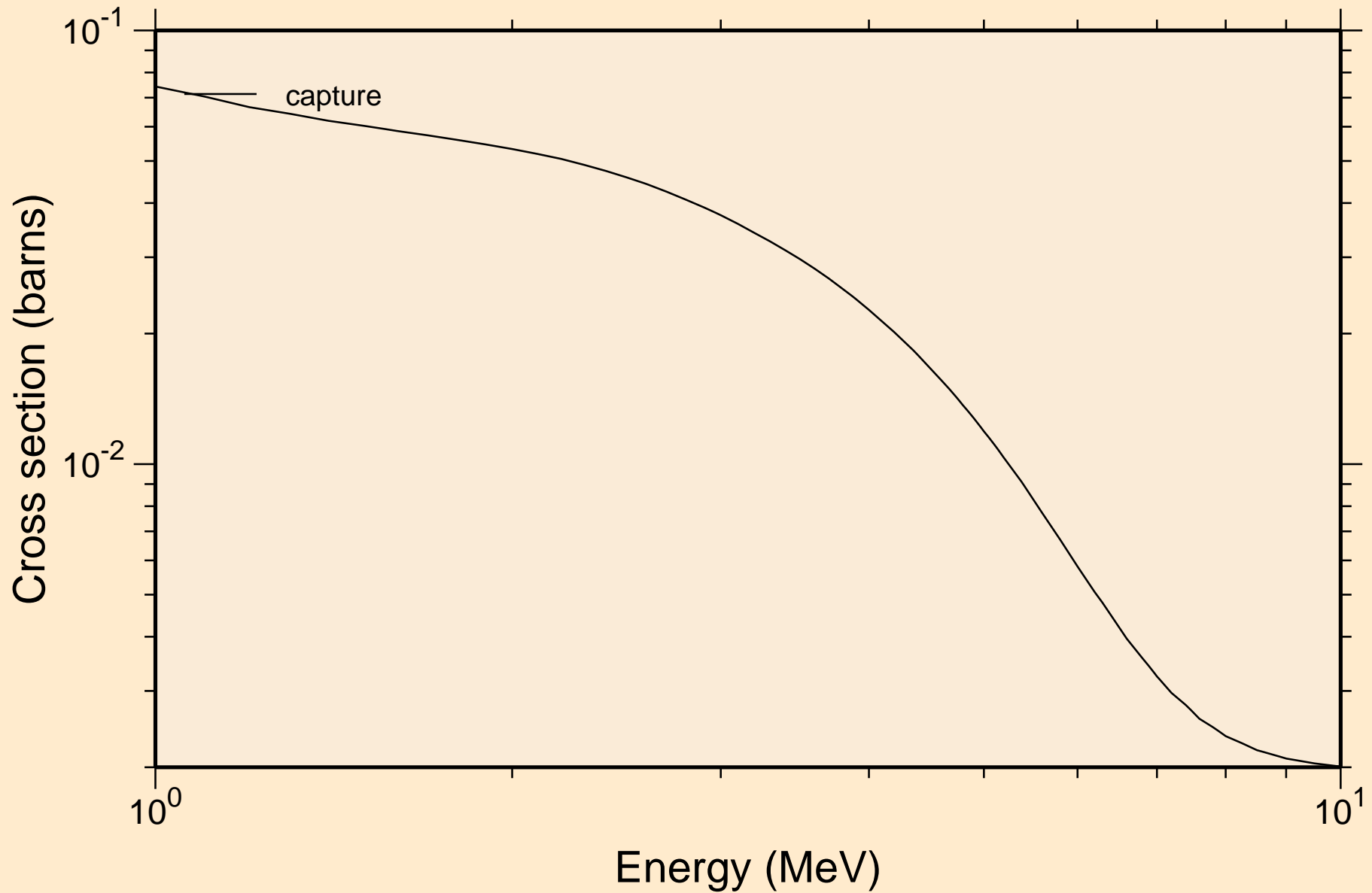

PT193 NEUTRON ACER TENDL-2023 LIBRARY; T=0.K  
Heating

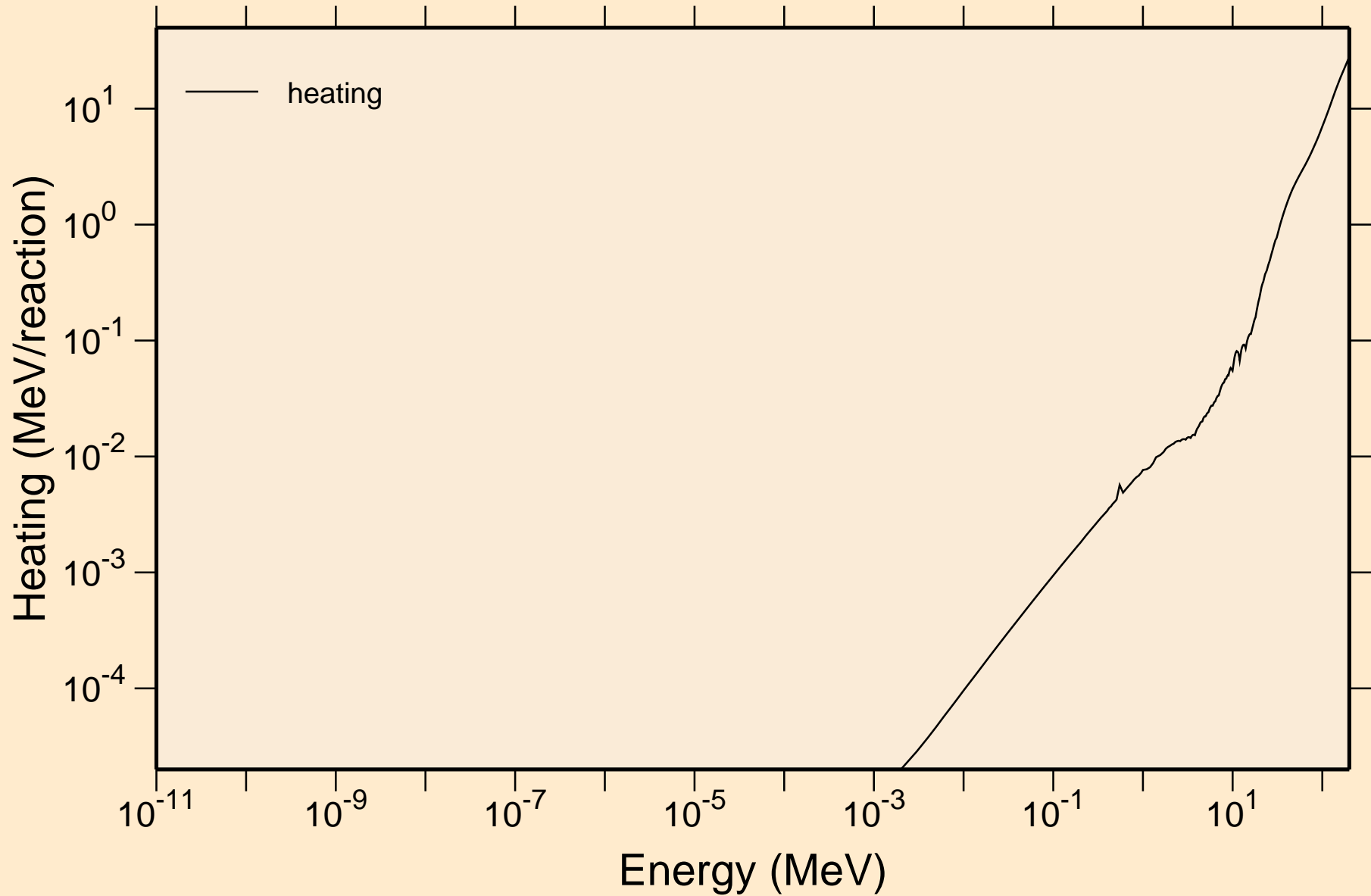

PT193 NEUTRON ACER TENDL-2023 LIBRARY; T=0.K  
Damage

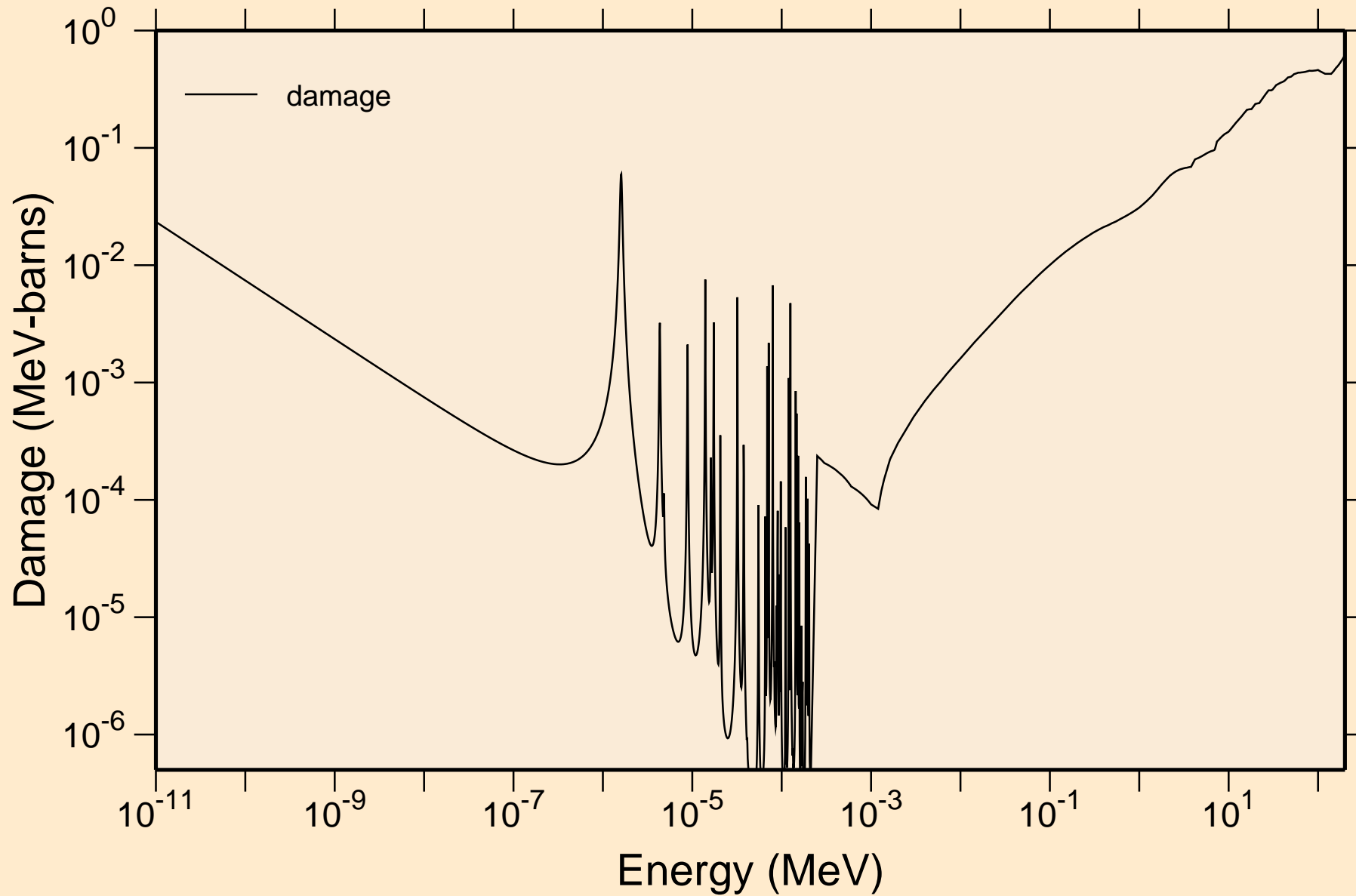

PT193 NEUTRON ACER TENDL-2023 LIBRARY; T=0.K  
Non-threshold reactions

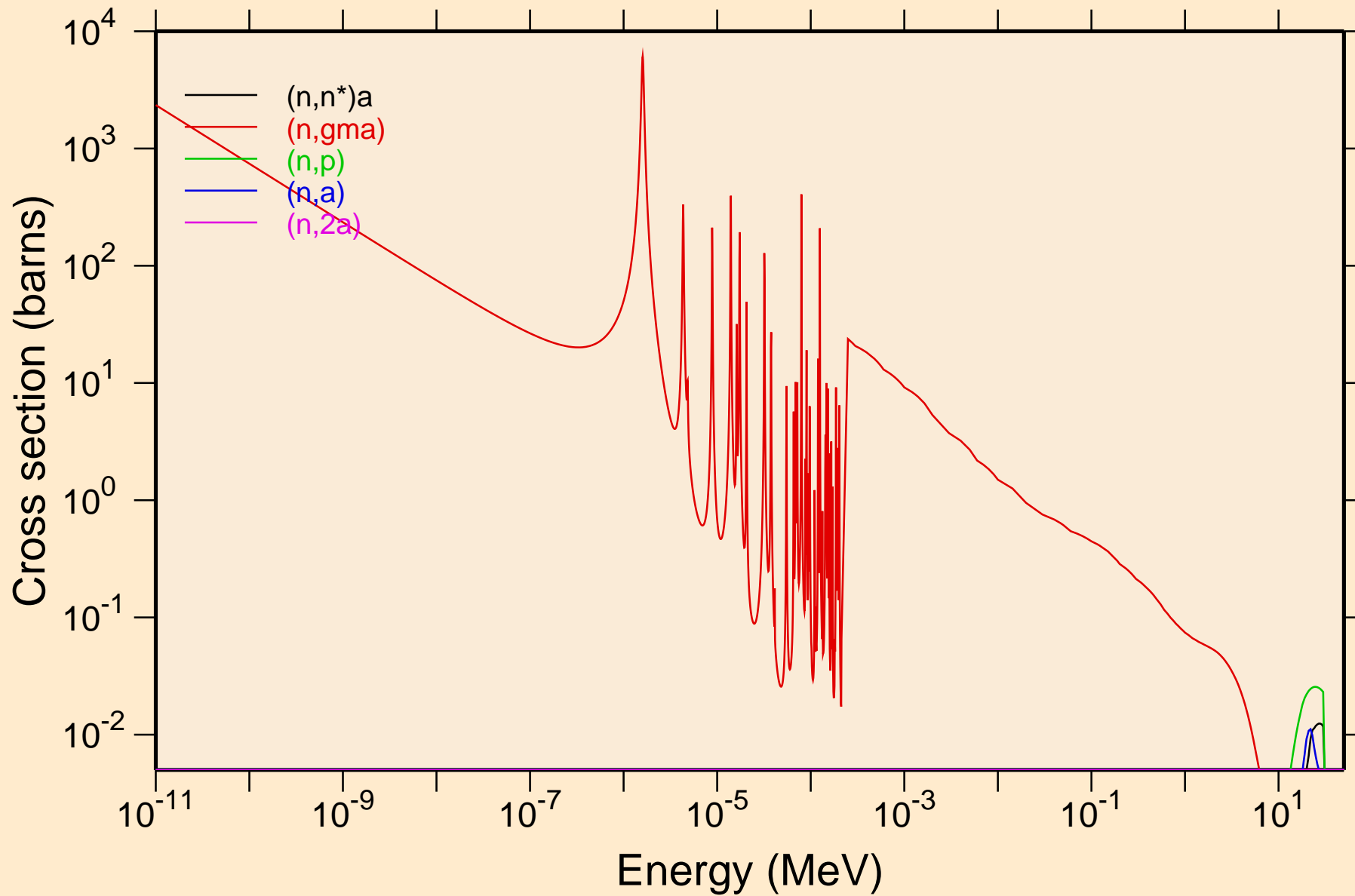

PT193 NEUTRON ACER TENDL-2023 LIBRARY; T=0.K  
Non-threshold reactions

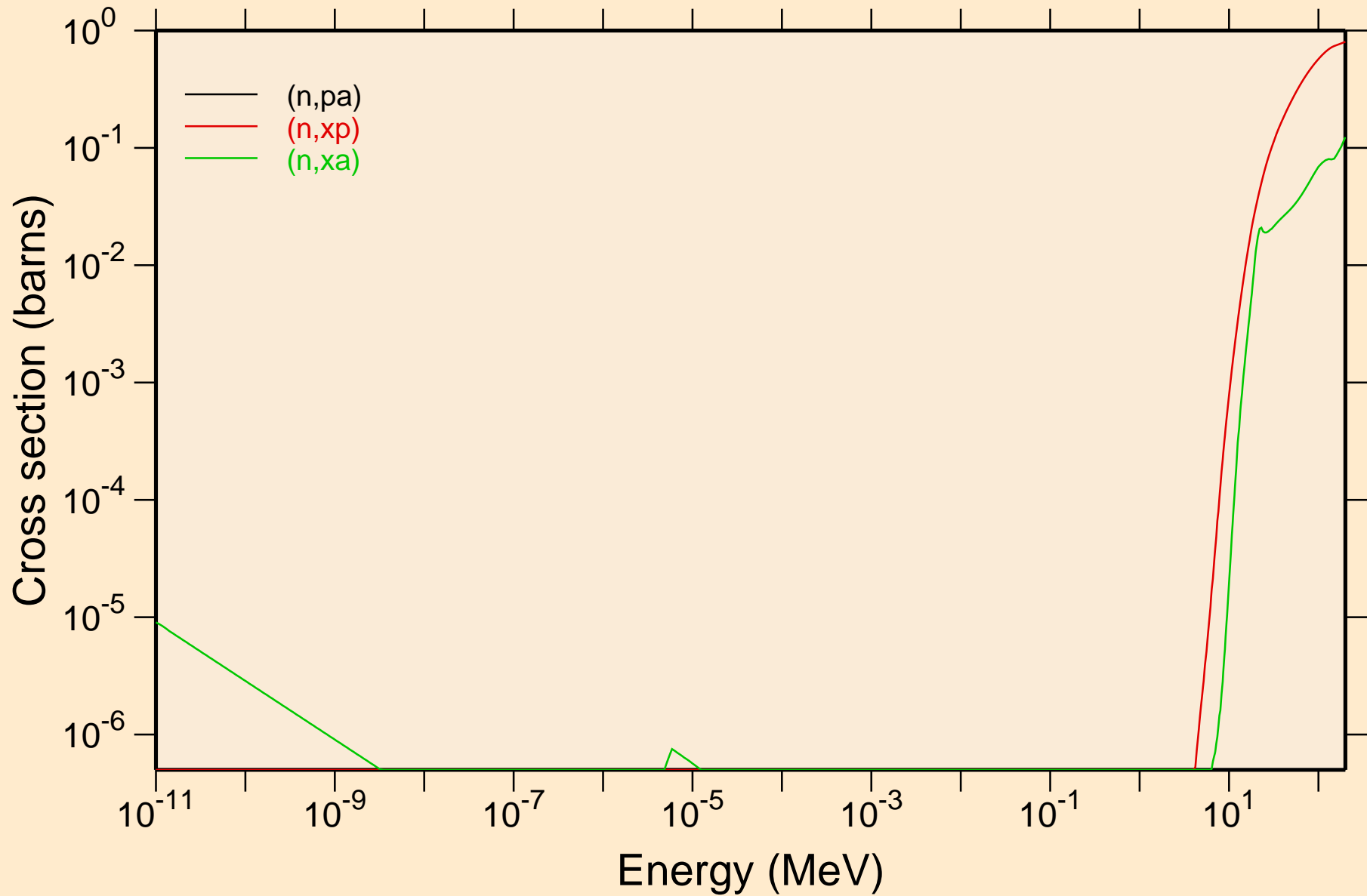

PT193 NEUTRON ACER TENDL-2023 LIBRARY; T=0.K  
Principal cross sections

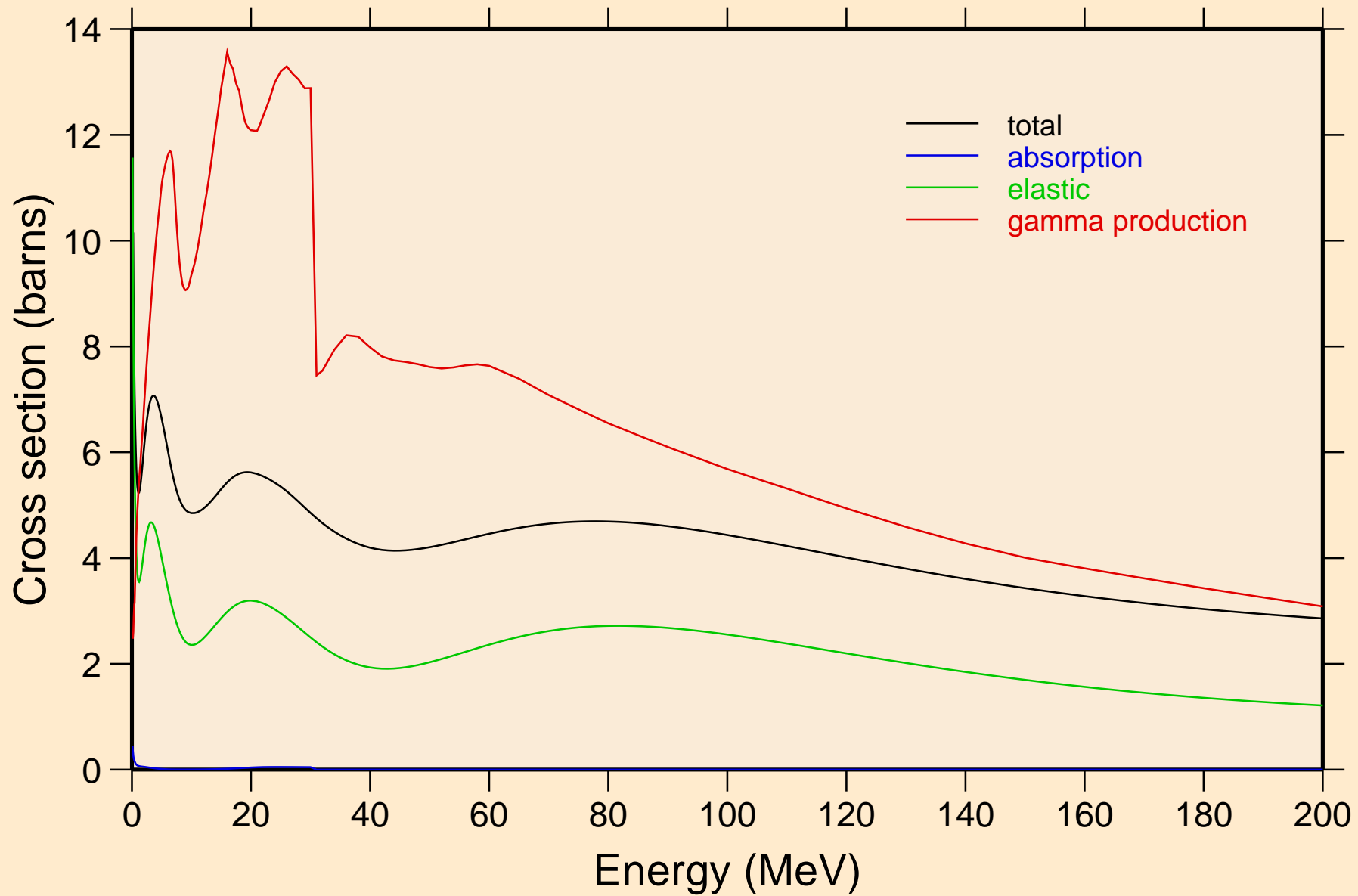

PT193 NEUTRON ACER TENDL-2023 LIBRARY; T=0.K

Heating

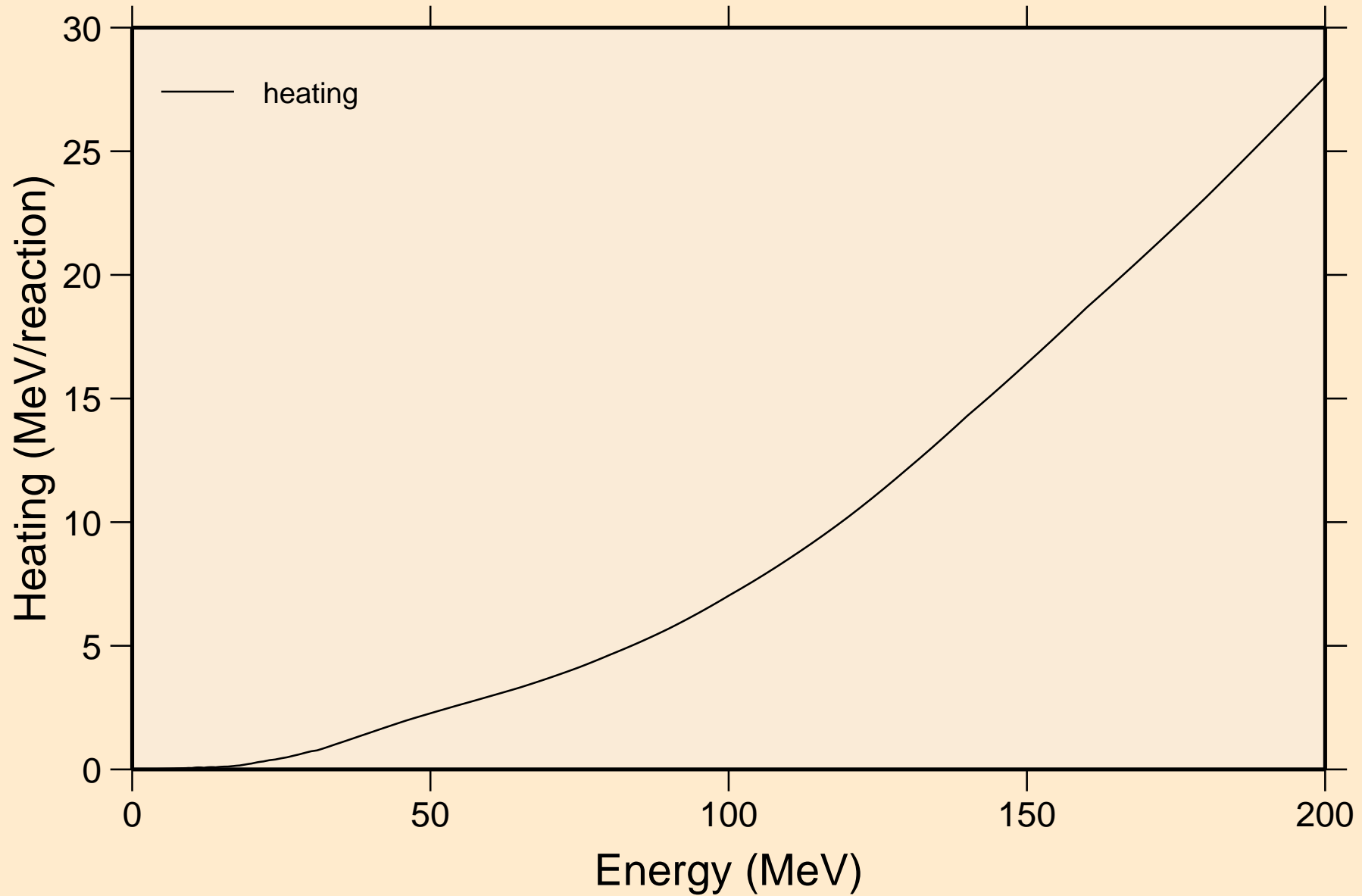

PT193 NEUTRON ACER TENDL-2023 LIBRARY; T=0.K  
Damage

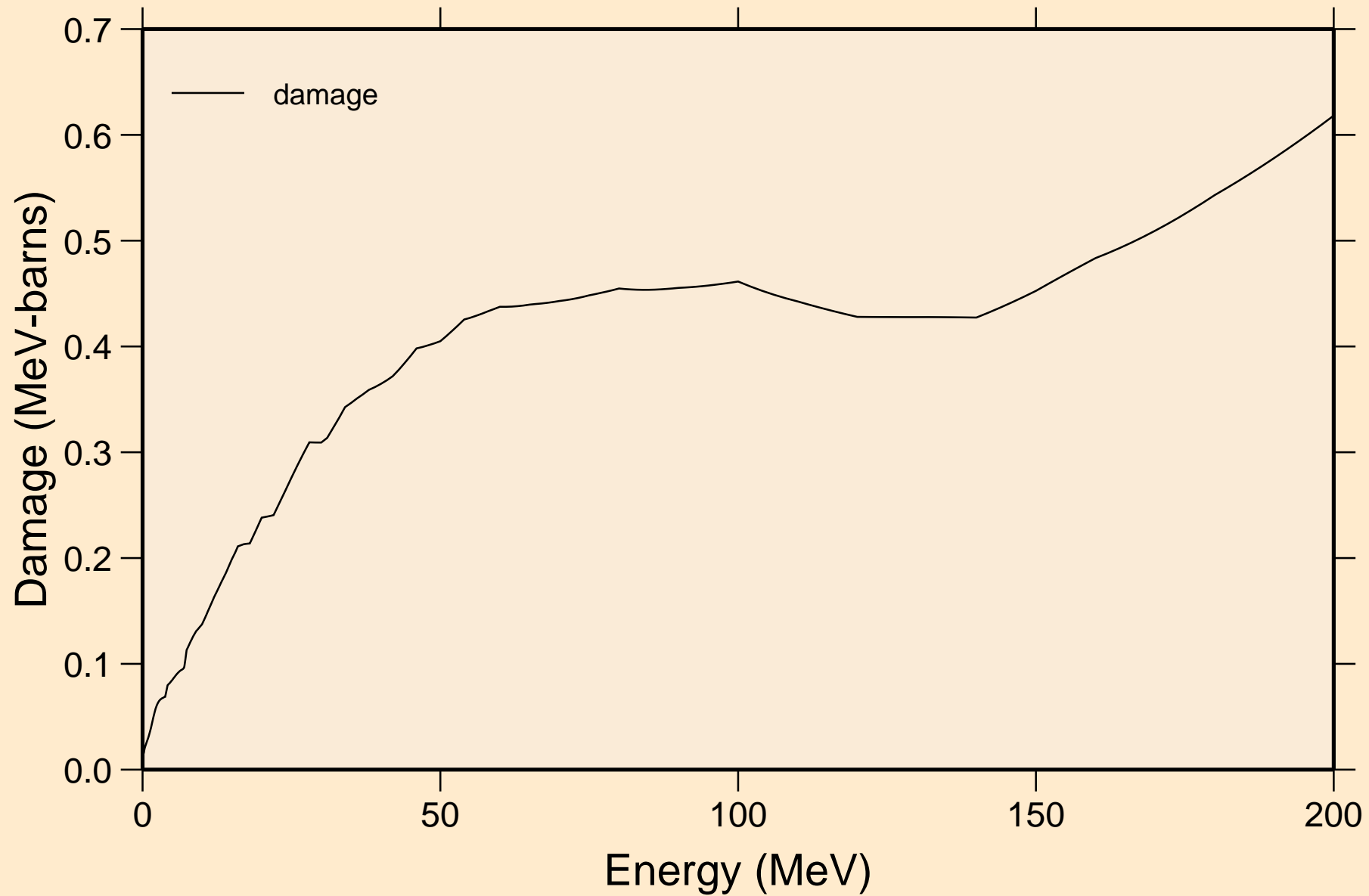



PT193 NEUTRON ACER TENDL-2023 LIBRARY; T=0.K  
Non-threshold reactions

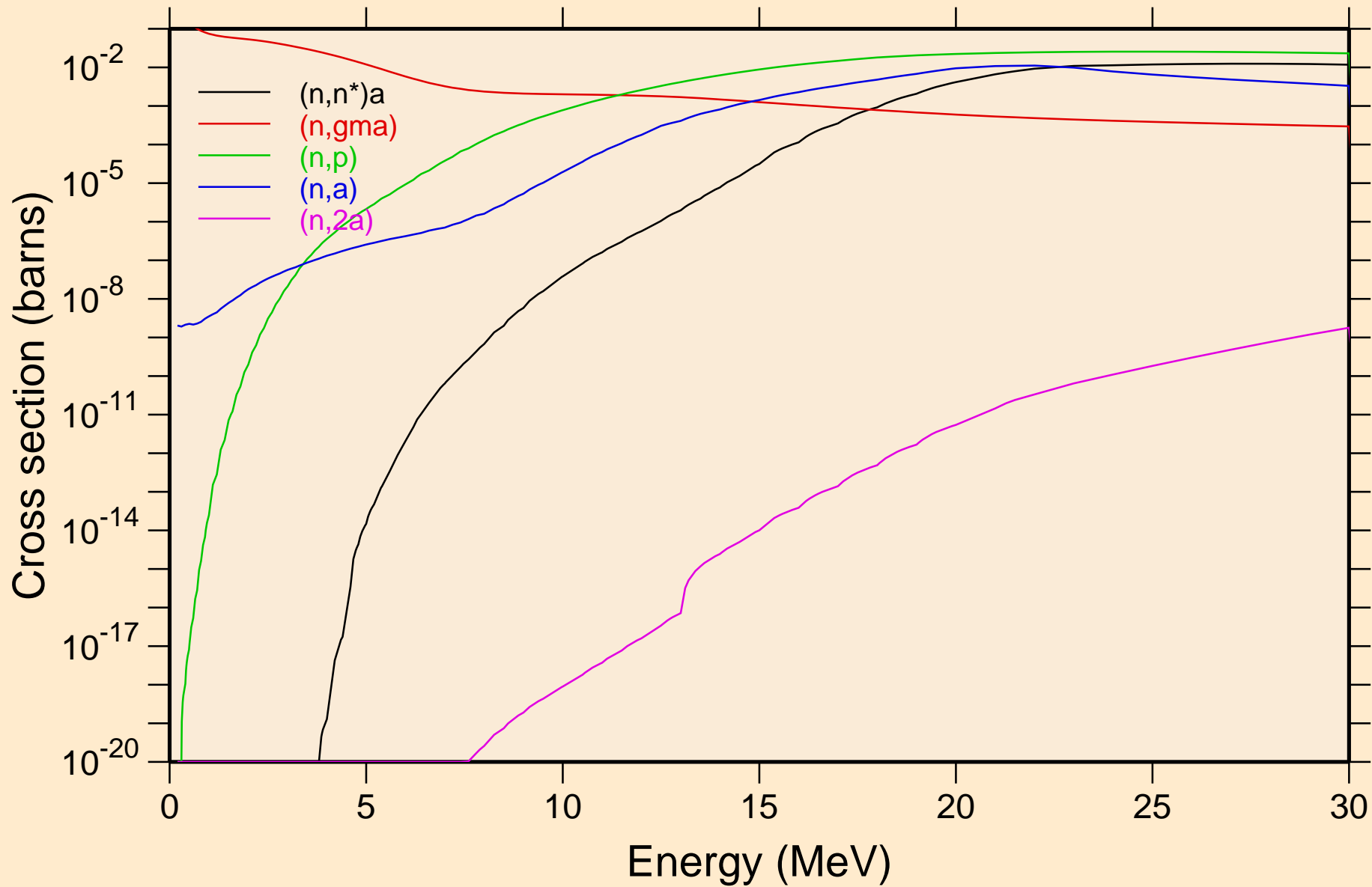

PT193 NEUTRON ACER TENDL-2023 LIBRARY; T=0.K  
Non-threshold reactions

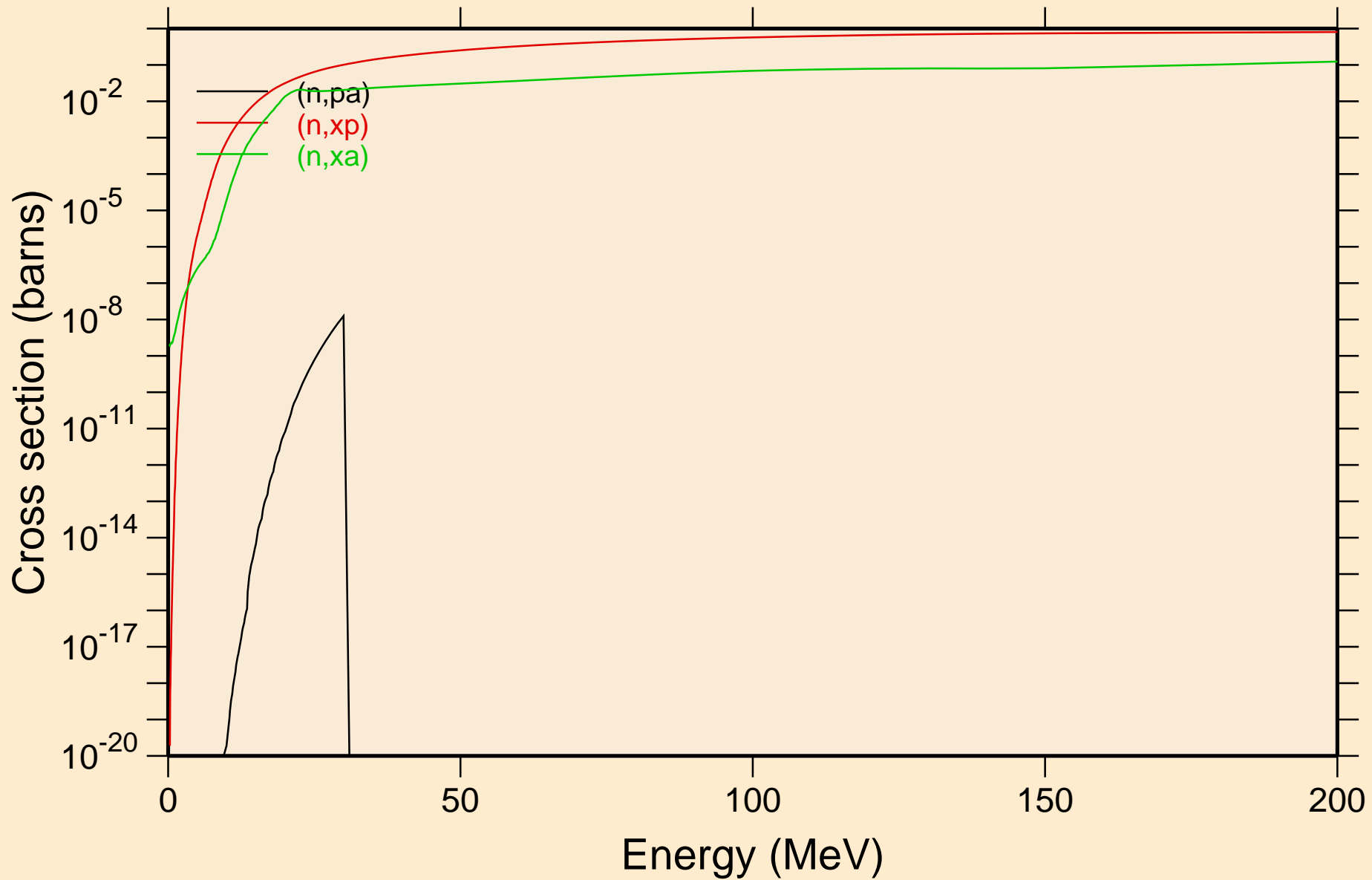

PT193 NEUTRON ACER TENDL-2023 LIBRARY; T=0.K  
Inelastic levels

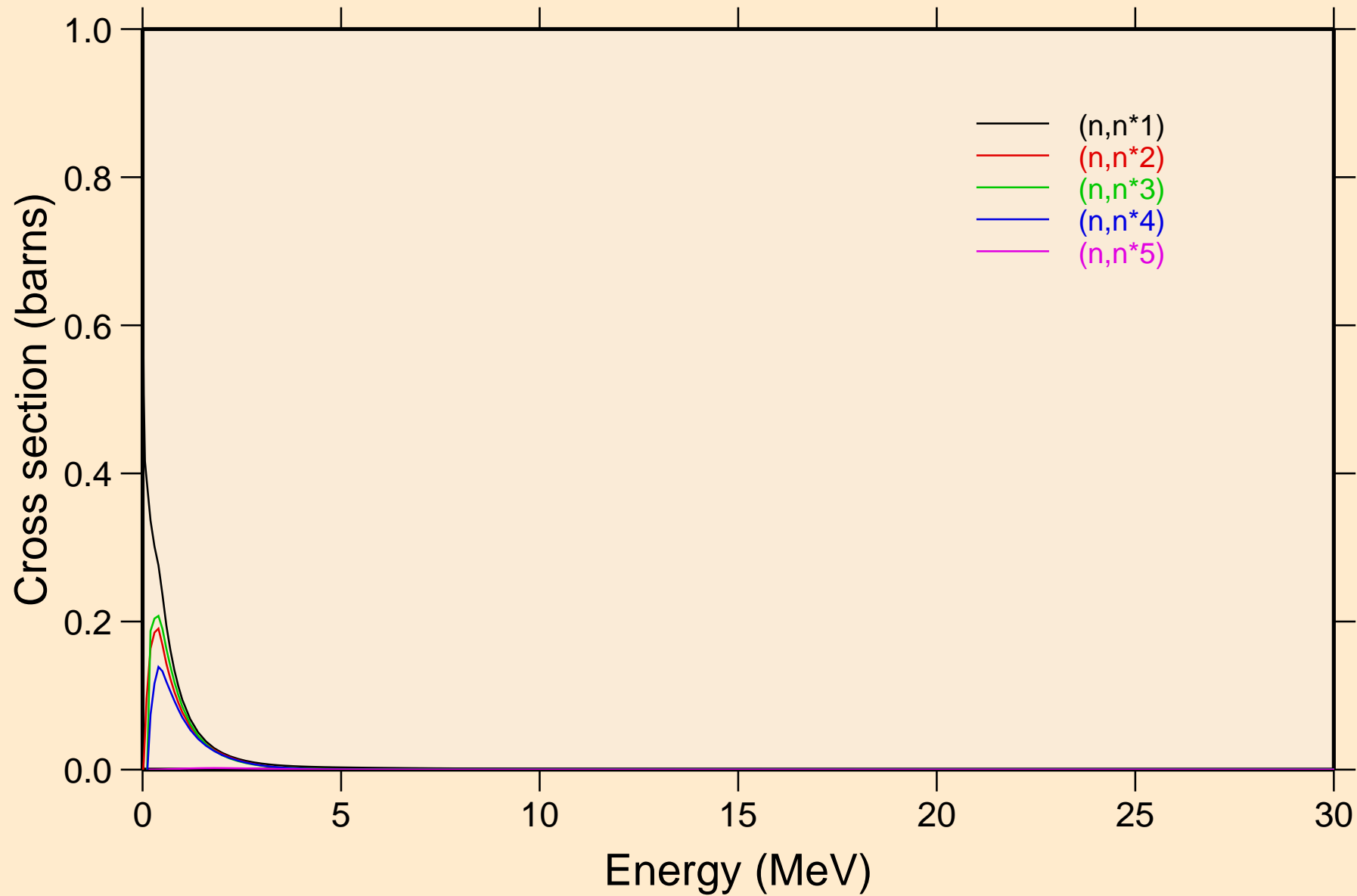

PT193 NEUTRON ACER TENDL-2023 LIBRARY; T=0.K  
Inelastic levels

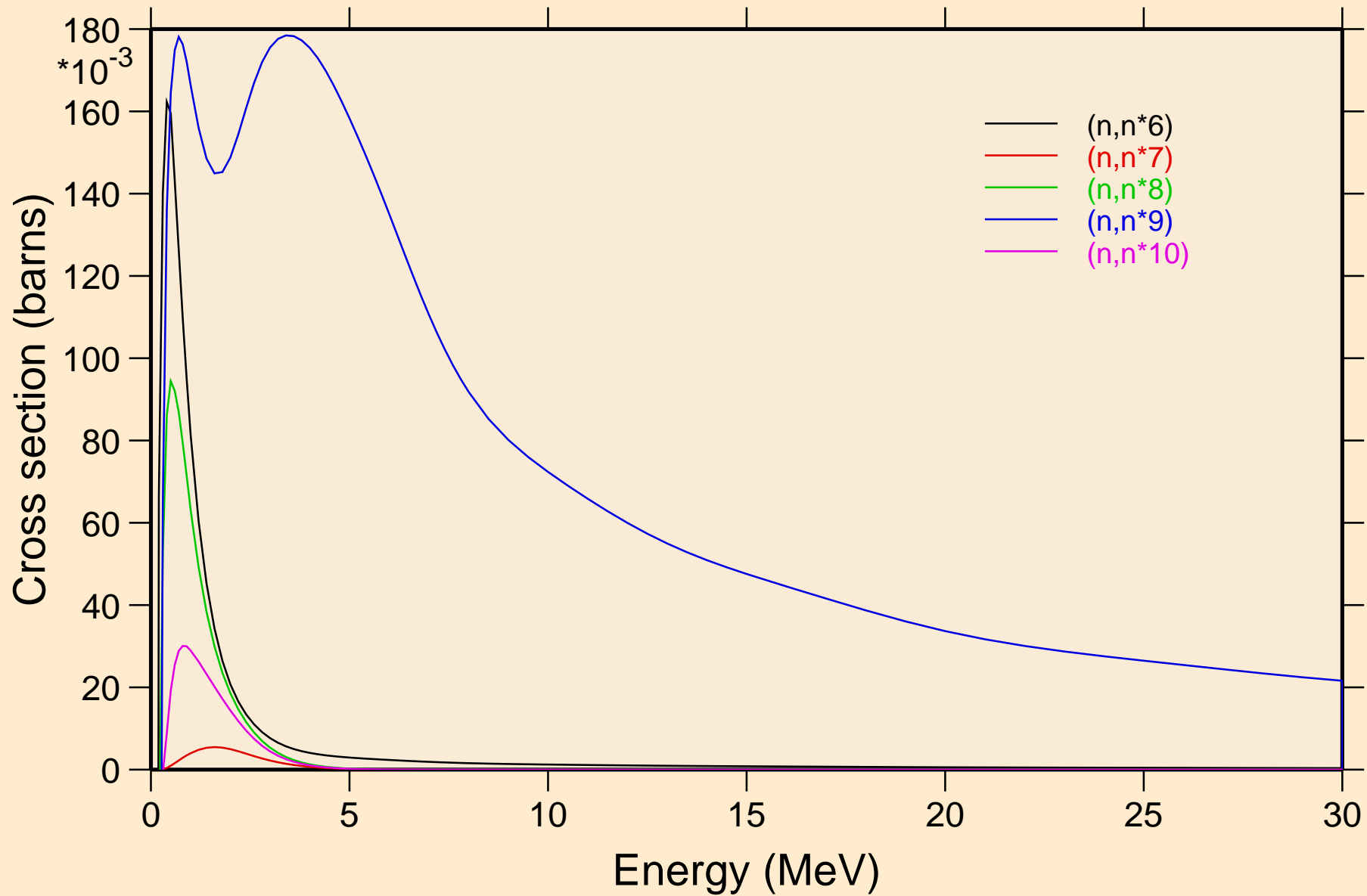

PT193 NEUTRON ACER TENDL-2023 LIBRARY; T=0.K  
Inelastic levels

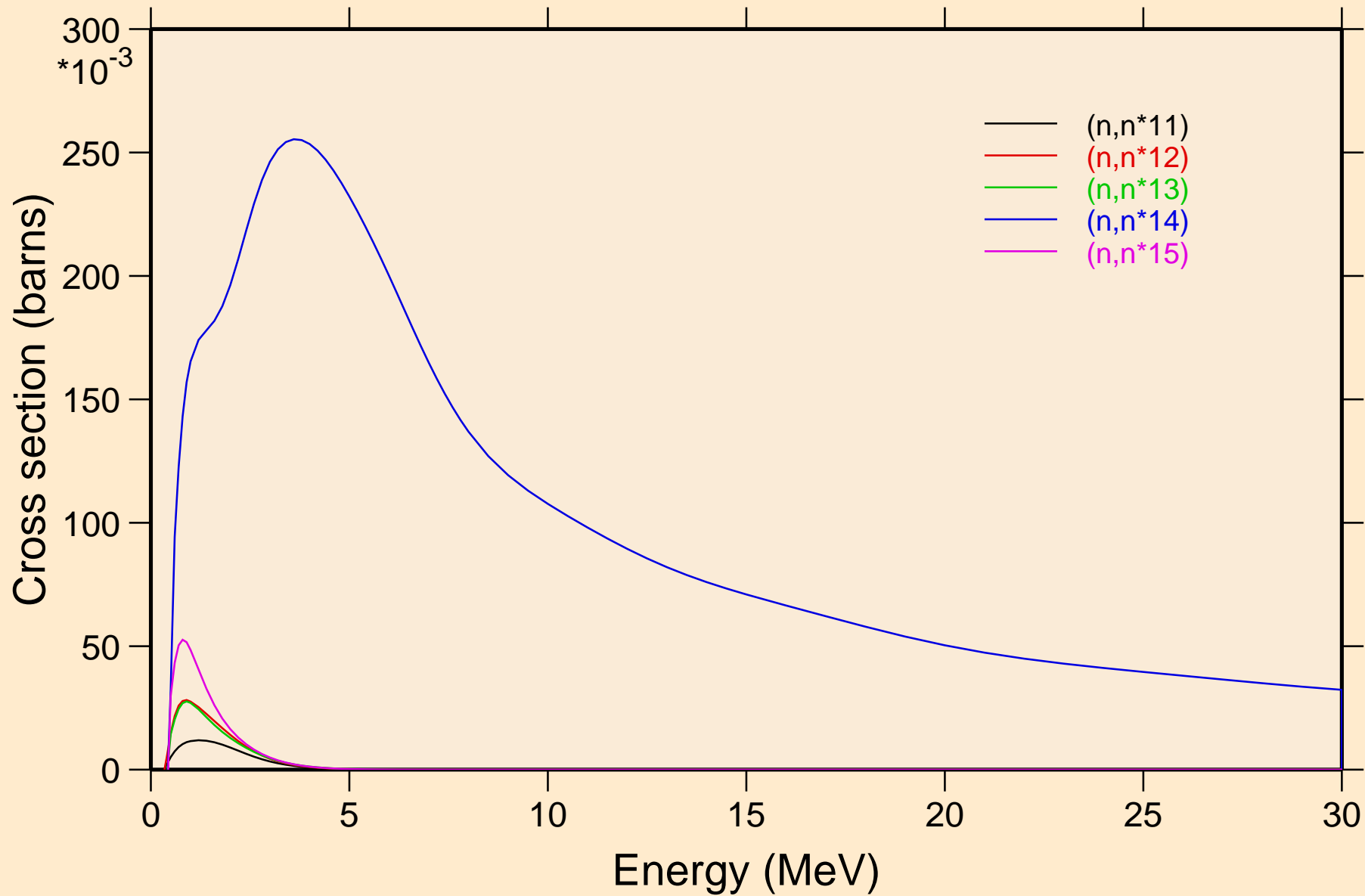

PT193 NEUTRON ACER TENDL-2023 LIBRARY; T=0.K  
Inelastic levels

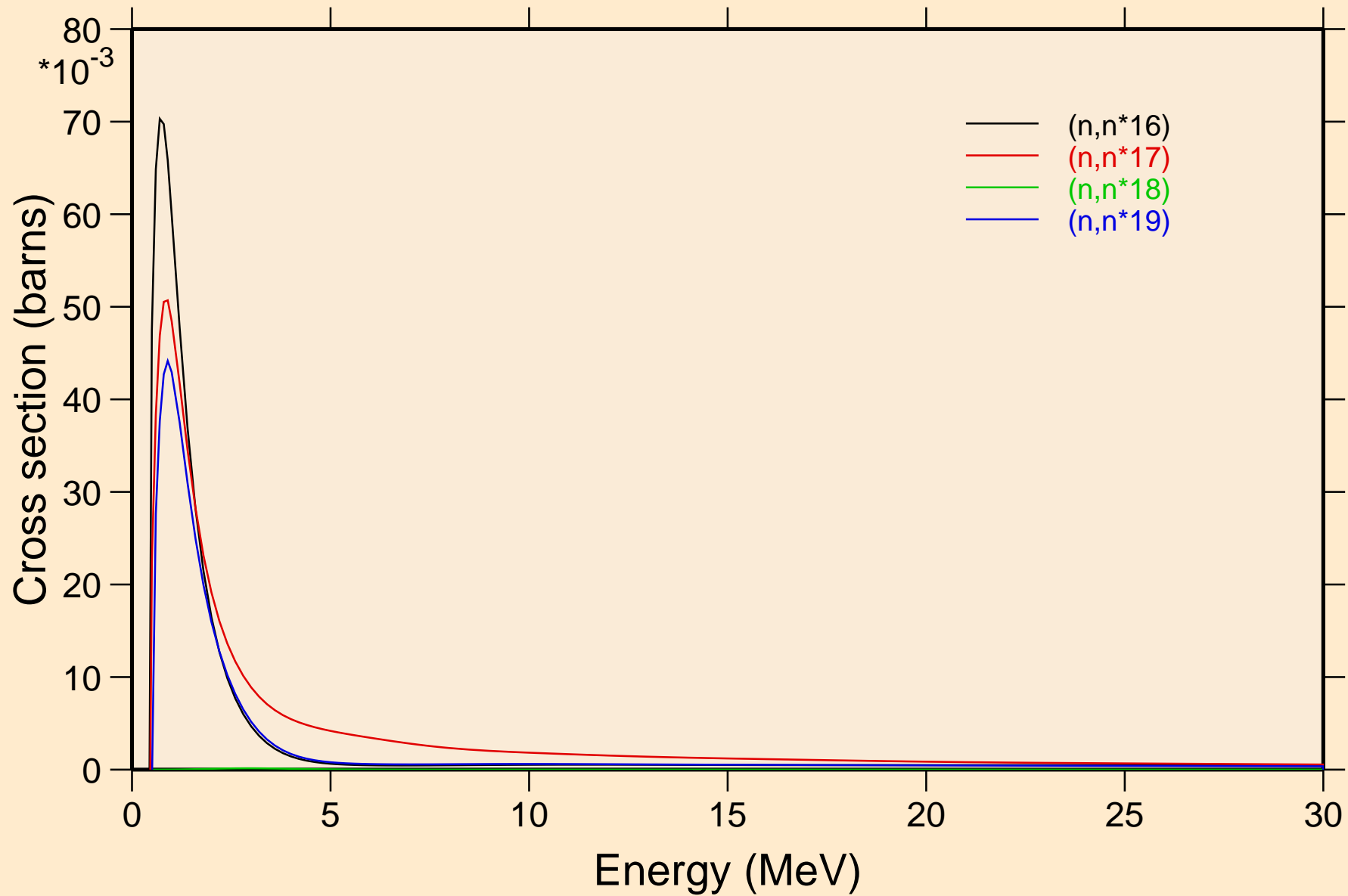

PT193 NEUTRON ACER TENDL-2023 LIBRARY; T=0.K  
Threshold reactions

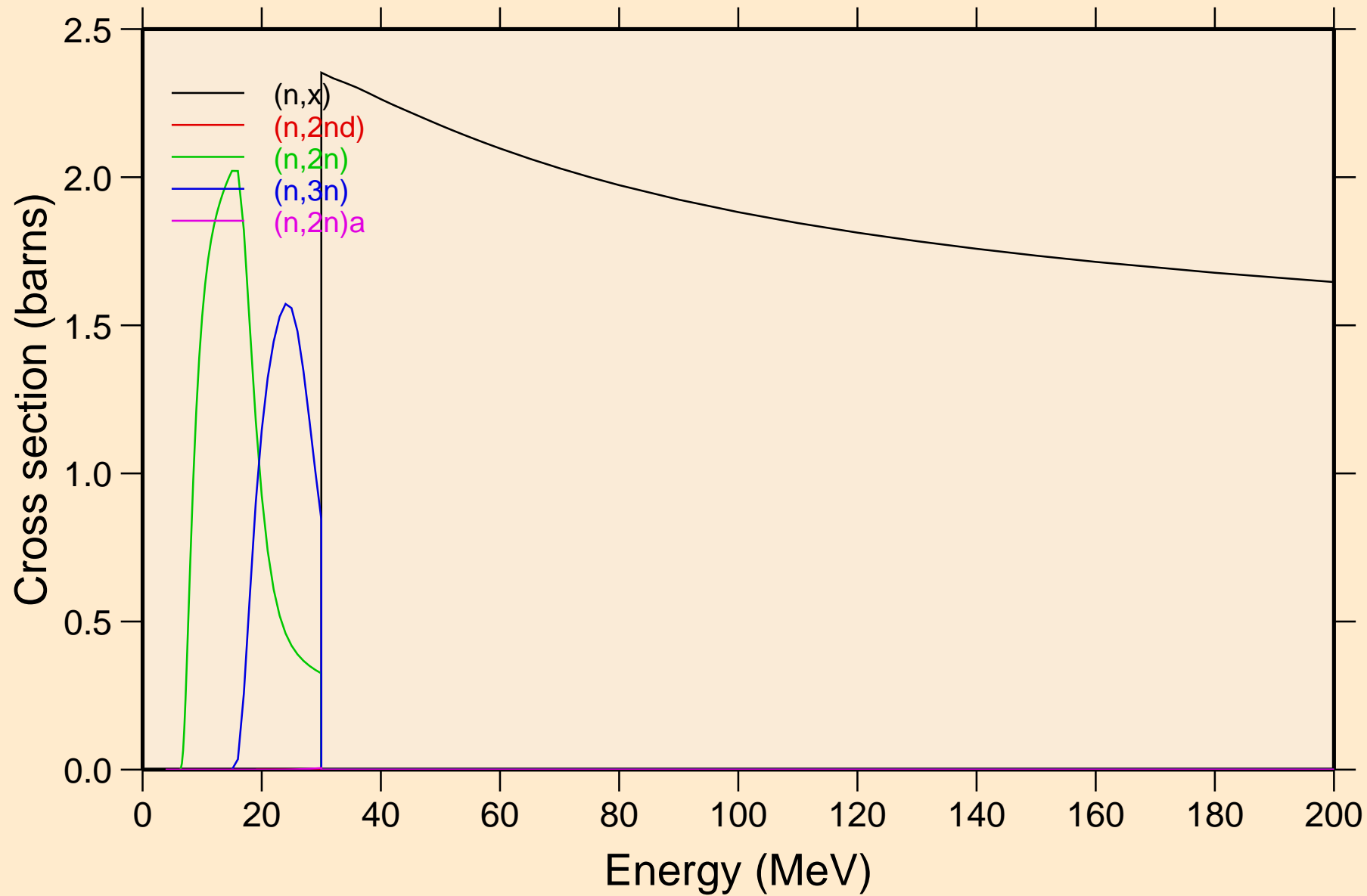

PT193 NEUTRON ACER TENDL-2023 LIBRARY; T=0.K  
Threshold reactions

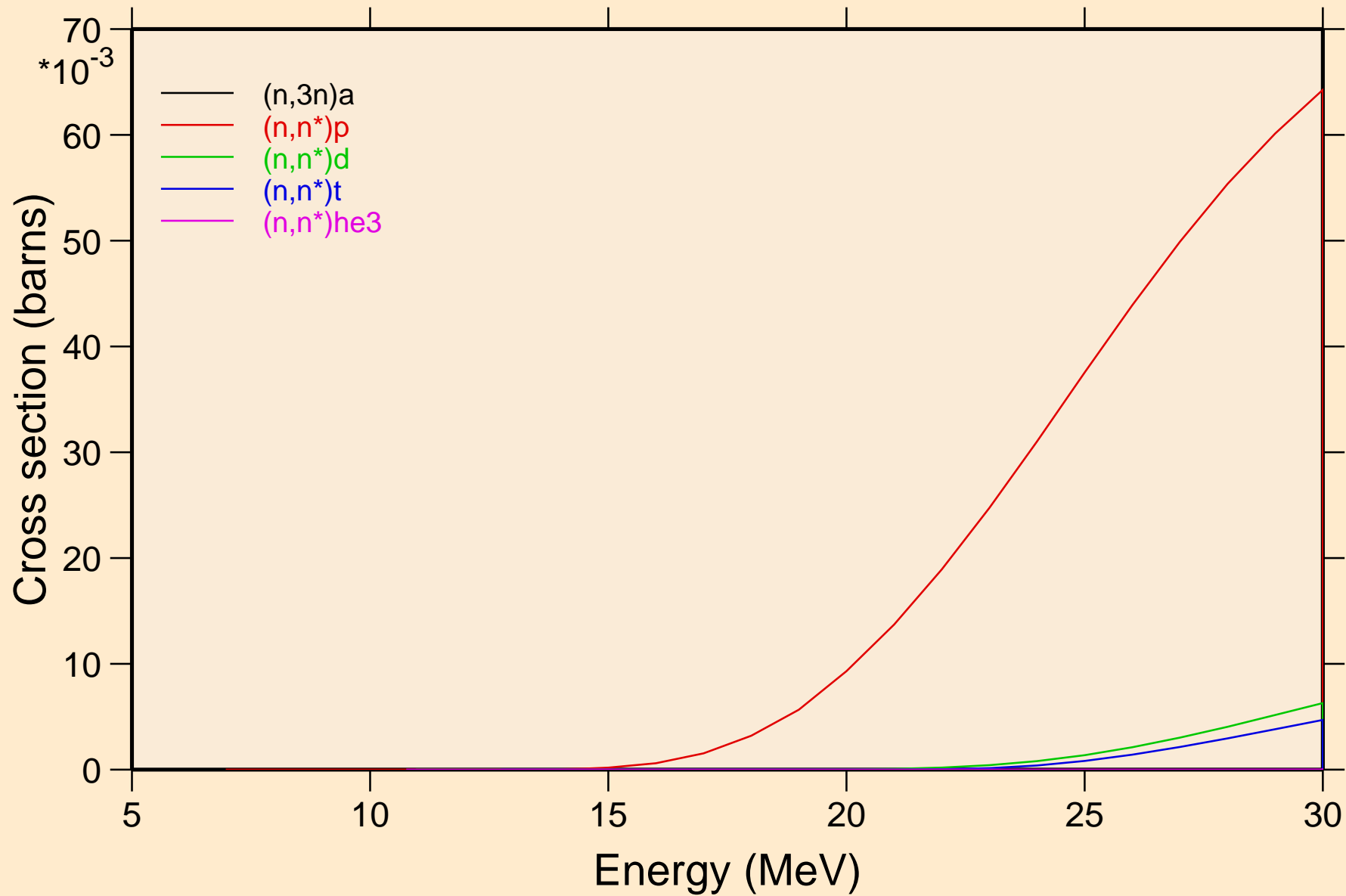



PT193 NEUTRON ACER TENDL-2023 LIBRARY; T=0.K  
Threshold reactions

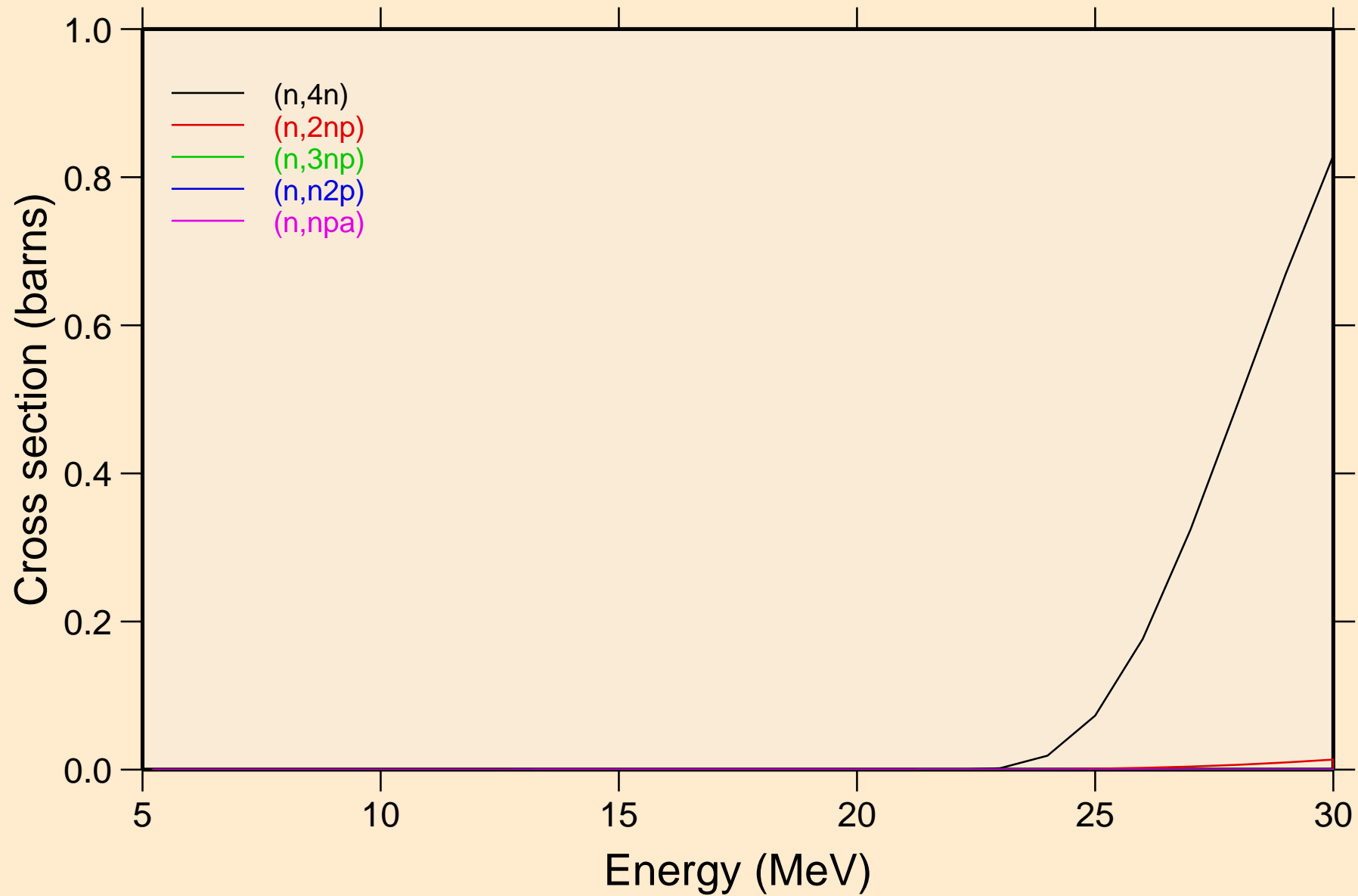

PT193 NEUTRON ACER TENDL-2023 LIBRARY; T=0.K  
Threshold reactions

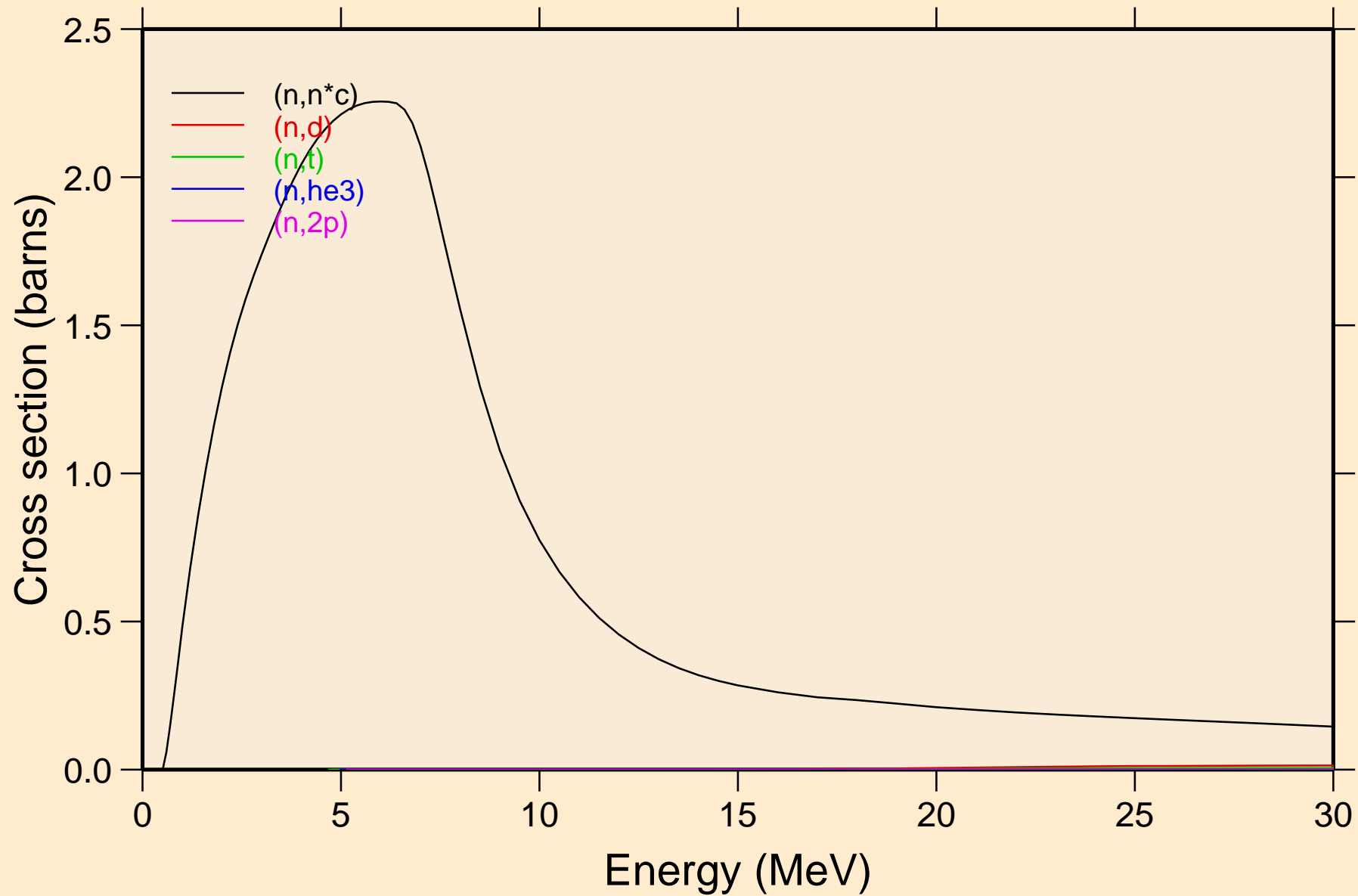

PT193 NEUTRON ACER TENDL-2023 LIBRARY; T=0.K  
Threshold reactions

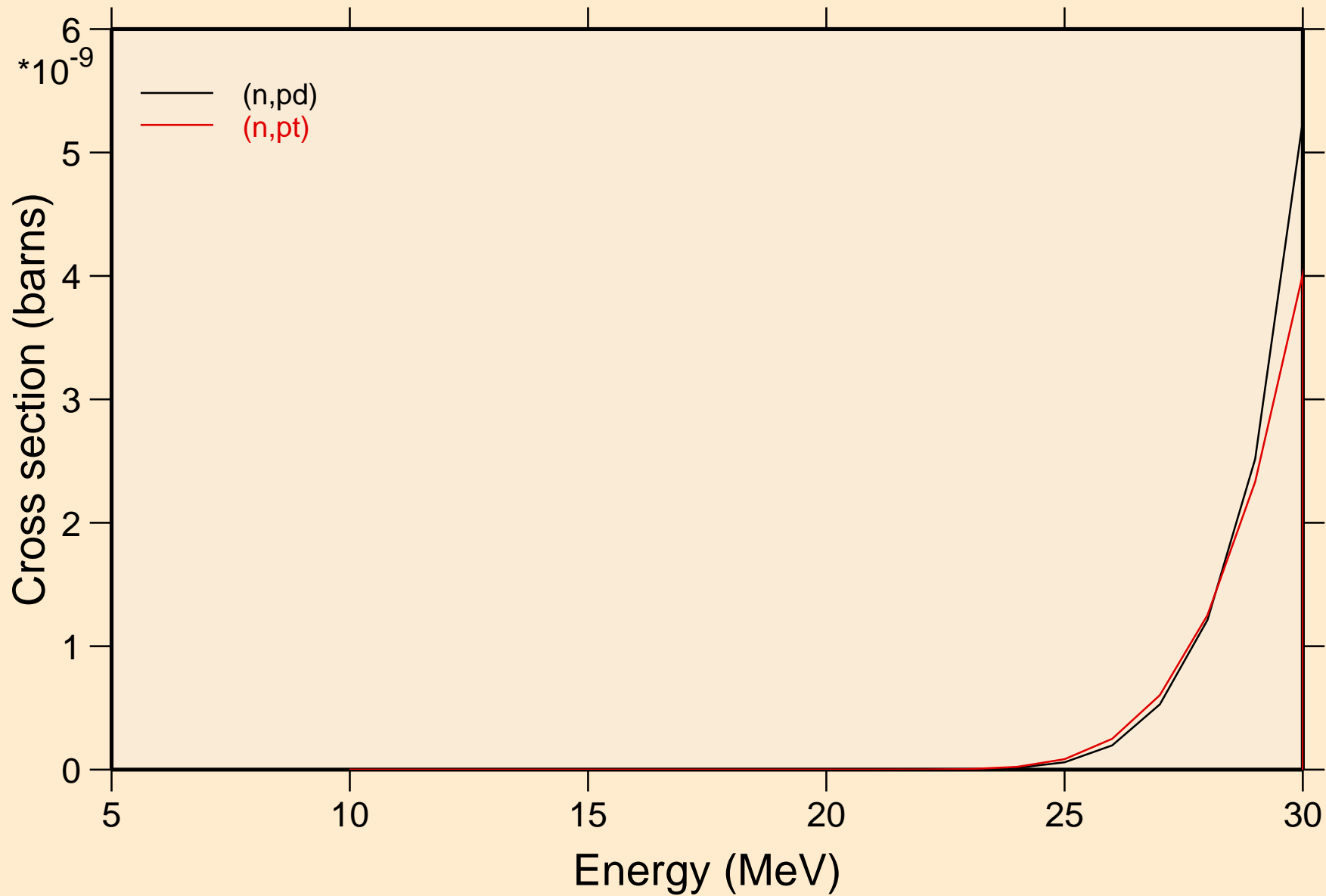

PT193 NEUTRON ACER TENDL-2023 LIBRARY; T=0.K  
Threshold reactions

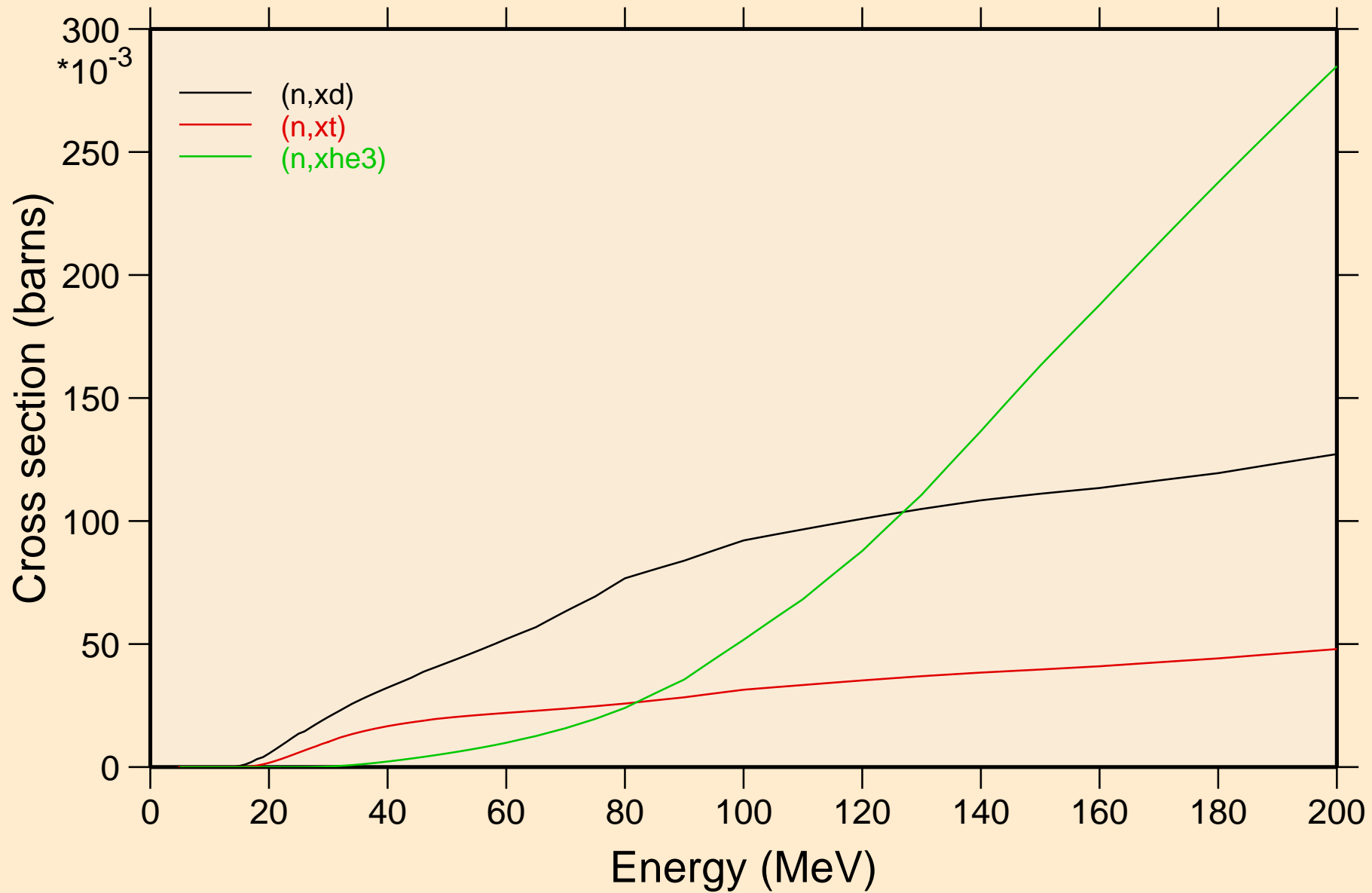

PT193 NEUTRON ACER TENDL-2023 LIBRARY; T=0.K  
angular distribution for elastic

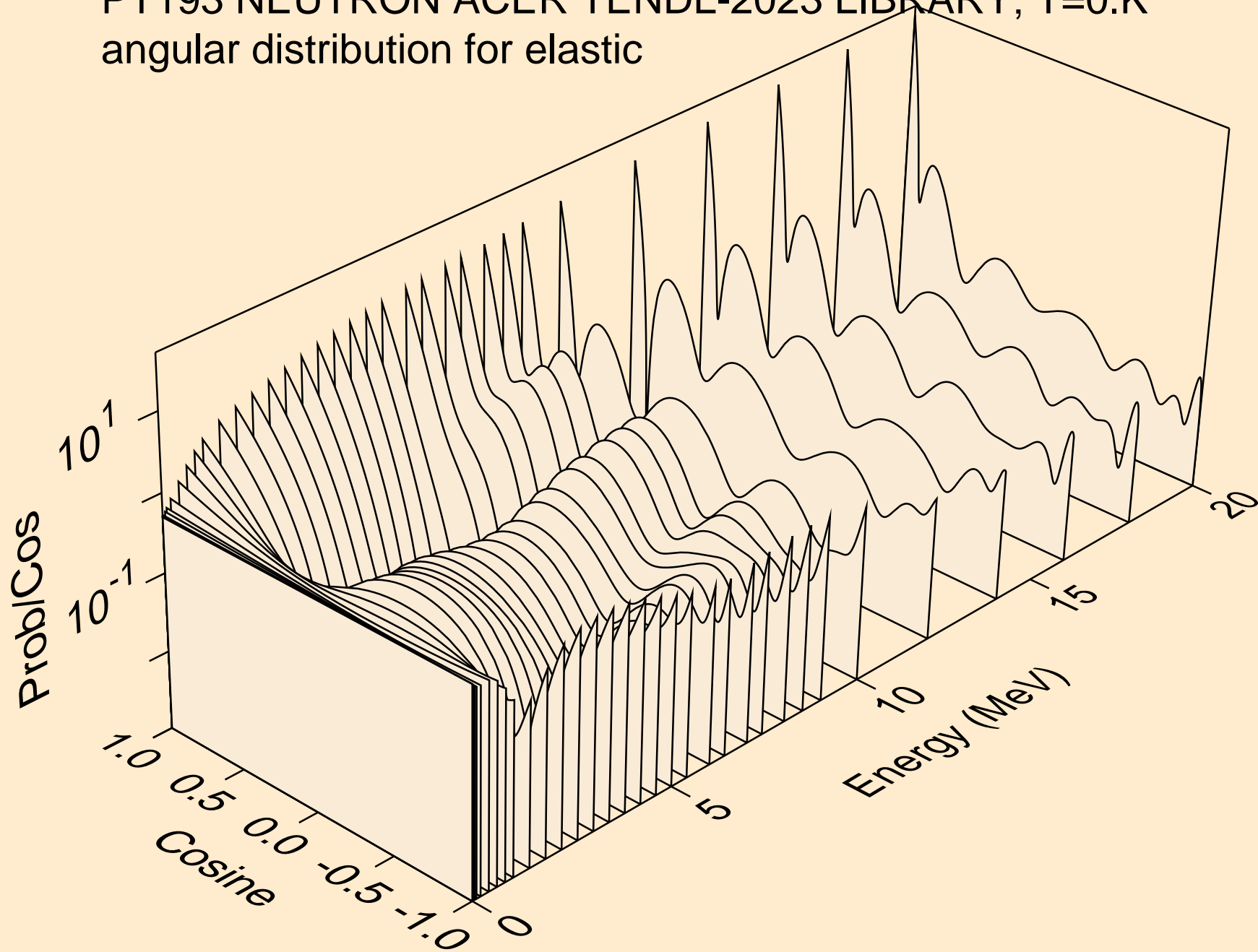

PT193 NEUTRON ACER TENDL-2023 LIBRARY; T=0.K  
angular distribution for elastic

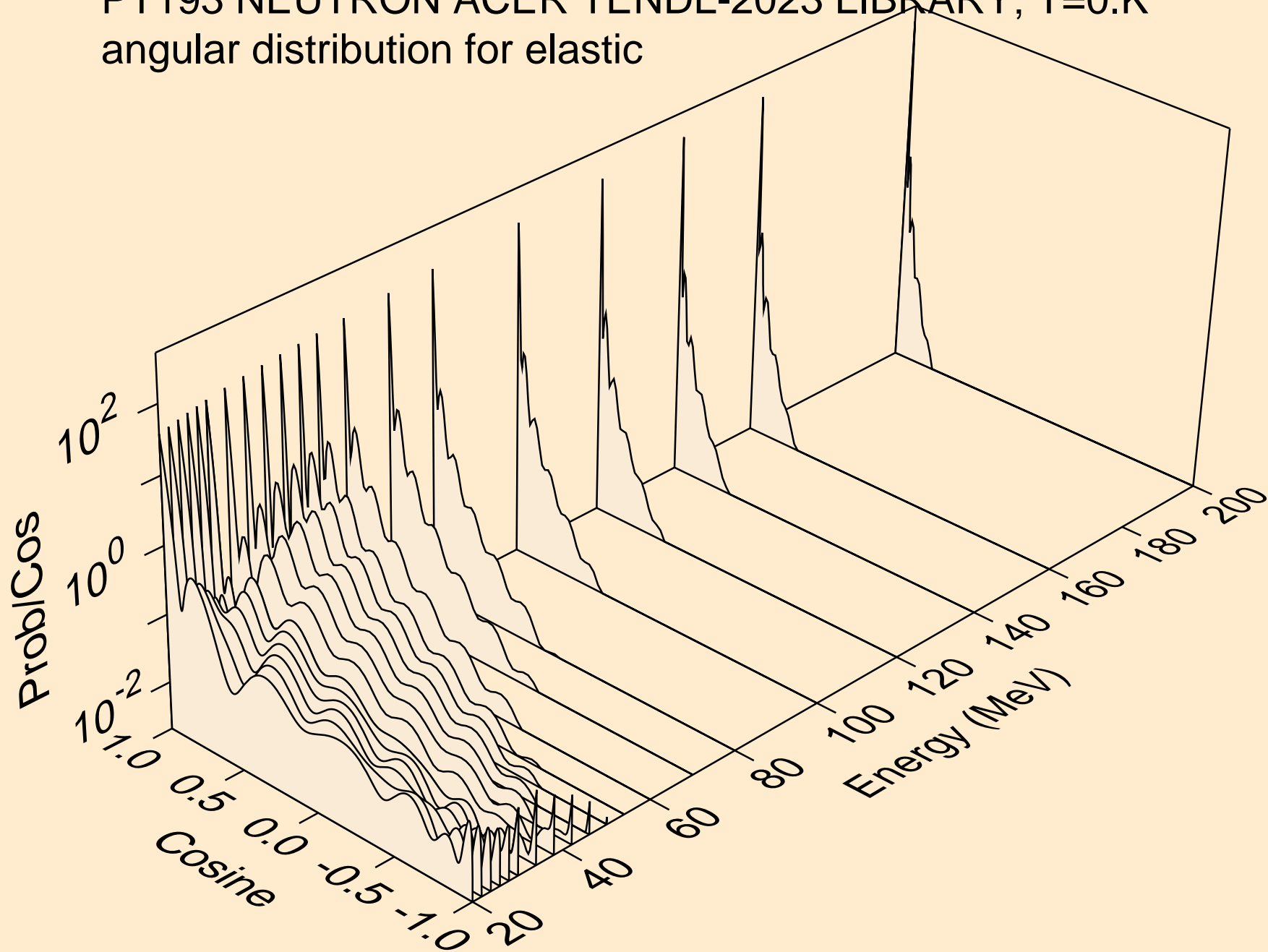

PT193 NEUTRON ACER TENDL-2023 LIBRARY; T=0.K  
angular distribution for (n,n\*1)

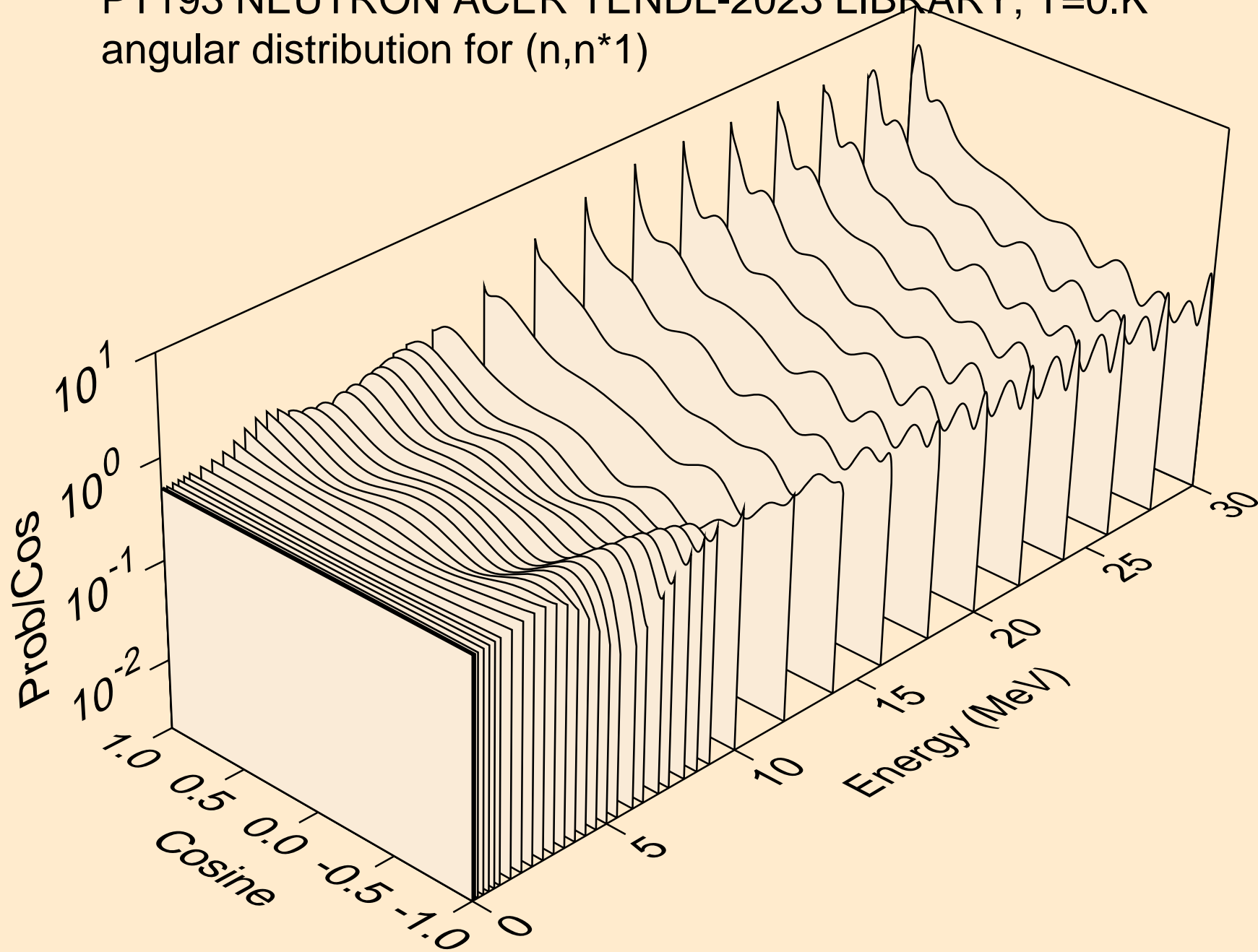

PT193 NEUTRON ACER TENDL-2023 LIBRARY; T=0.K  
angular distribution for (n,n\*2)

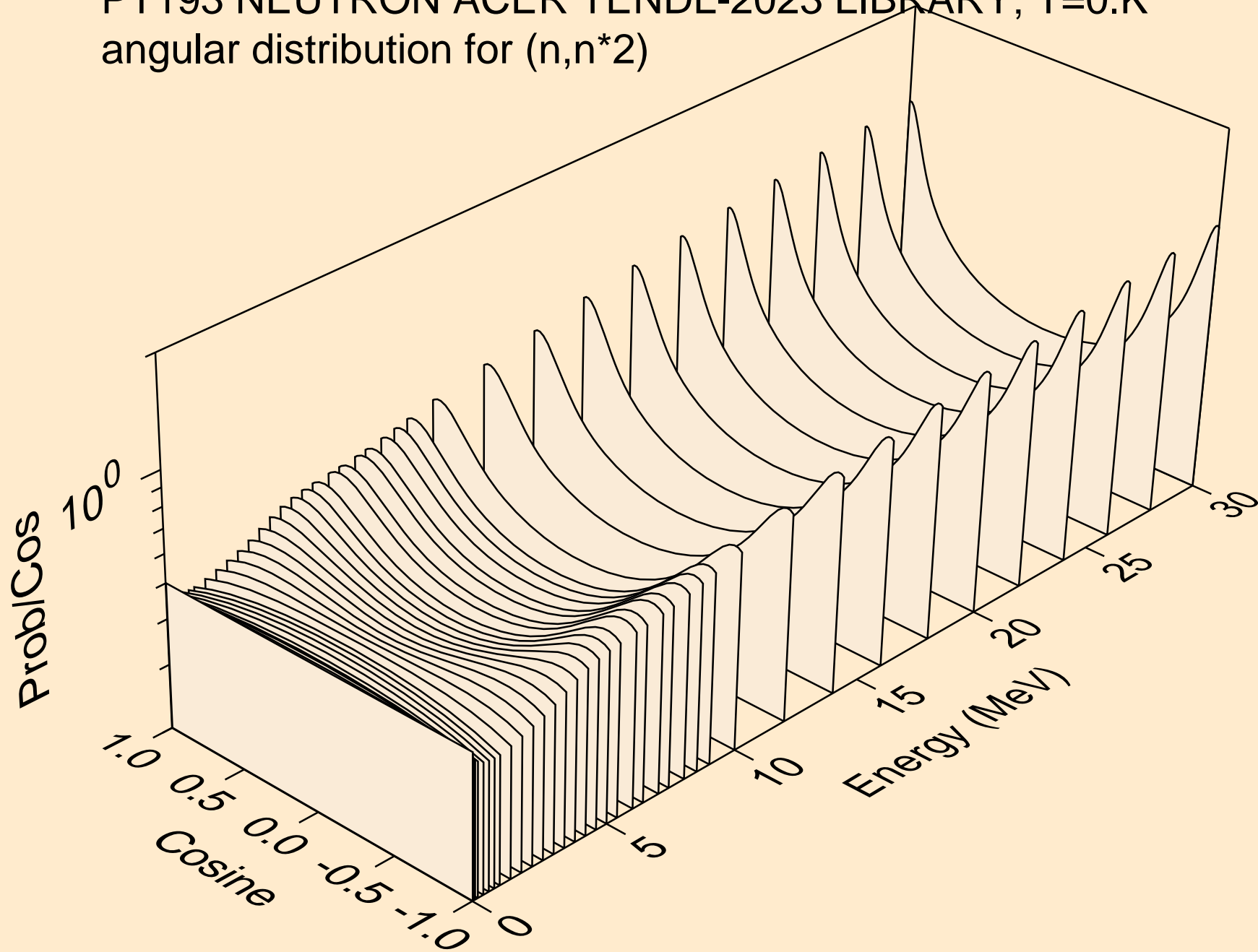



PT193 NEUTRON ACER TENDL-2023 LIBRARY; T=0.K  
angular distribution for (n,n\*3)

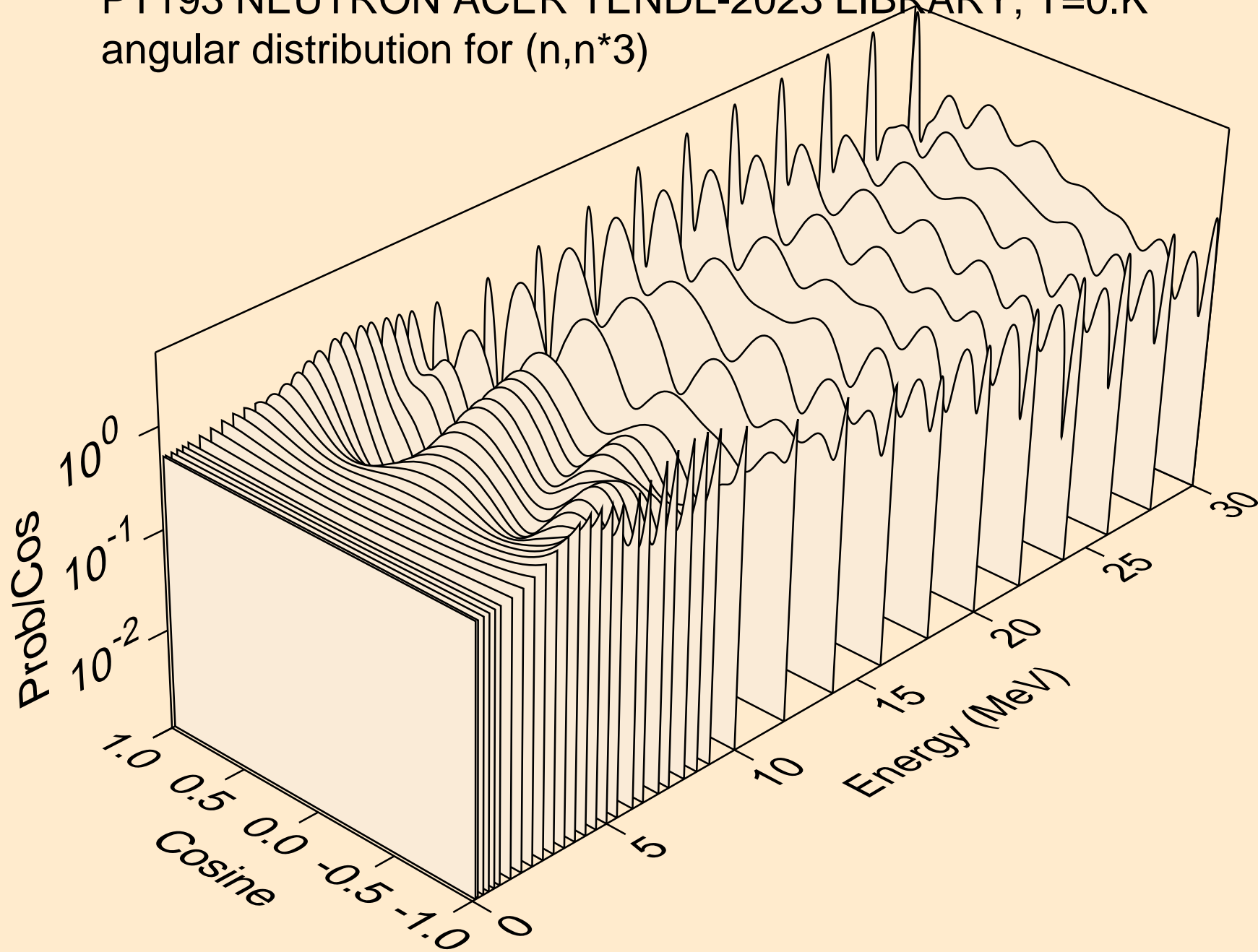

PT193 NEUTRON ACER TENDL-2023 LIBRARY; T=0.K  
angular distribution for (n,n\*4)

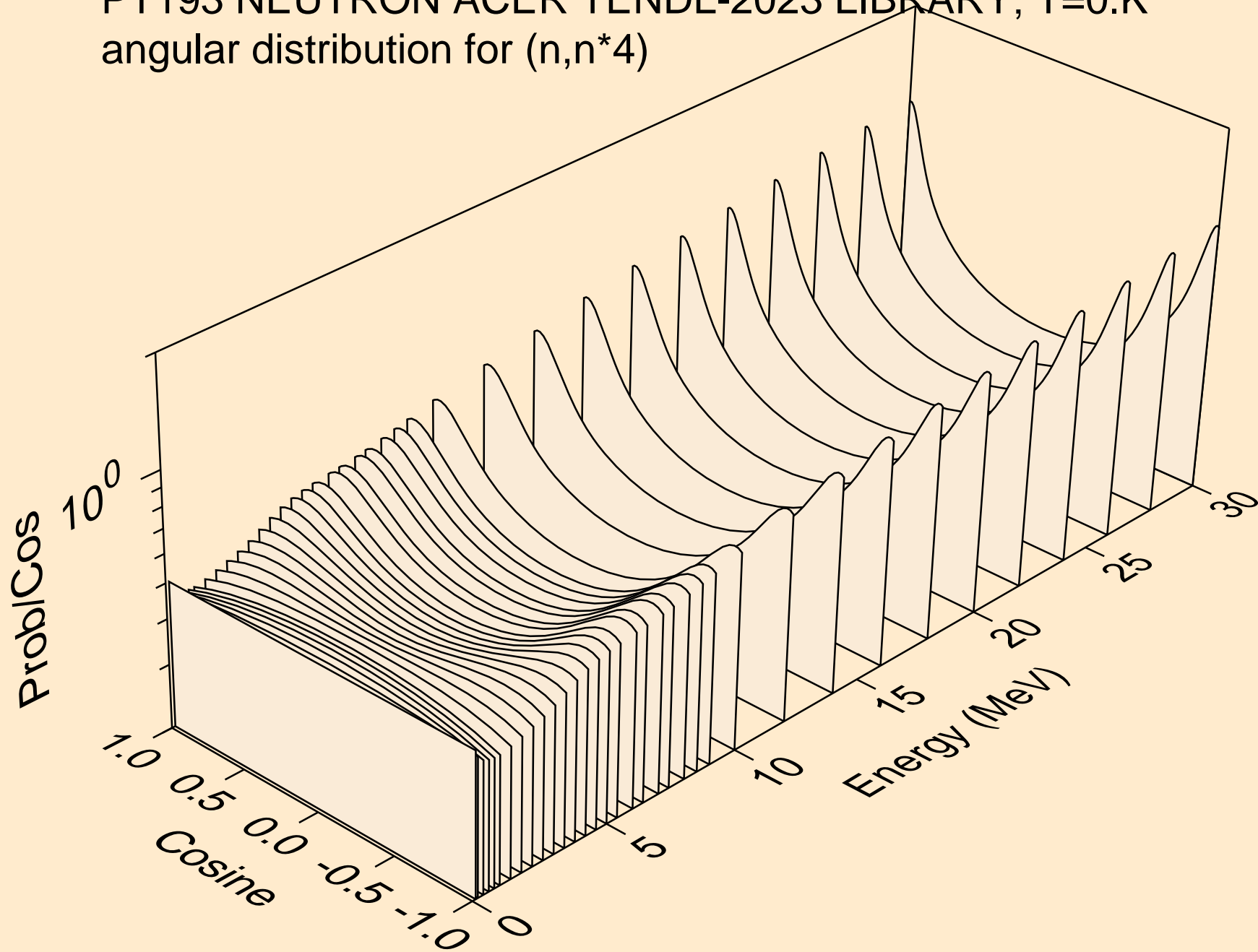

PT193 NEUTRON ACER TENDL-2023 LIBRARY; T=0.K  
angular distribution for (n,n\*5)

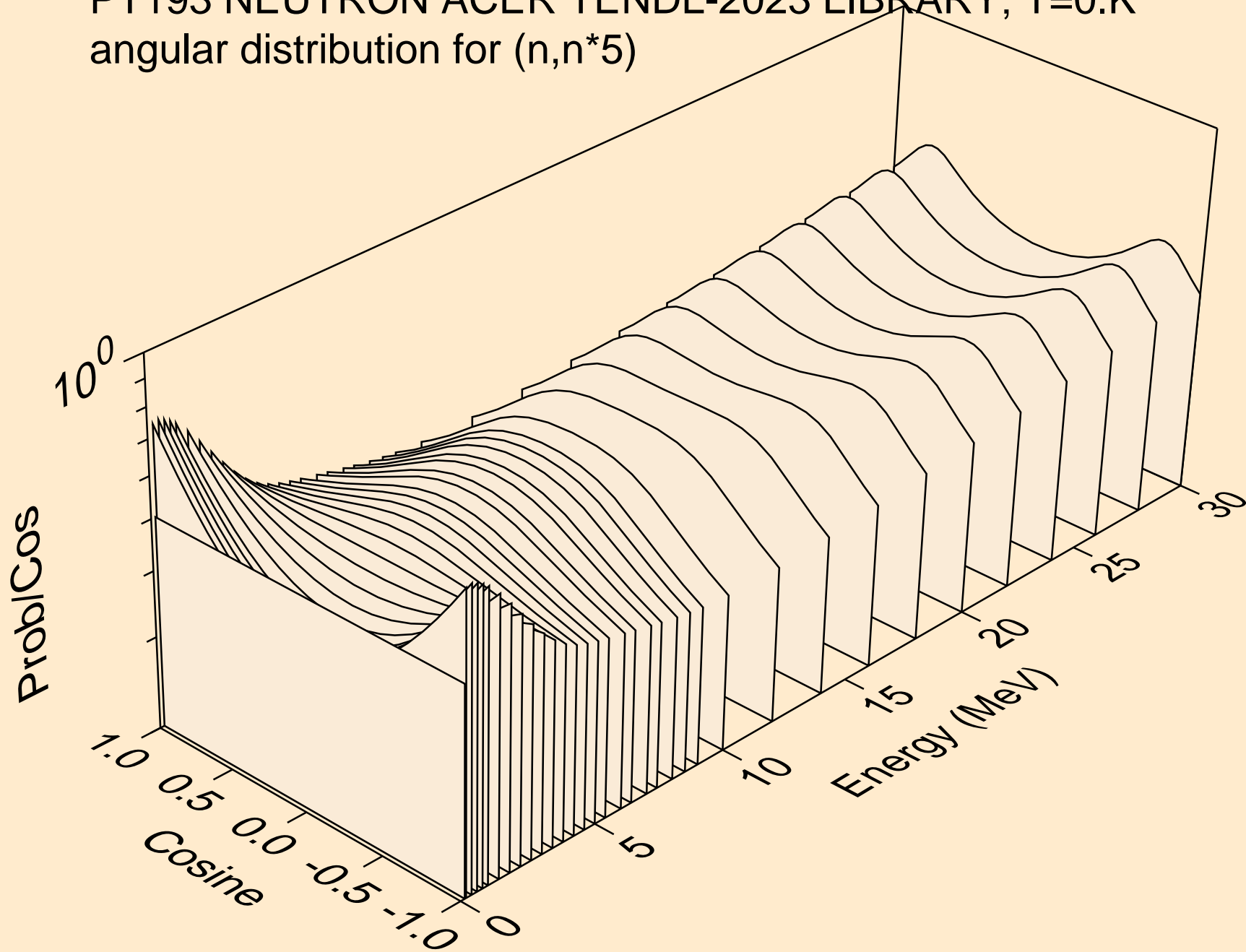

PT193 NEUTRON ACER TENDL-2023 LIBRARY; T=0.K  
angular distribution for (n,n\*6)

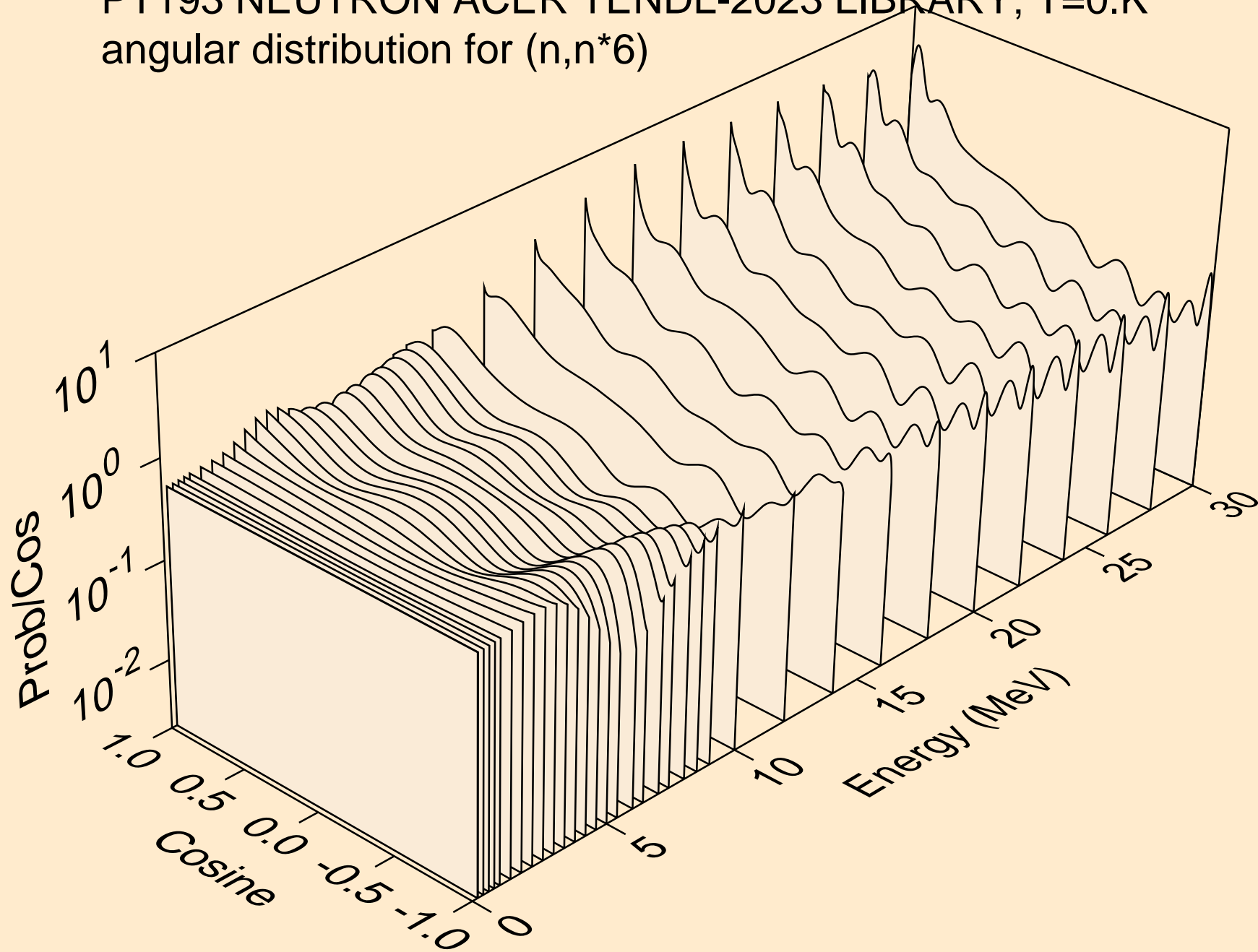

PT193 NEUTRON ACER TENDL-2023 LIBRARY; T=0.K  
angular distribution for (n,n\*7)

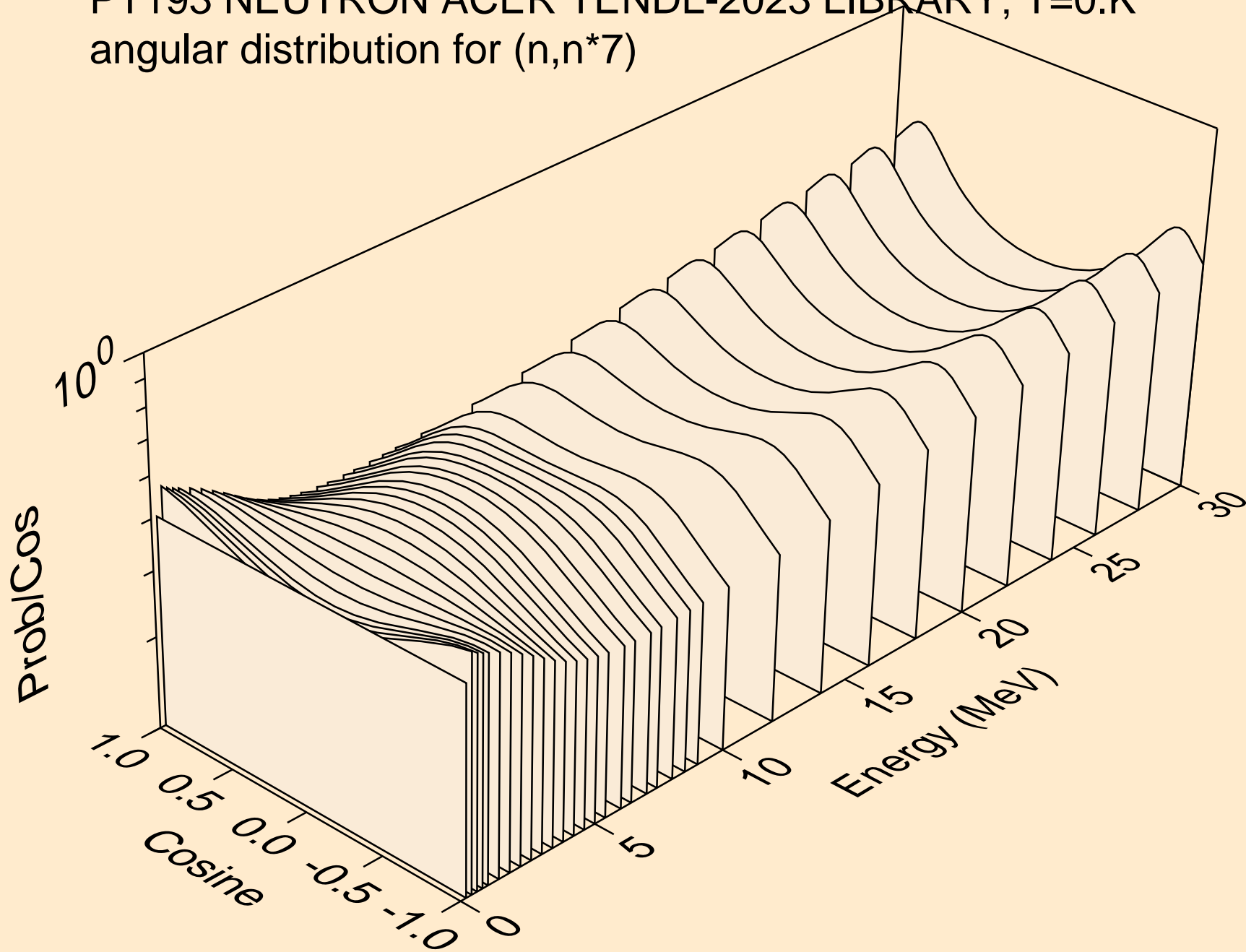

PT193 NEUTRON ACER TENDL-2023 LIBRARY; T=0.K  
angular distribution for (n,n\*8)

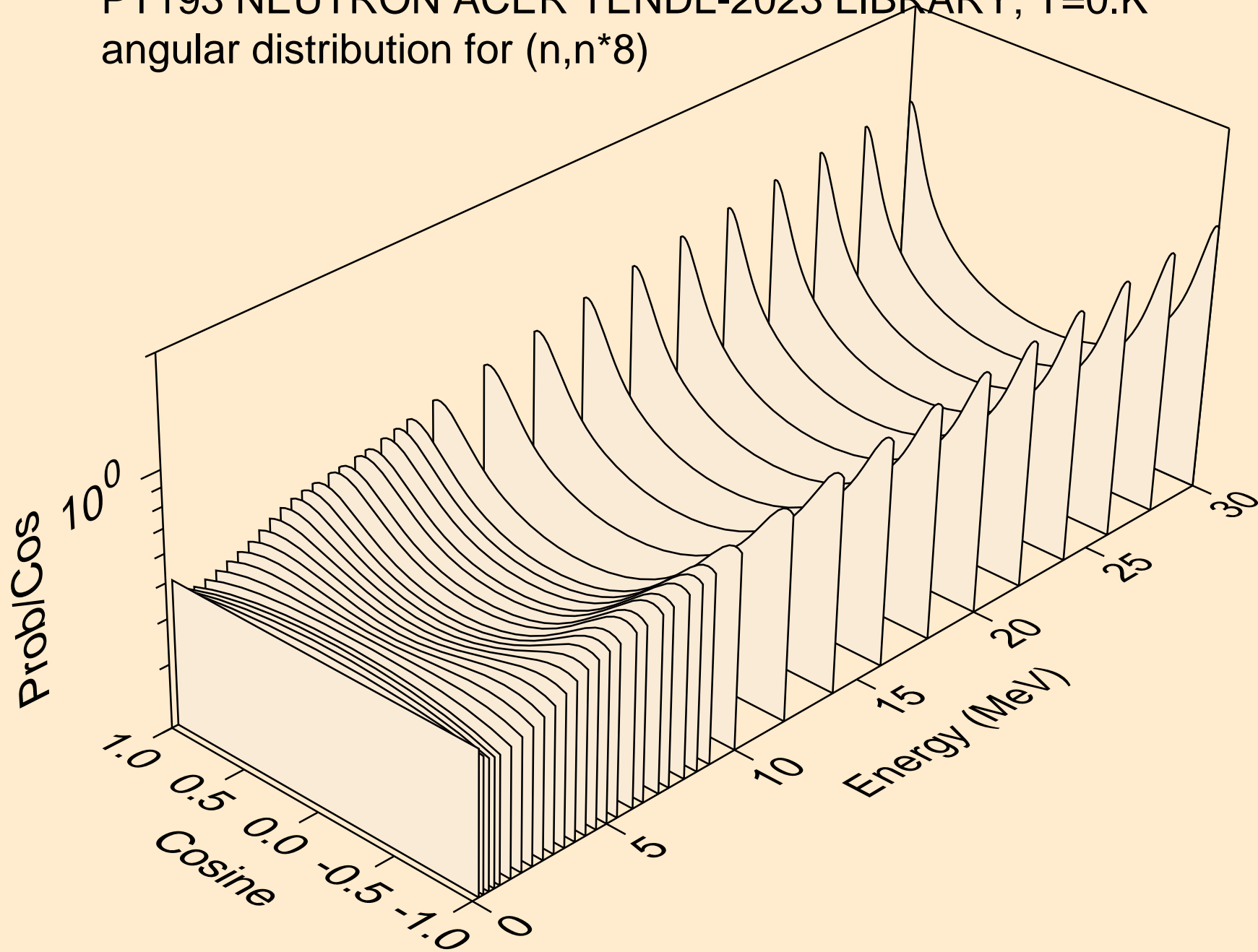

PT193 NEUTRON ACER TENDL-2023 LIBRARY; T=0.K  
angular distribution for (n,n\*9)

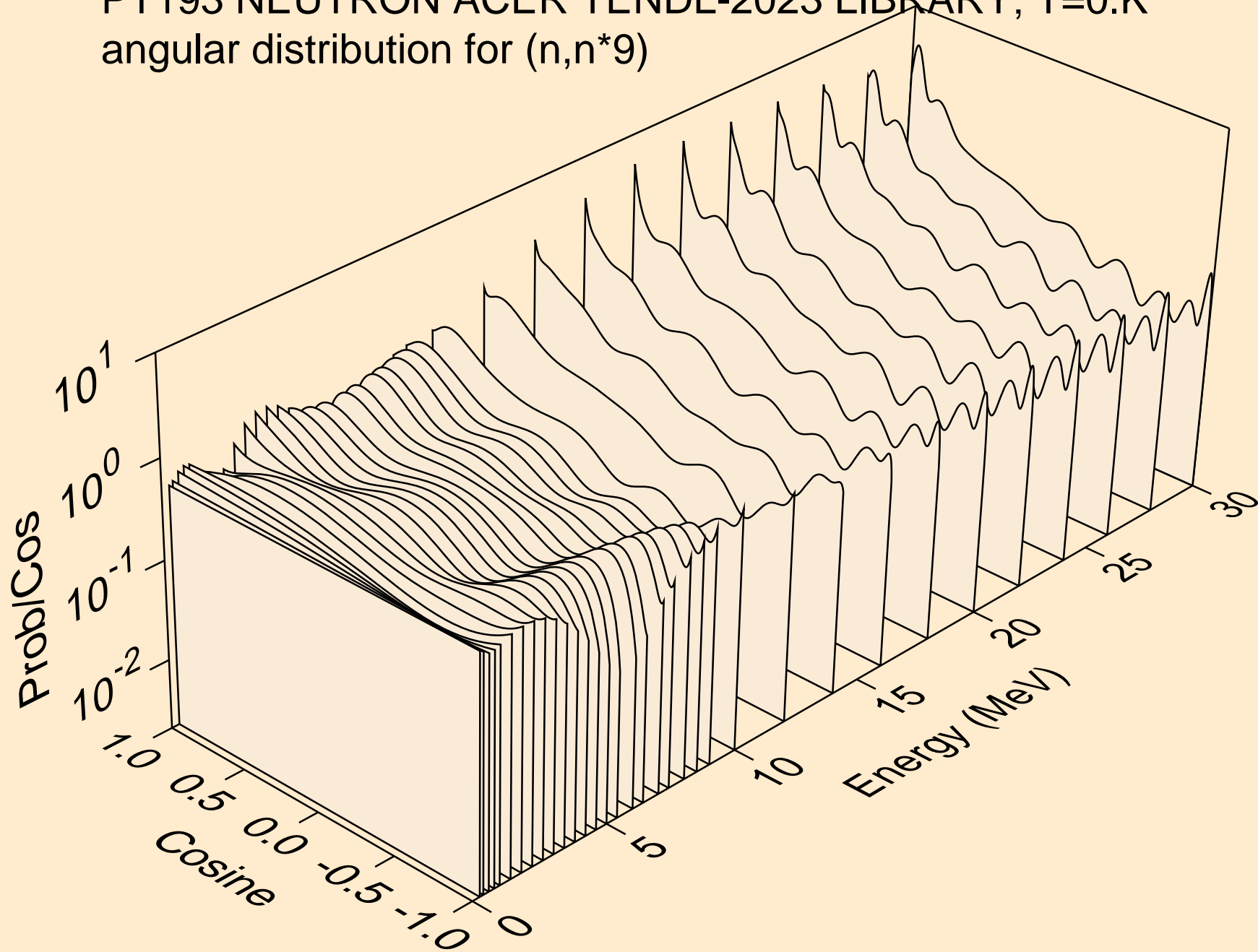

PT193 NEUTRON ACER TENDL-2023 LIBRARY; T=0.K  
angular distribution for (n,n\*10)

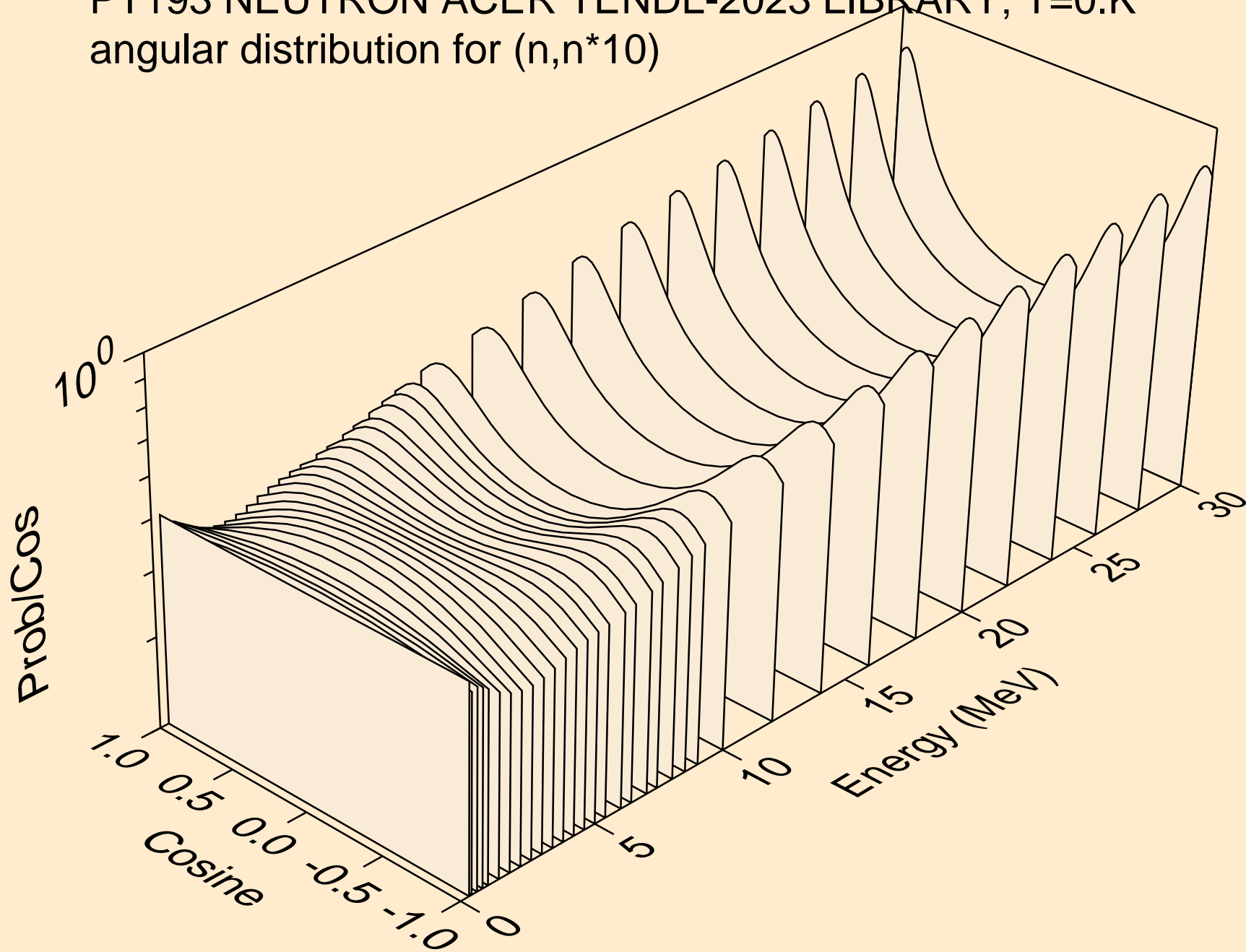



PT193 NEUTRON ACER TENDL-2023 LIBRARY; T=0.K  
angular distribution for (n,n\*11)

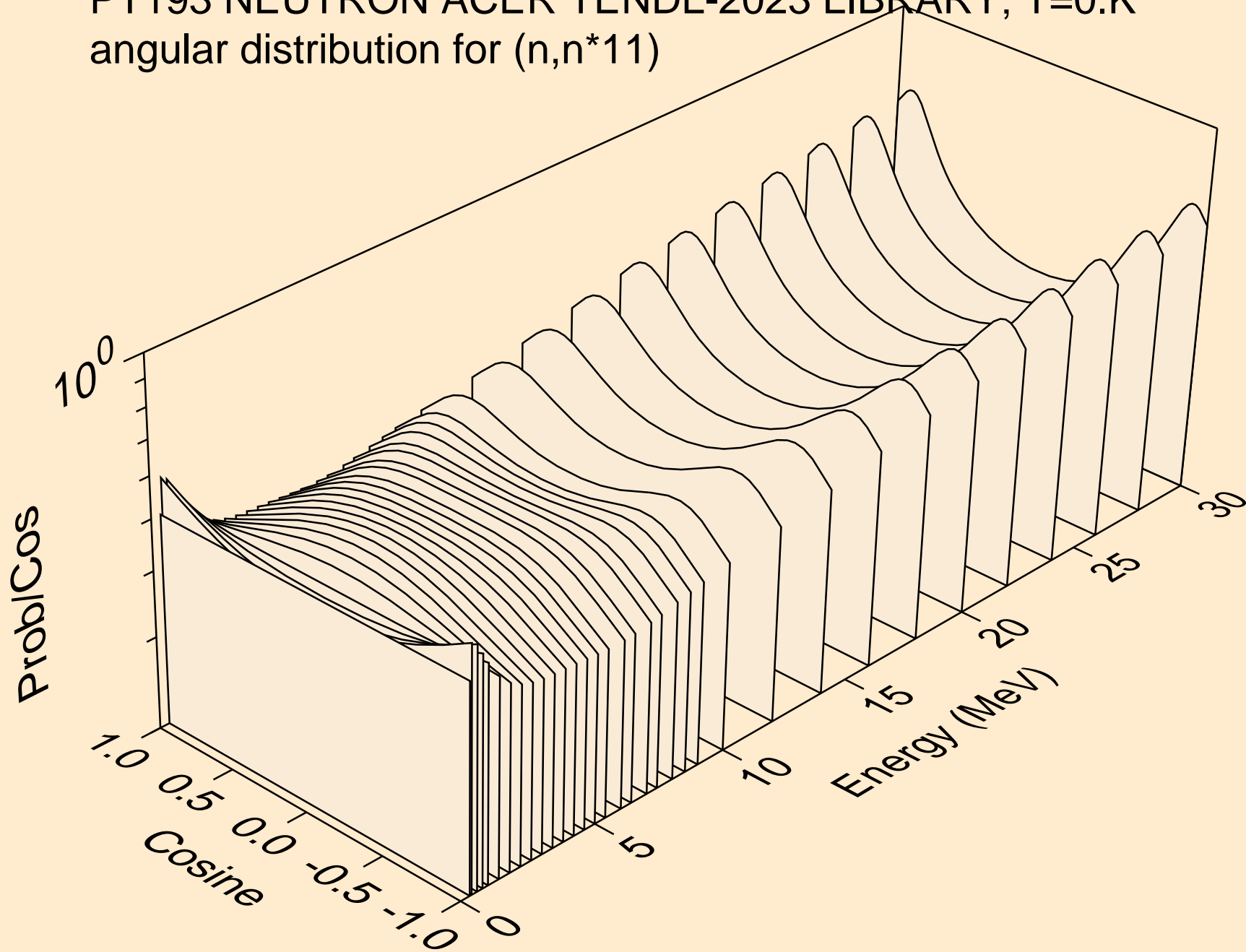

PT193 NEUTRON ACER TENDL-2023 LIBRARY; T=0.K  
angular distribution for (n,n\*12)

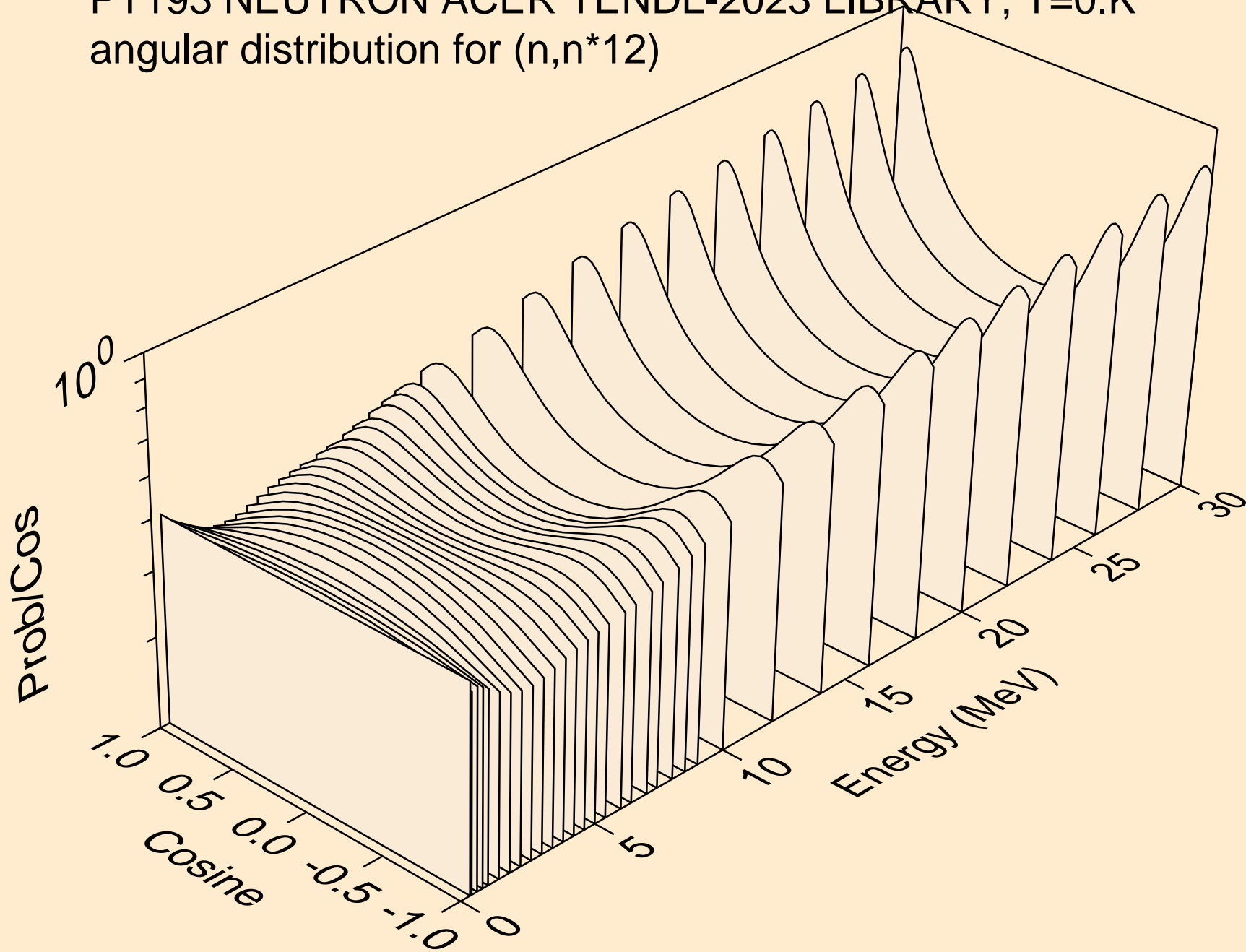

PT193 NEUTRON ACER TENDL-2023 LIBRARY; T=0.K  
angular distribution for (n,n\*13)

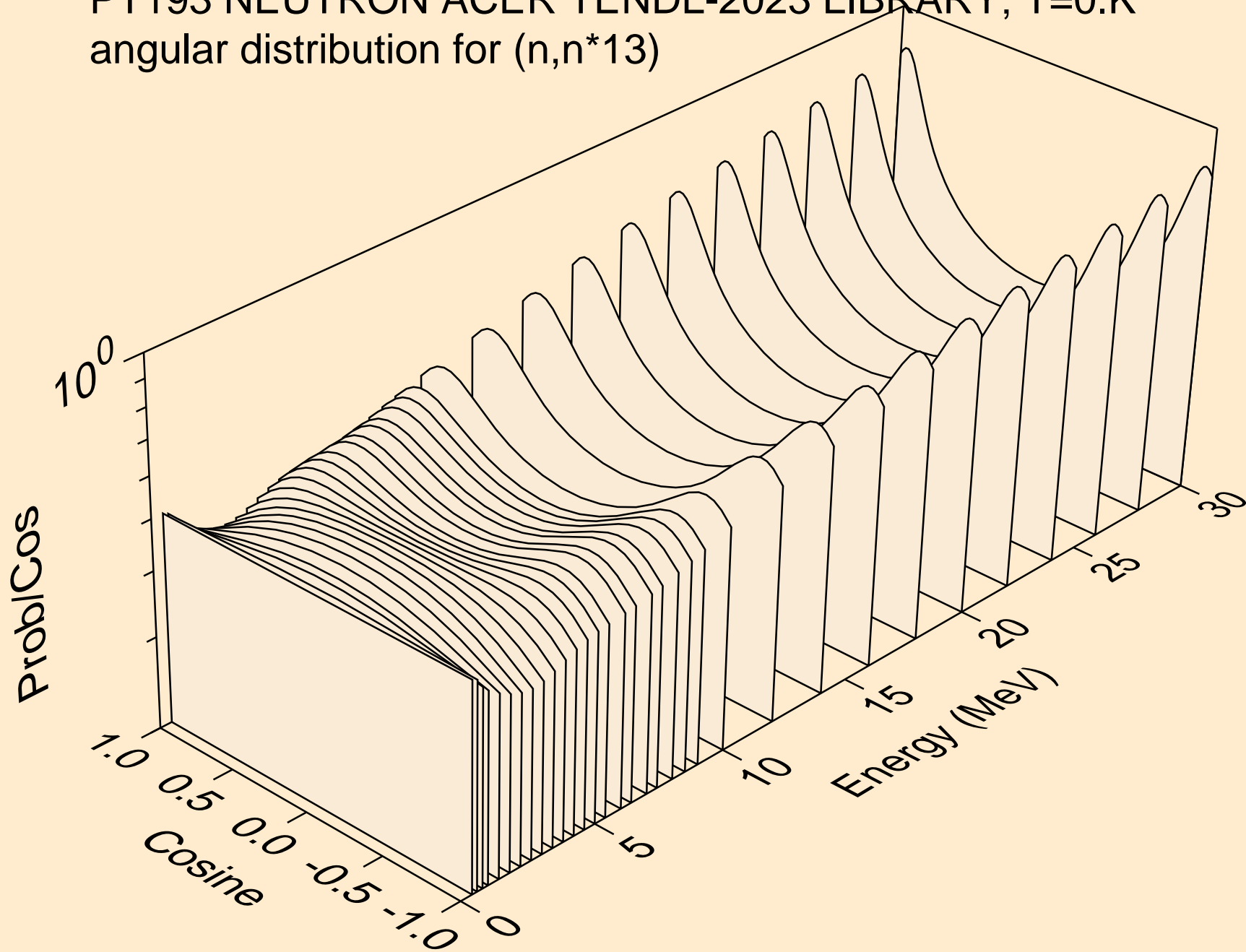

PT193 NEUTRON ACER TENDL-2023 LIBRARY; T=0.K  
angular distribution for (n,n\*14)

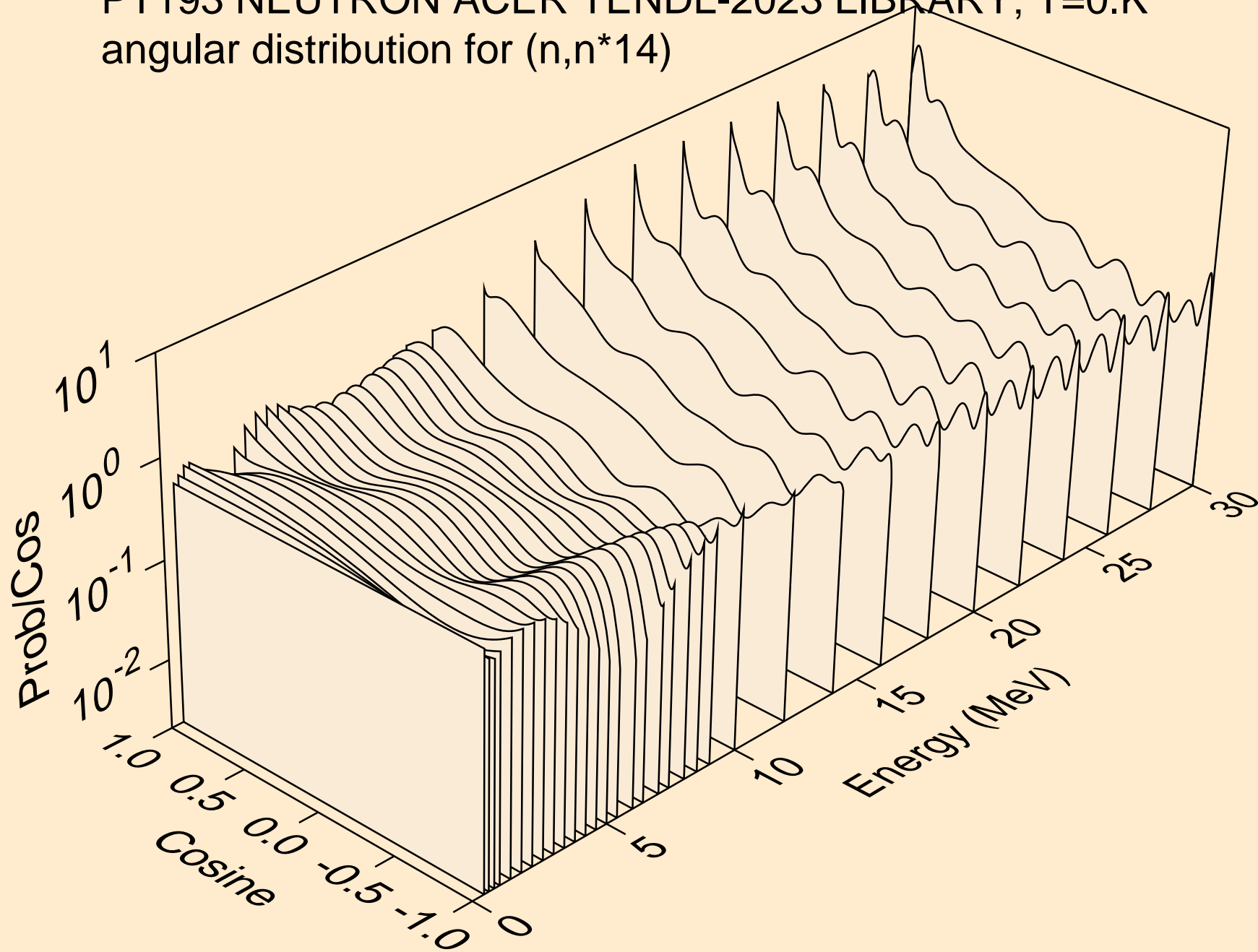

PT193 NEUTRON ACER TENDL-2023 LIBRARY; T=0.K  
angular distribution for (n,n\*15)

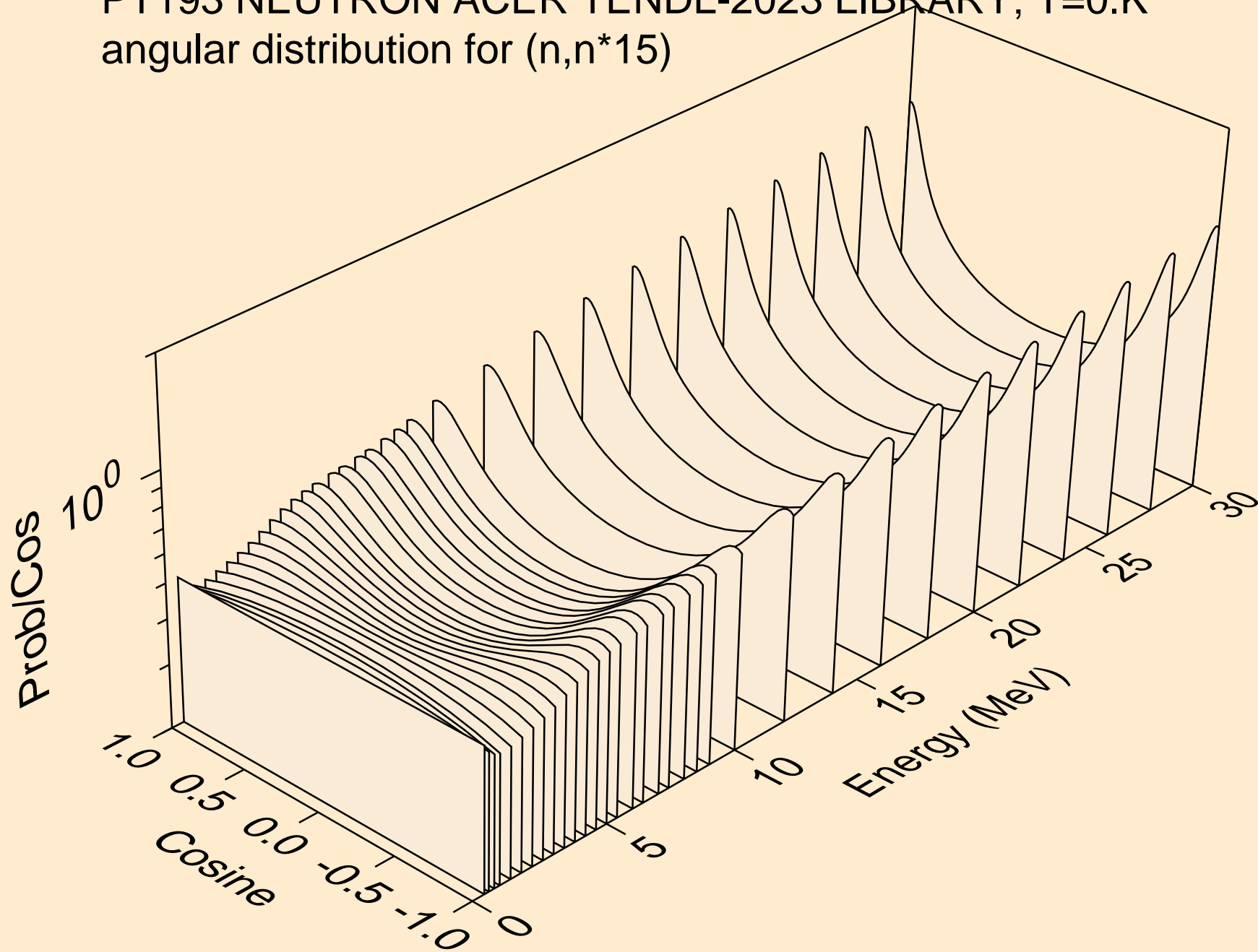

PT193 NEUTRON ACER TENDL-2023 LIBRARY; T=0.K  
angular distribution for (n,n\*16)

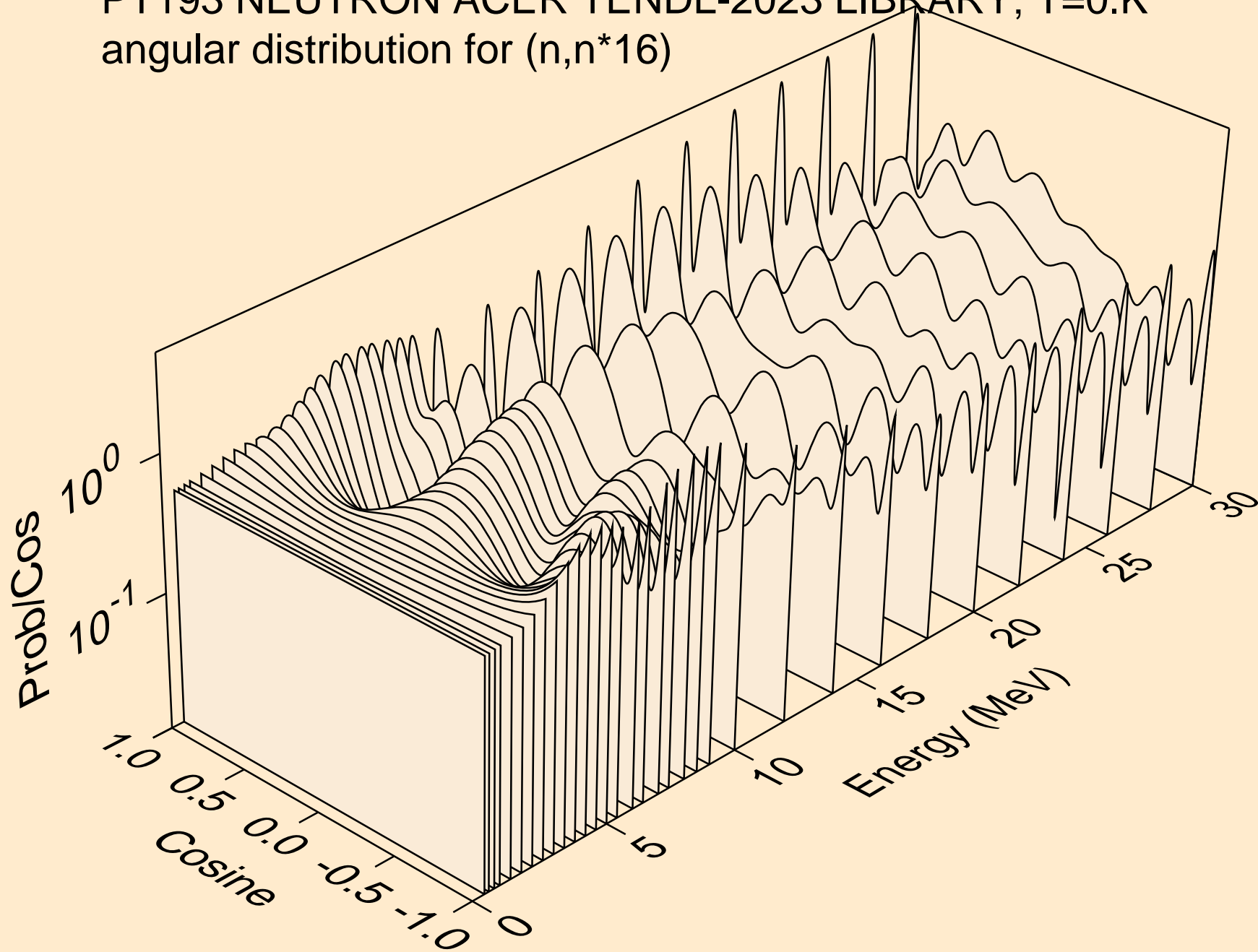

PT193 NEUTRON ACER TENDL-2023 LIBRARY; T=0.K  
angular distribution for (n,n\*17)

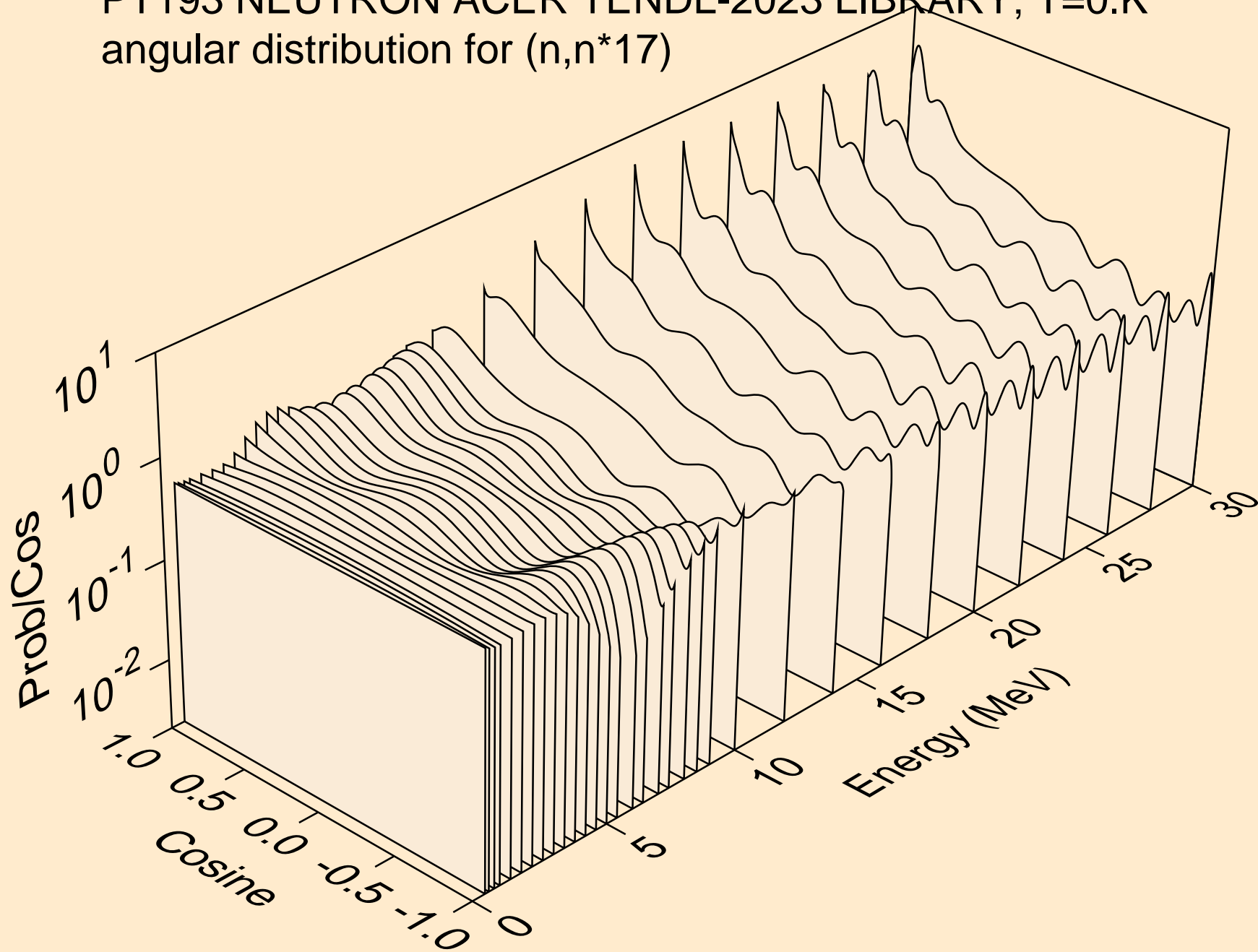

PT193 NEUTRON ACER TENDL-2023 LIBRARY; T=0.K  
angular distribution for (n,n\*18)

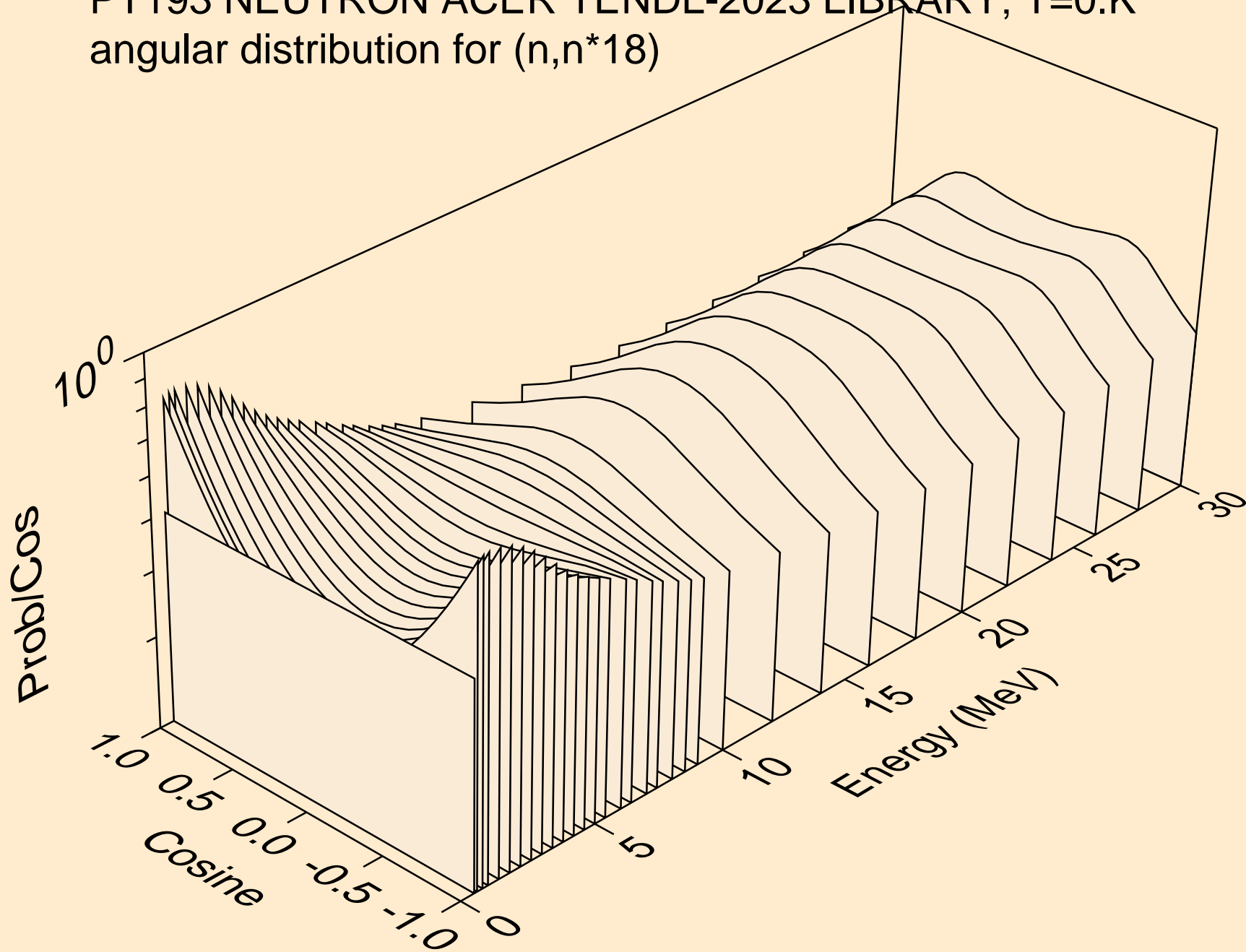



PT193 NEUTRON ACER TENDL-2023 LIBRARY; T=0.K  
angular distribution for (n,n\*19)

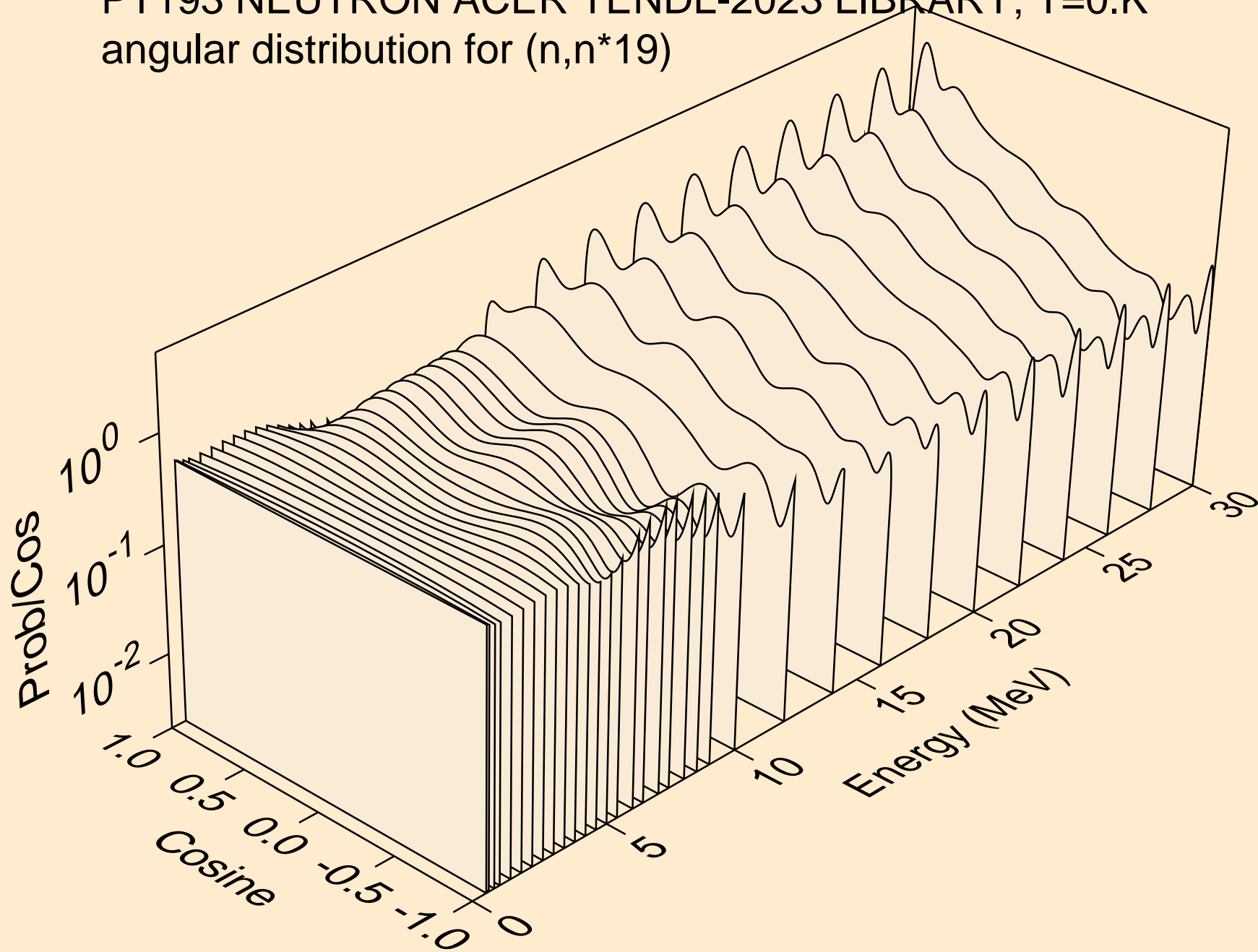

PT193 NEUTRON ACER TENDL-2023 LIBRARY; T=0.K  
Neutron emission for (n,x)

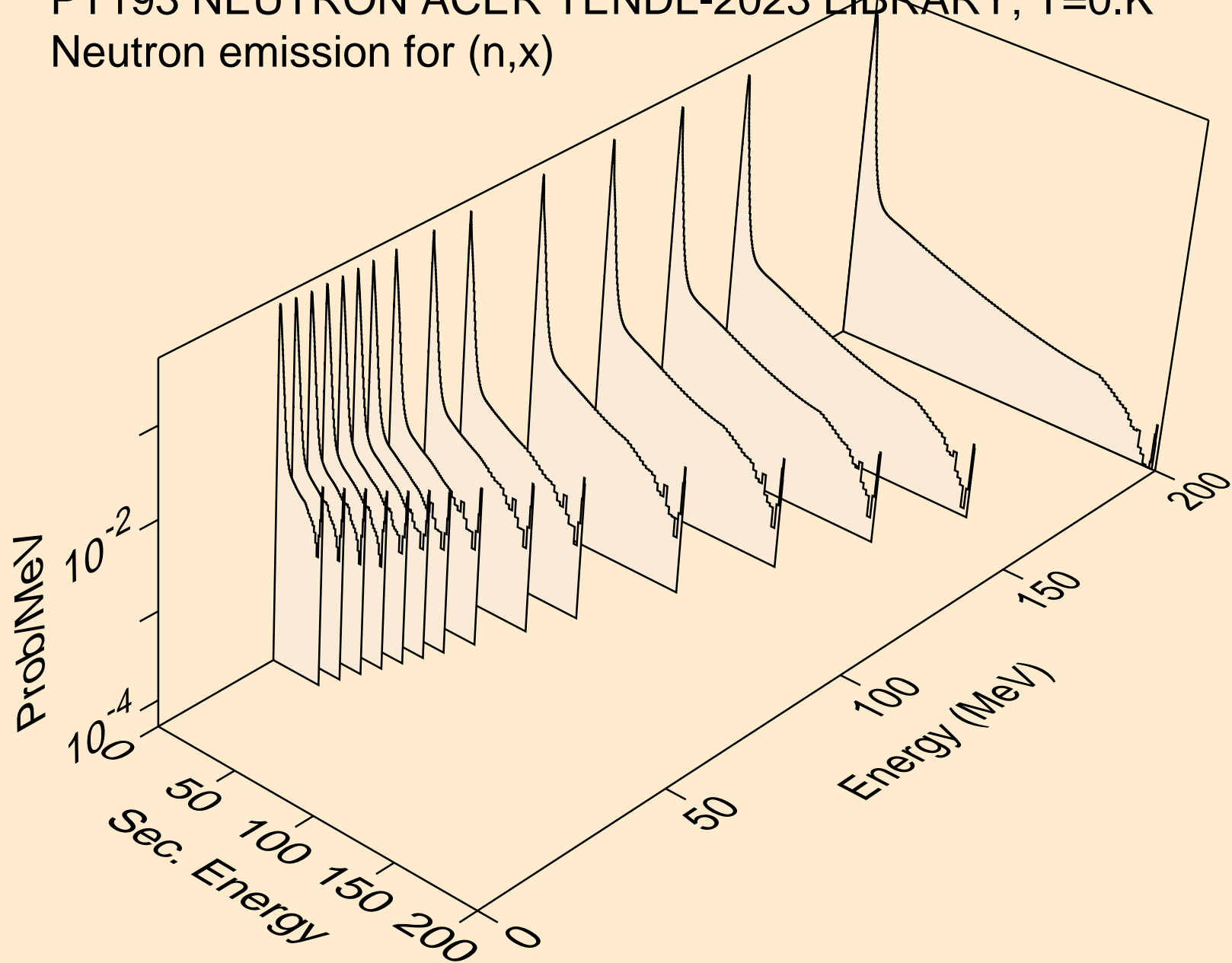

PT193 NEUTRON ACER TENDL-2023 LIBRARY; T=0.K  
Neutron emission for (n,2nd)

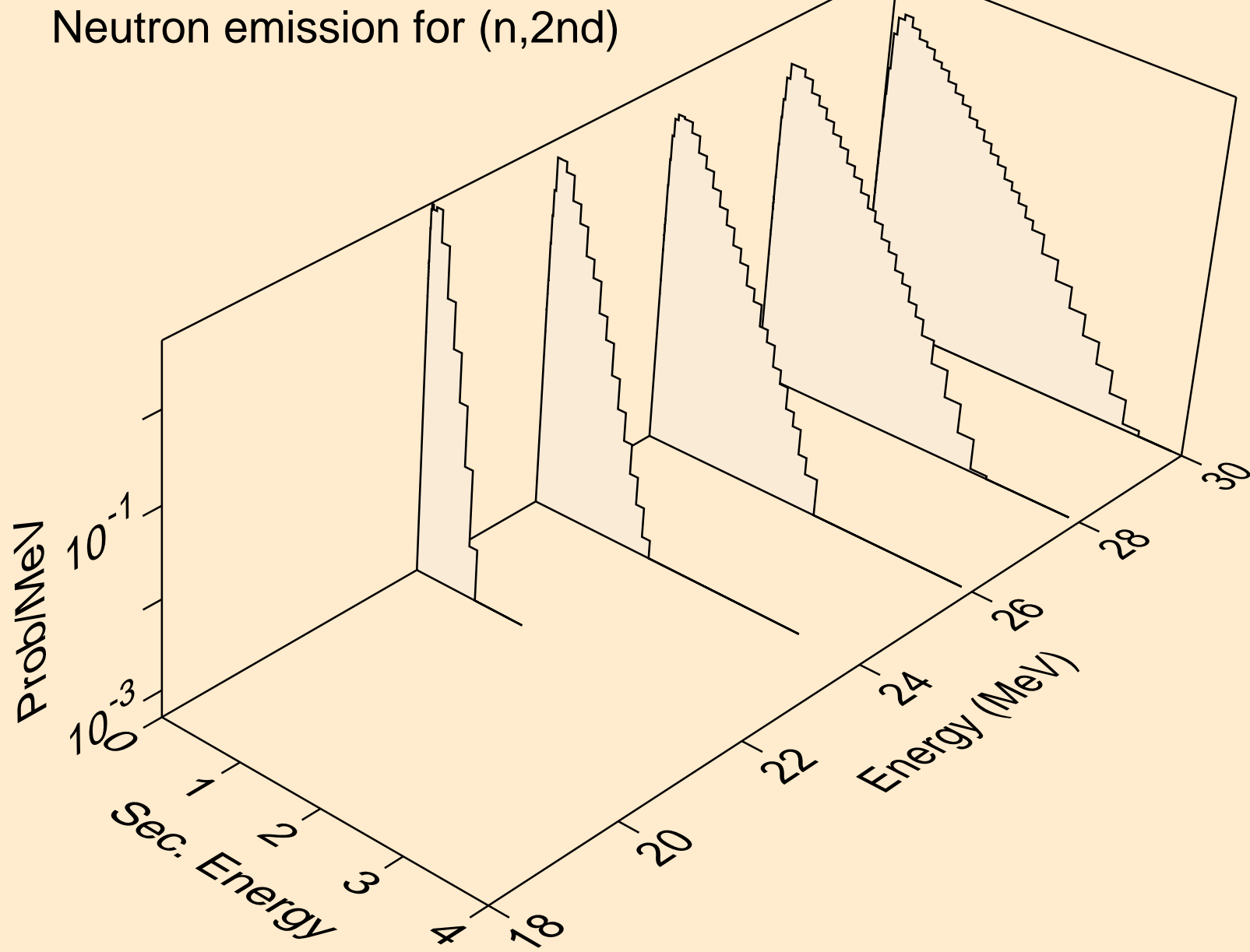

PT193 NEUTRON ACER TENDL-2023 LIBRARY; T=0.K  
Neutron emission for (n,2n)

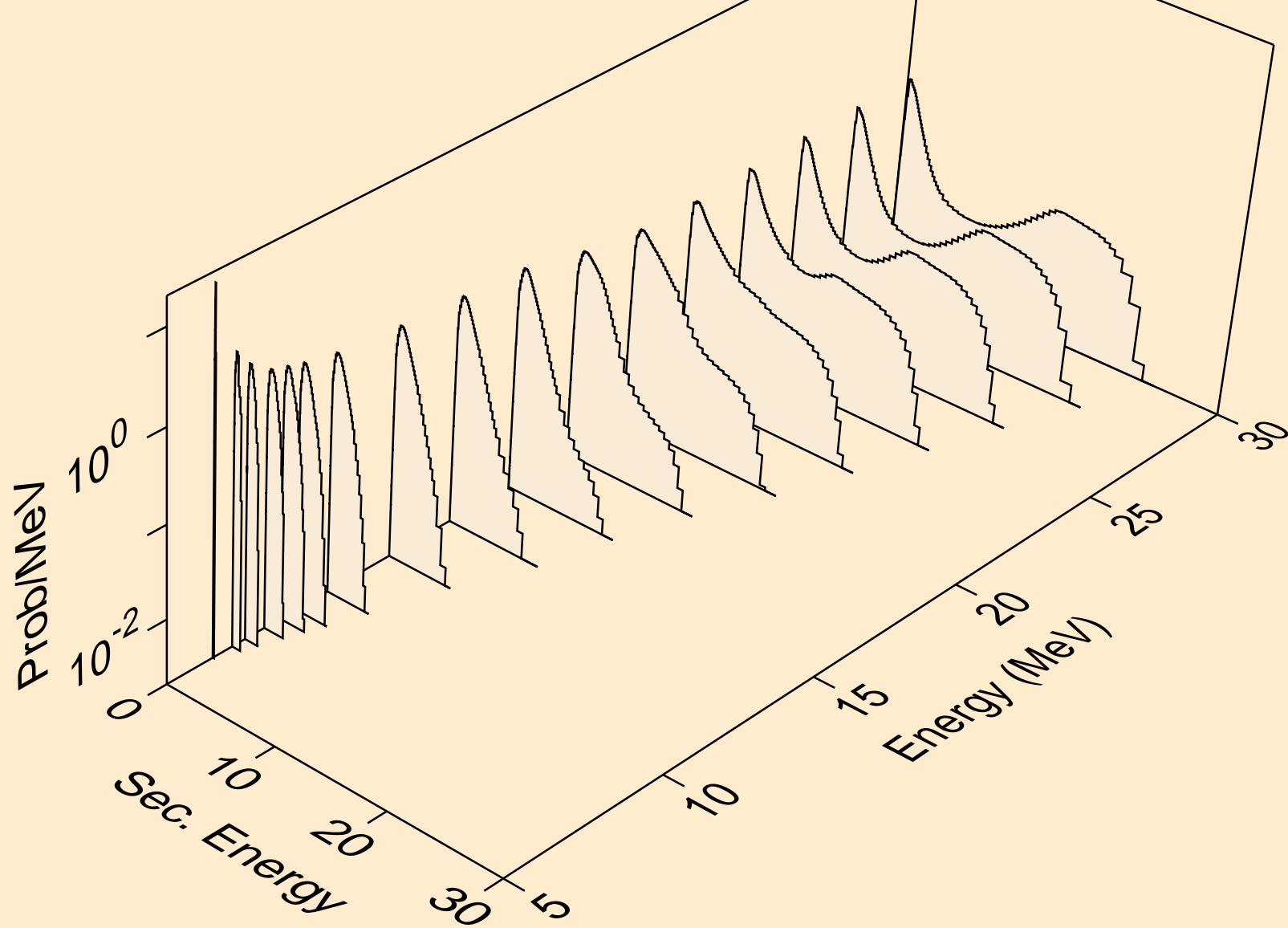

PT193 NEUTRON ACER TENDL-2023 LIBRARY; T=0.K  
Neutron emission for (n,3n)

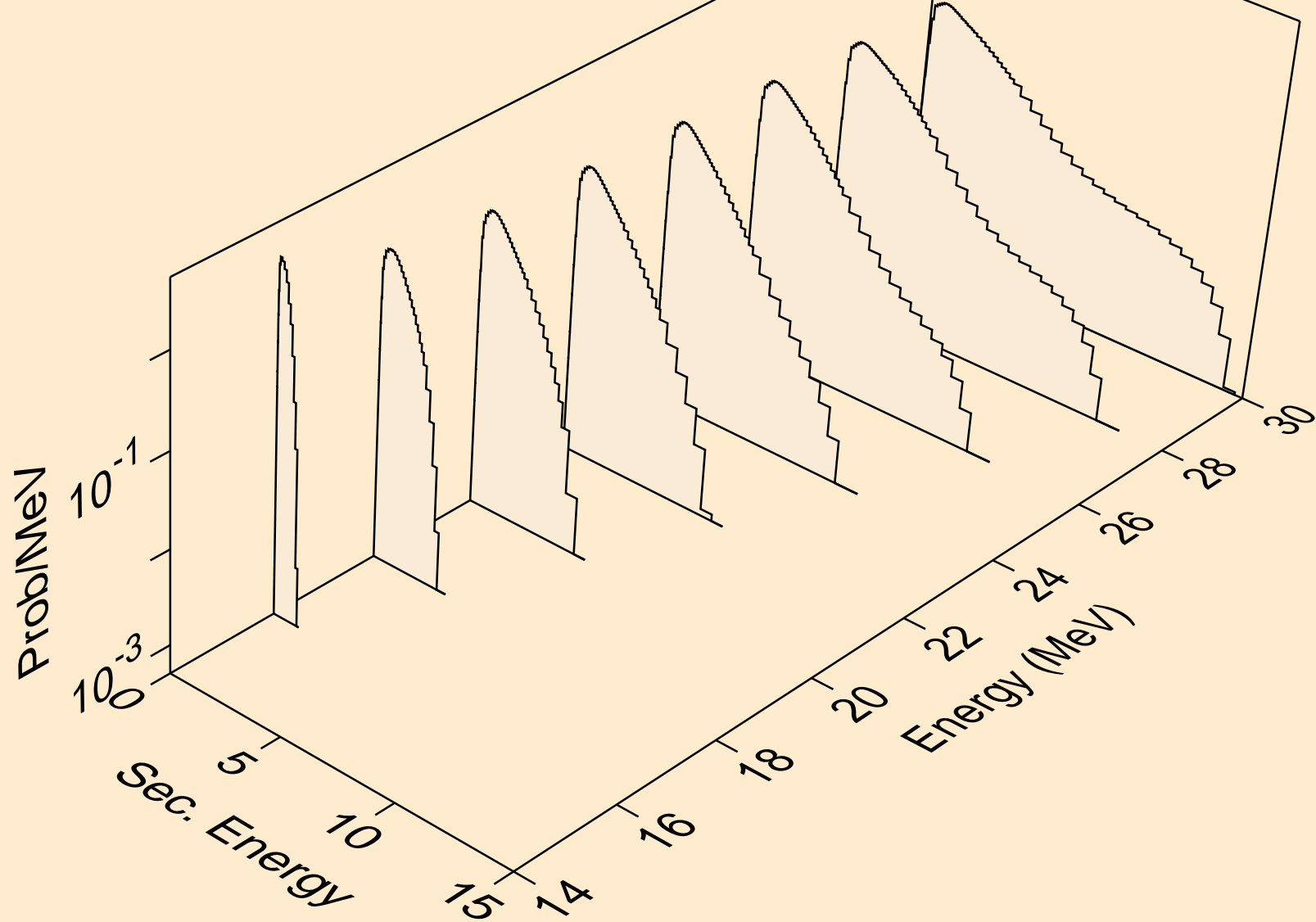

PT193 NEUTRON ACER TENDL-2023 LIBRARY; T=0.K  
Neutron emission for (n,n\*)a

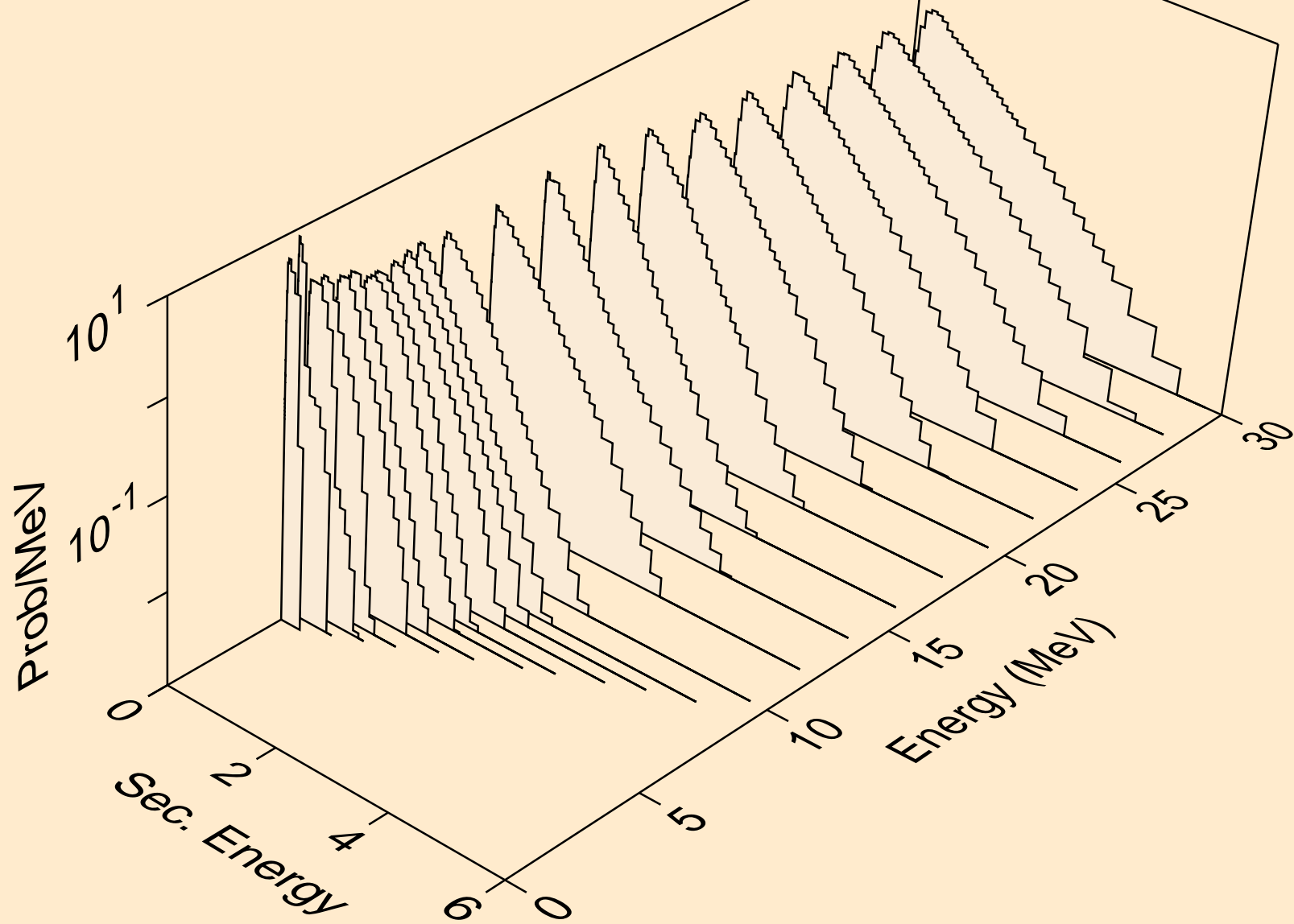

PT193 NEUTRON ACER TENDL-2023 LIBRARY; T=0.K  
Neutron emission for (n,2n)a

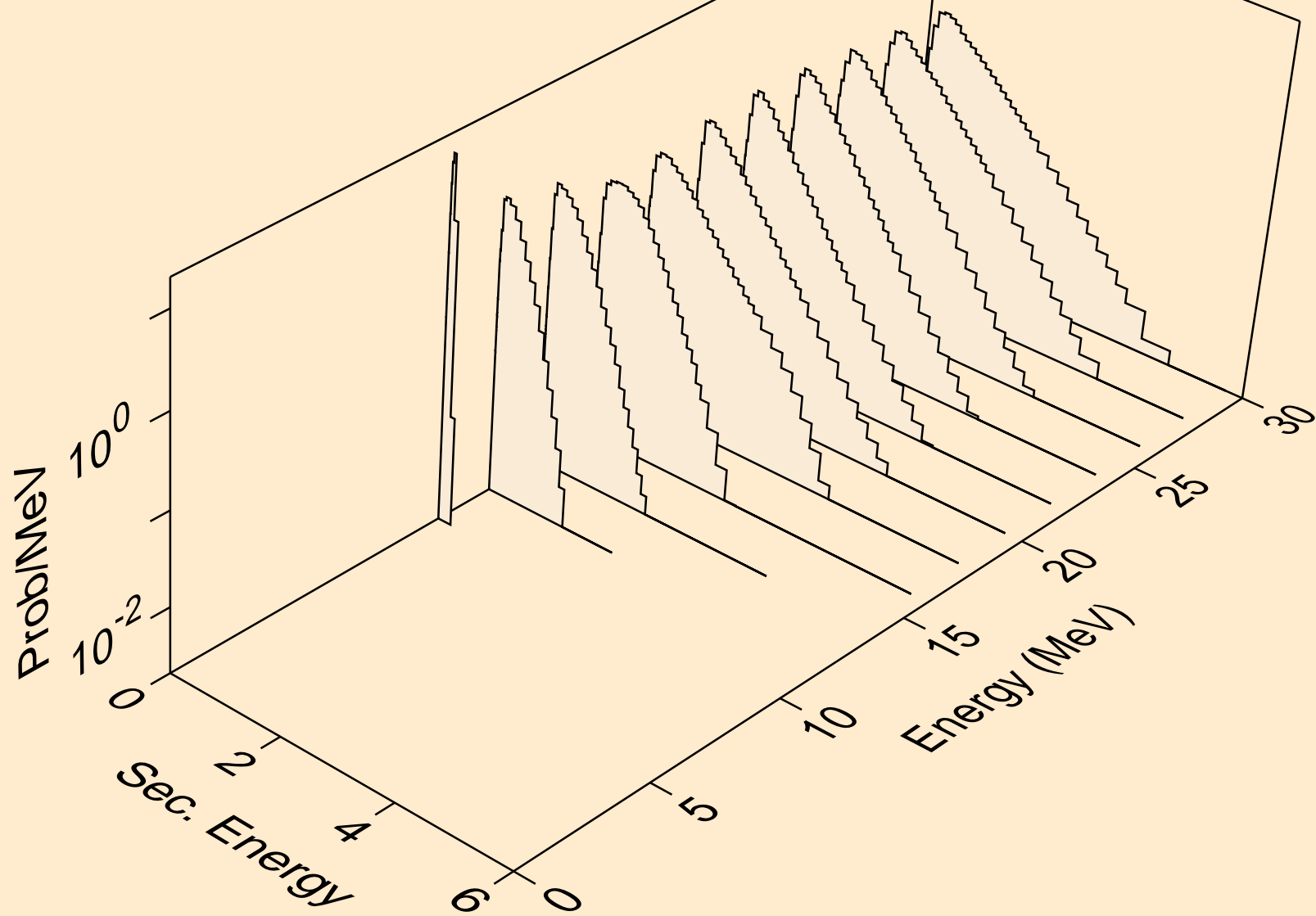

PT193 NEUTRON ACER TENDL-2023 LIBRARY; T=0.K  
Neutron emission for (n,3n)a

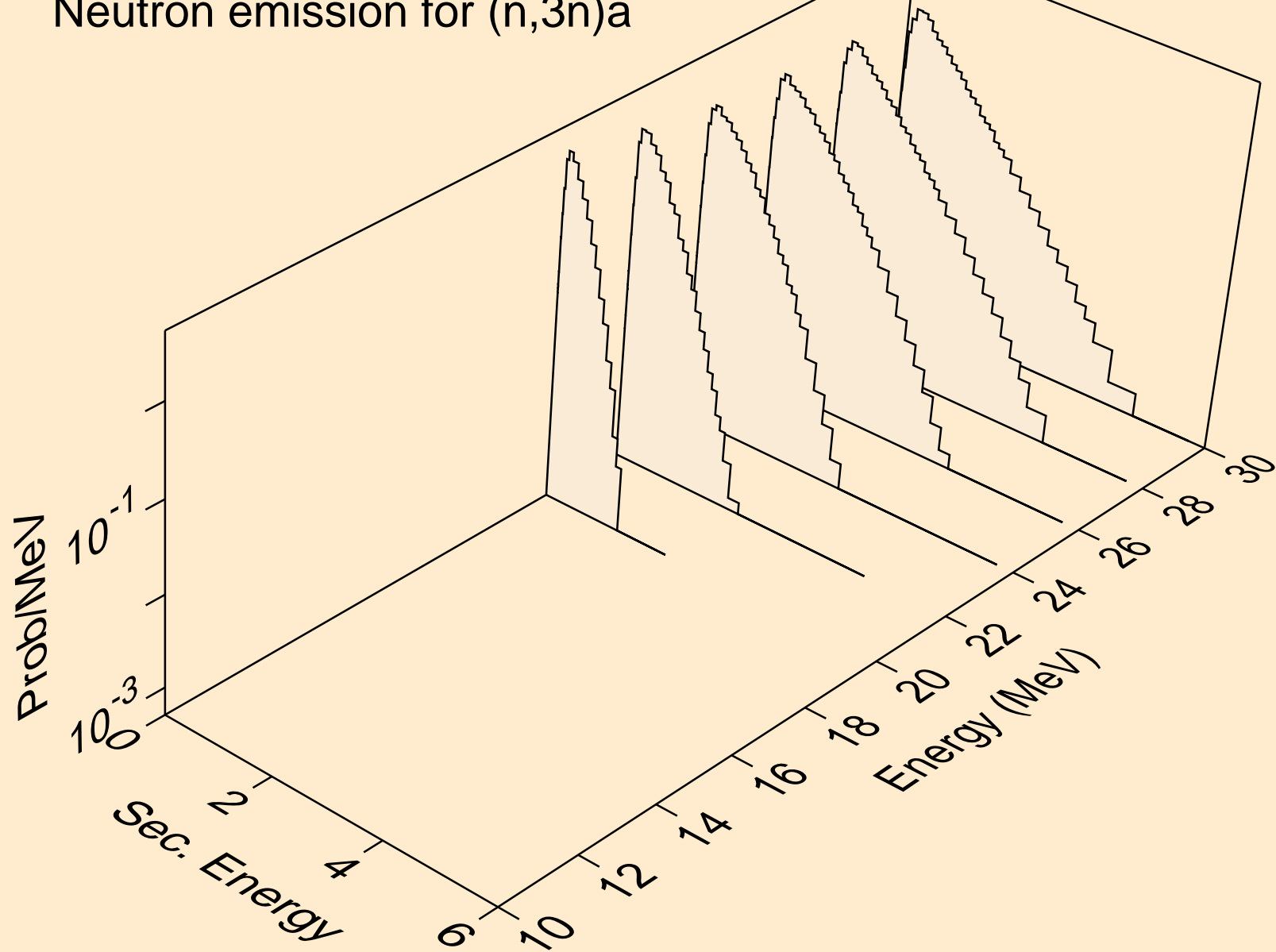



PT193 NEUTRON ACER TENDL-2023 LIBRARY; T=0.K  
Neutron emission for (n,n\*)p

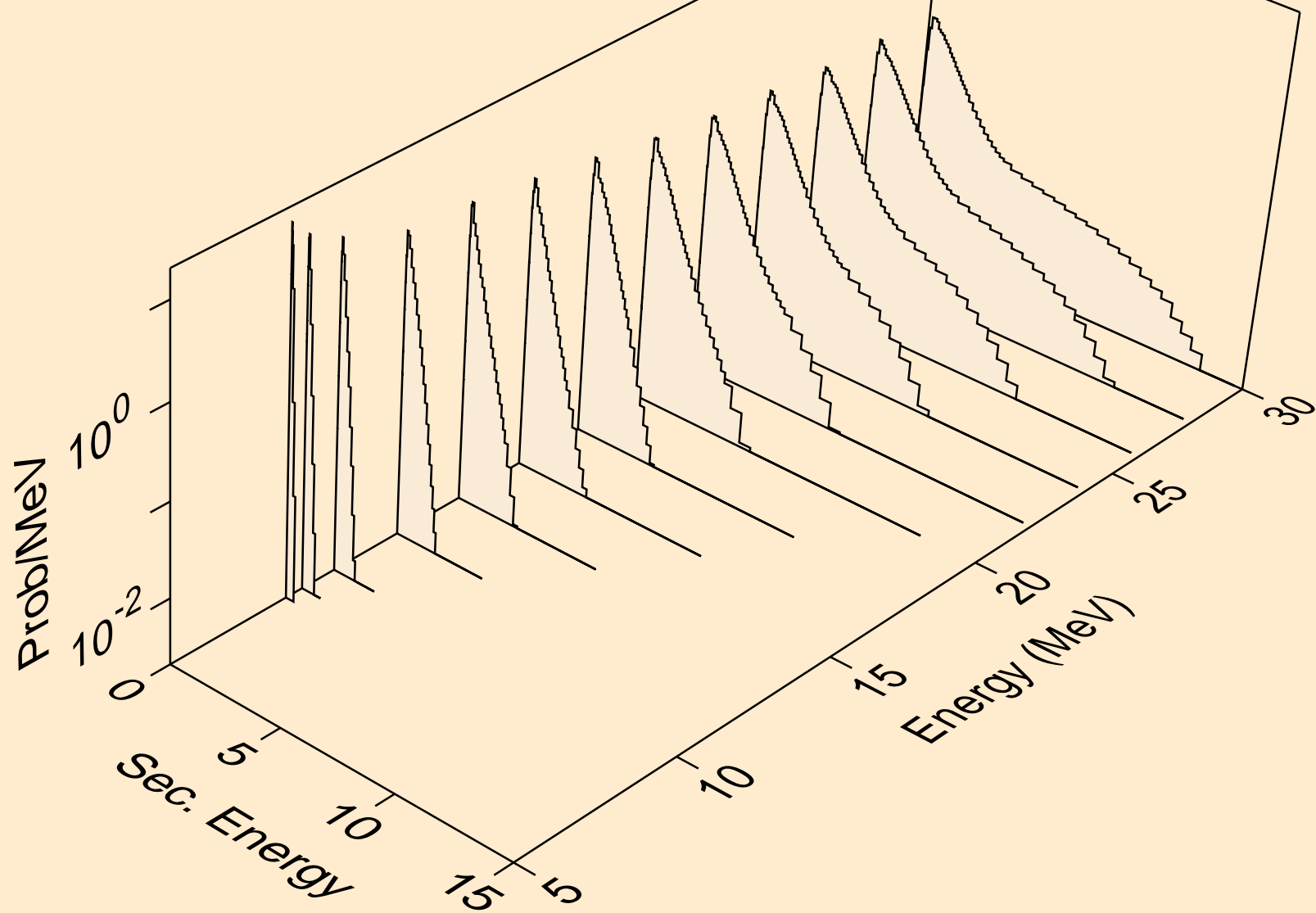

PT193 NEUTRON ACER TENDL-2023 LIBRARY; T=0.K  
Neutron emission for (n,n\*)d

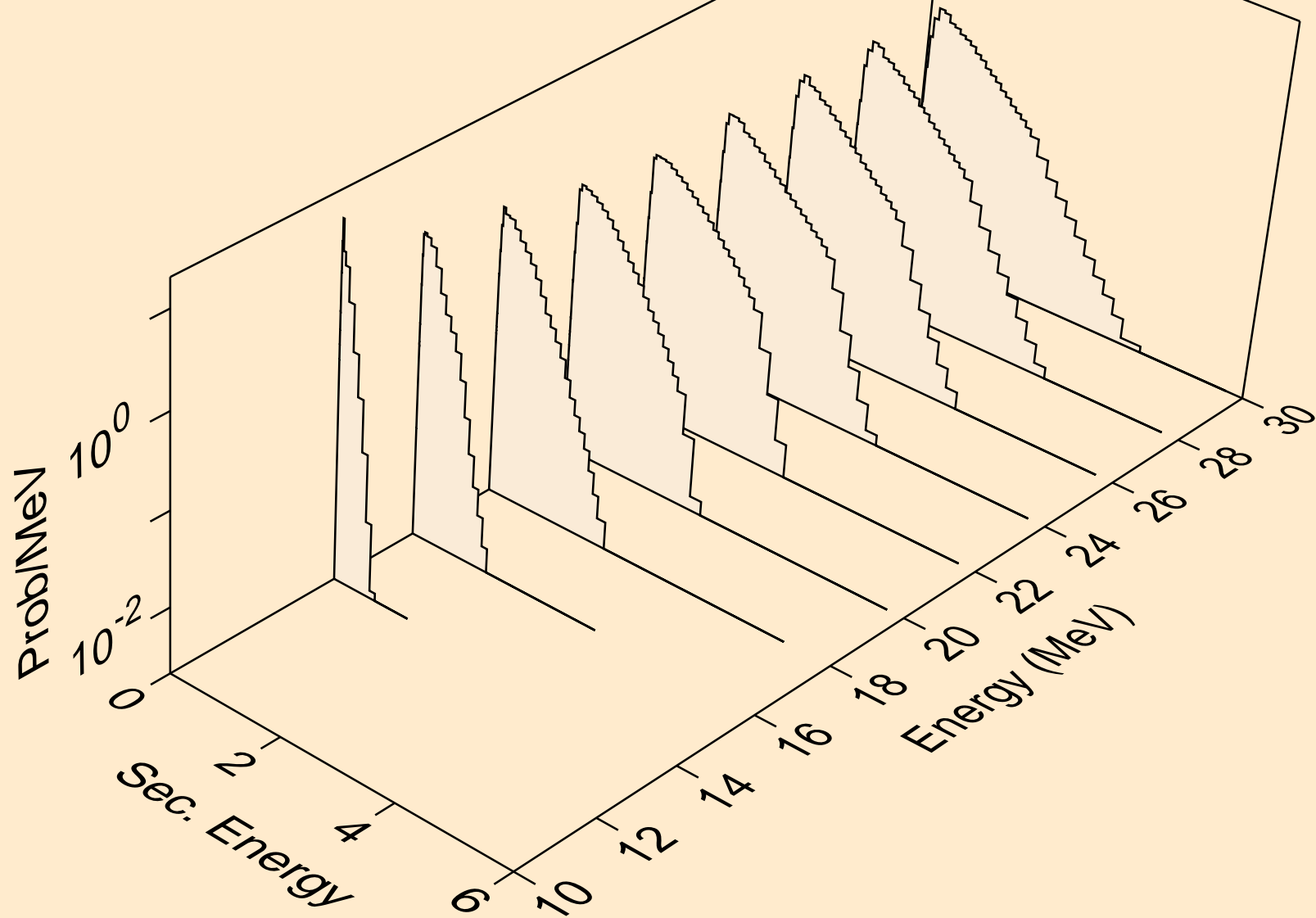

PT193 NEUTRON ACER TENDL-2023 LIBRARY; T=0.K  
Neutron emission for (n,n\*)t

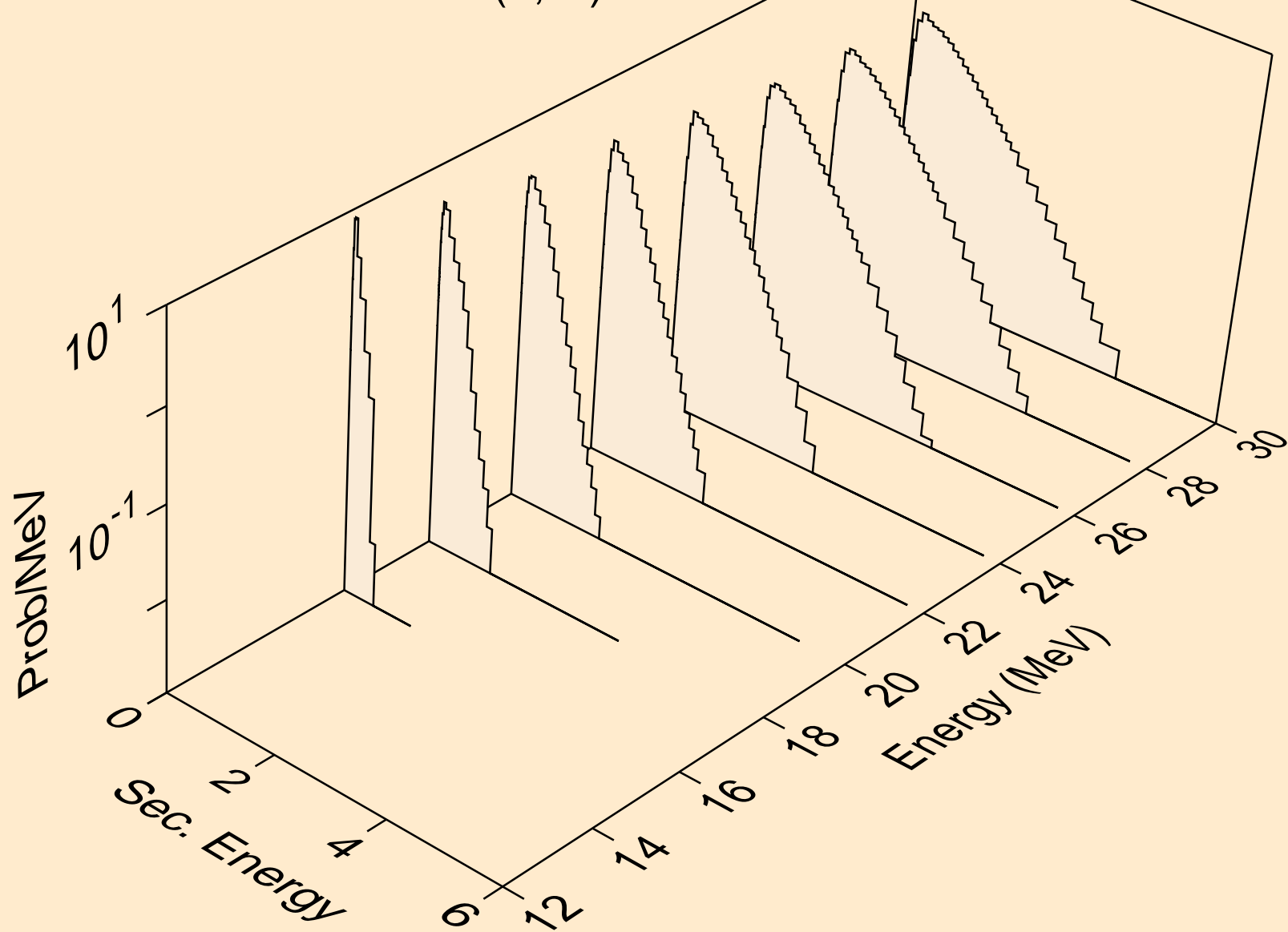

PT193 NEUTRON ACER TENDL-2023 LIBRARY; T=0.K  
Neutron emission for (n,n\*)he3

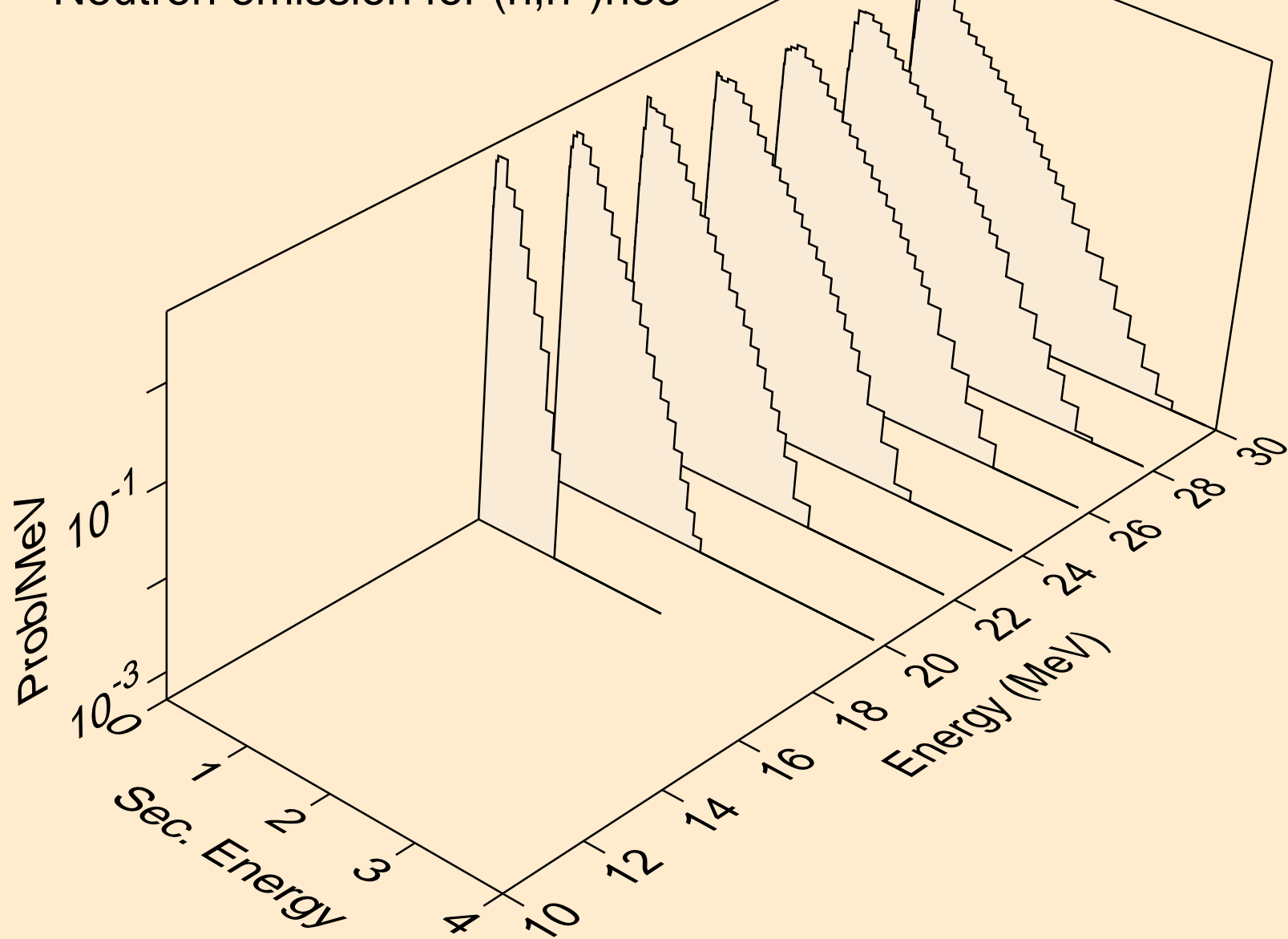

PT193 NEUTRON ACER TENDL-2023 LIBRARY; T=0.K  
Neutron emission for (n,4n)

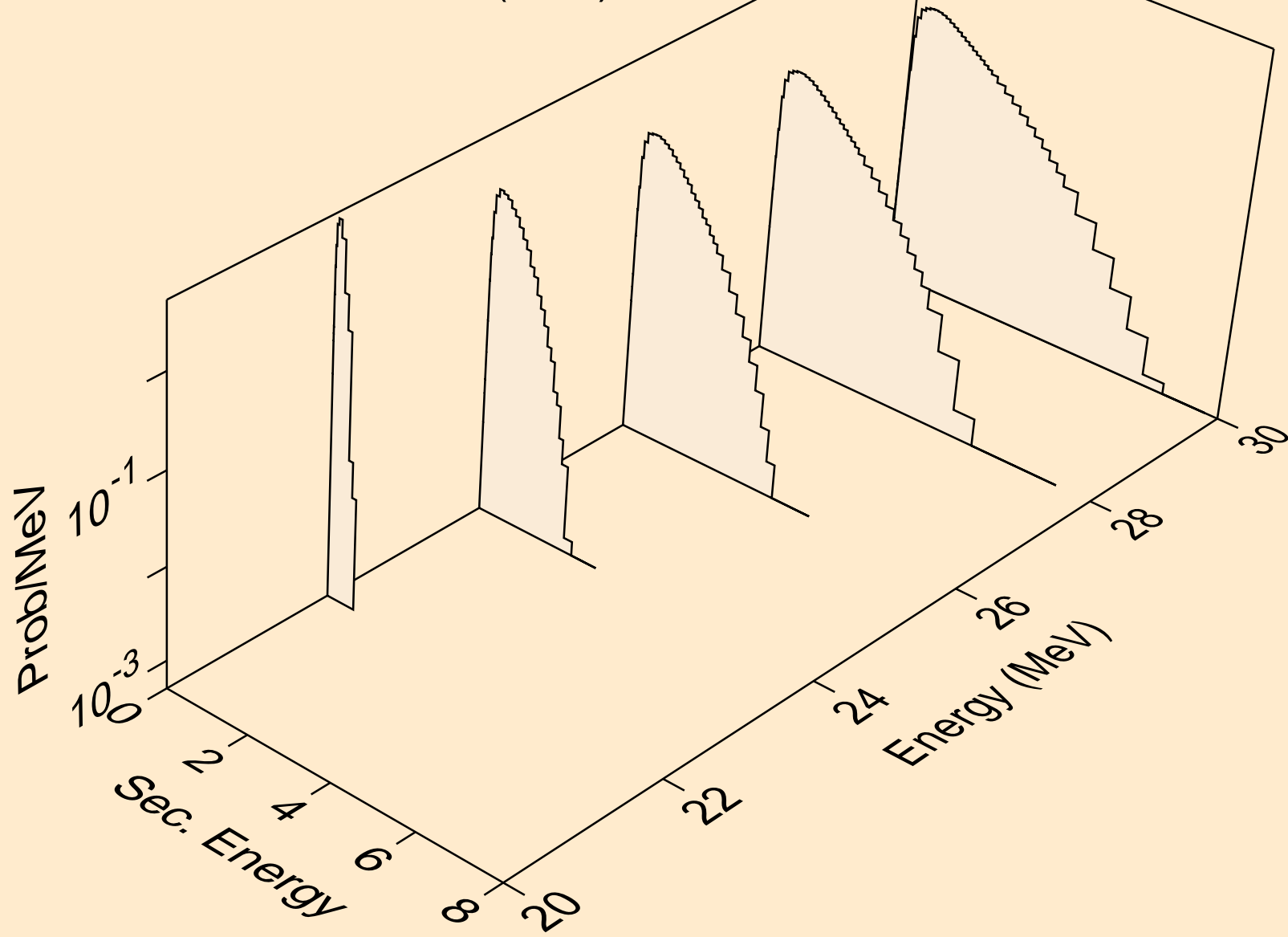

PT193 NEUTRON ACER TENDL-2023 LIBRARY; T=0.K  
Neutron emission for (n,2np)

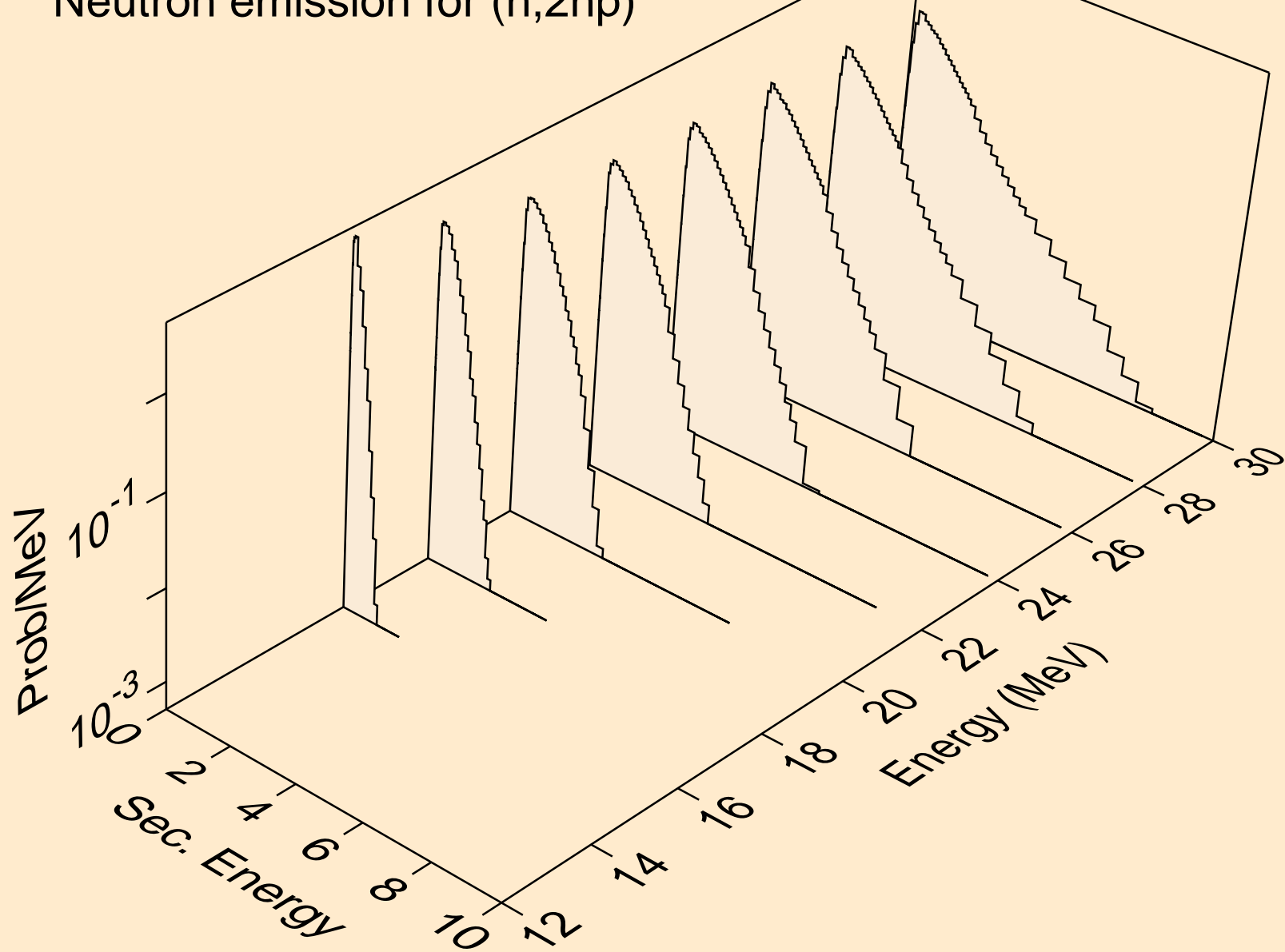

PT193 NEUTRON ACER TENDL-2023 LIBRARY; T=0.K  
Neutron emission for (n,3np)

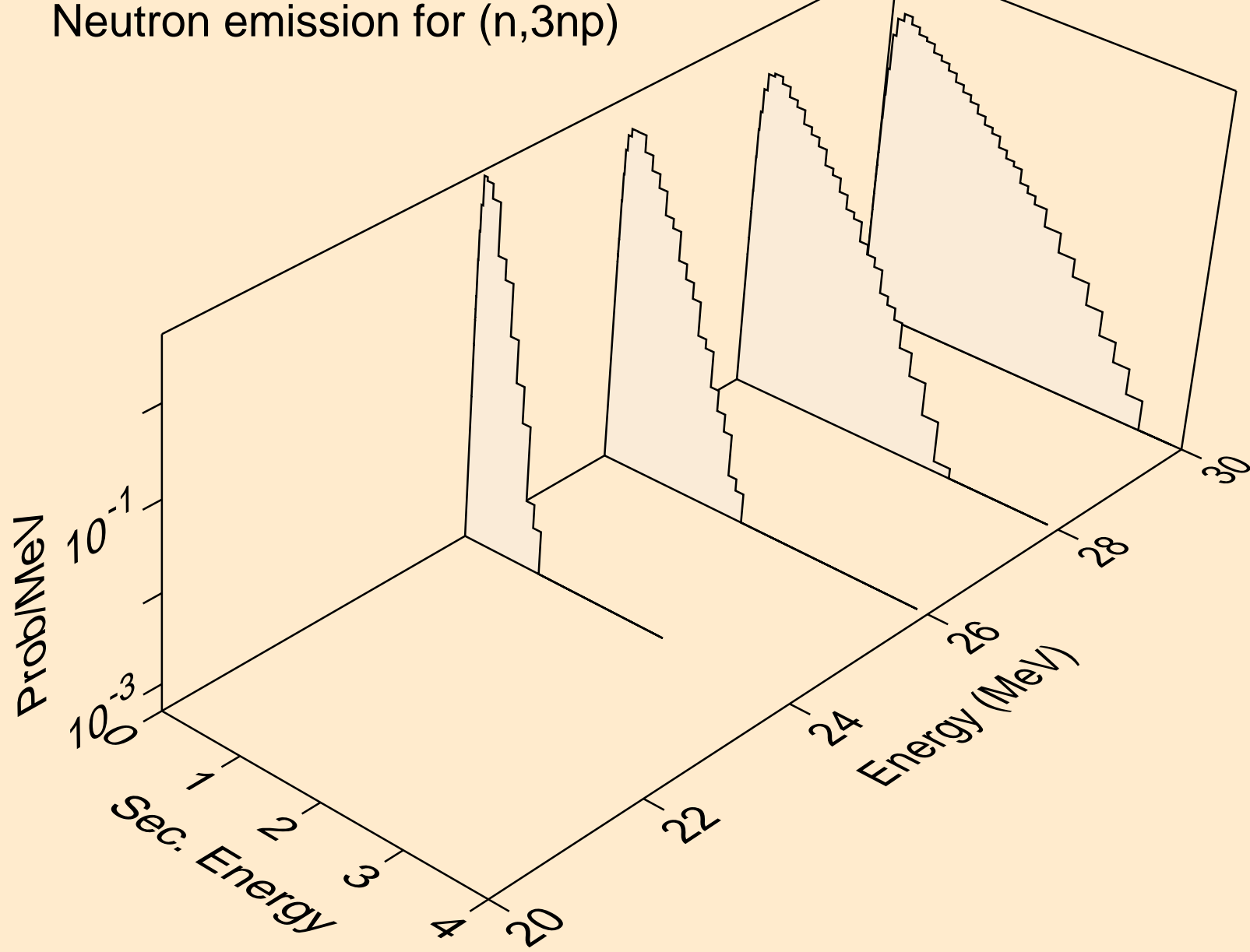

PT193 NEUTRON ACER TENDL-2023 LIBRARY; T=0.K  
Neutron emission for (n,n2p)

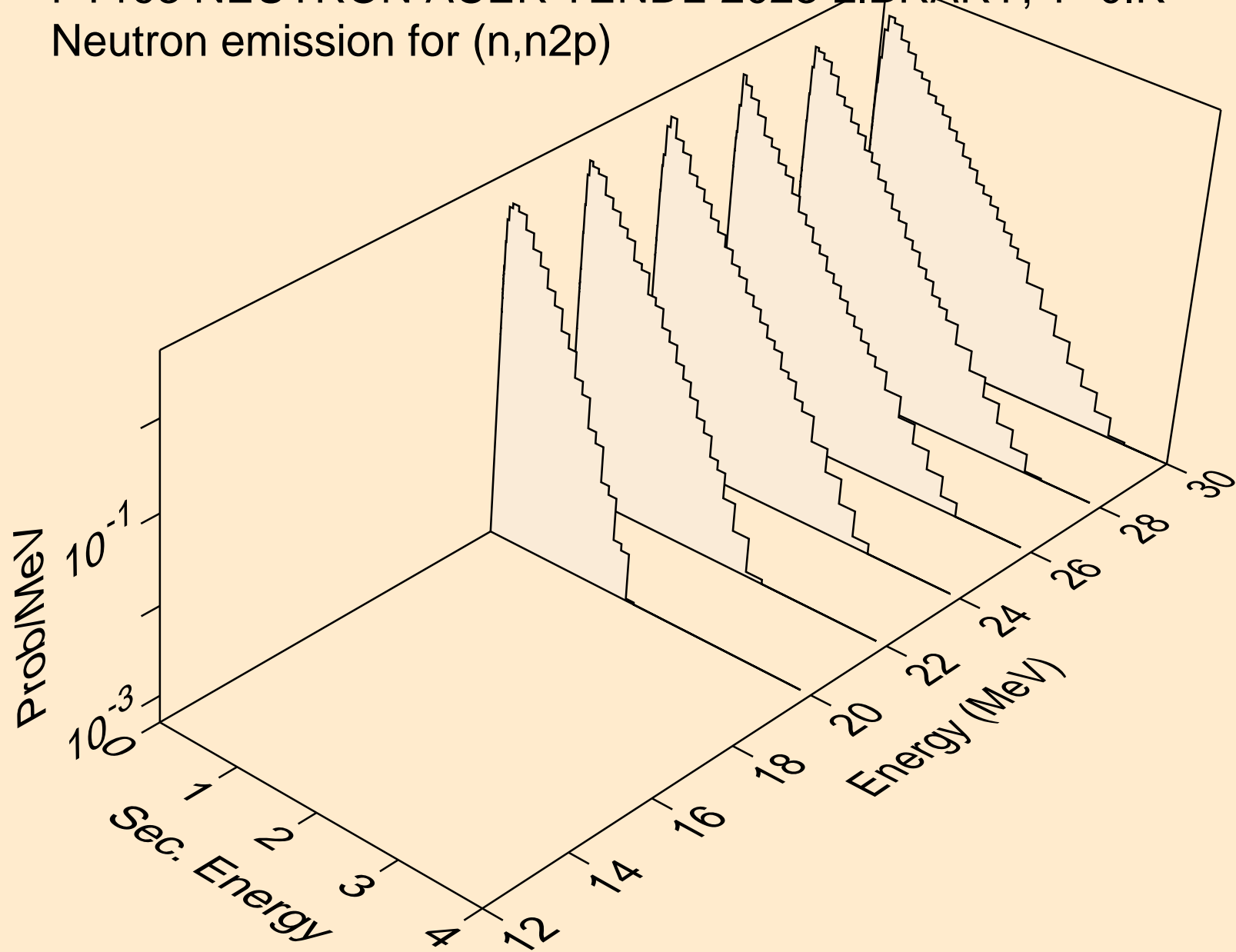



PT193 NEUTRON ACER TENDL-2023 LIBRARY; T=0.K  
Neutron emission for (n,npa)

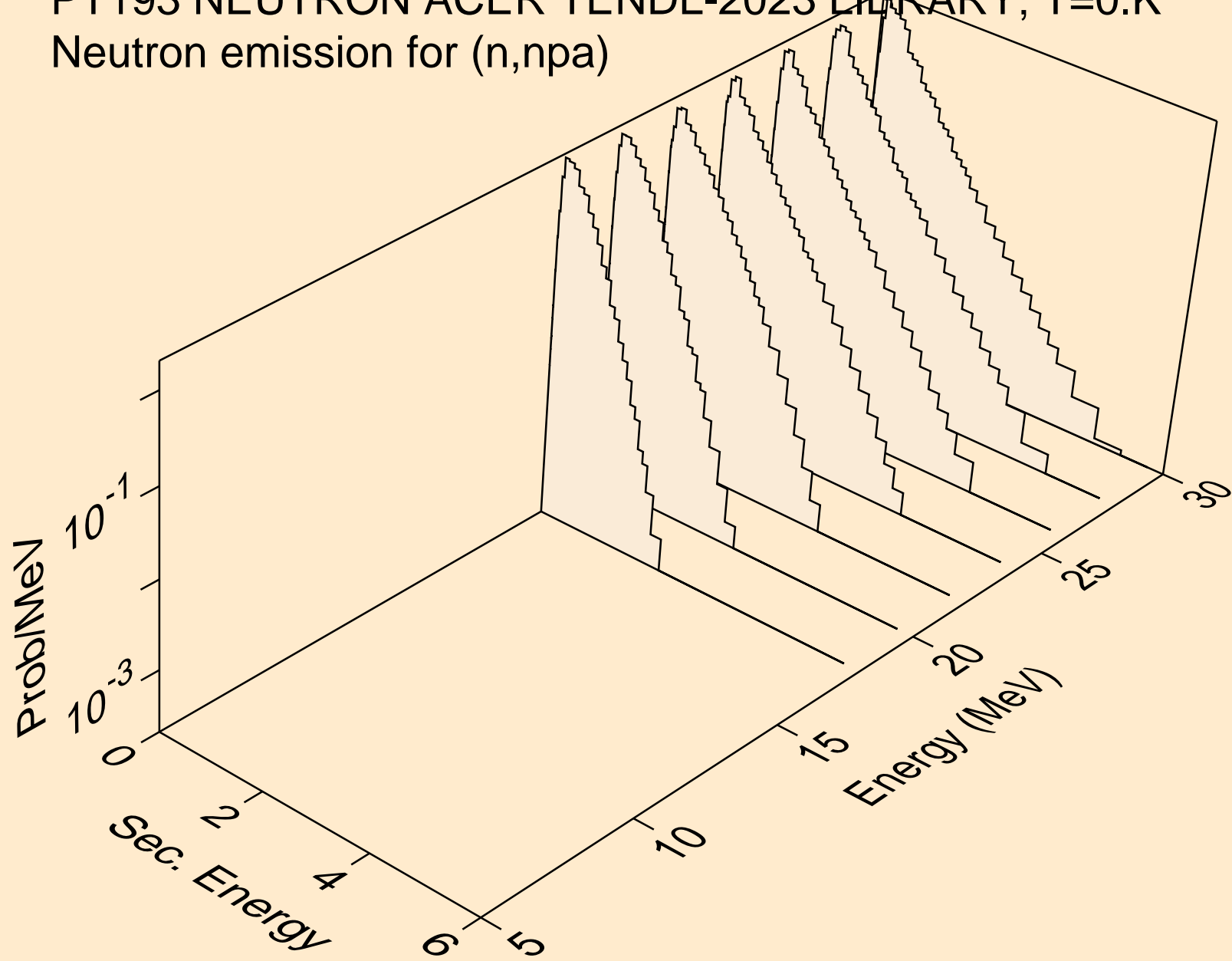

PT193 NEUTRON ACER TENDL-2023 LIBRARY; T=0.K  
Neutron emission for (n,n\*c)

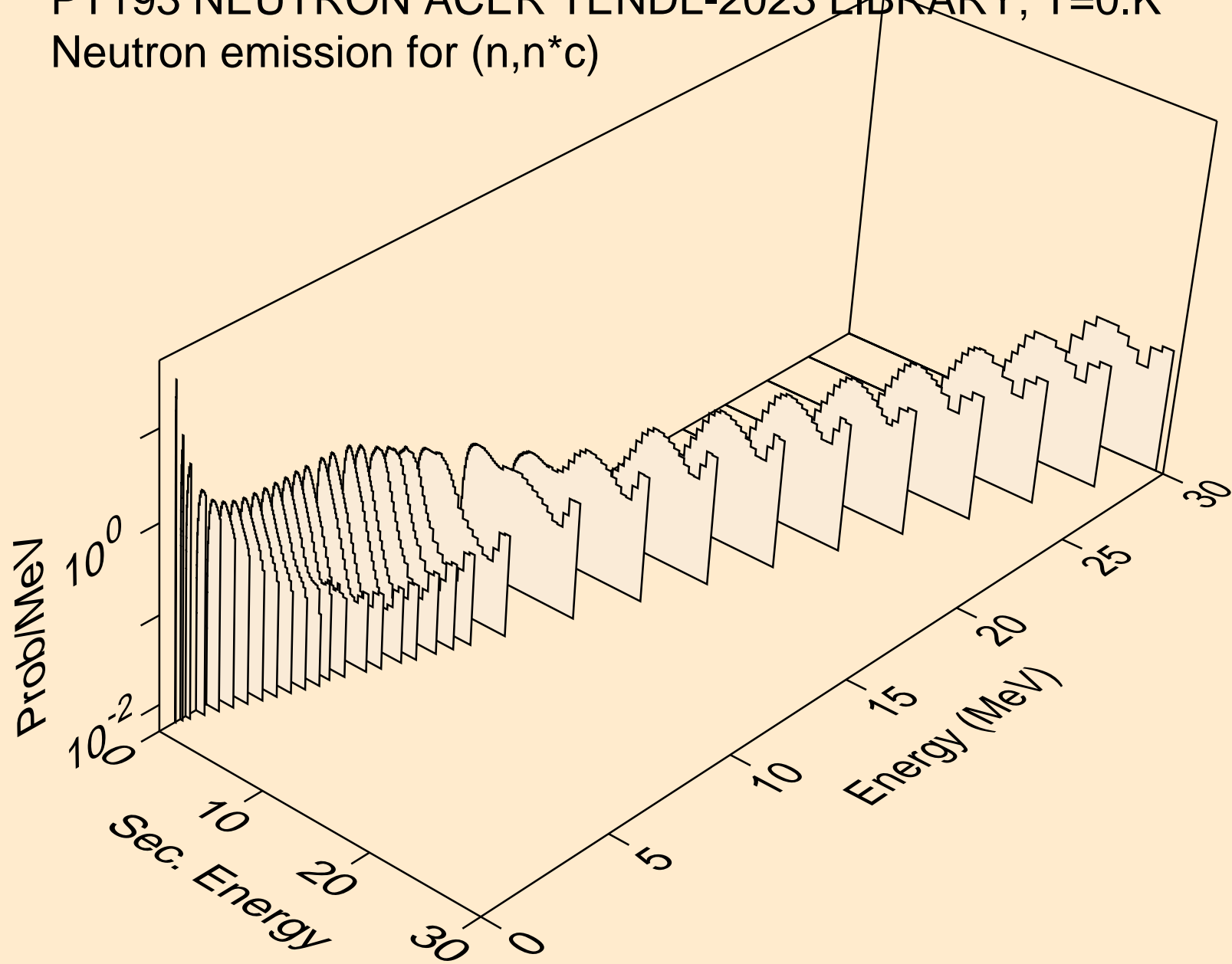

PT193 NEUTRON ACER TENDL-2023 LIBRARY; T=0.K  
Photon emission for (n,x)

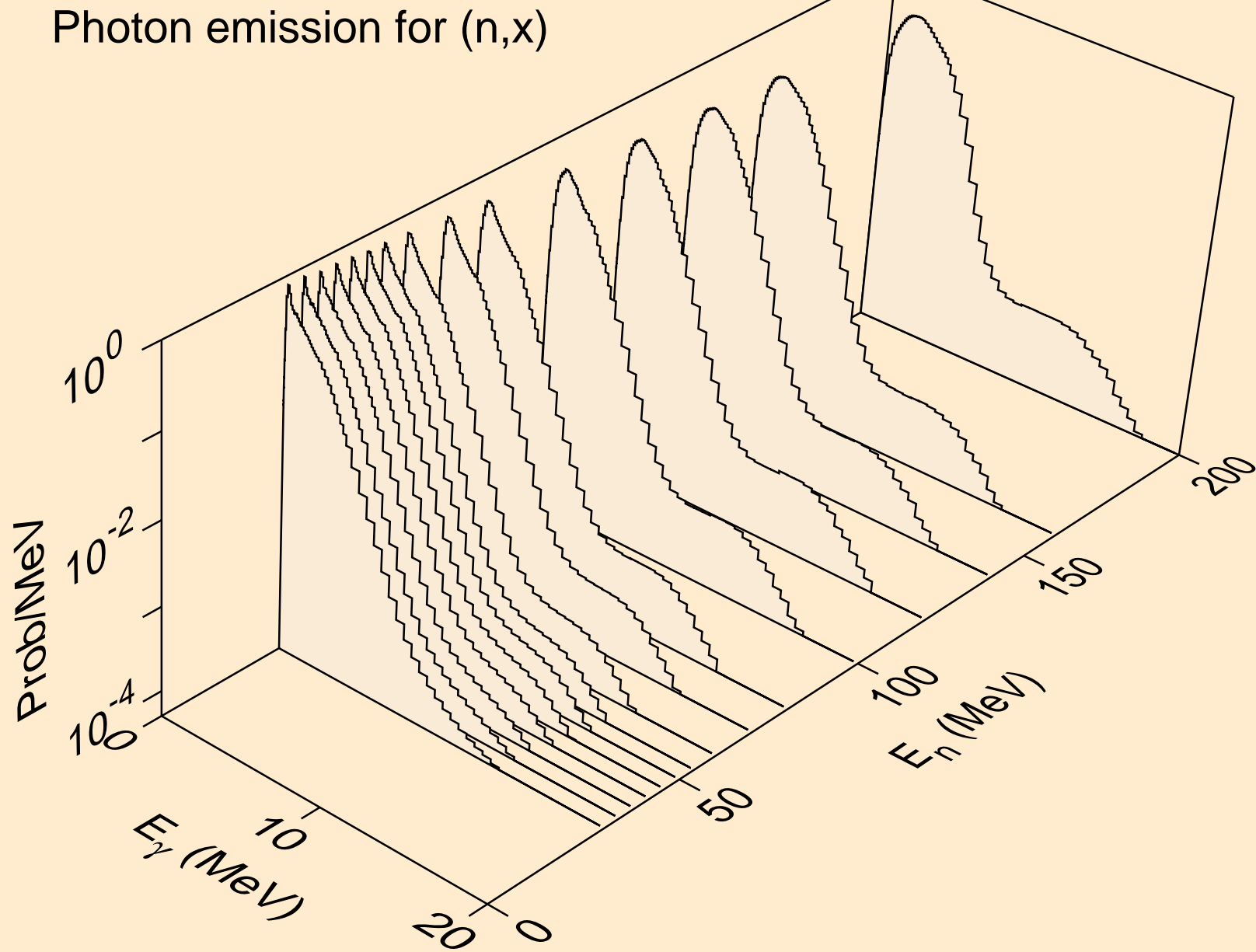

PT193 NEUTRON ACER TENDL-2023 LIBRARY; T=0.K  
Photon emission for (n,2nd)

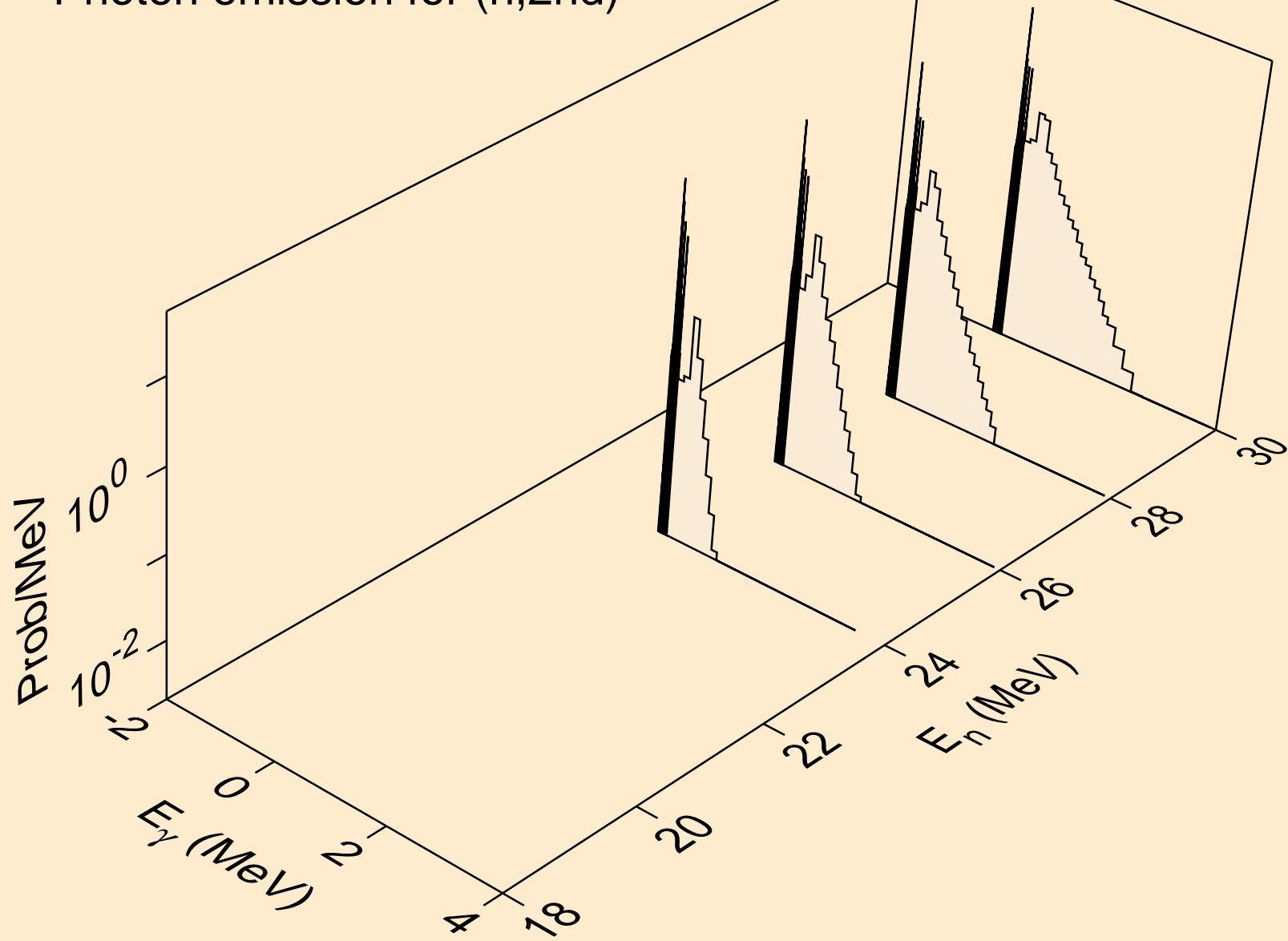

PT193 NEUTRON ACER TENDL-2023 LIBRARY; T=0.K  
Photon emission for (n,2n)

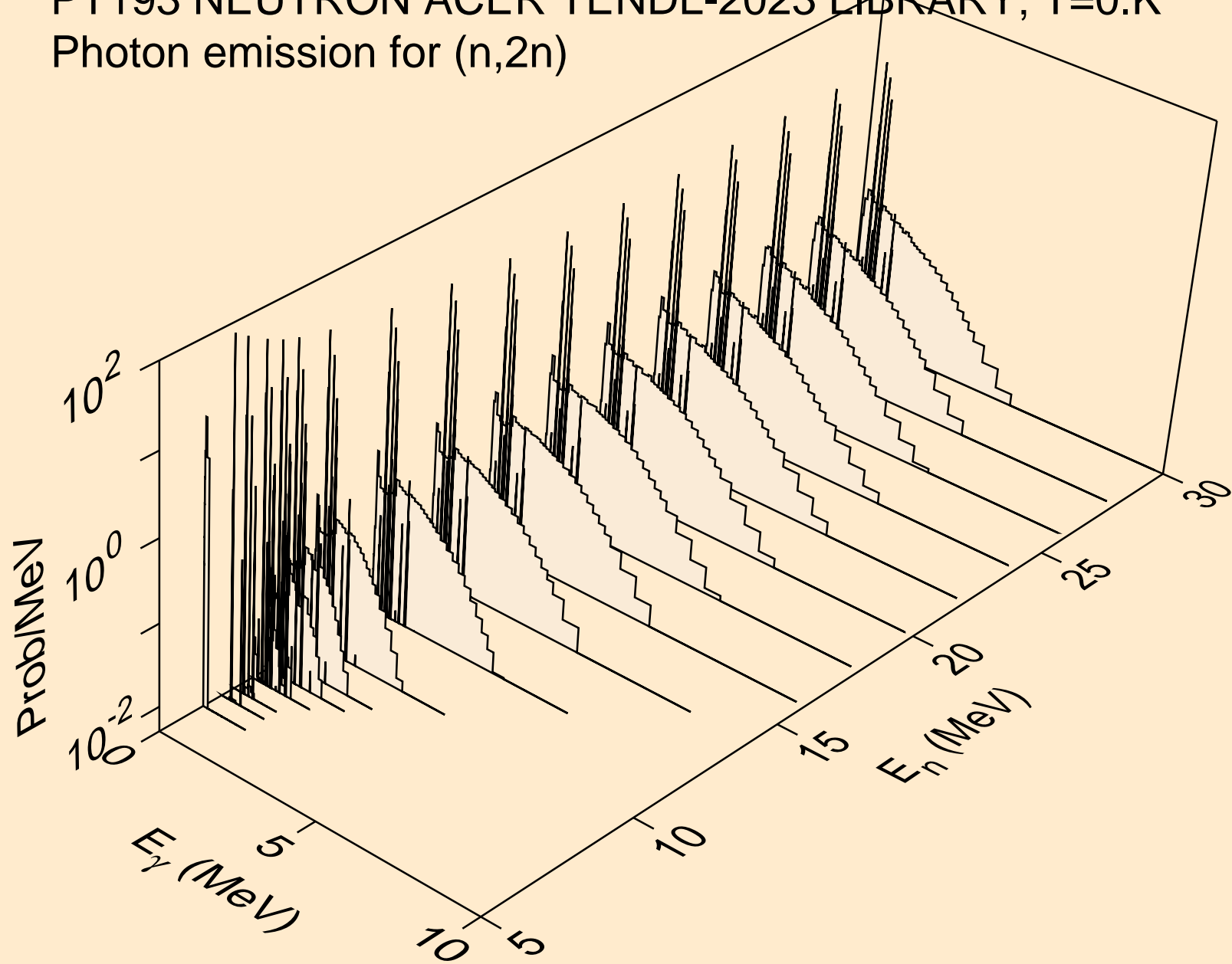

PT193 NEUTRON ACER TENDL-2023 LIBRARY; T=0.K  
Photon emission for (n,3n)

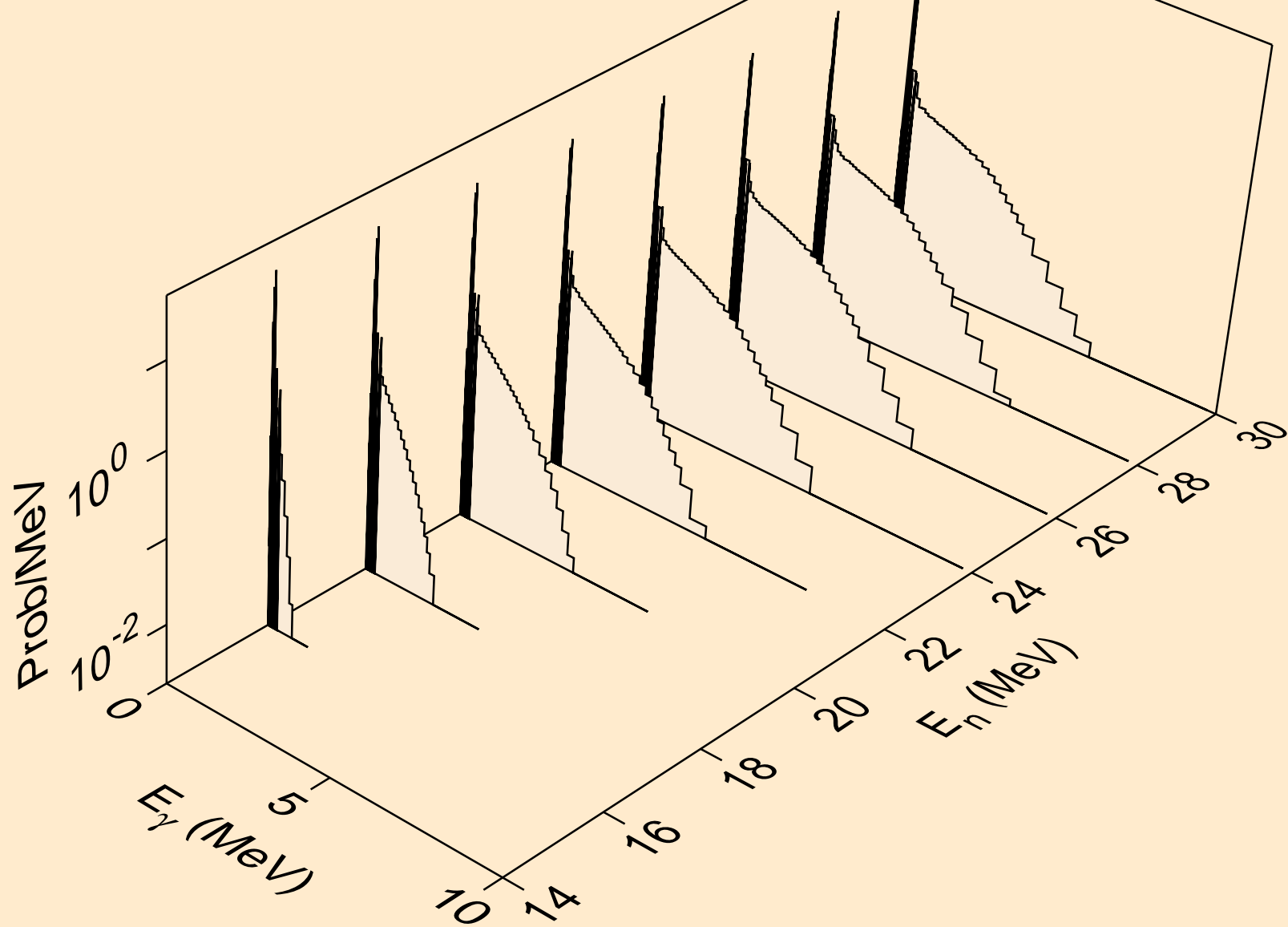

PT193 NEUTRON ACER TENDL-2023 LIBRARY; T=0.K  
Photon emission for (n,n\*)a

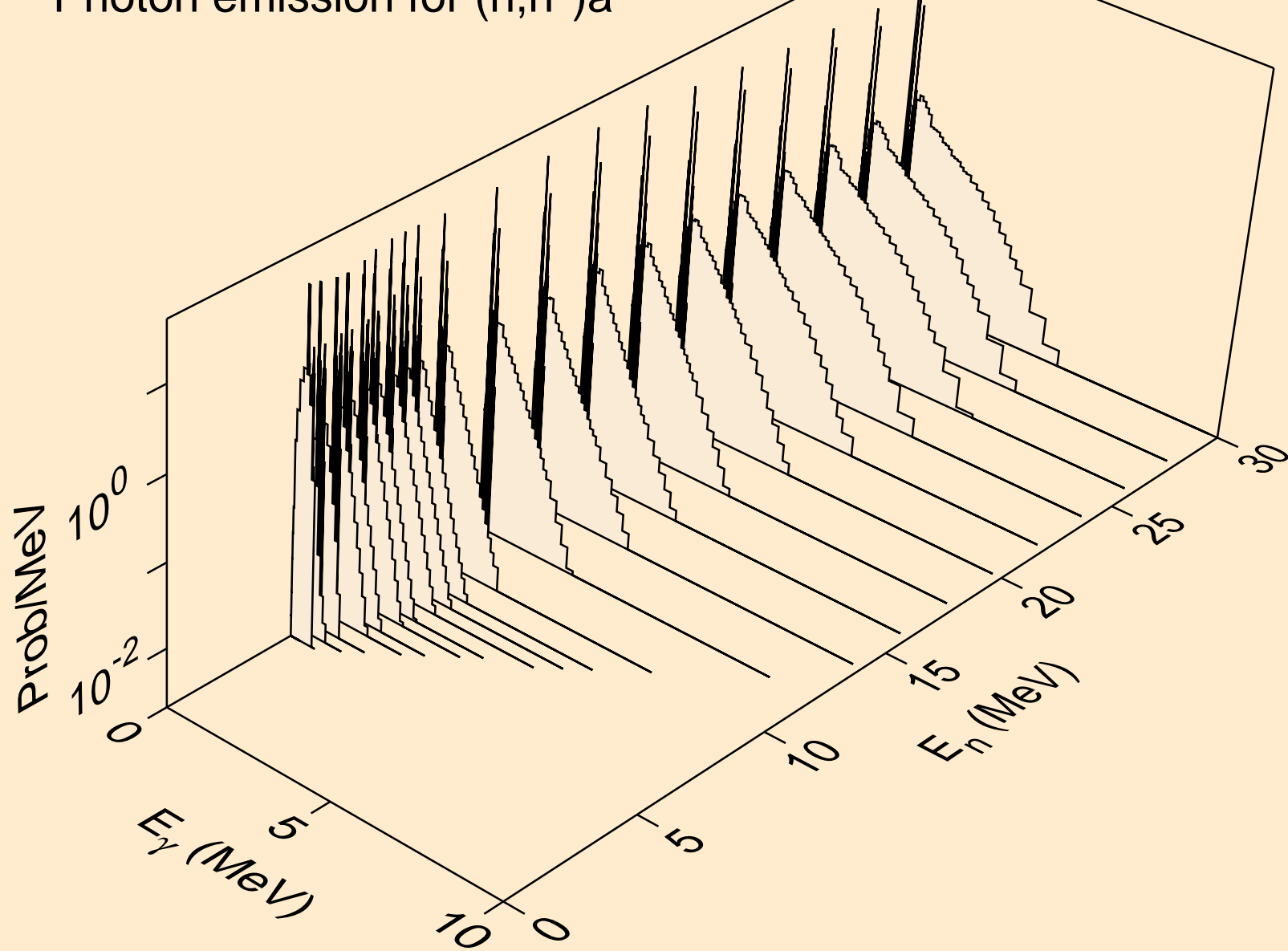

PT193 NEUTRON ACER TENDL-2023 LIBRARY; T=0.K  
Photon emission for (n,2n)a

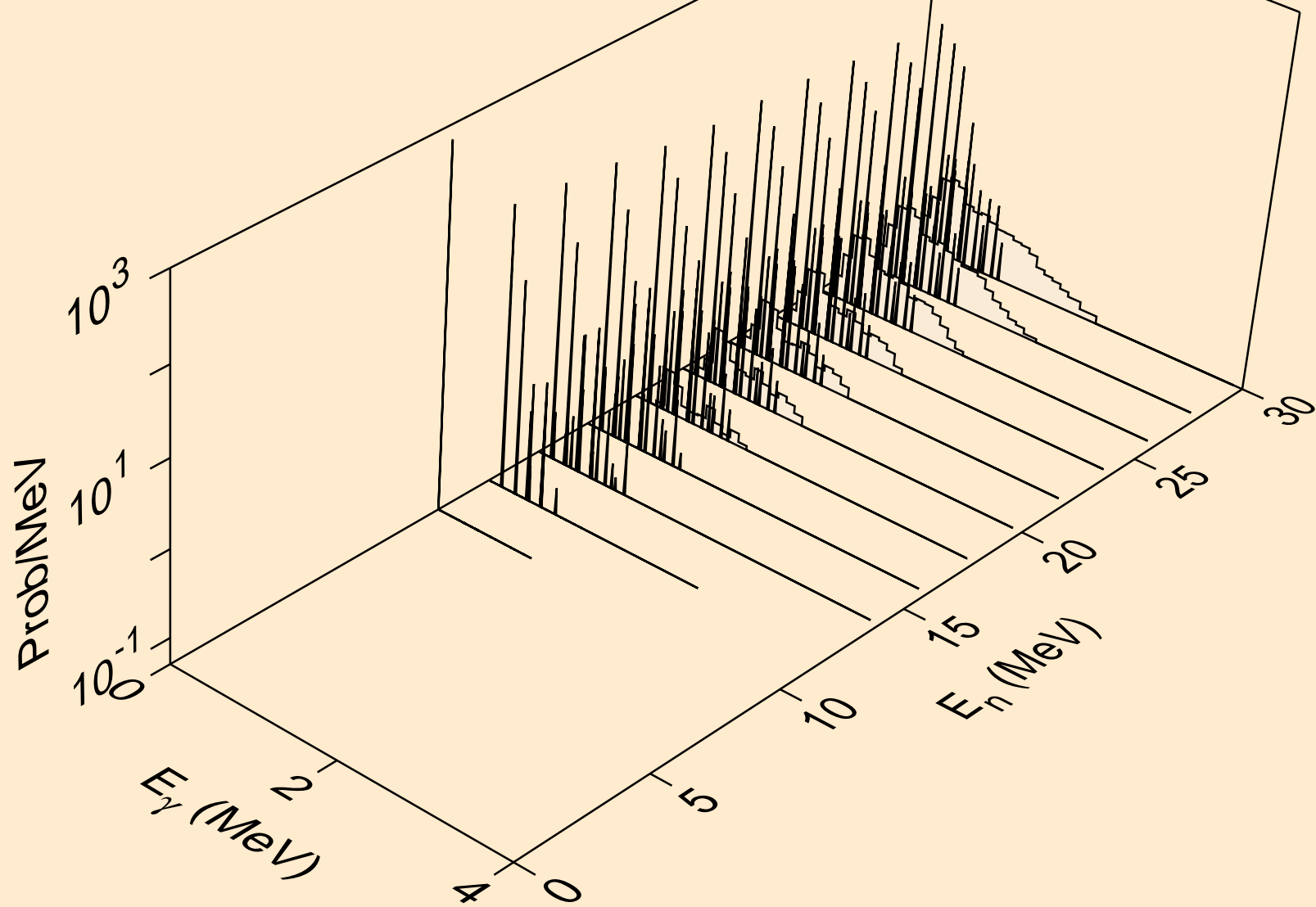



PT193 NEUTRON ACER TENDL-2023 LIBRARY; T=0.K  
Photon emission for (n,3n)a

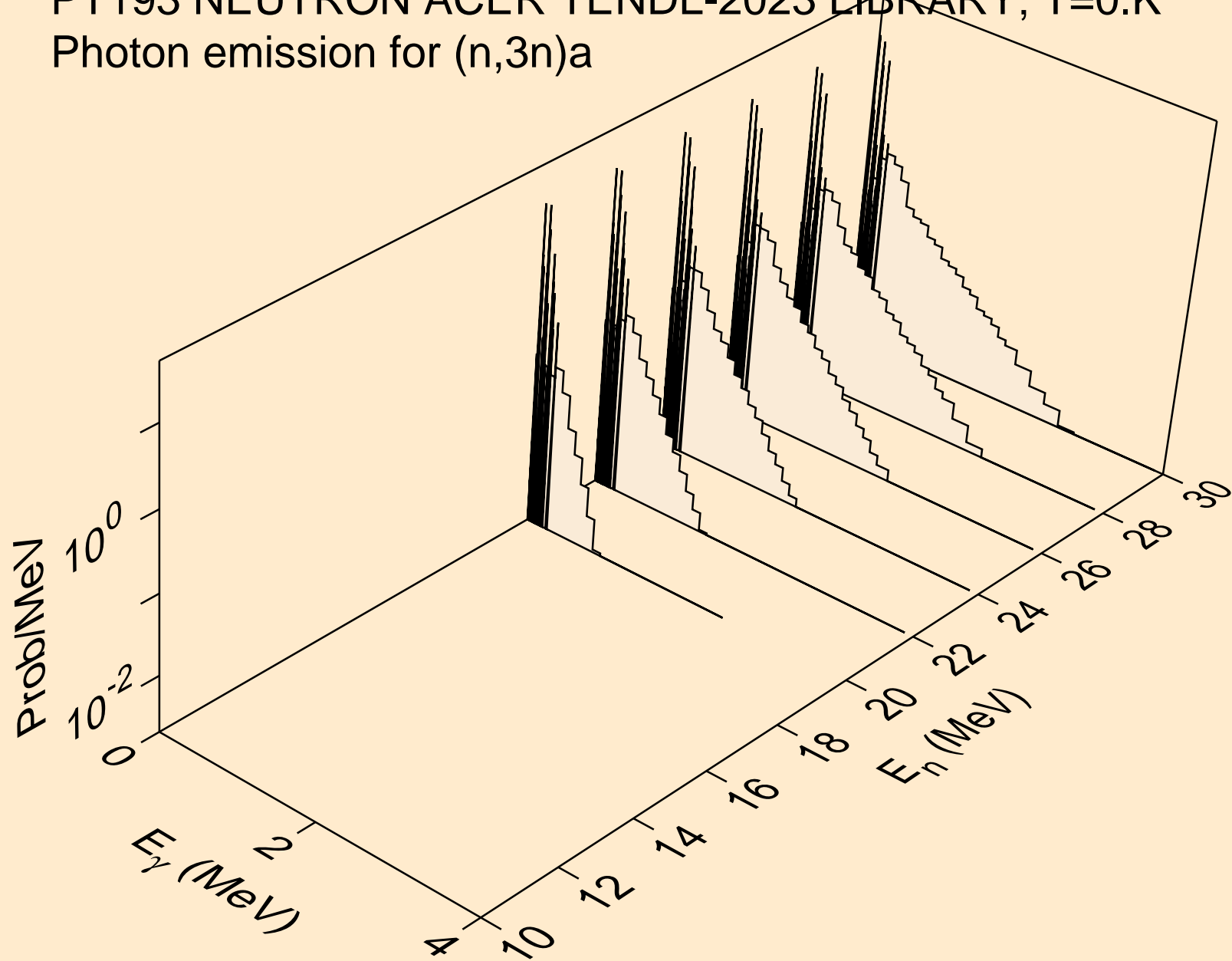

PT193 NEUTRON ACER TENDL-2023 LIBRARY; T=0.K  
Photon emission for (n,n\*)p

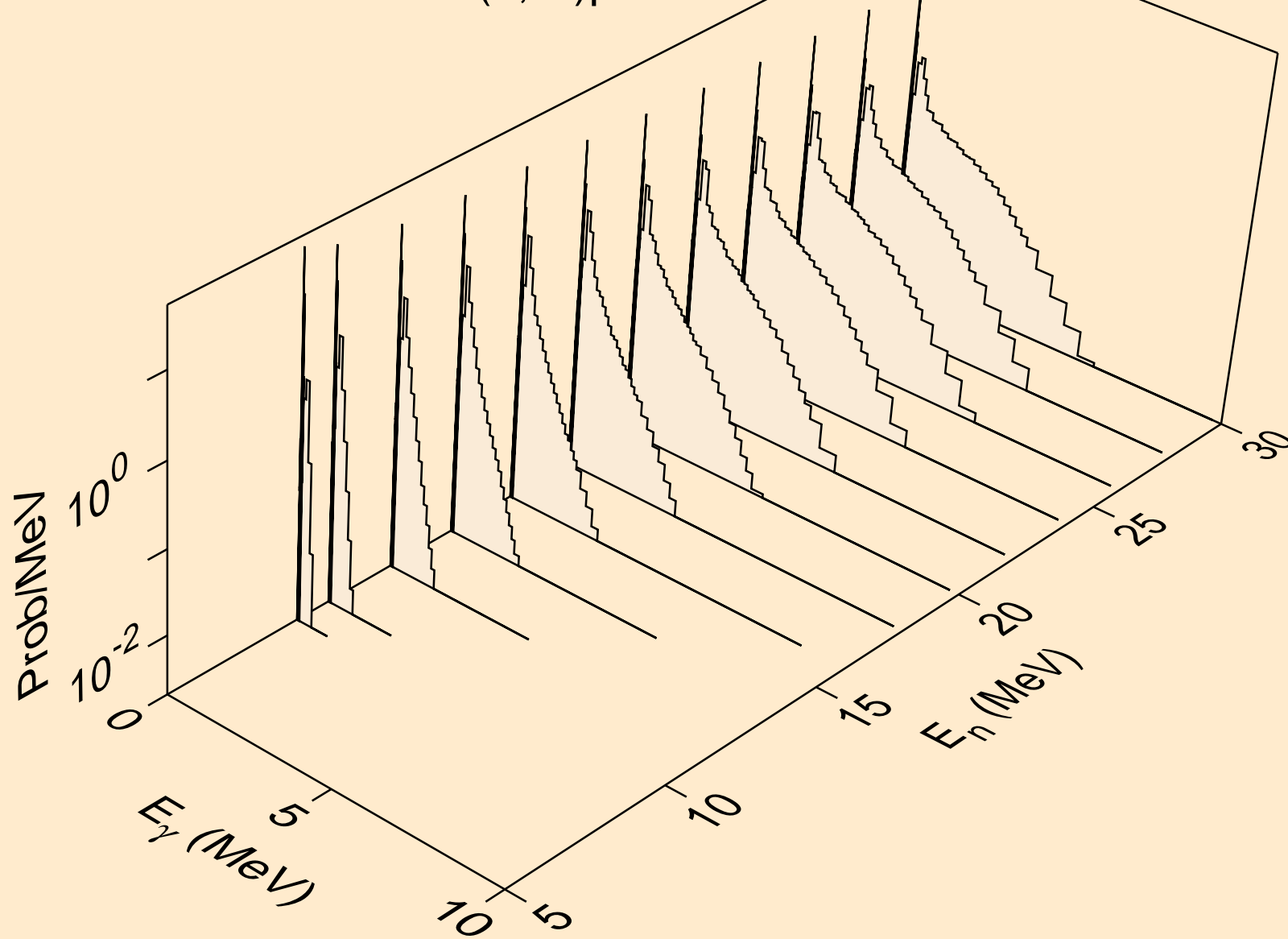

PT193 NEUTRON ACER TENDL-2023 LIBRARY; T=0.K  
Photon emission for (n,n\*)d

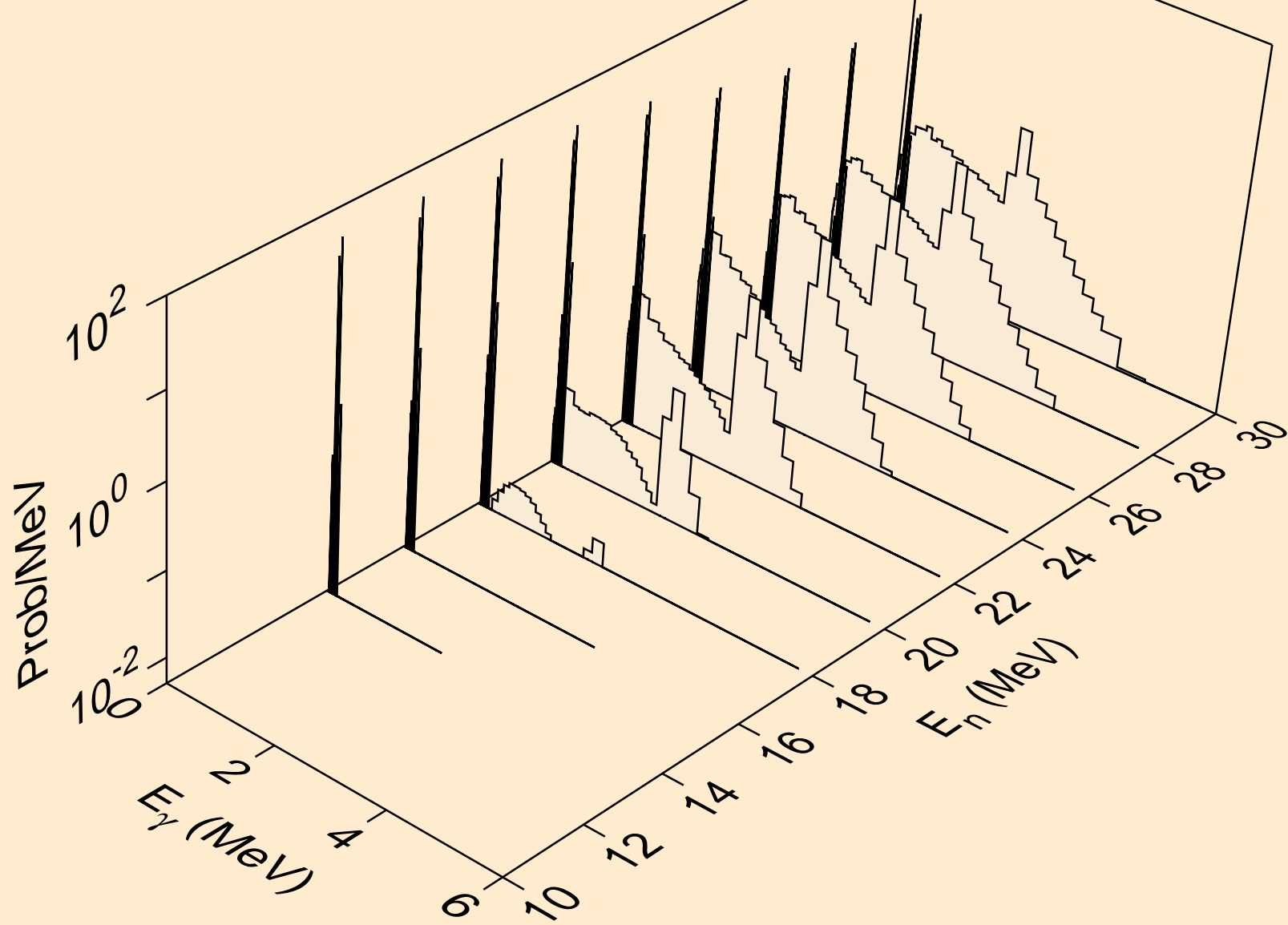

PT193 NEUTRON ACER TENDL-2023 LIBRARY; T=0.K  
Photon emission for (n,n\*)t

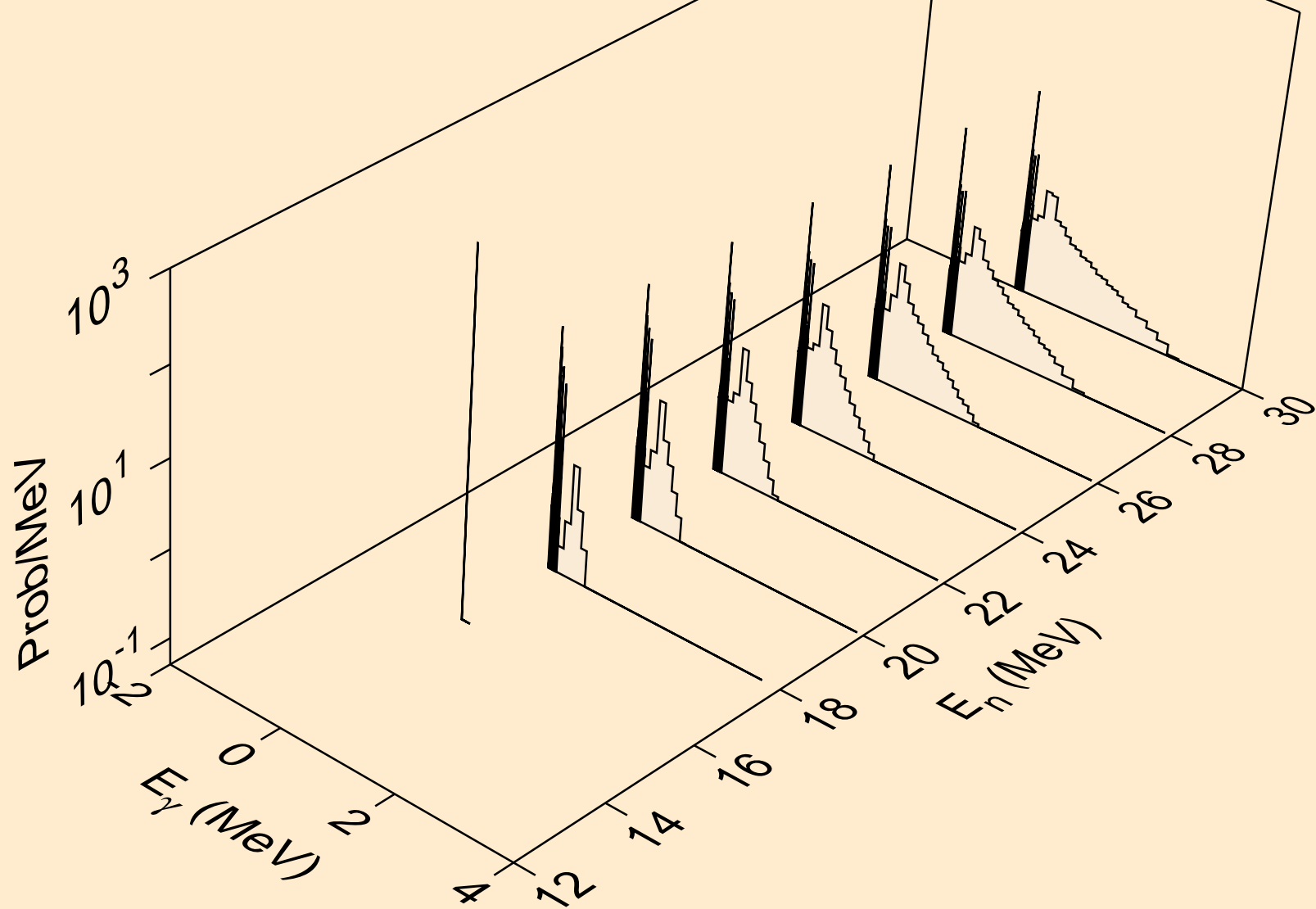

PT193 NEUTRON ACER TENDL-2023 LIBRARY; T=0.K  
Photon emission for (n,n\*)he3

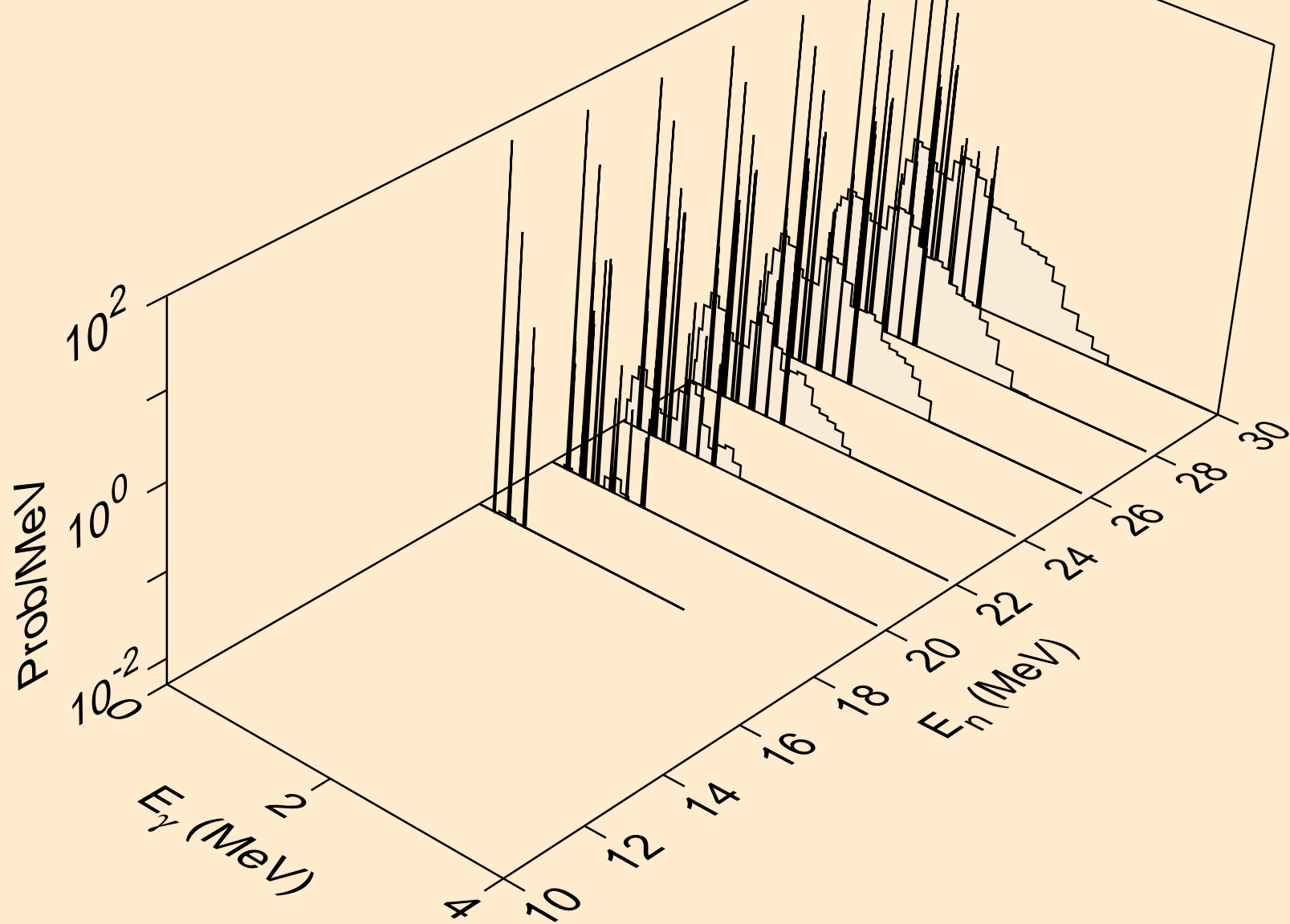

PT193 NEUTRON ACER TENDL-2023 LIBRARY; T=0.K  
Photon emission for (n,4n)

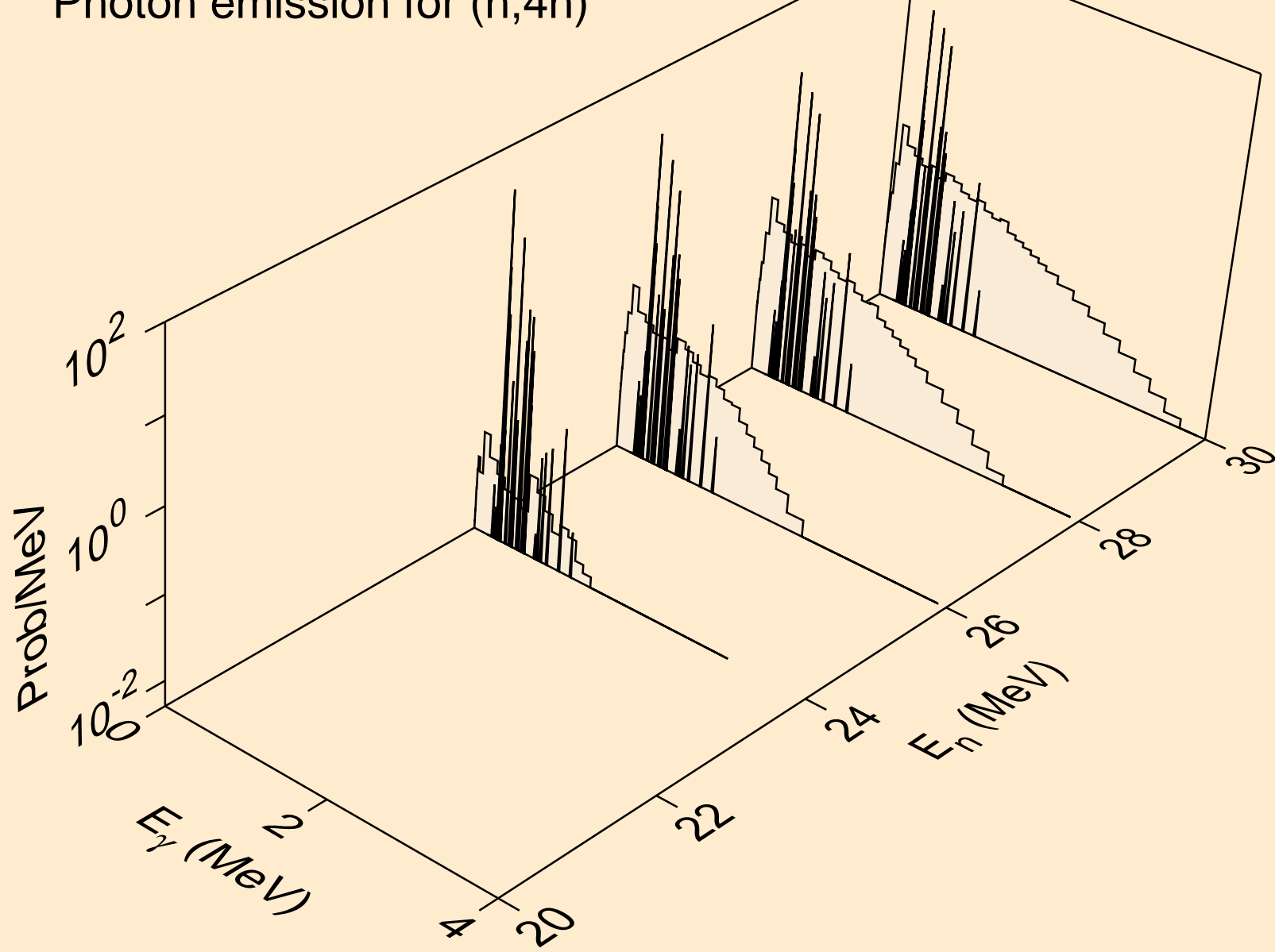

PT193 NEUTRON ACER TENDL-2023 LIBRARY; T=0.K  
Photon emission for (n,2np)

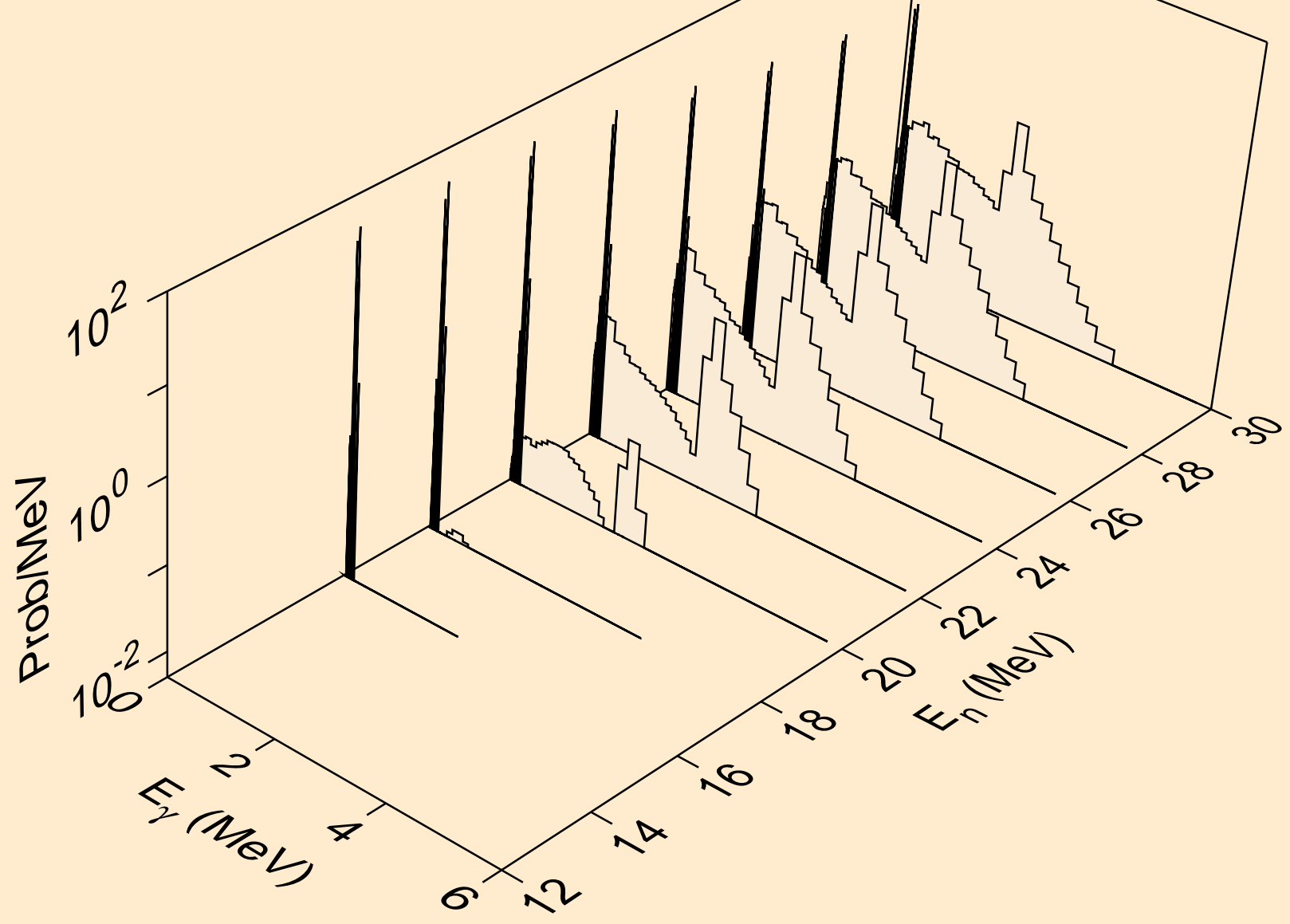

PT193 NEUTRON ACER TENDL-2023 LIBRARY; T=0.K  
Photon emission for (n,3np)

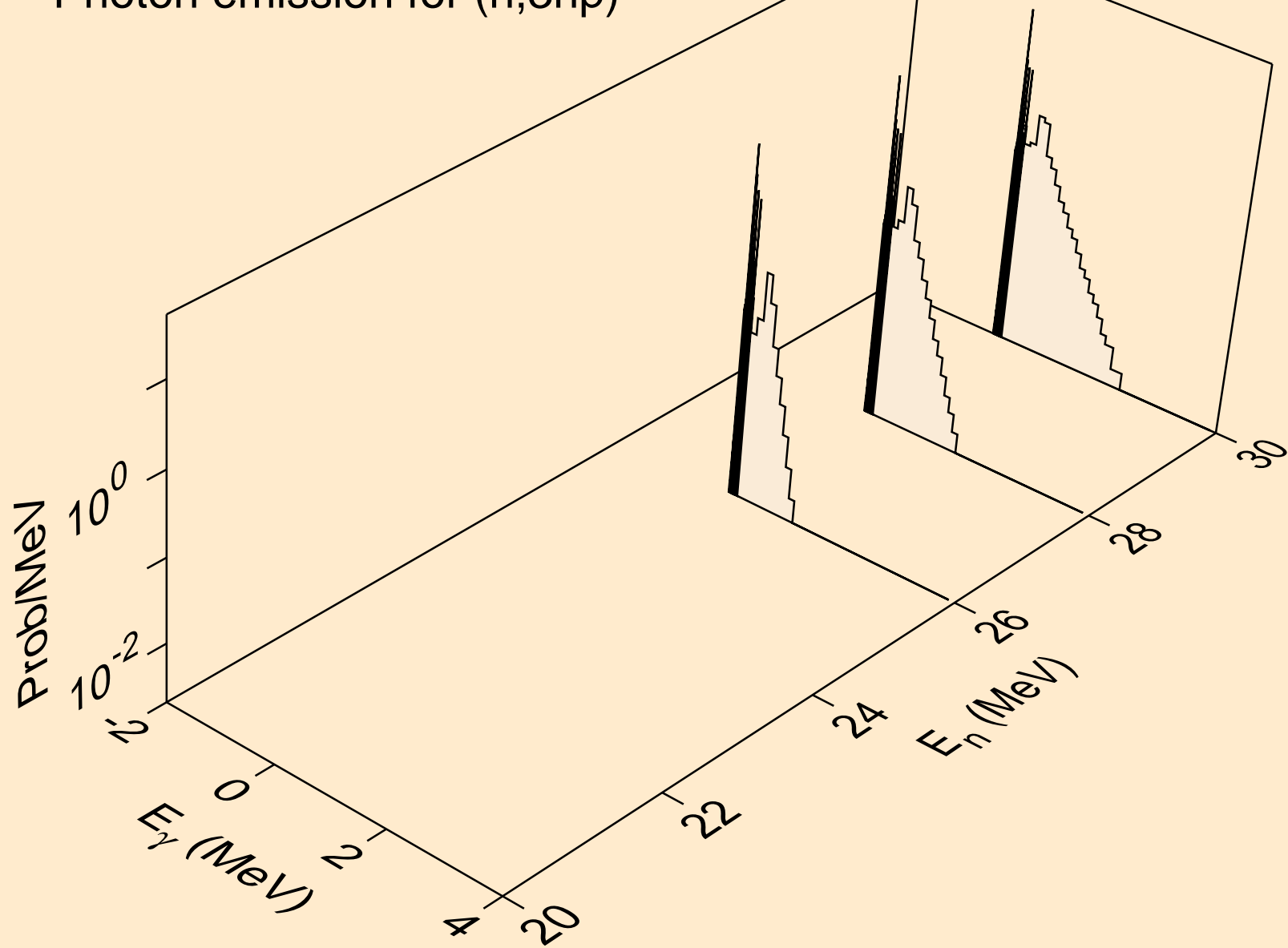



PT193 NEUTRON ACER TENDL-2023 LIBRARY; T=0.K  
Photon emission for (n,n2p)

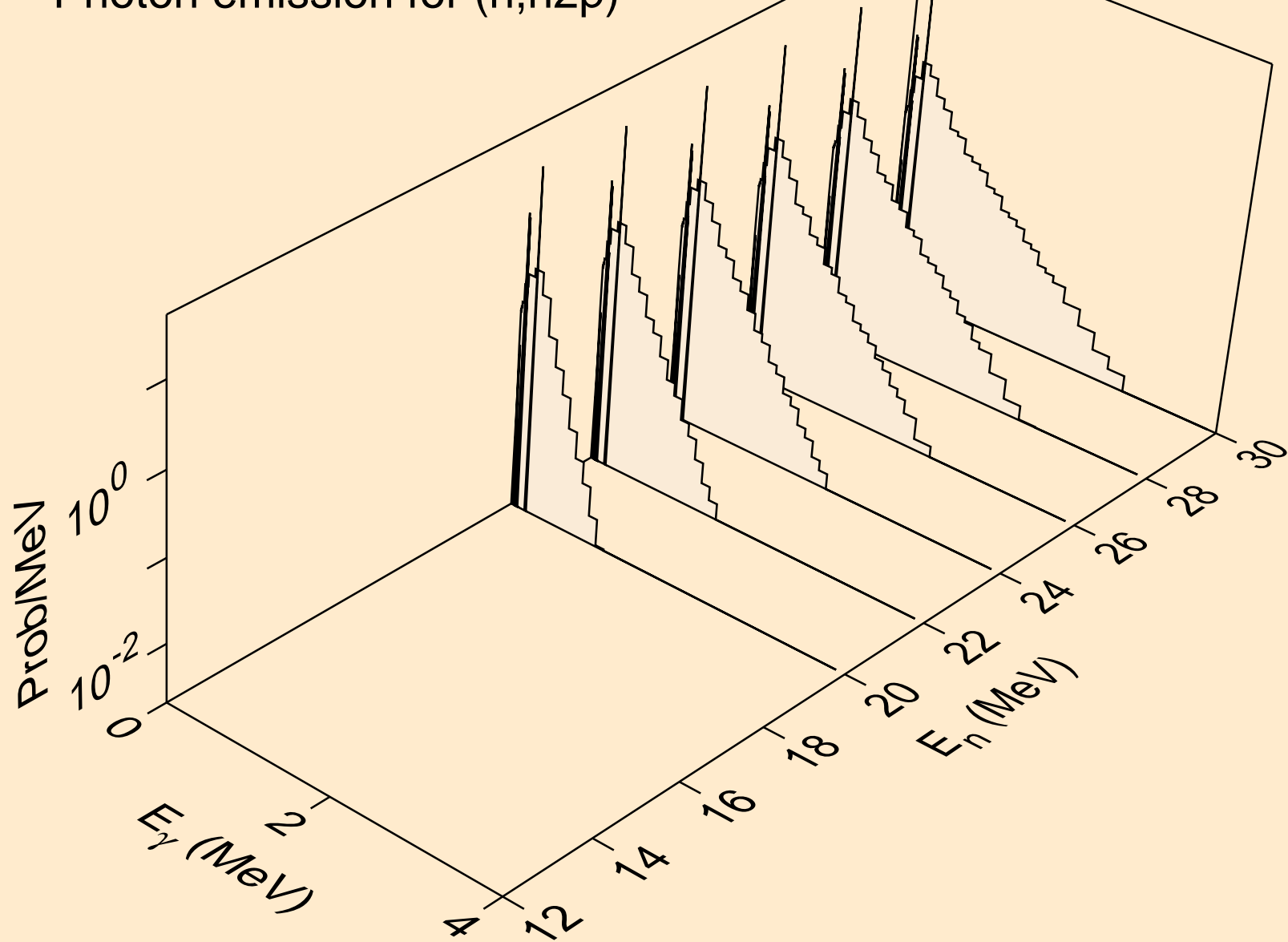

PT193 NEUTRON ACER TENDL-2023 LIBRARY; T=0.K  
Photon emission for (n,npa)

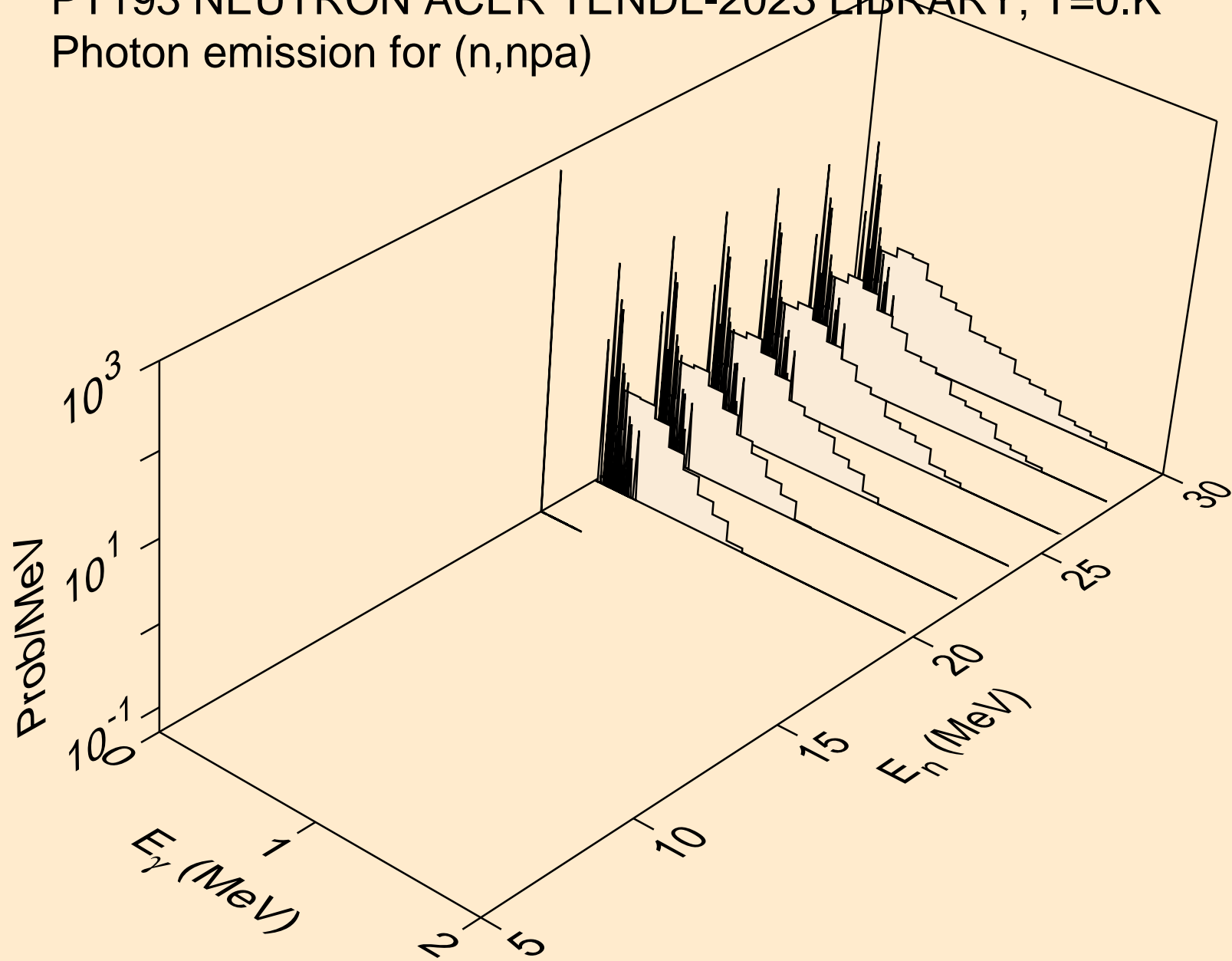

PT193 NEUTRON ACER TENDL-2023 LIBRARY; T=0.K  
Photon emission for (n,n\*c)

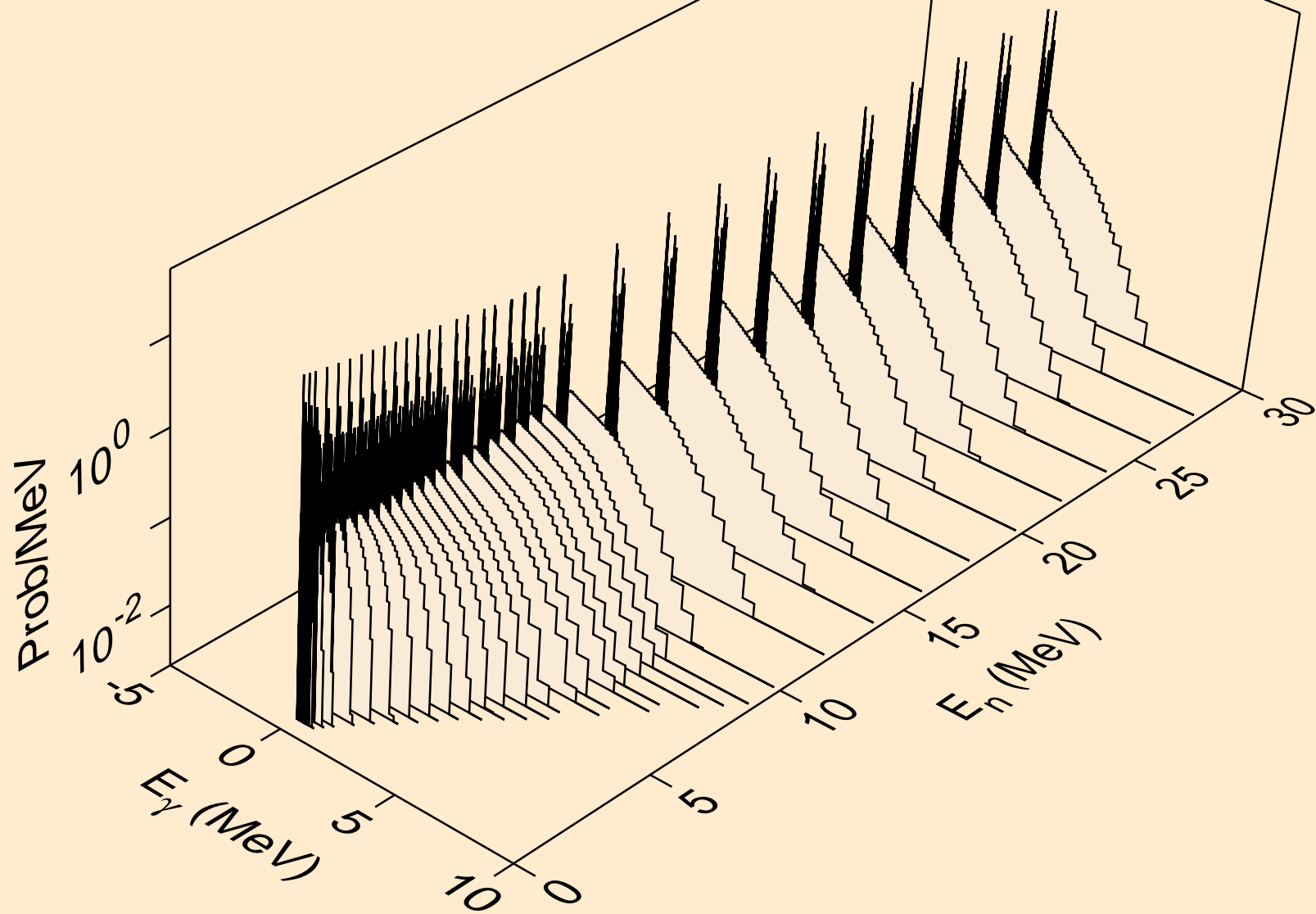

PT193 NEUTRON ACER TENDL-2023 LIBRARY; T=0.K  
Photon emission for (n,gma)

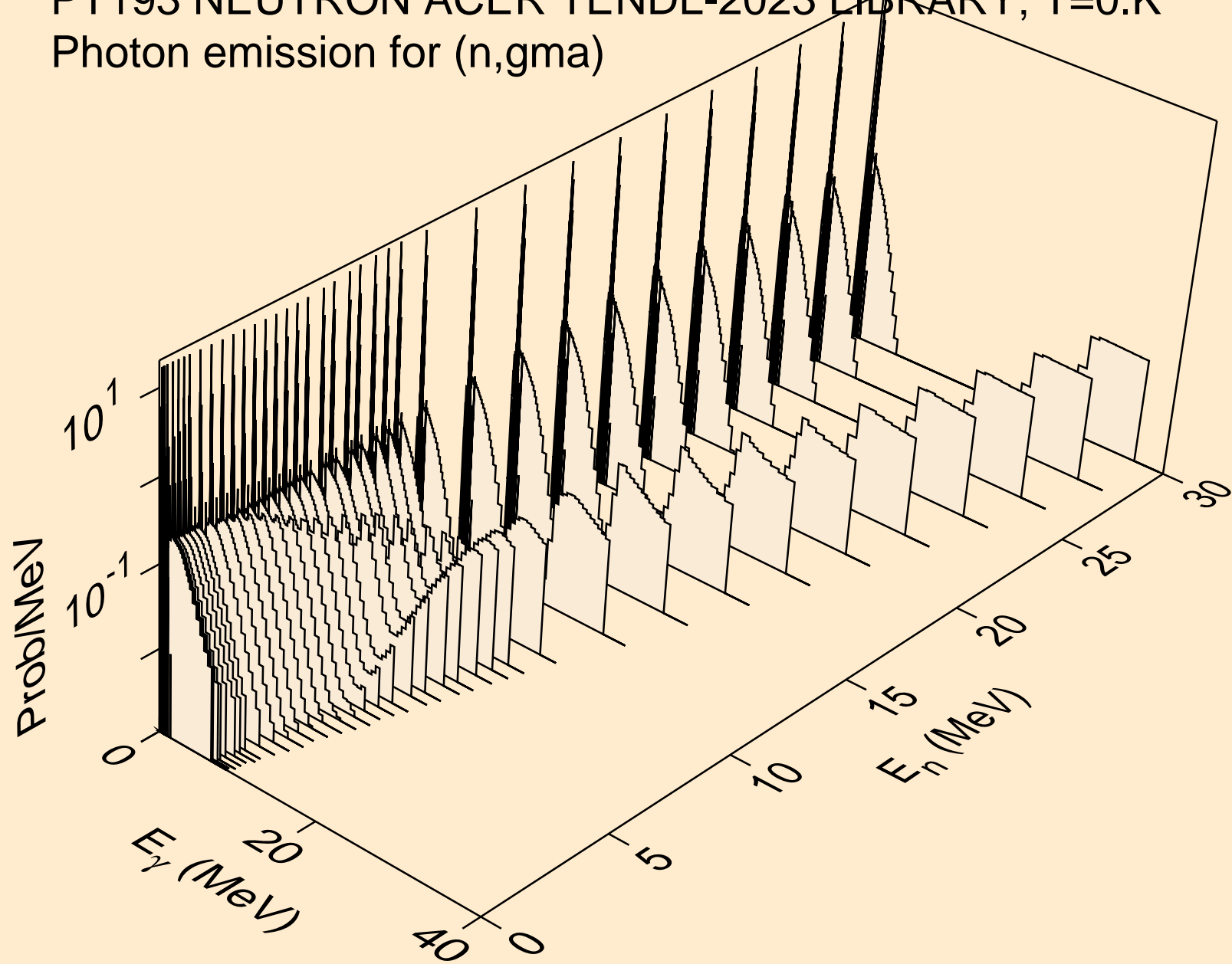

PT193 NEUTRON ACER TENDL-2023 LIBRARY; T=0.K  
Photon emission for (n,p)

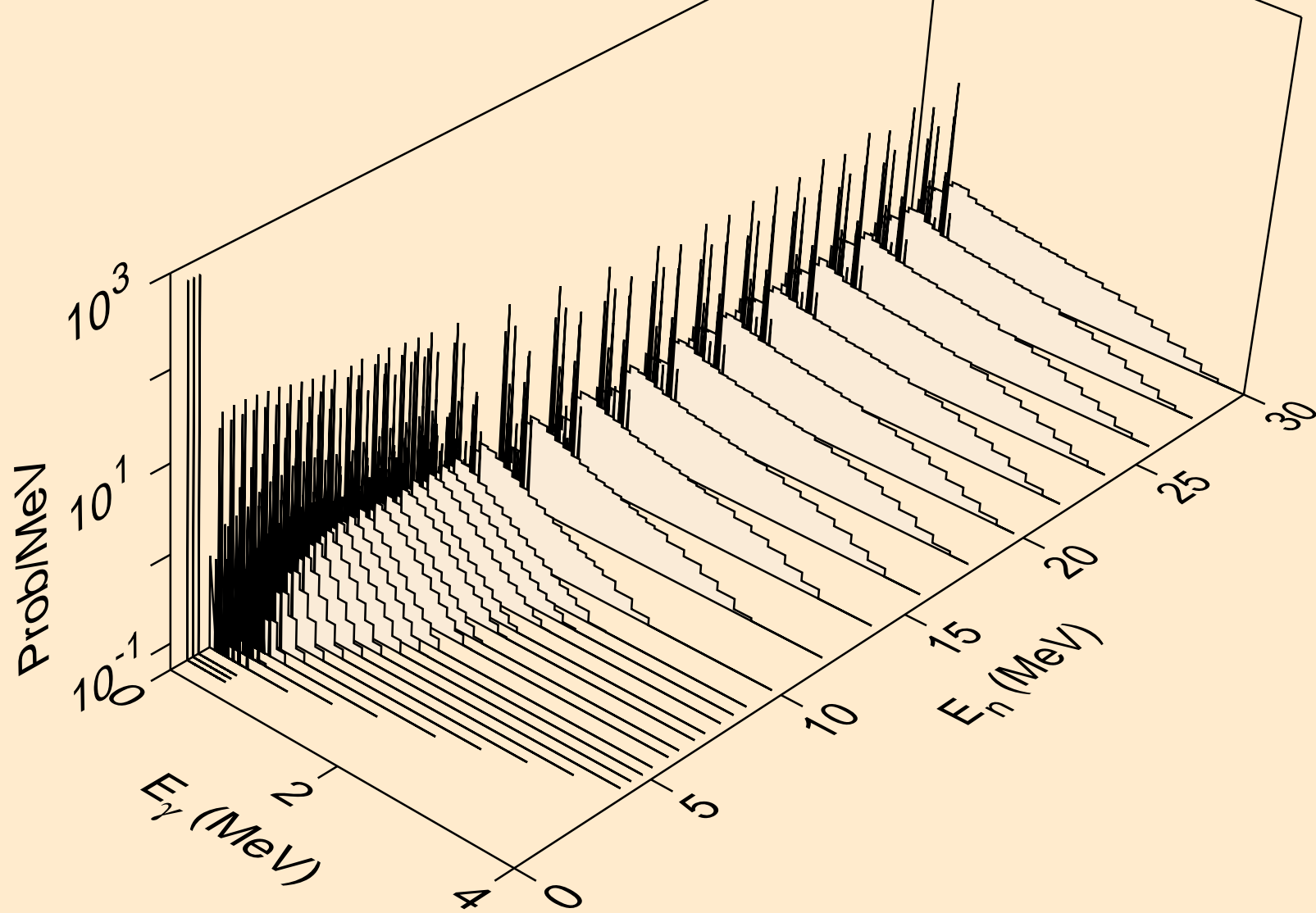

PT193 NEUTRON ACER TENDL-2023 LIBRARY; T=0.K  
Photon emission for (n,d)

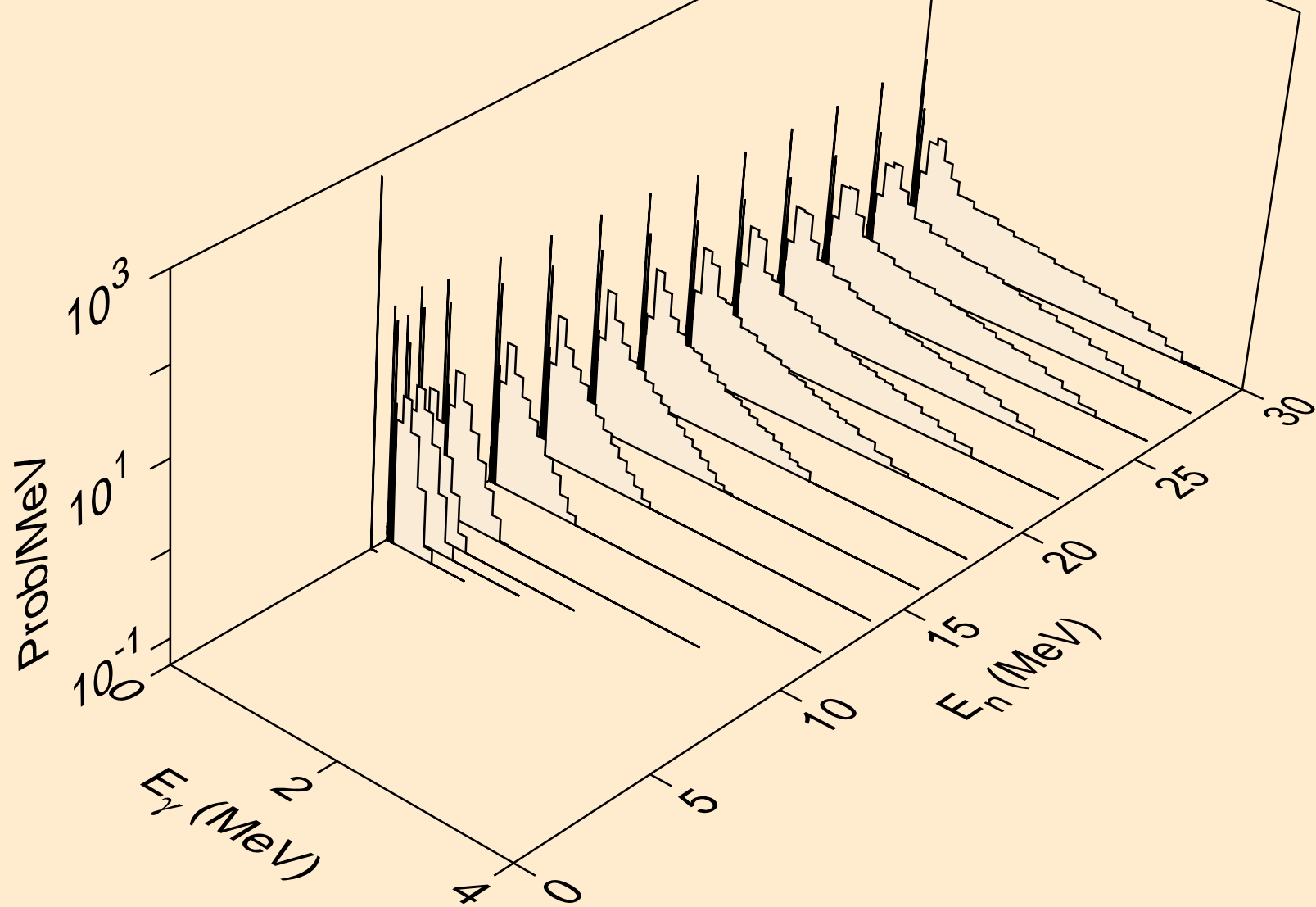

PT193 NEUTRON ACER TENDL-2023 LIBRARY; T=0.K  
Photon emission for (n,t)

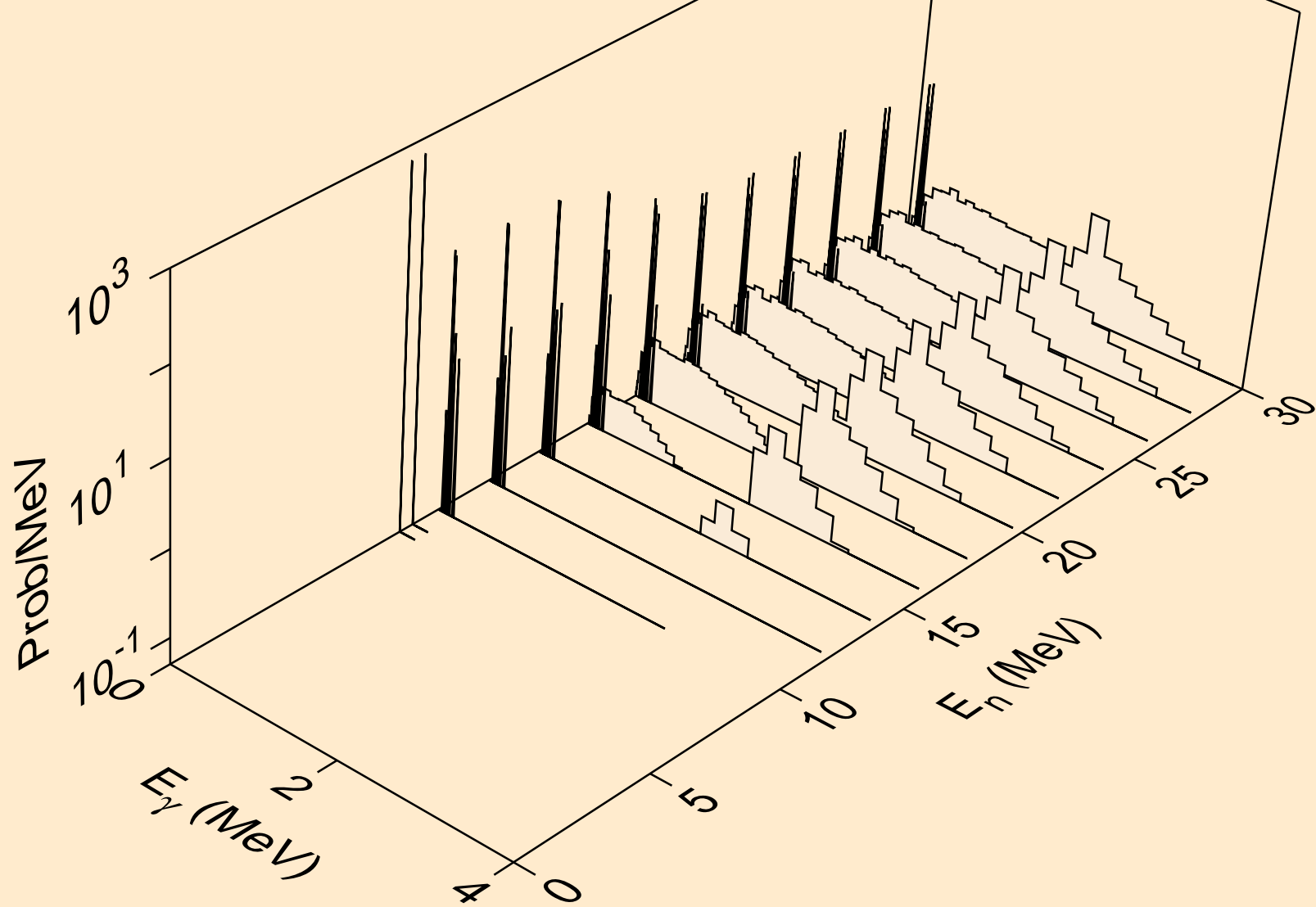

PT193 NEUTRON ACER TENDL-2023 LIBRARY; T=0.K  
Photon emission for (n,he3)

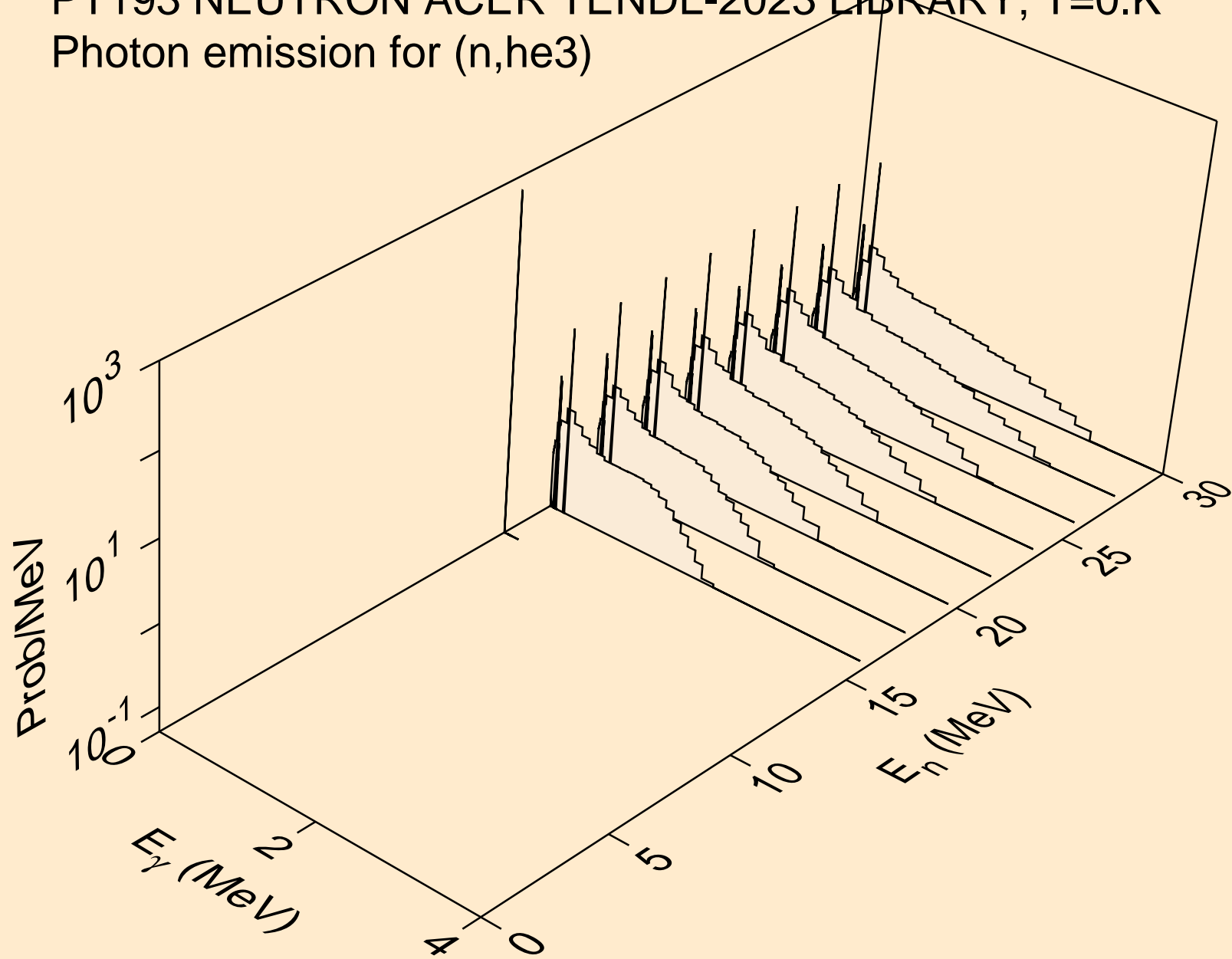



PT193 NEUTRON ACER TENDL-2023 LIBRARY; T=0.K  
Photon emission for (n,a)

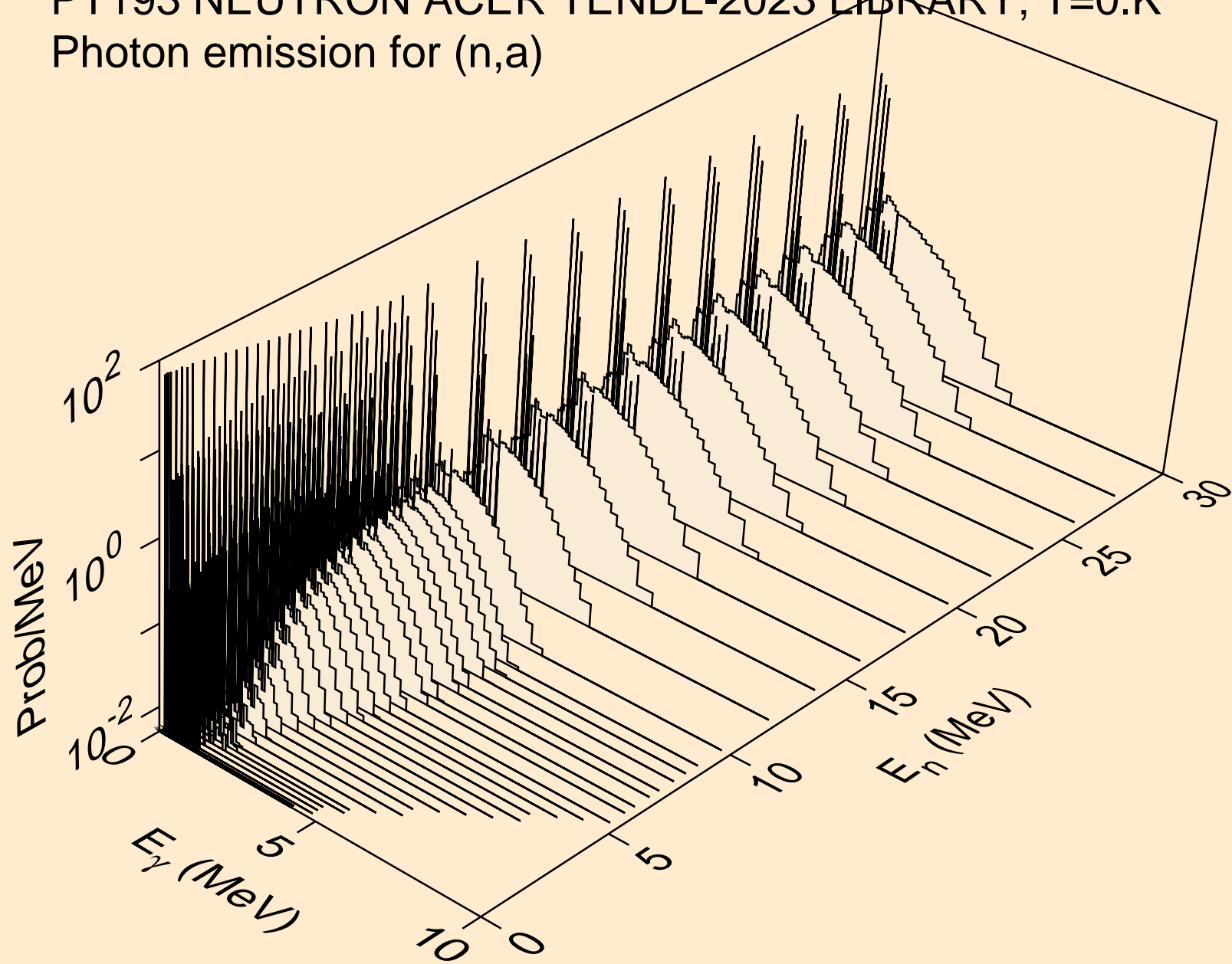

PT193 NEUTRON ACER TENDL-2023 LIBRARY; T=0.K  
Photon emission for (n,2a)

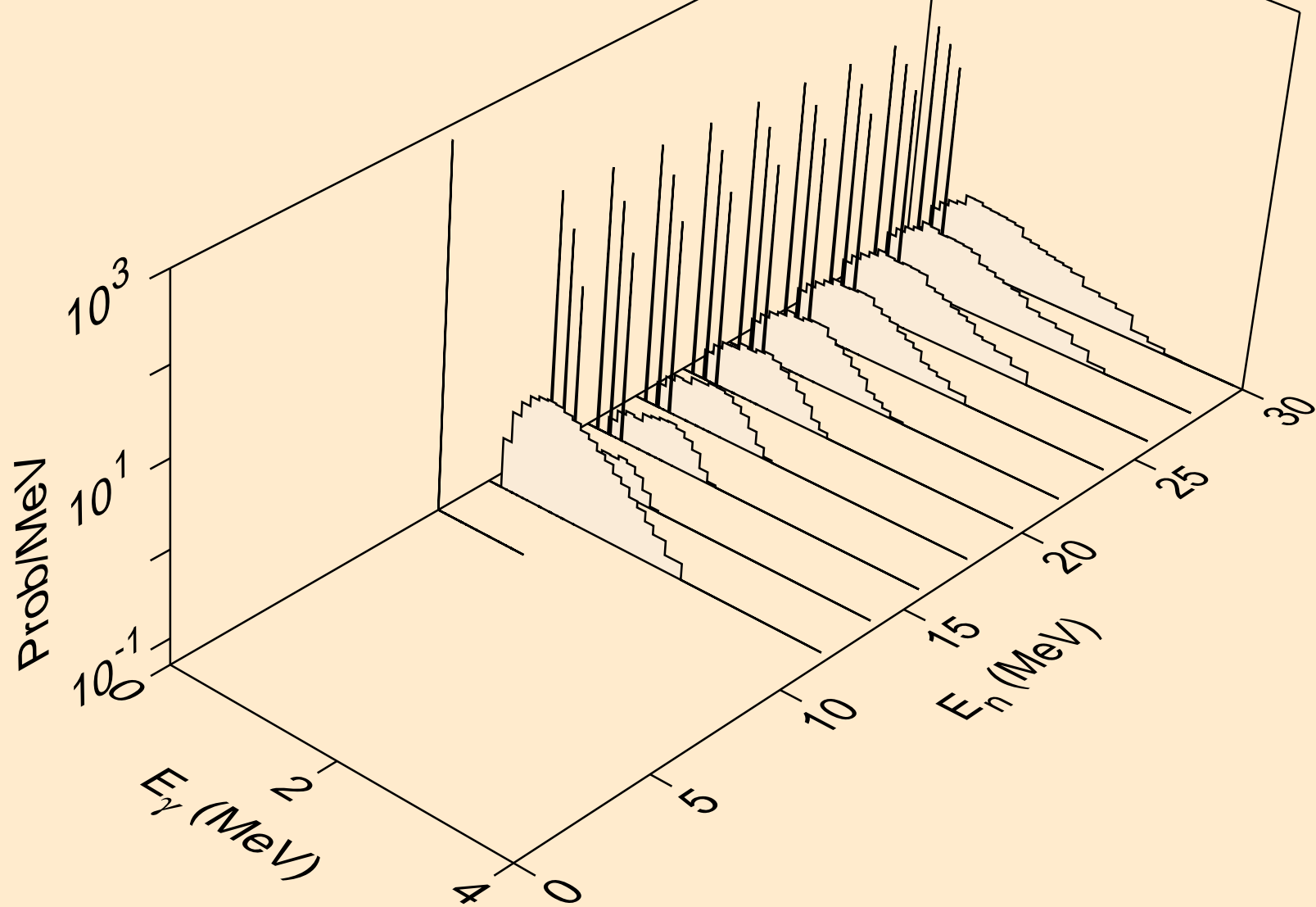

PT193 NEUTRON ACER TENDL-2023 LIBRARY; T=0.K  
Photon emission for (n,2p)

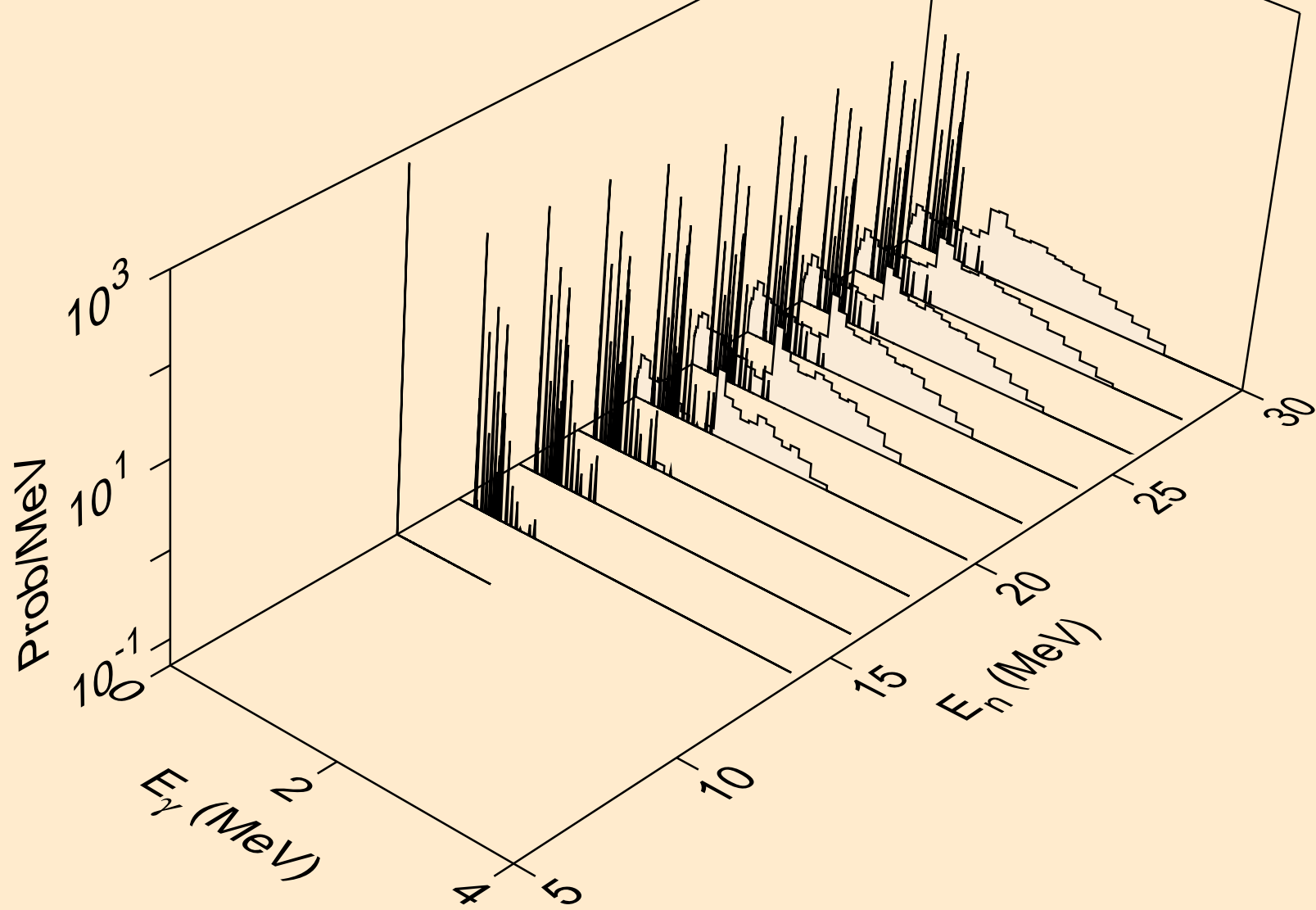

PT193 NEUTRON ACER TENDL-2023 LIBRARY; T=0.K  
Photon emission for (n,p $\alpha$ )

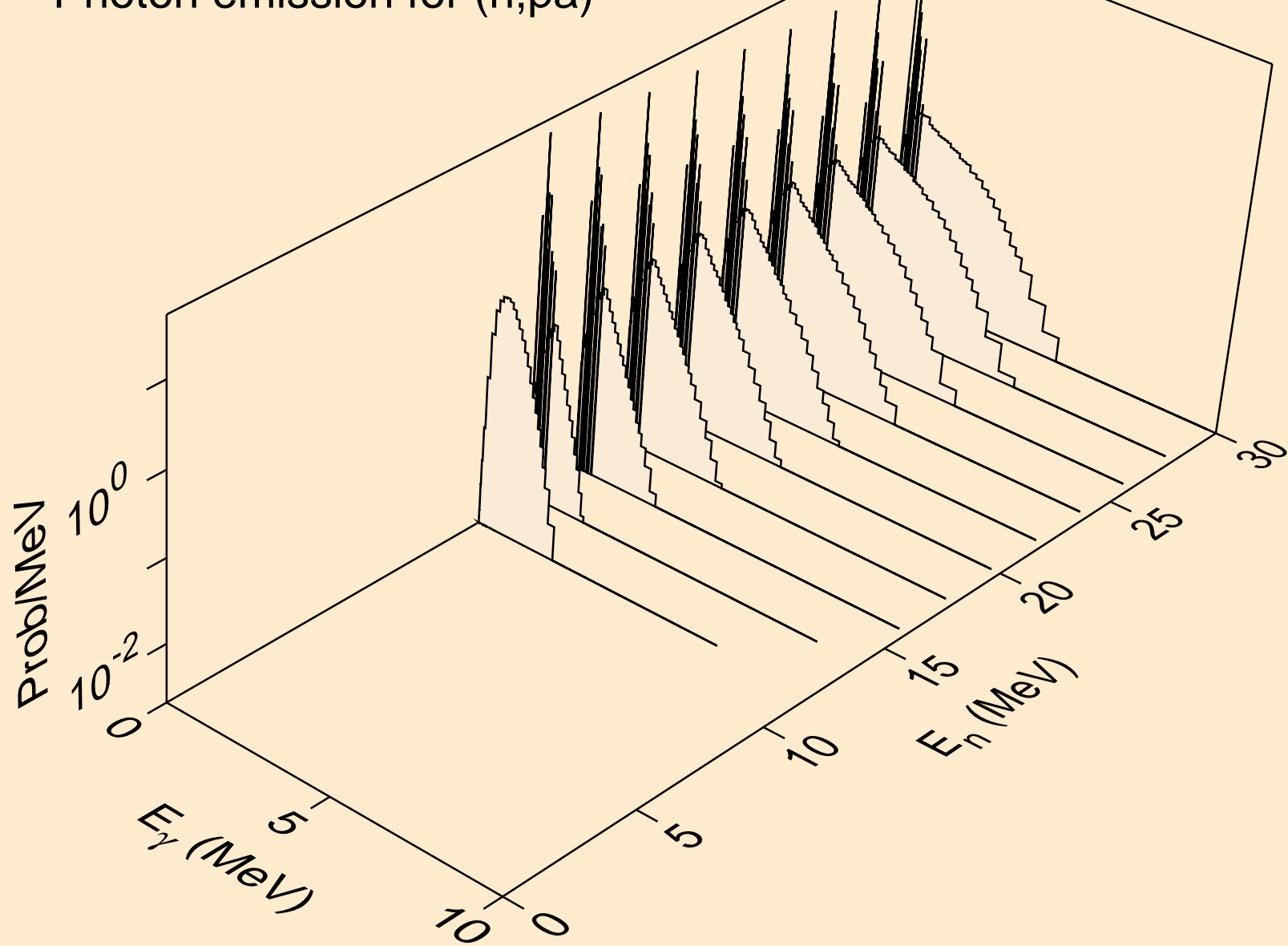

PT193 NEUTRON ACER TENDL-2023 LIBRARY; T=0.K  
Photon emission for (n,pd)

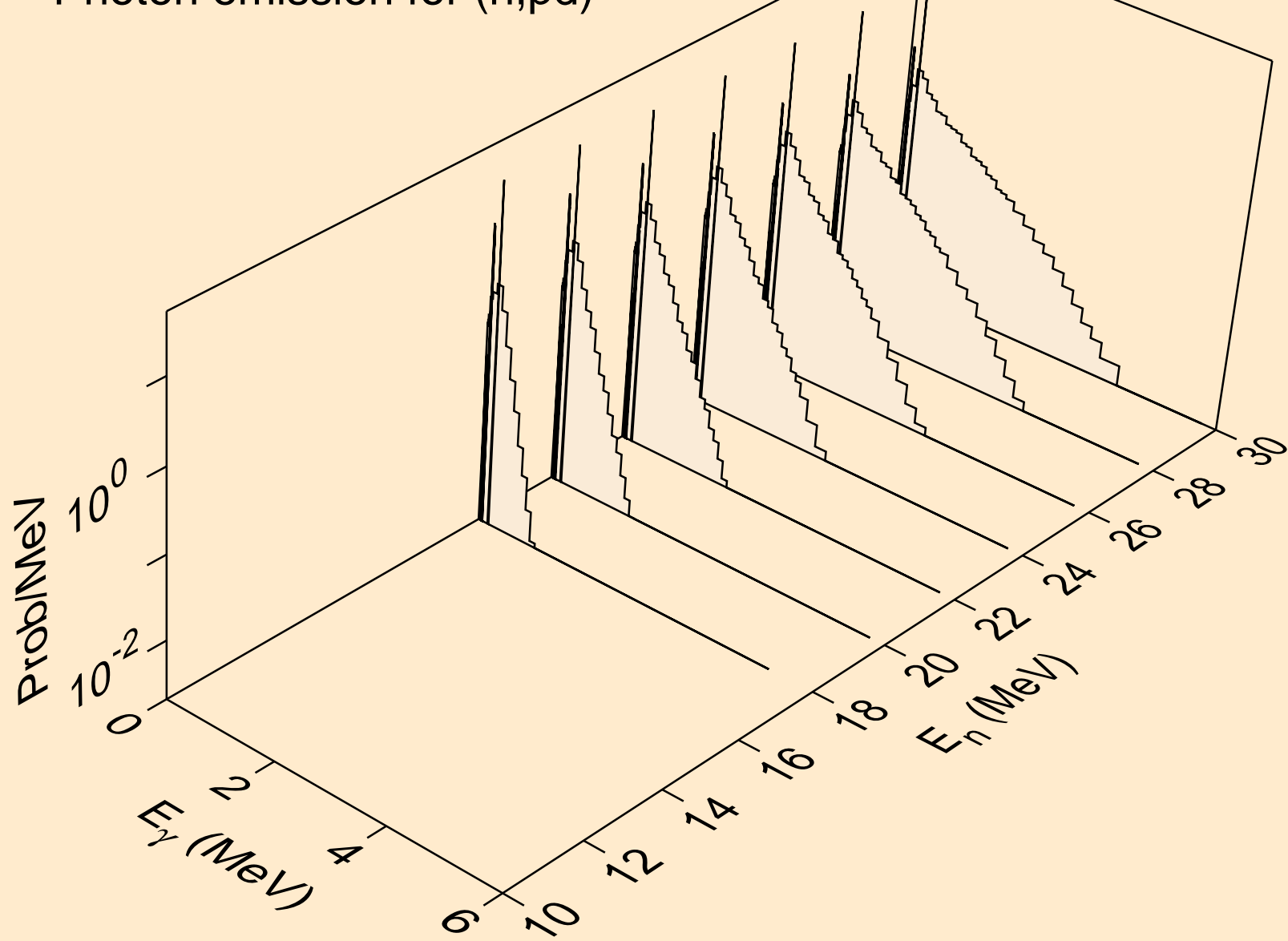

PT193 NEUTRON ACER TENDL-2023 LIBRARY; T=0.K  
Photon emission for (n,pt)

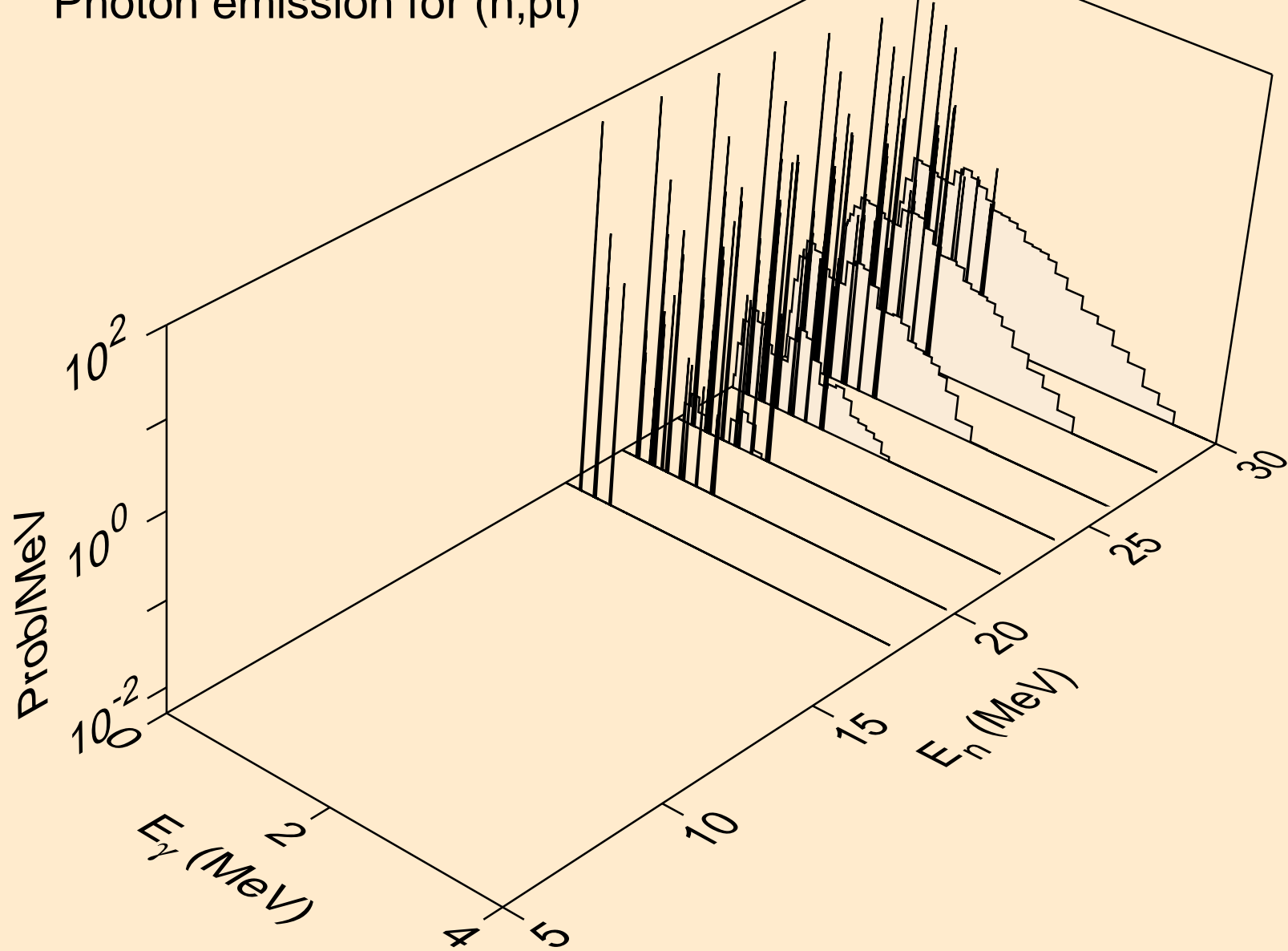

PT193 NEUTRON ACER TENDL-2023 LIBRARY; T=0.K  
thermal capture photon spectrum

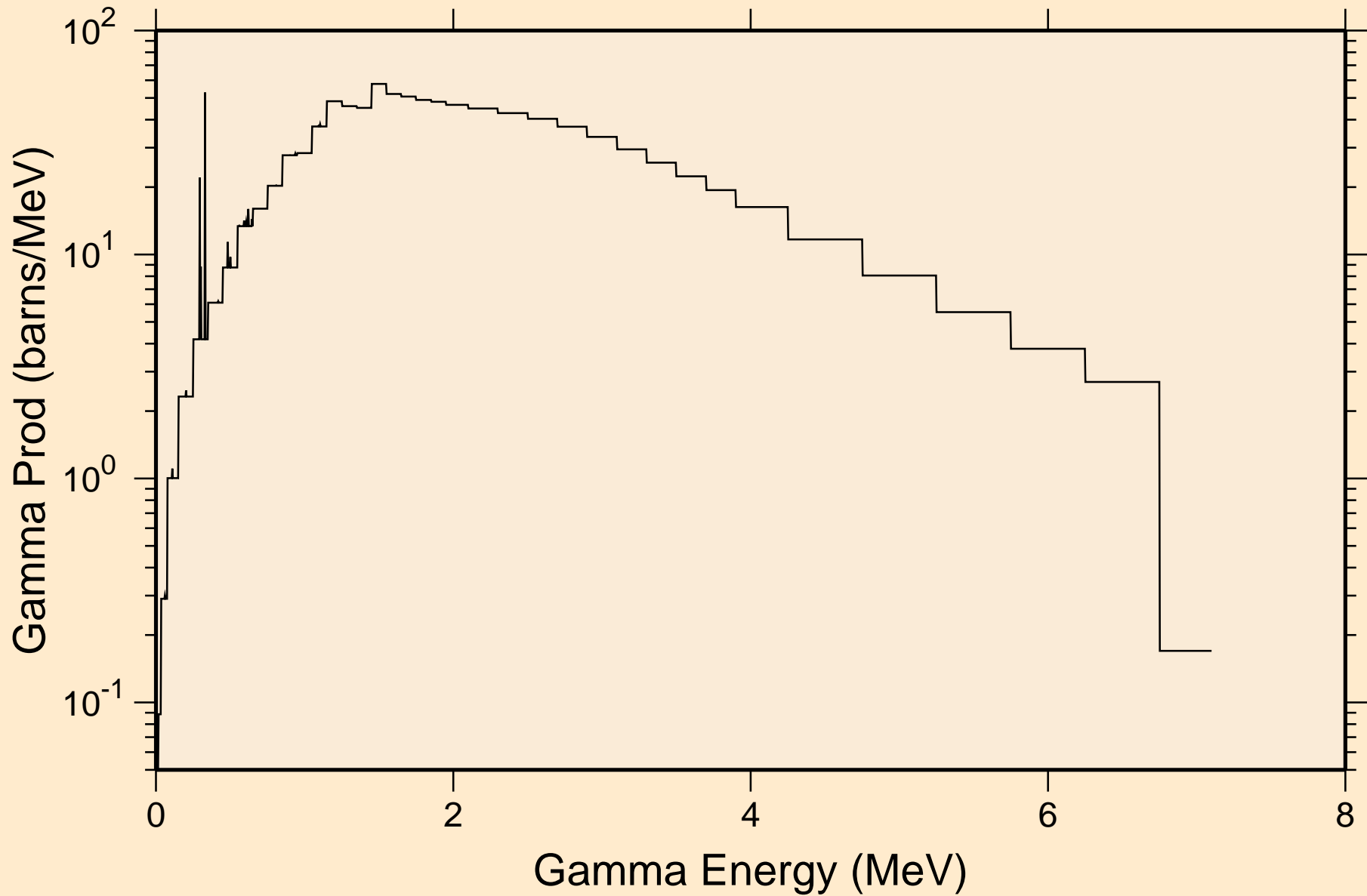

PT193 NEUTRON ACER TENDL-2023 LIBRARY; T=0.K  
14 MeV photon spectrum

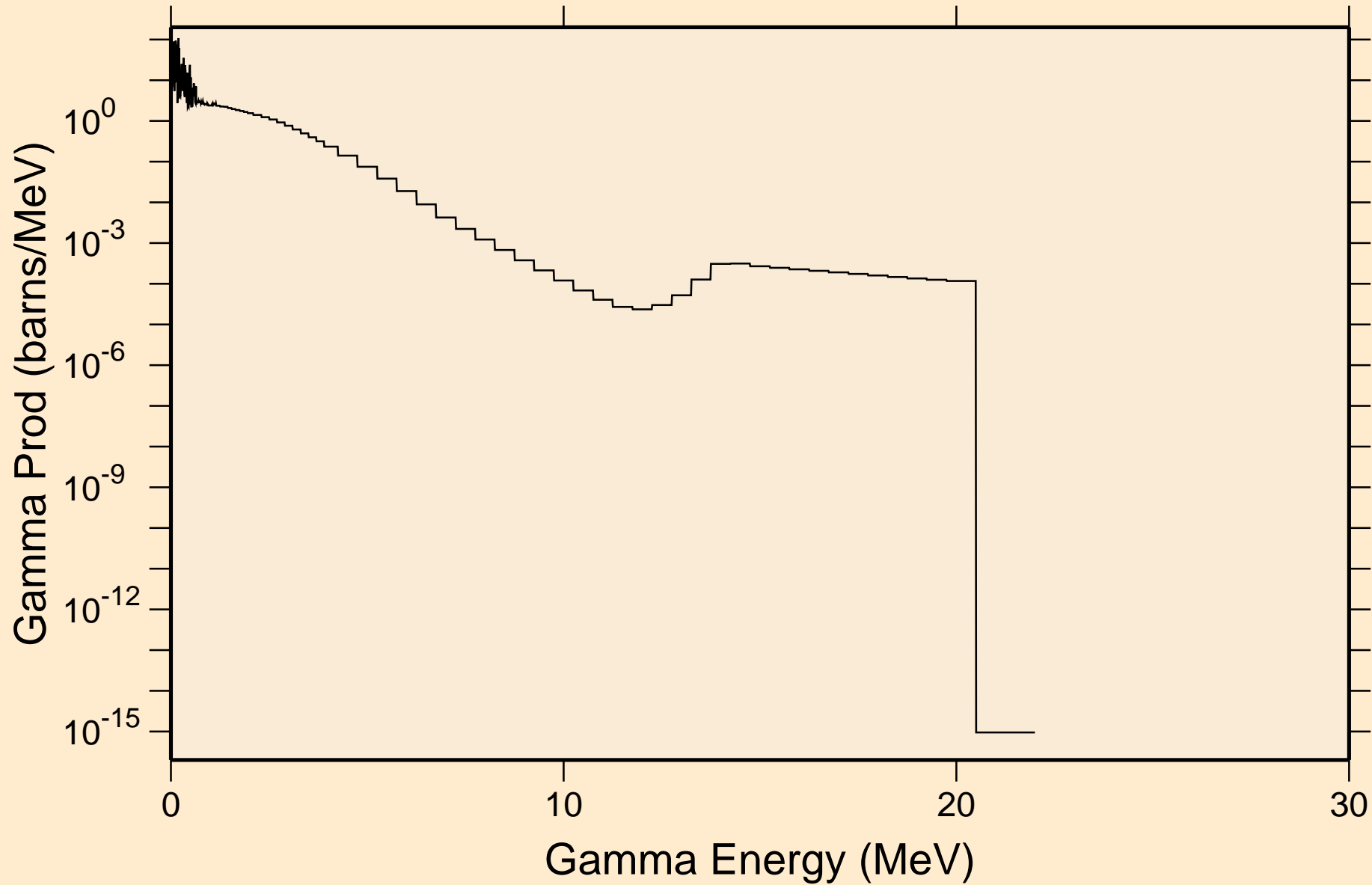



PT193 NEUTRON ACER TENDL-2023 LIBRARY; T=0.K  
Particle heating contributions

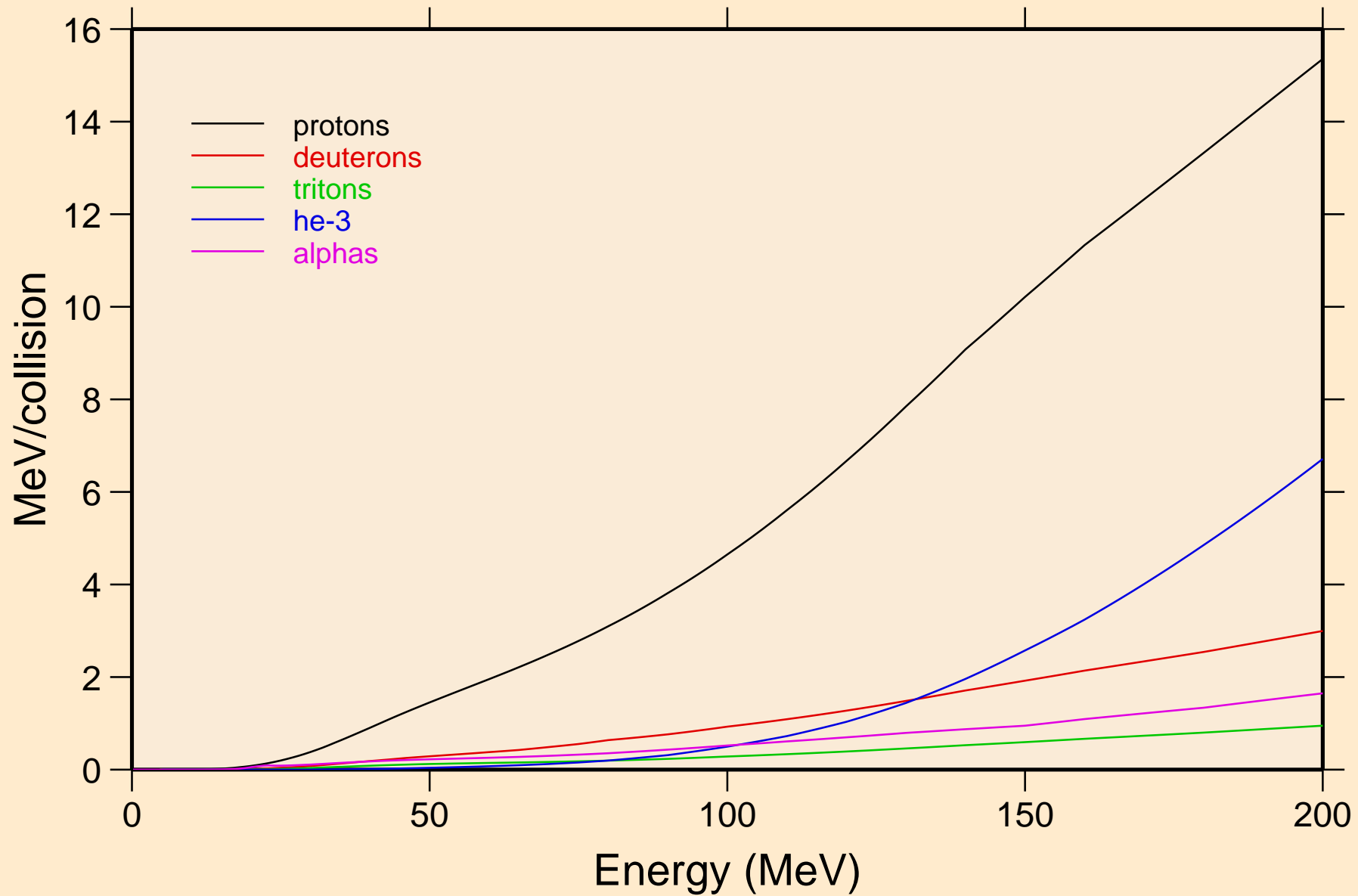

PT193 NEUTRON ACER TENDL-2023 LIBRARY; T=0.K  
Recoil Heating

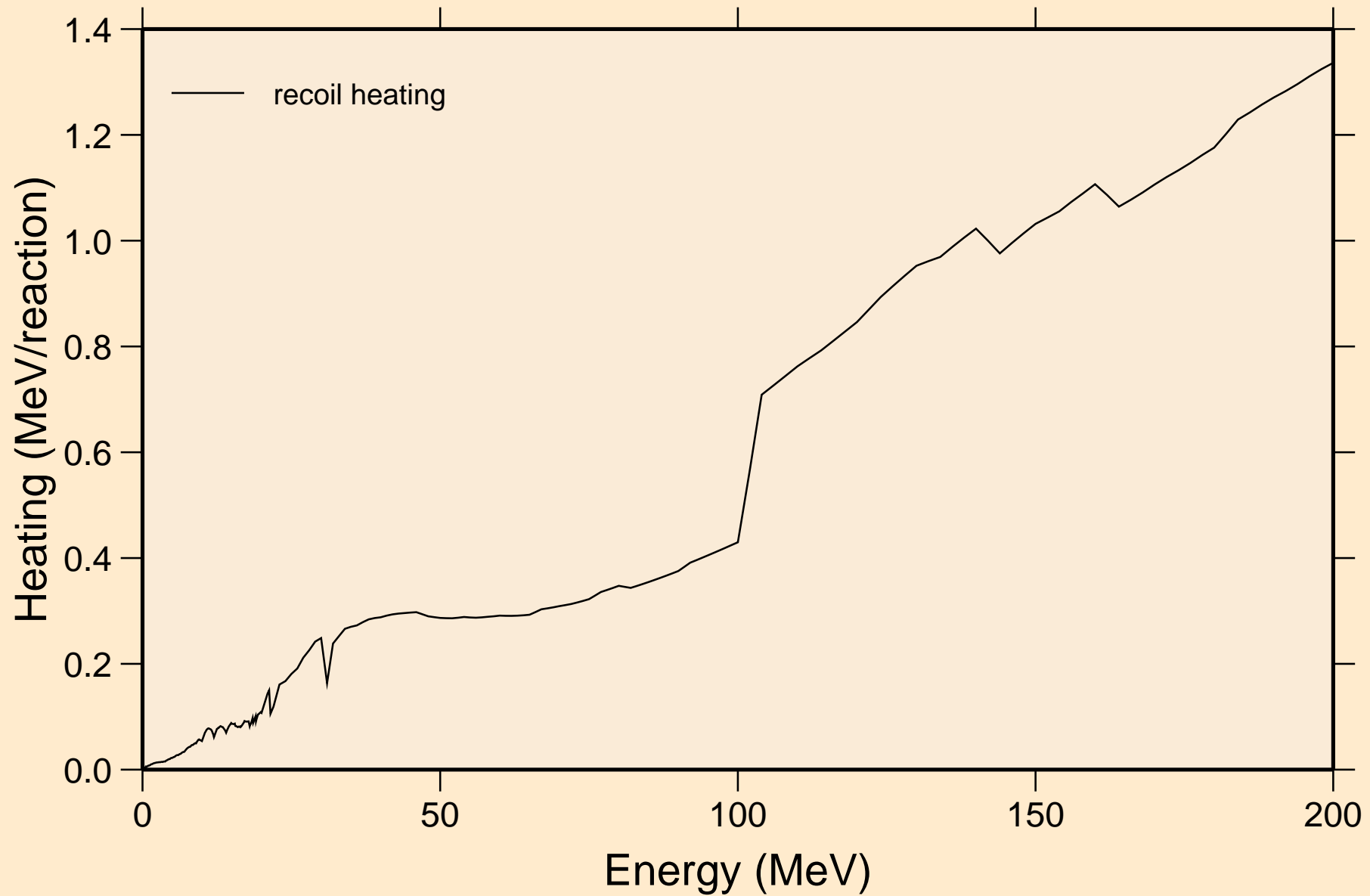

PT193 NEUTRON ACER TENDL-2023 LIBRARY; T=0.K  
Particle production cross sections

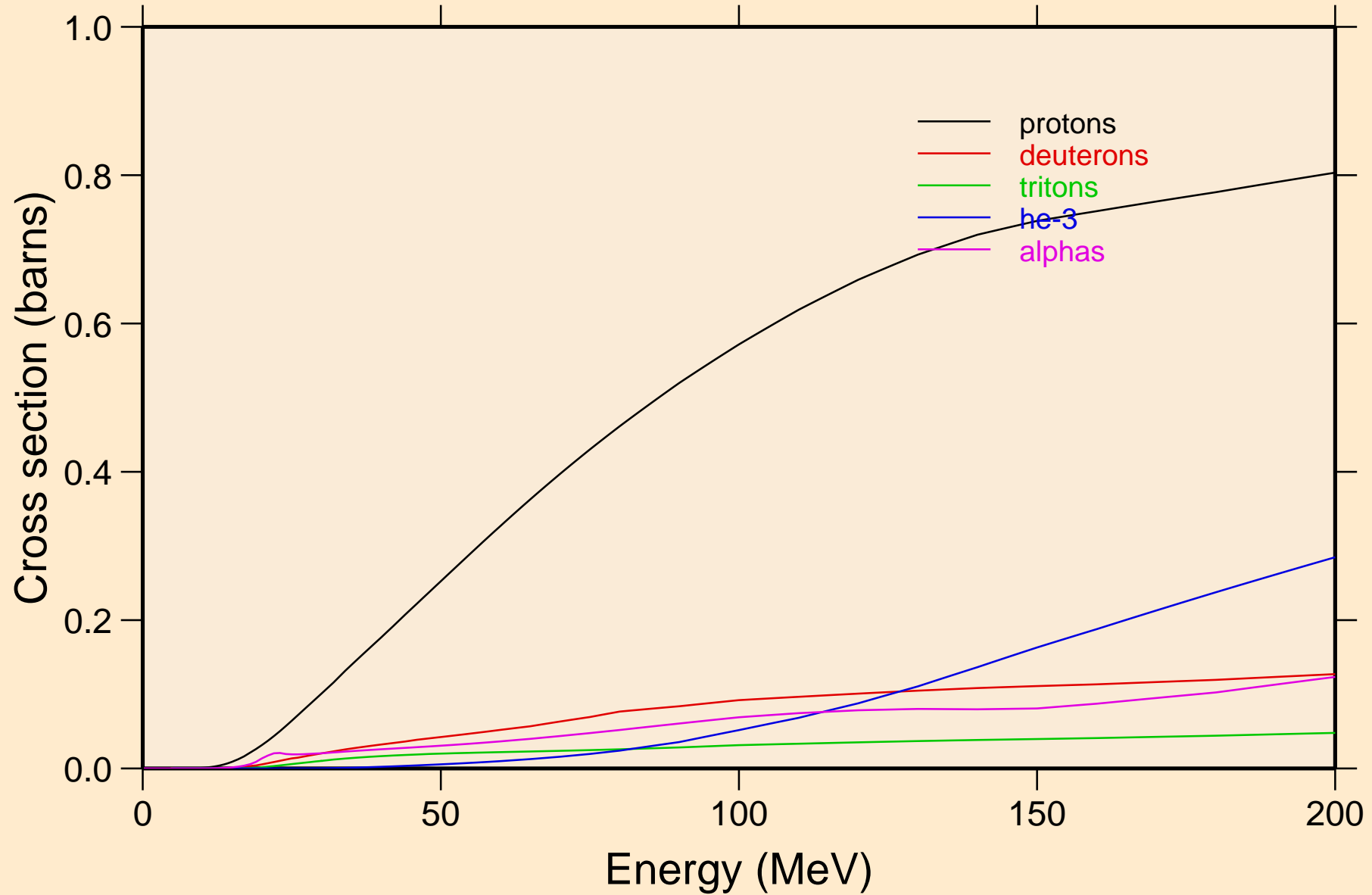

PT193 NEUTRON ACER TENDL-2023 LIBRARY; T=0.K  
protons from (n,x)

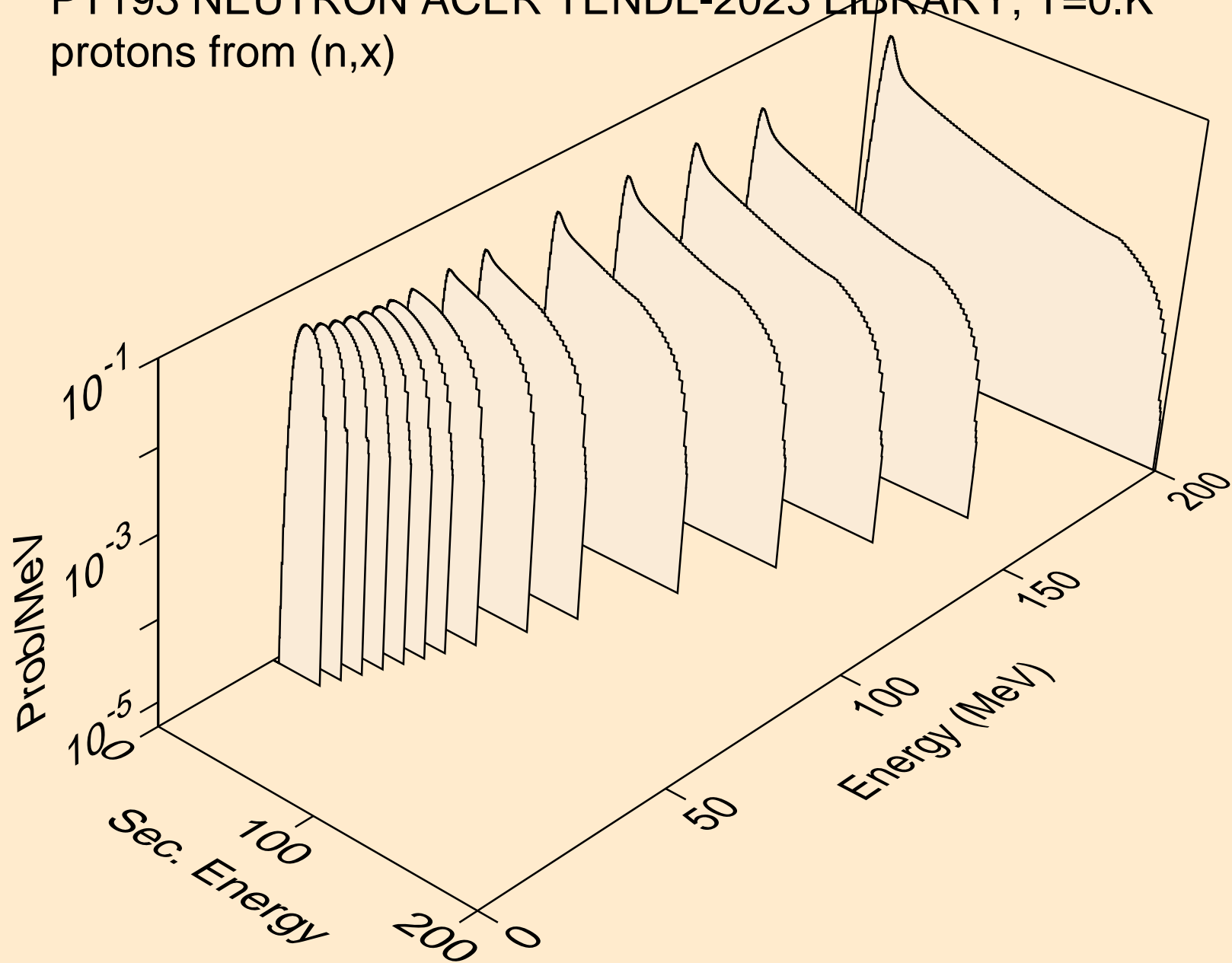

PT193 NEUTRON ACER TENDL-2023 LIBRARY; T=0.K  
protons from (n,n\*)p

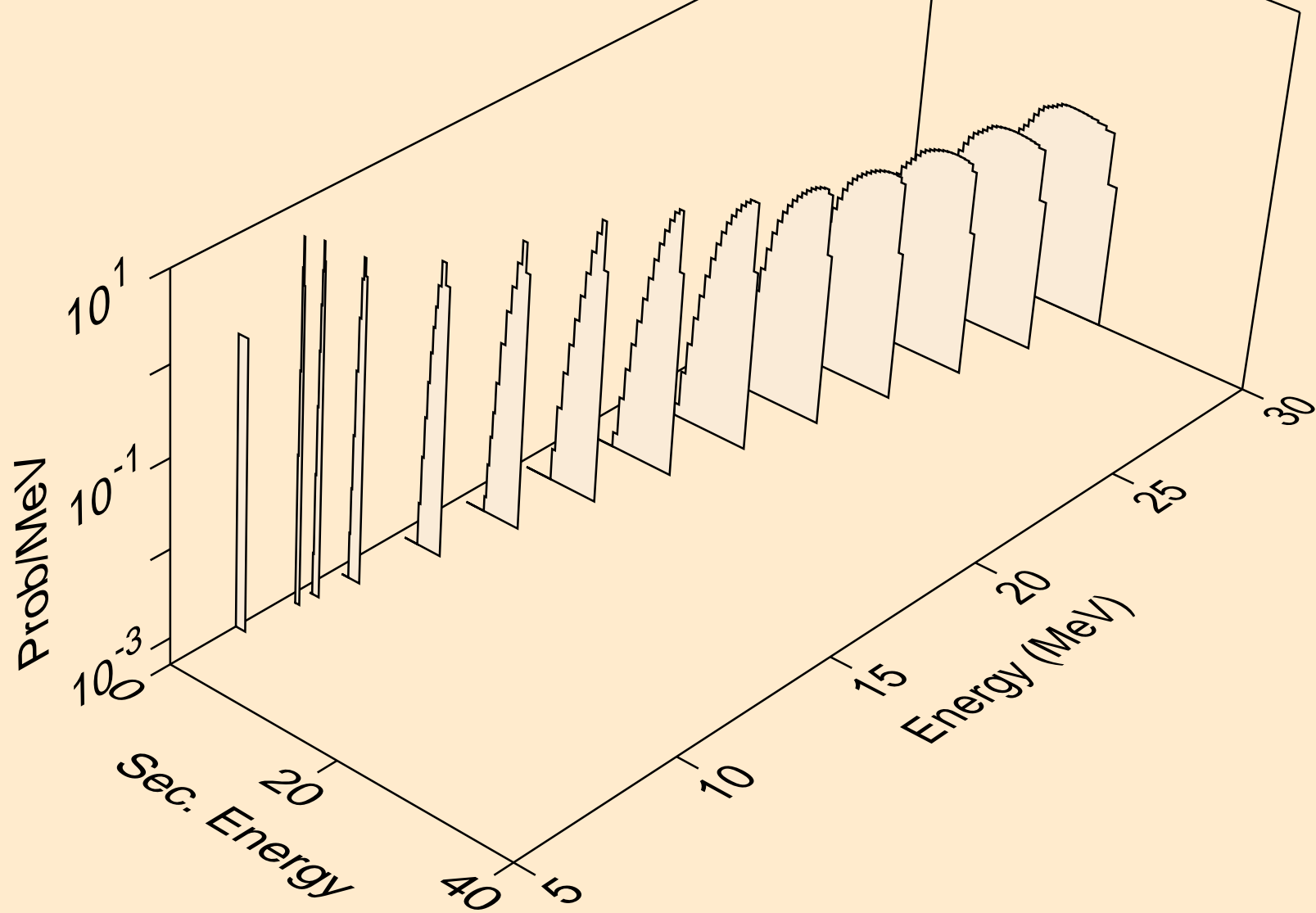

PT193 NEUTRON ACER TENDL-2023 LIBRARY; T=0.K  
protons from (n,2np)

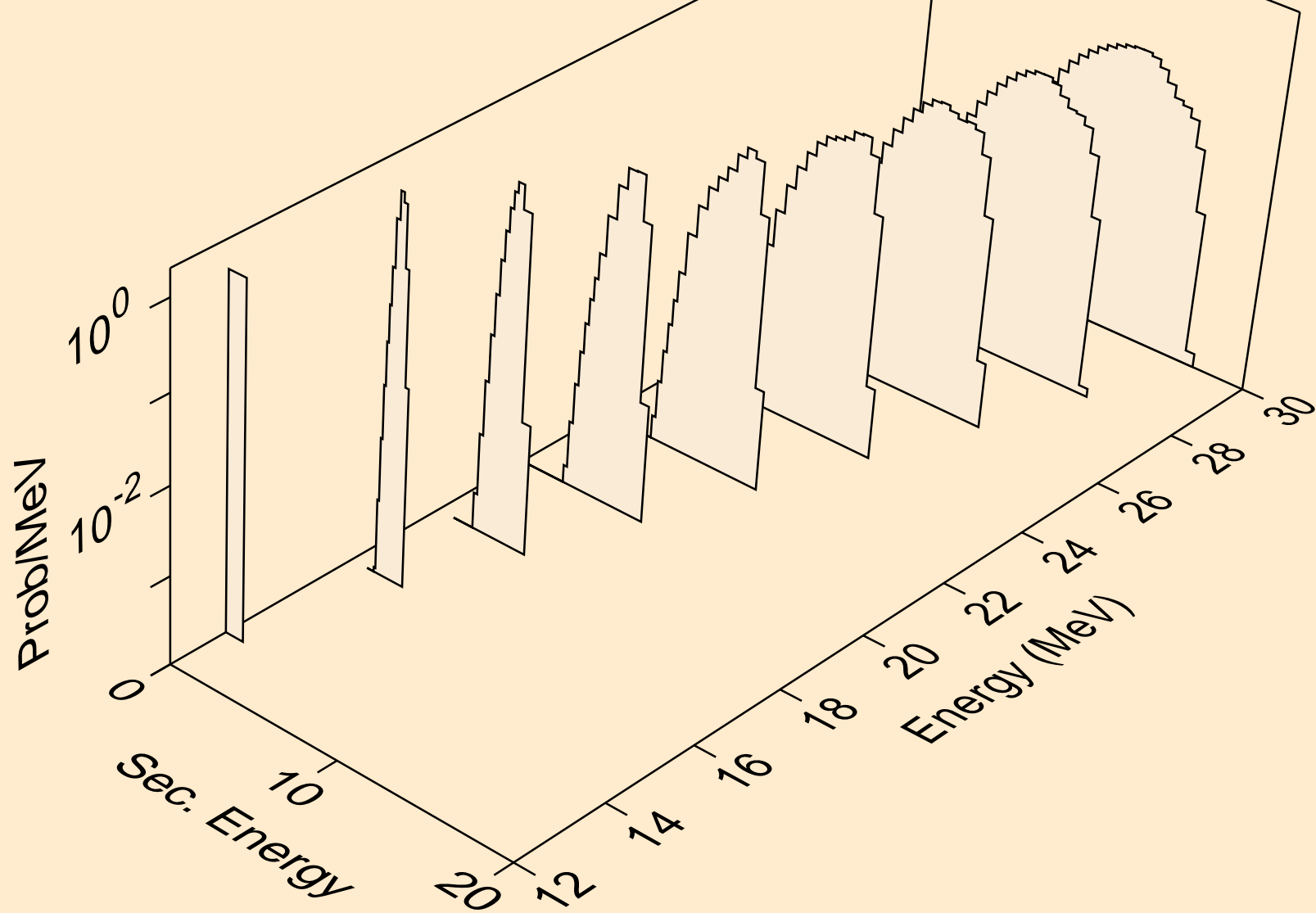

PT193 NEUTRON ACER TENDL-2023 LIBRARY; T=0.K  
protons from (n,3np)

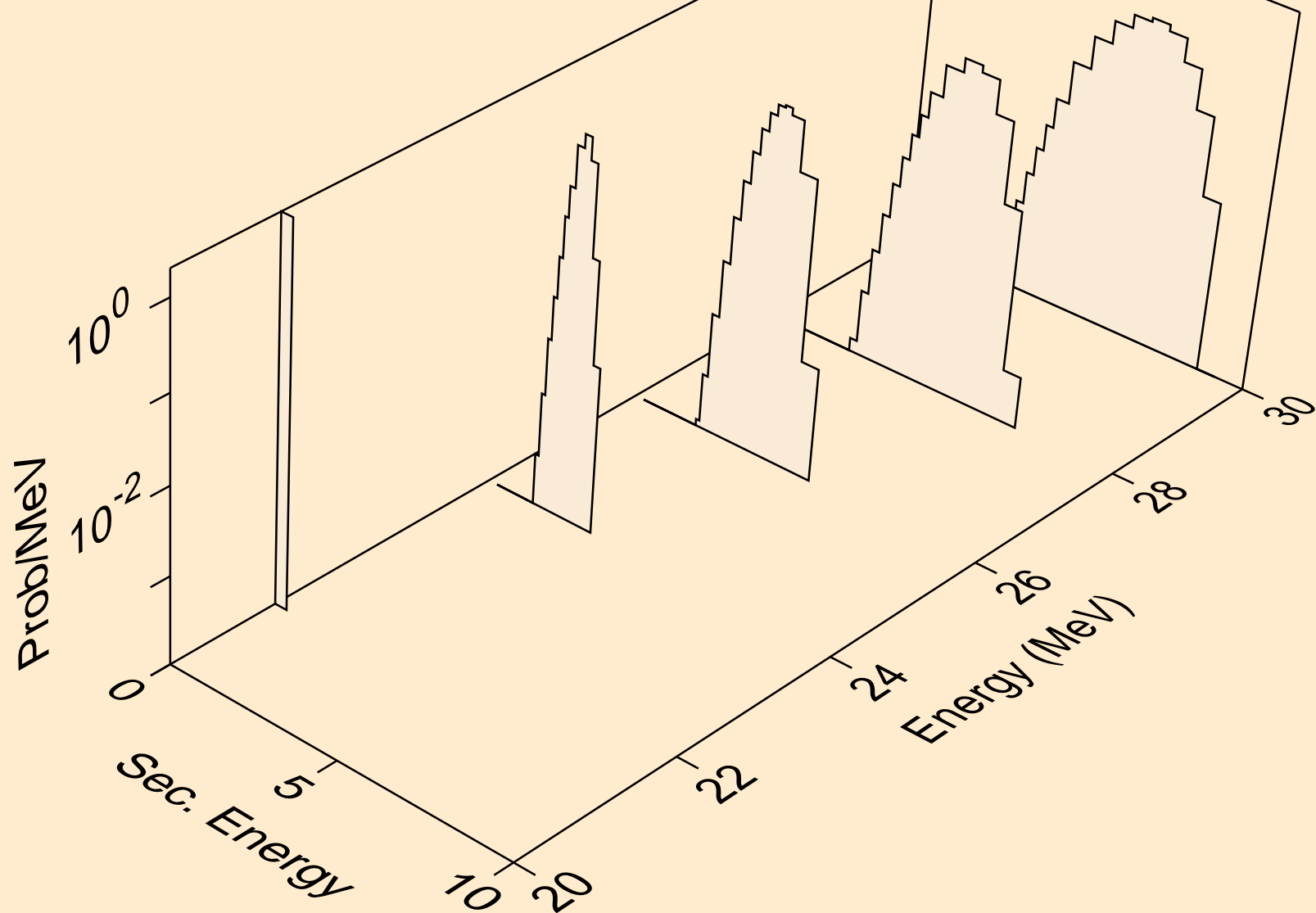

PT193 NEUTRON ACER TENDL-2023 LIBRARY; T=0.K  
protons from (n,n2p)

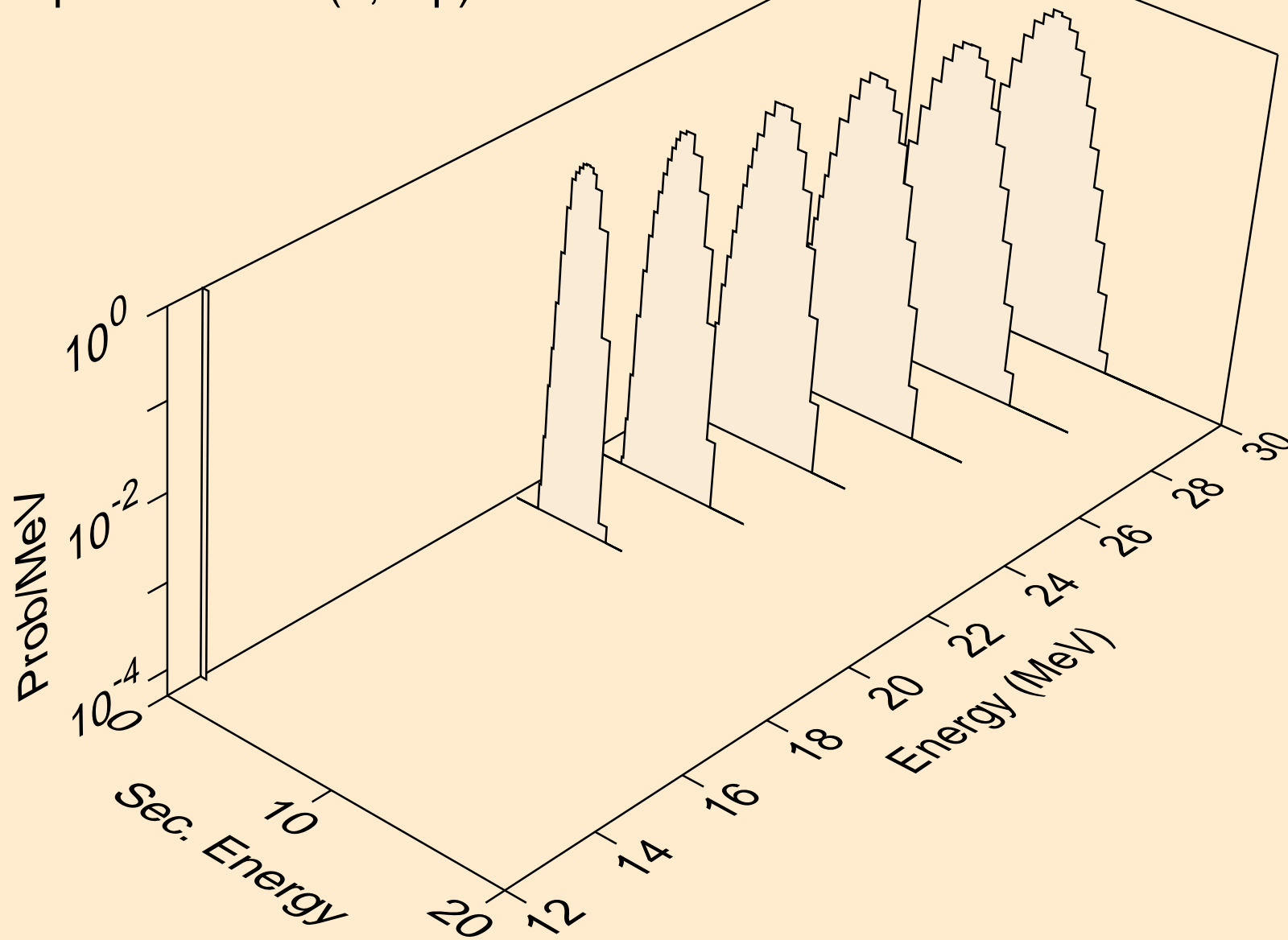



PT193 NEUTRON ACER TENDL-2023 LIBRARY; T=0.K  
protons from (n,npa)

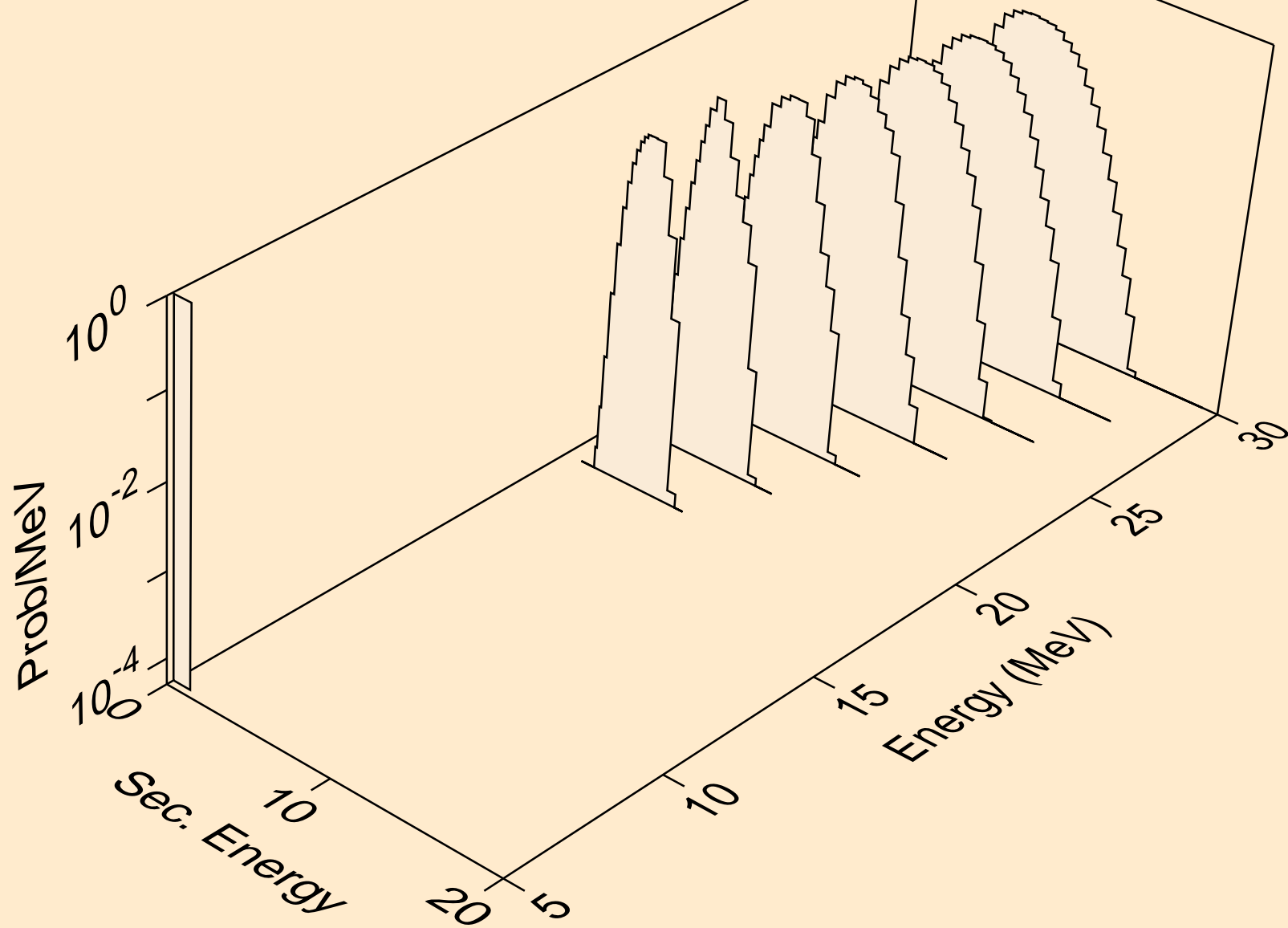

PT193 NEUTRON ACER TENDL-2023 LIBRARY; T=0.K  
protons from (n,p)

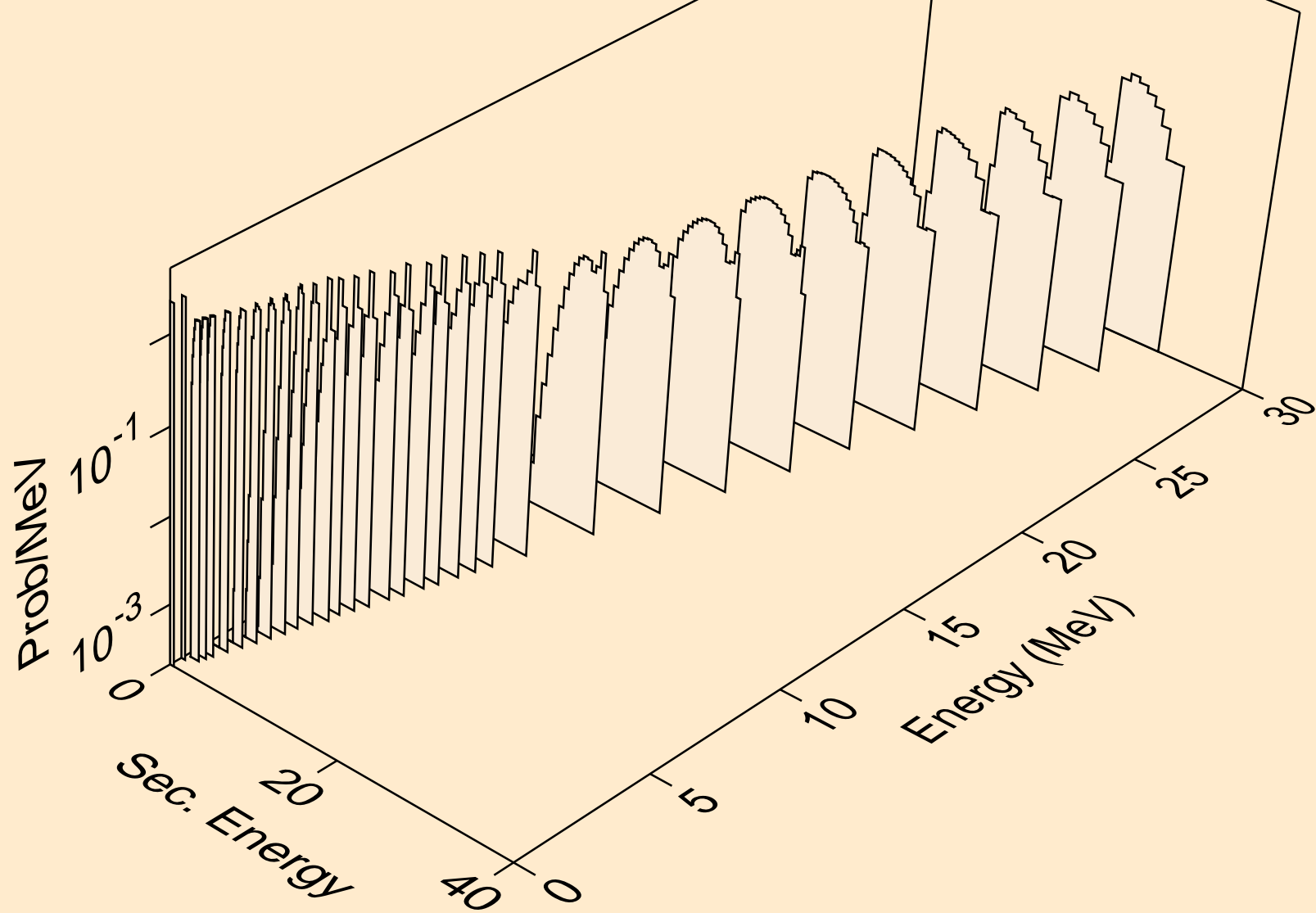

PT193 NEUTRON ACER TENDL-2023 LIBRARY; T=0.K  
protons from (n,2p)

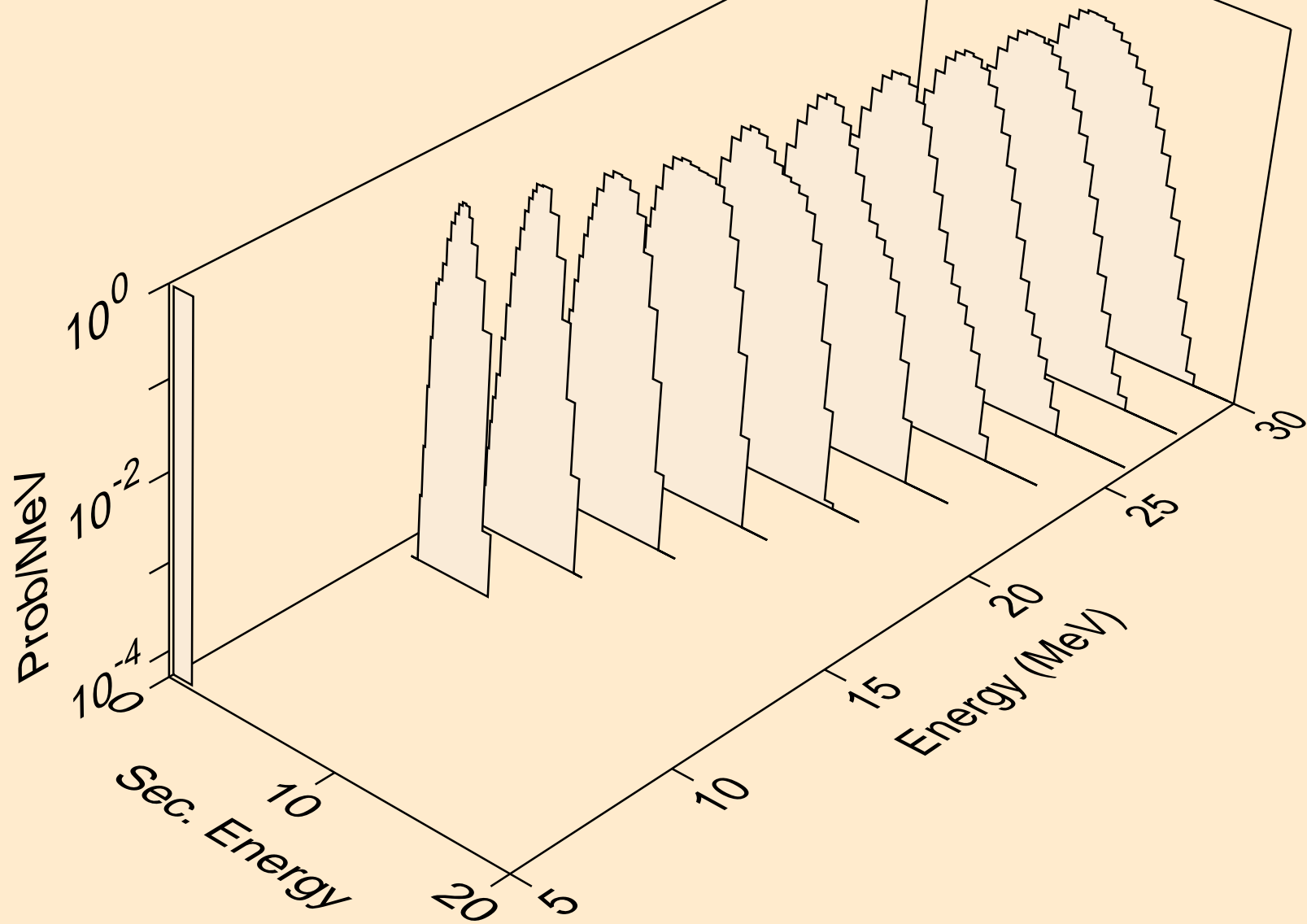

PT193 NEUTRON ACER TENDL-2023 LIBRARY; T=0.K  
protons from (n,pa)

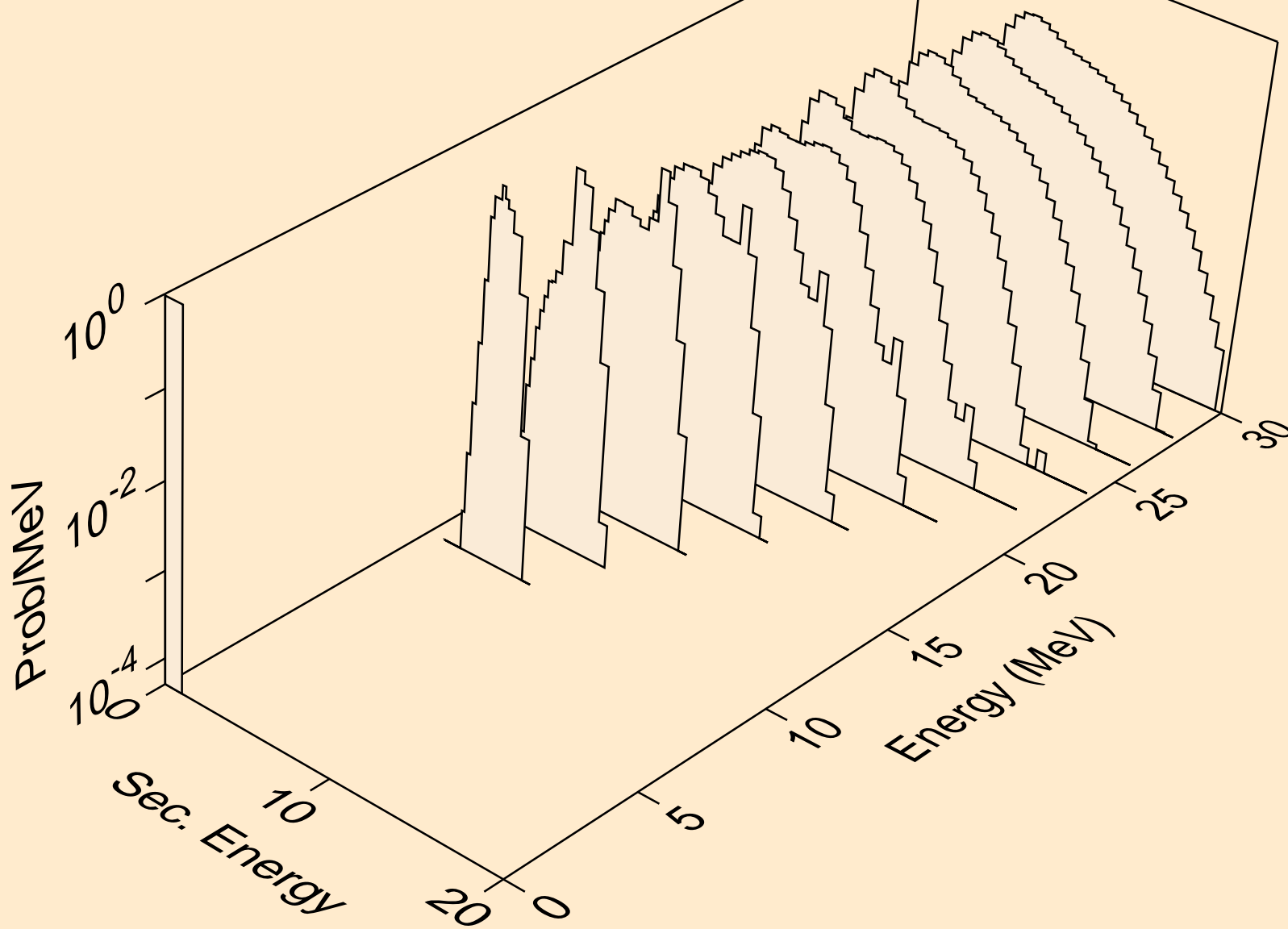

PT193 NEUTRON ACER TENDL-2023 LIBRARY; T=0.K  
protons from (n,pd)

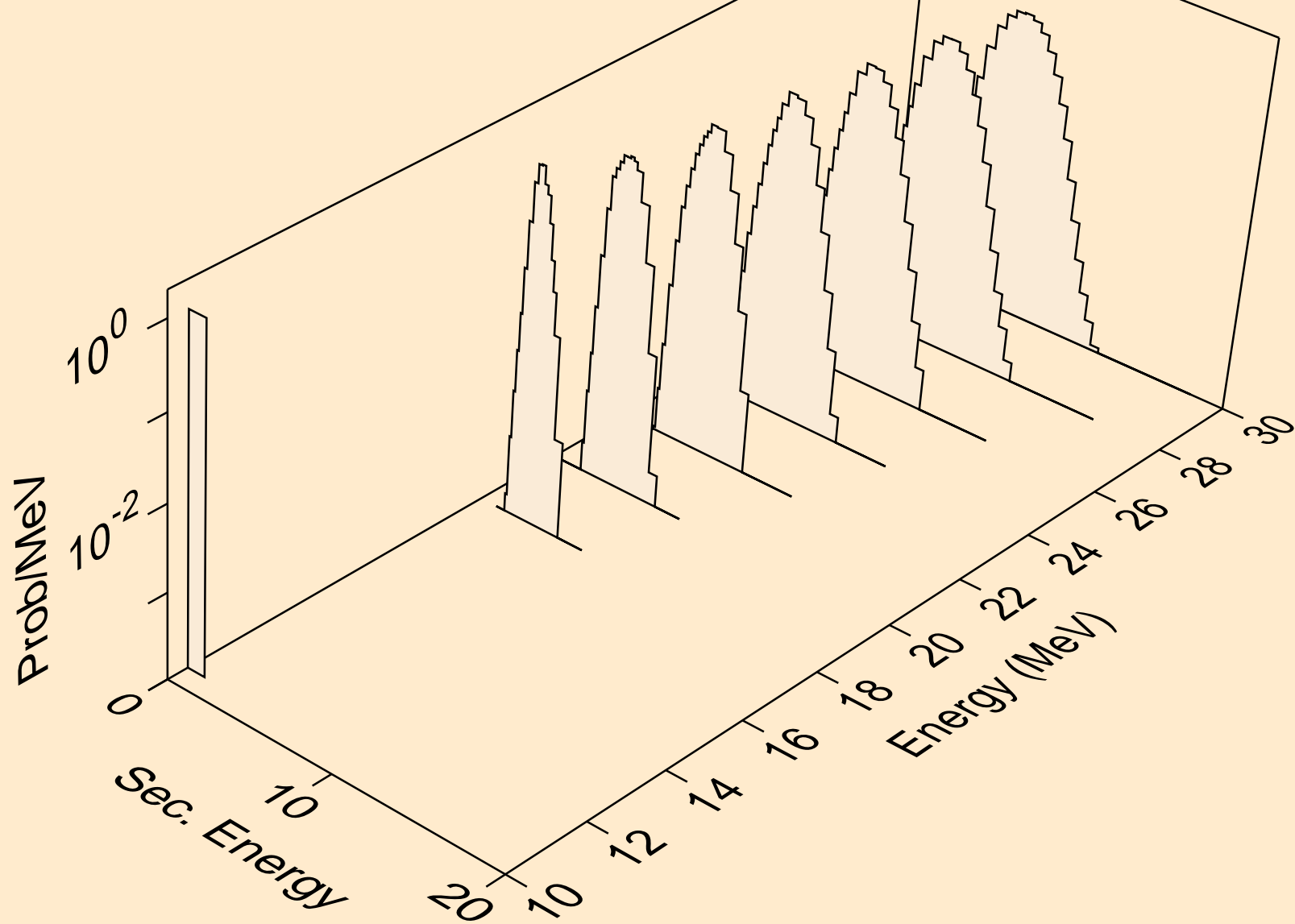

PT193 NEUTRON ACER TENDL-2023 LIBRARY; T=0.K  
protons from (n,pt)

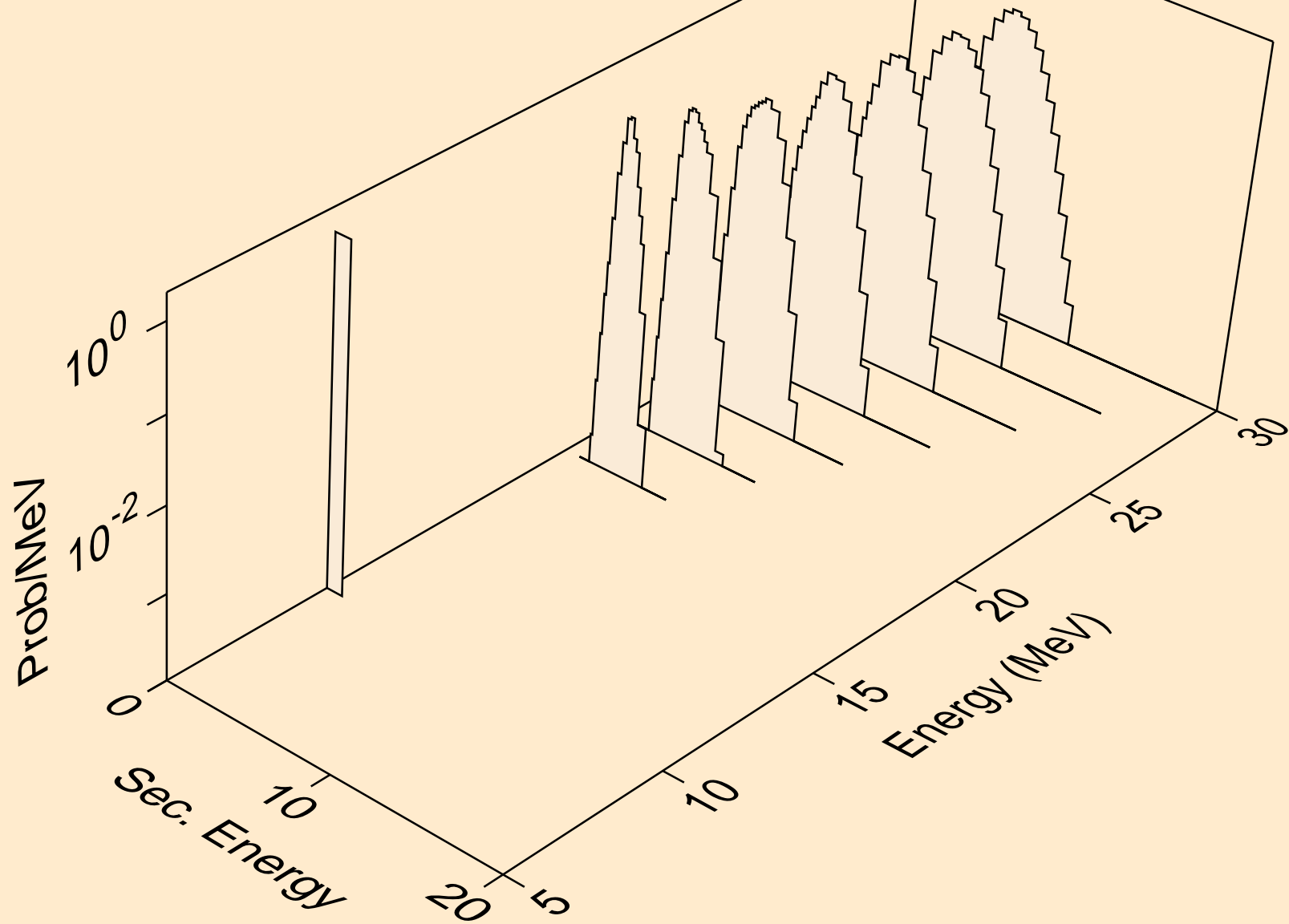

PT193 NEUTRON ACER TENDL-2023 LIBRARY; T=0.K  
deuterons from (n,x)

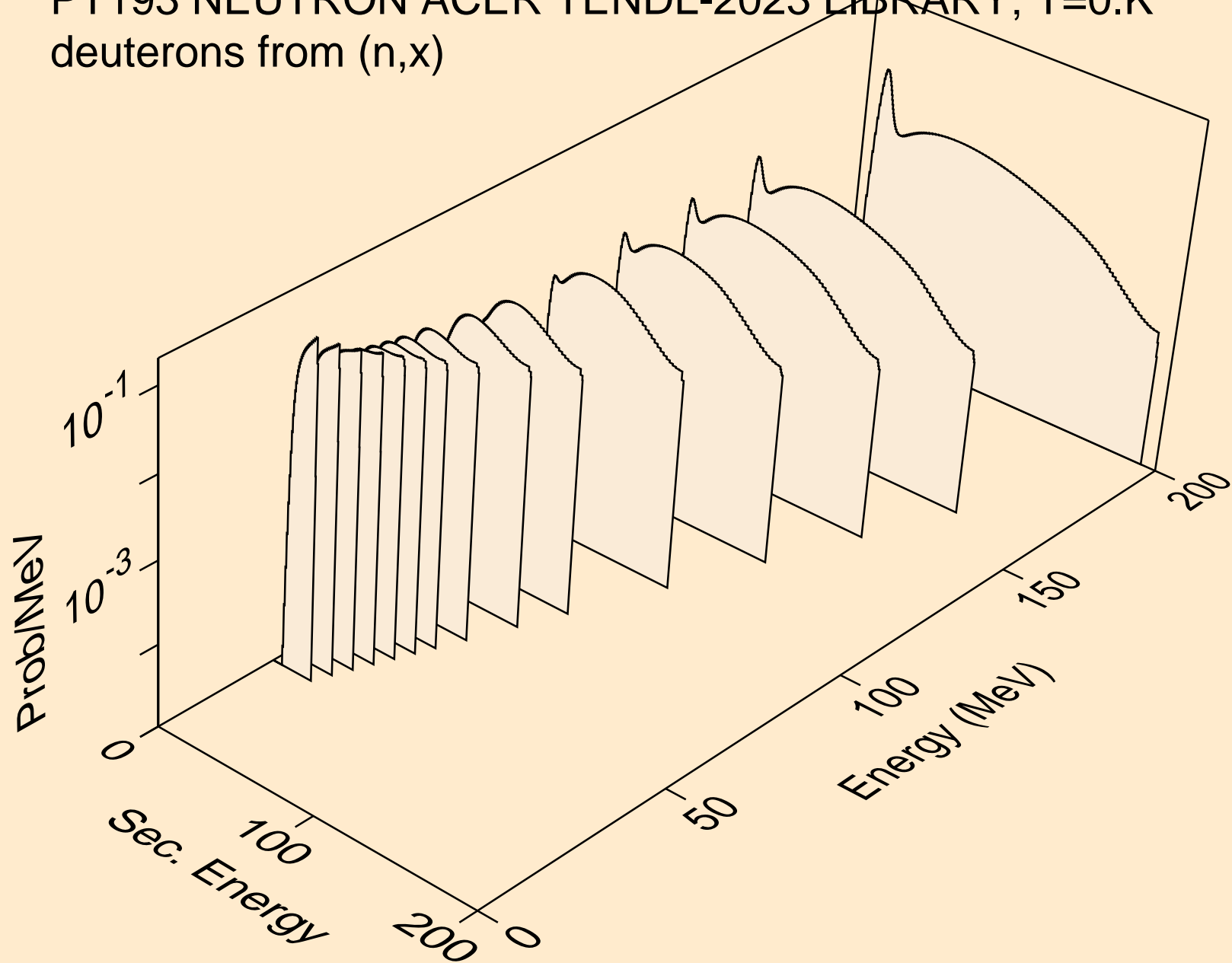

PT193 NEUTRON ACER TENDL-2023 LIBRARY; T=0.K  
deuterons from (n,2nd)

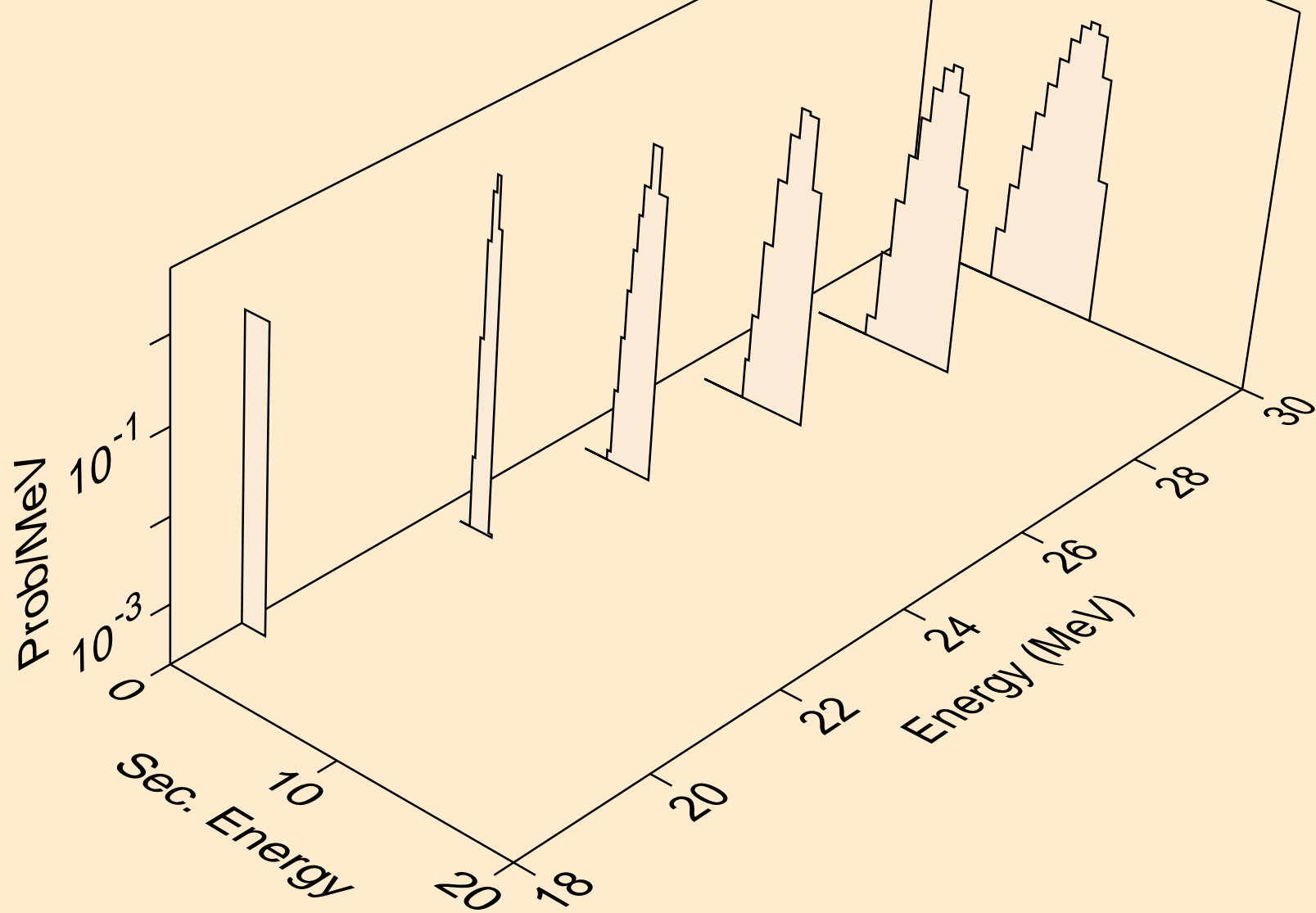



PT193 NEUTRON ACER TENDL-2023 LIBRARY; T=0.K  
deuterons from (n,n\*)d

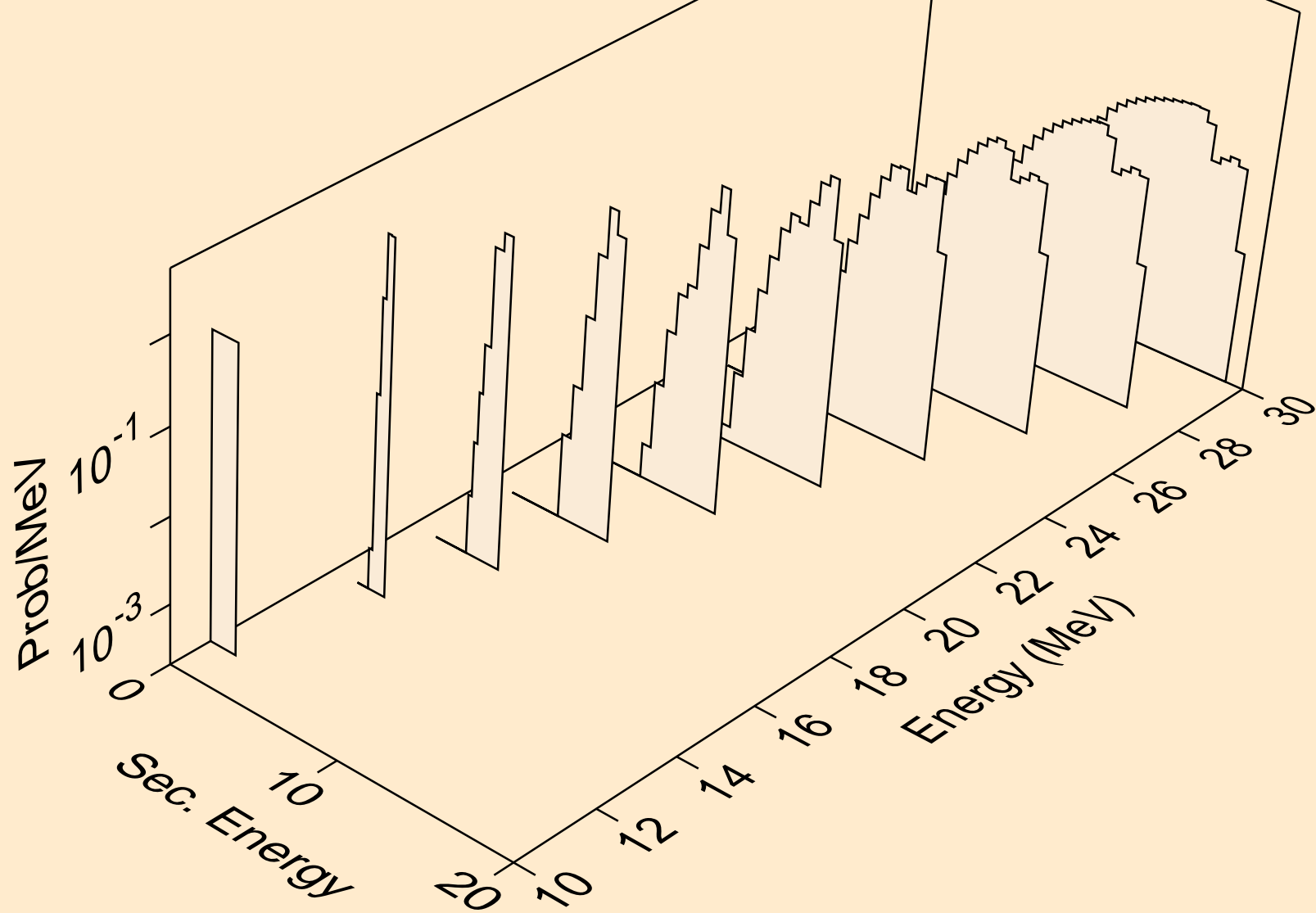

PT193 NEUTRON ACER TENDL-2023 LIBRARY; T=0.K  
deuterons from (n,d)

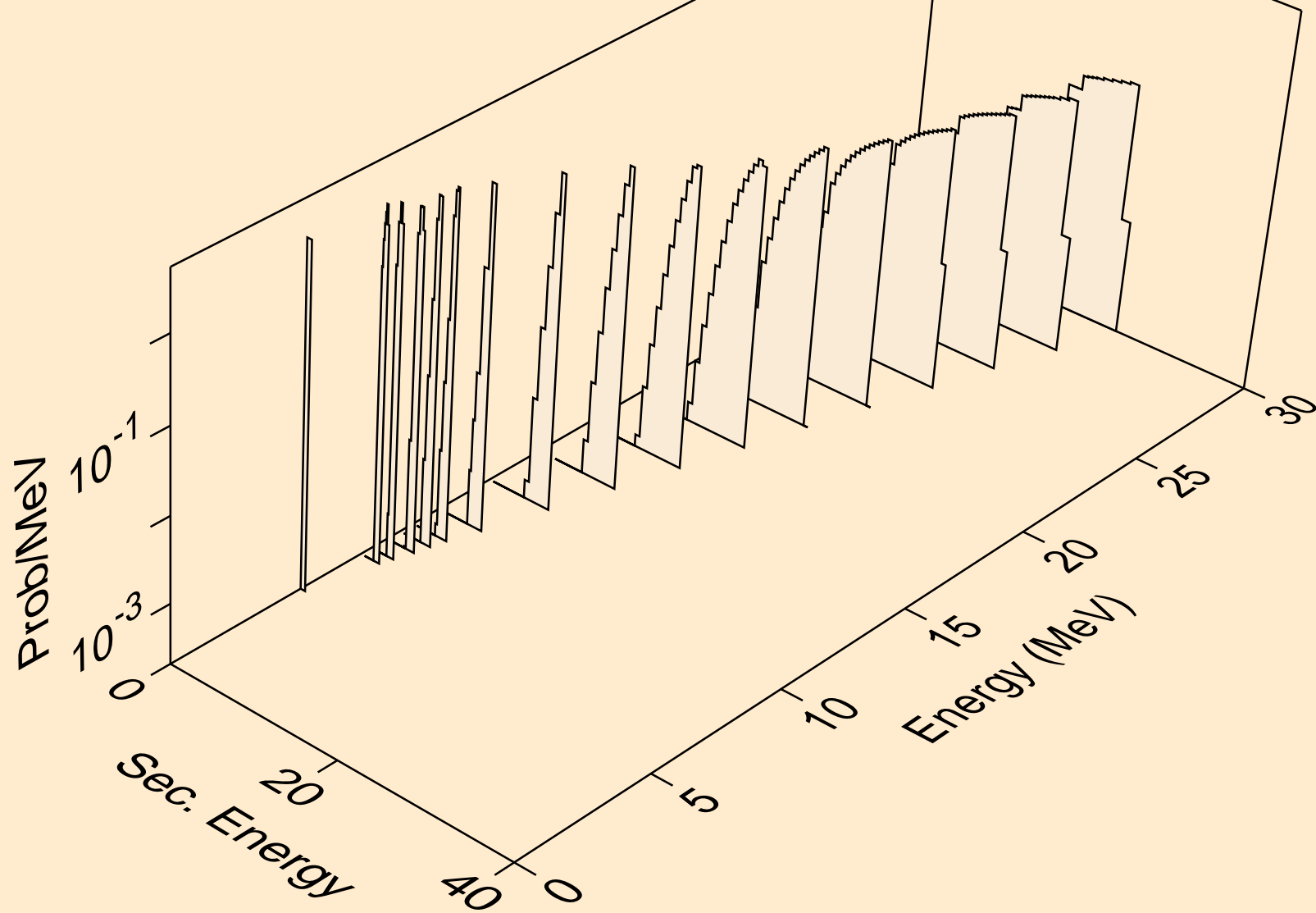

PT193 NEUTRON ACER TENDL-2023 LIBRARY; T=0.K  
deuterons from (n,pd)

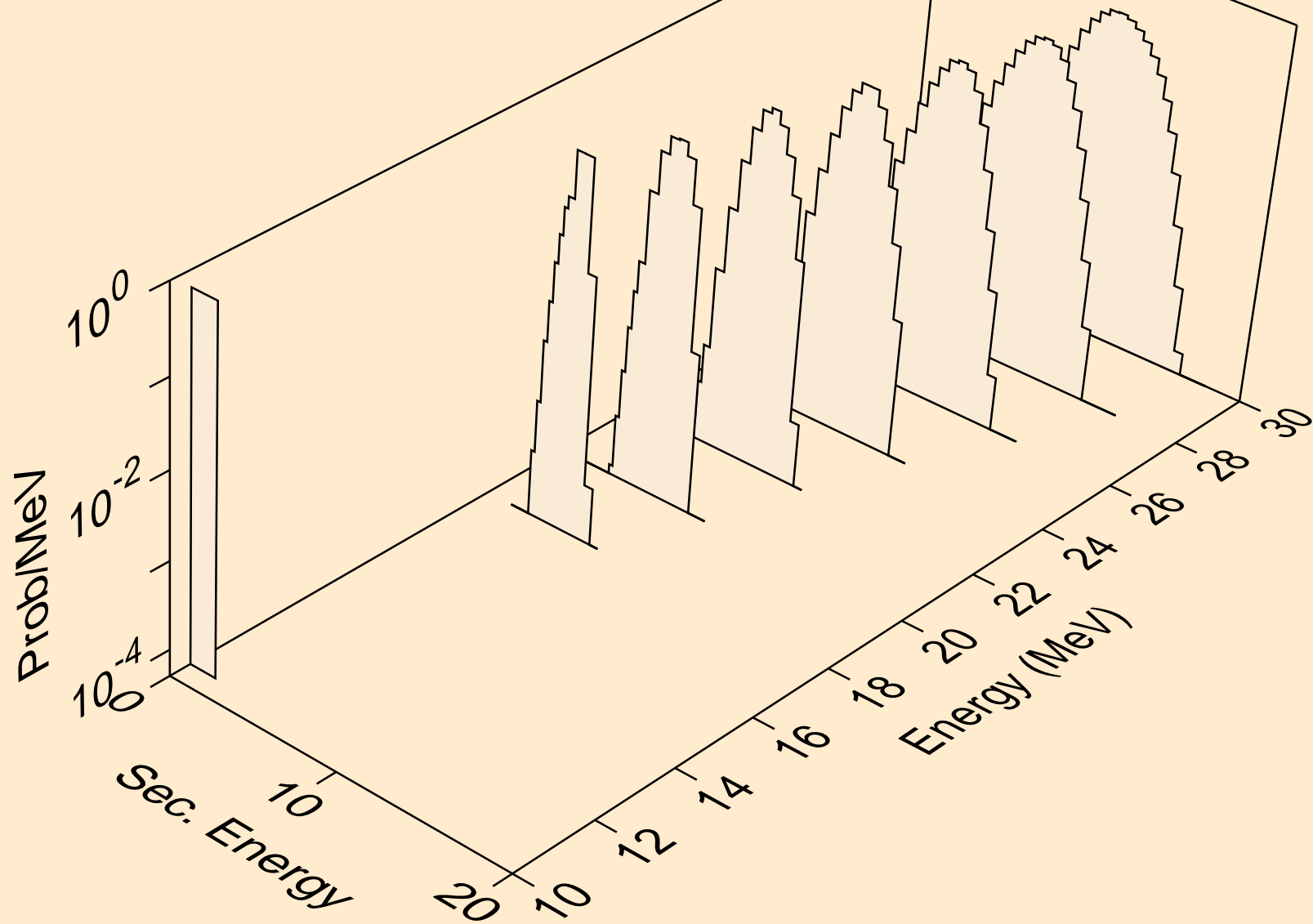

PT193 NEUTRON ACER TENDL-2023 LIBRARY; T=0.K  
tritons from (n,x)

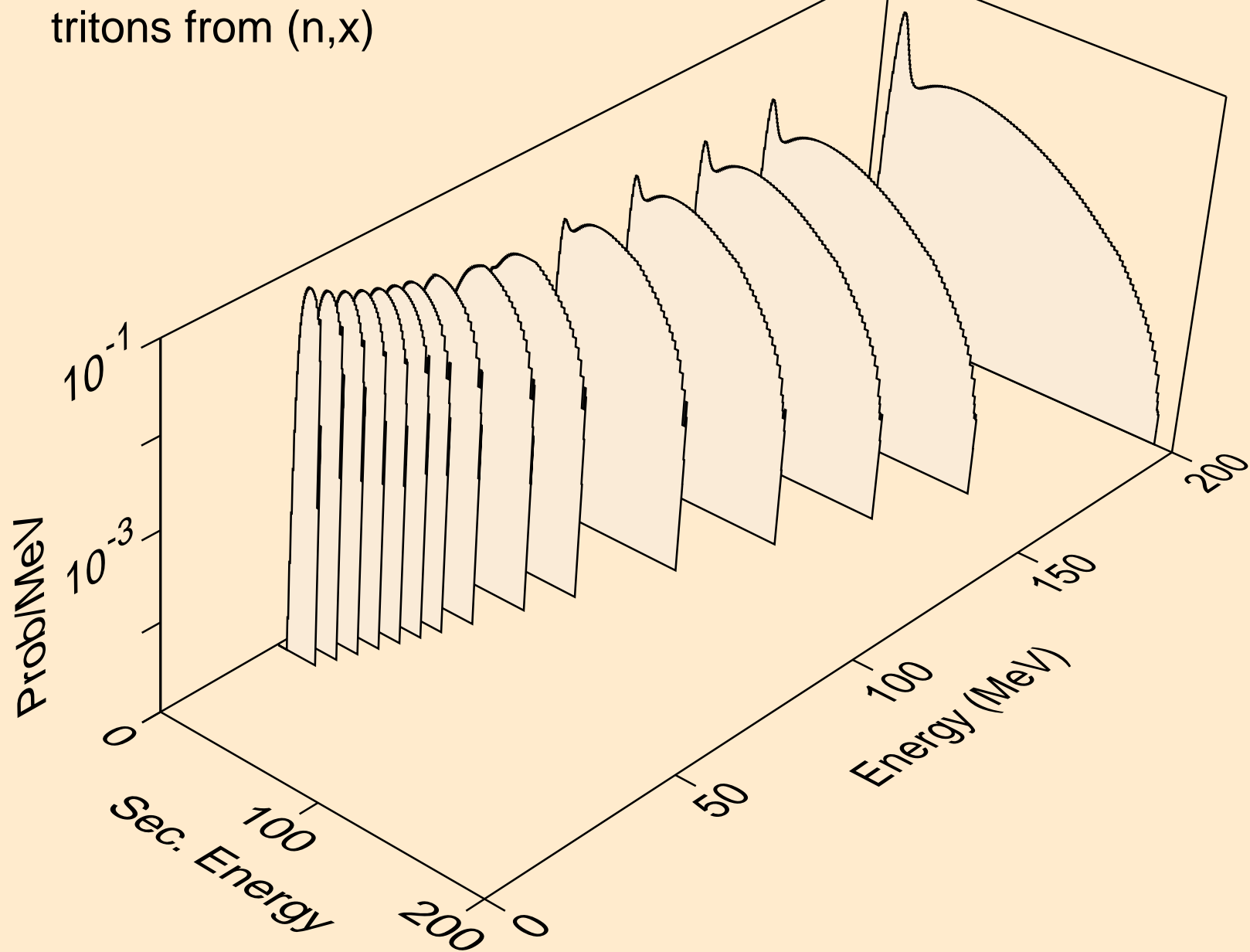

PT193 NEUTRON ACER TENDL-2023 LIBRARY; T=0.K  
tritons from (n,n\*)t

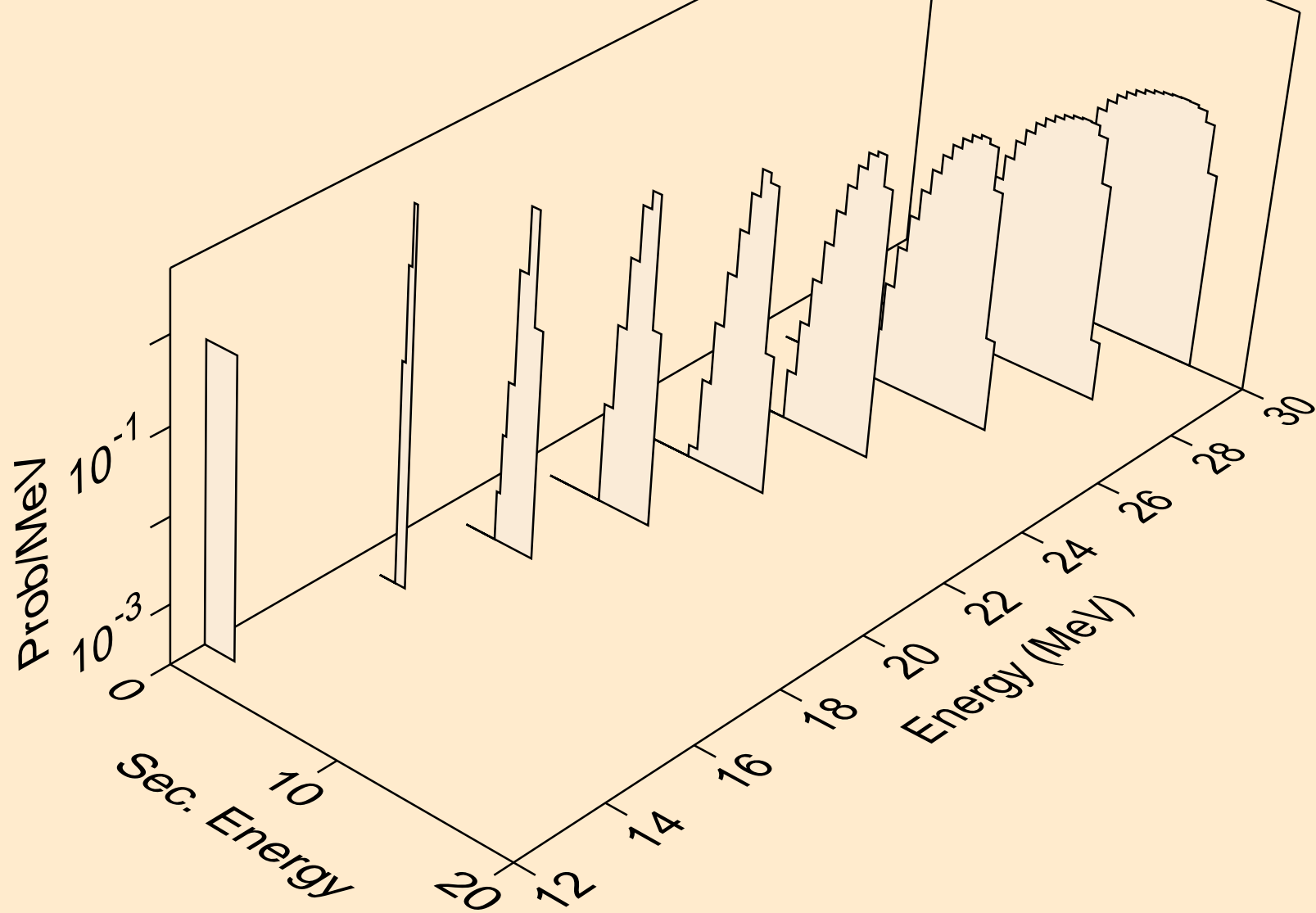

PT193 NEUTRON ACER TENDL-2023 LIBRARY; T=0.K  
tritons from (n,t)

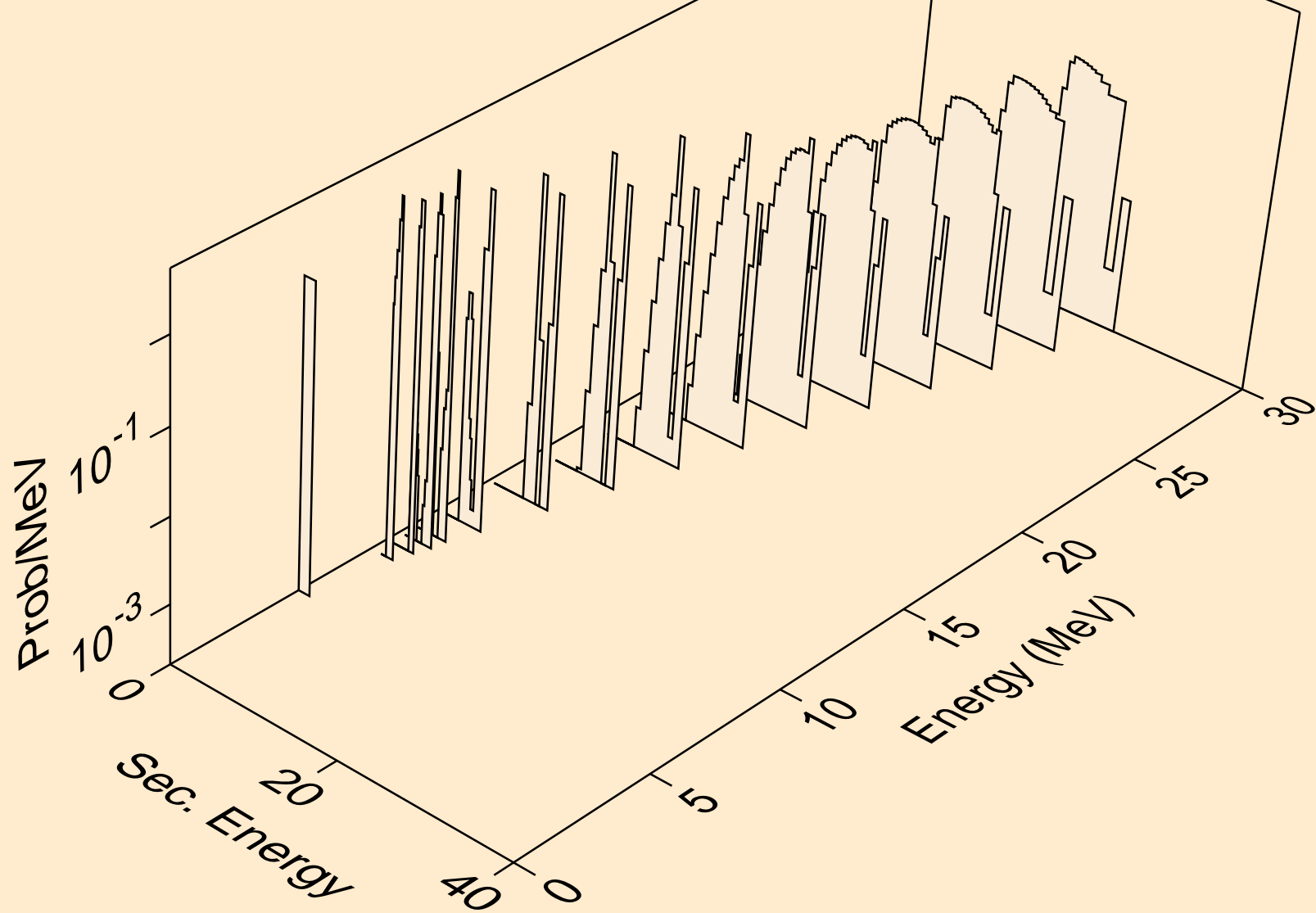

PT193 NEUTRON ACER TENDL-2023 LIBRARY; T=0.K  
tritons from (n,pt)

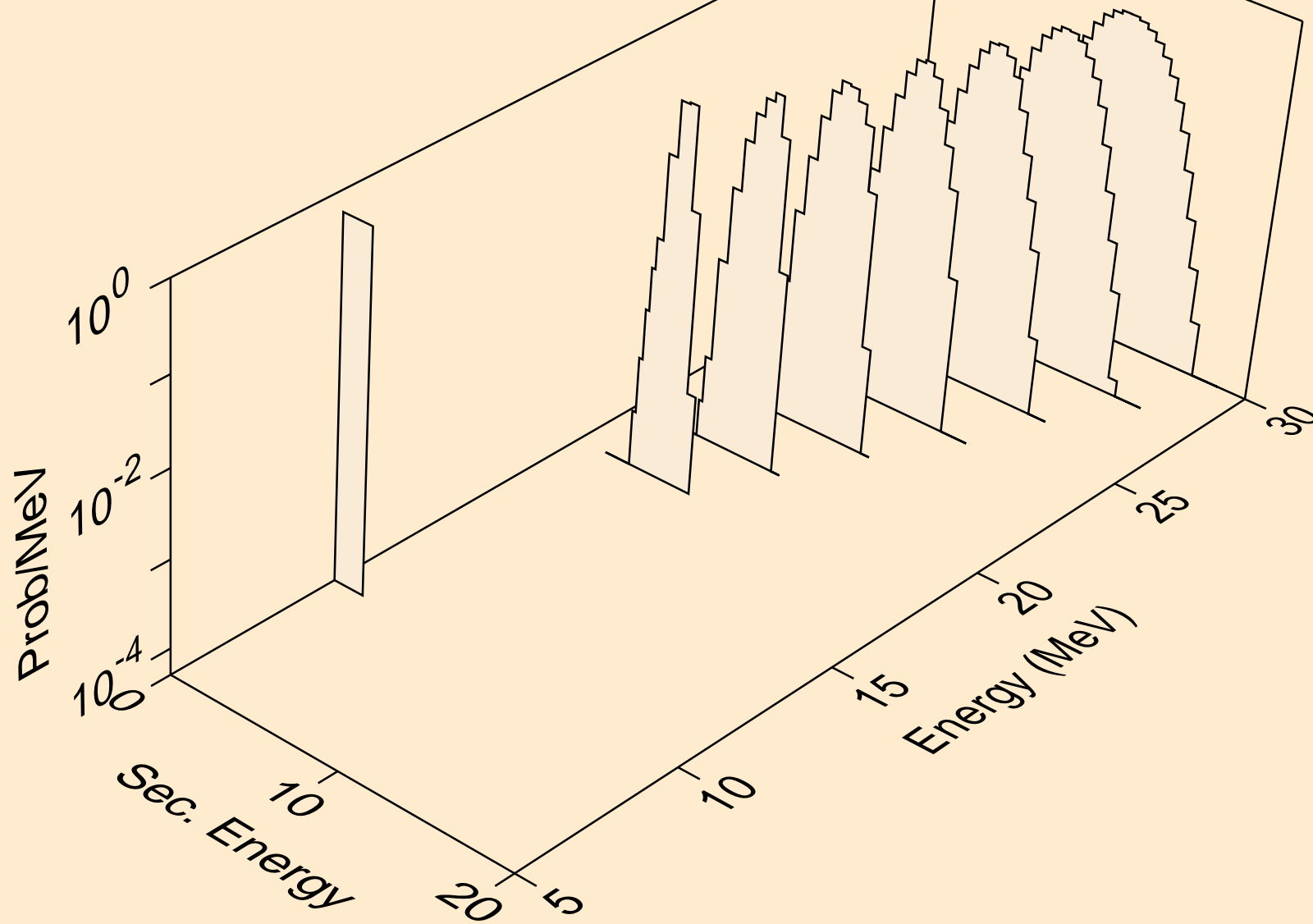

PT193 NEUTRON ACER TENDL-2023 LIBRARY; T=0.K  
he3s from (n,x)

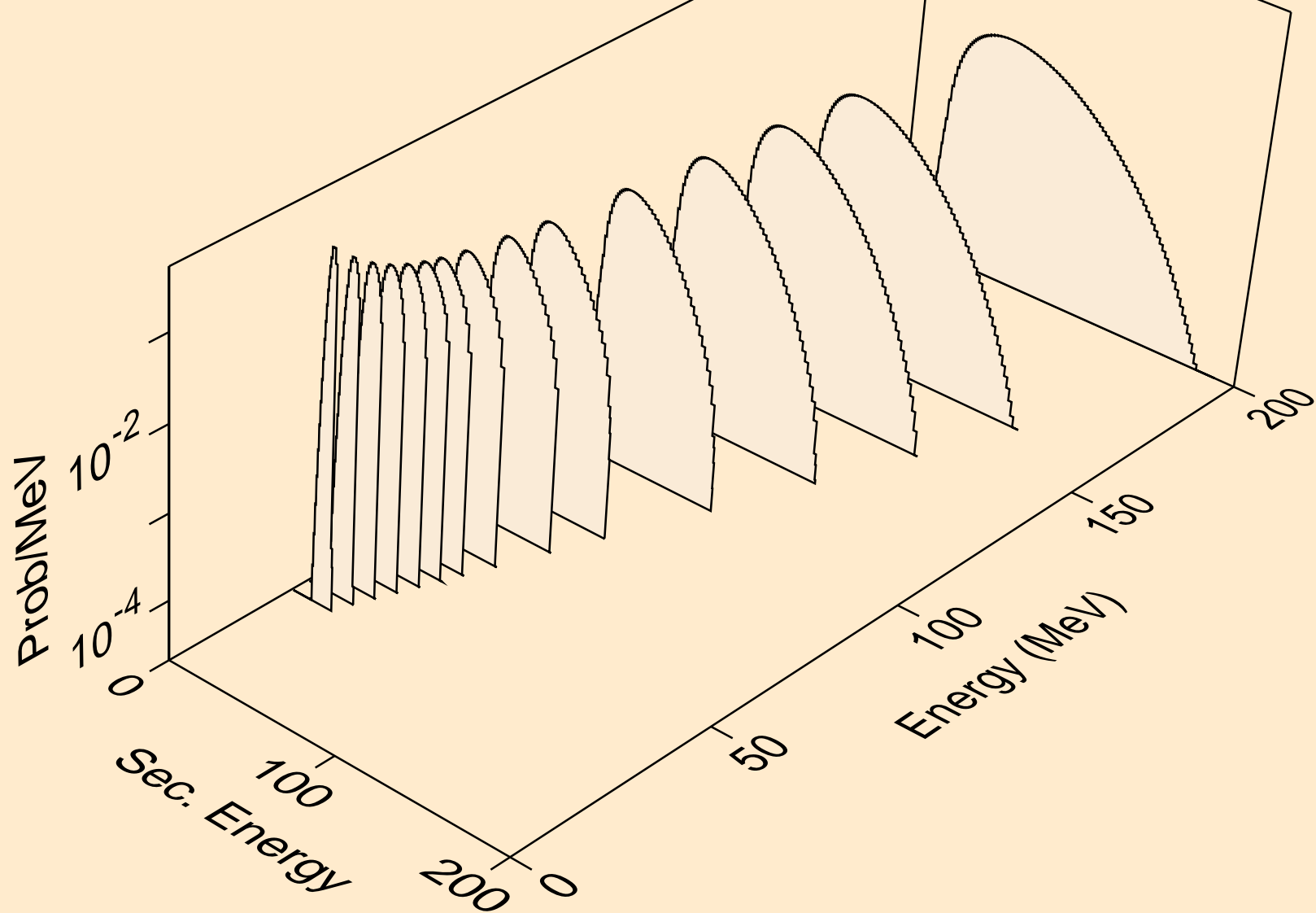



PT193 NEUTRON ACER TENDL-2023 LIBRARY; T=0.K  
he3s from (n,n\*)he3

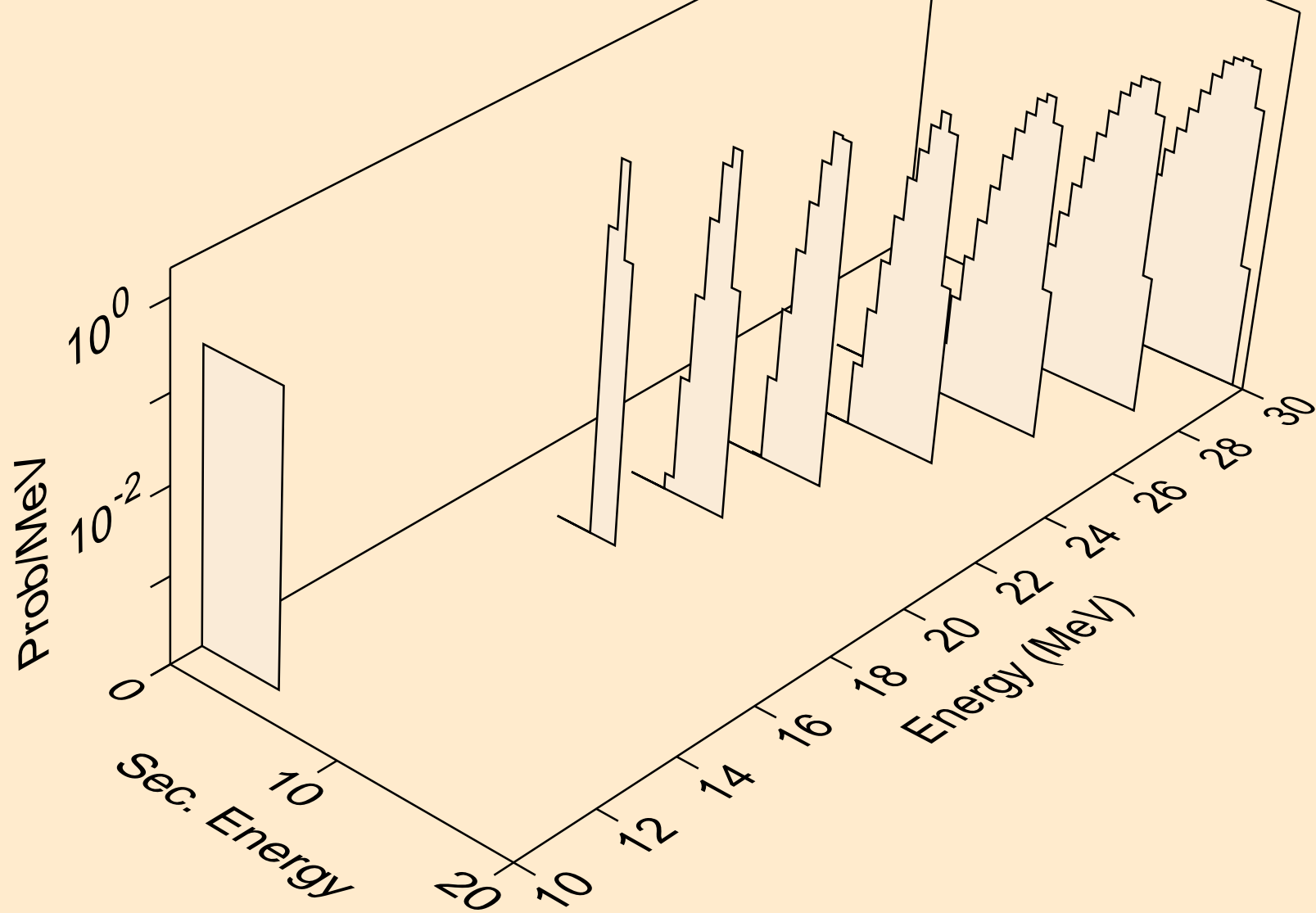

PT193 NEUTRON ACER TENDL-2023 LIBRARY; T=0.K  
he3s from (n,he3)

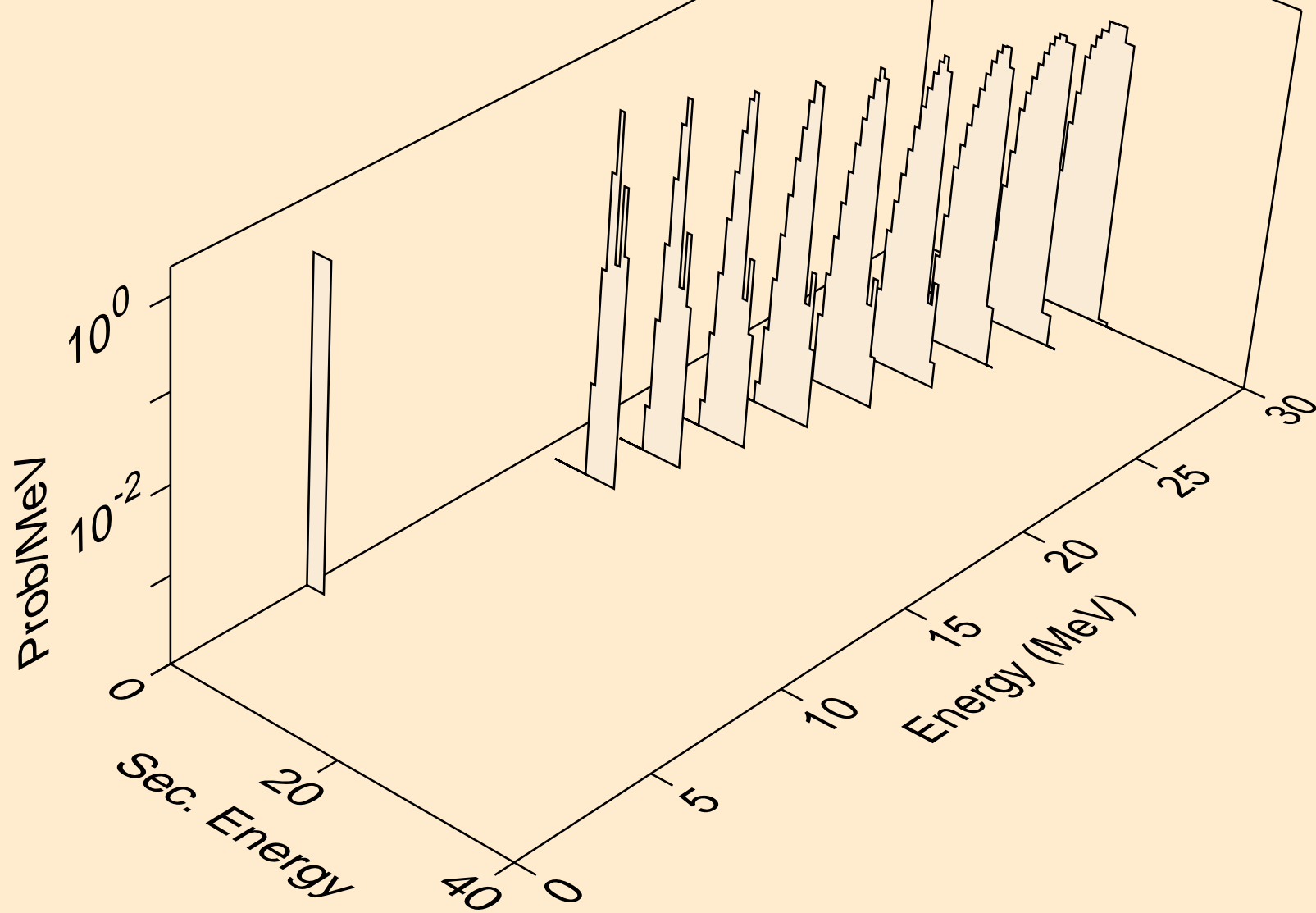

PT193 NEUTRON ACER TENDL-2023 LIBRARY; T=0.K  
alphas from (n,x)

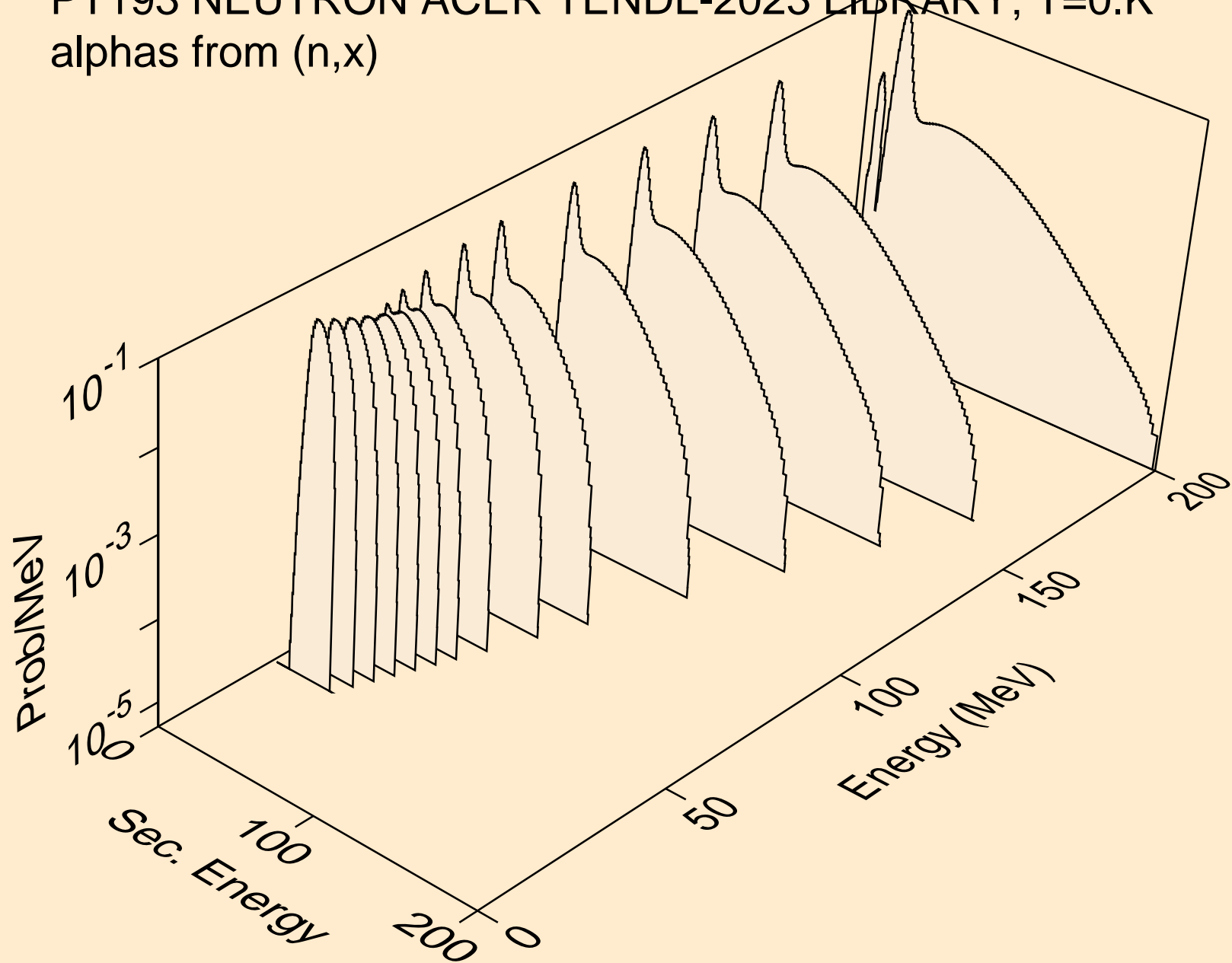

PT193 NEUTRON ACER TENDL-2023 LIBRARY; T=0.K  
alphas from (n,n\*)a

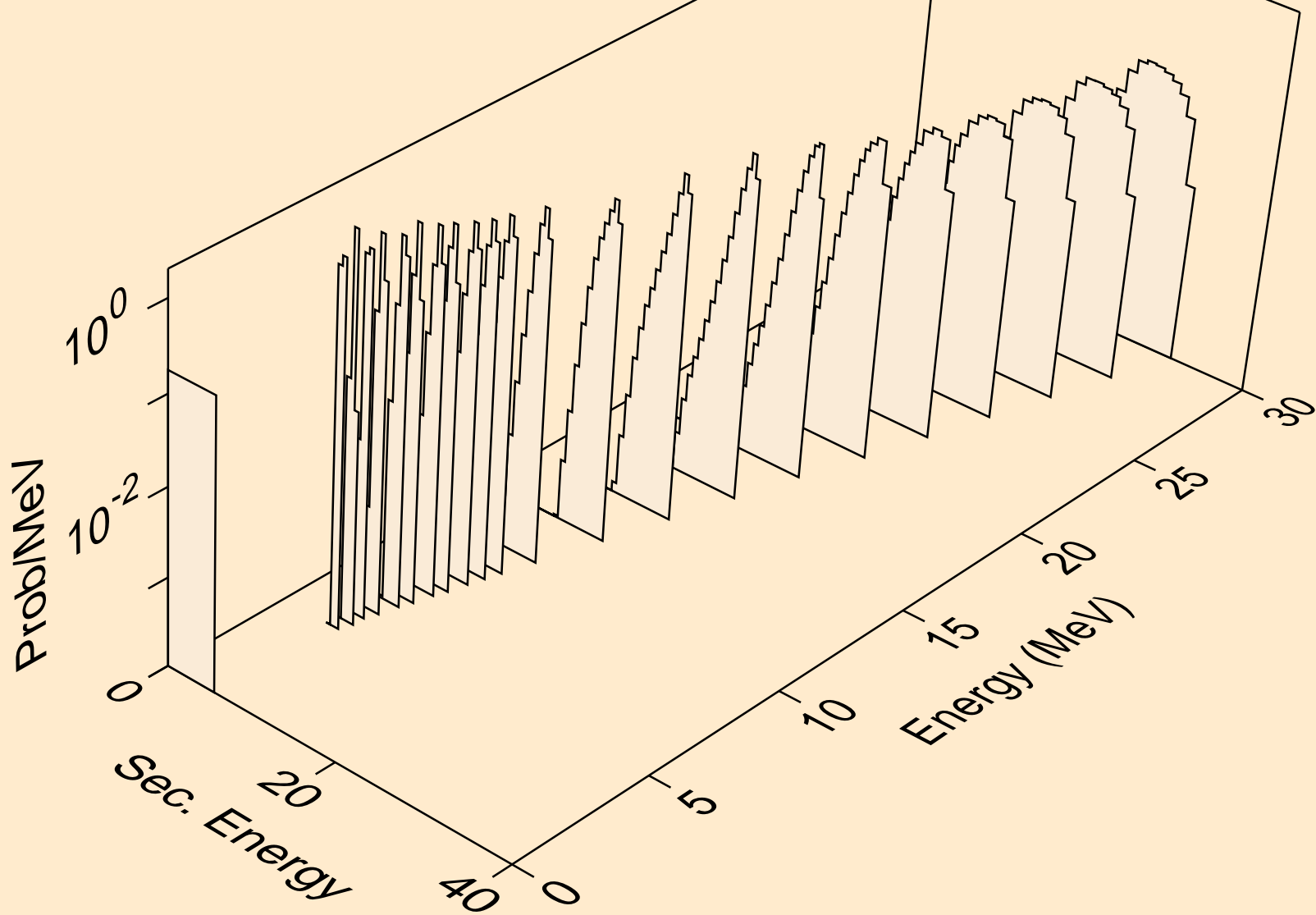

PT193 NEUTRON ACER TENDL-2023 LIBRARY; T=0.K  
alphas from (n,2n)a

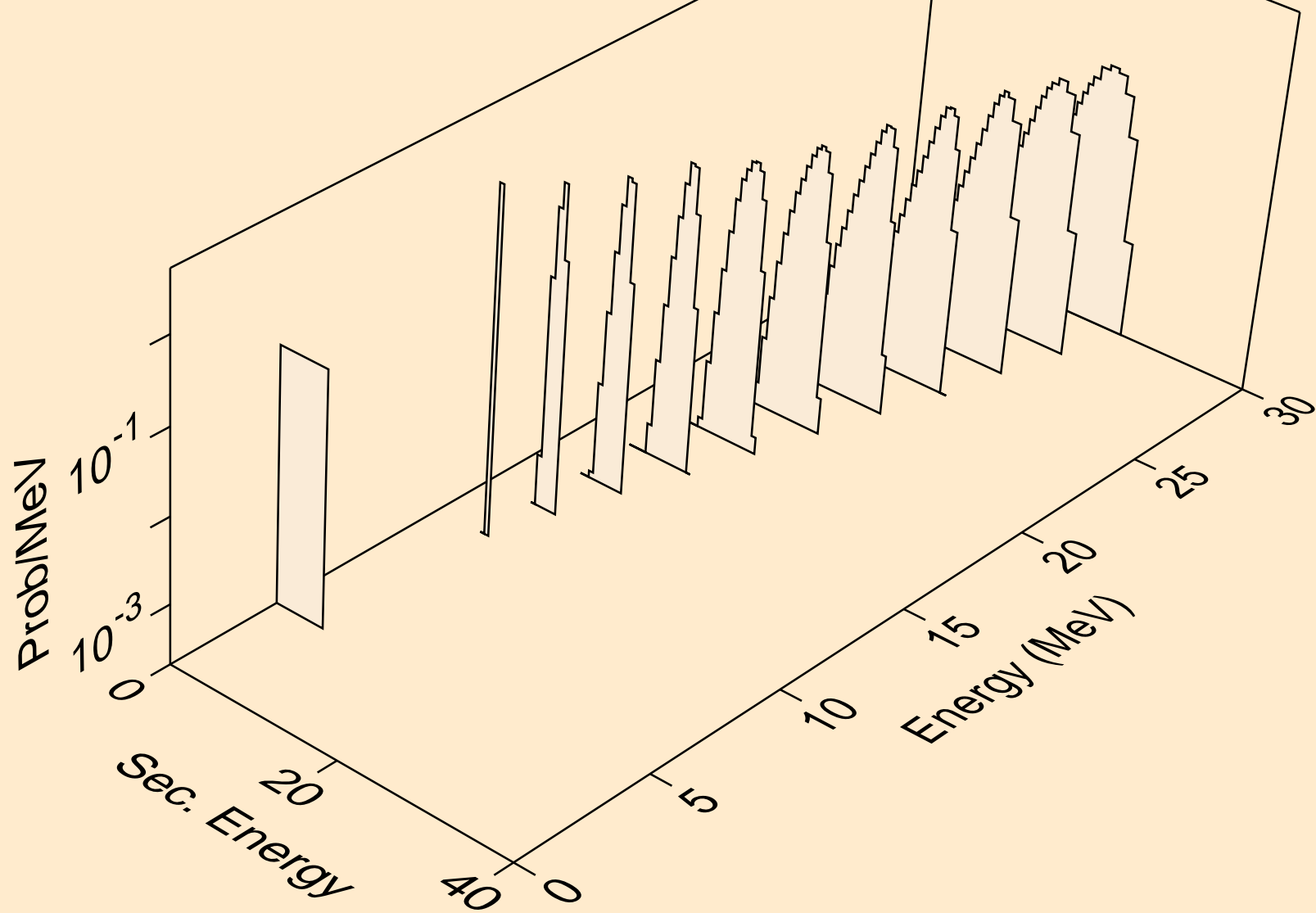

PT193 NEUTRON ACER TENDL-2023 LIBRARY; T=0.K  
alphas from (n,3n)a

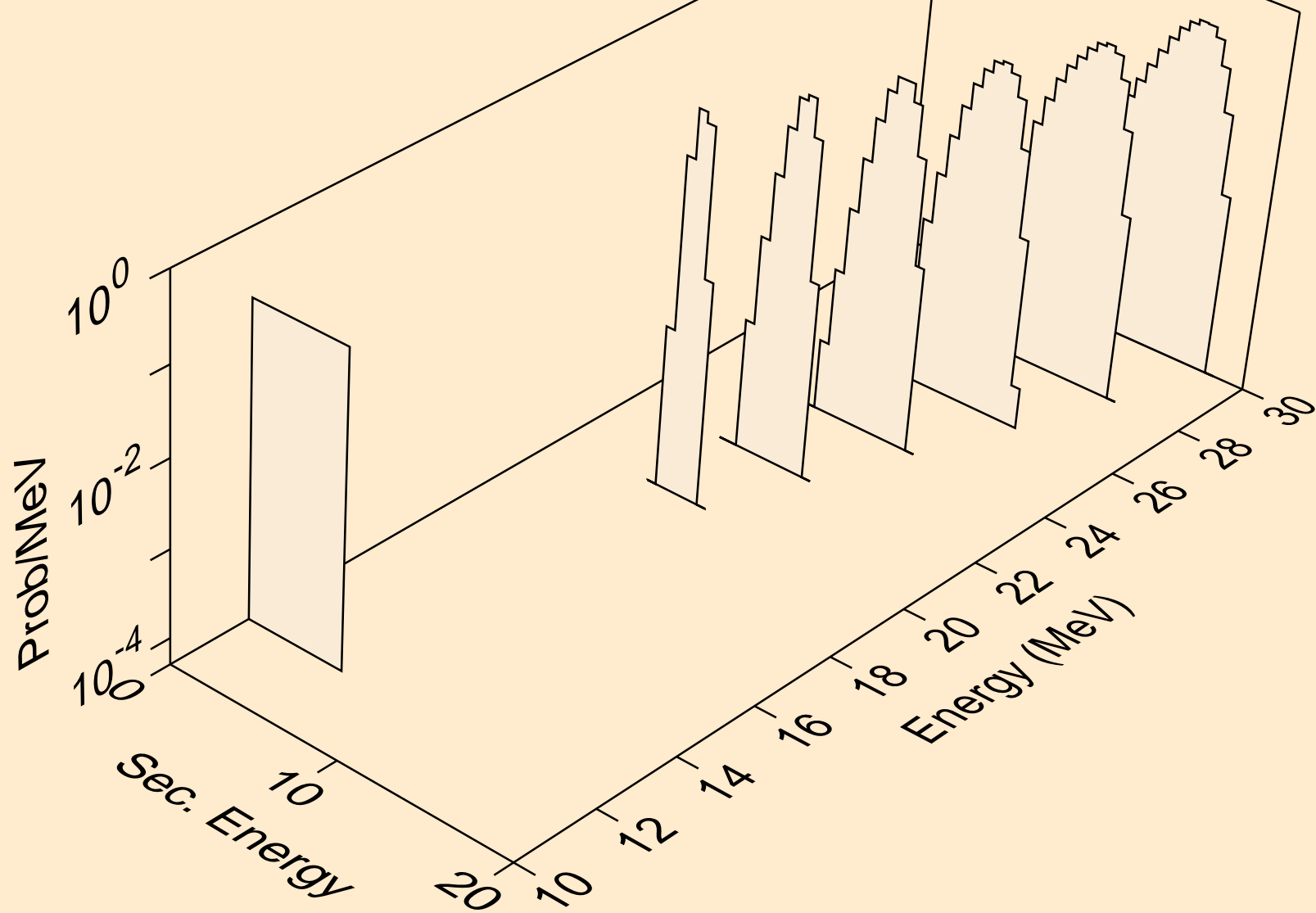

PT193 NEUTRON ACER TENDL-2023 LIBRARY; T=0.K  
alphas from (n,npa)

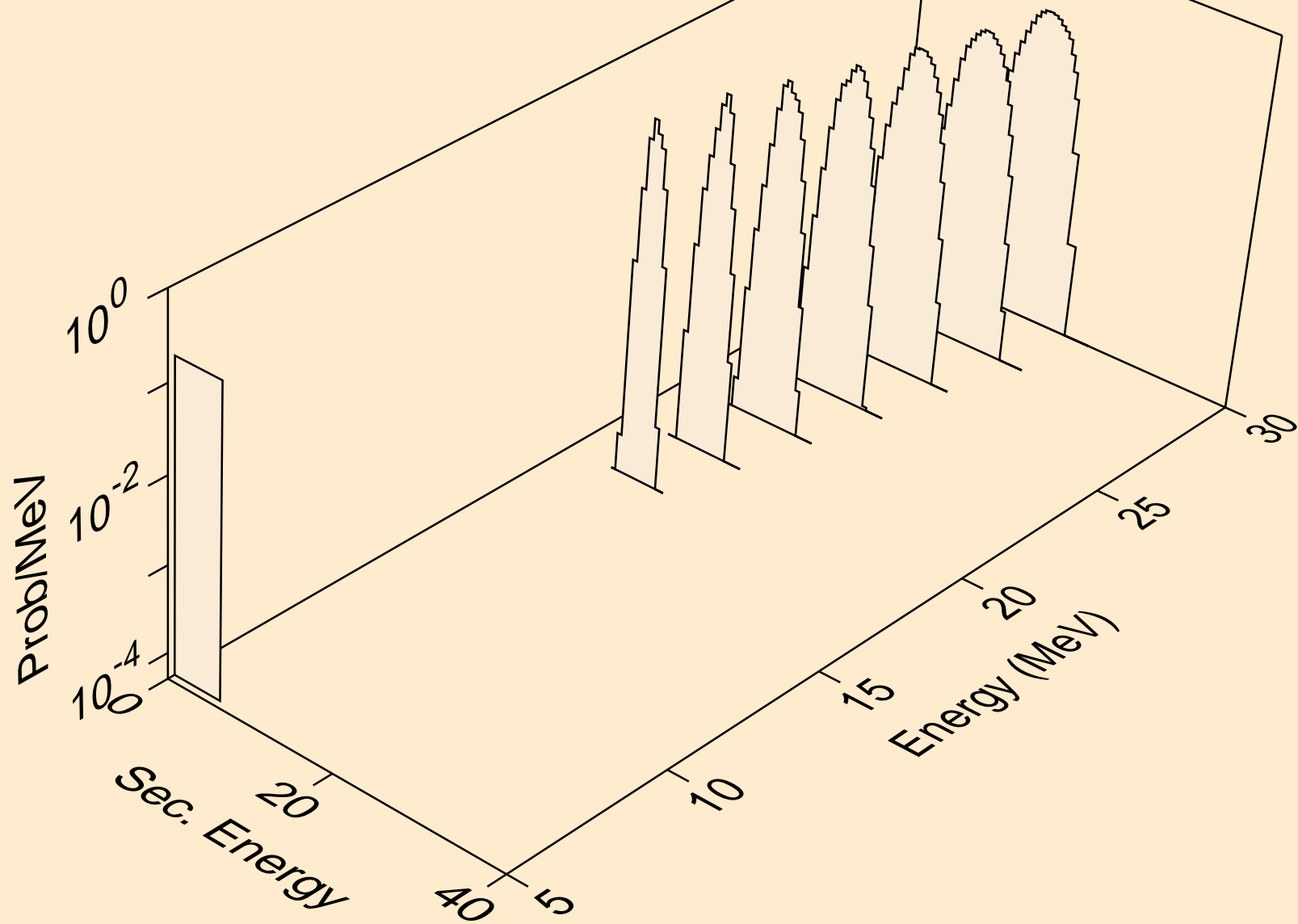

PT193 NEUTRON ACER TENDL-2023 LIBRARY; T=0.K  
alphas from (n,a)

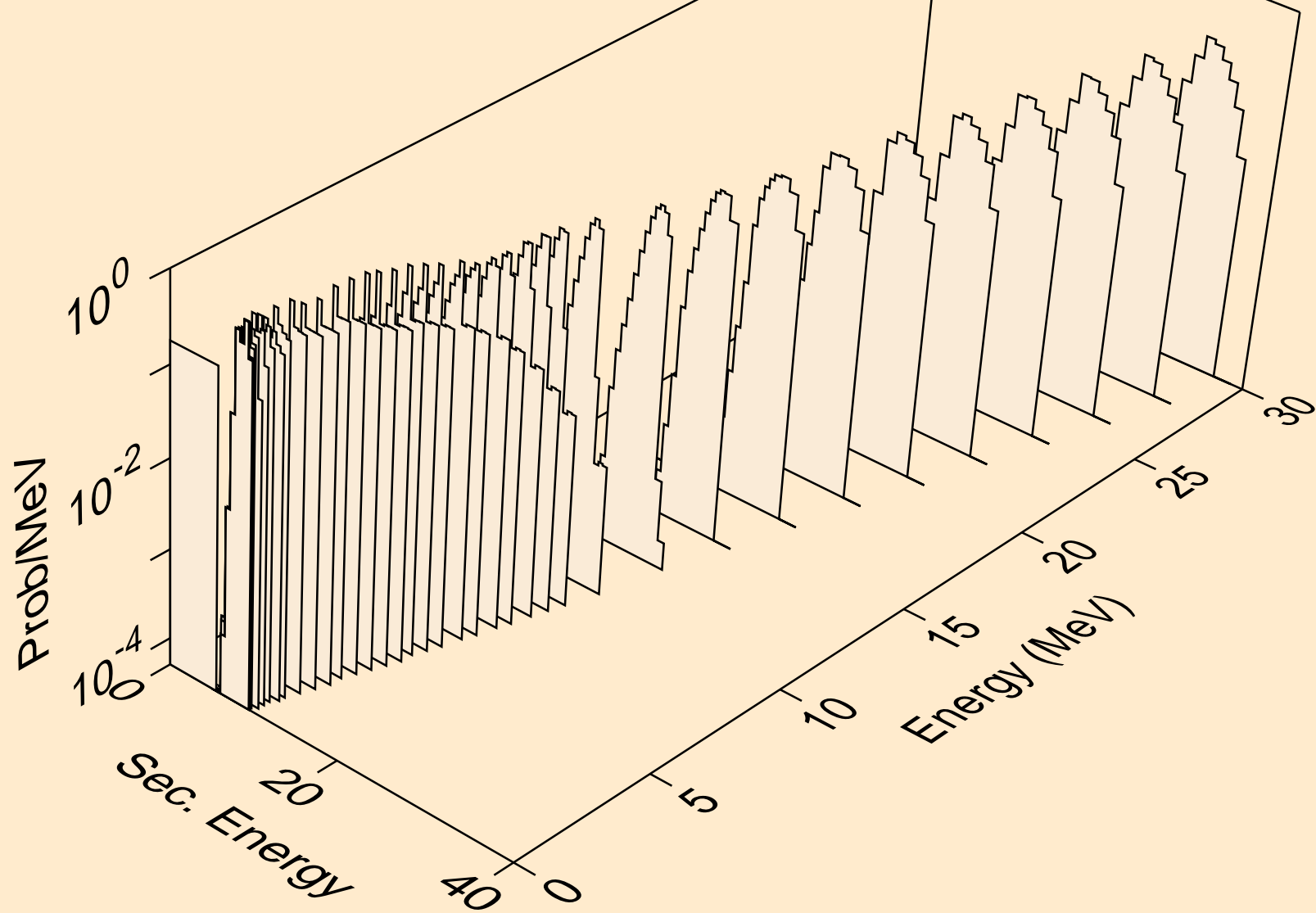



PT193 NEUTRON ACER TENDL-2023 LIBRARY; T=0.K  
alphas from (n,2a)

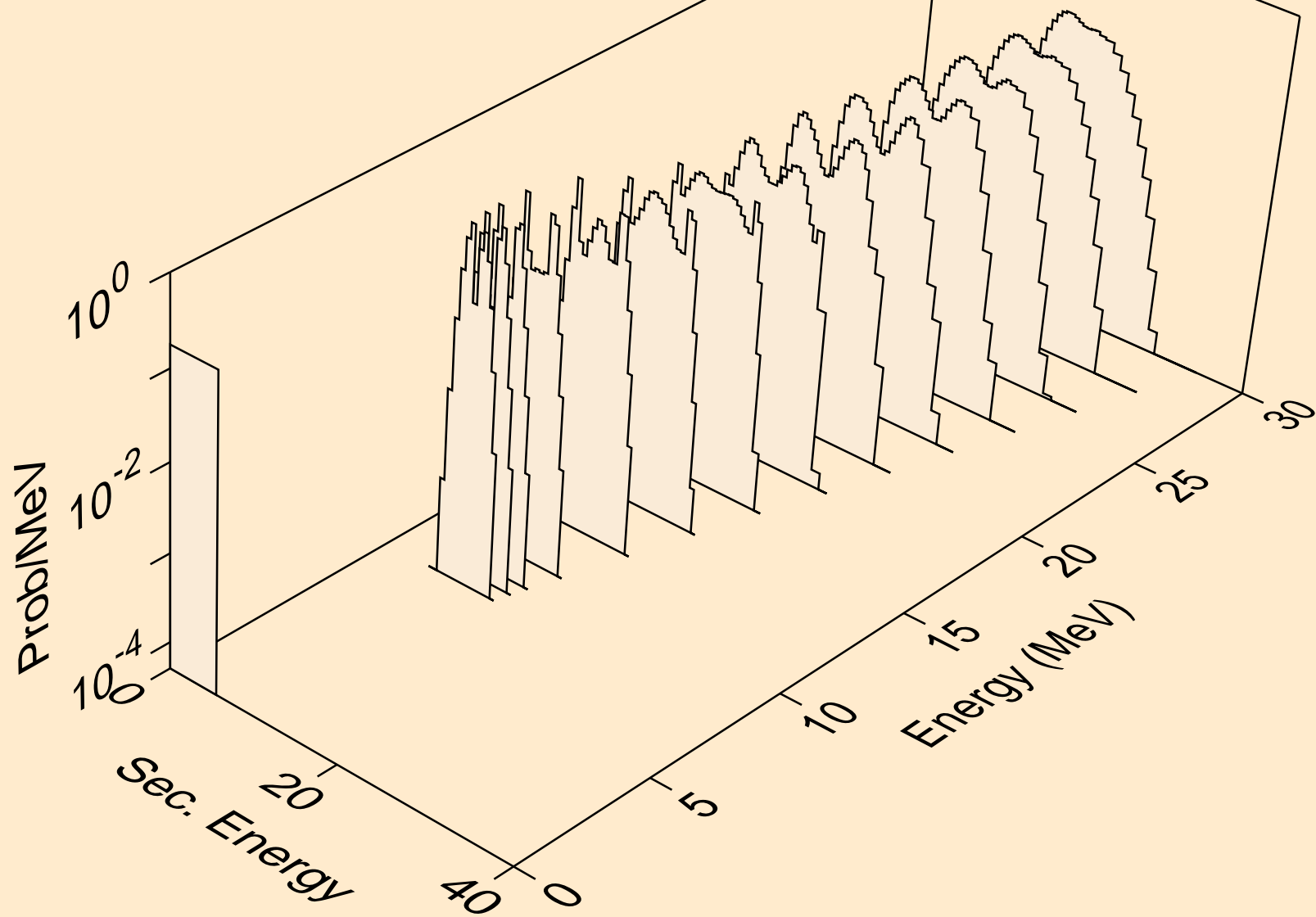

PT193 NEUTRON ACER TENDL-2023 LIBRARY; T=0.K  
alphas from (n,pa)

