

PT202 NEUTRON ACER TENDL-2023 LIBRARY; T=0.K  
Principal cross sections

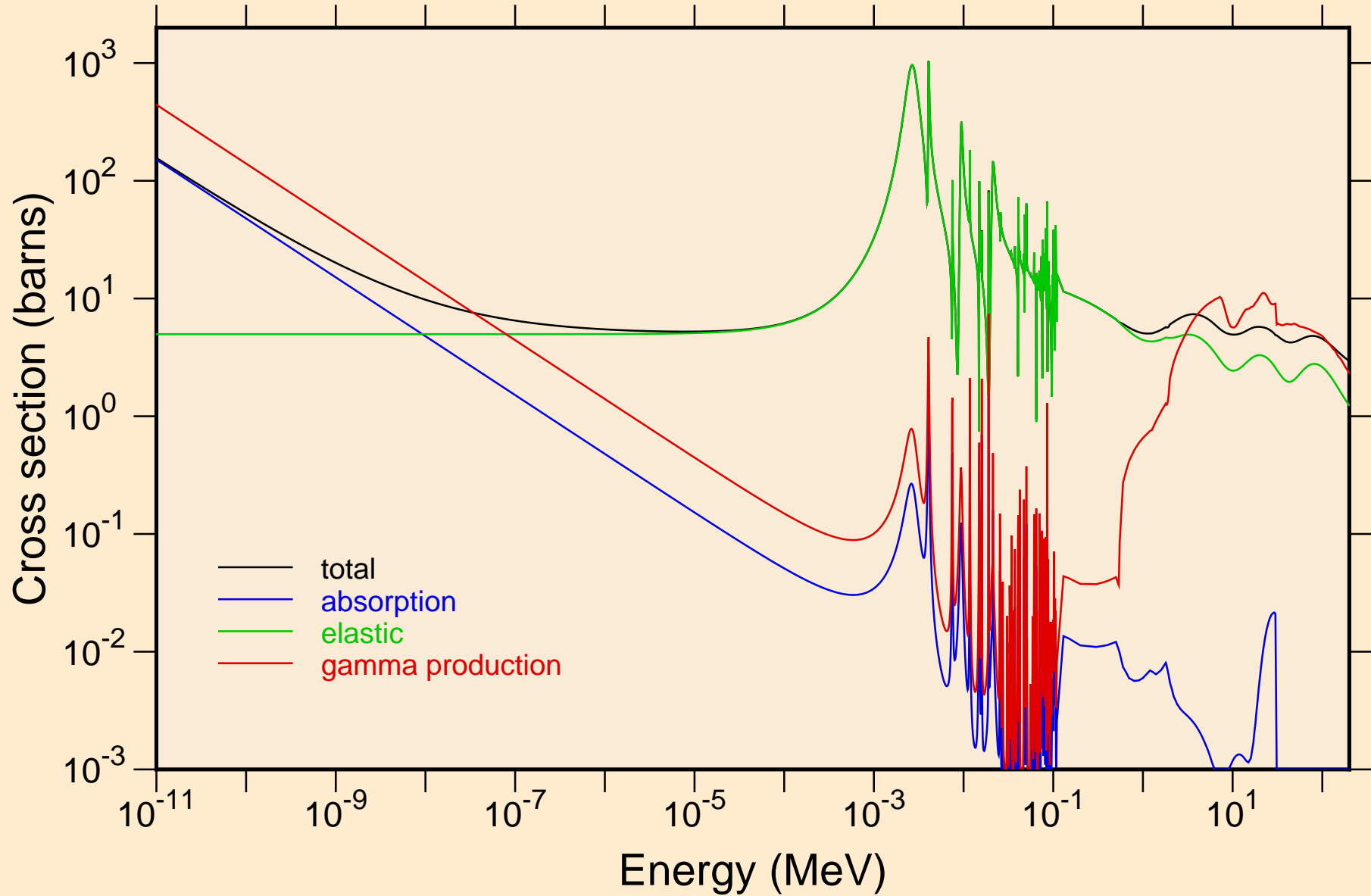

PT202 NEUTRON ACER TENDL-2023 LIBRARY; T=0.K  
resonance total cross section

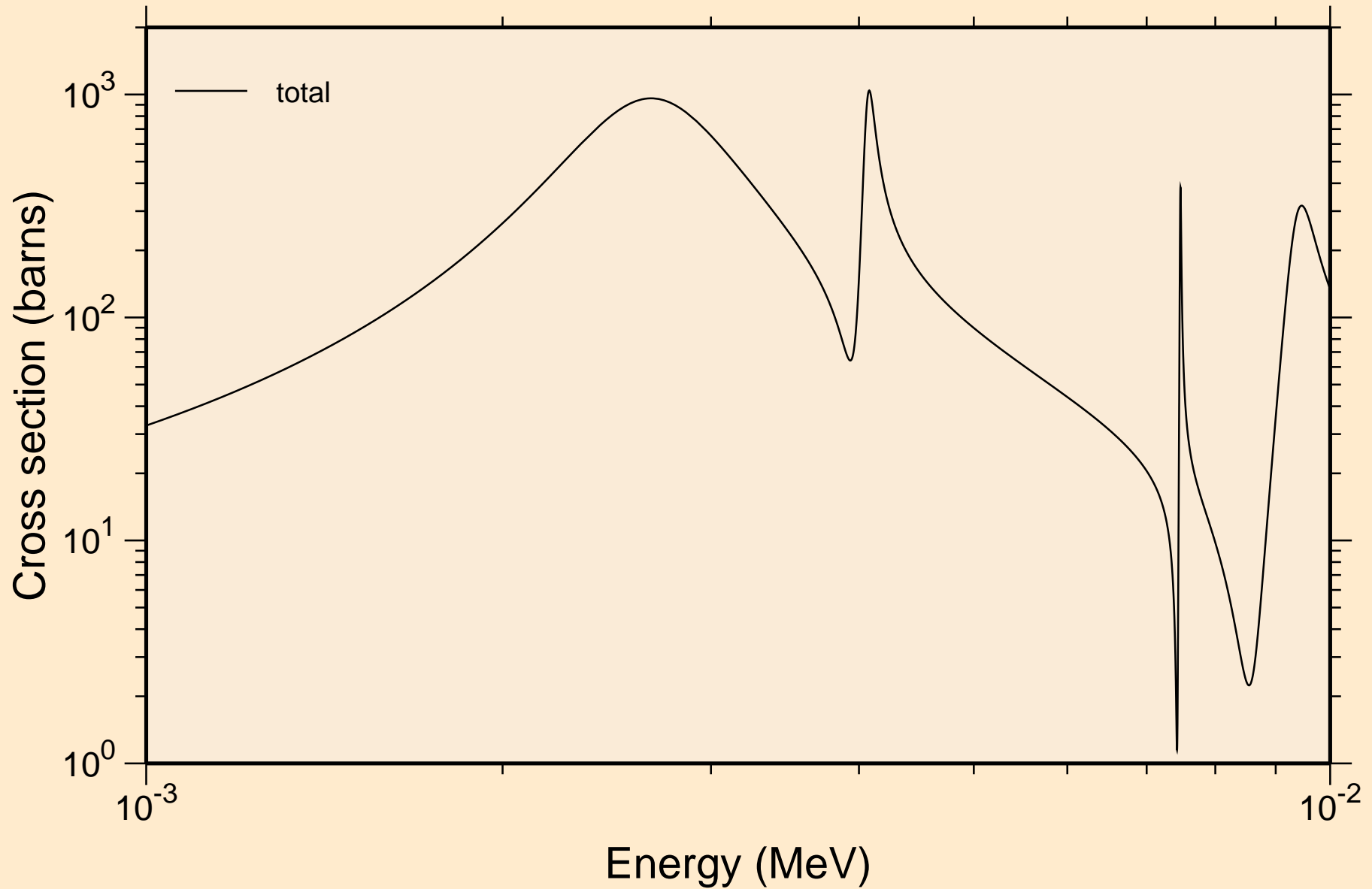

PT202 NEUTRON ACER TENDL-2023 LIBRARY; T=0.K  
resonance total cross section

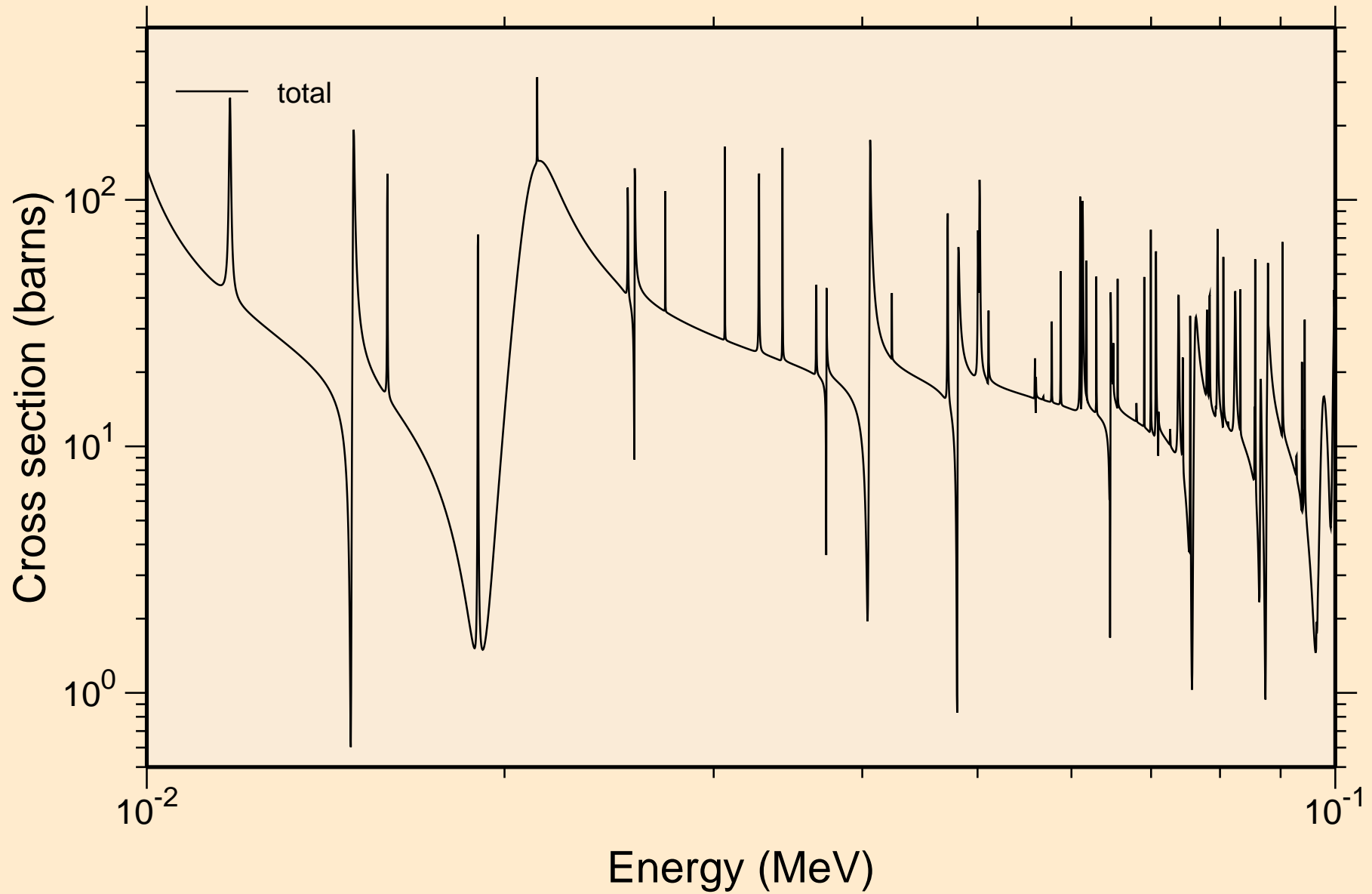

PT202 NEUTRON ACER TENDL-2023 LIBRARY; T=0.K  
resonance total cross section

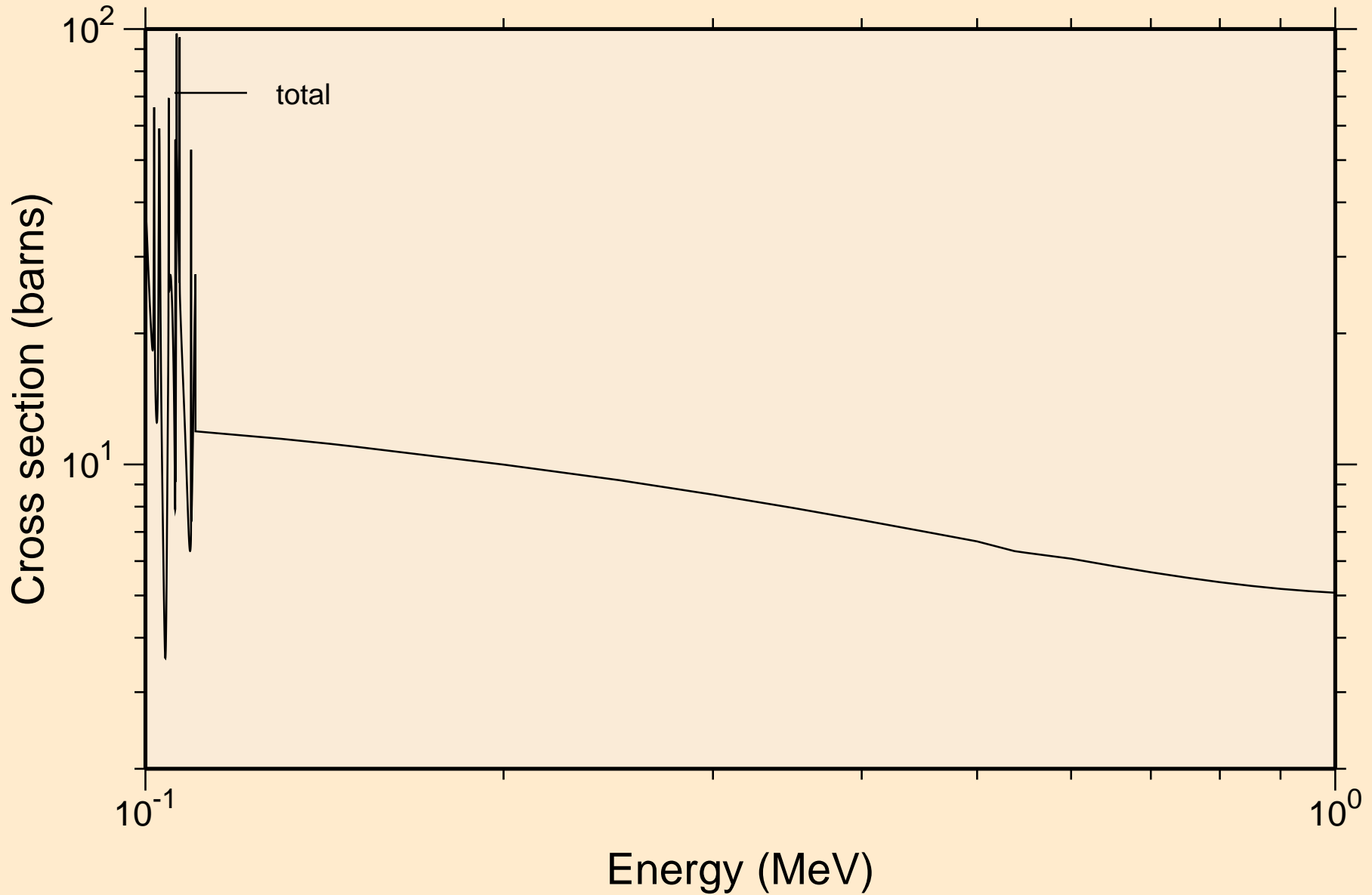

PT202 NEUTRON ACER TENDL-2023 LIBRARY; T=0.K  
resonance total cross section

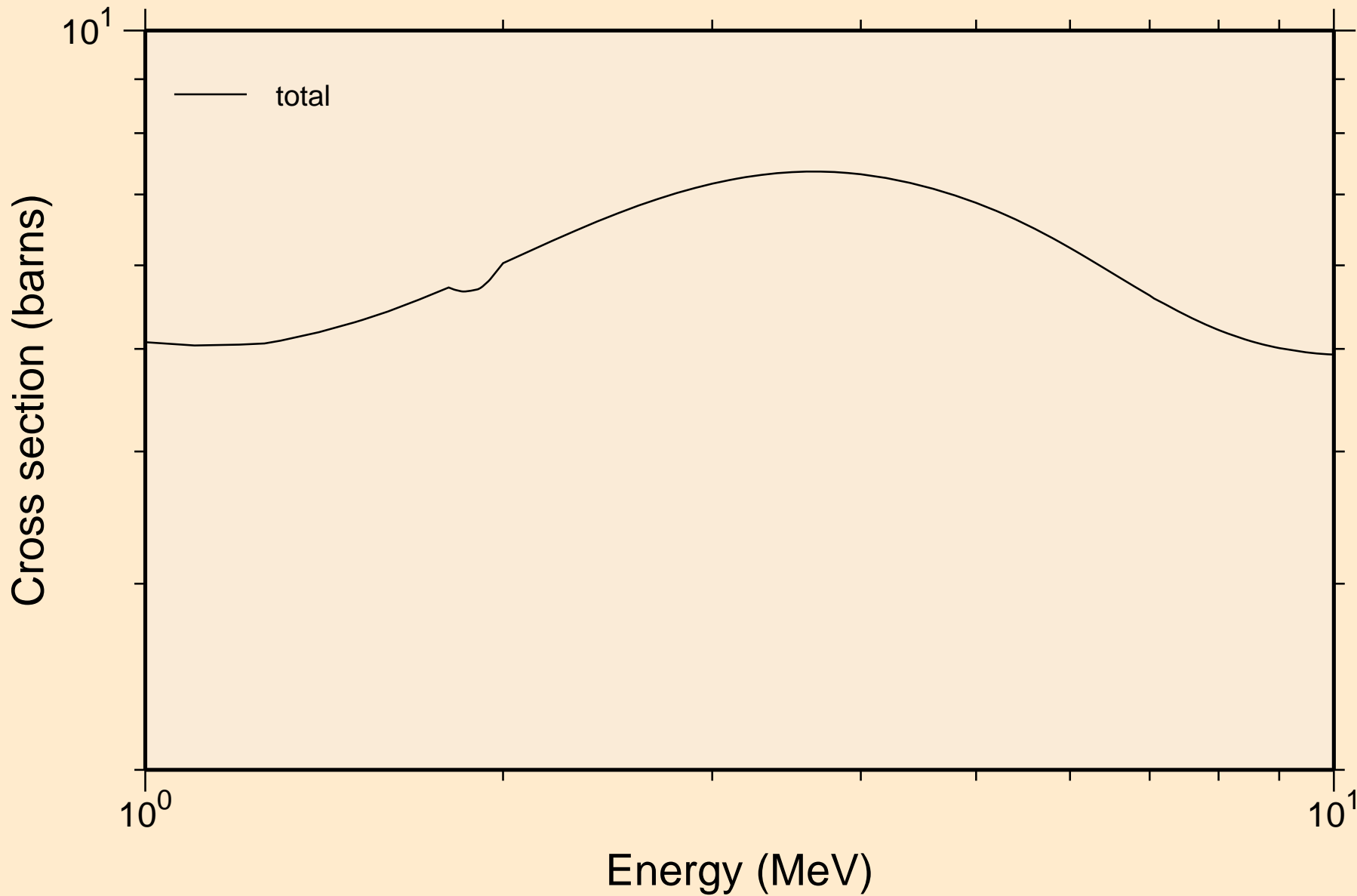

PT202 NEUTRON ACER TENDL-2023 LIBRARY; T=0.K  
resonance absorption cross sections

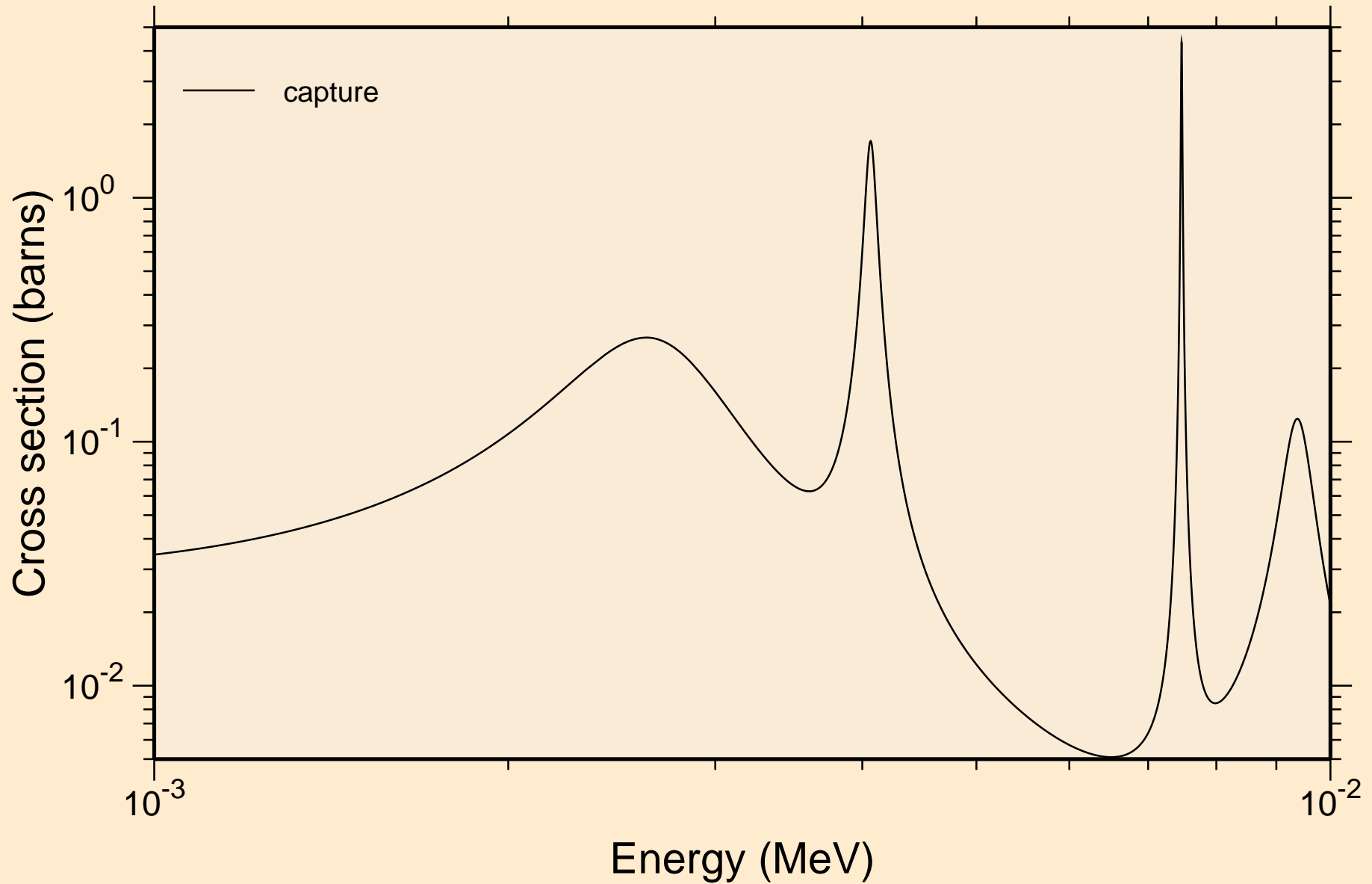

PT202 NEUTRON ACER TENDL-2023 LIBRARY; T=0.K  
resonance absorption cross sections

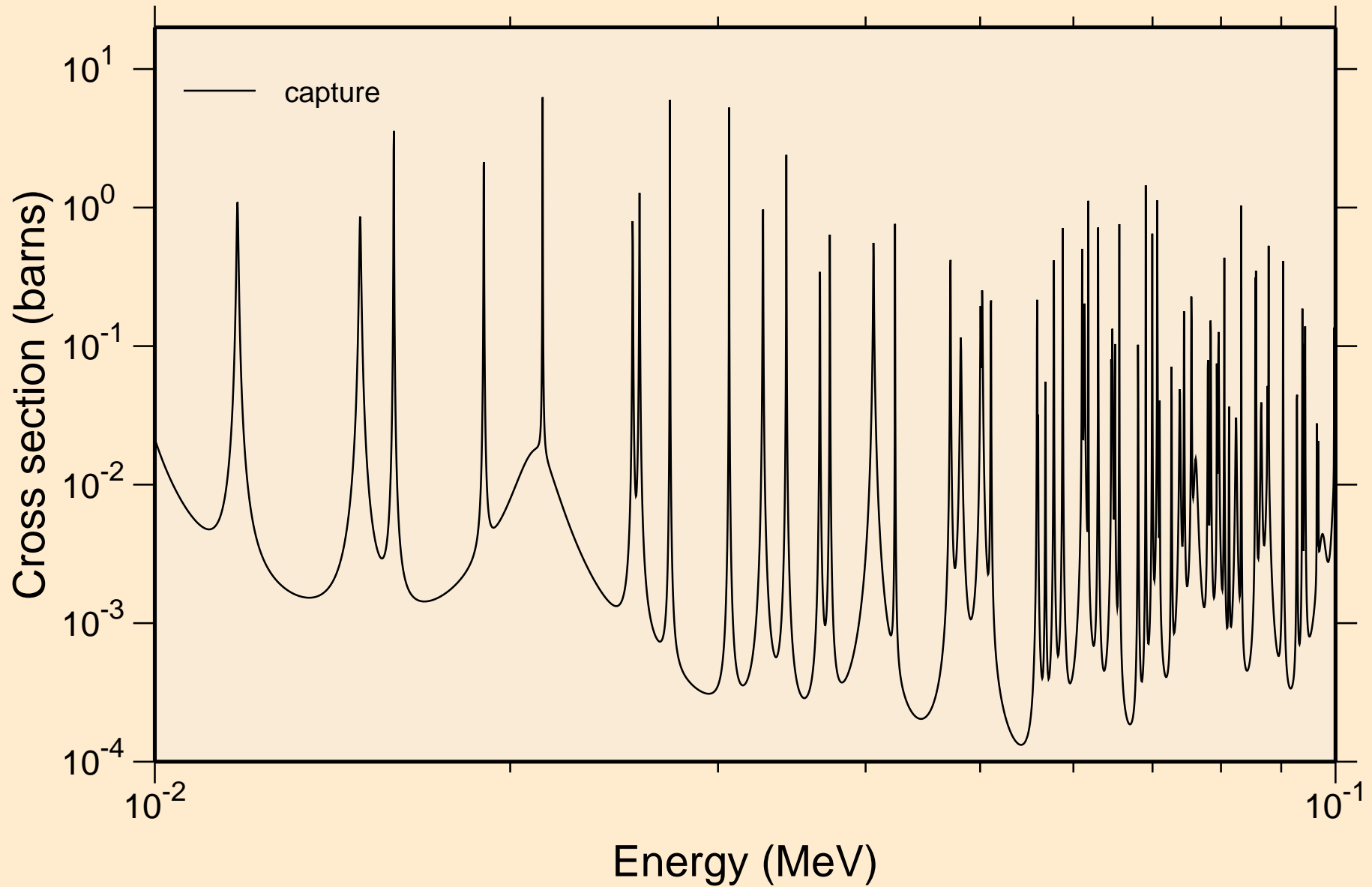

PT202 NEUTRON ACER TENDL-2023 LIBRARY; T=0.K  
resonance absorption cross sections

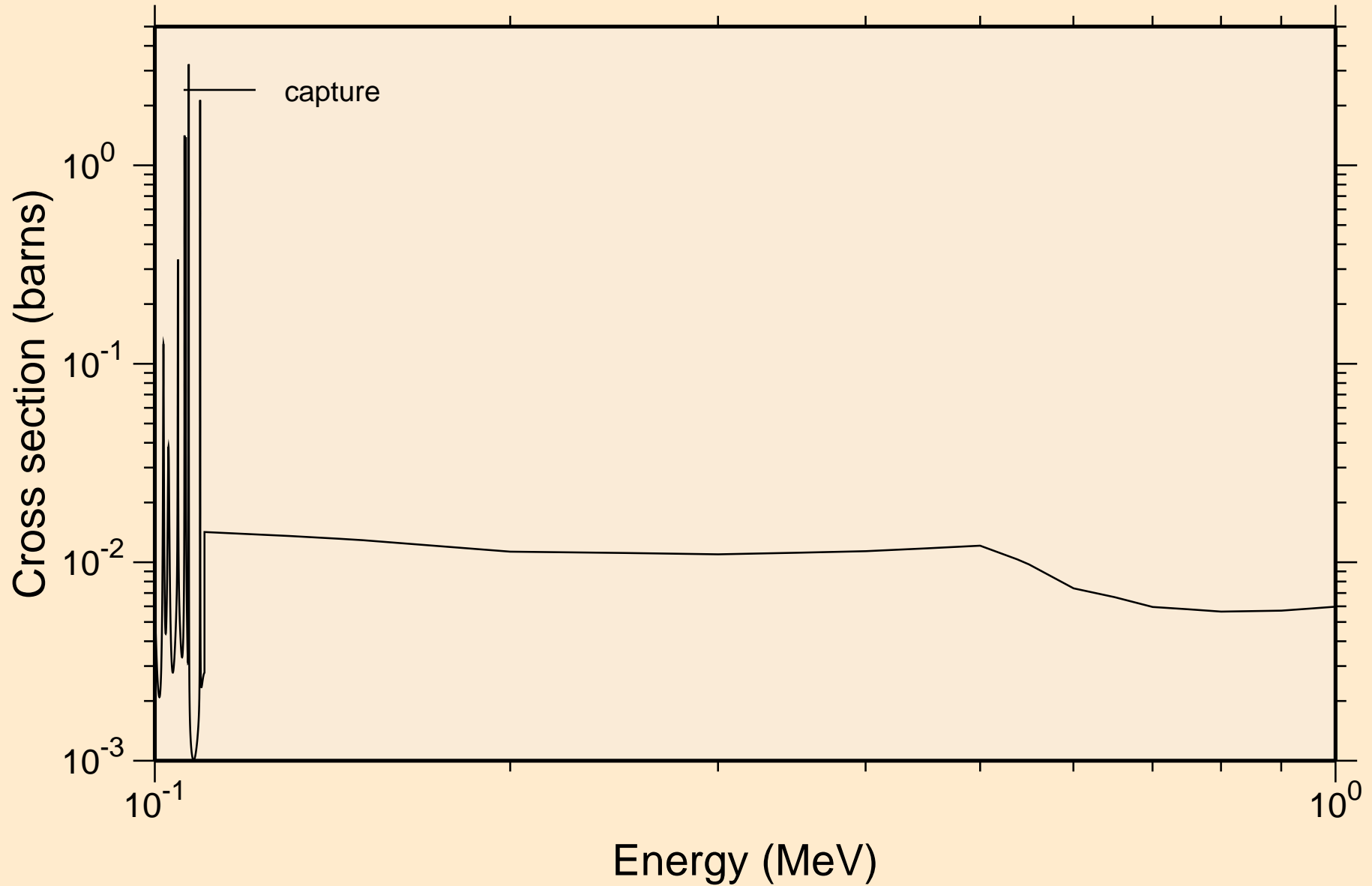



PT202 NEUTRON ACER TENDL-2023 LIBRARY; T=0.K  
resonance absorption cross sections

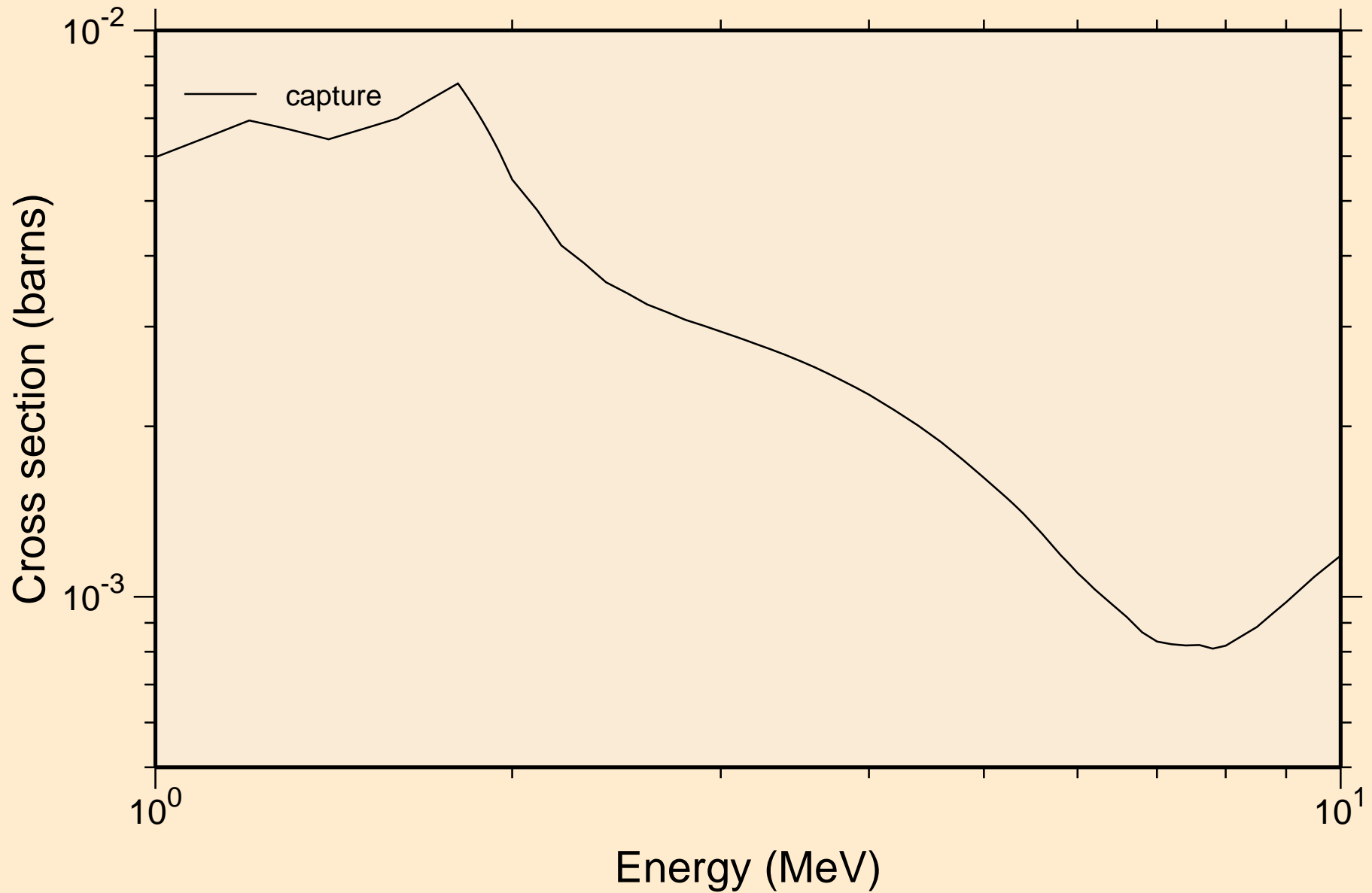

PT202 NEUTRON ACER TENDL-2023 LIBRARY; T=0.K  
Heating

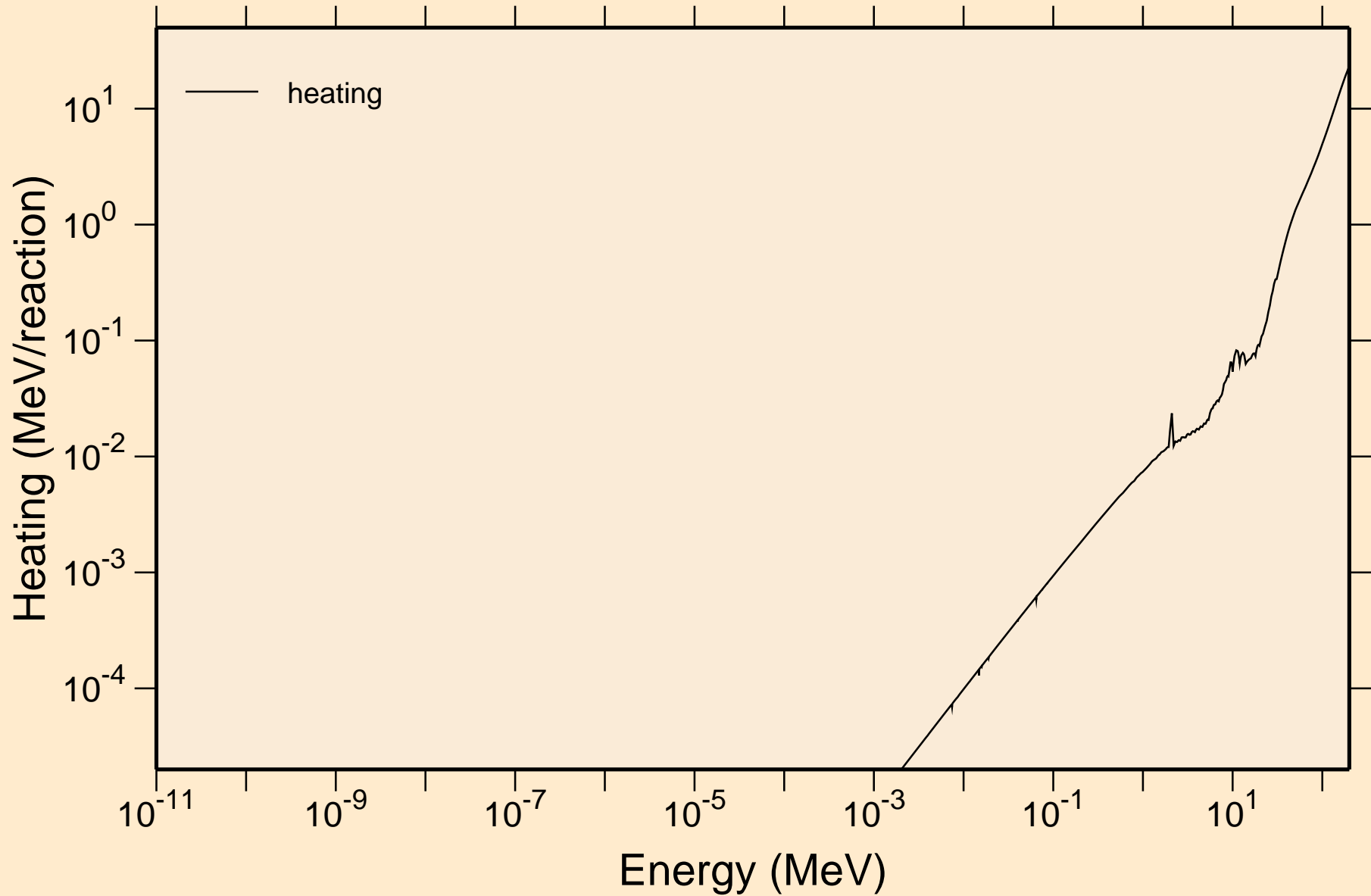

PT202 NEUTRON ACER TENDL-2023 LIBRARY; T=0.K  
Damage

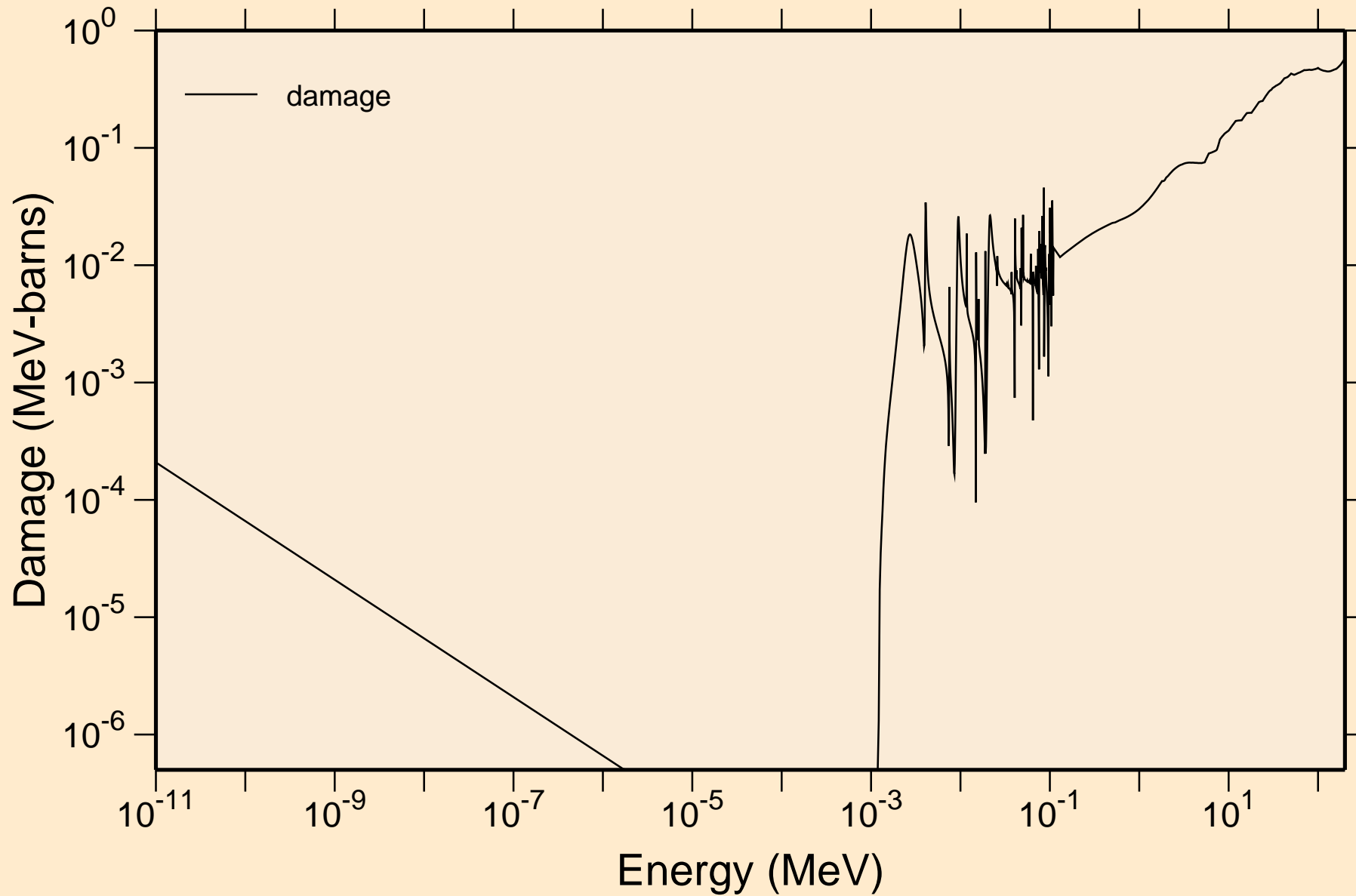

PT202 NEUTRON ACER TENDL-2023 LIBRARY; T=0.K  
Non-threshold reactions

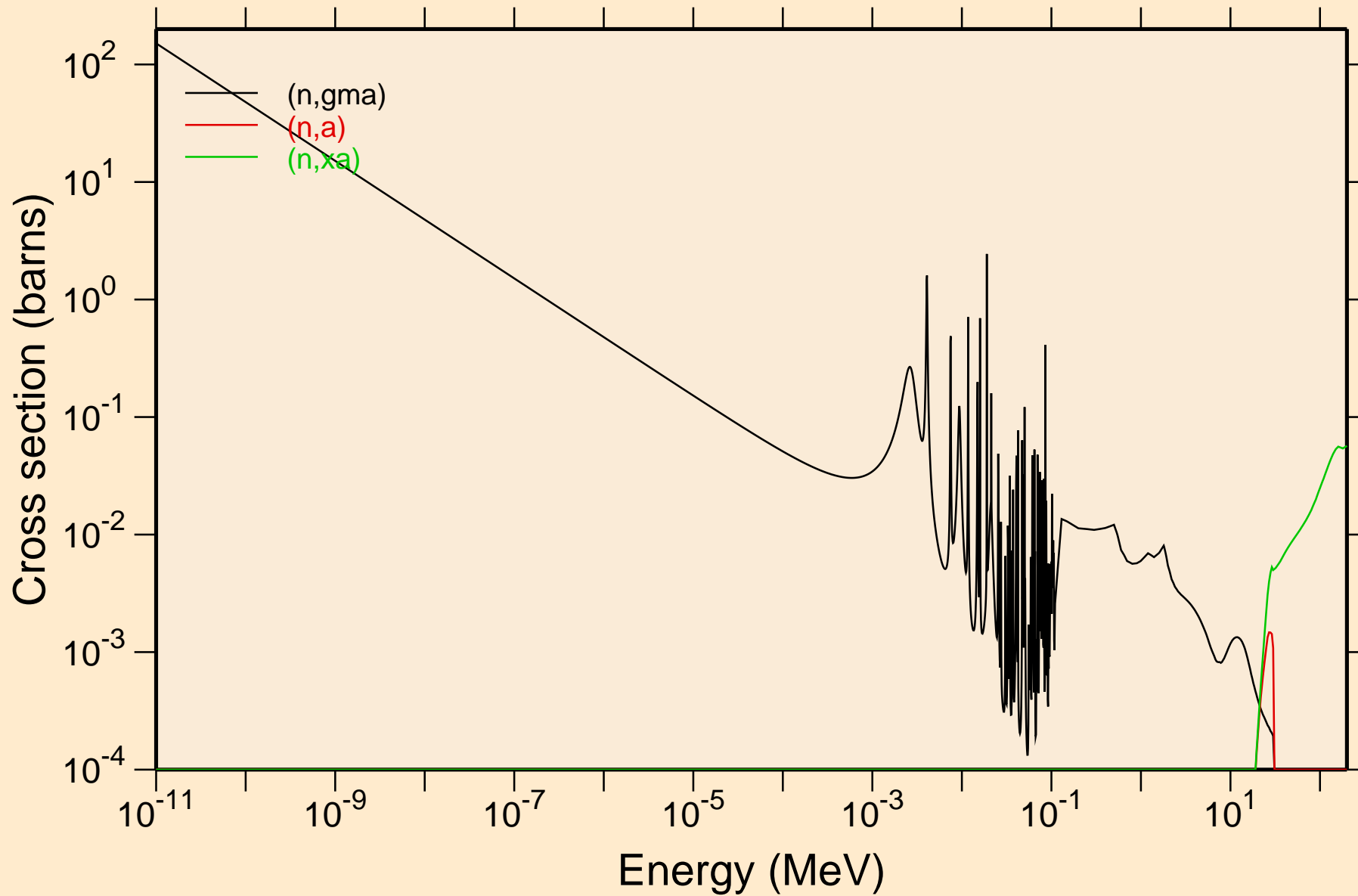

PT202 NEUTRON ACER TENDL-2023 LIBRARY; T=0.K  
Principal cross sections

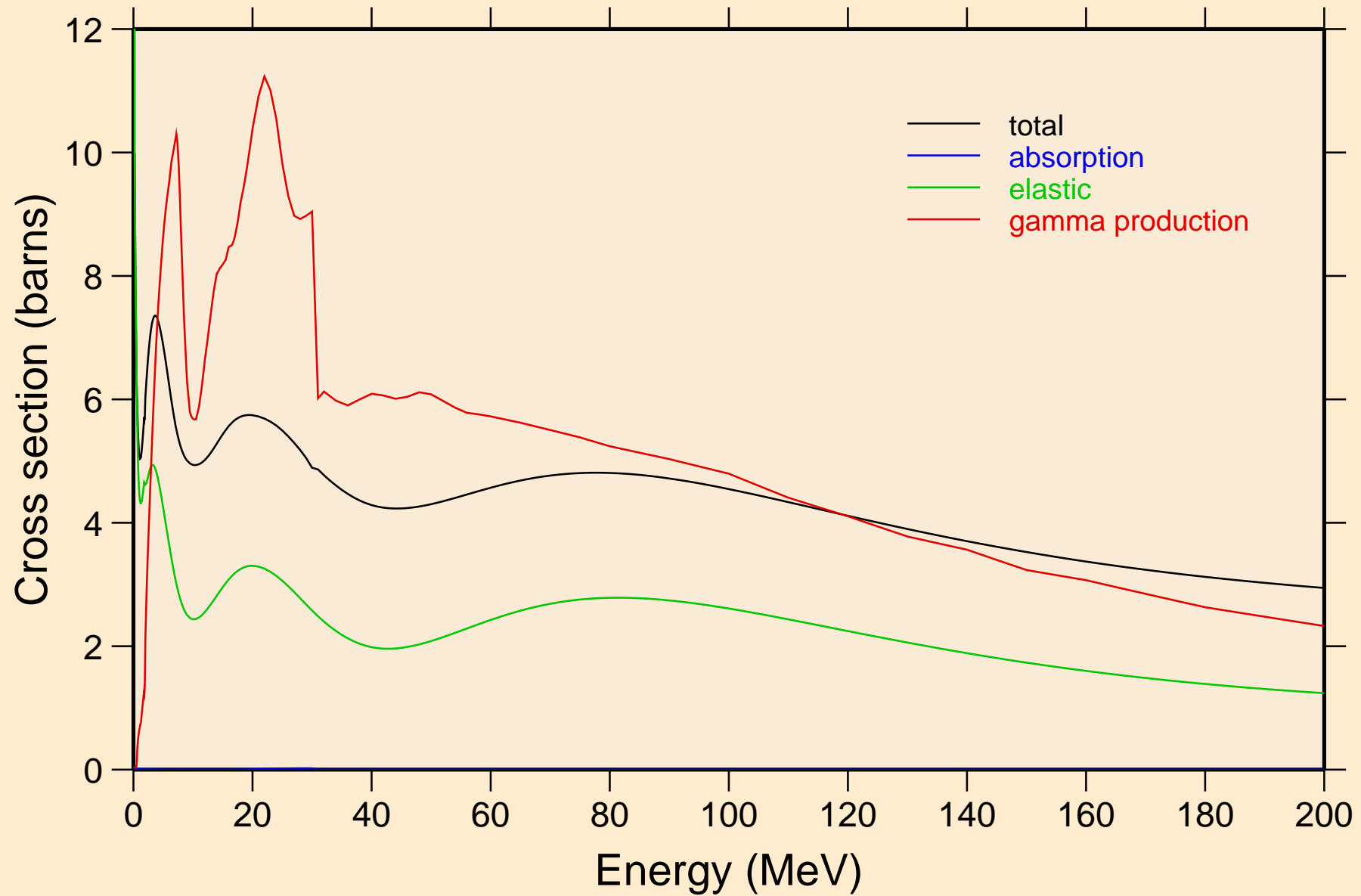

PT202 NEUTRON ACER TENDL-2023 LIBRARY; T=0.K

Heating

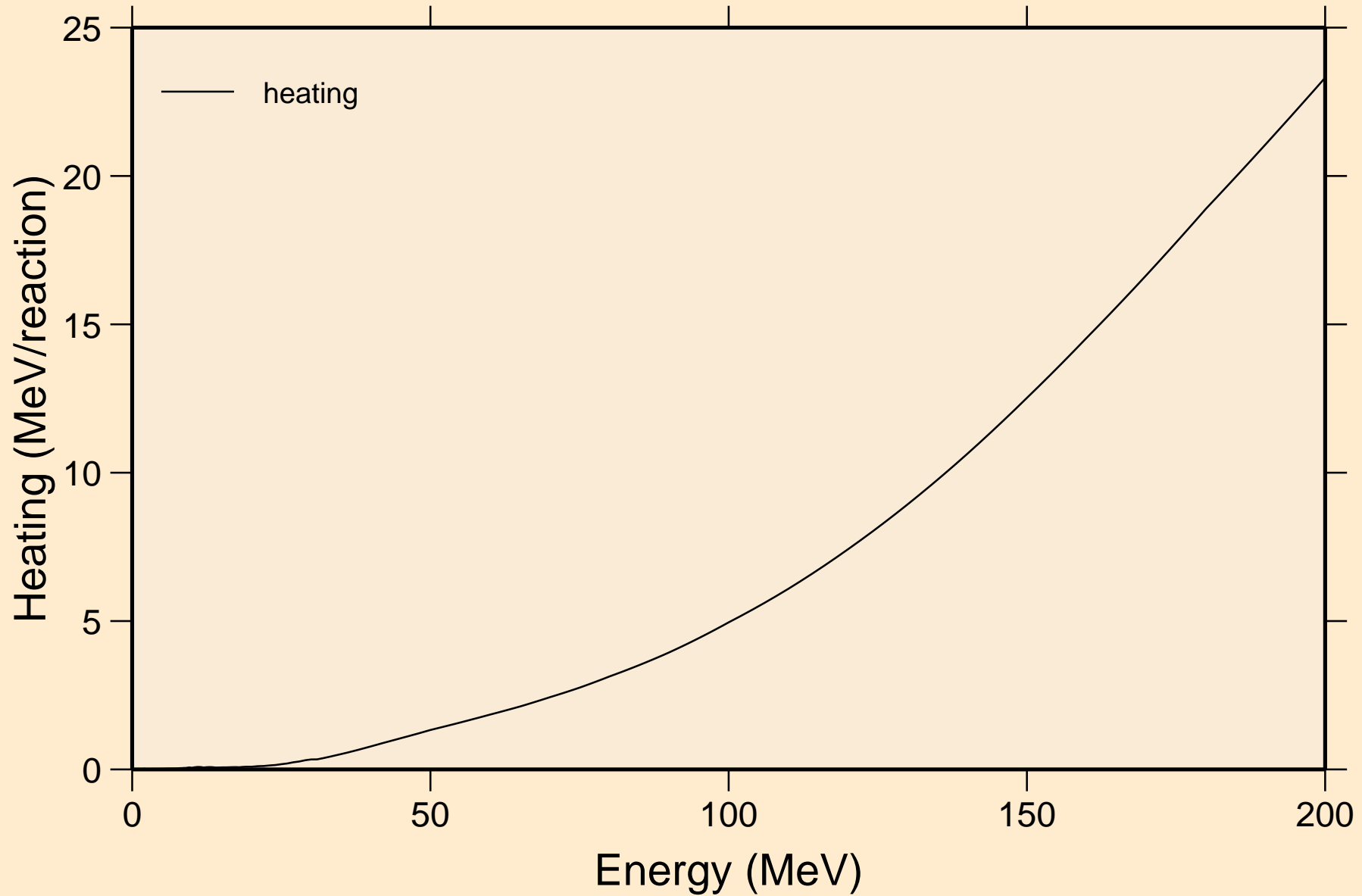

PT202 NEUTRON ACER TENDL-2023 LIBRARY; T=0.K  
Damage

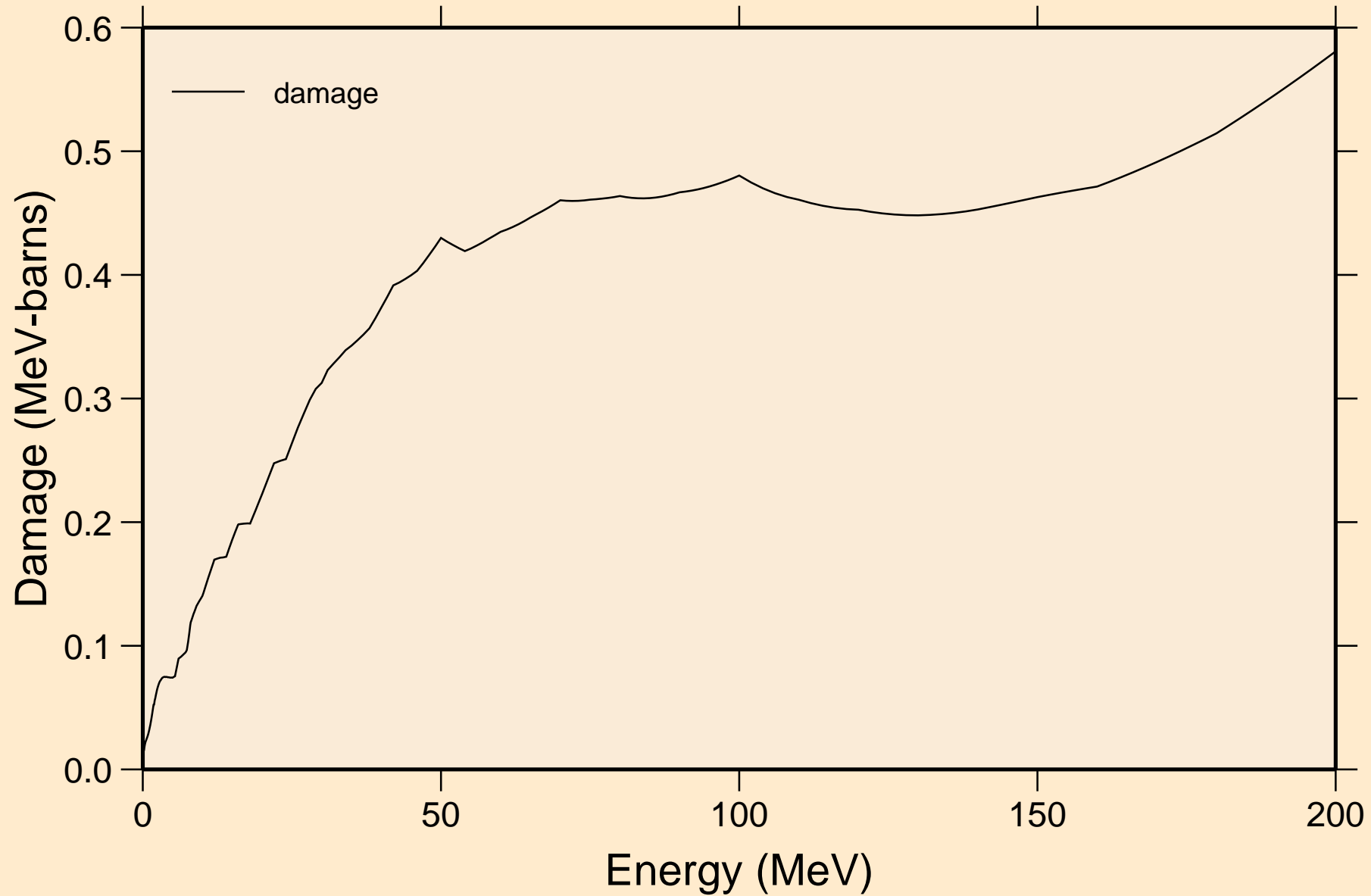

PT202 NEUTRON ACER TENDL-2023 LIBRARY; T=0.K  
Non-threshold reactions

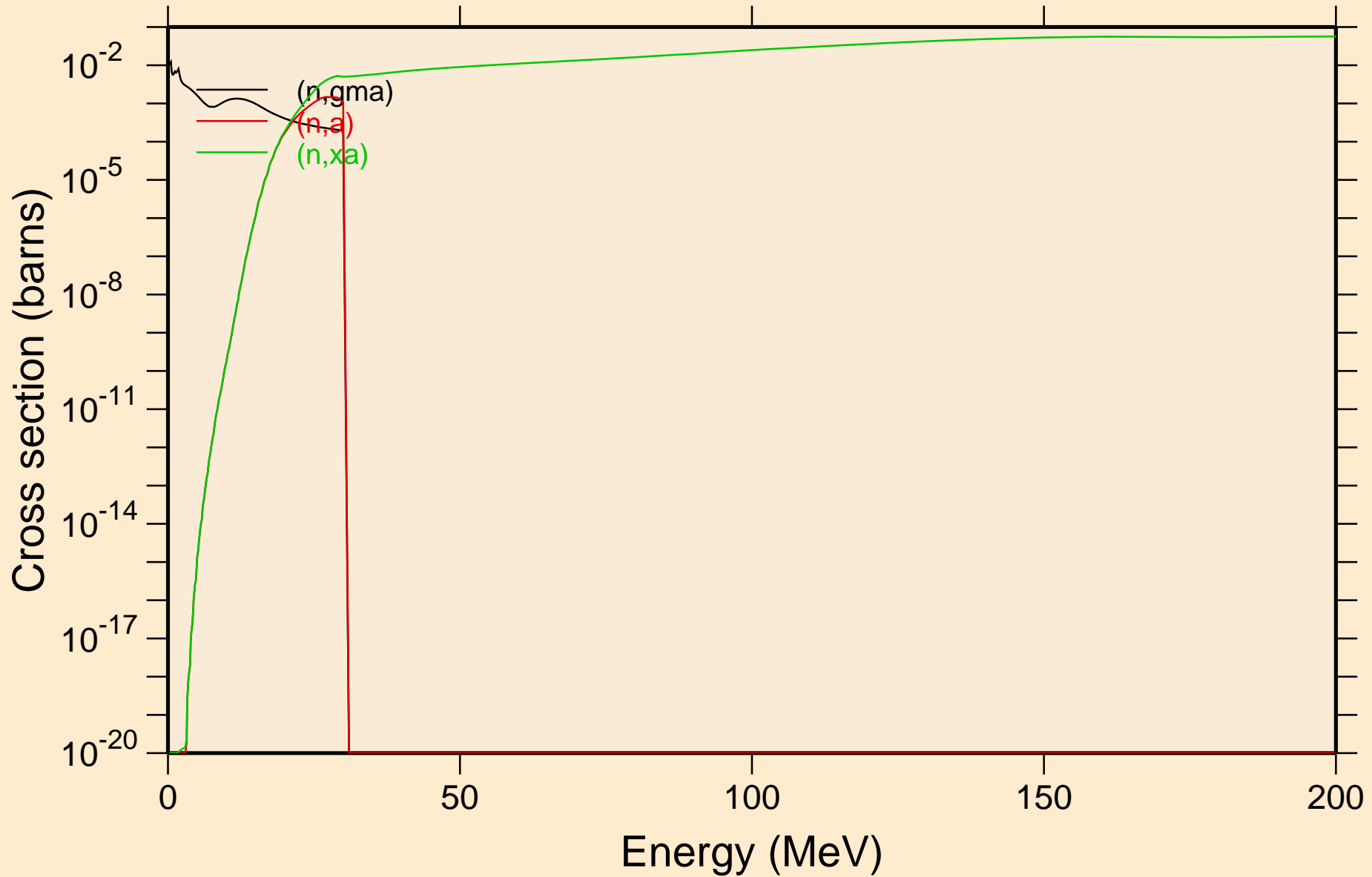



PT202 NEUTRON ACER TENDL-2023 LIBRARY; T=0.K  
Inelastic levels

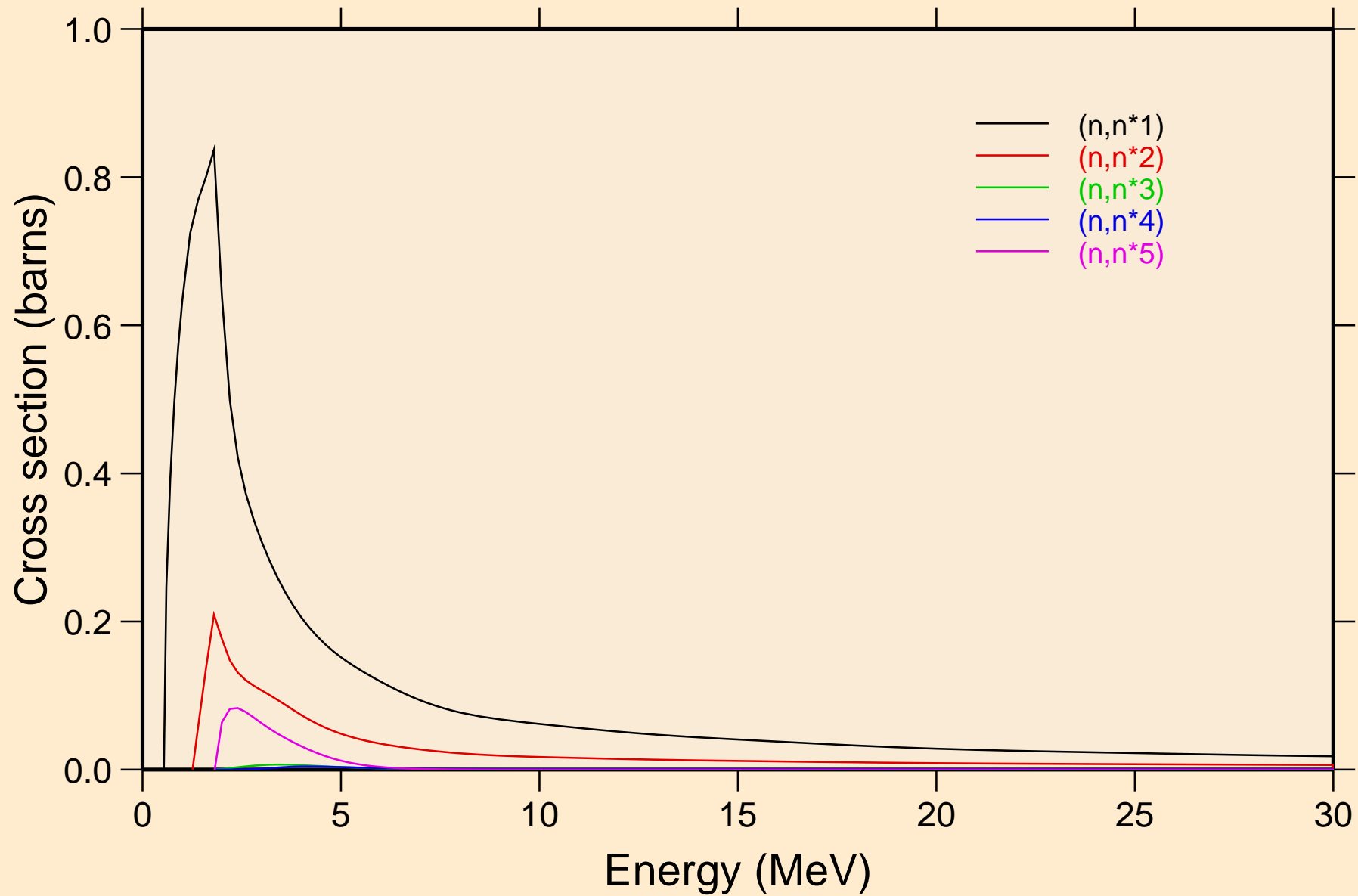

PT202 NEUTRON ACER TENDL-2023 LIBRARY; T=0.K  
Inelastic levels

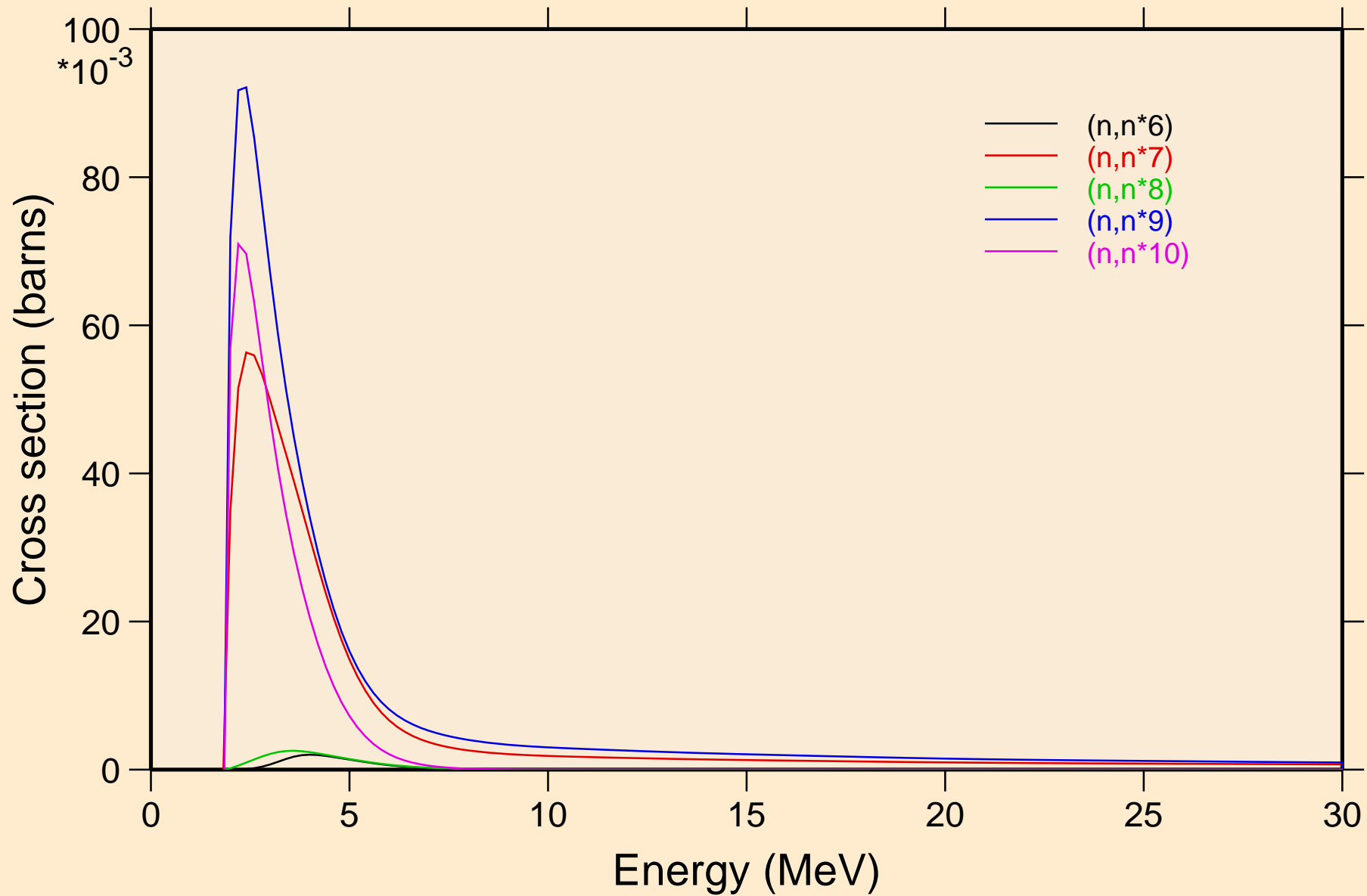

PT202 NEUTRON ACER TENDL-2023 LIBRARY; T=0.K  
Inelastic levels

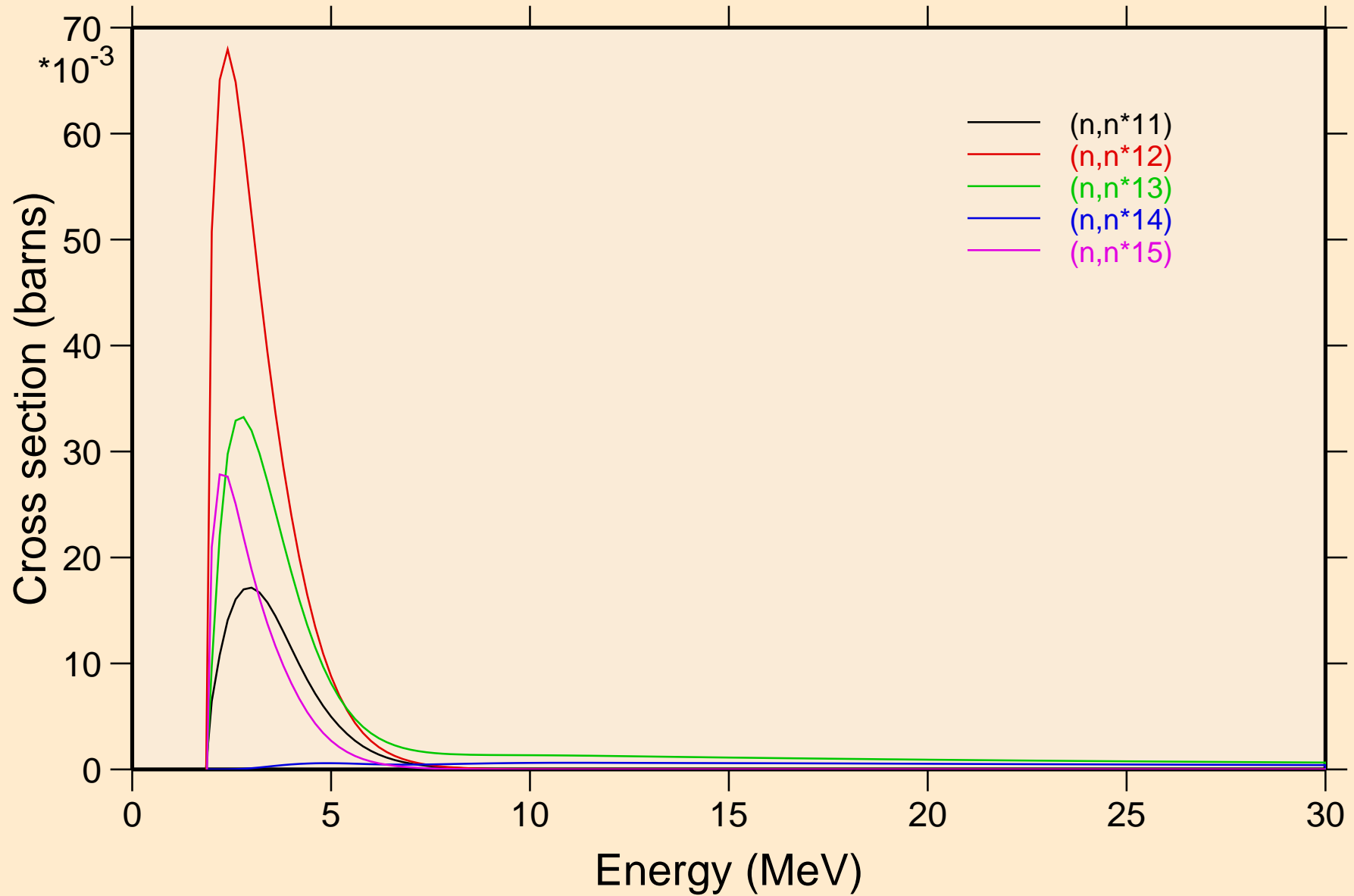

PT202 NEUTRON ACER TENDL-2023 LIBRARY; T=0.K  
Inelastic levels

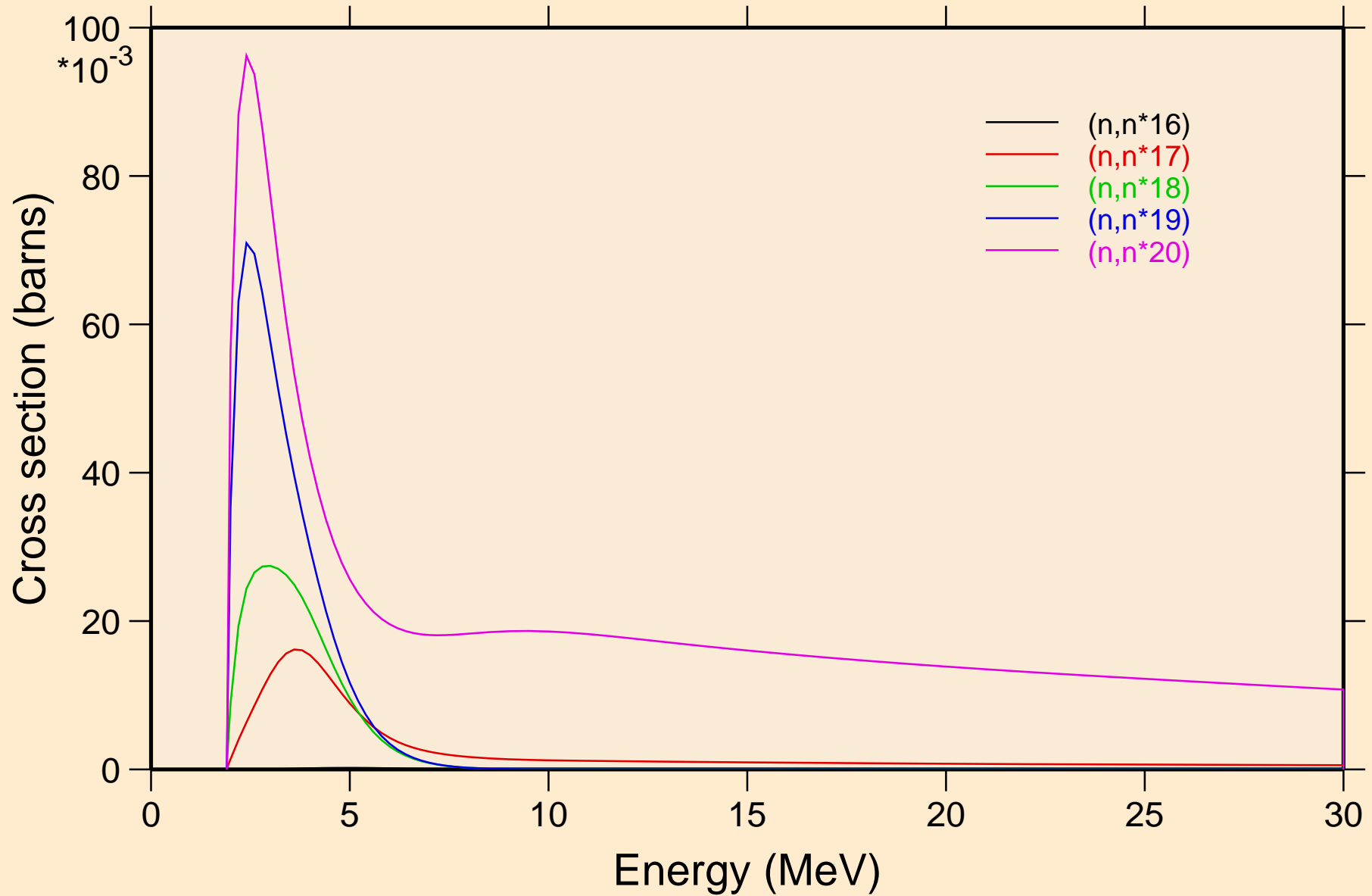

PT202 NEUTRON ACER TENDL-2023 LIBRARY; T=0.K  
Inelastic levels

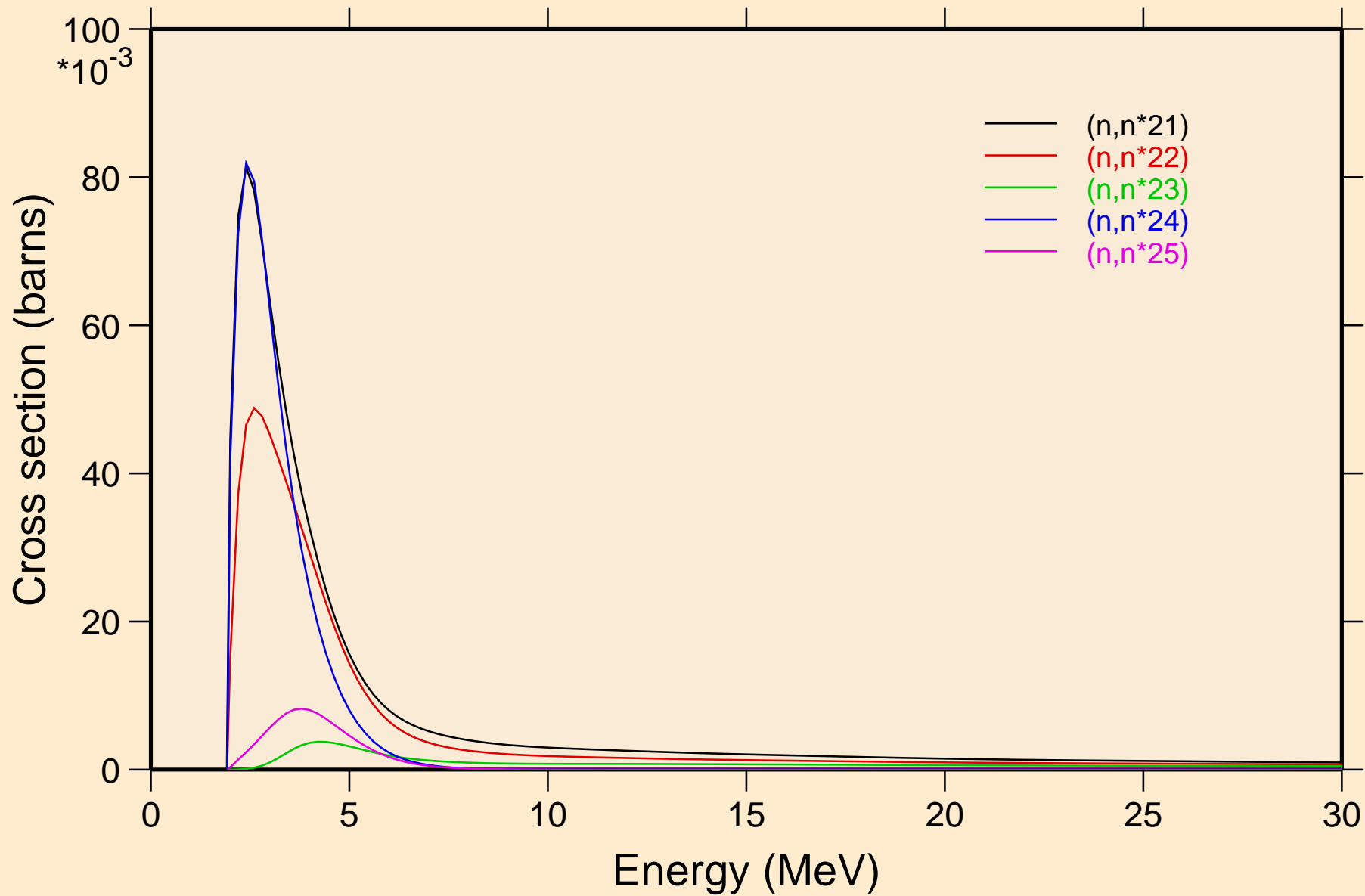

PT202 NEUTRON ACER TENDL-2023 LIBRARY; T=0.K  
Inelastic levels

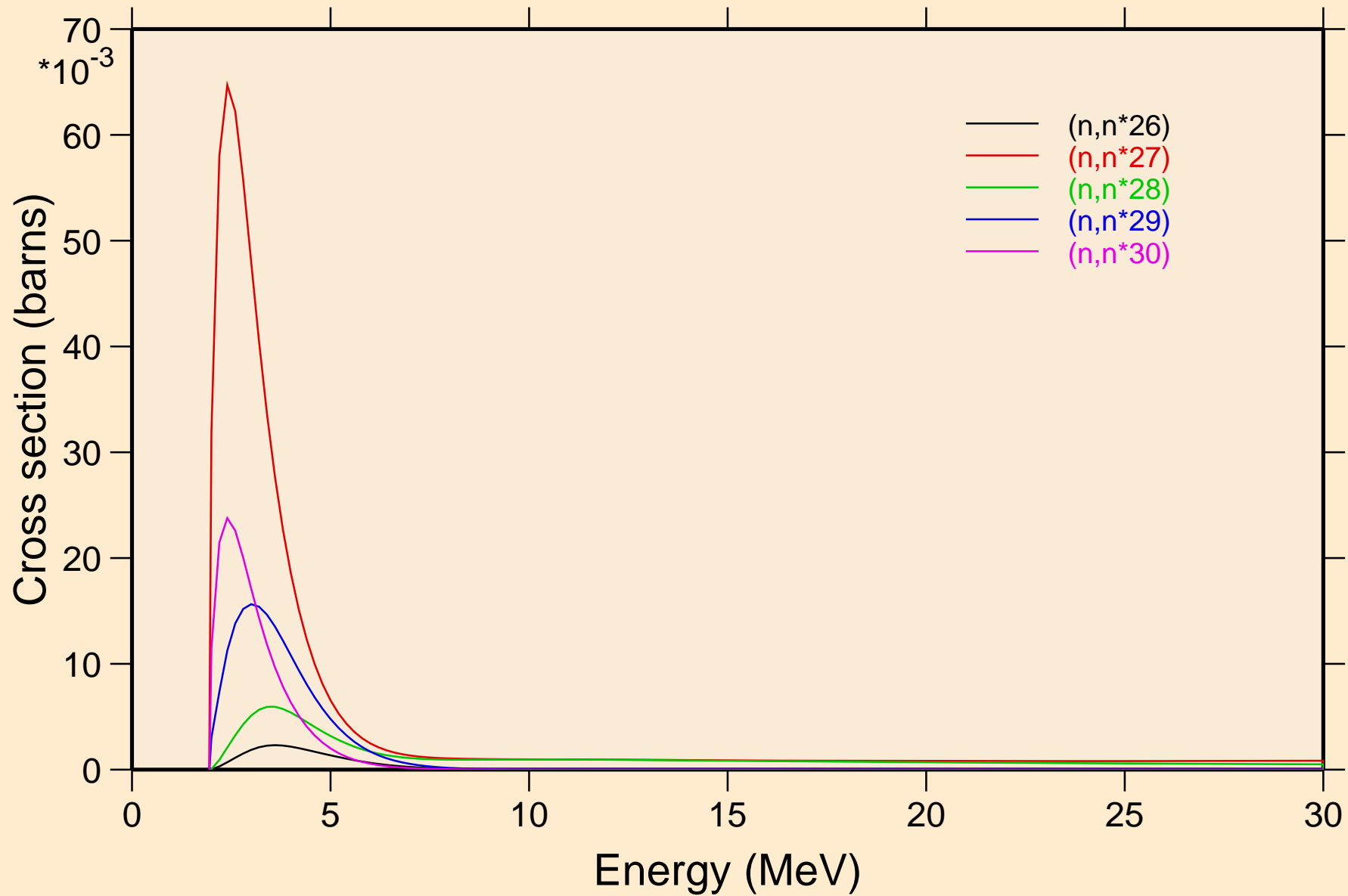

PT202 NEUTRON ACER TENDL-2023 LIBRARY; T=0.K  
Threshold reactions

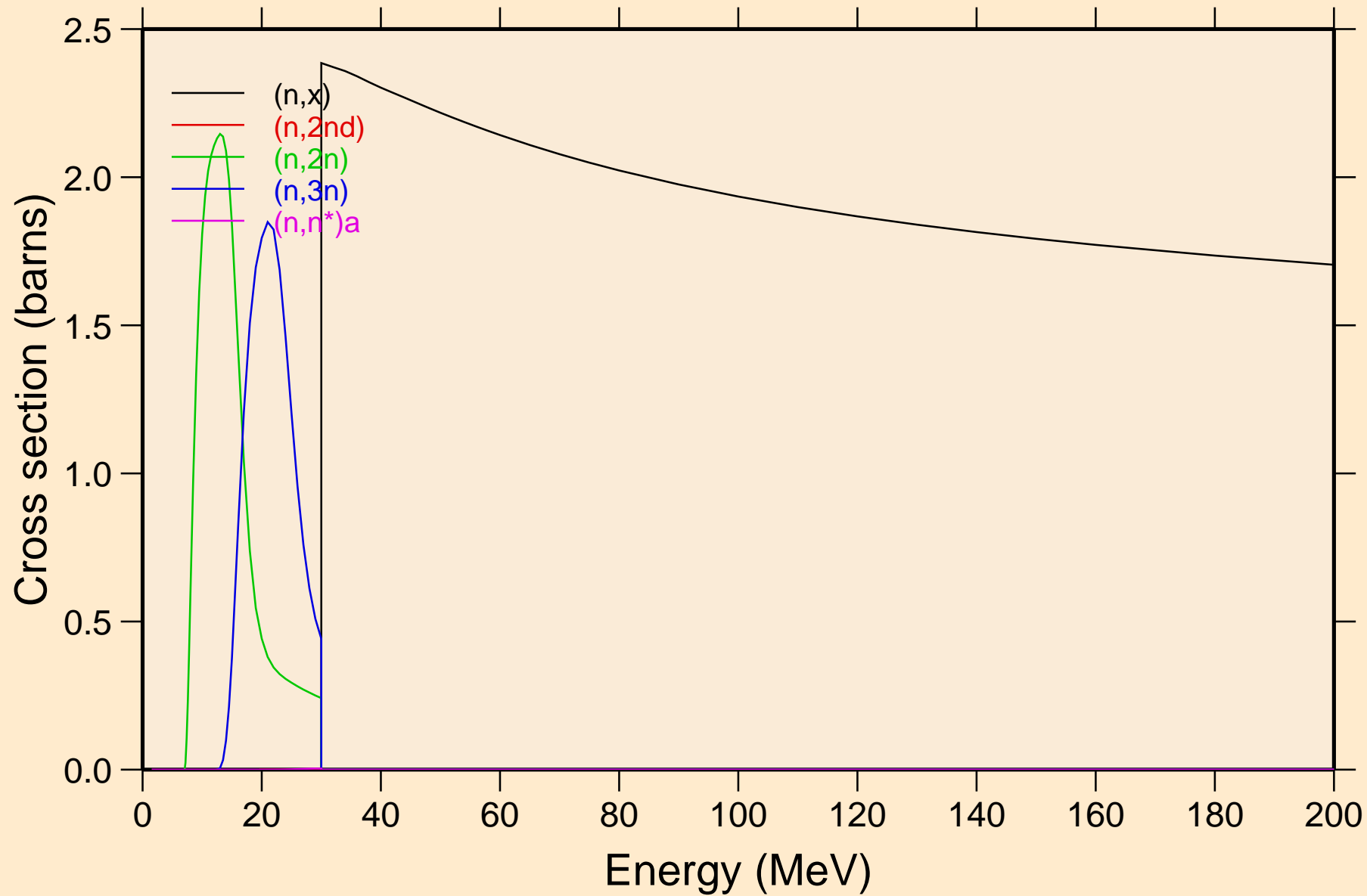

PT202 NEUTRON ACER TENDL-2023 LIBRARY; T=0.K  
Threshold reactions

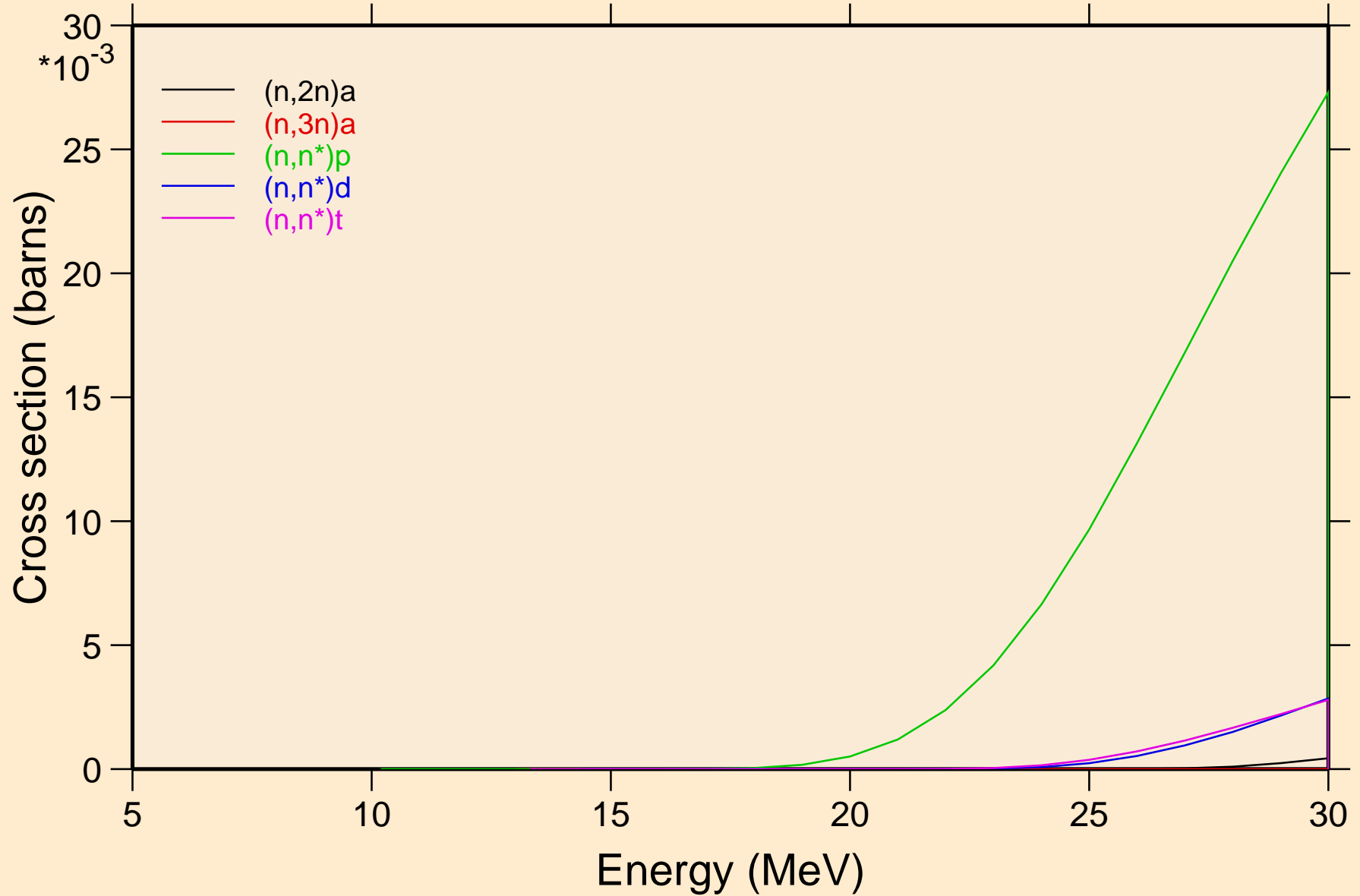



PT202 NEUTRON ACER TENDL-2023 LIBRARY; T=0.K  
Threshold reactions

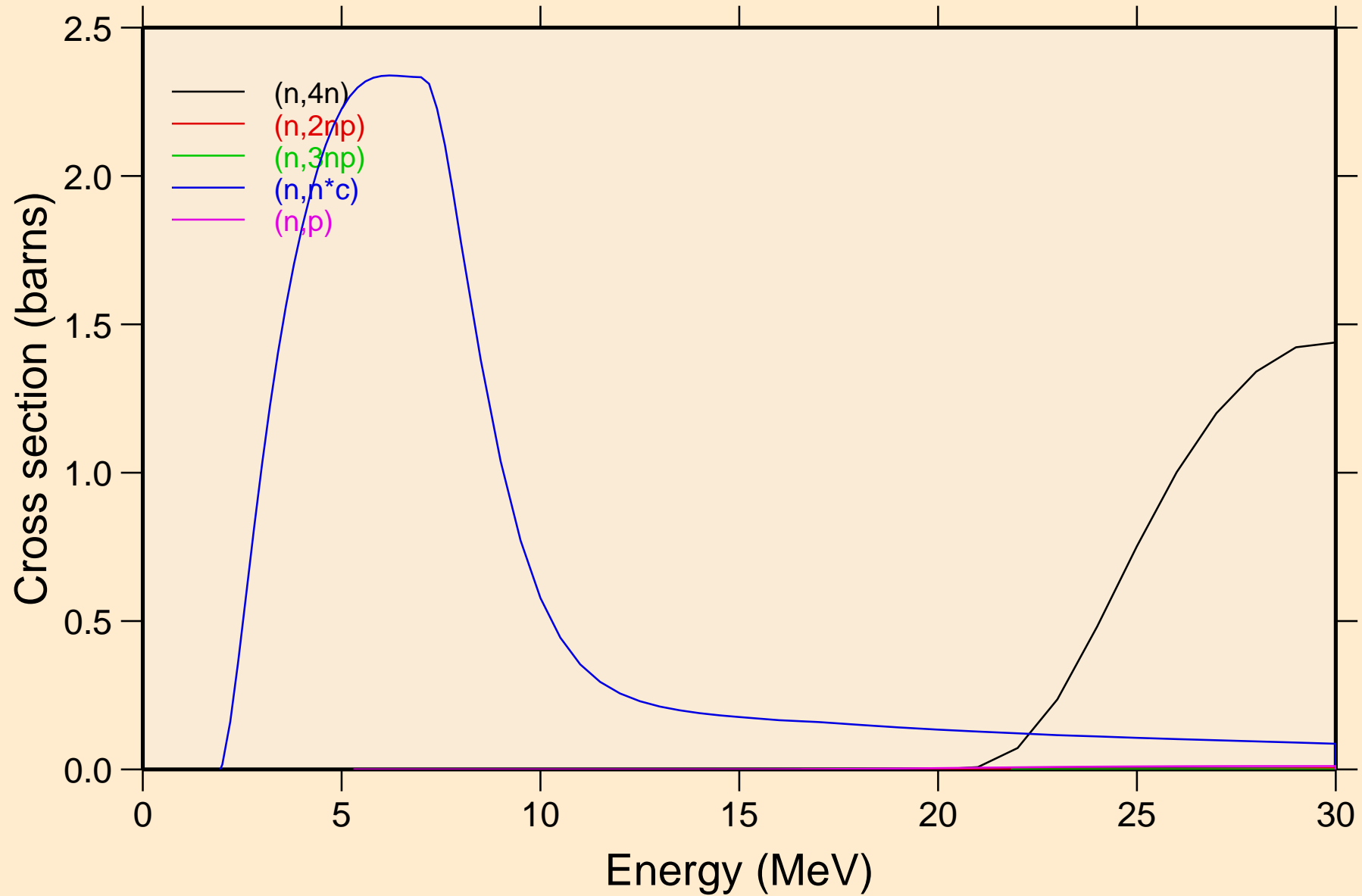

PT202 NEUTRON ACER TENDL-2023 LIBRARY; T=0.K  
Threshold reactions

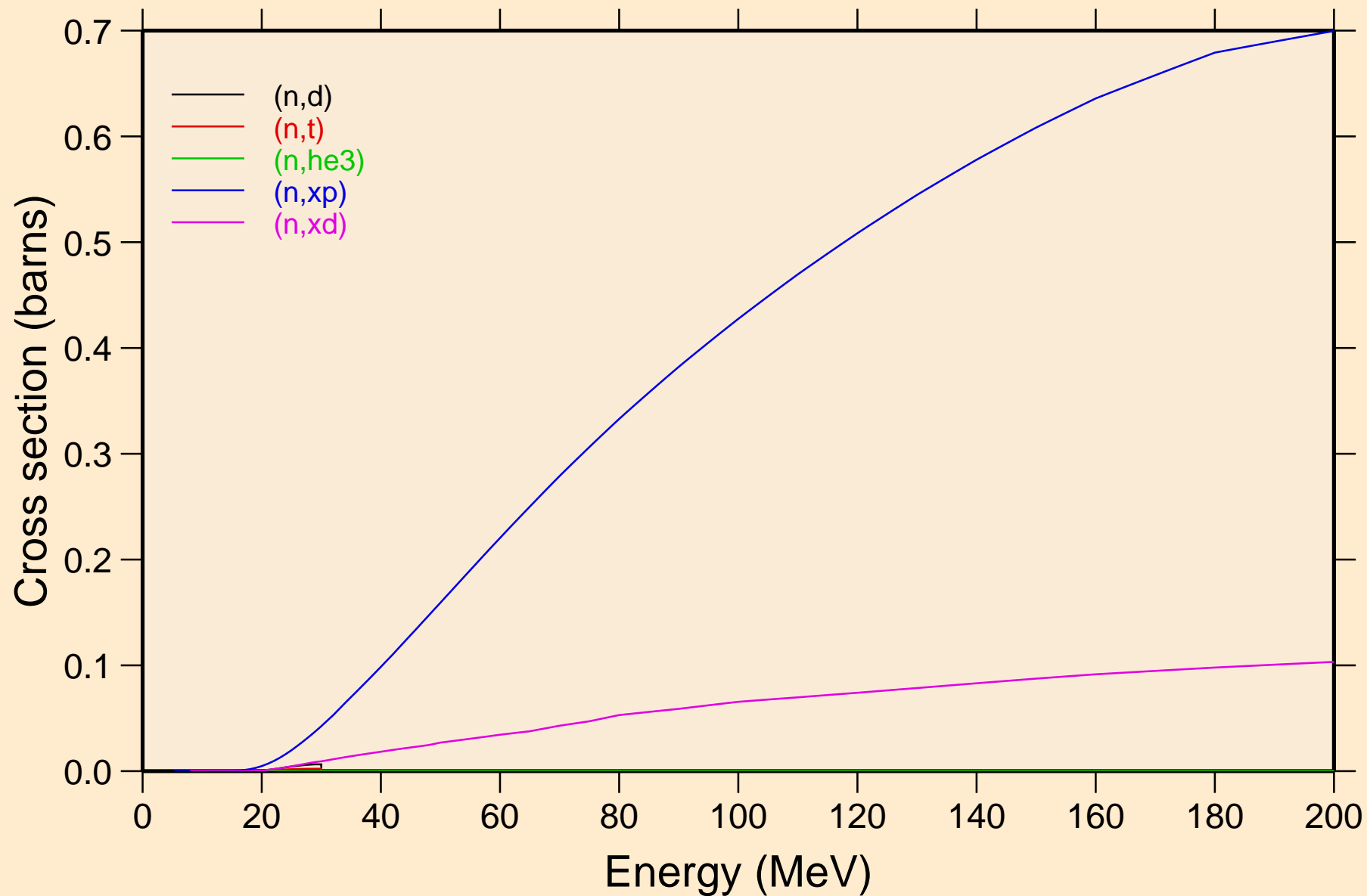

PT202 NEUTRON ACER TENDL-2023 LIBRARY; T=0.K  
Threshold reactions

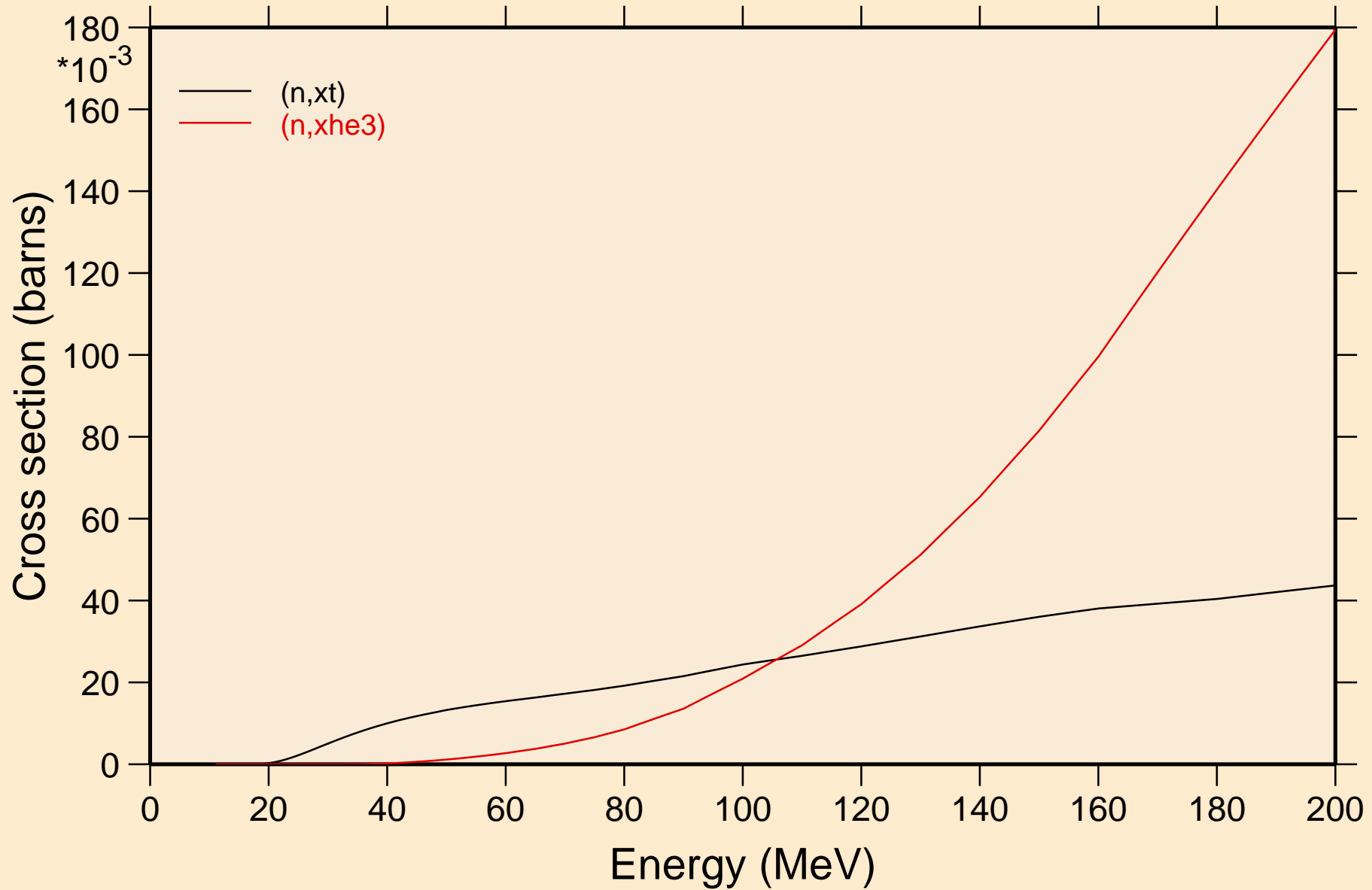

PT202 NEUTRON ACER TENDL-2023 LIBRARY; T=0.K  
angular distribution for elastic

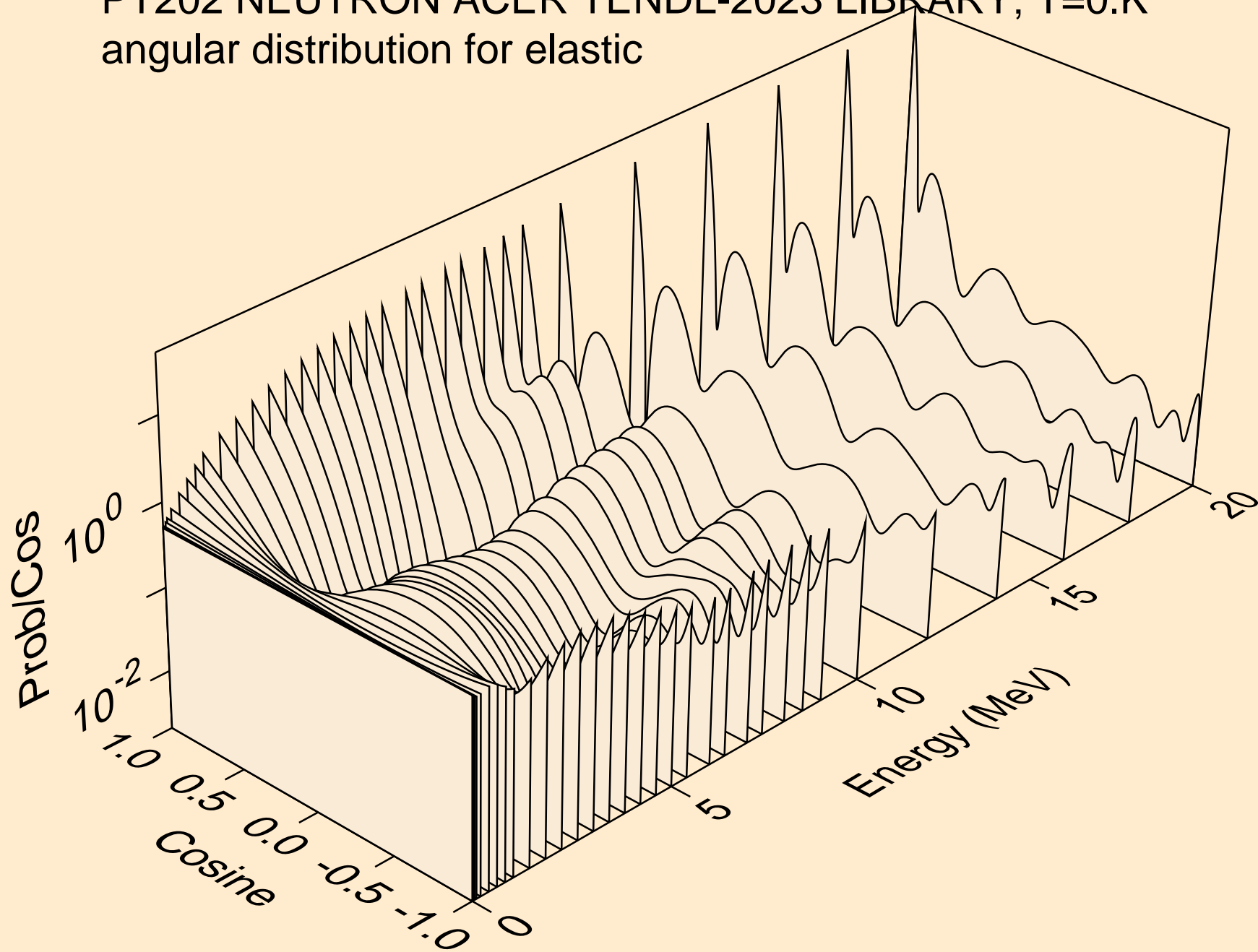

PT202 NEUTRON ACER TENDL-2023 LIBRARY; T=0.K  
angular distribution for elastic

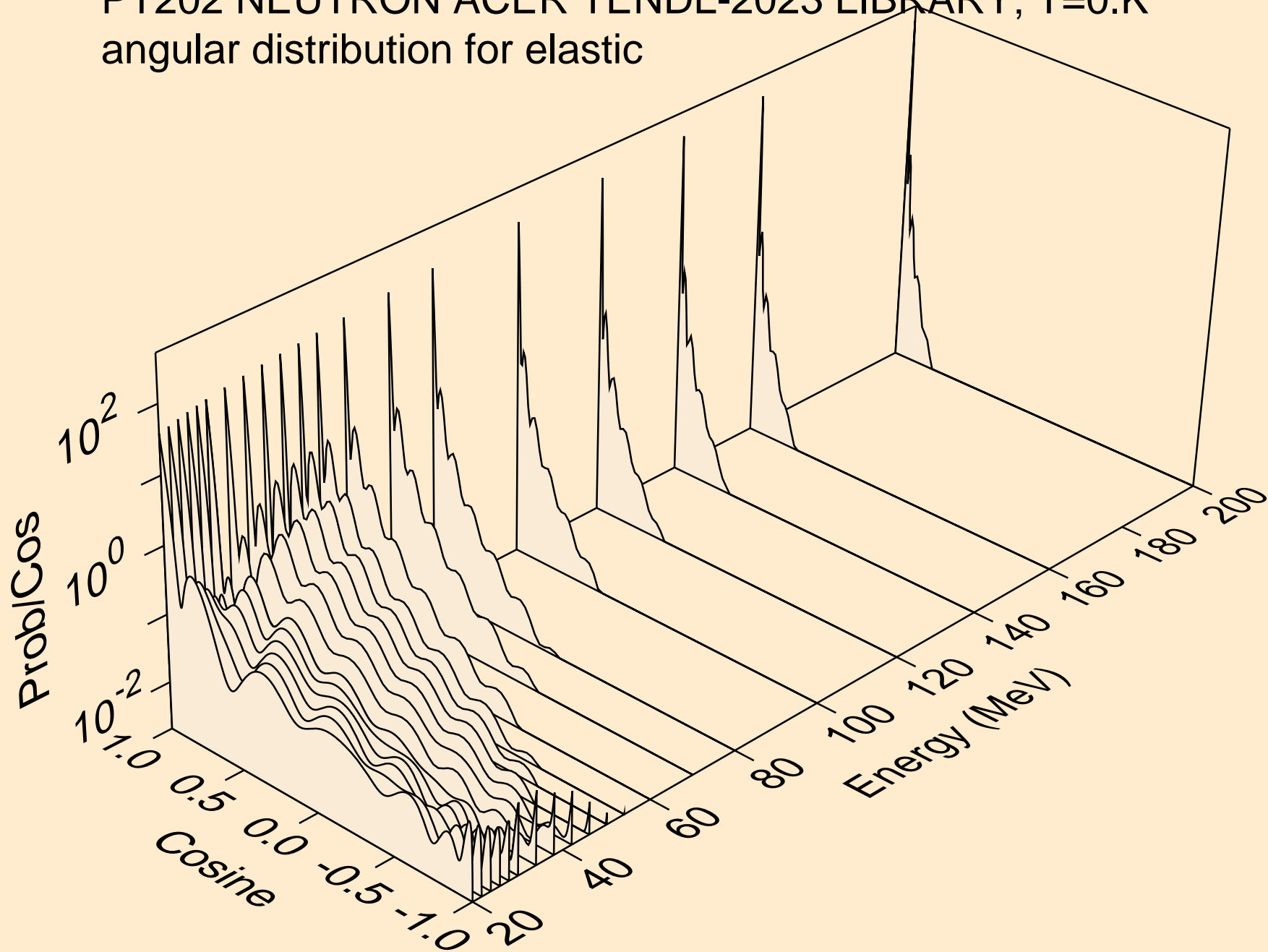

PT202 NEUTRON ACER TENDL-2023 LIBRARY; T=0.K  
angular distribution for (n,n\*1)

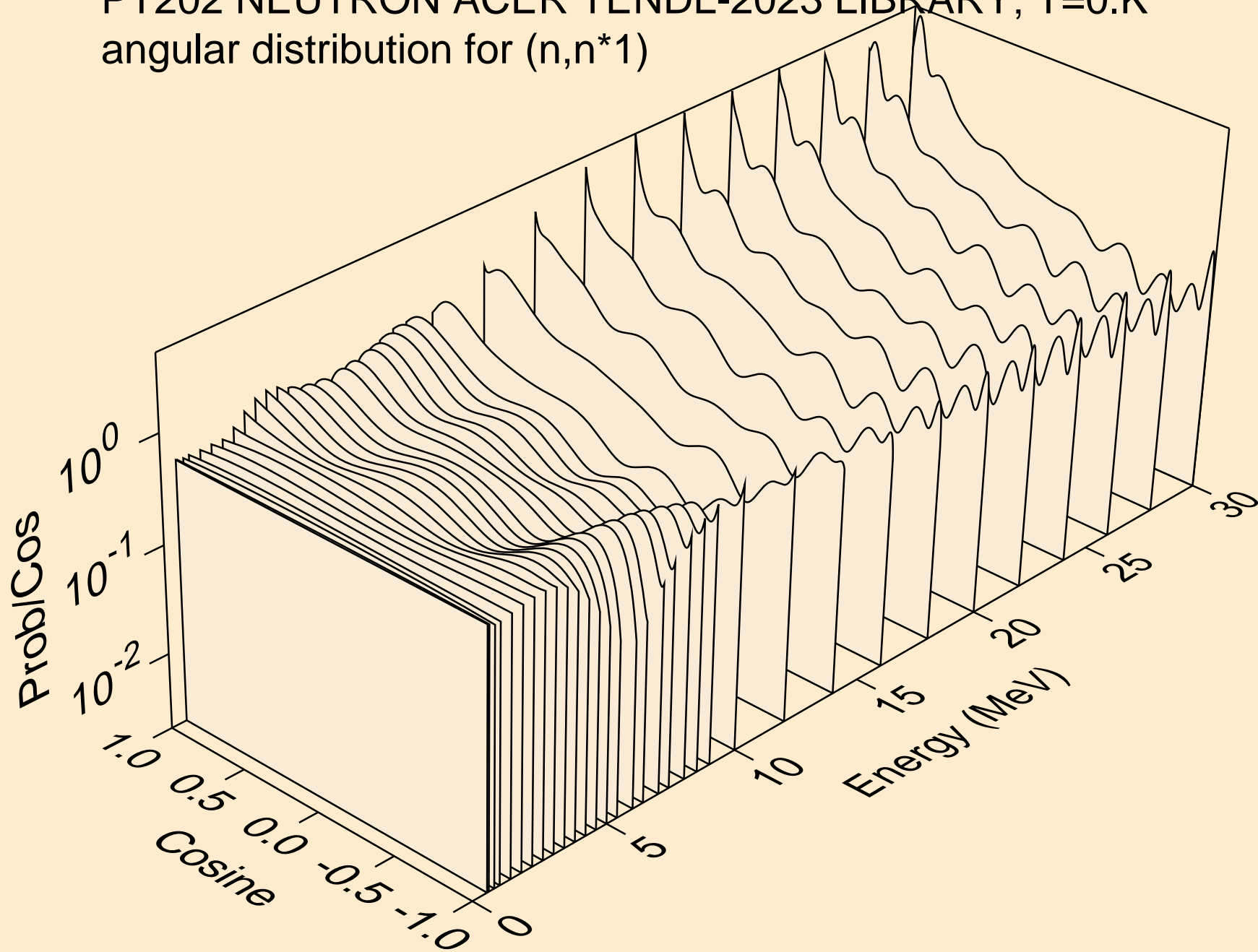

PT202 NEUTRON ACER TENDL-2023 LIBRARY; T=0.K  
angular distribution for (n,n\*2)

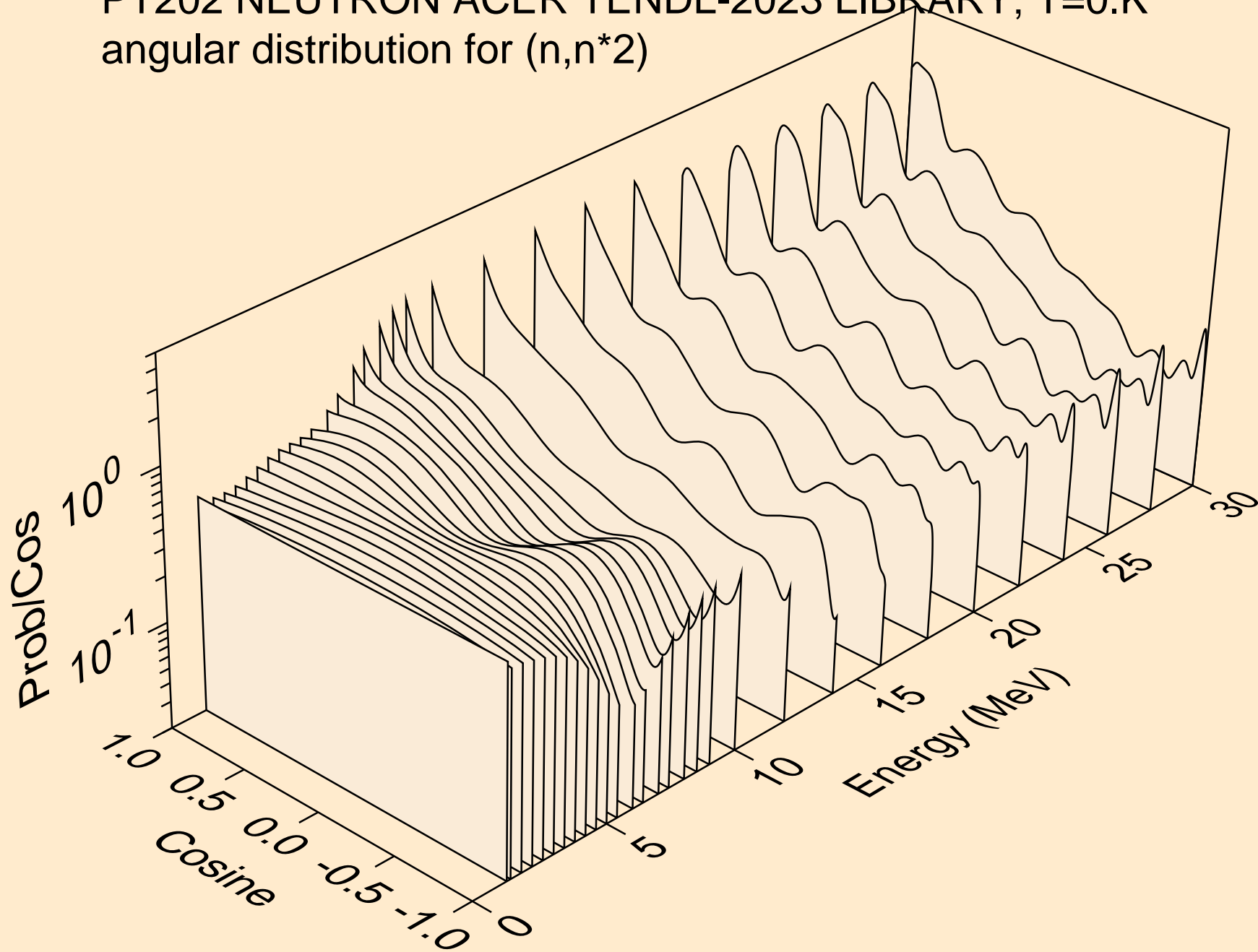

PT202 NEUTRON ACER TENDL-2023 LIBRARY; T=0.K  
angular distribution for (n,n\*3)

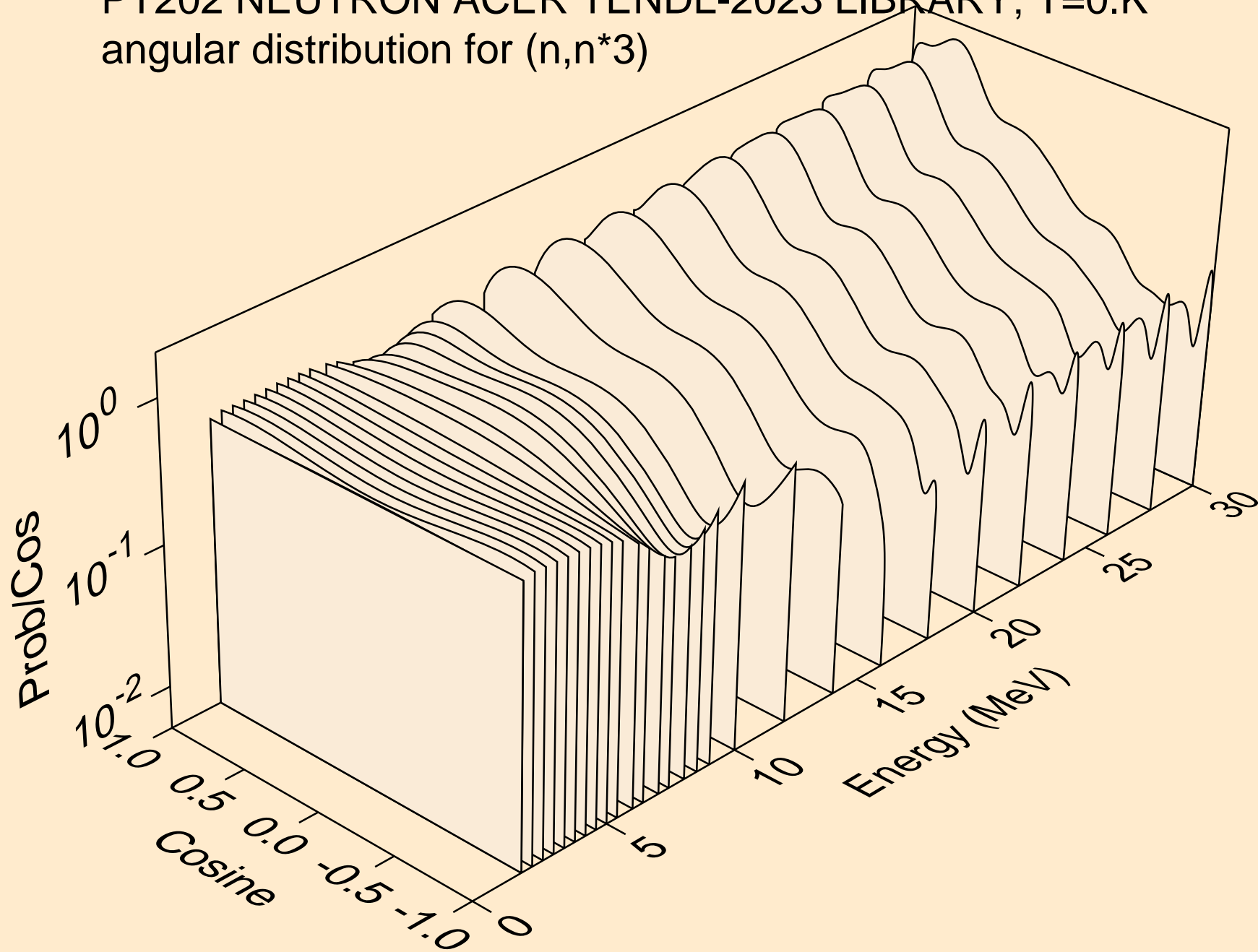



PT202 NEUTRON ACER TENDL-2023 LIBRARY; T=0.K  
angular distribution for (n,n\*4)

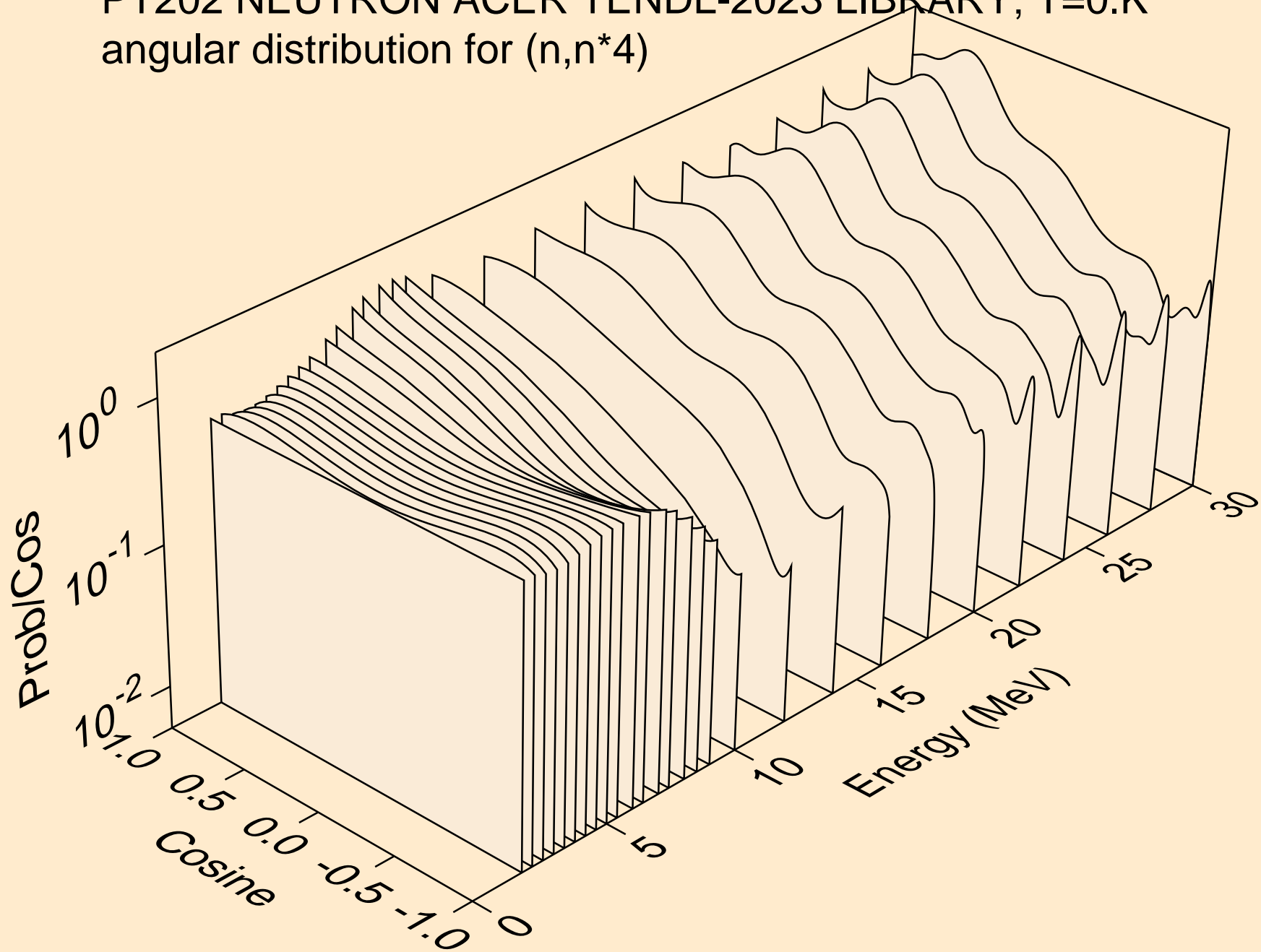

PT202 NEUTRON ACER TENDL-2023 LIBRARY; T=0.K  
angular distribution for (n,n\*5)

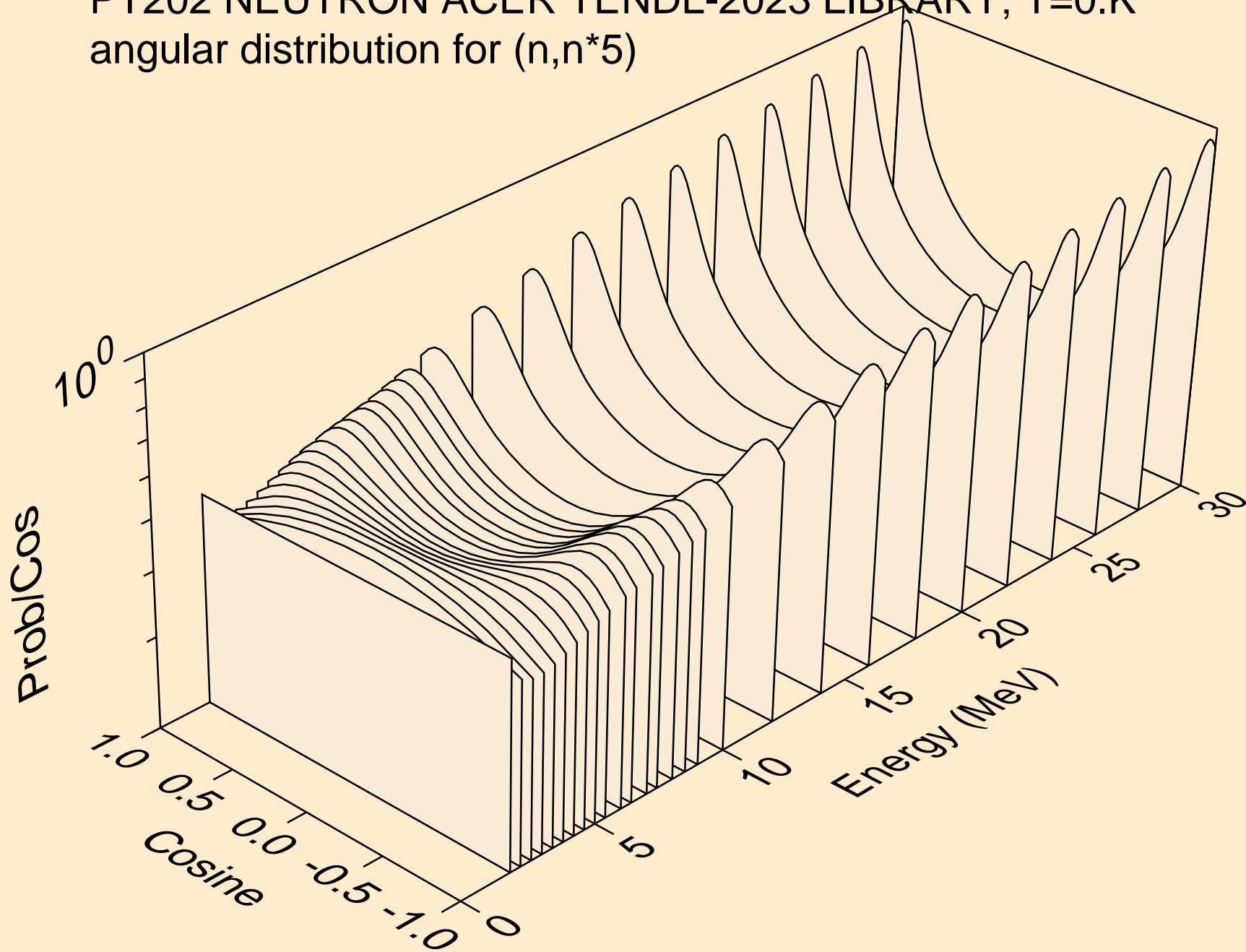

PT202 NEUTRON ACER TENDL-2023 LIBRARY; T=0.K  
angular distribution for (n,n\*6)

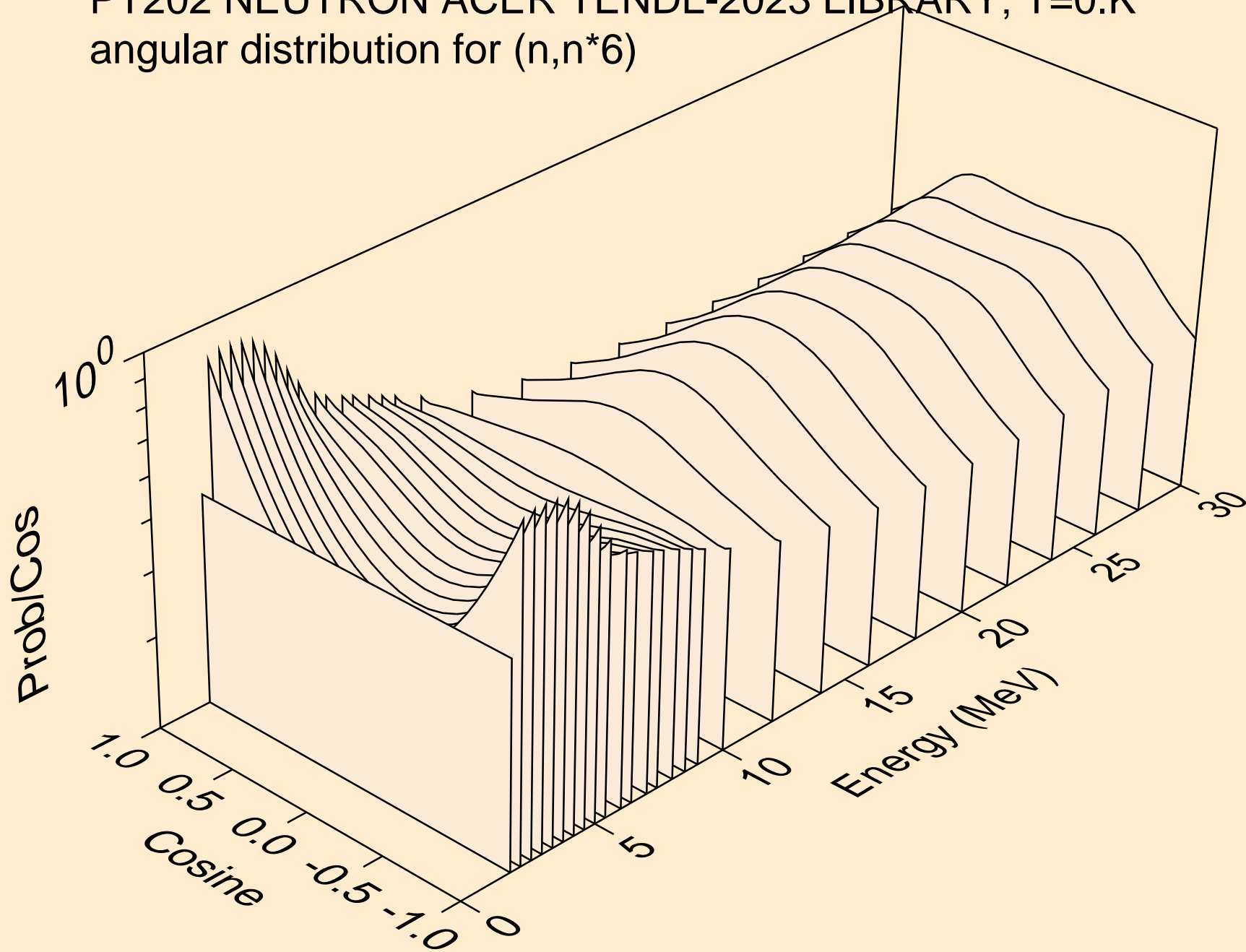

PT202 NEUTRON ACER TENDL-2023 LIBRARY; T=0.K  
angular distribution for (n,n\*7)

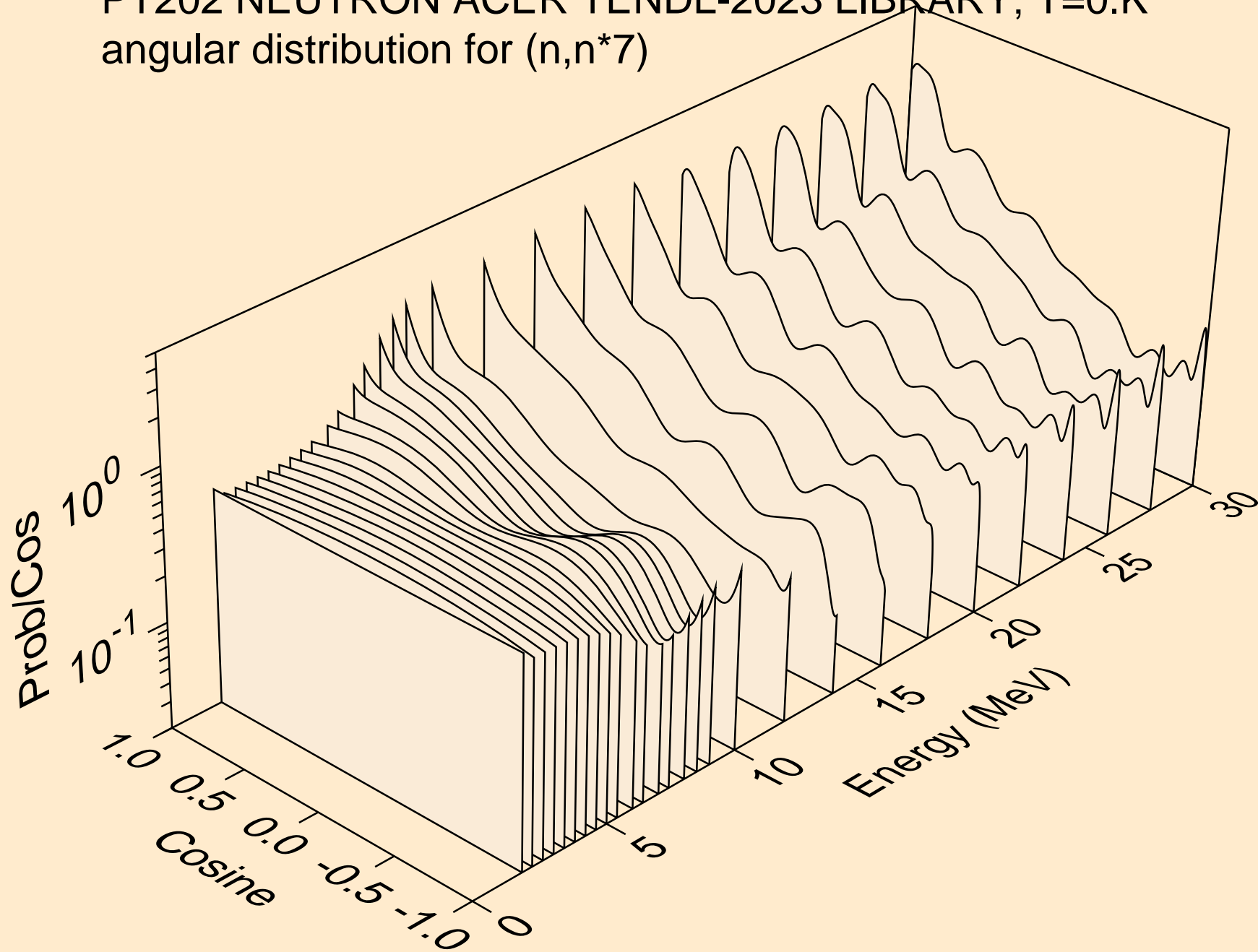

PT202 NEUTRON ACER TENDL-2023 LIBRARY; T=0.K  
angular distribution for (n,n\*8)

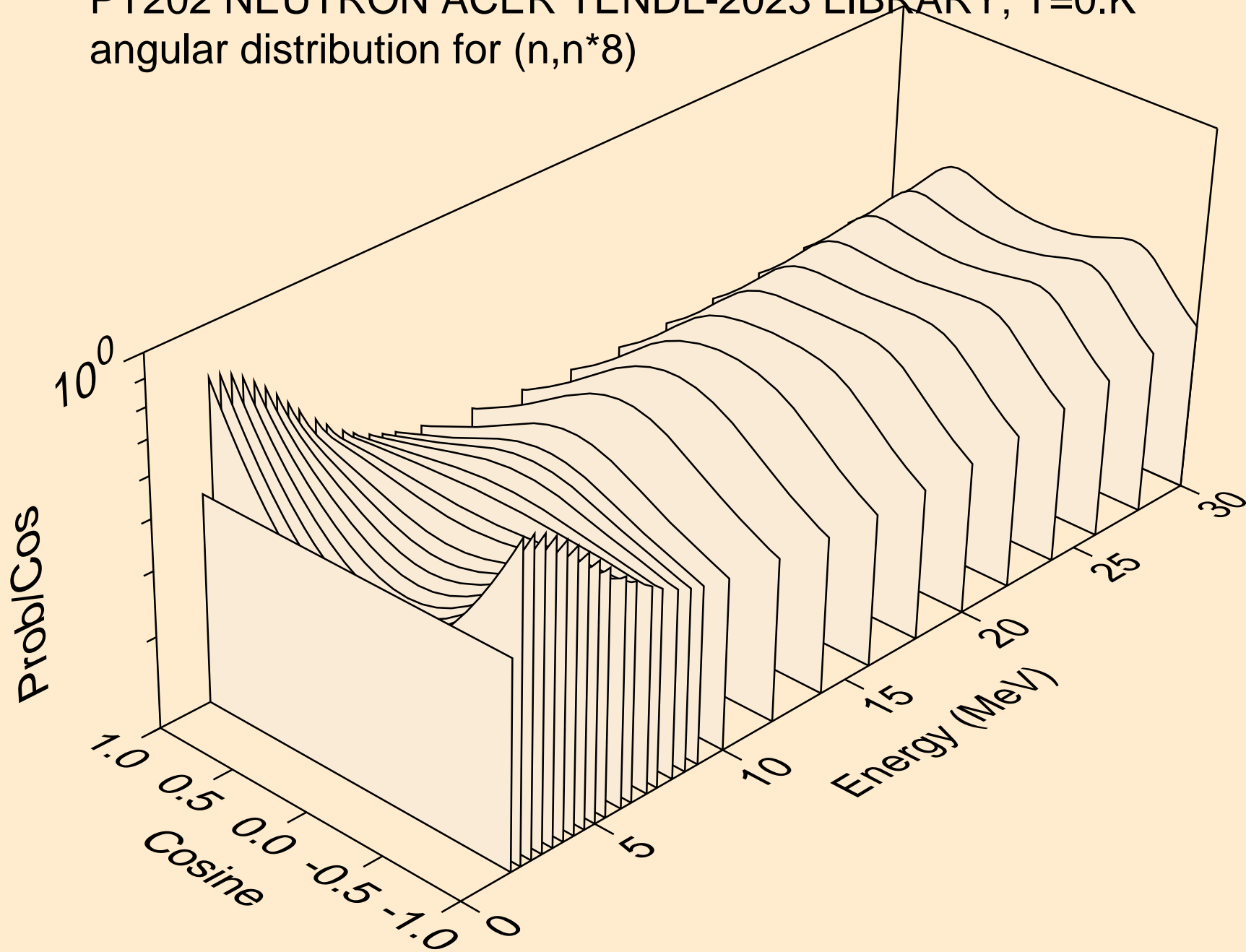

PT202 NEUTRON ACER TENDL-2023 LIBRARY; T=0.K  
angular distribution for (n,n\*9)

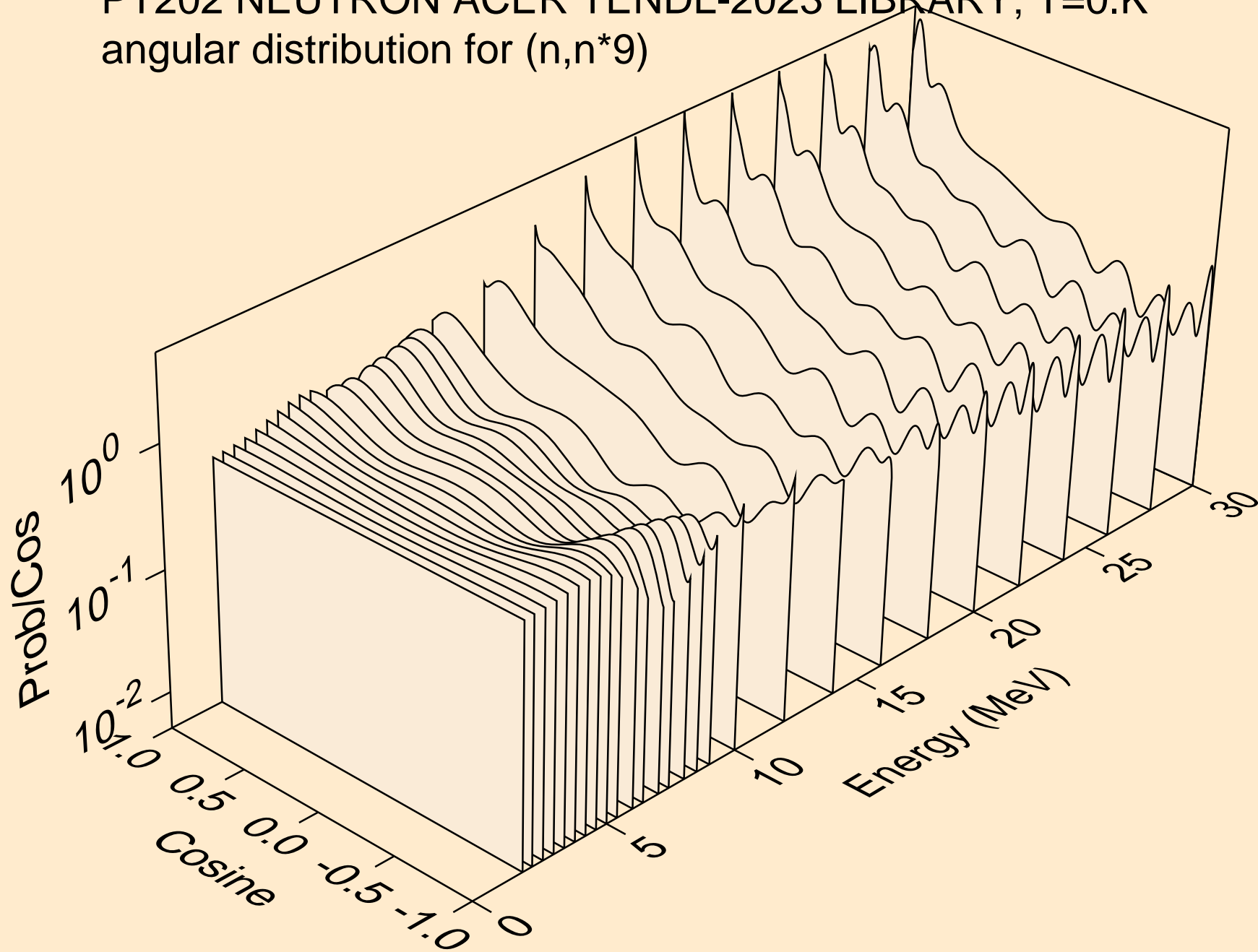

PT202 NEUTRON ACER TENDL-2023 LIBRARY; T=0.K  
angular distribution for (n,n\*10)

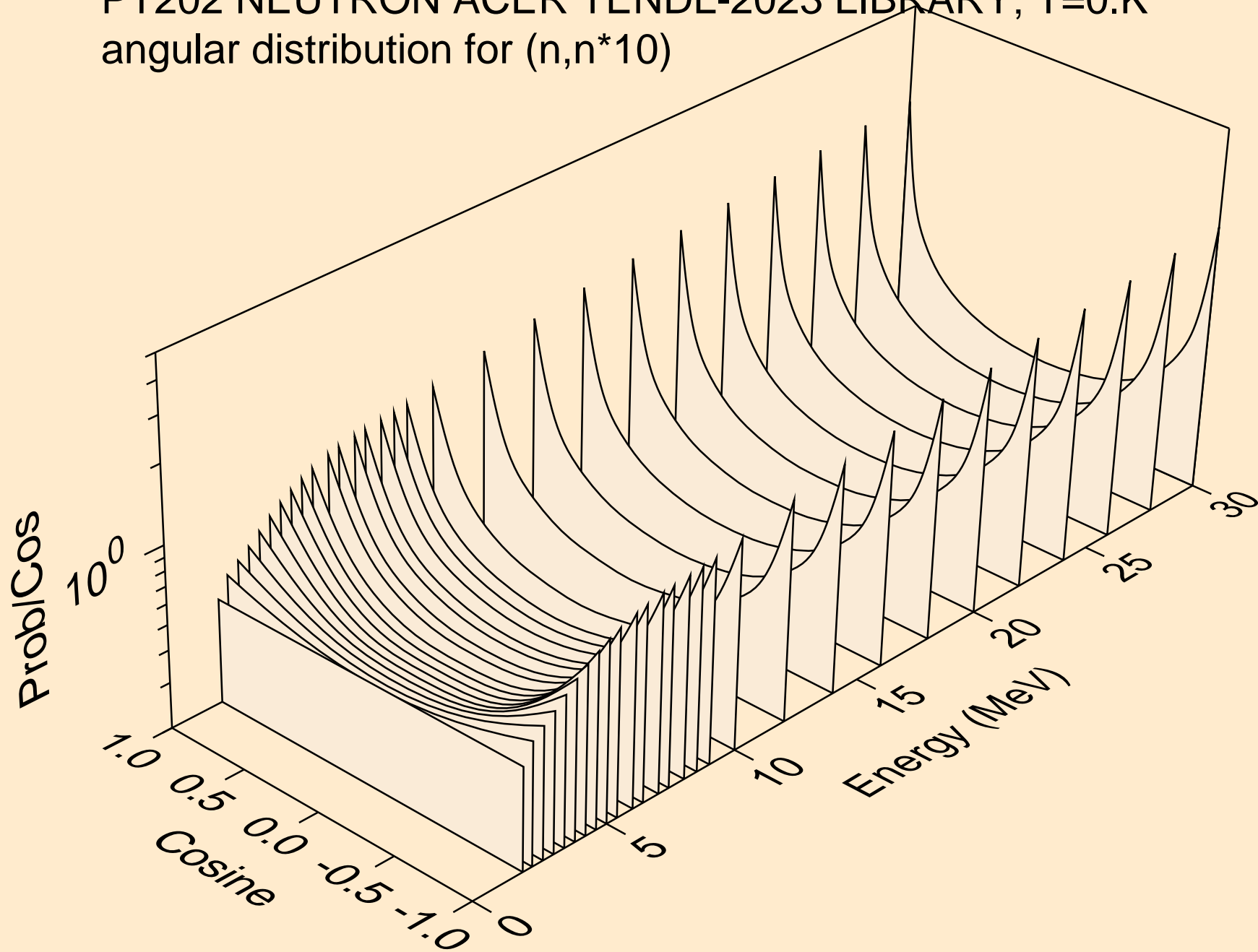

PT202 NEUTRON ACER TENDL-2023 LIBRARY; T=0.K  
angular distribution for (n,n\*11)

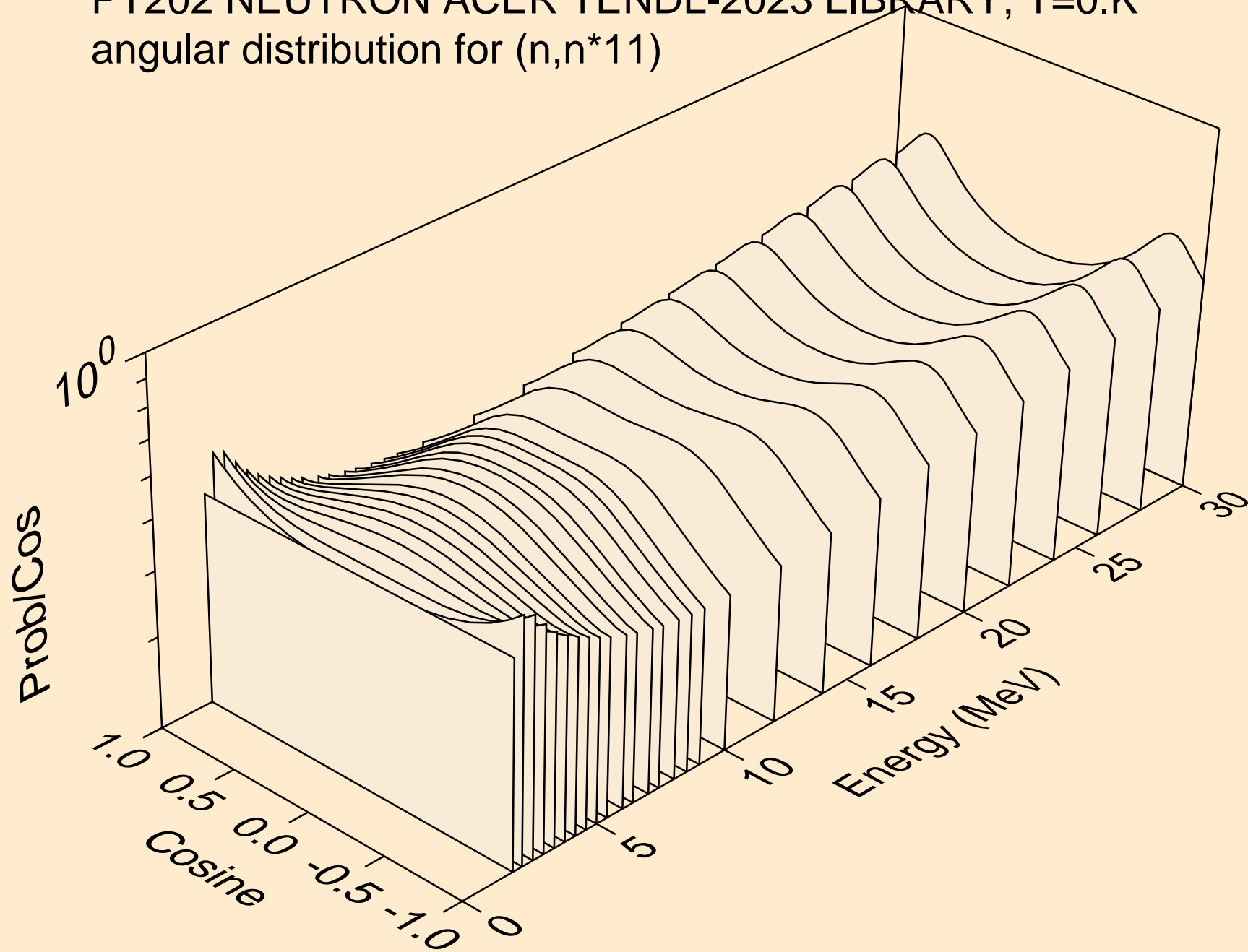



PT202 NEUTRON ACER TENDL-2023 LIBRARY; T=0.K  
angular distribution for (n,n\*12)

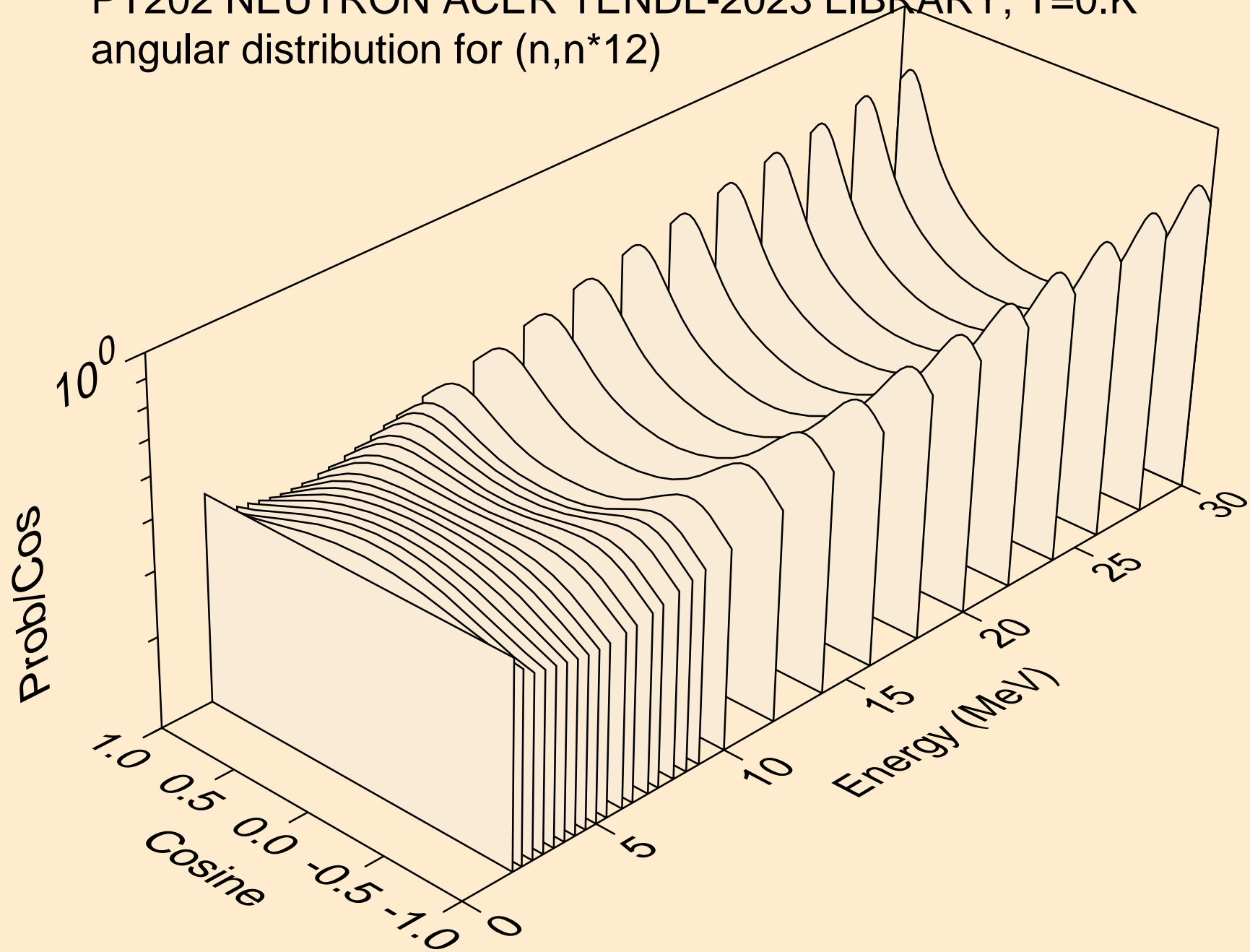

PT202 NEUTRON ACER TENDL-2023 LIBRARY; T=0.K  
angular distribution for (n,n\*13)

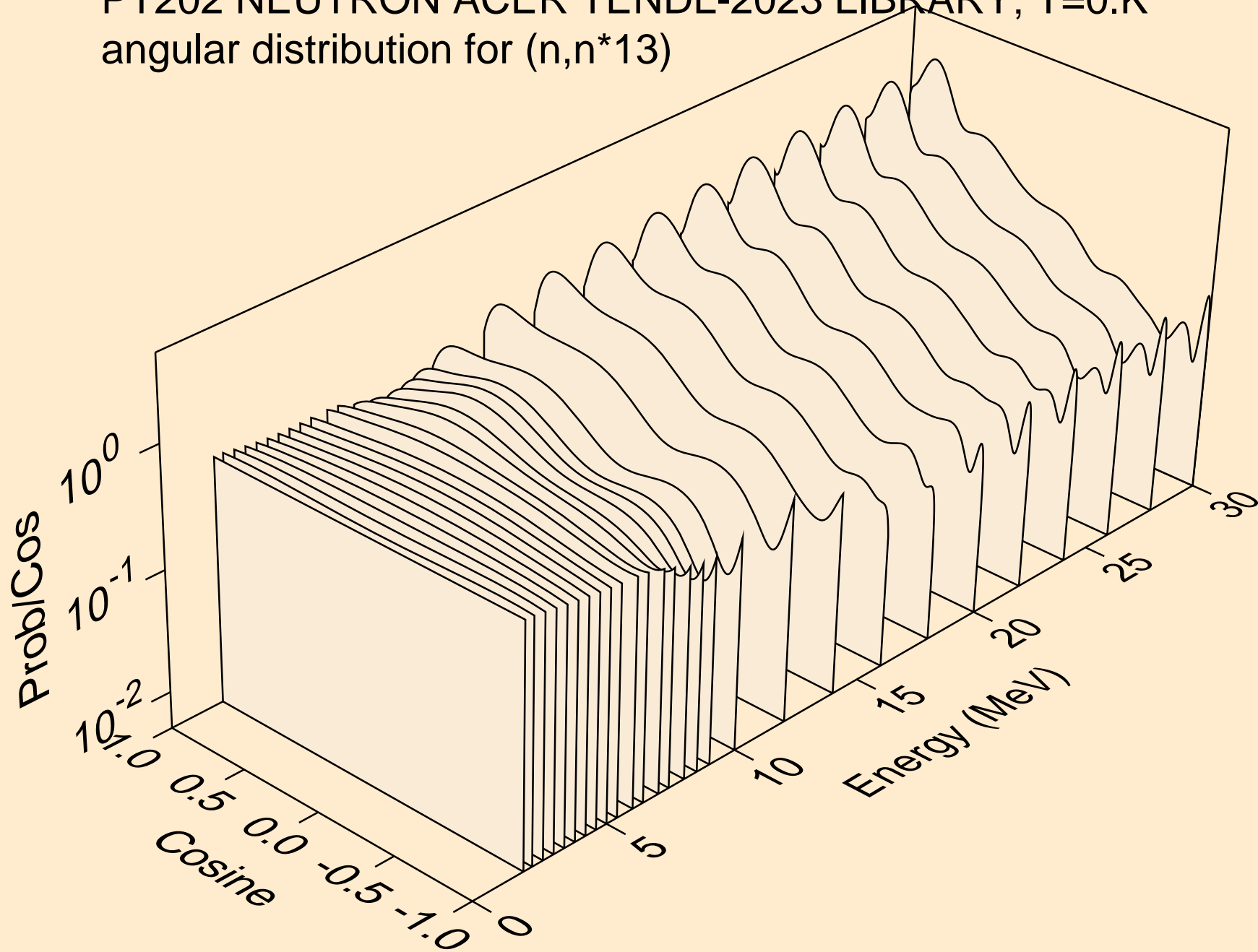

PT202 NEUTRON ACER TENDL-2023 LIBRARY; T=0.K  
angular distribution for (n,n\*14)

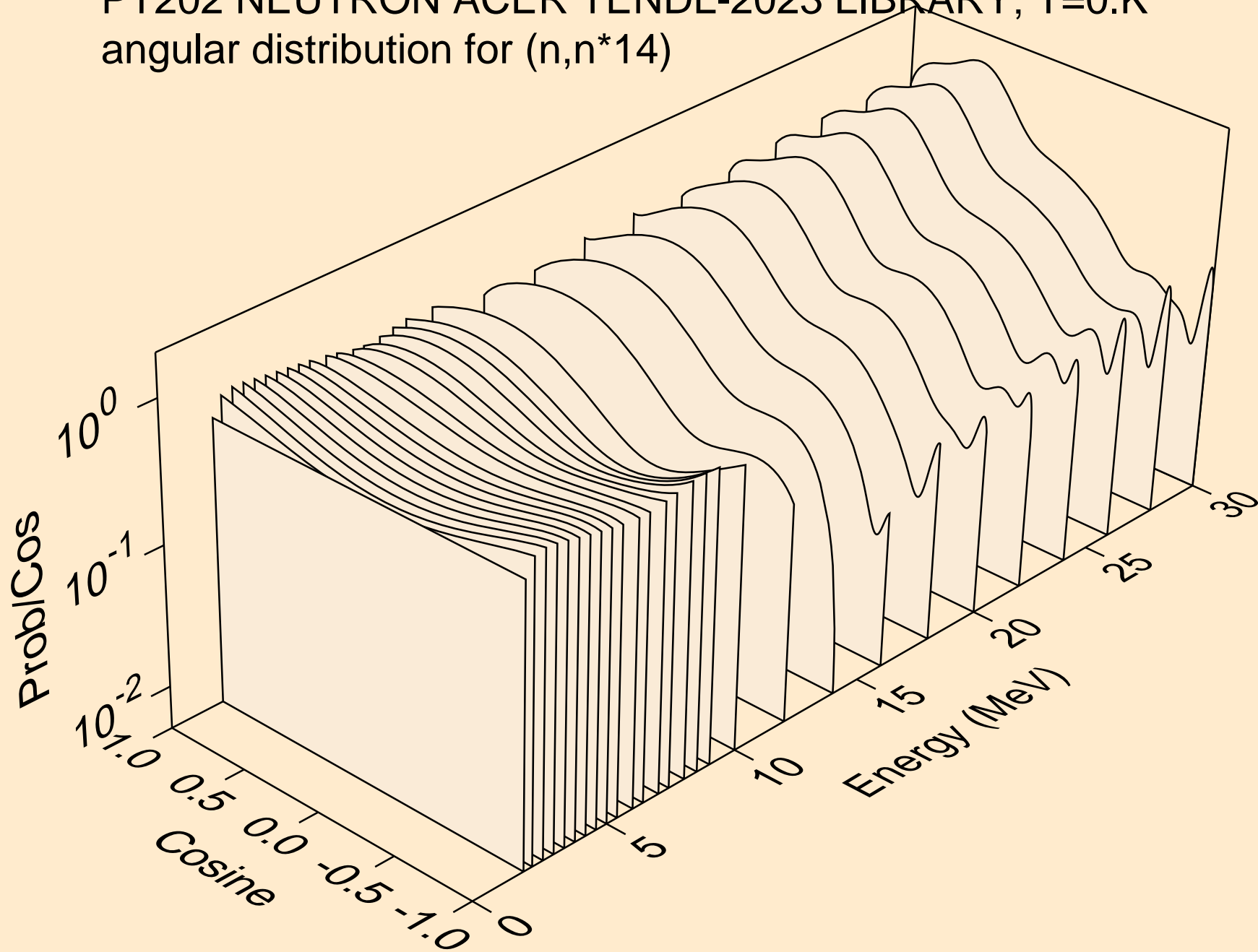

PT202 NEUTRON ACER TENDL-2023 LIBRARY; T=0.K  
angular distribution for (n,n\*15)

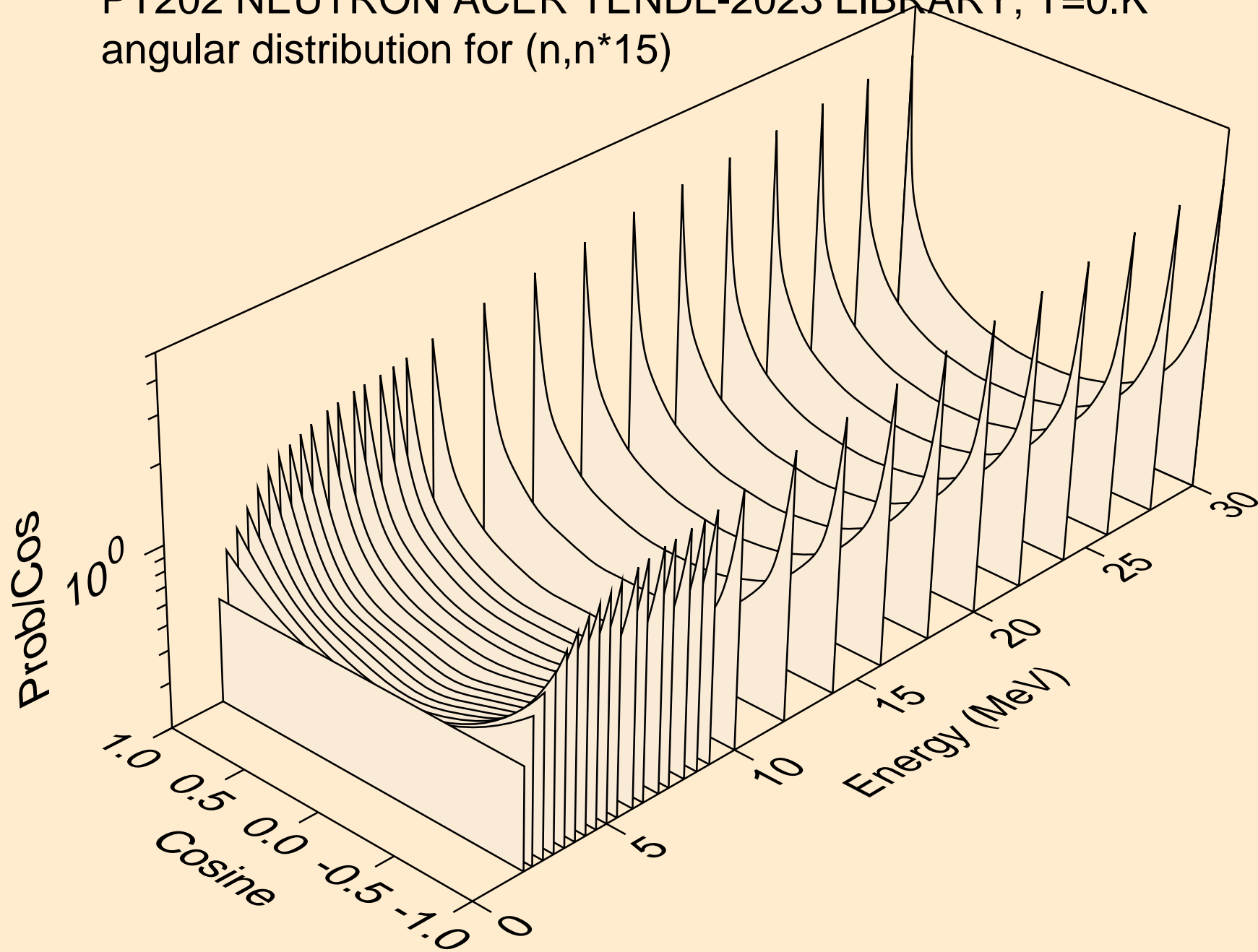

PT202 NEUTRON ACER TENDL-2023 LIBRARY; T=0.K  
angular distribution for (n,n\*16)

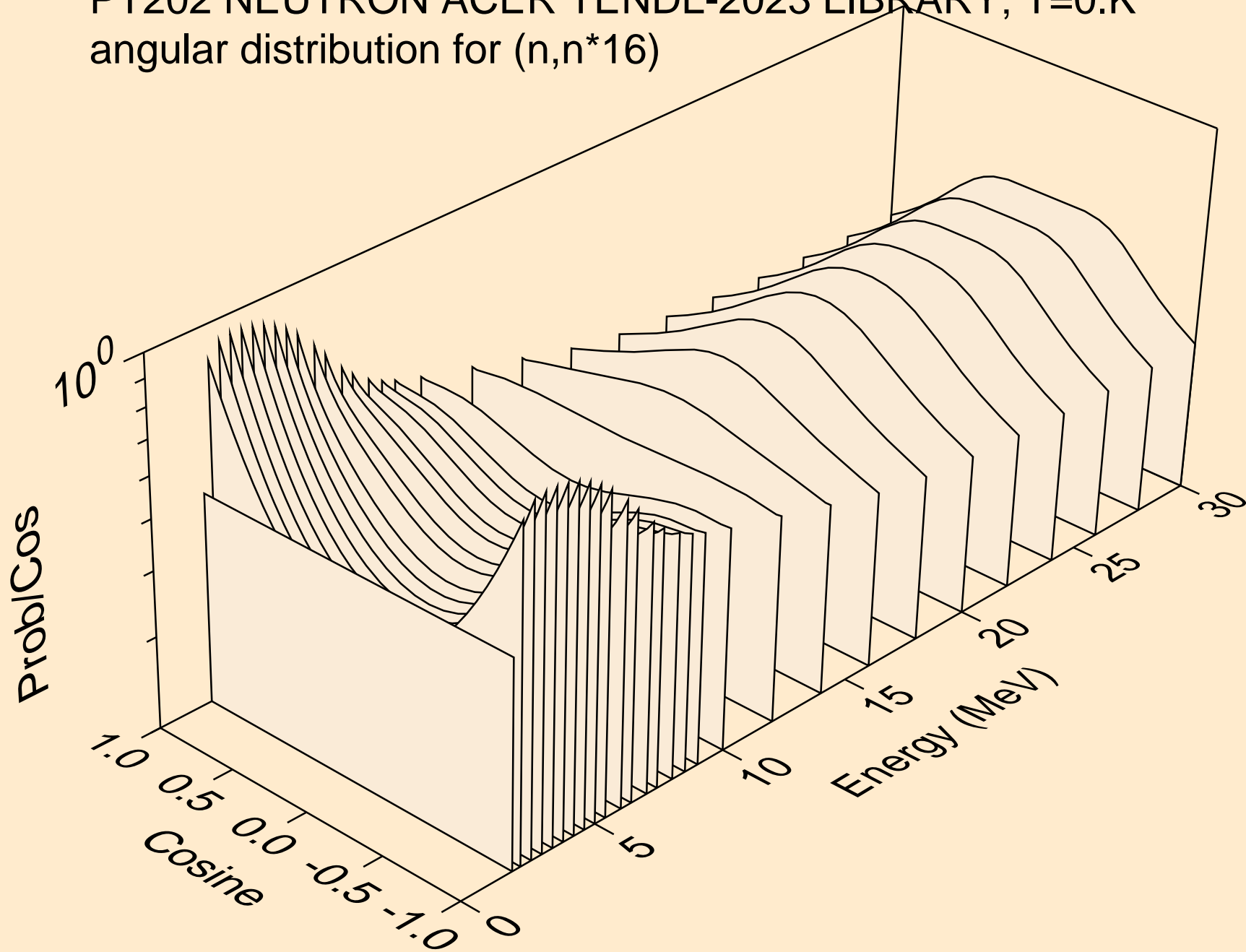

PT202 NEUTRON ACER TENDL-2023 LIBRARY; T=0.K  
angular distribution for (n,n\*17)

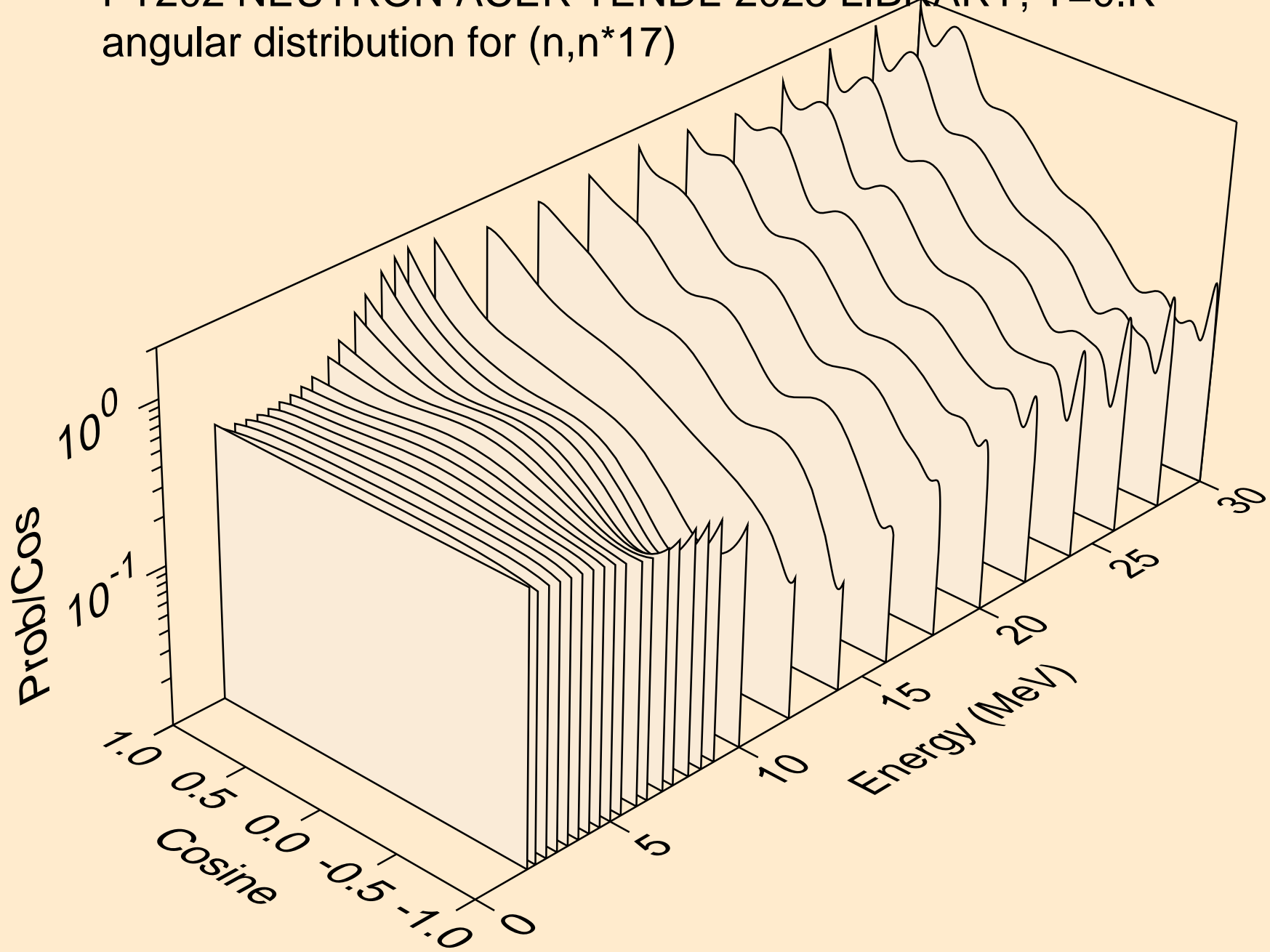

PT202 NEUTRON ACER TENDL-2023 LIBRARY; T=0.K  
angular distribution for (n,n\*18)

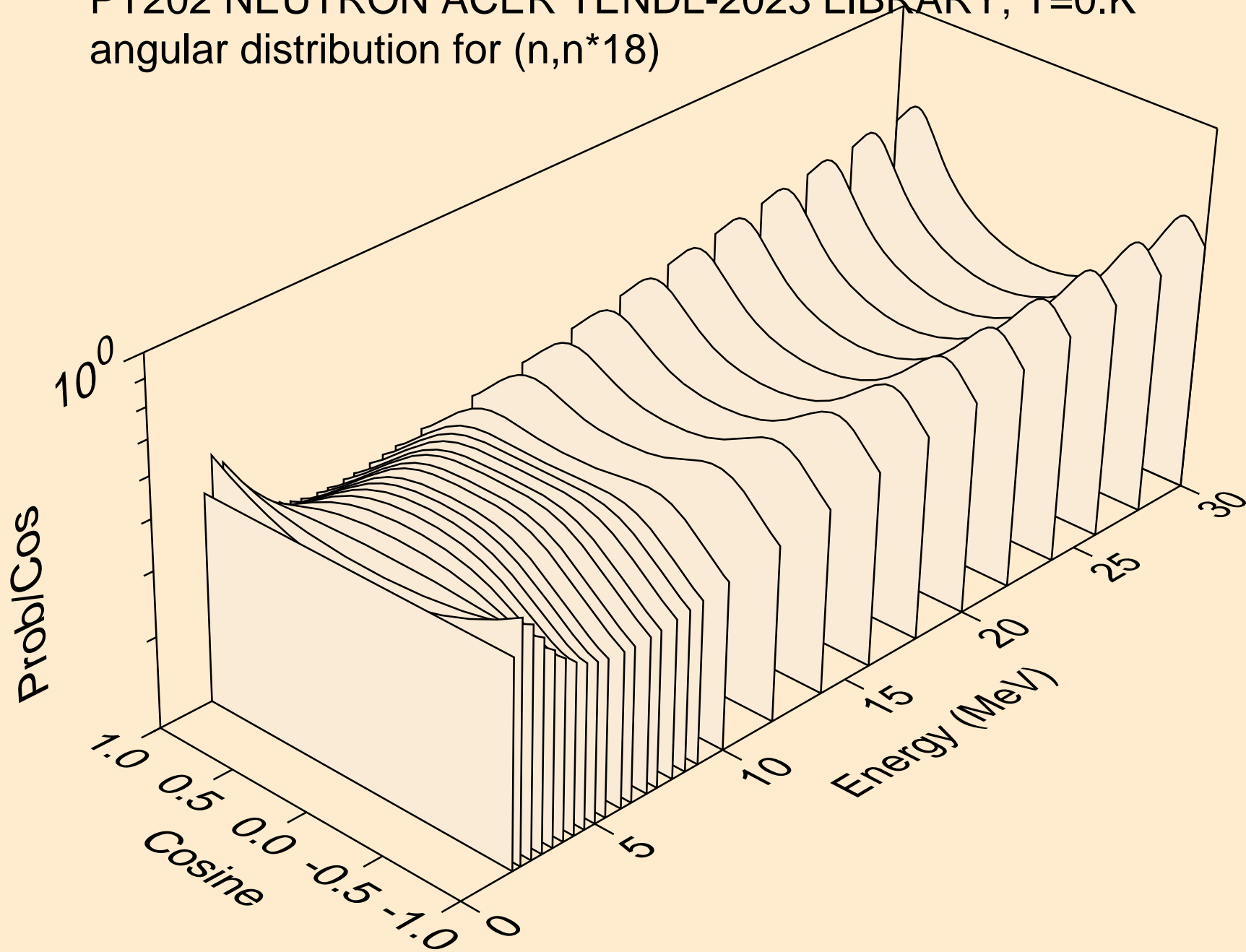

PT202 NEUTRON ACER TENDL-2023 LIBRARY; T=0.K  
angular distribution for (n,n\*19)

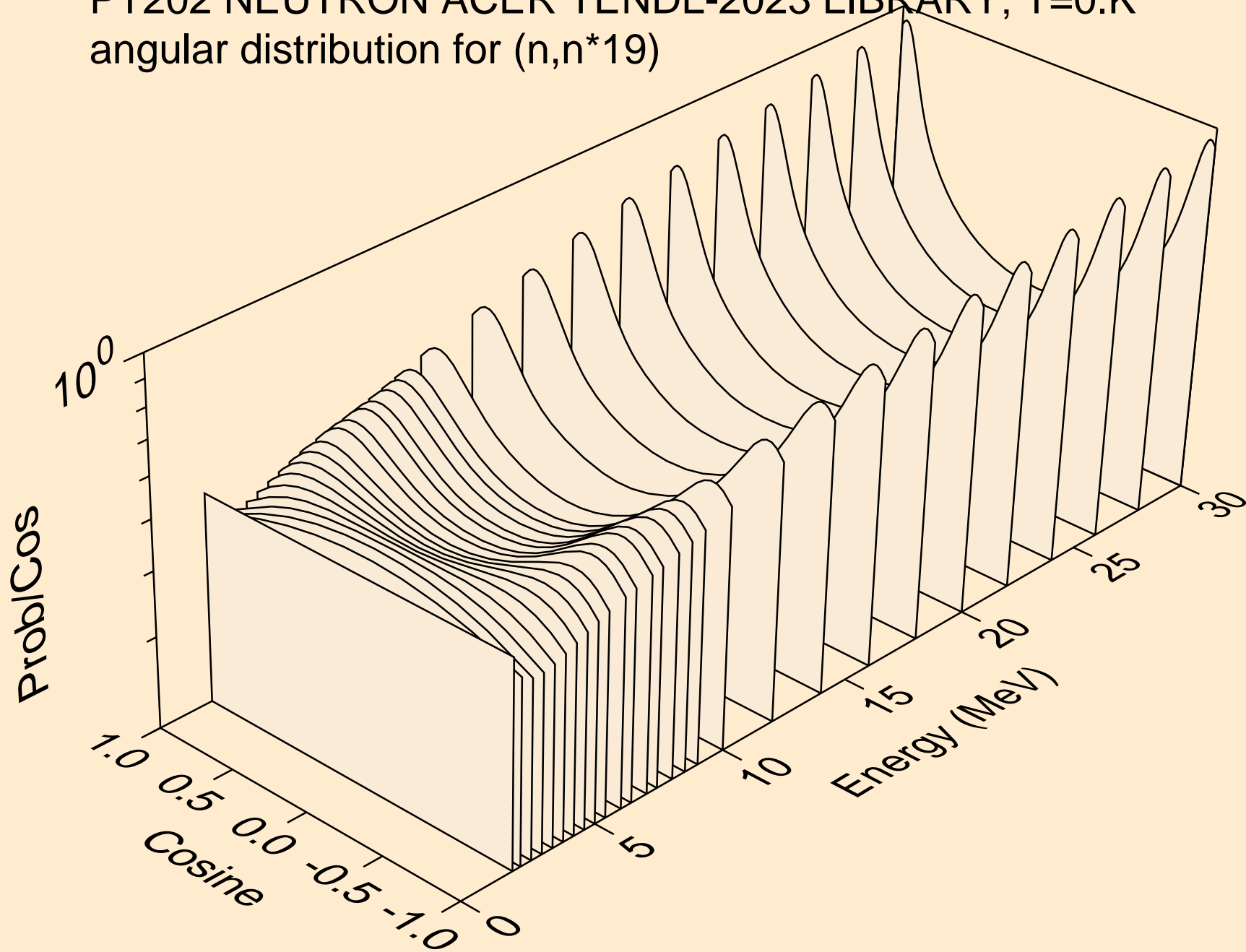



PT202 NEUTRON ACER TENDL-2023 LIBRARY; T=0.K  
angular distribution for (n,n\*20)

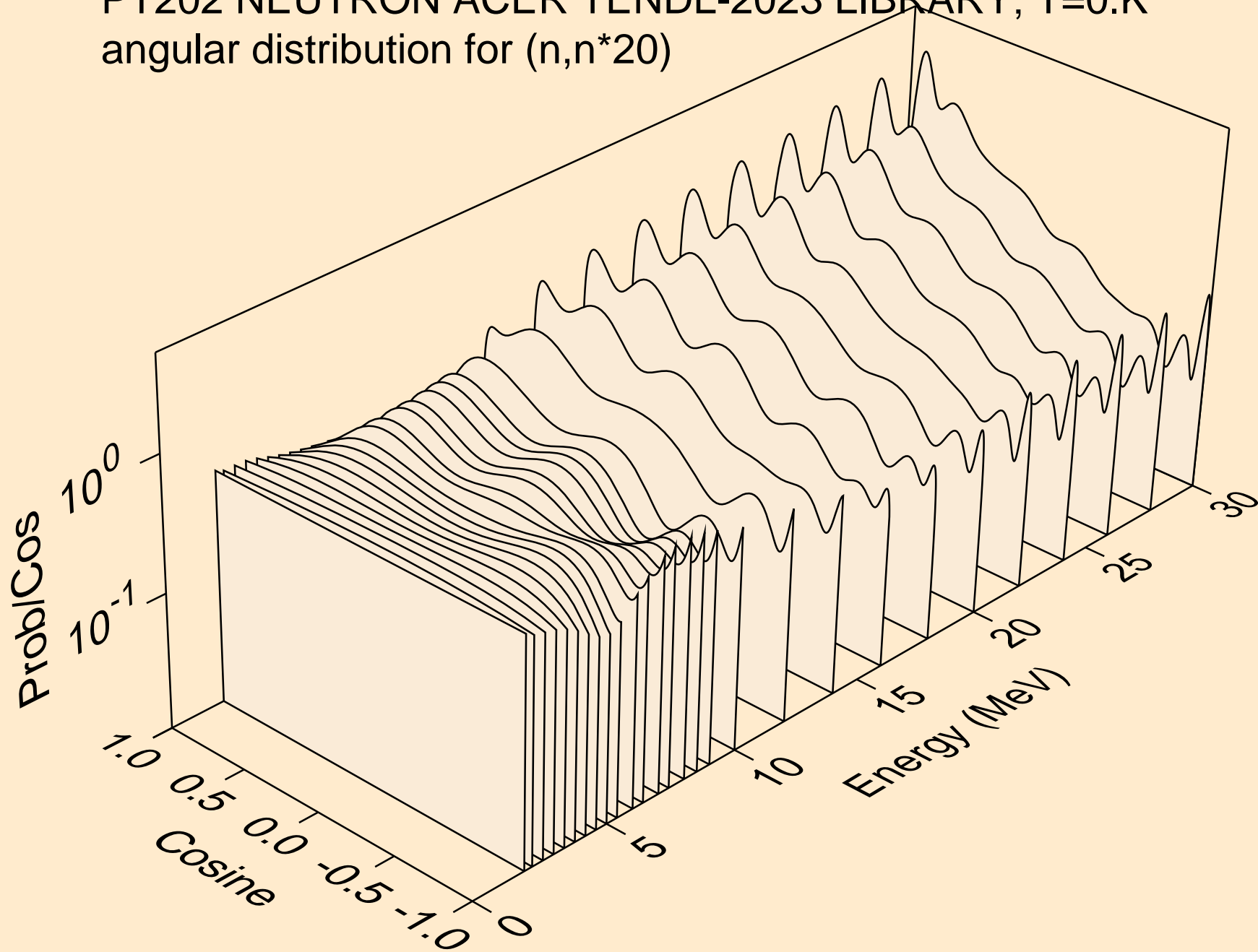

PT202 NEUTRON ACER TENDL-2023 LIBRARY; T=0.K  
angular distribution for (n,n\*21)

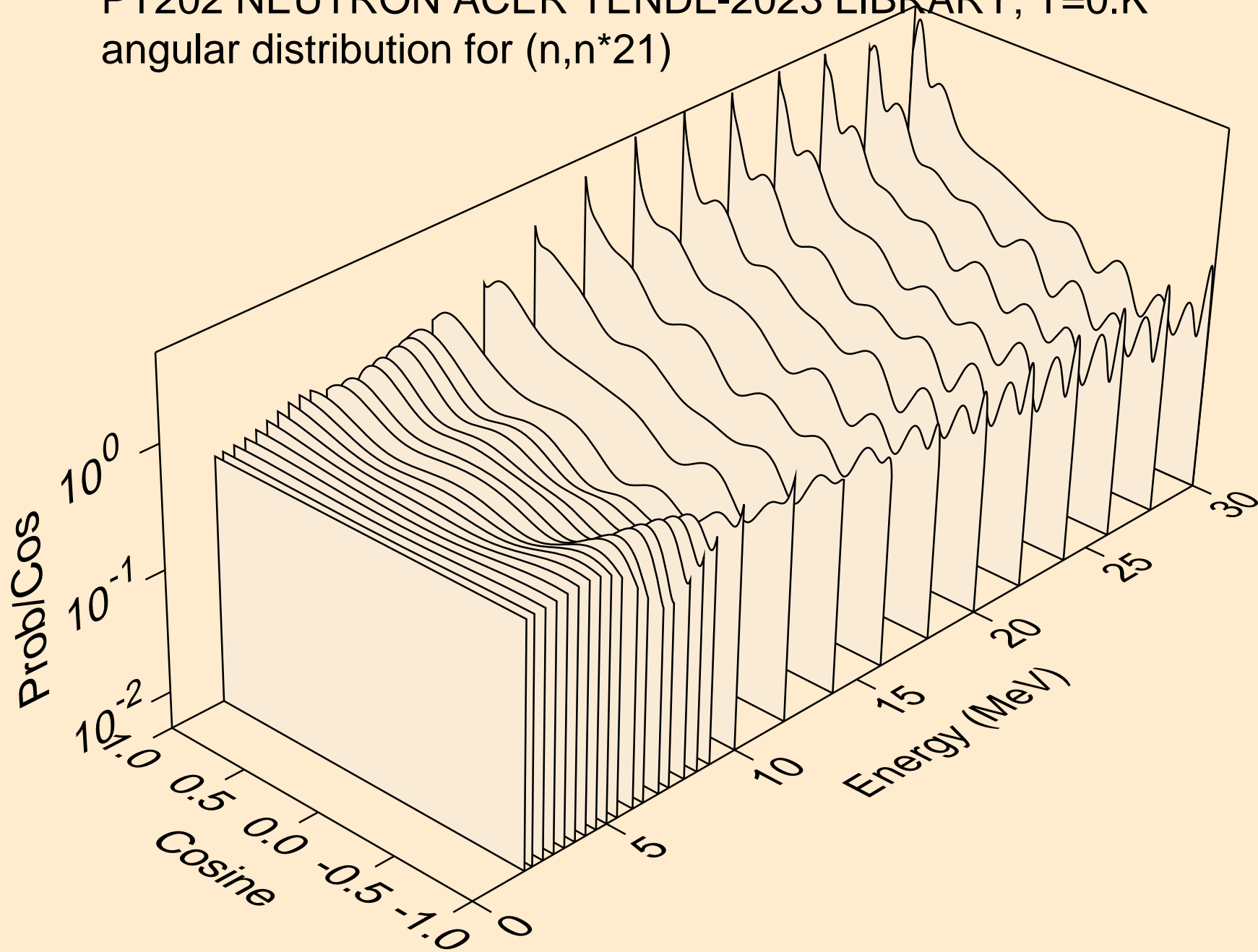

PT202 NEUTRON ACER TENDL-2023 LIBRARY; T=0.K  
angular distribution for (n,n\*22)

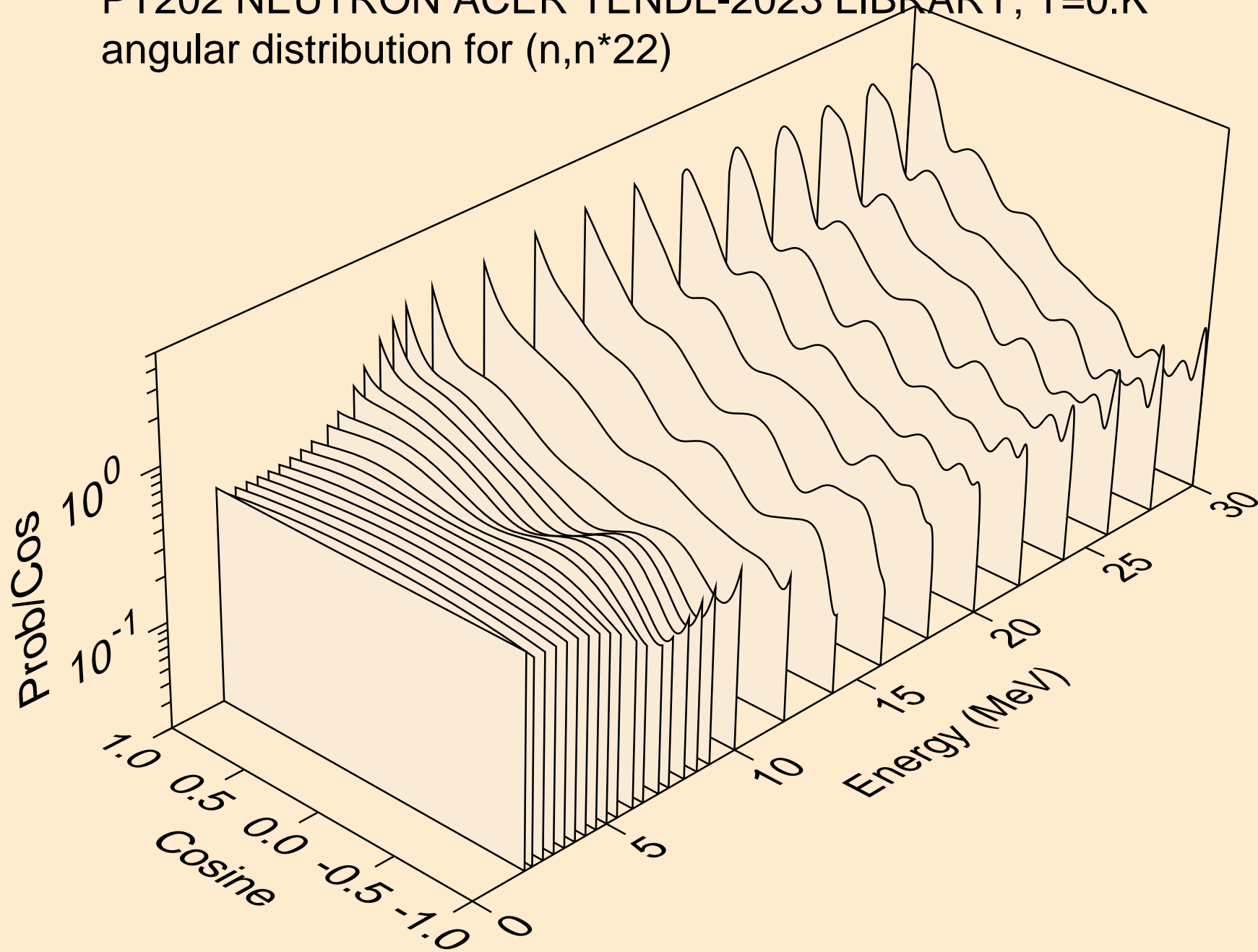

PT202 NEUTRON ACER TENDL-2023 LIBRARY; T=0.K  
angular distribution for (n,n\*23)

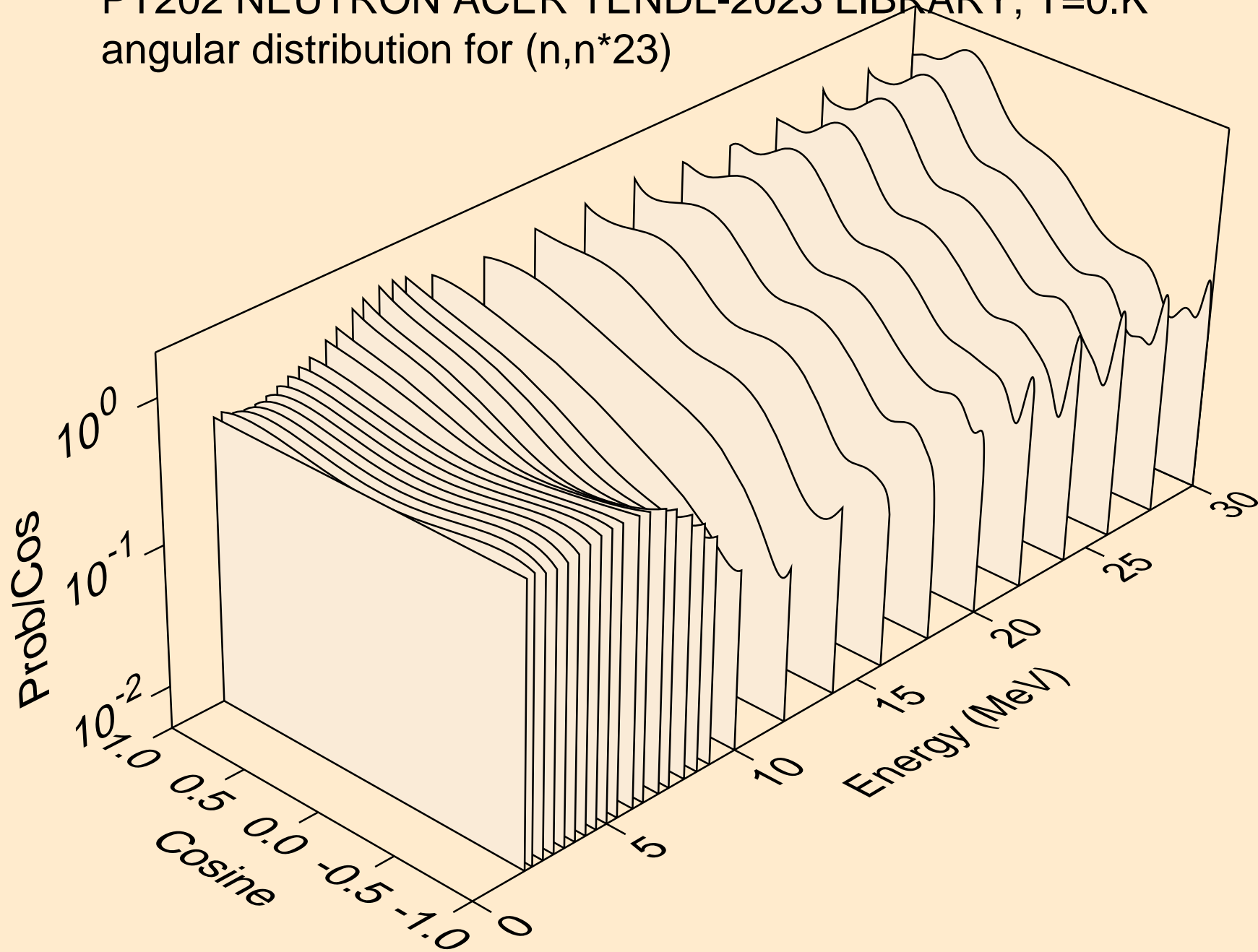

PT202 NEUTRON ACER TENDL-2023 LIBRARY; T=0.K  
angular distribution for (n,n\*24)

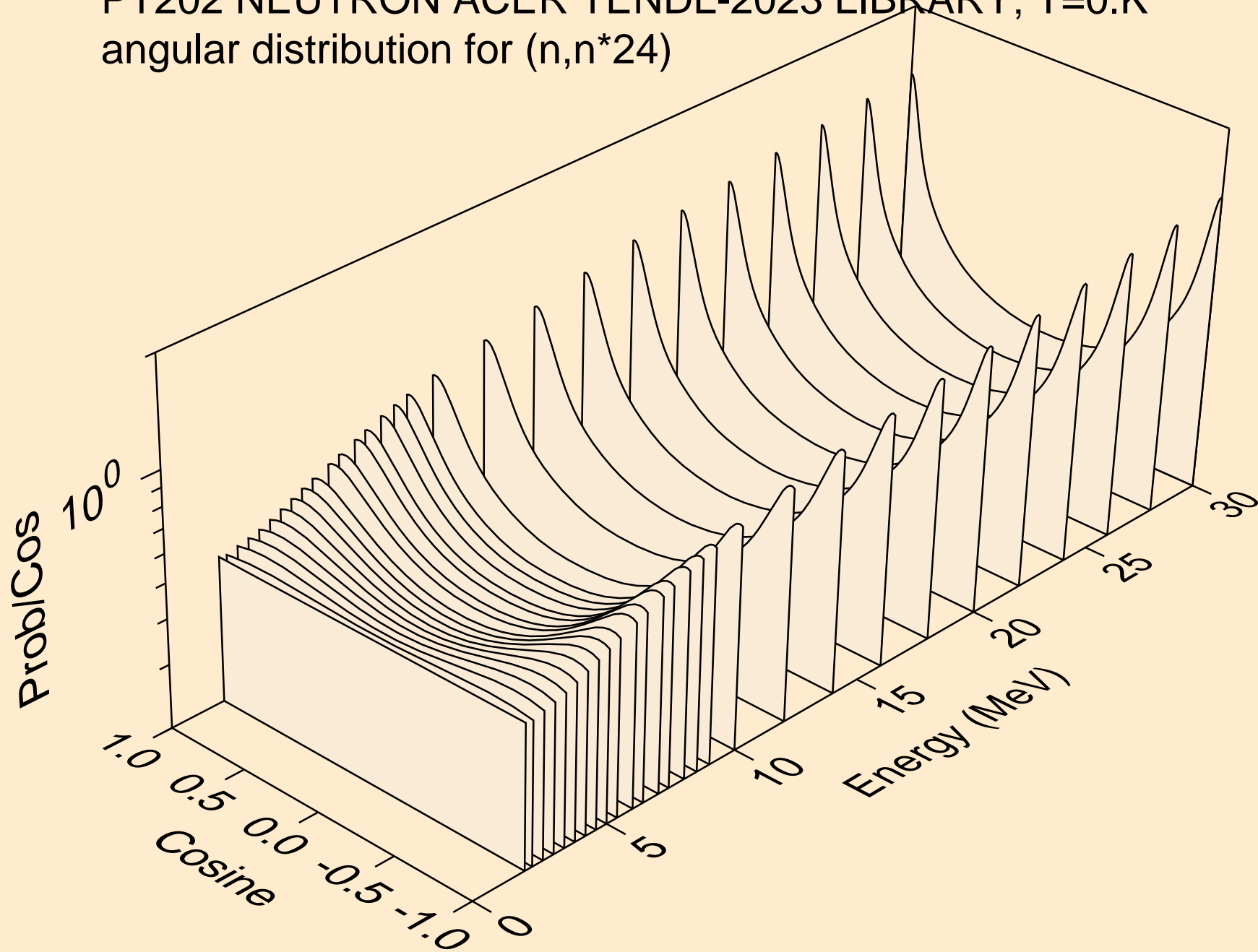

PT202 NEUTRON ACER TENDL-2023 LIBRARY; T=0.K  
angular distribution for (n,n\*25)

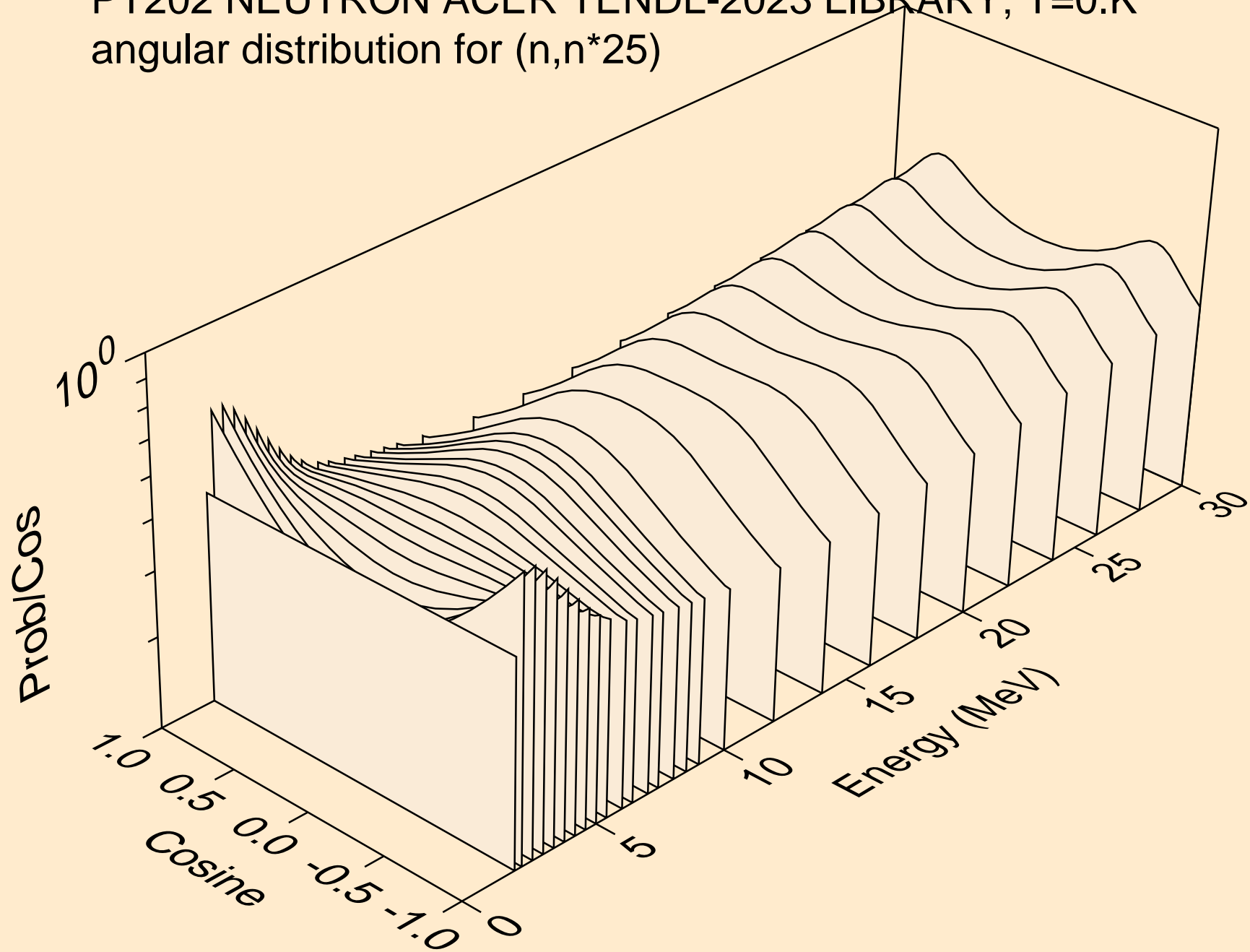

PT202 NEUTRON ACER TENDL-2023 LIBRARY; T=0.K  
angular distribution for (n,n\*26)

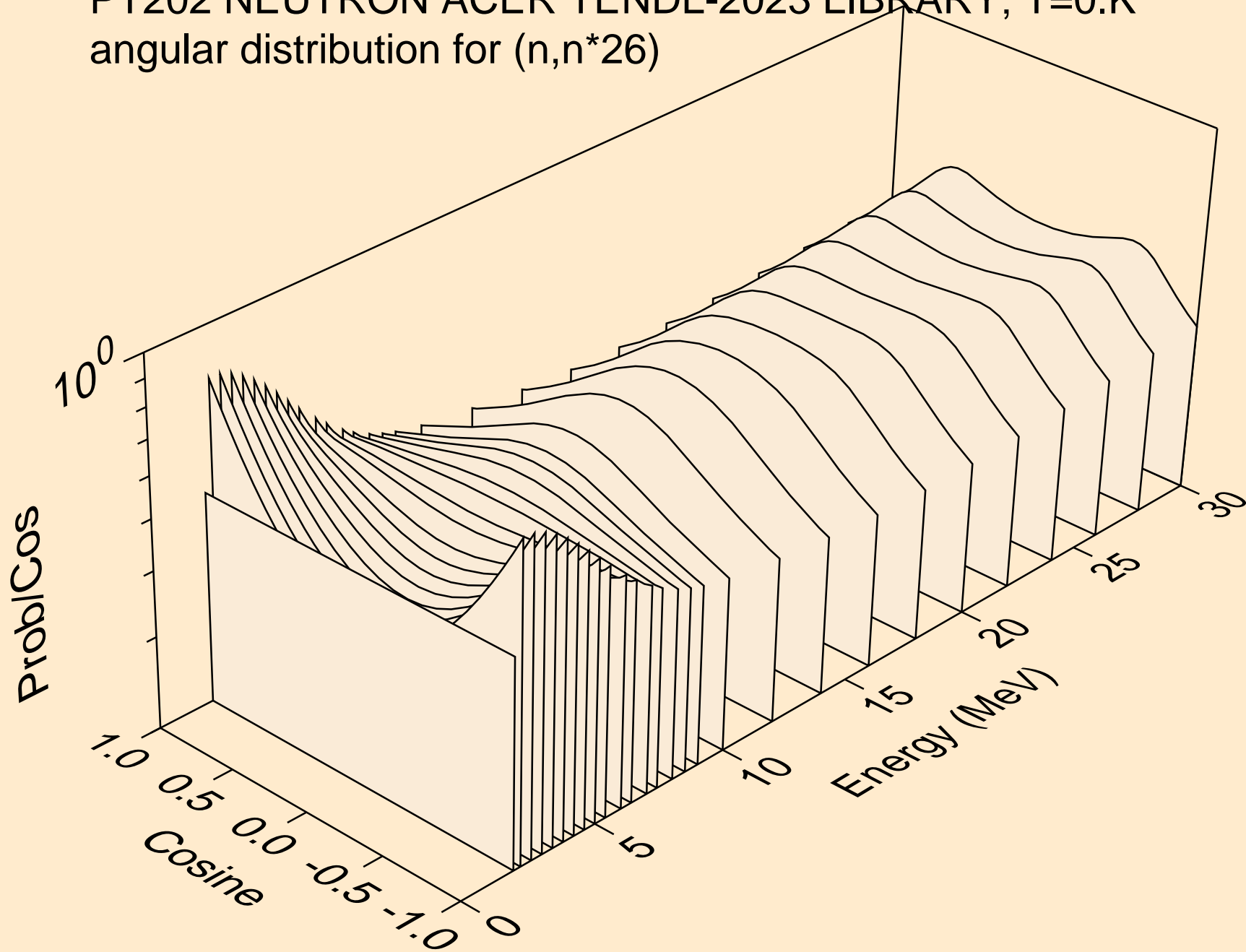

PT202 NEUTRON ACER TENDL-2023 LIBRARY; T=0.K  
angular distribution for (n,n\*27)

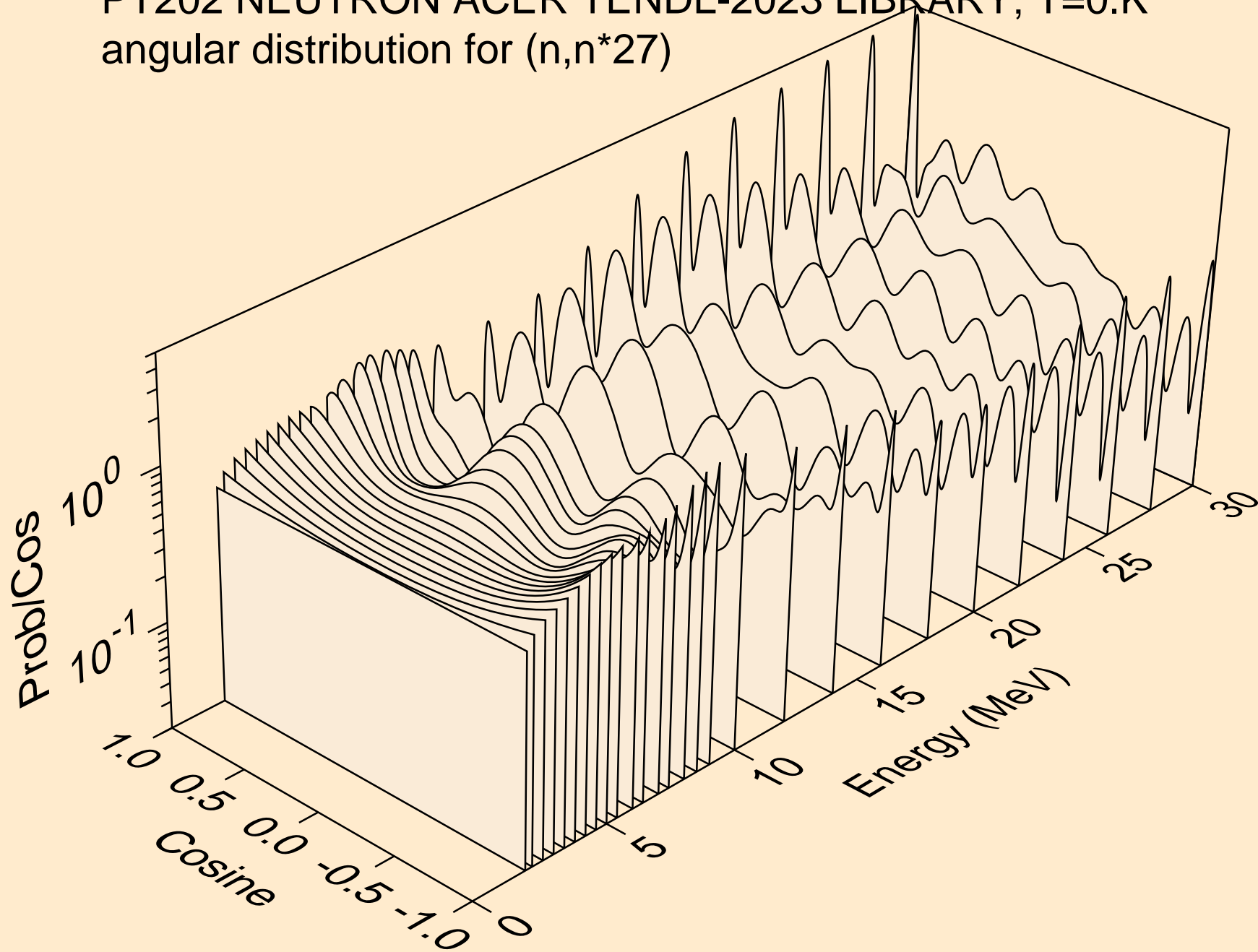



PT202 NEUTRON ACER TENDL-2023 LIBRARY; T=0.K  
angular distribution for (n,n\*28)

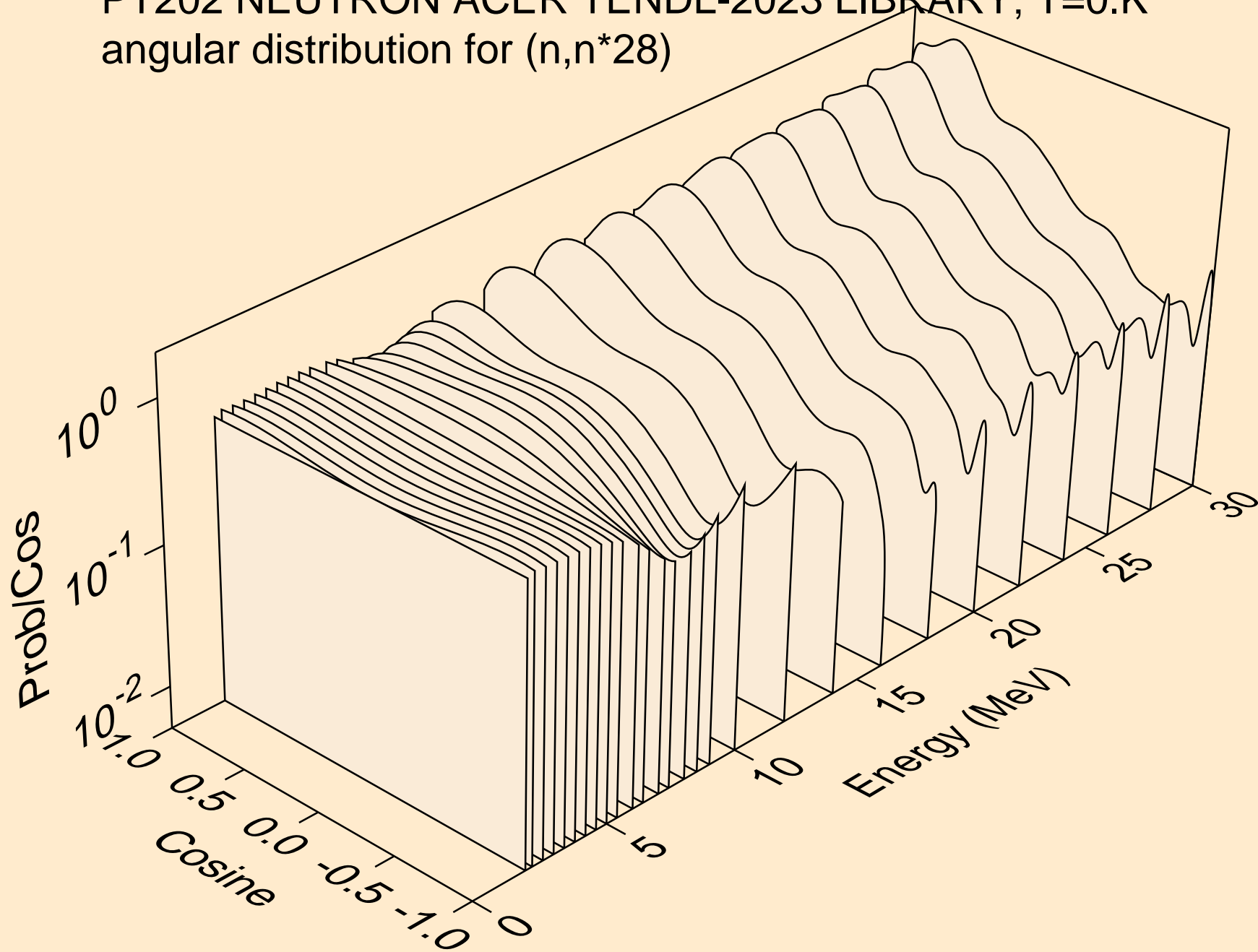

PT202 NEUTRON ACER TENDL-2023 LIBRARY; T=0.K  
angular distribution for (n,n\*29)

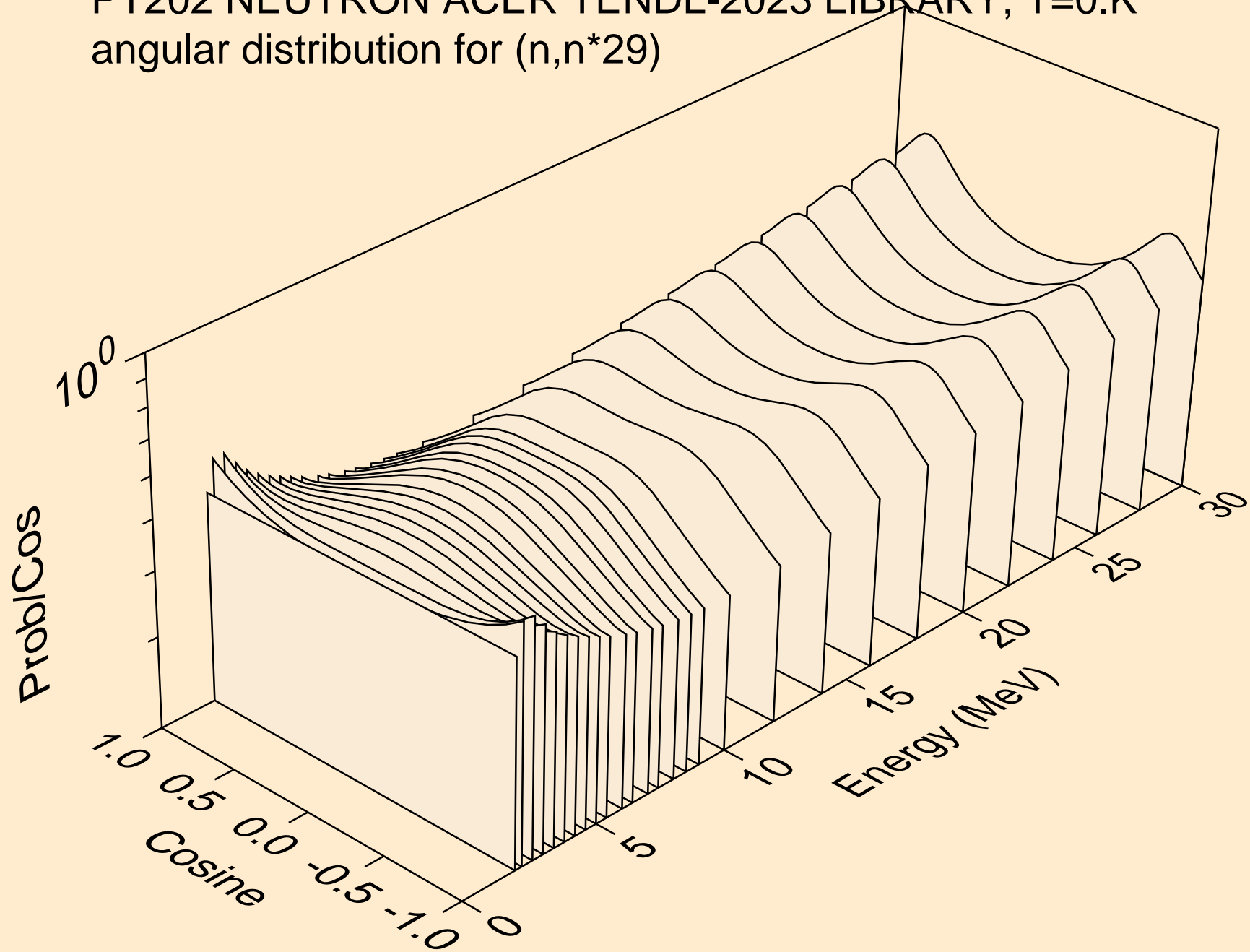

PT202 NEUTRON ACER TENDL-2023 LIBRARY; T=0.K  
angular distribution for (n,n\*30)

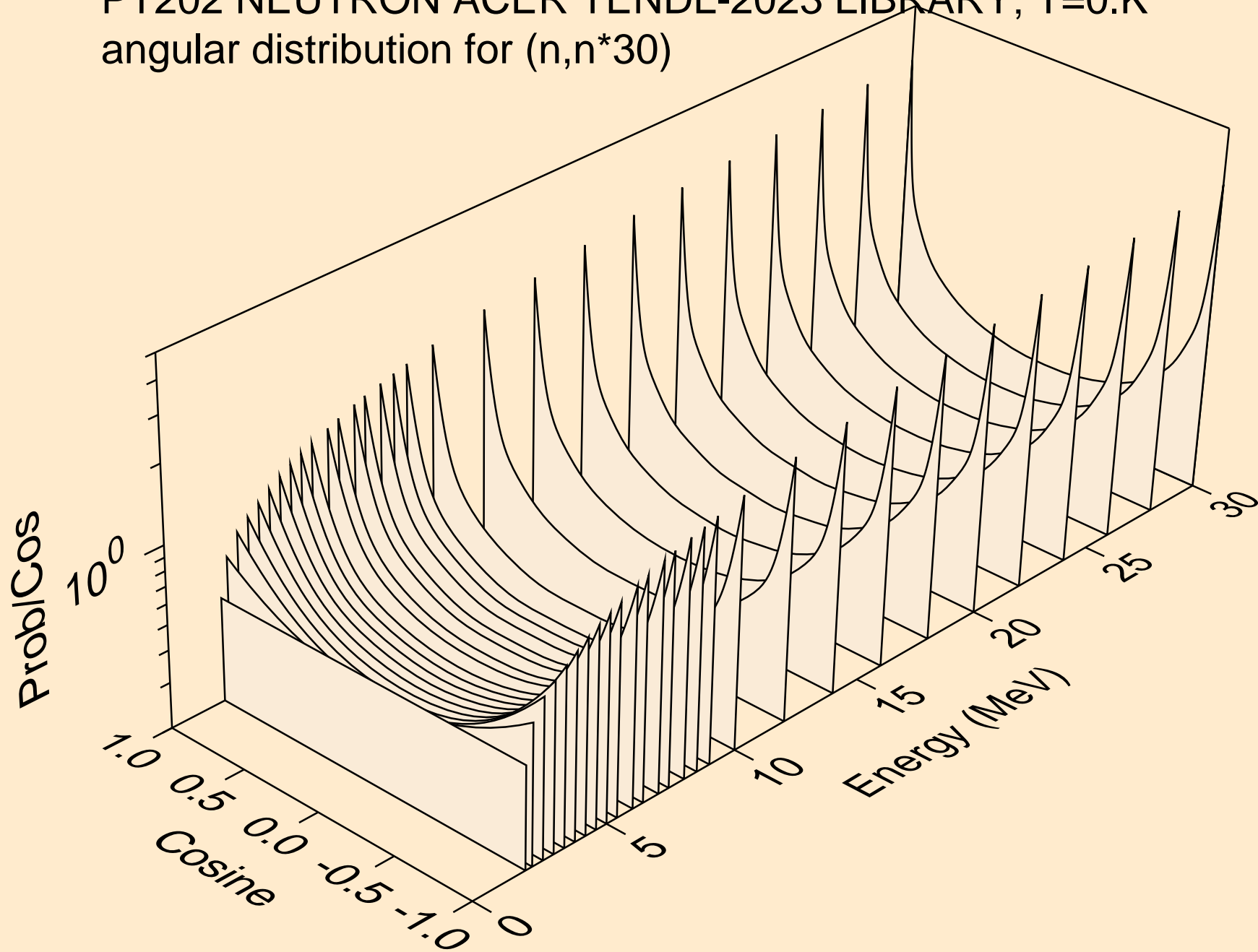

PT202 NEUTRON ACER TENDL-2023 LIBRARY; T=0.K  
Neutron emission for (n,x)

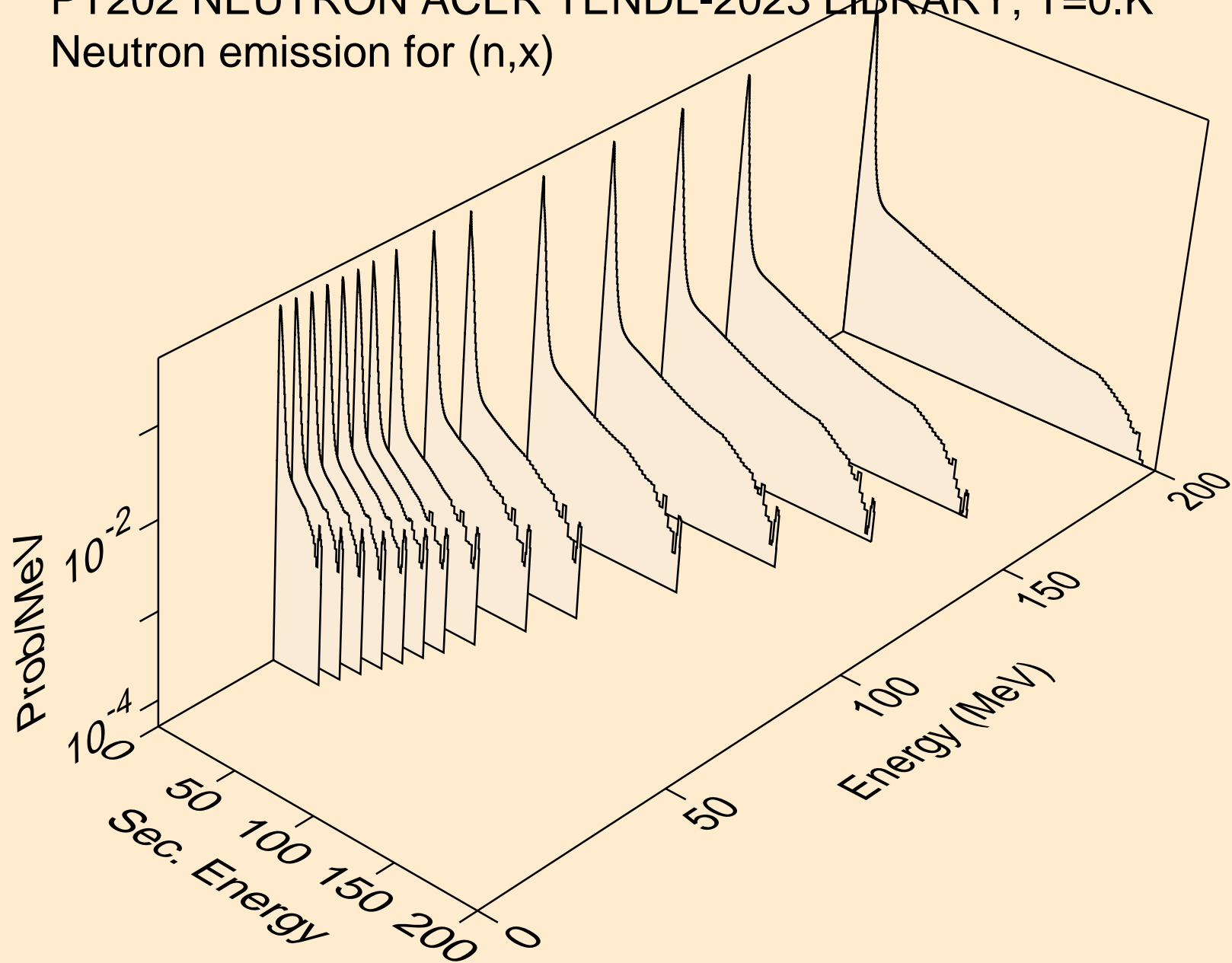

PT202 NEUTRON ACER TENDL-2023 LIBRARY; T=0.K  
Neutron emission for (n,2nd)

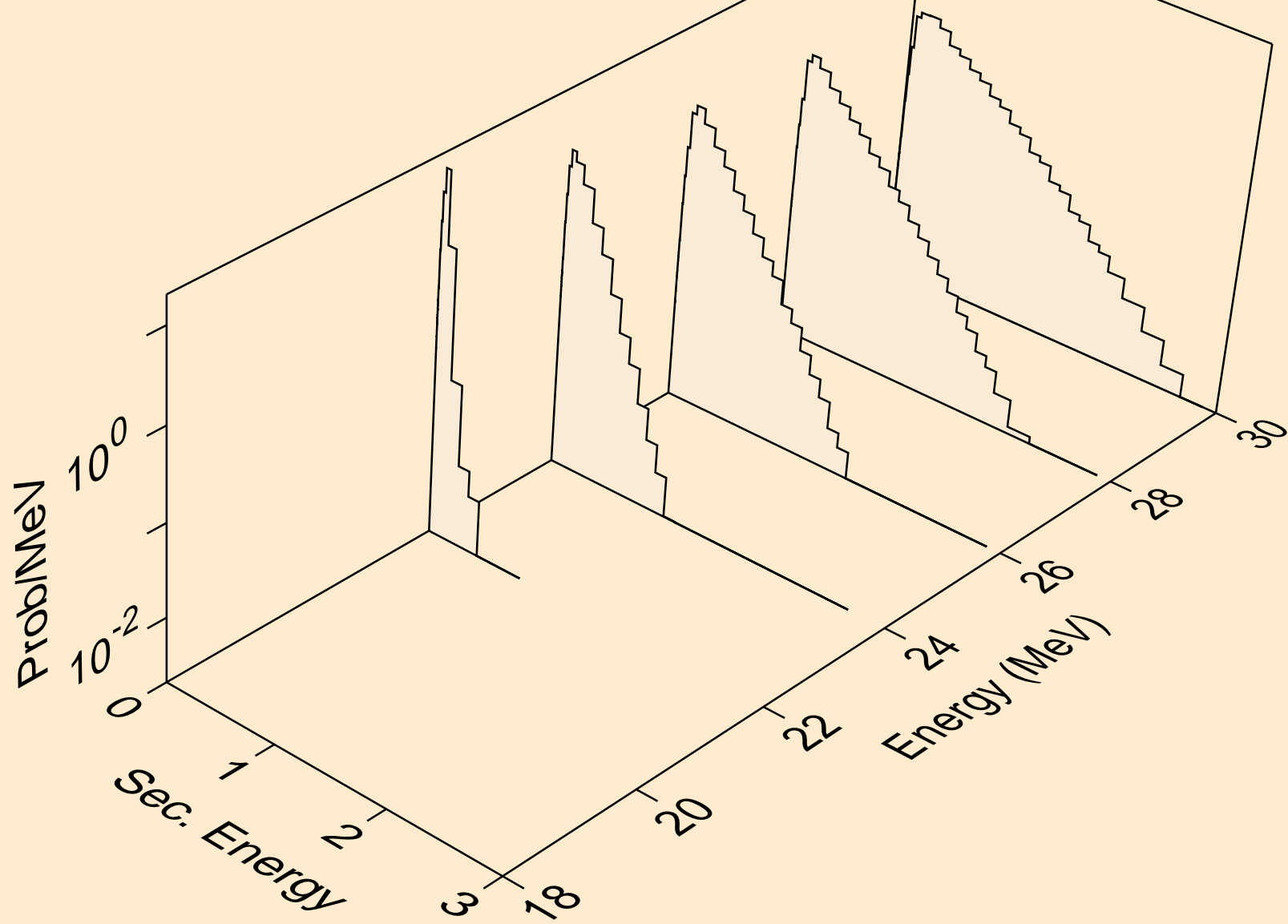

PT202 NEUTRON ACER TENDL-2023 LIBRARY; T=0.K  
Neutron emission for (n,2n)

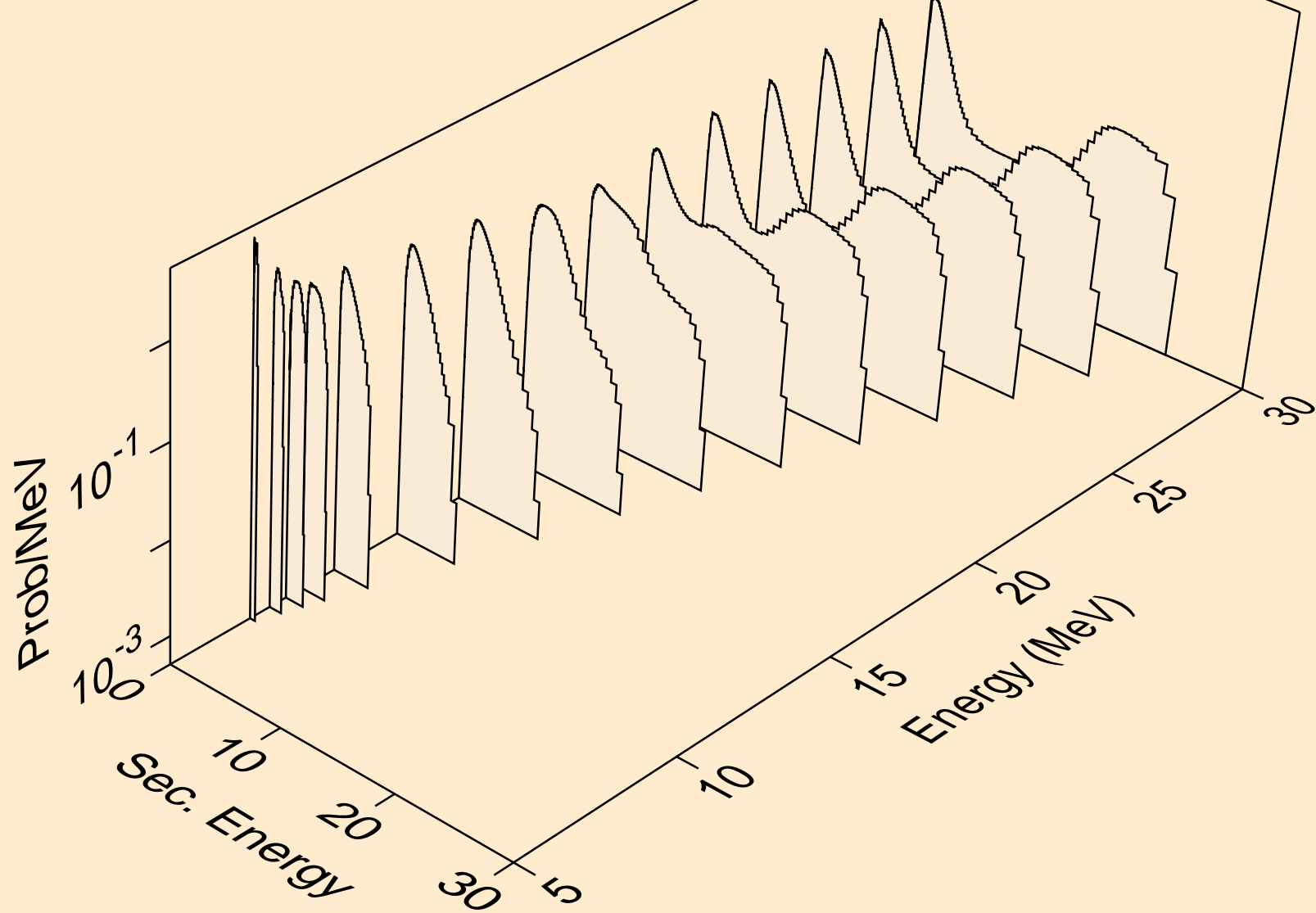

PT202 NEUTRON ACER TENDL-2023 LIBRARY; T=0.K  
Neutron emission for (n,3n)

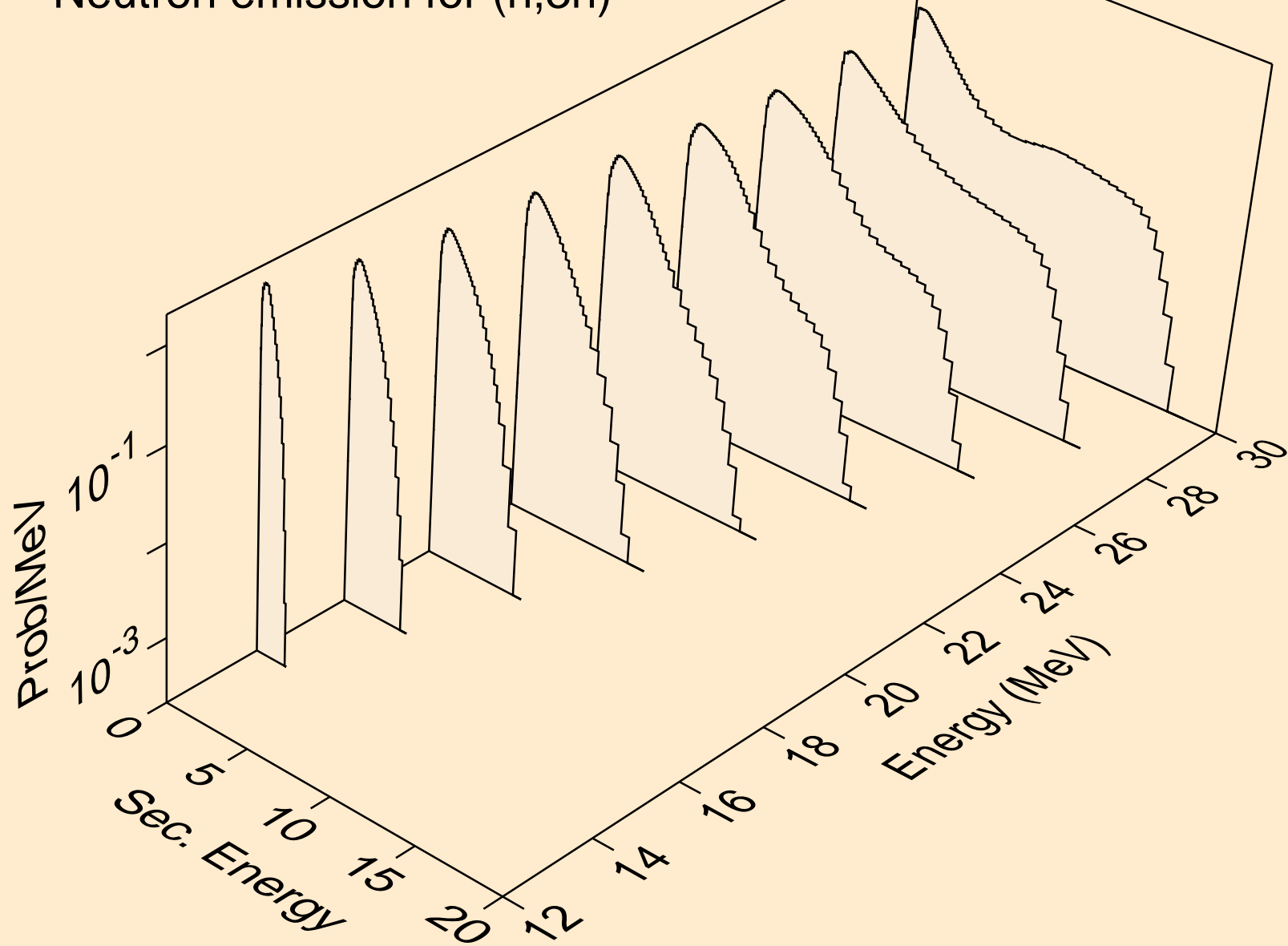

PT202 NEUTRON ACER TENDL-2023 LIBRARY; T=0.K  
Neutron emission for (n,n\*)a

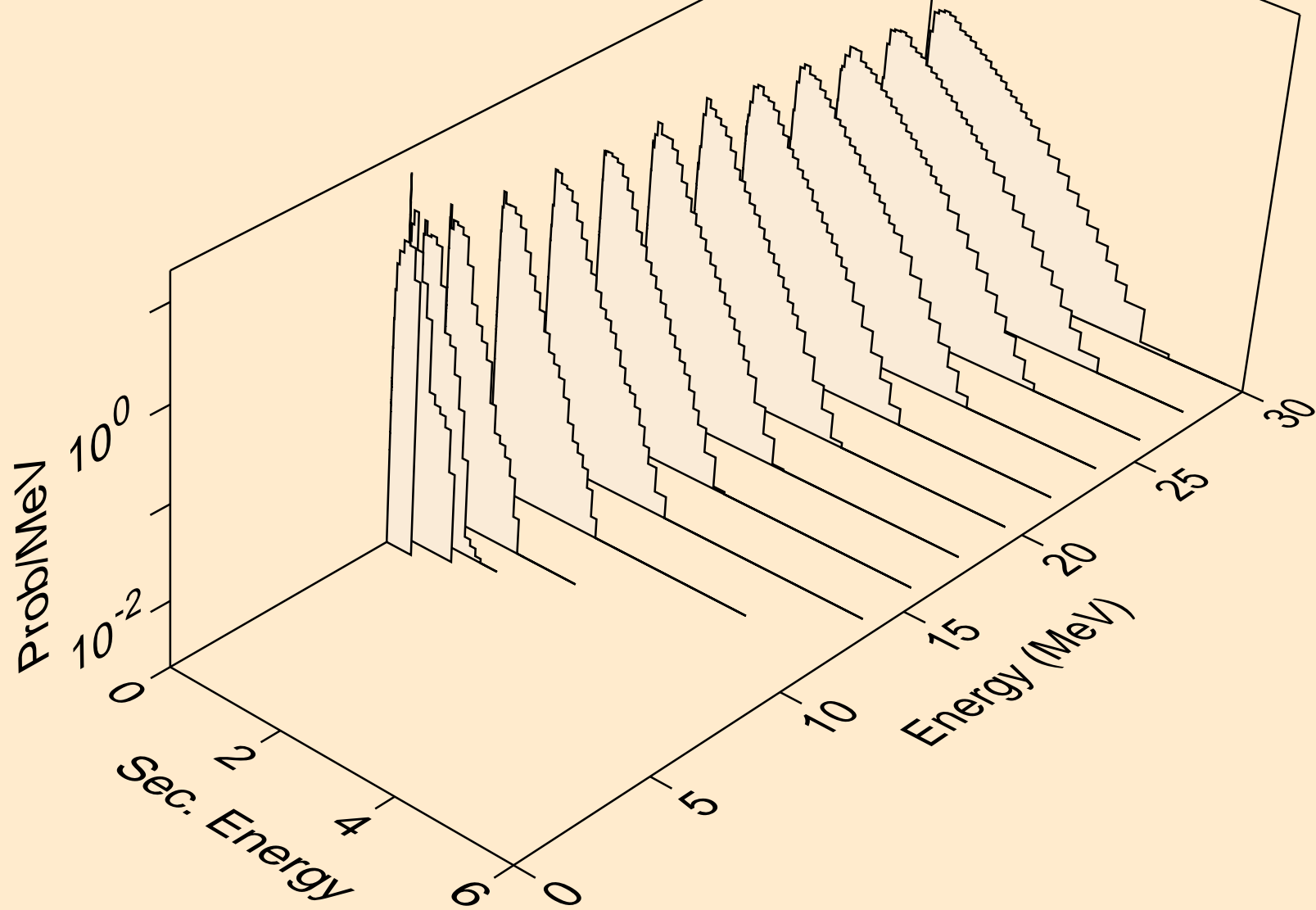



PT202 NEUTRON ACER TENDL-2023 LIBRARY; T=0.K  
Neutron emission for (n,2n)a

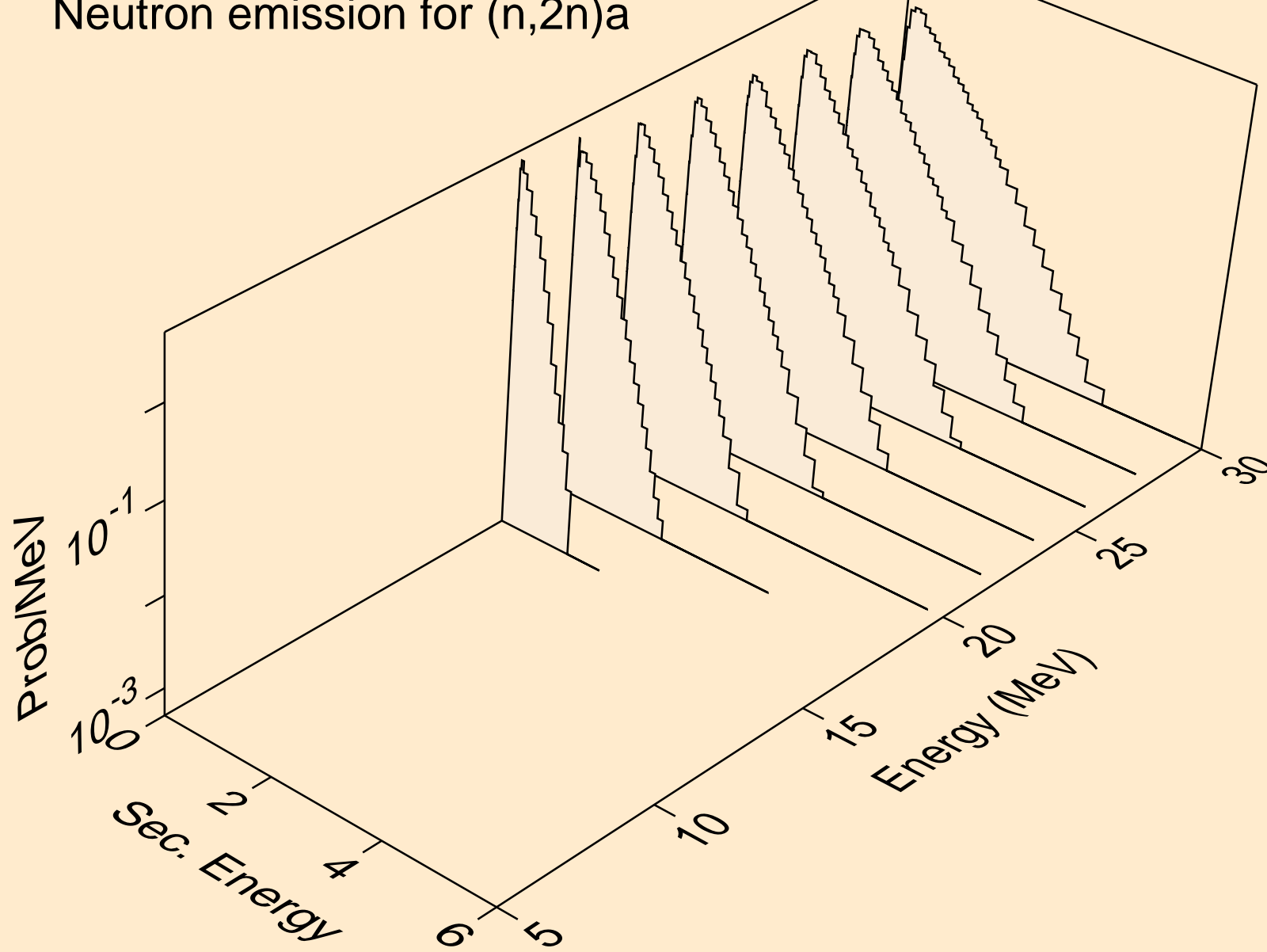

PT202 NEUTRON ACER TENDL-2023 LIBRARY; T=0.K  
Neutron emission for (n,3n)a

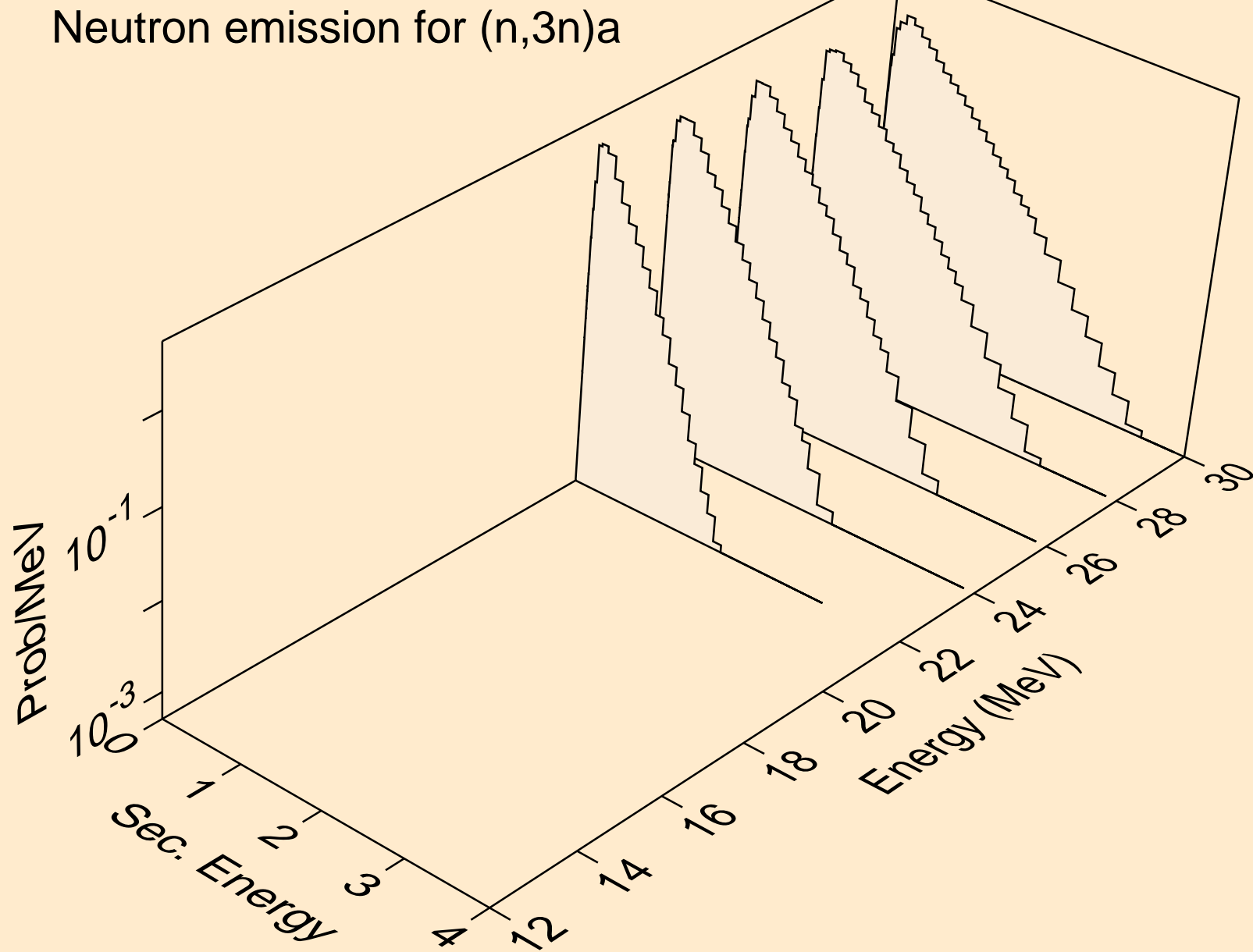

PT202 NEUTRON ACER TENDL-2023 LIBRARY; T=0.K  
Neutron emission for (n,n\*)p

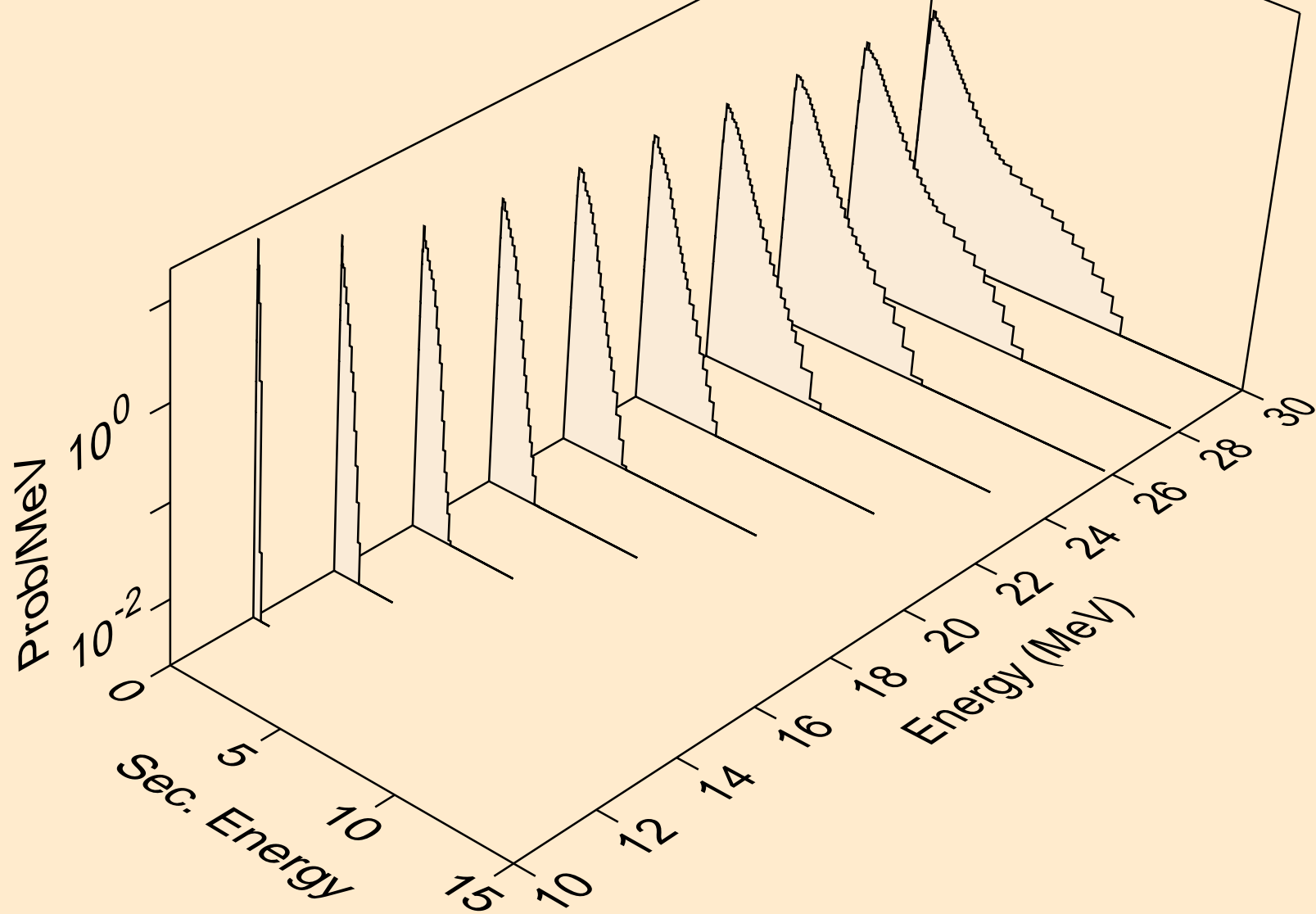

PT202 NEUTRON ACER TENDL-2023 LIBRARY; T=0.K  
Neutron emission for (n,n\*)d

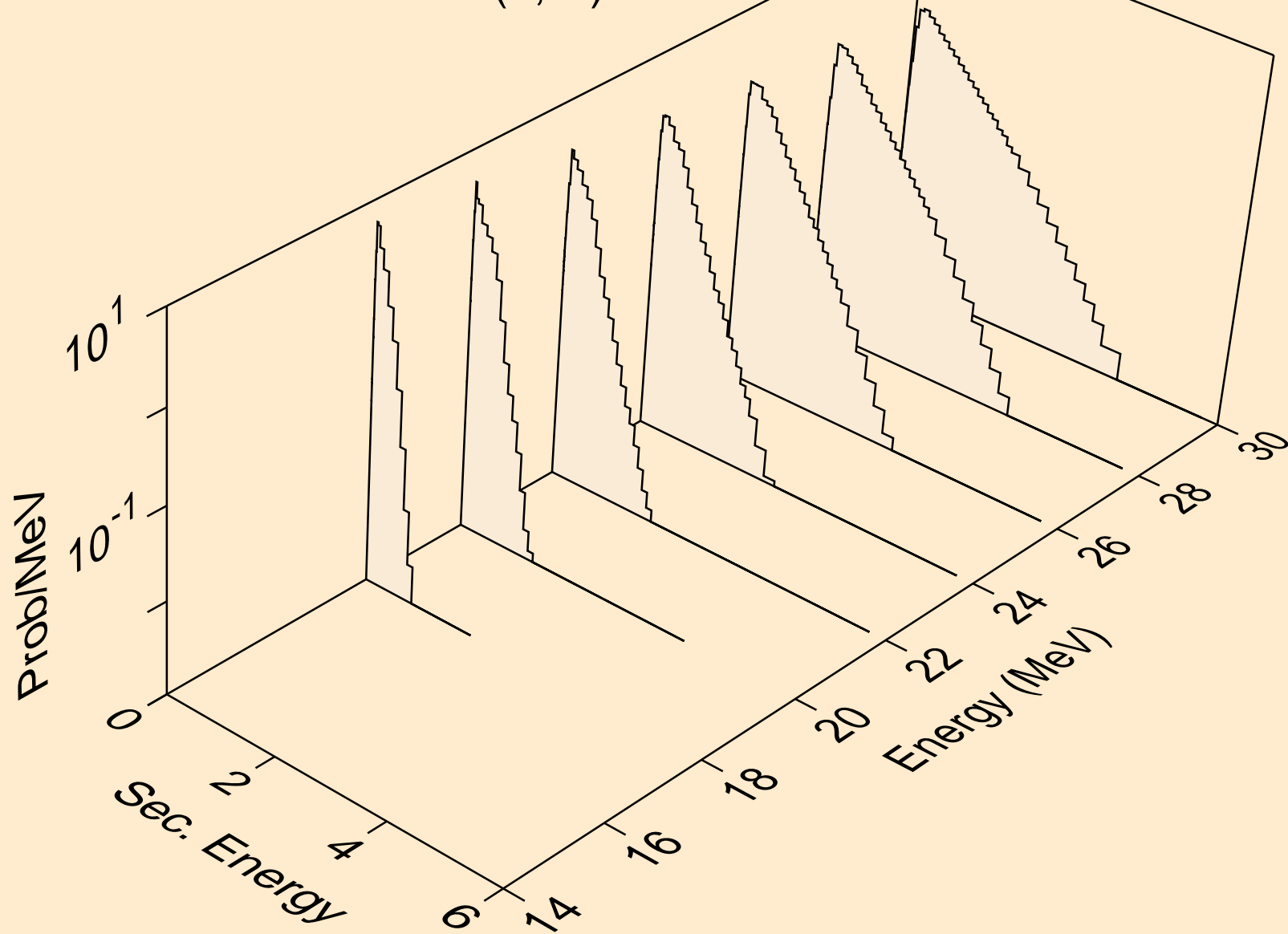

PT202 NEUTRON ACER TENDL-2023 LIBRARY; T=0.K  
Neutron emission for (n,n\*)t

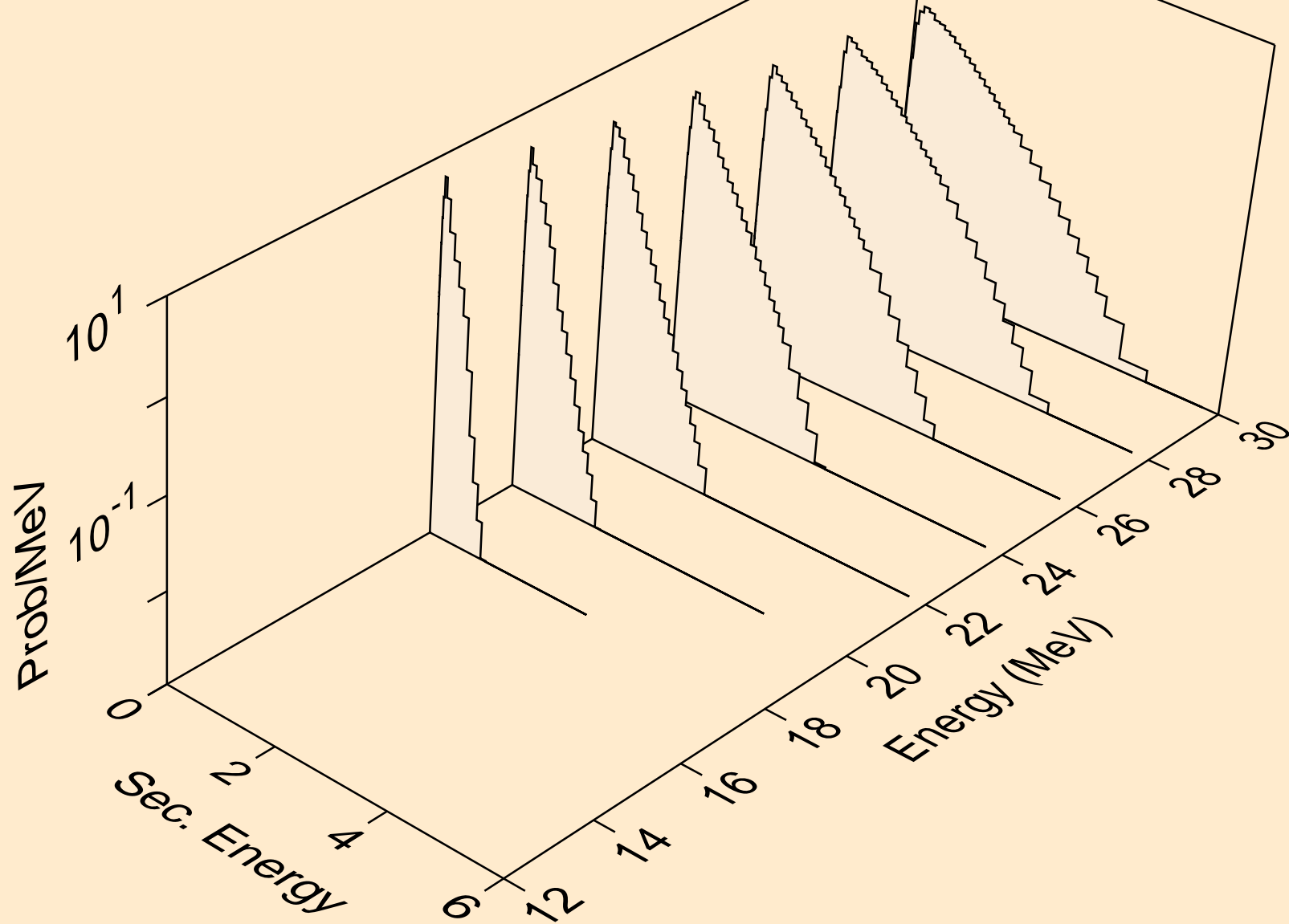

PT202 NEUTRON ACER TENDL-2023 LIBRARY; T=0.K  
Neutron emission for (n,4n)

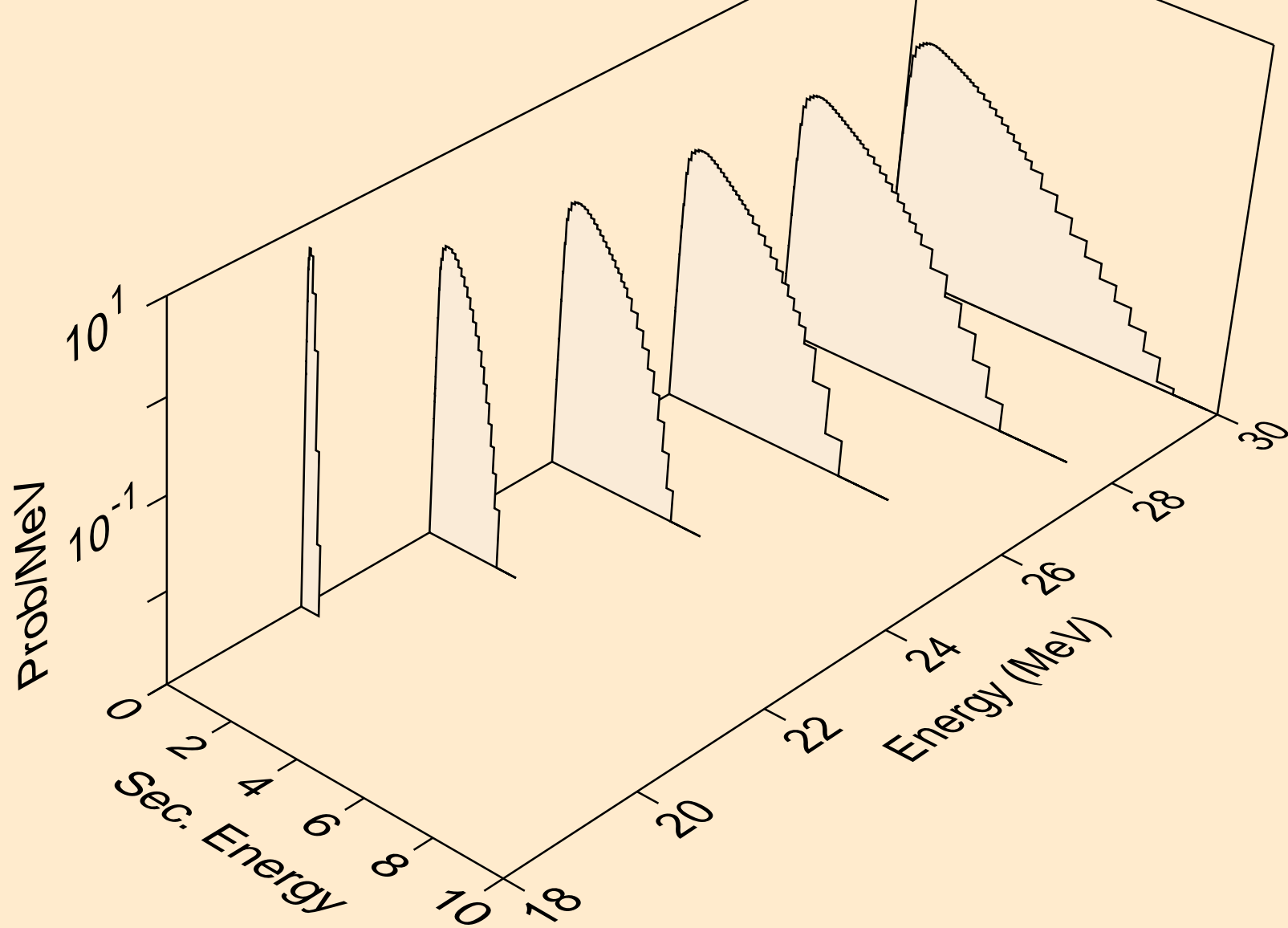

PT202 NEUTRON ACER TENDL-2023 LIBRARY; T=0.K  
Neutron emission for (n,2np)

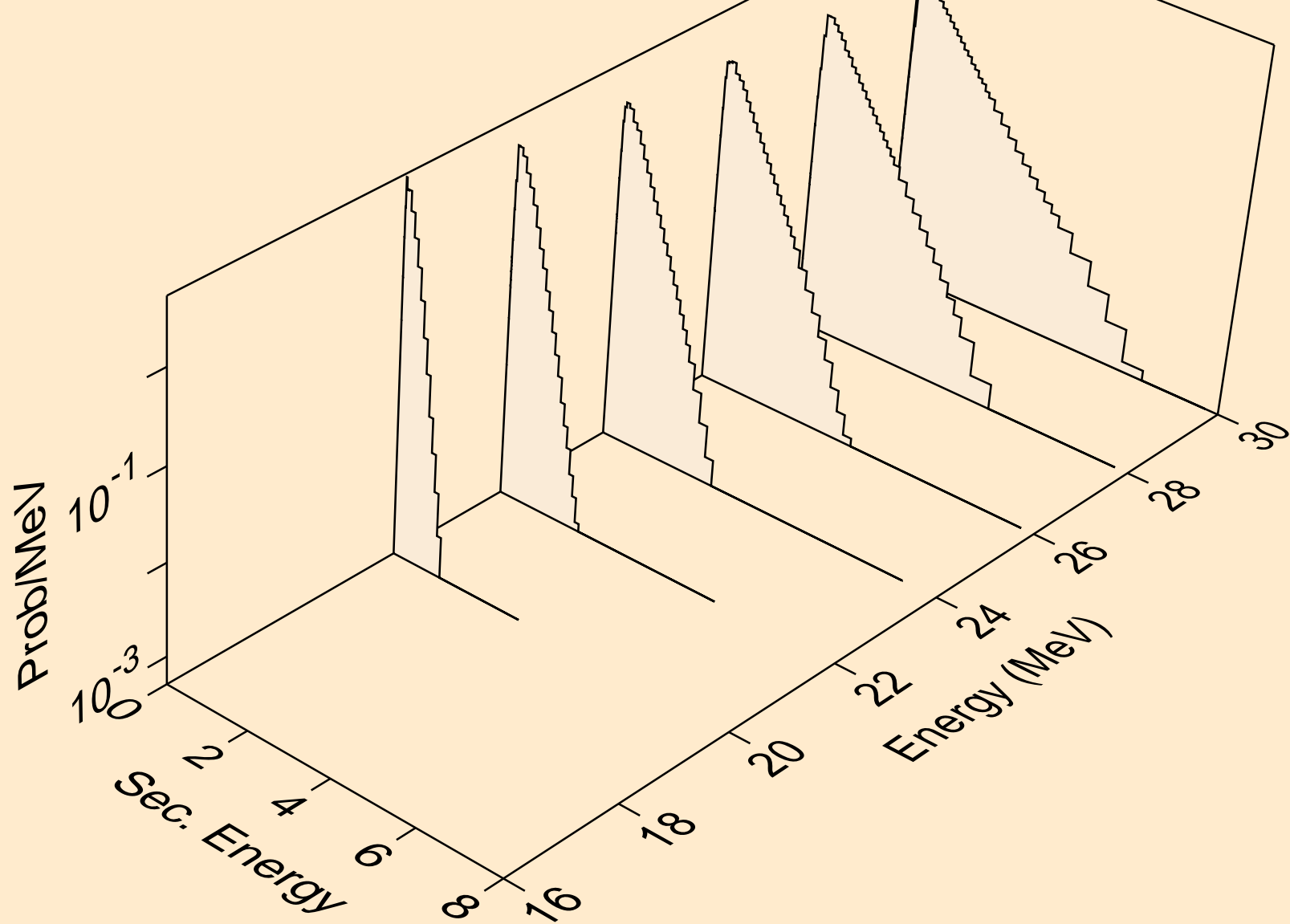

PT202 NEUTRON ACER TENDL-2023 LIBRARY; T=0.K  
Neutron emission for (n,3np)

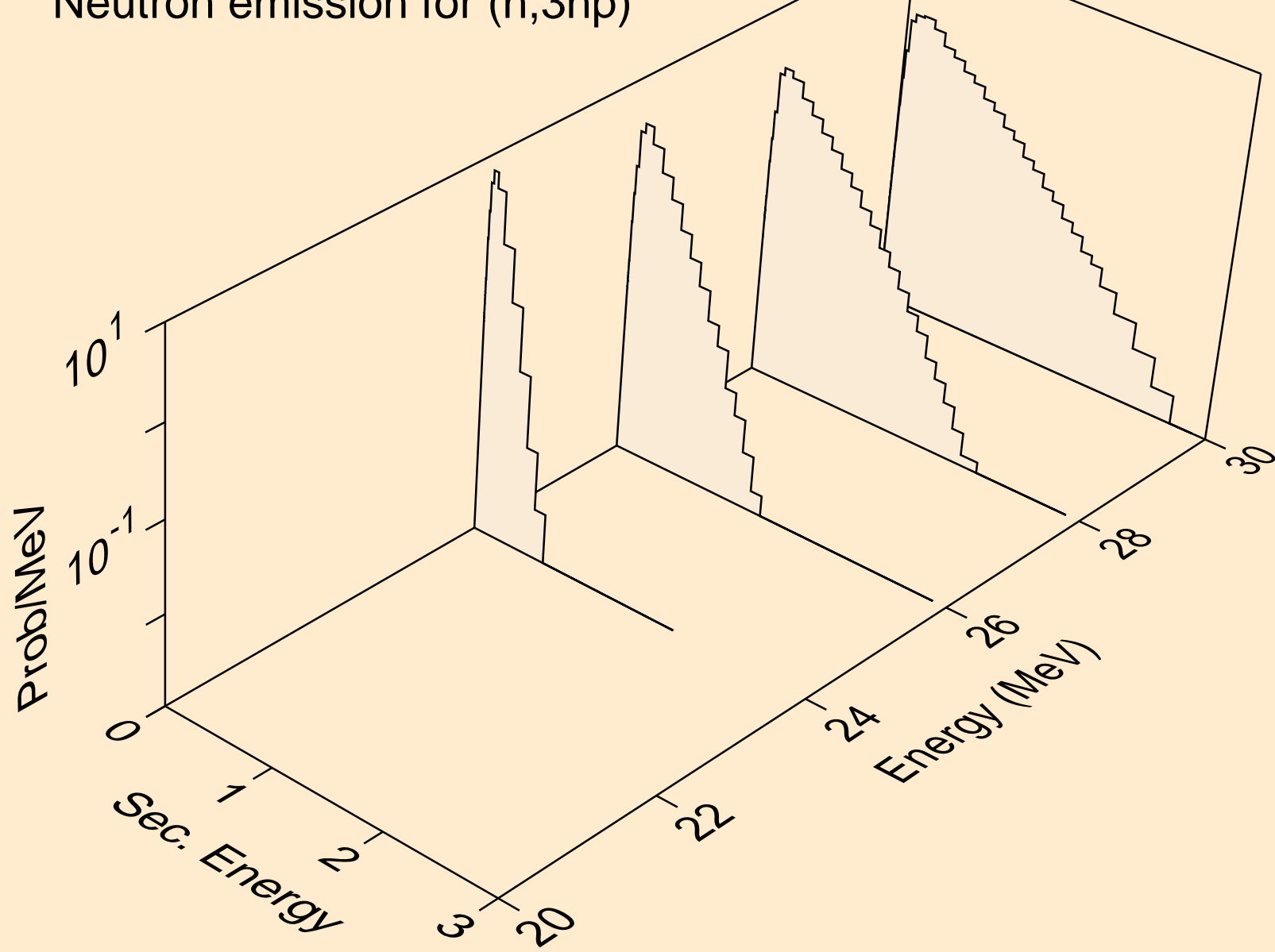



PT202 NEUTRON ACER TENDL-2023 LIBRARY; T=0.K  
Neutron emission for (n,n\*c)

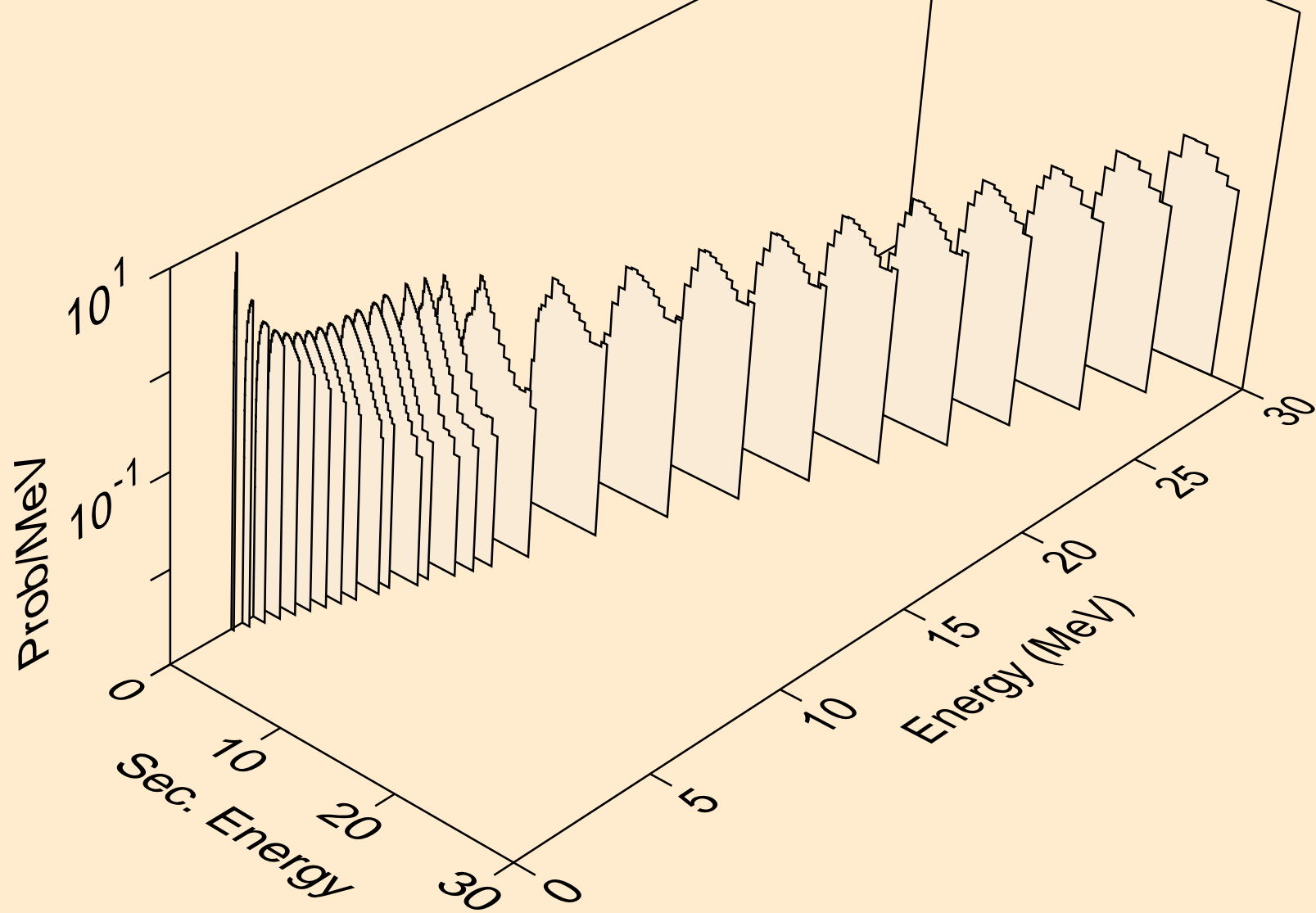

PT202 NEUTRON ACER TENDL-2023 LIBRARY; T=0.K  
Photon emission for (n,x)

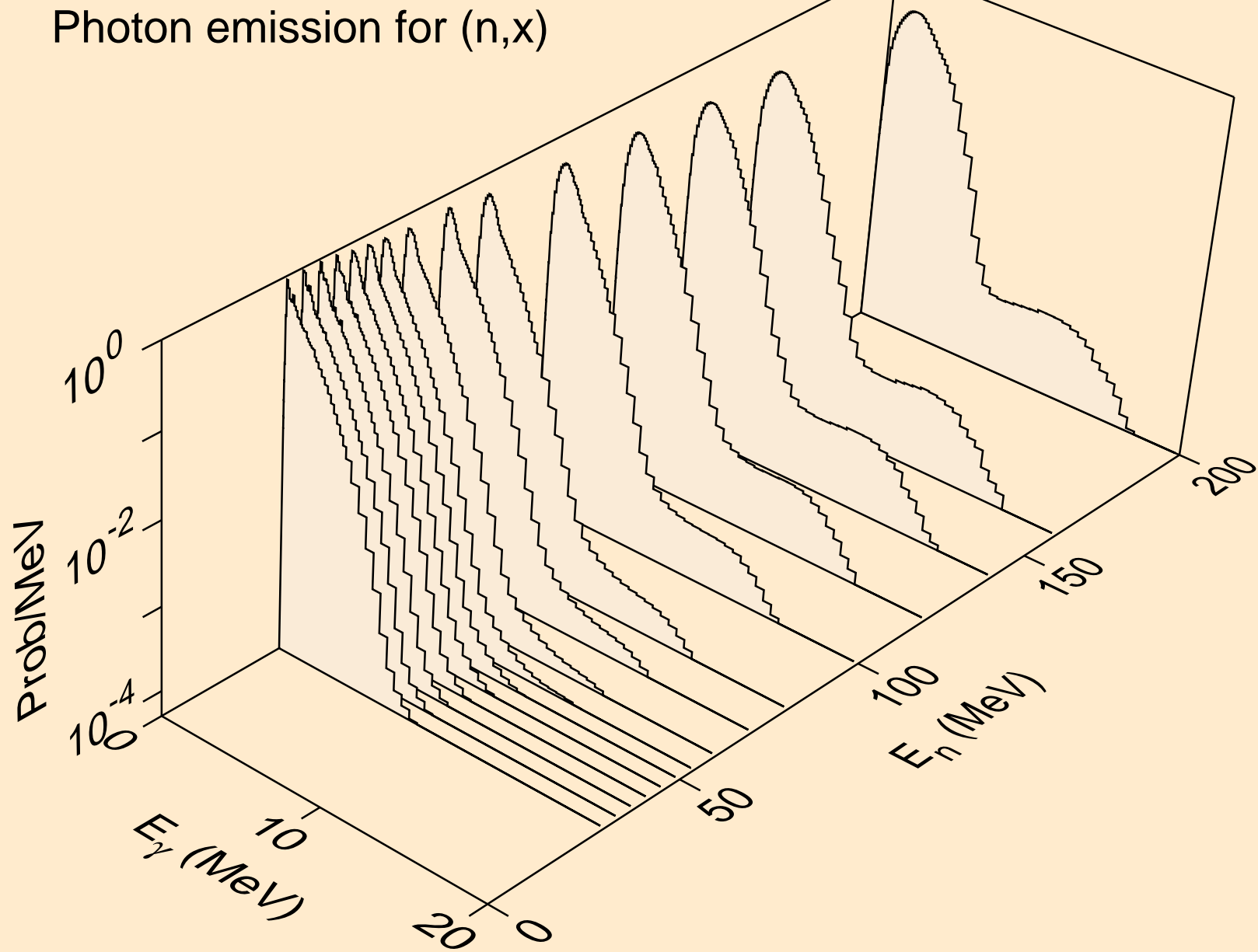

PT202 NEUTRON ACER TENDL-2023 LIBRARY; T=0.K  
Photon emission for (n,2nd)

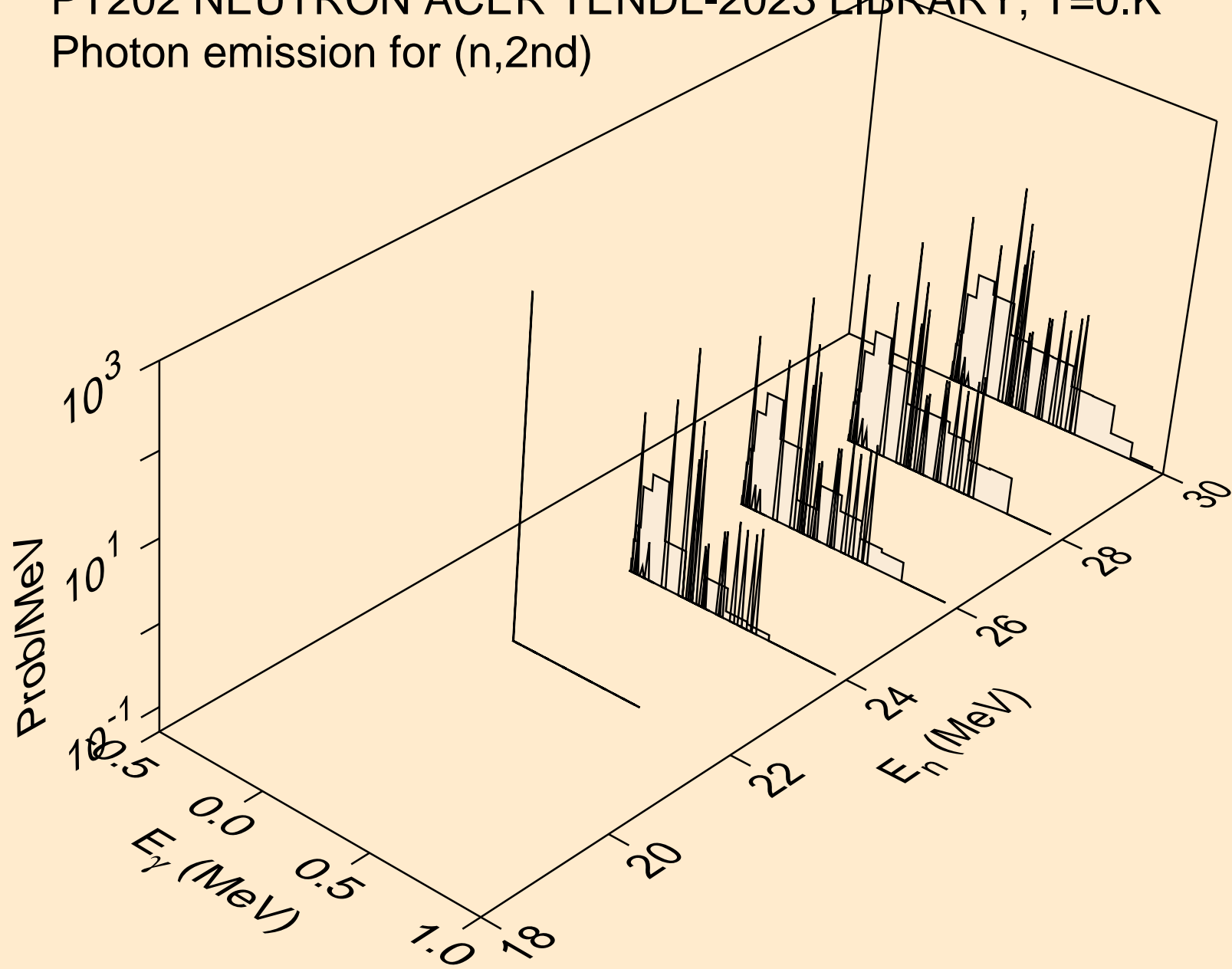

PT202 NEUTRON ACER TENDL-2023 LIBRARY; T=0.K  
Photon emission for (n,2n)

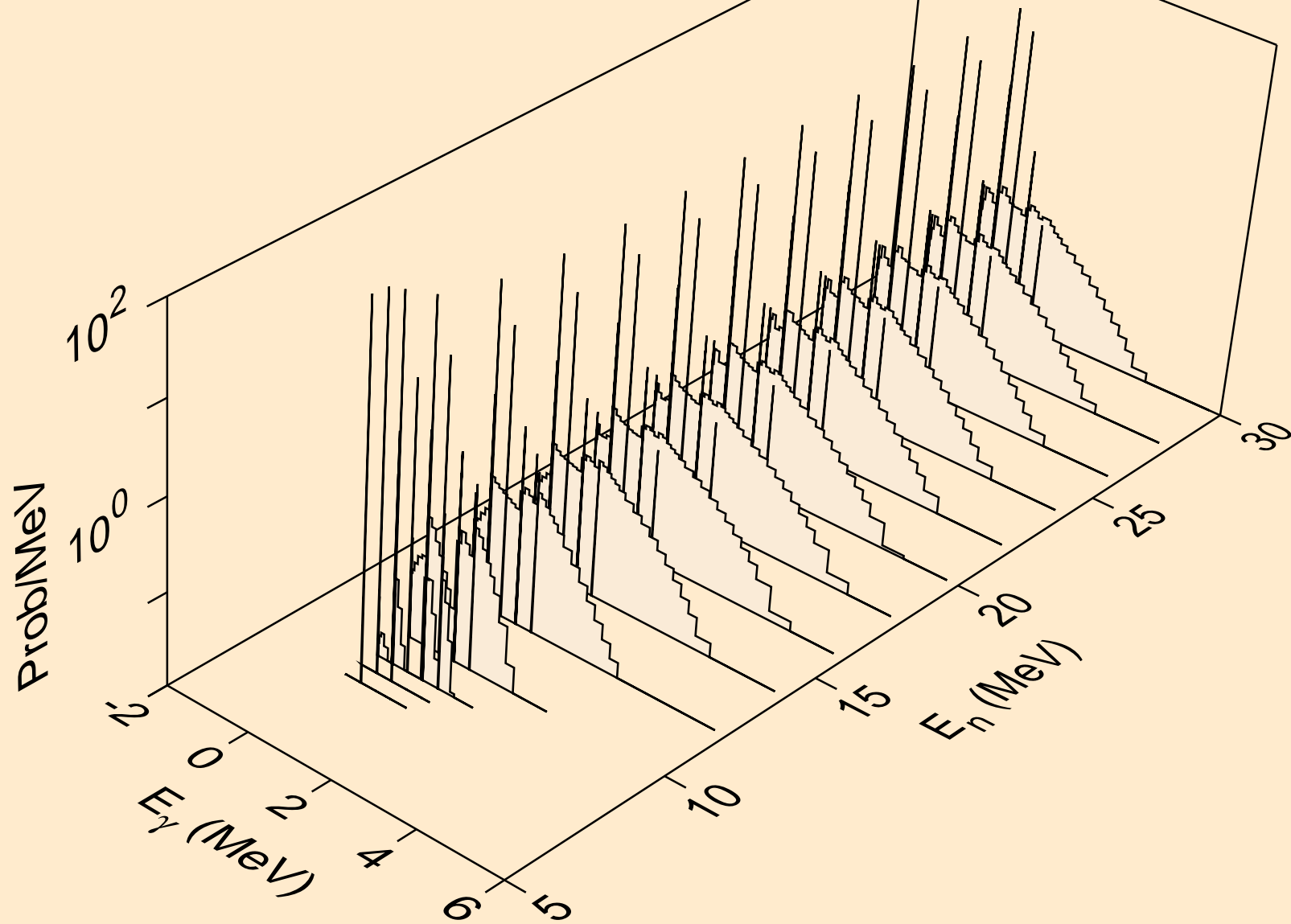

PT202 NEUTRON ACER TENDL-2023 LIBRARY; T=0.K  
Photon emission for (n,3n)

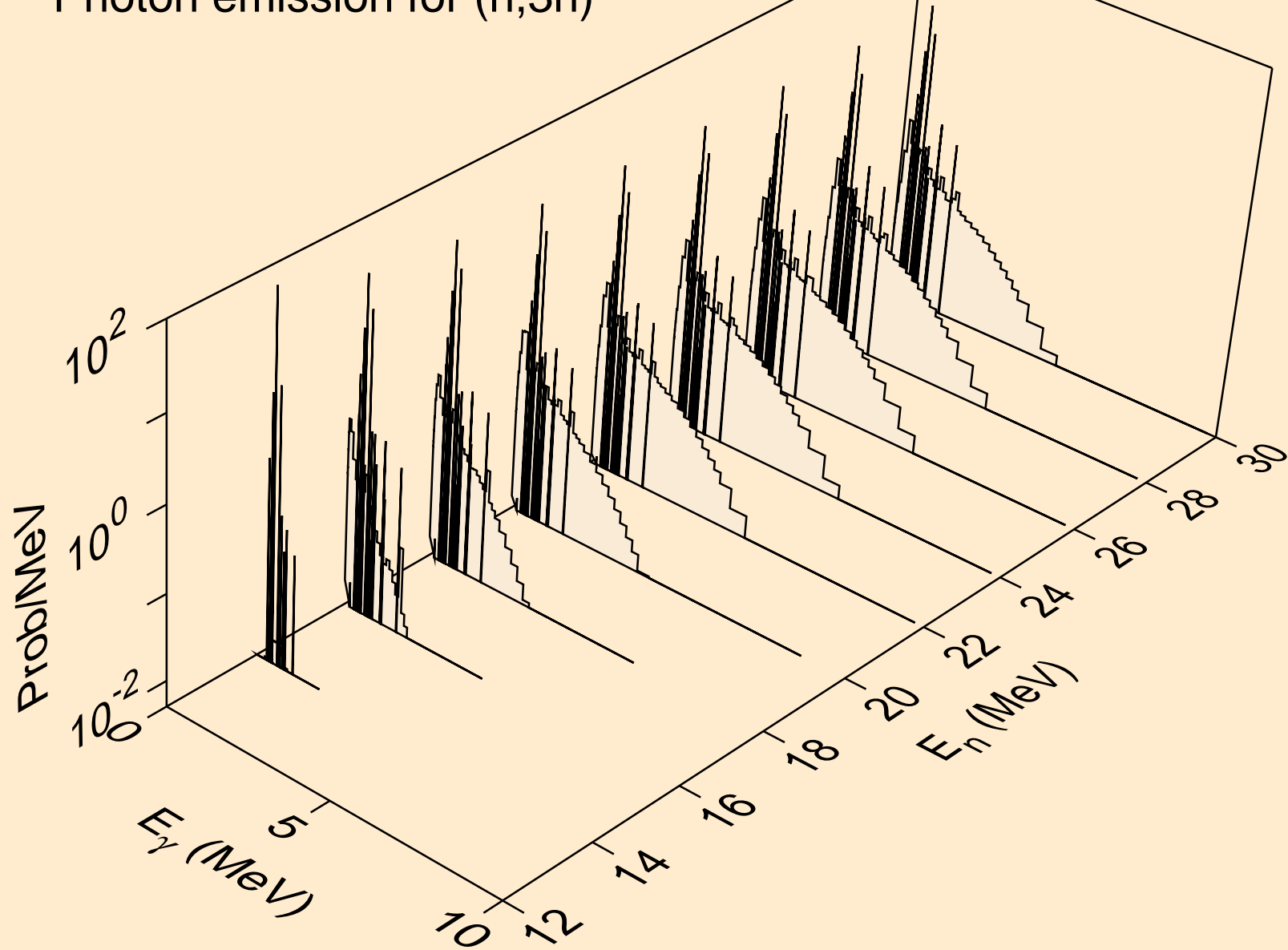

PT202 NEUTRON ACER TENDL-2023 LIBRARY; T=0.K  
Photon emission for (n,n\*)a

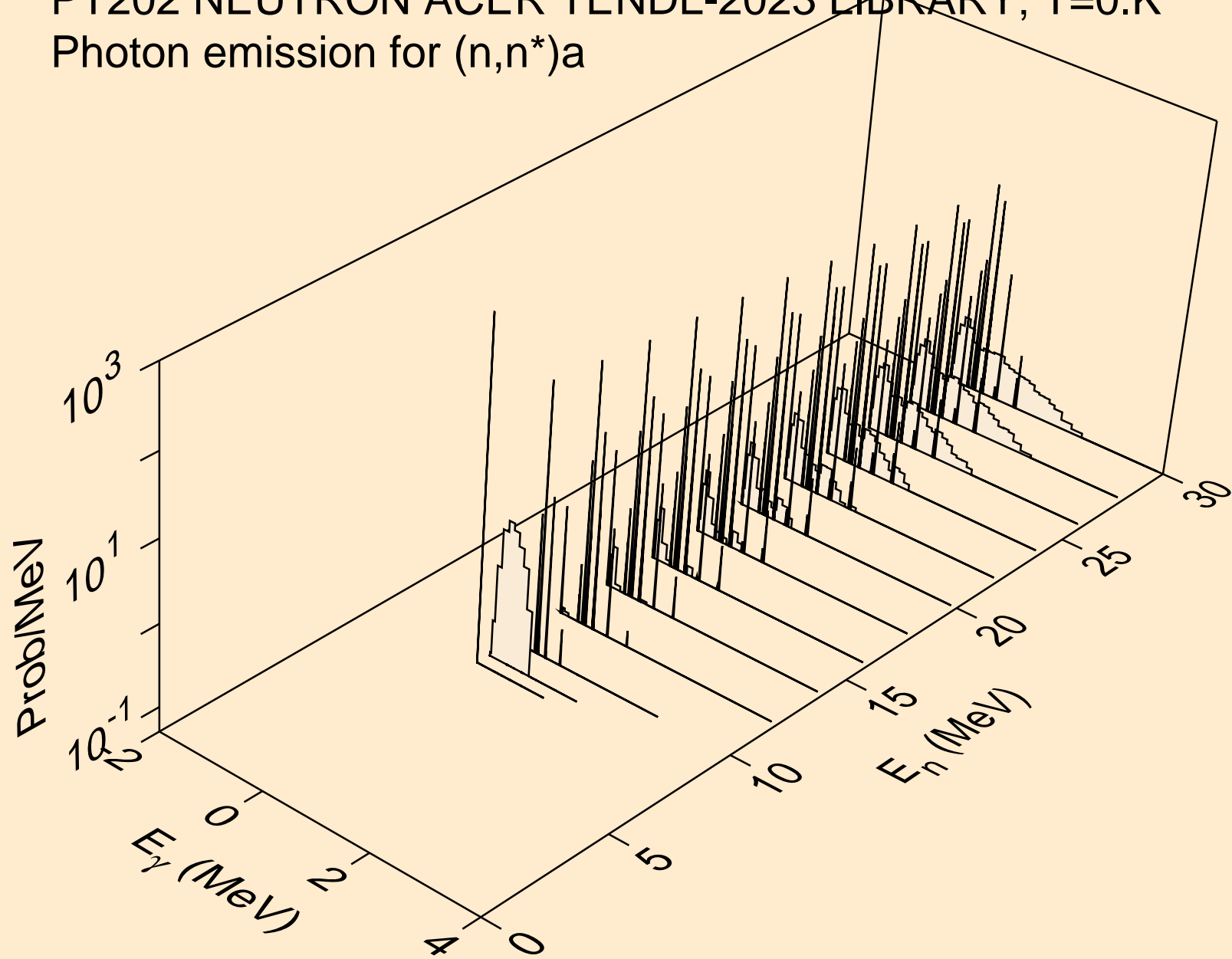

PT202 NEUTRON ACER TENDL-2023 LIBRARY; T=0.K  
Photon emission for (n,2n)a

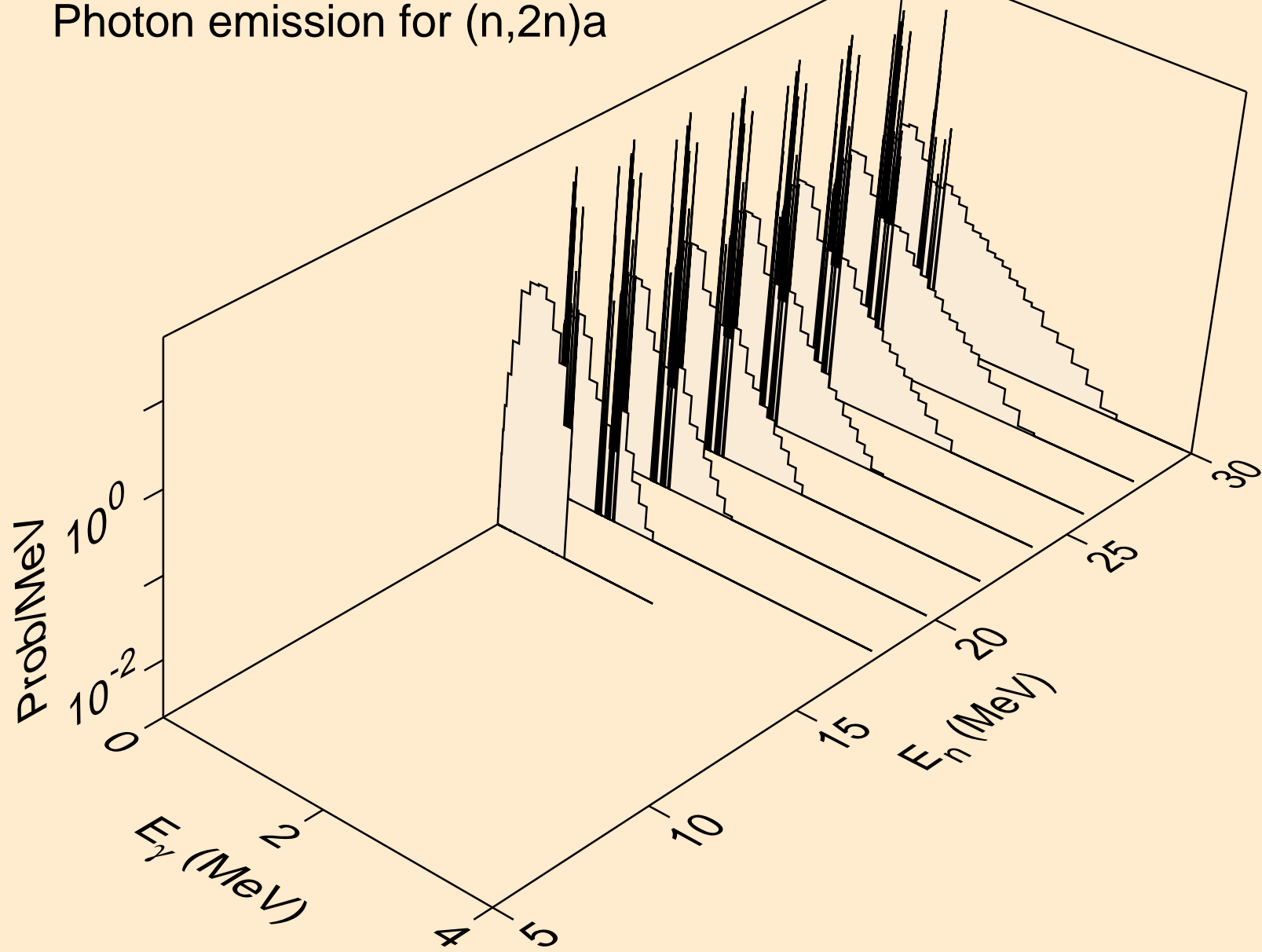

PT202 NEUTRON ACER TENDL-2023 LIBRARY; T=0.K  
Photon emission for (n,3n)a

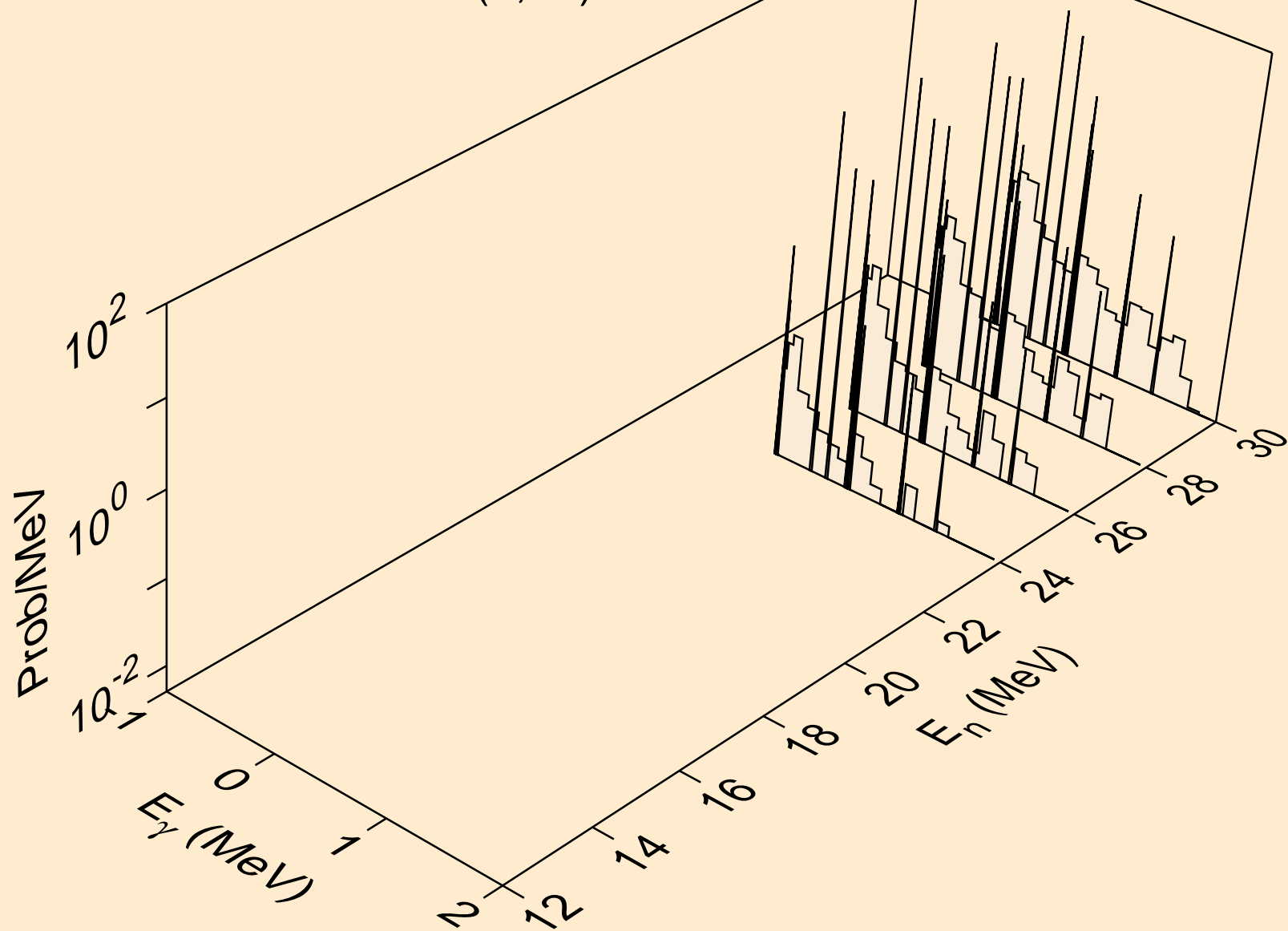



PT202 NEUTRON ACER TENDL-2023 LIBRARY; T=0.K  
Photon emission for (n,n\*)p

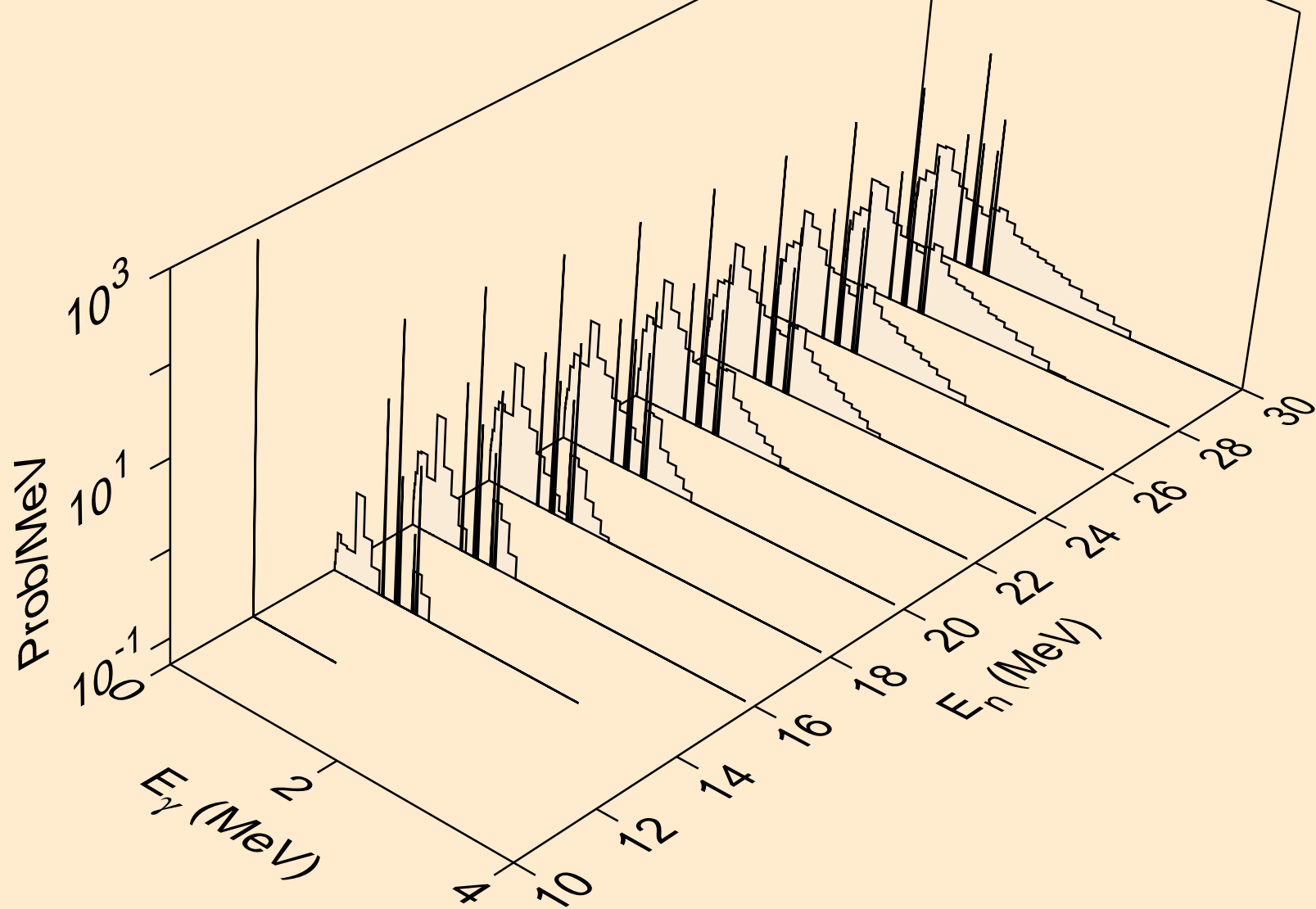

PT202 NEUTRON ACER TENDL-2023 LIBRARY; T=0.K  
Photon emission for (n,n\*)d

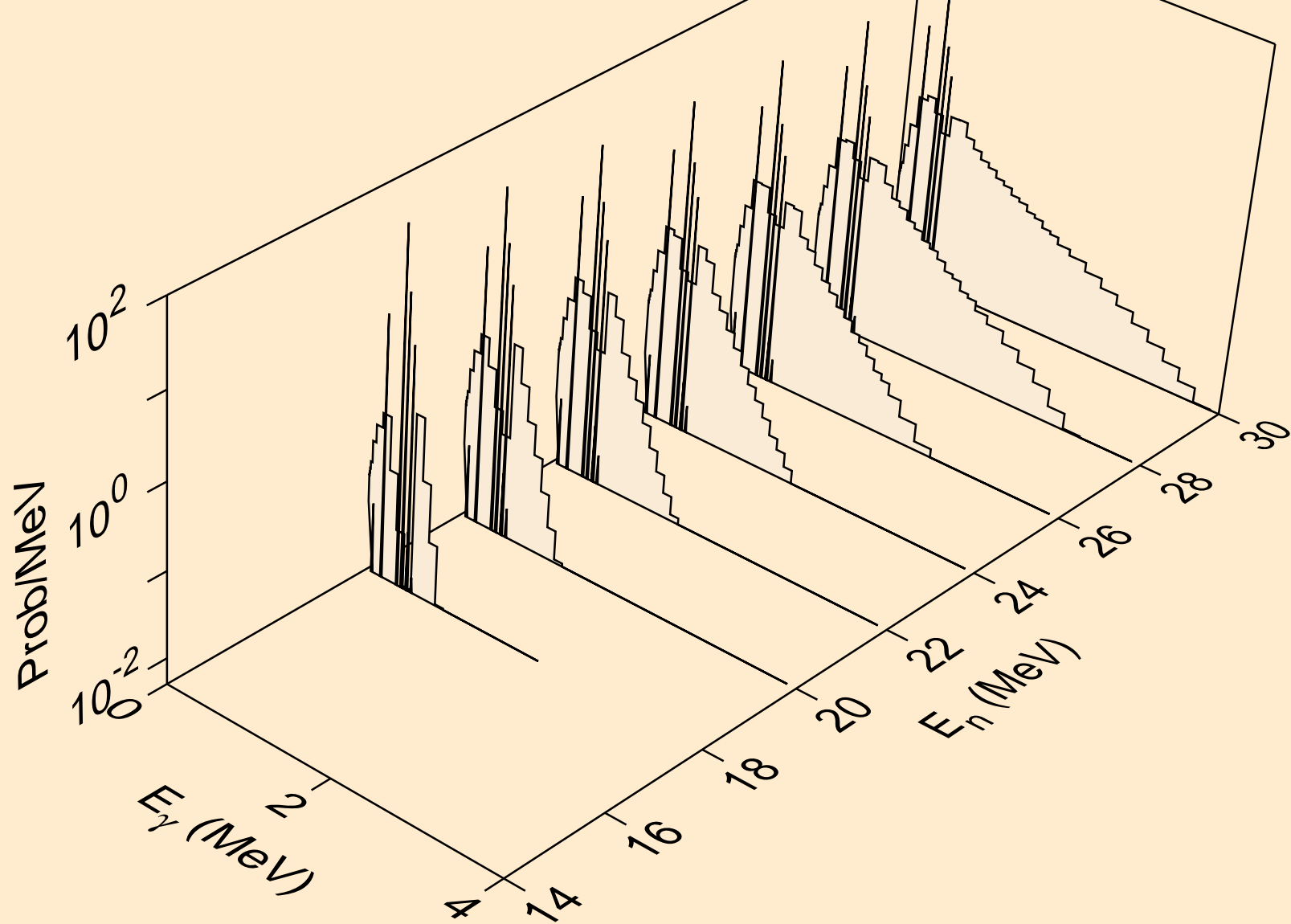

PT202 NEUTRON ACER TENDL-2023 LIBRARY; T=0.K  
Photon emission for (n,n\*)t

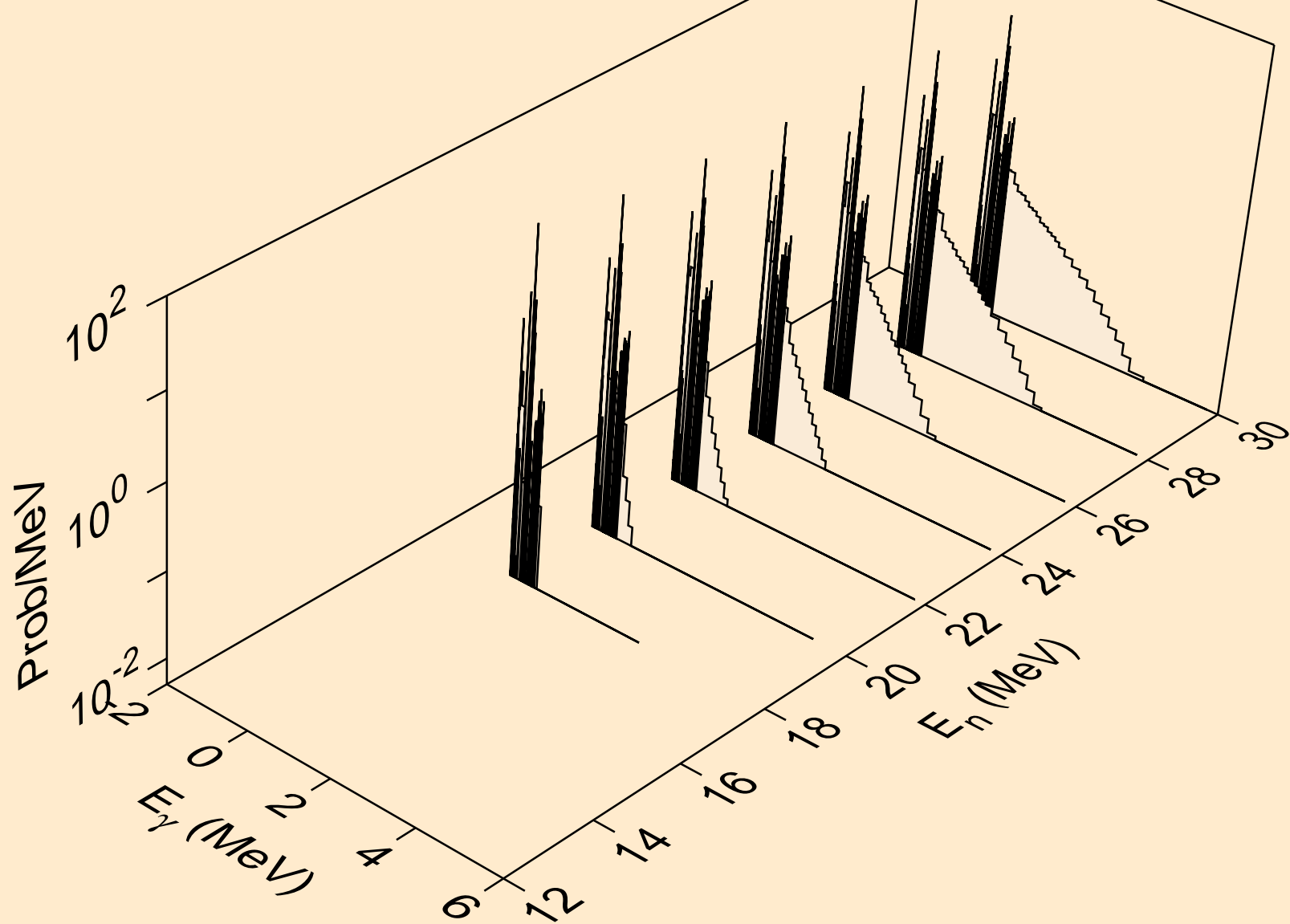

PT202 NEUTRON ACER TENDL-2023 LIBRARY; T=0.K  
Photon emission for (n,4n)

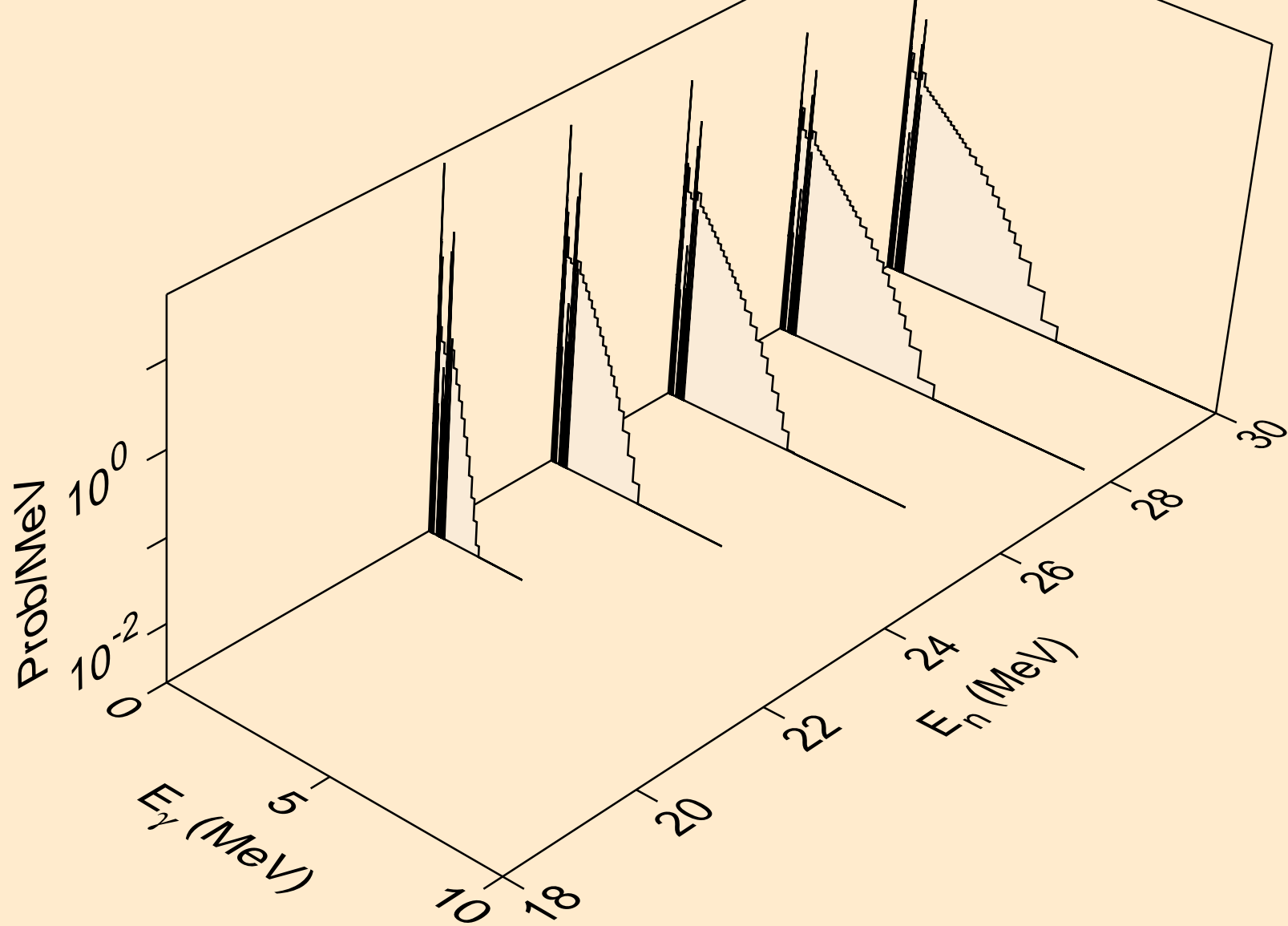

PT202 NEUTRON ACER TENDL-2023 LIBRARY; T=0.K  
Photon emission for (n,2np)

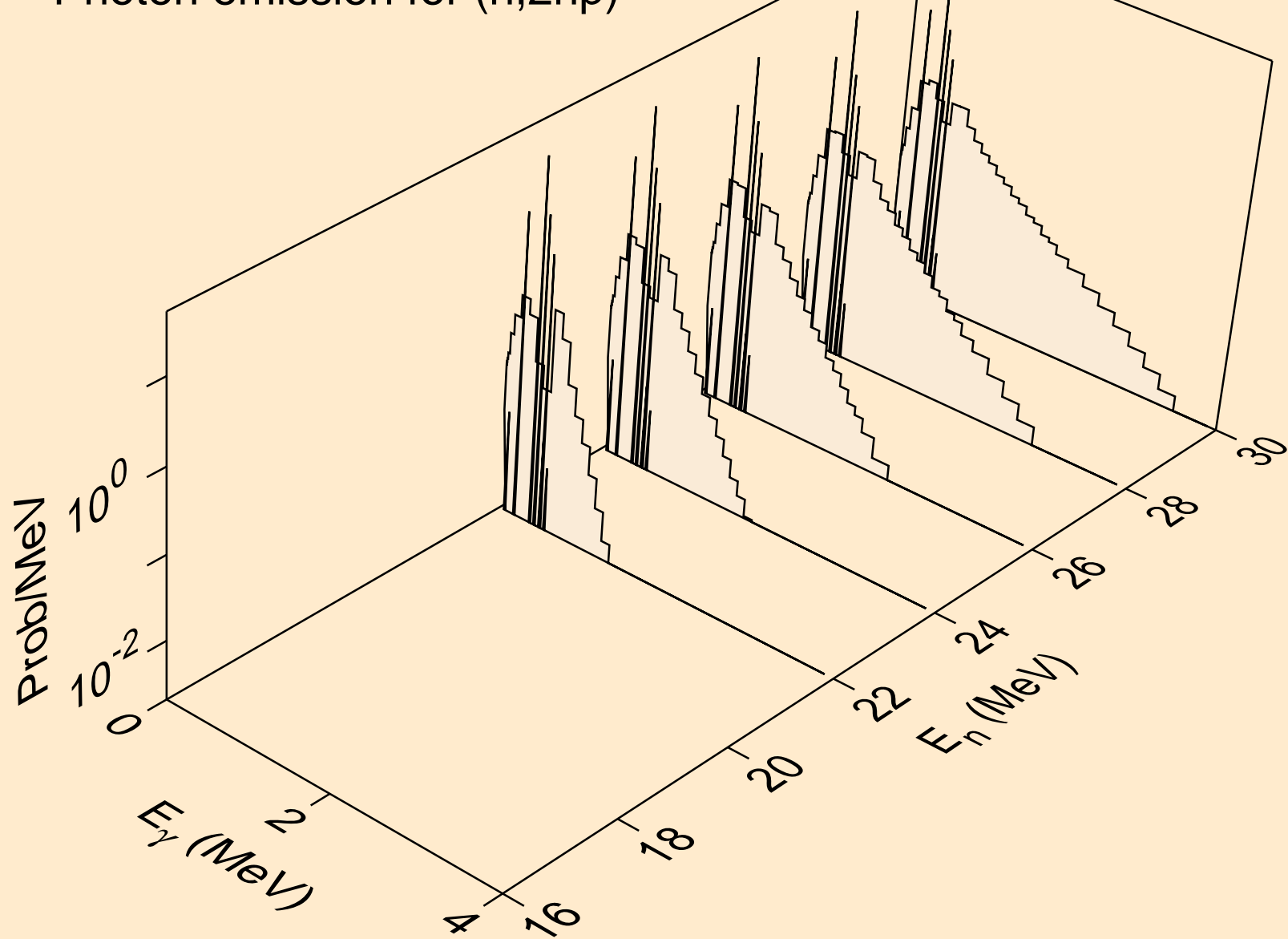

PT202 NEUTRON ACER TENDL-2023 LIBRARY; T=0.K  
Photon emission for (n,3np)

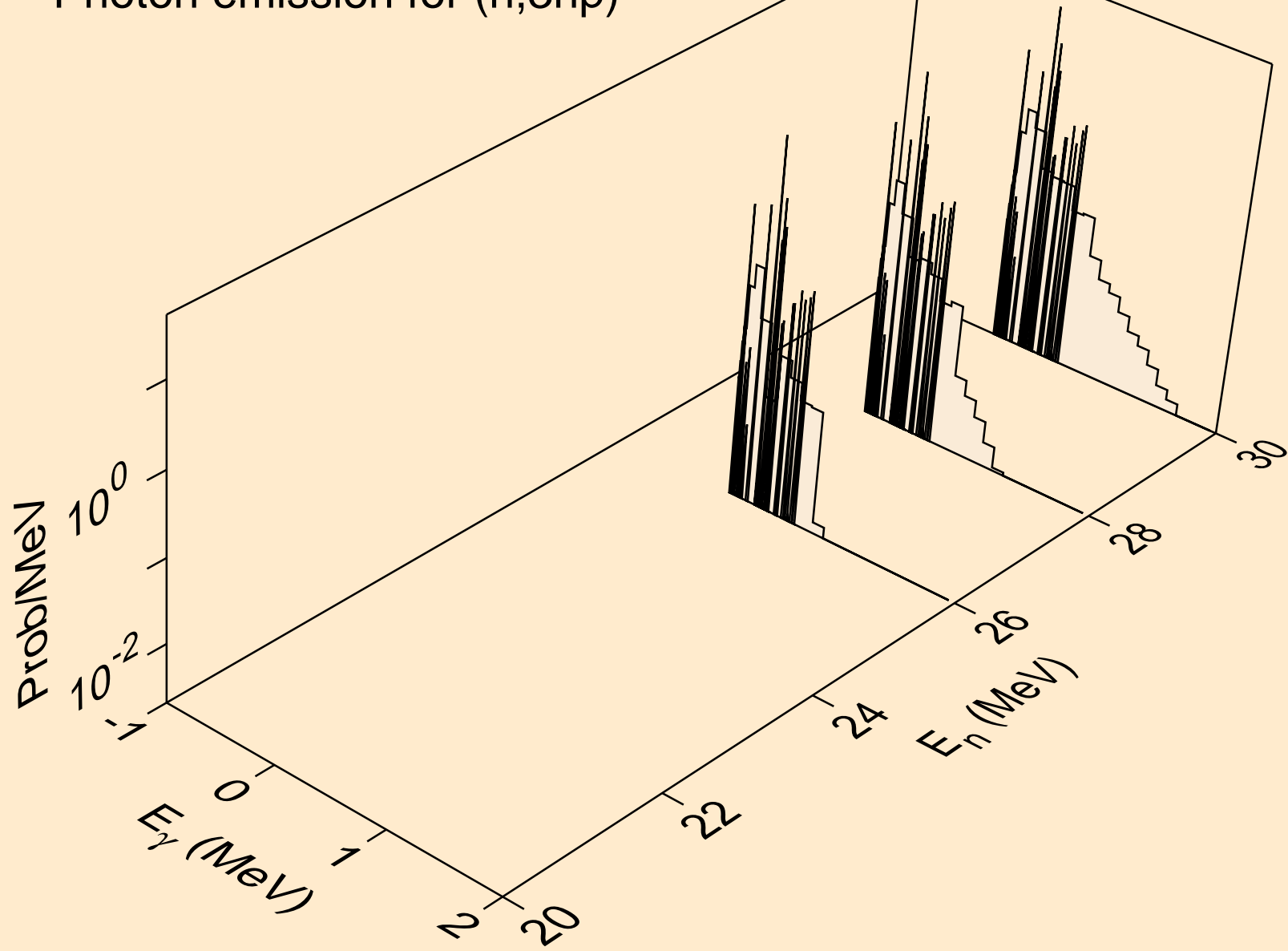

PT202 NEUTRON ACER TENDL-2023 LIBRARY; T=0.K  
Photon emission for (n,n\*c)

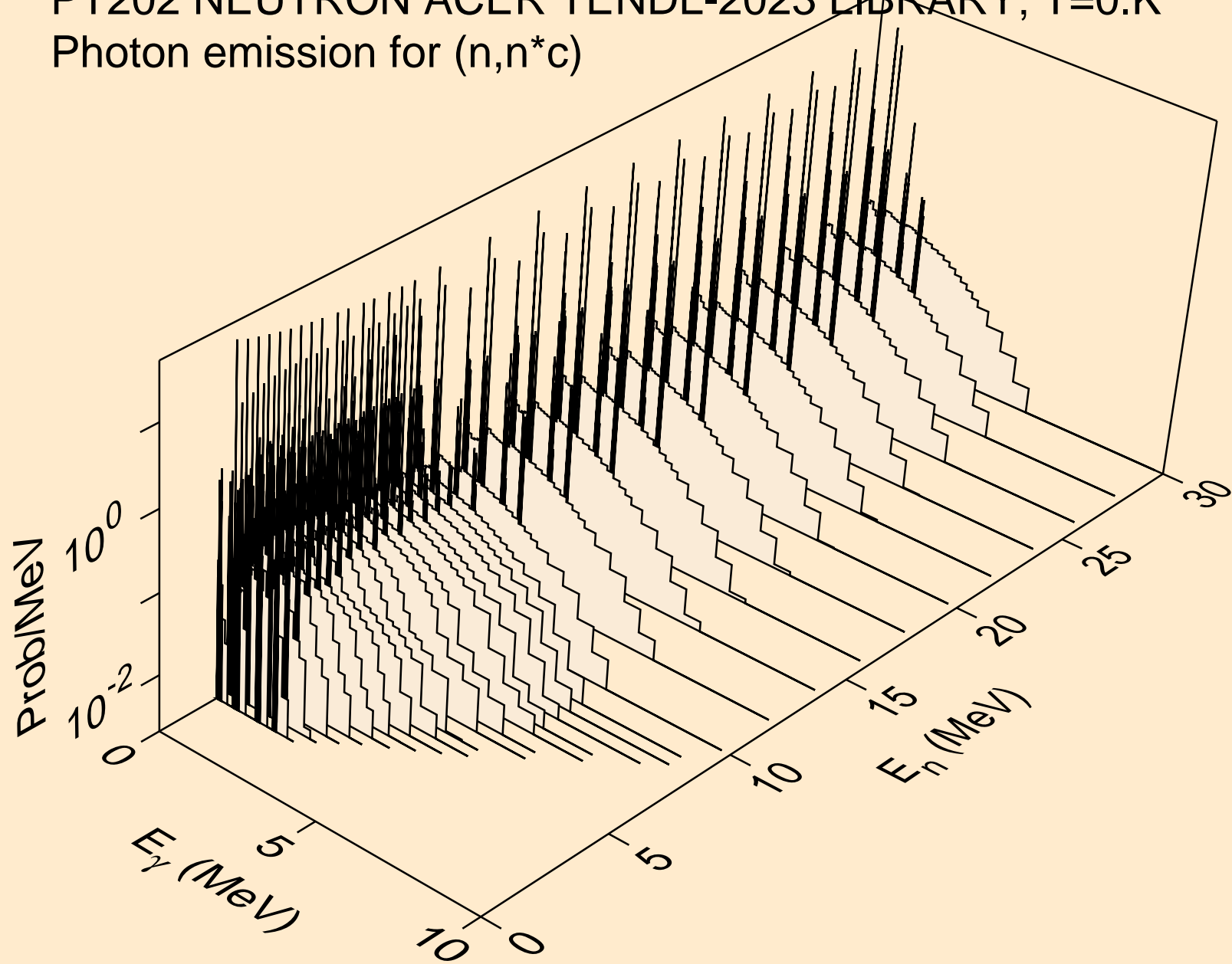

PT202 NEUTRON ACER TENDL-2023 LIBRARY; T=0.K  
Photon emission for (n,gma)

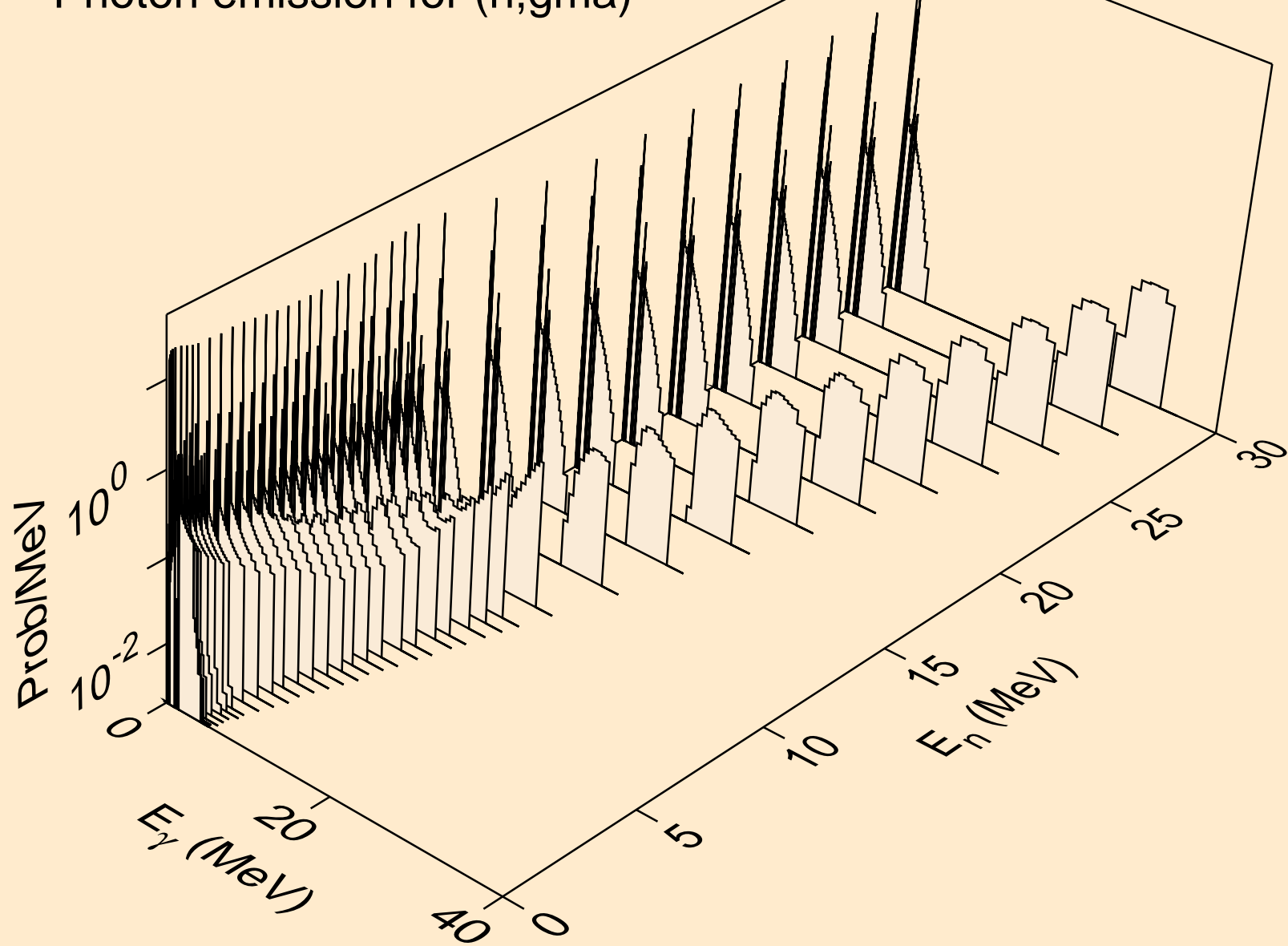



PT202 NEUTRON ACER TENDL-2023 LIBRARY; T=0.K  
Photon emission for (n,p)

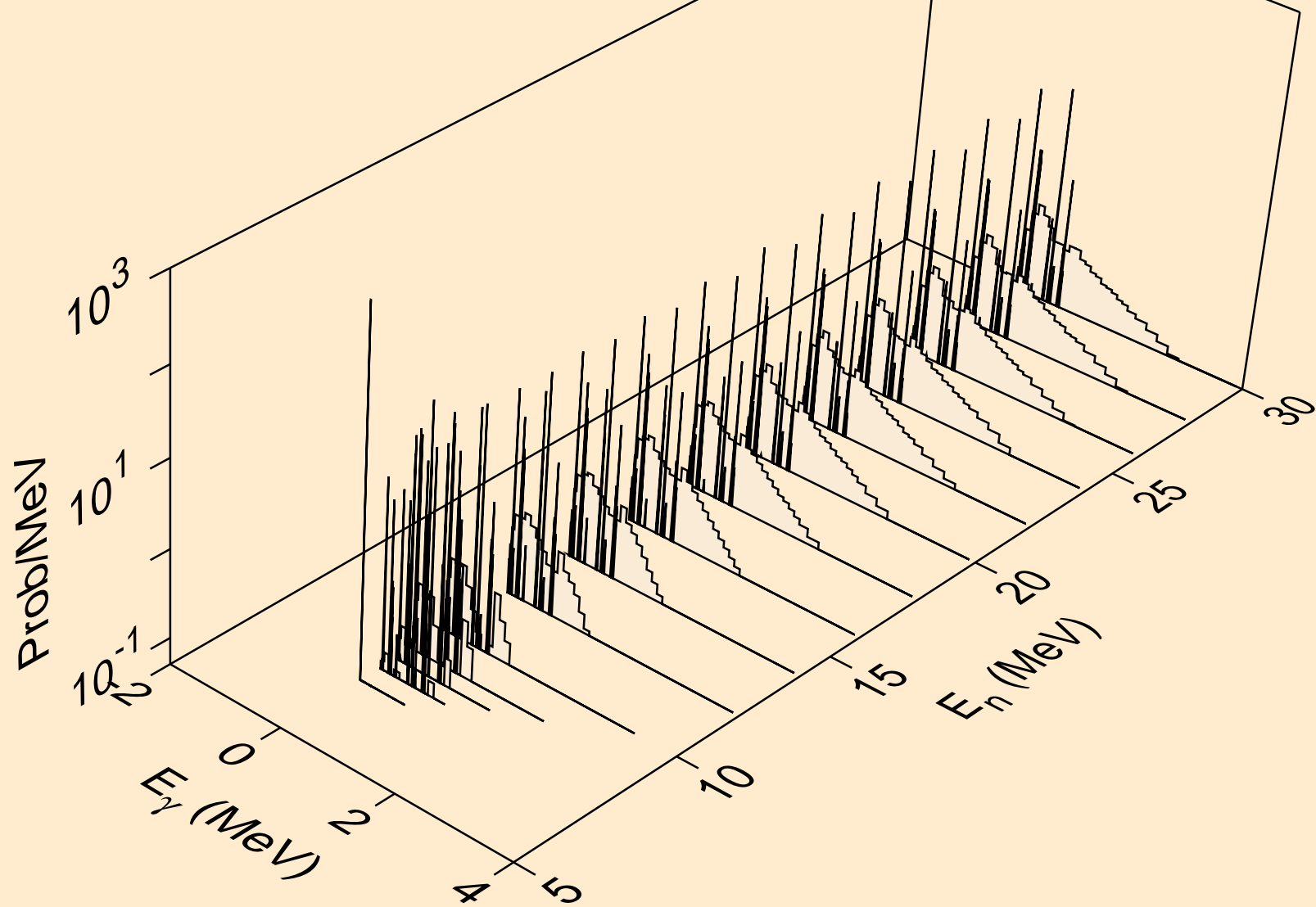

PT202 NEUTRON ACER TENDL-2023 LIBRARY; T=0.K  
Photon emission for (n,d)

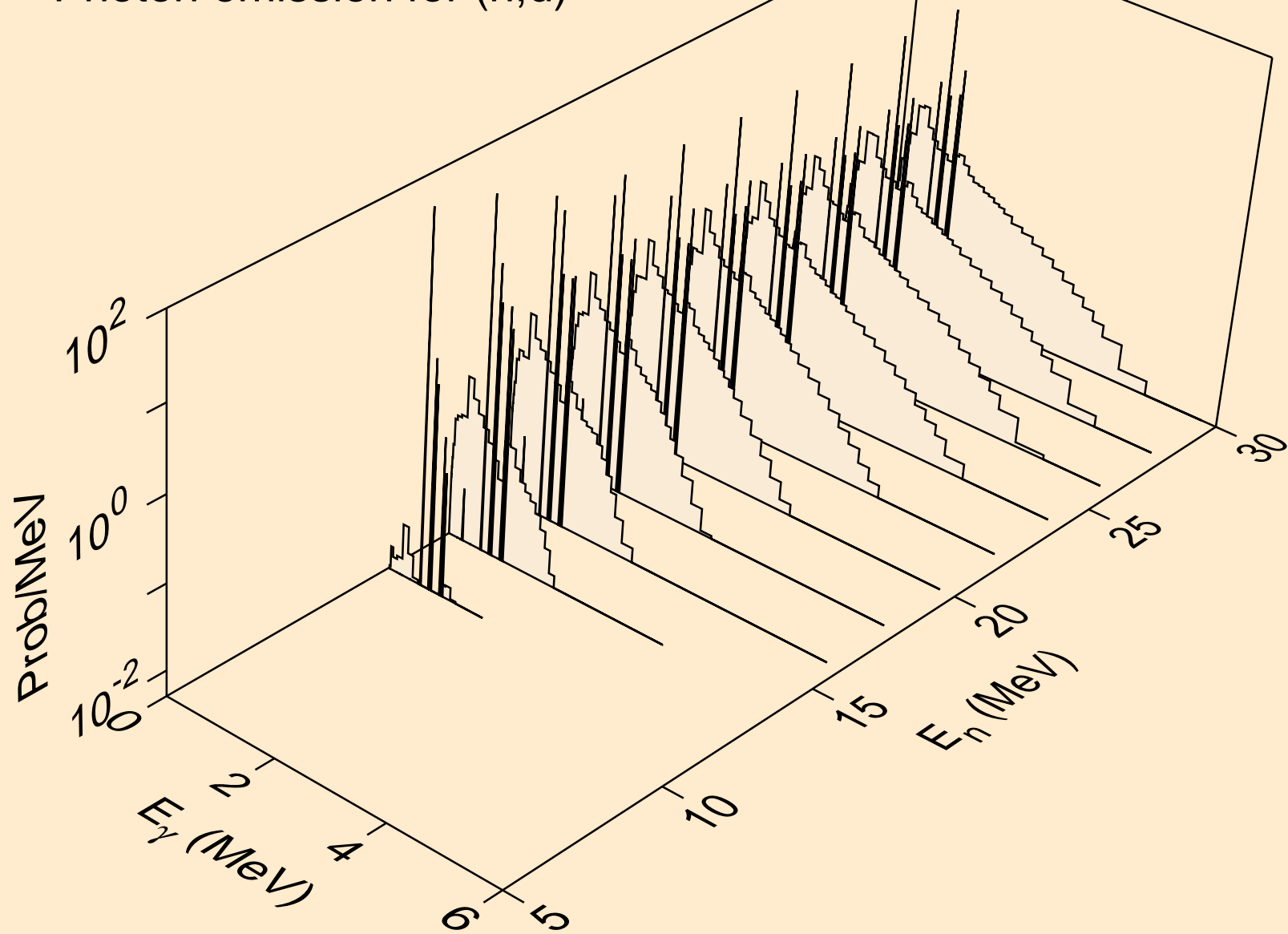

PT202 NEUTRON ACER TENDL-2023 LIBRARY; T=0.K  
Photon emission for (n,t)

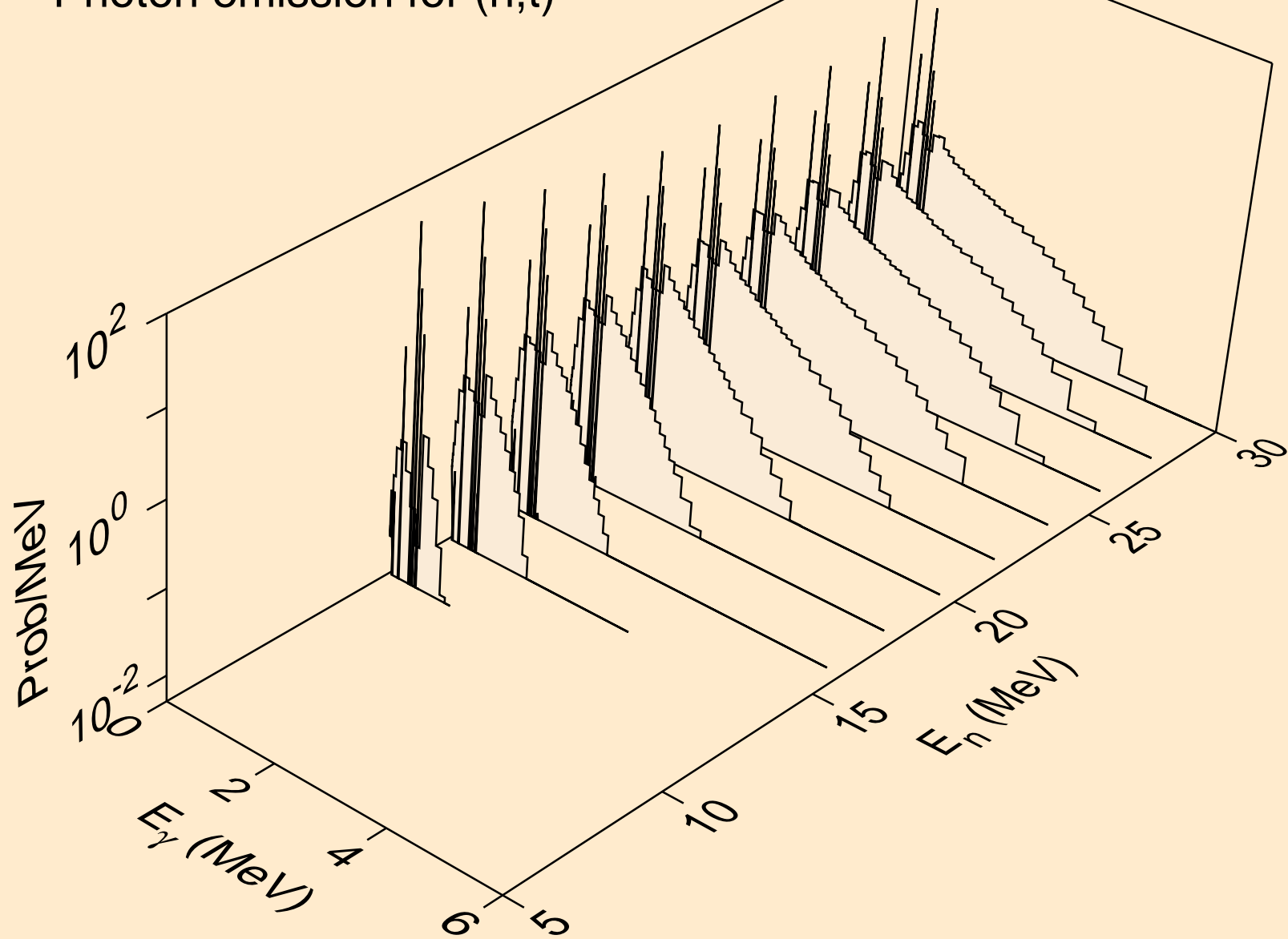

PT202 NEUTRON ACER TENDL-2023 LIBRARY; T=0.K  
Photon emission for (n,he3)

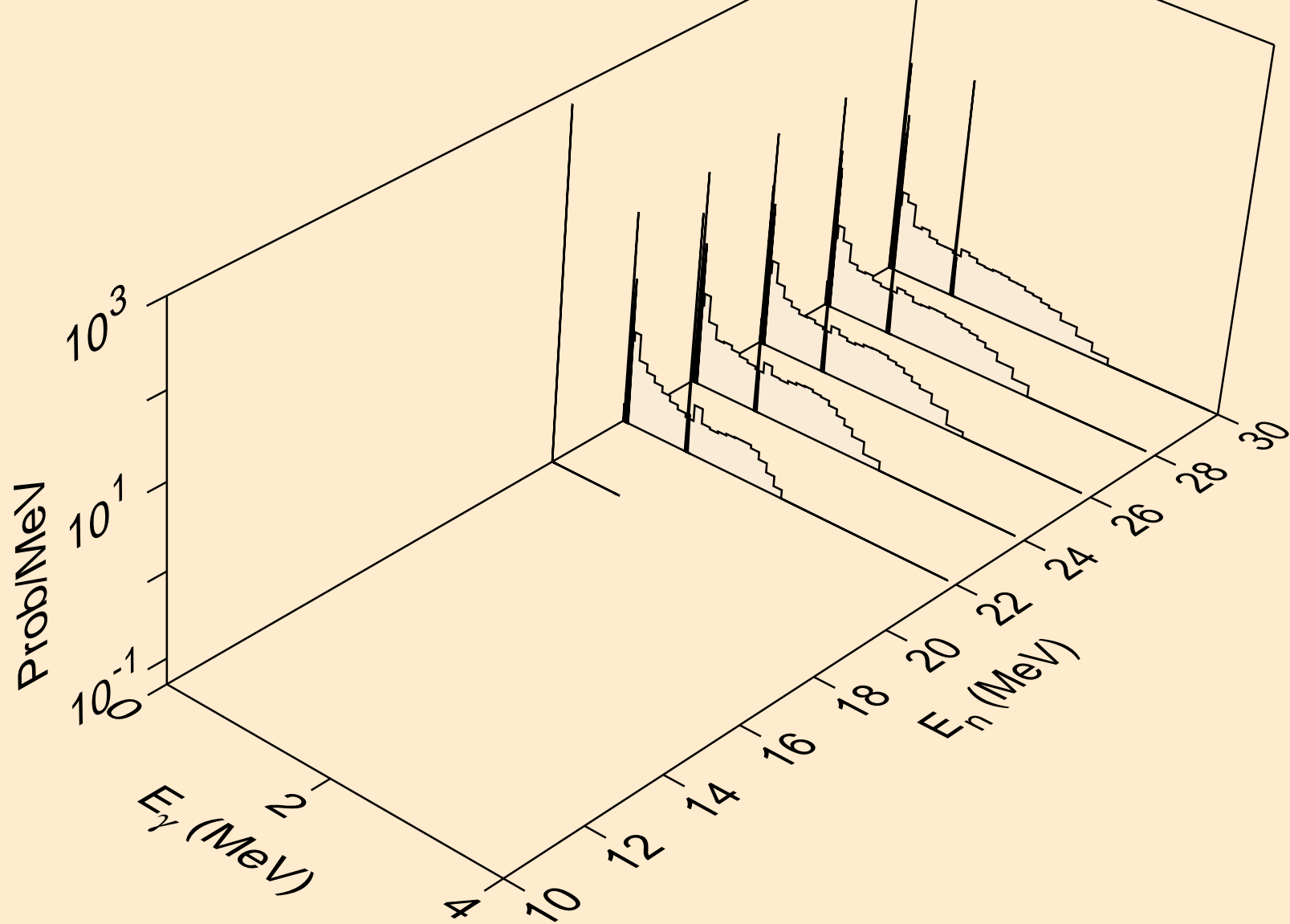

PT202 NEUTRON ACER TENDL-2023 LIBRARY; T=0.K  
Photon emission for (n,a)

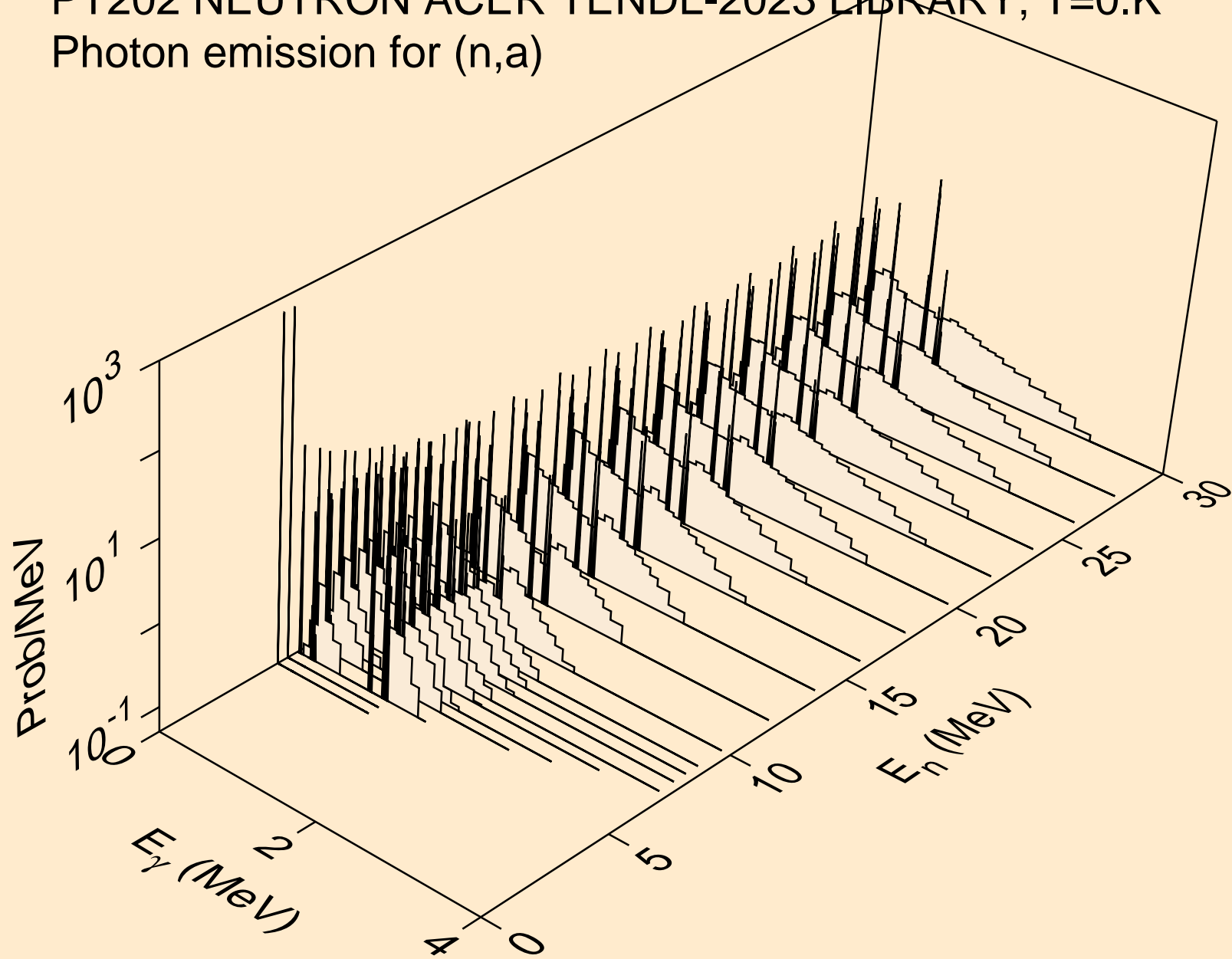

PT202 NEUTRON ACER TENDL-2023 LIBRARY; T=0.K  
thermal capture photon spectrum

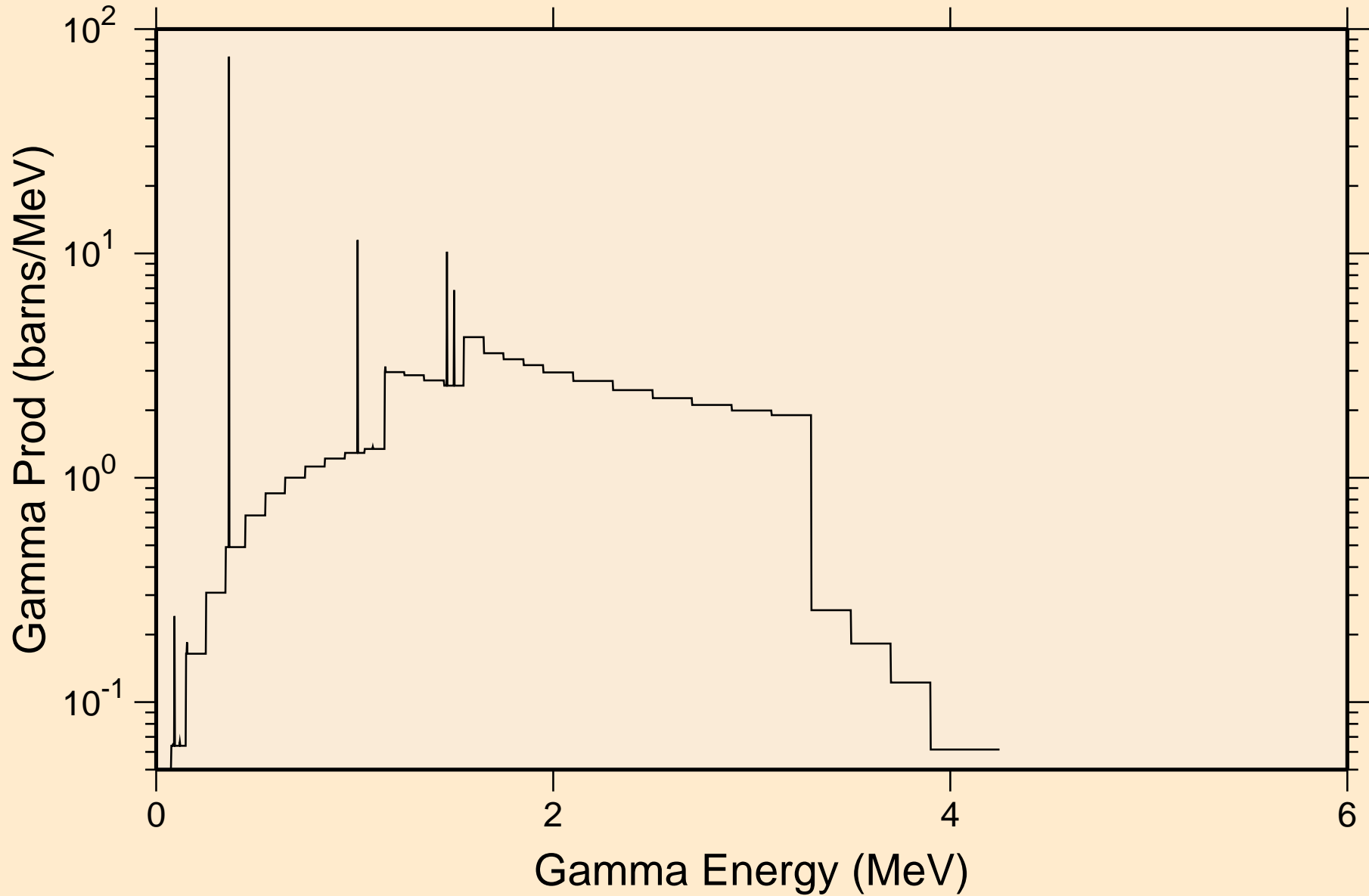

PT202 NEUTRON ACER TENDL-2023 LIBRARY; T=0.K  
14 MeV photon spectrum

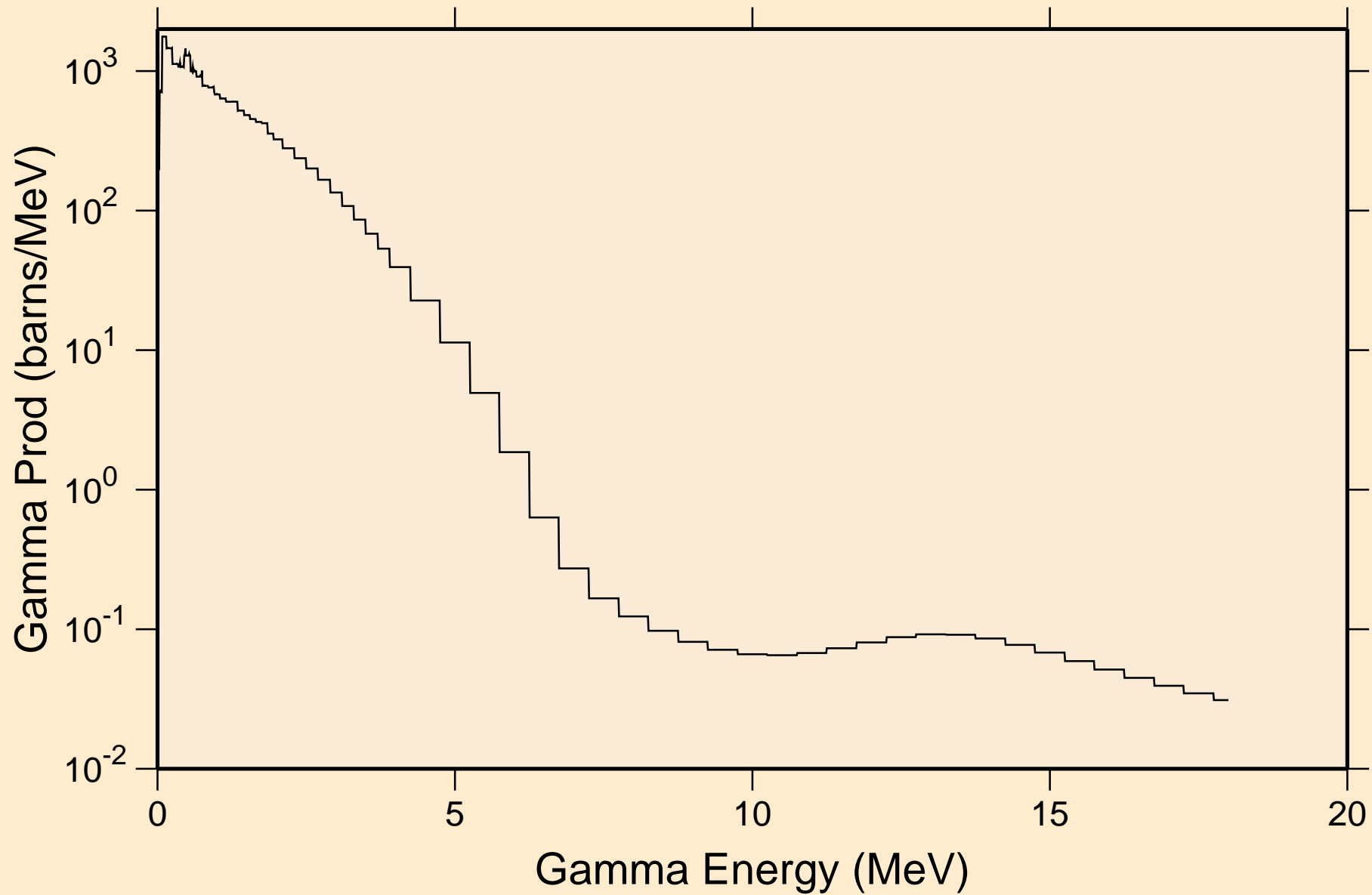

PT202 NEUTRON ACER TENDL-2023 LIBRARY; T=0.K  
Particle heating contributions

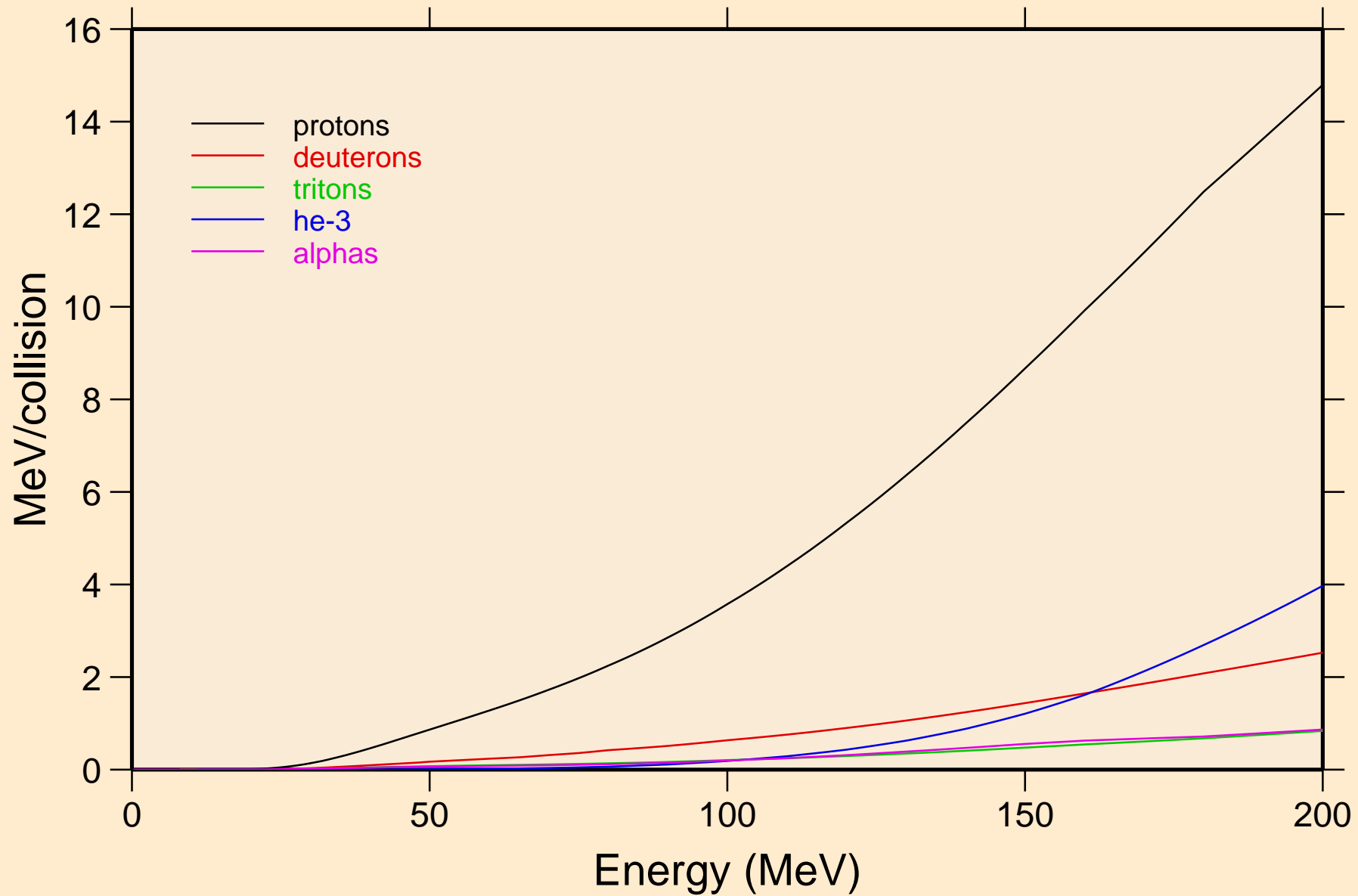



PT202 NEUTRON ACER TENDL-2023 LIBRARY; T=0.K  
Recoil Heating

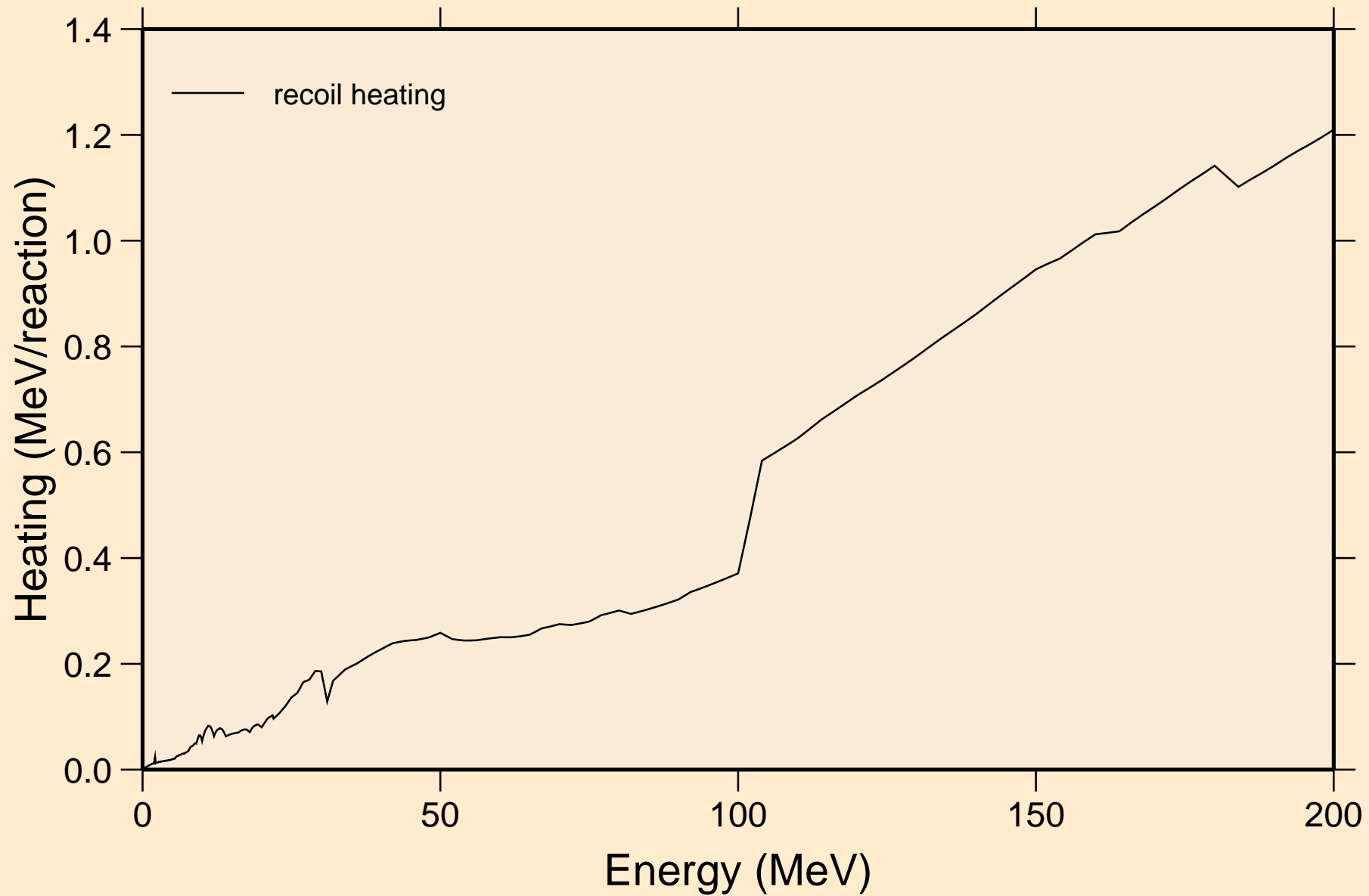

PT202 NEUTRON ACER TENDL-2023 LIBRARY; T=0.K  
Particle production cross sections

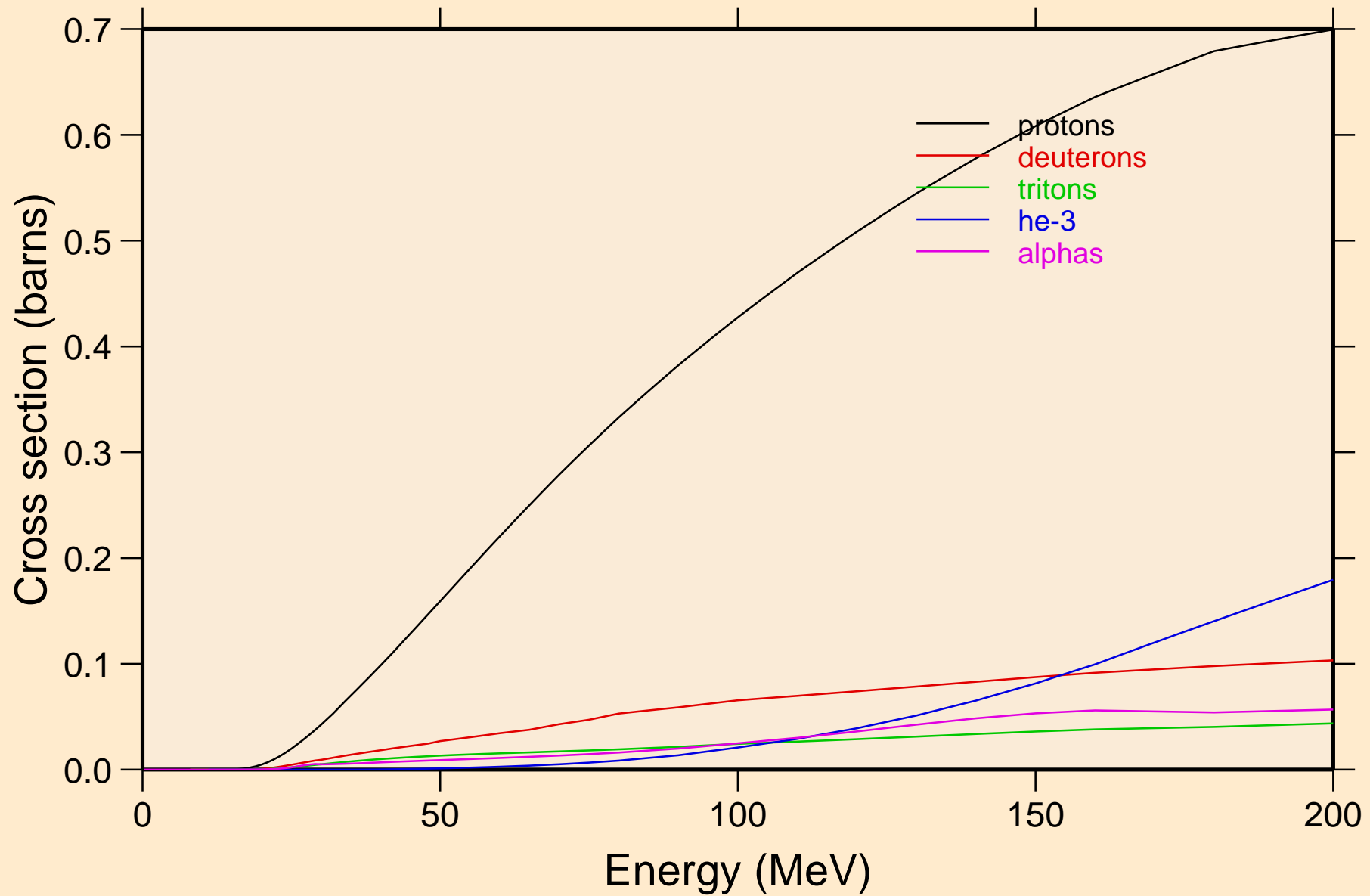

PT202 NEUTRON ACER TENDL-2023 LIBRARY; T=0.K  
protons from (n,x)

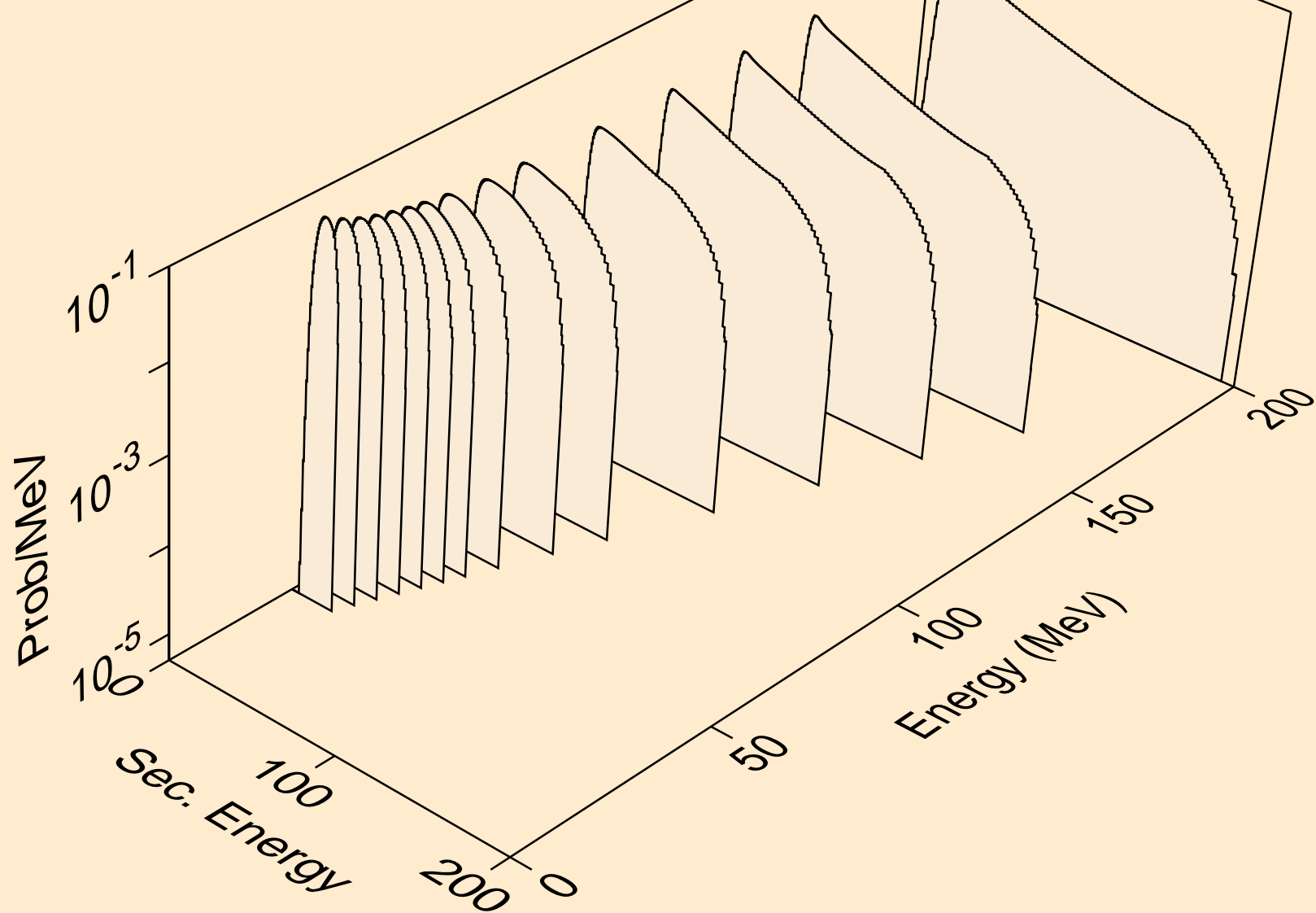

PT202 NEUTRON ACER TENDL-2023 LIBRARY; T=0.K  
protons from (n,n\*)p

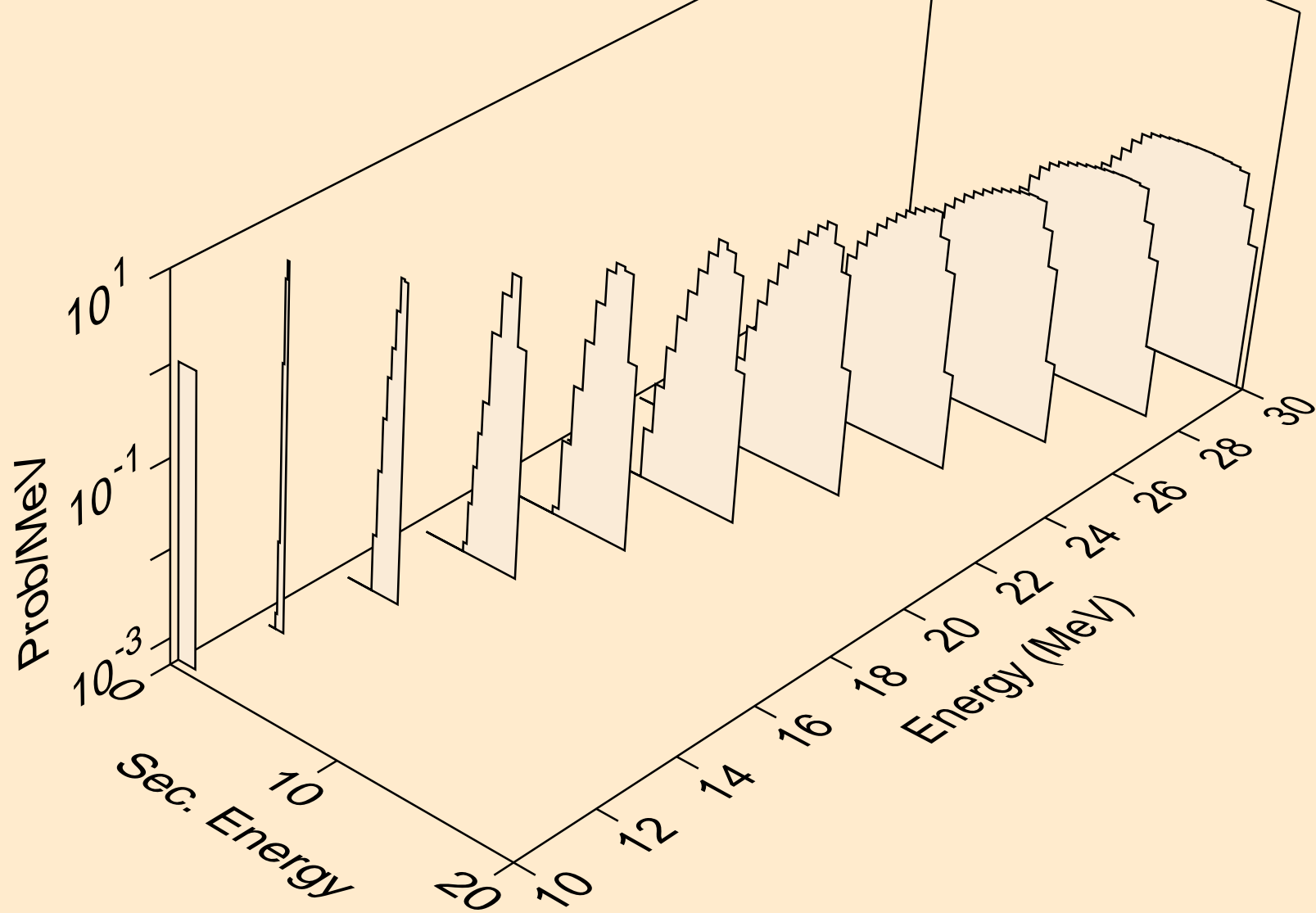

PT202 NEUTRON ACER TENDL-2023 LIBRARY; T=0.K  
protons from (n,2np)

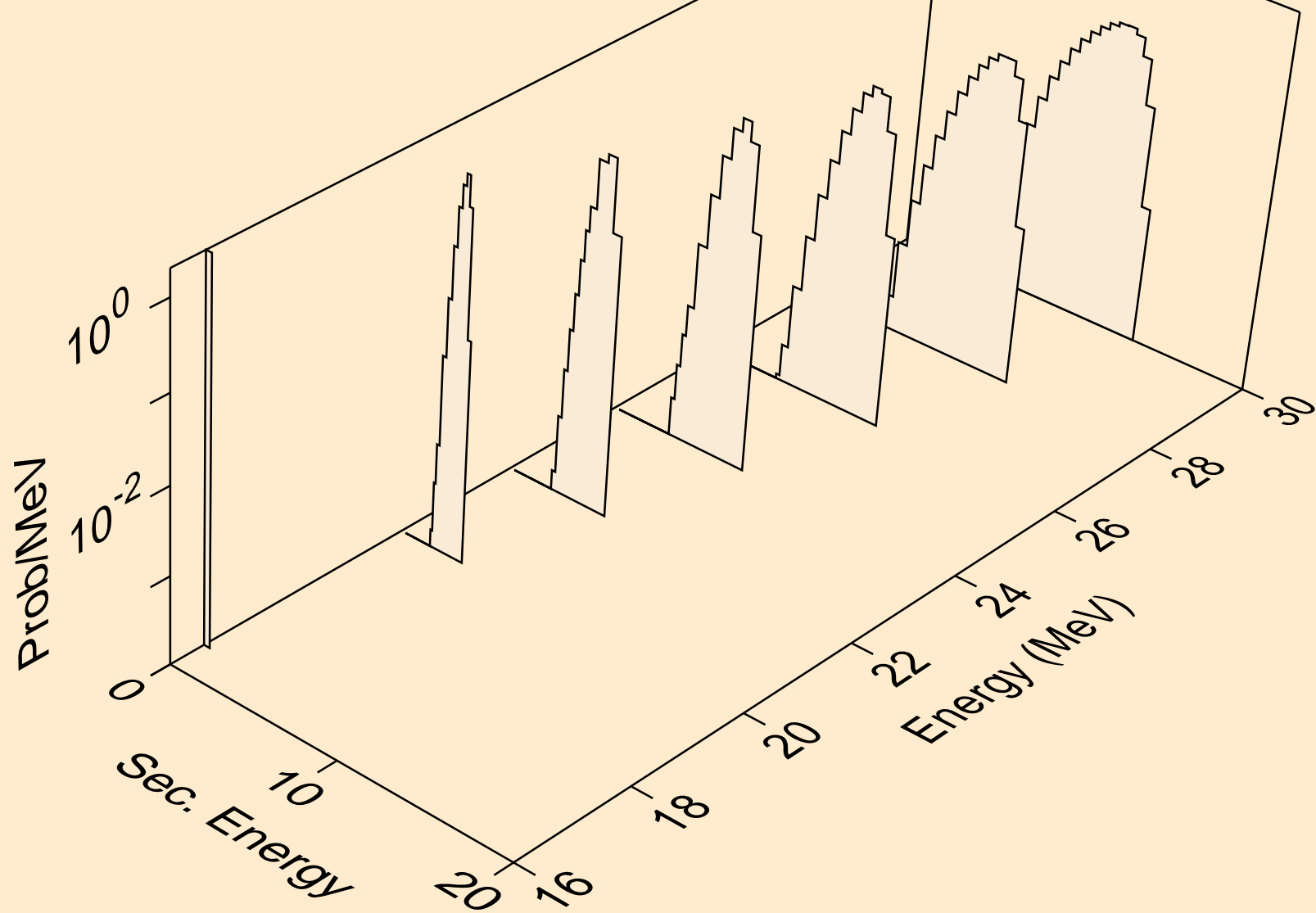

PT202 NEUTRON ACER TENDL-2023 LIBRARY; T=0.K  
protons from (n,3np)

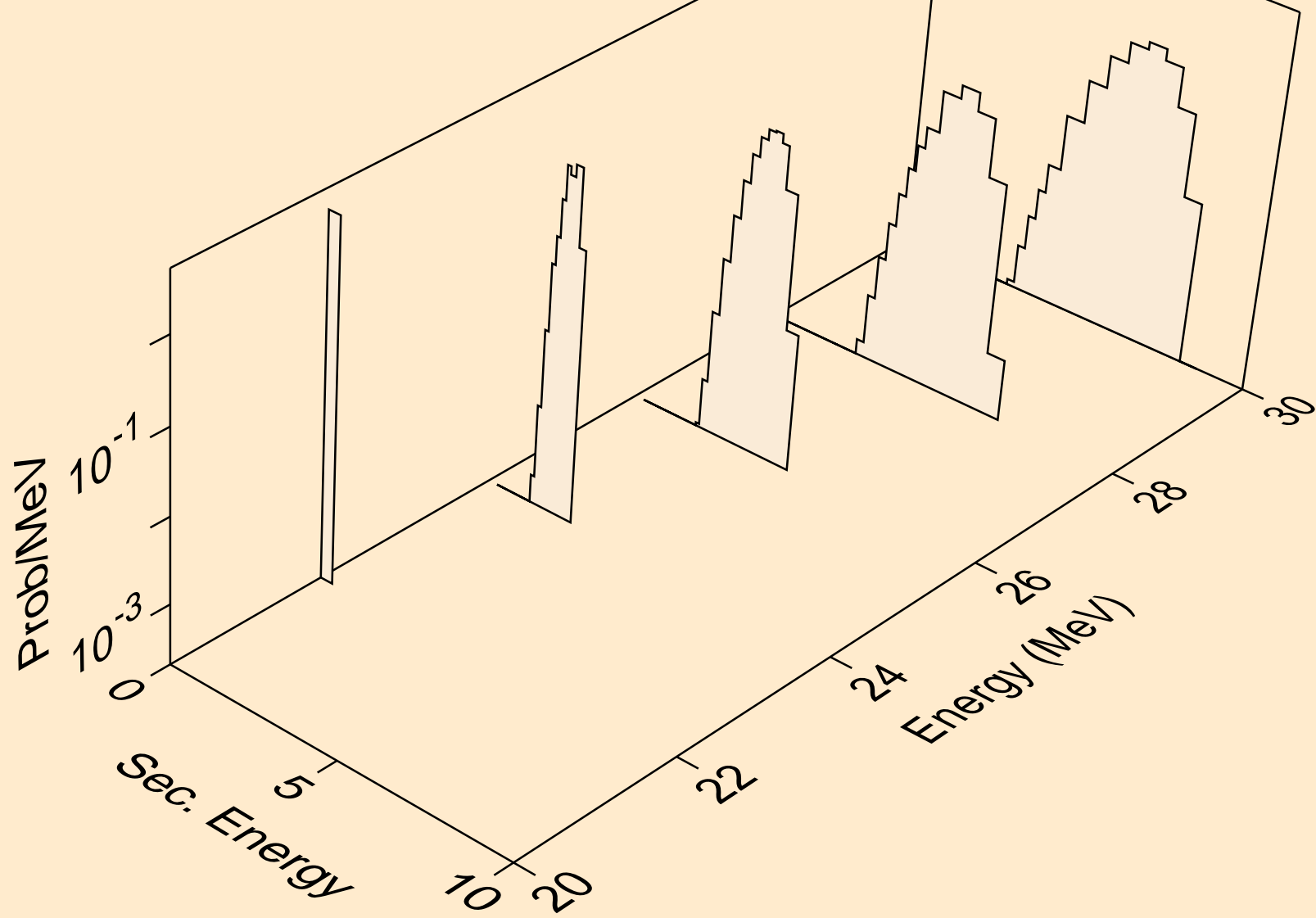

PT202 NEUTRON ACER TENDL-2023 LIBRARY; T=0.K  
protons from (n,p)

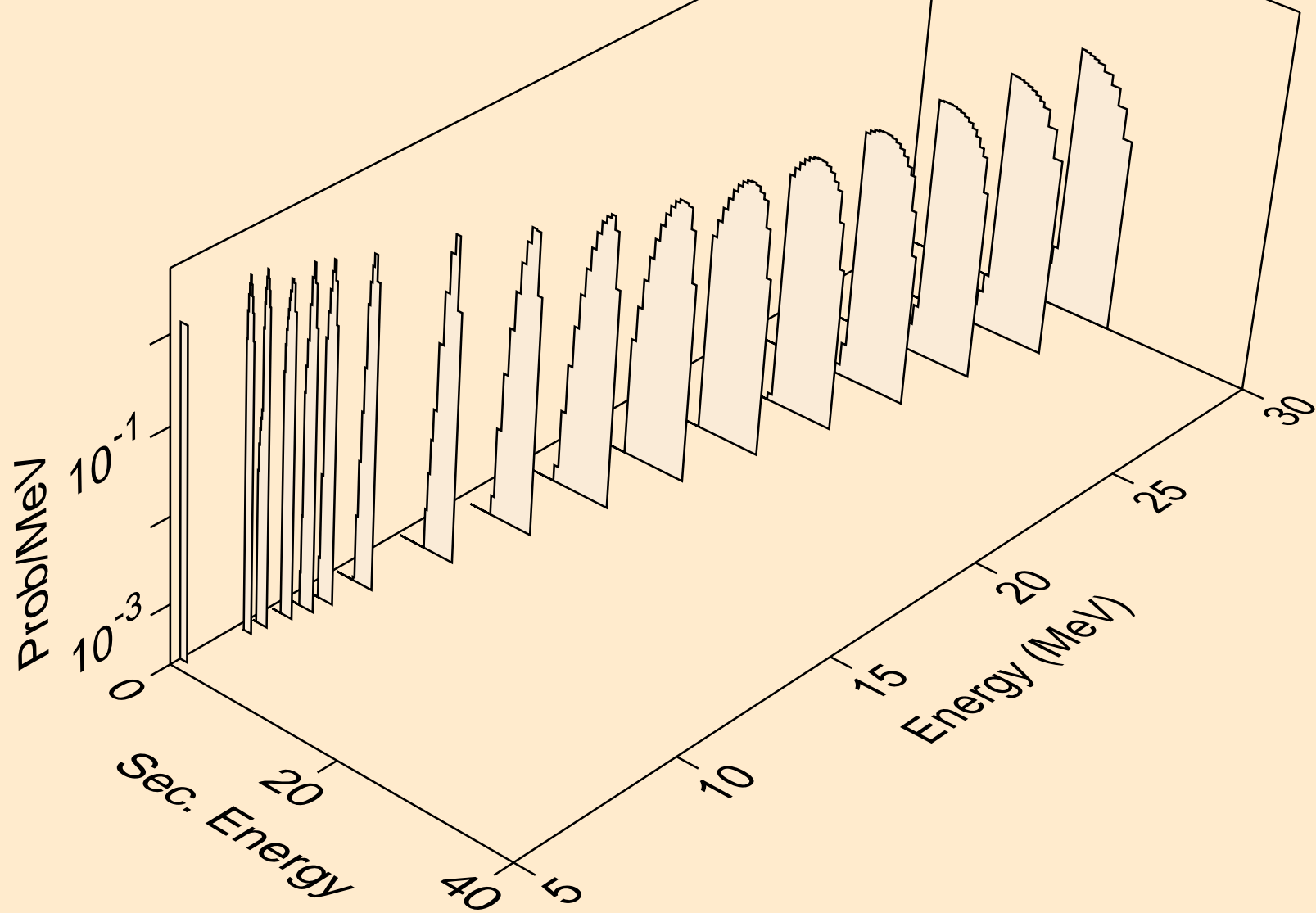

PT202 NEUTRON ACER TENDL-2023 LIBRARY; T=0.K  
deuterons from (n,x)

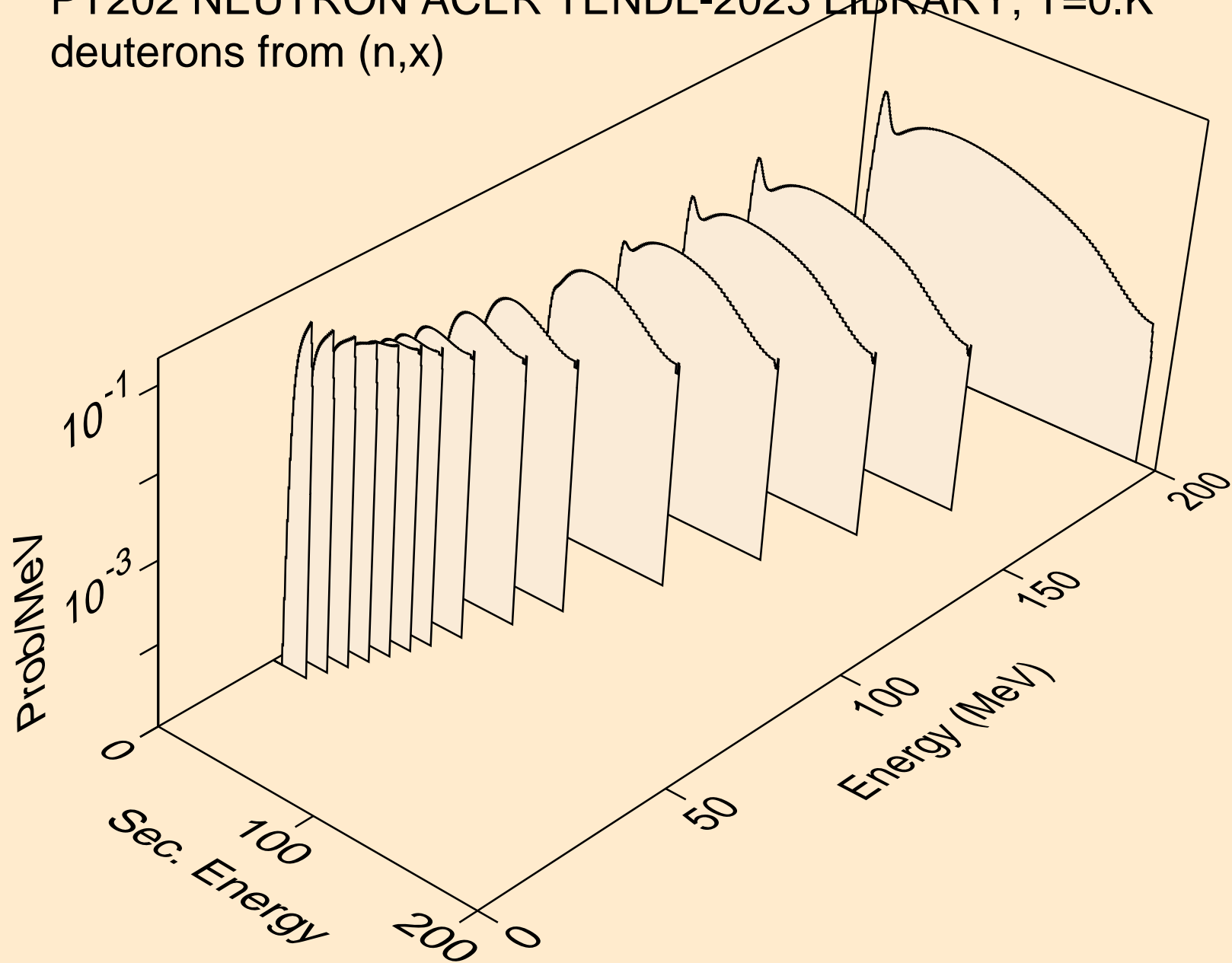



PT202 NEUTRON ACER TENDL-2023 LIBRARY; T=0.K  
deuterons from (n,2nd)

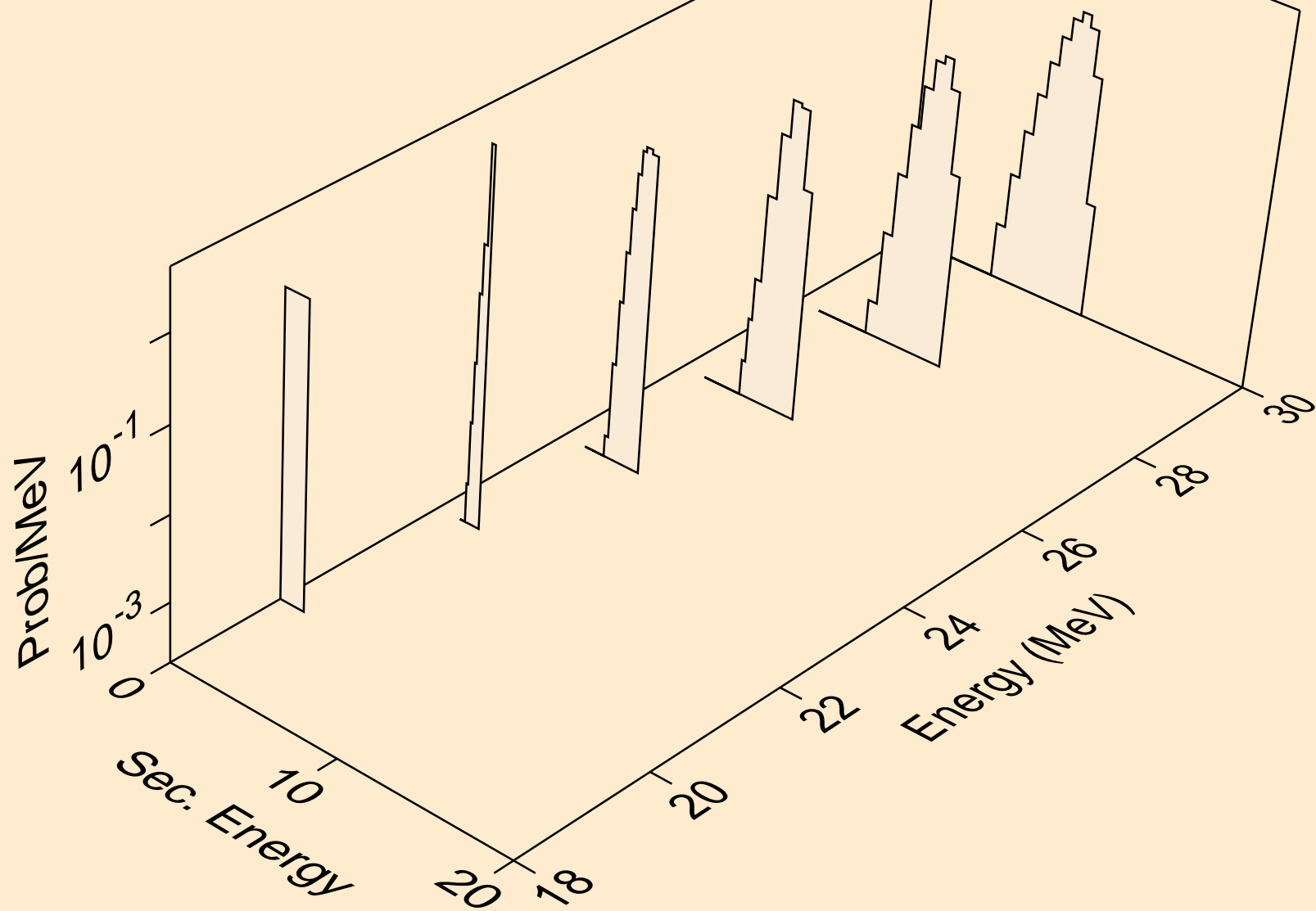

PT202 NEUTRON ACER TENDL-2023 LIBRARY; T=0.K  
deuterons from (n,n\*)d

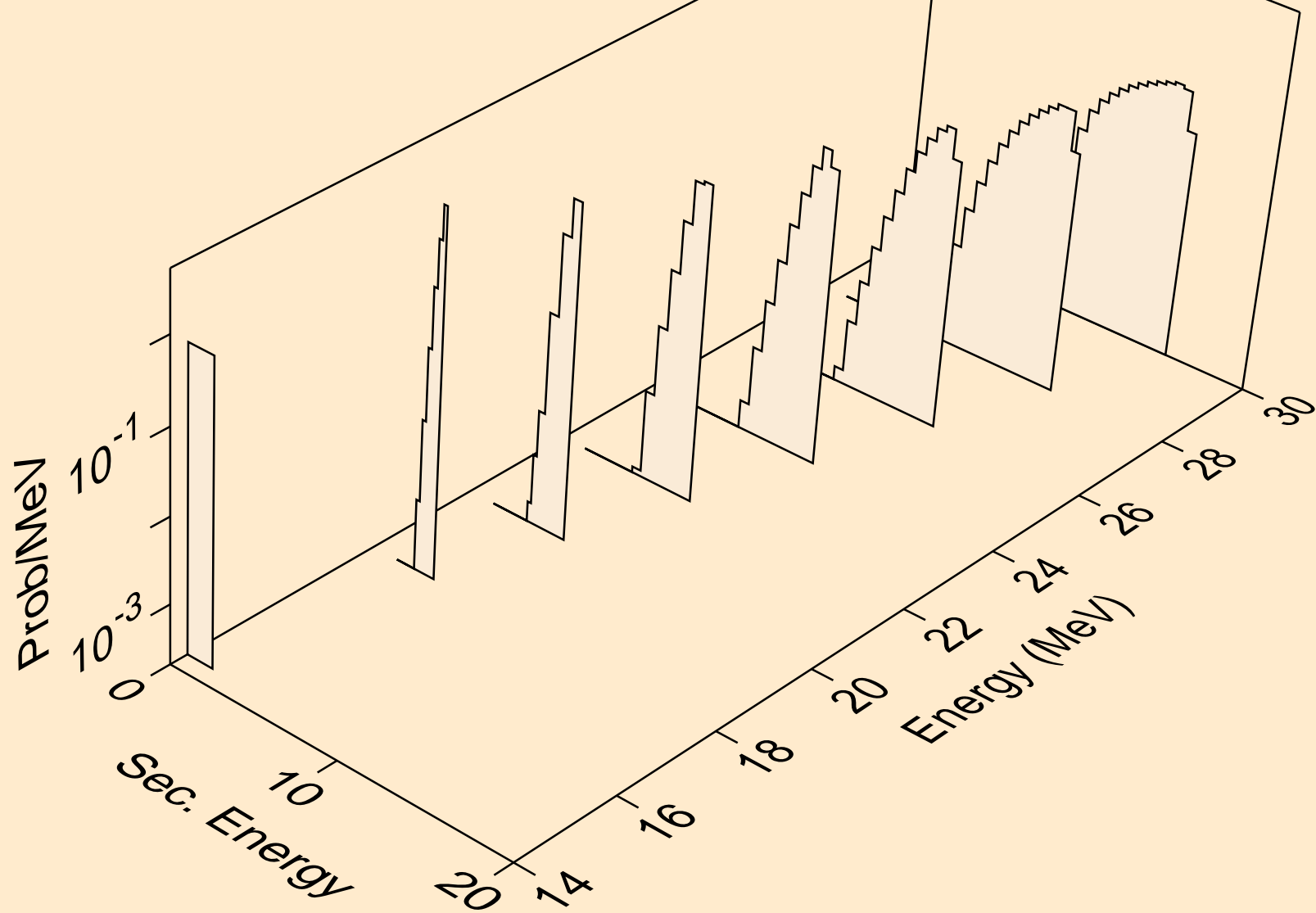

PT202 NEUTRON ACER TENDL-2023 LIBRARY; T=0.K  
deuterons from (n,d)

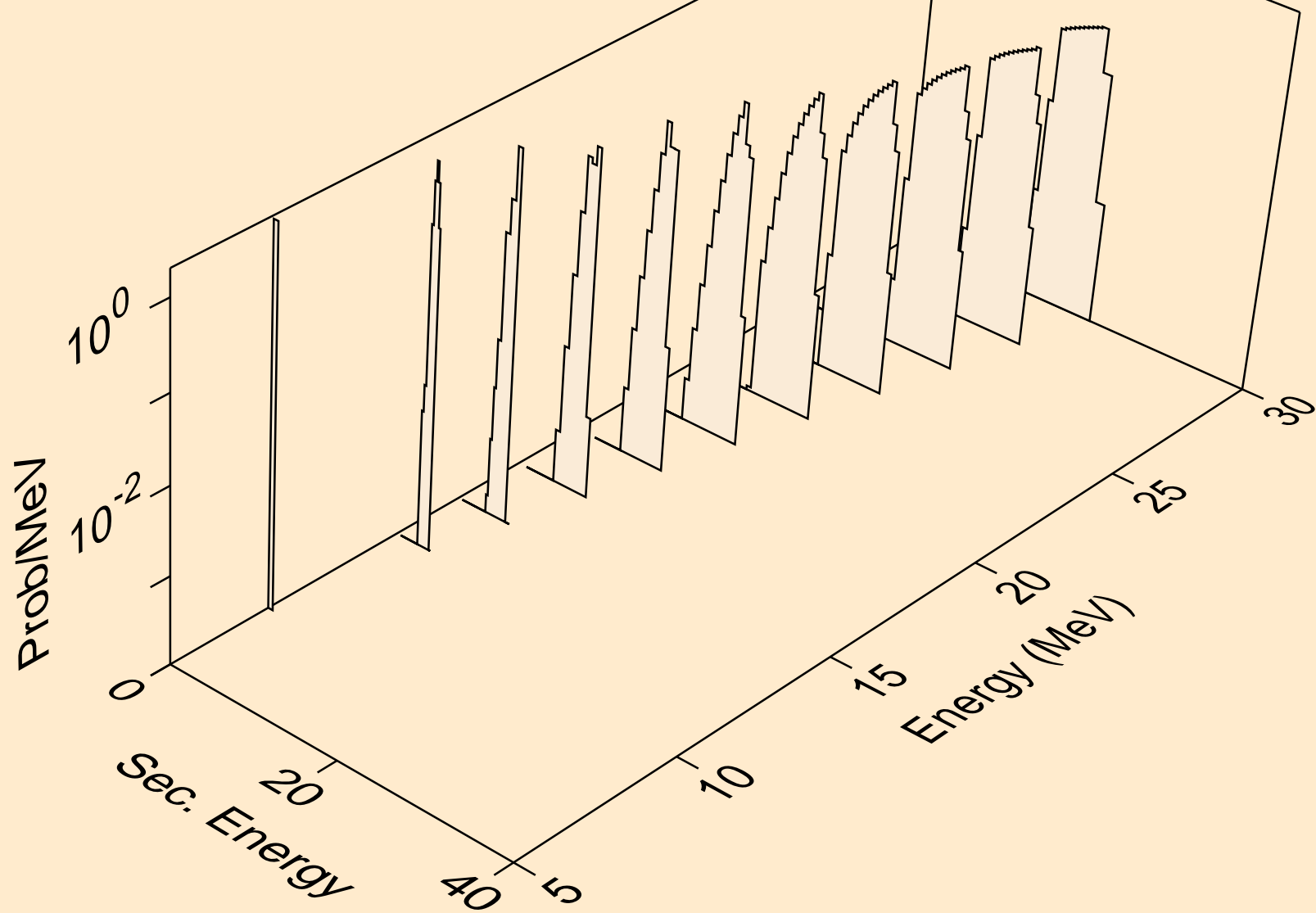

PT202 NEUTRON ACER TENDL-2023 LIBRARY; T=0.K  
tritons from (n,x)

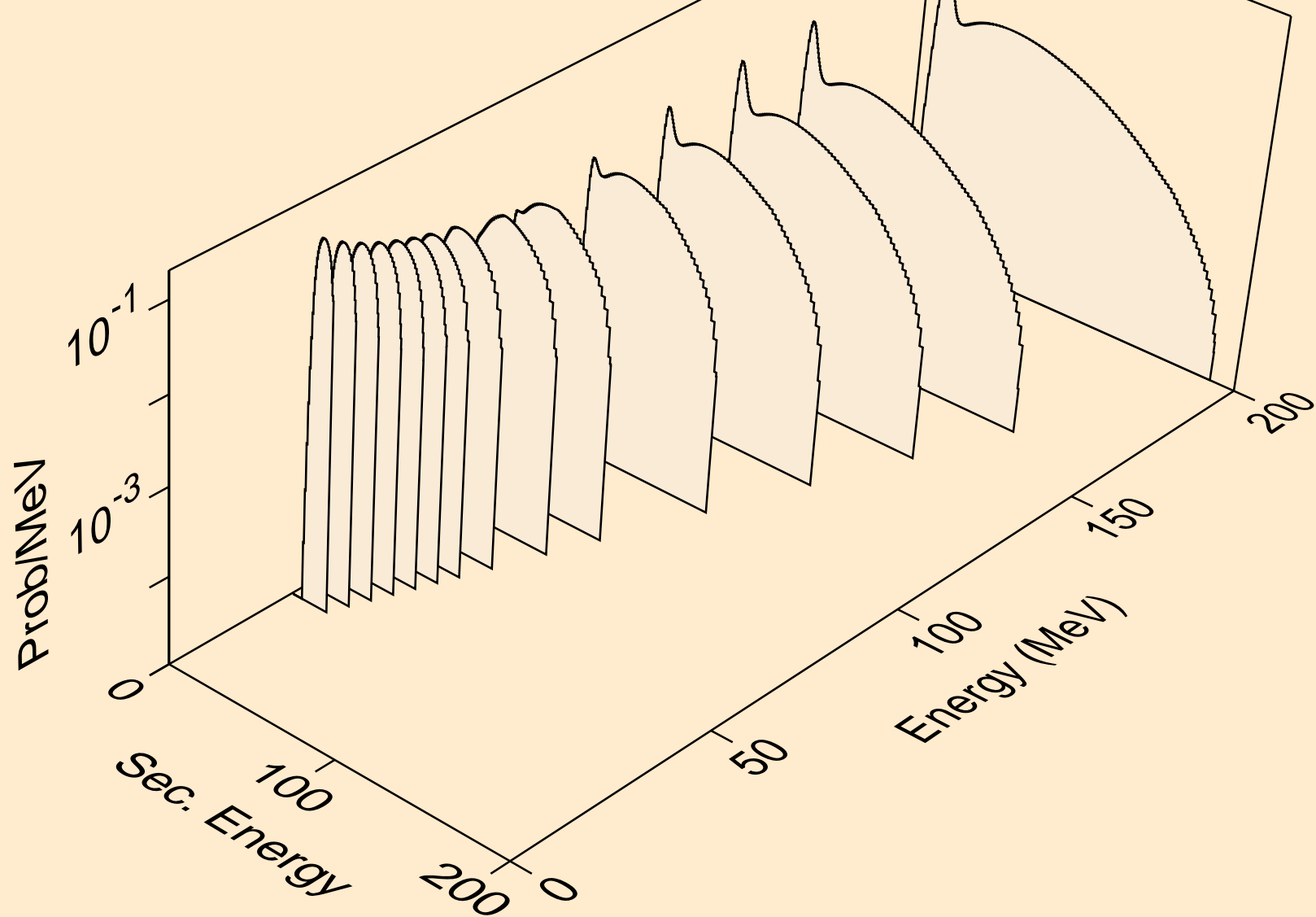

PT202 NEUTRON ACER TENDL-2023 LIBRARY; T=0.K  
tritons from (n,n\*)t

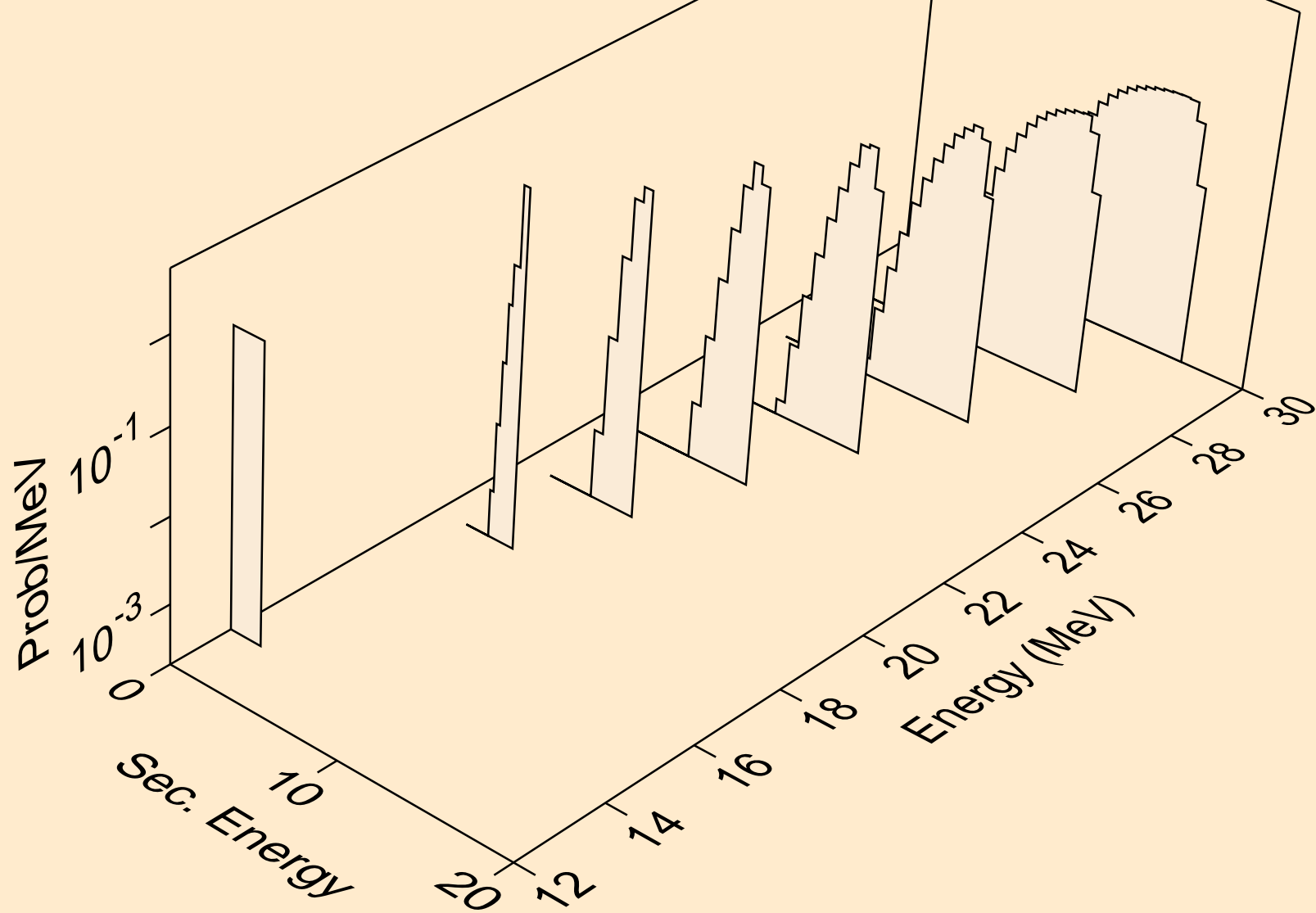

PT202 NEUTRON ACER TENDL-2023 LIBRARY; T=0.K  
tritons from (n,t)

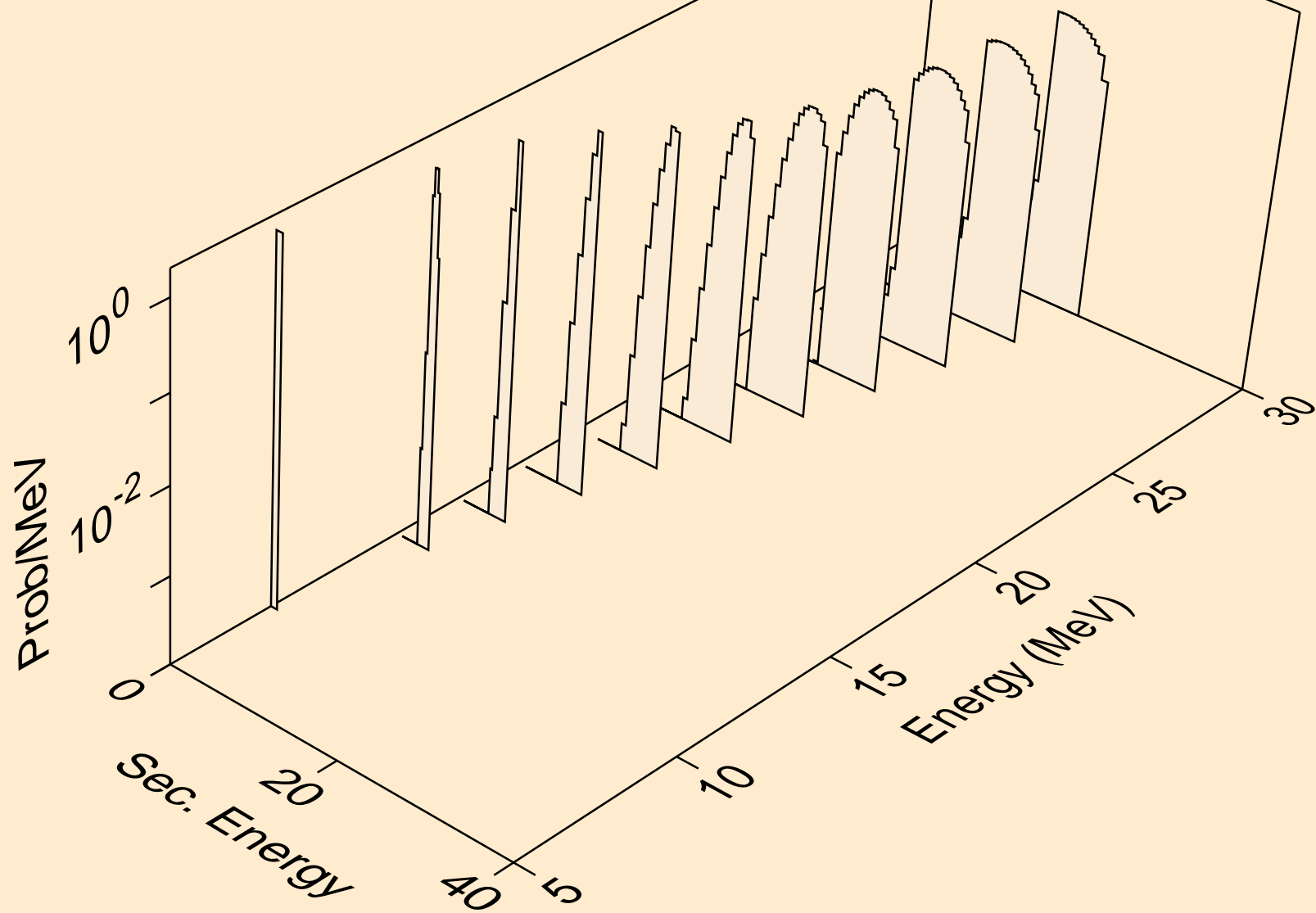

PT202 NEUTRON ACER TENDL-2023 LIBRARY; T=0.K  
he3s from (n,x)

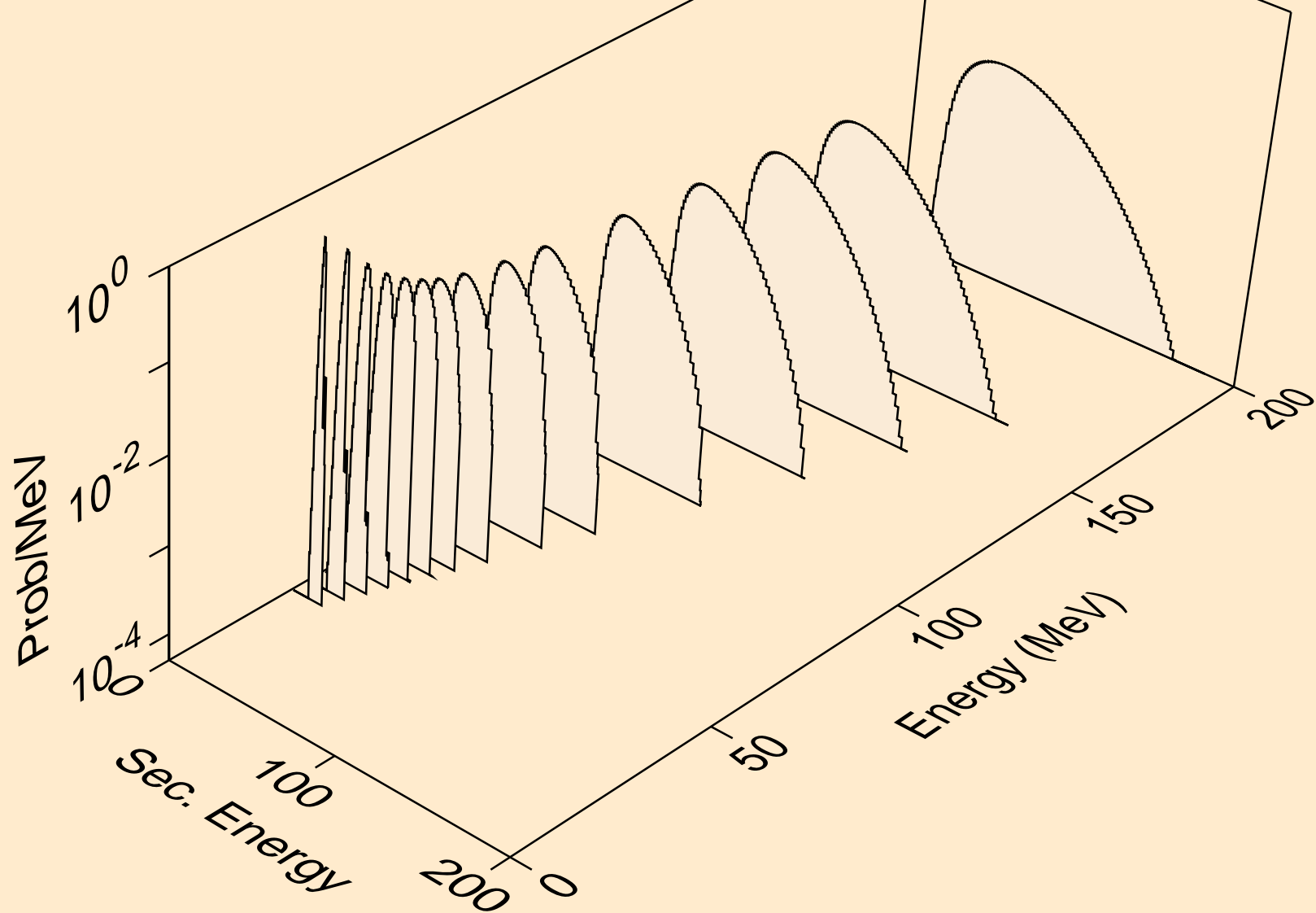

PT202 NEUTRON ACER TENDL-2023 LIBRARY; T=0.K  
he3s from (n,he3)

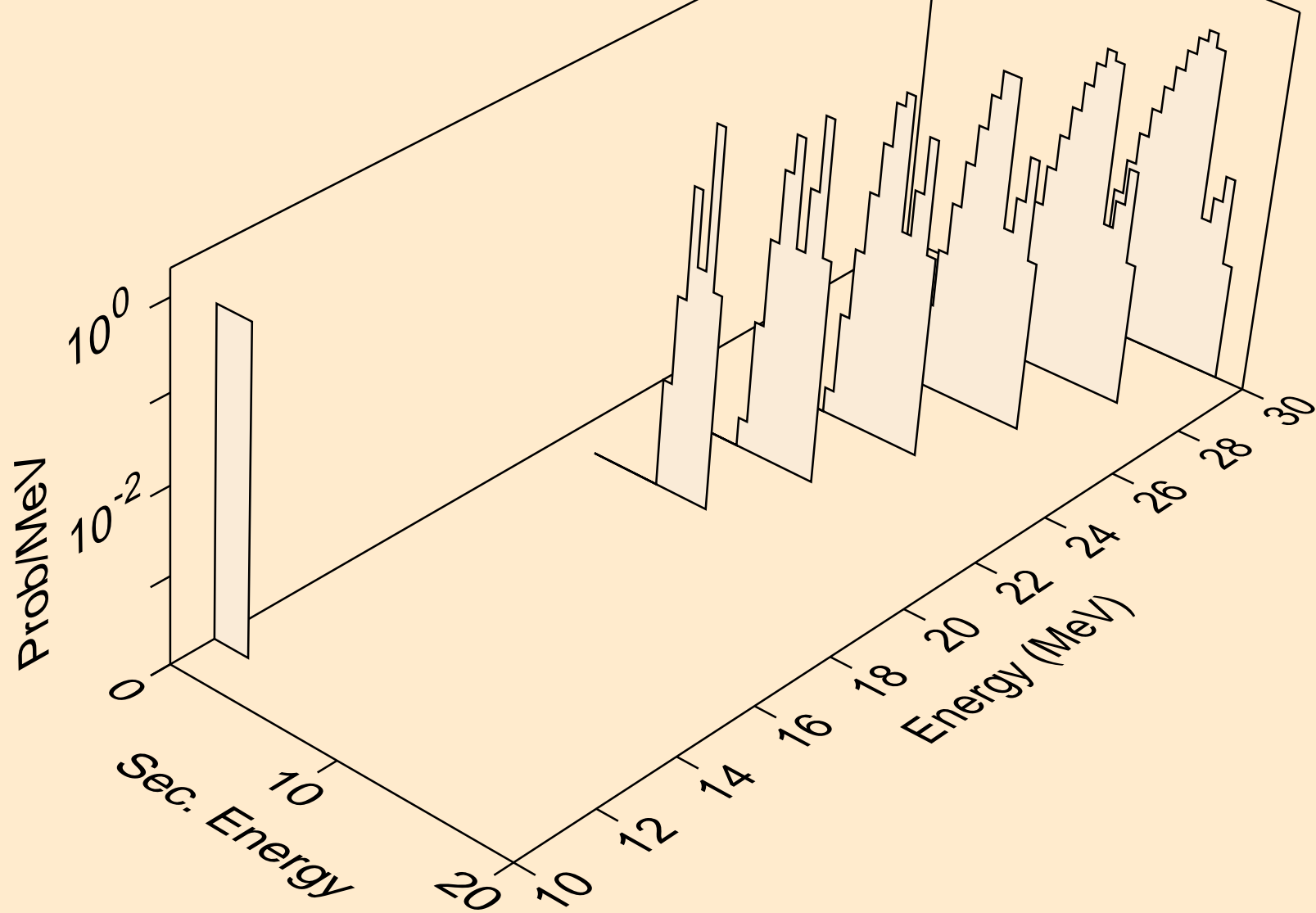



PT202 NEUTRON ACER TENDL-2023 LIBRARY; T=0.K  
alphas from (n,x)

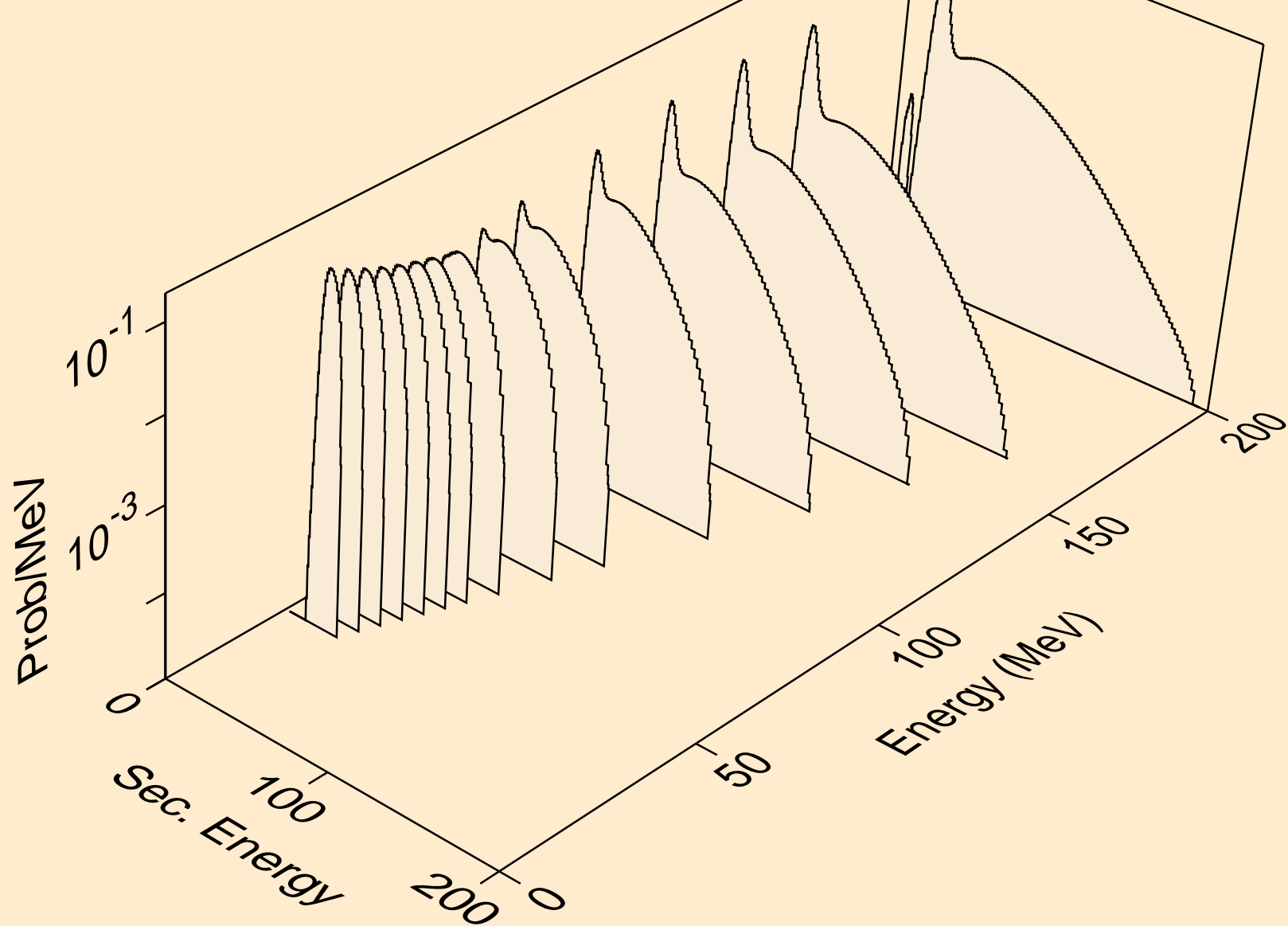

PT202 NEUTRON ACER TENDL-2023 LIBRARY; T=0.K  
alphas from (n,n\*)a

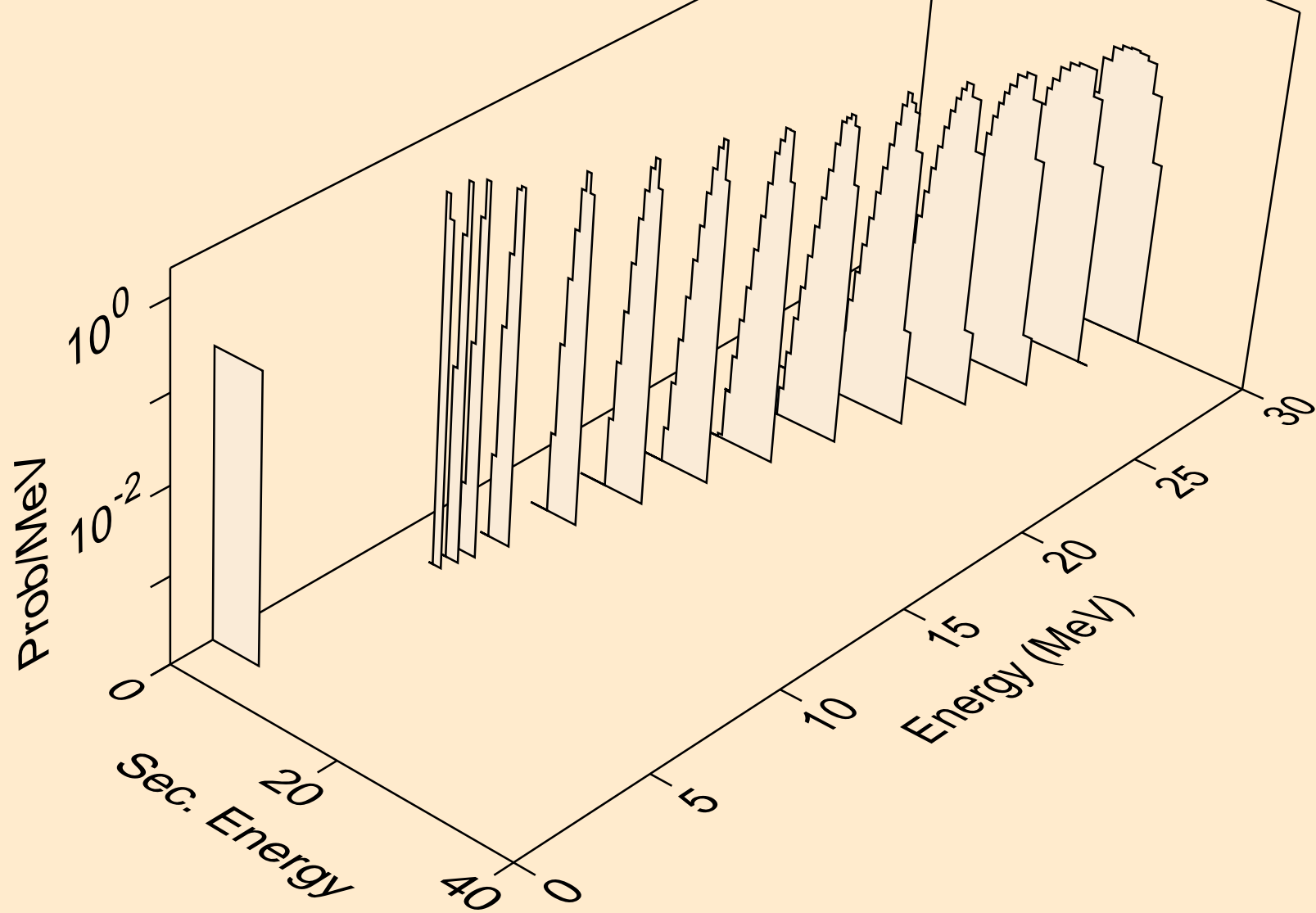

PT202 NEUTRON ACER TENDL-2023 LIBRARY; T=0.K  
alphas from (n,2n)a

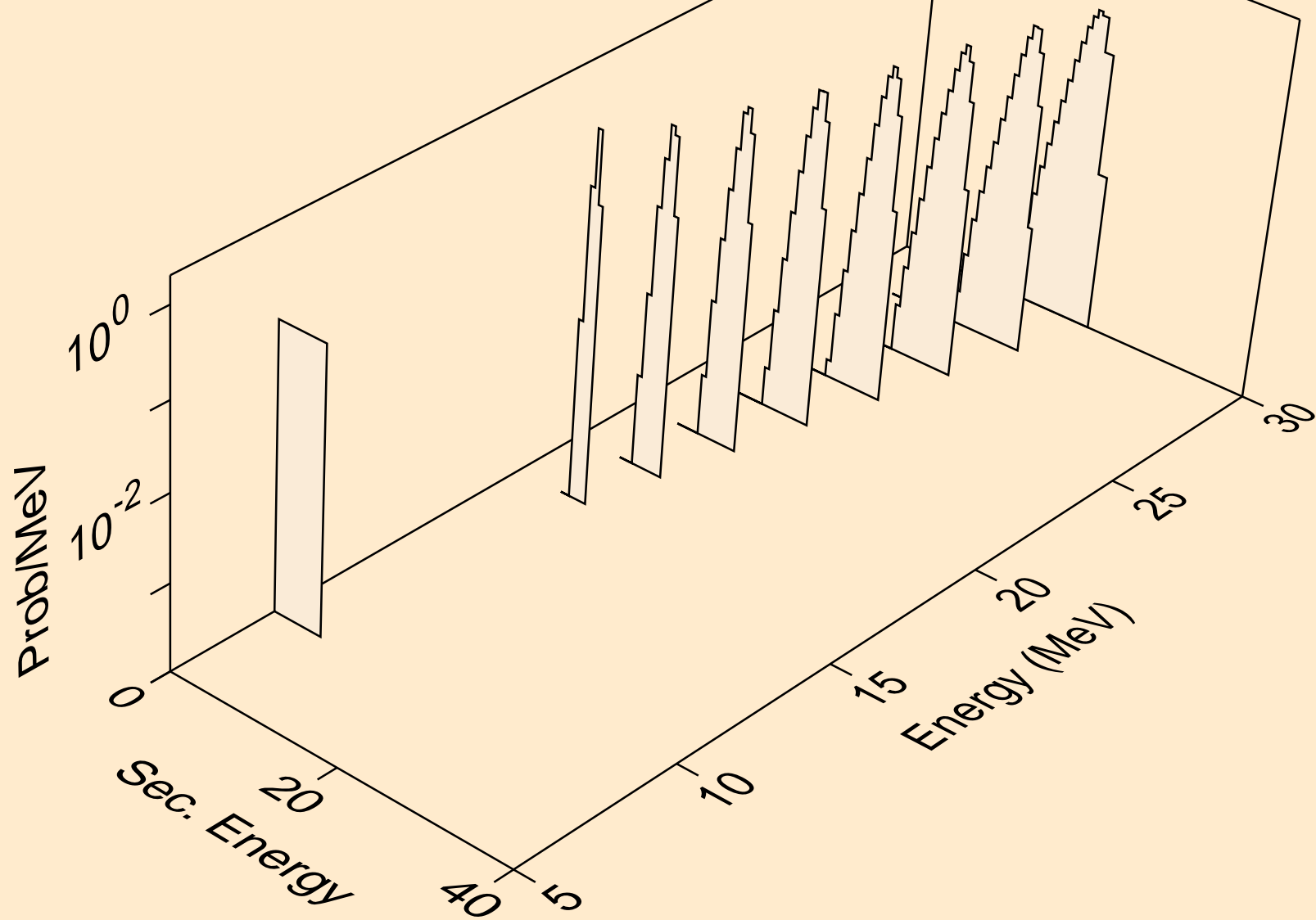

PT202 NEUTRON ACER TENDL-2023 LIBRARY; T=0.K  
alphas from (n,3n)a

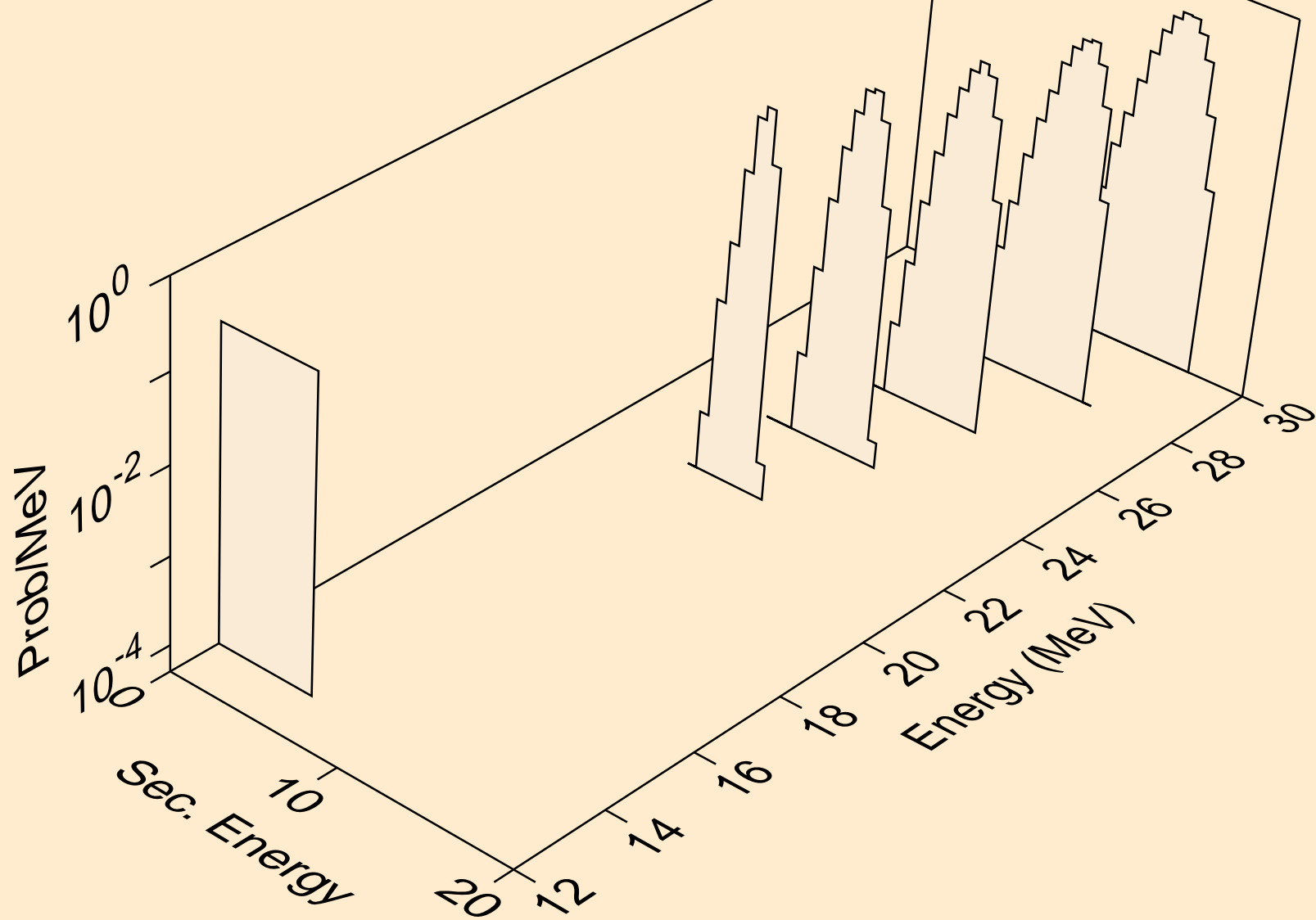

PT202 NEUTRON ACER TENDL-2023 LIBRARY; T=0.K  
alphas from (n,a)

