

# PU238 NEUTRON ACER TENDL-2023 LIBRARY; T=0.K

## Principal cross sections

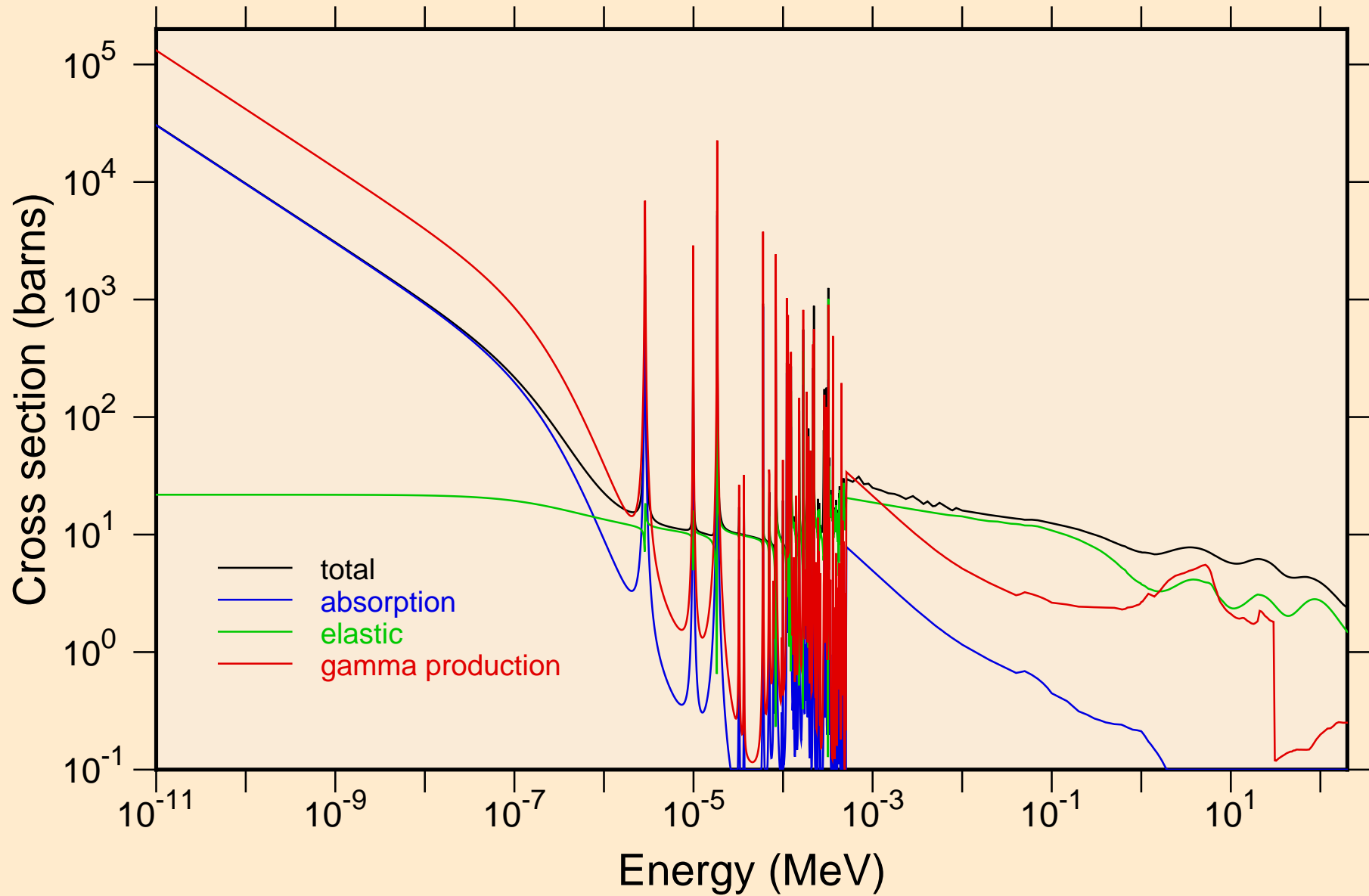

PU238 NEUTRON ACER TENDL-2023 LIBRARY; T=0.K  
resonance total cross section

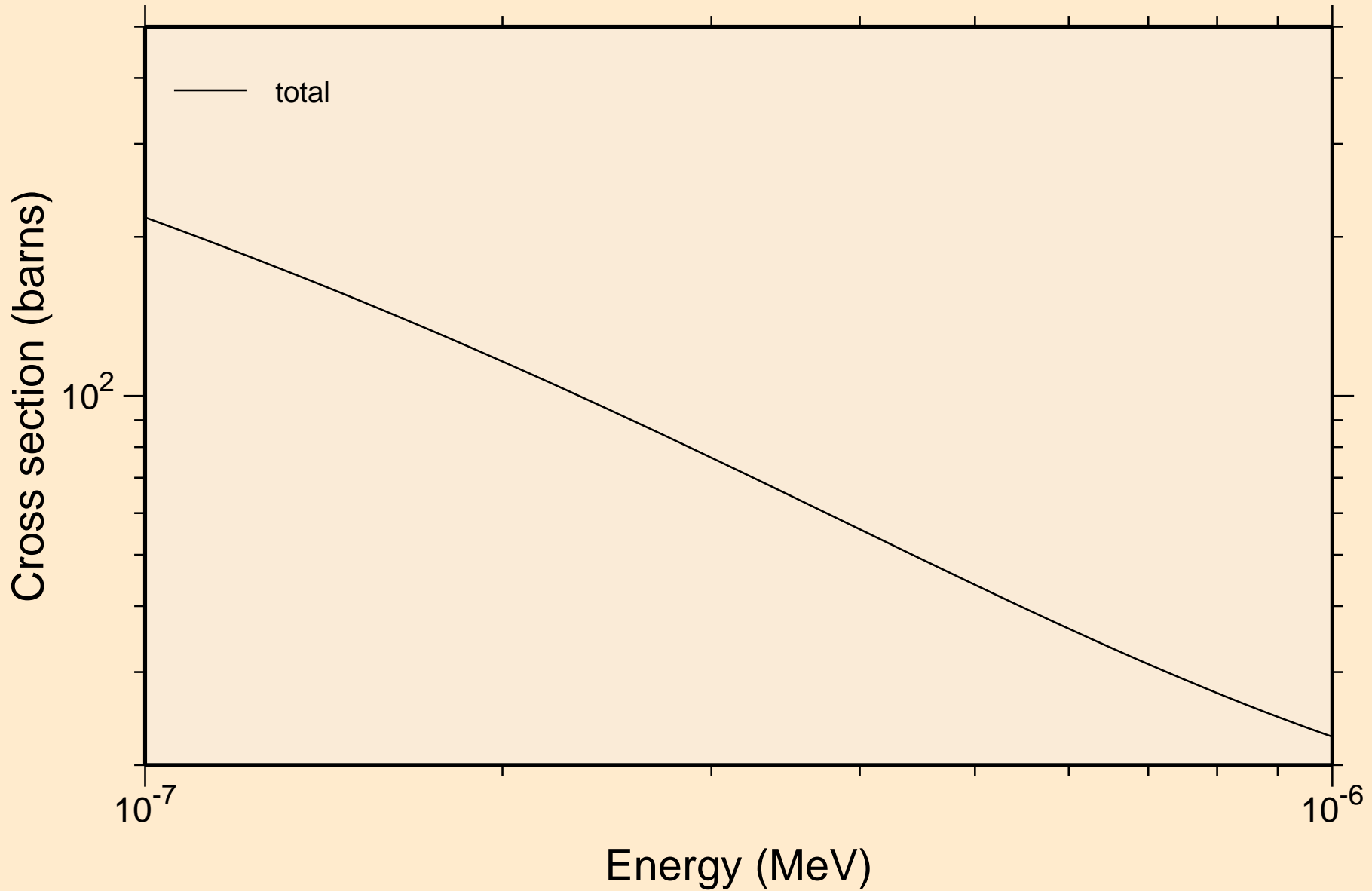

PU238 NEUTRON ACER TENDL-2023 LIBRARY; T=0.K  
resonance total cross section

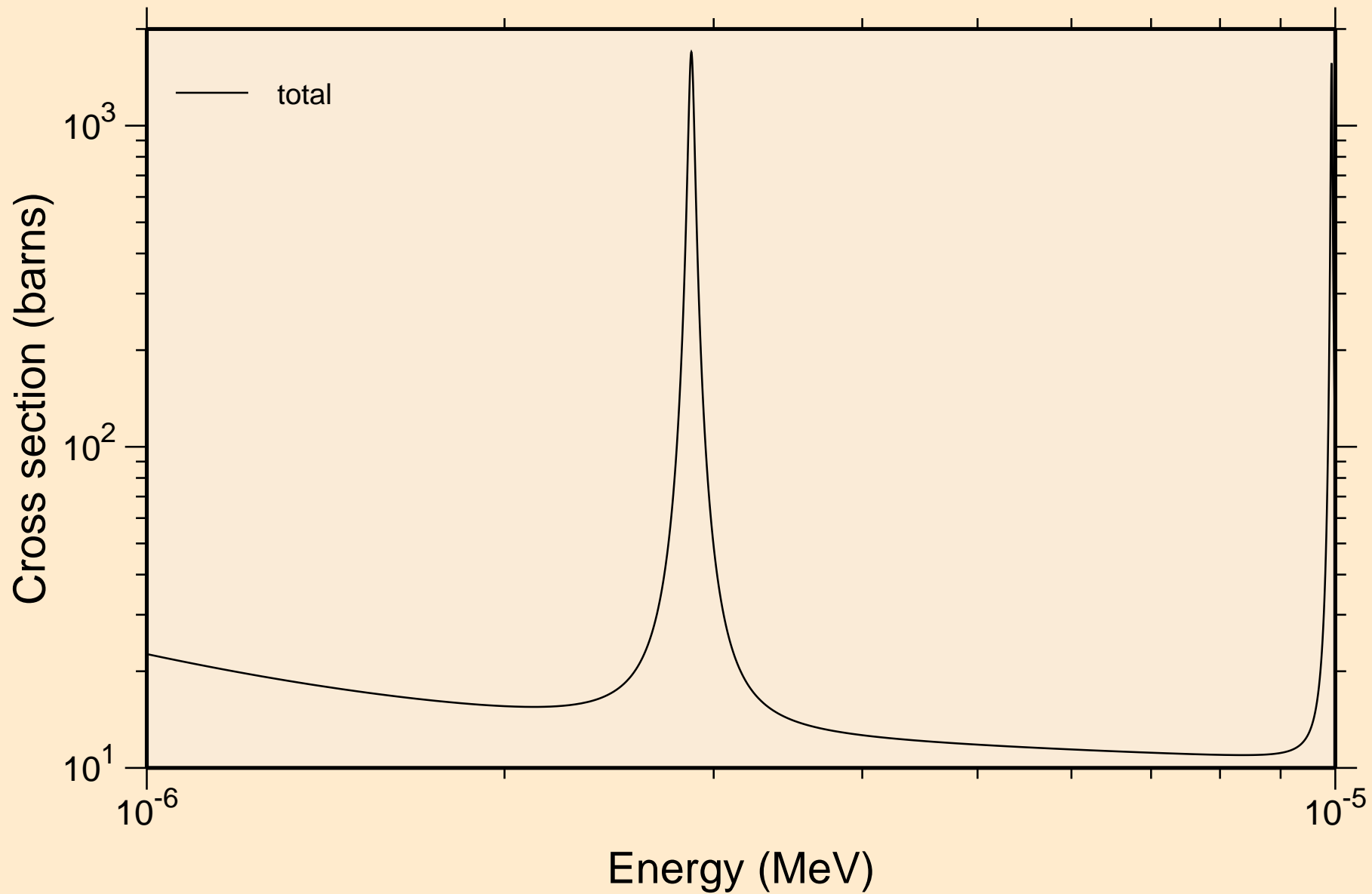

PU238 NEUTRON ACER TENDL-2023 LIBRARY; T=0.K  
resonance total cross section

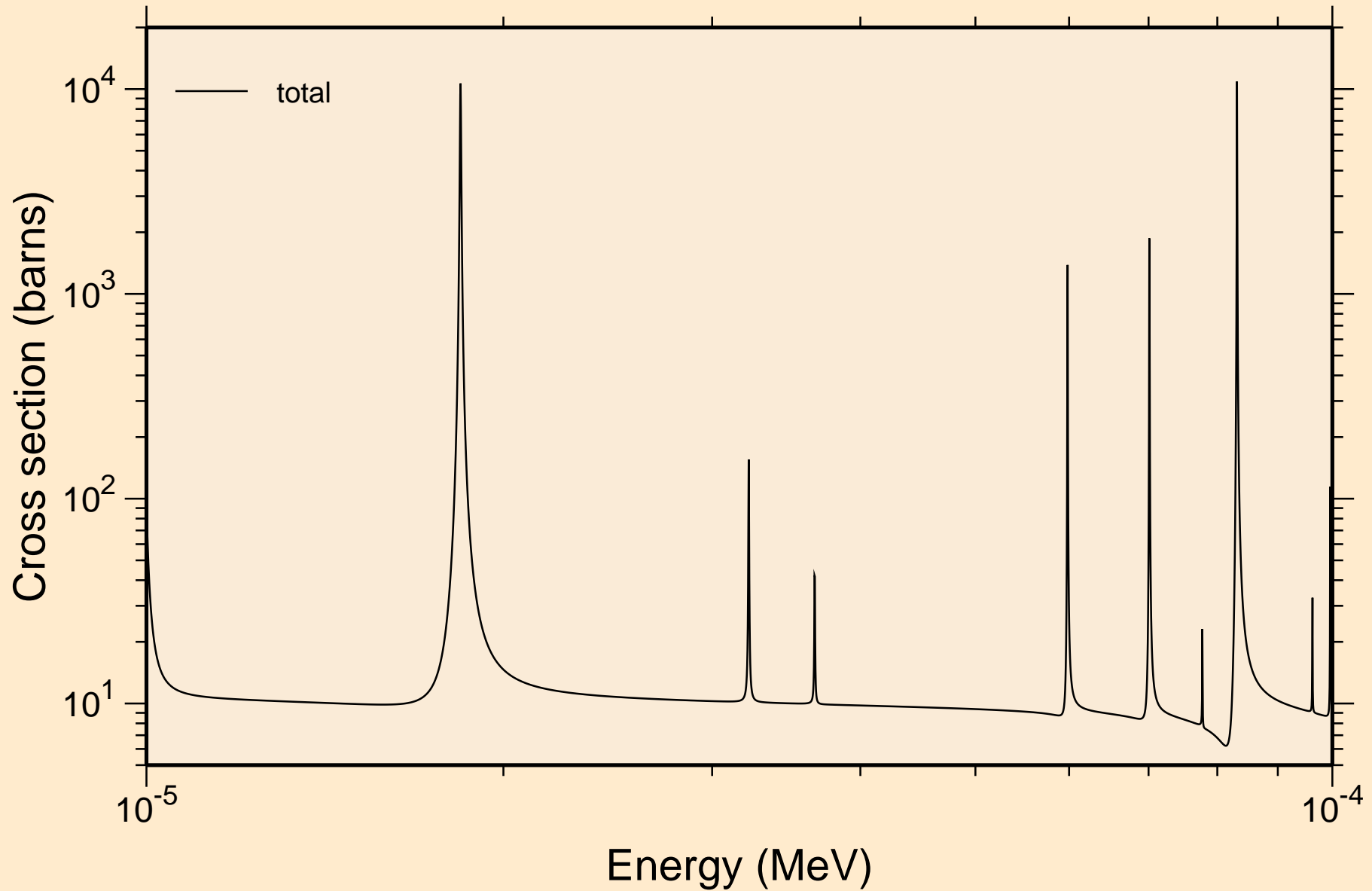

PU238 NEUTRON ACER TENDL-2023 LIBRARY; T=0.K  
resonance total cross section

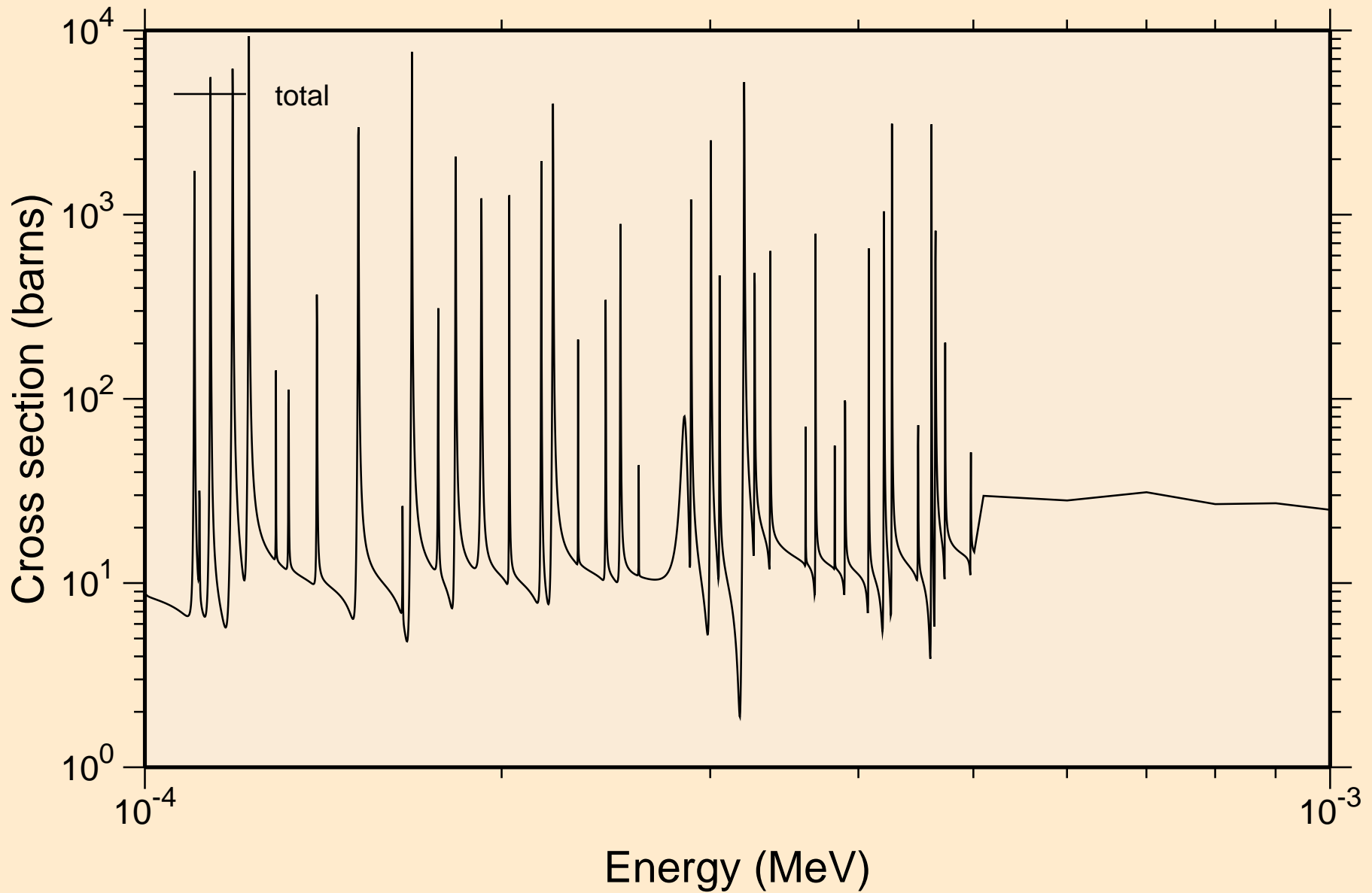

PU238 NEUTRON ACER TENDL-2023 LIBRARY; T=0.K  
resonance total cross section

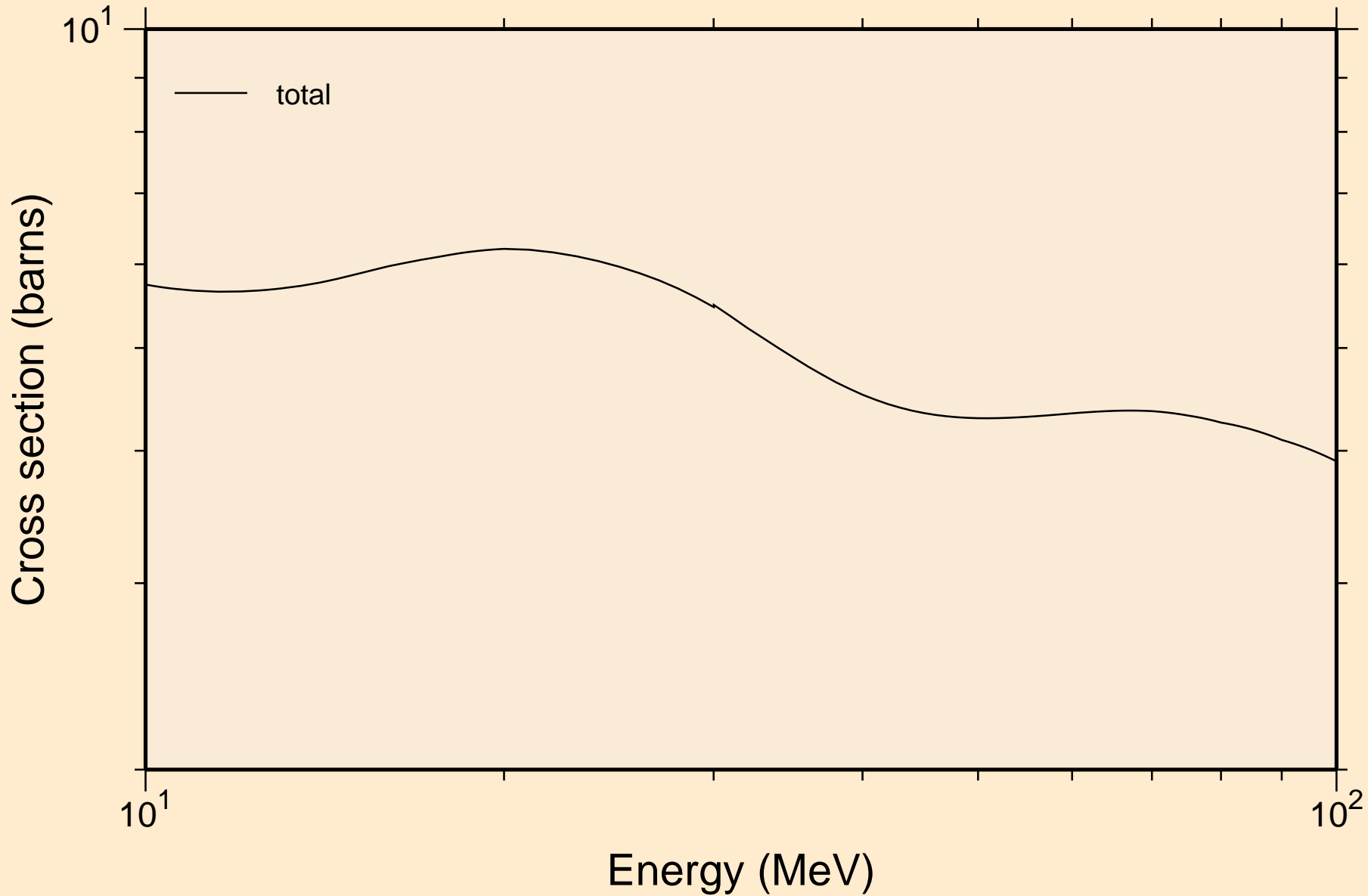

PU238 NEUTRON ACER TENDL-2023 LIBRARY; T=0.K  
resonance absorption cross sections

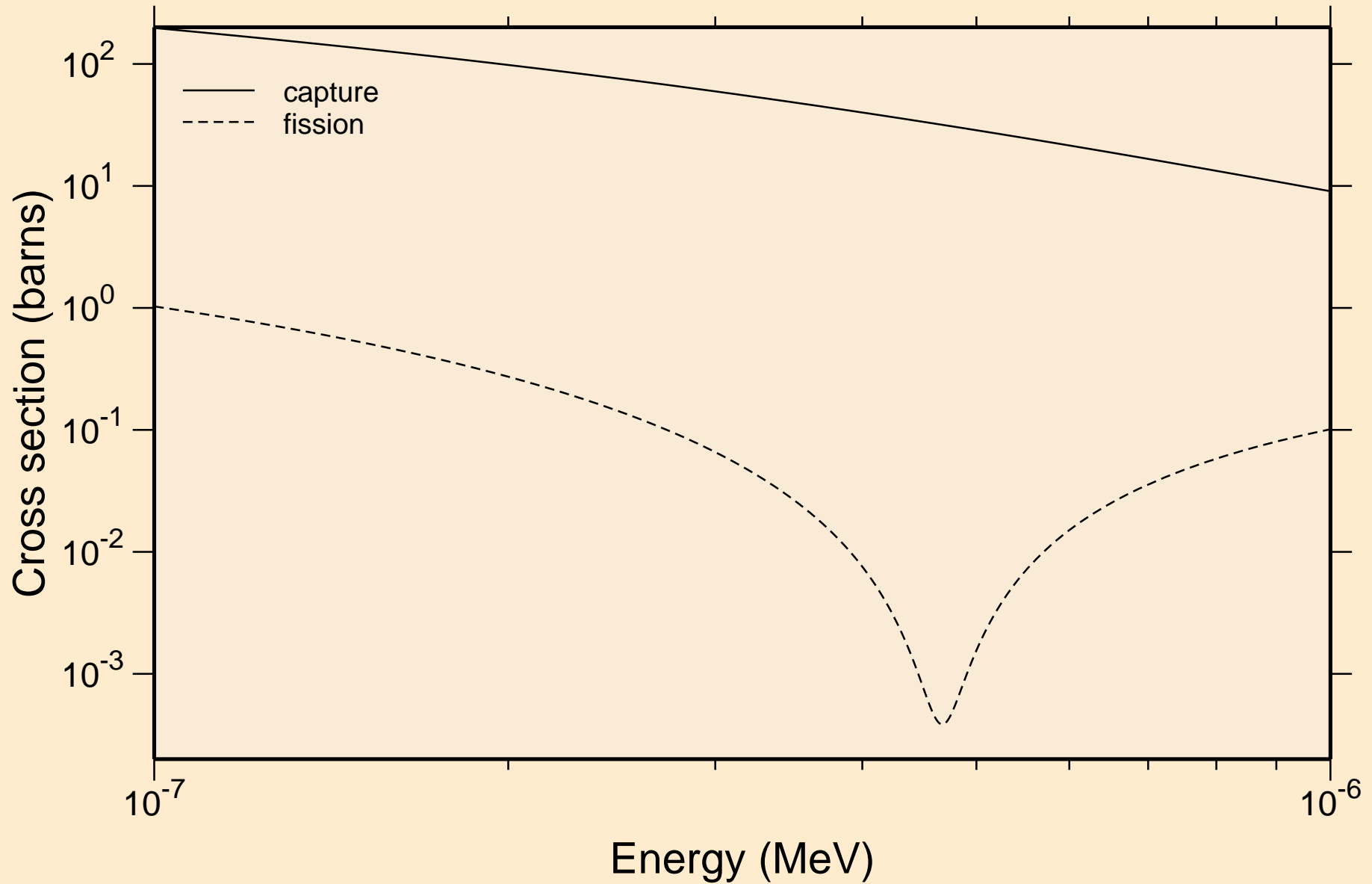

PU238 NEUTRON ACER TENDL-2023 LIBRARY; T=0.K  
resonance absorption cross sections

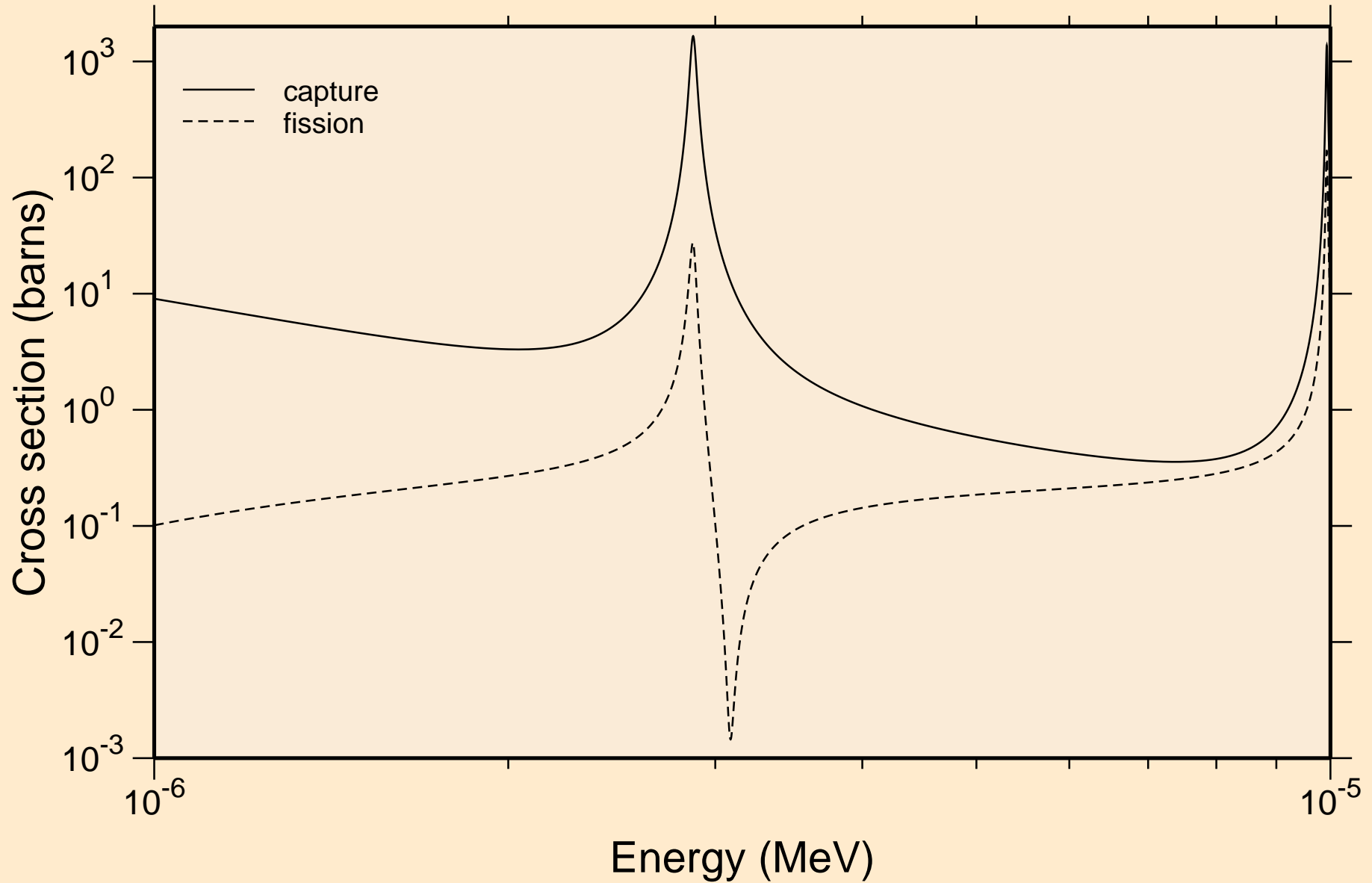



PU238 NEUTRON ACER TENDL-2023 LIBRARY; T=0.K  
resonance absorption cross sections

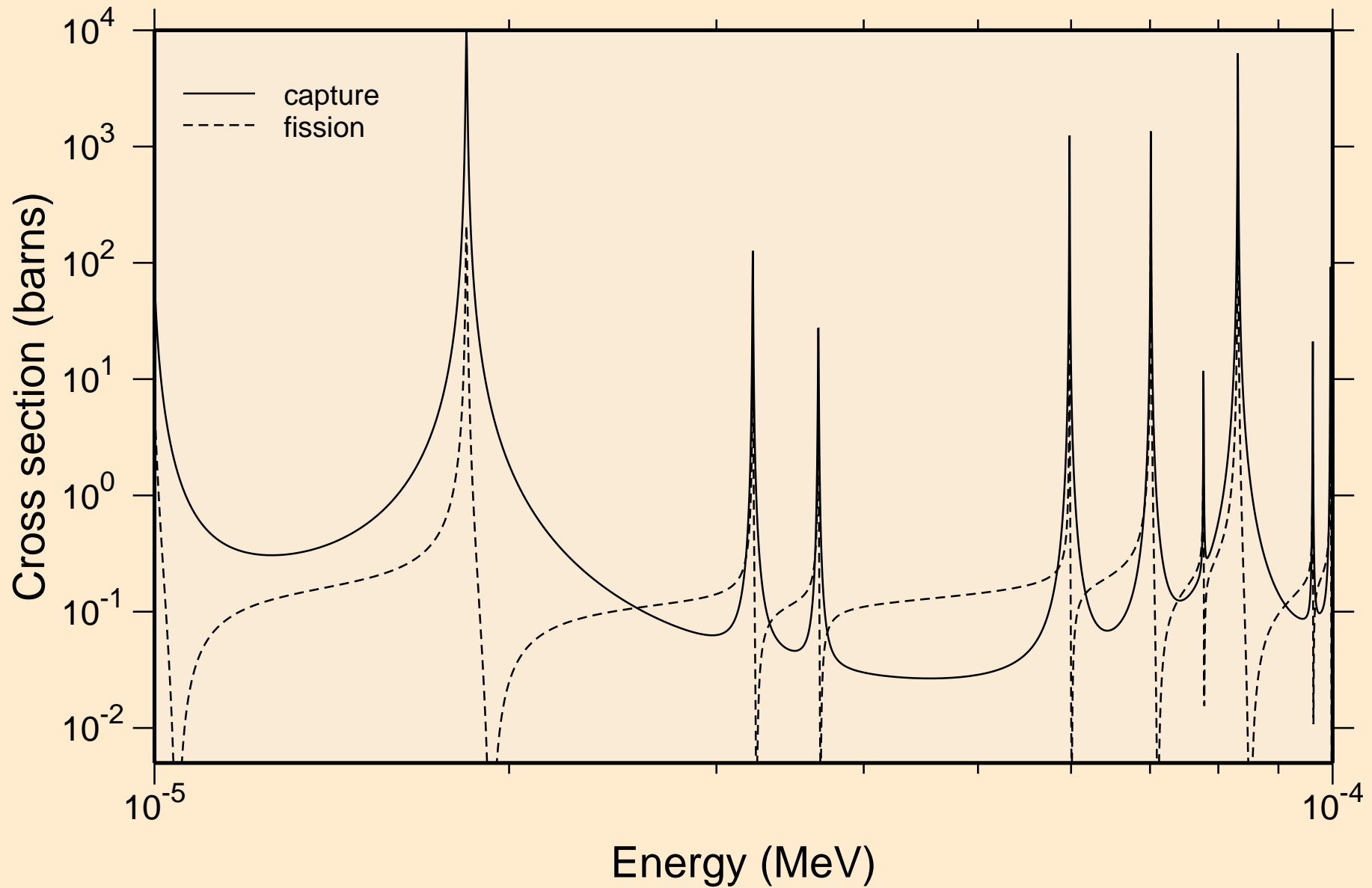

PU238 NEUTRON ACER TENDL-2023 LIBRARY; T=0.K  
resonance absorption cross sections

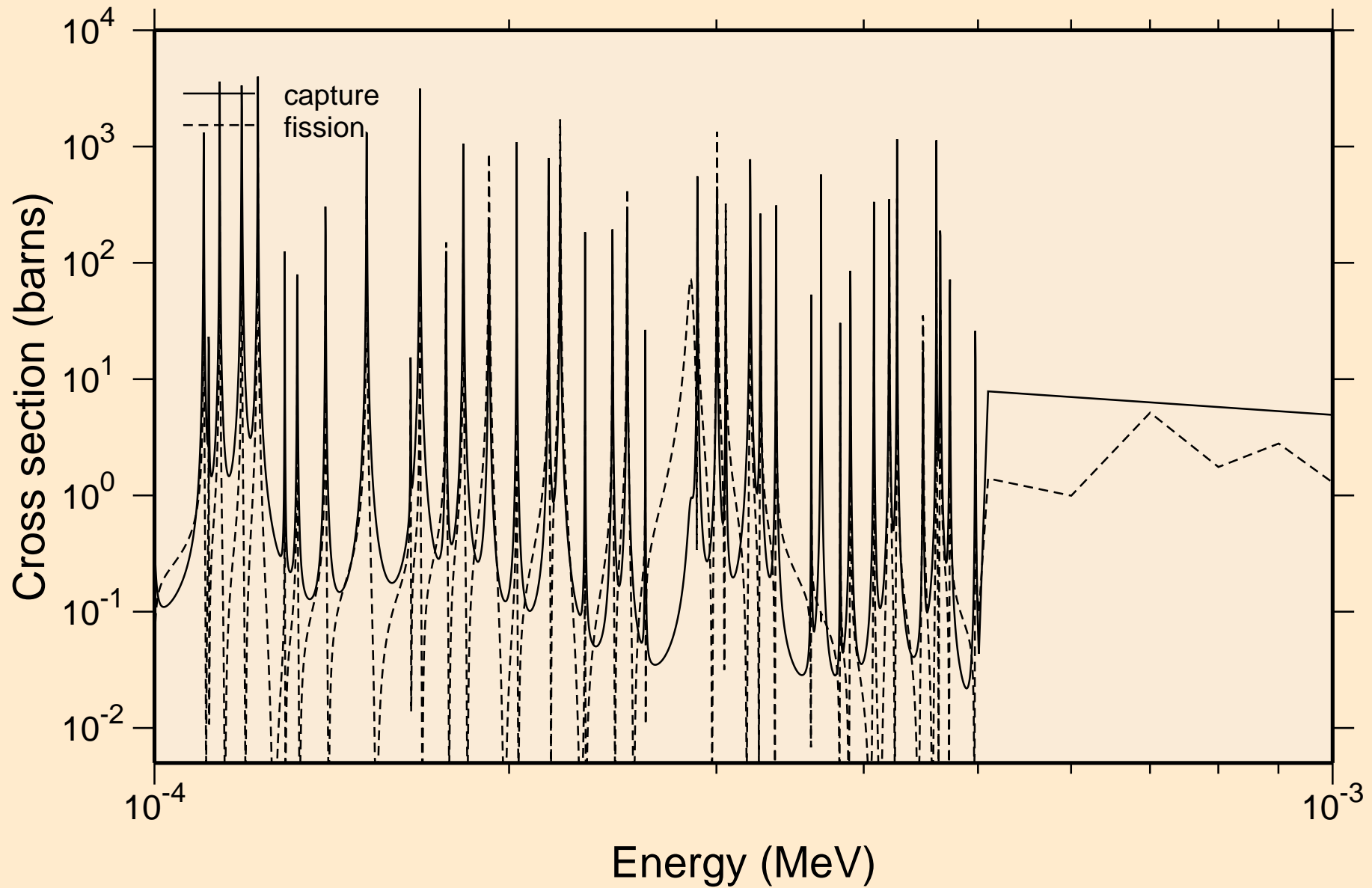

PU238 NEUTRON ACER TENDL-2023 LIBRARY; T=0.K  
resonance absorption cross sections

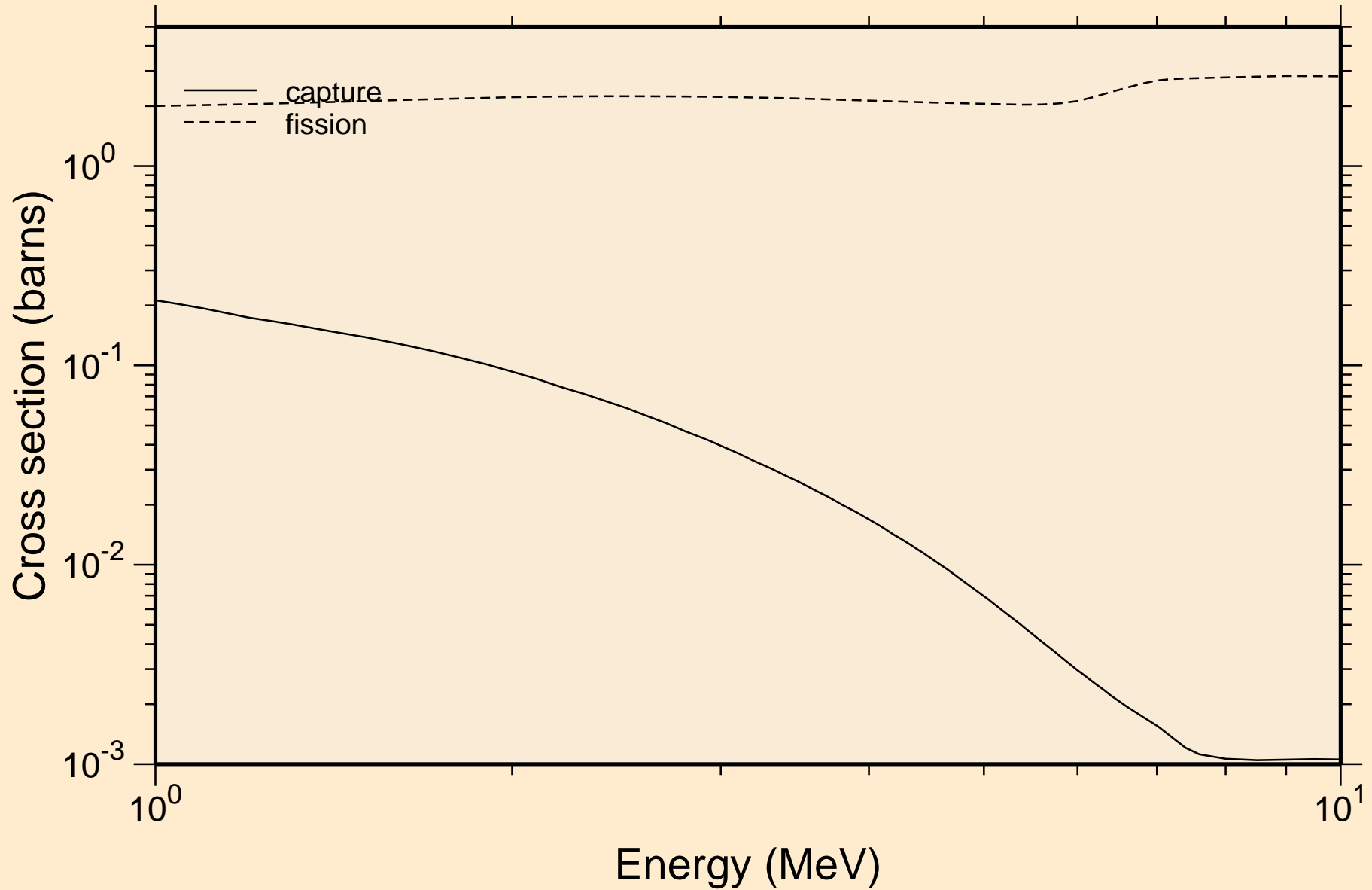

# PU238 NEUTRON ACER TENDL-2023 LIBRARY; T=0.K

## Heating

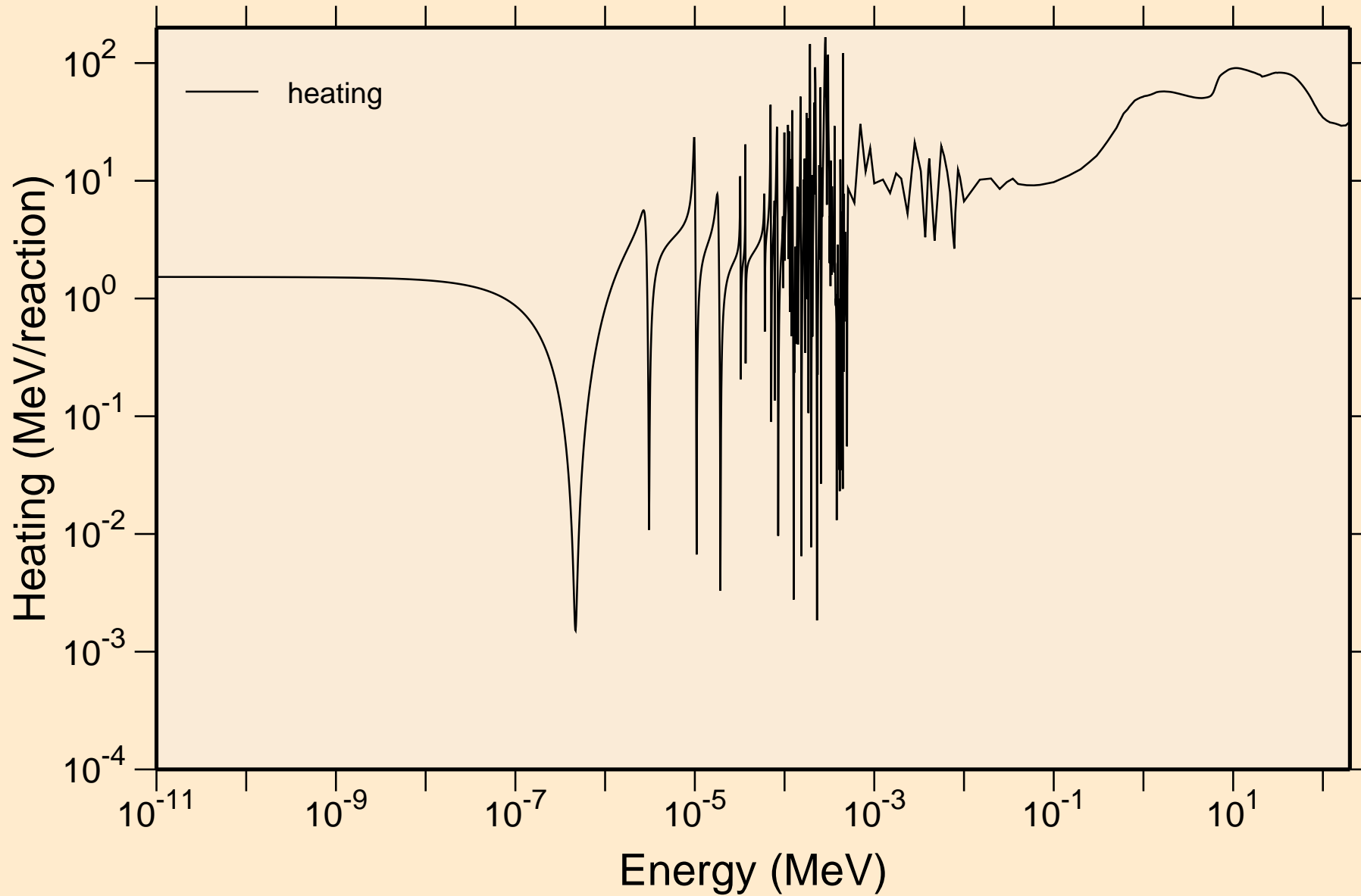

PU238 NEUTRON ACER TENDL-2023 LIBRARY; T=0.K  
Damage

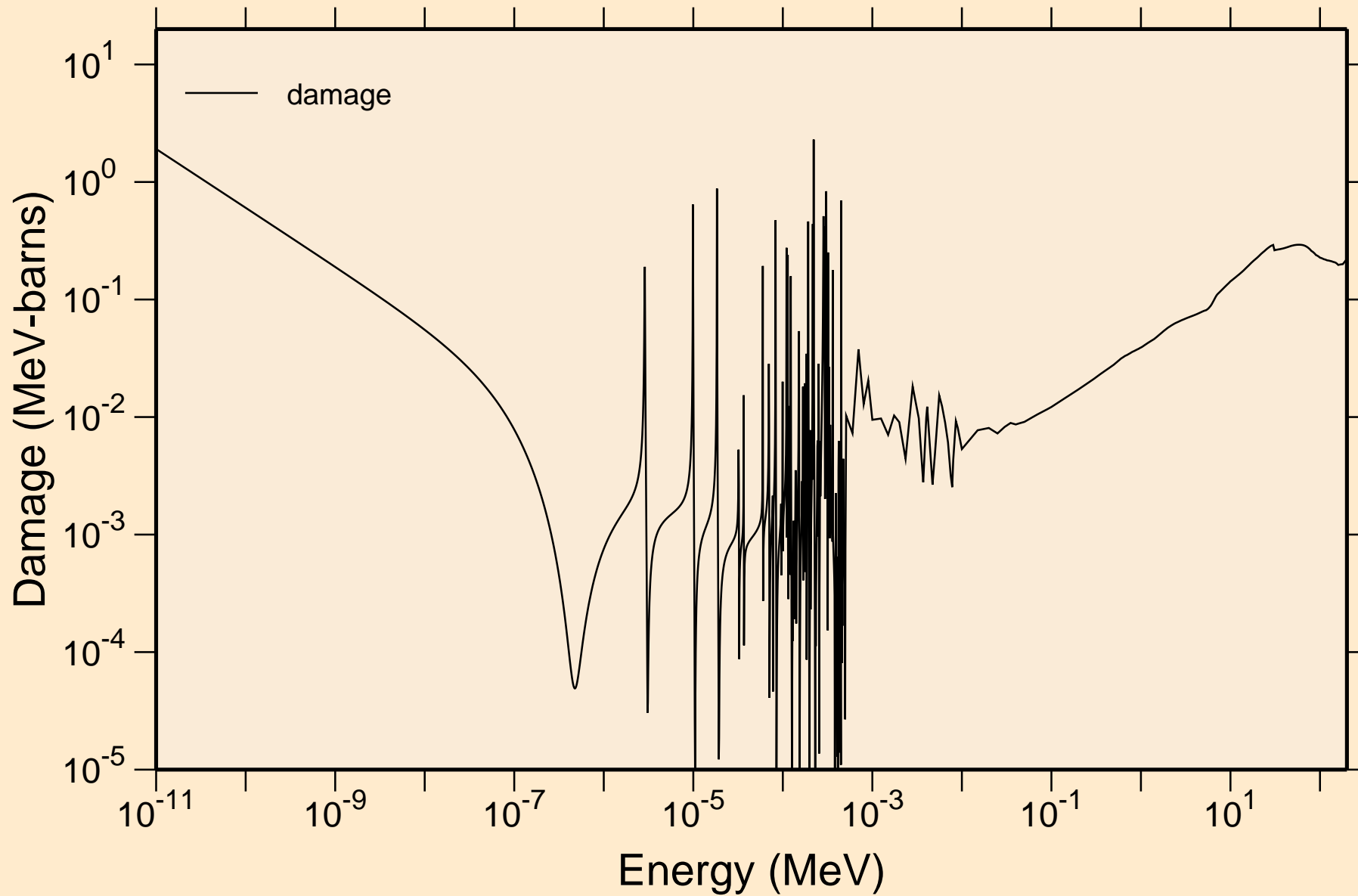

# PU238 NEUTRON ACER TENDL-2023 LIBRARY; T=0.K

## Non-threshold reactions

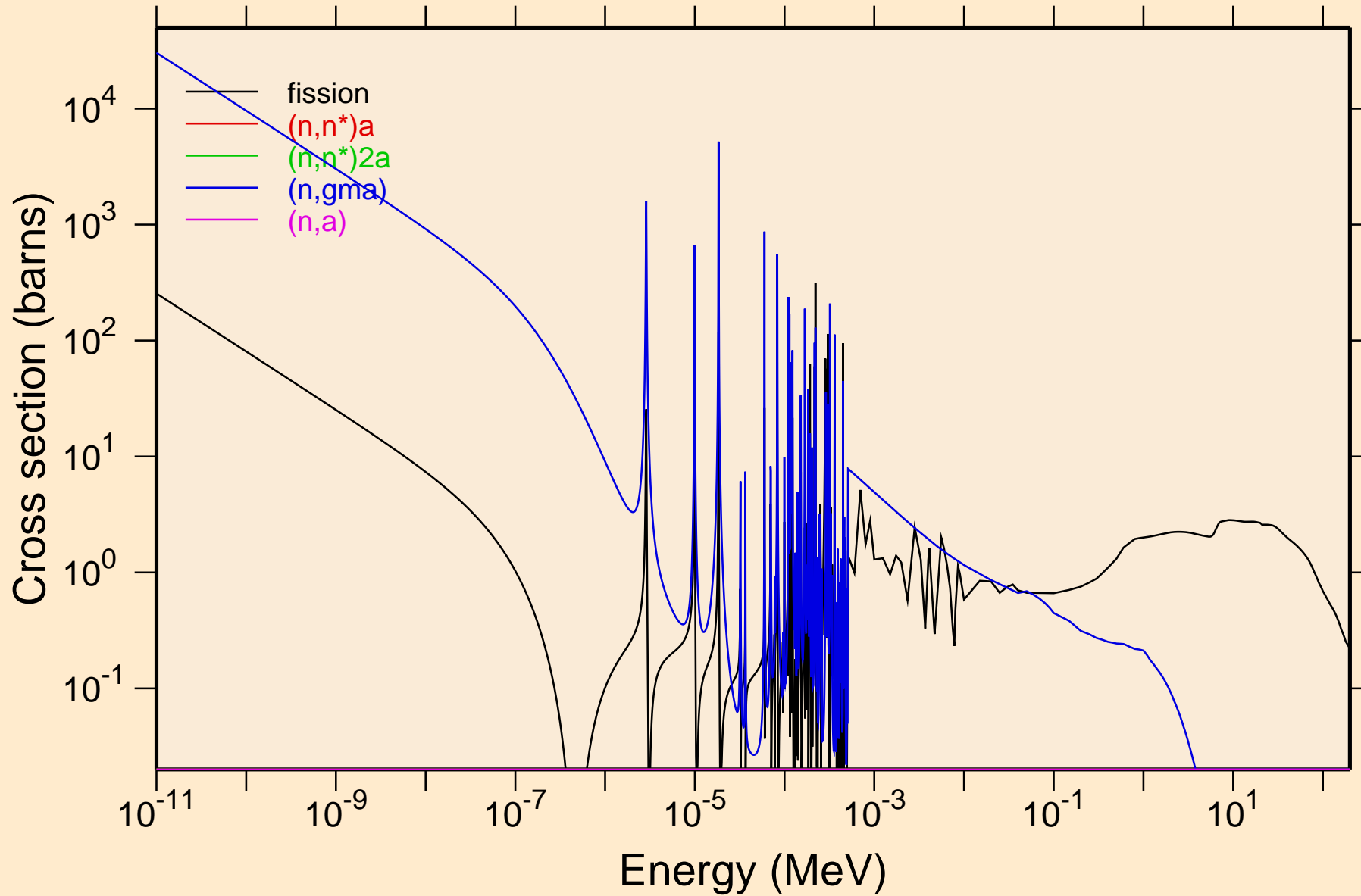

PU238 NEUTRON ACER TENDL-2023 LIBRARY; T=0.K  
Non-threshold reactions

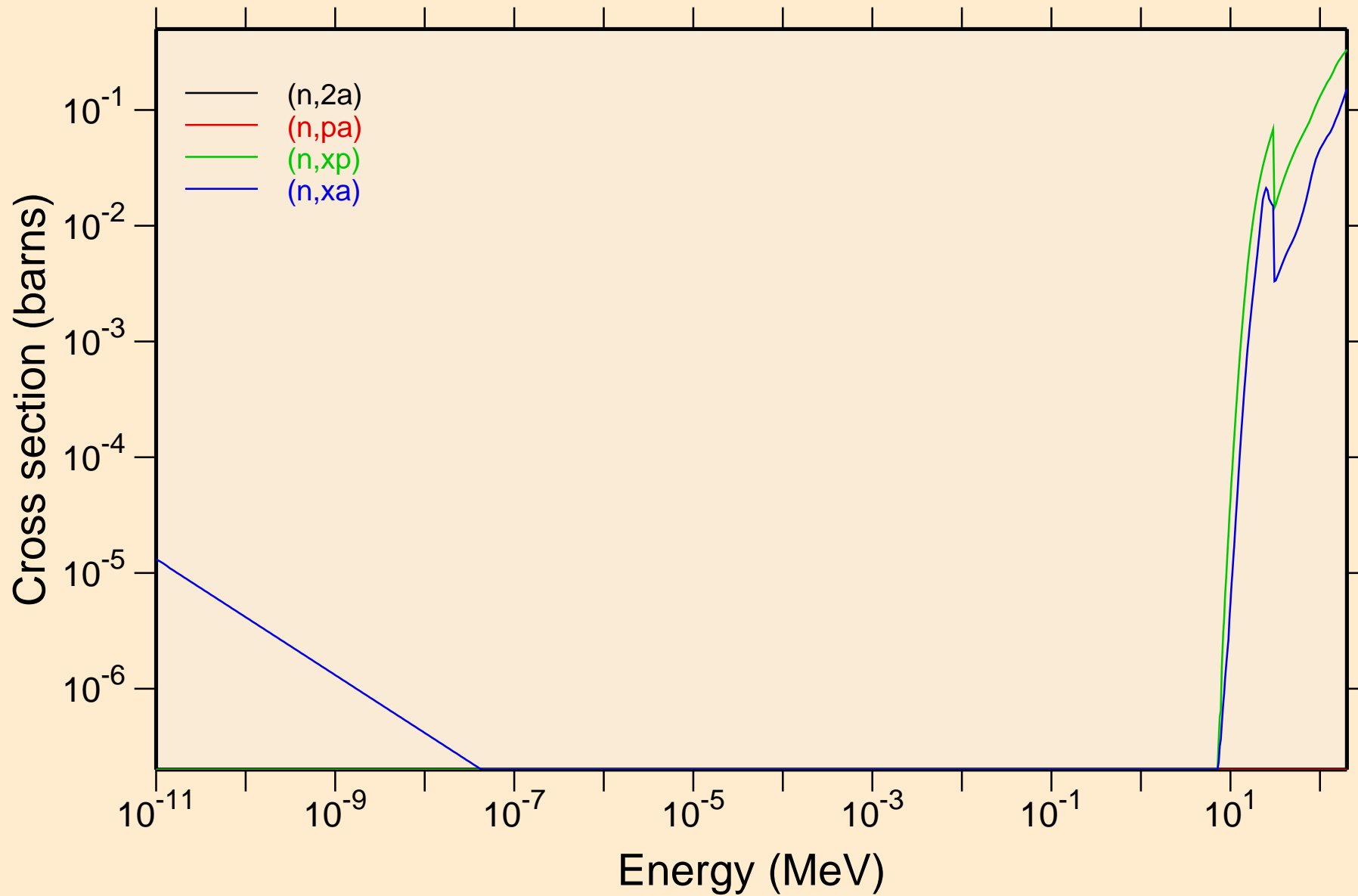

# PU238 NEUTRON ACER TENDL-2023 LIBRARY; T=0.K

## Principal cross sections

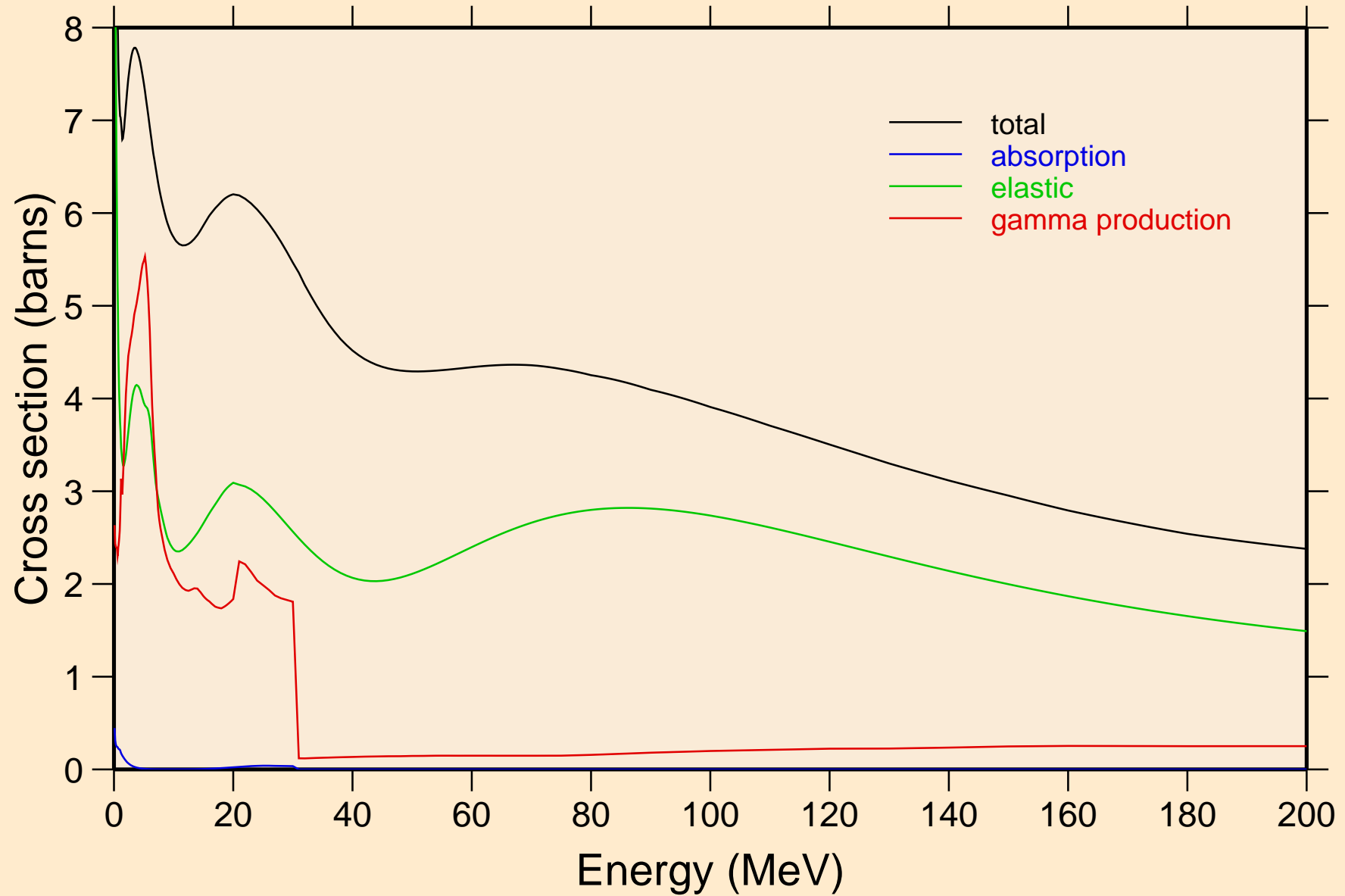



PU238 NEUTRON ACER TENDL-2023 LIBRARY; T=0.K  
Heating

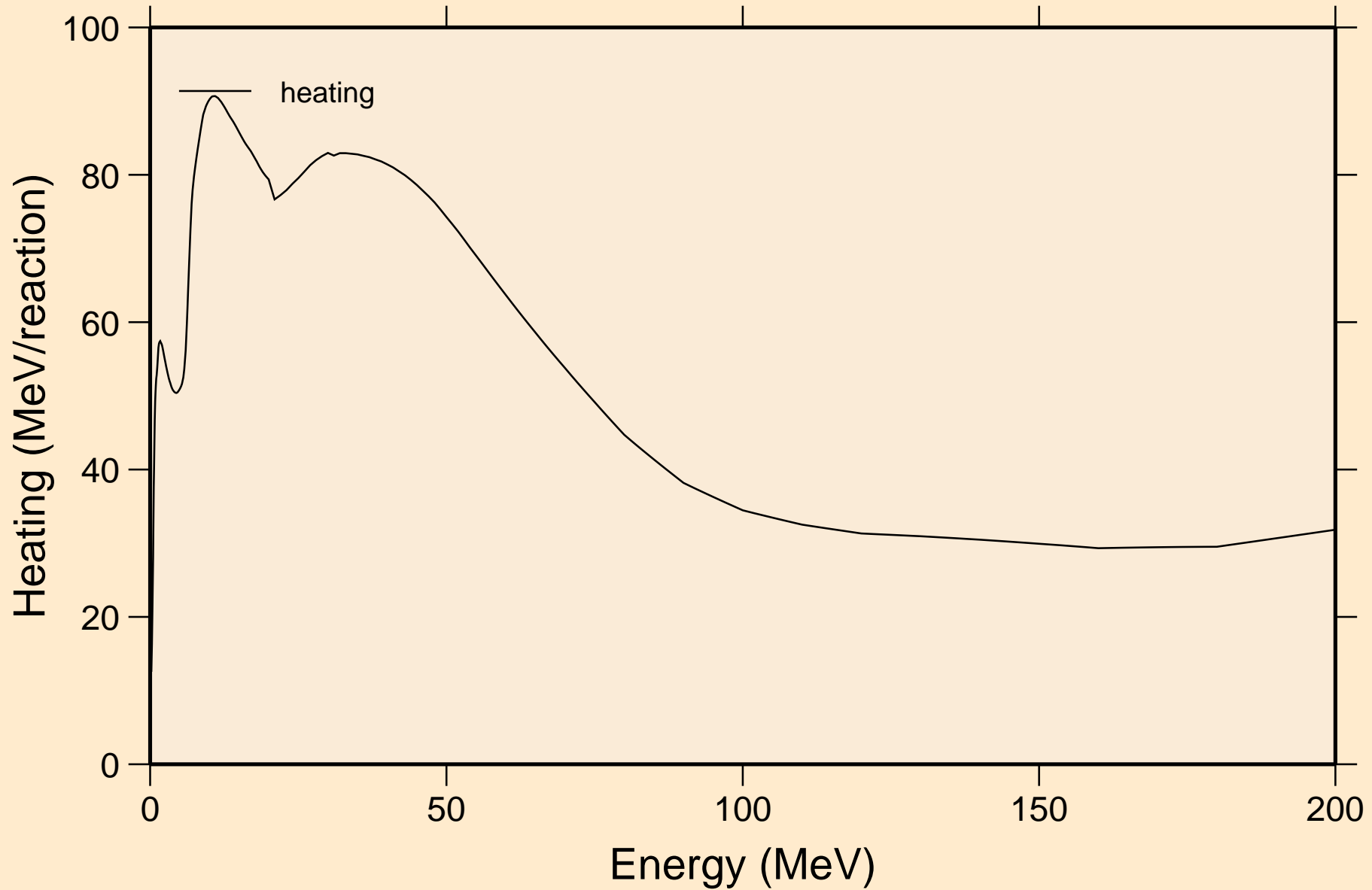

PU238 NEUTRON ACER TENDL-2023 LIBRARY; T=0.K  
Damage

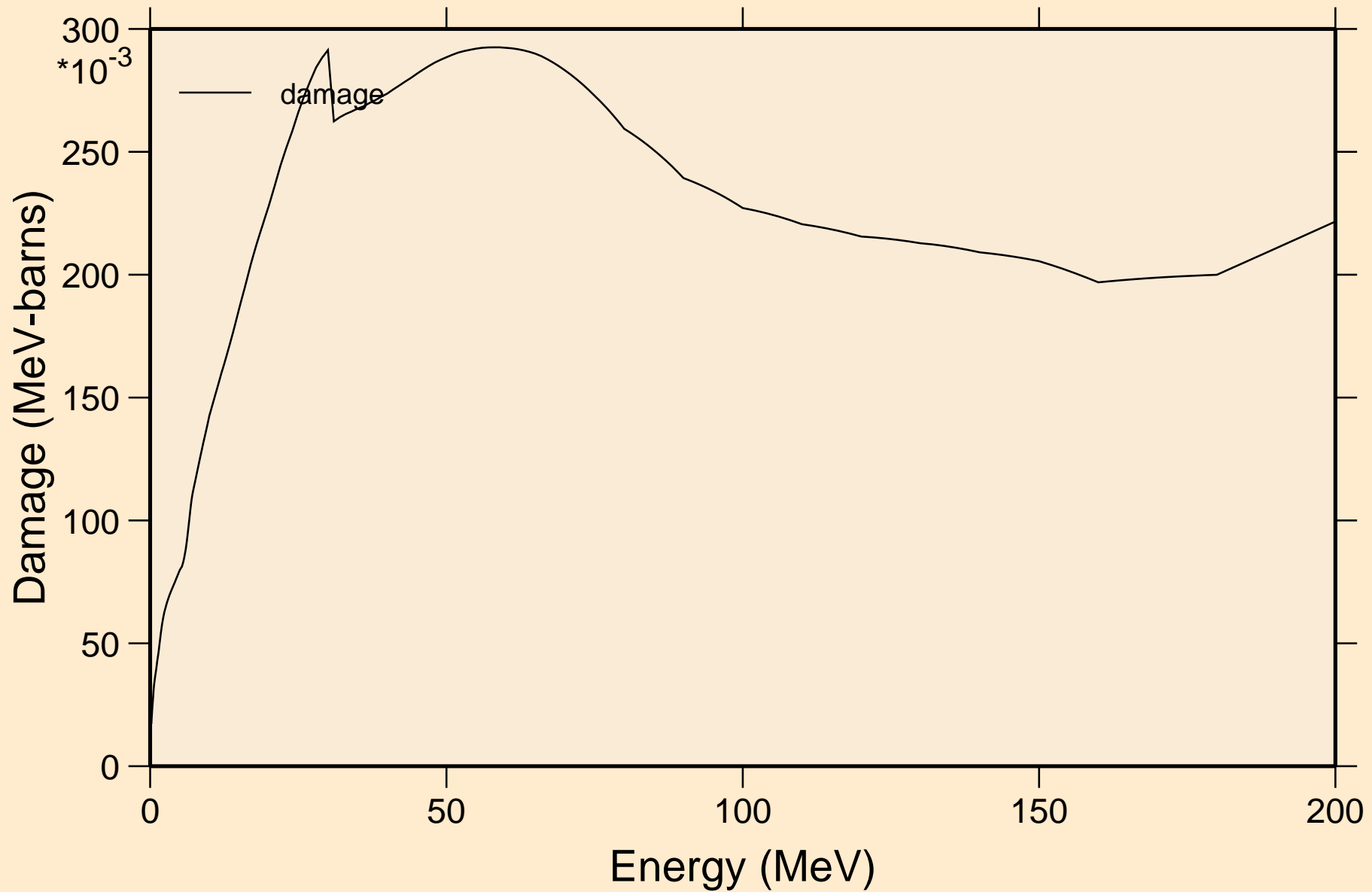

# PU238 NEUTRON ACER TENDL-2023 LIBRARY; T=0.K

## Non-threshold reactions

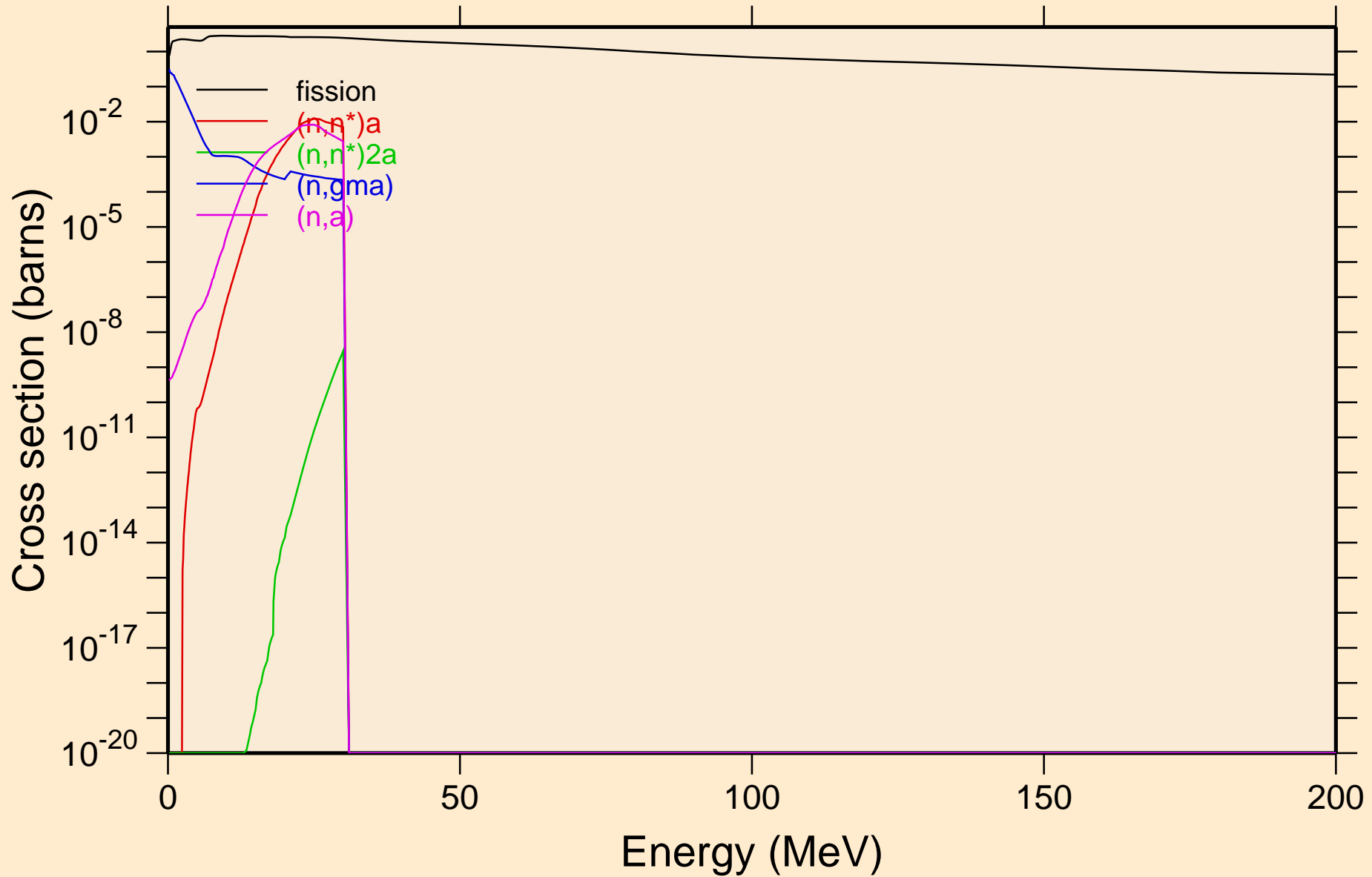

PU238 NEUTRON ACER TENDL-2023 LIBRARY; T=0.K  
Non-threshold reactions

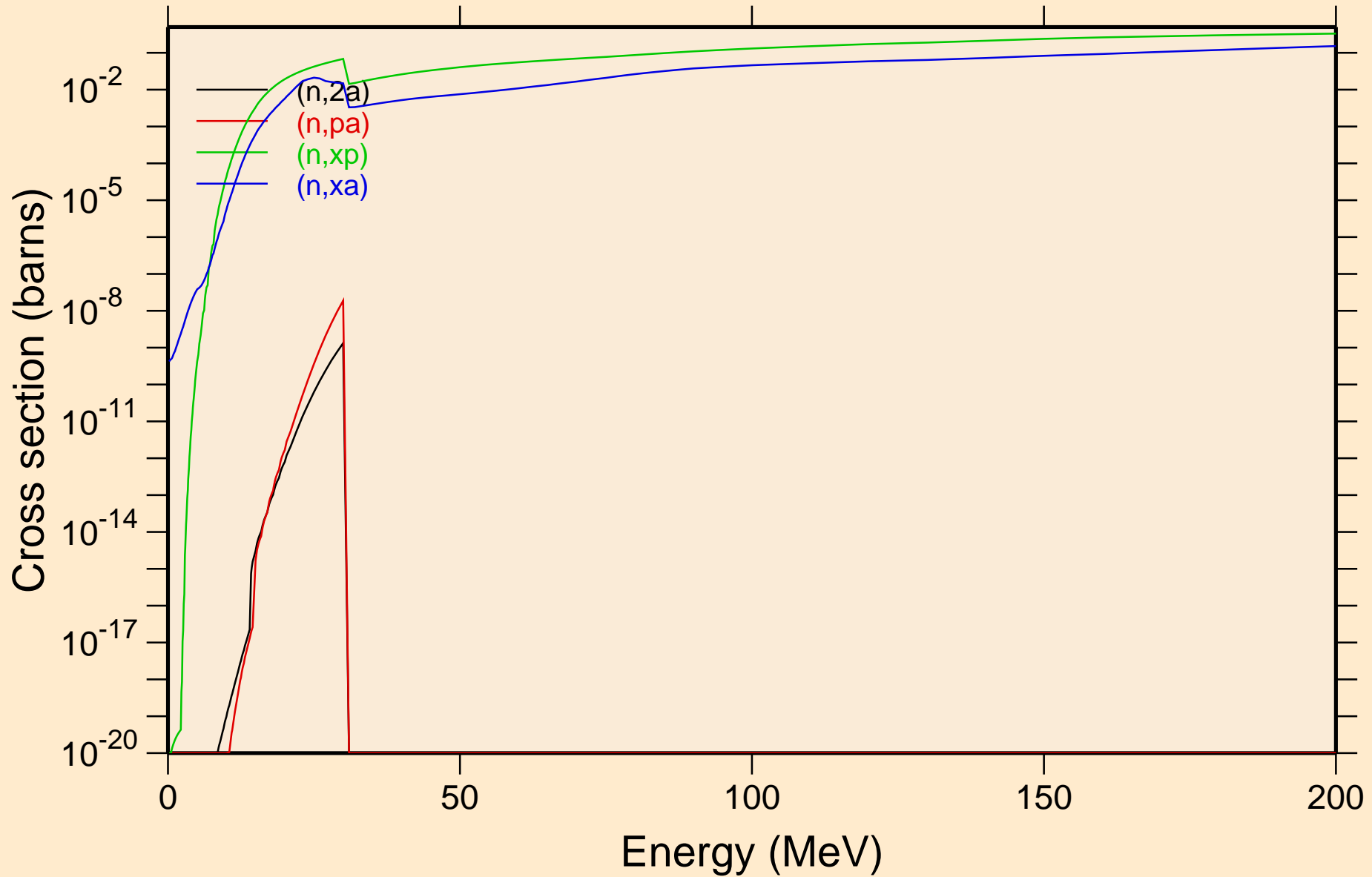

PU238 NEUTRON ACER TENDL-2023 LIBRARY; T=0.K  
Inelastic levels

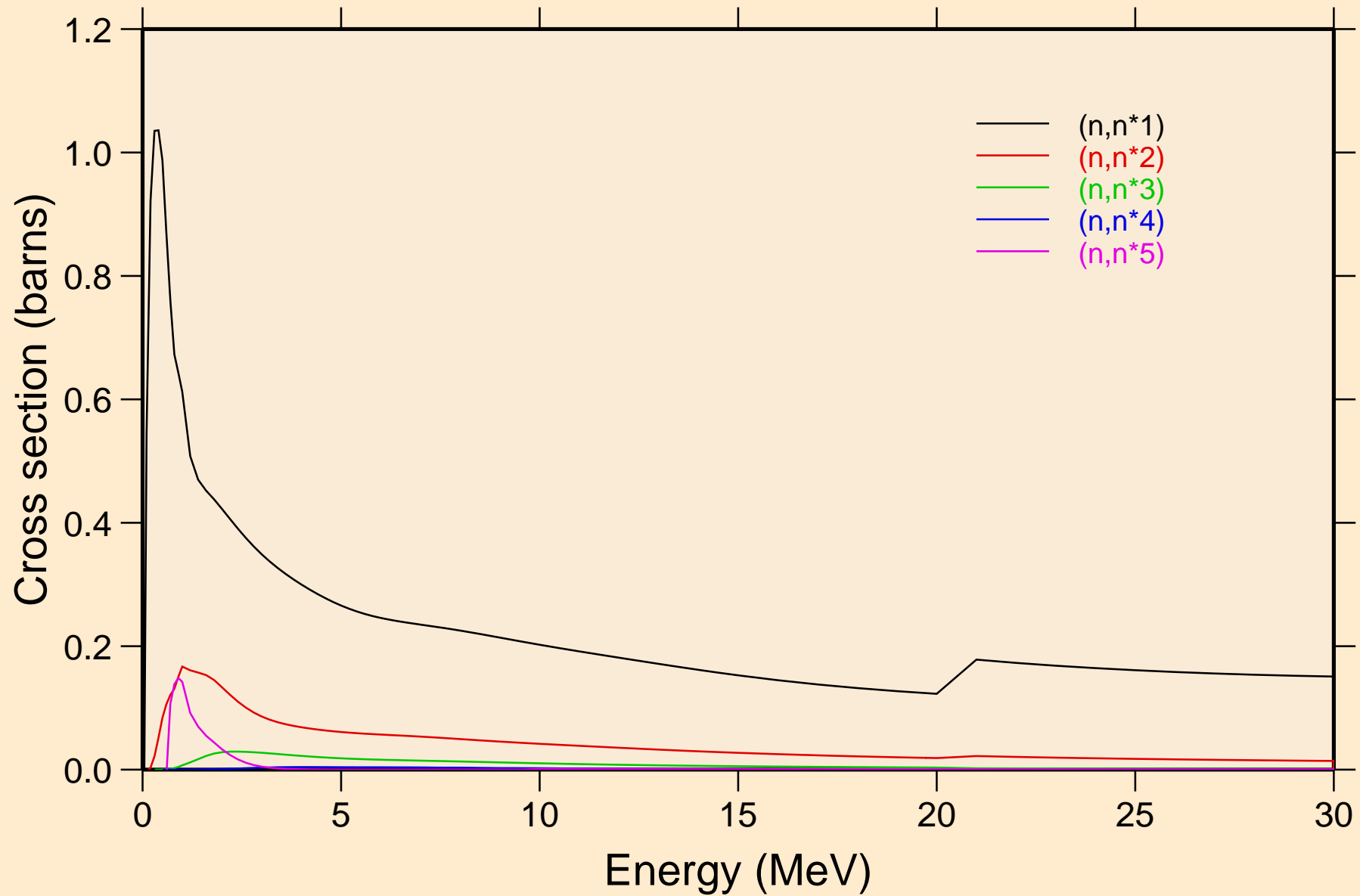

PU238 NEUTRON ACER TENDL-2023 LIBRARY; T=0.K  
Inelastic levels

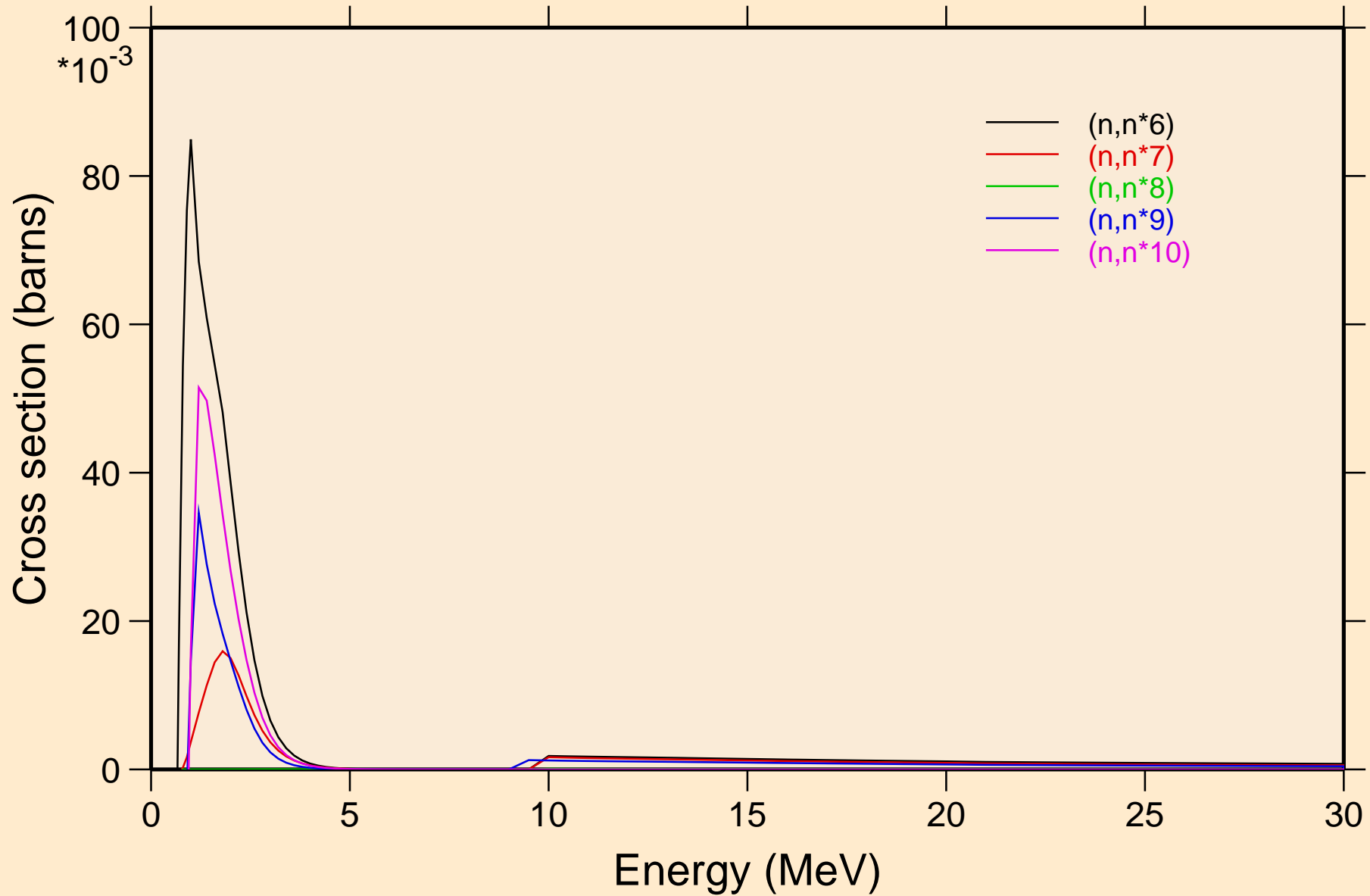

PU238 NEUTRON ACER TENDL-2023 LIBRARY; T=0.K  
Inelastic levels

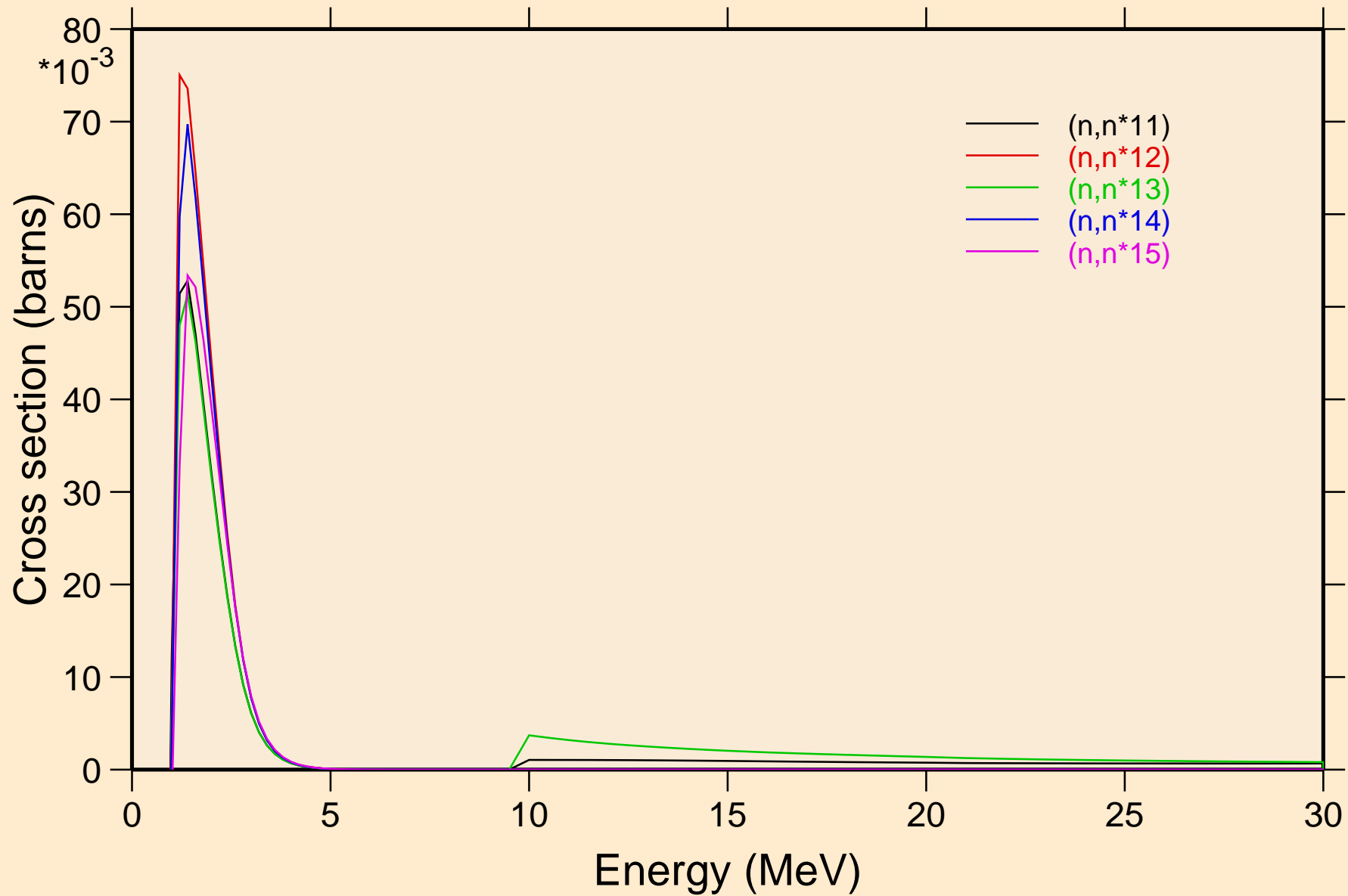

PU238 NEUTRON ACER TENDL-2023 LIBRARY; T=0.K  
Inelastic levels

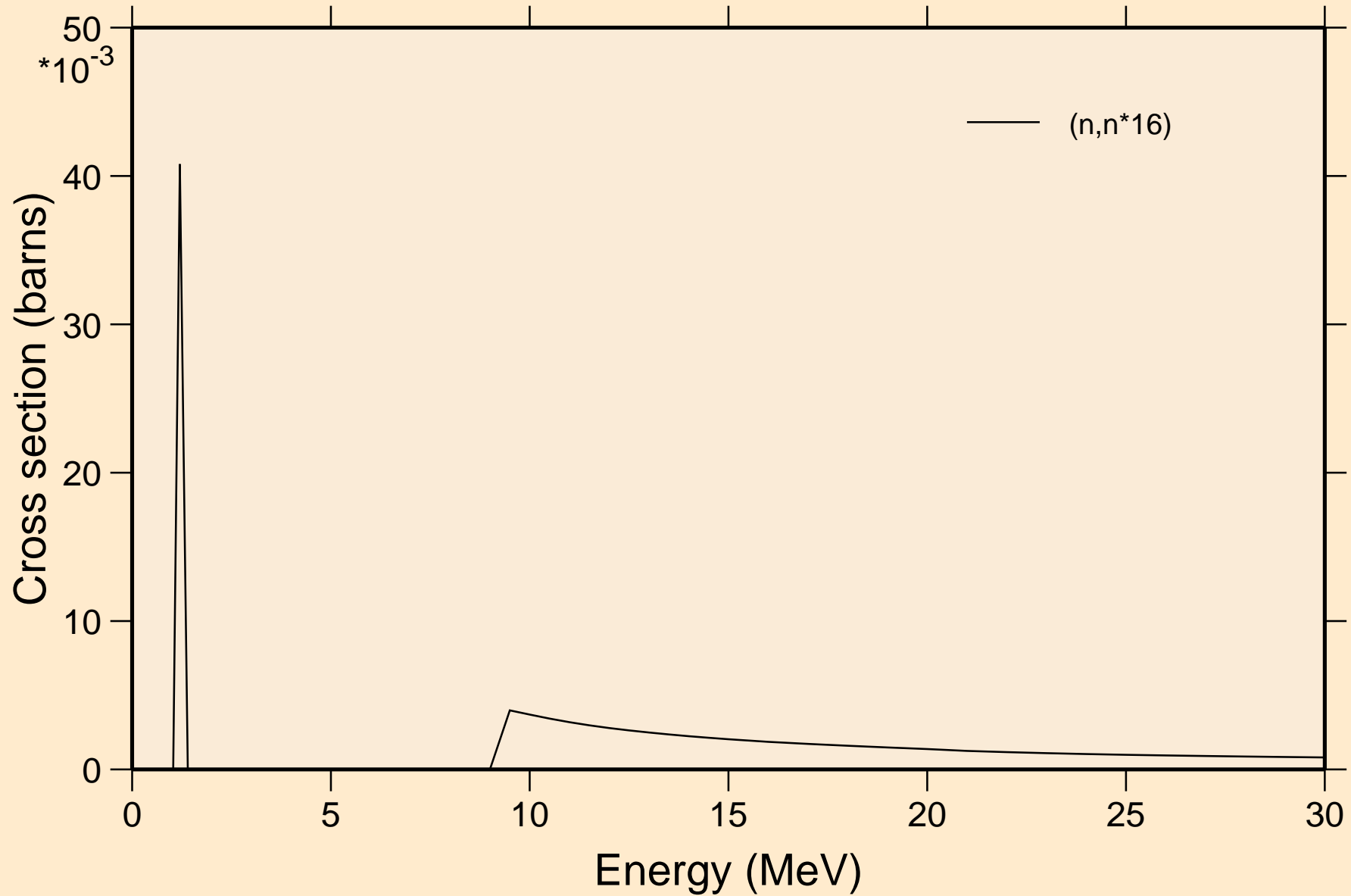



PU238 NEUTRON ACER TENDL-2023 LIBRARY; T=0.K  
Threshold reactions

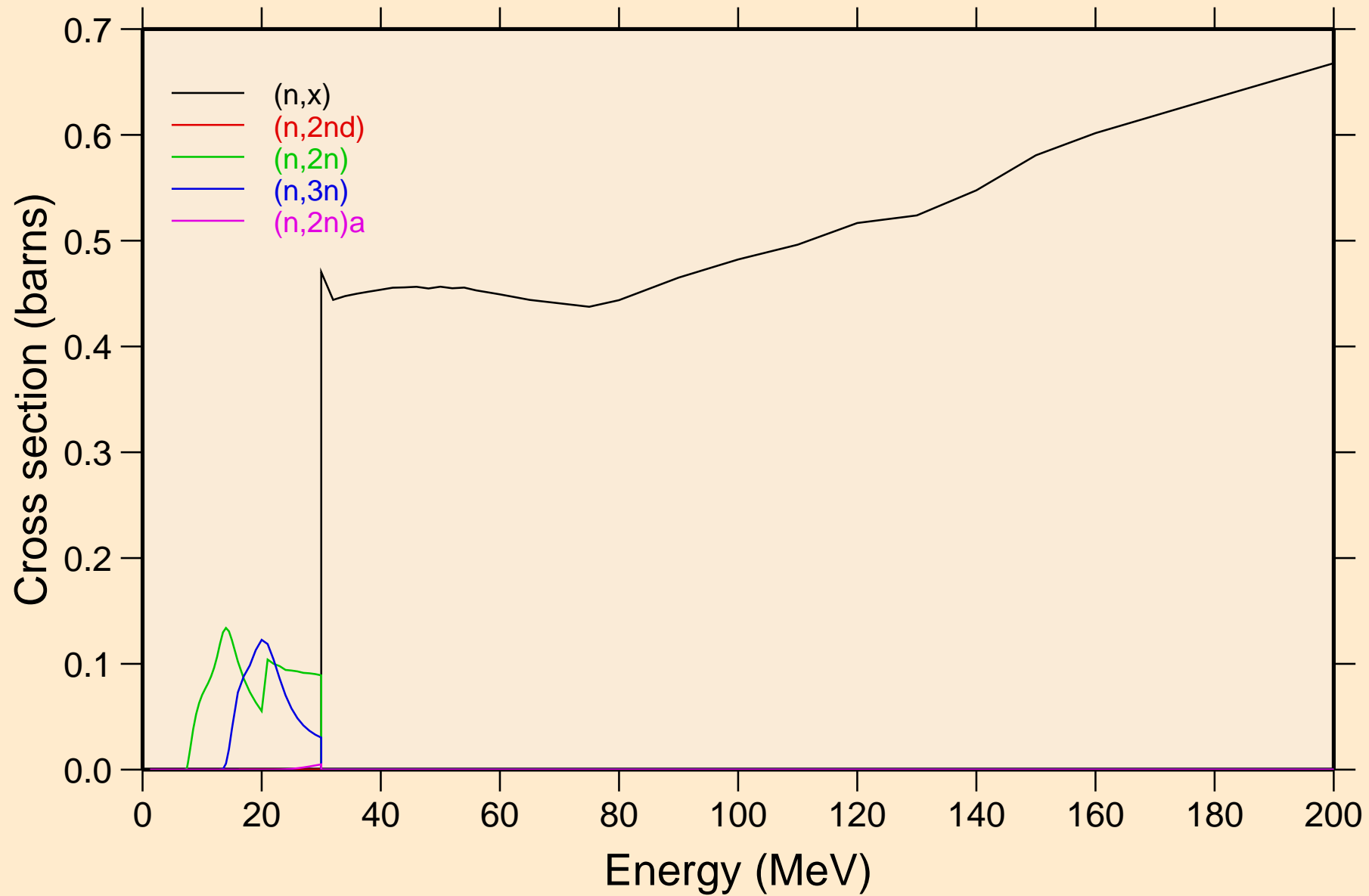

PU238 NEUTRON ACER TENDL-2023 LIBRARY; T=0.K  
Threshold reactions

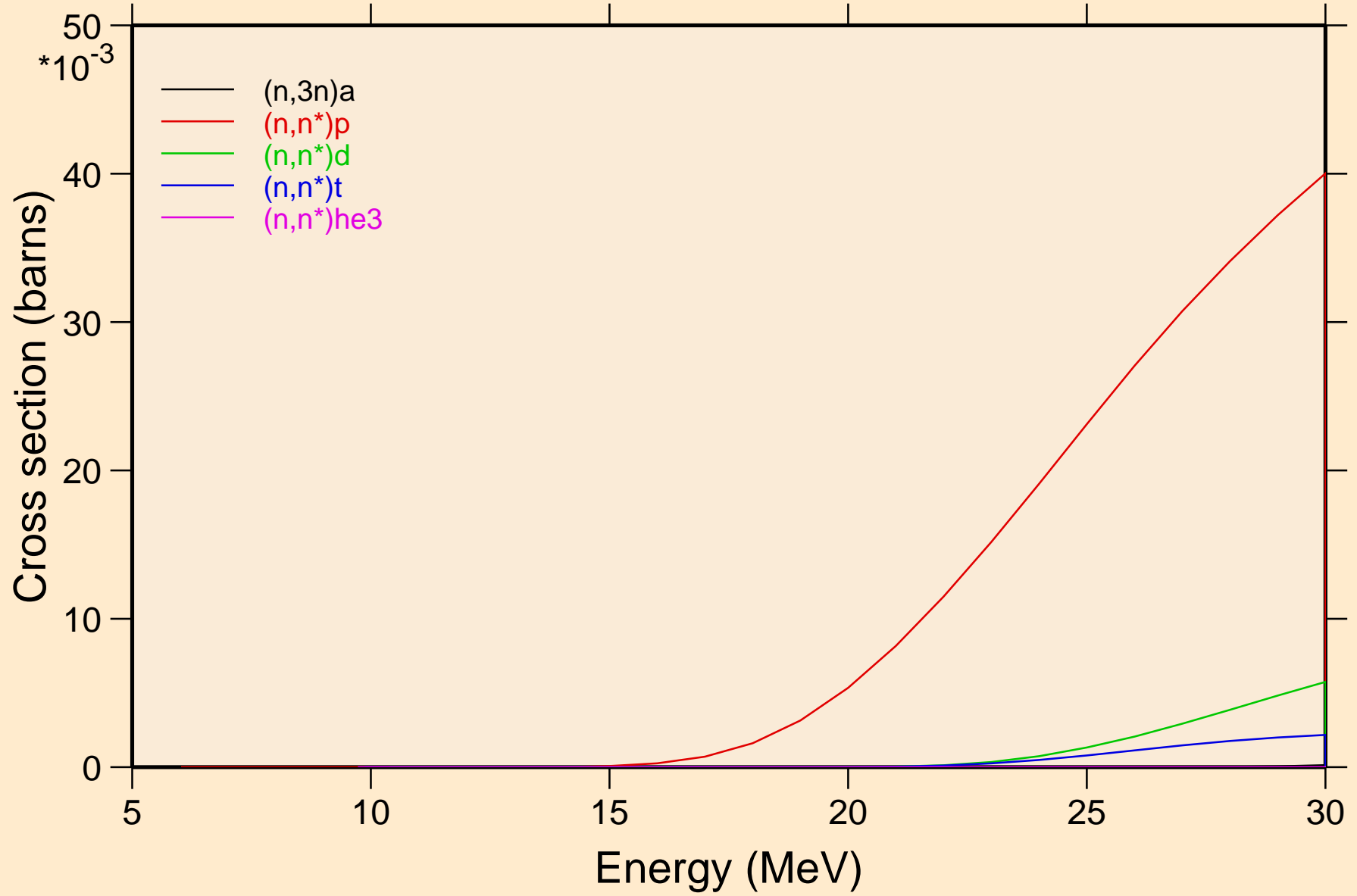

PU238 NEUTRON ACER TENDL-2023 LIBRARY; T=0.K  
Threshold reactions

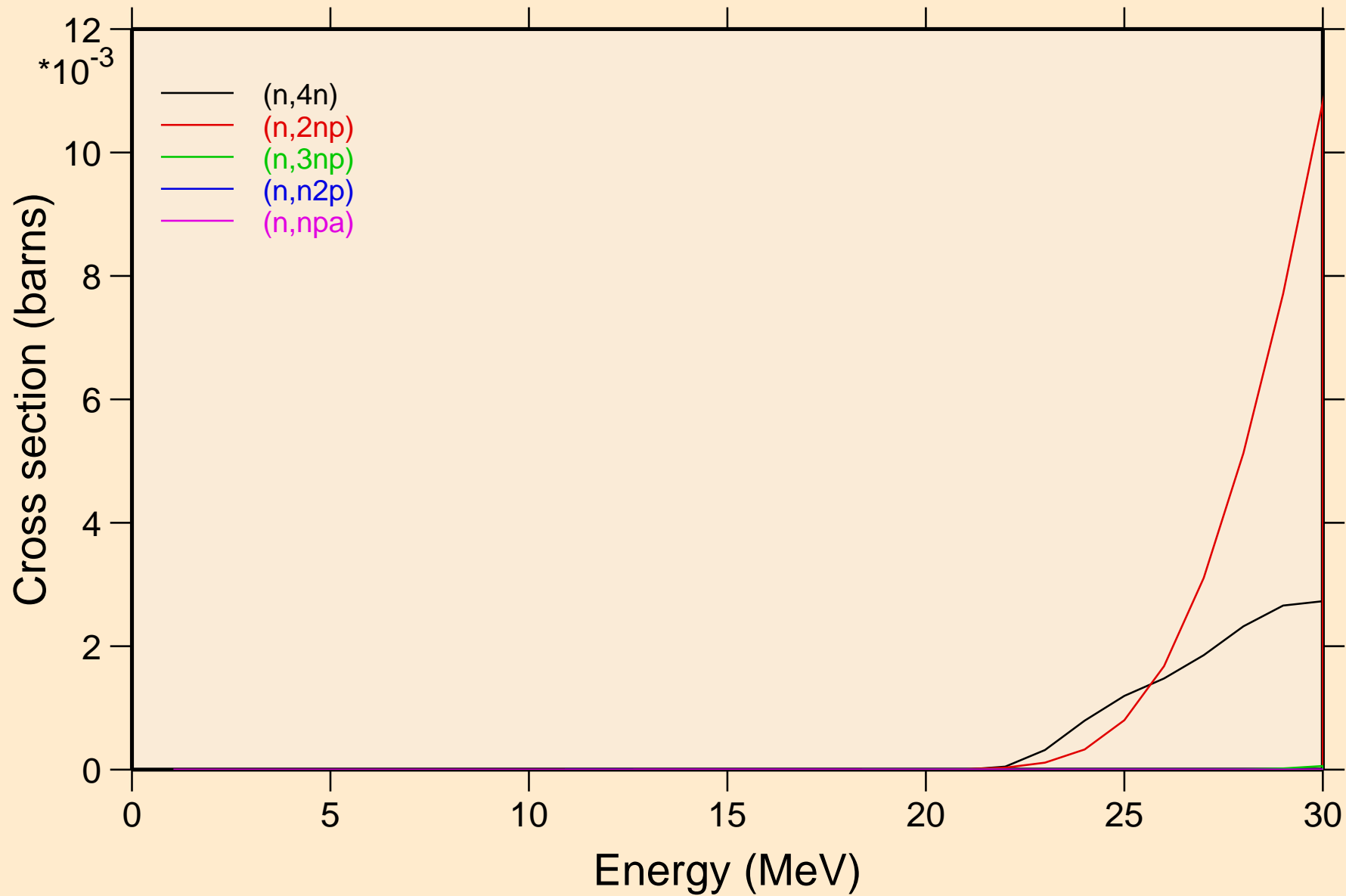

PU238 NEUTRON ACER TENDL-2023 LIBRARY; T=0.K  
Threshold reactions

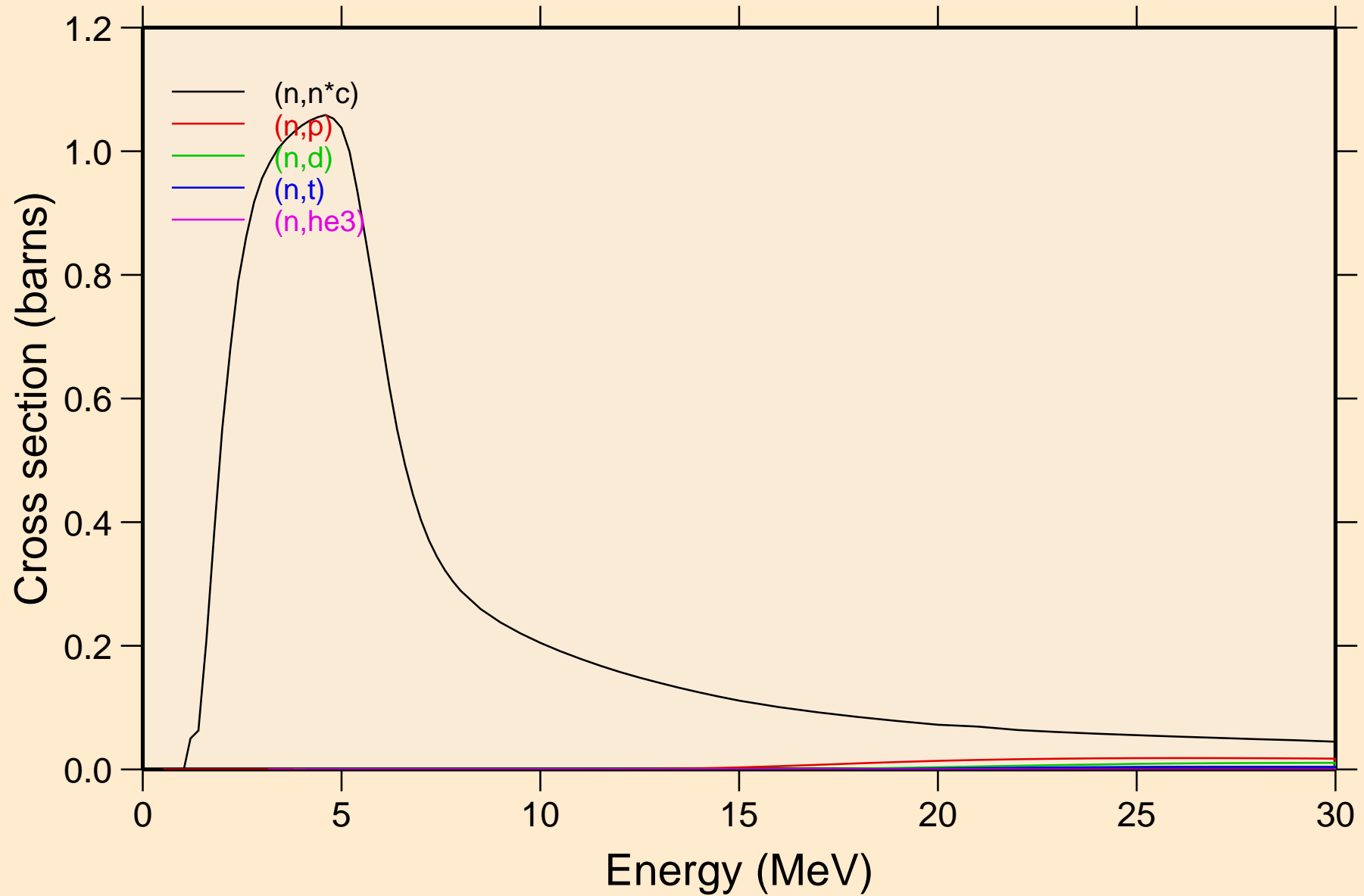

PU238 NEUTRON ACER TENDL-2023 LIBRARY; T=0.K  
Threshold reactions

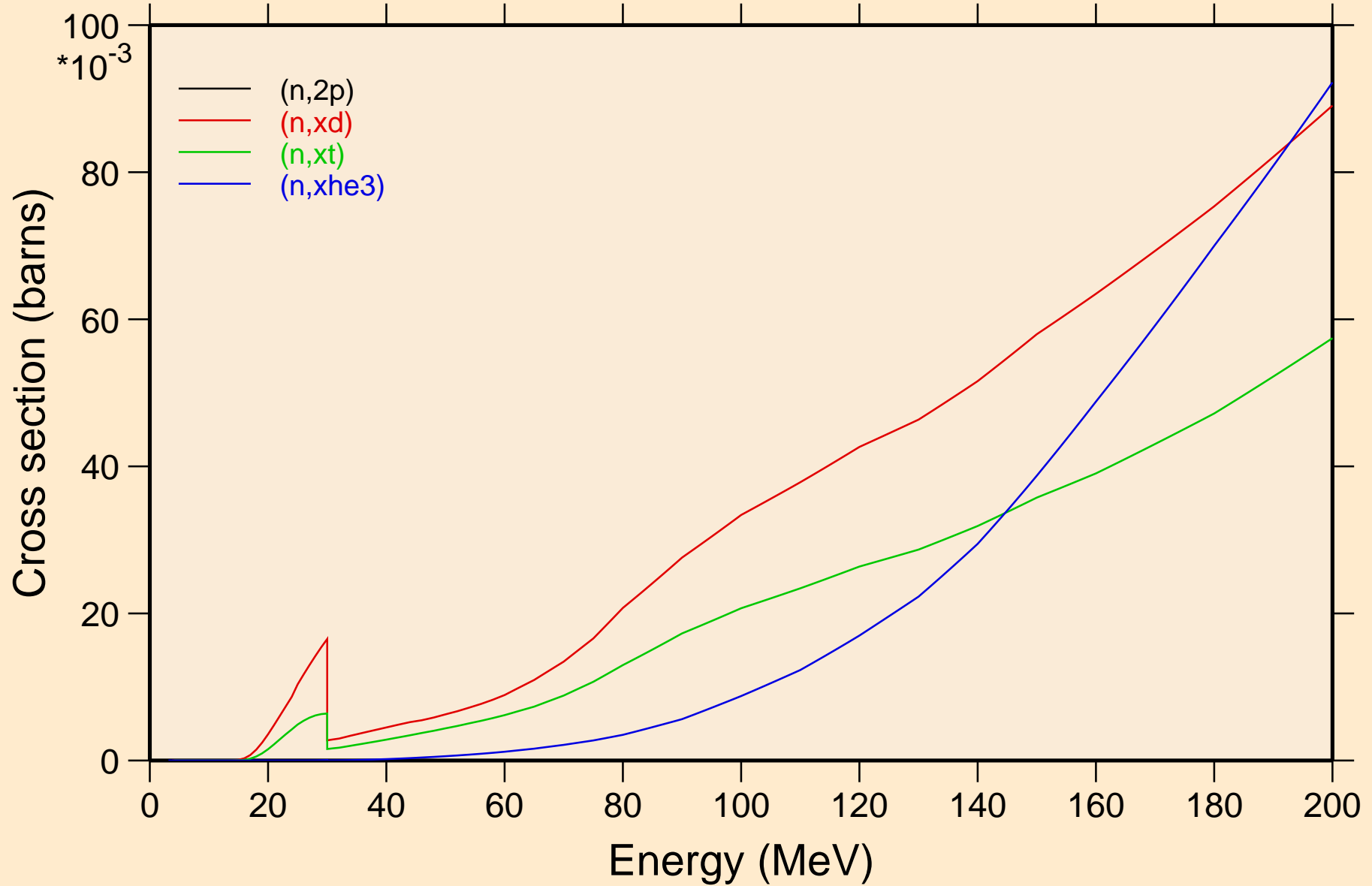

PU238 NEUTRON ACER TENDL-2023 LIBRARY; T=0.K  
angular distribution for elastic

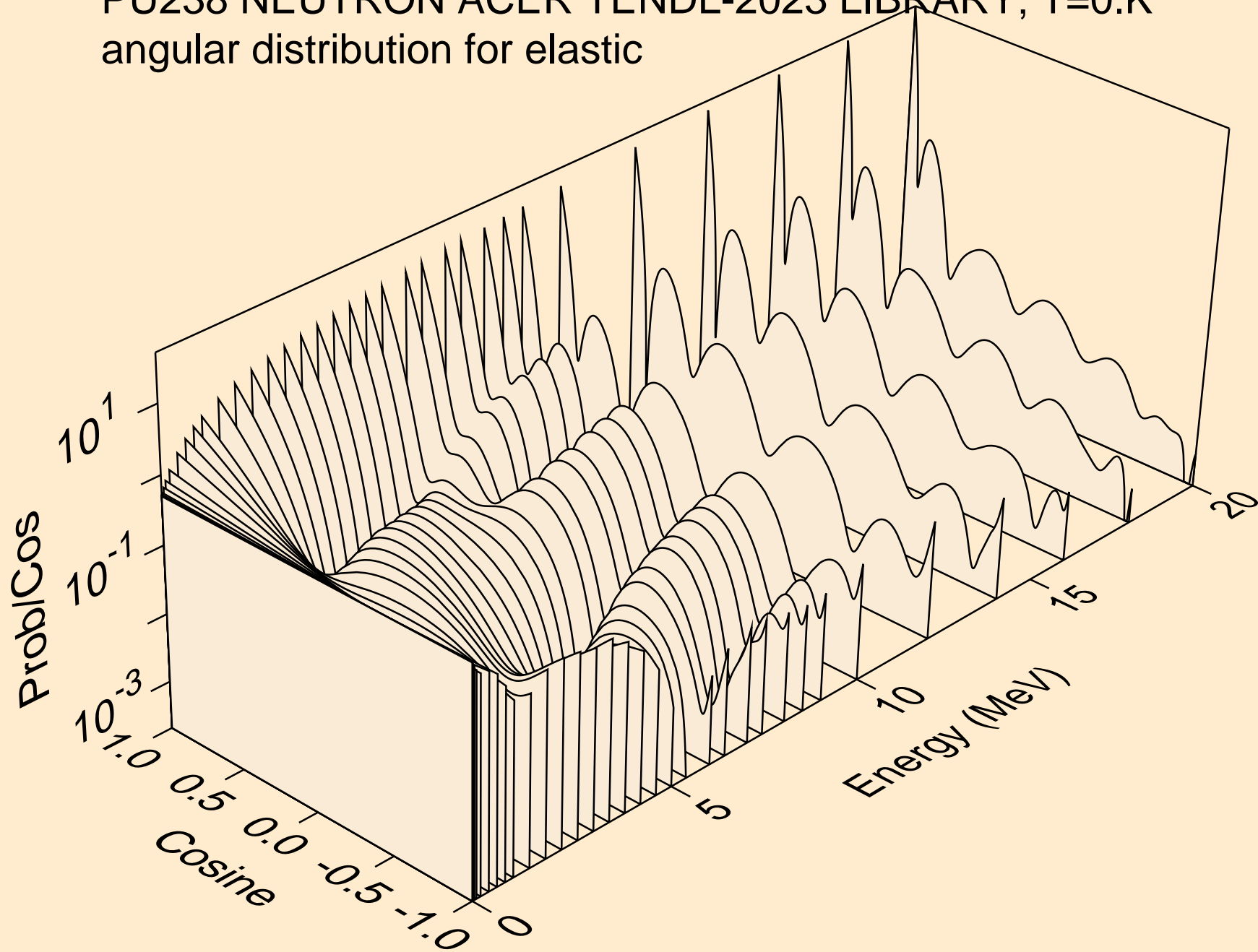

PU238 NEUTRON ACER TENDL-2023 LIBRARY; T=0.K  
angular distribution for elastic

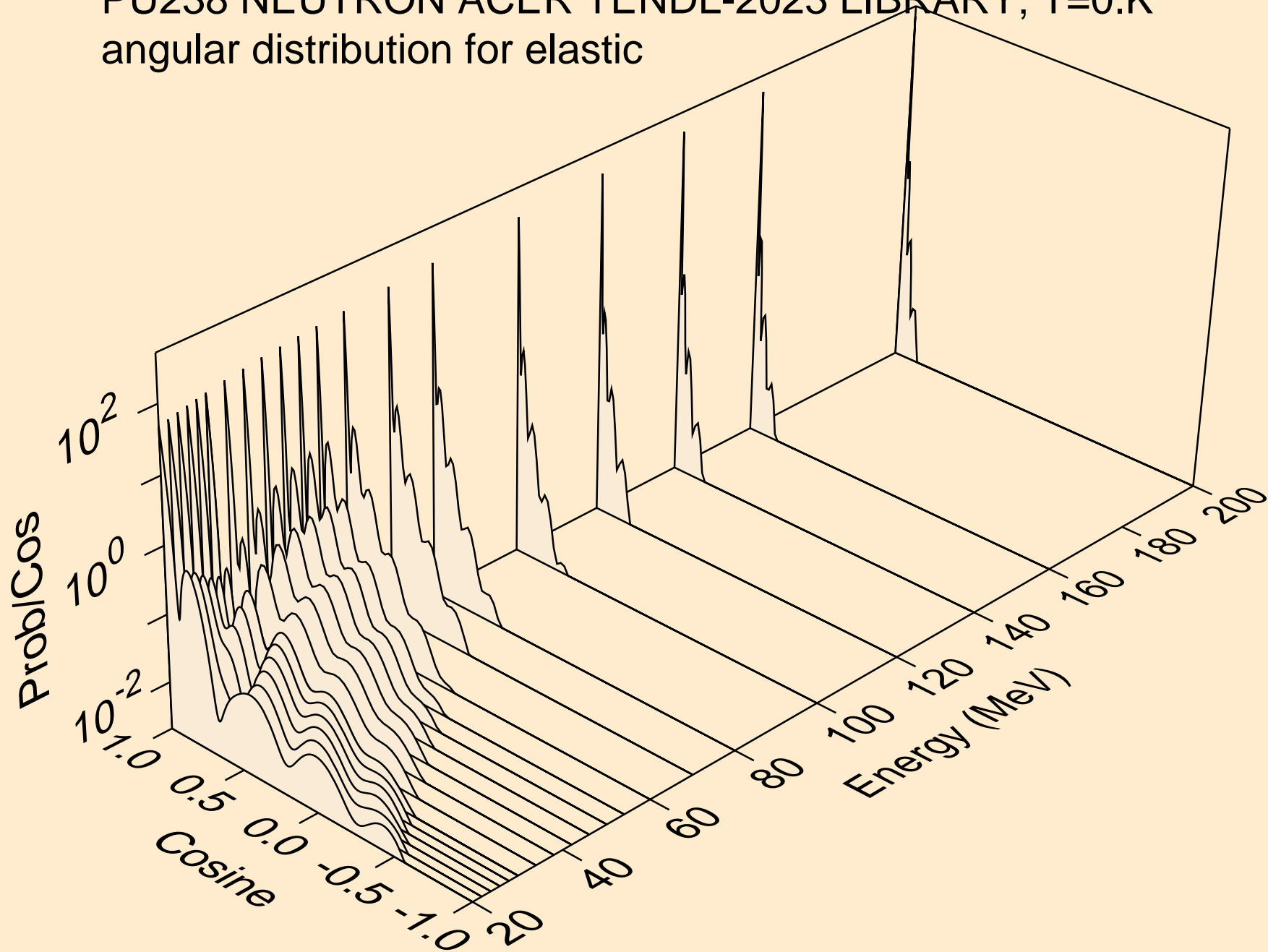

PU238 NEUTRON ACER TENDL-2023 LIBRARY; T=0.K  
angular distribution for (n,n\*1)

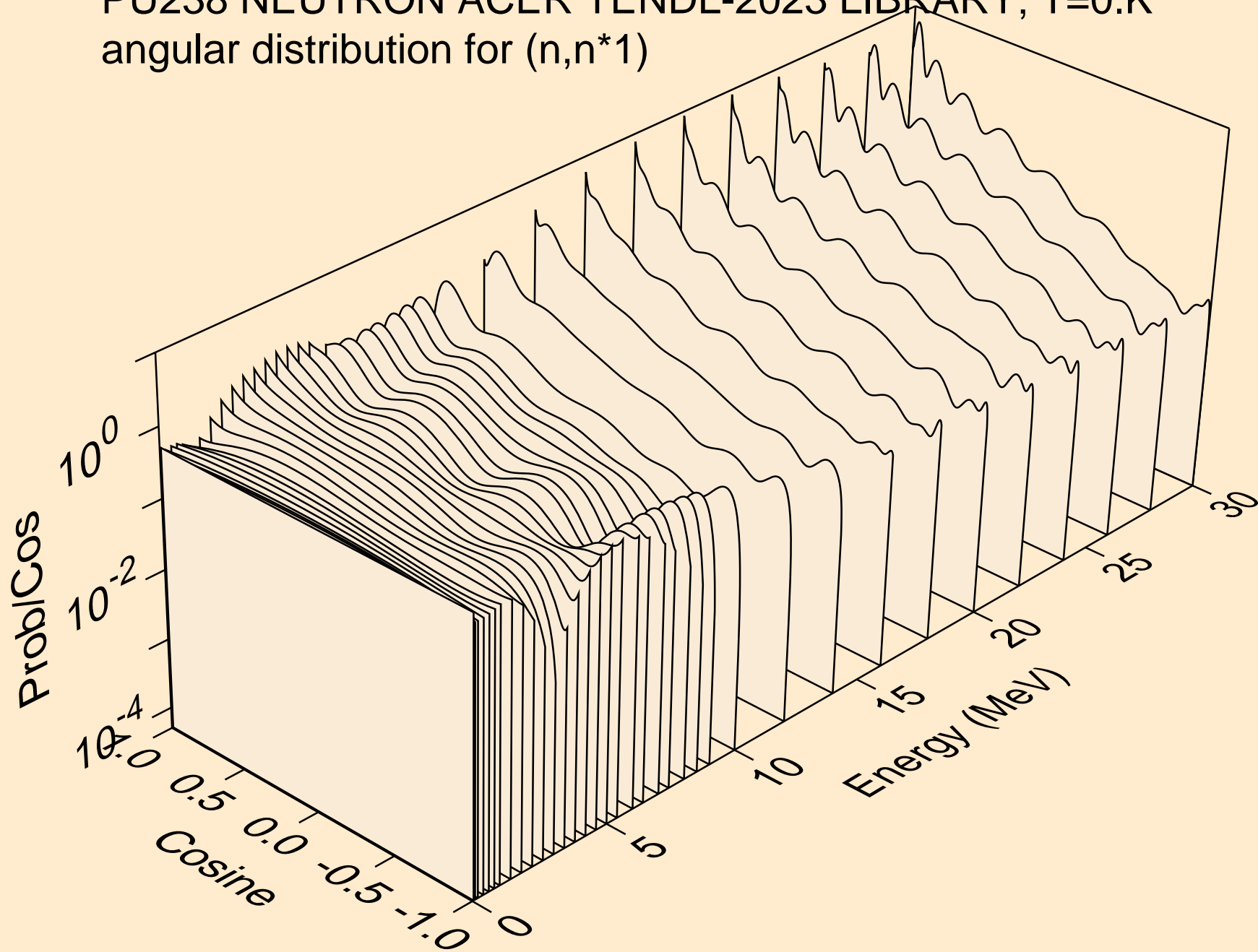



PU238 NEUTRON ACER TENDL-2023 LIBRARY; T=0.K  
angular distribution for (n,n\*2)

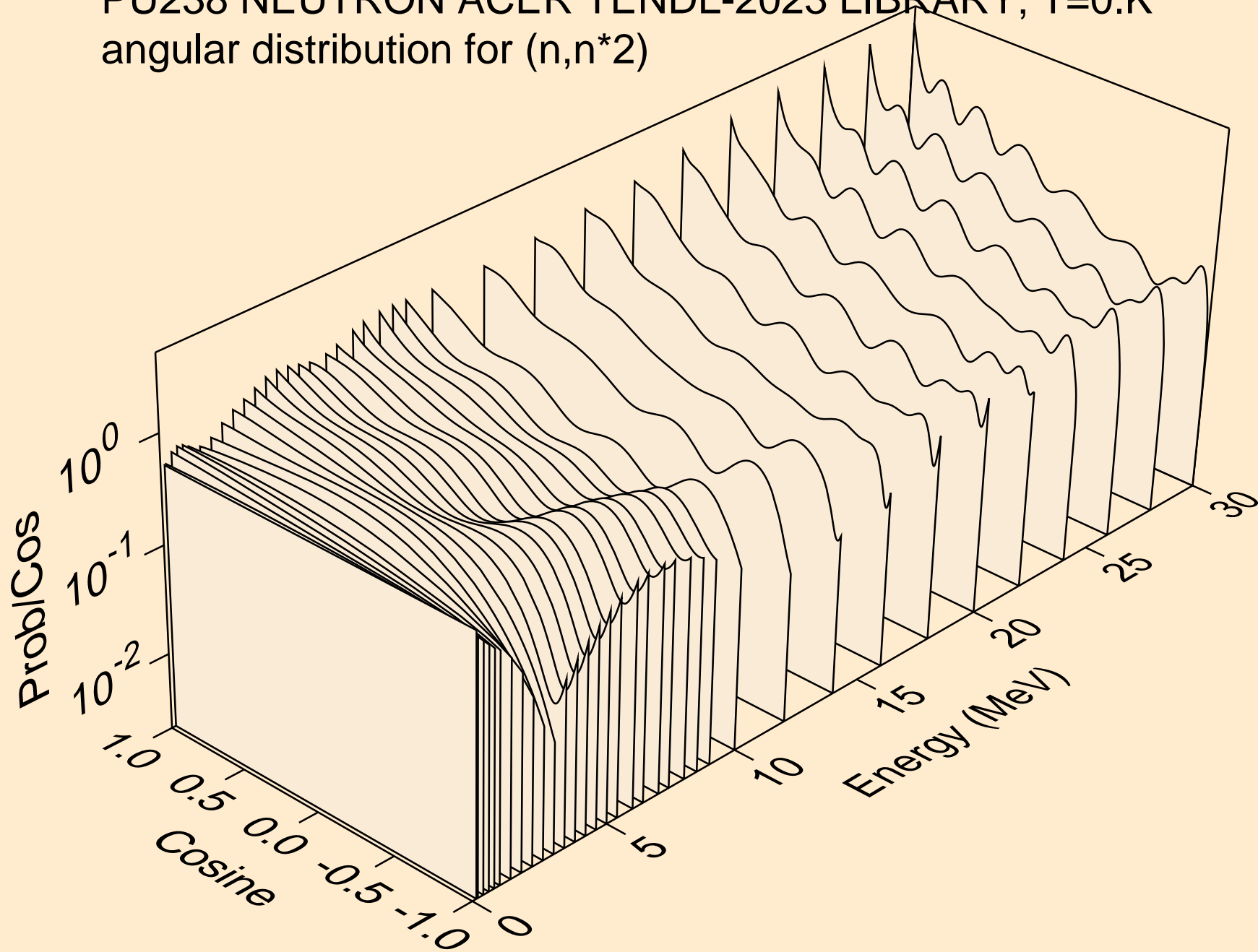

PU238 NEUTRON ACER TENDL-2023 LIBRARY; T=0.K  
angular distribution for (n,n\*3)

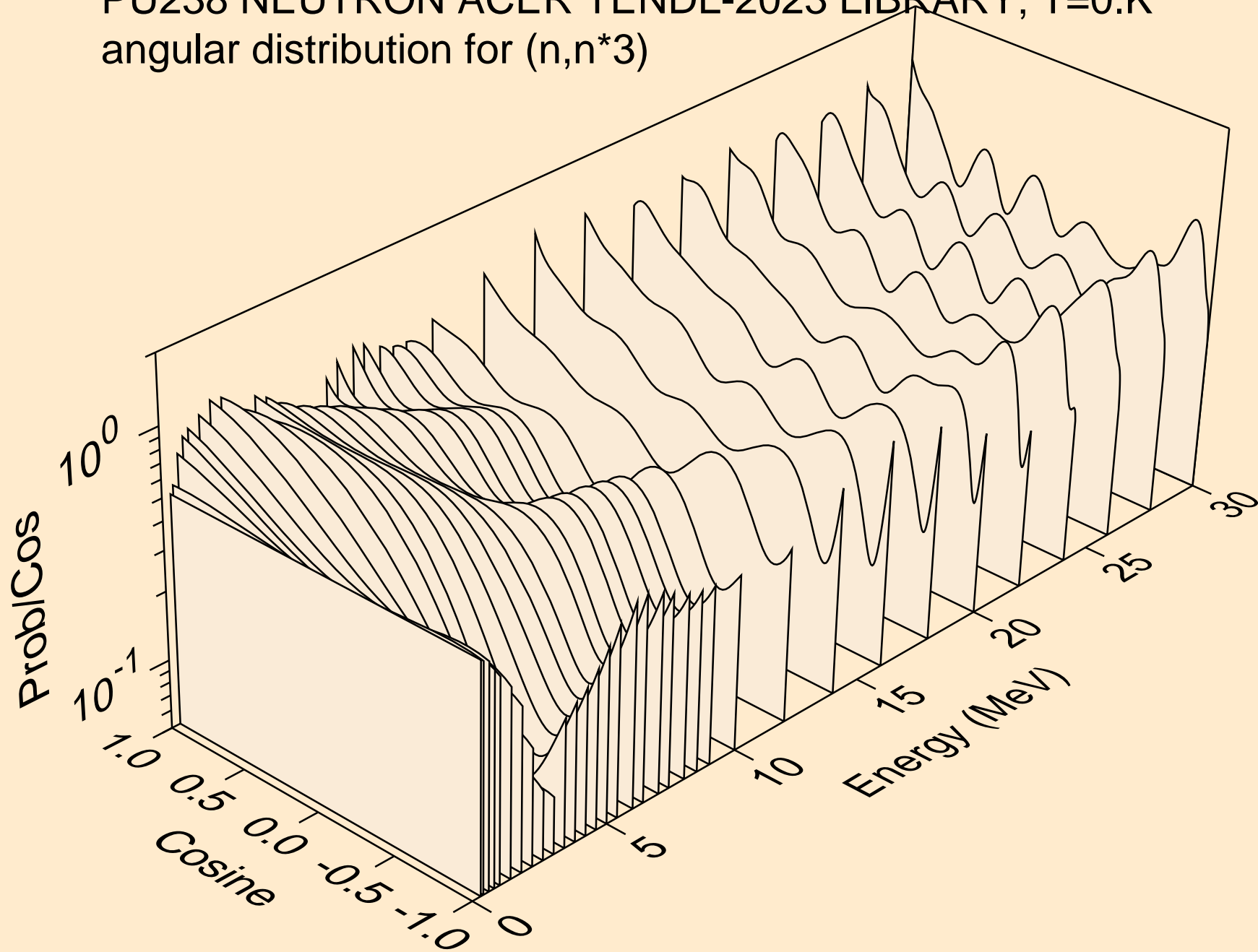

PU238 NEUTRON ACER TENDL-2023 LIBRARY; T=0.K  
angular distribution for (n,n\*4)

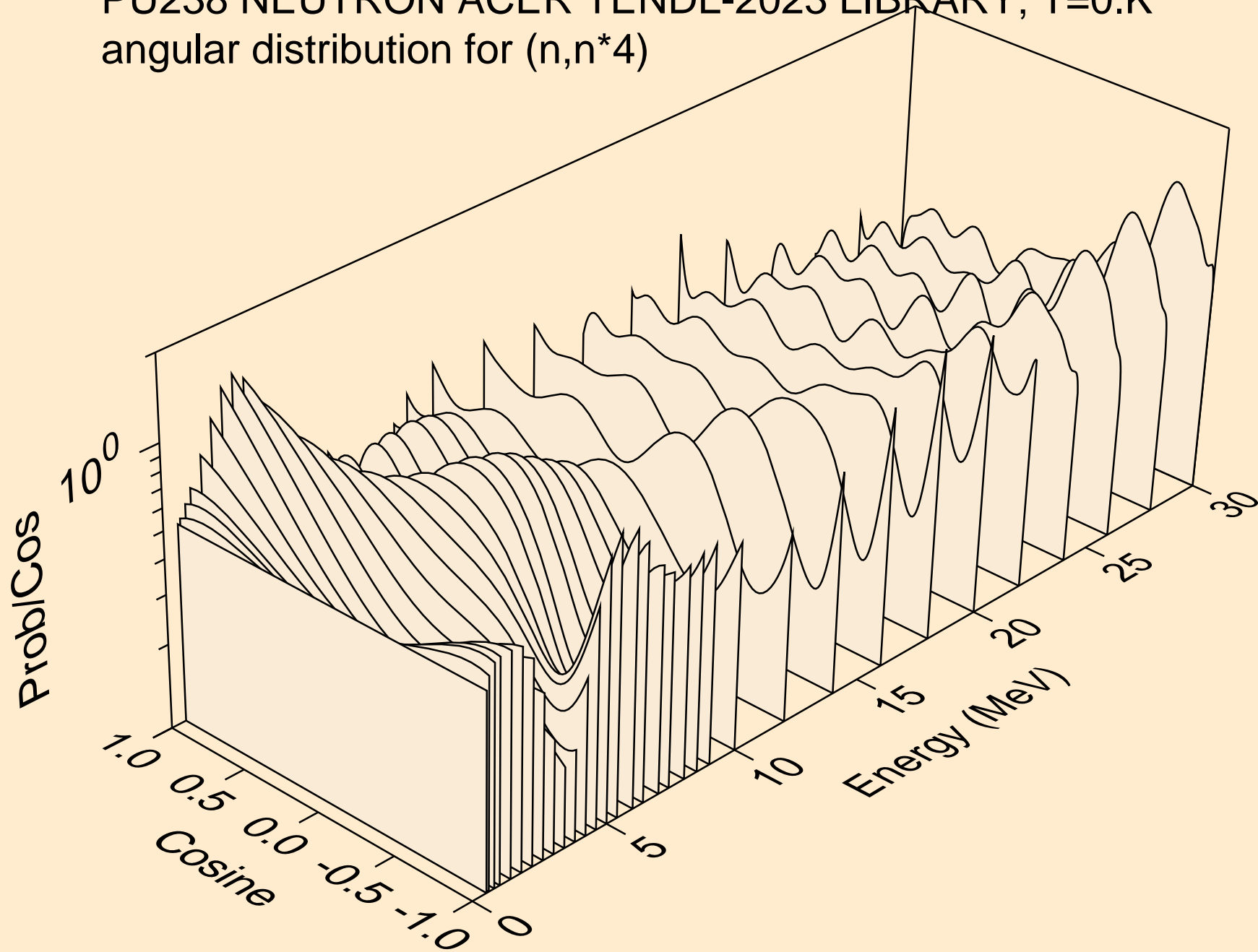

PU238 NEUTRON ACER TENDL-2023 LIBRARY; T=0.K  
angular distribution for (n,n\*5)

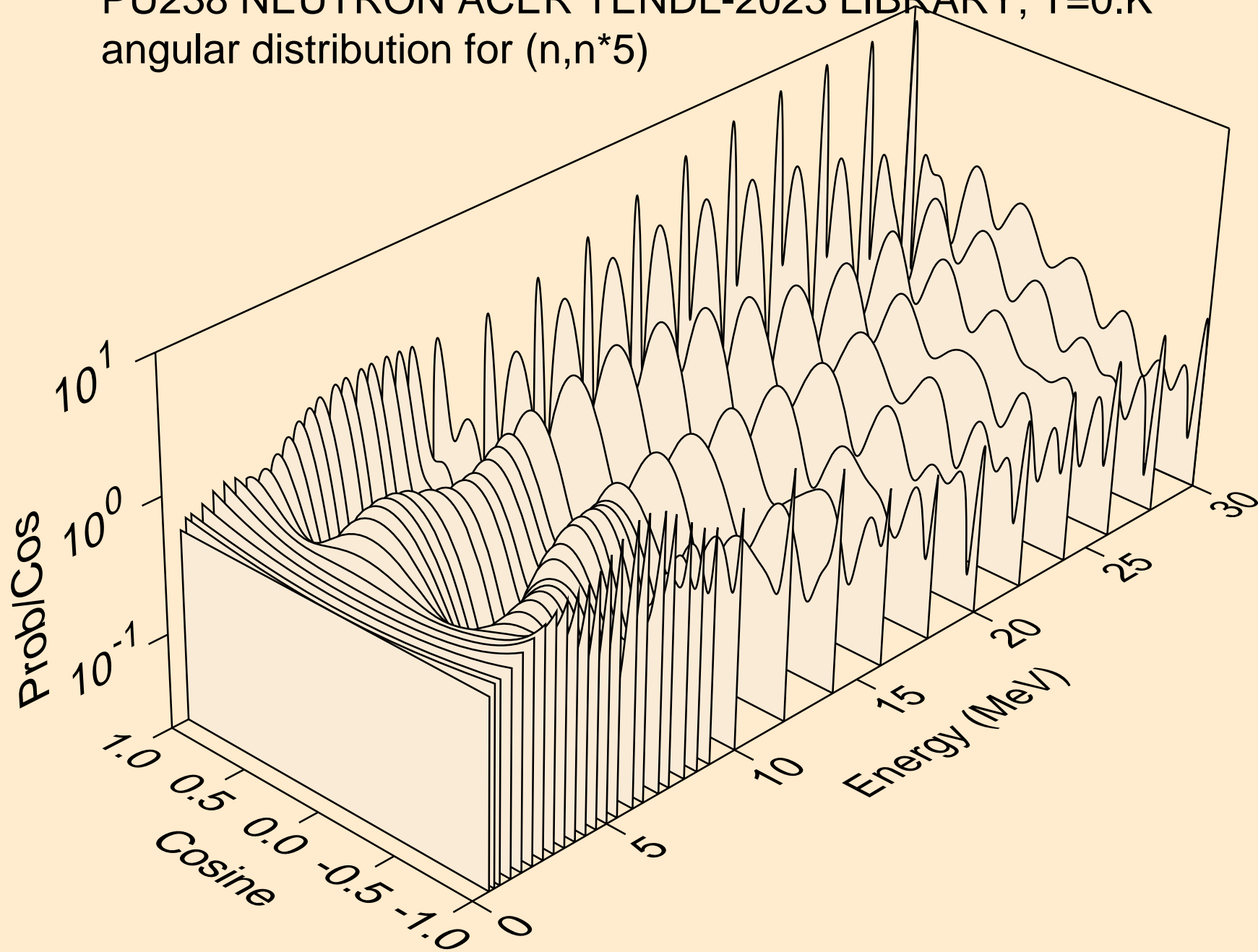

PU238 NEUTRON ACER TENDL-2023 LIBRARY; T=0.K  
angular distribution for (n,n\*6)

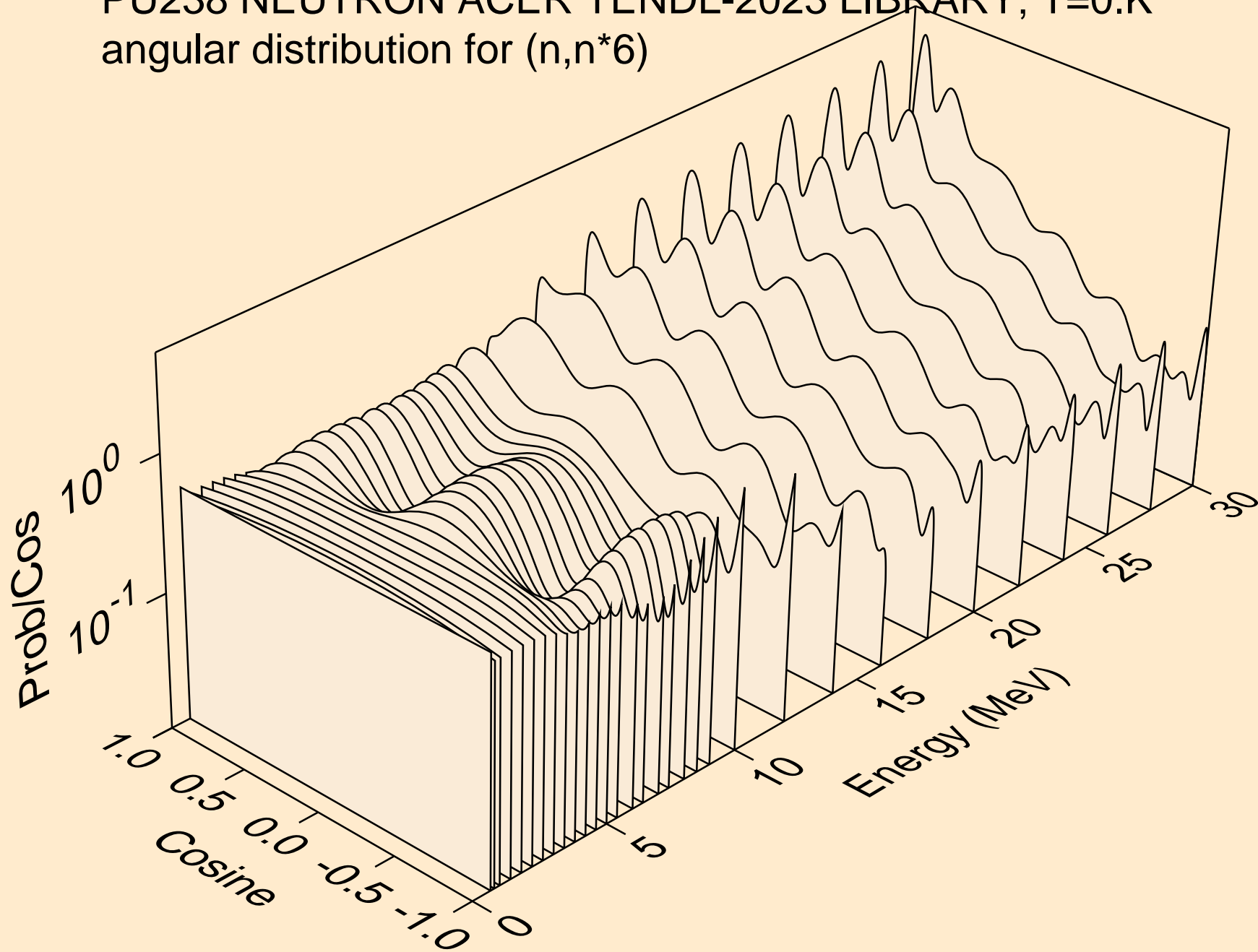

PU238 NEUTRON ACER TENDL-2023 LIBRARY; T=0.K  
angular distribution for (n,n\*7)

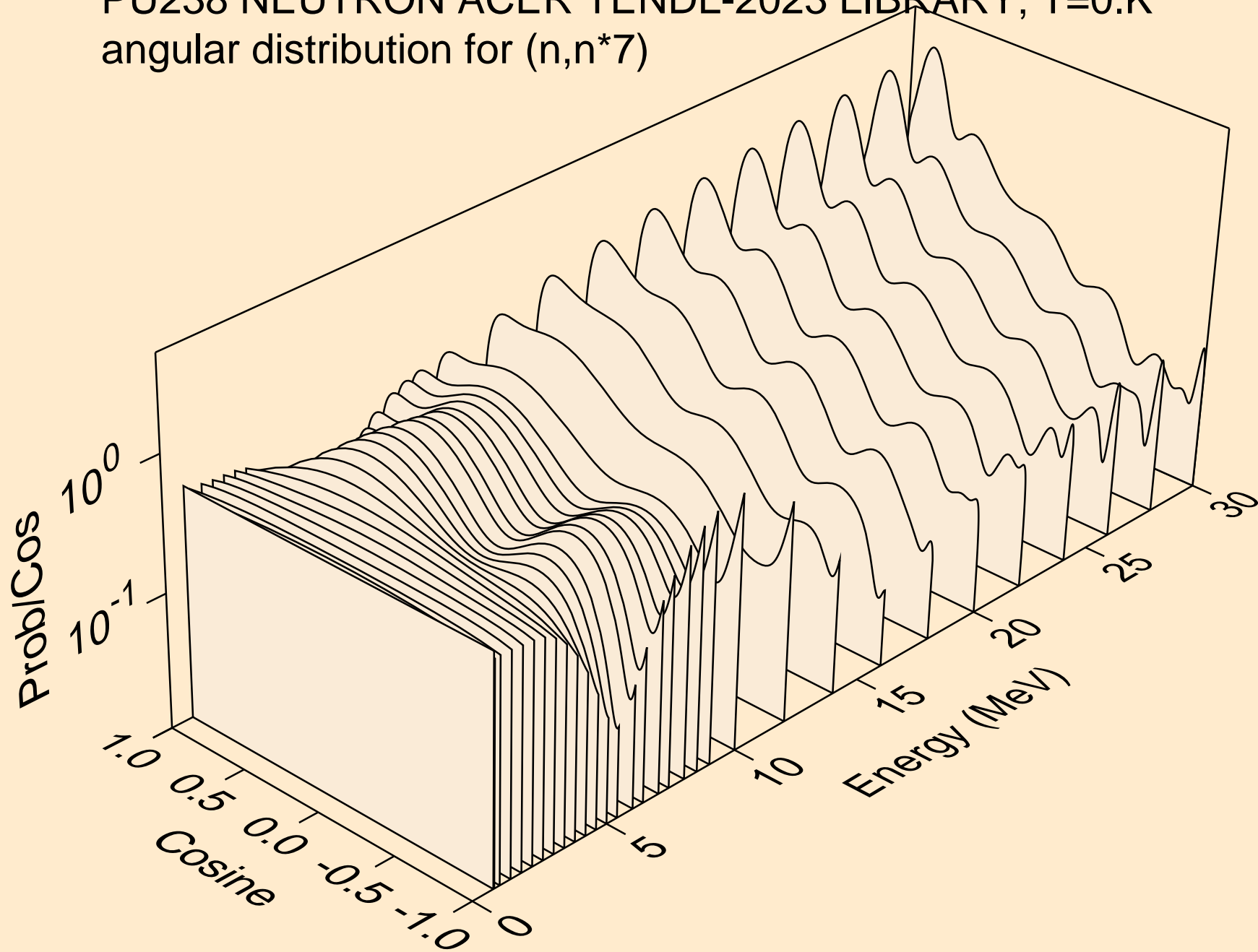

PU238 NEUTRON ACER TENDL-2023 LIBRARY; T=0.K  
angular distribution for (n,n\*8)

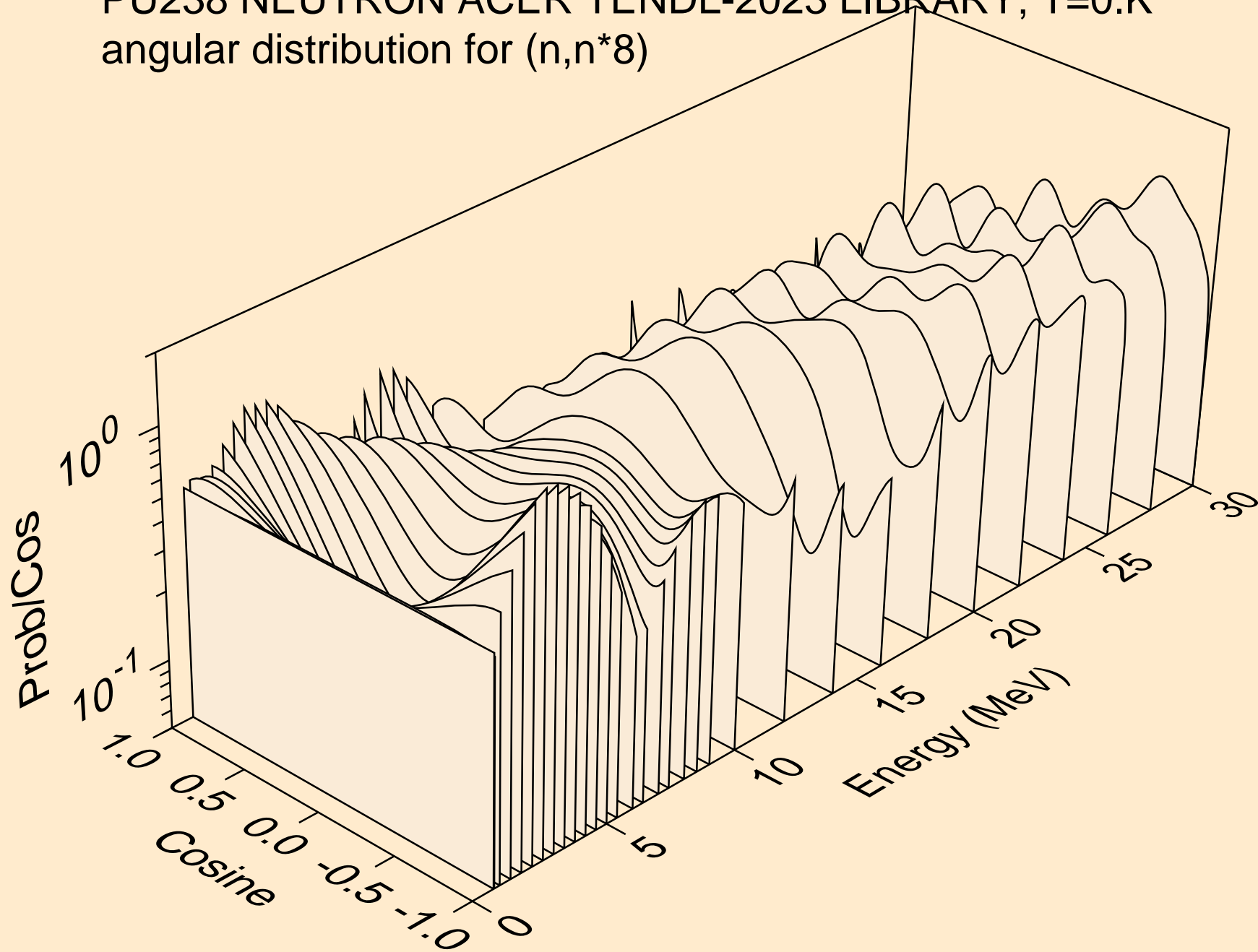

PU238 NEUTRON ACER TENDL-2023 LIBRARY; T=0.K  
angular distribution for (n,n\*9)

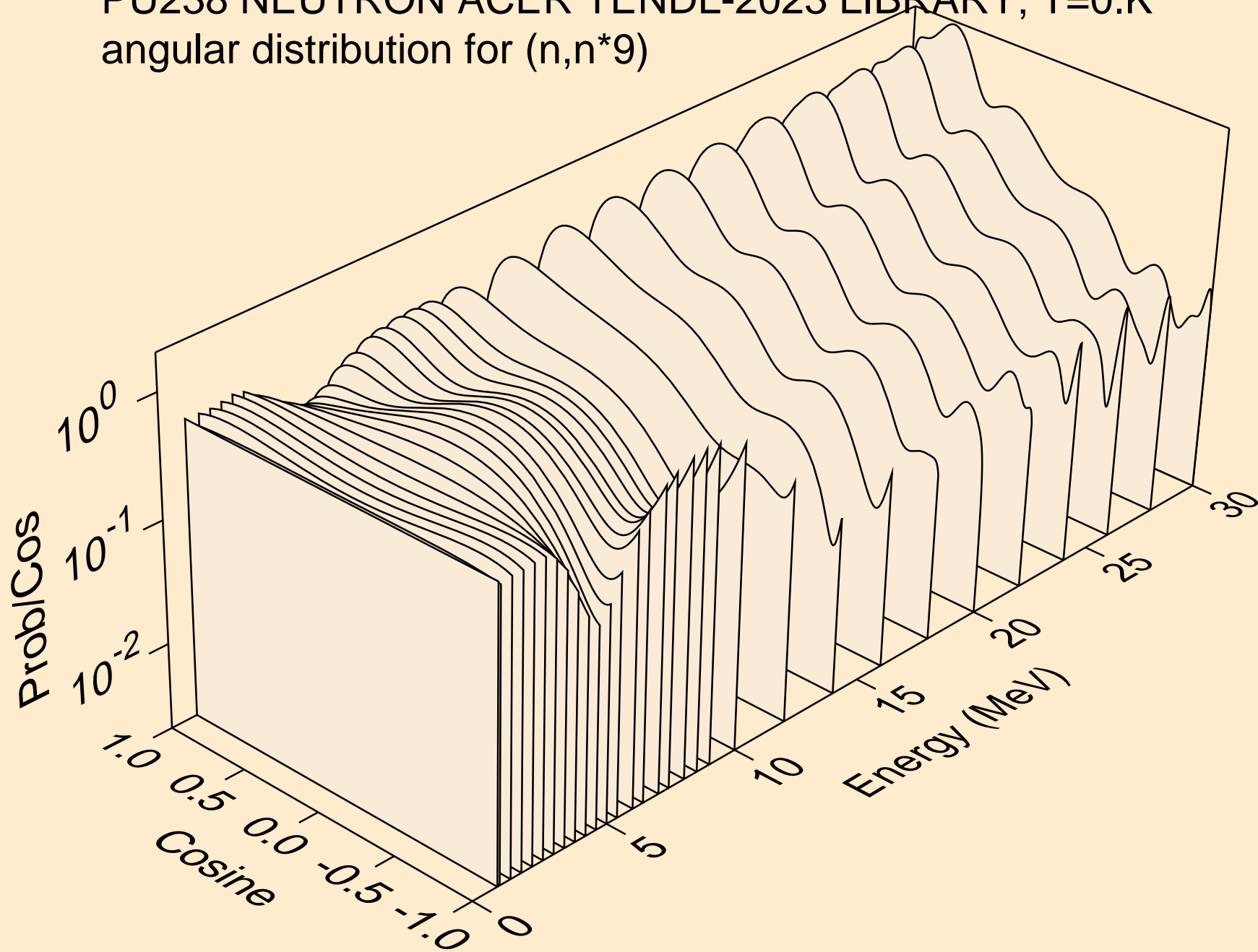



PU238 NEUTRON ACER TENDL-2023 LIBRARY; T=0.K  
angular distribution for (n,n\*10)

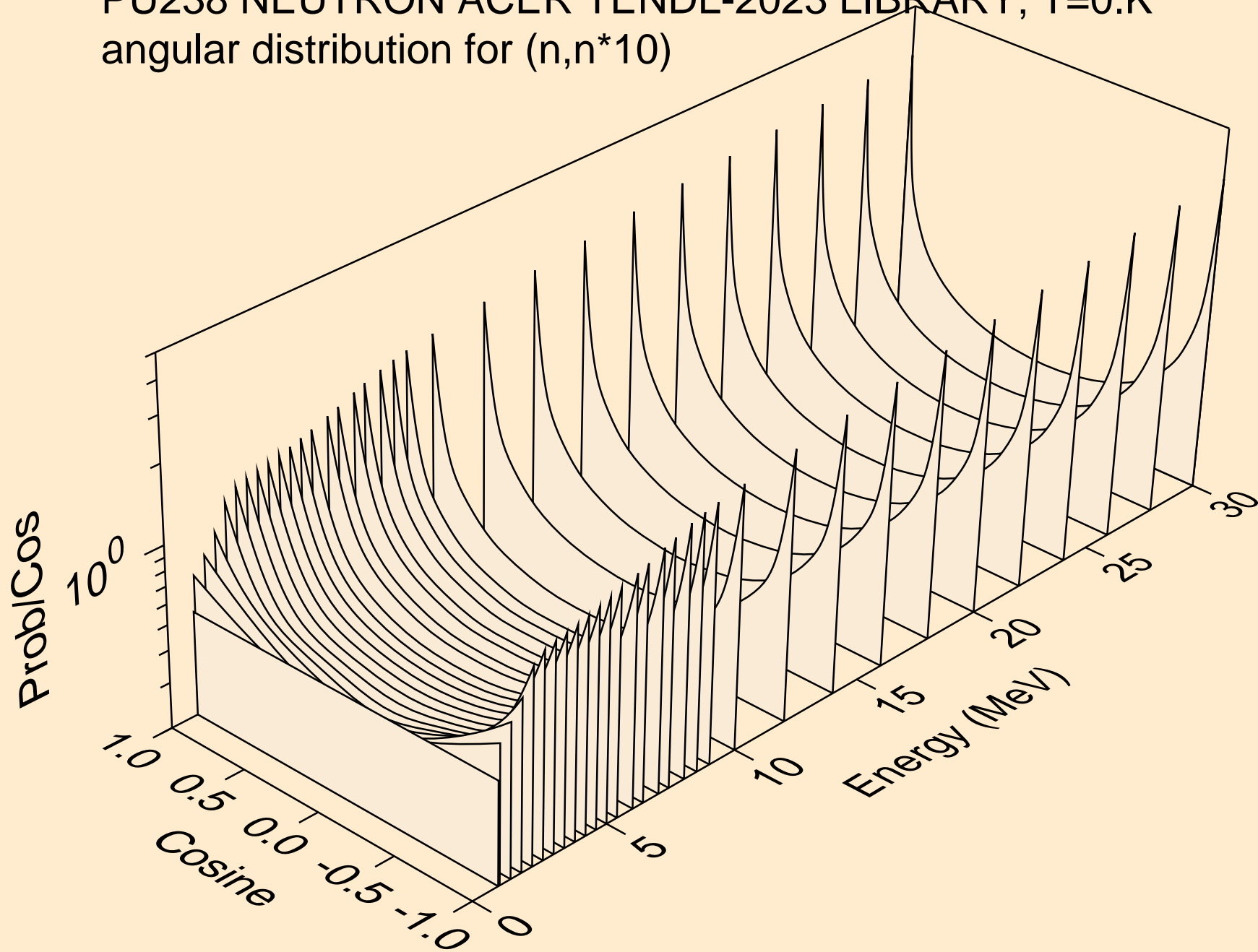

PU238 NEUTRON ACER TENDL-2023 LIBRARY; T=0.K  
angular distribution for (n,n\*11)

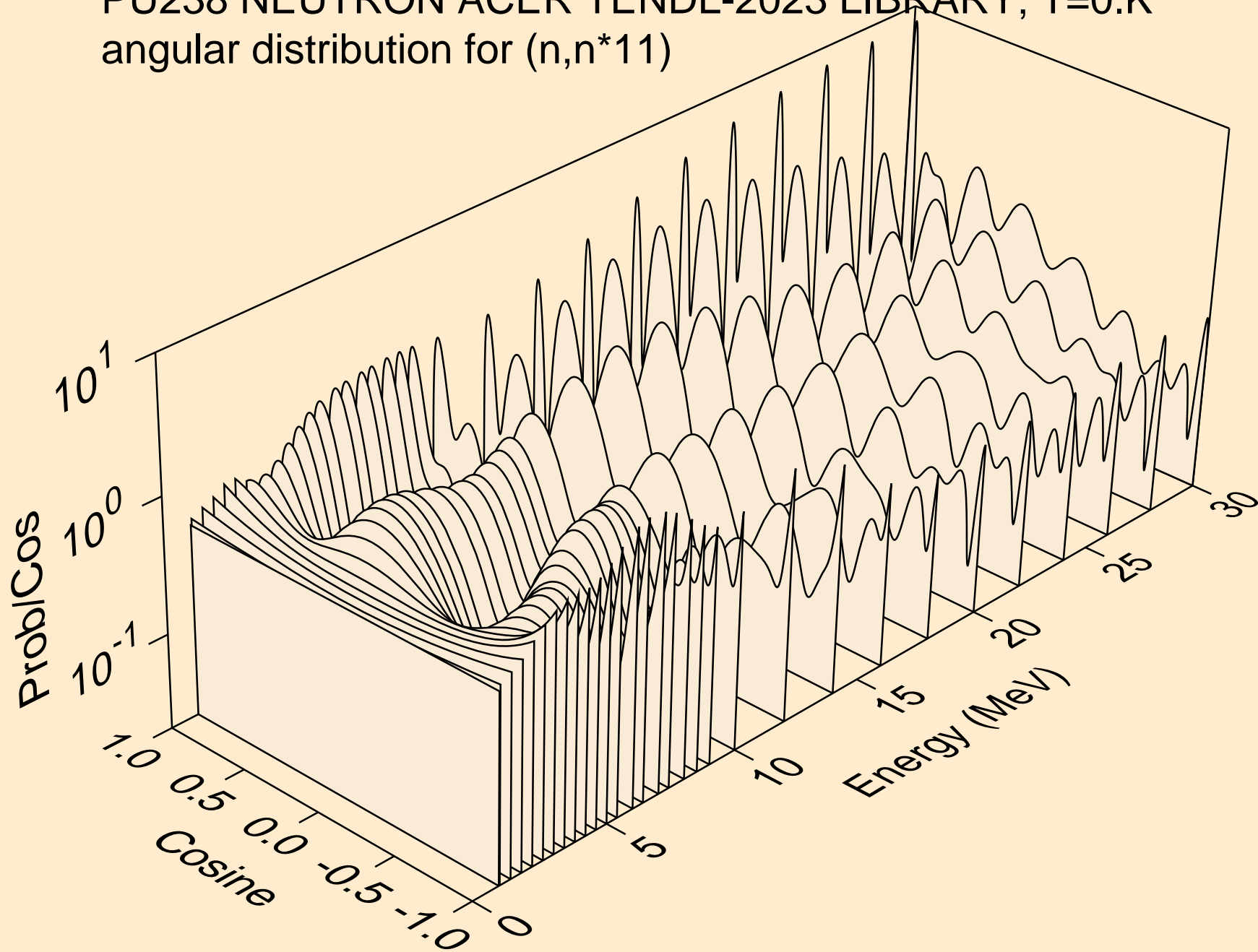

PU238 NEUTRON ACER TENDL-2023 LIBRARY; T=0.K  
angular distribution for (n,n\*12)

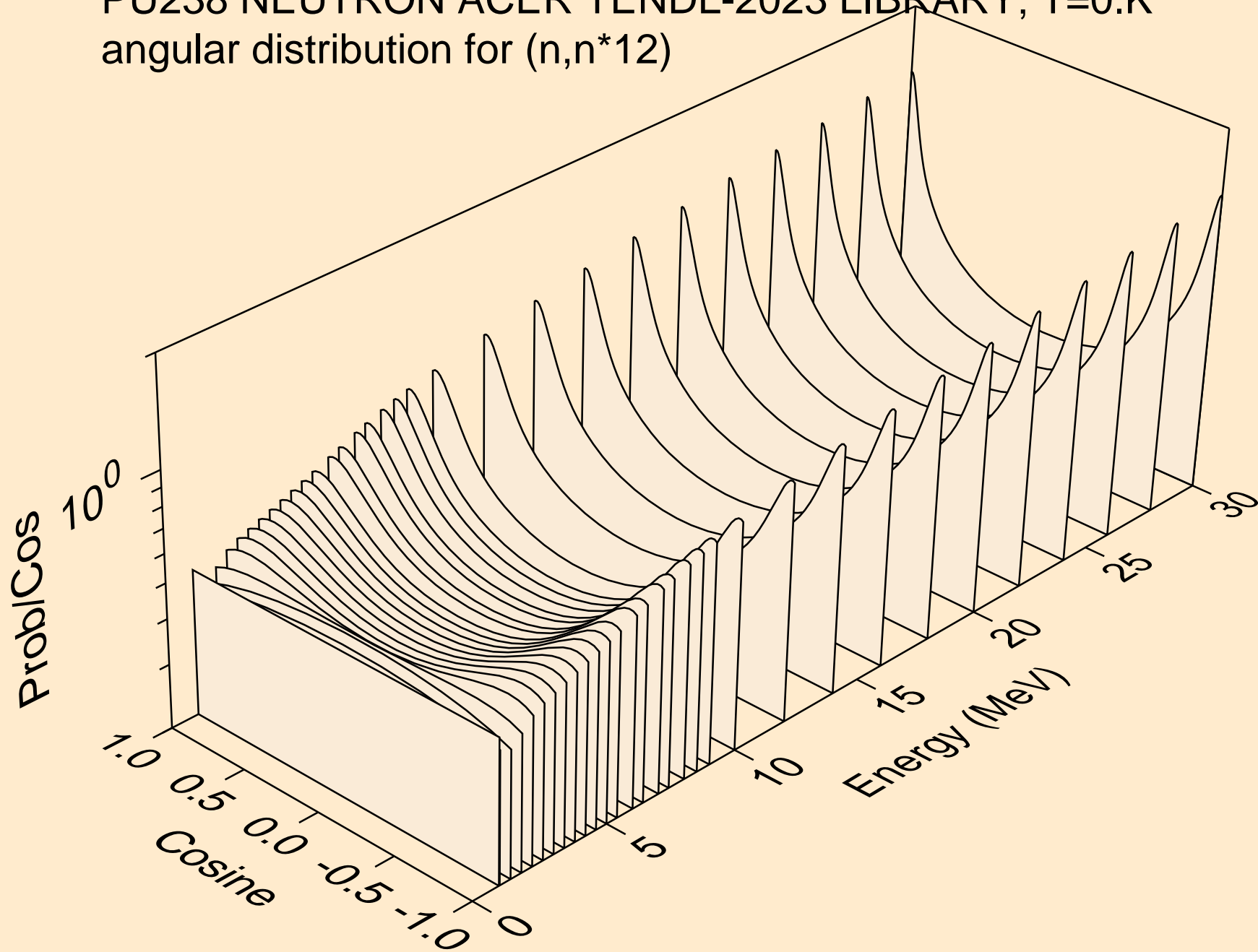

PU238 NEUTRON ACER TENDL-2023 LIBRARY; T=0.K  
angular distribution for (n,n\*13)

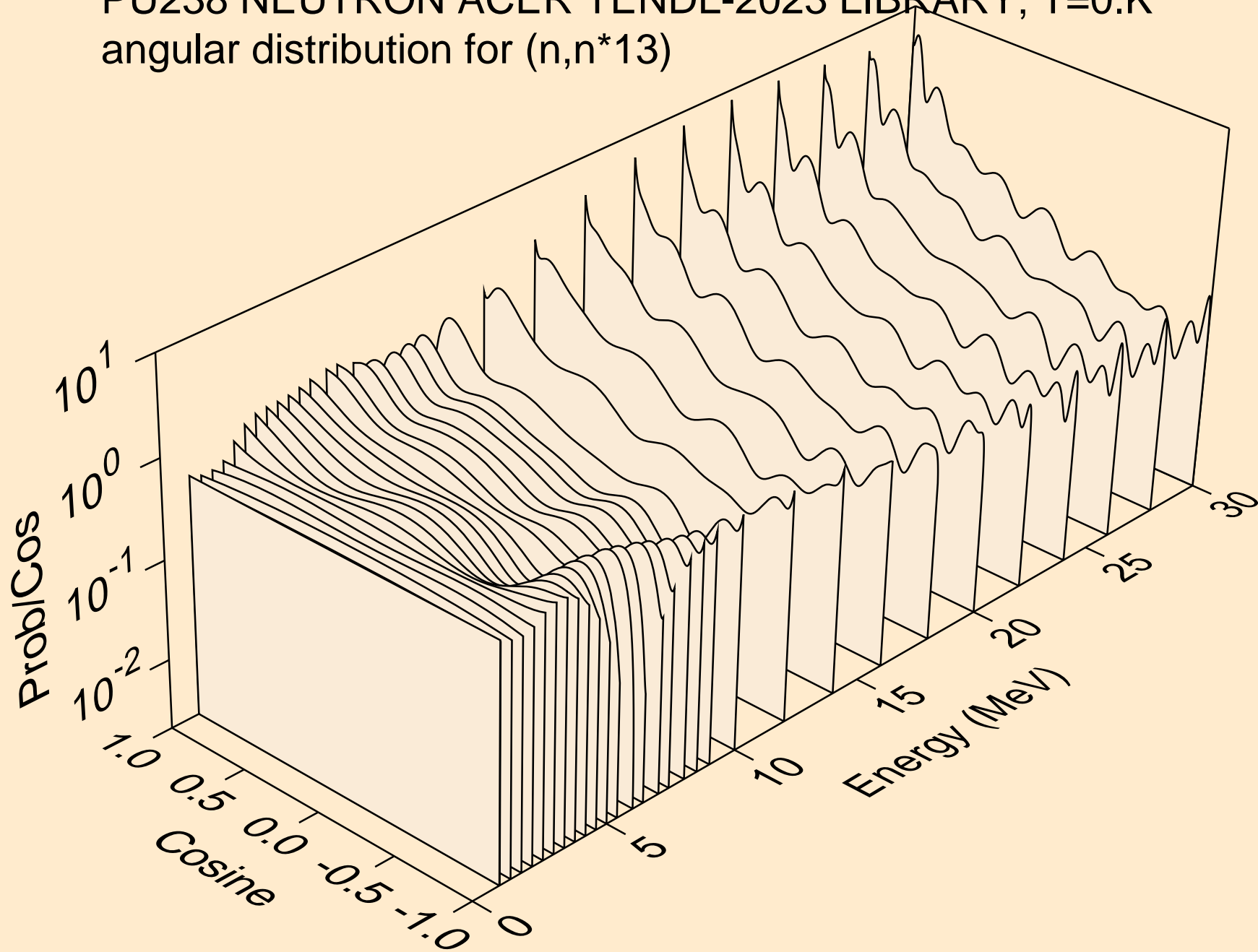

PU238 NEUTRON ACER TENDL-2023 LIBRARY; T=0.K  
angular distribution for (n,n\*14)

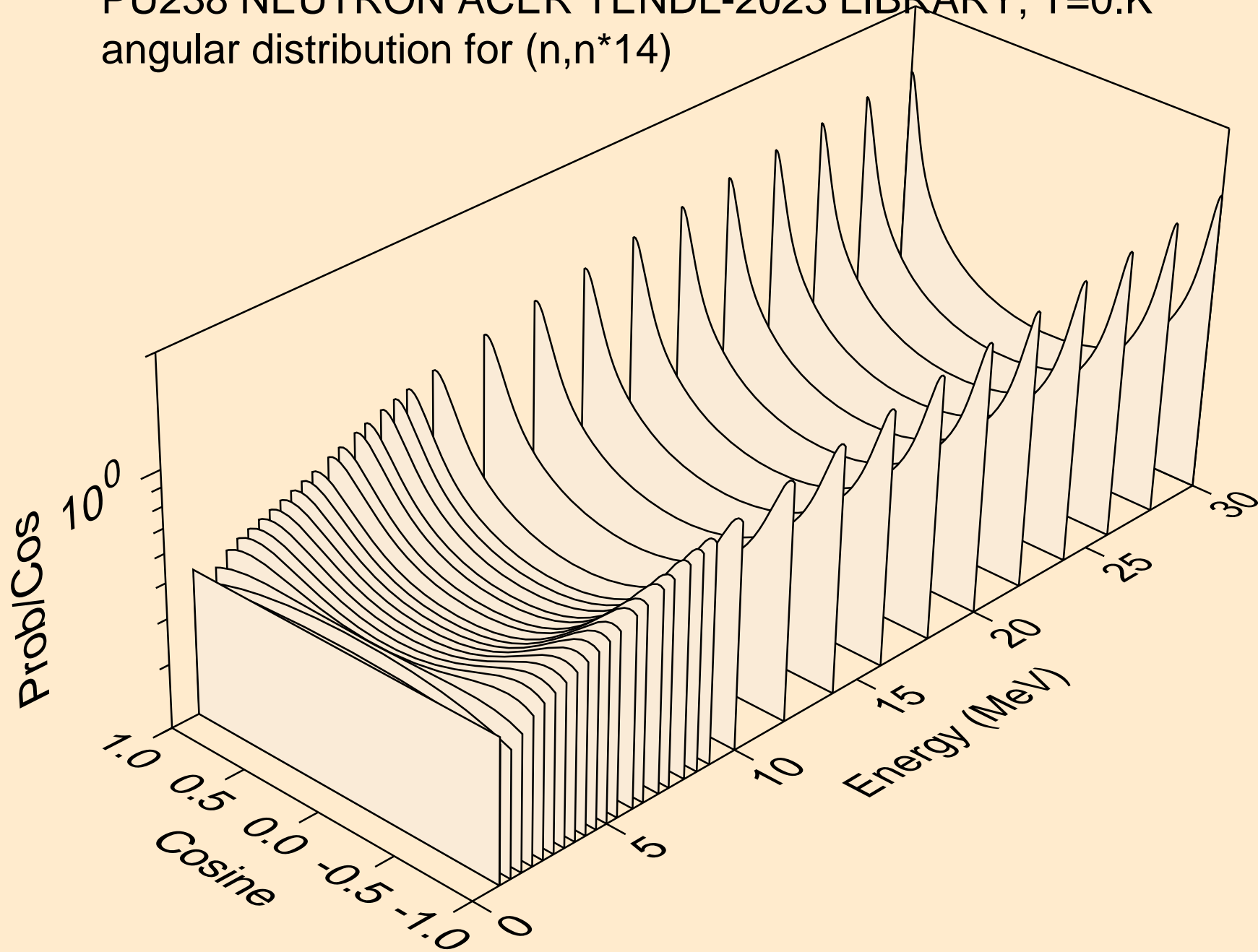

PU238 NEUTRON ACER TENDL-2023 LIBRARY; T=0.K  
angular distribution for (n,n\*15)

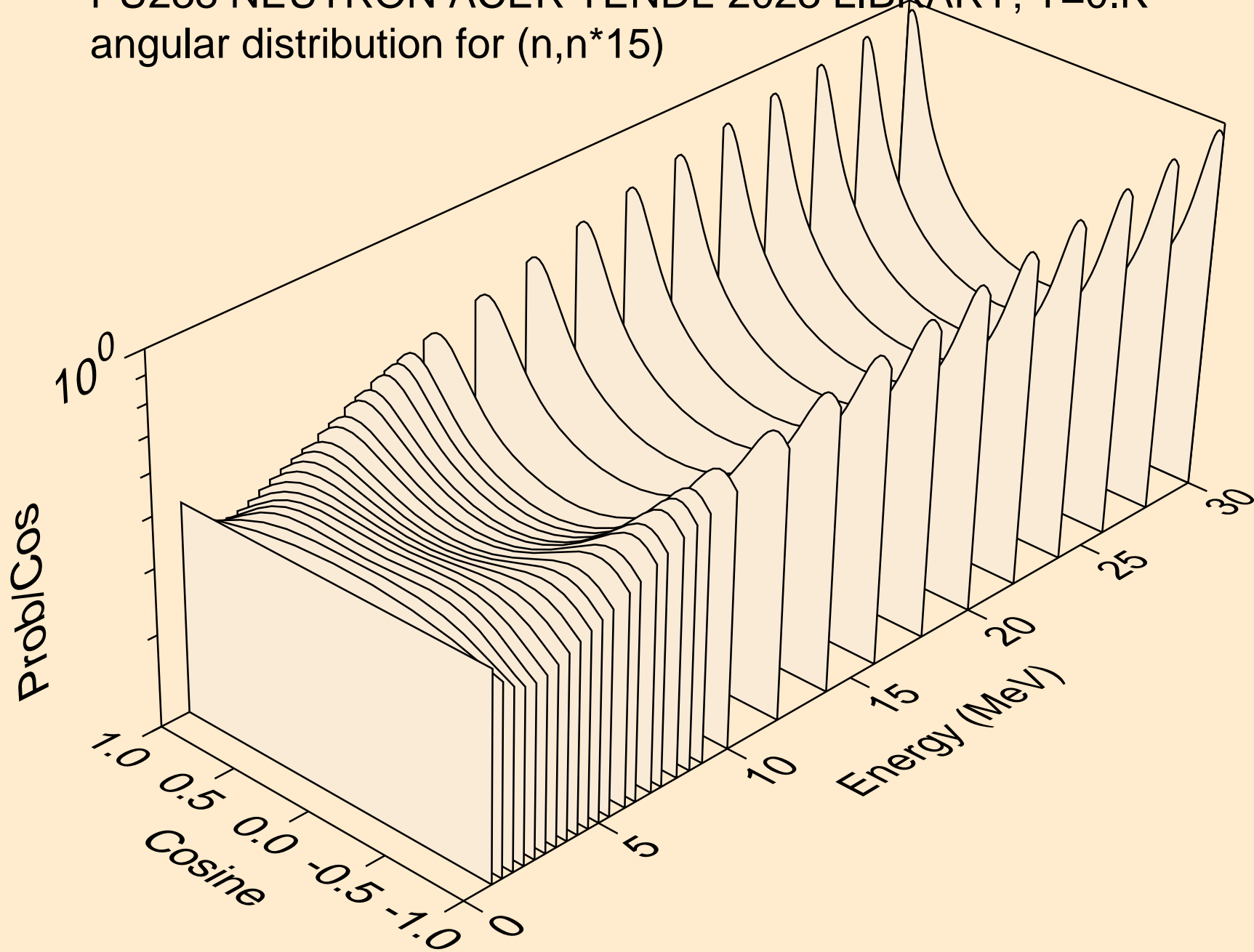

PU238 NEUTRON ACER TENDL-2023 LIBRARY; T=0.K  
angular distribution for (n,n\*16)

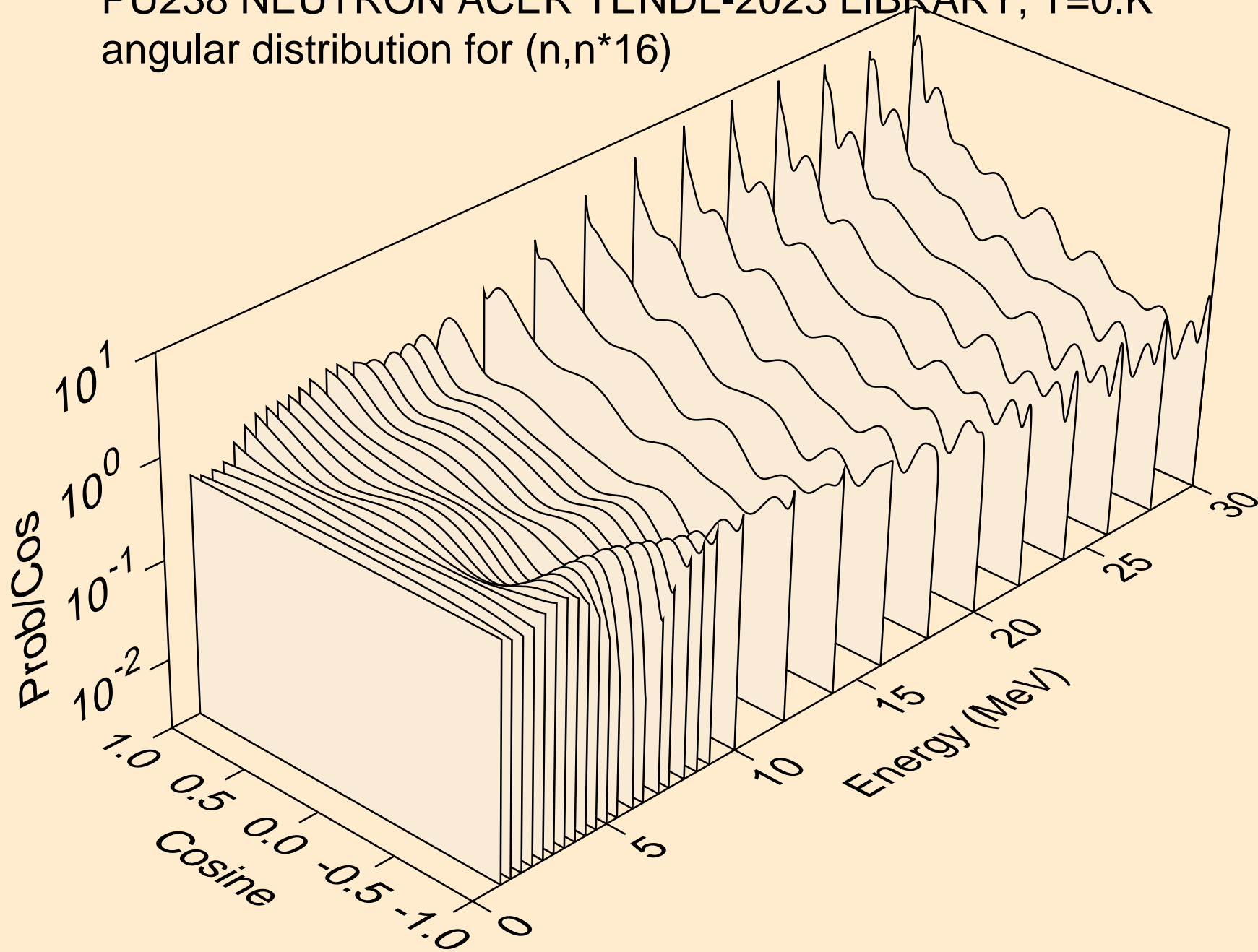

PU238 NEUTRON ACER TENDL-2023 LIBRARY; T=0.K

Total fission nubar

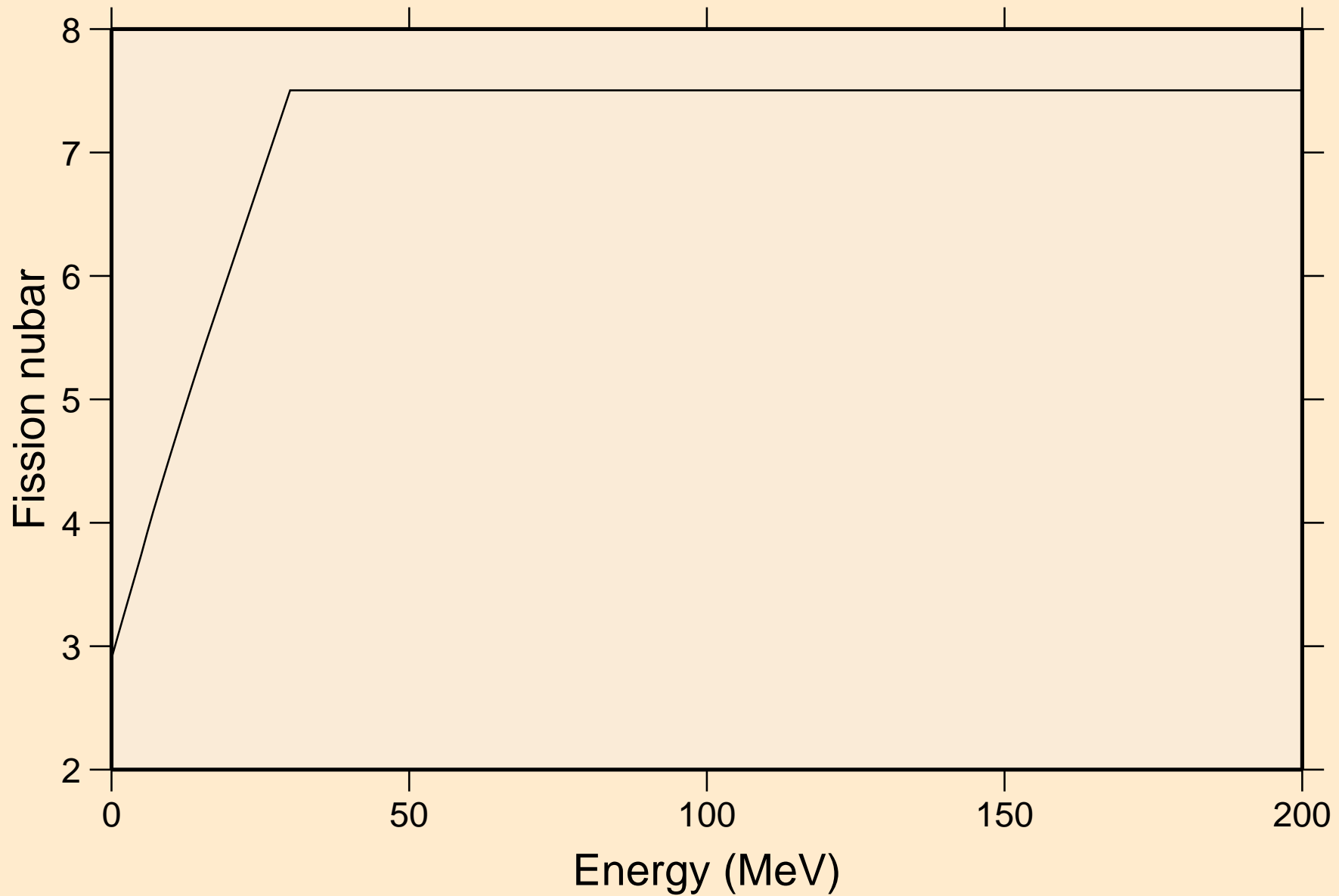



PU238 NEUTRON ACER TENDL-2023 LIBRARY; T=0.K  
Neutron emission for (n,x)

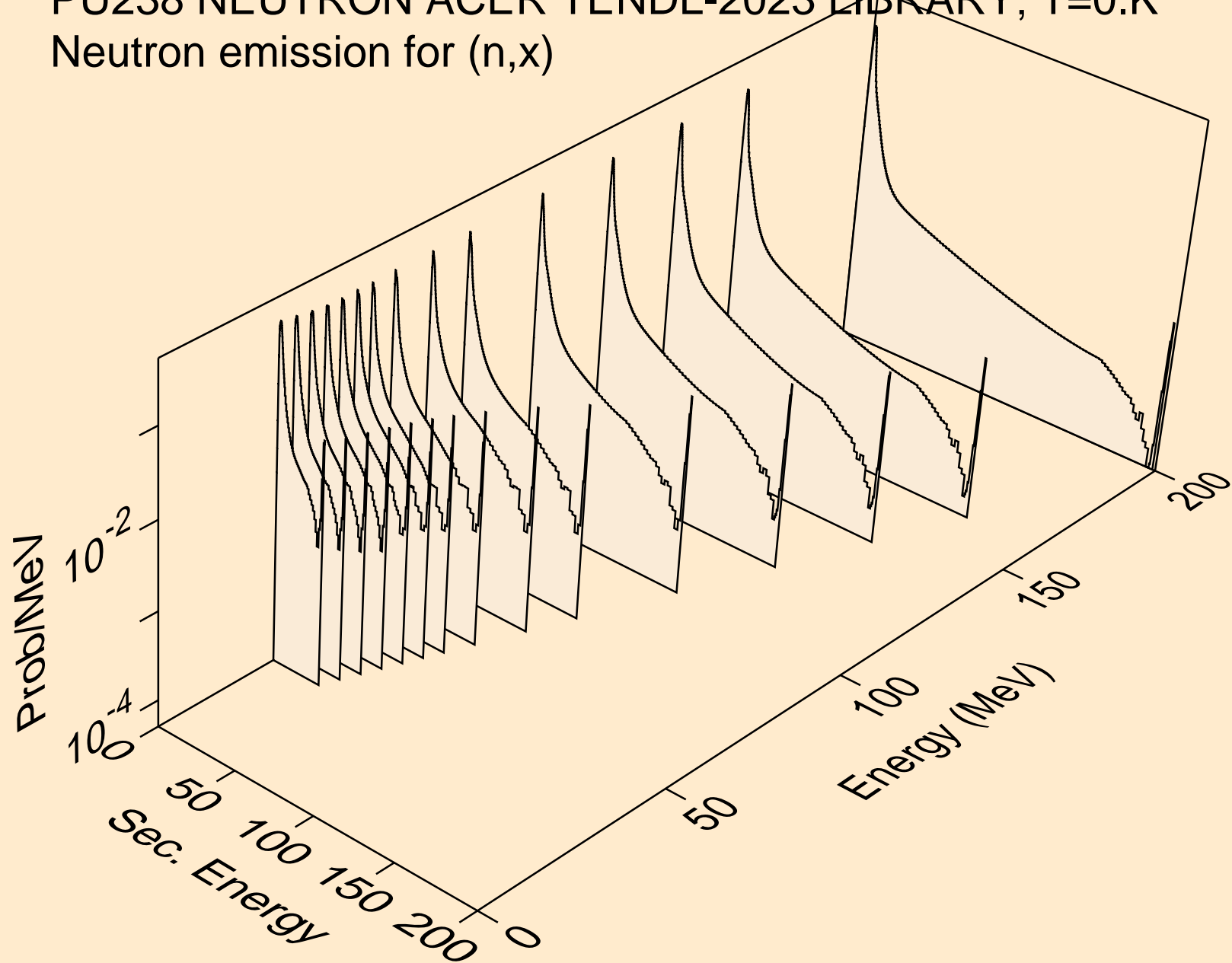

PU238 NEUTRON ACER TENDL-2023 LIBRARY; T=0.K  
Neutron emission for (n,2nd)

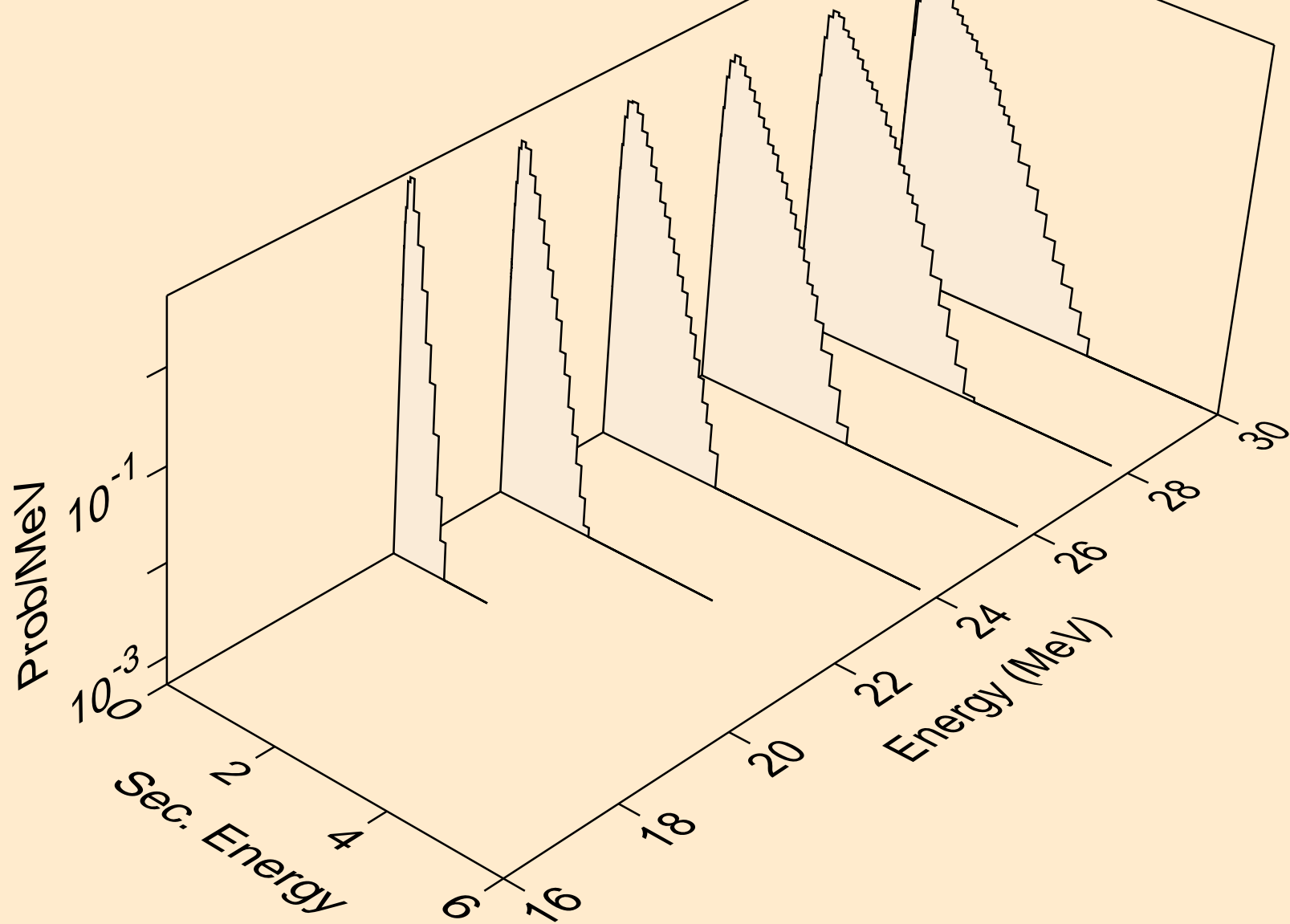

PU238 NEUTRON ACER TENDL-2023 LIBRARY; T=0.K  
Neutron emission for (n,2n)

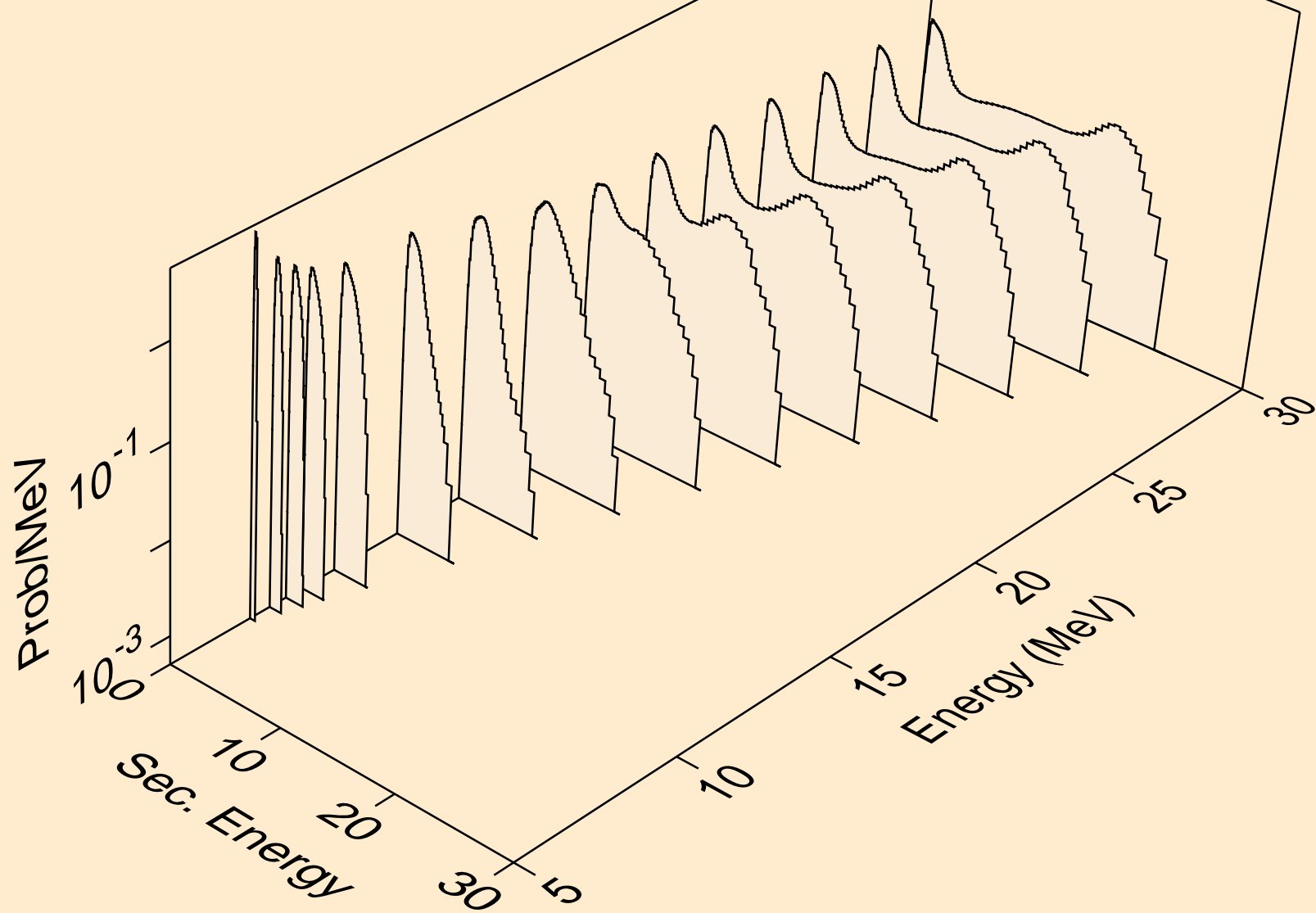

PU238 NEUTRON ACER TENDL-2023 LIBRARY; T=0.K  
Neutron emission for (n,3n)

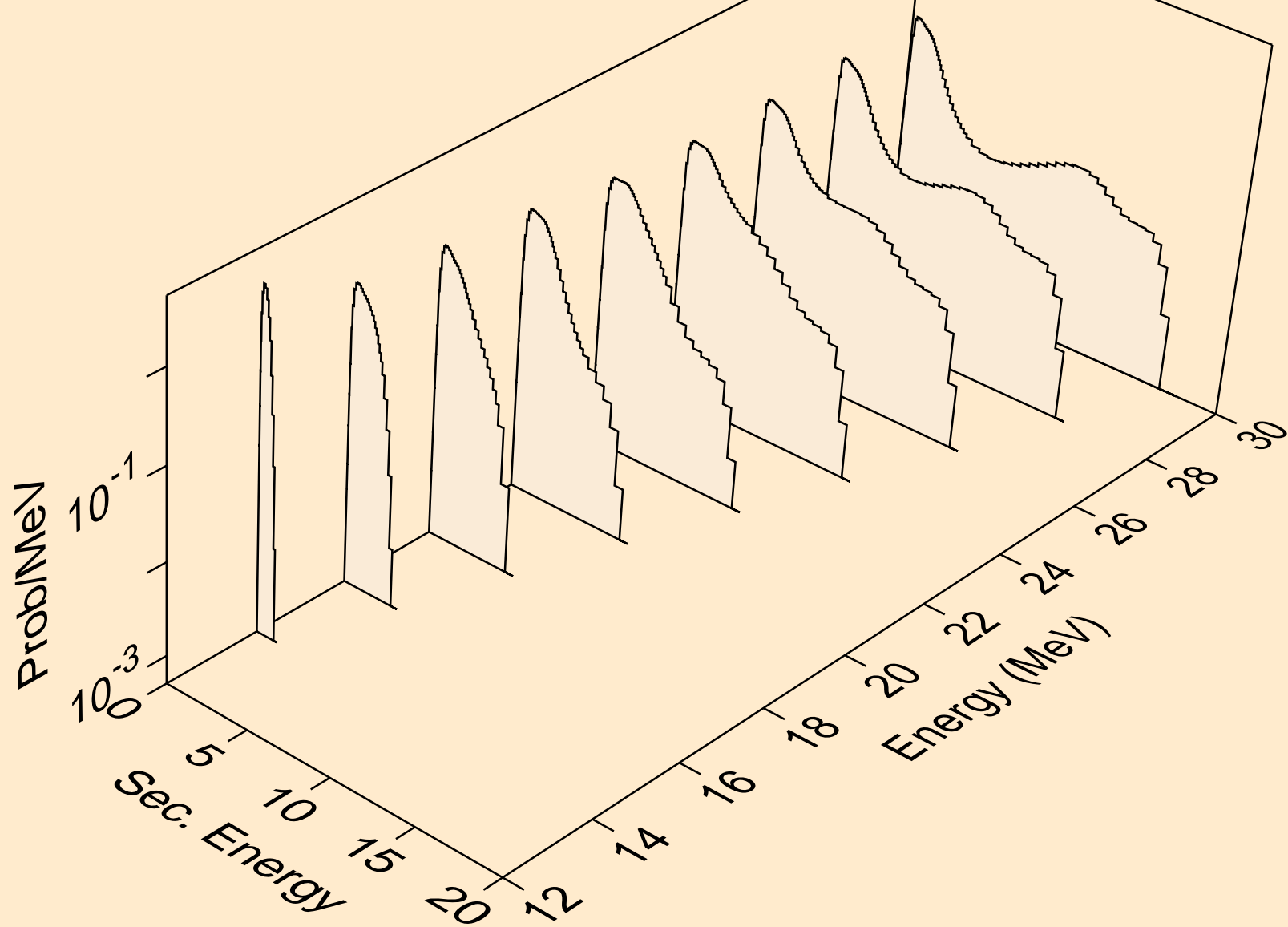

PU238 NEUTRON ACER TENDL-2023 LIBRARY; T=0.K  
Neutron emission for fission

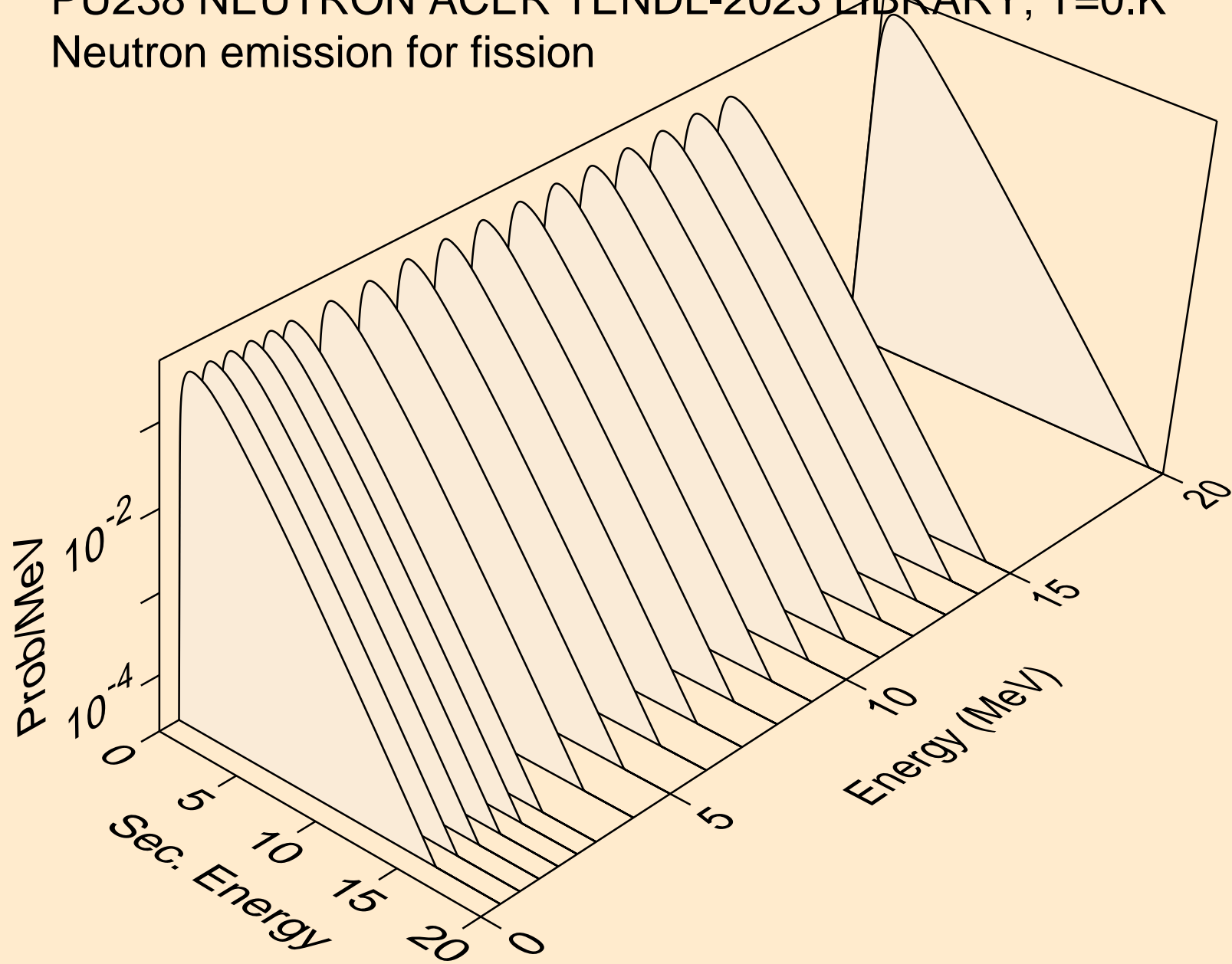

PU238 NEUTRON ACER TENDL-2023 LIBRARY; T=0.K  
Neutron emission for (n,n\*)a

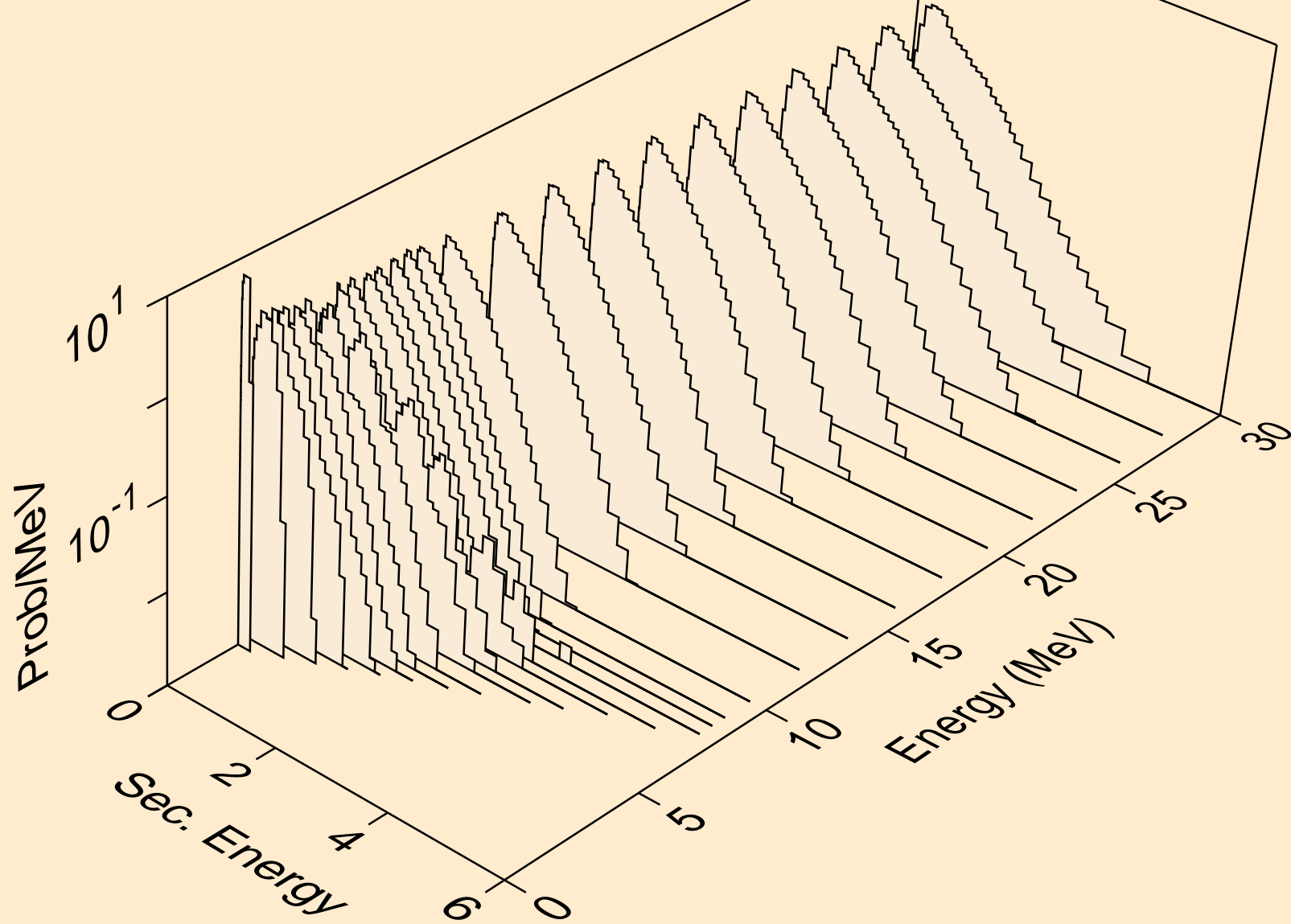

PU238 NEUTRON ACER TENDL-2023 LIBRARY; T=0.K  
Neutron emission for (n,2n)a

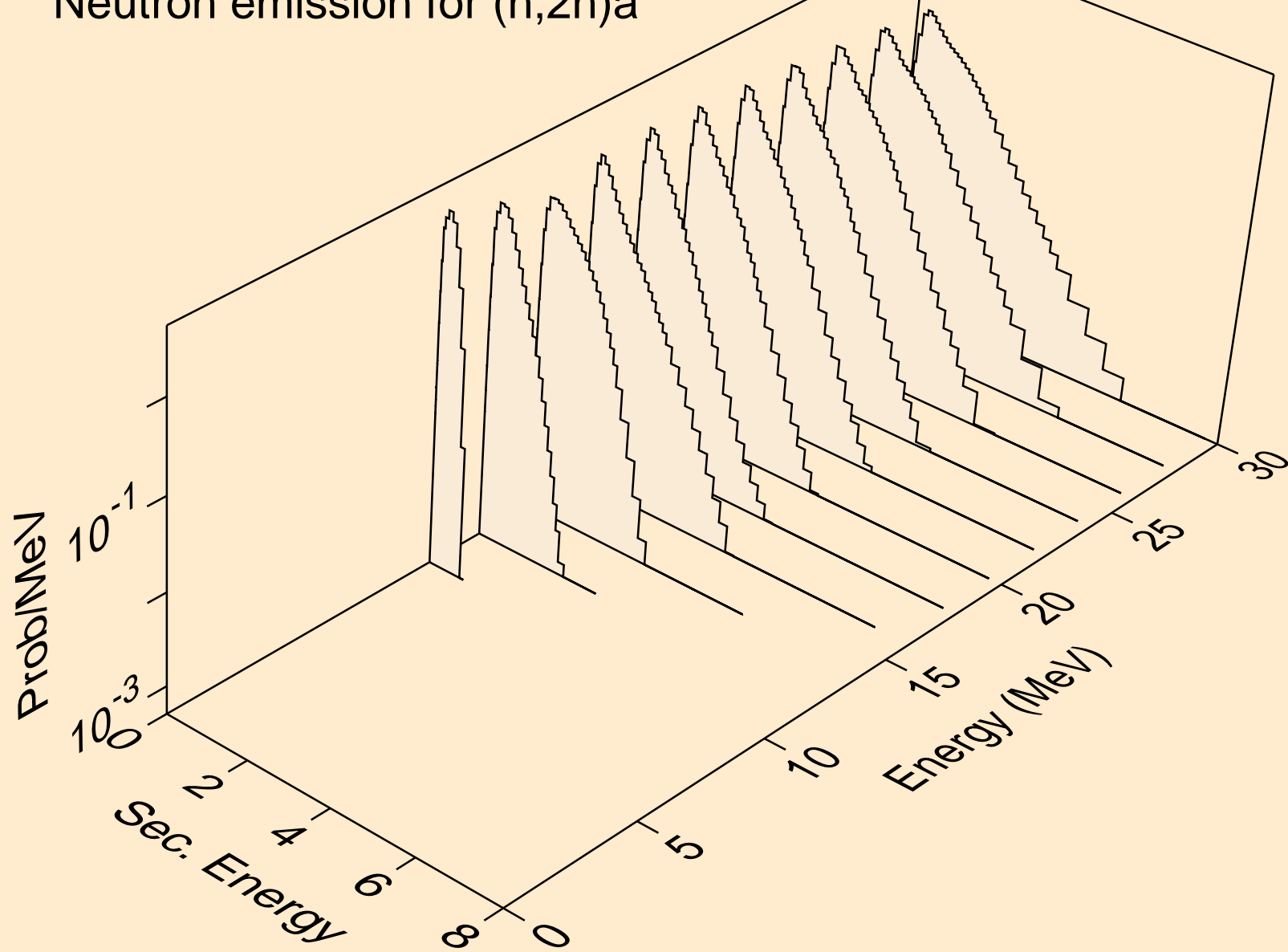

PU238 NEUTRON ACER TENDL-2023 LIBRARY; T=0.K  
Neutron emission for (n,3n)a

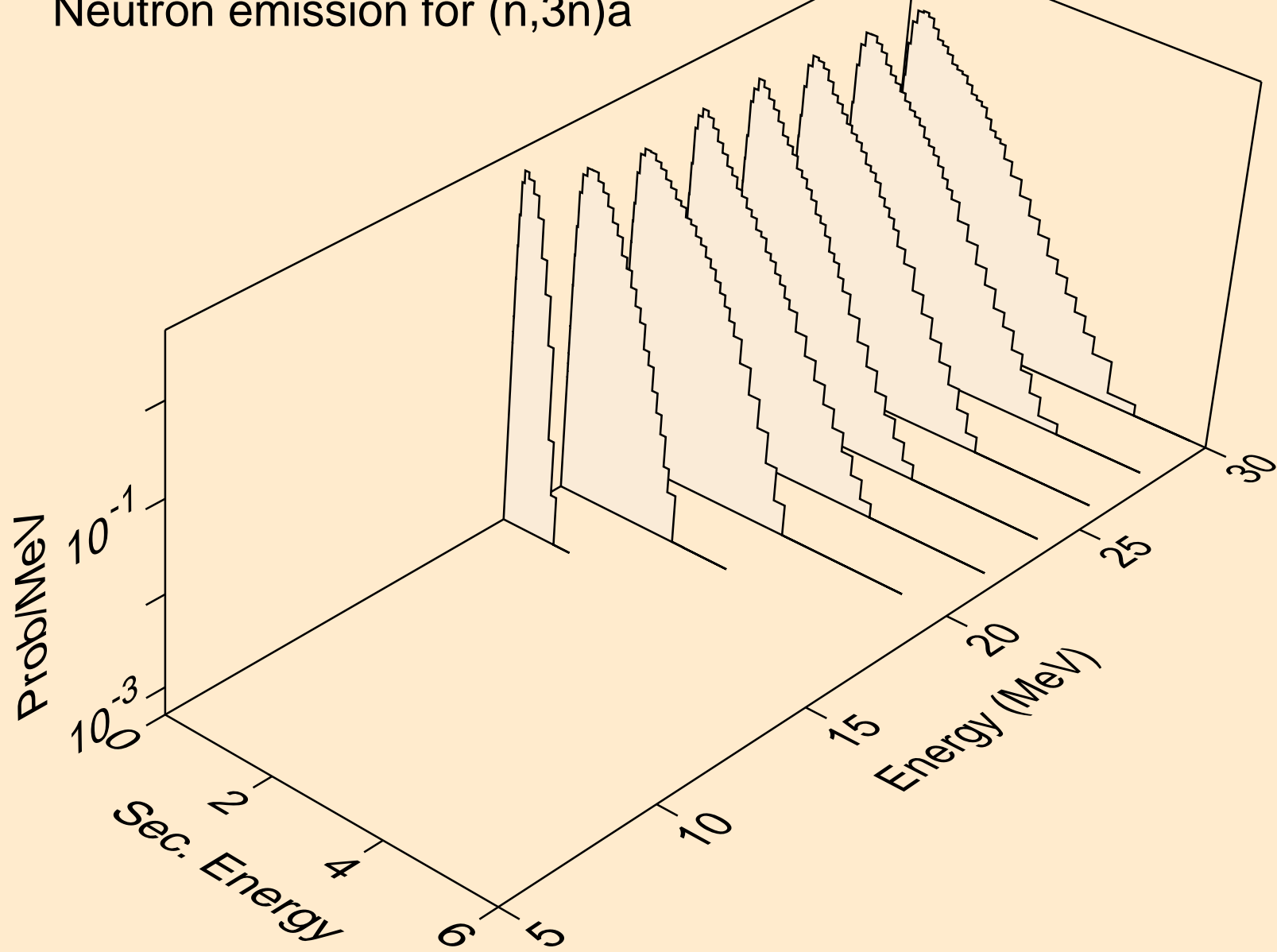



PU238 NEUTRON ACER TENDL-2023 LIBRARY; T=0.K  
Neutron emission for (n,n\*)p

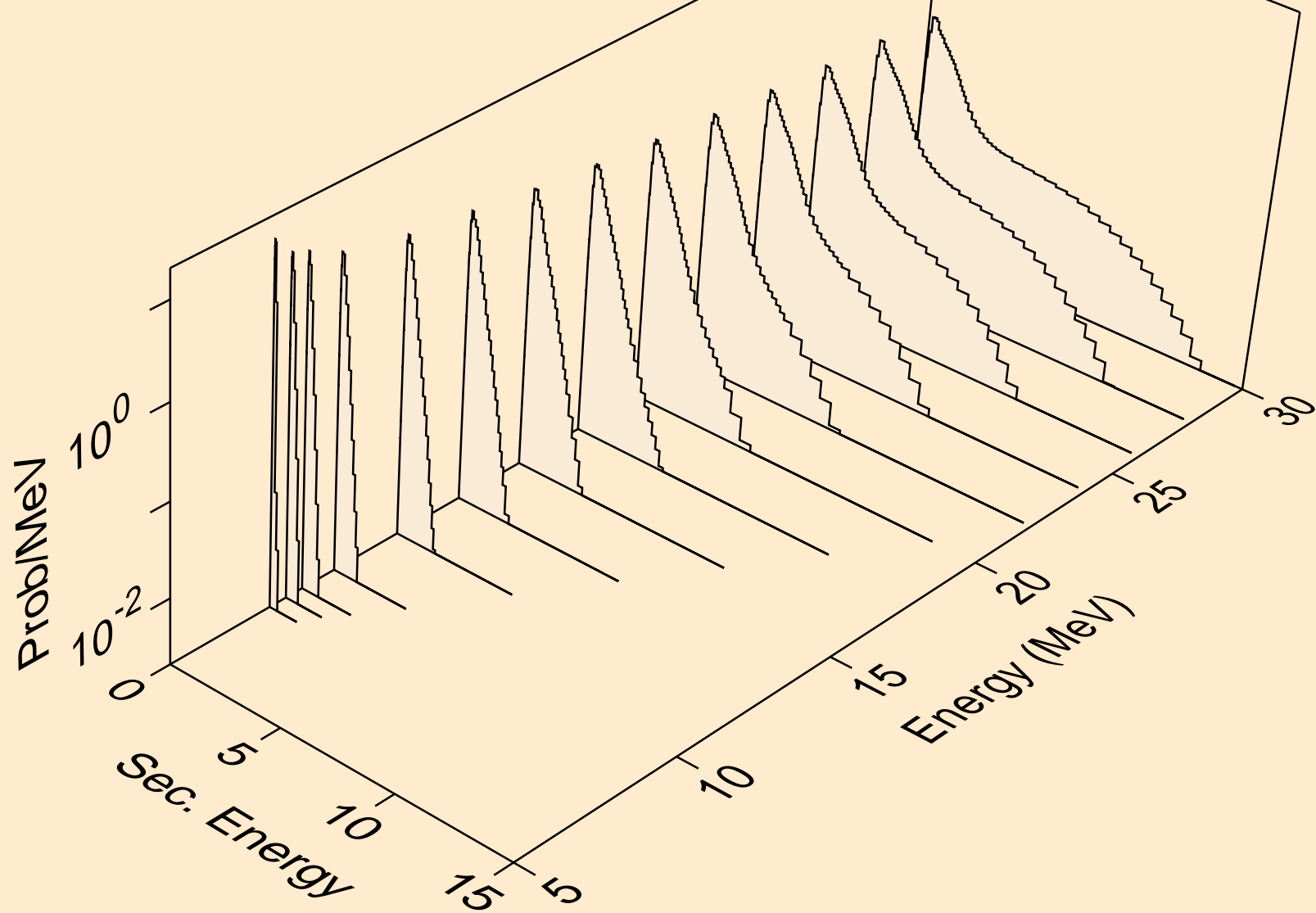

PU238 NEUTRON ACER TENDL-2023 LIBRARY; T=0.K  
Neutron emission for (n,n\*)2a

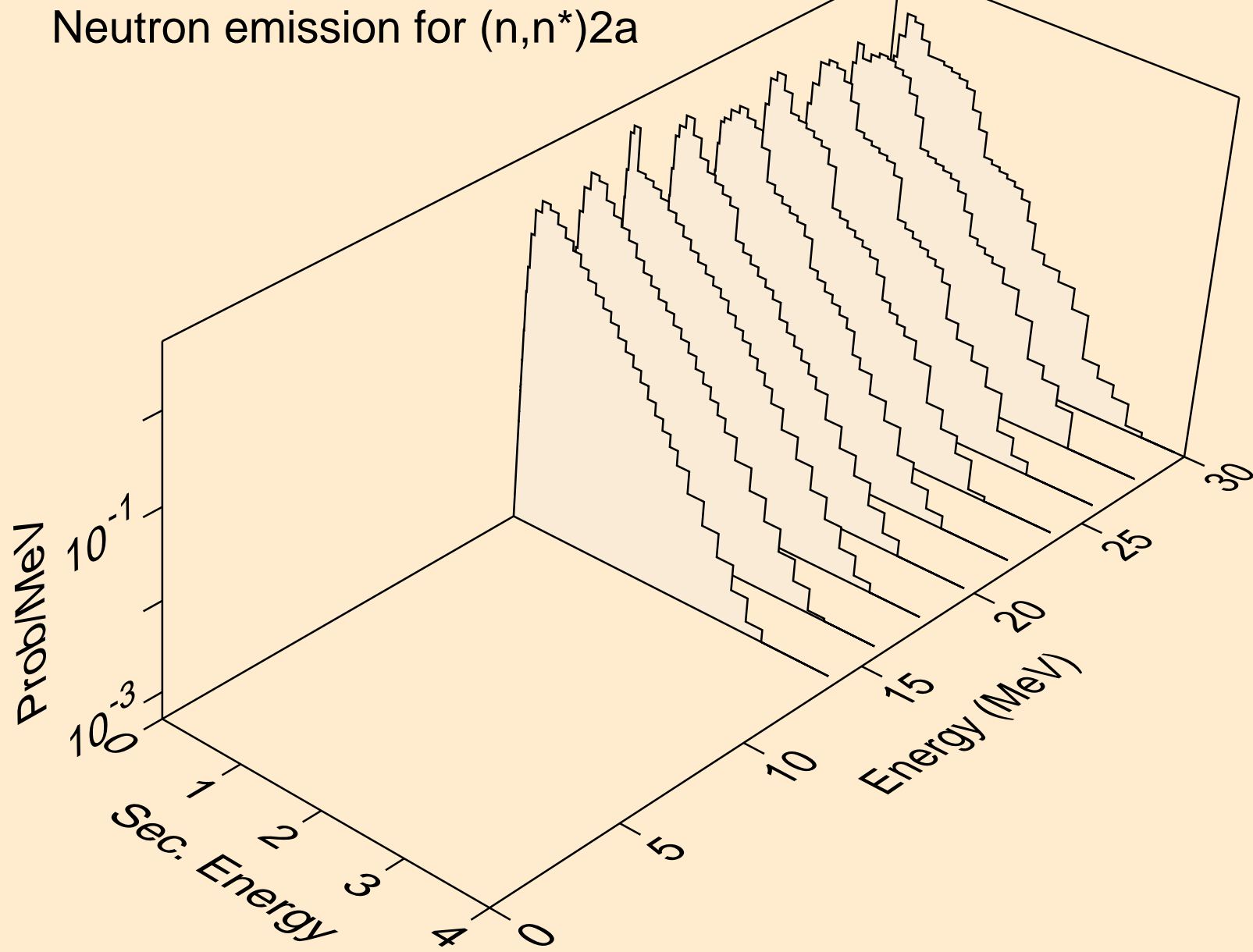

PU238 NEUTRON ACER TENDL-2023 LIBRARY; T=0.K  
Neutron emission for (n,n\*)d

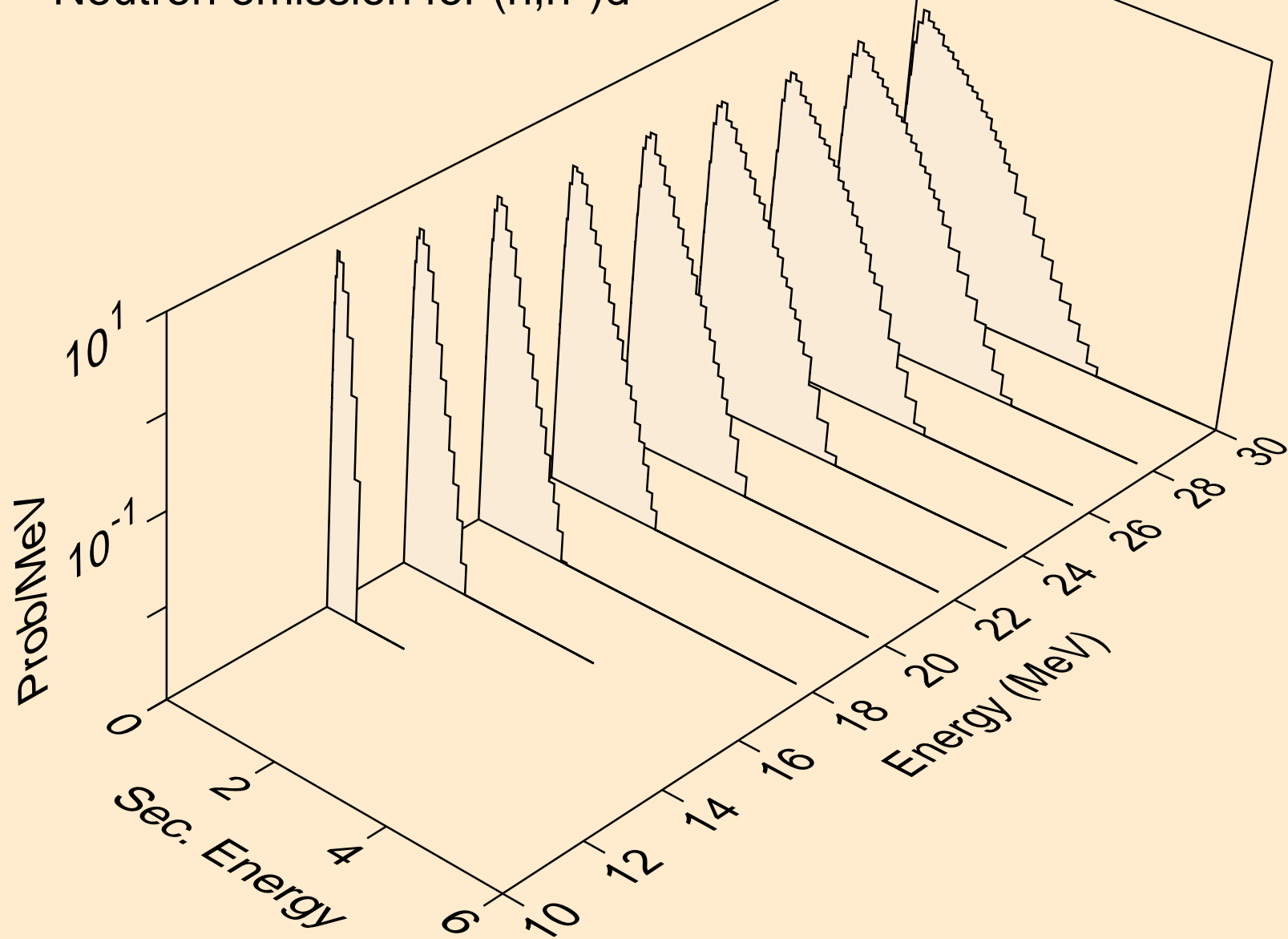

PU238 NEUTRON ACER TENDL-2023 LIBRARY; T=0.K  
Neutron emission for (n,n\*)t

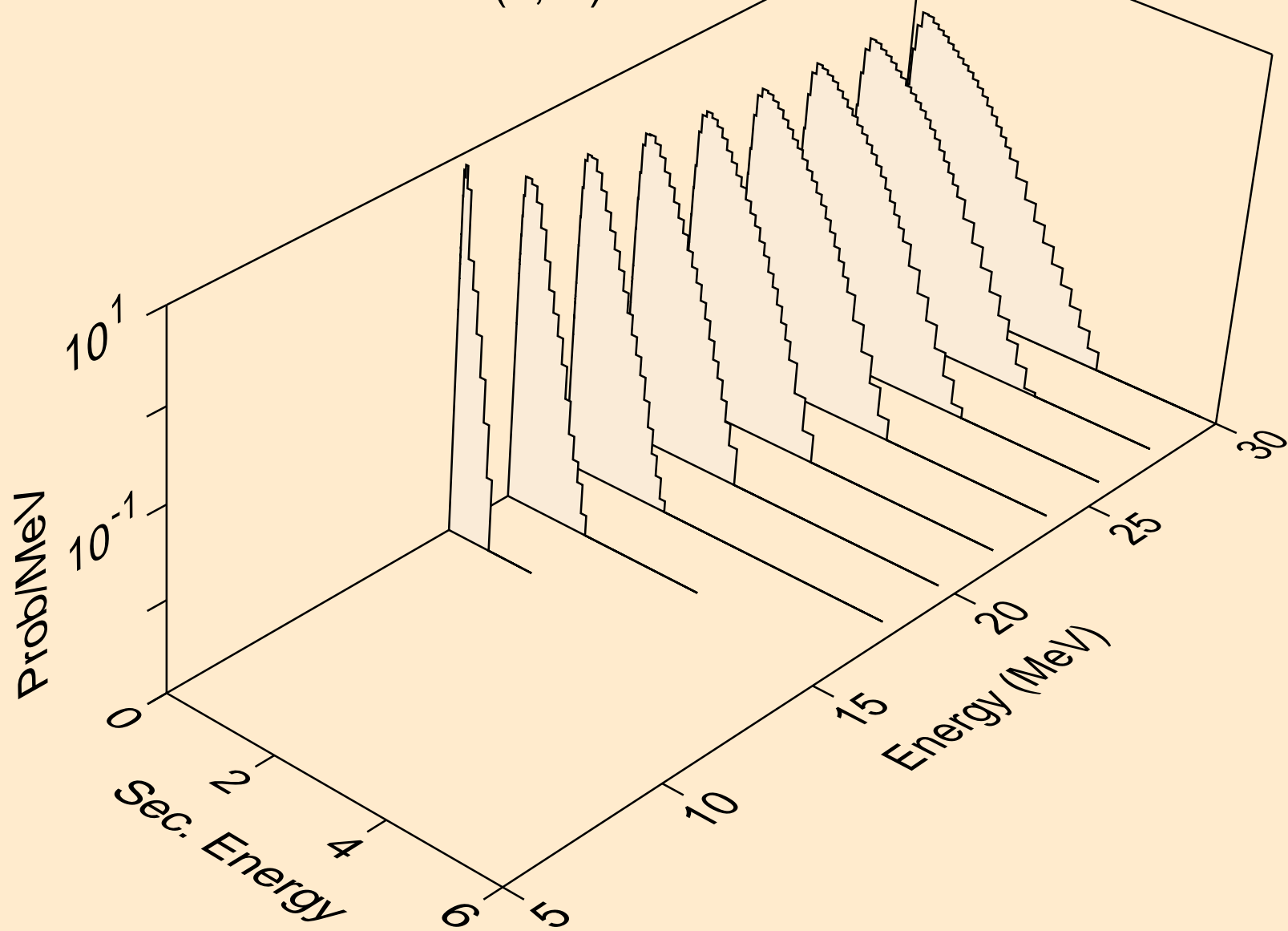

PU238 NEUTRON ACER TENDL-2023 LIBRARY; T=0.K  
Neutron emission for (n,n\*)he3

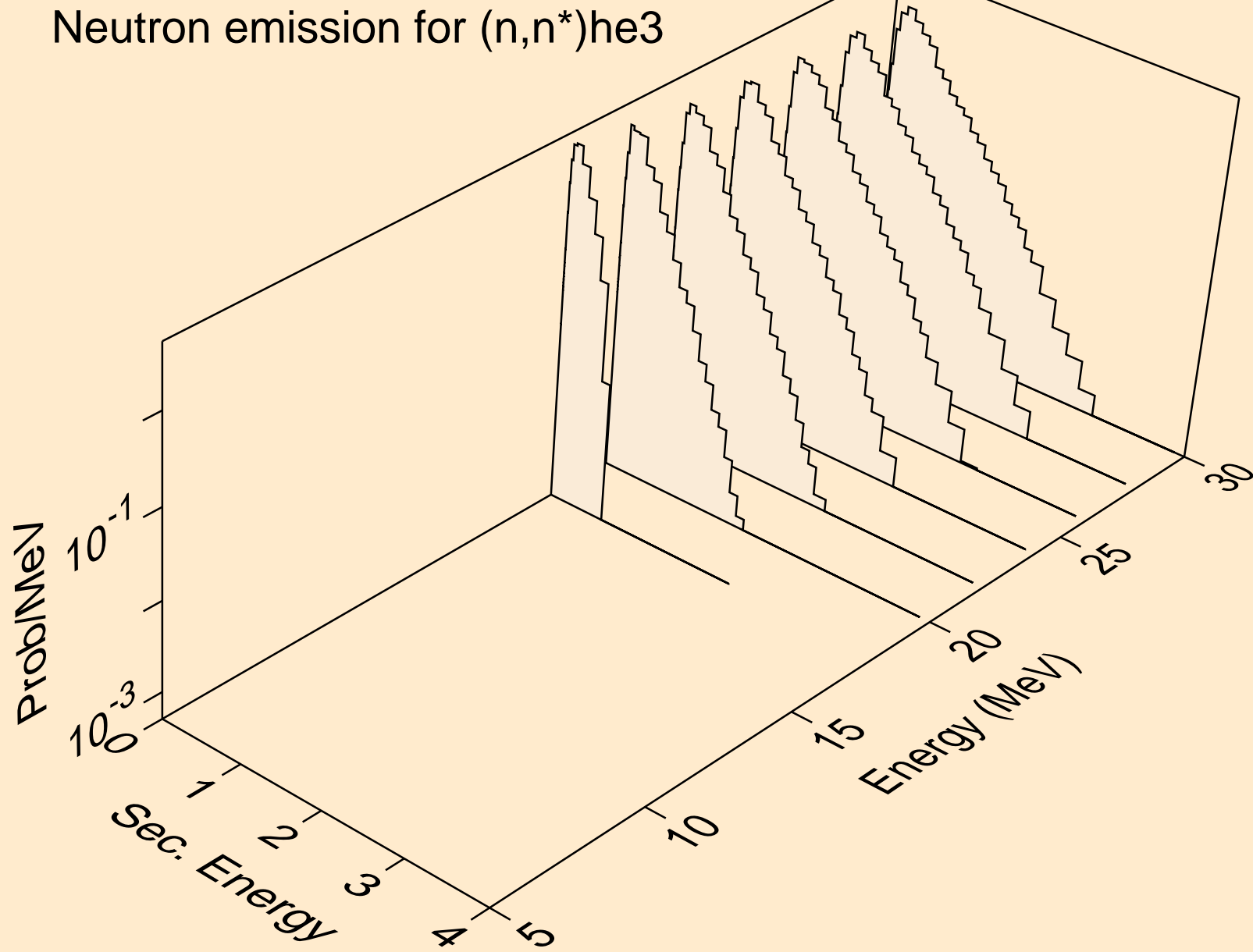

PU238 NEUTRON ACER TENDL-2023 LIBRARY; T=0.K  
Neutron emission for (n,4n)

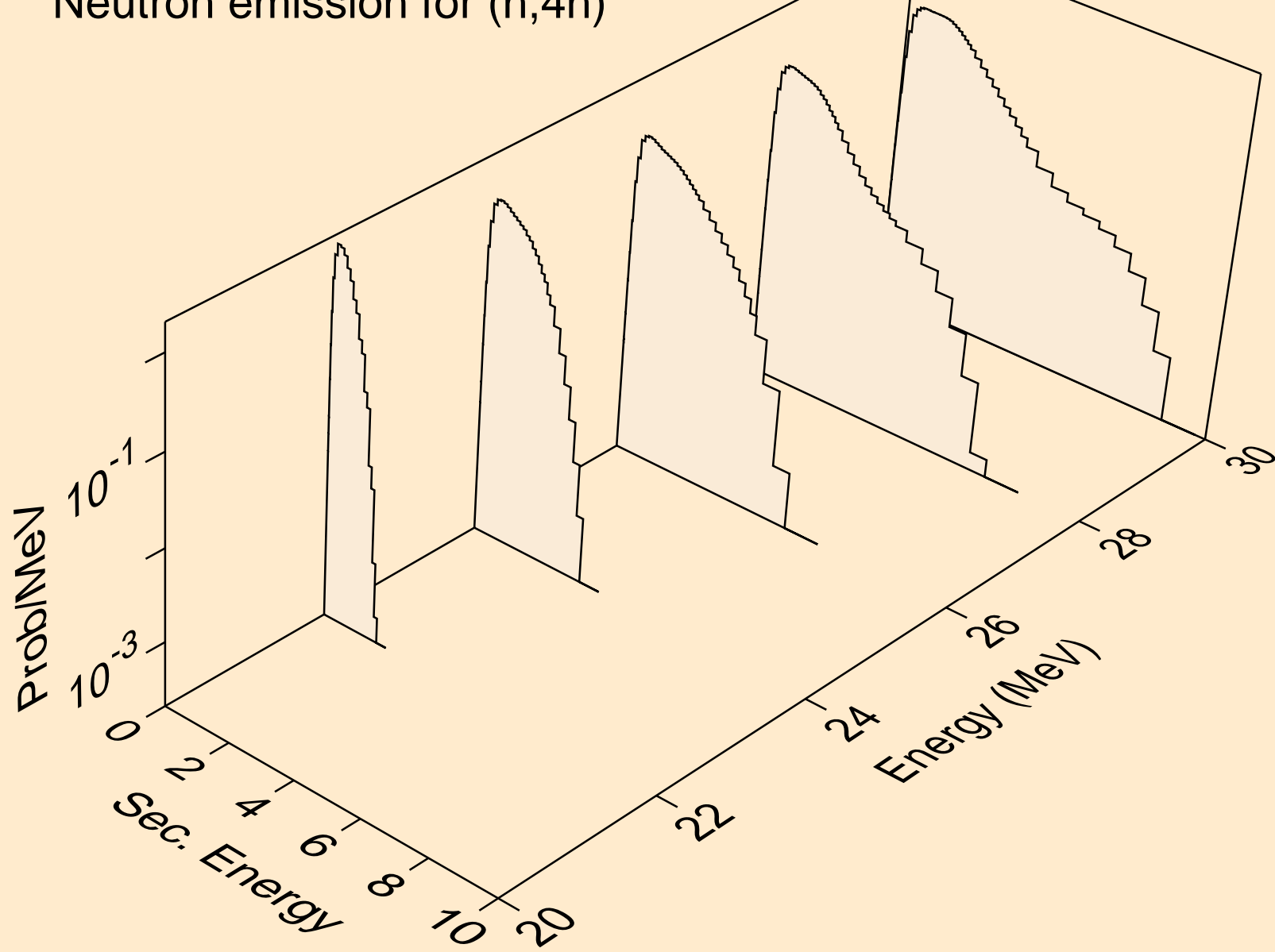

PU238 NEUTRON ACER TENDL-2023 LIBRARY; T=0.K  
Neutron emission for (n,2np)

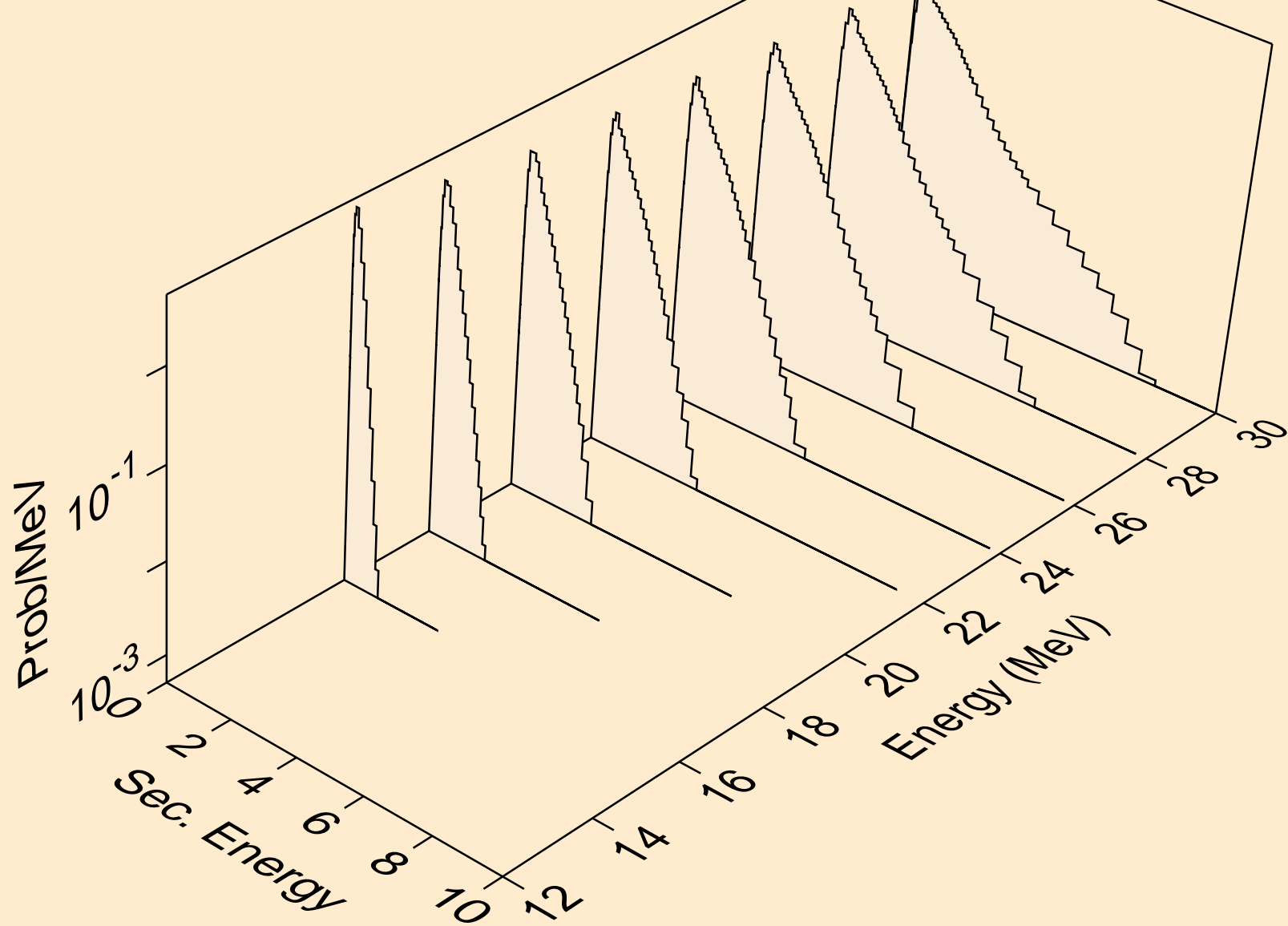

PU238 NEUTRON ACER TENDL-2023 LIBRARY; T=0.K  
Neutron emission for (n,3np)

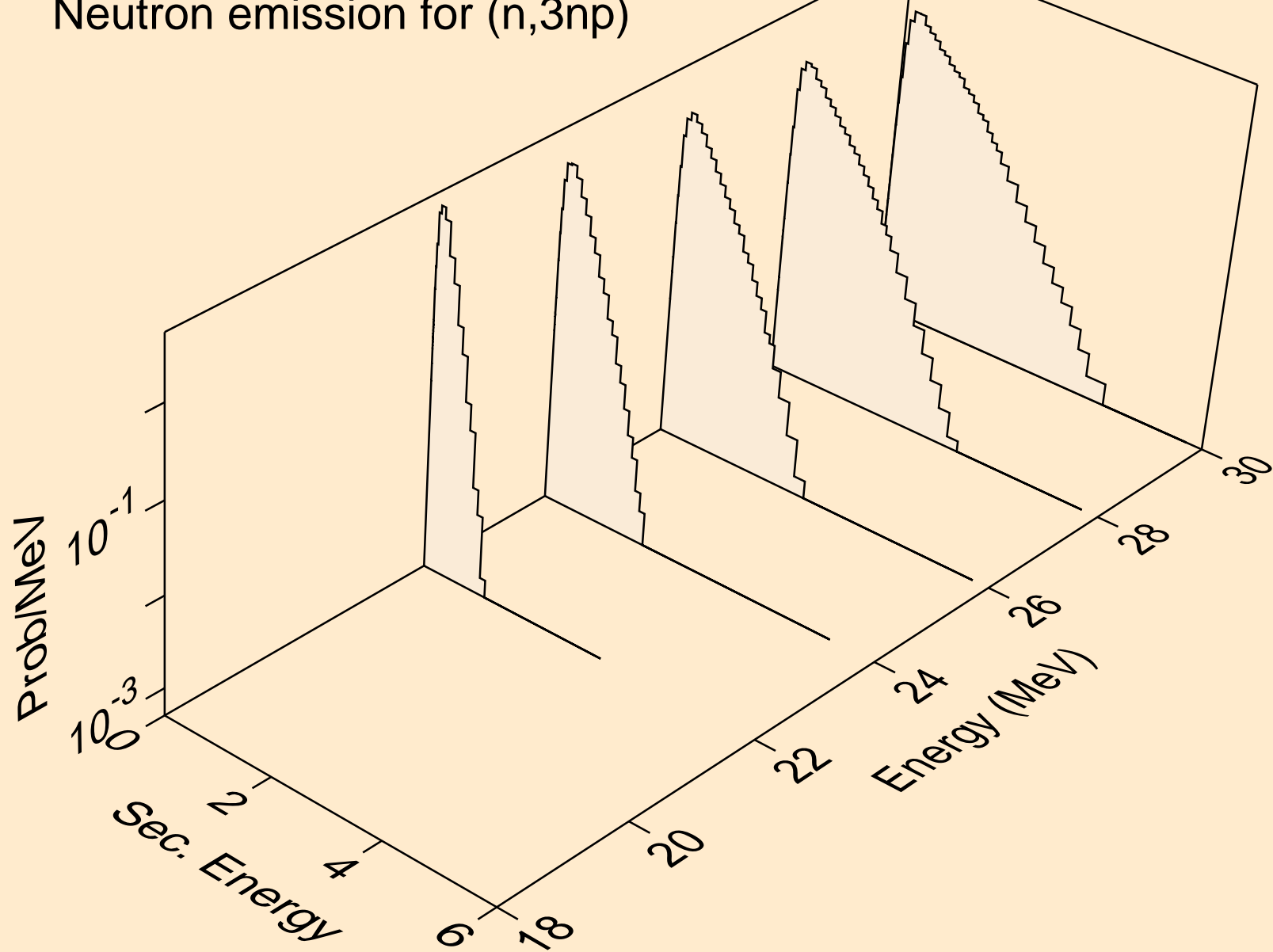



PU238 NEUTRON ACER TENDL-2023 LIBRARY; T=0.K  
Neutron emission for (n,n2p)

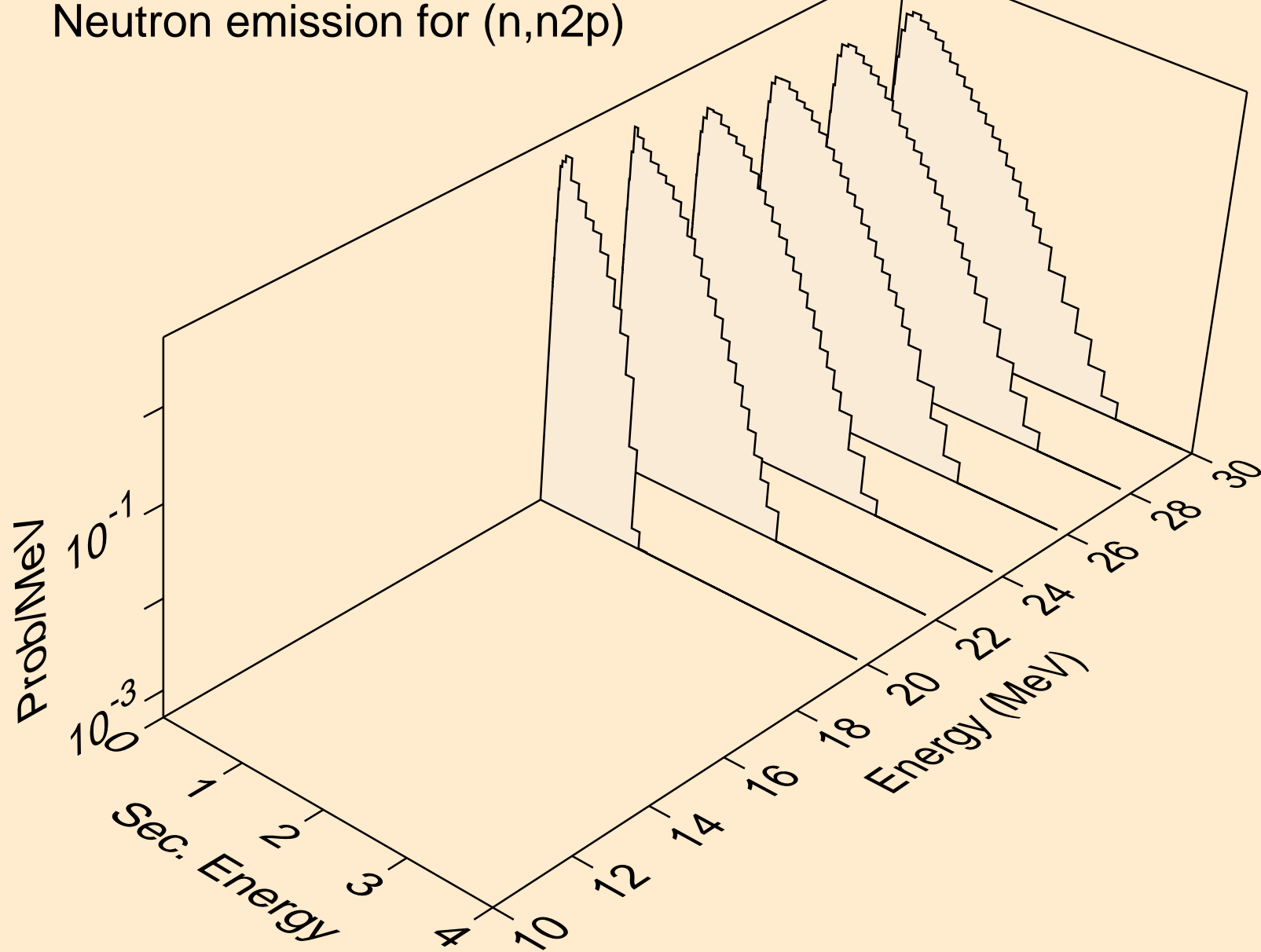

PU238 NEUTRON ACER TENDL-2023 LIBRARY; T=0.K  
Neutron emission for (n,npa)

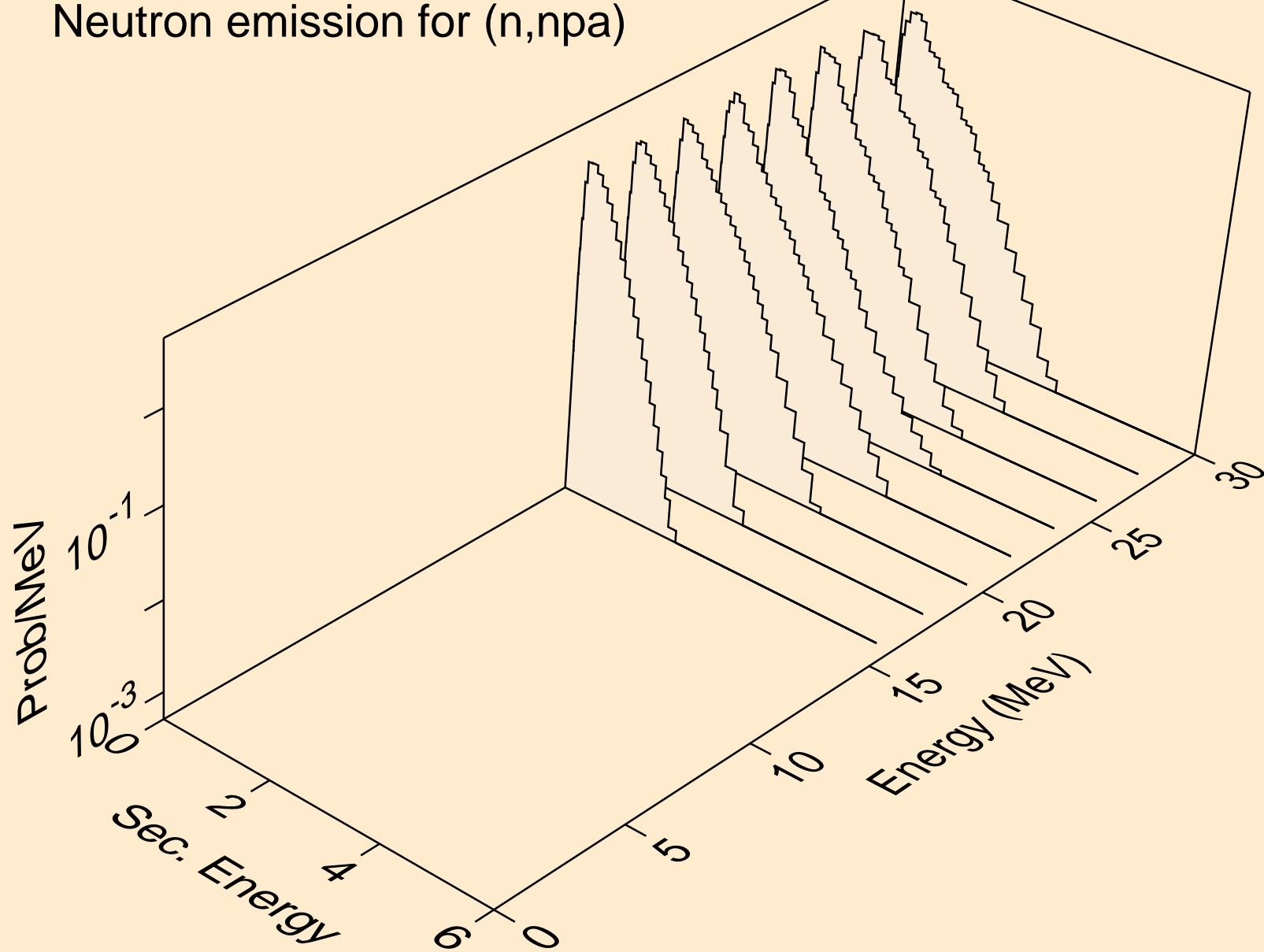

PU238 NEUTRON ACER TENDL-2023 LIBRARY; T=0.K  
Neutron emission for (n,n\*c)

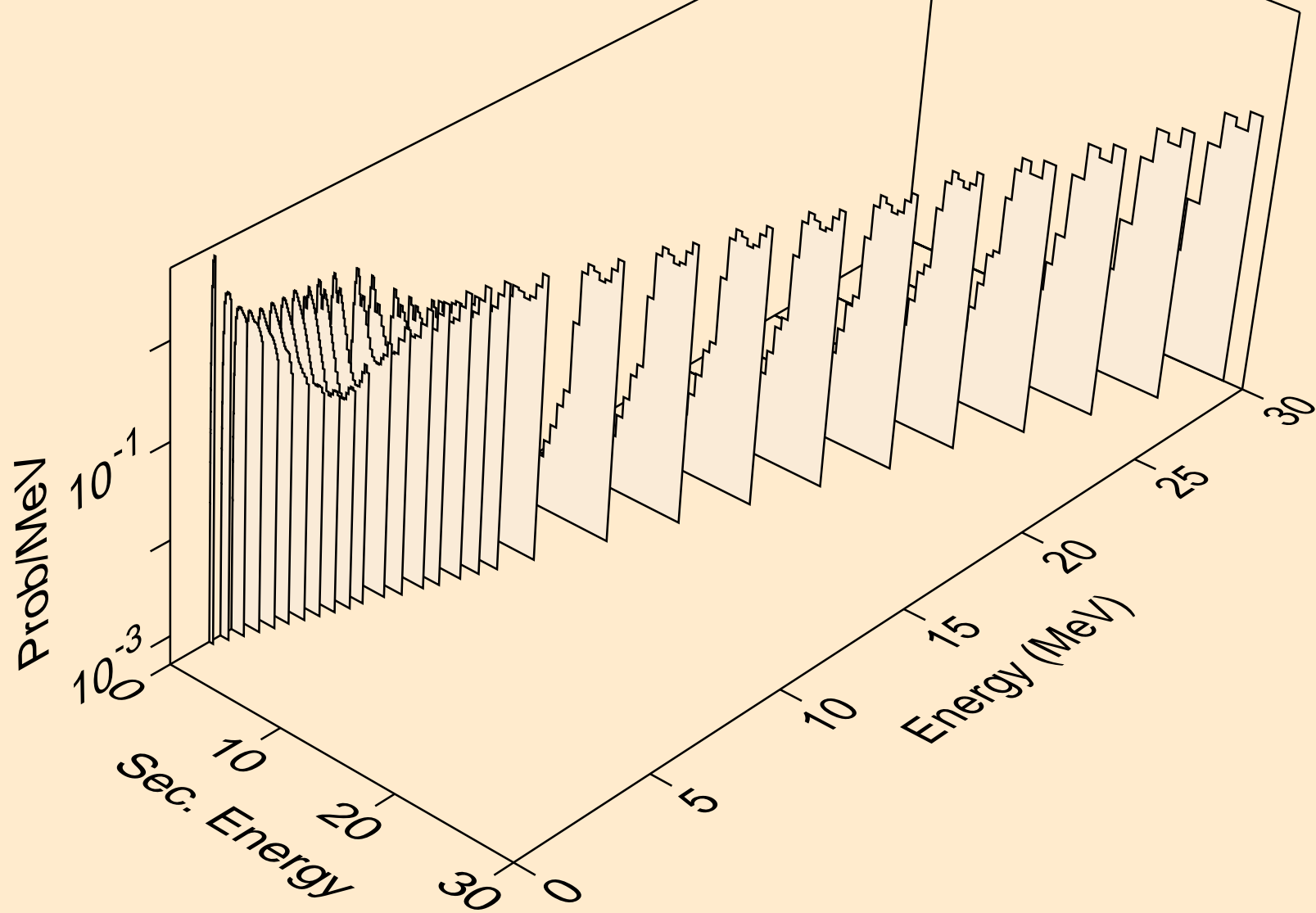

# PU238 NEUTRON ACER TENDL-2023 LIBRARY; T=0.K

Delayed nubar

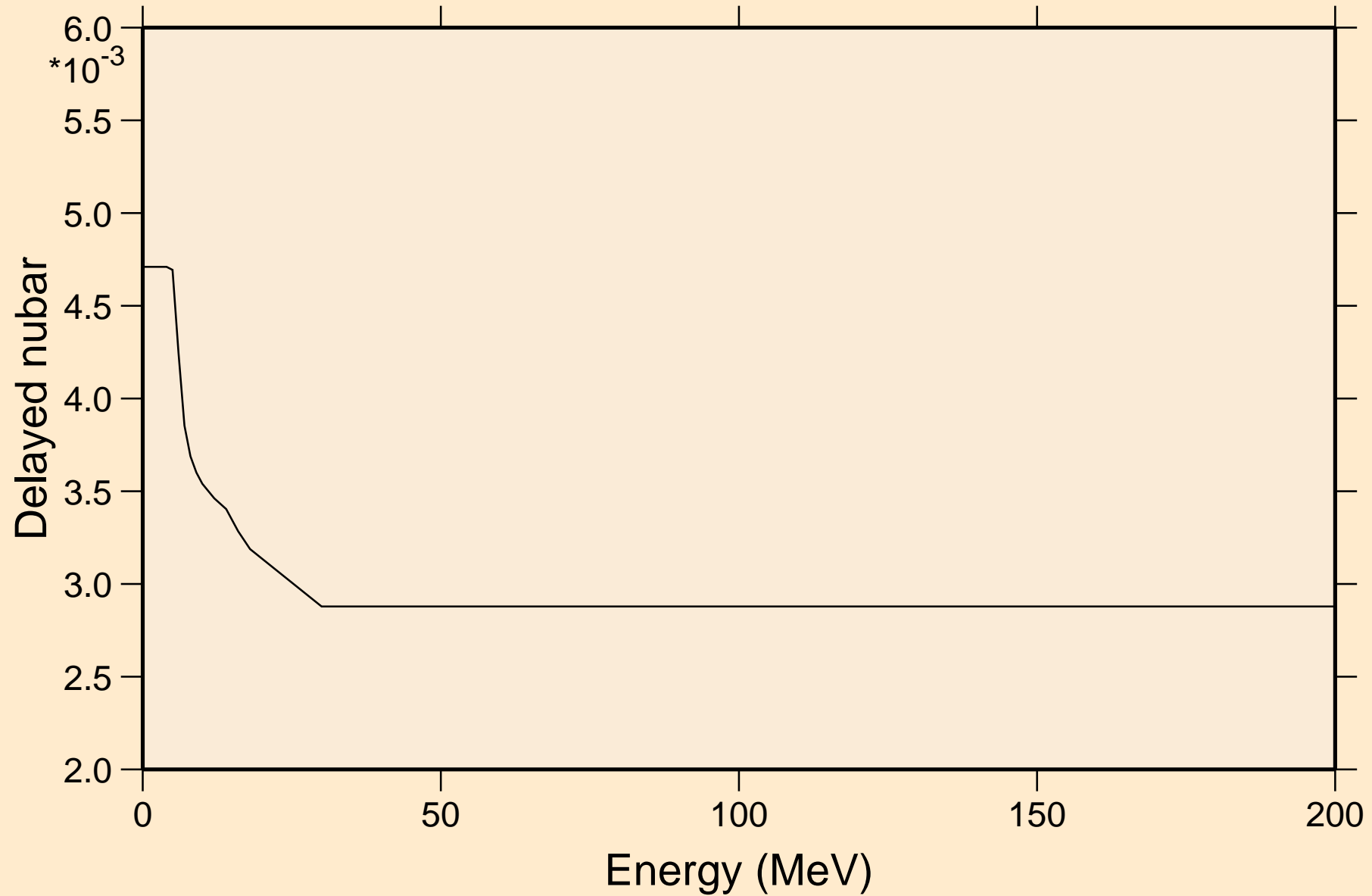

# PU238 NEUTRON ACER TENDL-2023 LIBRARY; T=0.K

## Delayed neutron spectra

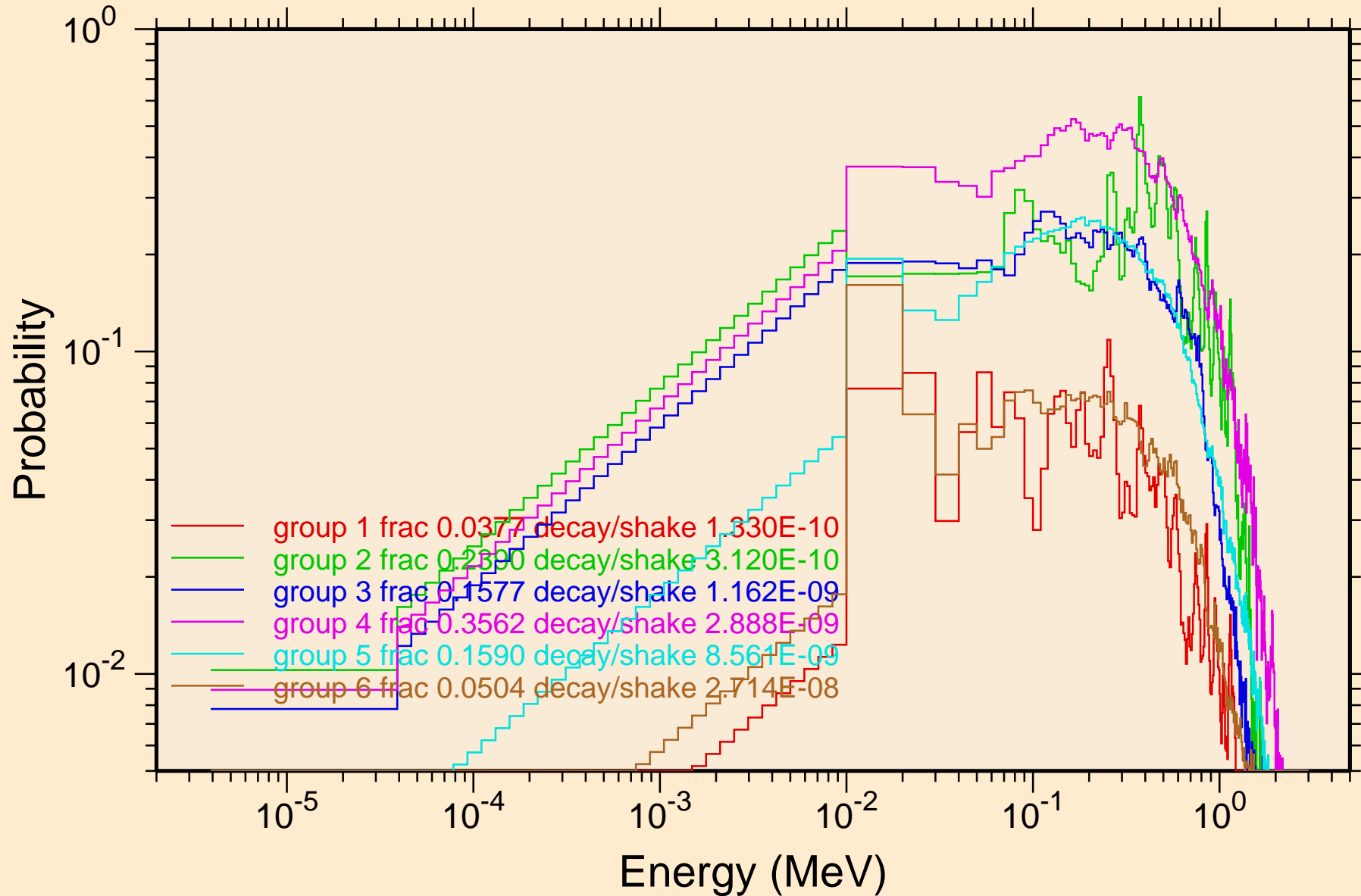

PU238 NEUTRON ACER TENDL-2023 LIBRARY; T=0.K  
Photon emission for (n,x)

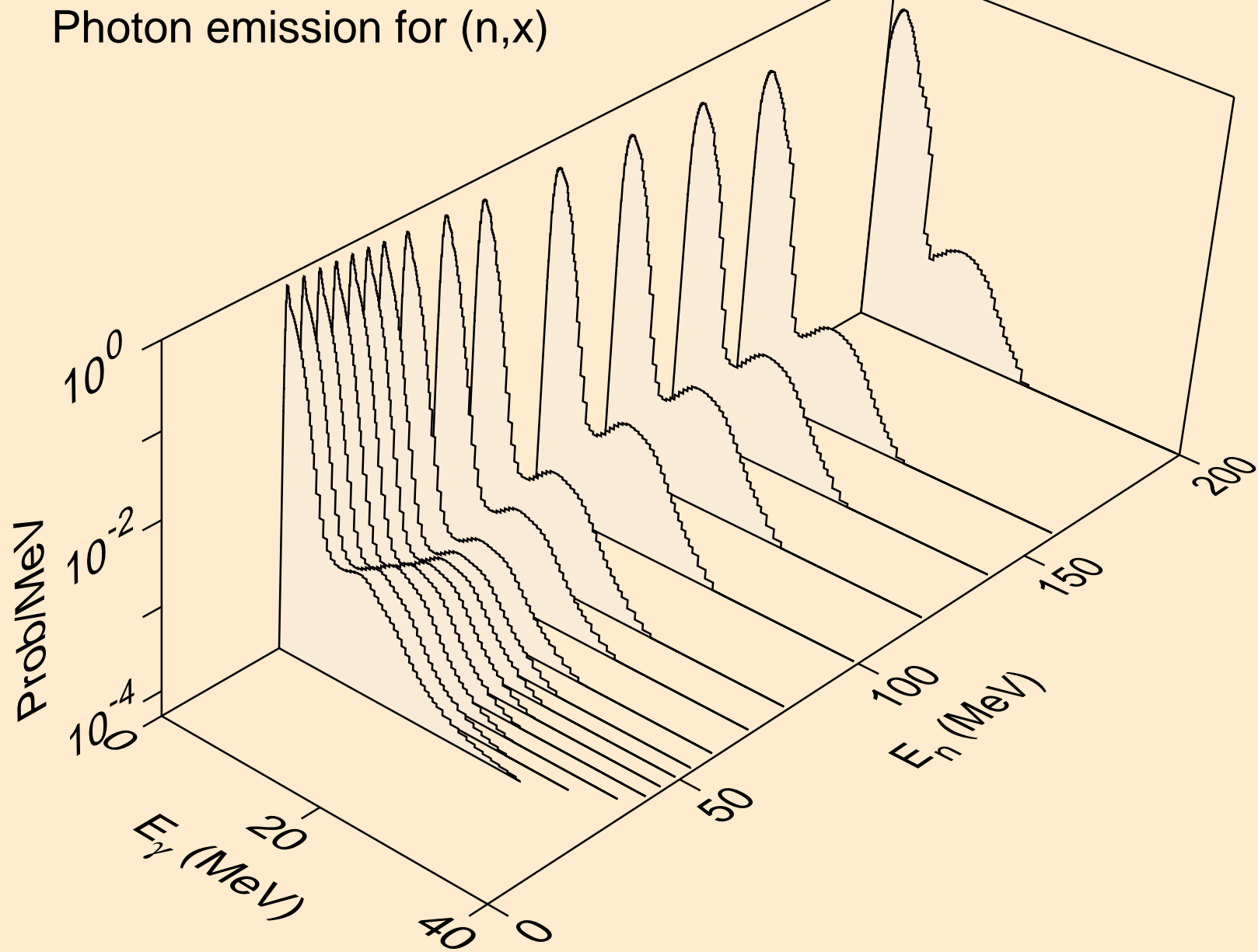

PU238 NEUTRON ACER TENDL-2023 LIBRARY; T=0.K  
Photon emission for (n,2nd)

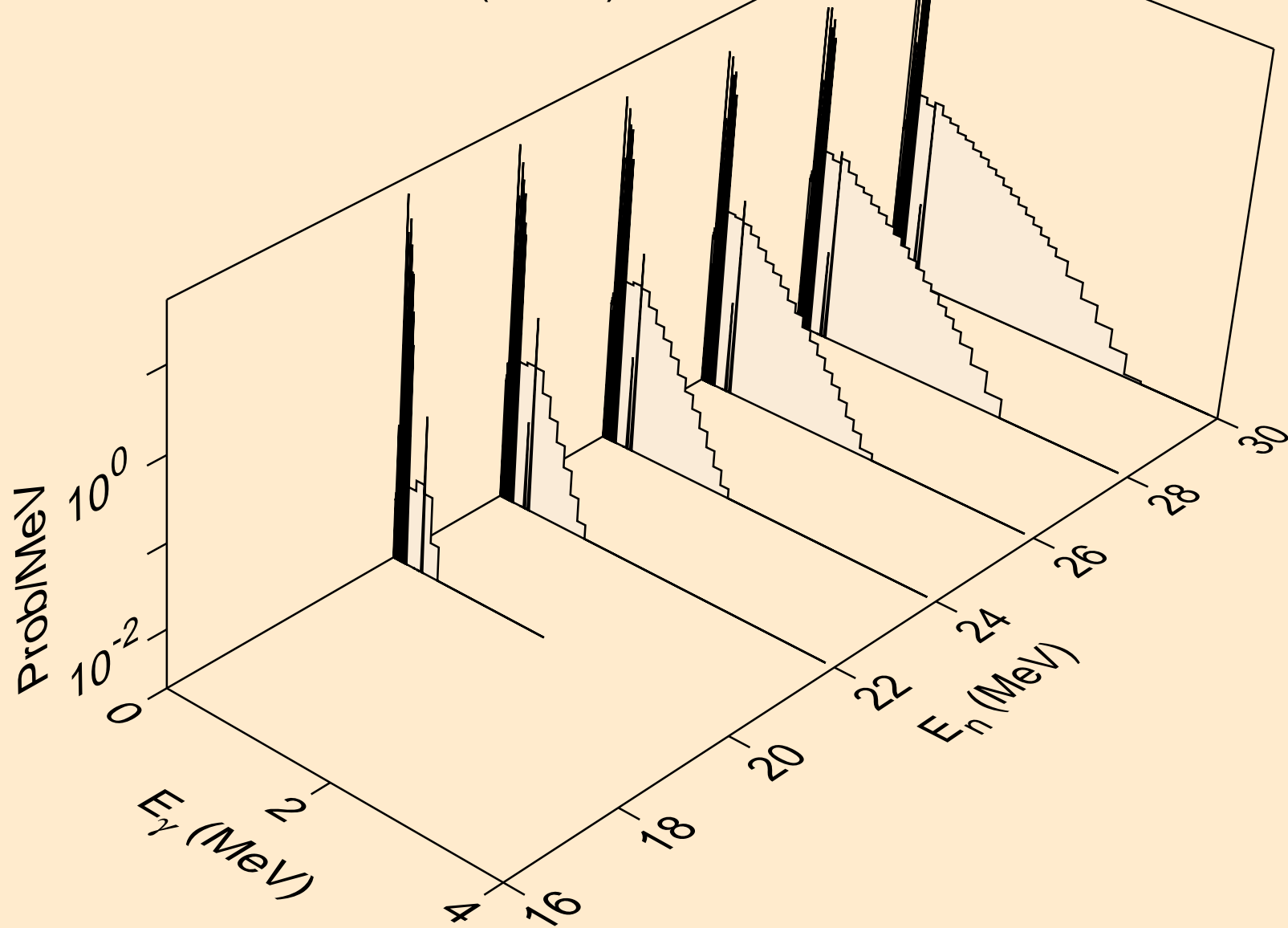

PU238 NEUTRON ACER TENDL-2023 LIBRARY; T=0.K  
Photon emission for (n,2n)

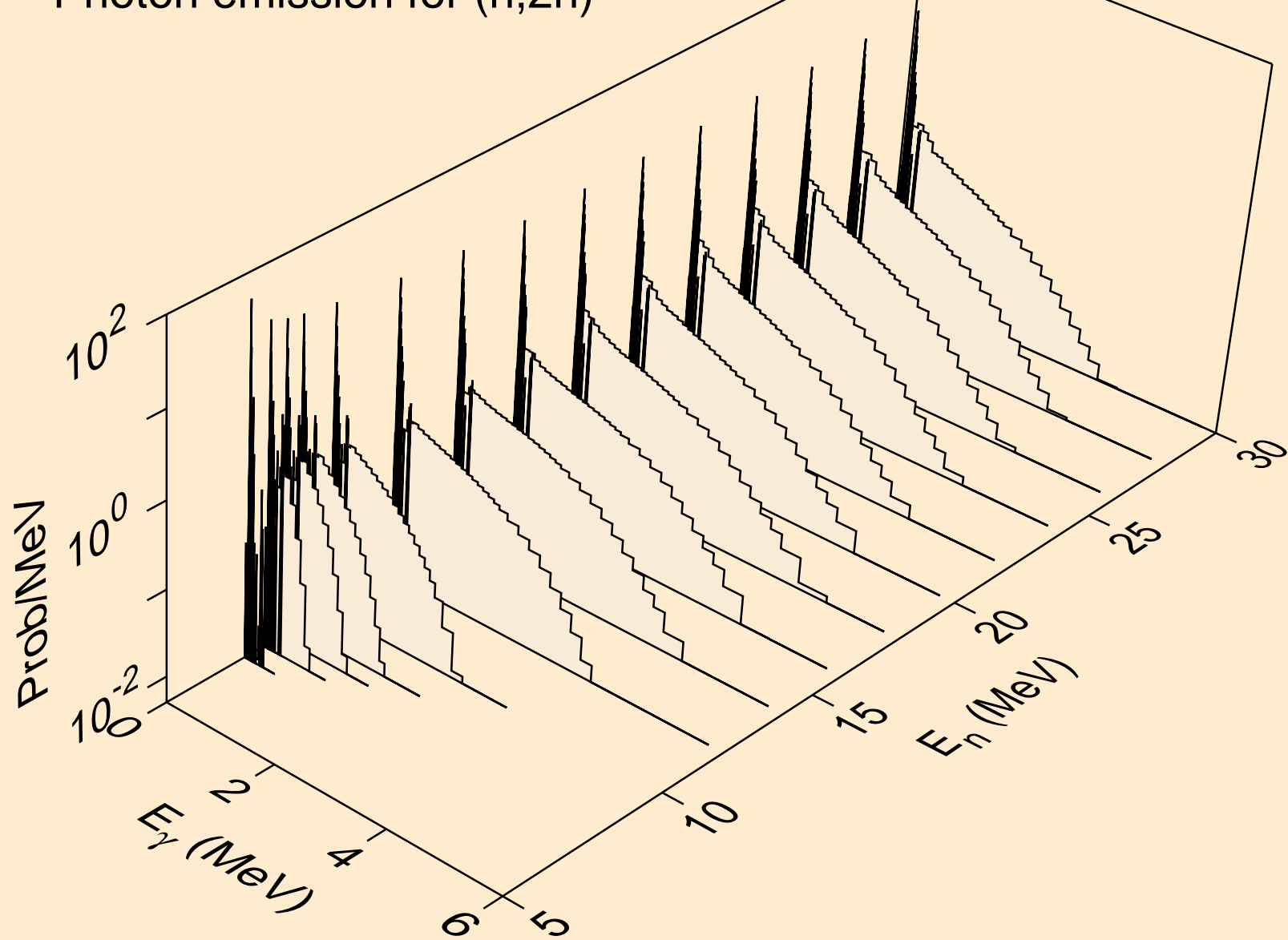



PU238 NEUTRON ACER TENDL-2023 LIBRARY; T=0.K  
Photon emission for (n,3n)

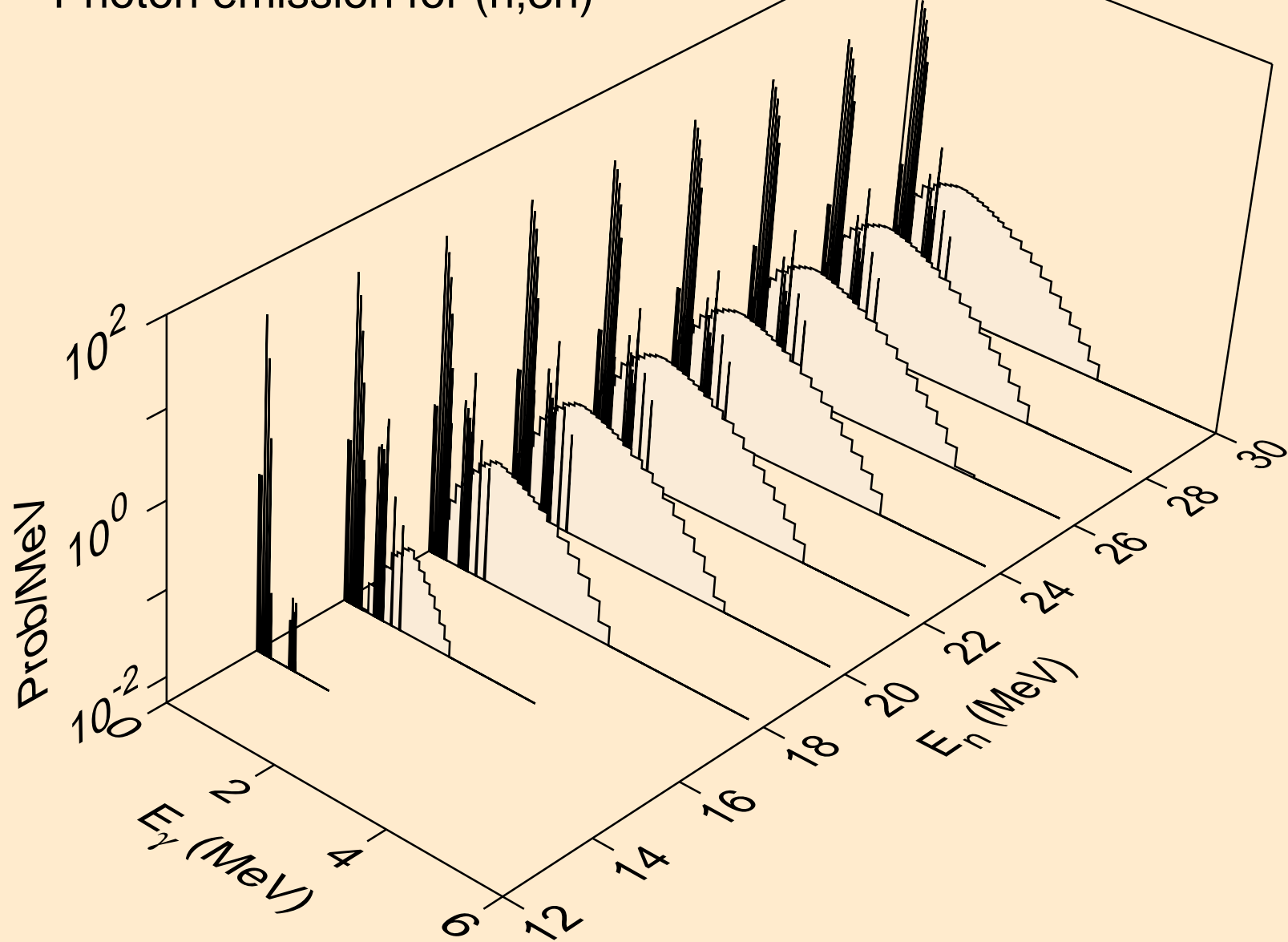

PU238 NEUTRON ACER TENDL-2023 LIBRARY; T=0.K  
Photon emission for (n,n\*)a

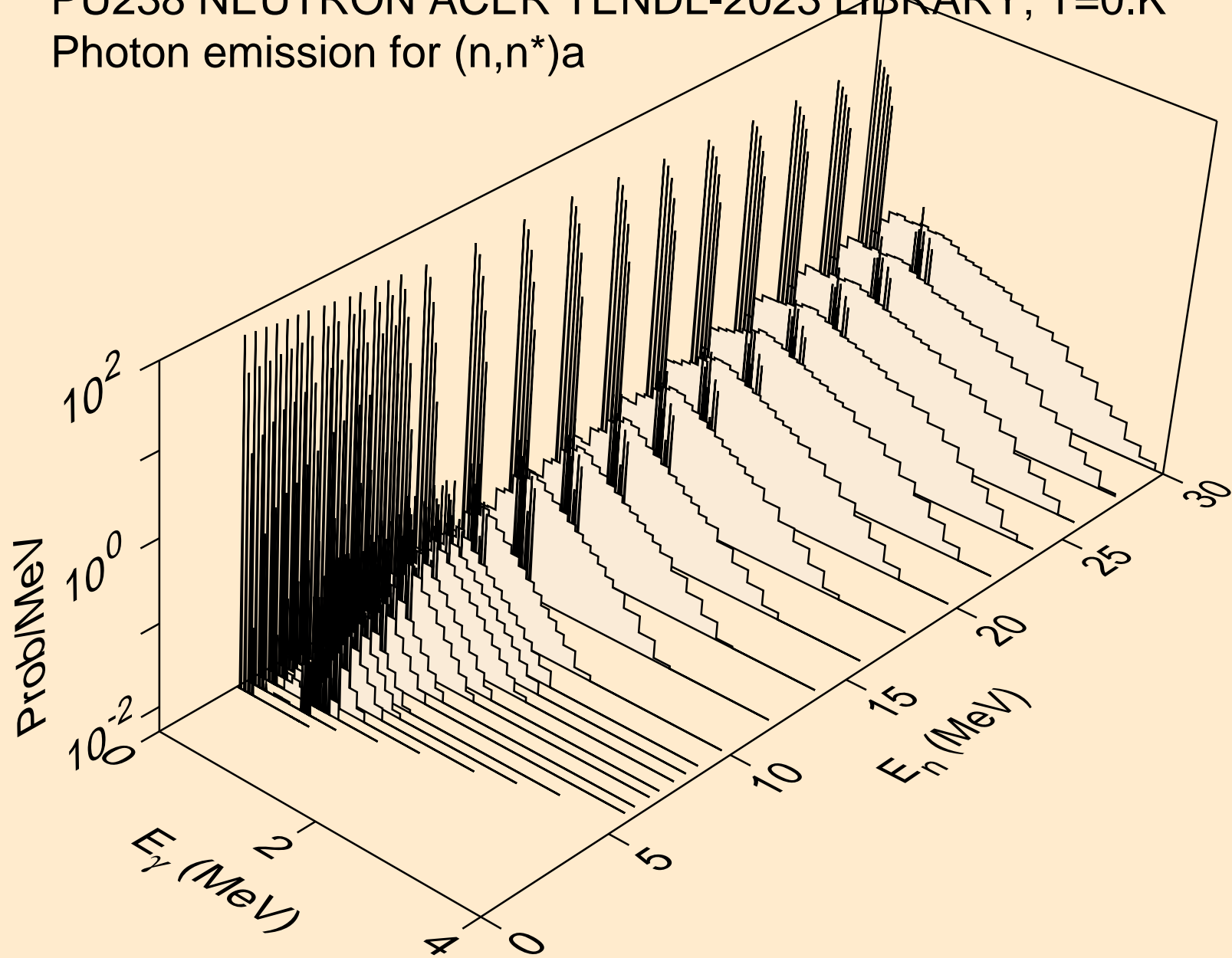

PU238 NEUTRON ACER TENDL-2023 LIBRARY; T=0.K  
Photon emission for (n,2n)a

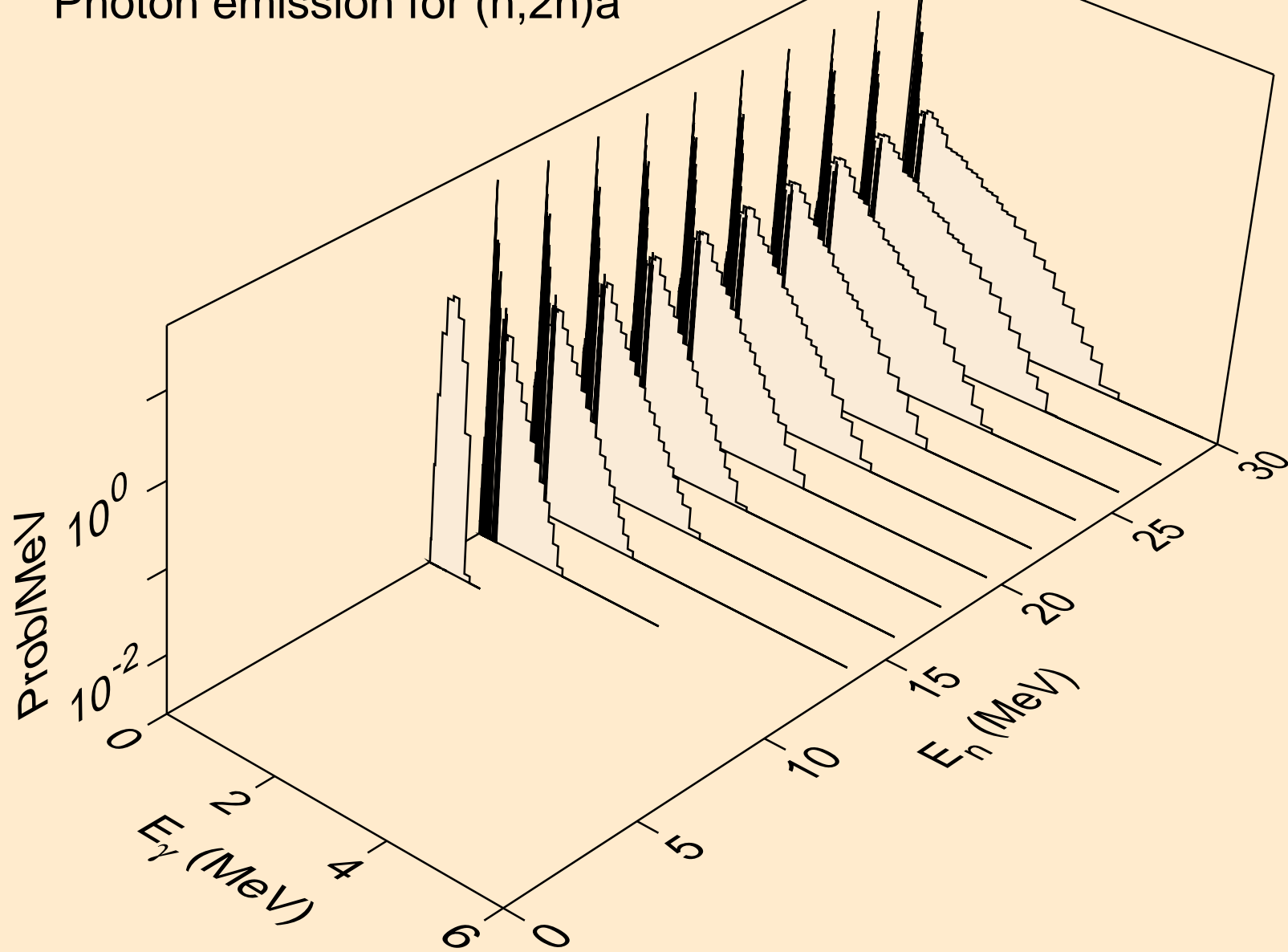

PU238 NEUTRON ACER TENDL-2023 LIBRARY; T=0.K  
Photon emission for (n,3n)a

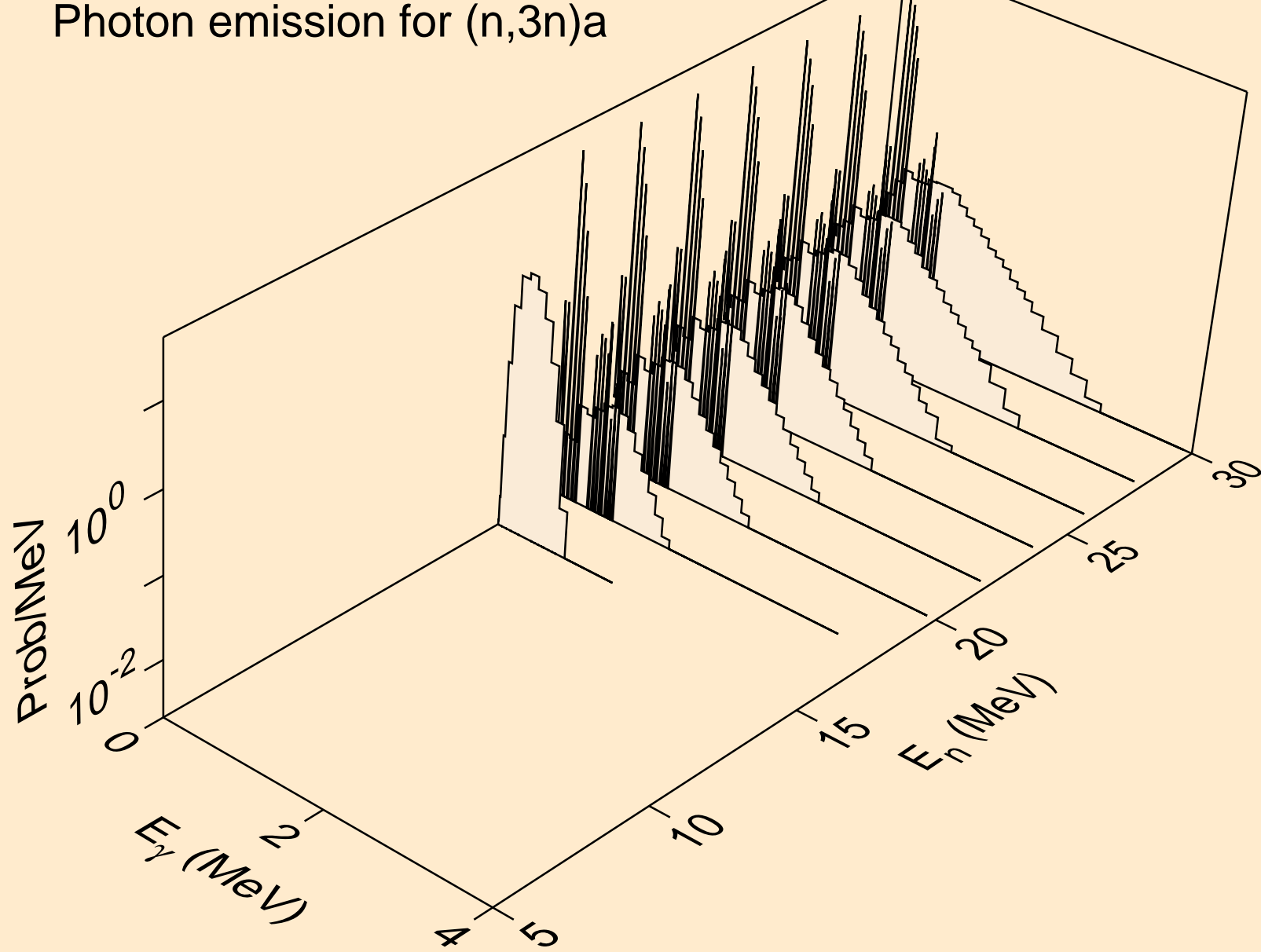

PU238 NEUTRON ACER TENDL-2023 LIBRARY; T=0.K  
Photon emission for (n,n\*)p

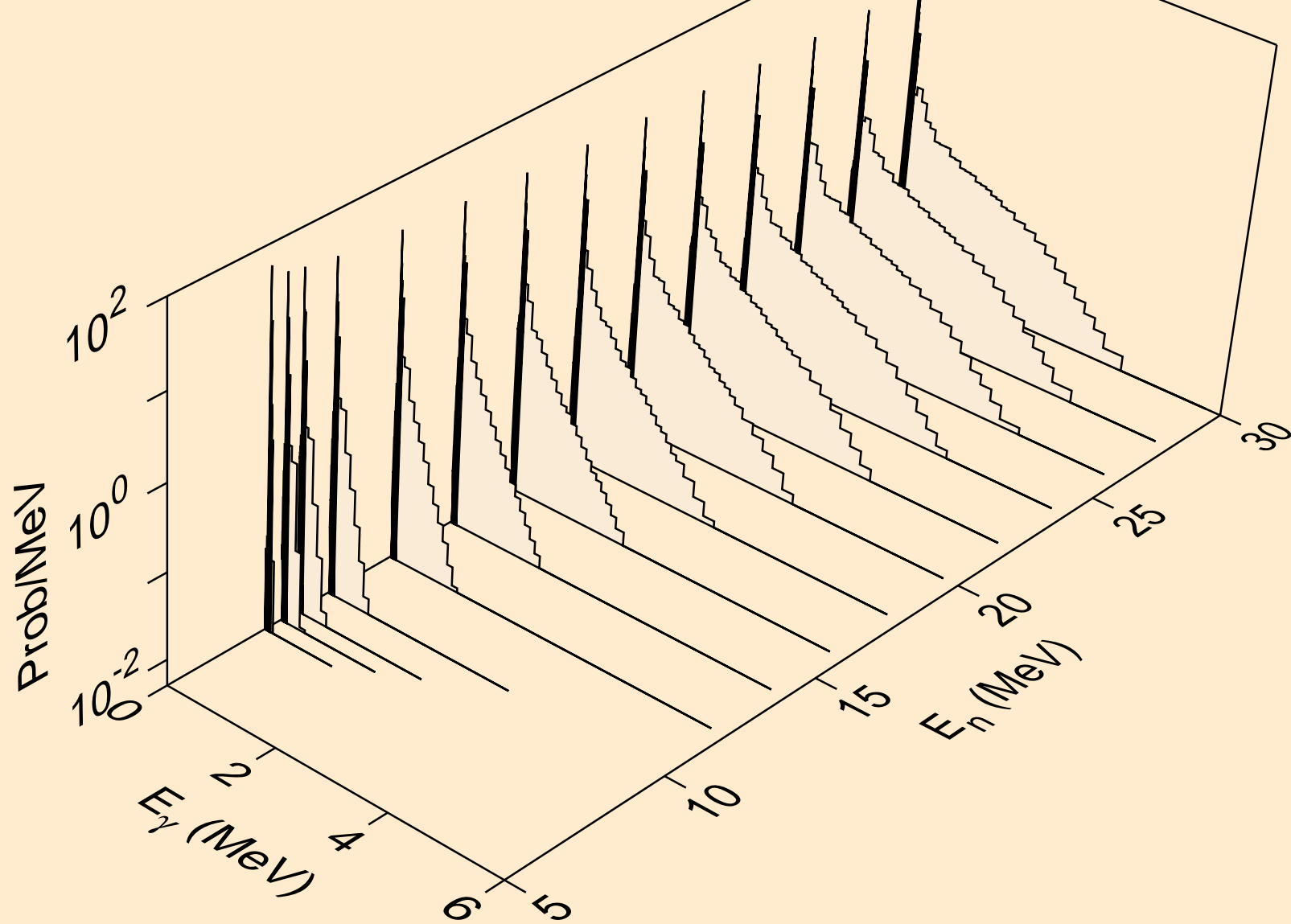

PU238 NEUTRON ACER TENDL-2023 LIBRARY; T=0.K  
Photon emission for (n,n\*)2a

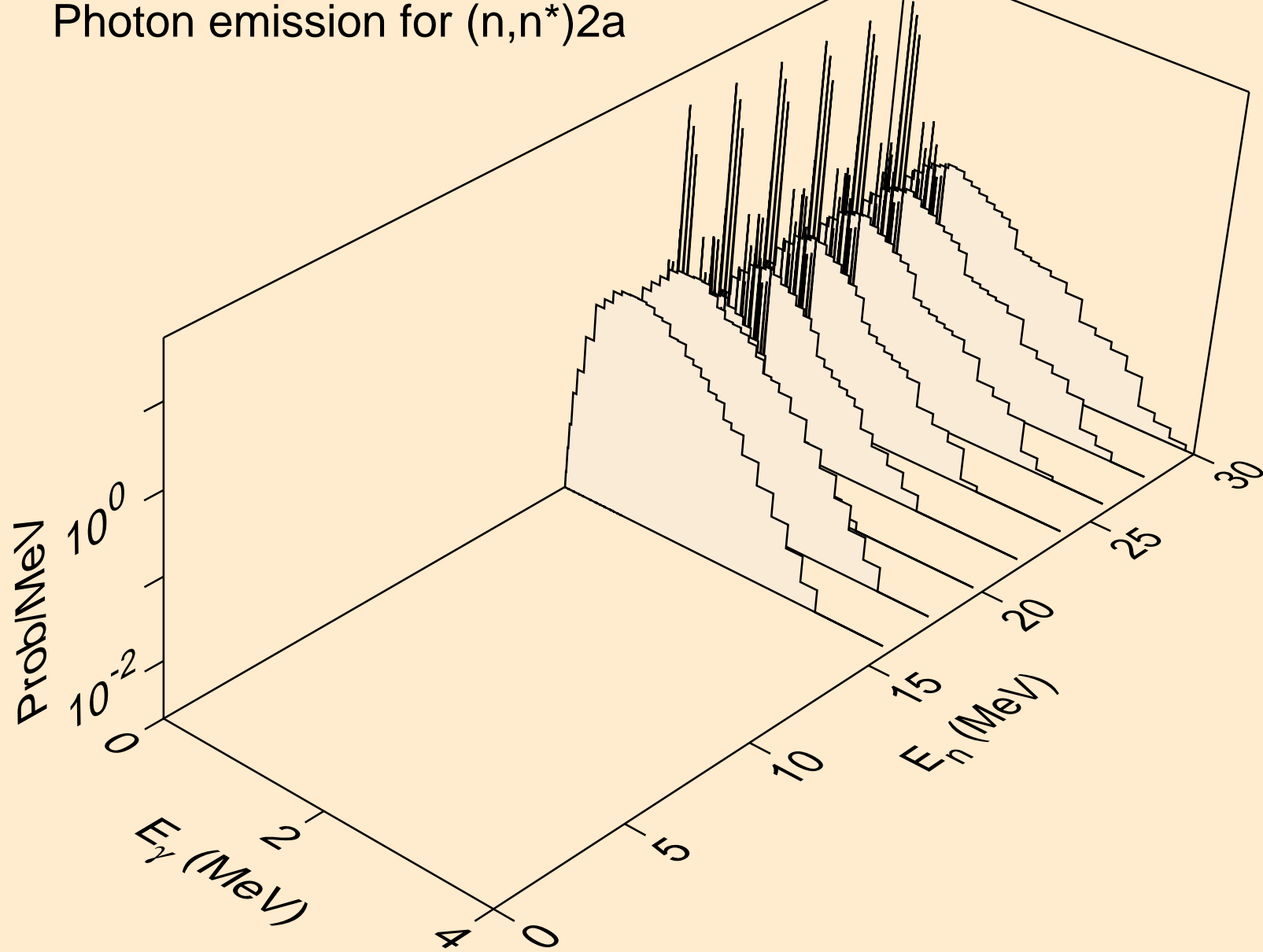

PU238 NEUTRON ACER TENDL-2023 LIBRARY; T=0.K  
Photon emission for (n,n\*)d

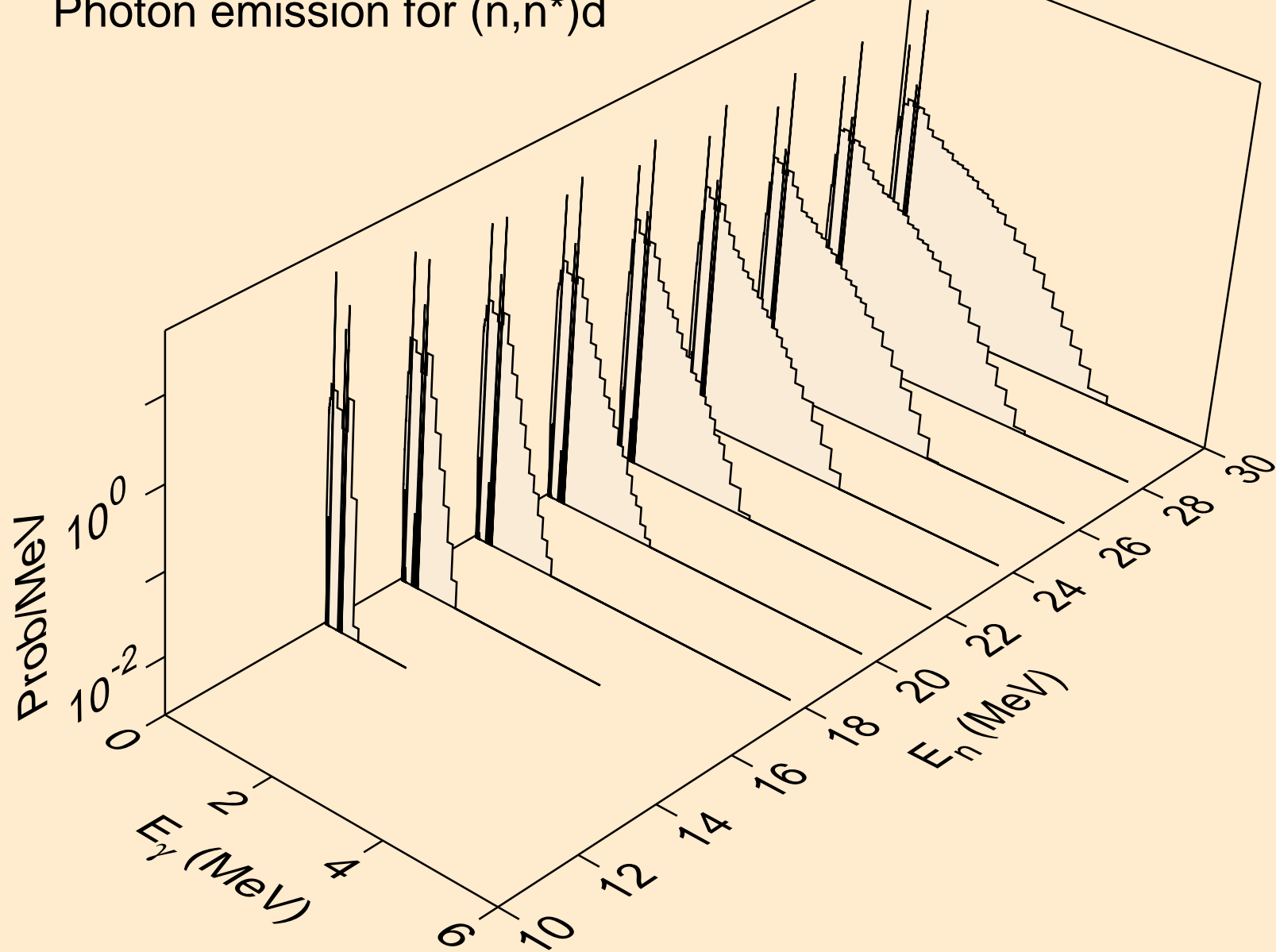

PU238 NEUTRON ACER TENDL-2023 LIBRARY; T=0.K  
Photon emission for (n,n\*)t

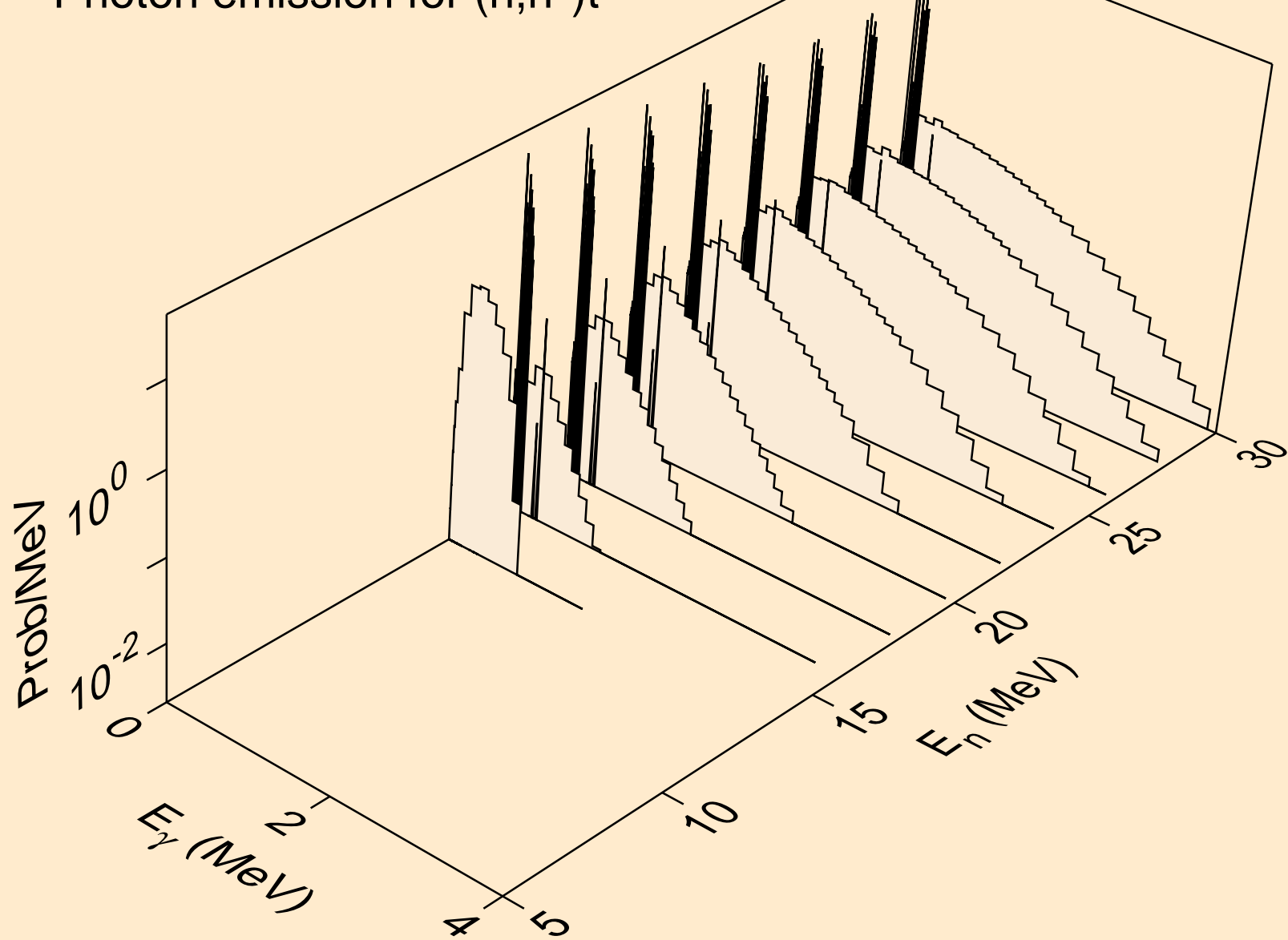



PU238 NEUTRON ACER TENDL-2023 LIBRARY; T=0.K  
Photon emission for (n,n\*)he3

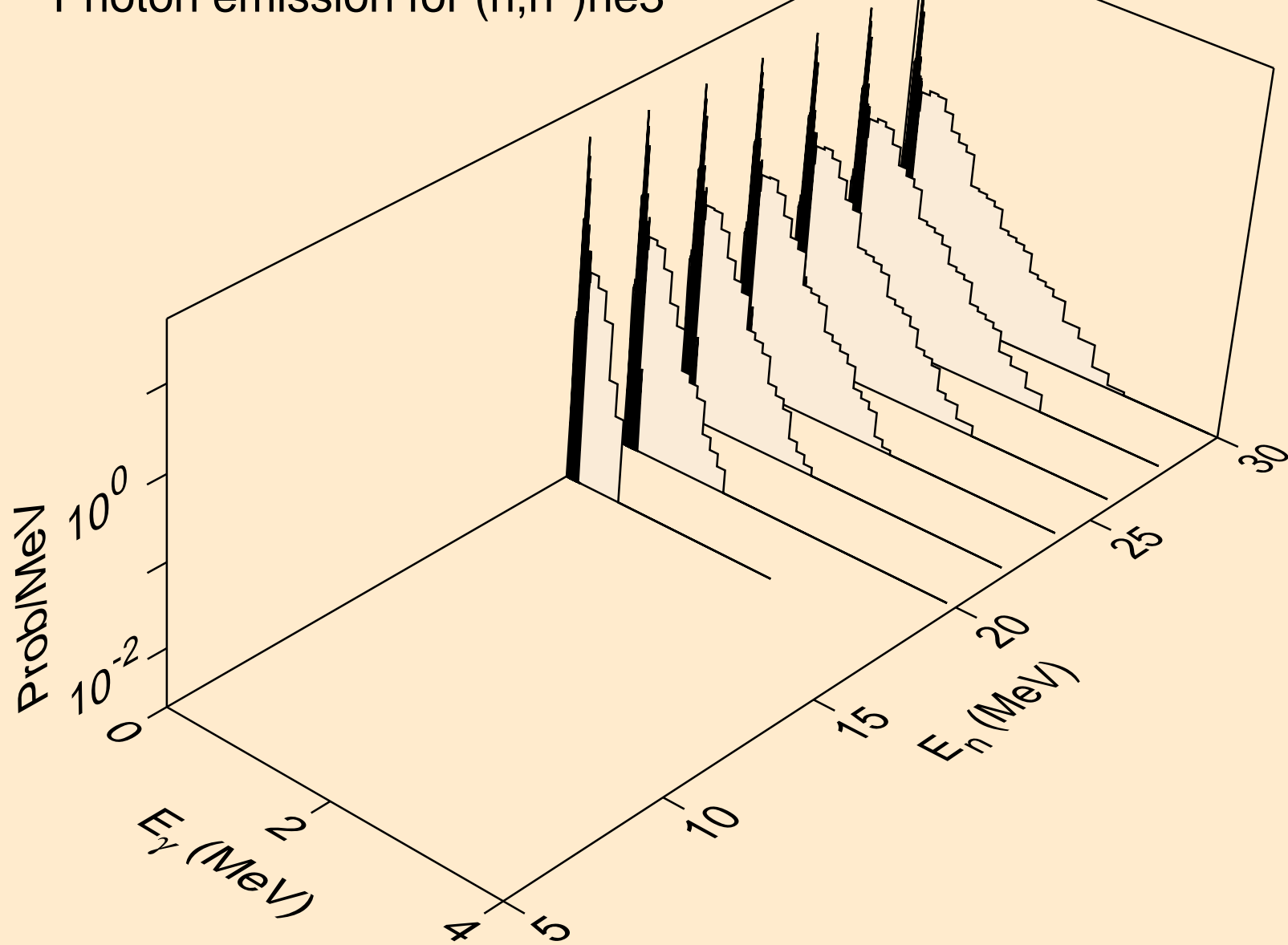

PU238 NEUTRON ACER TENDL-2023 LIBRARY; T=0.K  
Photon emission for (n,4n)

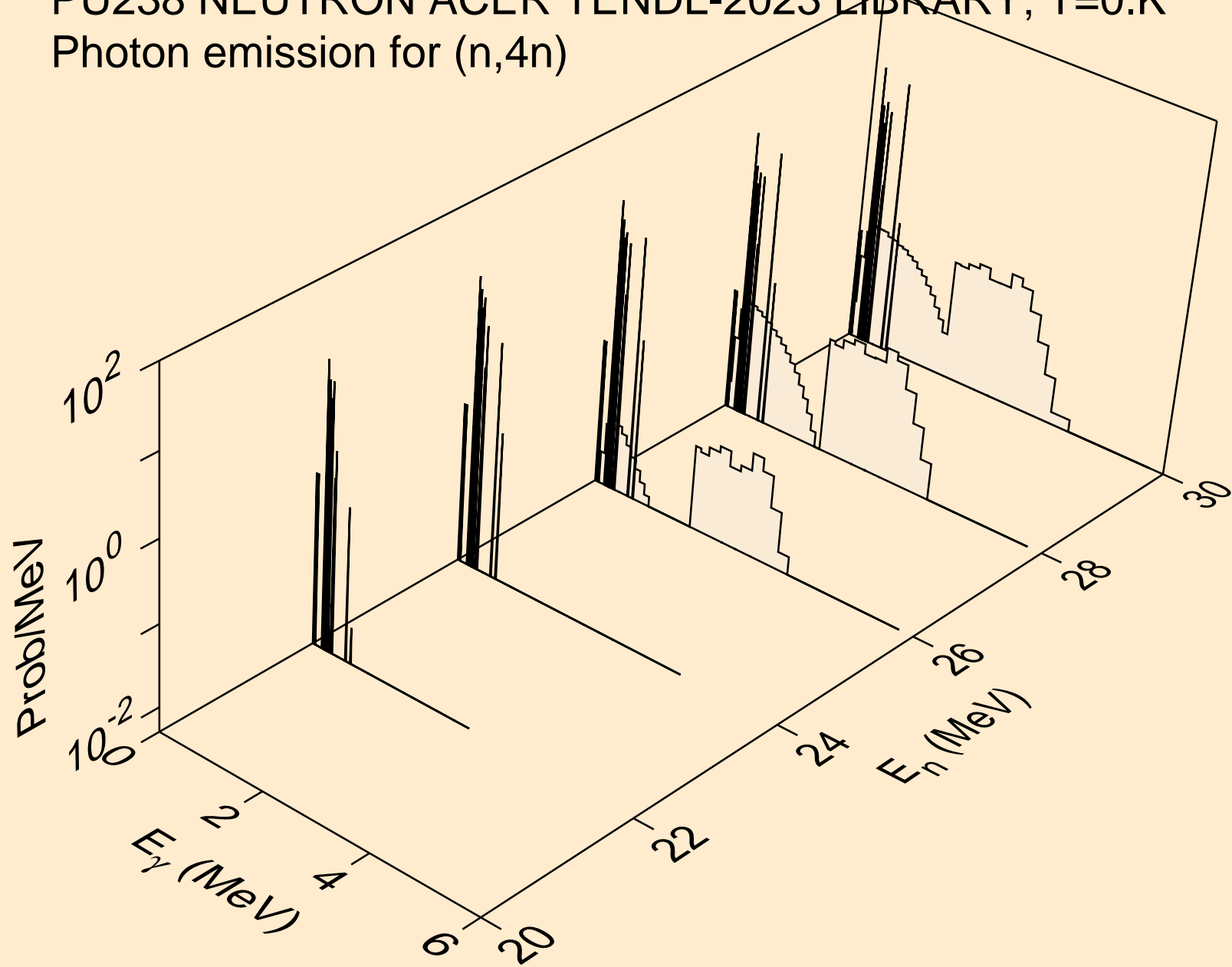

PU238 NEUTRON ACER TENDL-2023 LIBRARY; T=0.K  
Photon emission for (n,2np)

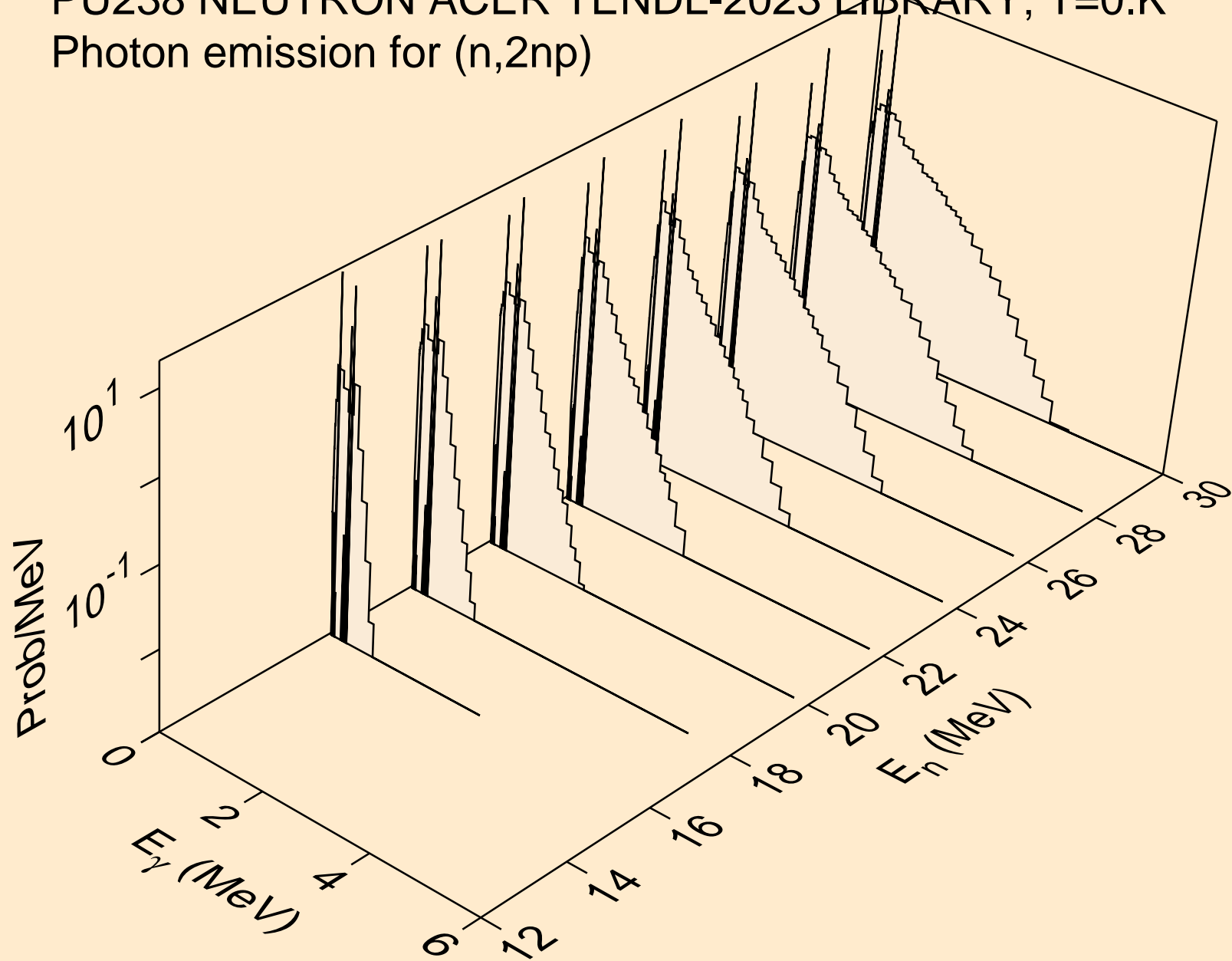

PU238 NEUTRON ACER TENDL-2023 LIBRARY; T=0.K  
Photon emission for (n,3np)

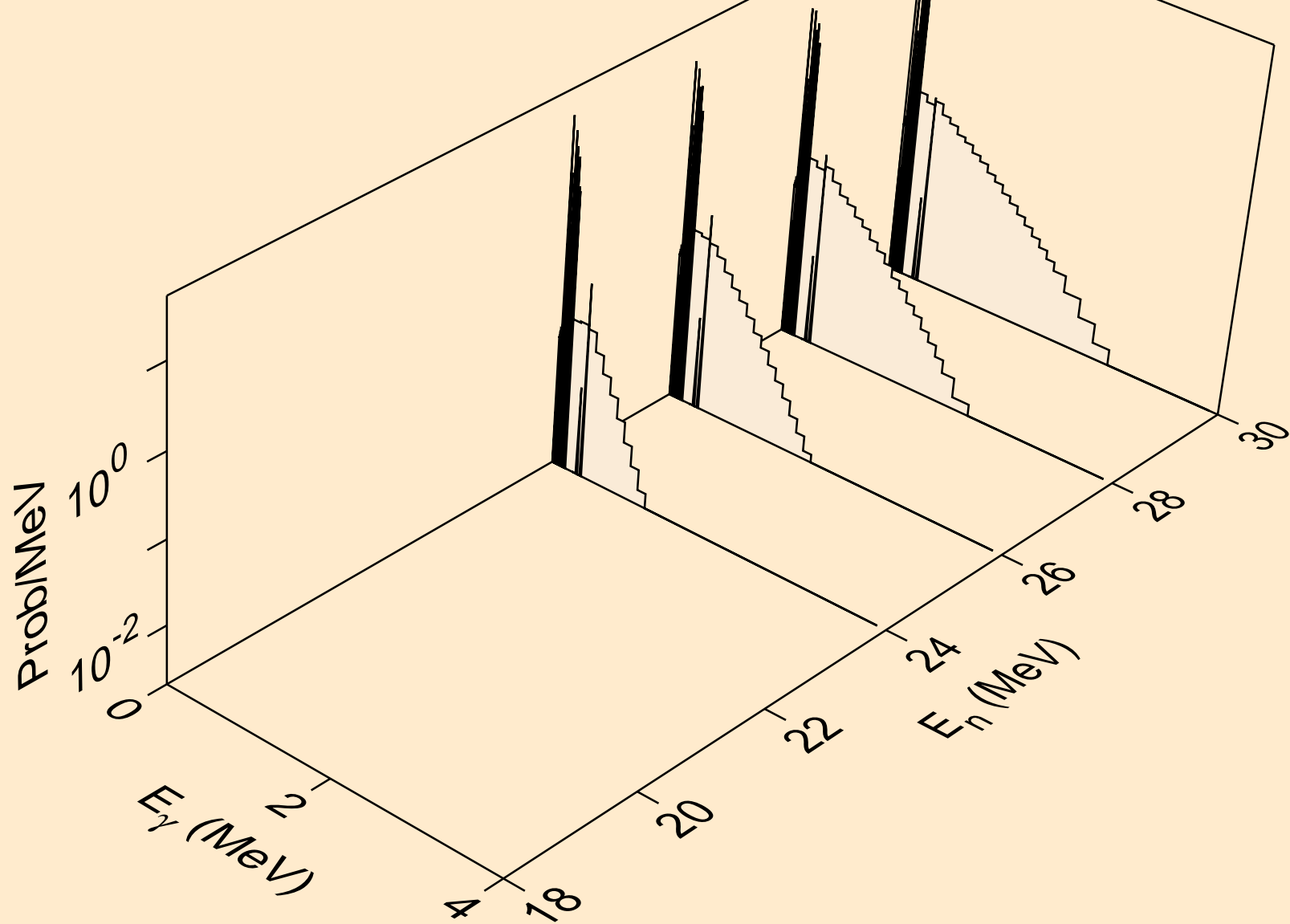

PU238 NEUTRON ACER TENDL-2023 LIBRARY; T=0.K  
Photon emission for (n,n2p)

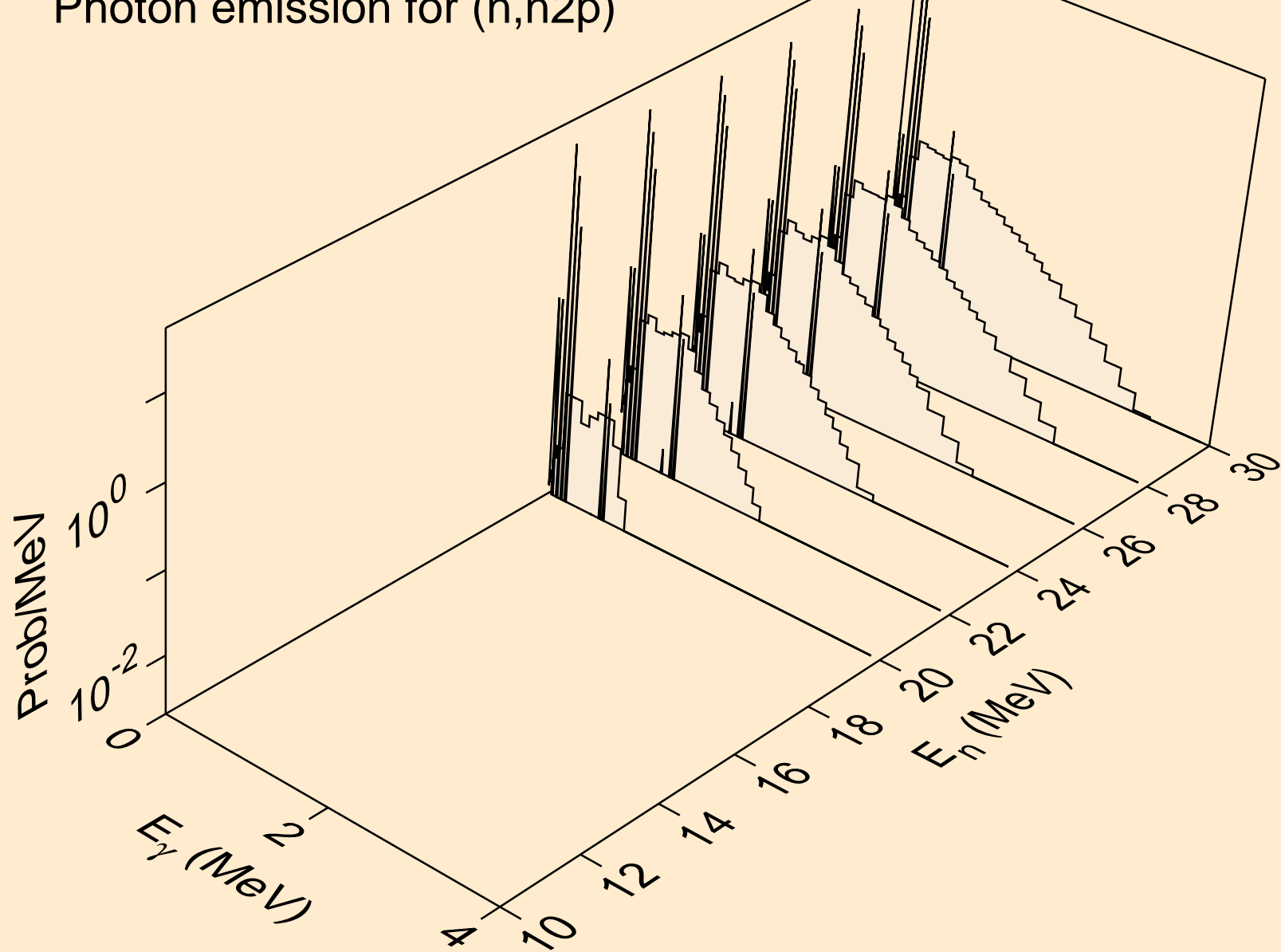

PU238 NEUTRON ACER TENDL-2023 LIBRARY; T=0.K  
Photon emission for (n,npa)

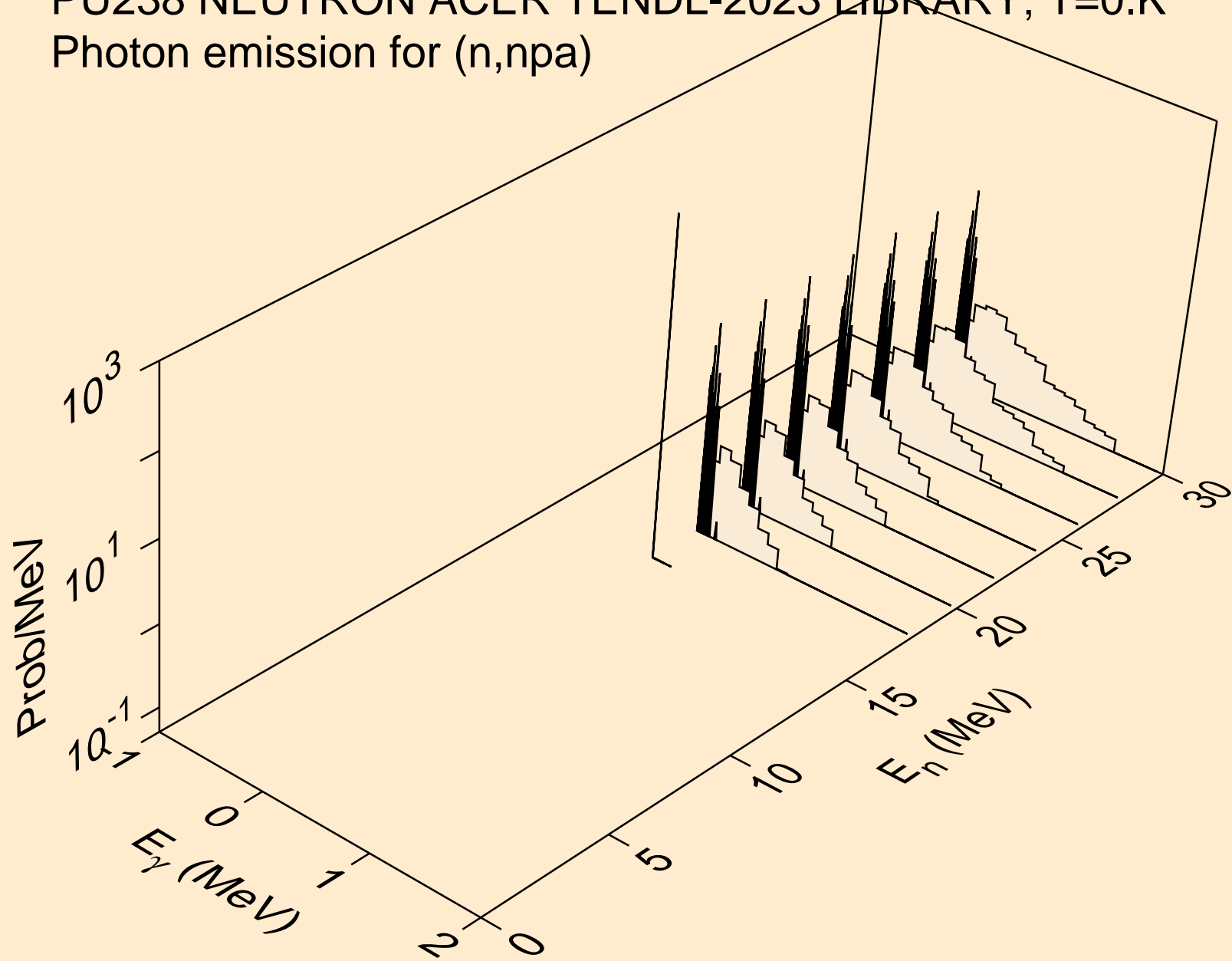

PU238 NEUTRON ACER TENDL-2023 LIBRARY; T=0.K  
Photon emission for (n,n\*c)

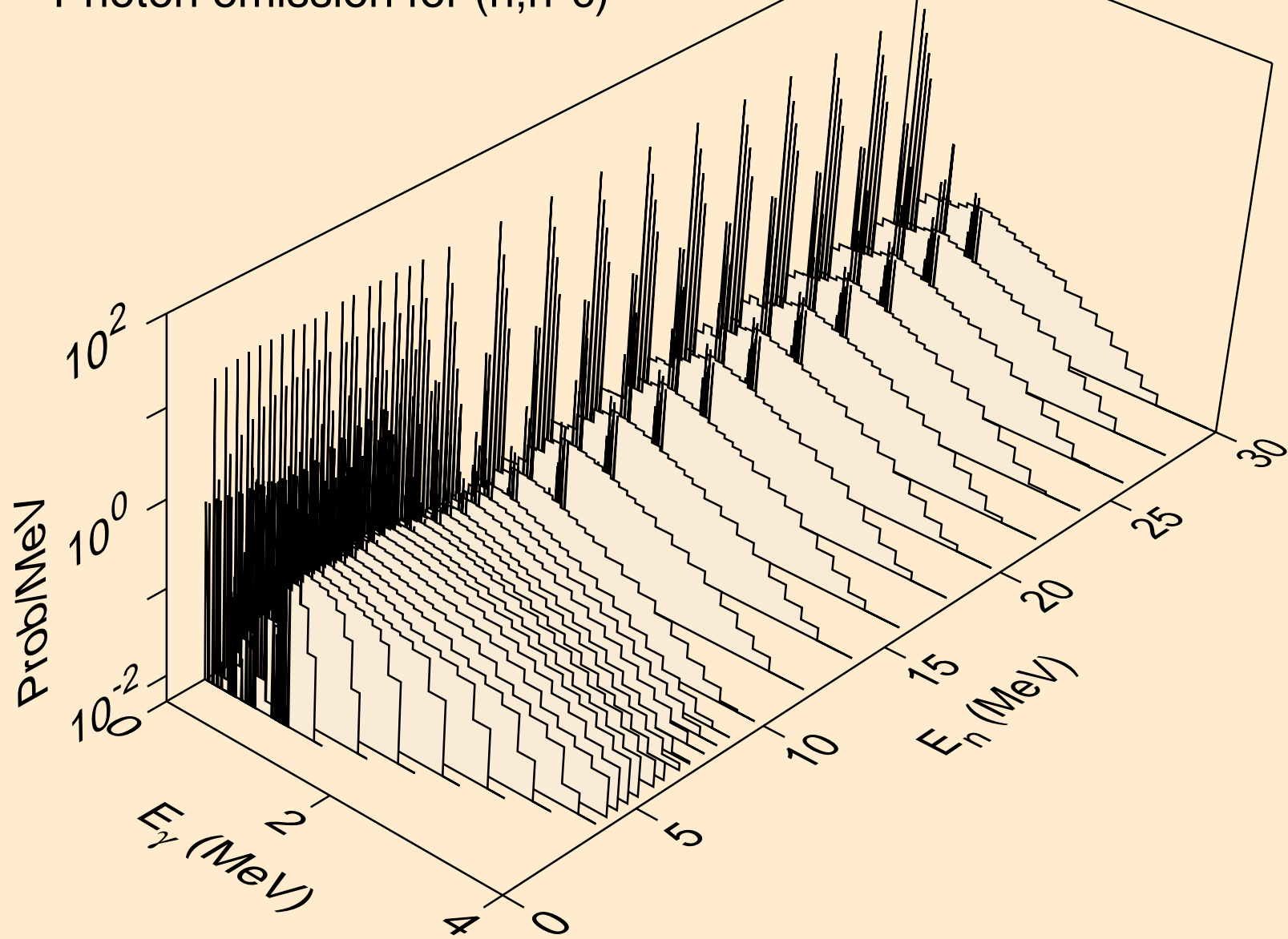

PU238 NEUTRON ACER TENDL-2023 LIBRARY; T=0.K  
Photon emission for (n,gma)

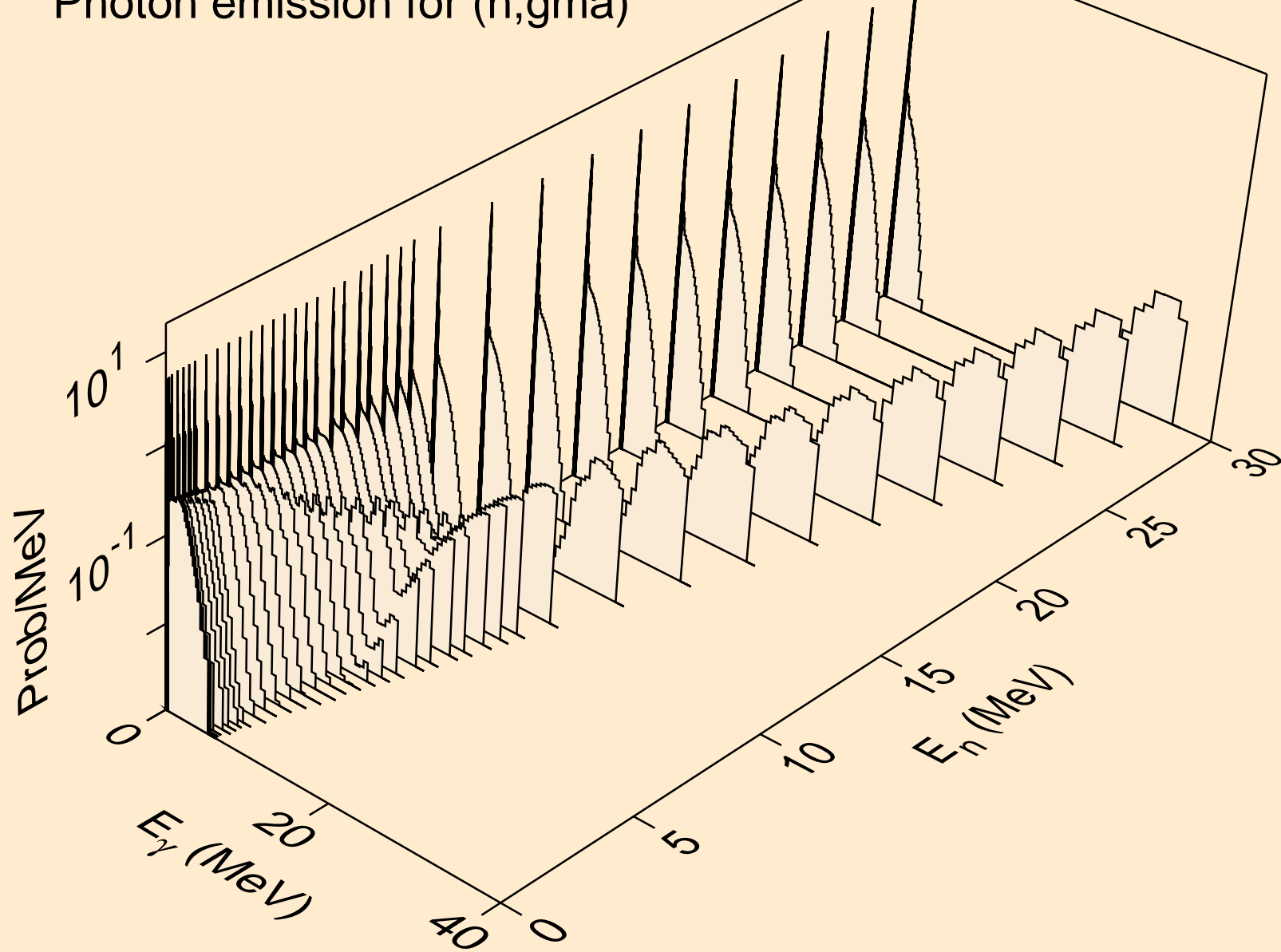



PU238 NEUTRON ACER TENDL-2023 LIBRARY; T=0.K  
Photon emission for (n,p)

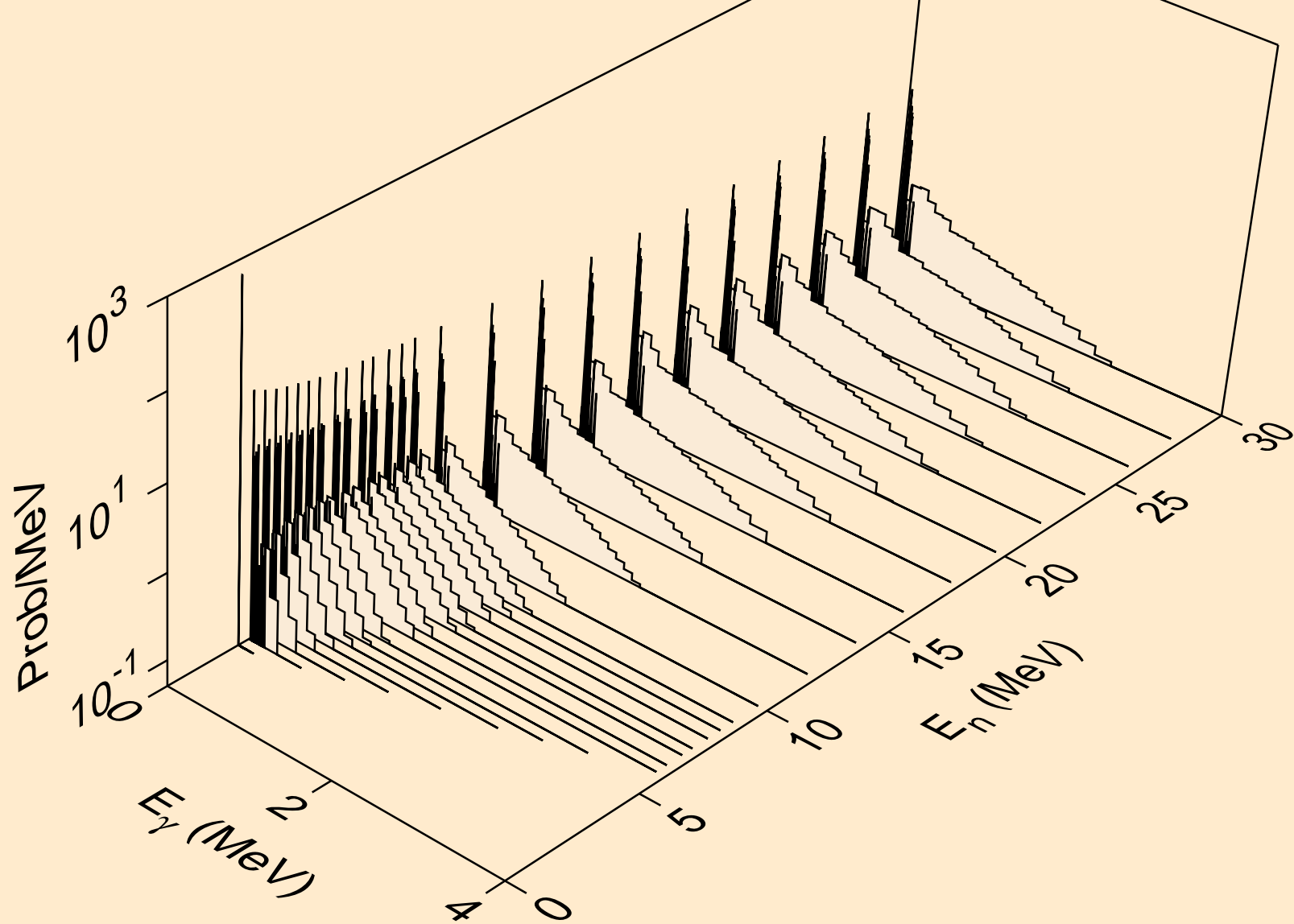

PU238 NEUTRON ACER TENDL-2023 LIBRARY; T=0.K  
Photon emission for (n,d)

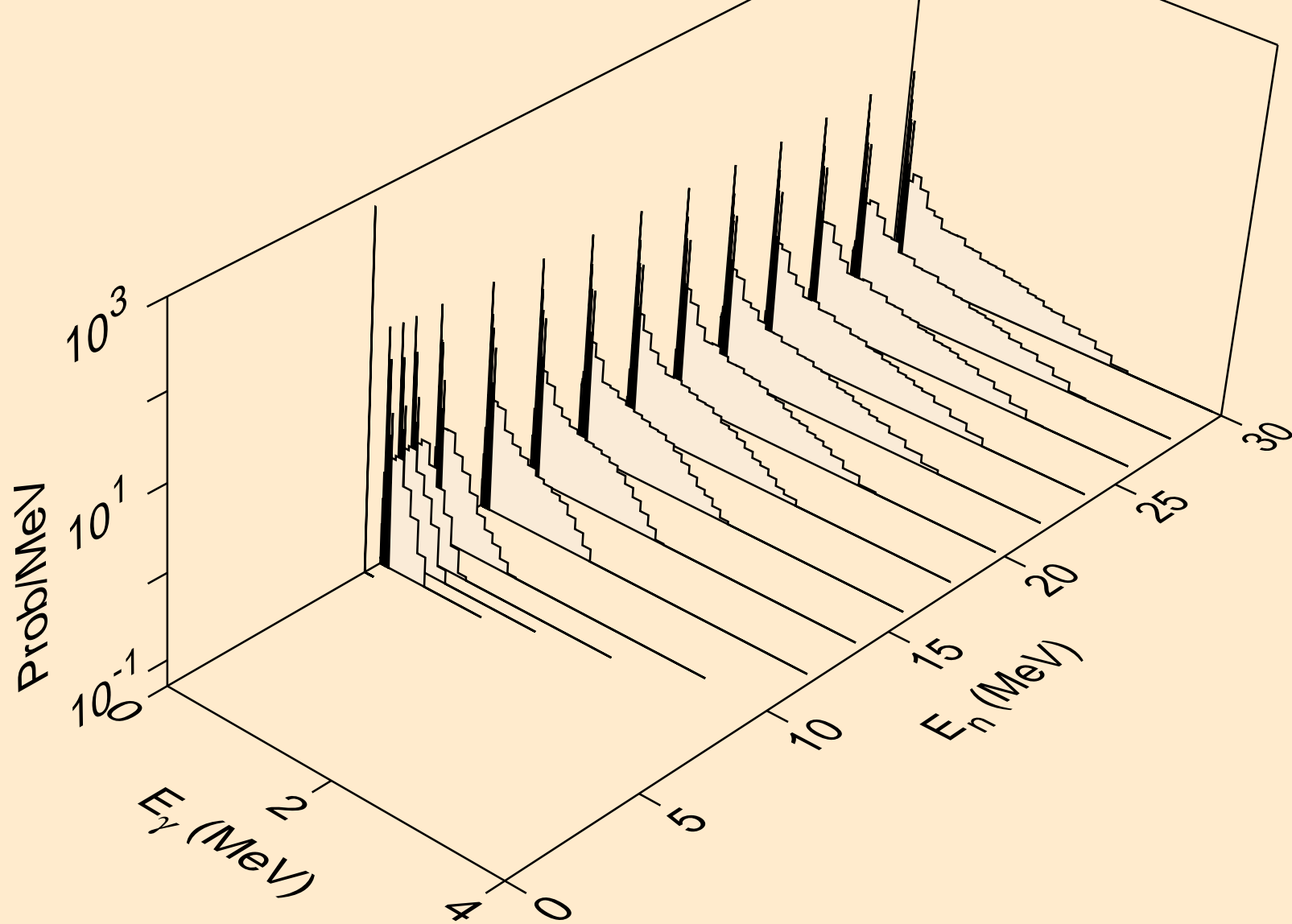

PU238 NEUTRON ACER TENDL-2023 LIBRARY; T=0.K  
Photon emission for (n,t)

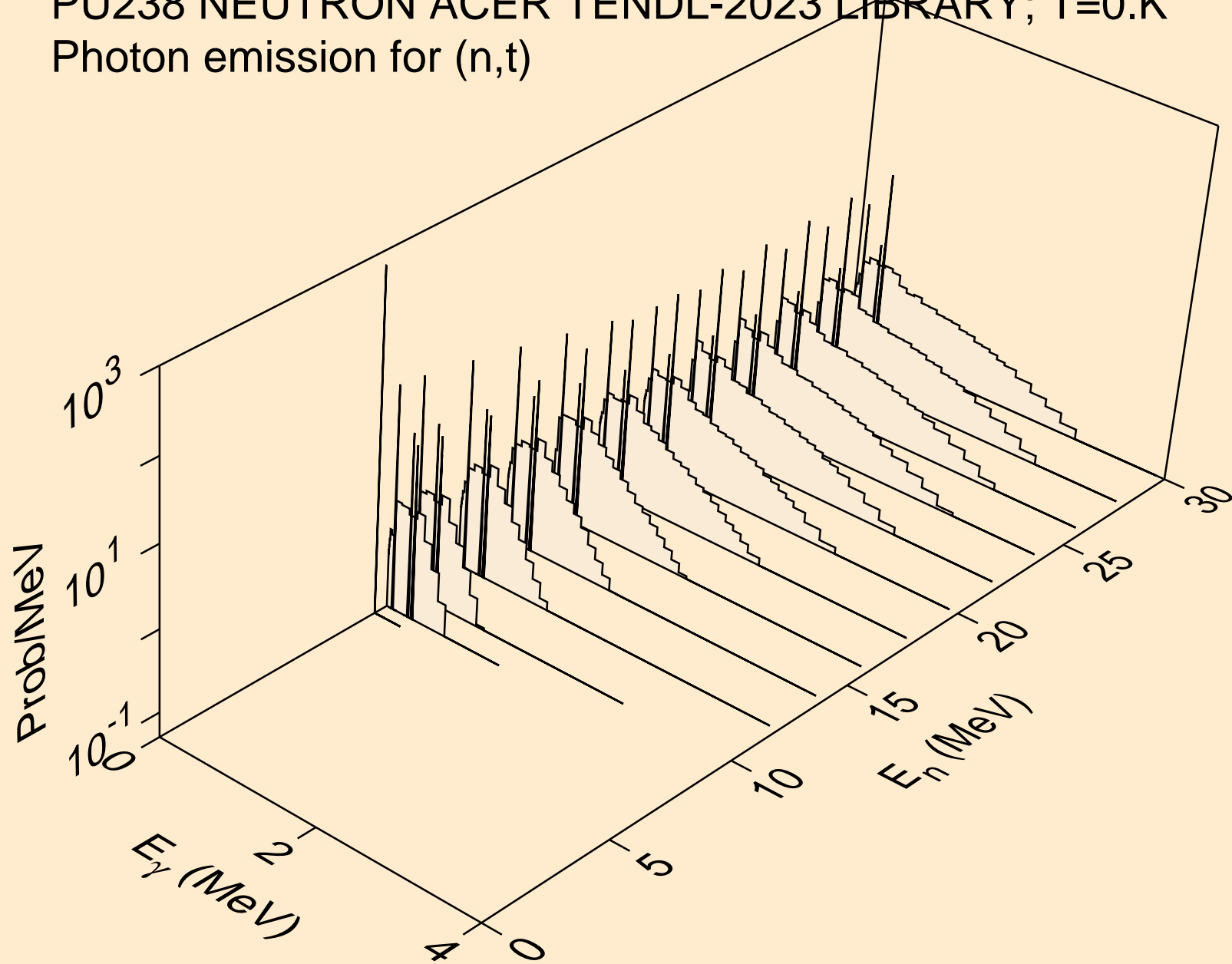

PU238 NEUTRON ACER TENDL-2023 LIBRARY; T=0.K  
Photon emission for (n,he3)

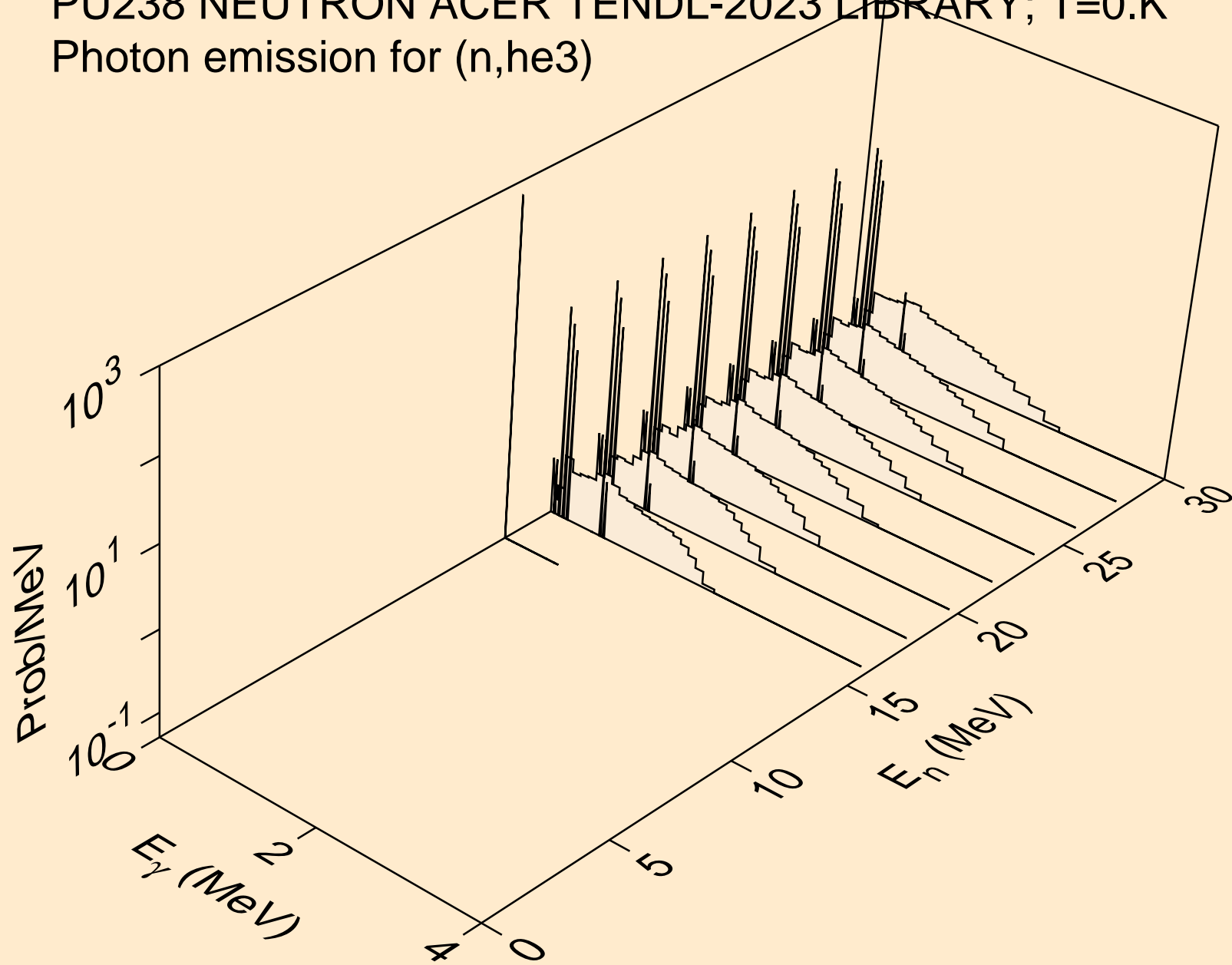

PU238 NEUTRON ACER TENDL-2023 LIBRARY; T=0.K  
Photon emission for (n,a)

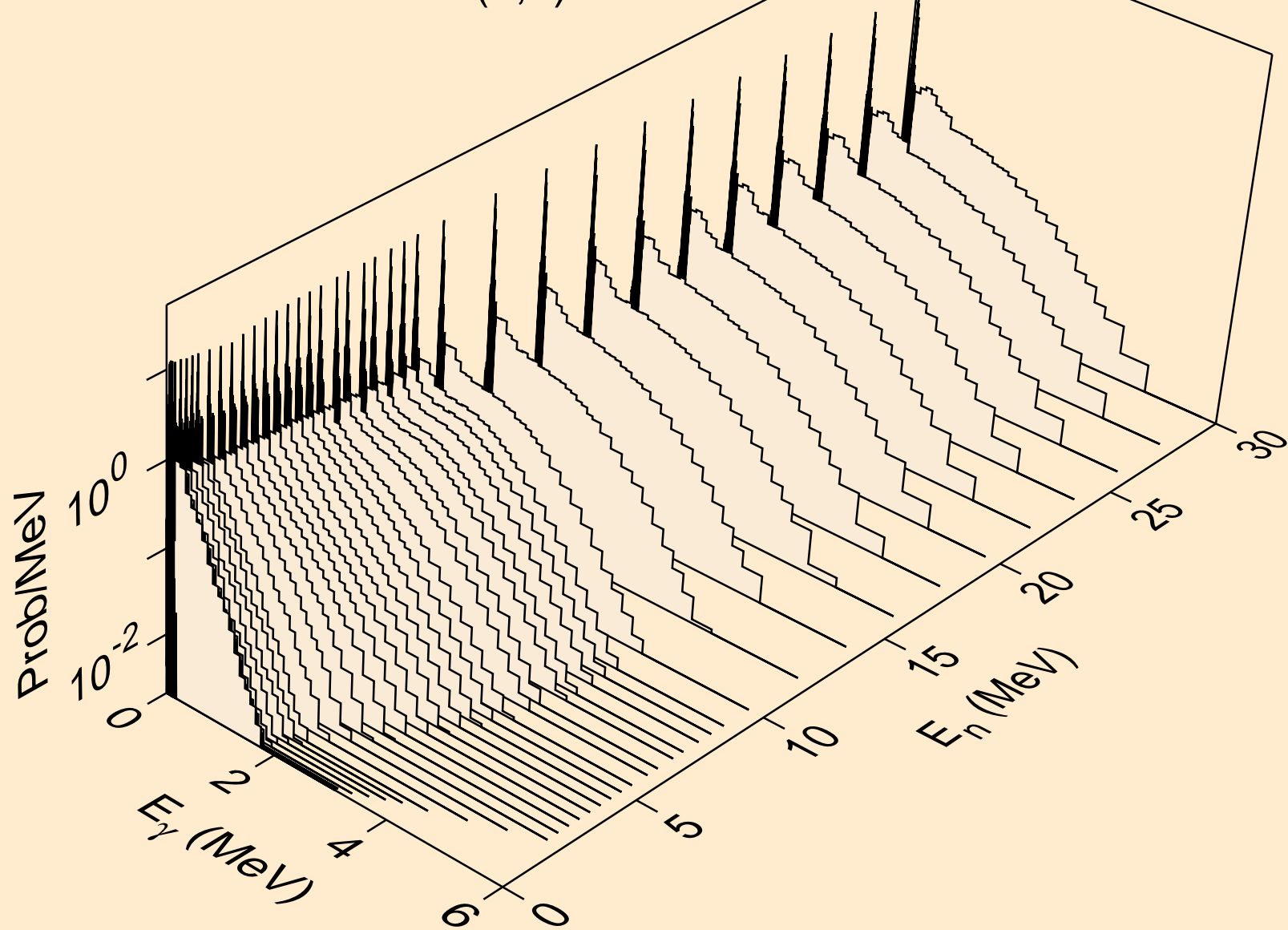

PU238 NEUTRON ACER TENDL-2023 LIBRARY; T=0.K  
Photon emission for (n,2a)

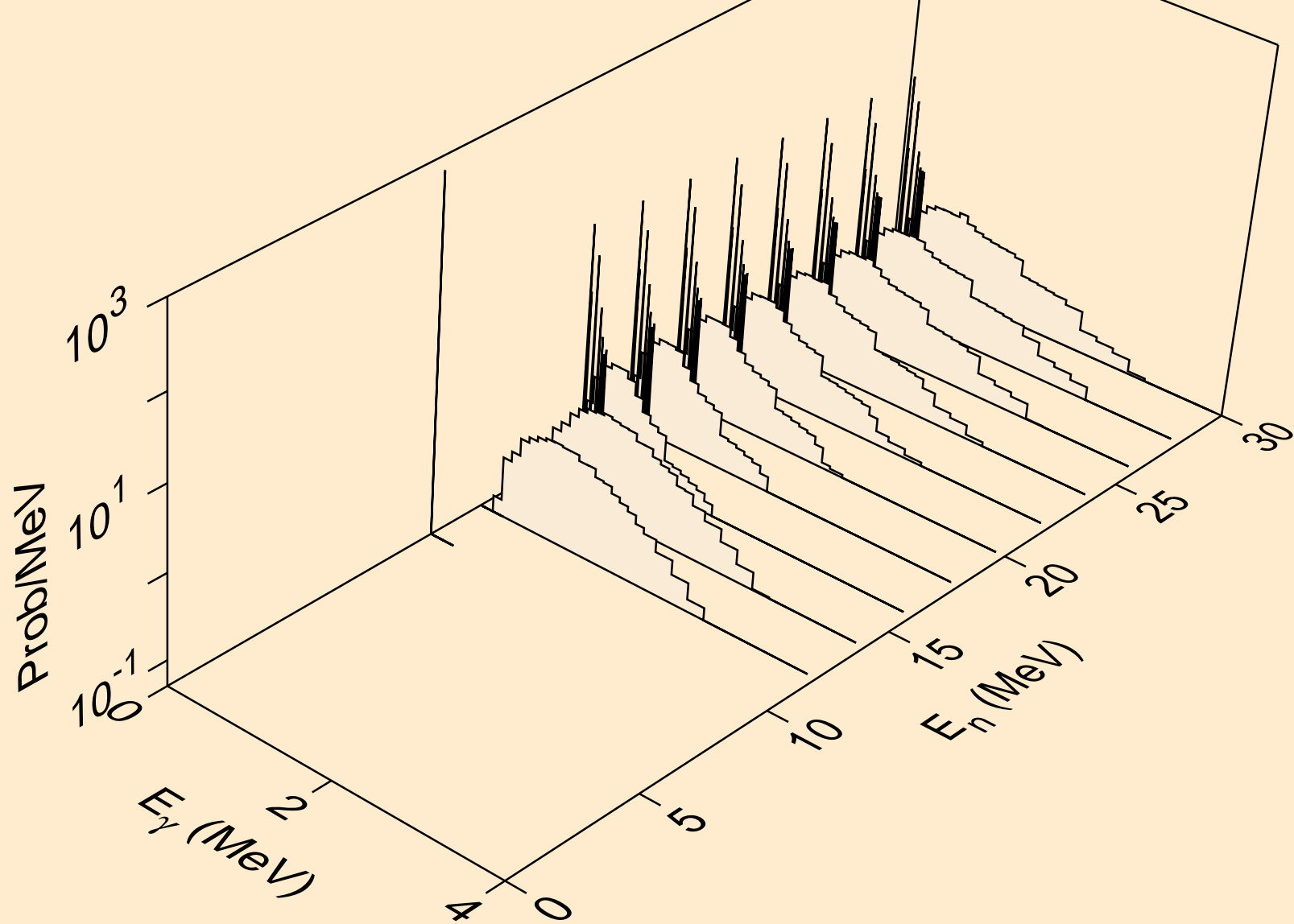

PU238 NEUTRON ACER TENDL-2023 LIBRARY; T=0.K  
Photon emission for (n,2p)

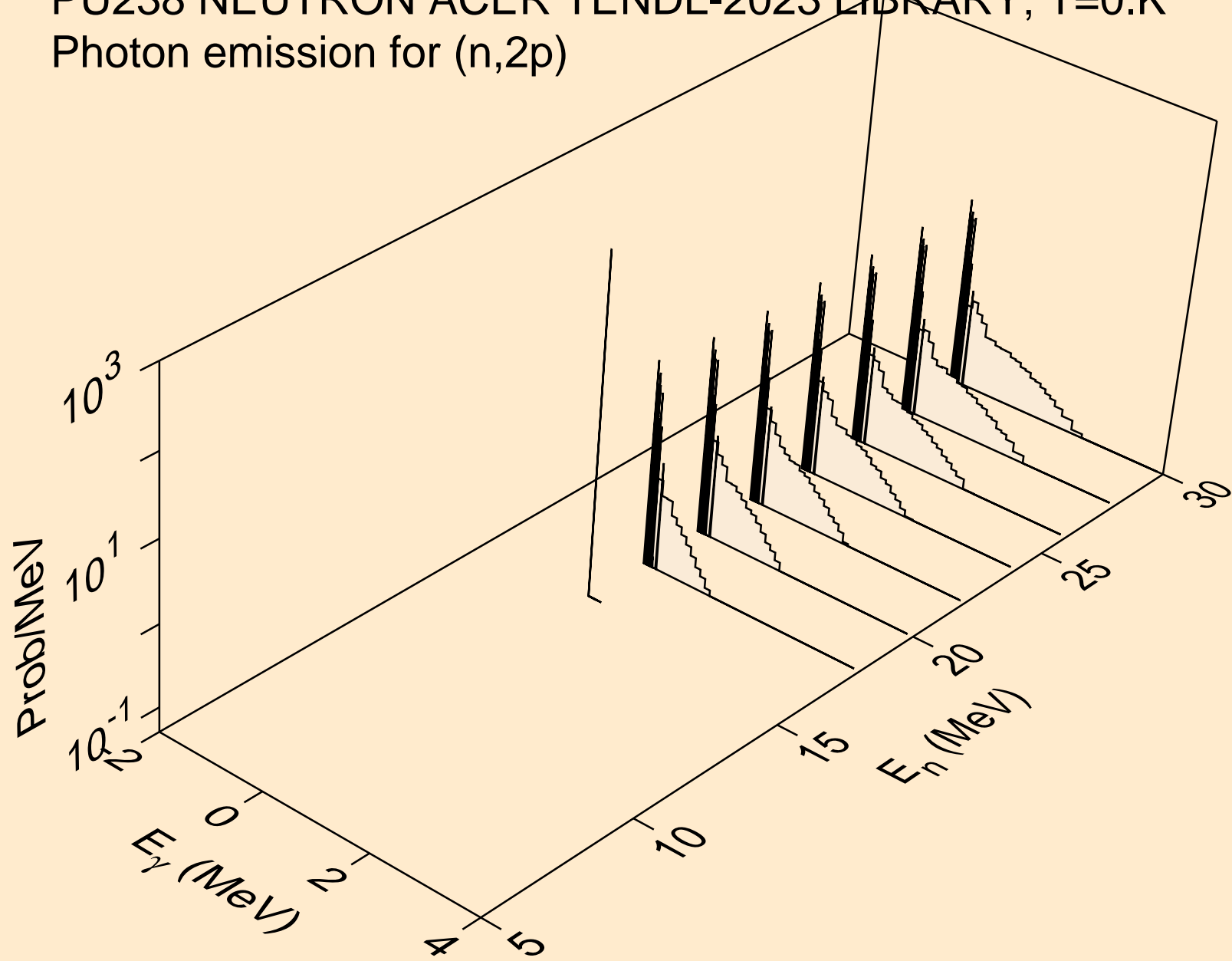

PU238 NEUTRON ACER TENDL-2023 LIBRARY; T=0.K  
Photon emission for (n,pa)

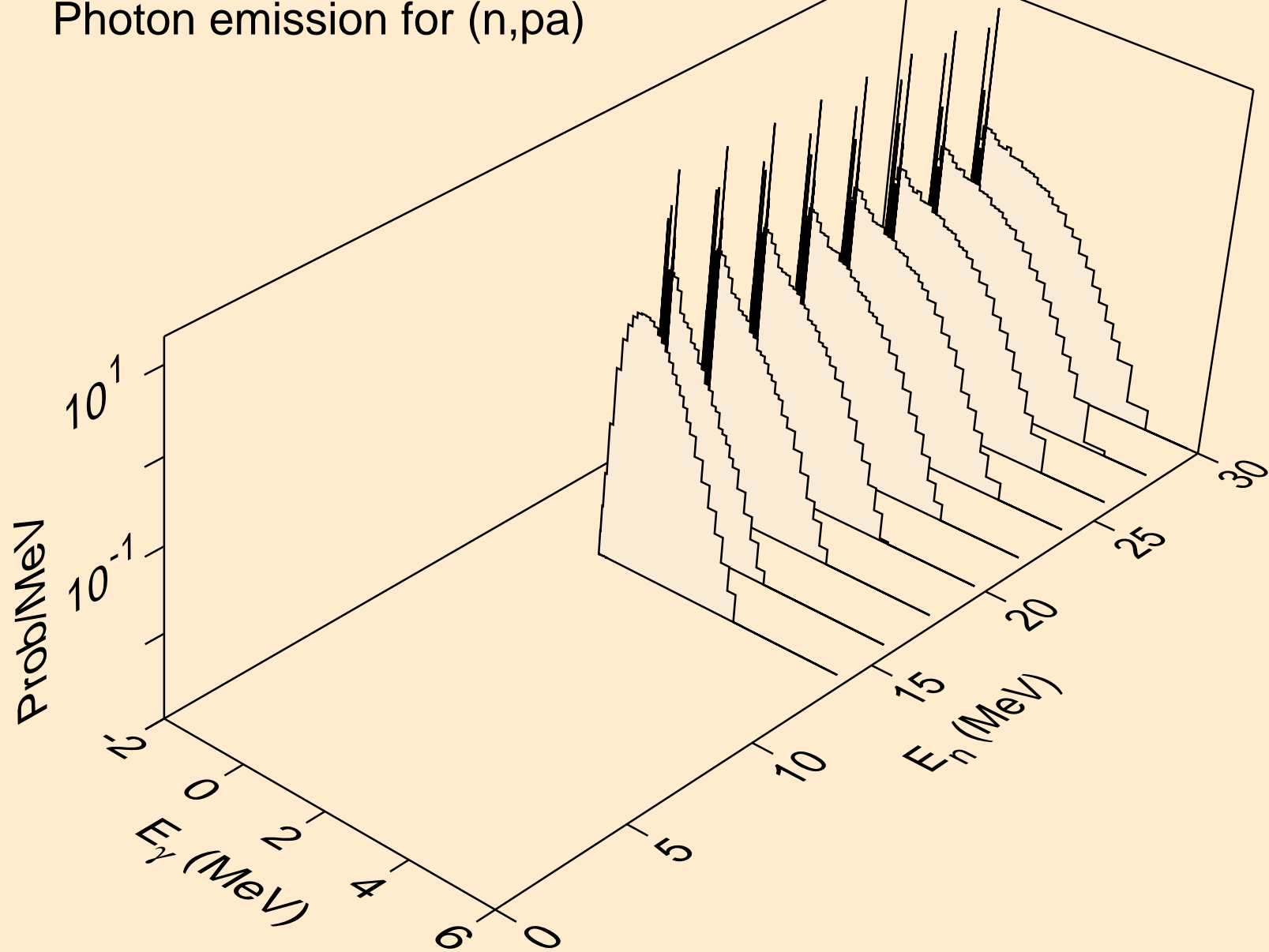



PU238 NEUTRON ACER TENDL-2023 LIBRARY; T=0.K  
thermal capture photon spectrum

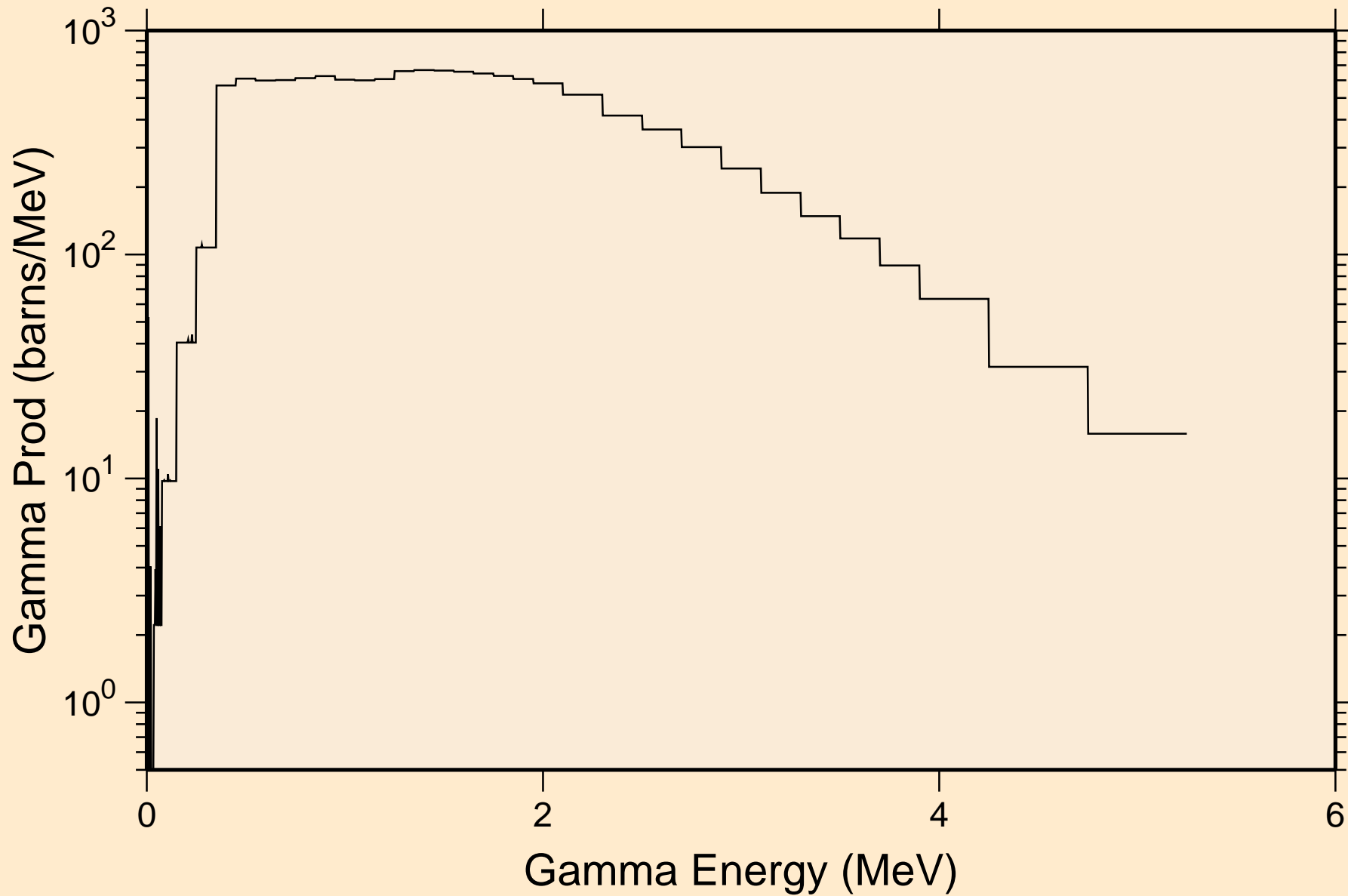

PU238 NEUTRON ACER TENDL-2023 LIBRARY; T=0.K  
14 MeV photon spectrum

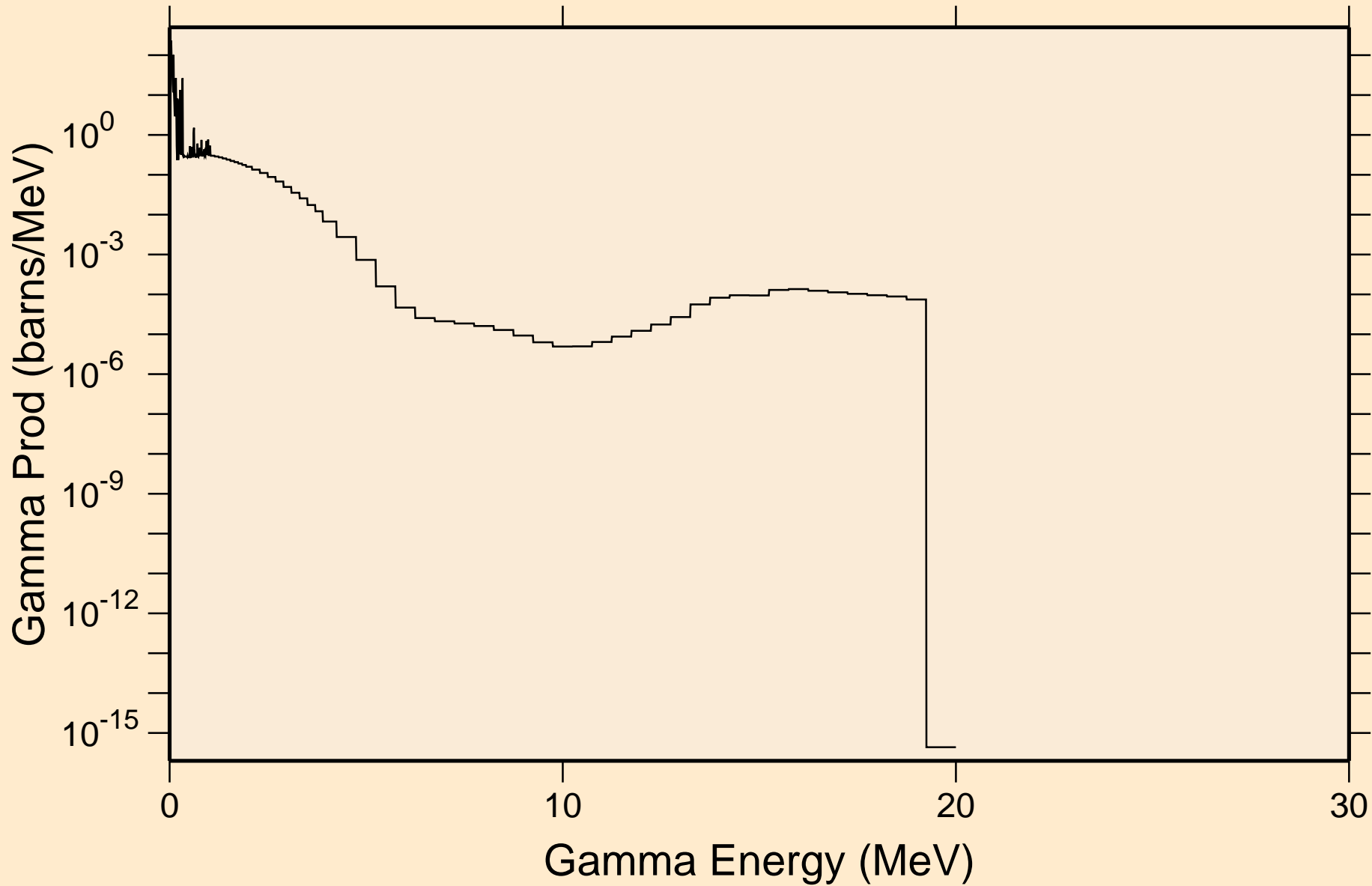

PU238 NEUTRON ACER TENDL-2023 LIBRARY; T=0.K  
Particle heating contributions

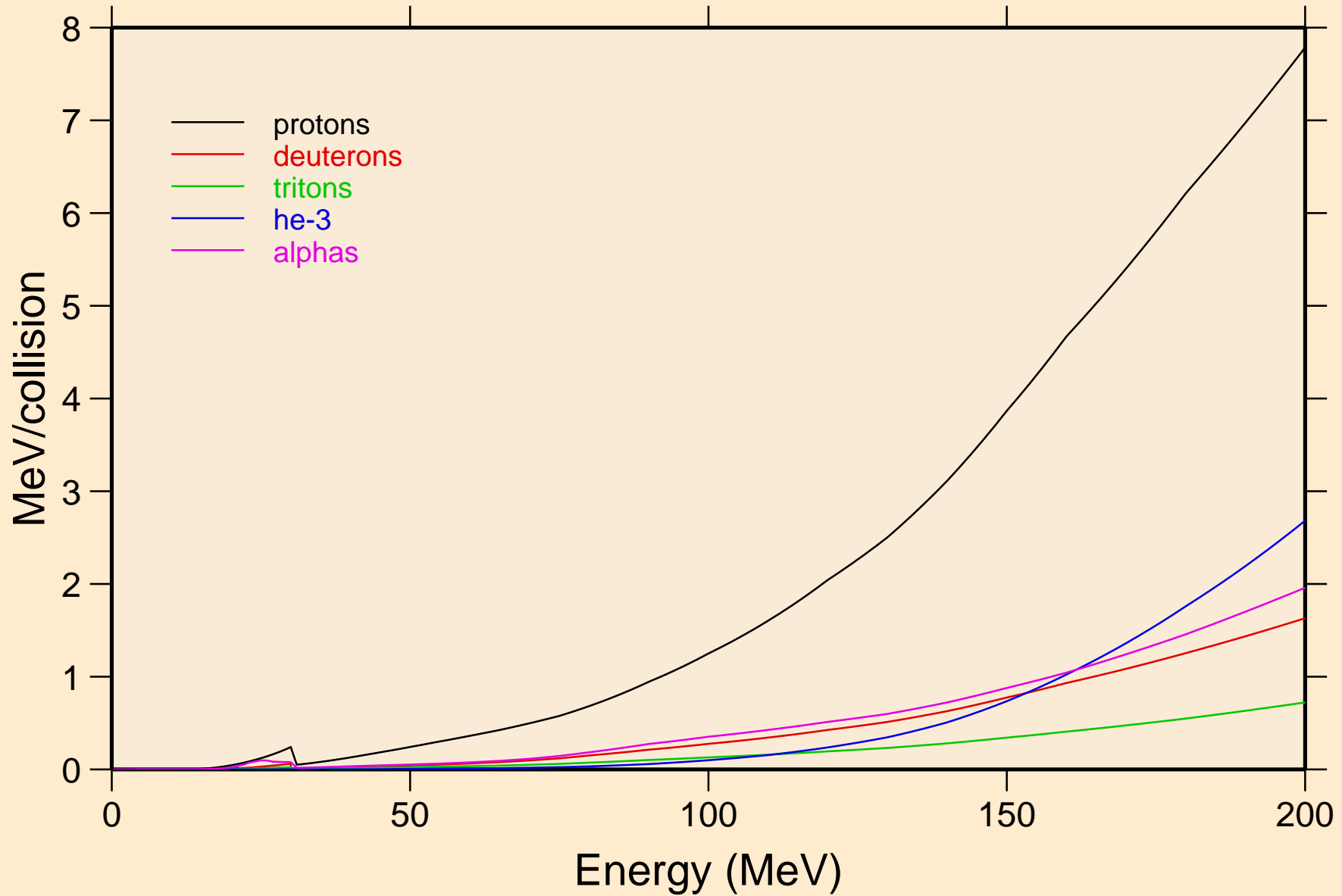

PU238 NEUTRON ACER TENDL-2023 LIBRARY; T=0.K  
Recoil Heating

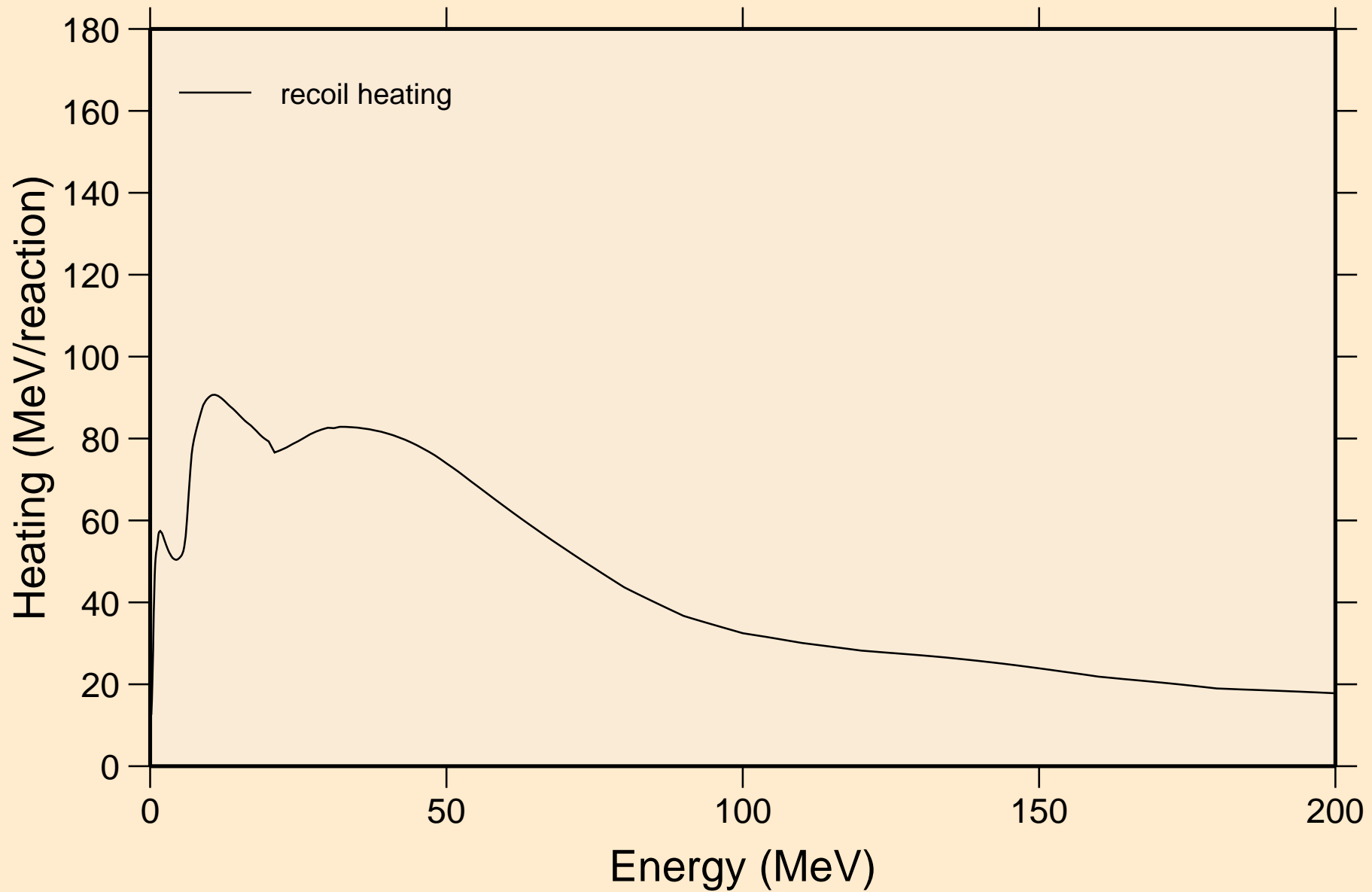

PU238 NEUTRON ACER TENDL-2023 LIBRARY; T=0.K  
Particle production cross sections

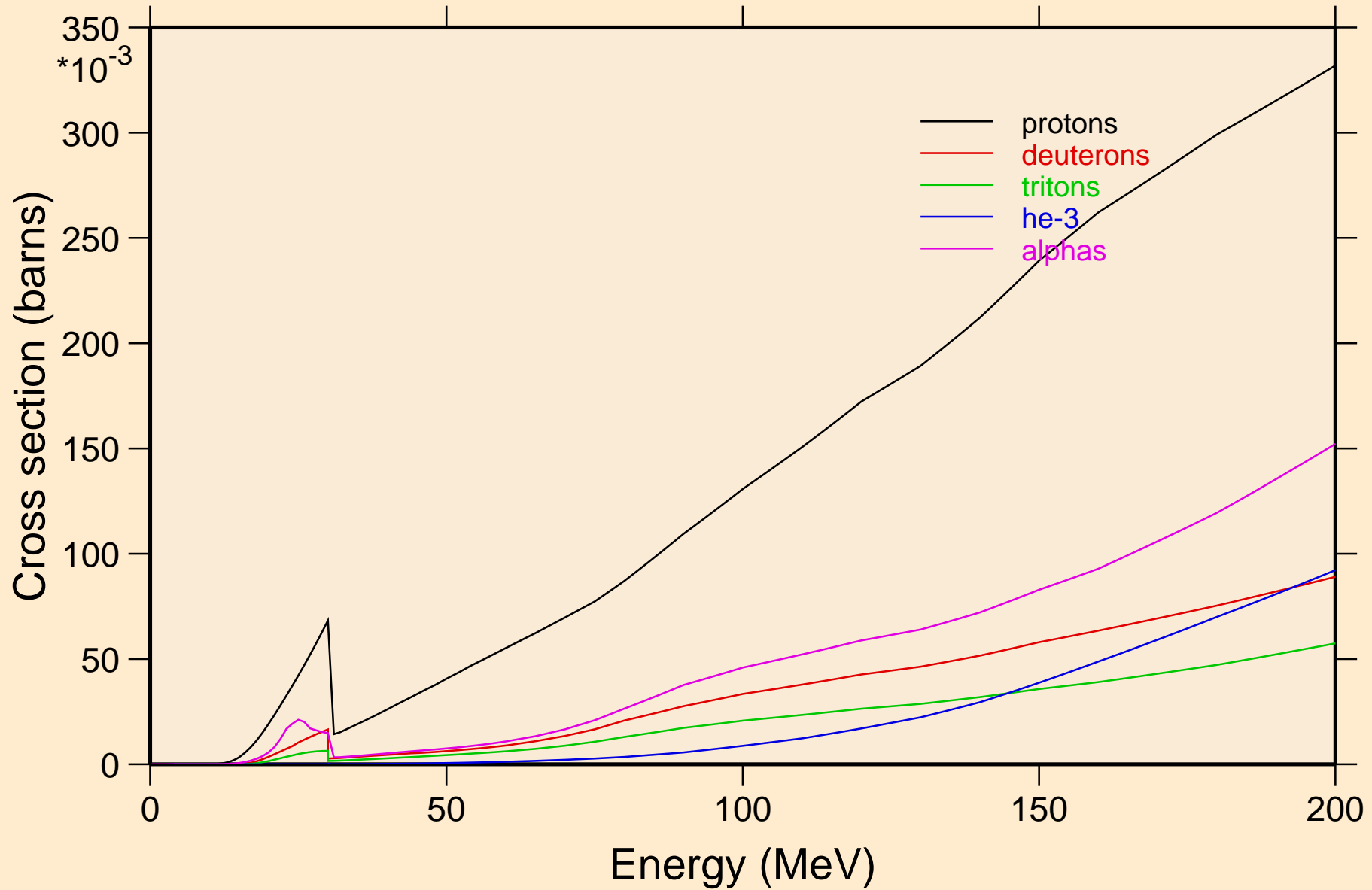

PU238 NEUTRON ACER TENDL-2023 LIBRARY; T=0.K  
protons from (n,x)

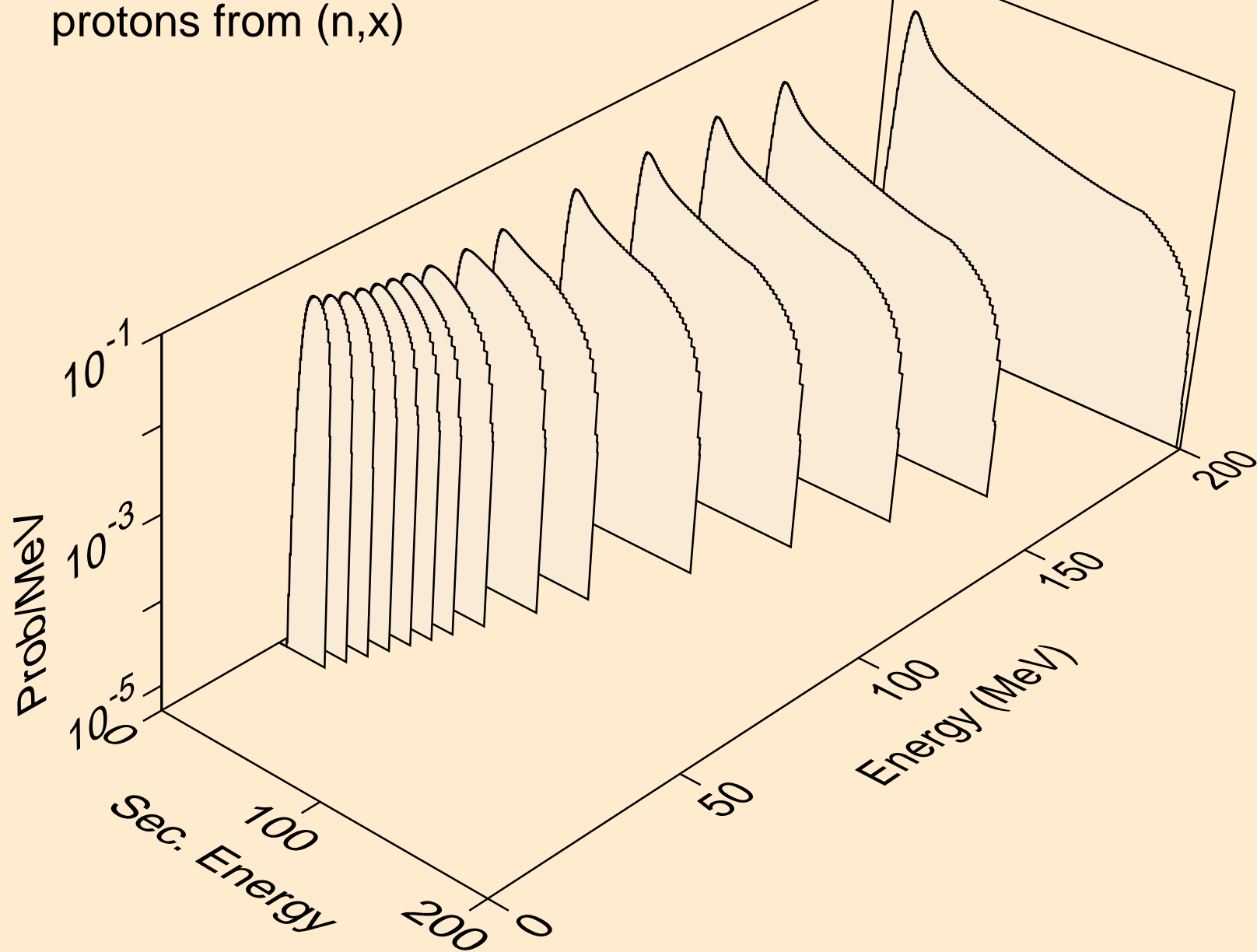

PU238 NEUTRON ACER TENDL-2023 LIBRARY; T=0.K  
protons from (n,n\*)p

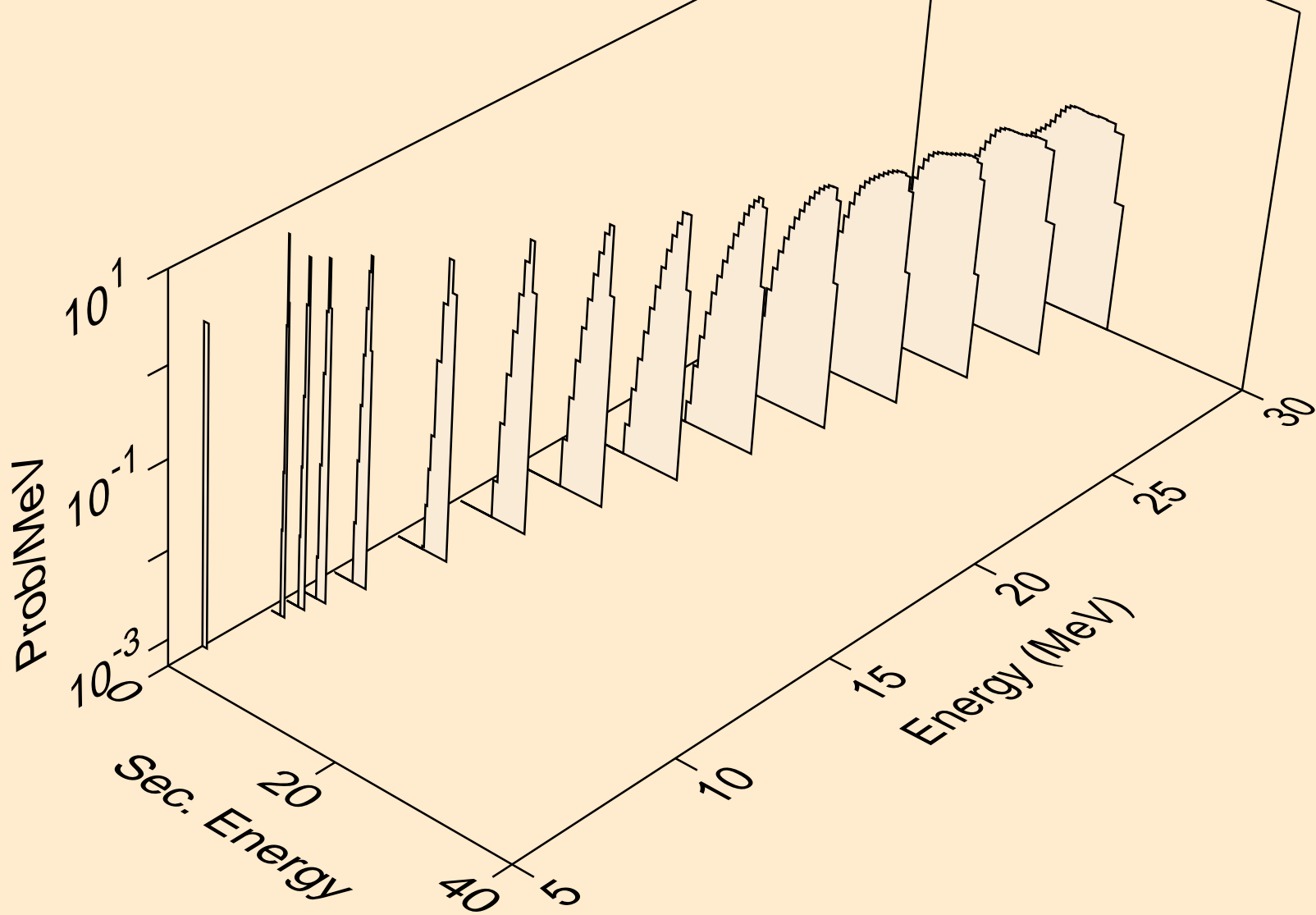

PU238 NEUTRON ACER TENDL-2023 LIBRARY; T=0.K  
protons from (n,2np)

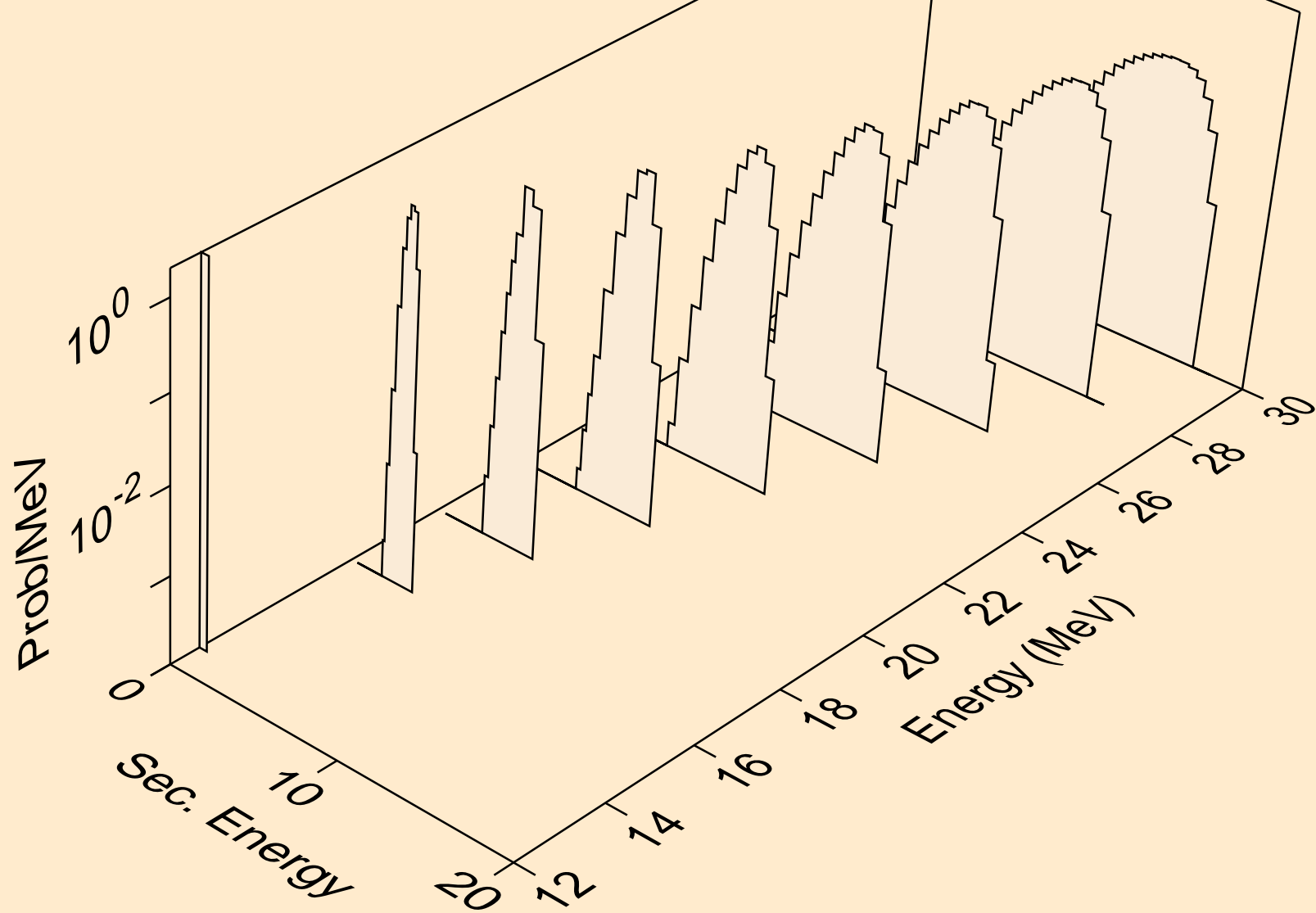



PU238 NEUTRON ACER TENDL-2023 LIBRARY; T=0.K  
protons from (n,3np)

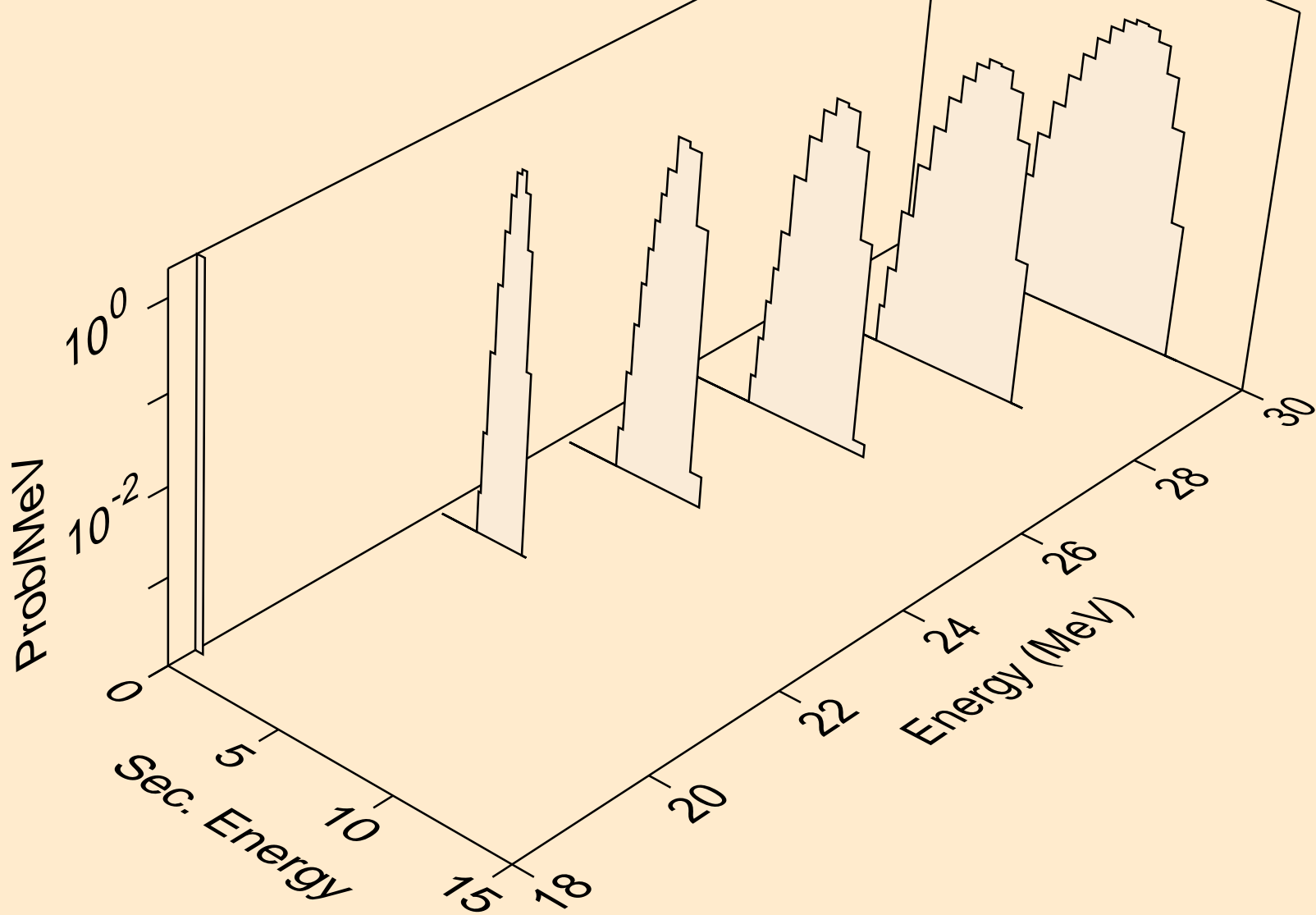

PU238 NEUTRON ACER TENDL-2023 LIBRARY; T=0.K  
protons from (n,n2p)

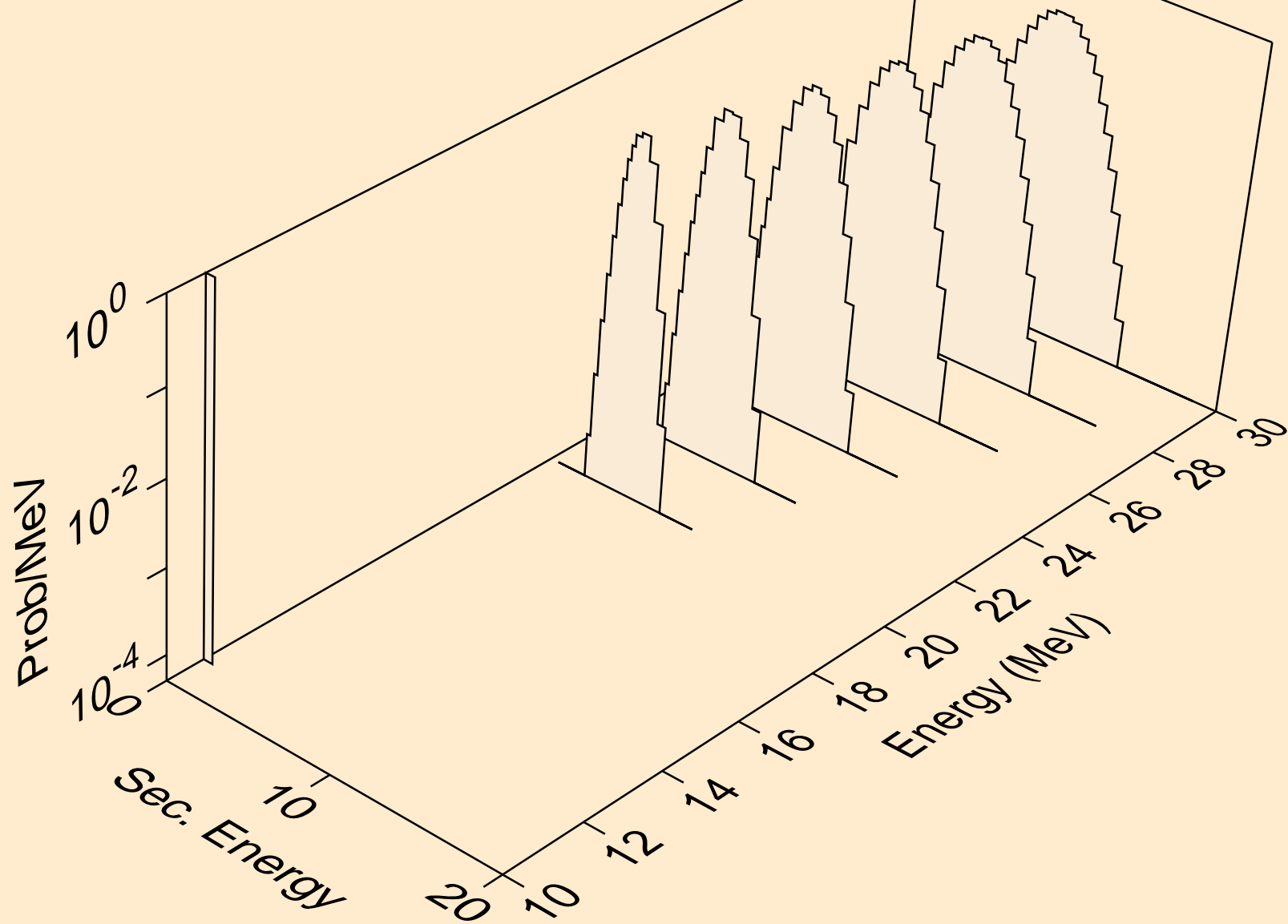

PU238 NEUTRON ACER TENDL-2023 LIBRARY; T=0.K  
protons from (n,npa)

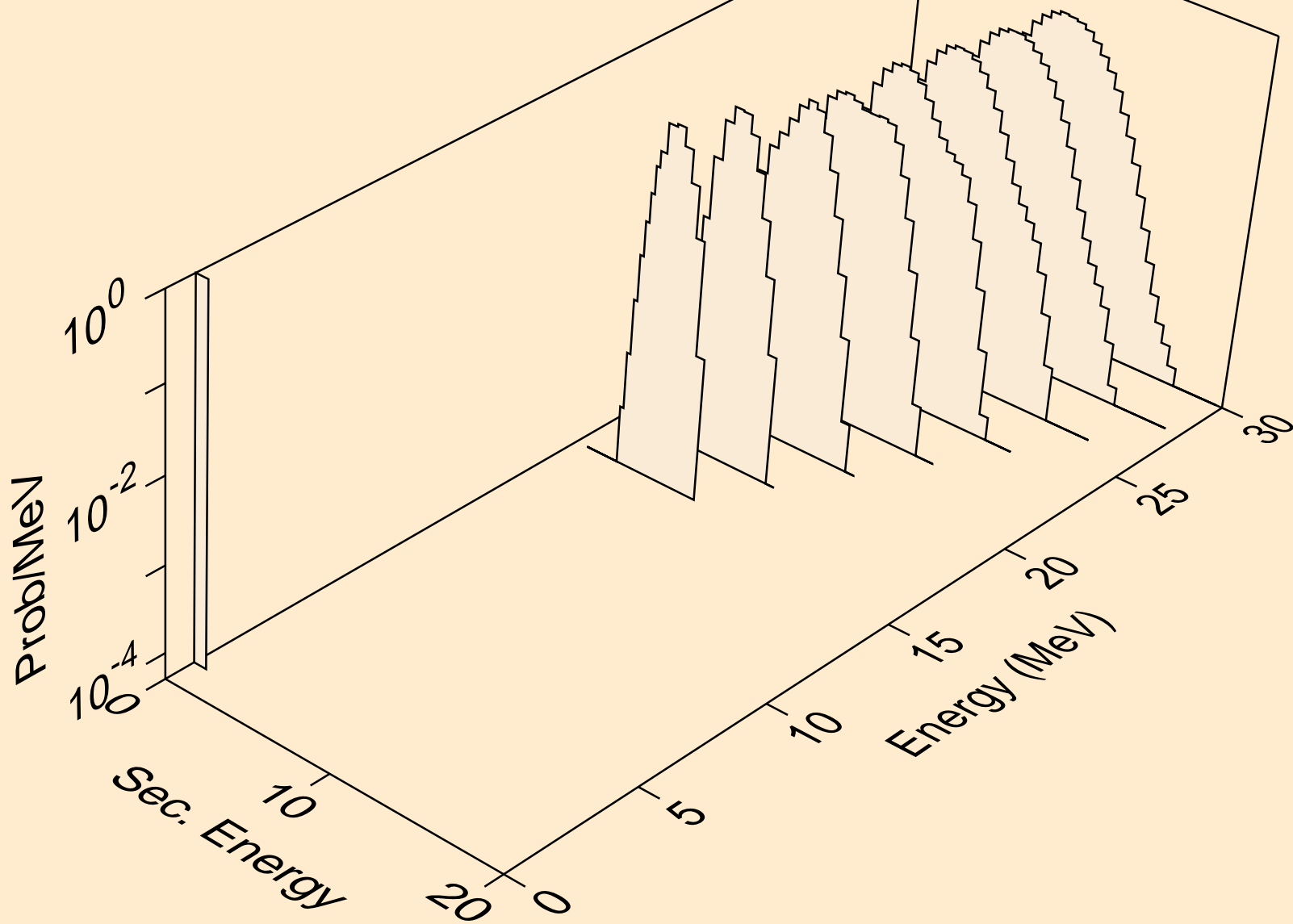

PU238 NEUTRON ACER TENDL-2023 LIBRARY; T=0.K  
protons from (n,p)

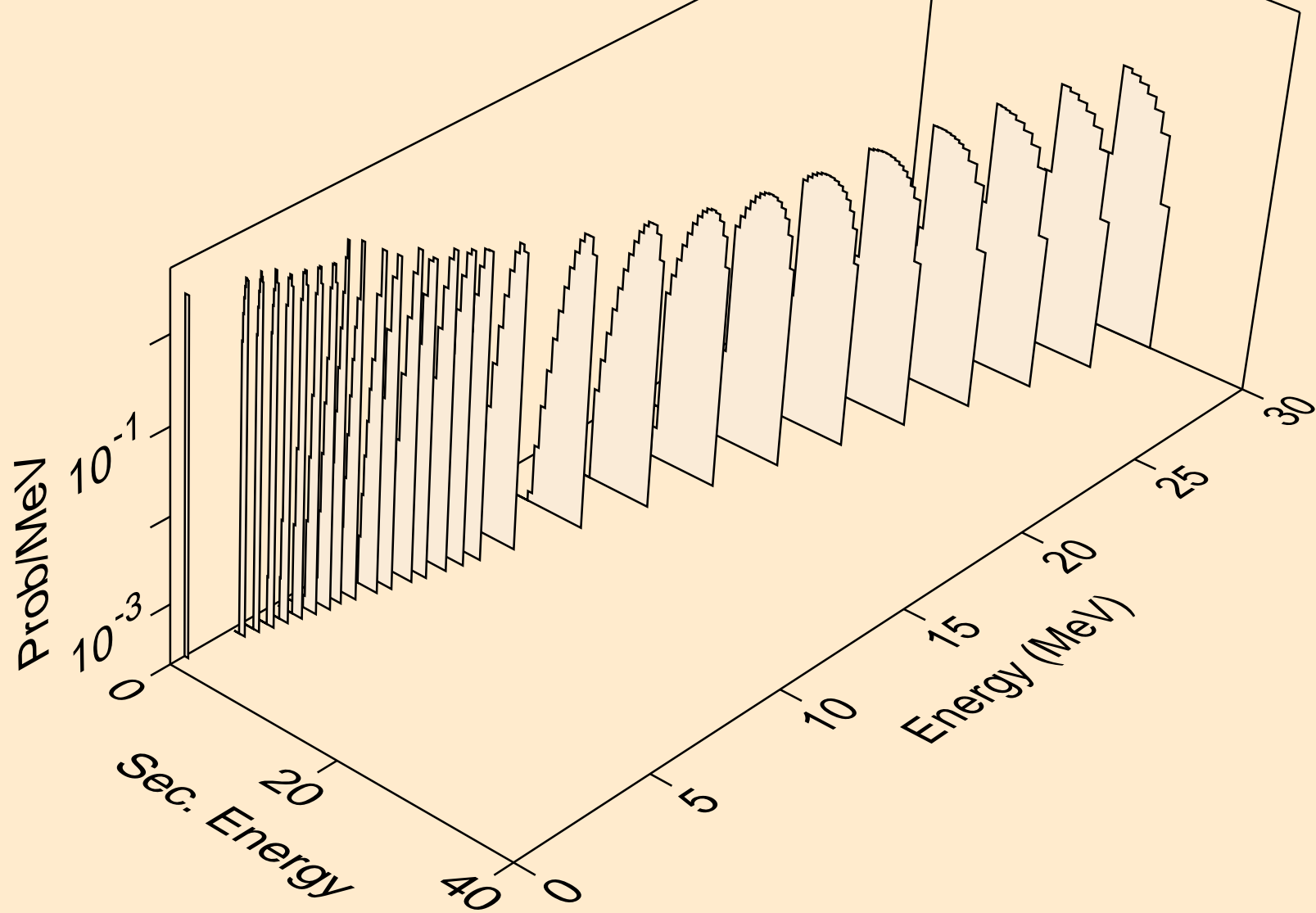

PU238 NEUTRON ACER TENDL-2023 LIBRARY; T=0.K  
protons from (n,2p)

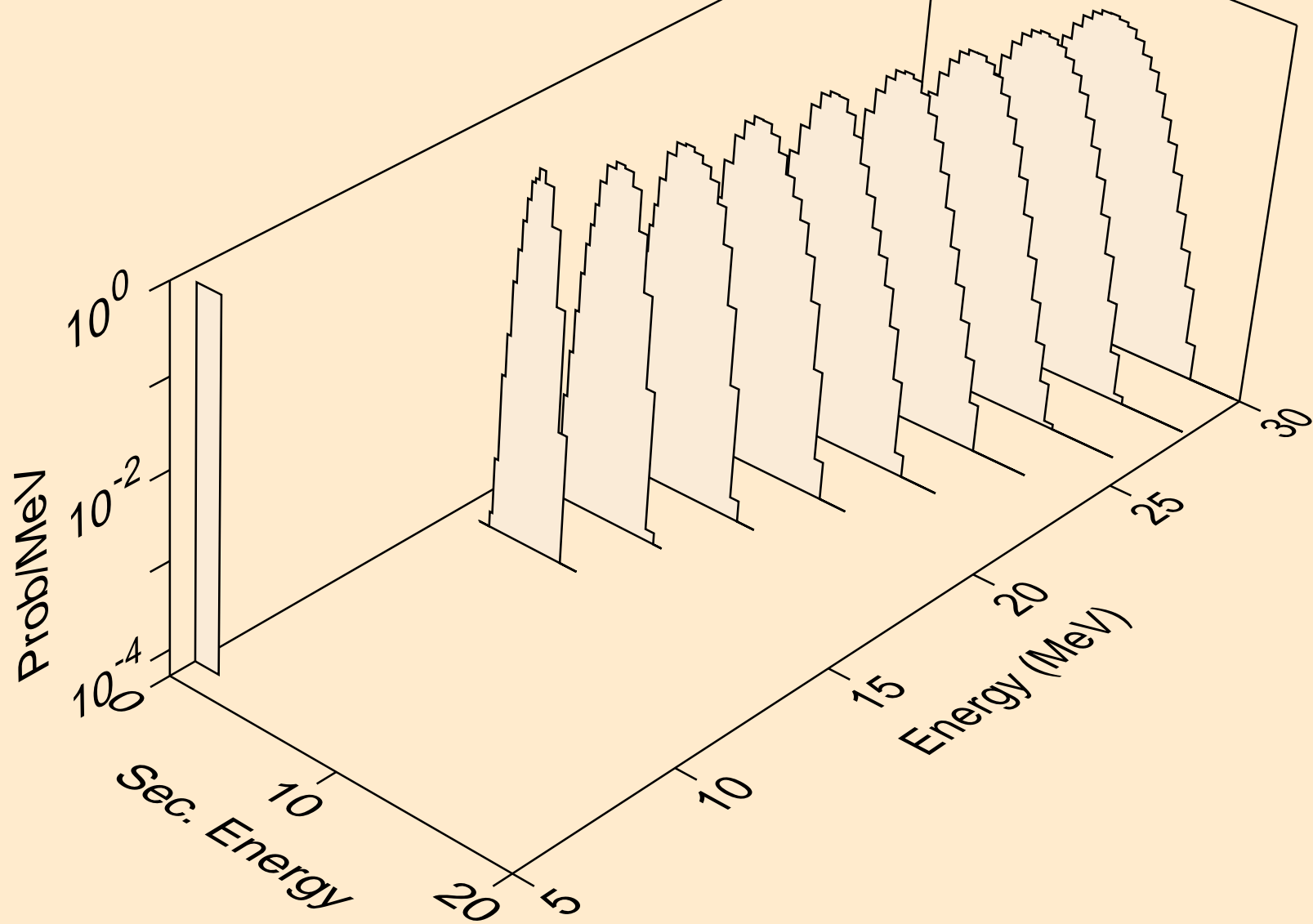

PU238 NEUTRON ACER TENDL-2023 LIBRARY; T=0.K  
protons from (n,p)

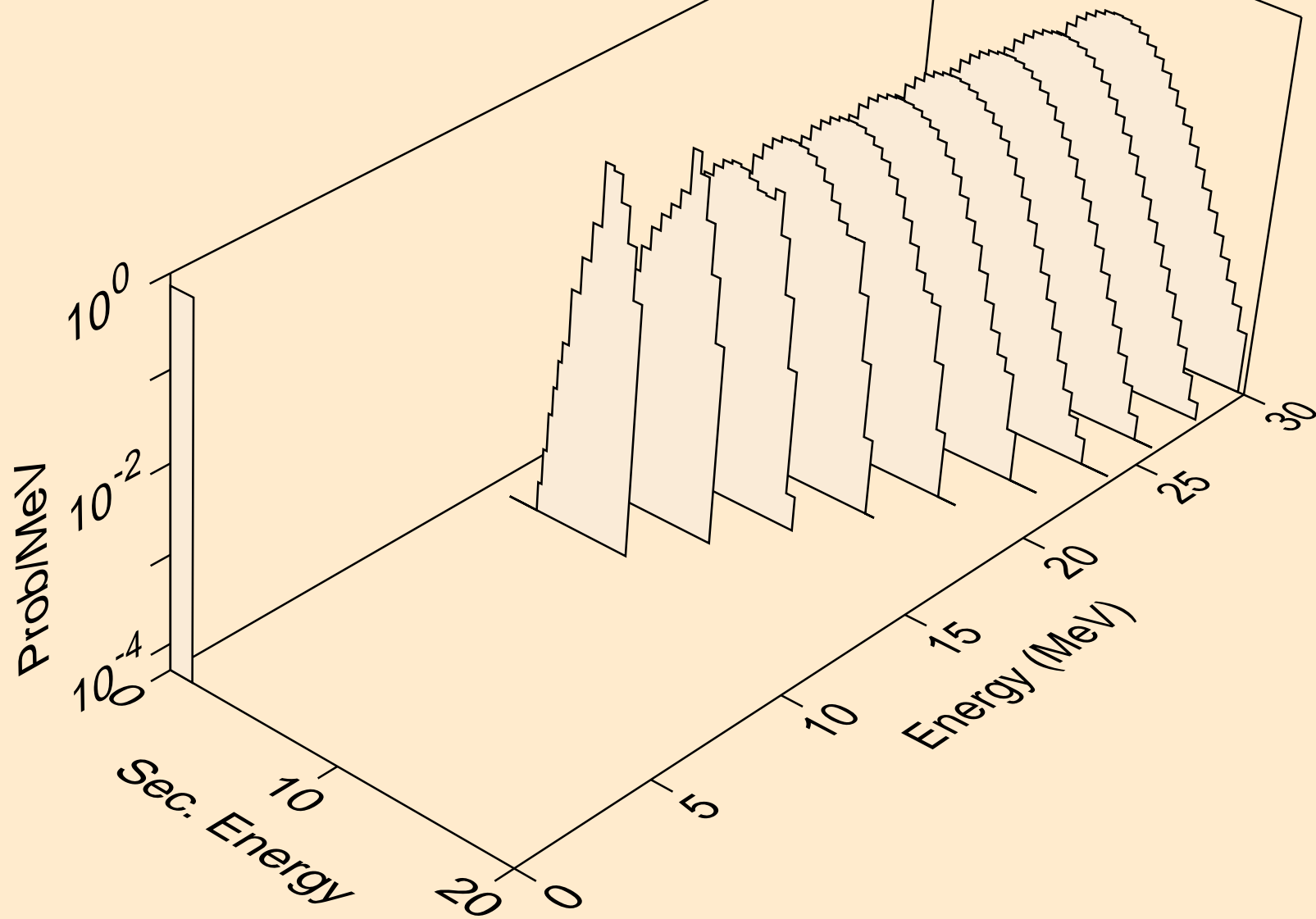

PU238 NEUTRON ACER TENDL-2023 LIBRARY; T=0.K  
deuterons from (n,x)

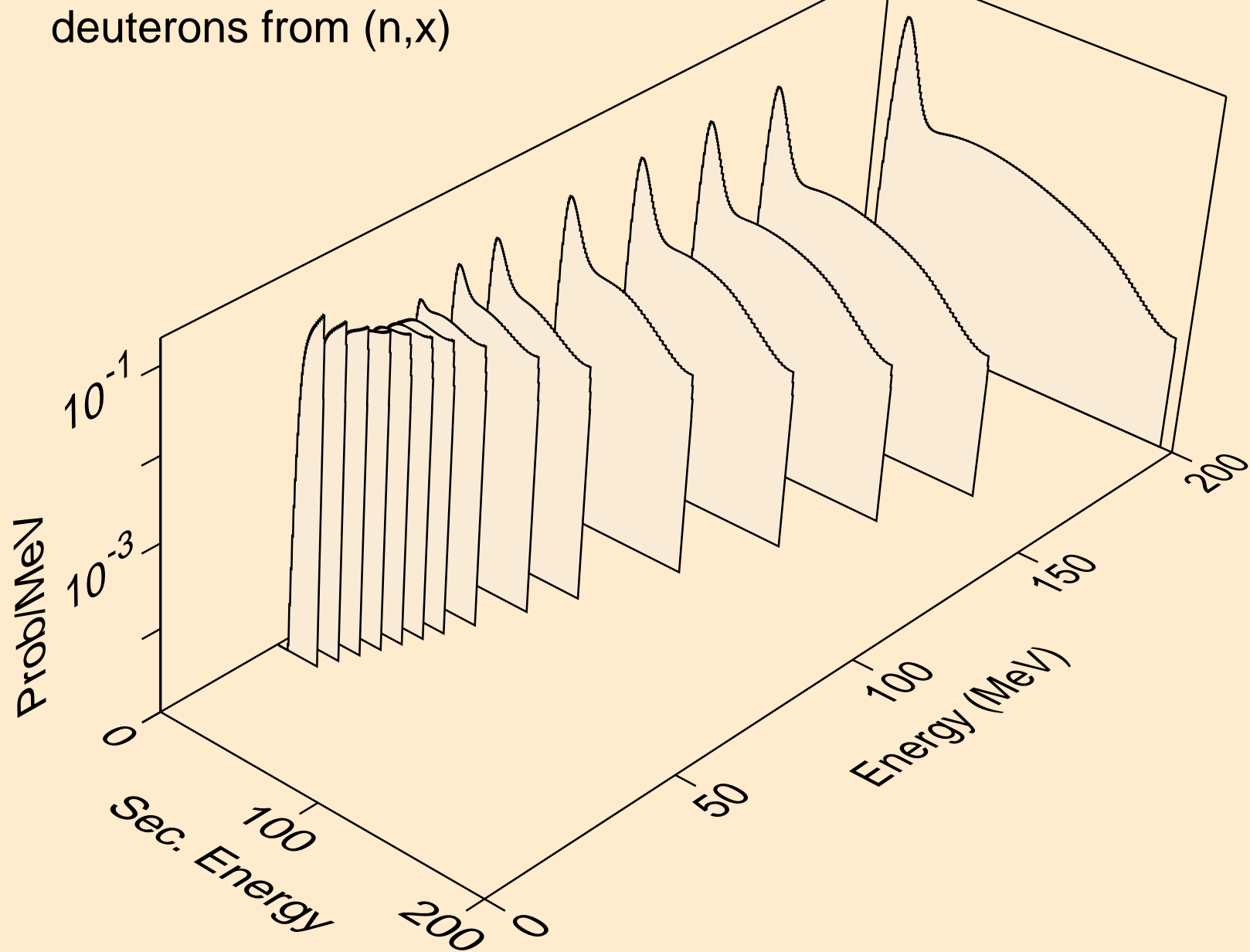

PU238 NEUTRON ACER TENDL-2023 LIBRARY; T=0.K  
deuterons from (n,2nd)

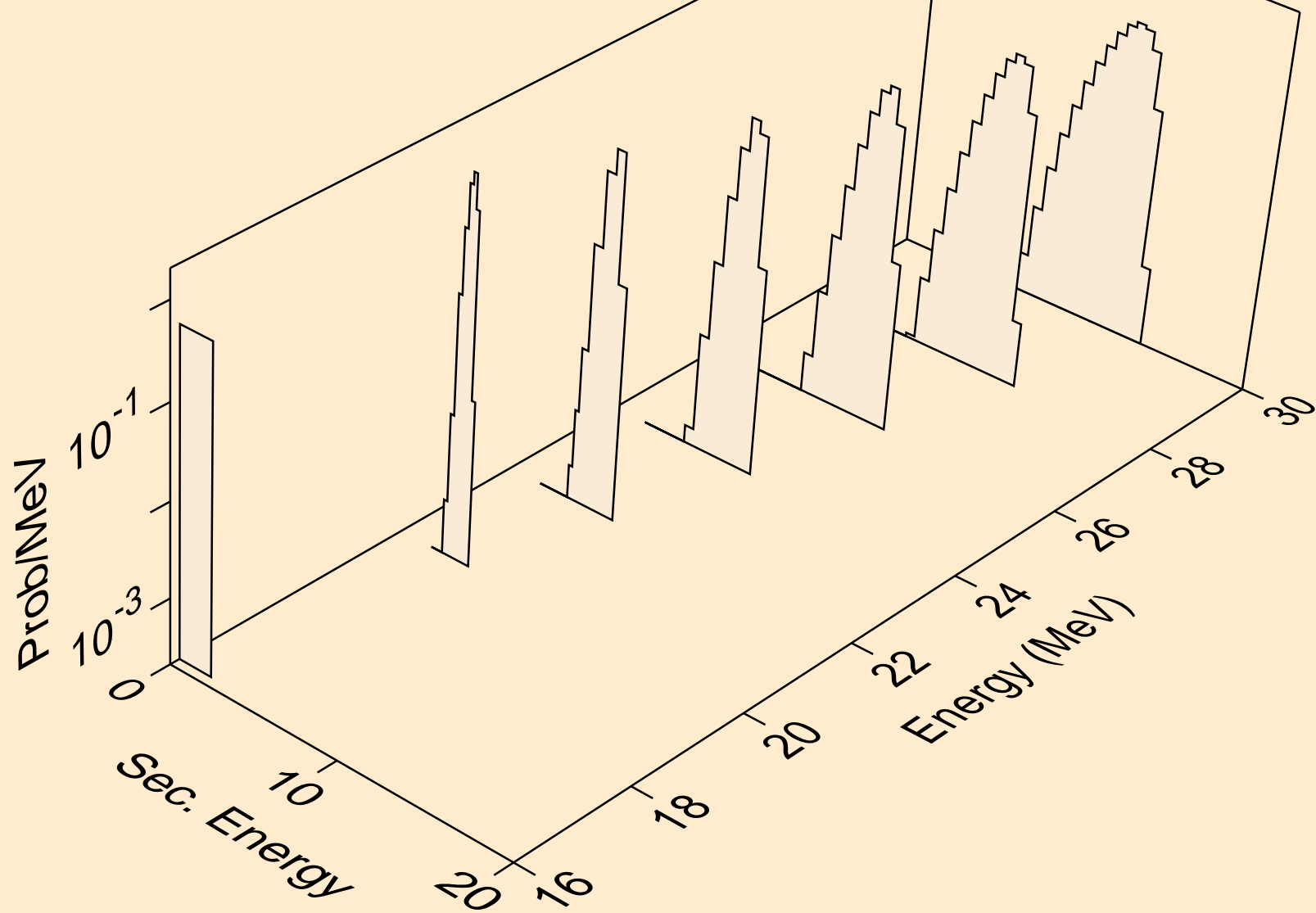



PU238 NEUTRON ACER TENDL-2023 LIBRARY; T=0.K  
deuterons from (n,n\*)d

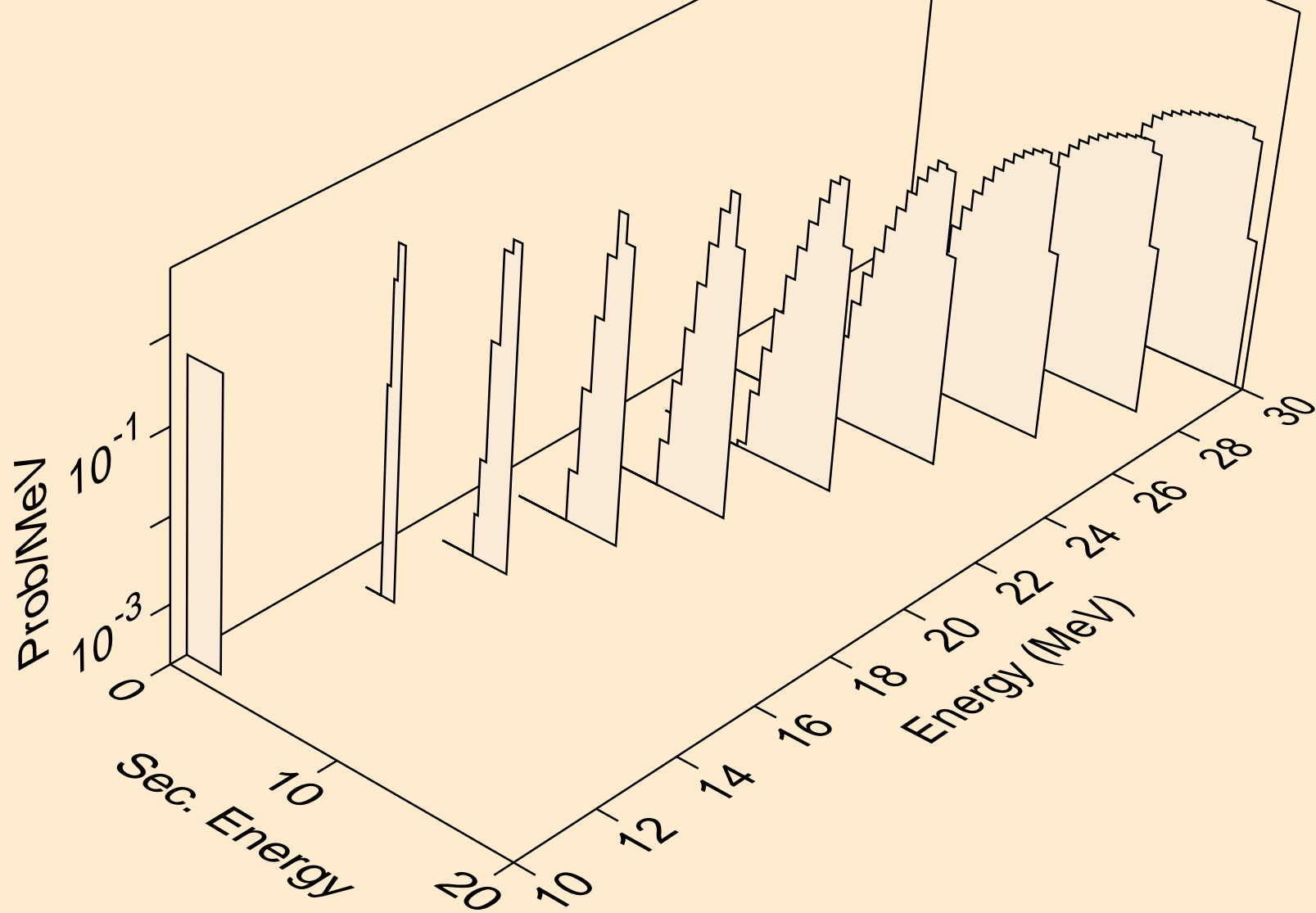

PU238 NEUTRON ACER TENDL-2023 LIBRARY; T=0.K  
deuterons from (n,d)

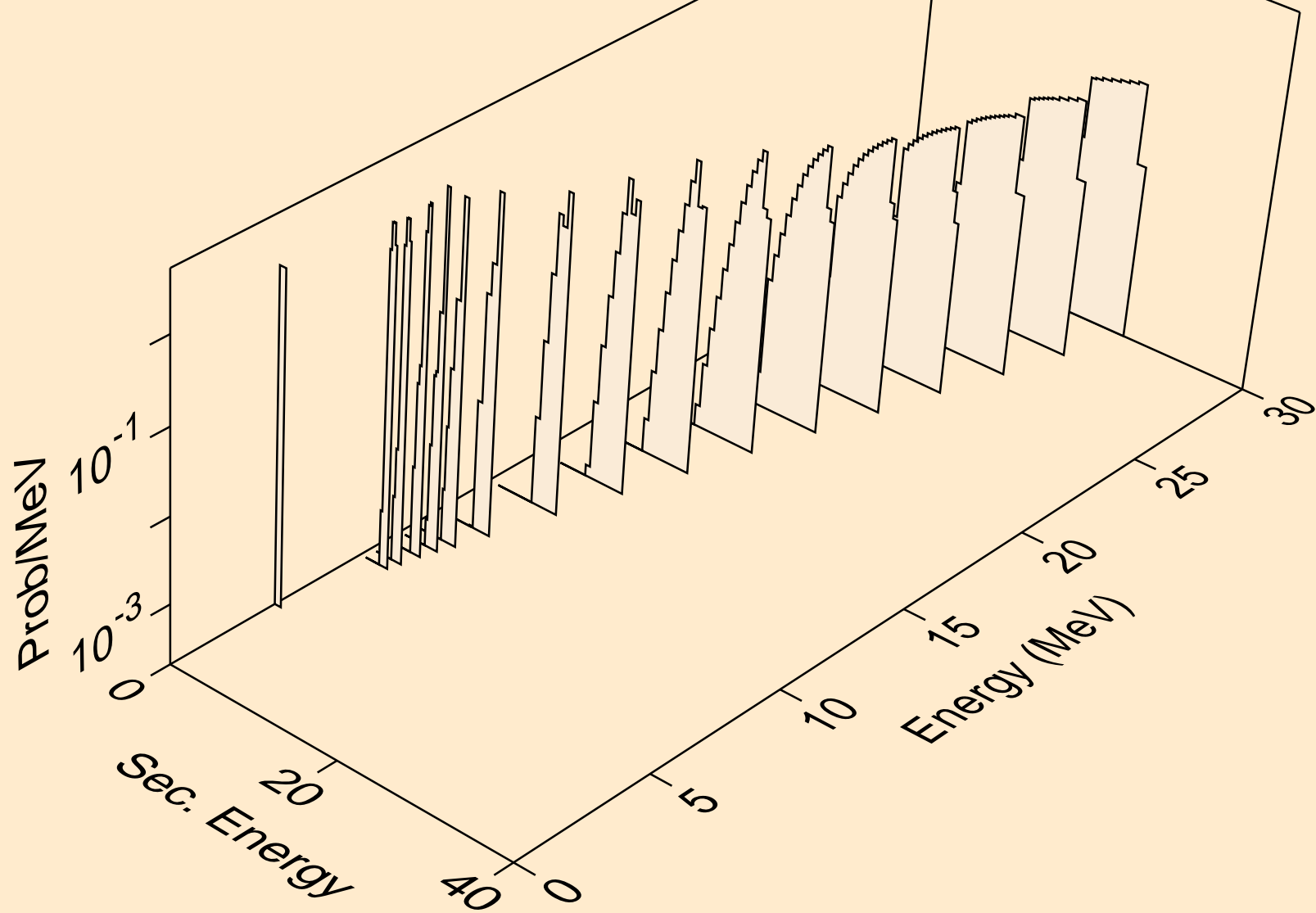

PU238 NEUTRON ACER TENDL-2023 LIBRARY; T=0.K  
tritons from (n,x)

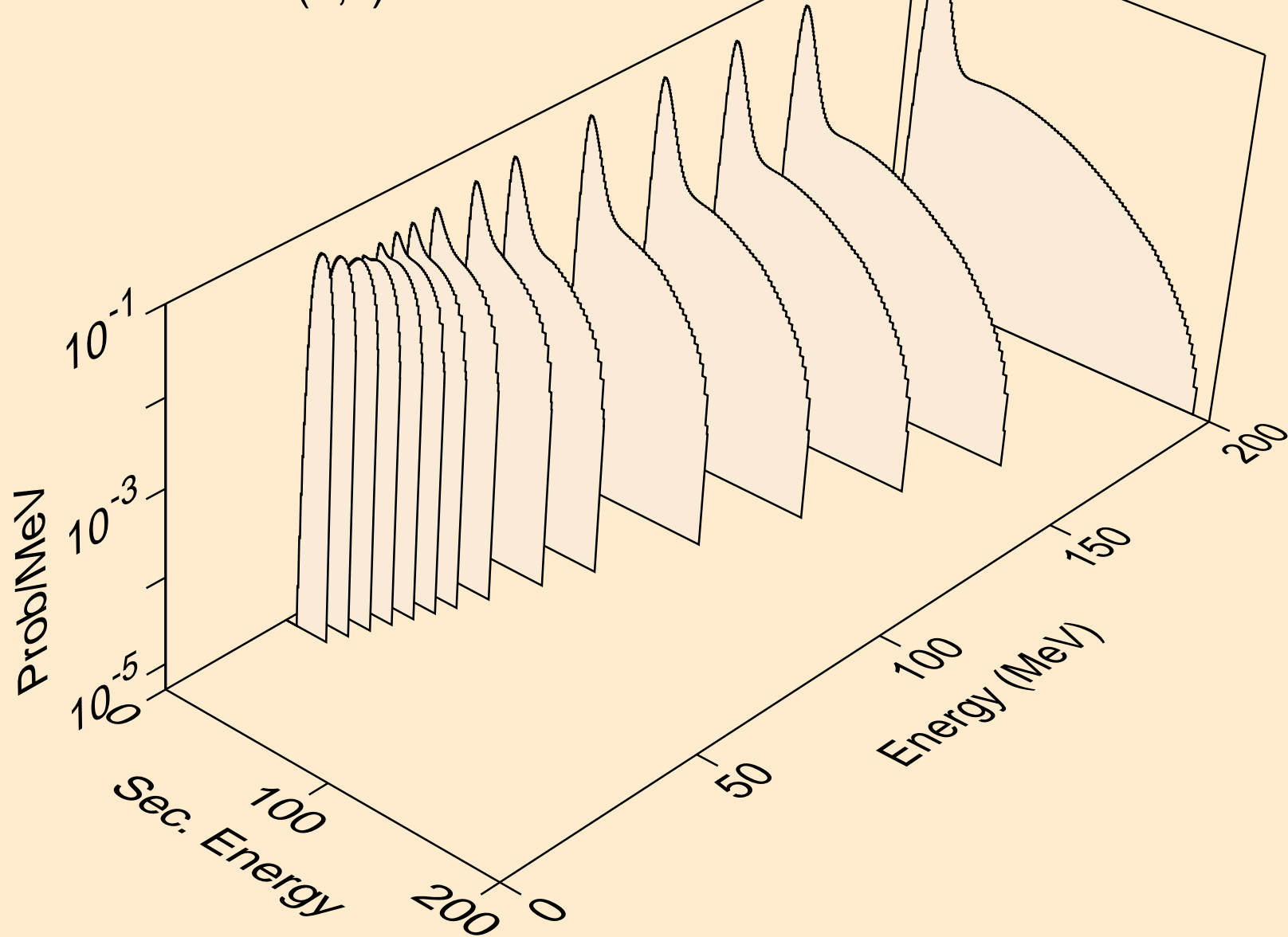

PU238 NEUTRON ACER TENDL-2023 LIBRARY; T=0.K  
tritons from (n,n\*)t

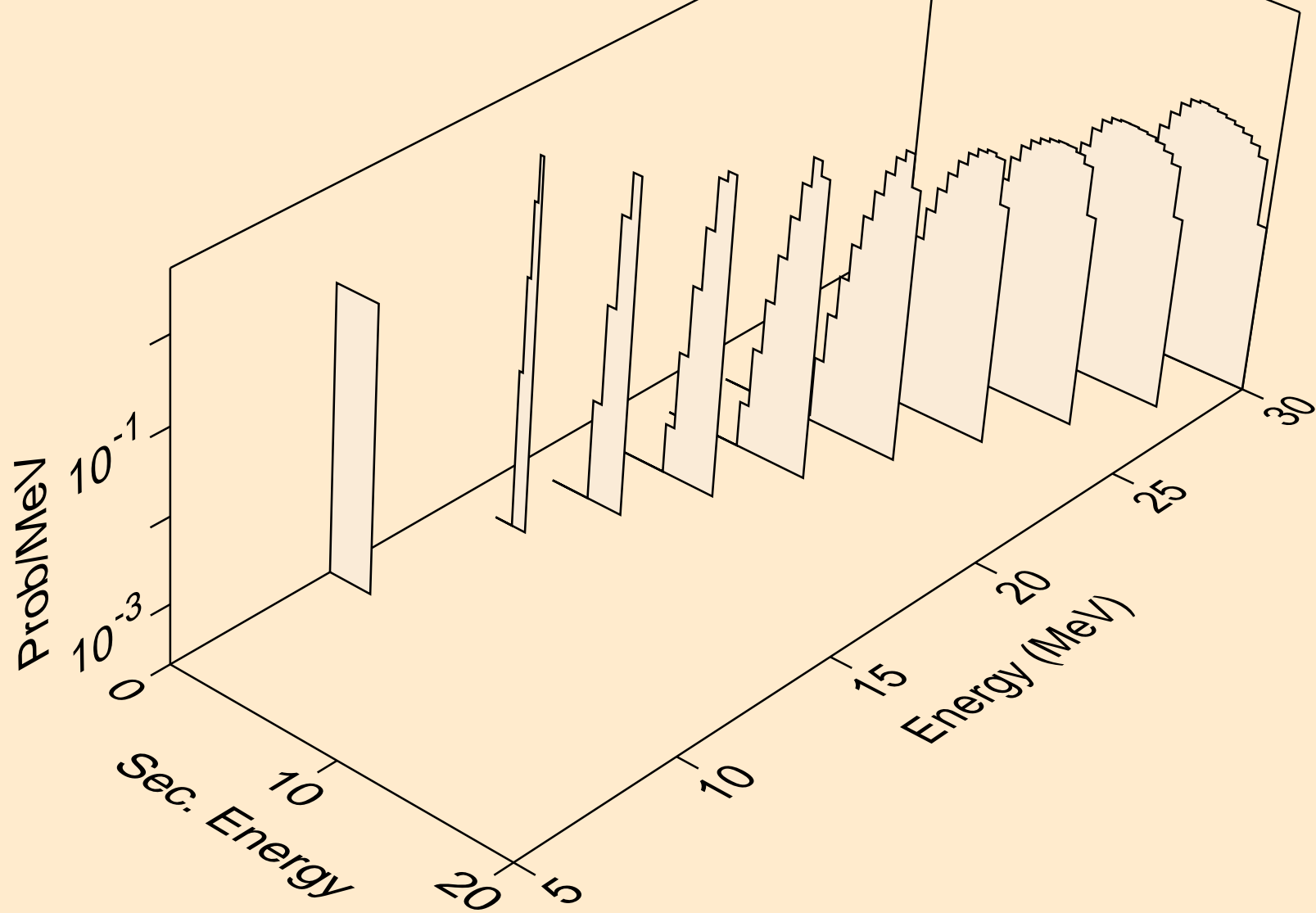

PU238 NEUTRON ACER TENDL-2023 LIBRARY; T=0.K  
tritons from (n,t)

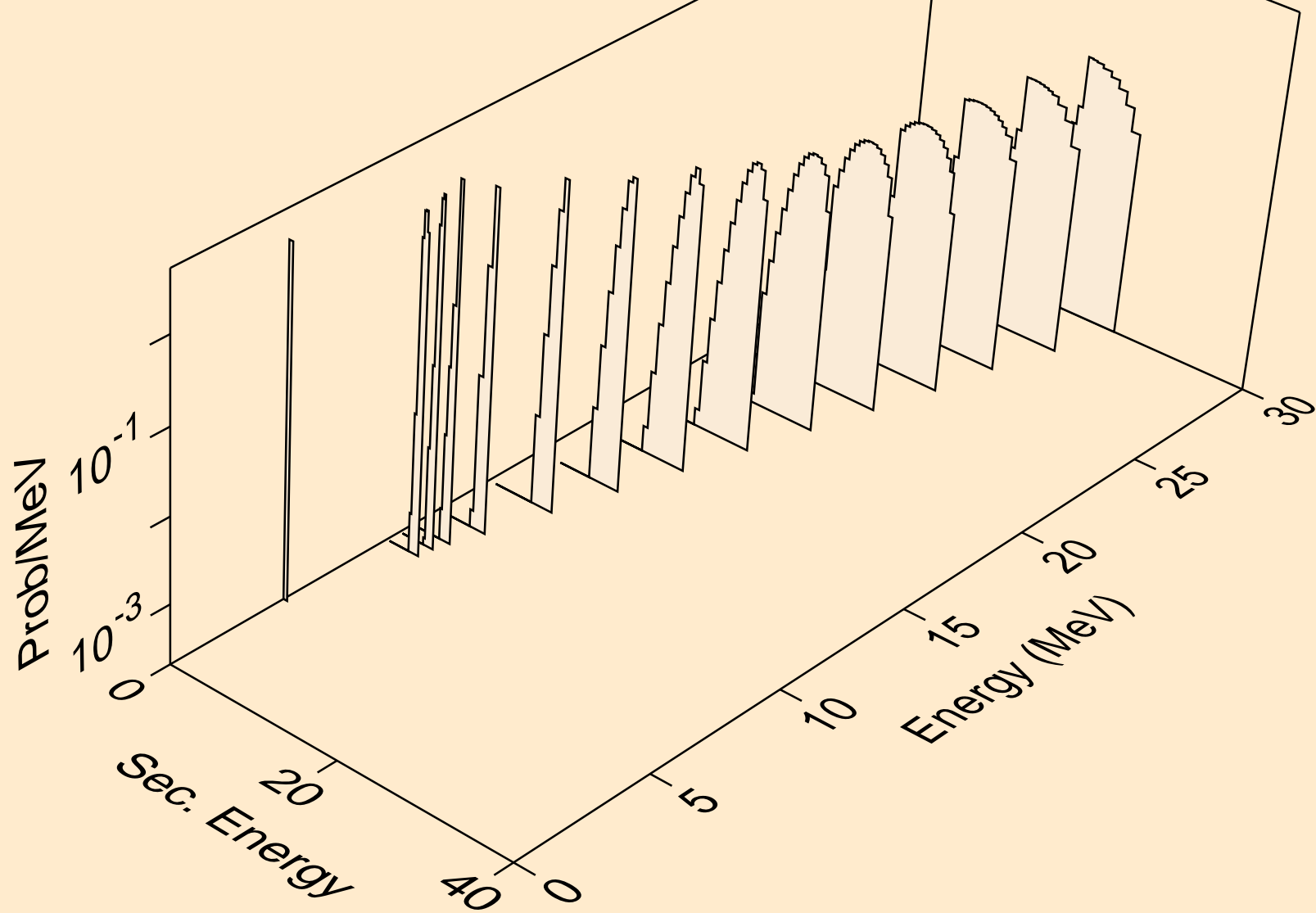

PU238 NEUTRON ACER TENDL-2023 LIBRARY; T=0.K  
he3s from (n,x)

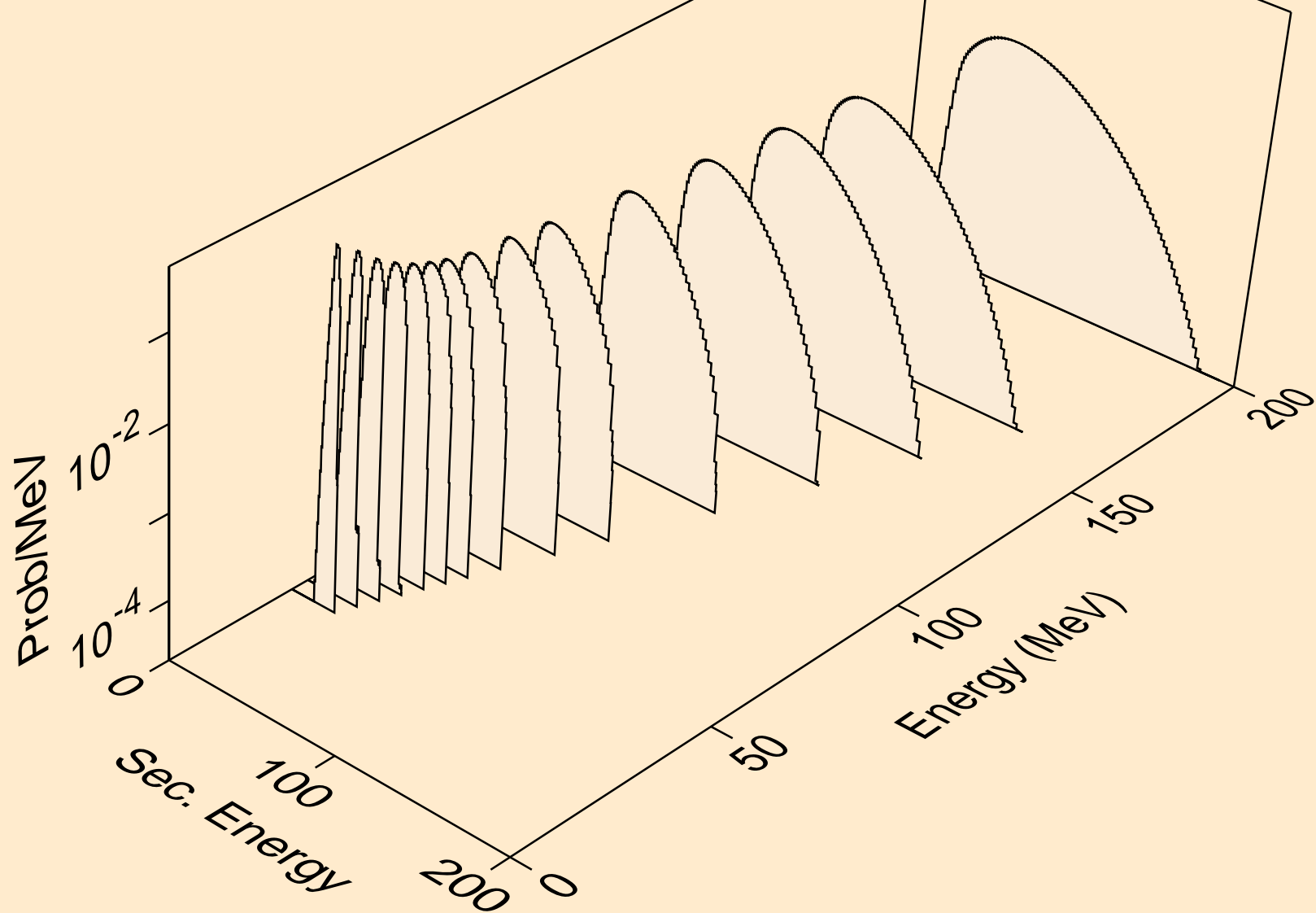

PU238 NEUTRON ACER TENDL-2023 LIBRARY; T=0.K  
he3s from (n,n\*)he3

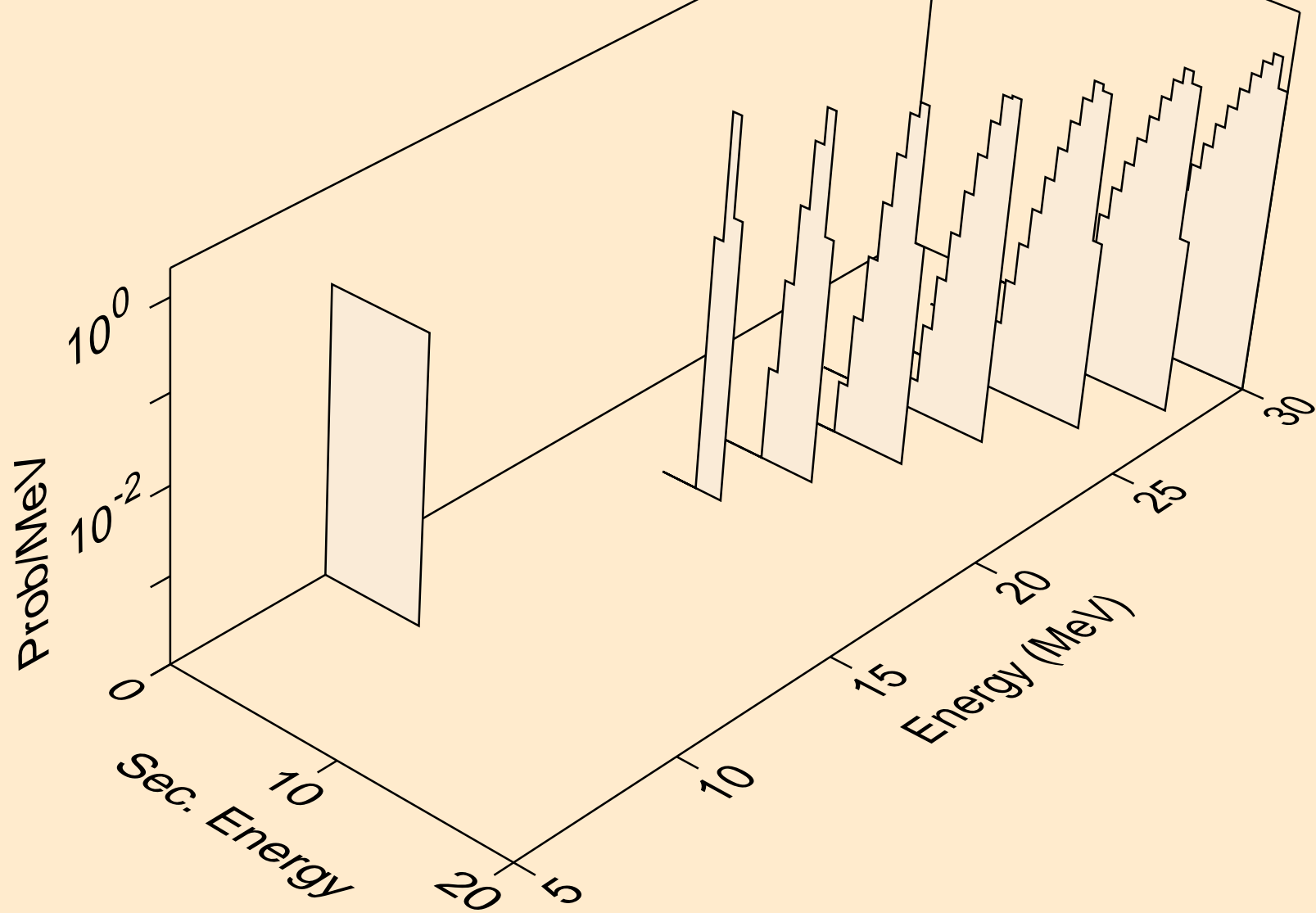

PU238 NEUTRON ACER TENDL-2023 LIBRARY; T=0.K  
he3s from (n,he3)

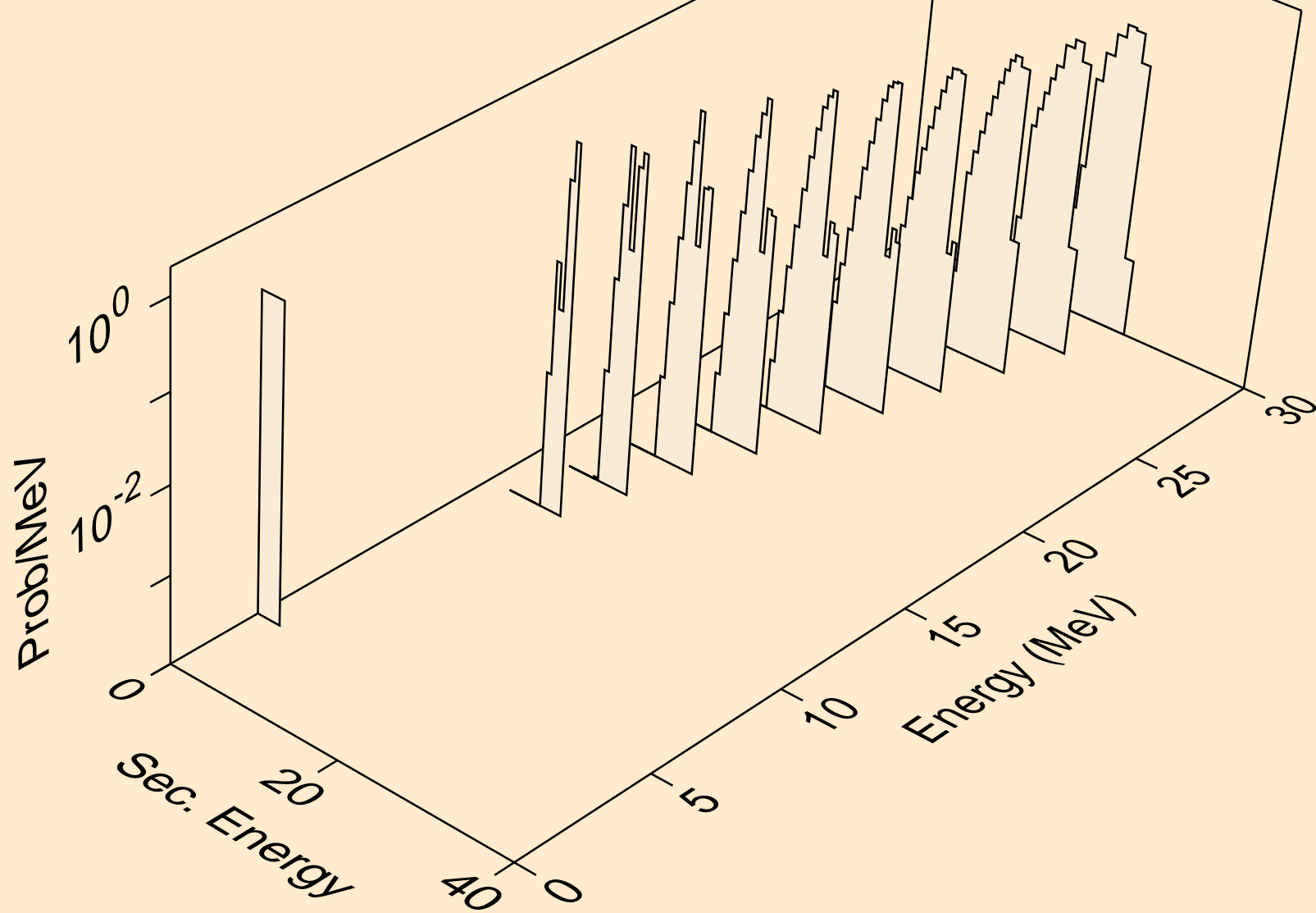



PU238 NEUTRON ACER TENDL-2023 LIBRARY; T=0.K  
alphas from (n,x)

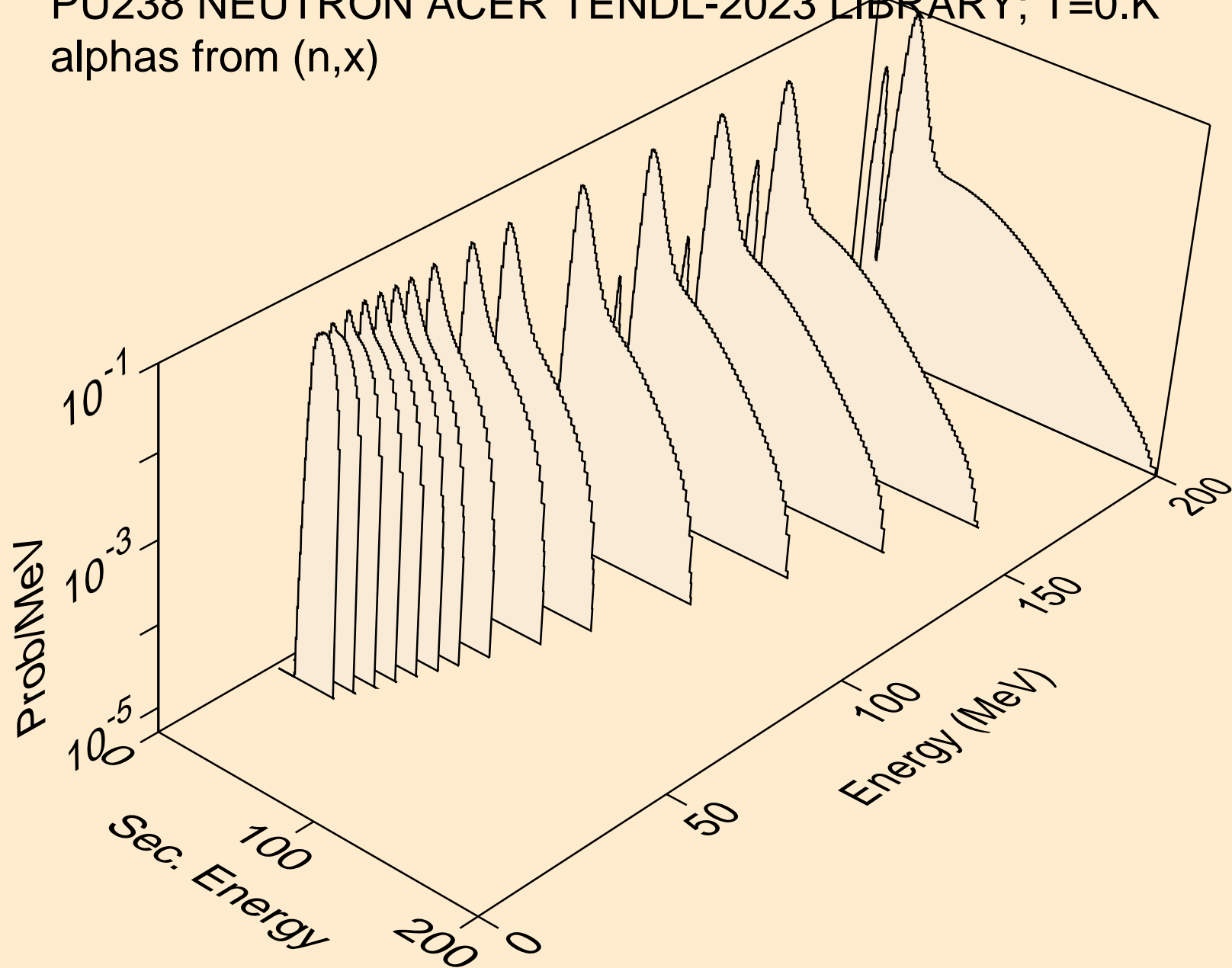

PU238 NEUTRON ACER TENDL-2023 LIBRARY; T=0.K  
alphas from (n,n\*)a

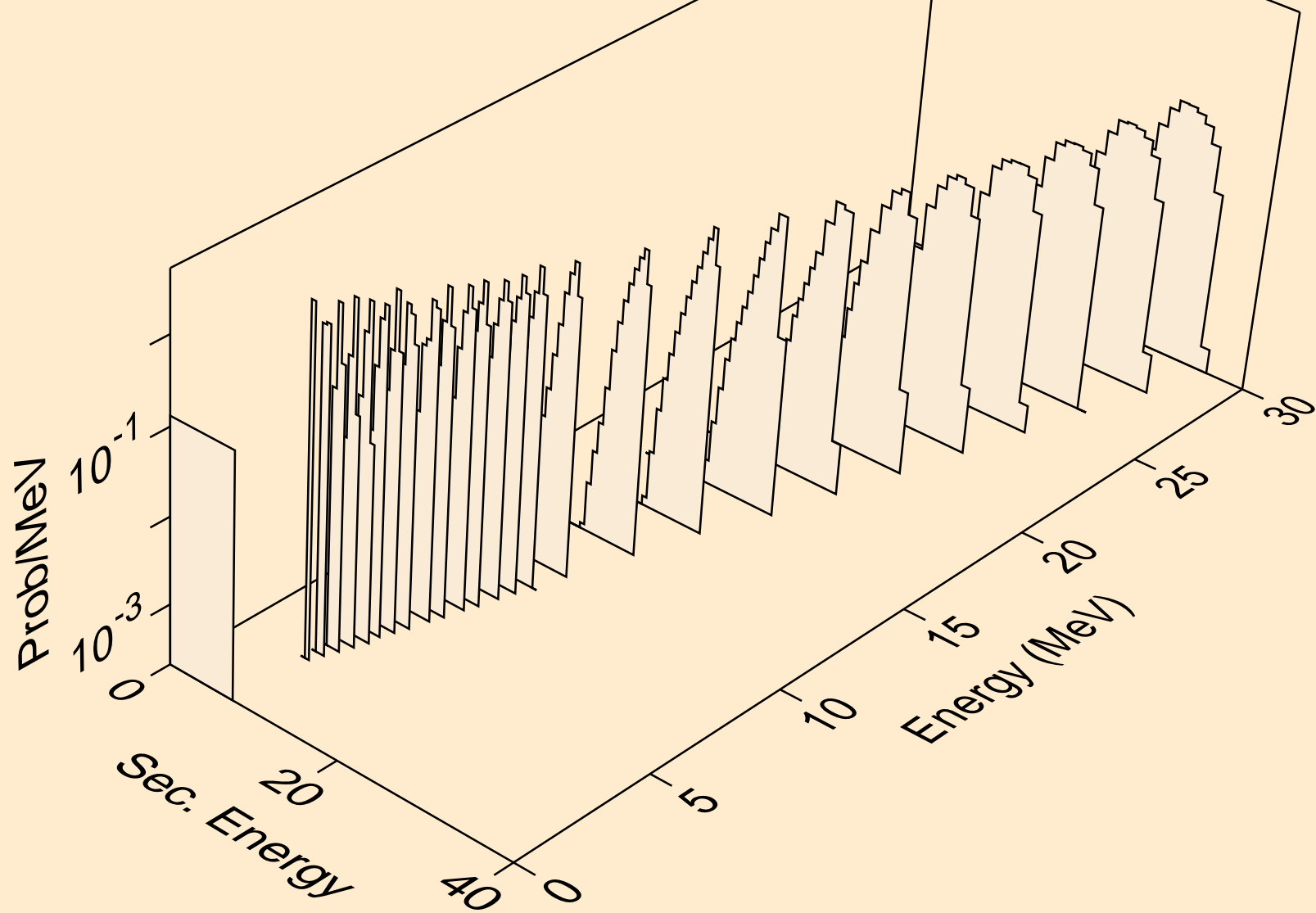

PU238 NEUTRON ACER TENDL-2023 LIBRARY; T=0.K  
alphas from (n,2n)a

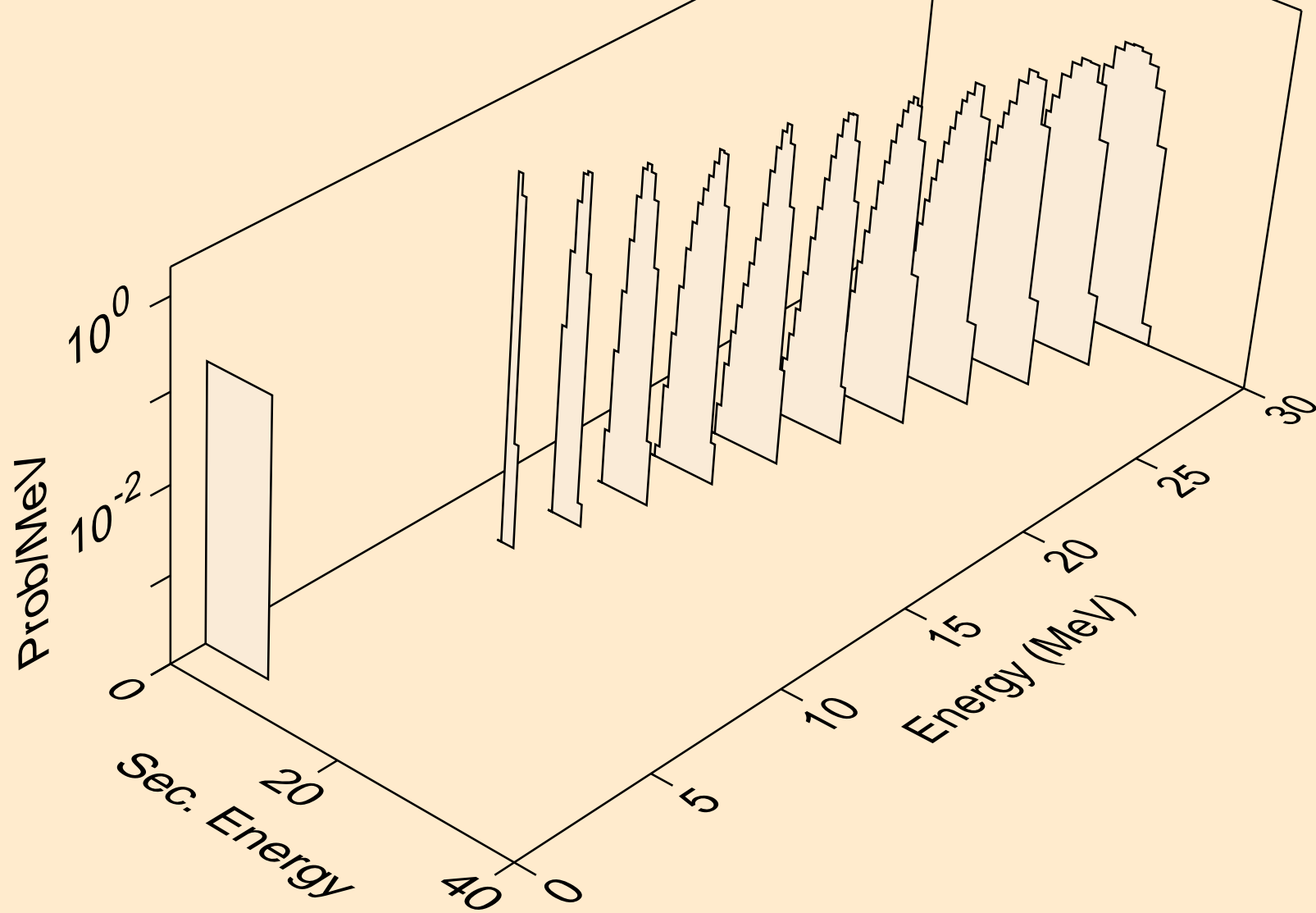

PU238 NEUTRON ACER TENDL-2023 LIBRARY; T=0.K  
alphas from (n,3n)a

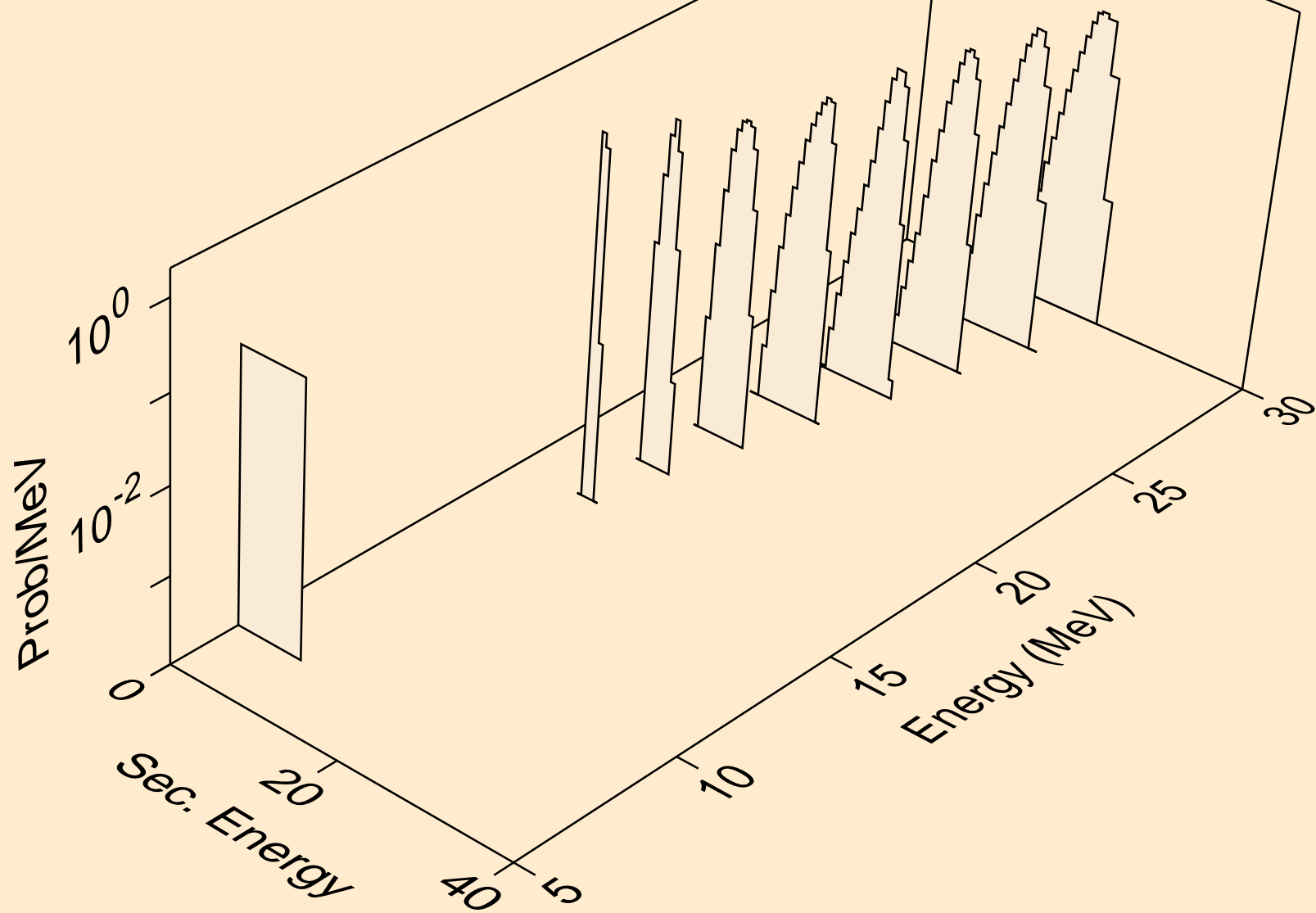

PU238 NEUTRON ACER TENDL-2023 LIBRARY; T=0.K  
alphas from (n,n\*)2a

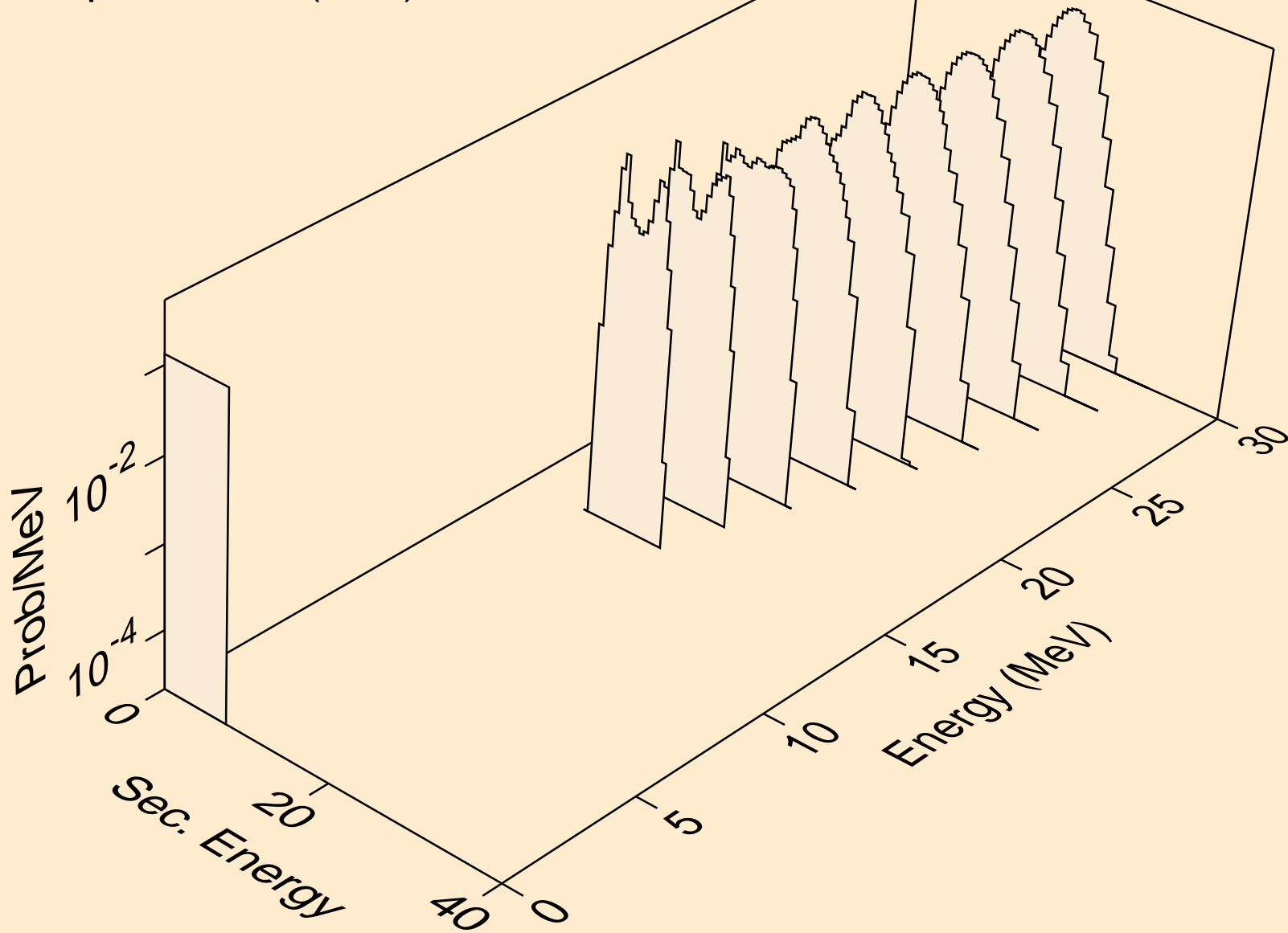

PU238 NEUTRON ACER TENDL-2023 LIBRARY; T=0.K  
alphas from (n,npa)

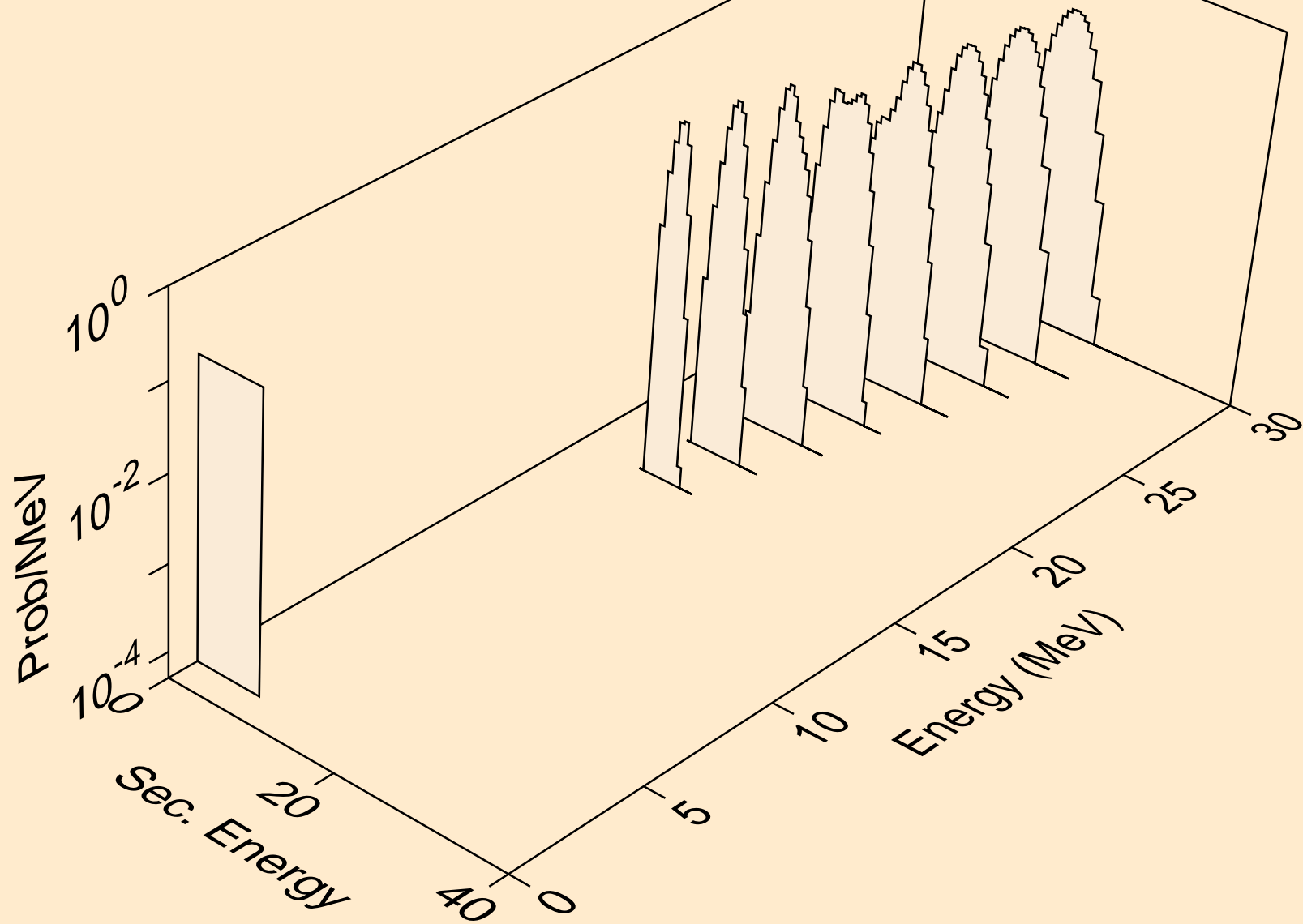

PU238 NEUTRON ACER TENDL-2023 LIBRARY; T=0.K  
alphas from (n,a)

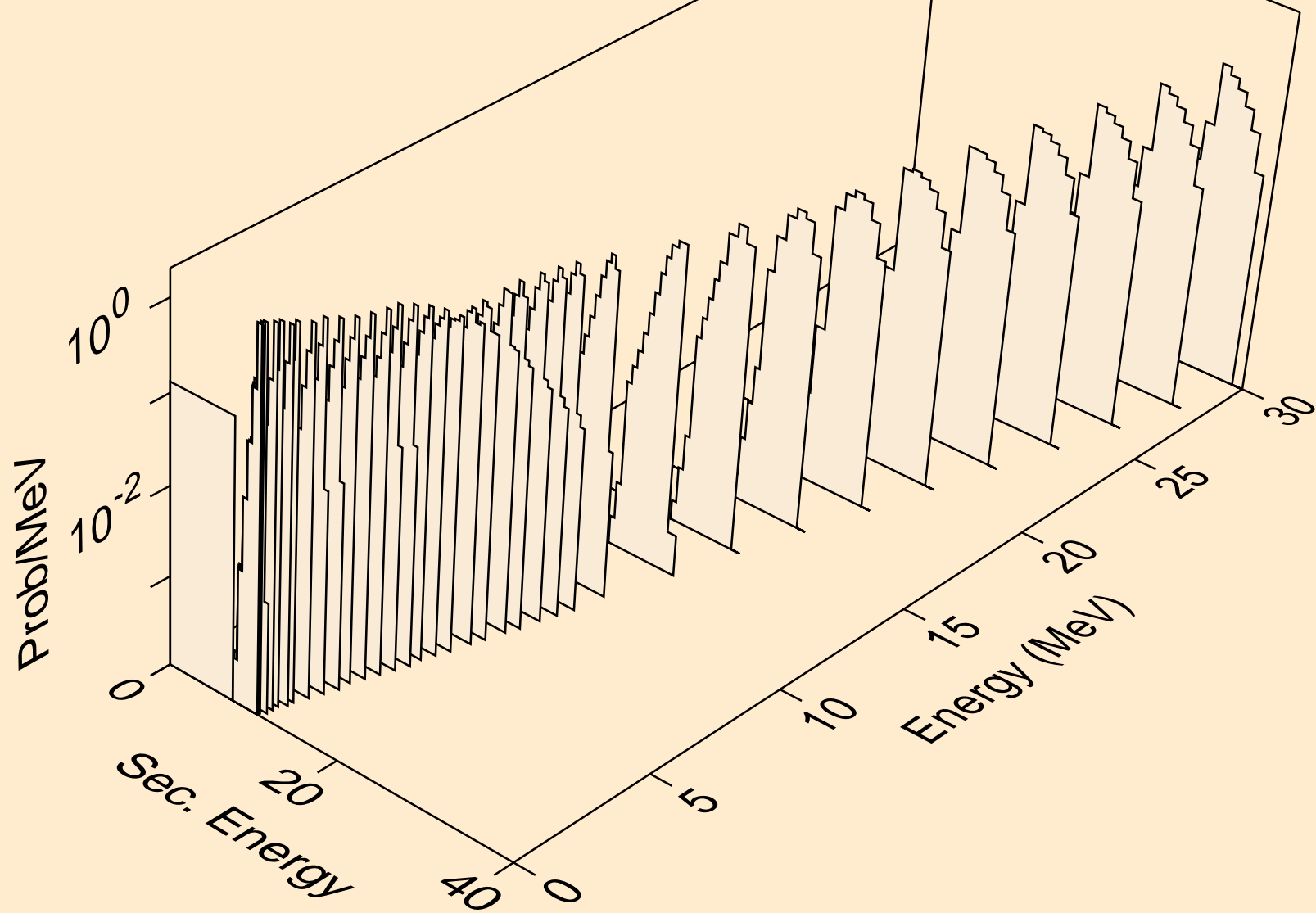

PU238 NEUTRON ACER TENDL-2023 LIBRARY; T=0.K  
alphas from (n,2a)

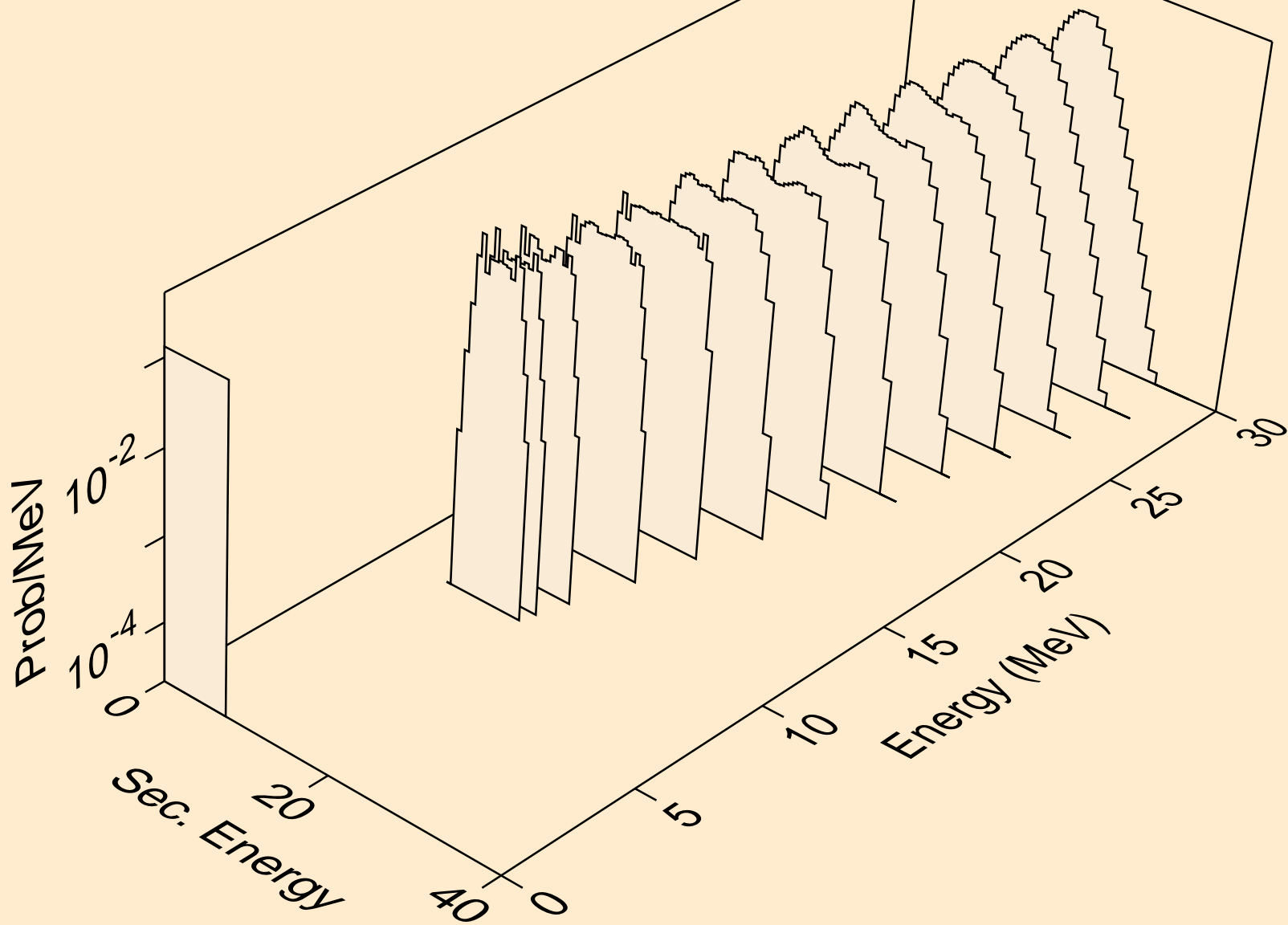



PU238 NEUTRON ACER TENDL-2023 LIBRARY; T=0.K  
alphas from (n,pa)

