

PU247 NEUTRON ACER TENDL-2023 LIBRARY; T=0.K
Principal cross sections

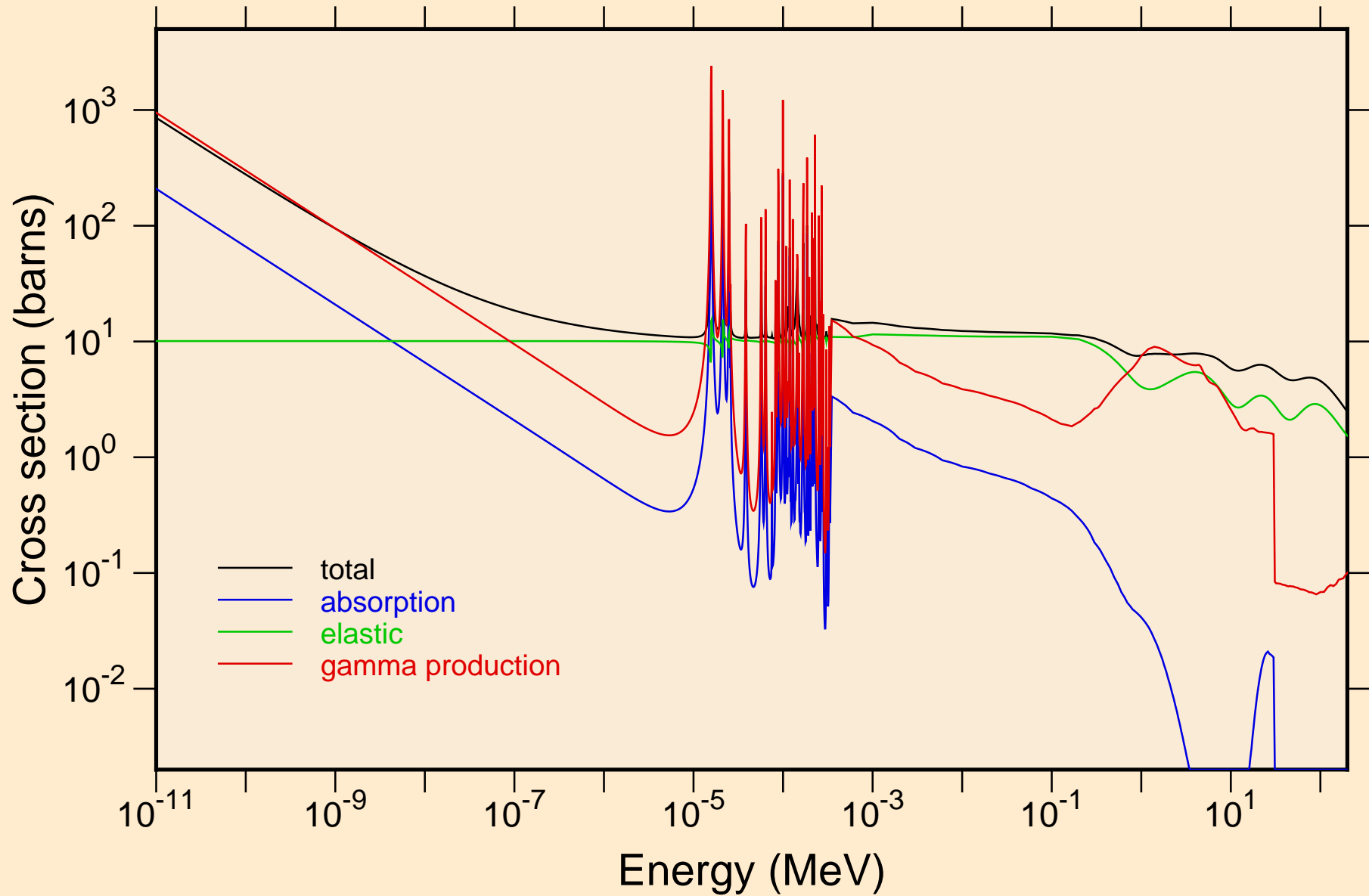

PU247 NEUTRON ACER TENDL-2023 LIBRARY; T=0.K
resonance total cross section

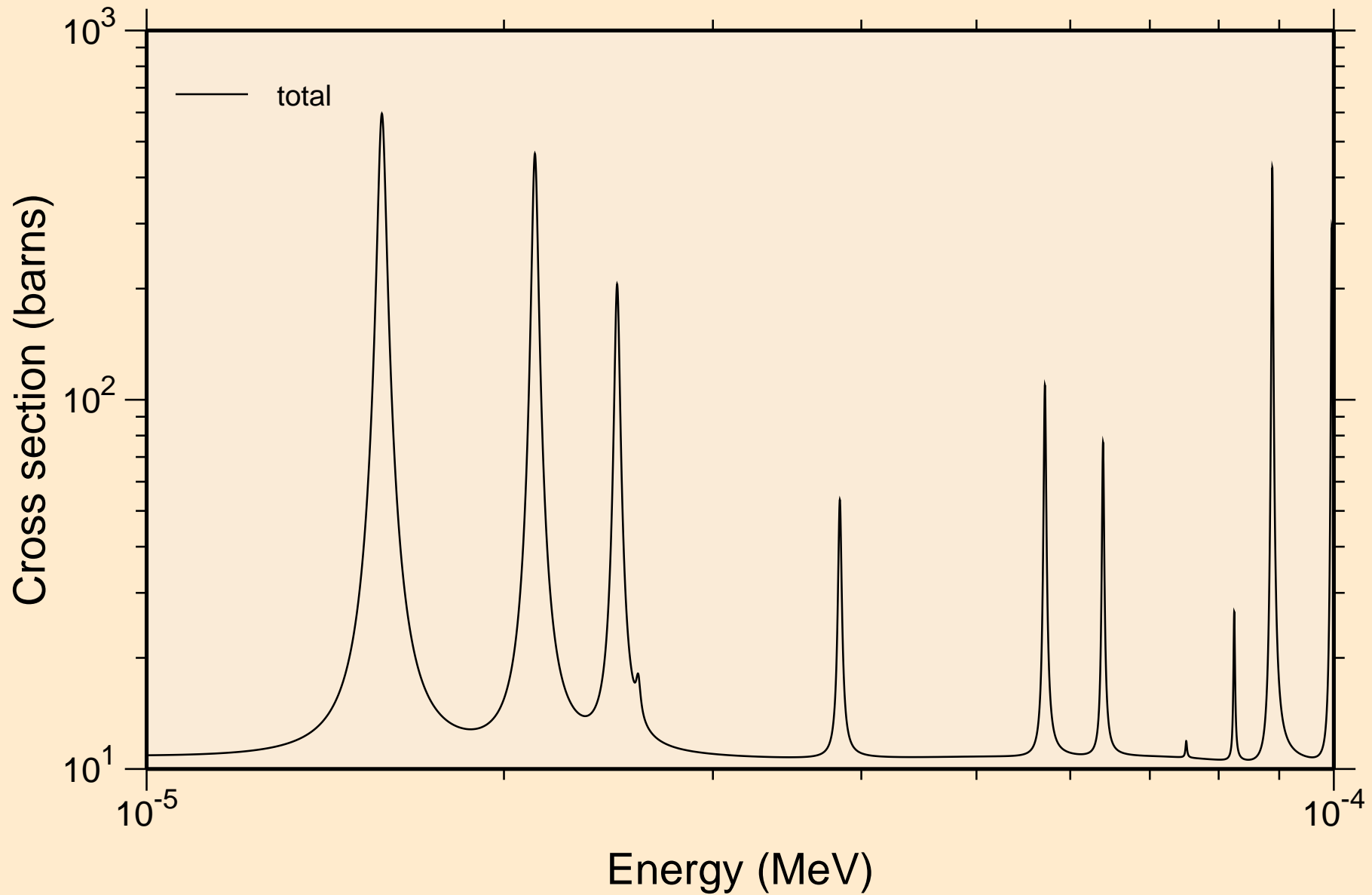

PU247 NEUTRON ACER TENDL-2023 LIBRARY; T=0.K
resonance total cross section

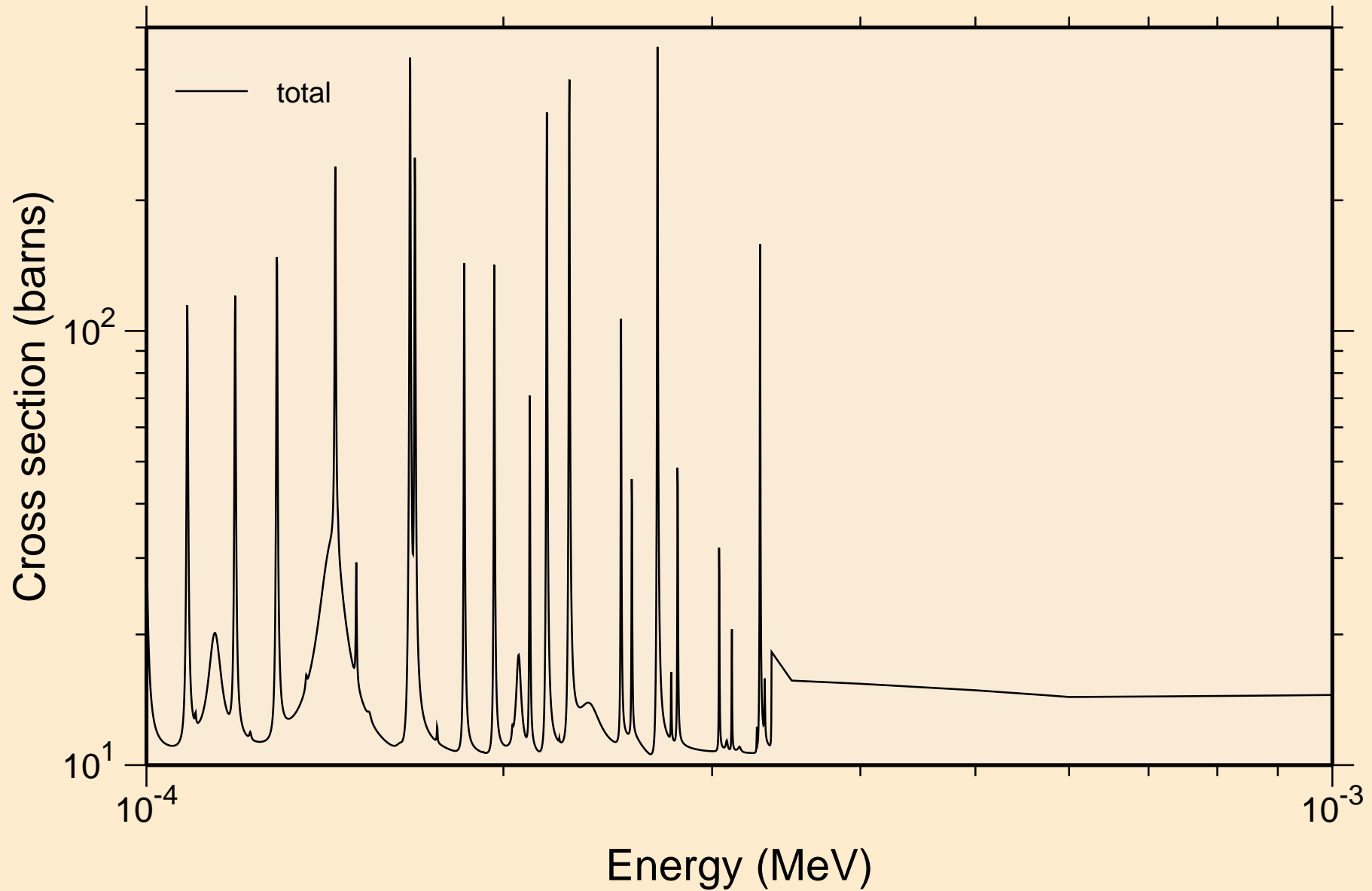

PU247 NEUTRON ACER TENDL-2023 LIBRARY; T=0.K
resonance total cross section

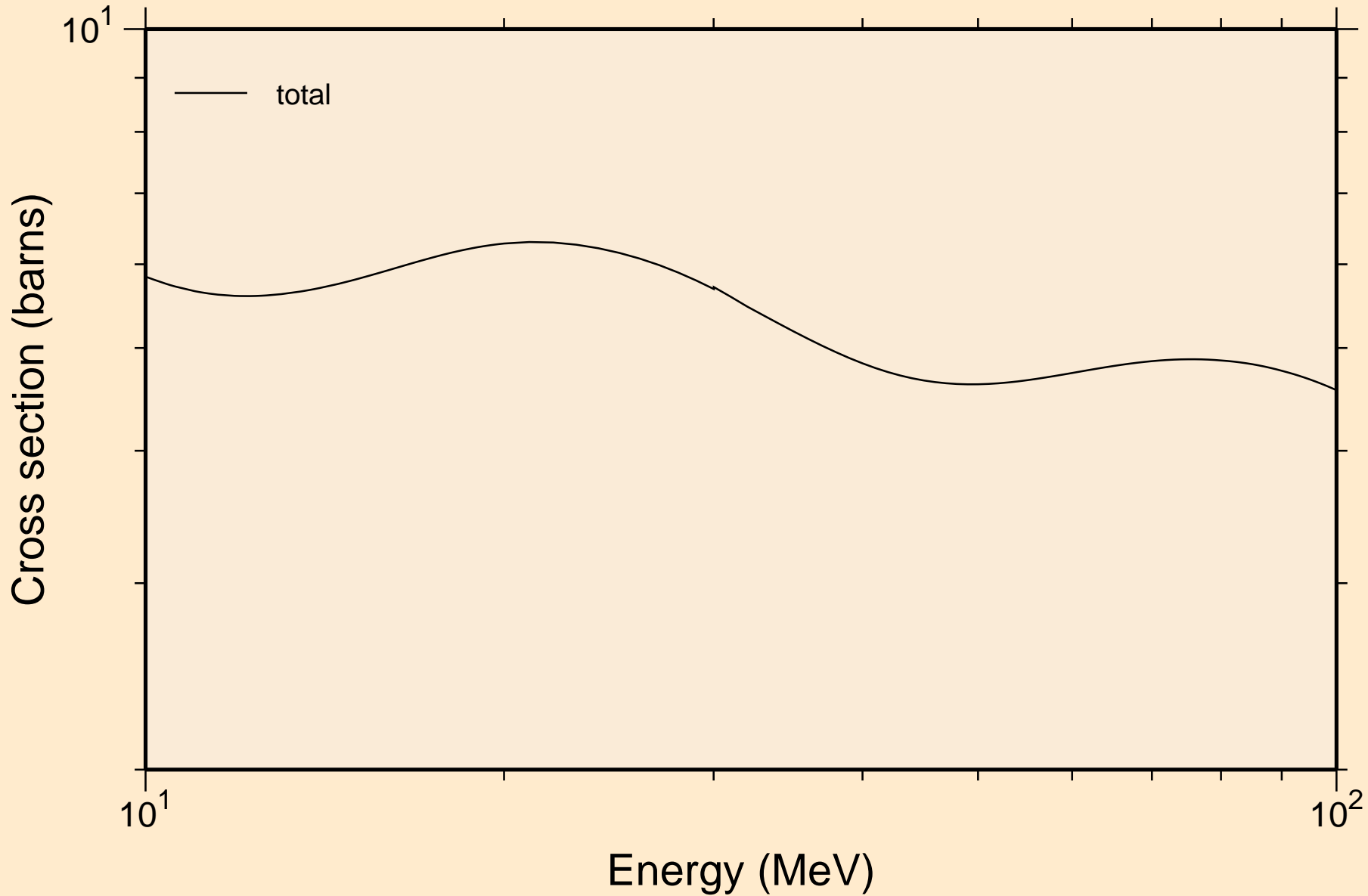

PU247 NEUTRON ACER TENDL-2023 LIBRARY; T=0.K
resonance absorption cross sections

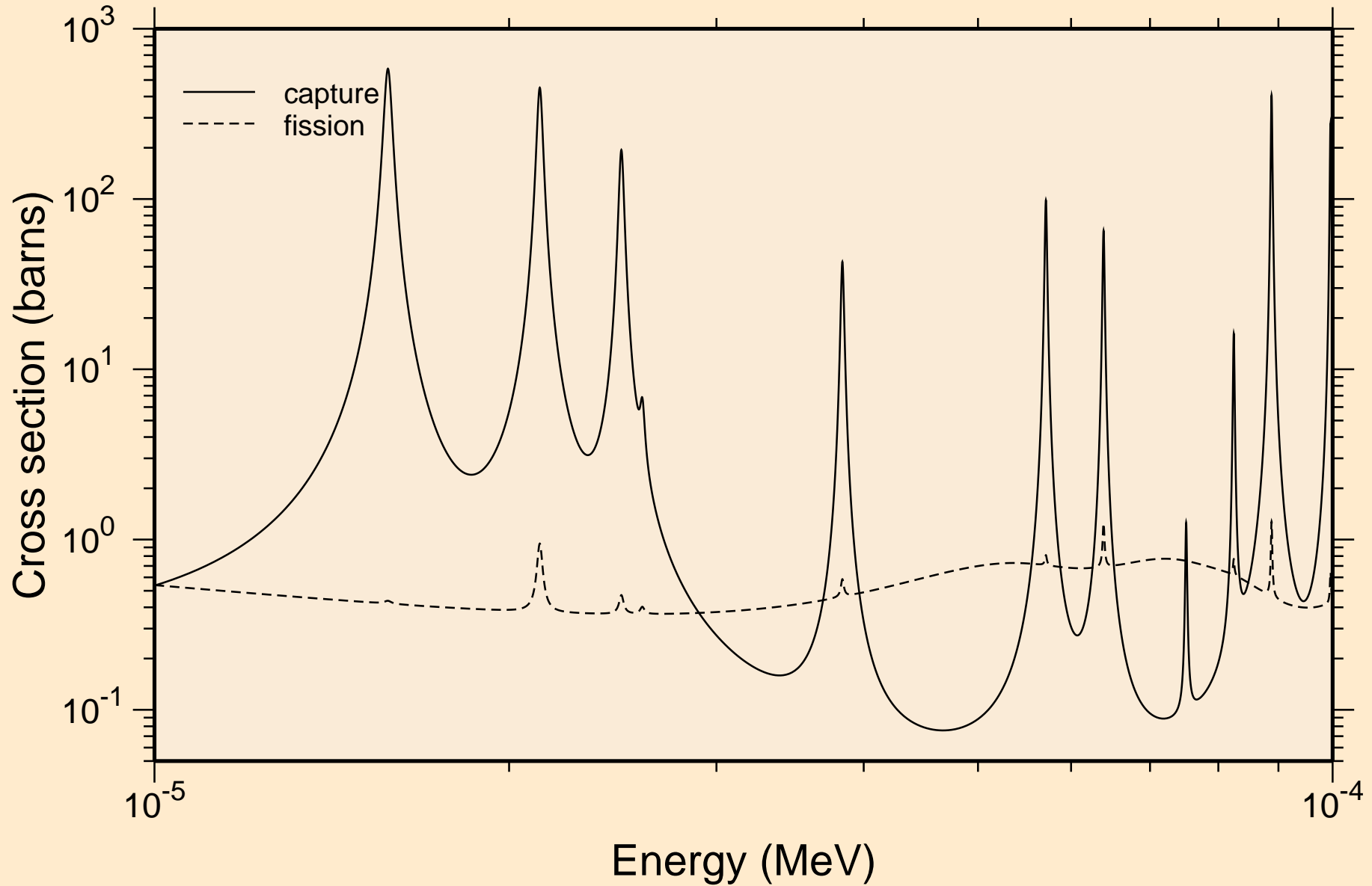

PU247 NEUTRON ACER TENDL-2023 LIBRARY; T=0.K
resonance absorption cross sections

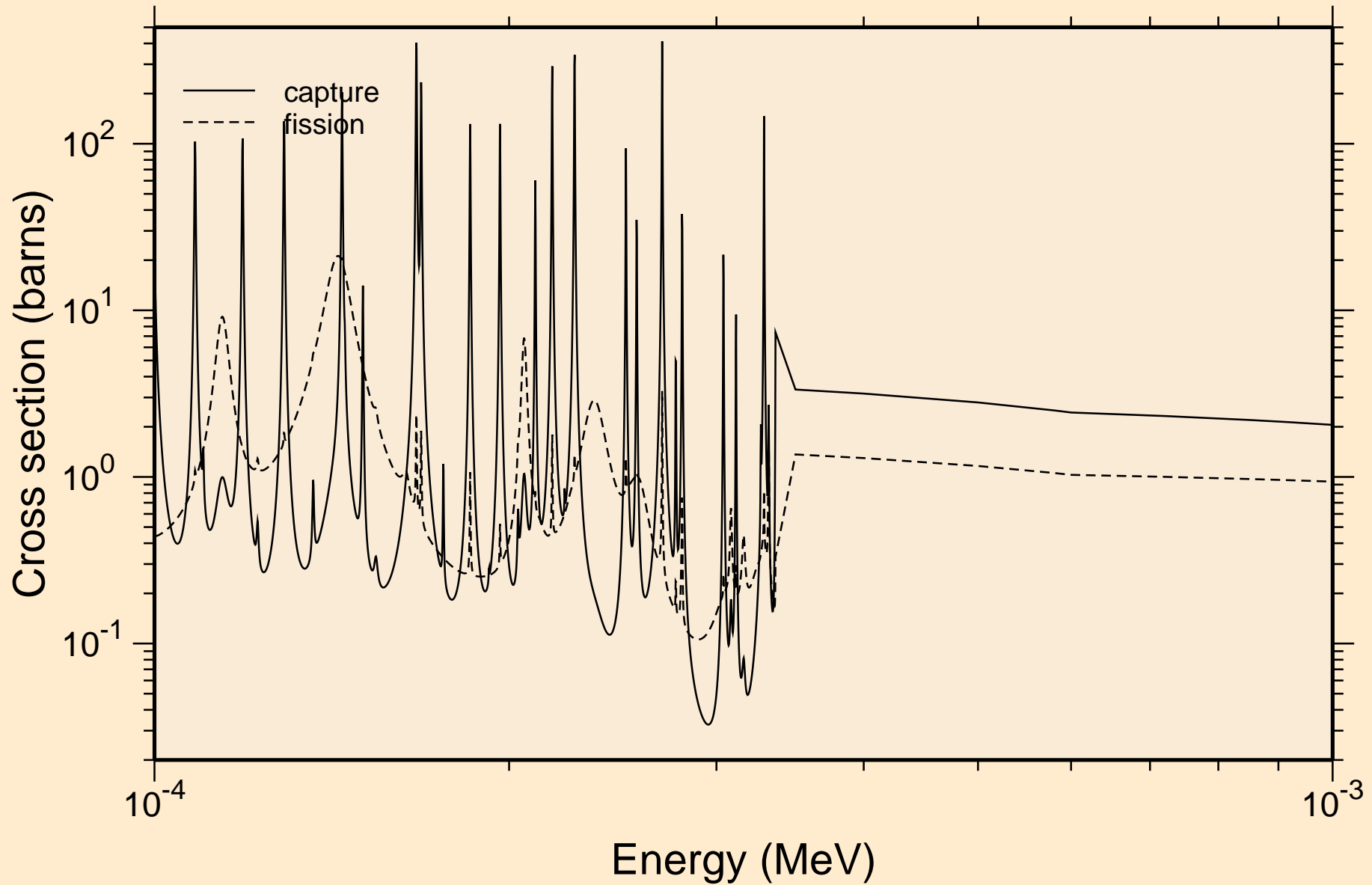

PU247 NEUTRON ACER TENDL-2023 LIBRARY; T=0.K
resonance absorption cross sections

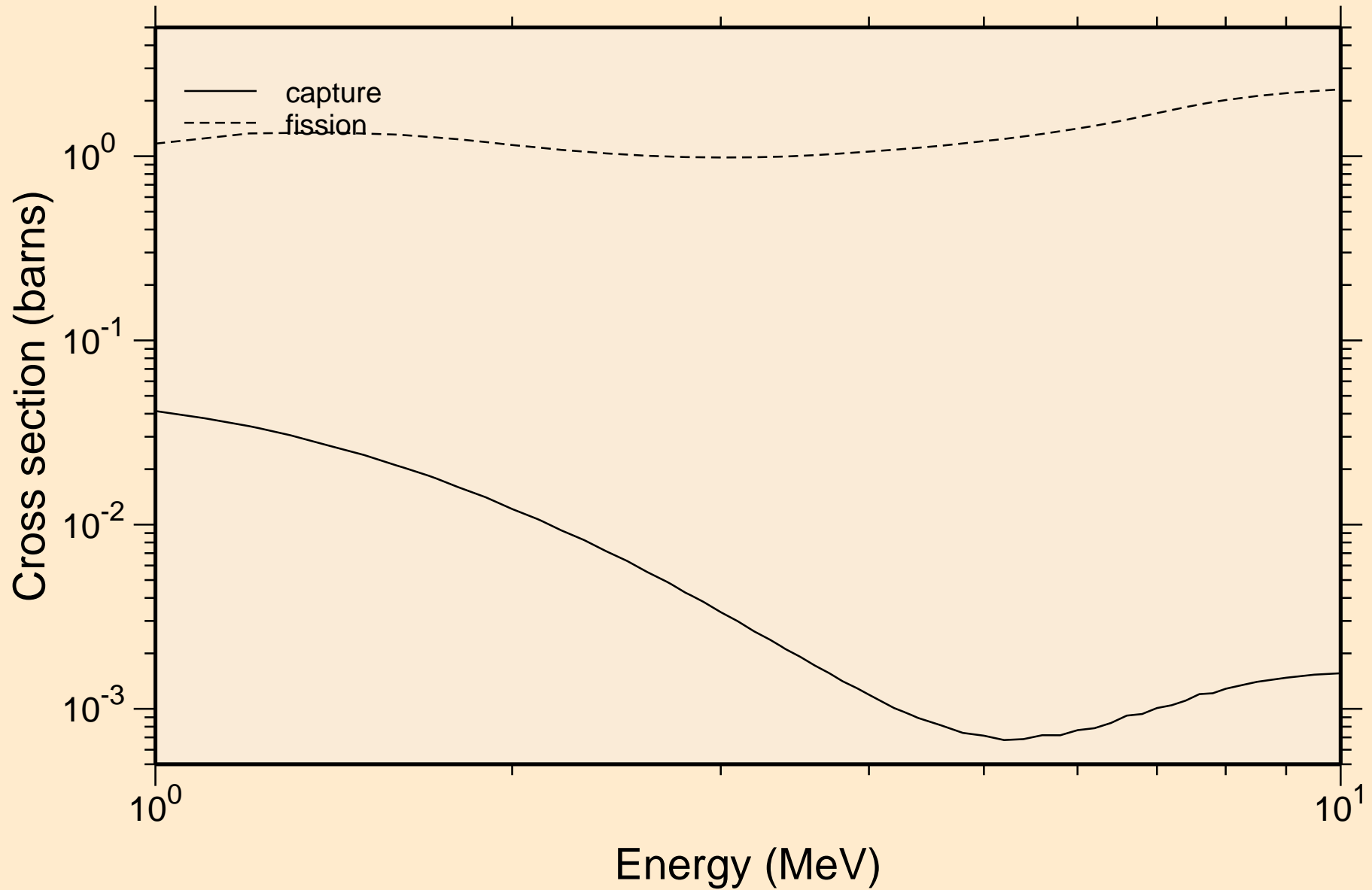

PU247 NEUTRON ACER TENDL-2023 LIBRARY; T=0.K

Heating

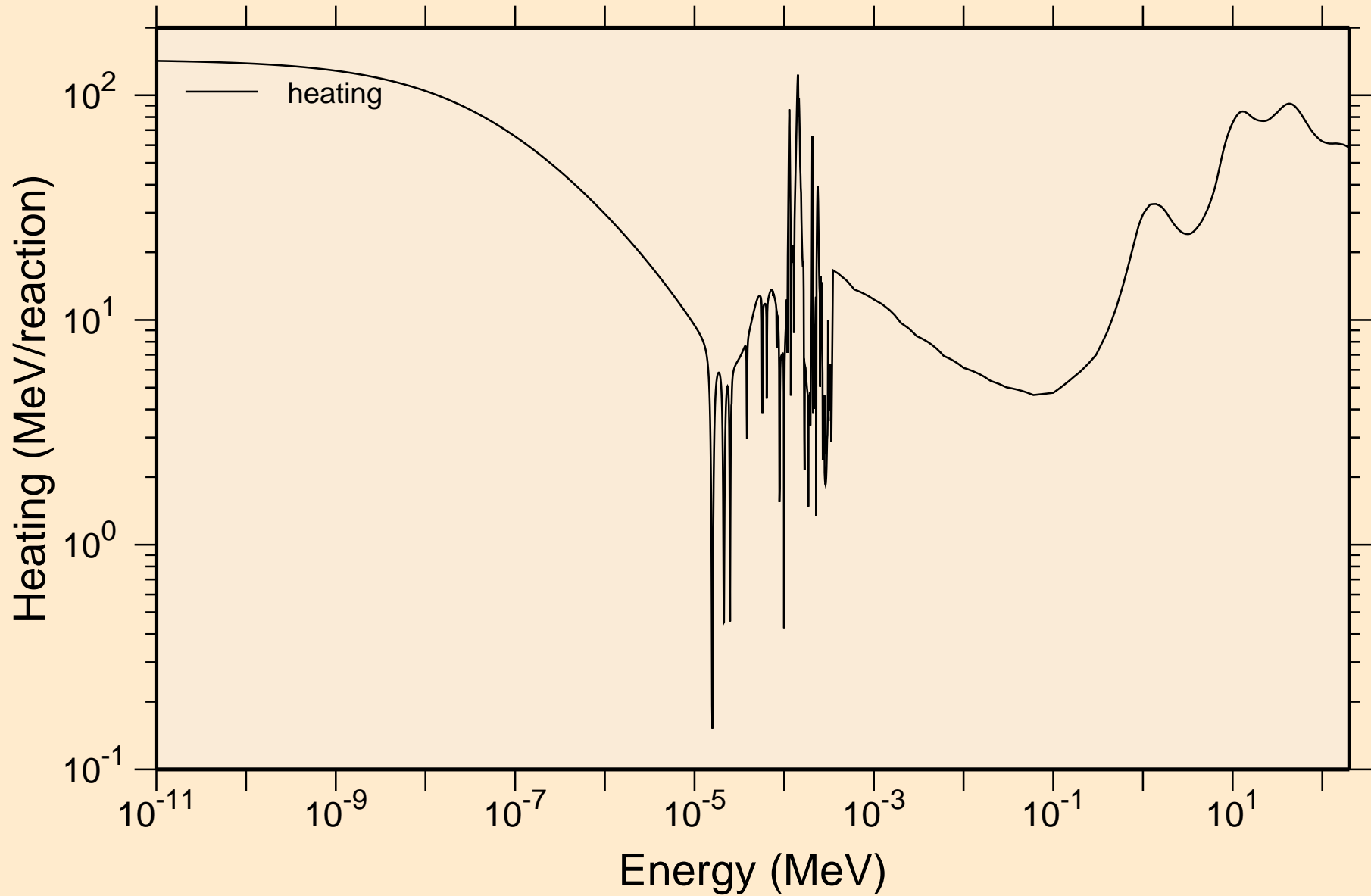

PU247 NEUTRON ACER TENDL-2023 LIBRARY; T=0.K
Damage

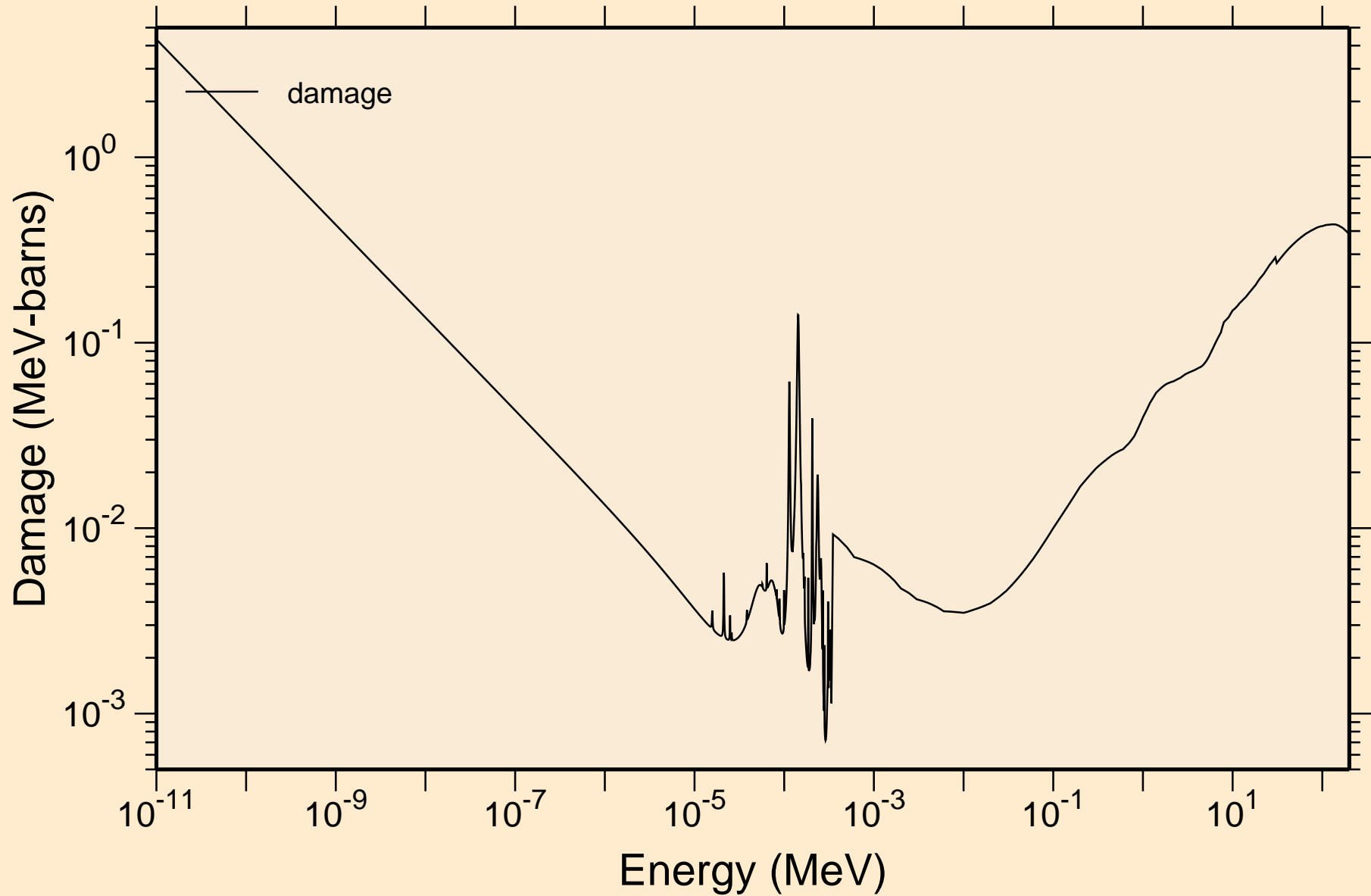

PU247 NEUTRON ACER TENDL-2023 LIBRARY; T=0.K
Non-threshold reactions

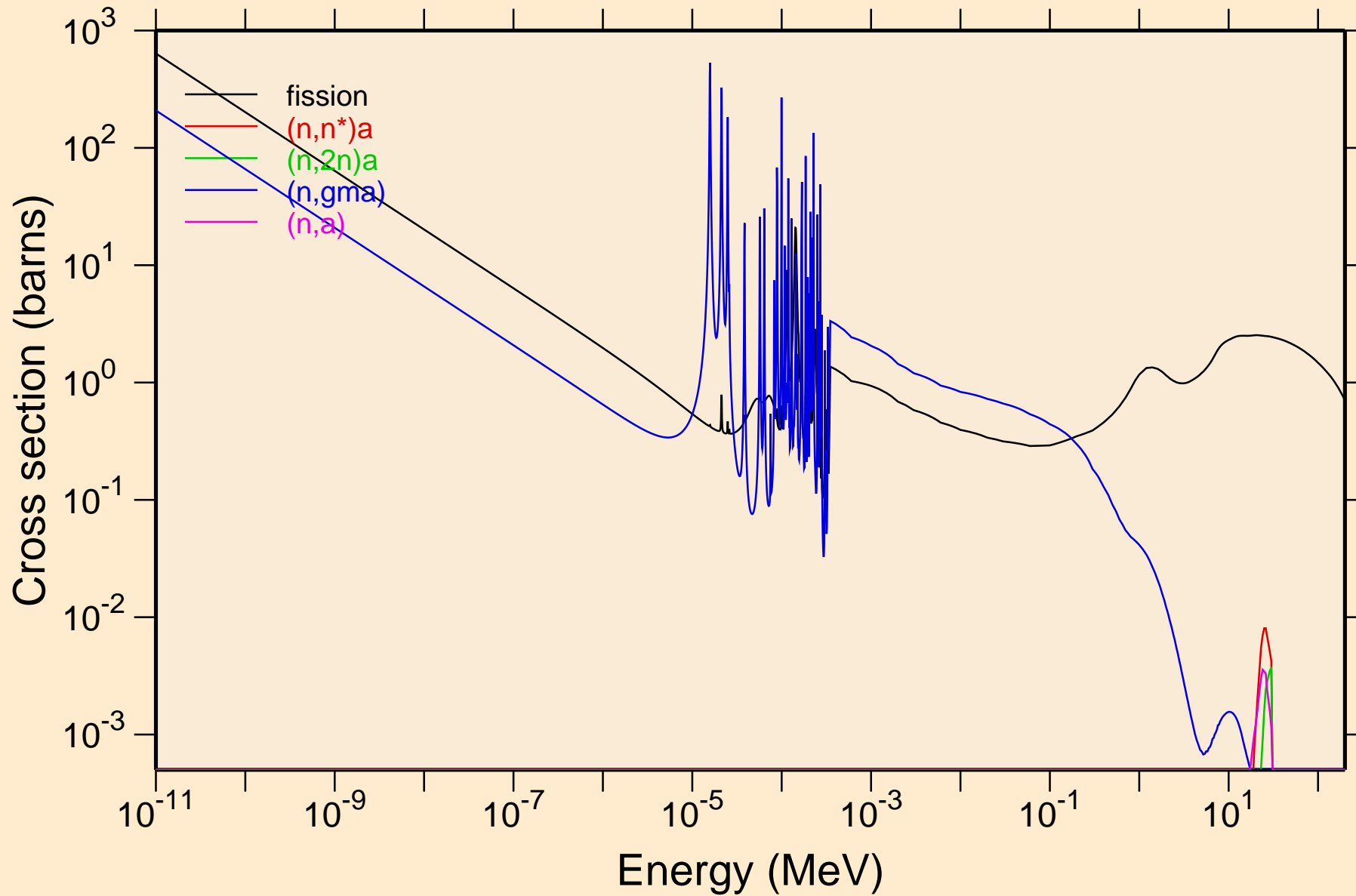

PU247 NEUTRON ACER TENDL-2023 LIBRARY; T=0.K
Non-threshold reactions

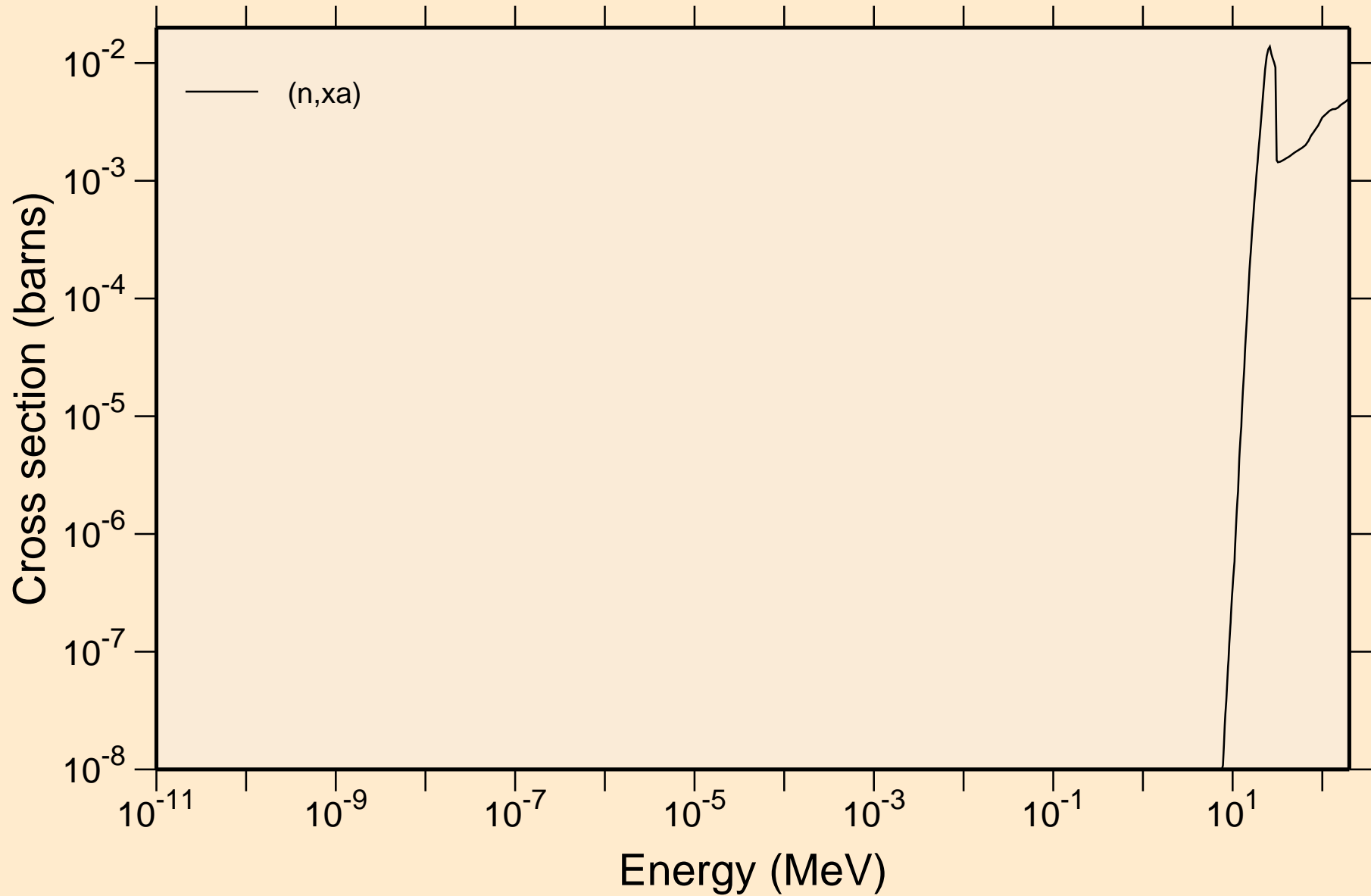

PU247 NEUTRON ACER TENDL-2023 LIBRARY; T=0.K

Principal cross sections

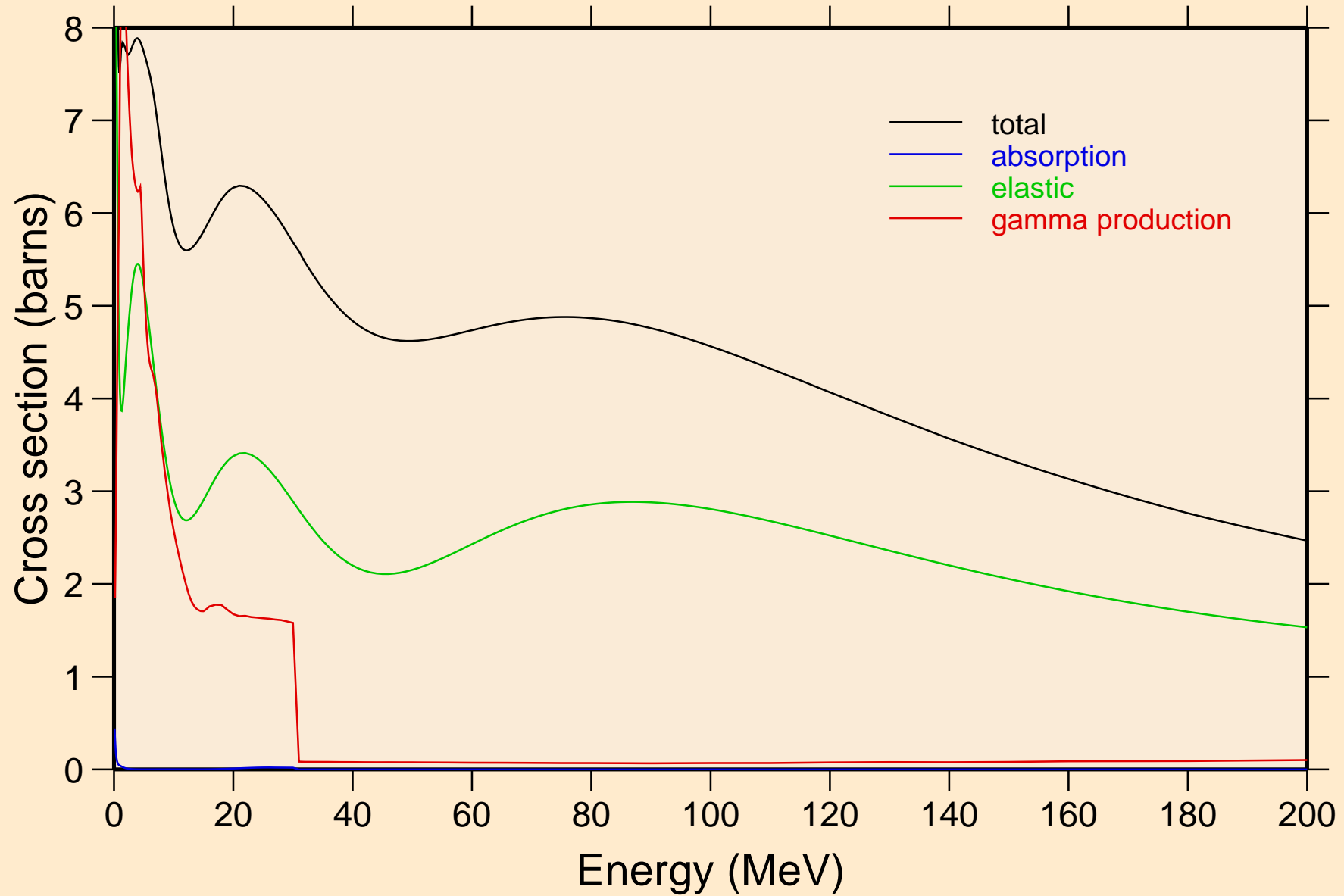

PU247 NEUTRON ACER TENDL-2023 LIBRARY; T=0.K
Heating

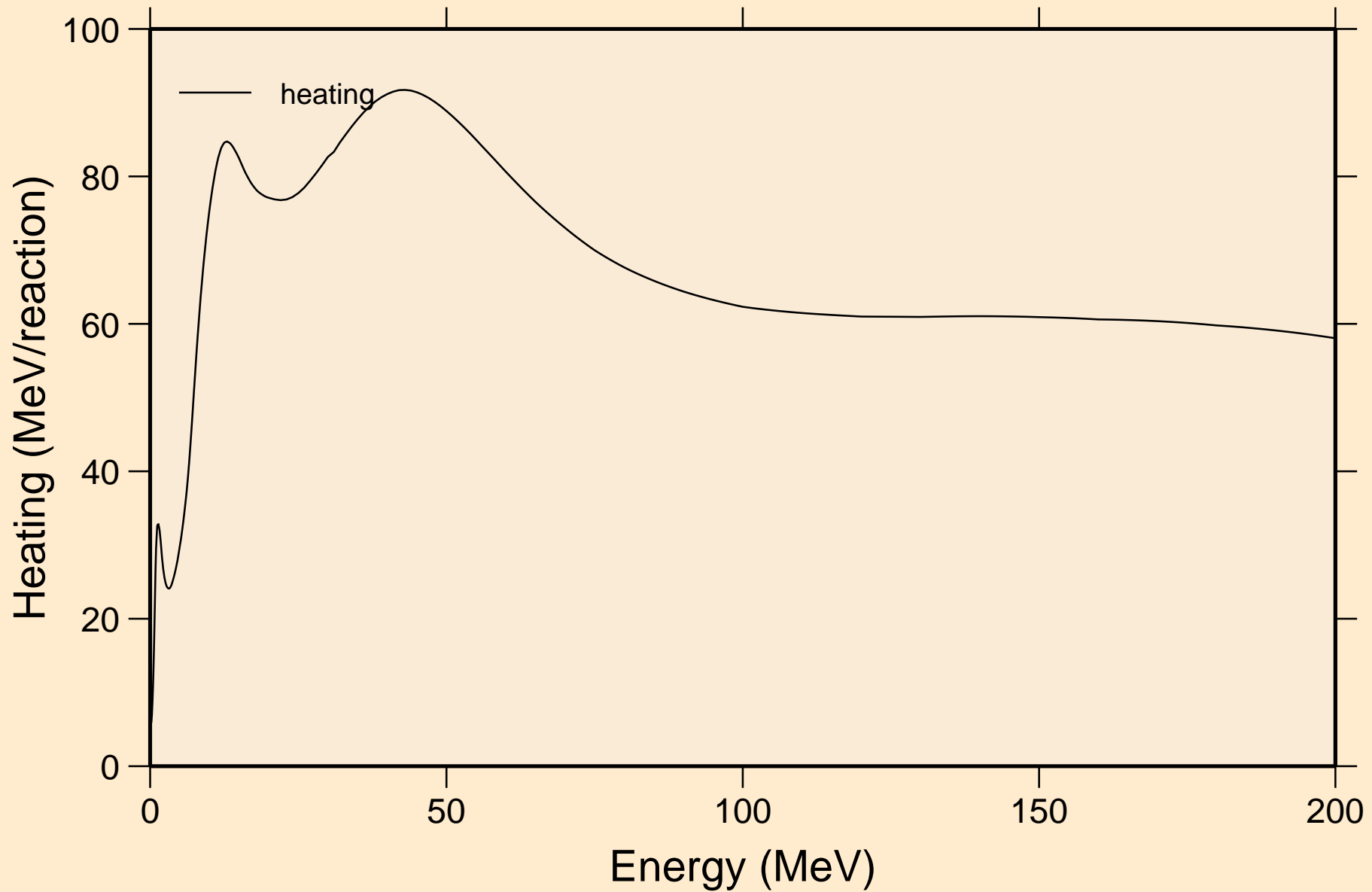

PU247 NEUTRON ACER TENDL-2023 LIBRARY; T=0.K
Damage

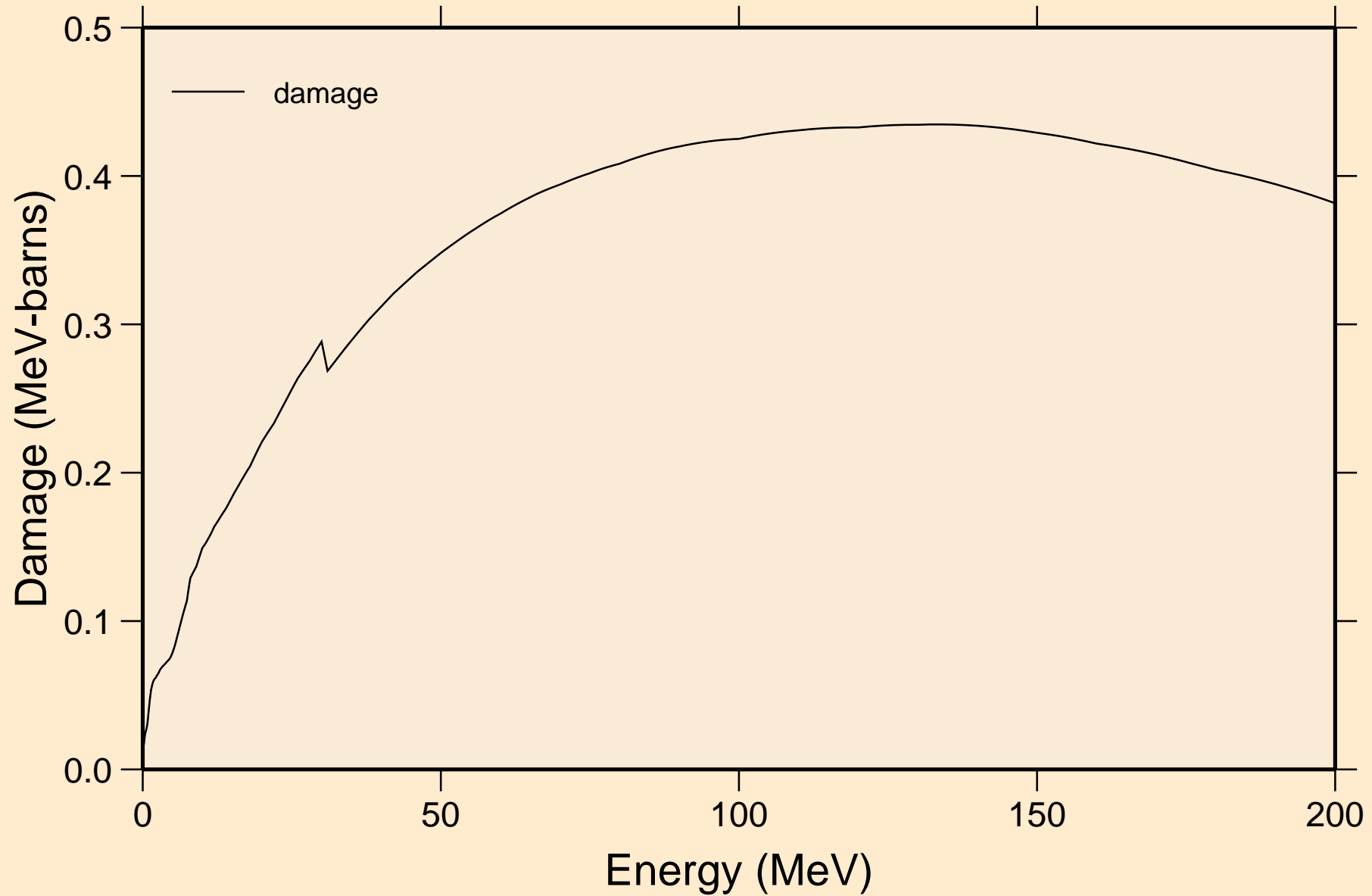

PU247 NEUTRON ACER TENDL-2023 LIBRARY; T=0.K

Non-threshold reactions

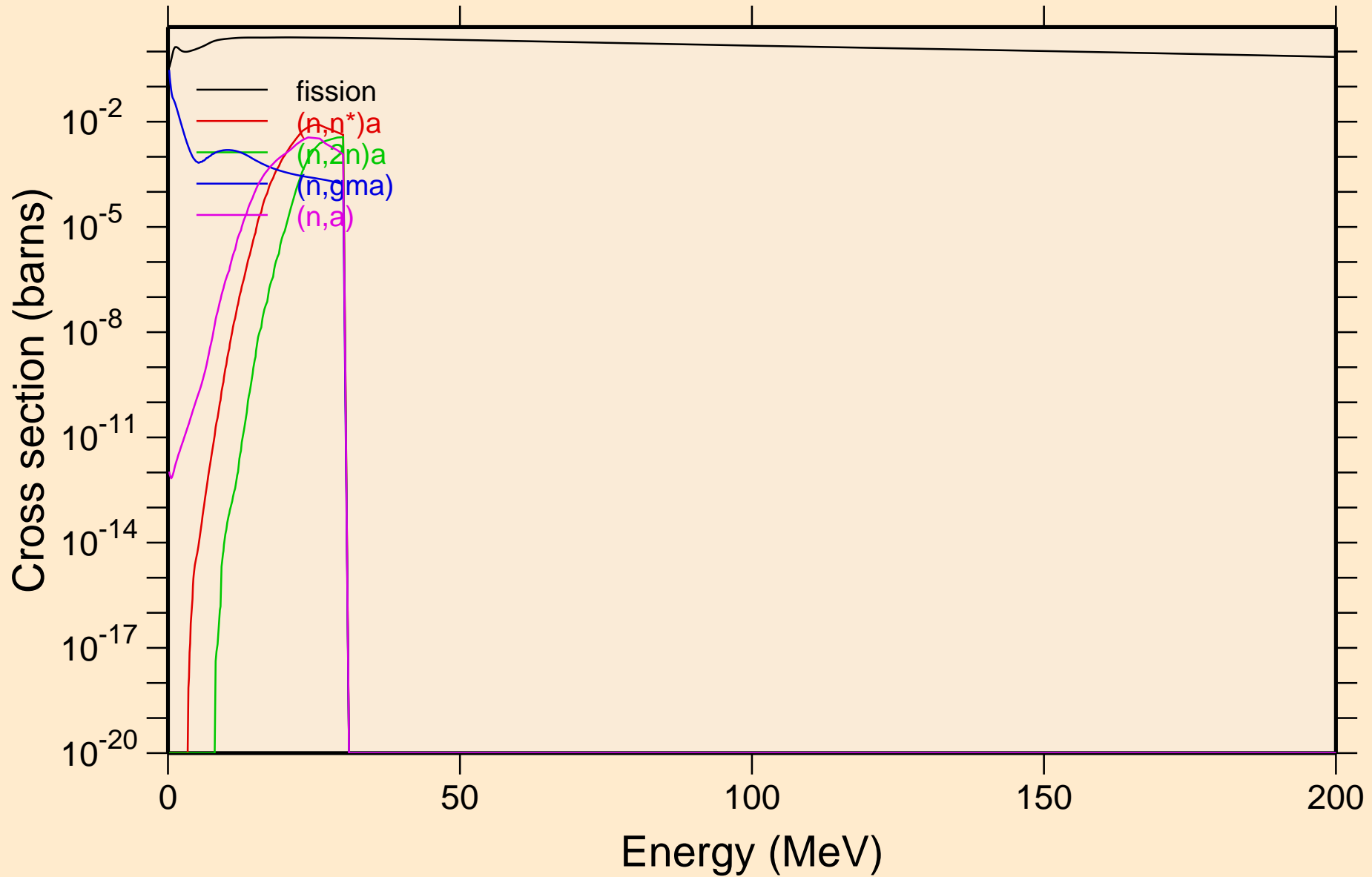

PU247 NEUTRON ACER TENDL-2023 LIBRARY; T=0.K
Non-threshold reactions

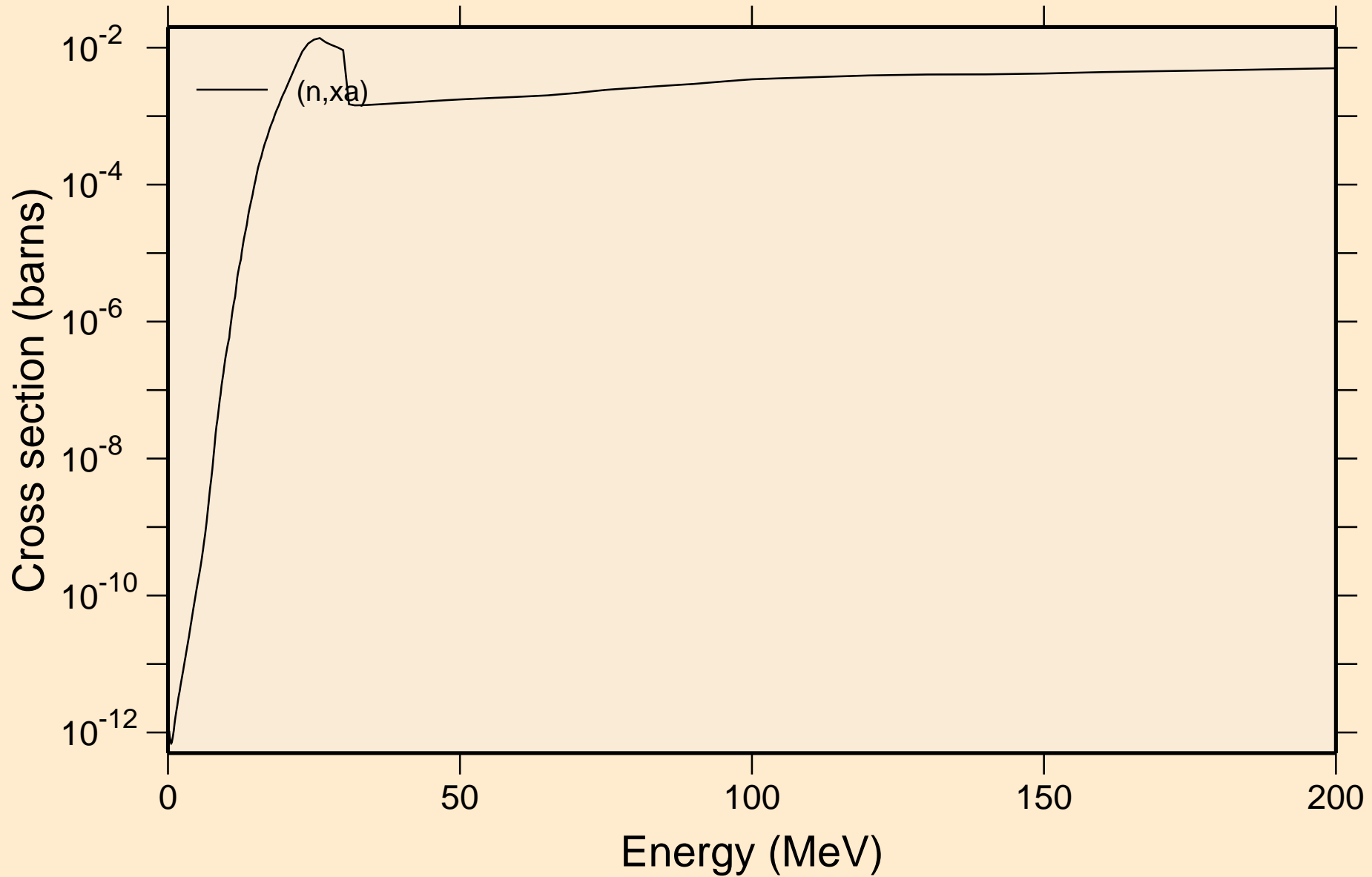

PU247 NEUTRON ACER TENDL-2023 LIBRARY; T=0.K
Inelastic levels

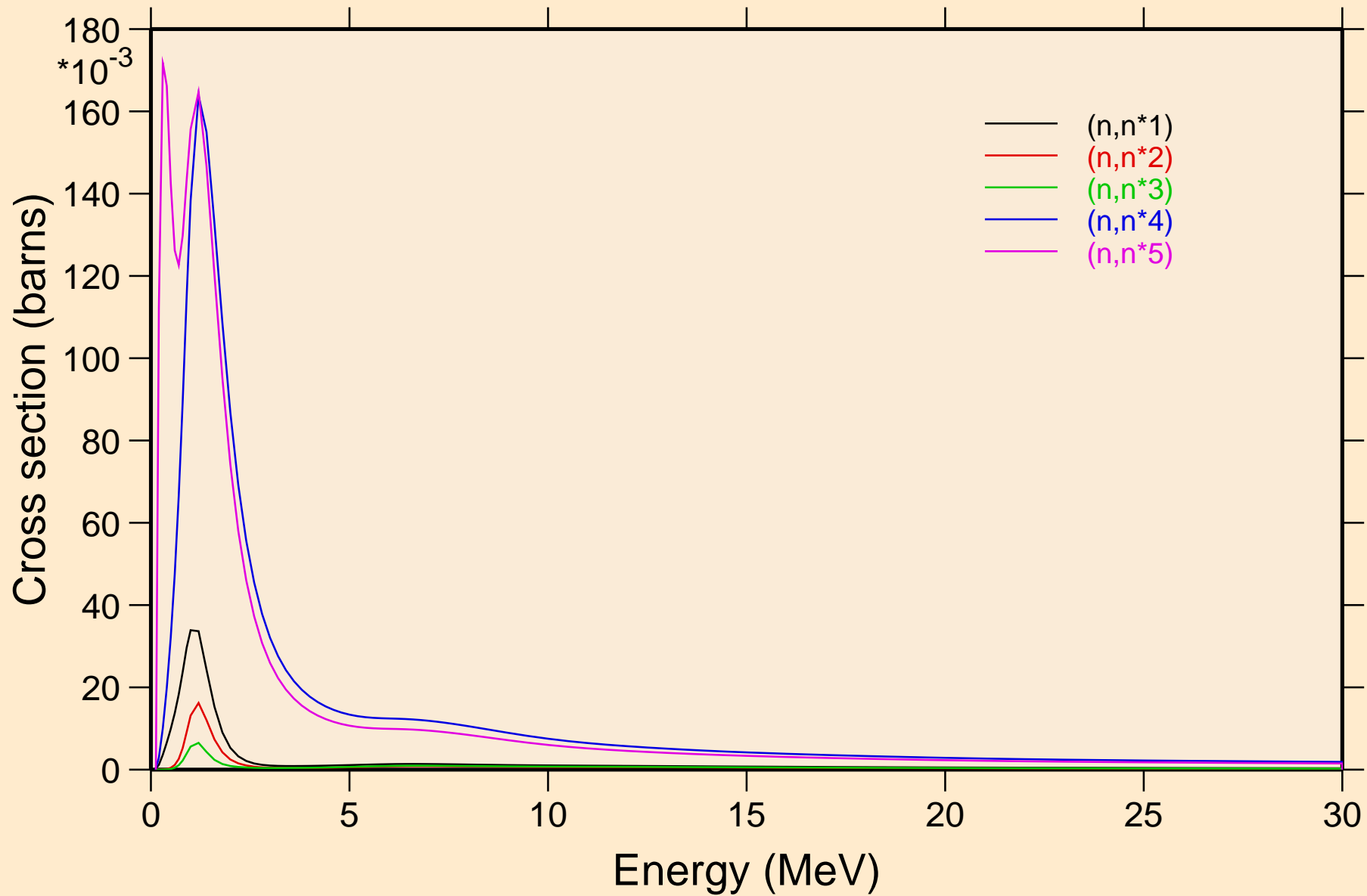

PU247 NEUTRON ACER TENDL-2023 LIBRARY; T=0.K
Inelastic levels

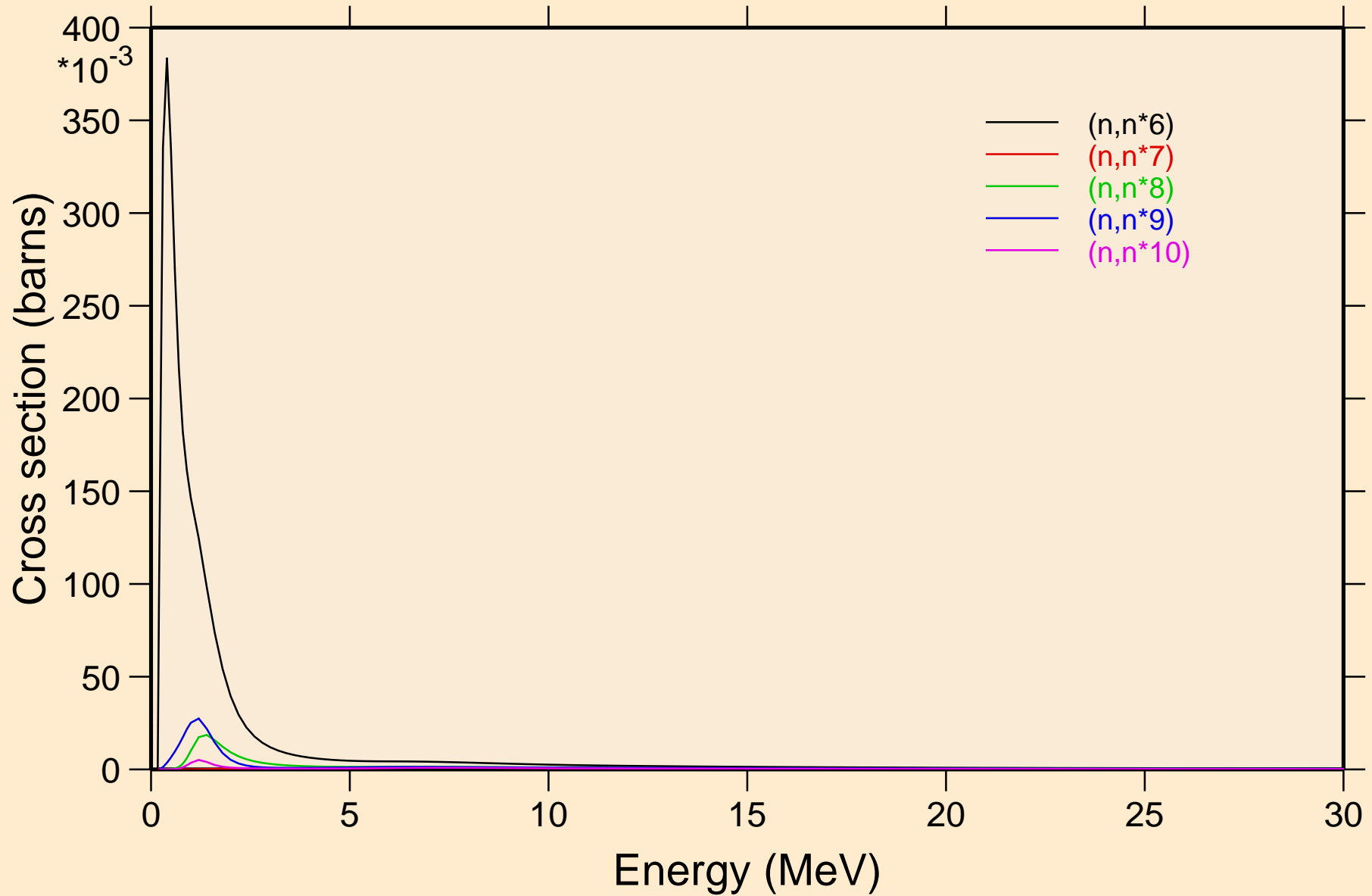

PU247 NEUTRON ACER TENDL-2023 LIBRARY; T=0.K
Inelastic levels

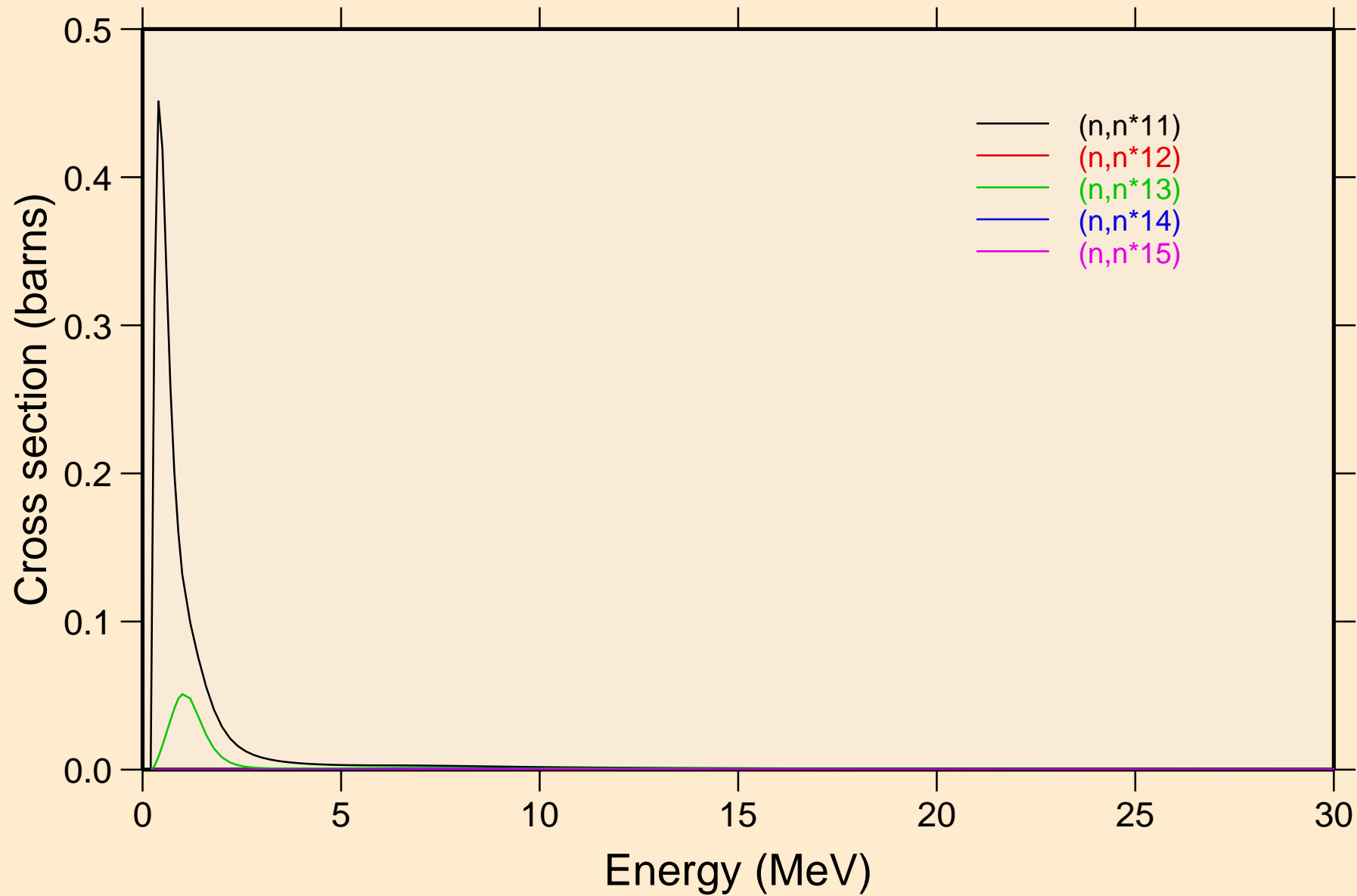

PU247 NEUTRON ACER TENDL-2023 LIBRARY; T=0.K
Inelastic levels

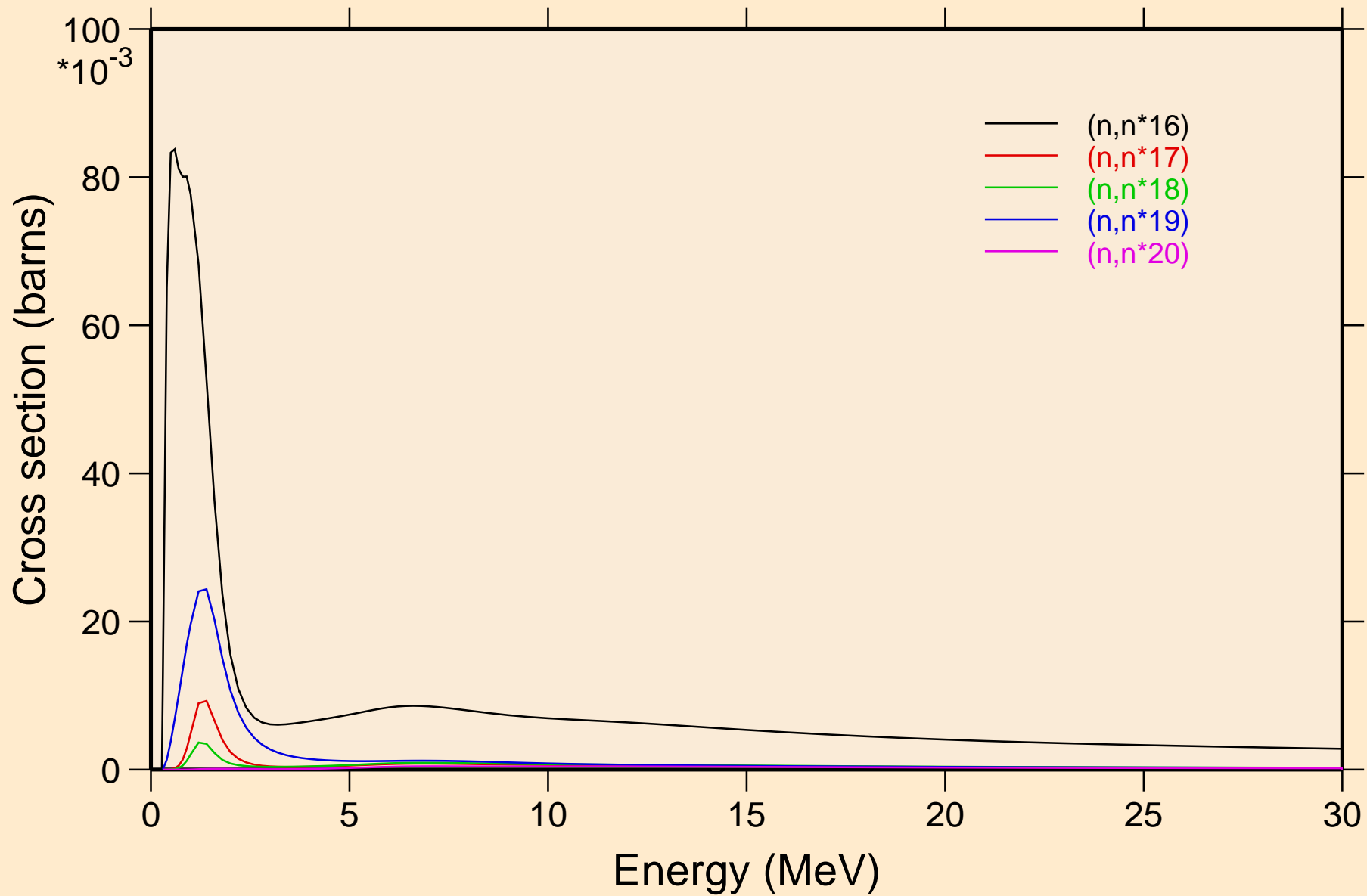

PU247 NEUTRON ACER TENDL-2023 LIBRARY; T=0.K
Inelastic levels

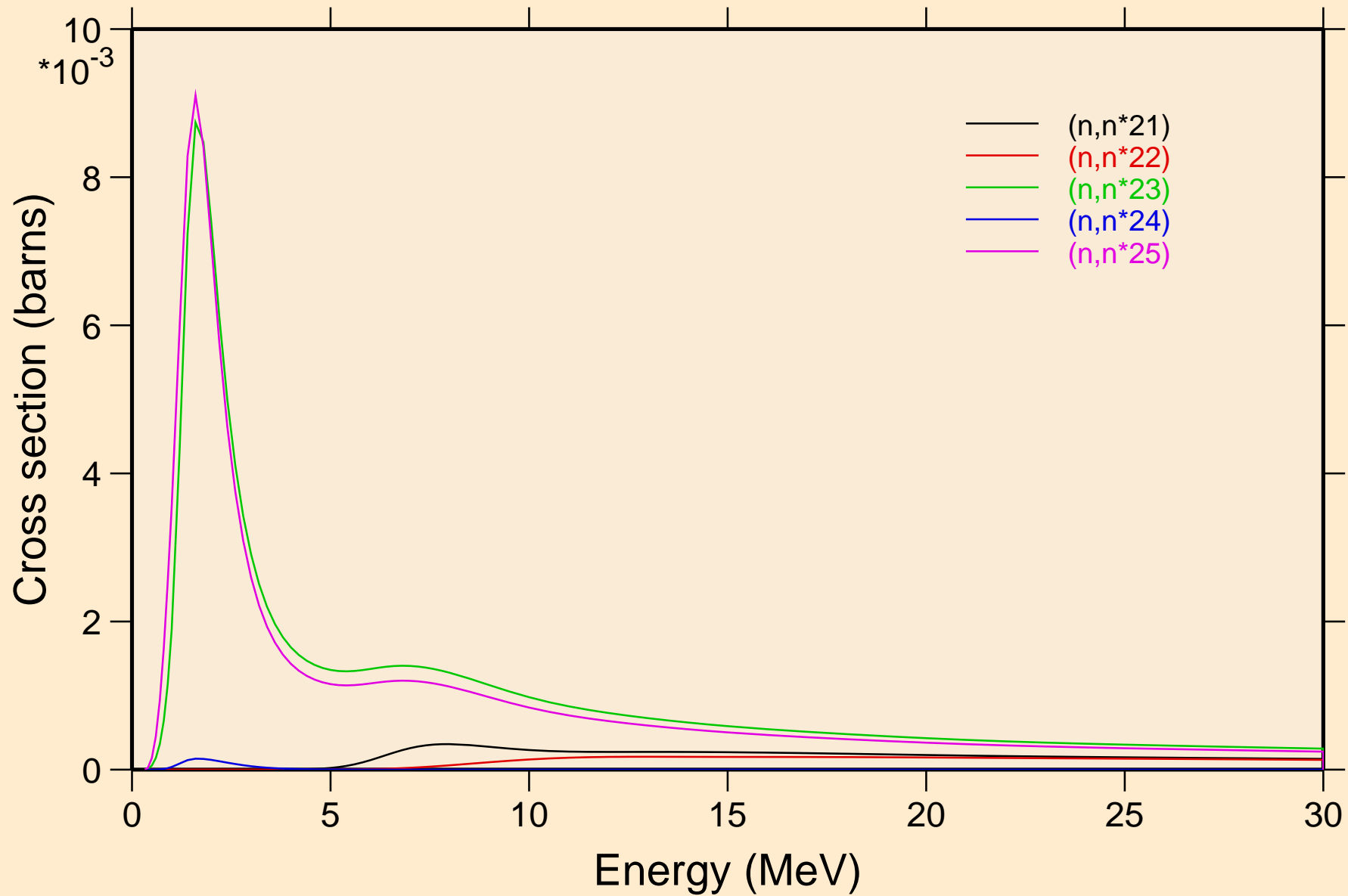

PU247 NEUTRON ACER TENDL-2023 LIBRARY; T=0.K
Inelastic levels

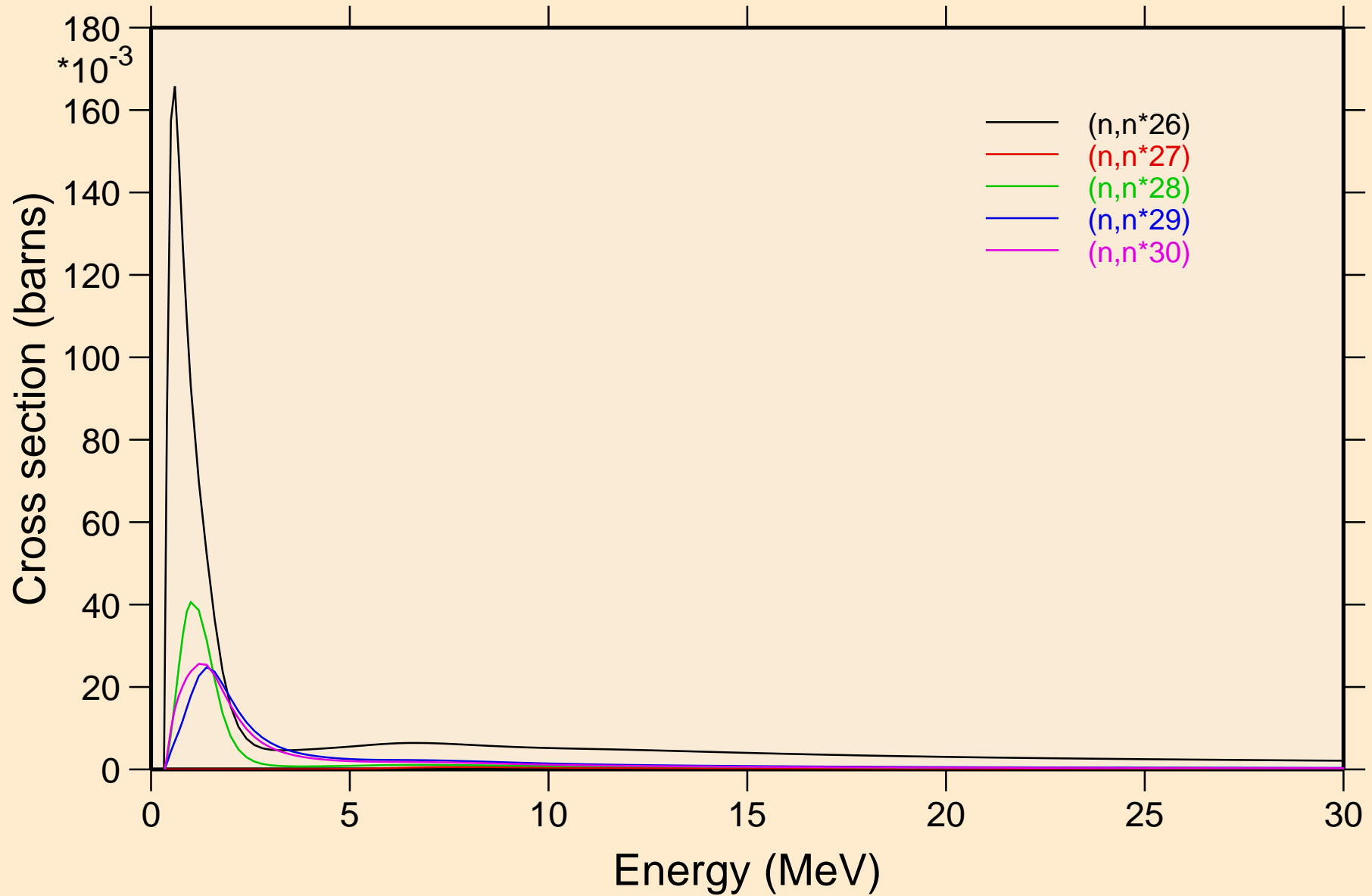

PU247 NEUTRON ACER TENDL-2023 LIBRARY; T=0.K
Threshold reactions

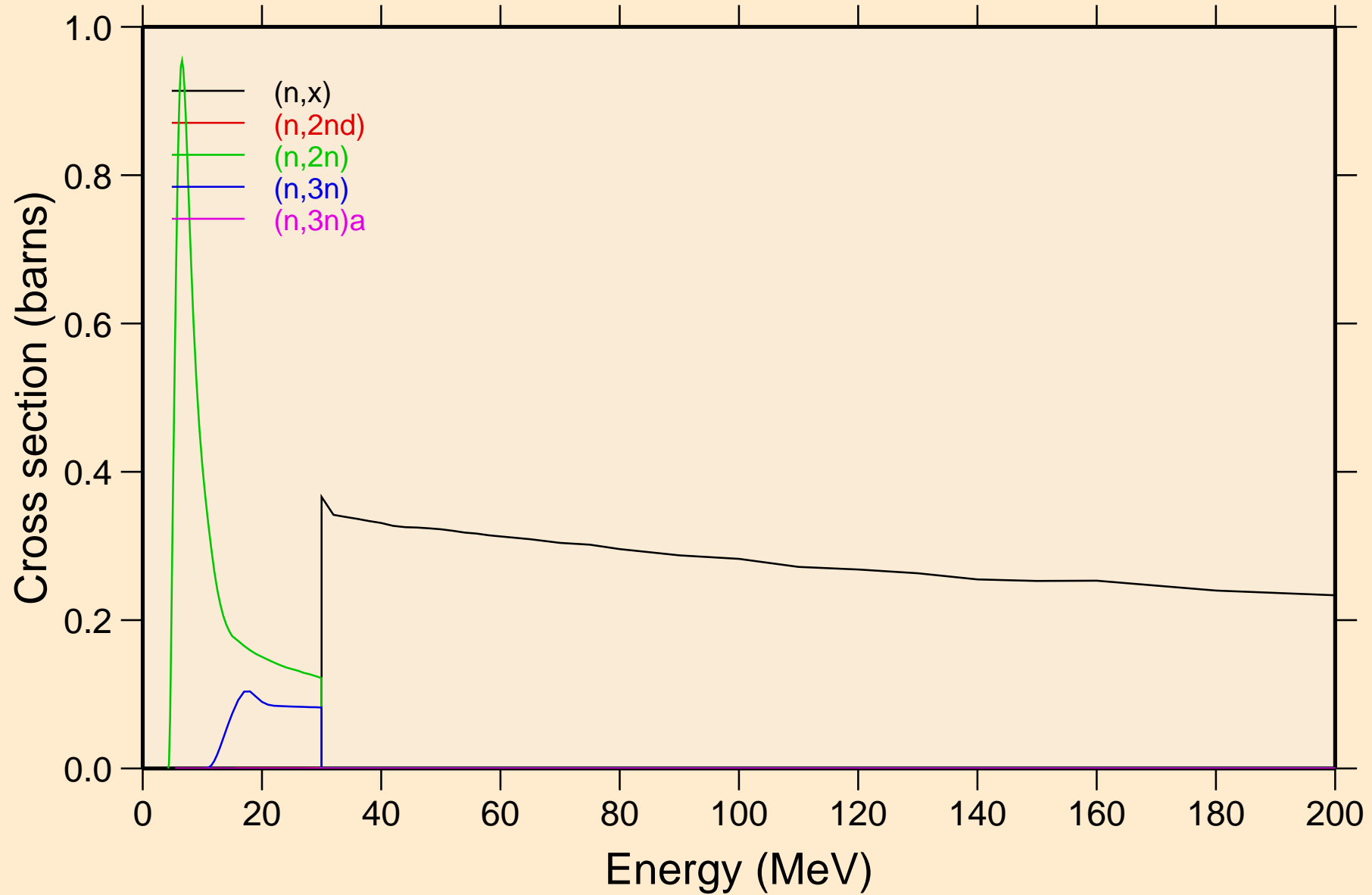

PU247 NEUTRON ACER TENDL-2023 LIBRARY; T=0.K
Threshold reactions

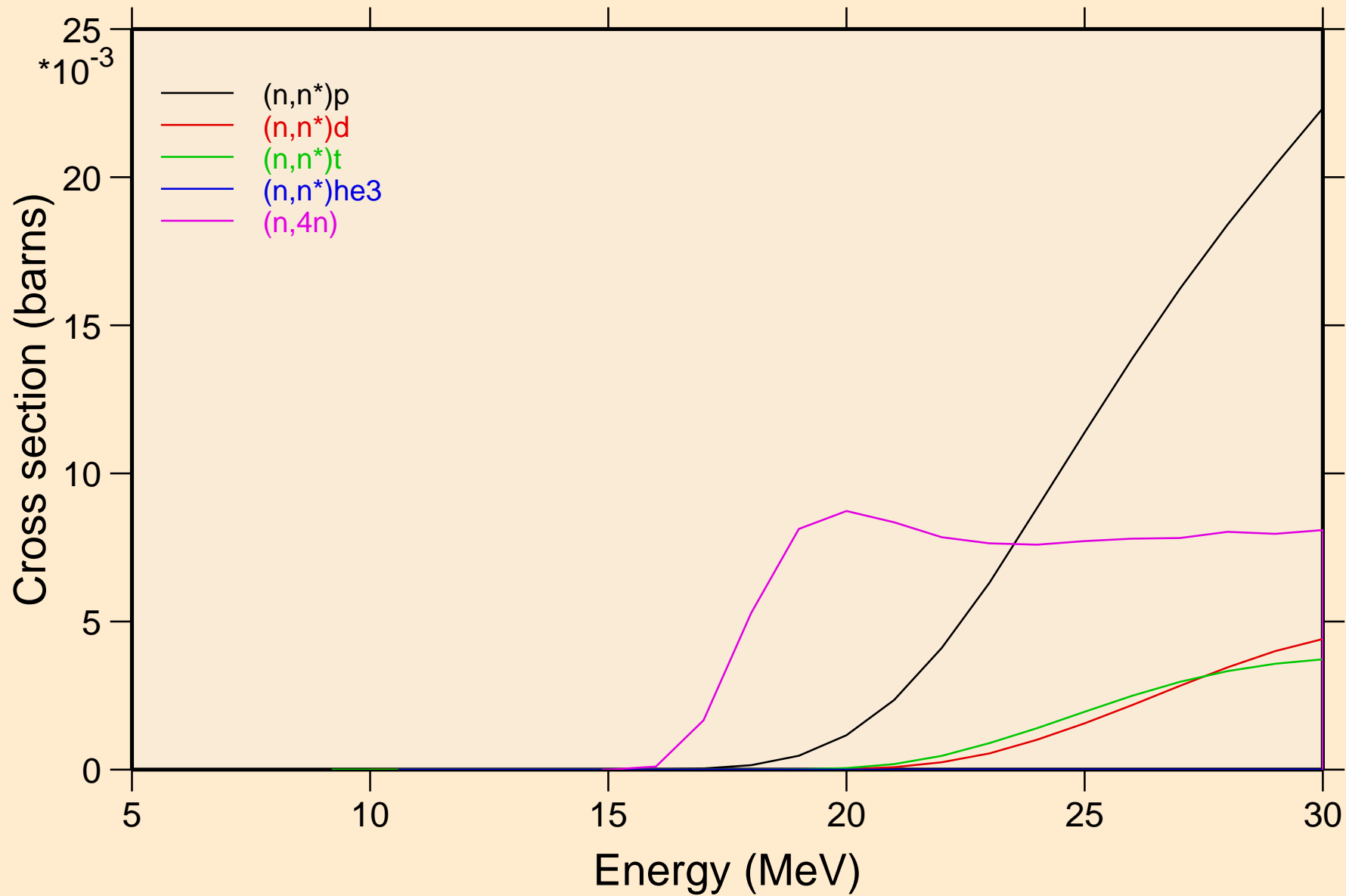

PU247 NEUTRON ACER TENDL-2023 LIBRARY; T=0.K
Threshold reactions

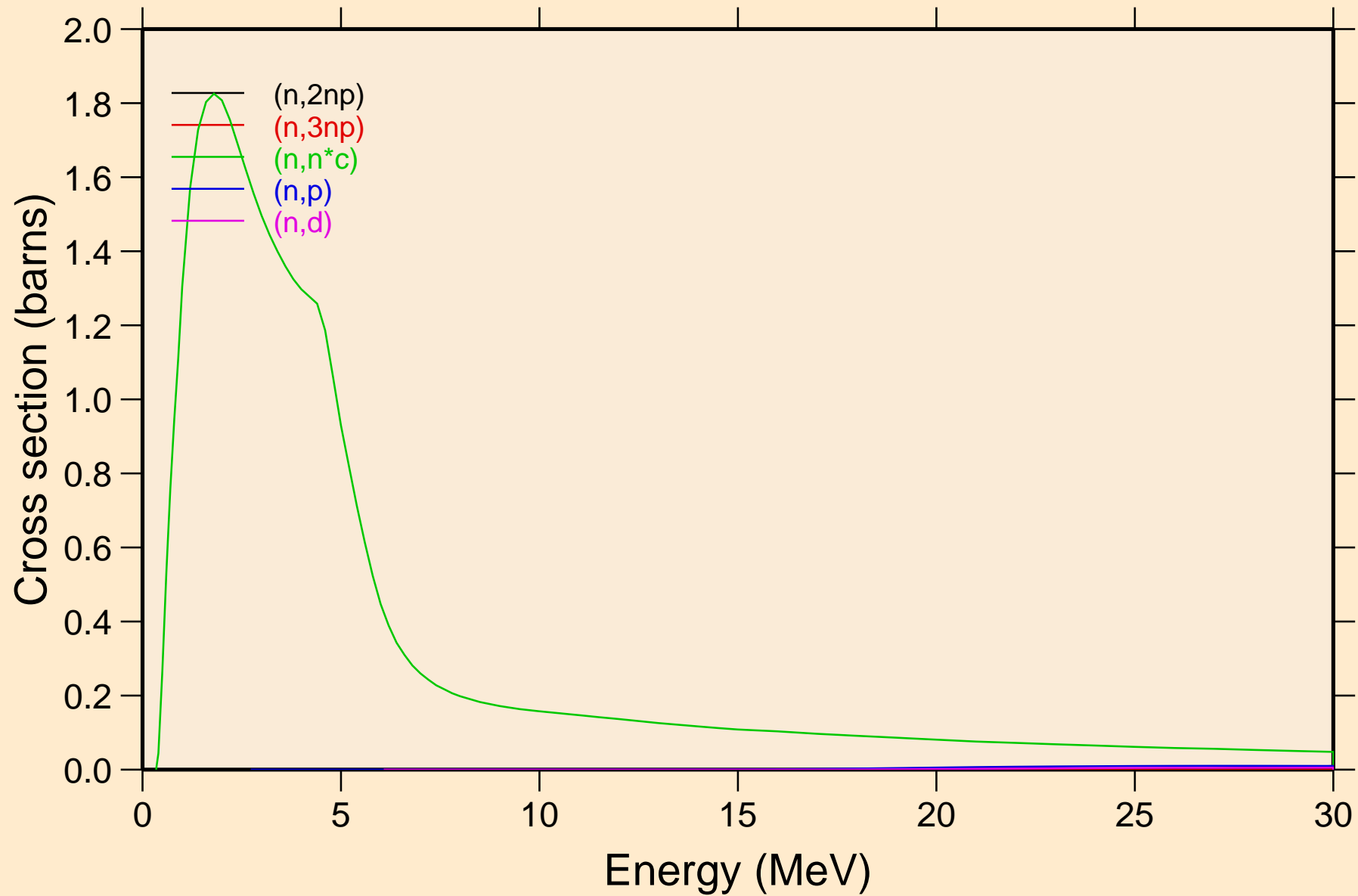

PU247 NEUTRON ACER TENDL-2023 LIBRARY; T=0.K
Threshold reactions

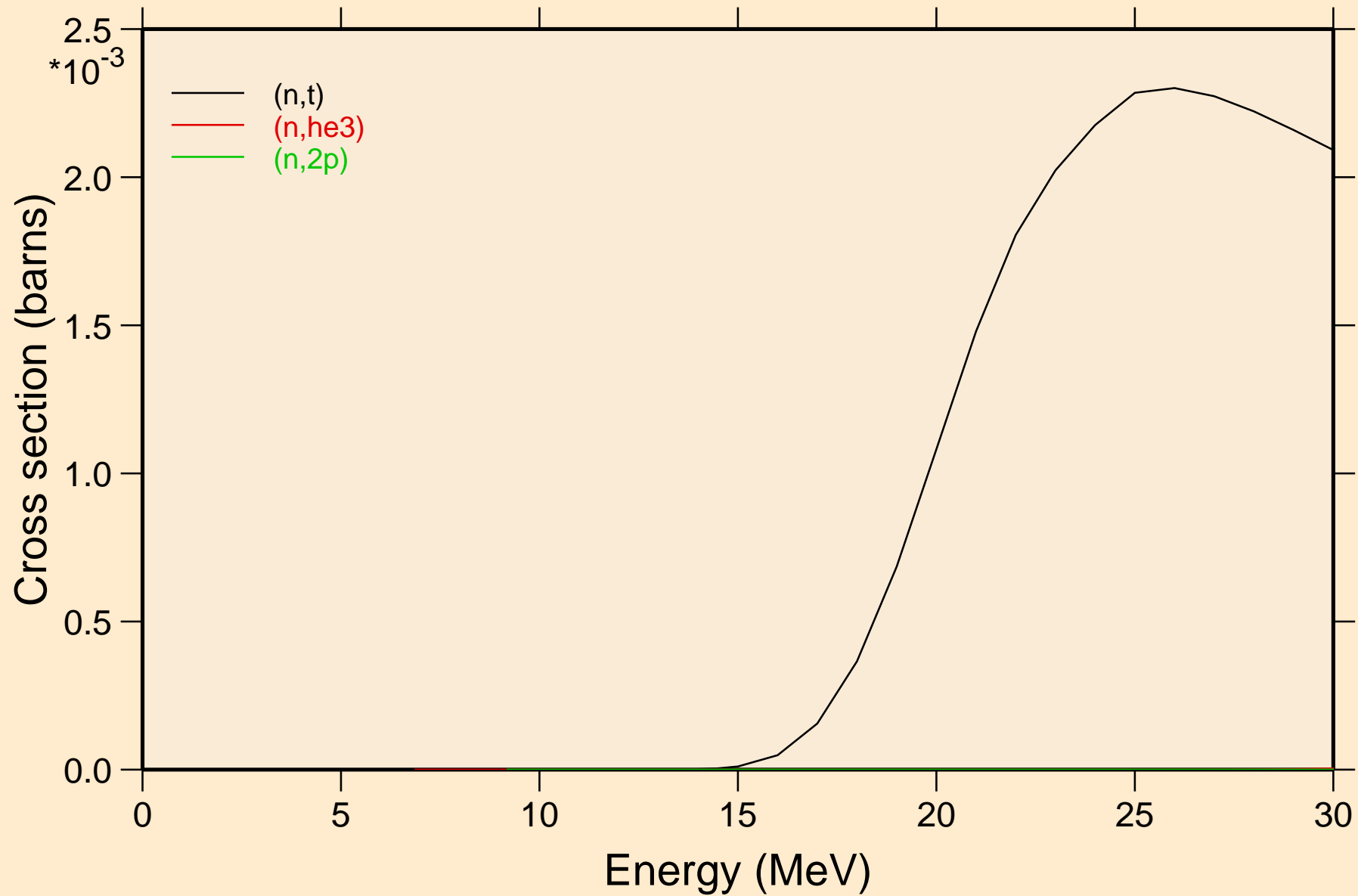

PU247 NEUTRON ACER TENDL-2023 LIBRARY; T=0.K
Threshold reactions

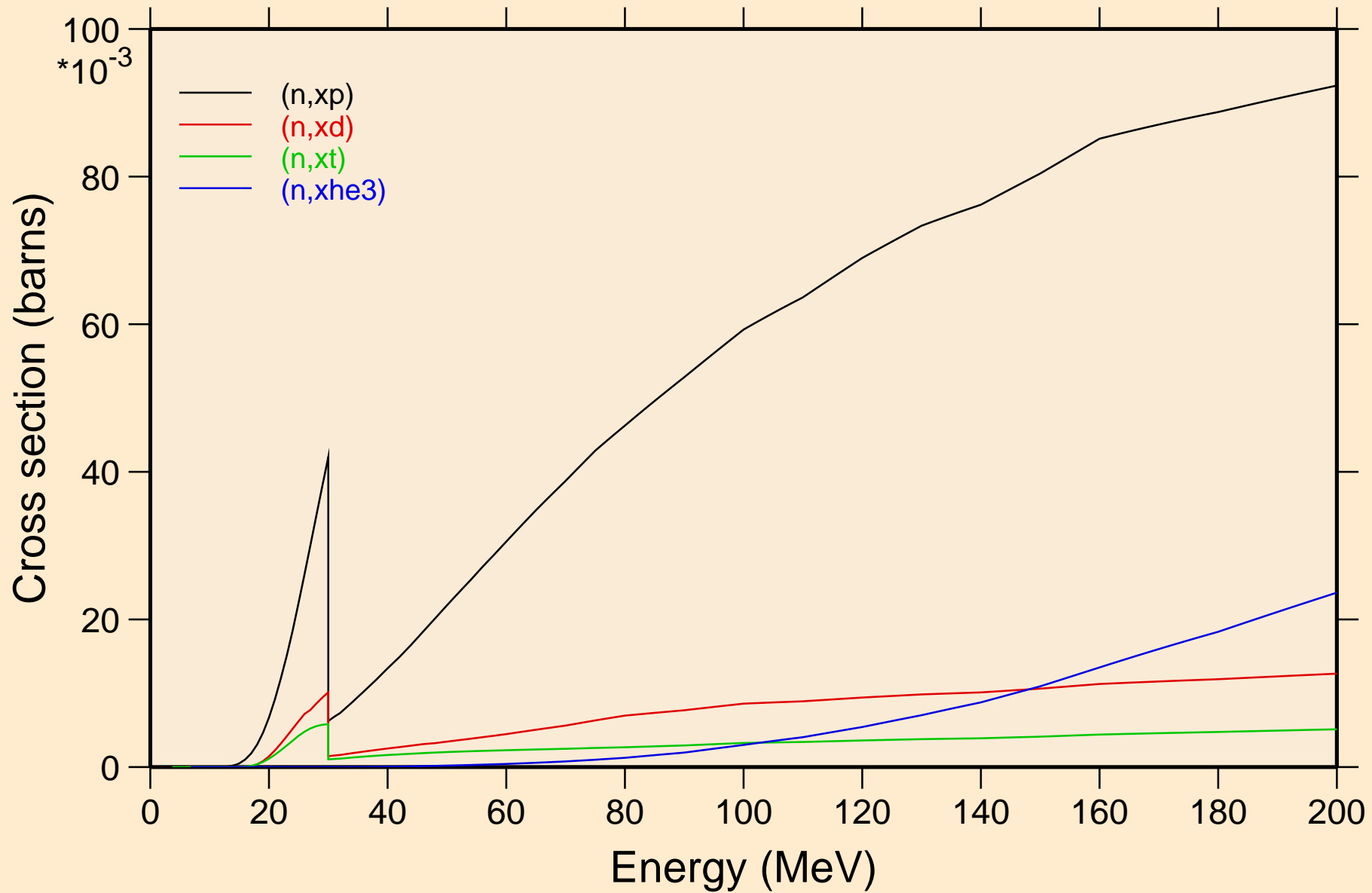

PU247 NEUTRON ACER TENDL-2023 LIBRARY; T=0.K
angular distribution for elastic

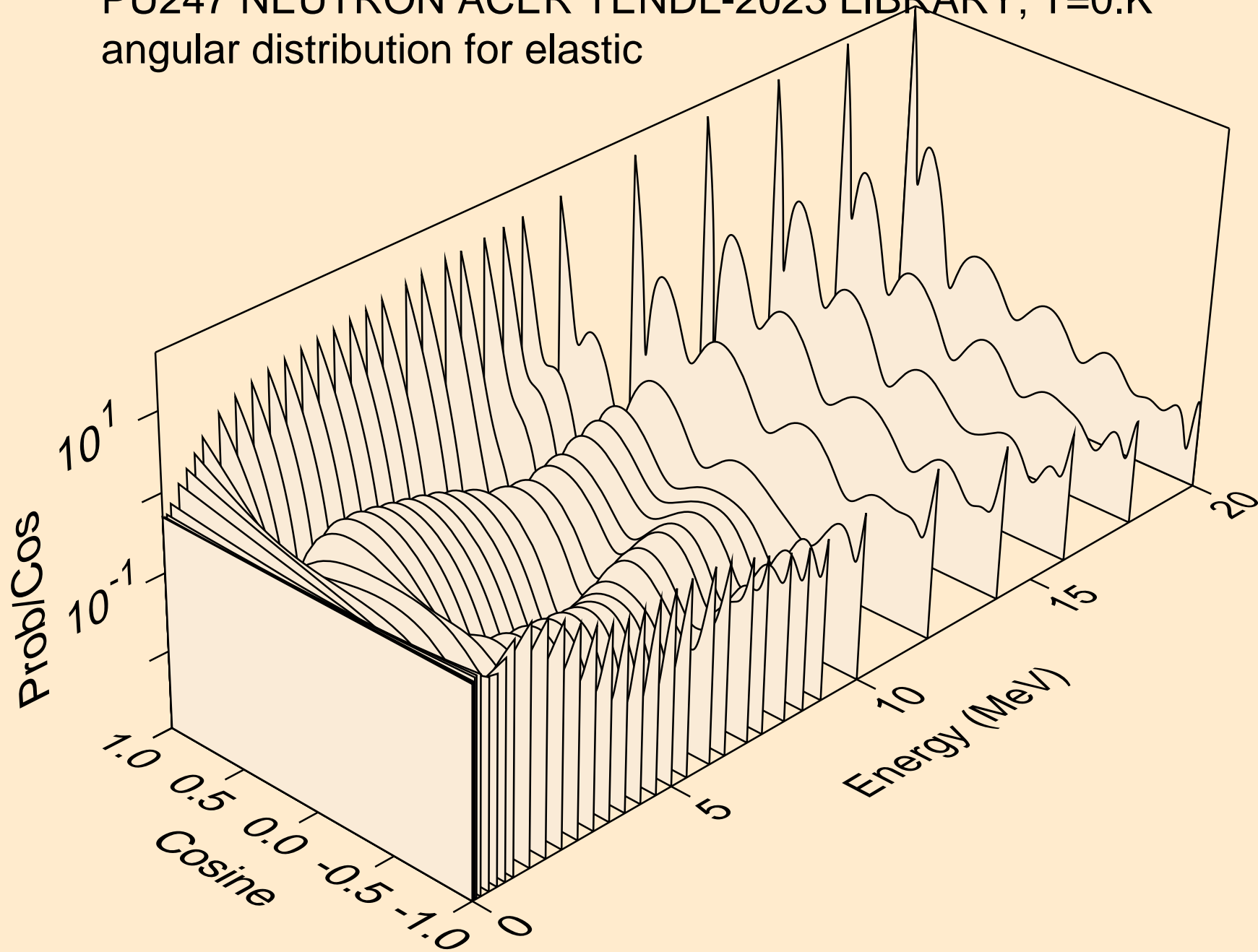

PU247 NEUTRON ACER TENDL-2023 LIBRARY; T=0.K
angular distribution for elastic

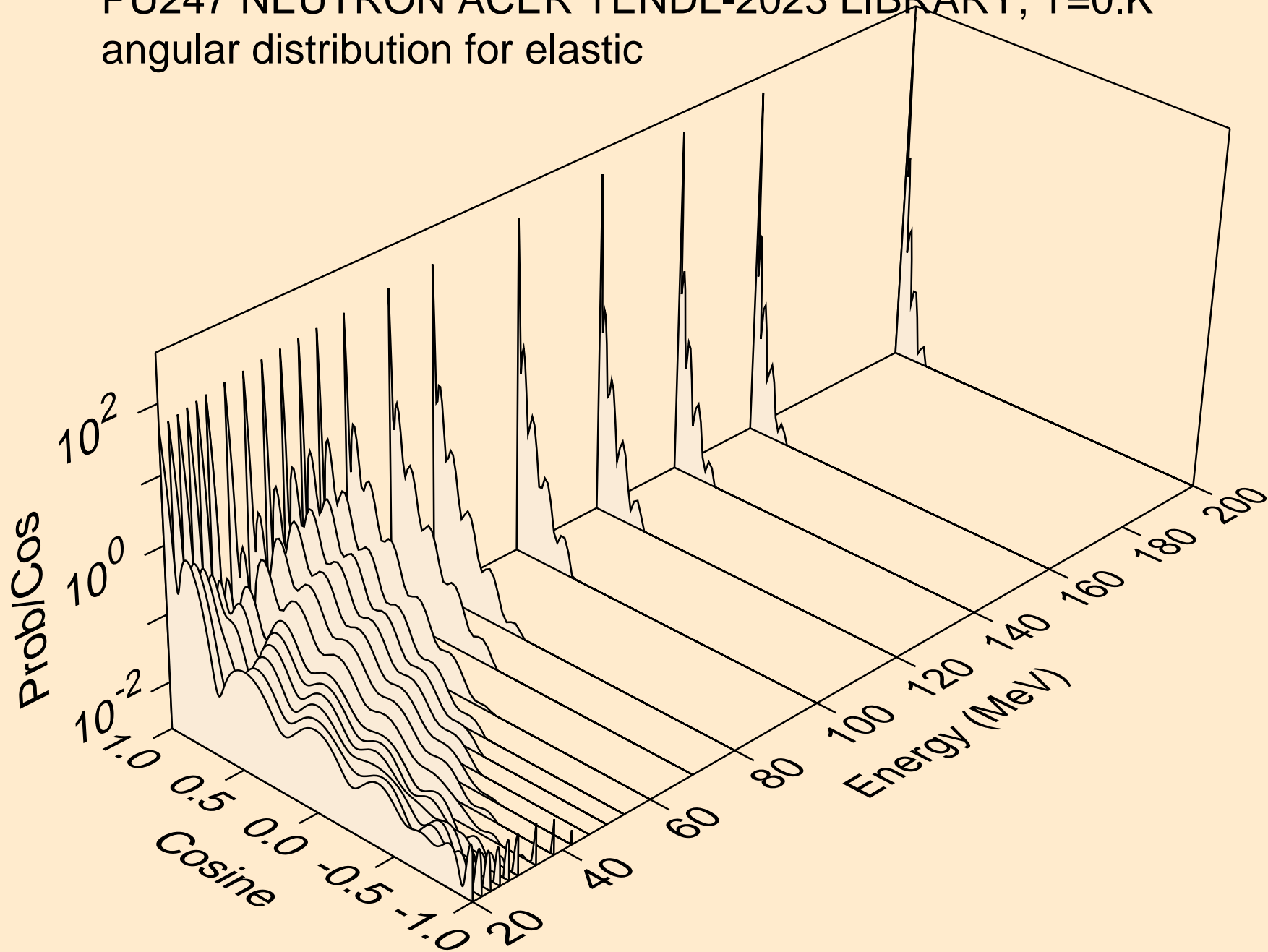

PU247 NEUTRON ACER TENDL-2023 LIBRARY; T=0.K
angular distribution for (n,n*1)

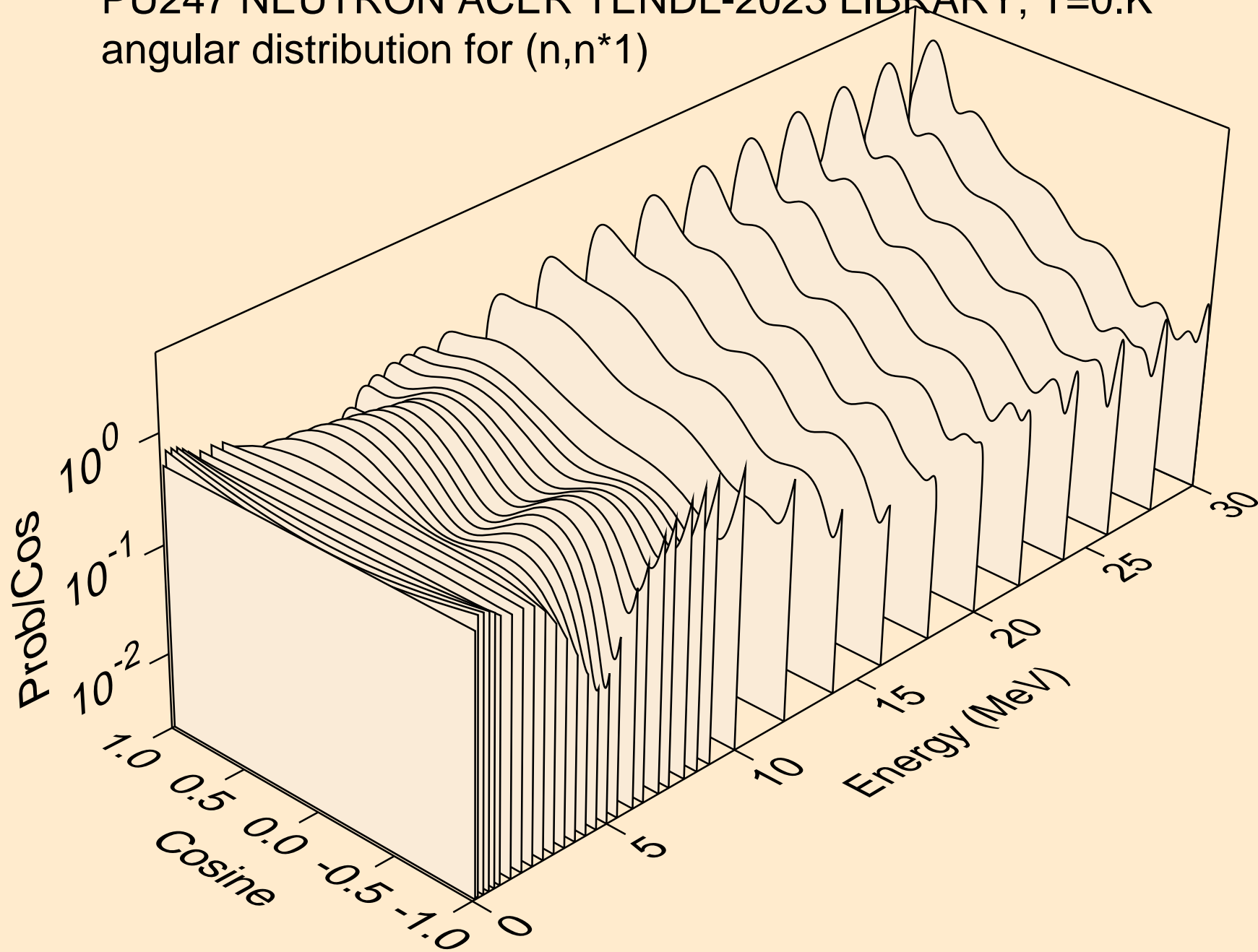

PU247 NEUTRON ACER TENDL-2023 LIBRARY; T=0.K
angular distribution for (n,n*2)

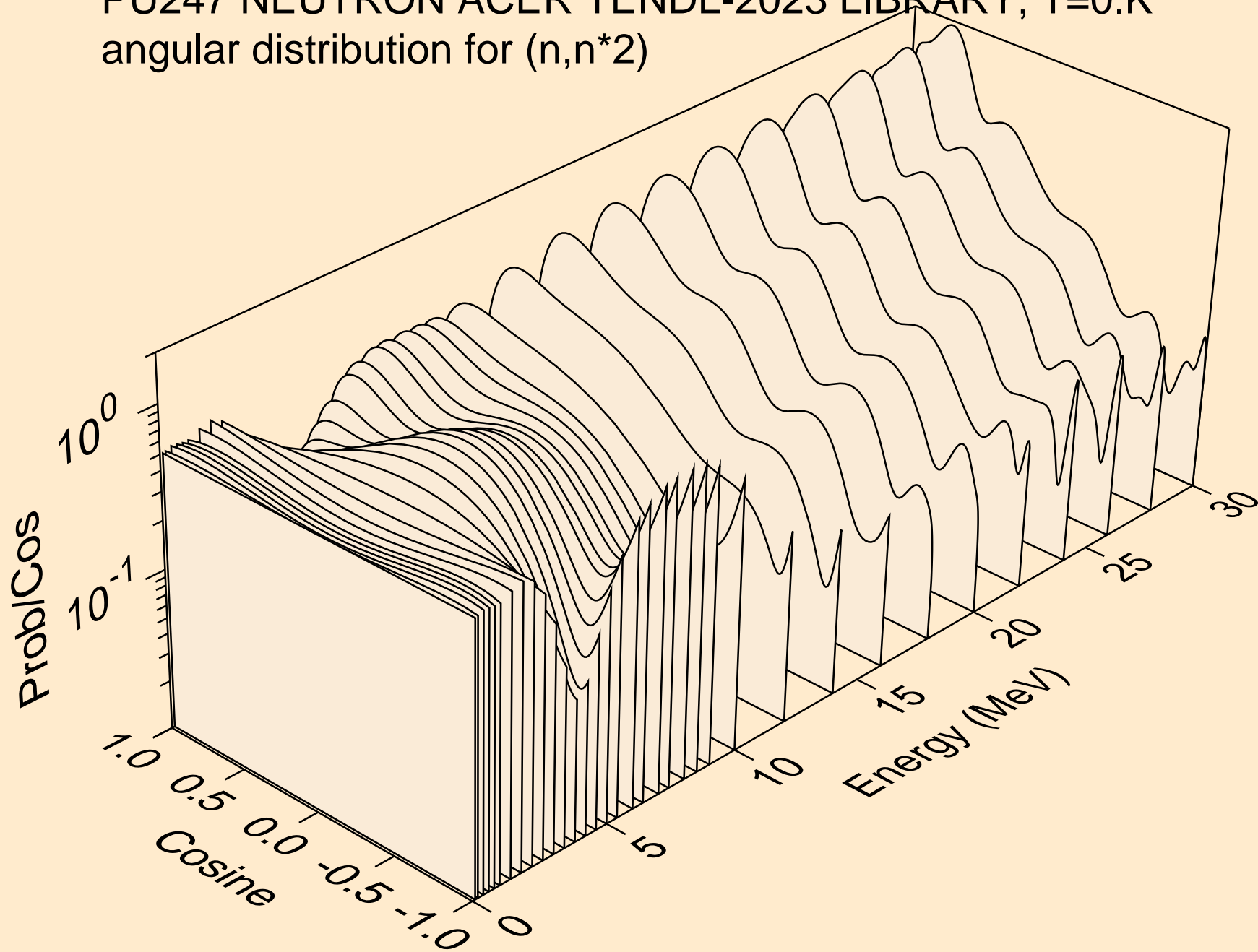

PU247 NEUTRON ACER TENDL-2023 LIBRARY; T=0.K
angular distribution for (n,n*3)

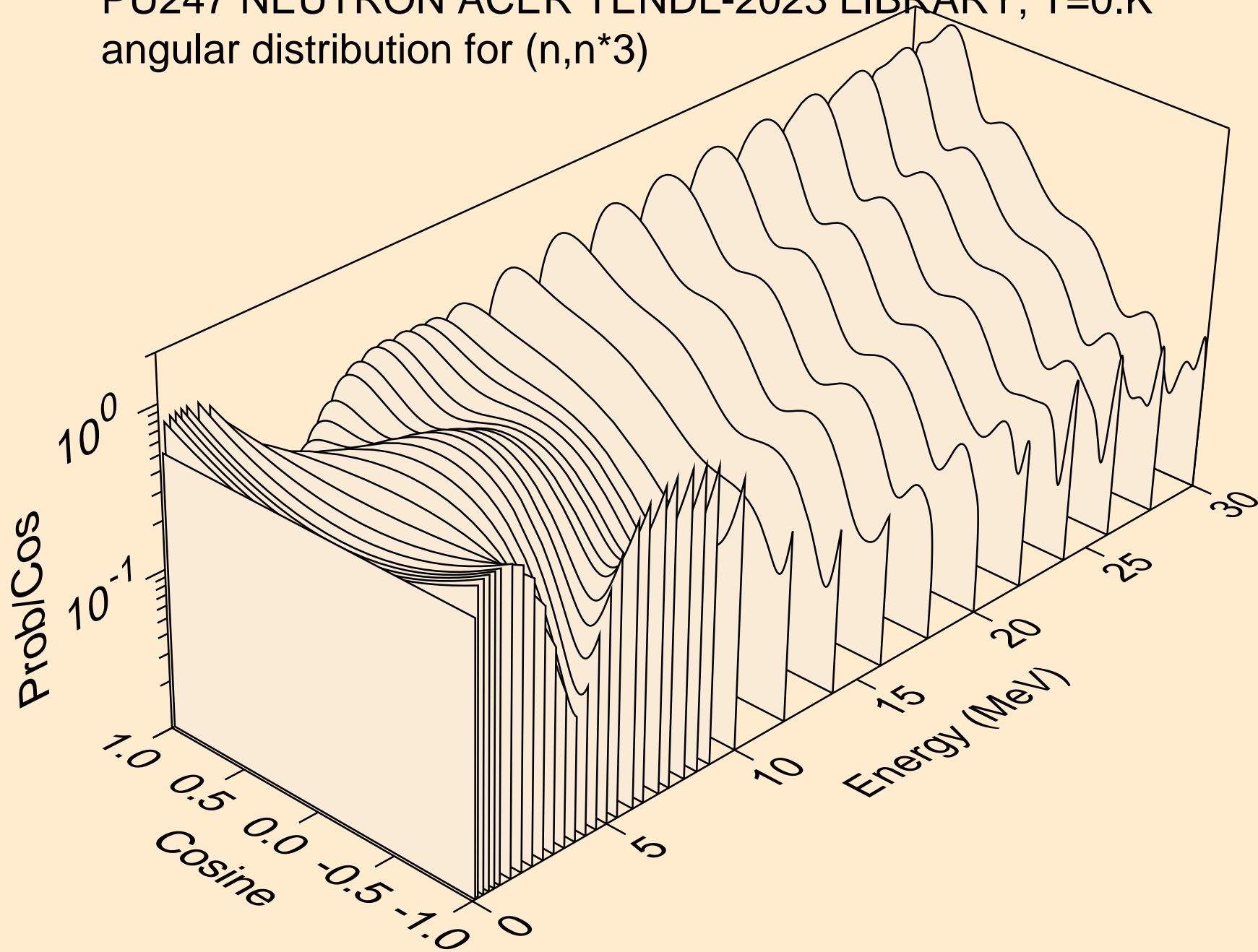

PU247 NEUTRON ACER TENDL-2023 LIBRARY; T=0.K
angular distribution for (n,n*4)

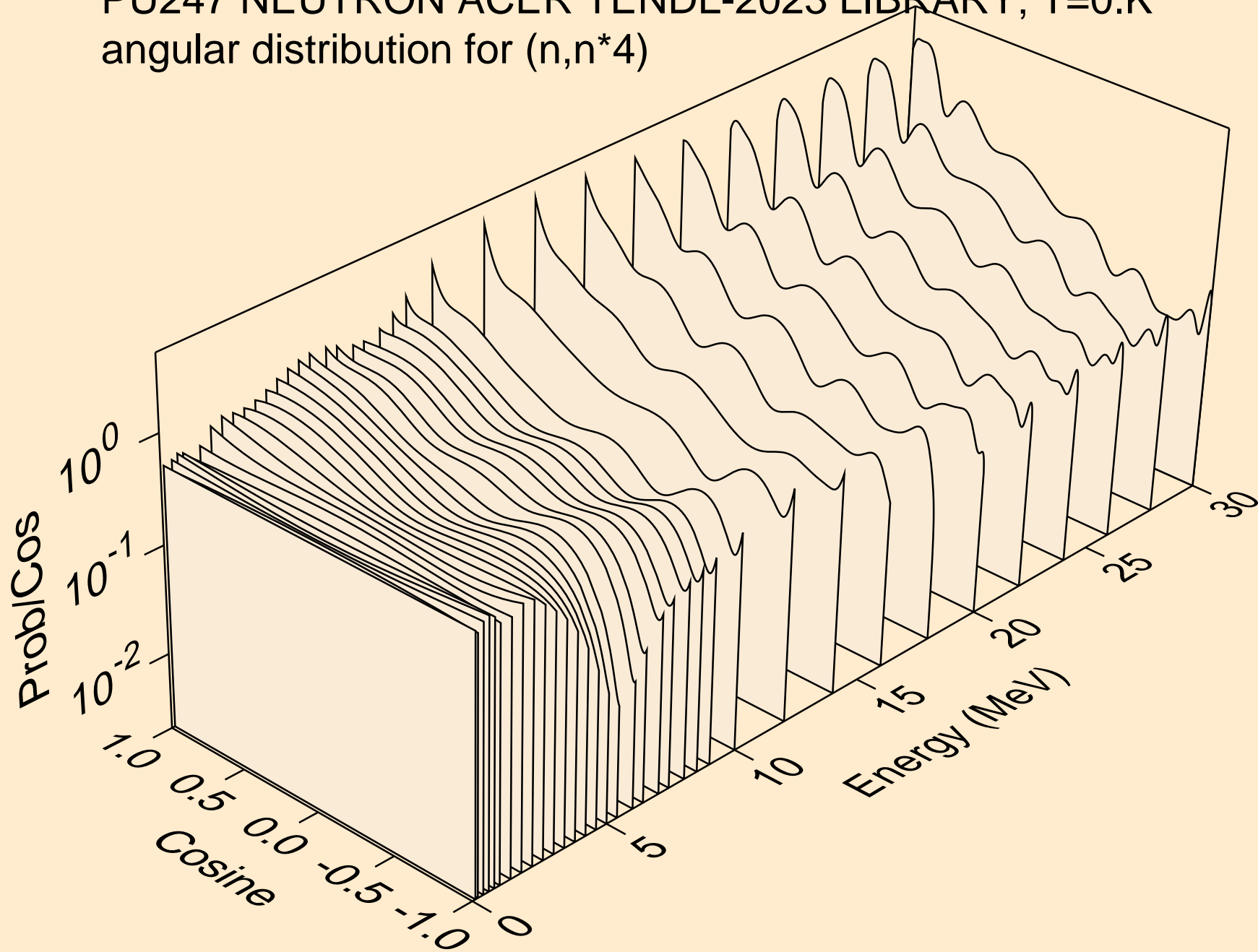

PU247 NEUTRON ACER TENDL-2023 LIBRARY; T=0.K
angular distribution for (n,n*5)

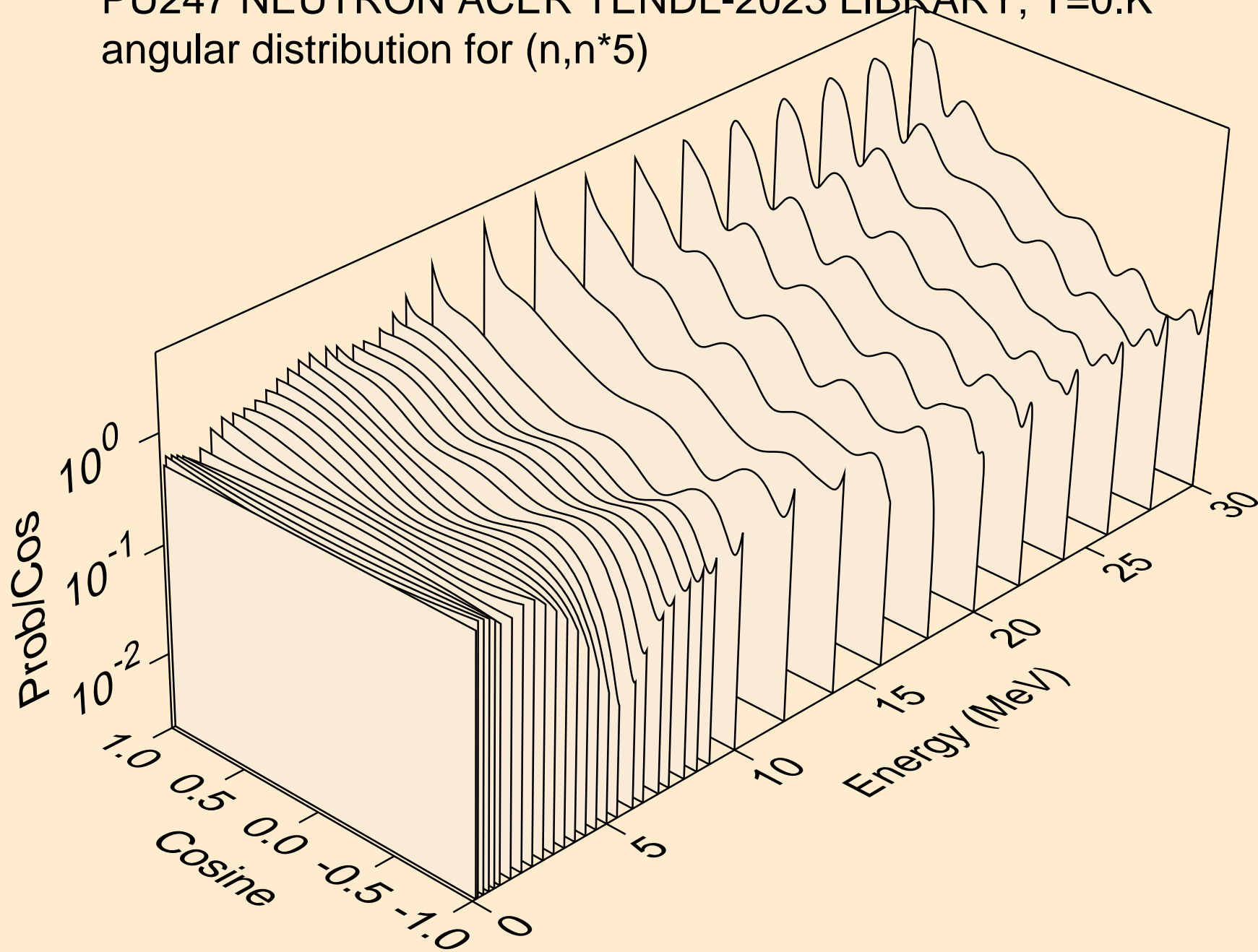

PU247 NEUTRON ACER TENDL-2023 LIBRARY; T=0.K
angular distribution for (n,n*6)

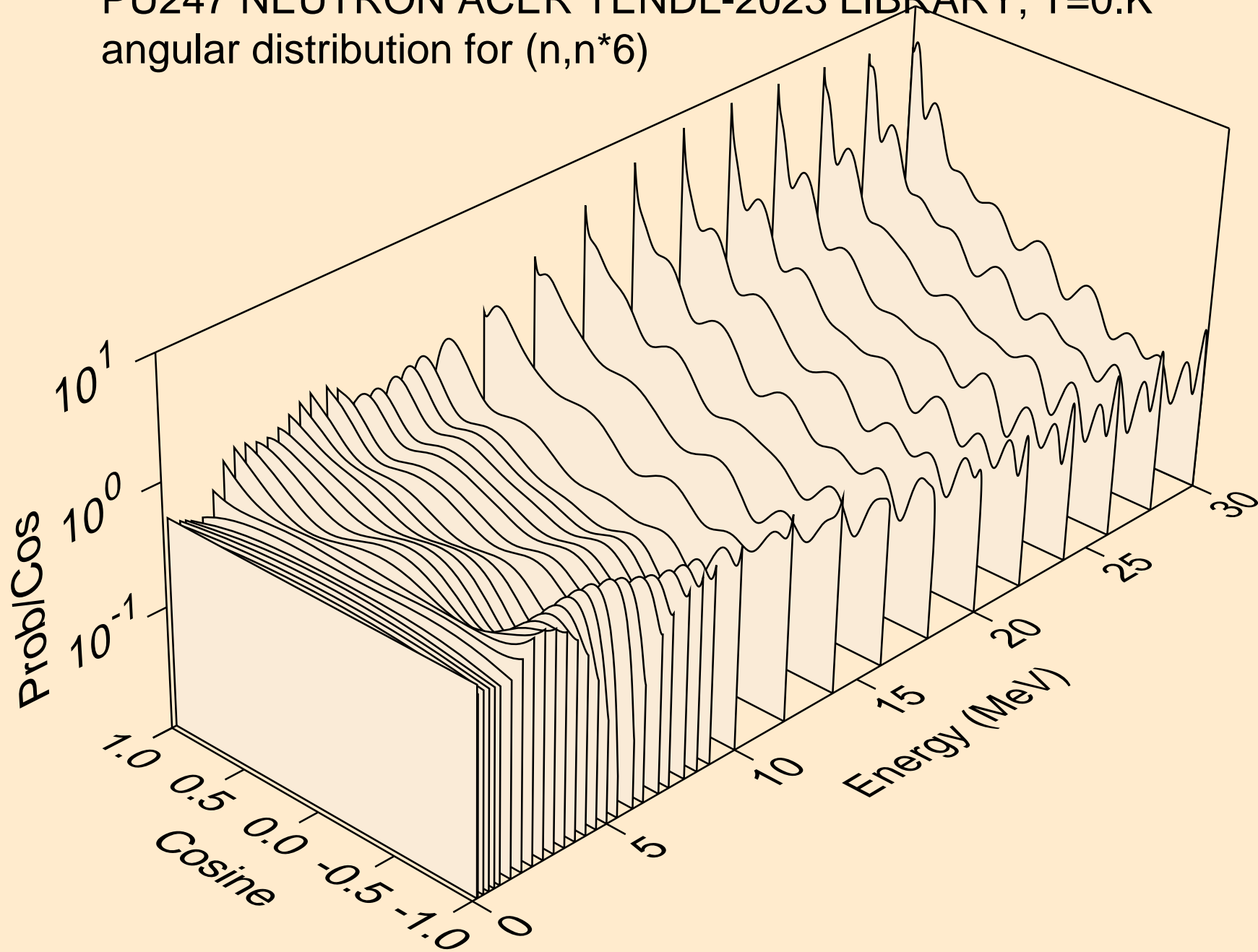

PU247 NEUTRON ACER TENDL-2023 LIBRARY; T=0.K
angular distribution for (n,n*7)

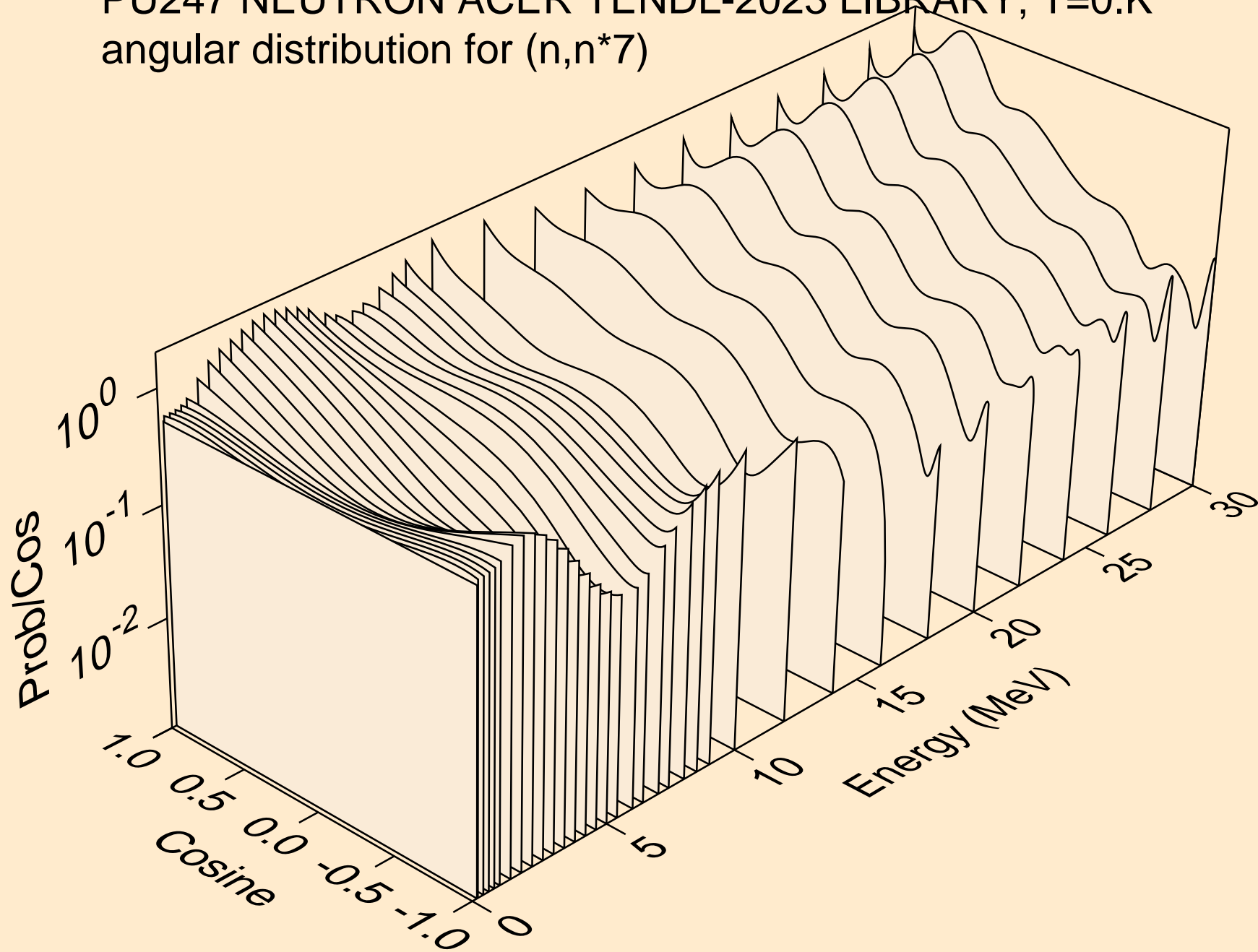

PU247 NEUTRON ACER TENDL-2023 LIBRARY; T=0.K
angular distribution for (n,n*8)

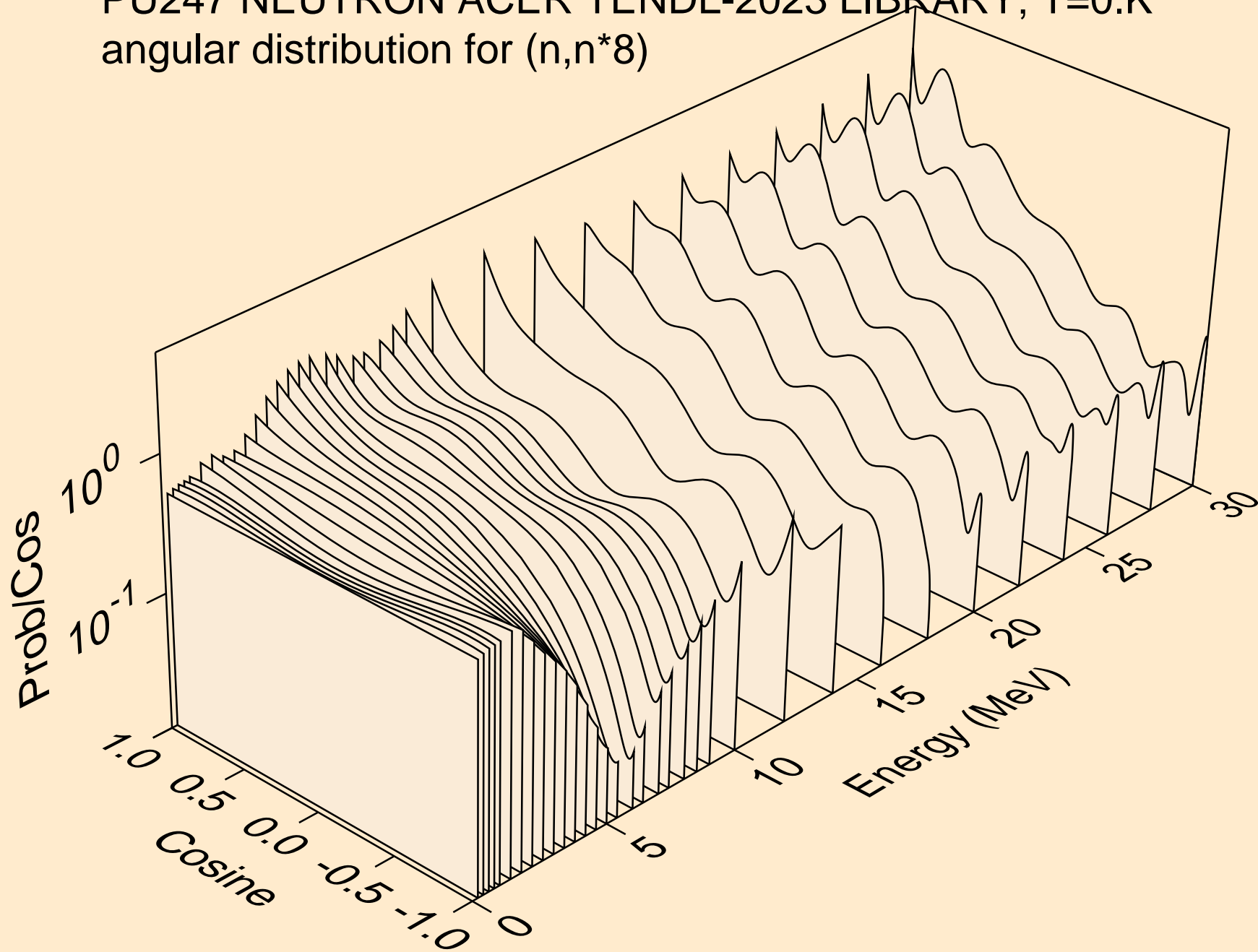

PU247 NEUTRON ACER TENDL-2023 LIBRARY; T=0.K
angular distribution for (n,n*9)

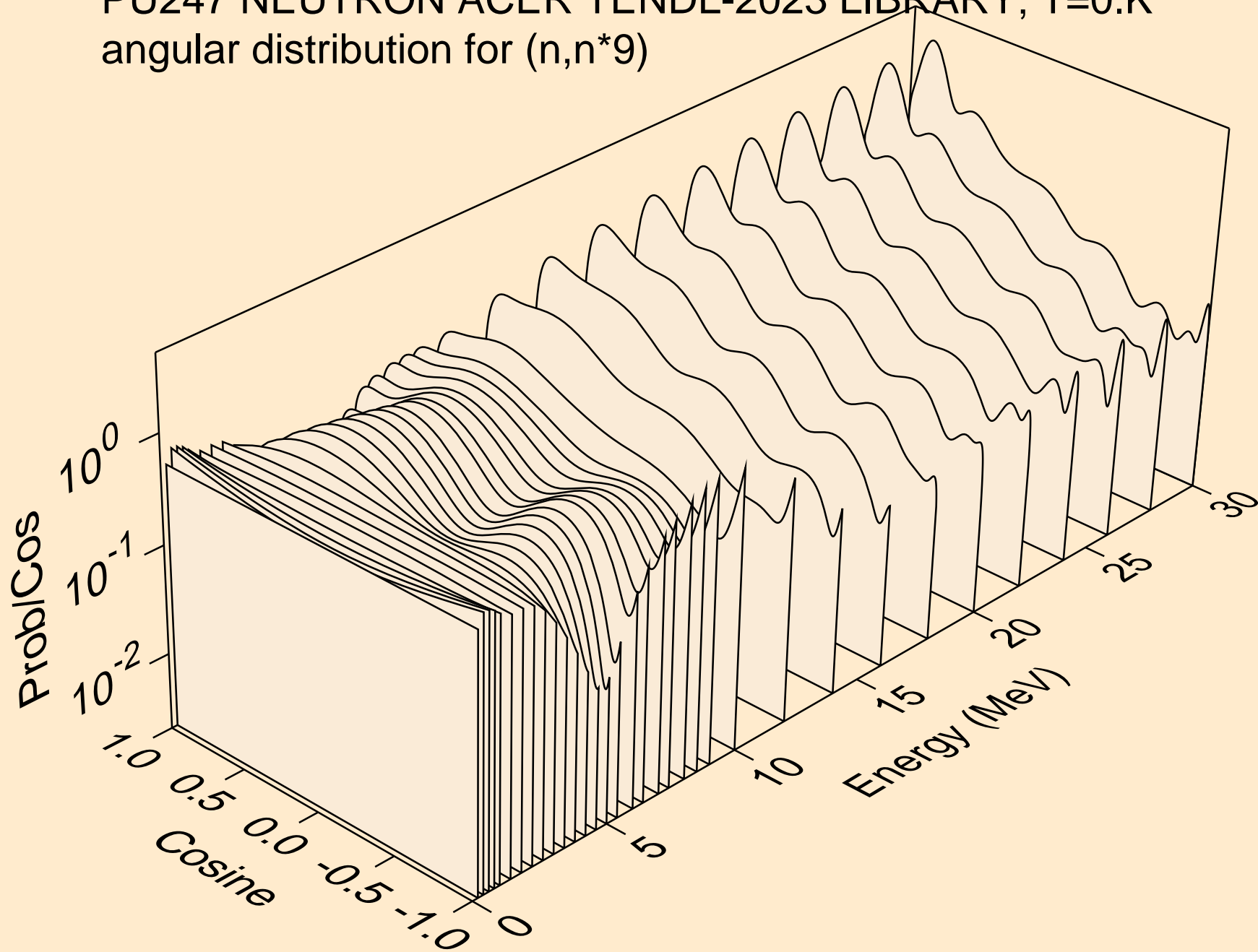

PU247 NEUTRON ACER TENDL-2023 LIBRARY; T=0.K
angular distribution for (n,n*10)

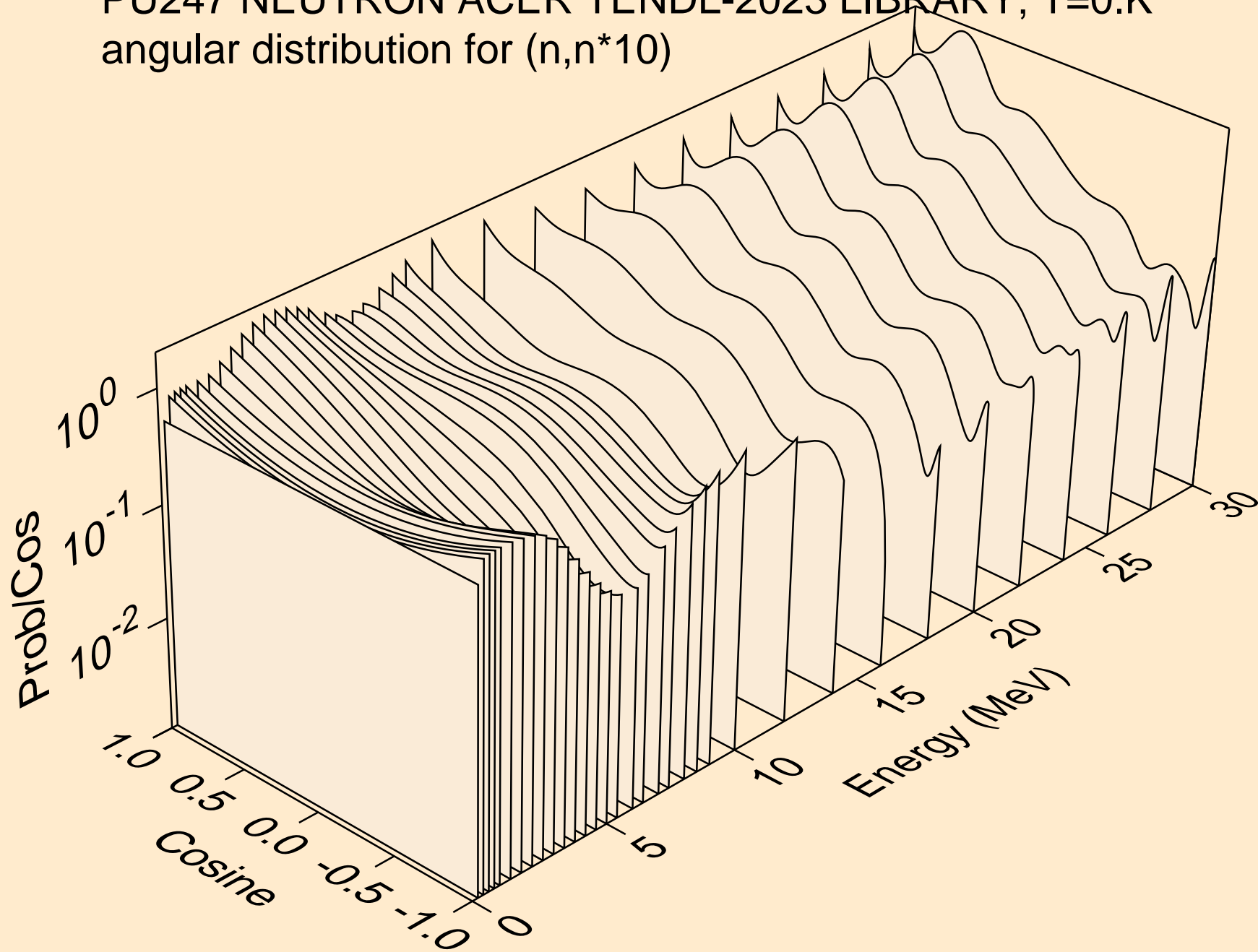

PU247 NEUTRON ACER TENDL-2023 LIBRARY; T=0.K
angular distribution for (n,n*11)

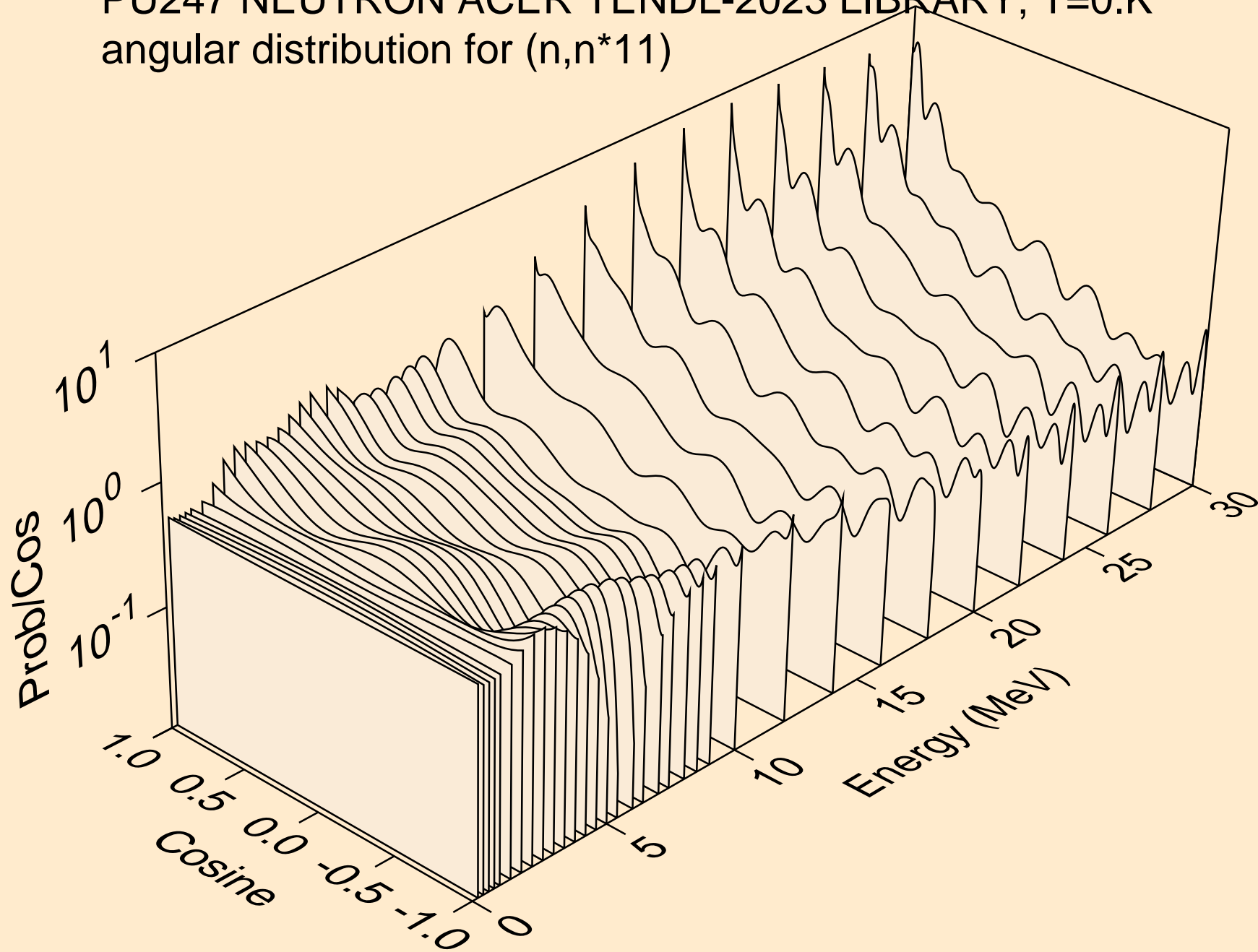

PU247 NEUTRON ACER TENDL-2023 LIBRARY; T=0.K
angular distribution for (n,n*12)

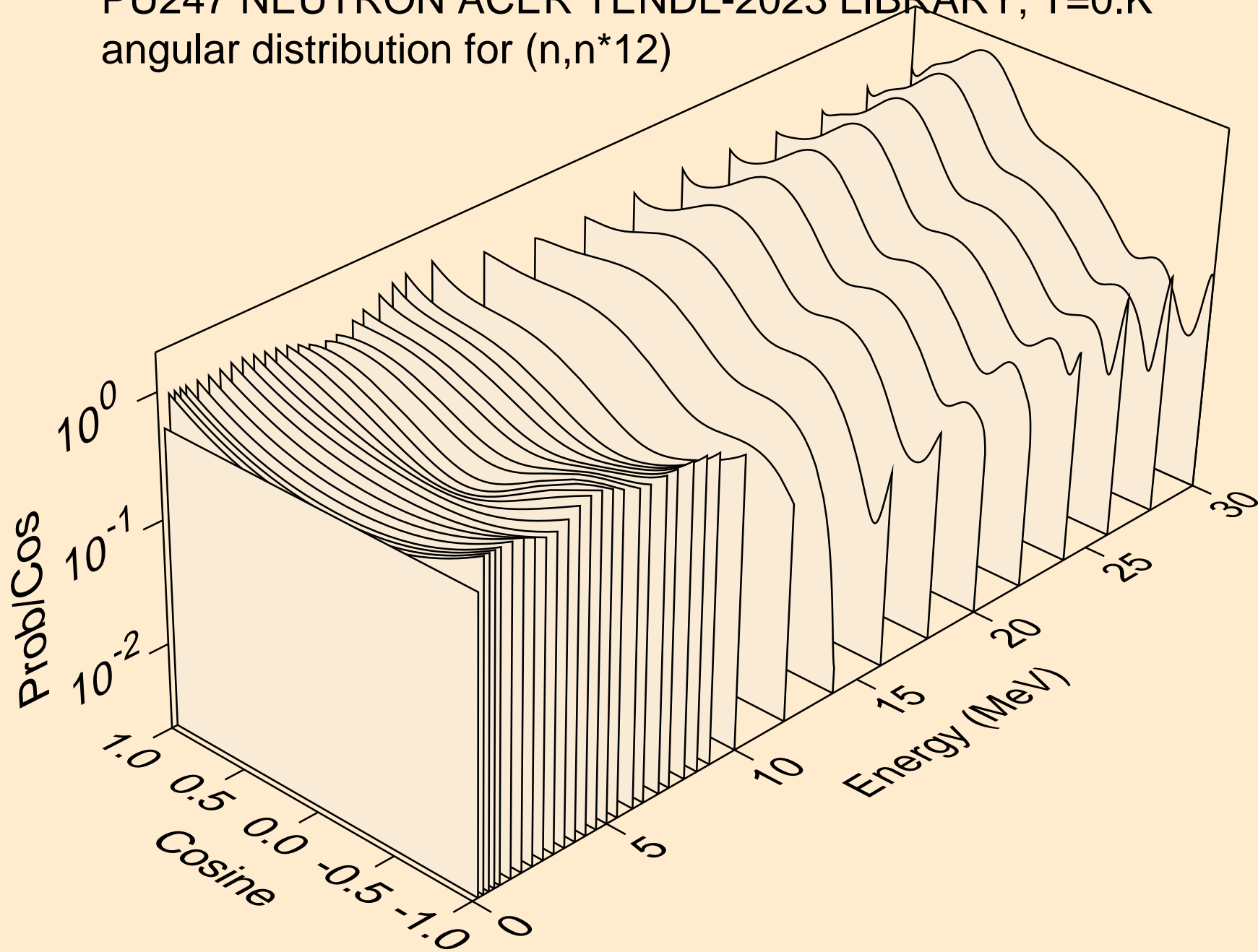

PU247 NEUTRON ACER TENDL-2023 LIBRARY; T=0.K
angular distribution for (n,n*13)

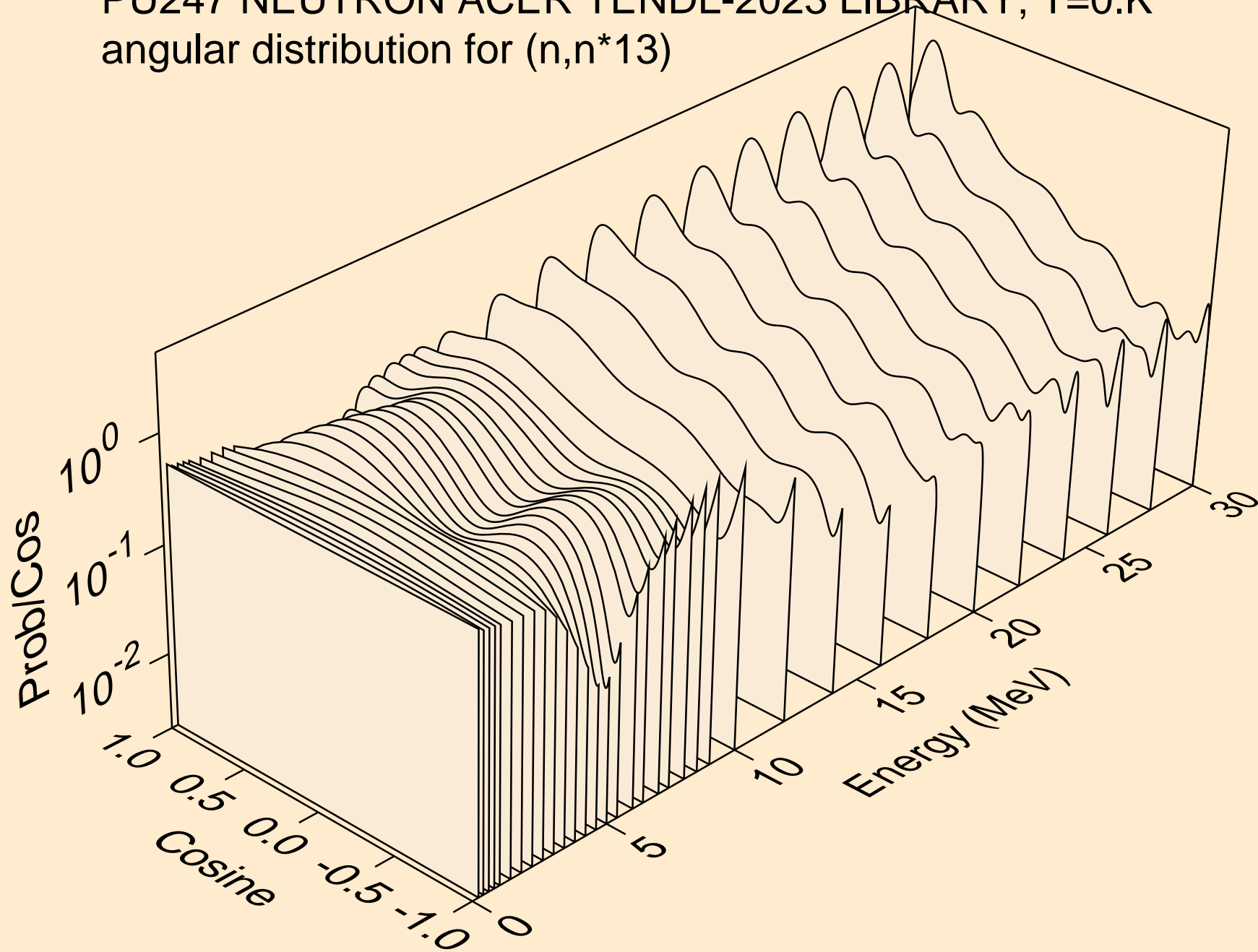

PU247 NEUTRON ACER TENDL-2023 LIBRARY; T=0.K
angular distribution for (n,n*14)

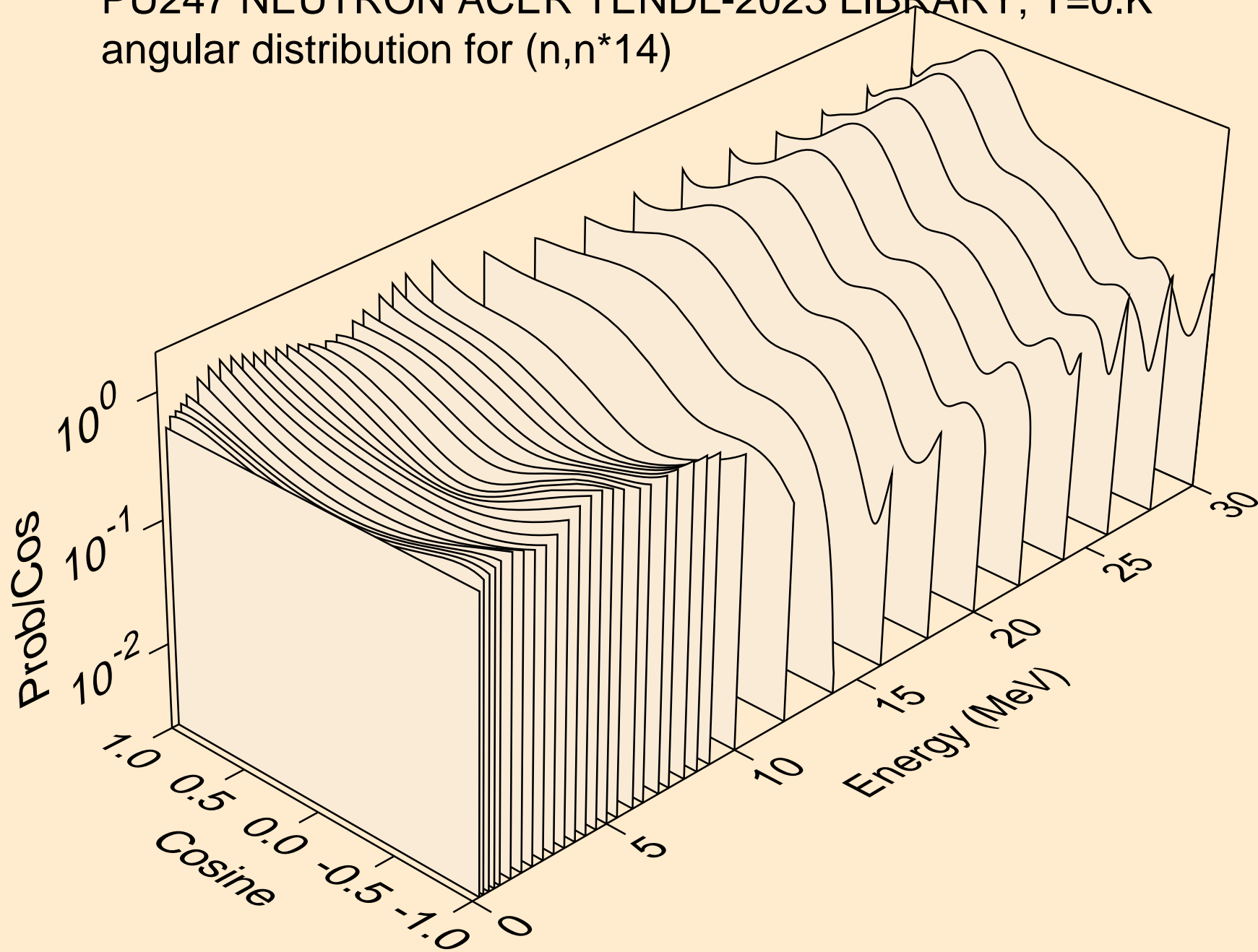

PU247 NEUTRON ACER TENDL-2023 LIBRARY; T=0.K
angular distribution for (n,n*15)

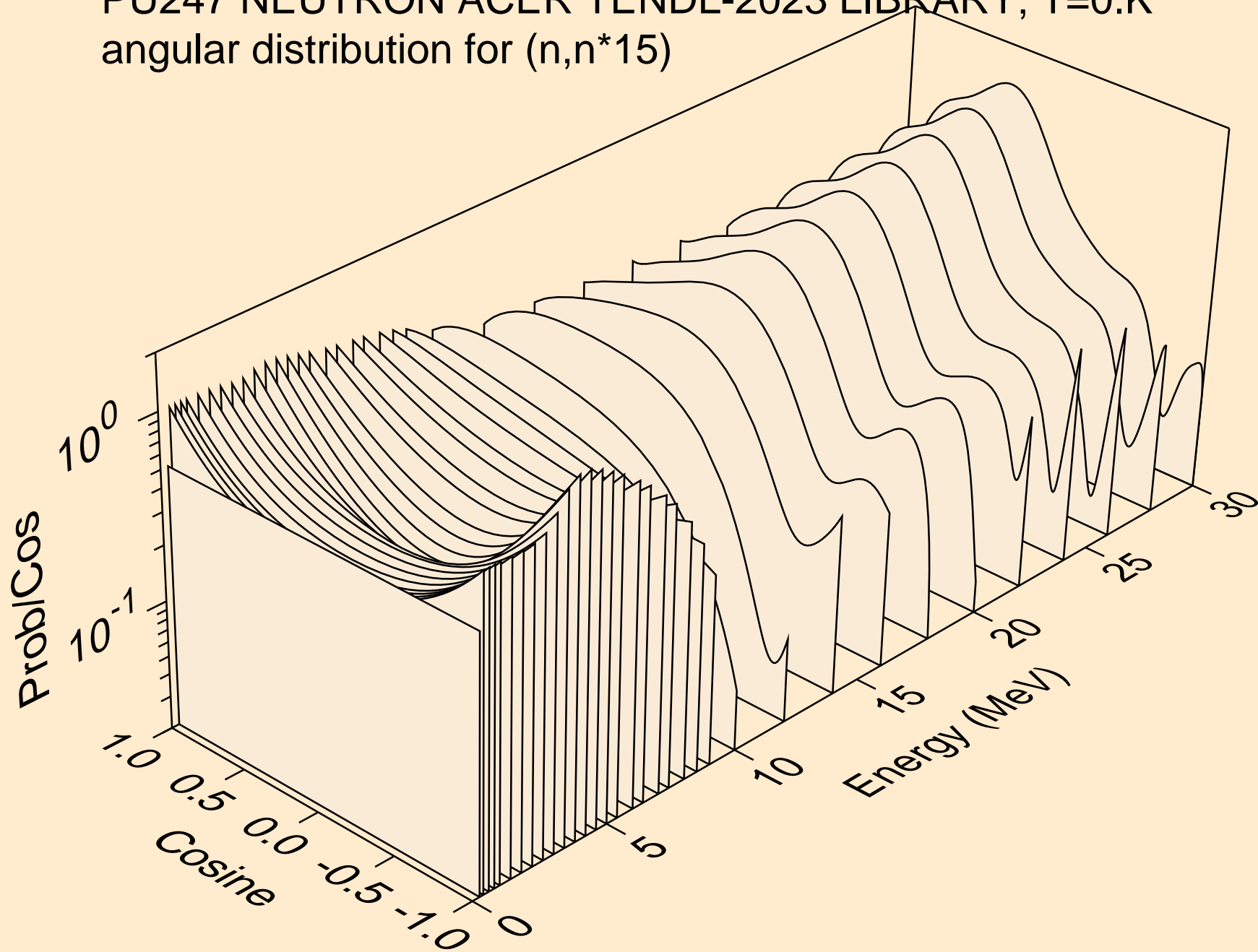

PU247 NEUTRON ACER TENDL-2023 LIBRARY; T=0.K
angular distribution for (n,n*16)

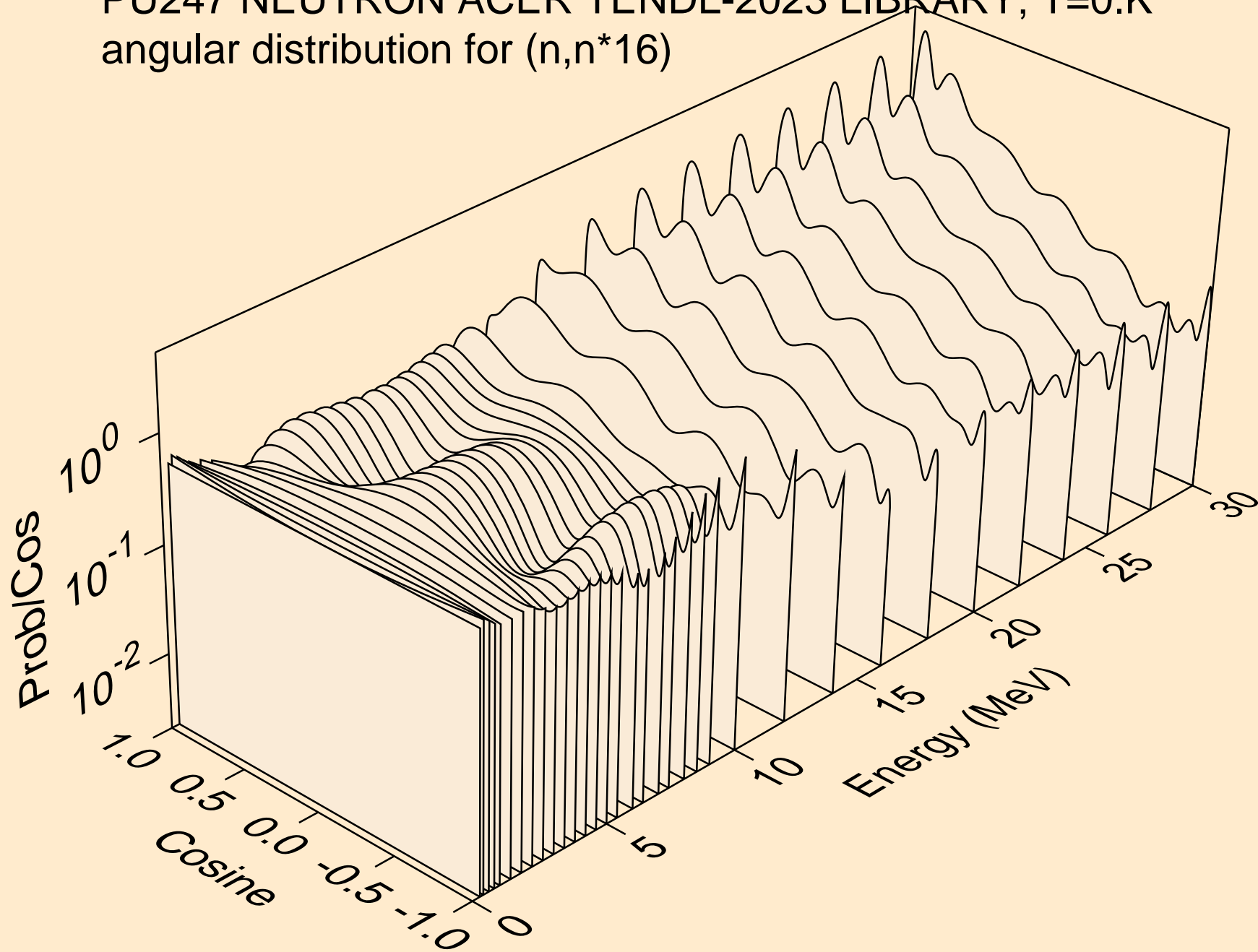

PU247 NEUTRON ACER TENDL-2023 LIBRARY; T=0.K
angular distribution for (n,n*17)

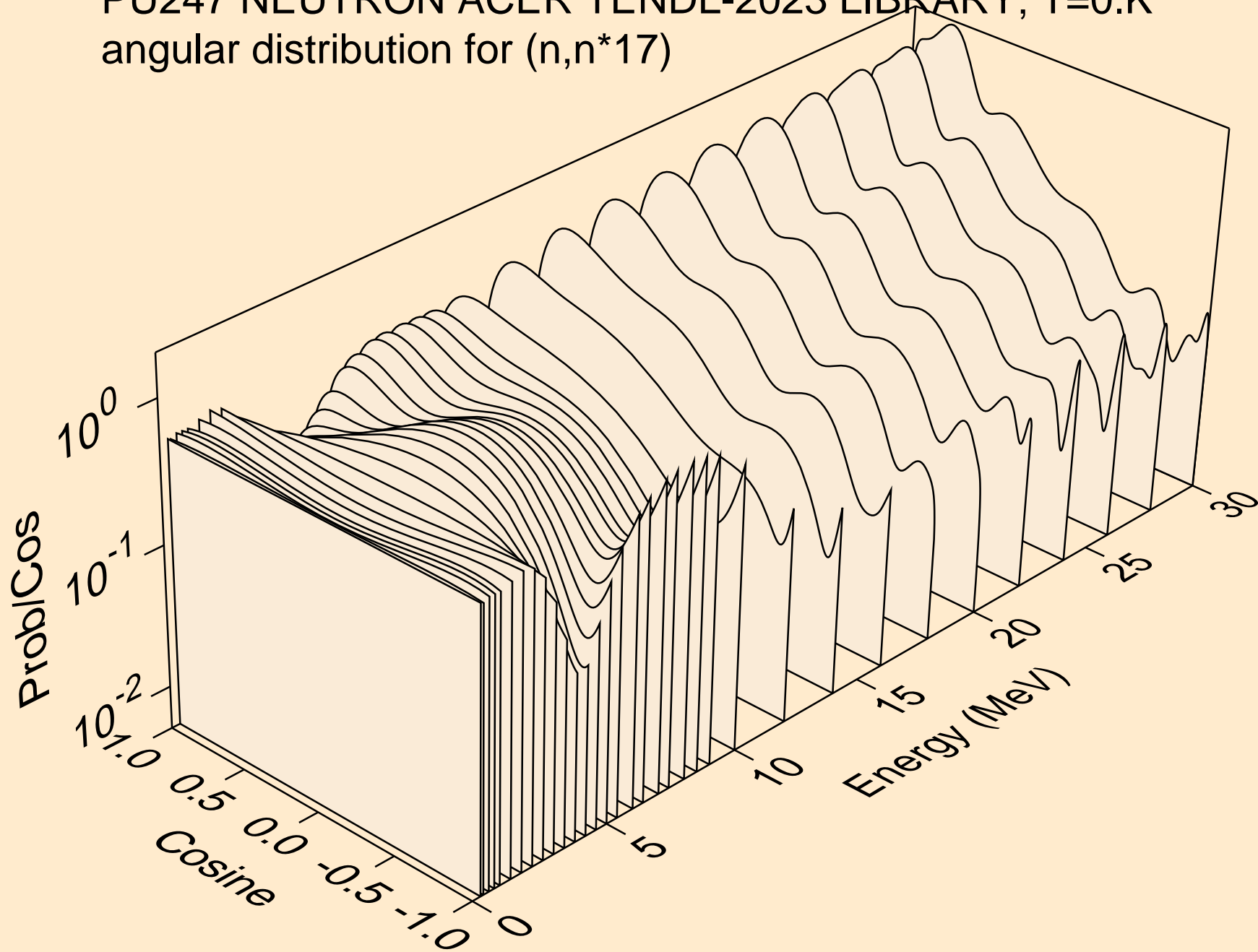

PU247 NEUTRON ACER TENDL-2023 LIBRARY; T=0.K
angular distribution for (n,n*18)

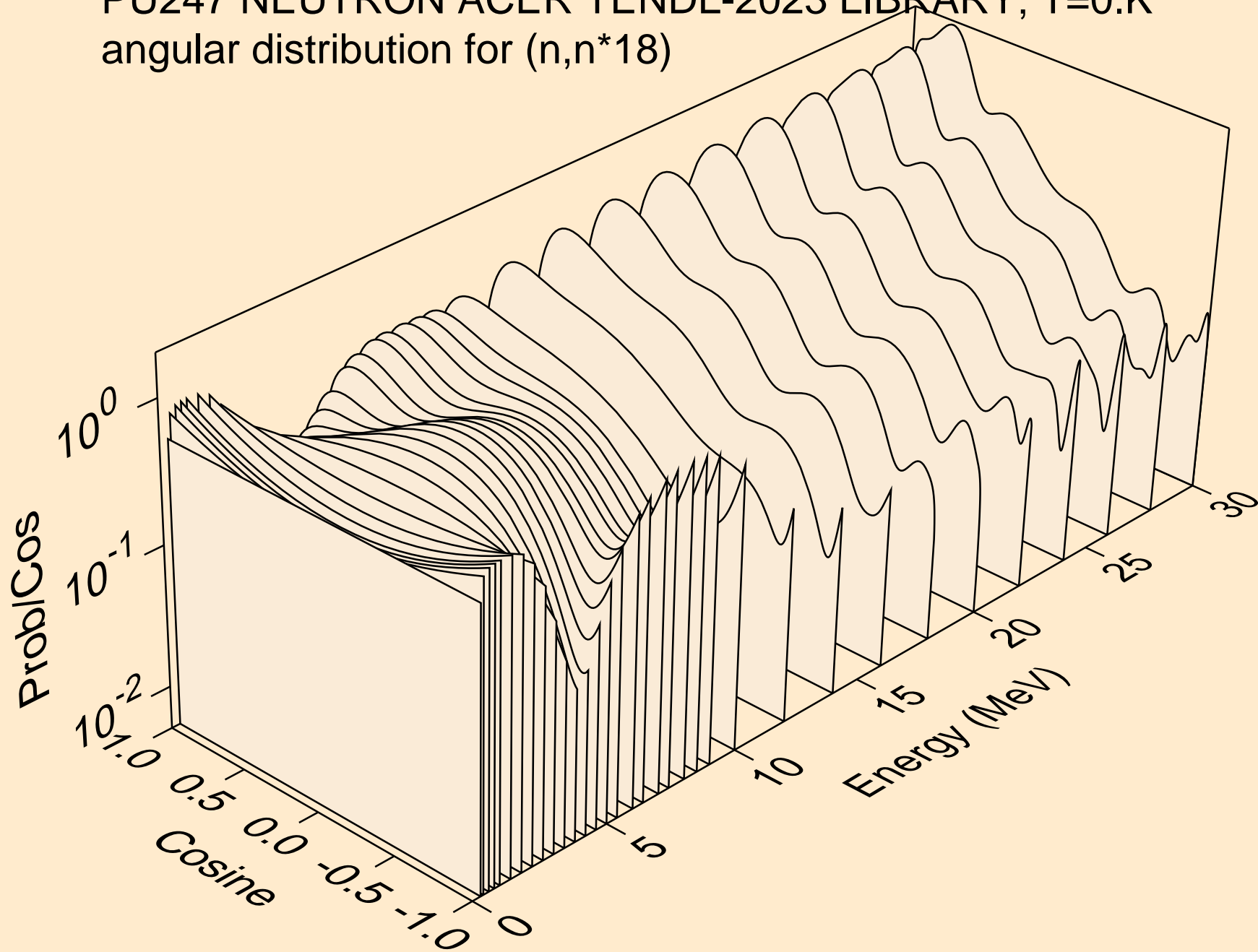

PU247 NEUTRON ACER TENDL-2023 LIBRARY; T=0.K
angular distribution for (n,n*19)

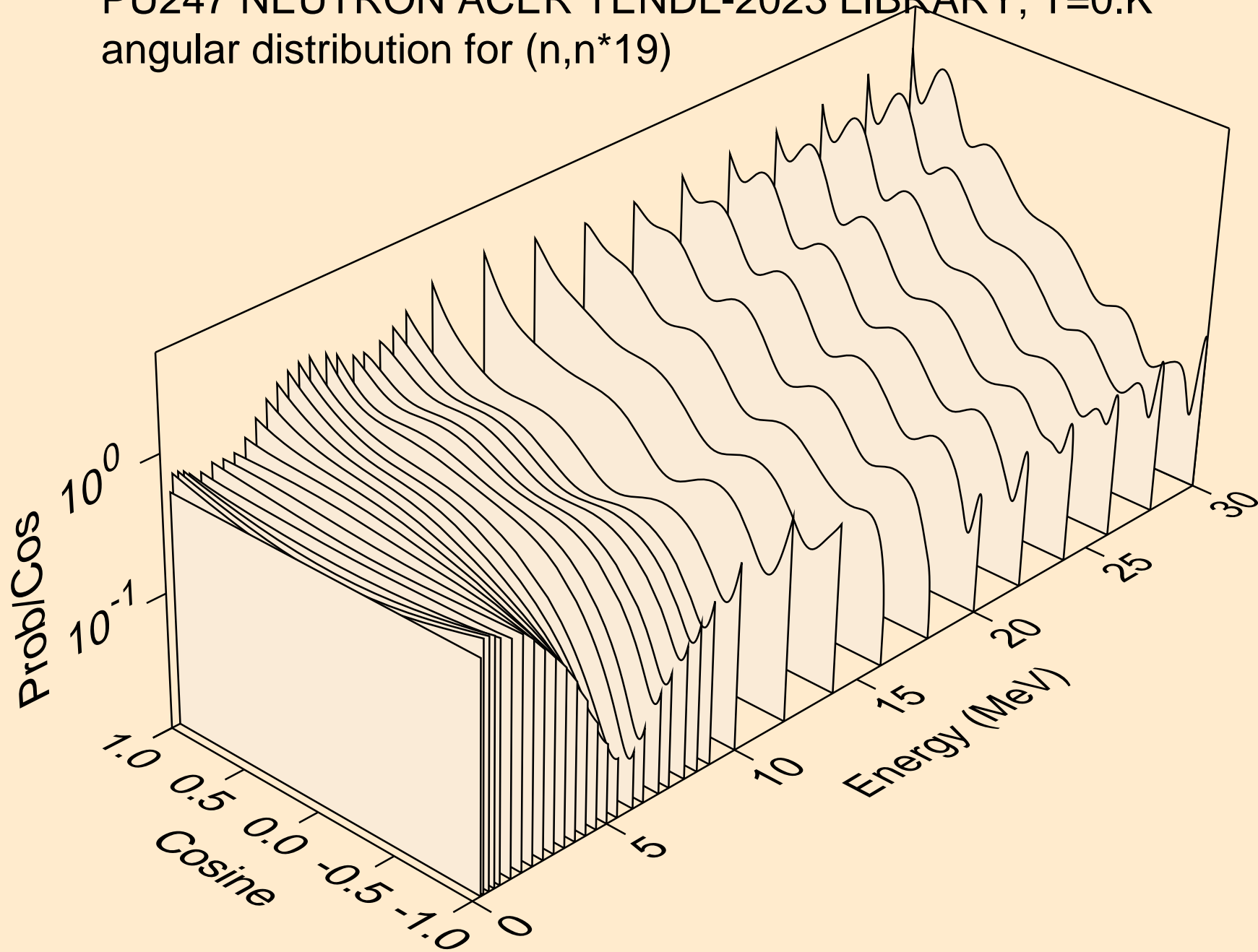

PU247 NEUTRON ACER TENDL-2023 LIBRARY; T=0.K
angular distribution for (n,n*20)

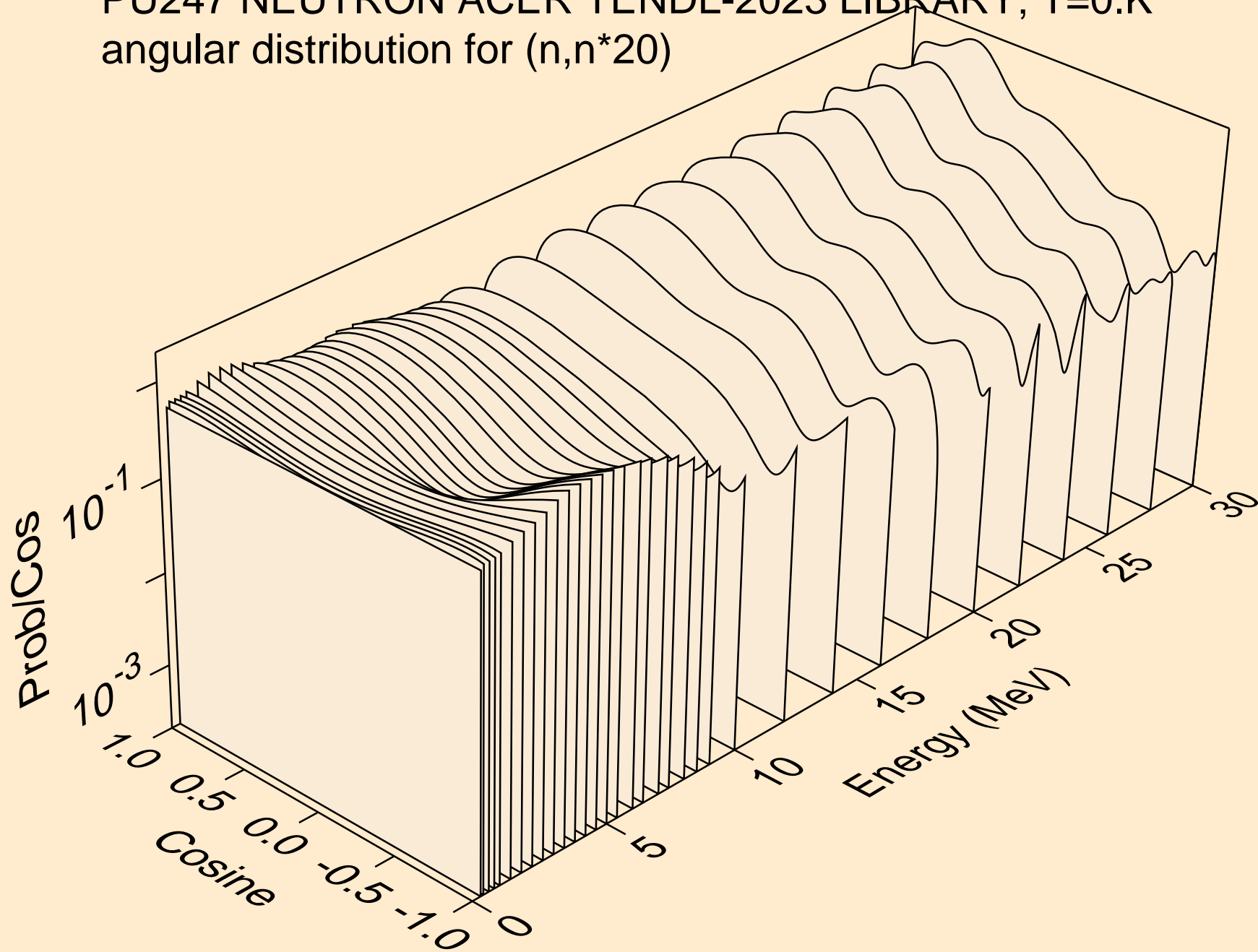

PU247 NEUTRON ACER TENDL-2023 LIBRARY; T=0.K
angular distribution for (n,n*21)

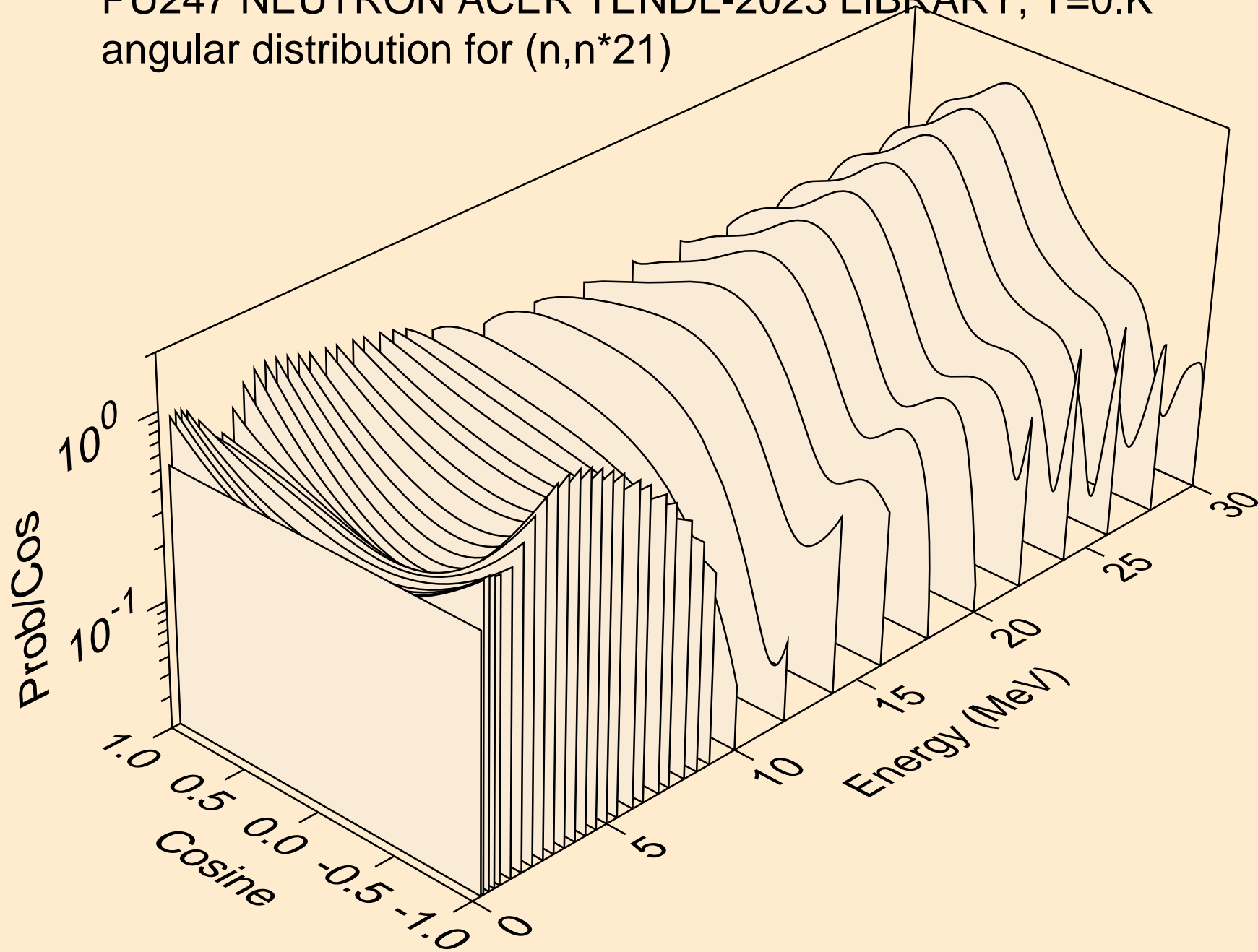

PU247 NEUTRON ACER TENDL-2023 LIBRARY; T=0.K
angular distribution for (n,n*22)

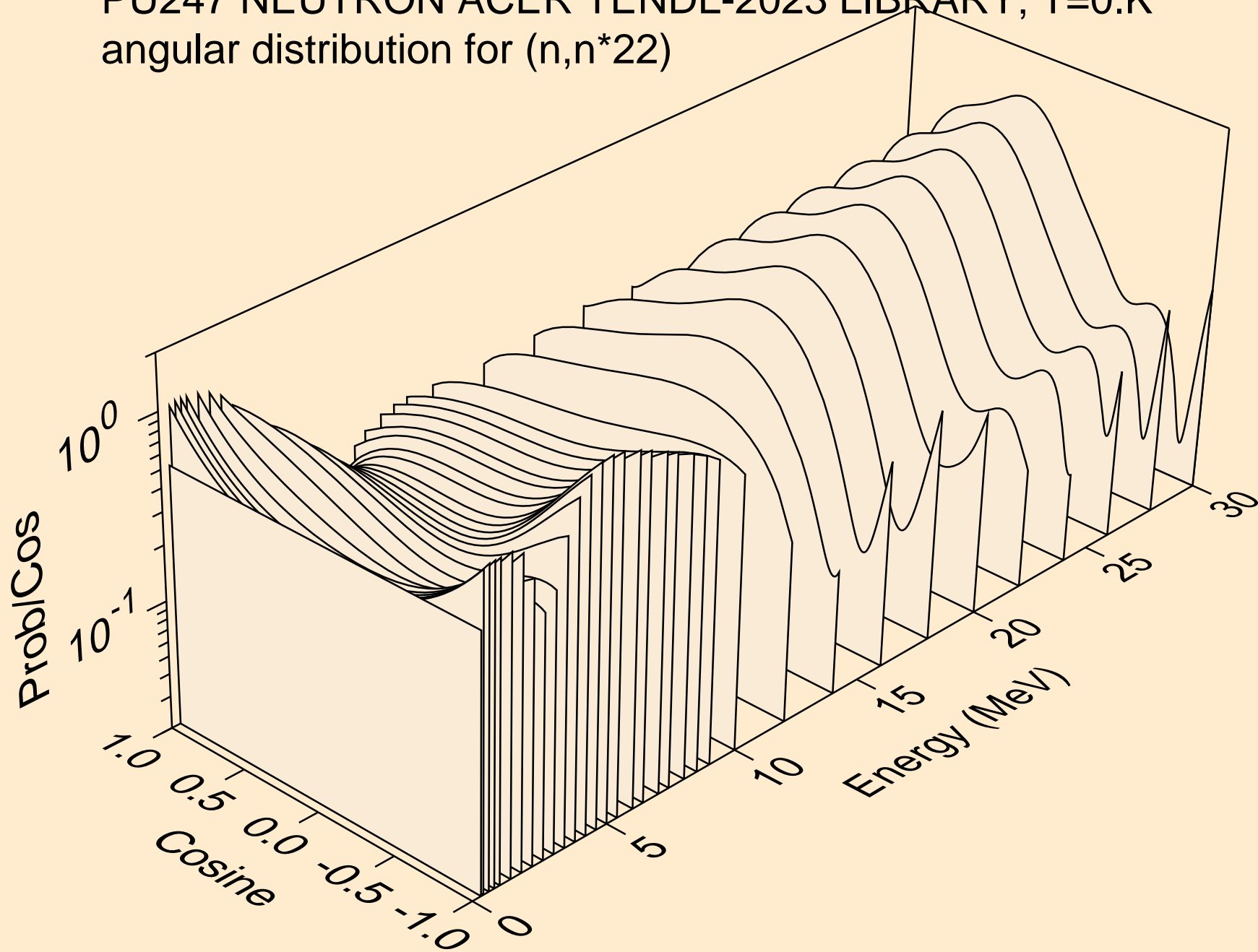

PU247 NEUTRON ACER TENDL-2023 LIBRARY; T=0.K
angular distribution for (n,n*23)

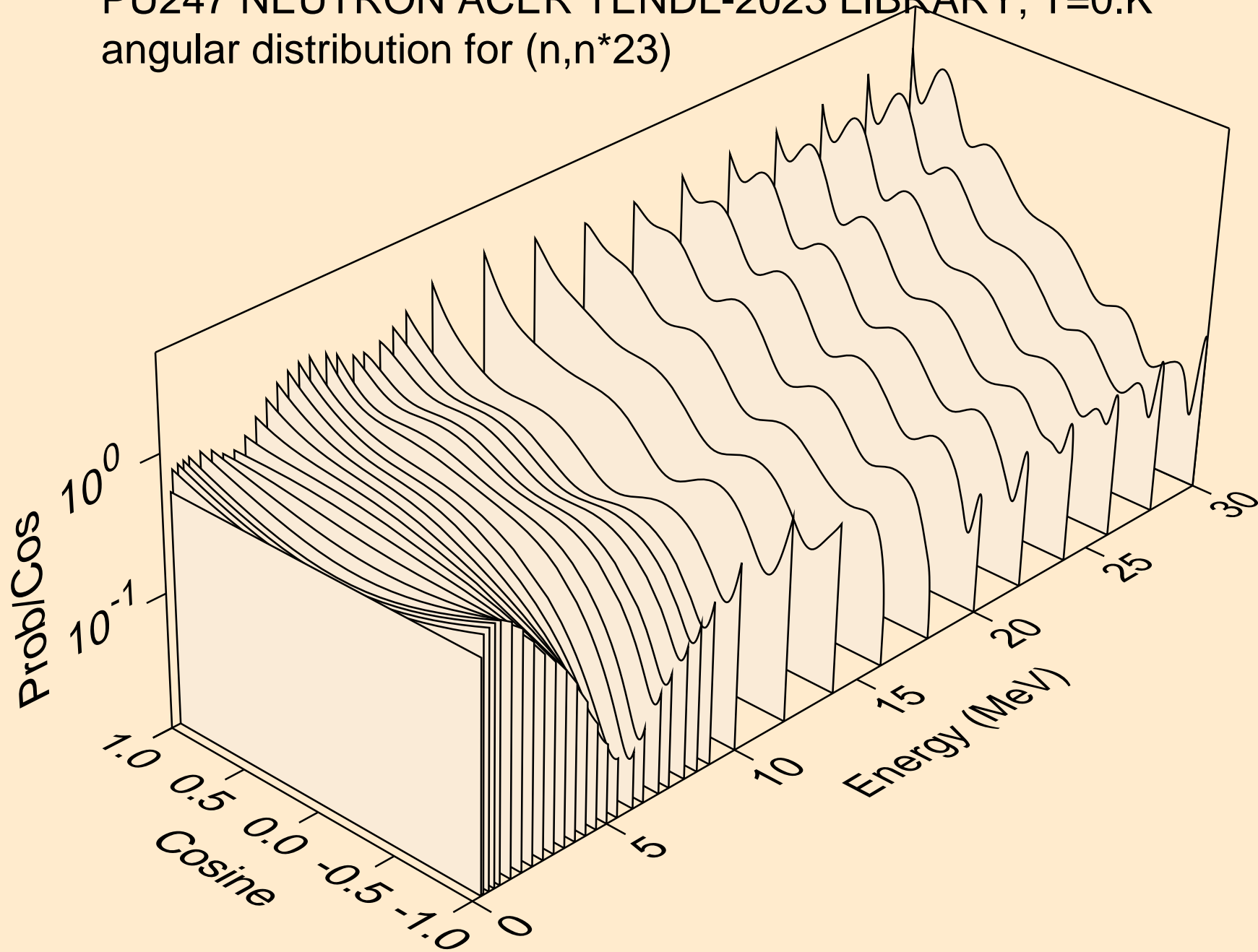

PU247 NEUTRON ACER TENDL-2023 LIBRARY; T=0.K
angular distribution for (n,n*24)

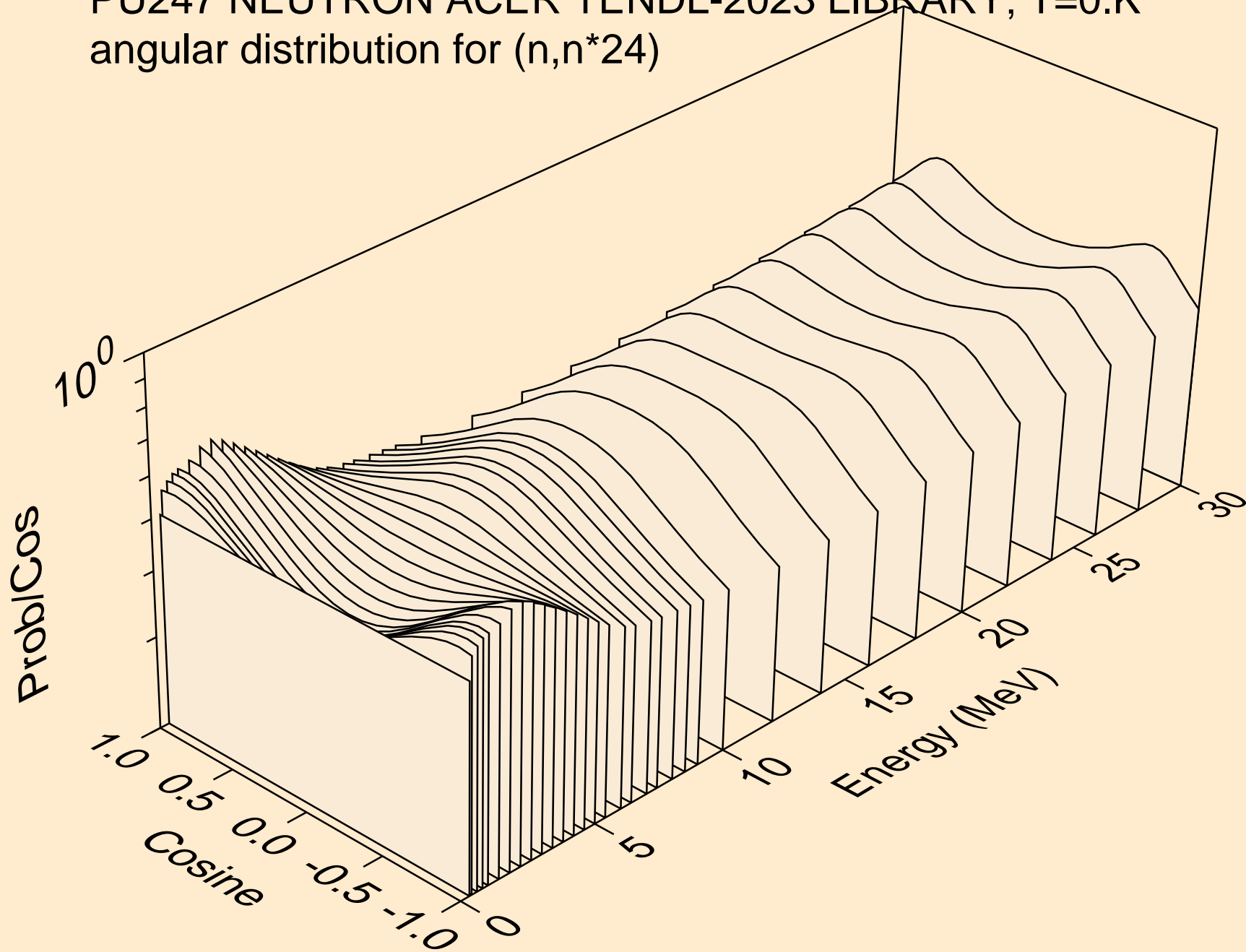

PU247 NEUTRON ACER TENDL-2023 LIBRARY; T=0.K
angular distribution for (n,n*25)

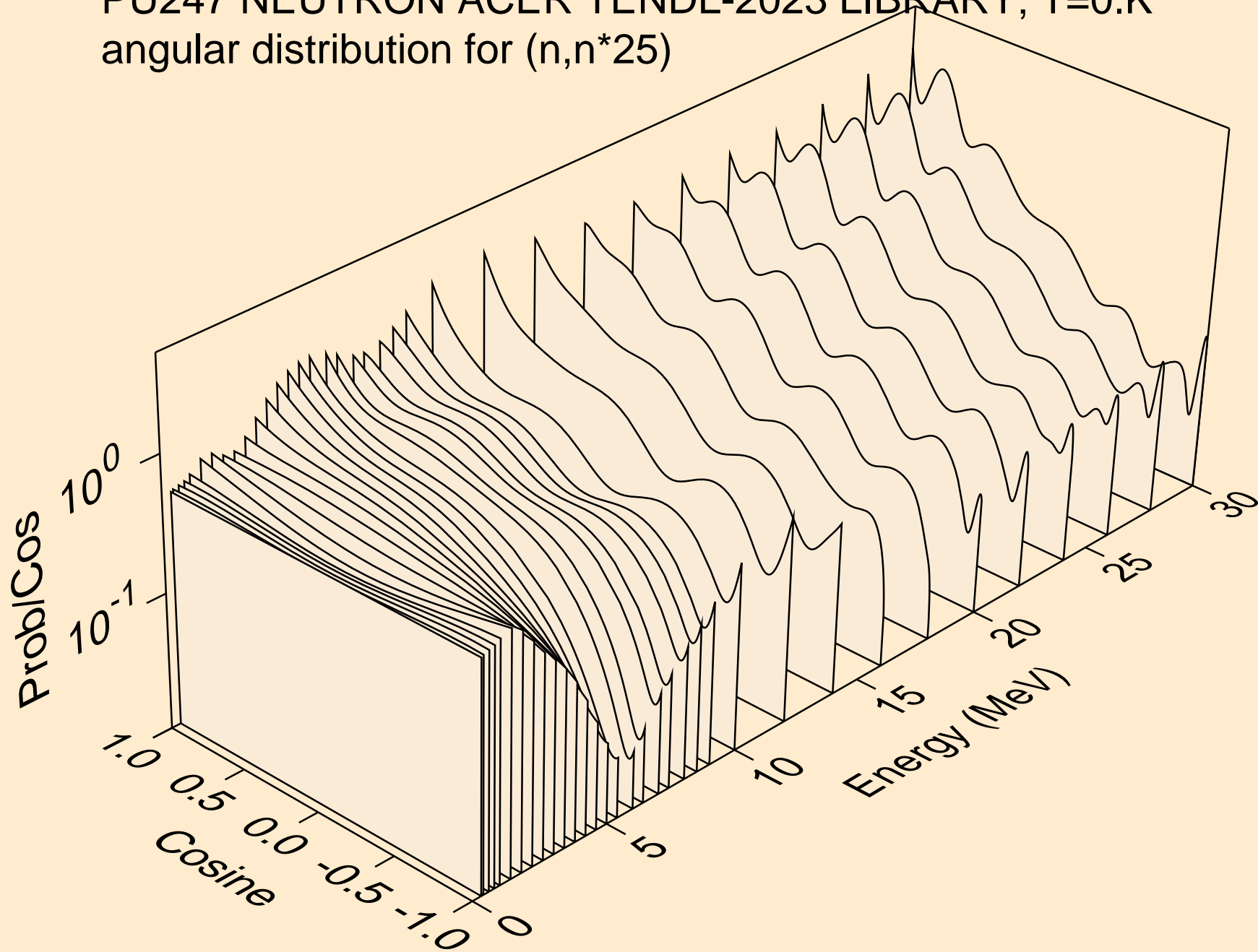

PU247 NEUTRON ACER TENDL-2023 LIBRARY; T=0.K
angular distribution for (n,n*26)

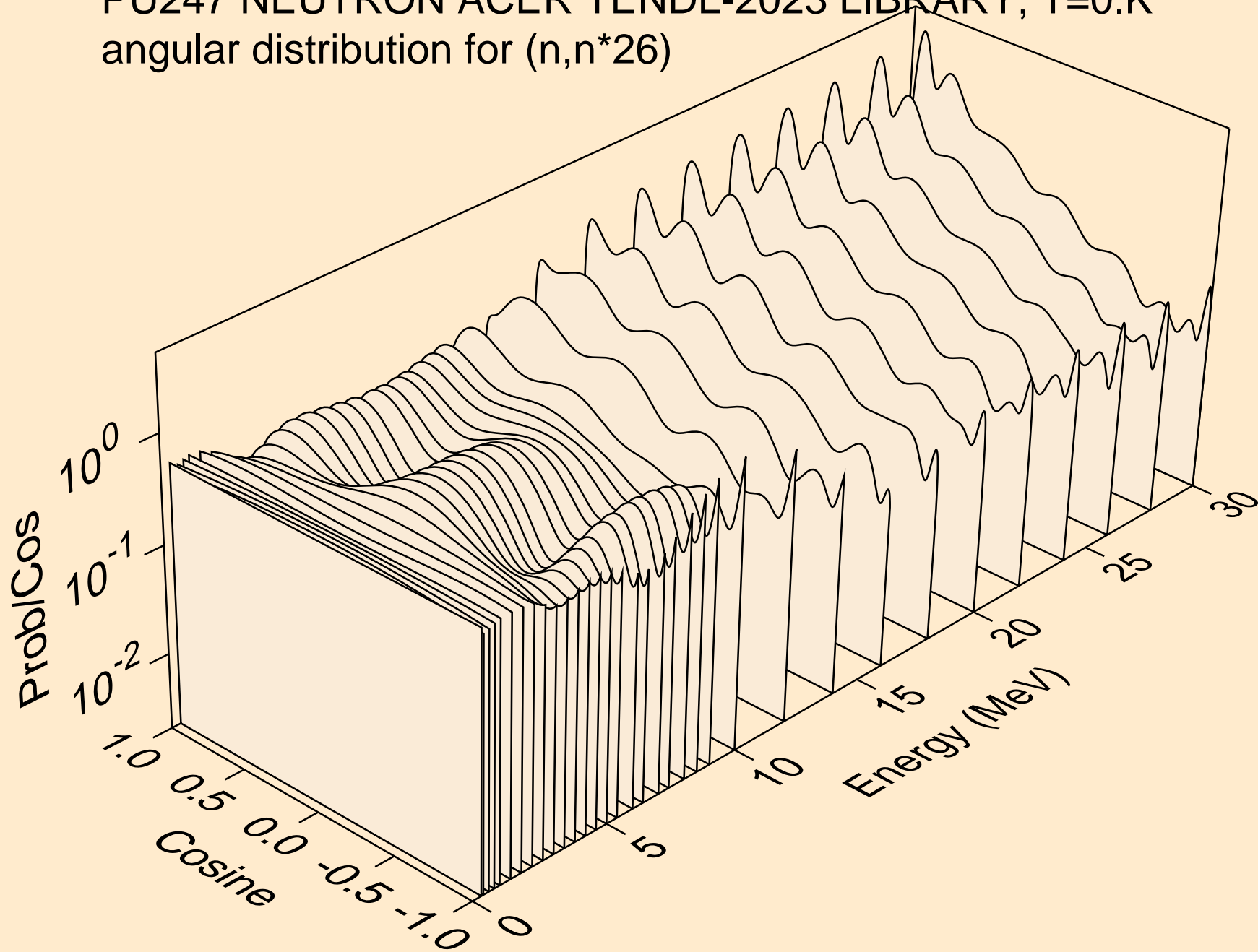

PU247 NEUTRON ACER TENDL-2023 LIBRARY; T=0.K
angular distribution for (n,n*27)

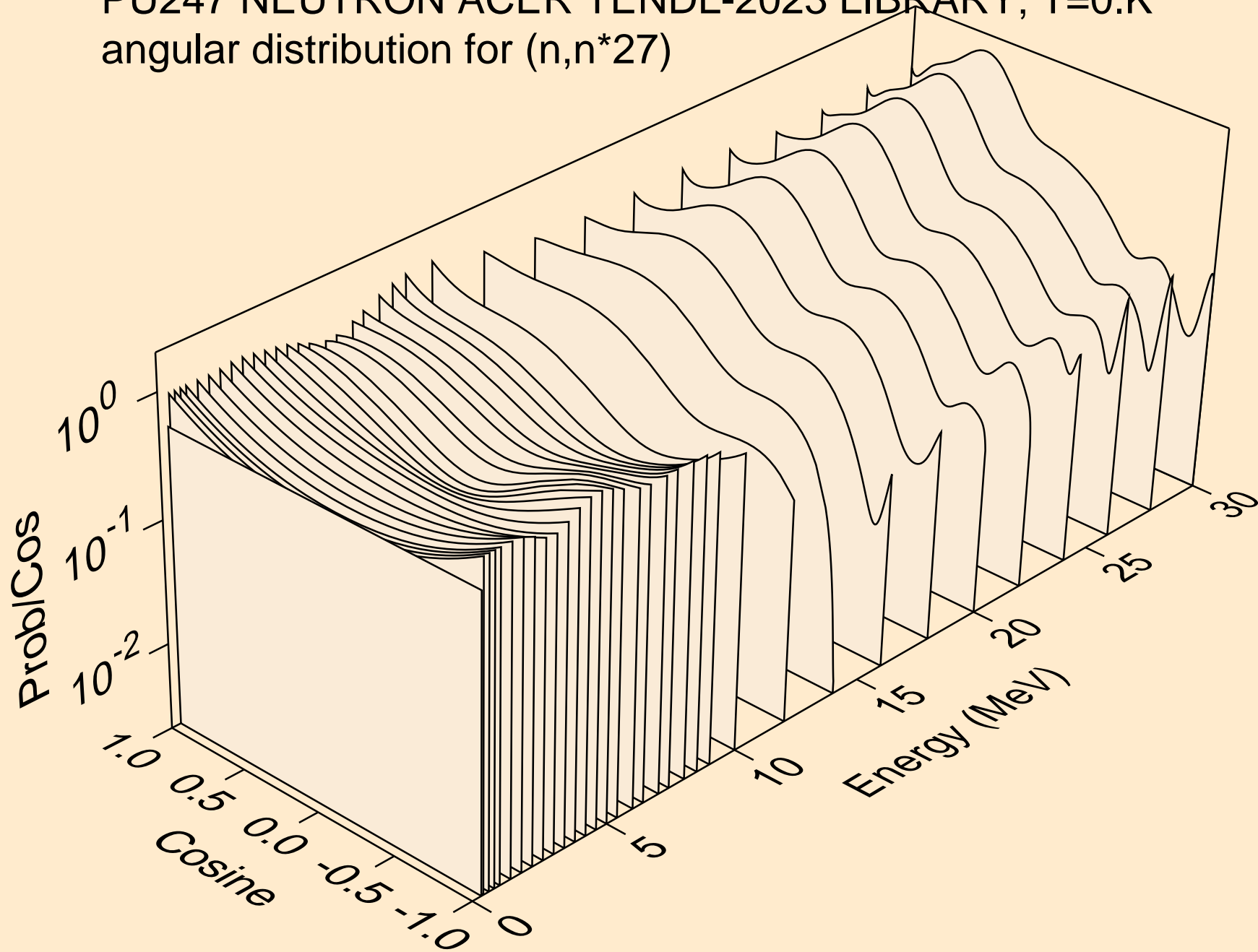

PU247 NEUTRON ACER TENDL-2023 LIBRARY; T=0.K
angular distribution for (n,n*28)

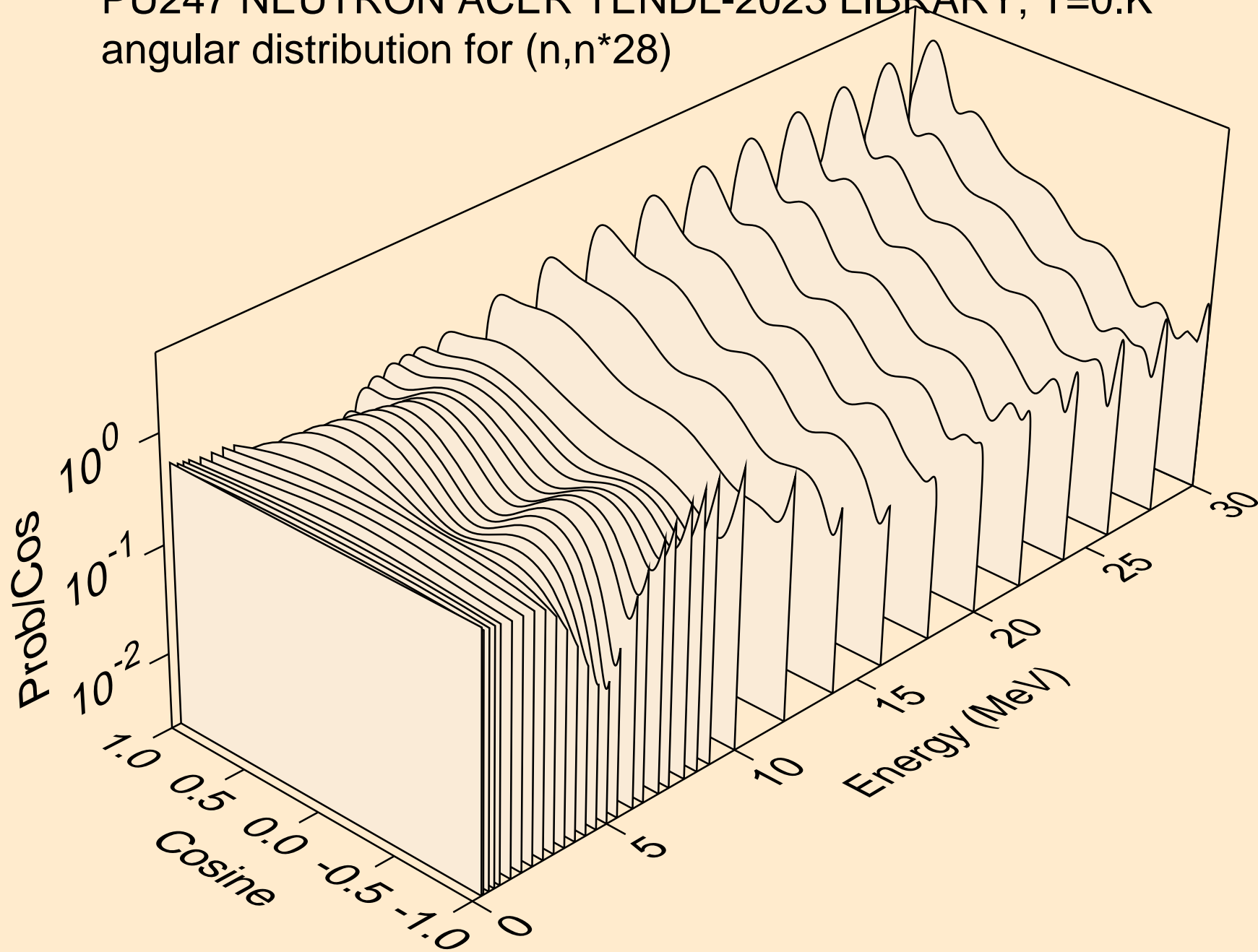

PU247 NEUTRON ACER TENDL-2023 LIBRARY; T=0.K
angular distribution for (n,n*29)

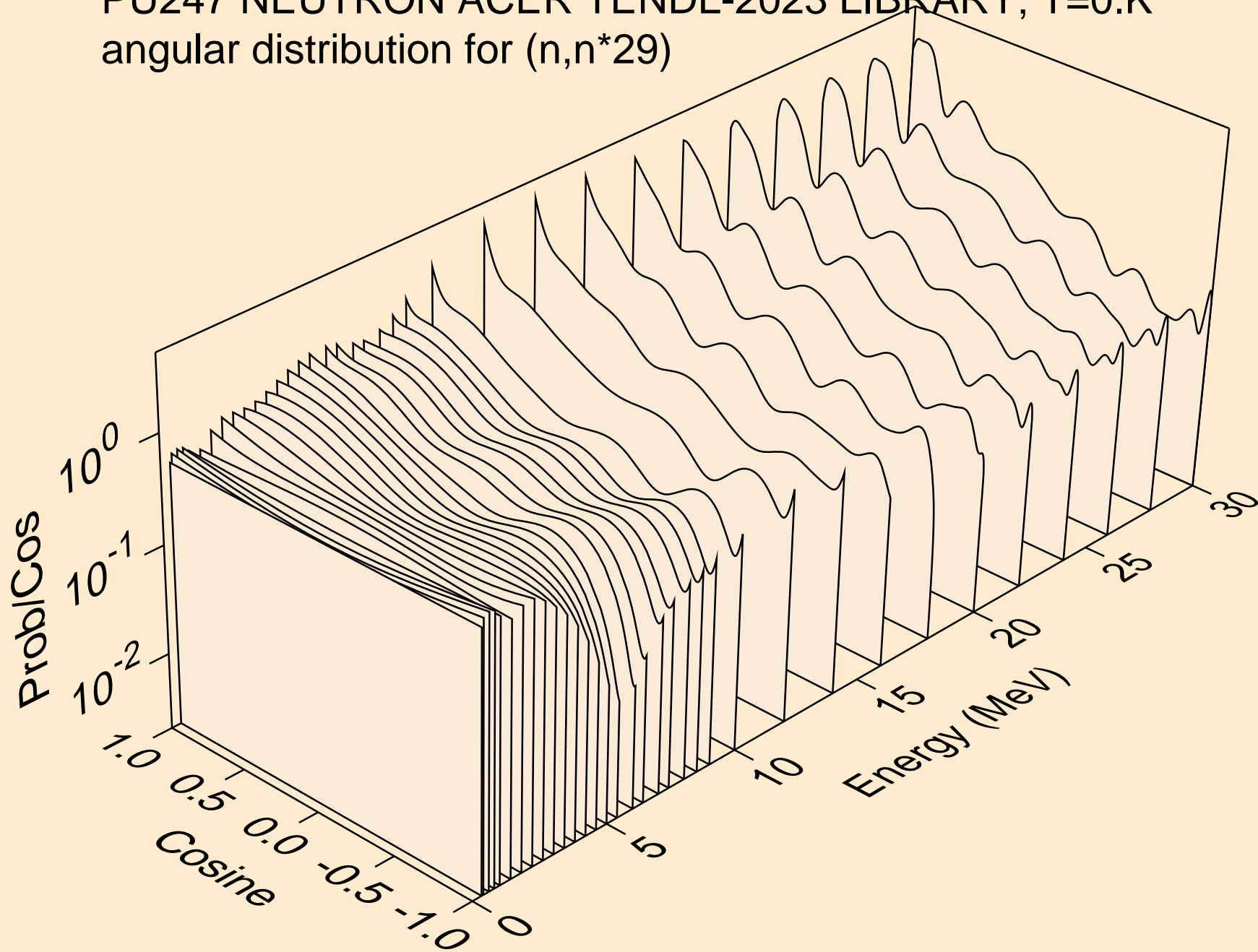

PU247 NEUTRON ACER TENDL-2023 LIBRARY; T=0.K
angular distribution for (n,n*30)

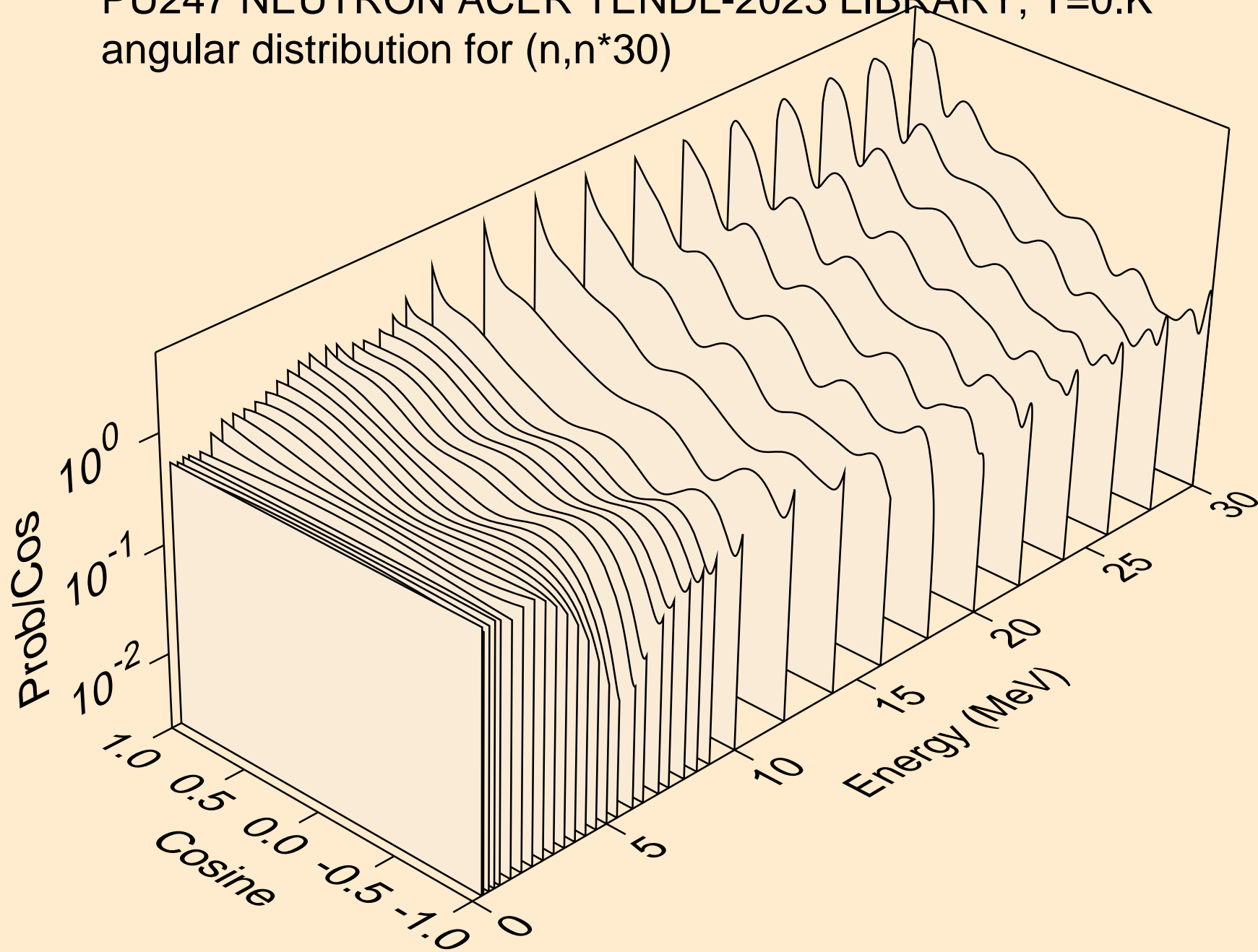

PU247 NEUTRON ACER TENDL-2023 LIBRARY; T=0.K
Total fission nubar

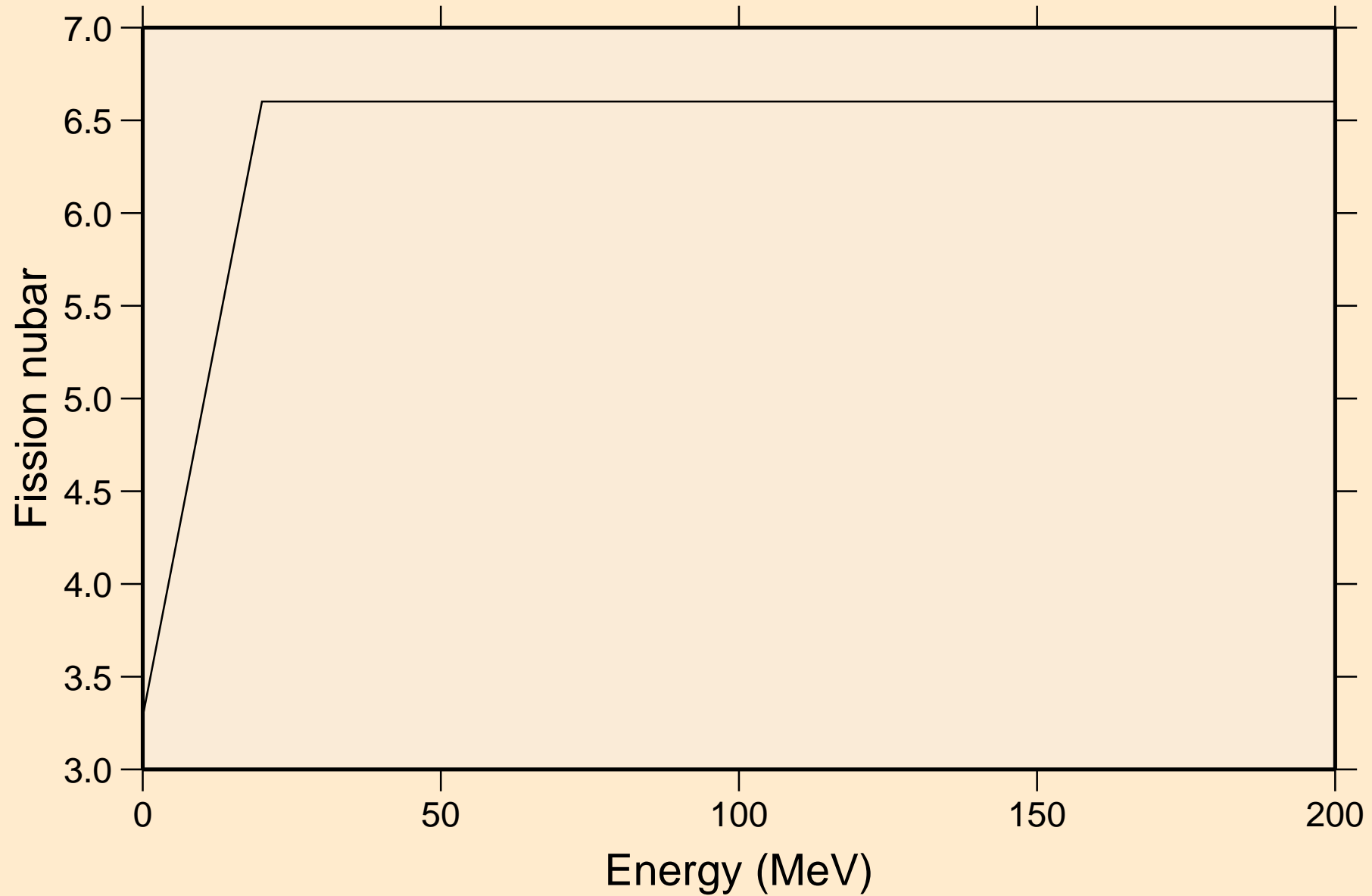

PU247 NEUTRON ACER TENDL-2023 LIBRARY; T=0.K
Neutron emission for (n,x)

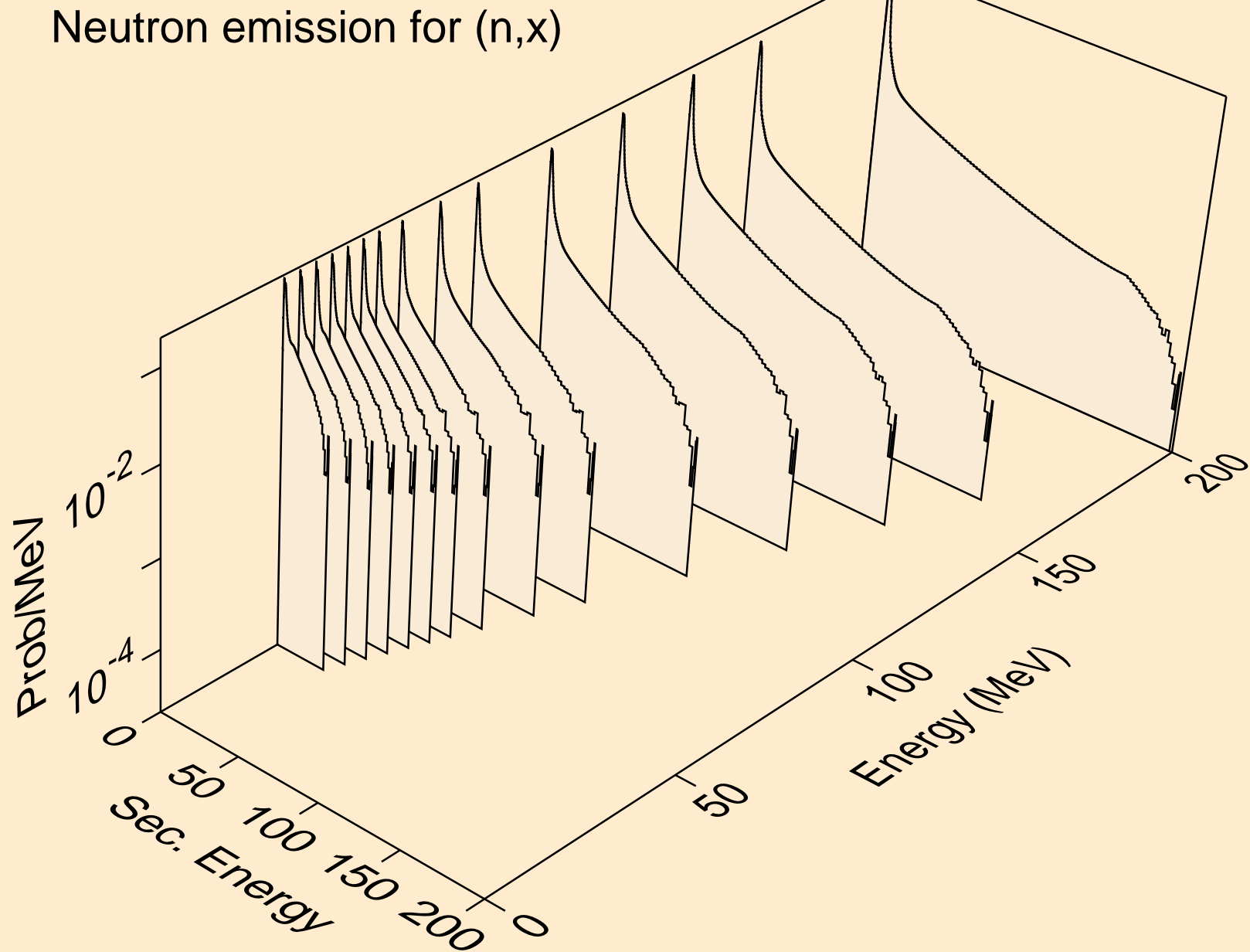

PU247 NEUTRON ACER TENDL-2023 LIBRARY; T=0.K
Neutron emission for (n,2nd)

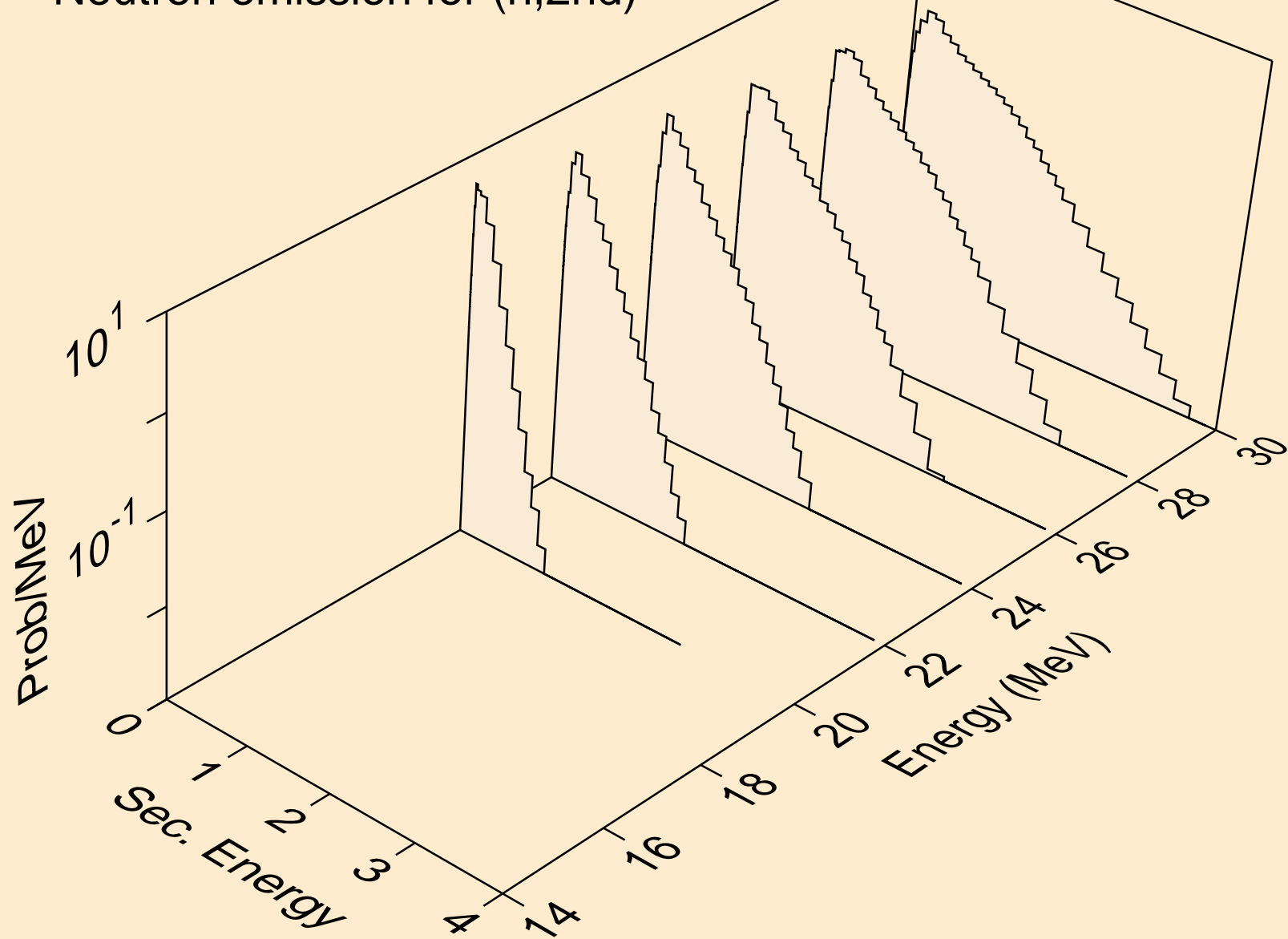

PU247 NEUTRON ACER TENDL-2023 LIBRARY; T=0.K
Neutron emission for (n,2n)

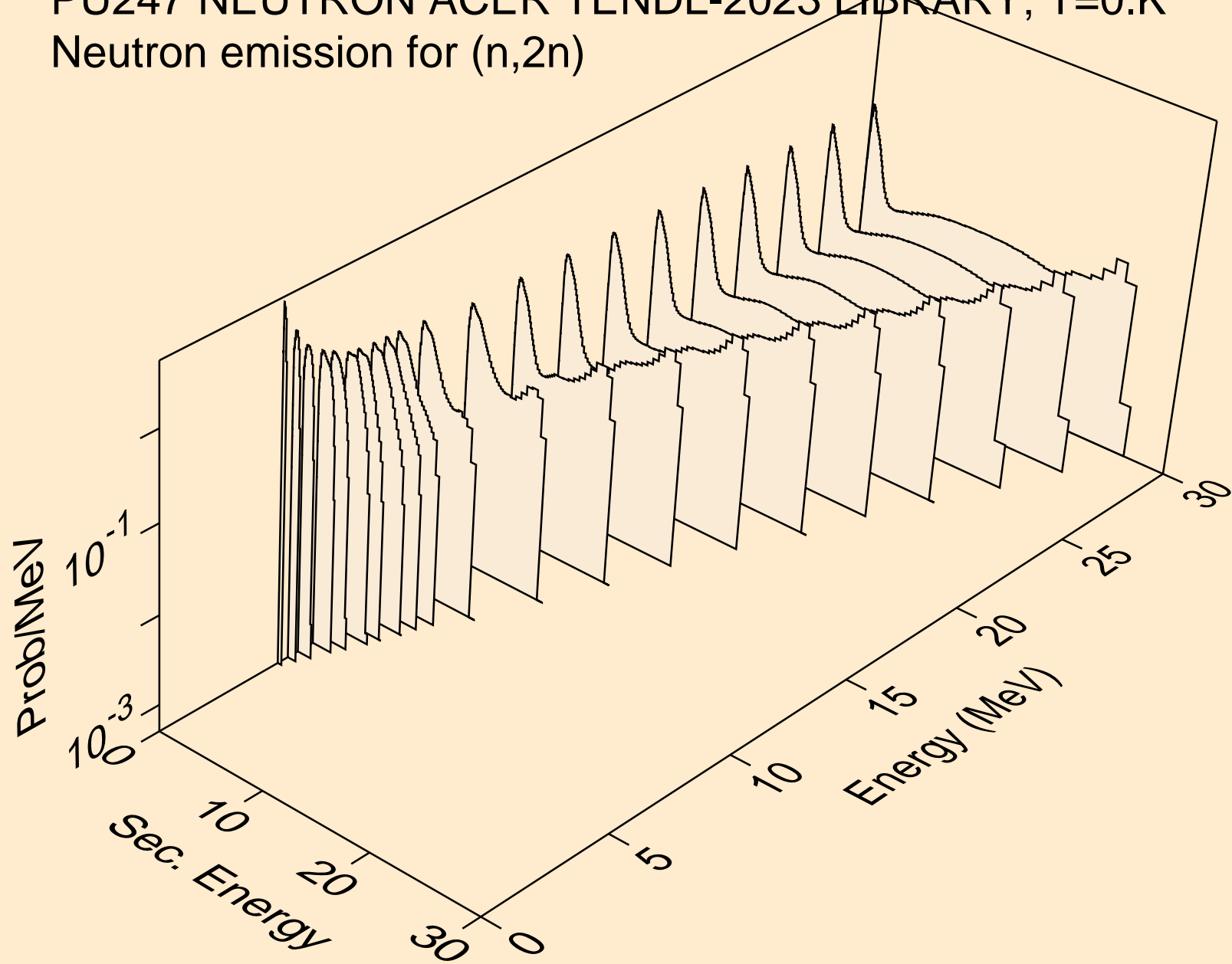

PU247 NEUTRON ACER TENDL-2023 LIBRARY; T=0.K
Neutron emission for (n,3n)

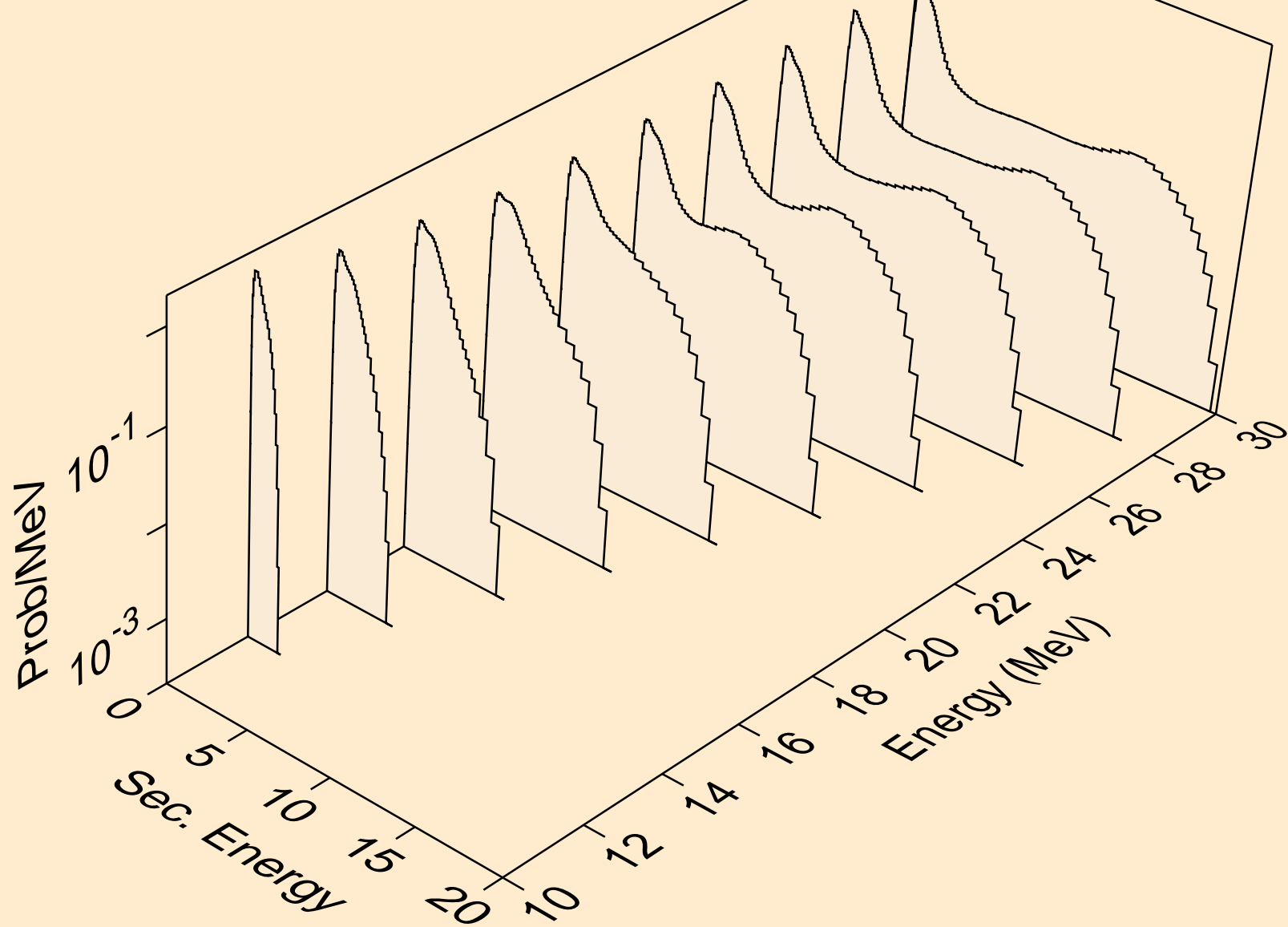

PU247 NEUTRON ACER TENDL-2023 LIBRARY; T=0.K
Neutron emission for fission

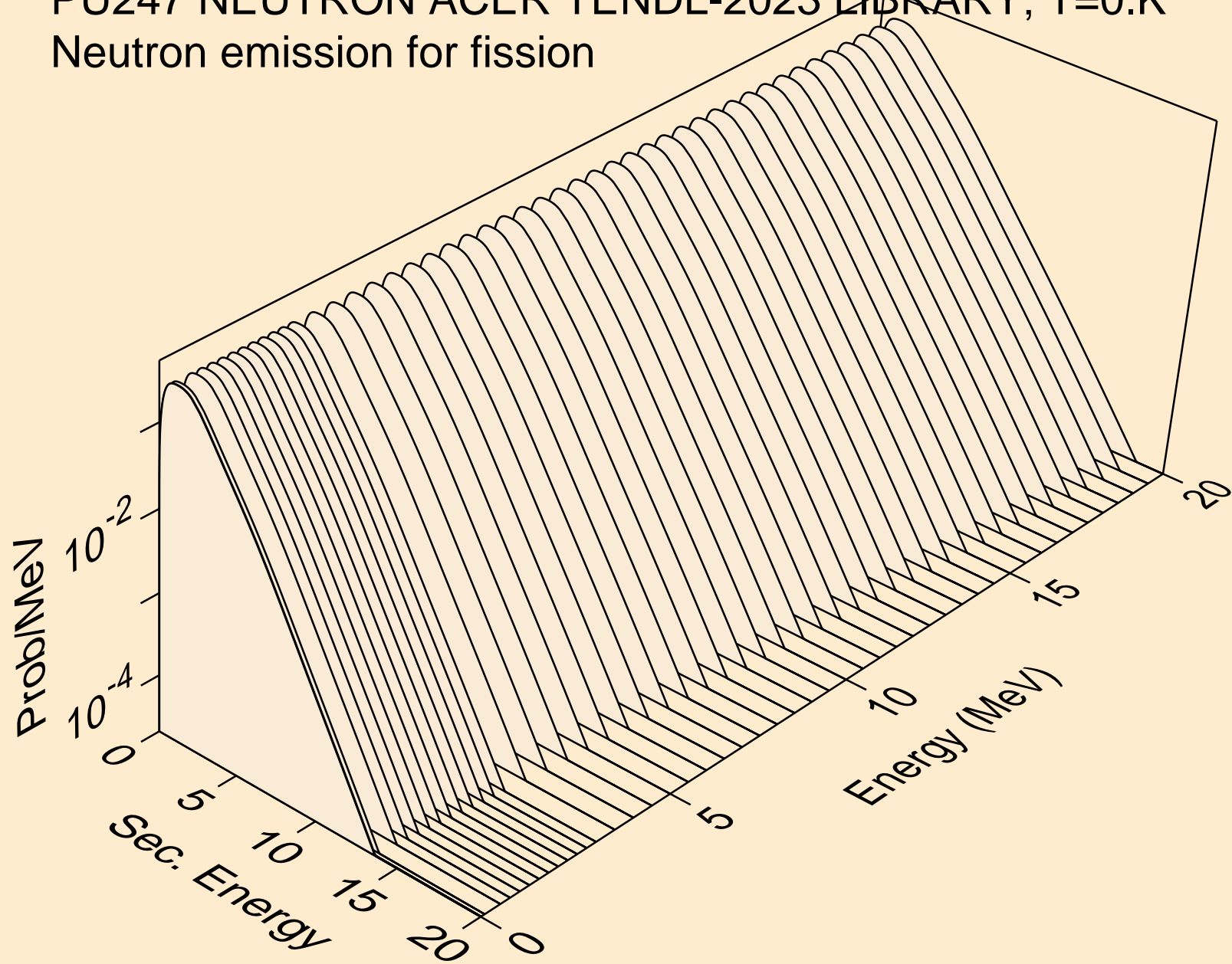

PU247 NEUTRON ACER TENDL-2023 LIBRARY; T=0.K
Neutron emission for (n,n*)a

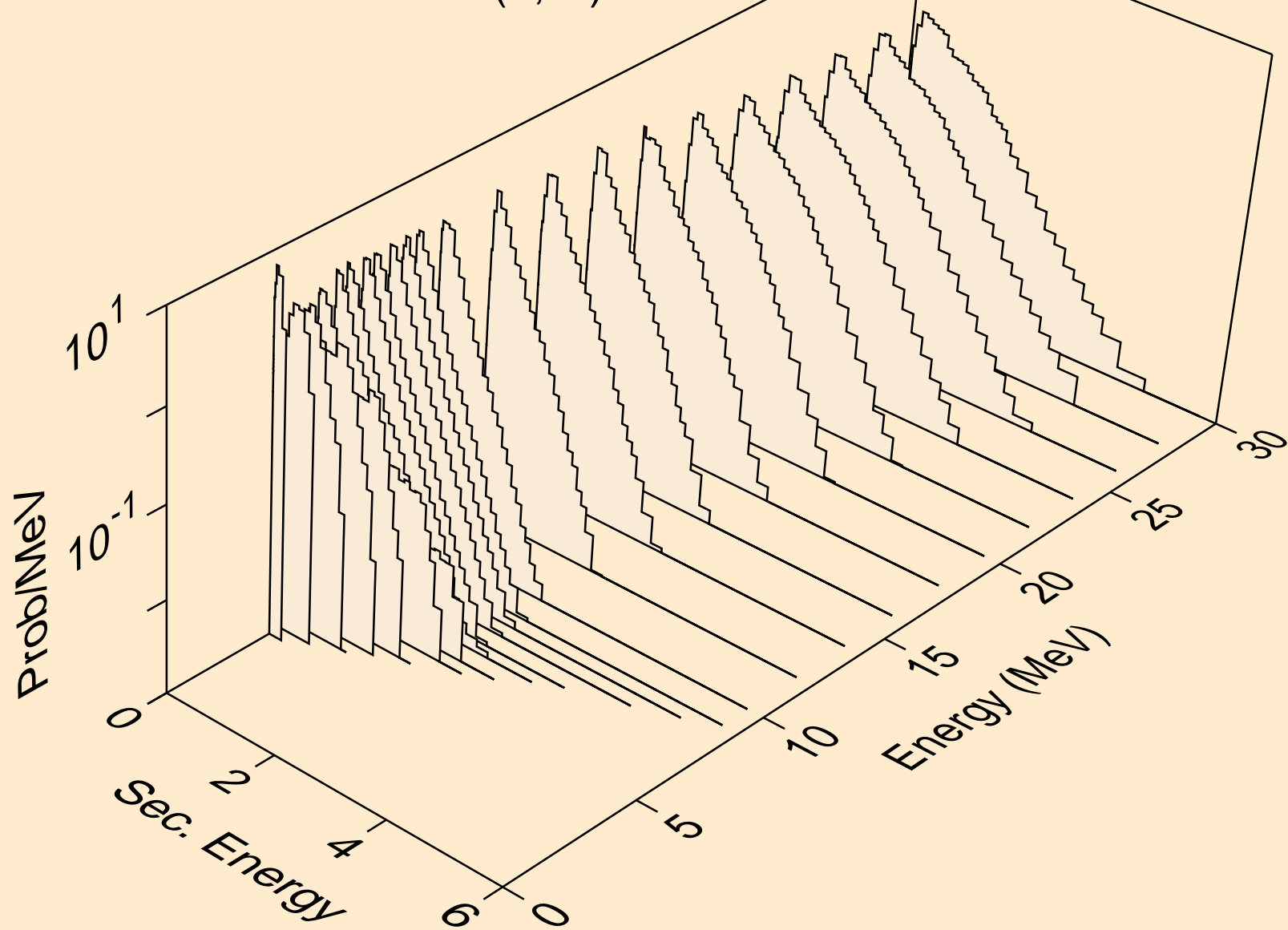

PU247 NEUTRON ACER TENDL-2023 LIBRARY; T=0.K
Neutron emission for (n,2n)a

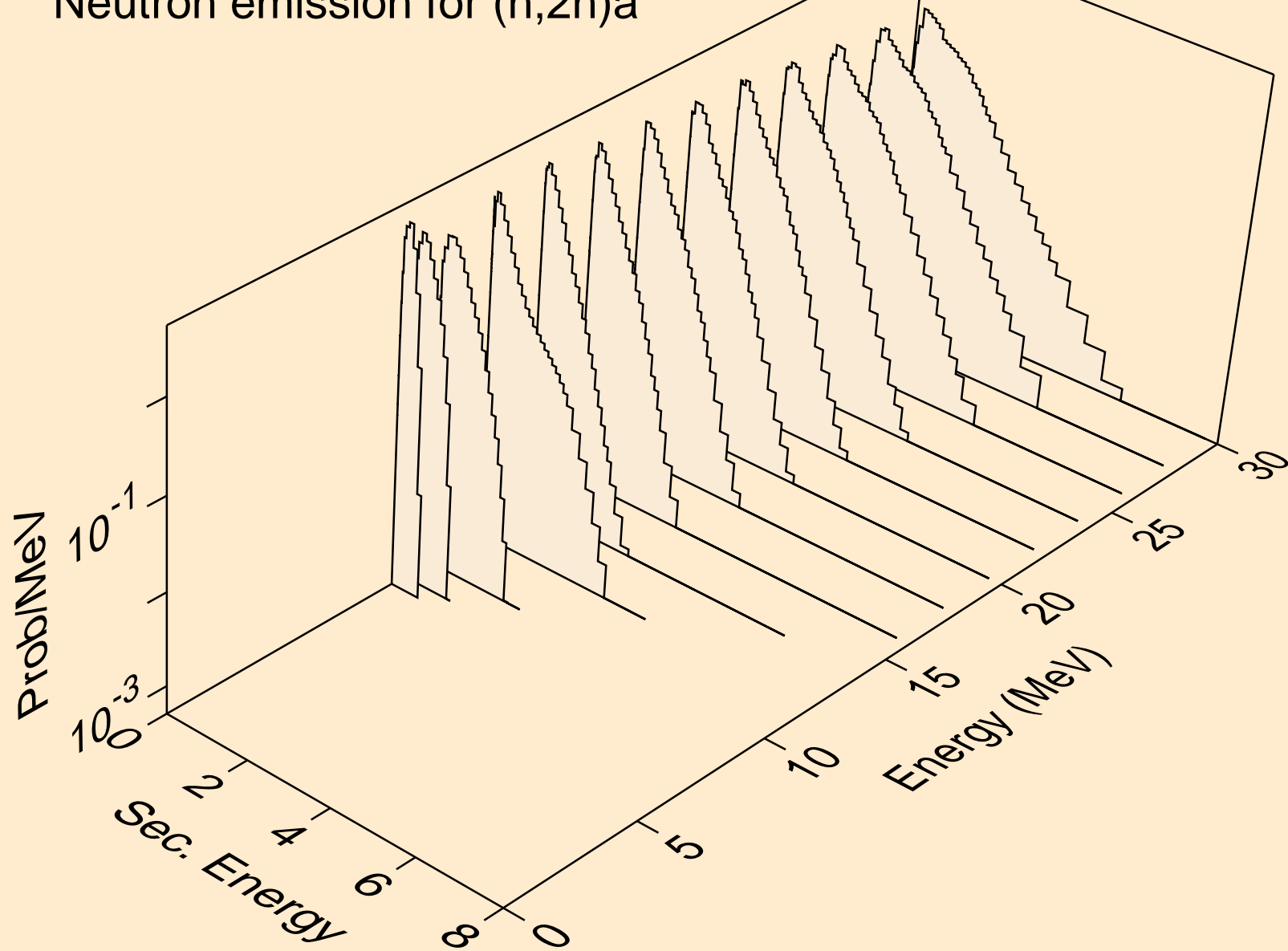

PU247 NEUTRON ACER TENDL-2023 LIBRARY; T=0.K
Neutron emission for (n,3n)a

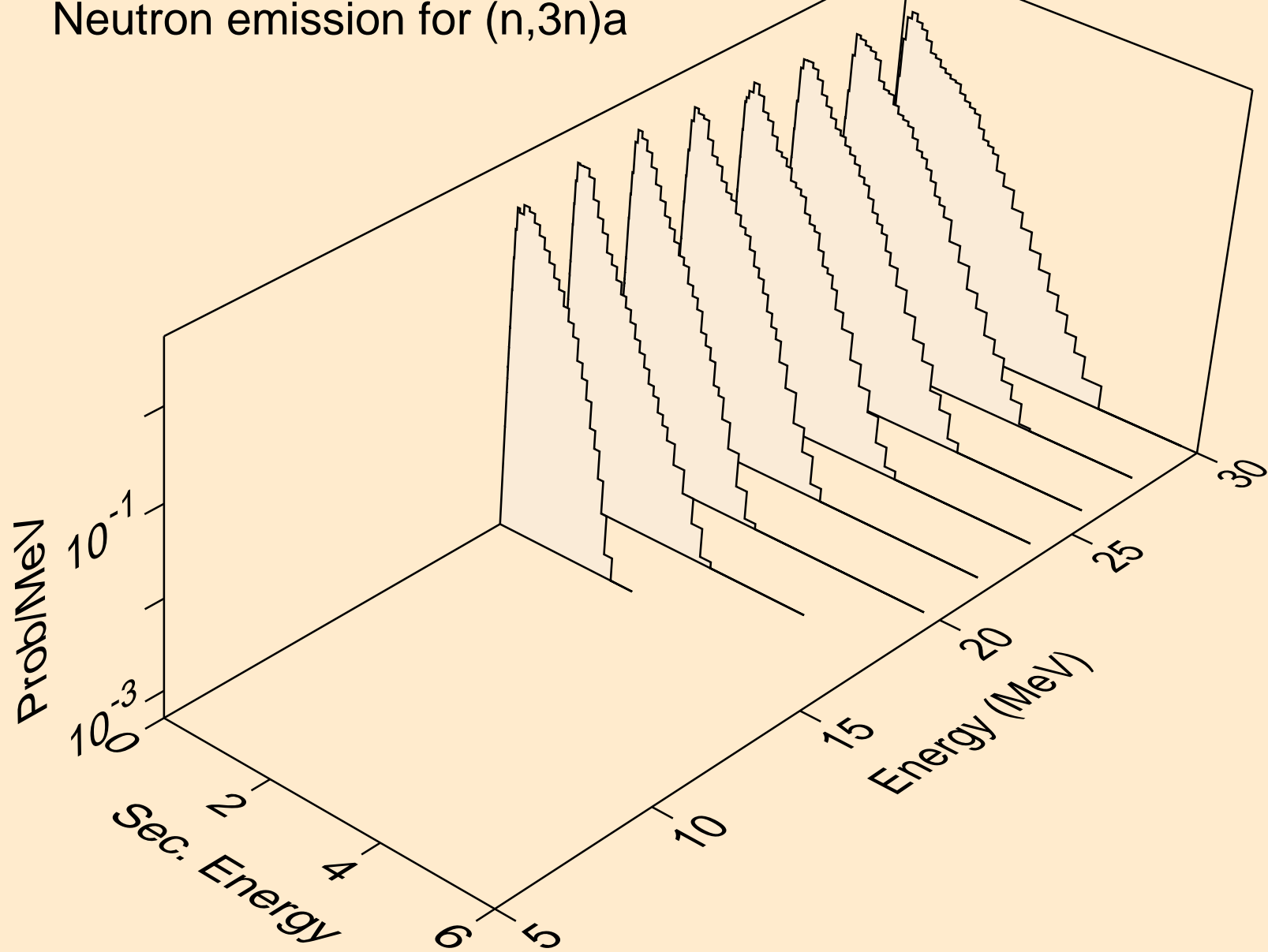

PU247 NEUTRON ACER TENDL-2023 LIBRARY; T=0.K
Neutron emission for (n,n*)p

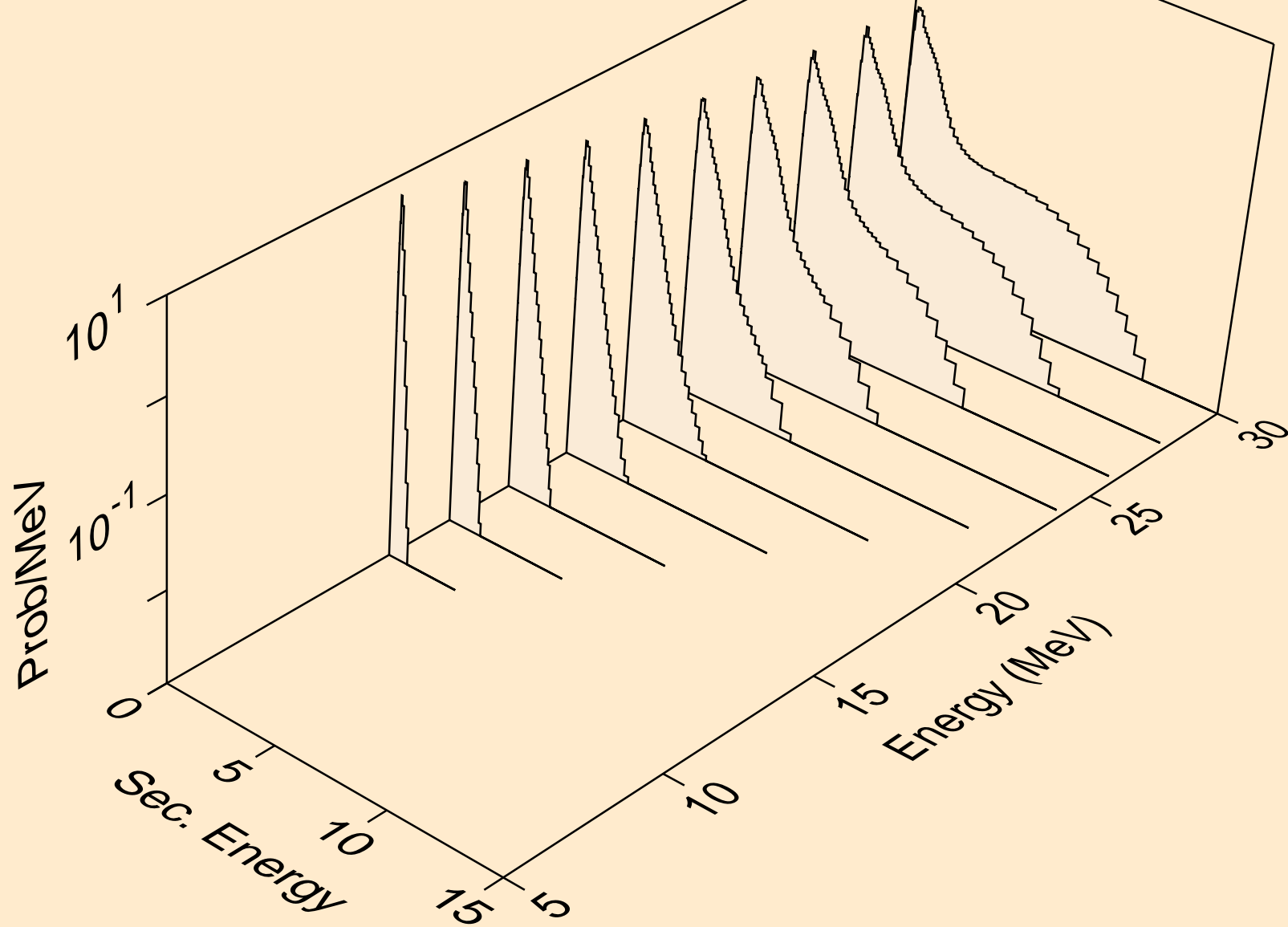

PU247 NEUTRON ACER TENDL-2023 LIBRARY; T=0.K
Neutron emission for (n,n*)d

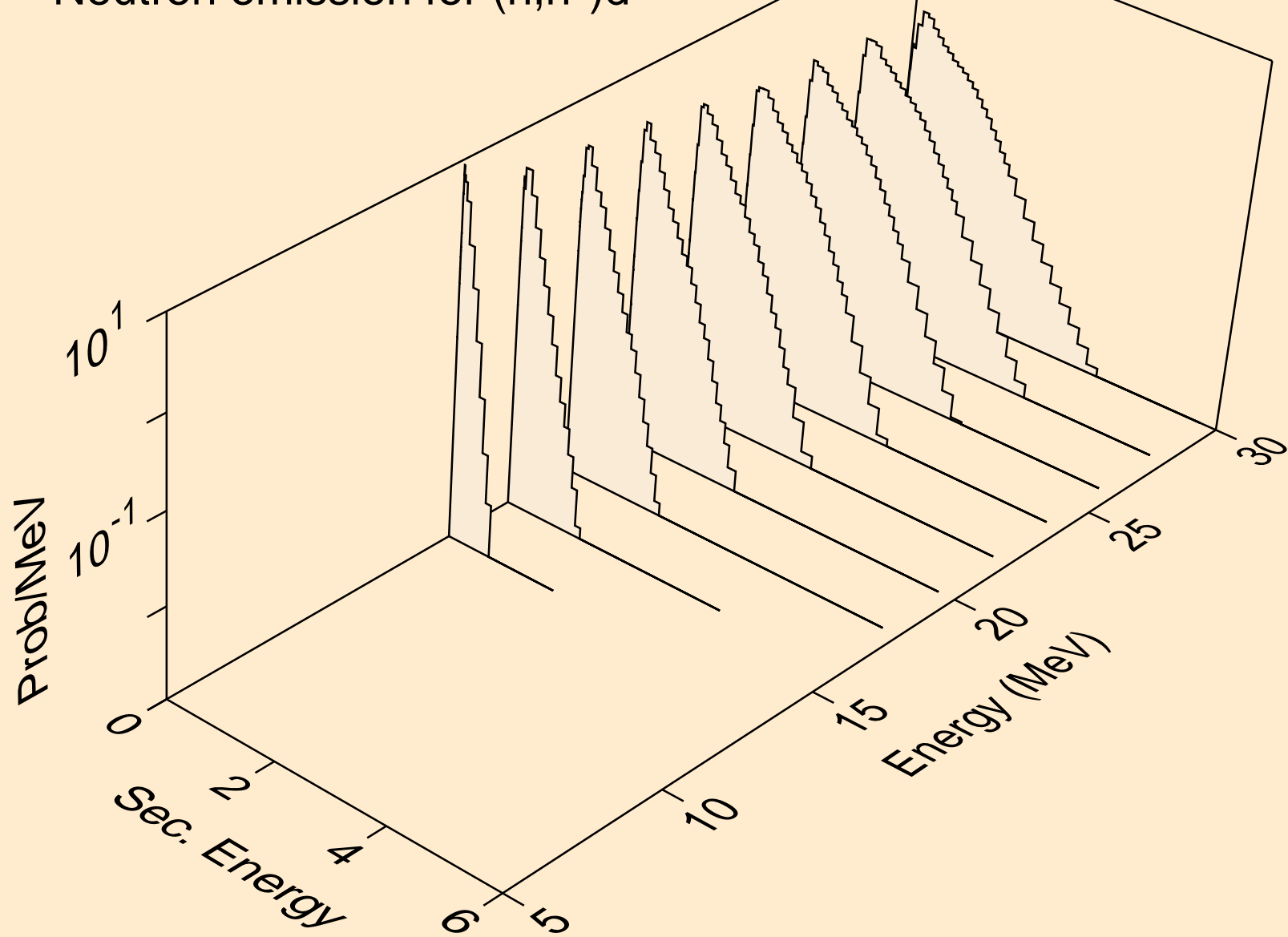

PU247 NEUTRON ACER TENDL-2023 LIBRARY; T=0.K
Neutron emission for (n,n*)t

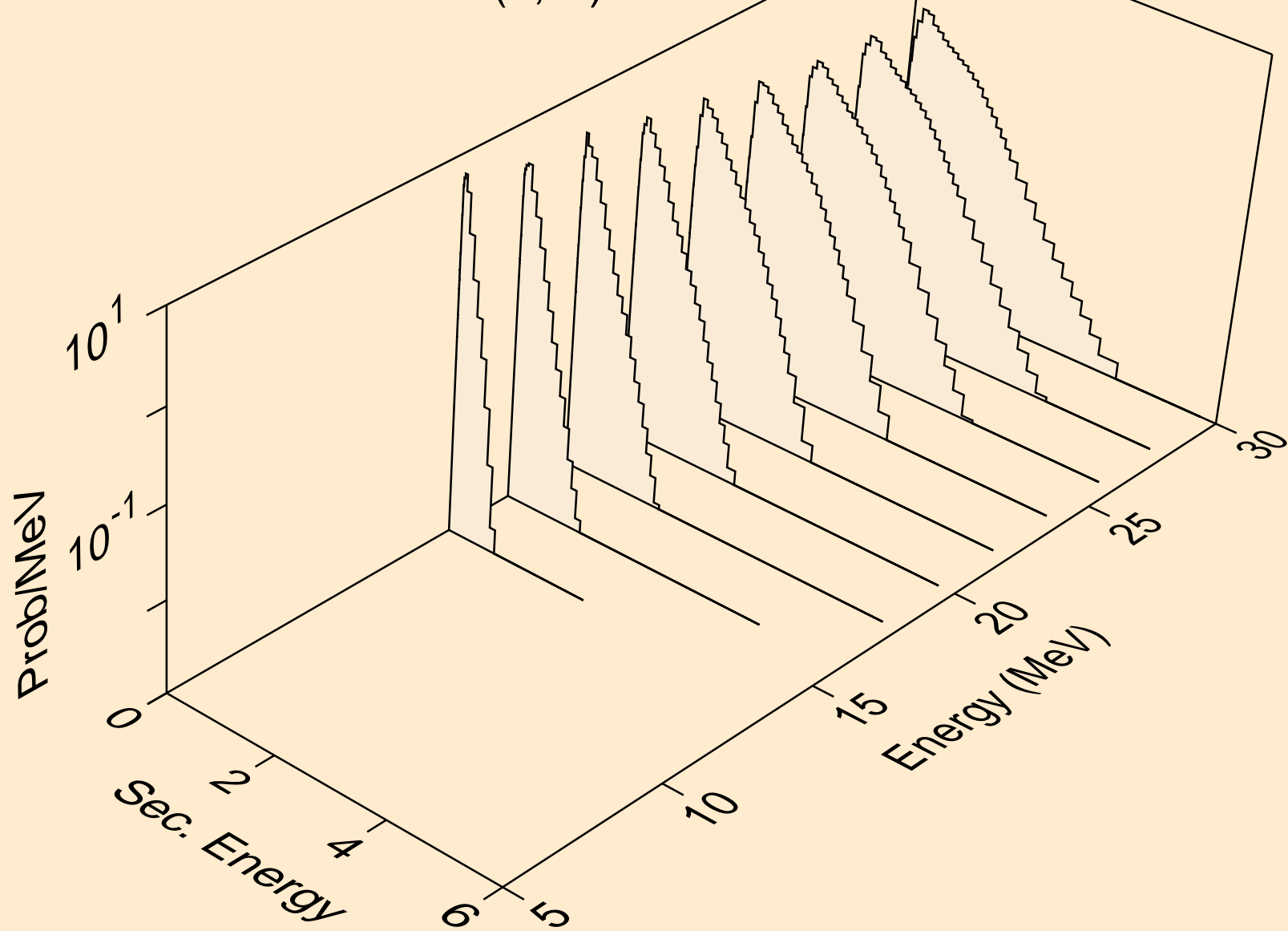

PU247 NEUTRON ACER TENDL-2023 LIBRARY; T=0.K
Neutron emission for (n,n*)he3

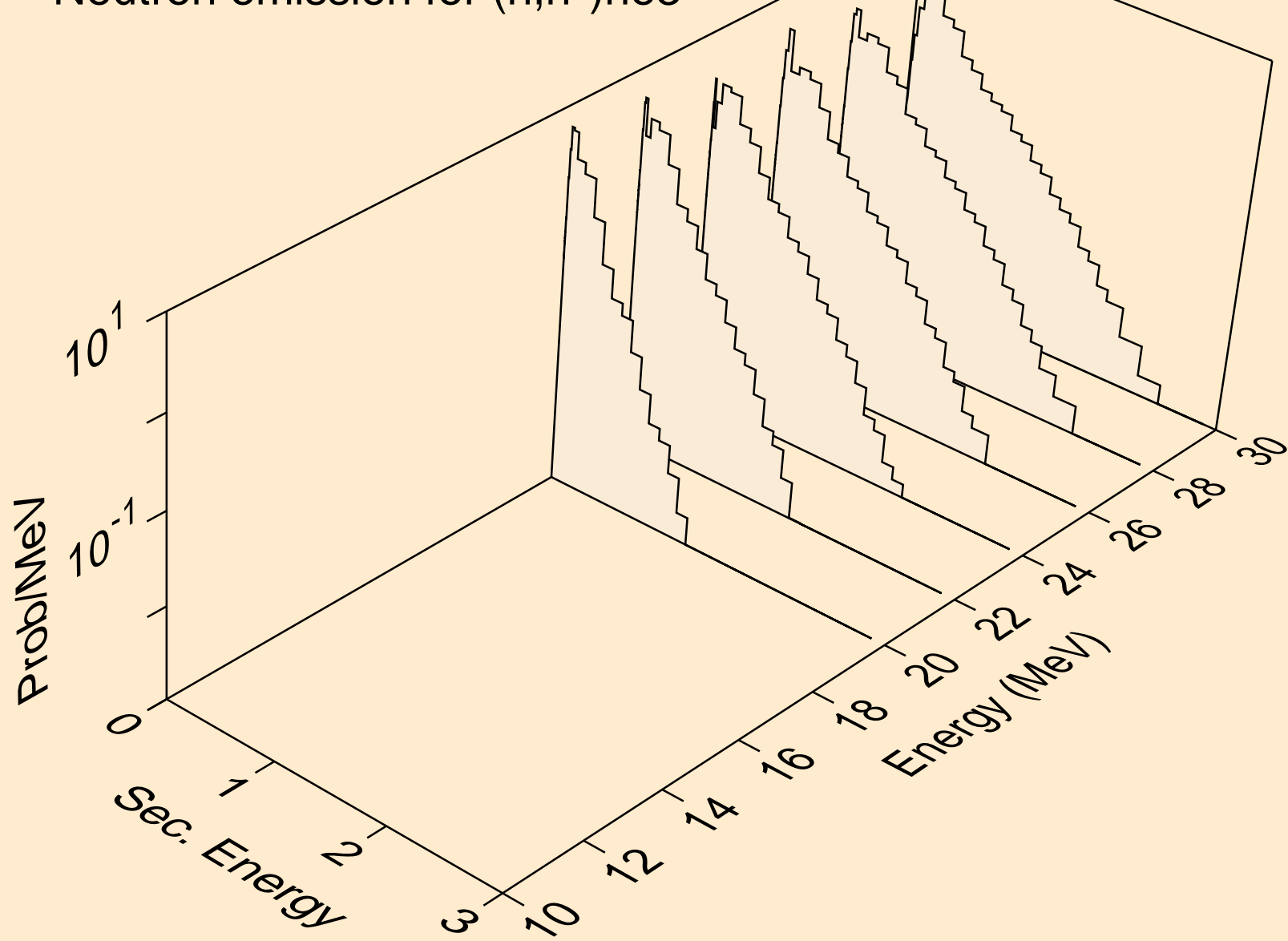

PU247 NEUTRON ACER TENDL-2023 LIBRARY; T=0.K
Neutron emission for (n,4n)

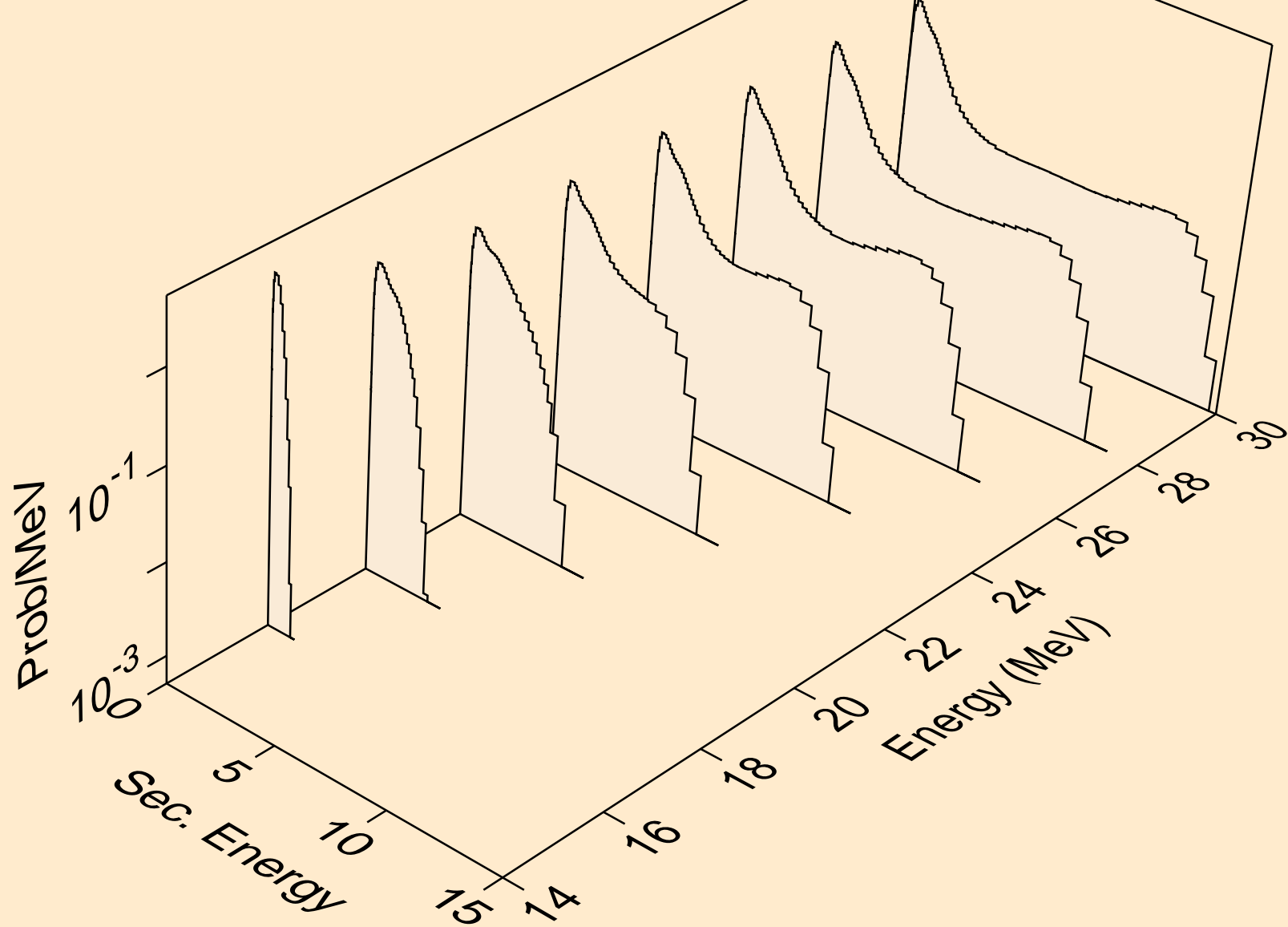

PU247 NEUTRON ACER TENDL-2023 LIBRARY; T=0.K
Neutron emission for (n,2np)

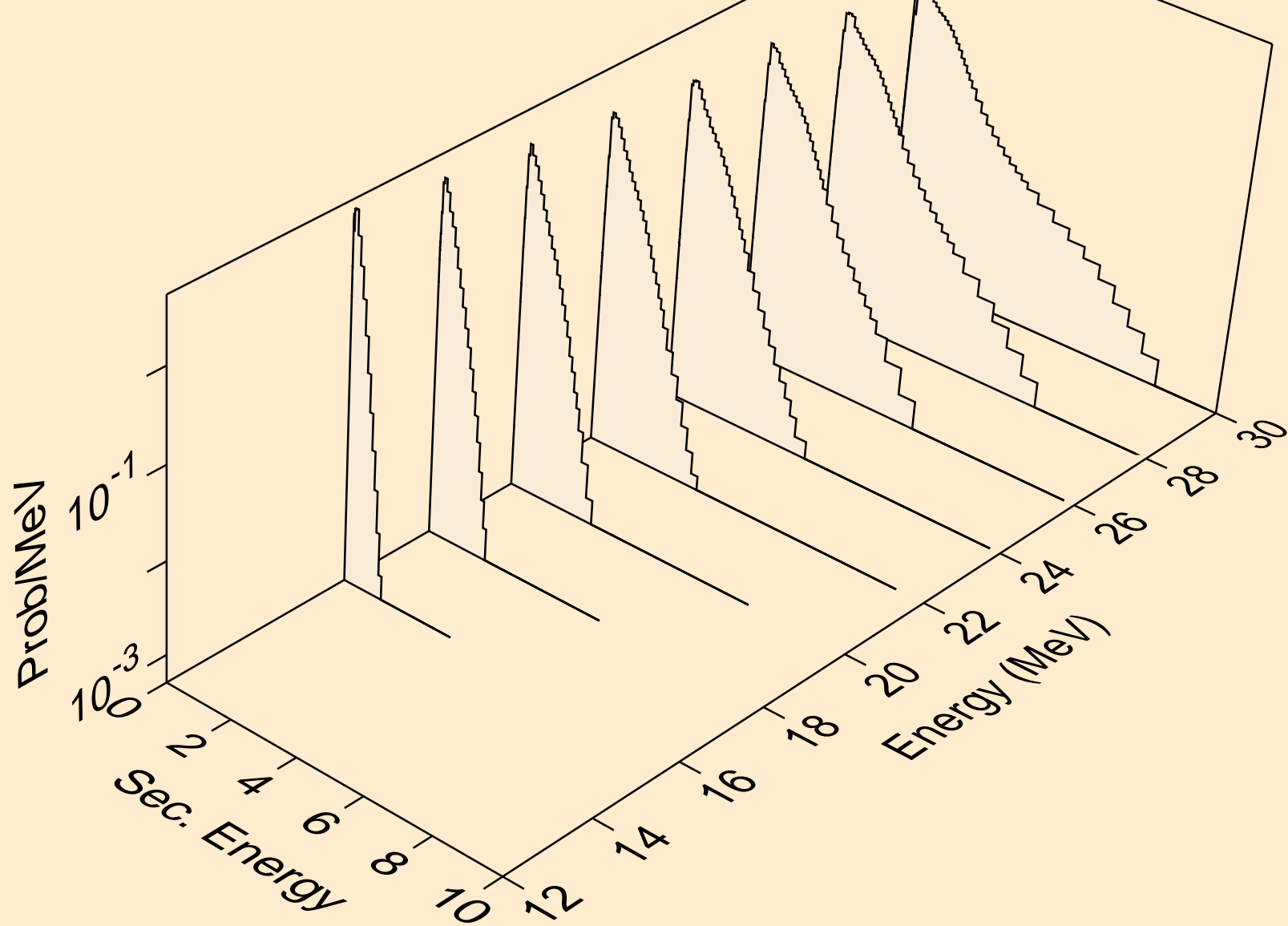

PU247 NEUTRON ACER TENDL-2023 LIBRARY; T=0.K
Neutron emission for (n,3np)

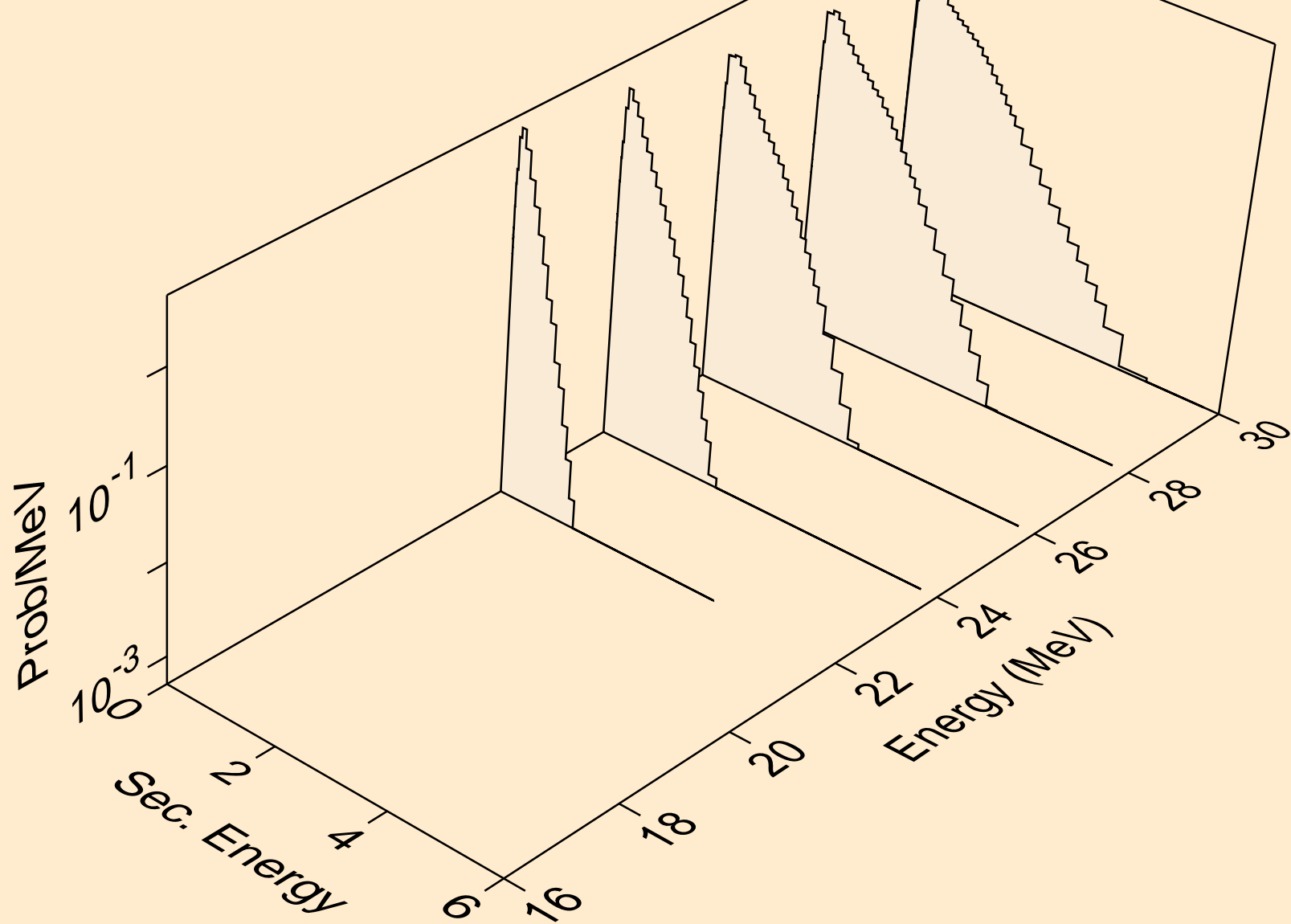

PU247 NEUTRON ACER TENDL-2023 LIBRARY; T=0.K
Neutron emission for (n,n*c)

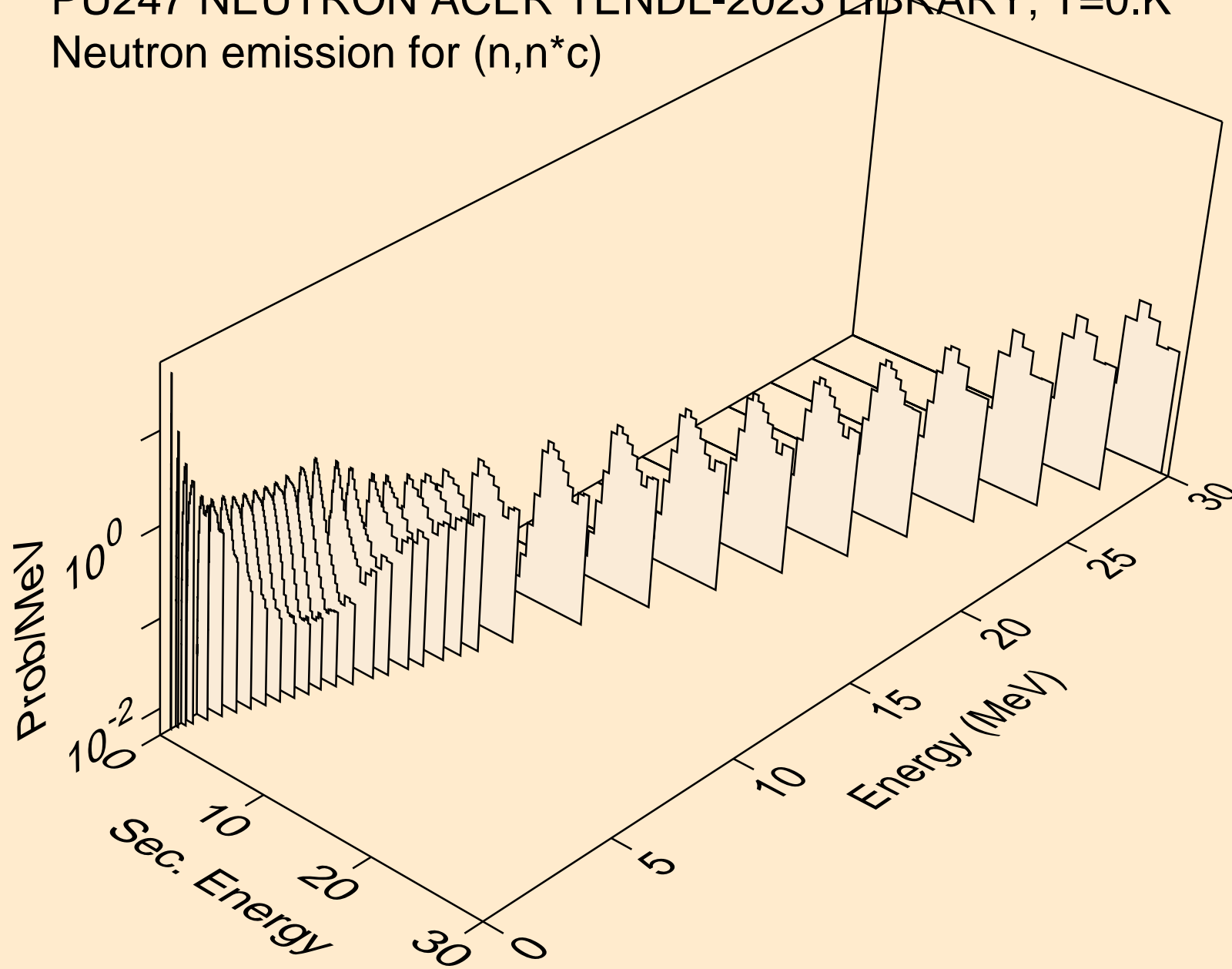

PU247 NEUTRON ACER TENDL-2023 LIBRARY; T=0.K

Delayed nubar

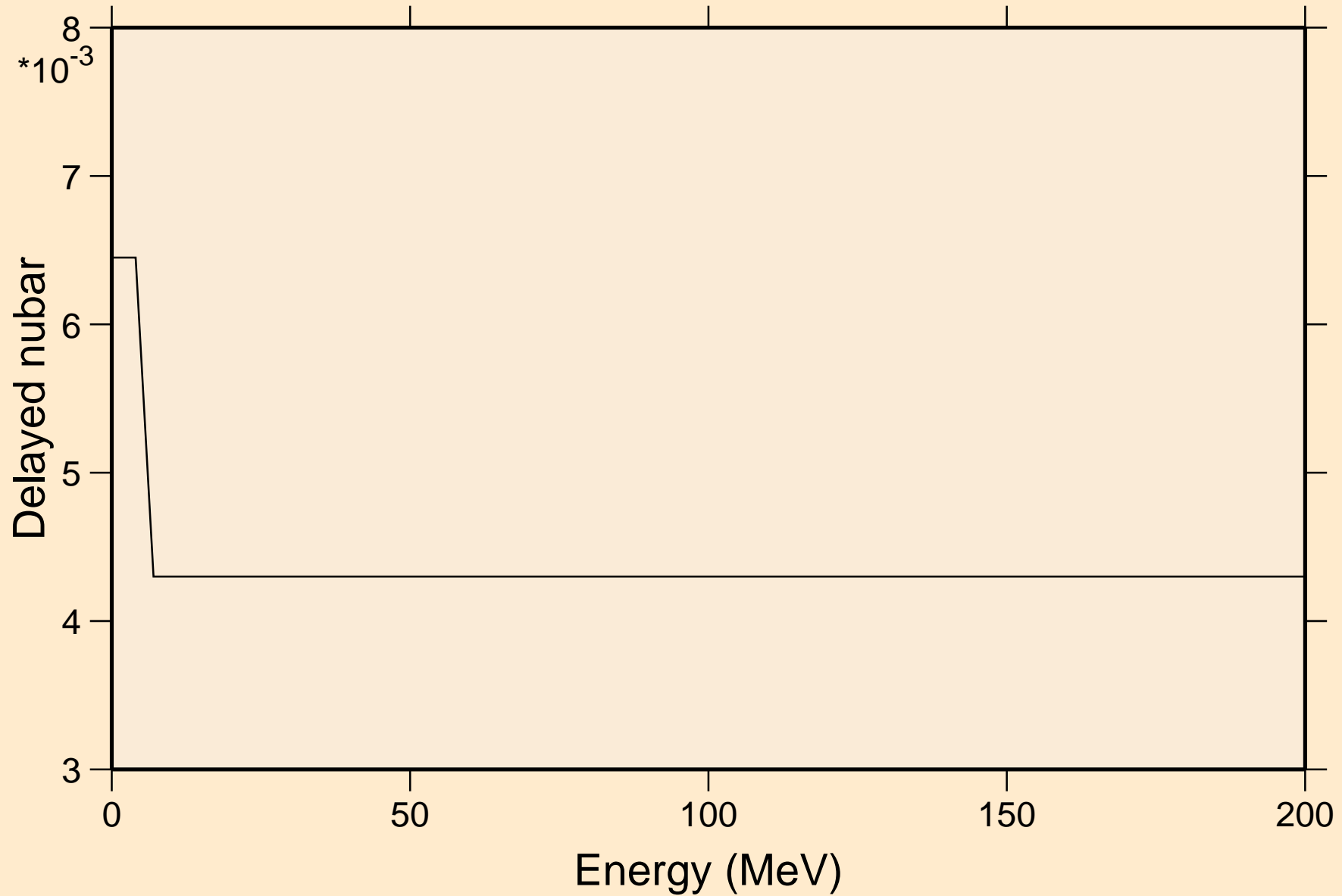

PU247 NEUTRON ACER TENDL-2023 LIBRARY; T=0.K

Delayed neutron spectra

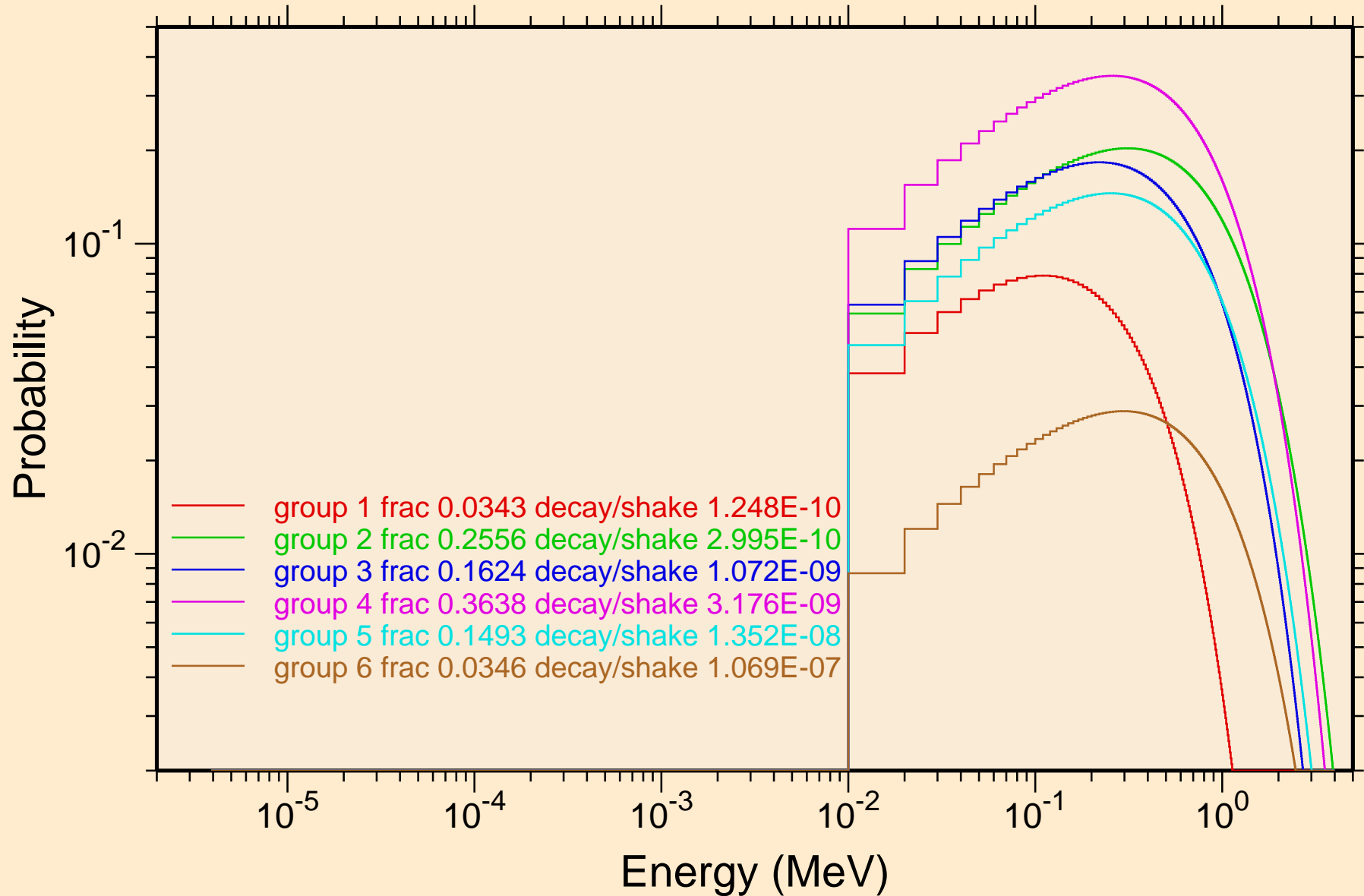

PU247 NEUTRON ACER TENDL-2023 LIBRARY; T=0.K
Photon emission for (n,x)

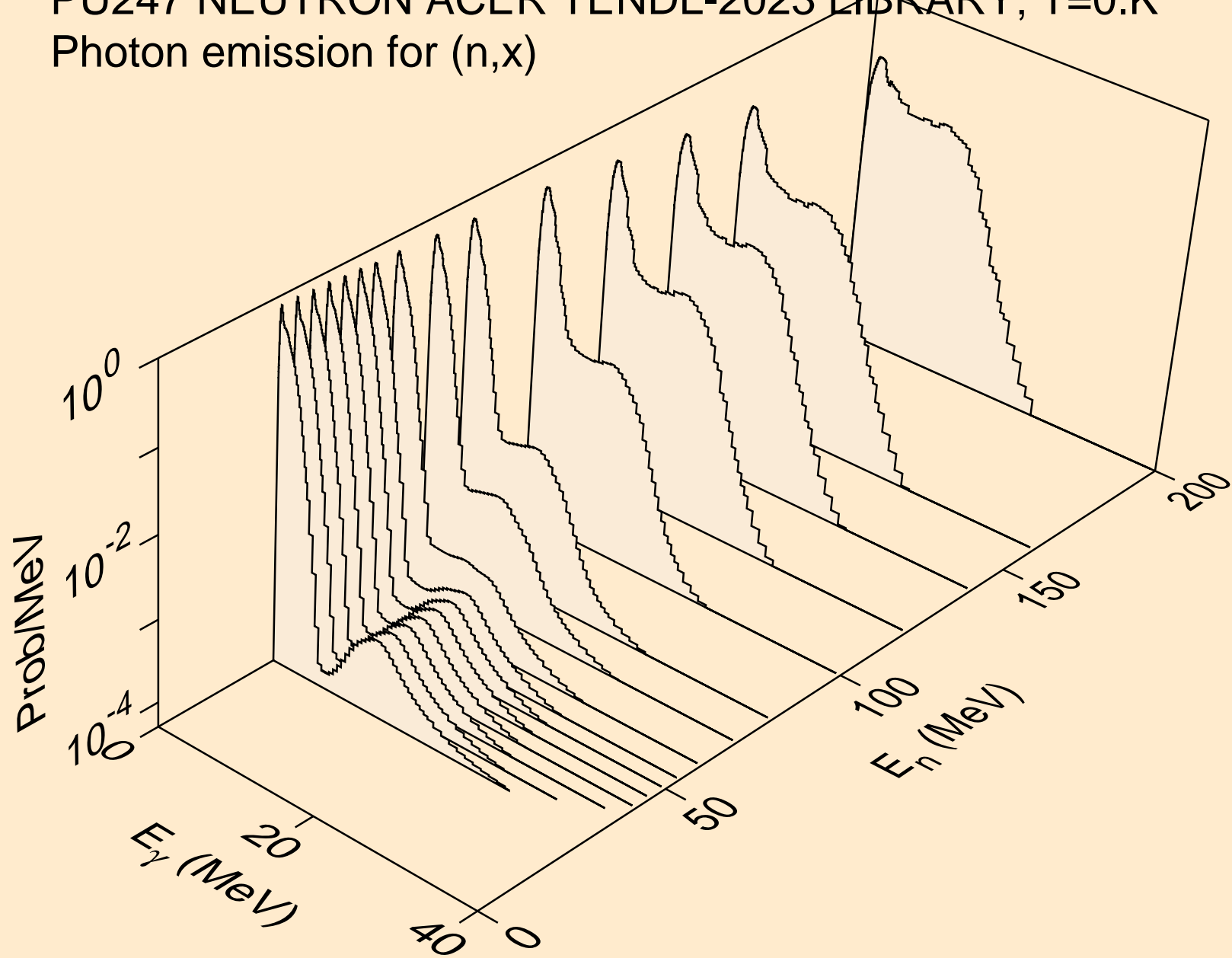

PU247 NEUTRON ACER TENDL-2023 LIBRARY; T=0.K
Photon emission for (n,2nd)

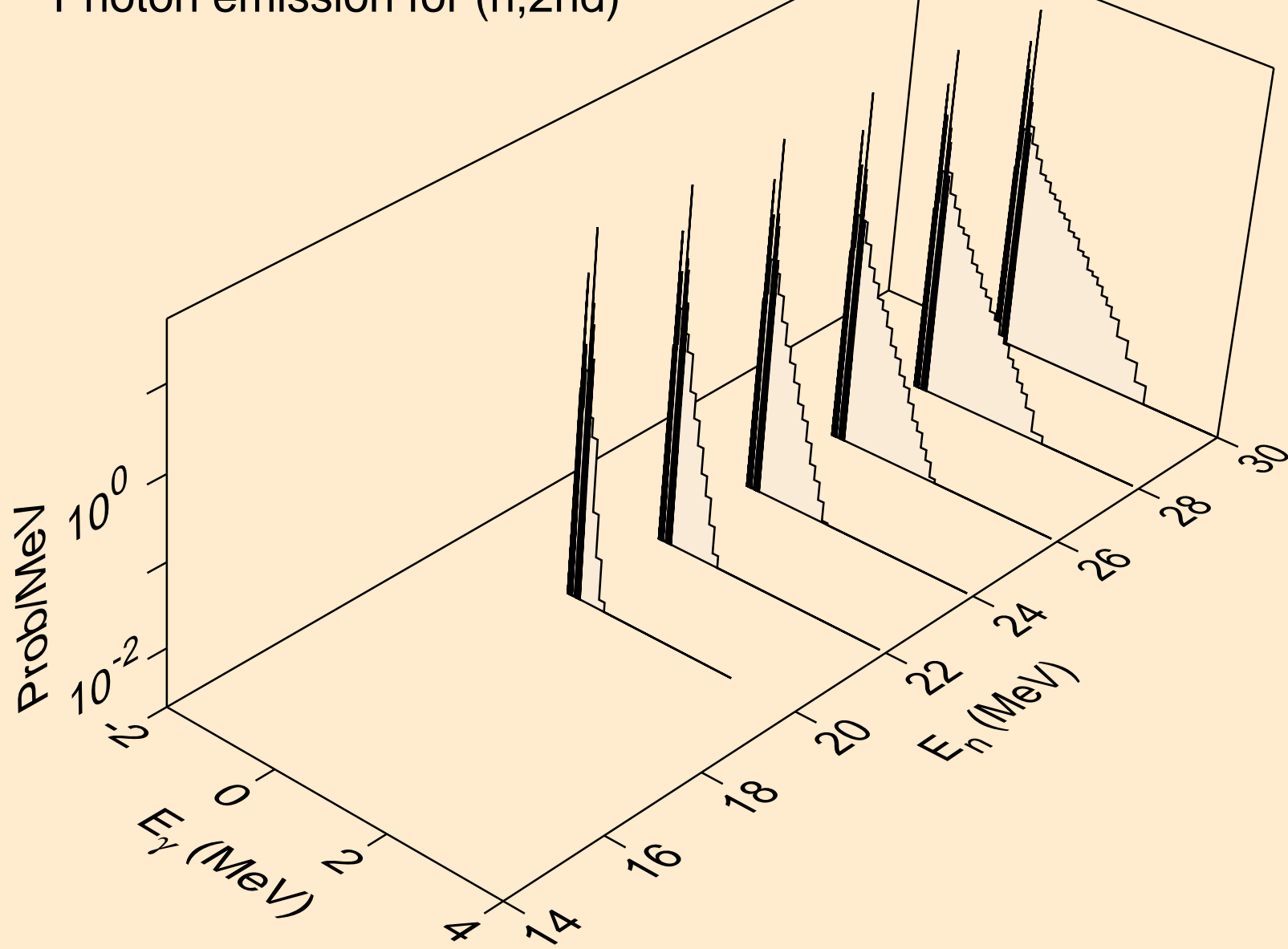

PU247 NEUTRON ACER TENDL-2023 LIBRARY; T=0.K
Photon emission for (n,2n)

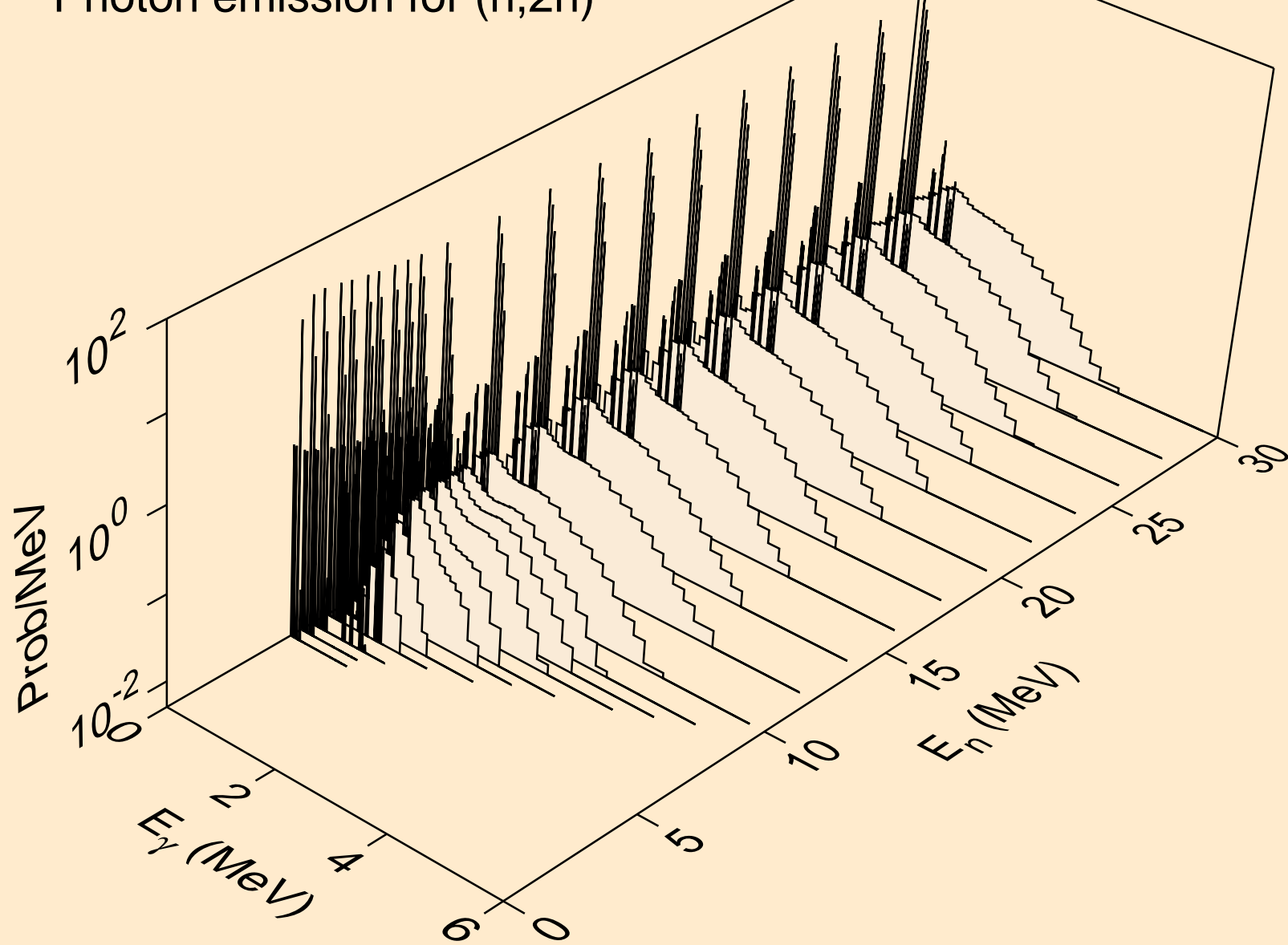

PU247 NEUTRON ACER TENDL-2023 LIBRARY; T=0.K
Photon emission for (n,3n)

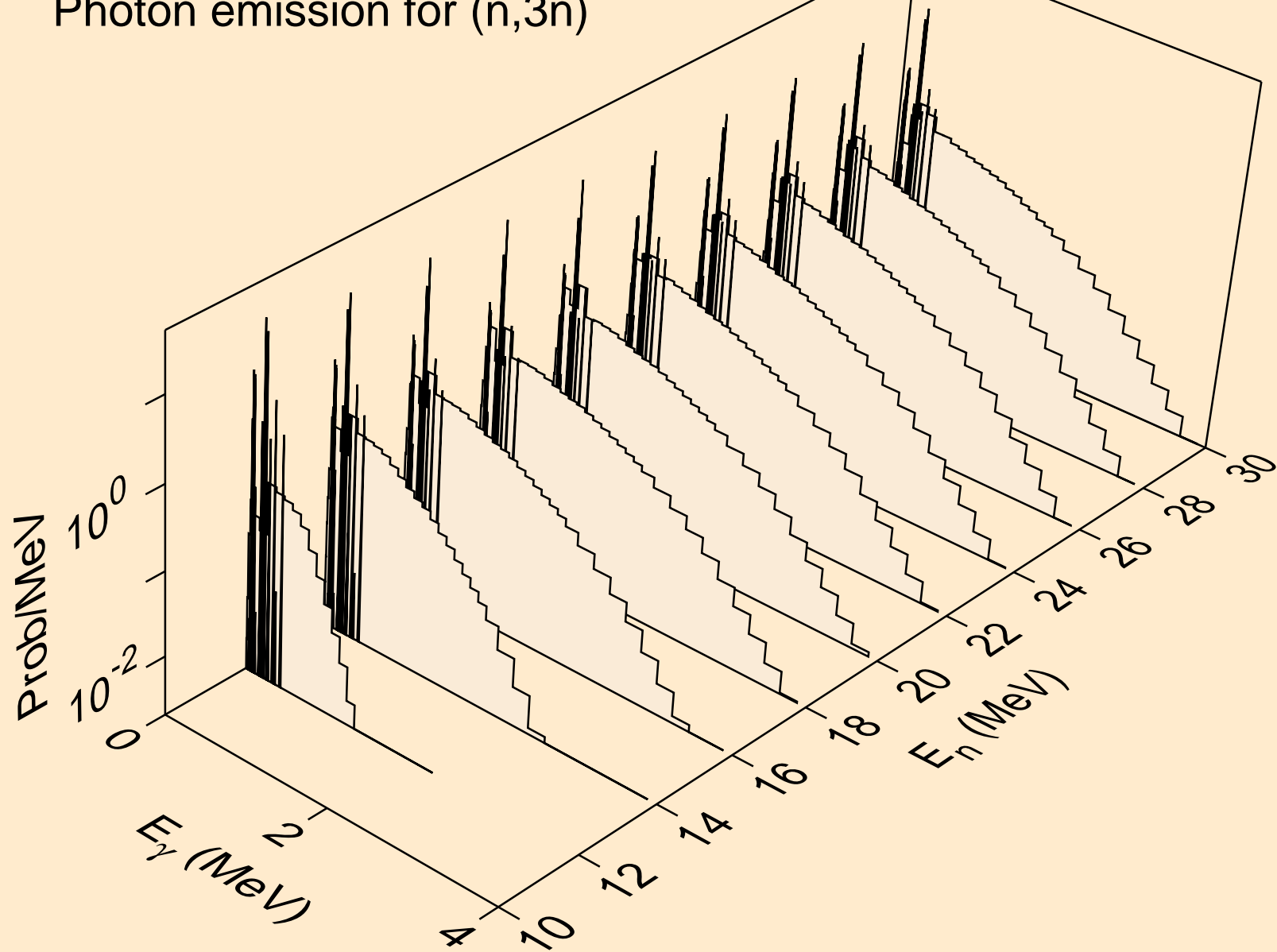

PU247 NEUTRON ACER TENDL-2023 LIBRARY; T=0.K
Photon emission for (n,n*)a

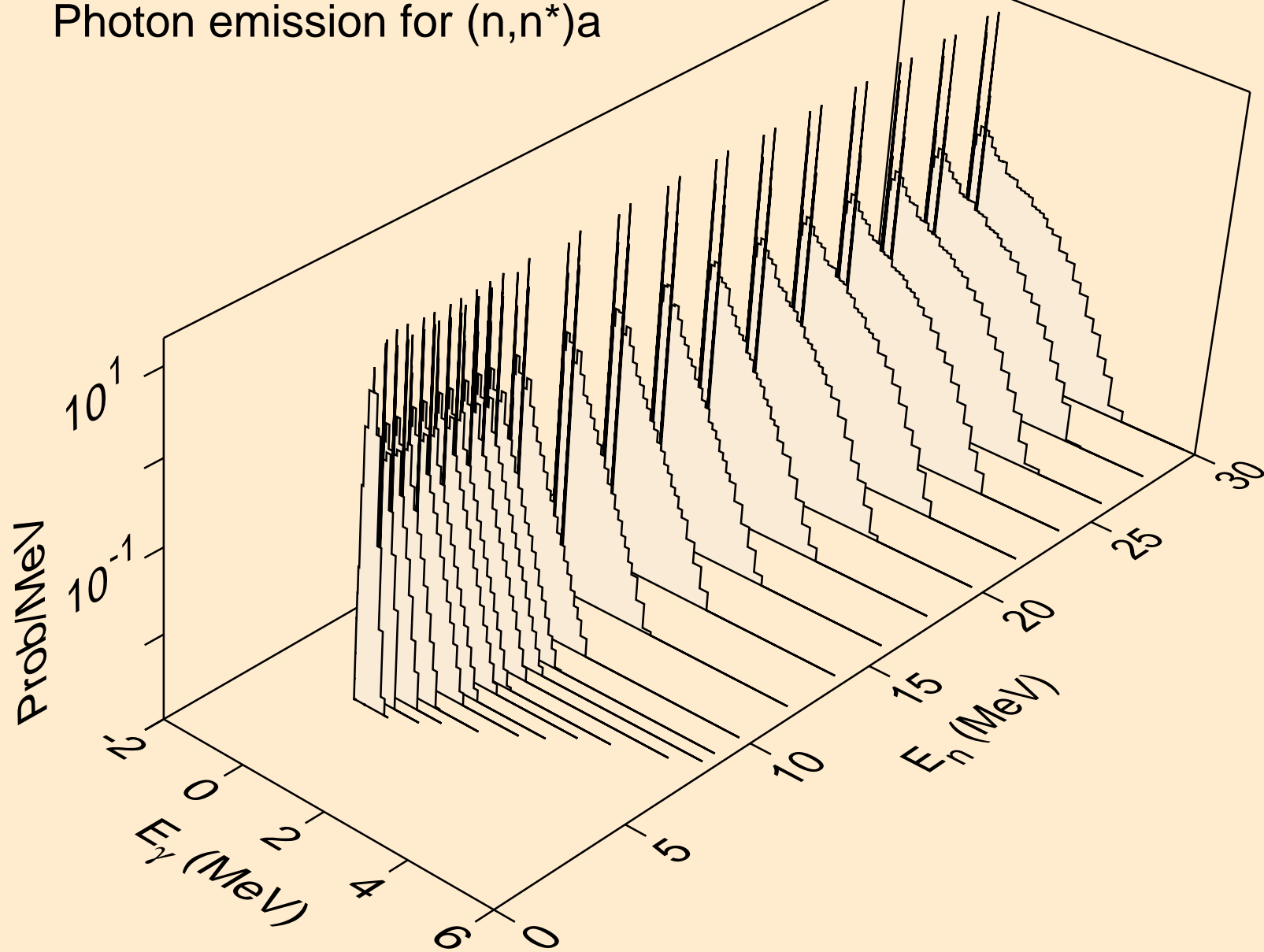

PU247 NEUTRON ACER TENDL-2023 LIBRARY; T=0.K
Photon emission for (n,2n)a

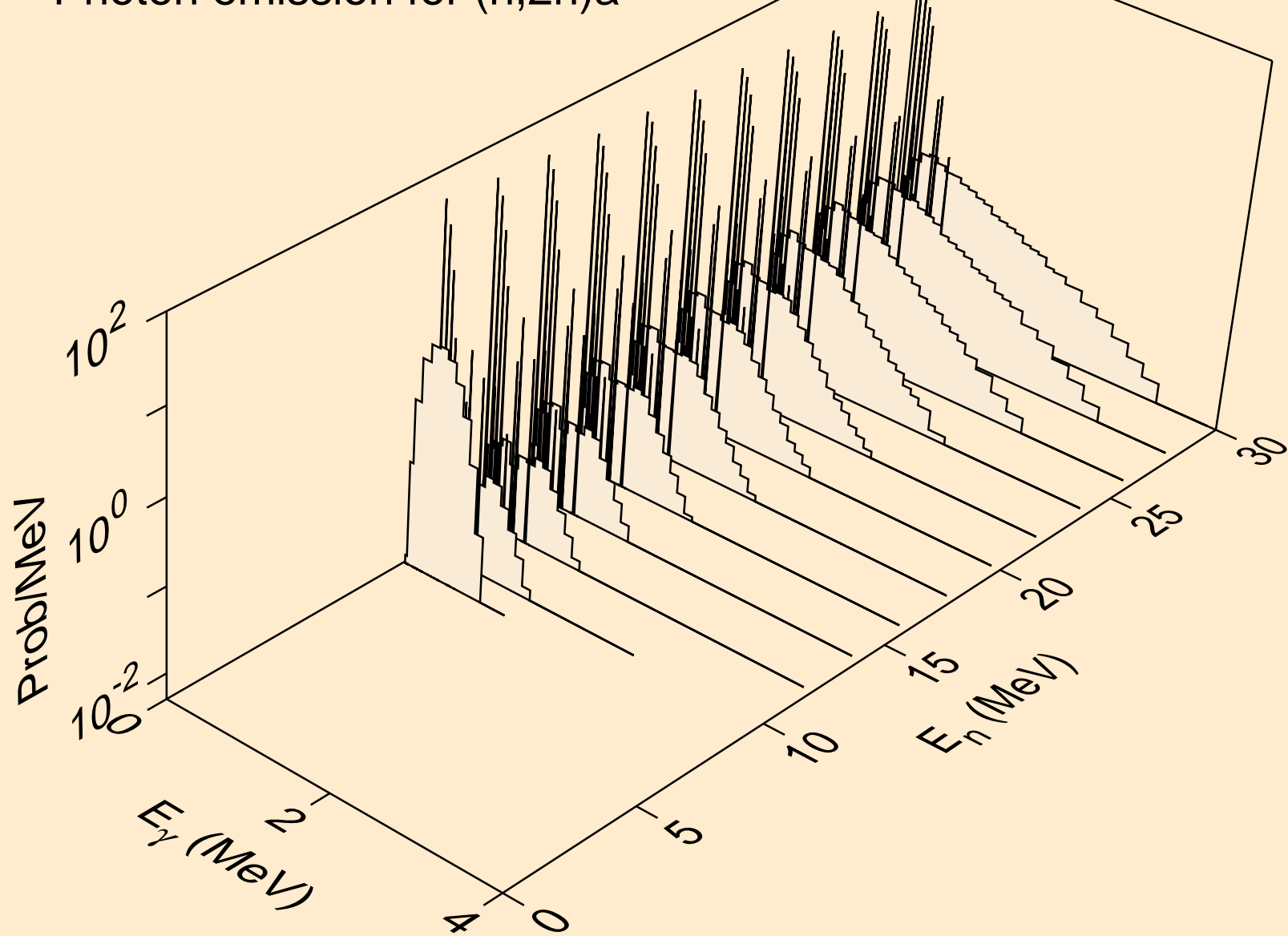

PU247 NEUTRON ACER TENDL-2023 LIBRARY; T=0.K
Photon emission for (n,3n)a

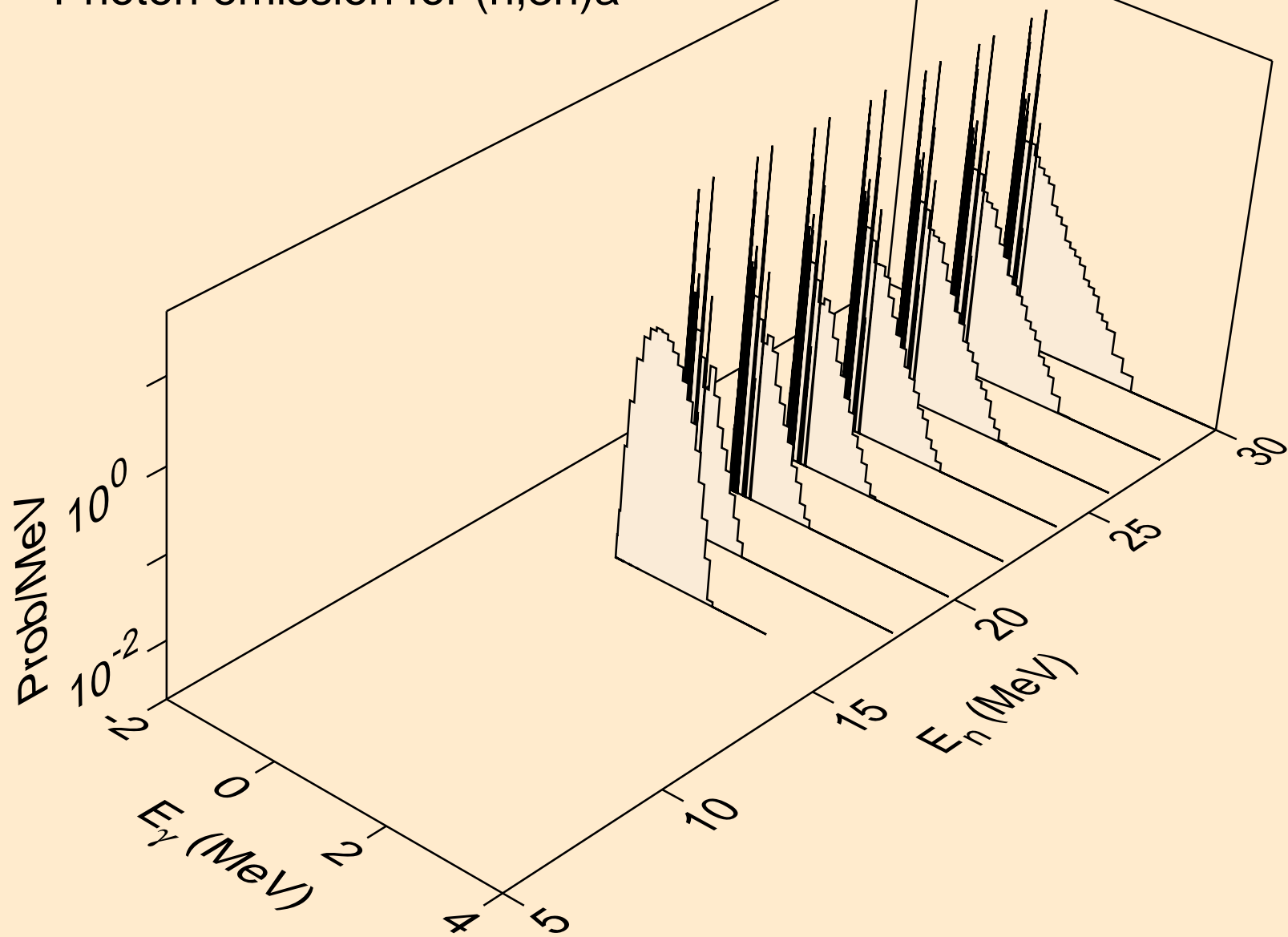

PU247 NEUTRON ACER TENDL-2023 LIBRARY; T=0.K
Photon emission for (n,n*)p

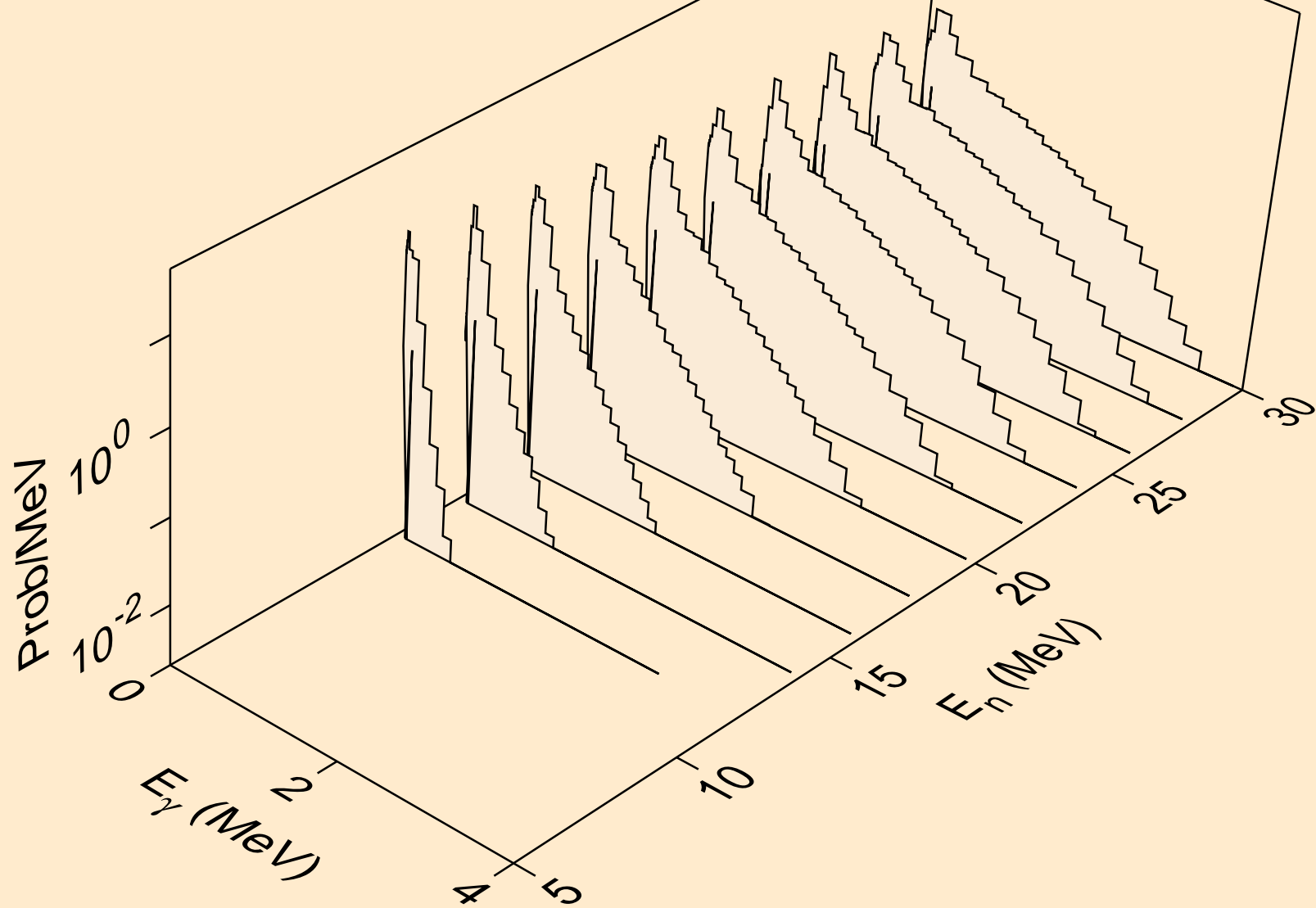

PU247 NEUTRON ACER TENDL-2023 LIBRARY; T=0.K
Photon emission for (n,n*)d

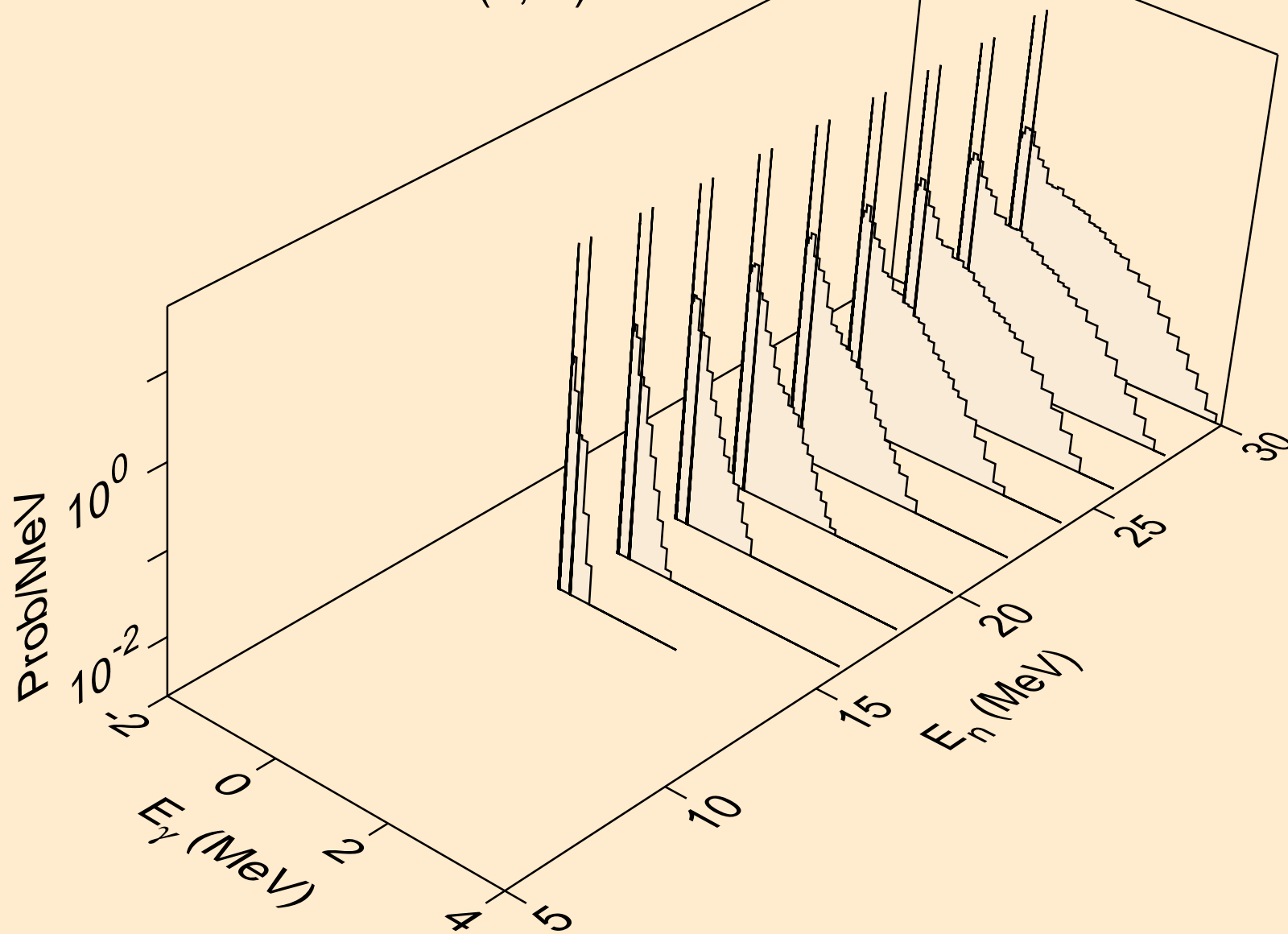

PU247 NEUTRON ACER TENDL-2023 LIBRARY; T=0.K
Photon emission for (n,n*)t

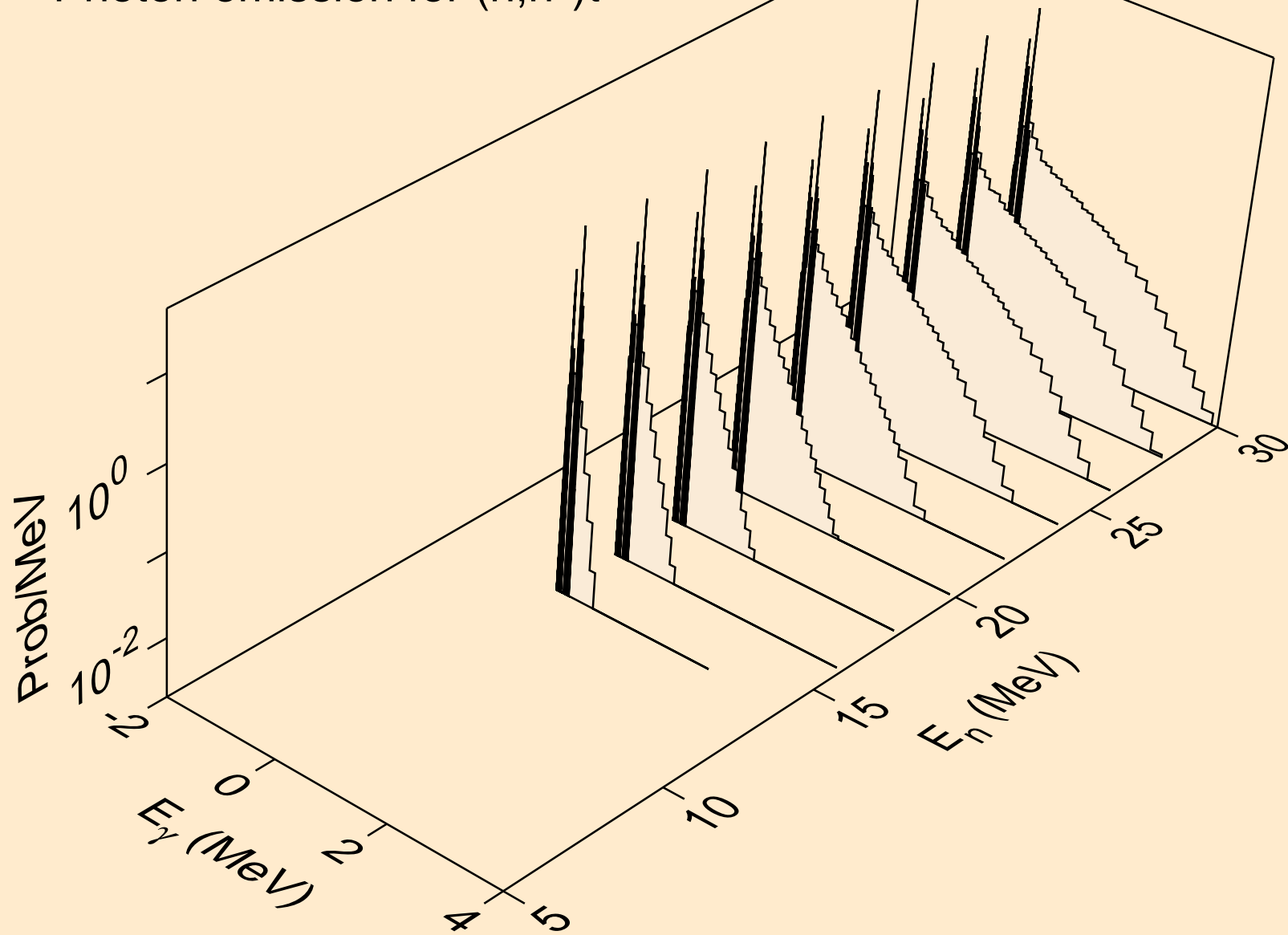

PU247 NEUTRON ACER TENDL-2023 LIBRARY; T=0.K
Photon emission for (n,n*)he3

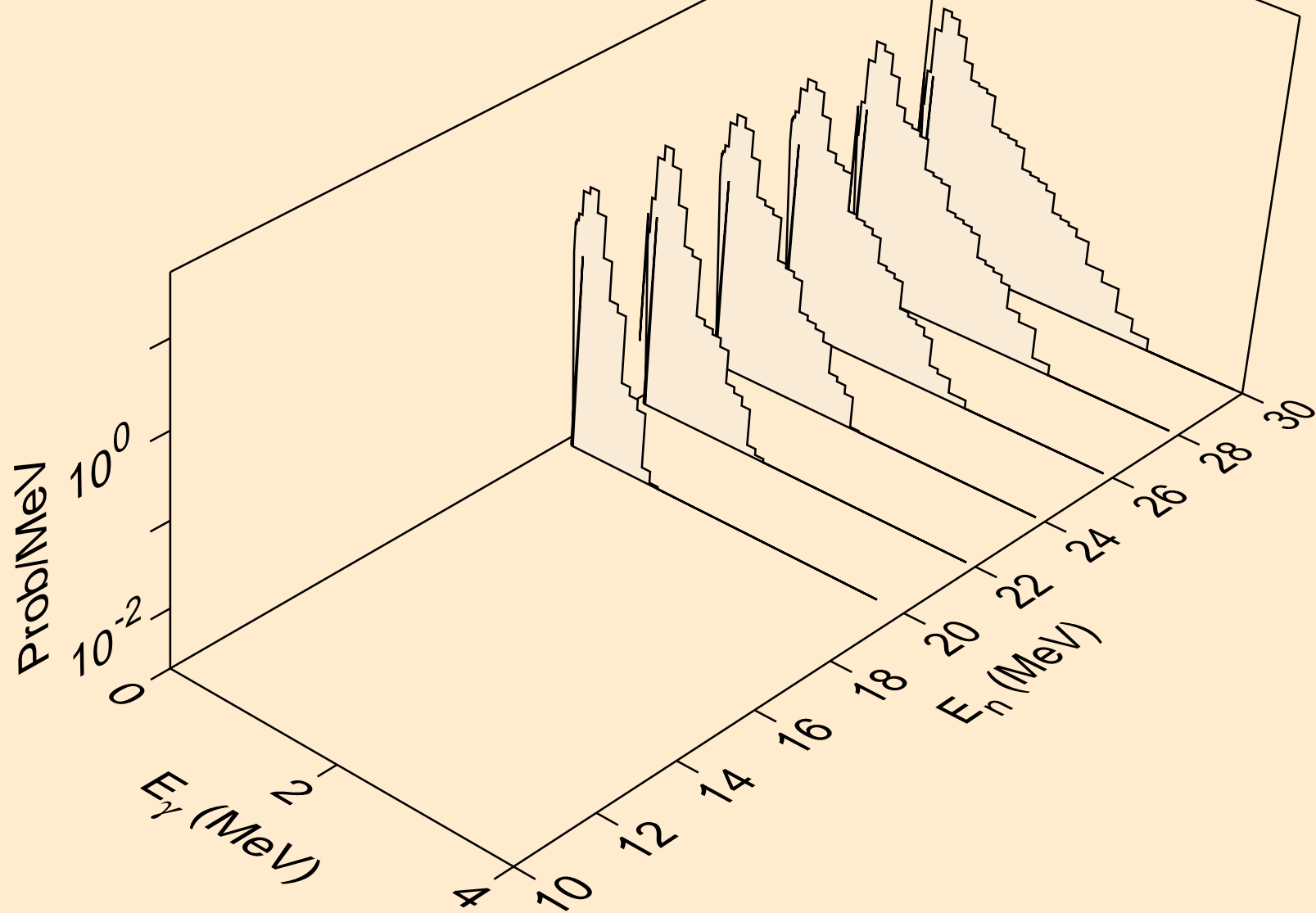

PU247 NEUTRON ACER TENDL-2023 LIBRARY; T=0.K
Photon emission for (n,4n)

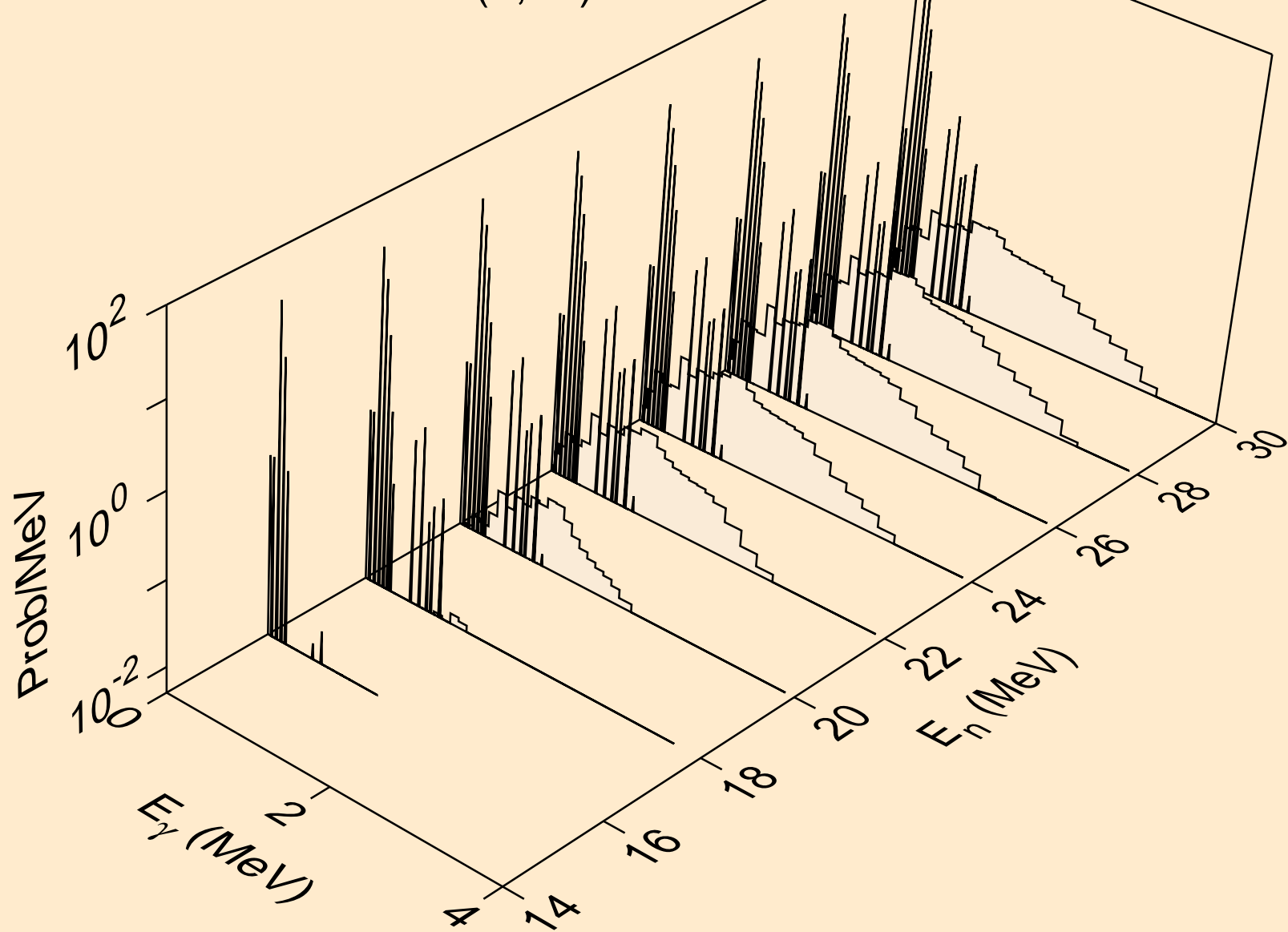

PU247 NEUTRON ACER TENDL-2023 LIBRARY; T=0.K
Photon emission for (n,2np)

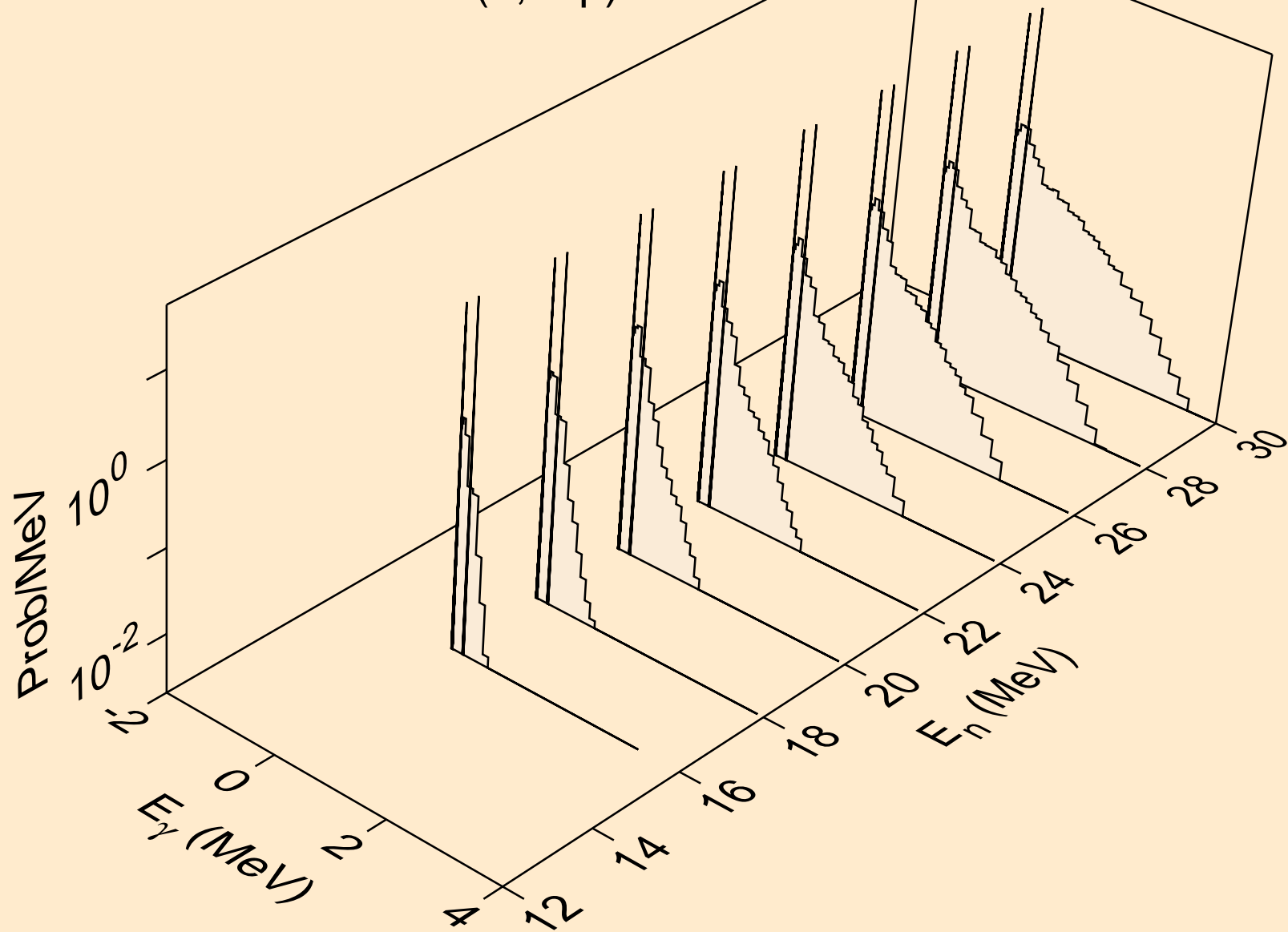

PU247 NEUTRON ACER TENDL-2023 LIBRARY; T=0.K
Photon emission for (n,3np)

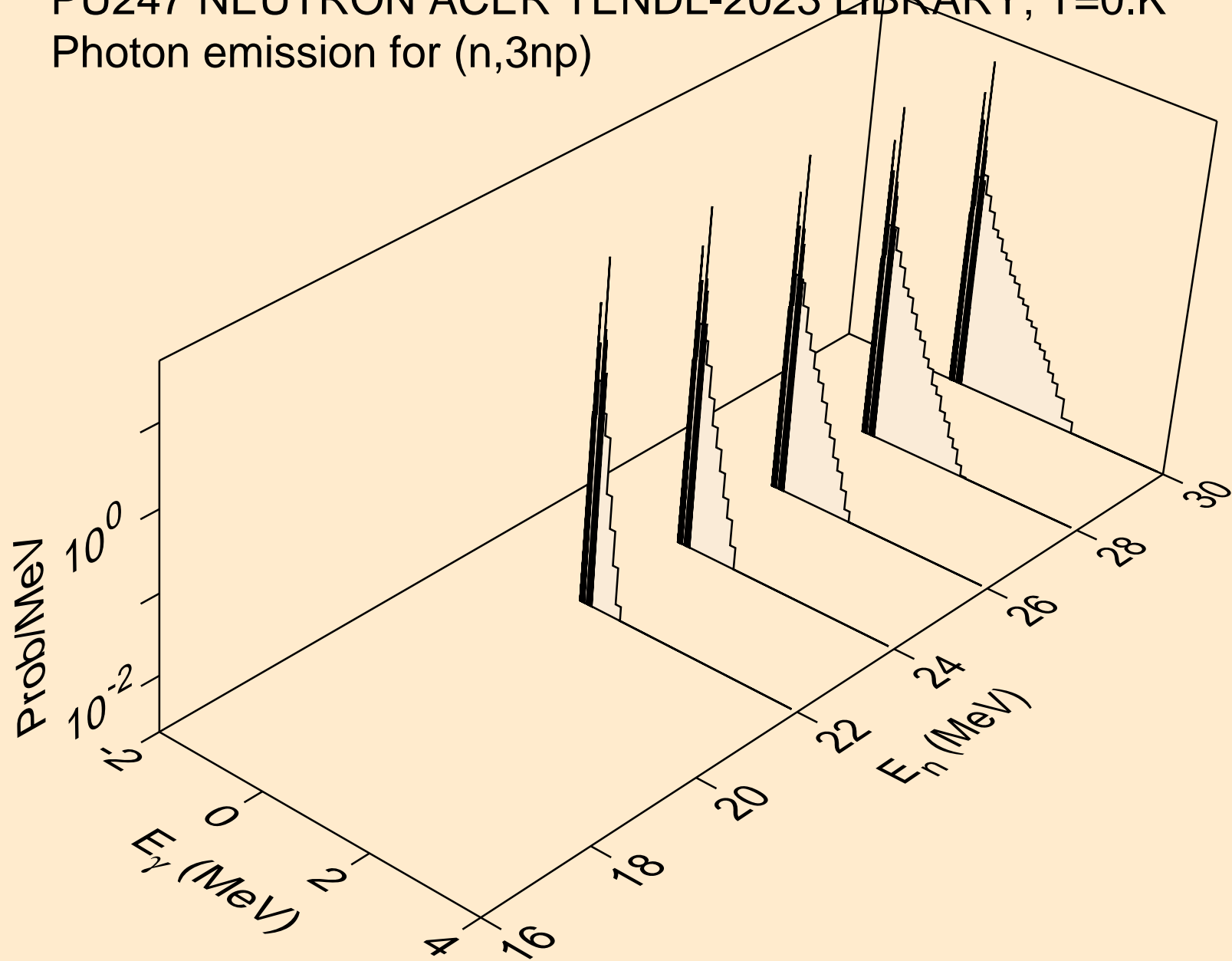

PU247 NEUTRON ACER TENDL-2023 LIBRARY; T=0.K
Photon emission for (n,n*c)

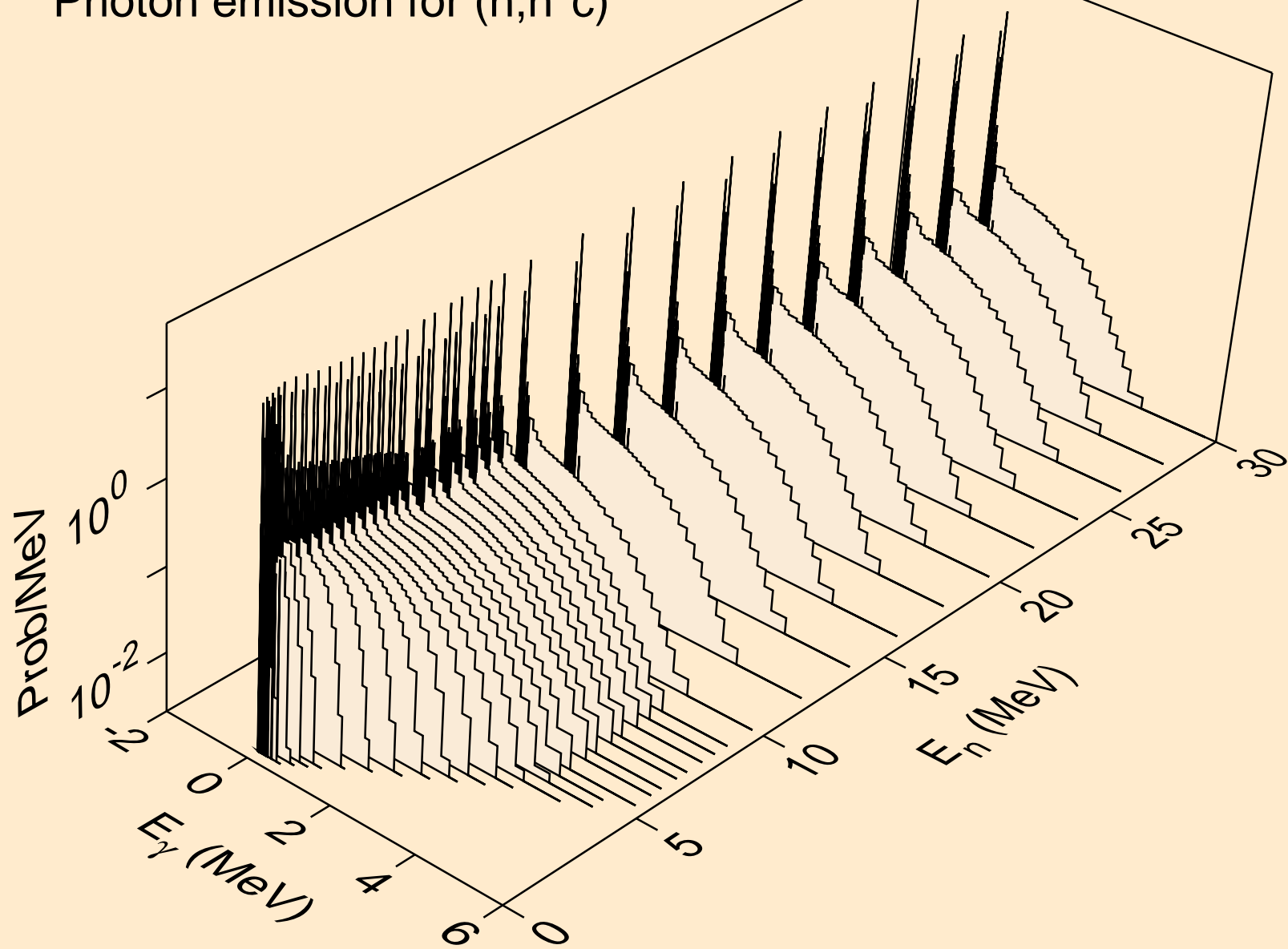

PU247 NEUTRON ACER TENDL-2023 LIBRARY; T=0.K
Photon emission for (n,gma)

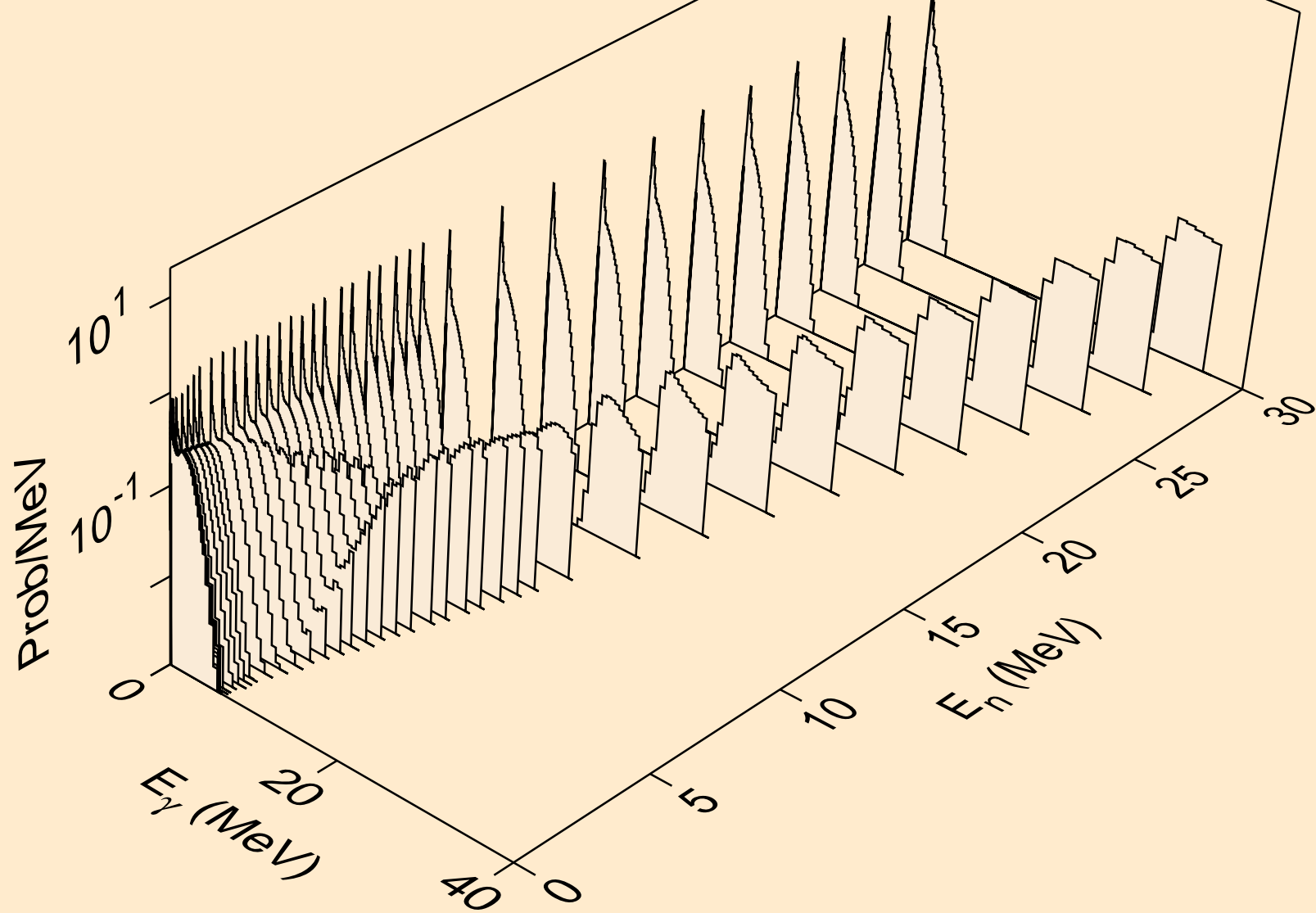

PU247 NEUTRON ACER TENDL-2023 LIBRARY; T=0.K
Photon emission for (n,p)

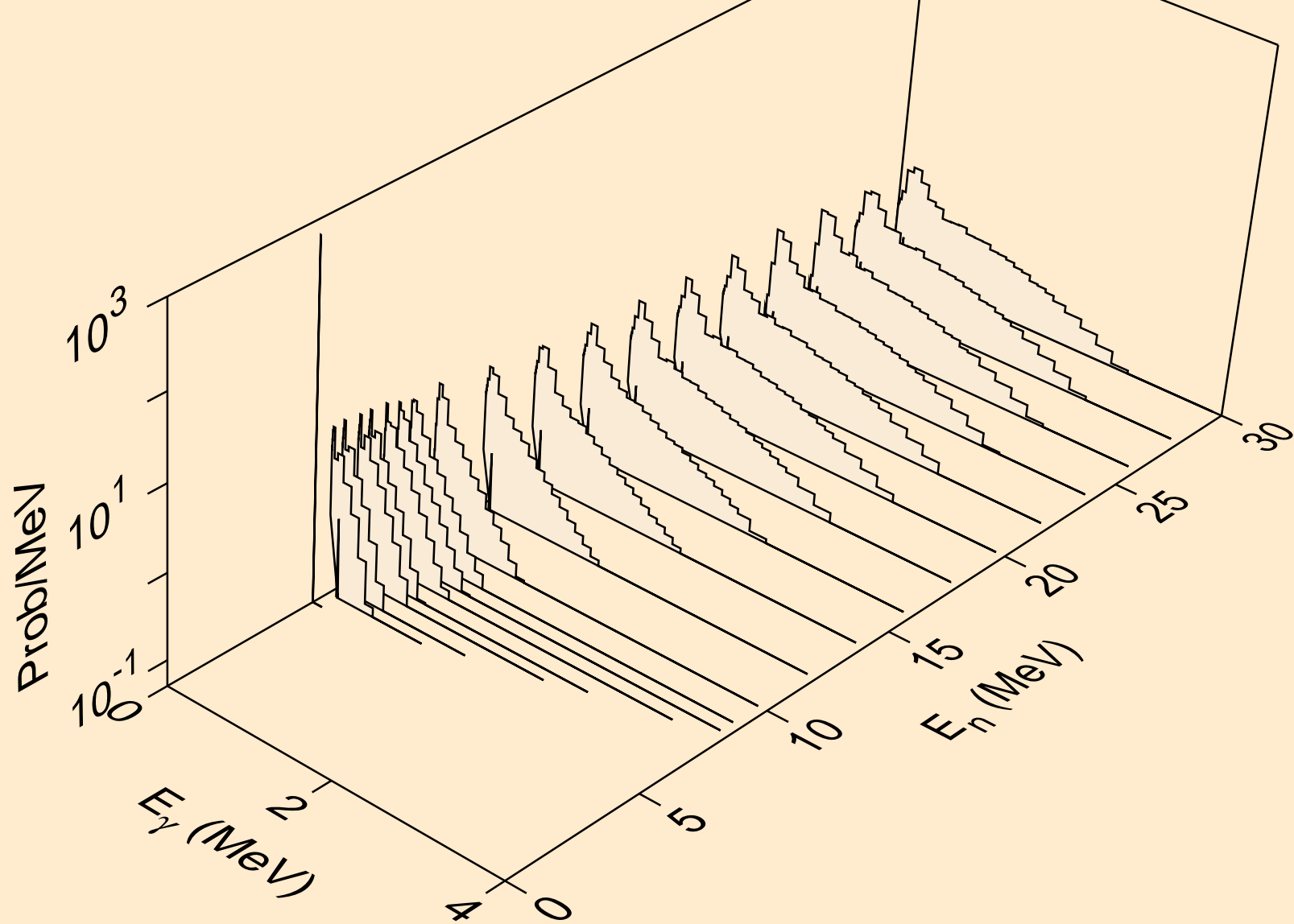

PU247 NEUTRON ACER TENDL-2023 LIBRARY; T=0.K
Photon emission for (n,d)

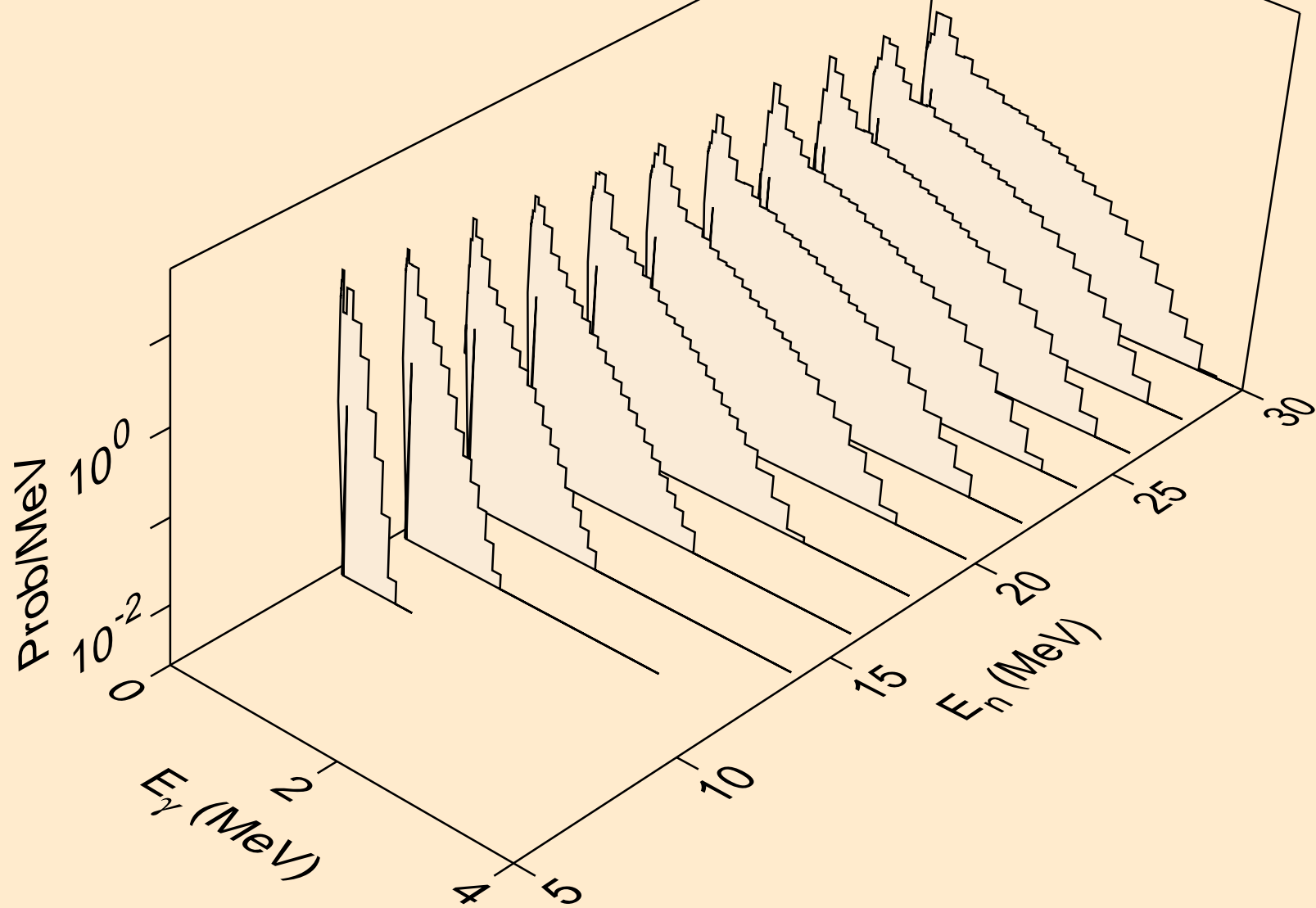

PU247 NEUTRON ACER TENDL-2023 LIBRARY; T=0.K
Photon emission for (n,t)

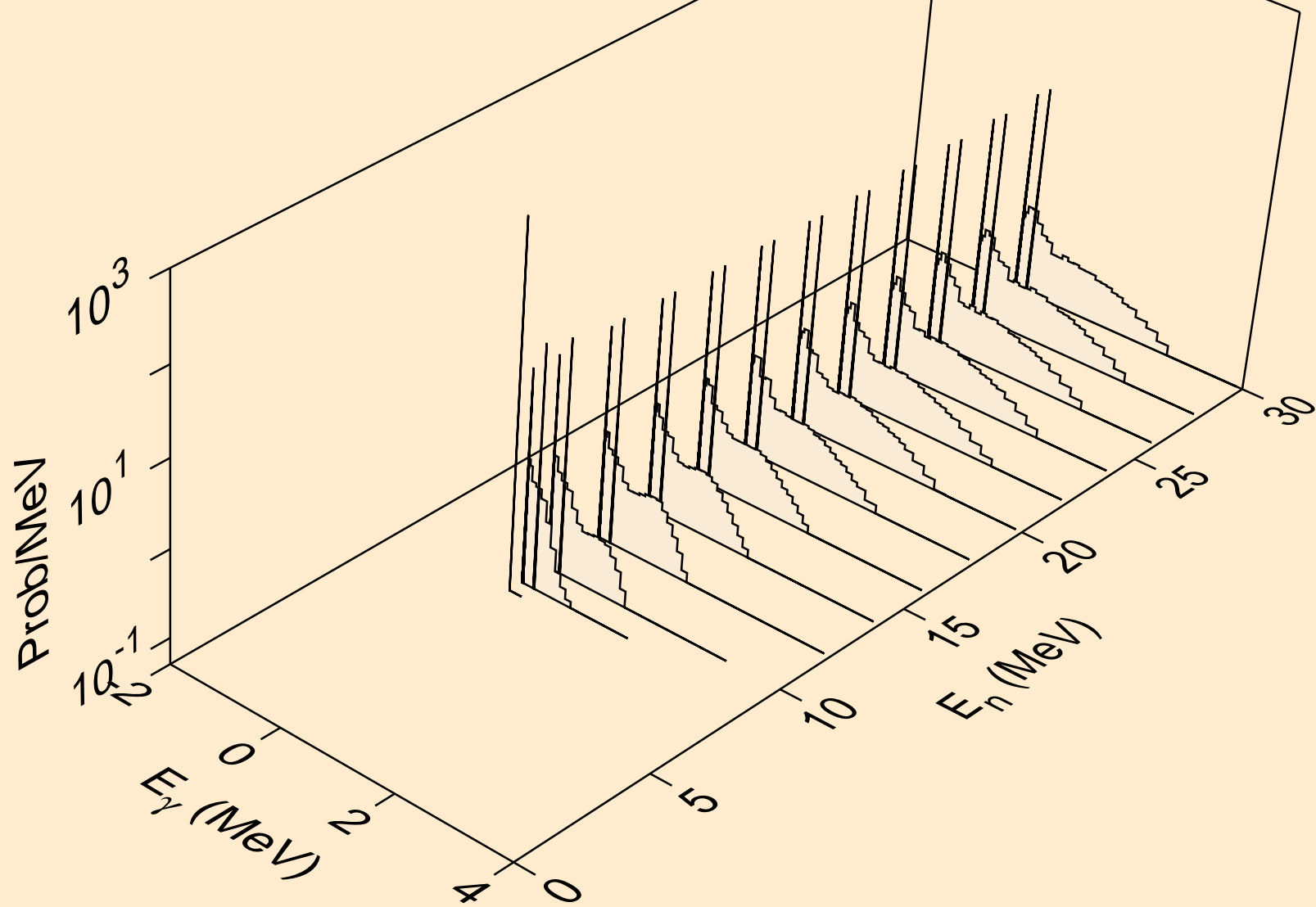

PU247 NEUTRON ACER TENDL-2023 LIBRARY; T=0.K
Photon emission for (n,he3)

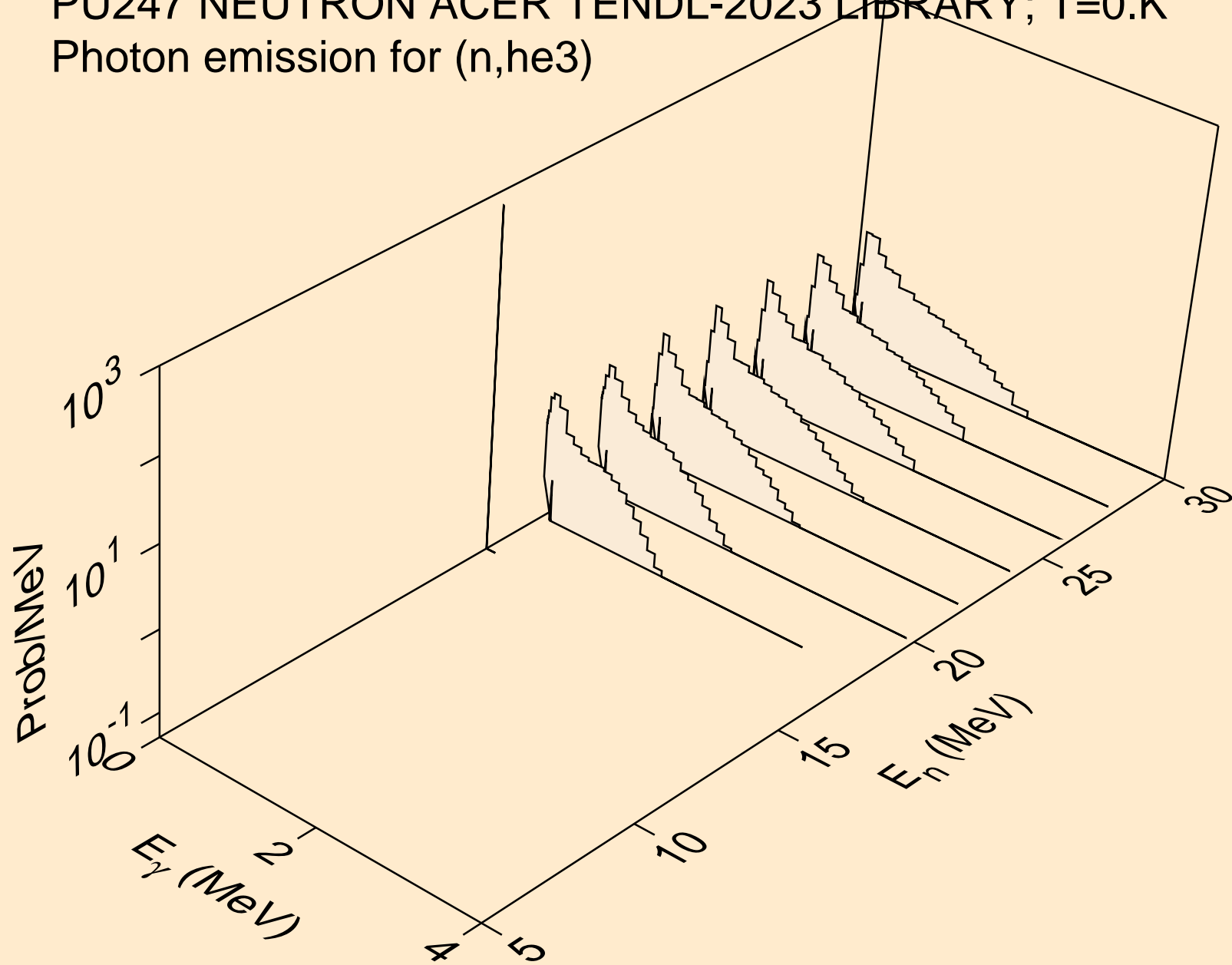

PU247 NEUTRON ACER TENDL-2023 LIBRARY; T=0.K
Photon emission for (n,a)

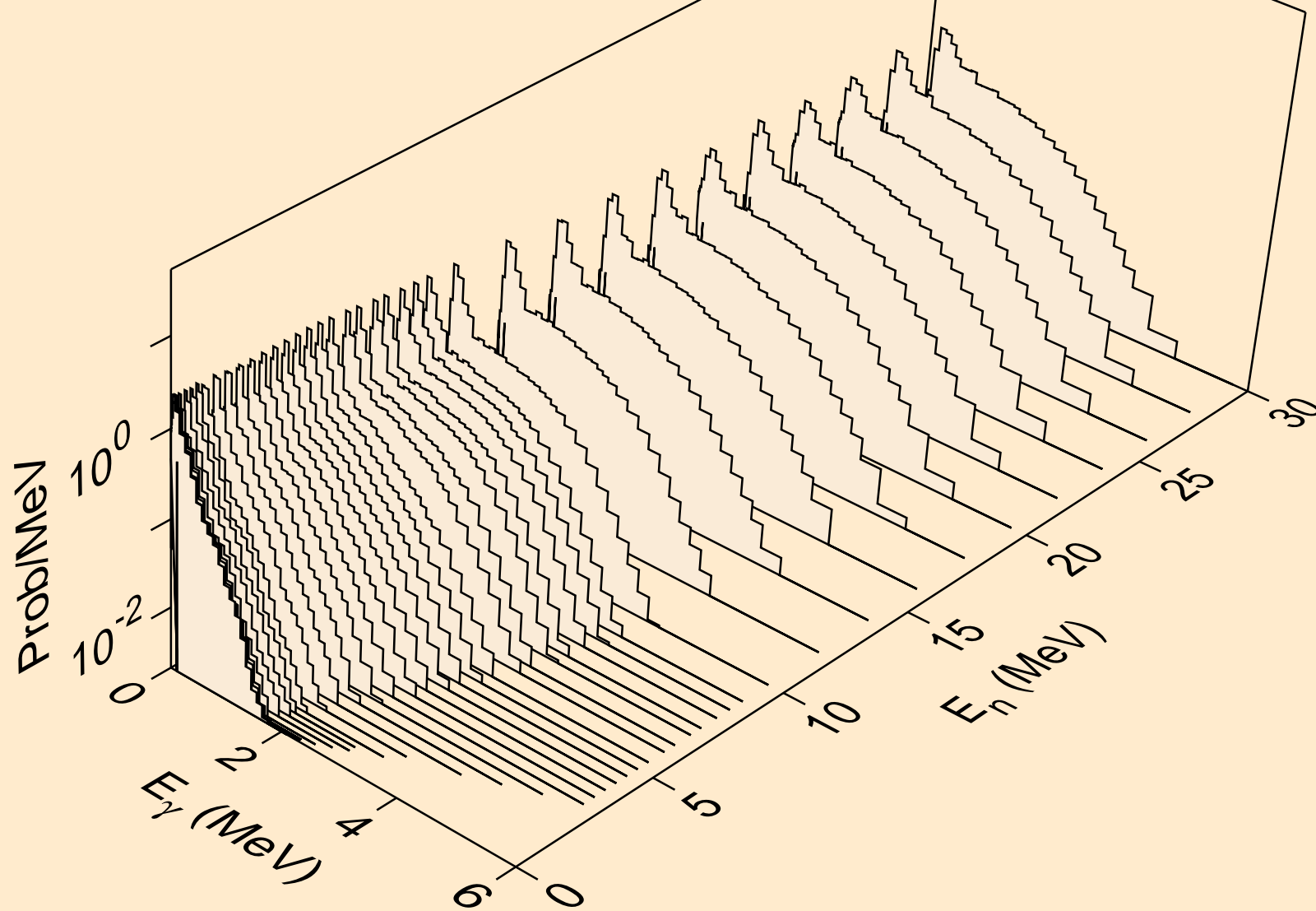

PU247 NEUTRON ACER TENDL-2023 LIBRARY; T=0.K
Photon emission for (n,2p)

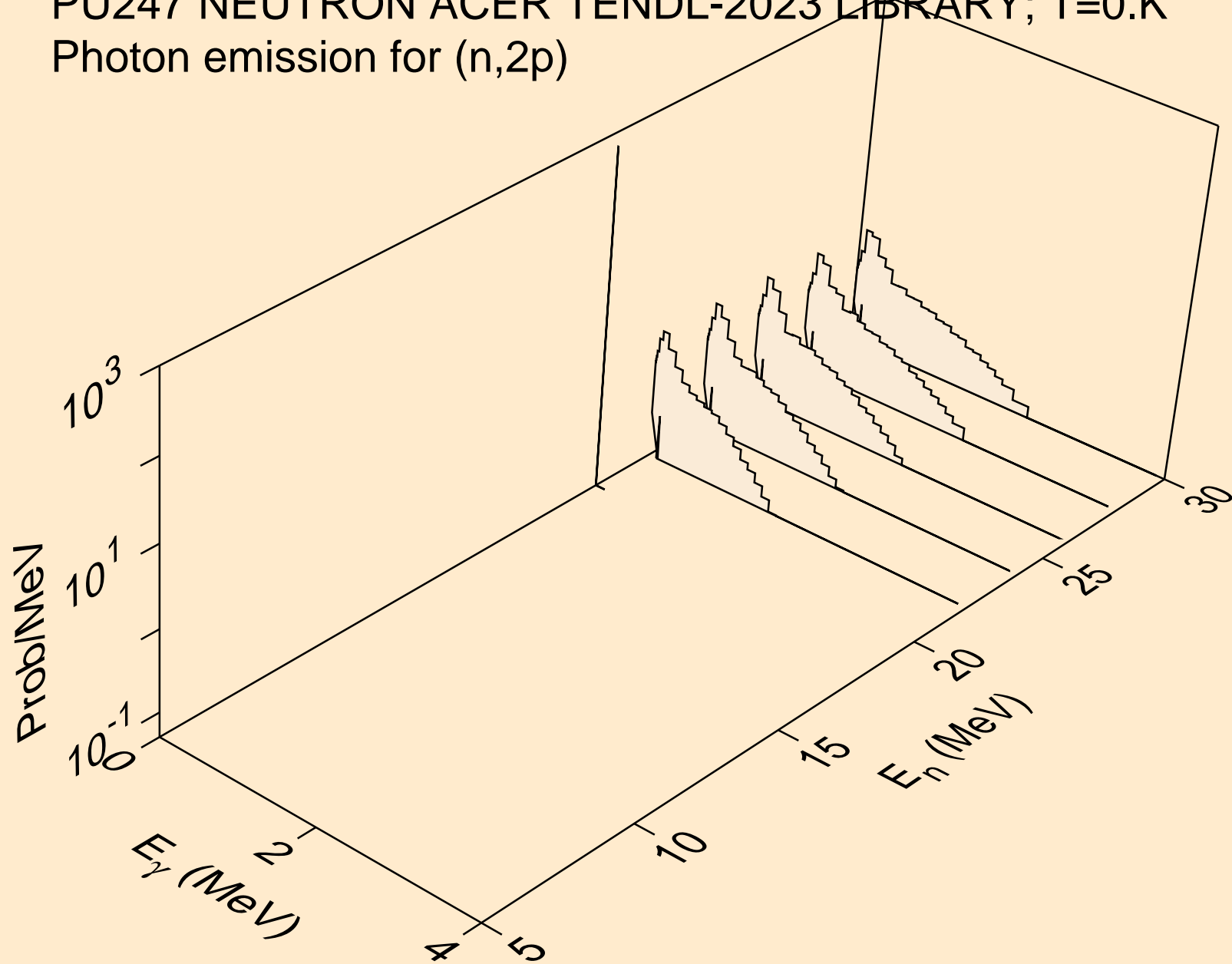

PU247 NEUTRON ACER TENDL-2023 LIBRARY; T=0.K
thermal capture photon spectrum

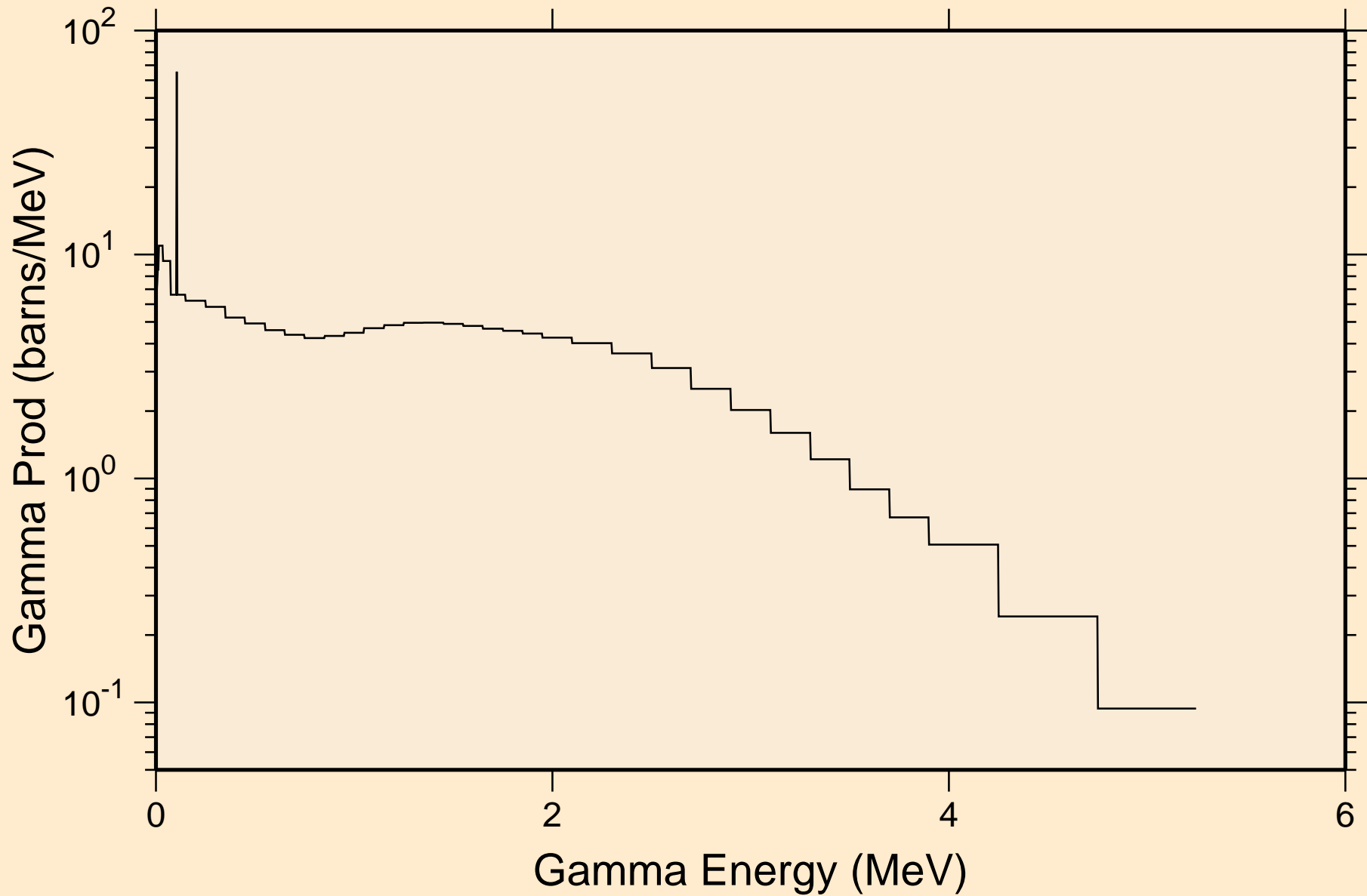

PU247 NEUTRON ACER TENDL-2023 LIBRARY; T=0.K
14 MeV photon spectrum

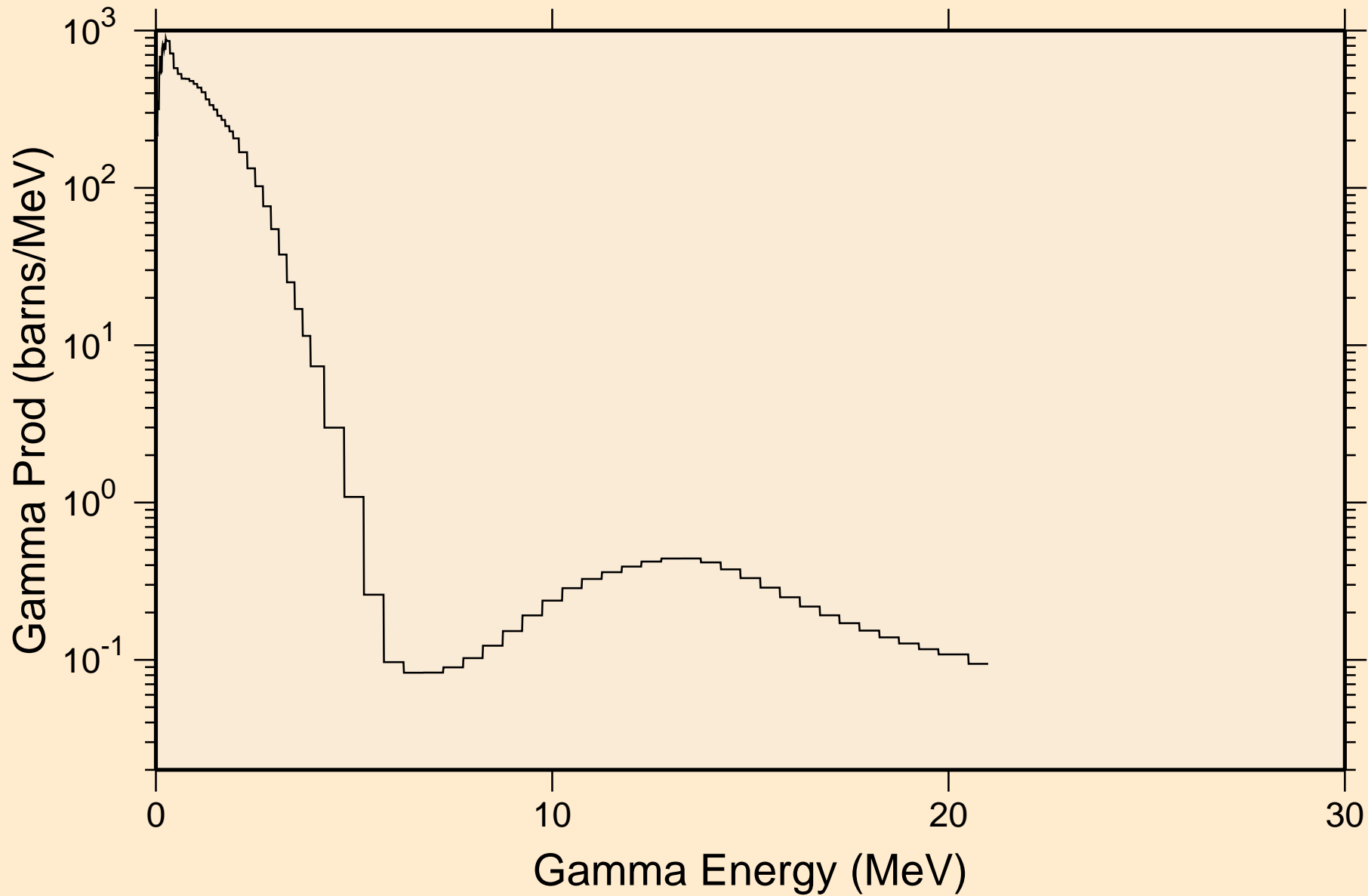

PU247 NEUTRON ACER TENDL-2023 LIBRARY; T=0.K
Particle heating contributions

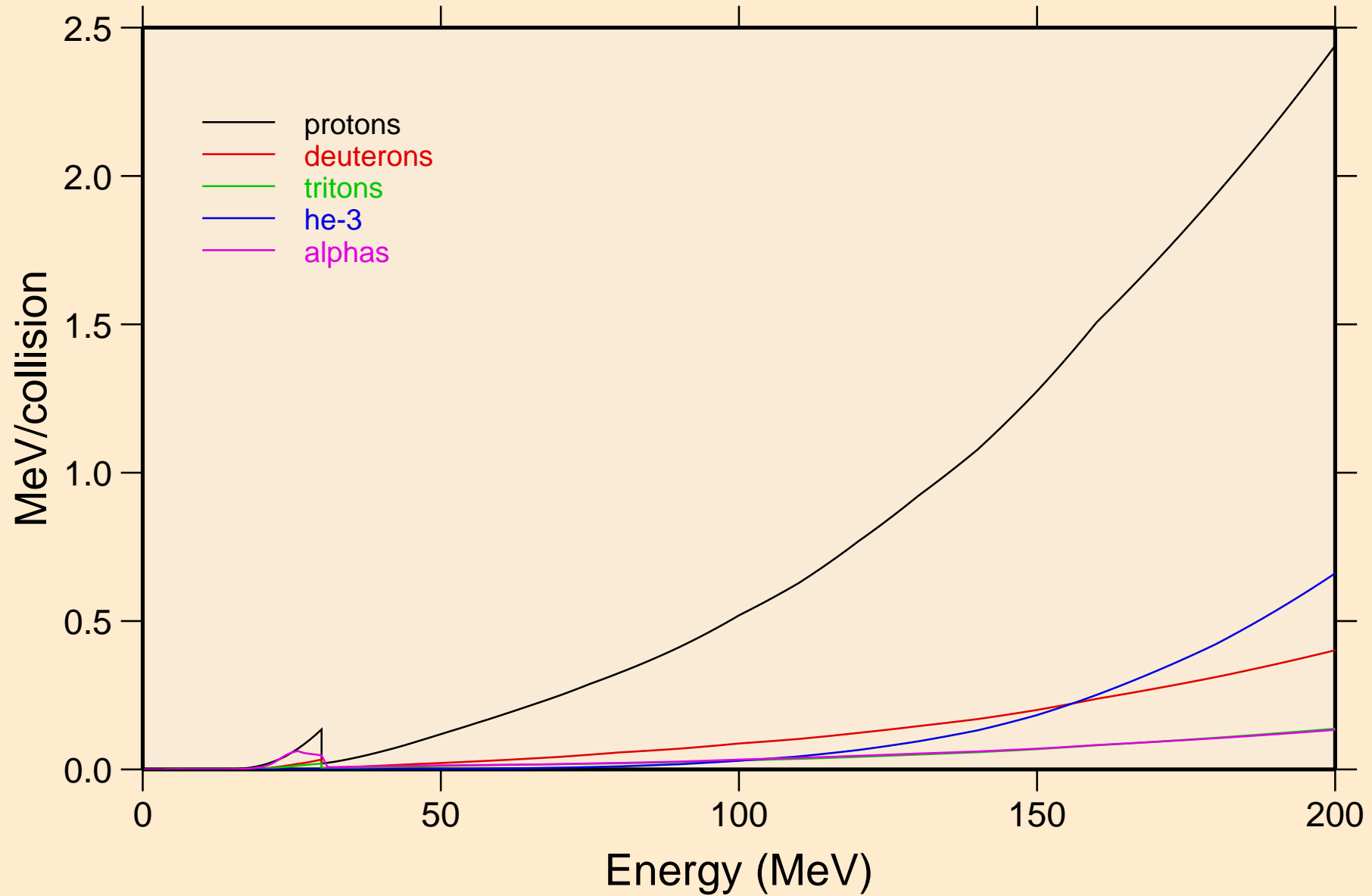

PU247 NEUTRON ACER TENDL-2023 LIBRARY; T=0.K
Recoil Heating

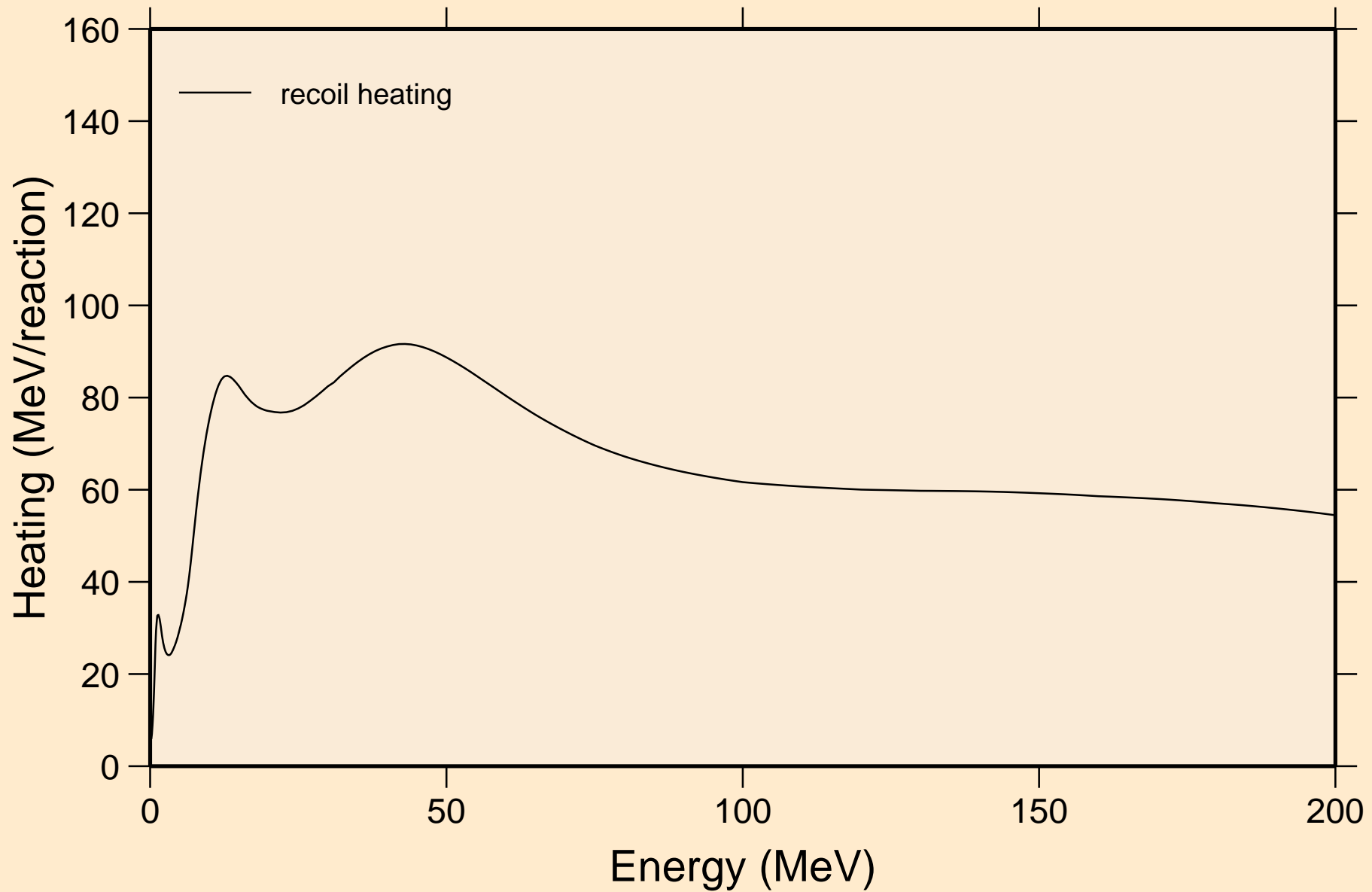

PU247 NEUTRON ACER TENDL-2023 LIBRARY; T=0.K
Particle production cross sections

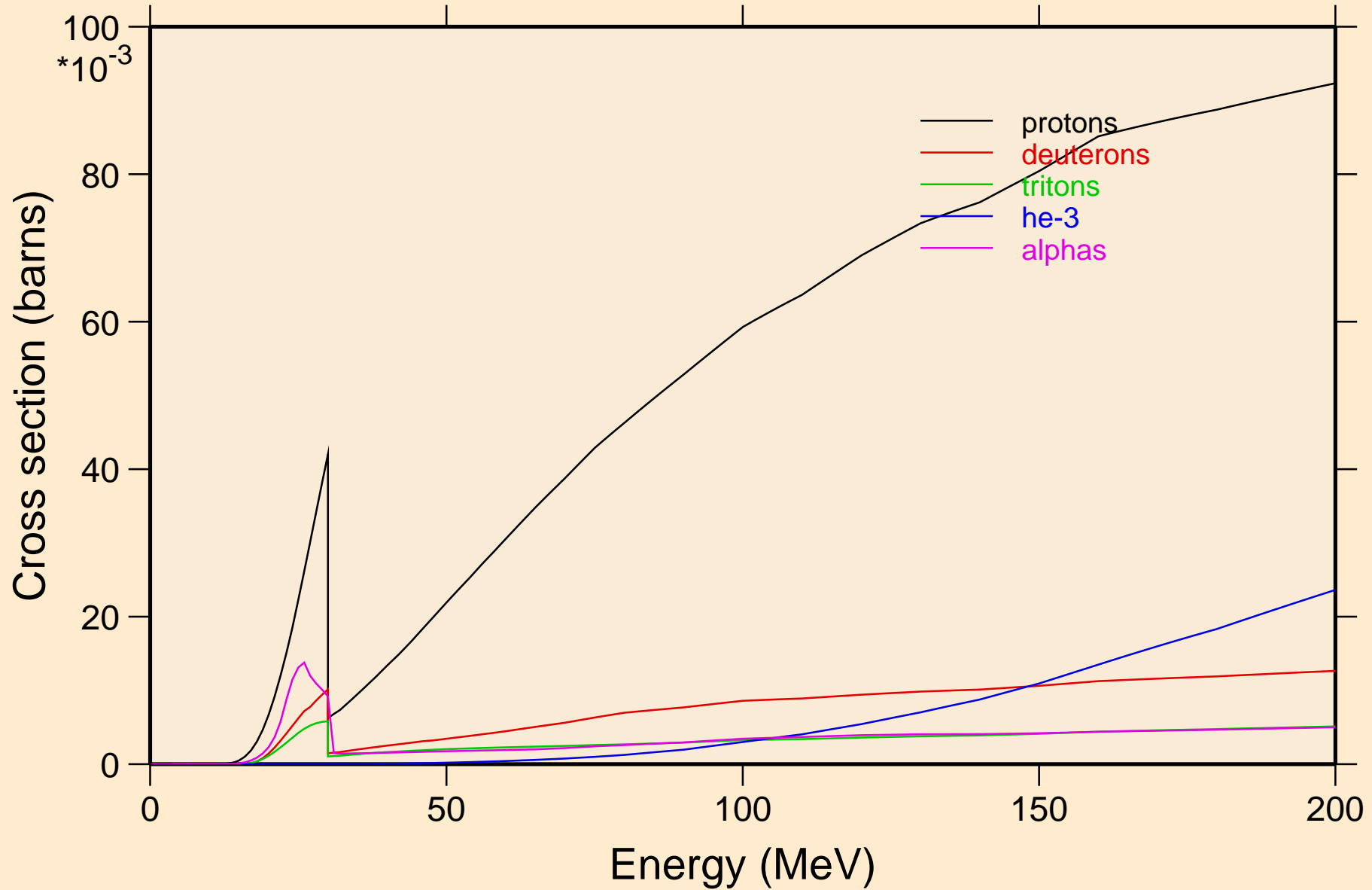

PU247 NEUTRON ACER TENDL-2023 LIBRARY; T=0.K
protons from (n,x)

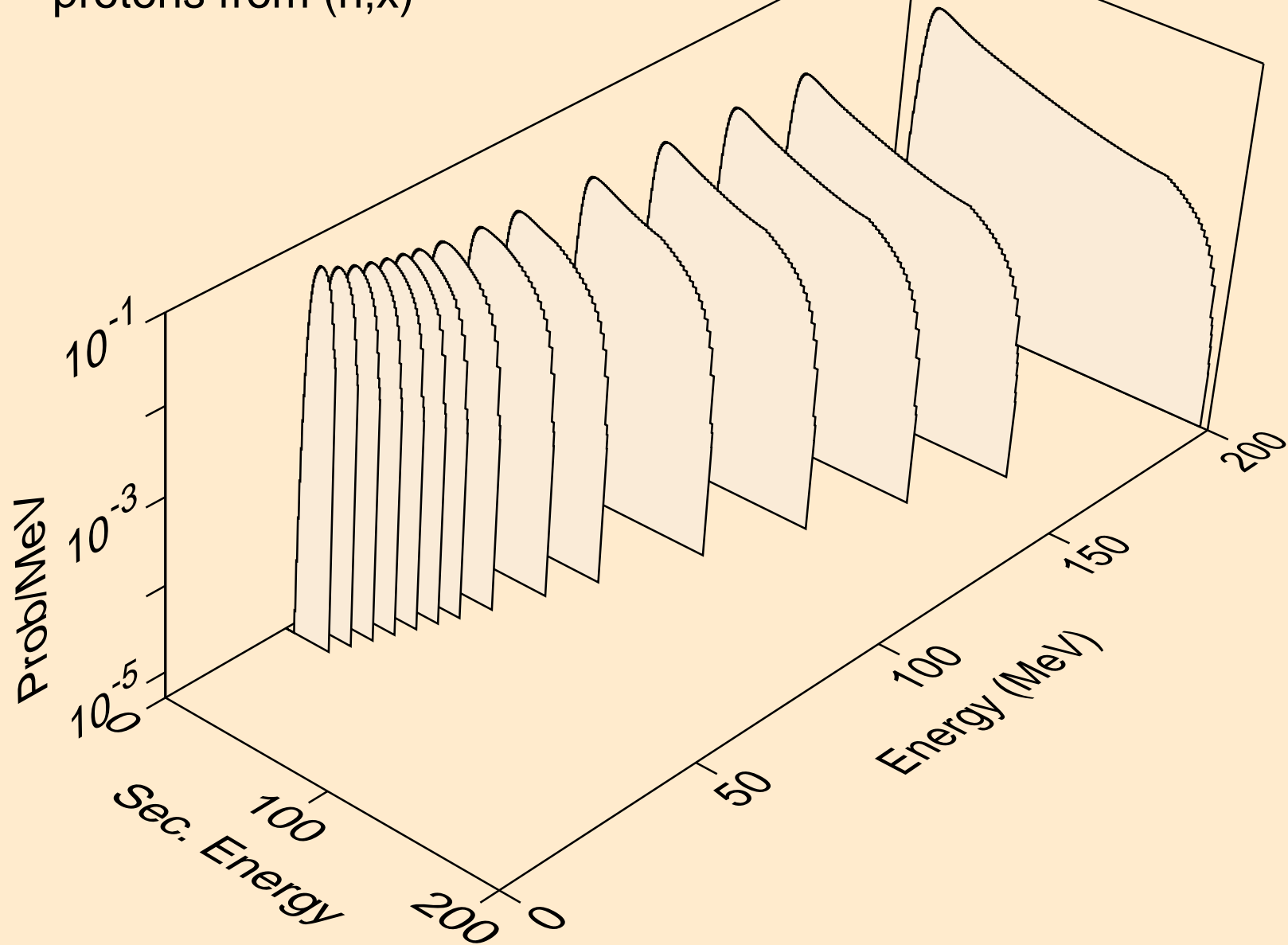

PU247 NEUTRON ACER TENDL-2023 LIBRARY; T=0.K
protons from (n,n*)p

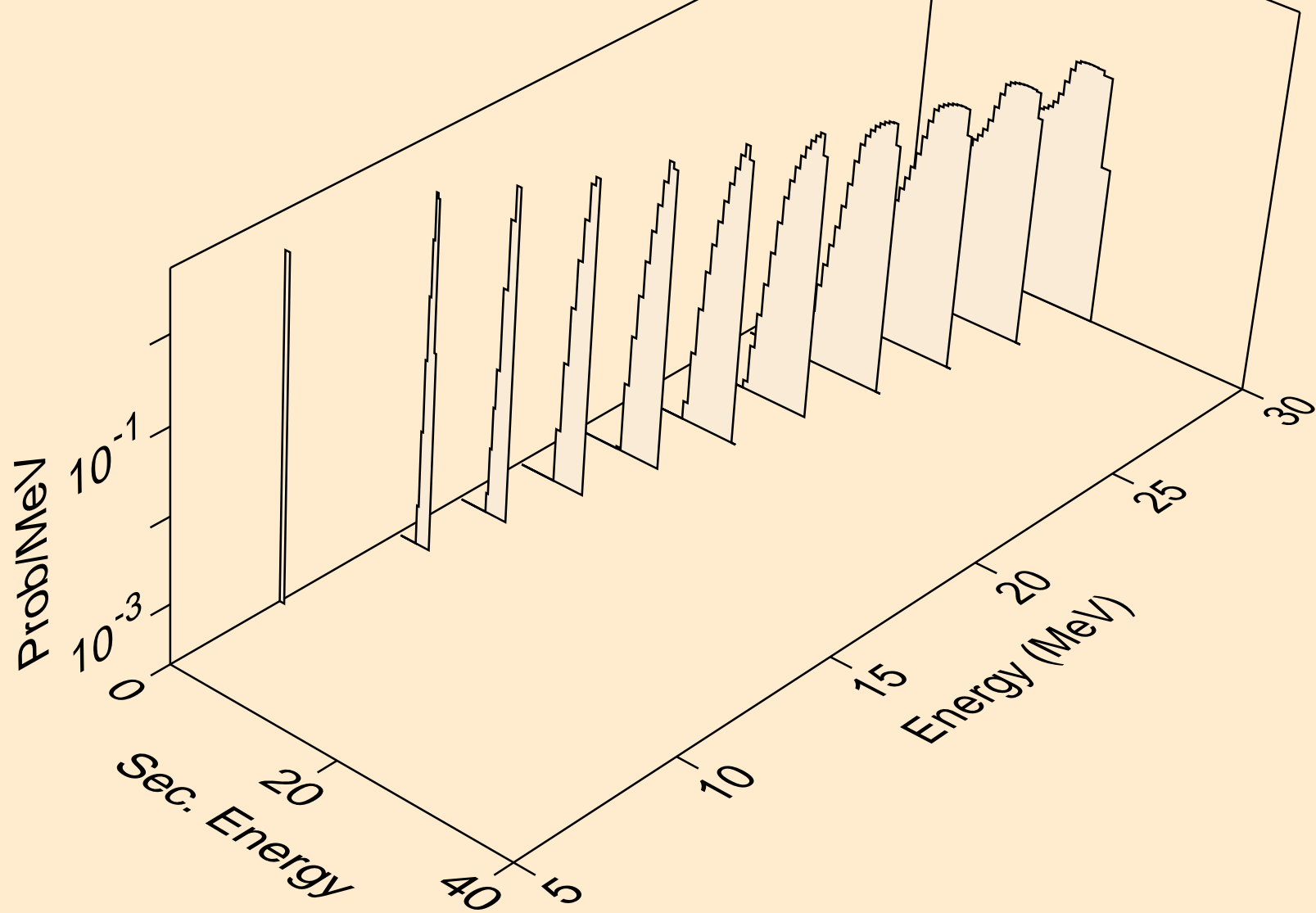

PU247 NEUTRON ACER TENDL-2023 LIBRARY; T=0.K
protons from (n,2np)

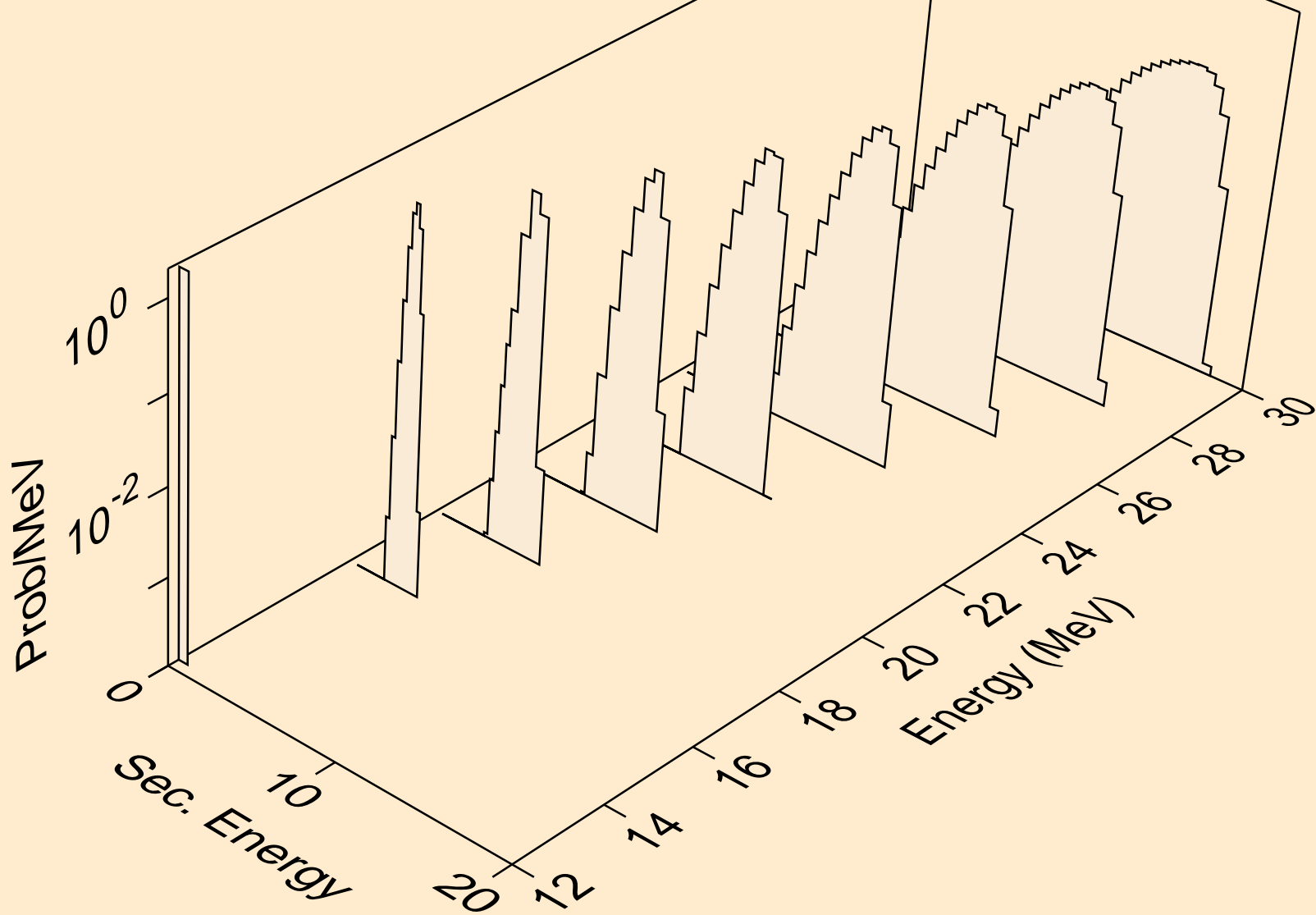

PU247 NEUTRON ACER TENDL-2023 LIBRARY; T=0.K
protons from (n,3np)

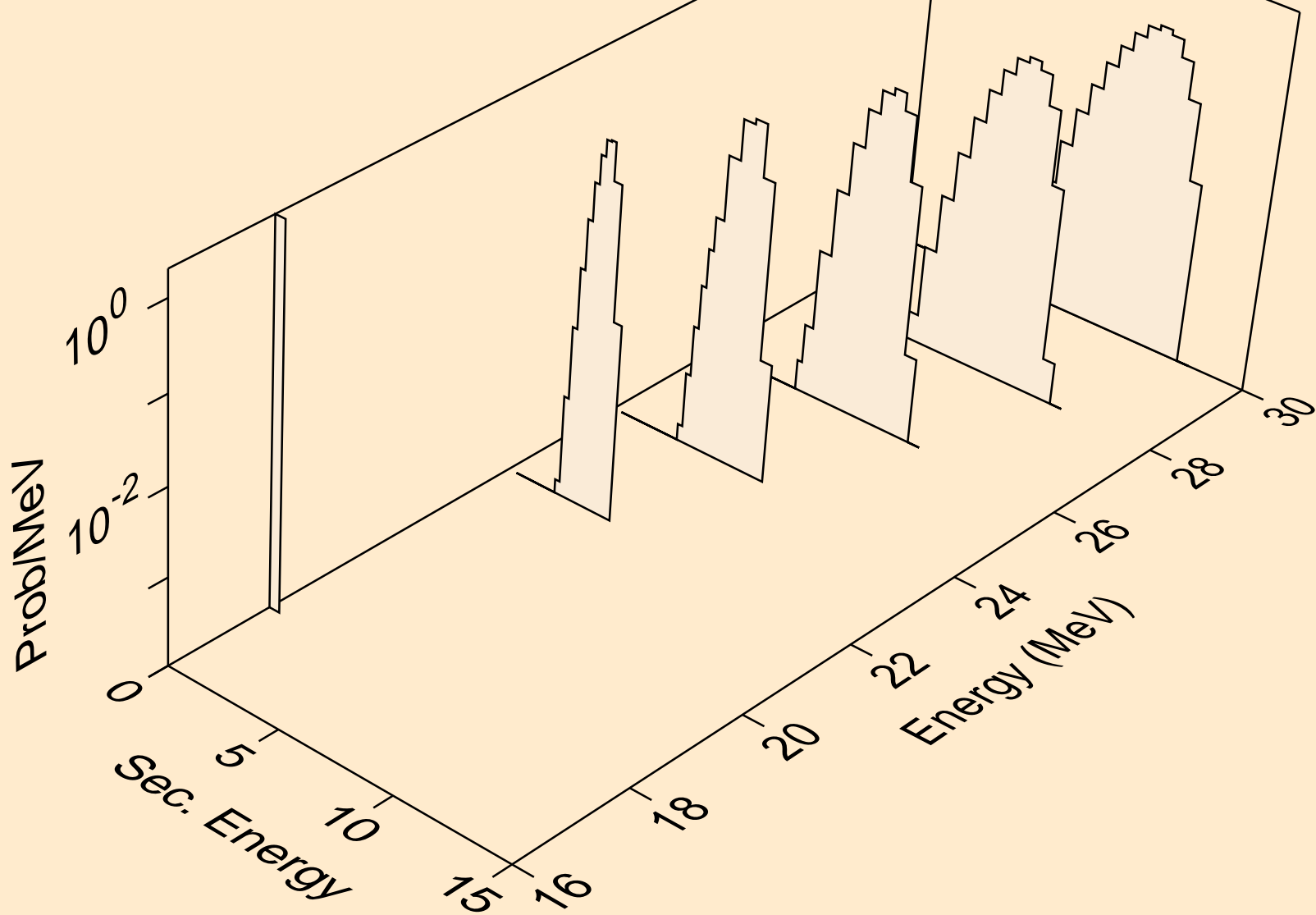

PU247 NEUTRON ACER TENDL-2023 LIBRARY; T=0.K
protons from (n,p)

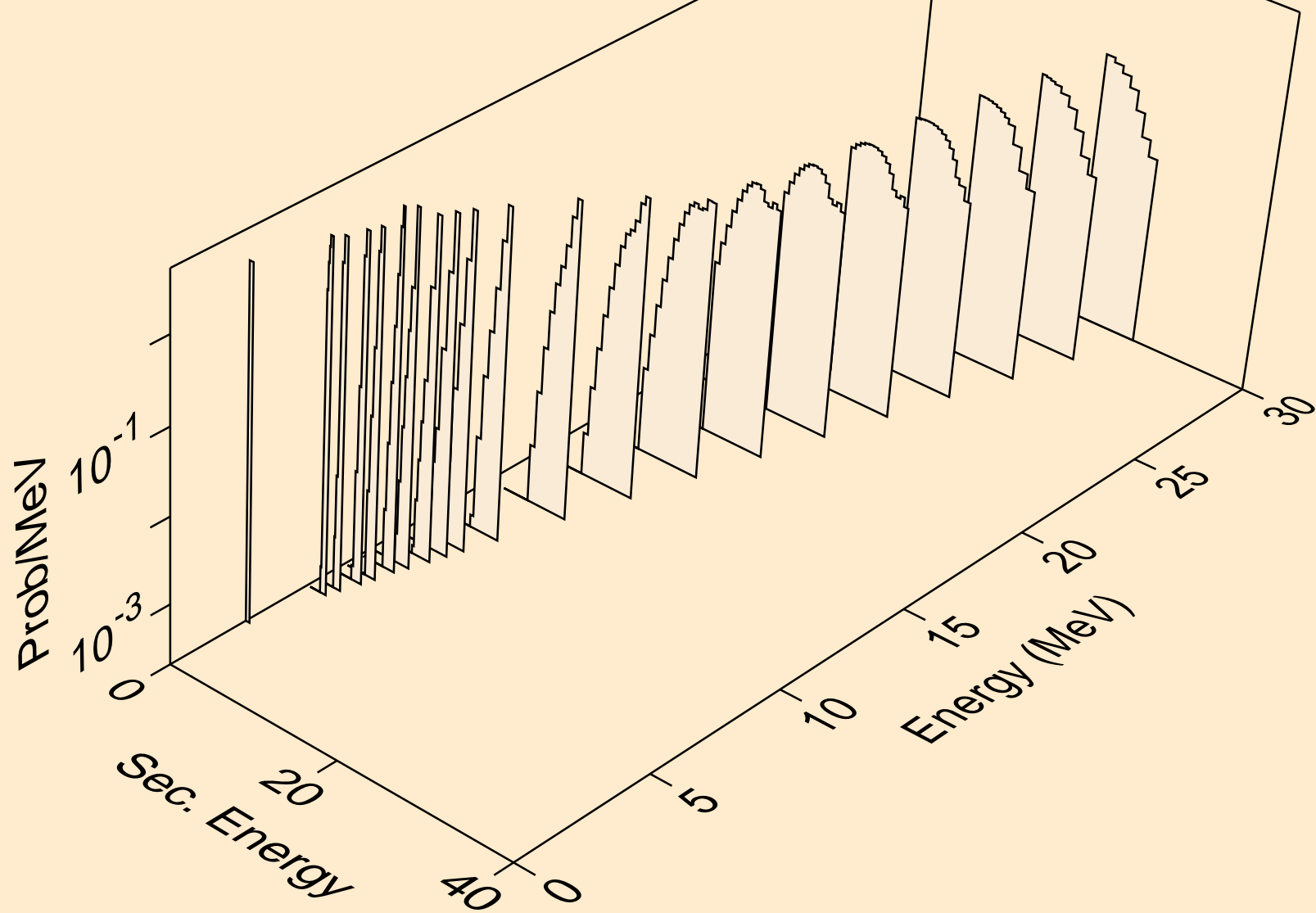

PU247 NEUTRON ACER TENDL-2023 LIBRARY; T=0.K
protons from (n,2p)

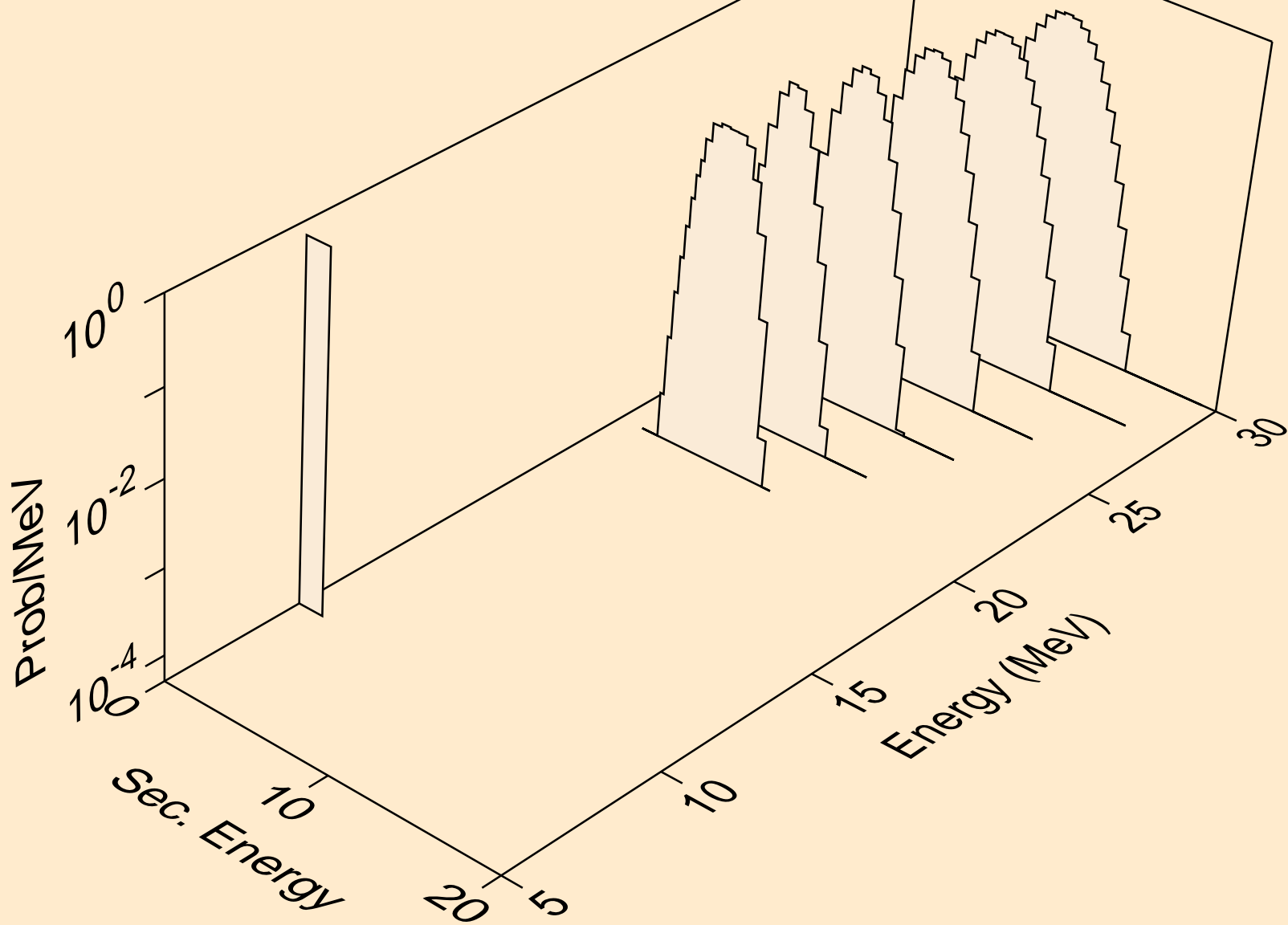

PU247 NEUTRON ACER TENDL-2023 LIBRARY; T=0.K
deuterons from (n,x)

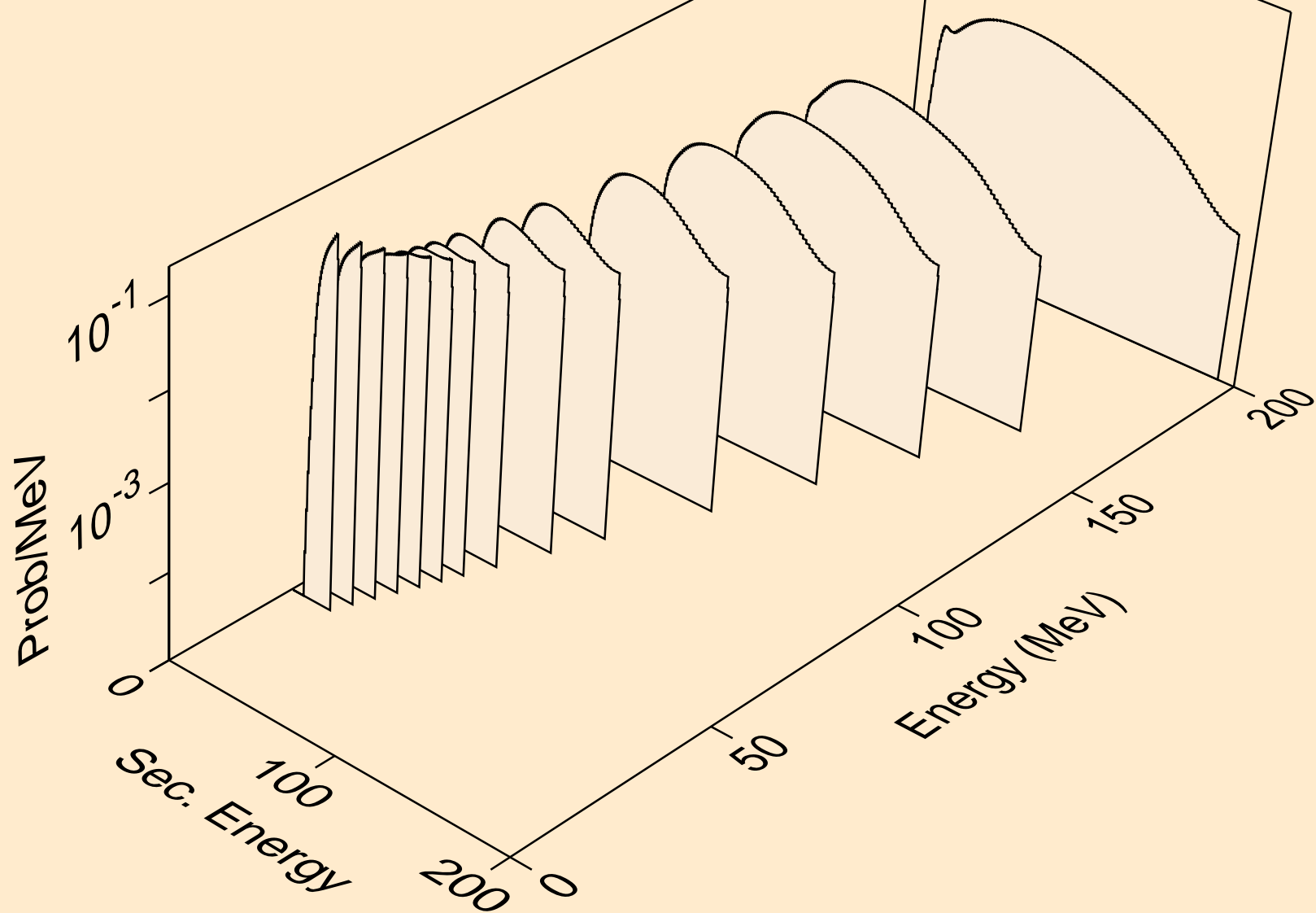

PU247 NEUTRON ACER TENDL-2023 LIBRARY; T=0.K
deuterons from (n,2nd)

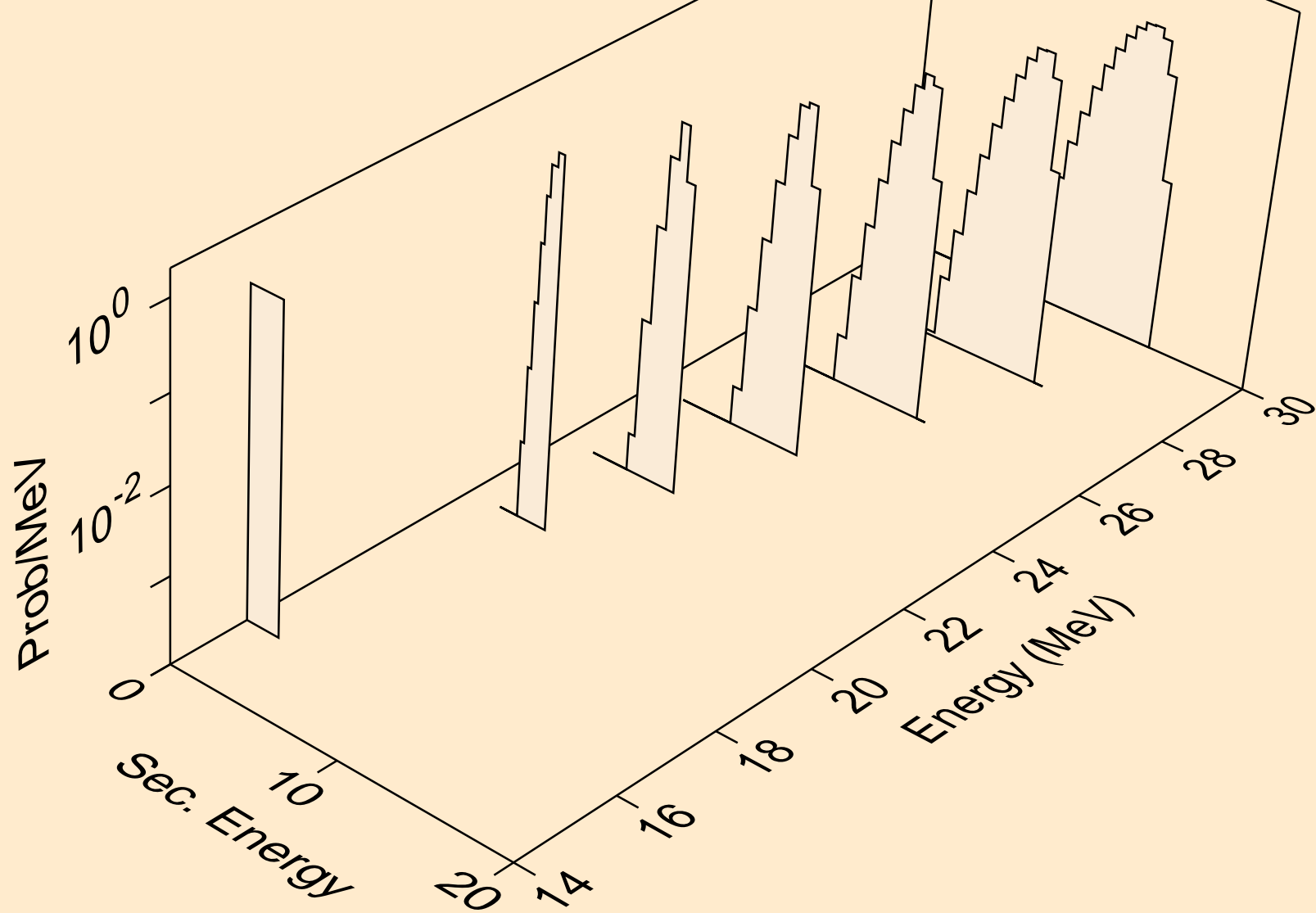

PU247 NEUTRON ACER TENDL-2023 LIBRARY; T=0.K
deuterons from (n,n*)d

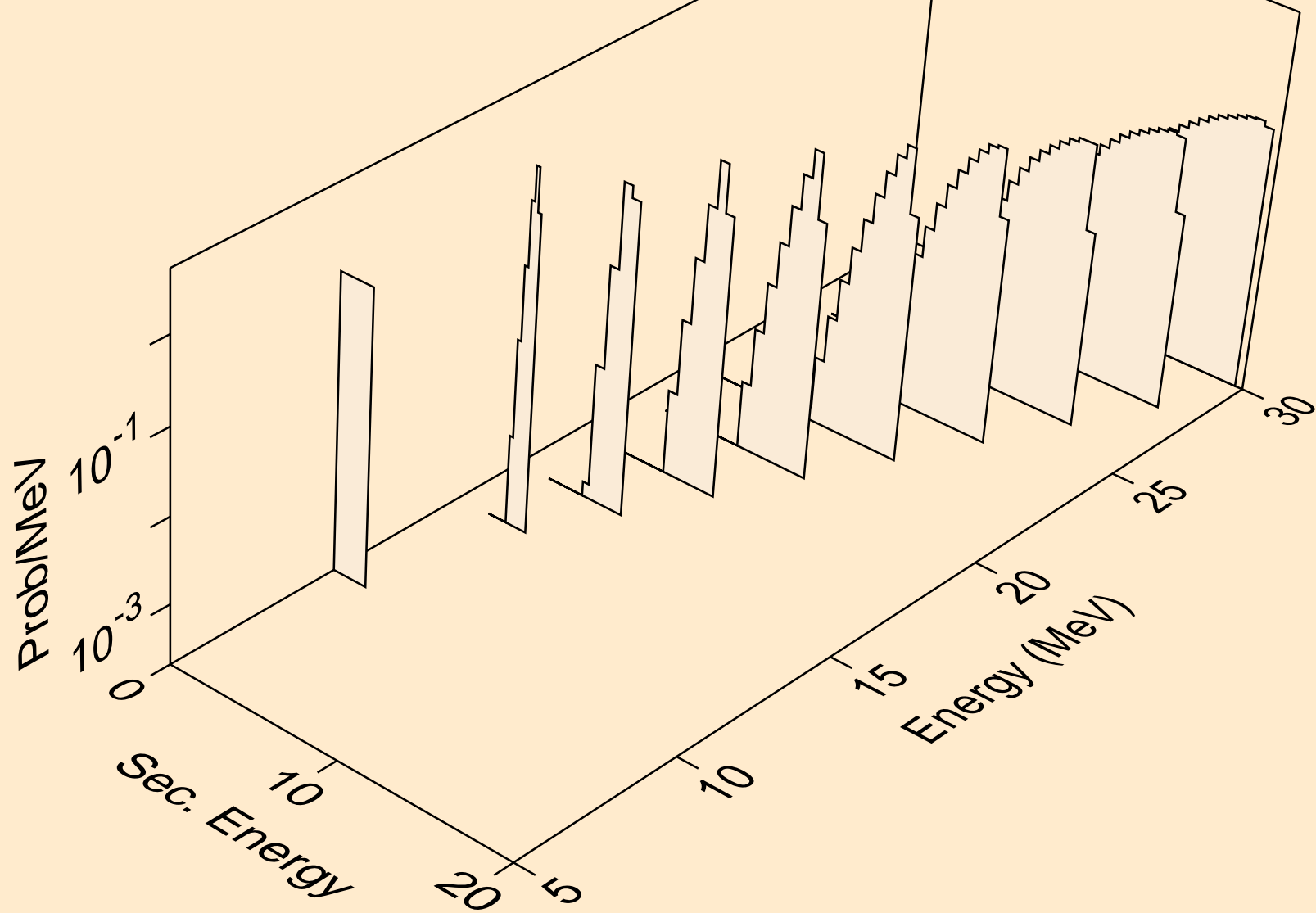

PU247 NEUTRON ACER TENDL-2023 LIBRARY; T=0.K
deuterons from (n,d)

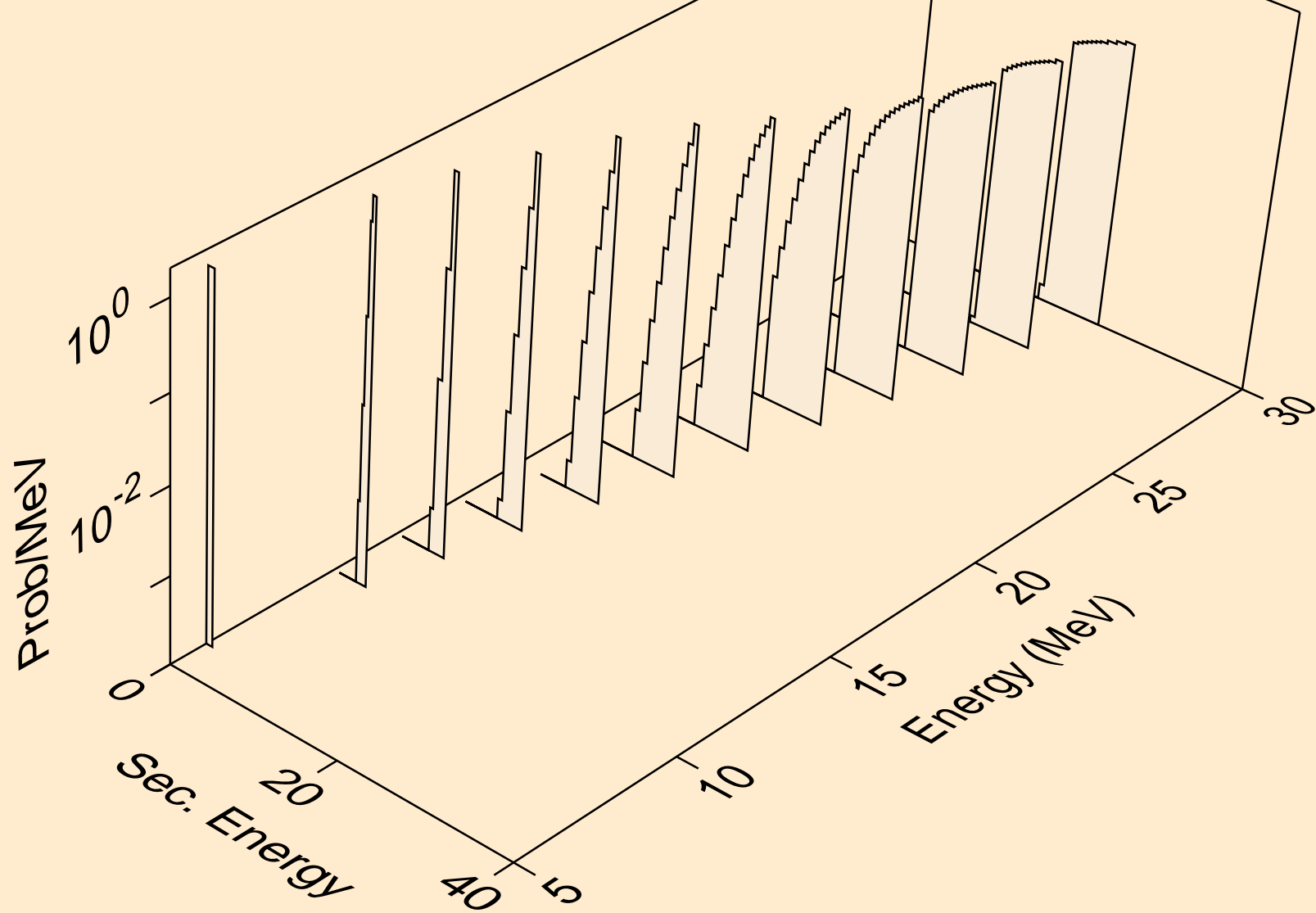

PU247 NEUTRON ACER TENDL-2023 LIBRARY; T=0.K
tritons from (n,x)

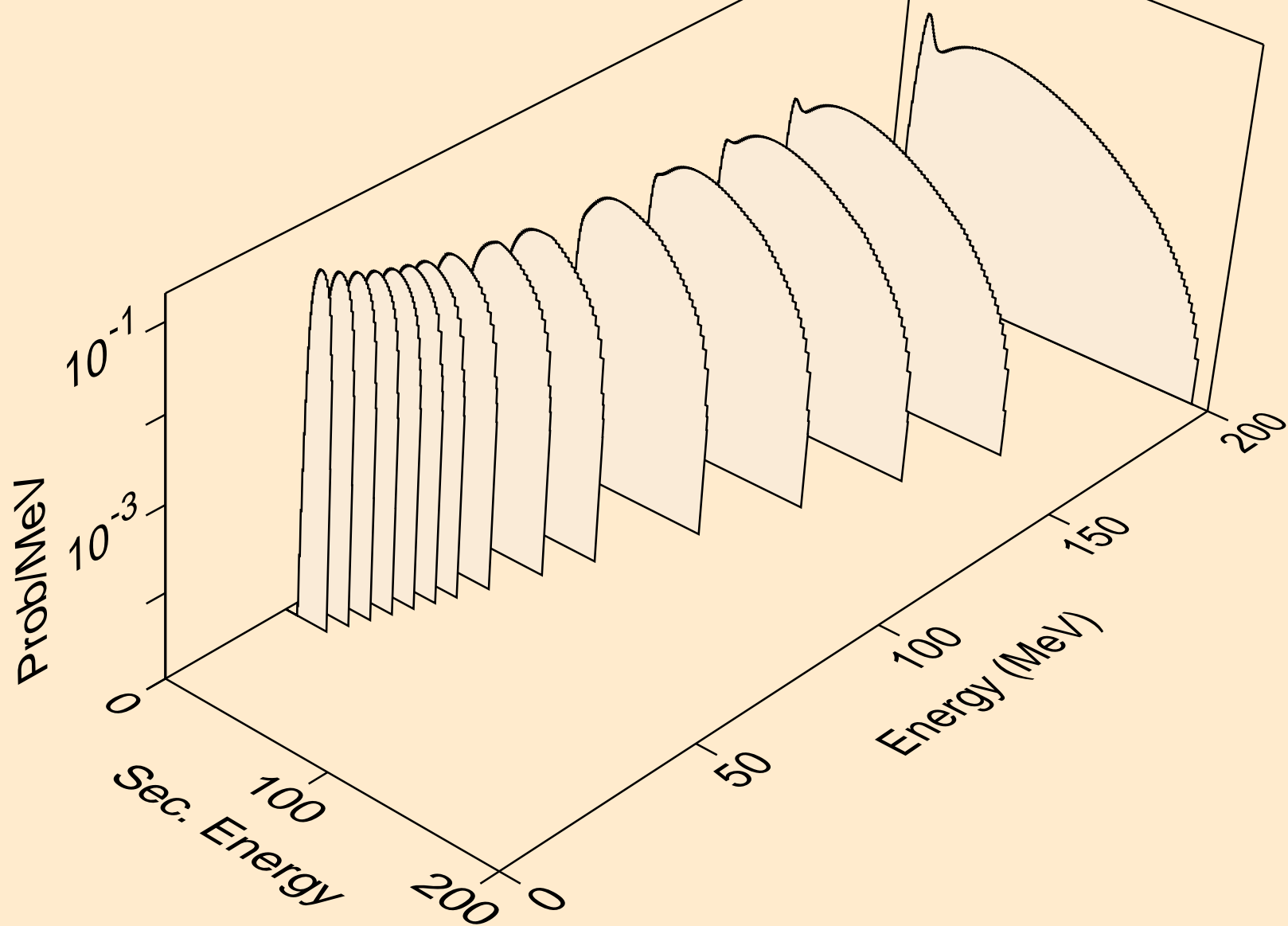

PU247 NEUTRON ACER TENDL-2023 LIBRARY; T=0.K
tritons from (n,n*)t

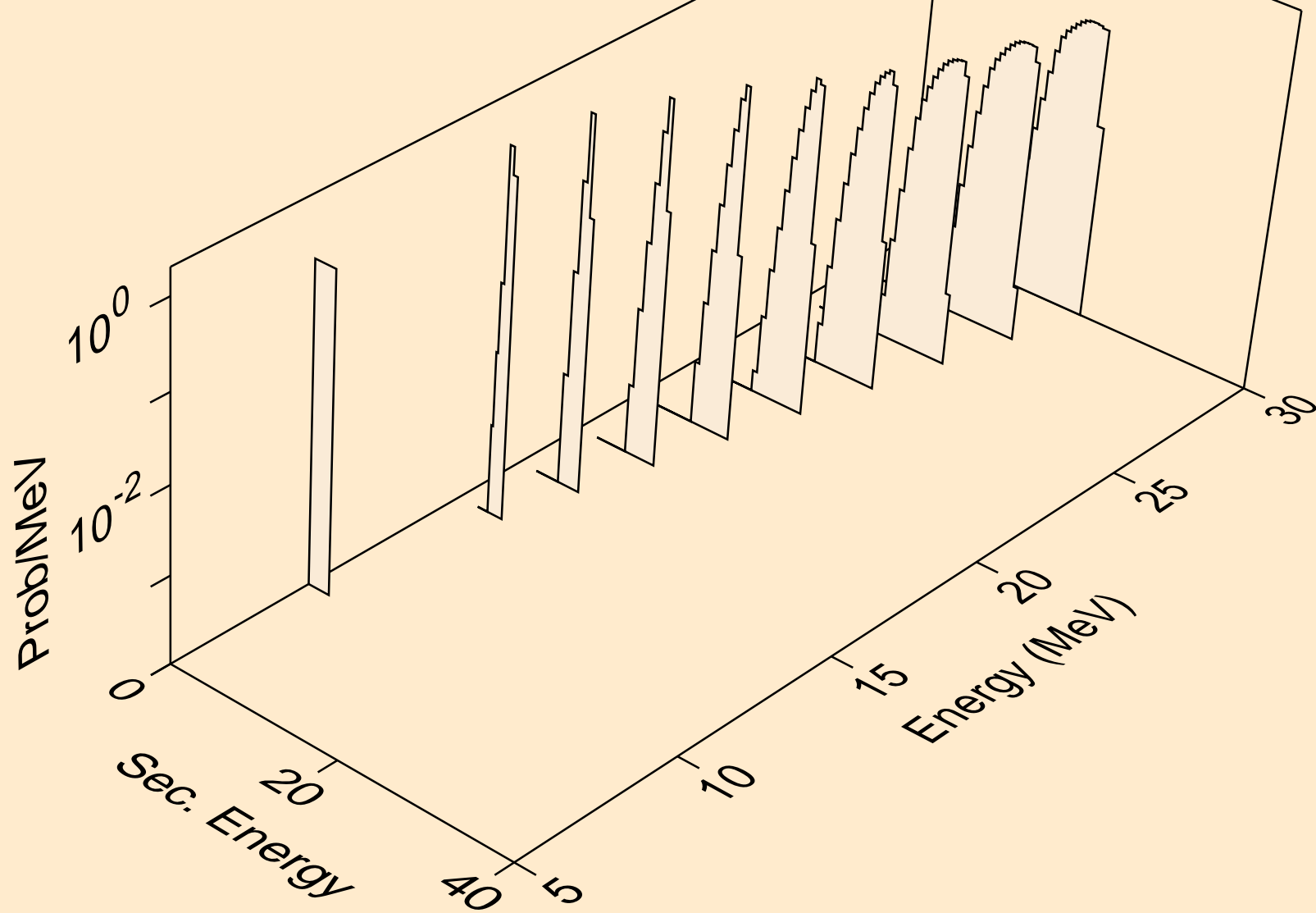

PU247 NEUTRON ACER TENDL-2023 LIBRARY; T=0.K
tritons from (n,t)

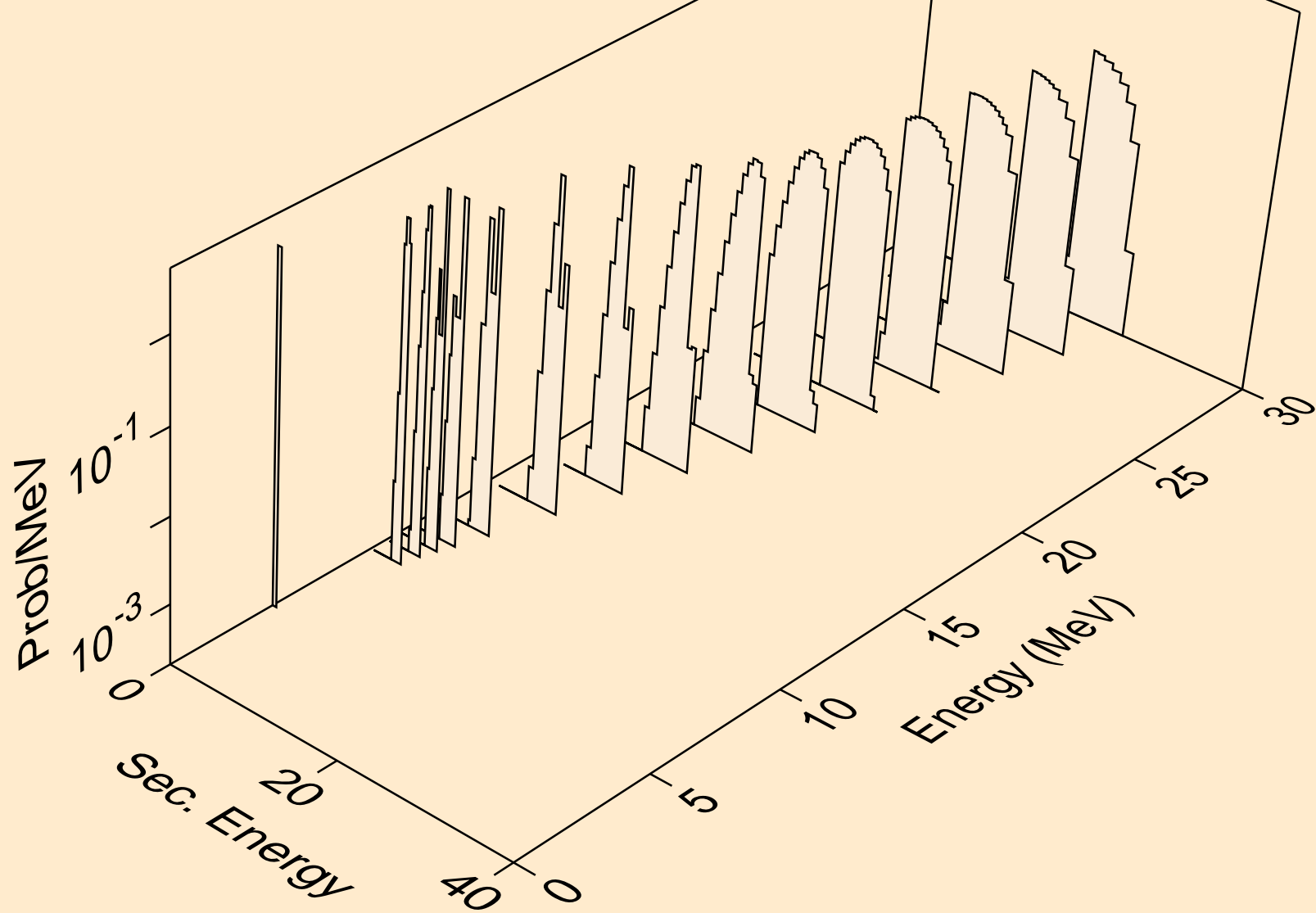

PU247 NEUTRON ACER TENDL-2023 LIBRARY; T=0.K
he3s from (n,x)

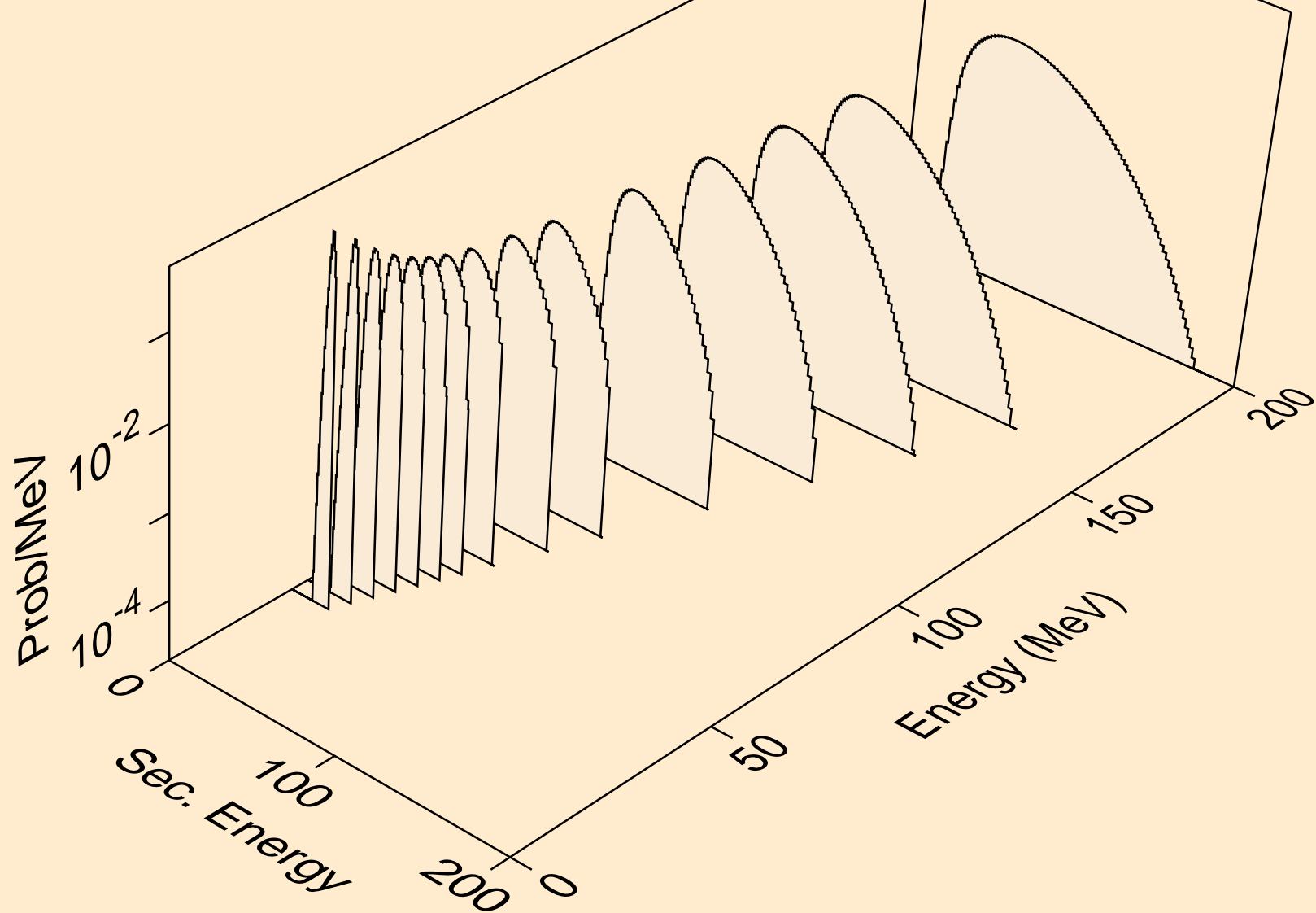

PU247 NEUTRON ACER TENDL-2023 LIBRARY; T=0.K
he3s from (n,n*)he3

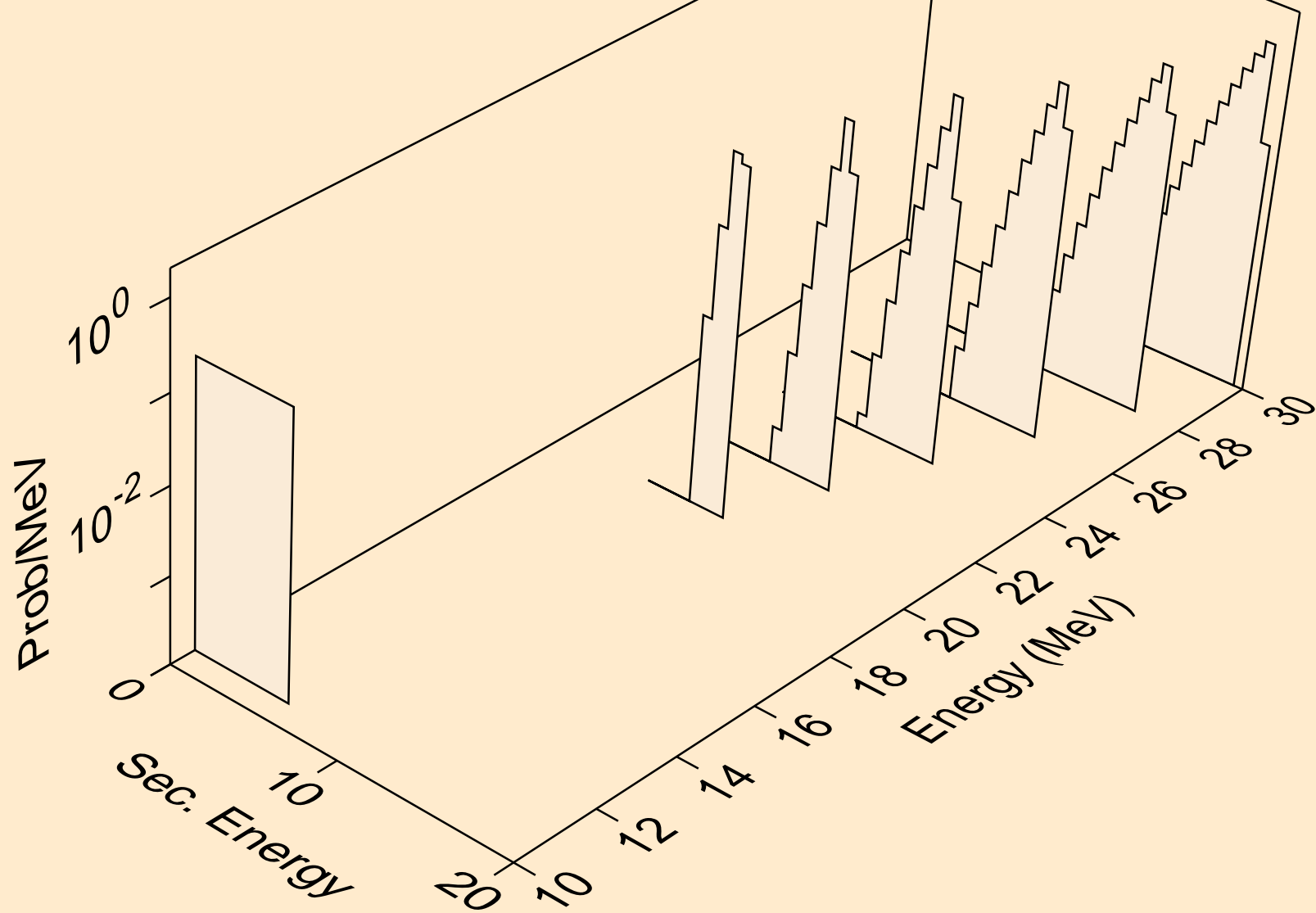

PU247 NEUTRON ACER TENDL-2023 LIBRARY; T=0.K
he3s from (n,he3)

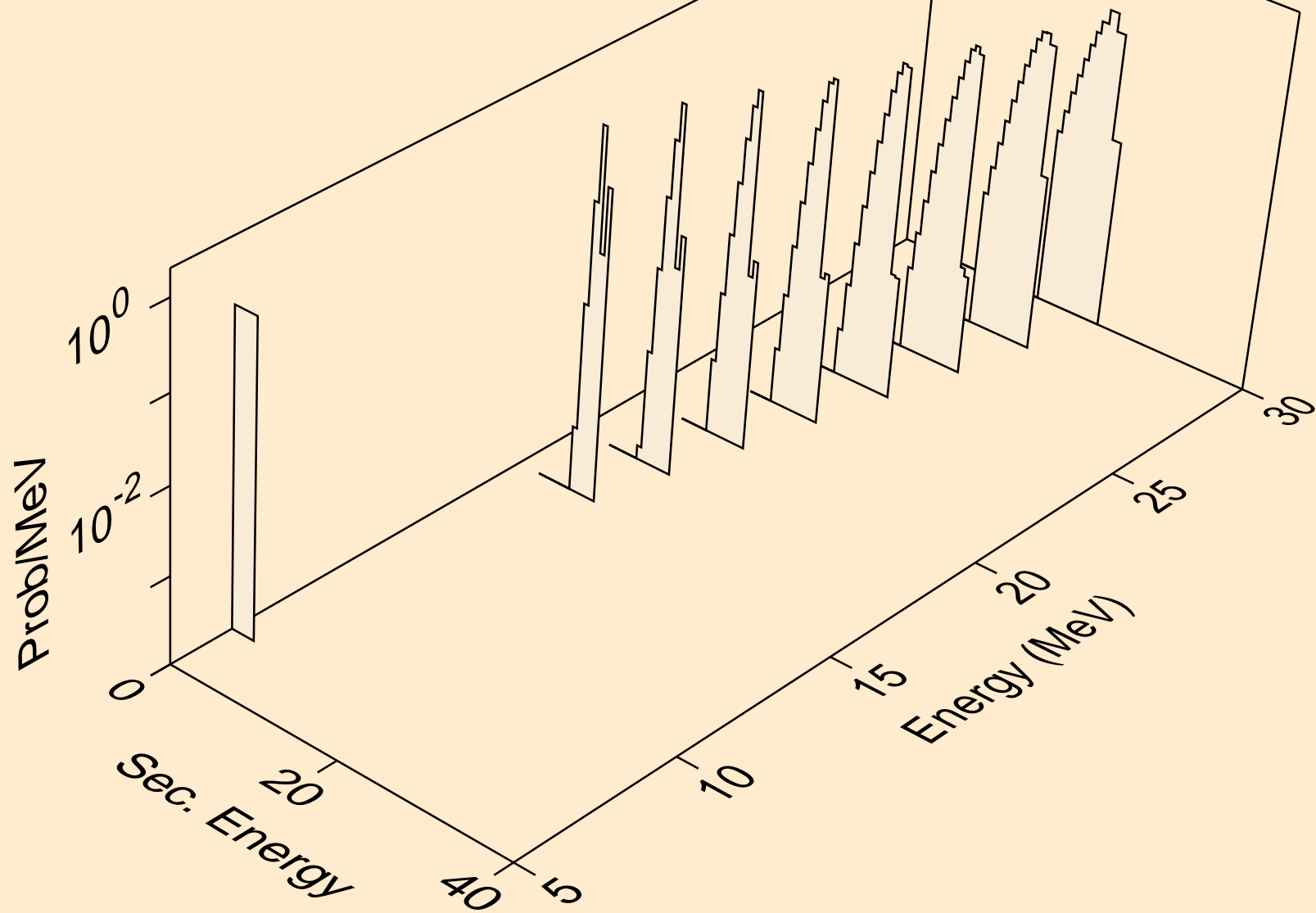

PU247 NEUTRON ACER TENDL-2023 LIBRARY; T=0.K
alphas from (n,x)

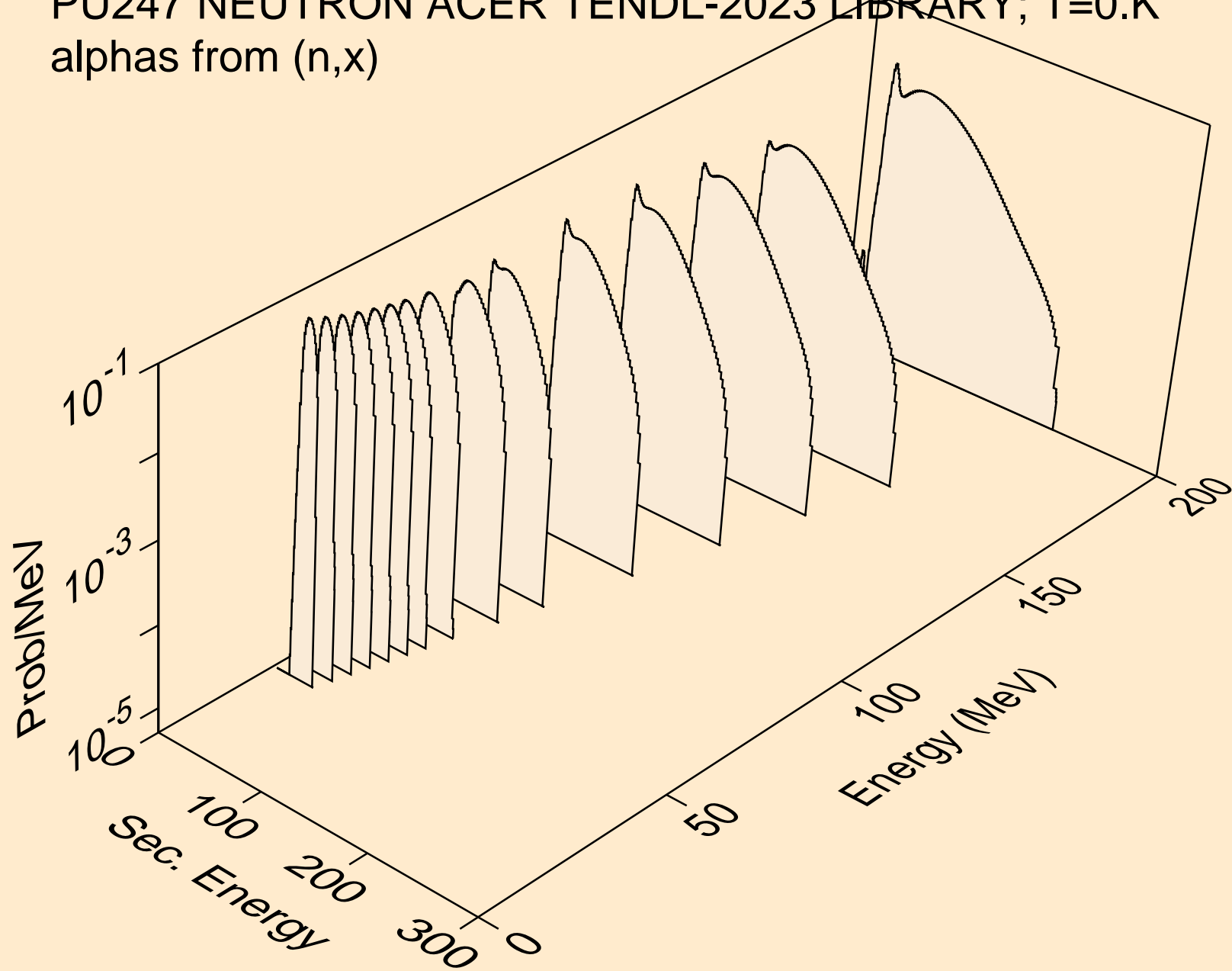

PU247 NEUTRON ACER TENDL-2023 LIBRARY; T=0.K
alphas from (n,n*)a

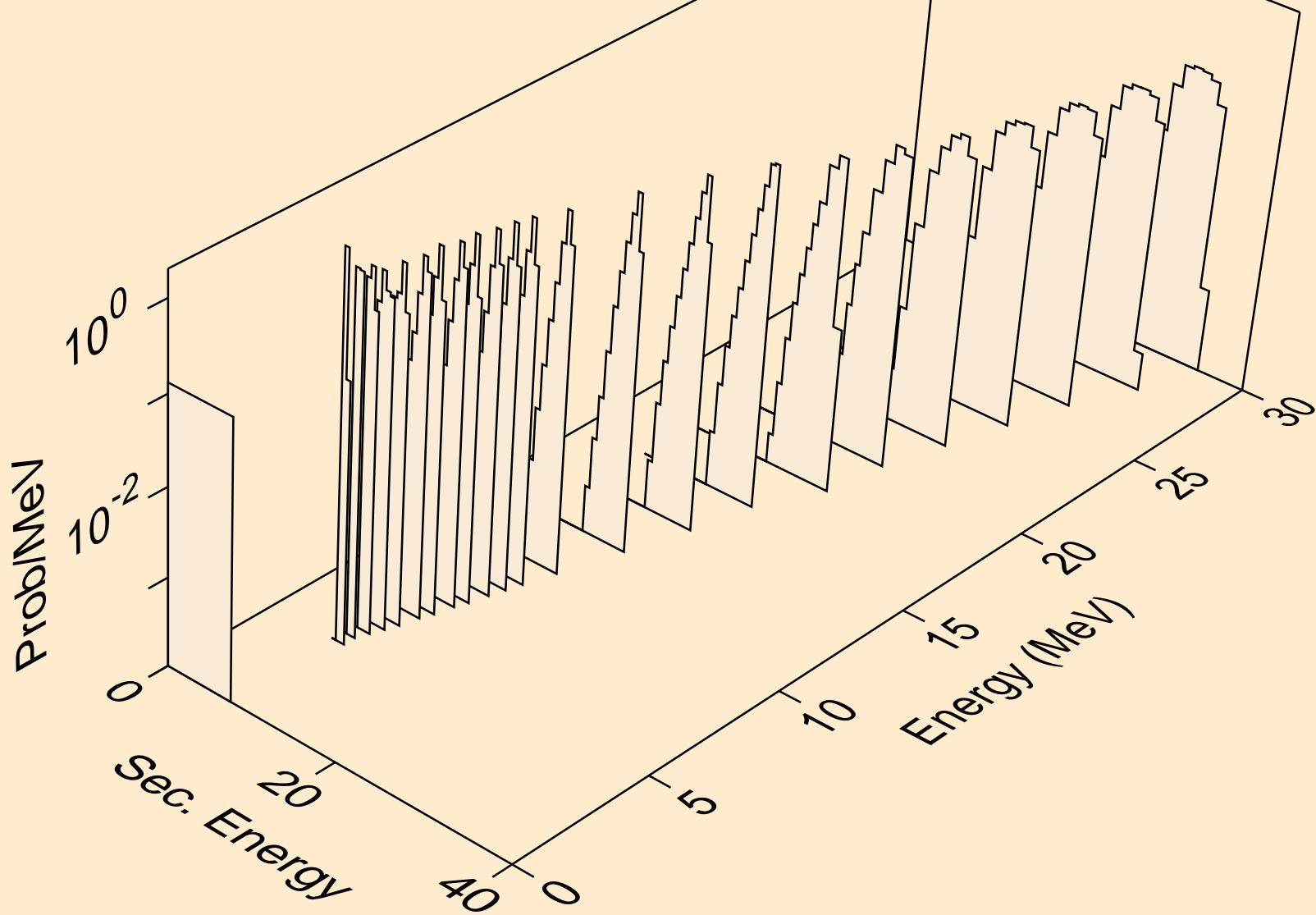

PU247 NEUTRON ACER TENDL-2023 LIBRARY; T=0.K
alphas from (n,2n)a

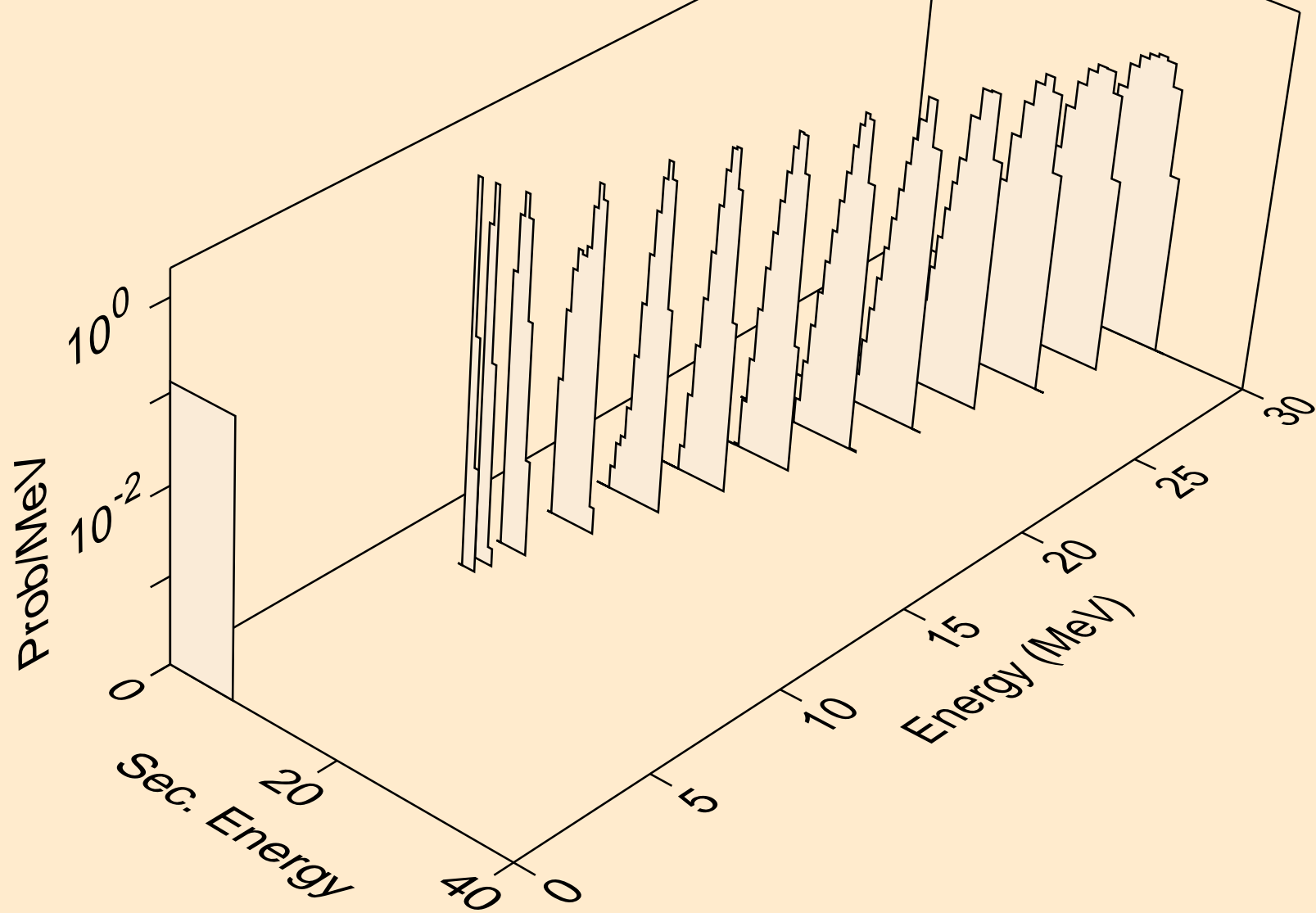

PU247 NEUTRON ACER TENDL-2023 LIBRARY; T=0.K
alphas from (n,3n)a

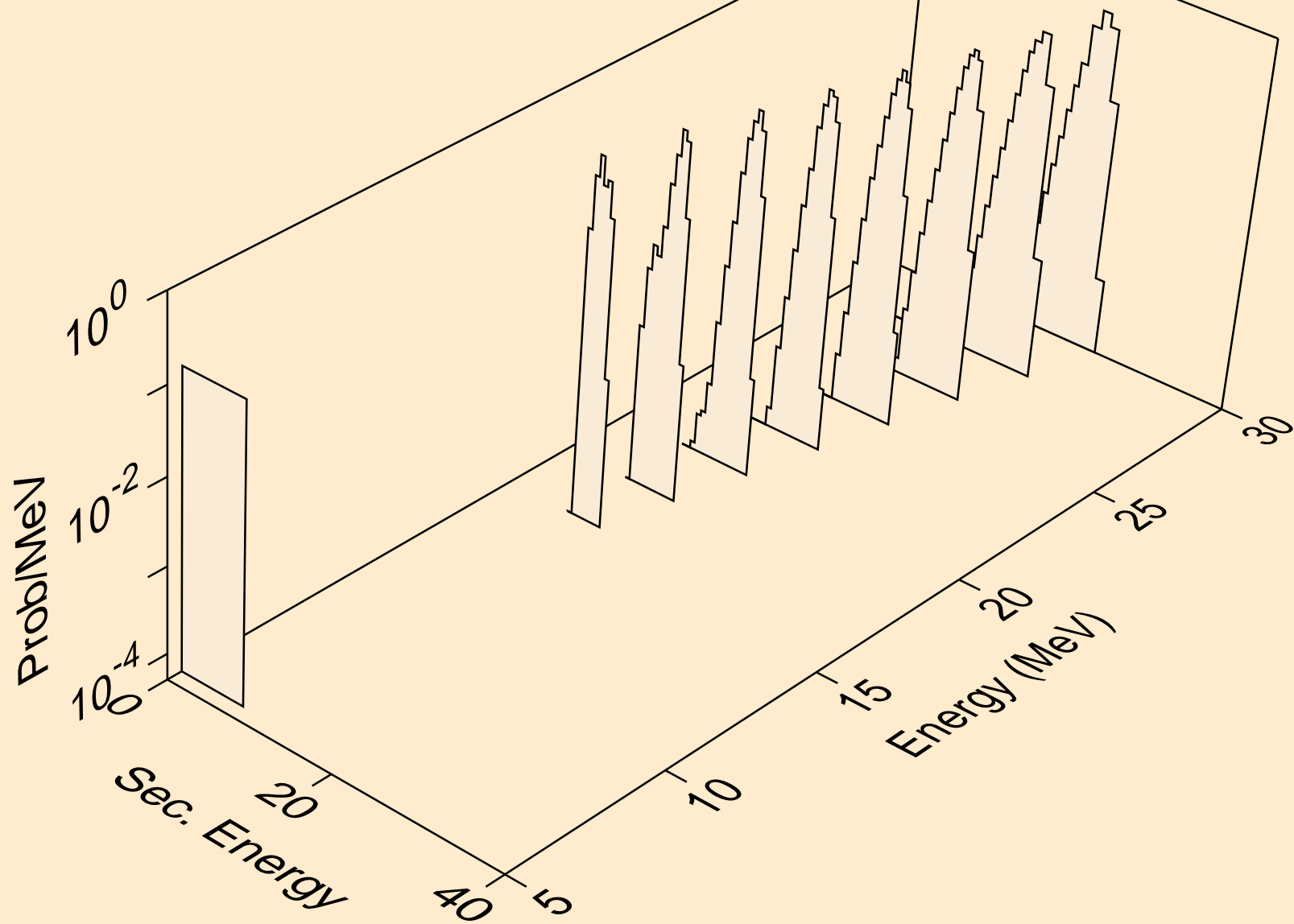

PU247 NEUTRON ACER TENDL-2023 LIBRARY; T=0.K
alphas from (n,a)

