

RA207 NEUTRON ACER TENDL-2023 LIBRARY; T=0.K  
Principal cross sections

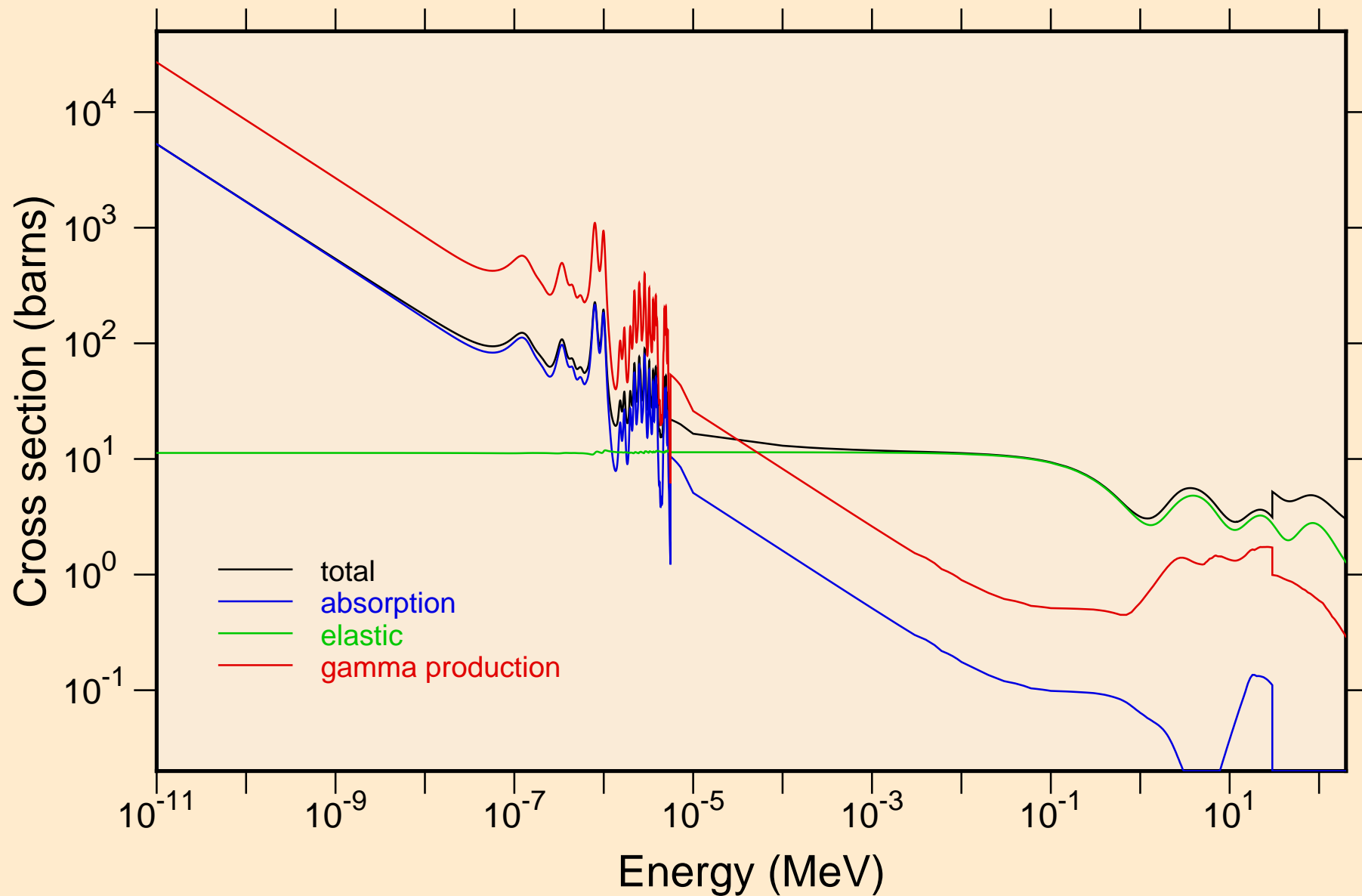

RA207 NEUTRON ACER TENDL-2023 LIBRARY; T=0.K  
resonance total cross section

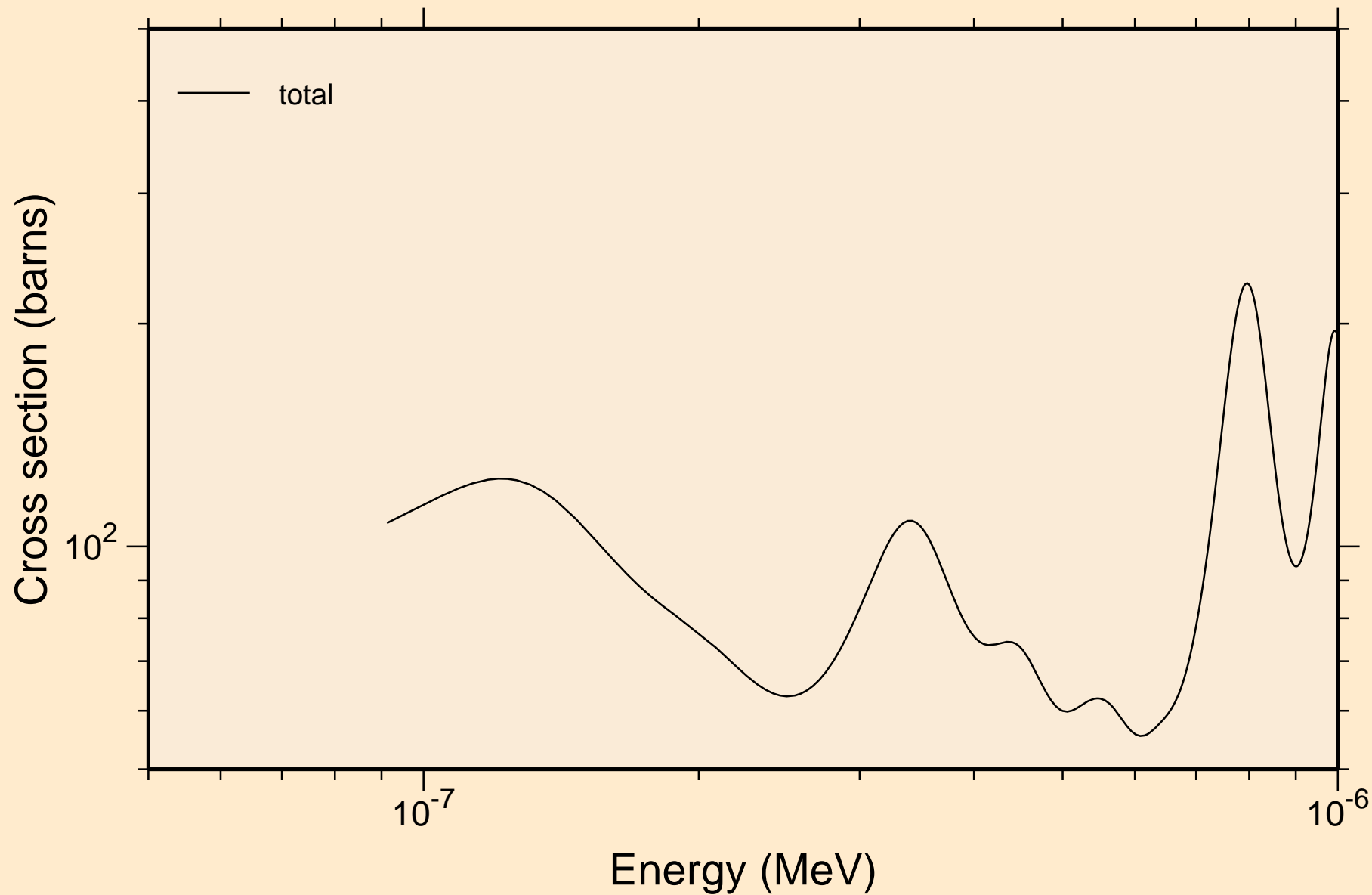

RA207 NEUTRON ACER TENDL-2023 LIBRARY; T=0.K  
resonance total cross section

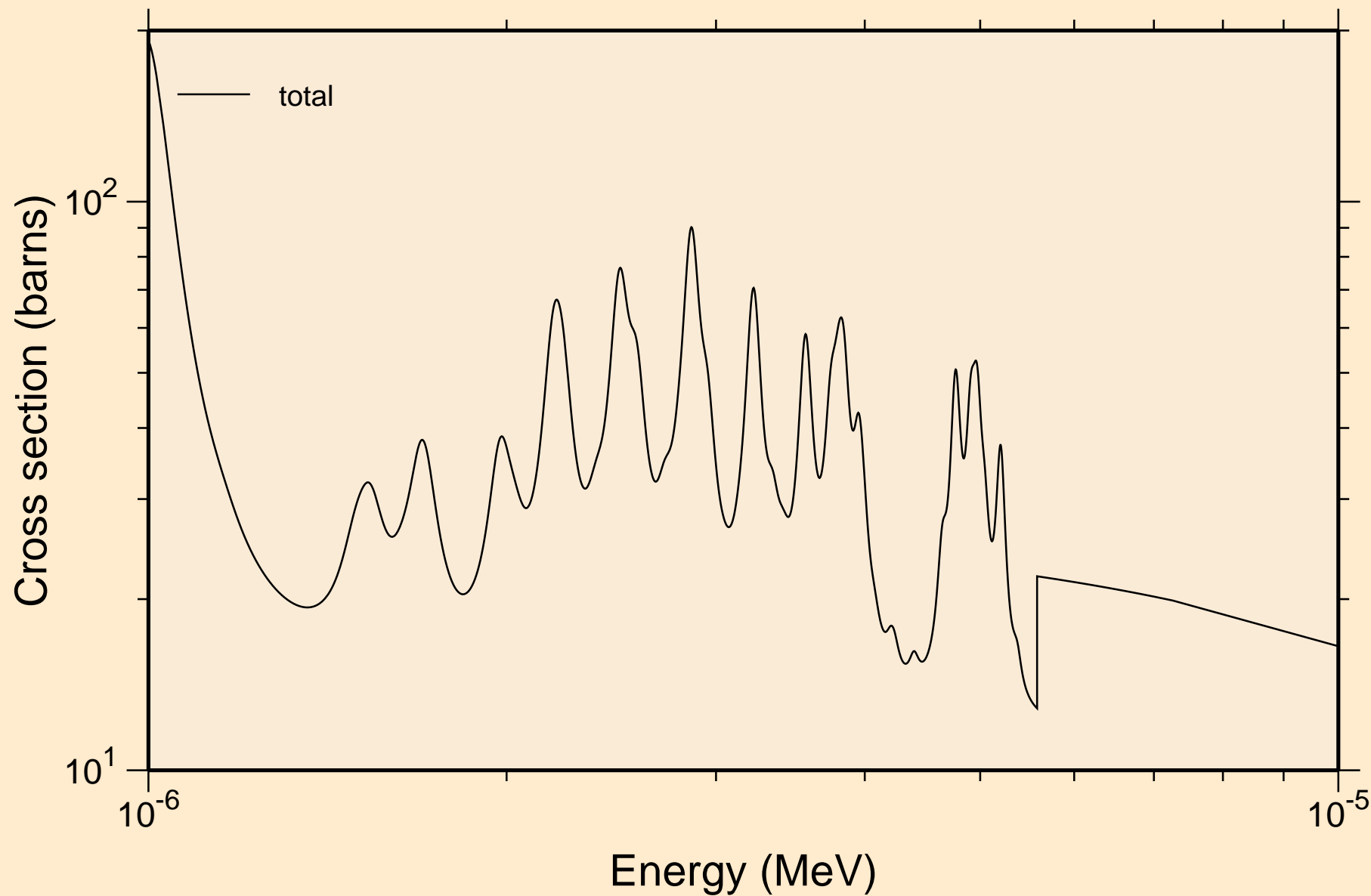

RA207 NEUTRON ACER TENDL-2023 LIBRARY; T=0.K  
resonance total cross section

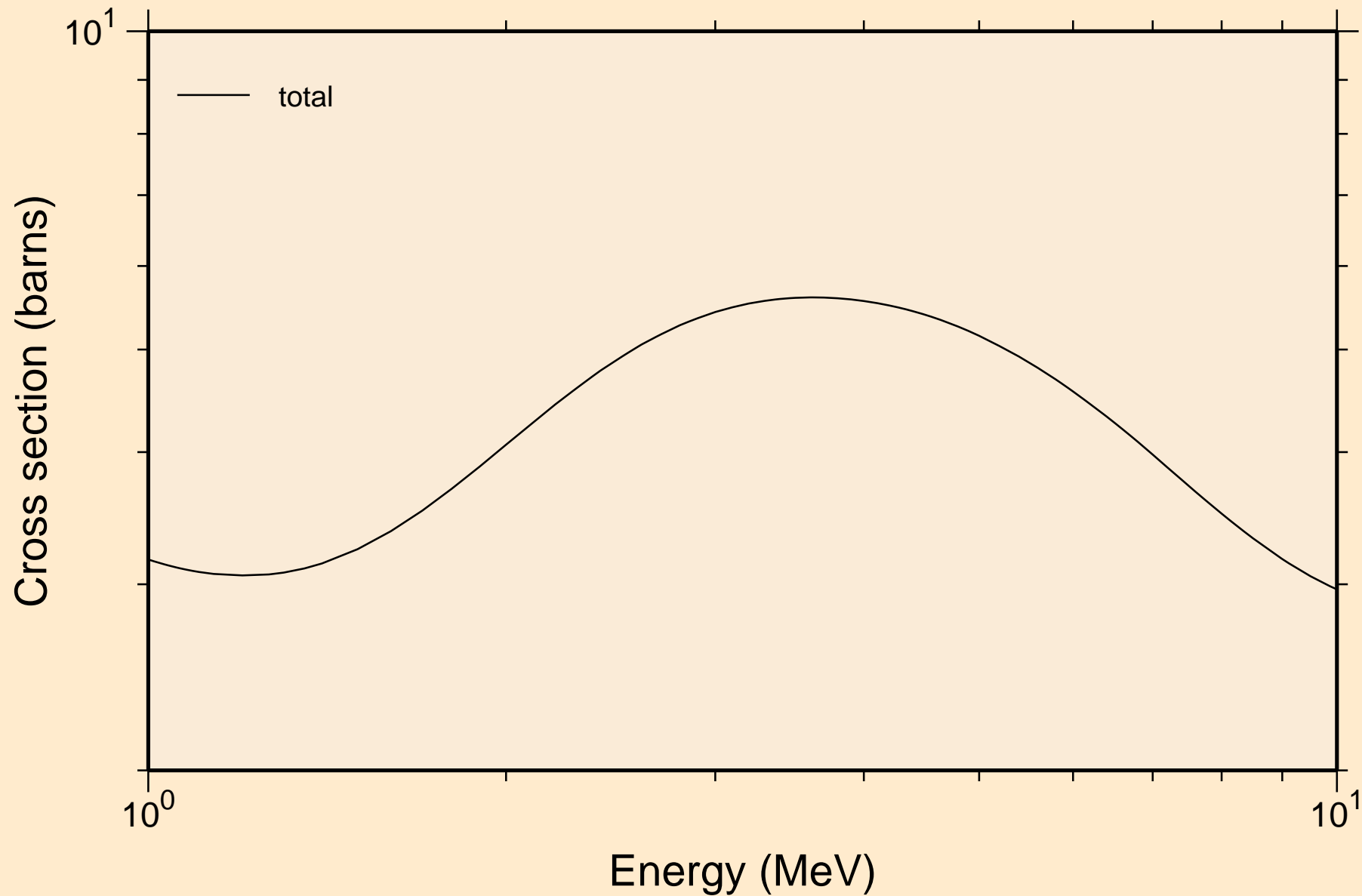

RA207 NEUTRON ACER TENDL-2023 LIBRARY; T=0.K  
resonance absorption cross sections

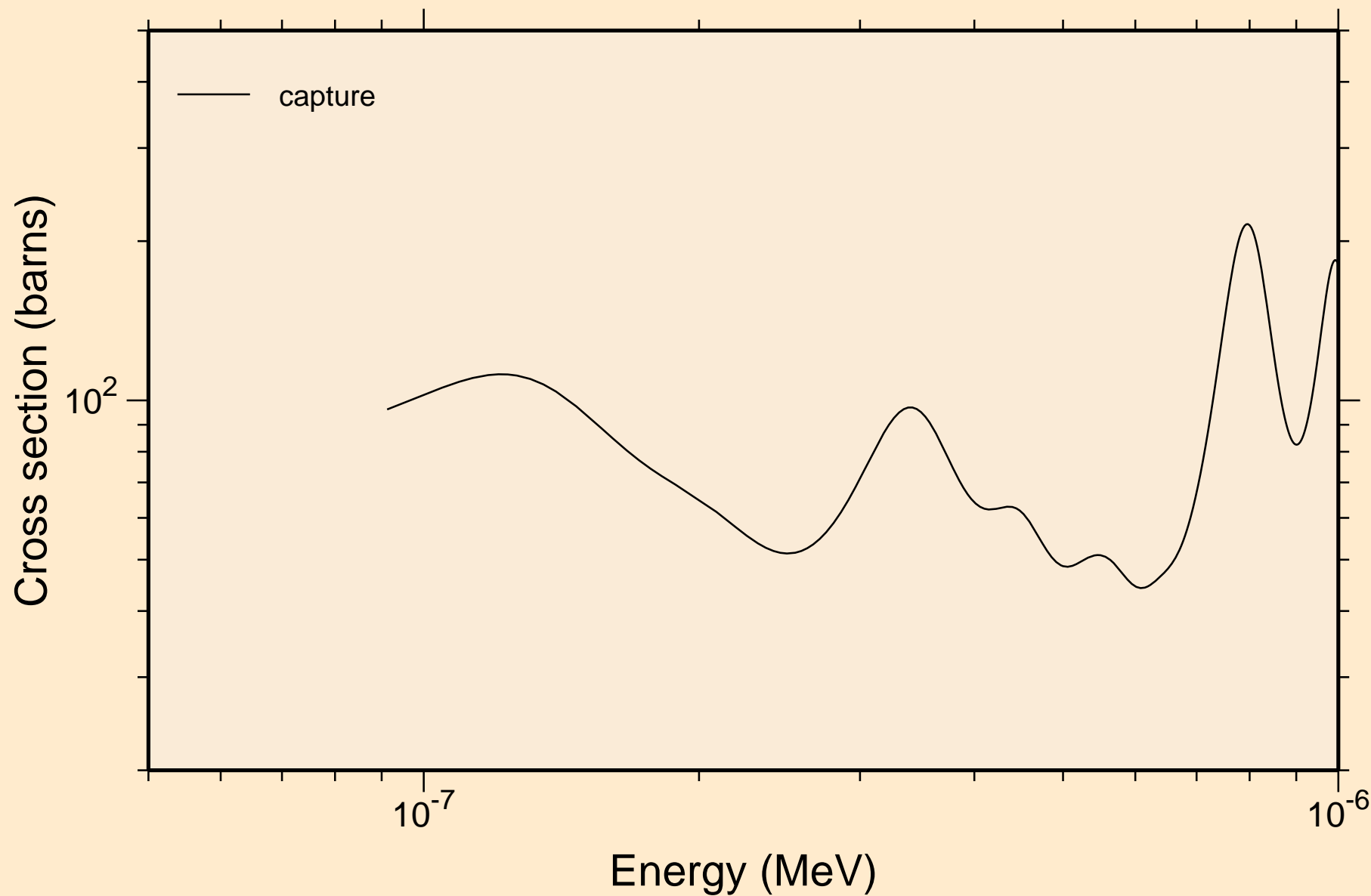

RA207 NEUTRON ACER TENDL-2023 LIBRARY; T=0.K  
resonance absorption cross sections

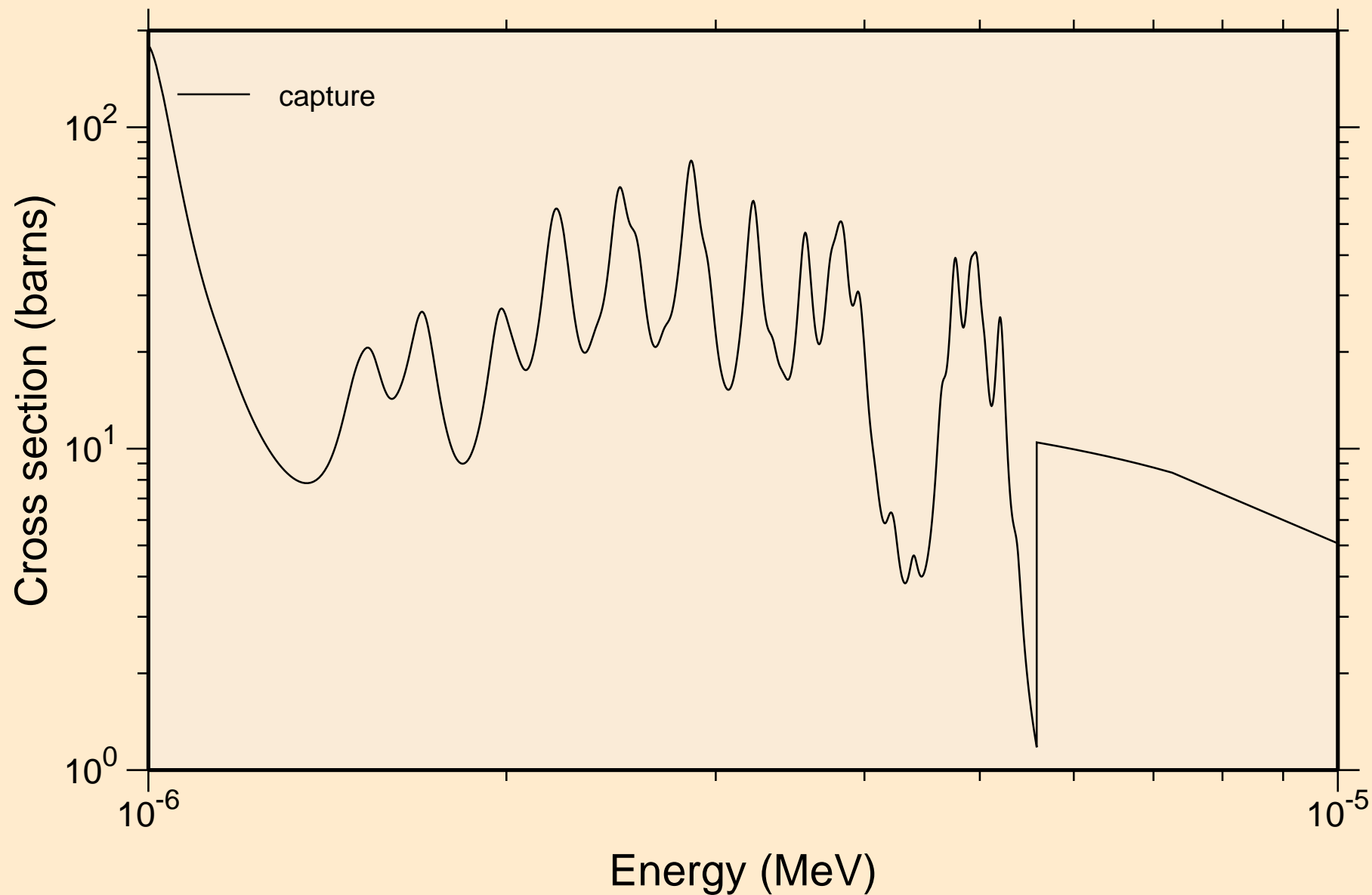

RA207 NEUTRON ACER TENDL-2023 LIBRARY; T=0.K  
resonance absorption cross sections

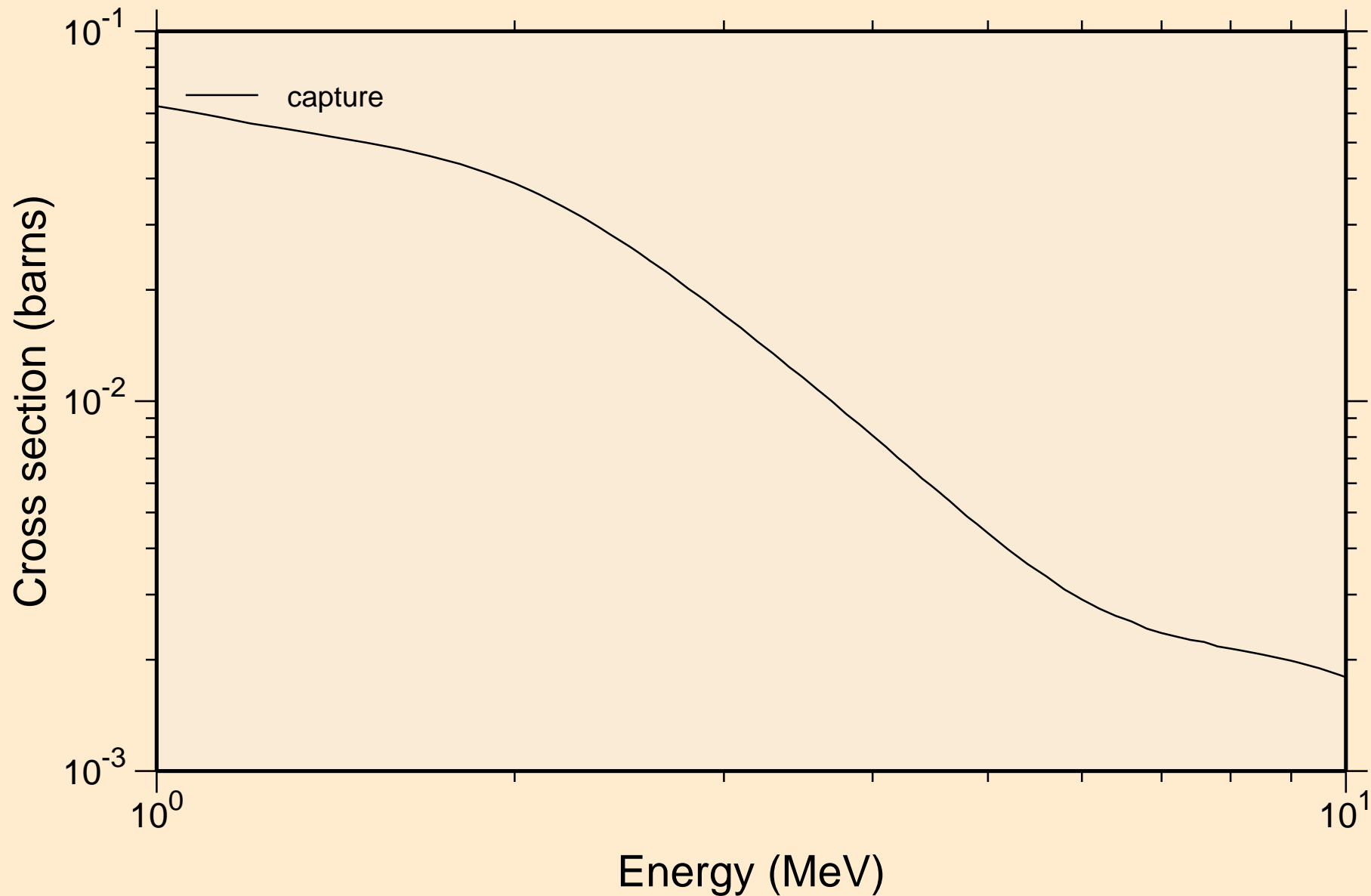

RA207 NEUTRON ACER TENDL-2023 LIBRARY; T=0.K  
Heating

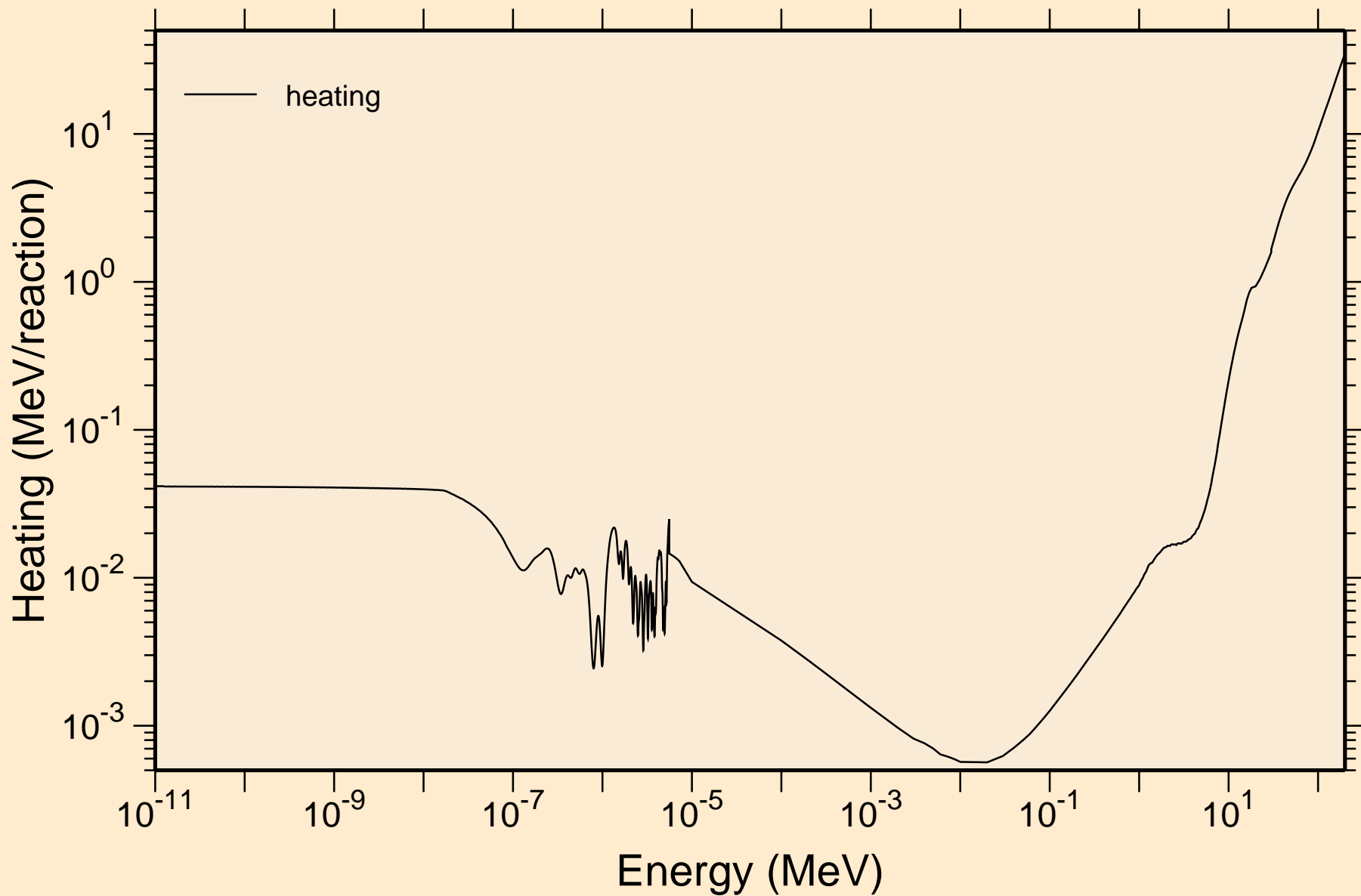



RA207 NEUTRON ACER TENDL-2023 LIBRARY; T=0.K  
Damage

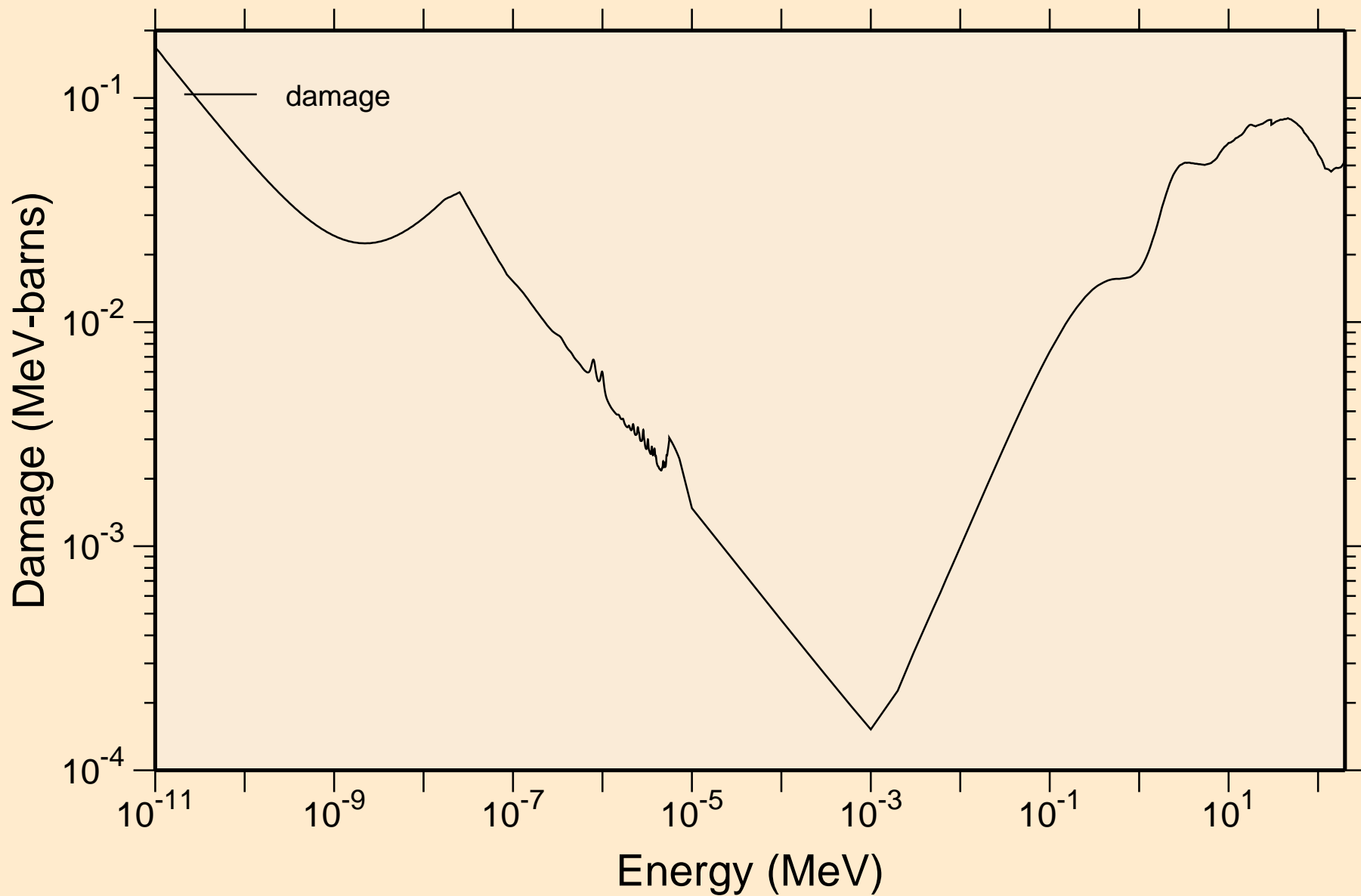

RA207 NEUTRON ACER TENDL-2023 LIBRARY; T=0.K  
Non-threshold reactions

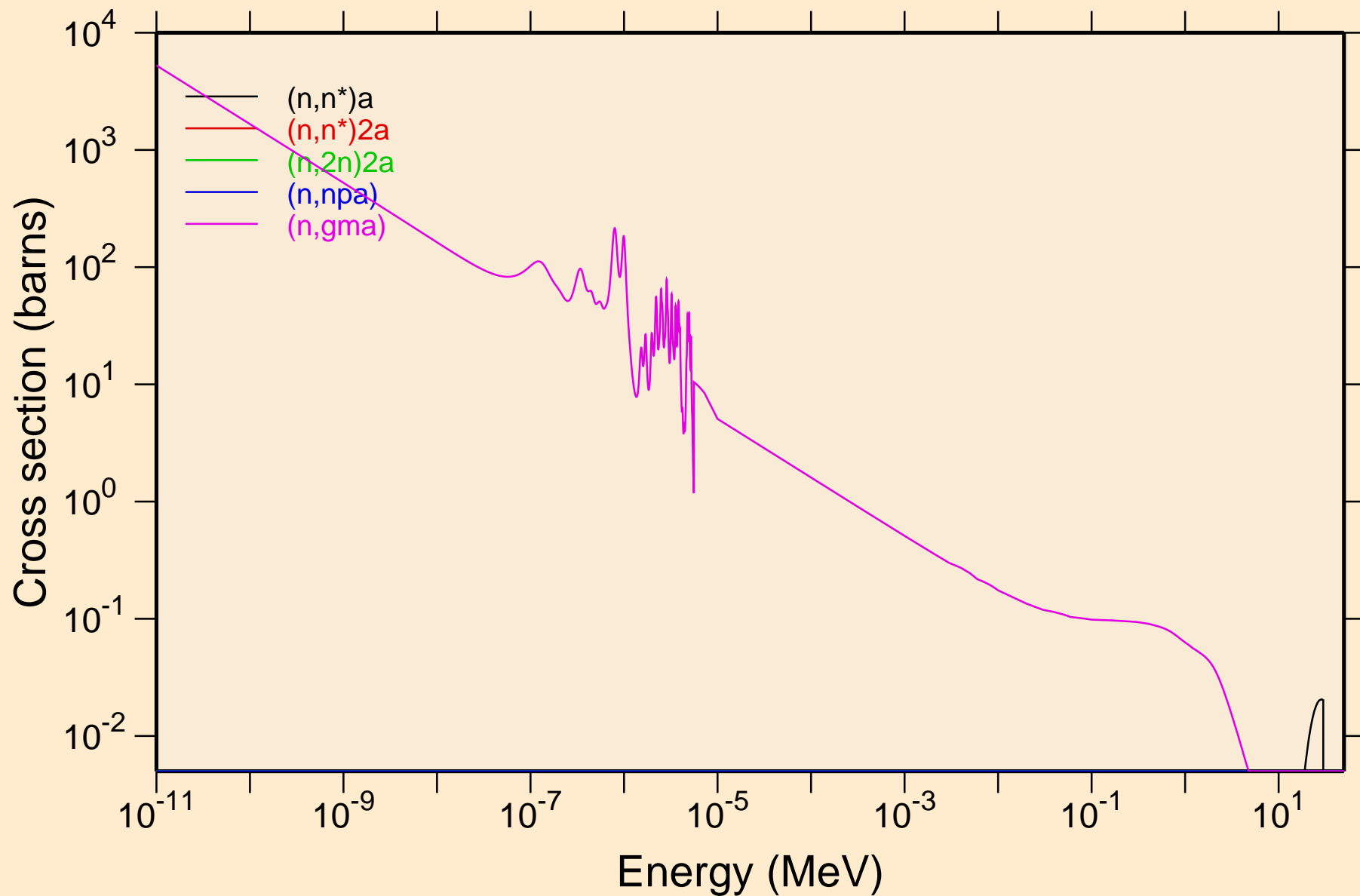

RA207 NEUTRON ACER TENDL-2023 LIBRARY; T=0.K  
Non-threshold reactions

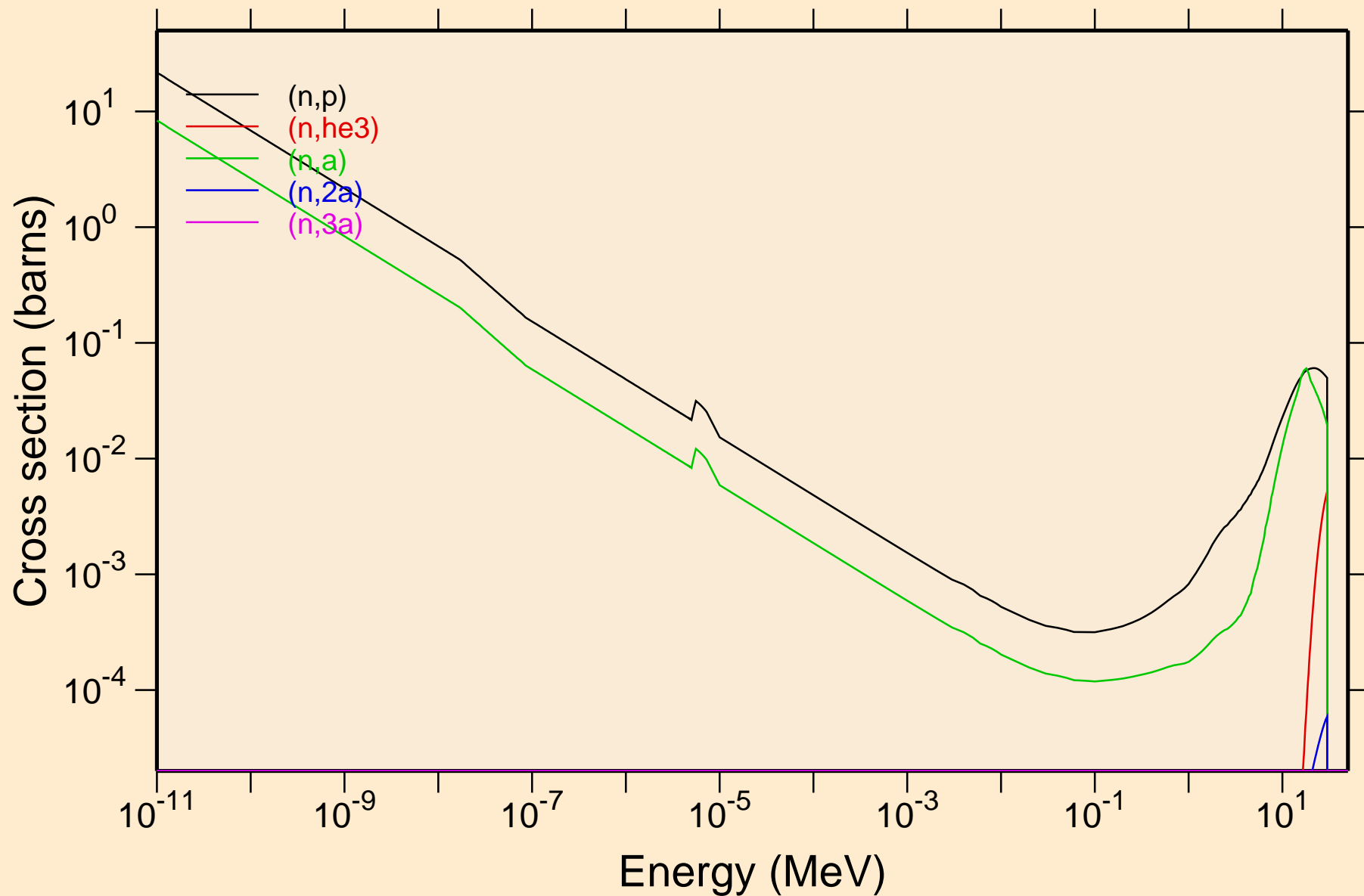

RA207 NEUTRON ACER TENDL-2023 LIBRARY; T=0.K  
Non-threshold reactions

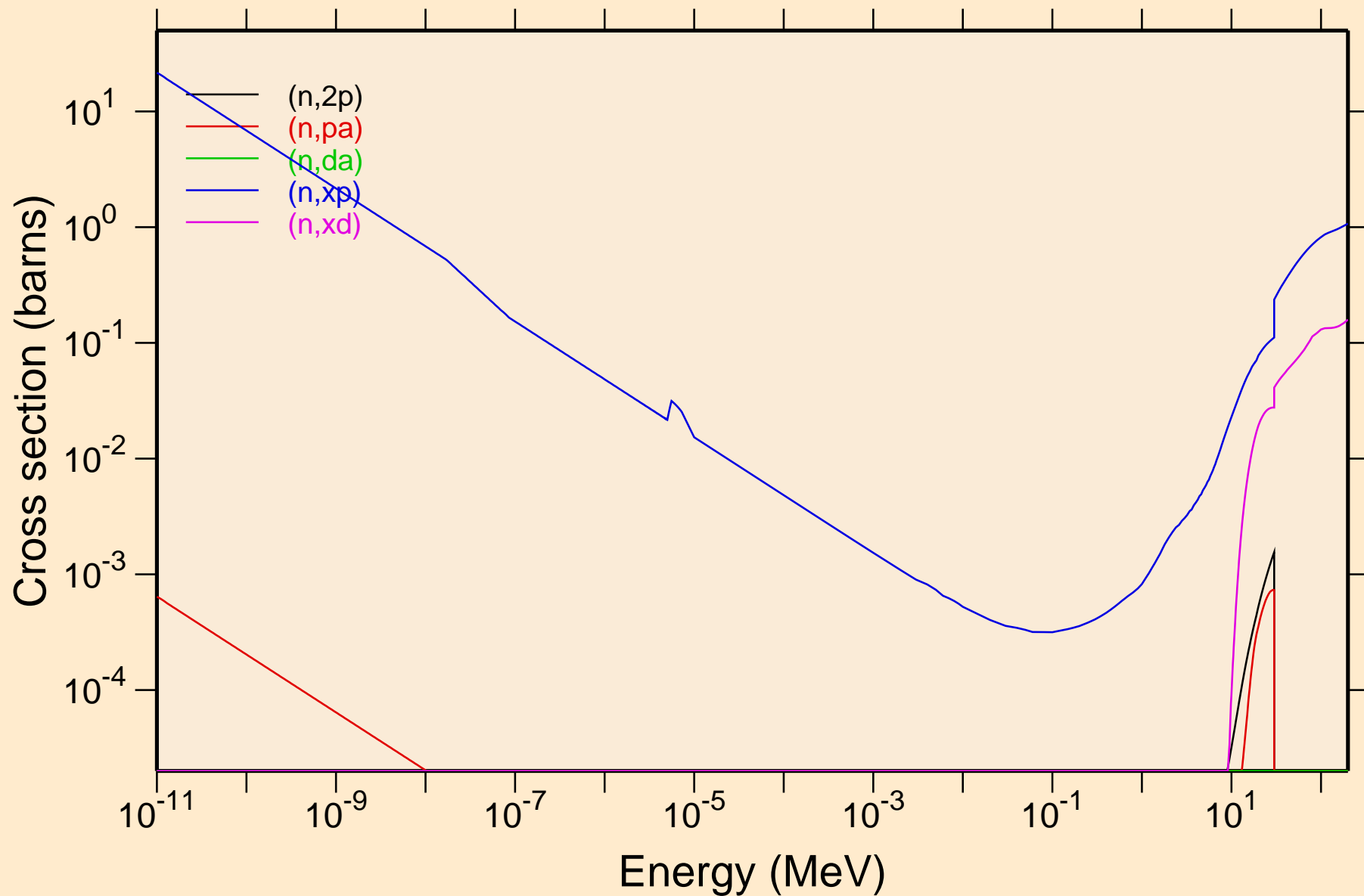

RA207 NEUTRON ACER TENDL-2023 LIBRARY; T=0.K  
Non-threshold reactions

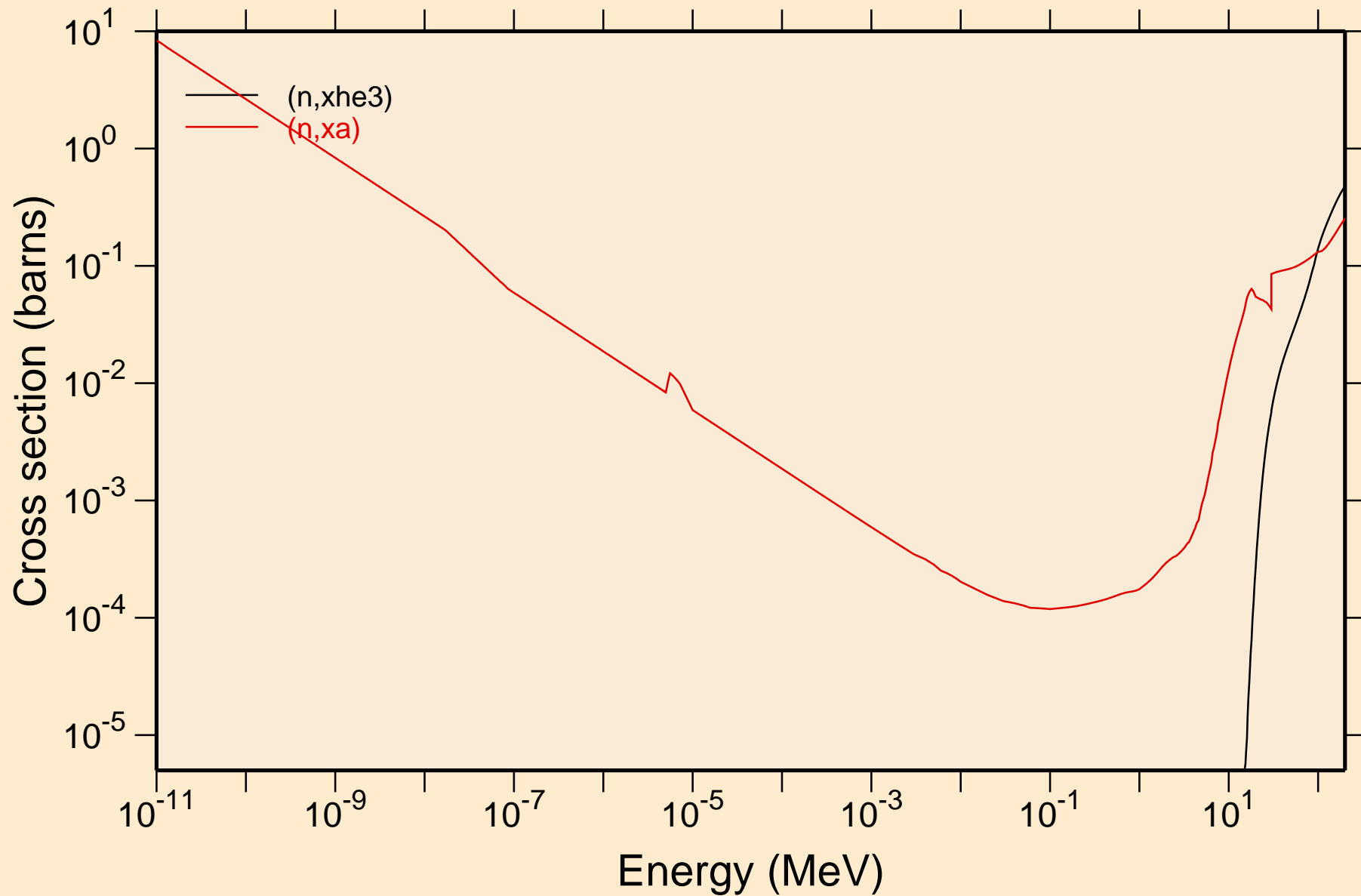

RA207 NEUTRON ACER TENDL-2023 LIBRARY; T=0.K  
Principal cross sections

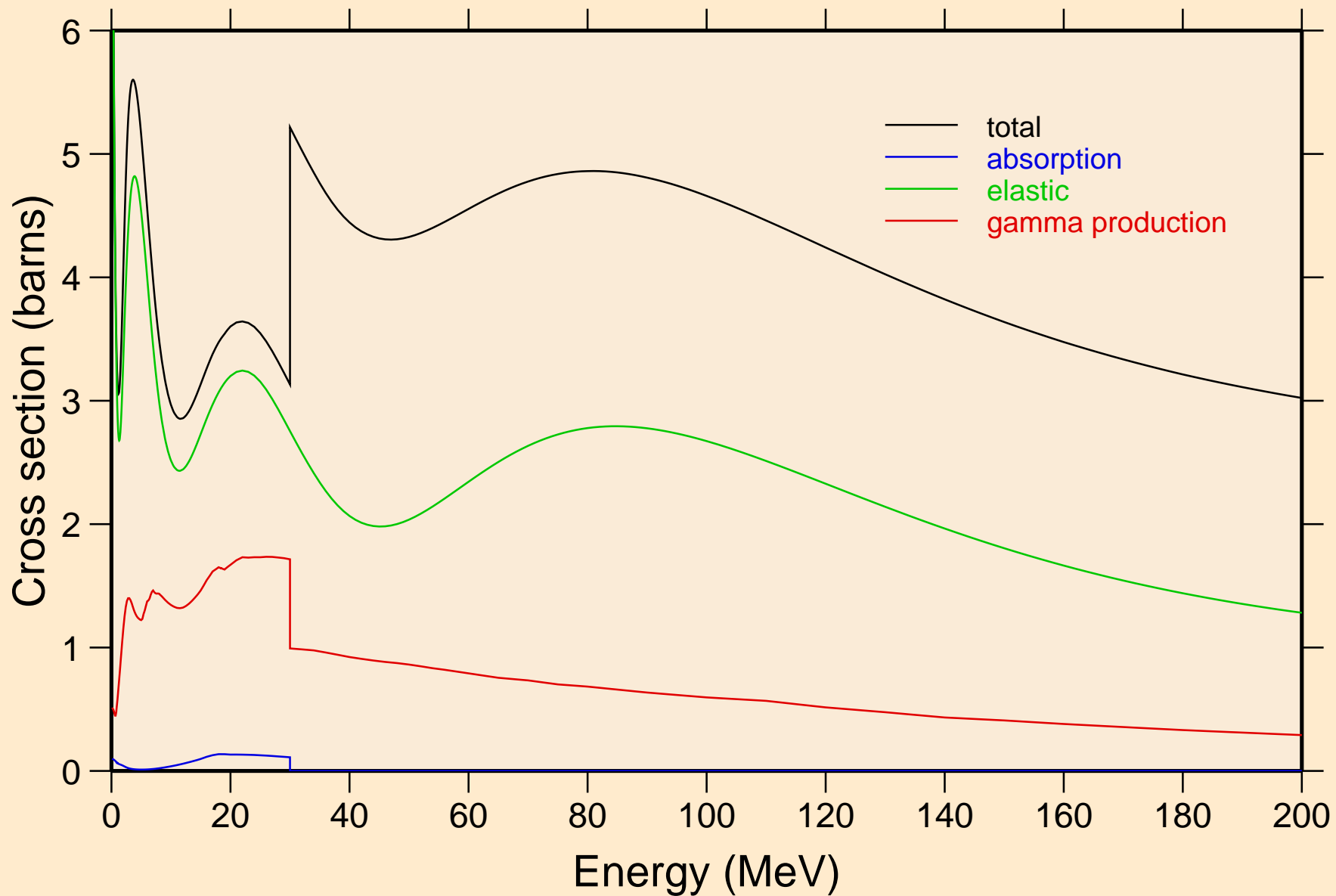

RA207 NEUTRON ACER TENDL-2023 LIBRARY; T=0.K  
Heating

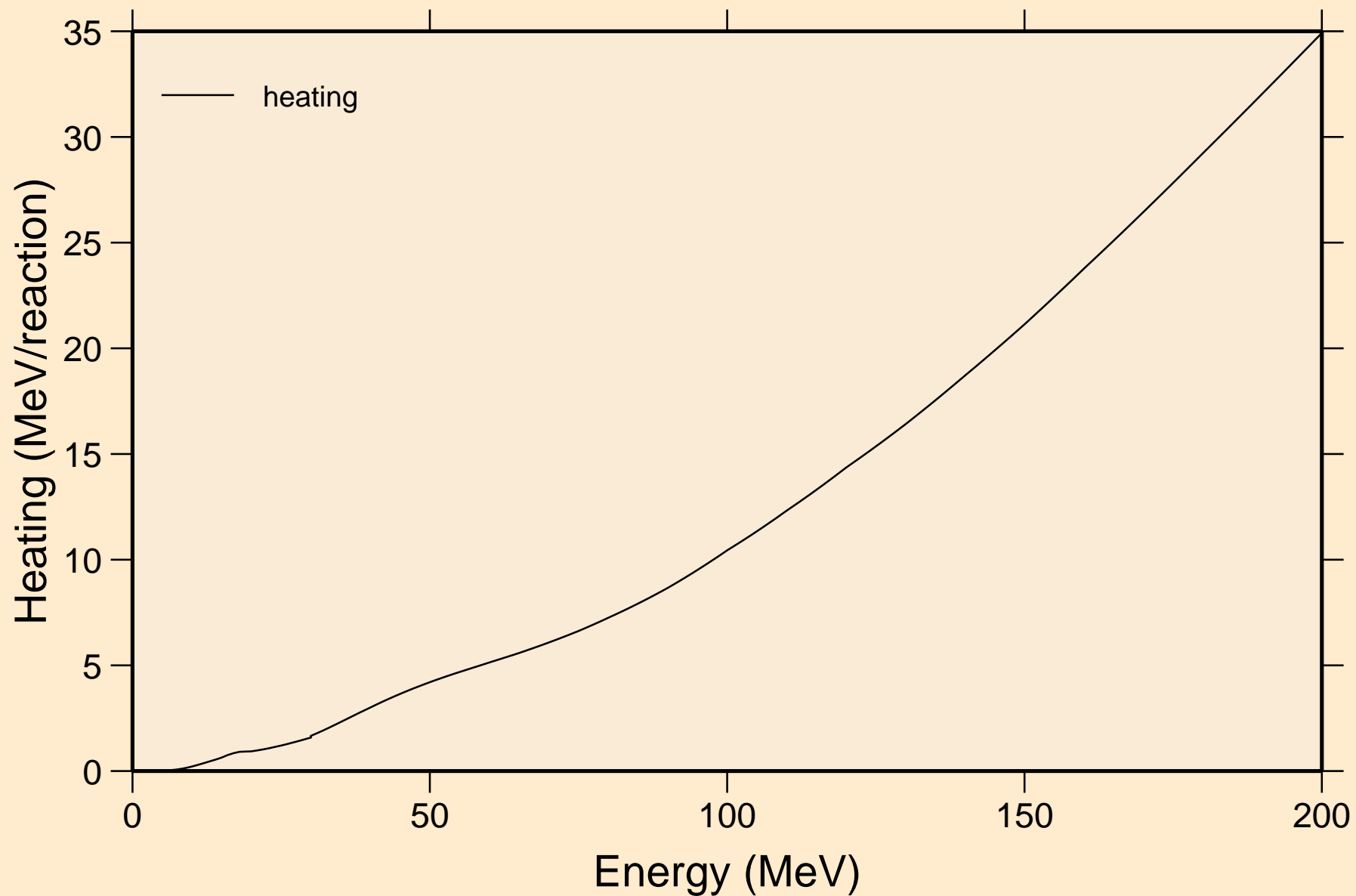

RA207 NEUTRON ACER TENDL-2023 LIBRARY; T=0.K  
Damage

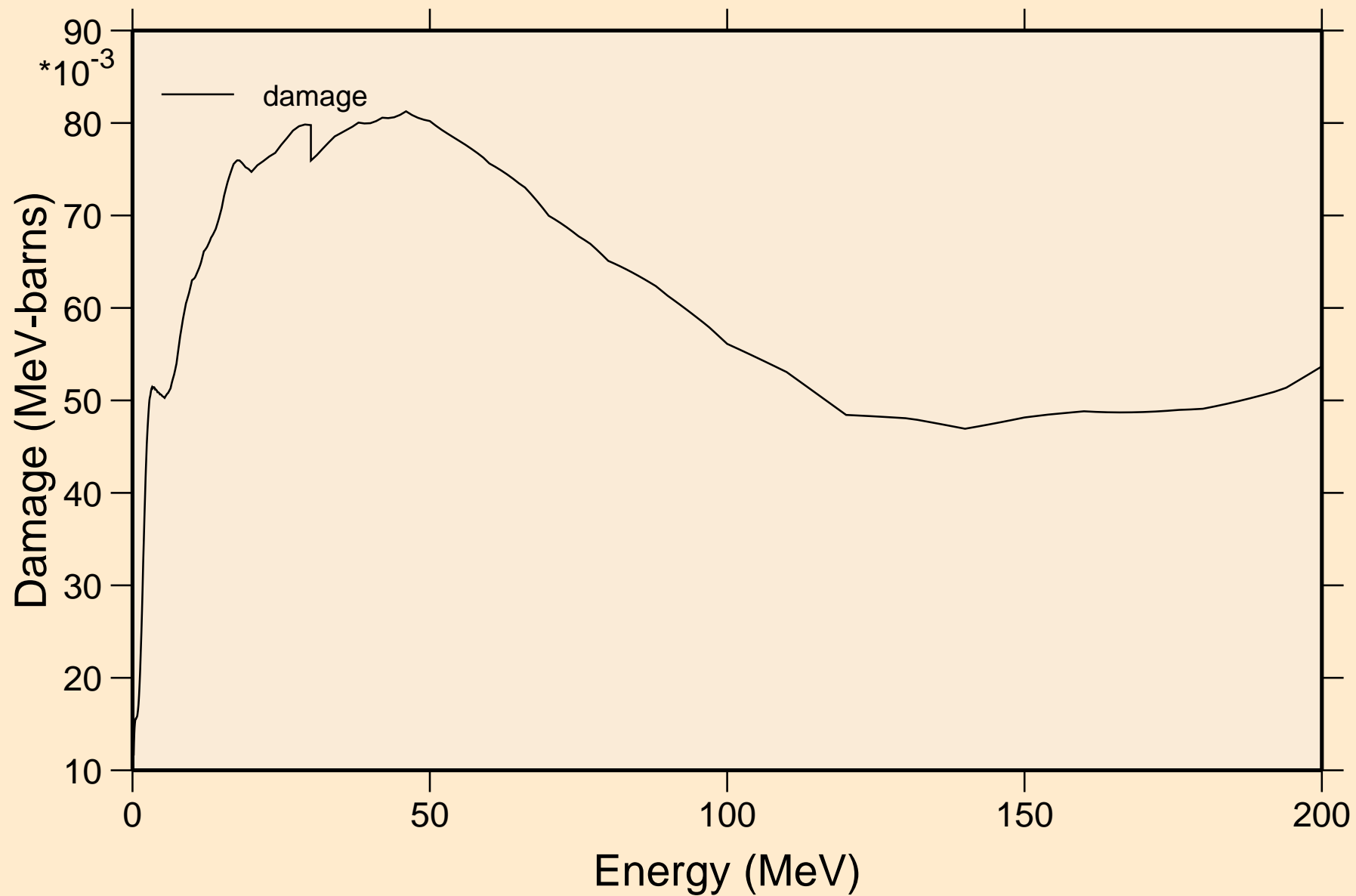



RA207 NEUTRON ACER TENDL-2023 LIBRARY; T=0.K  
Non-threshold reactions

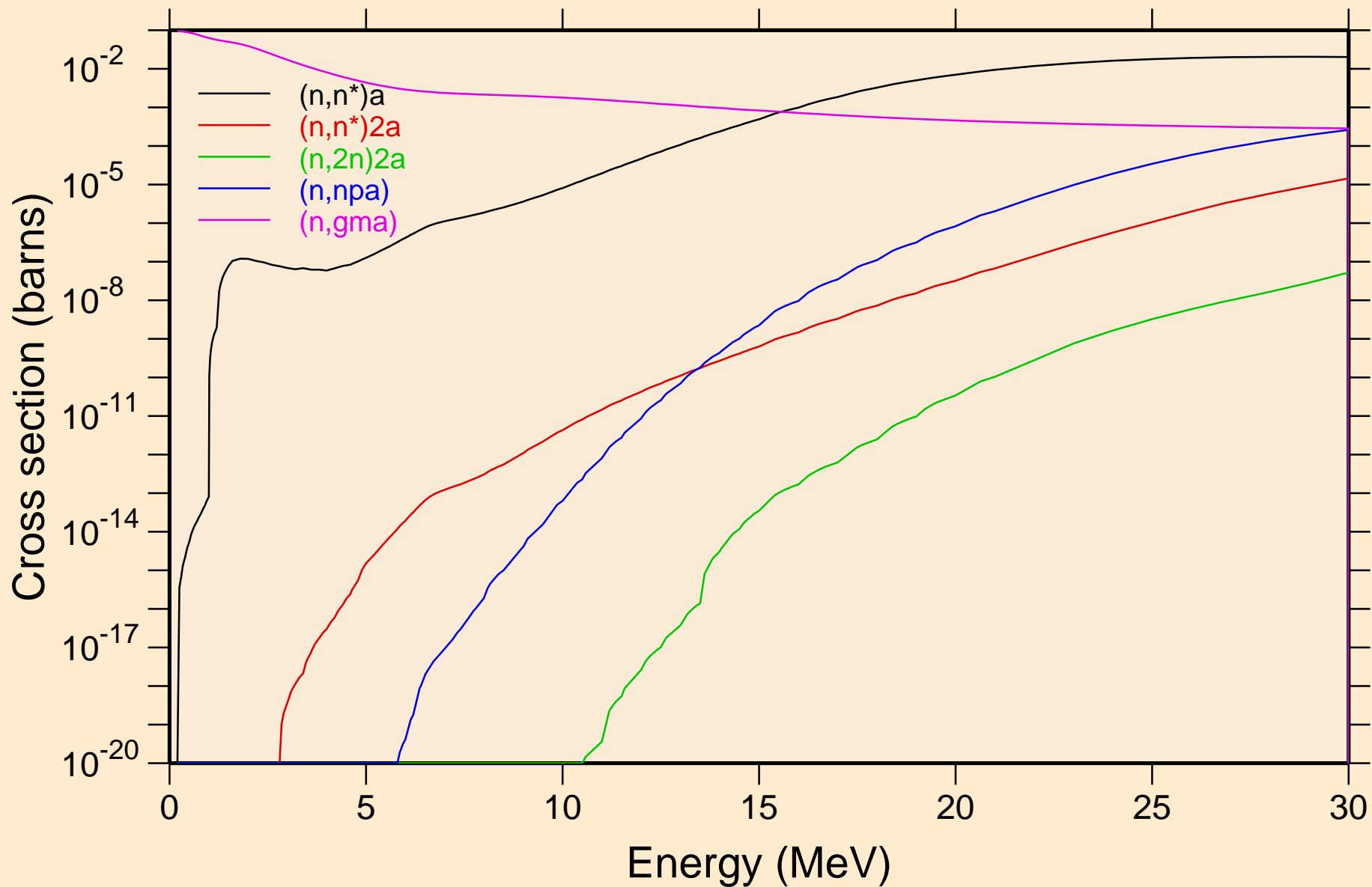

RA207 NEUTRON ACER TENDL-2023 LIBRARY; T=0.K  
Non-threshold reactions

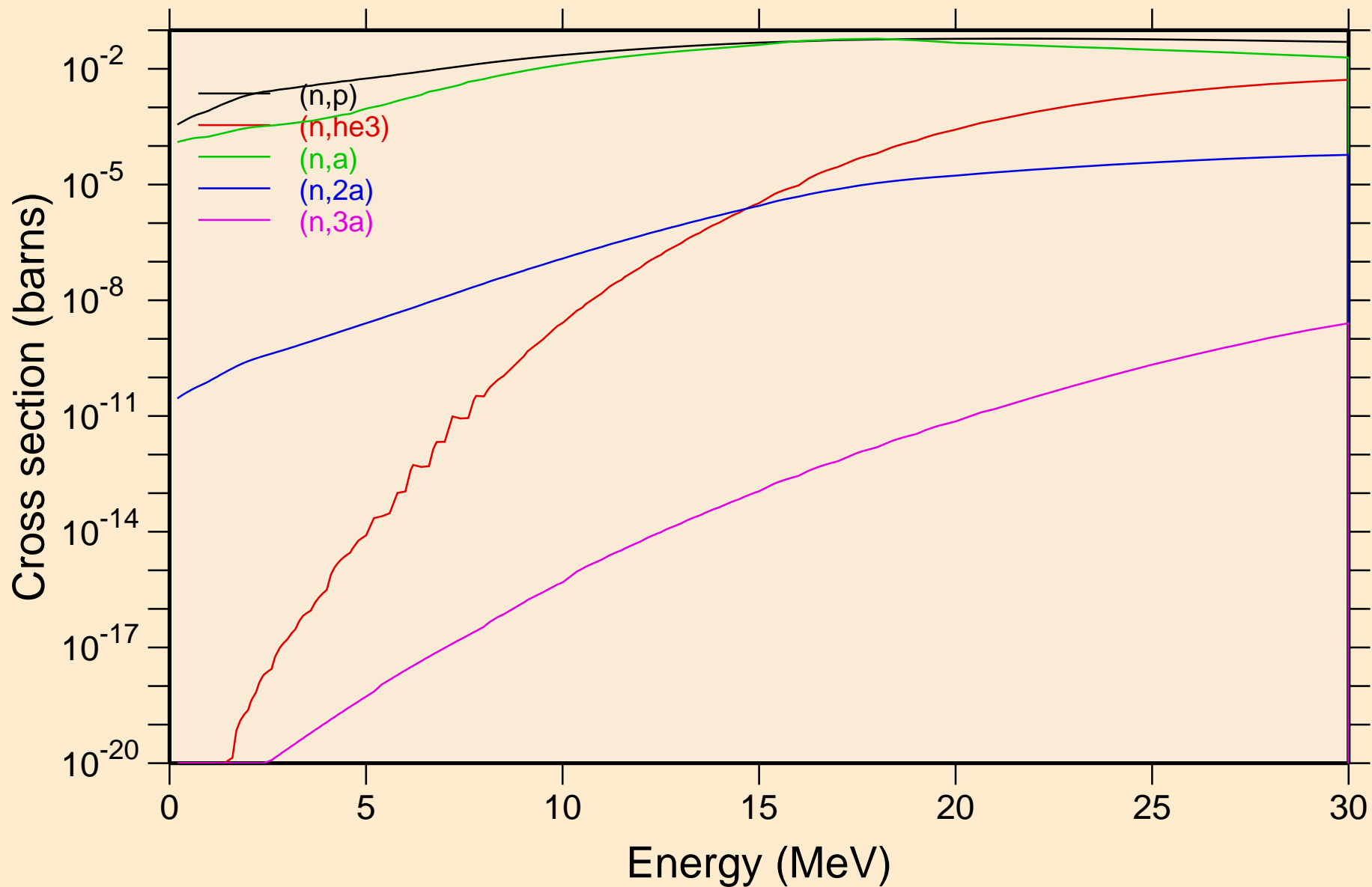

RA207 NEUTRON ACER TENDL-2023 LIBRARY; T=0.K  
Non-threshold reactions

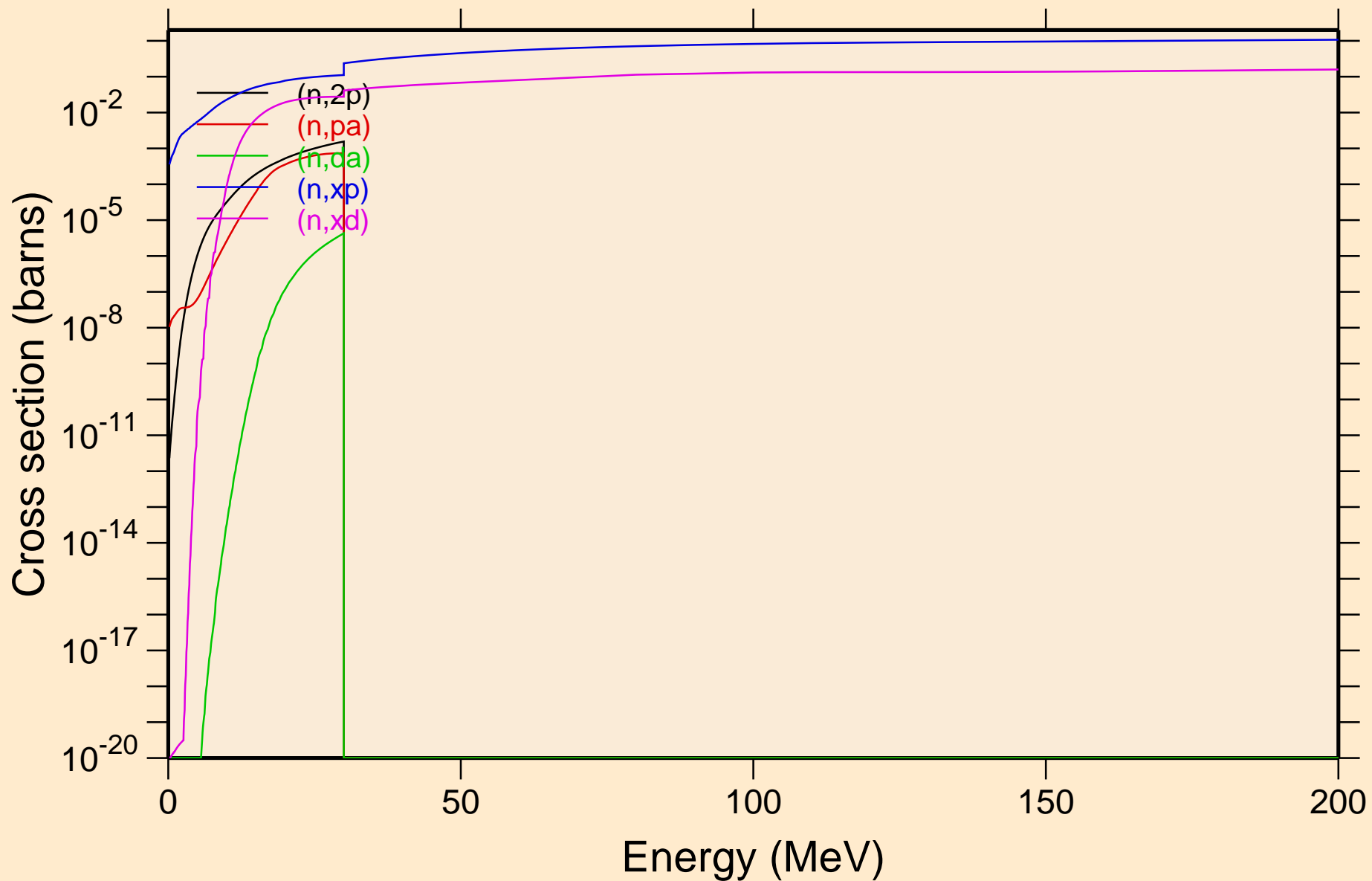

RA207 NEUTRON ACER TENDL-2023 LIBRARY; T=0.K  
Non-threshold reactions

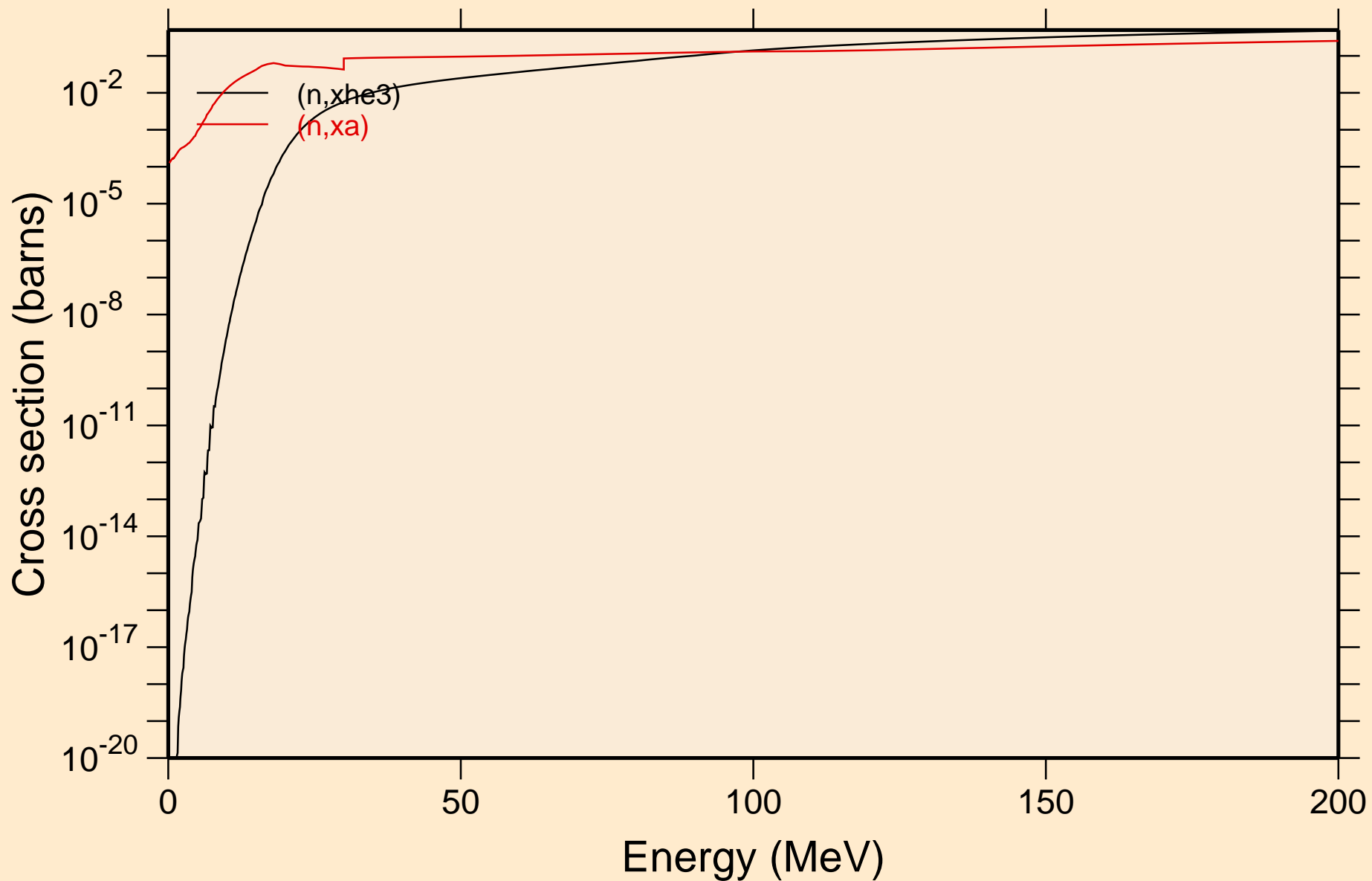

RA207 NEUTRON ACER TENDL-2023 LIBRARY; T=0.K  
Inelastic levels

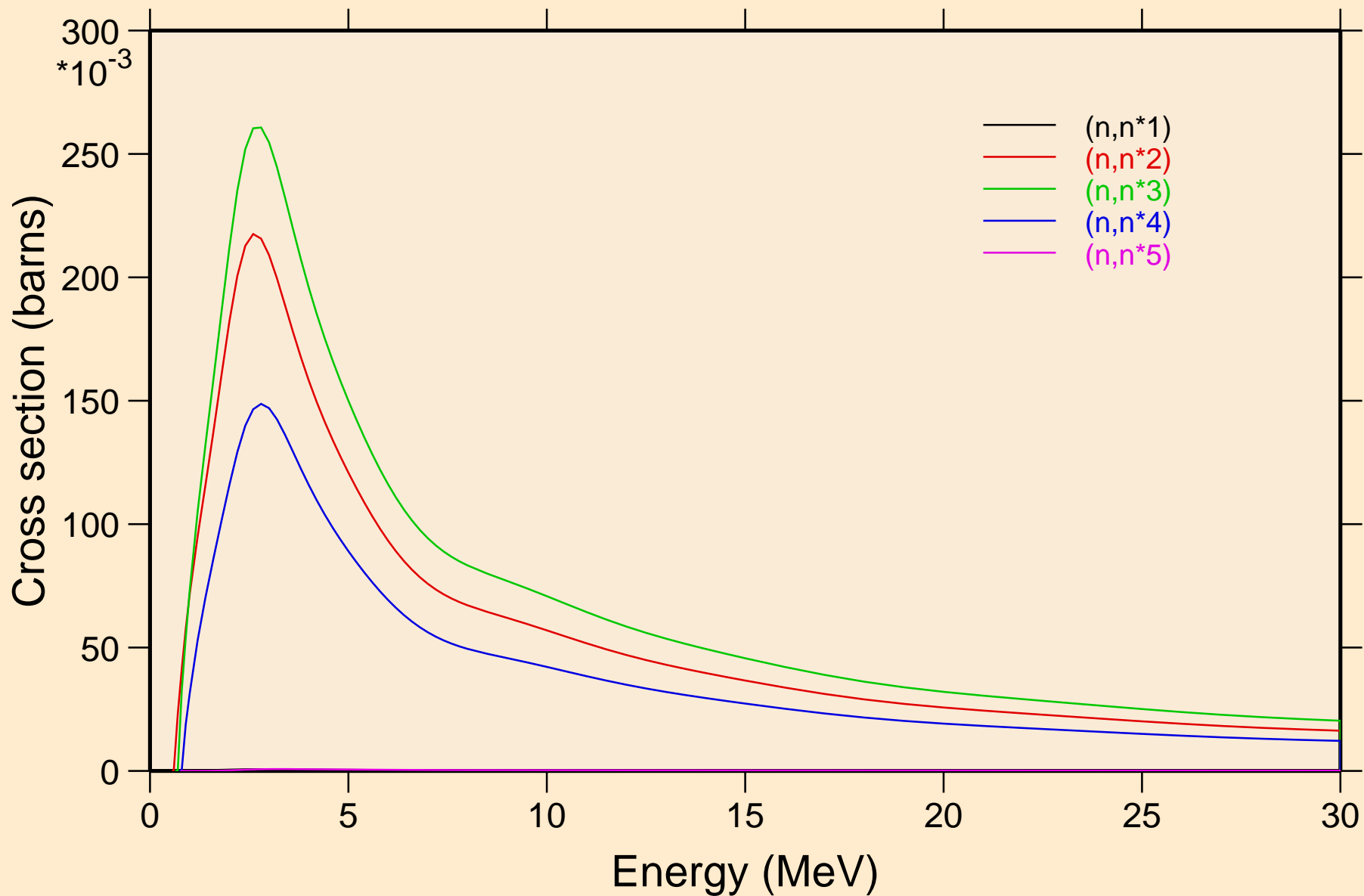

RA207 NEUTRON ACER TENDL-2023 LIBRARY; T=0.K  
Inelastic levels

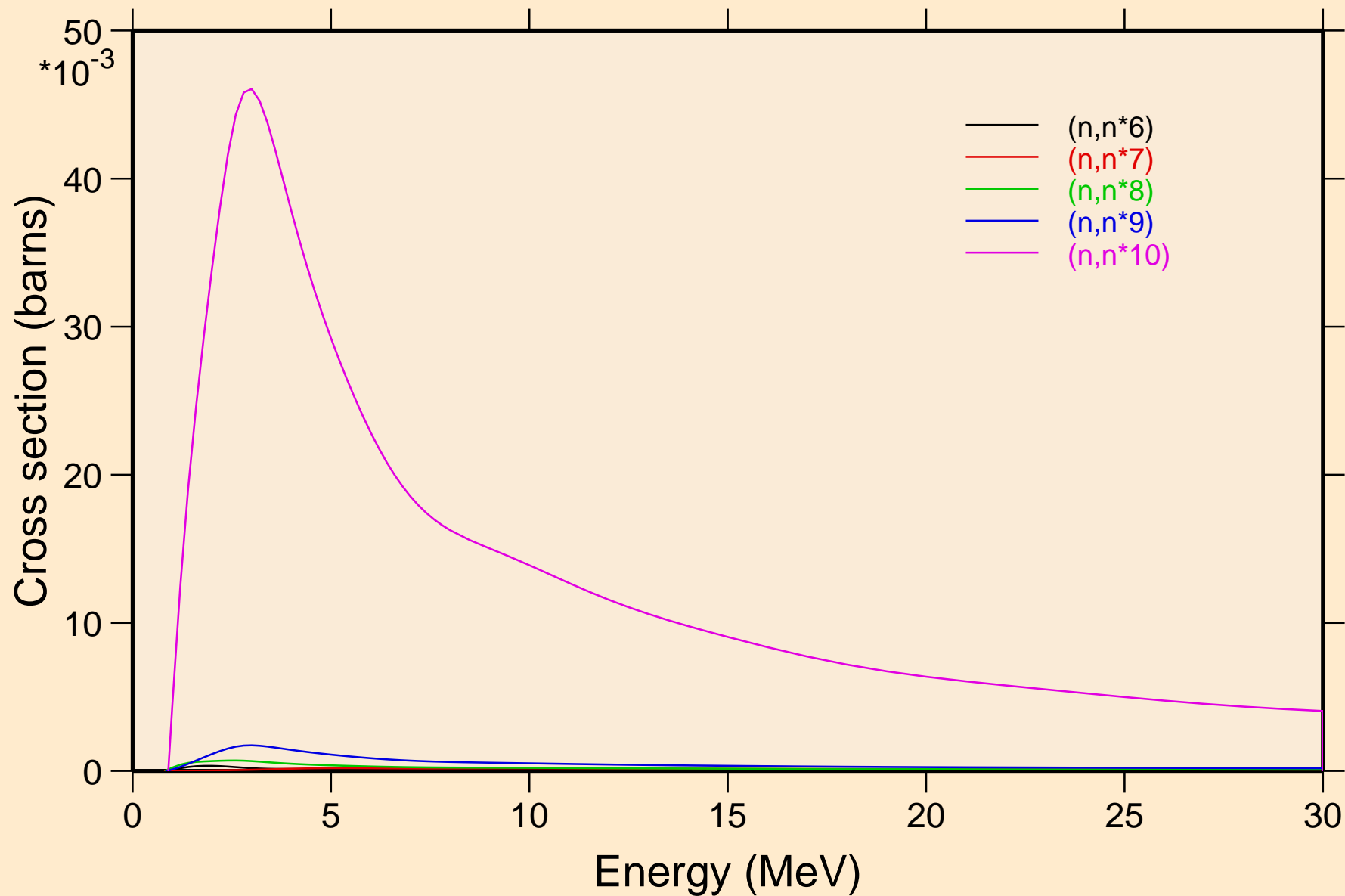

RA207 NEUTRON ACER TENDL-2023 LIBRARY; T=0.K  
Inelastic levels

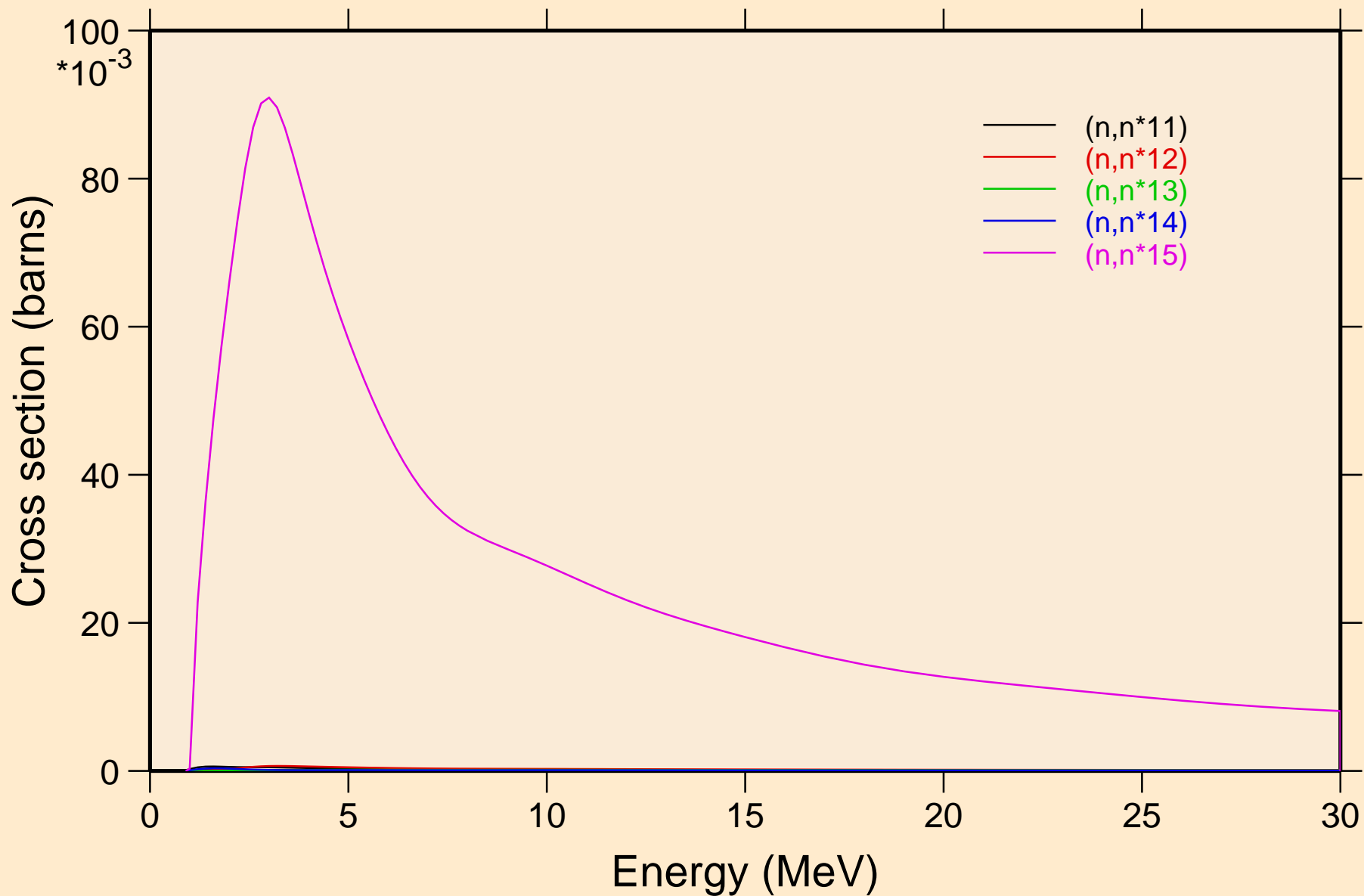

RA207 NEUTRON ACER TENDL-2023 LIBRARY; T=0.K  
Inelastic levels

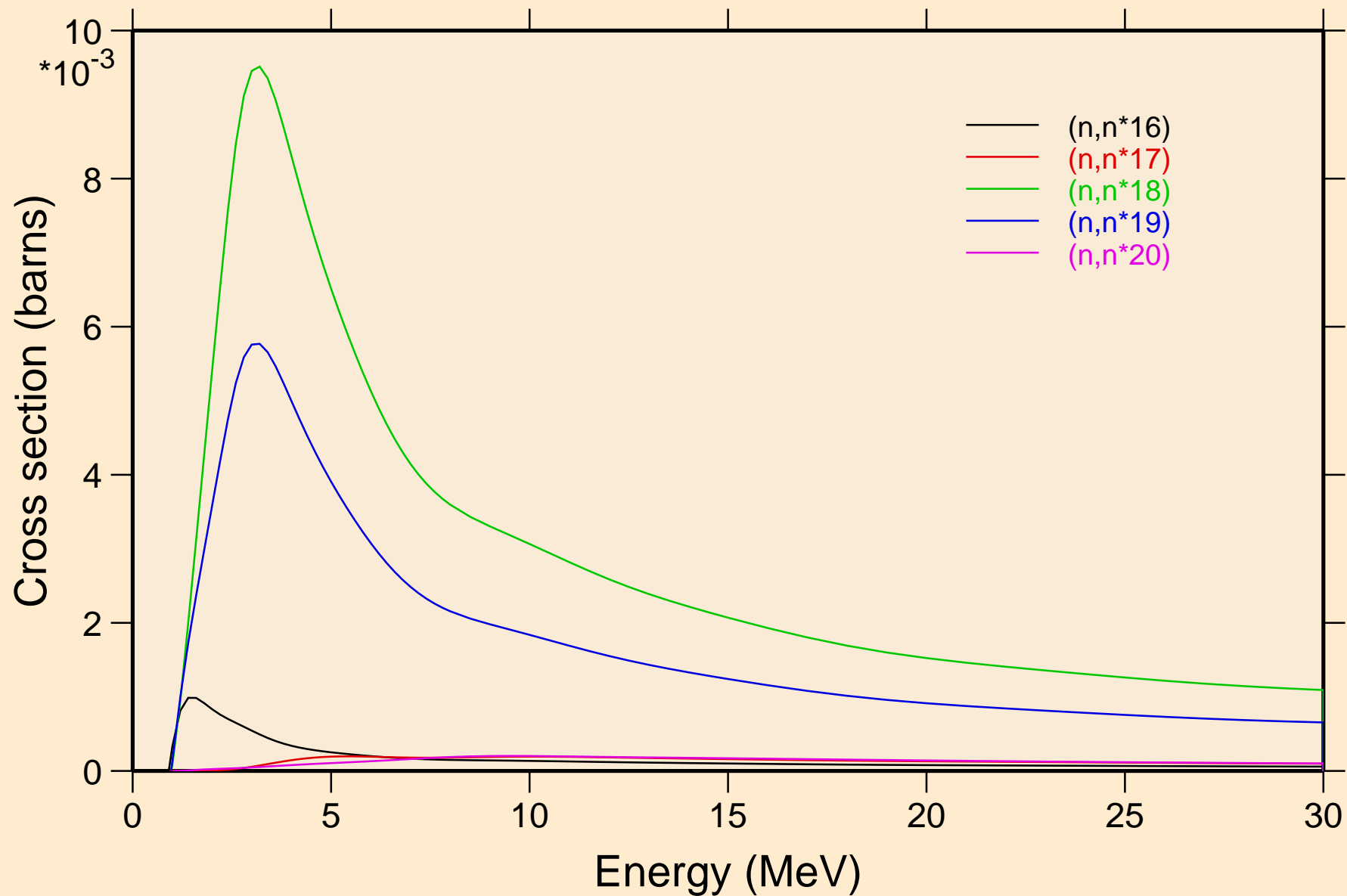



RA207 NEUTRON ACER TENDL-2023 LIBRARY; T=0.K  
Inelastic levels

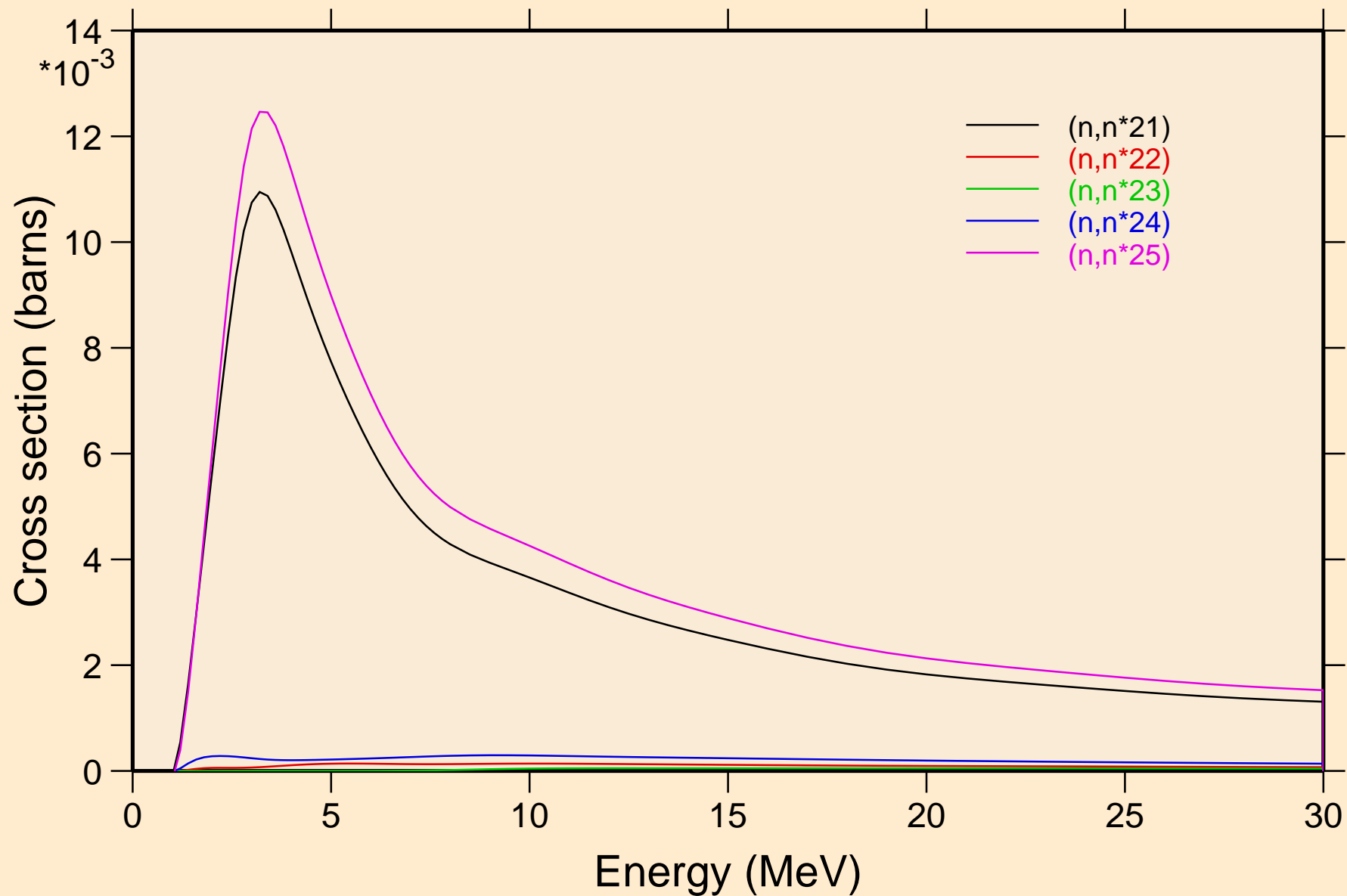

RA207 NEUTRON ACER TENDL-2023 LIBRARY; T=0.K  
Threshold reactions

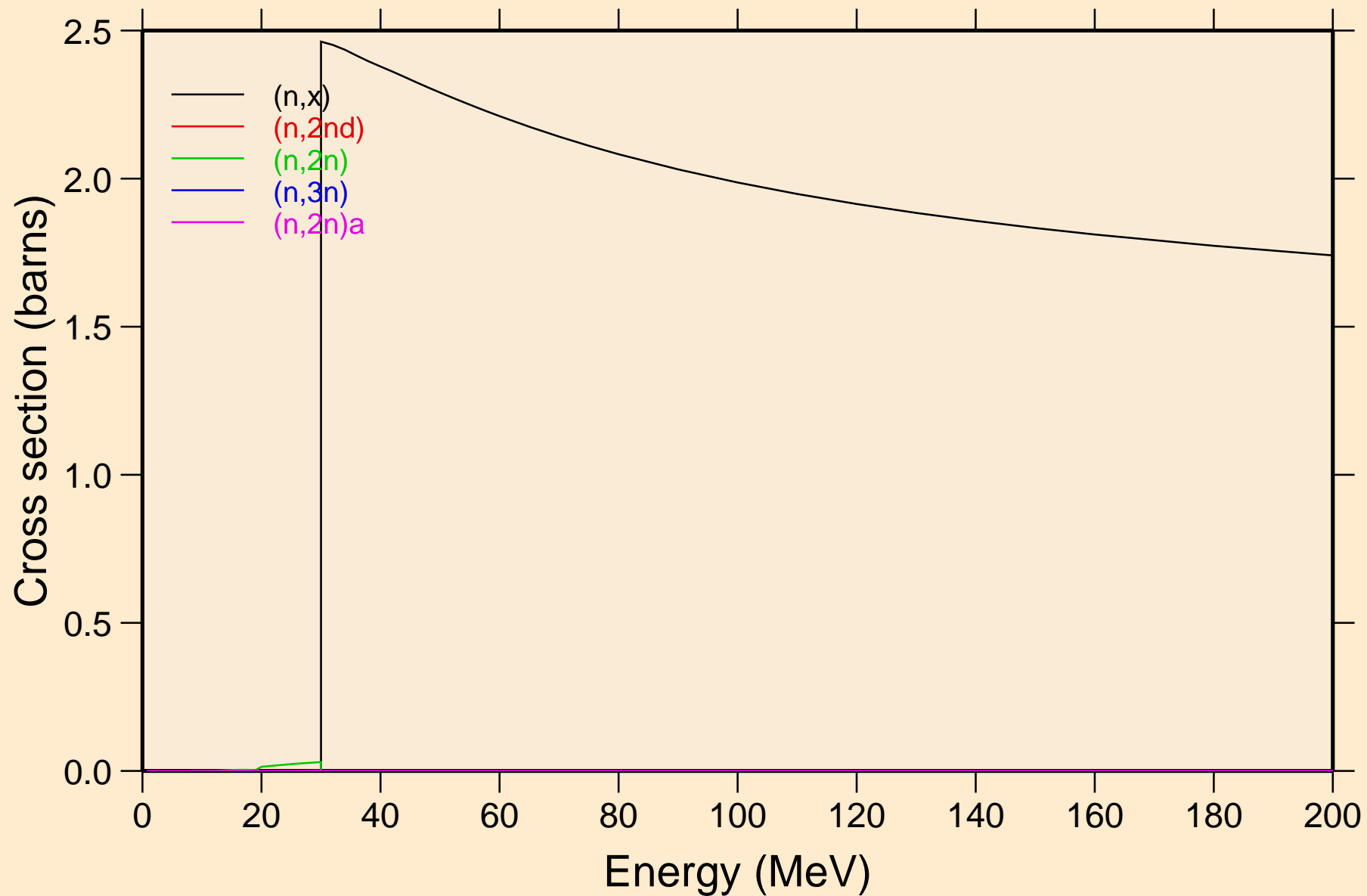

RA207 NEUTRON ACER TENDL-2023 LIBRARY; T=0.K  
Threshold reactions

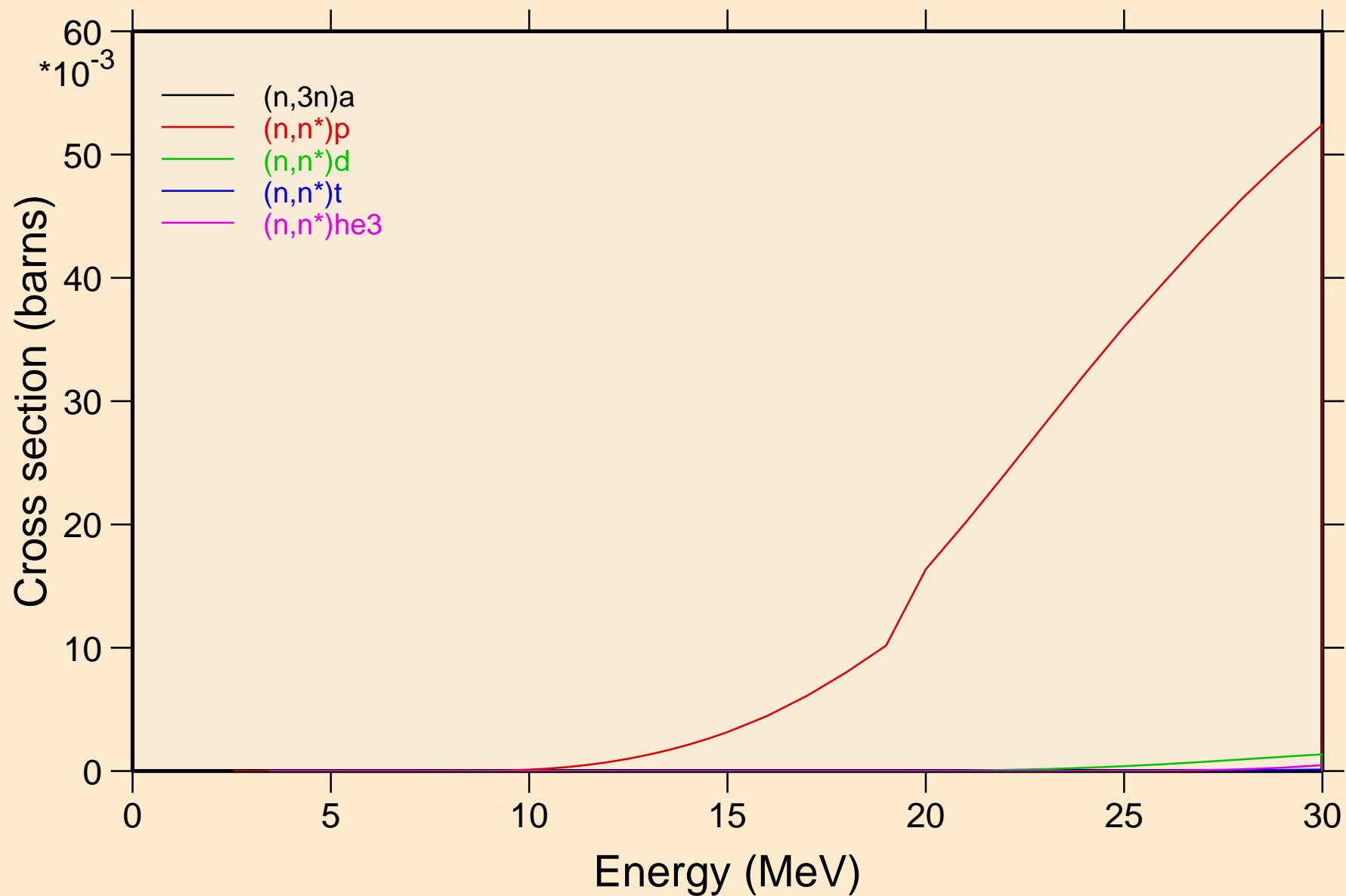

# RA207 NEUTRON ACER TENDL-2023 LIBRARY; T=0.K

## Threshold reactions

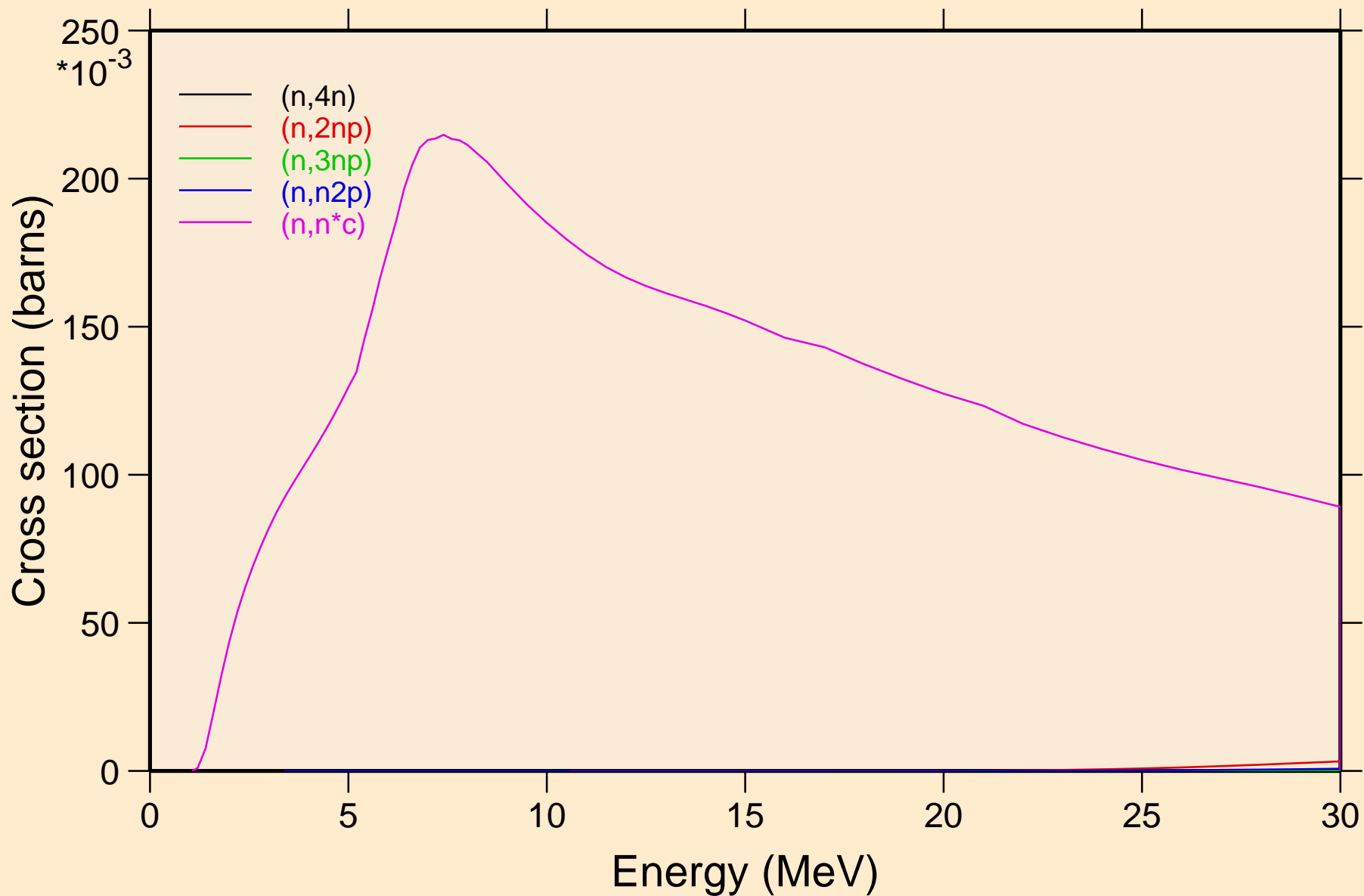

RA207 NEUTRON ACER TENDL-2023 LIBRARY; T=0.K  
Threshold reactions

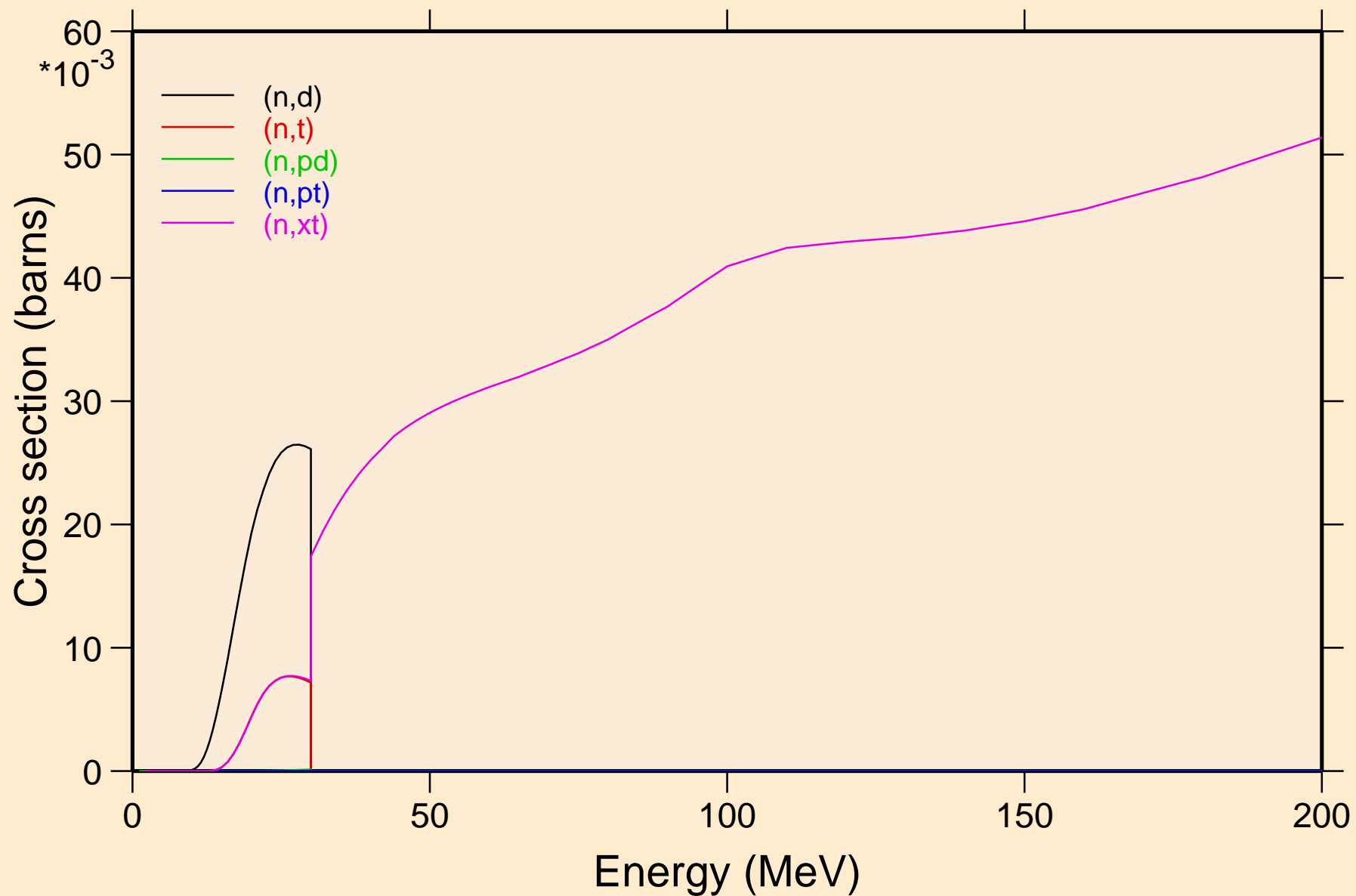

RA207 NEUTRON ACER TENDL-2023 LIBRARY; T=0.K  
angular distribution for elastic

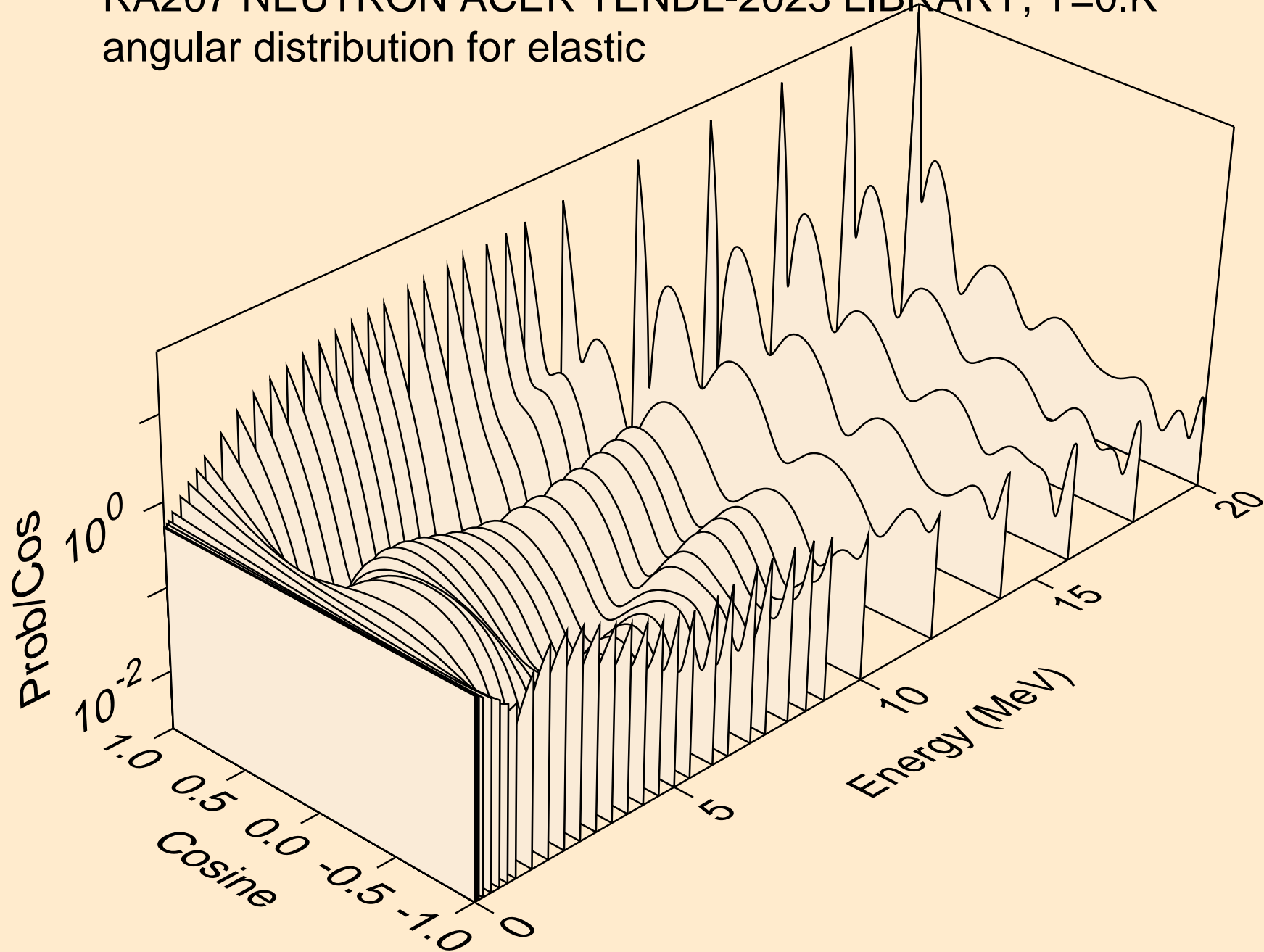

RA207 NEUTRON ACER TENDL-2023 LIBRARY; T=0.K  
angular distribution for elastic

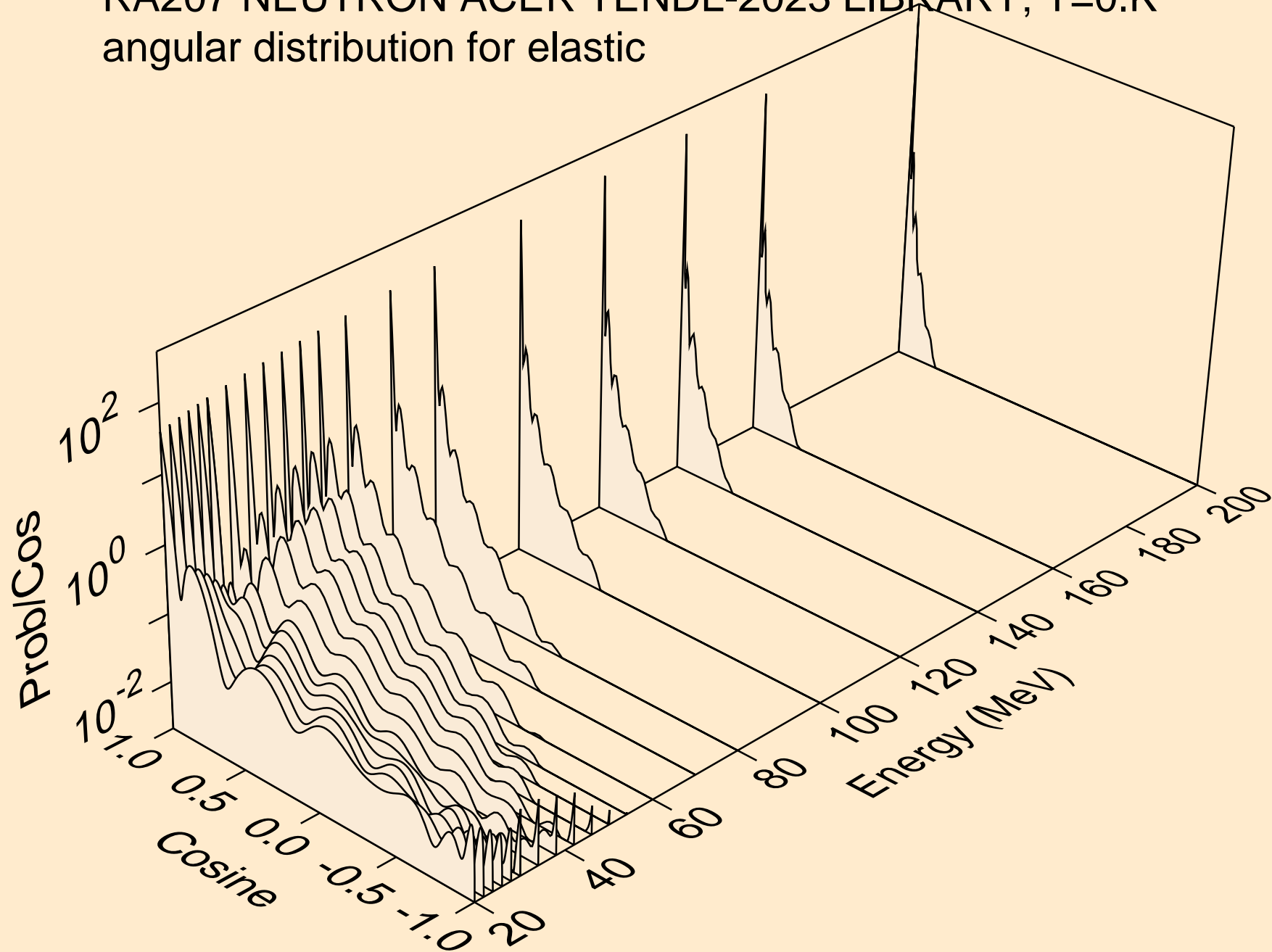

RA207 NEUTRON ACER TENDL-2023 LIBRARY; T=0.K  
angular distribution for (n,n\*1)

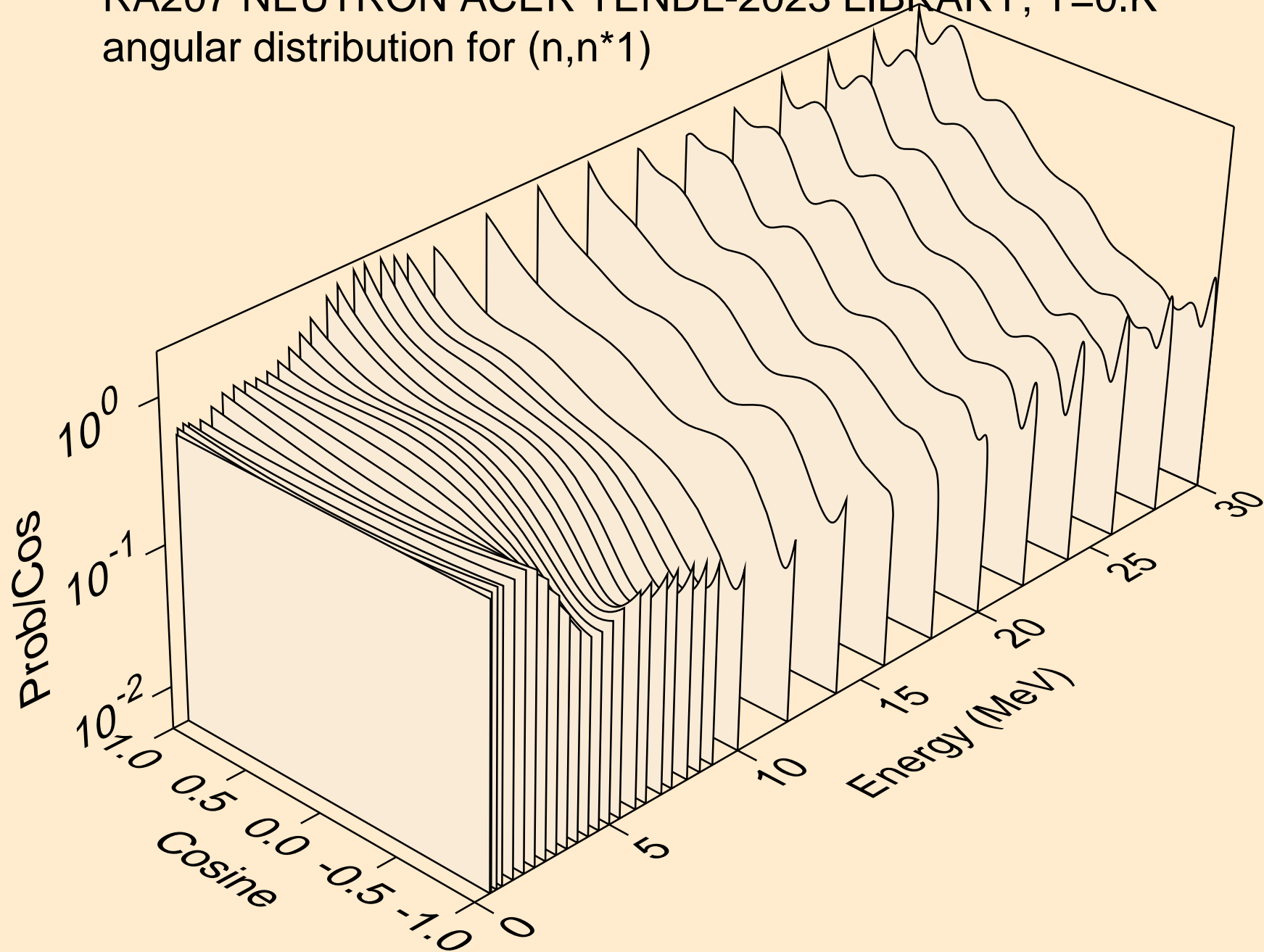



RA207 NEUTRON ACER TENDL-2023 LIBRARY; T=0.K  
angular distribution for (n,n\*2)

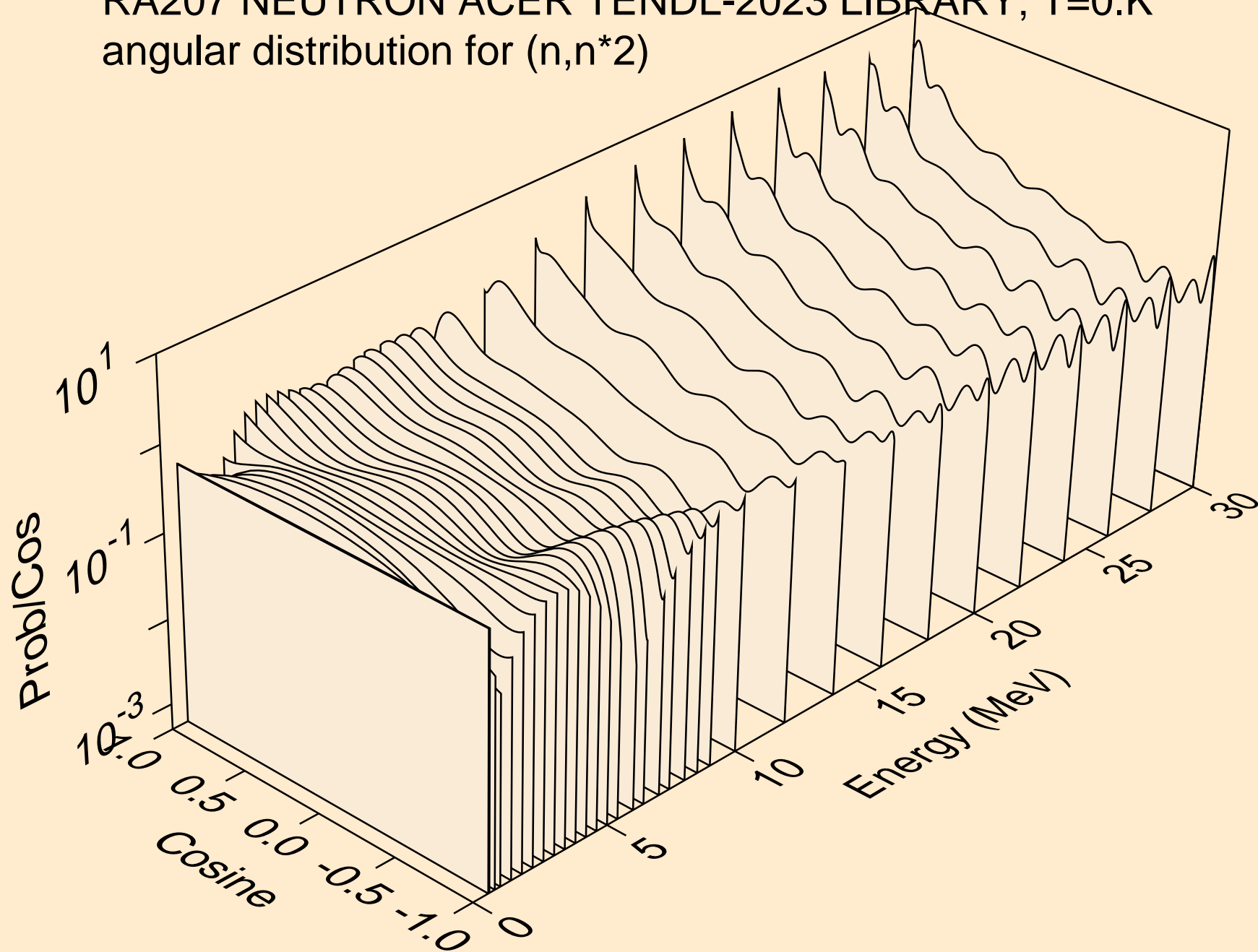

RA207 NEUTRON ACER TENDL-2023 LIBRARY; T=0.K  
angular distribution for (n,n\*3)

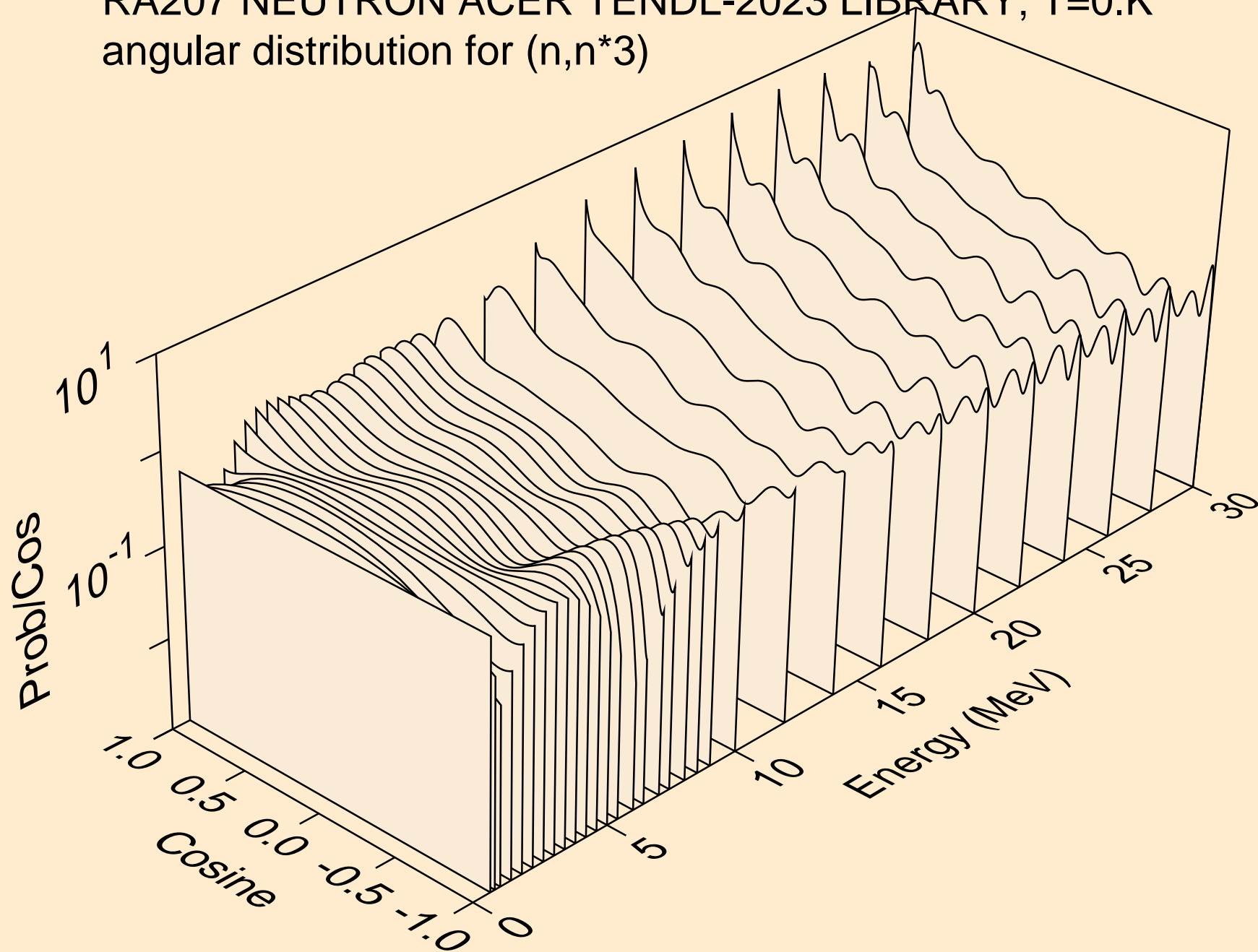

RA207 NEUTRON ACER TENDL-2023 LIBRARY; T=0.K  
angular distribution for (n,n\*4)

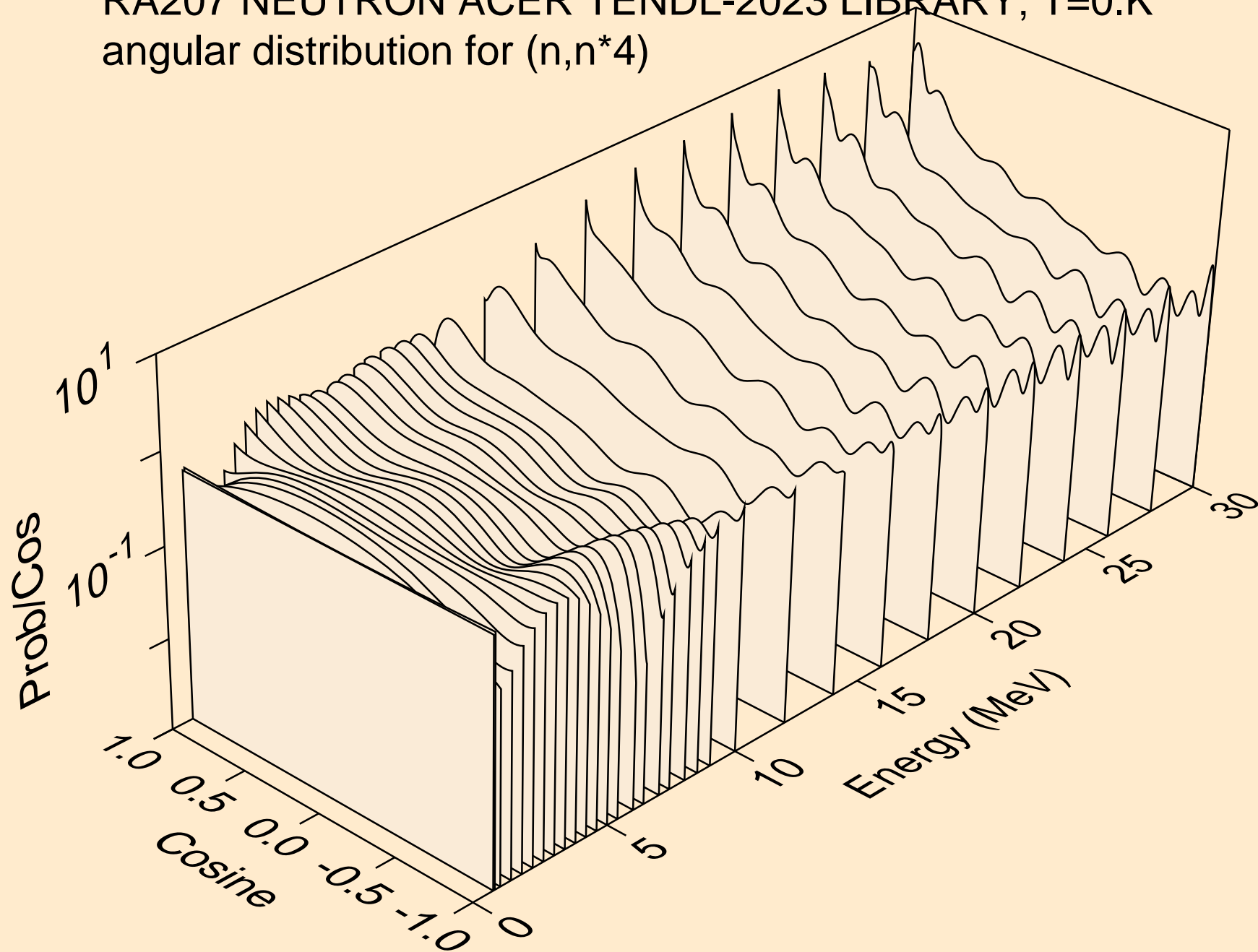

RA207 NEUTRON ACER TENDL-2023 LIBRARY; T=0.K  
angular distribution for (n,n\*5)

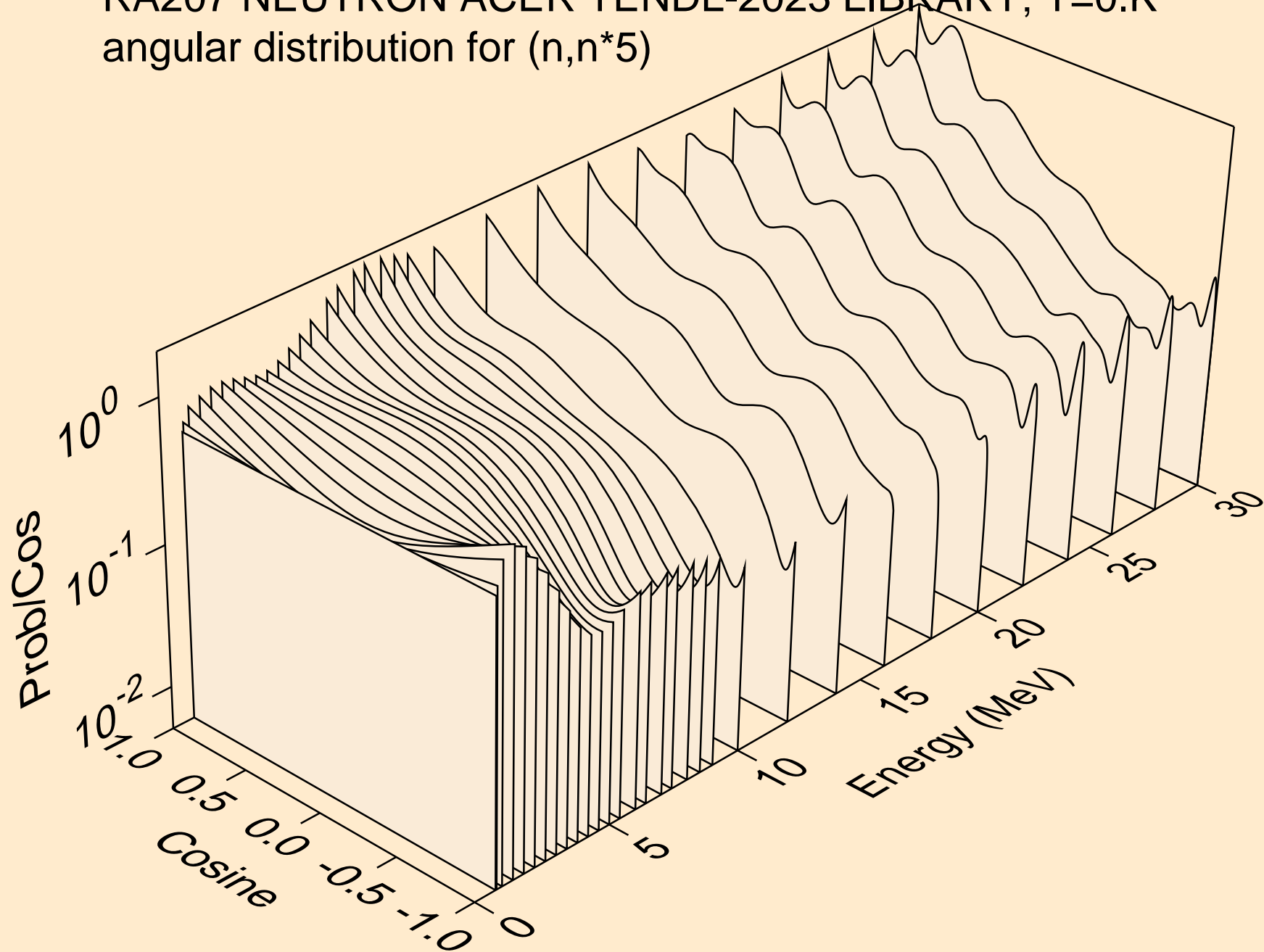

RA207 NEUTRON ACER TENDL-2023 LIBRARY; T=0.K  
angular distribution for (n,n\*6)

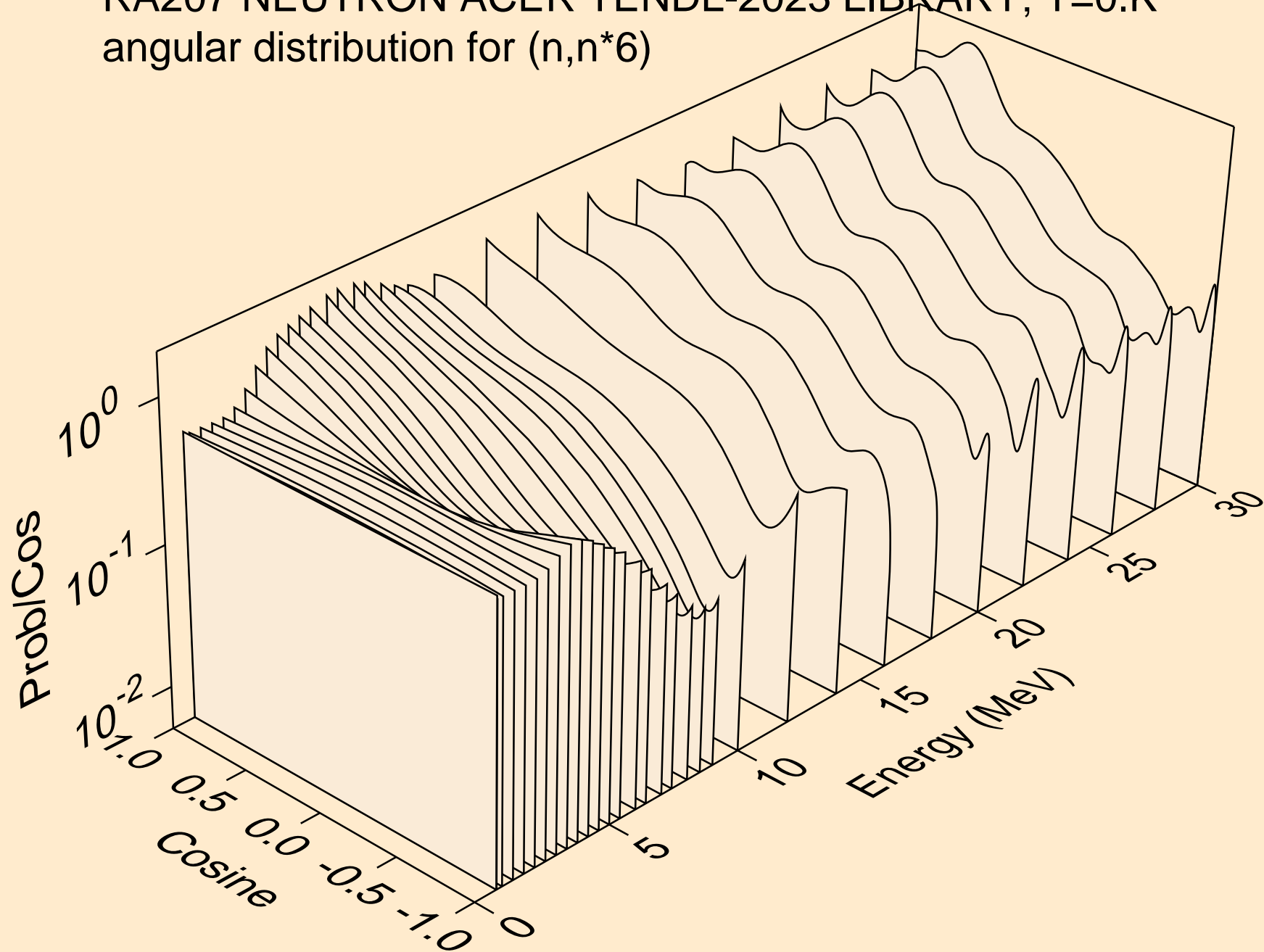

RA207 NEUTRON ACER TENDL-2023 LIBRARY; T=0.K  
angular distribution for (n,n\*7)

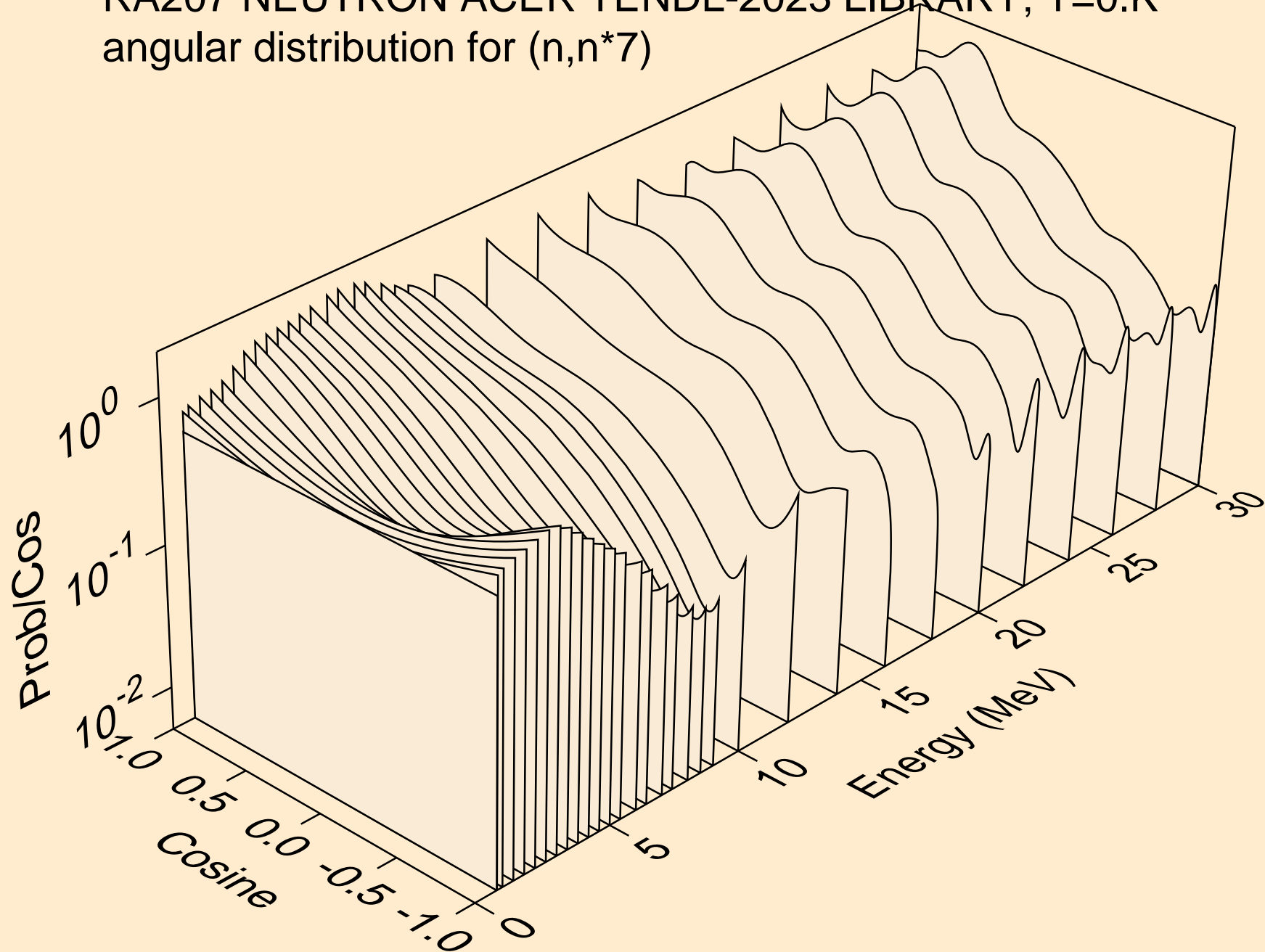

RA207 NEUTRON ACER TENDL-2023 LIBRARY; T=0.K  
angular distribution for (n,n\*8)

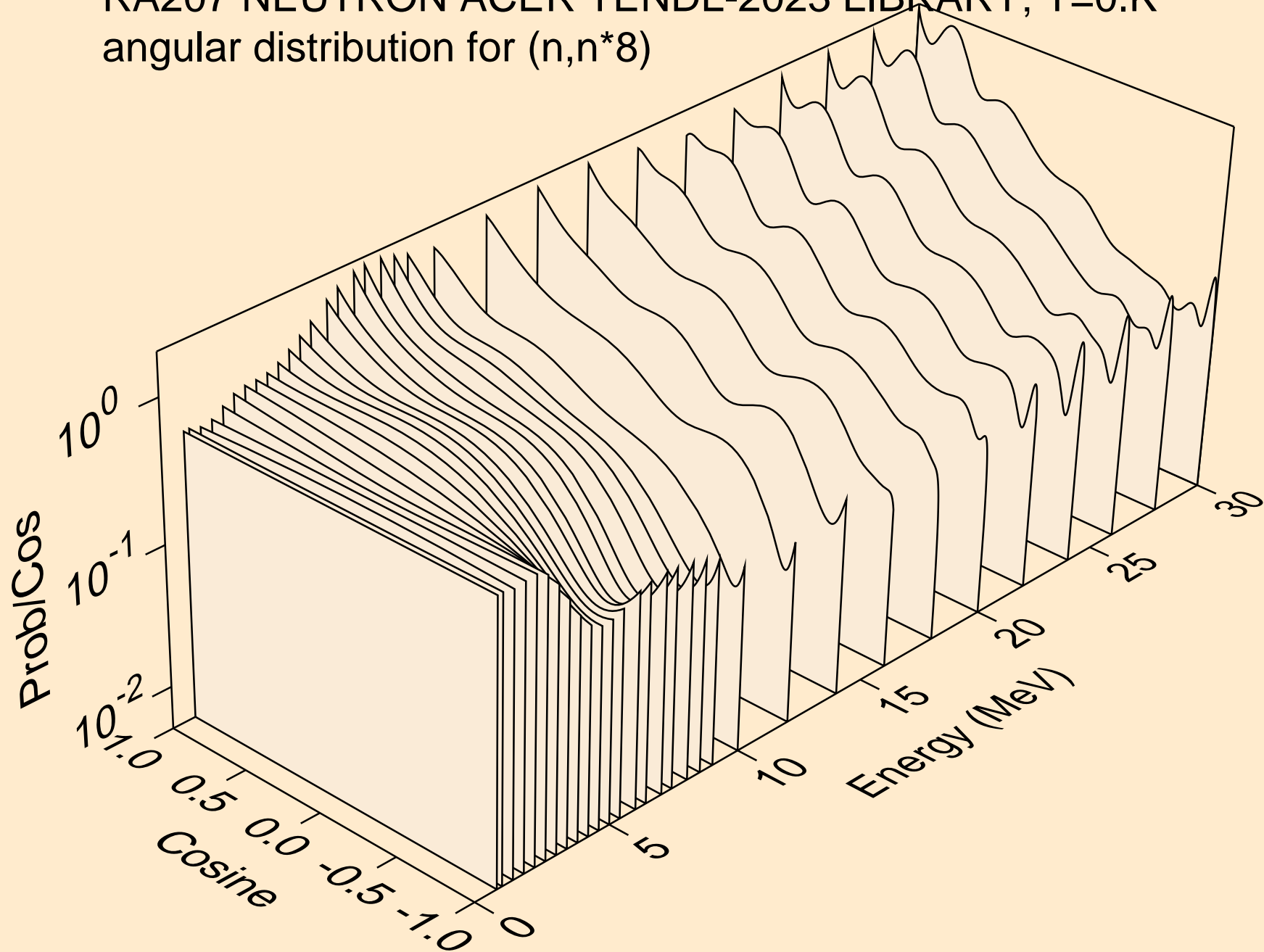

RA207 NEUTRON ACER TENDL-2023 LIBRARY; T=0.K  
angular distribution for (n,n\*9)

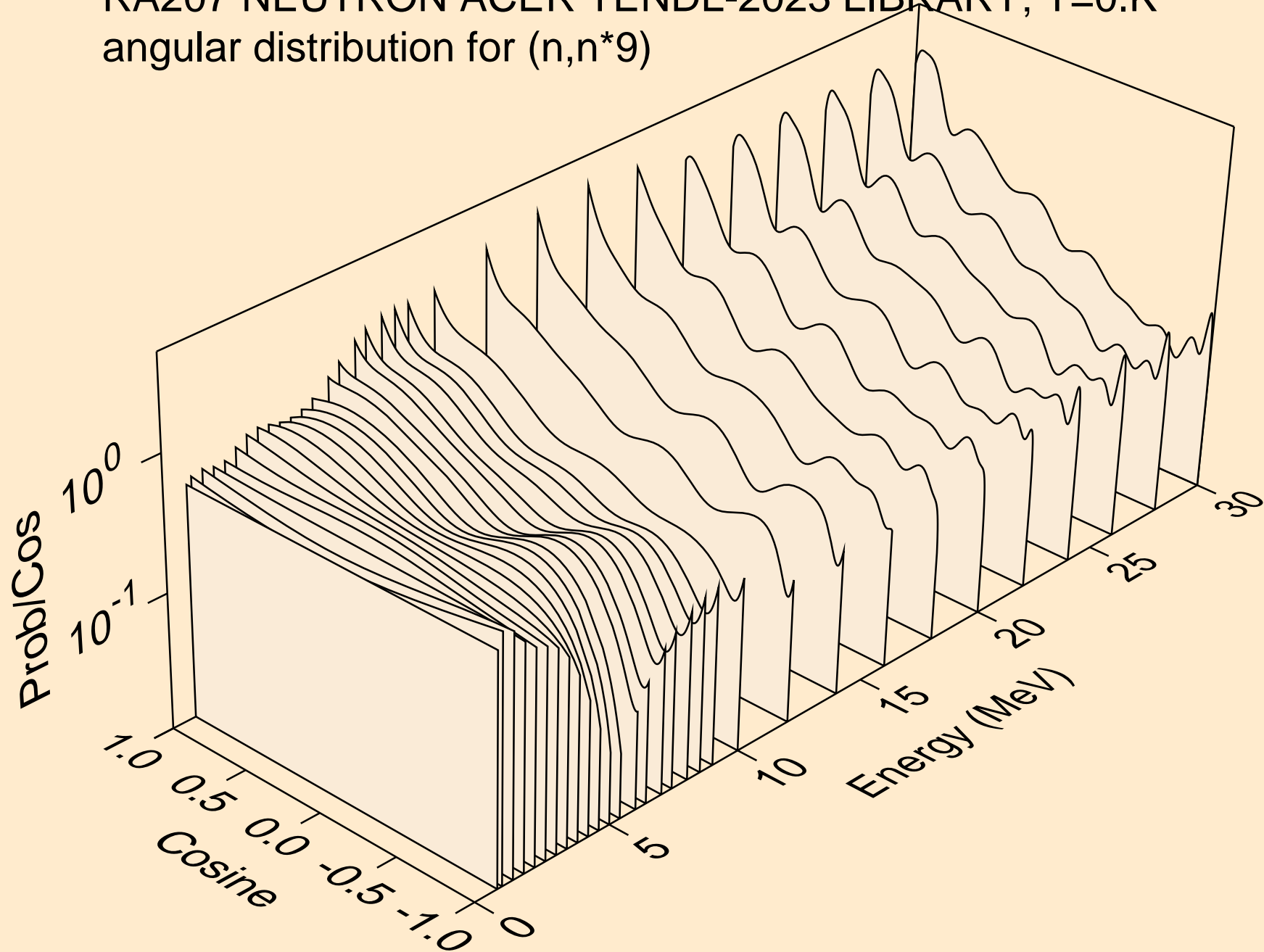



RA207 NEUTRON ACER TENDL-2023 LIBRARY; T=0.K  
angular distribution for (n,n\*10)

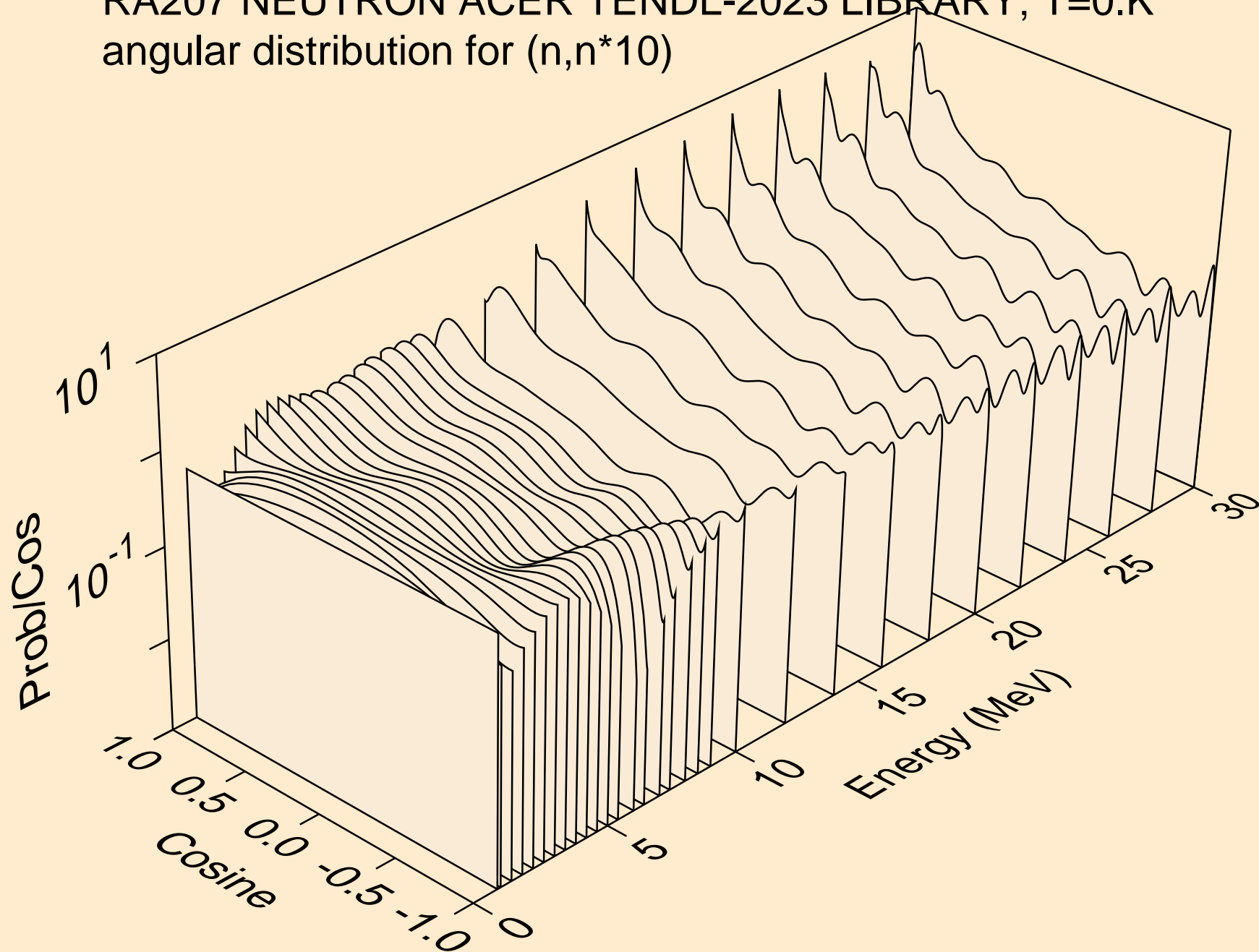

RA207 NEUTRON ACER TENDL-2023 LIBRARY; T=0.K  
angular distribution for (n,n\*11)

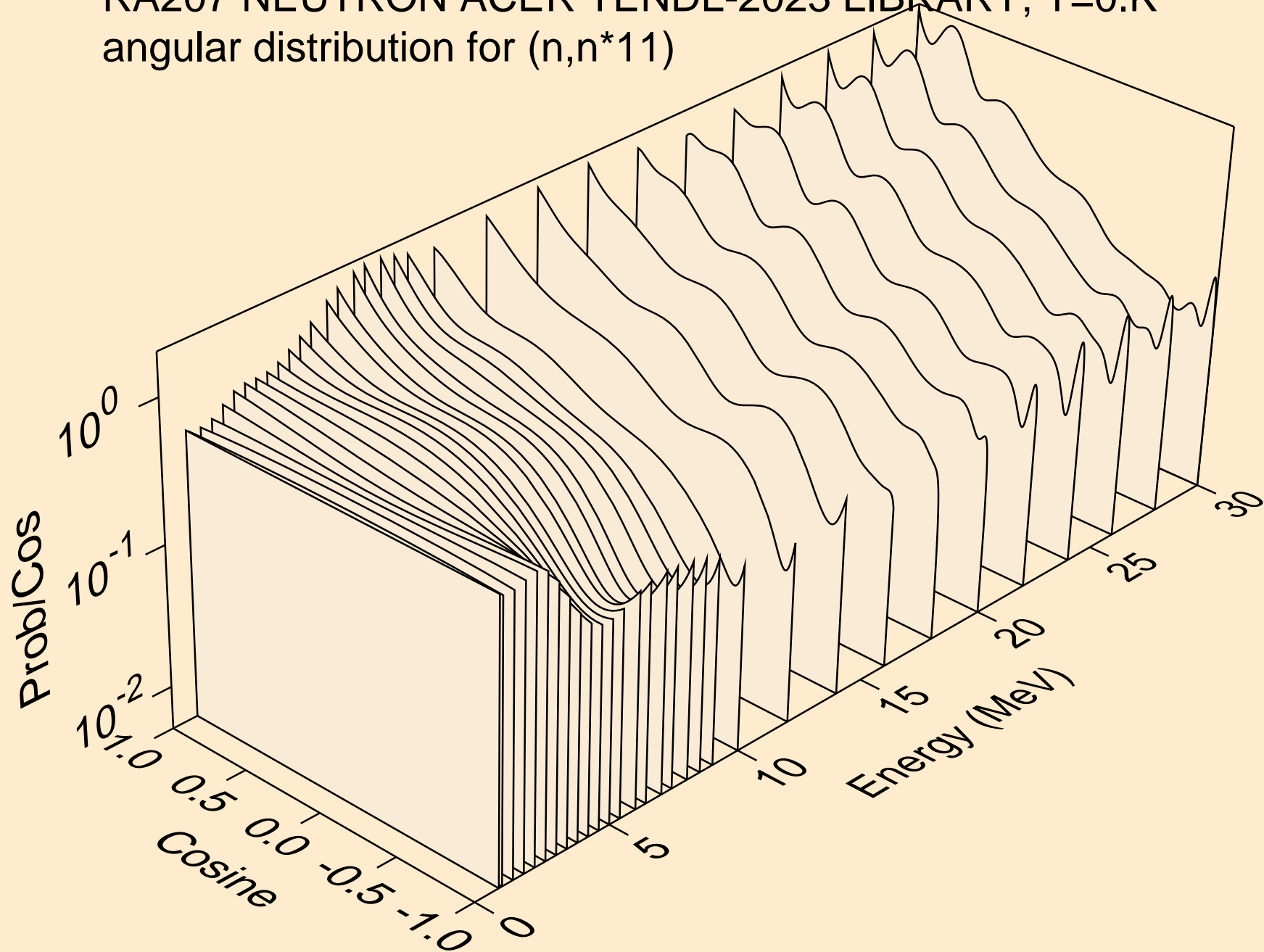

RA207 NEUTRON ACER TENDL-2023 LIBRARY; T=0.K  
angular distribution for (n,n\*12)

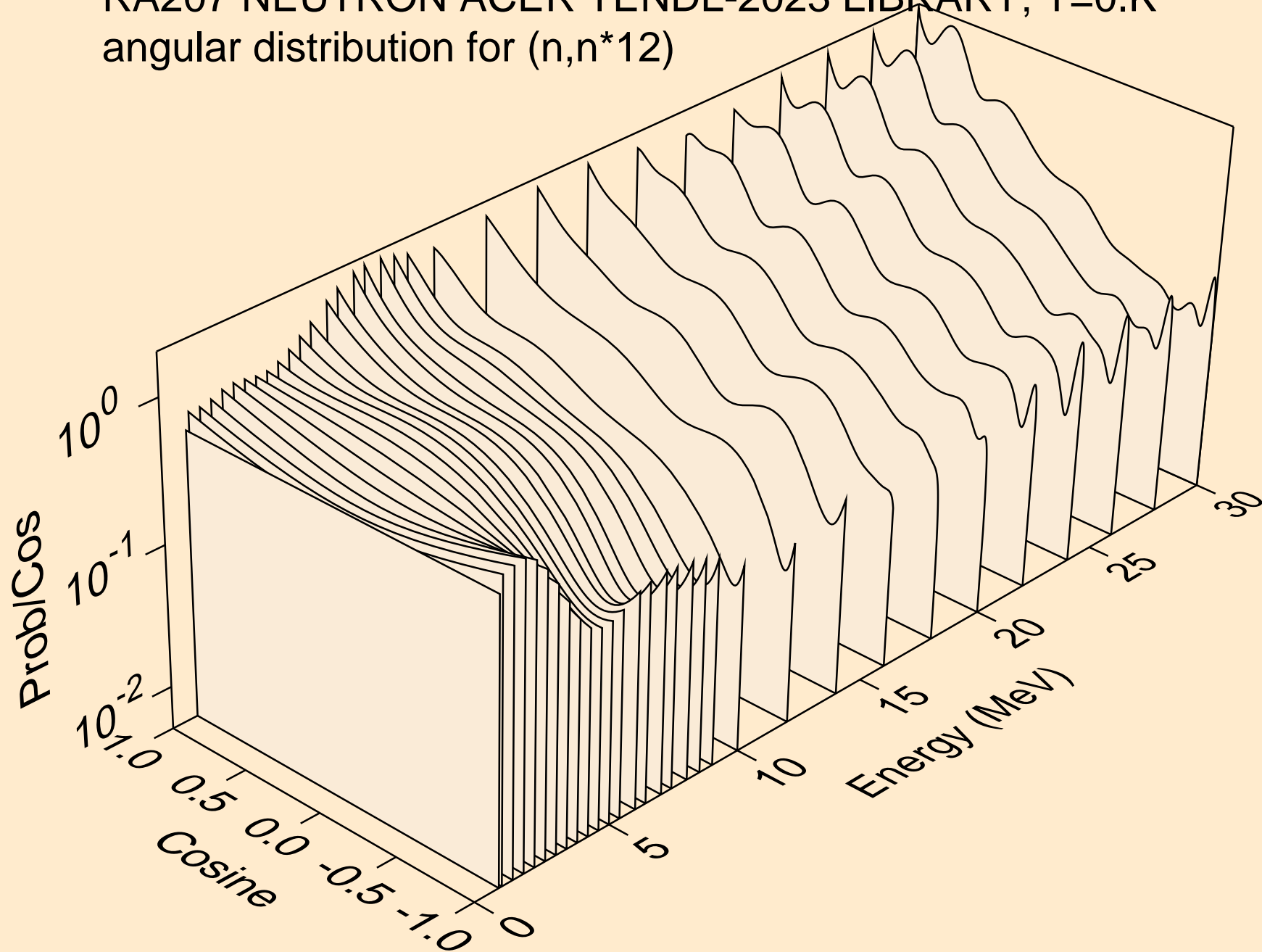

RA207 NEUTRON ACER TENDL-2023 LIBRARY; T=0.K  
angular distribution for (n,n\*13)

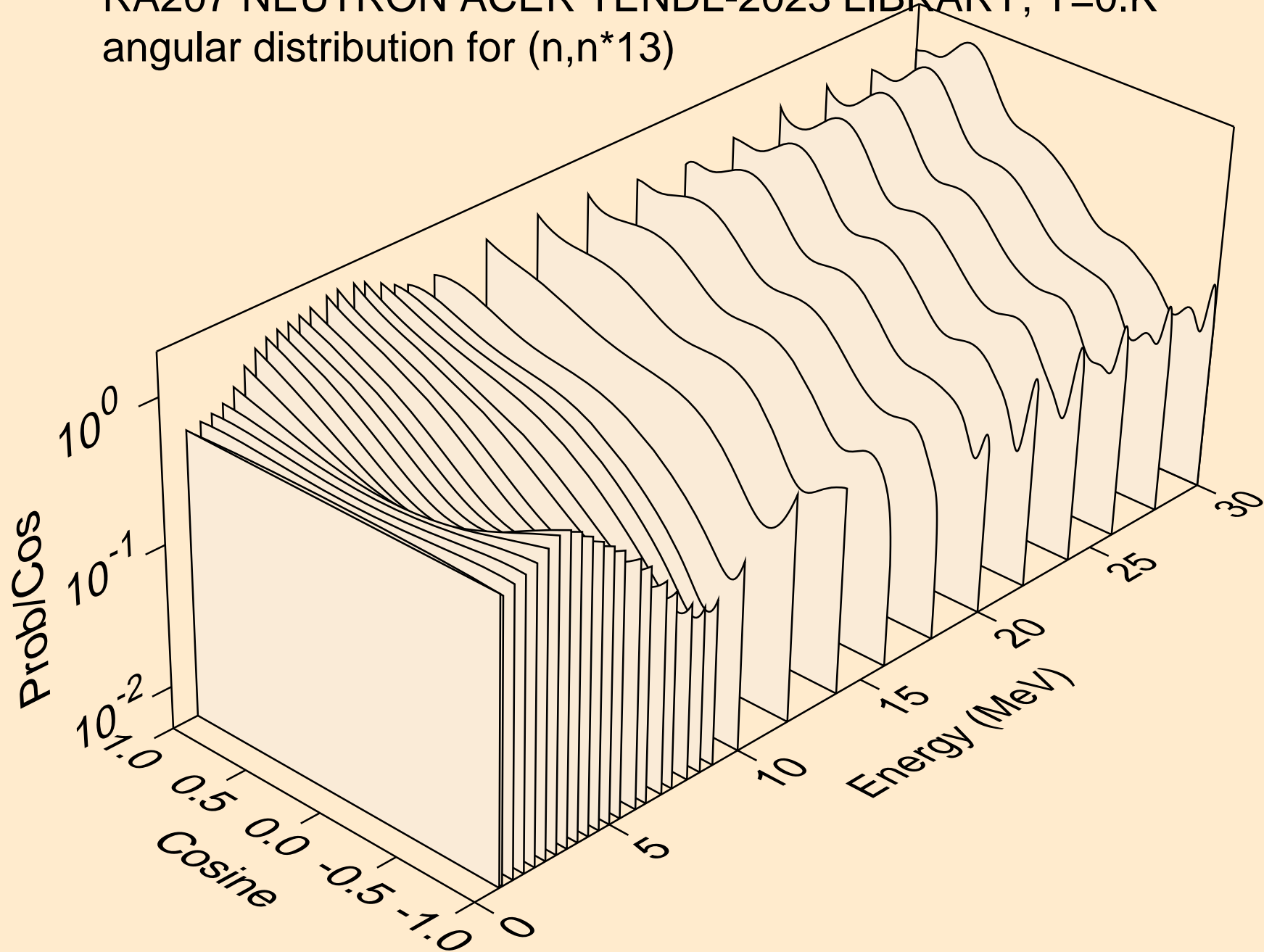

RA207 NEUTRON ACER TENDL-2023 LIBRARY; T=0.K  
angular distribution for (n,n\*14)

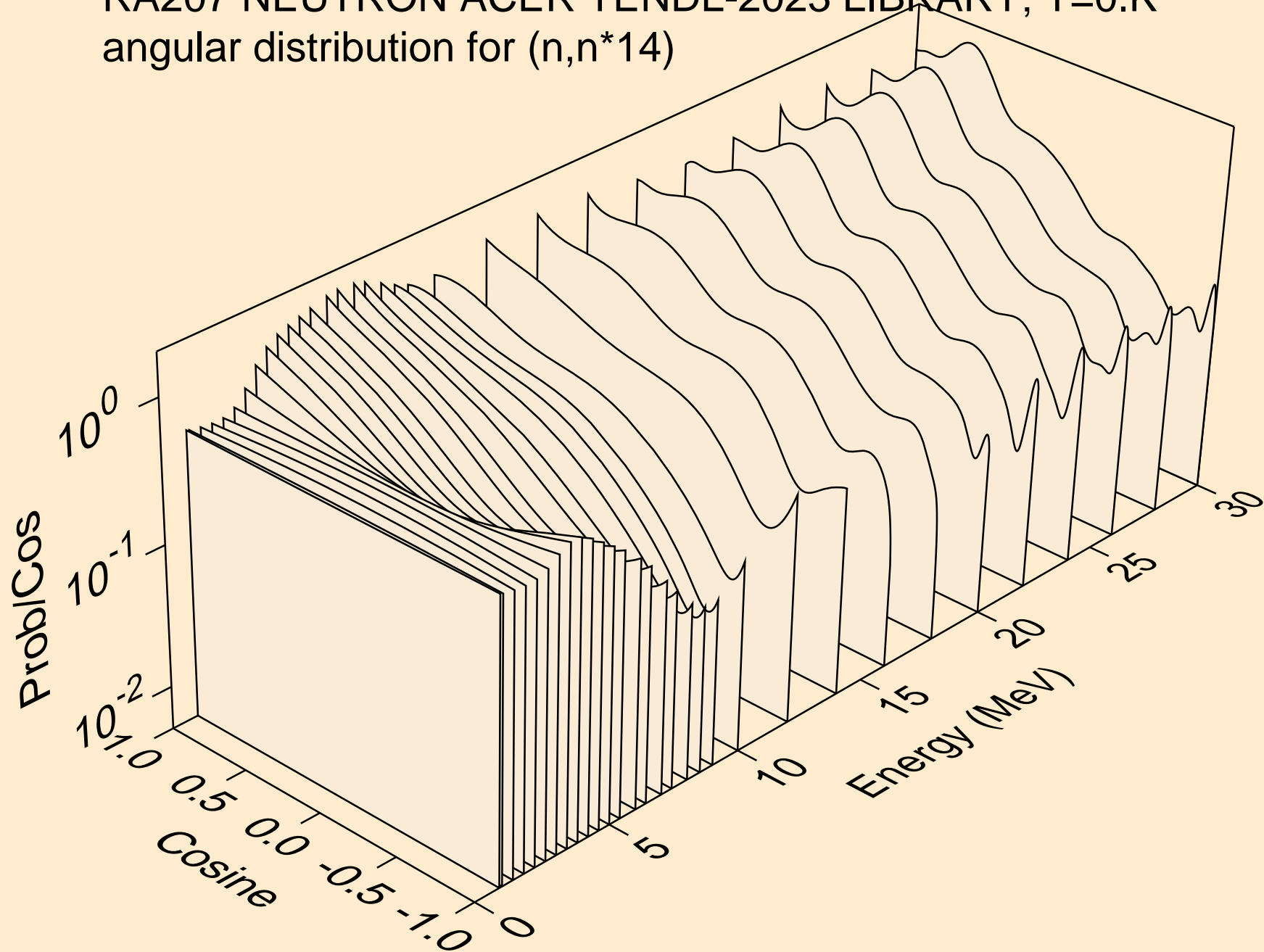

RA207 NEUTRON ACER TENDL-2023 LIBRARY; T=0.K  
angular distribution for (n,n\*15)

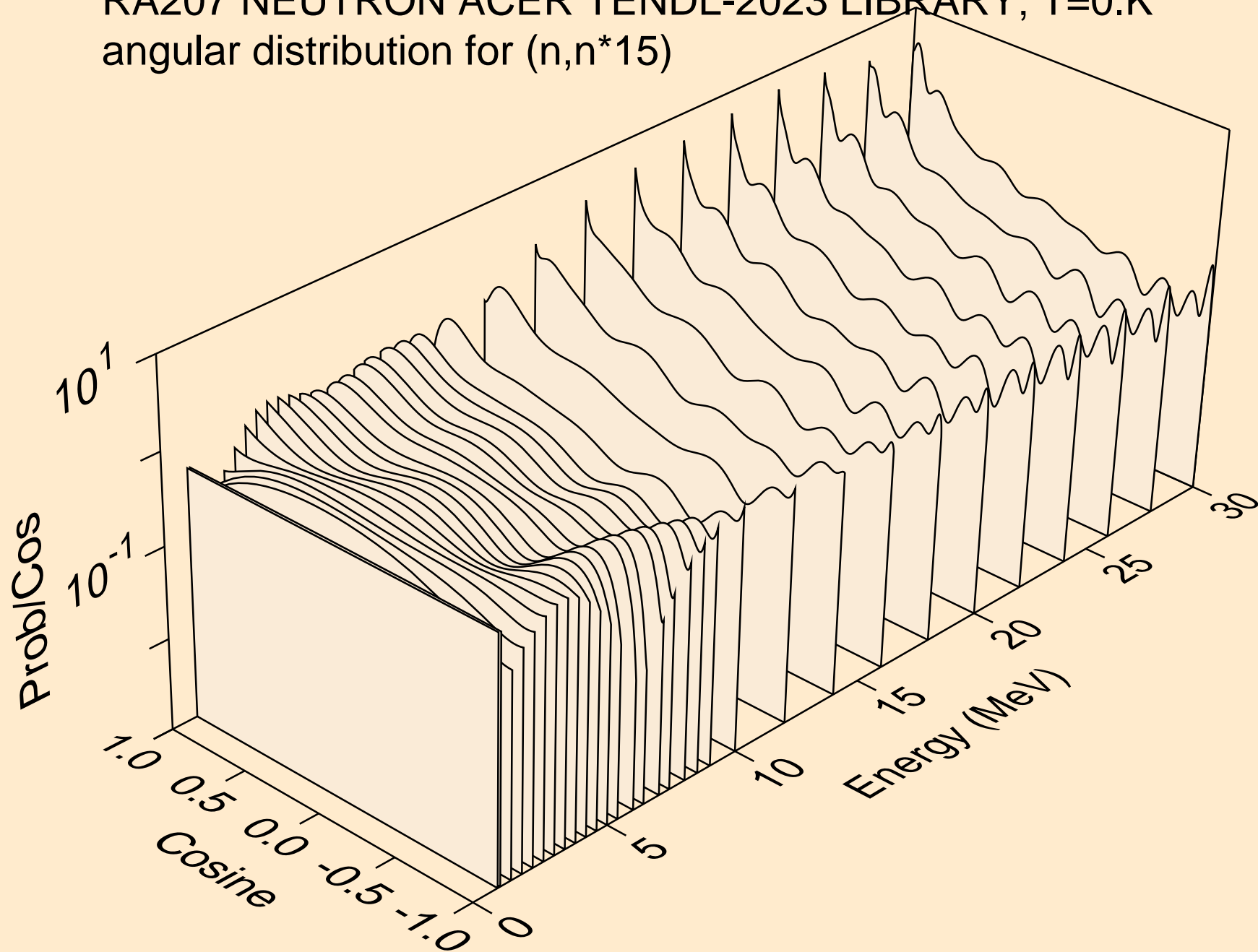

RA207 NEUTRON ACER TENDL-2023 LIBRARY; T=0.K  
angular distribution for (n,n\*16)

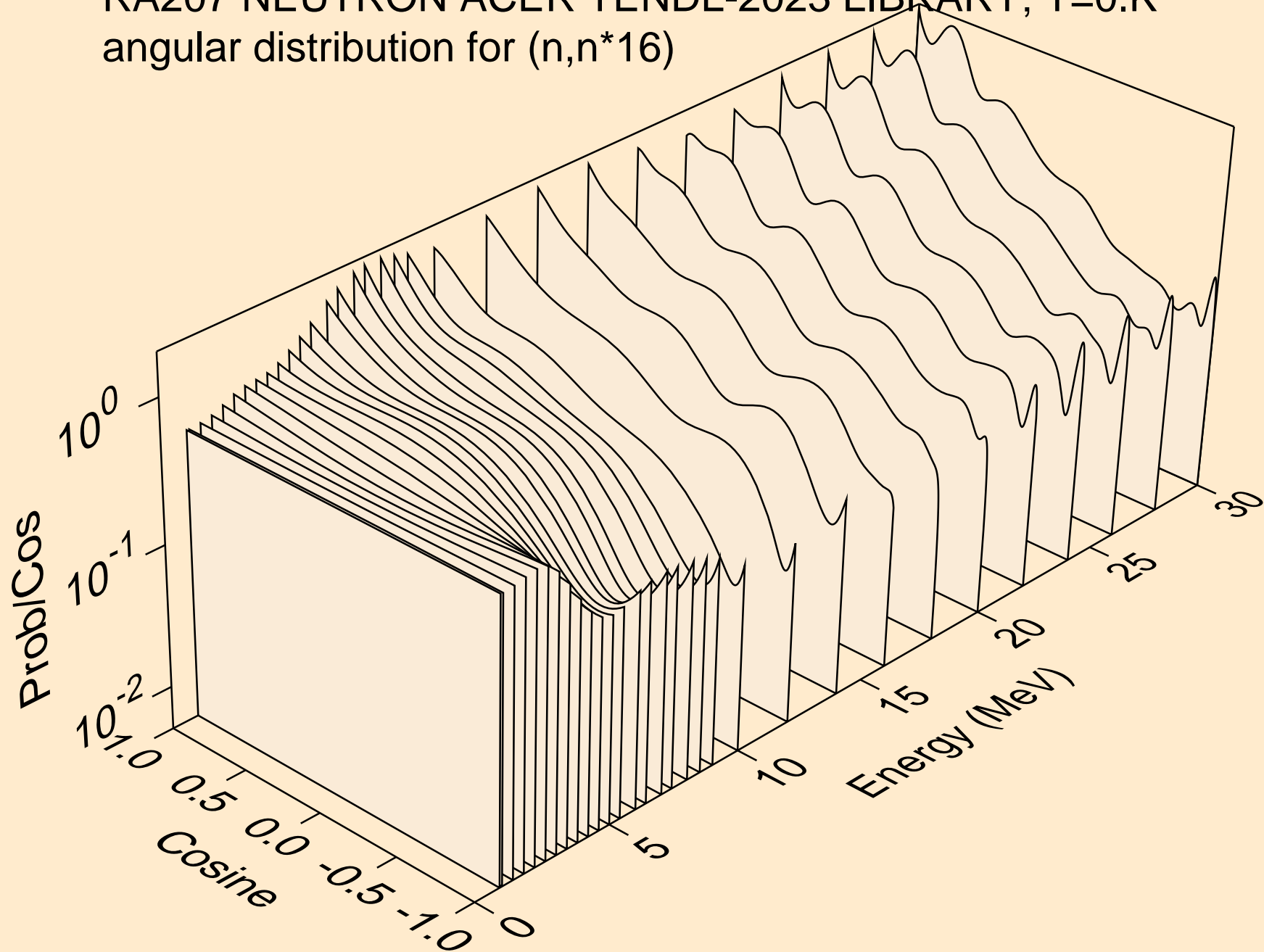

RA207 NEUTRON ACER TENDL-2023 LIBRARY; T=0.K  
angular distribution for (n,n\*17)

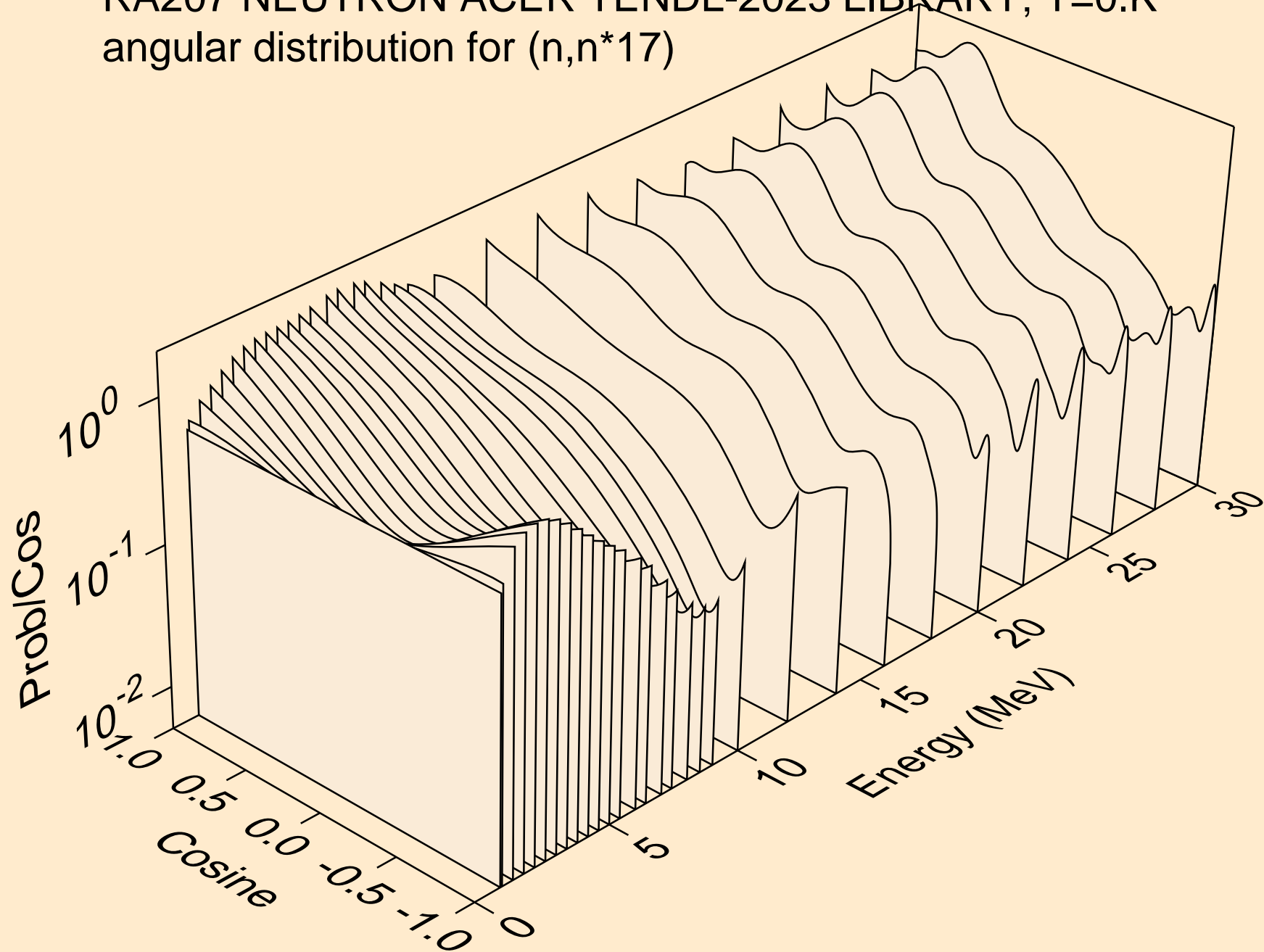



RA207 NEUTRON ACER TENDL-2023 LIBRARY; T=0.K  
angular distribution for (n,n\*18)

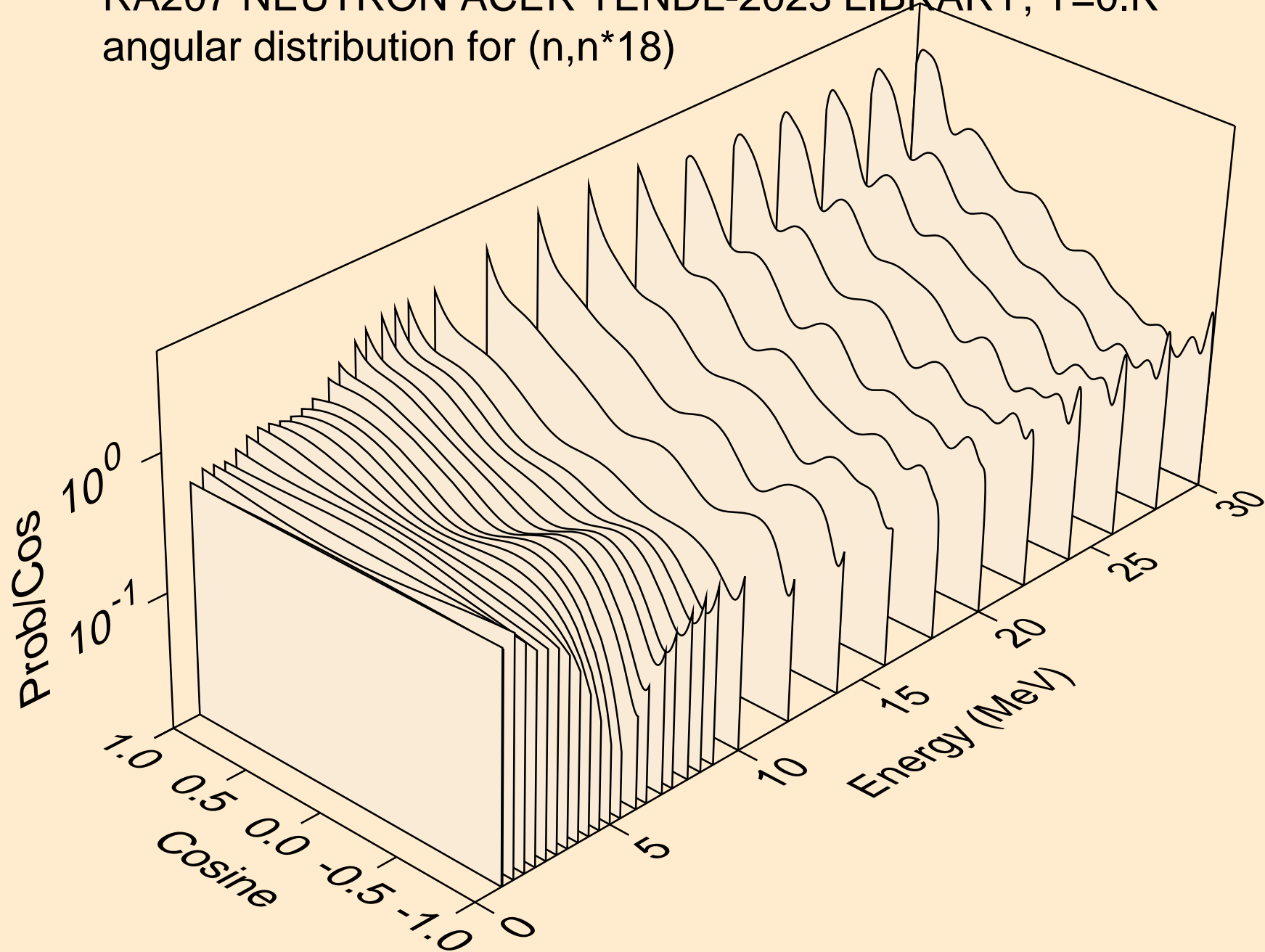

RA207 NEUTRON ACER TENDL-2023 LIBRARY; T=0.K  
angular distribution for (n,n\*19)

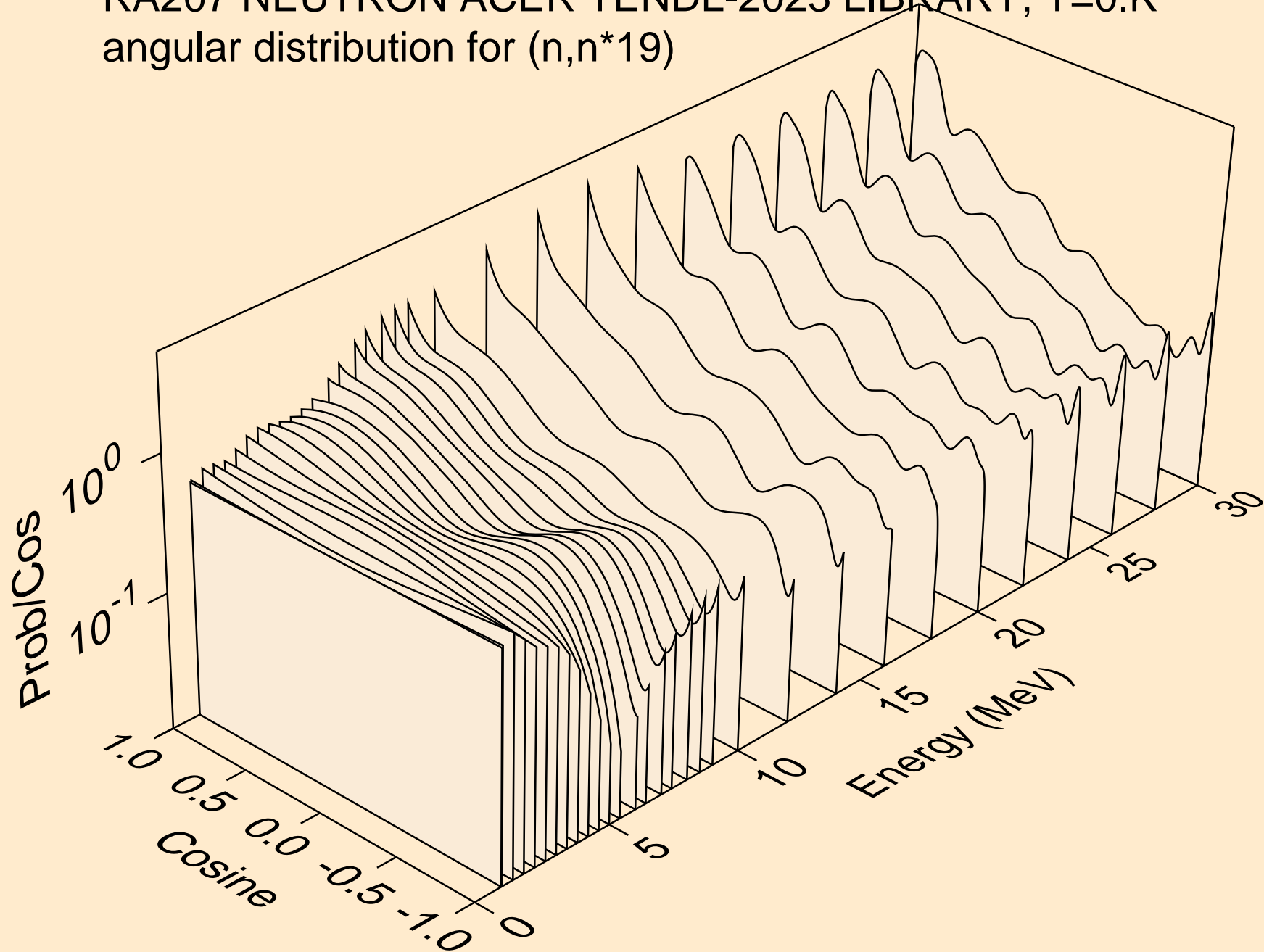

RA207 NEUTRON ACER TENDL-2023 LIBRARY; T=0.K  
angular distribution for (n,n\*20)

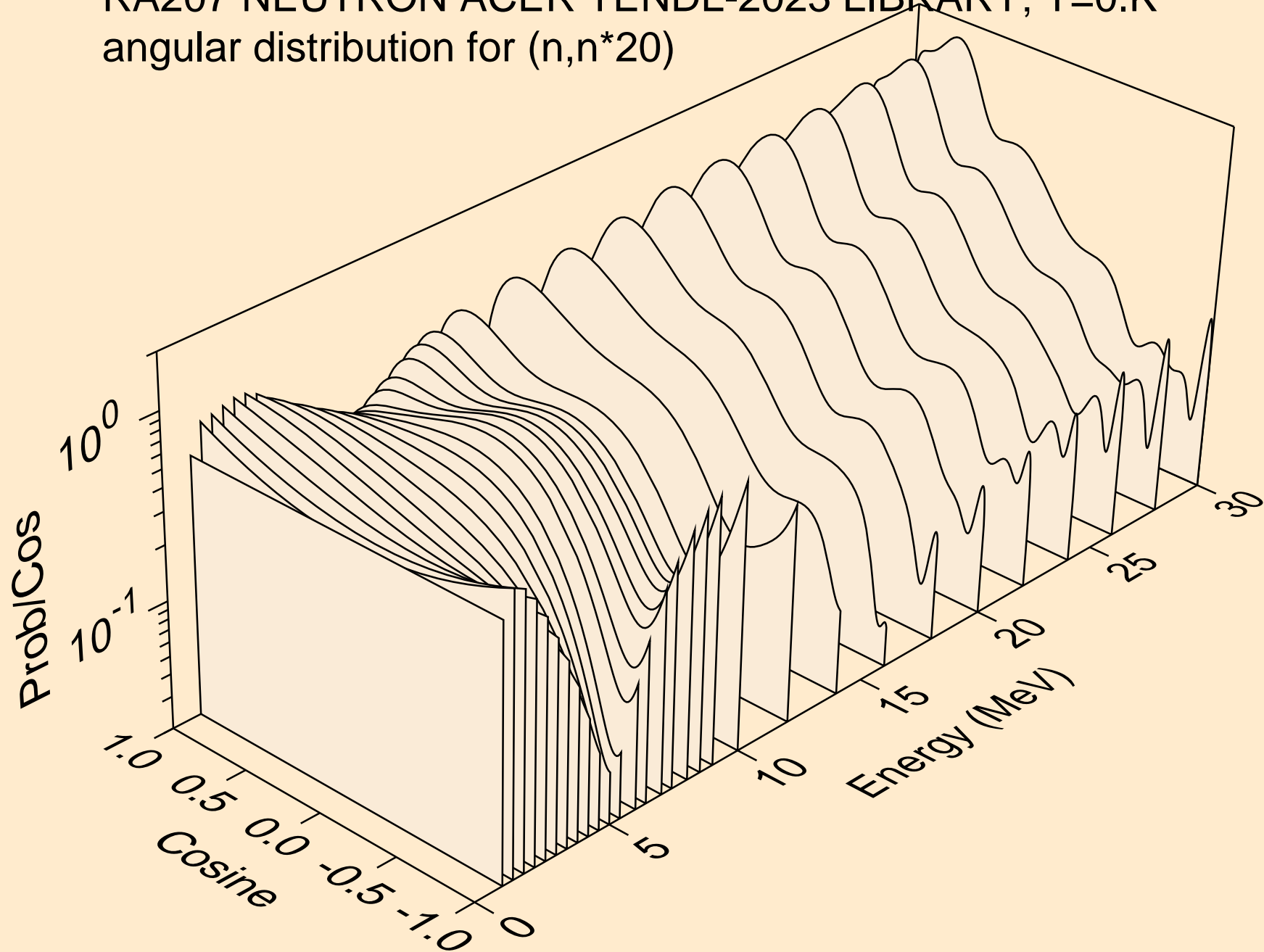

RA207 NEUTRON ACER TENDL-2023 LIBRARY; T=0.K  
angular distribution for (n,n\*21)

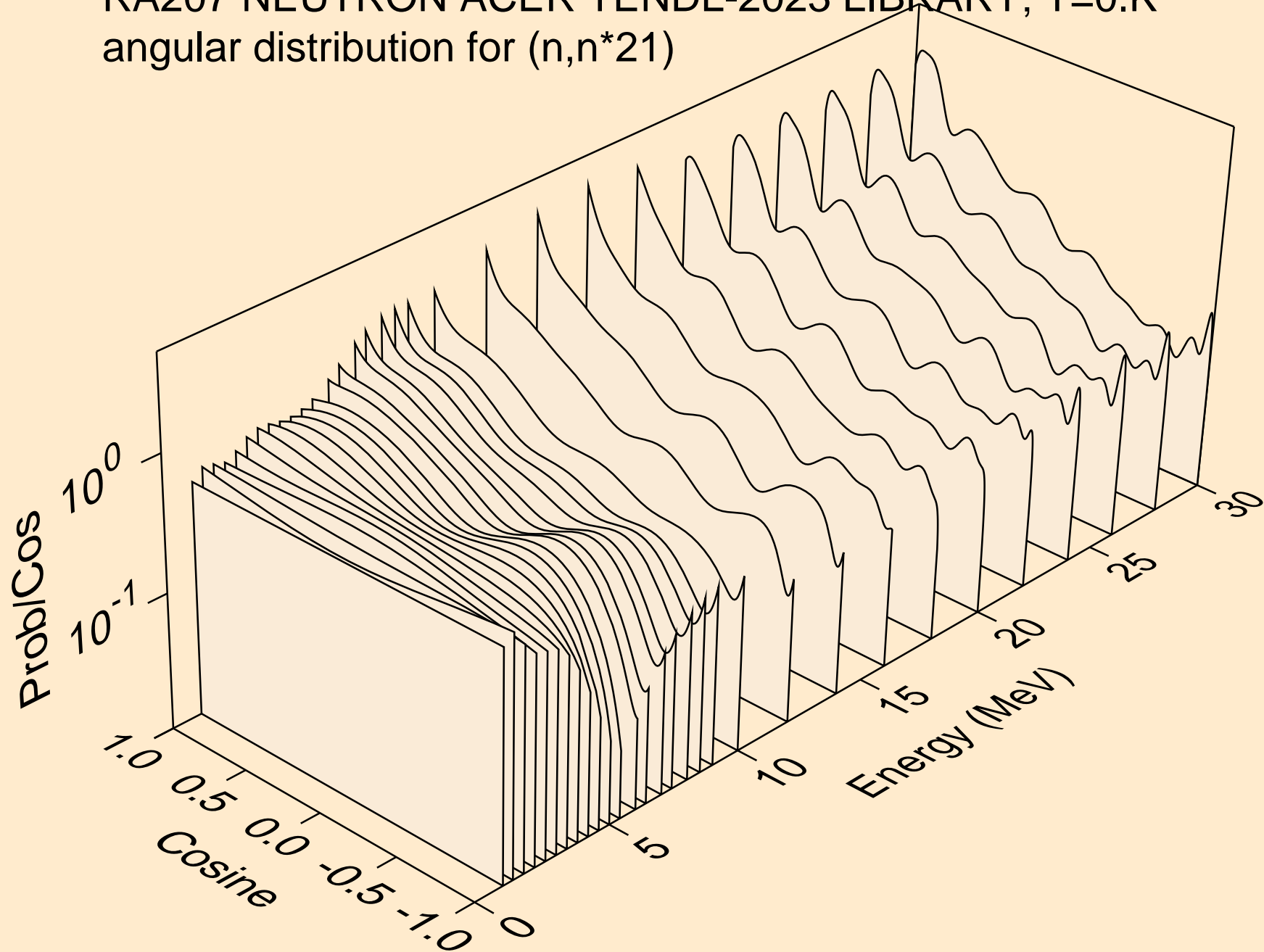

RA207 NEUTRON ACER TENDL-2023 LIBRARY; T=0.K  
angular distribution for (n,n\*22)

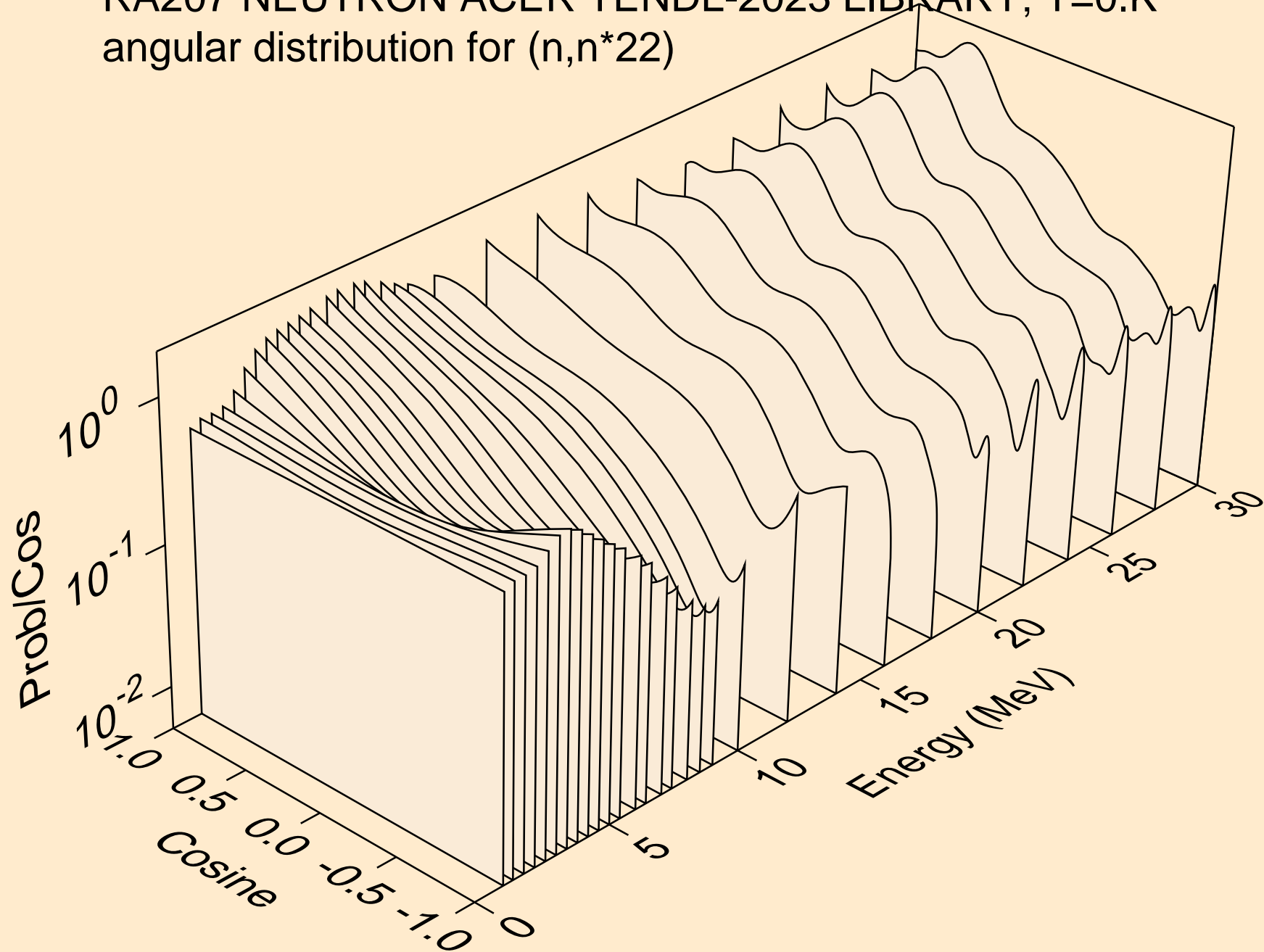

RA207 NEUTRON ACER TENDL-2023 LIBRARY; T=0.K  
angular distribution for (n,n\*23)

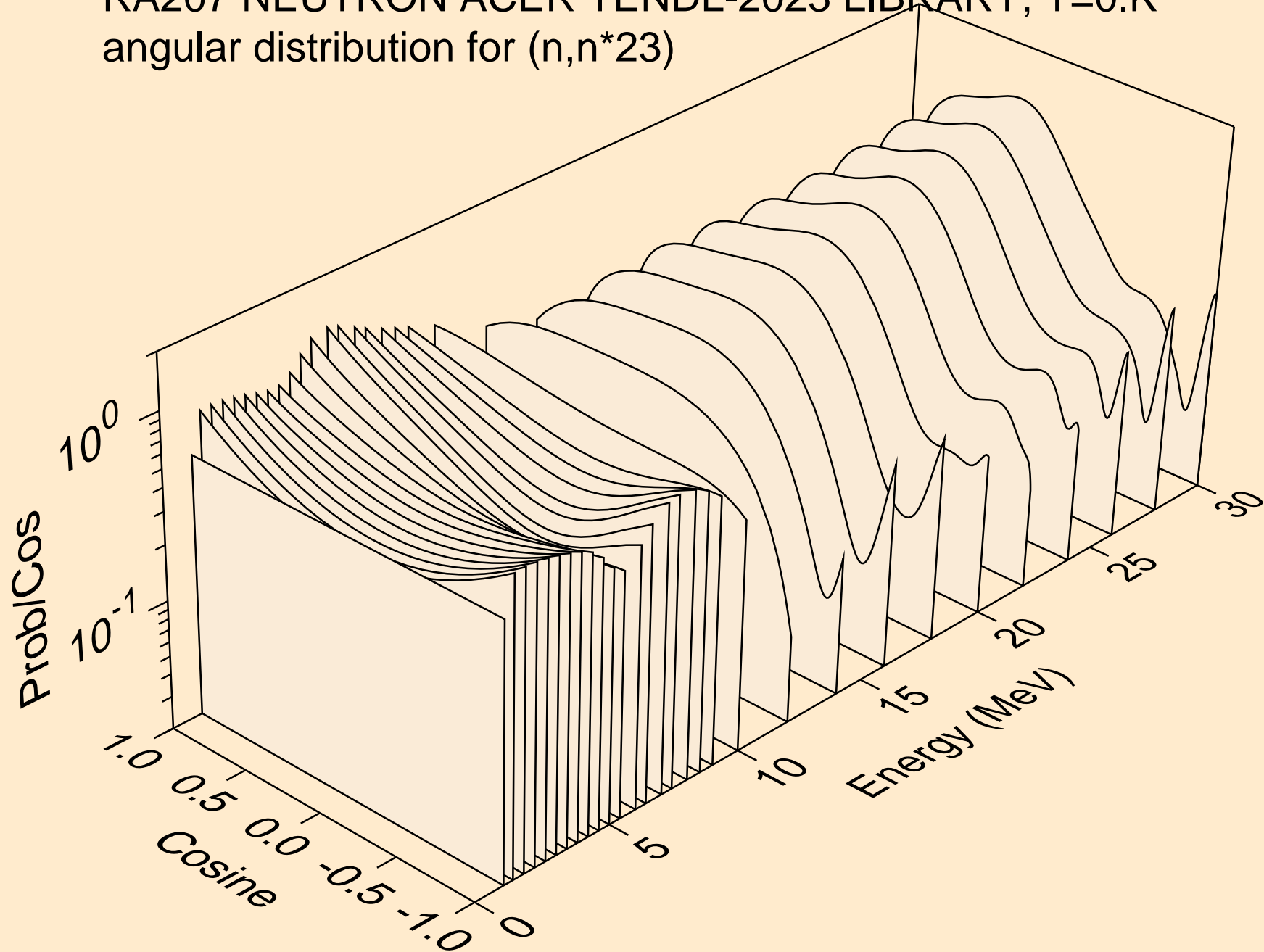

RA207 NEUTRON ACER TENDL-2023 LIBRARY; T=0.K  
angular distribution for (n,n\*24)

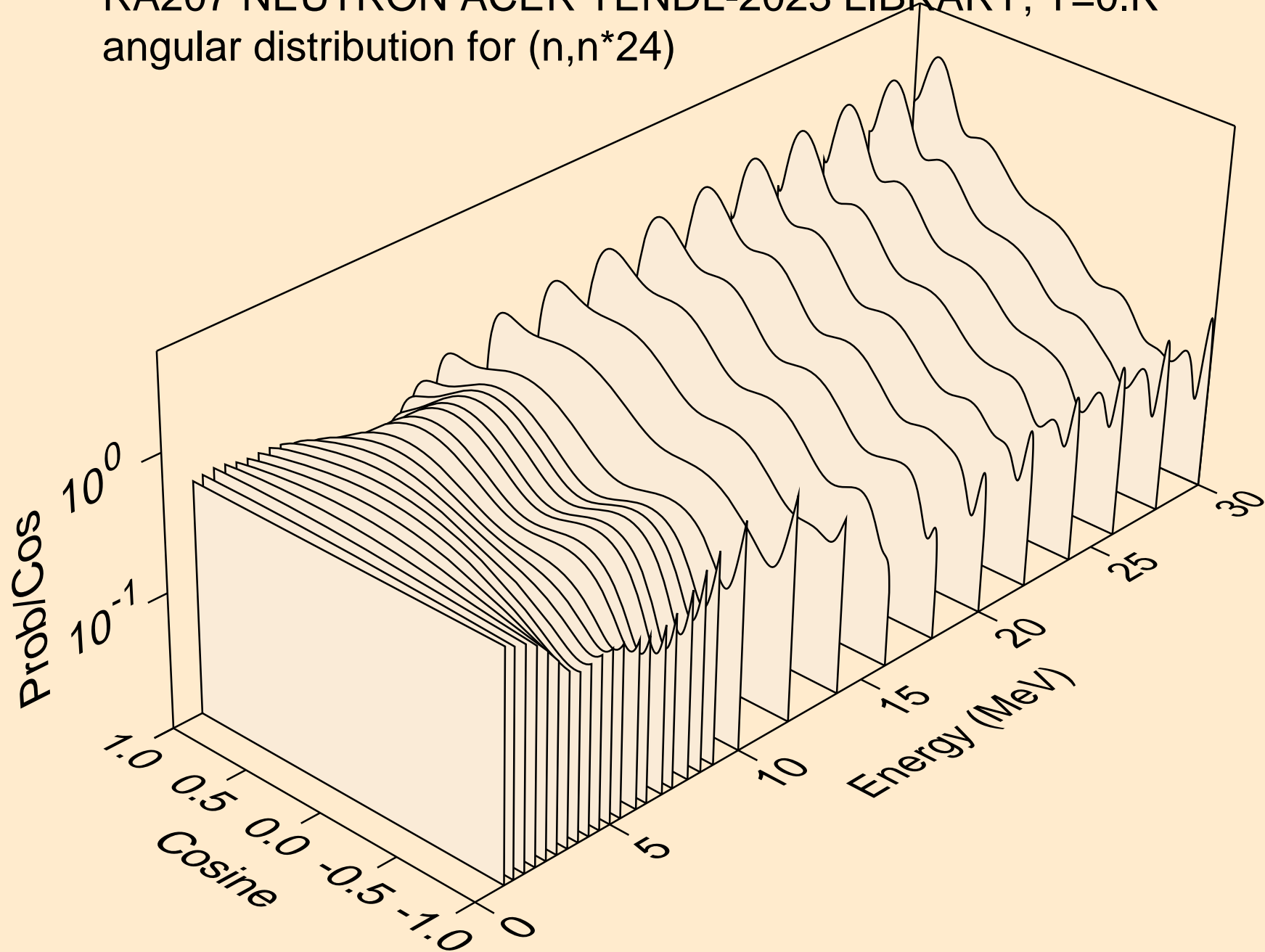

RA207 NEUTRON ACER TENDL-2023 LIBRARY; T=0.K  
angular distribution for (n,n\*25)

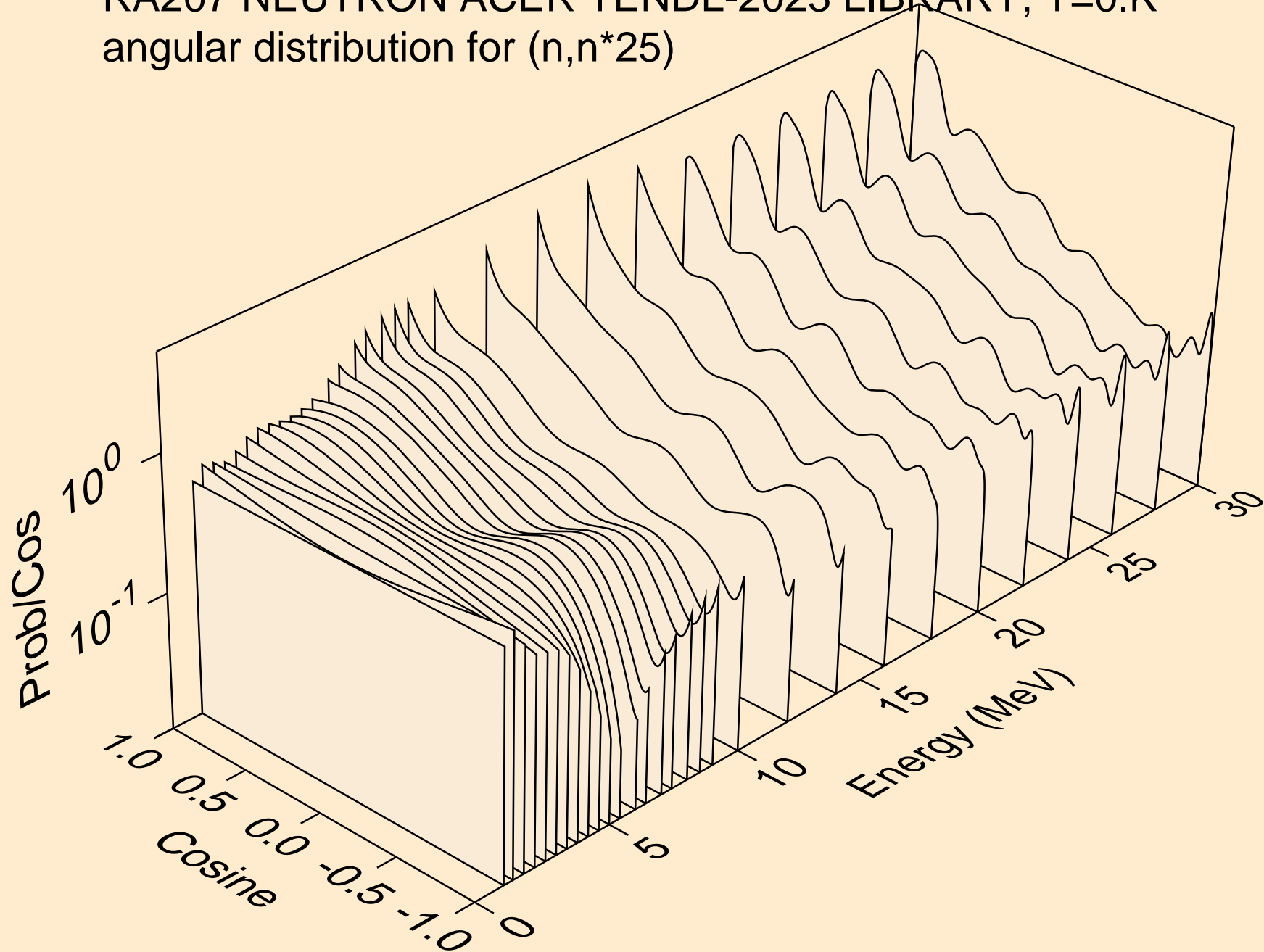



RA207 NEUTRON ACER TENDL-2023 LIBRARY; T=0.K  
Neutron emission for (n,x)

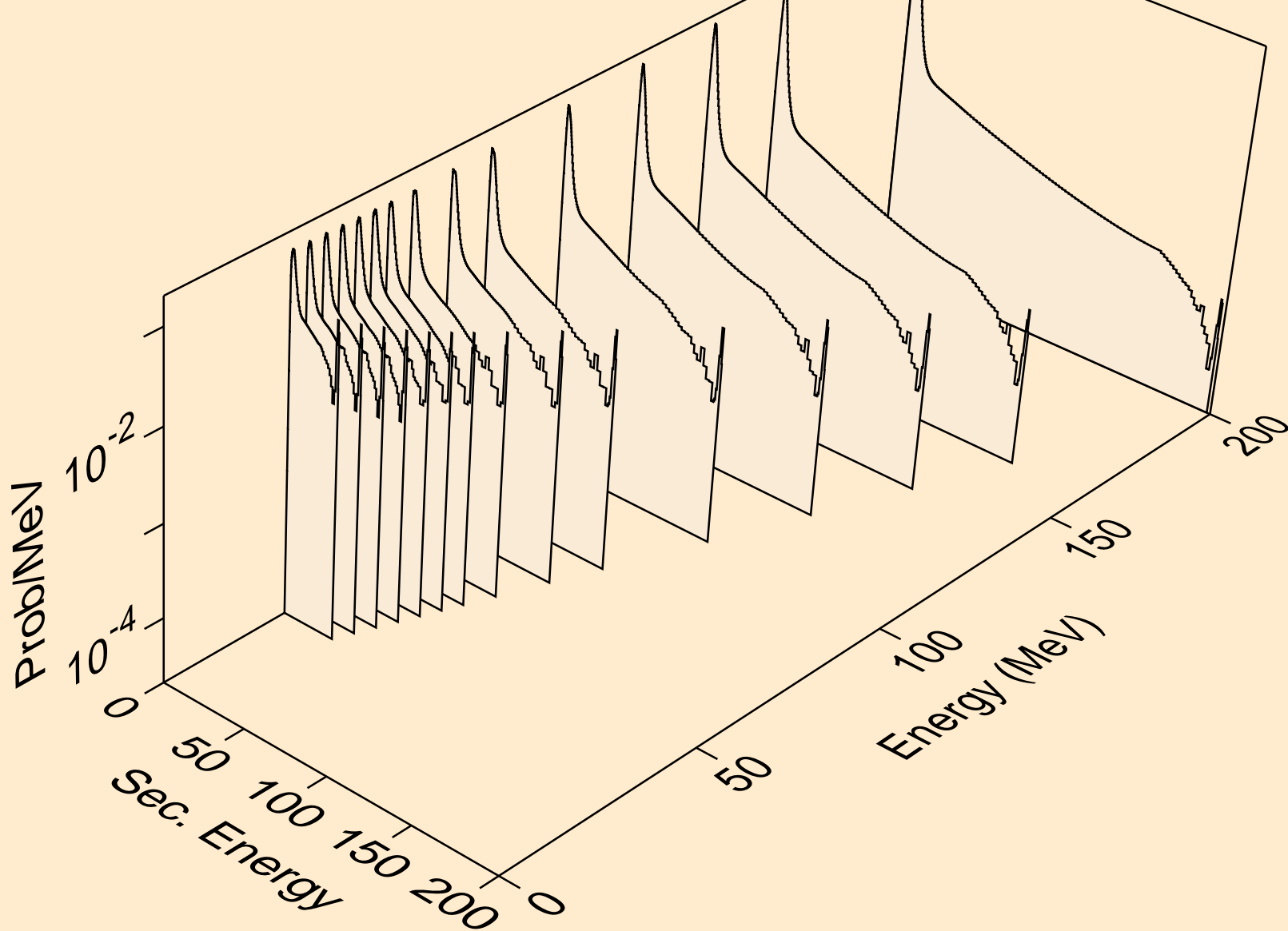

RA207 NEUTRON ACER TENDL-2023 LIBRARY; T=0.K  
Neutron emission for (n,2nd)

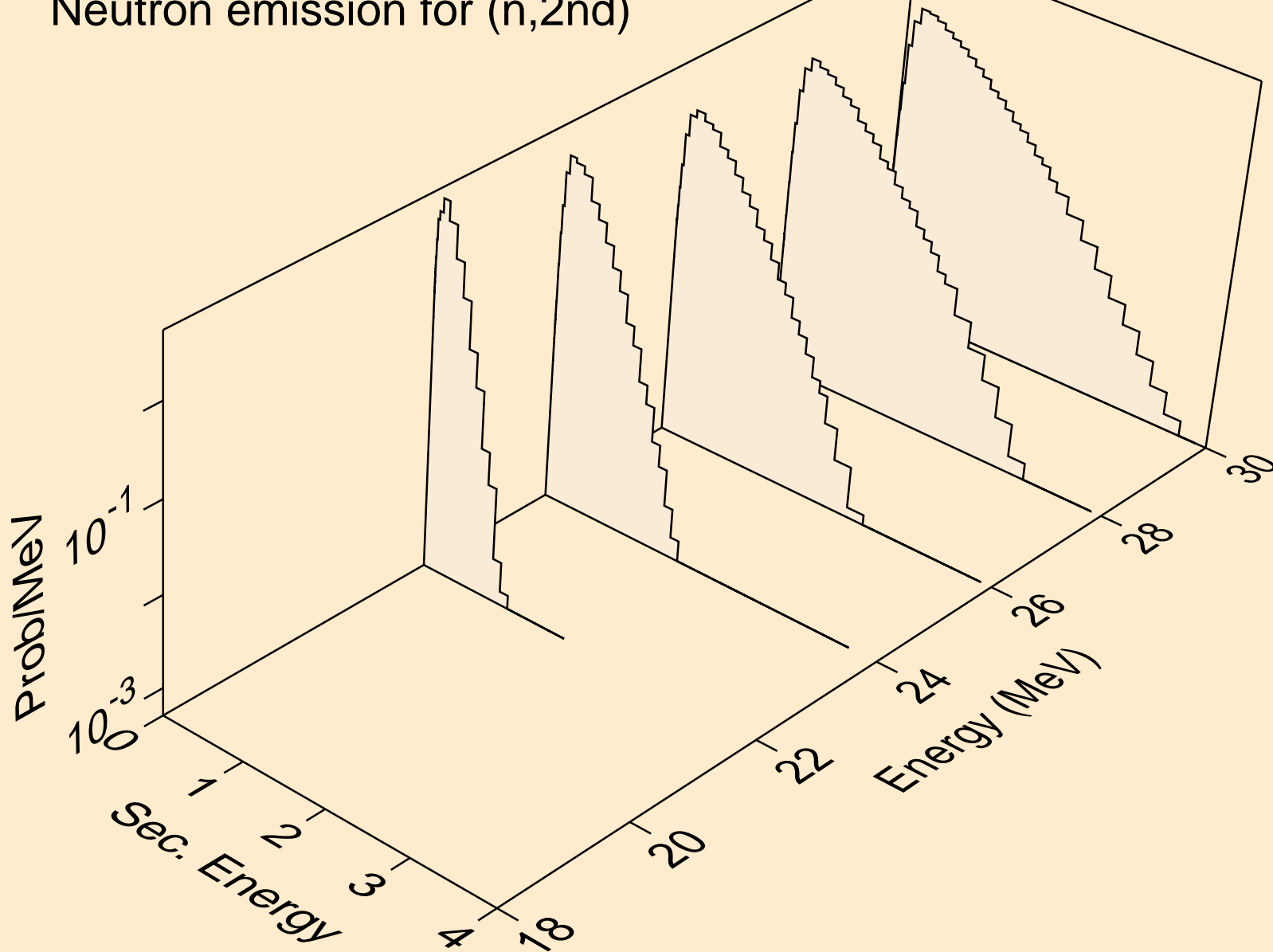

RA207 NEUTRON ACER TENDL-2023 LIBRARY; T=0.K  
Neutron emission for (n,2n)

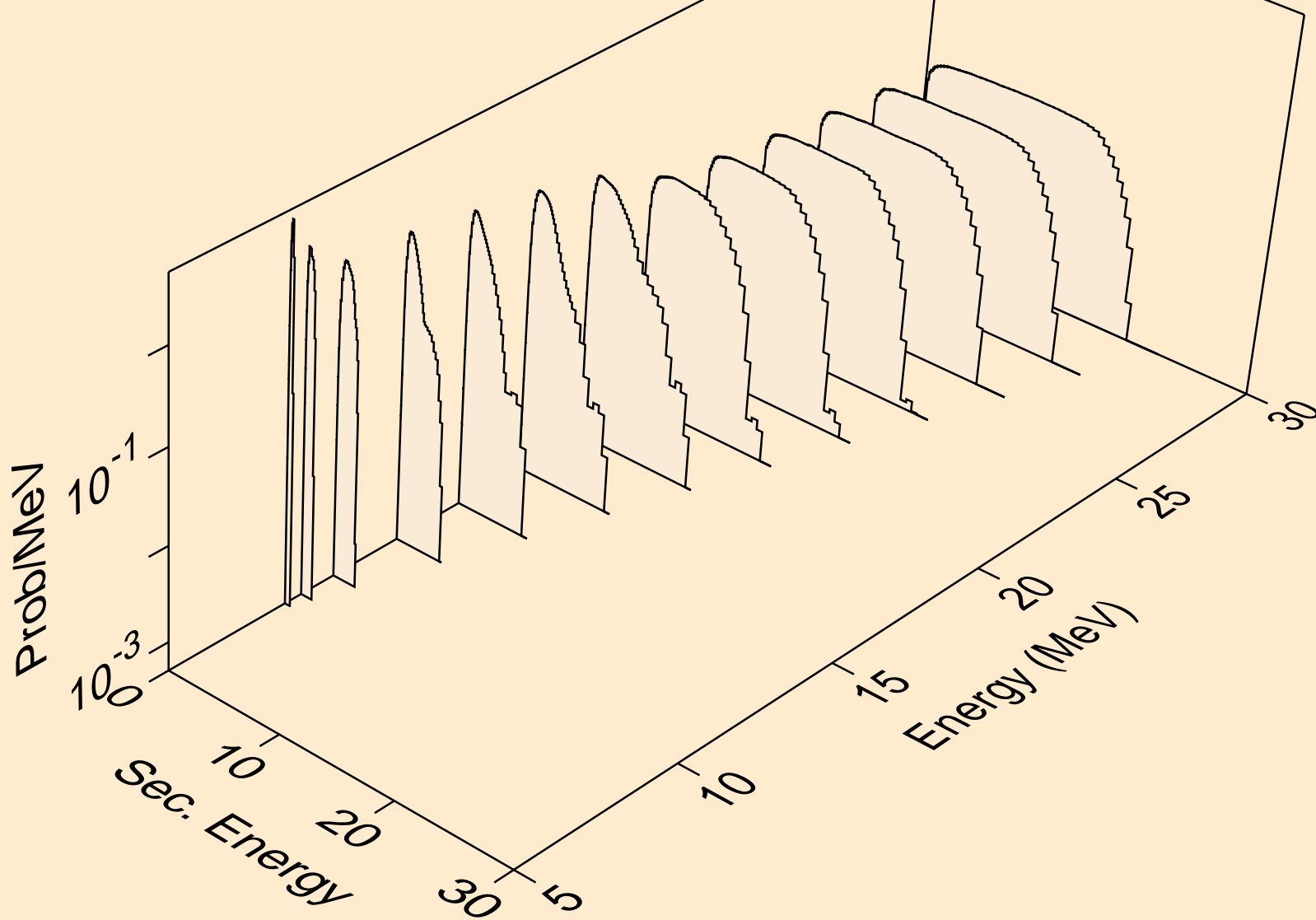

RA207 NEUTRON ACER TENDL-2023 LIBRARY; T=0.K  
Neutron emission for (n,3n)

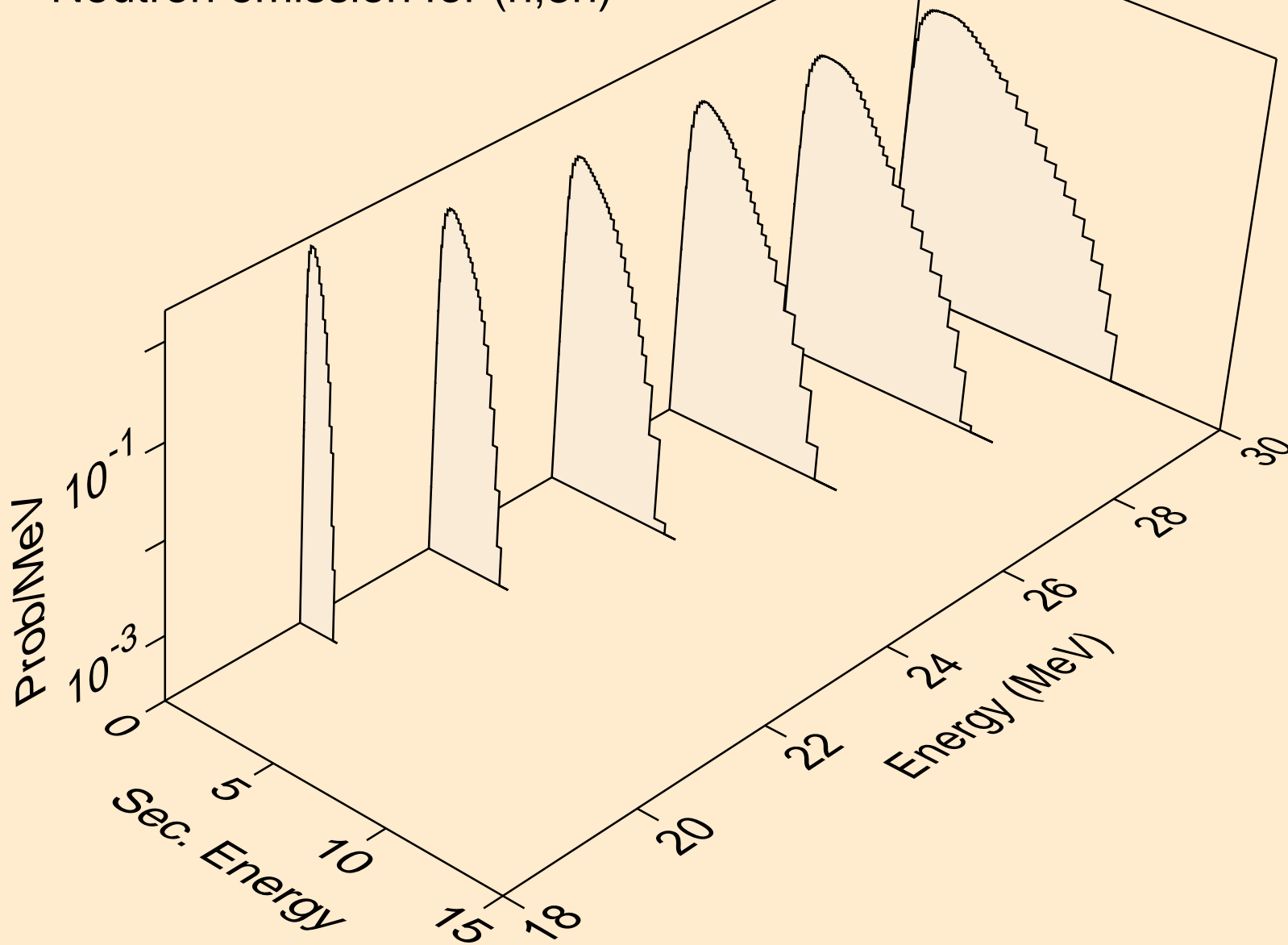

RA207 NEUTRON ACER TENDL-2023 LIBRARY; T=0.K  
Neutron emission for (n,n\*)a

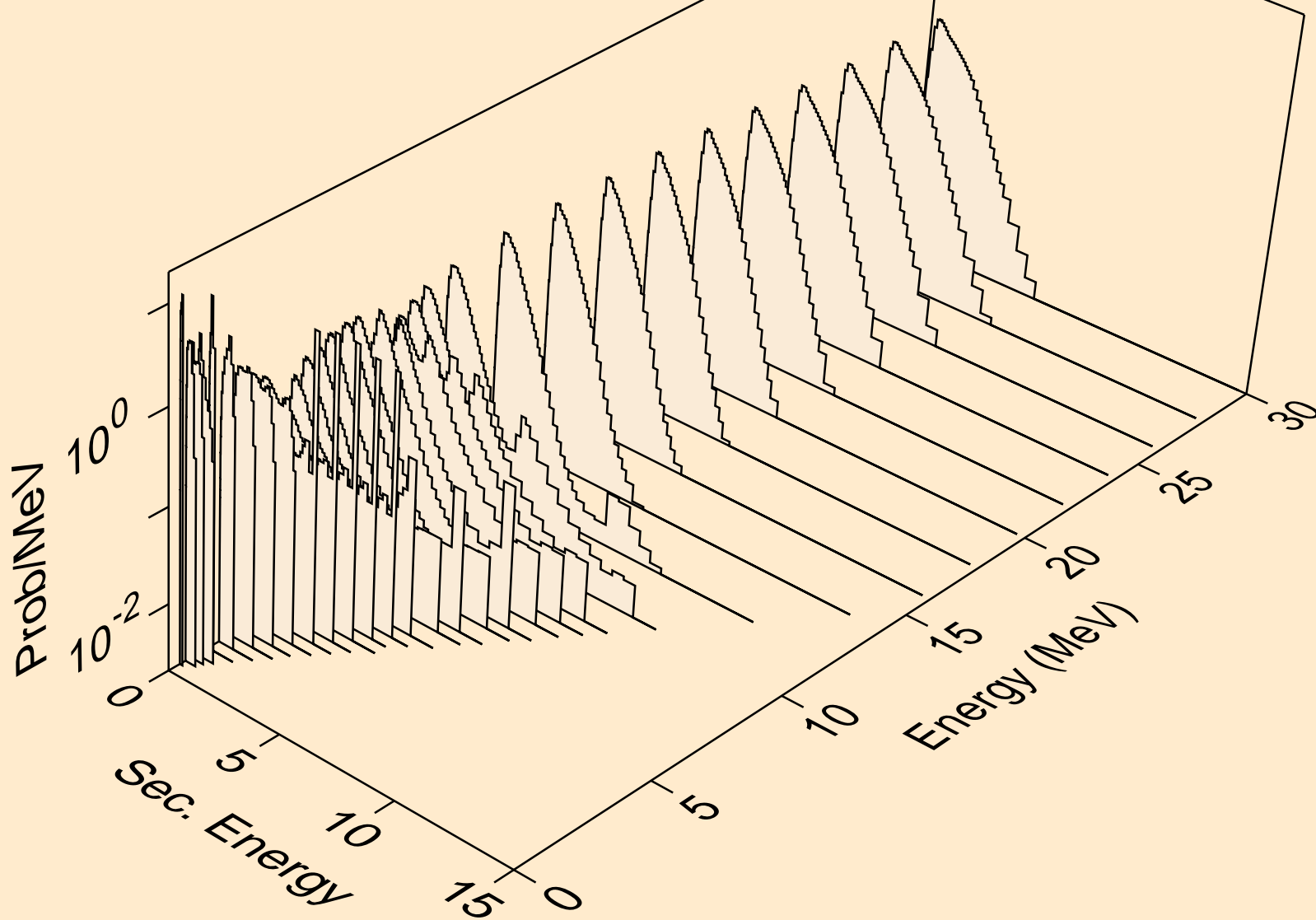

RA207 NEUTRON ACER TENDL-2023 LIBRARY; T=0.K  
Neutron emission for (n,2n)a

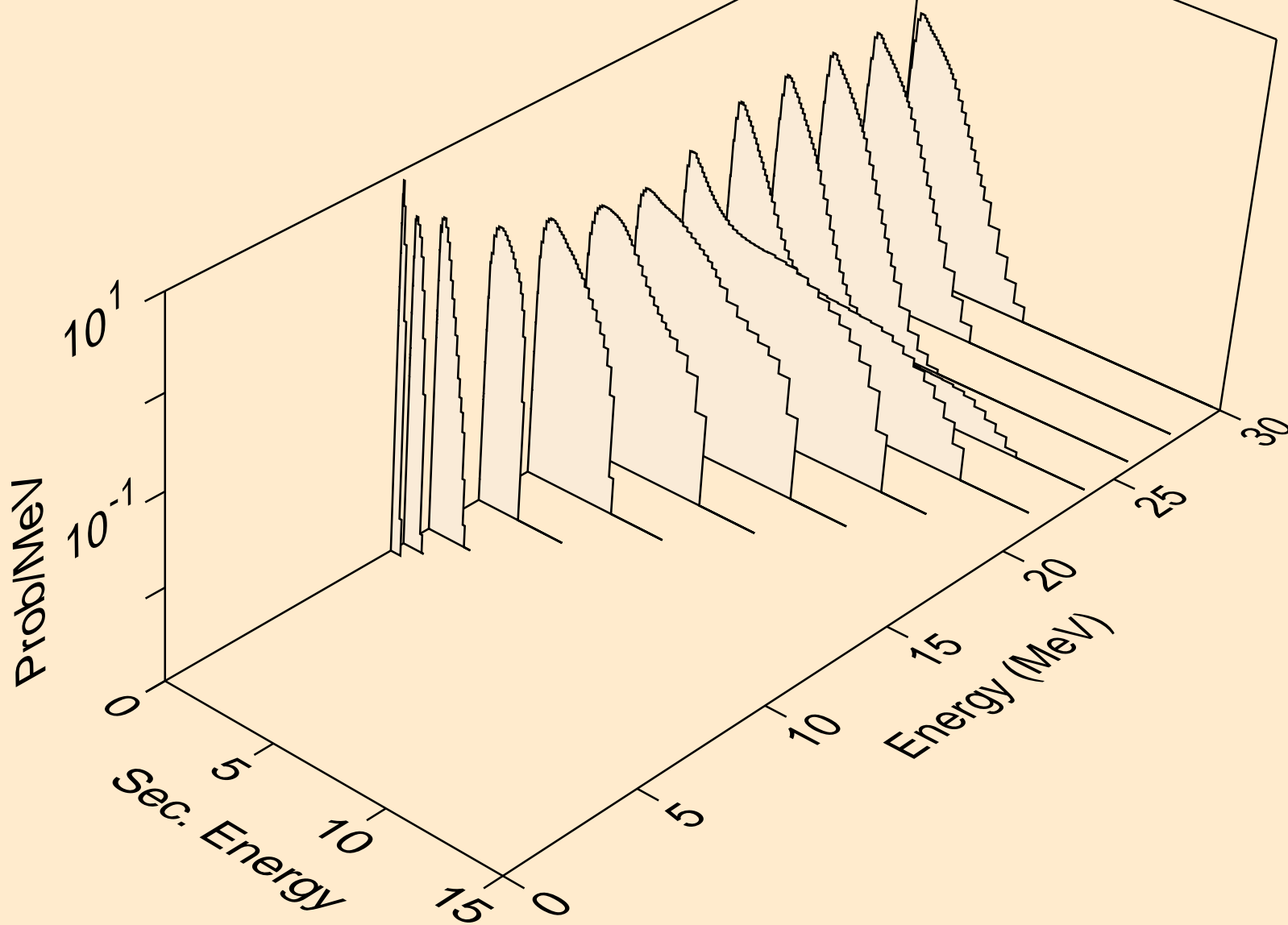

RA207 NEUTRON ACER TENDL-2023 LIBRARY; T=0.K  
Neutron emission for (n,3n)a

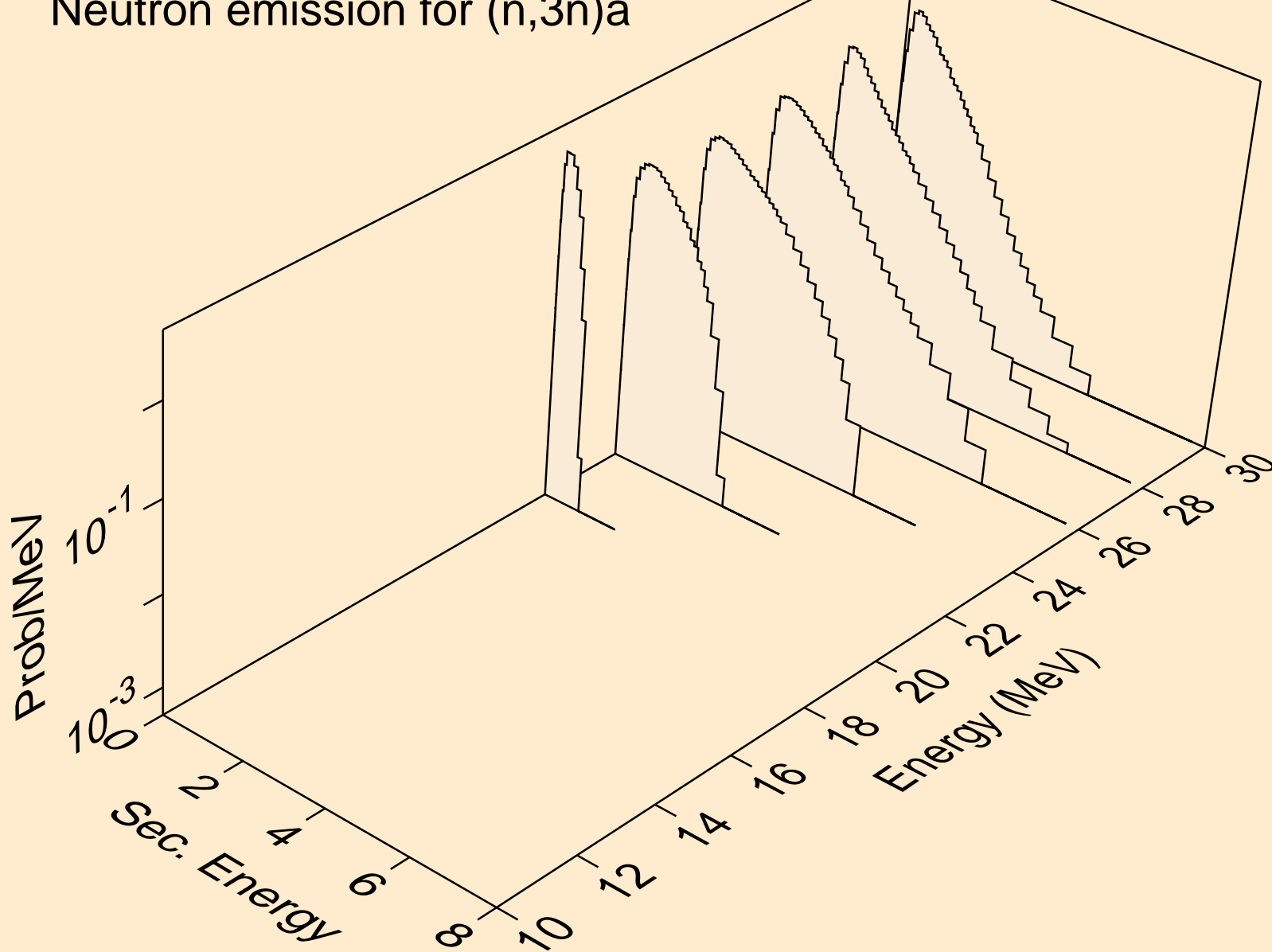

RA207 NEUTRON ACER TENDL-2023 LIBRARY; T=0.K  
Neutron emission for (n,n\*)p

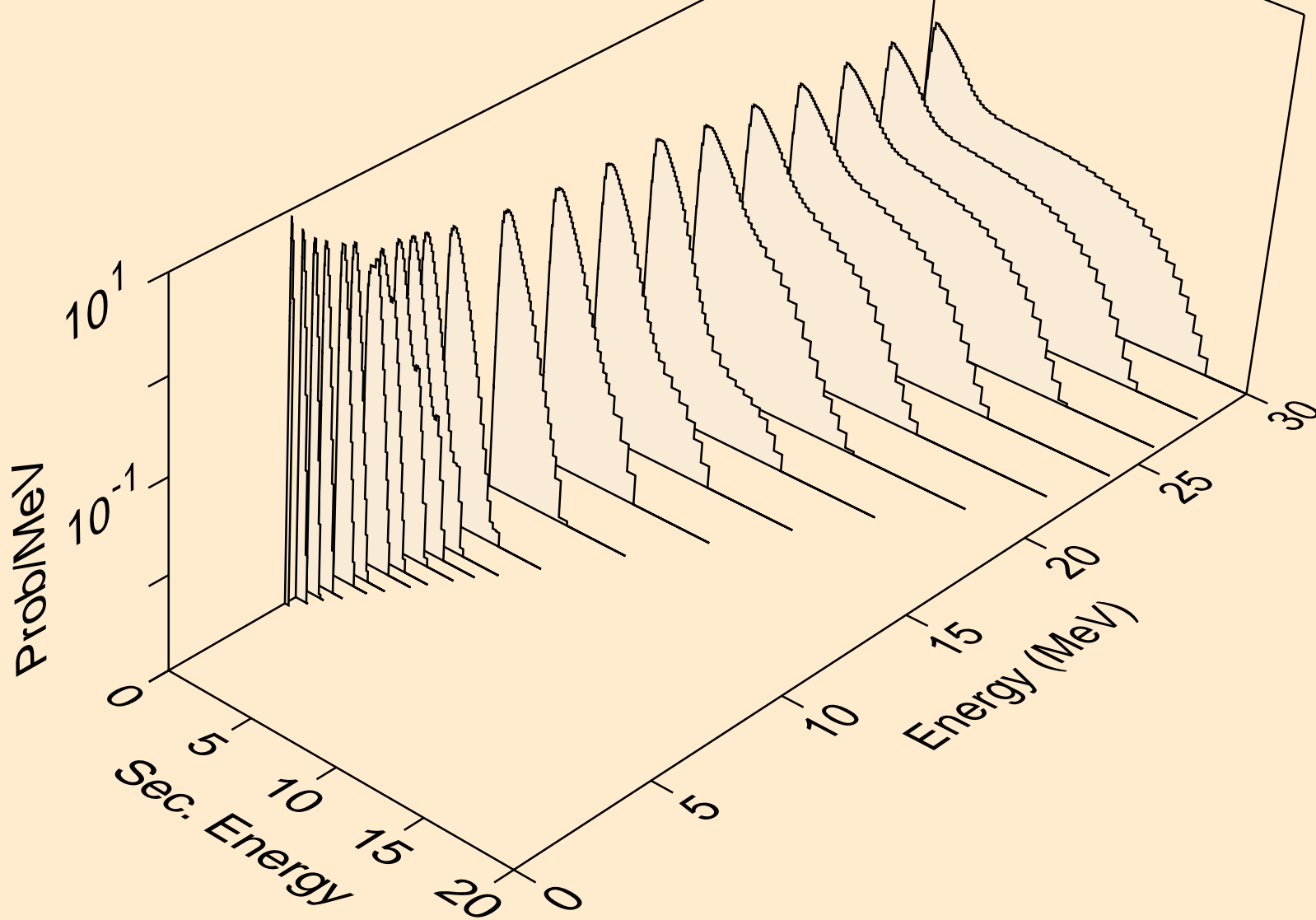



RA207 NEUTRON ACER TENDL-2023 LIBRARY; T=0.K  
Neutron emission for (n,n\*)2a

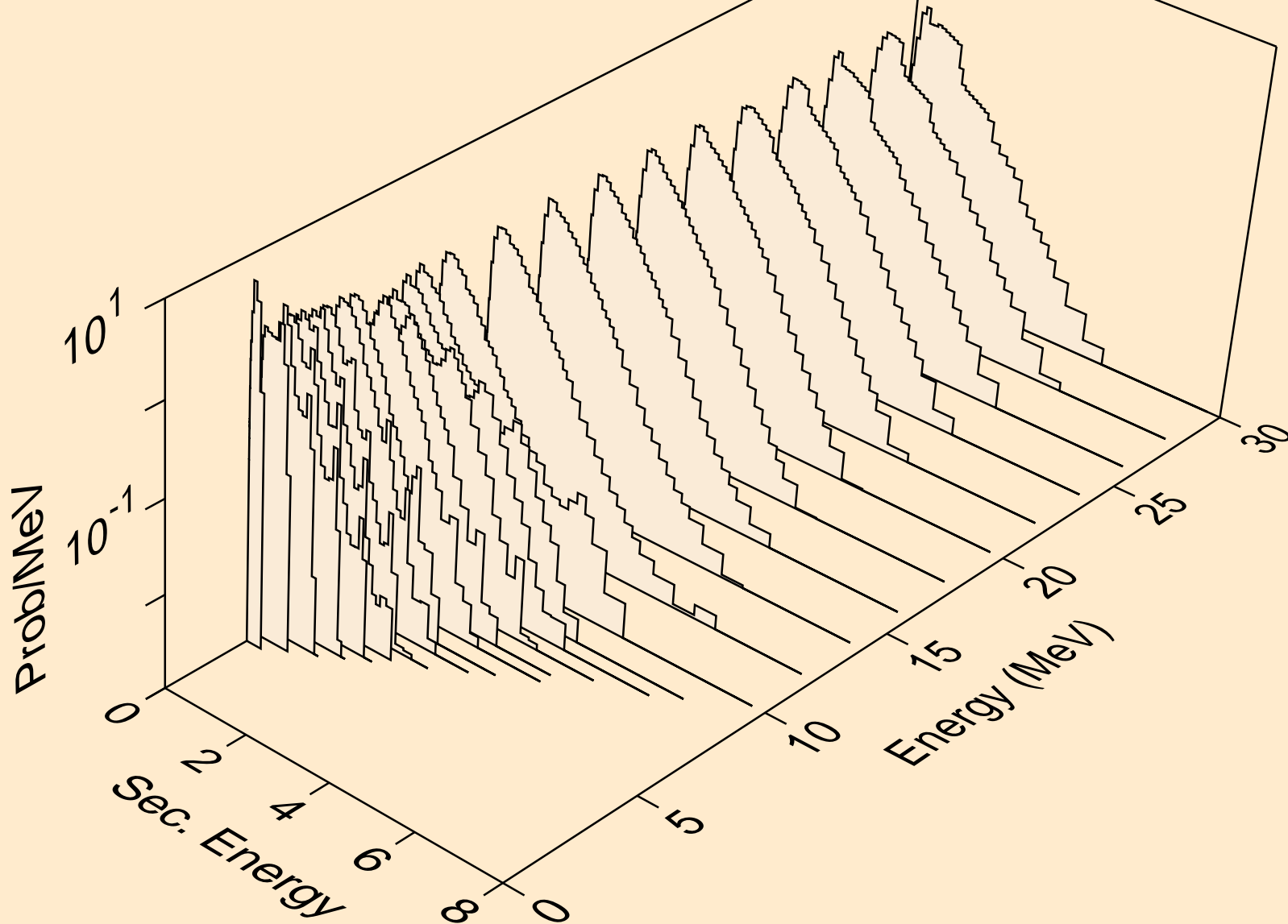

RA207 NEUTRON ACER TENDL-2023 LIBRARY; T=0.K  
Neutron emission for (n,2n)2a

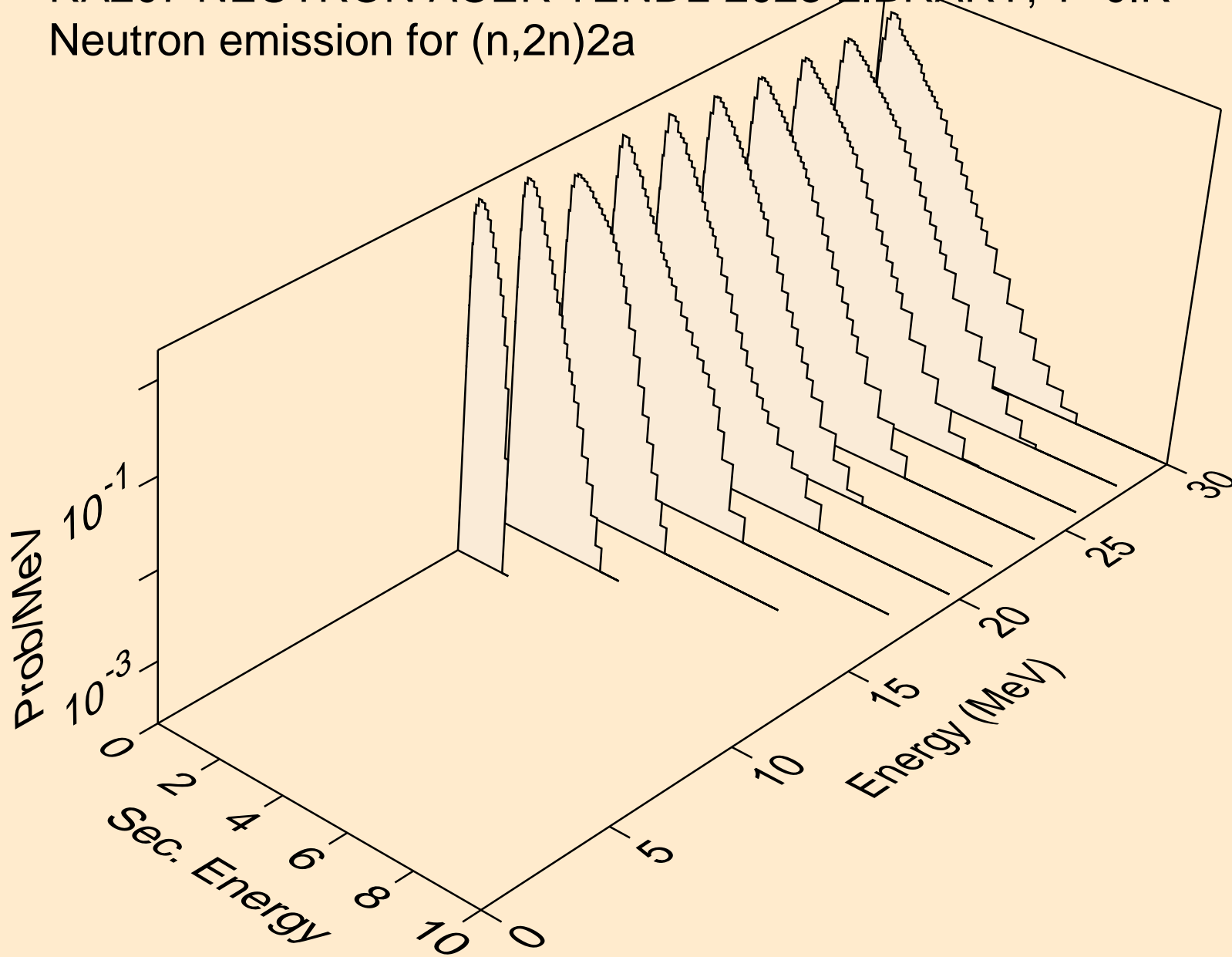

RA207 NEUTRON ACER TENDL-2023 LIBRARY; T=0.K  
Neutron emission for (n,n\*)d

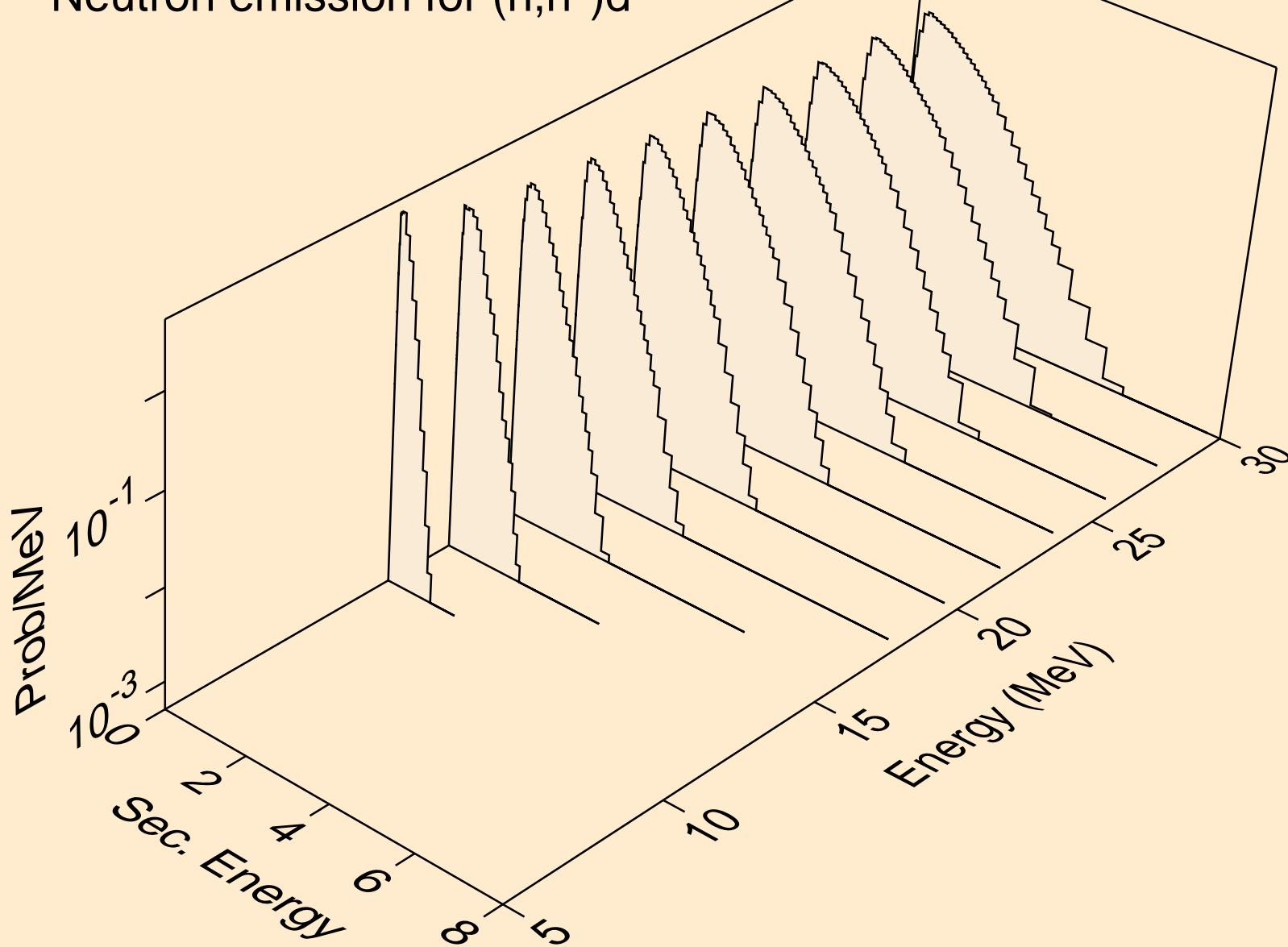

RA207 NEUTRON ACER TENDL-2023 LIBRARY; T=0.K  
Neutron emission for (n,n\*)t

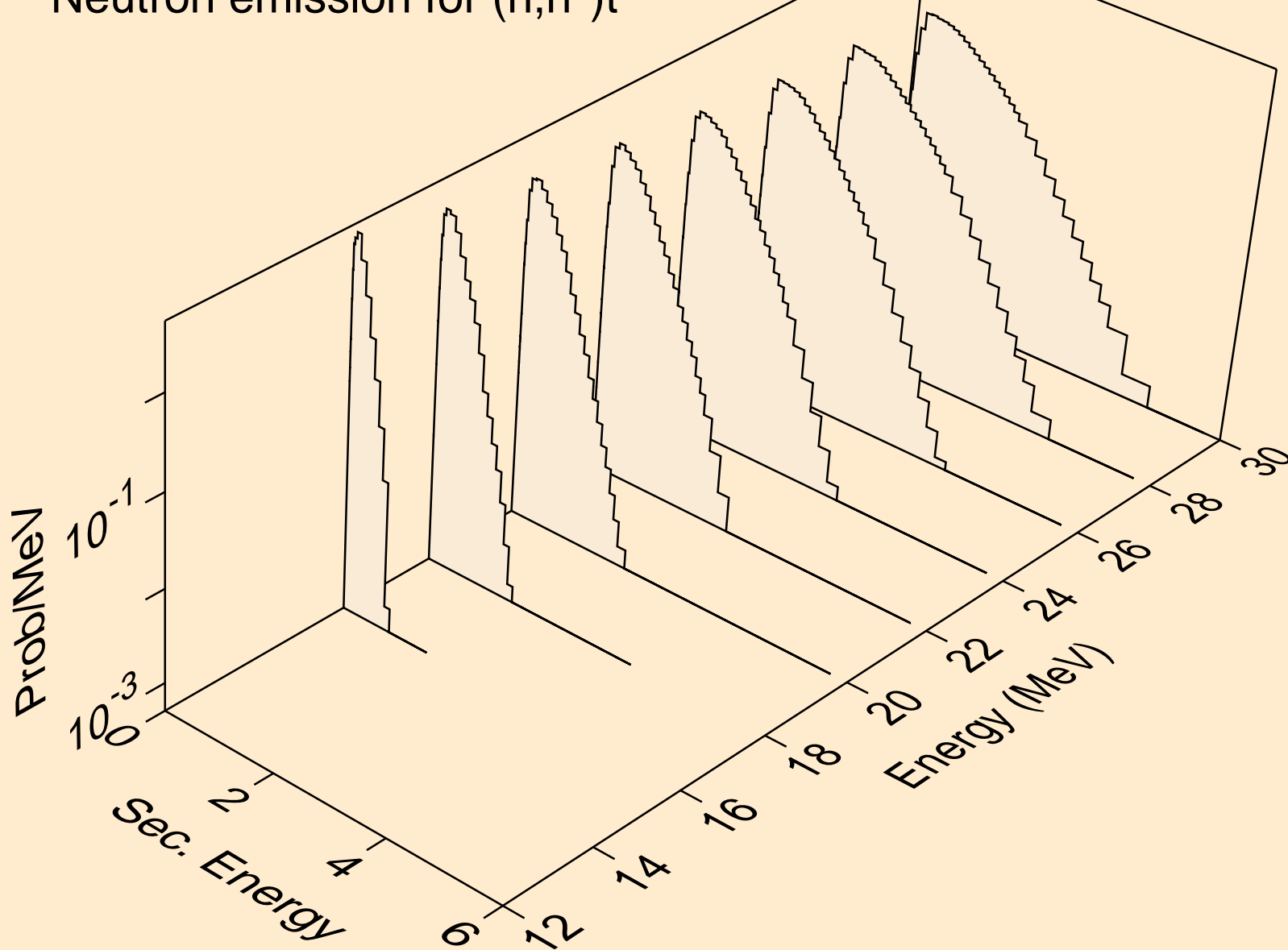

RA207 NEUTRON ACER TENDL-2023 LIBRARY; T=0.K  
Neutron emission for (n,n\*)he3

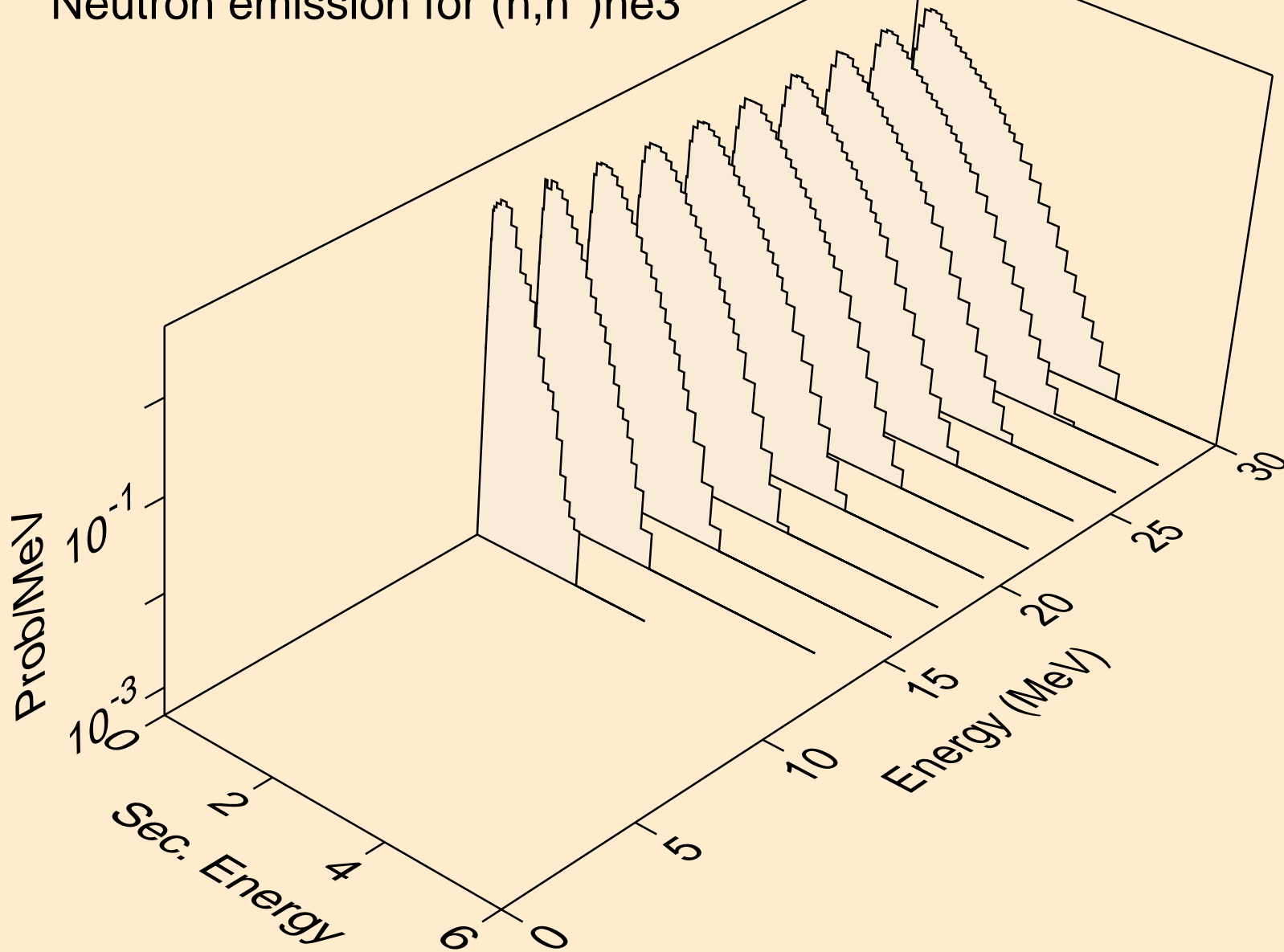

RA207 NEUTRON ACER TENDL-2023 LIBRARY; T=0.K  
Neutron emission for (n,4n)

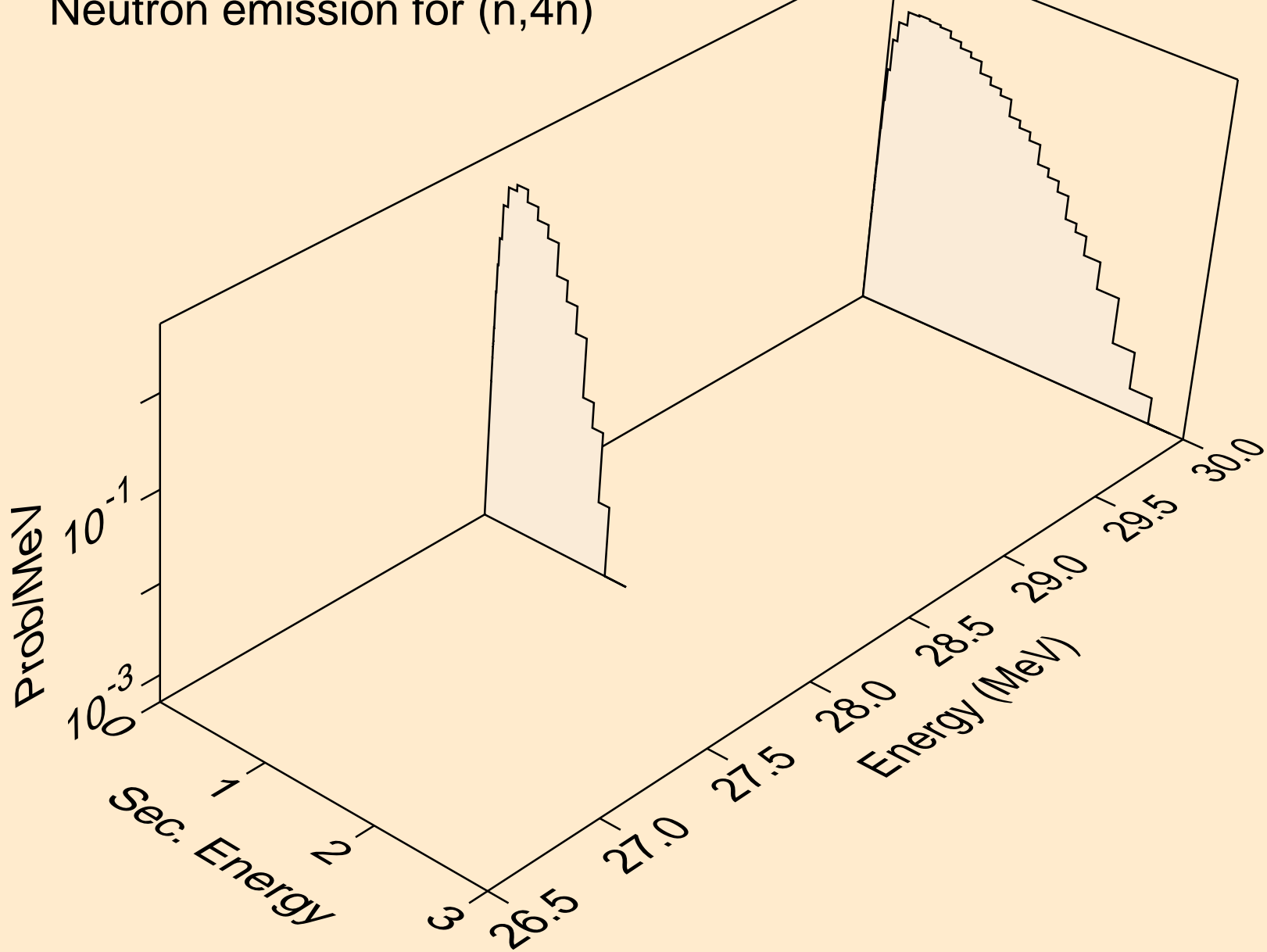

RA207 NEUTRON ACER TENDL-2023 LIBRARY; T=0.K  
Neutron emission for (n,2np)

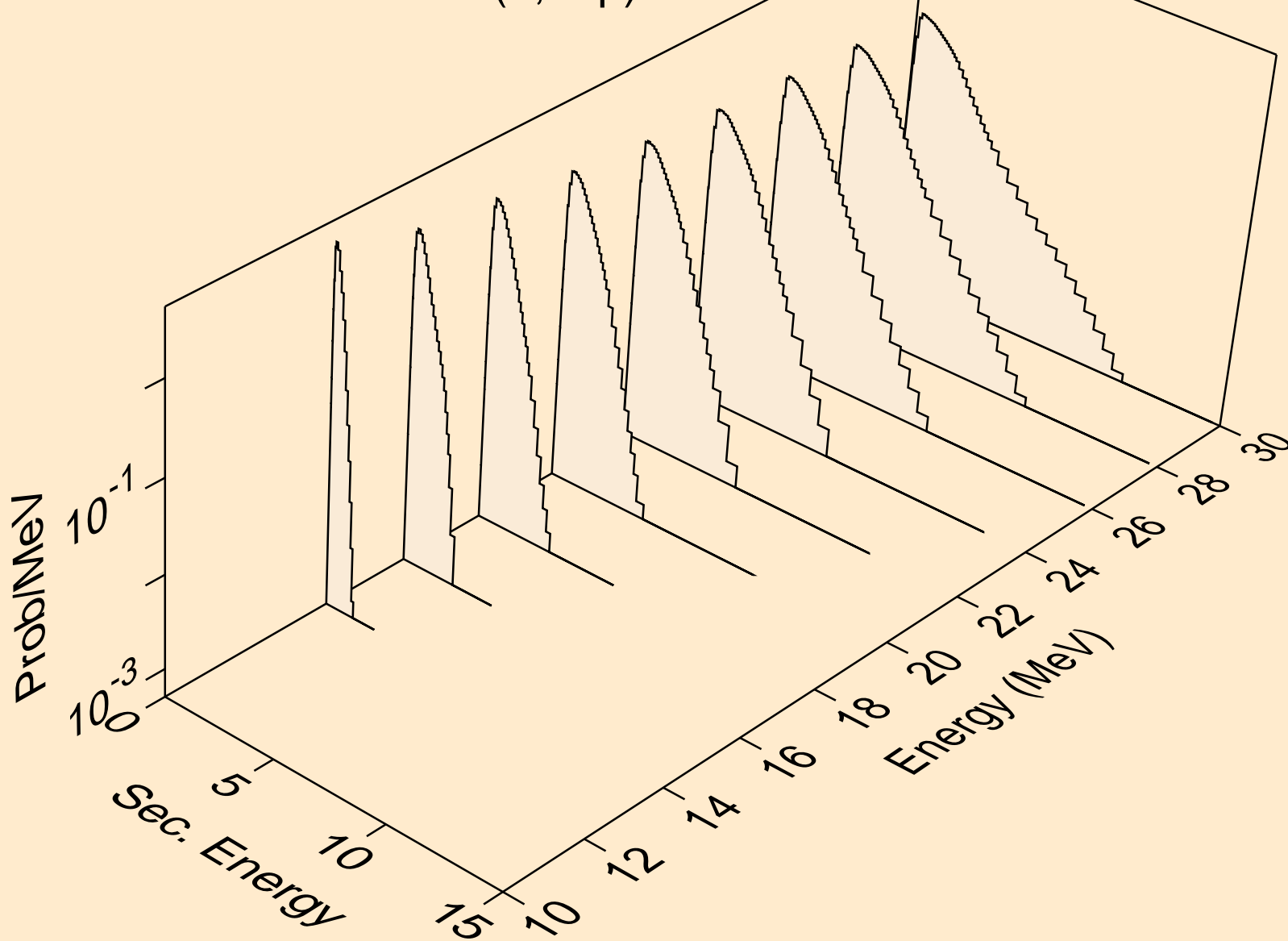

RA207 NEUTRON ACER TENDL-2023 LIBRARY; T=0.K  
Neutron emission for (n,3np)

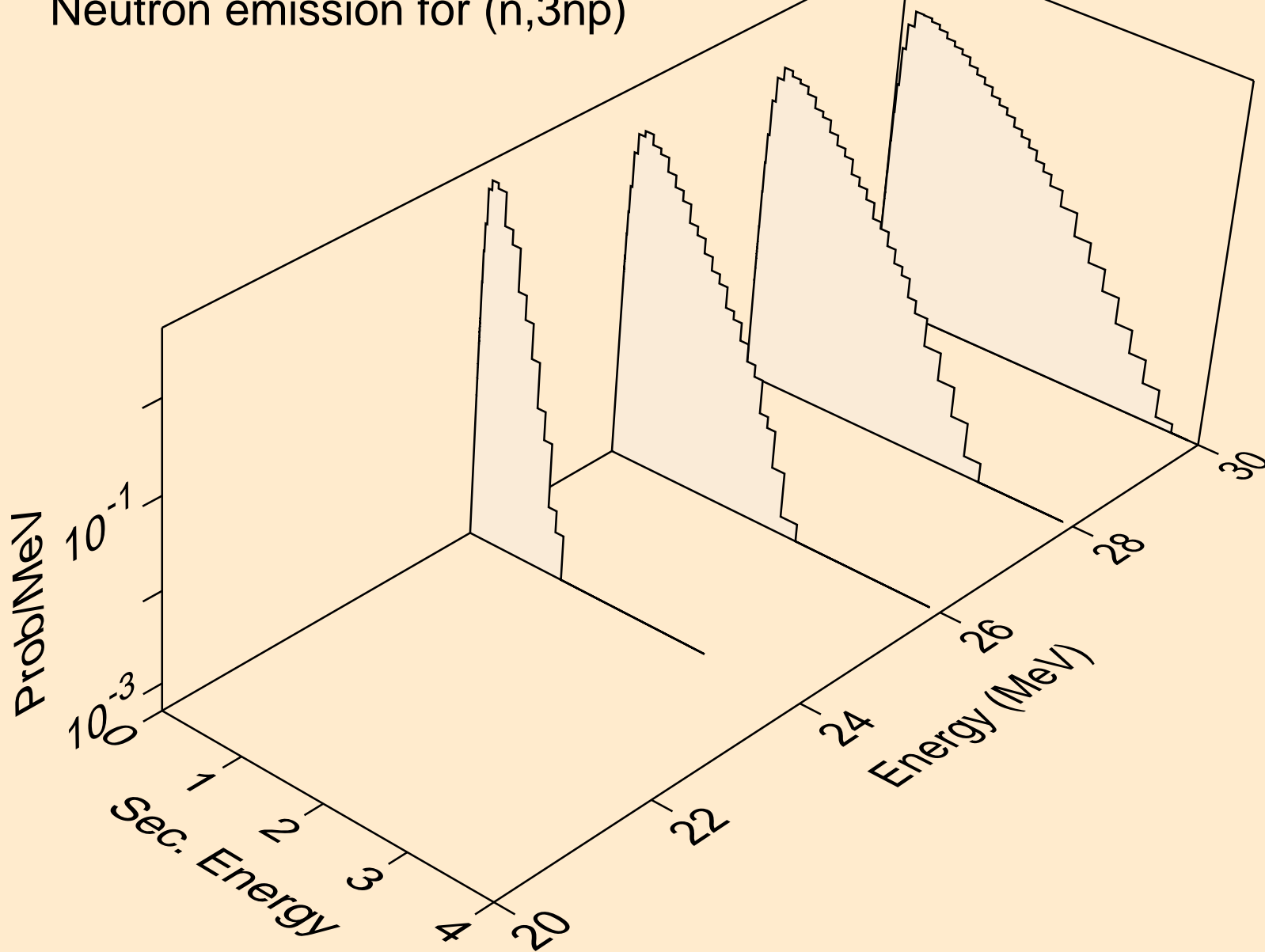



RA207 NEUTRON ACER TENDL-2023 LIBRARY; T=0.K  
Neutron emission for (n,n2p)

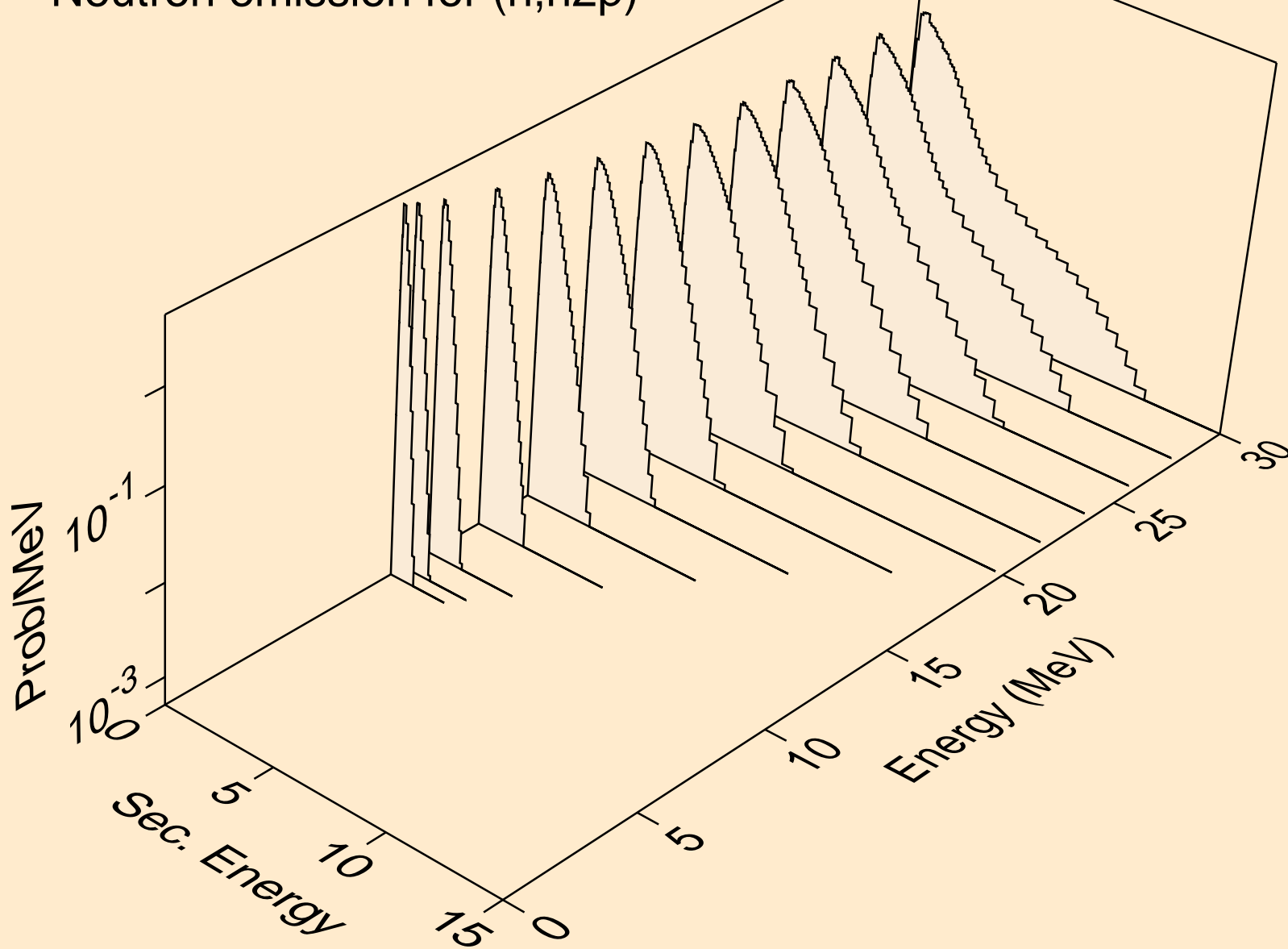

RA207 NEUTRON ACER TENDL-2023 LIBRARY; T=0.K  
Neutron emission for (n,npa)

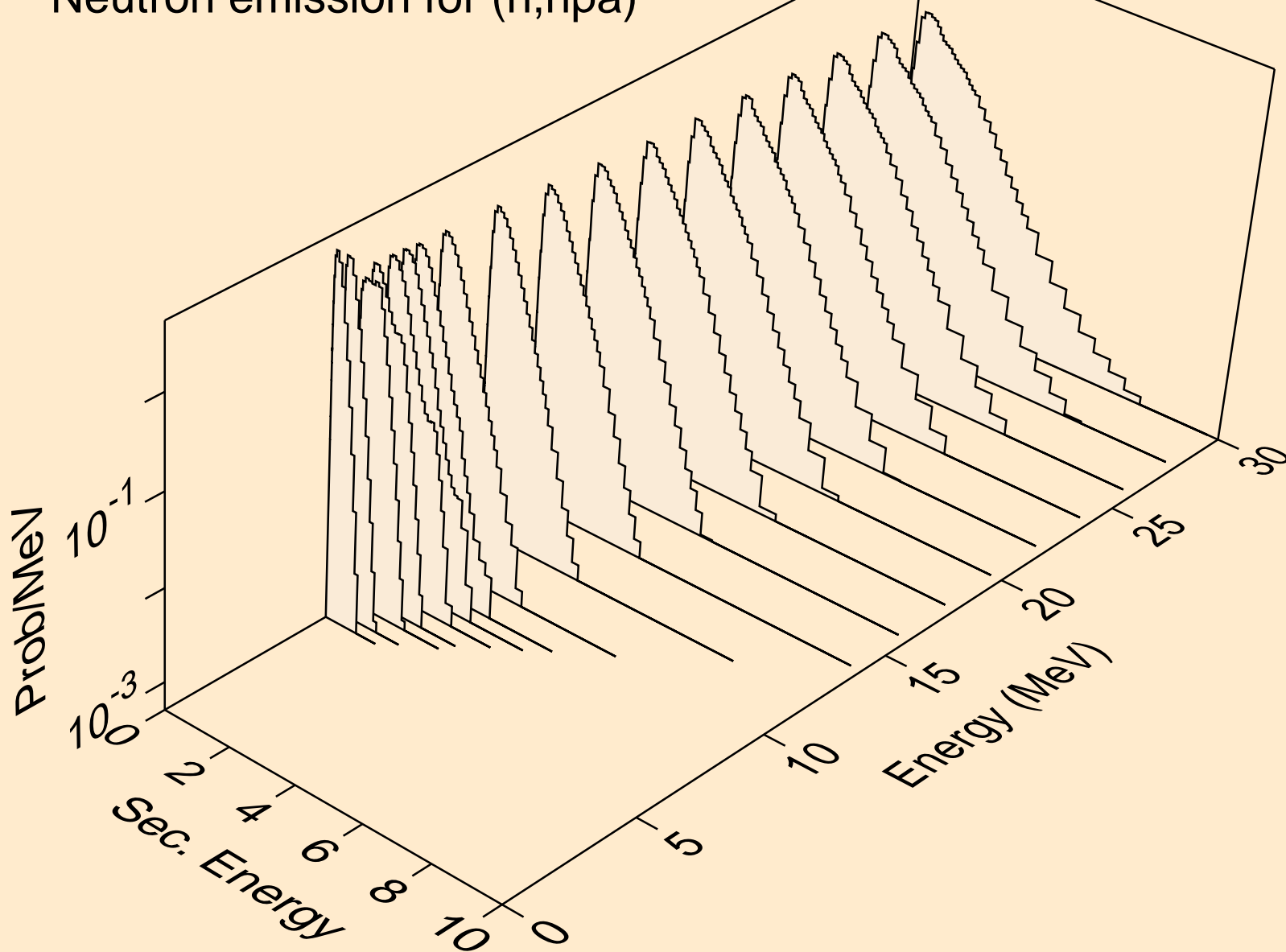

RA207 NEUTRON ACER TENDL-2023 LIBRARY; T=0.K  
Neutron emission for (n,n\*c)

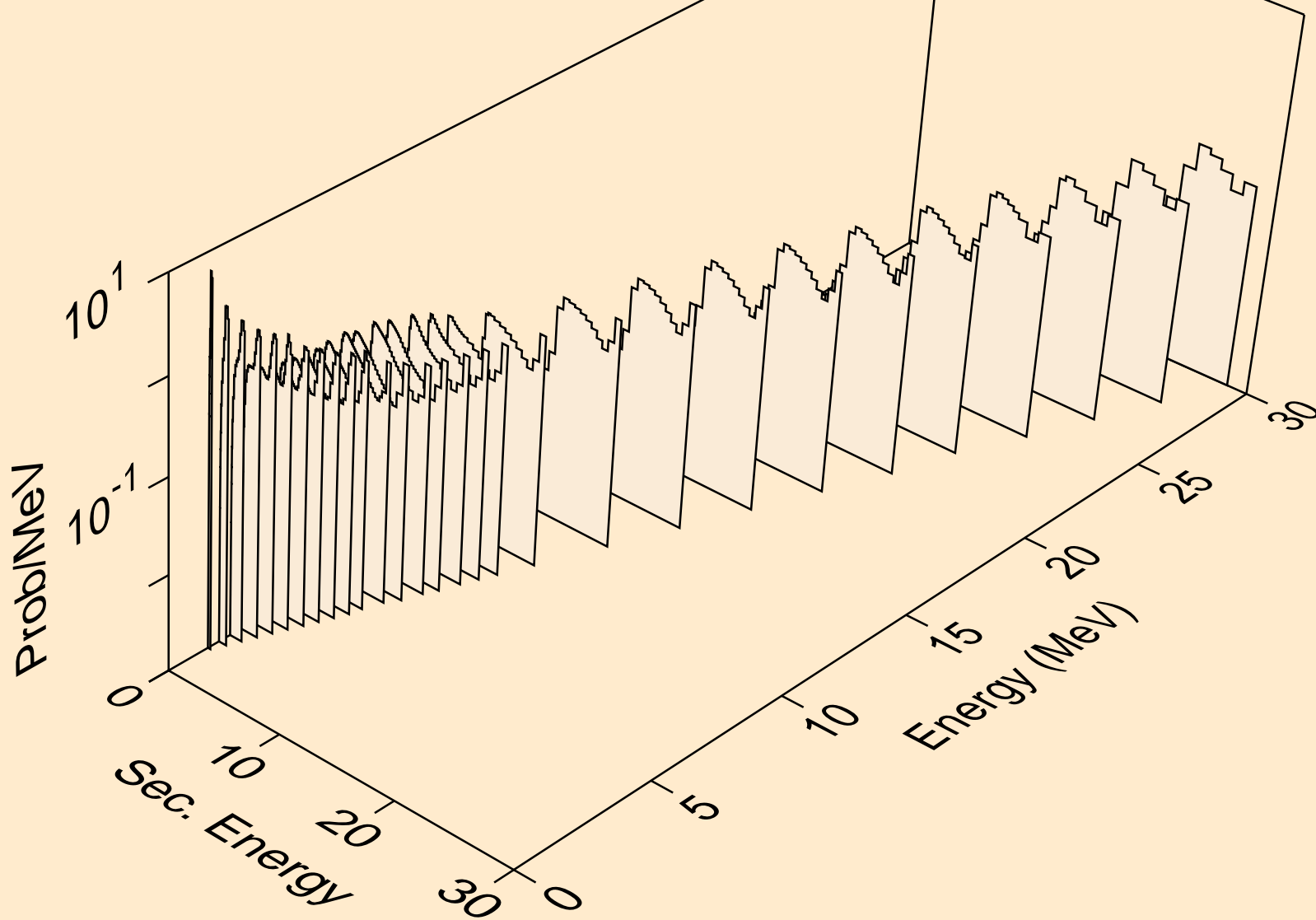

RA207 NEUTRON ACER TENDL-2023 LIBRARY; T=0.K  
Photon emission for (n,x)

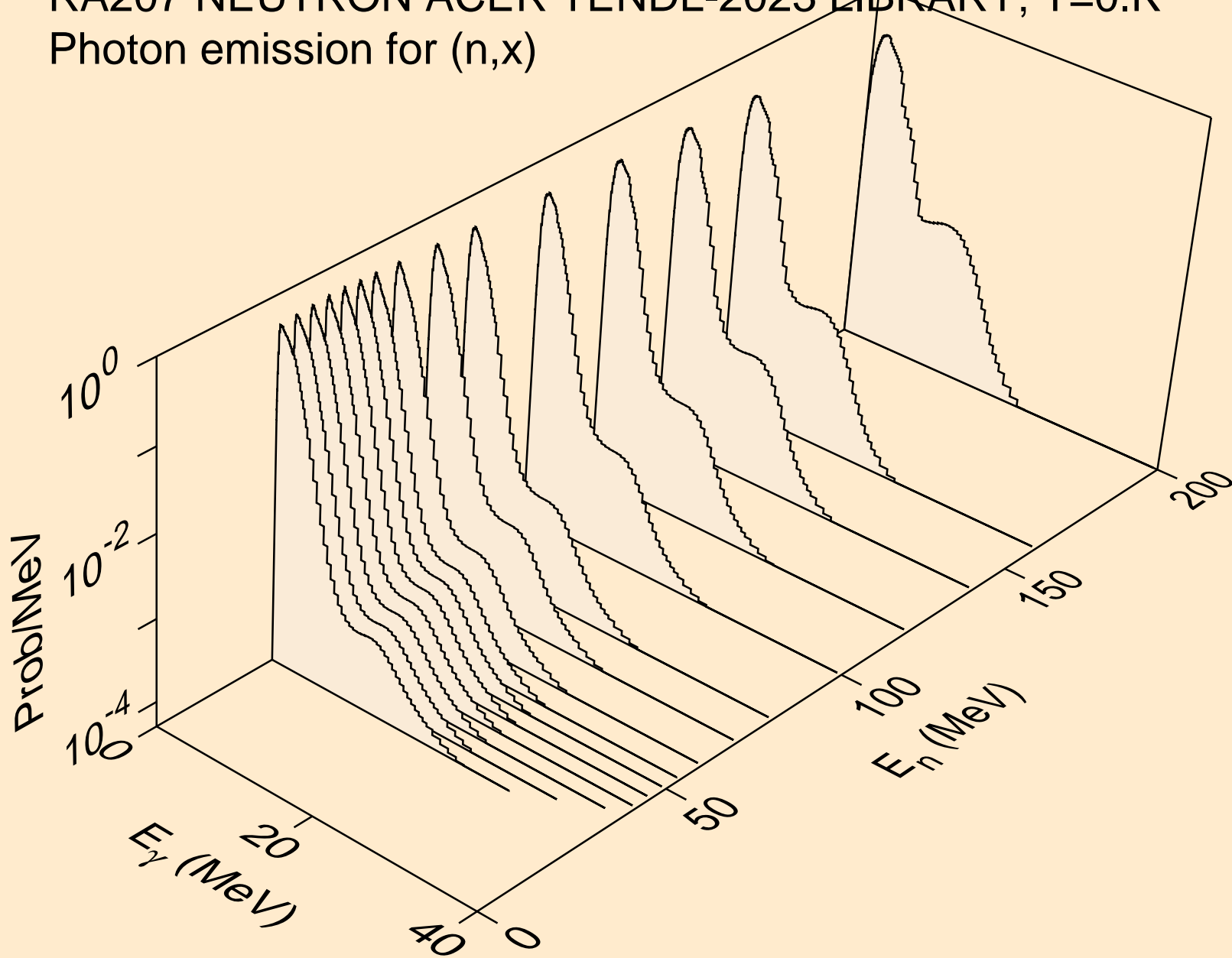

RA207 NEUTRON ACER TENDL-2023 LIBRARY; T=0.K  
Photon emission for (n,2nd)

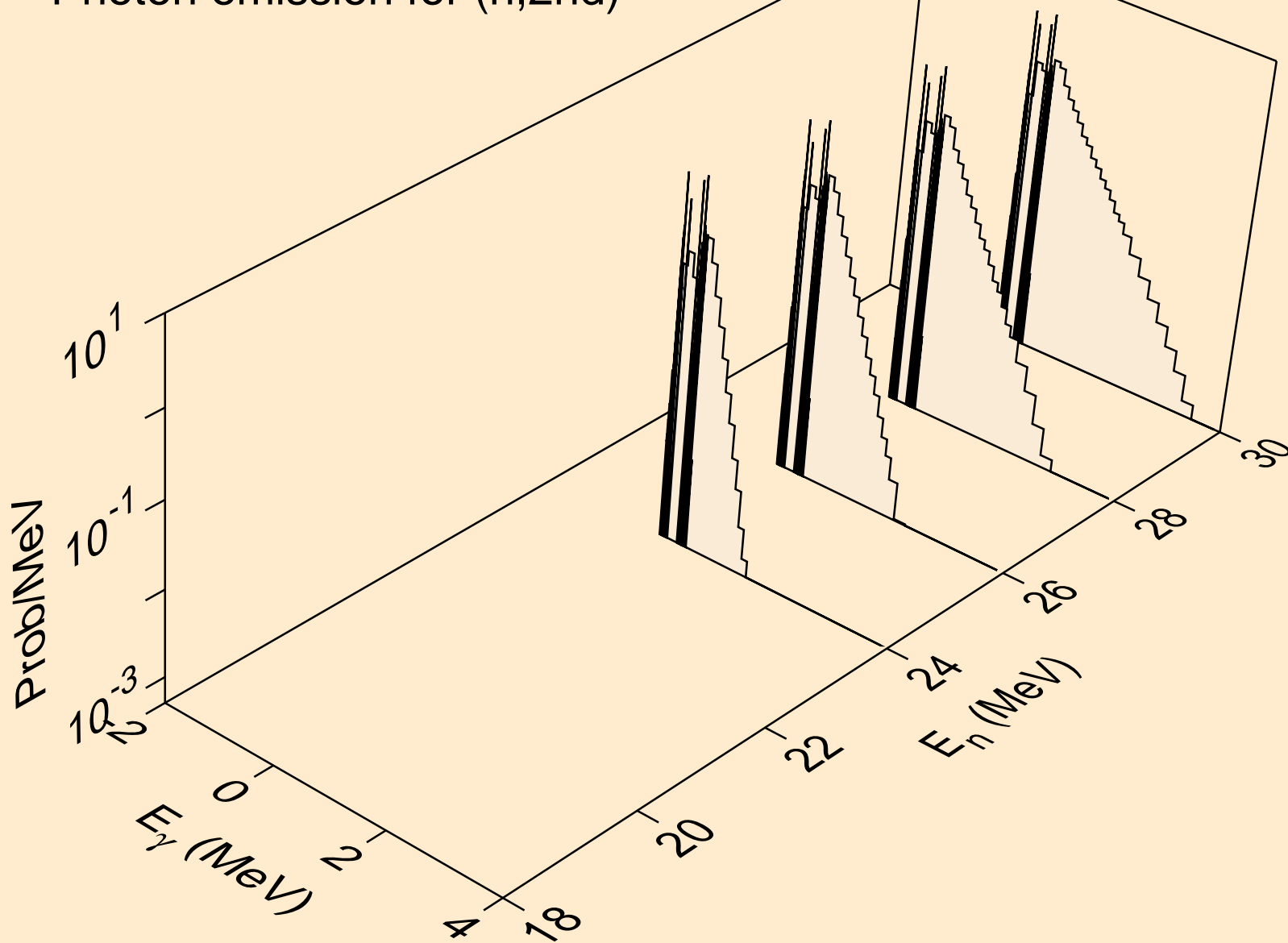

RA207 NEUTRON ACER TENDL-2023 LIBRARY; T=0.K  
Photon emission for (n,2n)

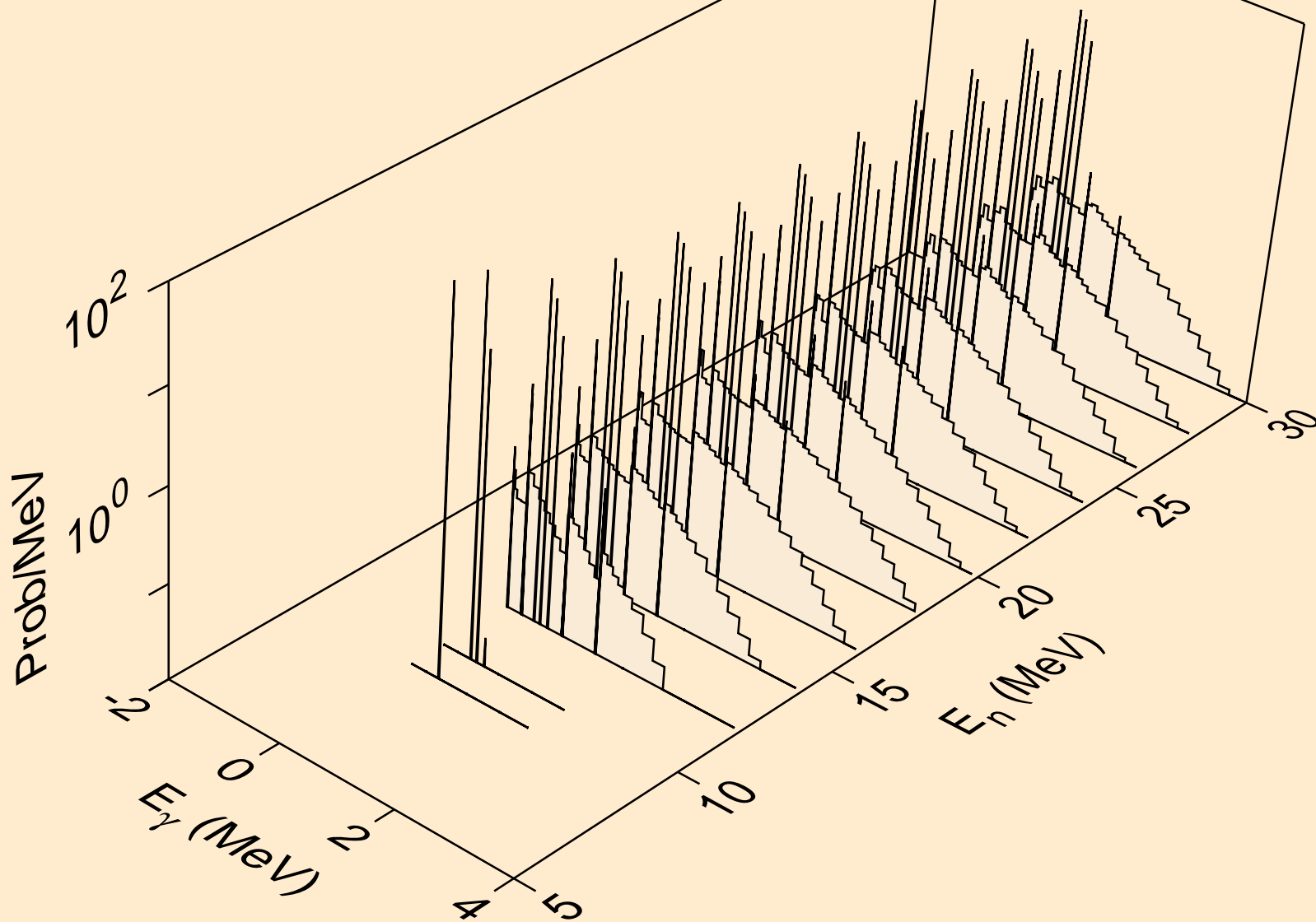

RA207 NEUTRON ACER TENDL-2023 LIBRARY; T=0.K  
Photon emission for (n,3n)

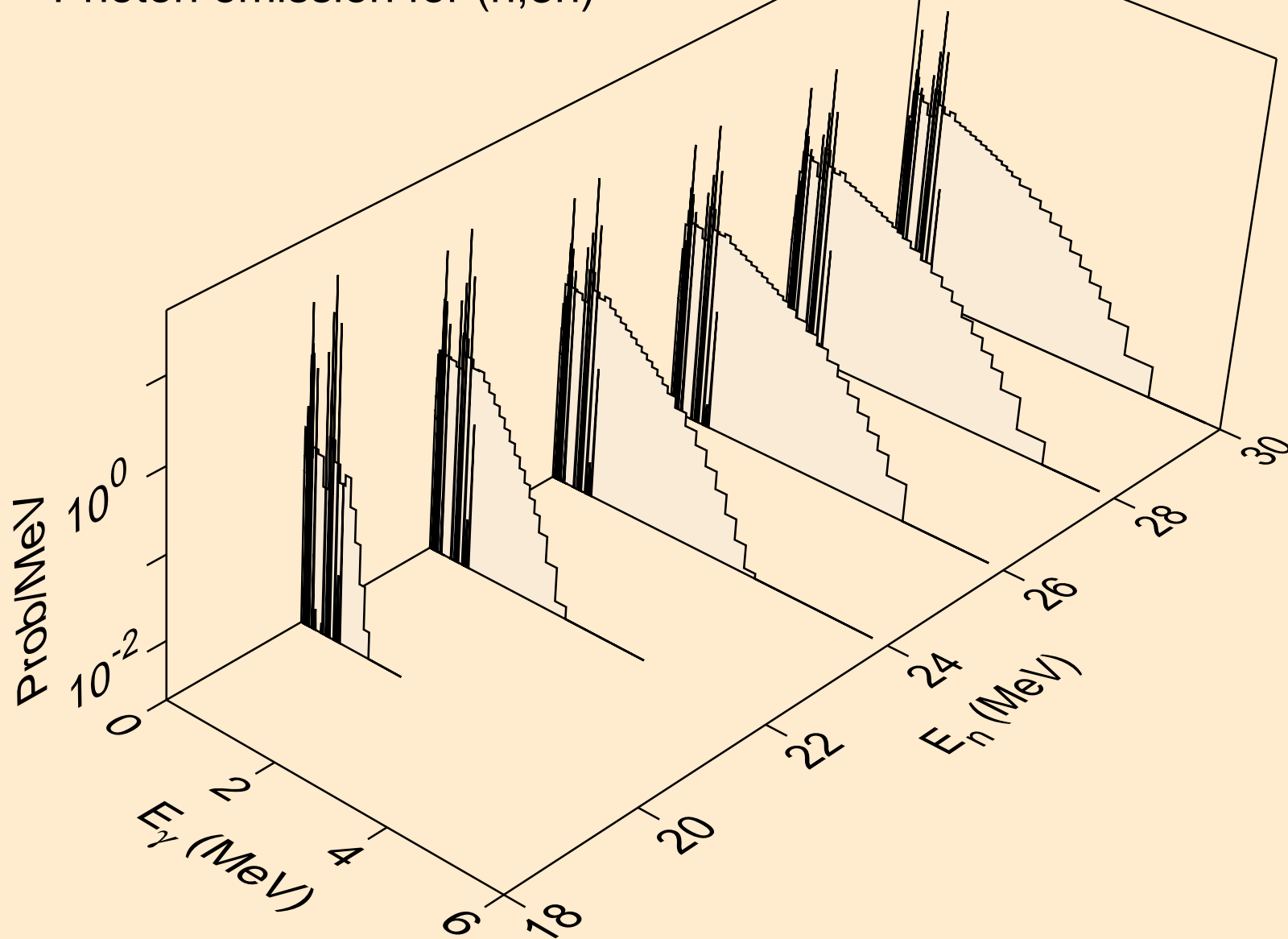

RA207 NEUTRON ACER TENDL-2023 LIBRARY; T=0.K  
Photon emission for (n,n\*)a

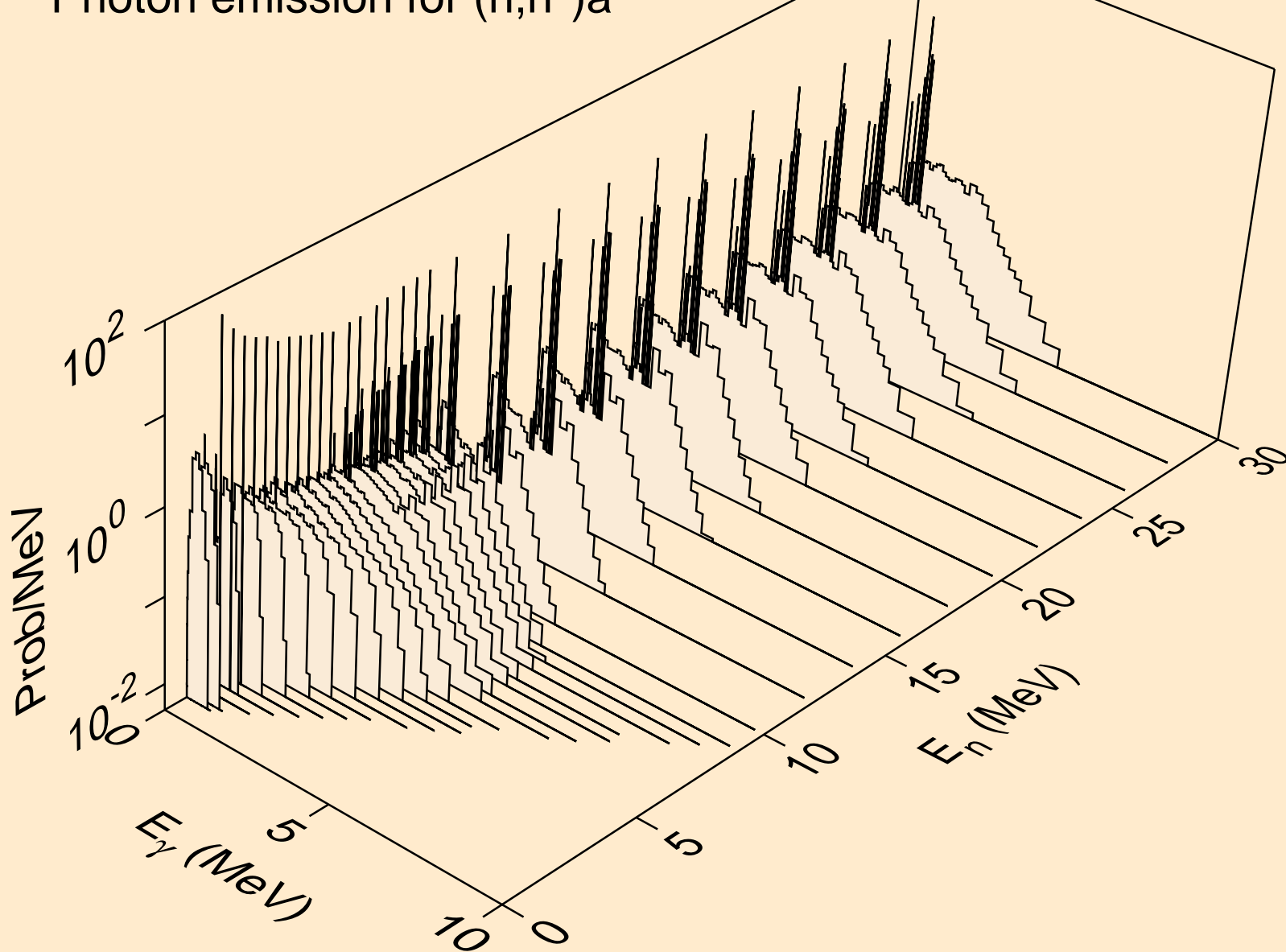



RA207 NEUTRON ACER TENDL-2023 LIBRARY; T=0.K  
Photon emission for (n,2n)a

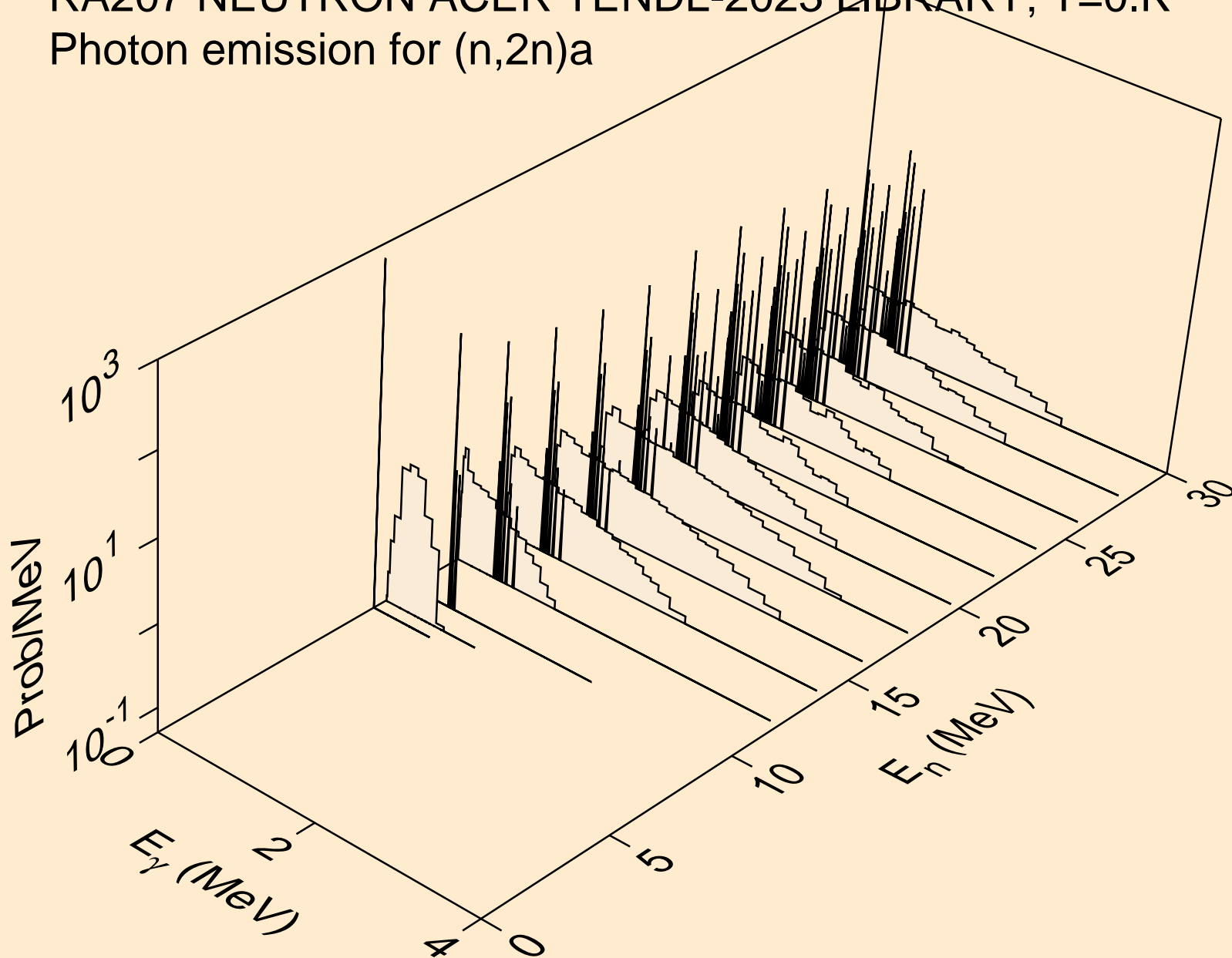

RA207 NEUTRON ACER TENDL-2023 LIBRARY; T=0.K  
Photon emission for (n,3n)a

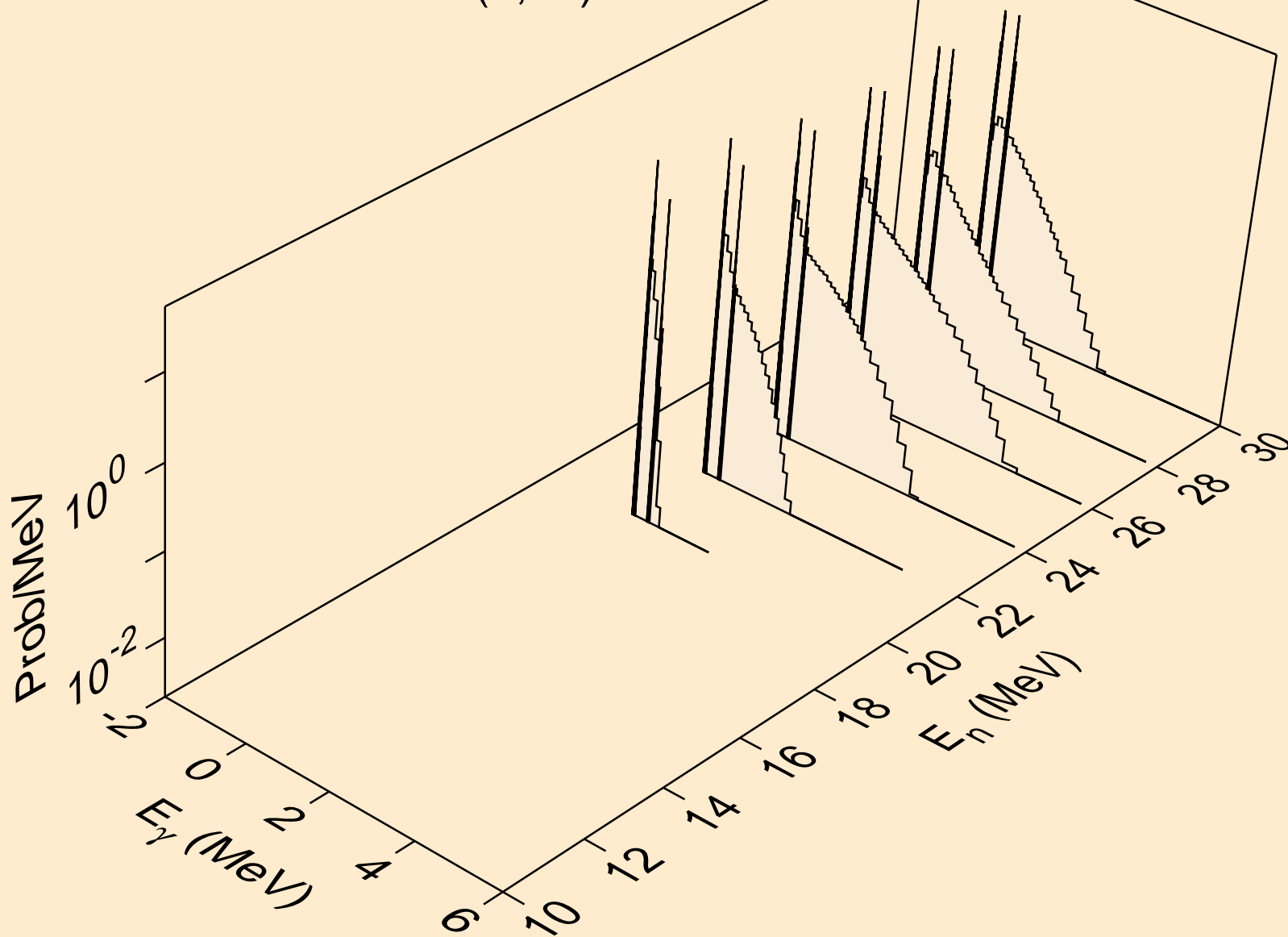

RA207 NEUTRON ACER TENDL-2023 LIBRARY; T=0.K  
Photon emission for (n,n\*)p

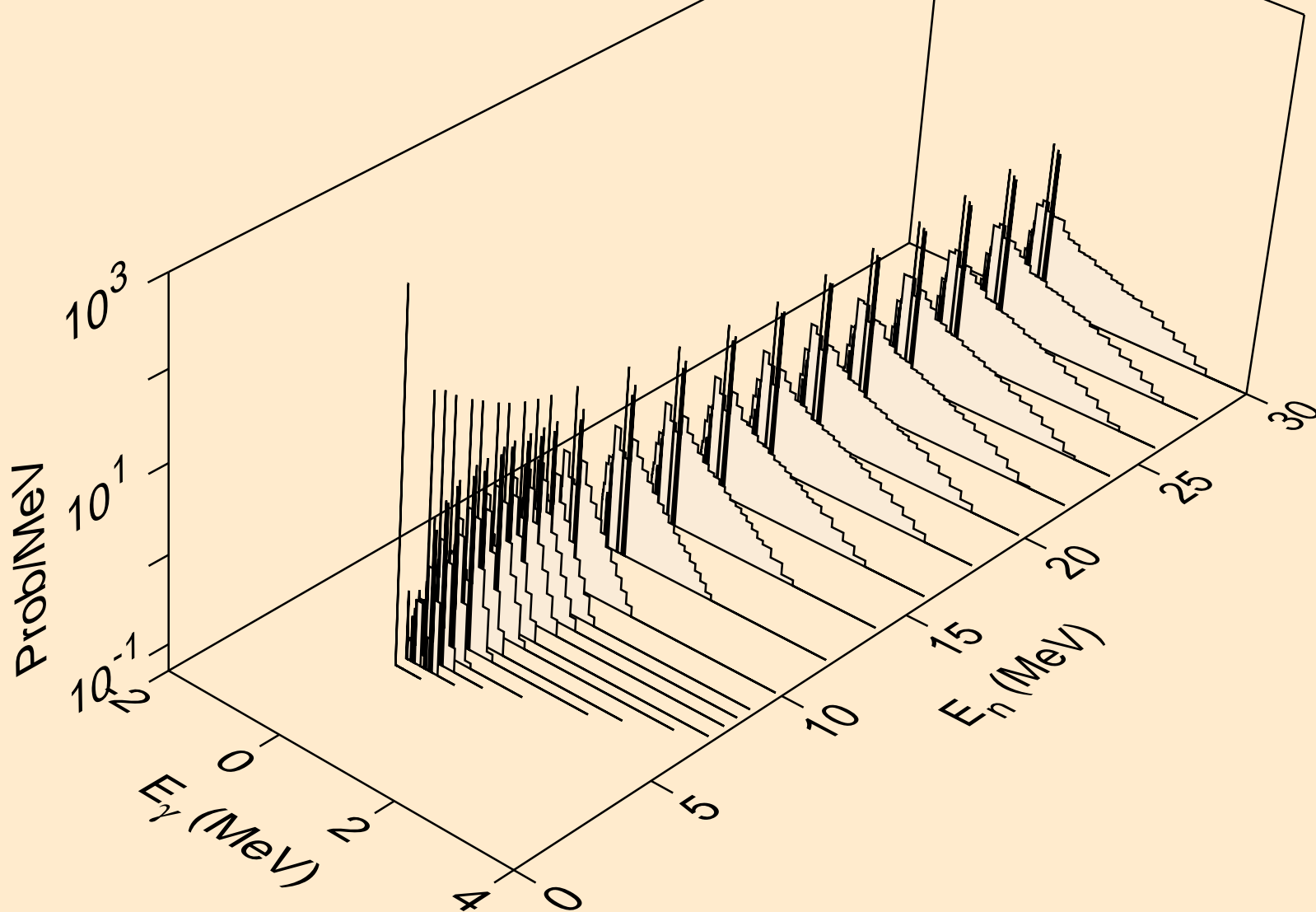

RA207 NEUTRON ACER TENDL-2023 LIBRARY; T=0.K  
Photon emission for (n,n\*)2a

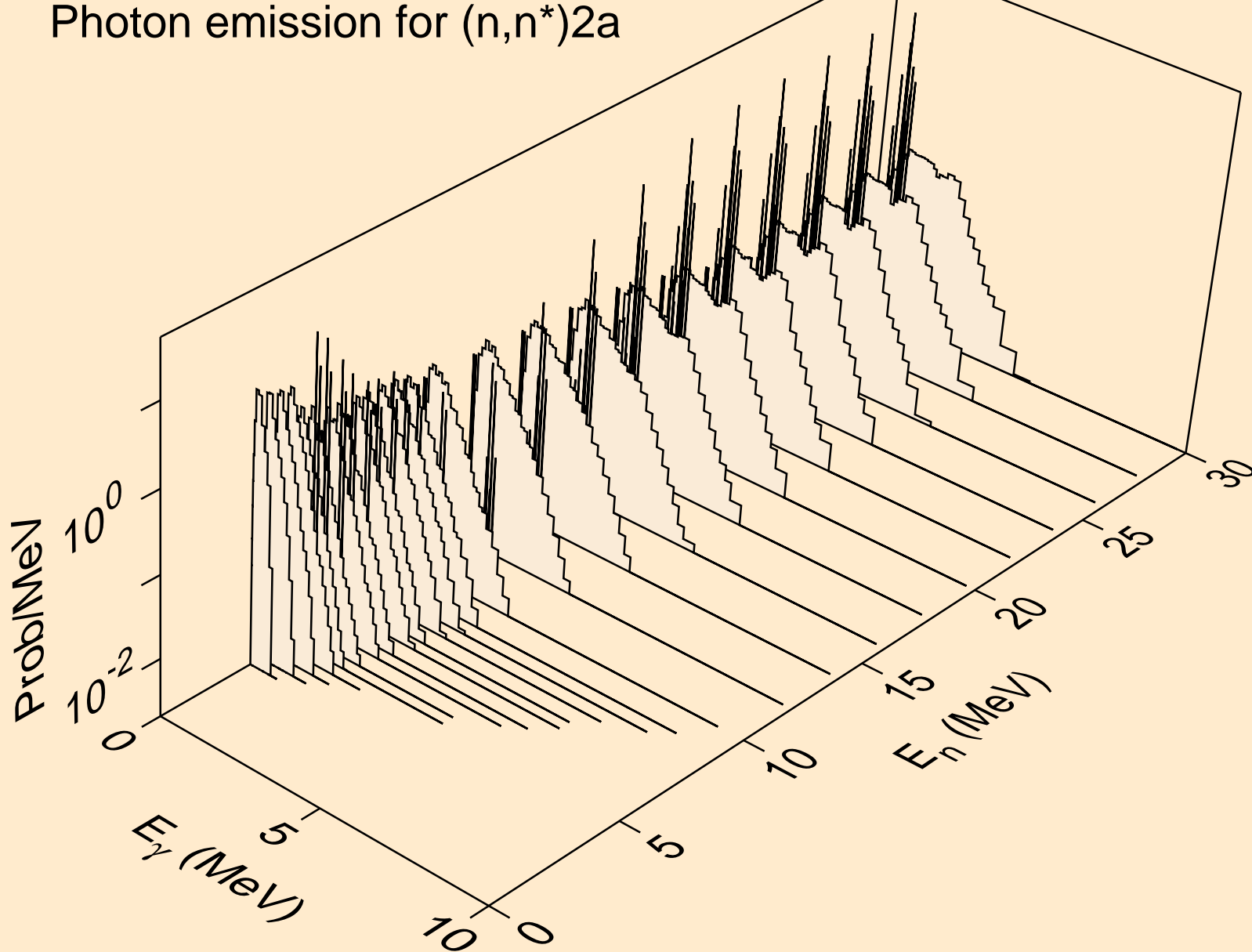

RA207 NEUTRON ACER TENDL-2023 LIBRARY; T=0.K  
Photon emission for (n,2n)2a

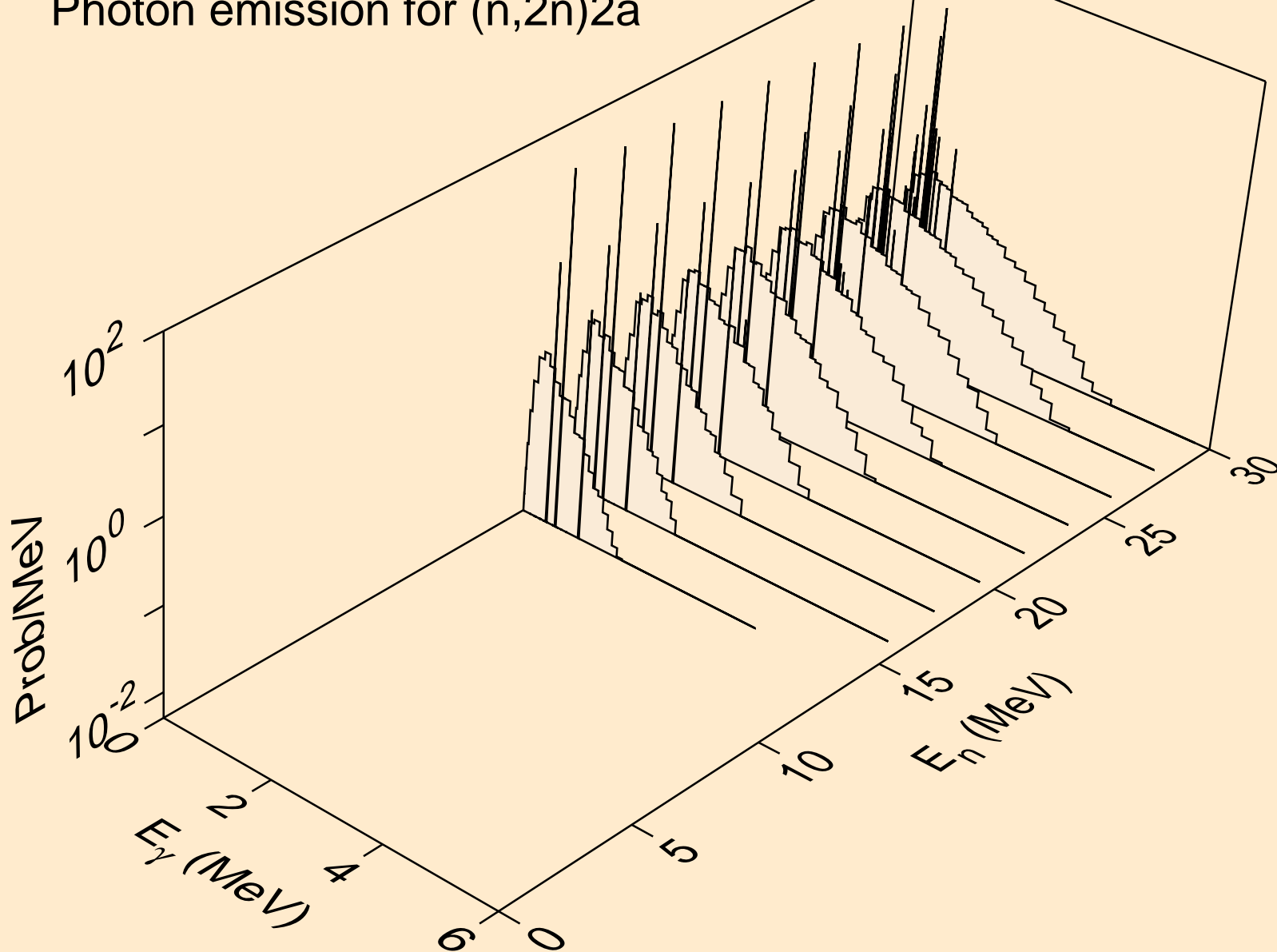

RA207 NEUTRON ACER TENDL-2023 LIBRARY; T=0.K  
Photon emission for (n,n\*)d

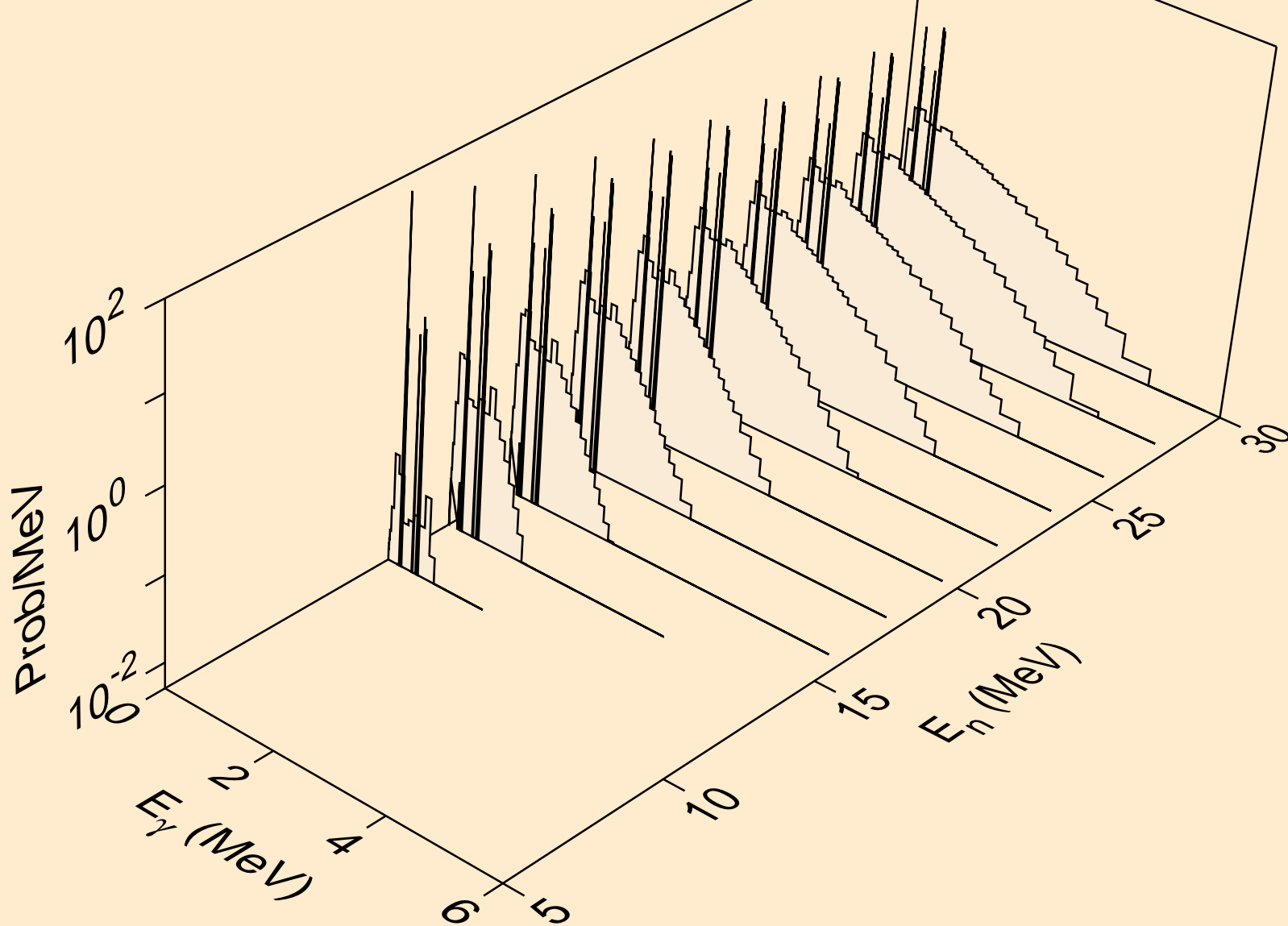

RA207 NEUTRON ACER TENDL-2023 LIBRARY; T=0.K  
Photon emission for (n,n\*)t

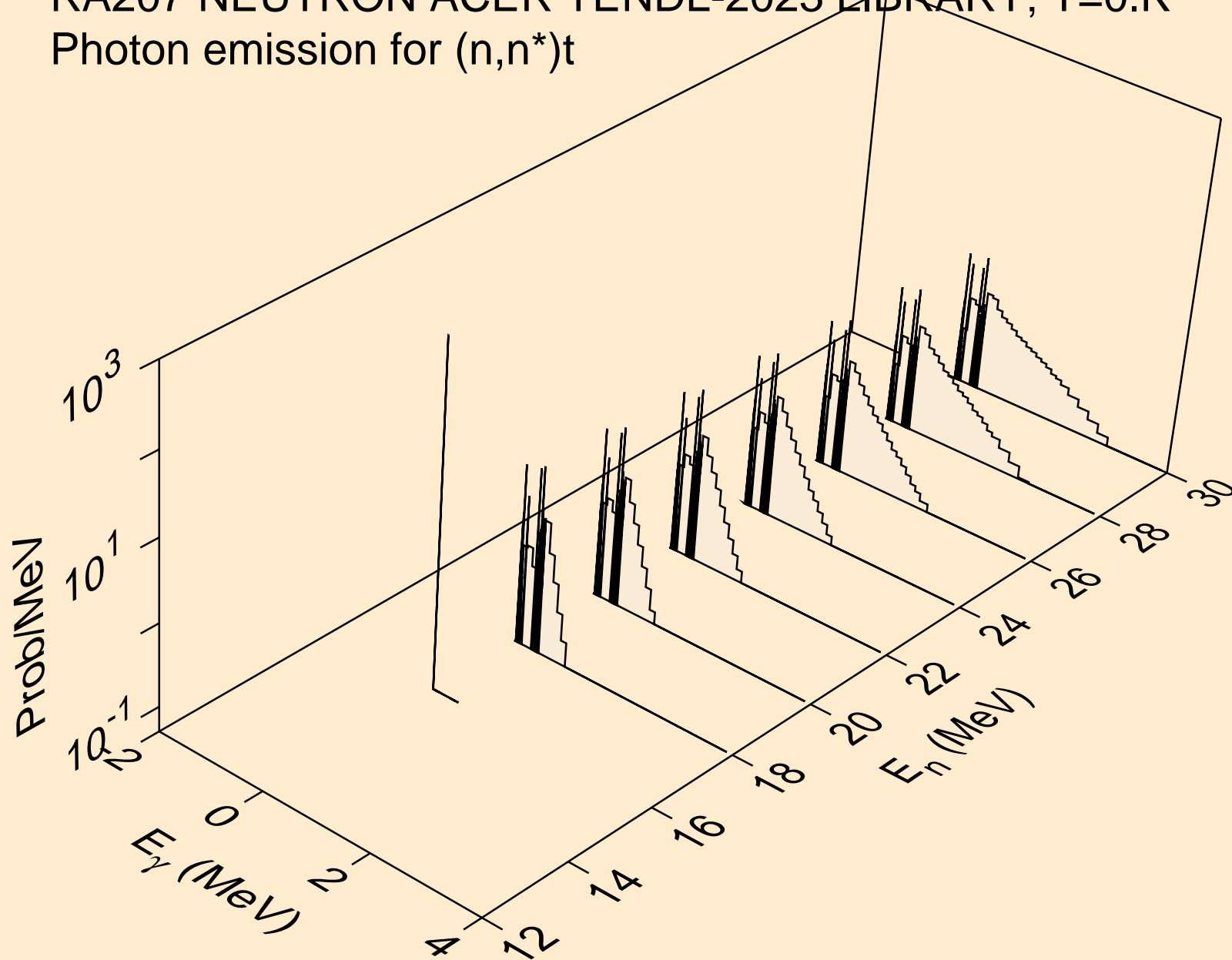

RA207 NEUTRON ACER TENDL-2023 LIBRARY; T=0.K  
Photon emission for (n,n\*)he3

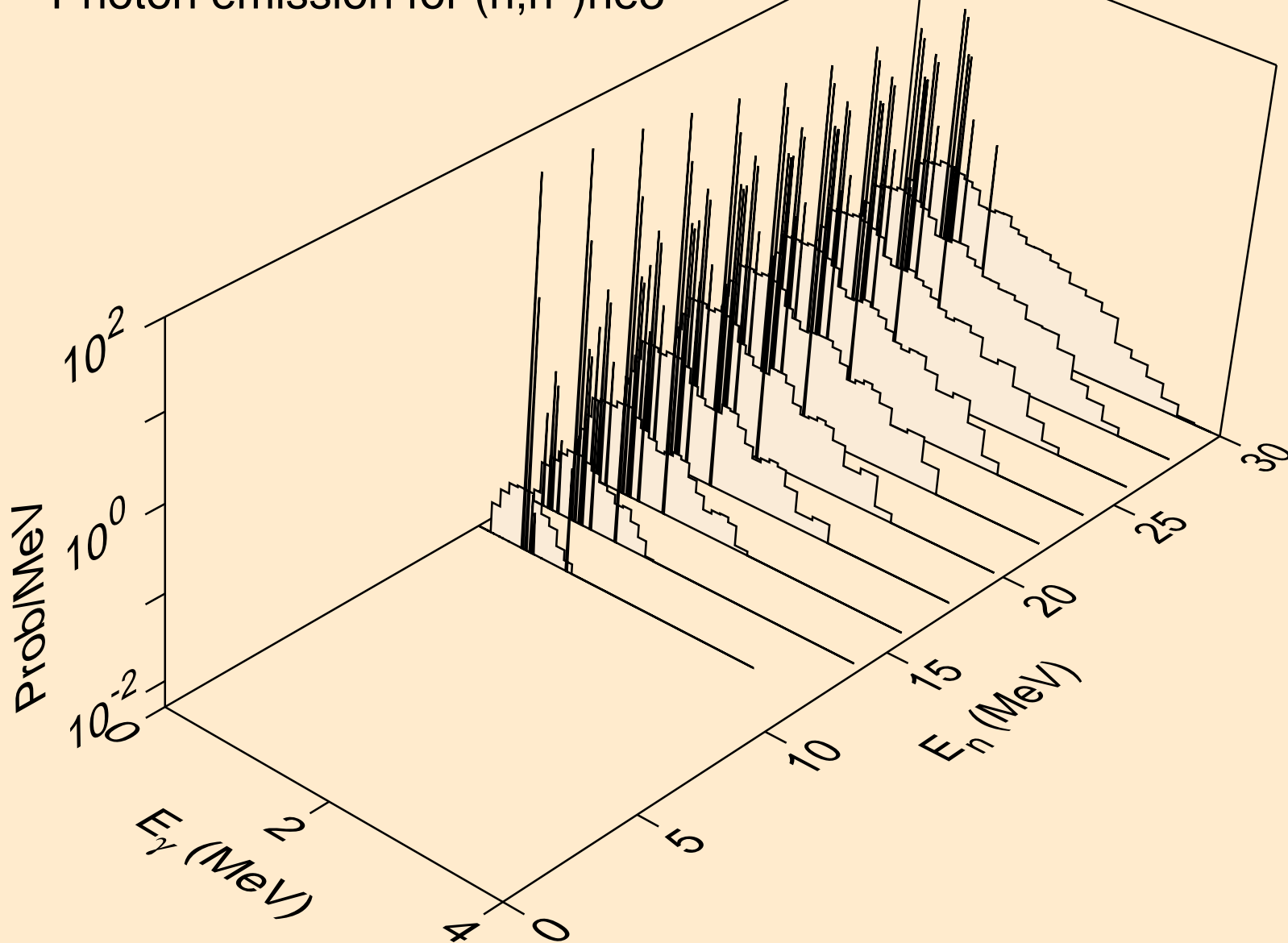



RA207 NEUTRON ACER TENDL-2023 LIBRARY; T=0.K  
Photon emission for (n,4n)

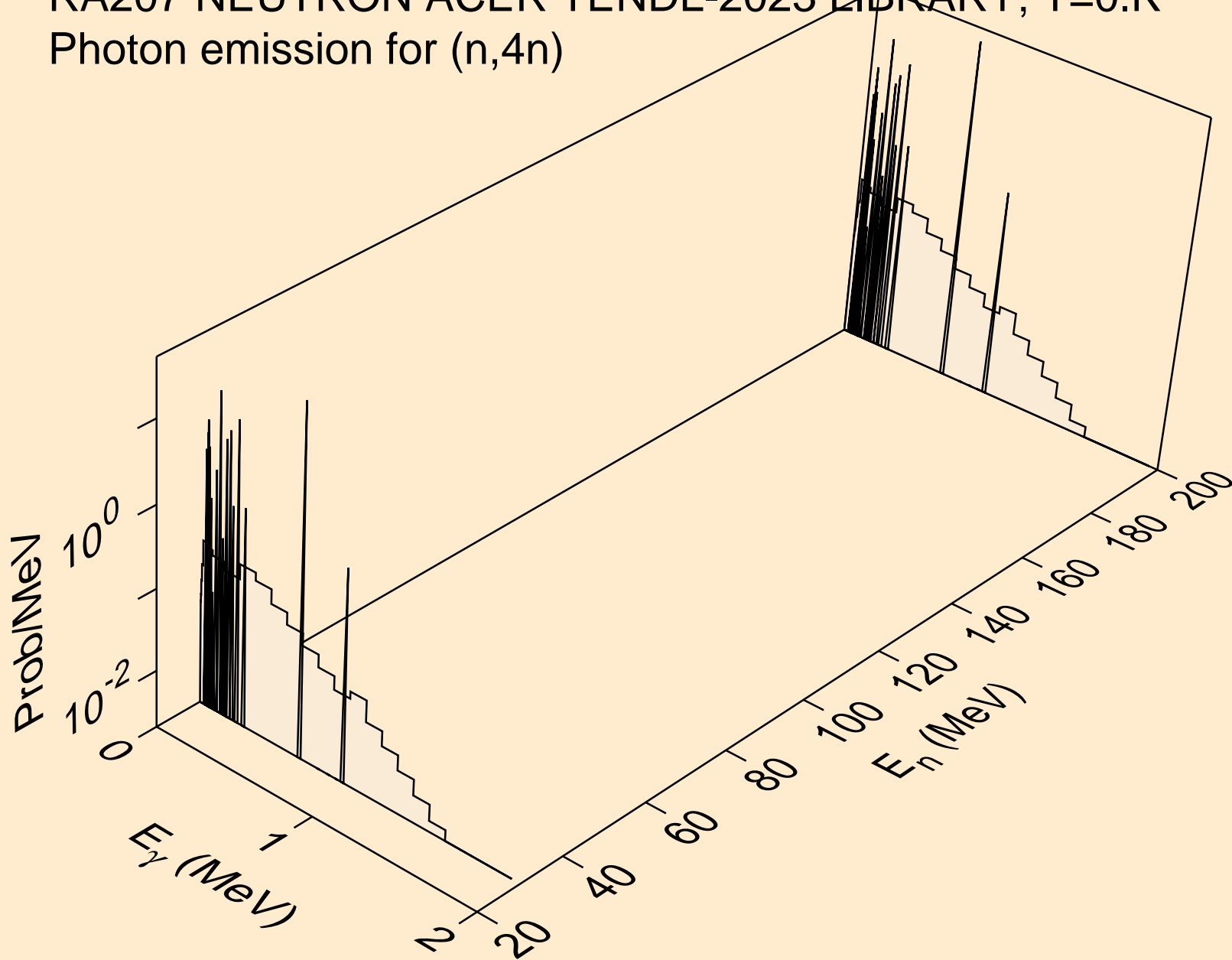

RA207 NEUTRON ACER TENDL-2023 LIBRARY; T=0.K  
Photon emission for (n,2np)

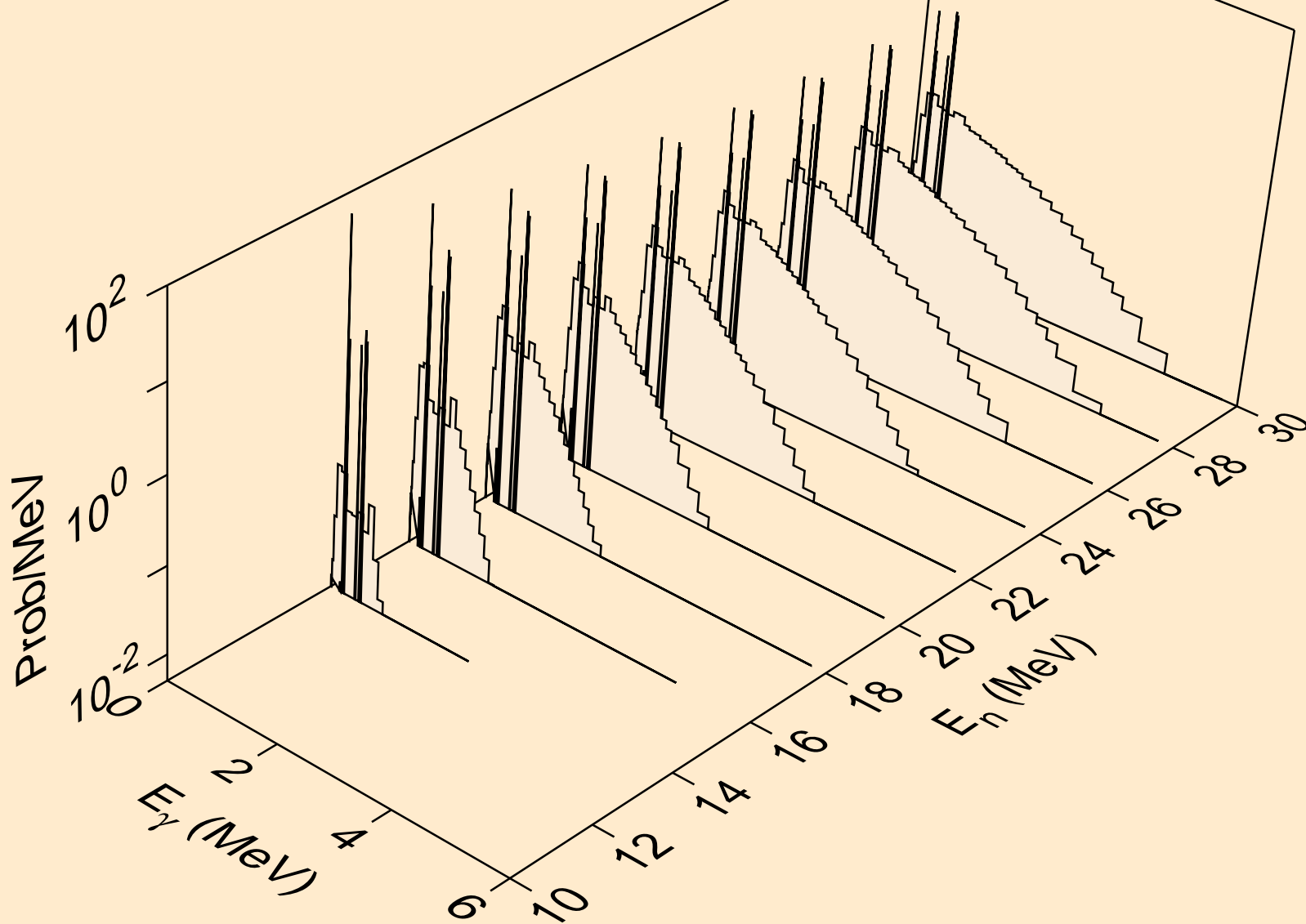

RA207 NEUTRON ACER TENDL-2023 LIBRARY; T=0.K  
Photon emission for (n,3np)

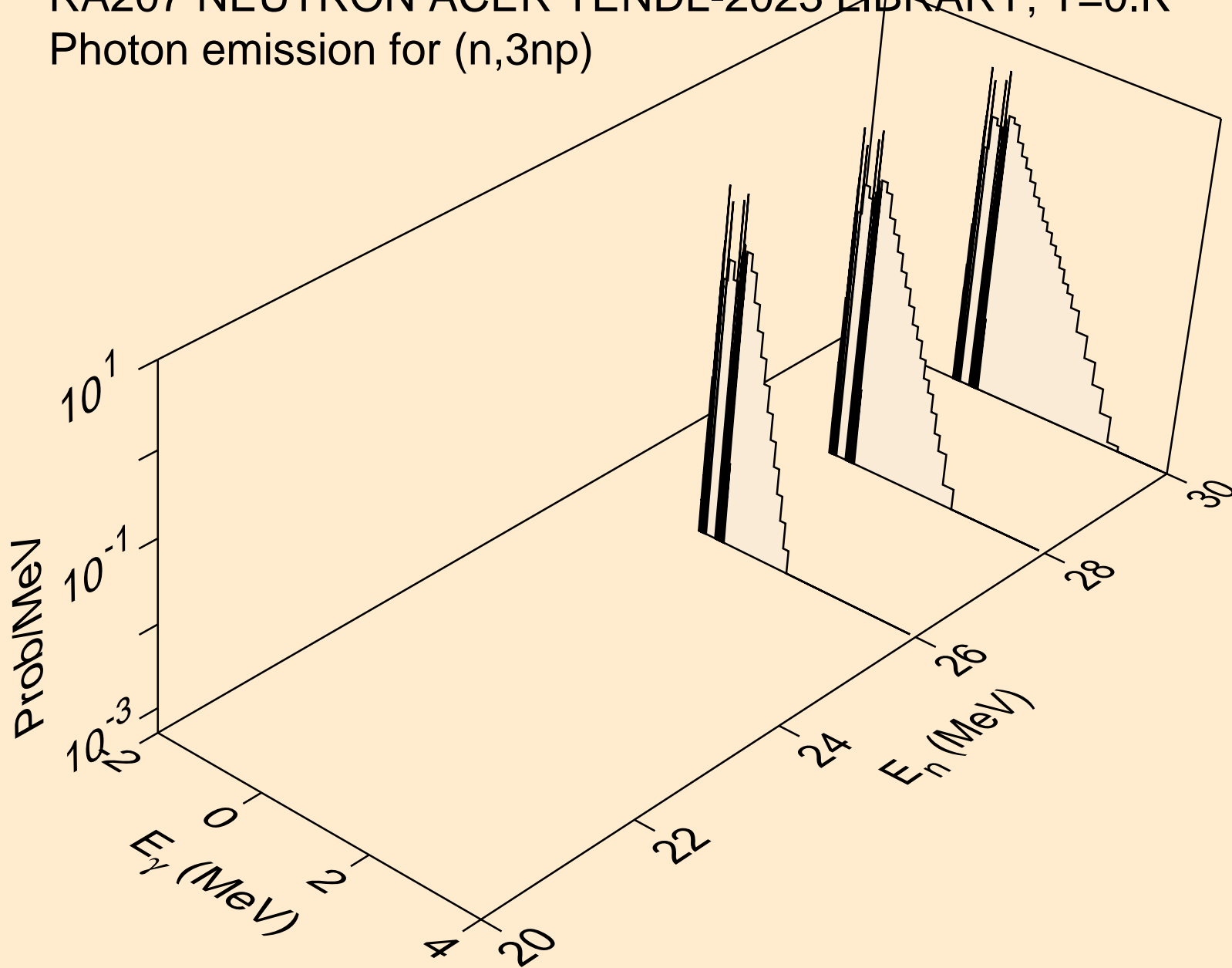

RA207 NEUTRON ACER TENDL-2023 LIBRARY; T=0.K  
Photon emission for (n,n2p)

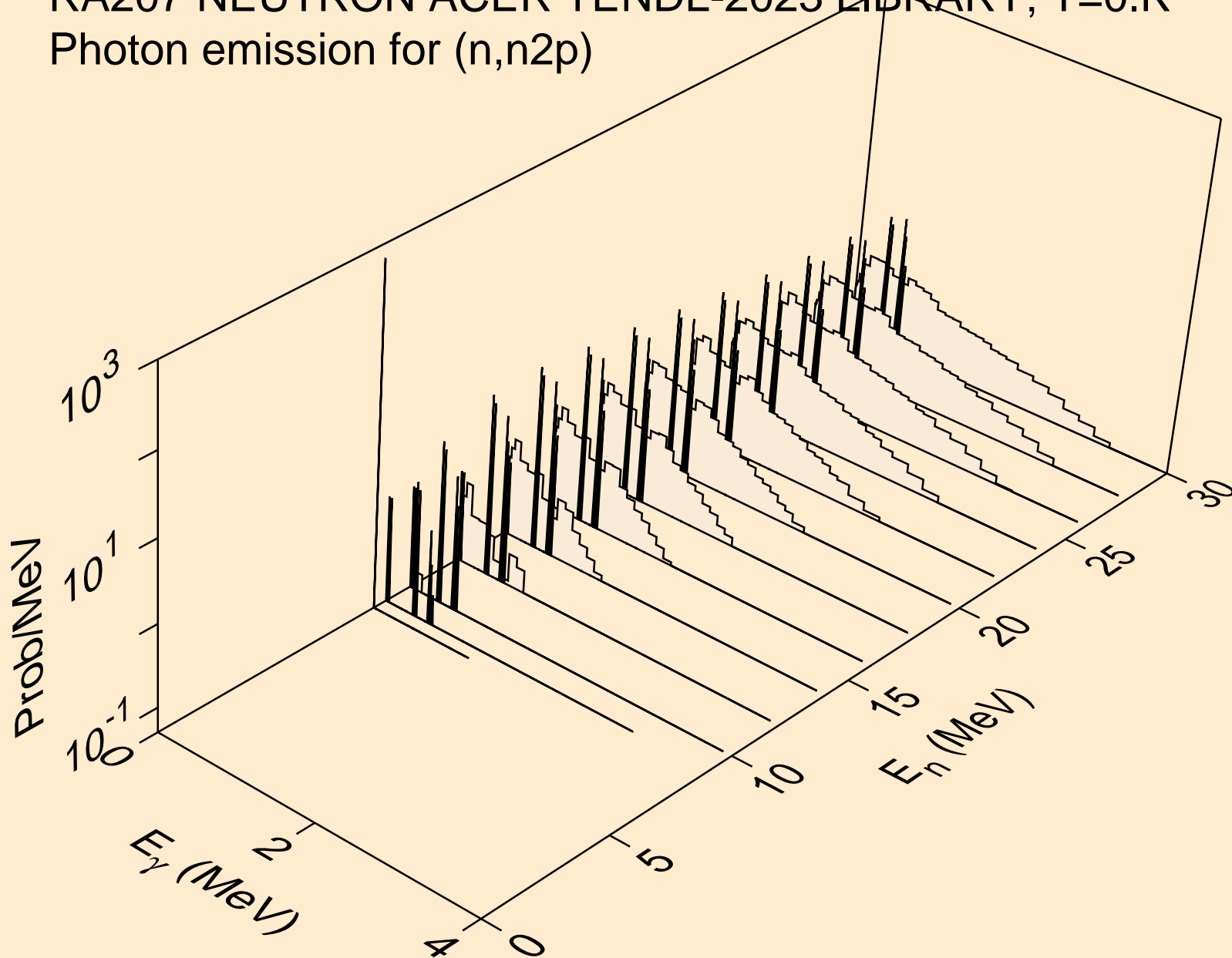

RA207 NEUTRON ACER TENDL-2023 LIBRARY; T=0.K  
Photon emission for (n,npa)

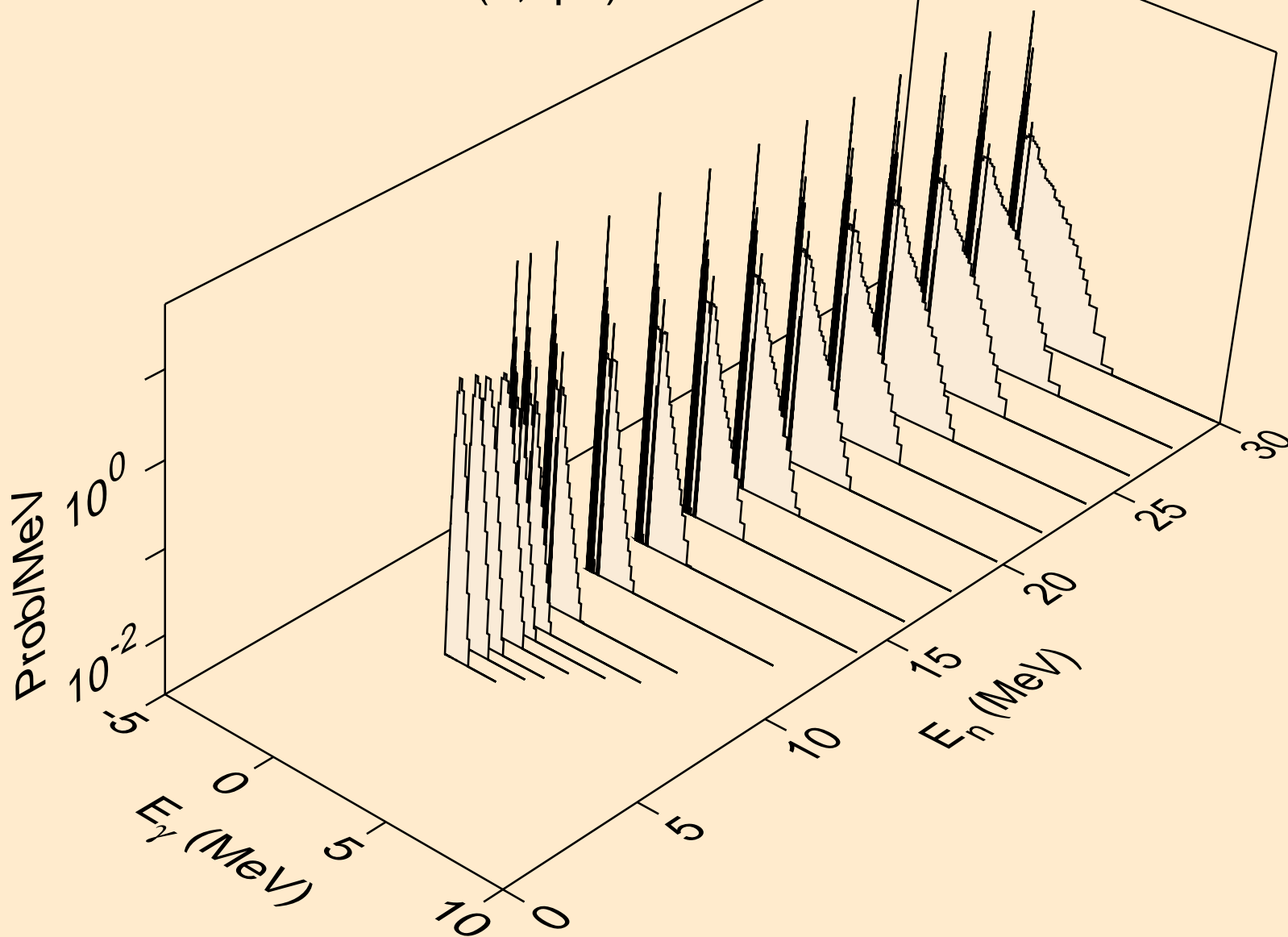

RA207 NEUTRON ACER TENDL-2023 LIBRARY; T=0.K  
Photon emission for (n,n\*c)

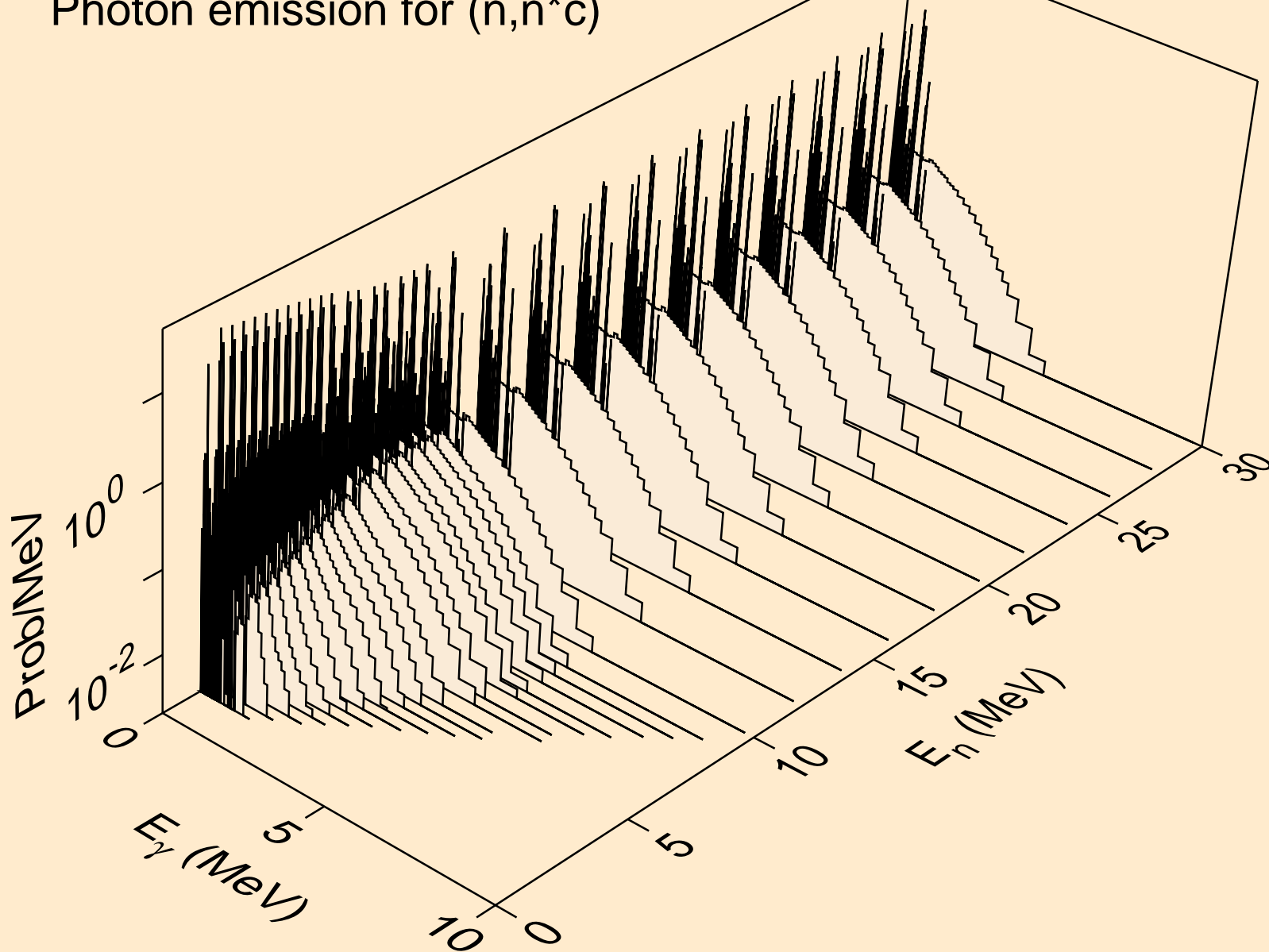

RA207 NEUTRON ACER TENDL-2023 LIBRARY; T=0.K  
Photon emission for (n,gma)

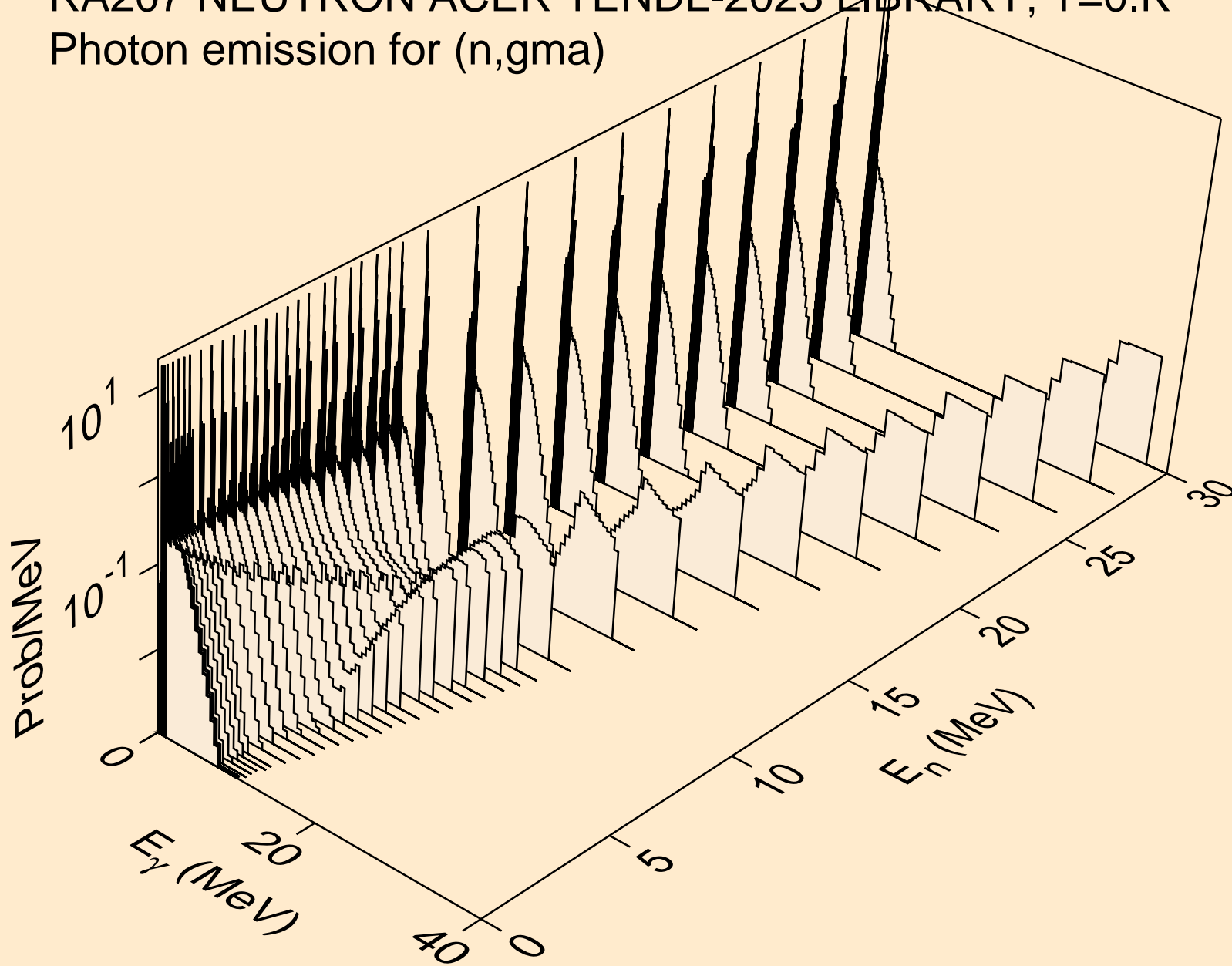

RA207 NEUTRON ACER TENDL-2023 LIBRARY; T=0.K  
Photon emission for (n,p)

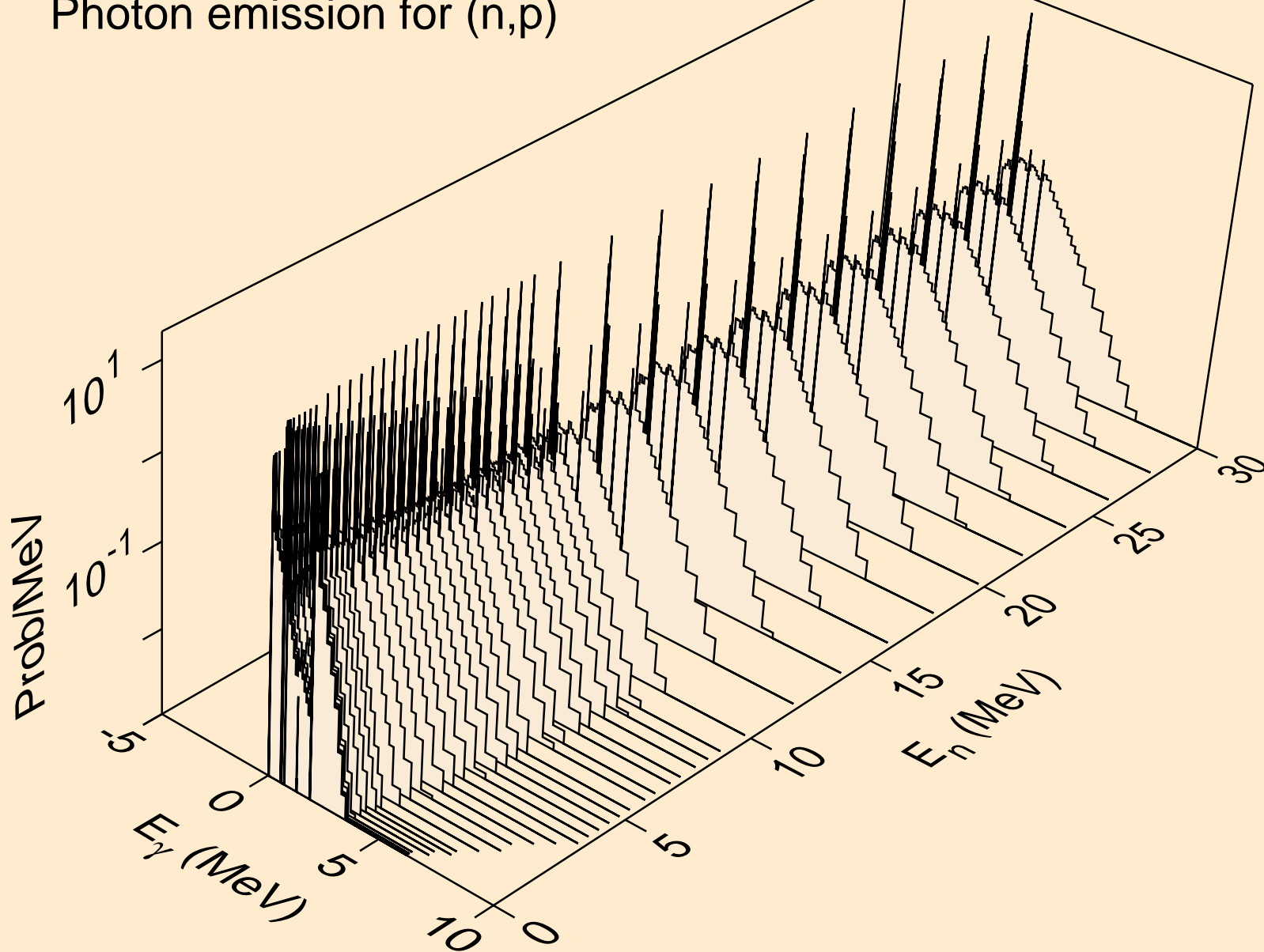



RA207 NEUTRON ACER TENDL-2023 LIBRARY; T=0.K  
Photon emission for (n,d)

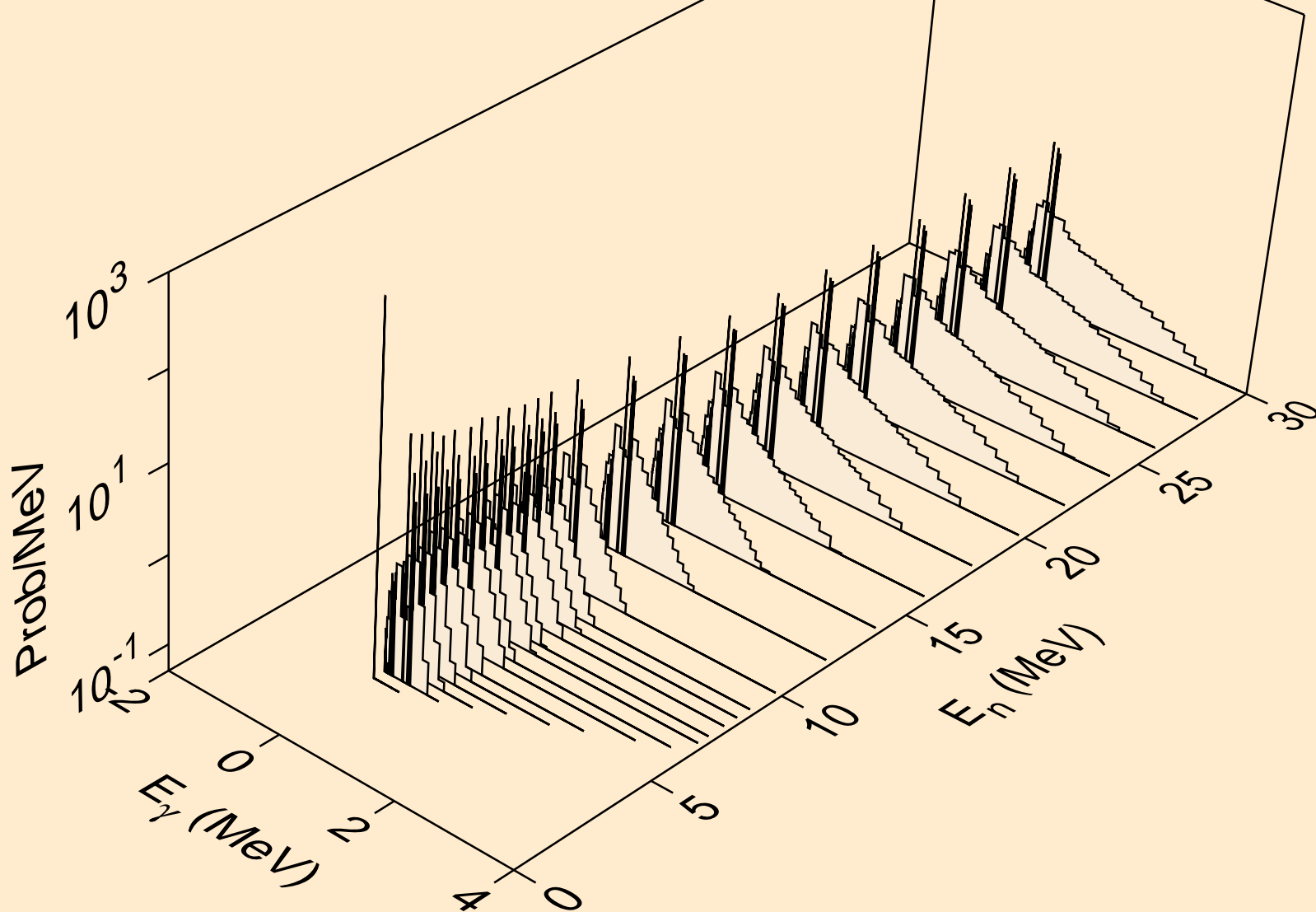

RA207 NEUTRON ACER TENDL-2023 LIBRARY; T=0.K  
Photon emission for (n,t)

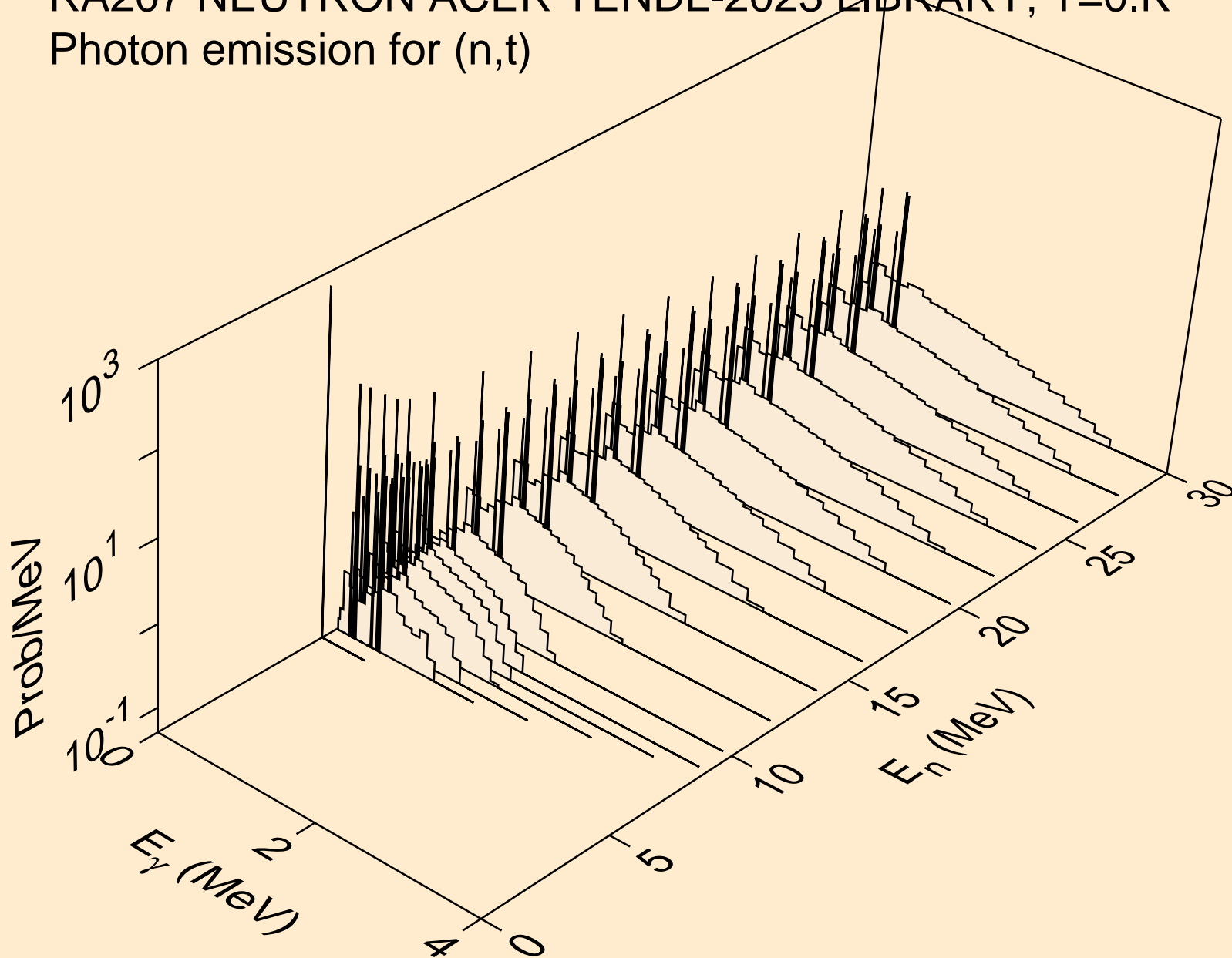

RA207 NEUTRON ACER TENDL-2023 LIBRARY; T=0.K  
Photon emission for (n,he3)

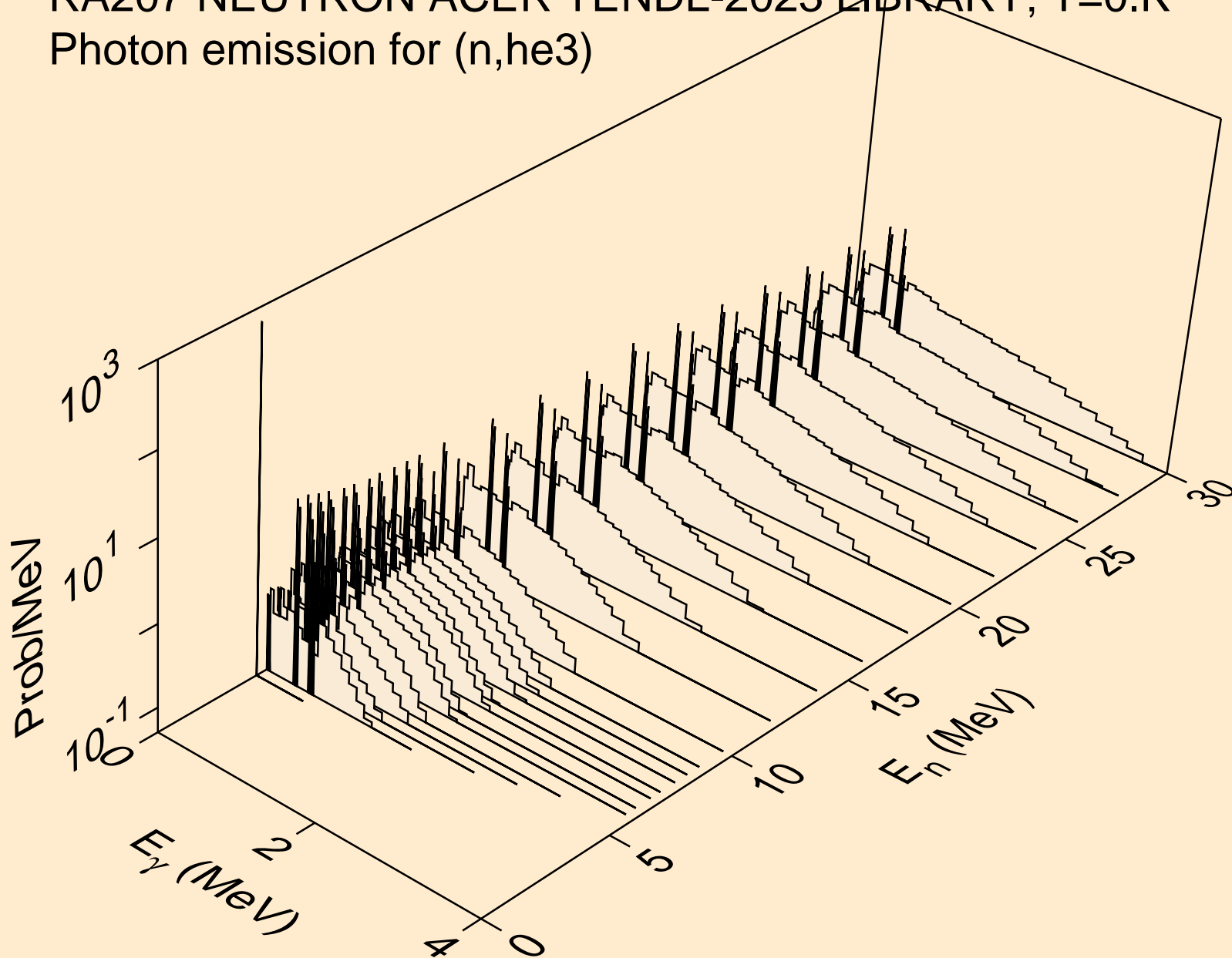

RA207 NEUTRON ACER TENDL-2023 LIBRARY; T=0.K  
Photon emission for (n,a)

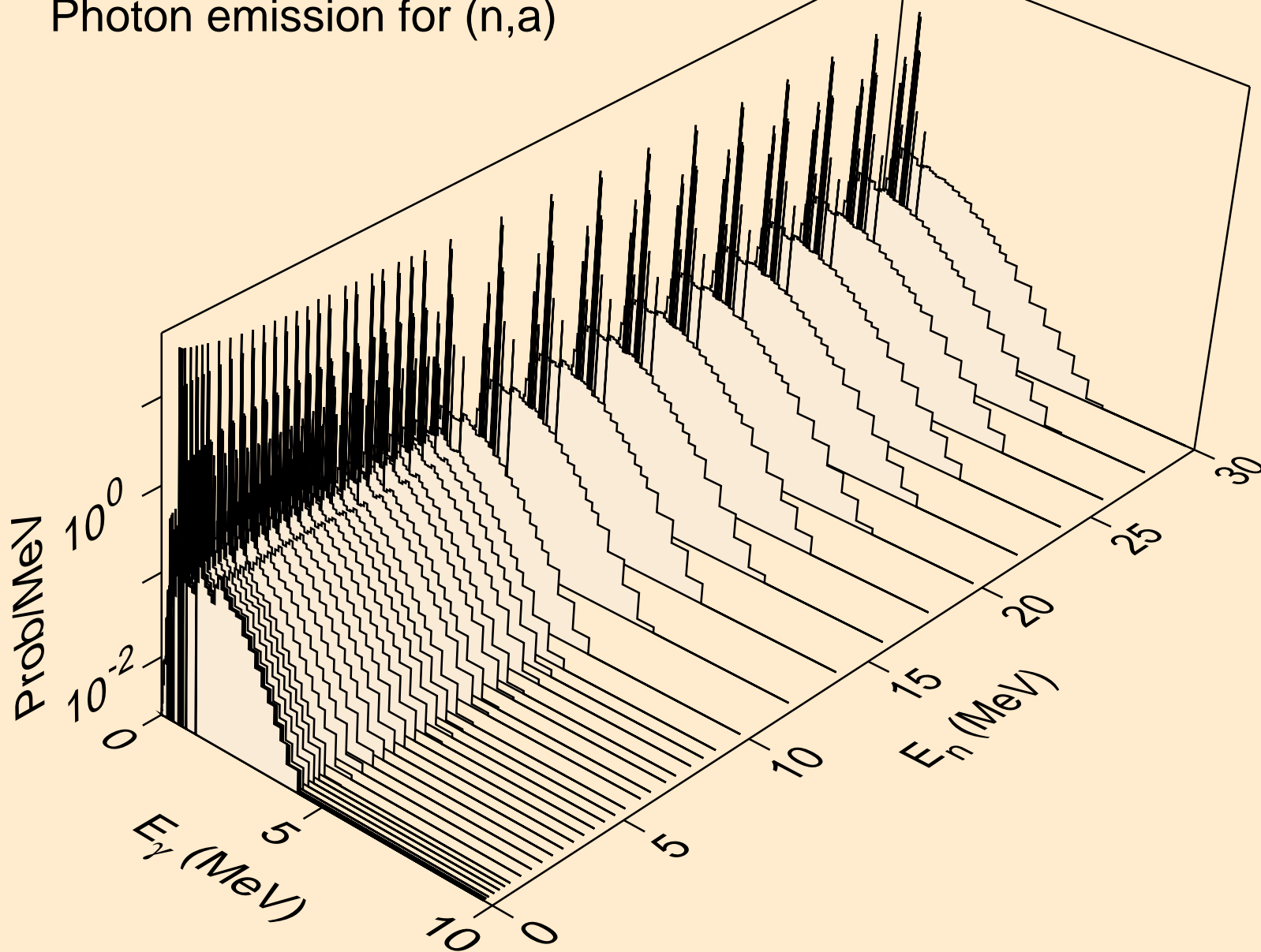

RA207 NEUTRON ACER TENDL-2023 LIBRARY; T=0.K  
Photon emission for (n,2a)

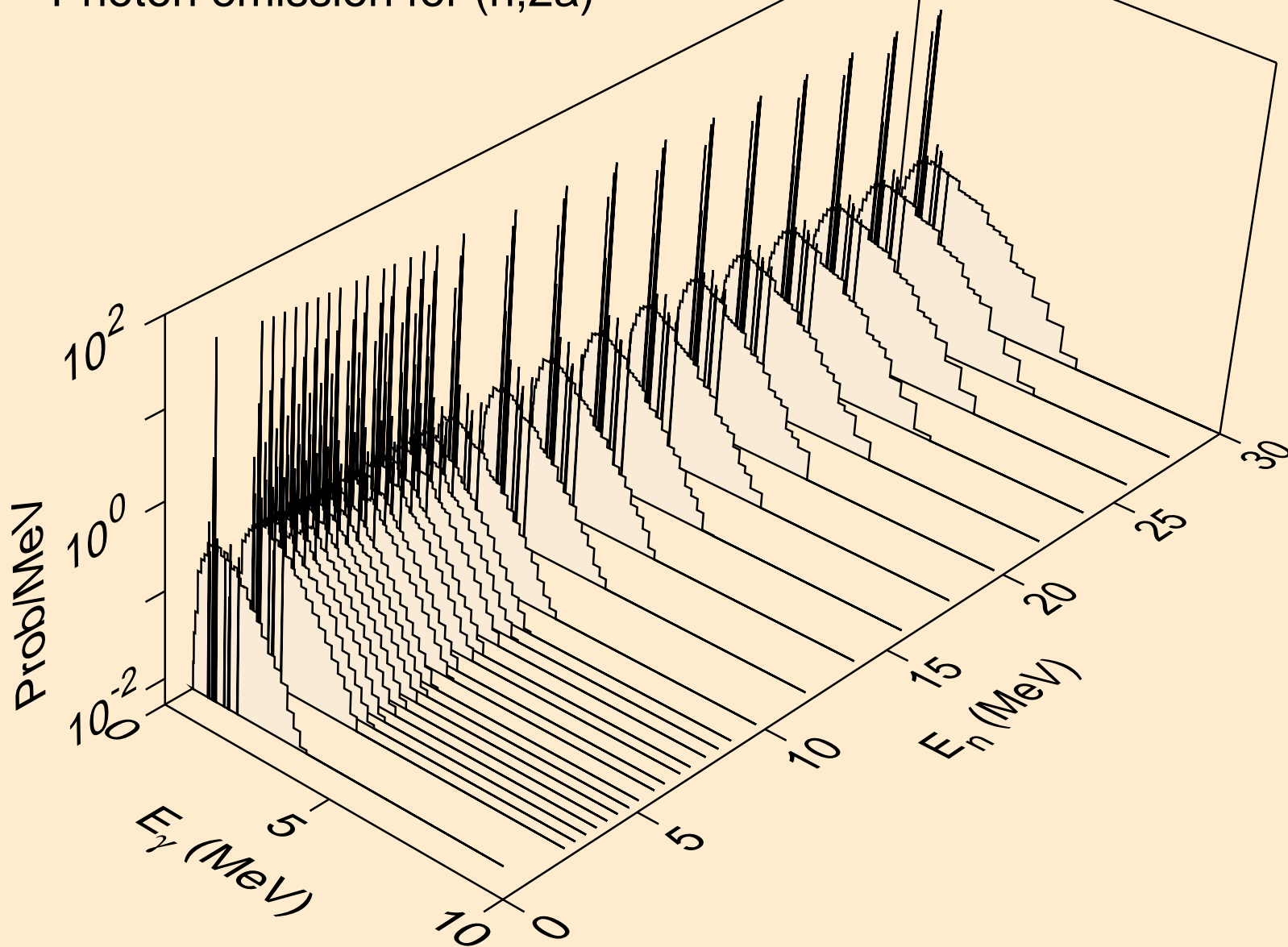

RA207 NEUTRON ACER TENDL-2023 LIBRARY; T=0.K  
Photon emission for (n,3a)

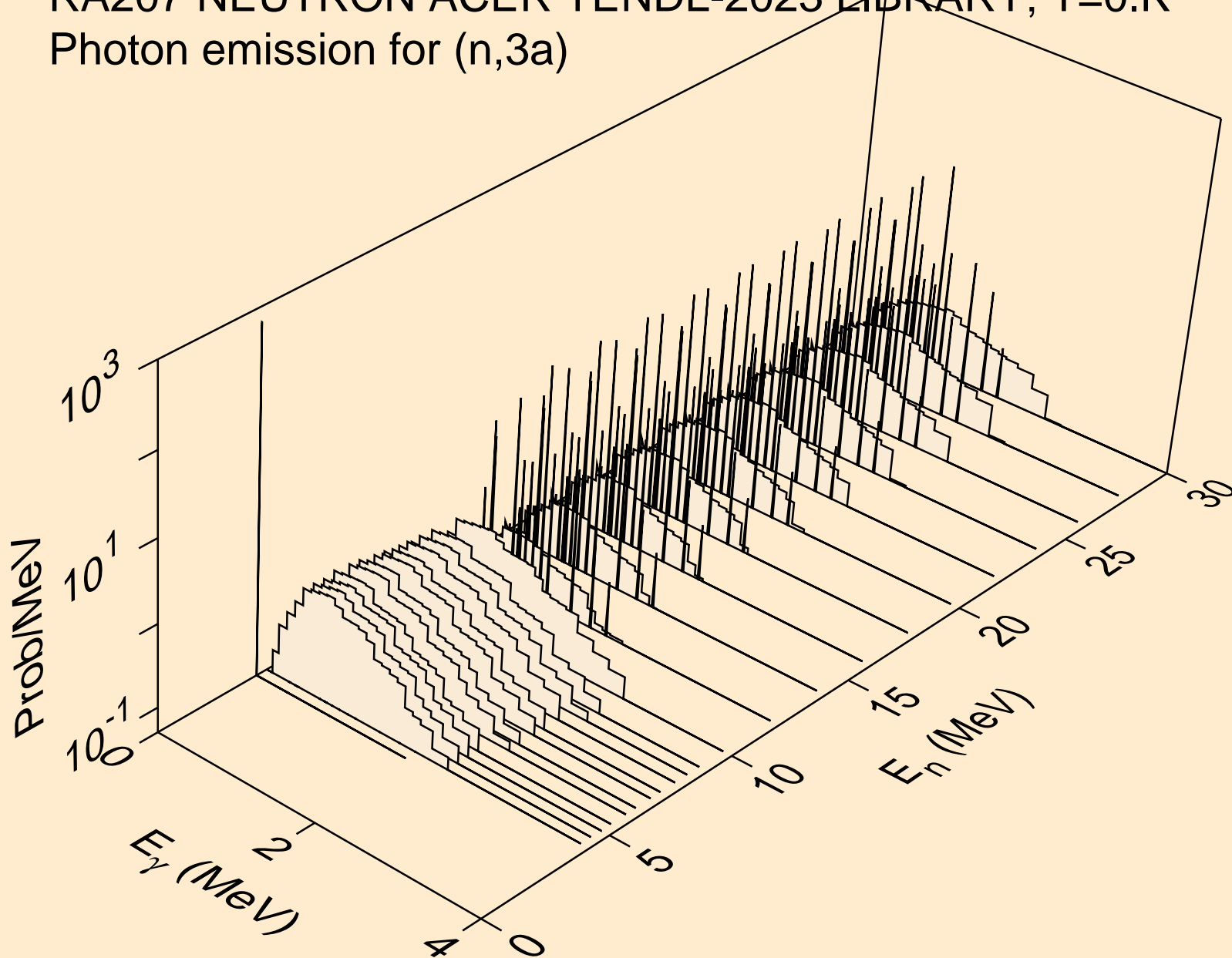

RA207 NEUTRON ACER TENDL-2023 LIBRARY; T=0.K  
Photon emission for (n,2p)

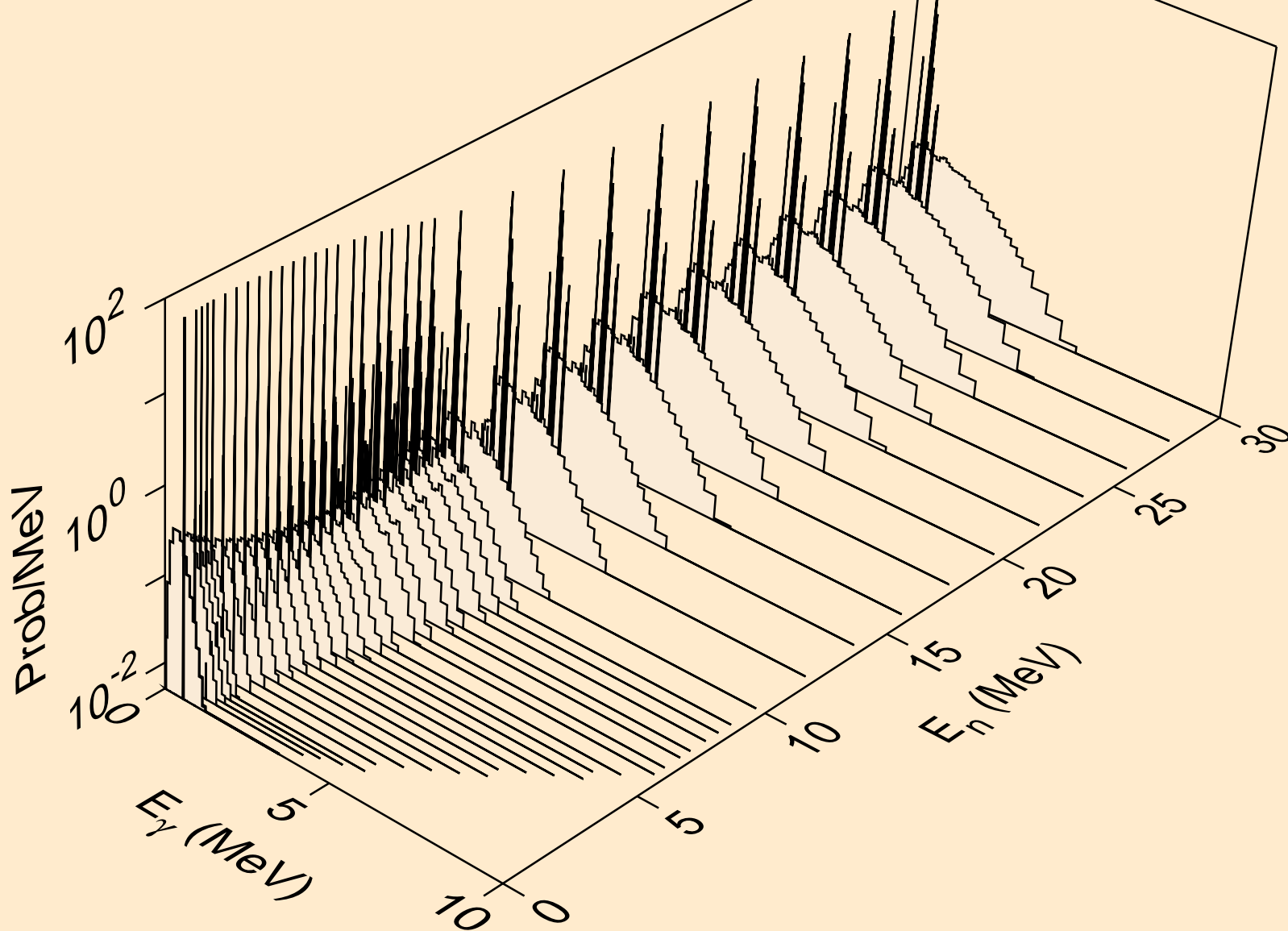

RA207 NEUTRON ACER TENDL-2023 LIBRARY; T=0.K  
Photon emission for (n,p $\alpha$ )

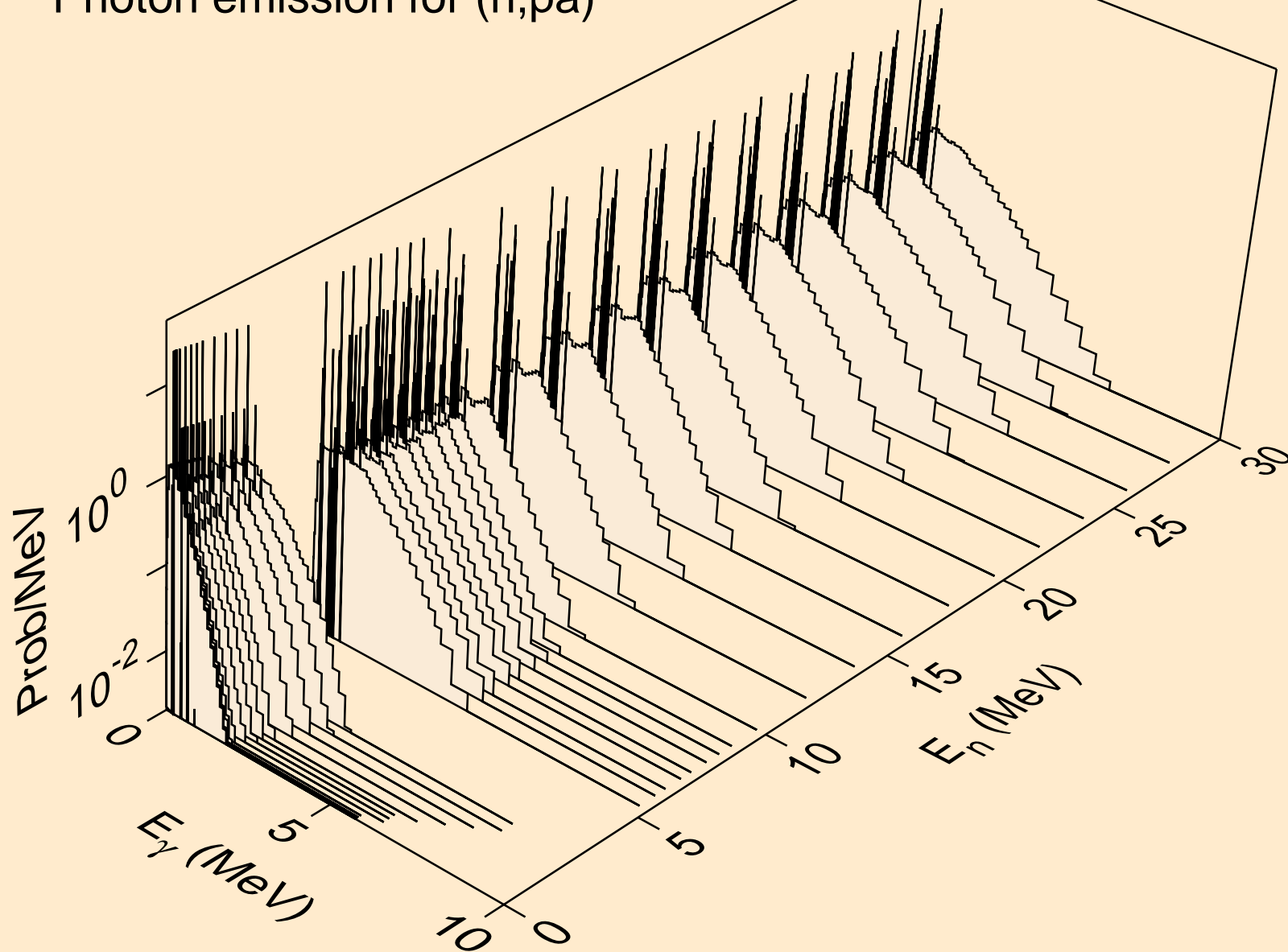



RA207 NEUTRON ACER TENDL-2023 LIBRARY; T=0.K  
Photon emission for (n,pd)

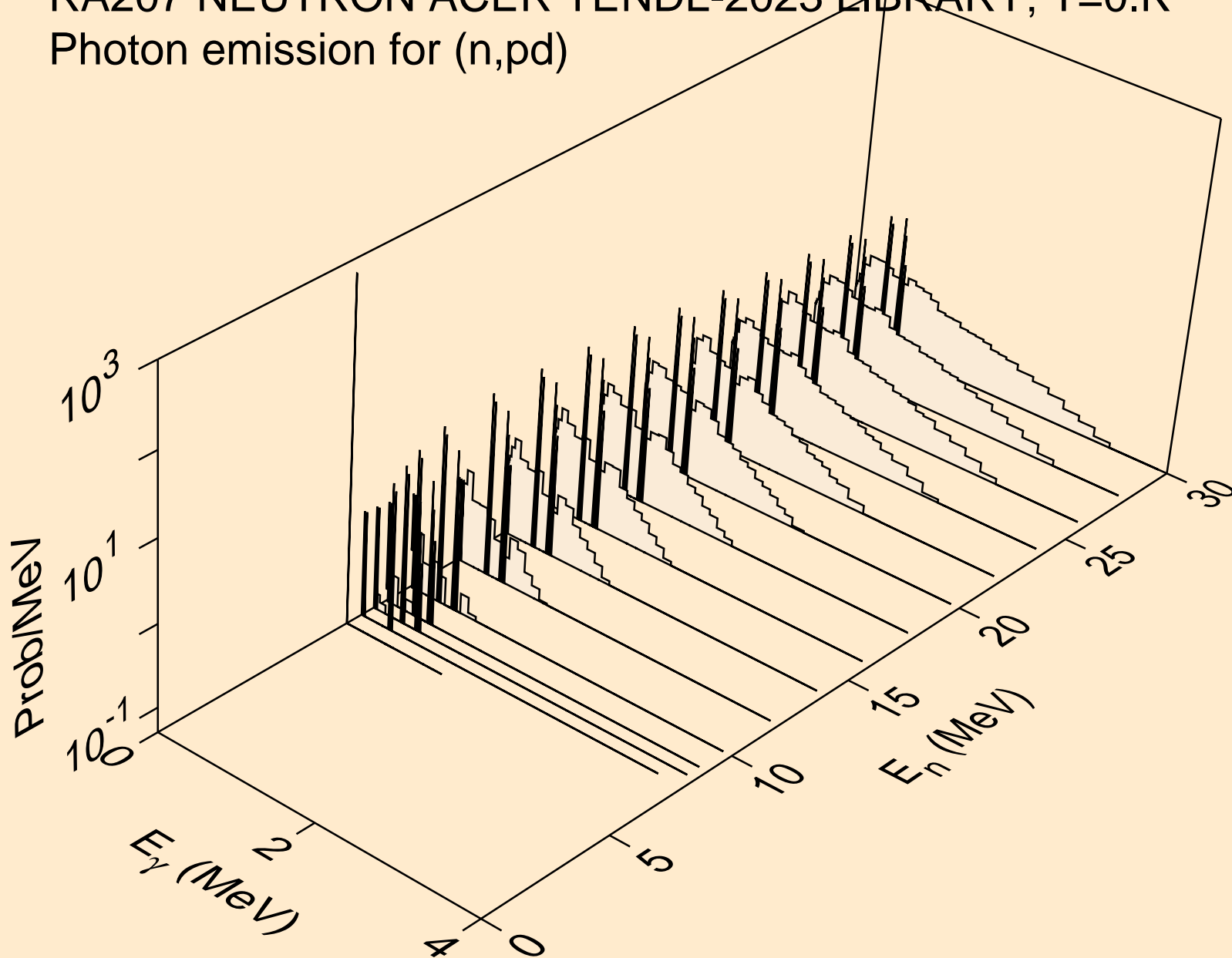

RA207 NEUTRON ACER TENDL-2023 LIBRARY; T=0.K  
Photon emission for (n,pt)

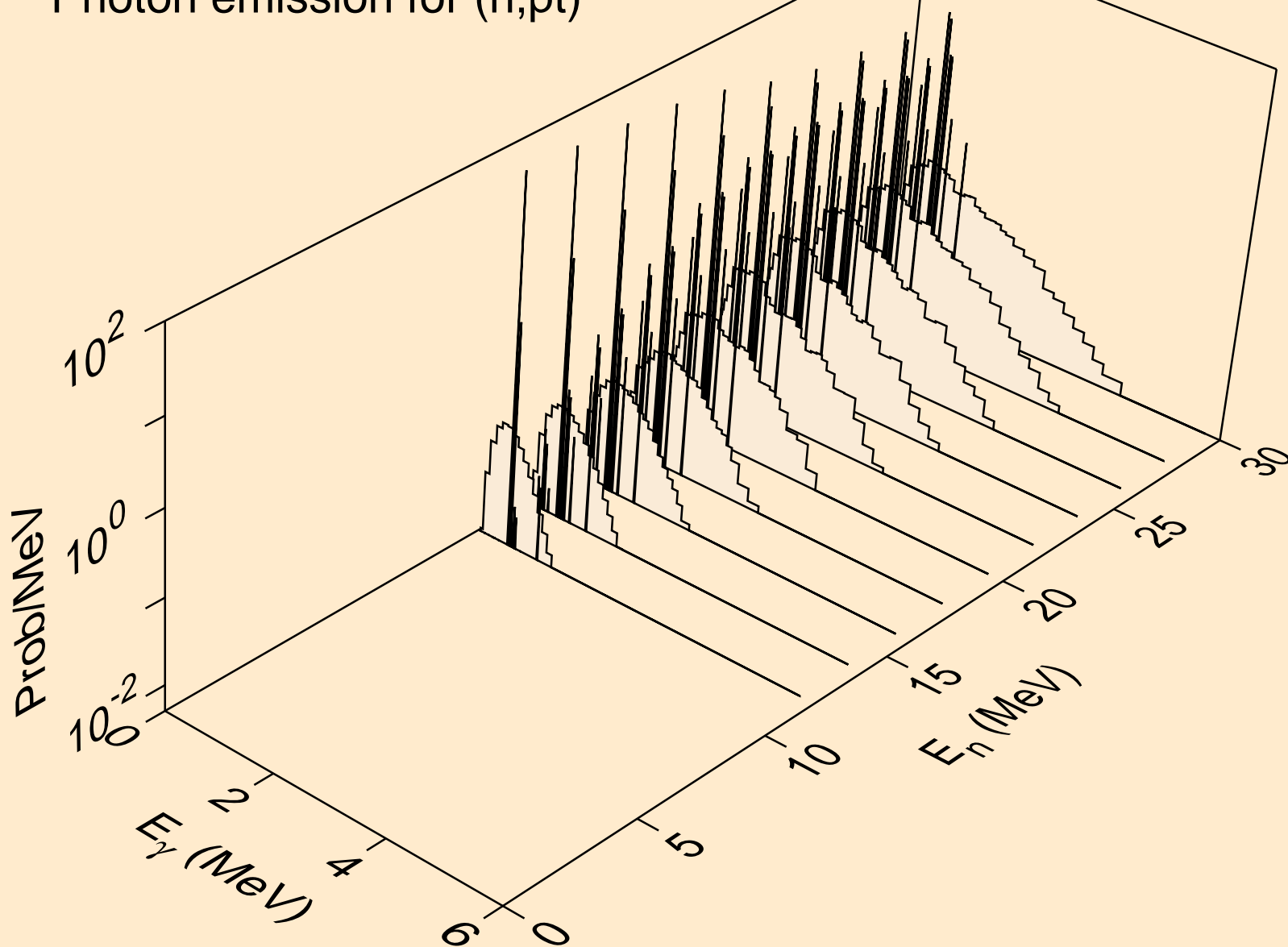

RA207 NEUTRON ACER TENDL-2023 LIBRARY; T=0.K  
Photon emission for (n,da)

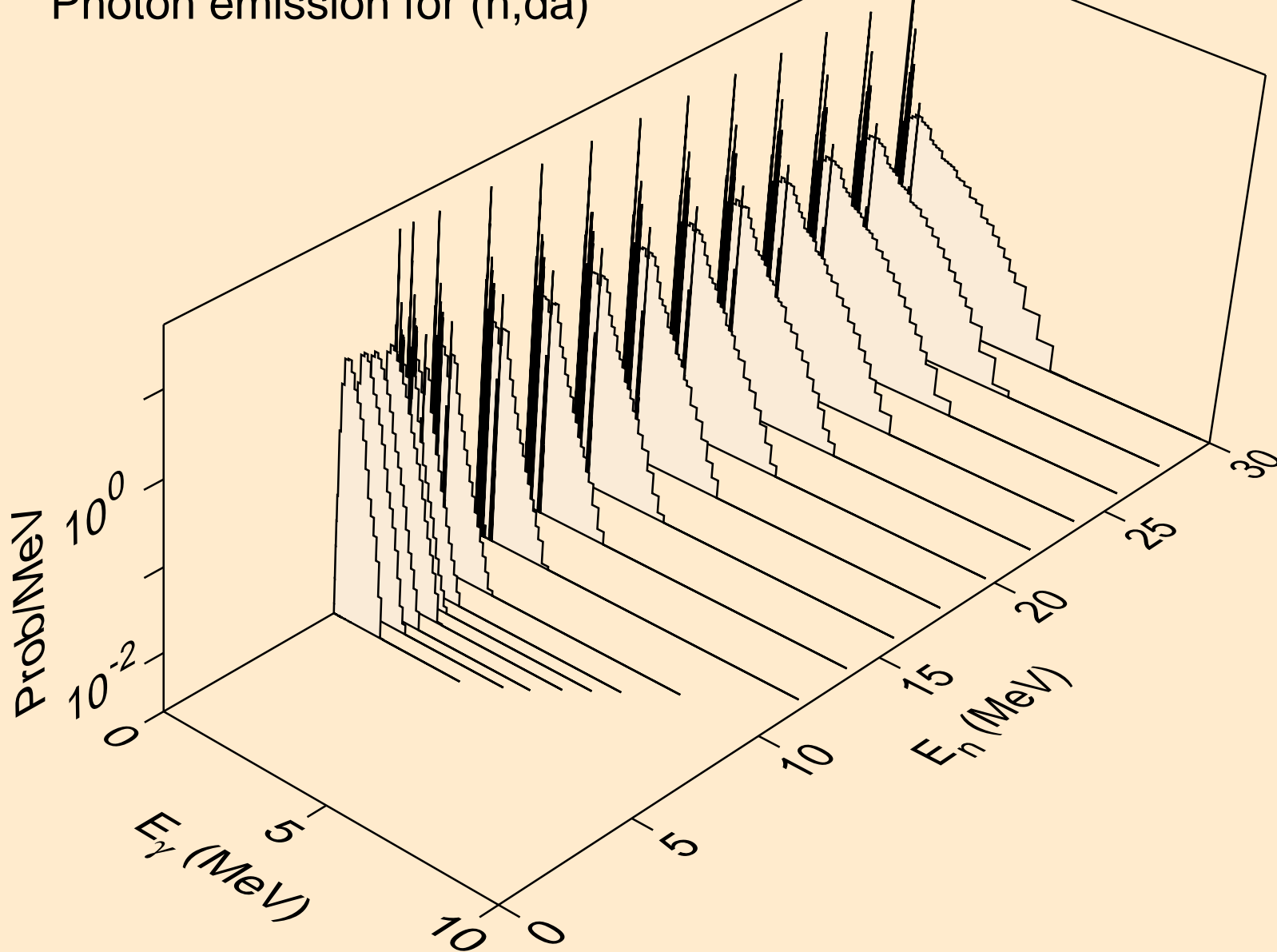

RA207 NEUTRON ACER TENDL-2023 LIBRARY; T=0.K  
thermal capture photon spectrum

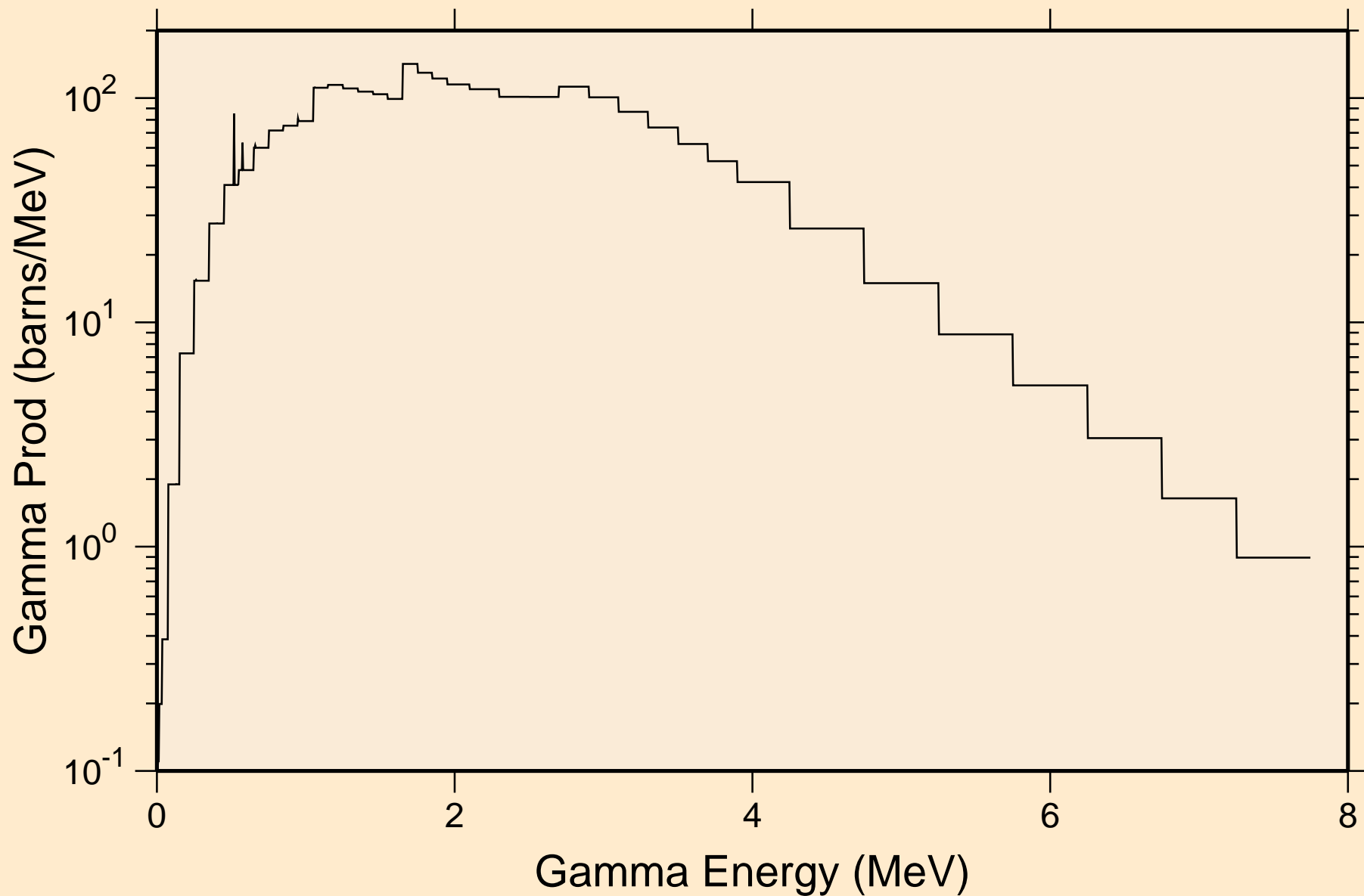

RA207 NEUTRON ACER TENDL-2023 LIBRARY; T=0.K  
14 MeV photon spectrum

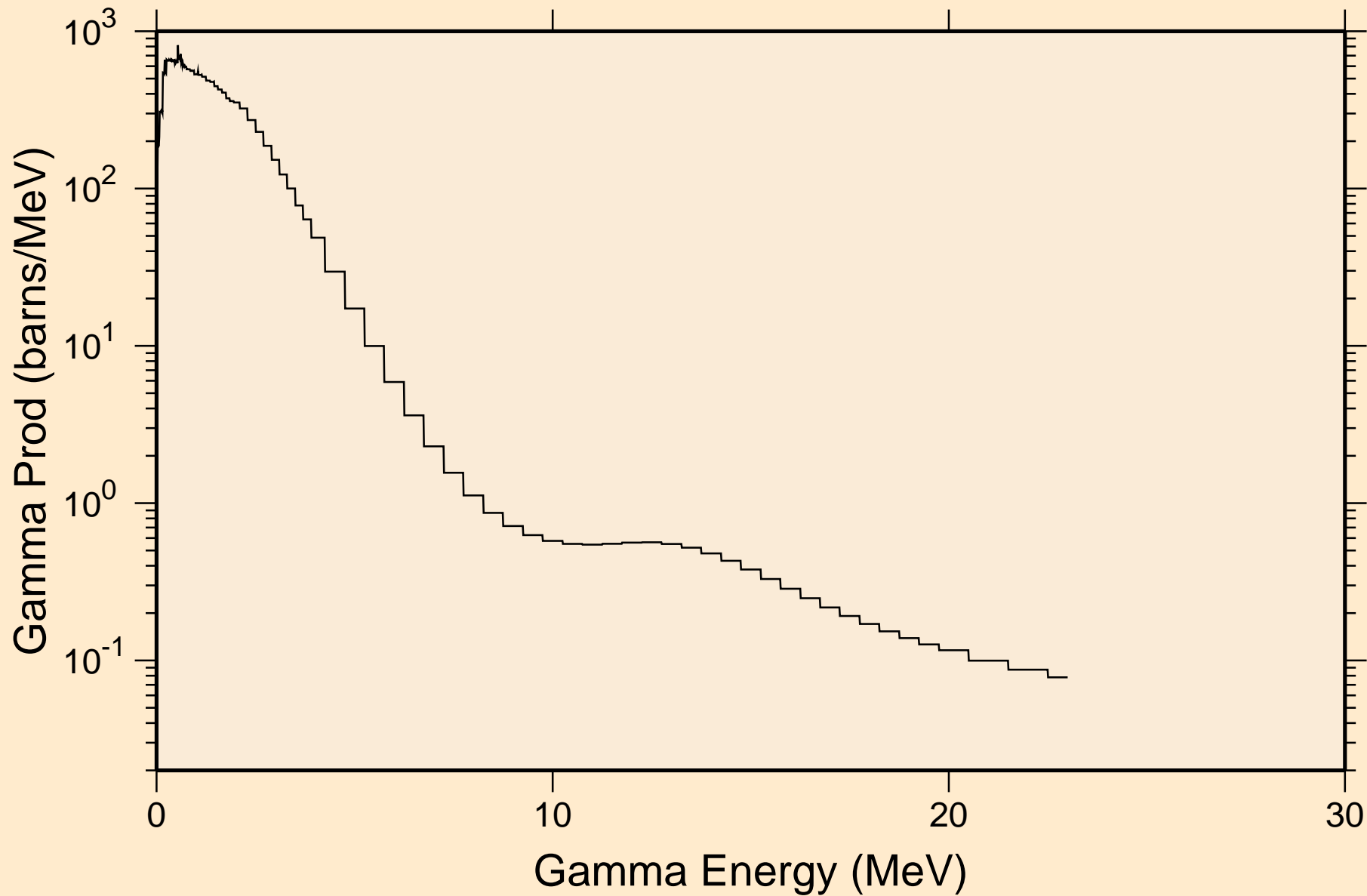

# RA207 NEUTRON ACER TENDL-2023 LIBRARY; T=0.K

## Particle heating contributions

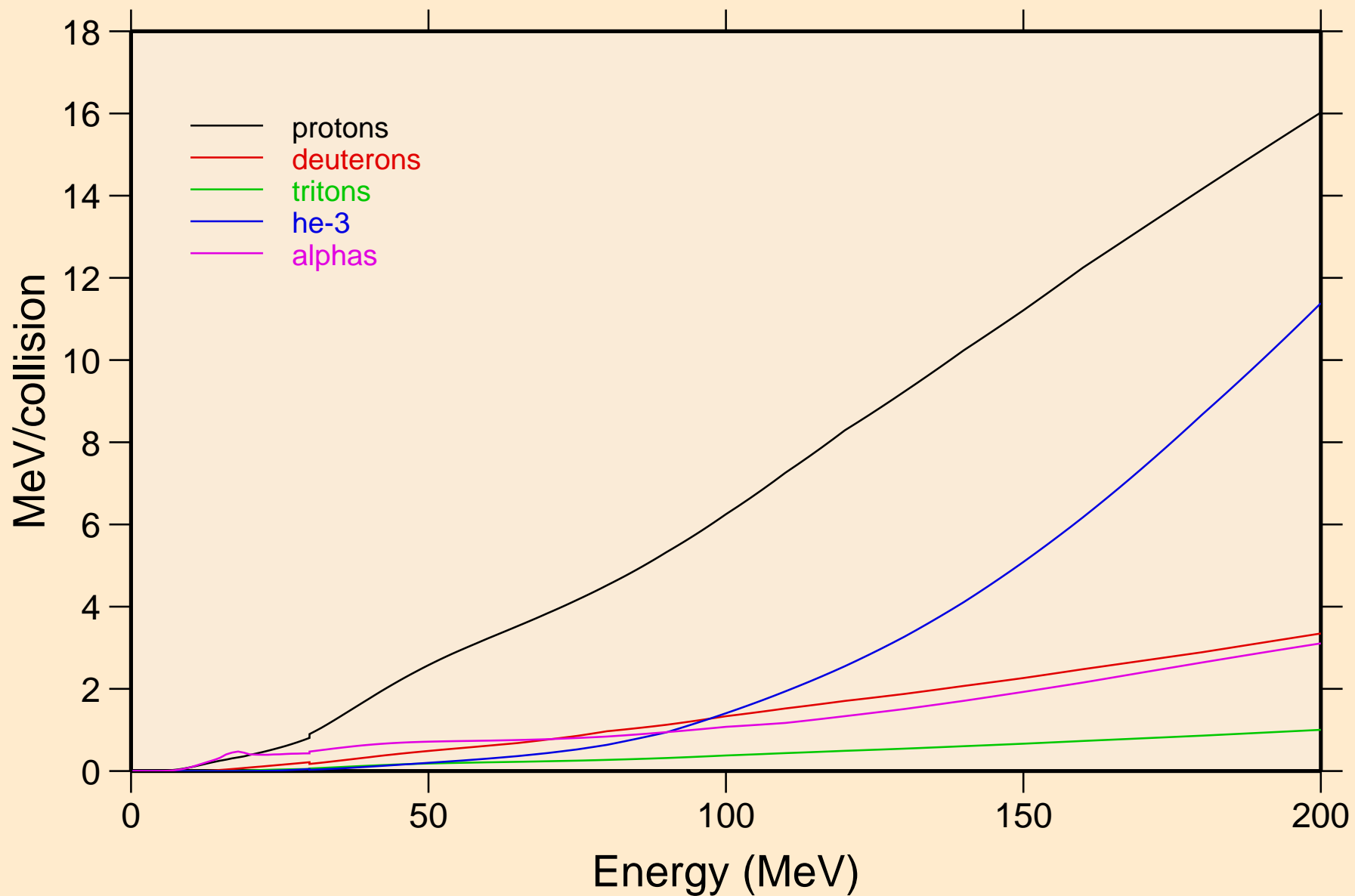

RA207 NEUTRON ACER TENDL-2023 LIBRARY; T=0.K  
Recoil Heating

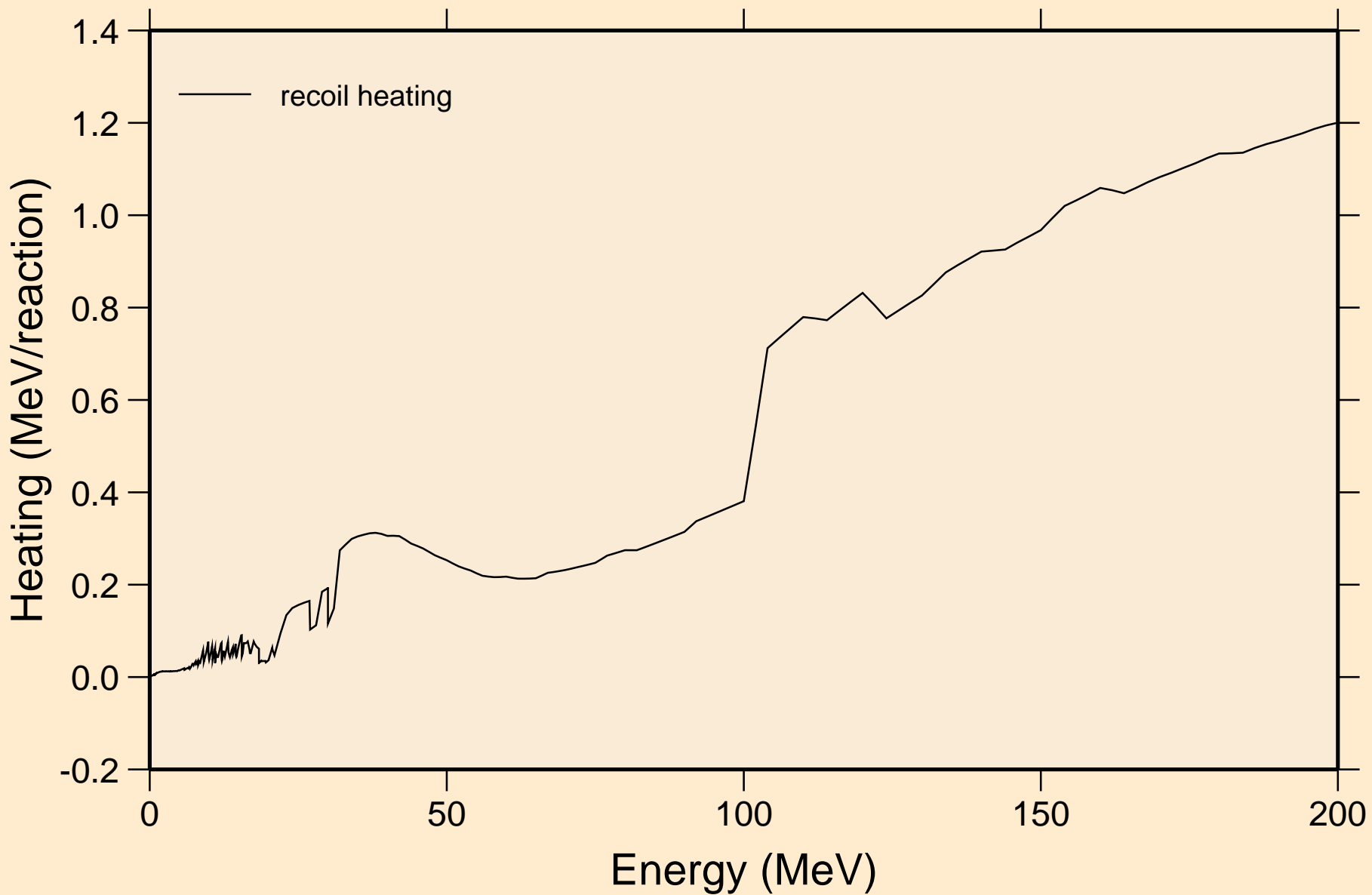

RA207 NEUTRON ACER TENDL-2023 LIBRARY; T=0.K  
Particle production cross sections

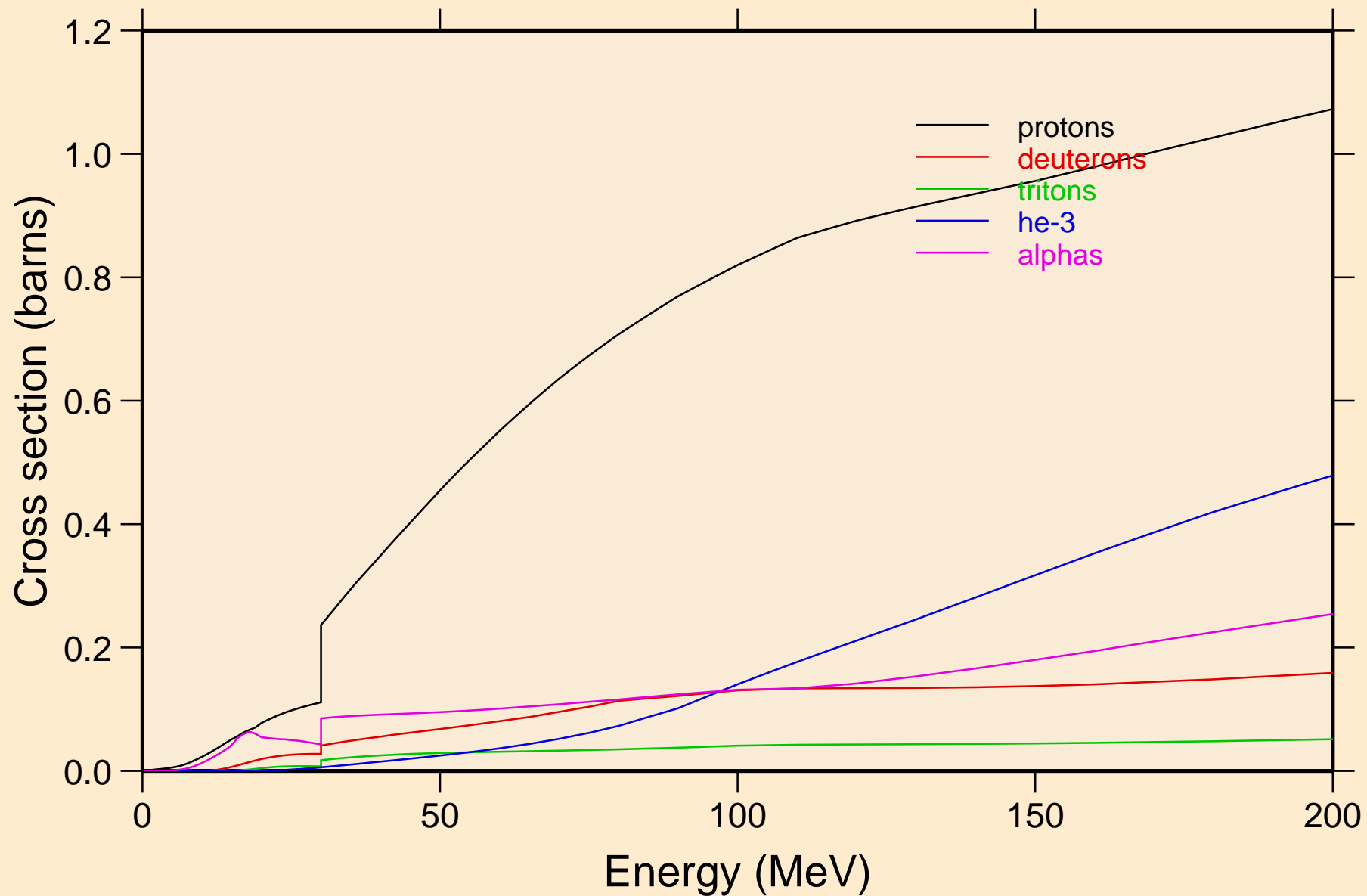



RA207 NEUTRON ACER TENDL-2023 LIBRARY; T=0.K  
protons from (n,x)

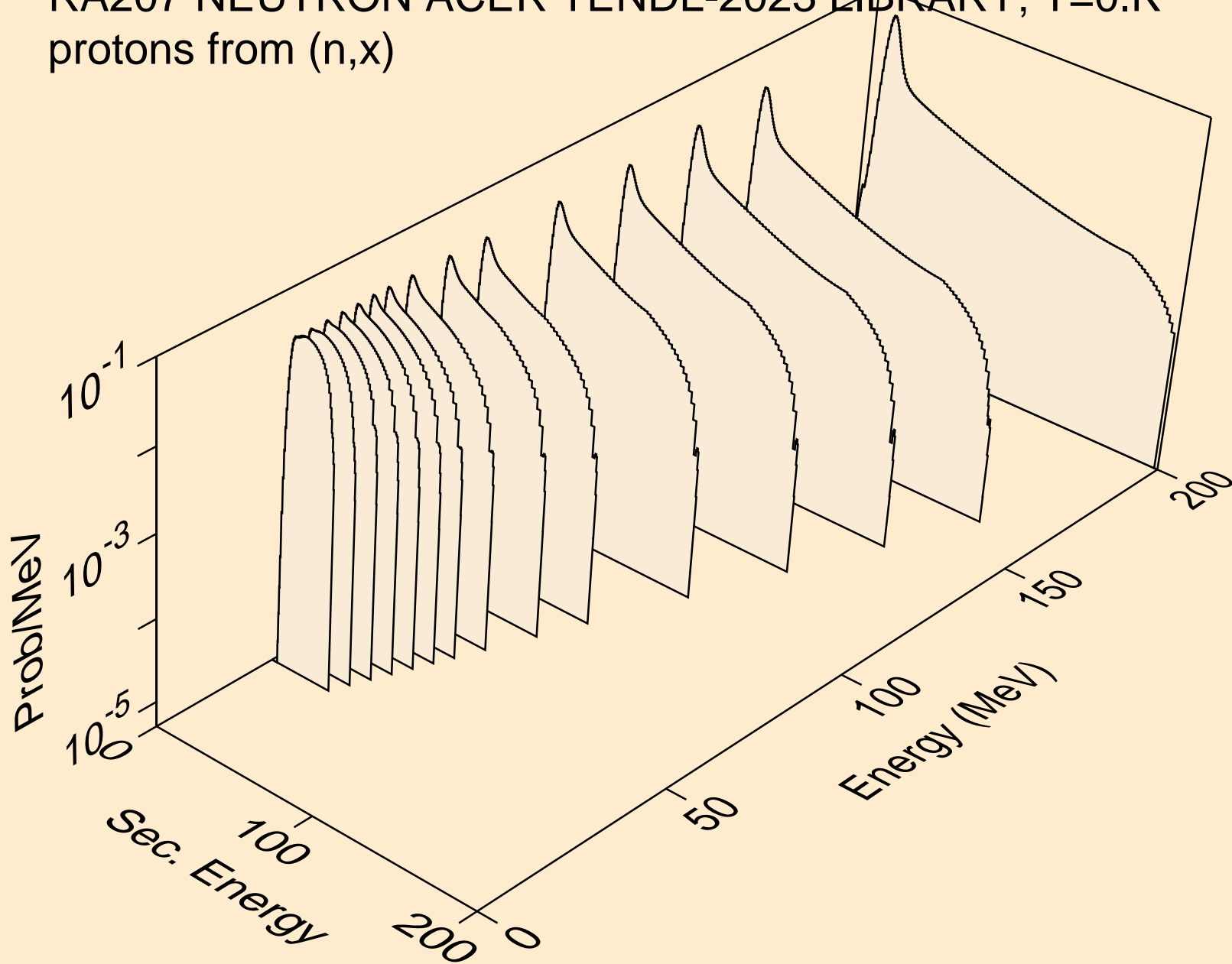

RA207 NEUTRON ACER TENDL-2023 LIBRARY; T=0.K  
protons from (n,n\*)p

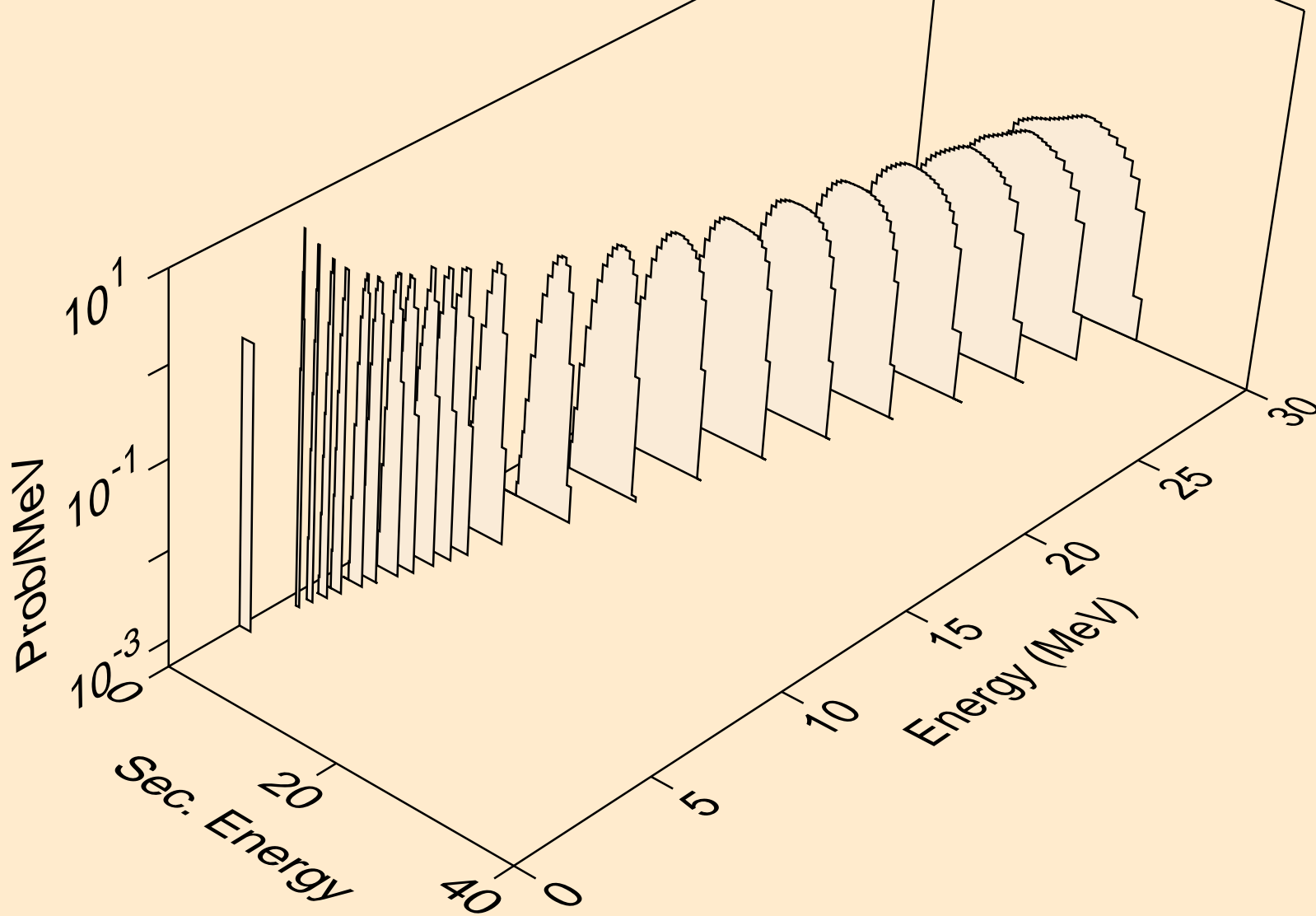

RA207 NEUTRON ACER TENDL-2023 LIBRARY; T=0.K  
protons from (n,2np)

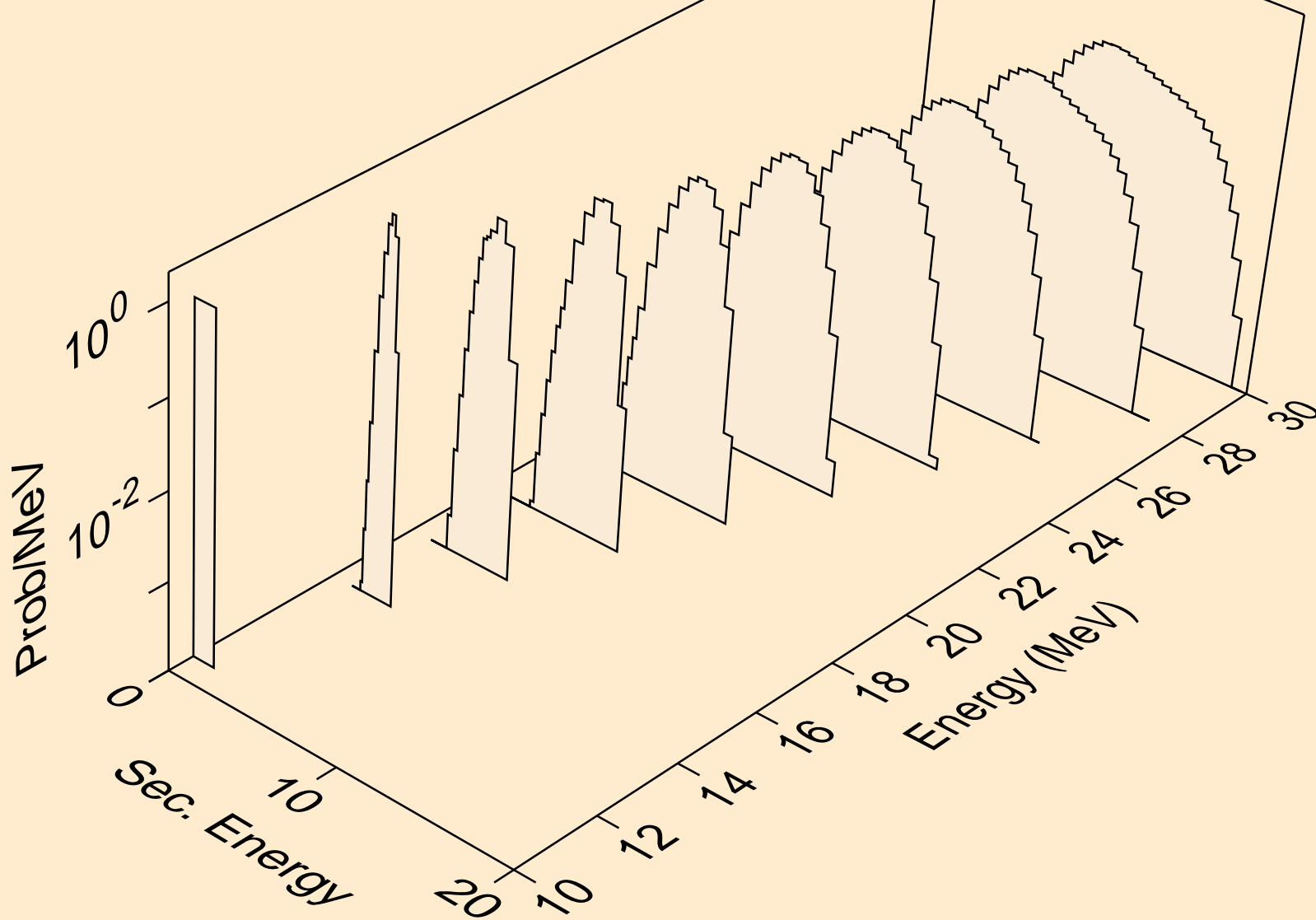

RA207 NEUTRON ACER TENDL-2023 LIBRARY; T=0.K  
protons from (n,3np)

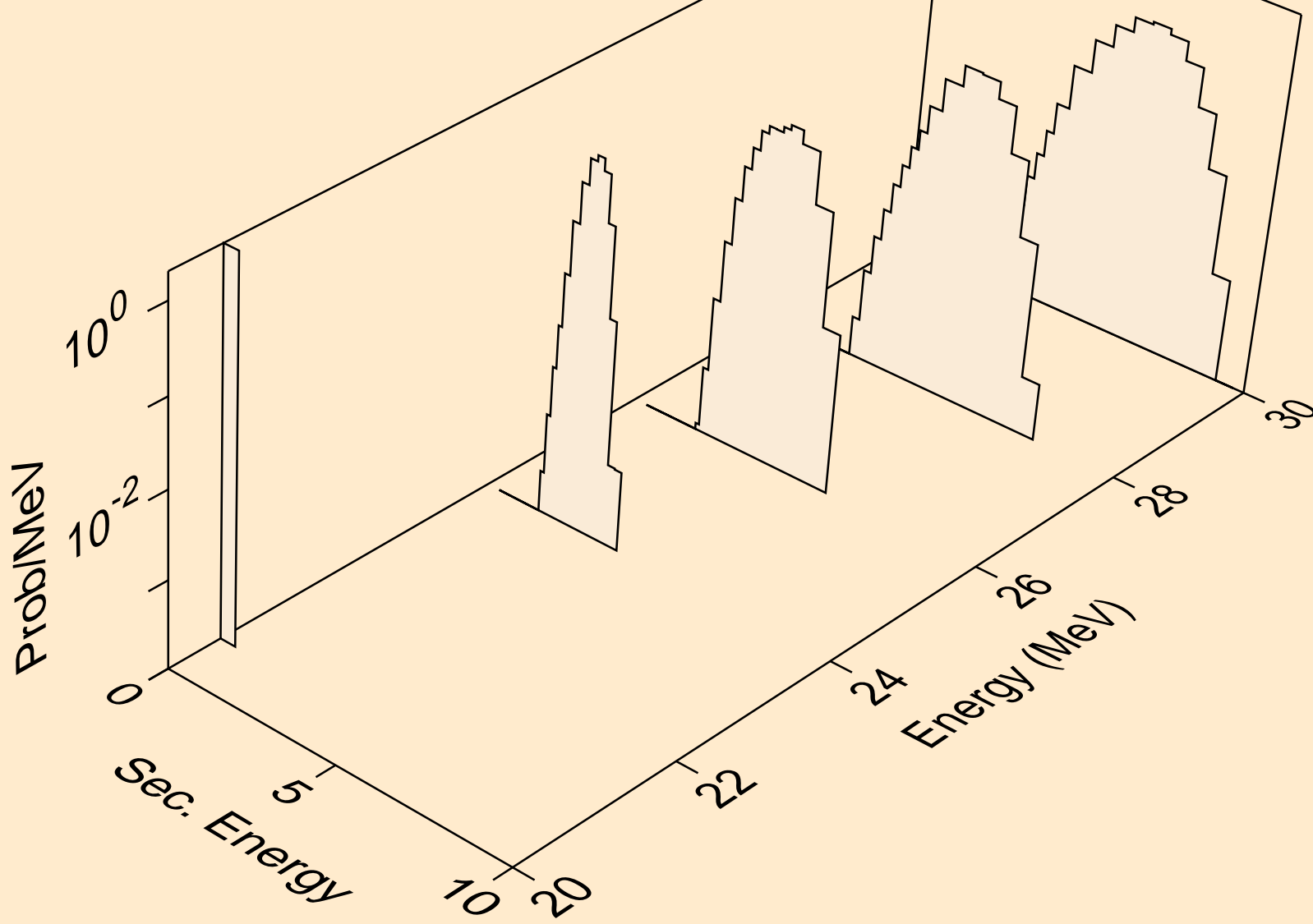

RA207 NEUTRON ACER TENDL-2023 LIBRARY; T=0.K  
protons from (n,n2p)

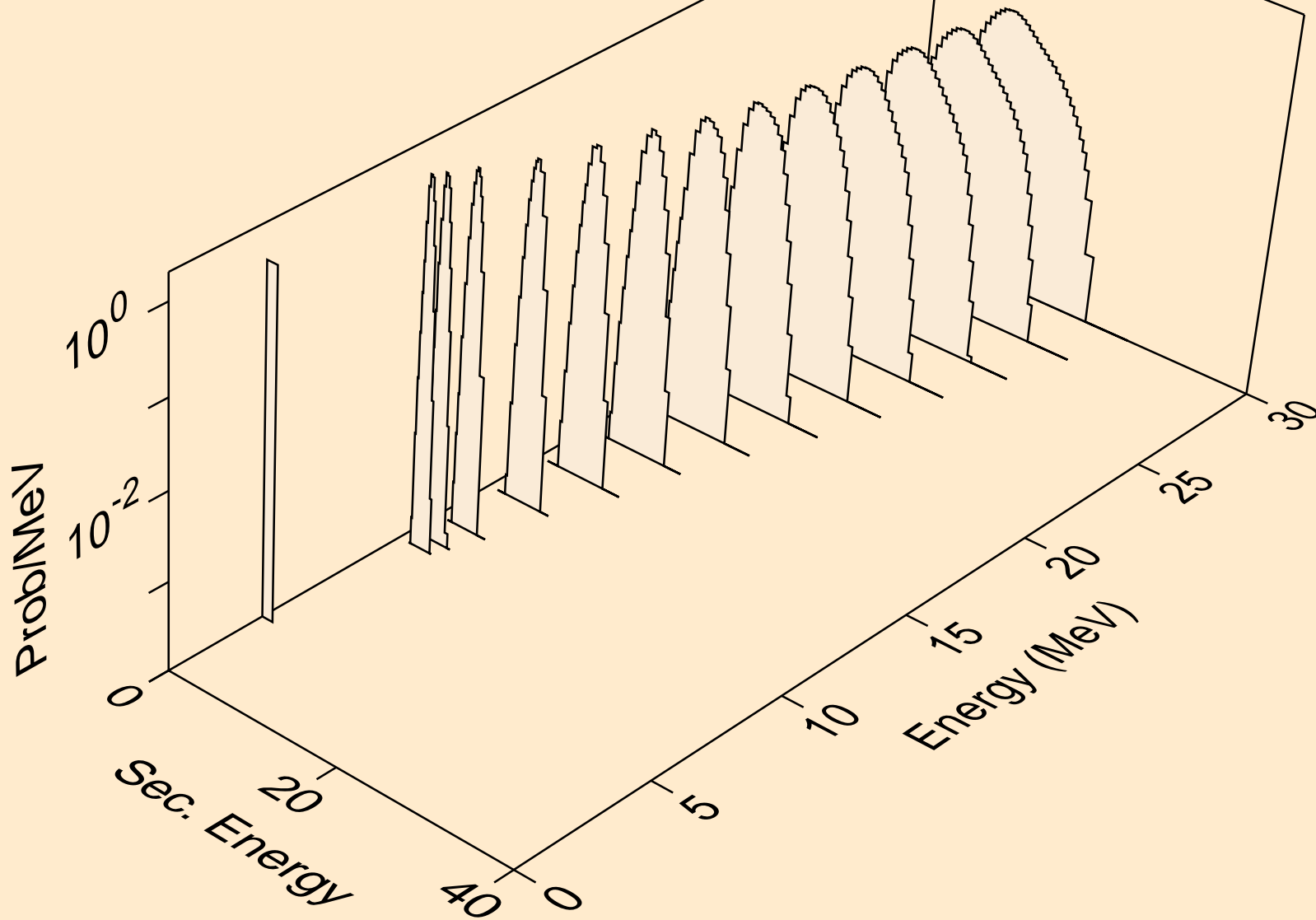

RA207 NEUTRON ACER TENDL-2023 LIBRARY; T=0.K  
protons from (n,npa)

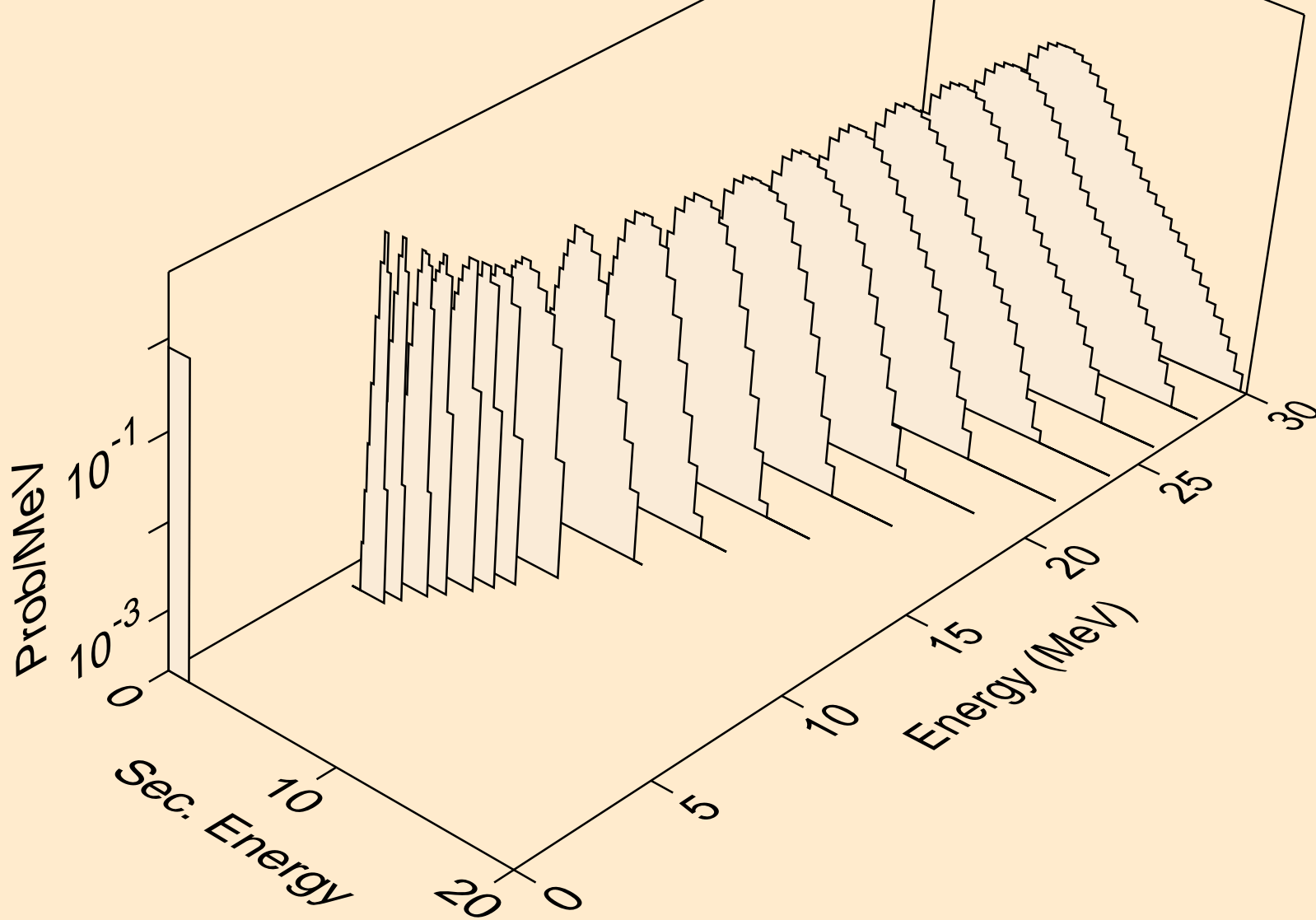

RA207 NEUTRON ACER TENDL-2023 LIBRARY; T=0.K  
protons from (n,p)

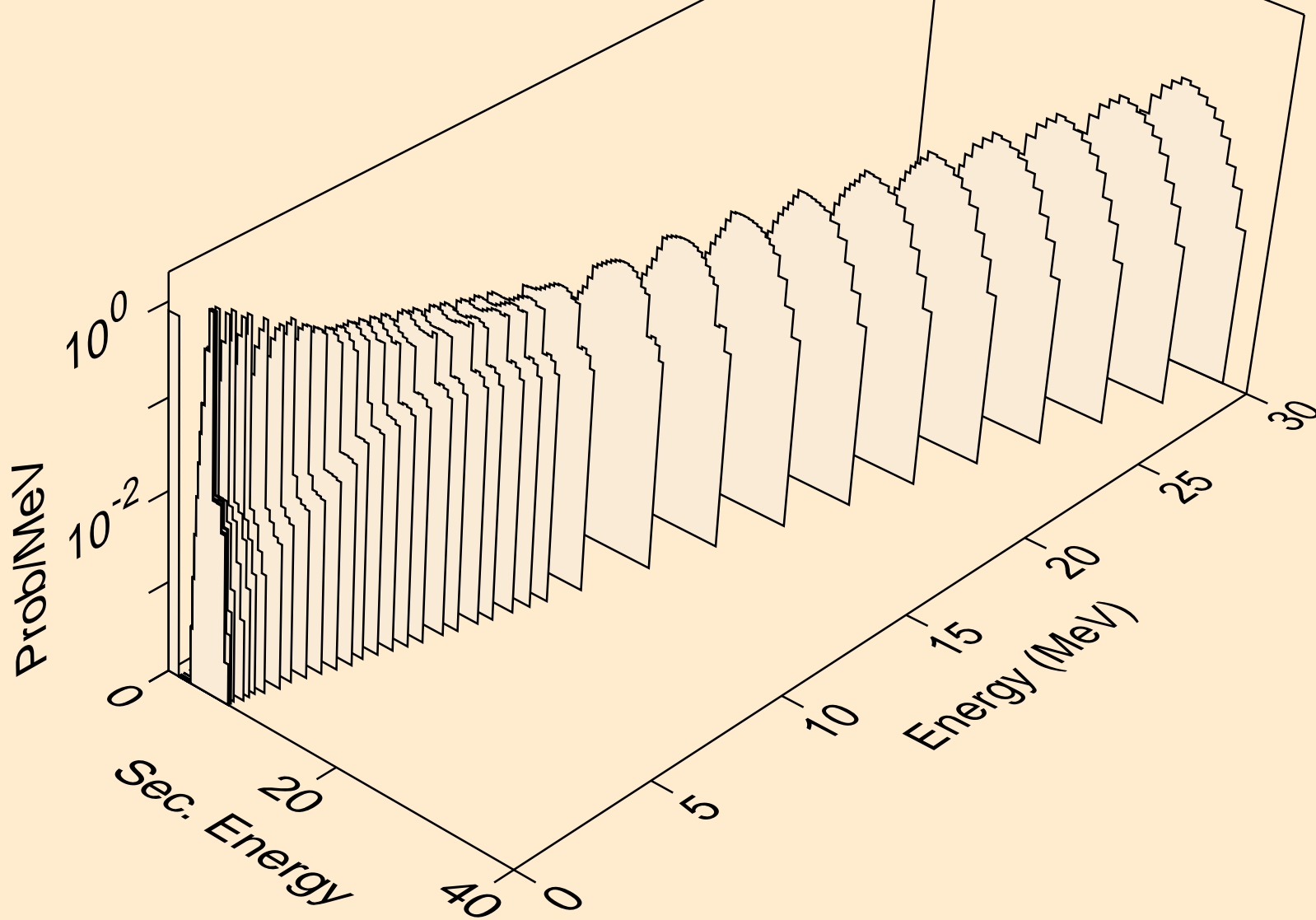

RA207 NEUTRON ACER TENDL-2023 LIBRARY; T=0.K  
protons from (n,2p)

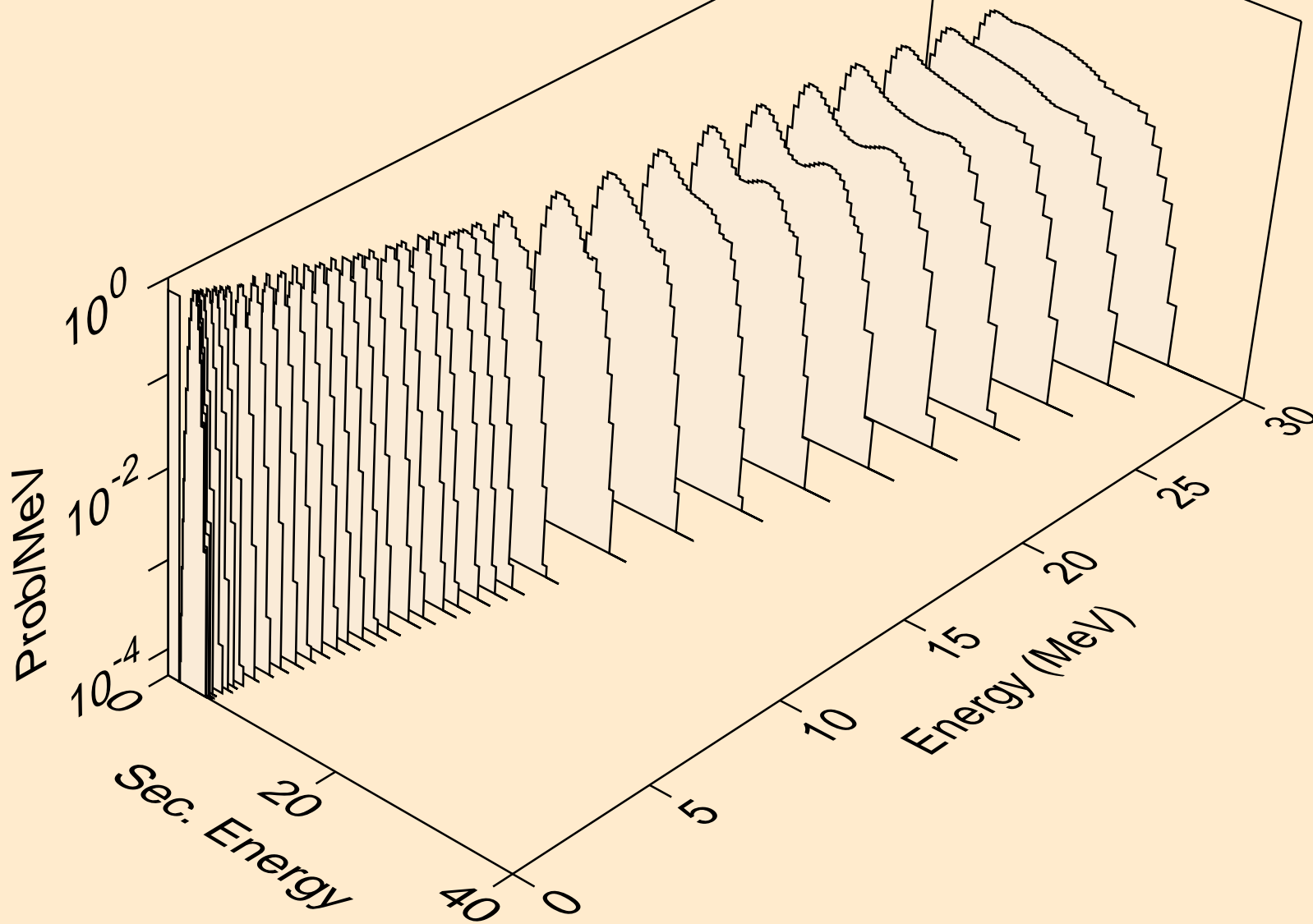



RA207 NEUTRON ACER TENDL-2023 LIBRARY; T=0.K  
protons from (n,p)

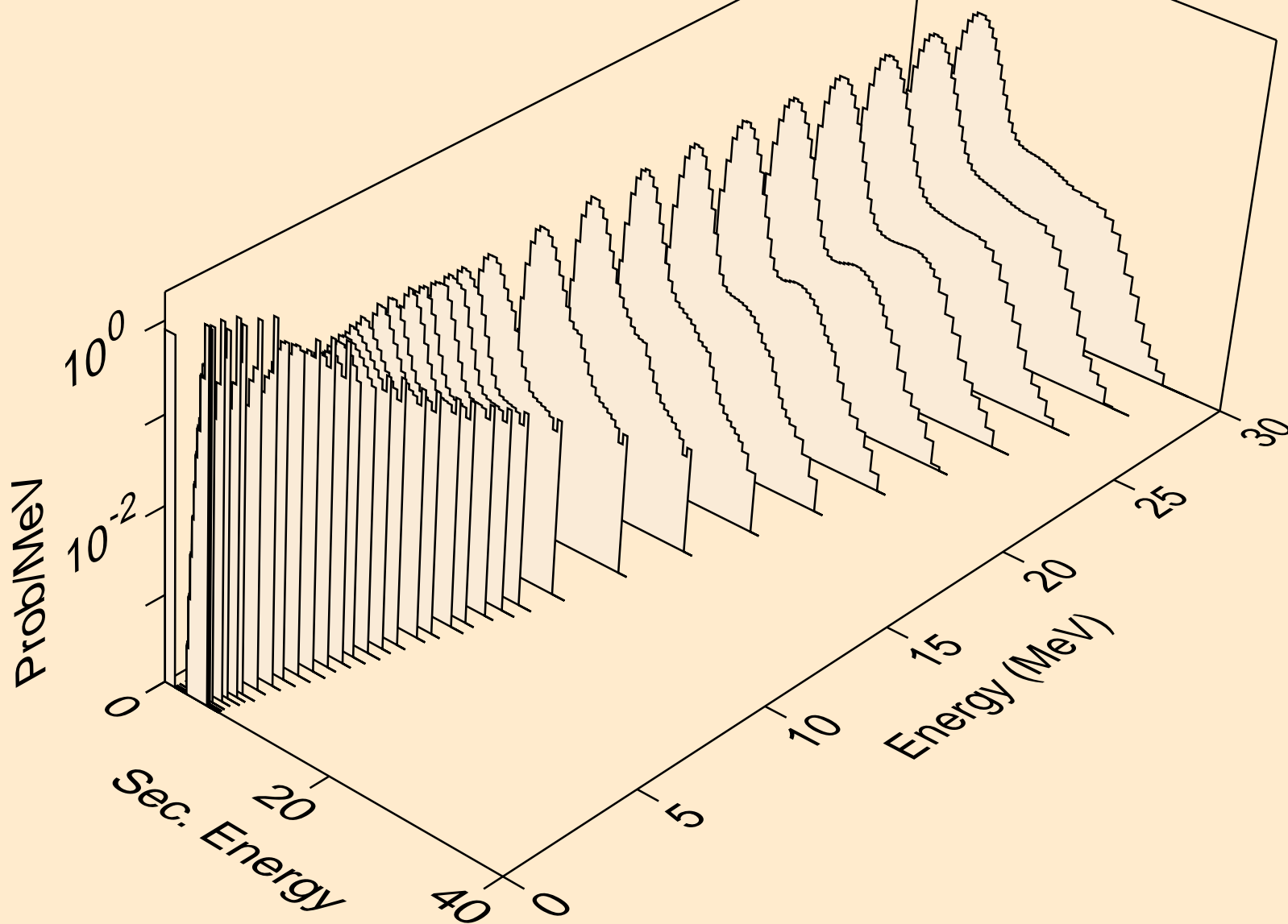

RA207 NEUTRON ACER TENDL-2023 LIBRARY; T=0.K  
protons from (n,pd)

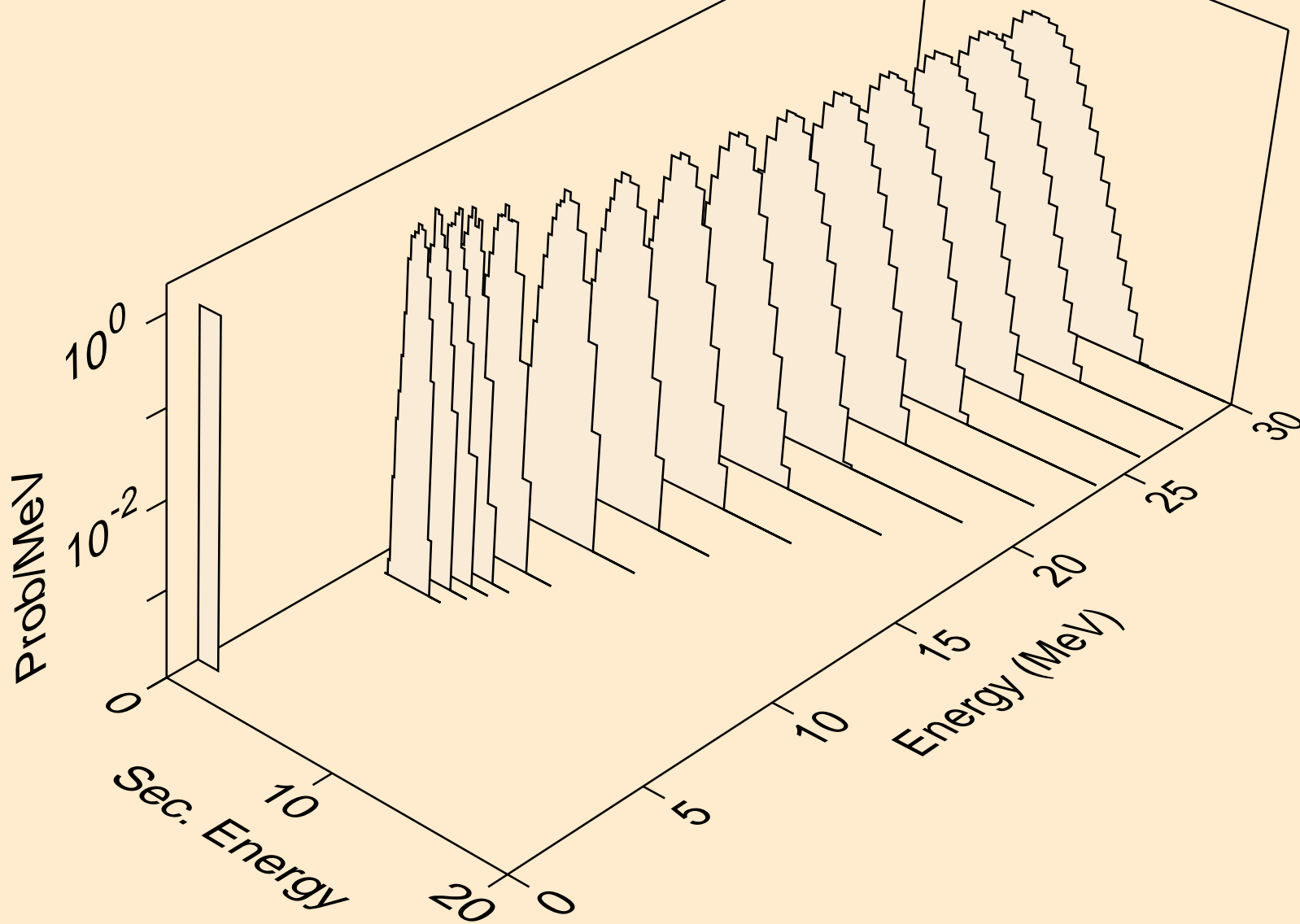

RA207 NEUTRON ACER TENDL-2023 LIBRARY; T=0.K  
protons from (n,pt)

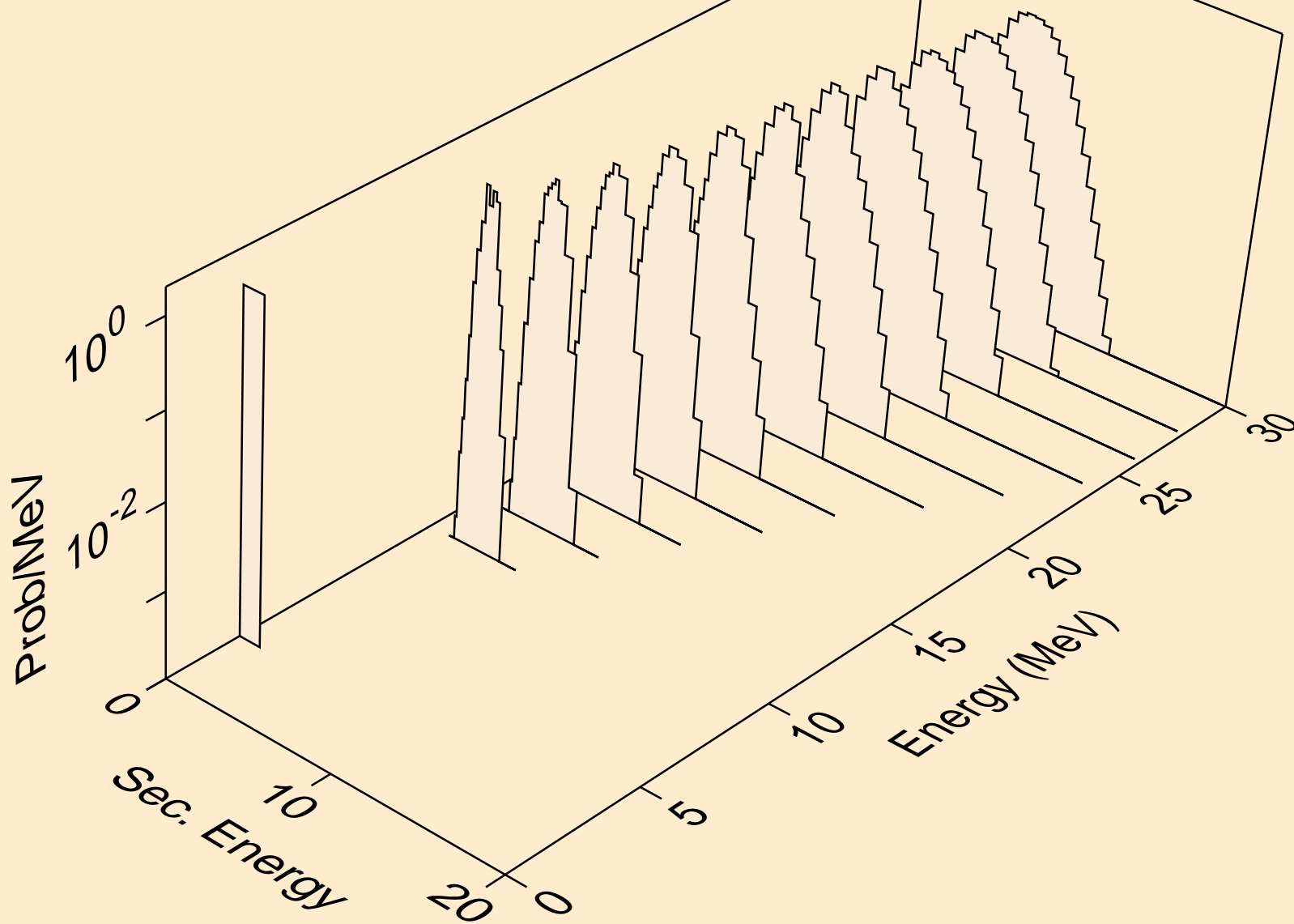

RA207 NEUTRON ACER TENDL-2023 LIBRARY; T=0.K  
deuterons from (n,x)

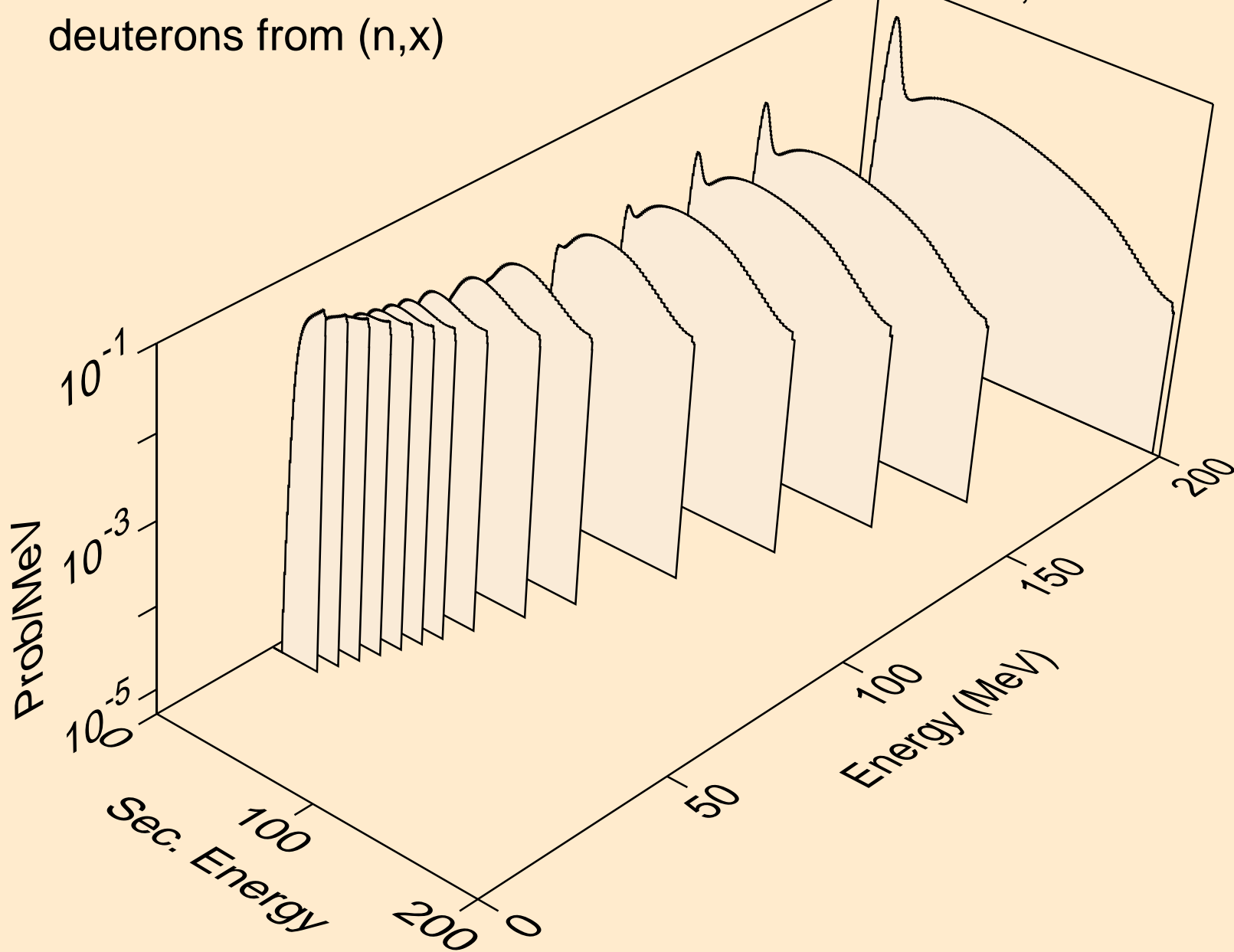

RA207 NEUTRON ACER TENDL-2023 LIBRARY; T=0.K  
deuterons from (n,2nd)

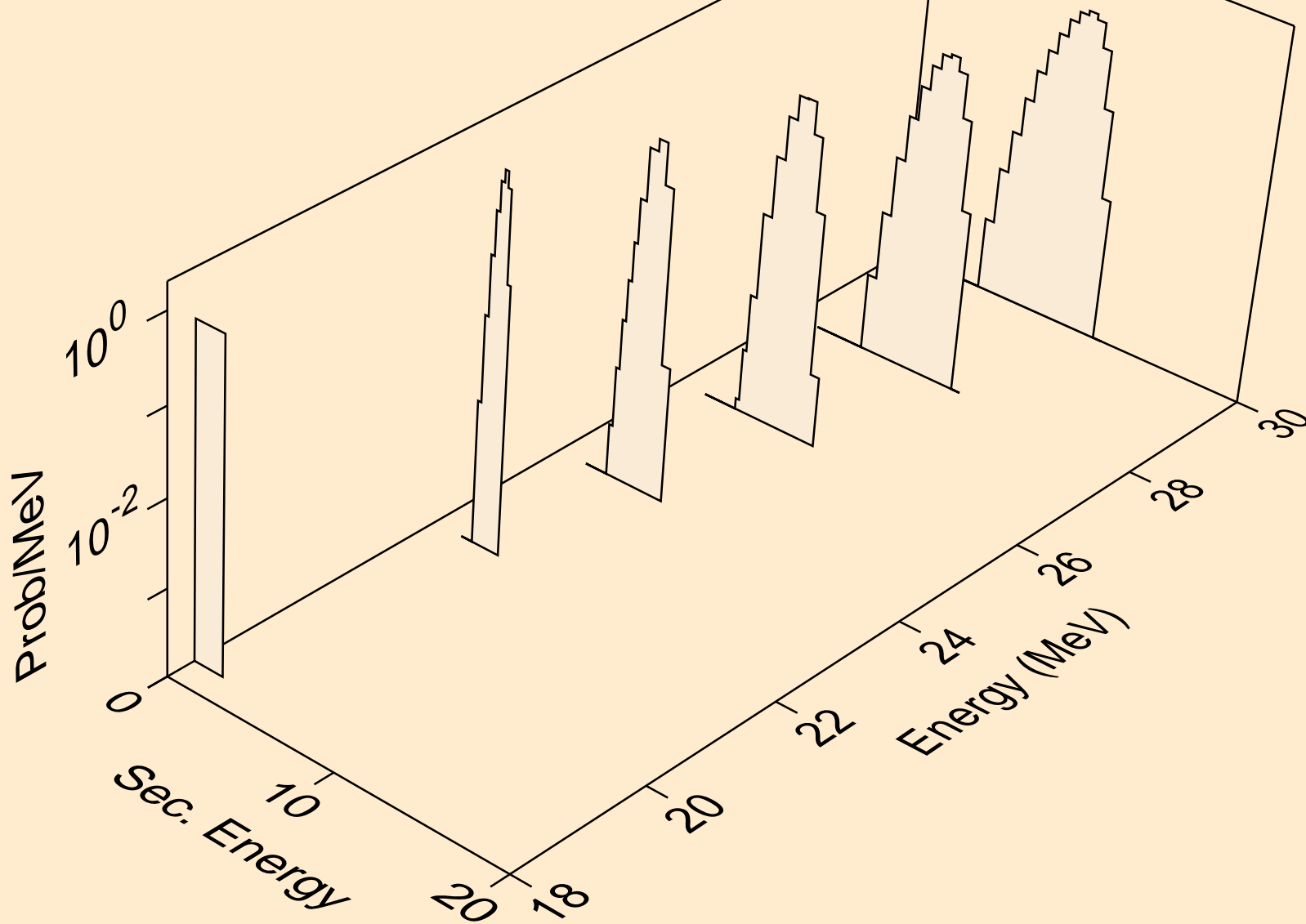

RA207 NEUTRON ACER TENDL-2023 LIBRARY; T=0.K  
deuterons from (n,n\*)d

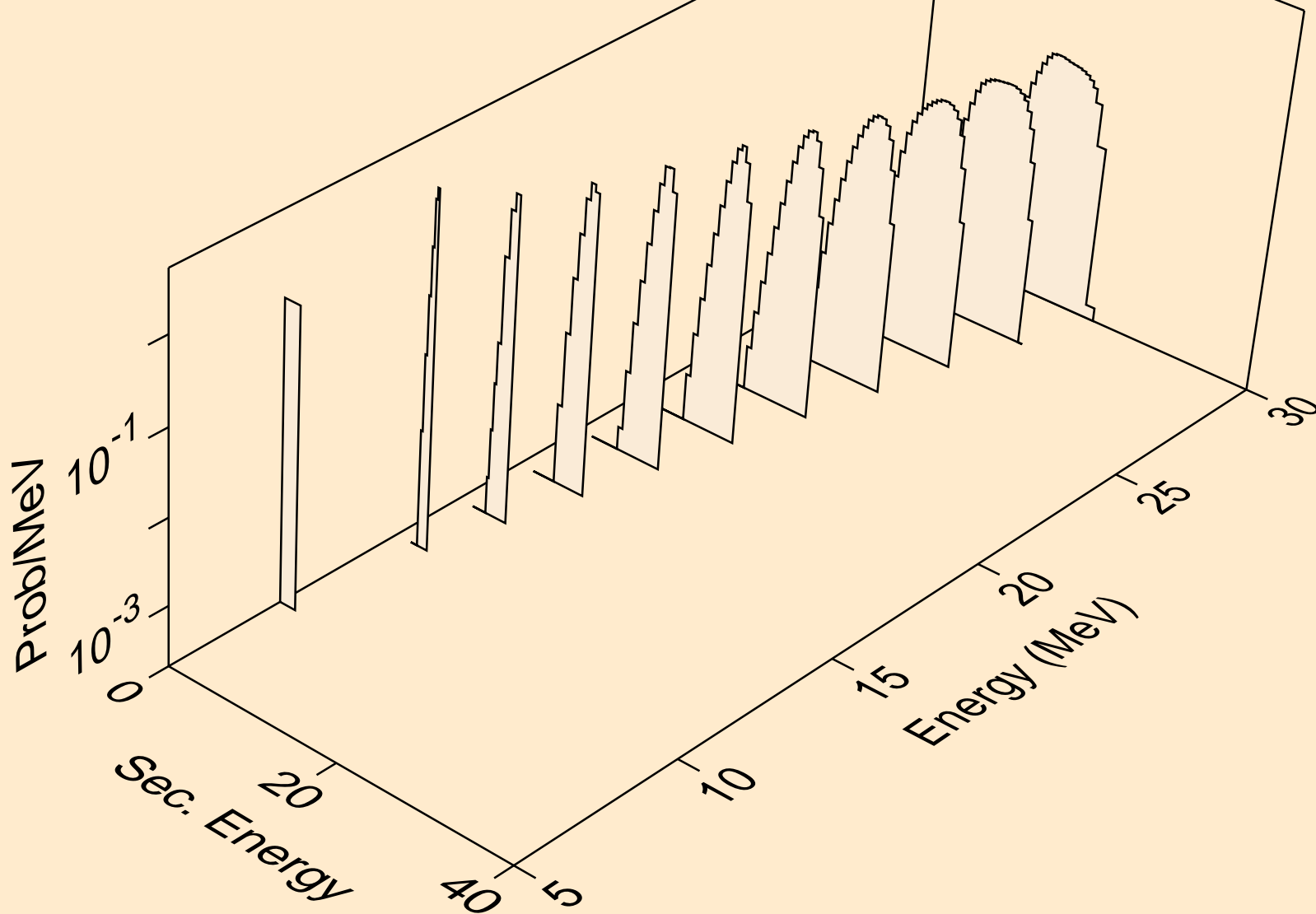

RA207 NEUTRON ACER TENDL-2023 LIBRARY; T=0.K  
deuterons from (n,d)

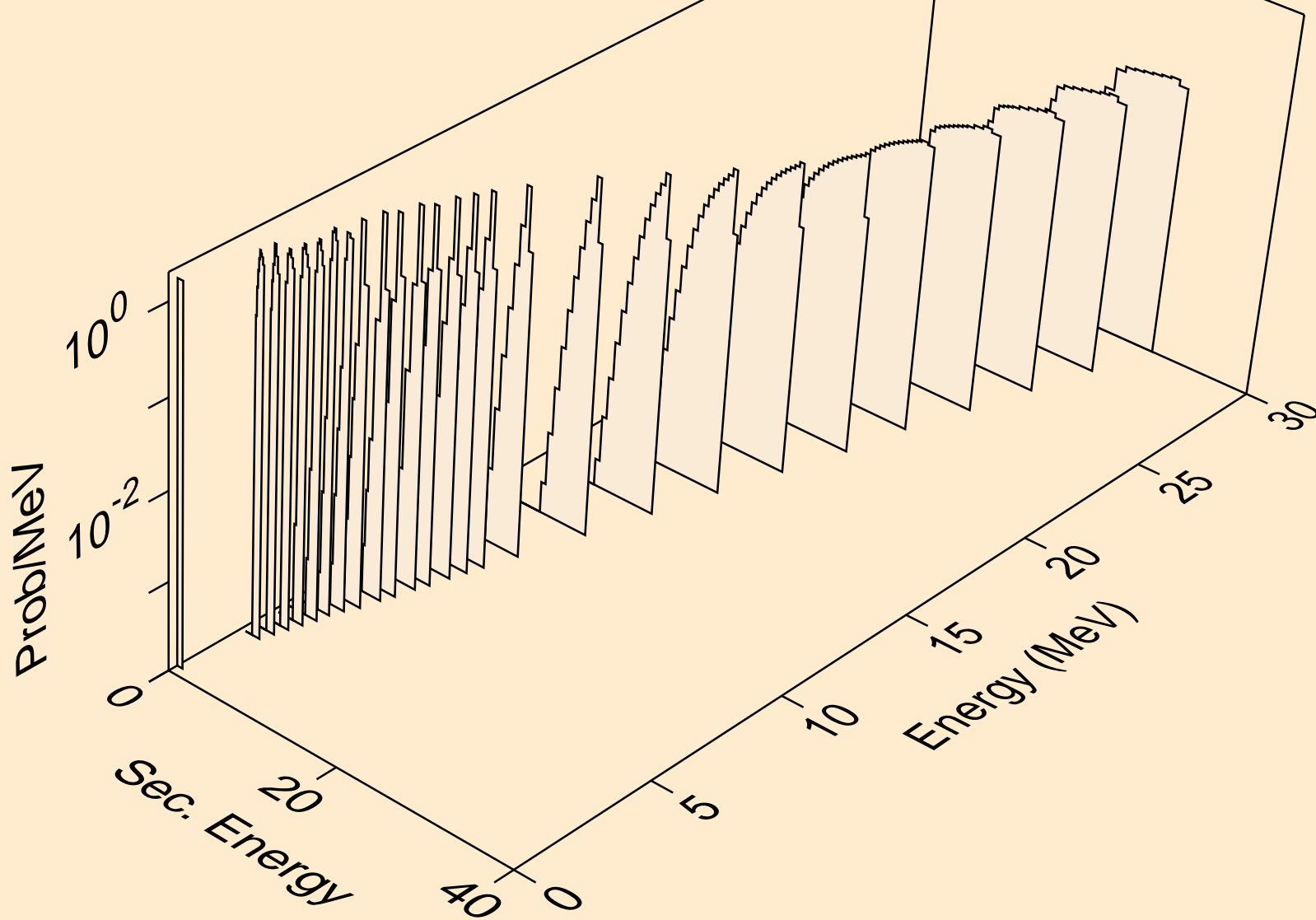

RA207 NEUTRON ACER TENDL-2023 LIBRARY; T=0.K  
deuterons from (n,pd)

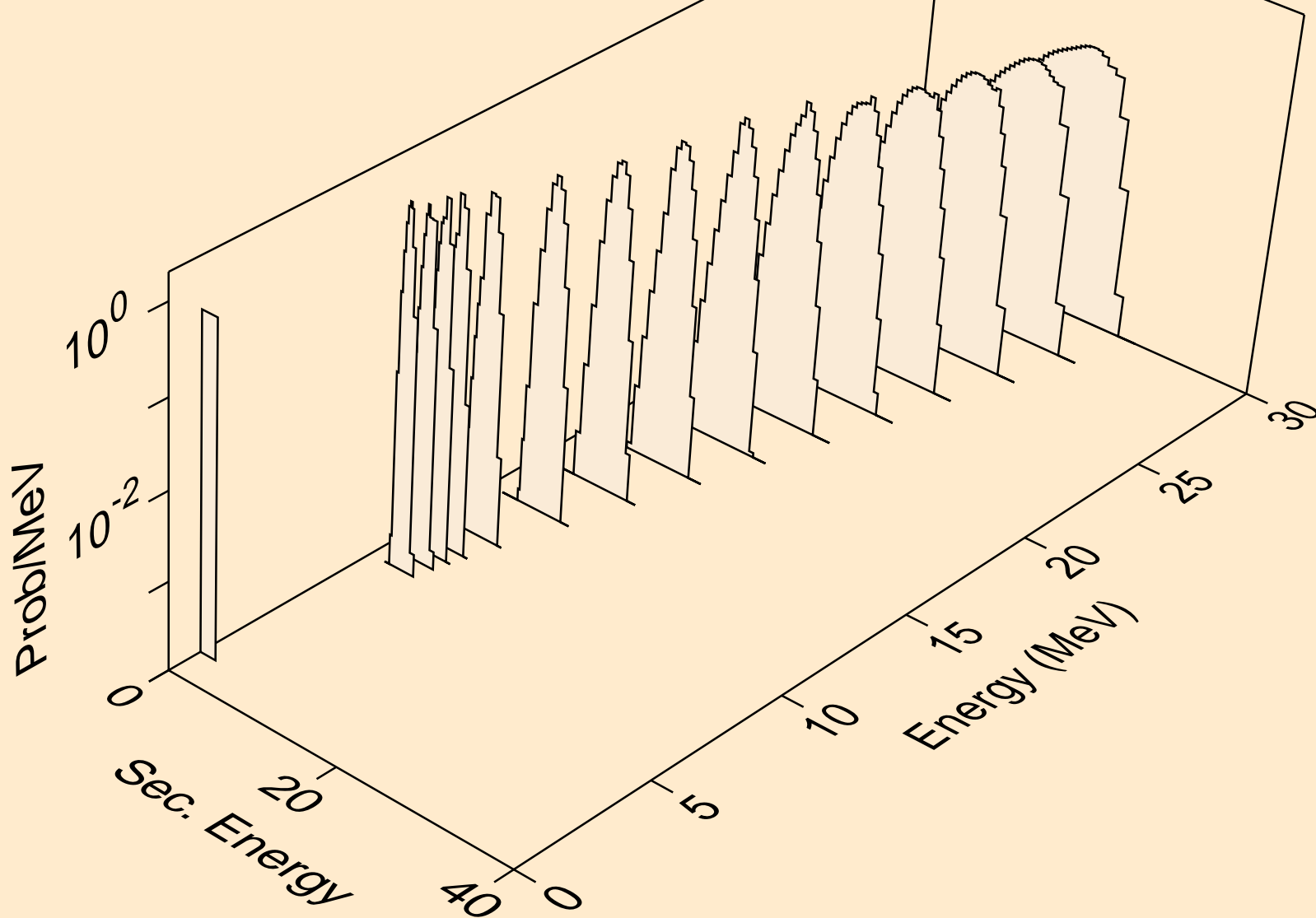



RA207 NEUTRON ACER TENDL-2023 LIBRARY; T=0.K  
deuterons from (n,da)

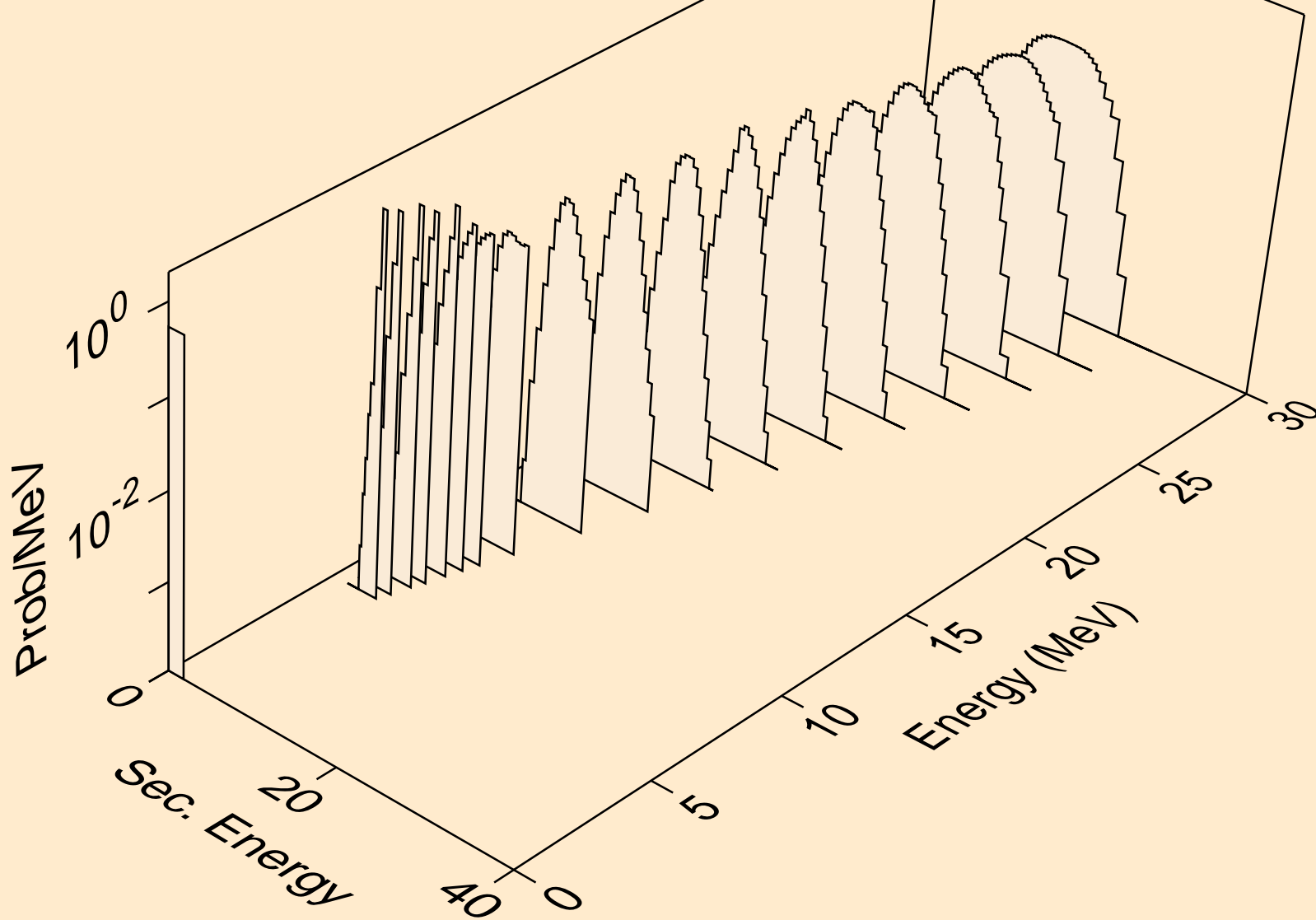

RA207 NEUTRON ACER TENDL-2023 LIBRARY; T=0.K  
tritons from (n,x)

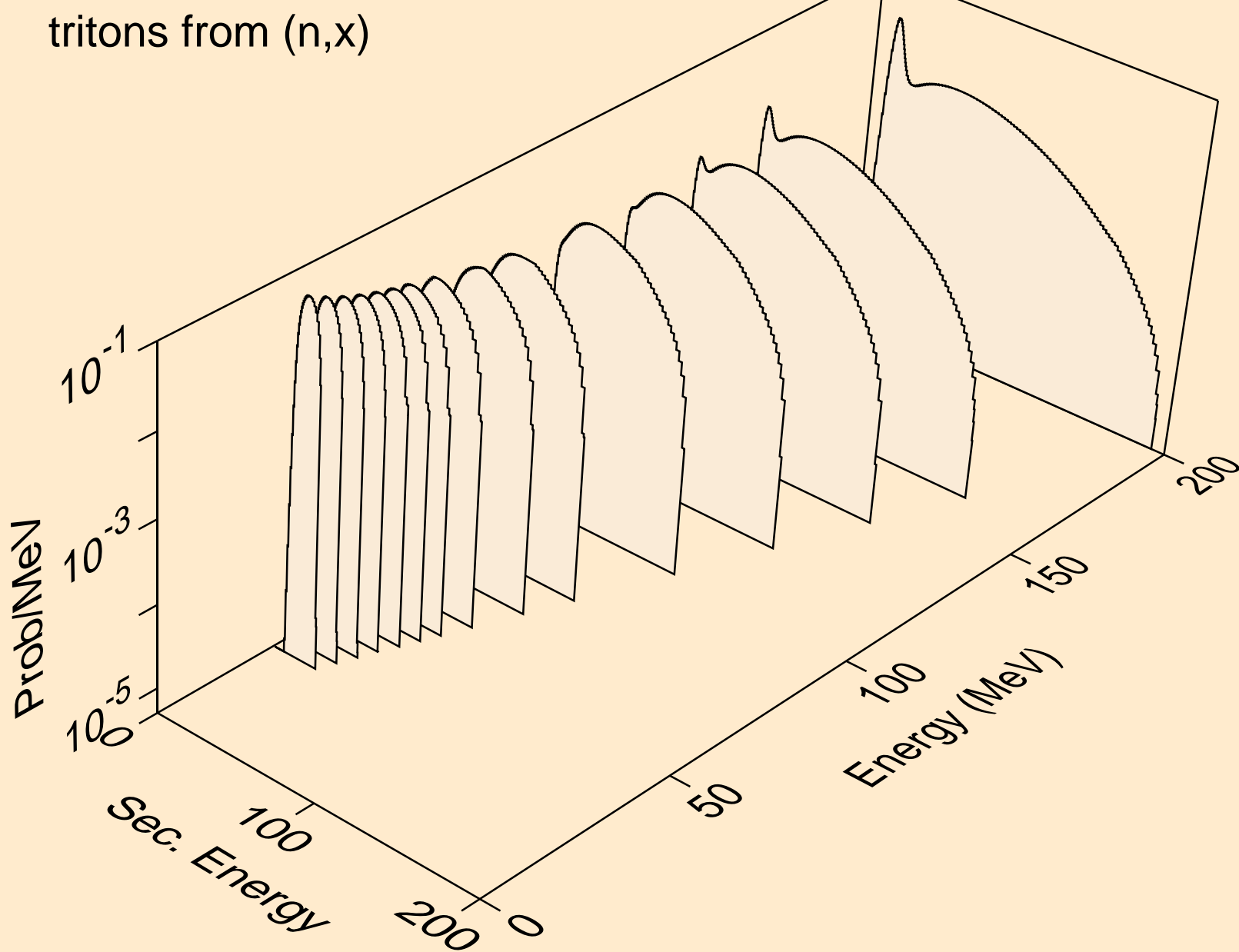

RA207 NEUTRON ACER TENDL-2023 LIBRARY; T=0.K  
tritons from (n,n\*)t

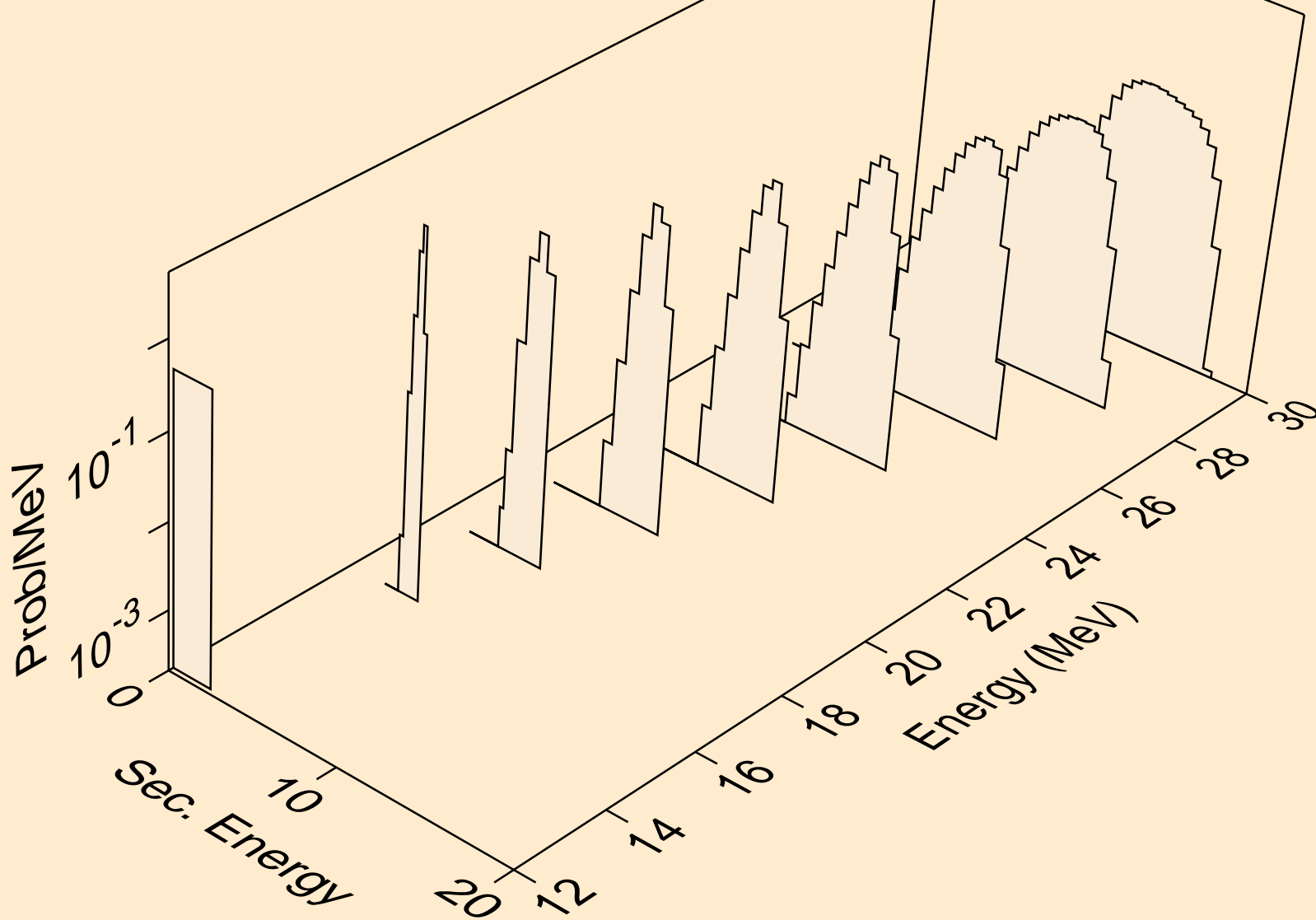

RA207 NEUTRON ACER TENDL-2023 LIBRARY; T=0.K  
tritons from (n,t)

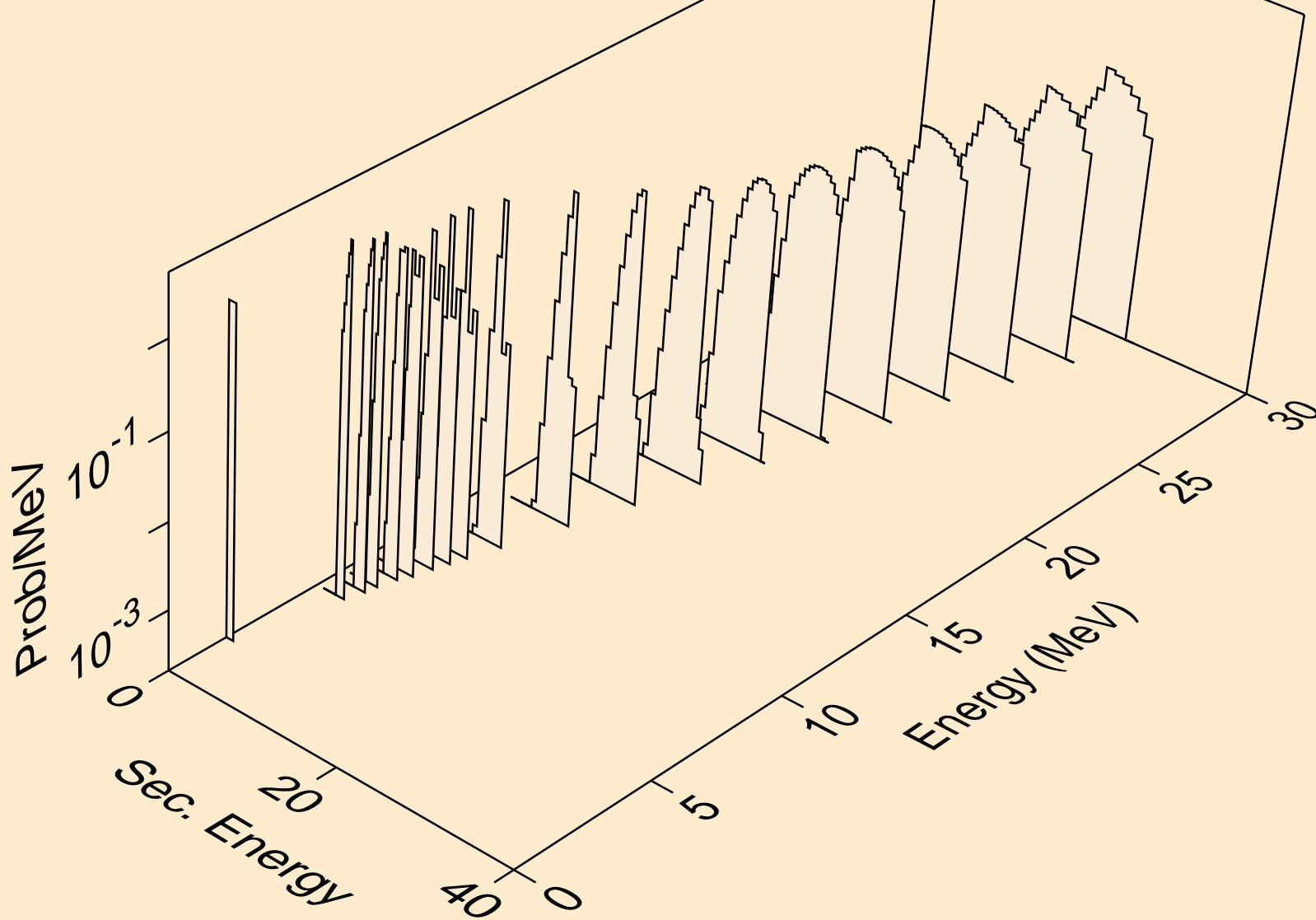

RA207 NEUTRON ACER TENDL-2023 LIBRARY; T=0.K  
tritons from (n,pt)

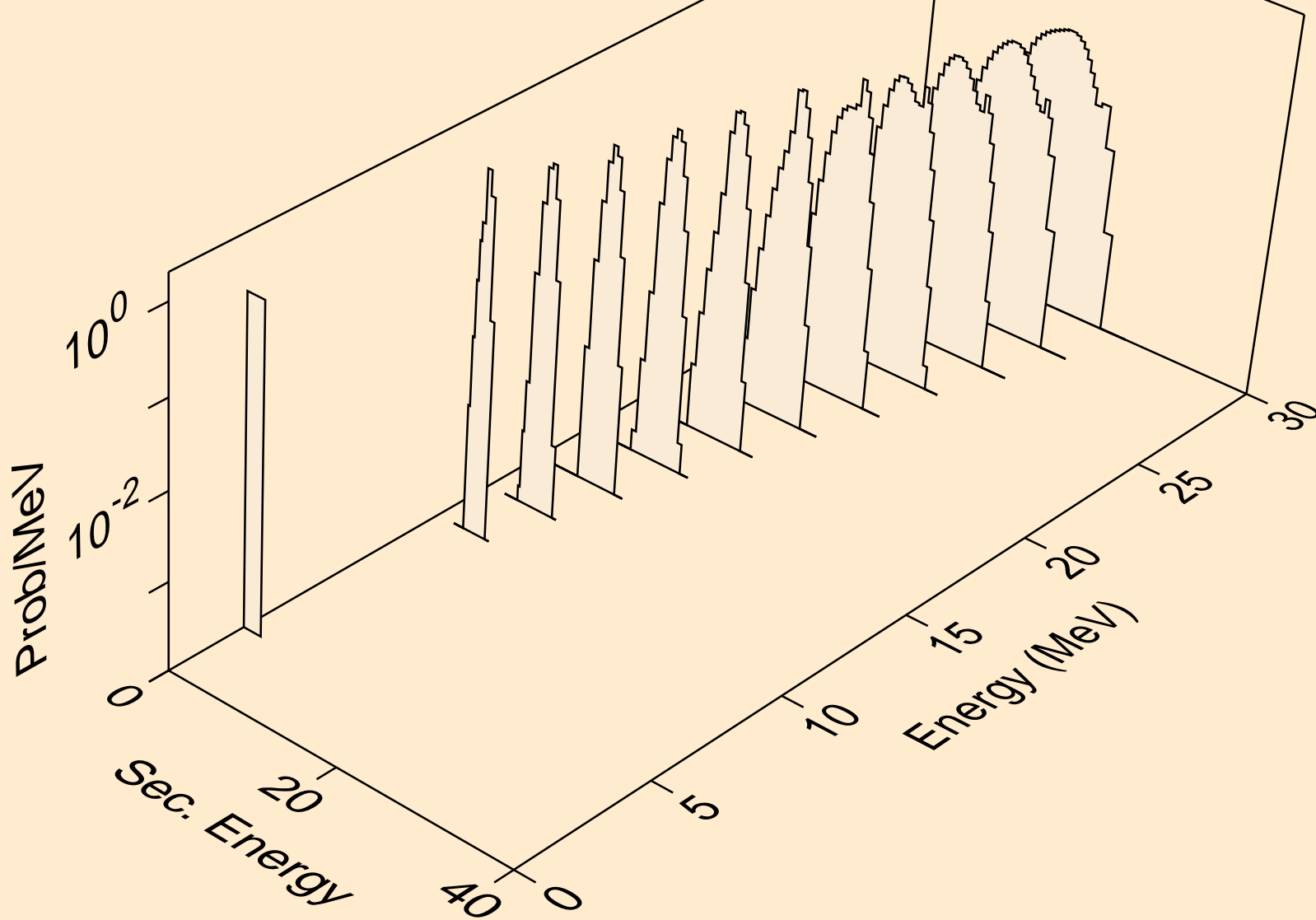

RA207 NEUTRON ACER TENDL-2023 LIBRARY; T=0.K  
he3s from (n,x)

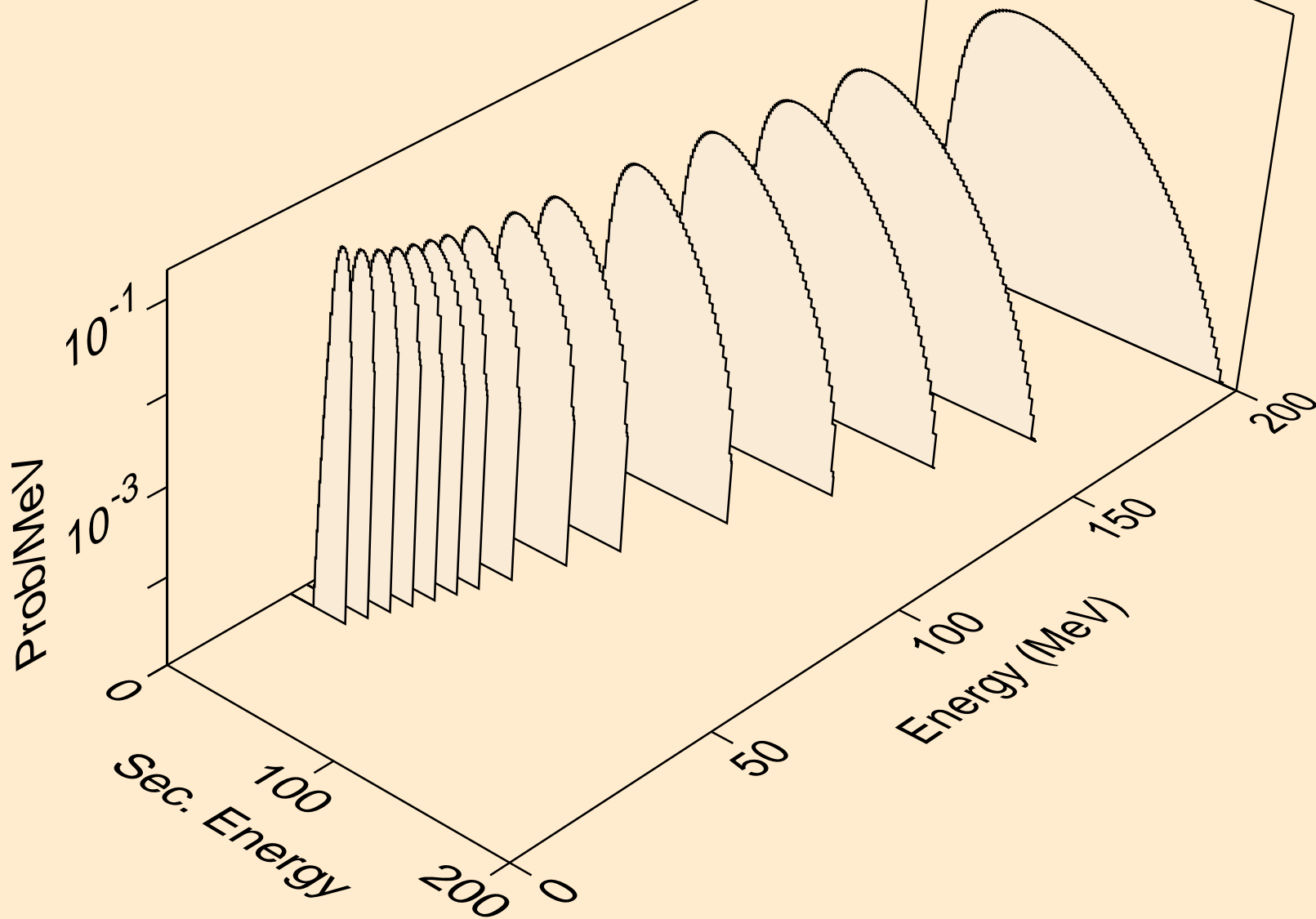

RA207 NEUTRON ACER TENDL-2023 LIBRARY; T=0.K  
he3s from (n,n\*)he3

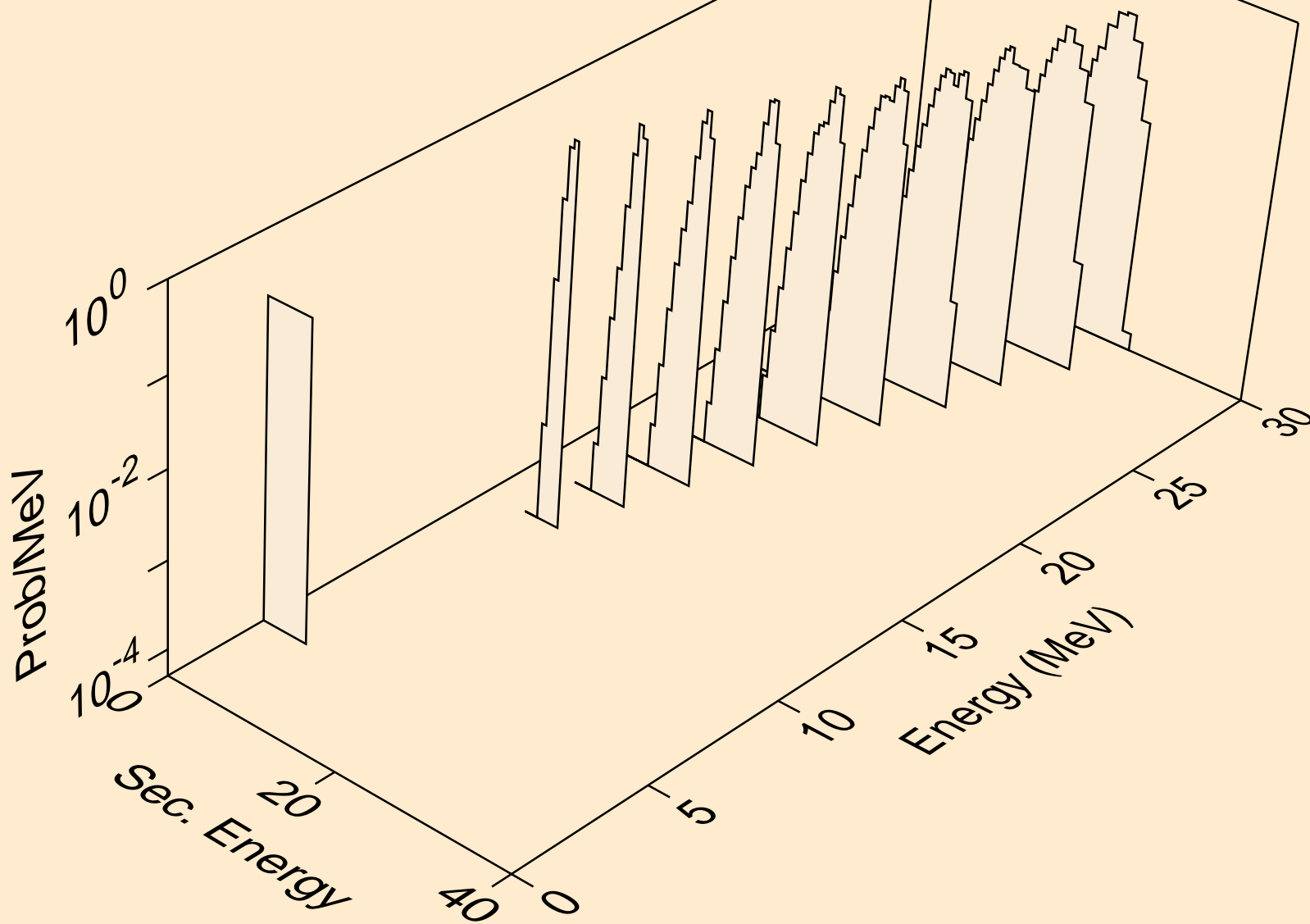

RA207 NEUTRON ACER TENDL-2023 LIBRARY; T=0.K  
he3s from (n,he3)

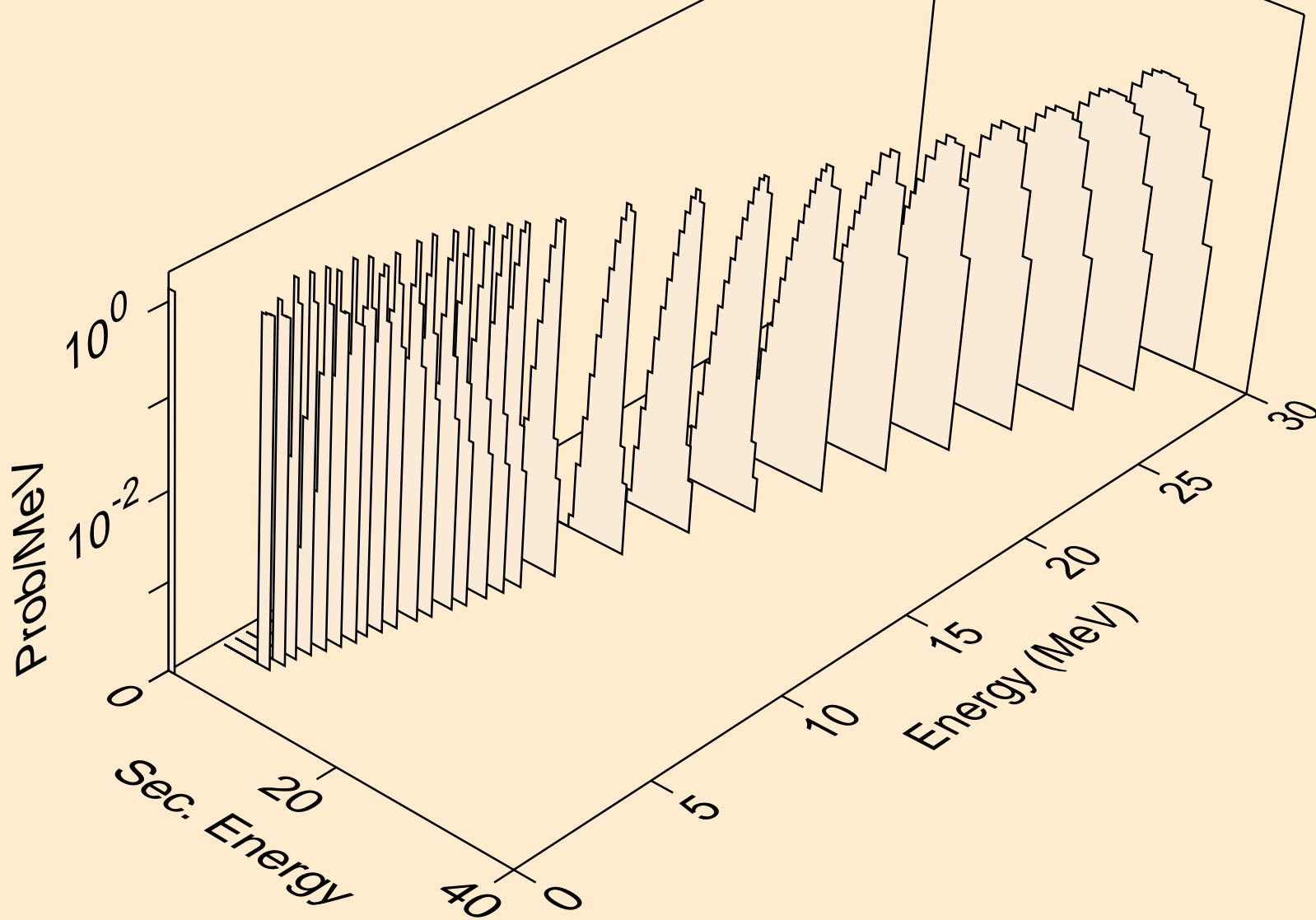



RA207 NEUTRON ACER TENDL-2023 LIBRARY; T=0.K  
alphas from (n,x)

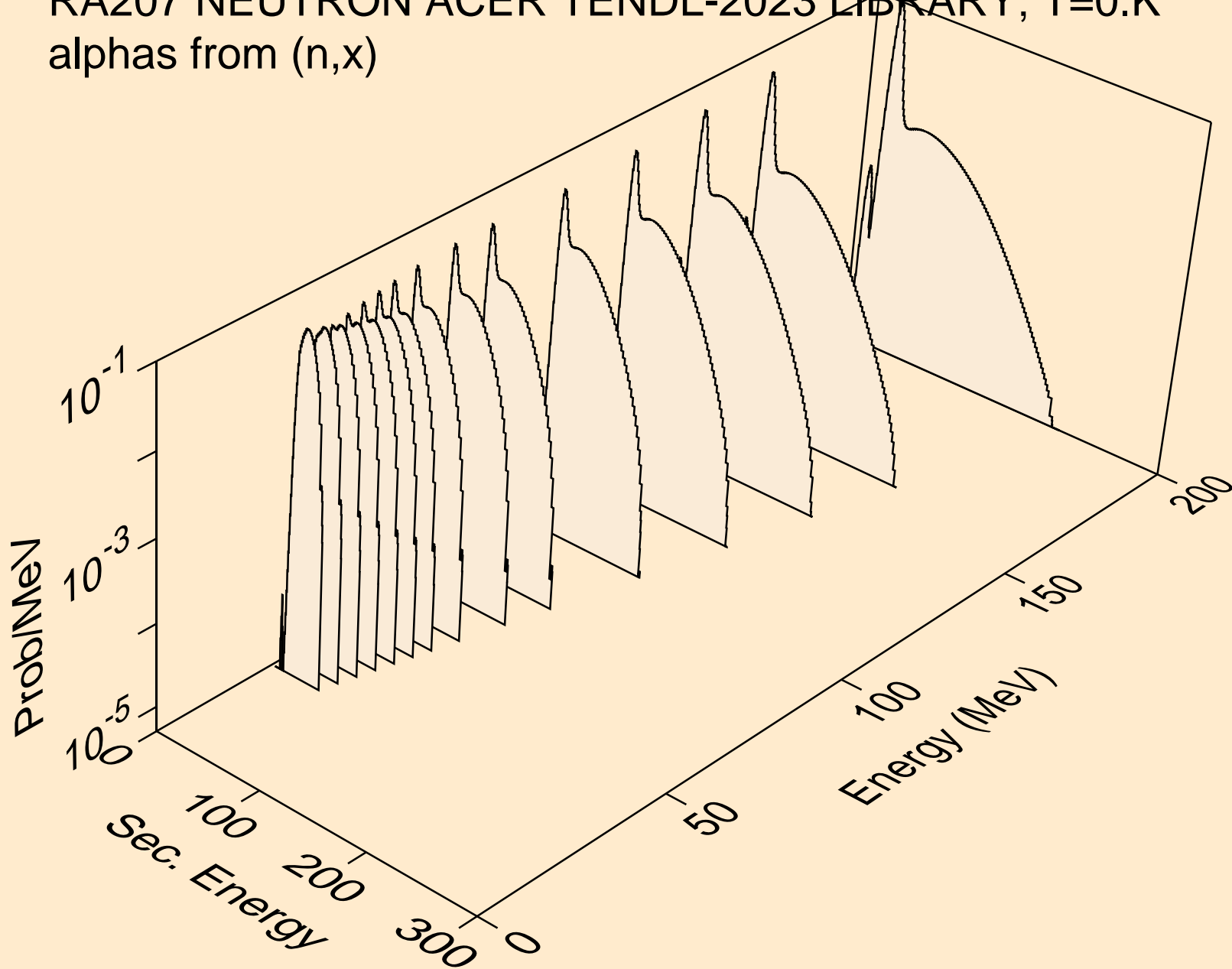

RA207 NEUTRON ACER TENDL-2023 LIBRARY; T=0.K  
alphas from (n,n\*)a

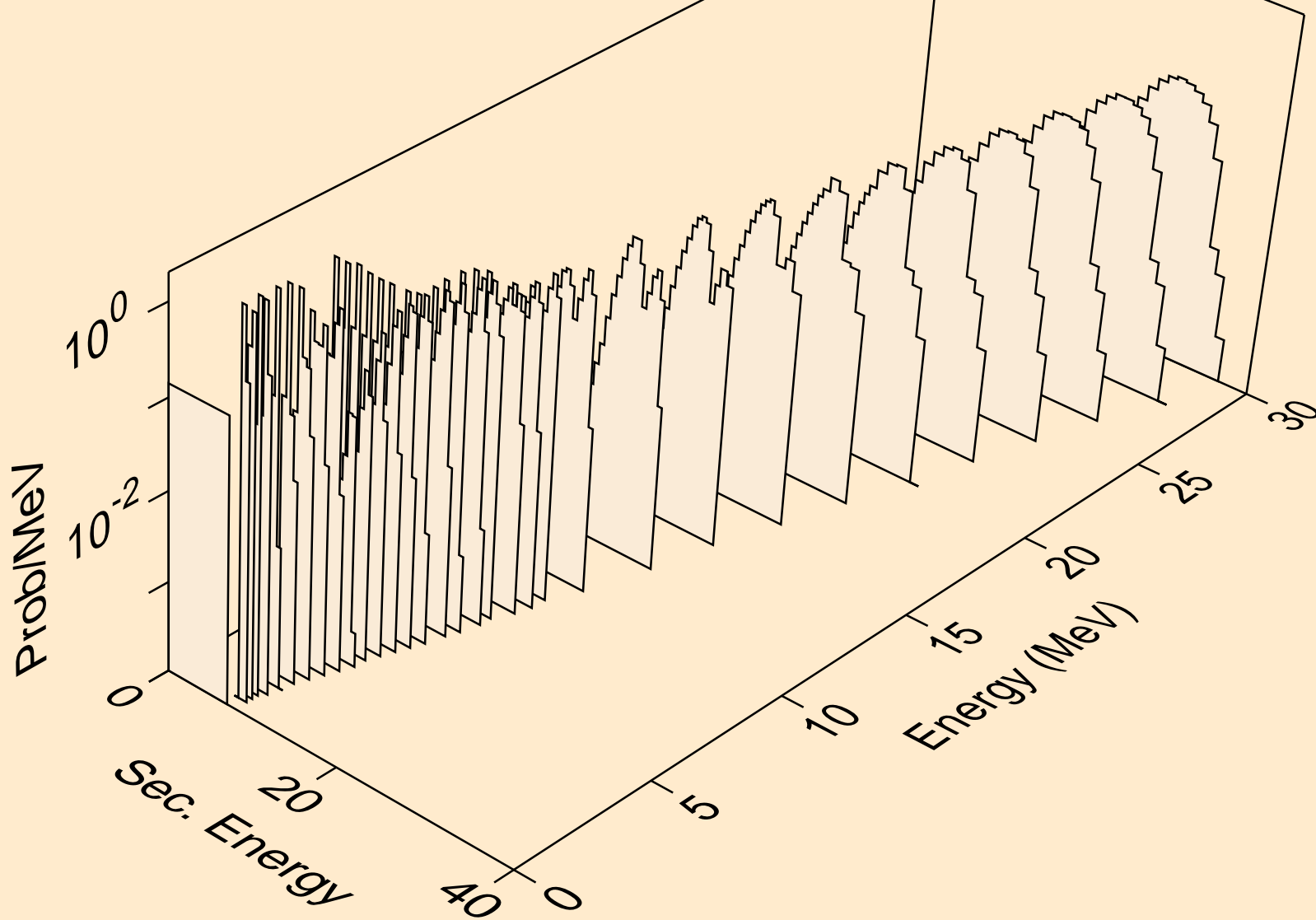

RA207 NEUTRON ACER TENDL-2023 LIBRARY; T=0.K  
alphas from (n,2n)a

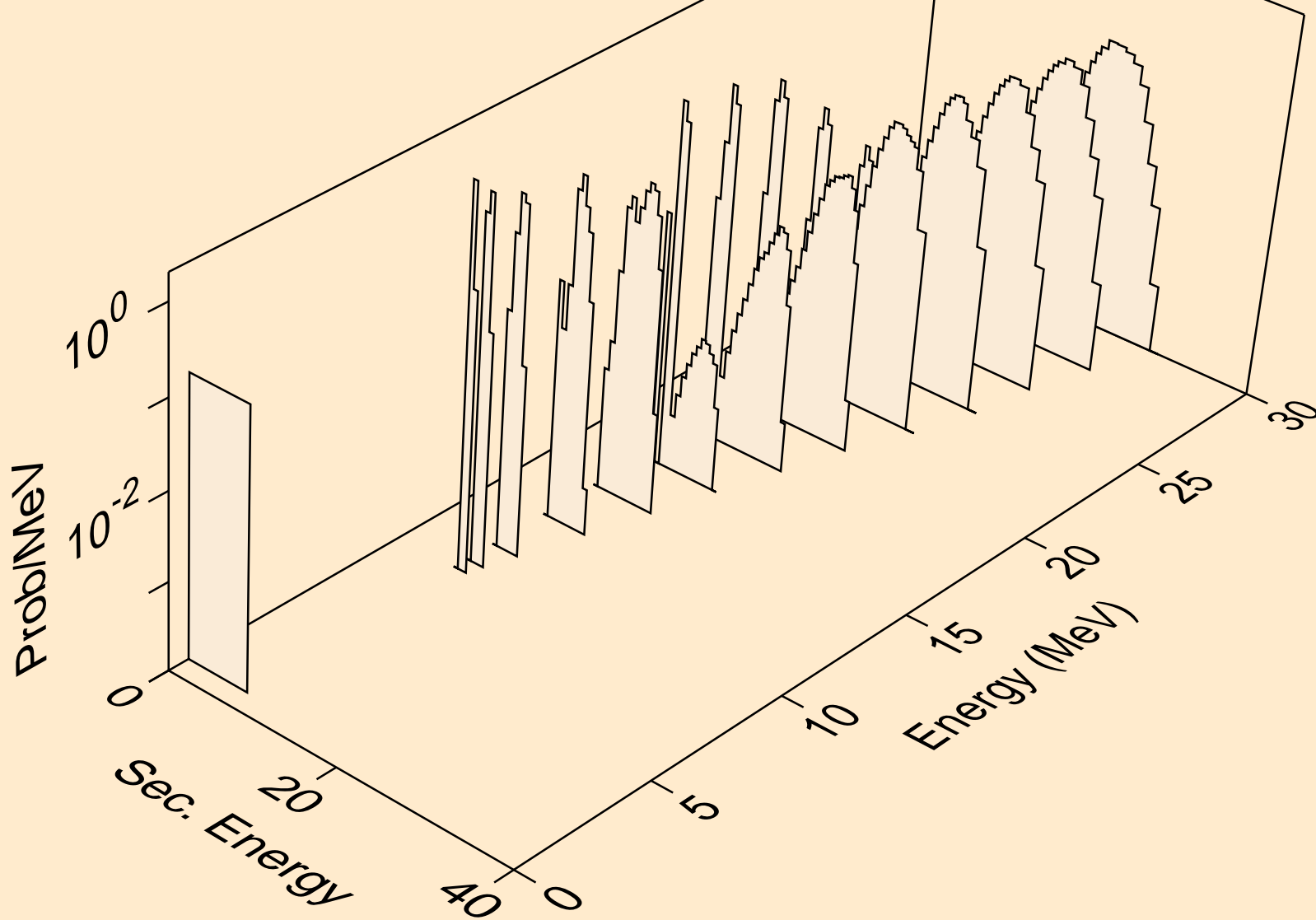

RA207 NEUTRON ACER TENDL-2023 LIBRARY; T=0.K  
alphas from (n,3n)a

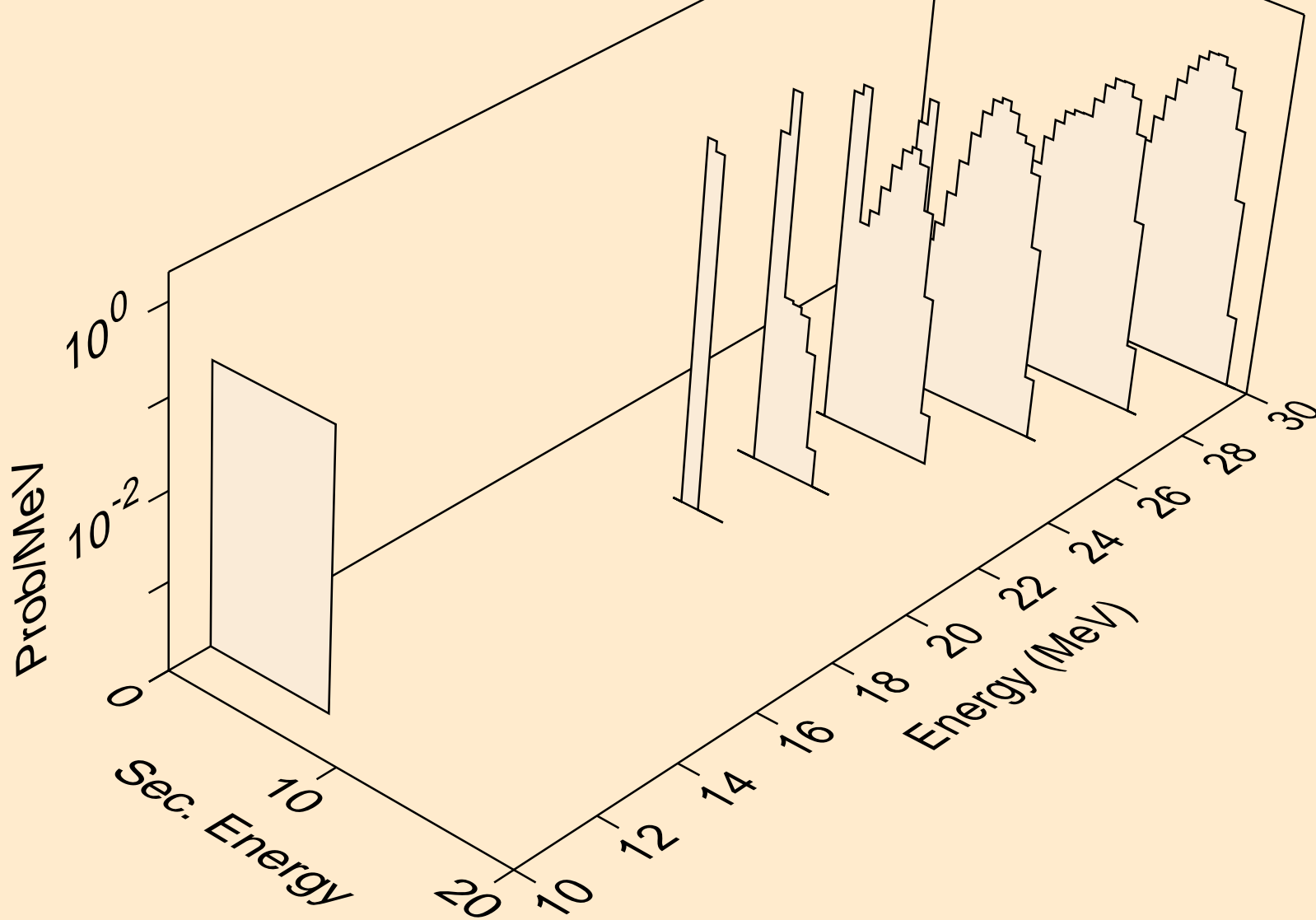

RA207 NEUTRON ACER TENDL-2023 LIBRARY; T=0.K  
alphas from (n,n\*)2a

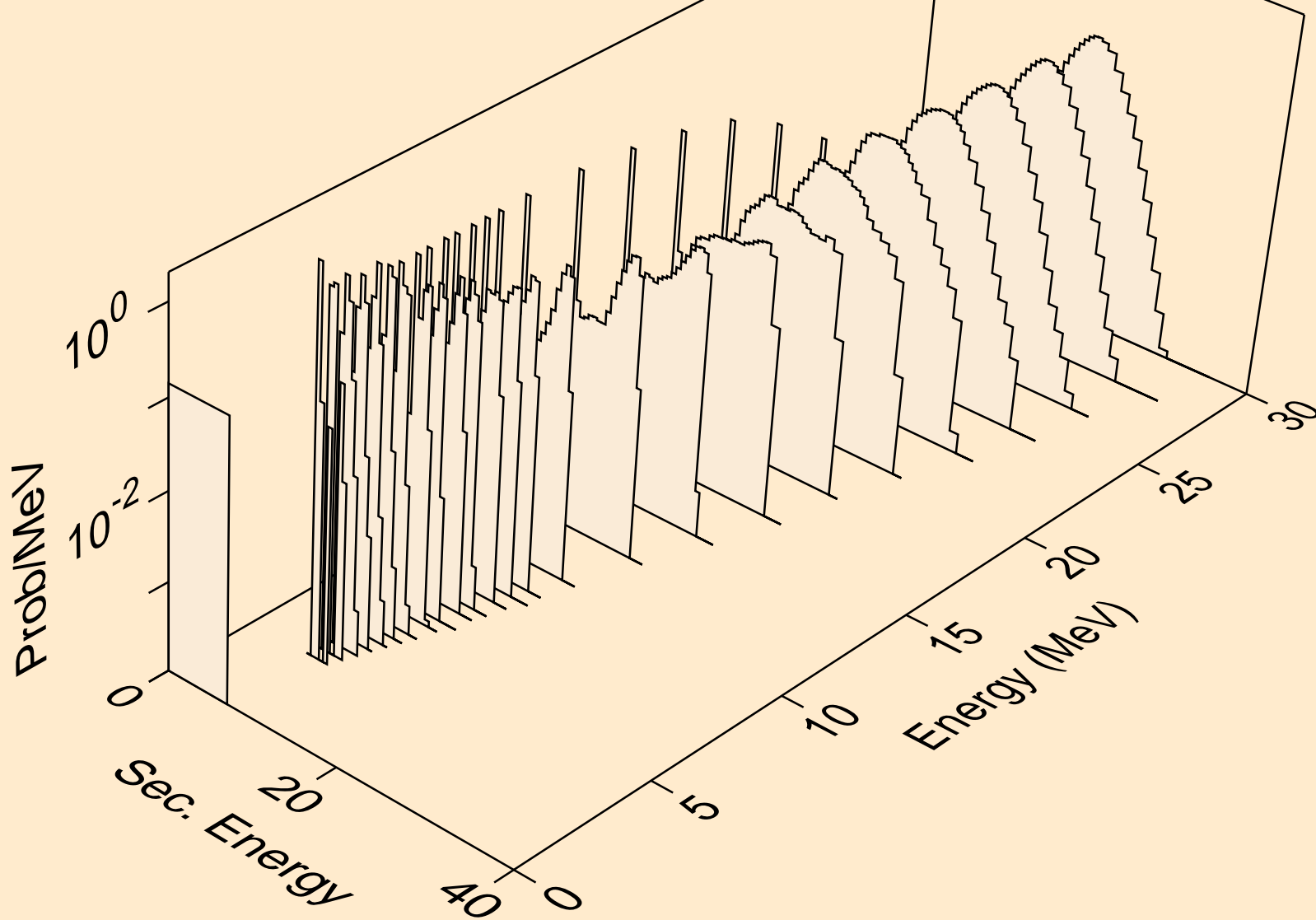

RA207 NEUTRON ACER TENDL-2023 LIBRARY; T=0.K  
alphas from (n,2n)2a

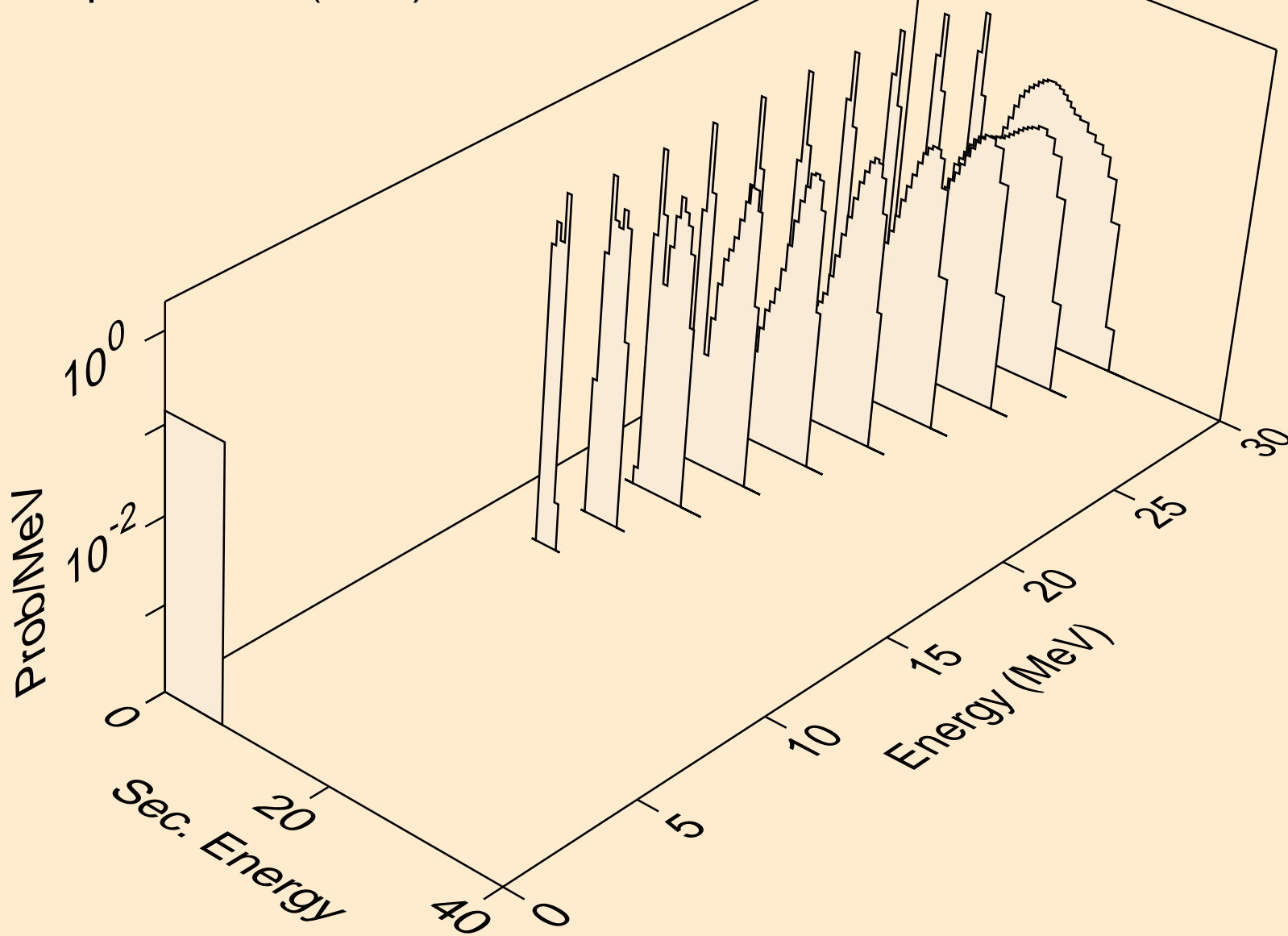

RA207 NEUTRON ACER TENDL-2023 LIBRARY; T=0.K  
alphas from (n,npa)

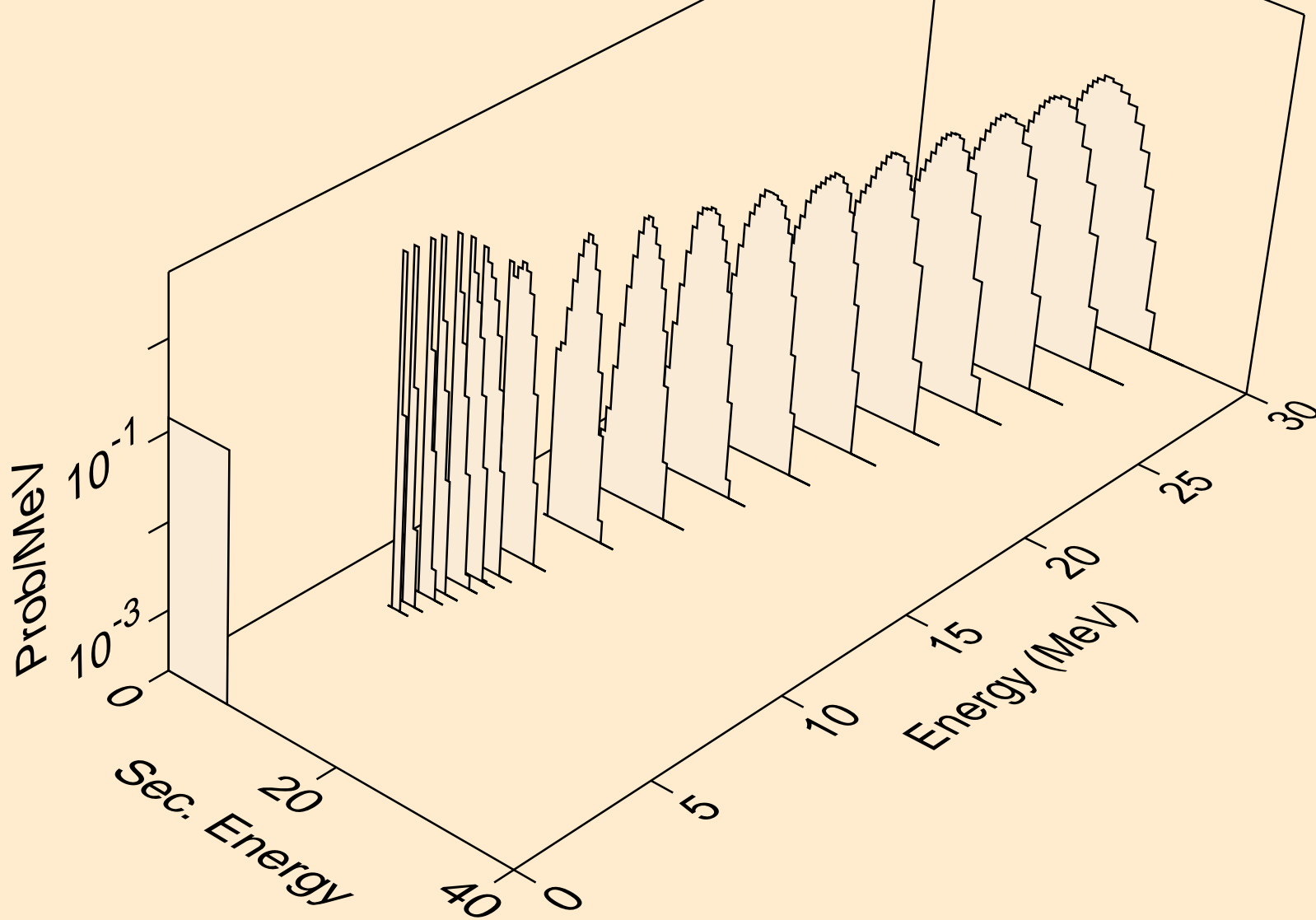

RA207 NEUTRON ACER TENDL-2023 LIBRARY; T=0.K  
alphas from (n,a)

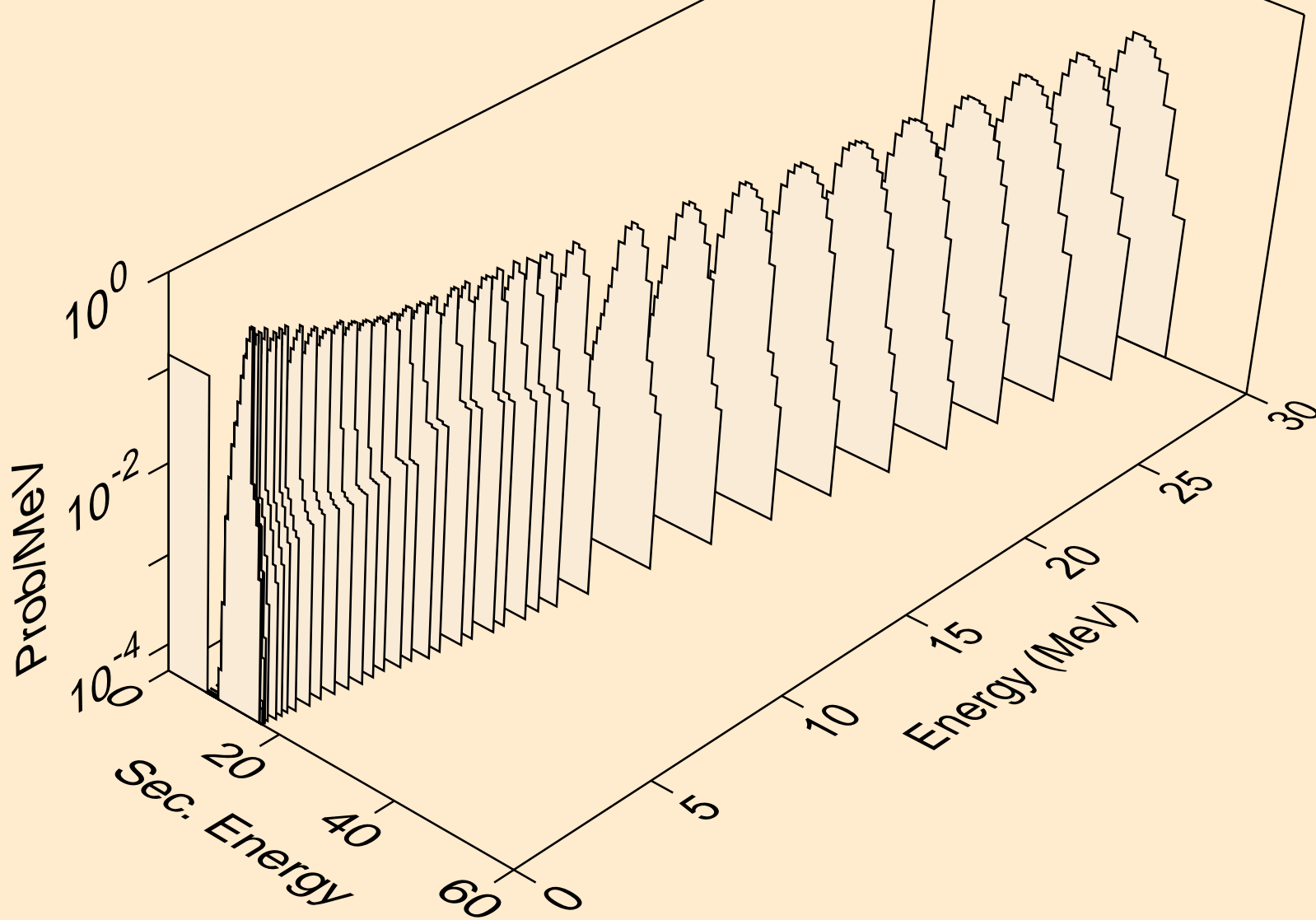



RA207 NEUTRON ACER TENDL-2023 LIBRARY; T=0.K  
alphas from (n,2a)

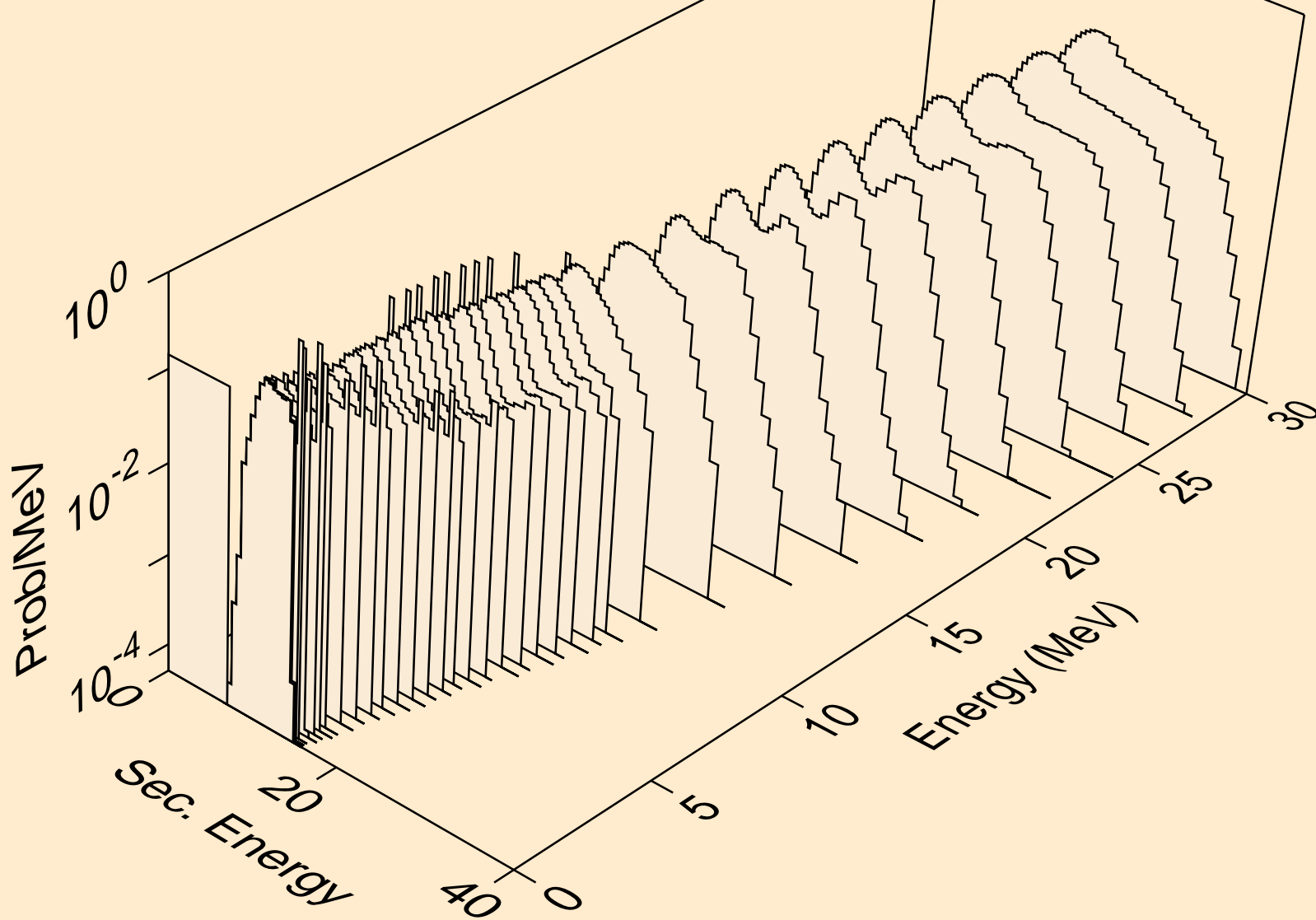

RA207 NEUTRON ACER TENDL-2023 LIBRARY; T=0.K  
alphas from (n,3a)

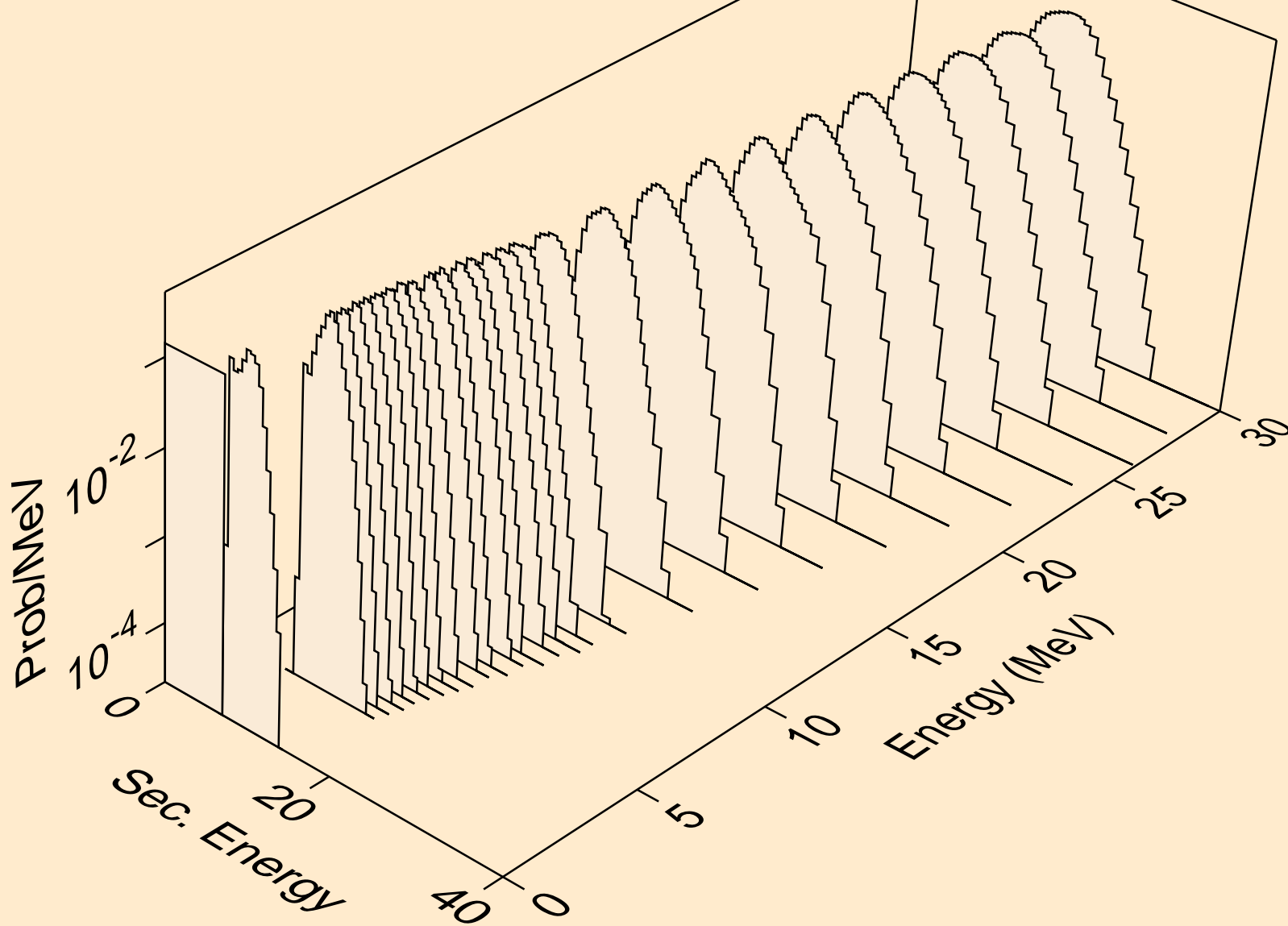

RA207 NEUTRON ACER TENDL-2023 LIBRARY; T=0.K  
alphas from (n,pa)

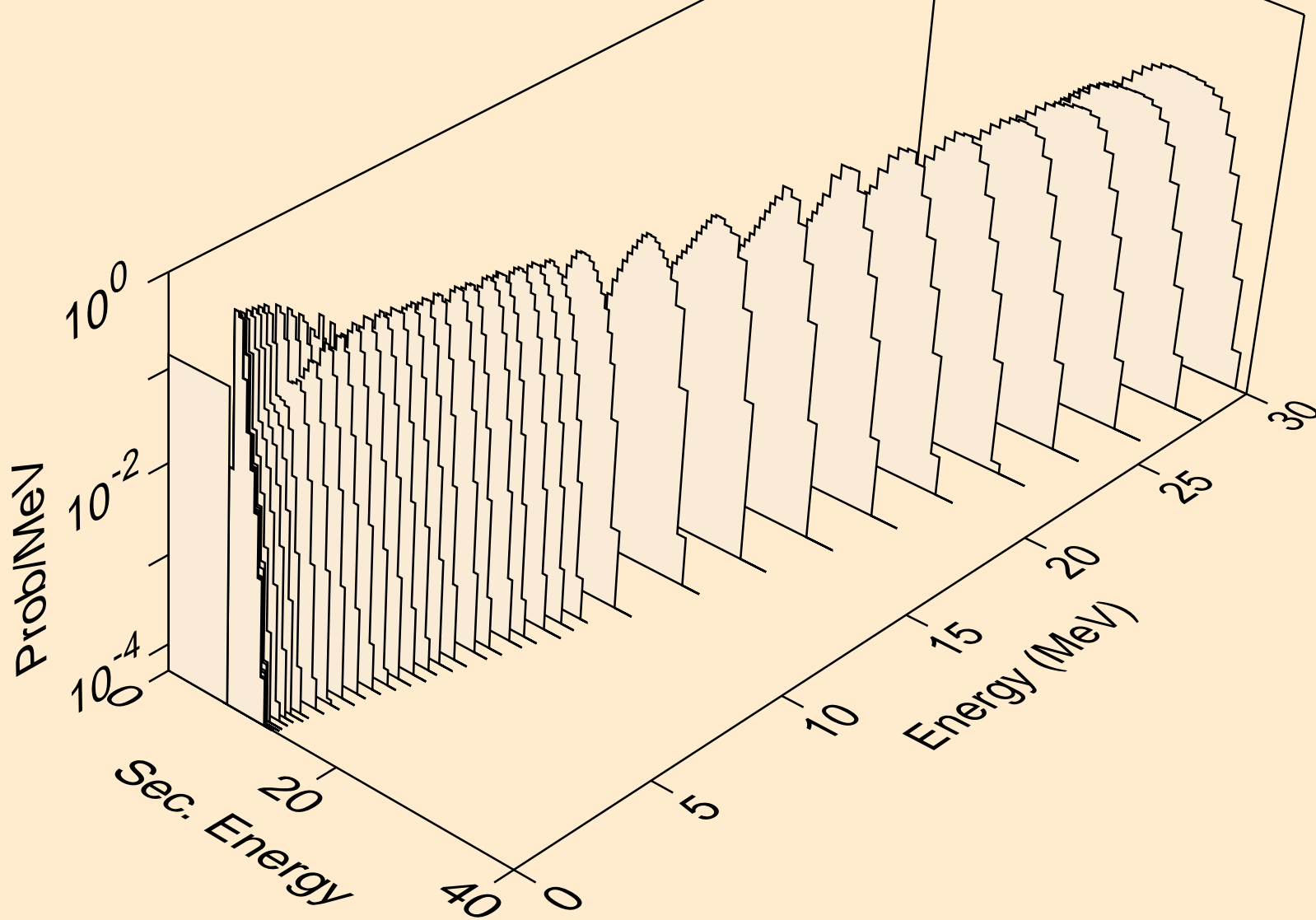

RA207 NEUTRON ACER TENDL-2023 LIBRARY; T=0.K  
alphas from (n,da)

