

RA208 NEUTRON ACER TENDL-2023 LIBRARY; T=0.K
Principal cross sections

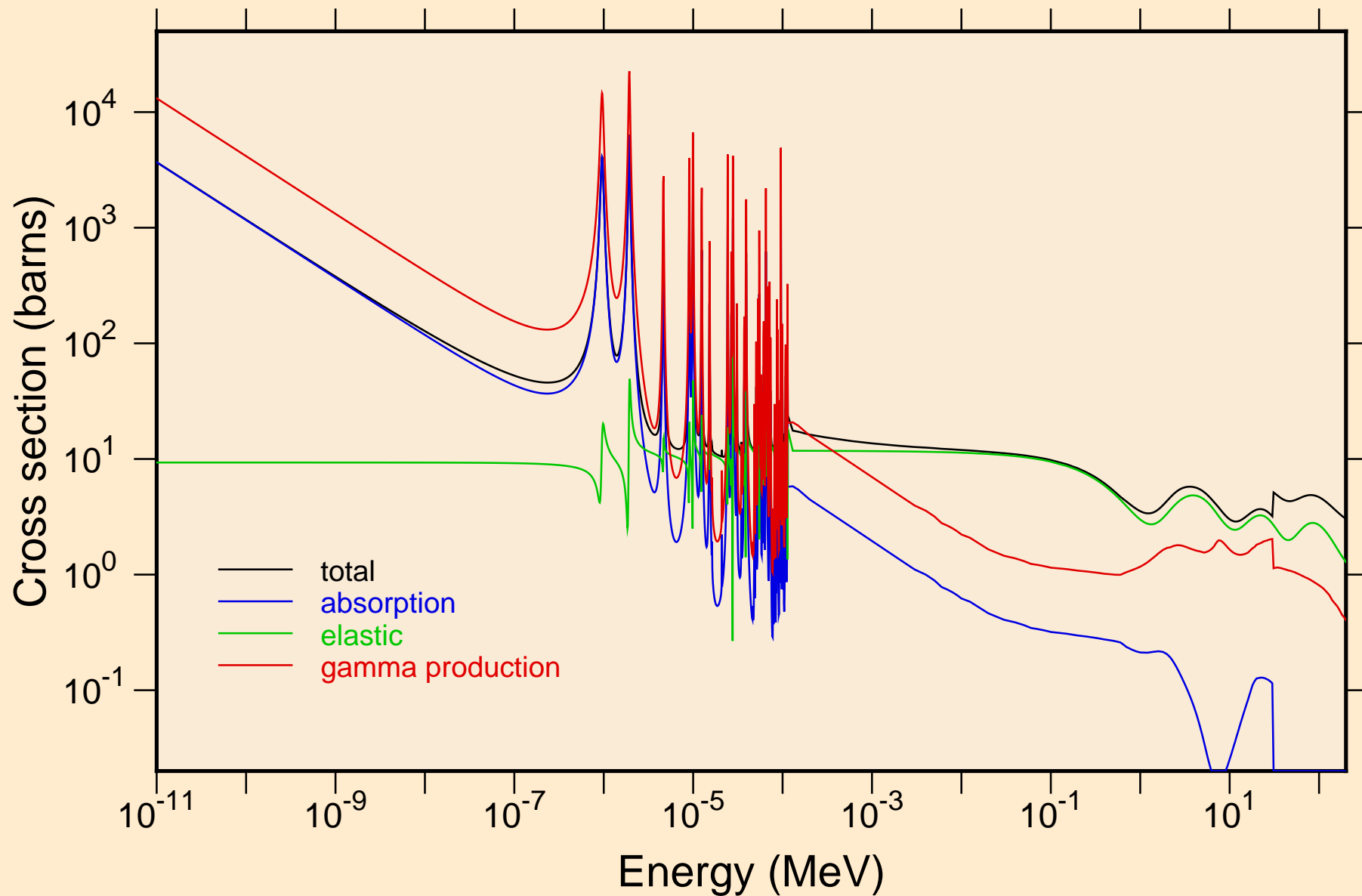

RA208 NEUTRON ACER TENDL-2023 LIBRARY; T=0.K
resonance total cross section

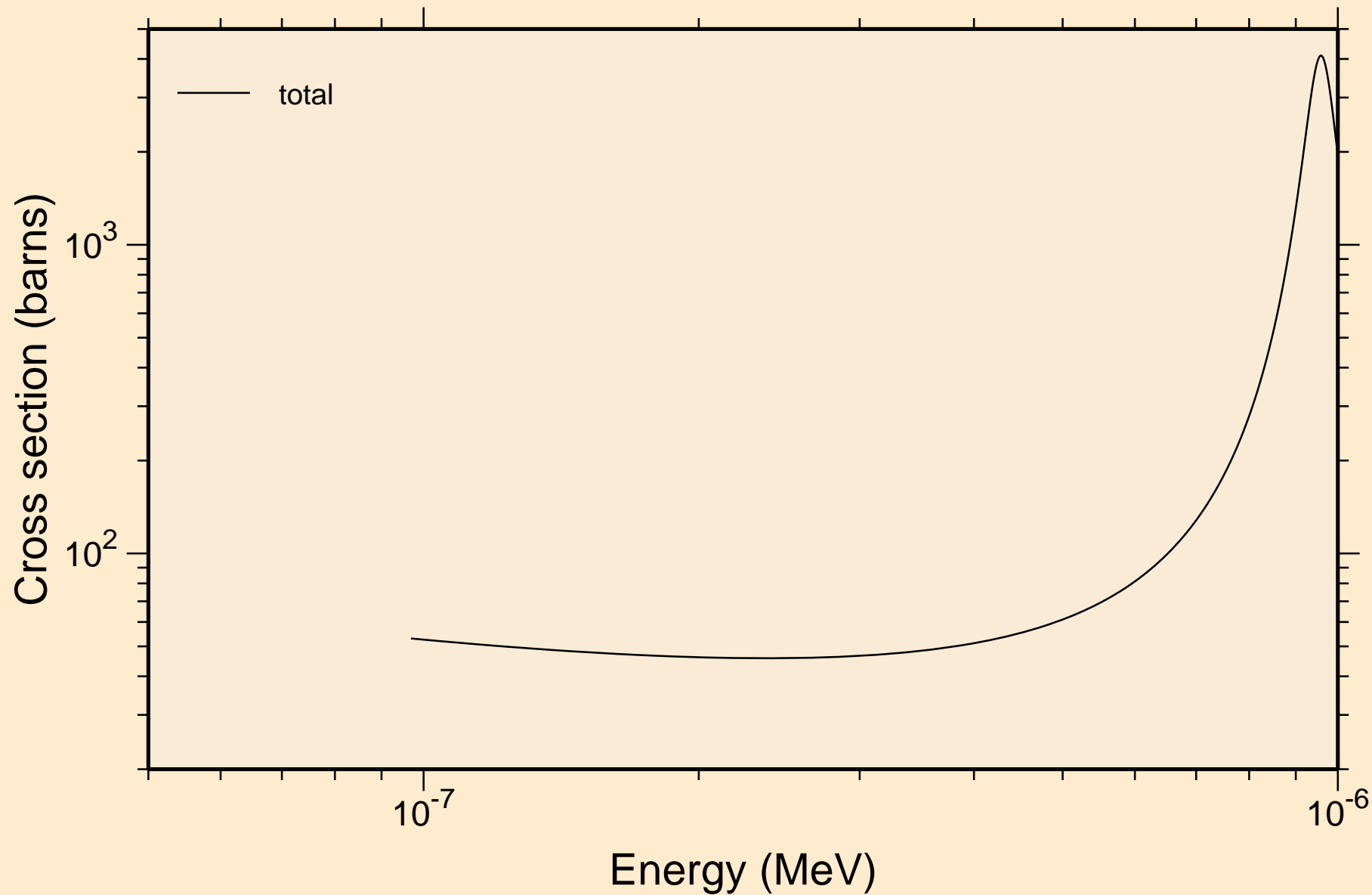

RA208 NEUTRON ACER TENDL-2023 LIBRARY; T=0.K
resonance total cross section

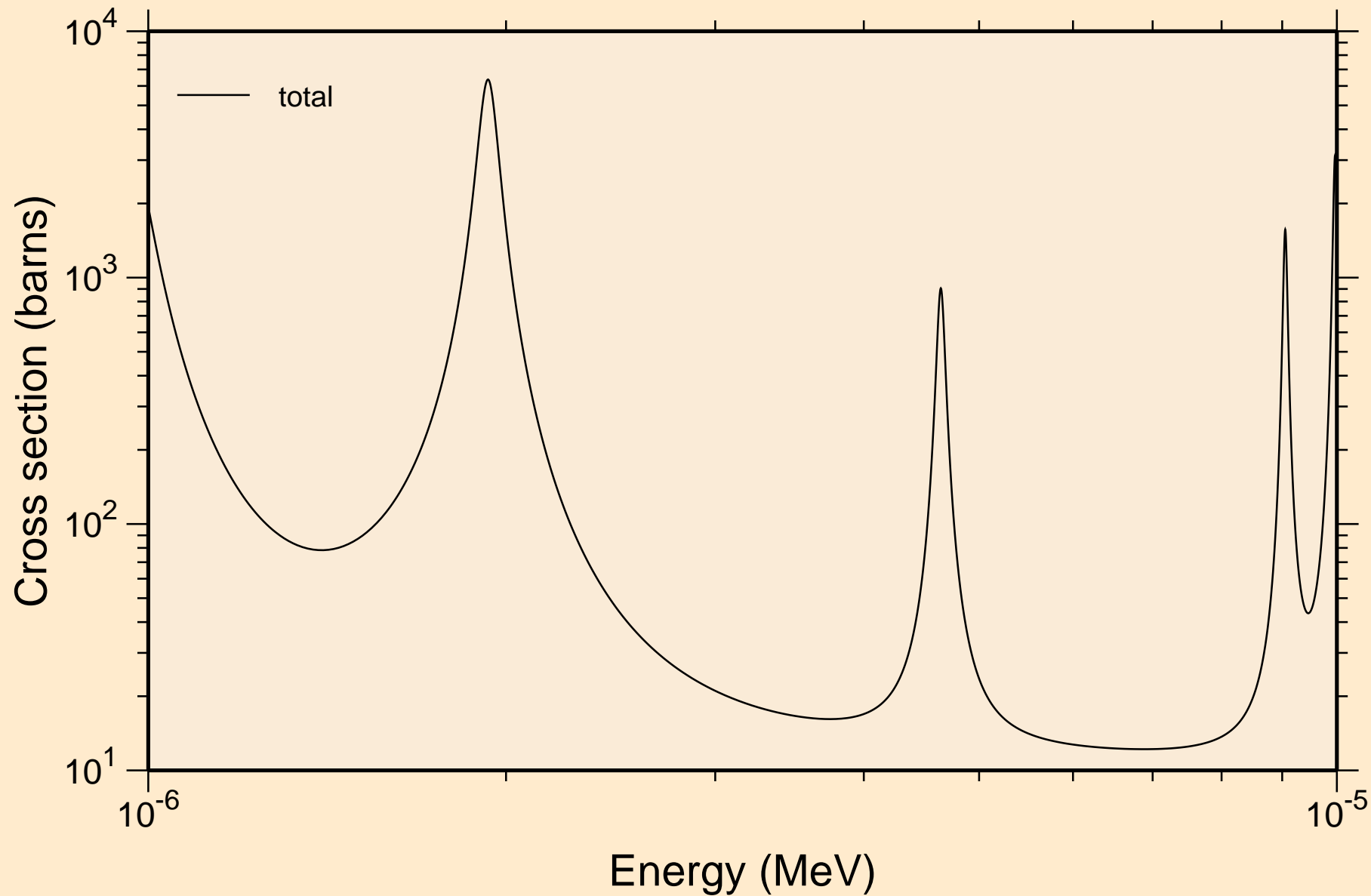

RA208 NEUTRON ACER TENDL-2023 LIBRARY; T=0.K
resonance total cross section

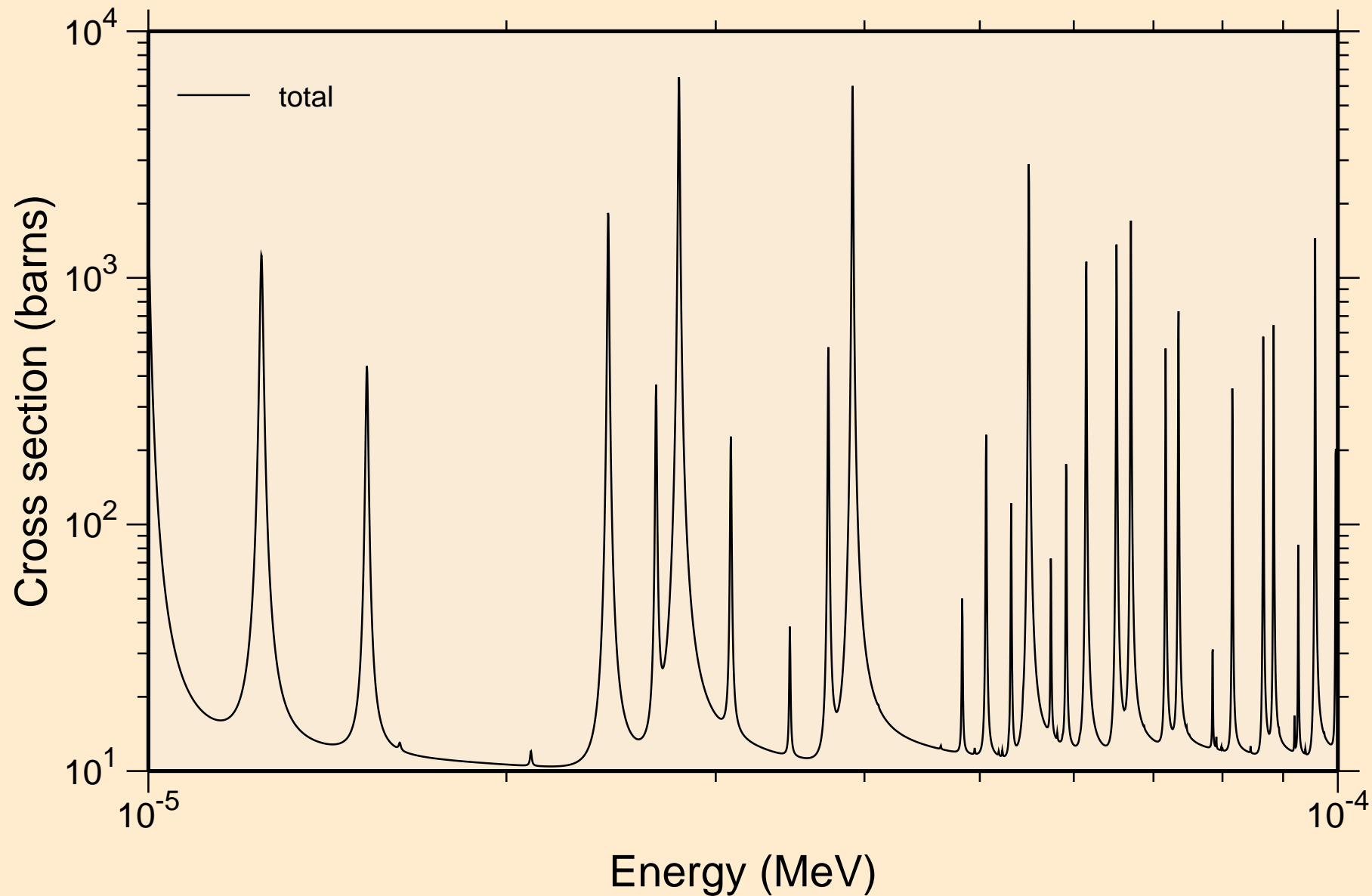

RA208 NEUTRON ACER TENDL-2023 LIBRARY; T=0.K
resonance total cross section

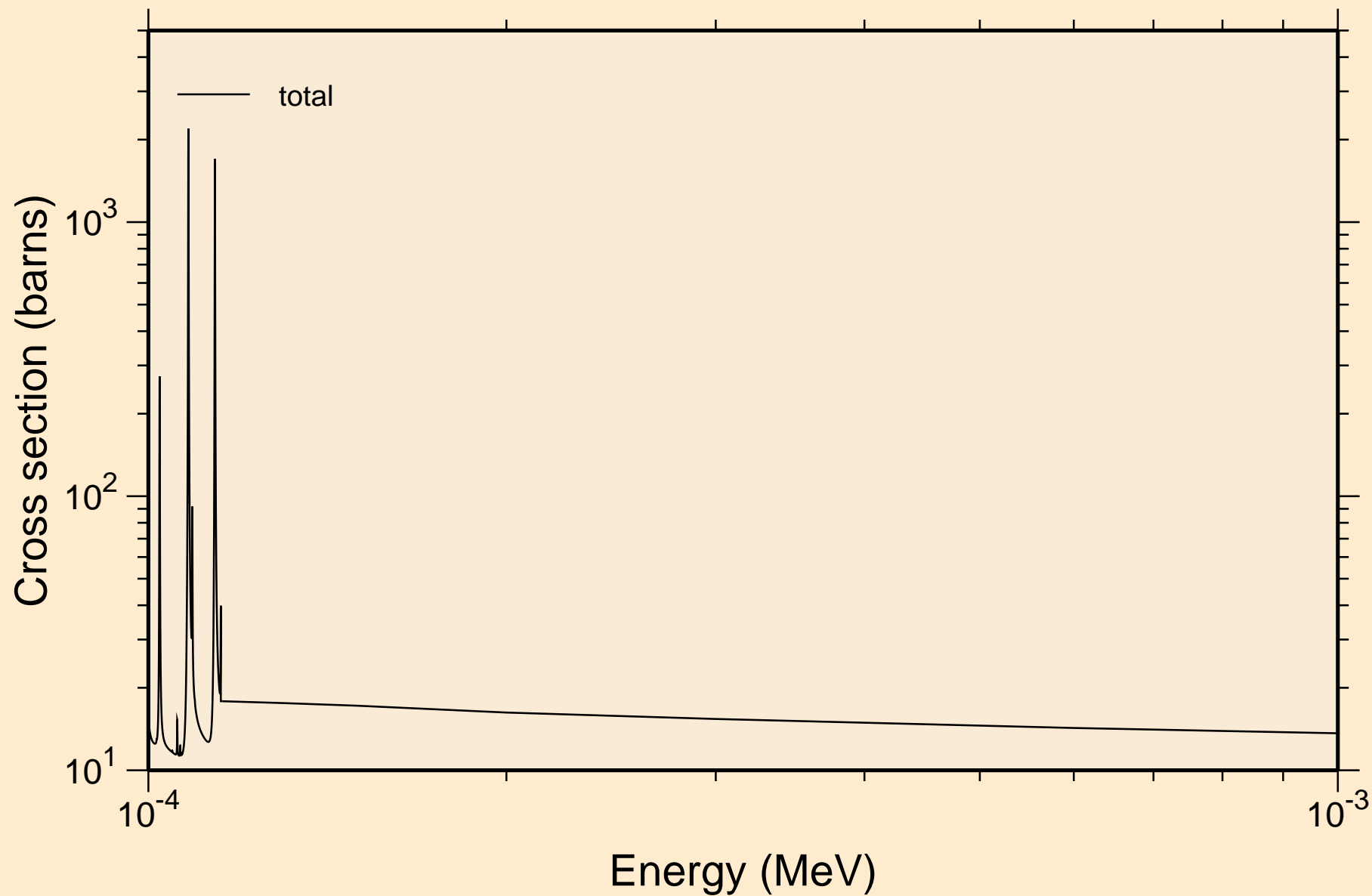

RA208 NEUTRON ACER TENDL-2023 LIBRARY; T=0.K
resonance total cross section

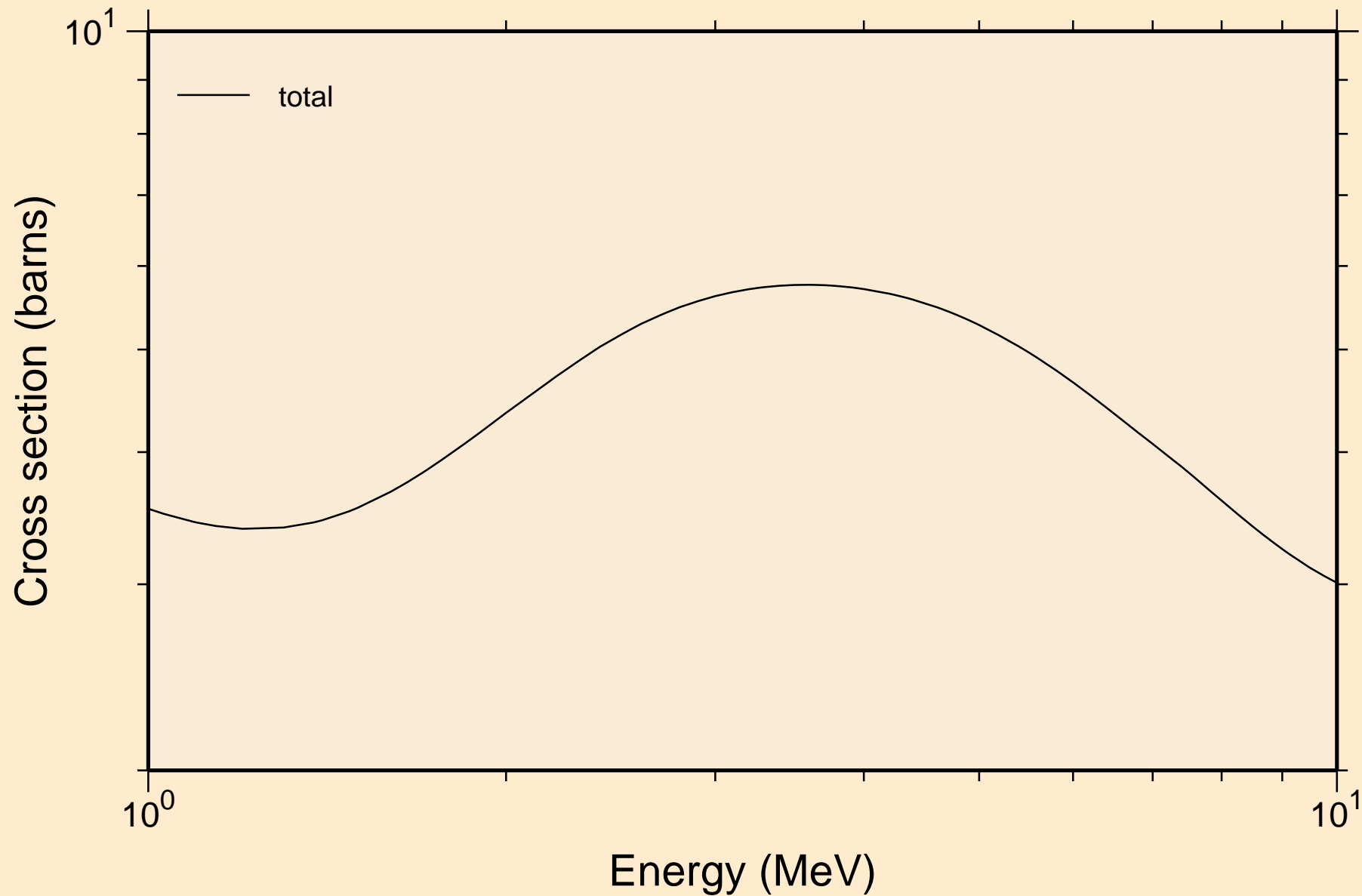

RA208 NEUTRON ACER TENDL-2023 LIBRARY; T=0.K
resonance absorption cross sections

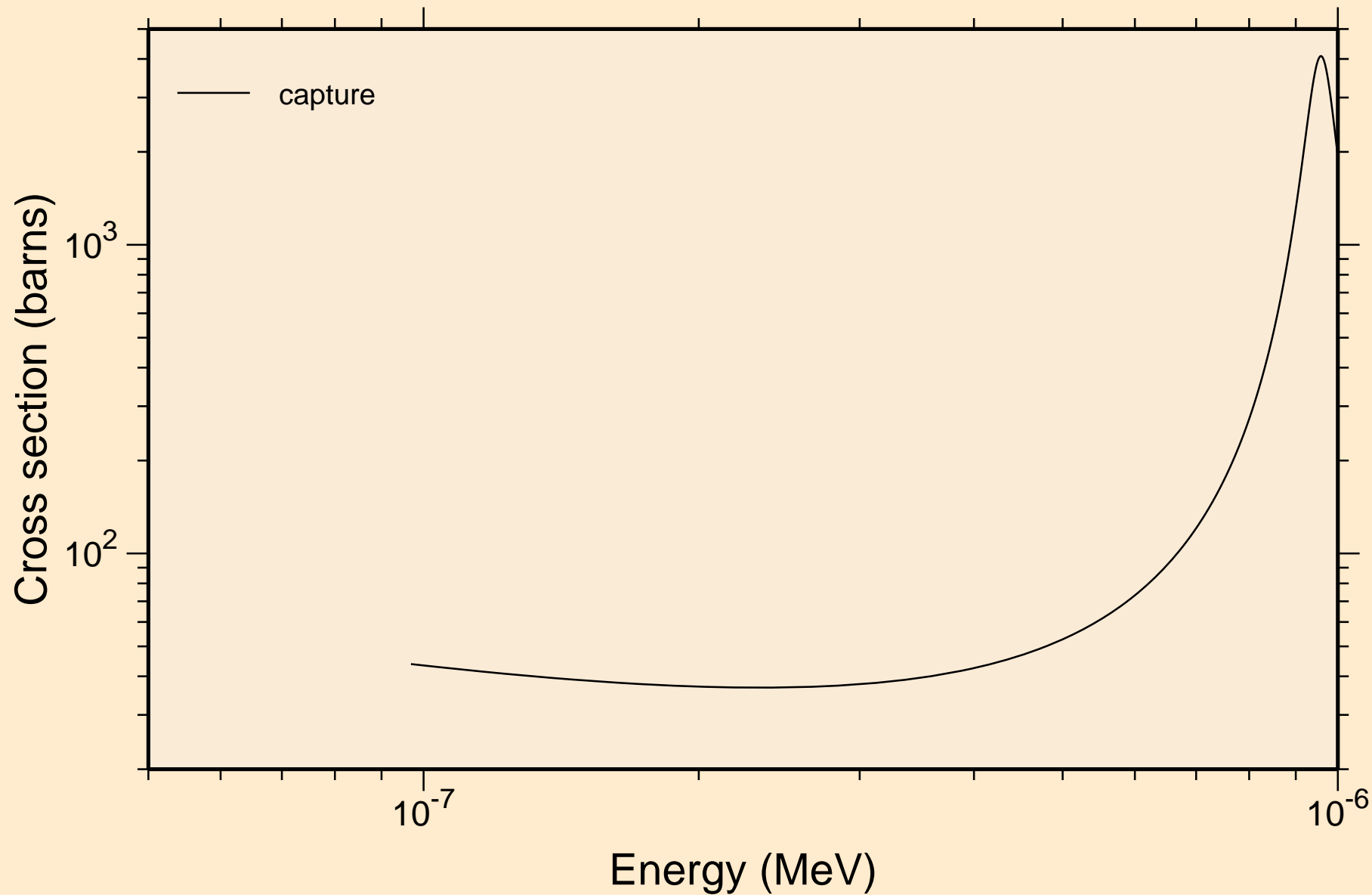

RA208 NEUTRON ACER TENDL-2023 LIBRARY; T=0.K
resonance absorption cross sections

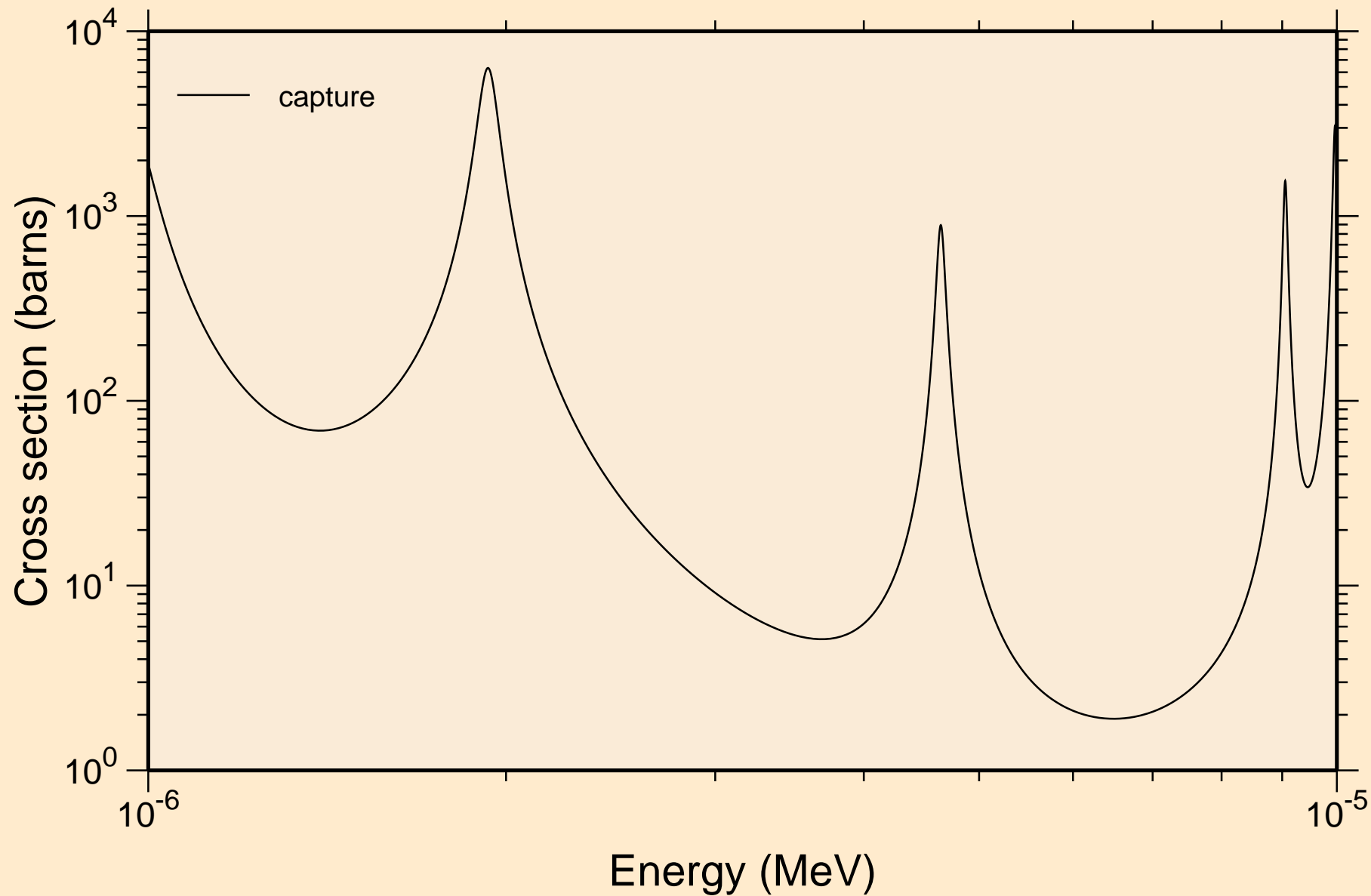

RA208 NEUTRON ACER TENDL-2023 LIBRARY; T=0.K
resonance absorption cross sections

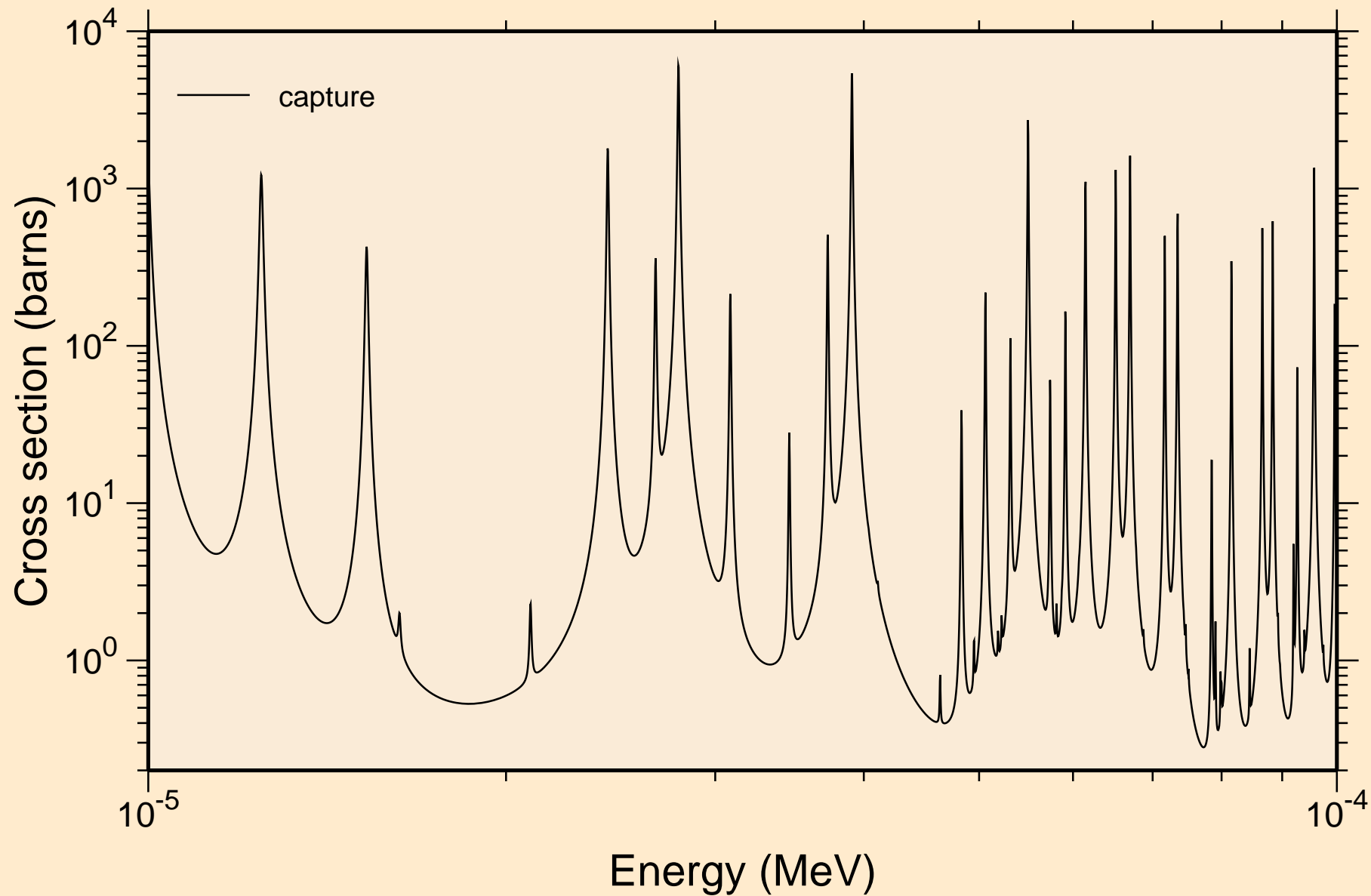

RA208 NEUTRON ACER TENDL-2023 LIBRARY; T=0.K
resonance absorption cross sections

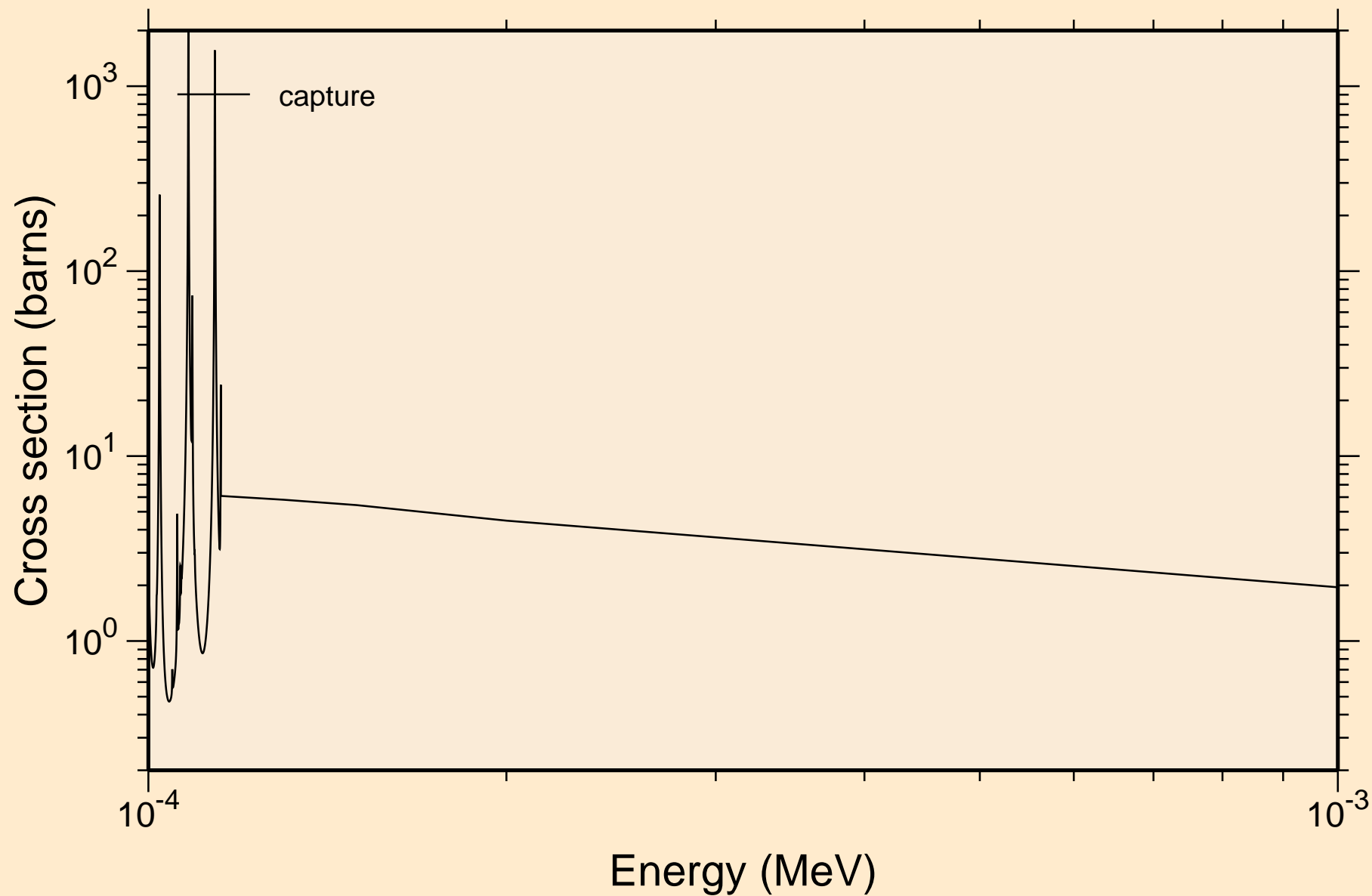

RA208 NEUTRON ACER TENDL-2023 LIBRARY; T=0.K
resonance absorption cross sections

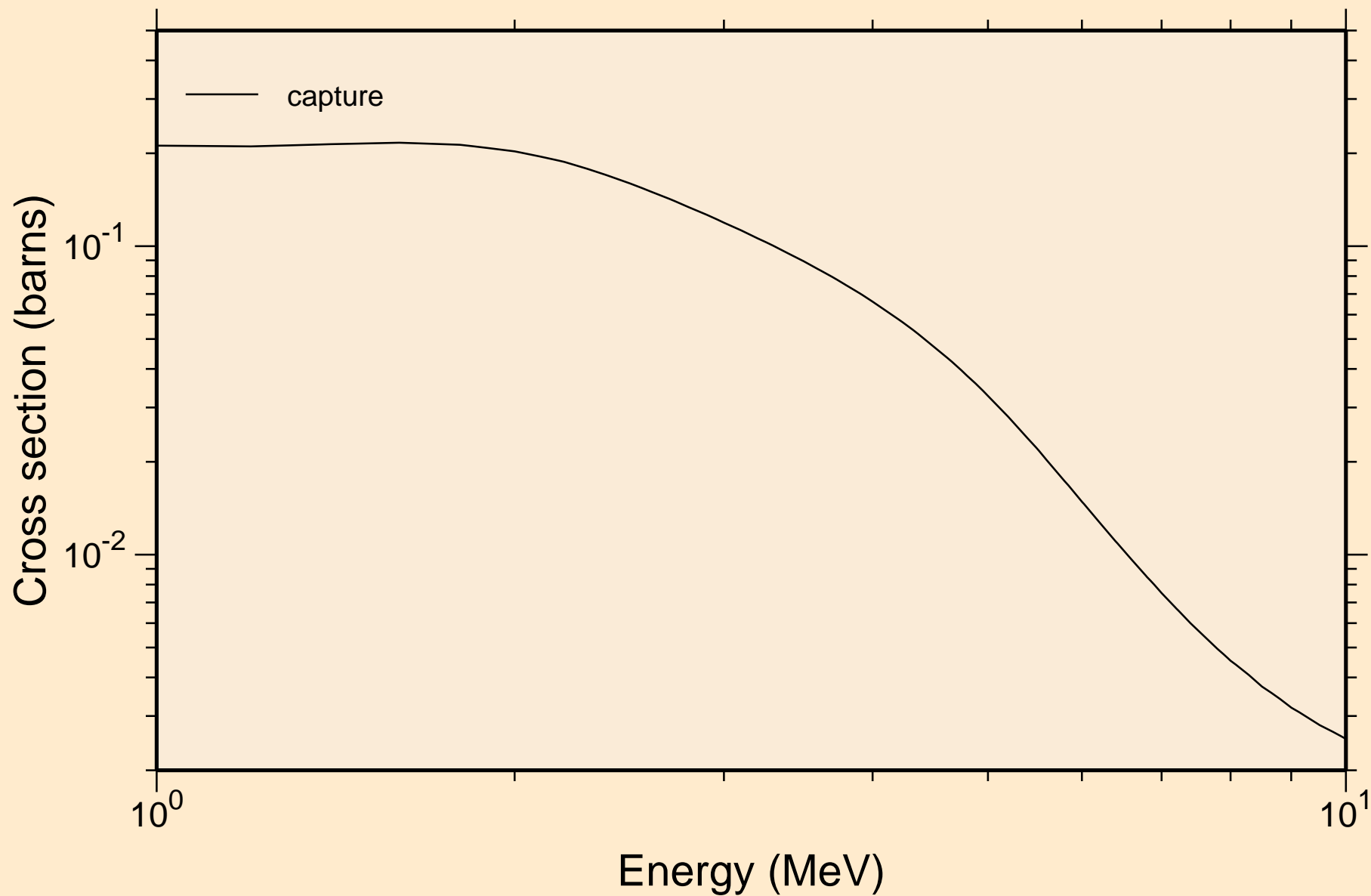

RA208 NEUTRON ACER TENDL-2023 LIBRARY; T=0.K
Heating

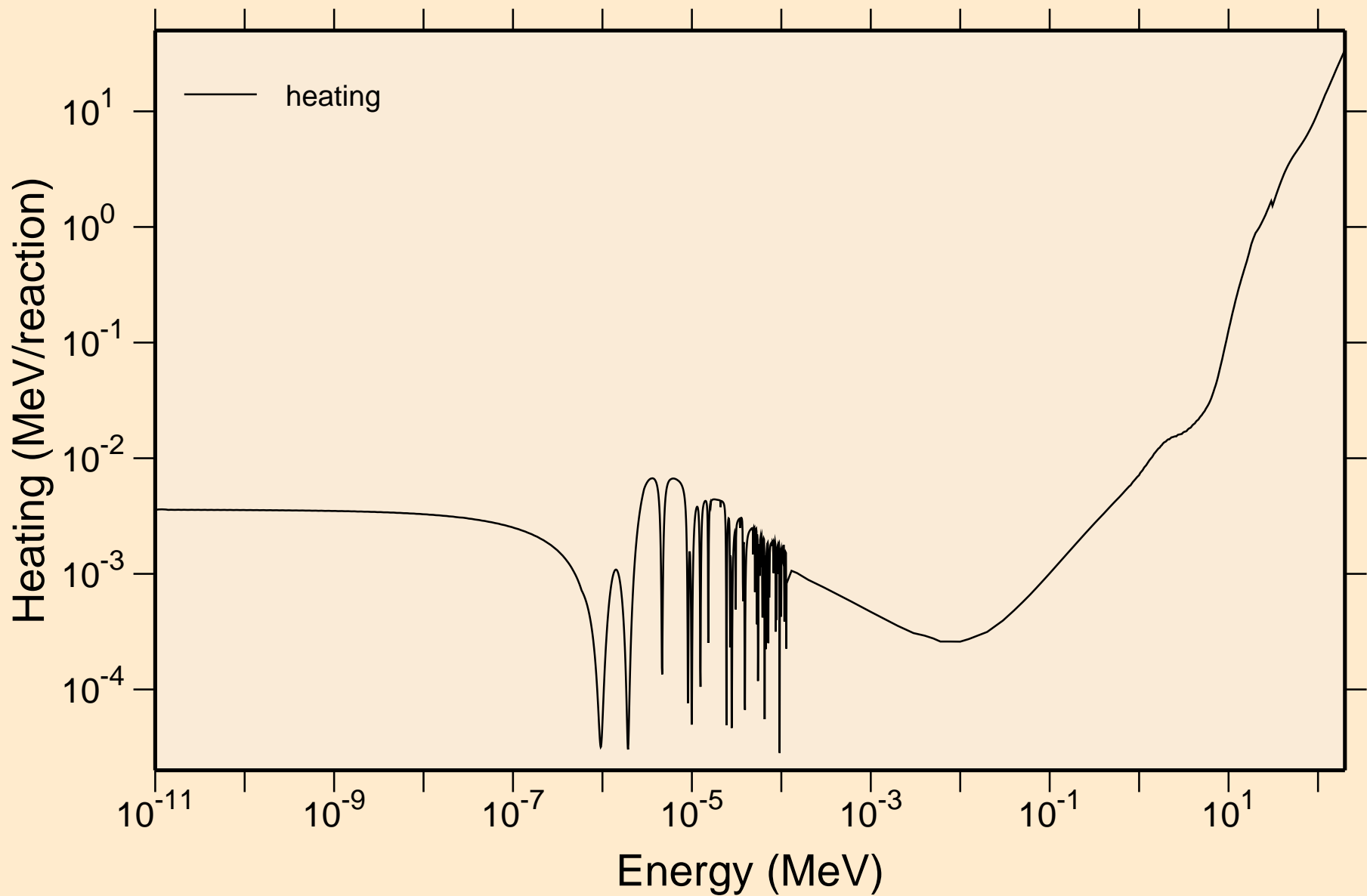

RA208 NEUTRON ACER TENDL-2023 LIBRARY; T=0.K
Damage

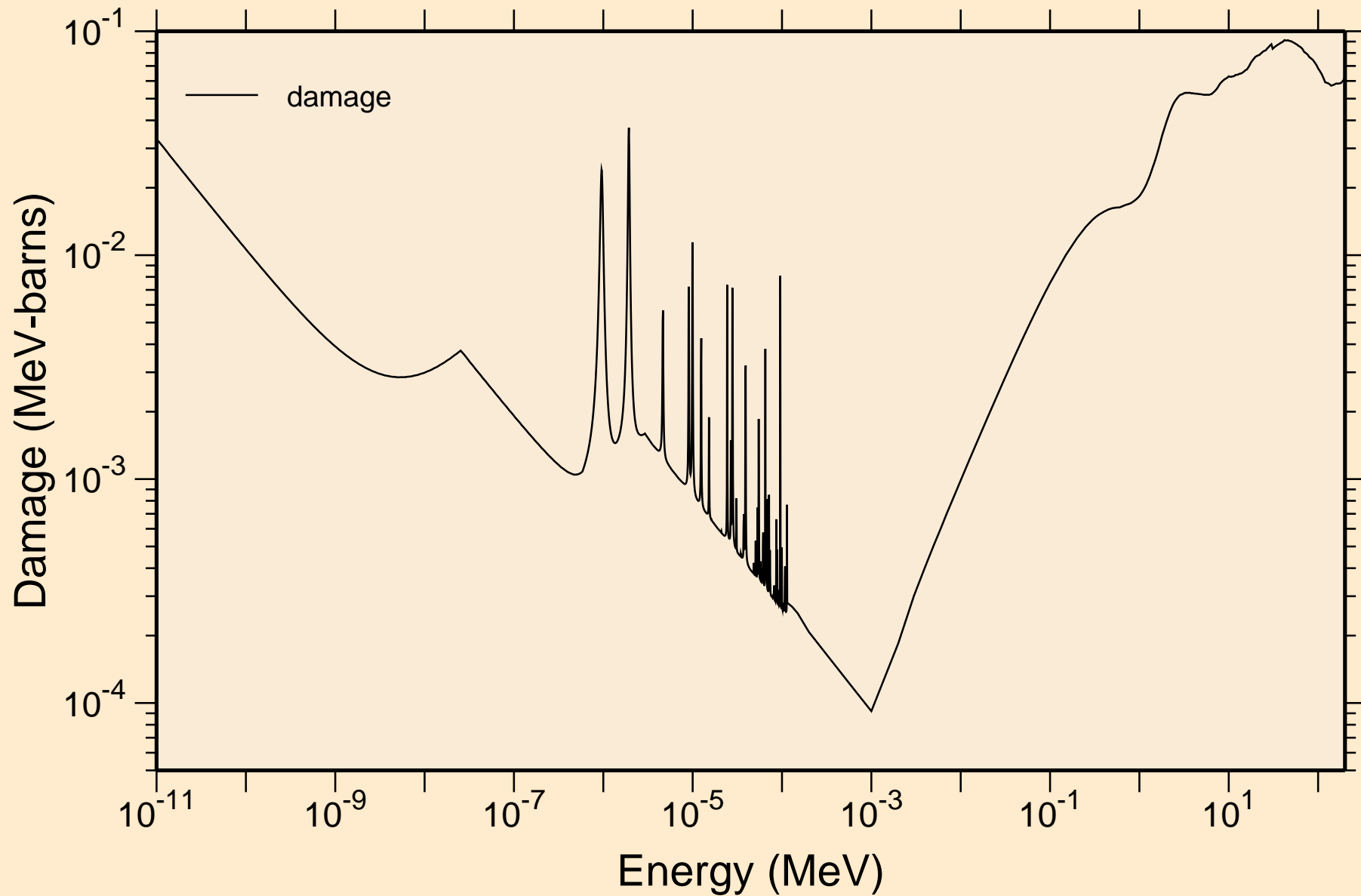

RA208 NEUTRON ACER TENDL-2023 LIBRARY; T=0.K
Non-threshold reactions

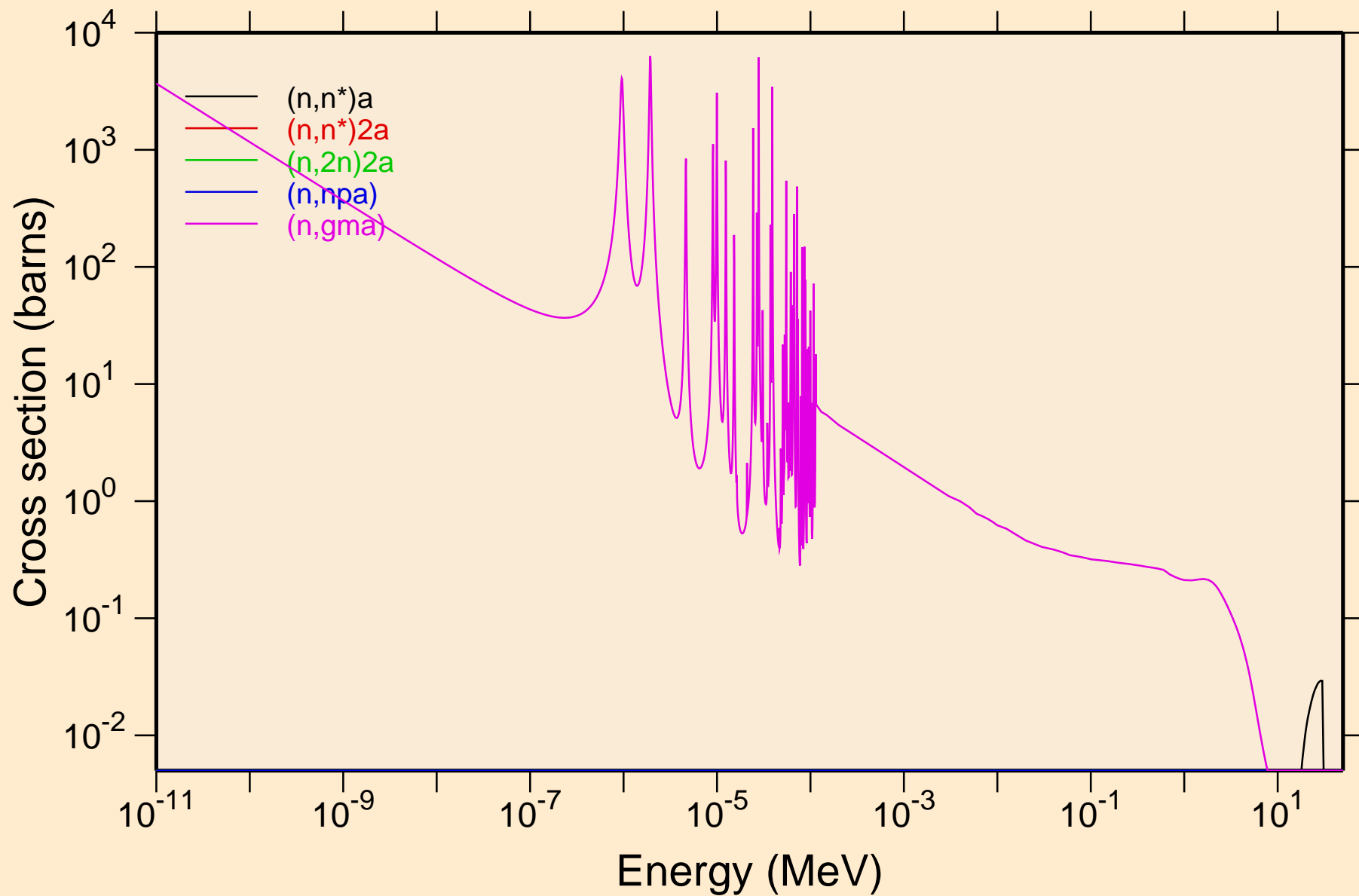

RA208 NEUTRON ACER TENDL-2023 LIBRARY; T=0.K
Non-threshold reactions

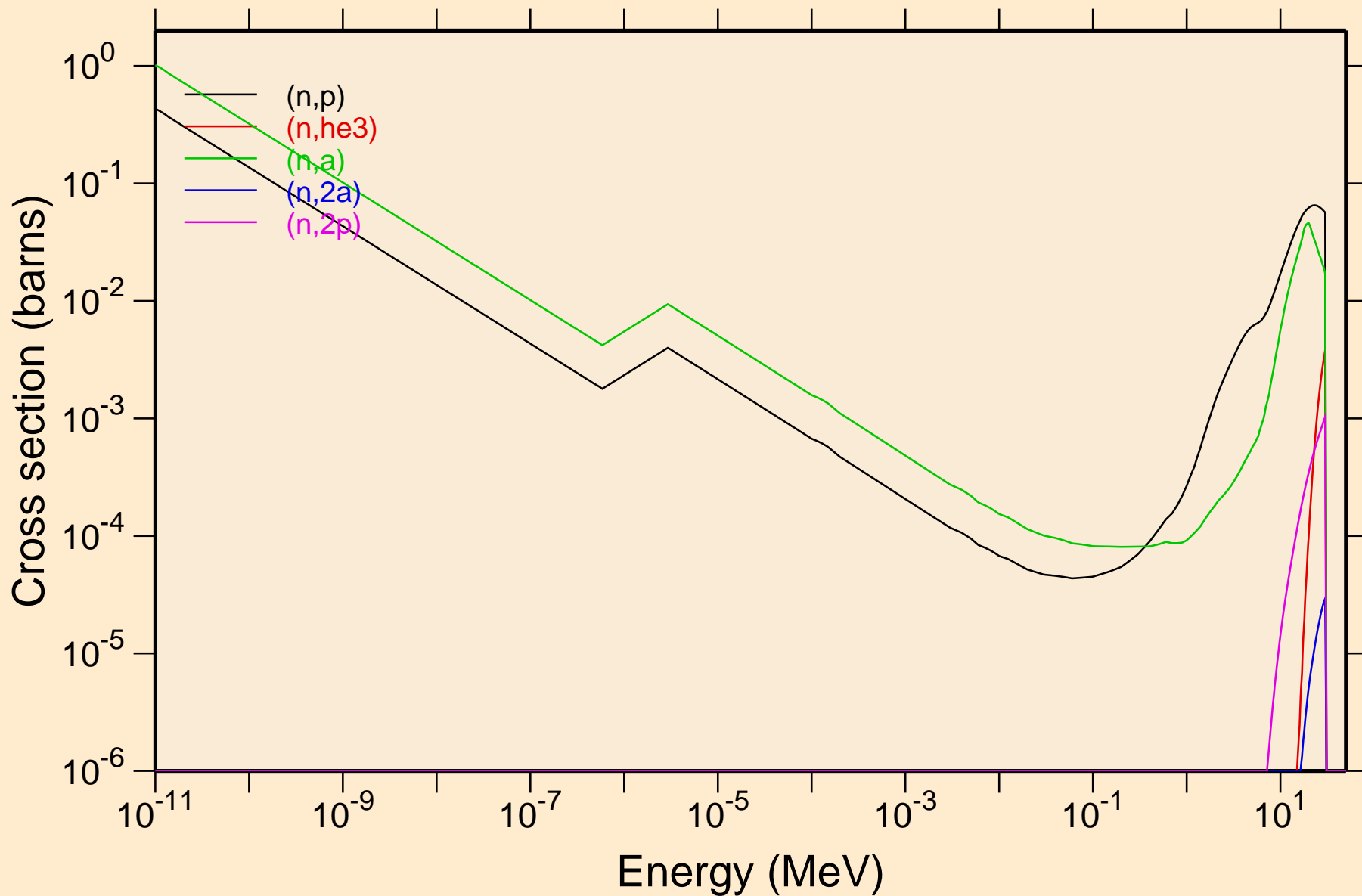

RA208 NEUTRON ACER TENDL-2023 LIBRARY; T=0.K
Non-threshold reactions

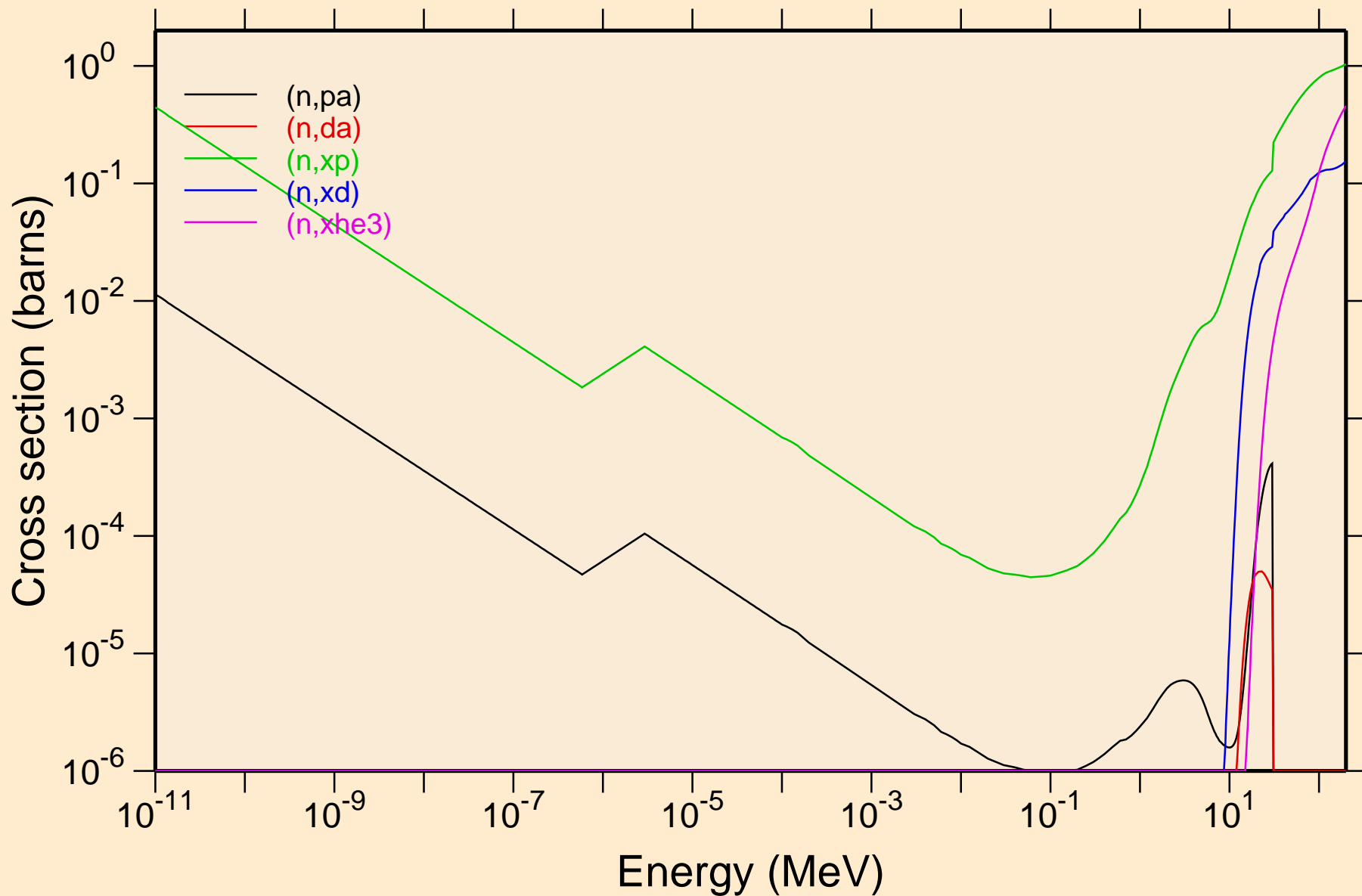

RA208 NEUTRON ACER TENDL-2023 LIBRARY; T=0.K
Non-threshold reactions

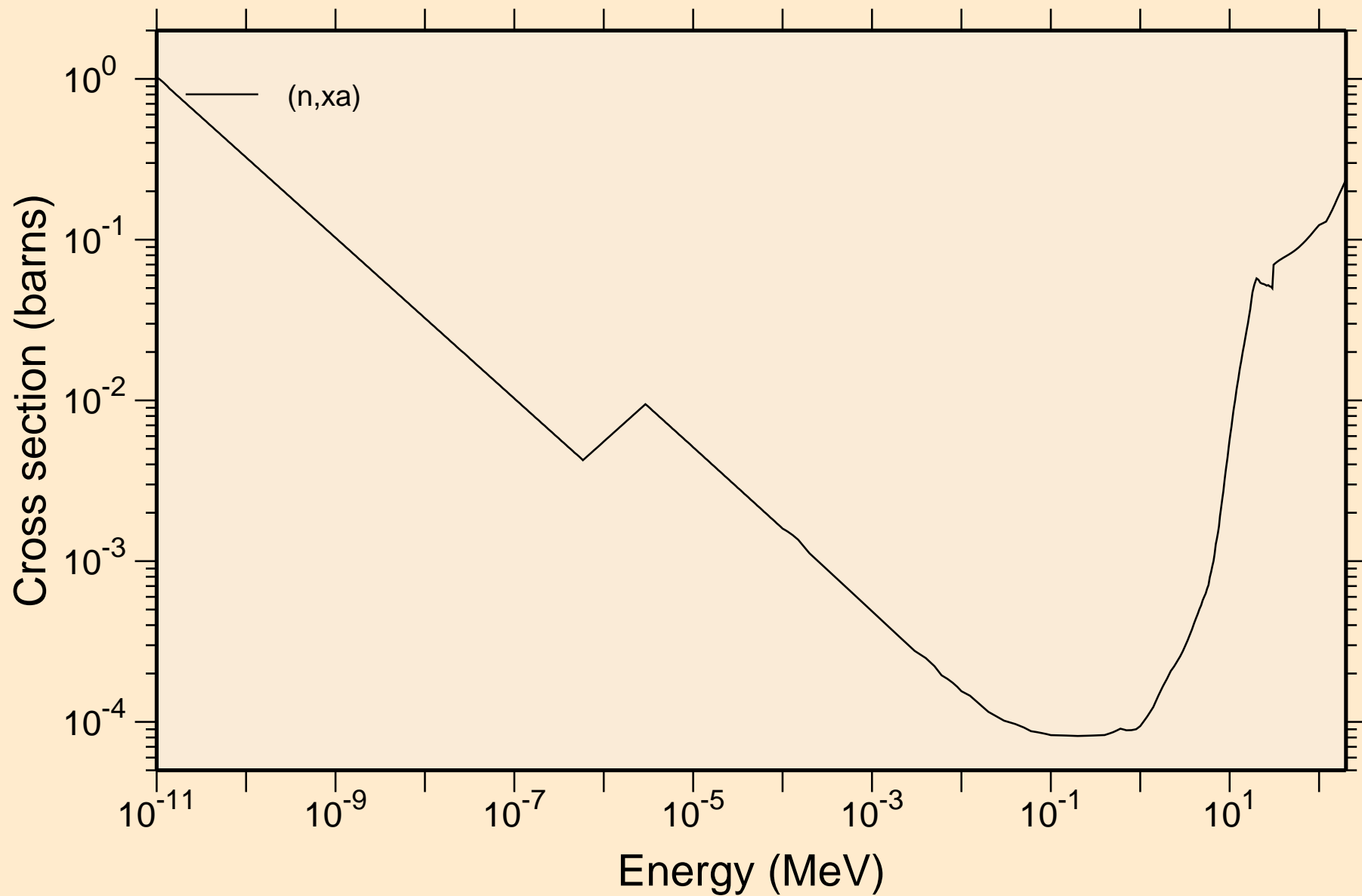

RA208 NEUTRON ACER TENDL-2023 LIBRARY; T=0.K
Principal cross sections

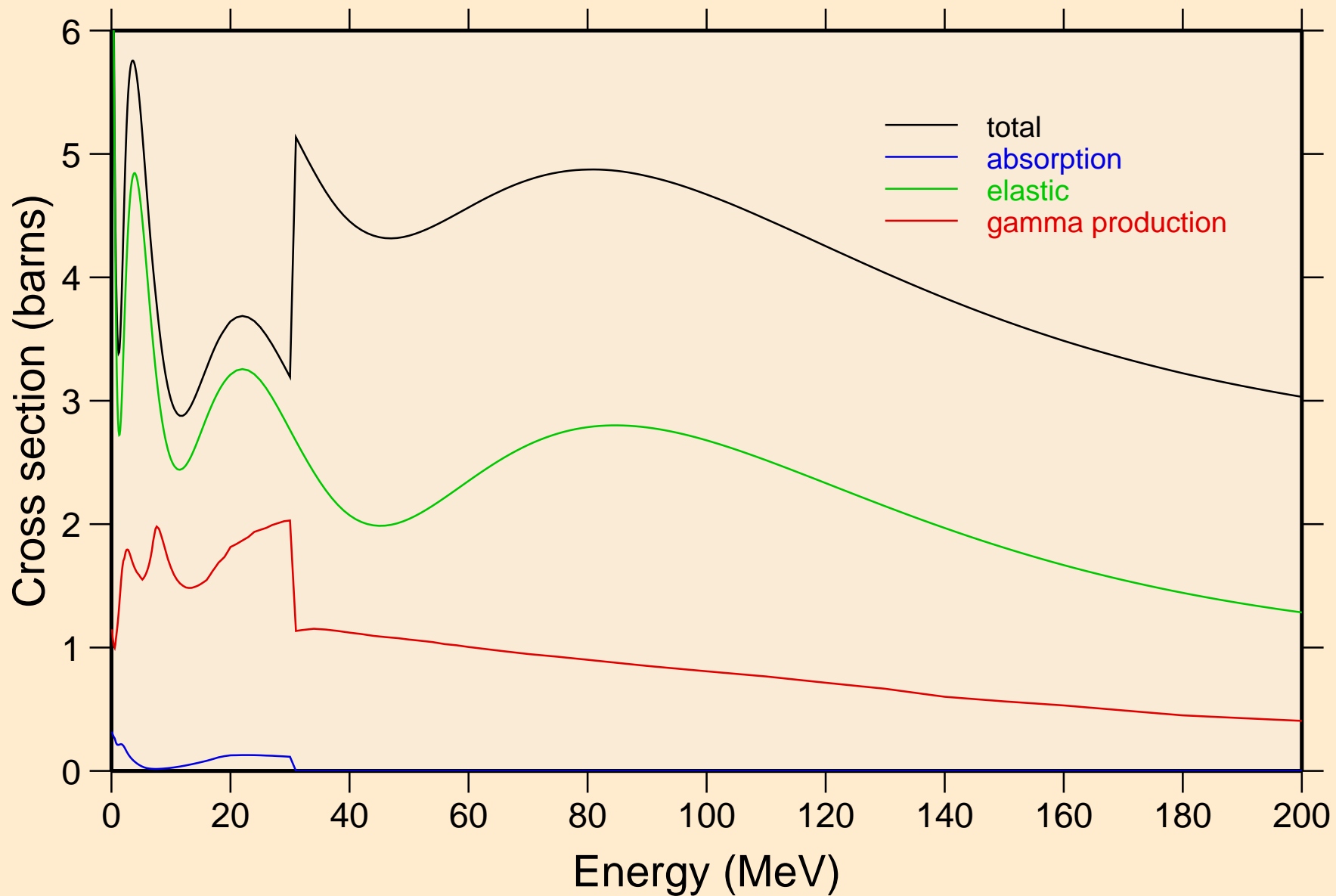

RA208 NEUTRON ACER TENDL-2023 LIBRARY; T=0.K
Heating

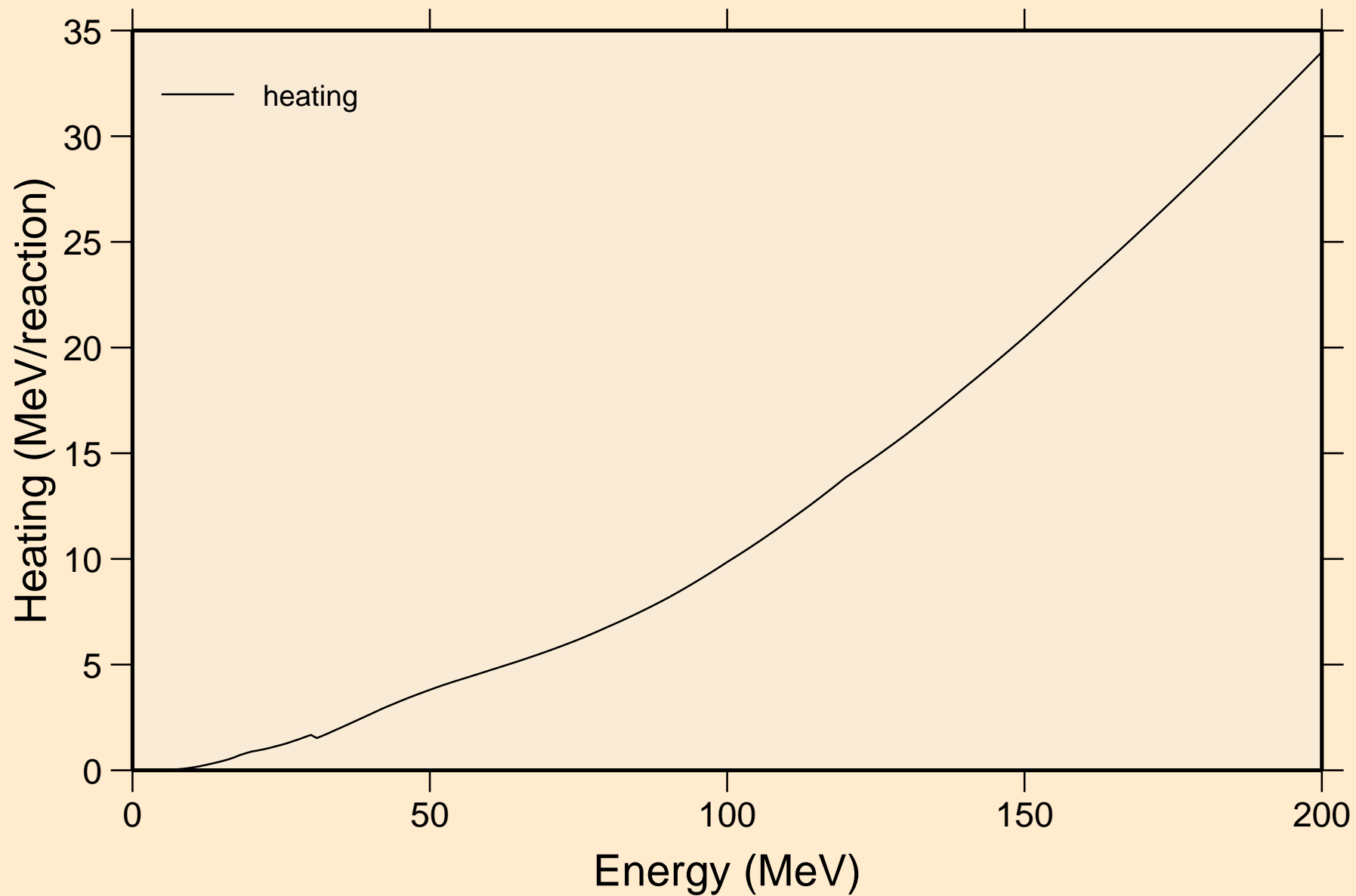

RA208 NEUTRON ACER TENDL-2023 LIBRARY; T=0.K
Damage

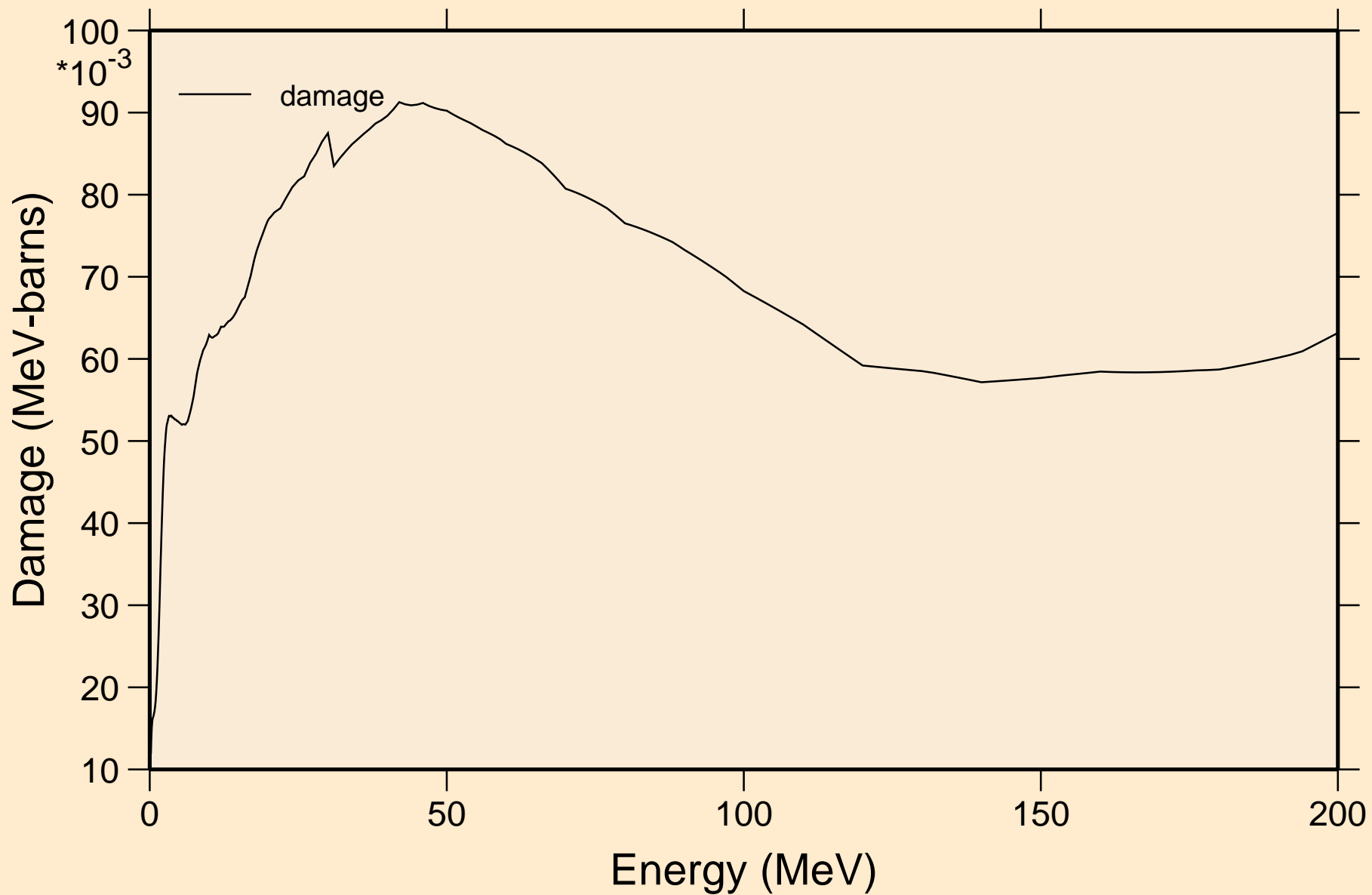

RA208 NEUTRON ACER TENDL-2023 LIBRARY; T=0.K
Non-threshold reactions

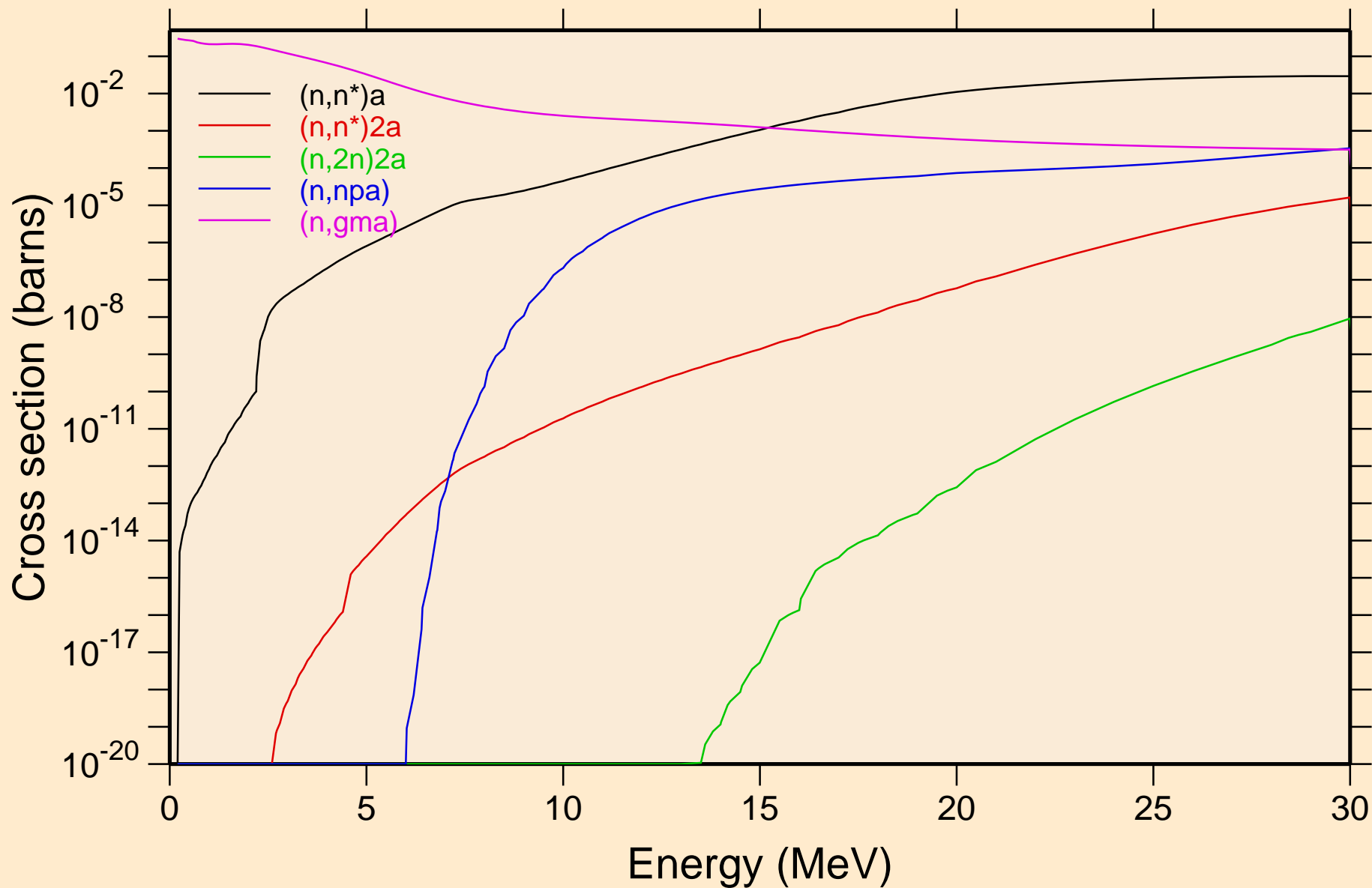

RA208 NEUTRON ACER TENDL-2023 LIBRARY; T=0.K
Non-threshold reactions

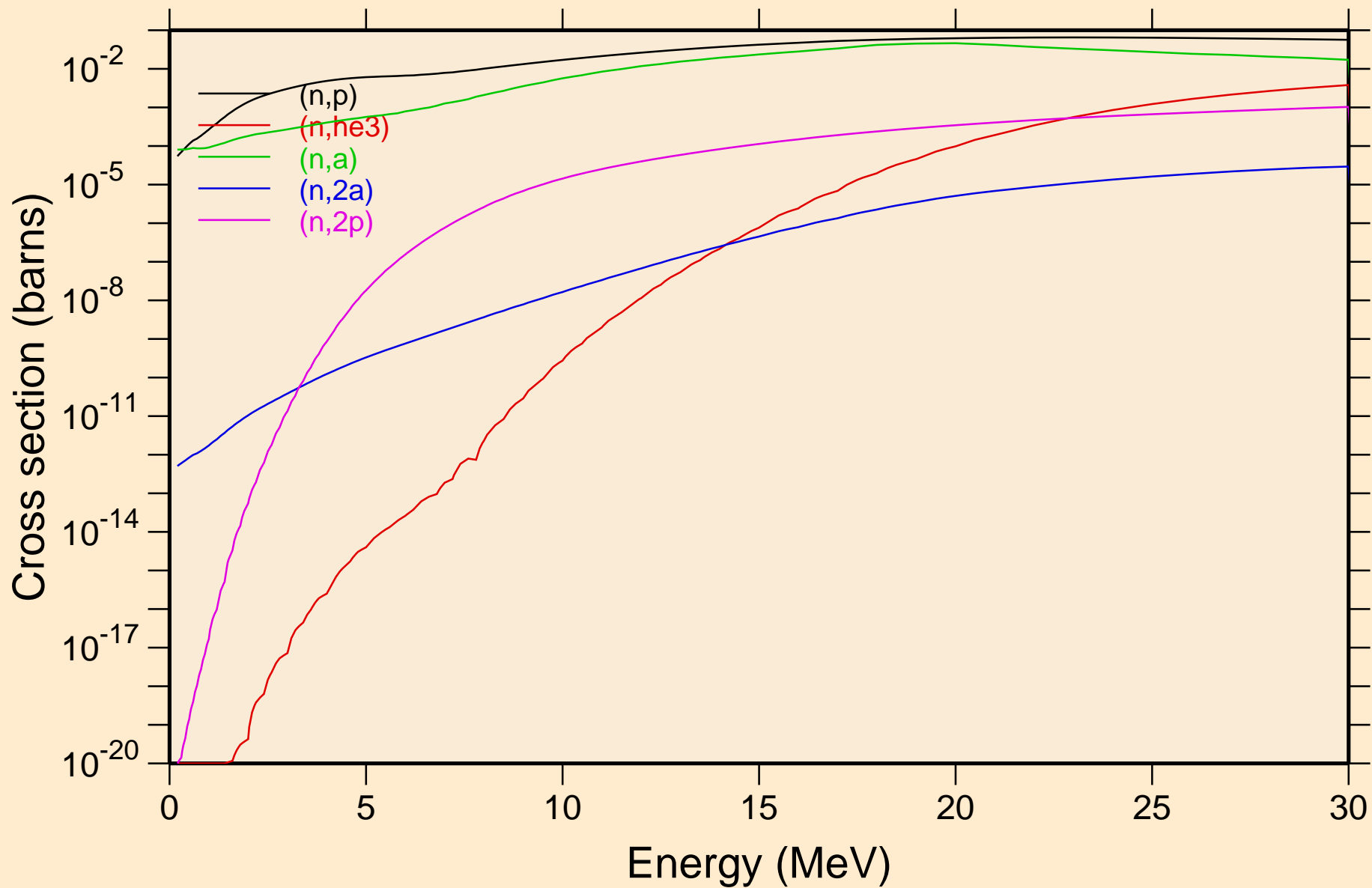

RA208 NEUTRON ACER TENDL-2023 LIBRARY; T=0.K
Non-threshold reactions

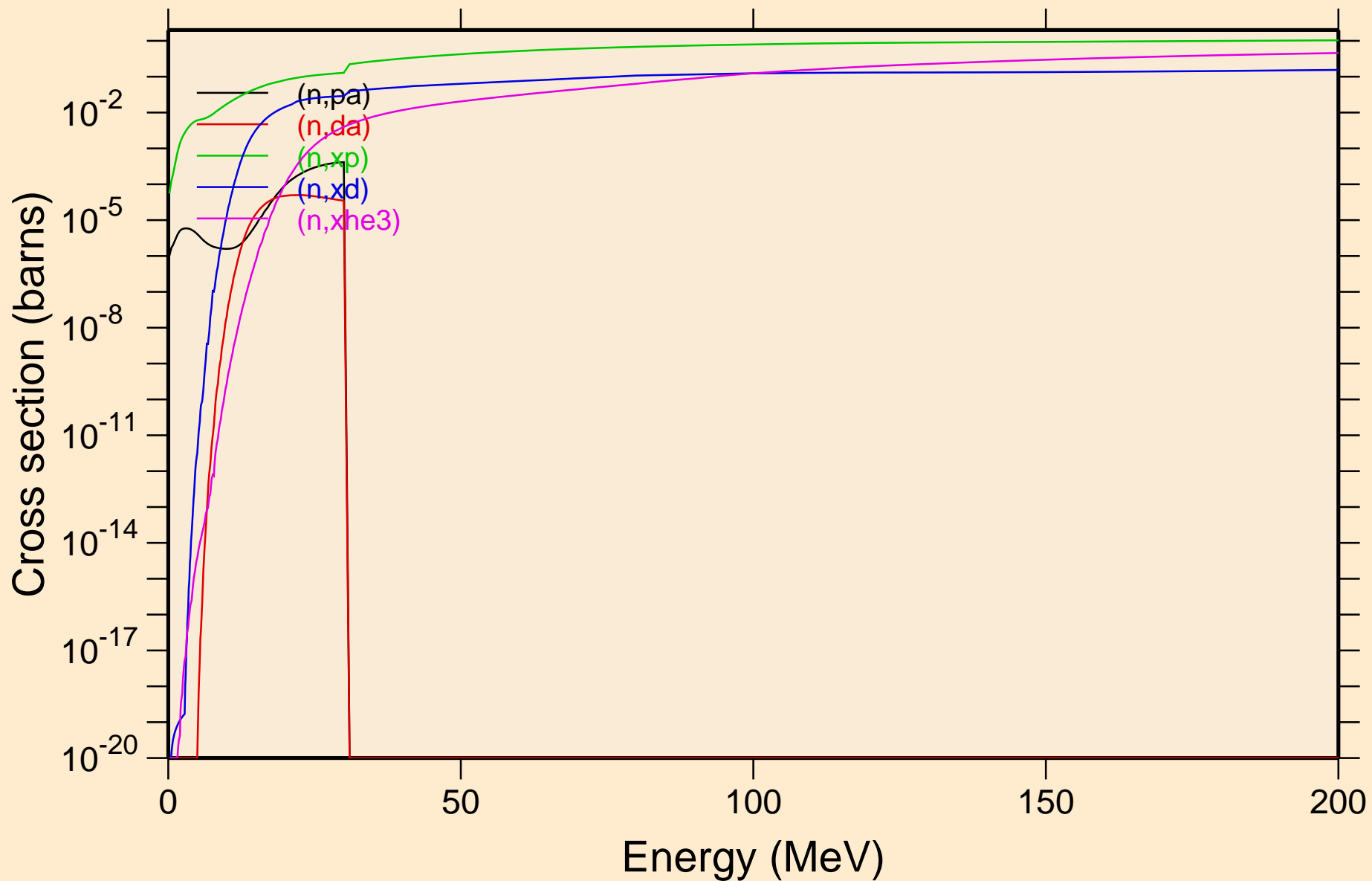

RA208 NEUTRON ACER TENDL-2023 LIBRARY; T=0.K
Non-threshold reactions

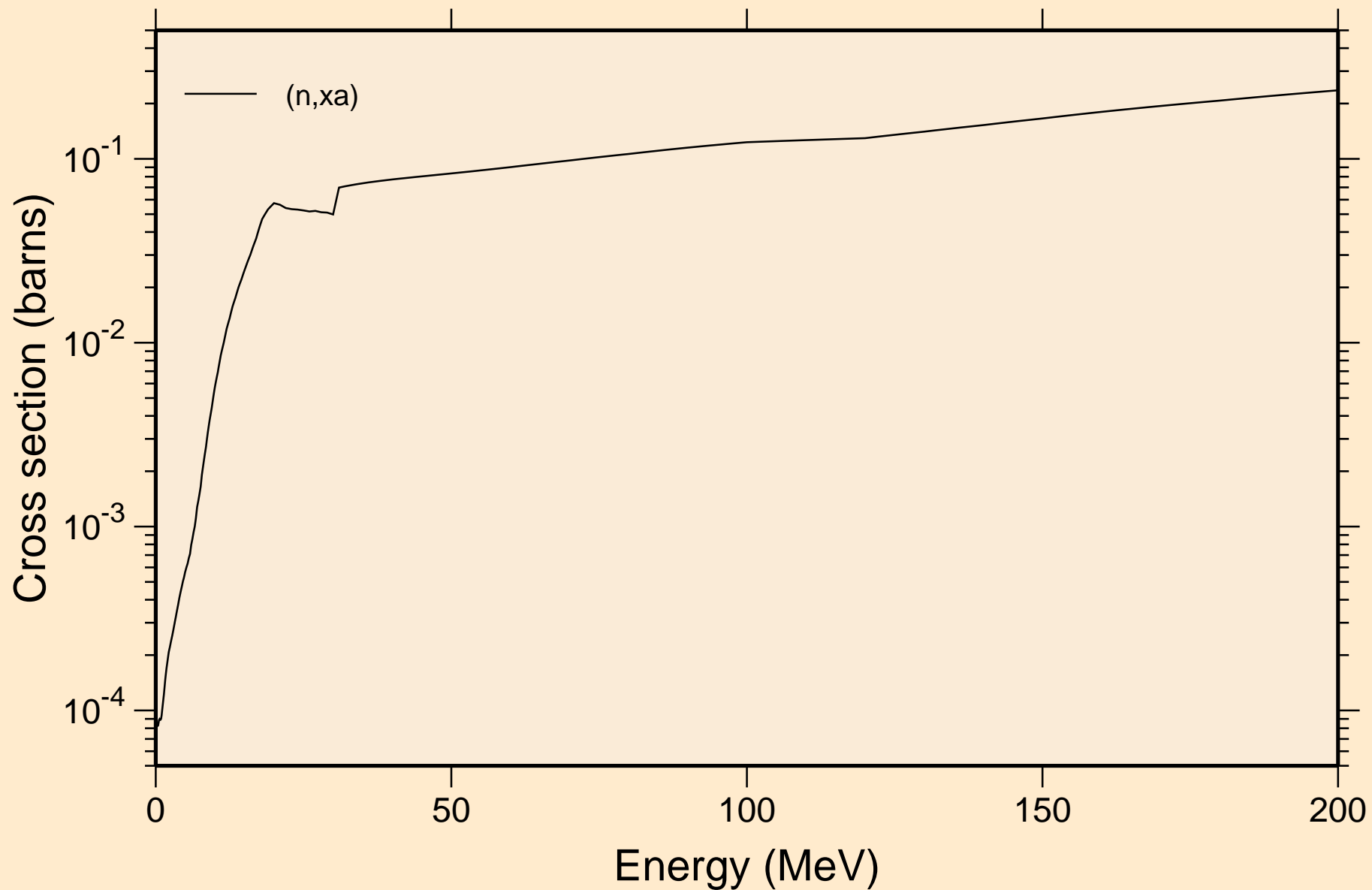

RA208 NEUTRON ACER TENDL-2023 LIBRARY; T=0.K
Inelastic levels

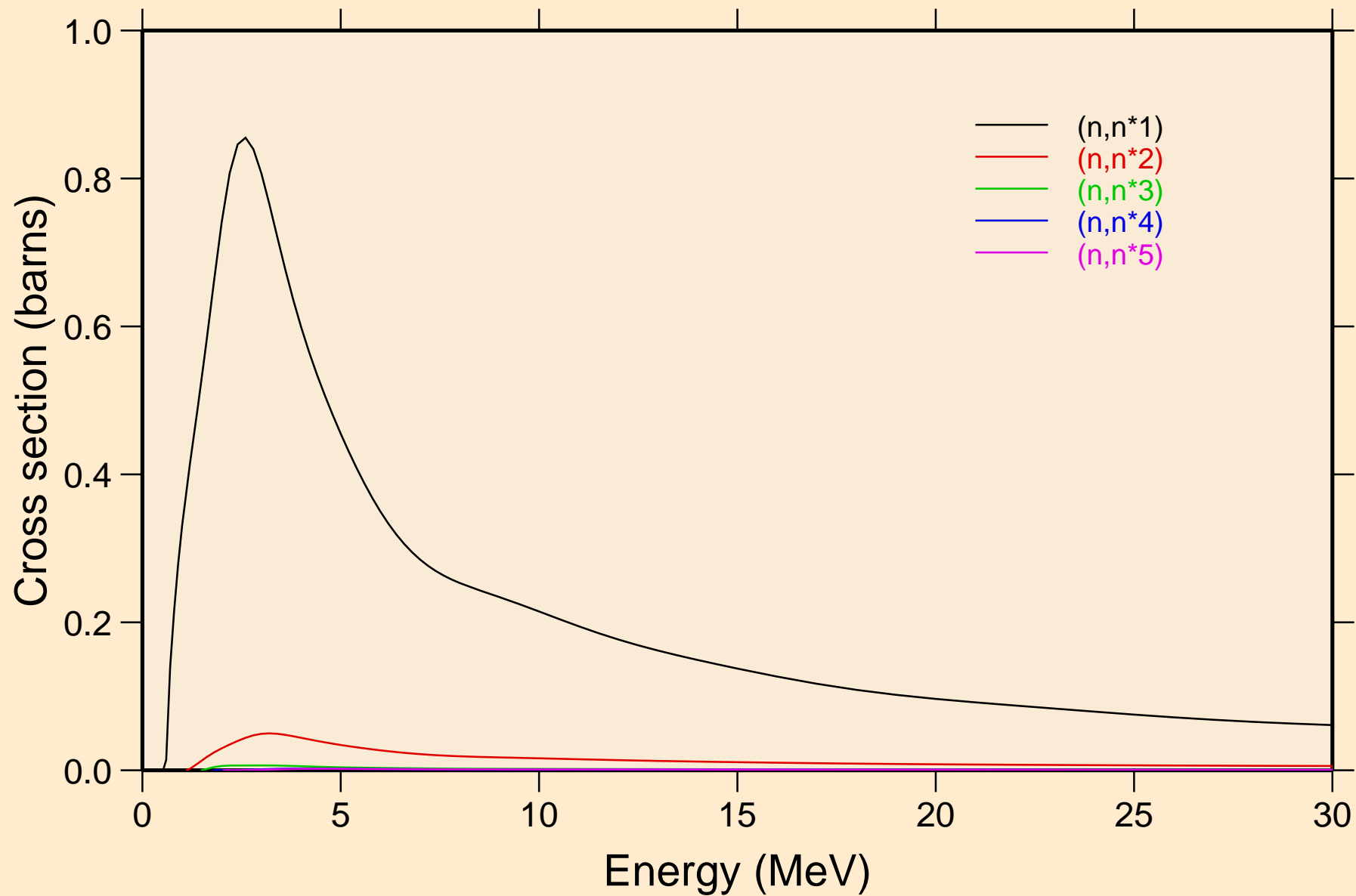

RA208 NEUTRON ACER TENDL-2023 LIBRARY; T=0.K
Inelastic levels

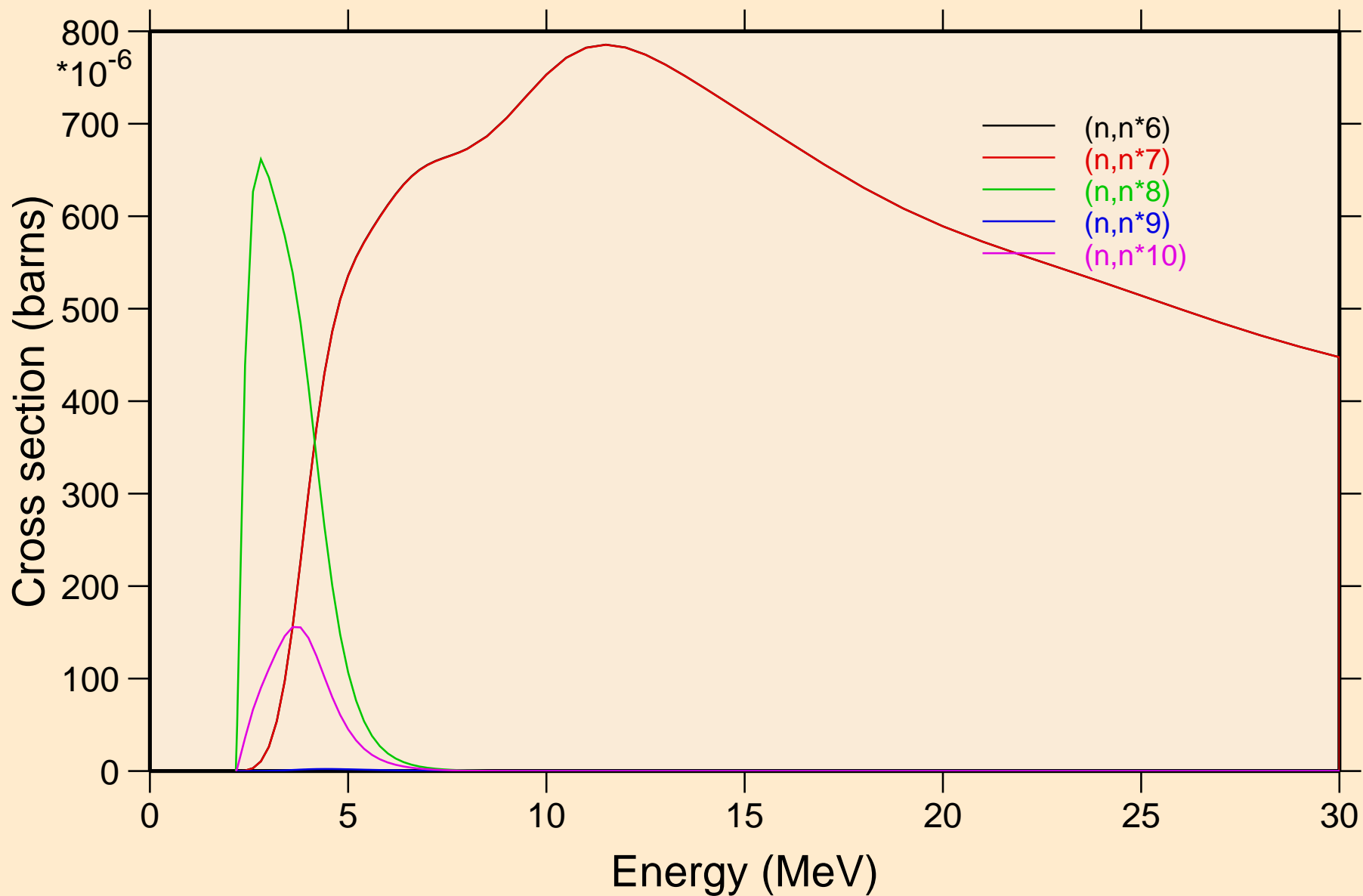

RA208 NEUTRON ACER TENDL-2023 LIBRARY; T=0.K
Inelastic levels

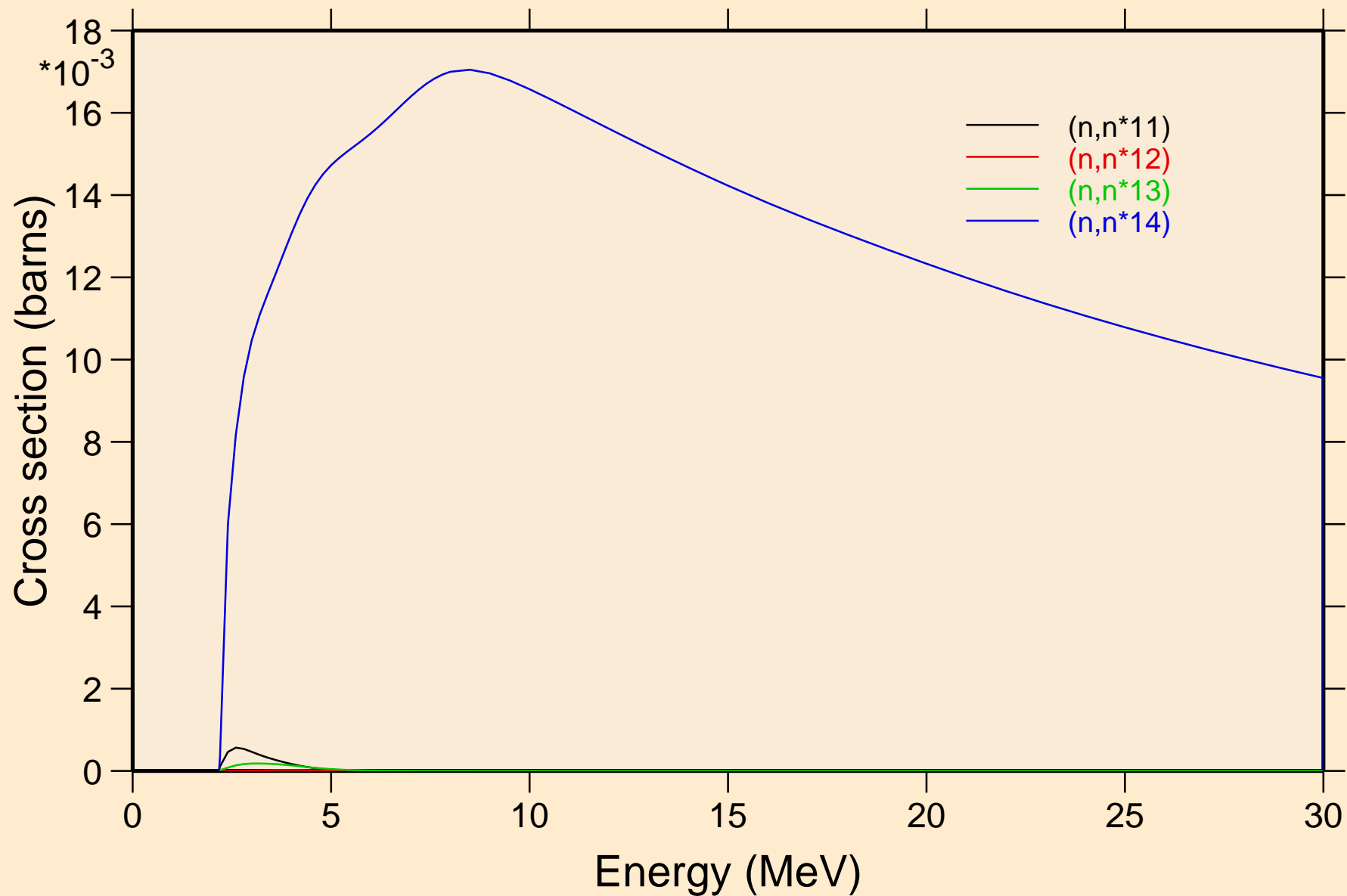

RA208 NEUTRON ACER TENDL-2023 LIBRARY; T=0.K
Threshold reactions

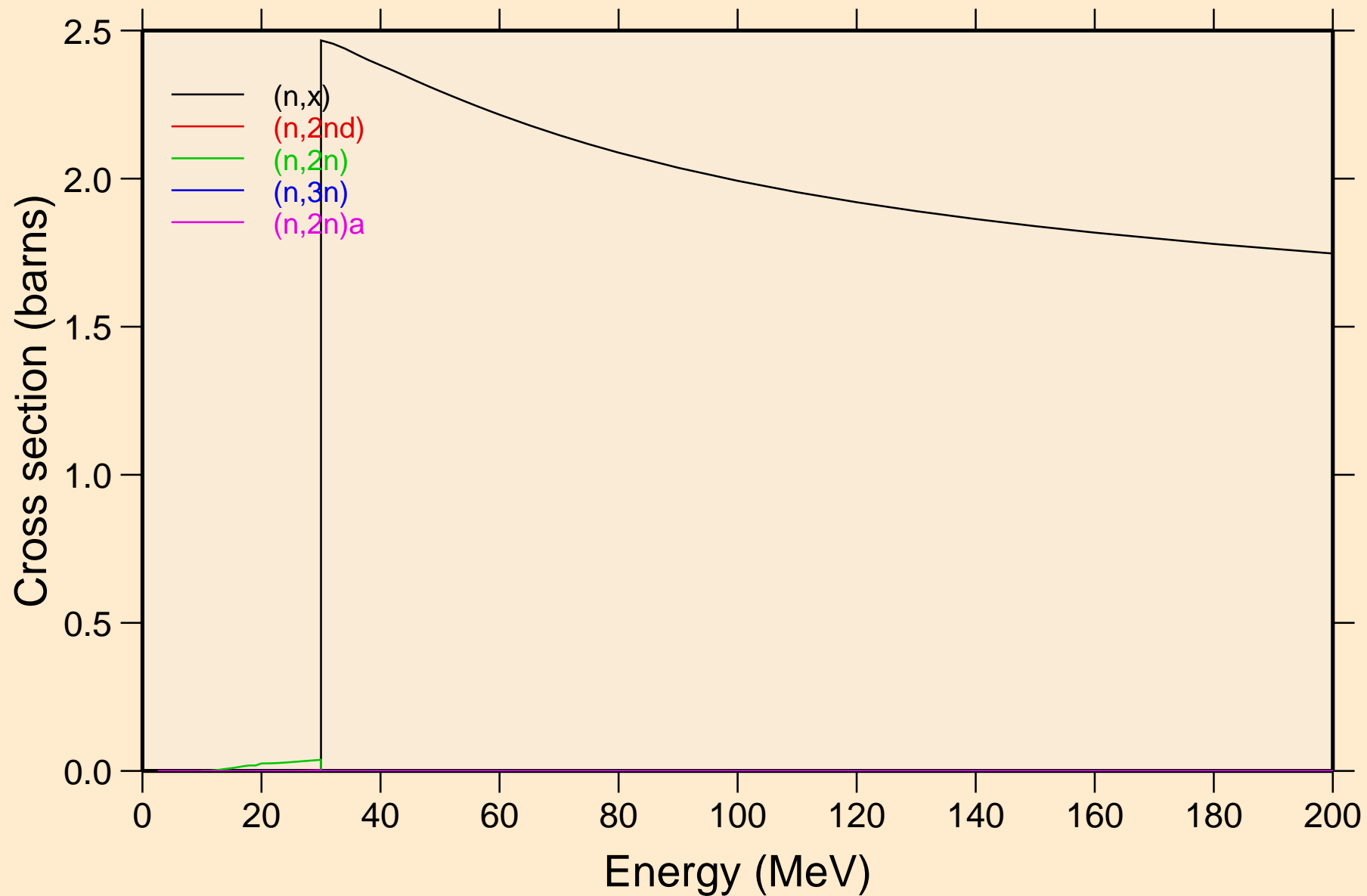

RA208 NEUTRON ACER TENDL-2023 LIBRARY; T=0.K
Threshold reactions

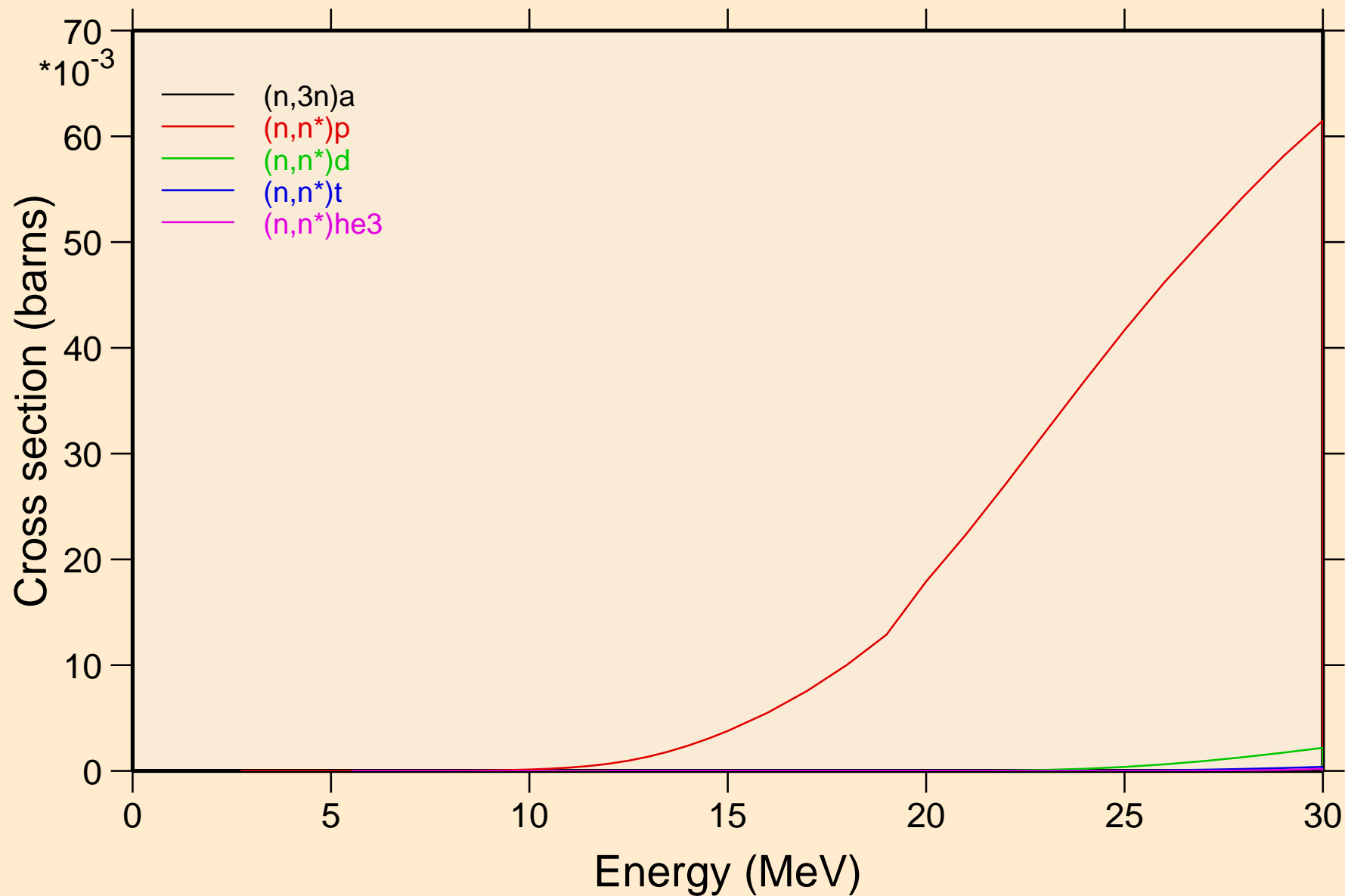

RA208 NEUTRON ACER TENDL-2023 LIBRARY; T=0.K
Threshold reactions

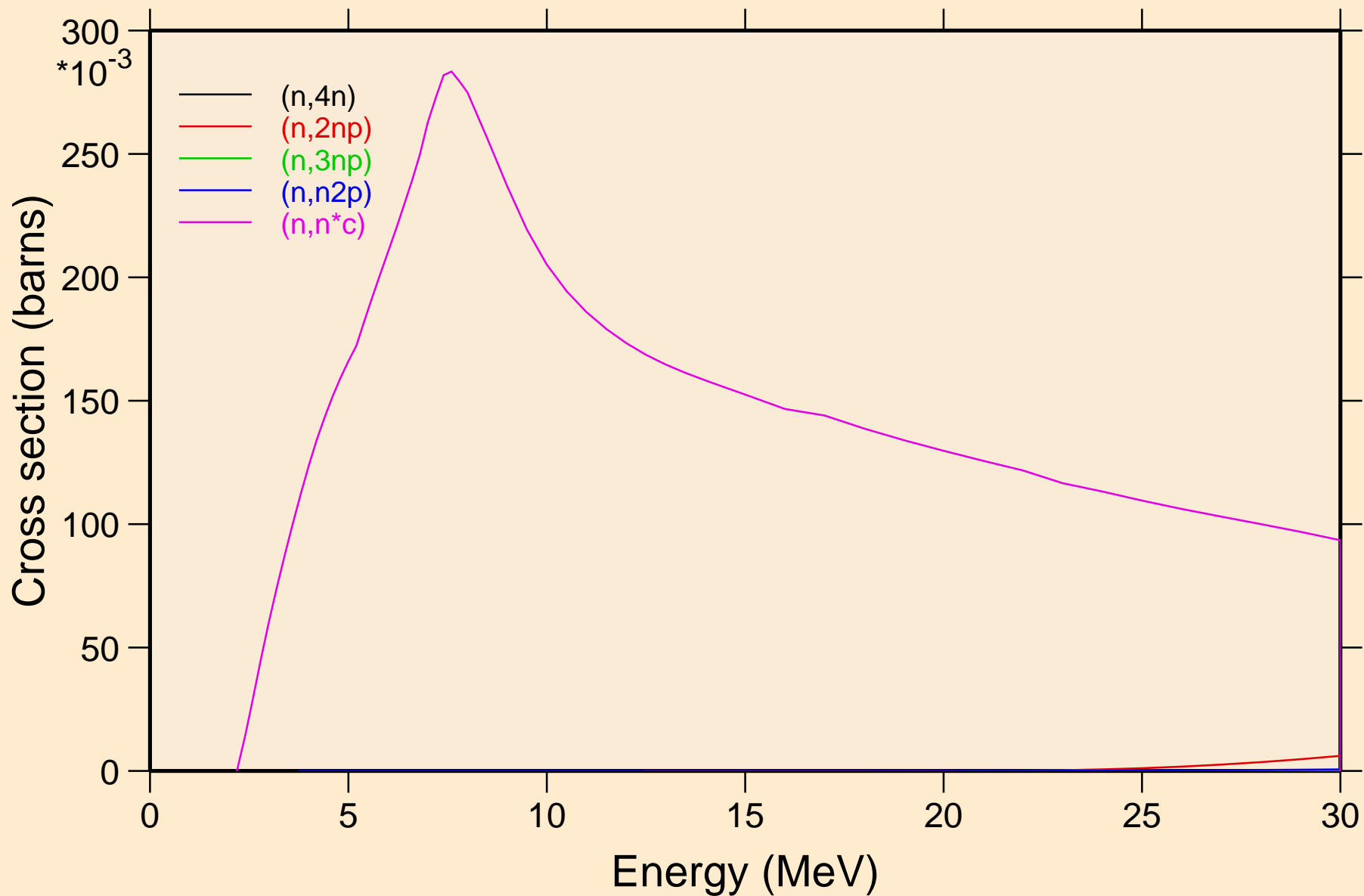

RA208 NEUTRON ACER TENDL-2023 LIBRARY; T=0.K

Threshold reactions

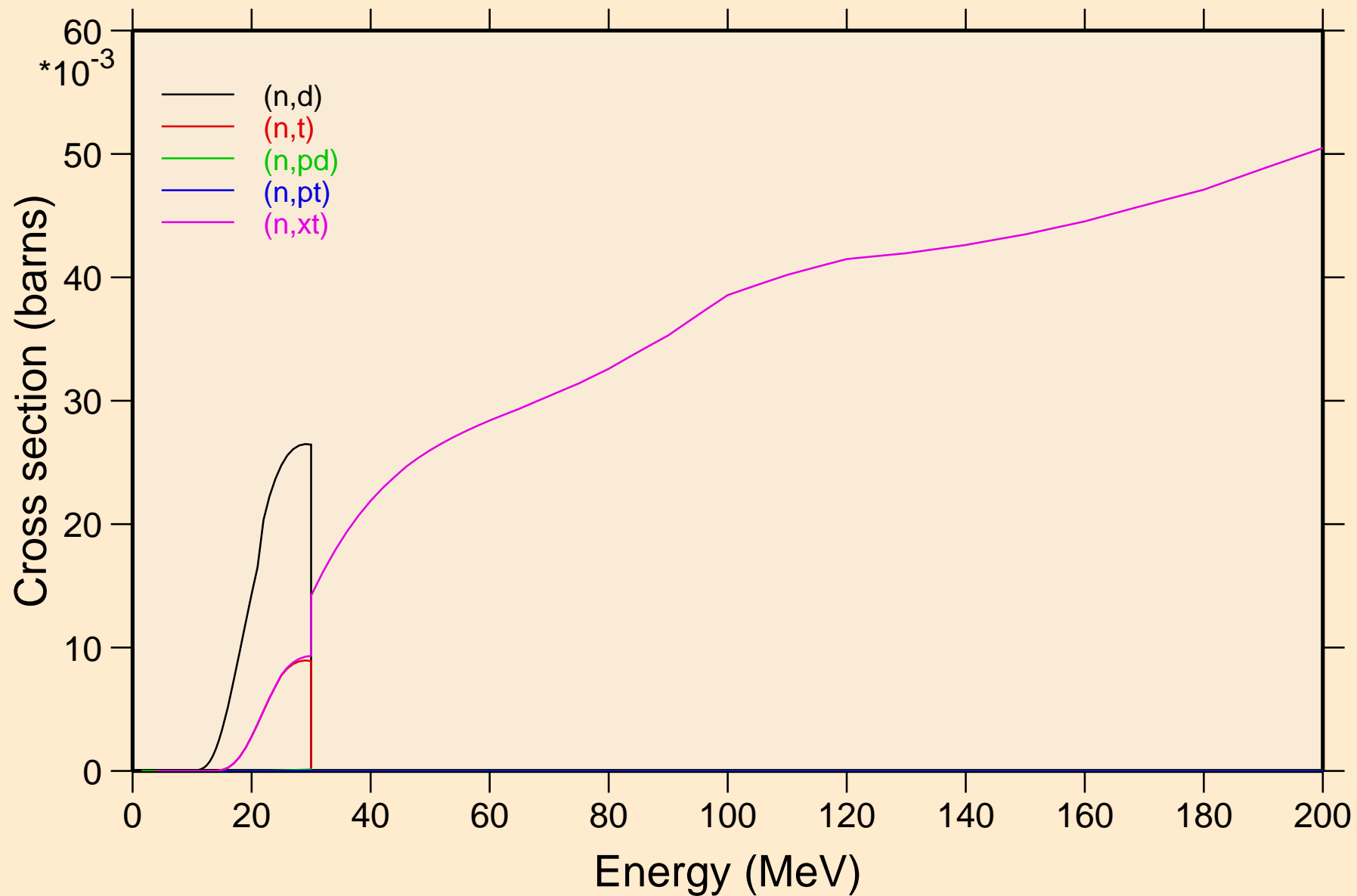

RA208 NEUTRON ACER TENDL-2023 LIBRARY; T=0.K
angular distribution for elastic

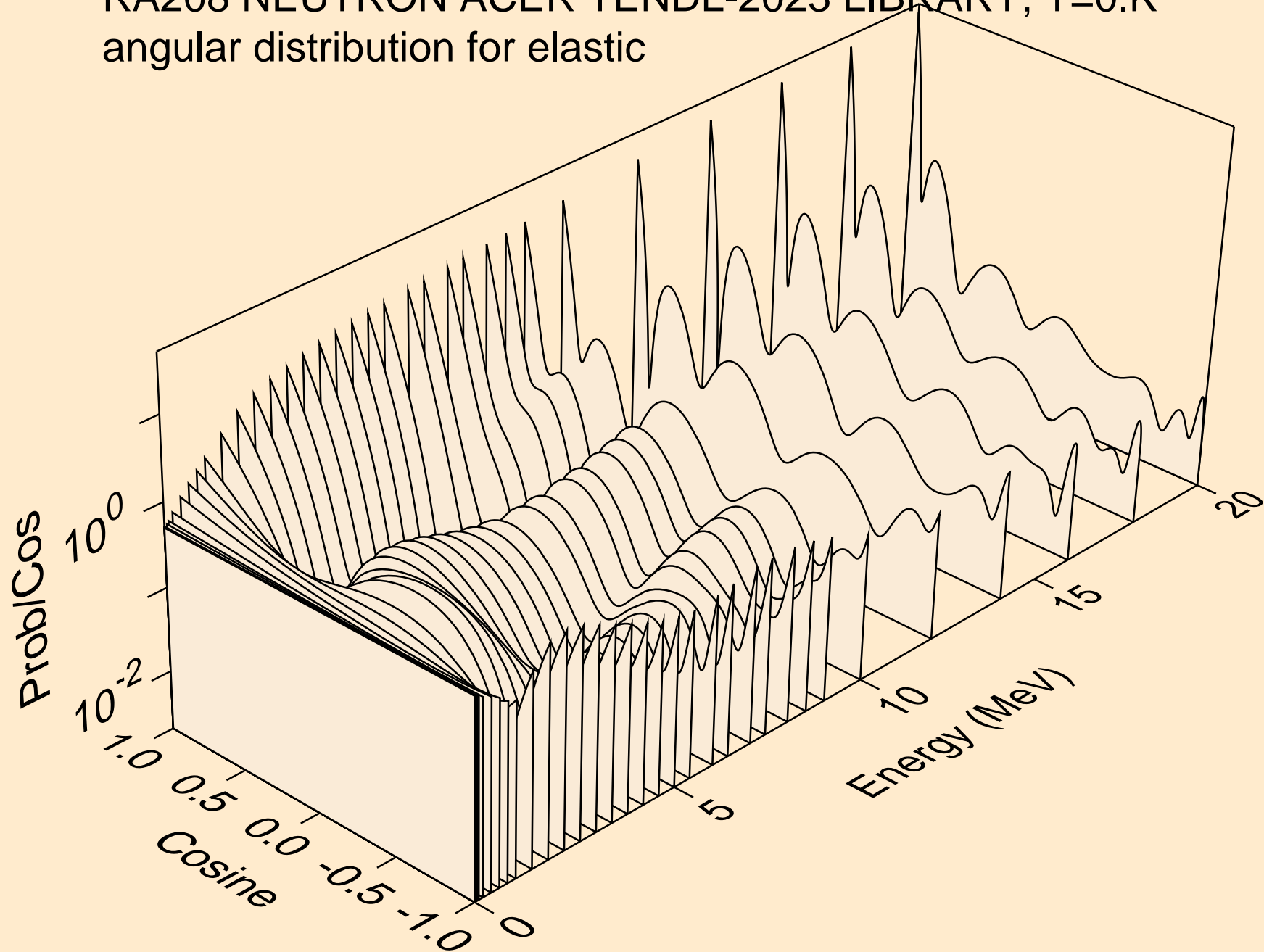

RA208 NEUTRON ACER TENDL-2023 LIBRARY; T=0.K
angular distribution for elastic

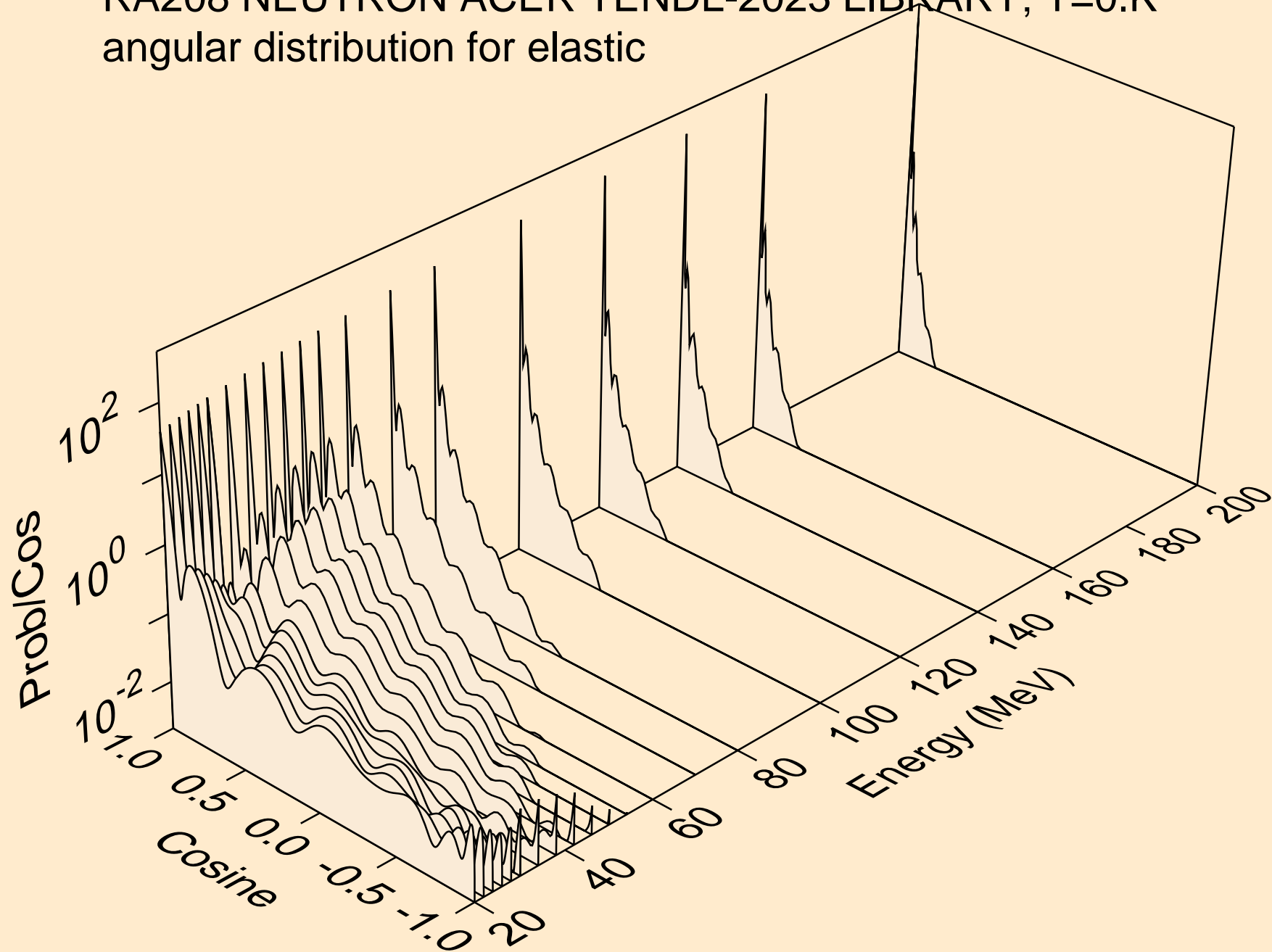

RA208 NEUTRON ACER TENDL-2023 LIBRARY; T=0.K
angular distribution for (n,n*1)

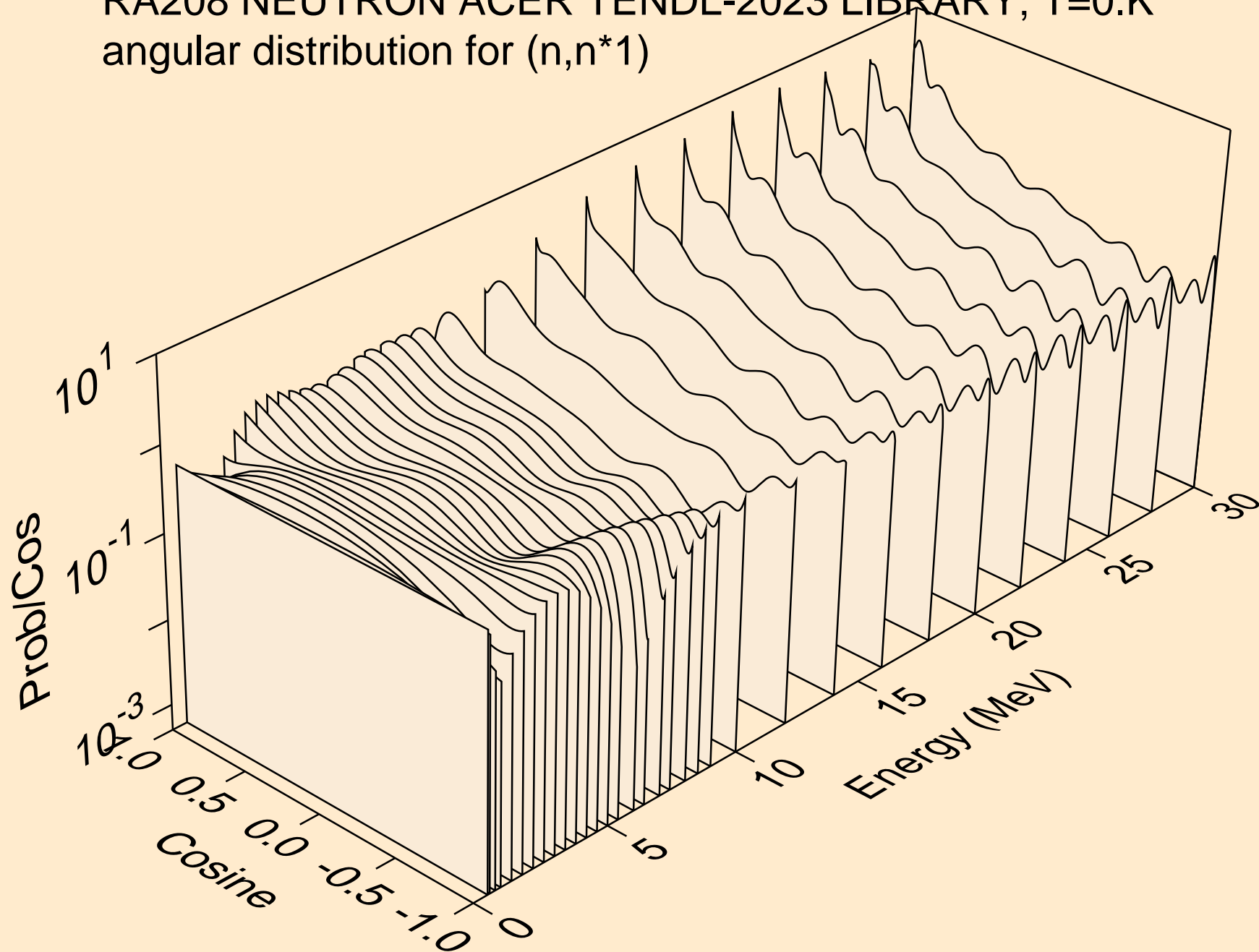

RA208 NEUTRON ACER TENDL-2023 LIBRARY; T=0.K
angular distribution for (n,n*2)

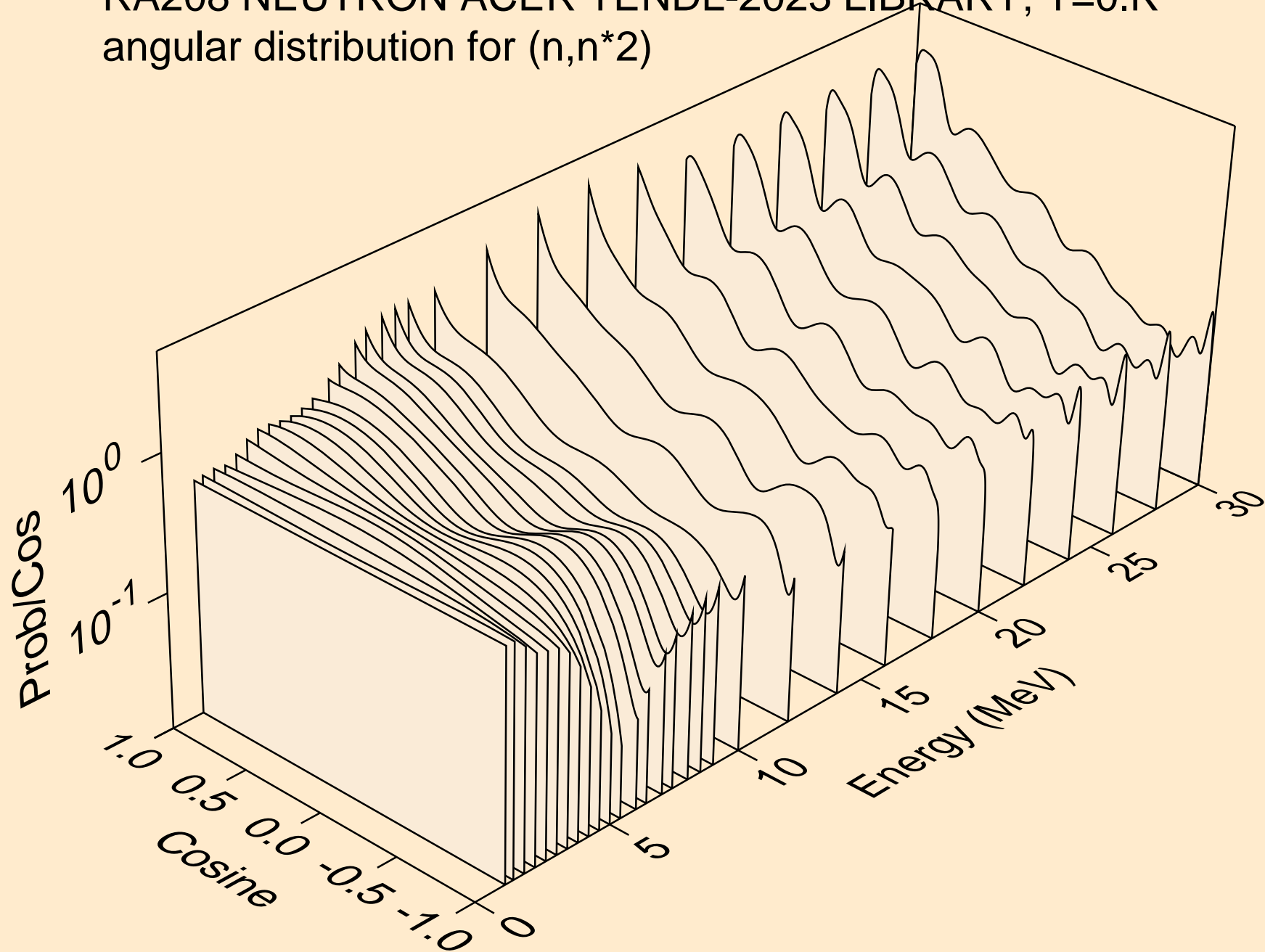

RA208 NEUTRON ACER TENDL-2023 LIBRARY; T=0.K
angular distribution for (n,n*3)

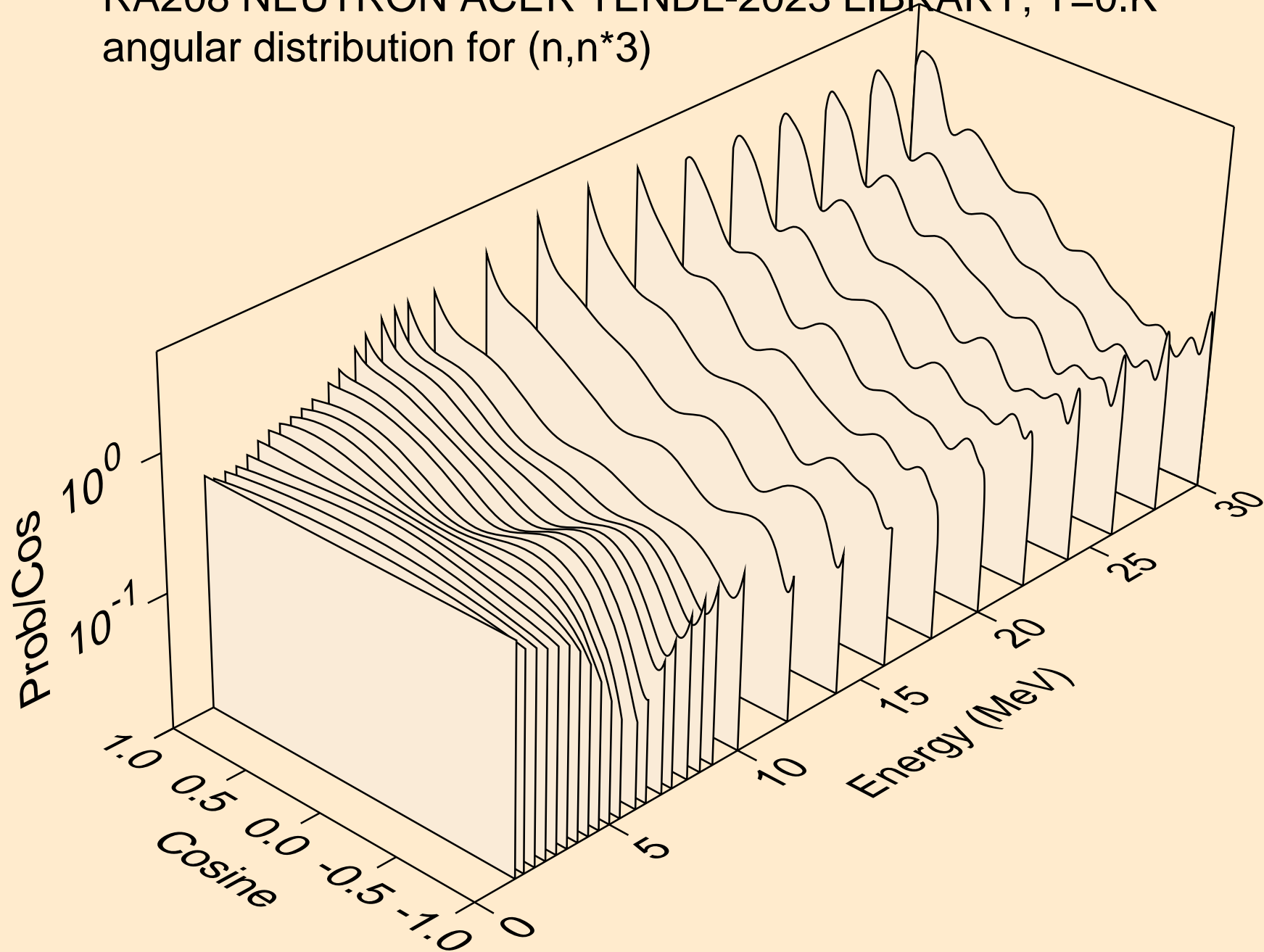

RA208 NEUTRON ACER TENDL-2023 LIBRARY; T=0.K
angular distribution for (n,n*4)

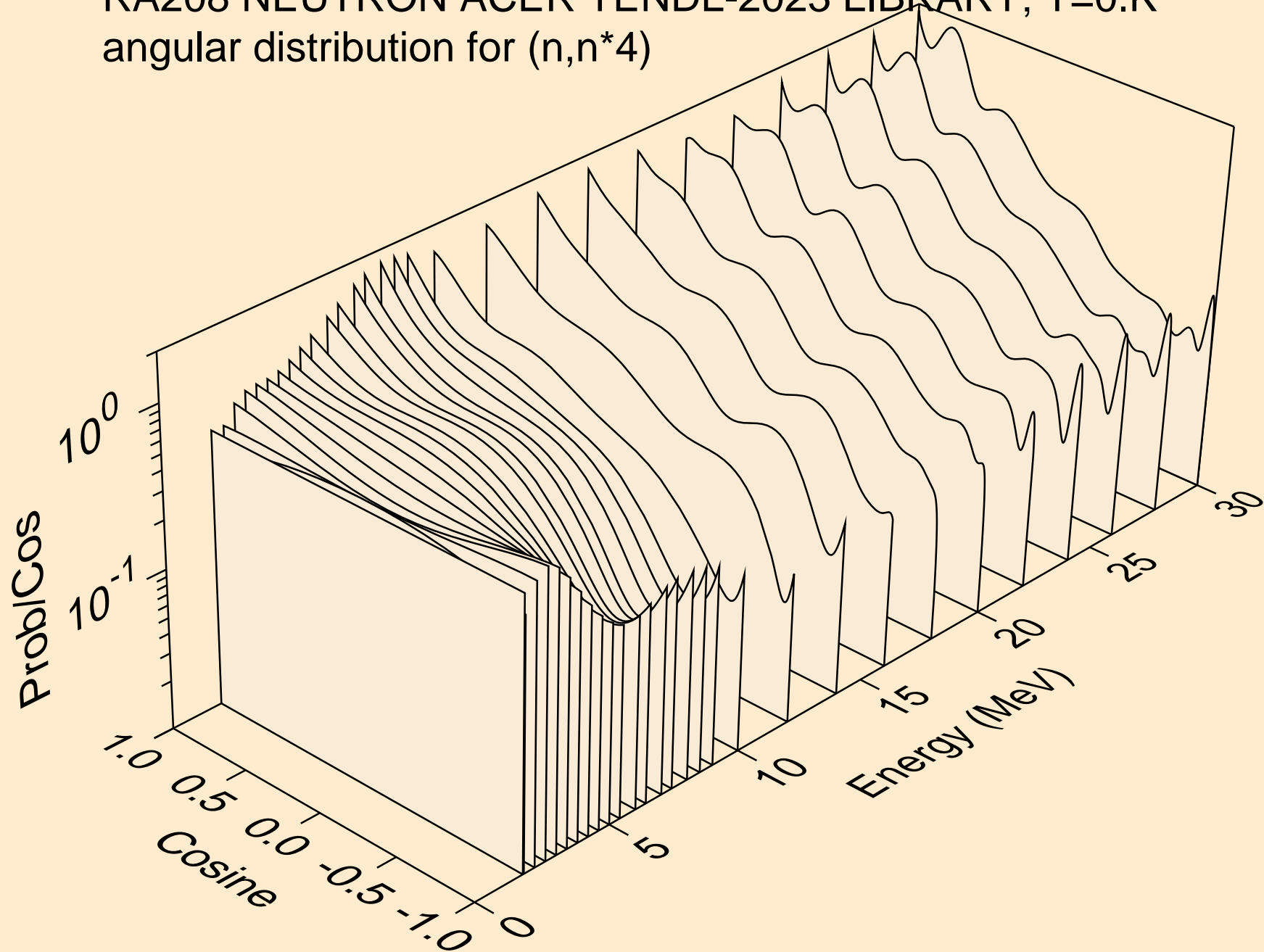

RA208 NEUTRON ACER TENDL-2023 LIBRARY; T=0.K
angular distribution for (n,n*5)

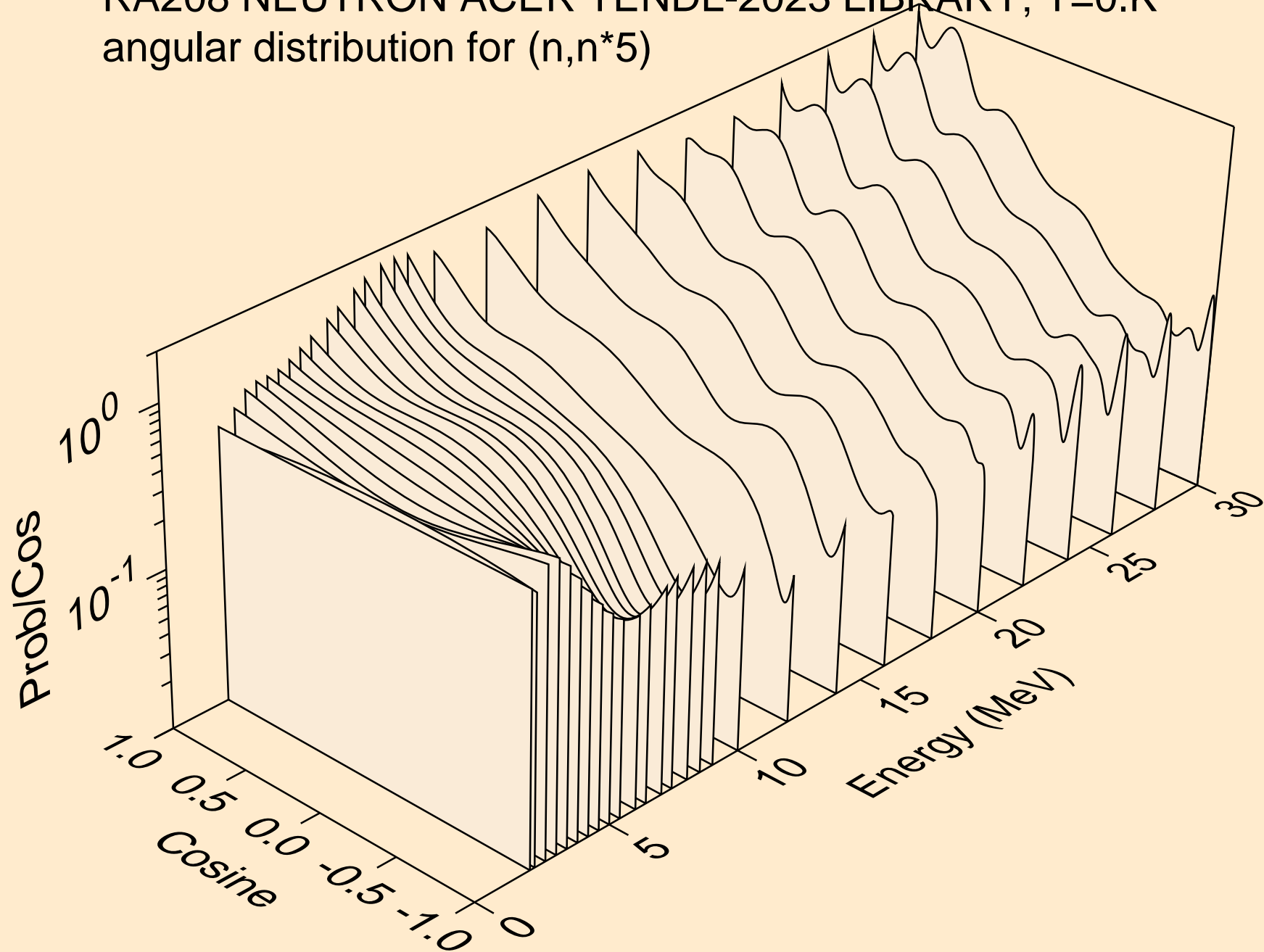

RA208 NEUTRON ACER TENDL-2023 LIBRARY; T=0.K
angular distribution for (n,n*6)

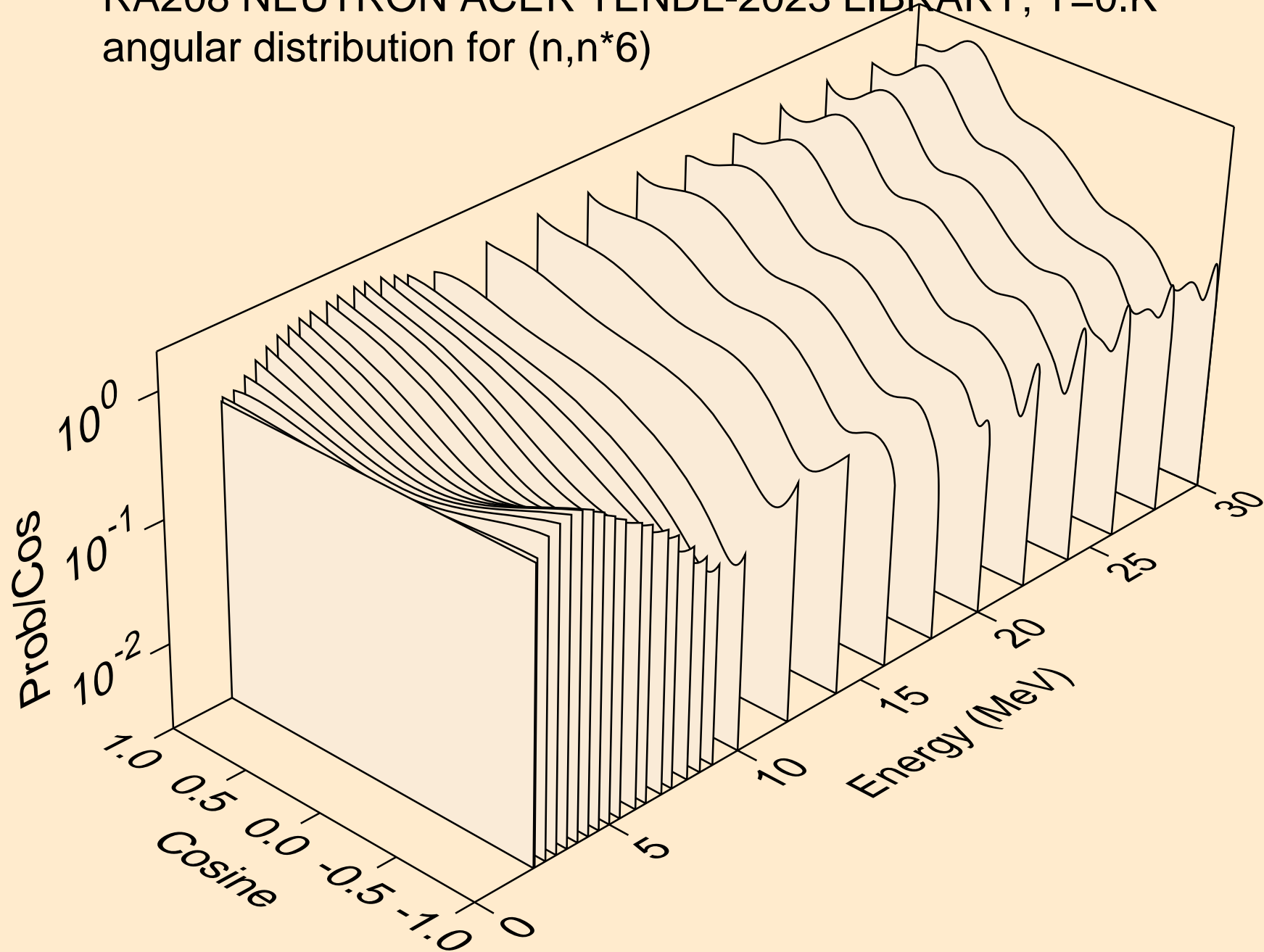

RA208 NEUTRON ACER TENDL-2023 LIBRARY; T=0.K
angular distribution for (n,n*7)

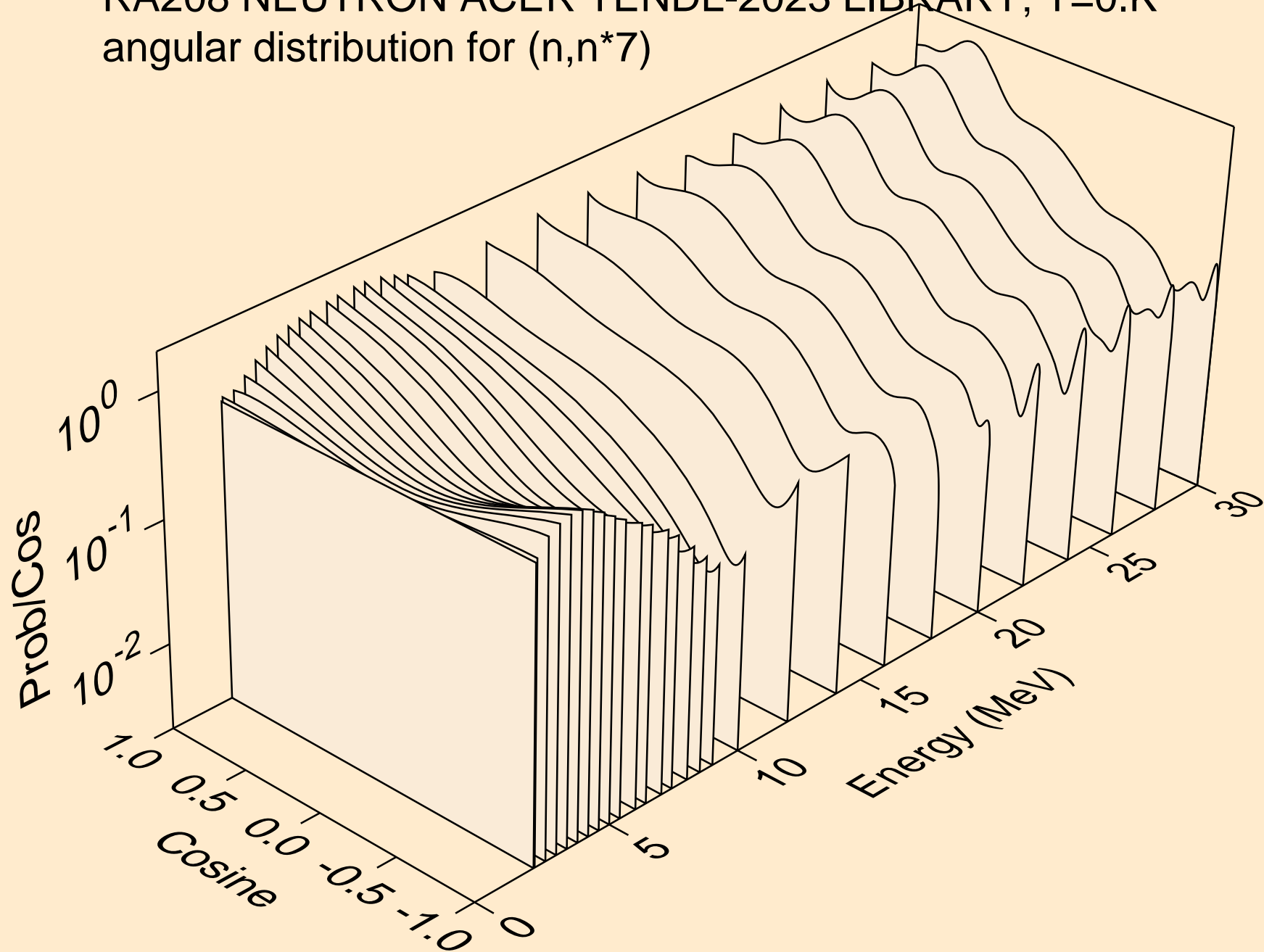

RA208 NEUTRON ACER TENDL-2023 LIBRARY; T=0.K
angular distribution for (n,n*8)

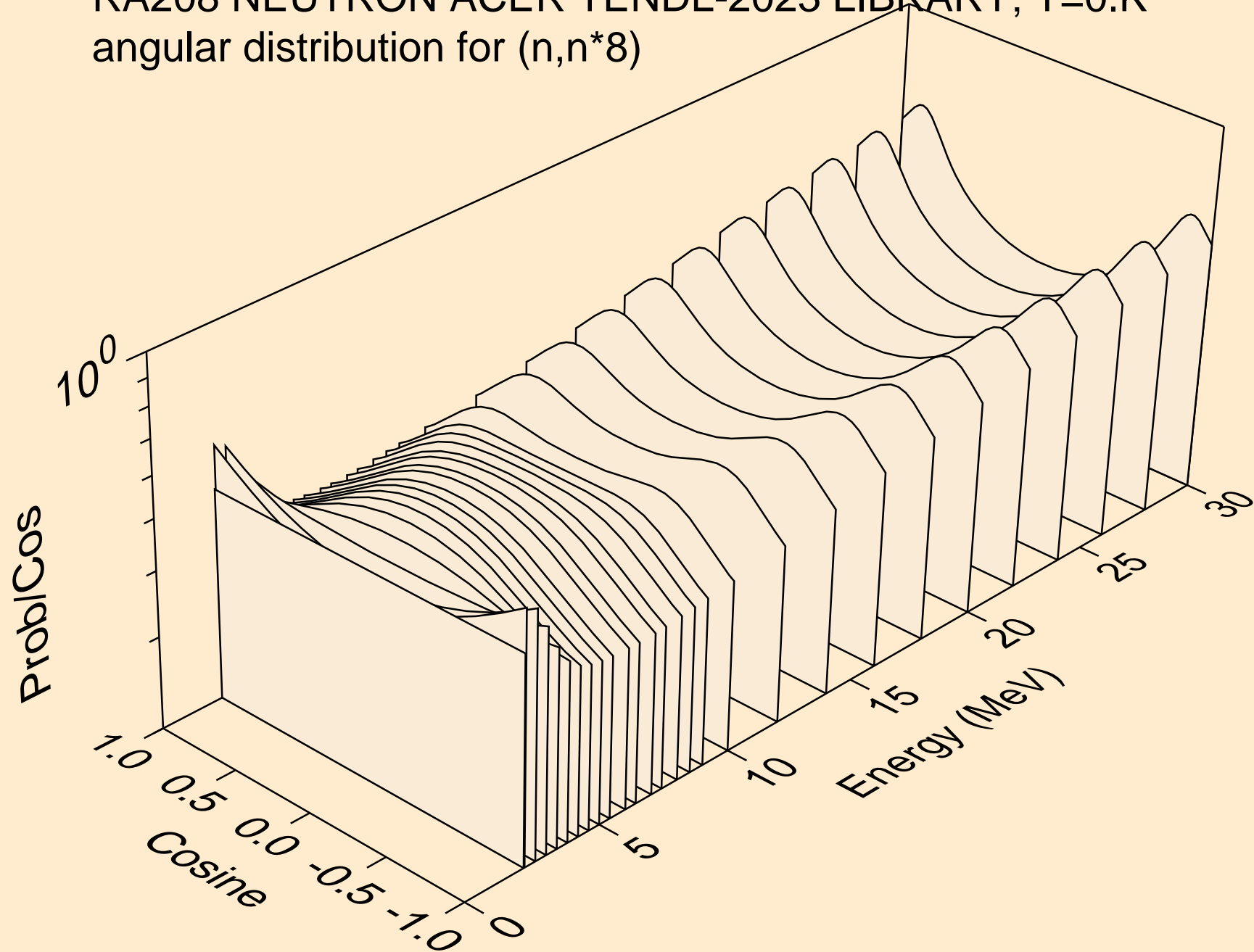

RA208 NEUTRON ACER TENDL-2023 LIBRARY; T=0.K
angular distribution for (n,n*9)

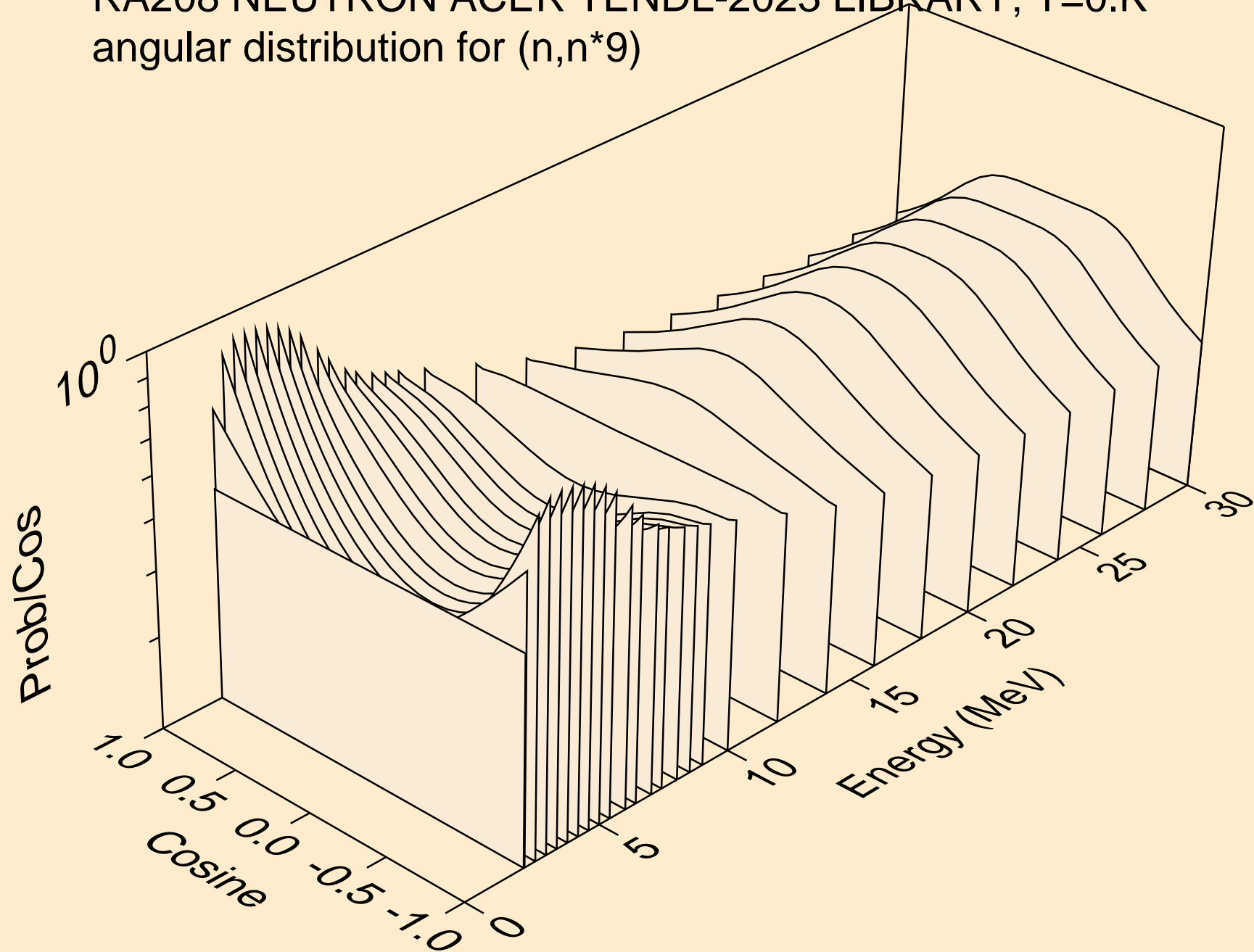

RA208 NEUTRON ACER TENDL-2023 LIBRARY; T=0.K
angular distribution for (n,n*10)

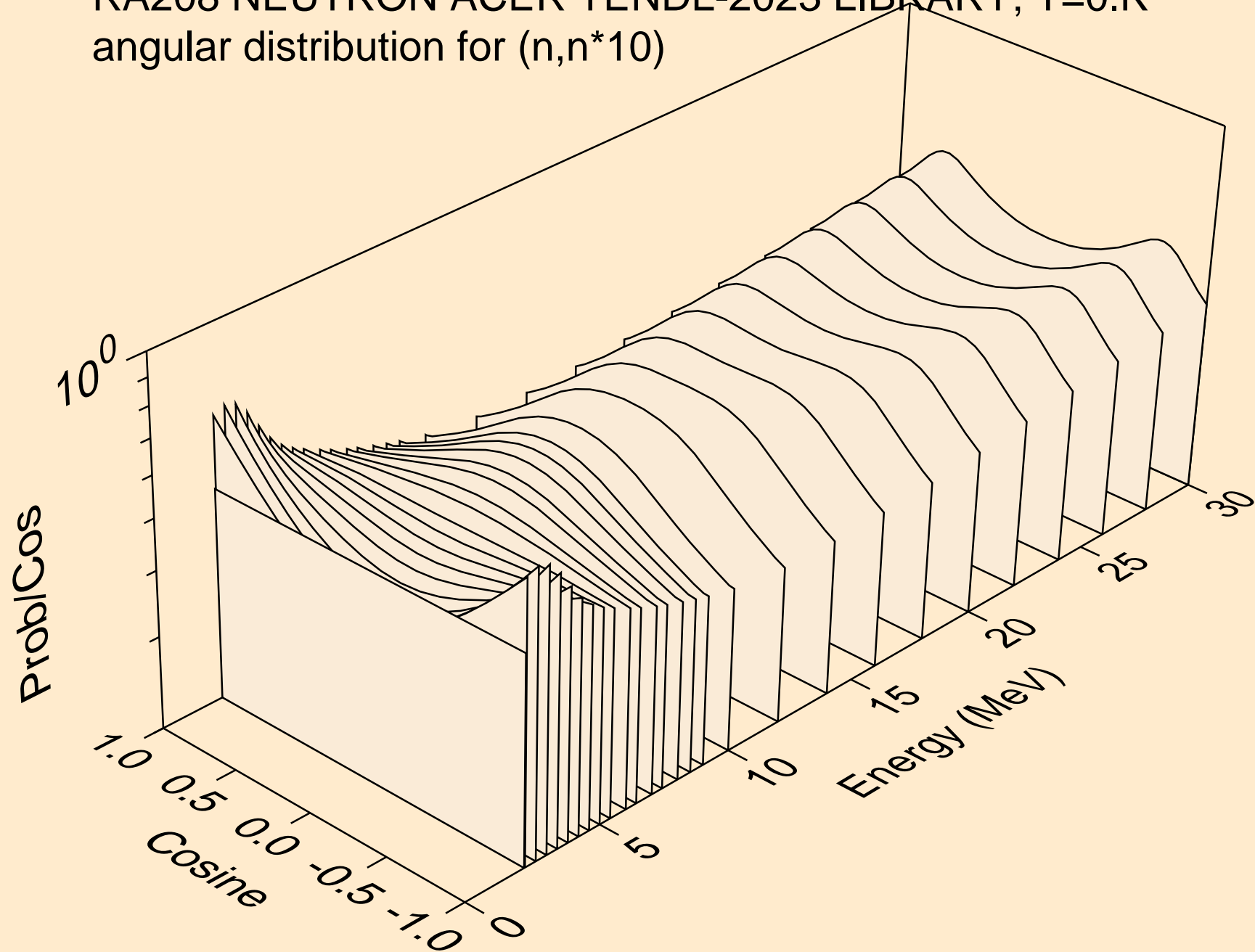

RA208 NEUTRON ACER TENDL-2023 LIBRARY; T=0.K
angular distribution for (n,n*11)

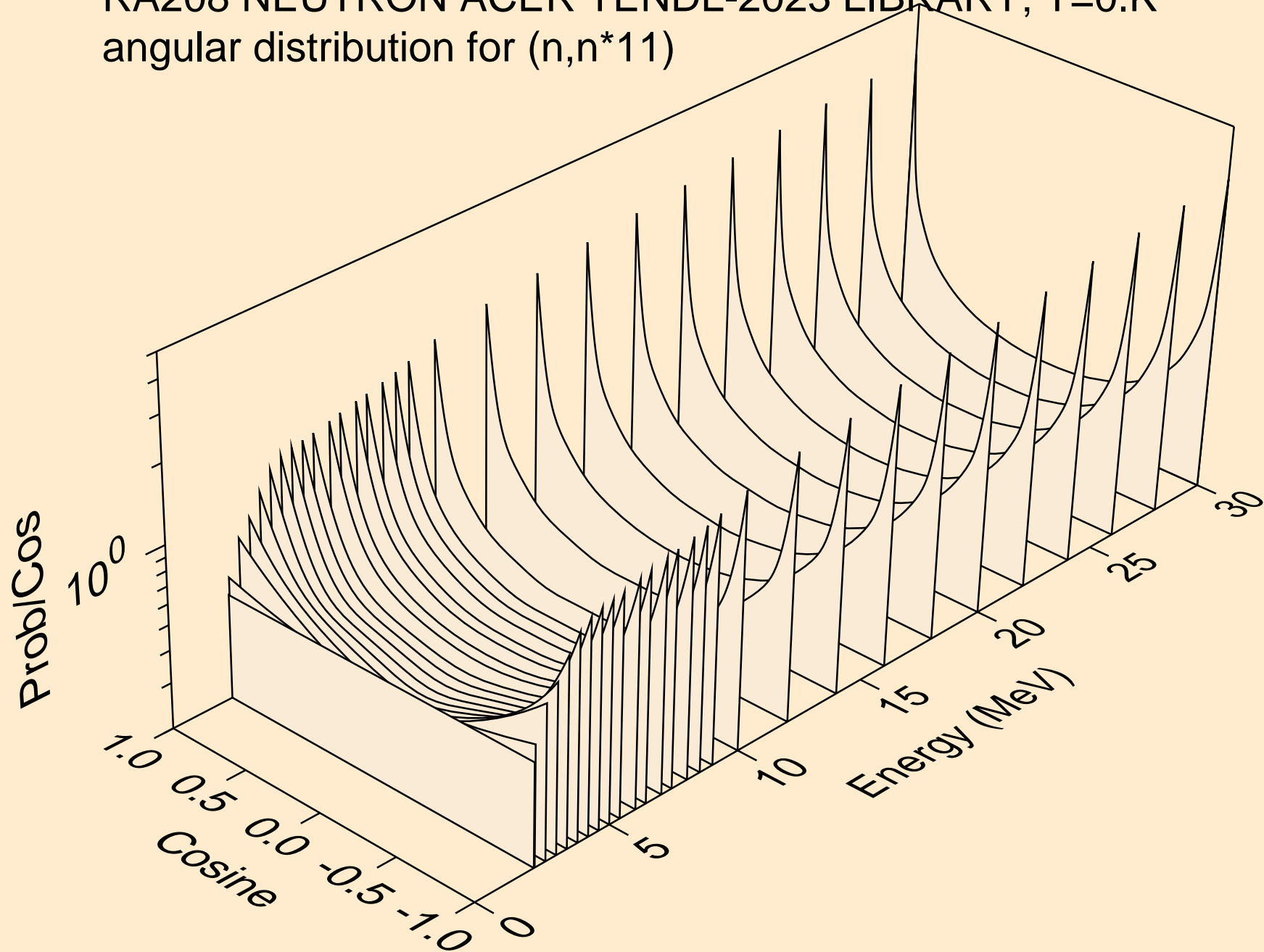

RA208 NEUTRON ACER TENDL-2023 LIBRARY; T=0.K
angular distribution for (n,n*12)

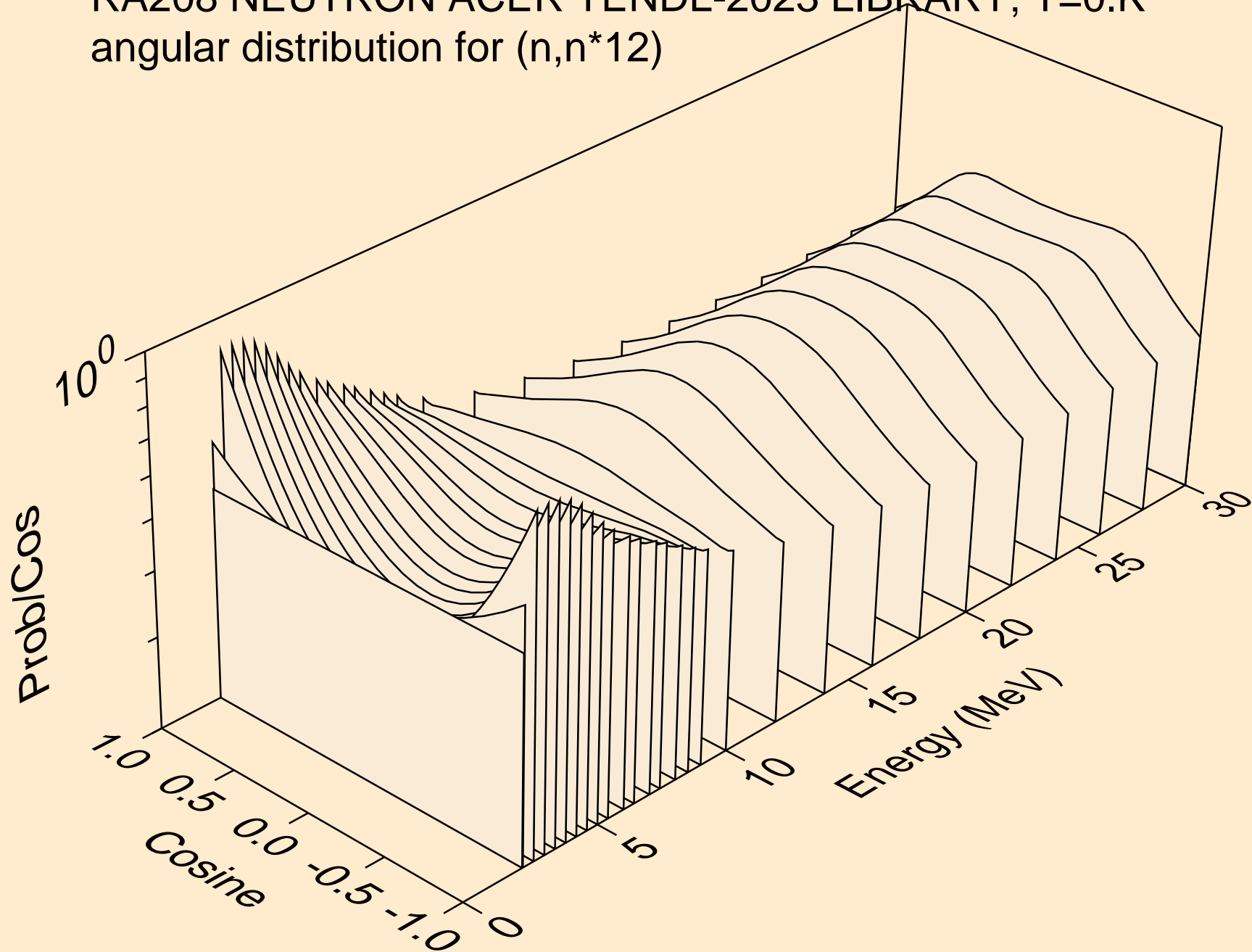

RA208 NEUTRON ACER TENDL-2023 LIBRARY; T=0.K
angular distribution for (n,n*13)

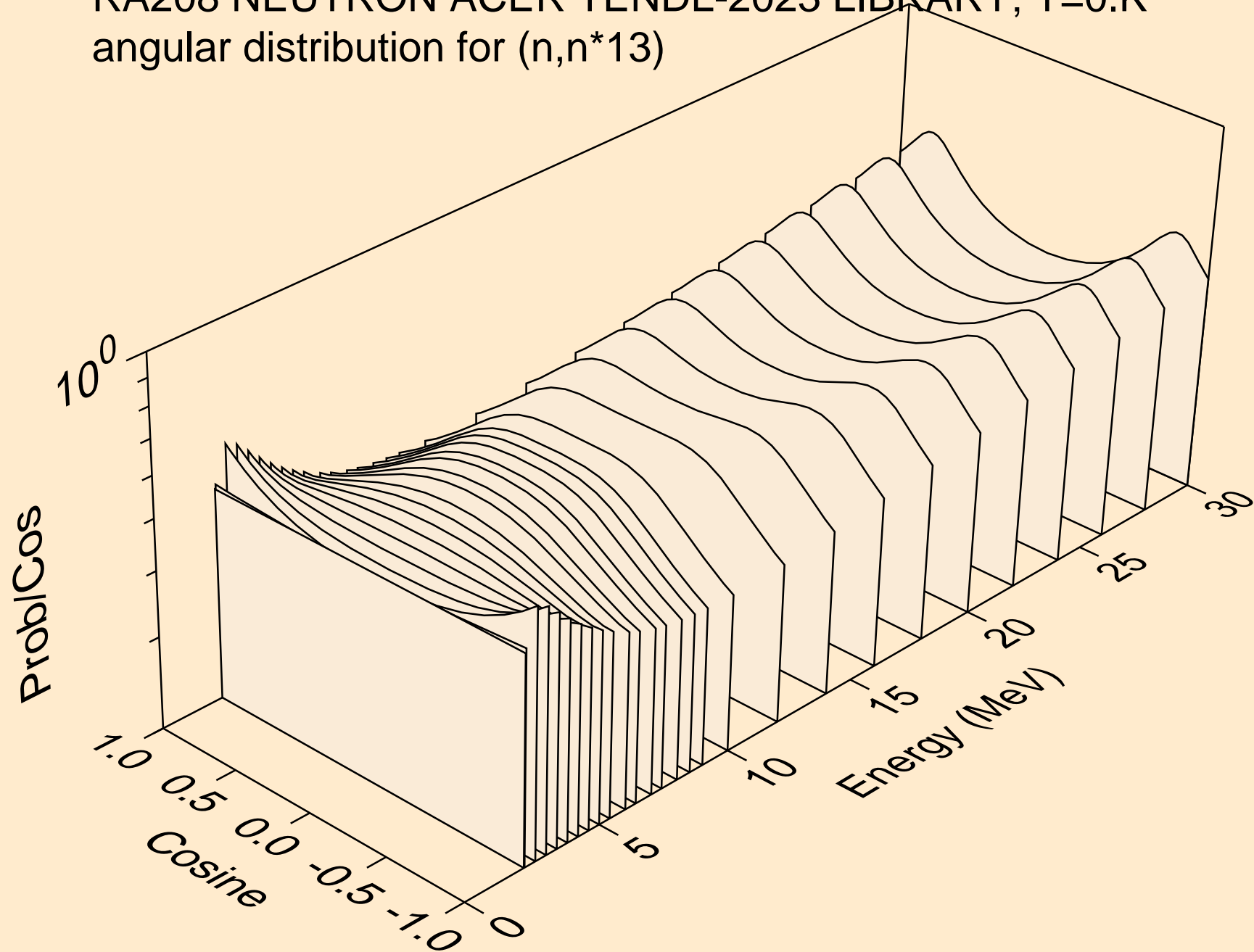

RA208 NEUTRON ACER TENDL-2023 LIBRARY; T=0.K
angular distribution for (n,n*14)

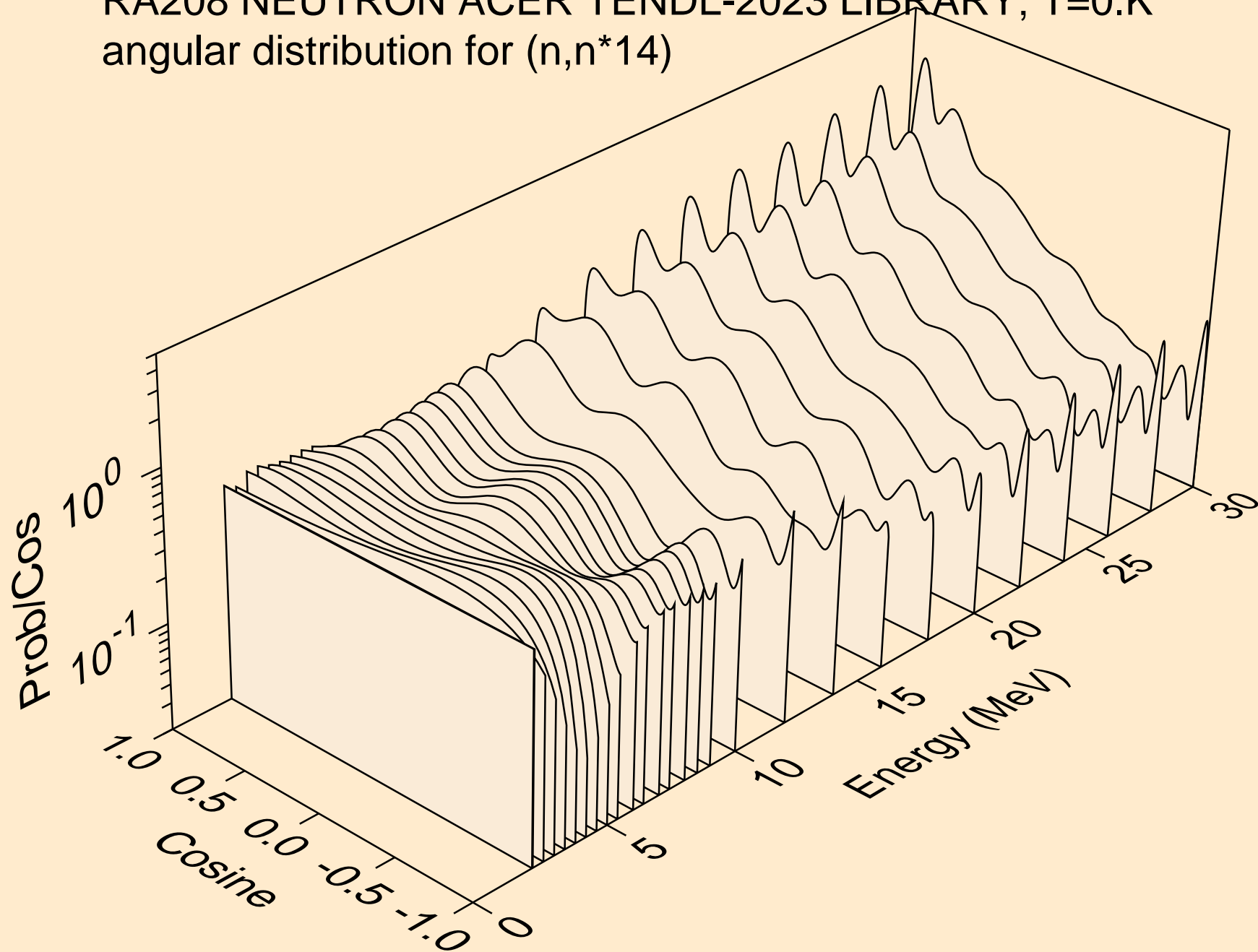

RA208 NEUTRON ACER TENDL-2023 LIBRARY; T=0.K
Neutron emission for (n,x)

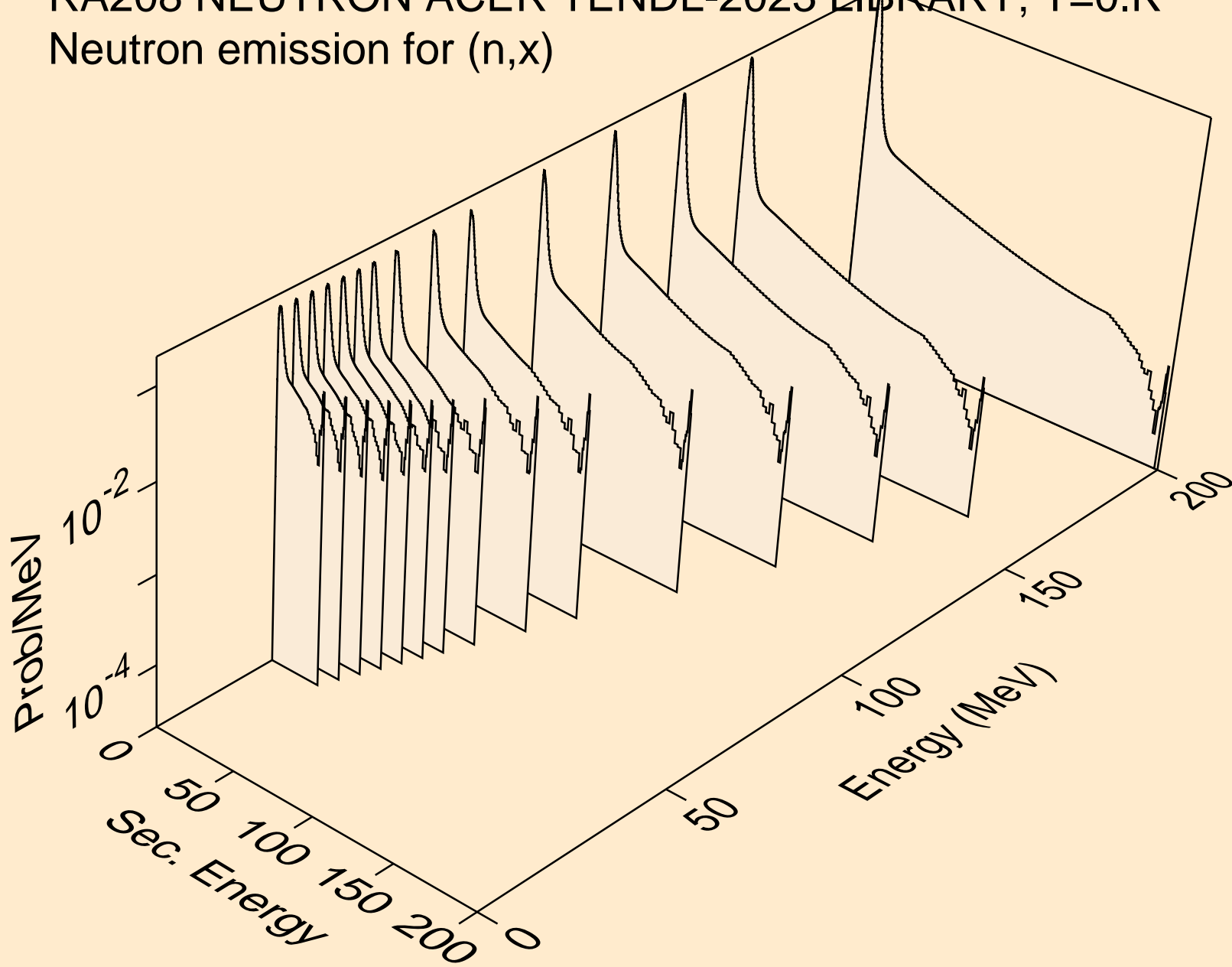

RA208 NEUTRON ACER TENDL-2023 LIBRARY; T=0.K
Neutron emission for (n,2nd)

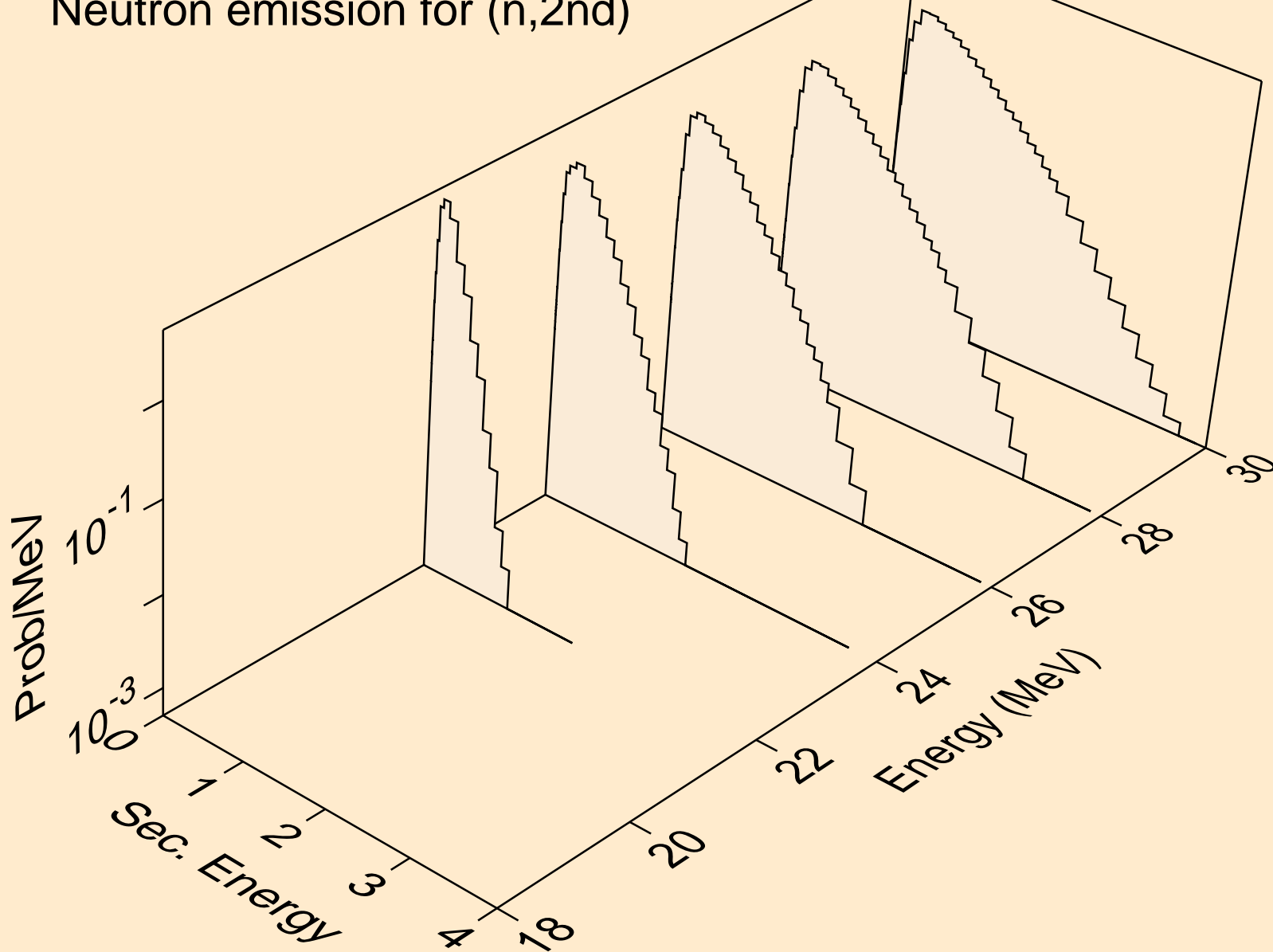

RA208 NEUTRON ACER TENDL-2023 LIBRARY; T=0.K
Neutron emission for (n,2n)

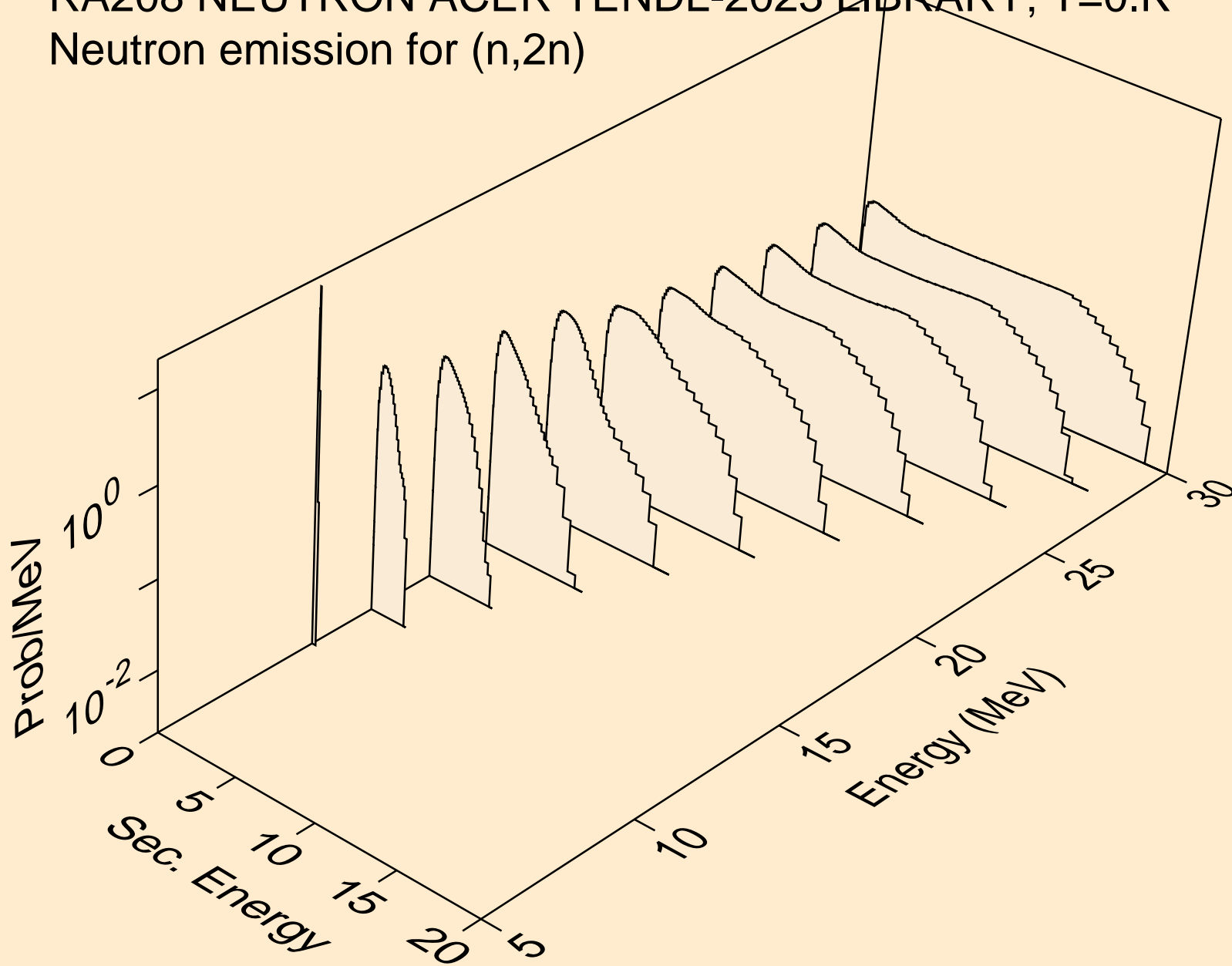

RA208 NEUTRON ACER TENDL-2023 LIBRARY; T=0.K
Neutron emission for (n,3n)

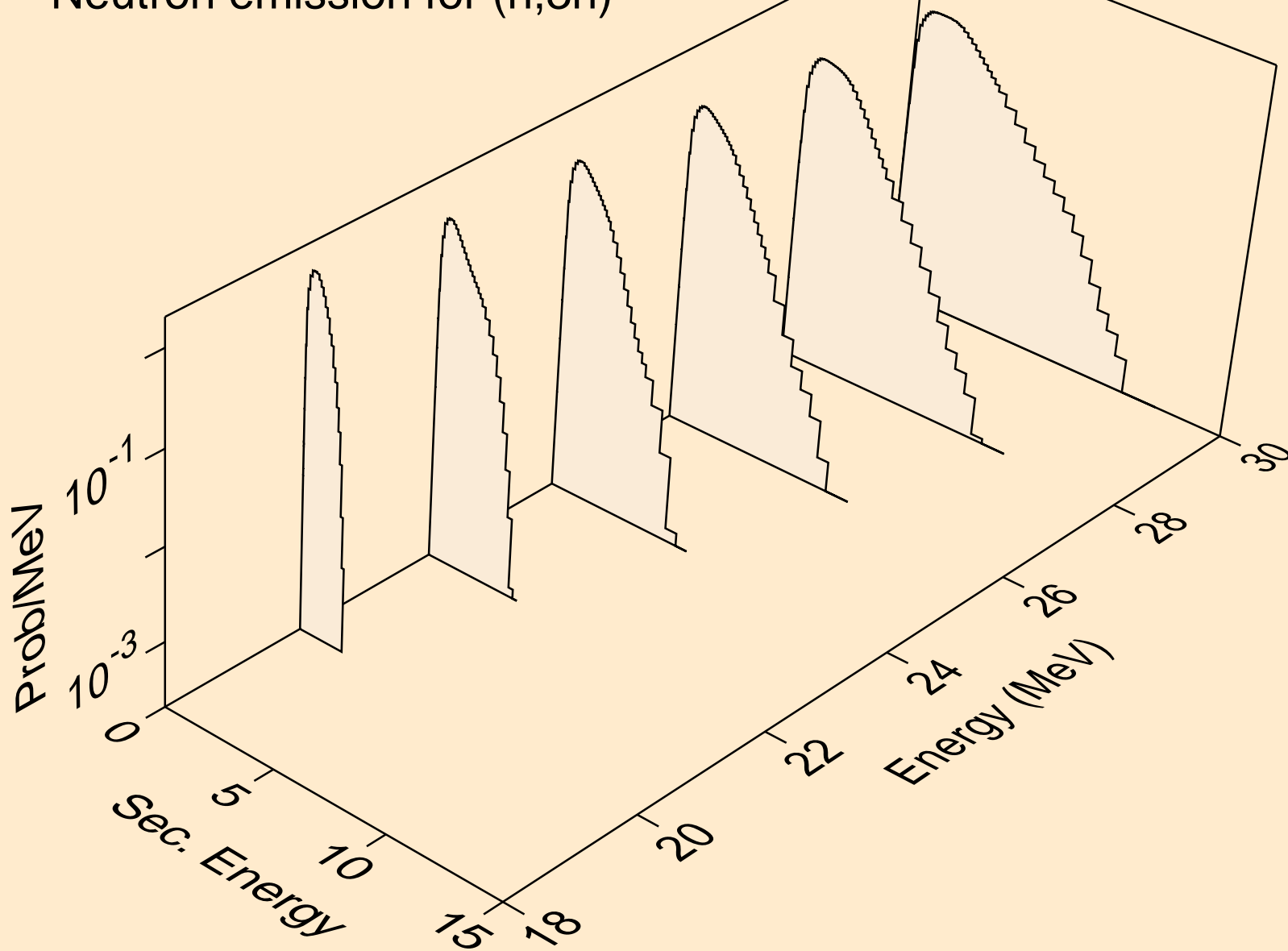

RA208 NEUTRON ACER TENDL-2023 LIBRARY; T=0.K
Neutron emission for (n,n*)a

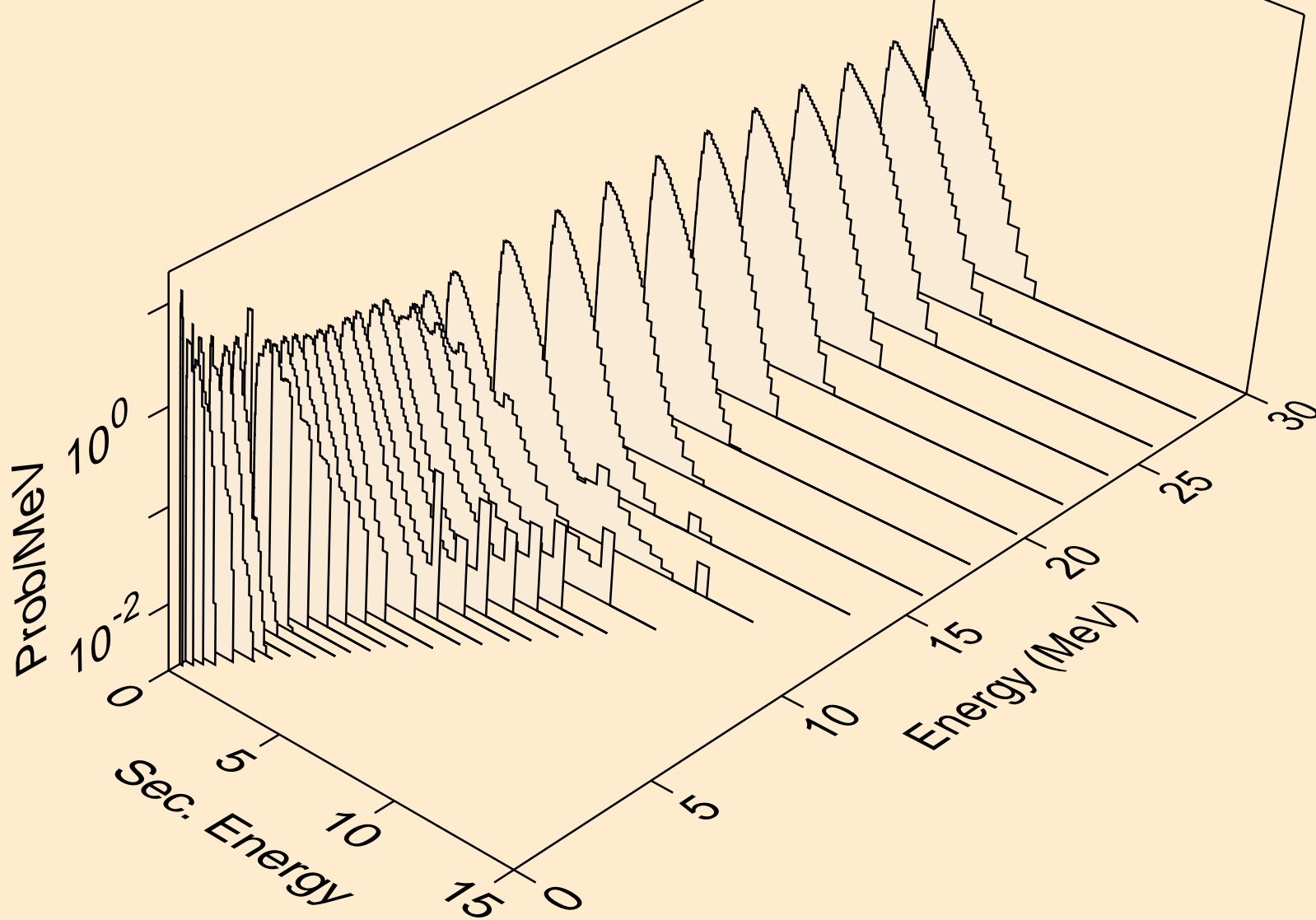

RA208 NEUTRON ACER TENDL-2023 LIBRARY; T=0.K
Neutron emission for (n,2n)a

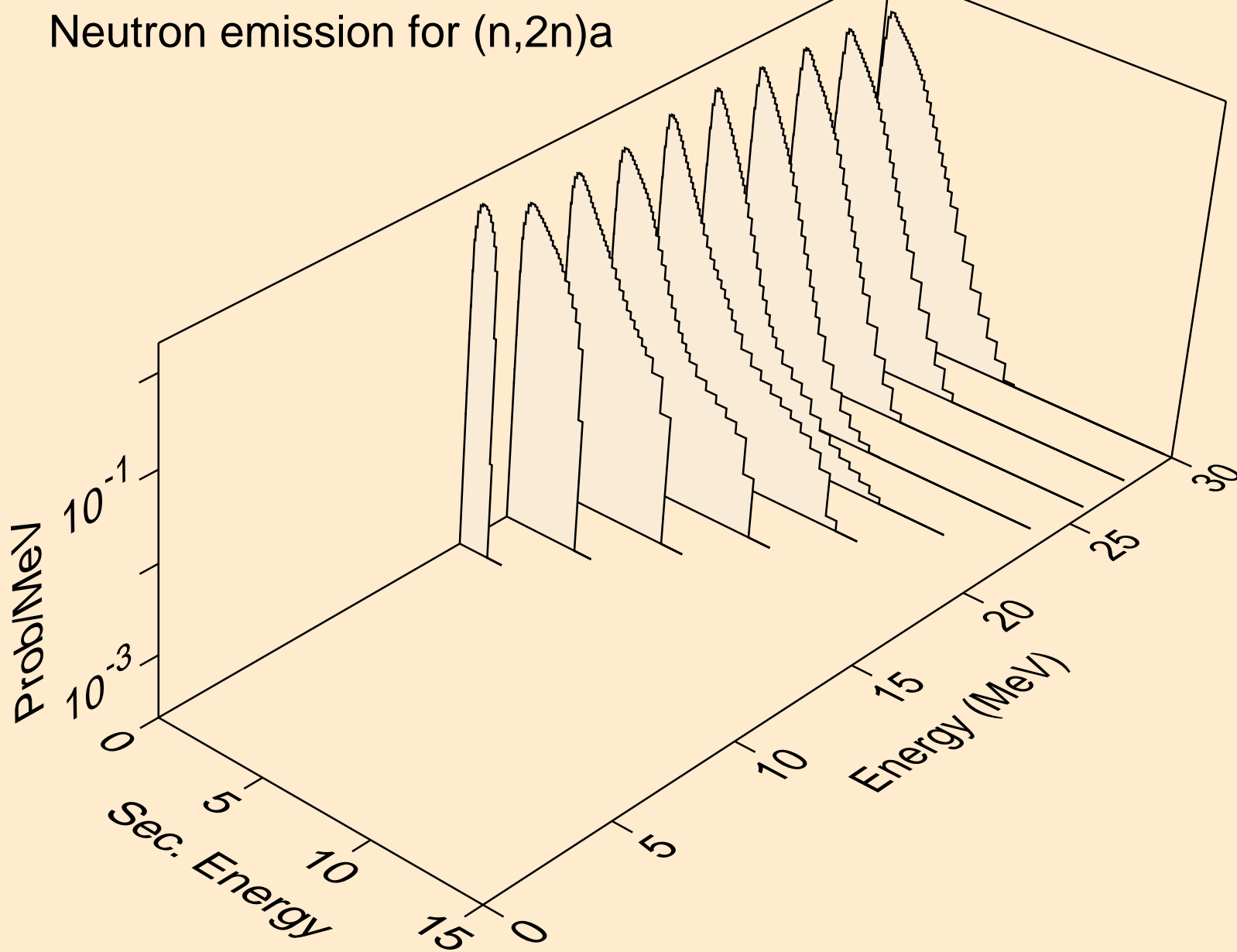

RA208 NEUTRON ACER TENDL-2023 LIBRARY; T=0.K
Neutron emission for (n,3n)a

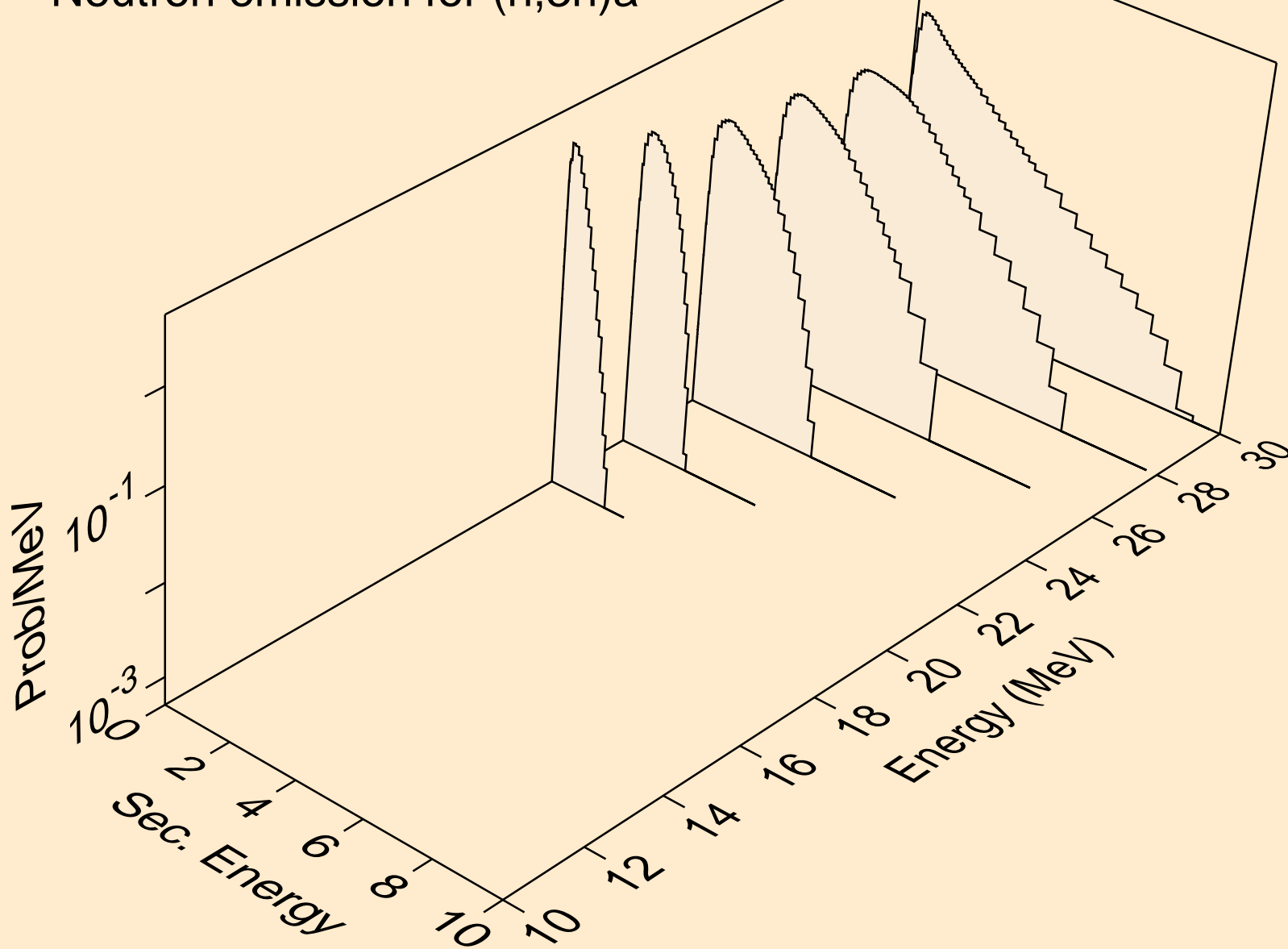

RA208 NEUTRON ACER TENDL-2023 LIBRARY; T=0.K
Neutron emission for (n,n*)p

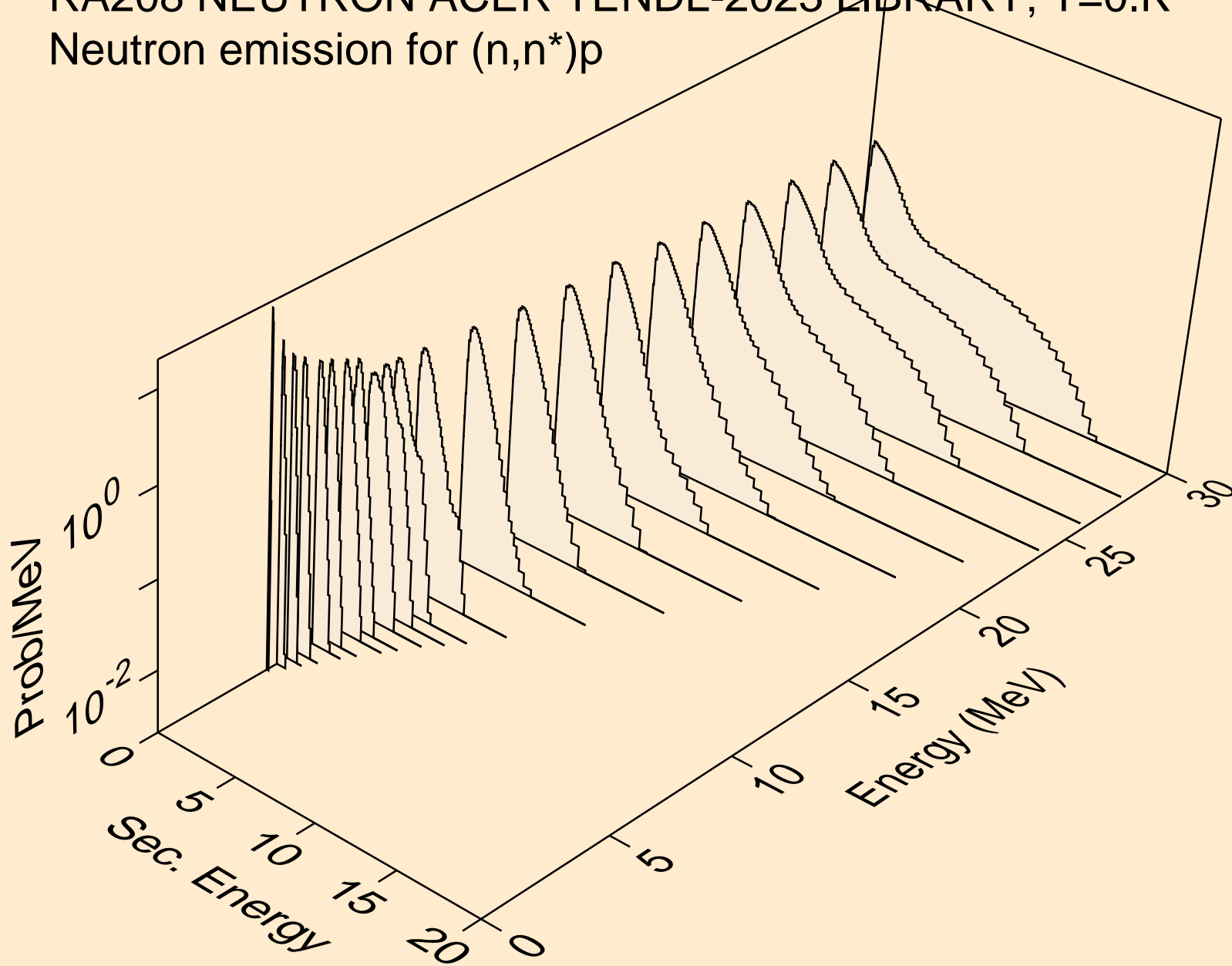

RA208 NEUTRON ACER TENDL-2023 LIBRARY; T=0.K
Neutron emission for (n,n*)2a

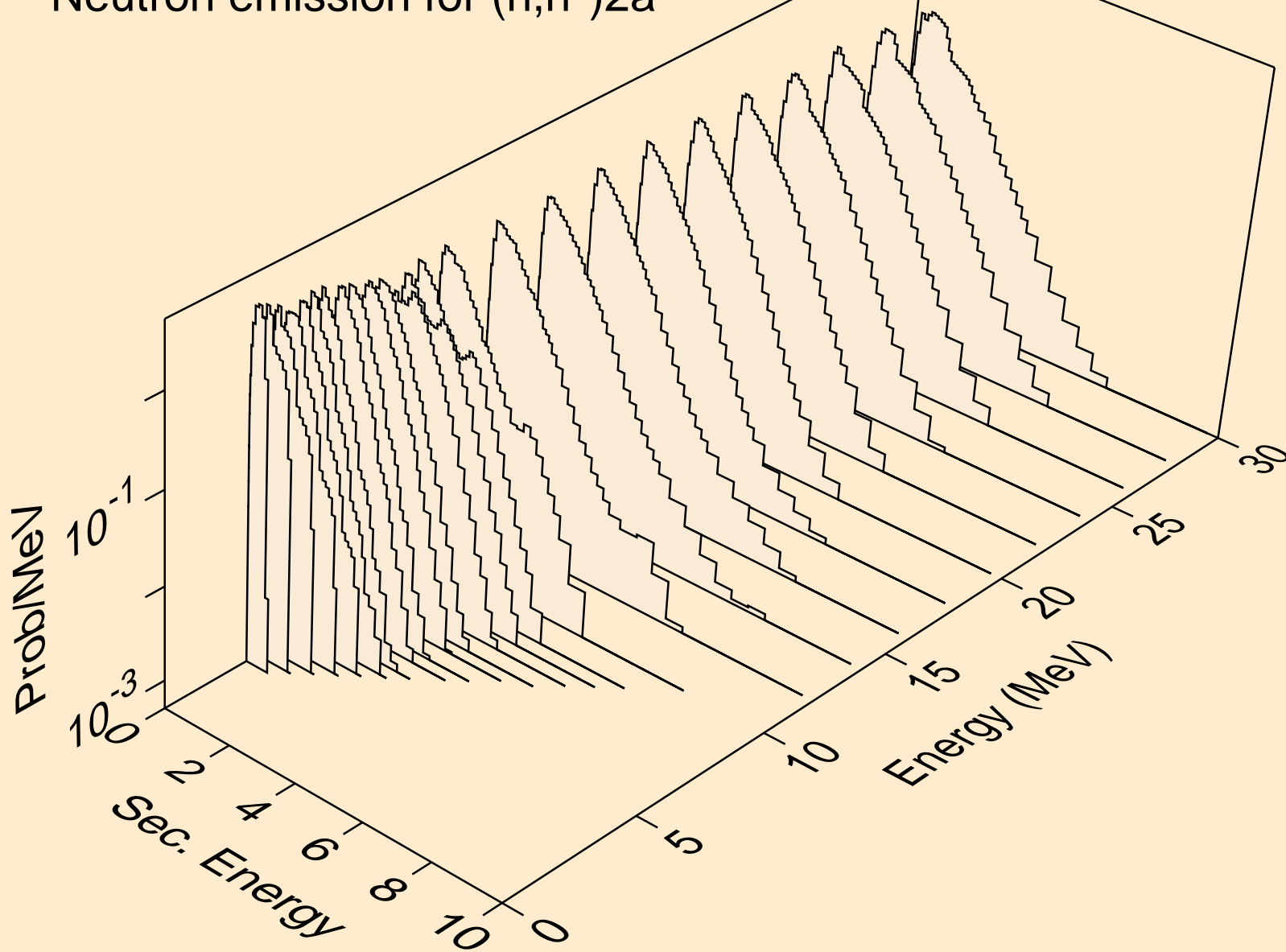

RA208 NEUTRON ACER TENDL-2023 LIBRARY; T=0.K
Neutron emission for (n,2n)2a

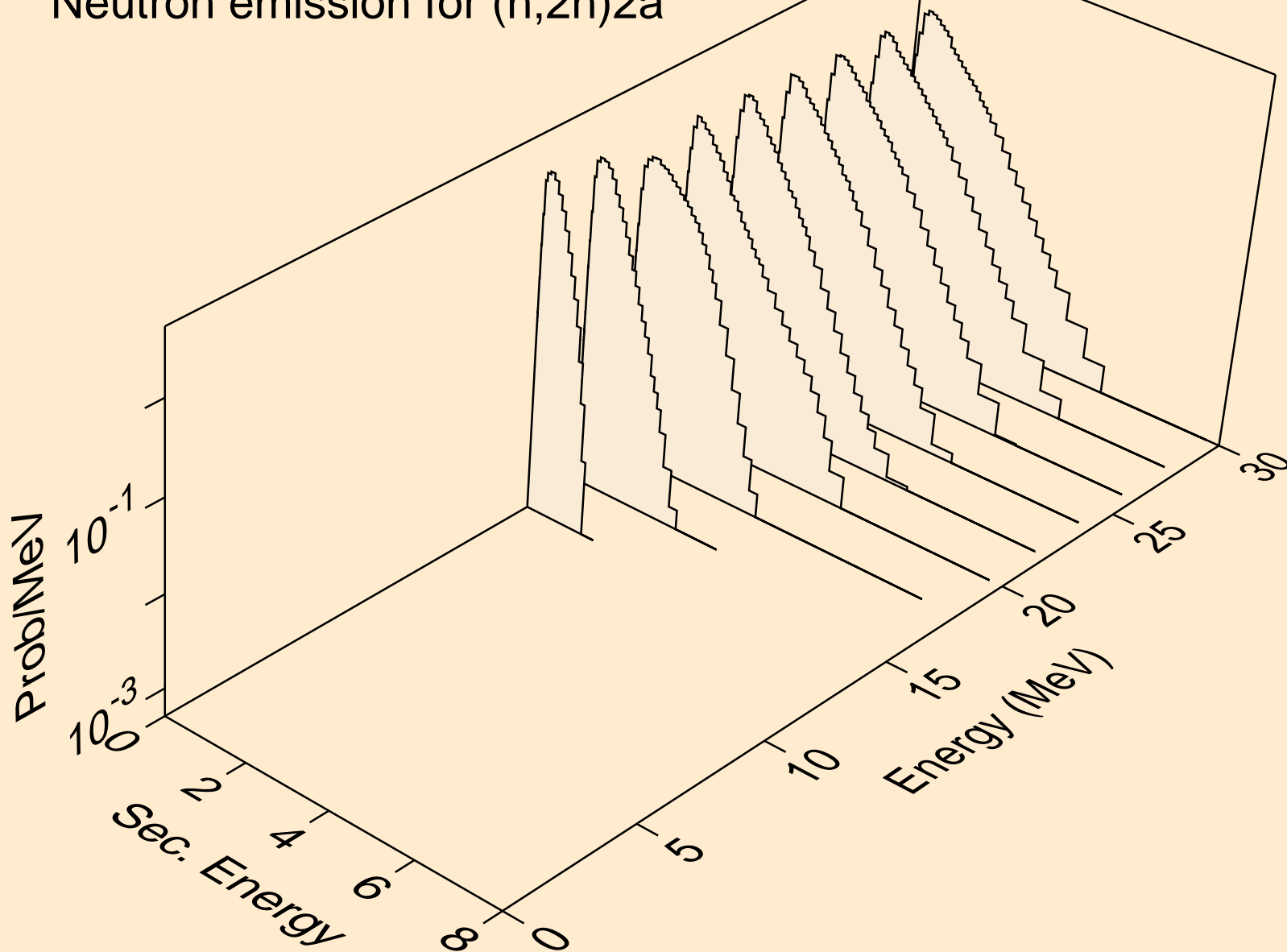

RA208 NEUTRON ACER TENDL-2023 LIBRARY; T=0.K
Neutron emission for (n,n*)d

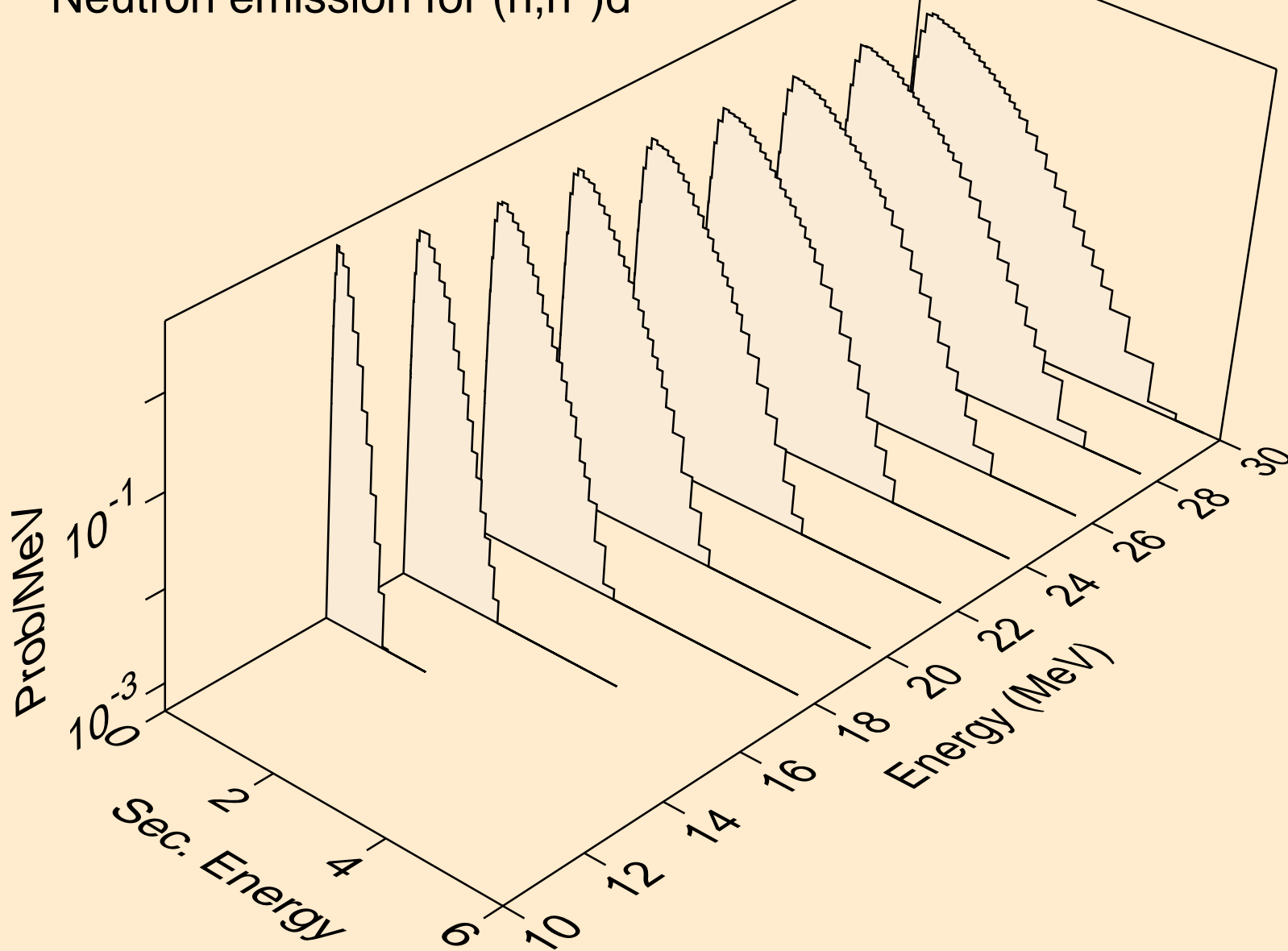

RA208 NEUTRON ACER TENDL-2023 LIBRARY; T=0.K
Neutron emission for (n,n*)t

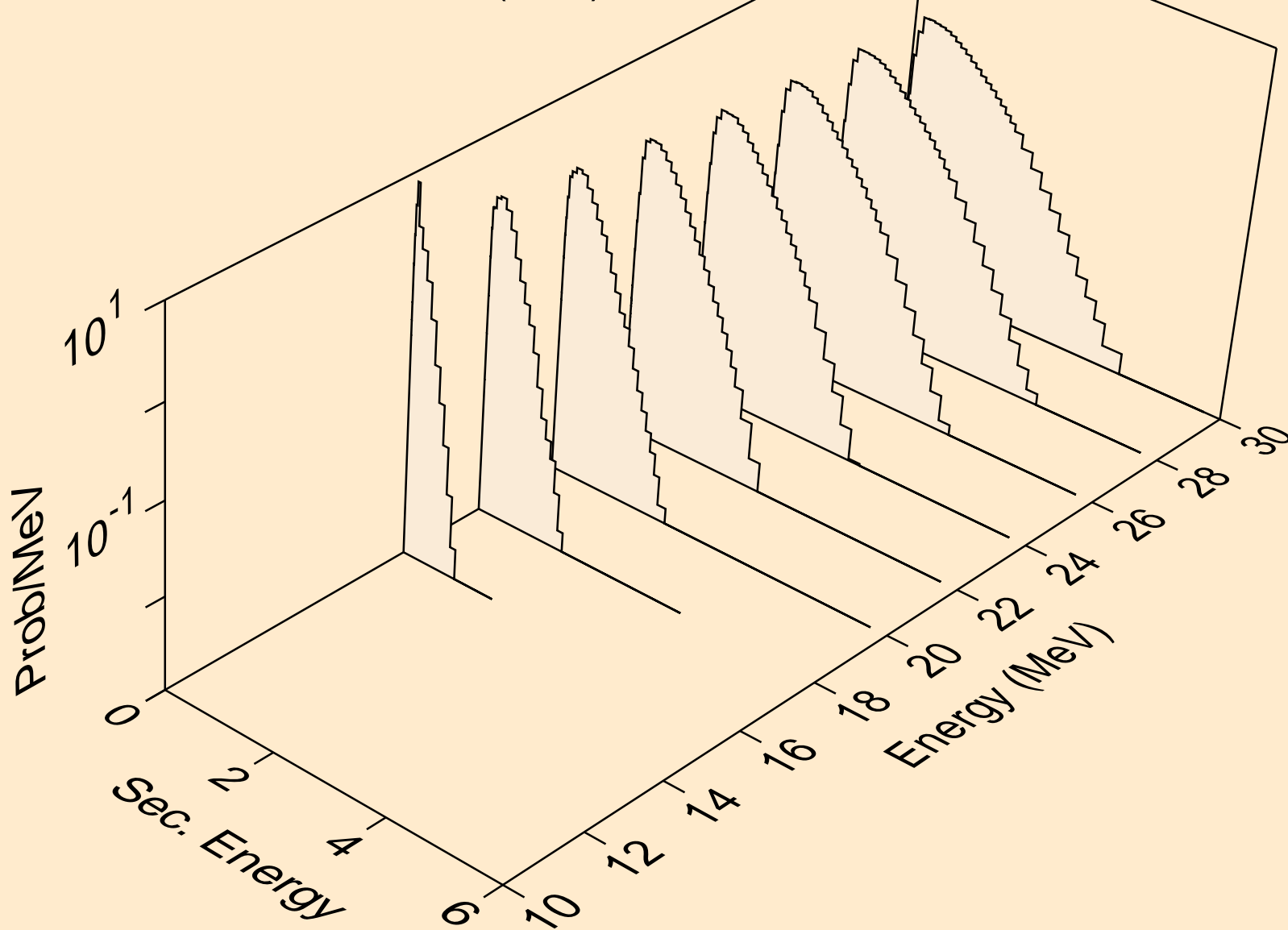

RA208 NEUTRON ACER TENDL-2023 LIBRARY; T=0.K
Neutron emission for (n,n*)he3

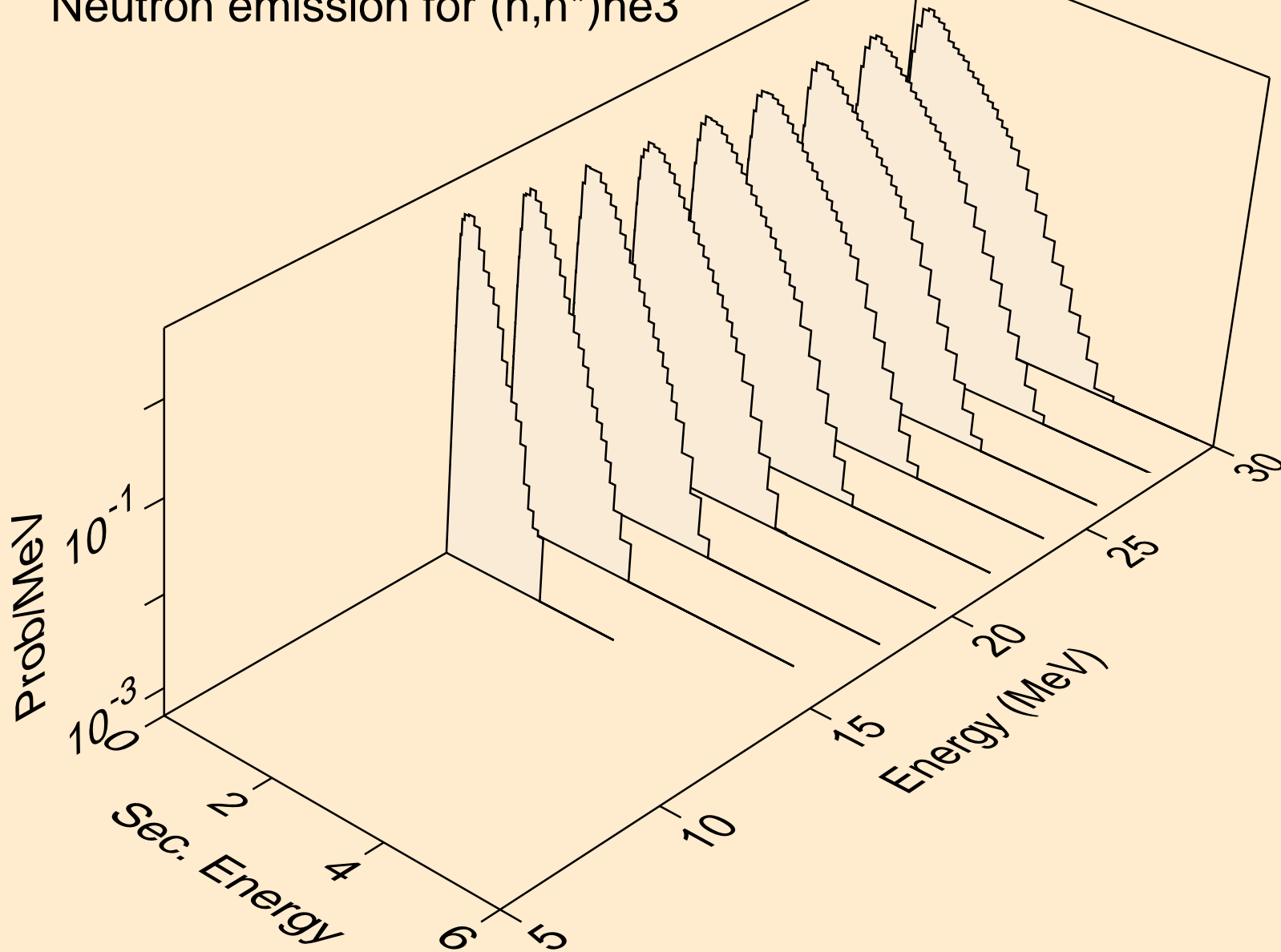

RA208 NEUTRON ACER TENDL-2023 LIBRARY; T=0.K
Neutron emission for (n,4n)

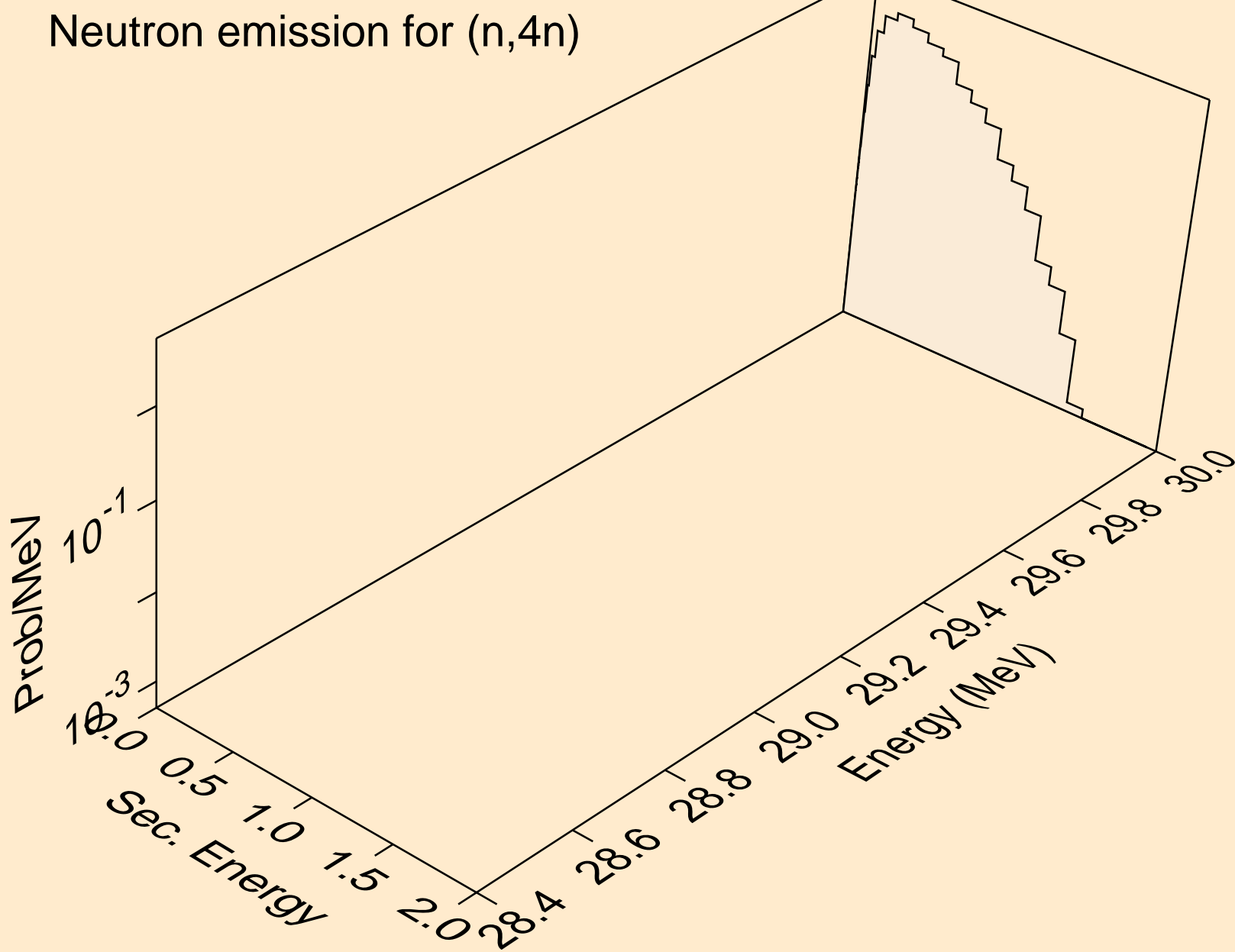

RA208 NEUTRON ACER TENDL-2023 LIBRARY; T=0.K
Neutron emission for (n,2np)

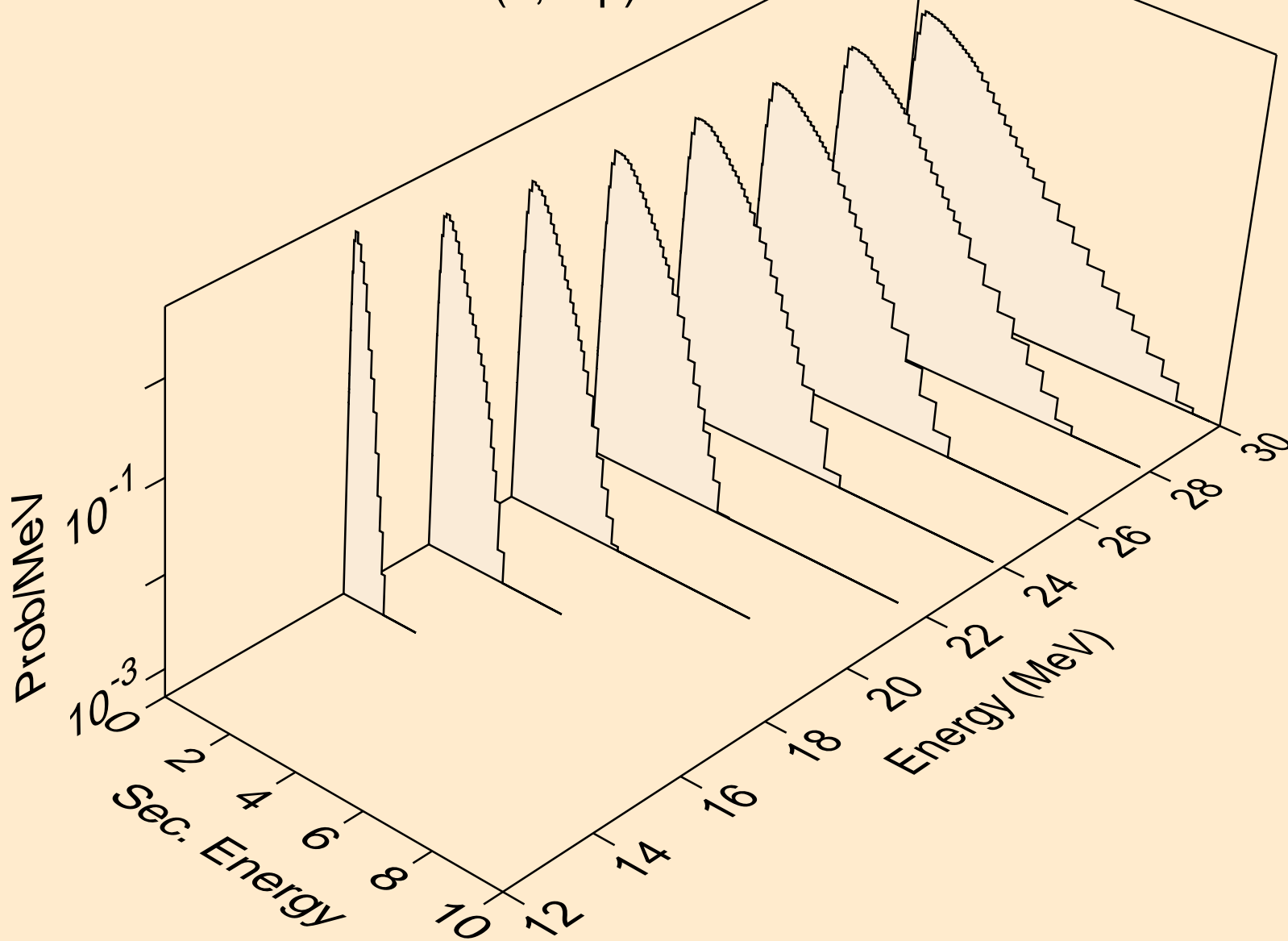

RA208 NEUTRON ACER TENDL-2023 LIBRARY; T=0.K
Neutron emission for (n,3np)

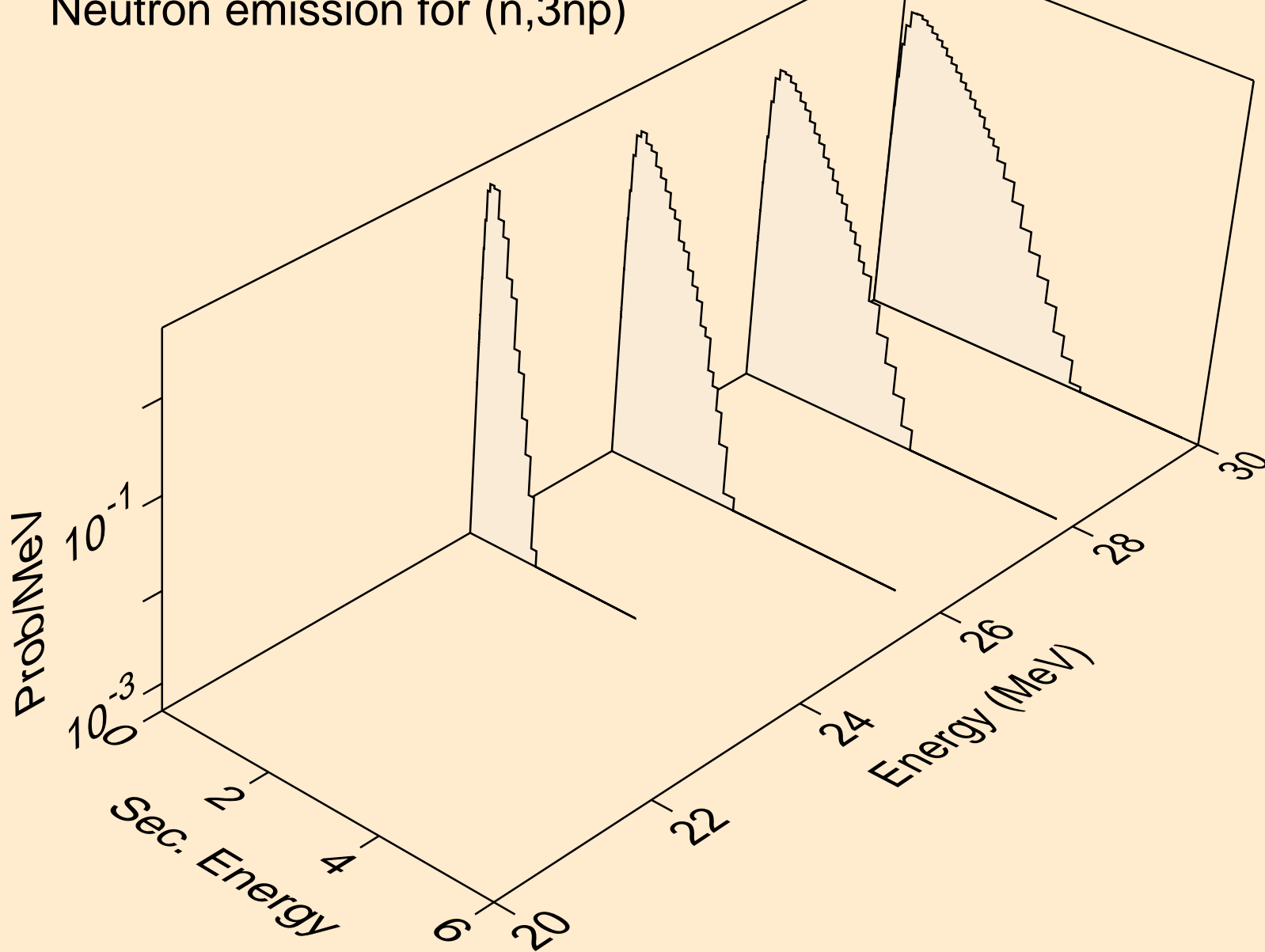

RA208 NEUTRON ACER TENDL-2023 LIBRARY; T=0.K
Neutron emission for (n,n2p)

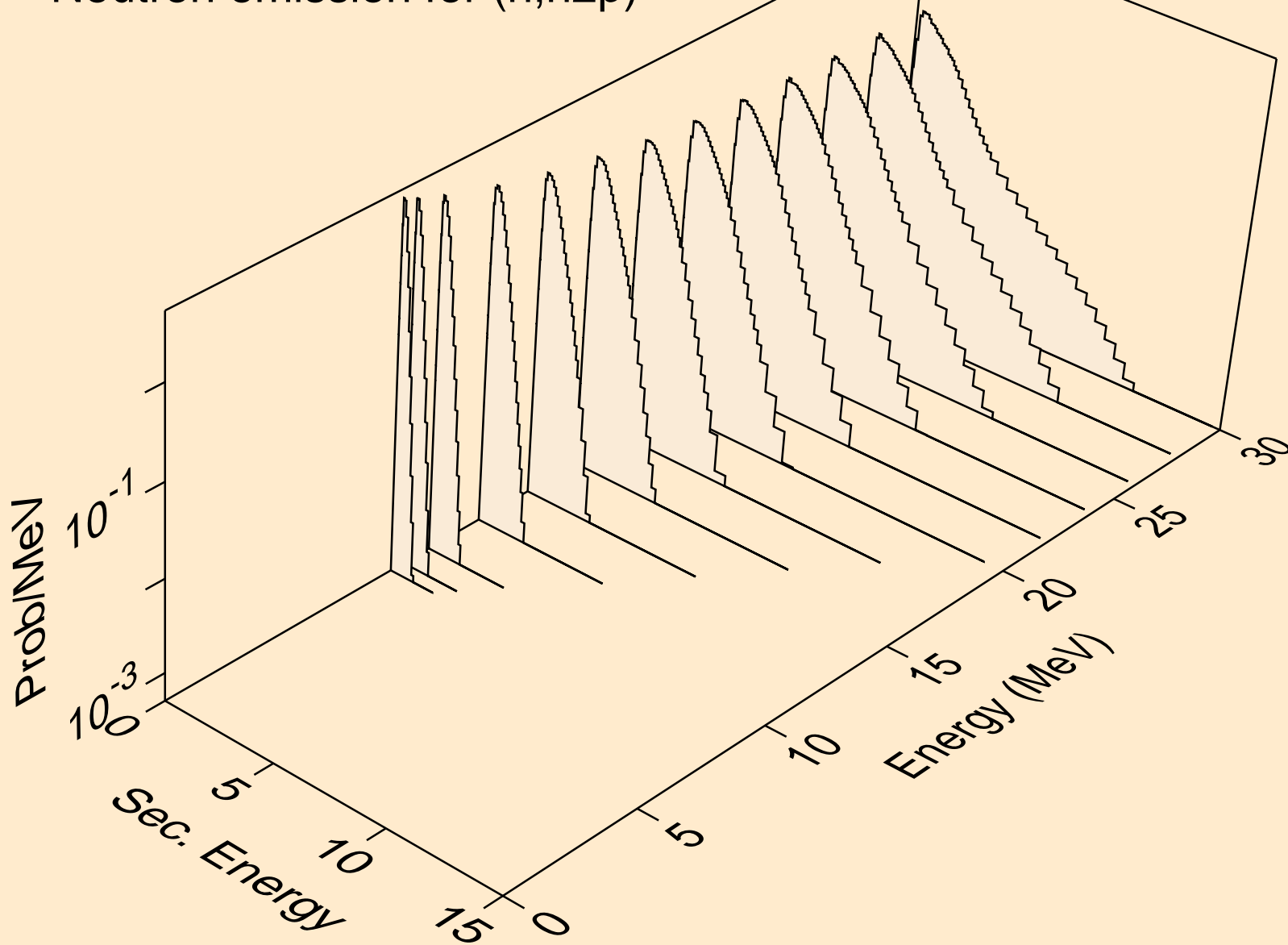

RA208 NEUTRON ACER TENDL-2023 LIBRARY; T=0.K
Neutron emission for (n,npa)

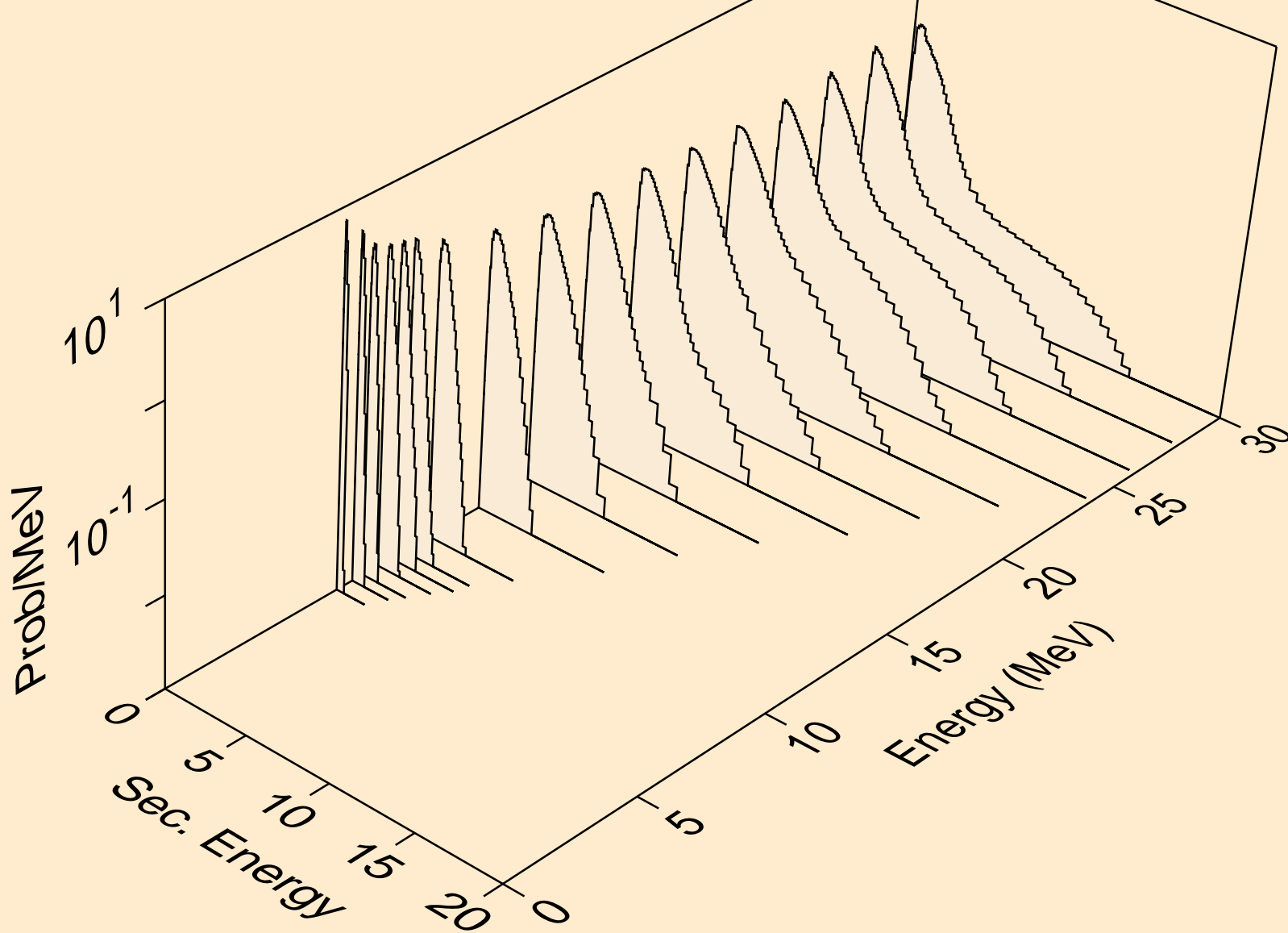

RA208 NEUTRON ACER TENDL-2023 LIBRARY; T=0.K
Neutron emission for (n,n*c)

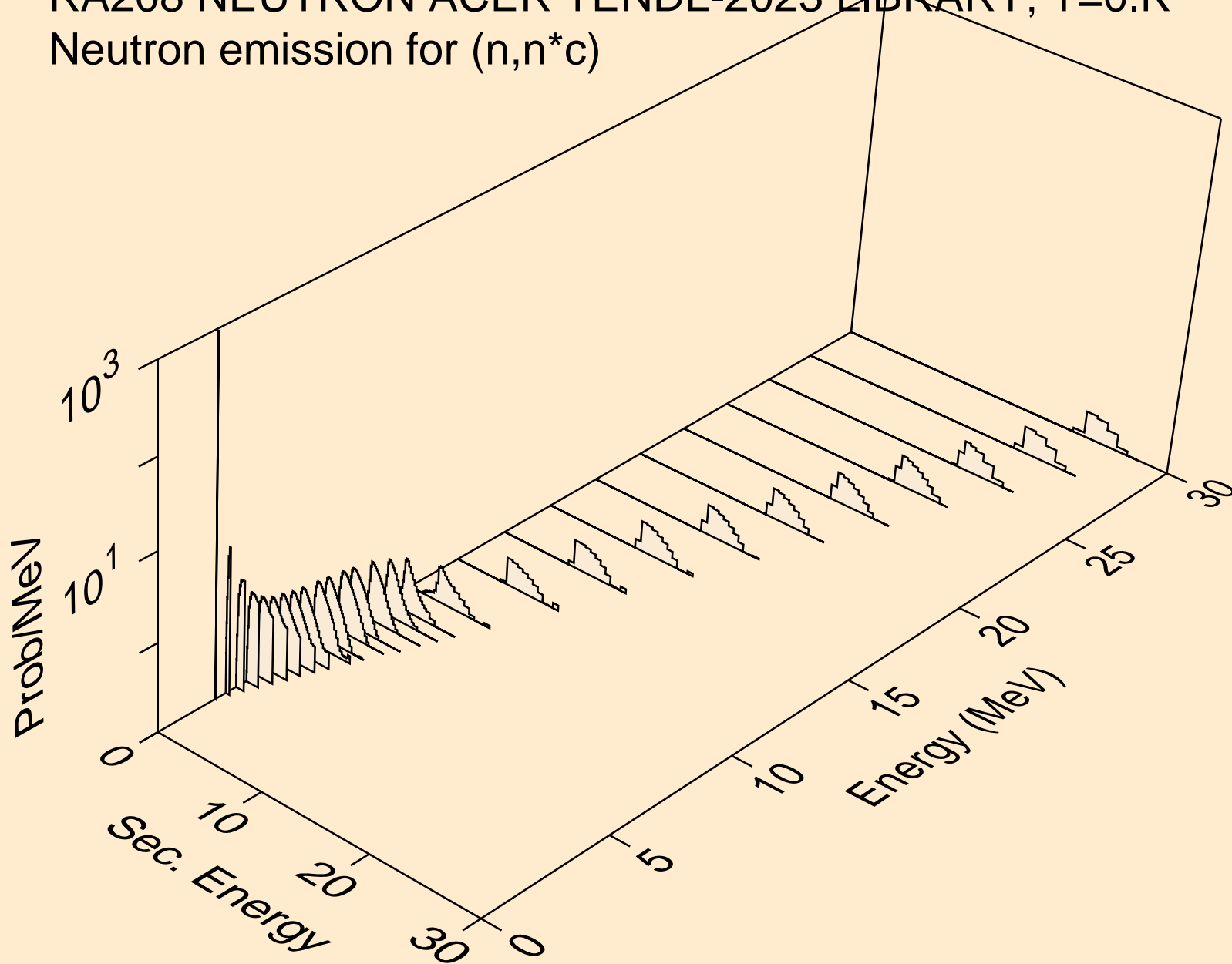

RA208 NEUTRON ACER TENDL-2023 LIBRARY; T=0.K
Photon emission for (n,x)

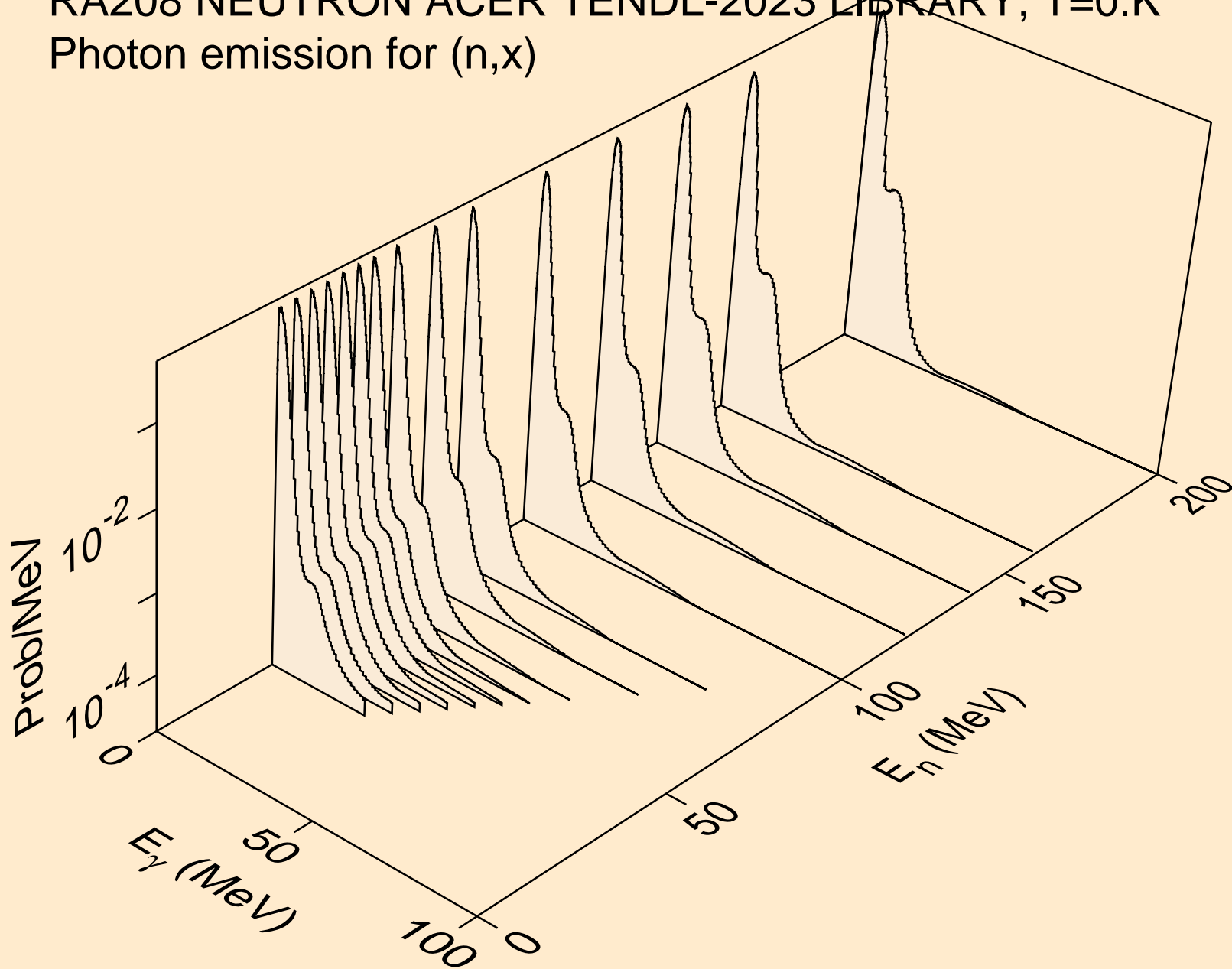

RA208 NEUTRON ACER TENDL-2023 LIBRARY; T=0.K
Photon emission for (n,2nd)

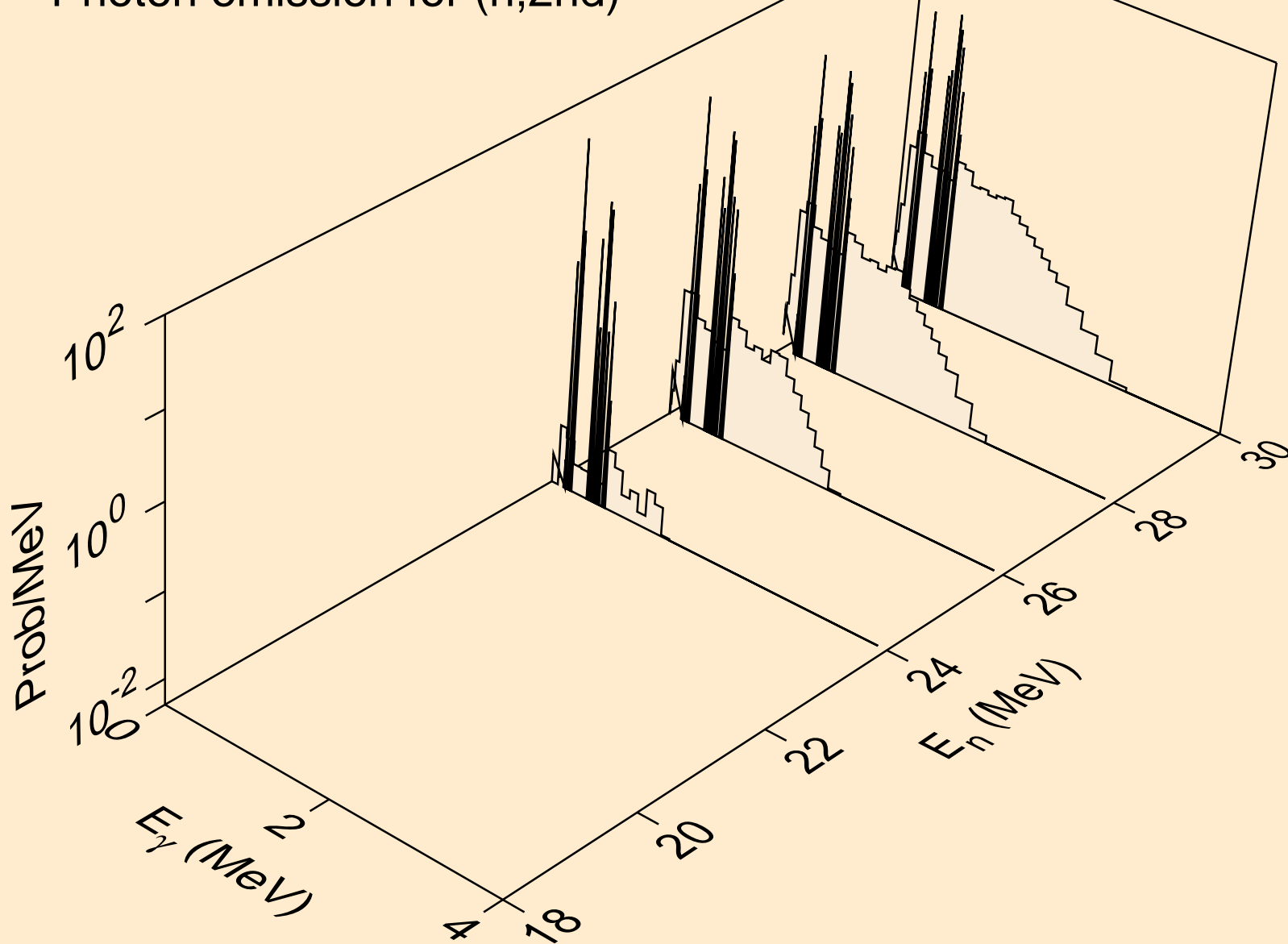

RA208 NEUTRON ACER TENDL-2023 LIBRARY; T=0.K
Photon emission for (n,2n)

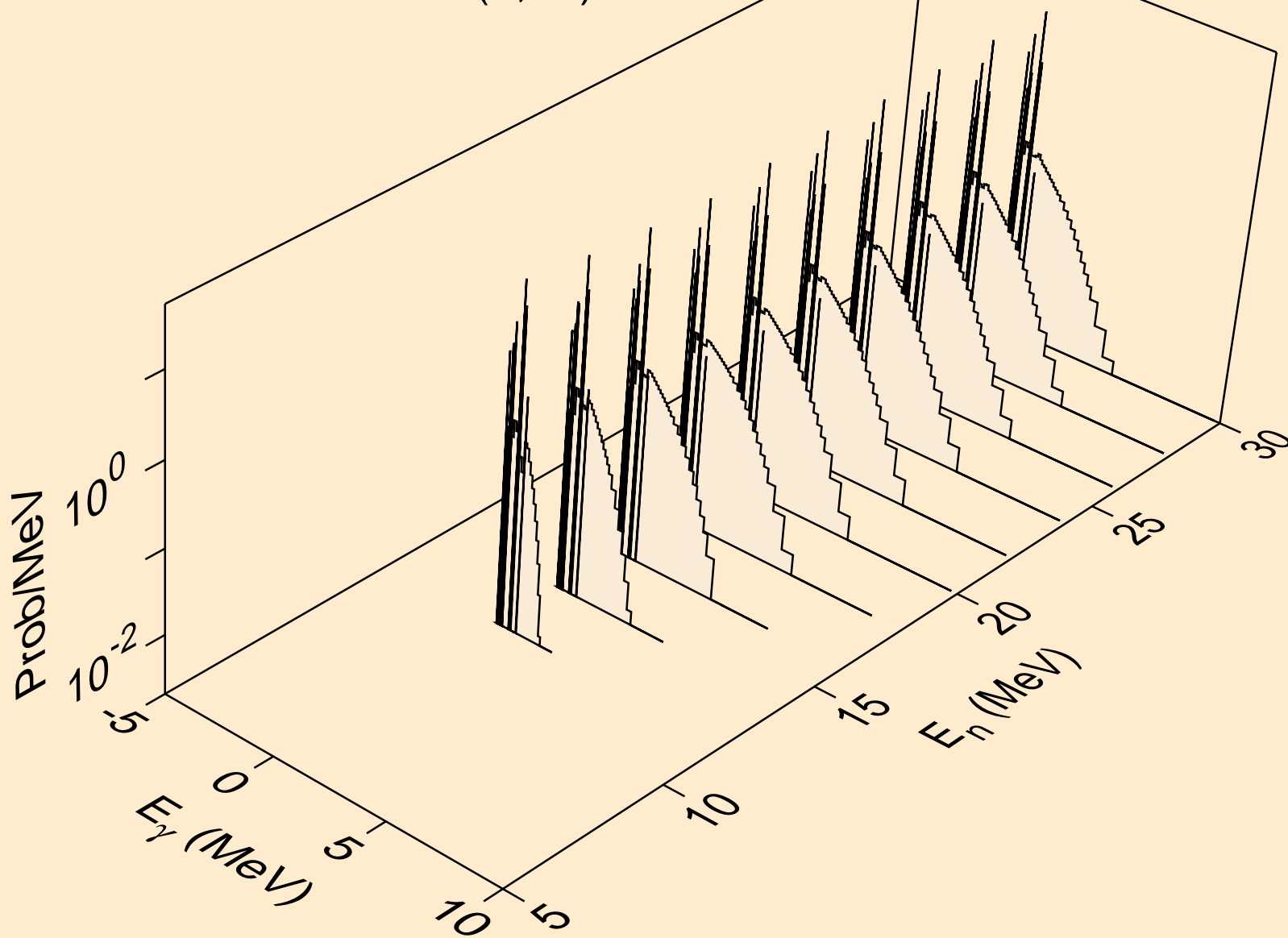

RA208 NEUTRON ACER TENDL-2023 LIBRARY; T=0.K
Photon emission for (n,3n)

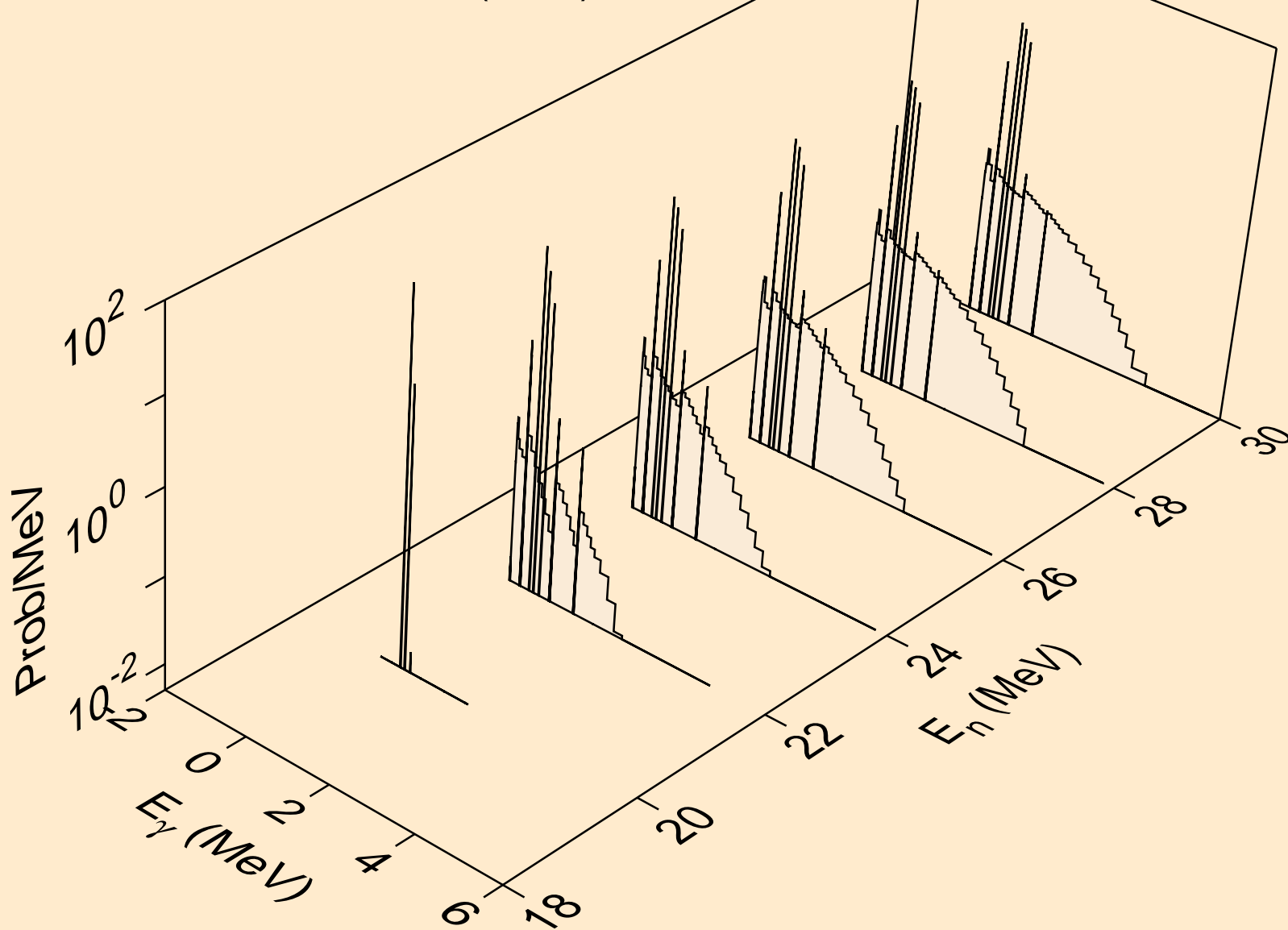

RA208 NEUTRON ACER TENDL-2023 LIBRARY; T=0.K
Photon emission for (n,n*)a

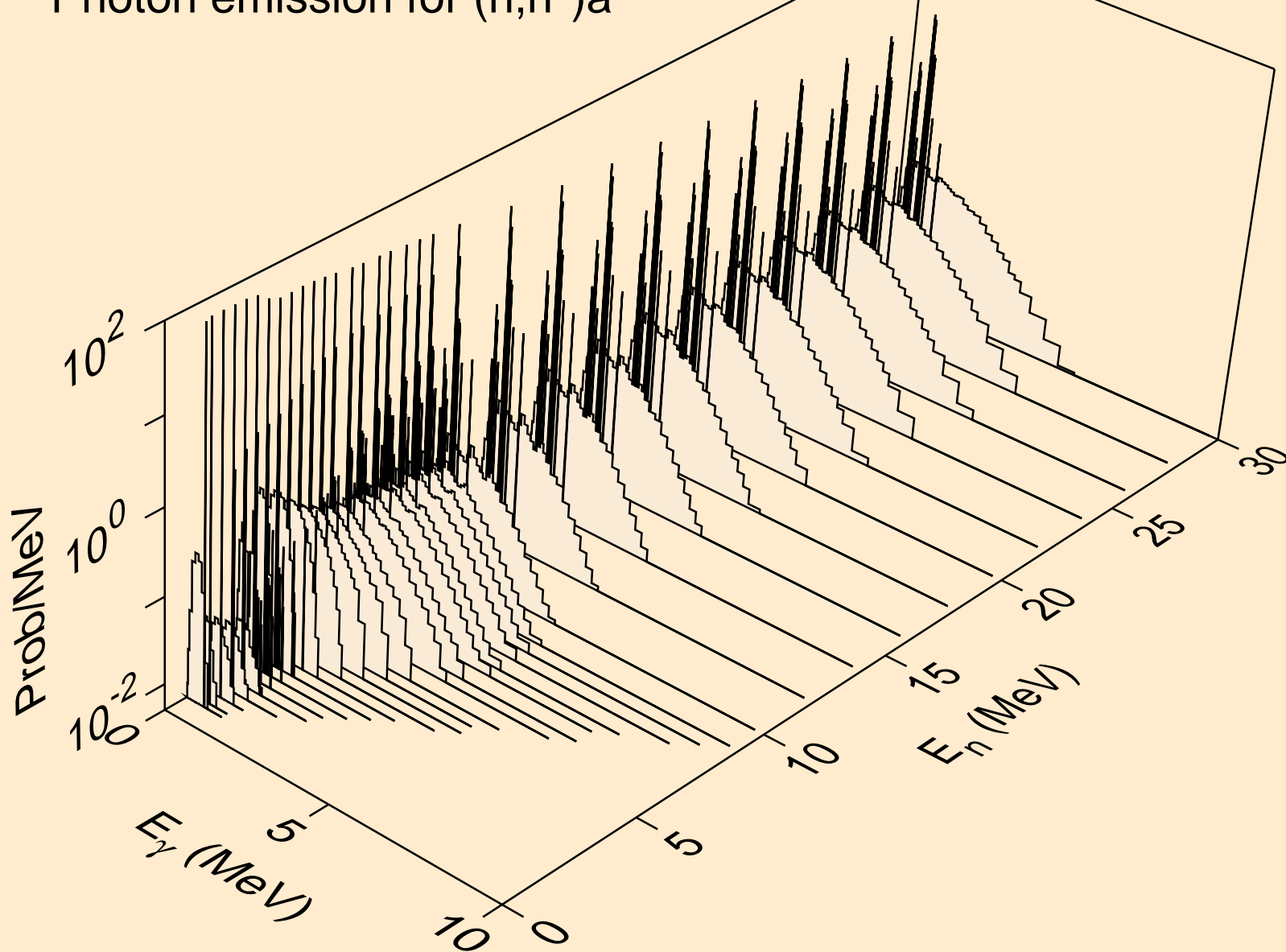

RA208 NEUTRON ACER TENDL-2023 LIBRARY; T=0.K
Photon emission for (n,2n)a

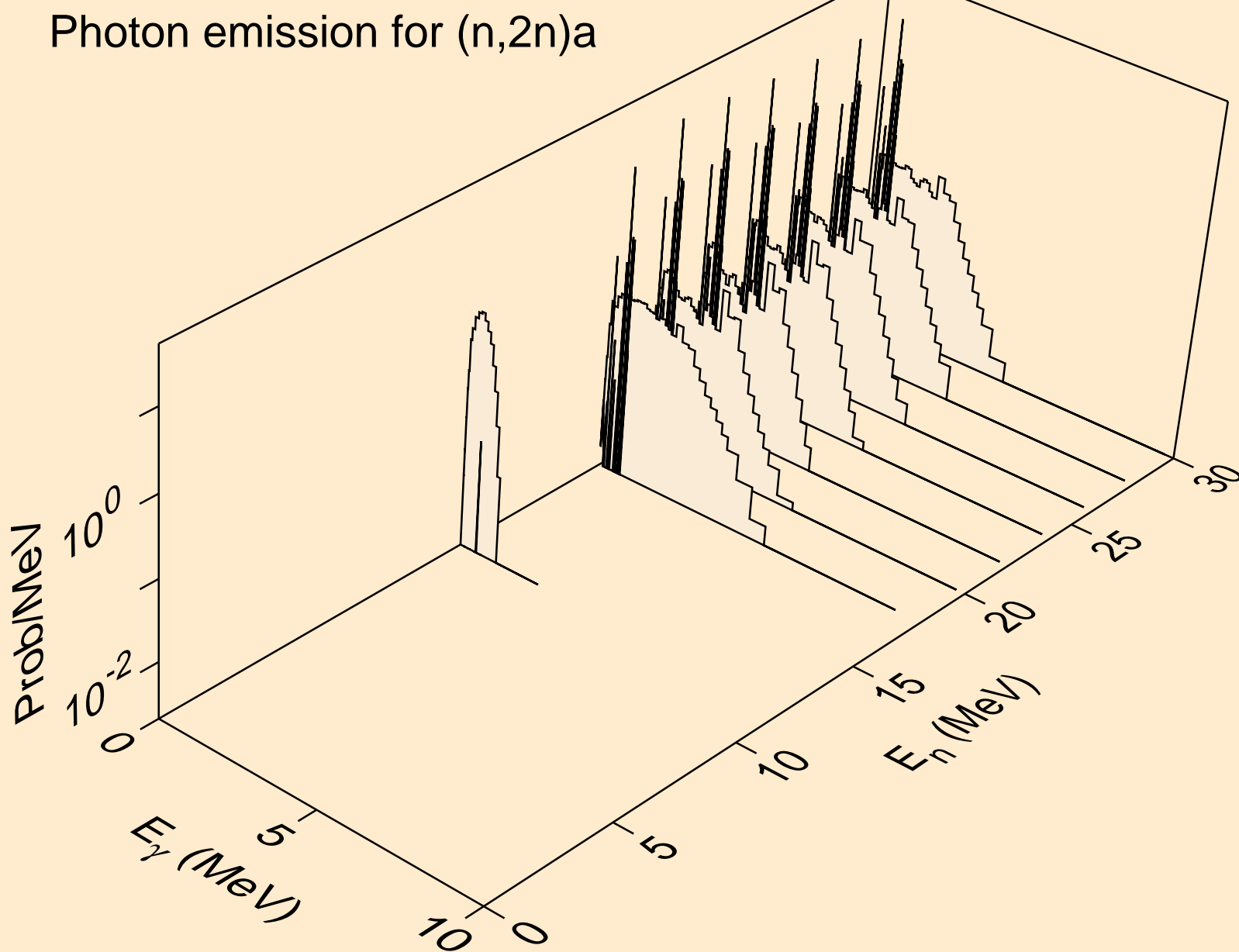

RA208 NEUTRON ACER TENDL-2023 LIBRARY; T=0.K
Photon emission for (n,3n)a

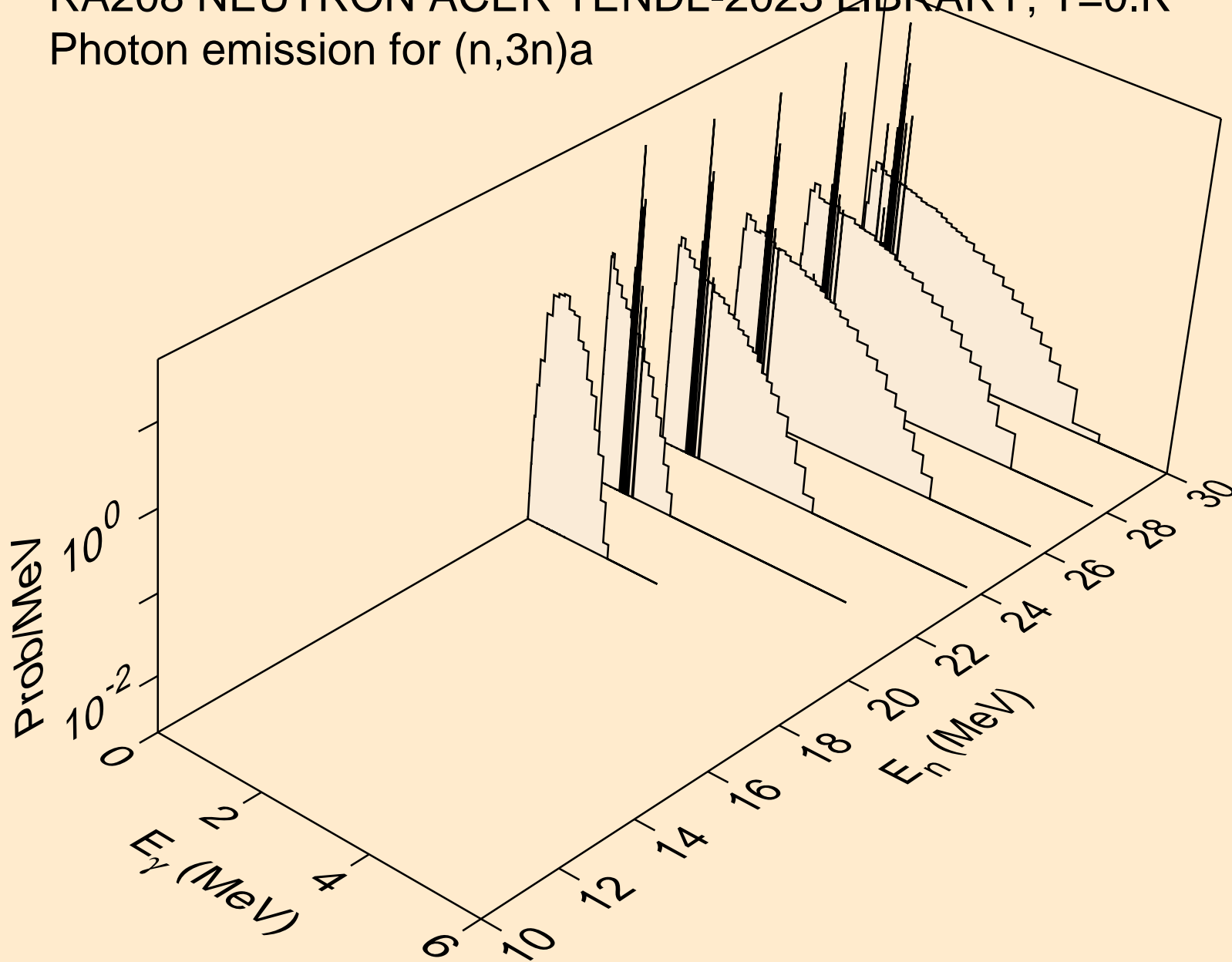

RA208 NEUTRON ACER TENDL-2023 LIBRARY; T=0.K
Photon emission for (n,n*)p

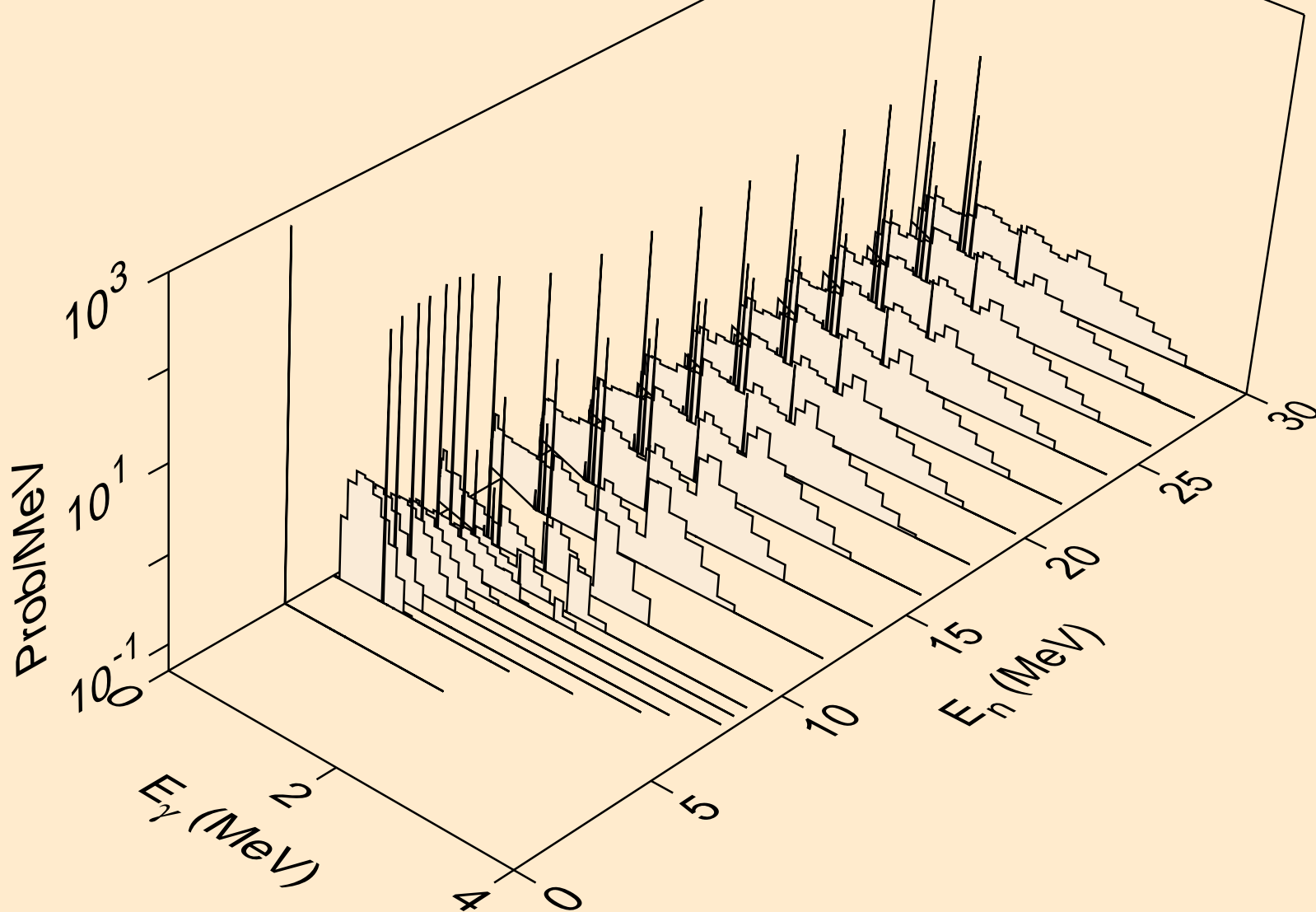

RA208 NEUTRON ACER TENDL-2023 LIBRARY; T=0.K
Photon emission for (n,n*)2a

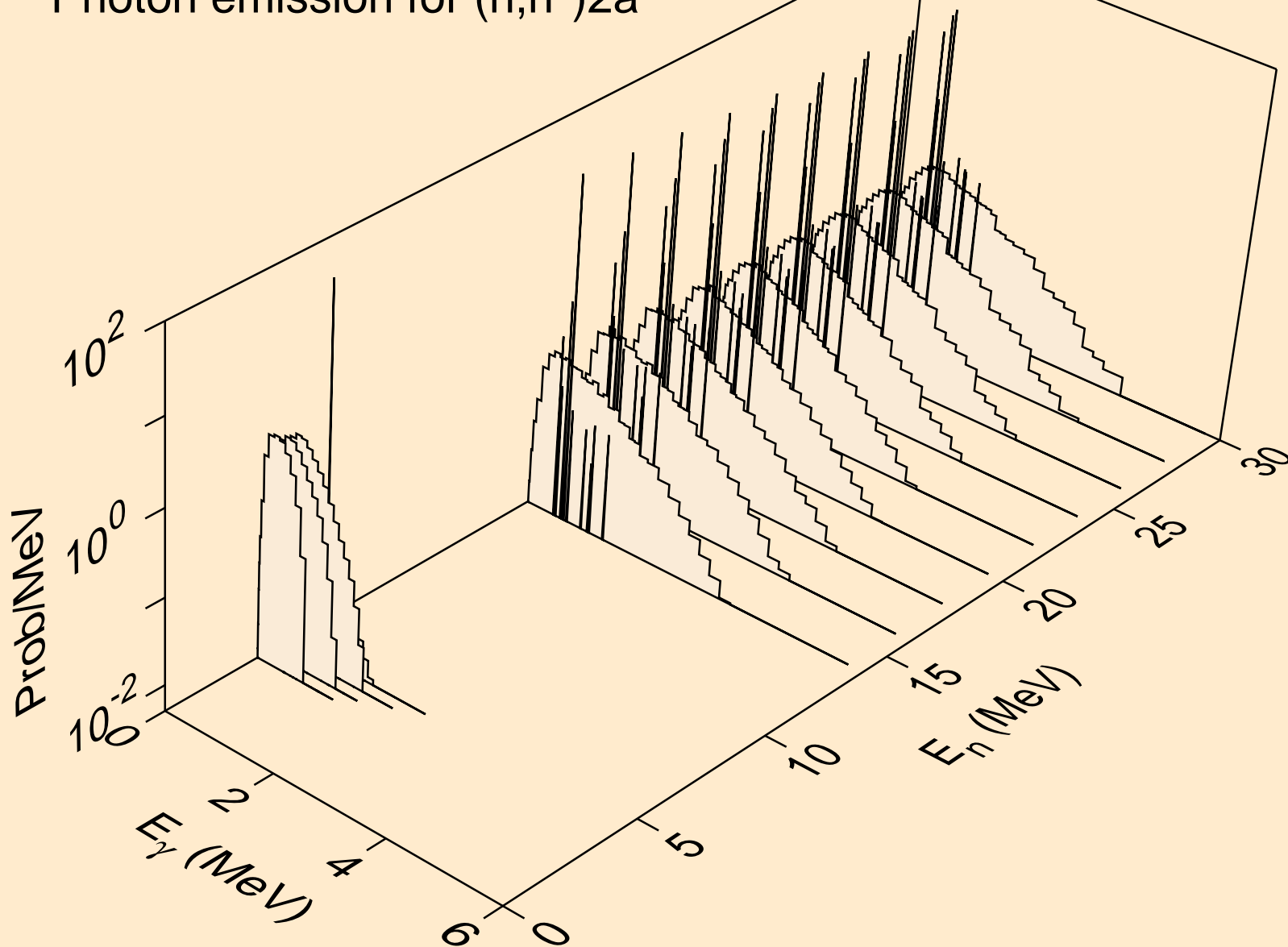

RA208 NEUTRON ACER TENDL-2023 LIBRARY; T=0.K
Photon emission for (n,2n)2a

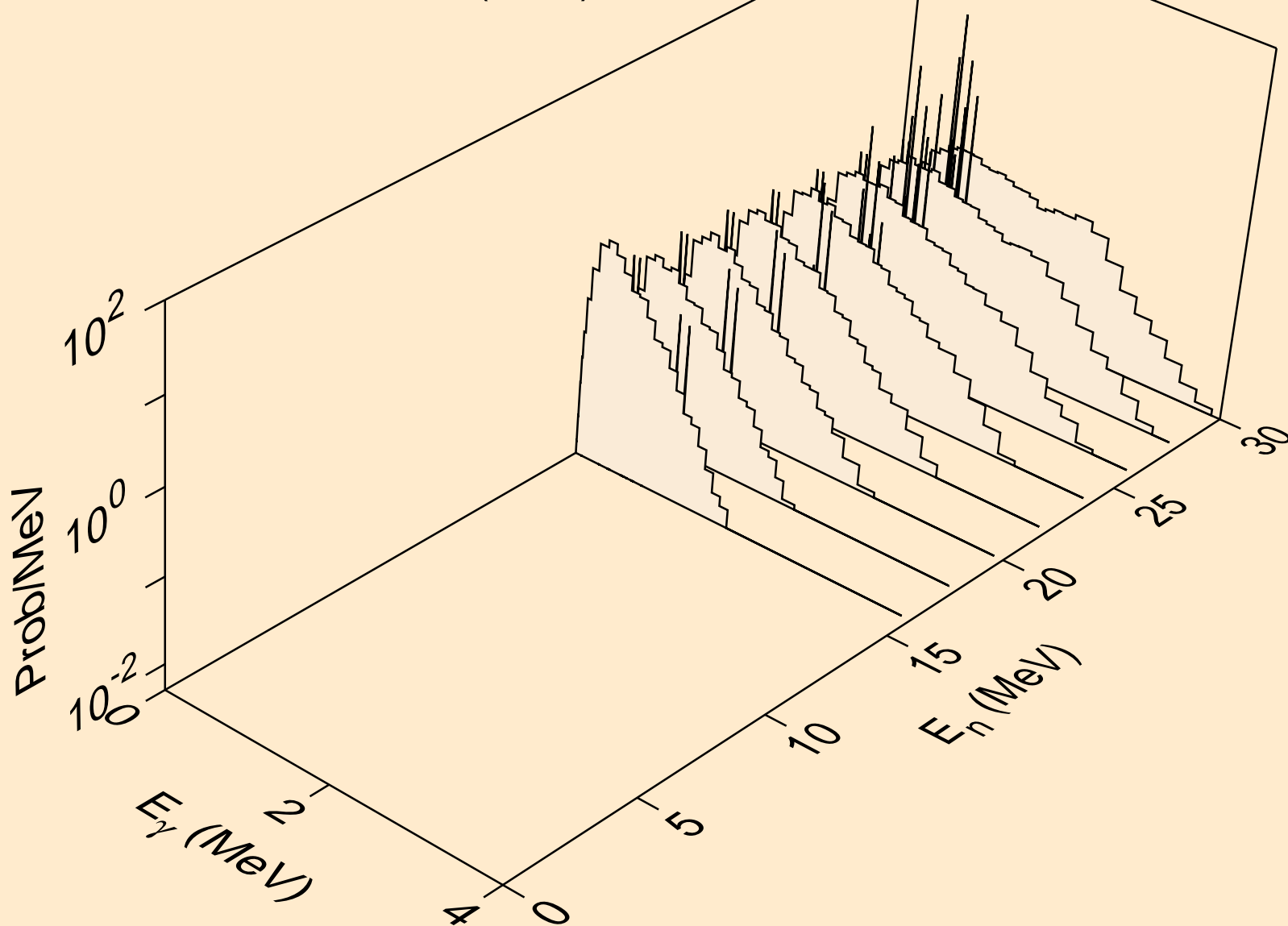

RA208 NEUTRON ACER TENDL-2023 LIBRARY; T=0.K
Photon emission for (n,n*)d

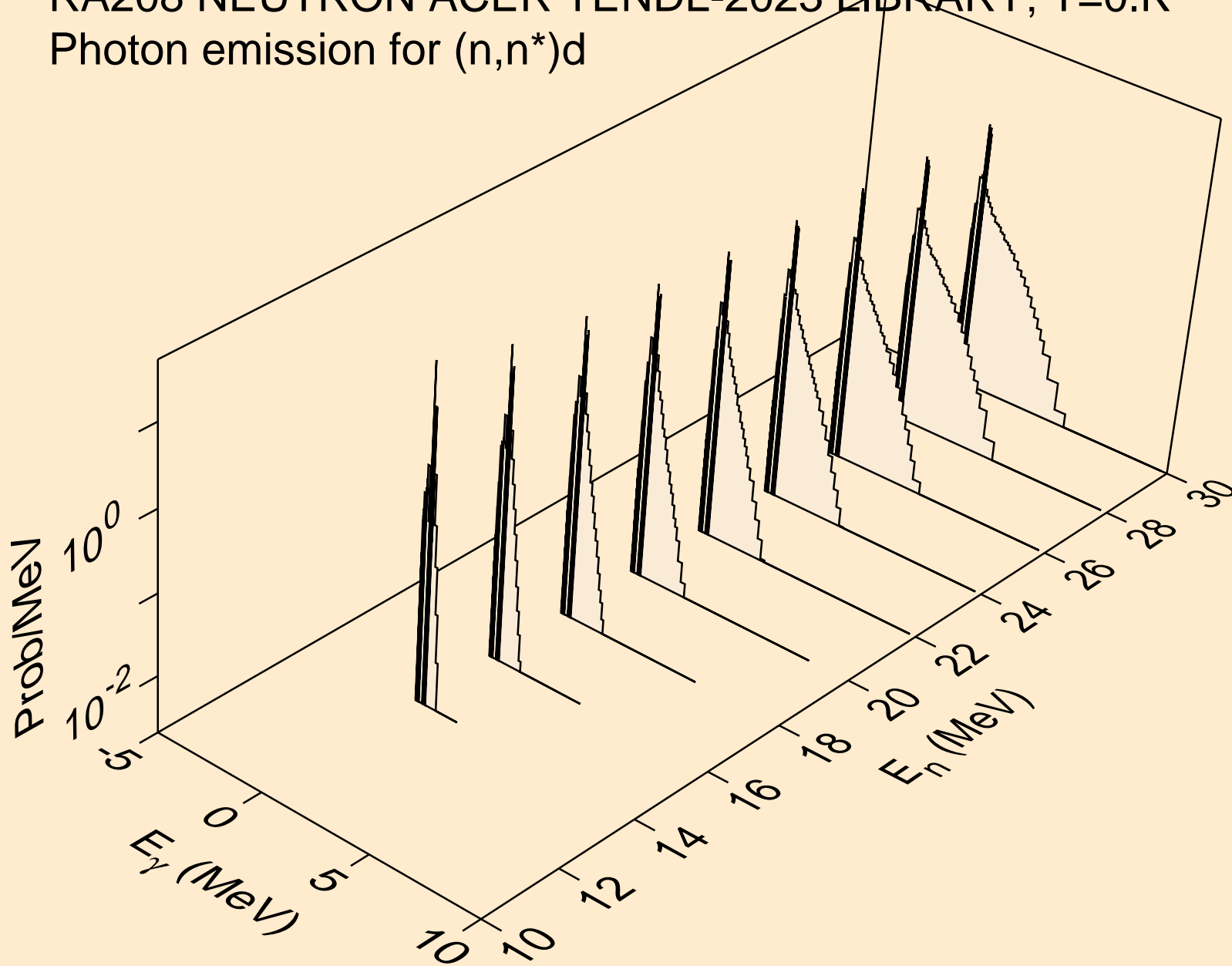

RA208 NEUTRON ACER TENDL-2023 LIBRARY; T=0.K
Photon emission for (n,n*)t

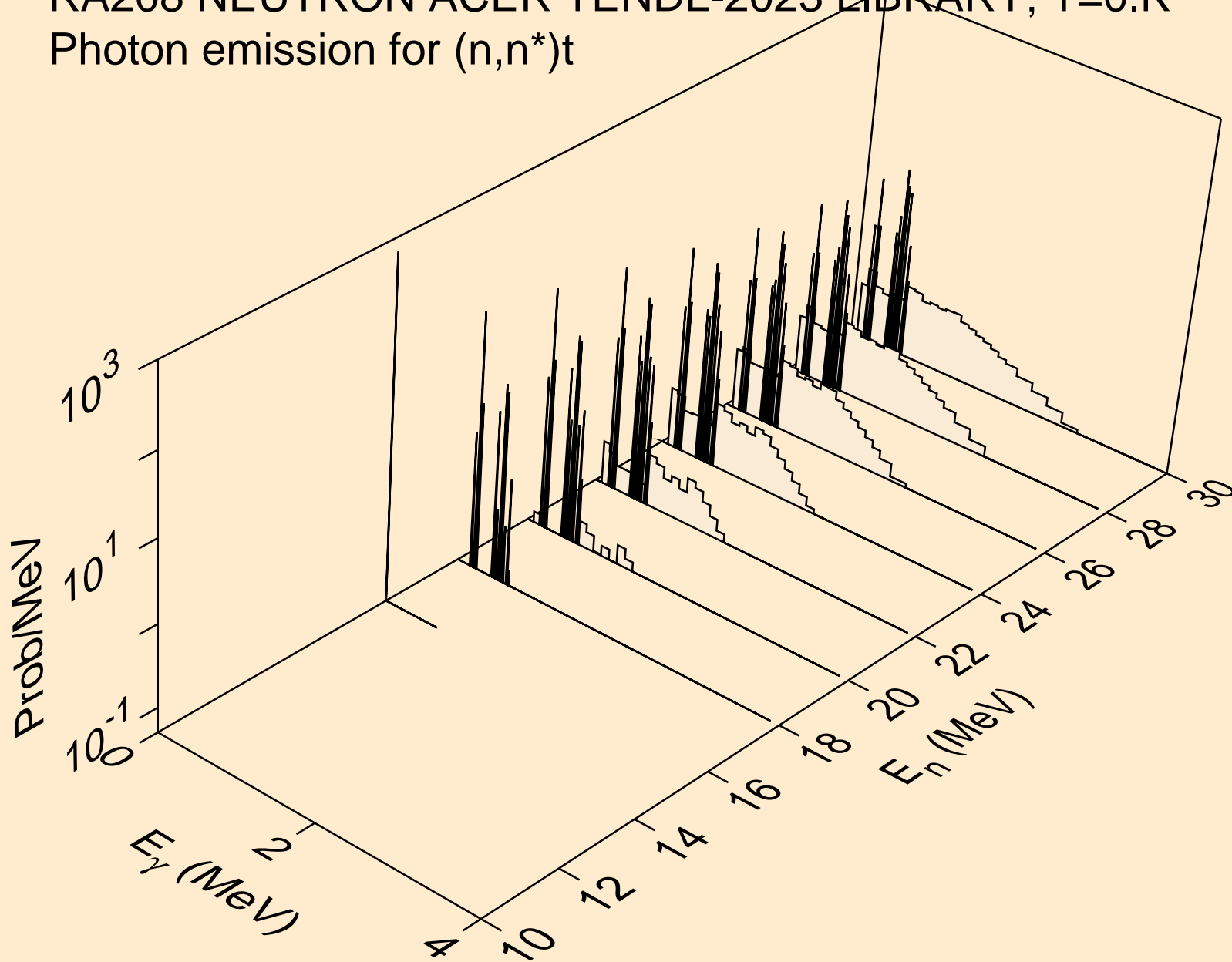

RA208 NEUTRON ACER TENDL-2023 LIBRARY; T=0.K
Photon emission for (n,n*)he3

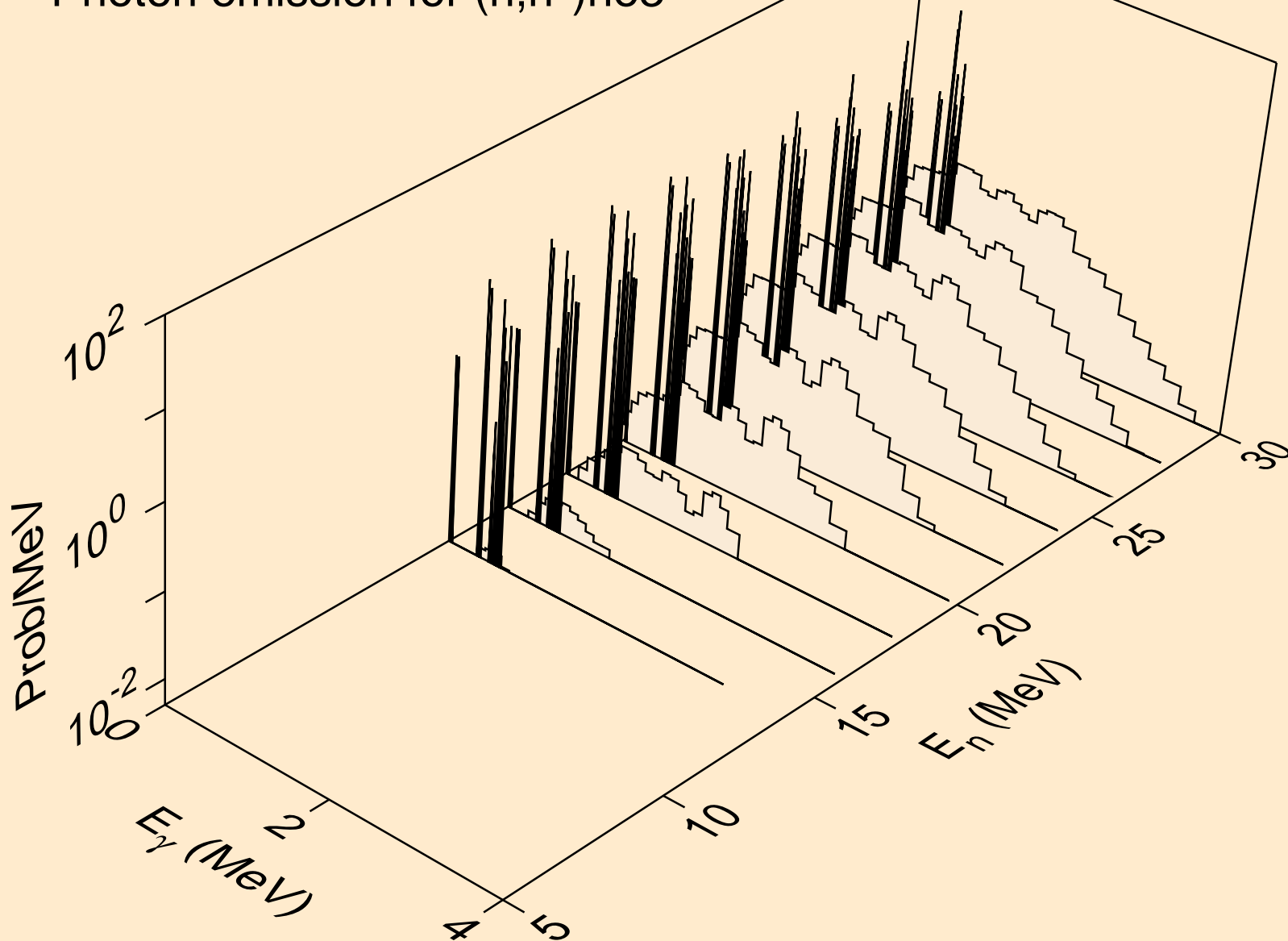

RA208 NEUTRON ACER TENDL-2023 LIBRARY; T=0.K
Photon emission for (n,4n)

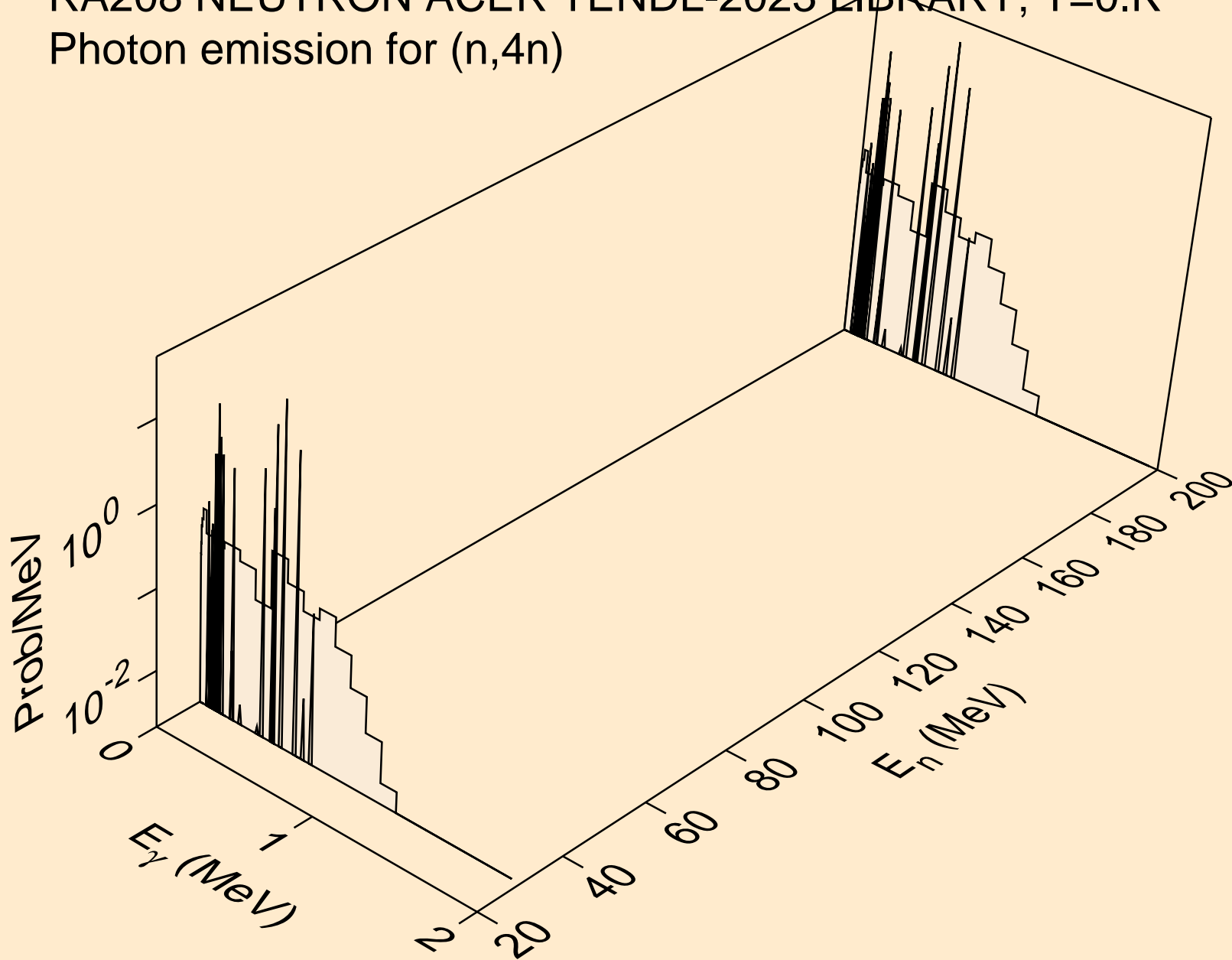

RA208 NEUTRON ACER TENDL-2023 LIBRARY; T=0.K
Photon emission for (n,2np)

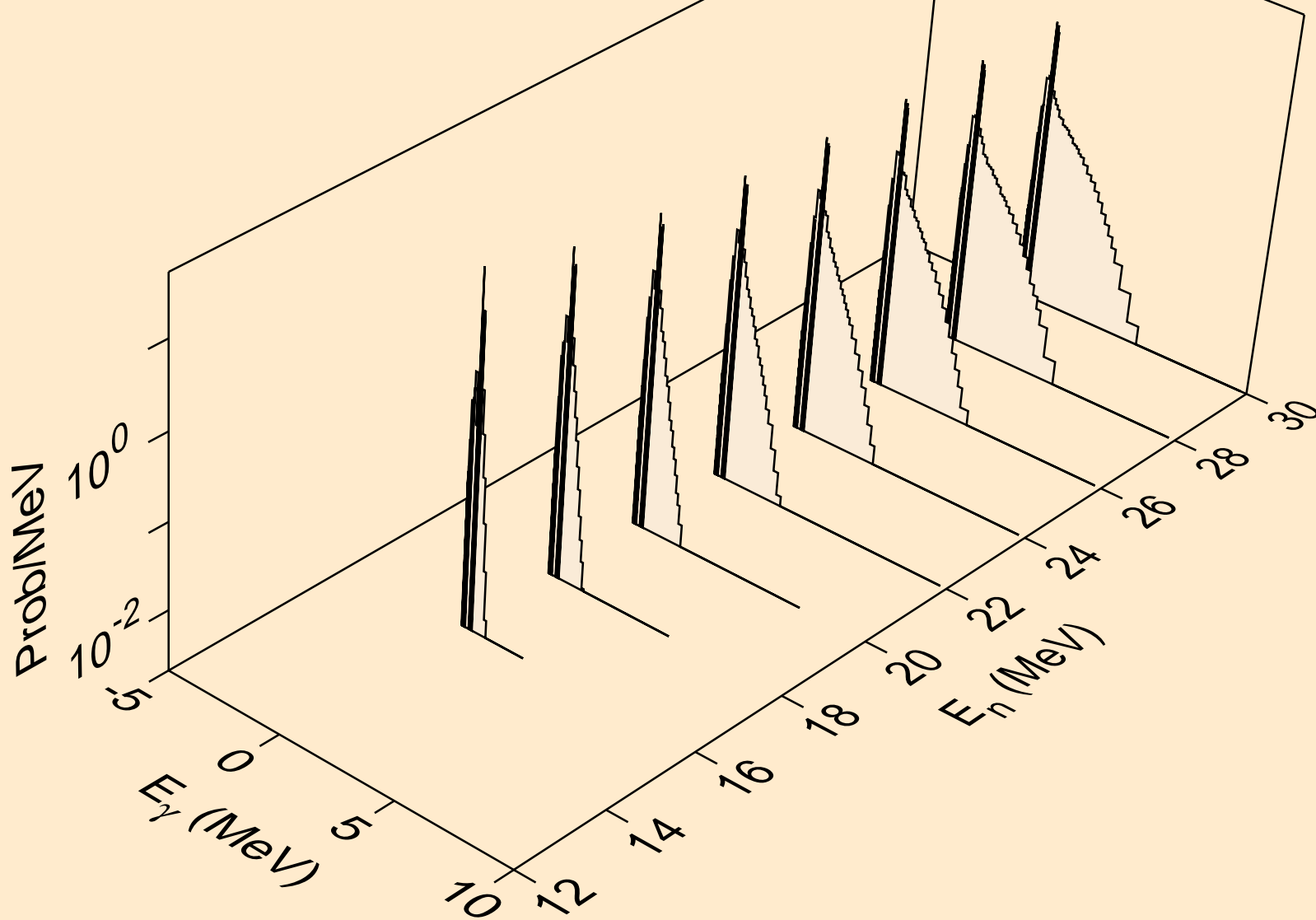

RA208 NEUTRON ACER TENDL-2023 LIBRARY; T=0.K
Photon emission for (n,3np)

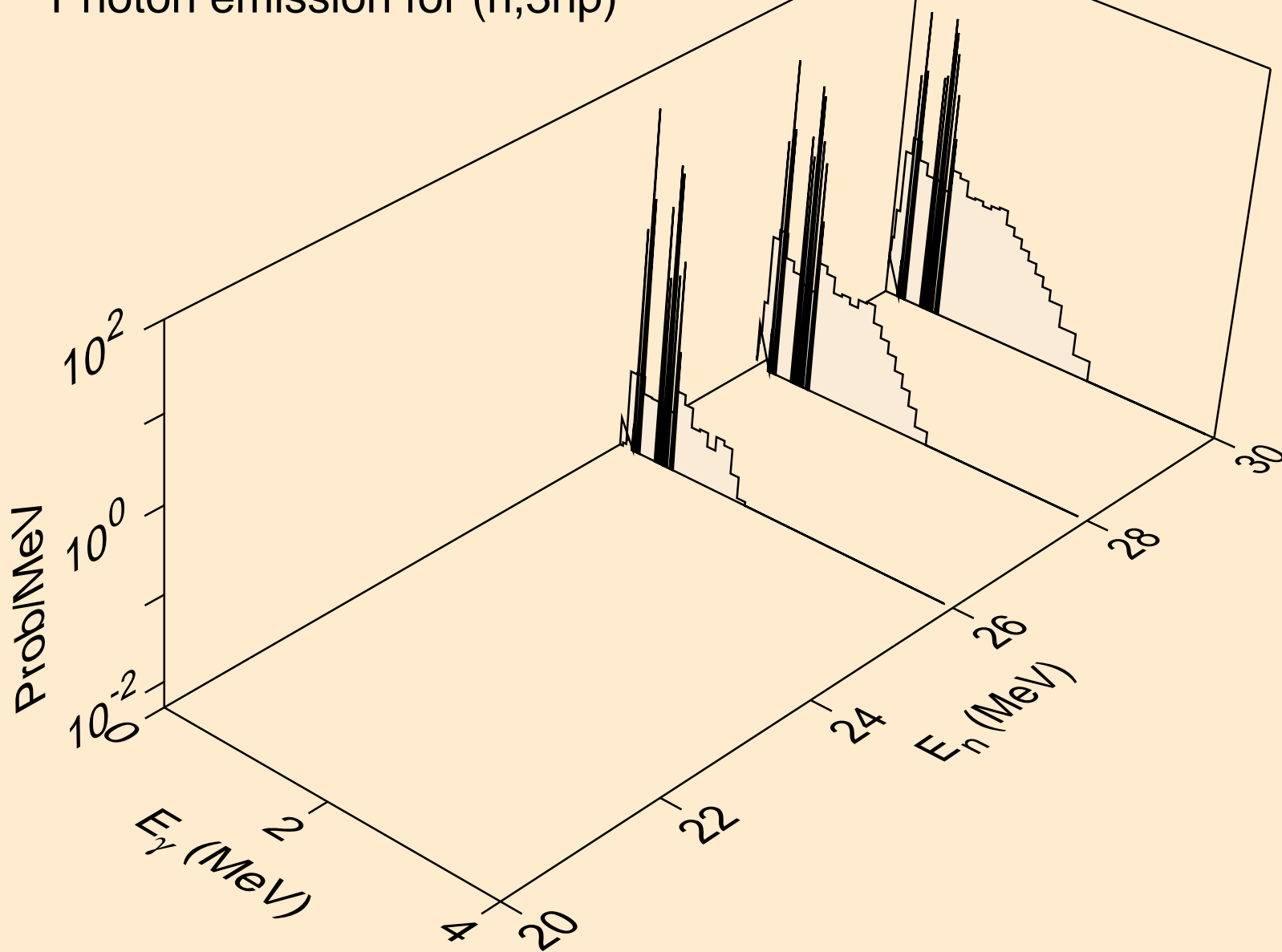

RA208 NEUTRON ACER TENDL-2023 LIBRARY; T=0.K
Photon emission for (n,n2p)

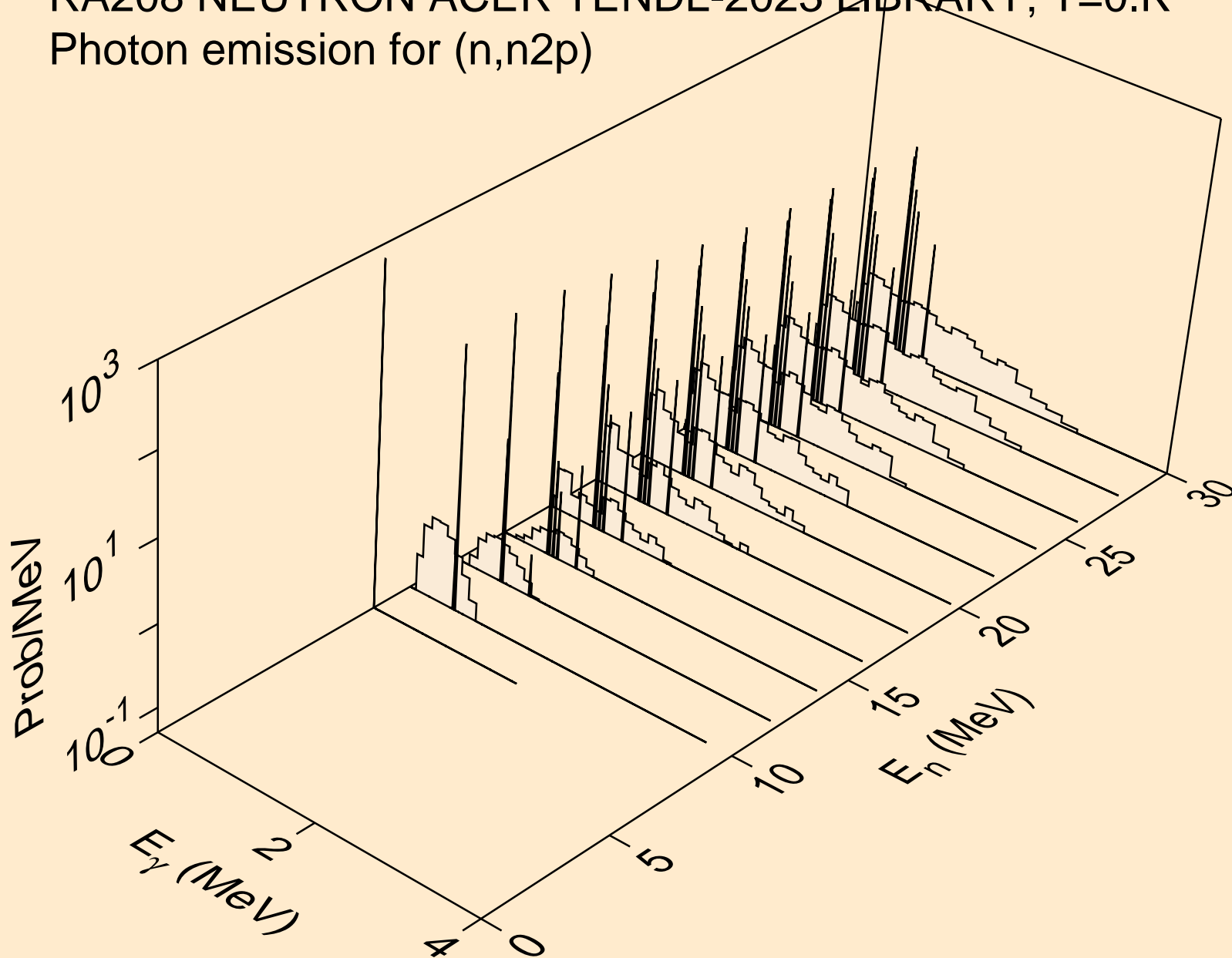

RA208 NEUTRON ACER TENDL-2023 LIBRARY; T=0.K
Photon emission for (n,npa)

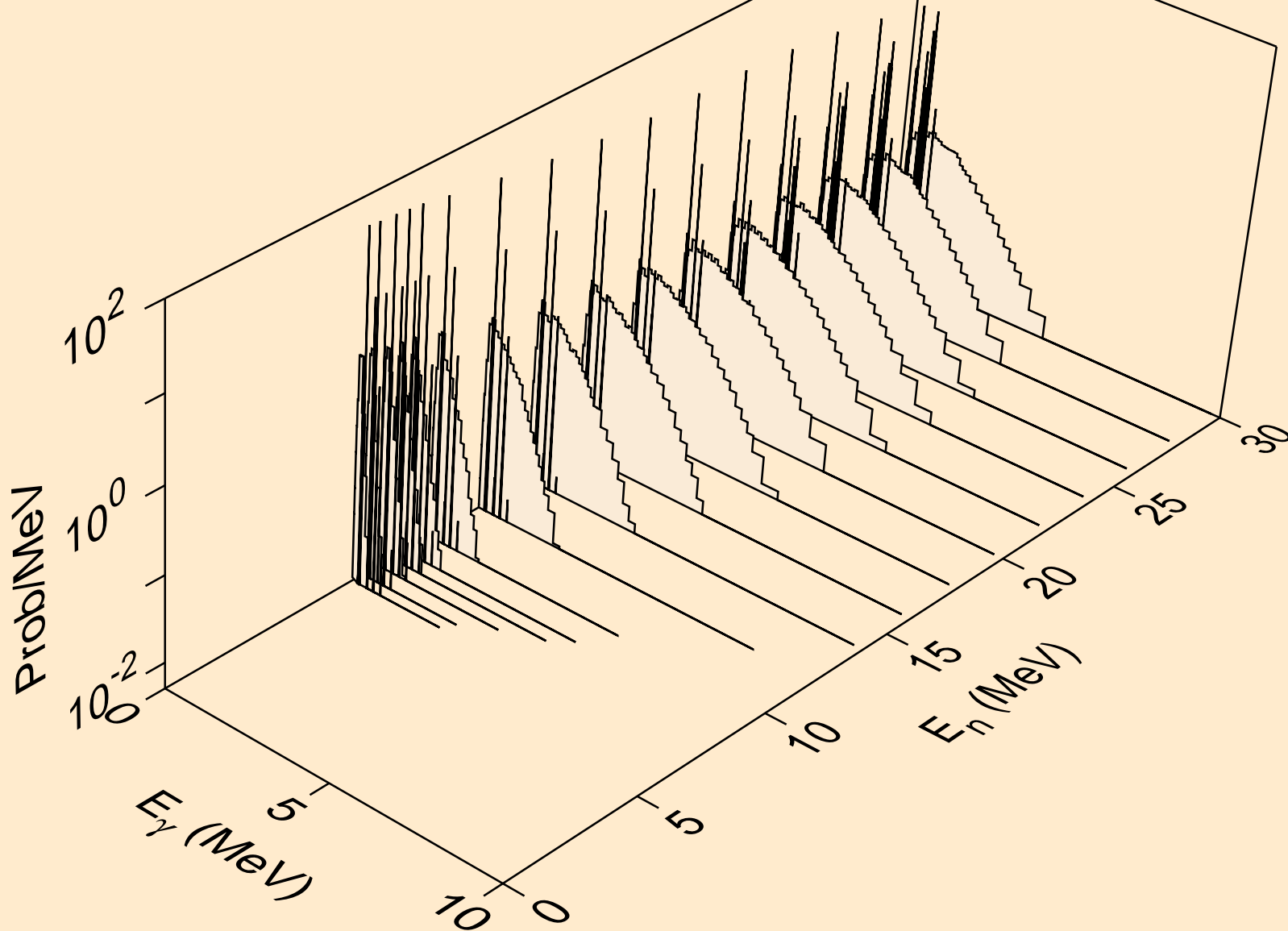

RA208 NEUTRON ACER TENDL-2023 LIBRARY; T=0.K
Photon emission for (n,n*c)

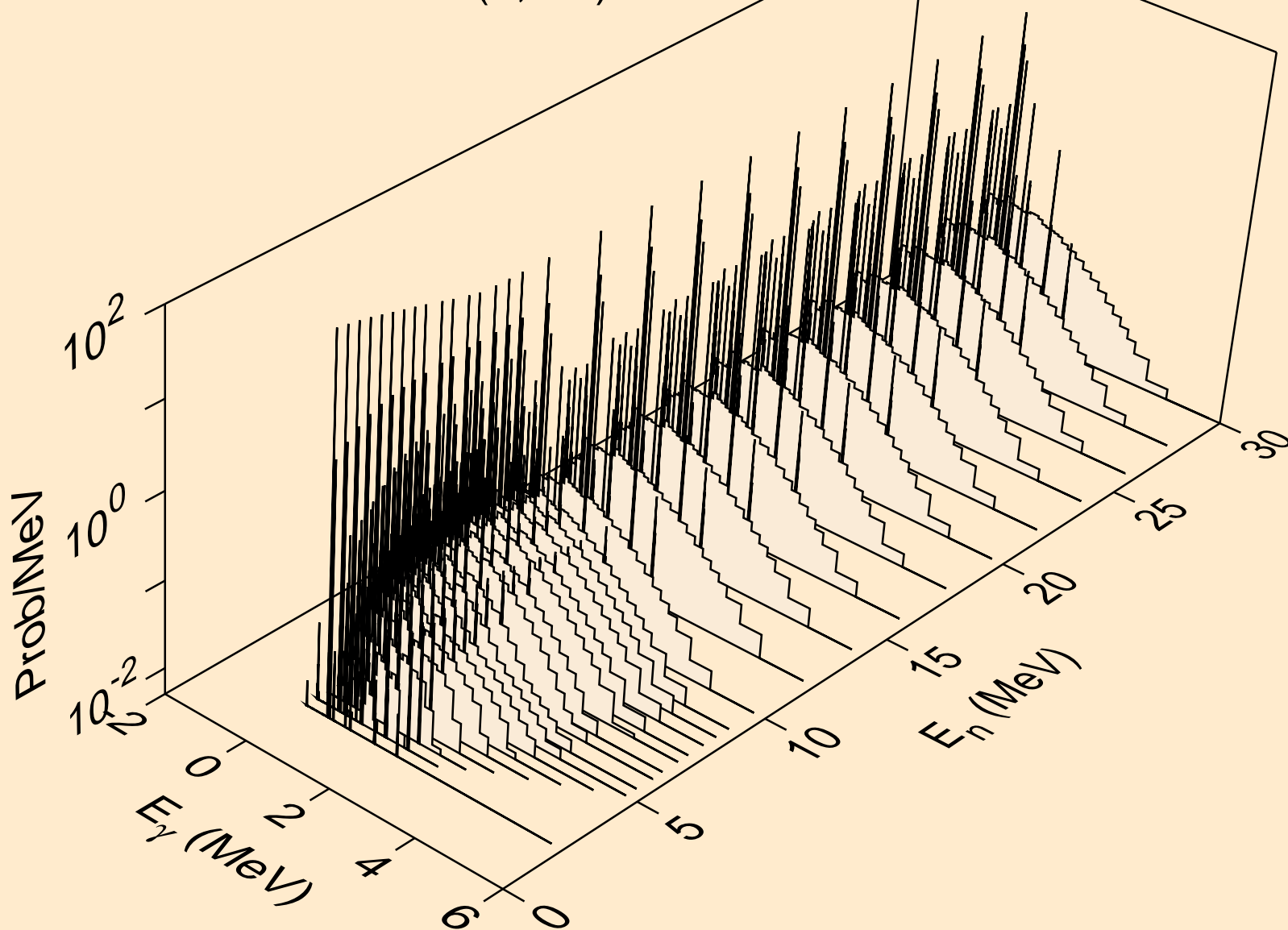

RA208 NEUTRON ACER TENDL-2023 LIBRARY; T=0.K
Photon emission for (n,gma)

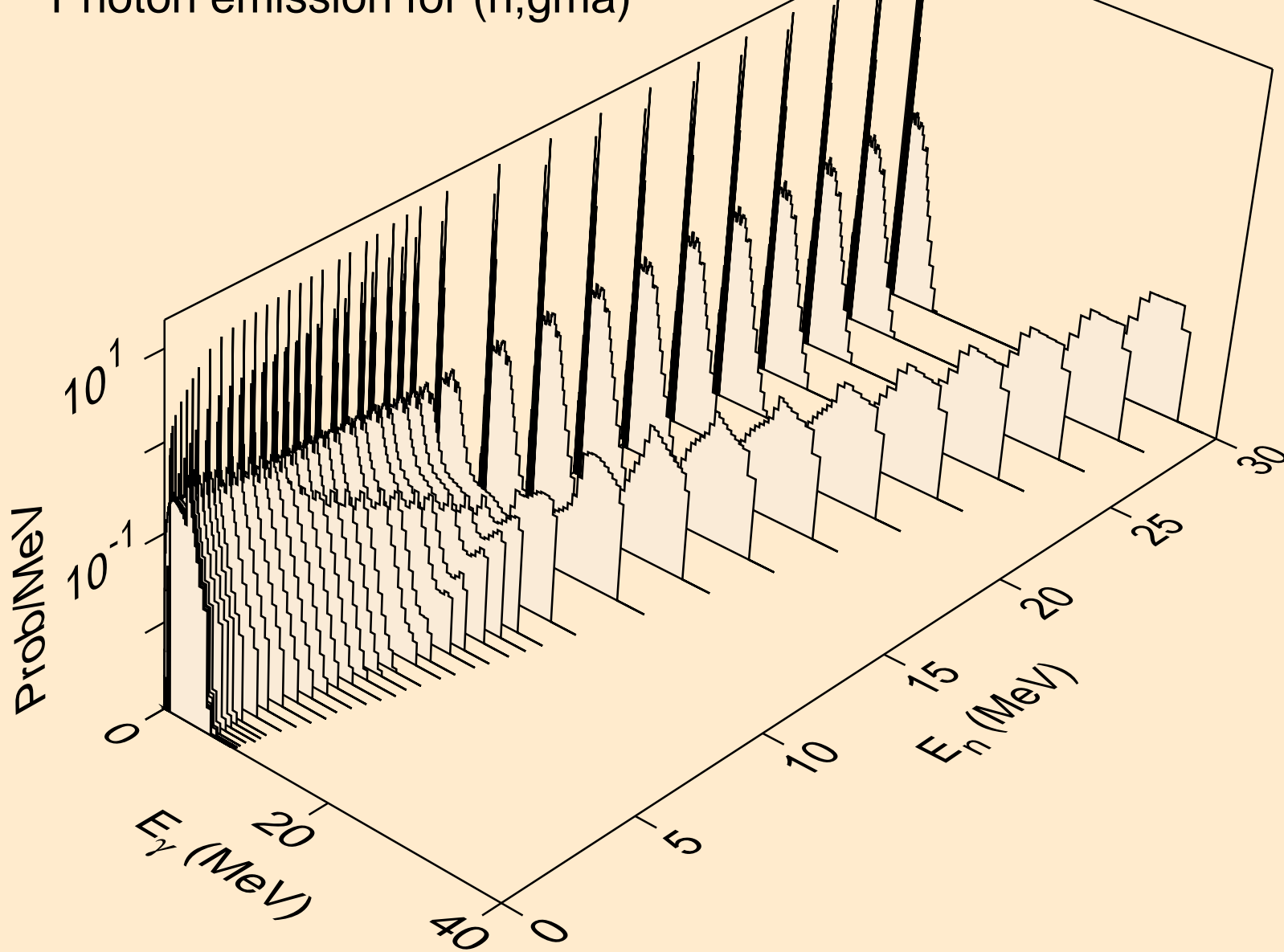

RA208 NEUTRON ACER TENDL-2023 LIBRARY; T=0.K
Photon emission for (n,p)

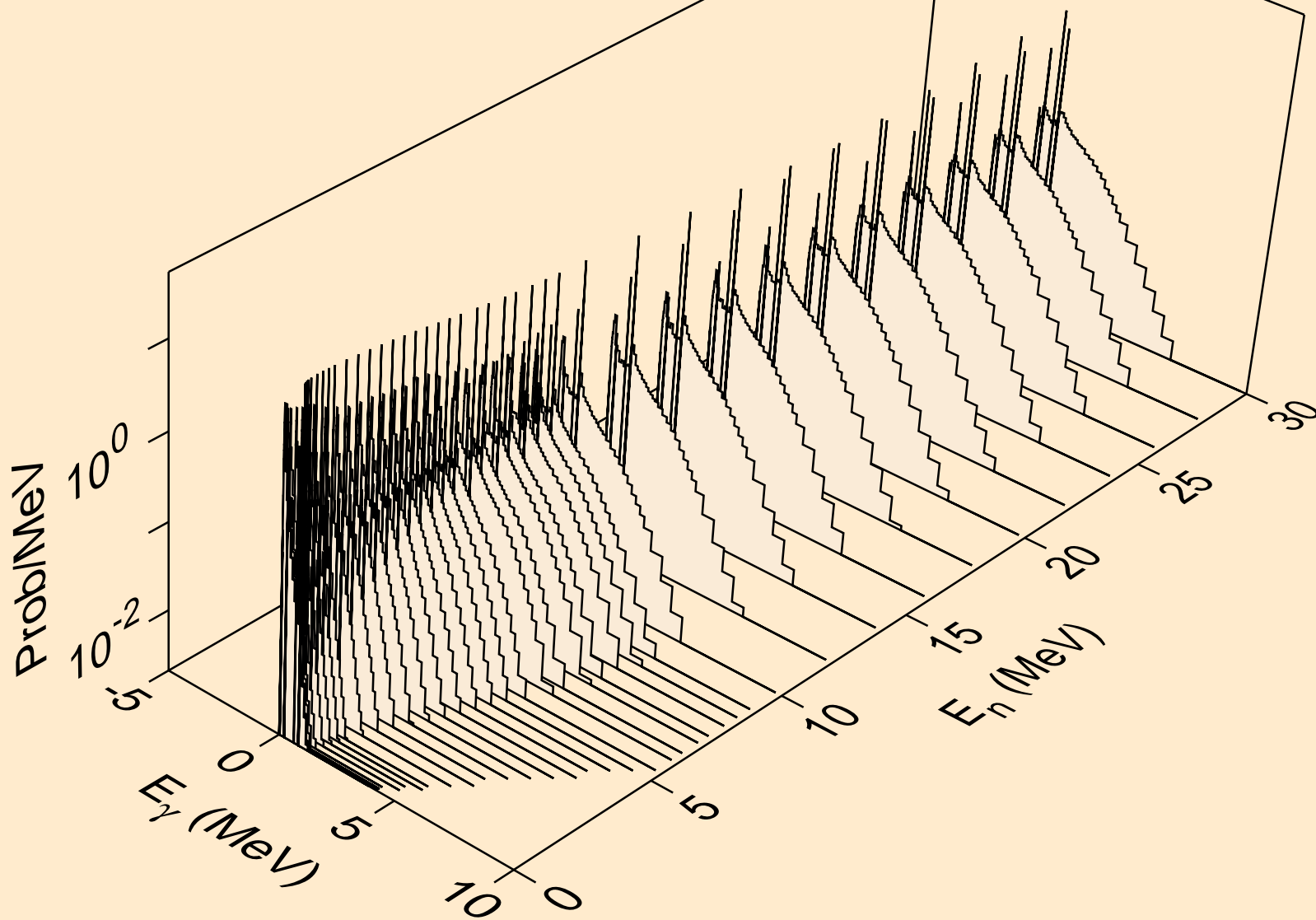

RA208 NEUTRON ACER TENDL-2023 LIBRARY; T=0.K
Photon emission for (n,d)

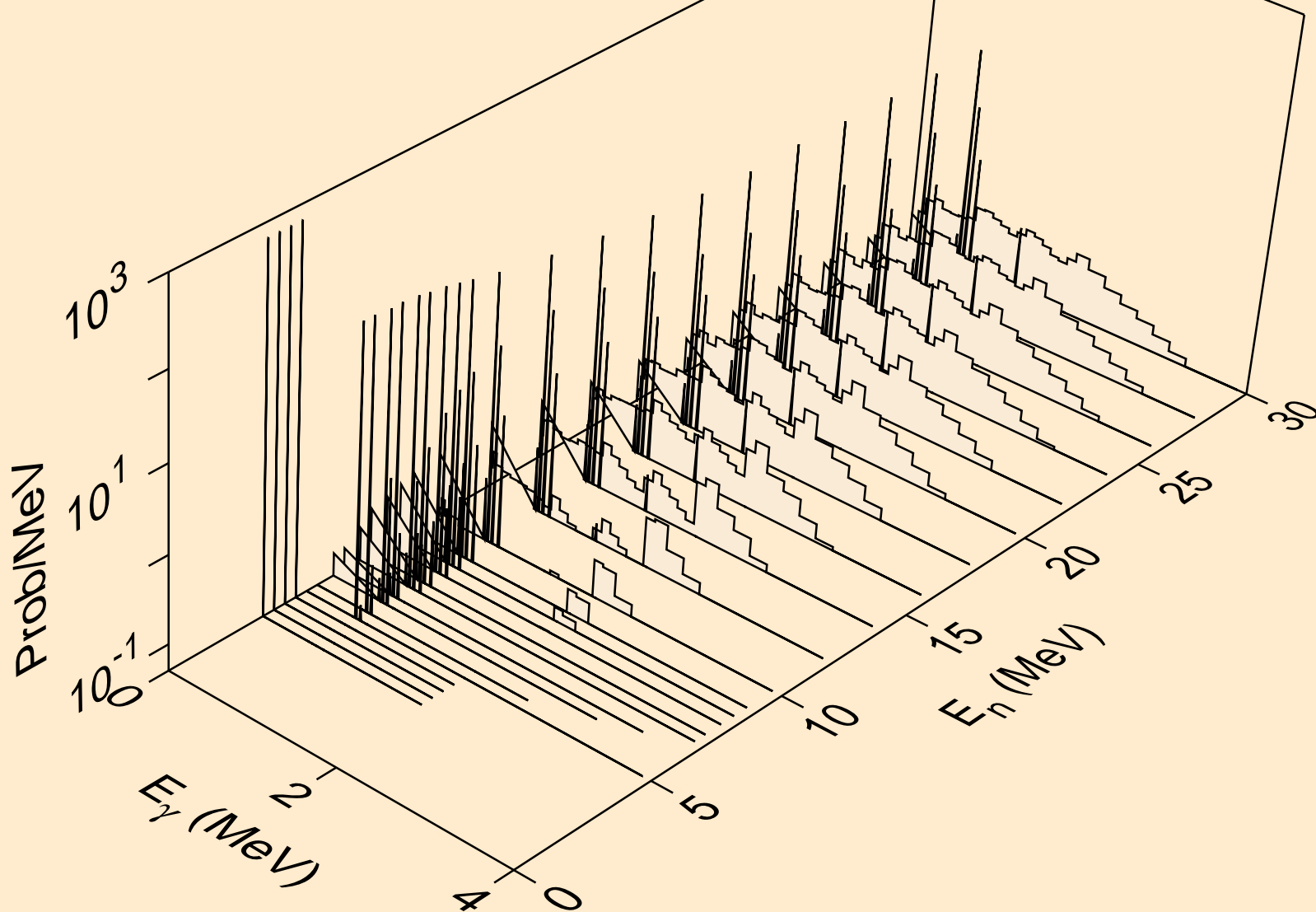

RA208 NEUTRON ACER TENDL-2023 LIBRARY; T=0.K
Photon emission for (n,t)

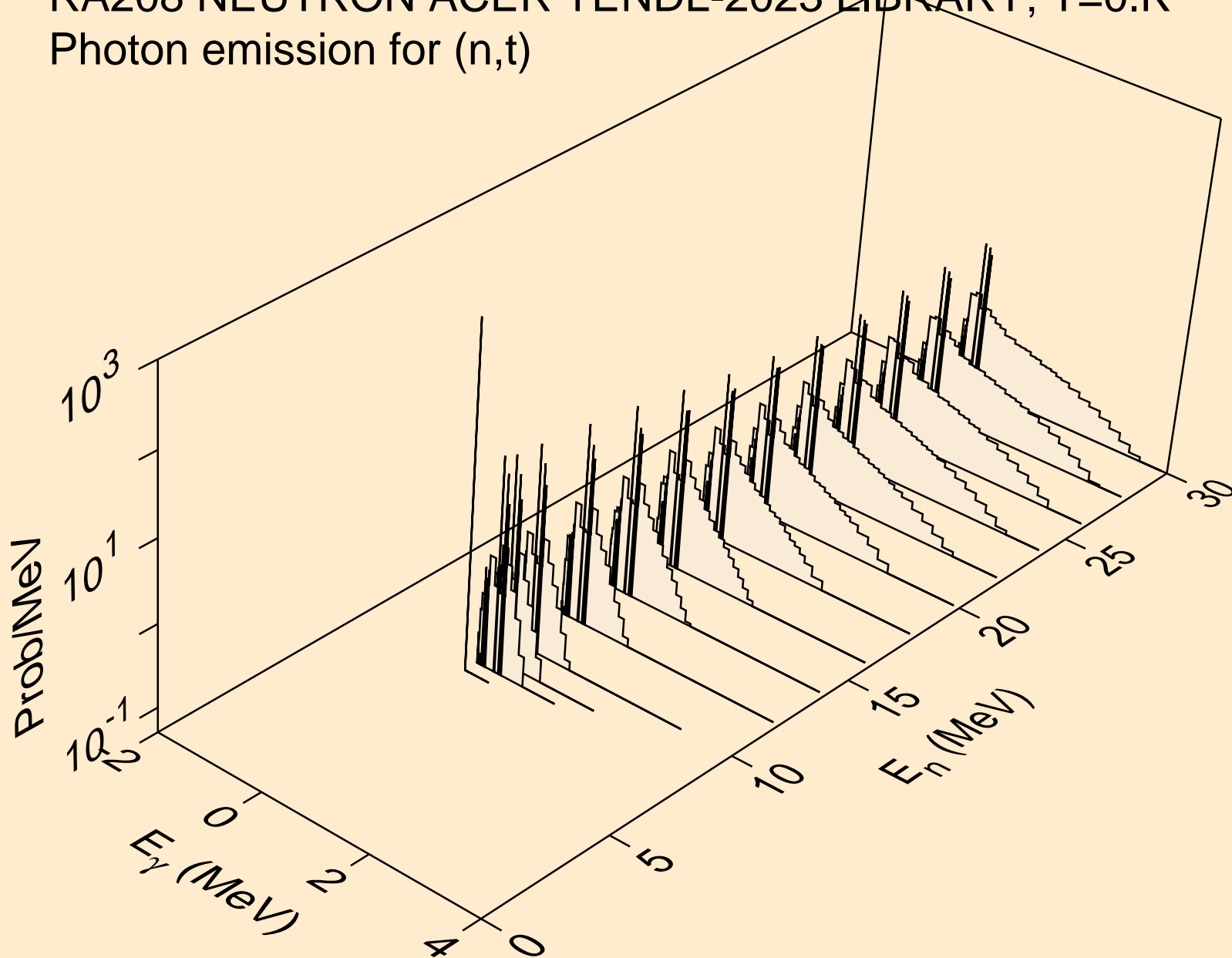

RA208 NEUTRON ACER TENDL-2023 LIBRARY; T=0.K
Photon emission for (n,he3)

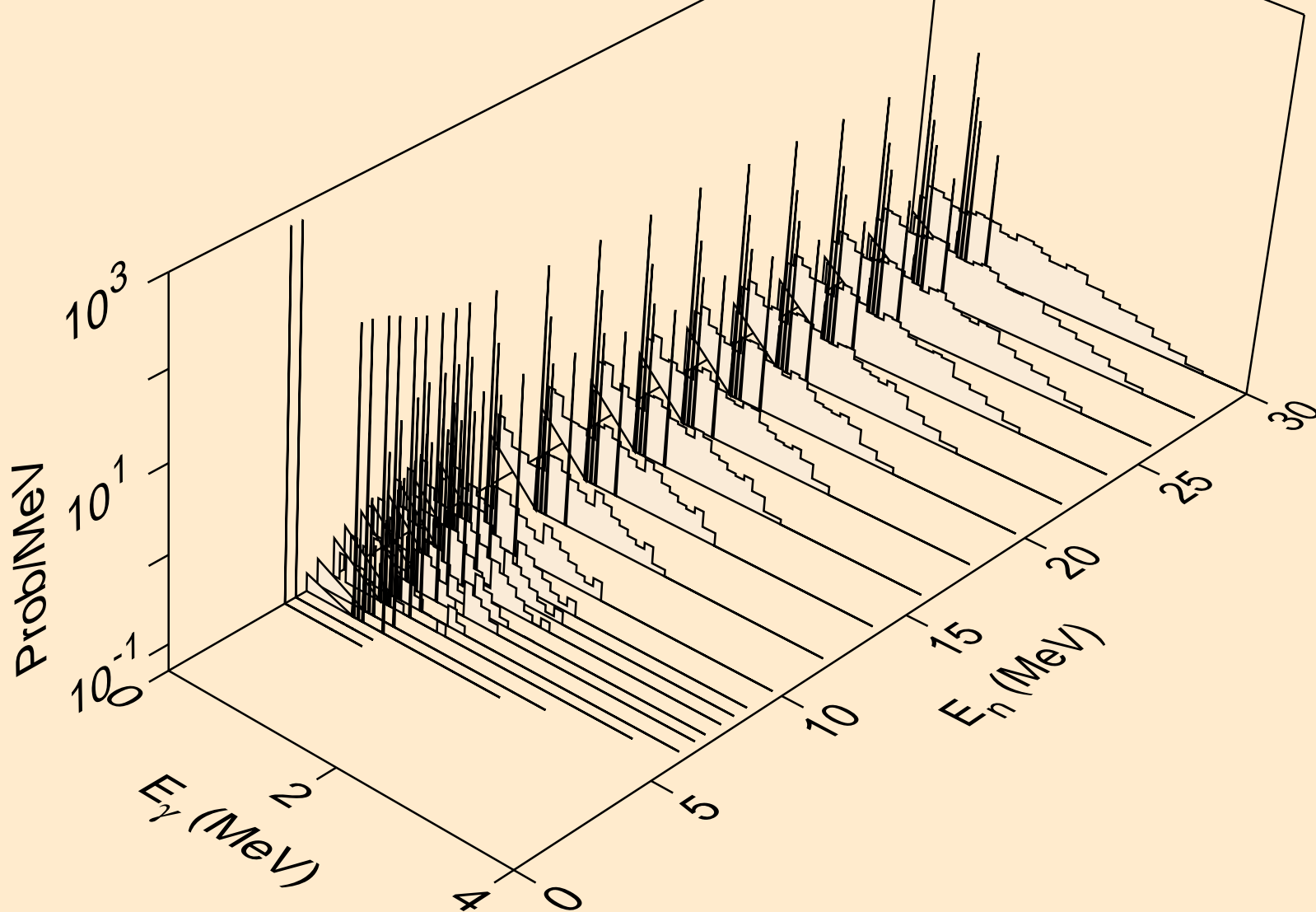

RA208 NEUTRON ACER TENDL-2023 LIBRARY; T=0.K
Photon emission for (n,a)

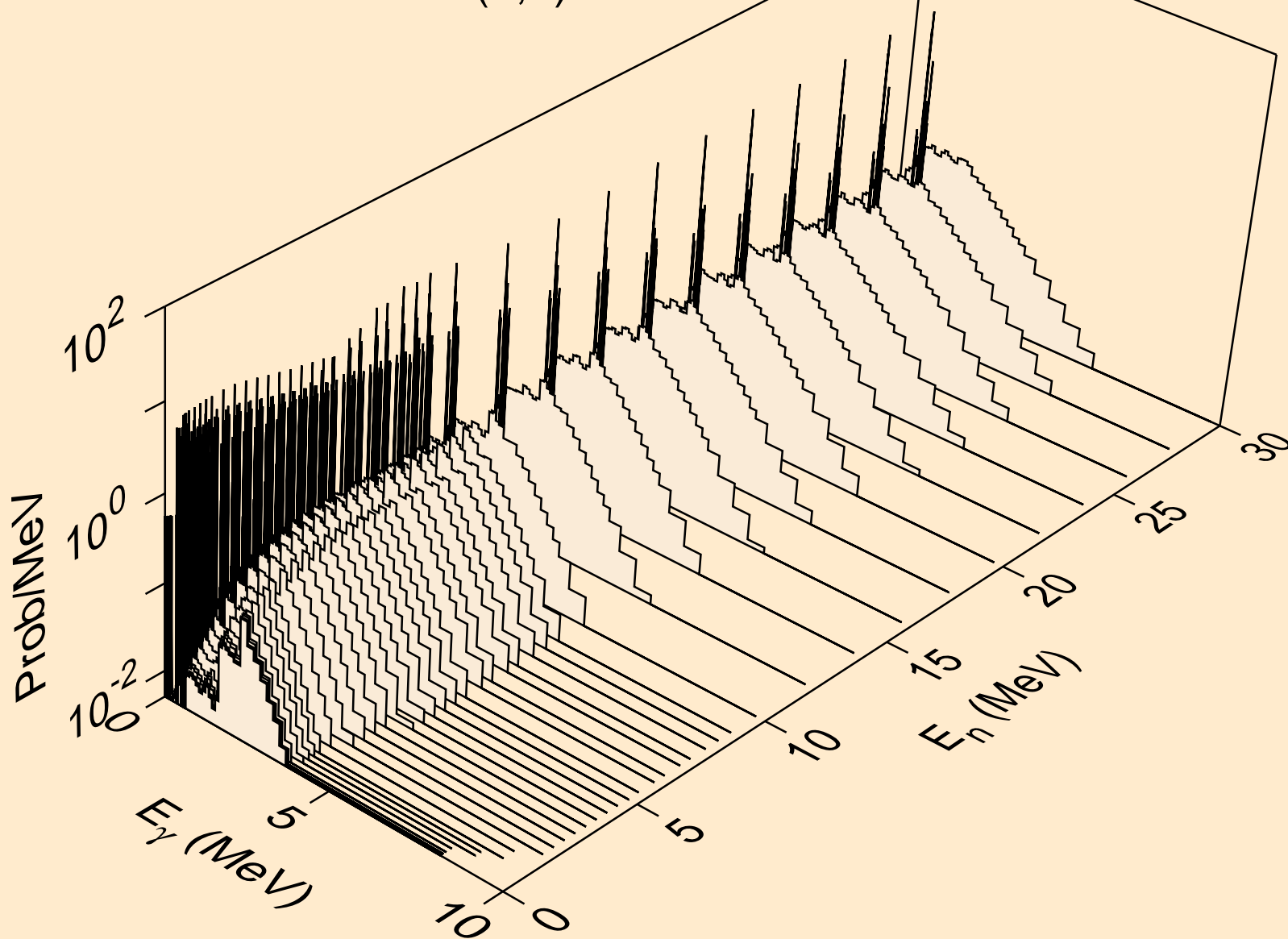

RA208 NEUTRON ACER TENDL-2023 LIBRARY; T=0.K
Photon emission for (n,2a)

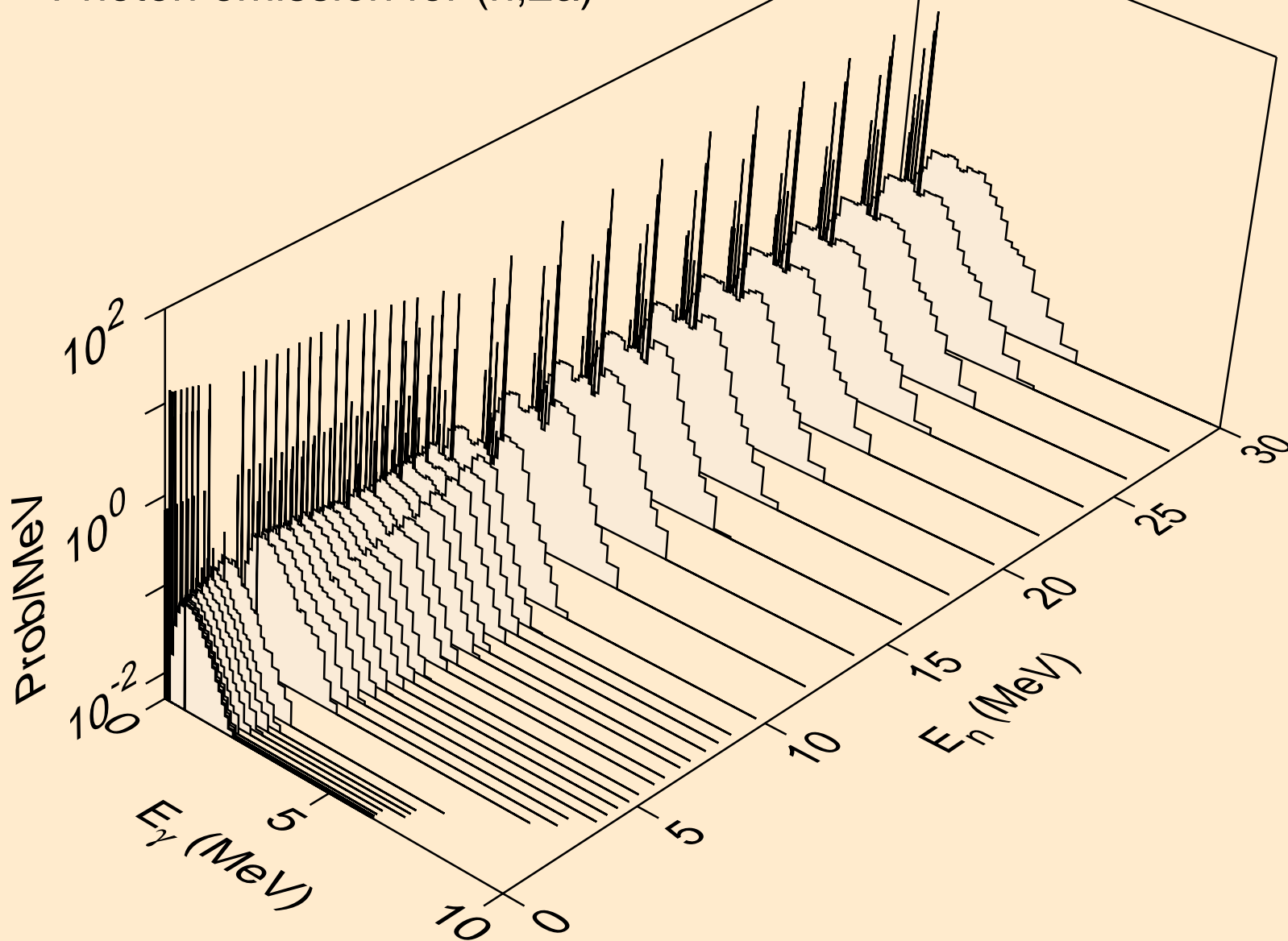

RA208 NEUTRON ACER TENDL-2023 LIBRARY; T=0.K
Photon emission for (n,2p)

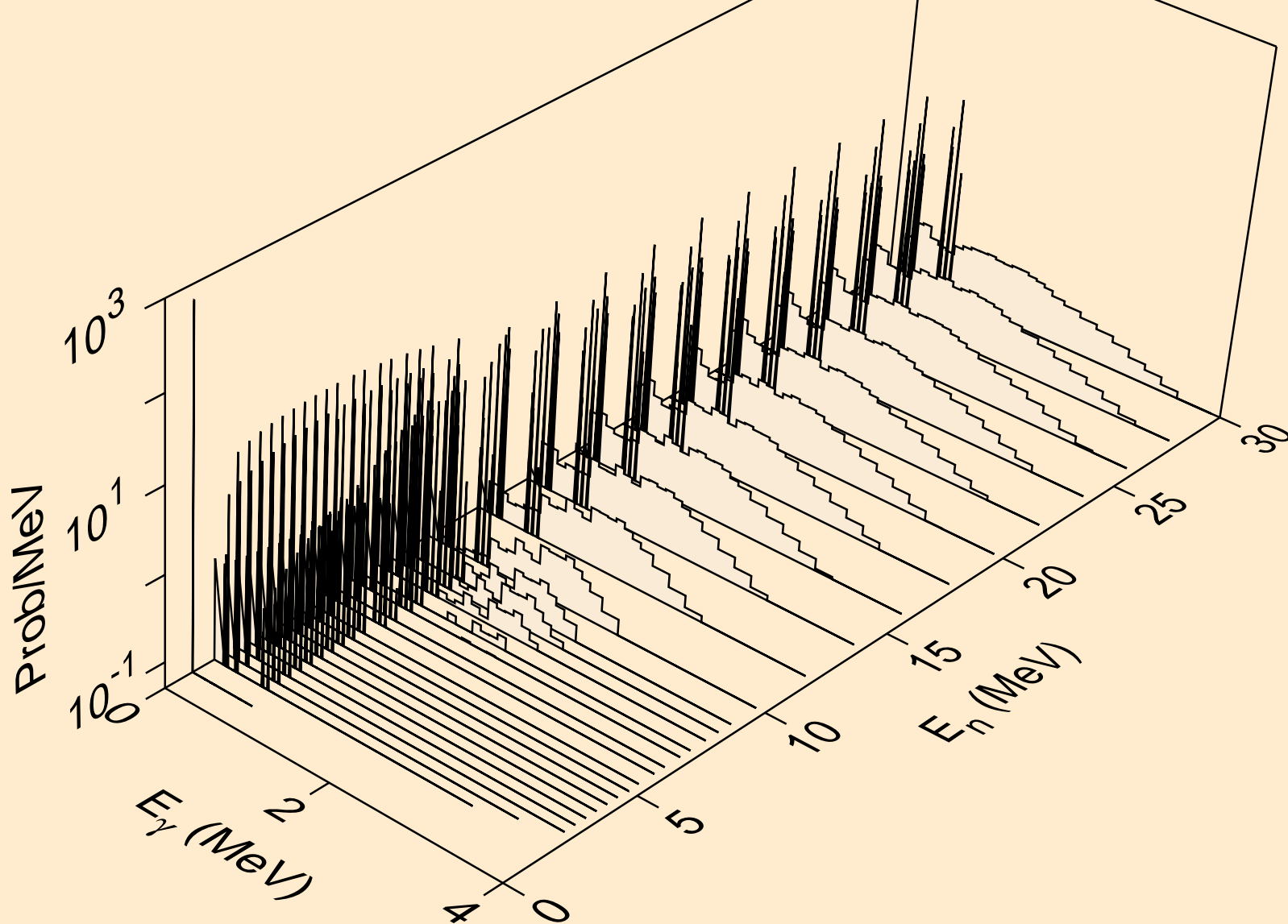

RA208 NEUTRON ACER TENDL-2023 LIBRARY; T=0.K
Photon emission for (n,p α)

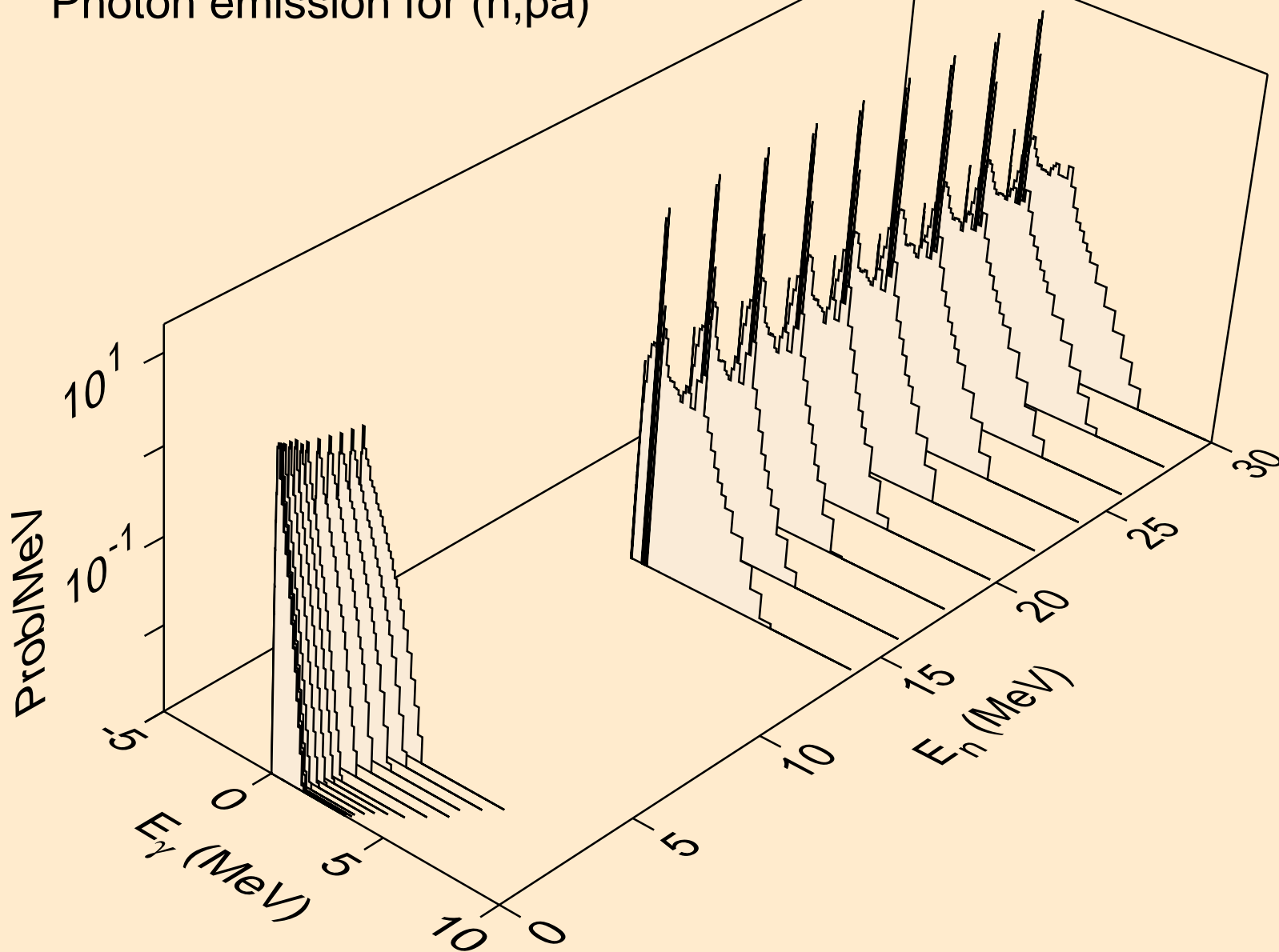

RA208 NEUTRON ACER TENDL-2023 LIBRARY; T=0.K
Photon emission for (n,pd)

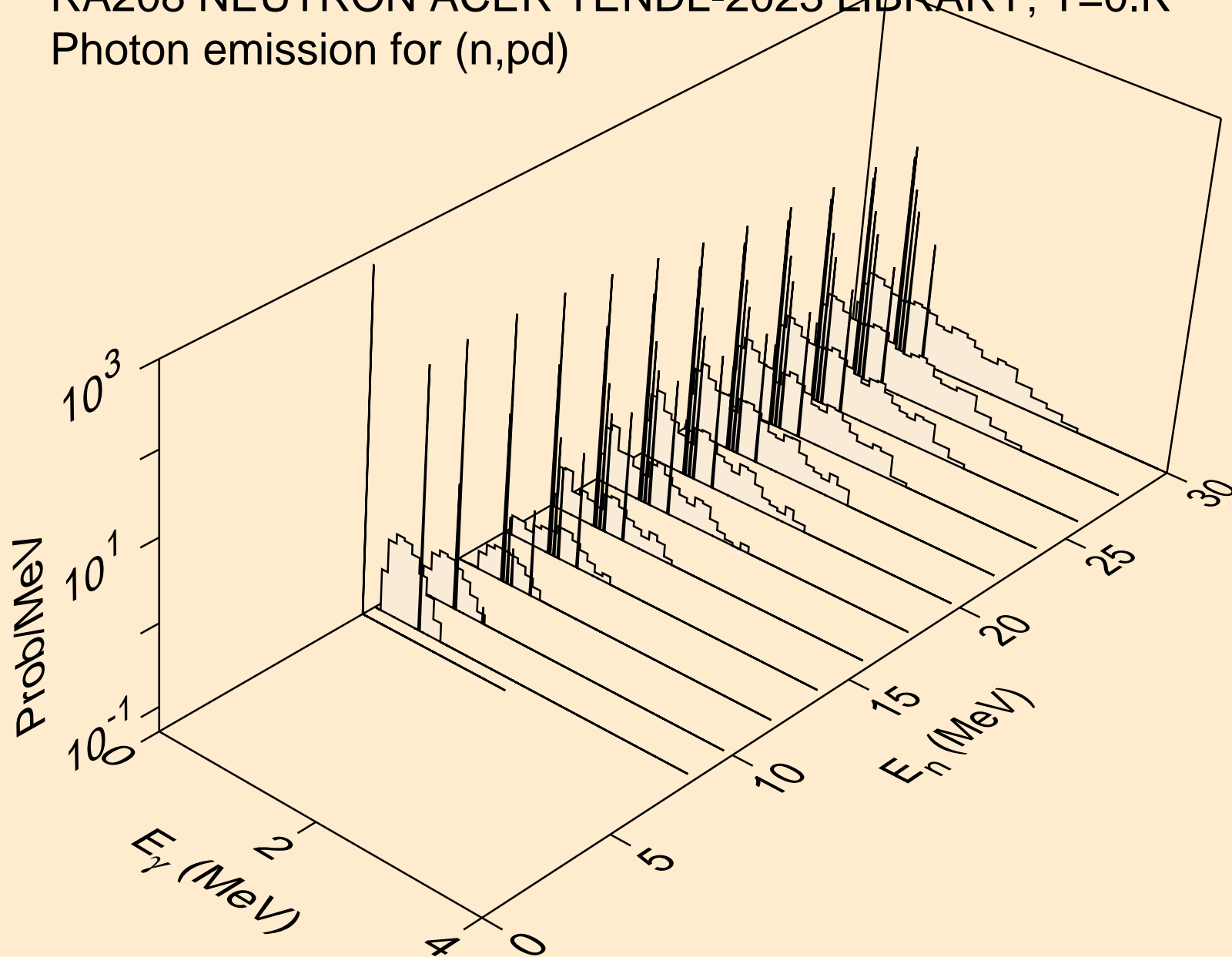

RA208 NEUTRON ACER TENDL-2023 LIBRARY; T=0.K
Photon emission for (n,pt)

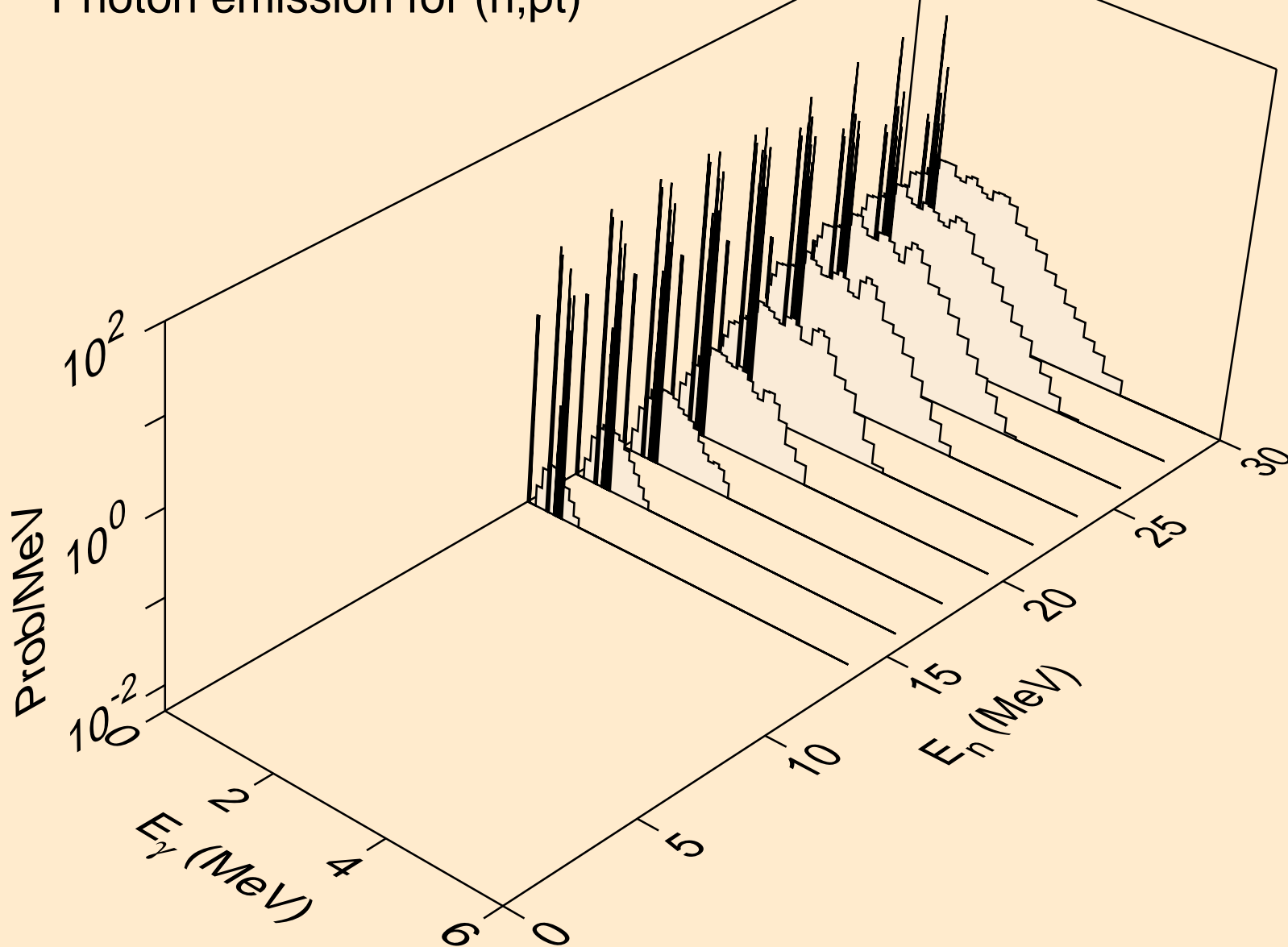

RA208 NEUTRON ACER TENDL-2023 LIBRARY; T=0.K
Photon emission for (n,da)

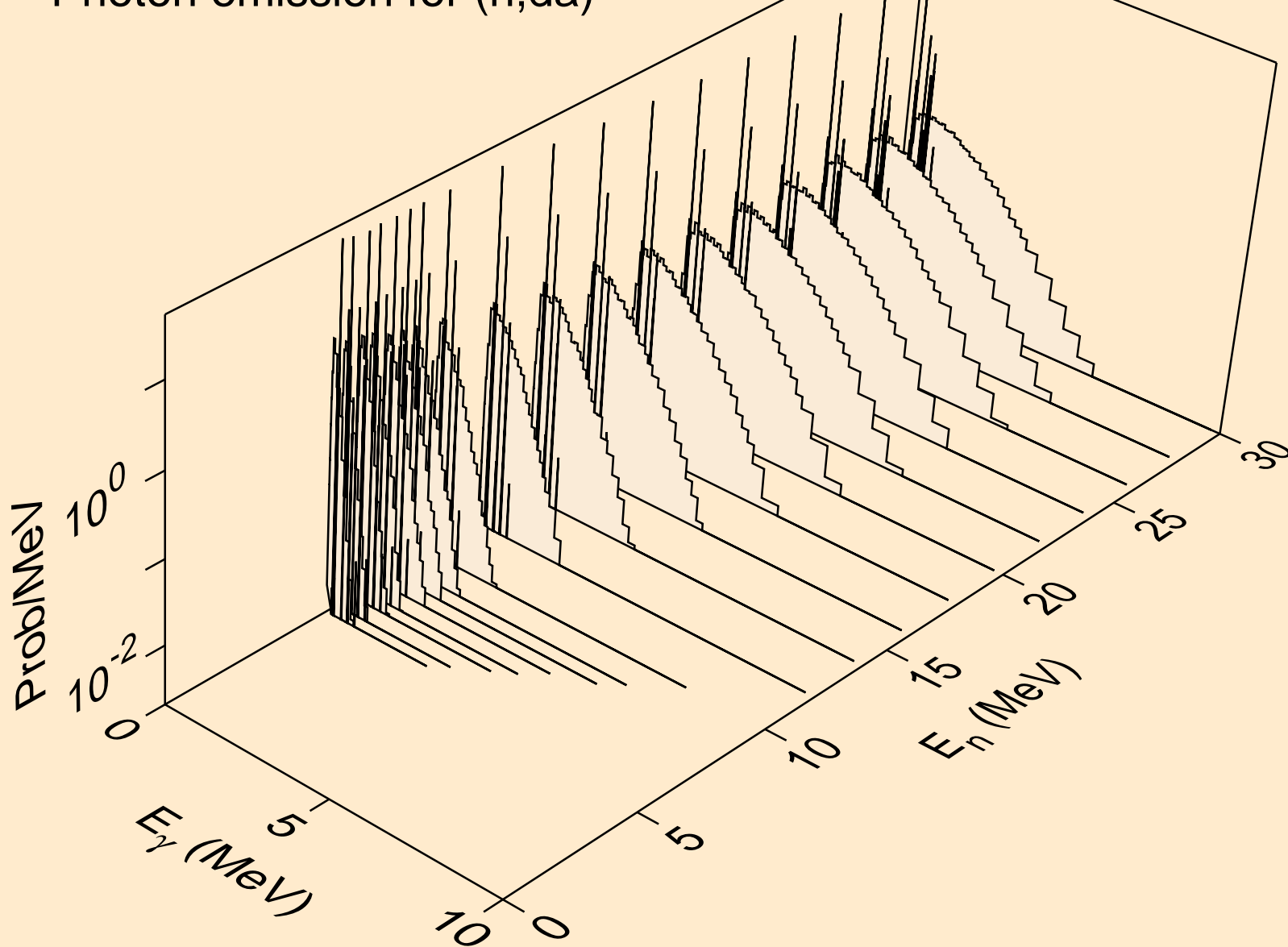

RA208 NEUTRON ACER TENDL-2023 LIBRARY; T=0.K
thermal capture photon spectrum

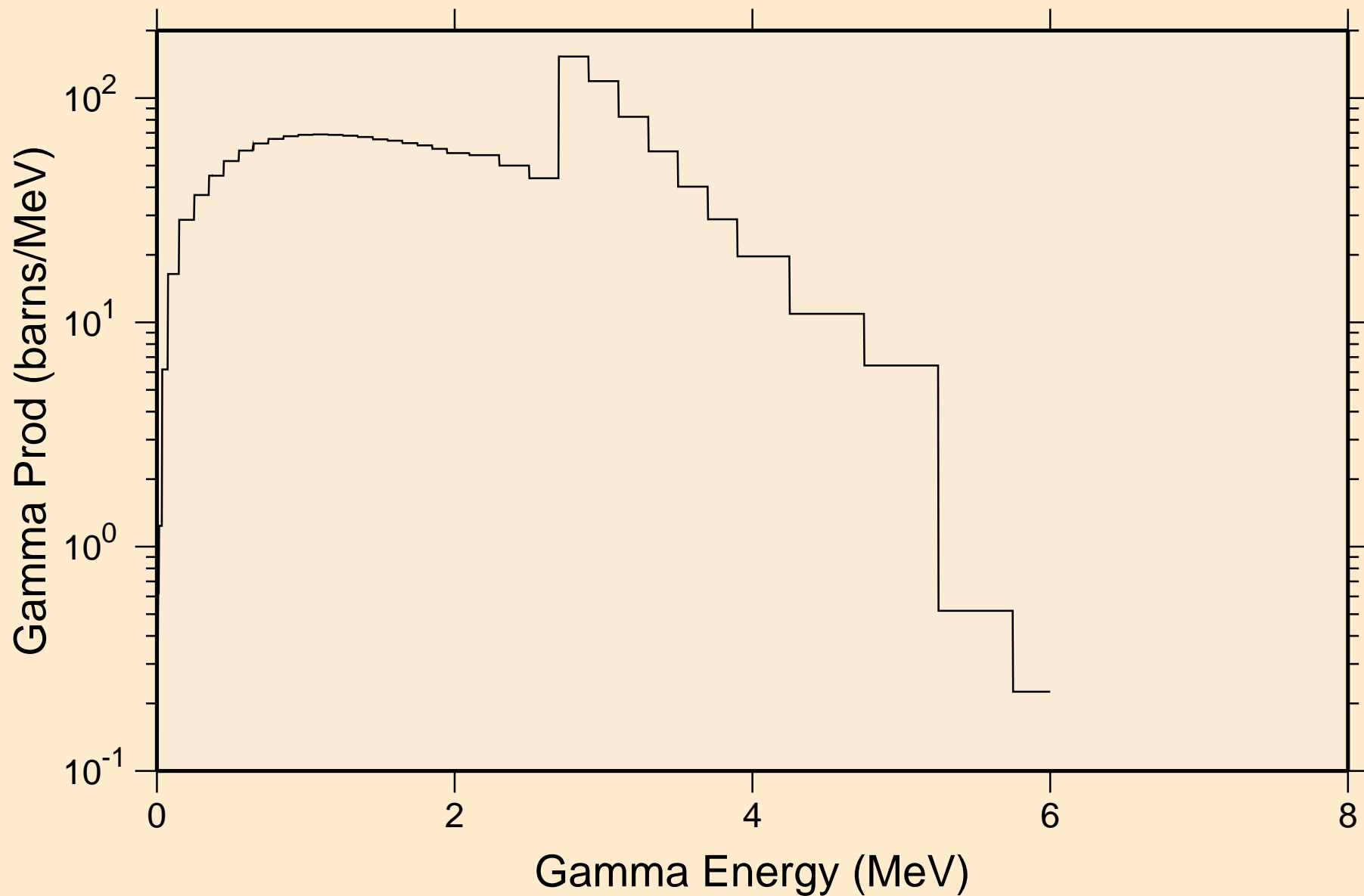

RA208 NEUTRON ACER TENDL-2023 LIBRARY; T=0.K
14 MeV photon spectrum

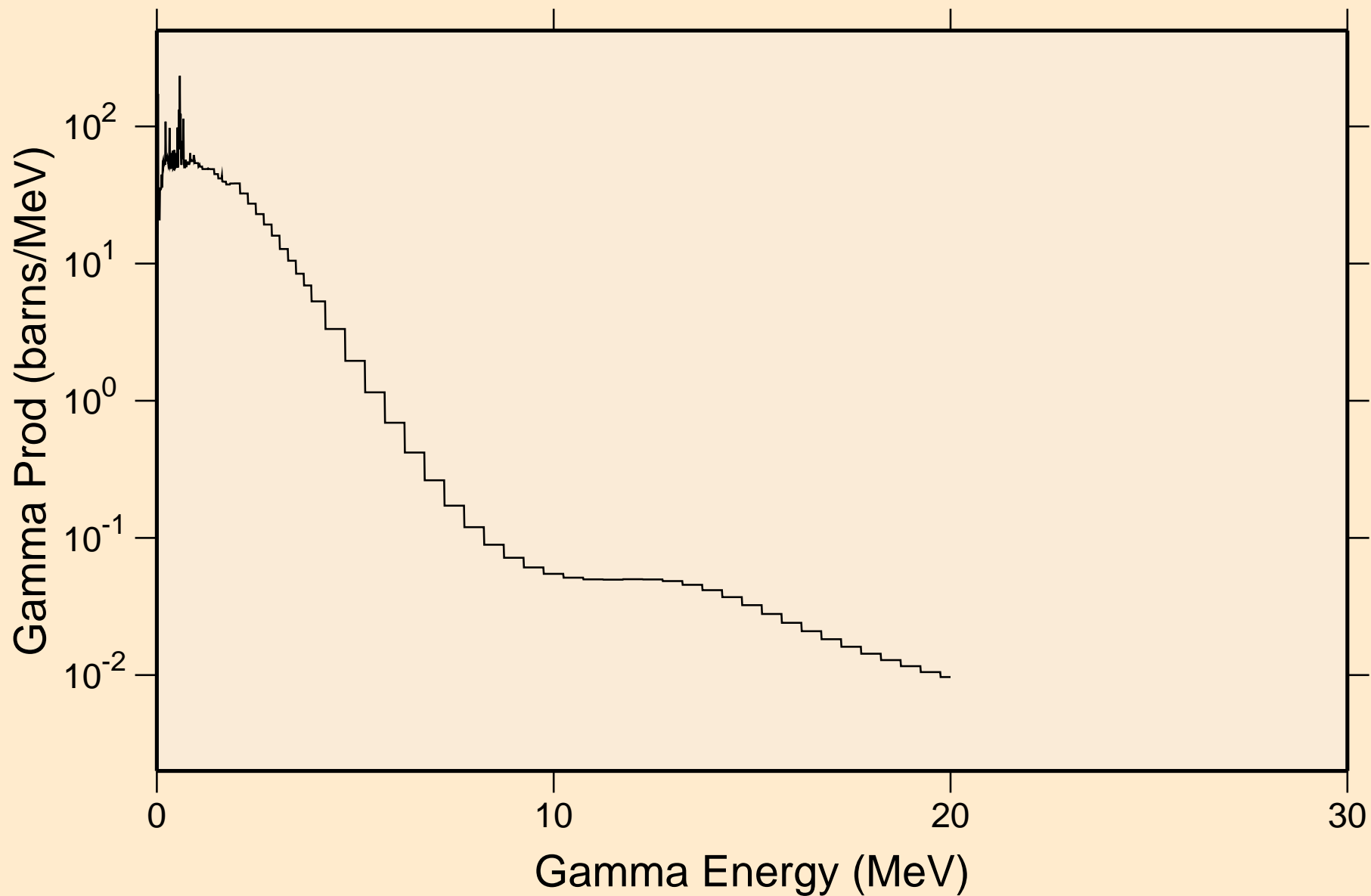

RA208 NEUTRON ACER TENDL-2023 LIBRARY; T=0.K

Particle heating contributions

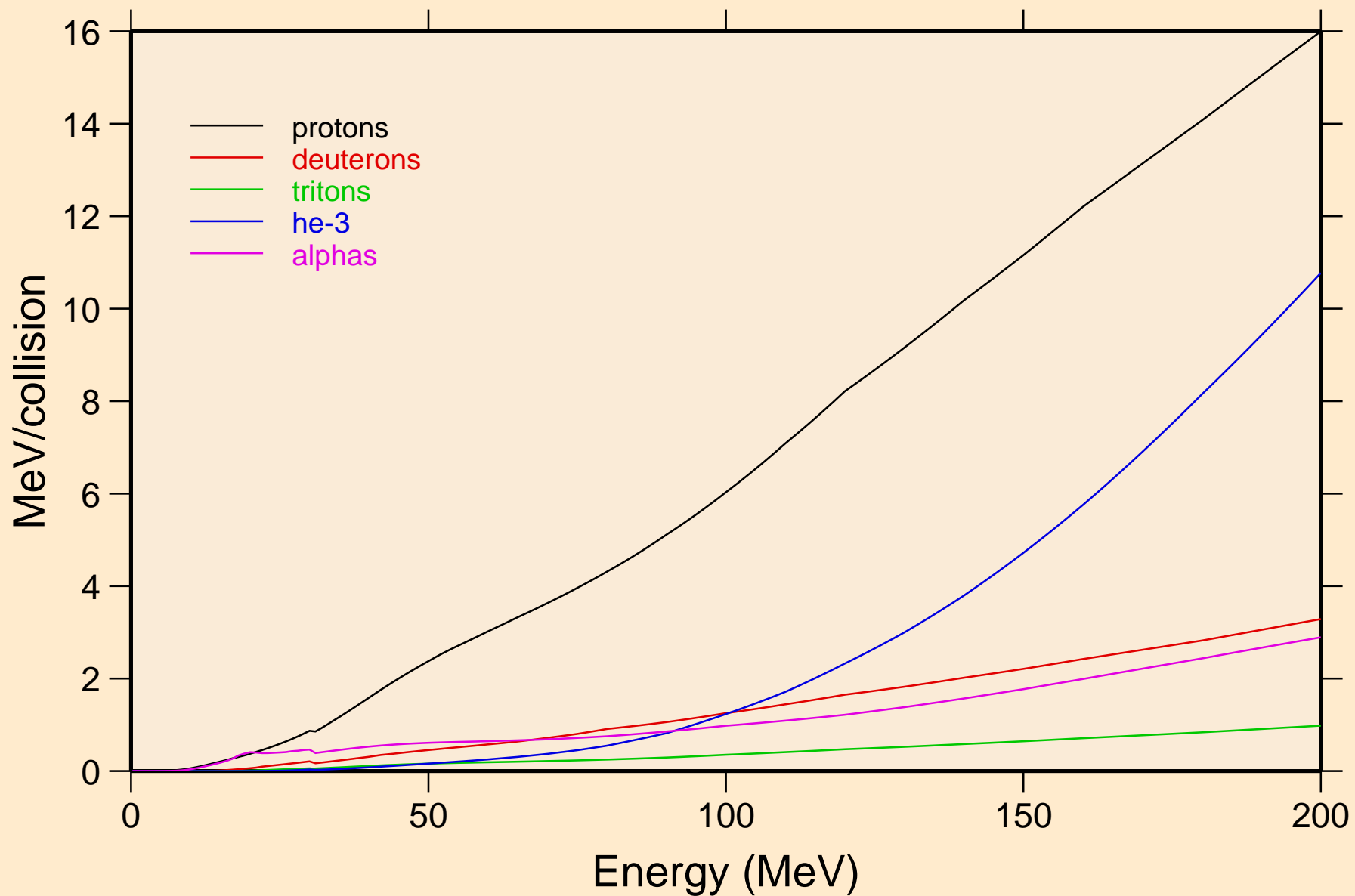

RA208 NEUTRON ACER TENDL-2023 LIBRARY; T=0.K
Recoil Heating

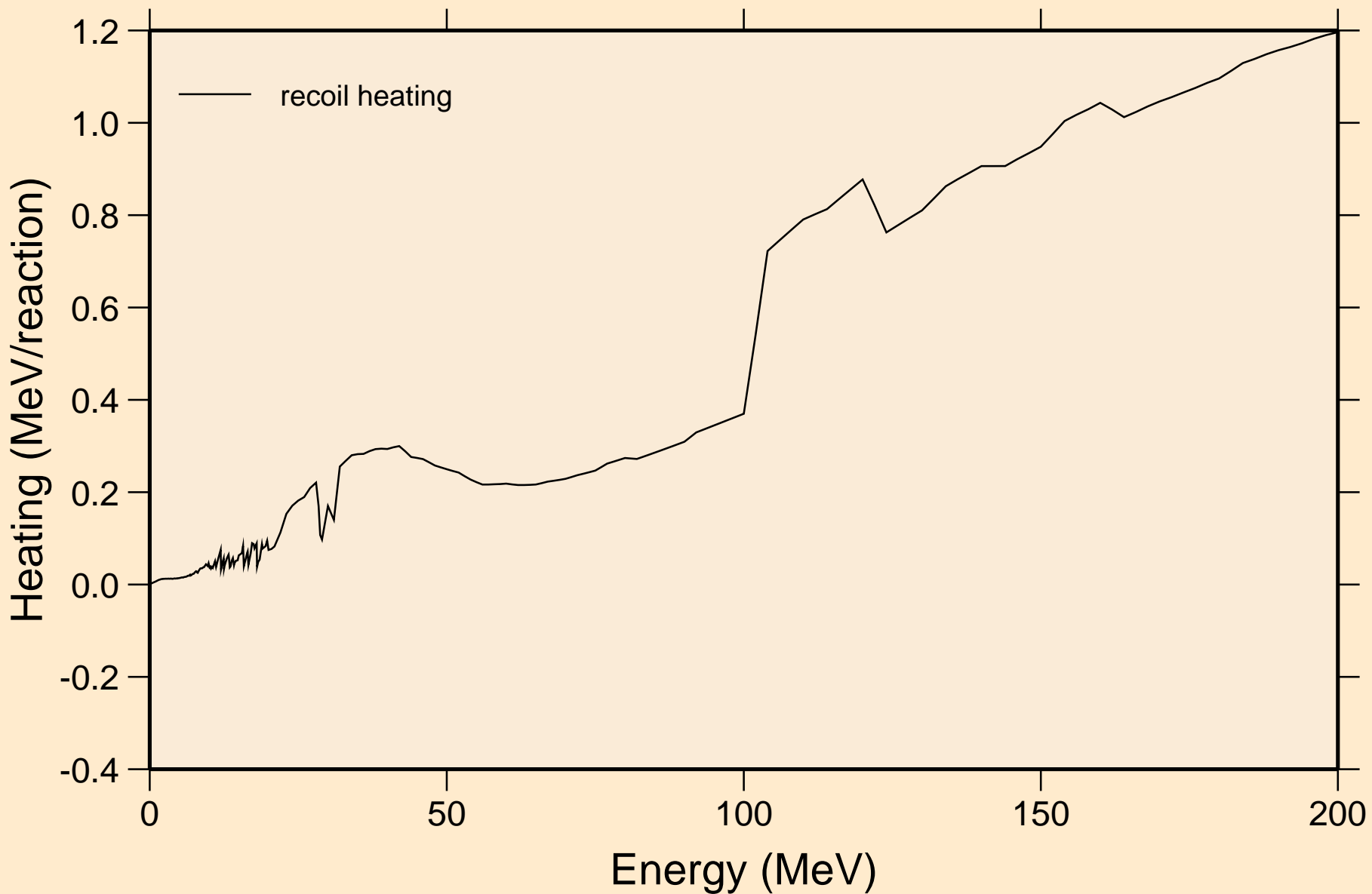

RA208 NEUTRON ACER TENDL-2023 LIBRARY; T=0.K
Particle production cross sections

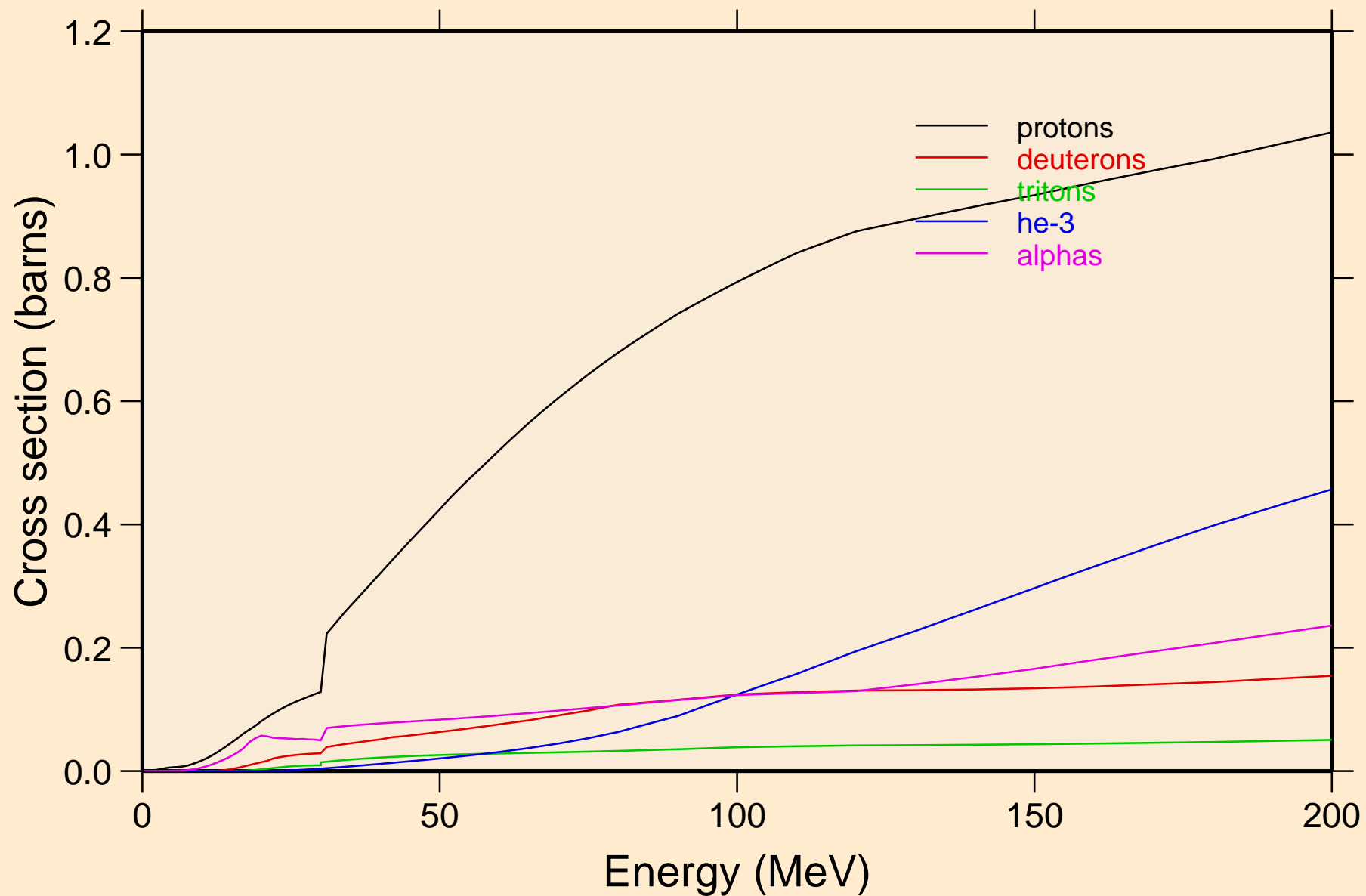

RA208 NEUTRON ACER TENDL-2023 LIBRARY; T=0.K
protons from (n,x)

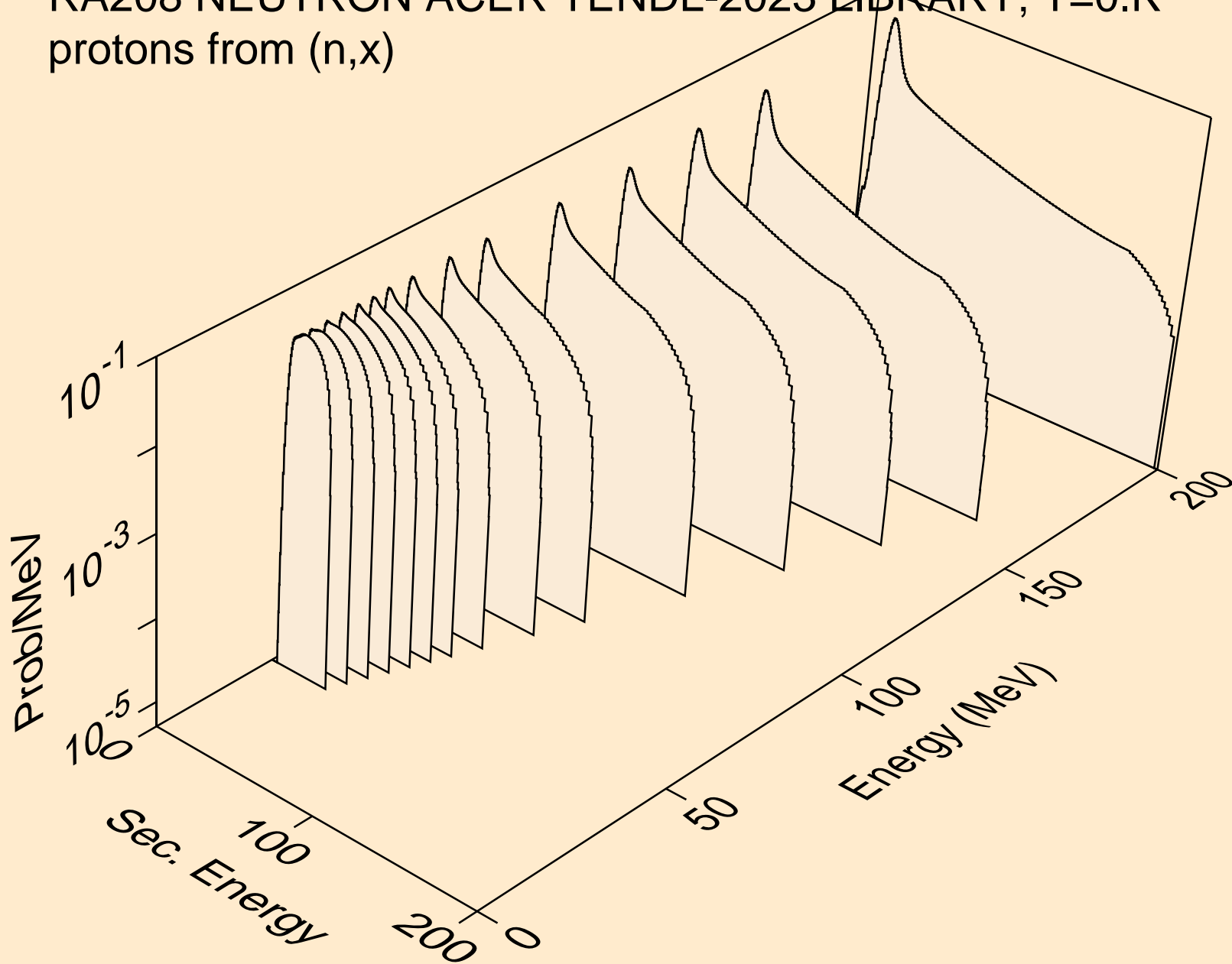

RA208 NEUTRON ACER TENDL-2023 LIBRARY; T=0.K
protons from (n,n*)p

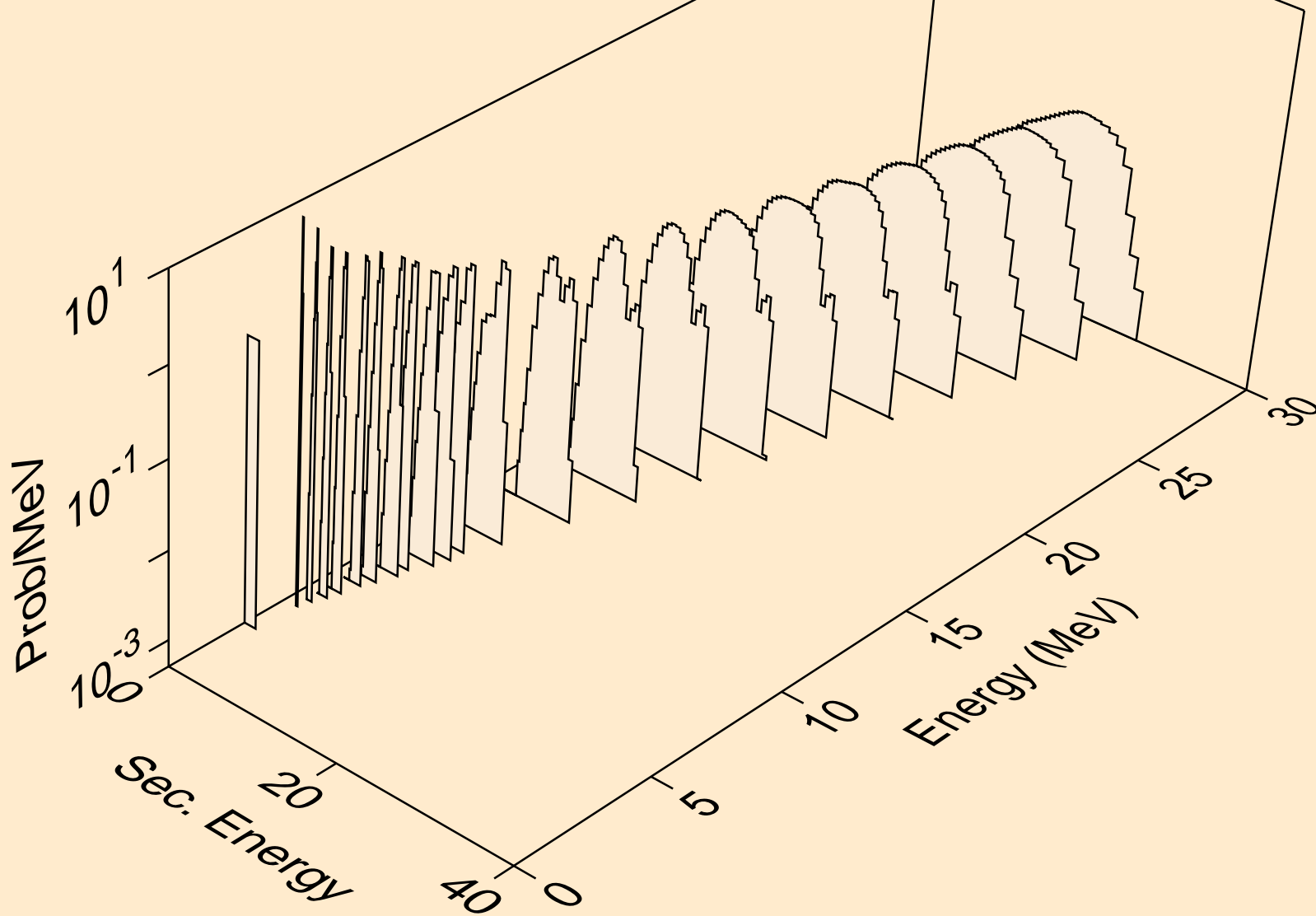

RA208 NEUTRON ACER TENDL-2023 LIBRARY; T=0.K
protons from (n,2np)

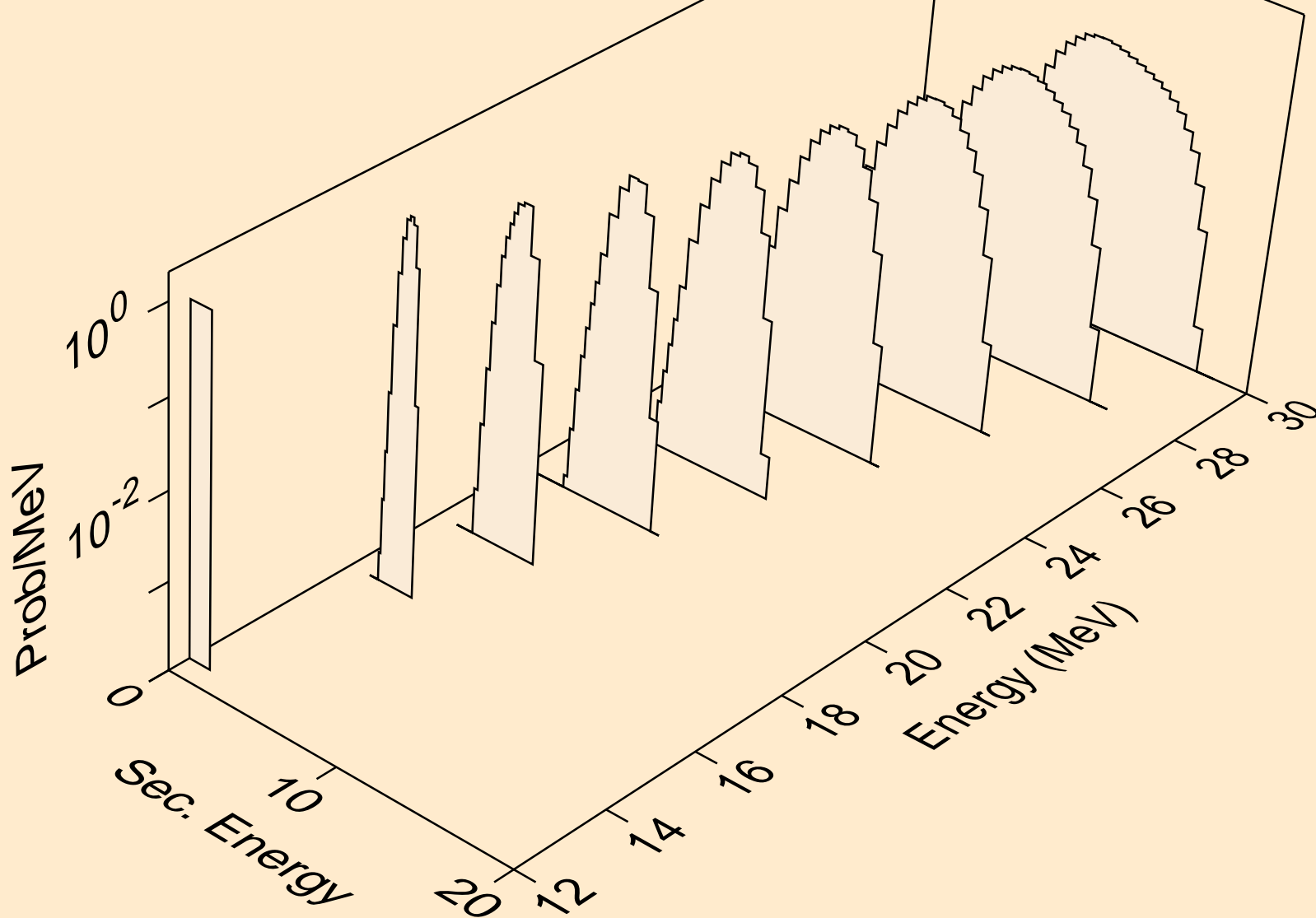

RA208 NEUTRON ACER TENDL-2023 LIBRARY; T=0.K
protons from (n,3np)

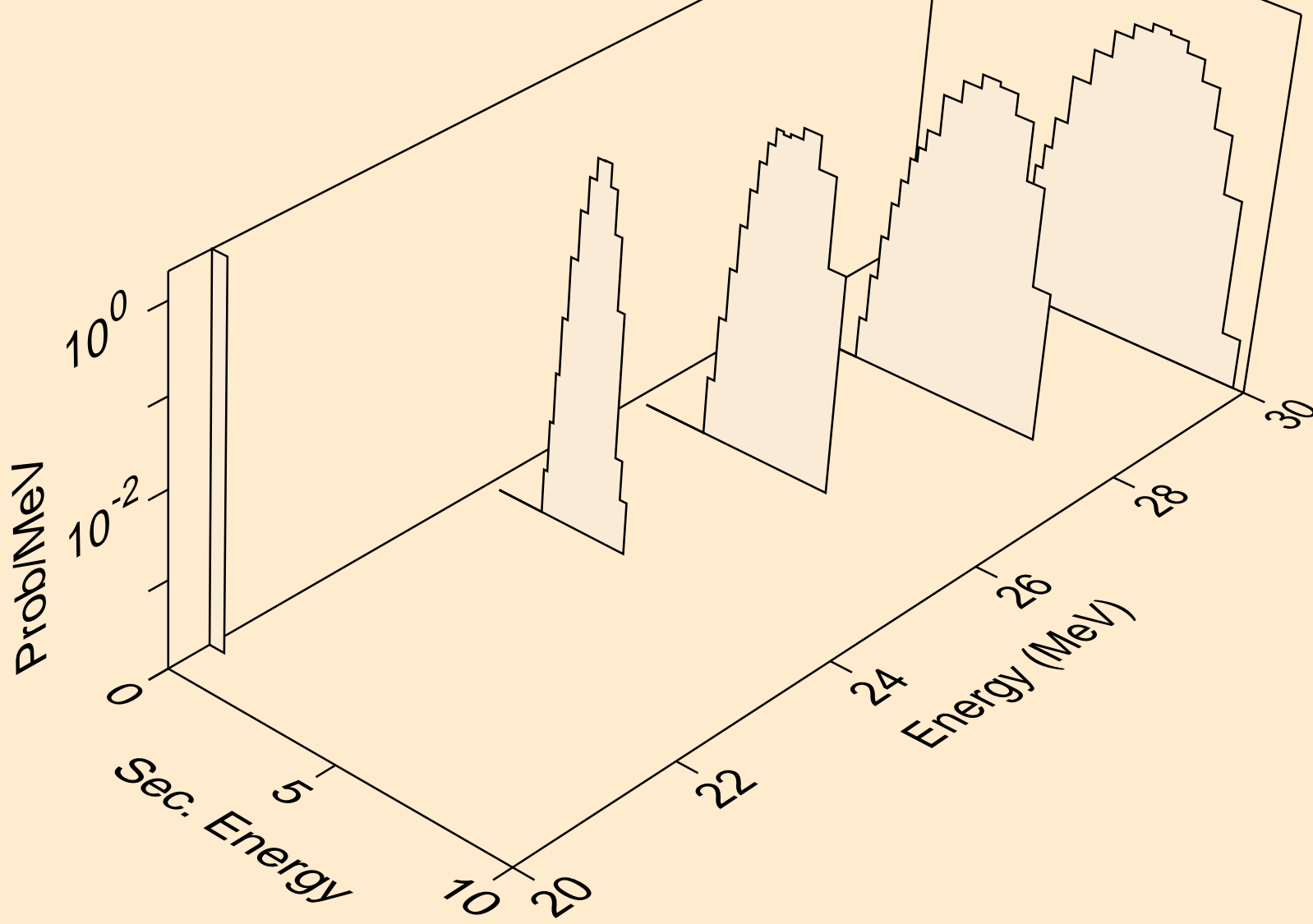

RA208 NEUTRON ACER TENDL-2023 LIBRARY; T=0.K
protons from (n,n2p)

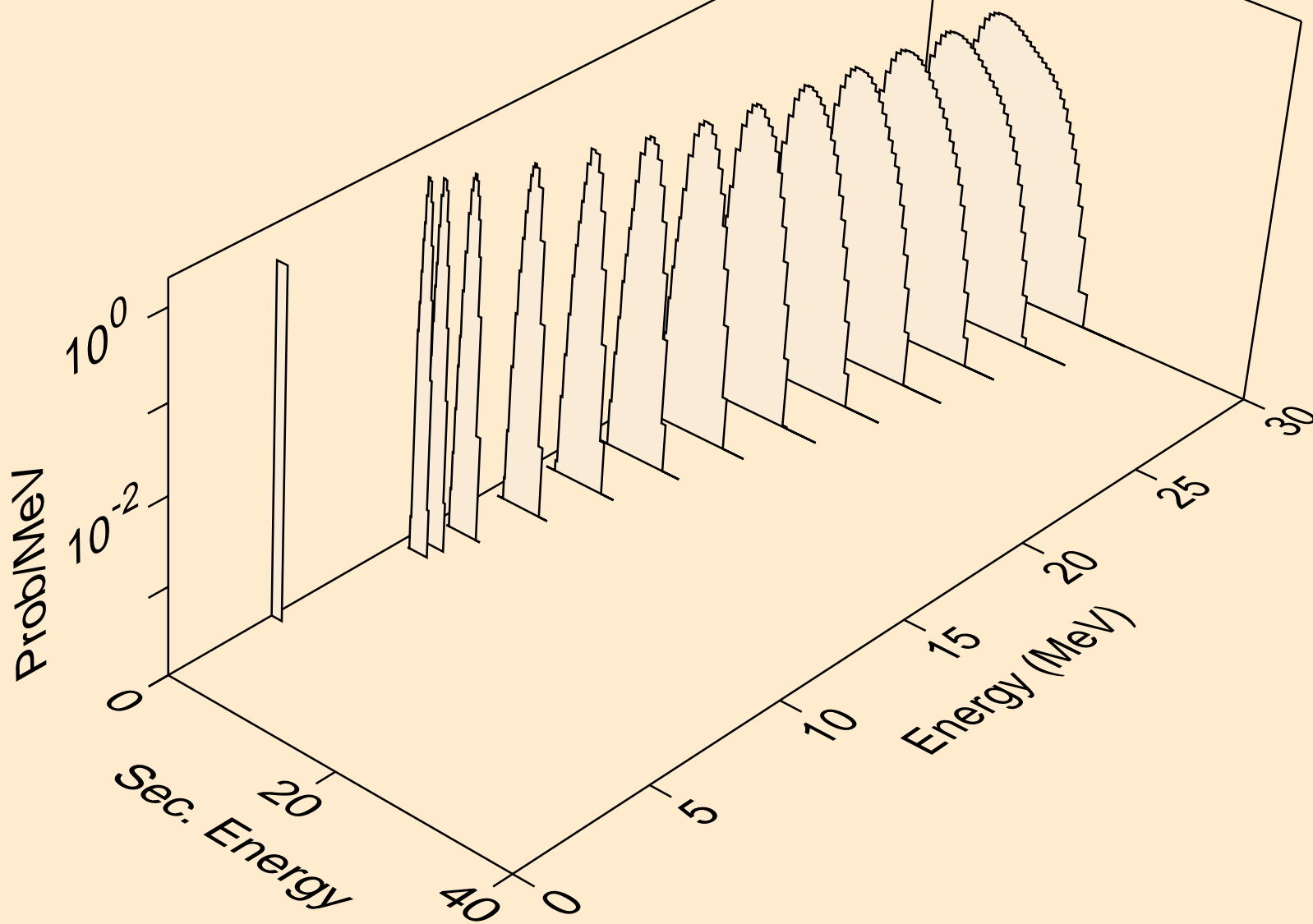

RA208 NEUTRON ACER TENDL-2023 LIBRARY; T=0.K
protons from (n,npa)

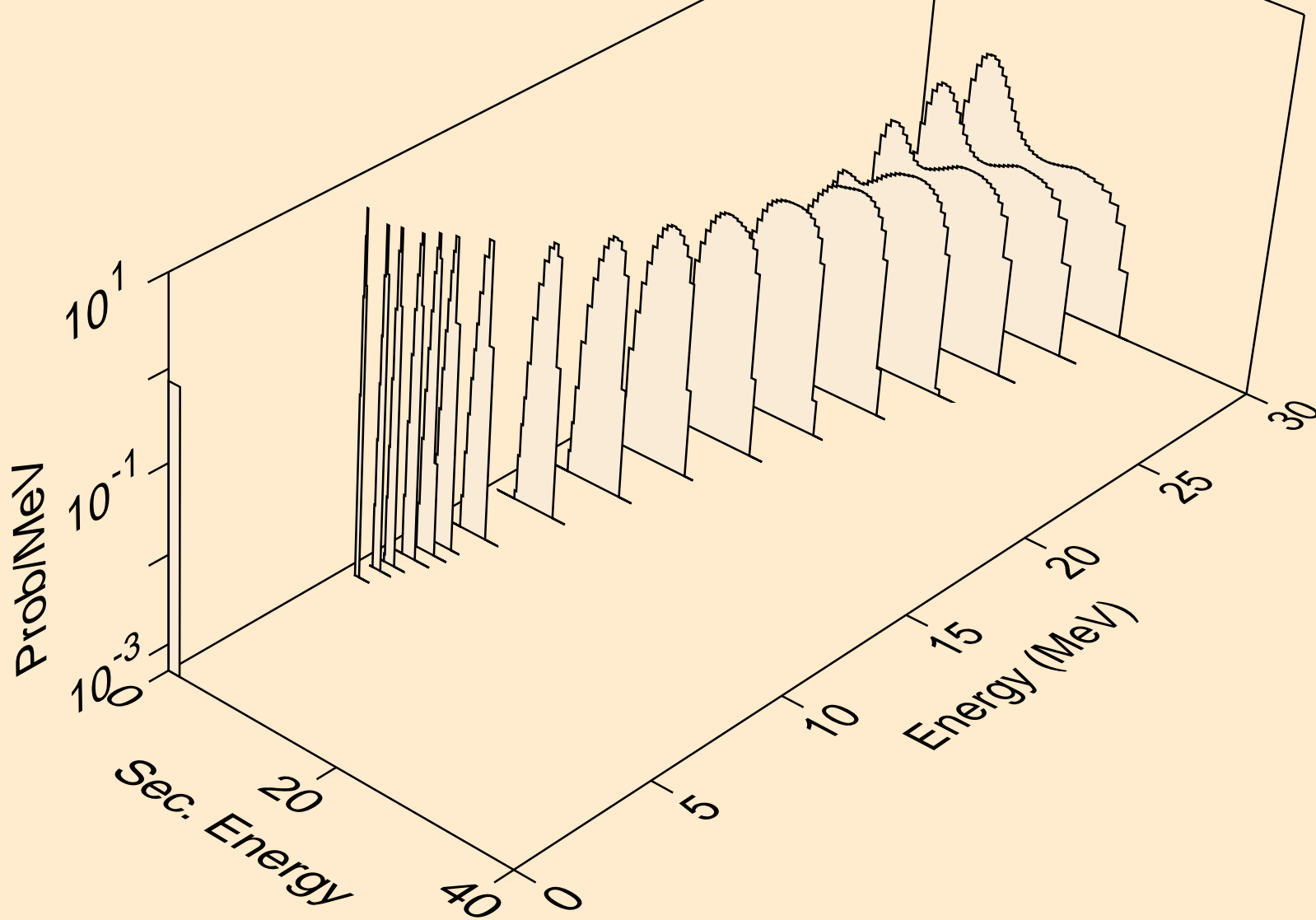

RA208 NEUTRON ACER TENDL-2023 LIBRARY; T=0.K
protons from (n,p)

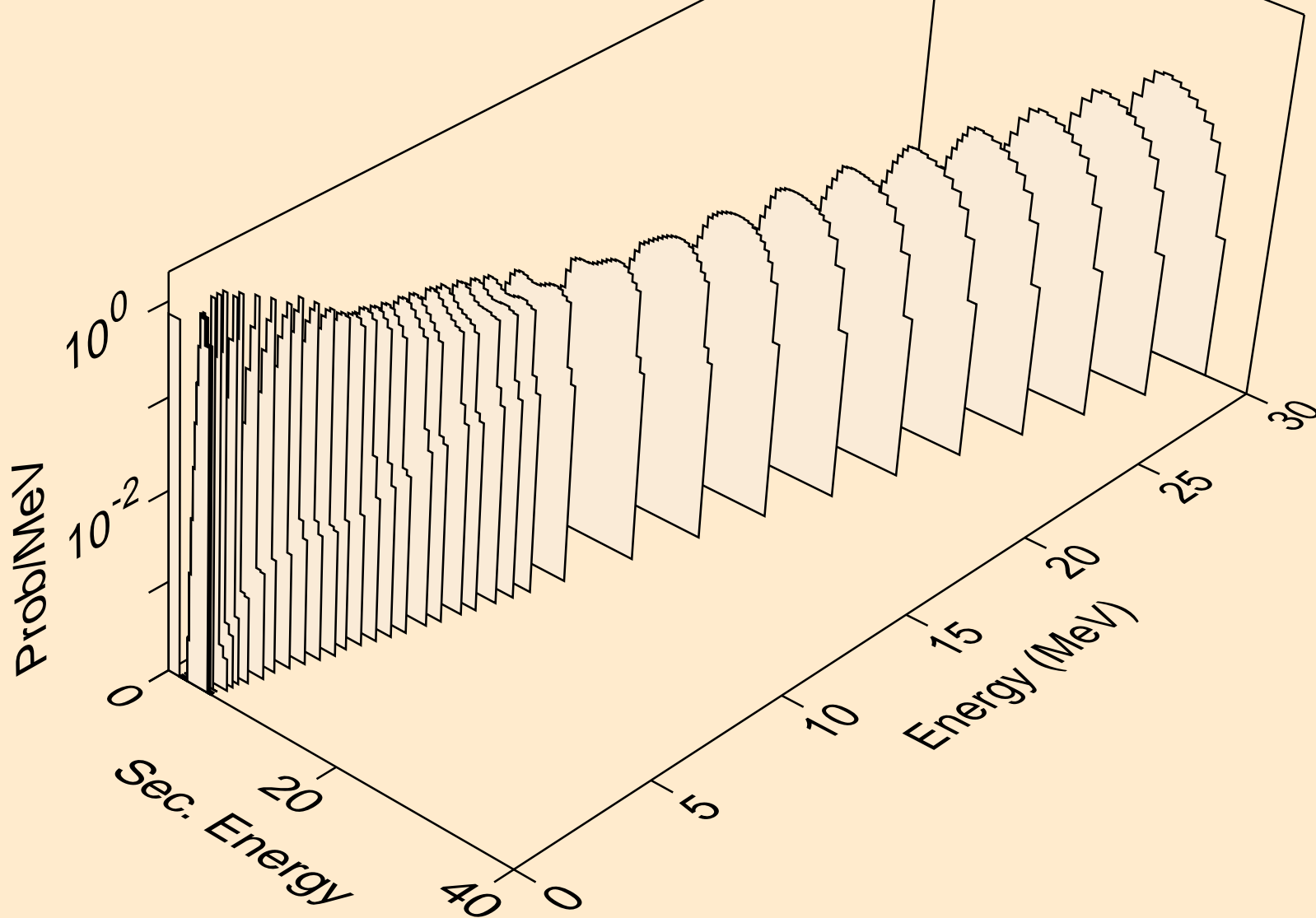

RA208 NEUTRON ACER TENDL-2023 LIBRARY; T=0.K
protons from (n,2p)

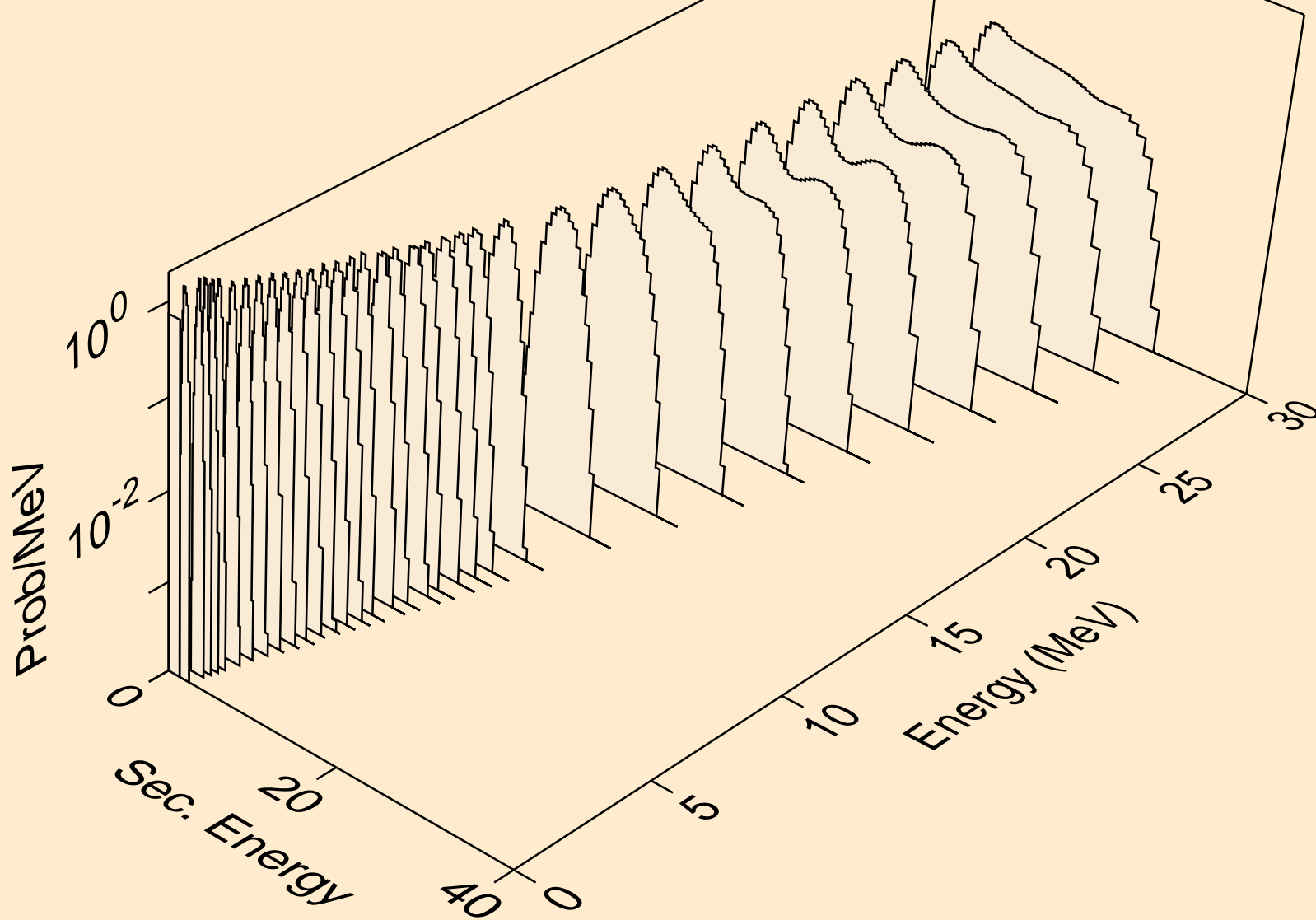

RA208 NEUTRON ACER TENDL-2023 LIBRARY; T=0.K
protons from (n,p)

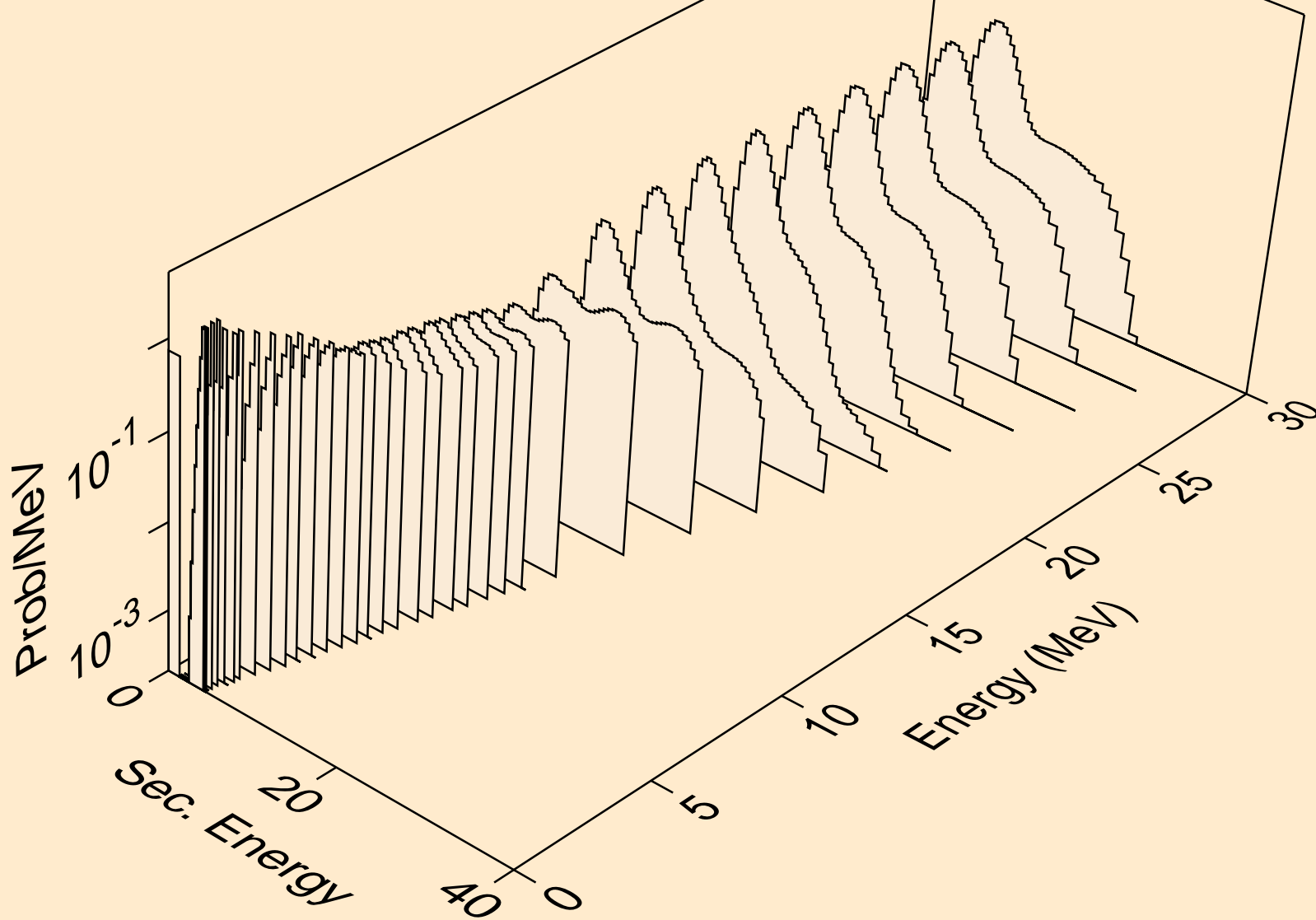

RA208 NEUTRON ACER TENDL-2023 LIBRARY; T=0.K
protons from (n,pd)

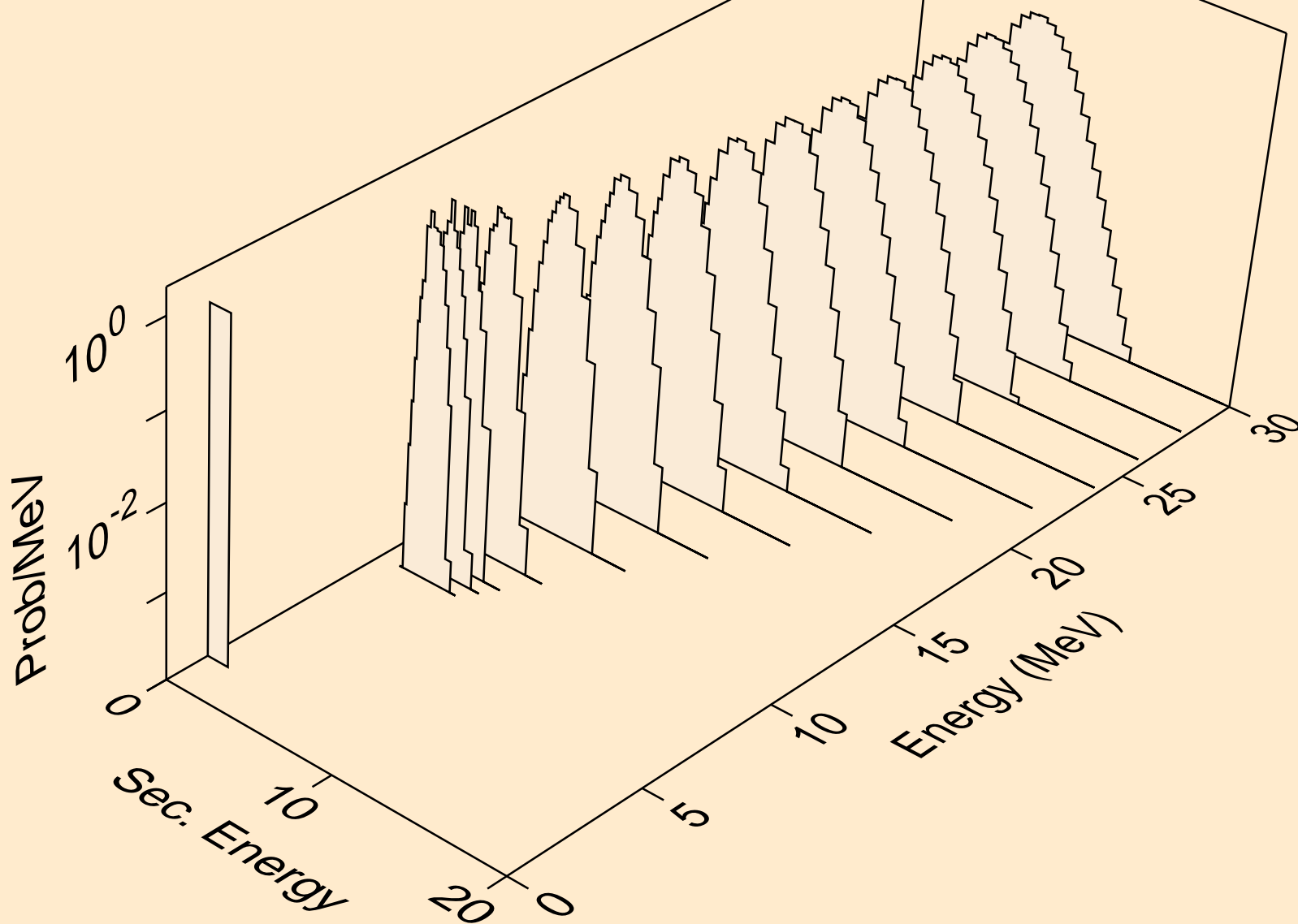

RA208 NEUTRON ACER TENDL-2023 LIBRARY; T=0.K
protons from (n,pt)

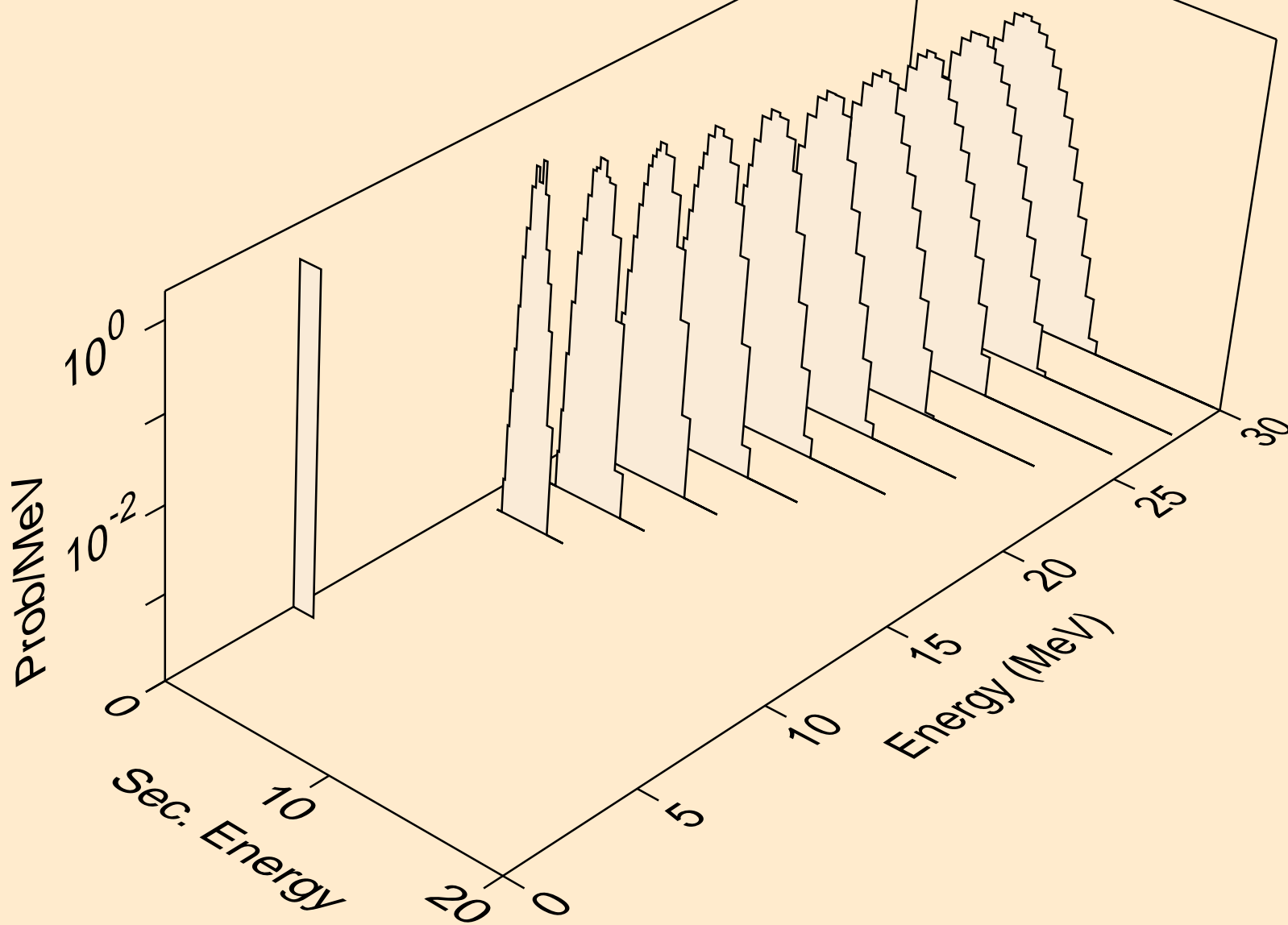

RA208 NEUTRON ACER TENDL-2023 LIBRARY; T=0.K
deuterons from (n,x)

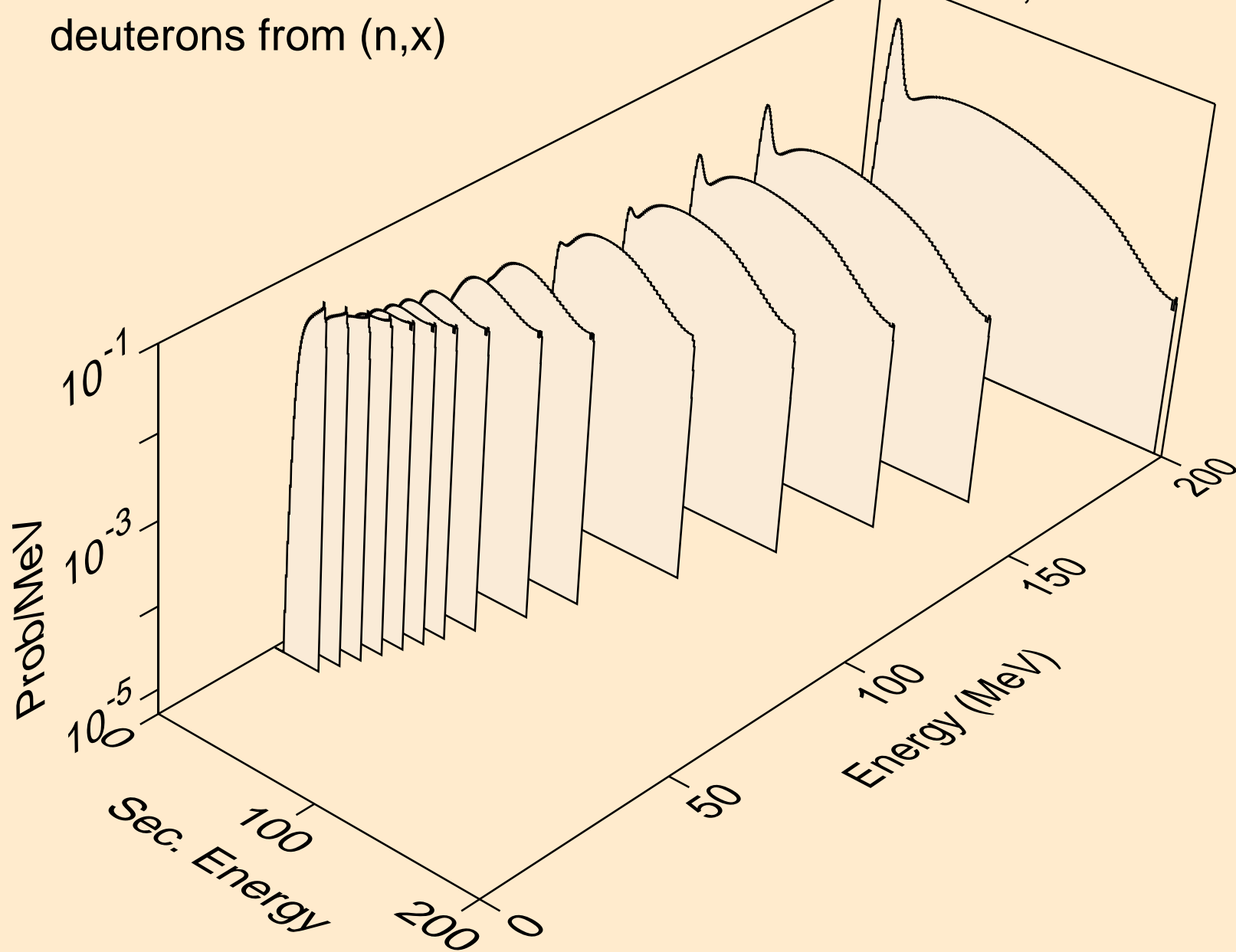

RA208 NEUTRON ACER TENDL-2023 LIBRARY; T=0.K
deuterons from (n,2nd)

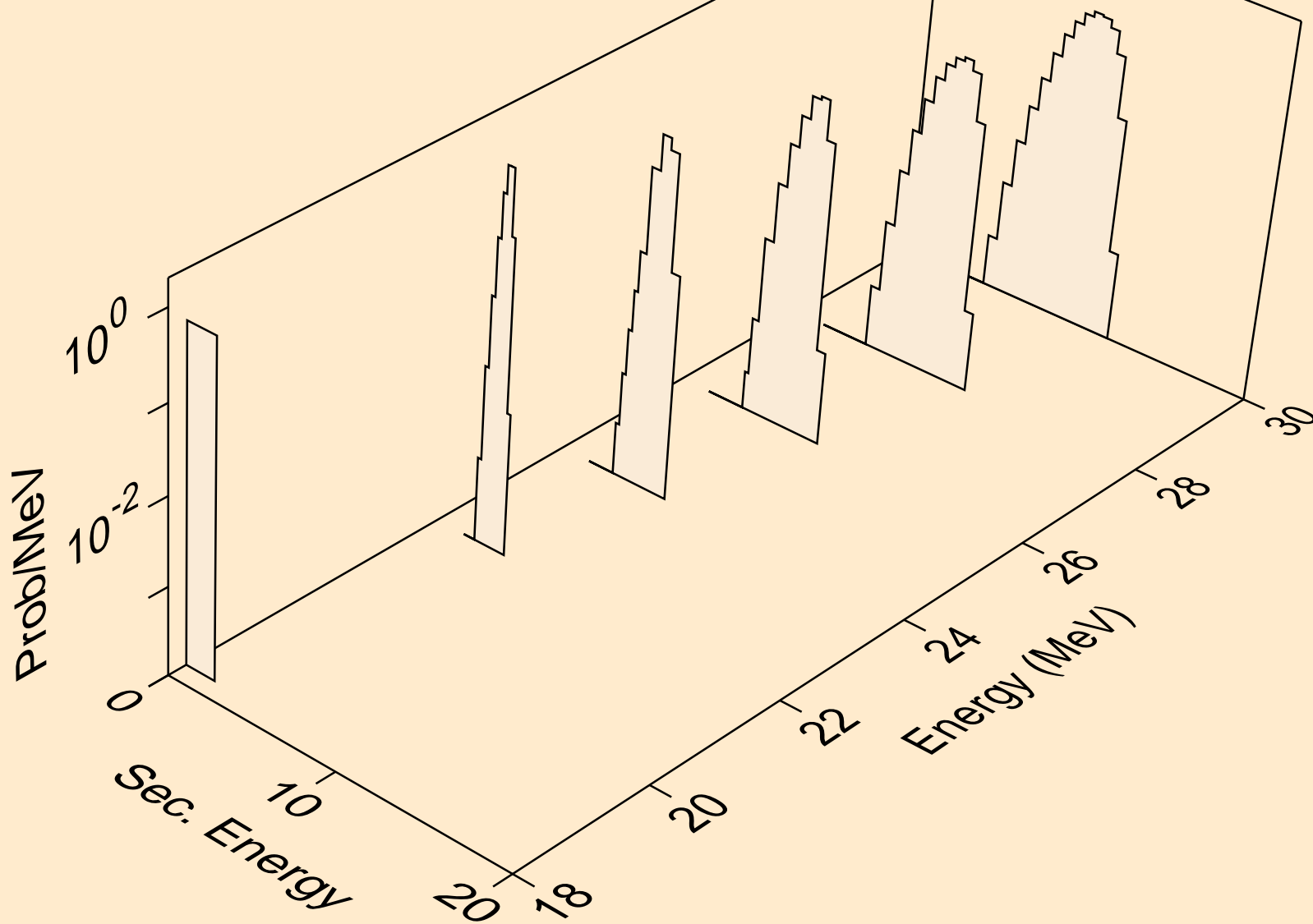

RA208 NEUTRON ACER TENDL-2023 LIBRARY; T=0.K
deuterons from (n,n*)d

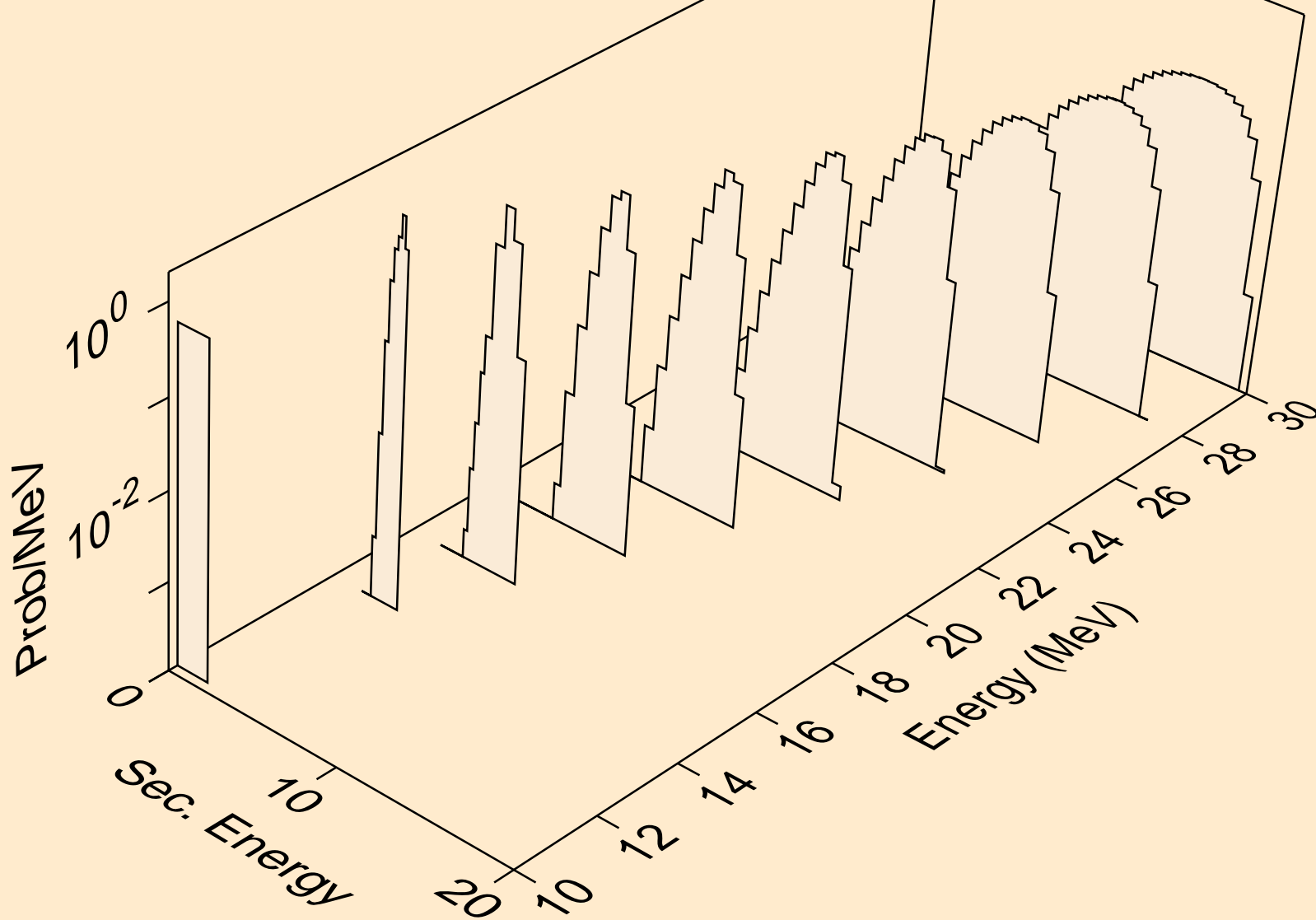

RA208 NEUTRON ACER TENDL-2023 LIBRARY; T=0.K
deuterons from (n,d)

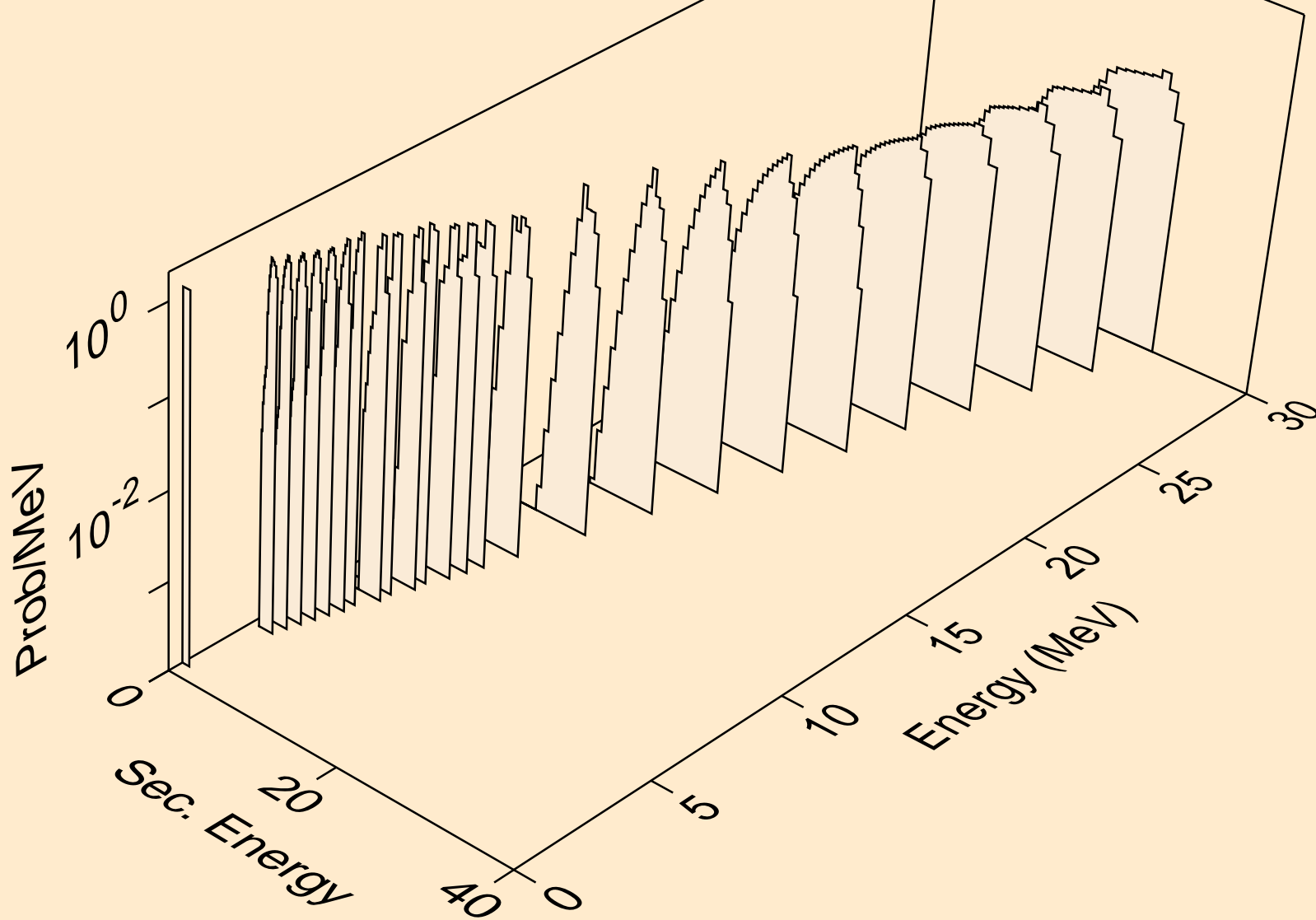

RA208 NEUTRON ACER TENDL-2023 LIBRARY; T=0.K
deuterons from (n,pd)

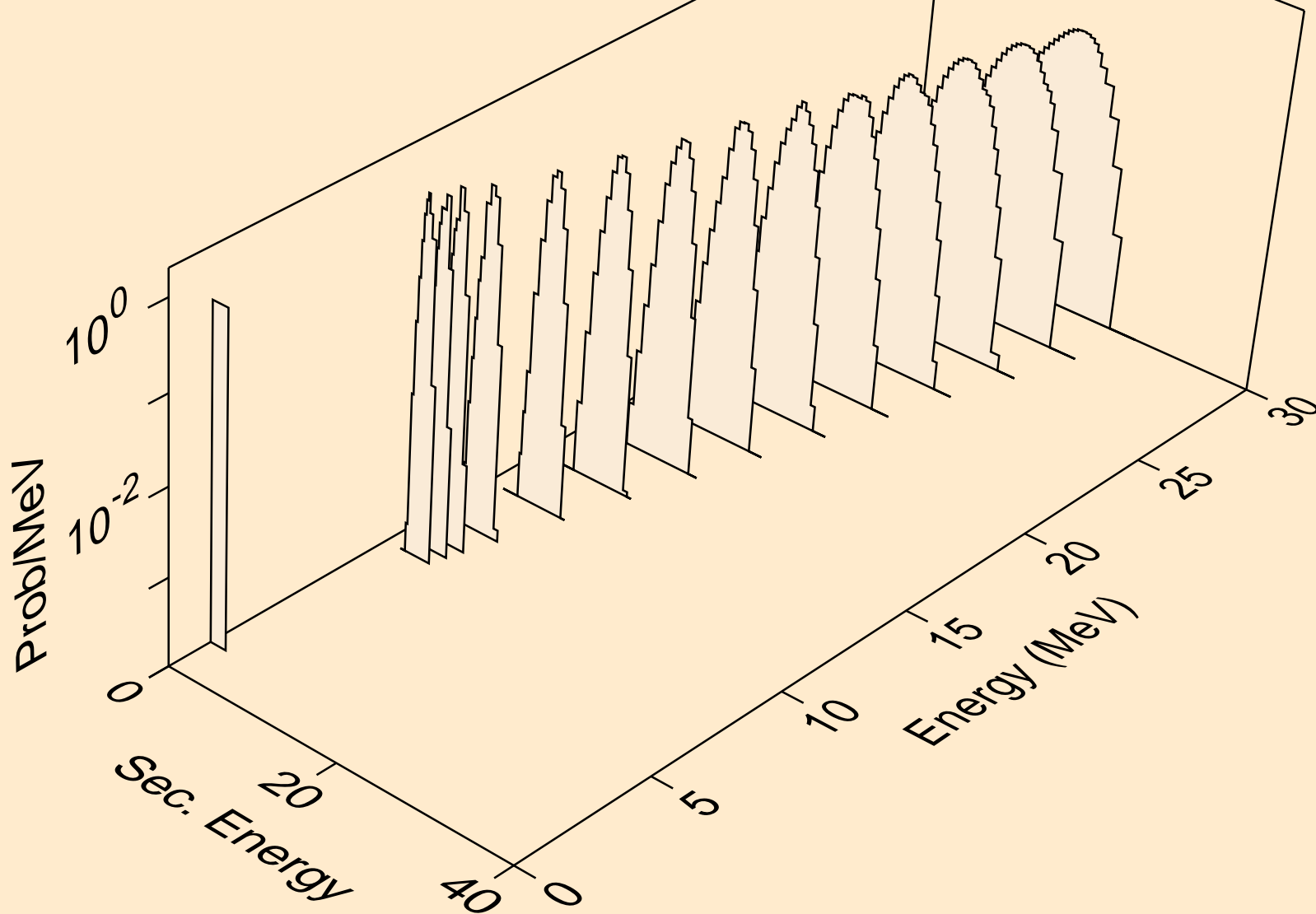

RA208 NEUTRON ACER TENDL-2023 LIBRARY; T=0.K
deuterons from (n,da)

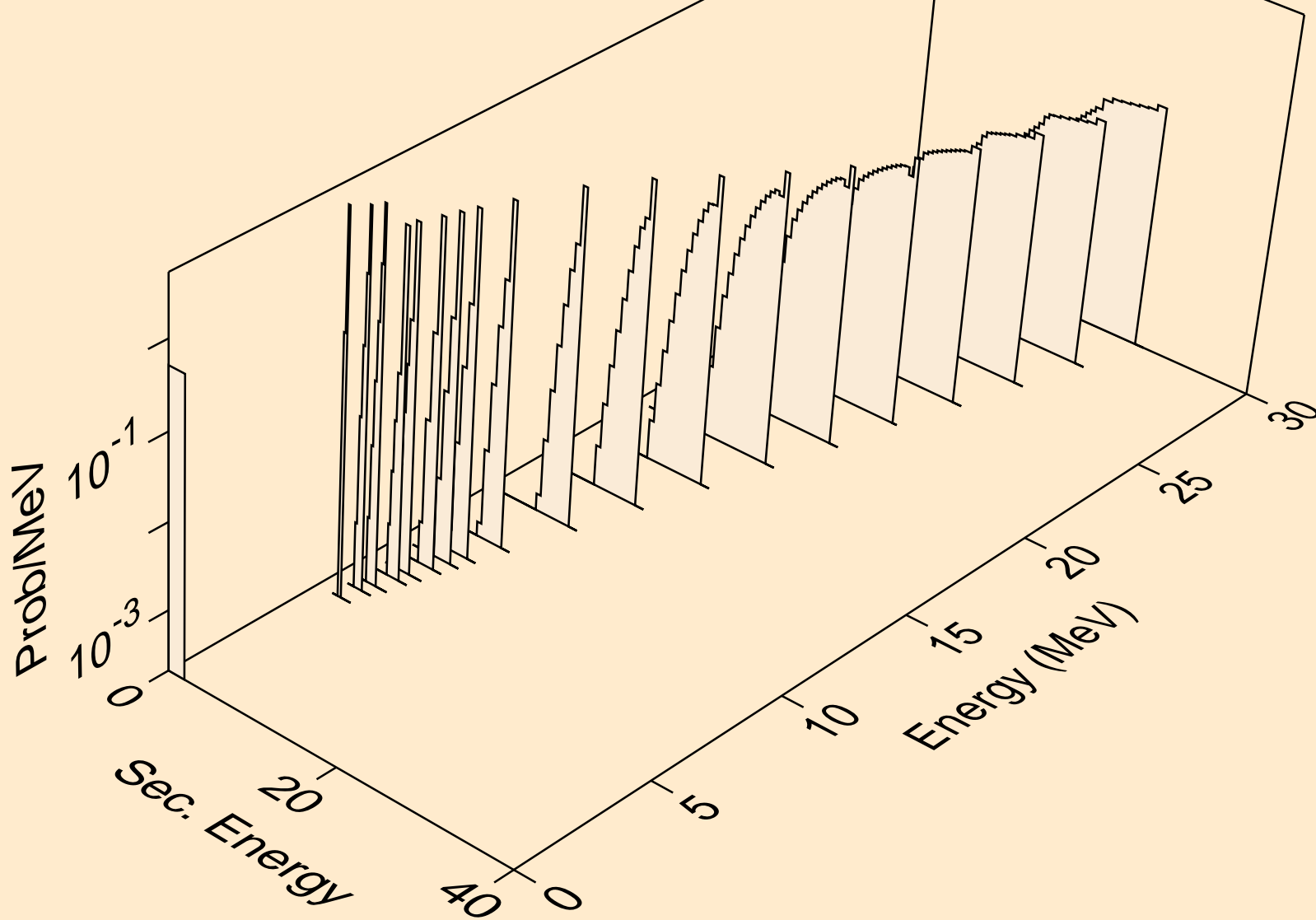

RA208 NEUTRON ACER TENDL-2023 LIBRARY; T=0.K
tritons from (n,x)

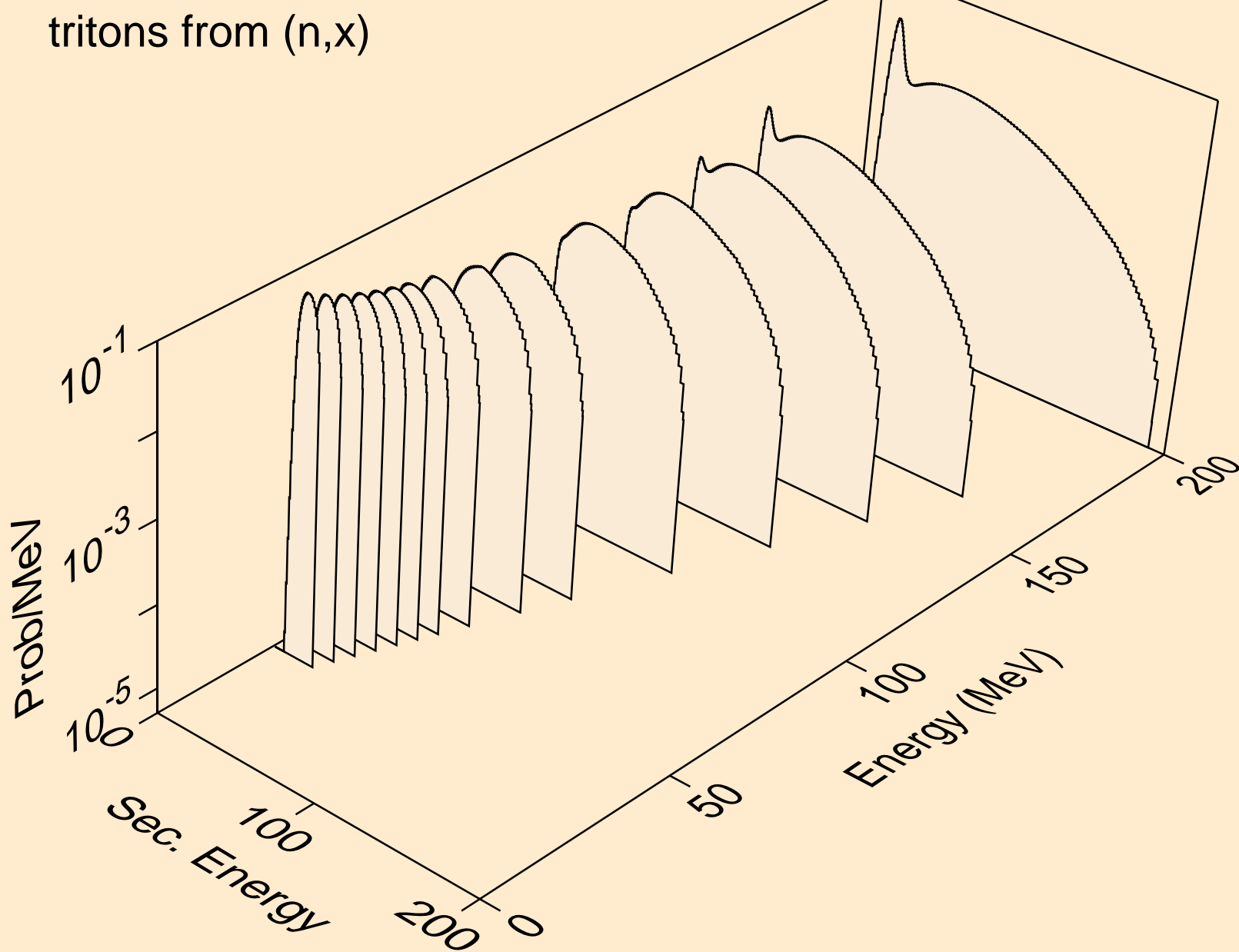

RA208 NEUTRON ACER TENDL-2023 LIBRARY; T=0.K
tritons from (n,n*)t

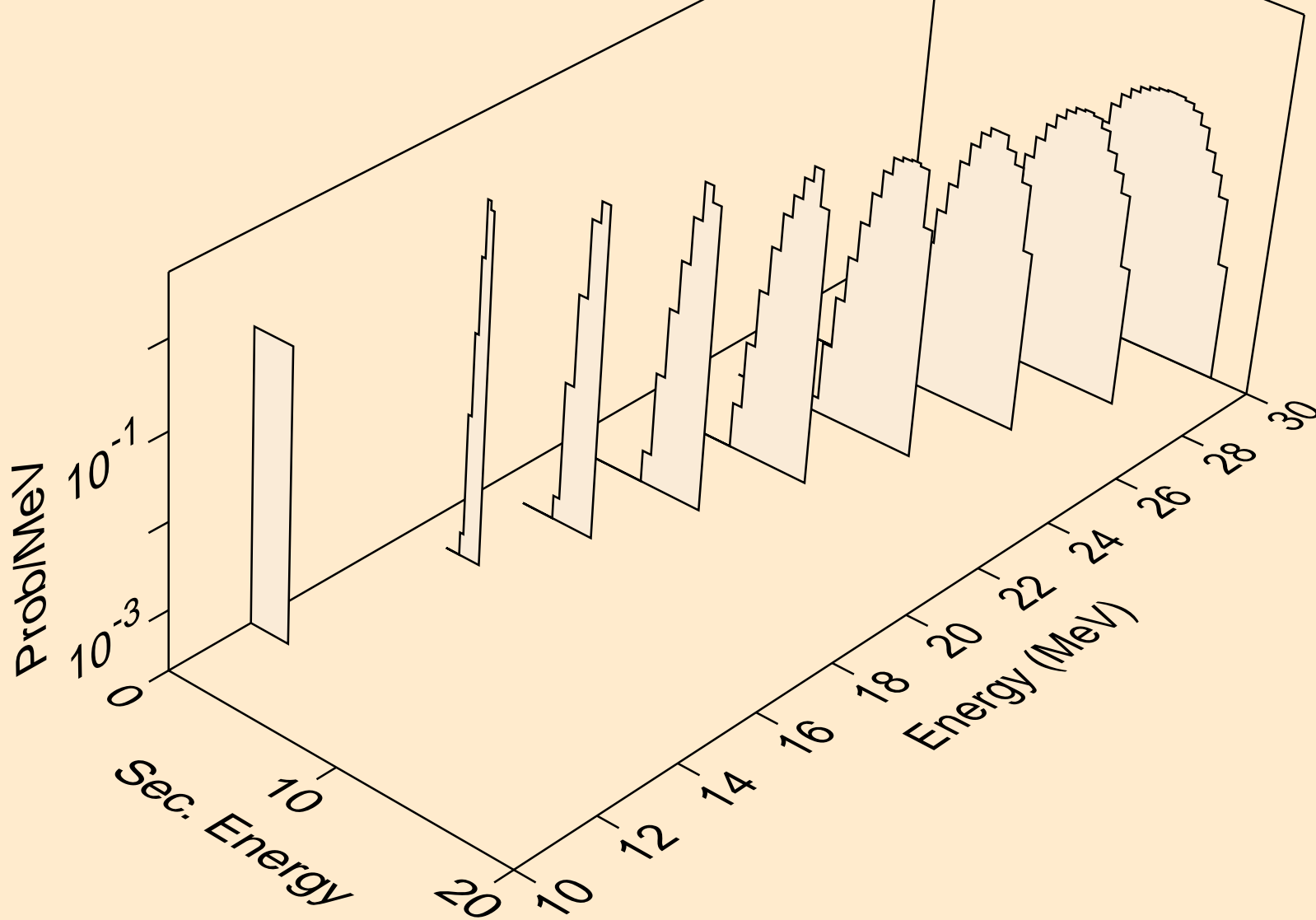

RA208 NEUTRON ACER TENDL-2023 LIBRARY; T=0.K
tritons from (n,t)

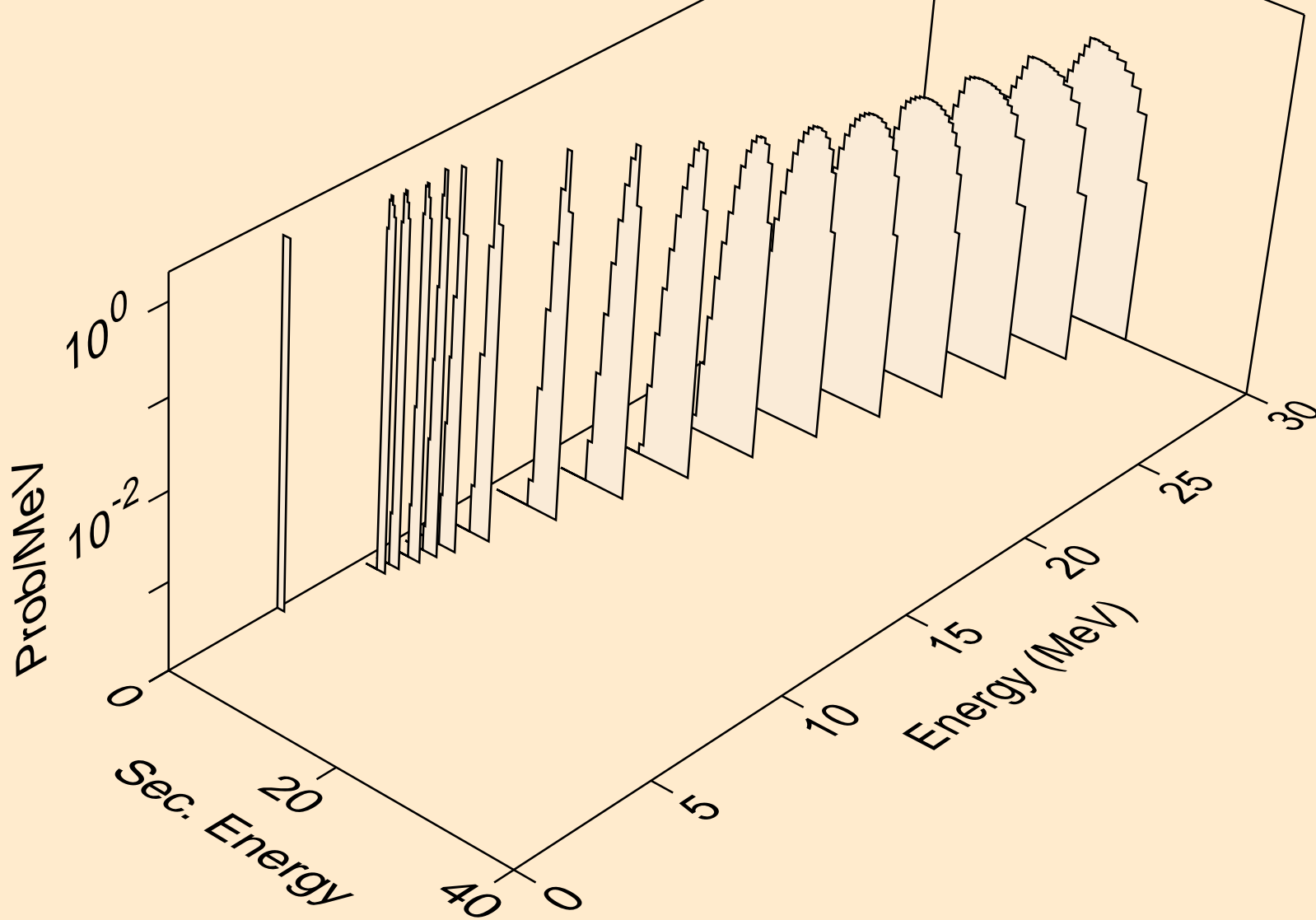

RA208 NEUTRON ACER TENDL-2023 LIBRARY; T=0.K
tritons from (n,pt)

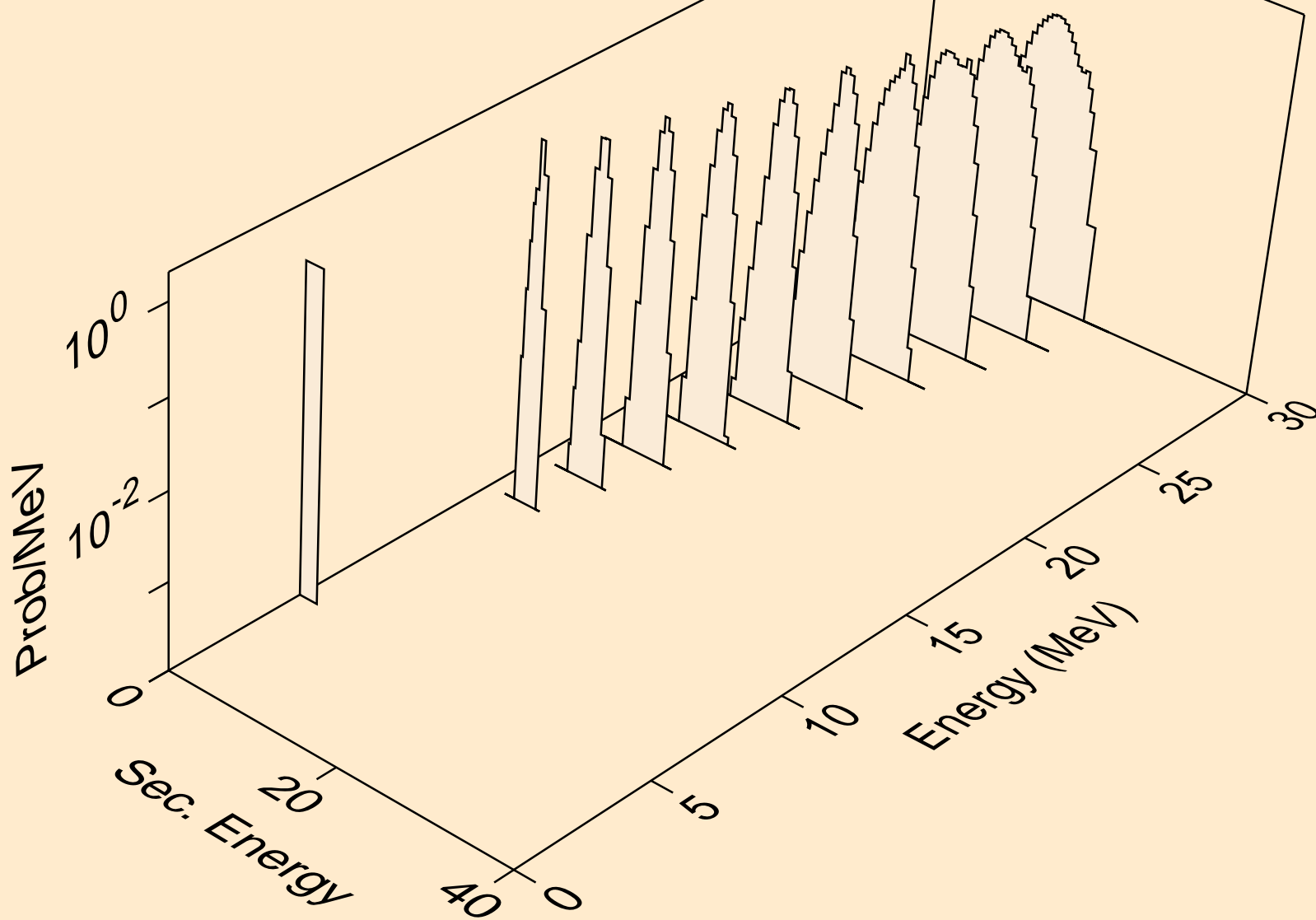

RA208 NEUTRON ACER TENDL-2023 LIBRARY; T=0.K
he3s from (n,x)

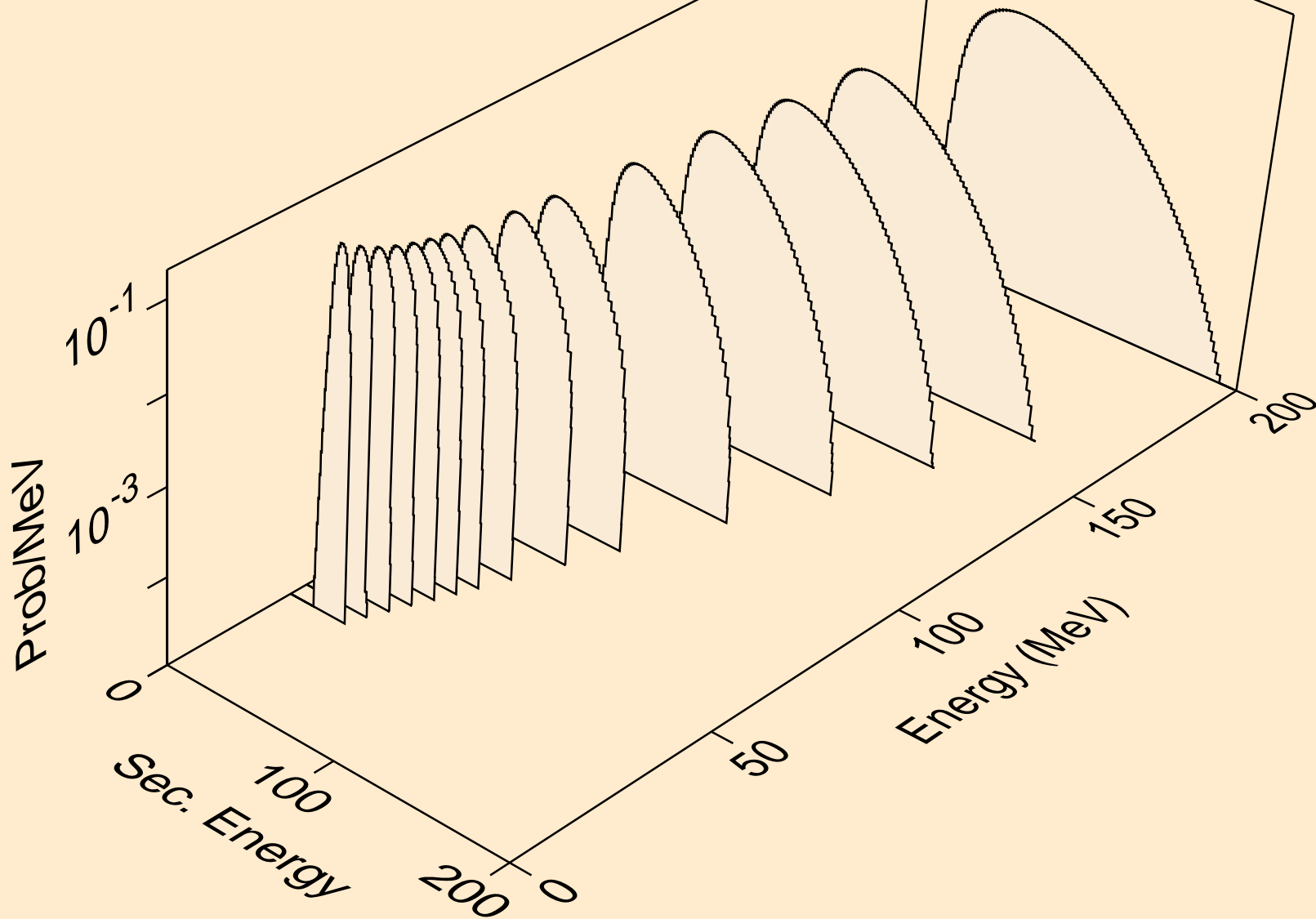

RA208 NEUTRON ACER TENDL-2023 LIBRARY; T=0.K
he3s from (n,n*)he3

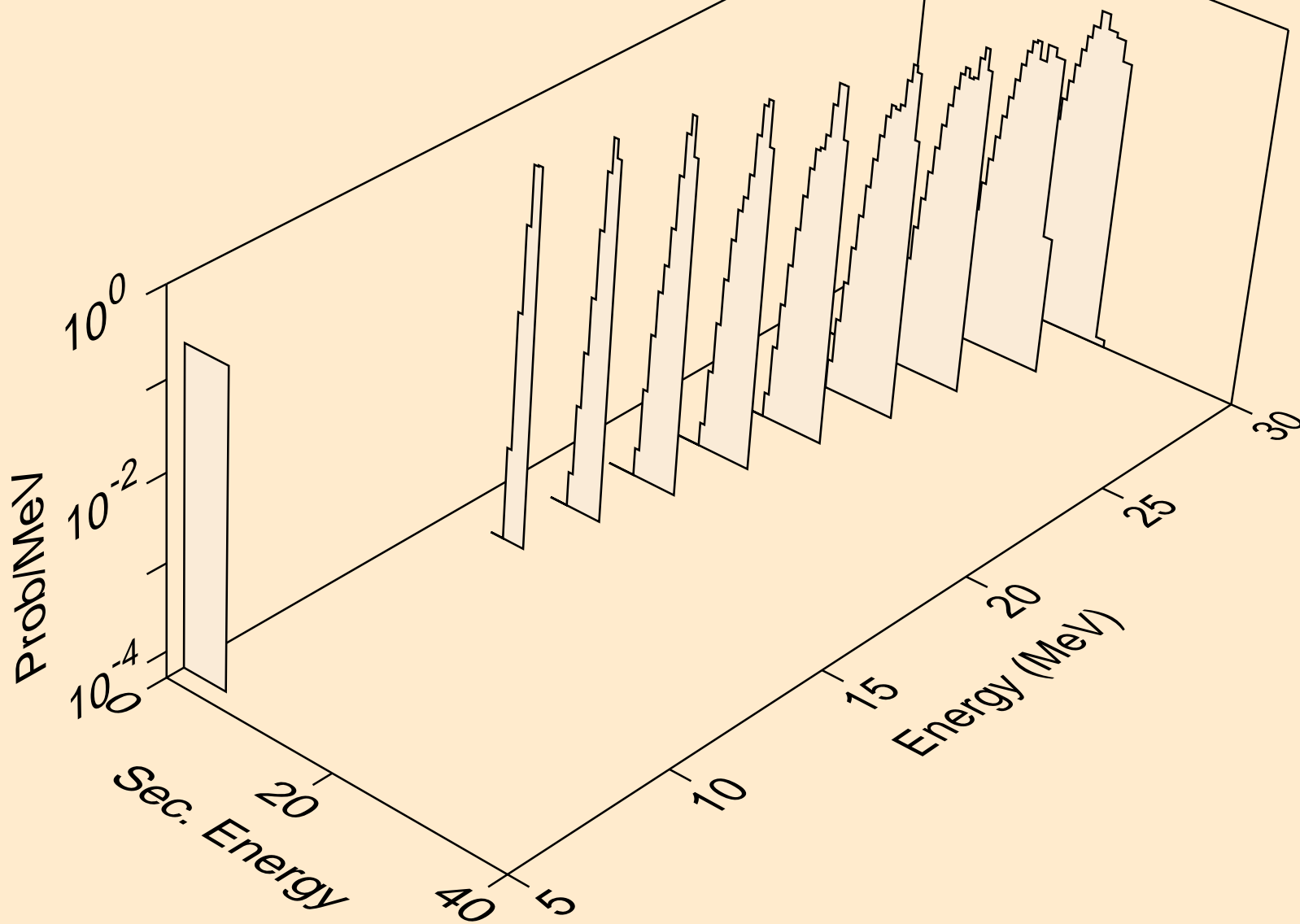

RA208 NEUTRON ACER TENDL-2023 LIBRARY; T=0.K
he3s from (n,he3)

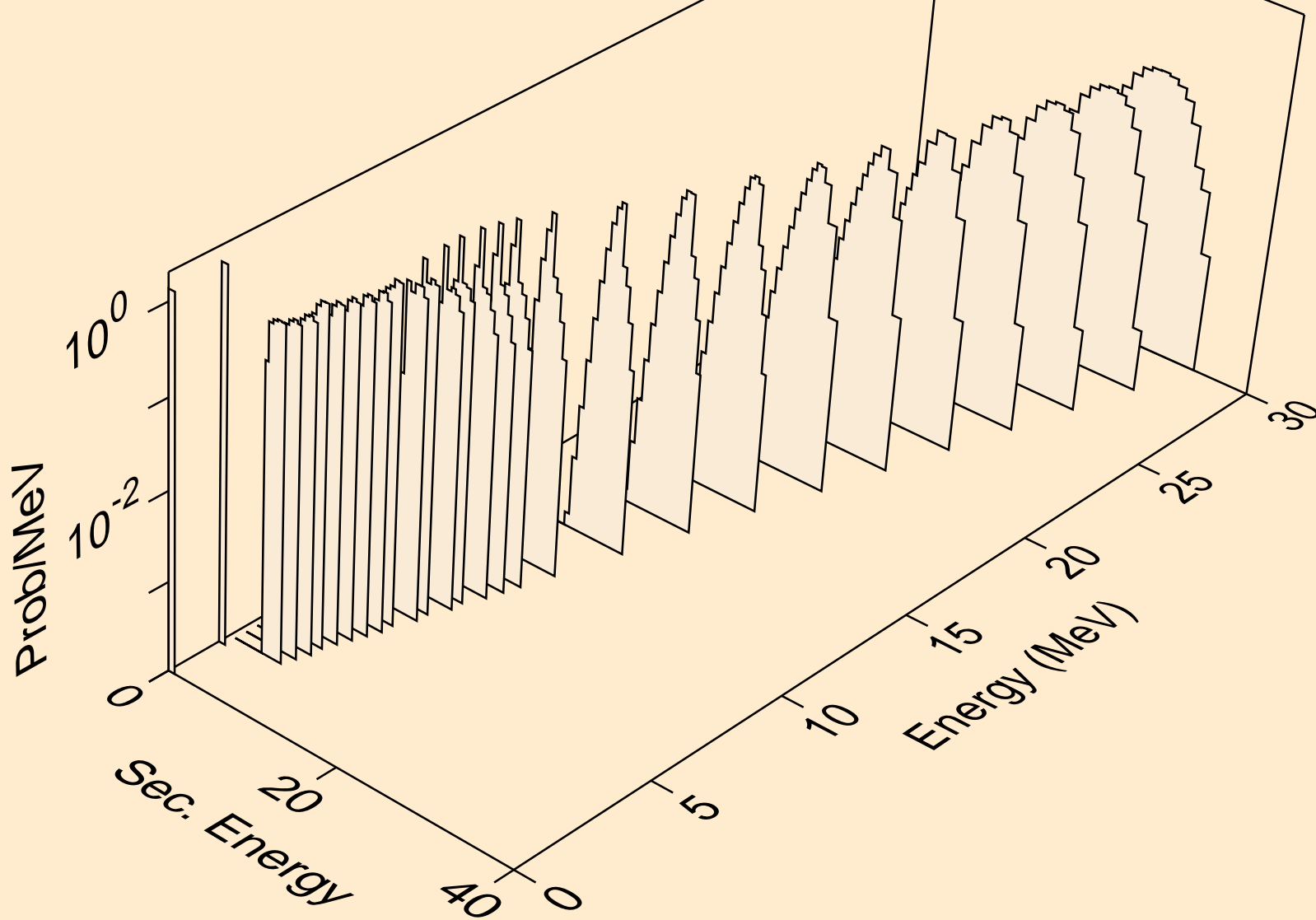

RA208 NEUTRON ACER TENDL-2023 LIBRARY; T=0.K
alphas from (n,x)

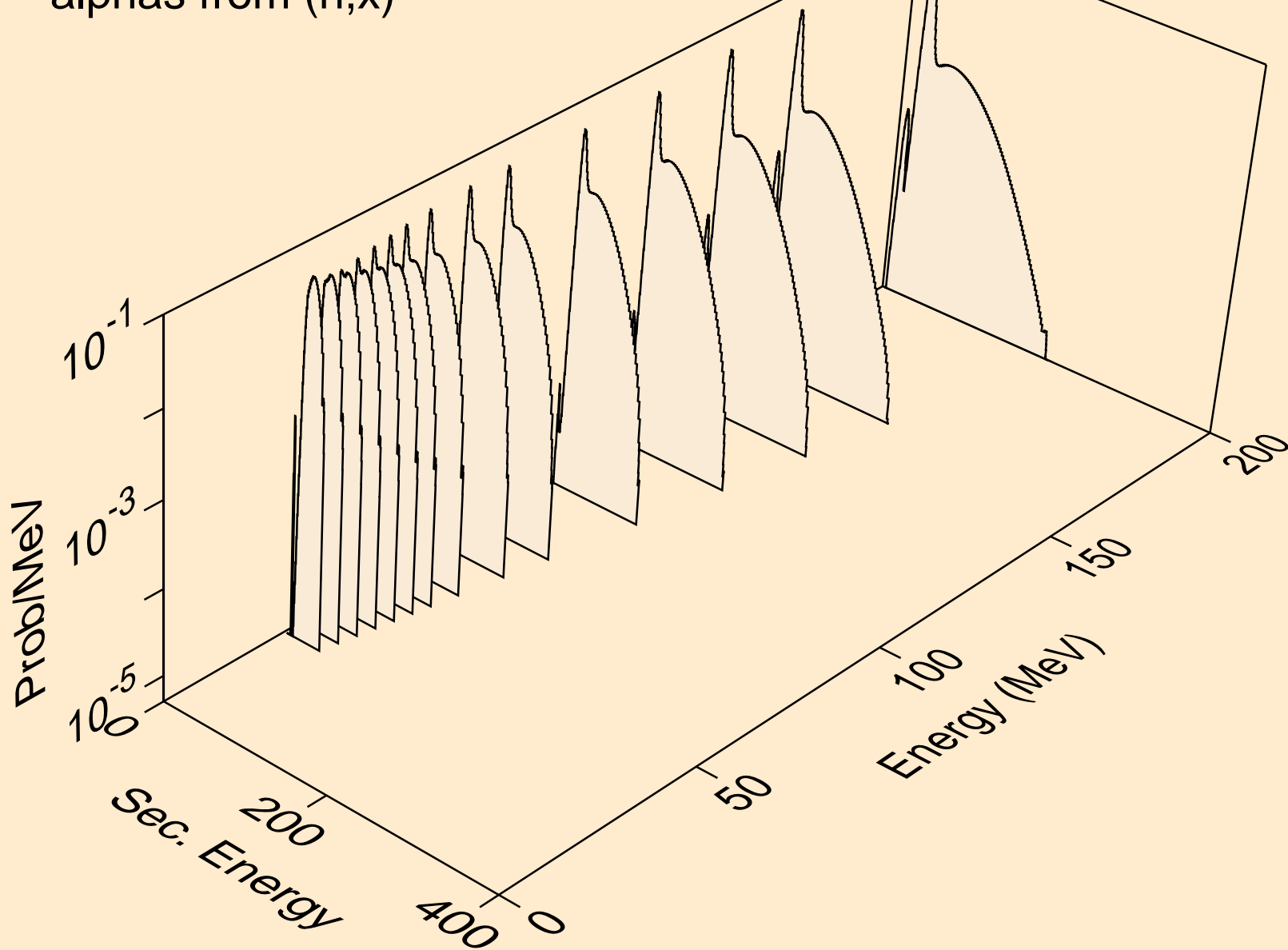

RA208 NEUTRON ACER TENDL-2023 LIBRARY; T=0.K
alphas from (n,n*)a

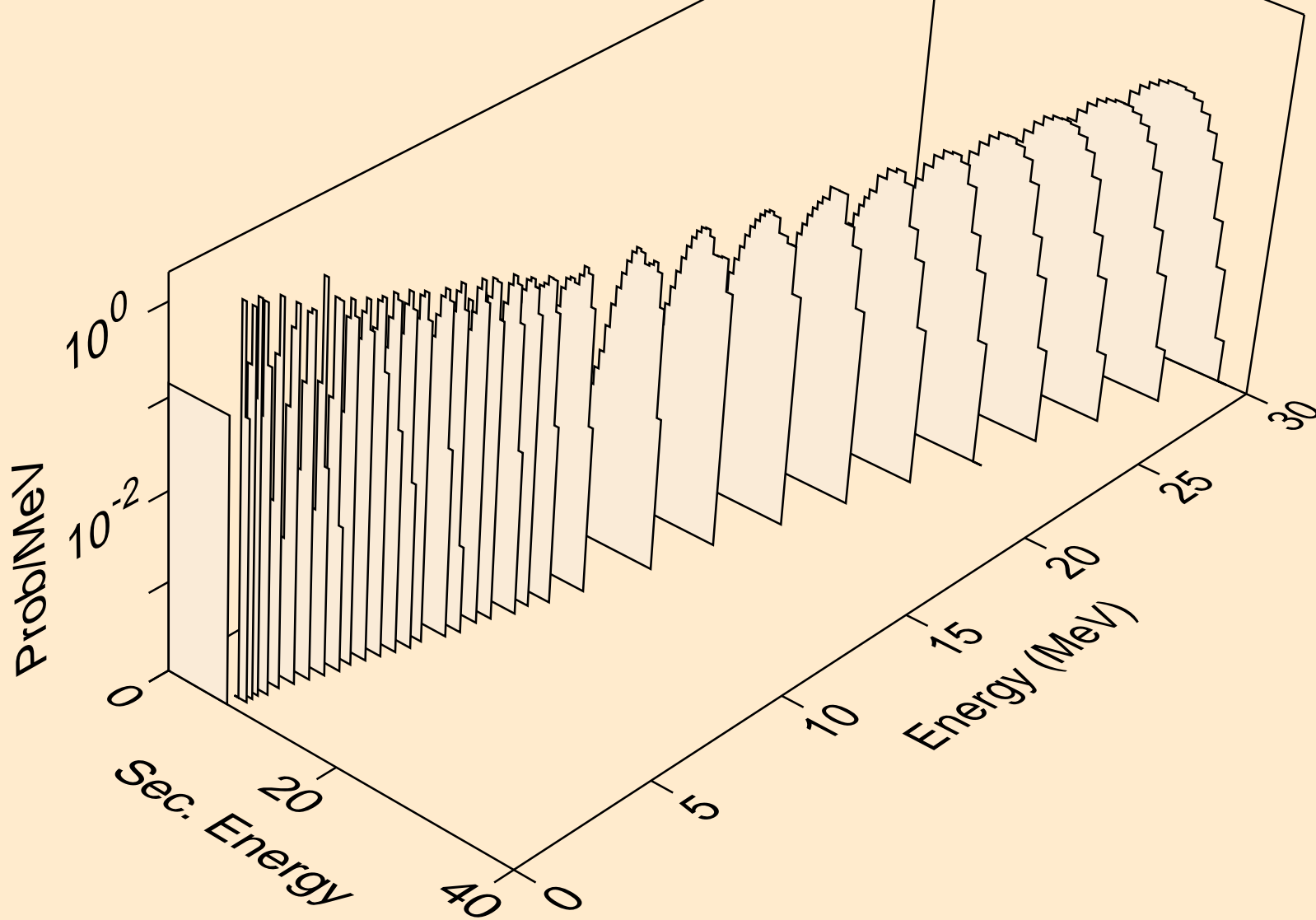

RA208 NEUTRON ACER TENDL-2023 LIBRARY; T=0.K
alphas from (n,2n)a

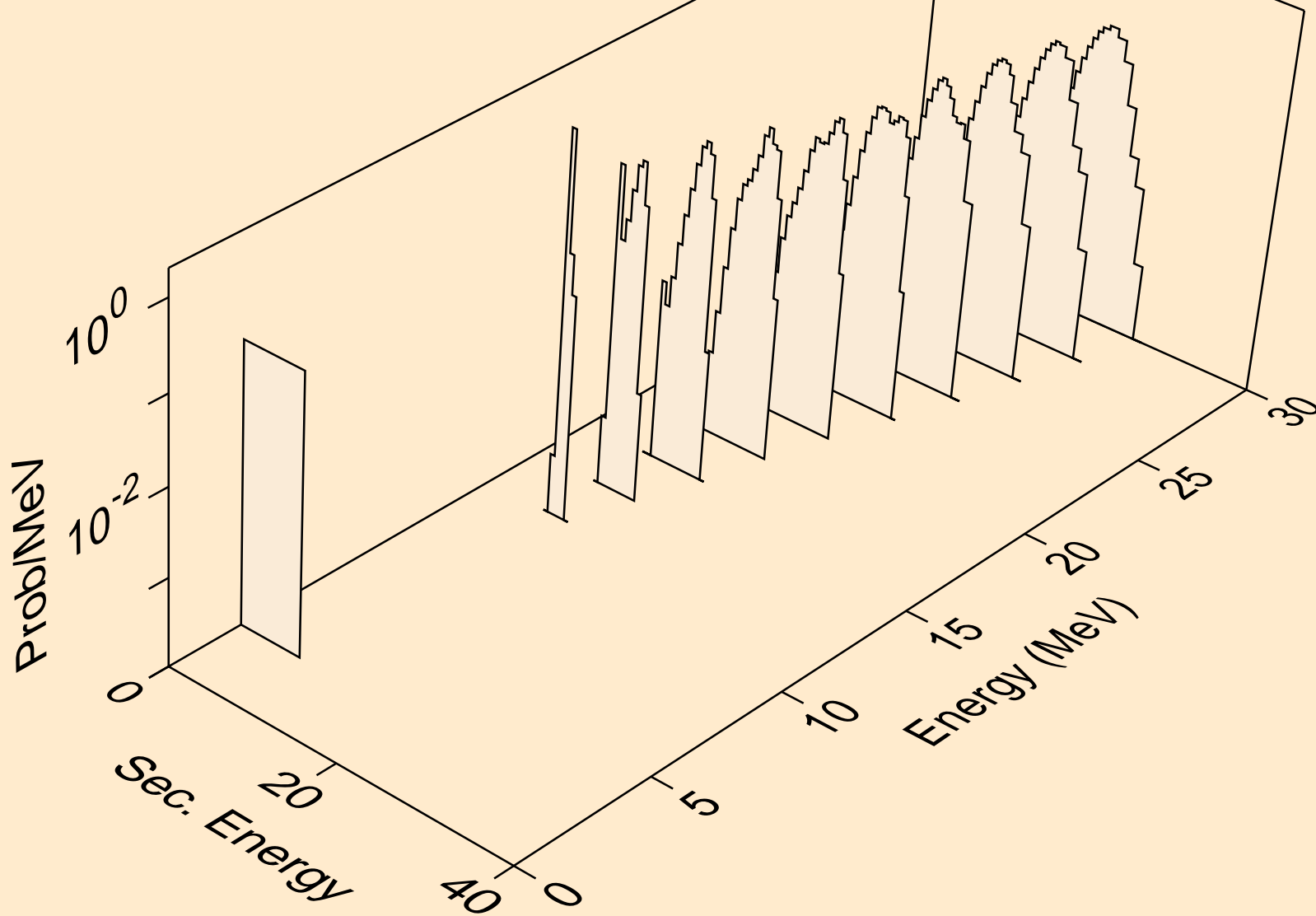

RA208 NEUTRON ACER TENDL-2023 LIBRARY; T=0.K
alphas from (n,3n)a

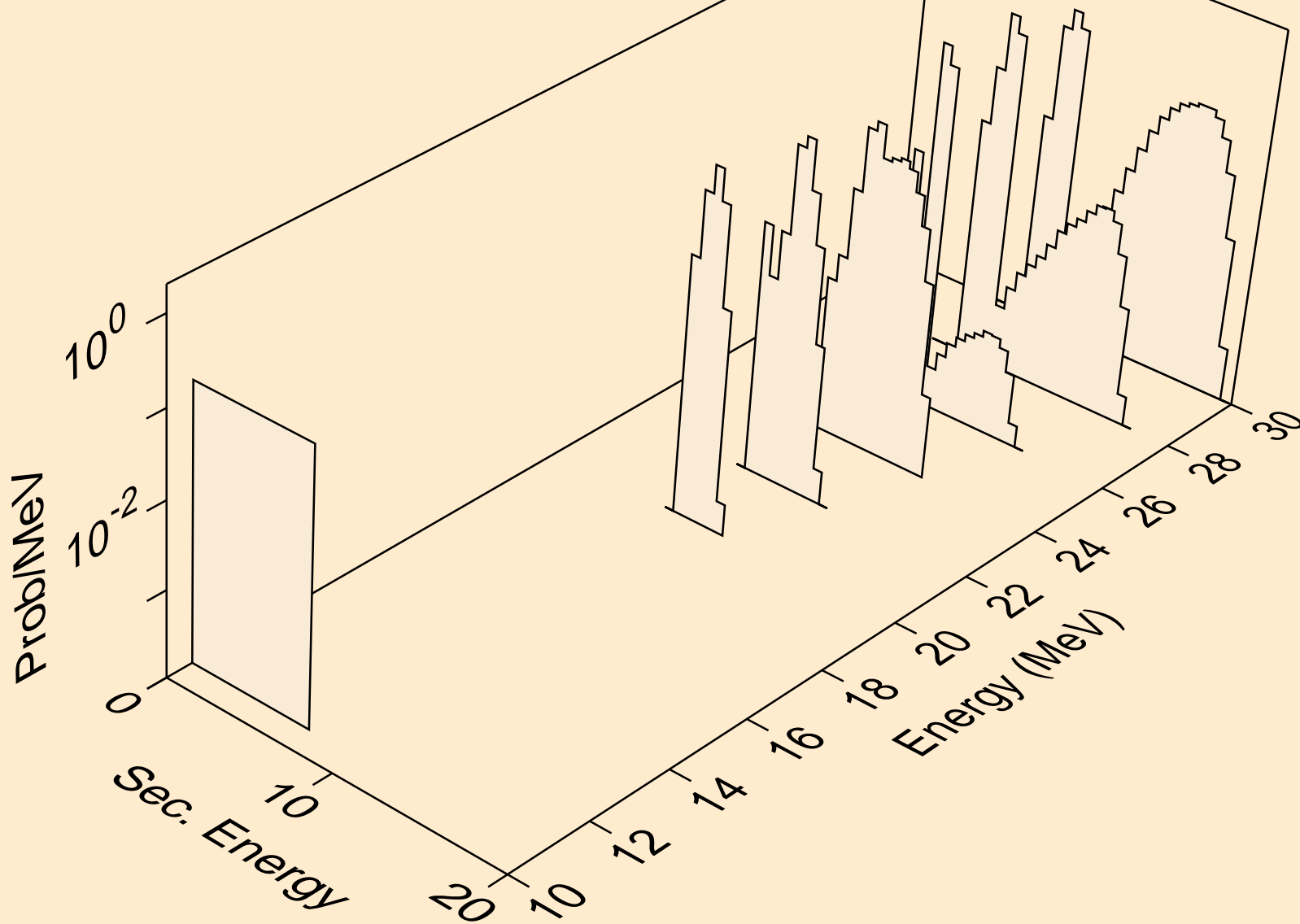

RA208 NEUTRON ACER TENDL-2023 LIBRARY; T=0.K
alphas from (n,n*)2a

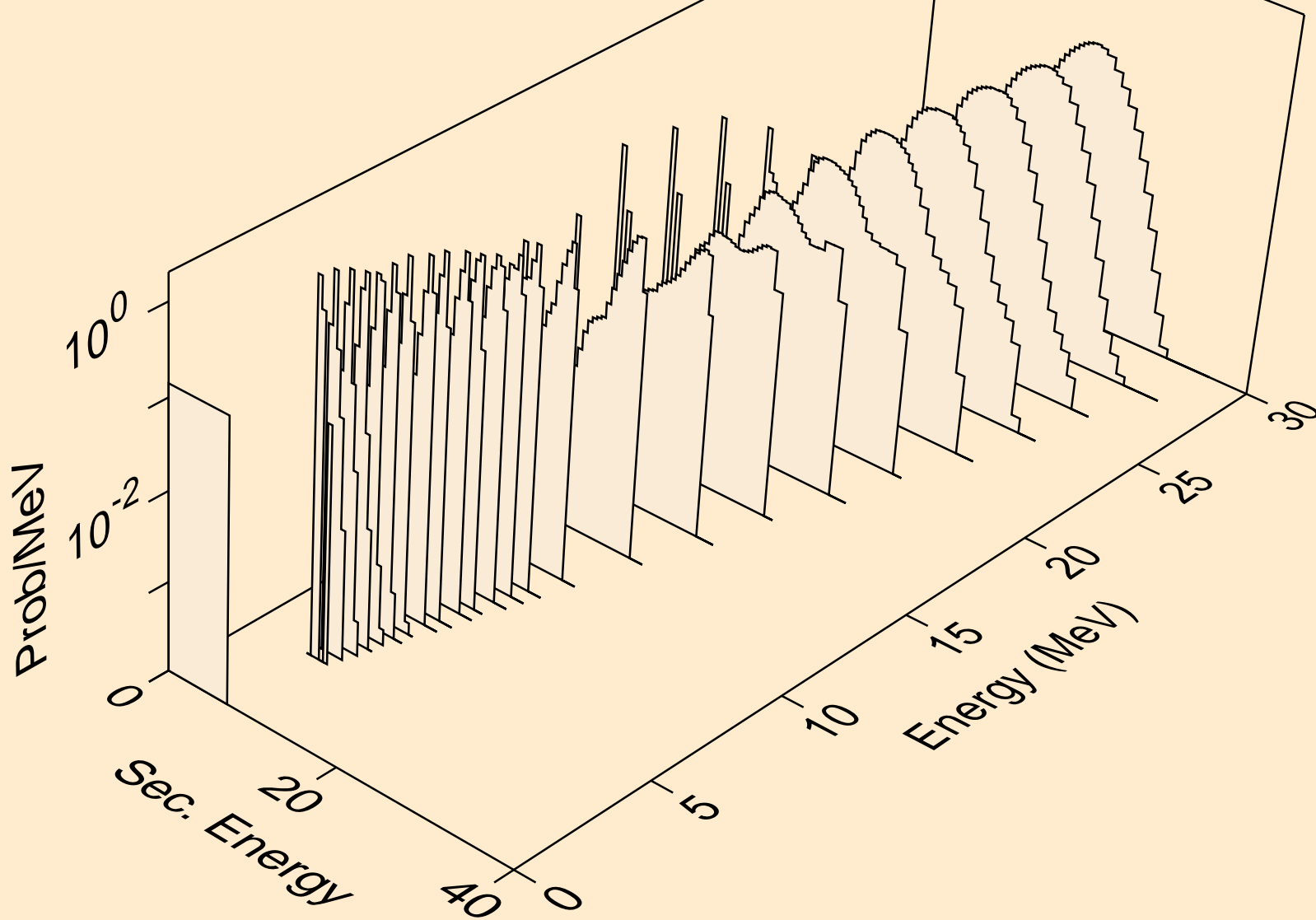

RA208 NEUTRON ACER TENDL-2023 LIBRARY; T=0.K
alphas from (n,2n)2a

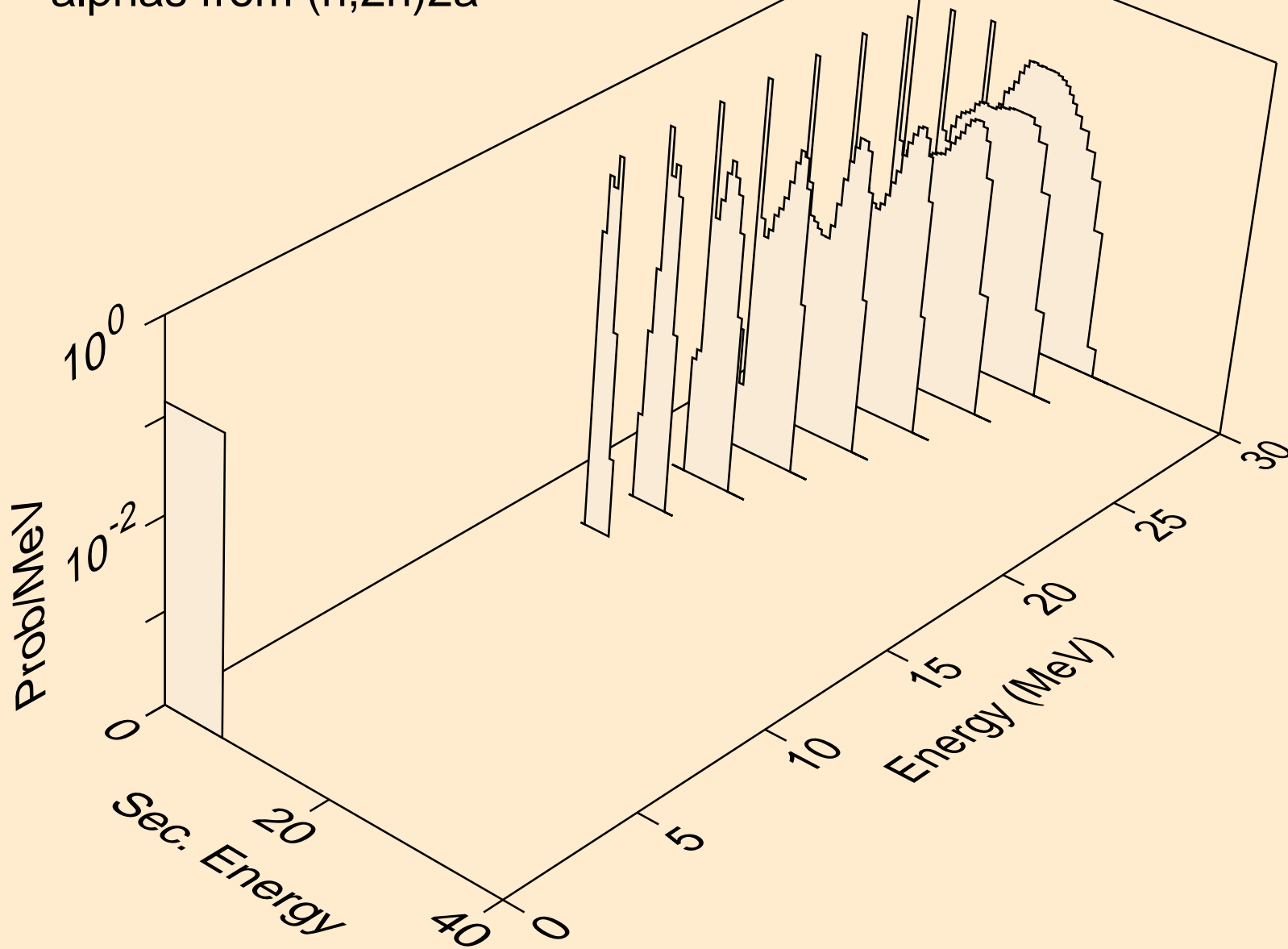

RA208 NEUTRON ACER TENDL-2023 LIBRARY; T=0.K
alphas from (n,npa)

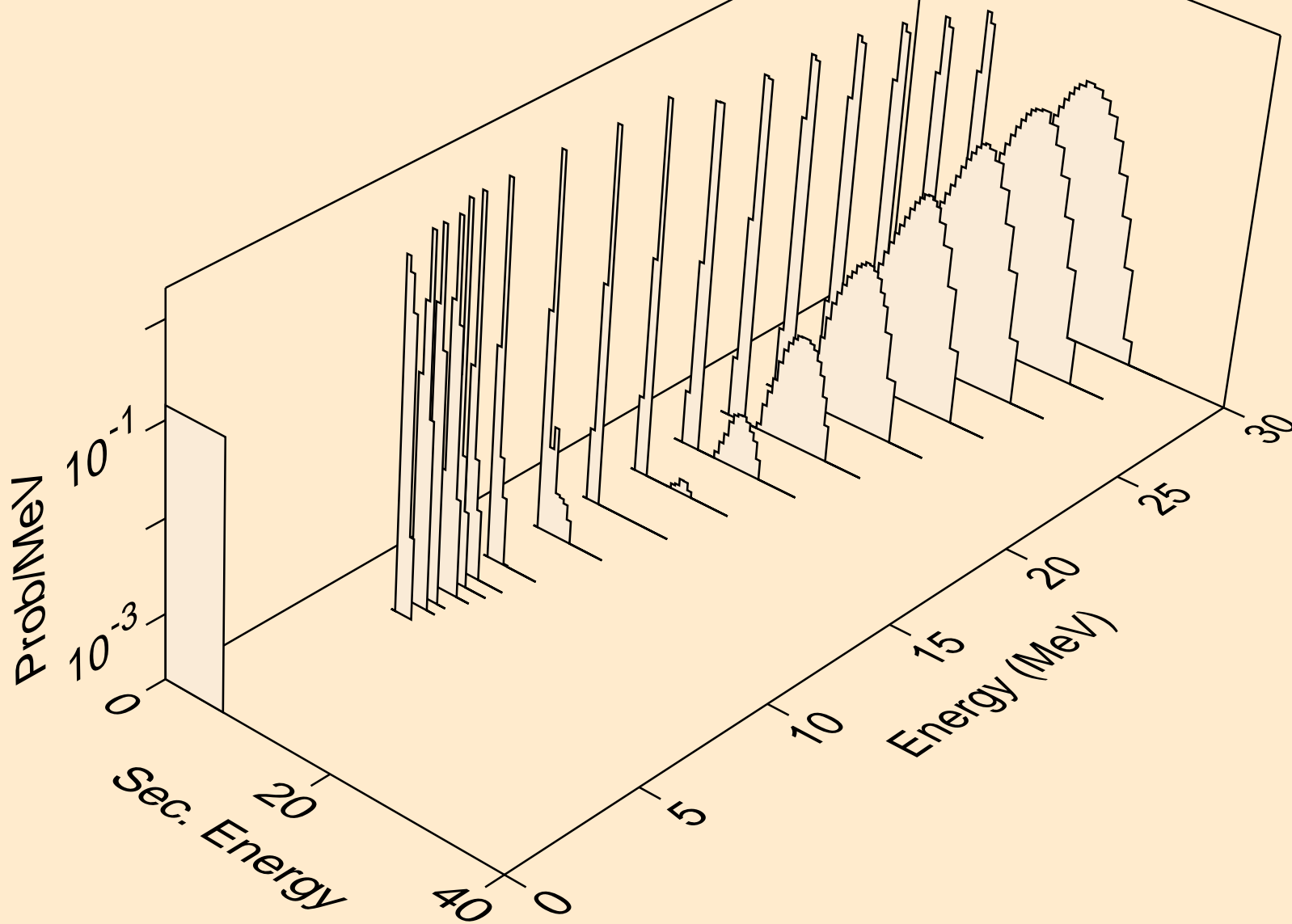

RA208 NEUTRON ACER TENDL-2023 LIBRARY; T=0.K
alphas from (n,a)

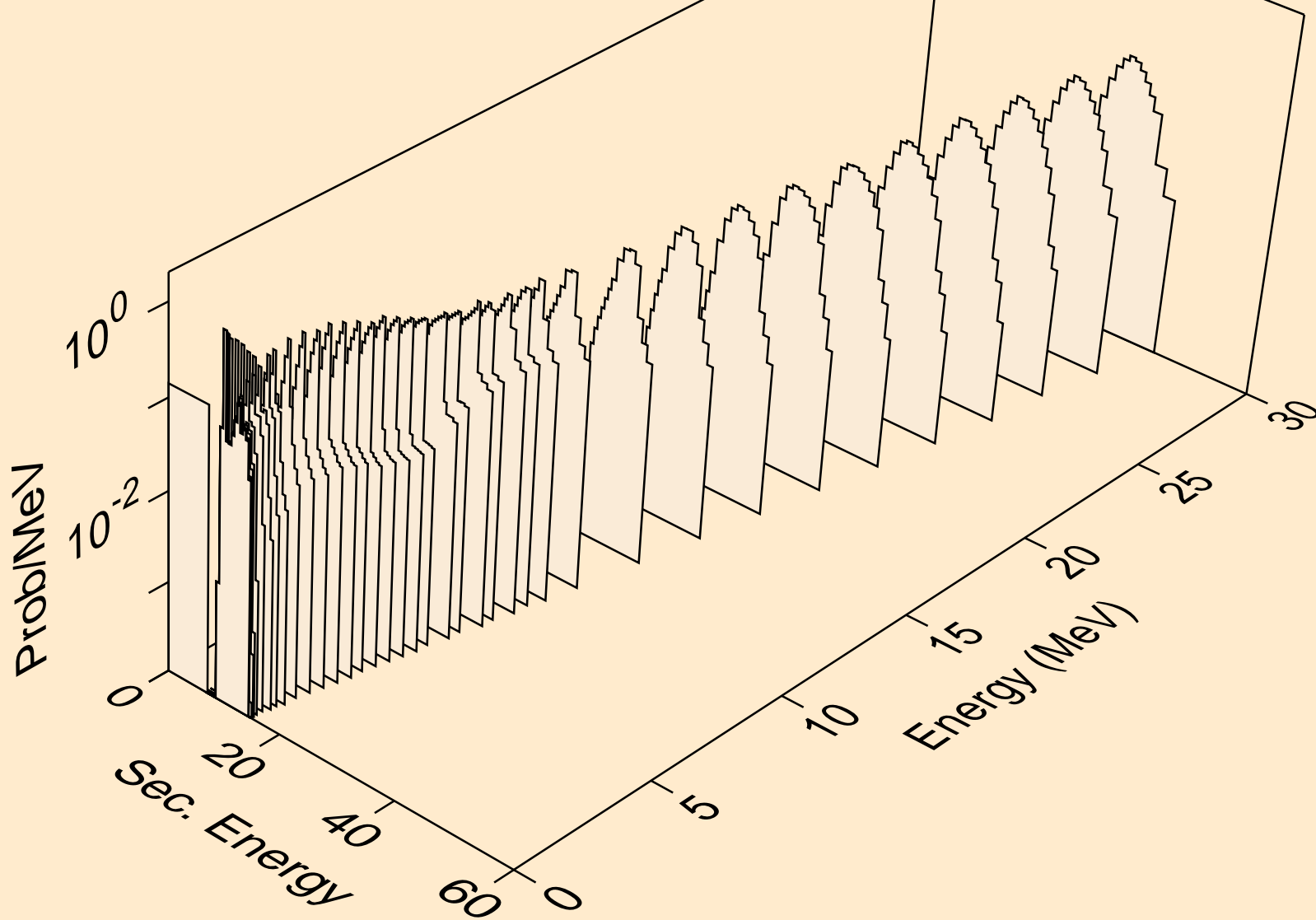

RA208 NEUTRON ACER TENDL-2023 LIBRARY; T=0.K
alphas from (n,2a)

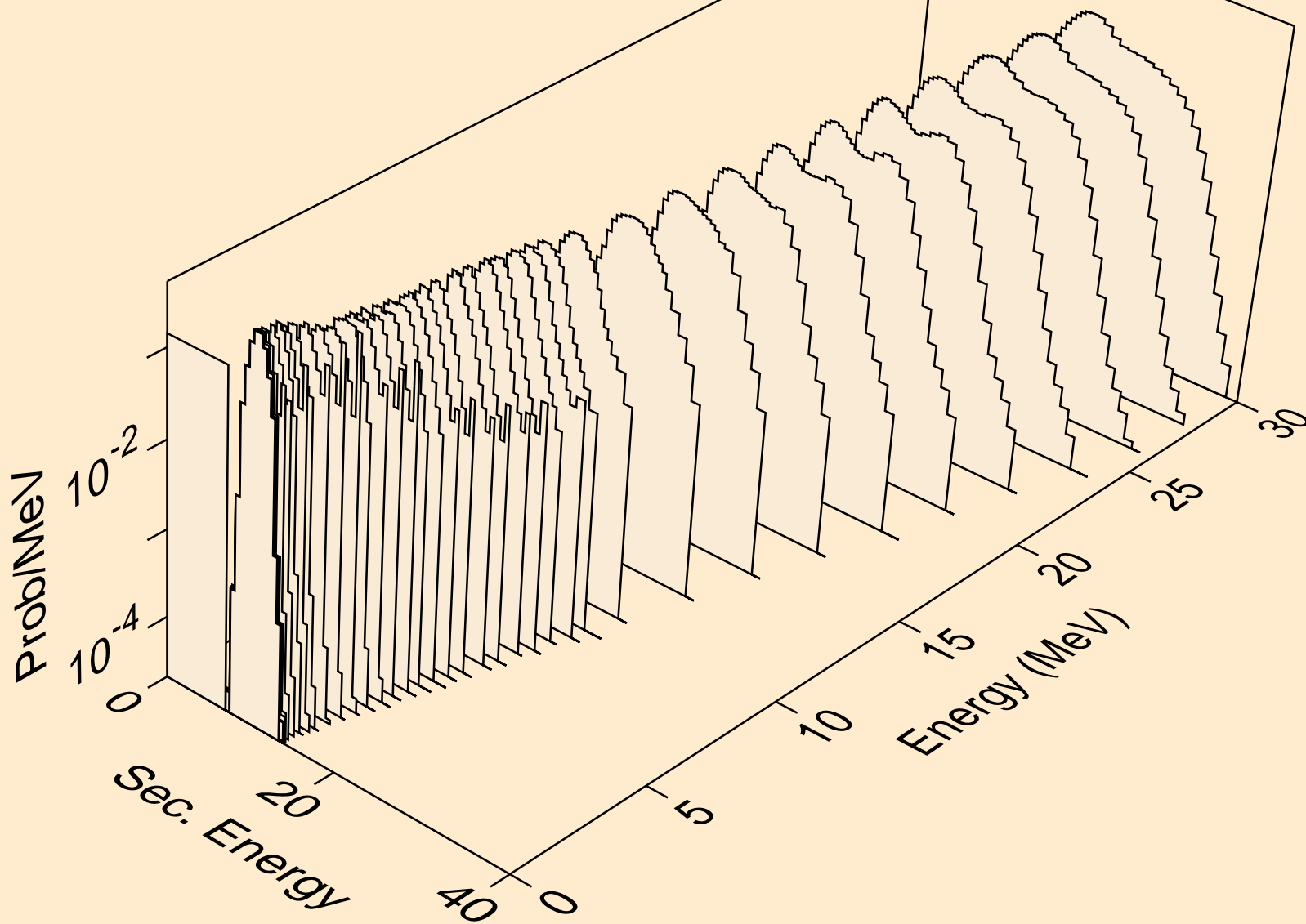

RA208 NEUTRON ACER TENDL-2023 LIBRARY; T=0.K
alphas from (n,pa)

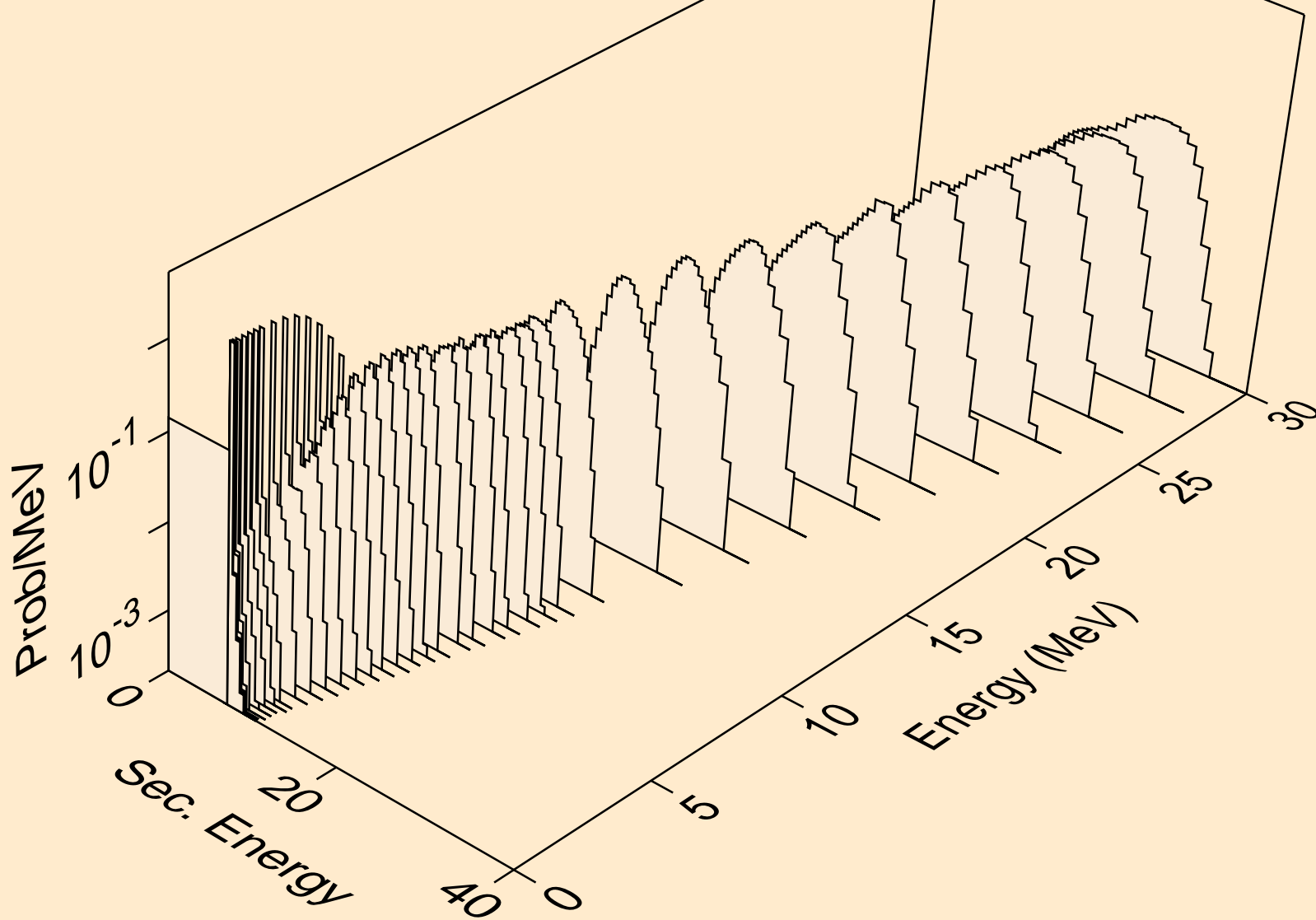

RA208 NEUTRON ACER TENDL-2023 LIBRARY; T=0.K
alphas from (n,da)

