

# RA228 NEUTRON ACER TENDL-2023 LIBRARY; T=0.K

## Principal cross sections

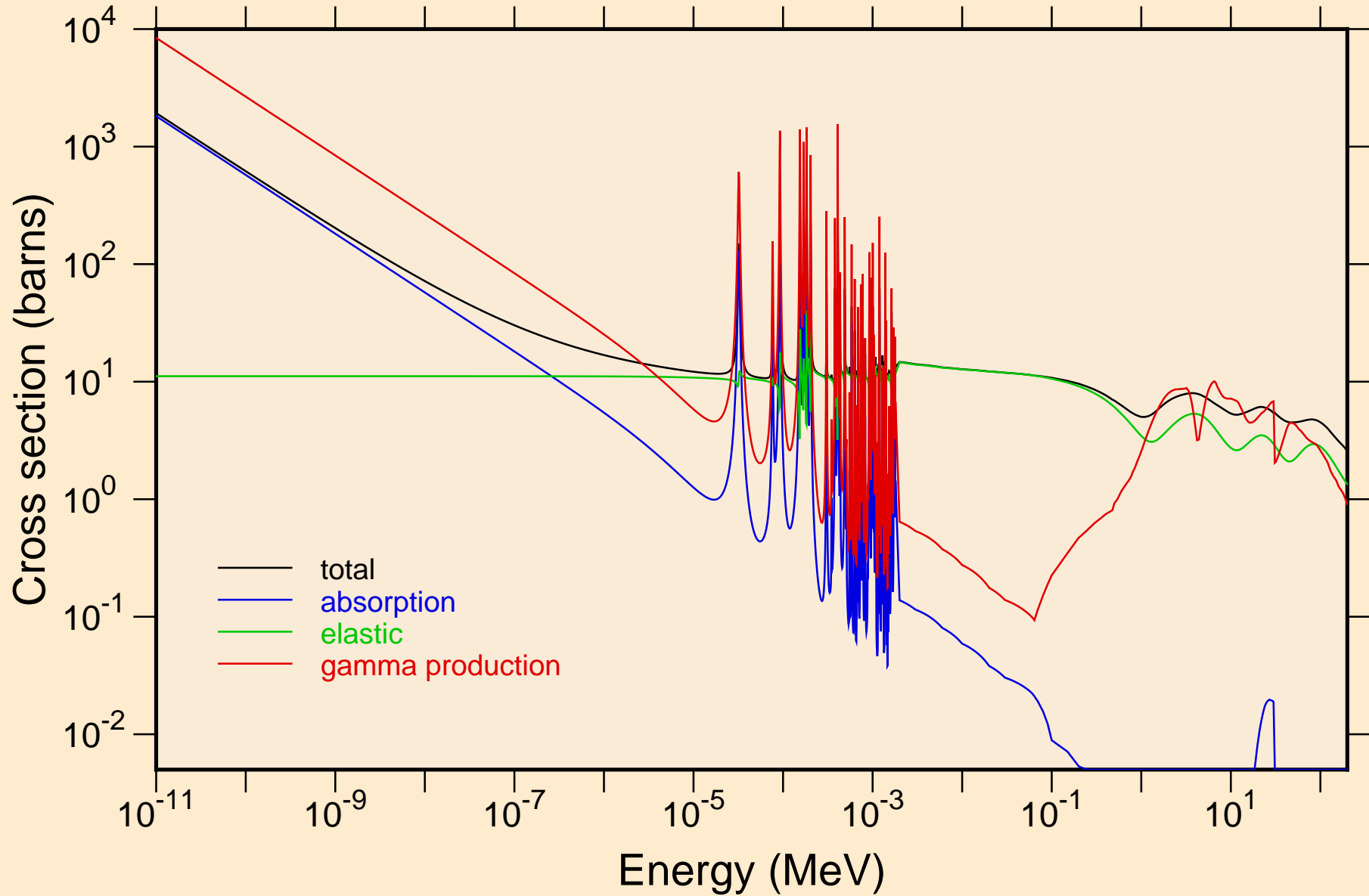

RA228 NEUTRON ACER TENDL-2023 LIBRARY; T=0.K  
resonance total cross section

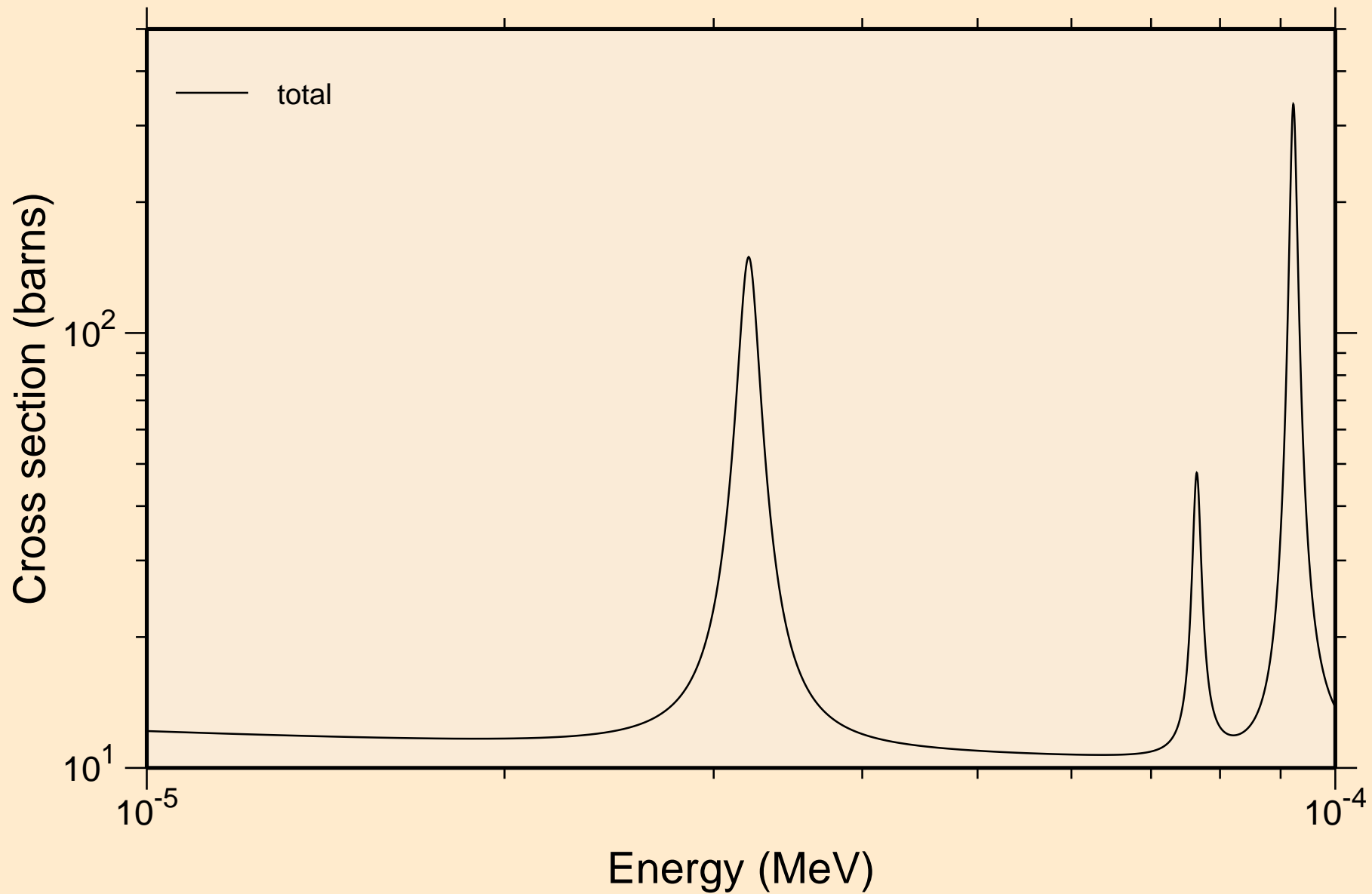

RA228 NEUTRON ACER TENDL-2023 LIBRARY; T=0.K  
resonance total cross section

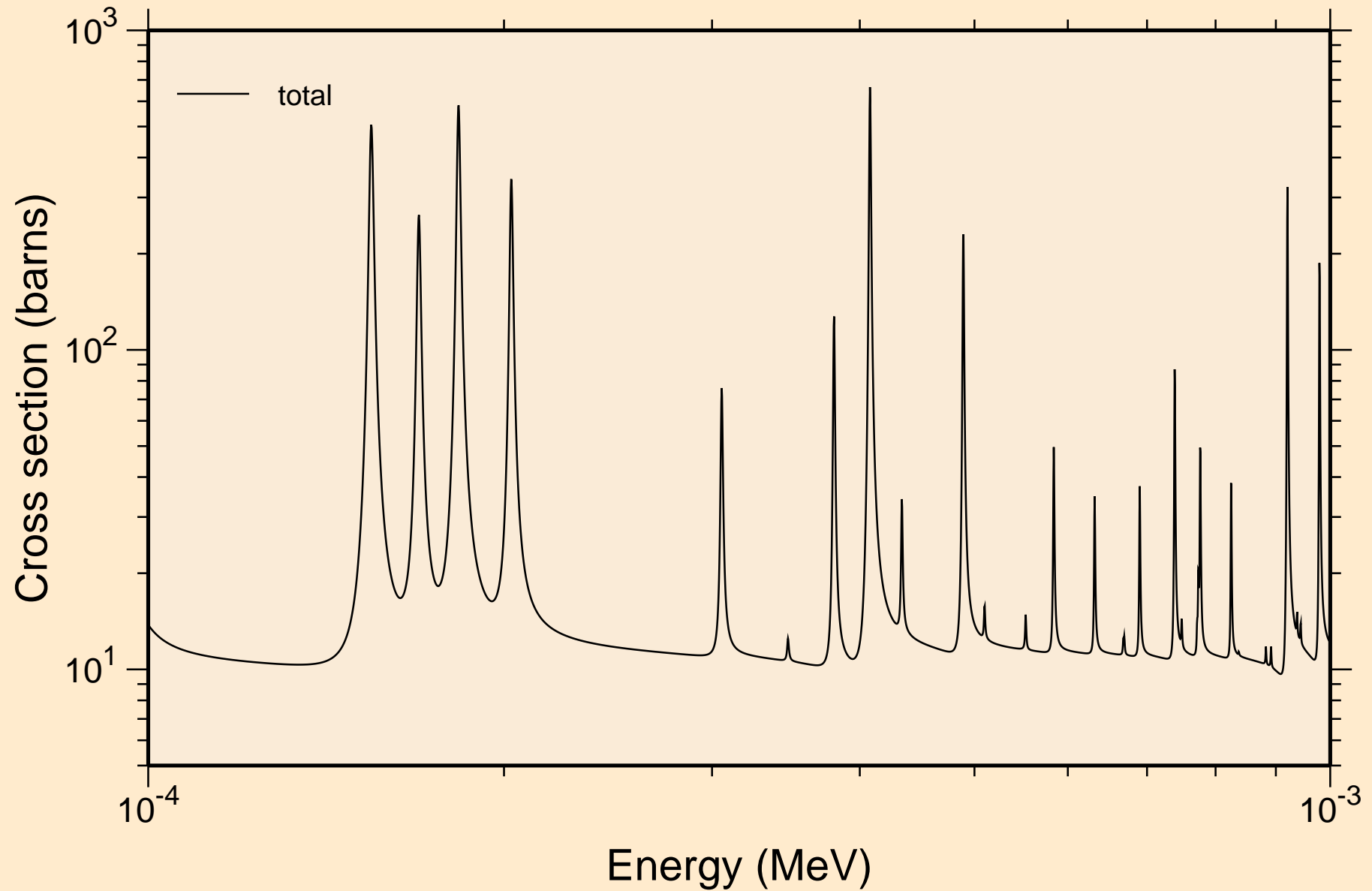

RA228 NEUTRON ACER TENDL-2023 LIBRARY; T=0.K  
resonance total cross section

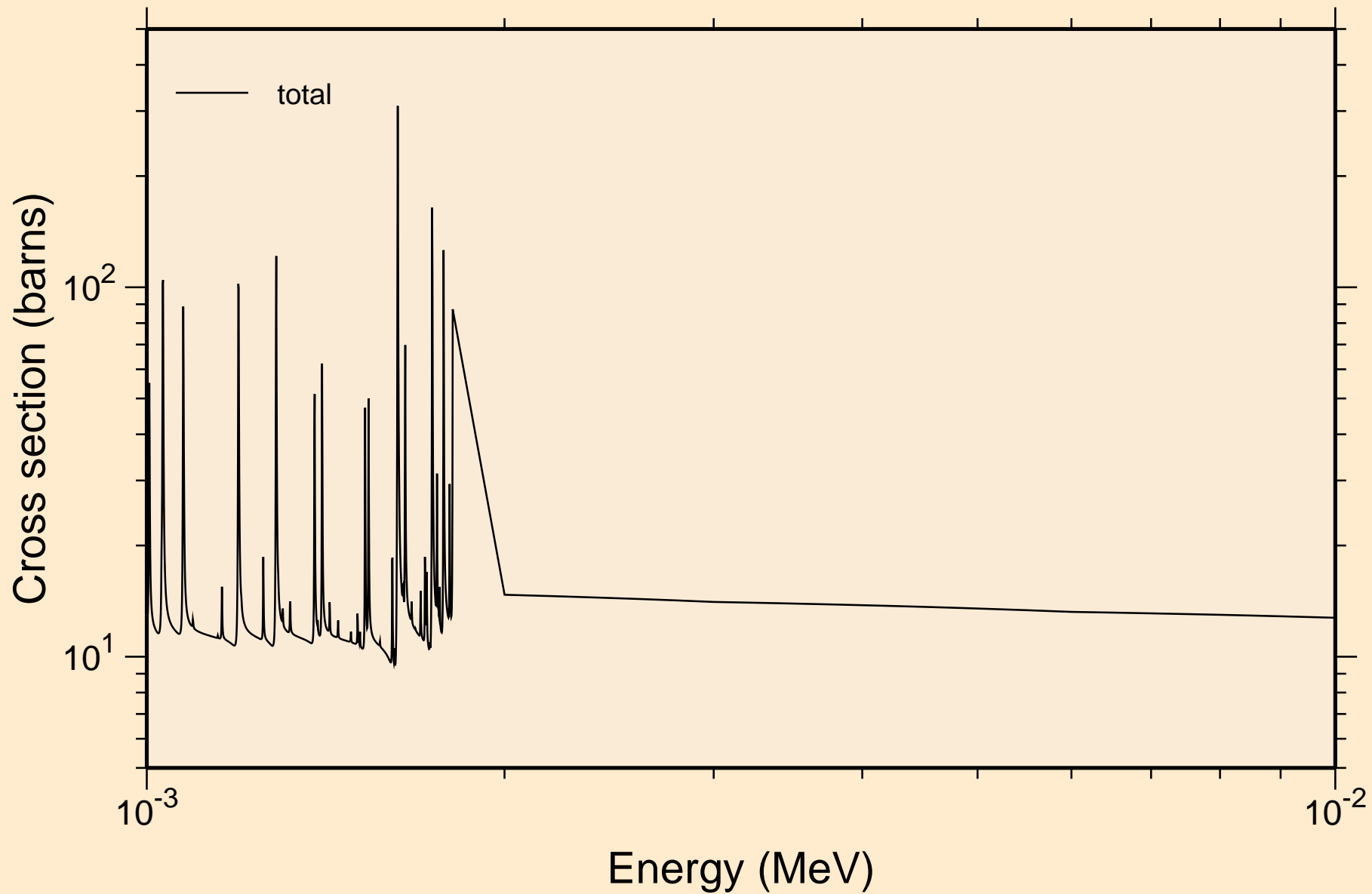

RA228 NEUTRON ACER TENDL-2023 LIBRARY; T=0.K  
resonance total cross section

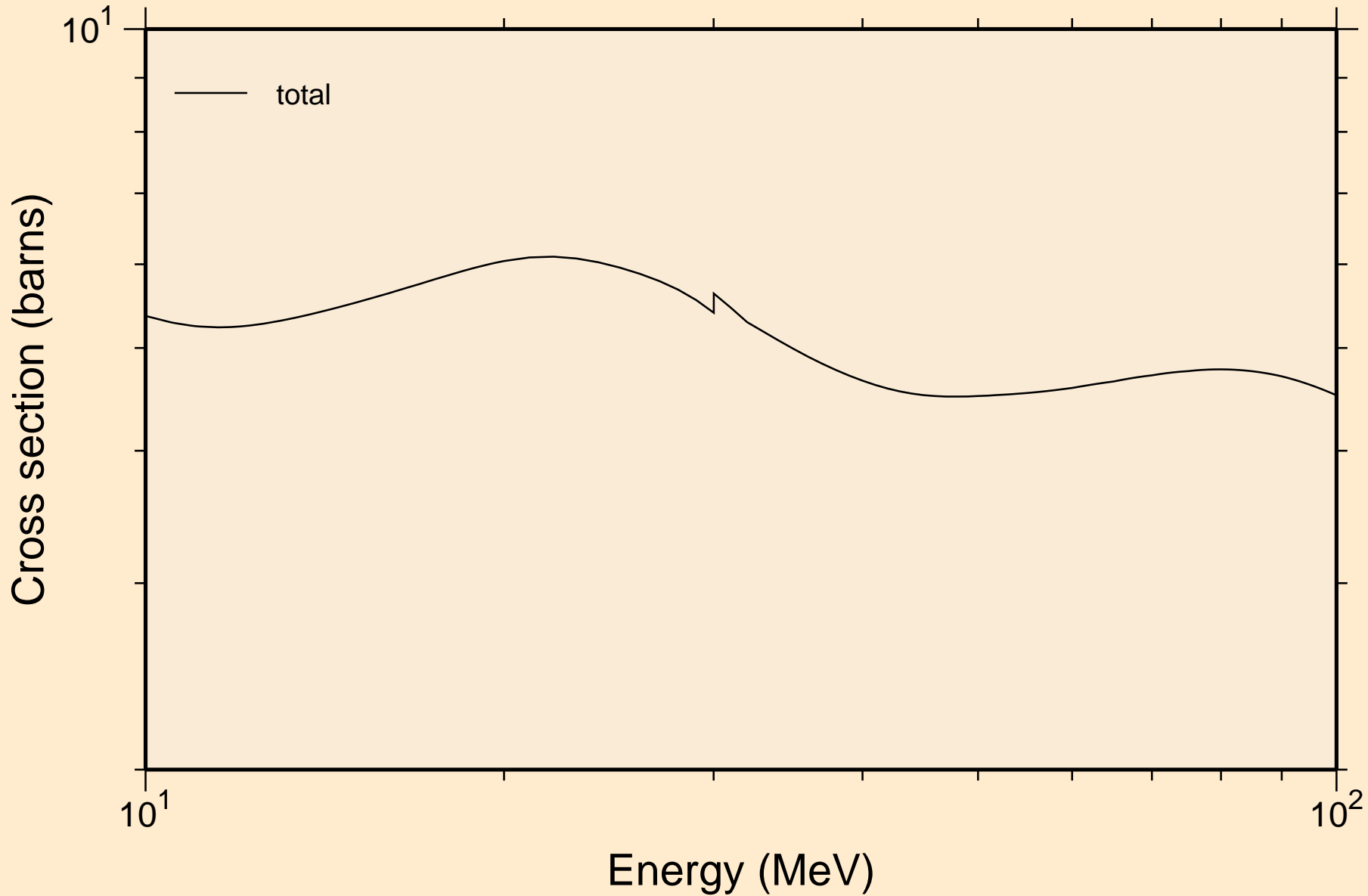

RA228 NEUTRON ACER TENDL-2023 LIBRARY; T=0.K  
resonance absorption cross sections

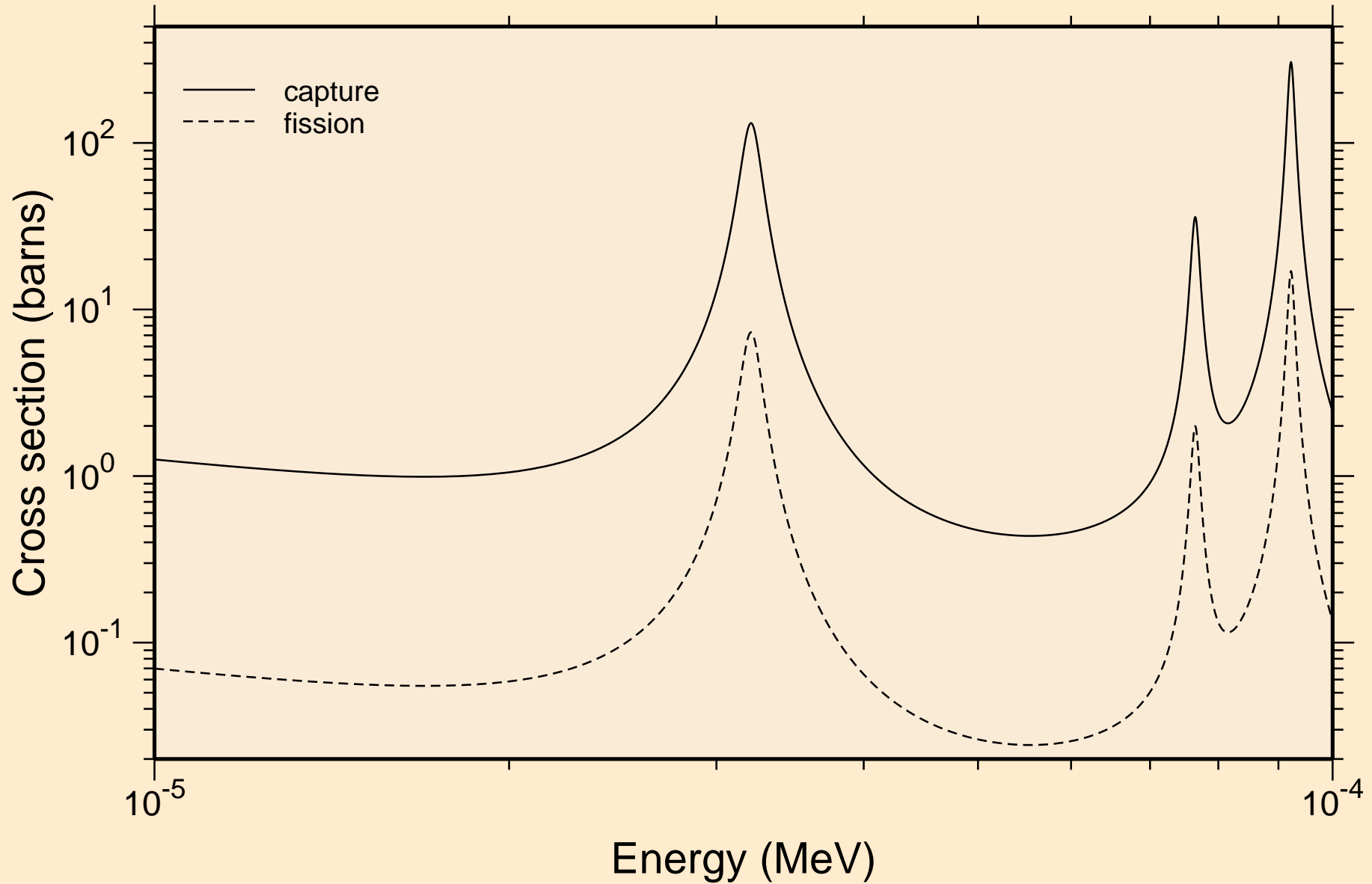

RA228 NEUTRON ACER TENDL-2023 LIBRARY; T=0.K  
resonance absorption cross sections

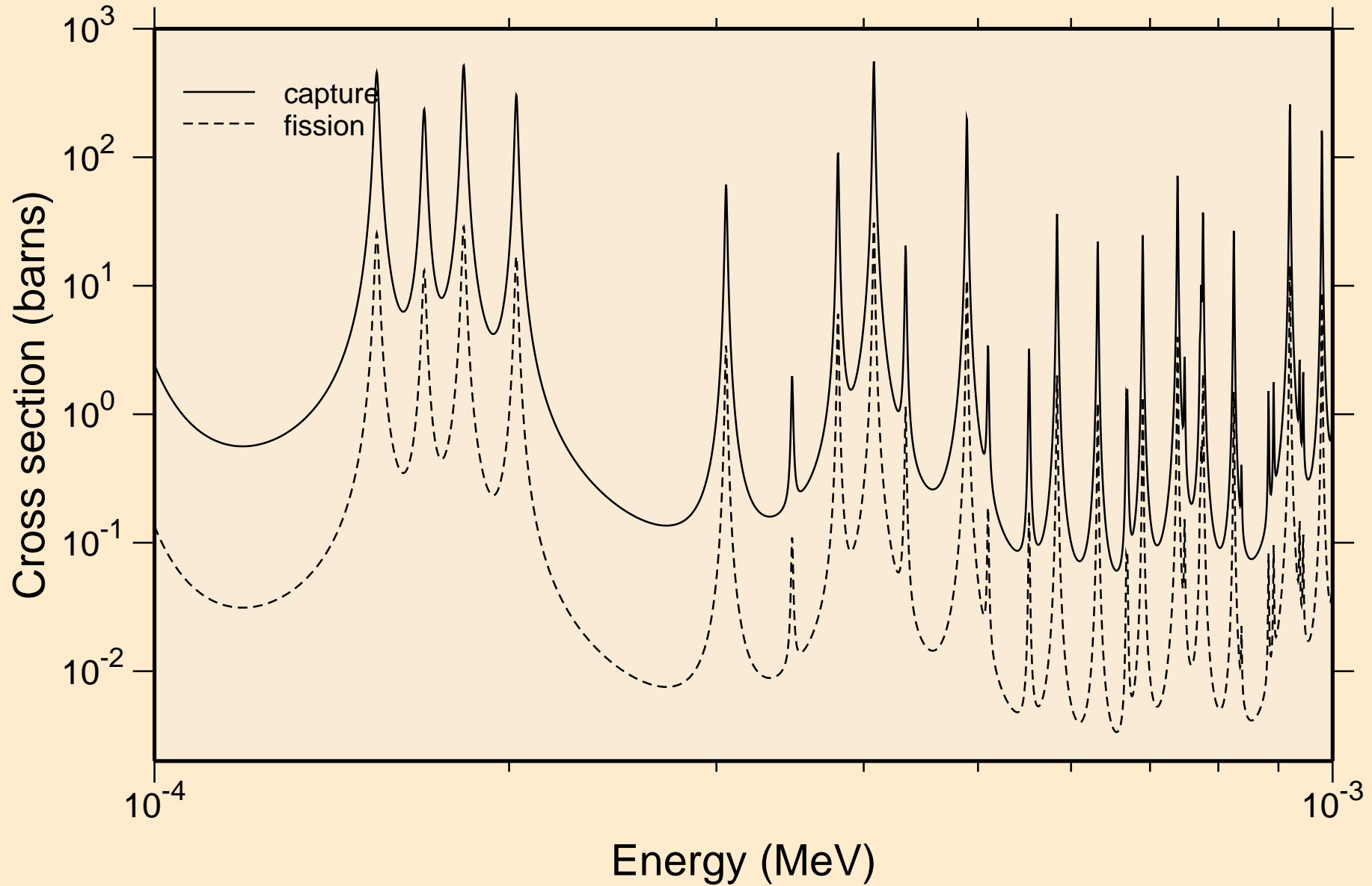

RA228 NEUTRON ACER TENDL-2023 LIBRARY; T=0.K  
resonance absorption cross sections

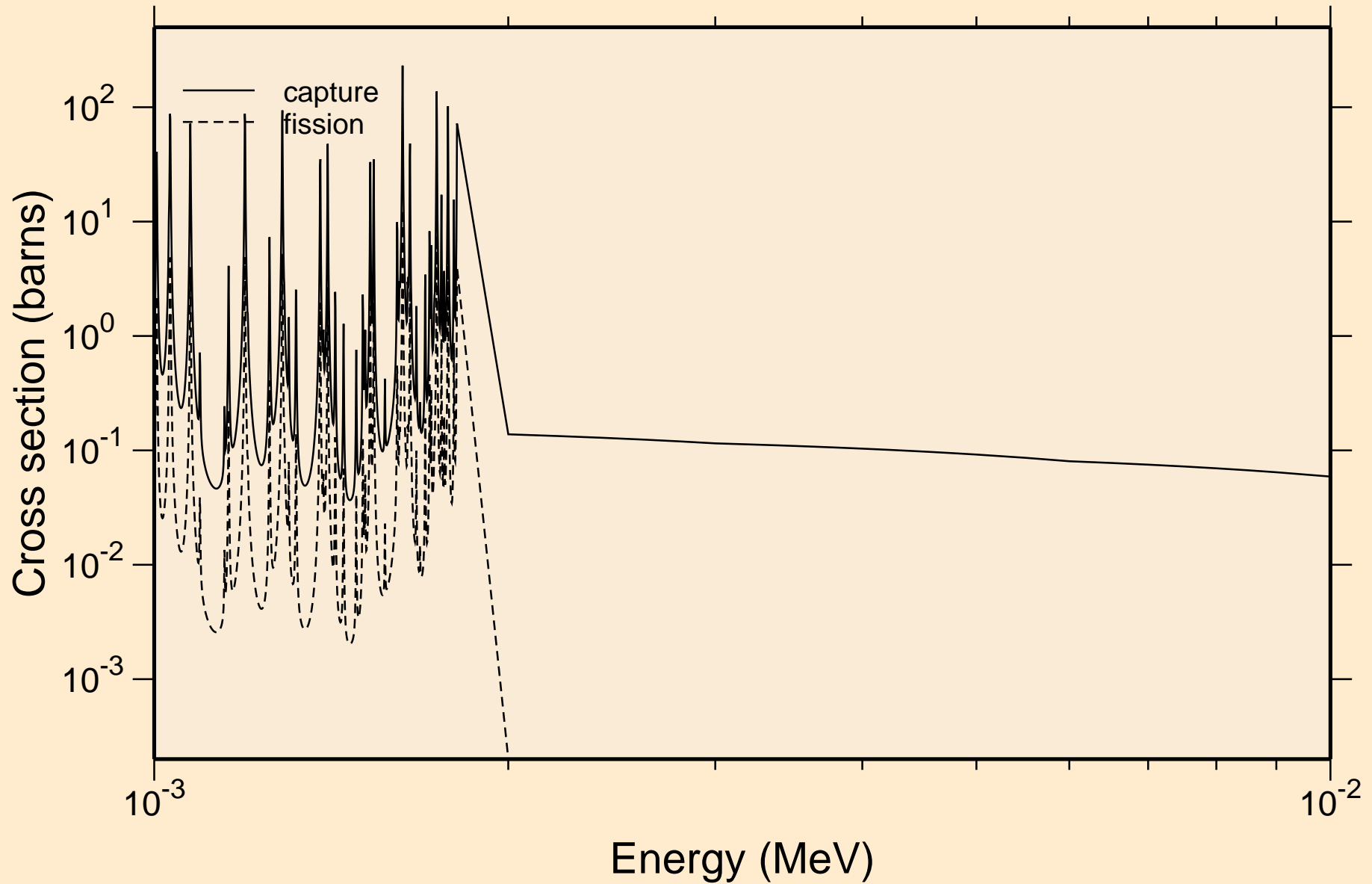



RA228 NEUTRON ACER TENDL-2023 LIBRARY; T=0.K  
resonance absorption cross sections

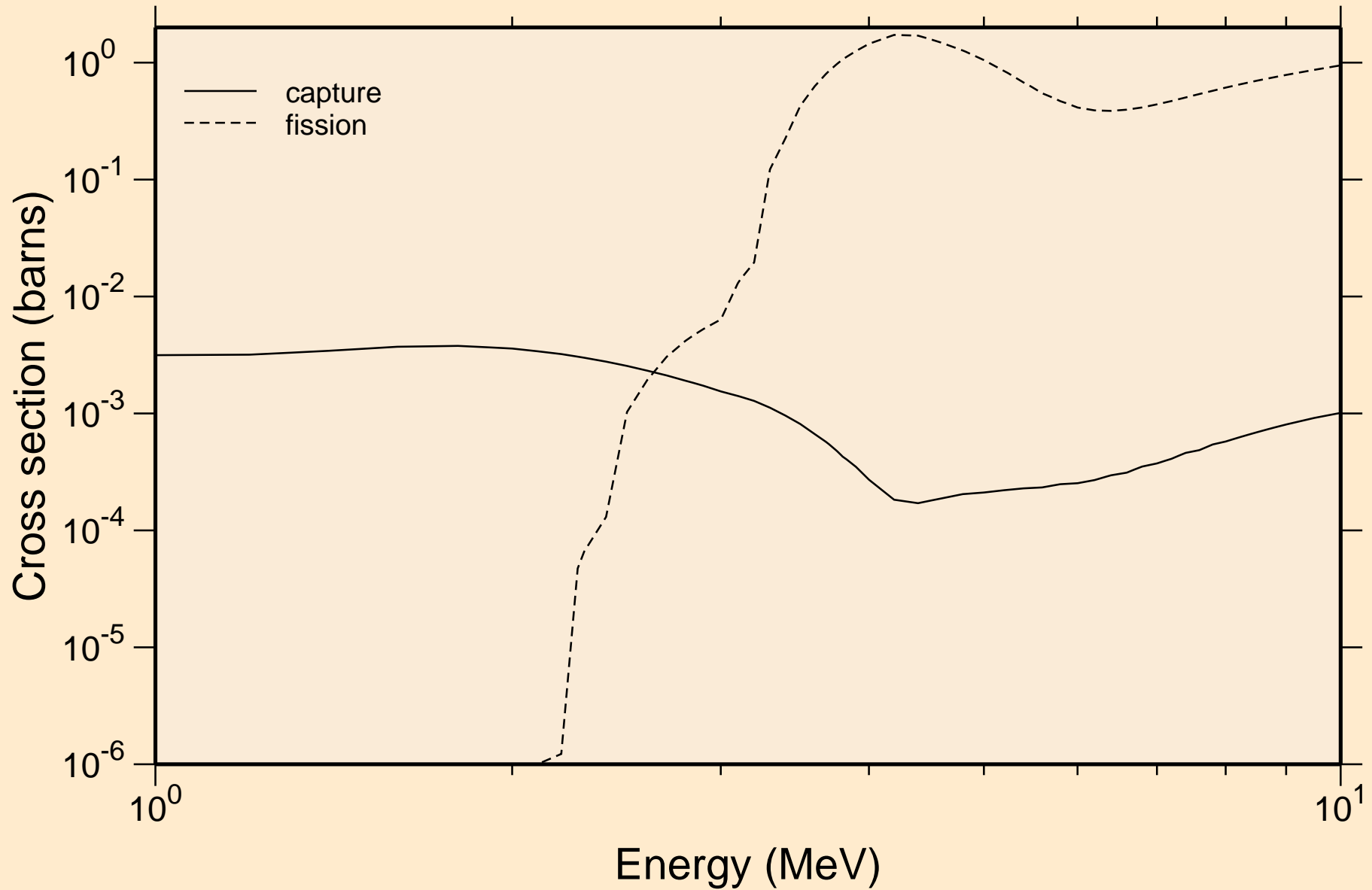

# RA228 NEUTRON ACER TENDL-2023 LIBRARY; T=0.K

## Heating

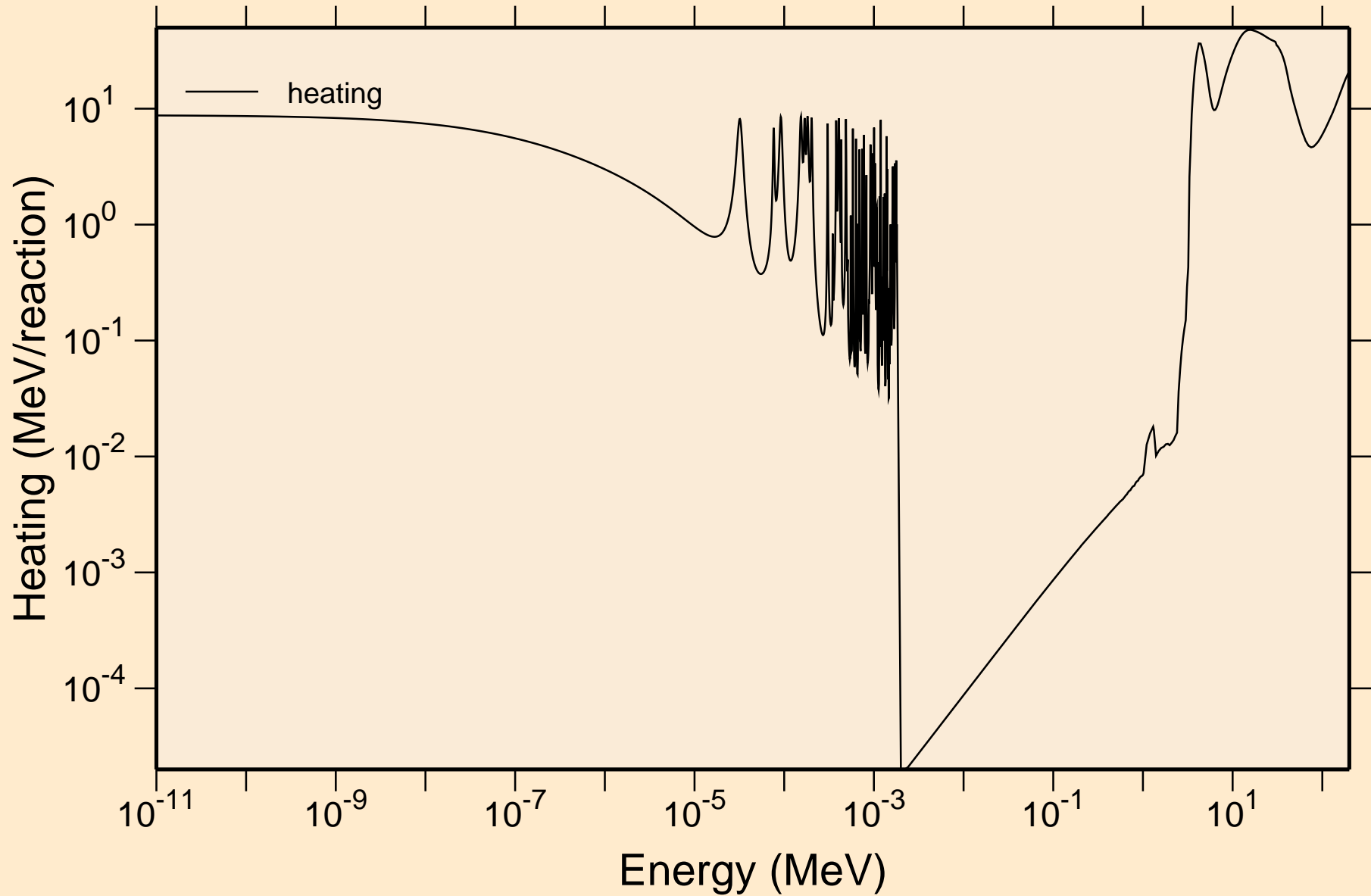

# RA228 NEUTRON ACER TENDL-2023 LIBRARY; T=0.K

## Damage

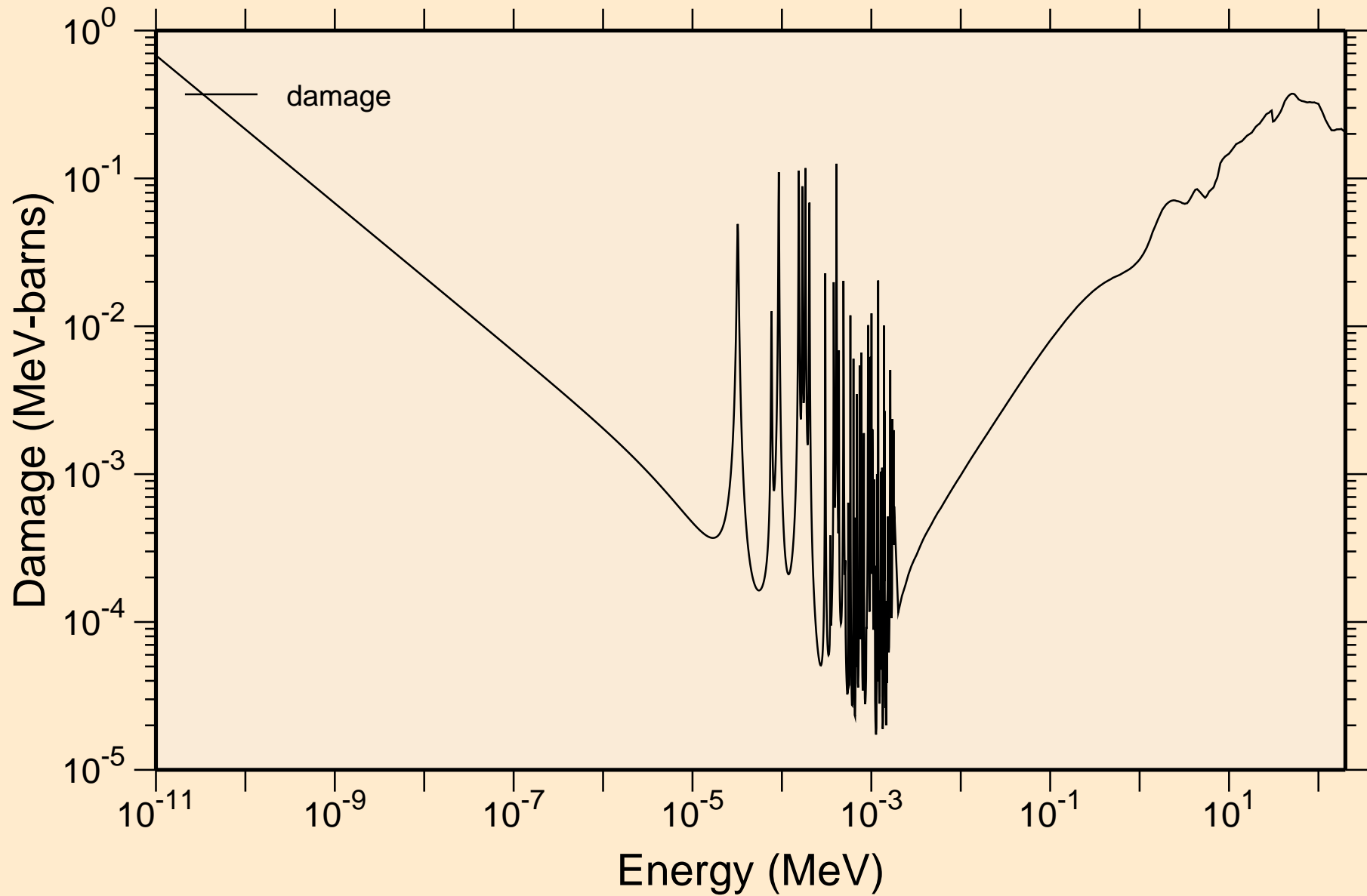

RA228 NEUTRON ACER TENDL-2023 LIBRARY; T=0.K  
Non-threshold reactions

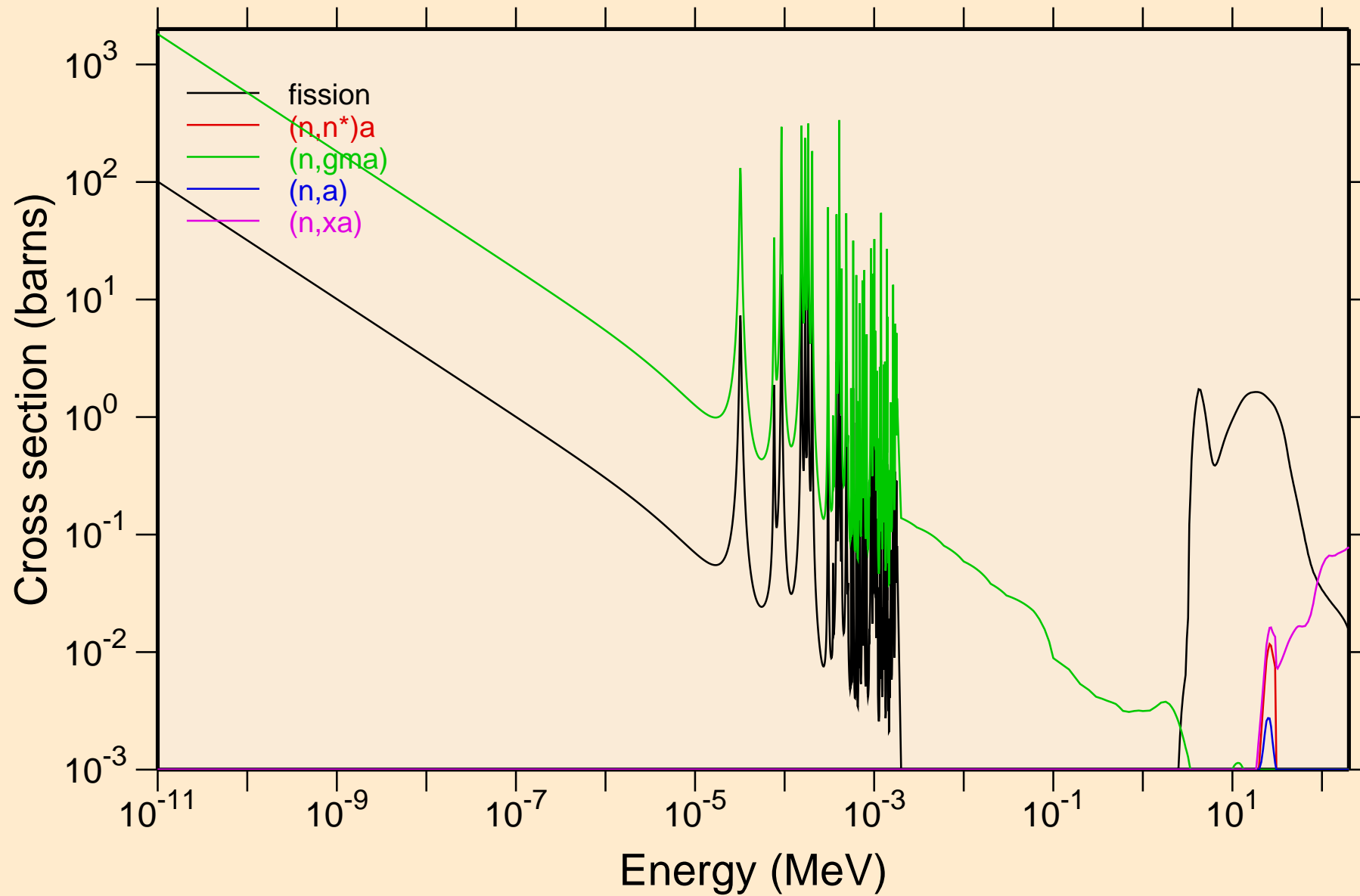

# RA228 NEUTRON ACER TENDL-2023 LIBRARY; T=0.K

## Principal cross sections

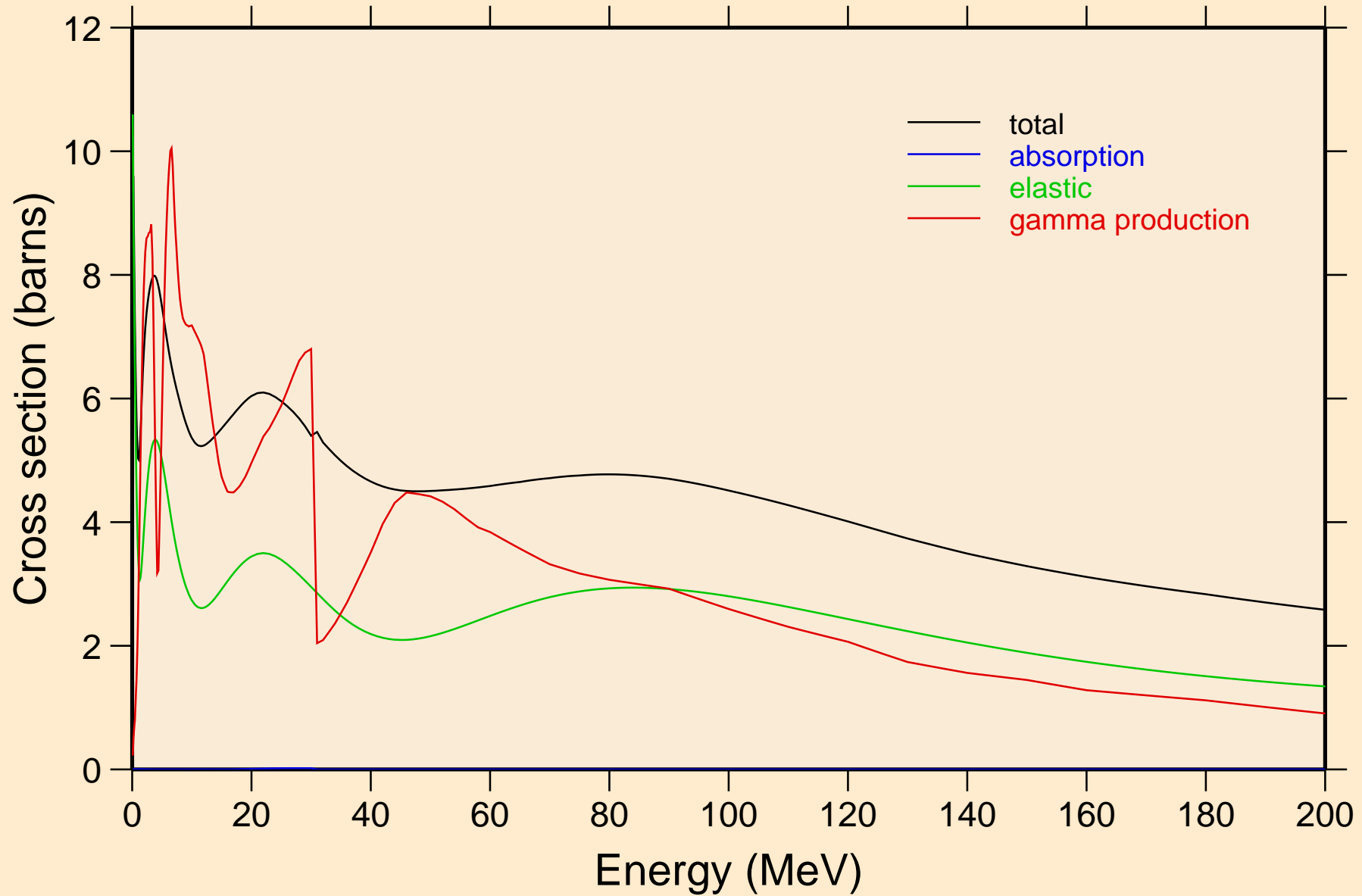

# RA228 NEUTRON ACER TENDL-2023 LIBRARY; T=0.K

## Heating

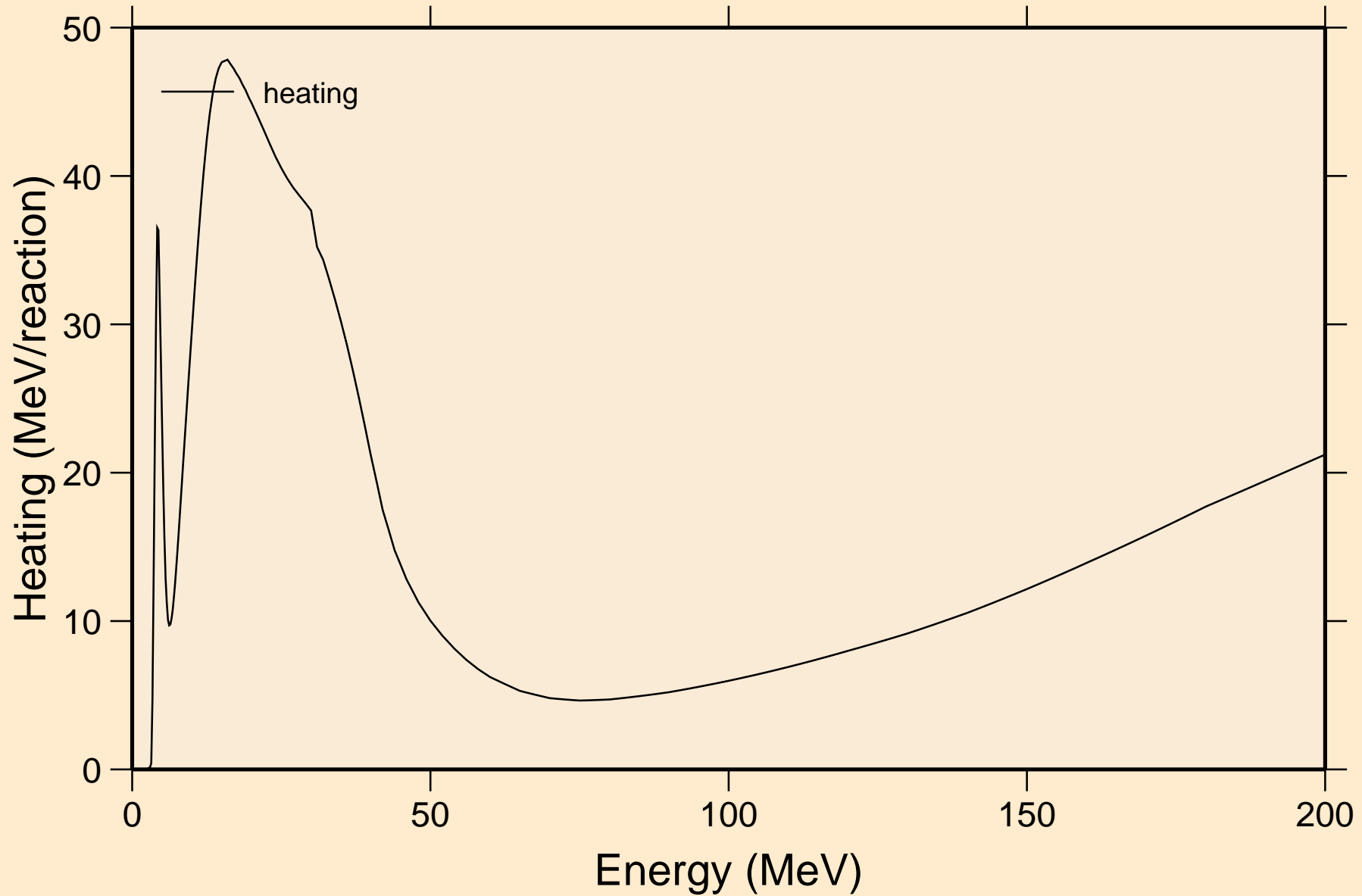

# RA228 NEUTRON ACER TENDL-2023 LIBRARY; T=0.K

## Damage

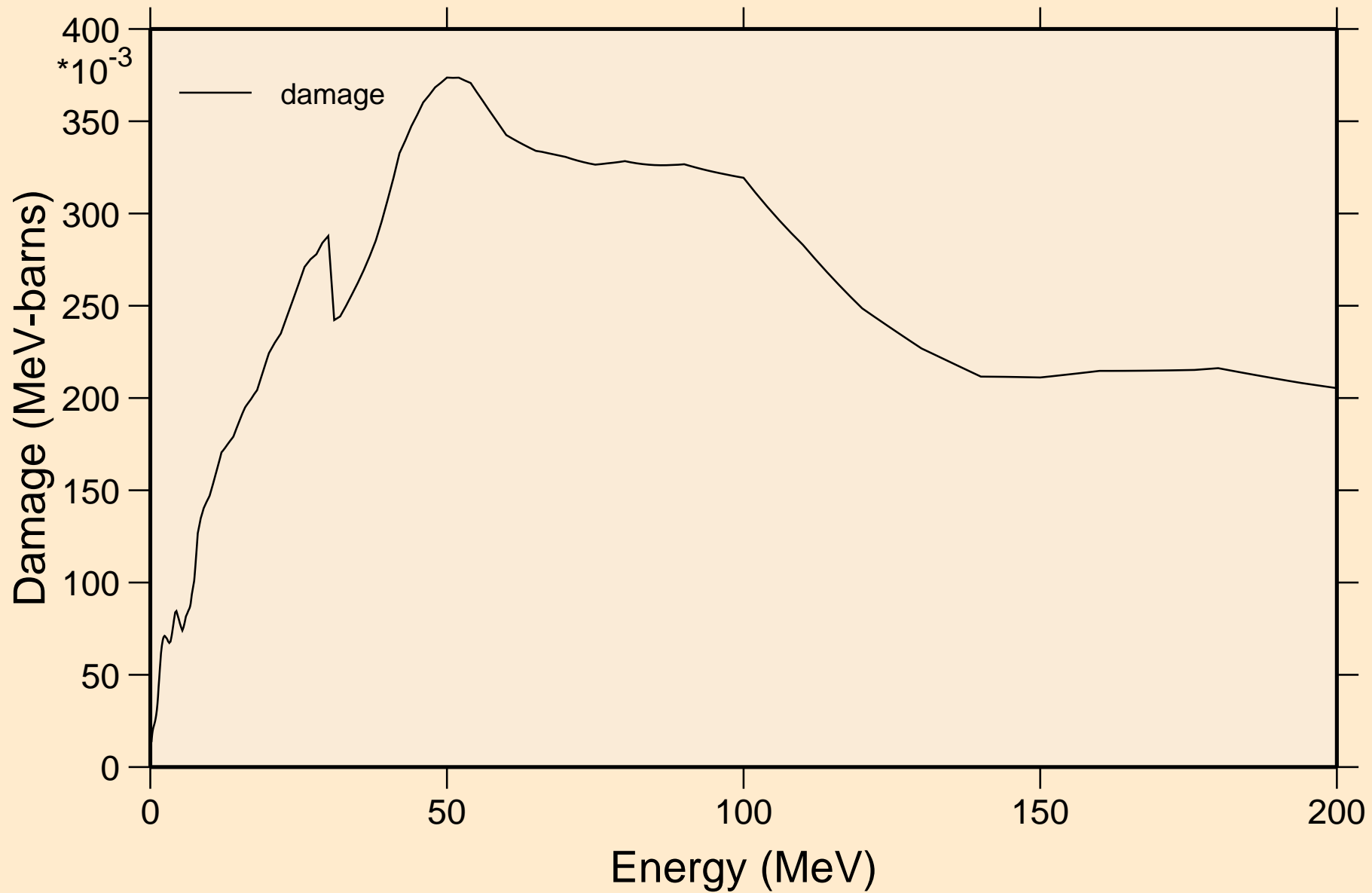

RA228 NEUTRON ACER TENDL-2023 LIBRARY; T=0.K  
Non-threshold reactions

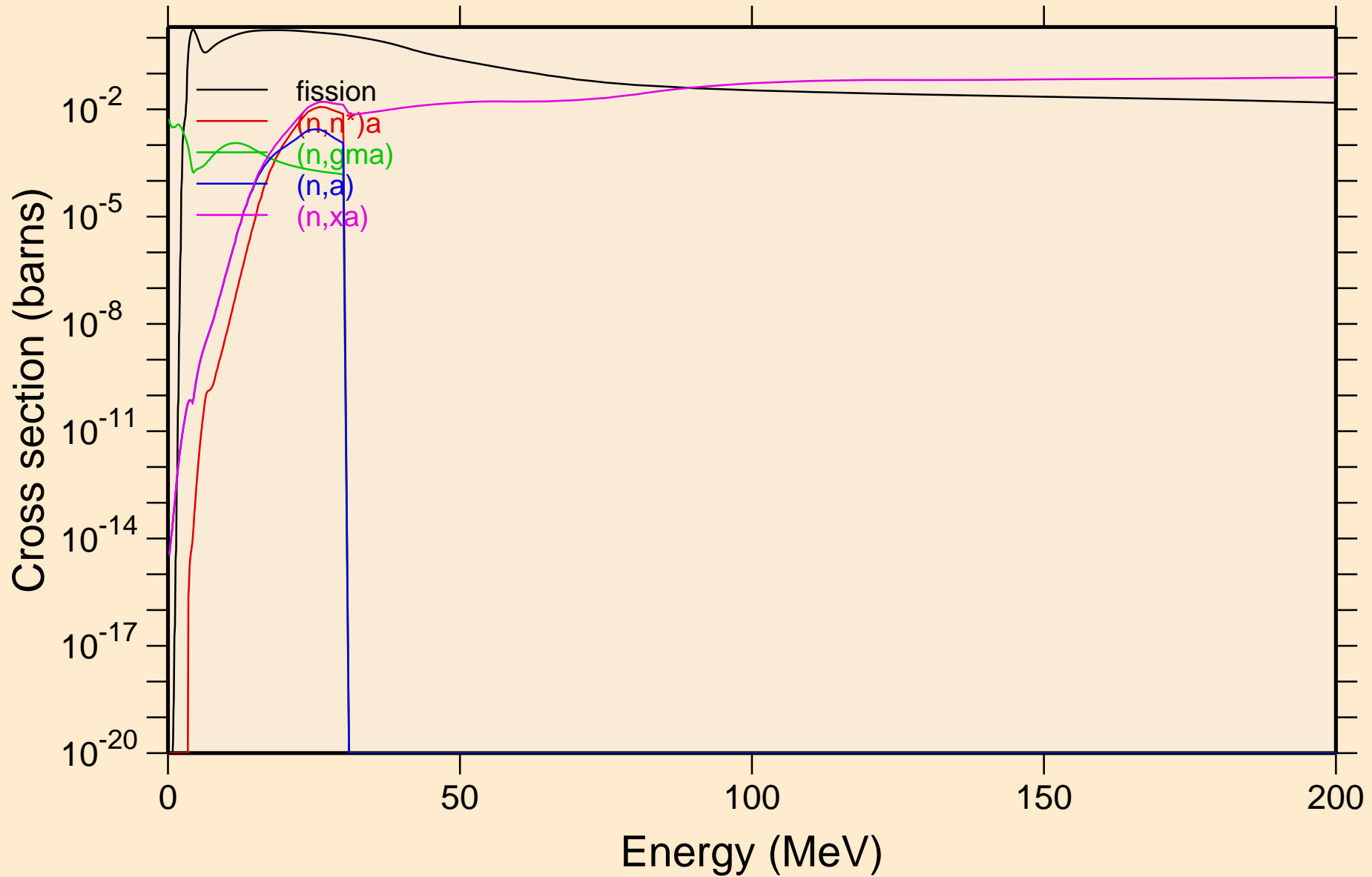



RA228 NEUTRON ACER TENDL-2023 LIBRARY; T=0.K  
Inelastic levels

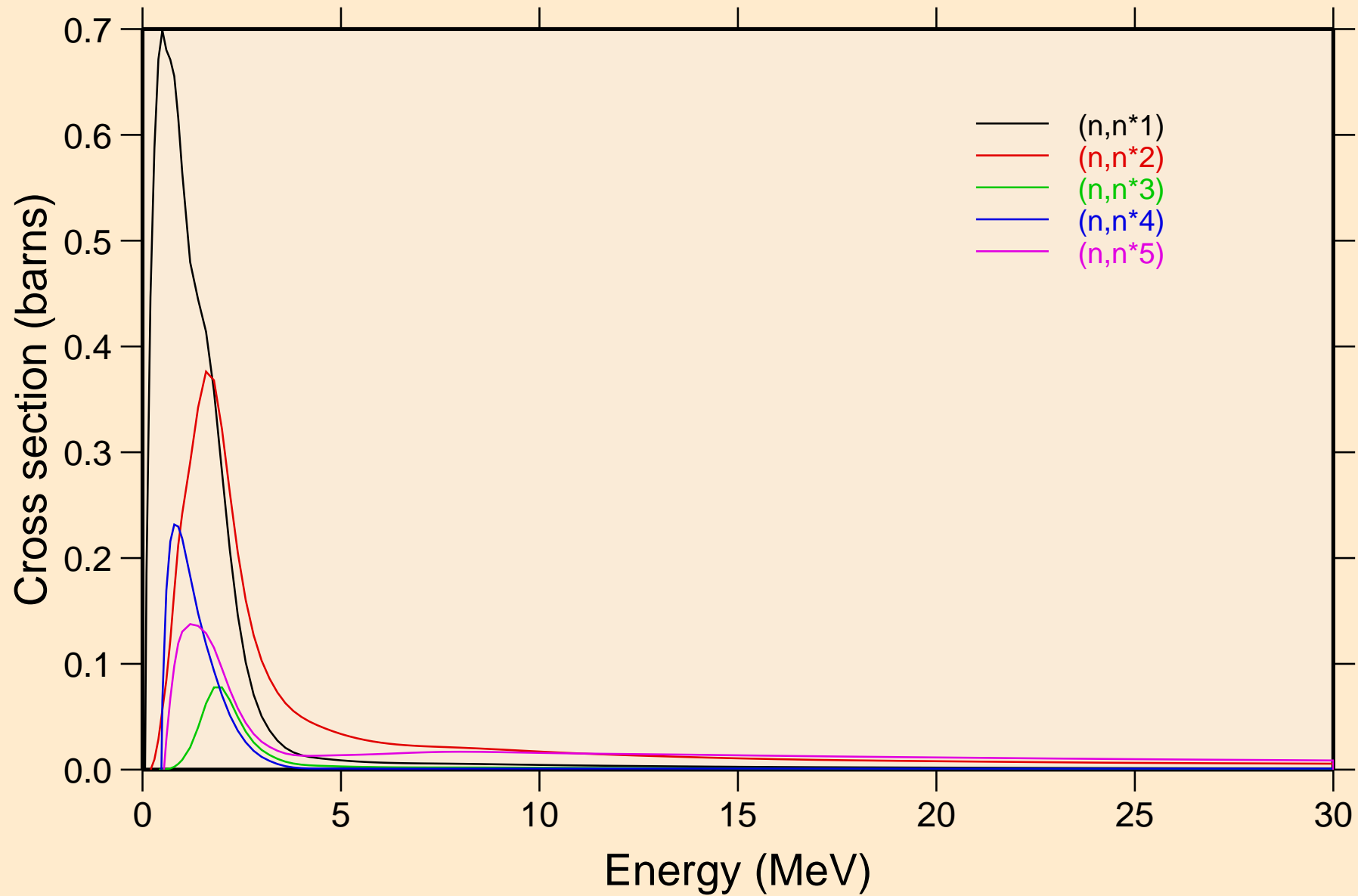

RA228 NEUTRON ACER TENDL-2023 LIBRARY; T=0.K  
Inelastic levels

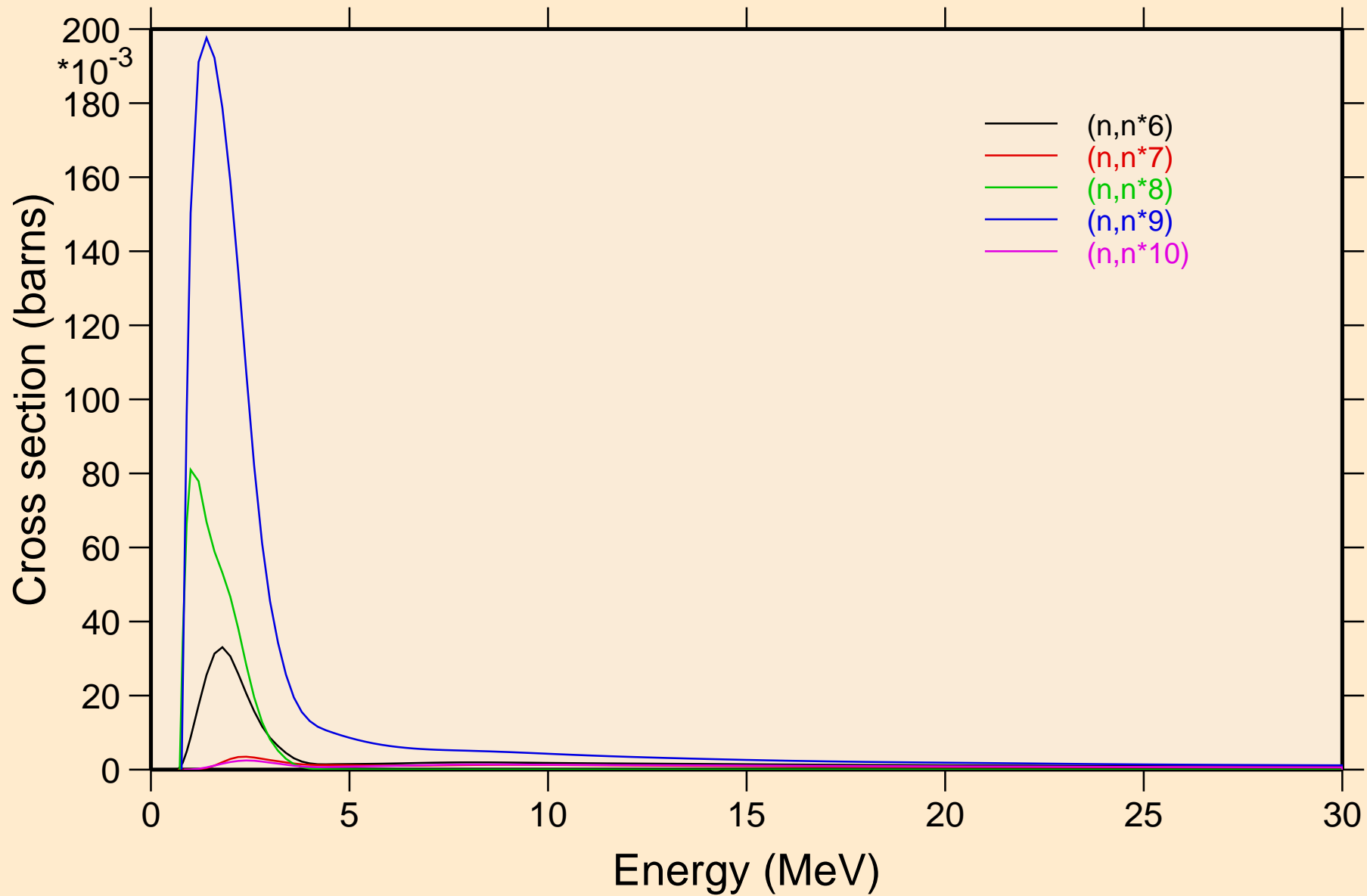

RA228 NEUTRON ACER TENDL-2023 LIBRARY; T=0.K  
Inelastic levels

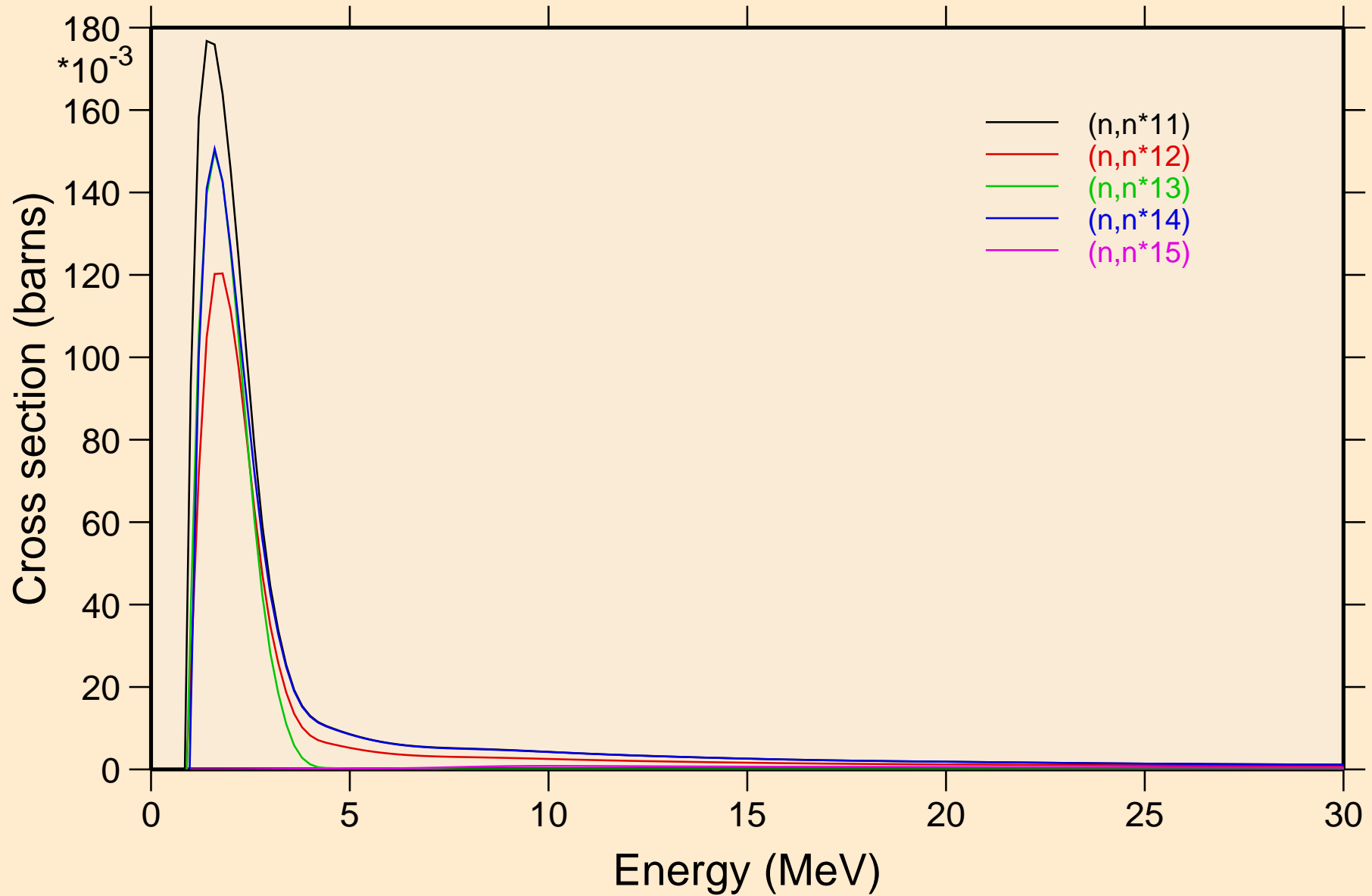

RA228 NEUTRON ACER TENDL-2023 LIBRARY; T=0.K  
Inelastic levels

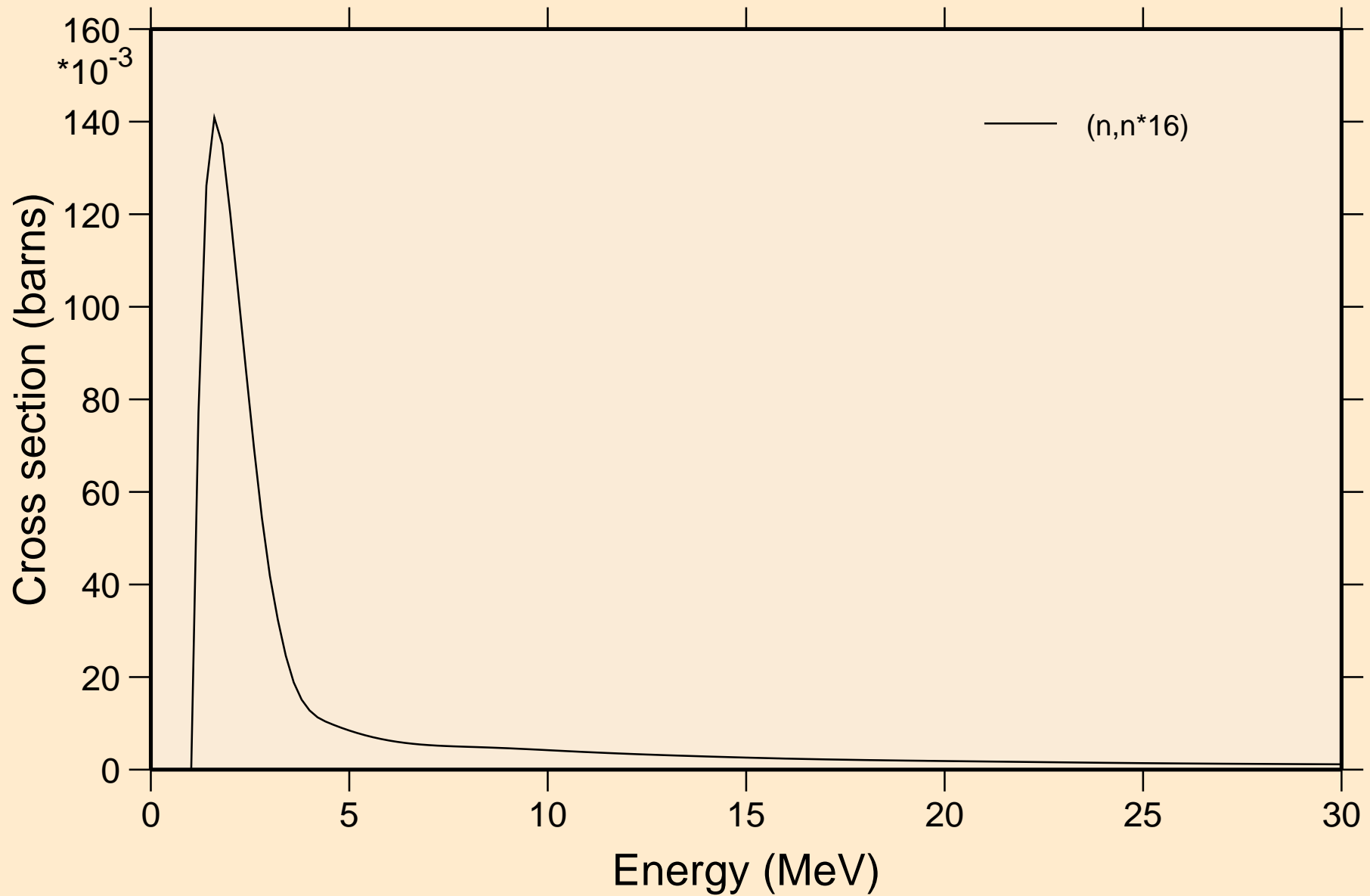

RA228 NEUTRON ACER TENDL-2023 LIBRARY; T=0.K  
Threshold reactions

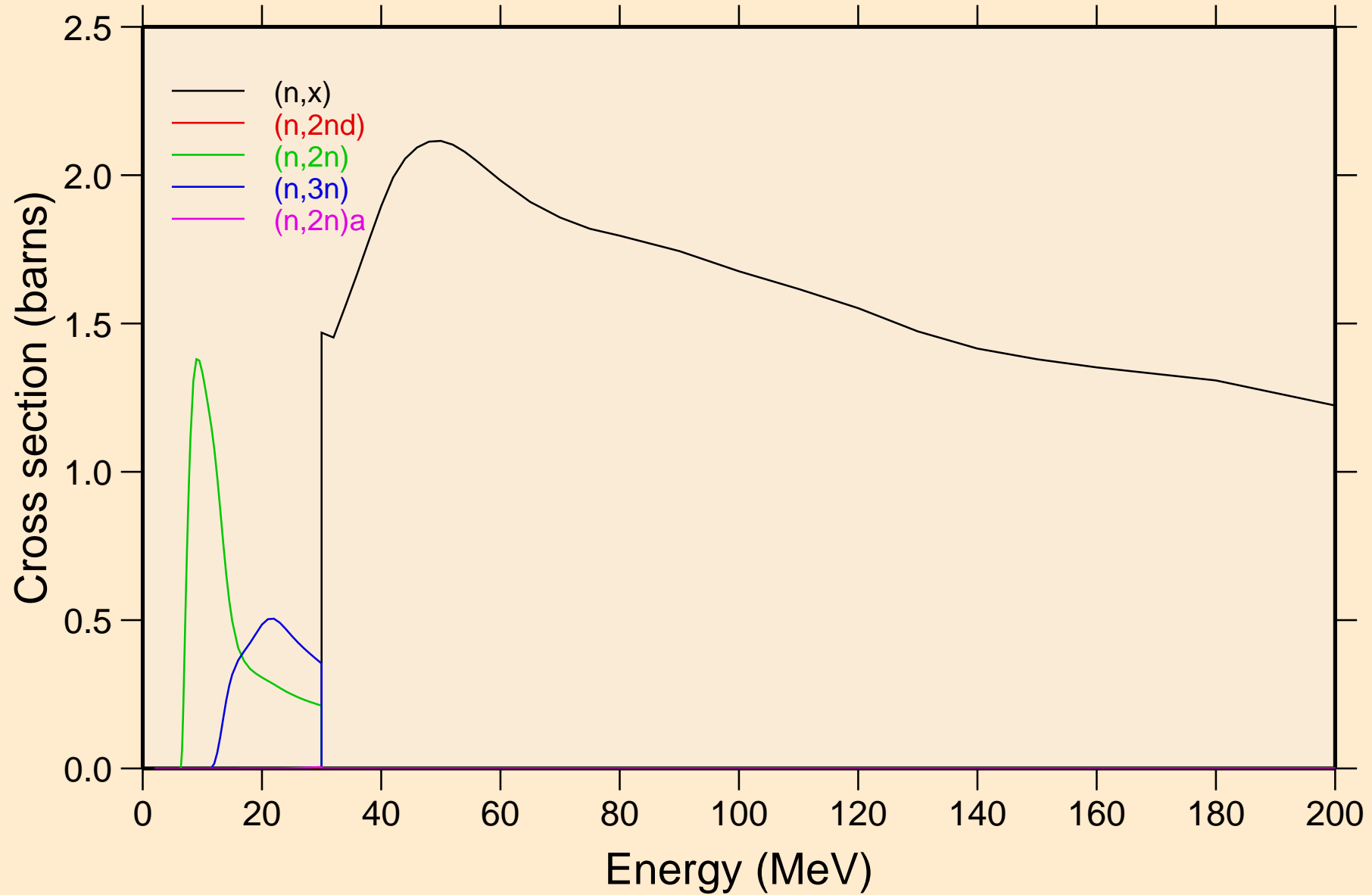

# RA228 NEUTRON ACER TENDL-2023 LIBRARY; T=0.K

## Threshold reactions

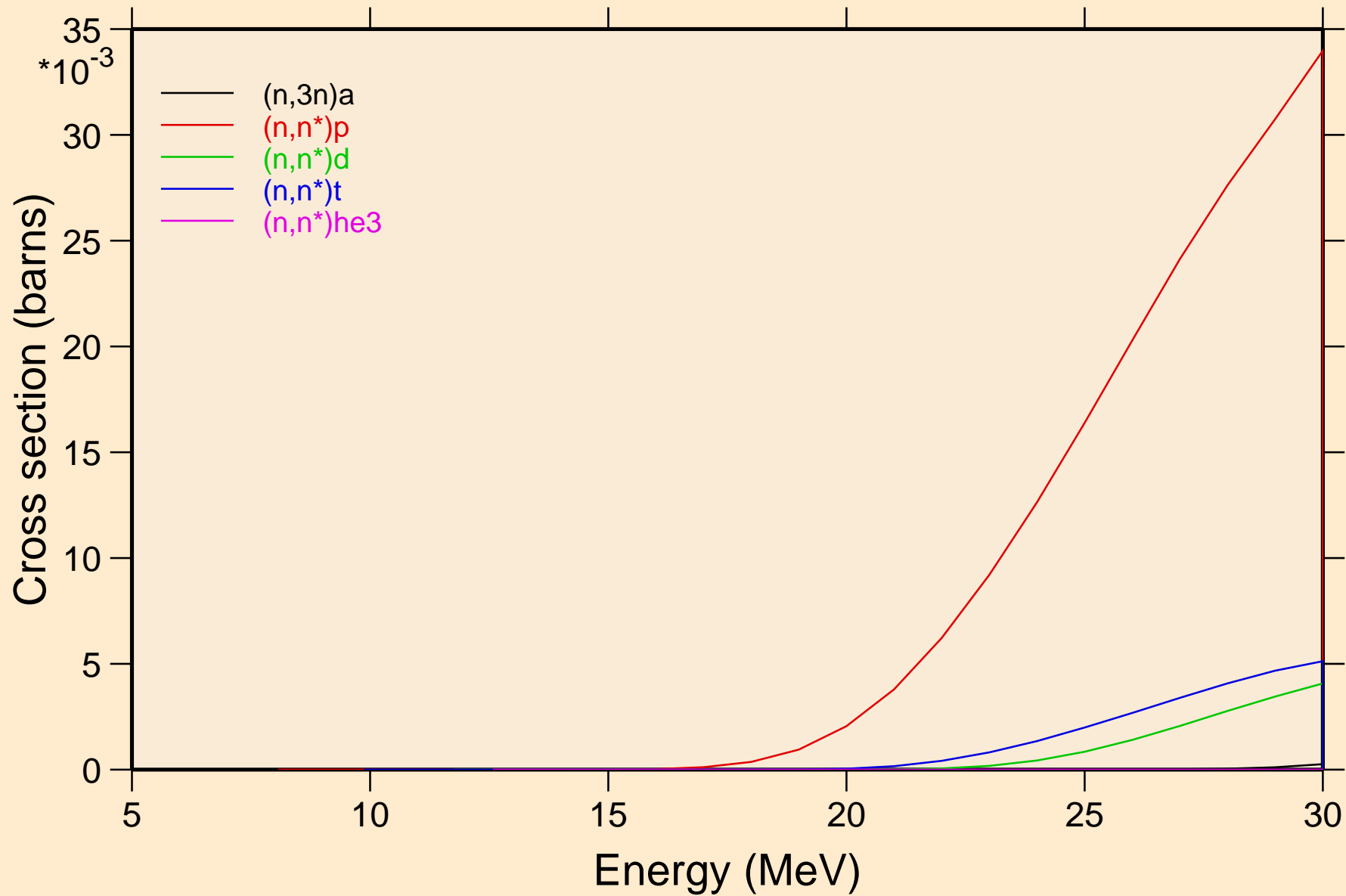

# RA228 NEUTRON ACER TENDL-2023 LIBRARY; T=0.K

## Threshold reactions

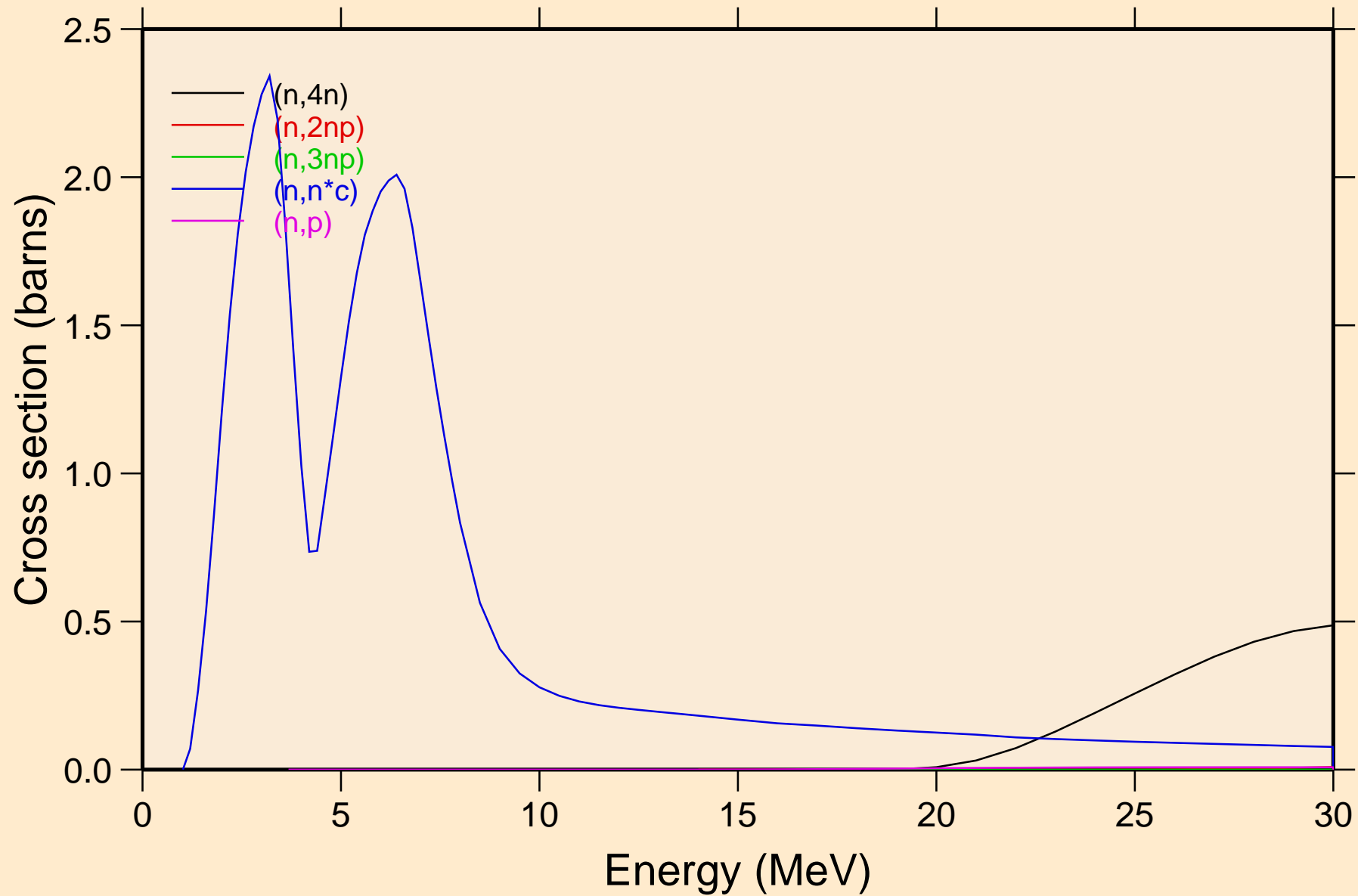

RA228 NEUTRON ACER TENDL-2023 LIBRARY; T=0.K  
Threshold reactions

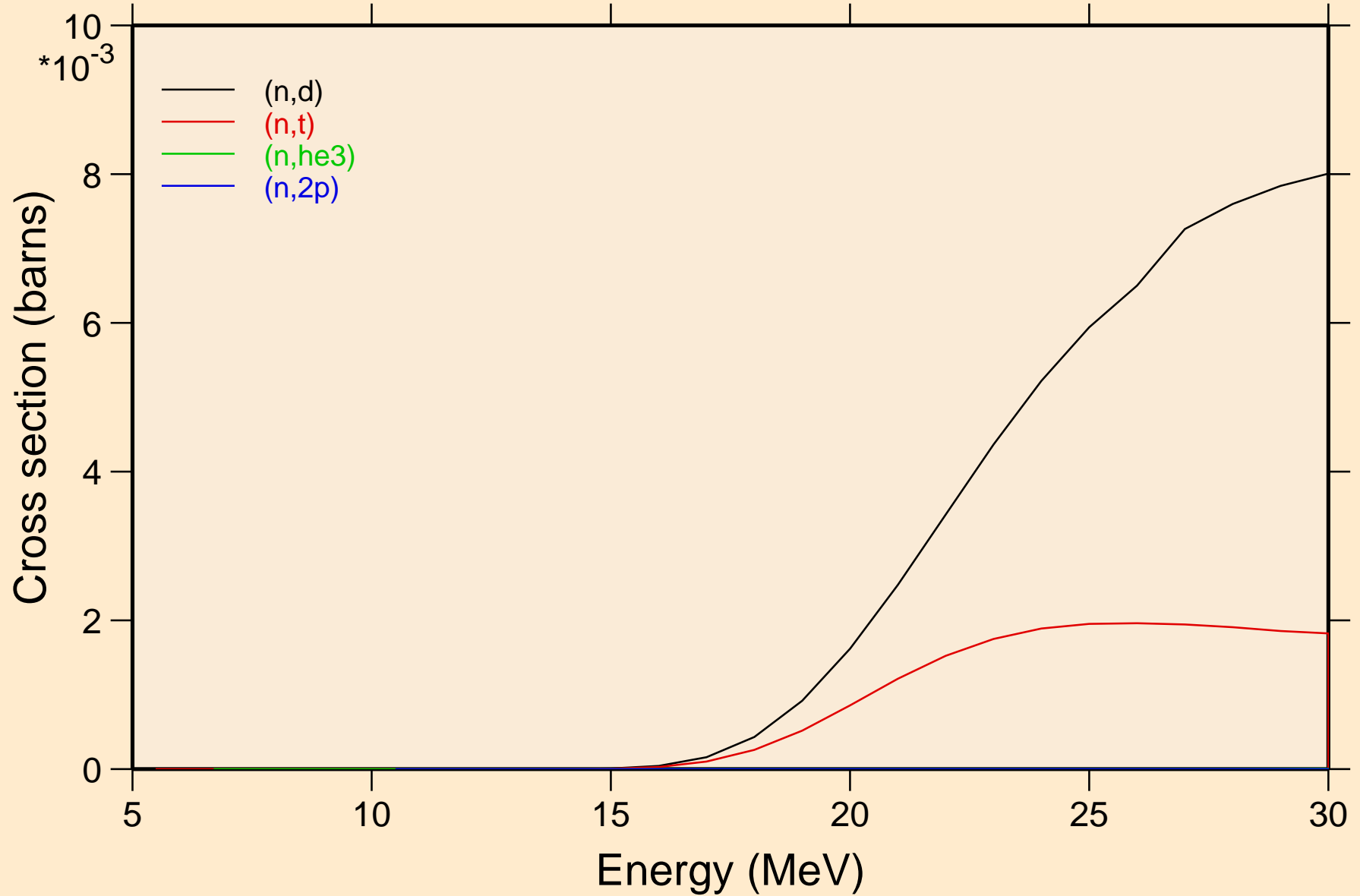



RA228 NEUTRON ACER TENDL-2023 LIBRARY; T=0.K  
Threshold reactions

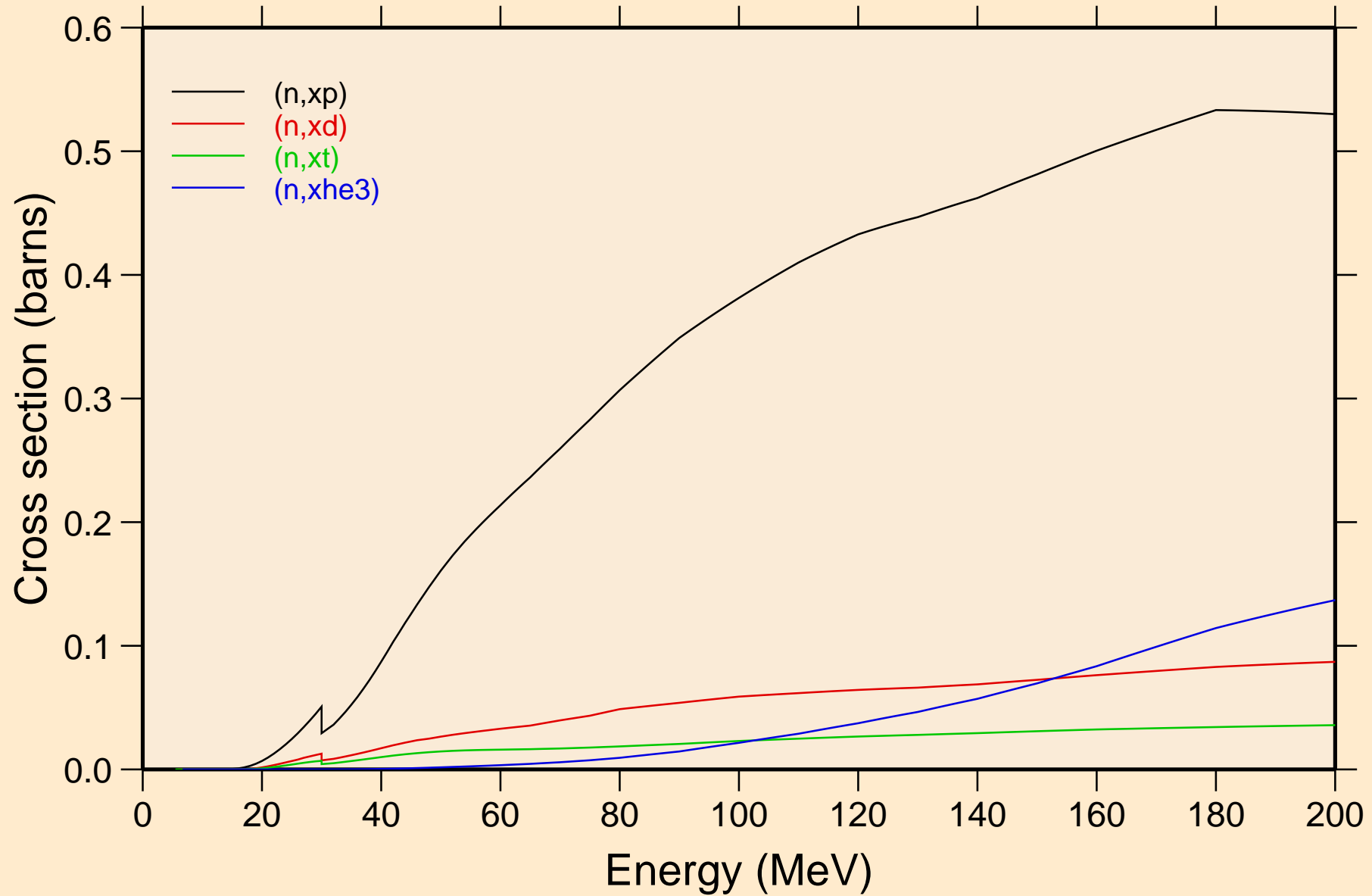

RA228 NEUTRON ACER TENDL-2023 LIBRARY; T=0.K  
angular distribution for elastic

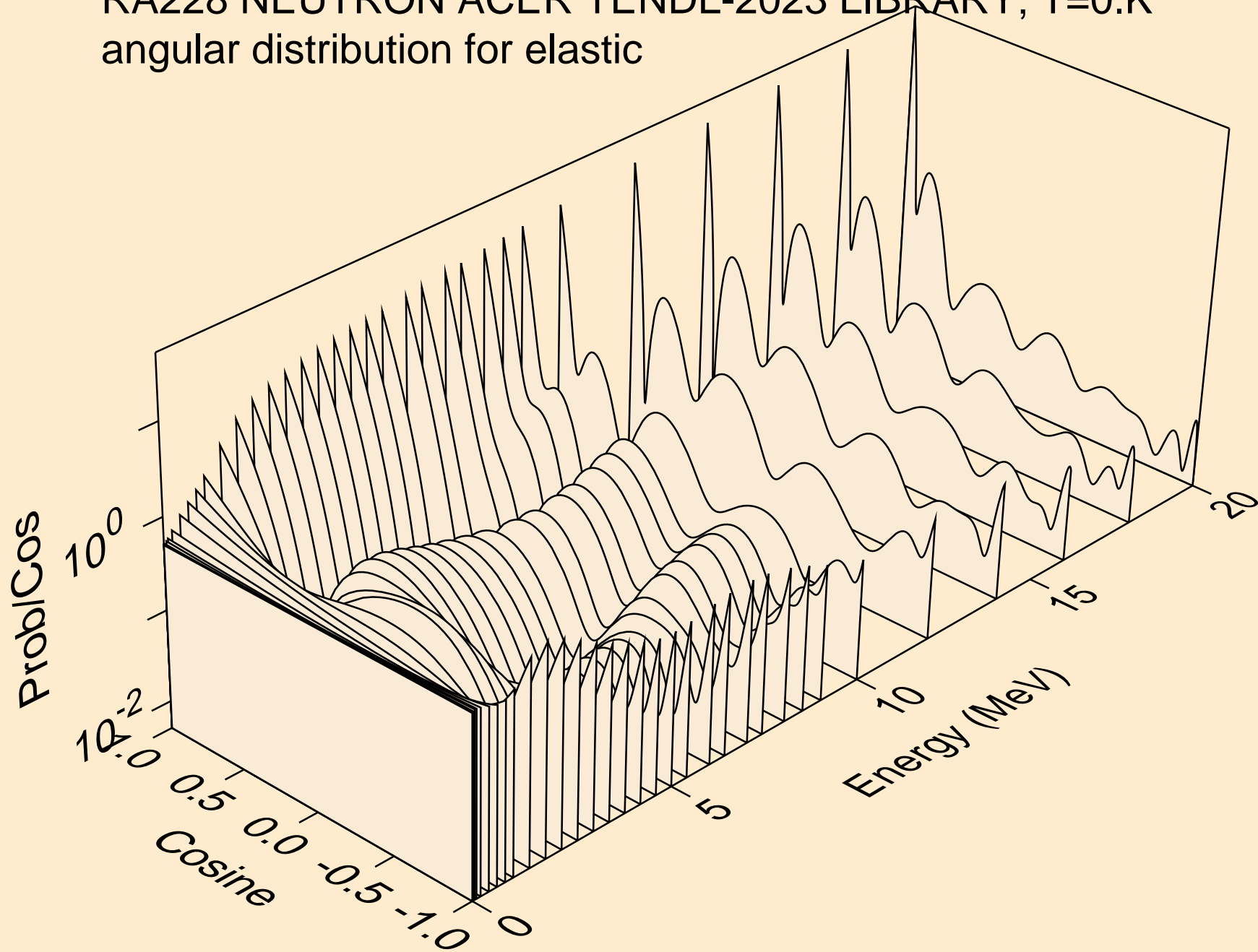

RA228 NEUTRON ACER TENDL-2023 LIBRARY; T=0.K  
angular distribution for elastic

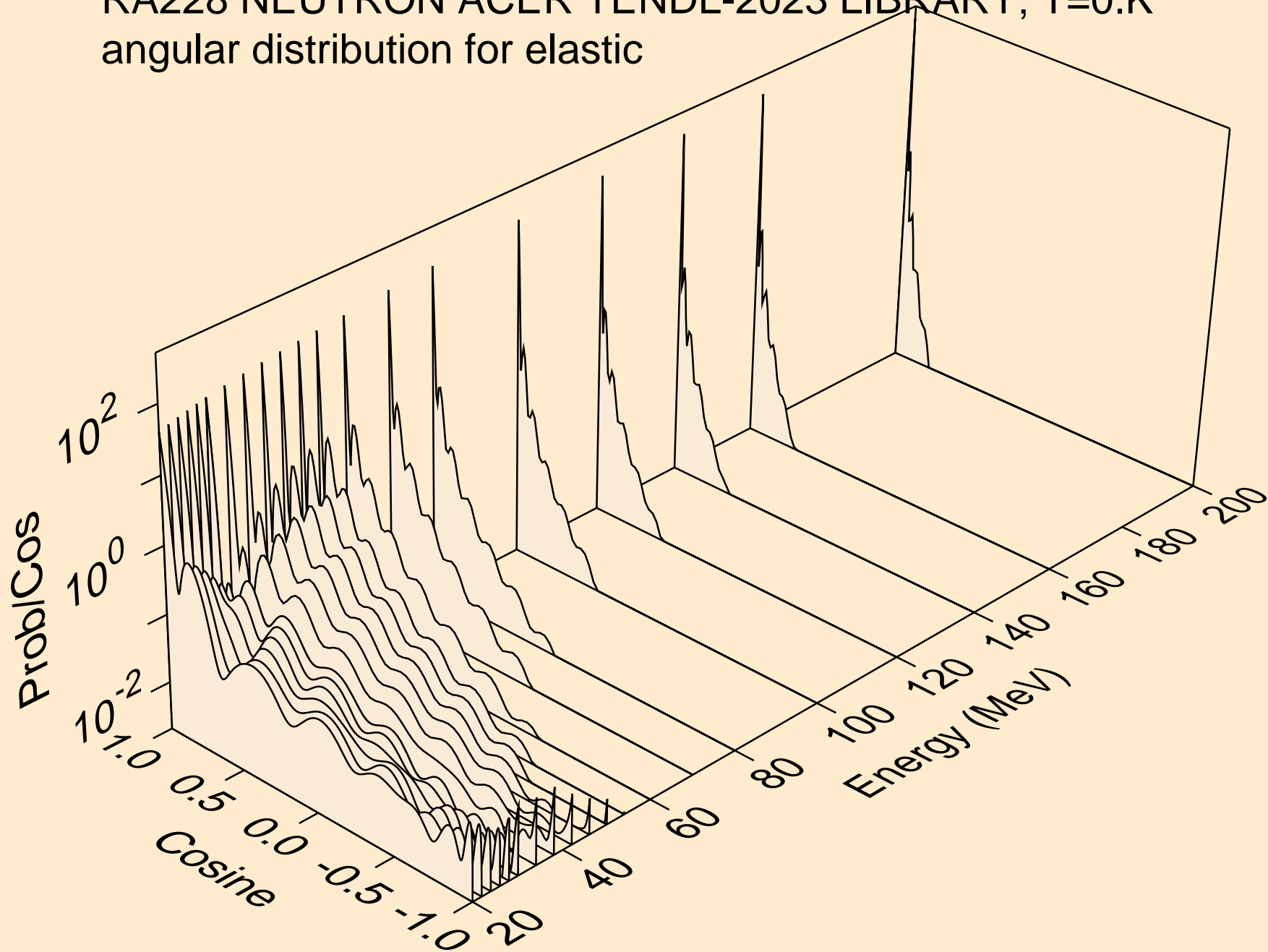

RA228 NEUTRON ACER TENDL-2023 LIBRARY; T=0.K  
angular distribution for (n,n\*1)

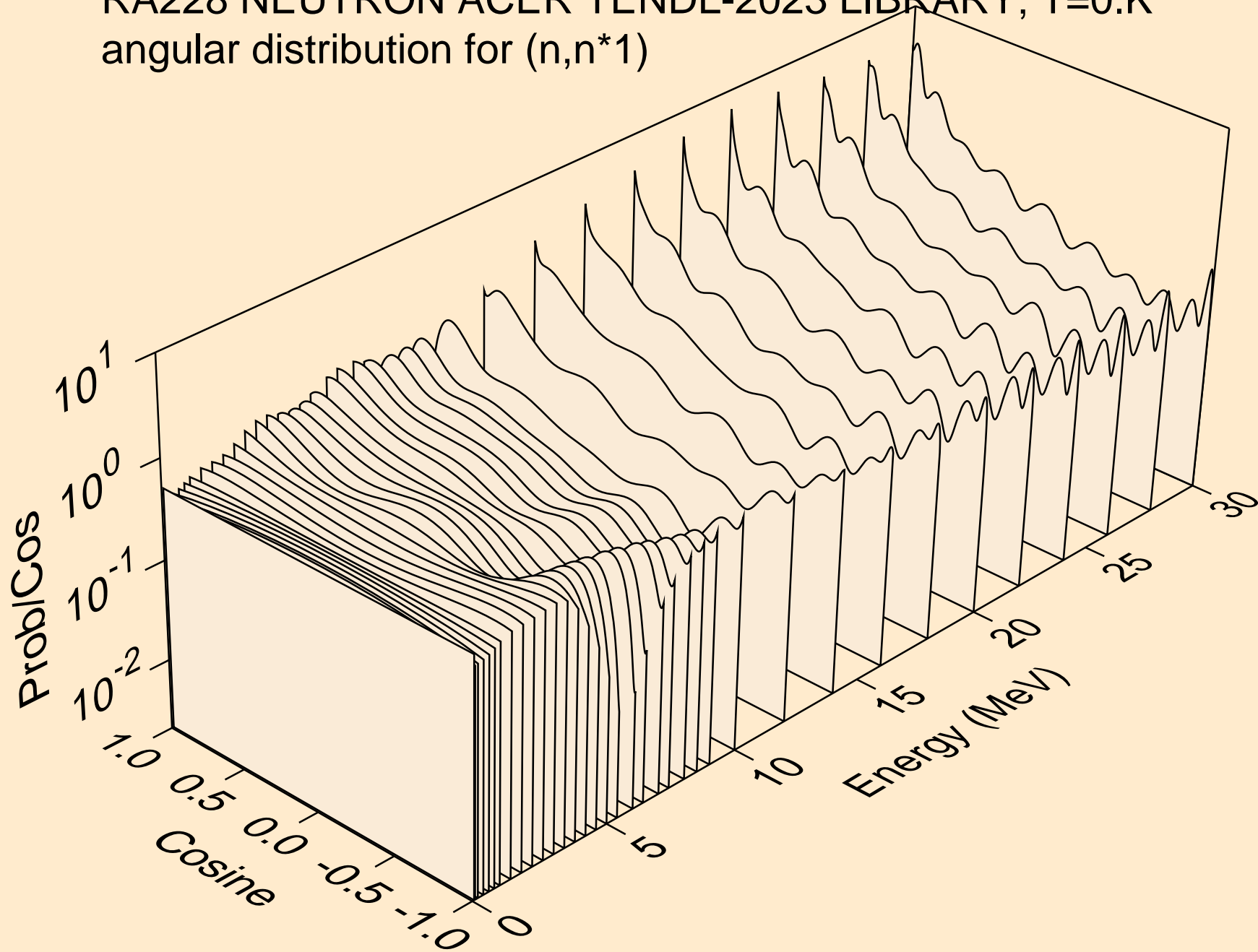

RA228 NEUTRON ACER TENDL-2023 LIBRARY; T=0.K  
angular distribution for (n,n\*2)

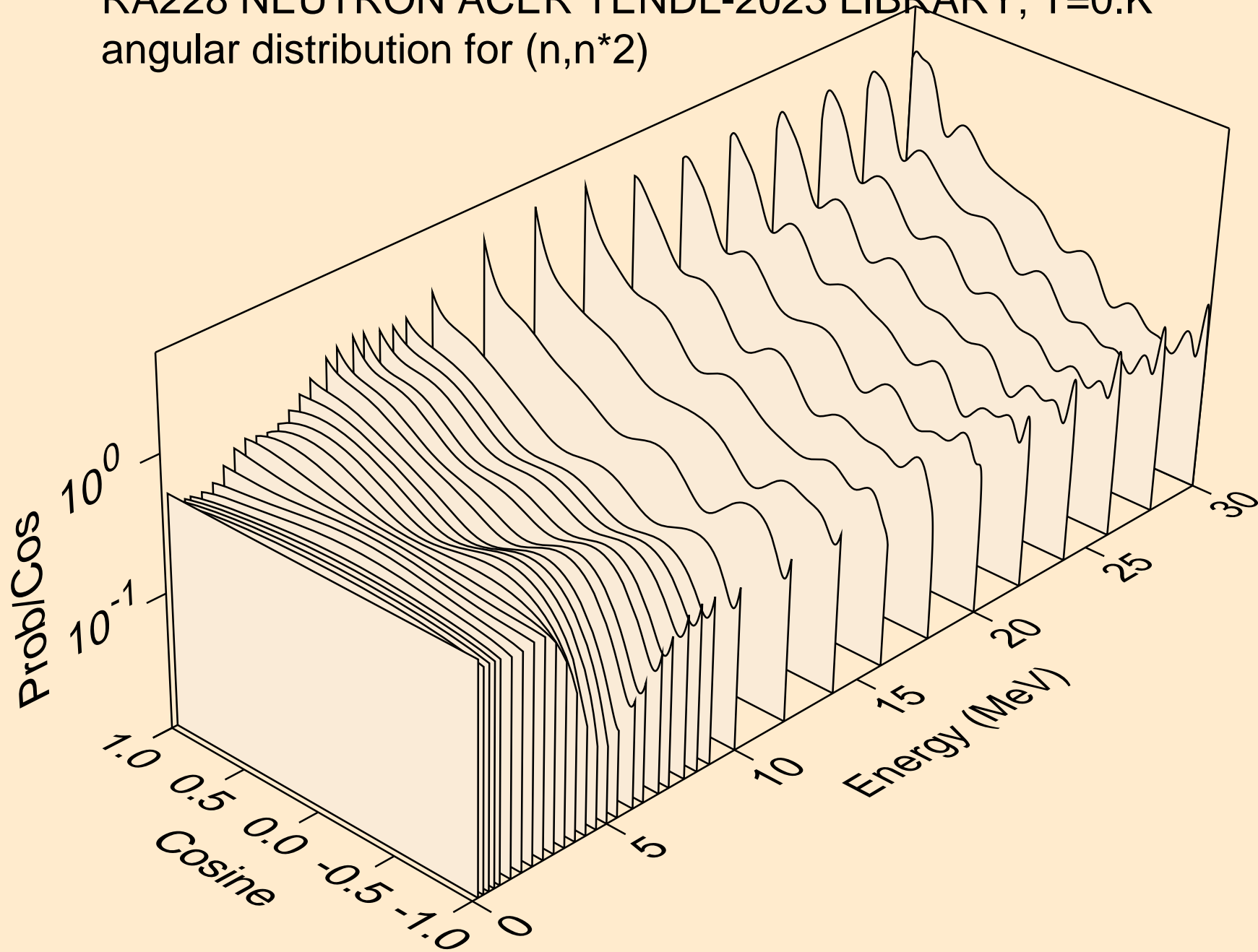

RA228 NEUTRON ACER TENDL-2023 LIBRARY; T=0.K  
angular distribution for (n,n\*3)

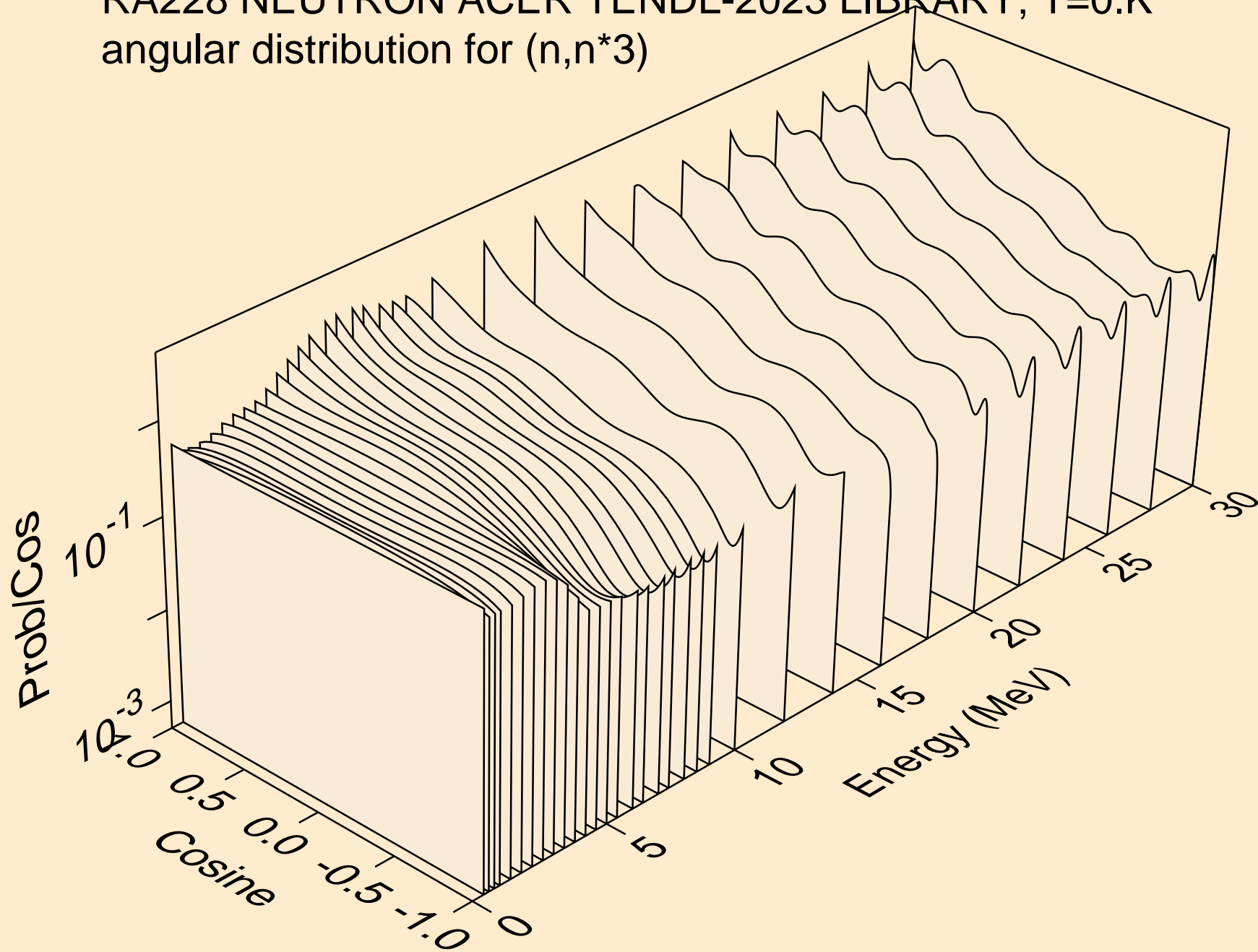

RA228 NEUTRON ACER TENDL-2023 LIBRARY; T=0.K  
angular distribution for (n,n\*4)

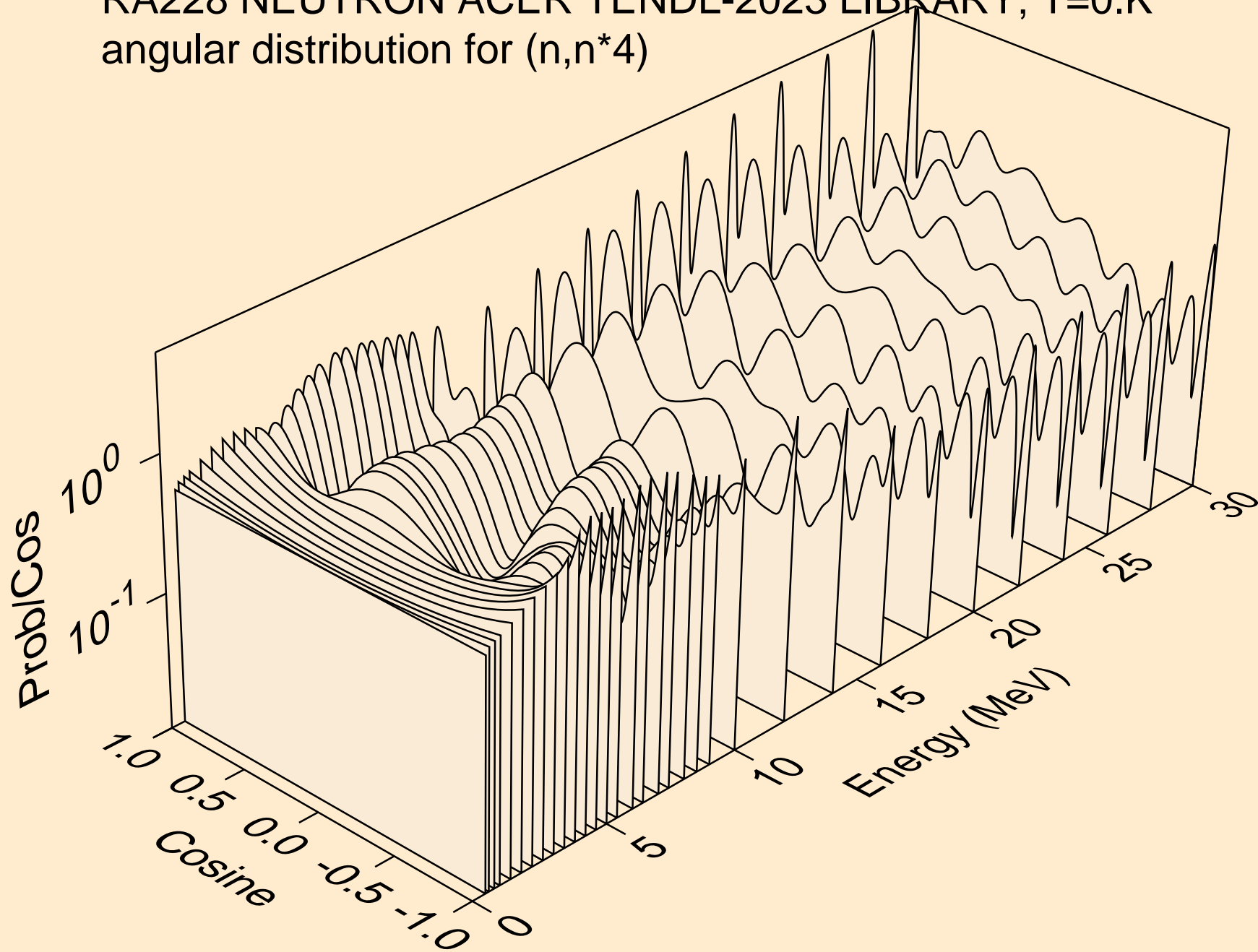

RA228 NEUTRON ACER TENDL-2023 LIBRARY; T=0.K  
angular distribution for (n,n\*5)

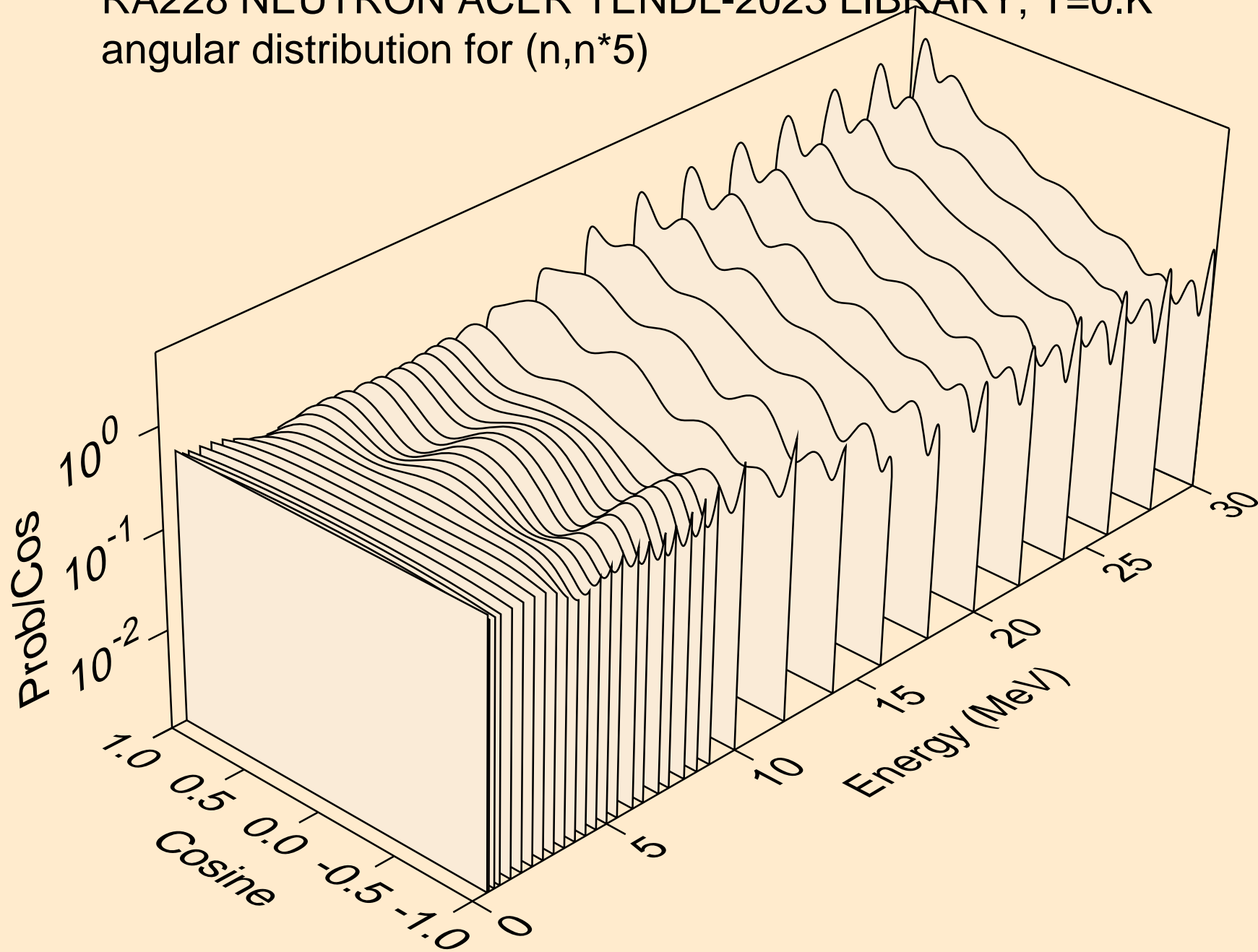



RA228 NEUTRON ACER TENDL-2023 LIBRARY; T=0.K  
angular distribution for (n,n\*6)

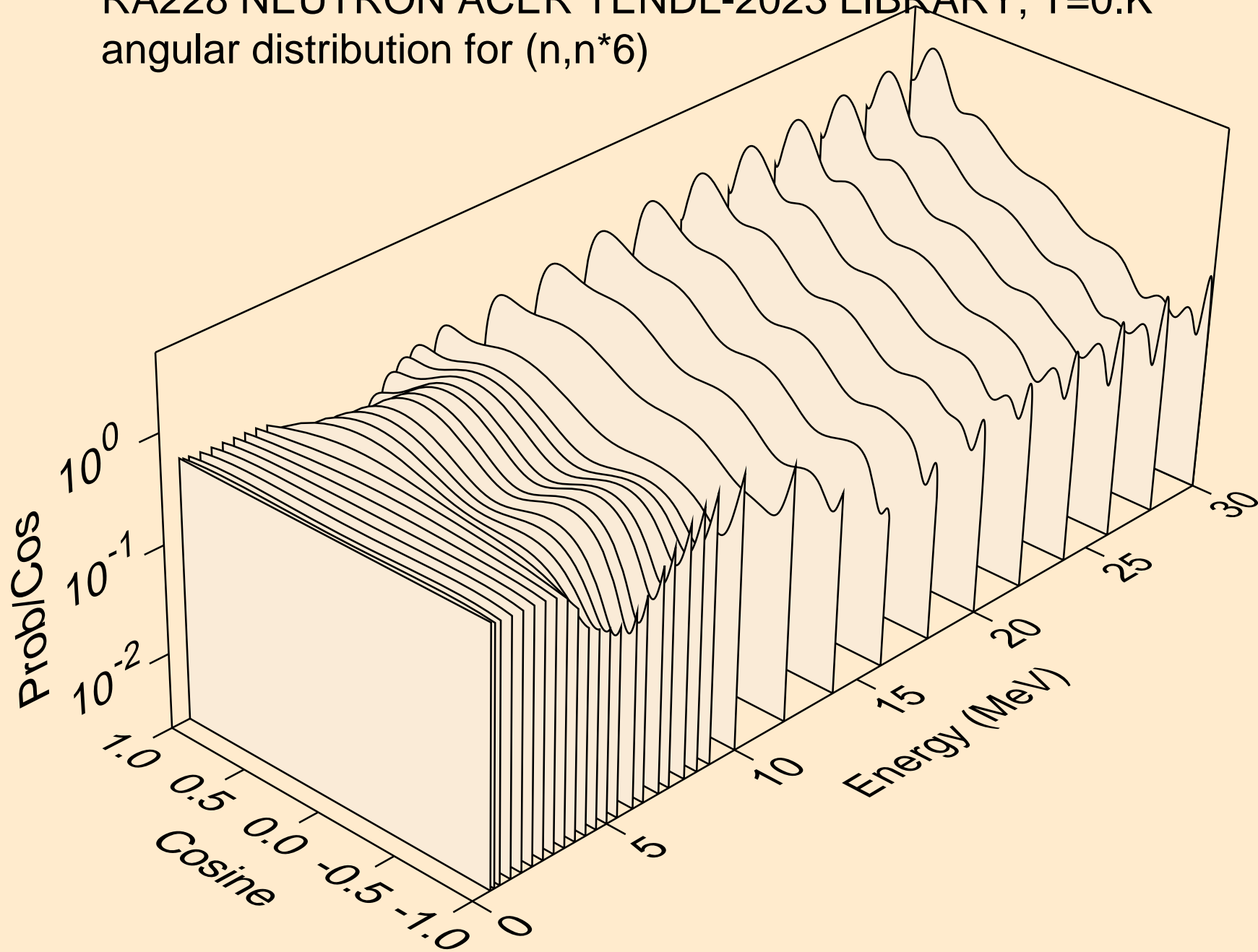

RA228 NEUTRON ACER TENDL-2023 LIBRARY; T=0.K  
angular distribution for (n,n\*7)

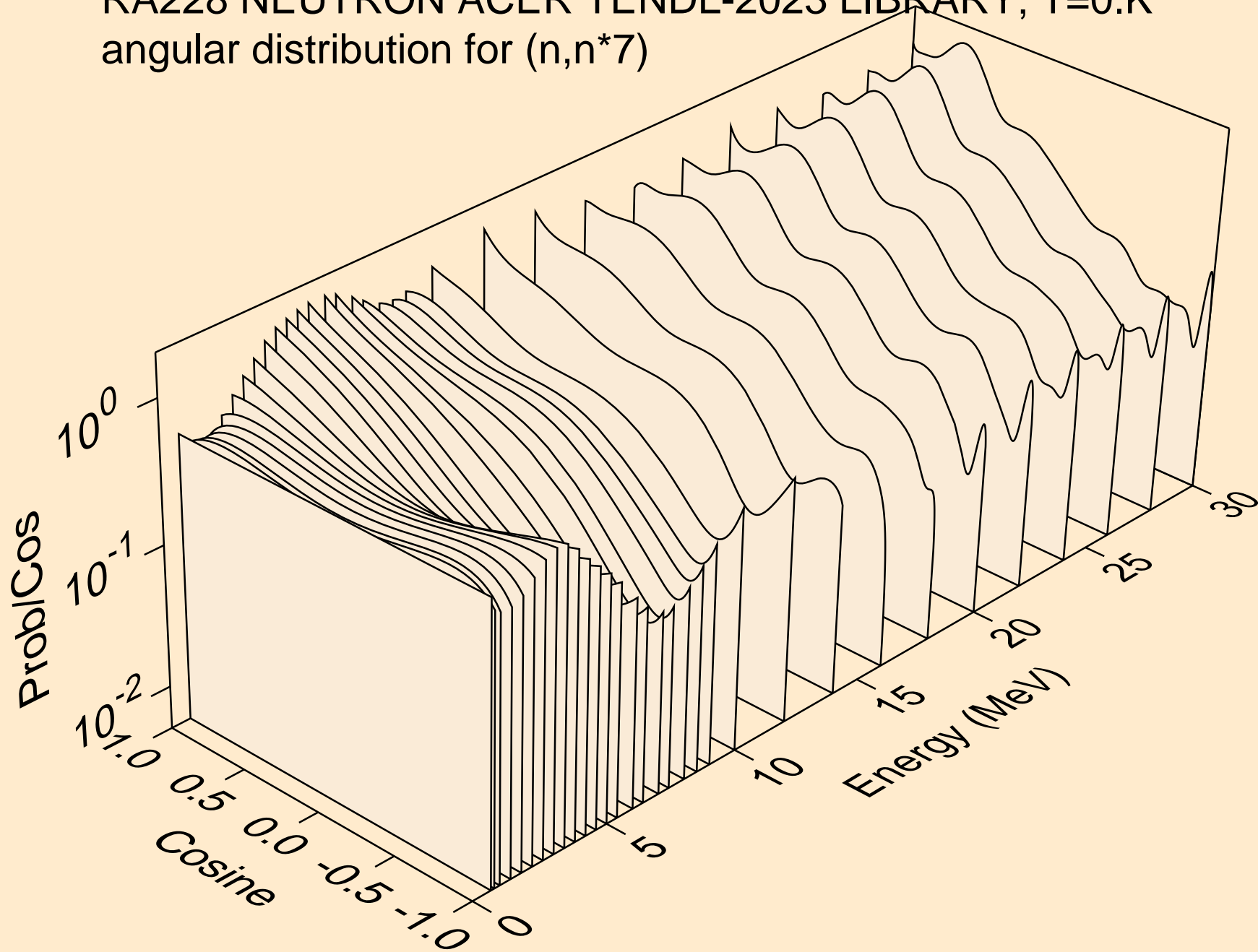

RA228 NEUTRON ACER TENDL-2023 LIBRARY; T=0.K  
angular distribution for (n,n\*8)

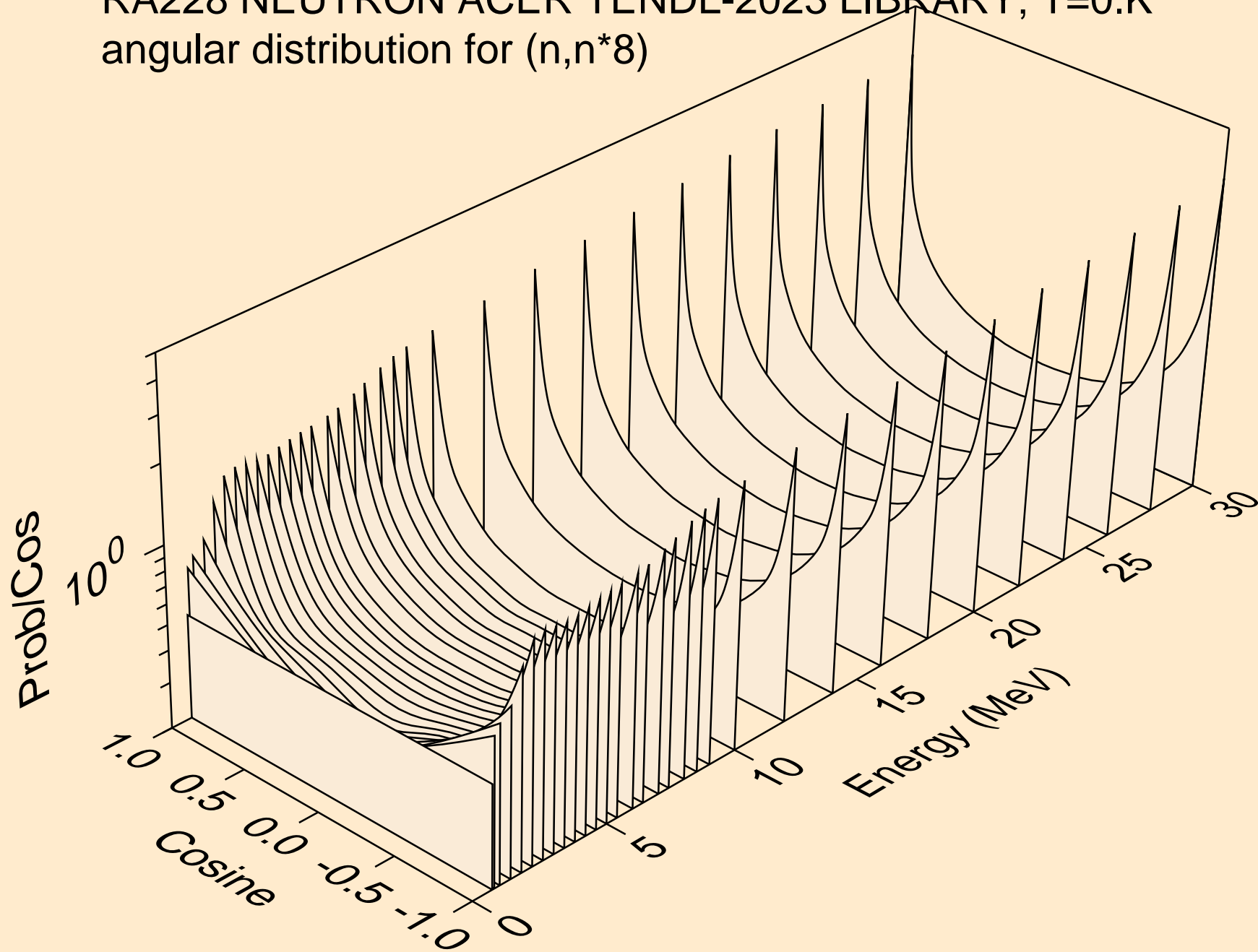

RA228 NEUTRON ACER TENDL-2023 LIBRARY; T=0.K  
angular distribution for (n,n\*9)

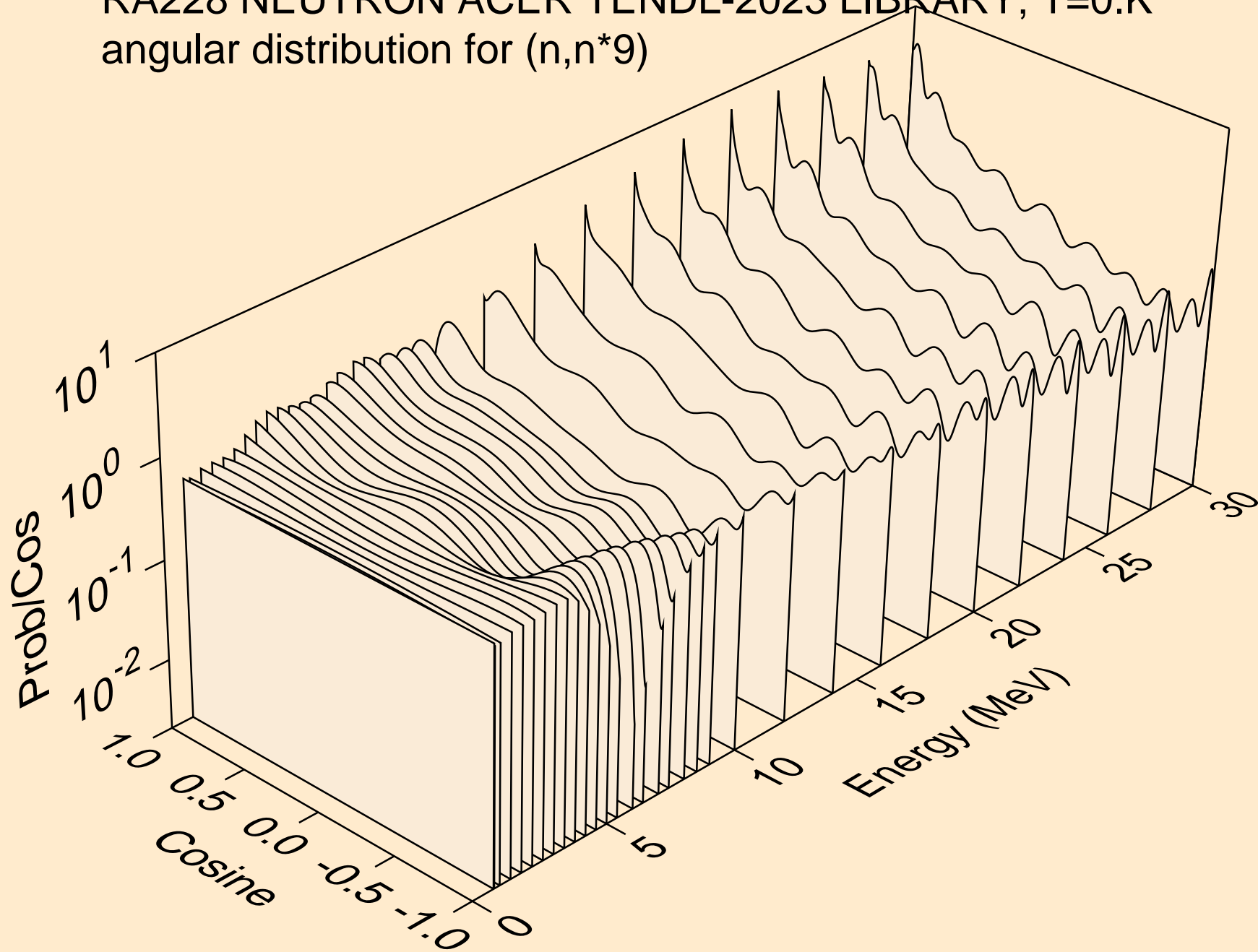

RA228 NEUTRON ACER TENDL-2023 LIBRARY; T=0.K  
angular distribution for (n,n\*10)

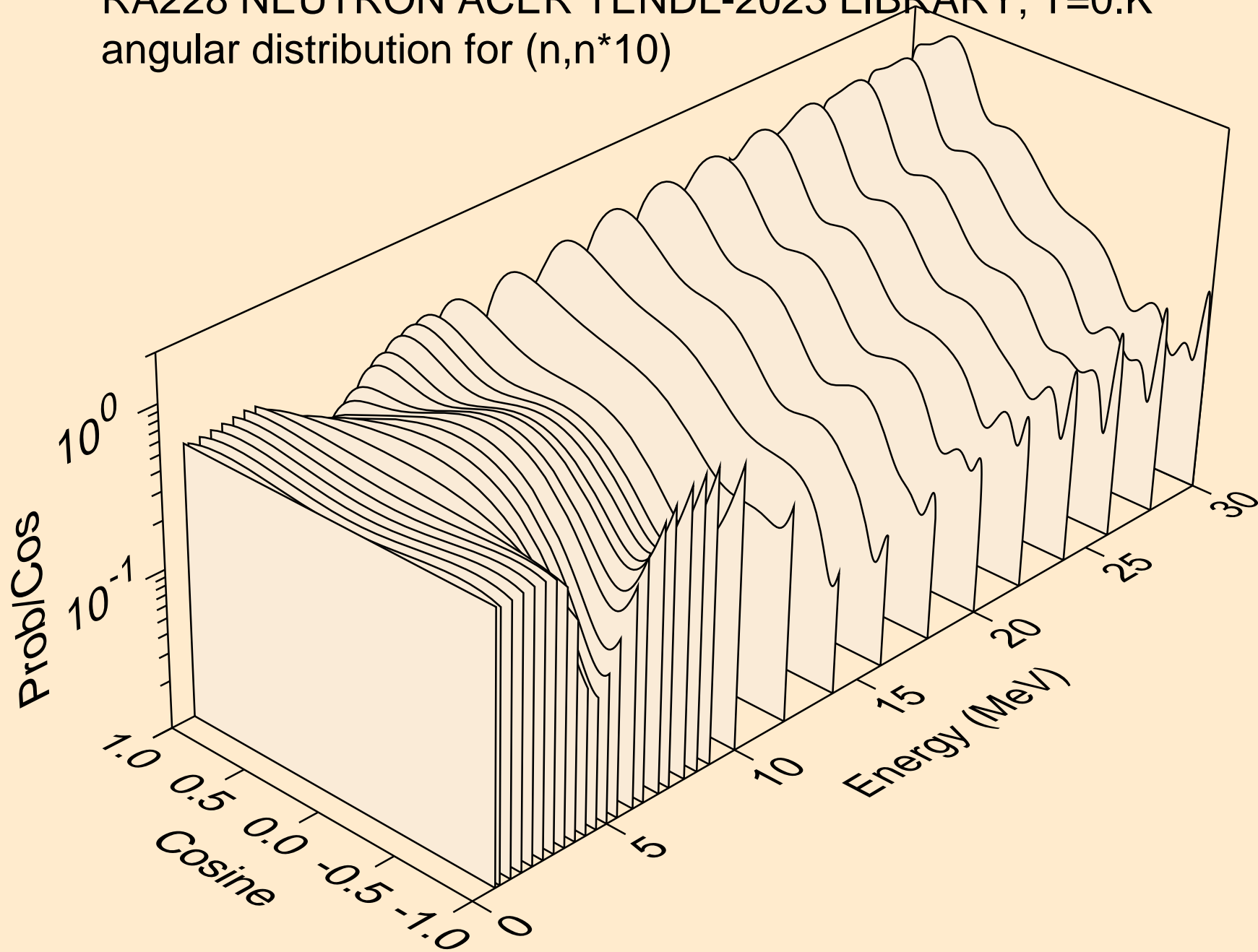

RA228 NEUTRON ACER TENDL-2023 LIBRARY; T=0.K  
angular distribution for (n,n\*11)

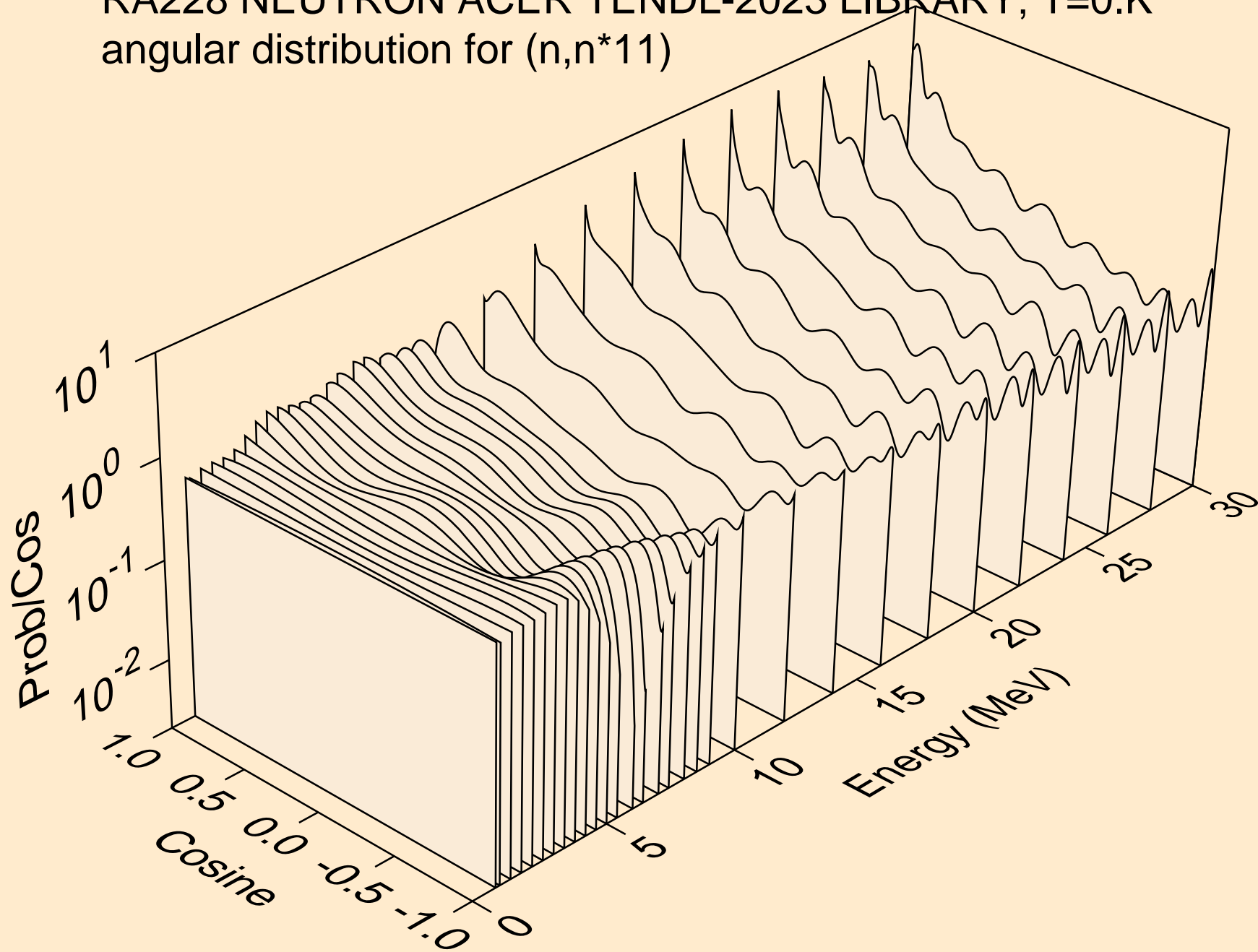

RA228 NEUTRON ACER TENDL-2023 LIBRARY; T=0.K  
angular distribution for (n,n\*12)

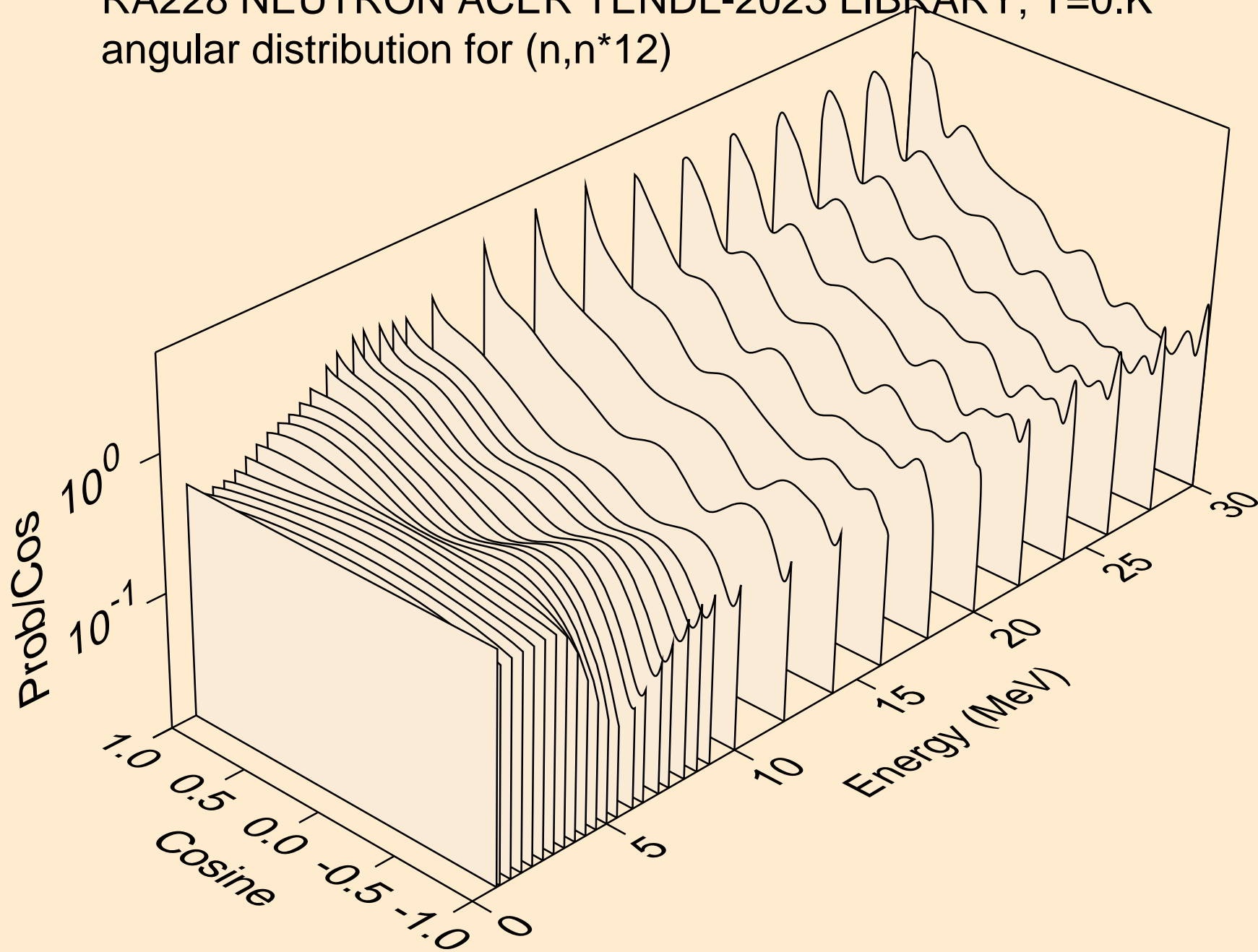

RA228 NEUTRON ACER TENDL-2023 LIBRARY; T=0.K  
angular distribution for (n,n\*13)

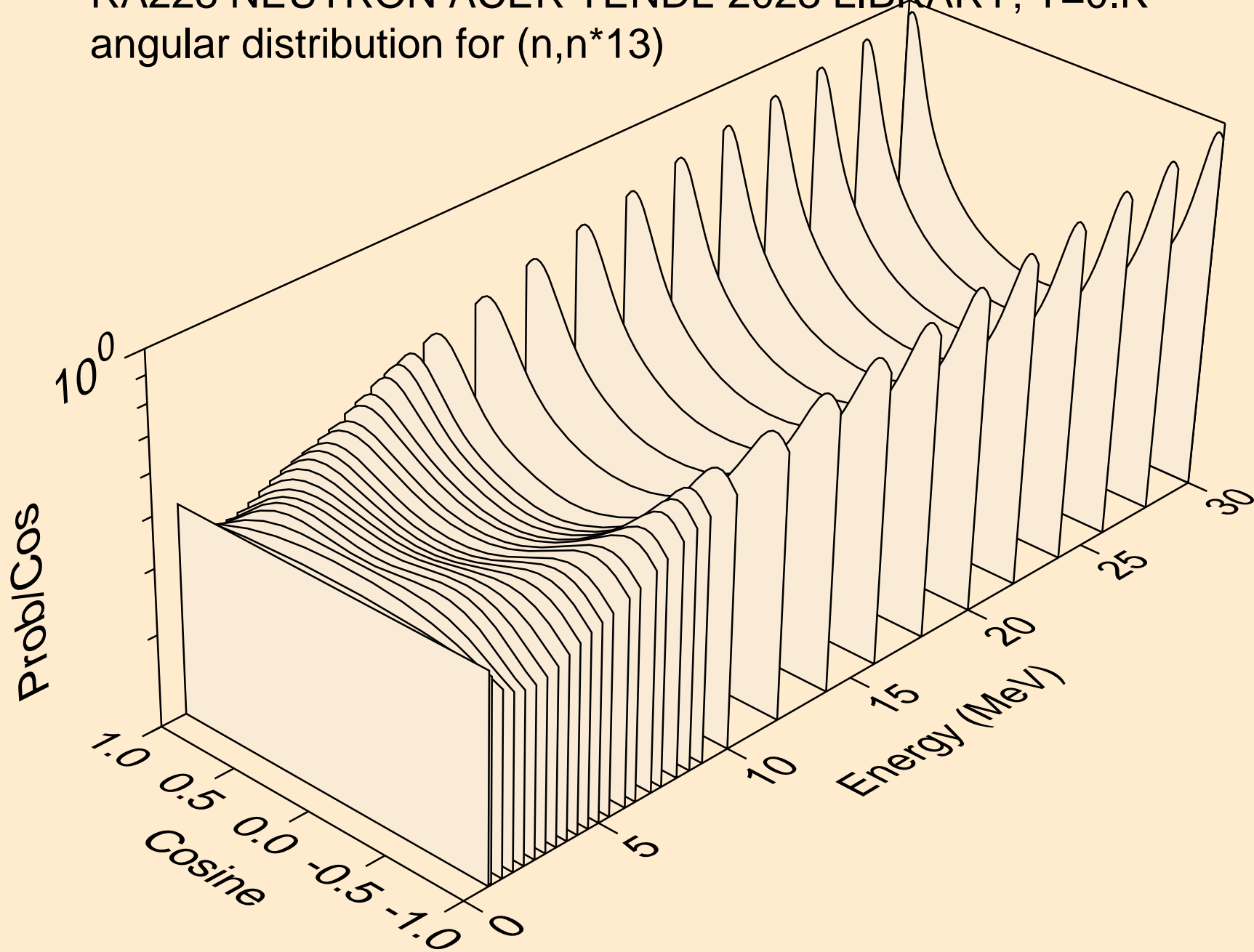



RA228 NEUTRON ACER TENDL-2023 LIBRARY; T=0.K  
angular distribution for (n,n\*14)

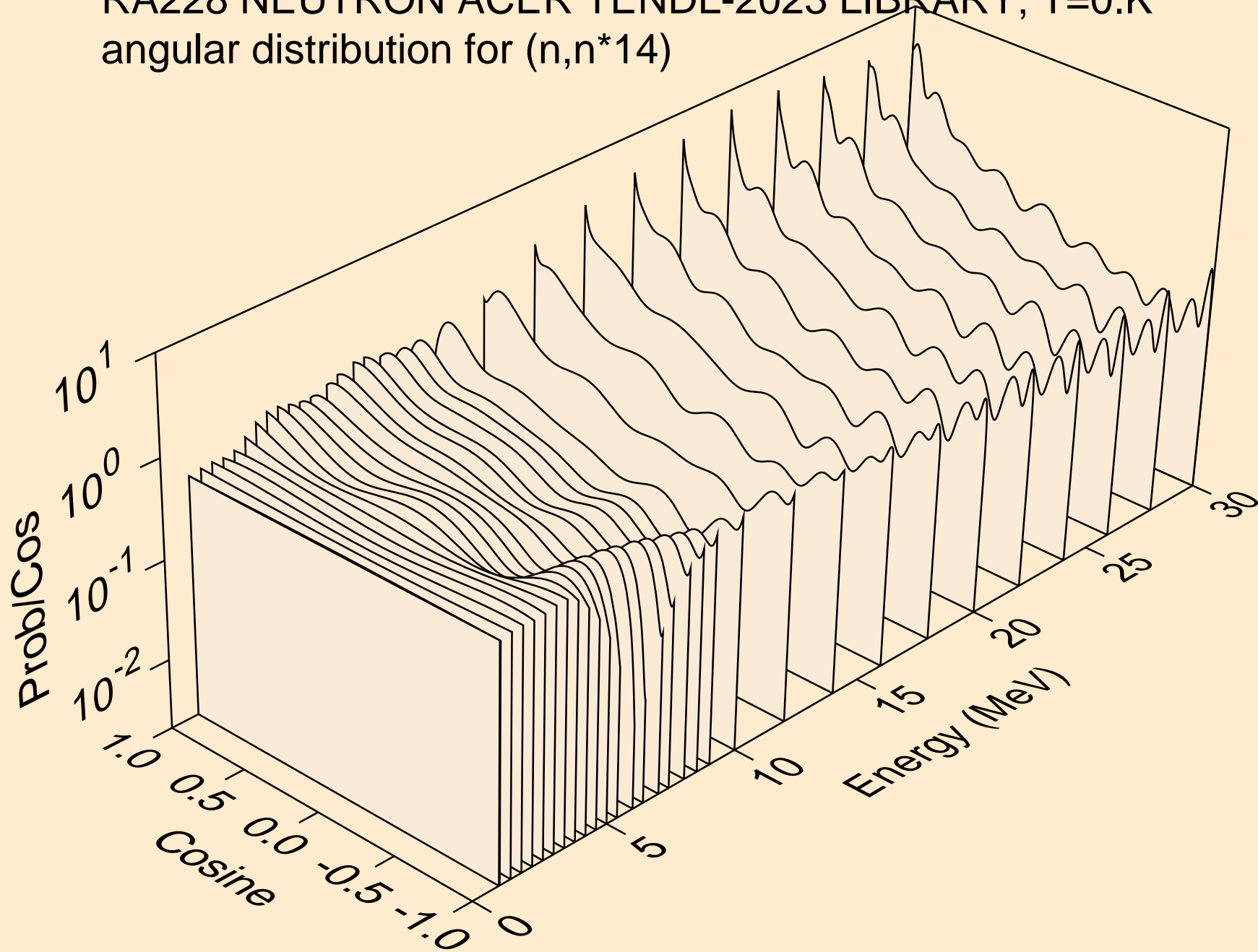

RA228 NEUTRON ACER TENDL-2023 LIBRARY; T=0.K  
angular distribution for (n,n\*15)

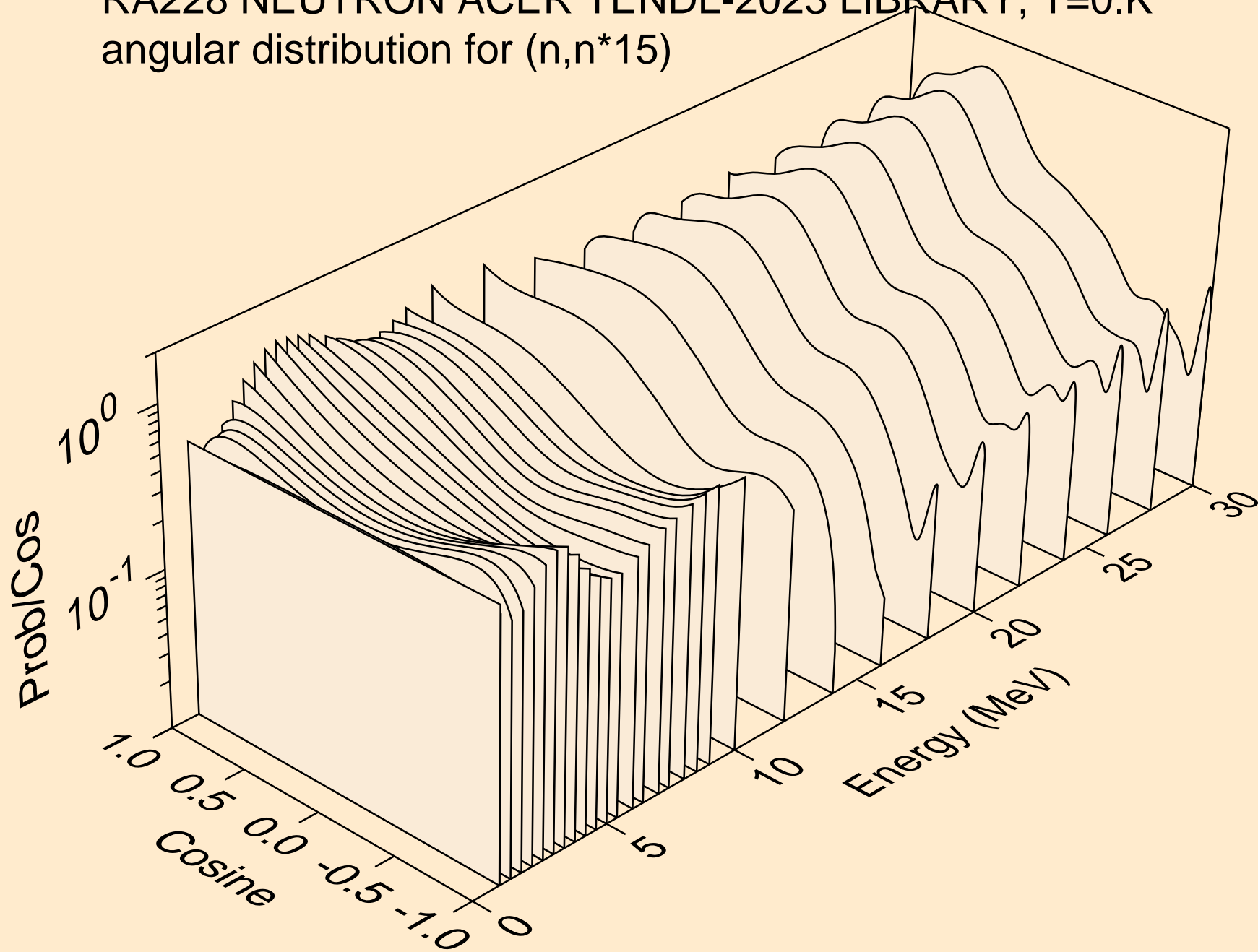

RA228 NEUTRON ACER TENDL-2023 LIBRARY; T=0.K  
angular distribution for (n,n\*16)

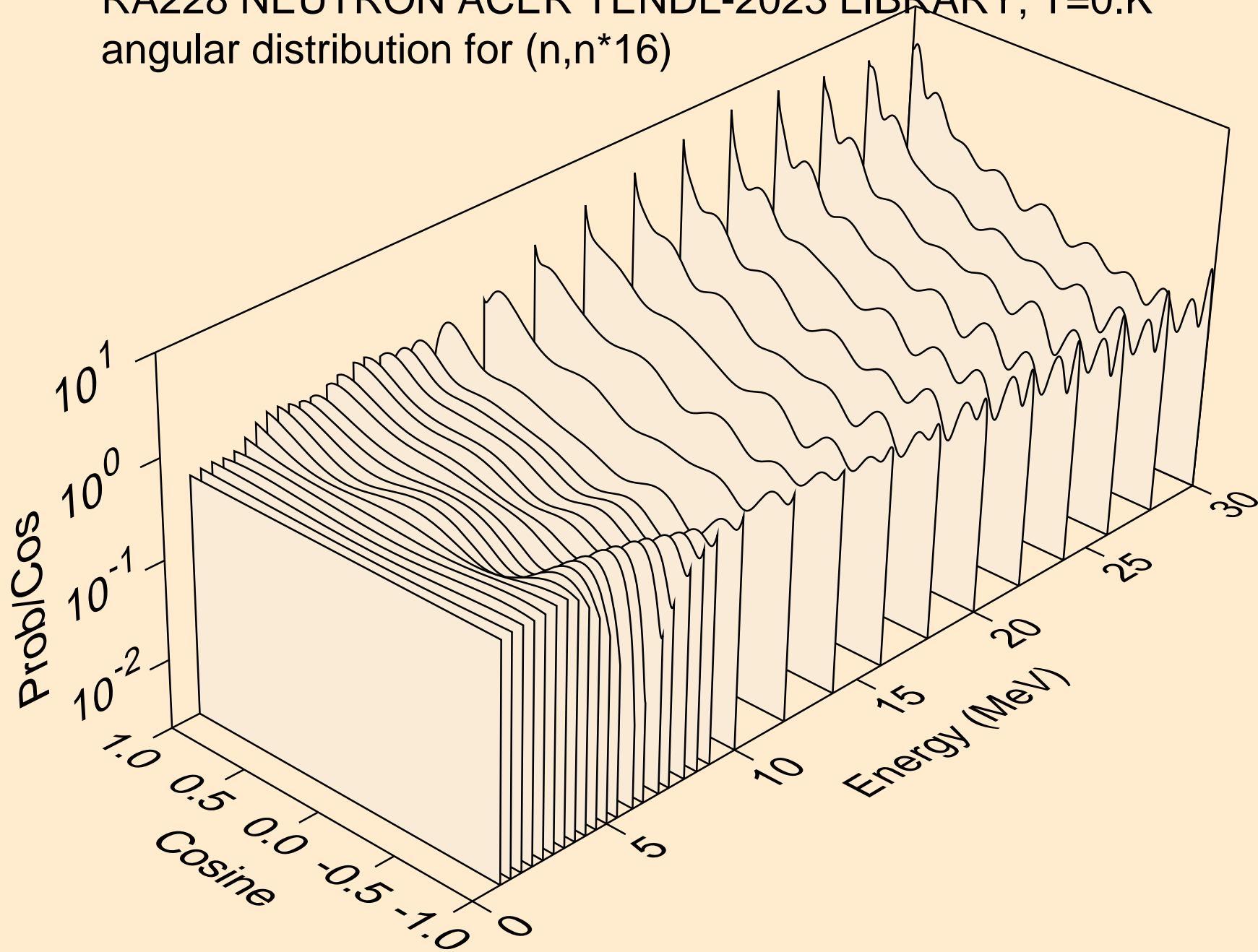

RA228 NEUTRON ACER TENDL-2023 LIBRARY; T=0.K

Total fission nubar

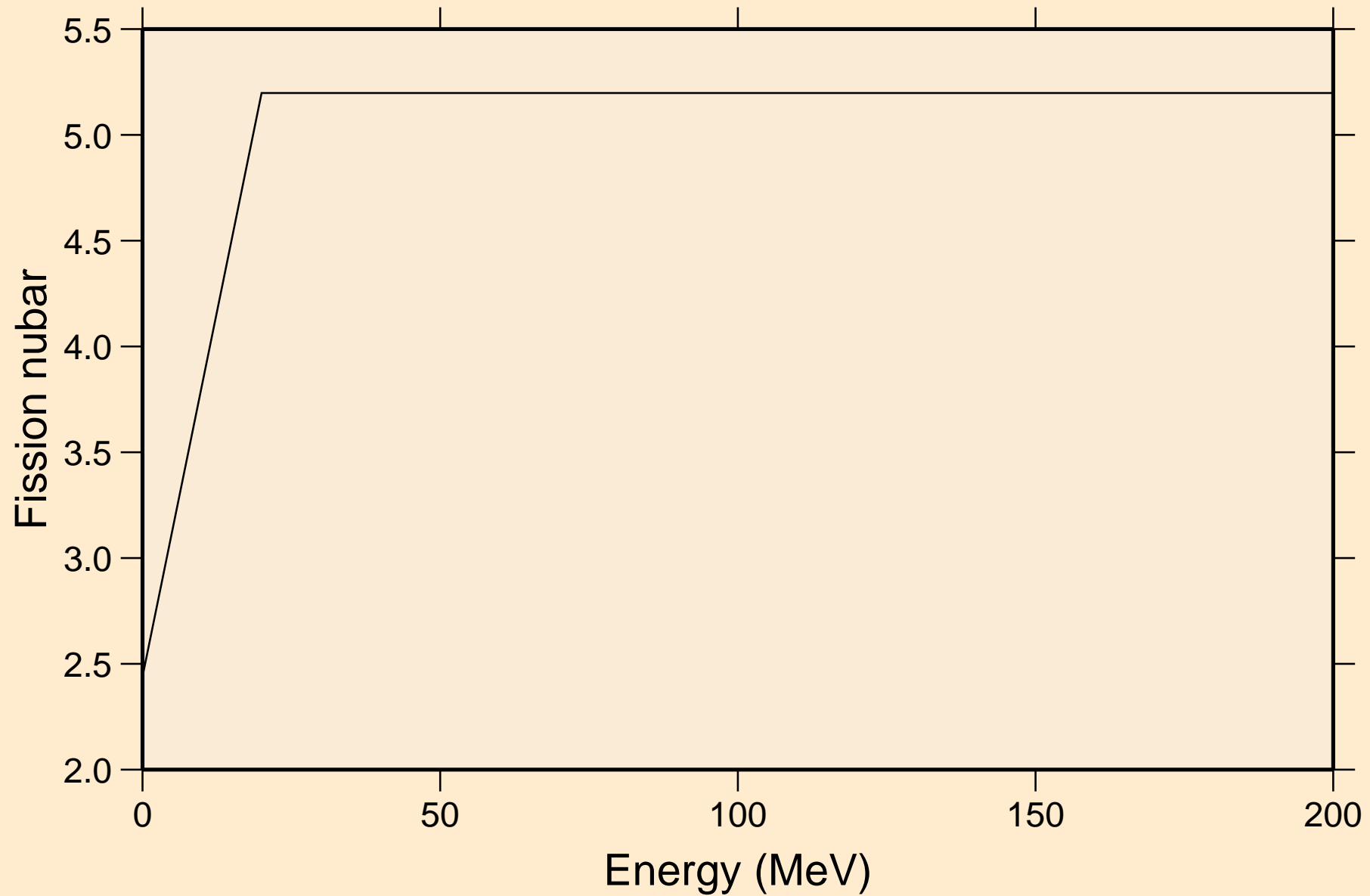

RA228 NEUTRON ACER TENDL-2023 LIBRARY; T=0.K  
Neutron emission for (n,x)

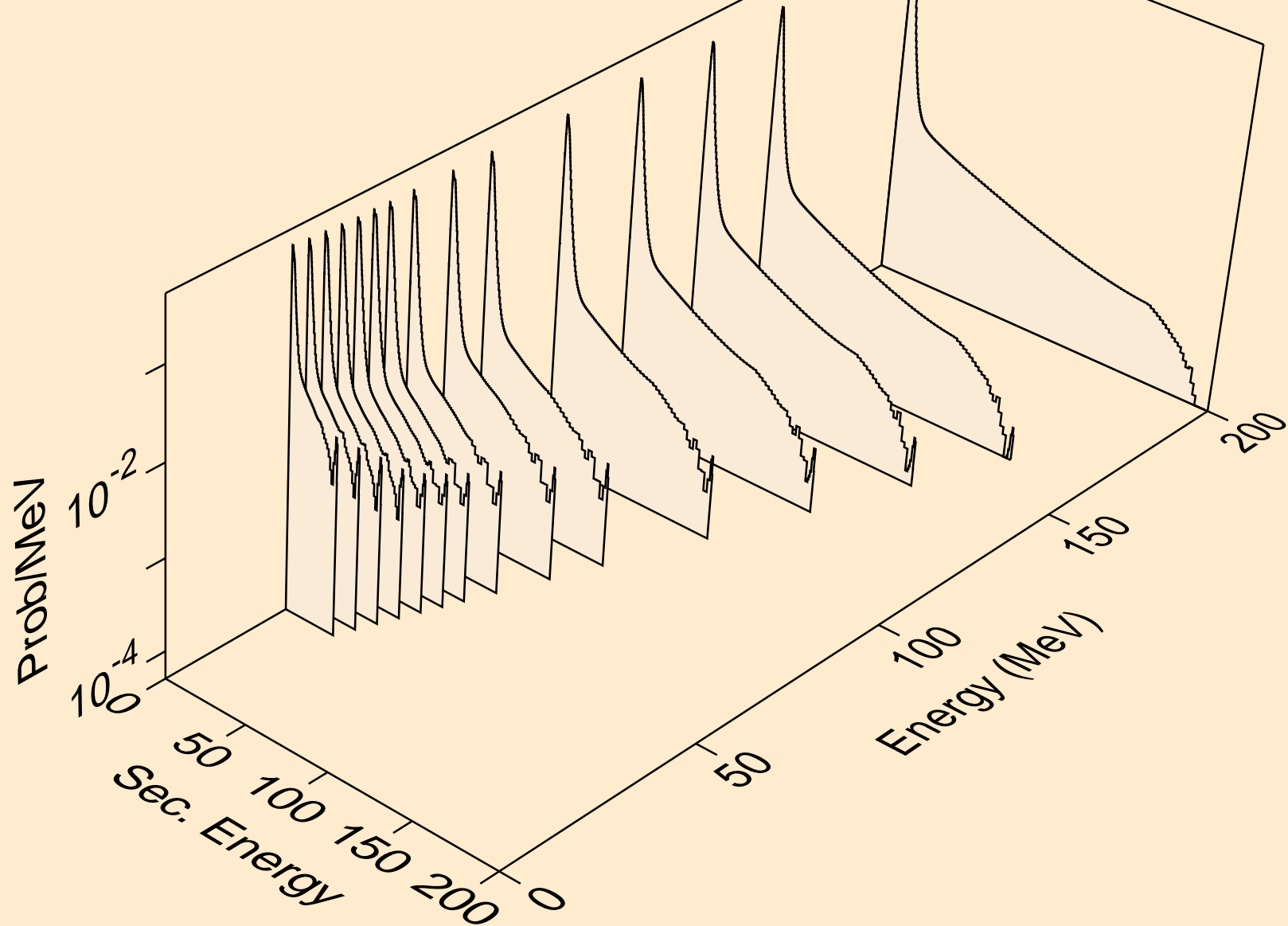

RA228 NEUTRON ACER TENDL-2023 LIBRARY; T=0.K  
Neutron emission for (n,2nd)

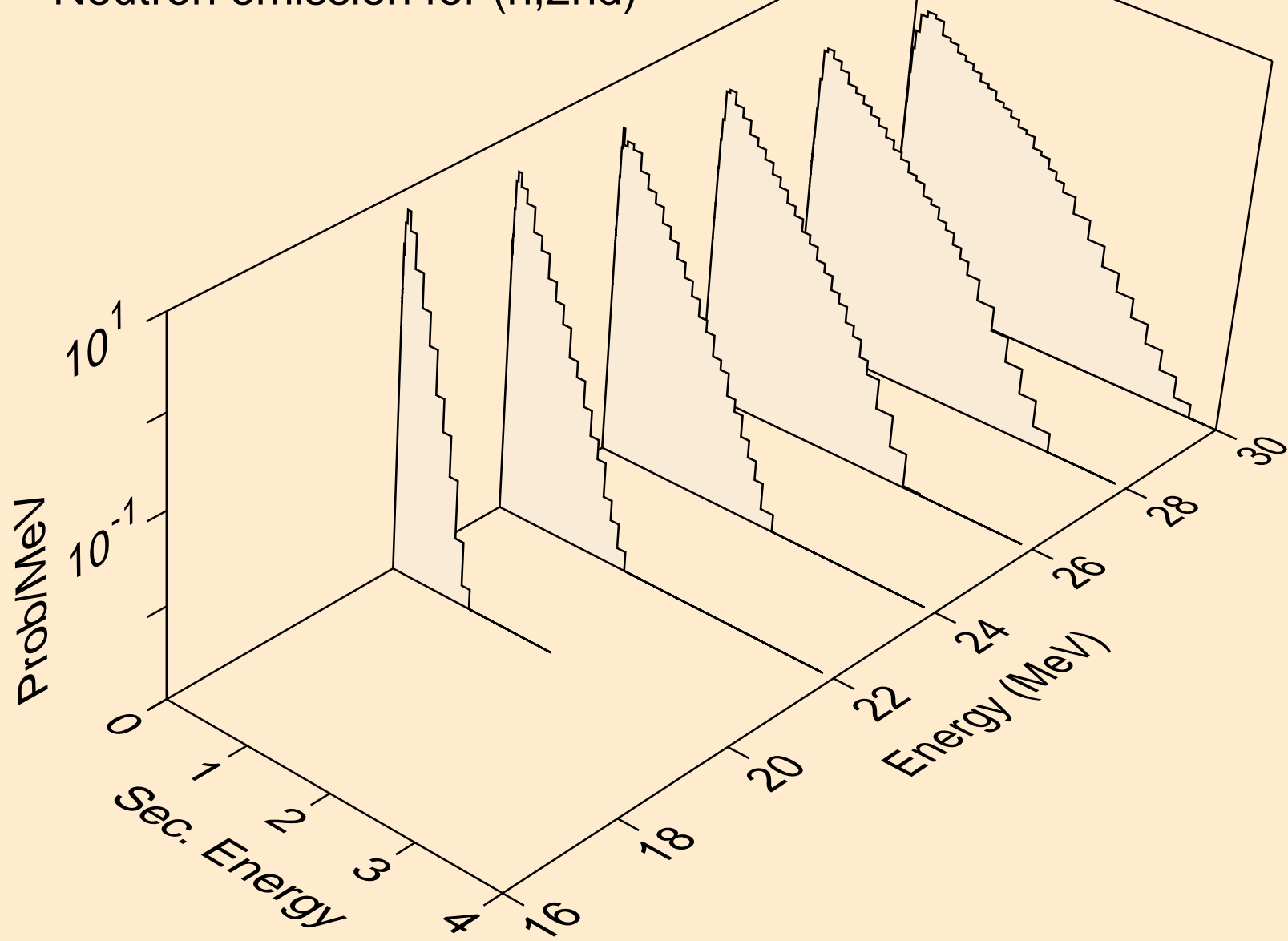

RA228 NEUTRON ACER TENDL-2023 LIBRARY; T=0.K  
Neutron emission for (n,2n)

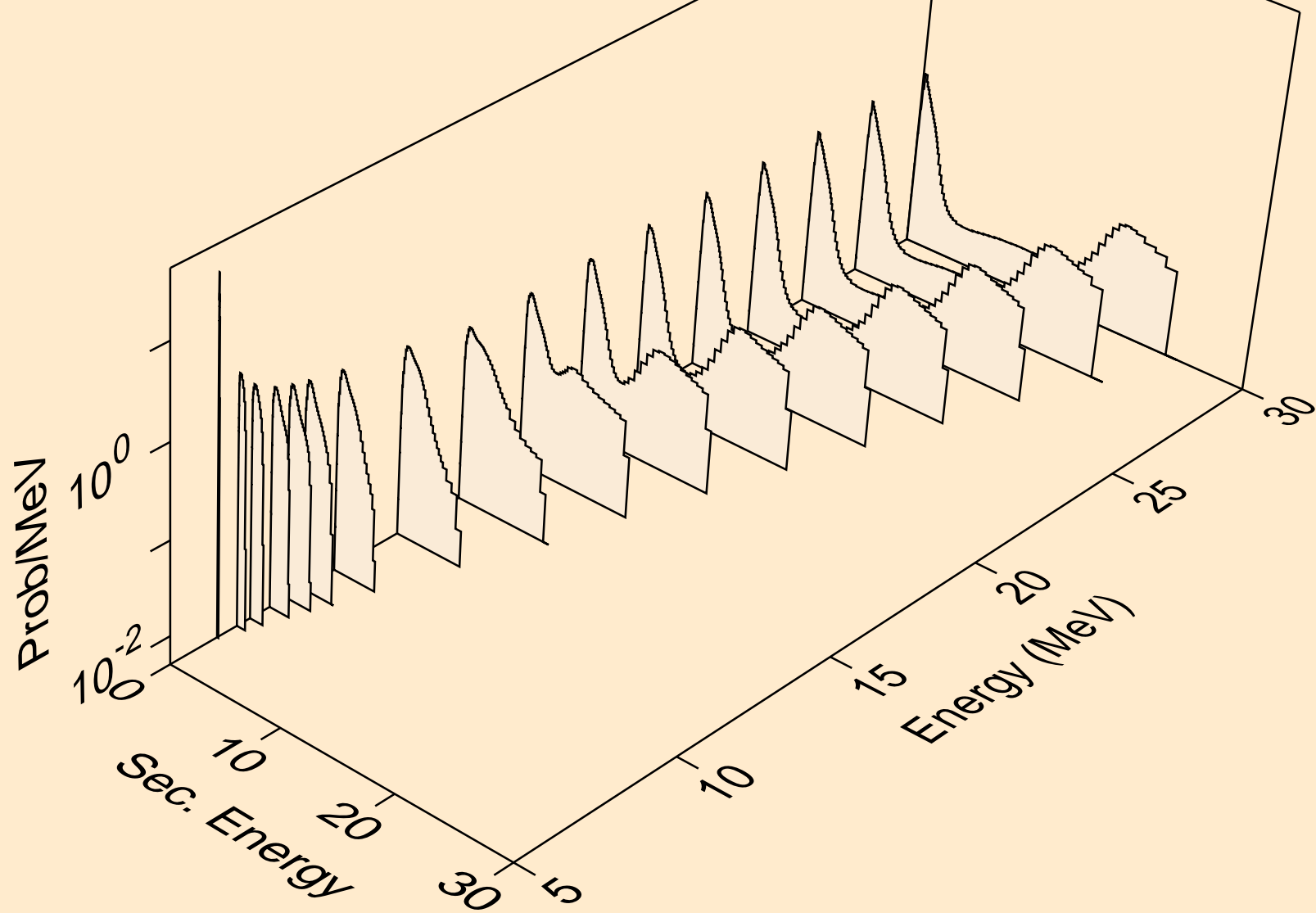

RA228 NEUTRON ACER TENDL-2023 LIBRARY; T=0.K  
Neutron emission for (n,3n)

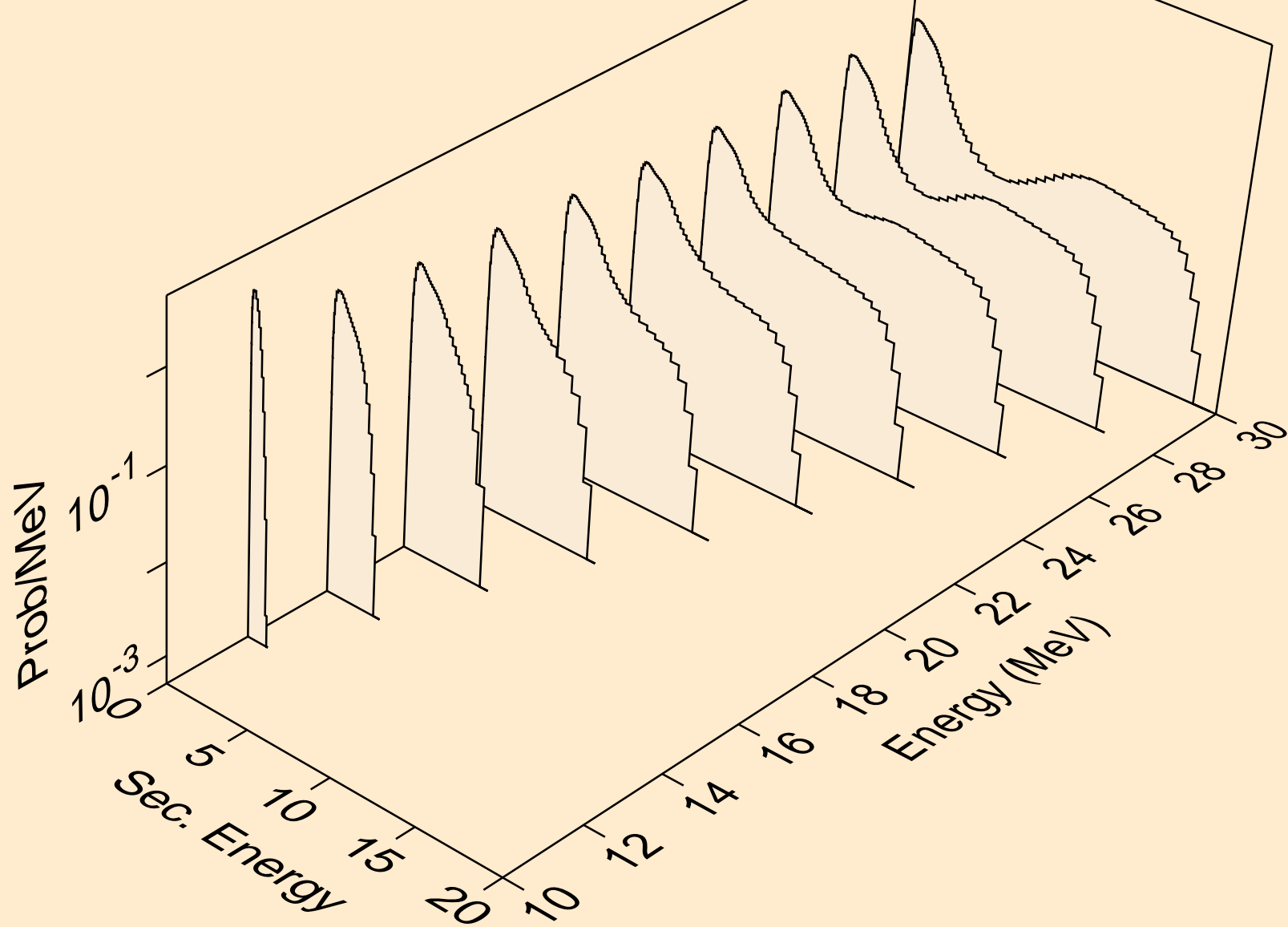



RA228 NEUTRON ACER TENDL-2023 LIBRARY; T=0.K  
Neutron emission for fission

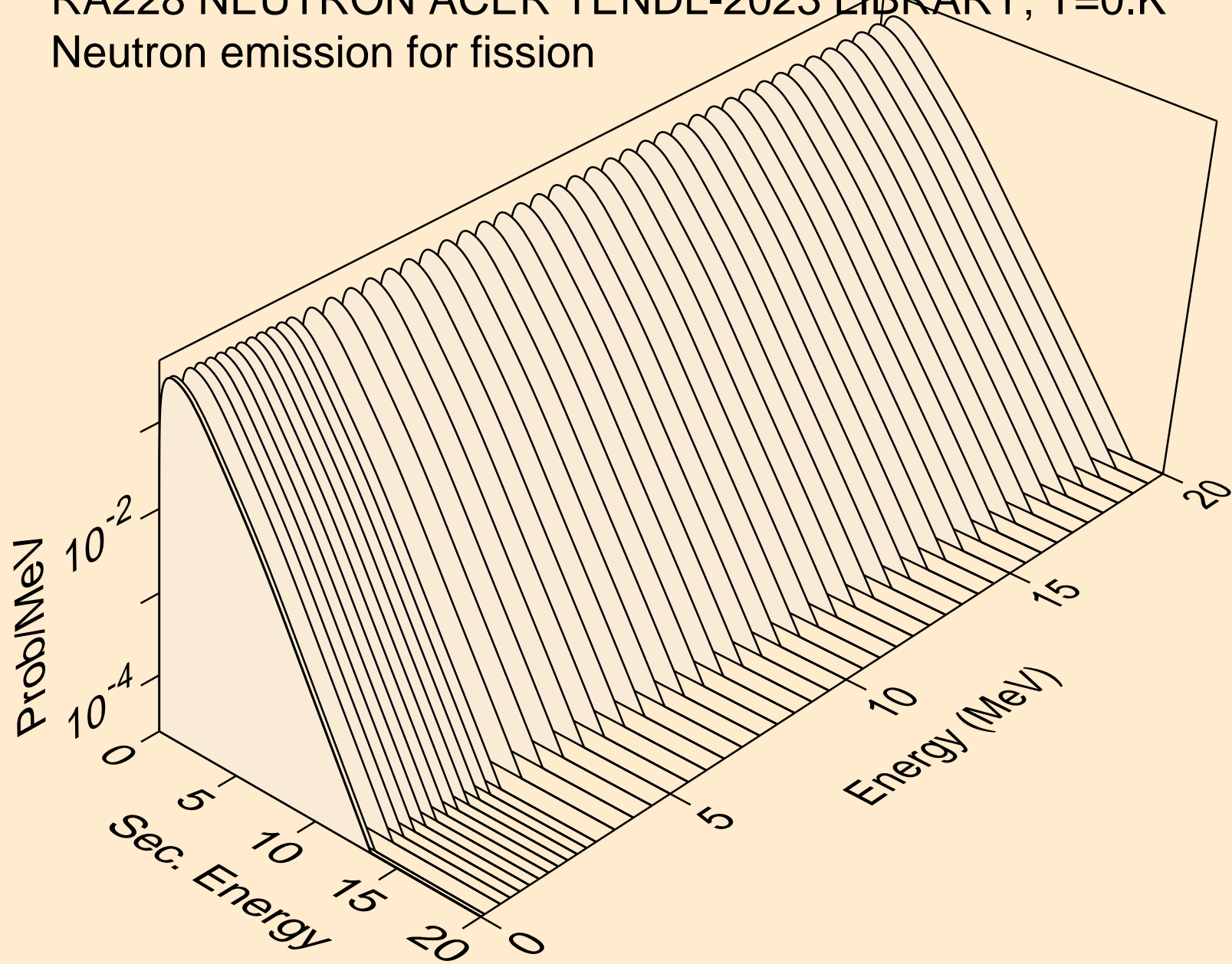

RA228 NEUTRON ACER TENDL-2023 LIBRARY; T=0.K  
Neutron emission for (n,n\*)a

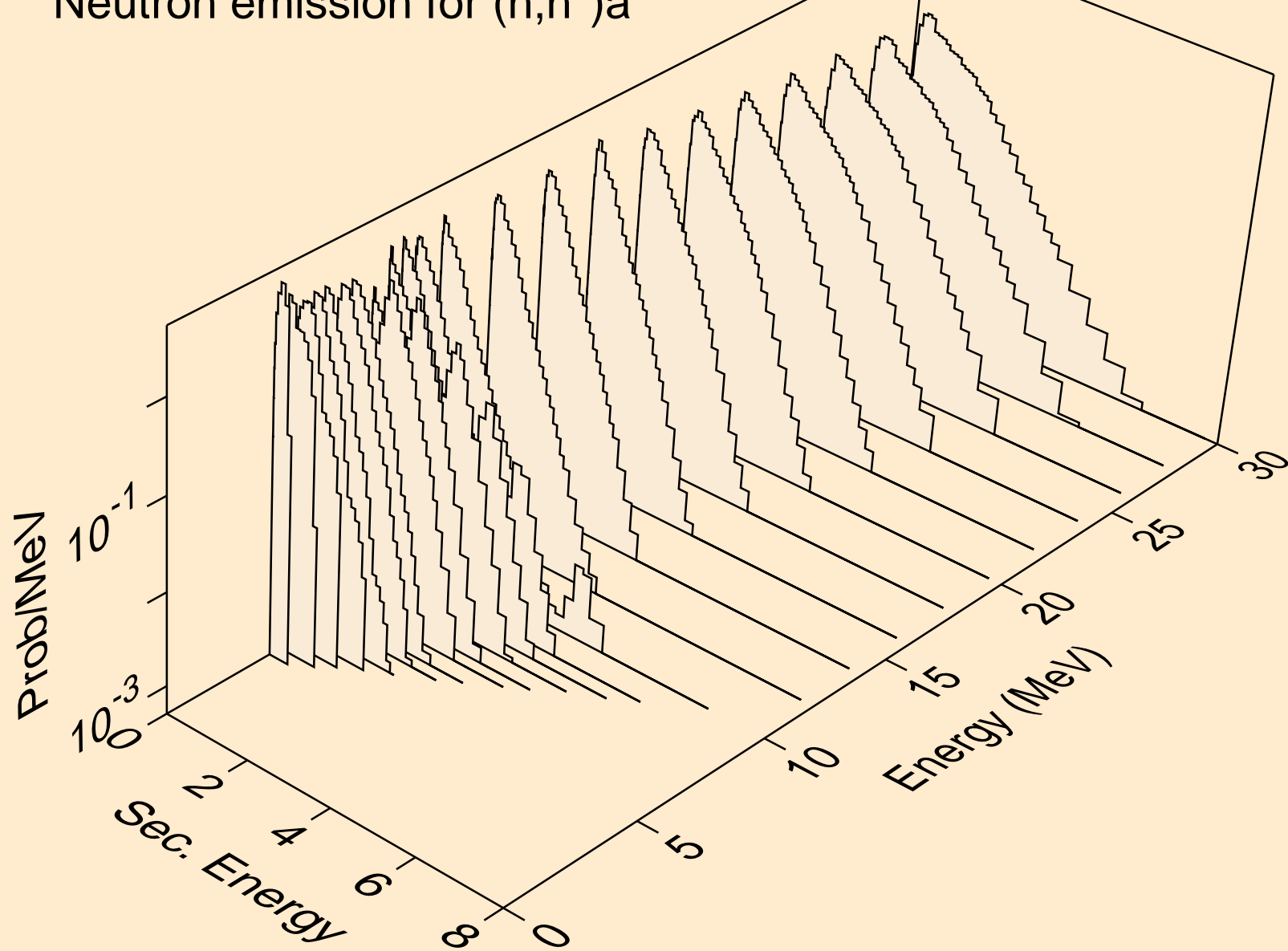

RA228 NEUTRON ACER TENDL-2023 LIBRARY; T=0.K  
Neutron emission for (n,2n)a

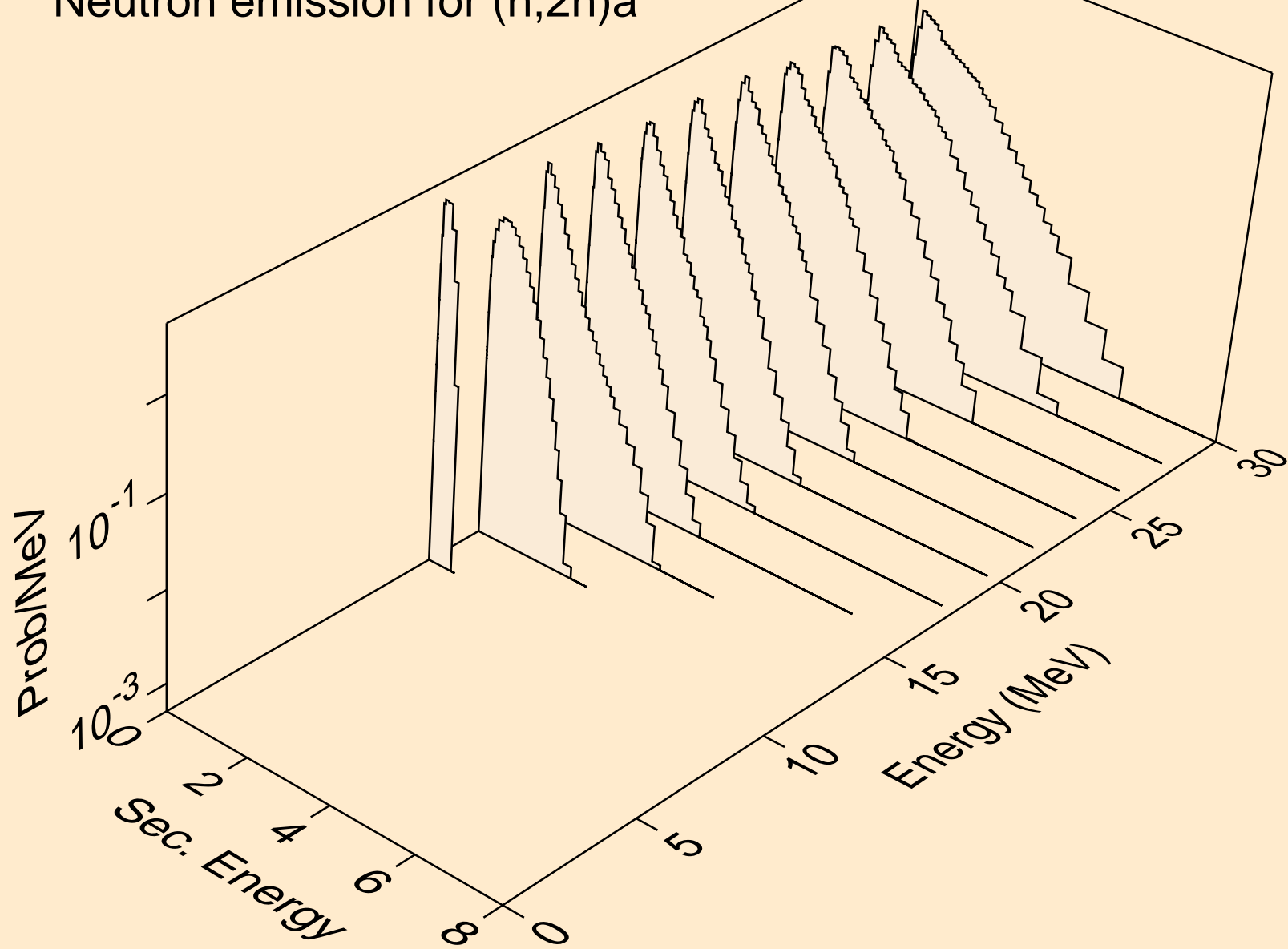

RA228 NEUTRON ACER TENDL-2023 LIBRARY; T=0.K  
Neutron emission for (n,3n)a

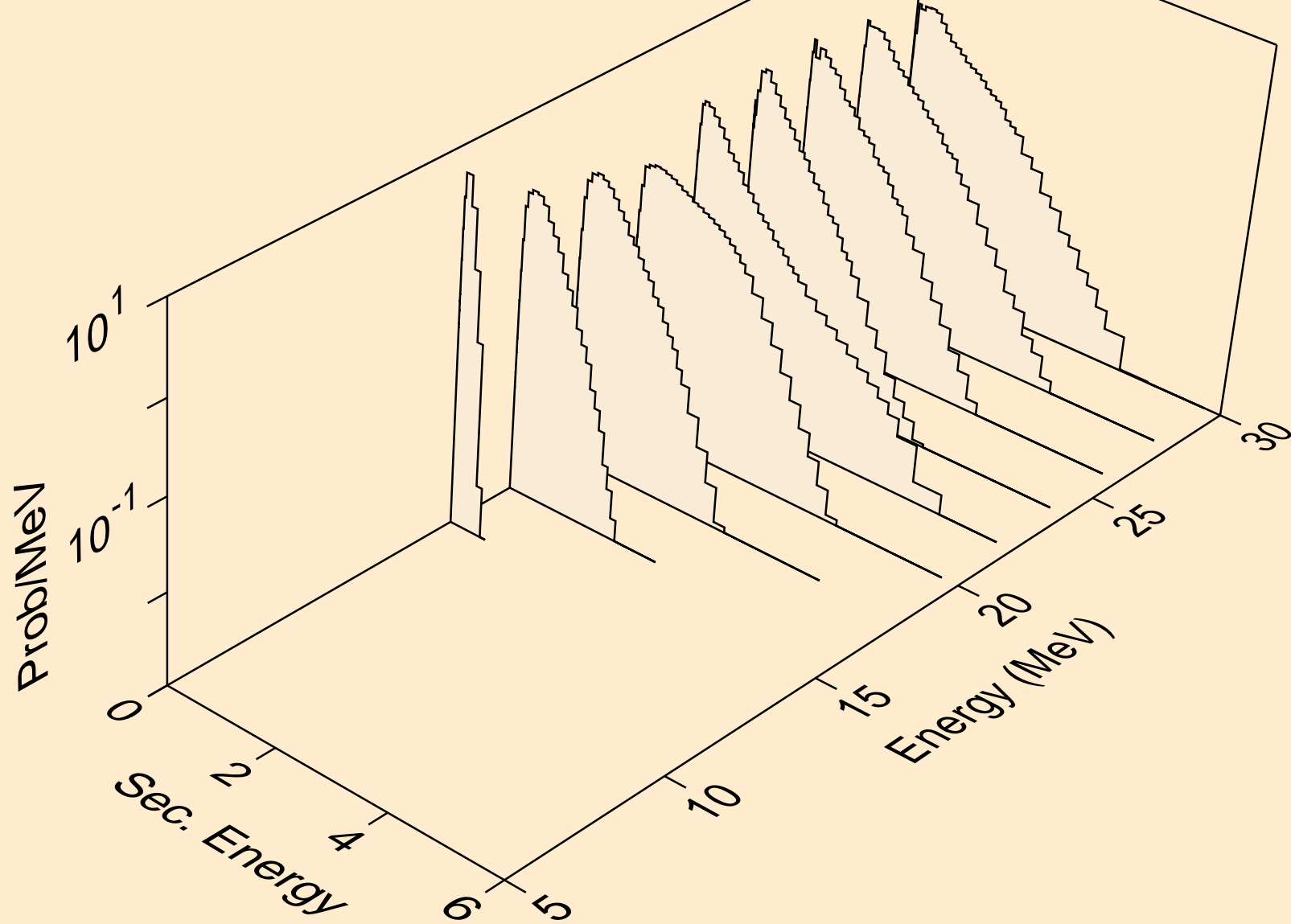

RA228 NEUTRON ACER TENDL-2023 LIBRARY; T=0.K  
Neutron emission for (n,n\*)p

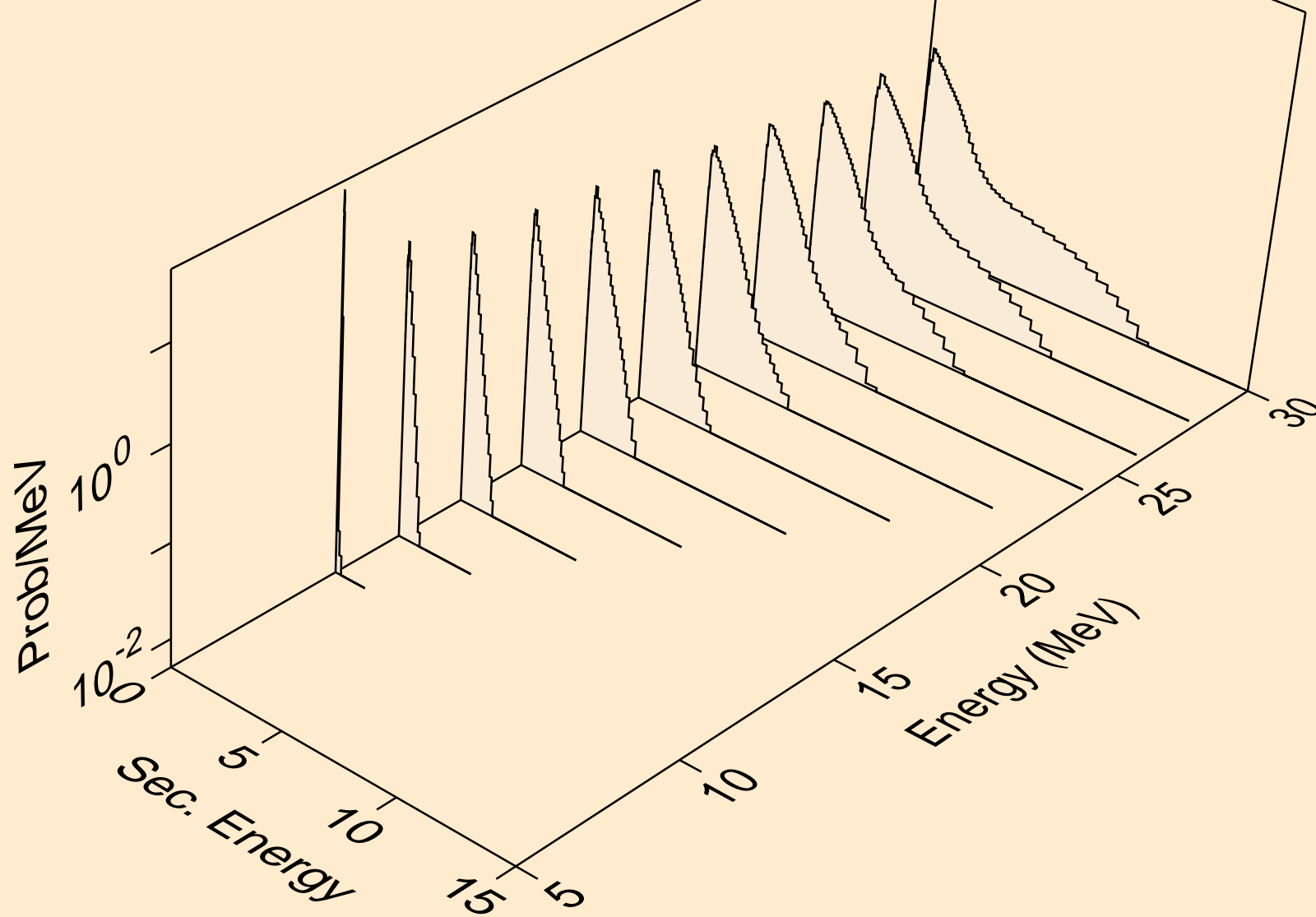

RA228 NEUTRON ACER TENDL-2023 LIBRARY; T=0.K  
Neutron emission for (n,n\*)d

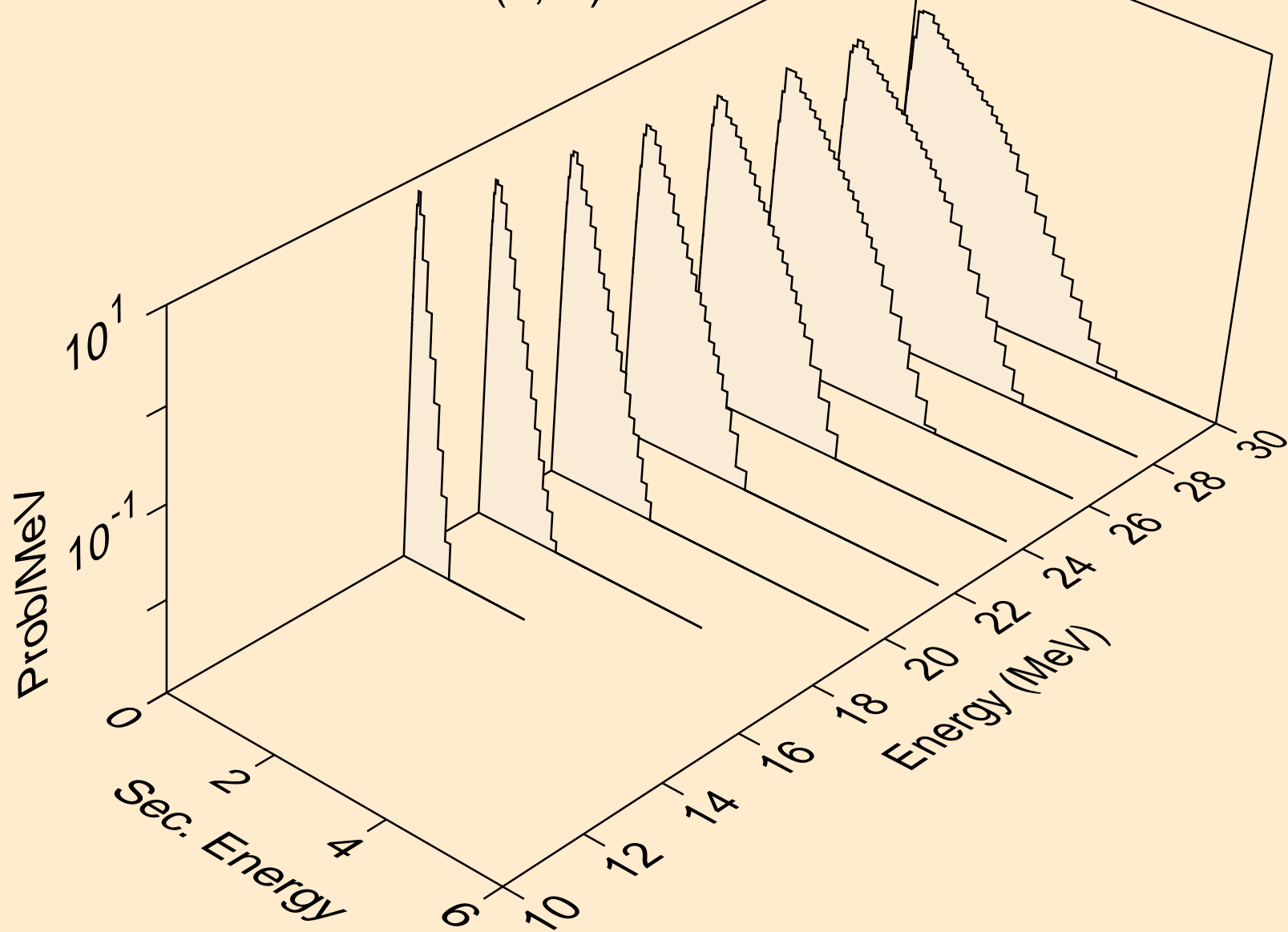

RA228 NEUTRON ACER TENDL-2023 LIBRARY; T=0.K  
Neutron emission for (n,n\*)t

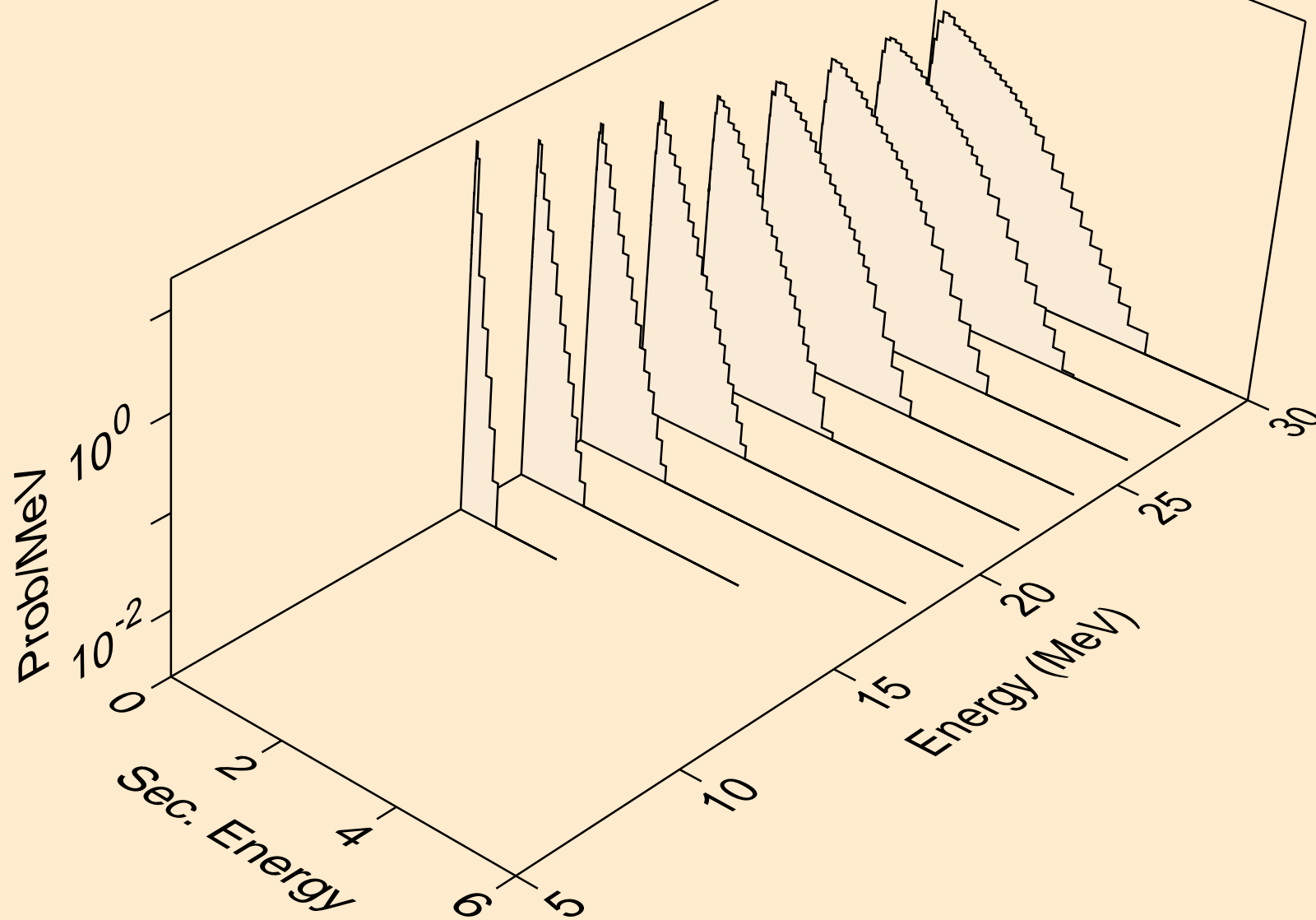

RA228 NEUTRON ACER TENDL-2023 LIBRARY; T=0.K  
Neutron emission for (n,n\*)he3

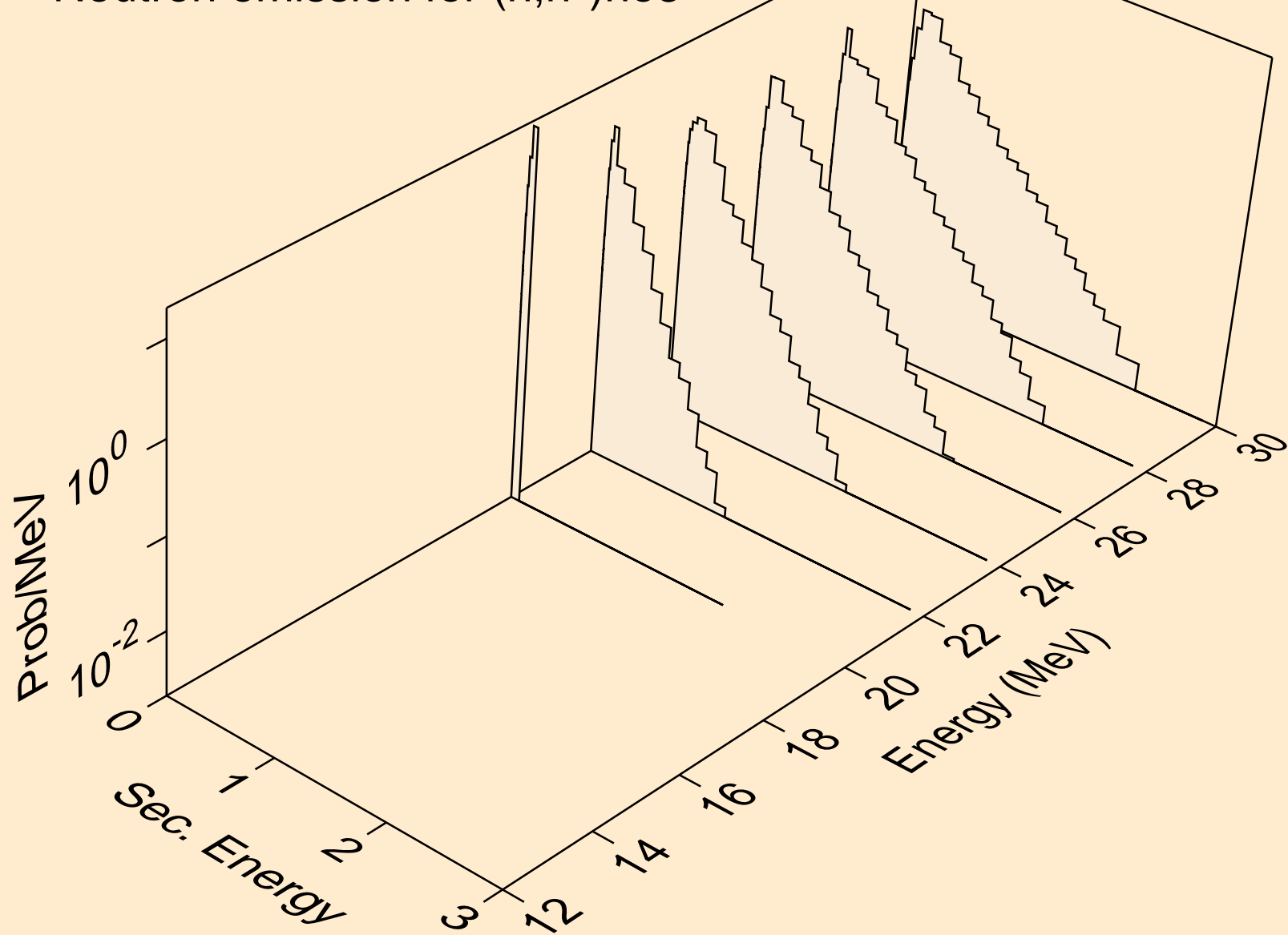



RA228 NEUTRON ACER TENDL-2023 LIBRARY; T=0.K  
Neutron emission for (n,4n)

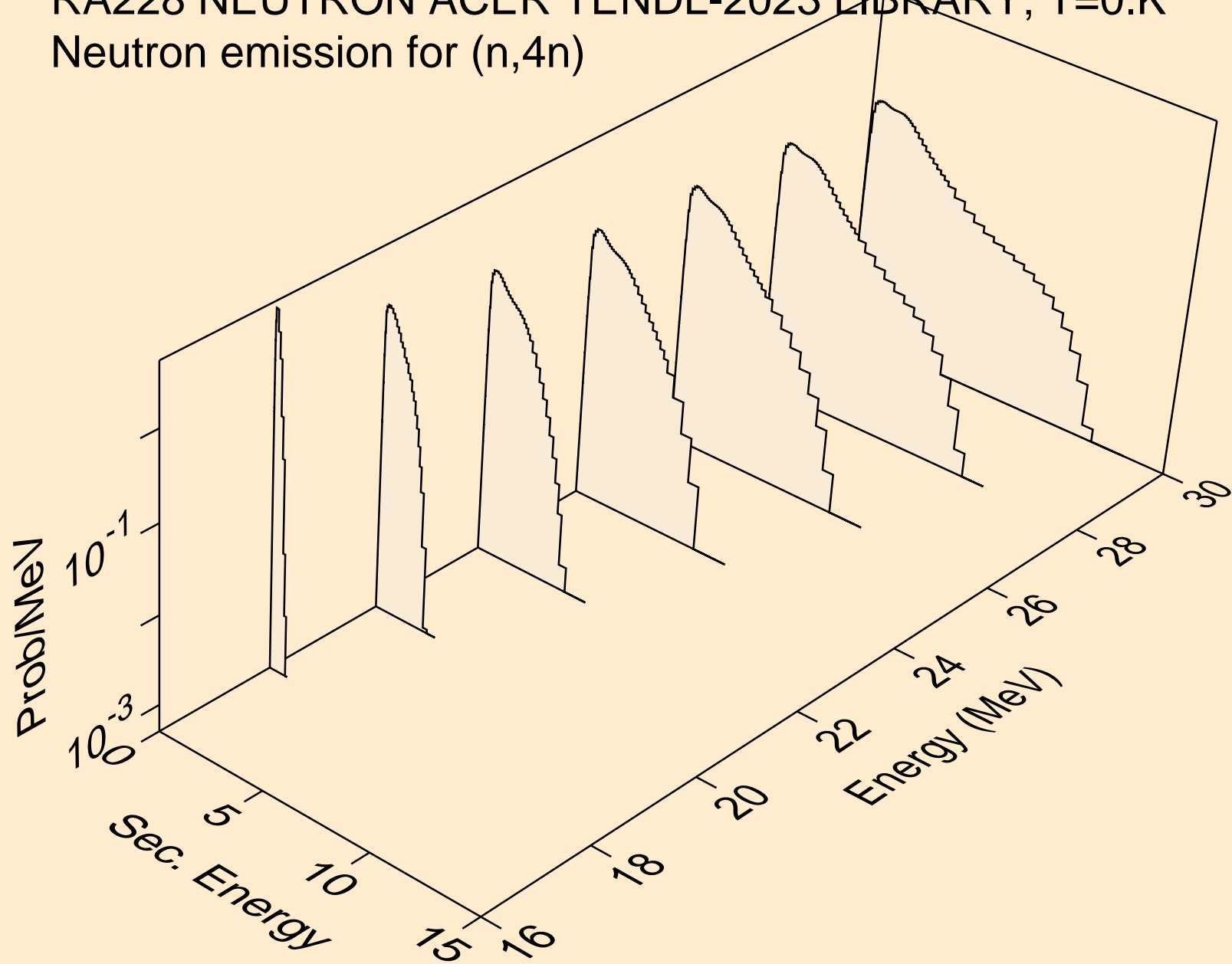

RA228 NEUTRON ACER TENDL-2023 LIBRARY; T=0.K  
Neutron emission for (n,2np)

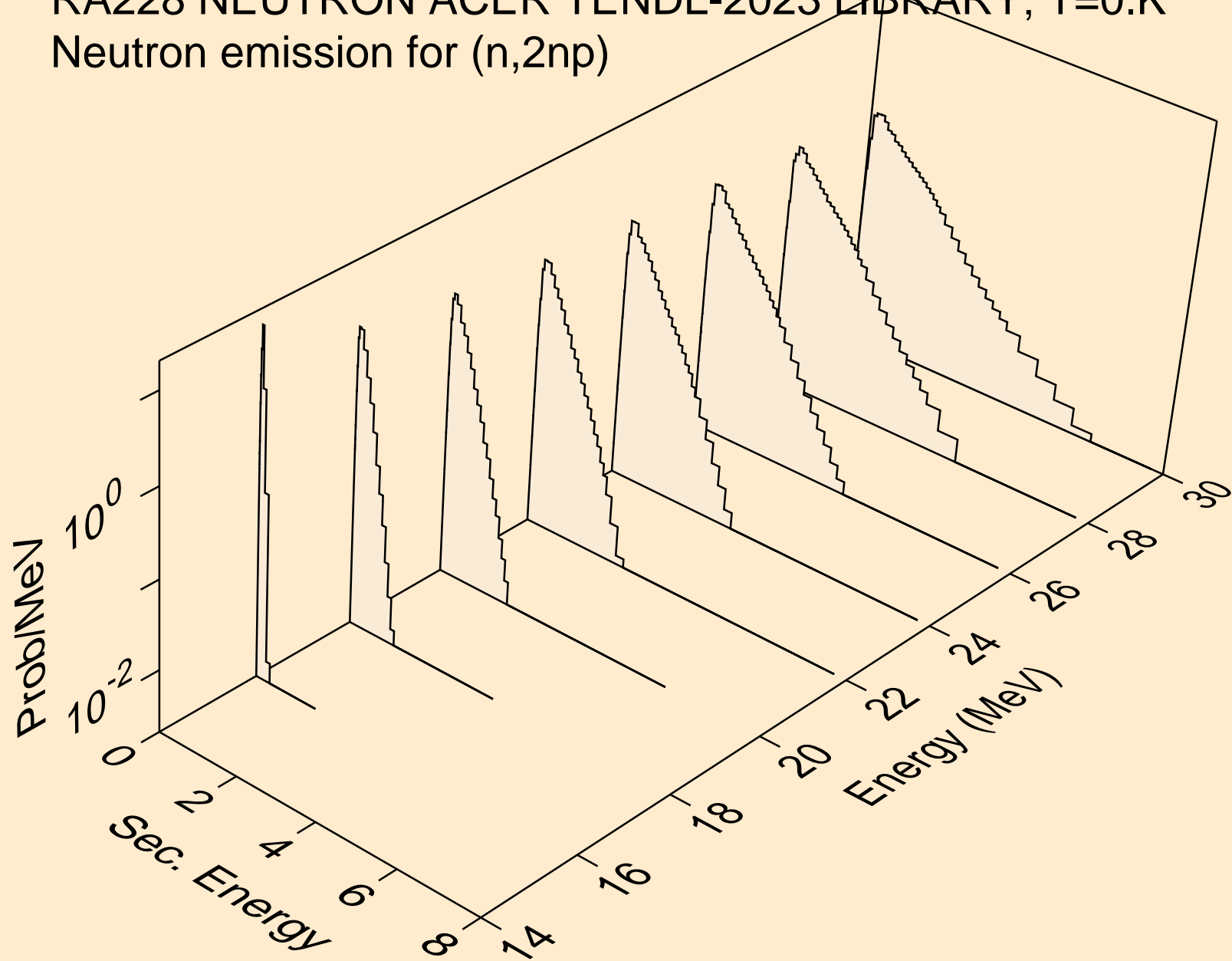

RA228 NEUTRON ACER TENDL-2023 LIBRARY; T=0.K  
Neutron emission for (n,3np)

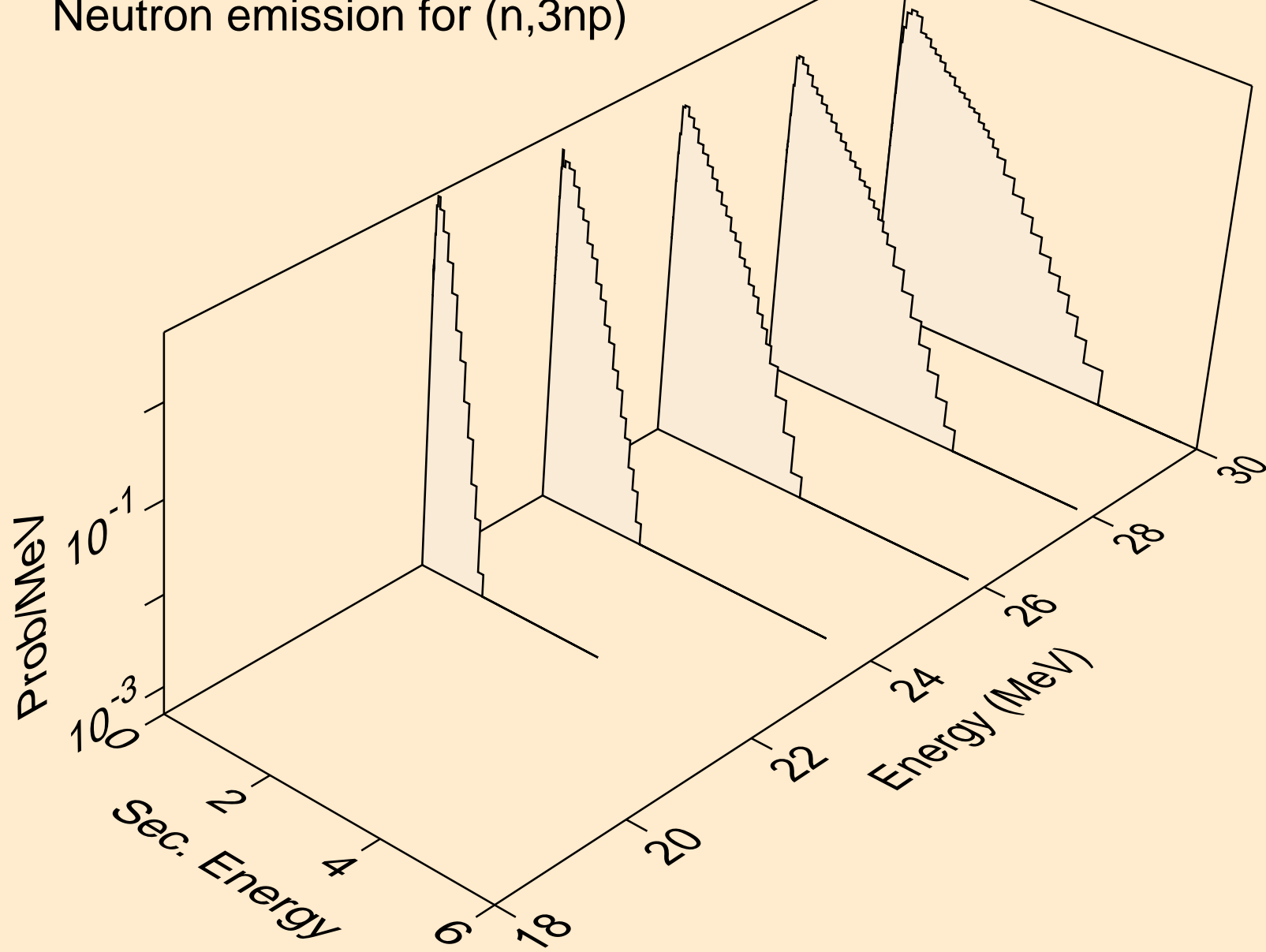

RA228 NEUTRON ACER TENDL-2023 LIBRARY; T=0.K  
Neutron emission for (n,n\*c)

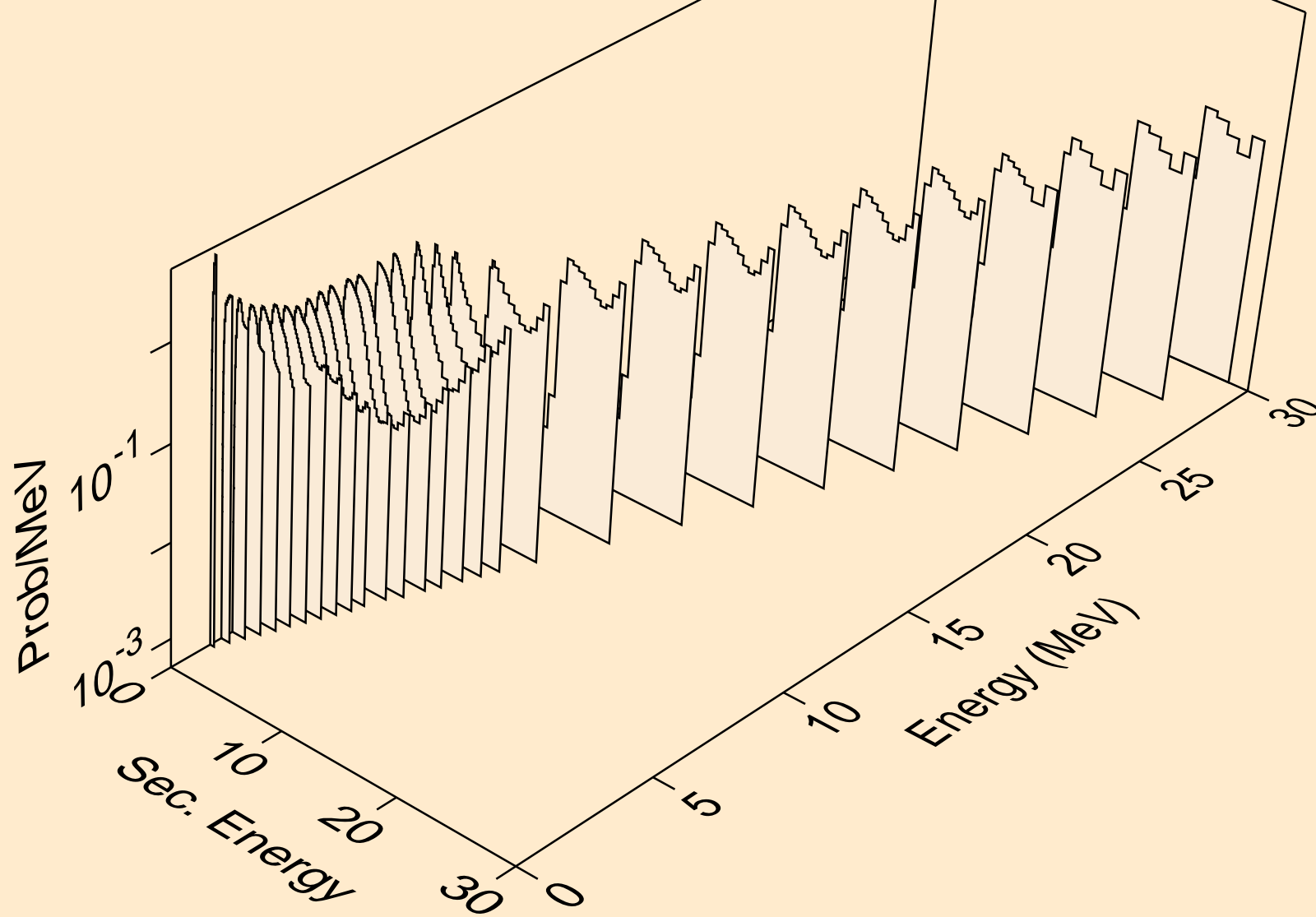

# RA228 NEUTRON ACER TENDL-2023 LIBRARY; T=0.K

## Delayed nubar

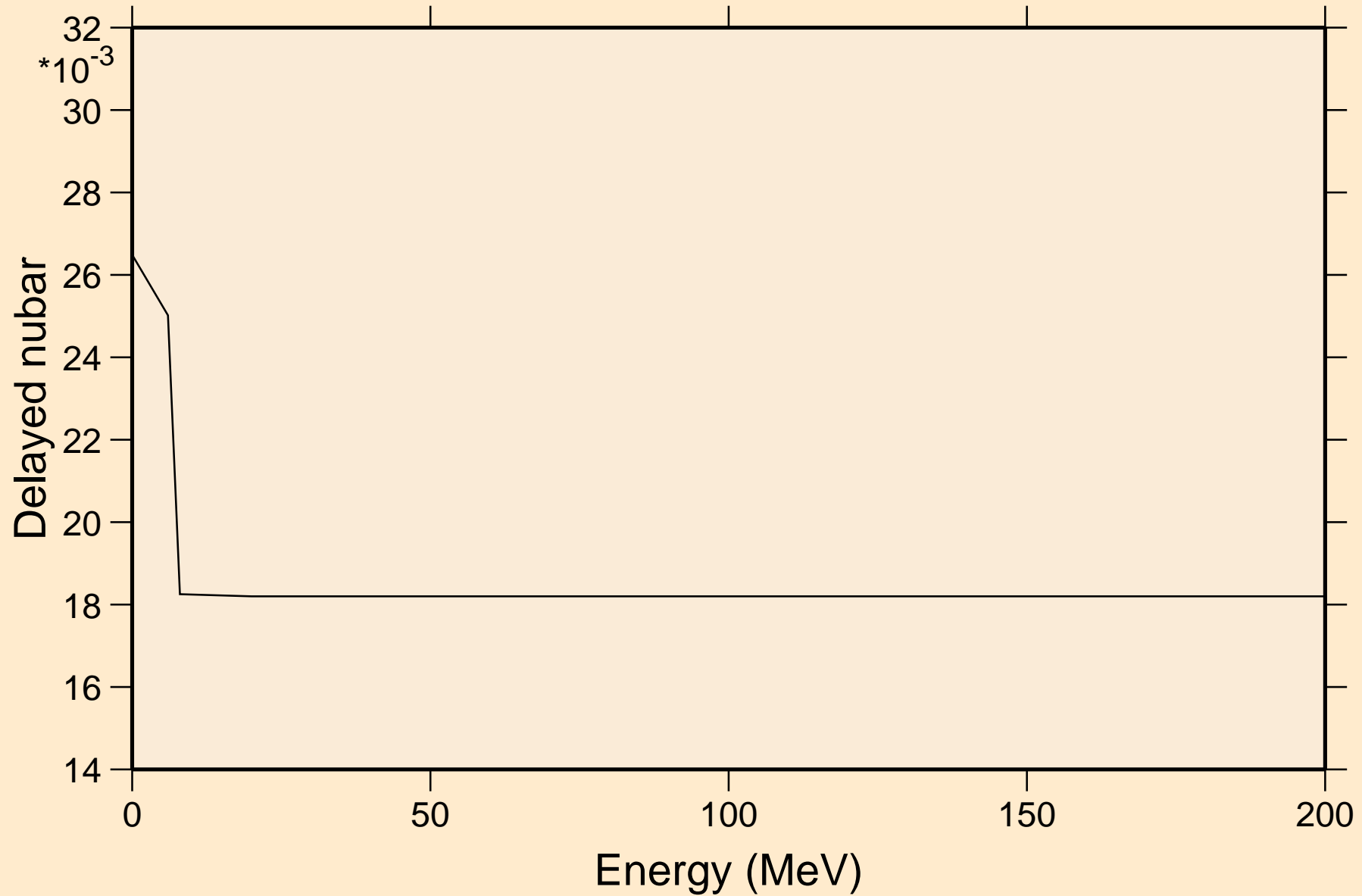

# RA228 NEUTRON ACER TENDL-2023 LIBRARY; T=0.K

## Delayed neutron spectra

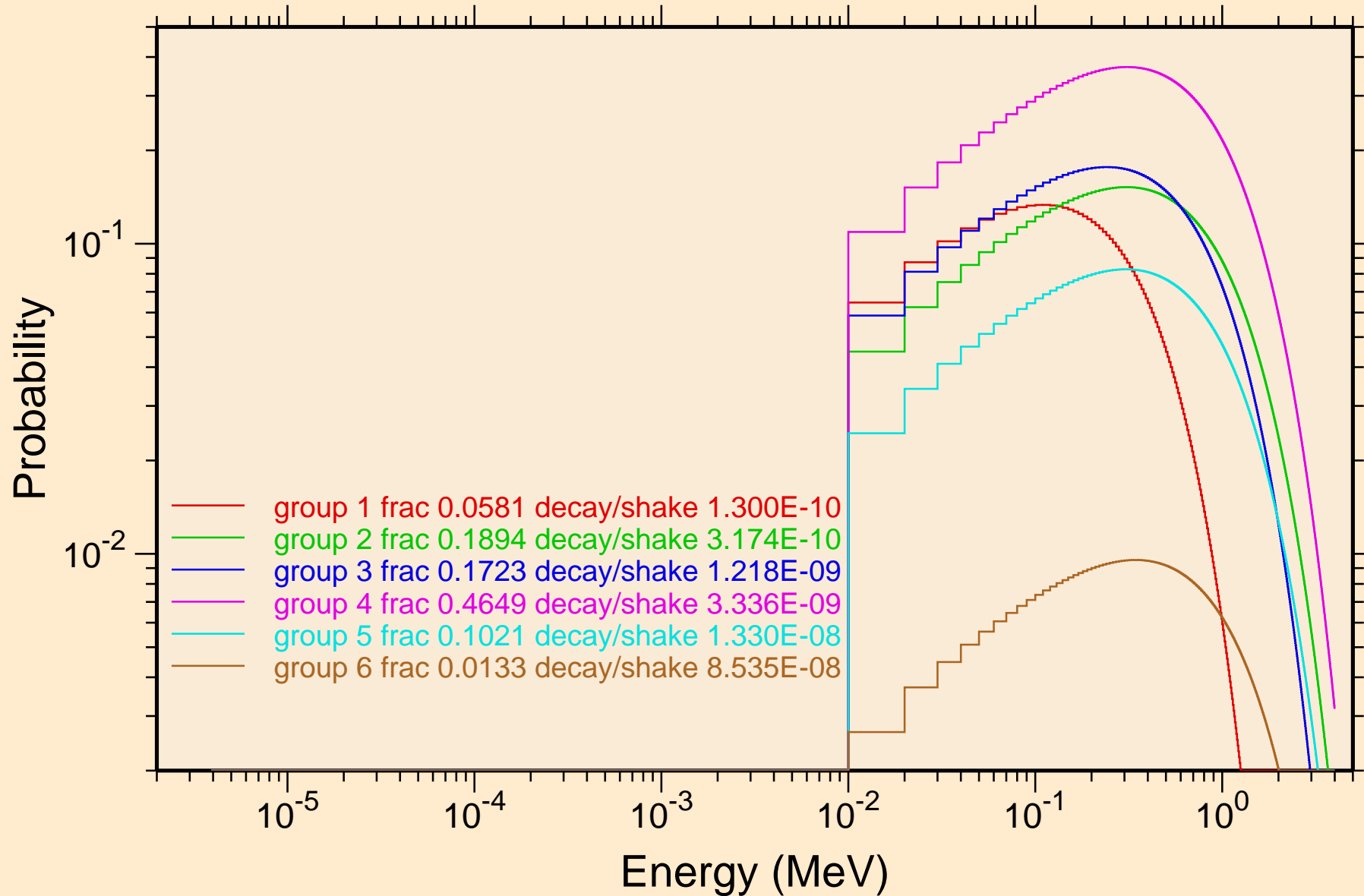

RA228 NEUTRON ACER TENDL-2023 LIBRARY; T=0.K  
Photon emission for (n,x)

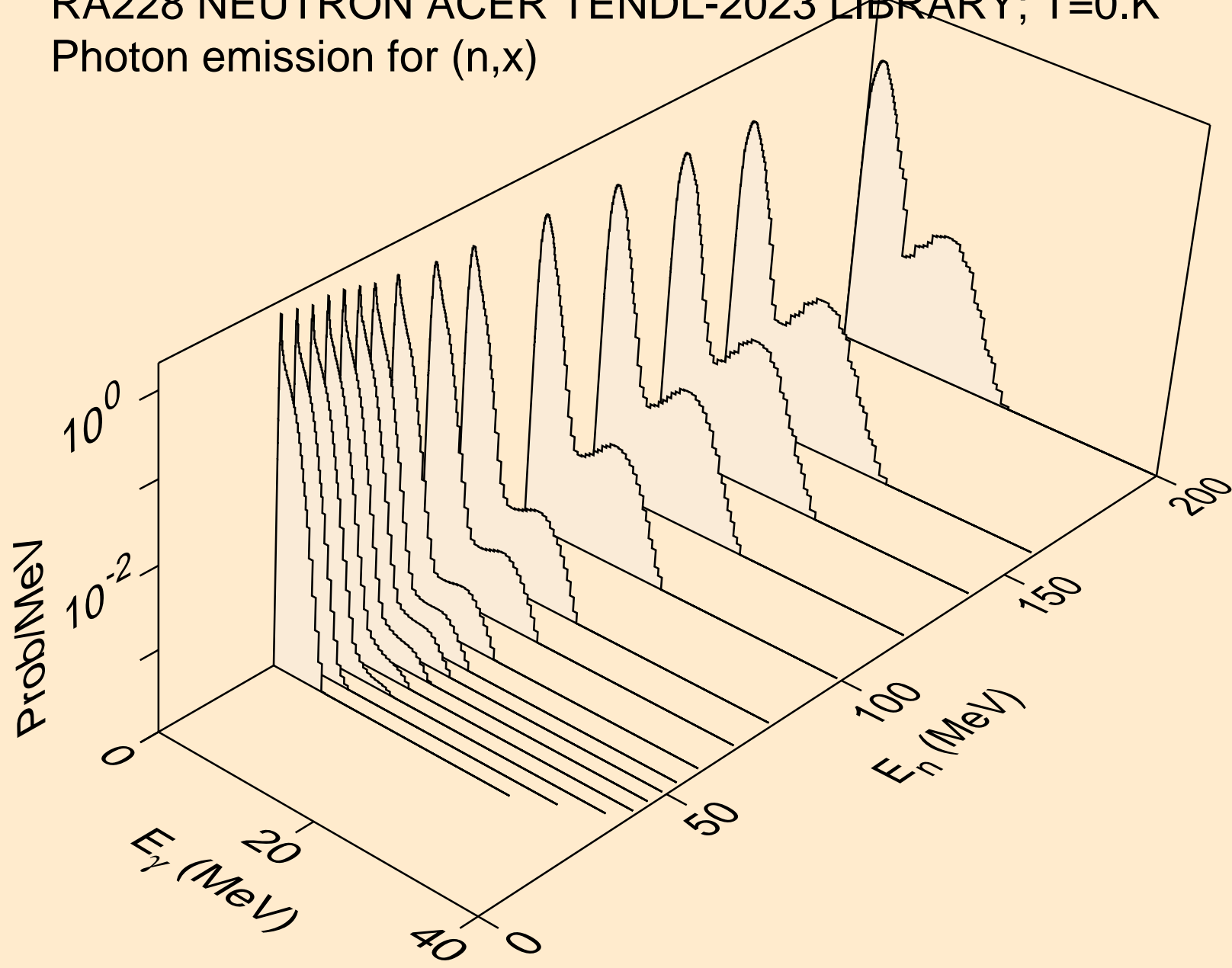

RA228 NEUTRON ACER TENDL-2023 LIBRARY; T=0.K  
Photon emission for (n,2nd)

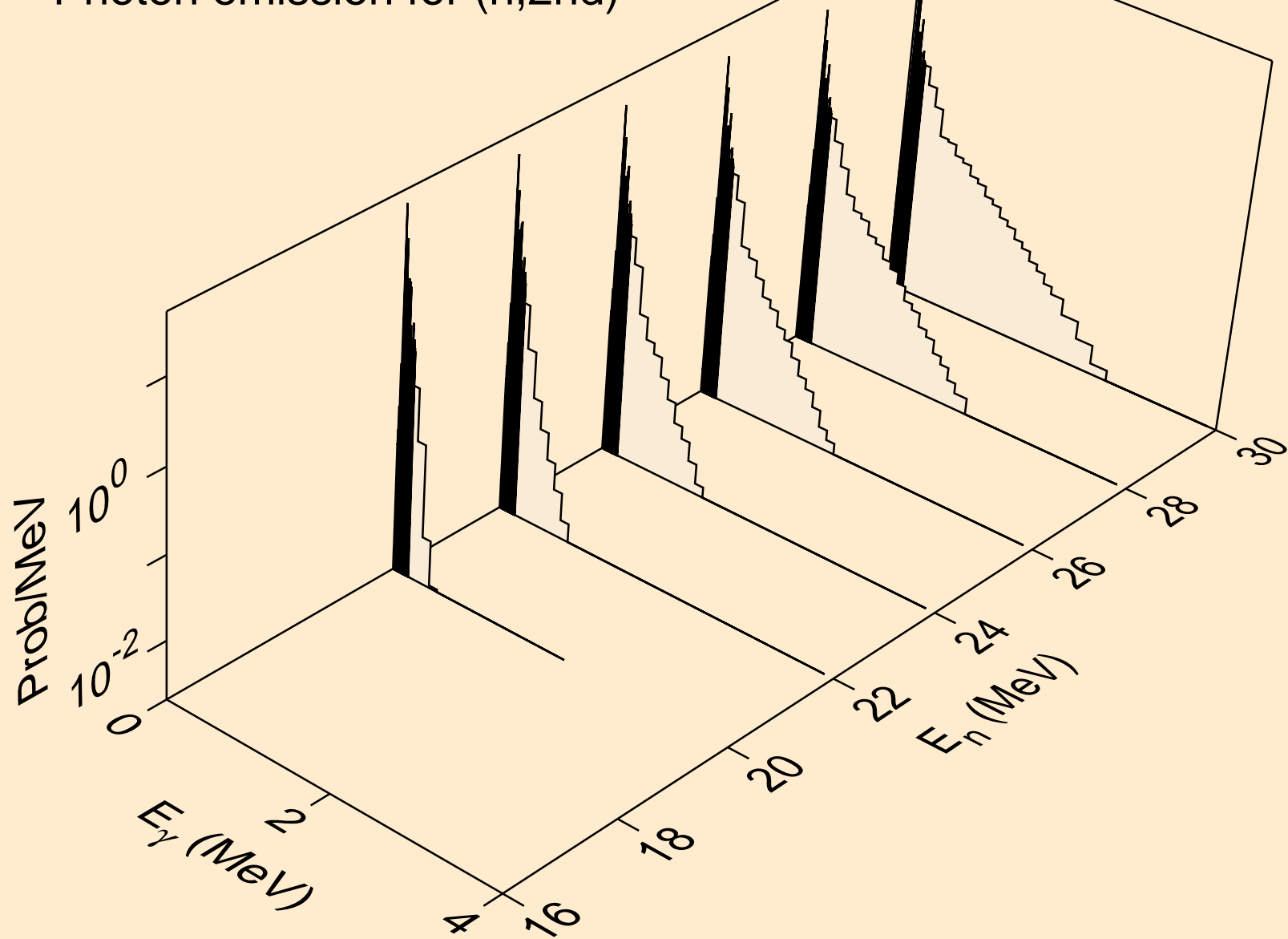



RA228 NEUTRON ACER TENDL-2023 LIBRARY; T=0.K  
Photon emission for (n,2n)

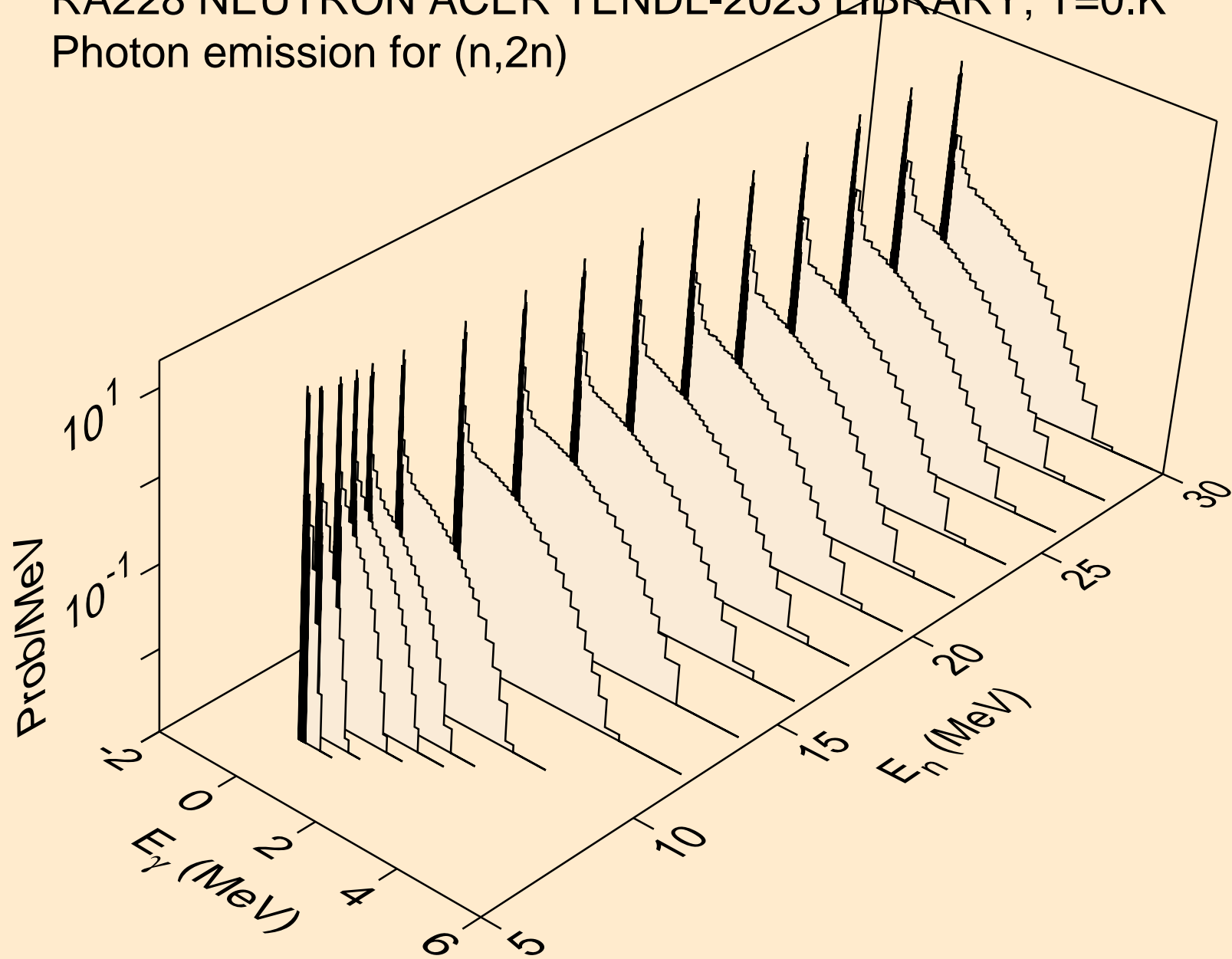

RA228 NEUTRON ACER TENDL-2023 LIBRARY; T=0.K  
Photon emission for (n,3n)

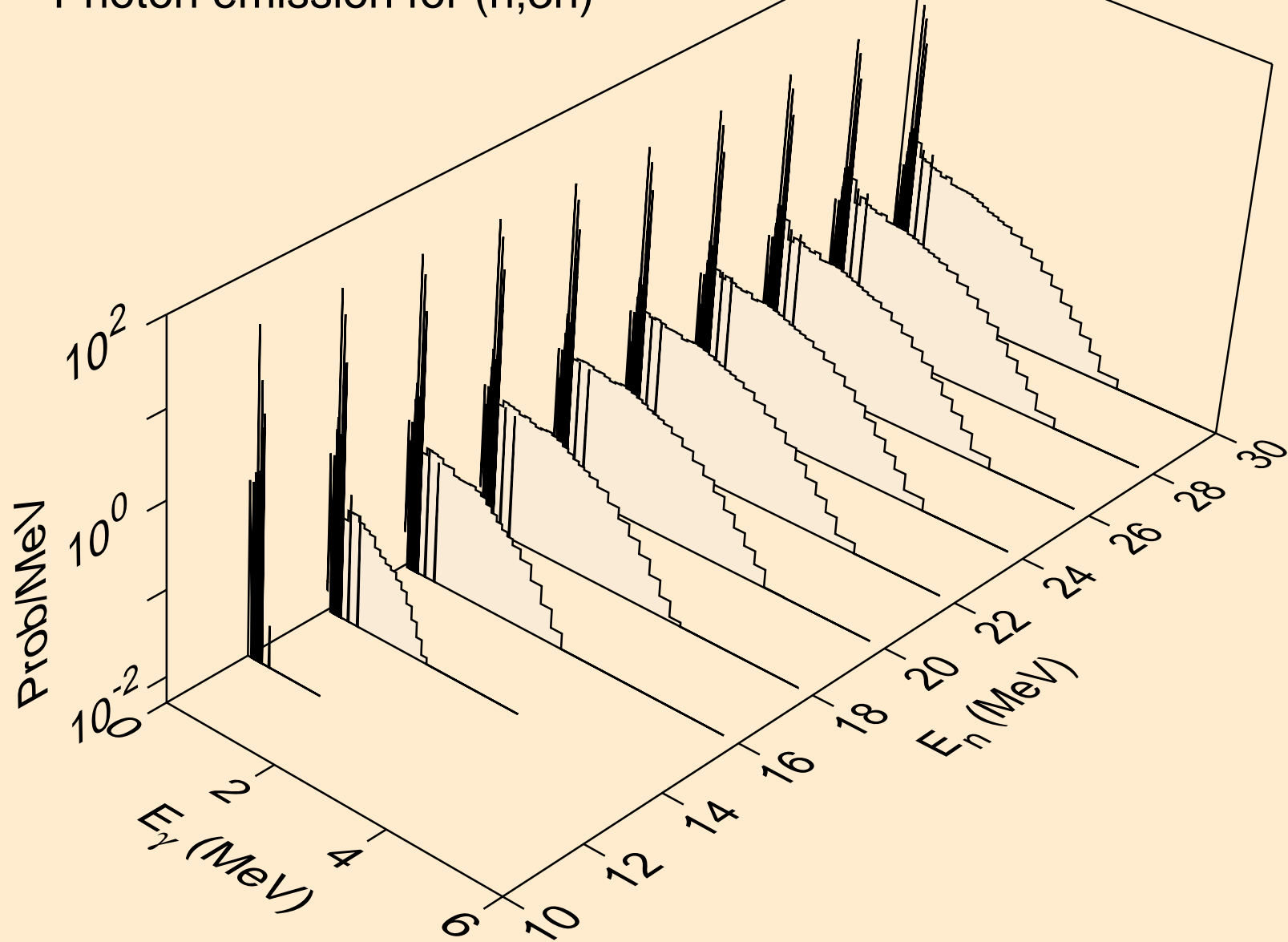

RA228 NEUTRON ACER TENDL-2023 LIBRARY; T=0.K  
Photon emission for (n,n\*)a

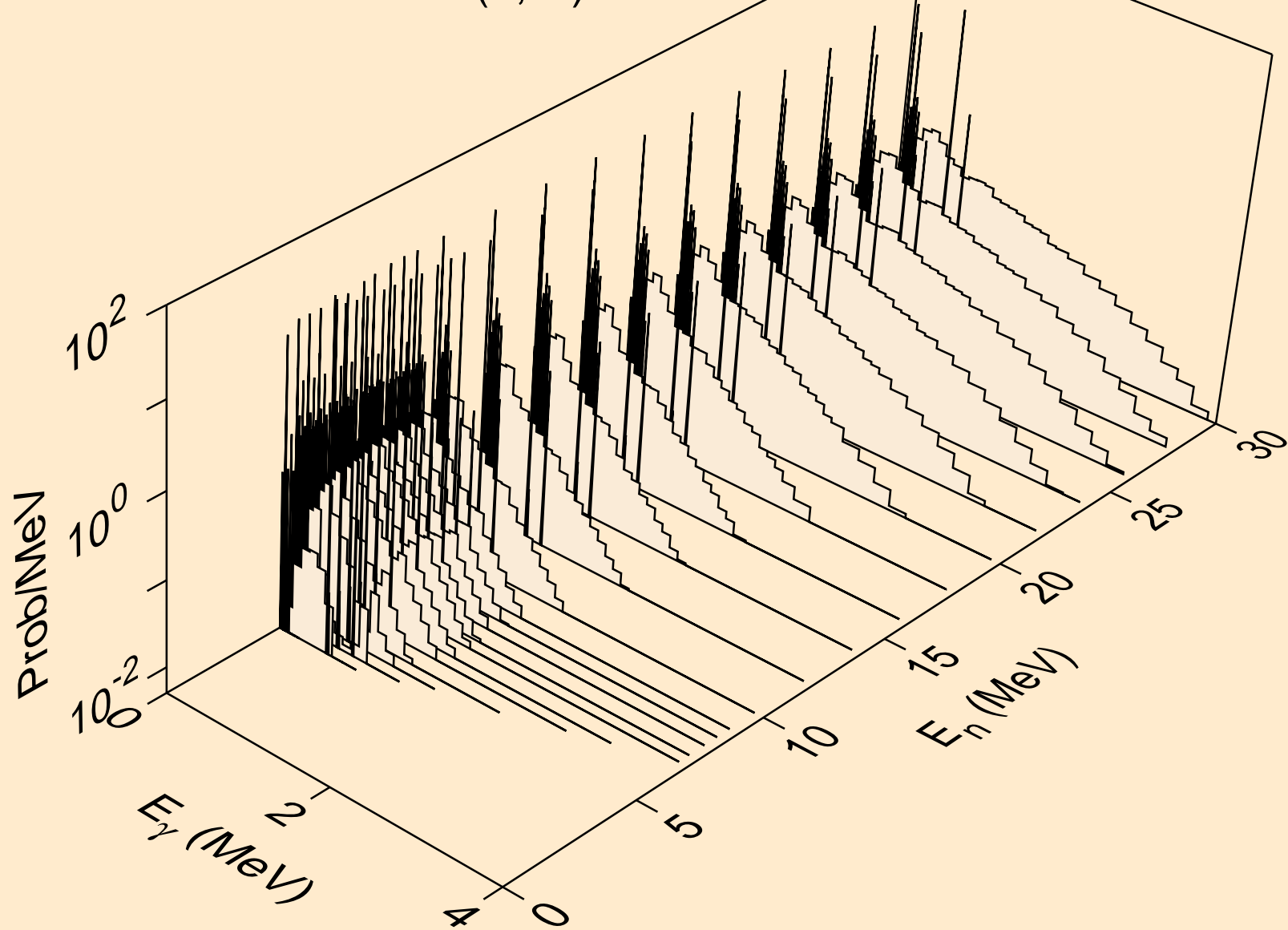

RA228 NEUTRON ACER TENDL-2023 LIBRARY; T=0.K  
Photon emission for (n,2n)a

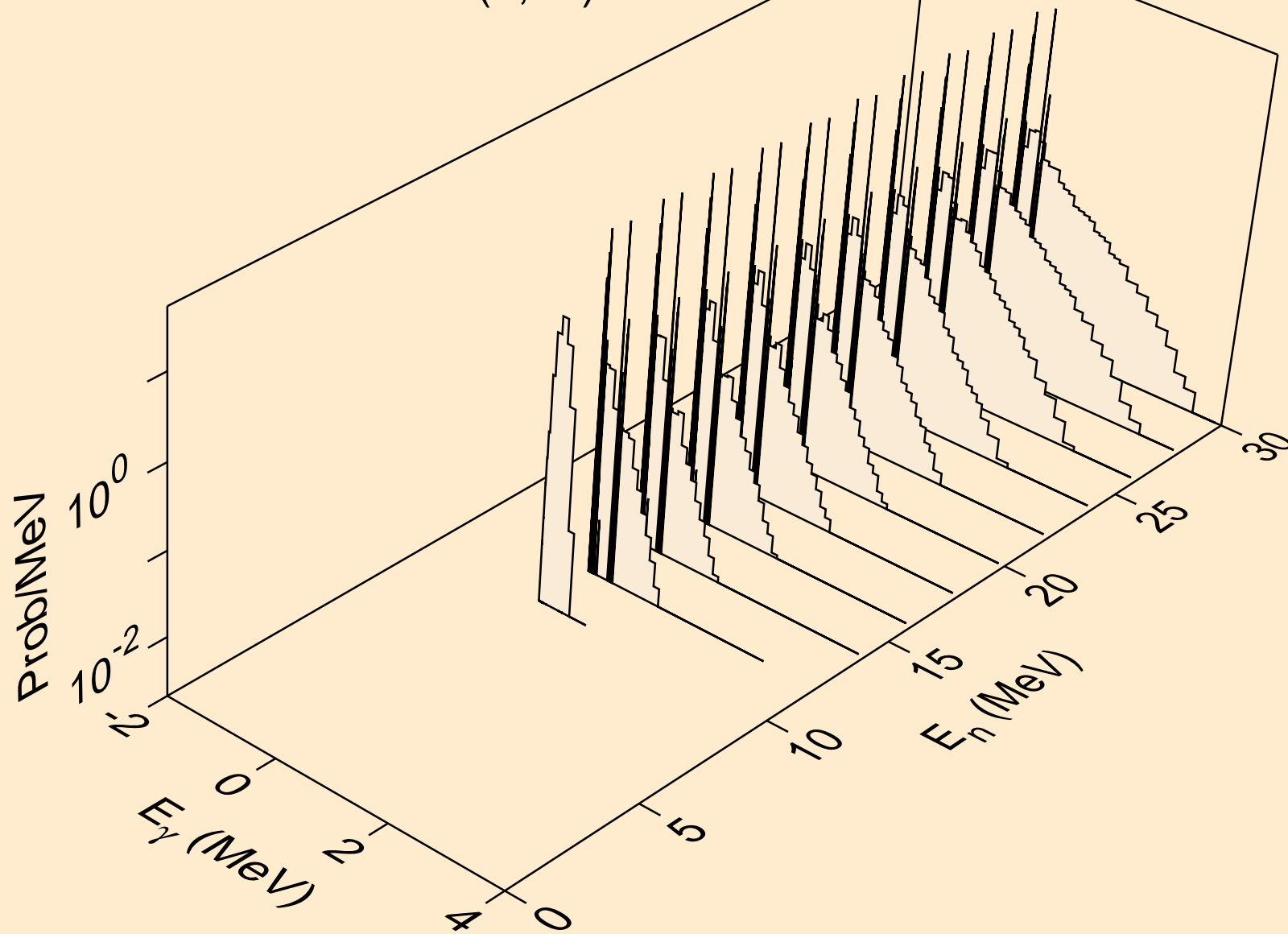

RA228 NEUTRON ACER TENDL-2023 LIBRARY; T=0.K  
Photon emission for (n,3n)a

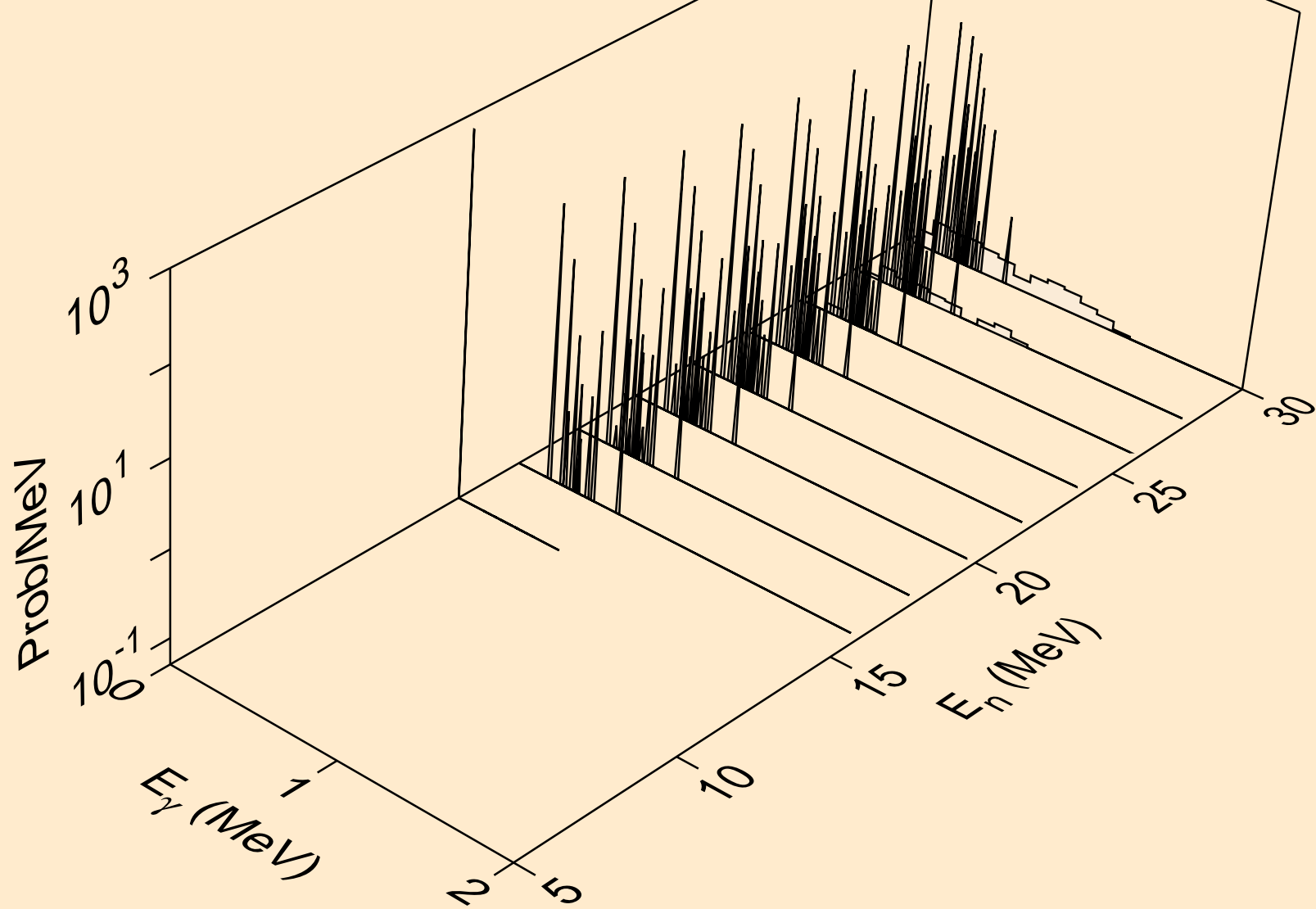

RA228 NEUTRON ACER TENDL-2023 LIBRARY; T=0.K  
Photon emission for (n,n\*)p

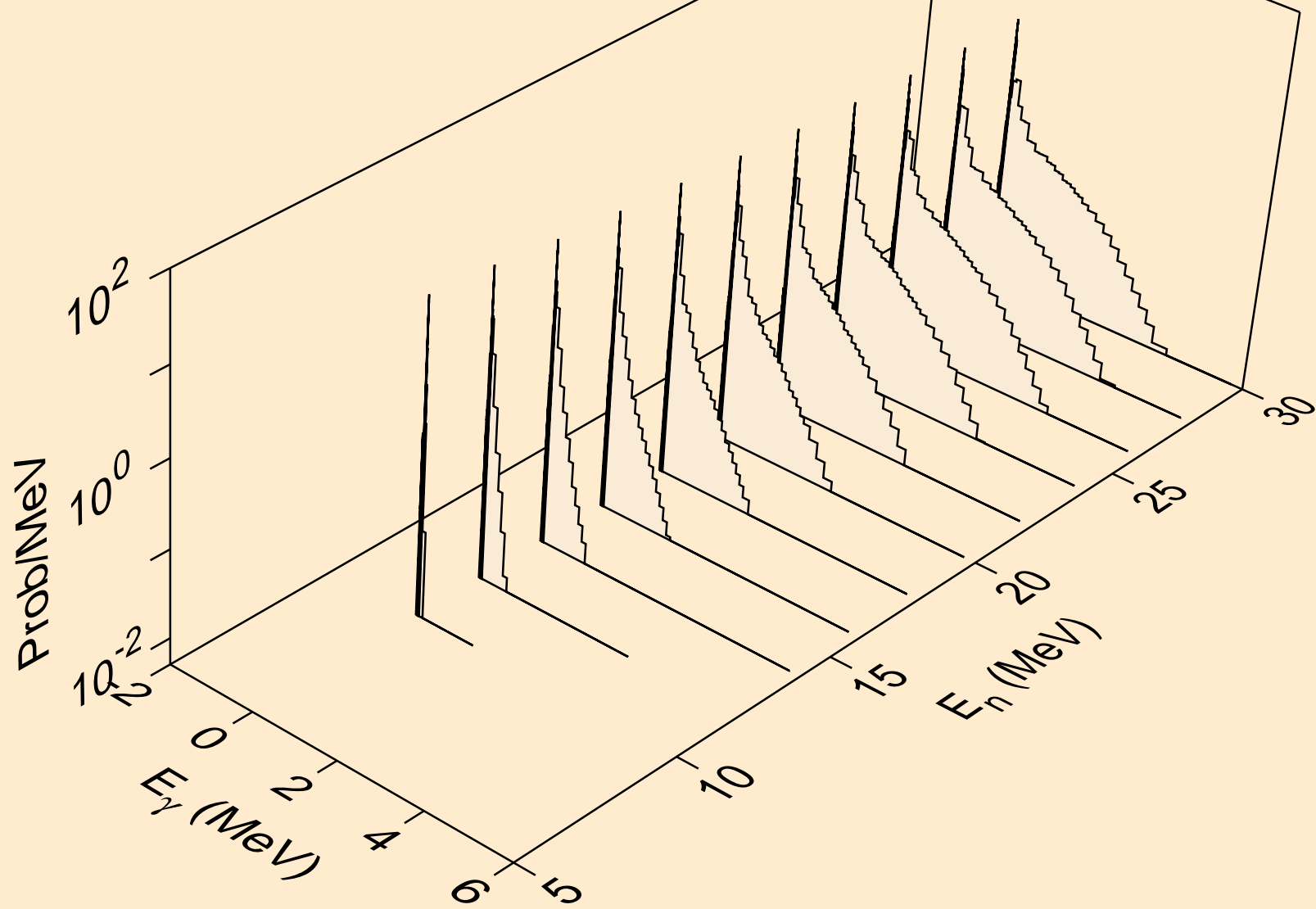

RA228 NEUTRON ACER TENDL-2023 LIBRARY; T=0.K  
Photon emission for (n,n\*)d

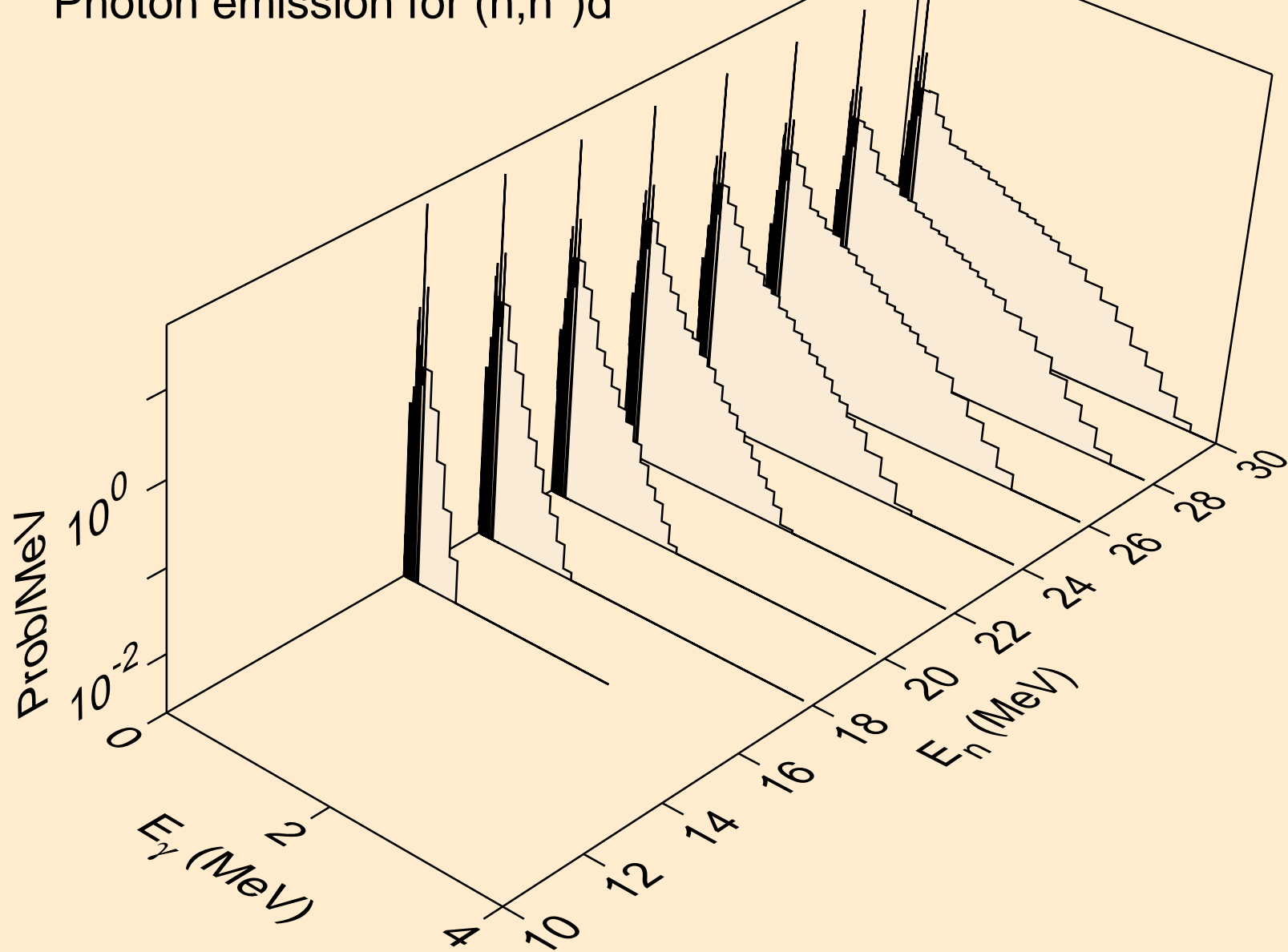

RA228 NEUTRON ACER TENDL-2023 LIBRARY; T=0.K  
Photon emission for (n,n\*)t

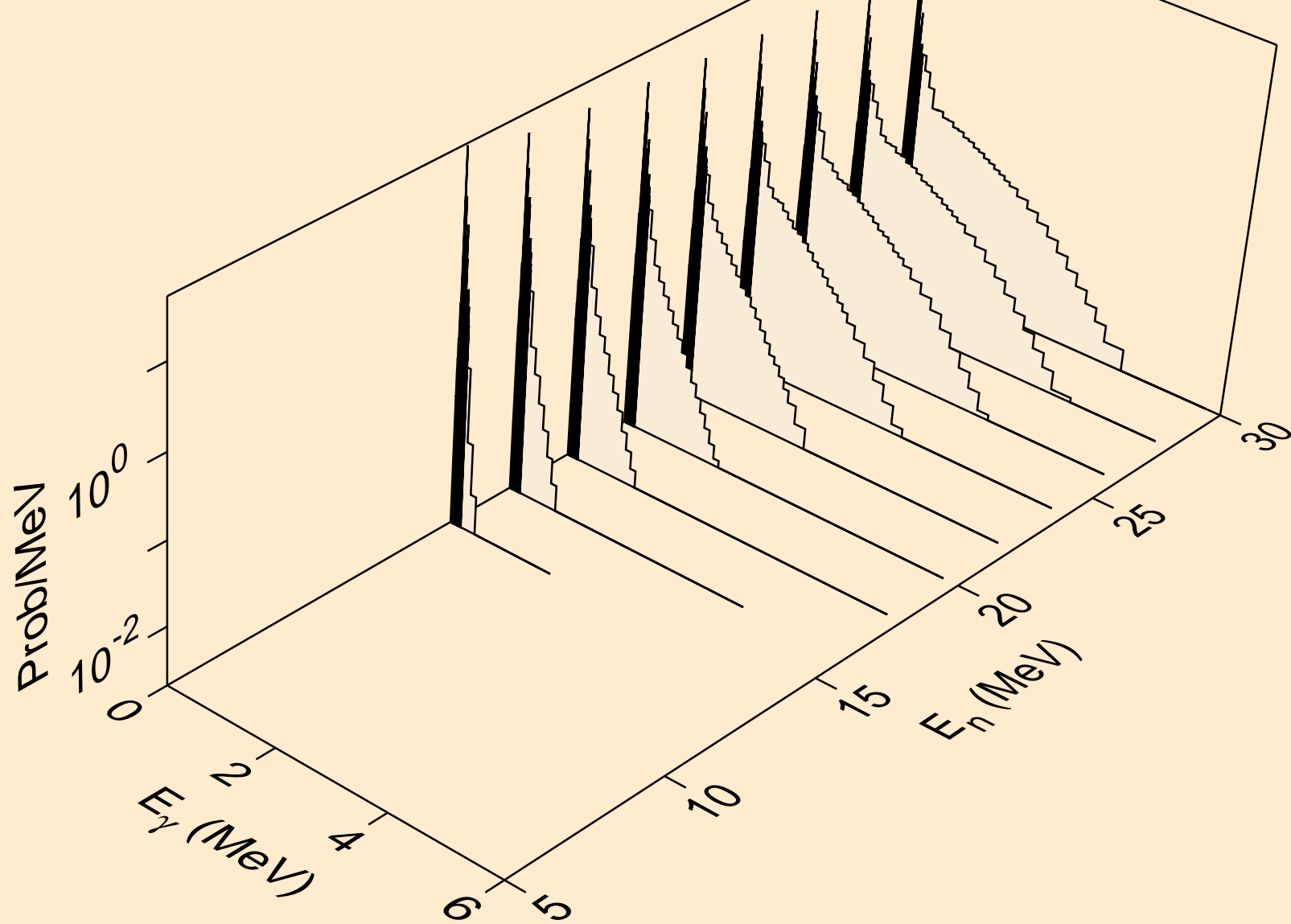



RA228 NEUTRON ACER TENDL-2023 LIBRARY; T=0.K  
Photon emission for (n,n\*)he3

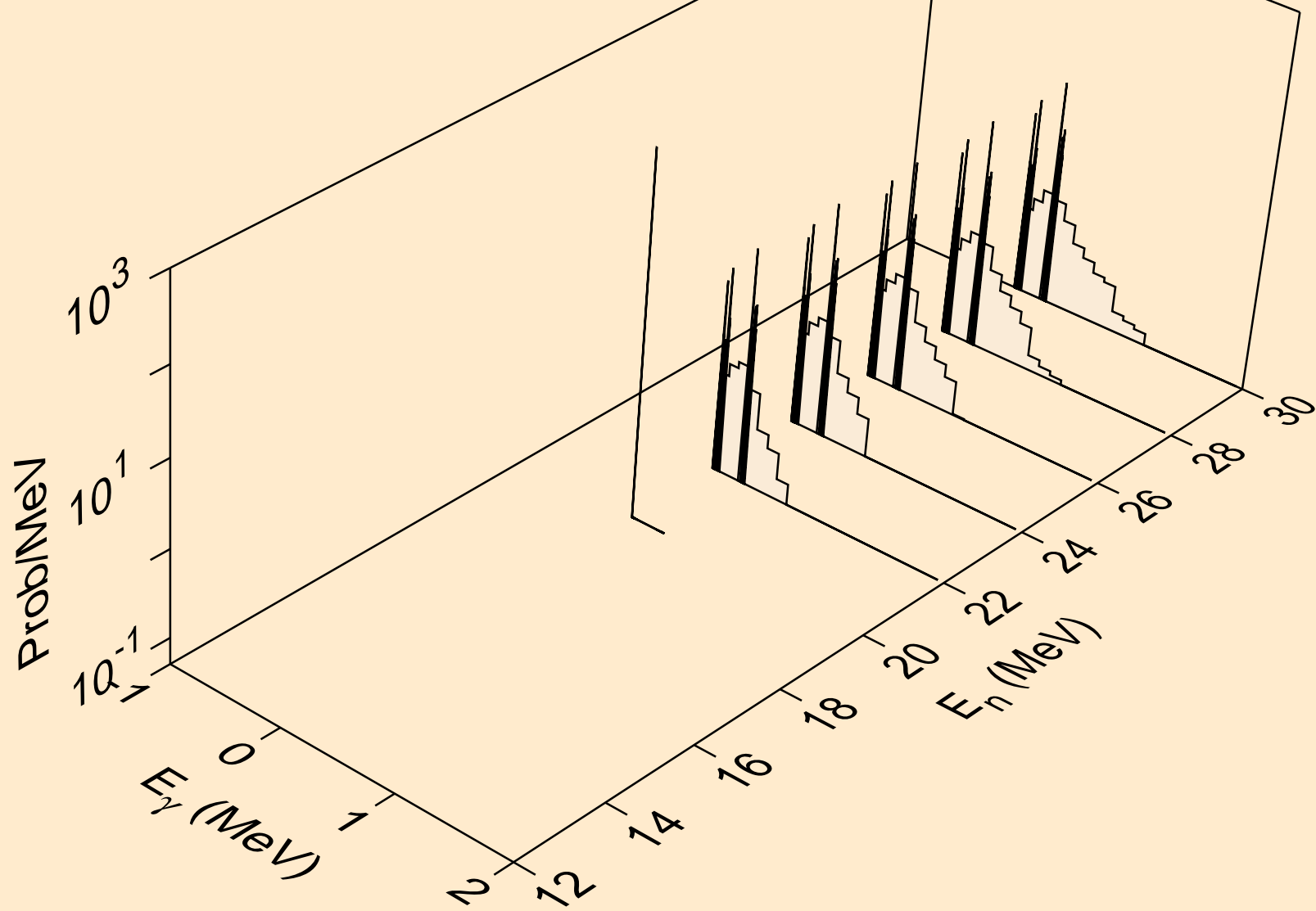

RA228 NEUTRON ACER TENDL-2023 LIBRARY; T=0.K  
Photon emission for (n,4n)

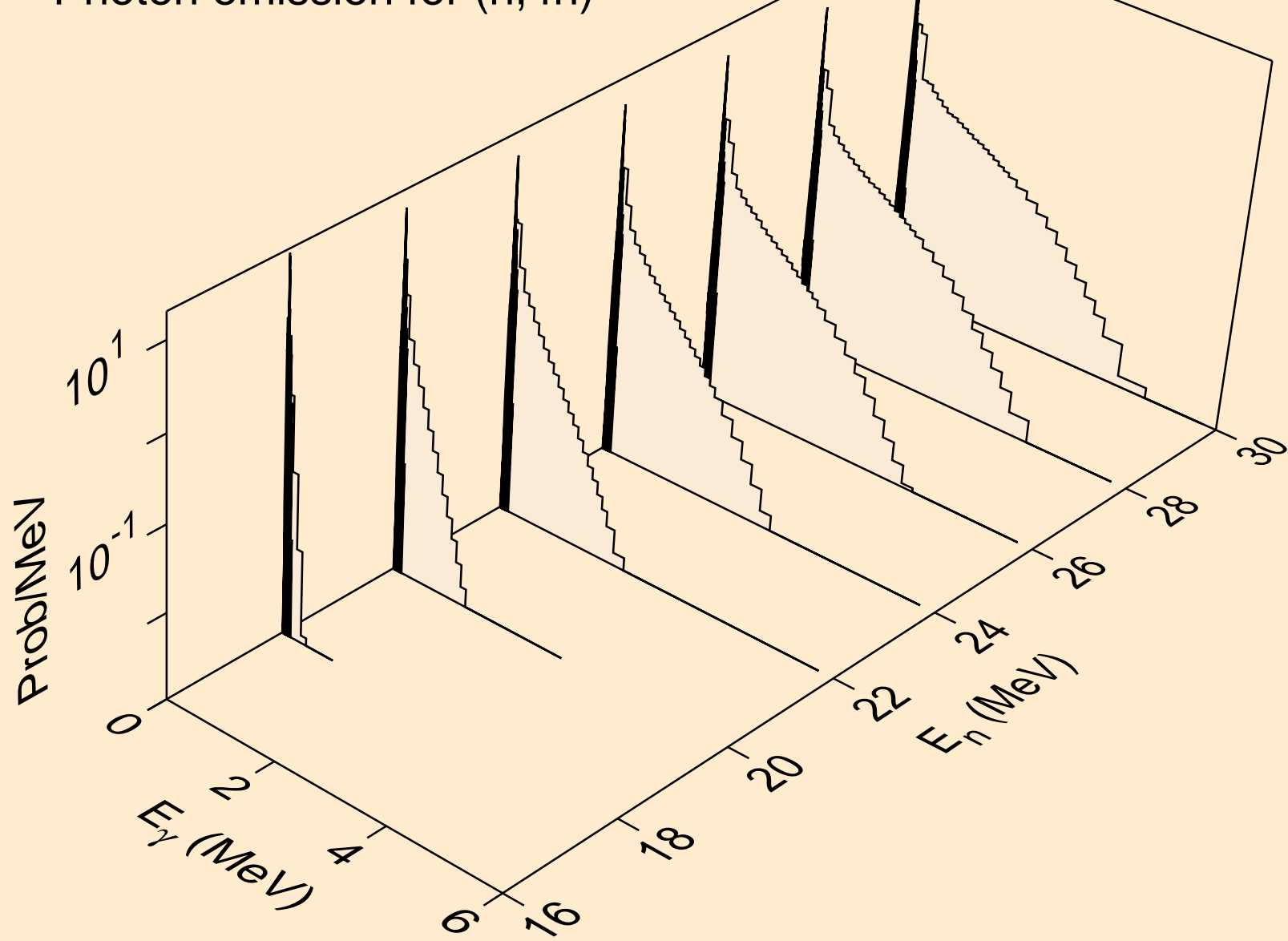

RA228 NEUTRON ACER TENDL-2023 LIBRARY; T=0.K  
Photon emission for (n,2np)

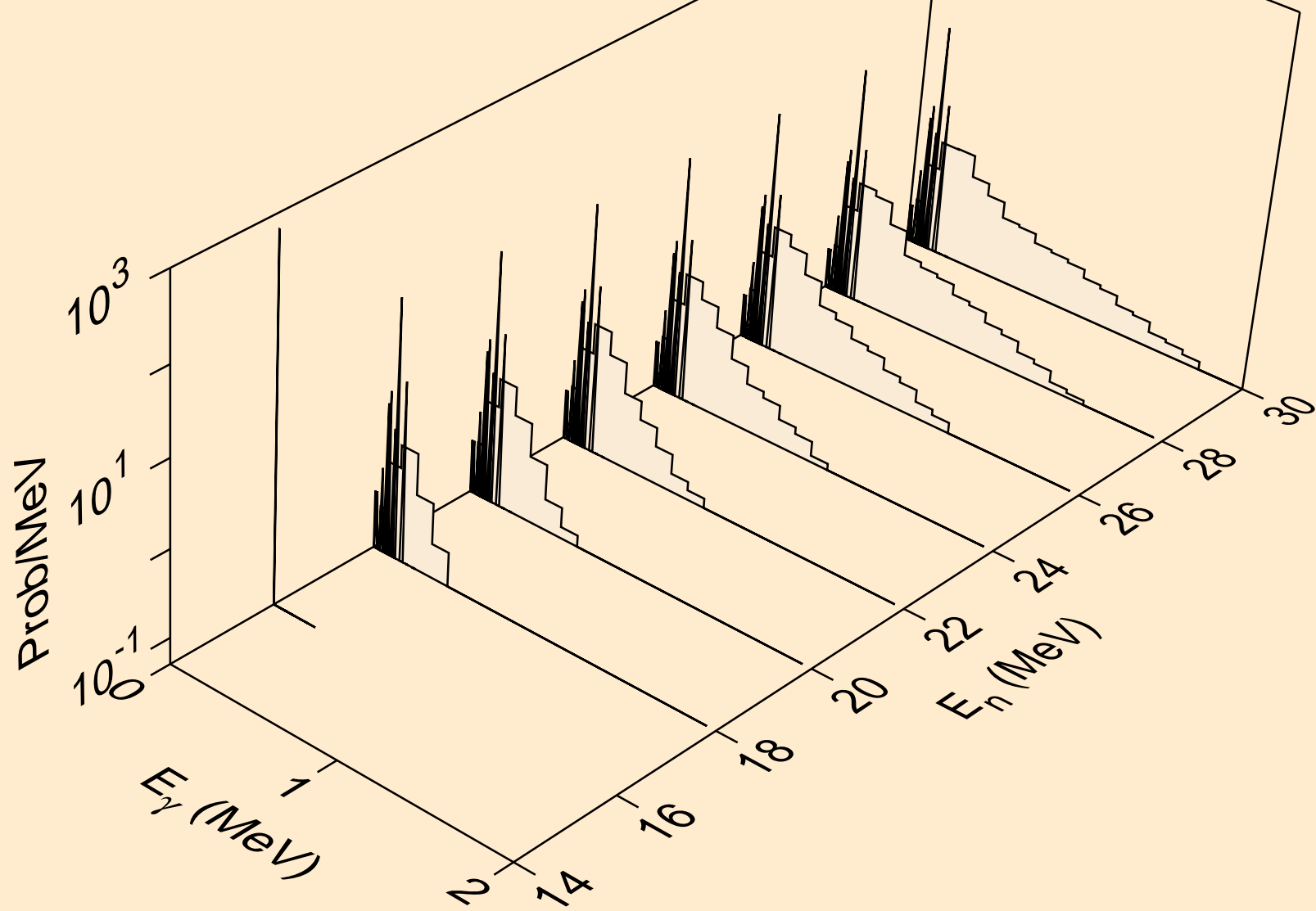

RA228 NEUTRON ACER TENDL-2023 LIBRARY; T=0.K  
Photon emission for (n,3np)

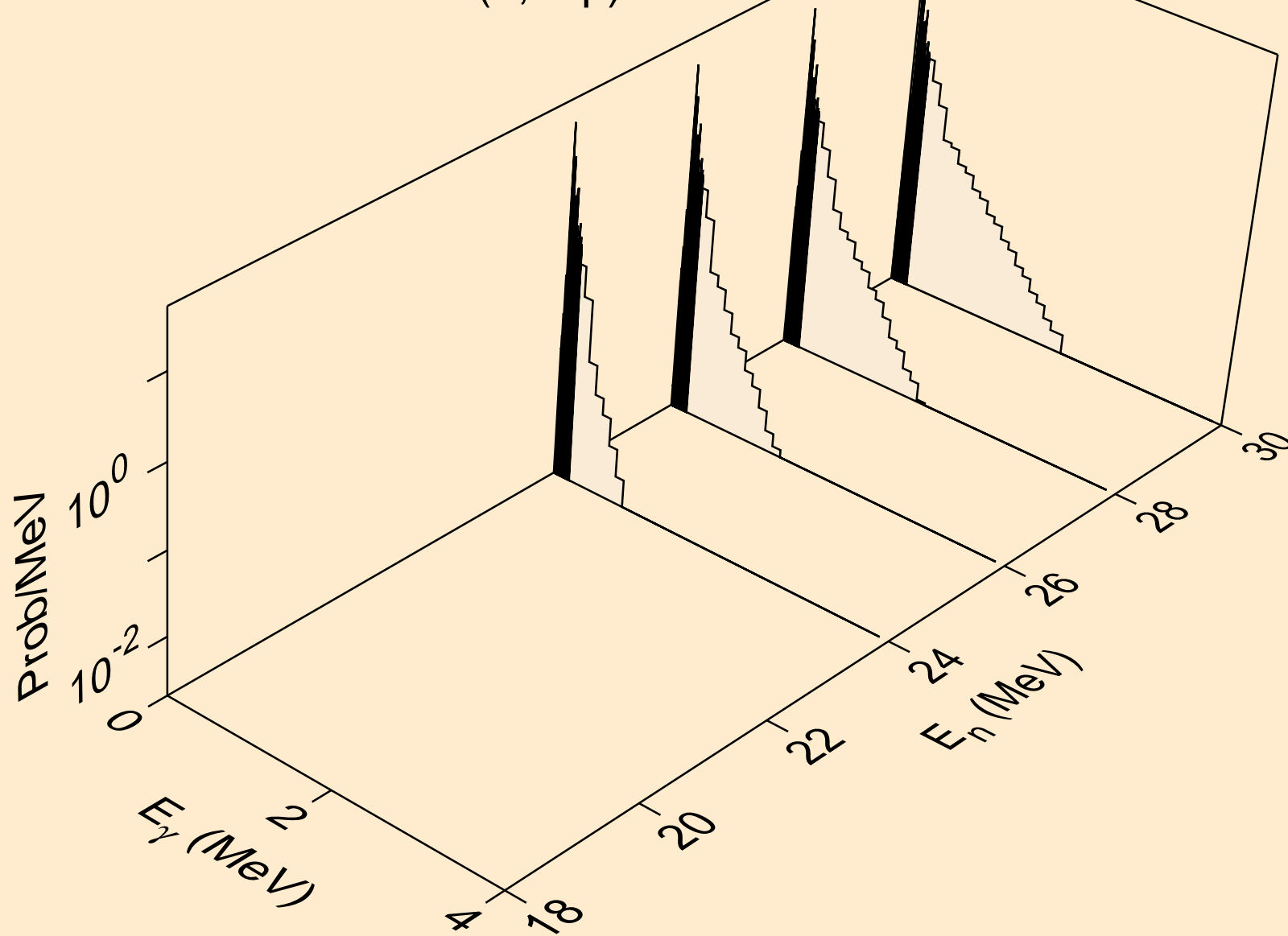

RA228 NEUTRON ACER TENDL-2023 LIBRARY; T=0.K  
Photon emission for (n,n\*c)

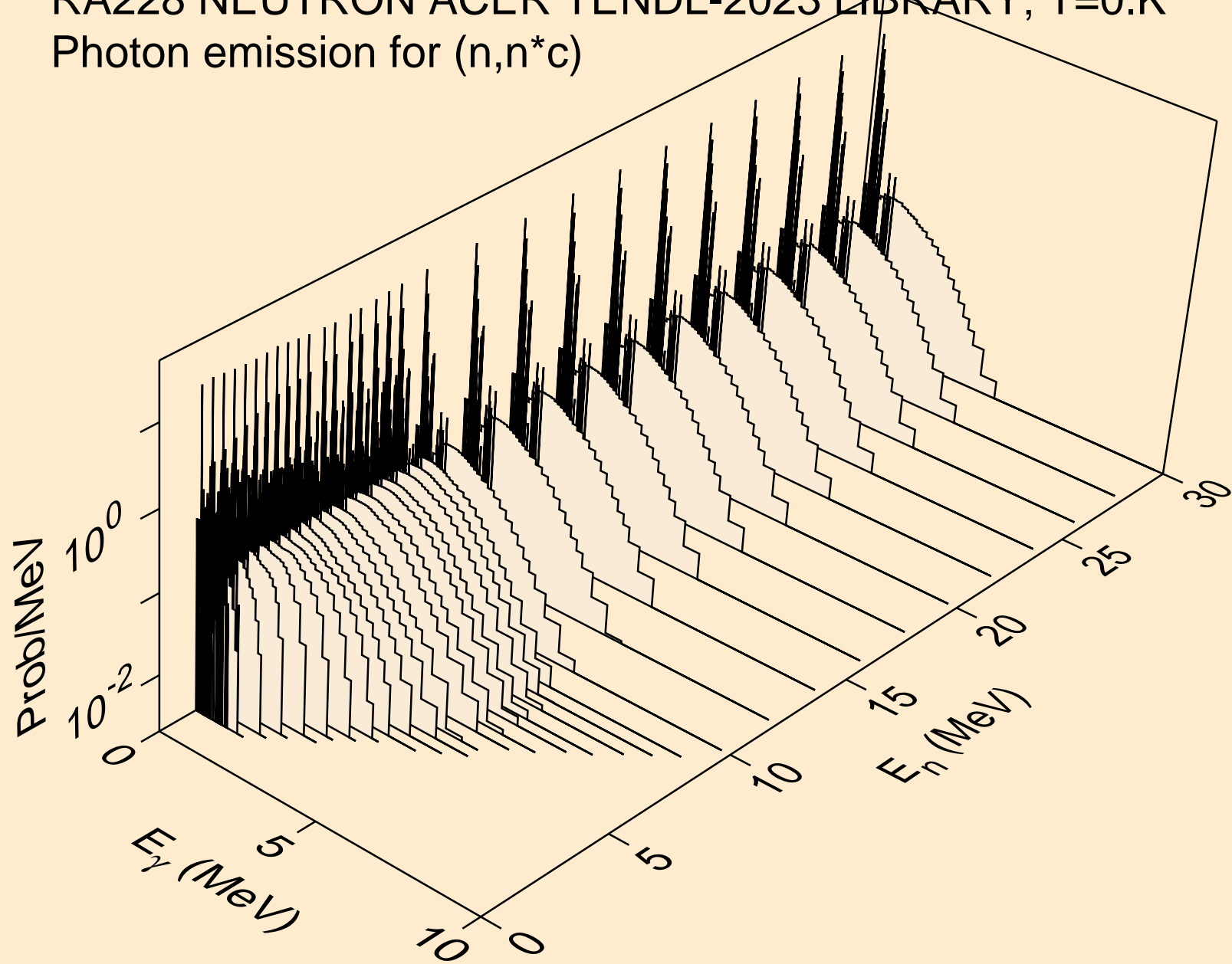

RA228 NEUTRON ACER TENDL-2023 LIBRARY; T=0.K  
Photon emission for (n,gma)

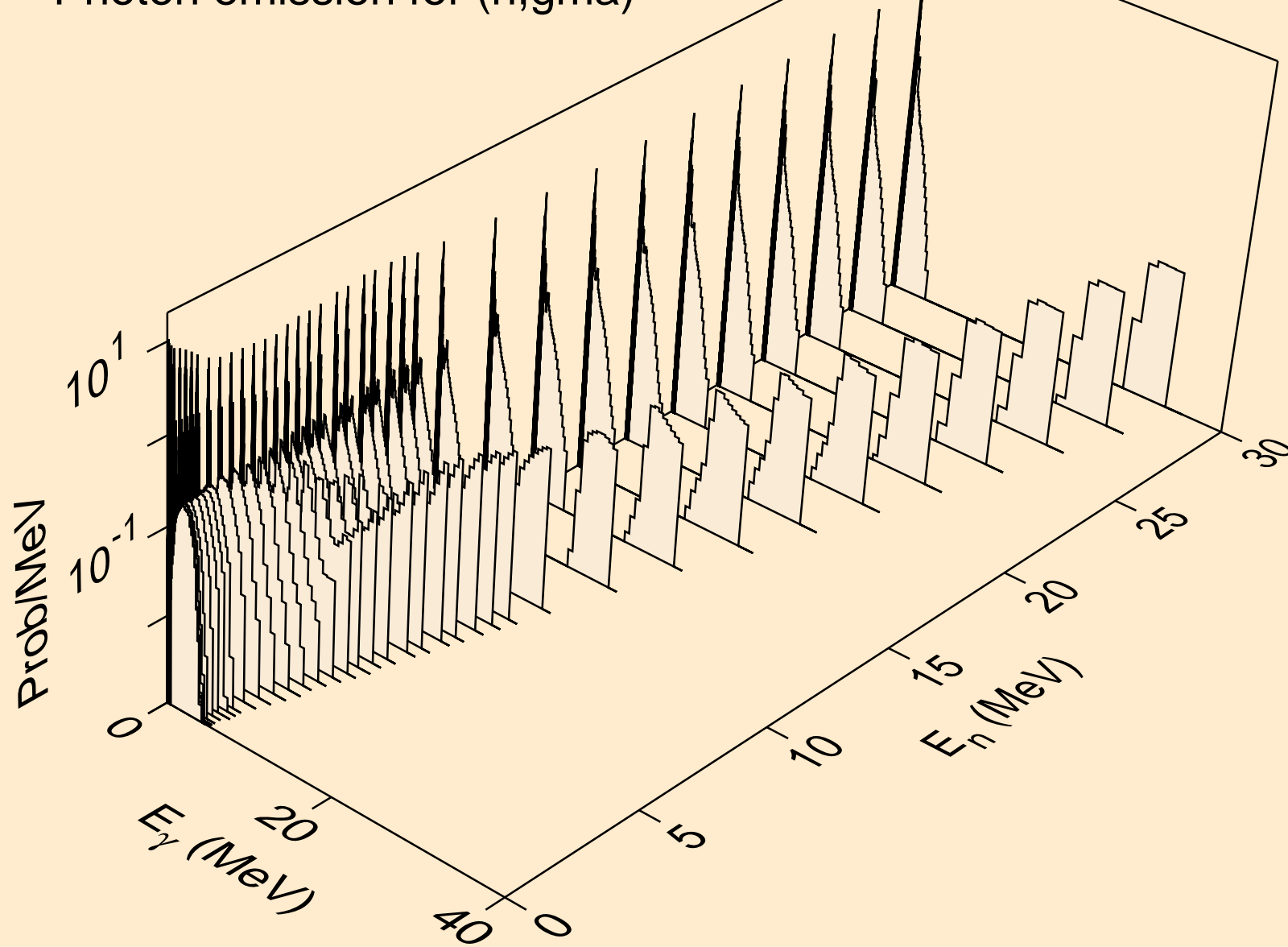

RA228 NEUTRON ACER TENDL-2023 LIBRARY; T=0.K  
Photon emission for (n,p)

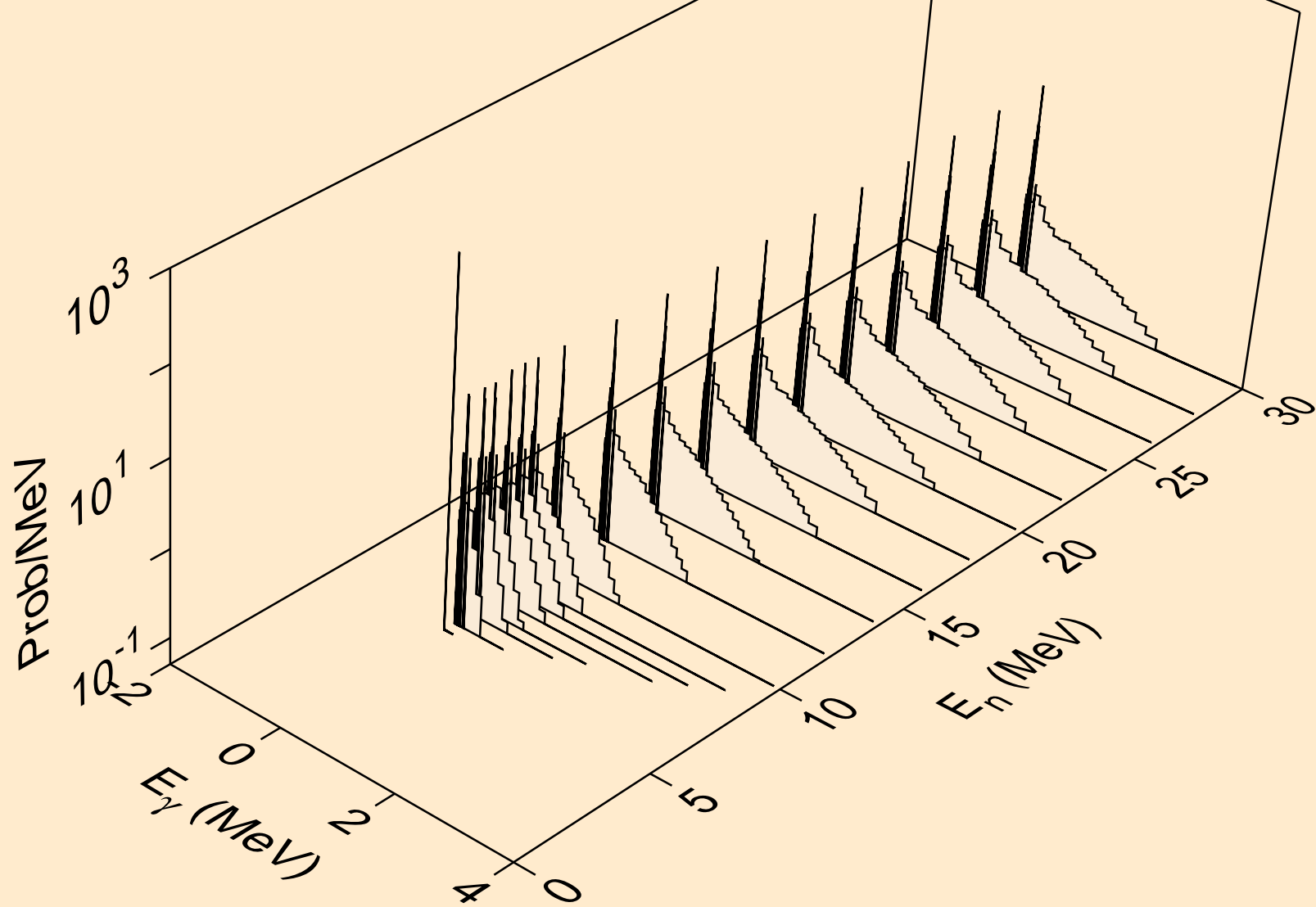

RA228 NEUTRON ACER TENDL-2023 LIBRARY; T=0.K  
Photon emission for (n,d)

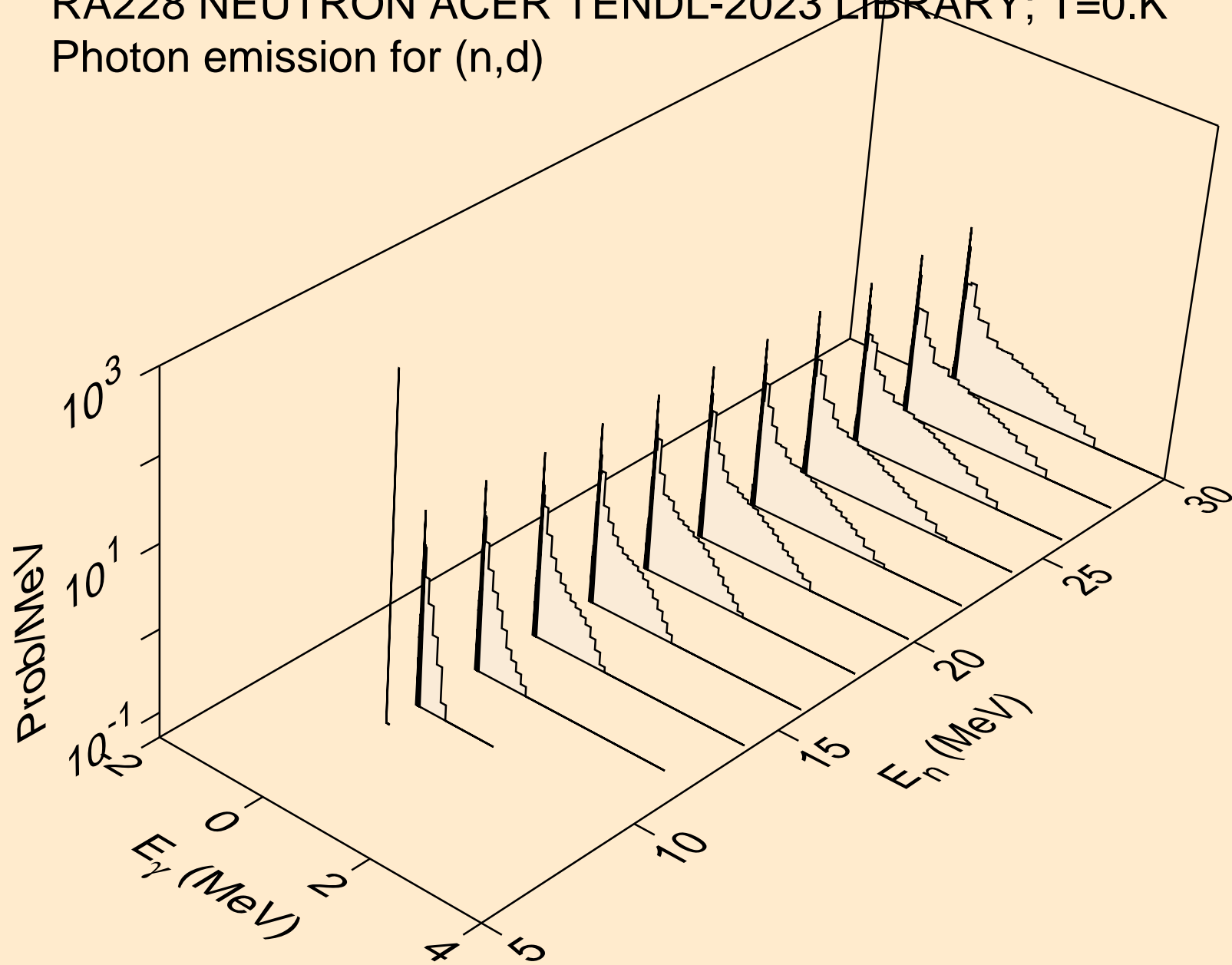



RA228 NEUTRON ACER TENDL-2023 LIBRARY; T=0.K  
Photon emission for (n,t)

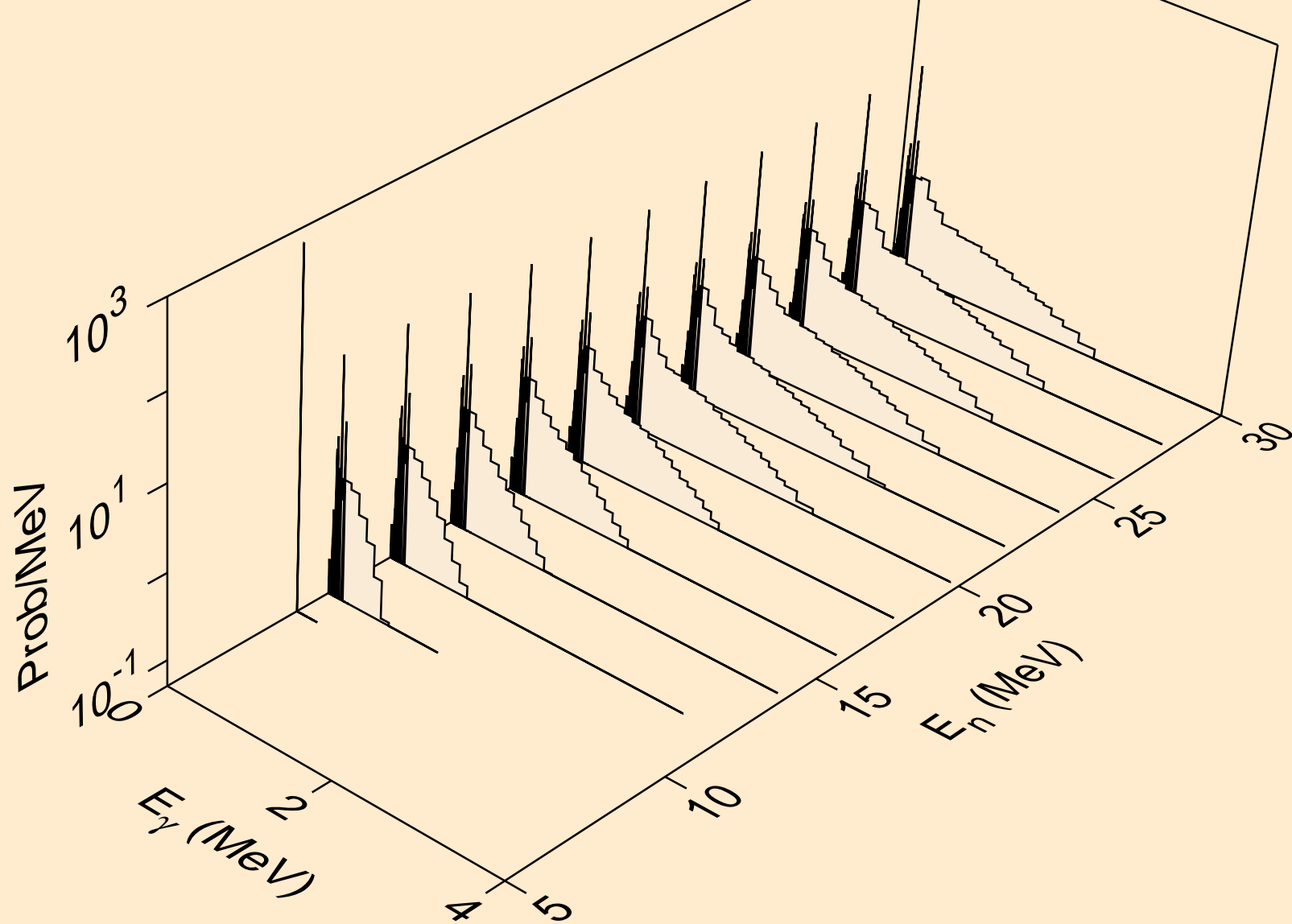

RA228 NEUTRON ACER TENDL-2023 LIBRARY; T=0.K  
Photon emission for (n,he3)

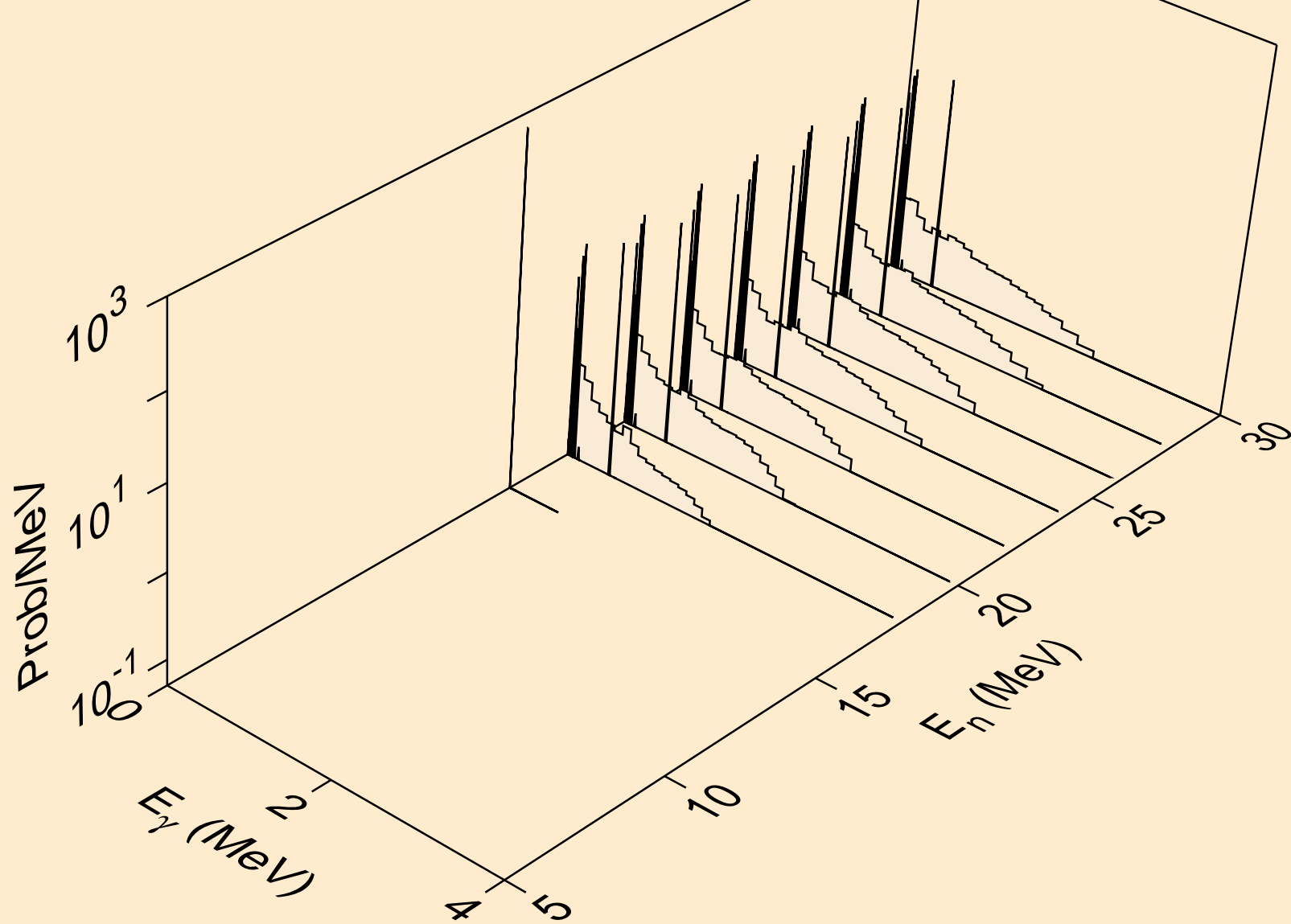

RA228 NEUTRON ACER TENDL-2023 LIBRARY; T=0.K  
Photon emission for (n,a)

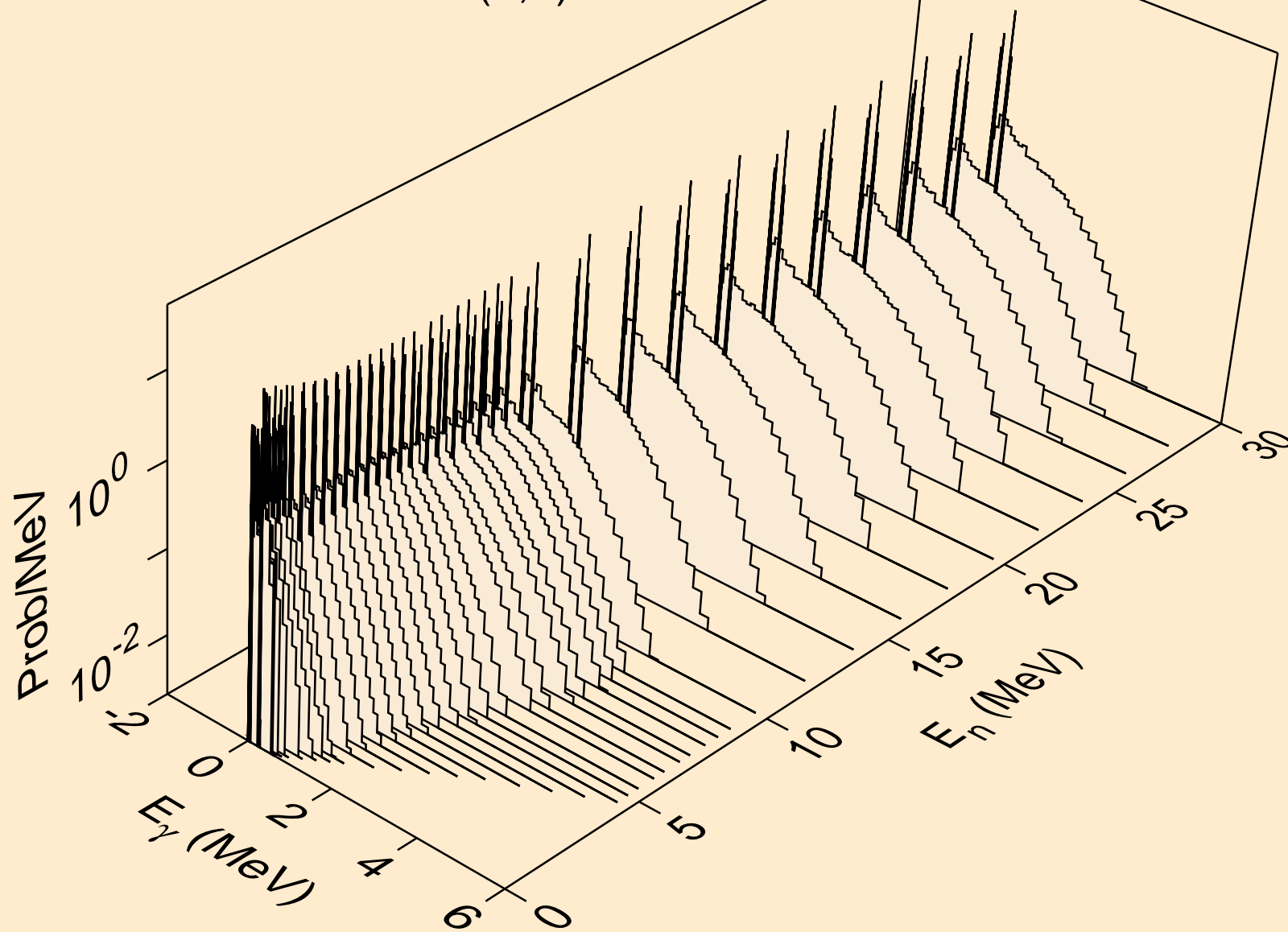

RA228 NEUTRON ACER TENDL-2023 LIBRARY; T=0.K  
Photon emission for (n,2p)

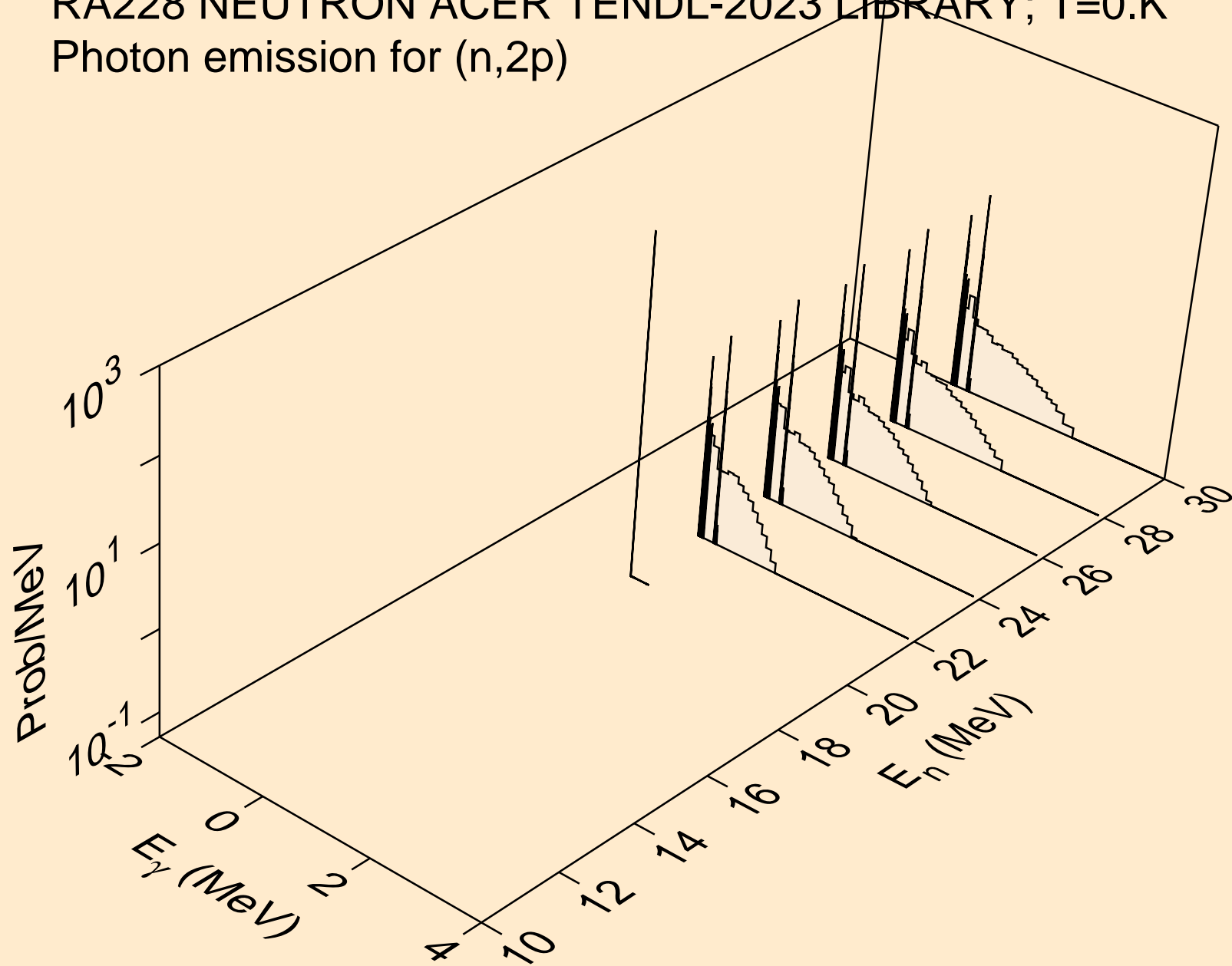

RA228 NEUTRON ACER TENDL-2023 LIBRARY; T=0.K  
thermal capture photon spectrum

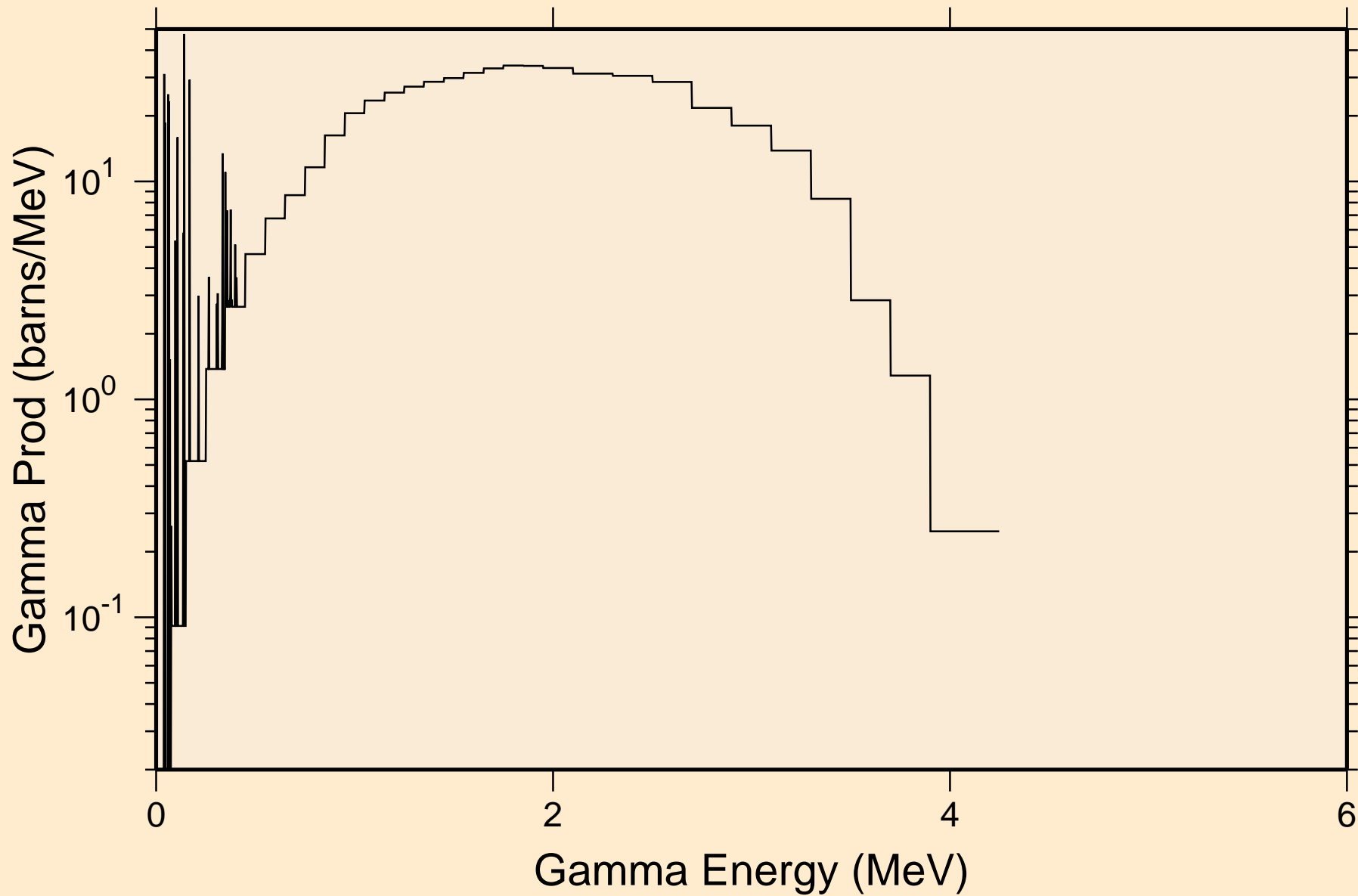

RA228 NEUTRON ACER TENDL-2023 LIBRARY; T=0.K  
14 MeV photon spectrum

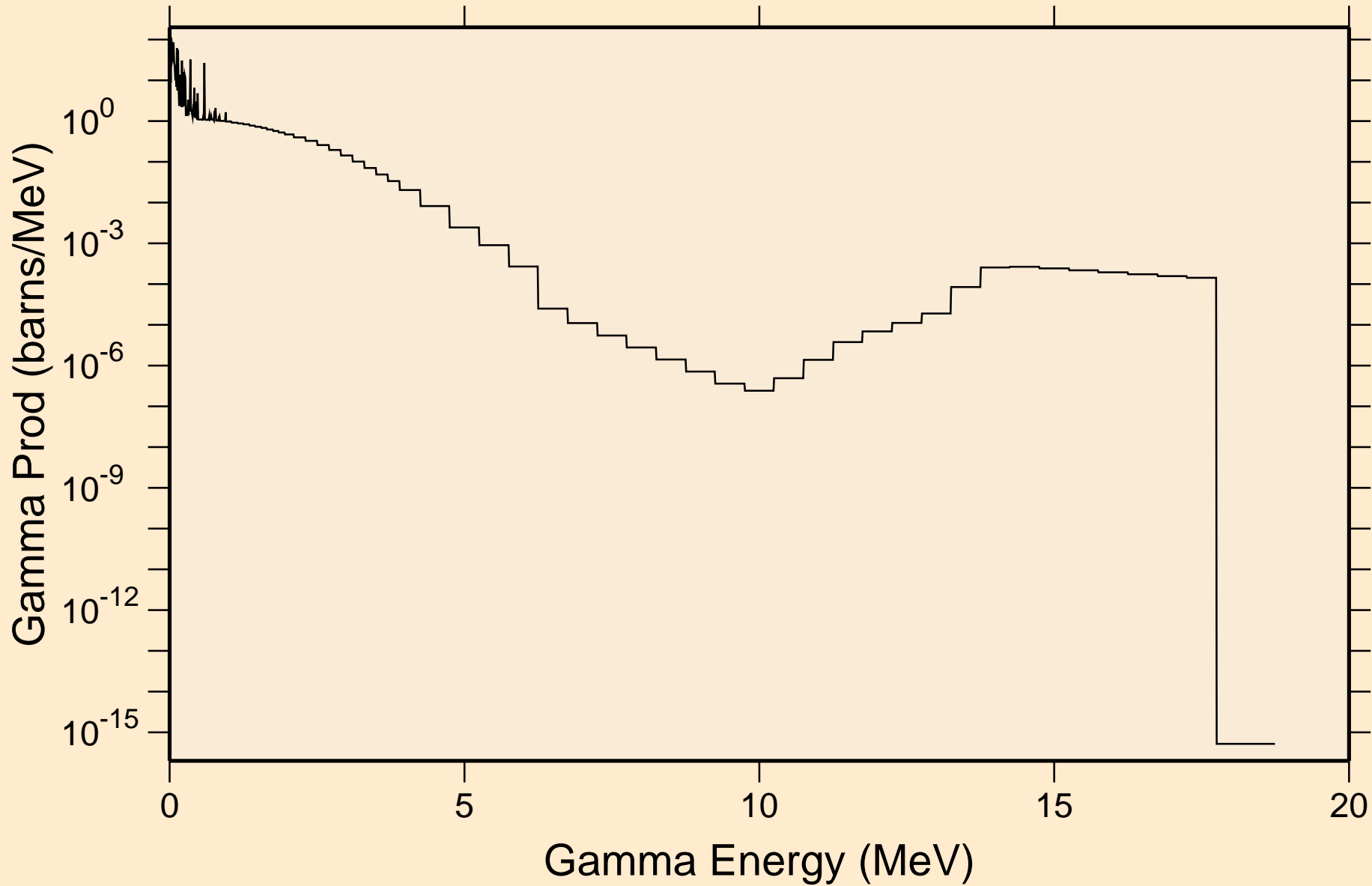

# RA228 NEUTRON ACER TENDL-2023 LIBRARY; T=0.K

## Particle heating contributions

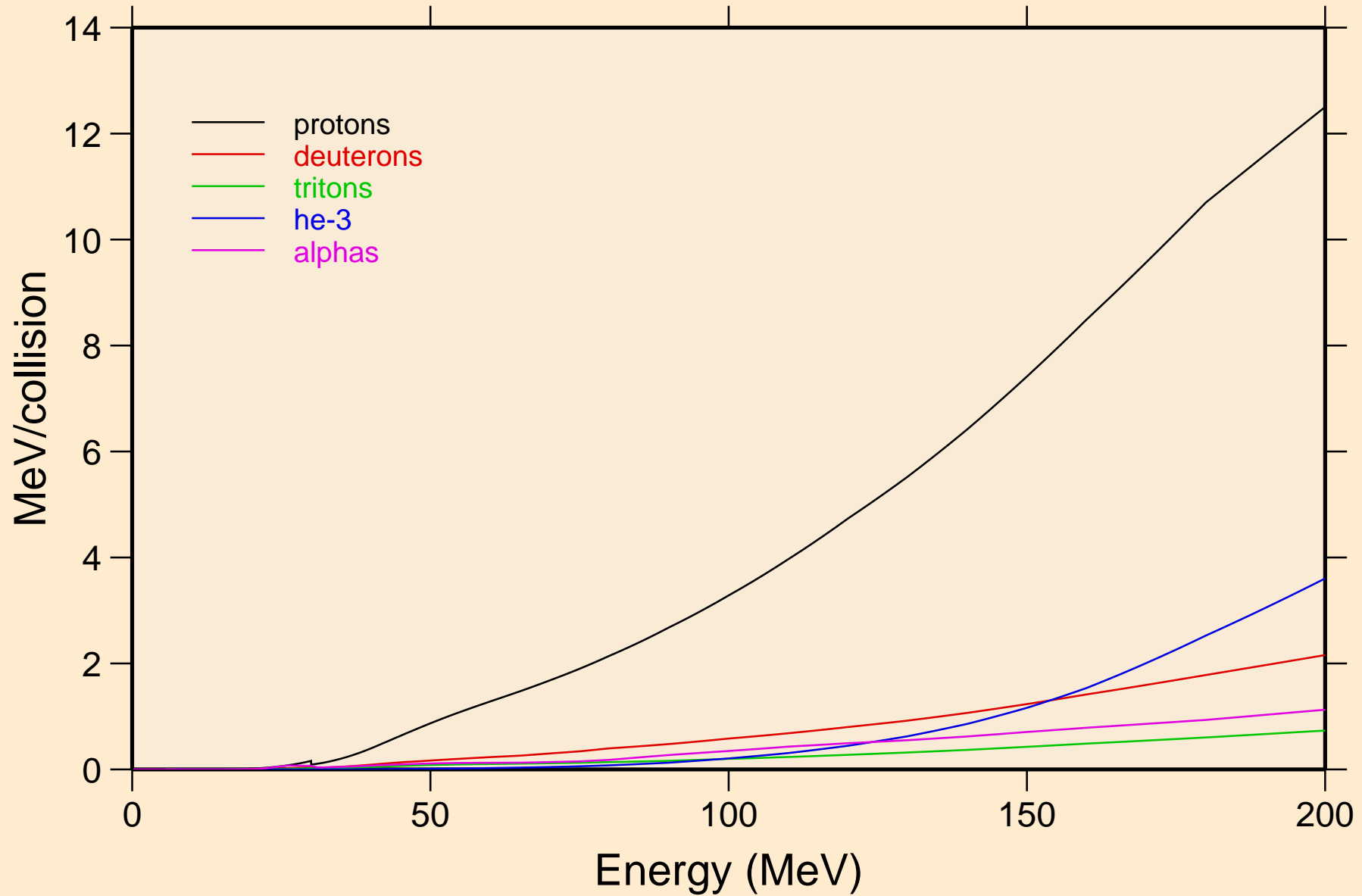

RA228 NEUTRON ACER TENDL-2023 LIBRARY; T=0.K  
Recoil Heating

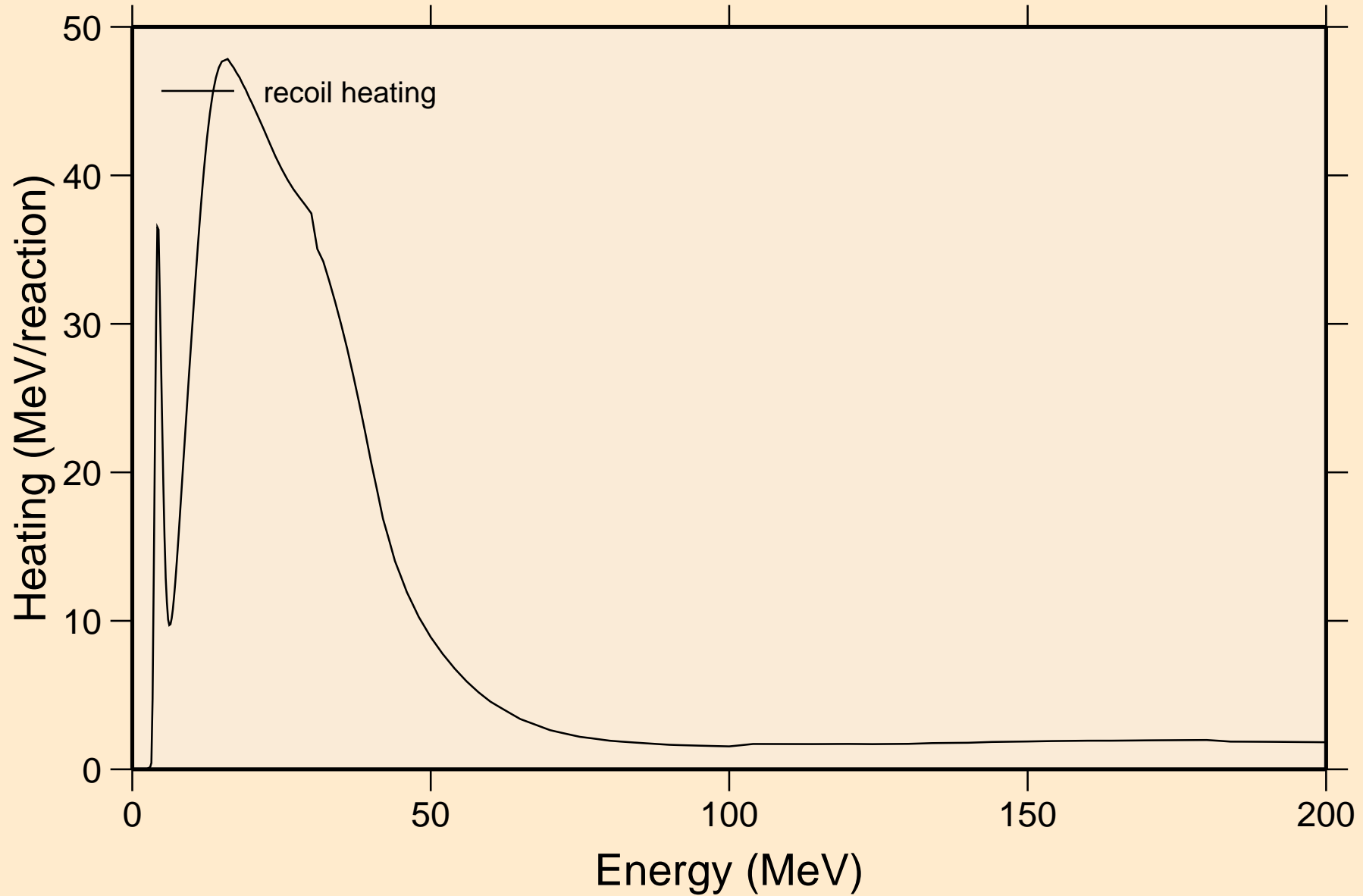



# RA228 NEUTRON ACER TENDL-2023 LIBRARY; T=0.K

## Particle production cross sections

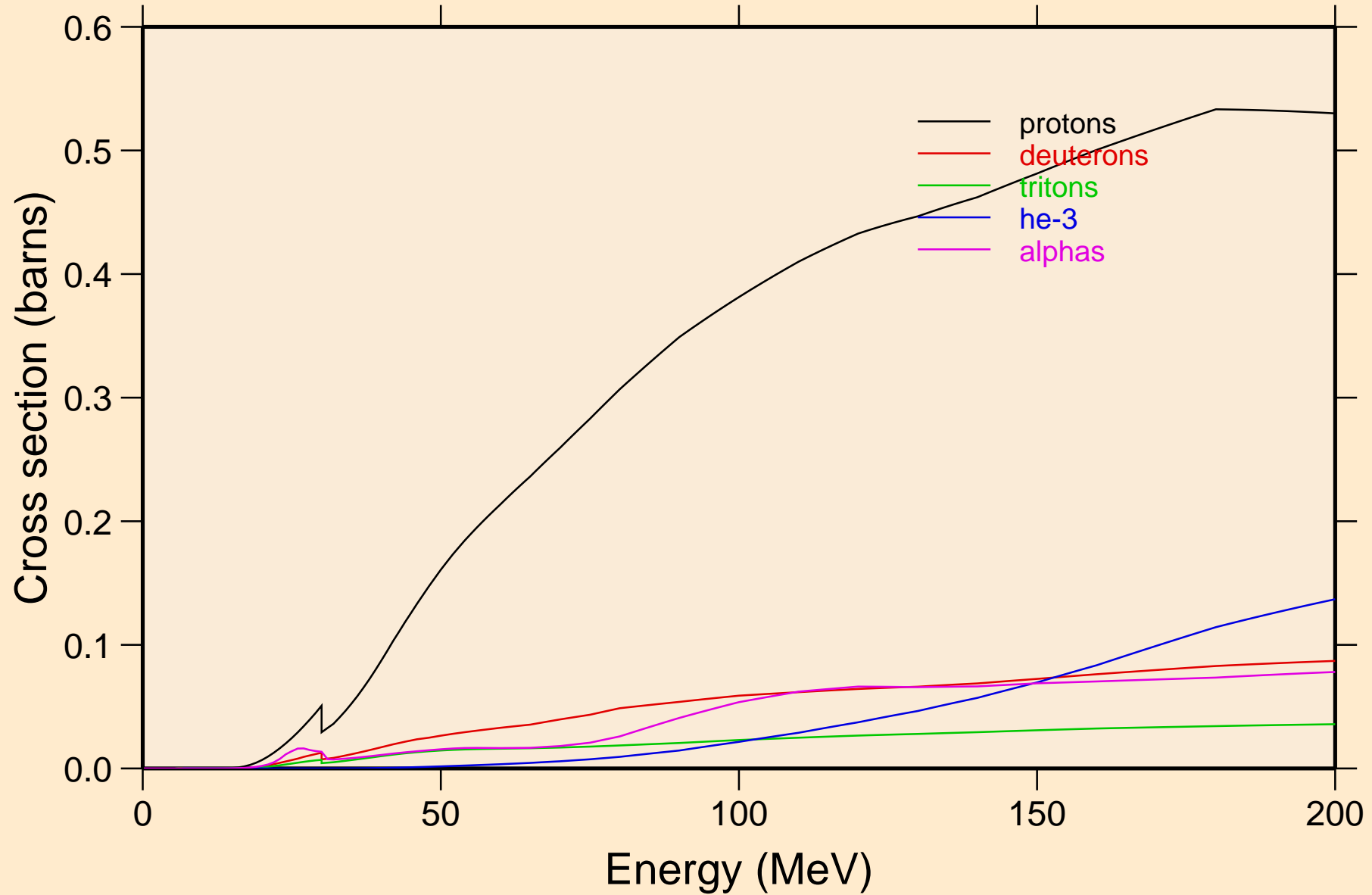

RA228 NEUTRON ACER TENDL-2023 LIBRARY; T=0.K  
protons from (n,x)

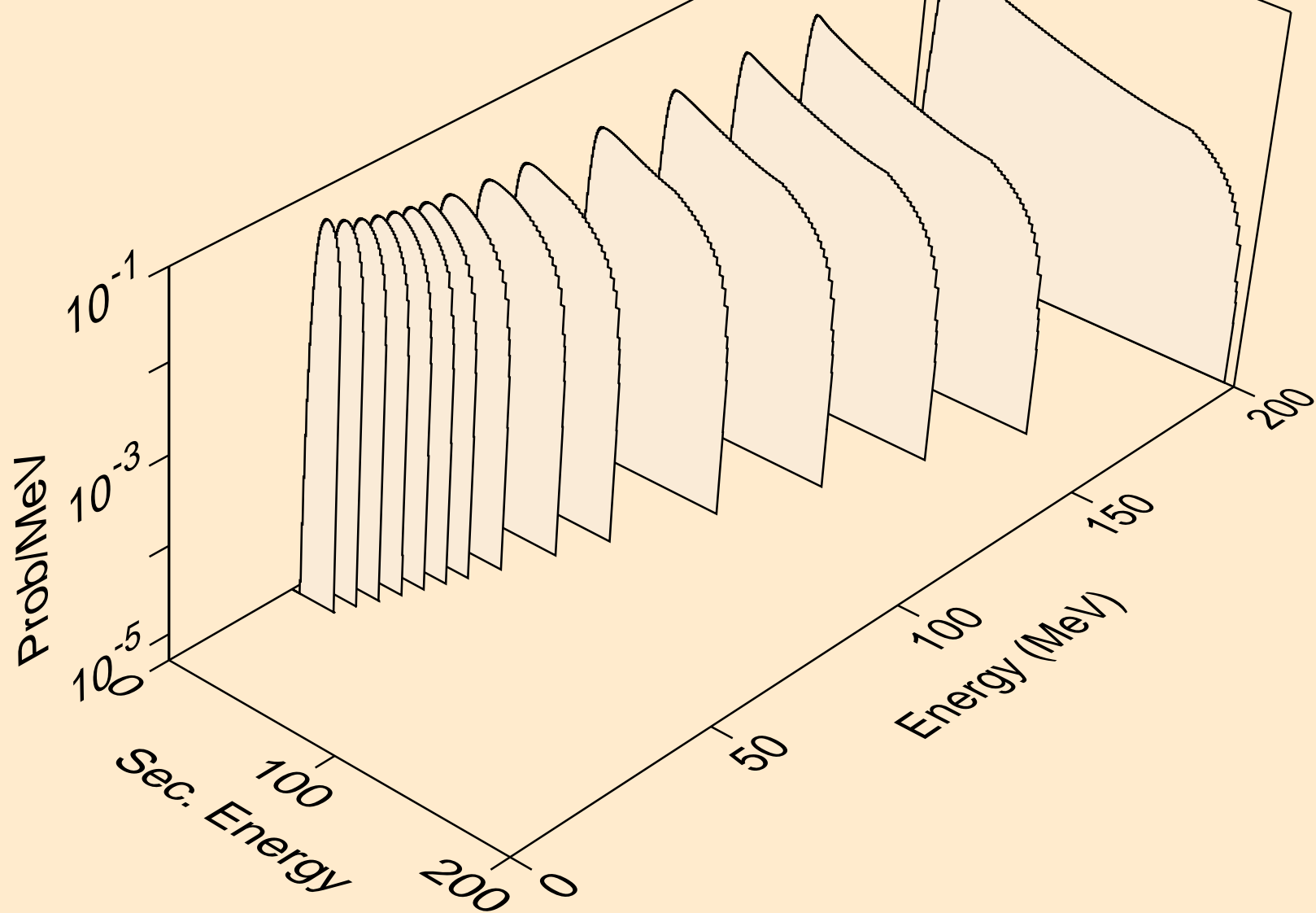

RA228 NEUTRON ACER TENDL-2023 LIBRARY; T=0.K  
protons from (n,n\*)p

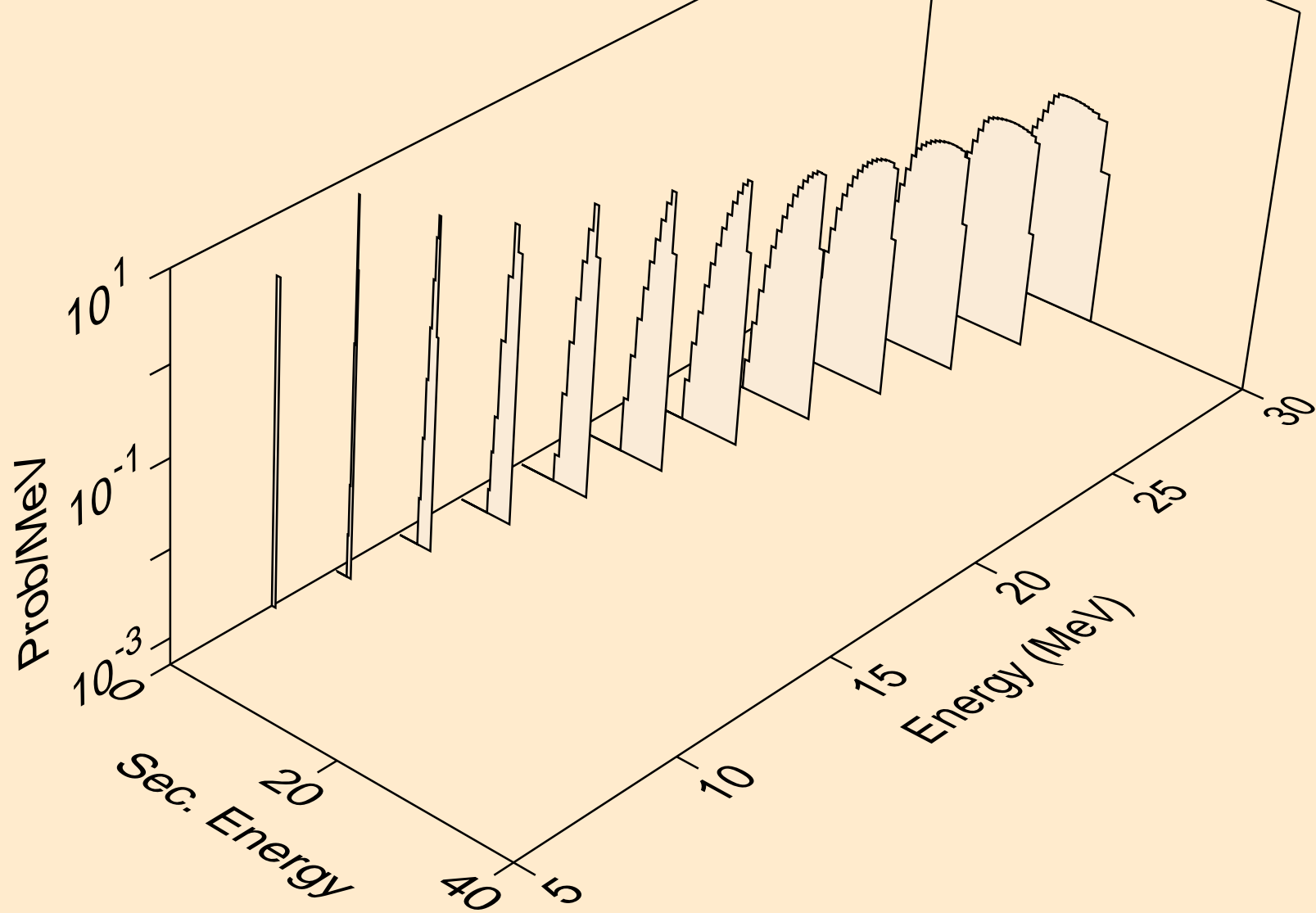

RA228 NEUTRON ACER TENDL-2023 LIBRARY; T=0.K  
protons from (n,2np)

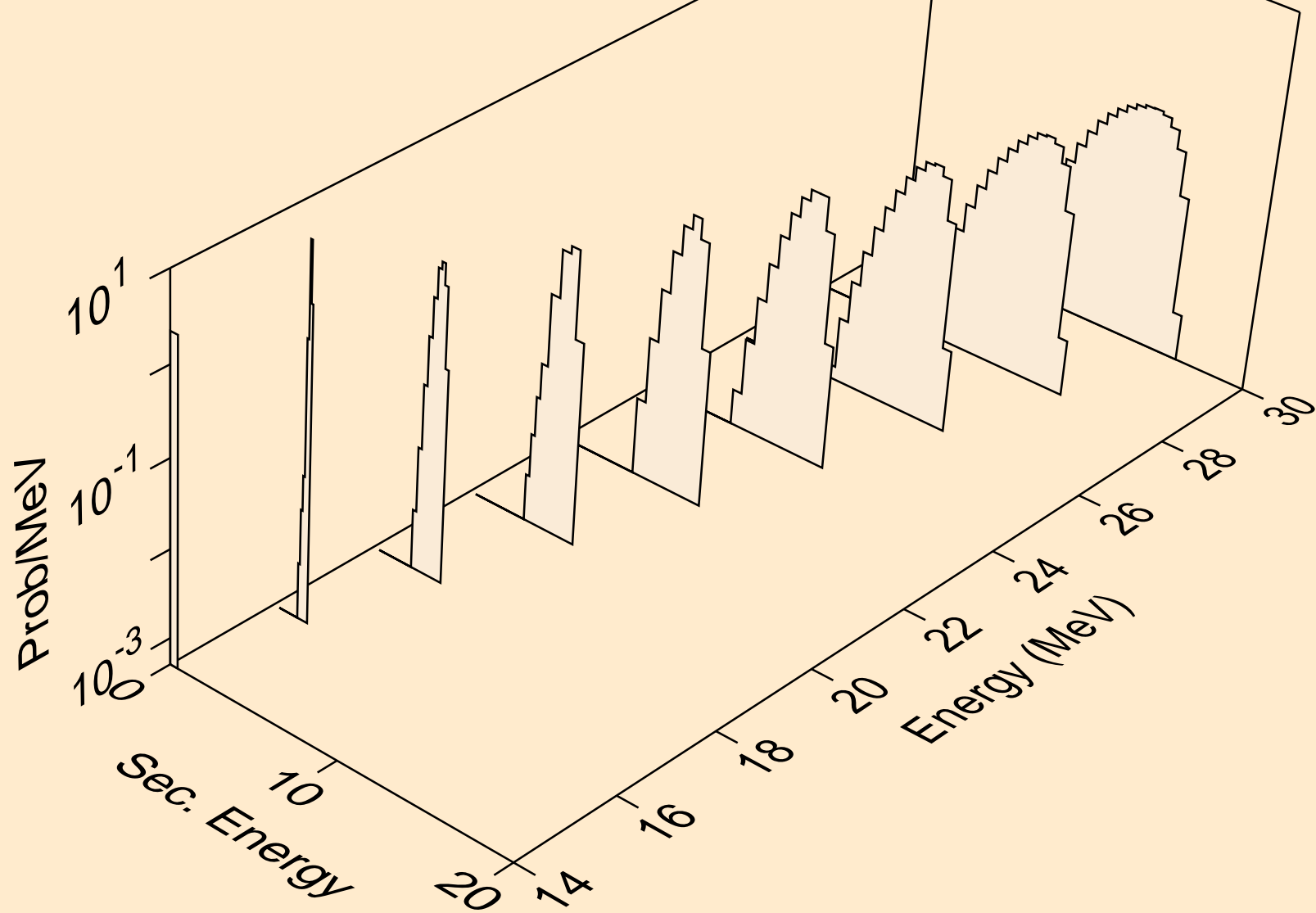

RA228 NEUTRON ACER TENDL-2023 LIBRARY; T=0.K  
protons from (n,3np)

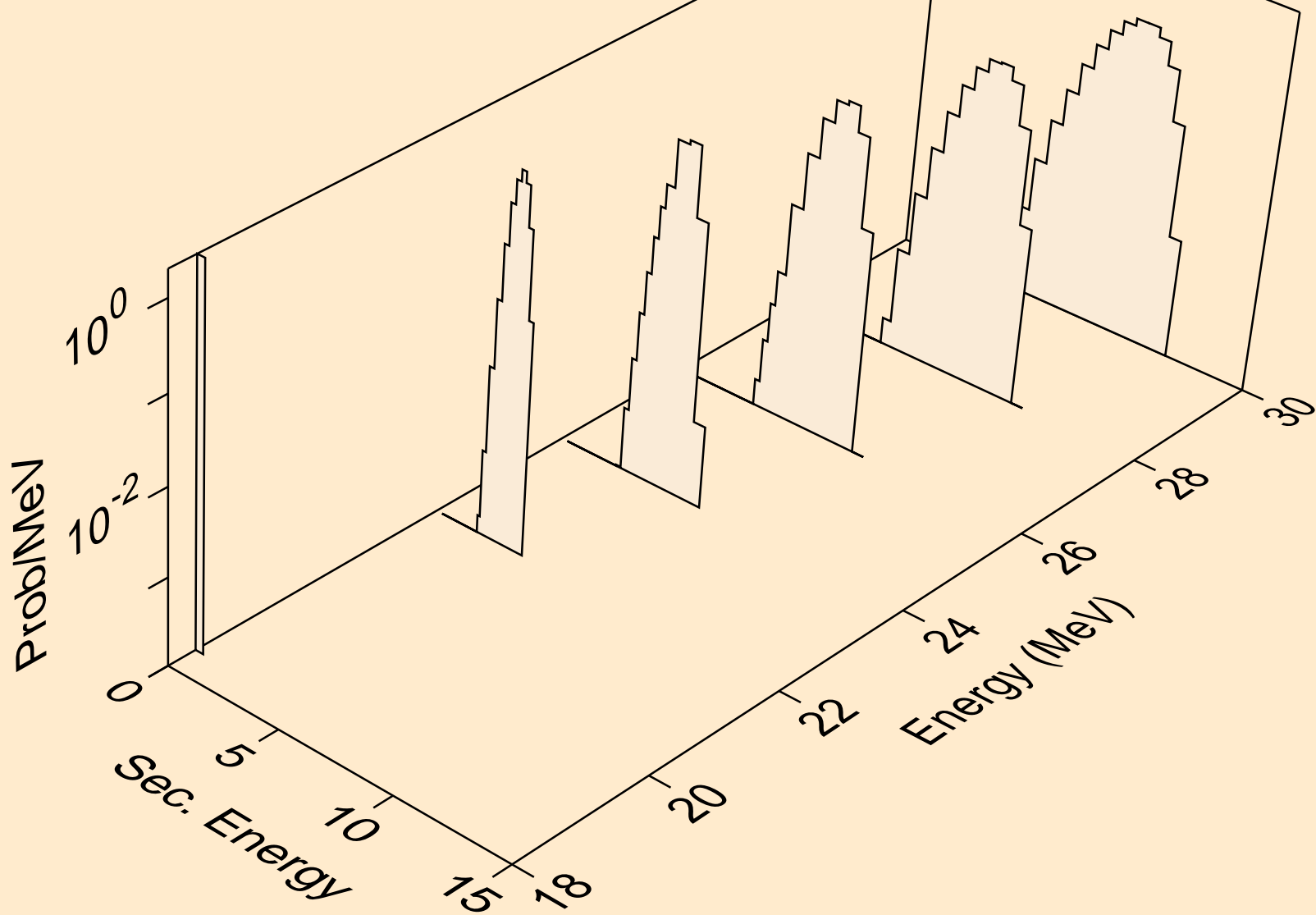

RA228 NEUTRON ACER TENDL-2023 LIBRARY; T=0.K  
protons from (n,p)

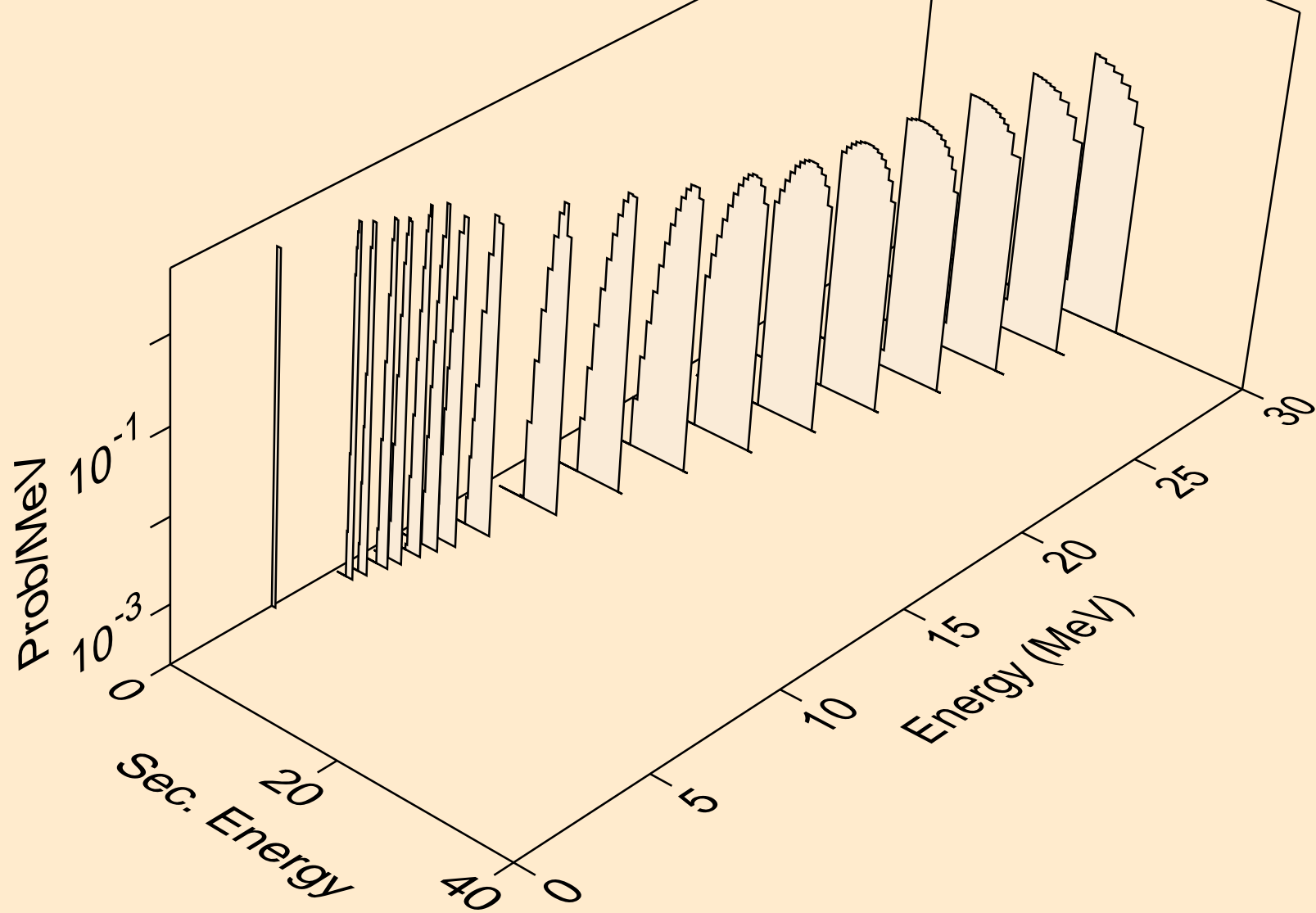

RA228 NEUTRON ACER TENDL-2023 LIBRARY; T=0.K  
protons from (n,2p)

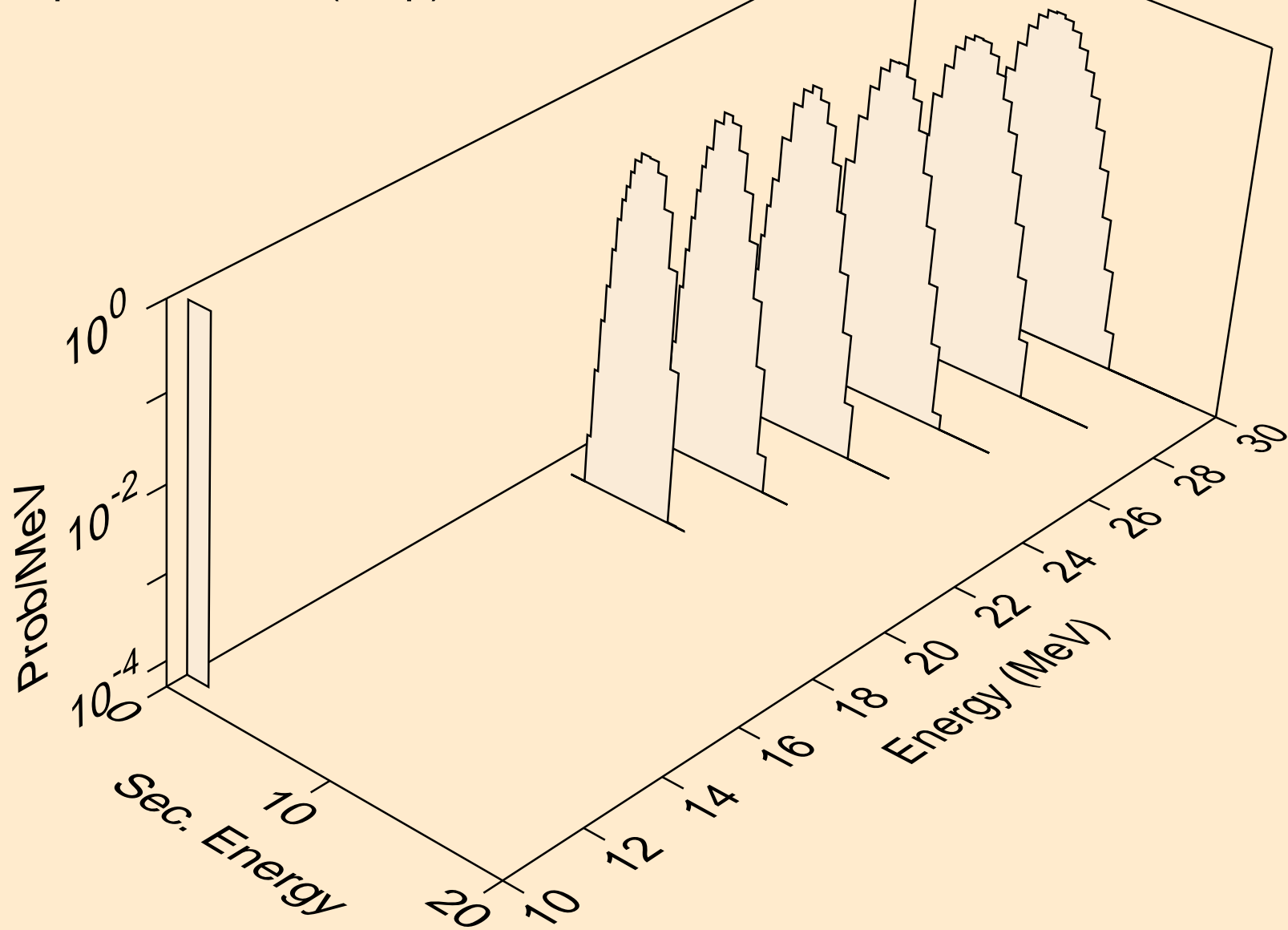

RA228 NEUTRON ACER TENDL-2023 LIBRARY; T=0.K  
deuterons from (n,x)

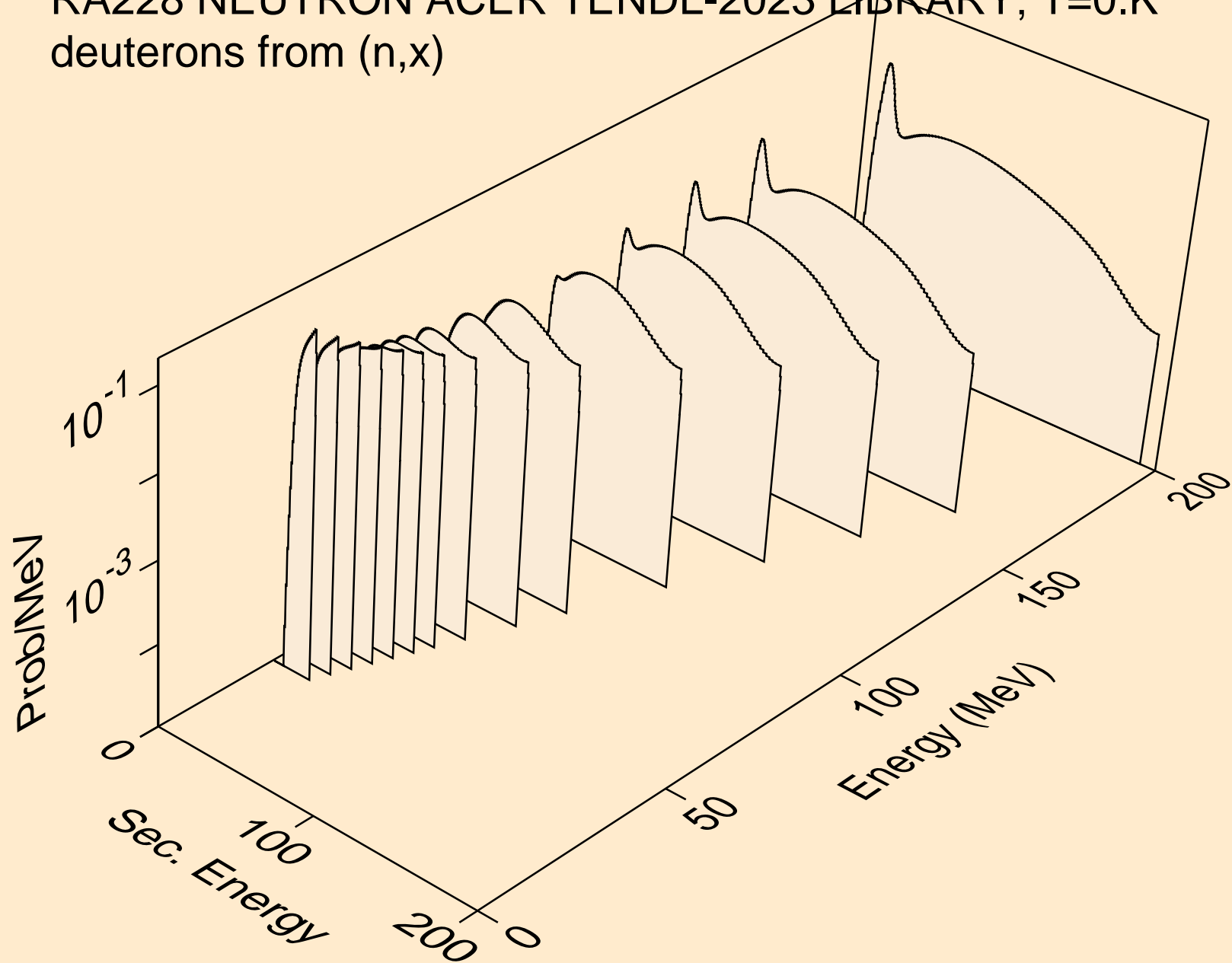



RA228 NEUTRON ACER TENDL-2023 LIBRARY; T=0.K  
deuterons from (n,2nd)

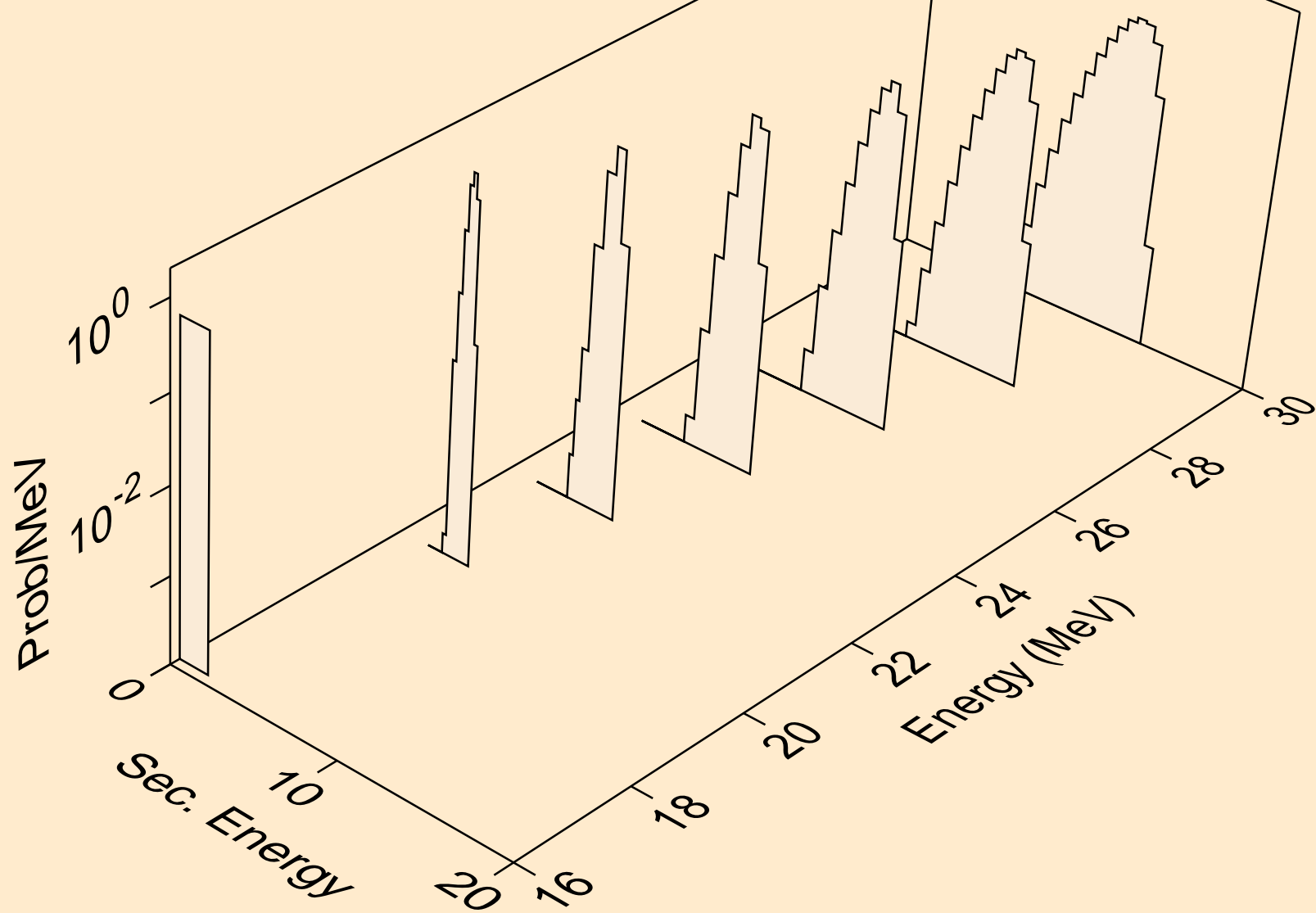

RA228 NEUTRON ACER TENDL-2023 LIBRARY; T=0.K  
deuterons from (n,n\*)d

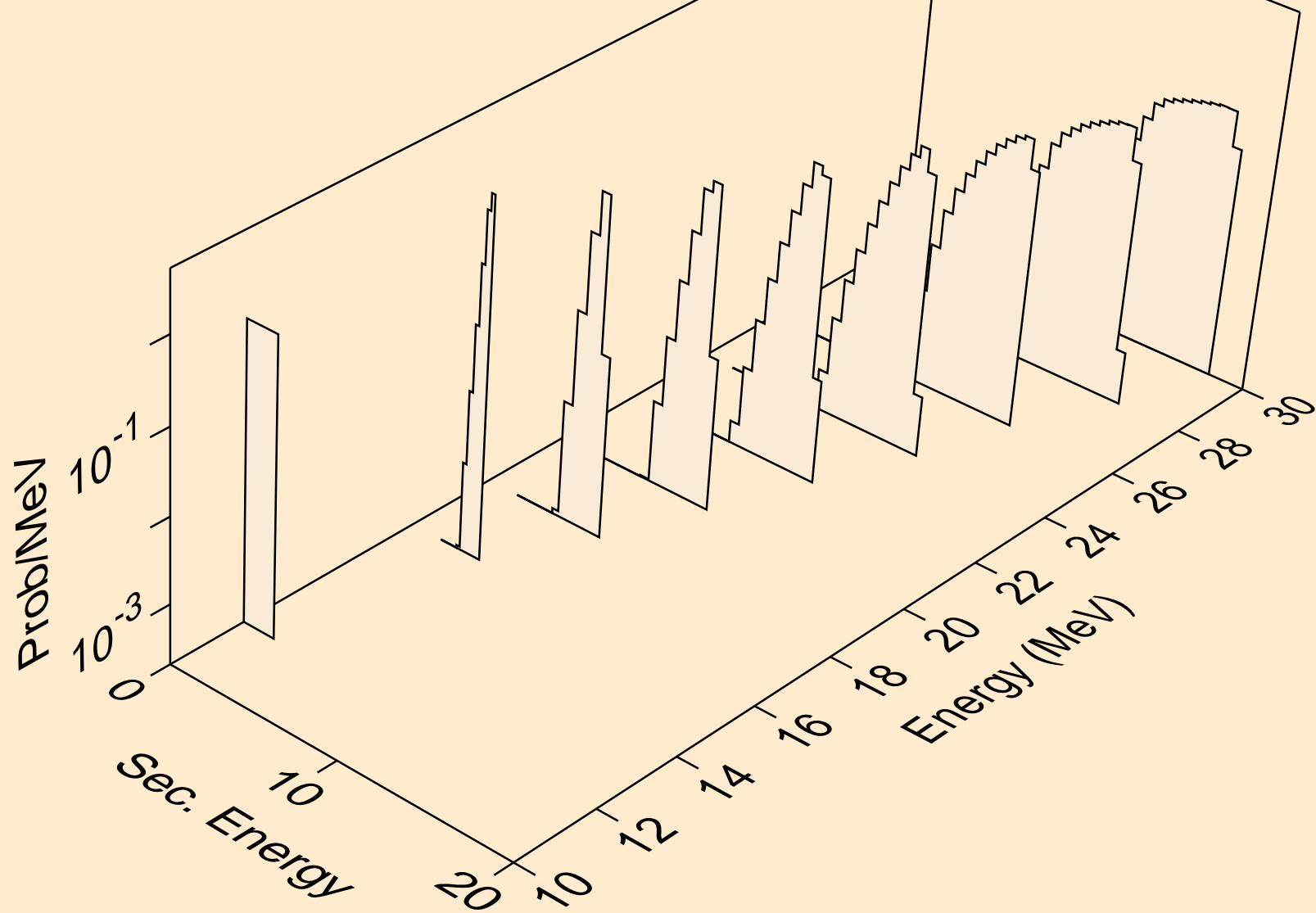

RA228 NEUTRON ACER TENDL-2023 LIBRARY; T=0.K  
deuterons from (n,d)

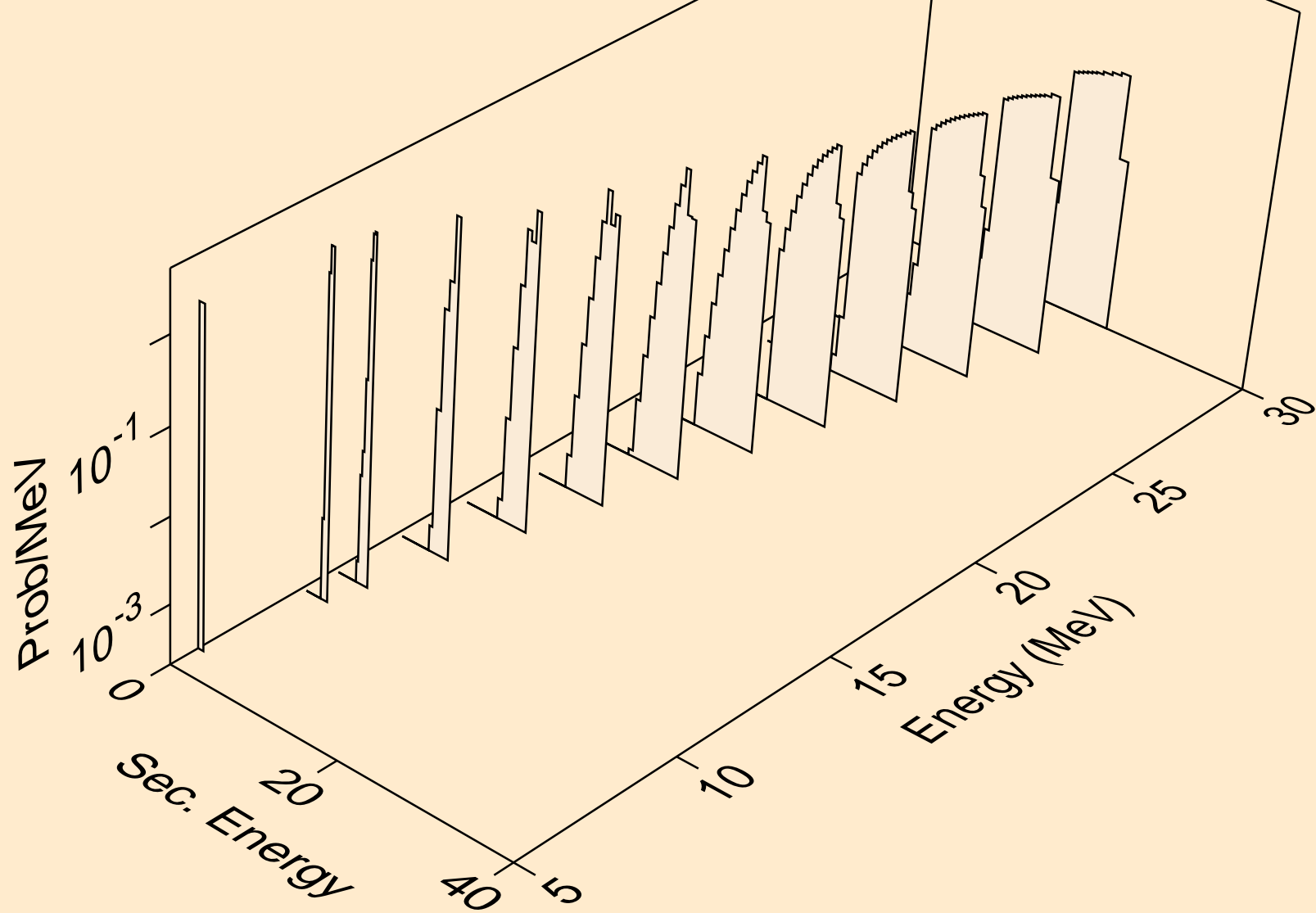

RA228 NEUTRON ACER TENDL-2023 LIBRARY; T=0.K  
tritons from (n,x)

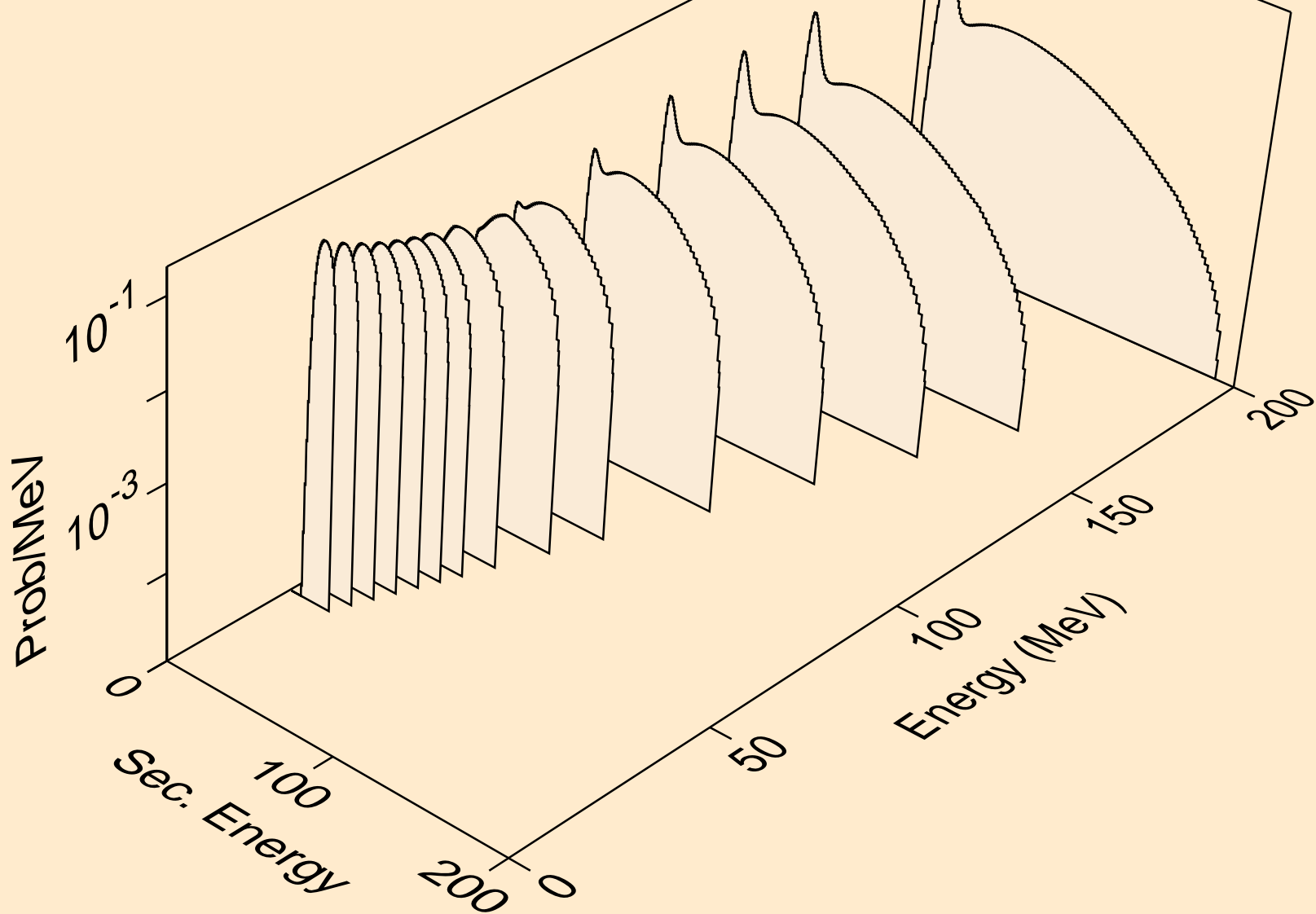

RA228 NEUTRON ACER TENDL-2023 LIBRARY; T=0.K  
tritons from (n,n\*)t

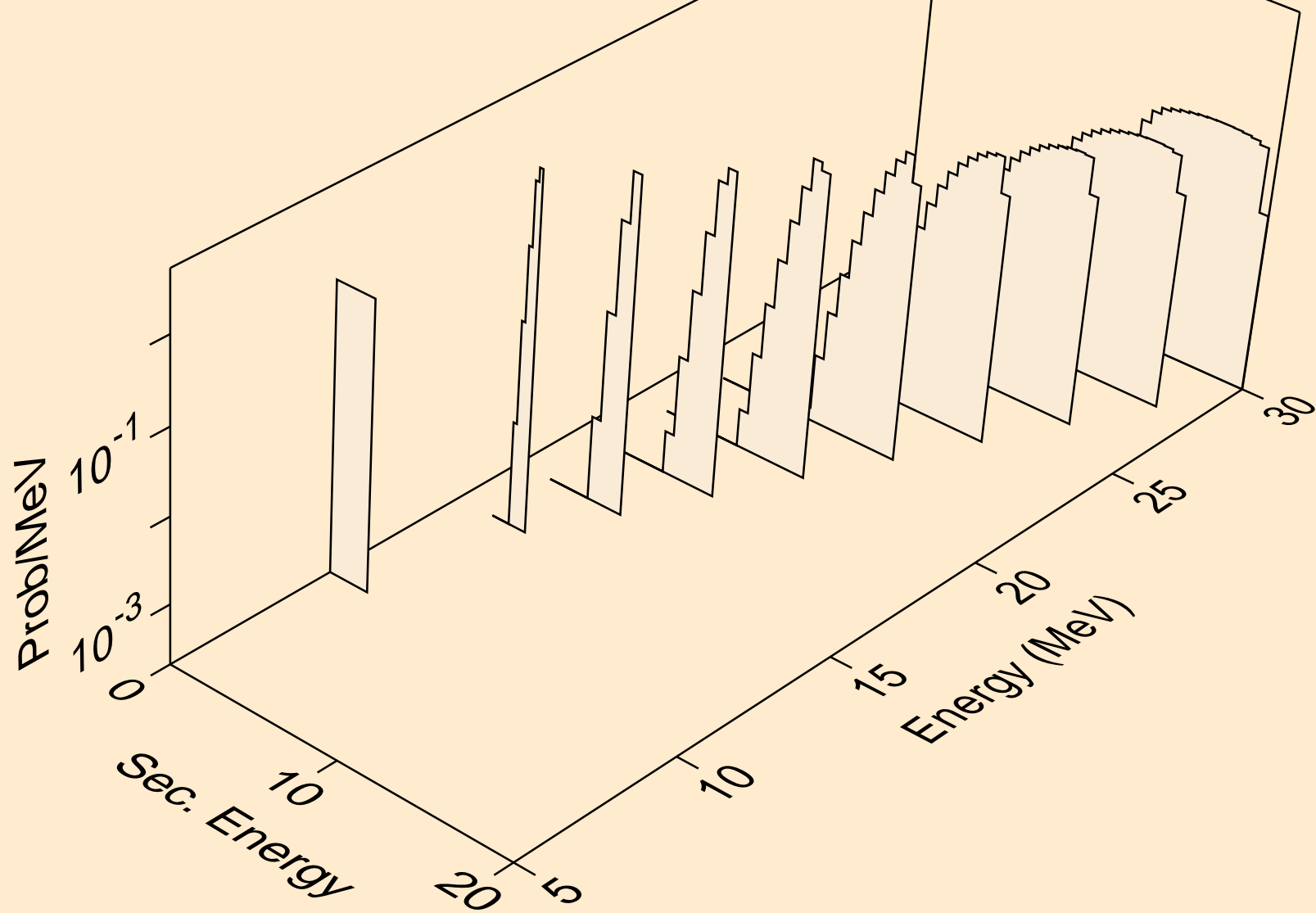

RA228 NEUTRON ACER TENDL-2023 LIBRARY; T=0.K  
tritons from (n,t)

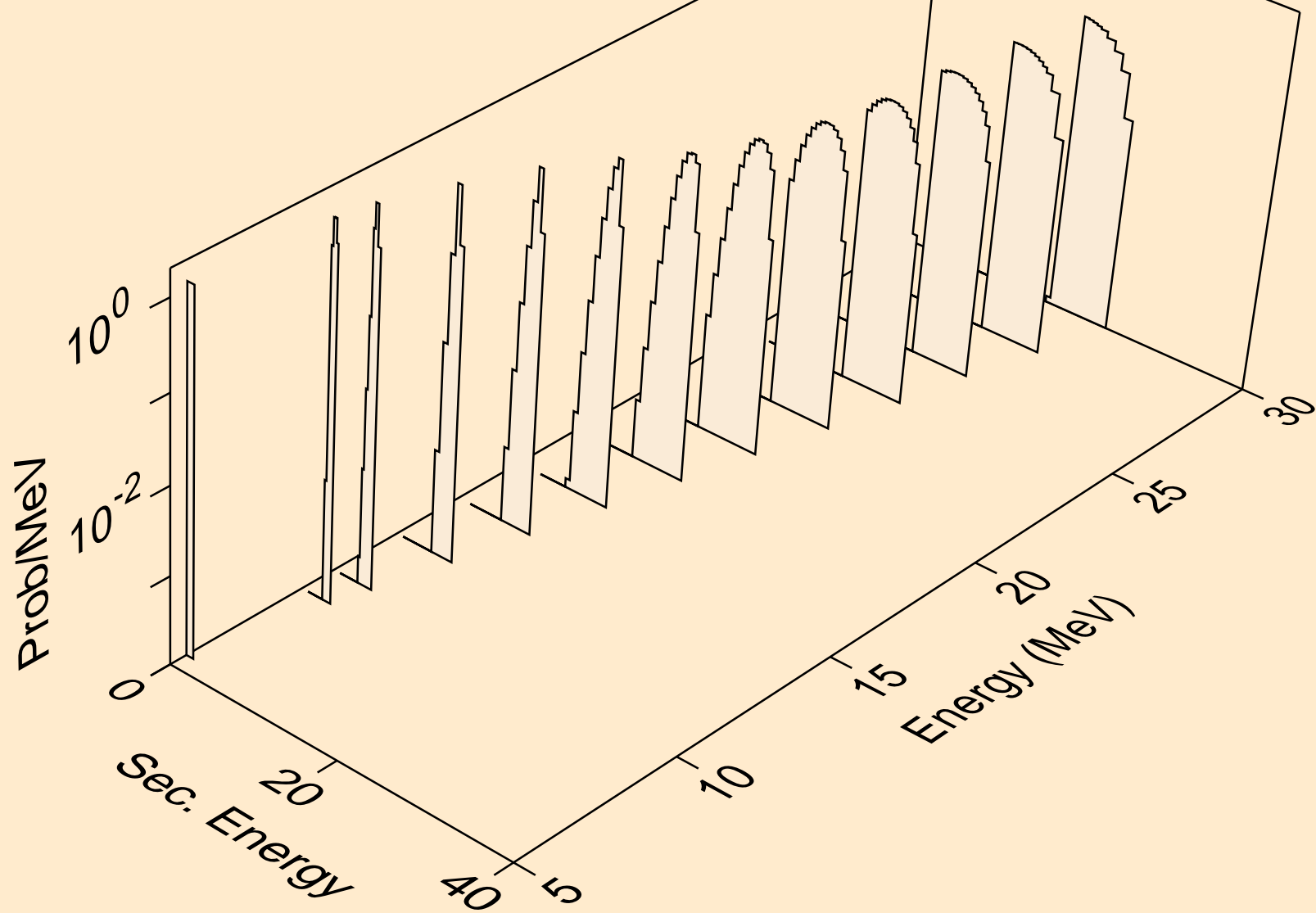

RA228 NEUTRON ACER TENDL-2023 LIBRARY; T=0.K  
he3s from (n,x)

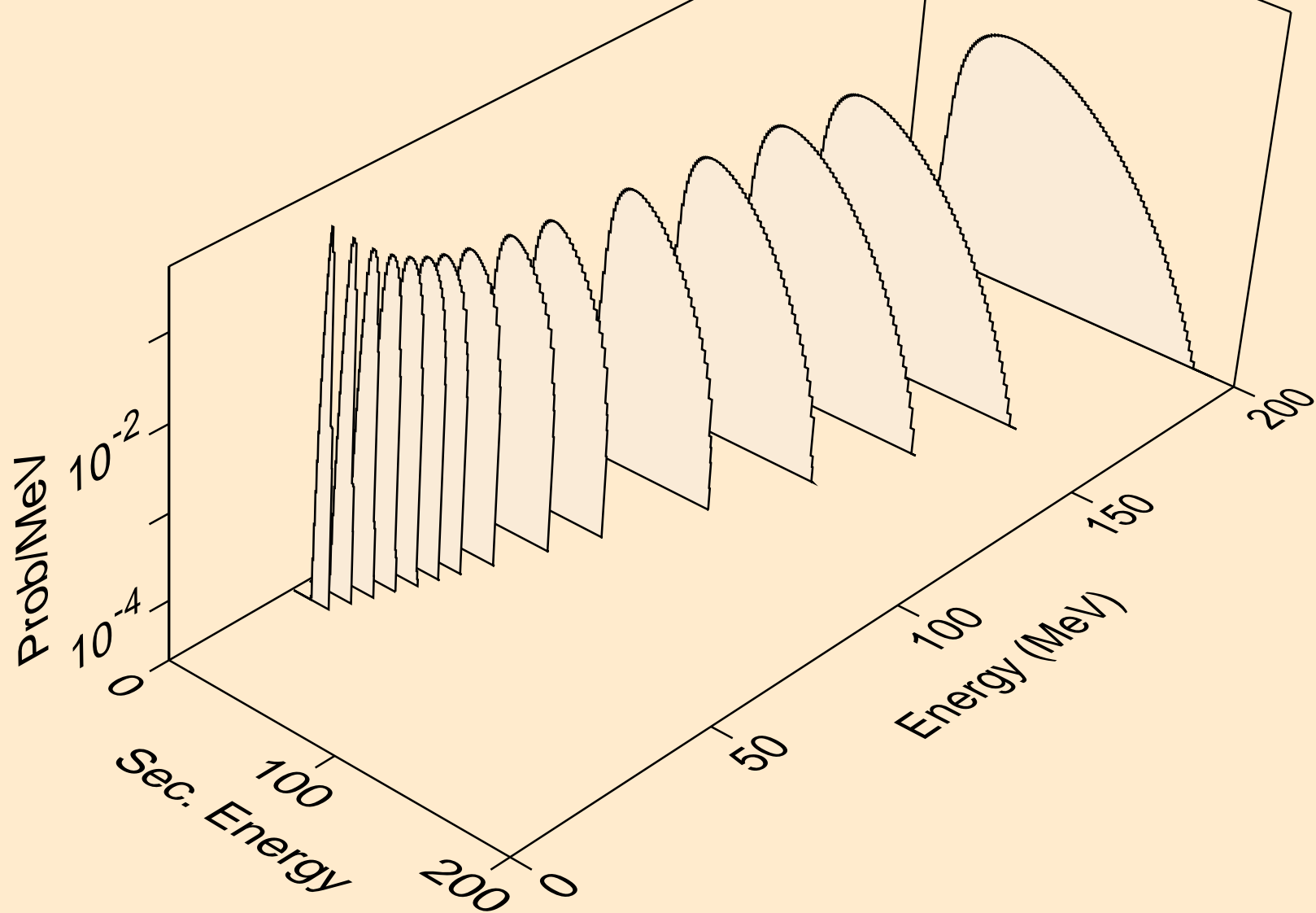

RA228 NEUTRON ACER TENDL-2023 LIBRARY; T=0.K  
he3s from (n,n\*)he3

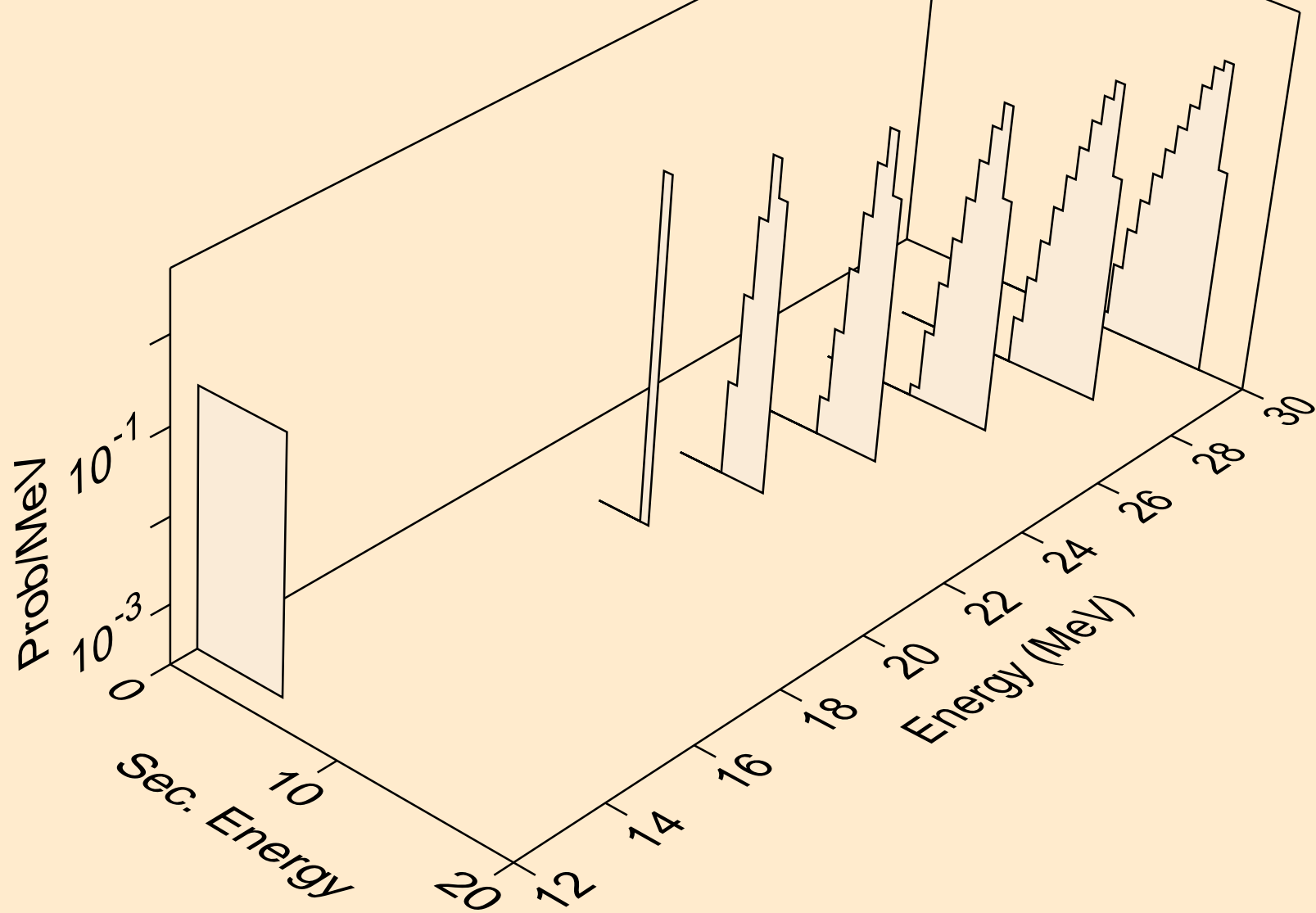



RA228 NEUTRON ACER TENDL-2023 LIBRARY; T=0.K  
he3s from (n,he3)

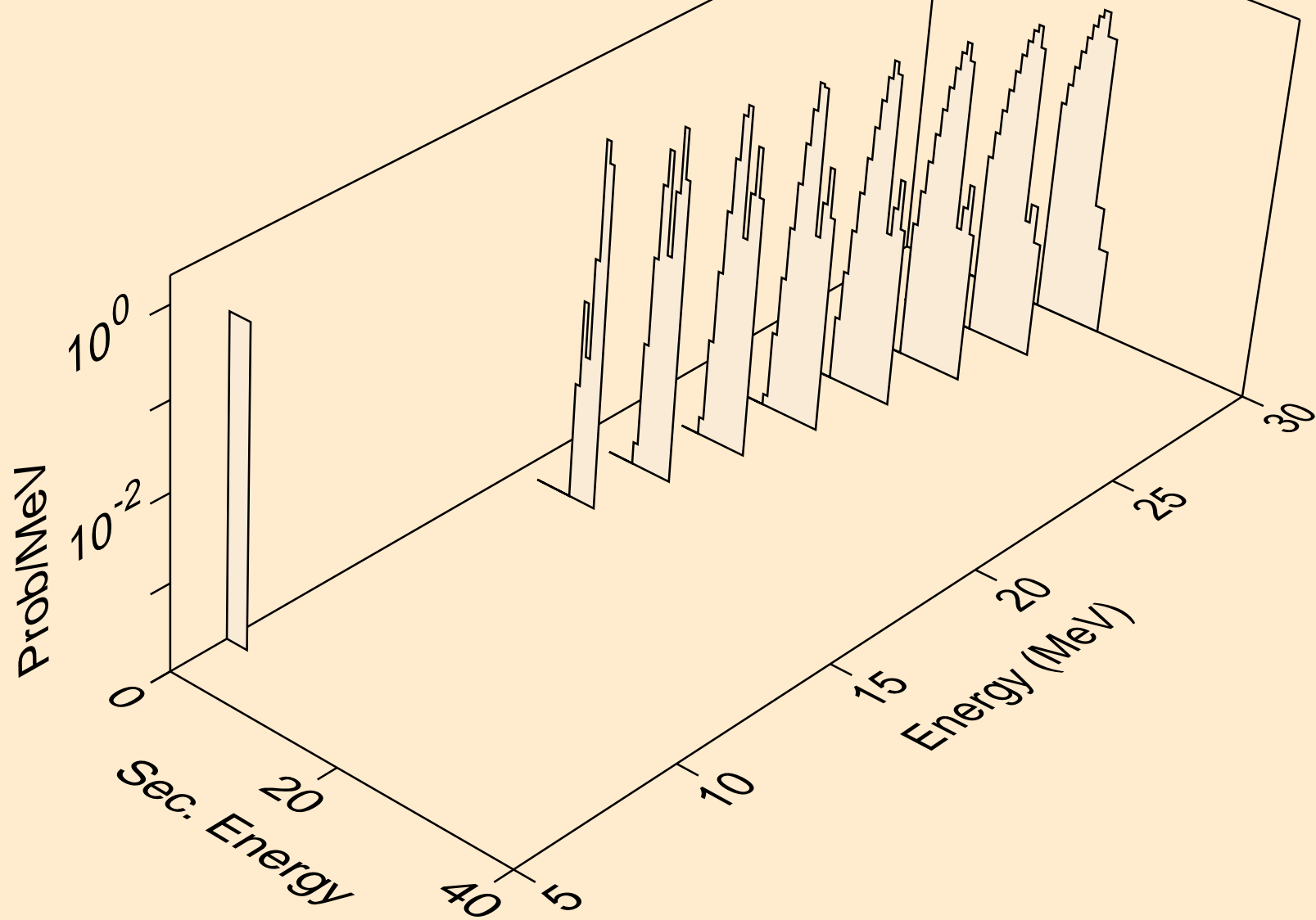

RA228 NEUTRON ACER TENDL-2023 LIBRARY; T=0.K  
alphas from (n,x)

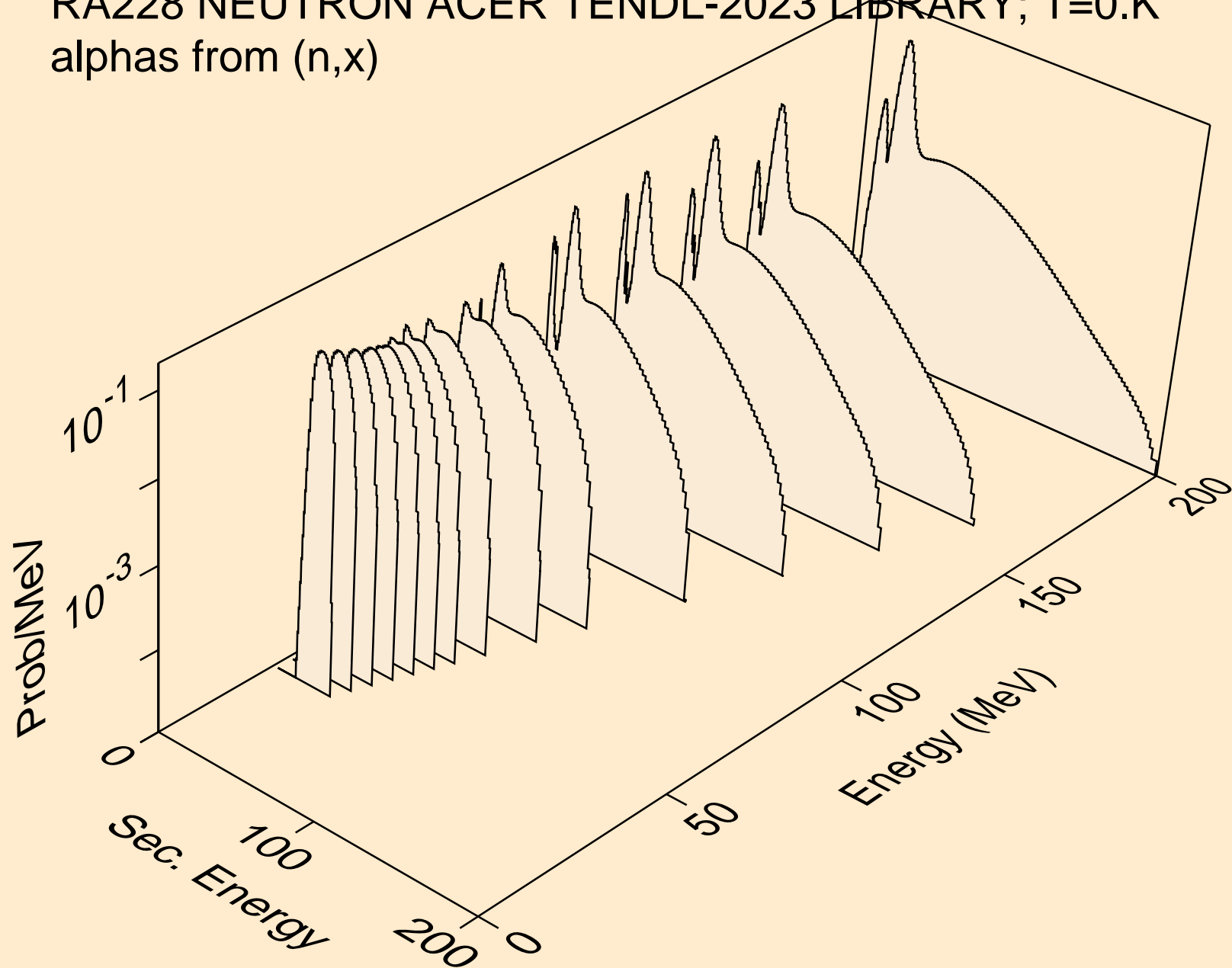

RA228 NEUTRON ACER TENDL-2023 LIBRARY; T=0.K  
alphas from (n,n\*)a

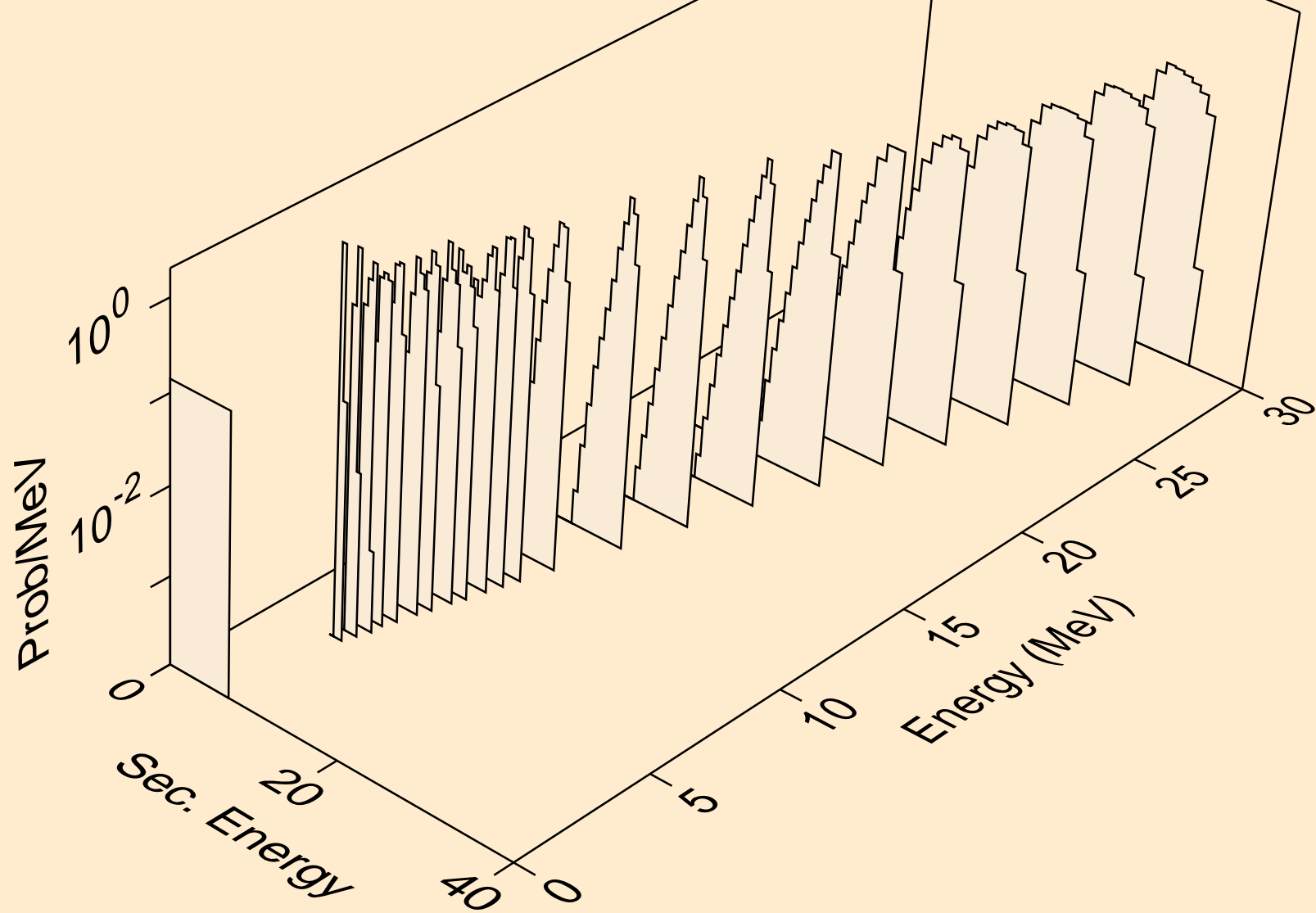

RA228 NEUTRON ACER TENDL-2023 LIBRARY; T=0.K  
alphas from (n,2n)a

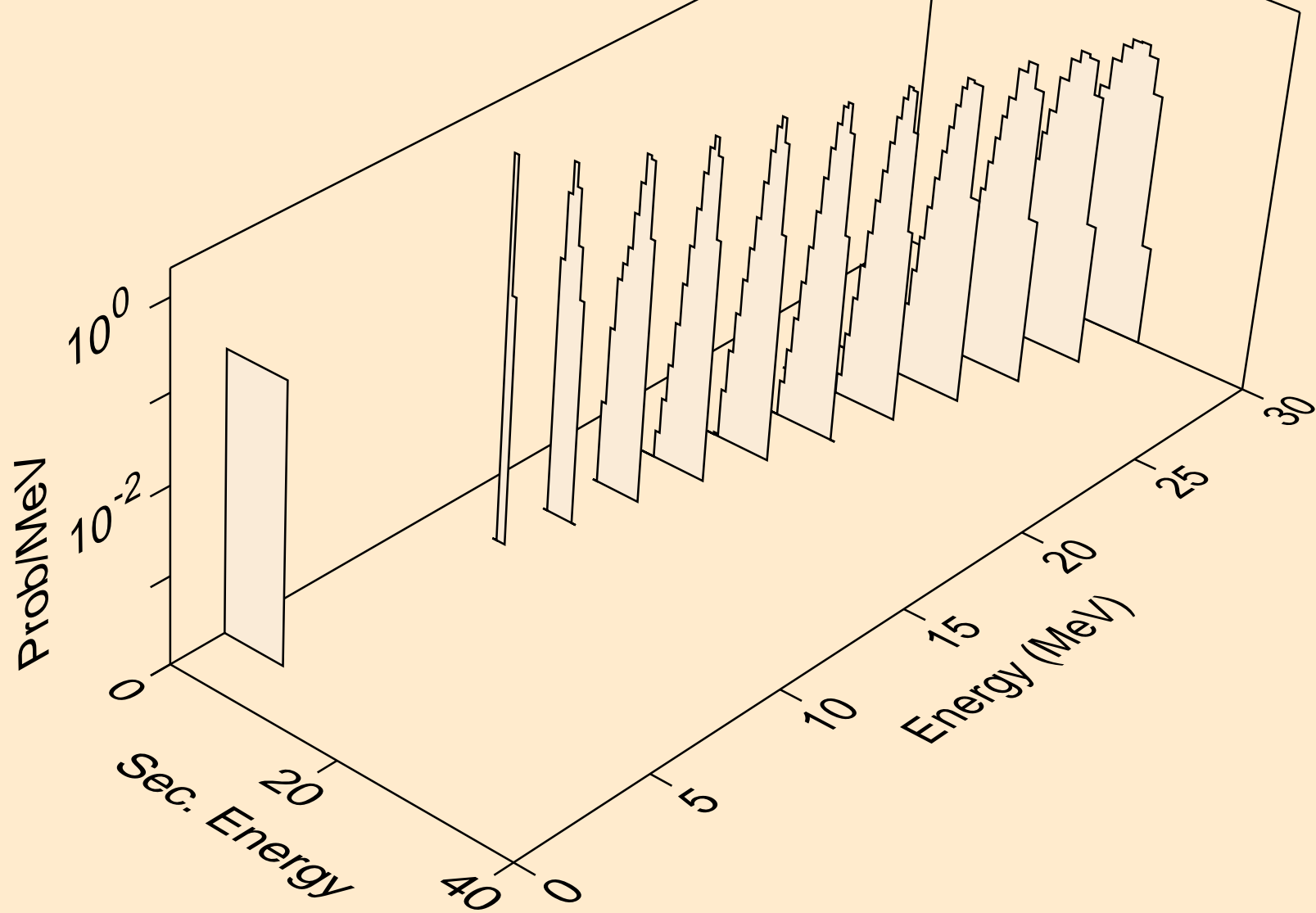

RA228 NEUTRON ACER TENDL-2023 LIBRARY; T=0.K  
alphas from (n,3n)a

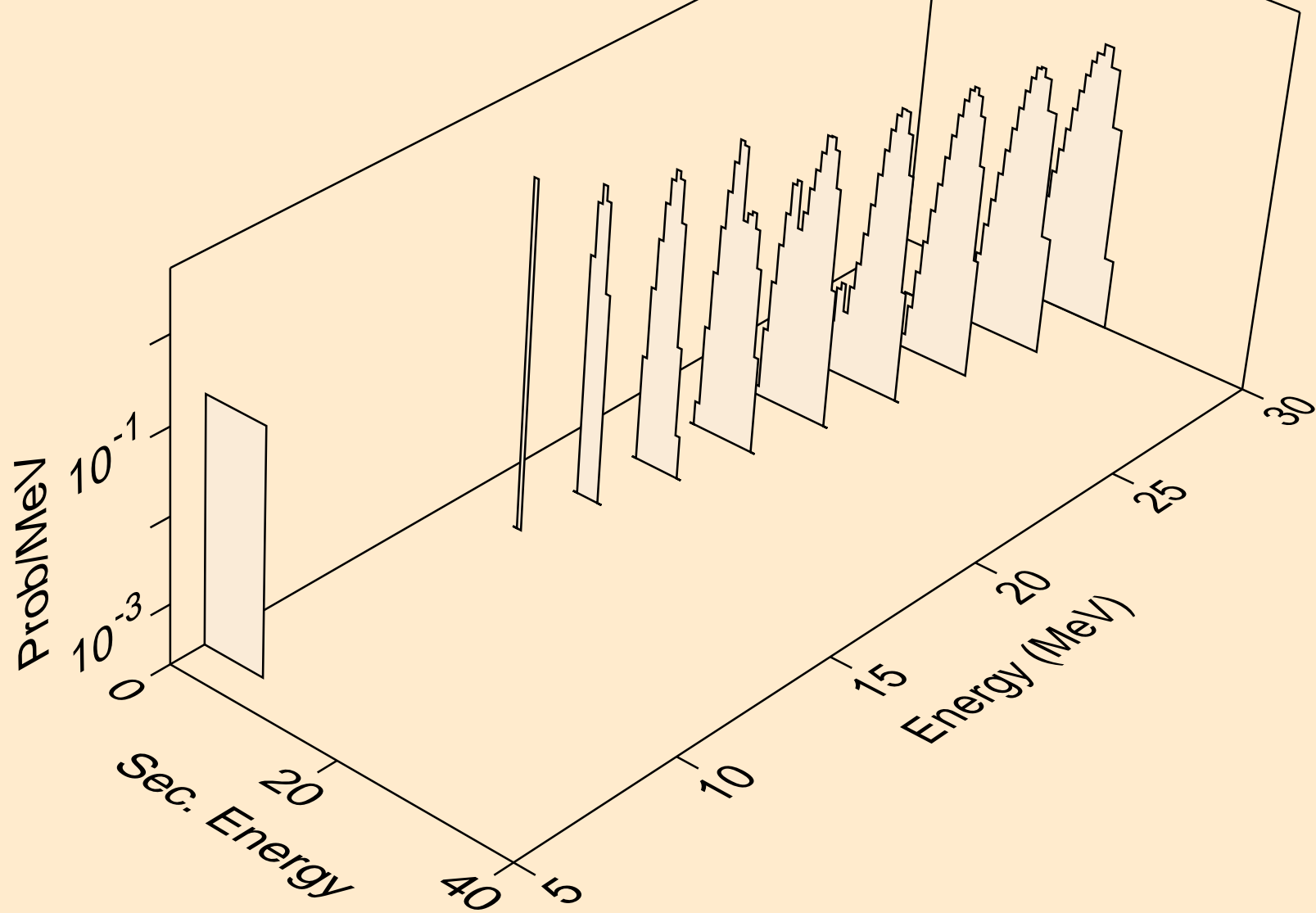

RA228 NEUTRON ACER TENDL-2023 LIBRARY; T=0.K  
alphas from (n,a)

