

RE177 NEUTRON ACER TENDL-2023 LIBRARY; T=0.K

Principal cross sections

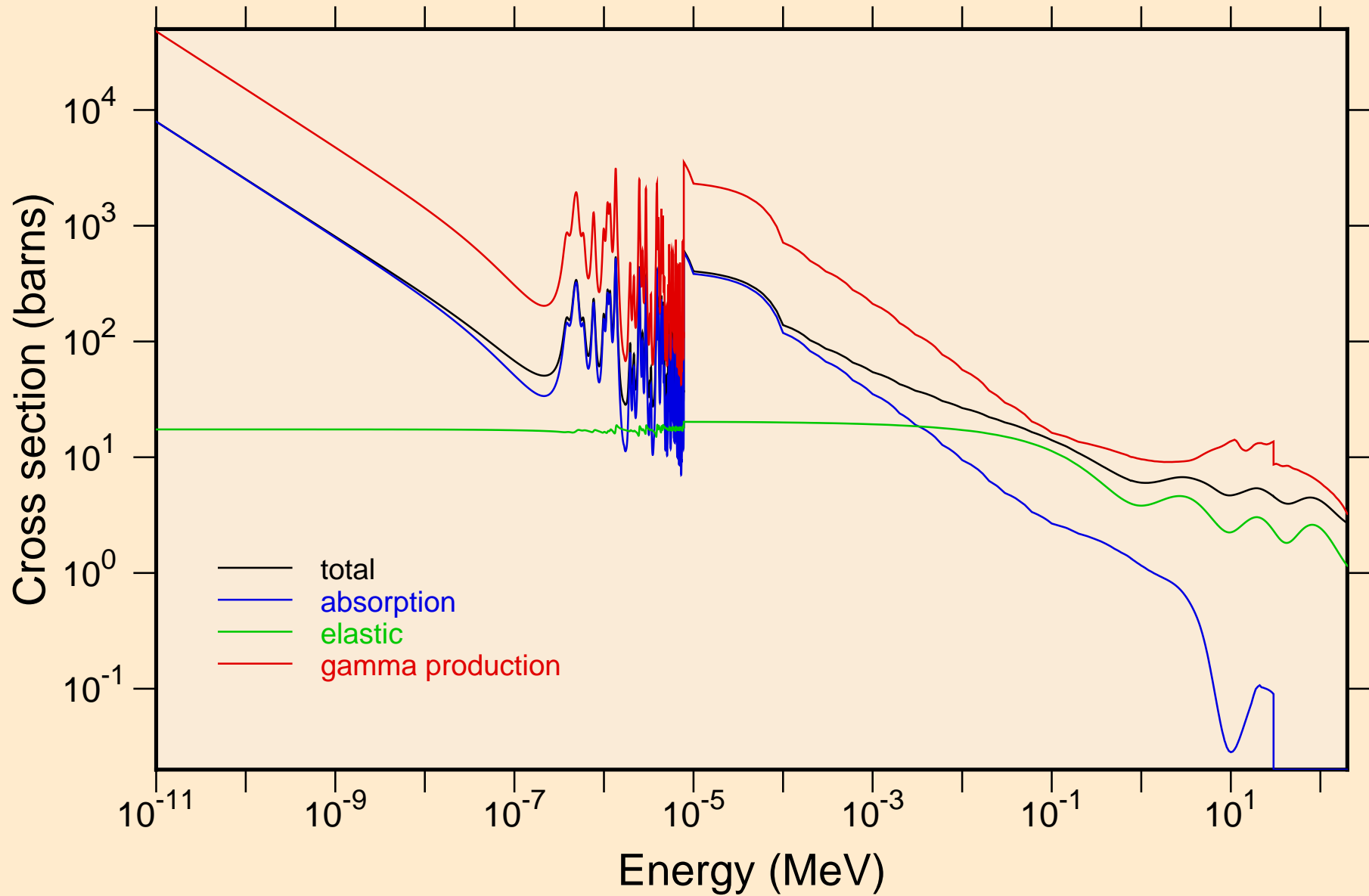

RE177 NEUTRON ACER TENDL-2023 LIBRARY; T=0.K
resonance total cross section

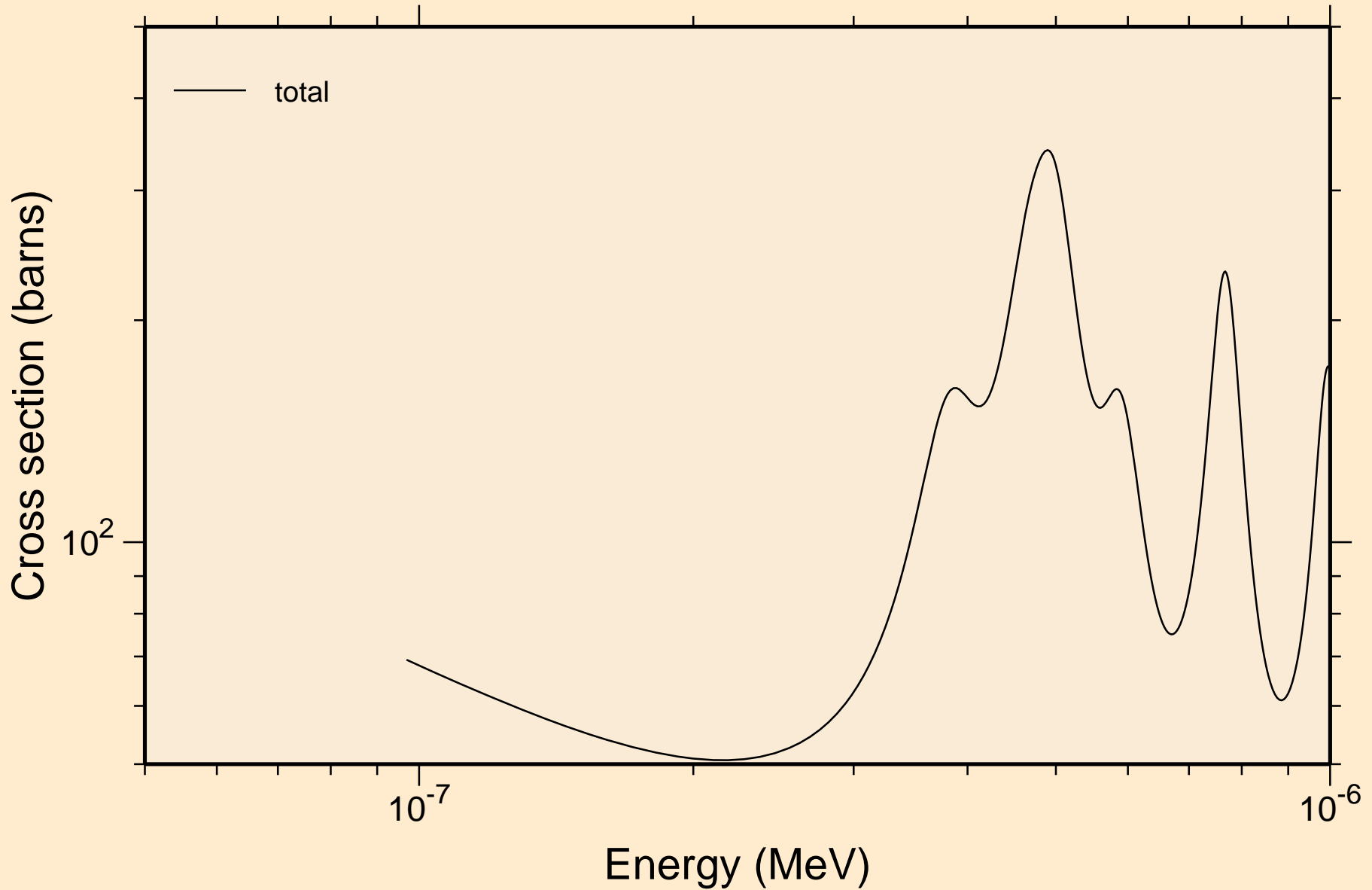

RE177 NEUTRON ACER TENDL-2023 LIBRARY; T=0.K
resonance total cross section

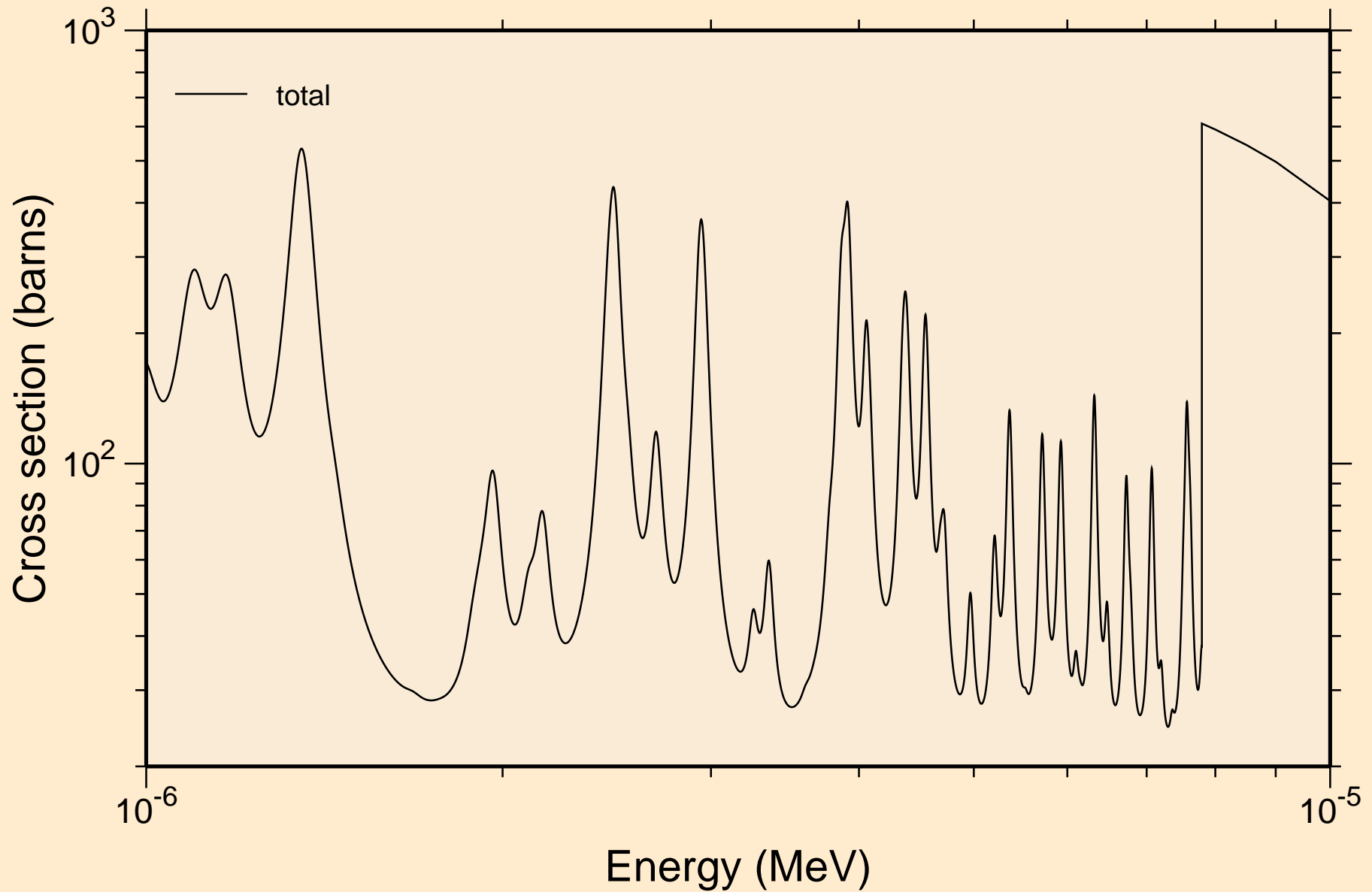

RE177 NEUTRON ACER TENDL-2023 LIBRARY; T=0.K
resonance total cross section

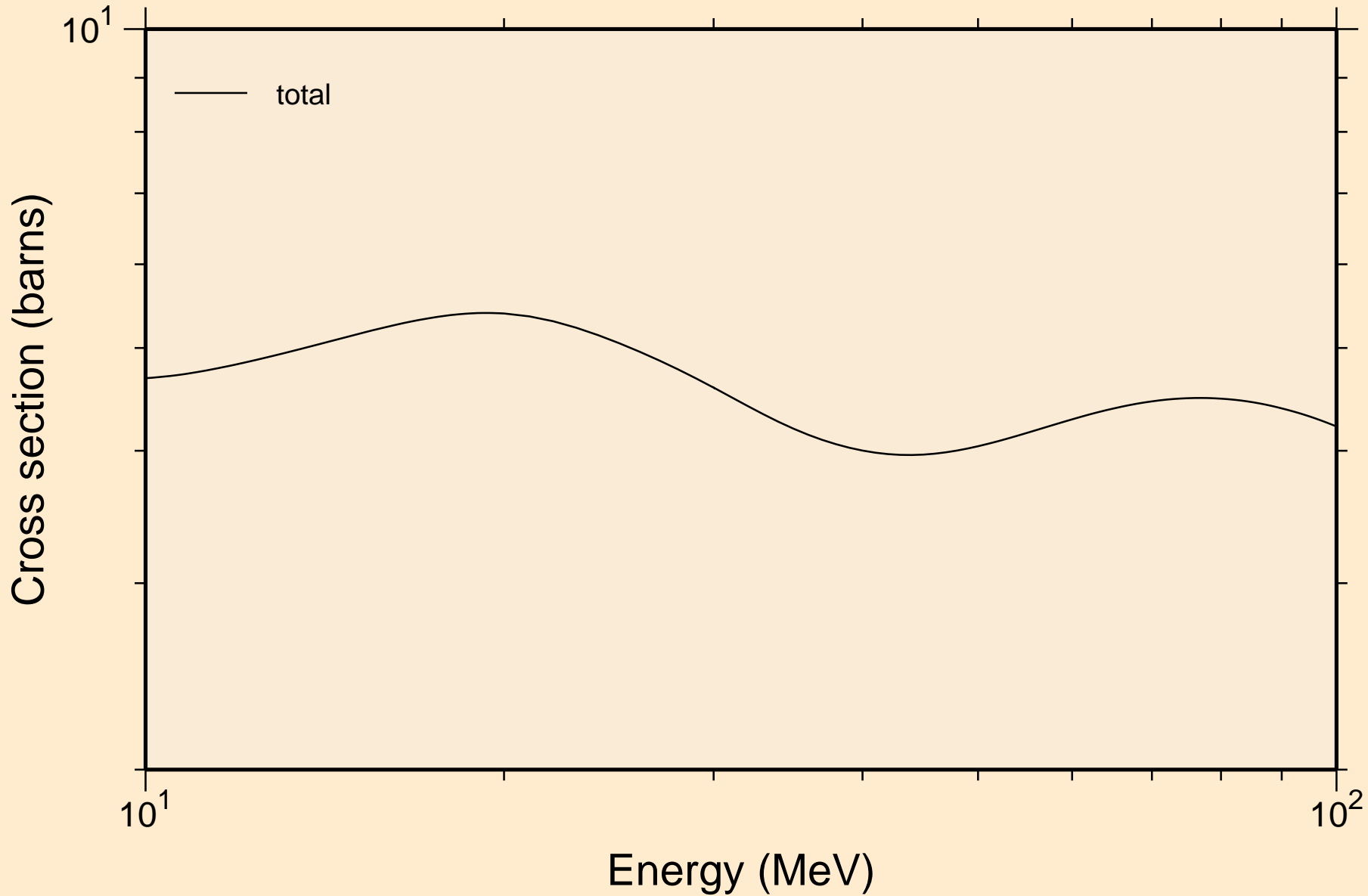

RE177 NEUTRON ACER TENDL-2023 LIBRARY; T=0.K
resonance absorption cross sections

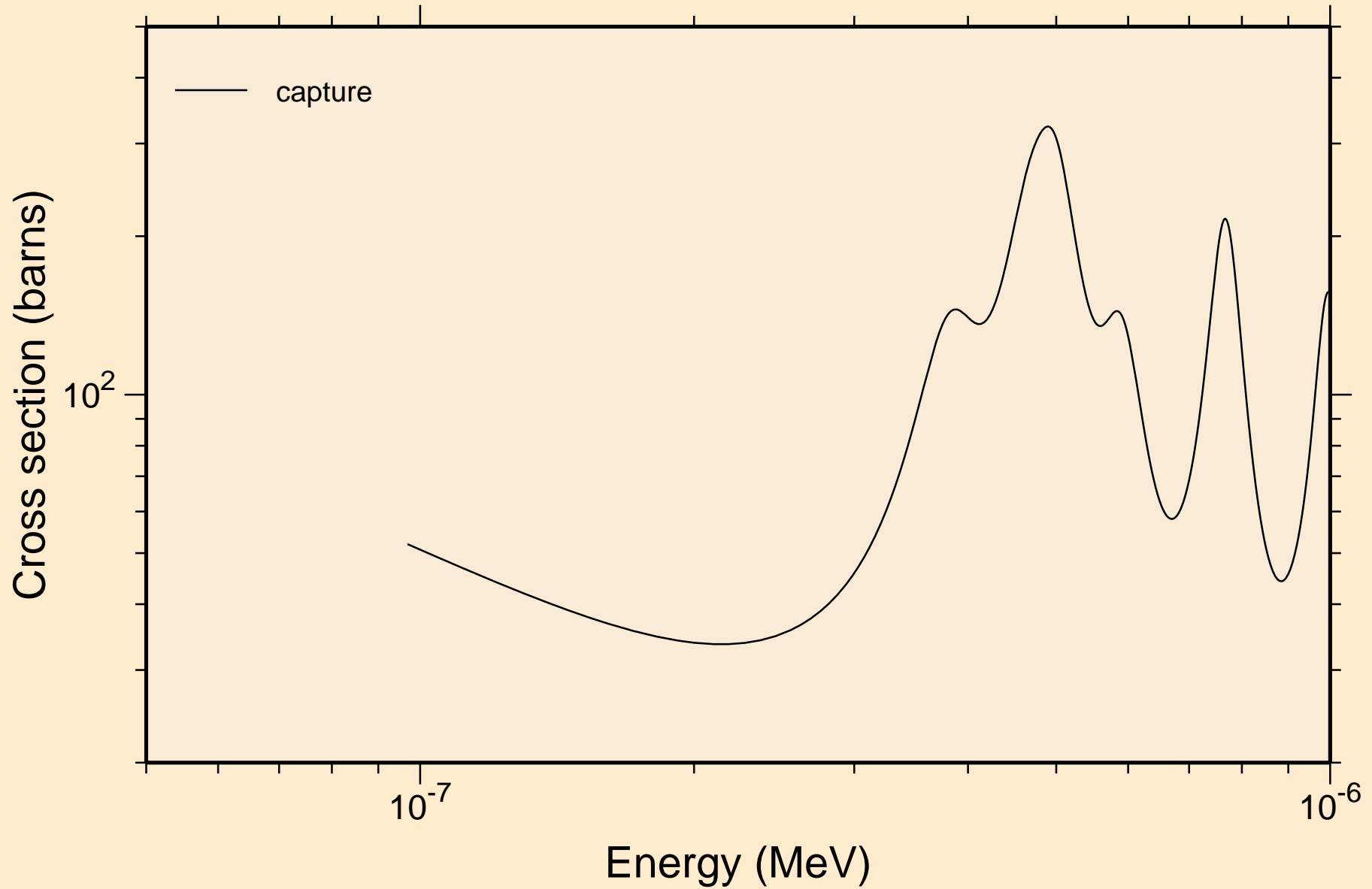

RE177 NEUTRON ACER TENDL-2023 LIBRARY; T=0.K
resonance absorption cross sections

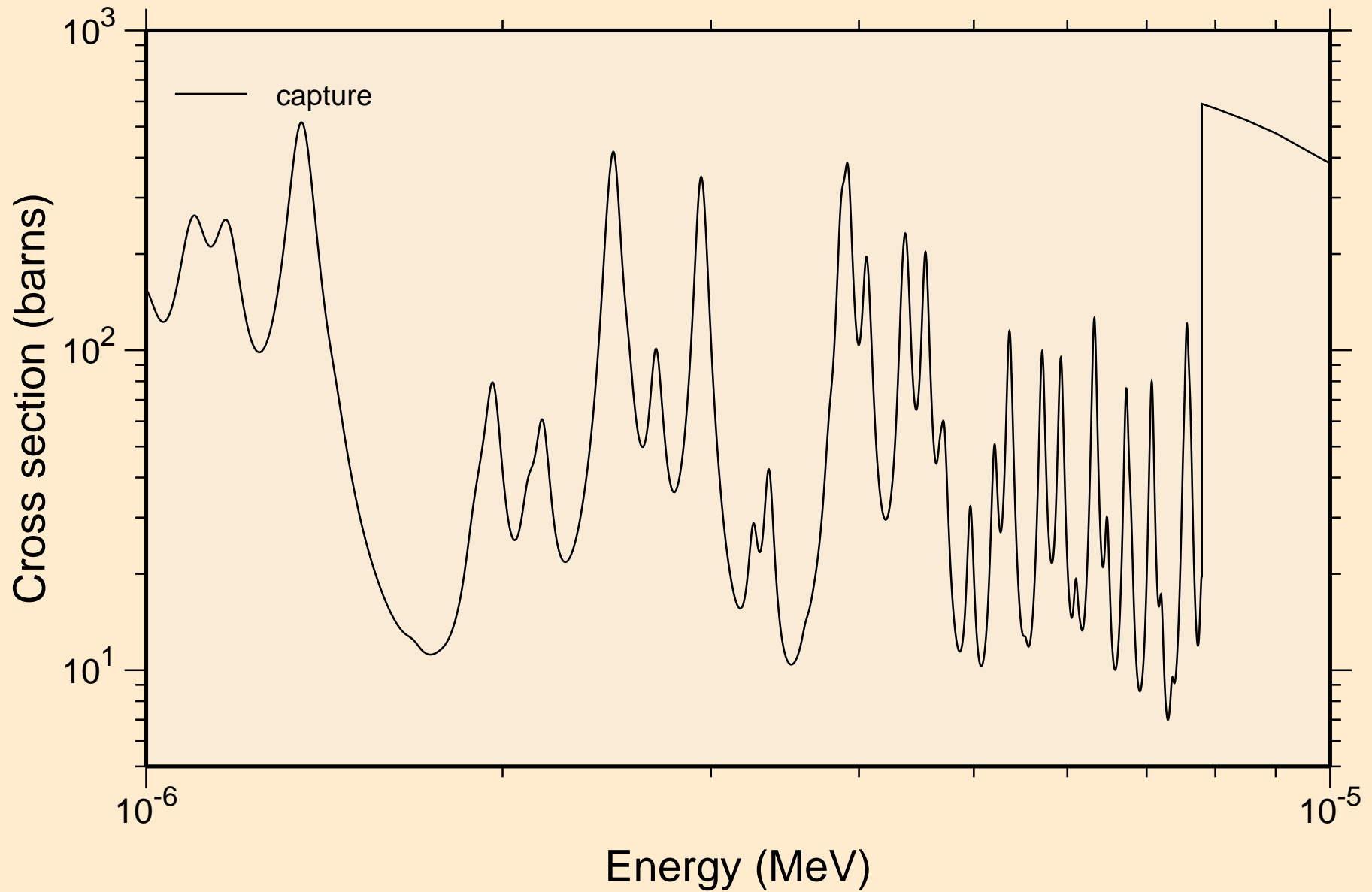

RE177 NEUTRON ACER TENDL-2023 LIBRARY; T=0.K
resonance absorption cross sections

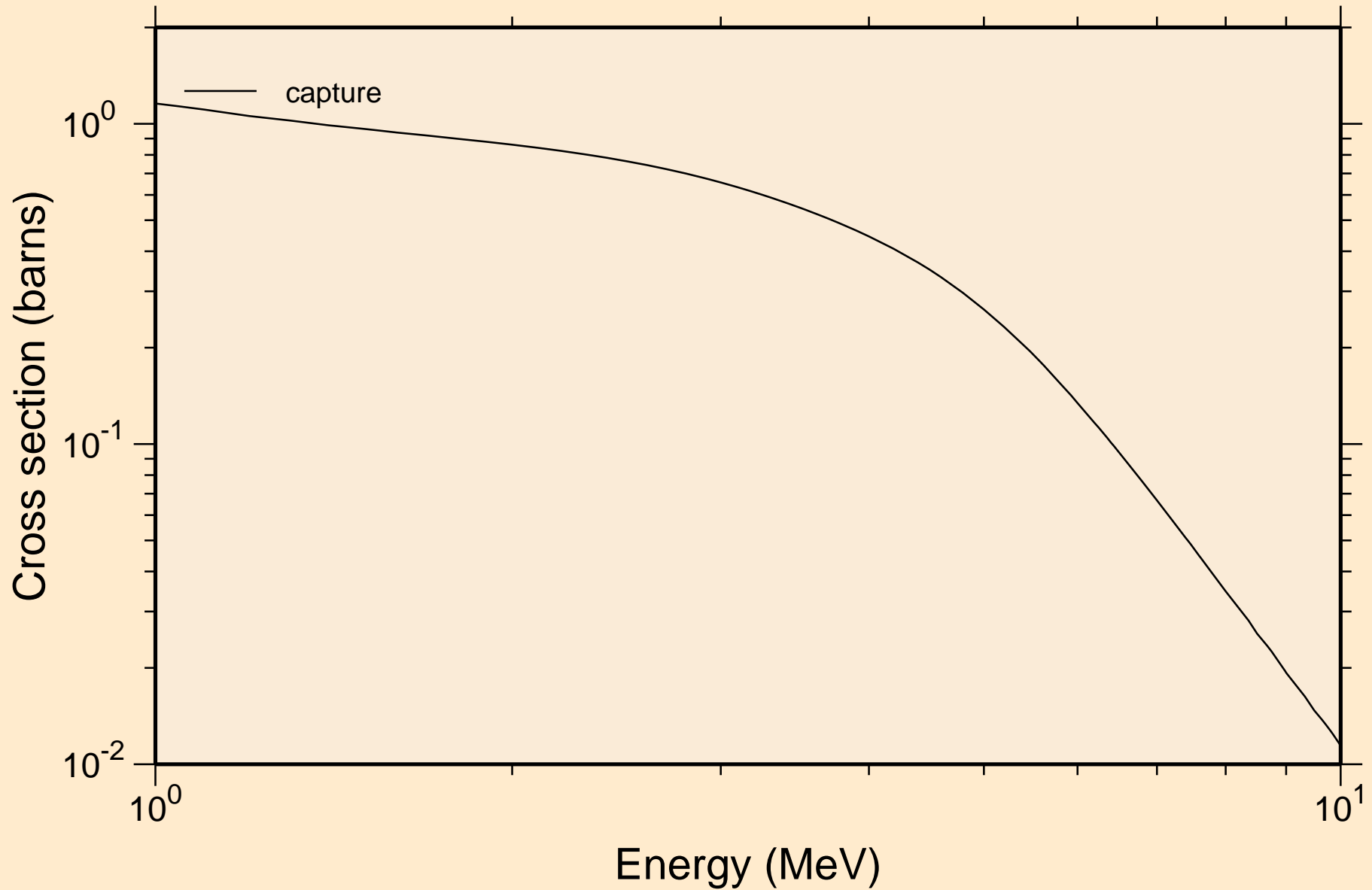

RE177 NEUTRON ACER TENDL-2023 LIBRARY; T=0.K

Heating

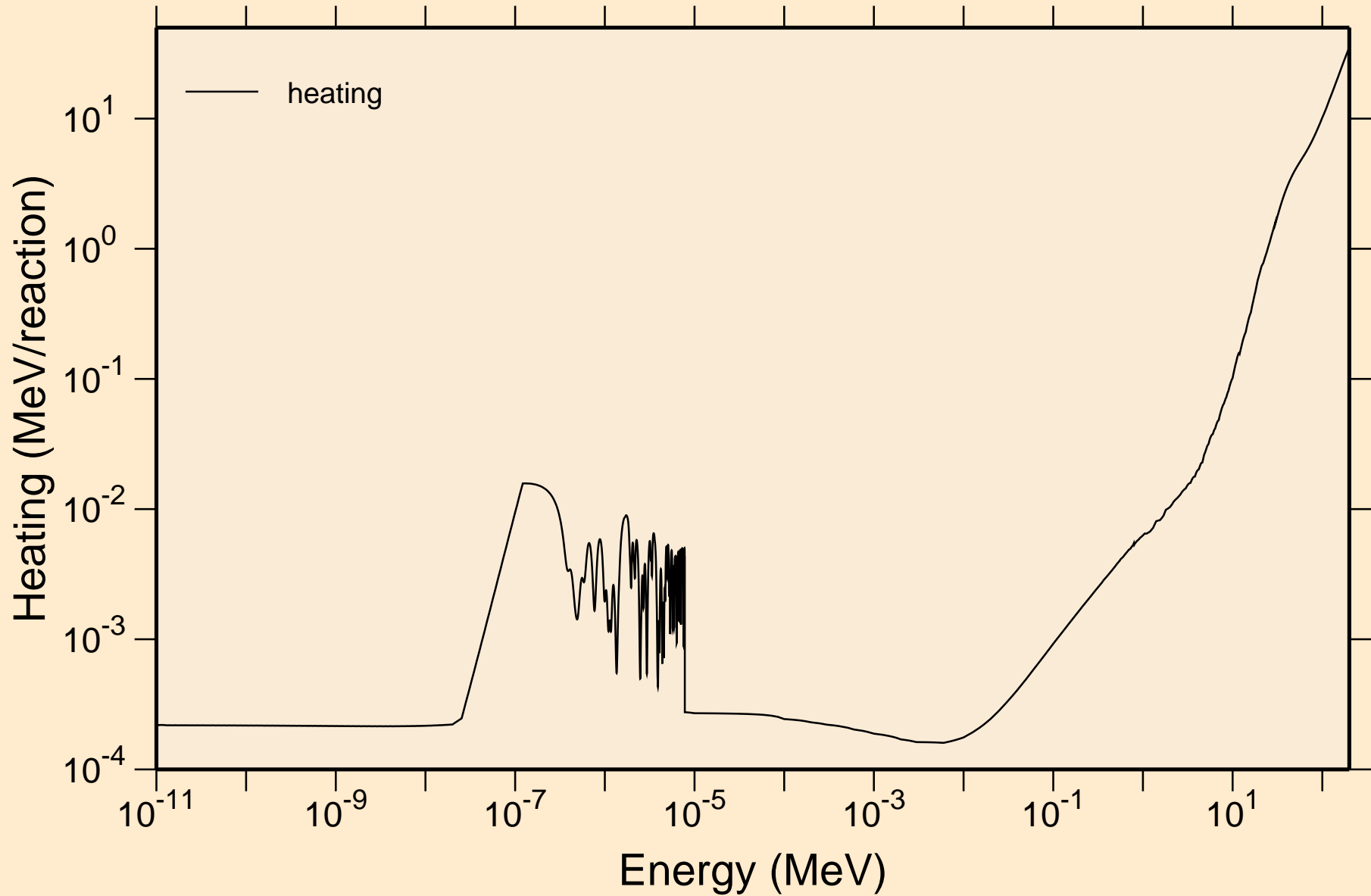

RE177 NEUTRON ACER TENDL-2023 LIBRARY; T=0.K
Damage

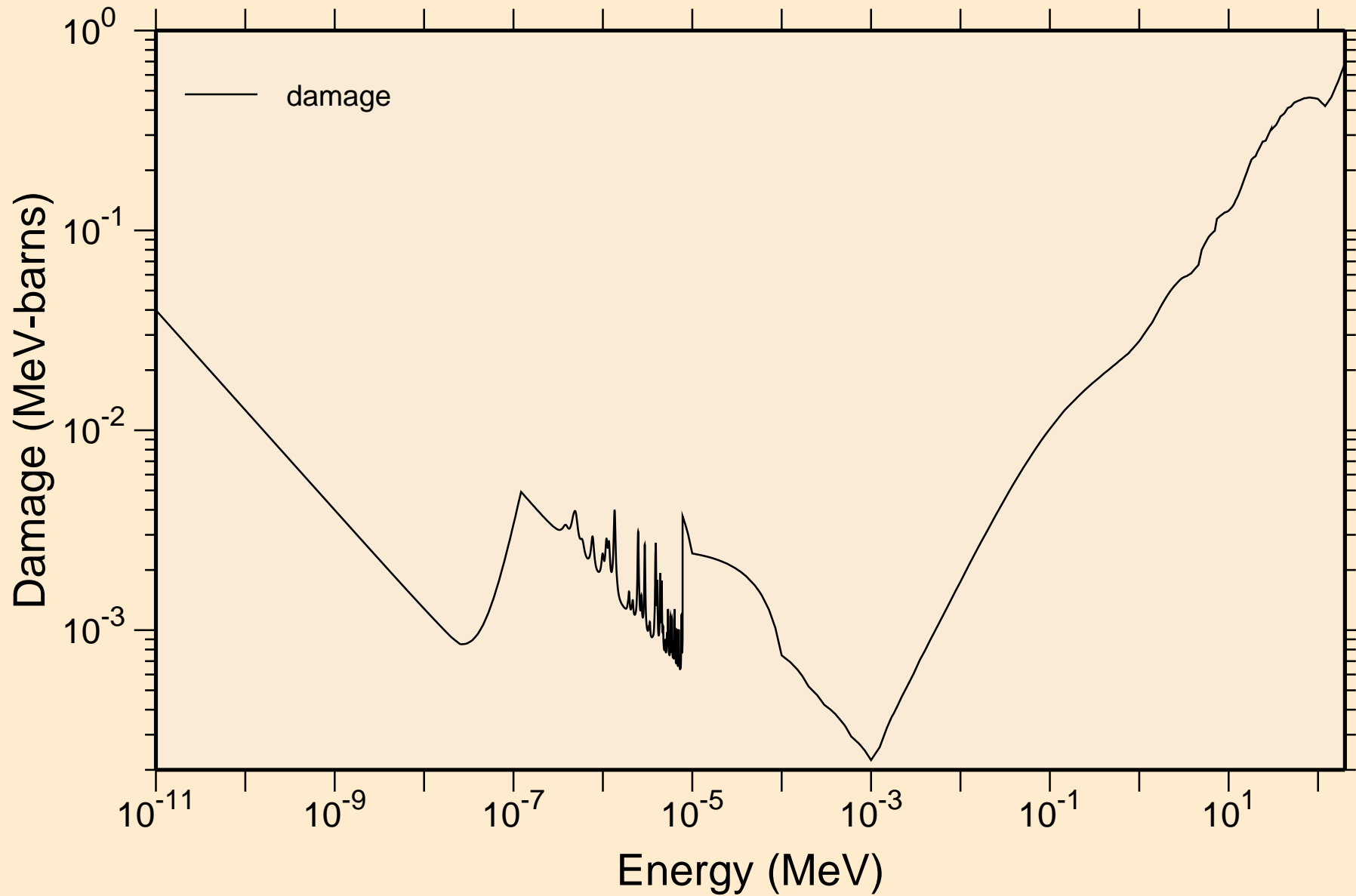

RE177 NEUTRON ACER TENDL-2023 LIBRARY; T=0.K
Non-threshold reactions

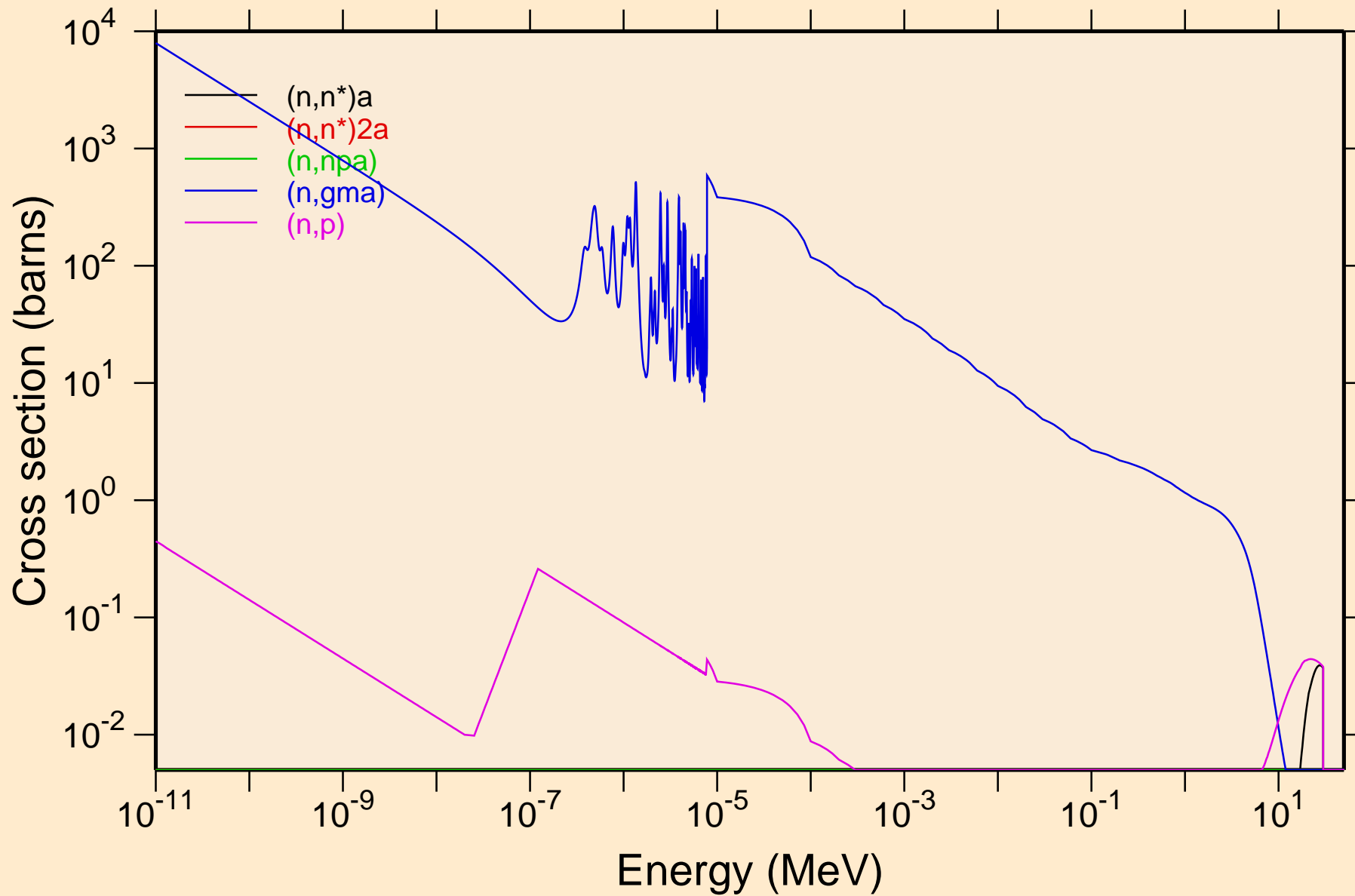

RE177 NEUTRON ACER TENDL-2023 LIBRARY; T=0.K
Non-threshold reactions

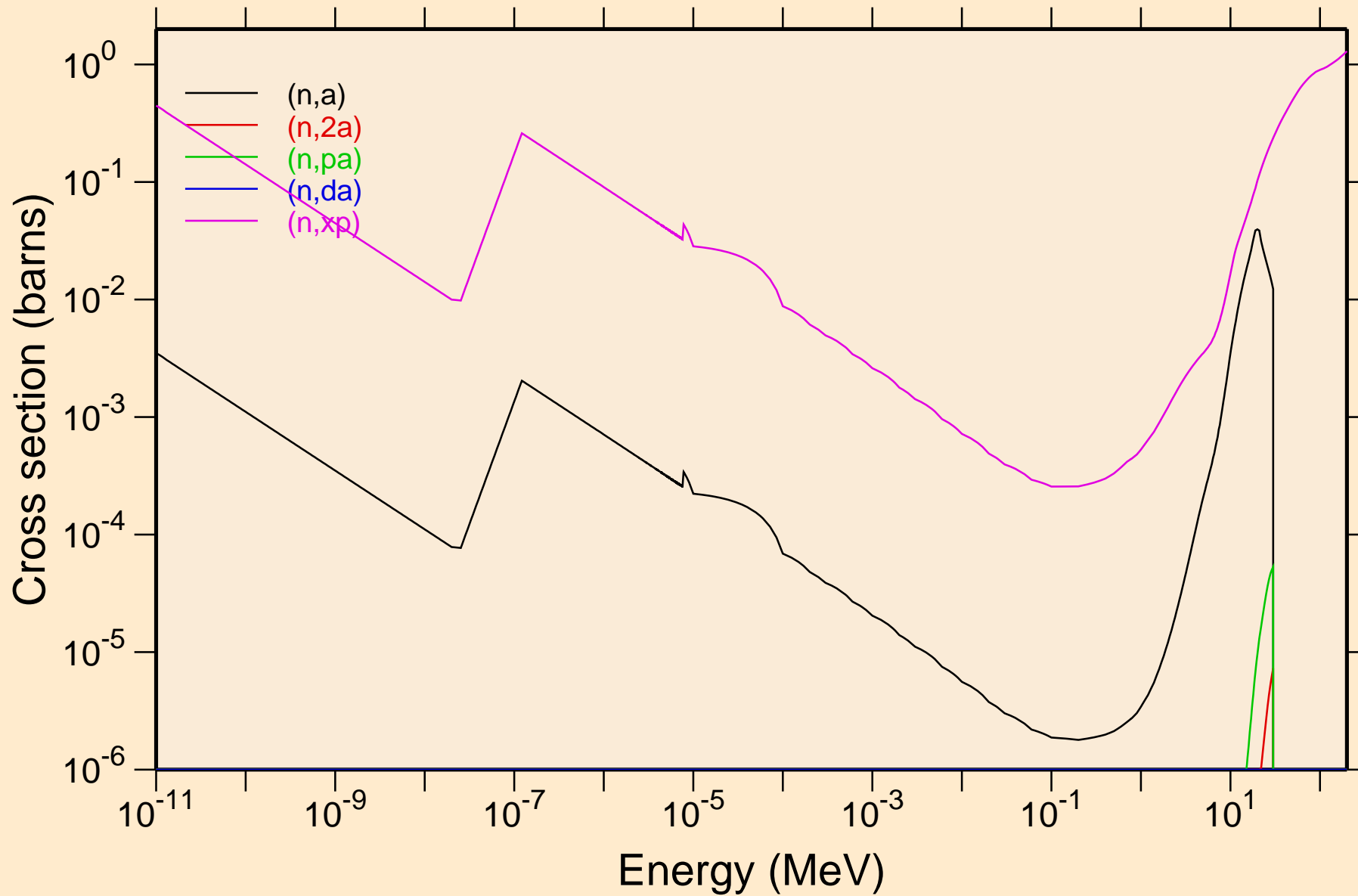

RE177 NEUTRON ACER TENDL-2023 LIBRARY; T=0.K
Non-threshold reactions

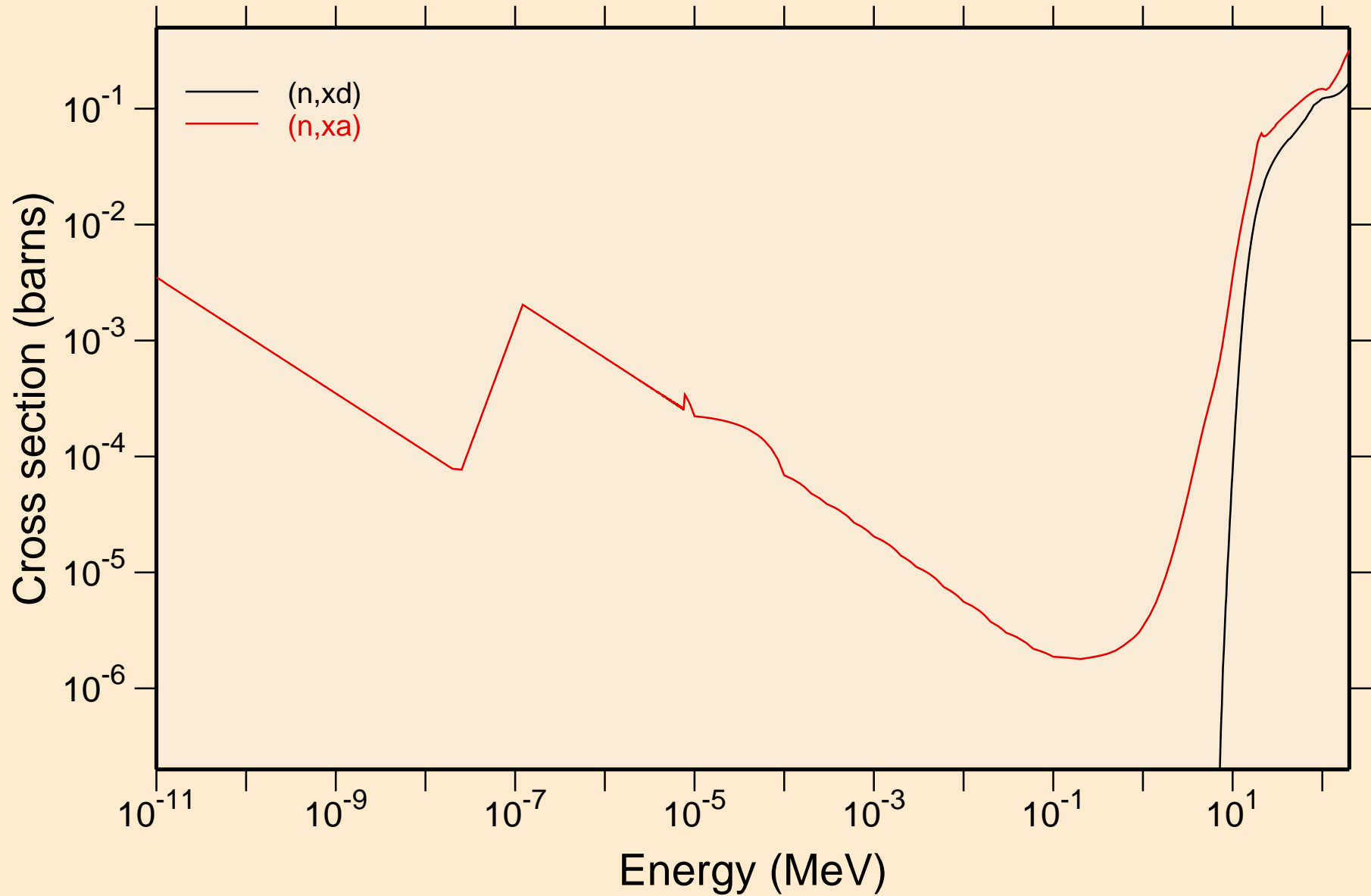

RE177 NEUTRON ACER TENDL-2023 LIBRARY; T=0.K

Principal cross sections

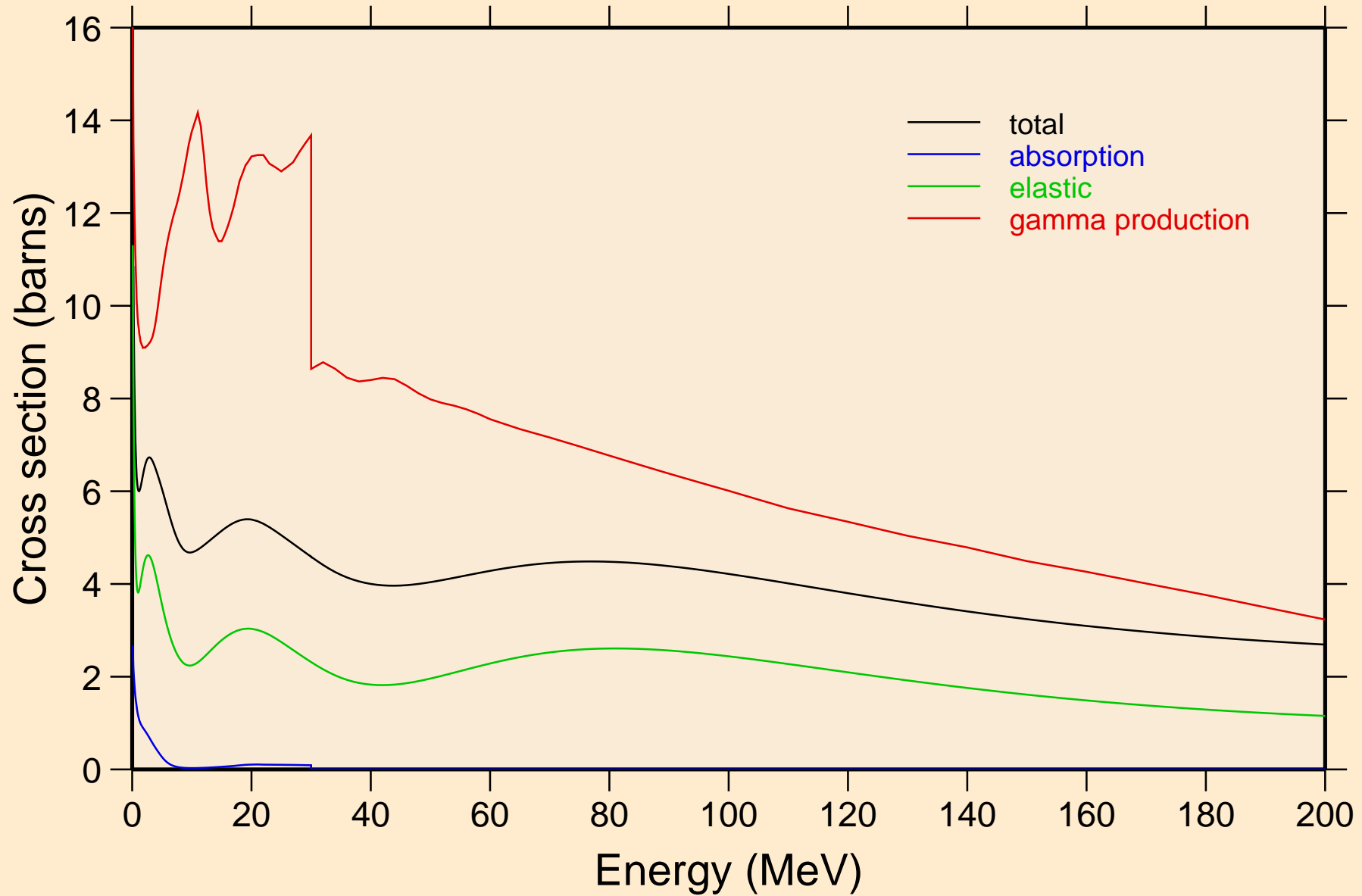

RE177 NEUTRON ACER TENDL-2023 LIBRARY; T=0.K

Heating

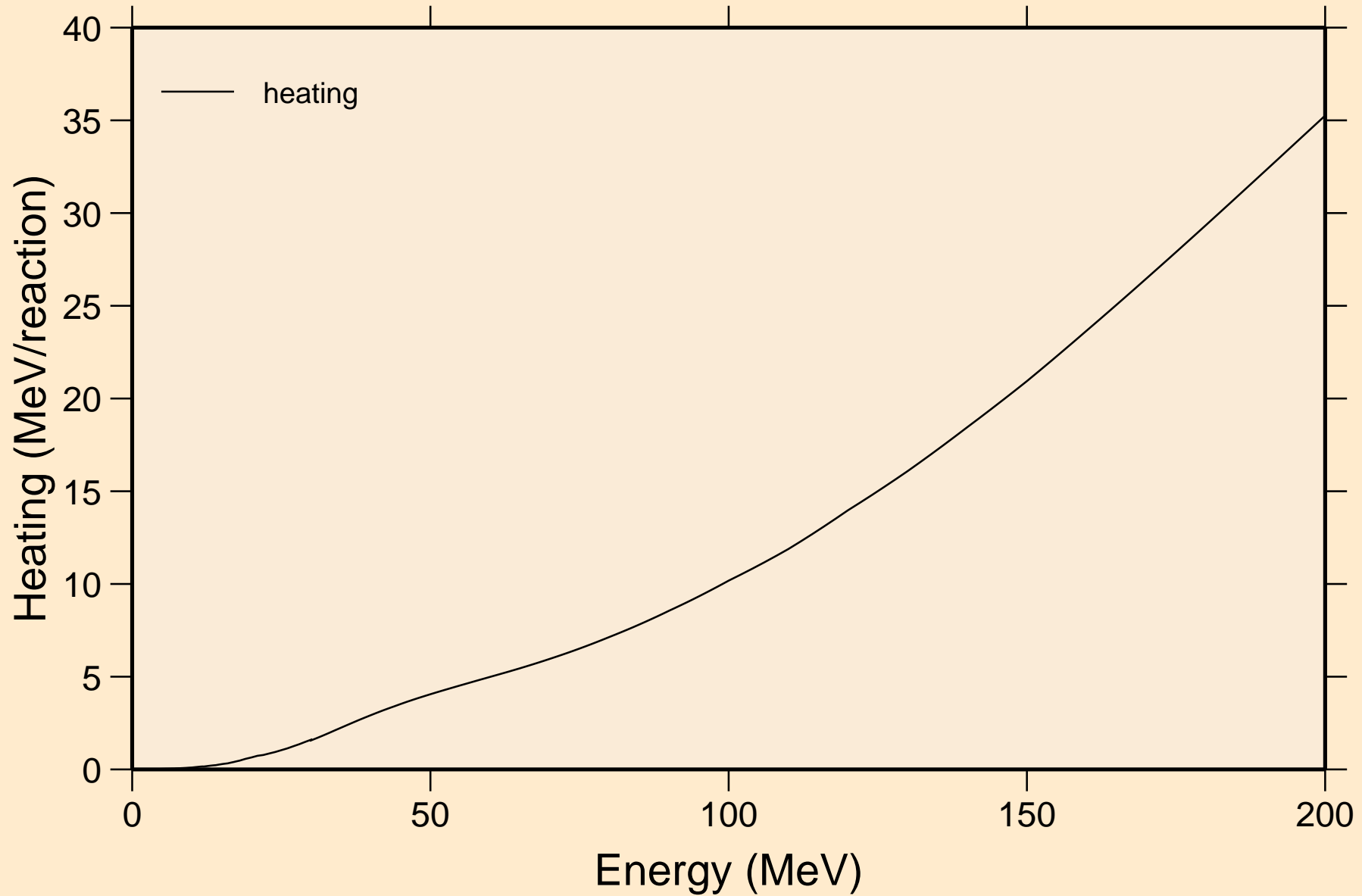

RE177 NEUTRON ACER TENDL-2023 LIBRARY; T=0.K

Damage

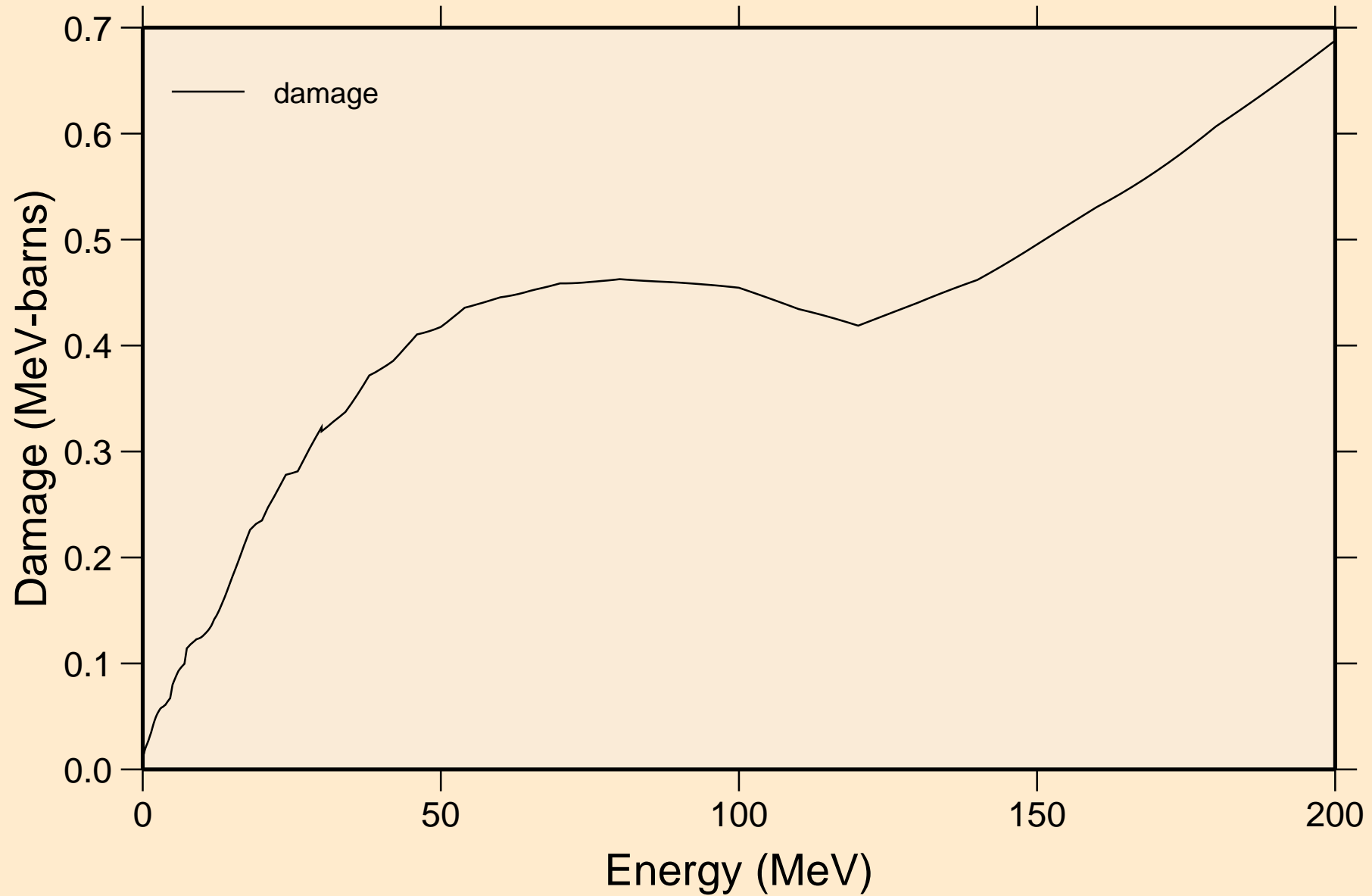

RE177 NEUTRON ACER TENDL-2023 LIBRARY; T=0.K

Non-threshold reactions

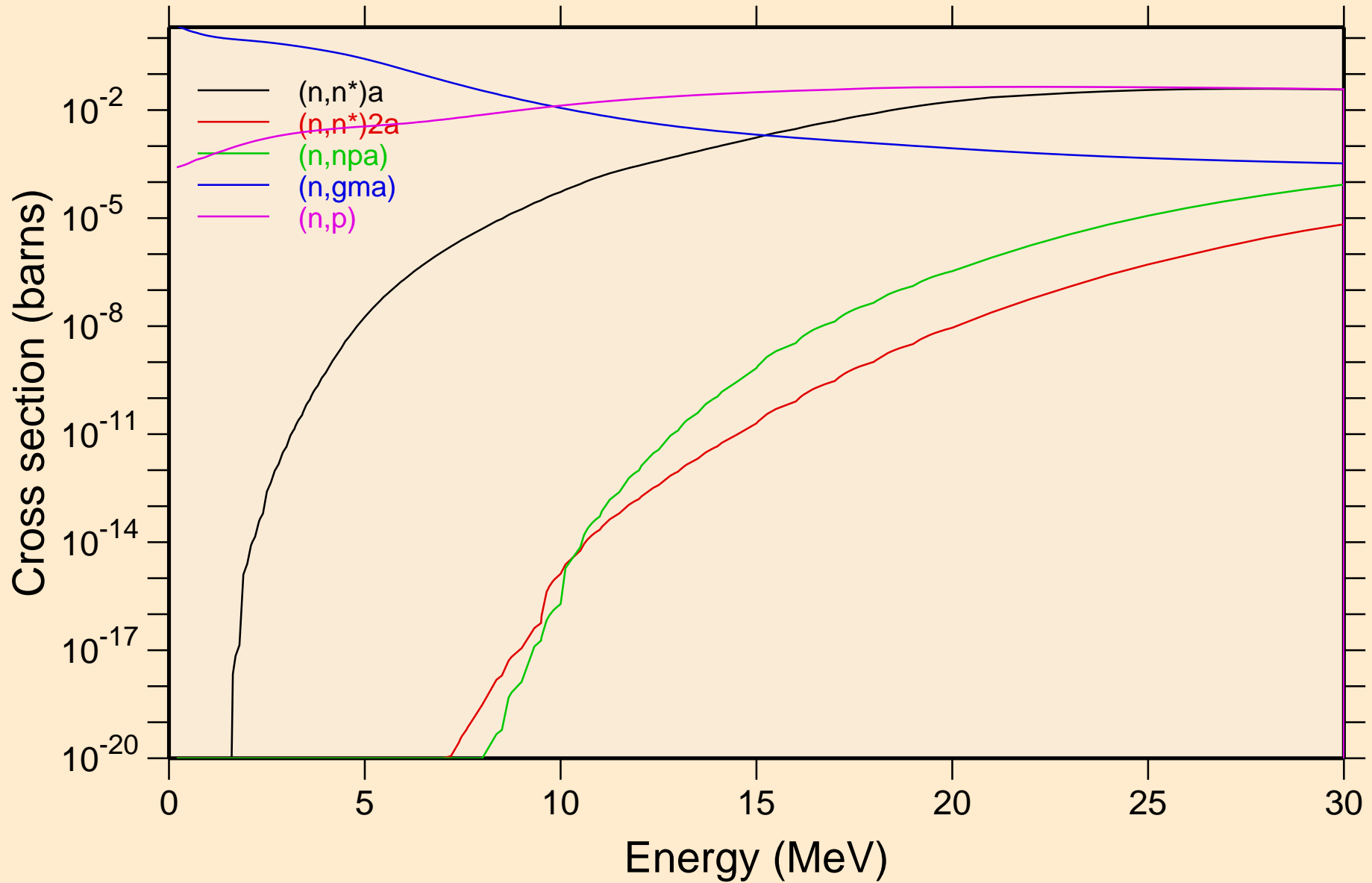

RE177 NEUTRON ACER TENDL-2023 LIBRARY; T=0.K
Non-threshold reactions

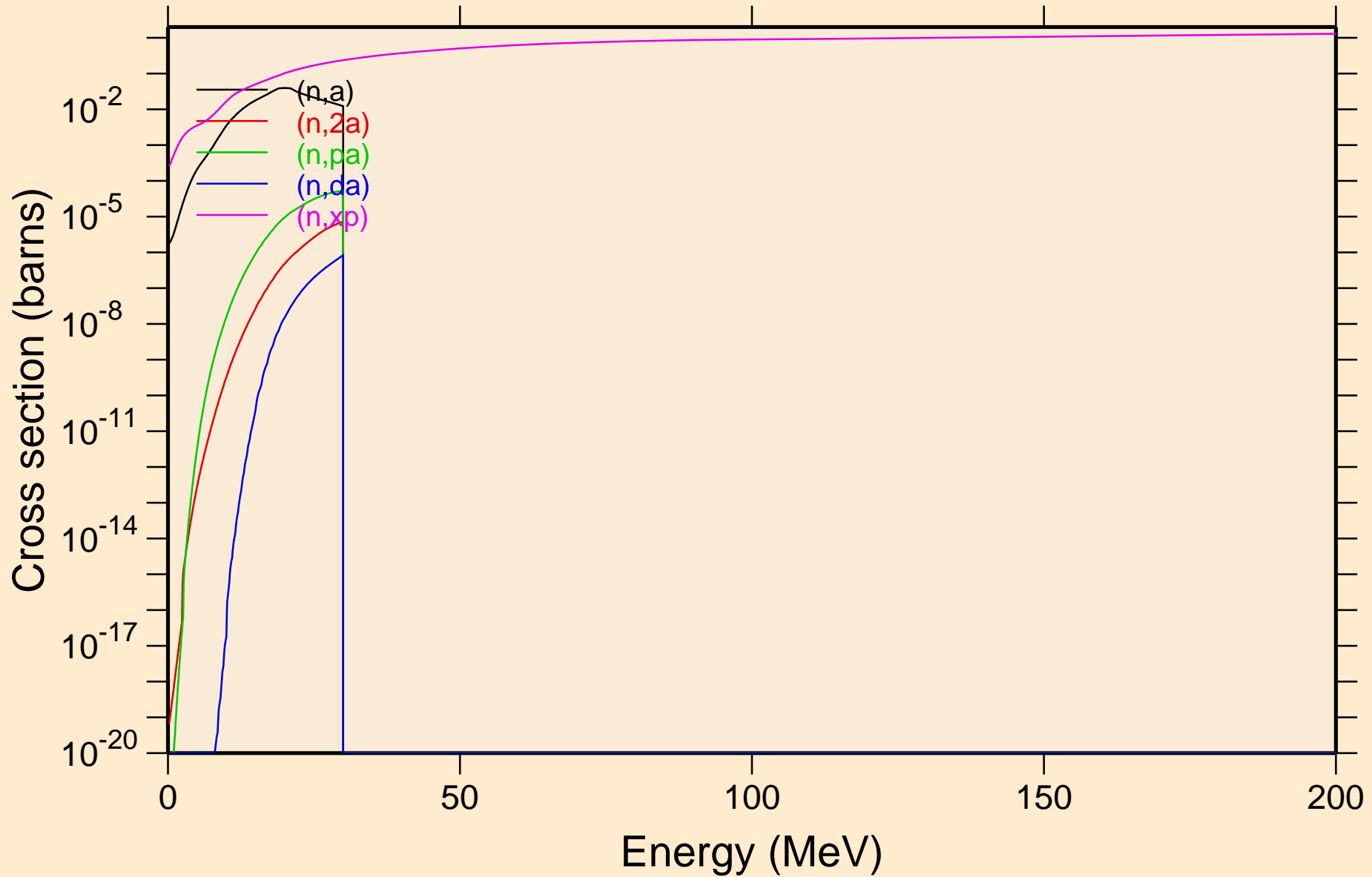

RE177 NEUTRON ACER TENDL-2023 LIBRARY; T=0.K
Non-threshold reactions

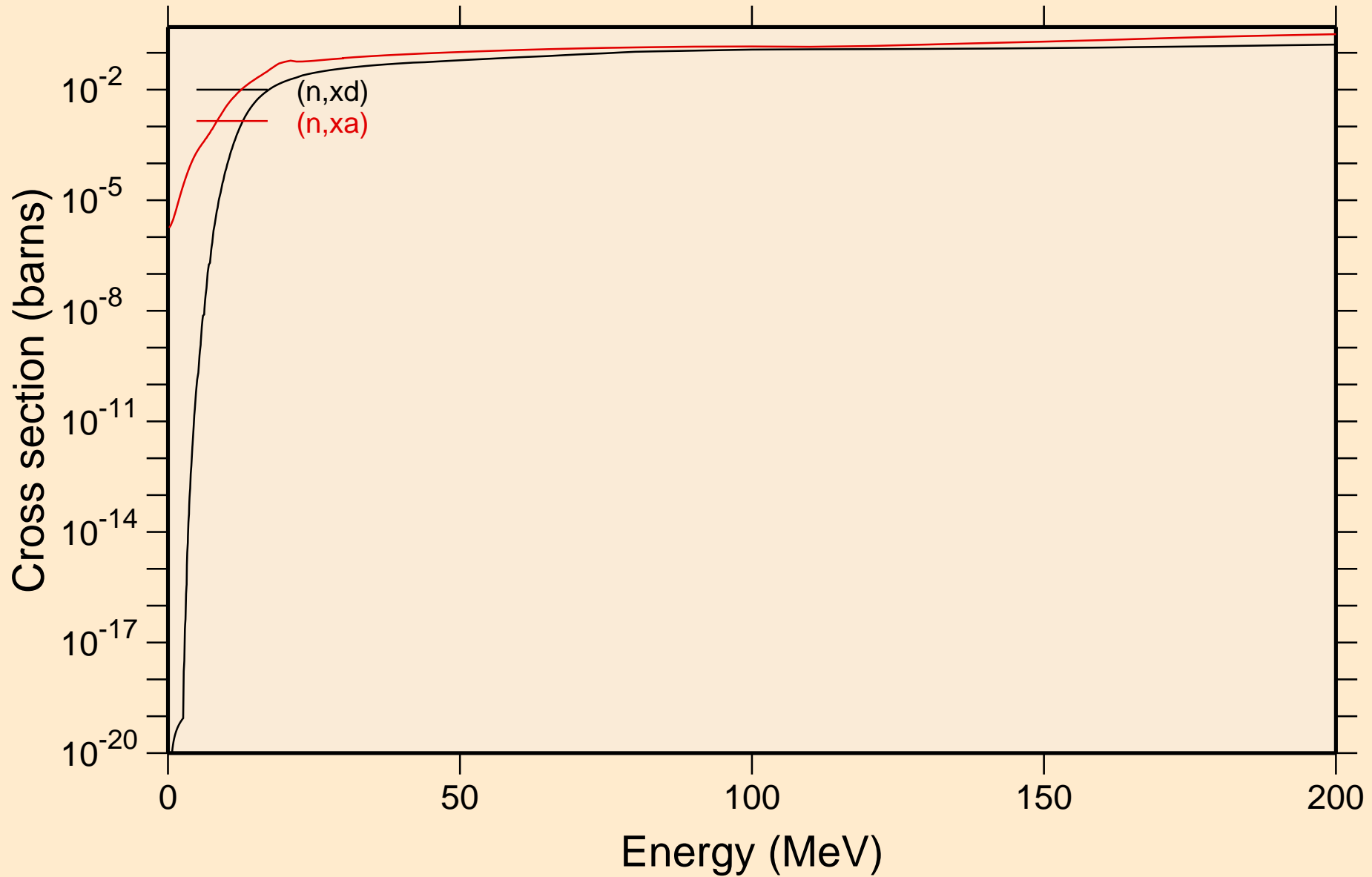

RE177 NEUTRON ACER TENDL-2023 LIBRARY; T=0.K
Inelastic levels

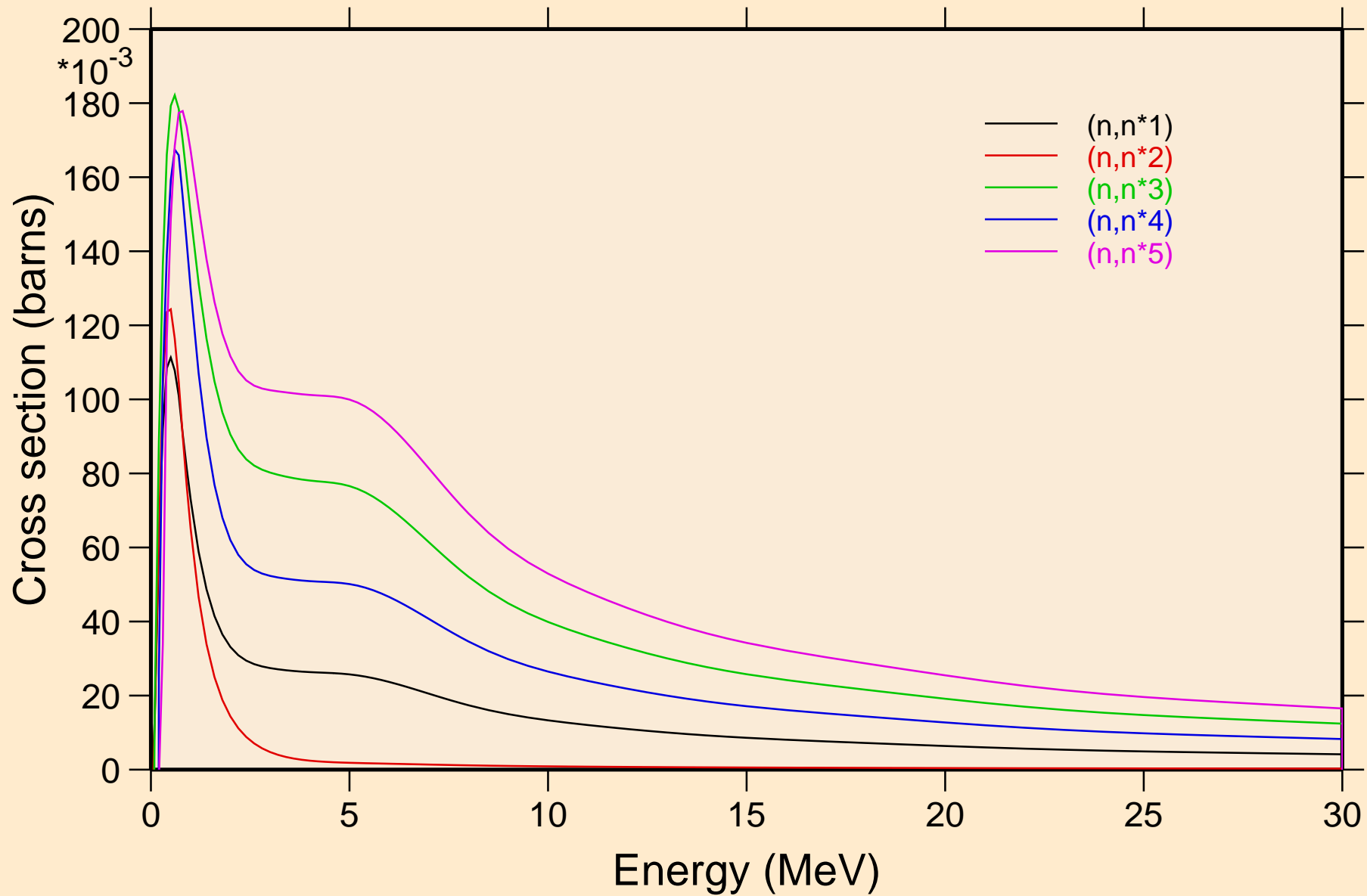

RE177 NEUTRON ACER TENDL-2023 LIBRARY; T=0.K
Inelastic levels

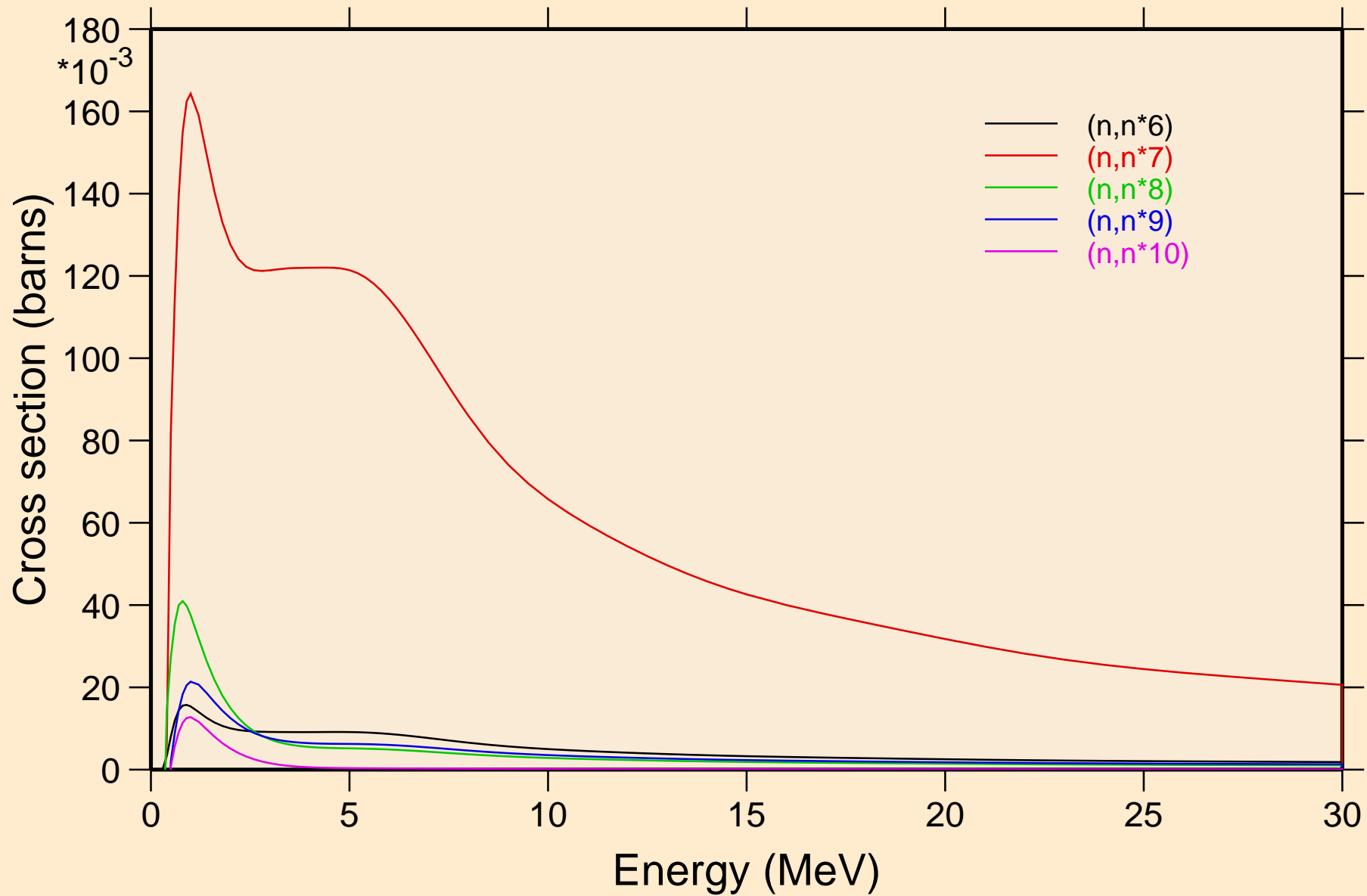

RE177 NEUTRON ACER TENDL-2023 LIBRARY; T=0.K
Inelastic levels

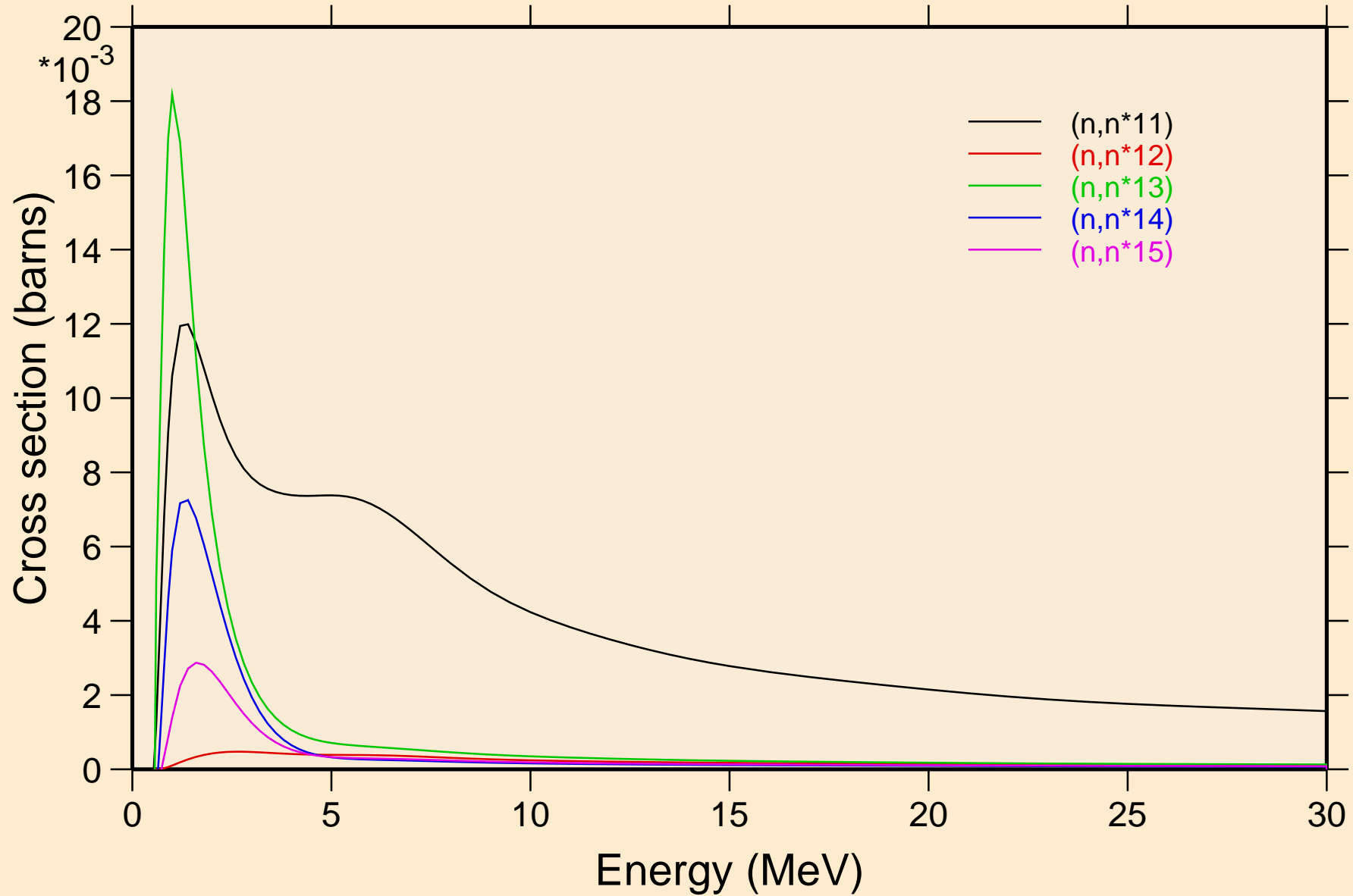

RE177 NEUTRON ACER TENDL-2023 LIBRARY; T=0.K
Inelastic levels

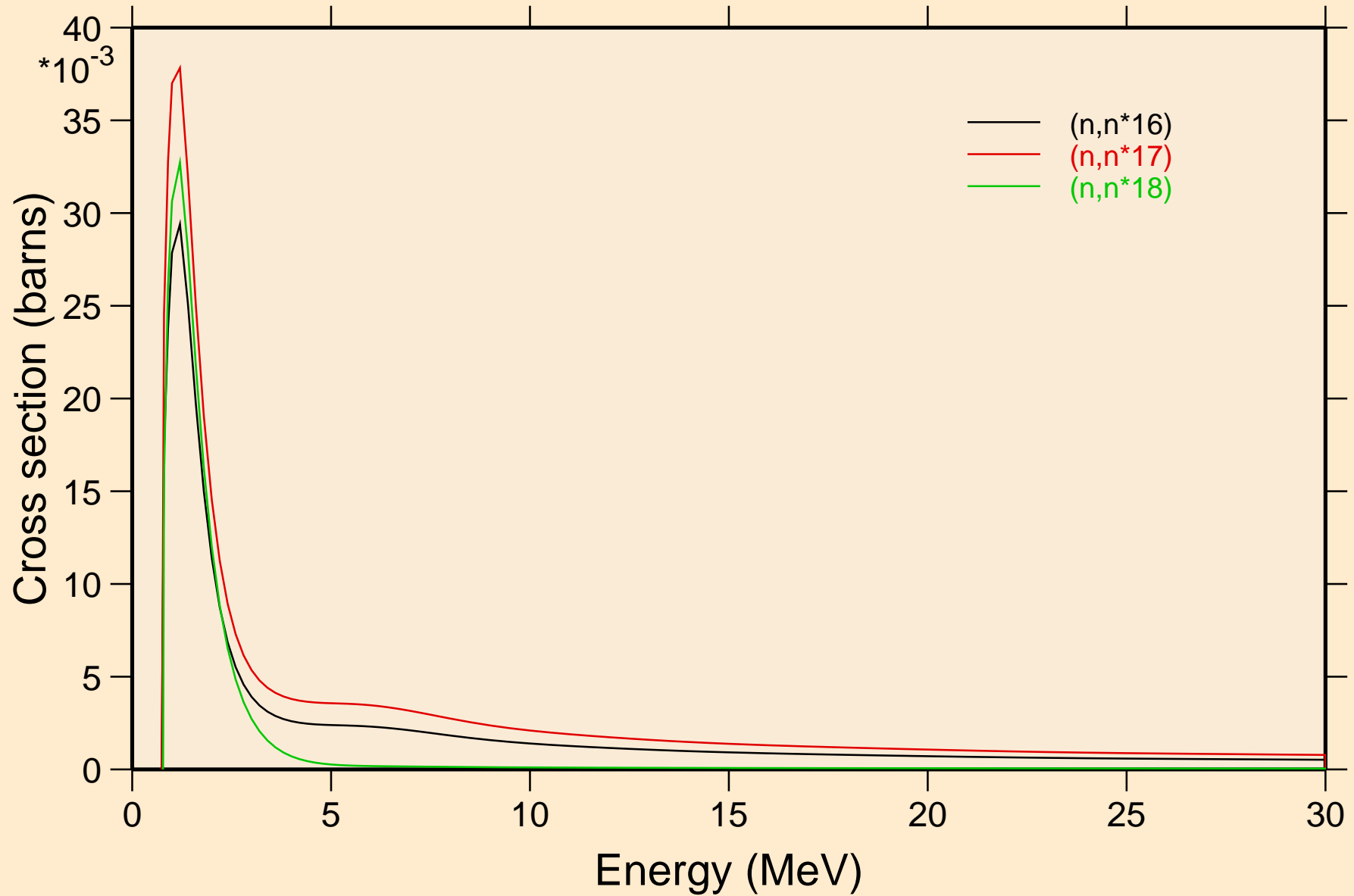

RE177 NEUTRON ACER TENDL-2023 LIBRARY; T=0.K
Threshold reactions

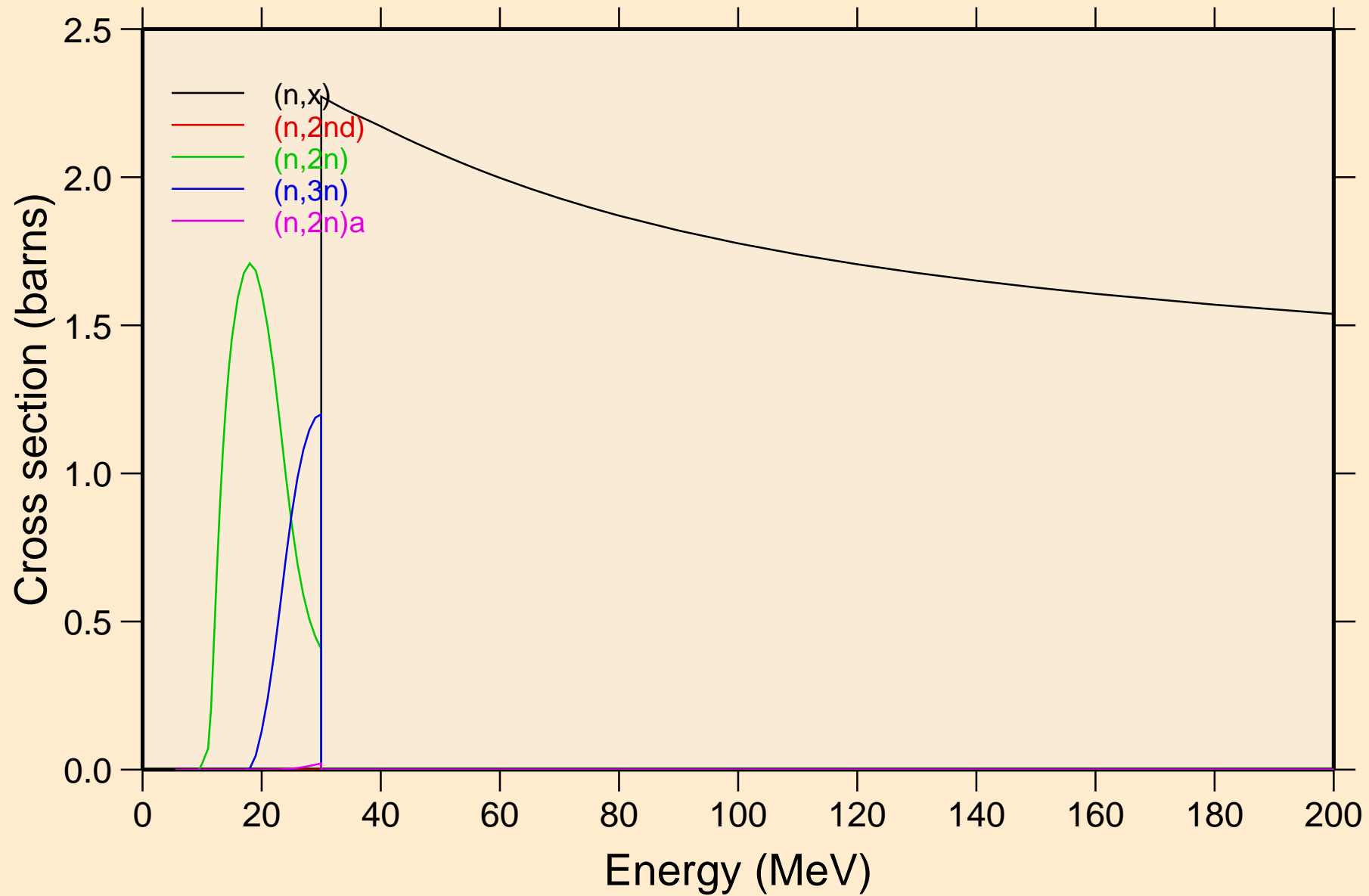

RE177 NEUTRON ACER TENDL-2023 LIBRARY; T=0.K

Threshold reactions

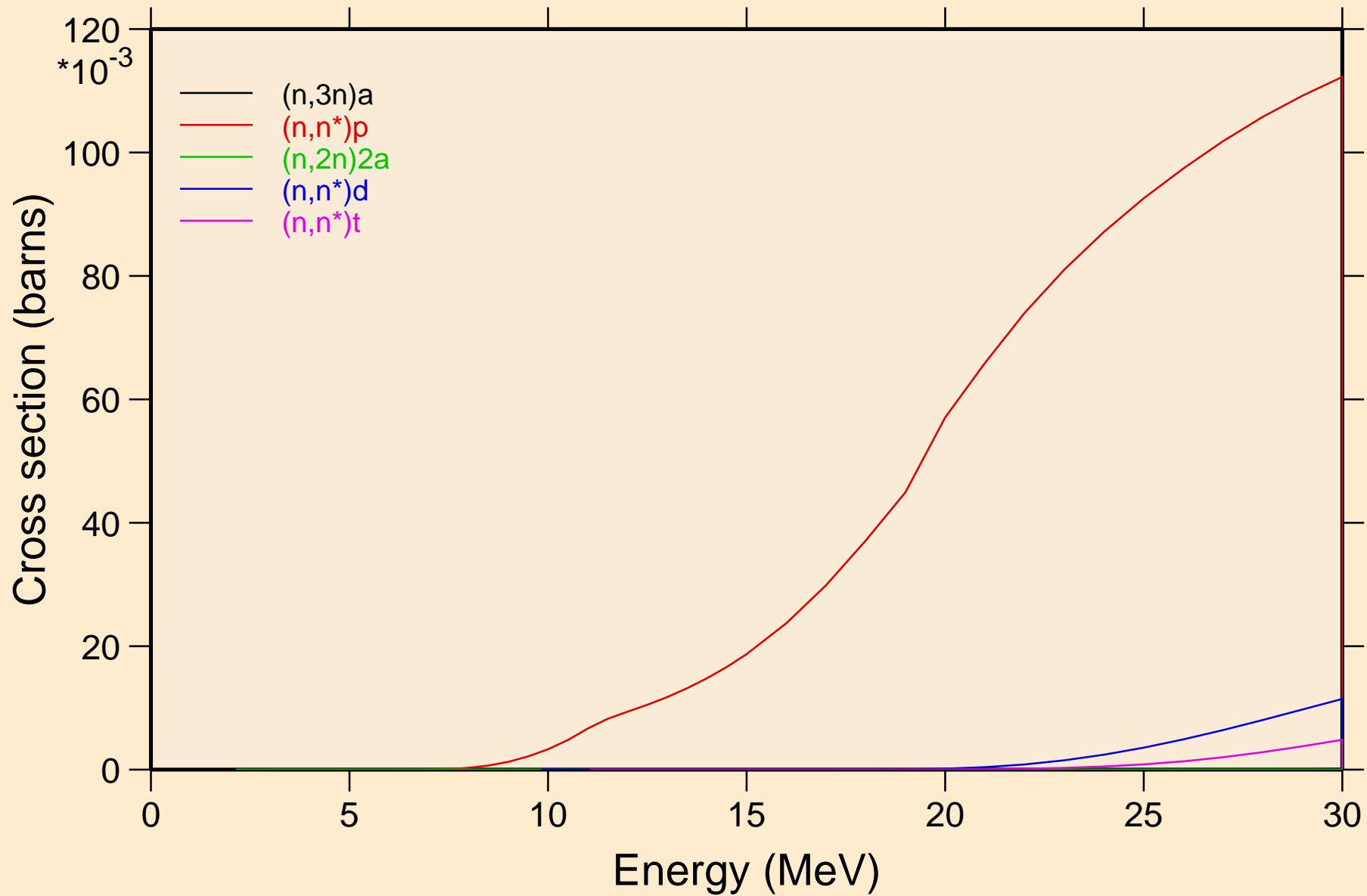

RE177 NEUTRON ACER TENDL-2023 LIBRARY; T=0.K
Threshold reactions

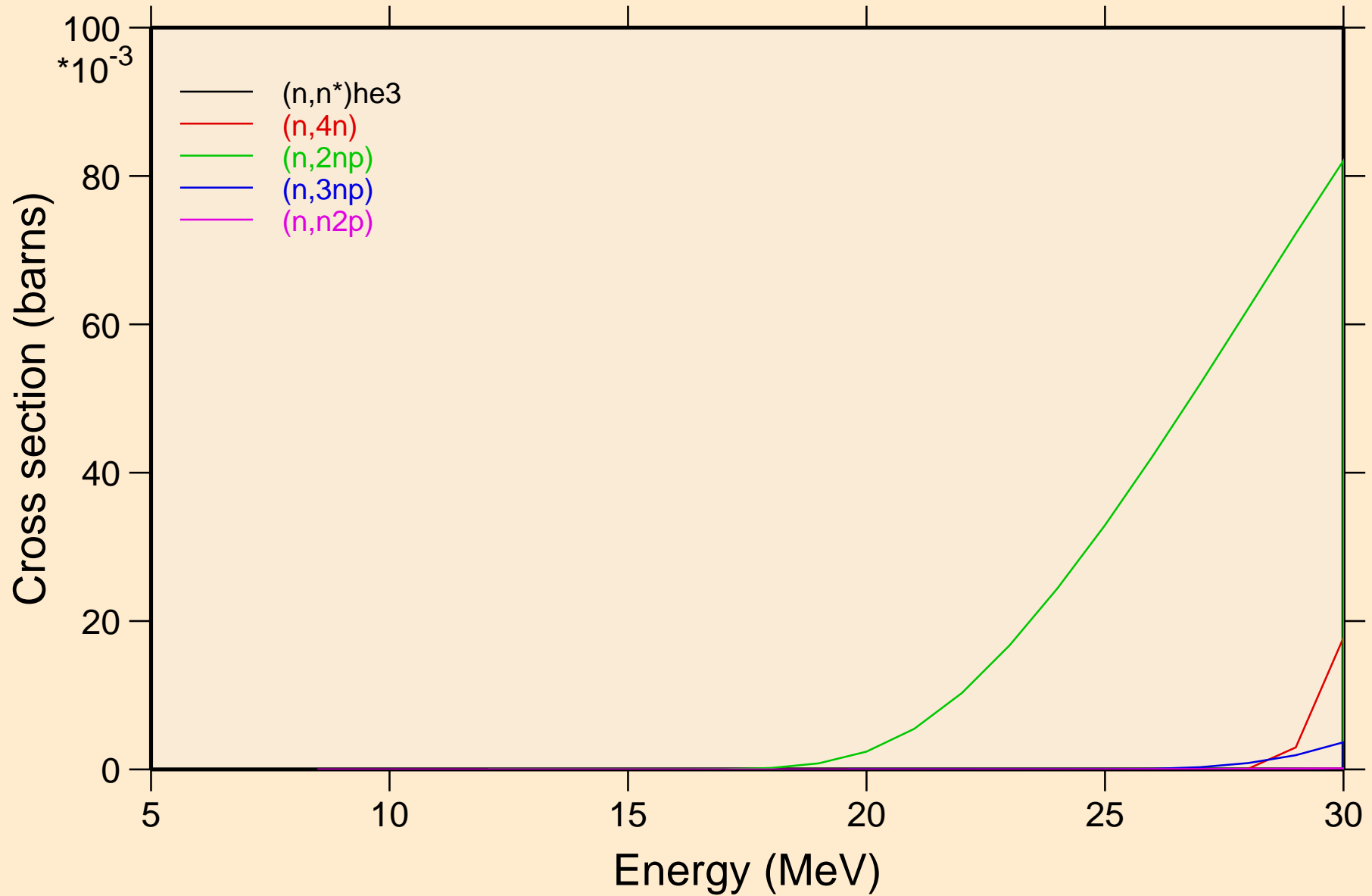

RE177 NEUTRON ACER TENDL-2023 LIBRARY; T=0.K
Threshold reactions

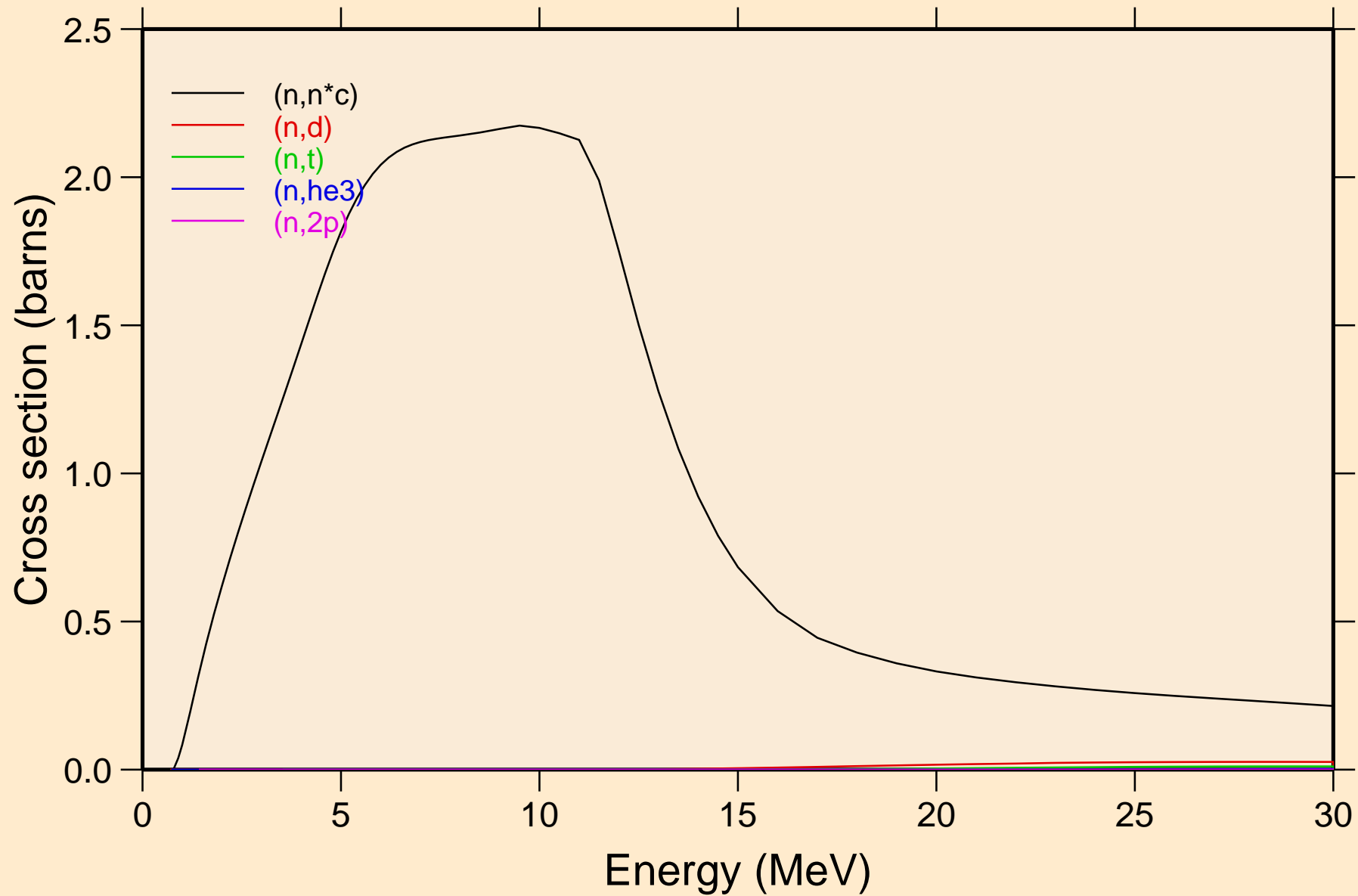

RE177 NEUTRON ACER TENDL-2023 LIBRARY; T=0.K
Threshold reactions

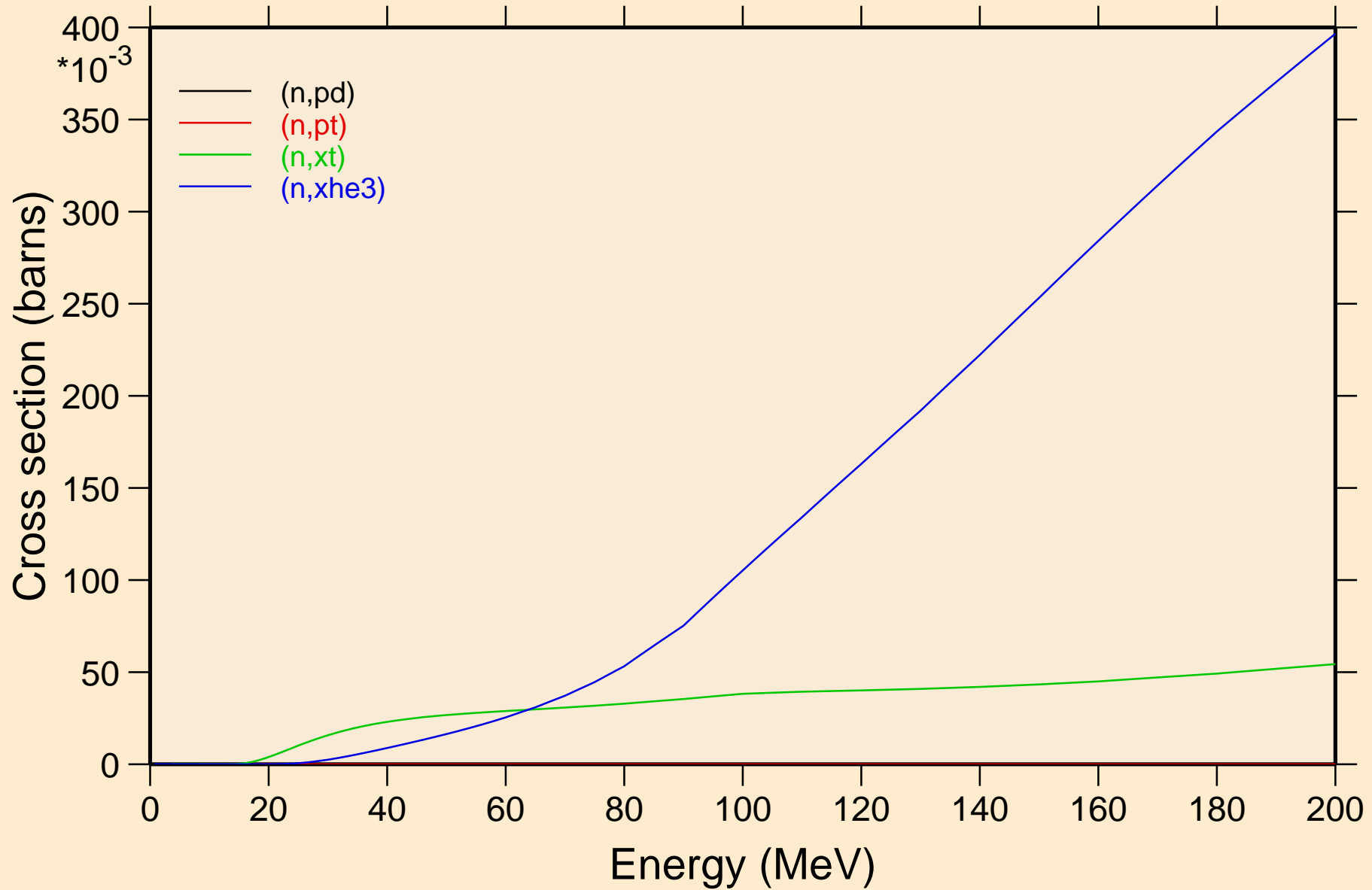

RE177 NEUTRON ACER TENDL-2023 LIBRARY; T=0.K
angular distribution for elastic

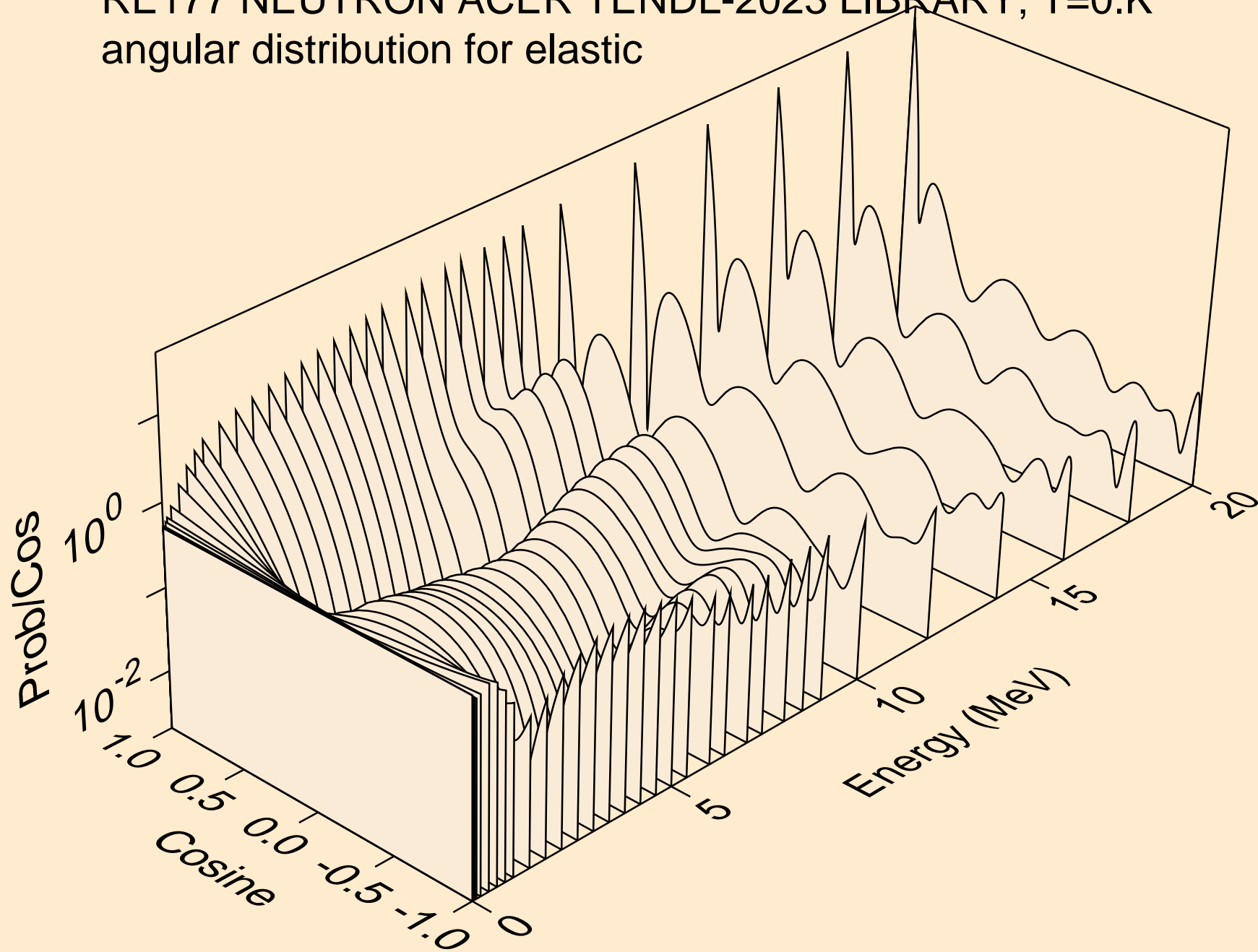

RE177 NEUTRON ACER TENDL-2023 LIBRARY; T=0.K
angular distribution for elastic

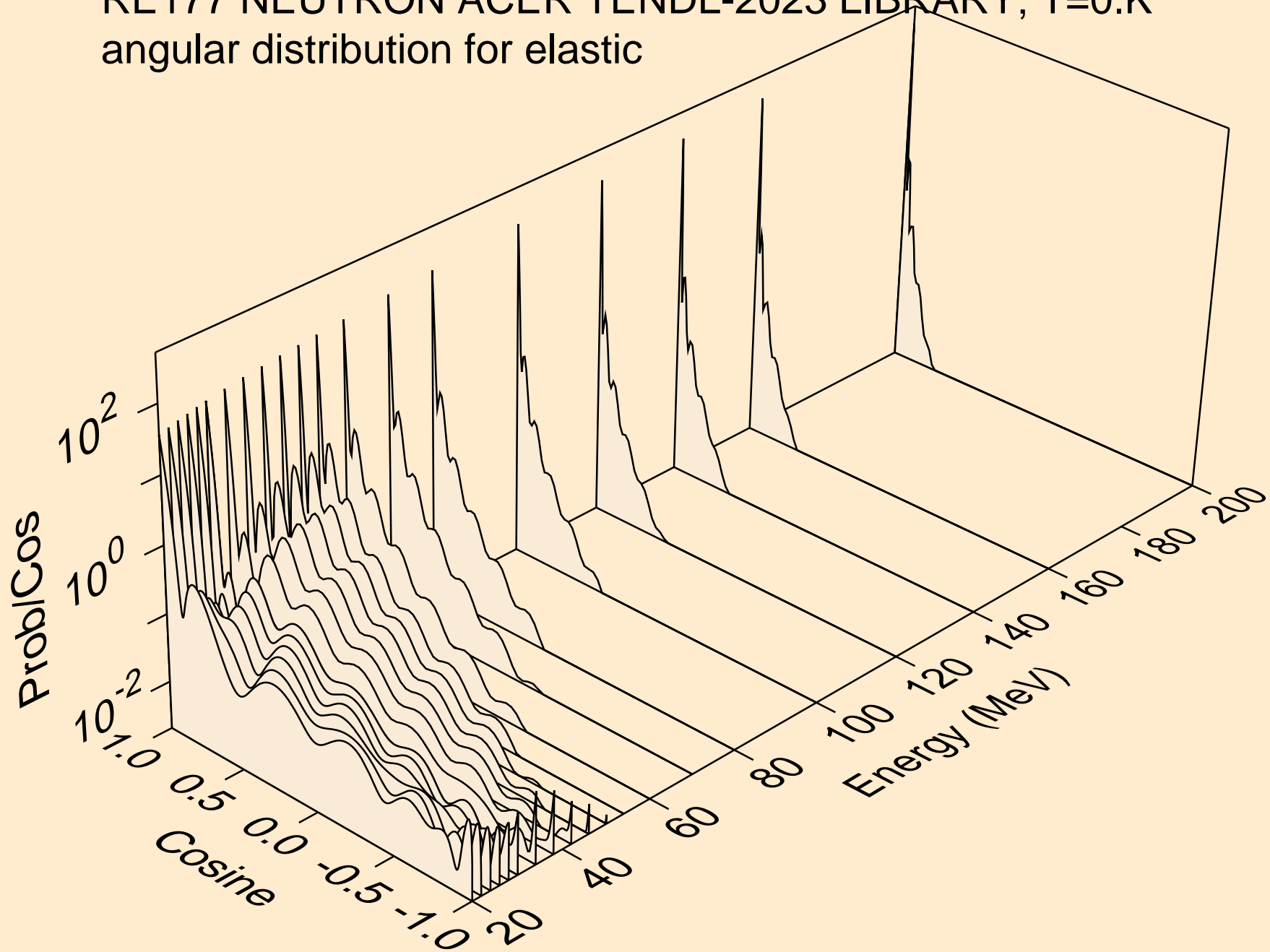

RE177 NEUTRON ACER TENDL-2023 LIBRARY; T=0.K
angular distribution for (n,n*1)

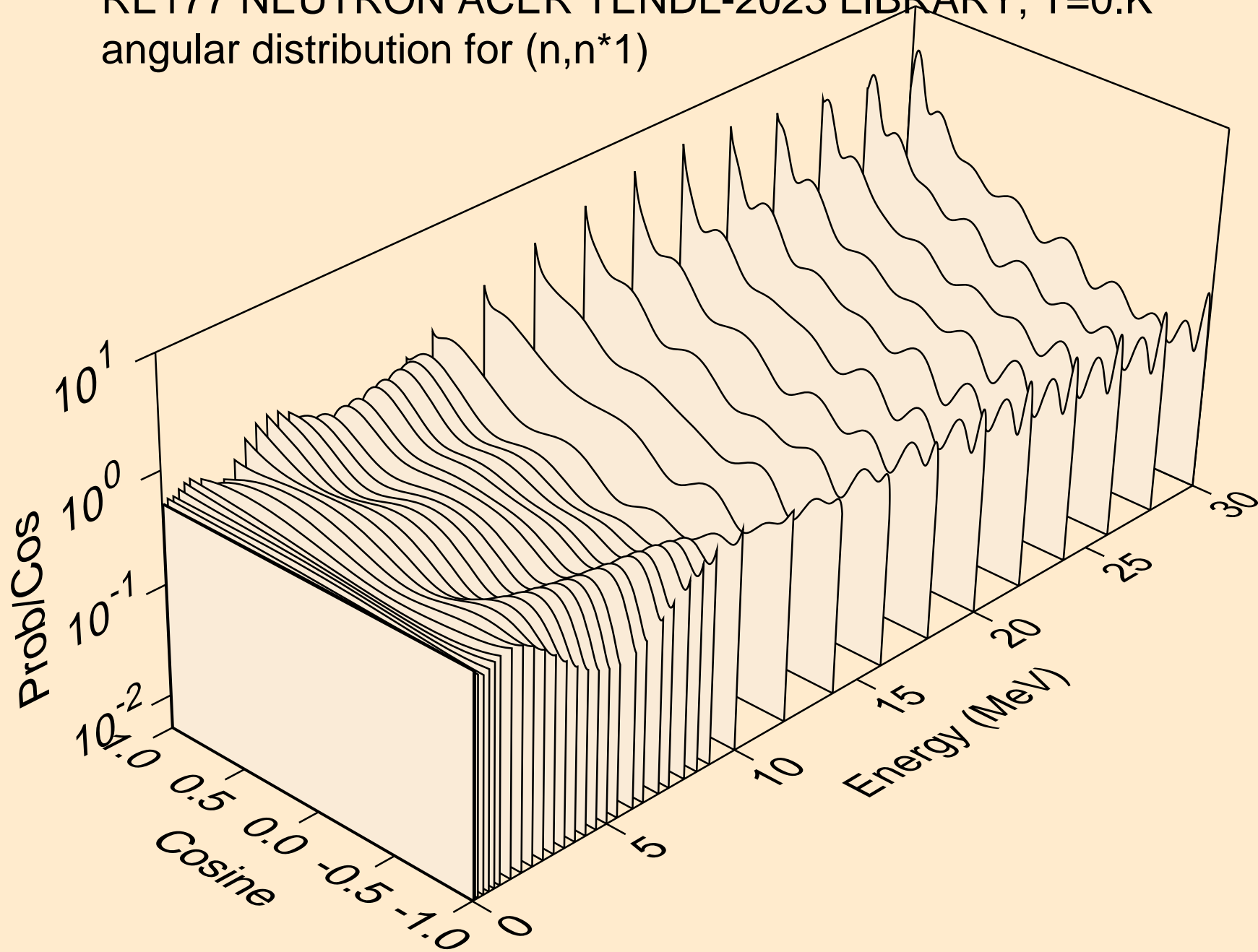

RE177 NEUTRON ACER TENDL-2023 LIBRARY; T=0.K
angular distribution for (n,n*2)

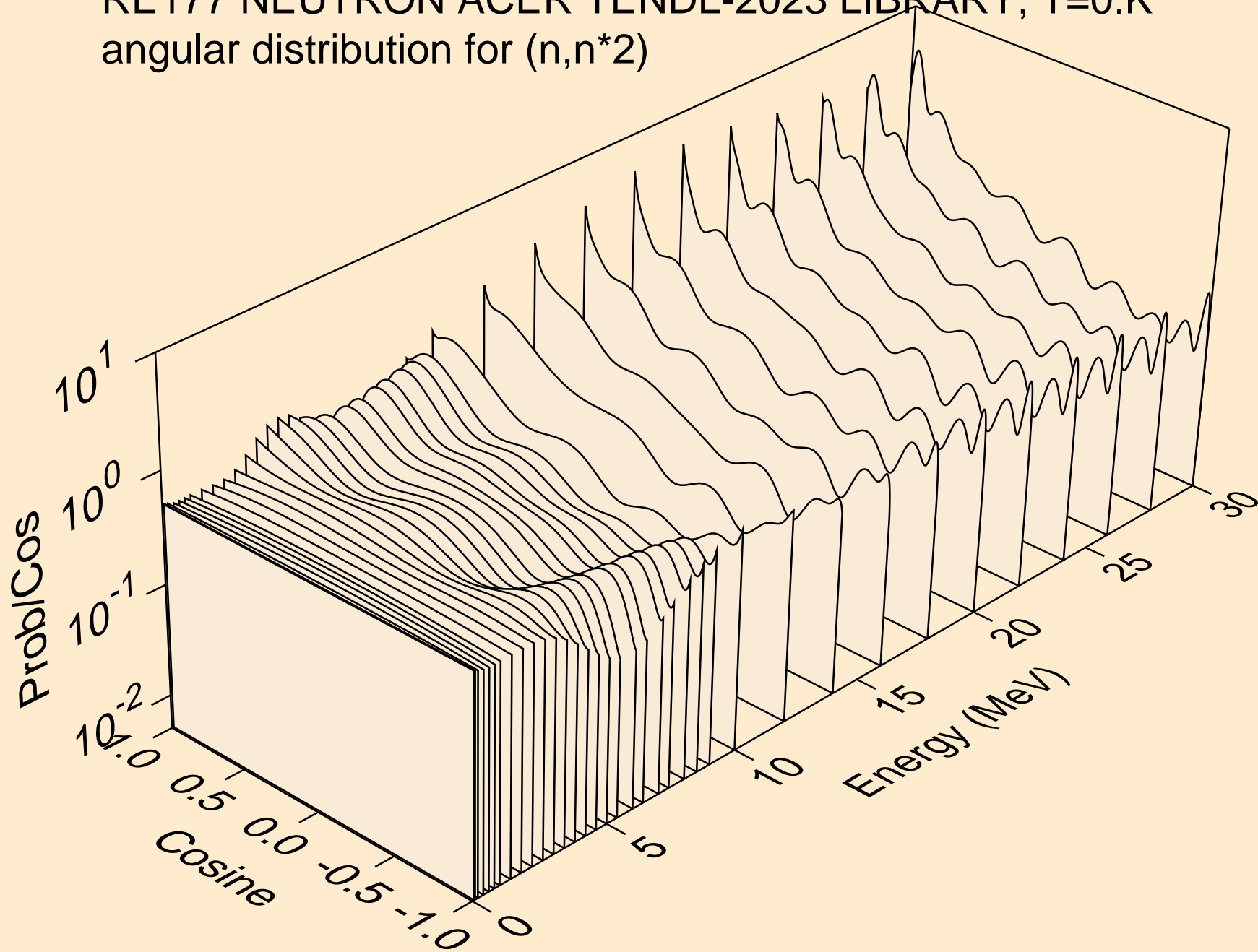

RE177 NEUTRON ACER TENDL-2023 LIBRARY; T=0.K
angular distribution for (n,n*3)

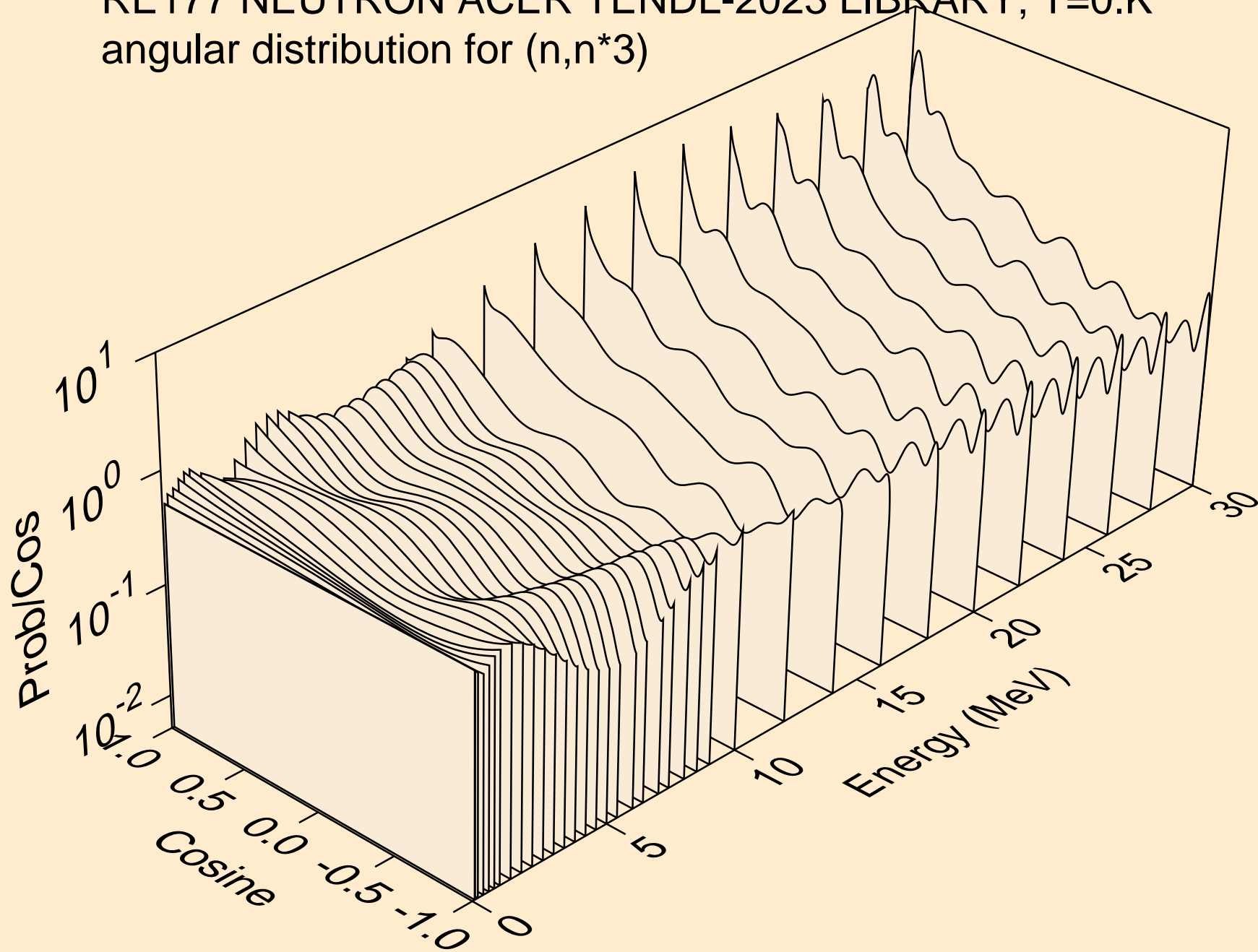

RE177 NEUTRON ACER TENDL-2023 LIBRARY; T=0.K
angular distribution for (n,n*4)

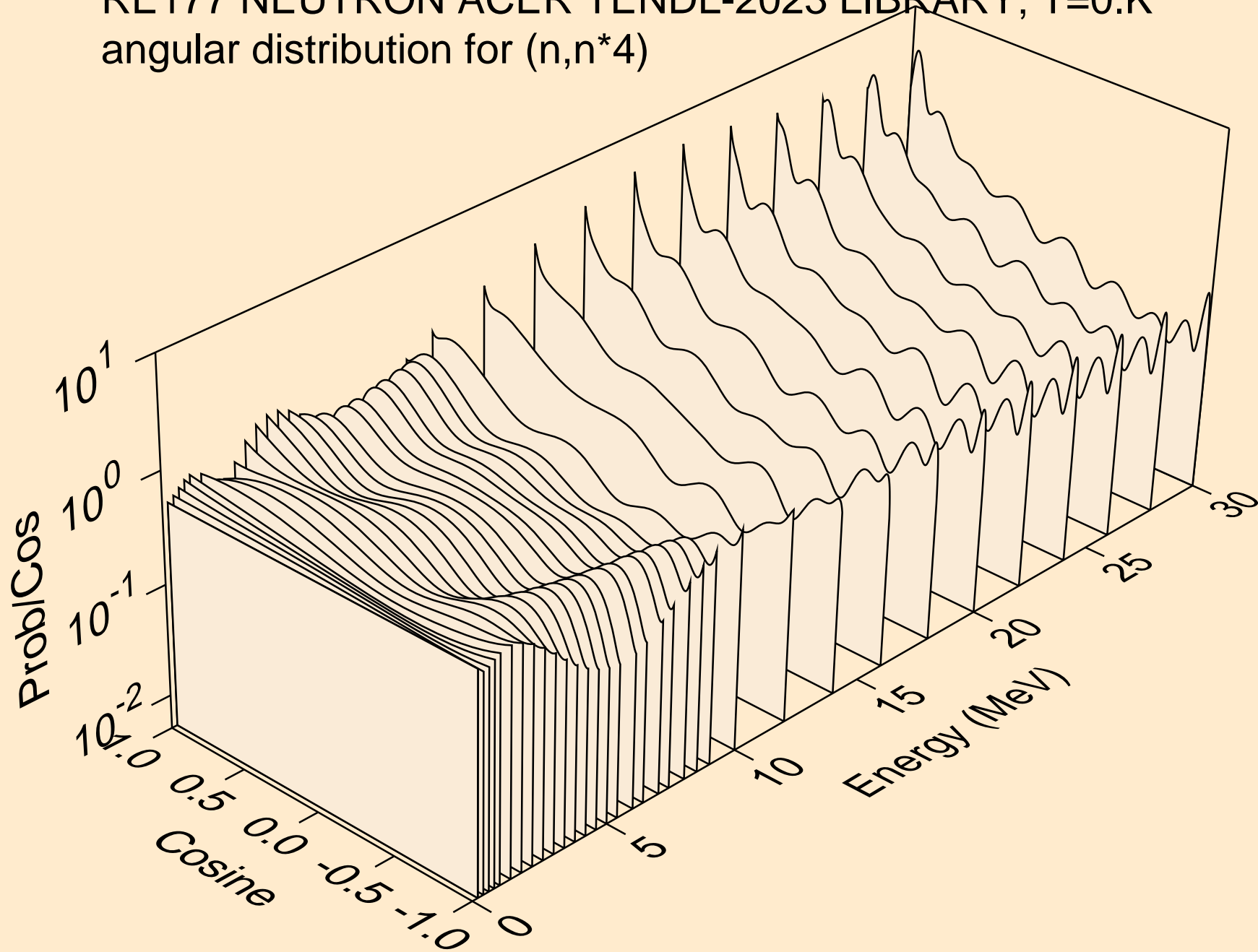

RE177 NEUTRON ACER TENDL-2023 LIBRARY; T=0.K
angular distribution for (n,n*5)

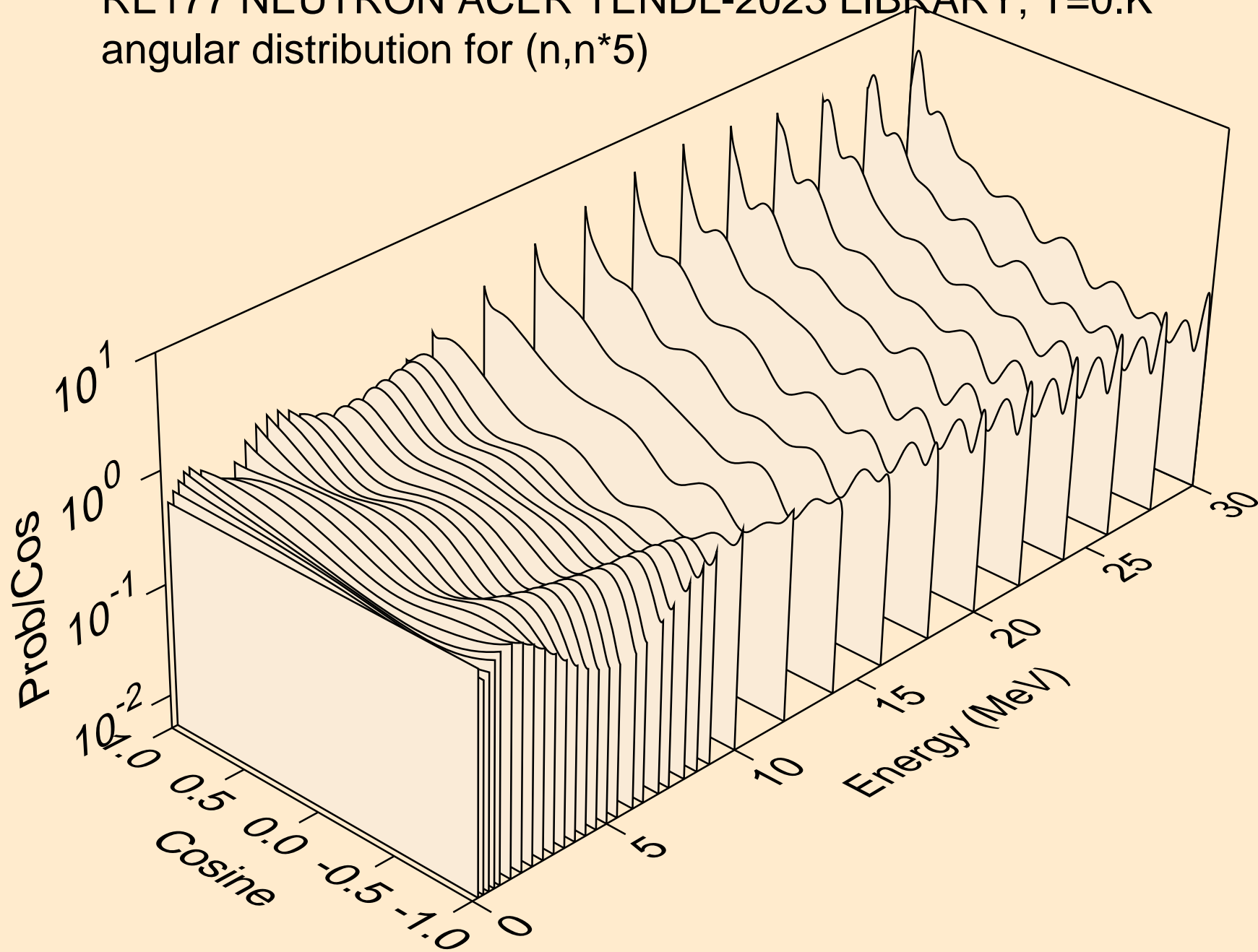

RE177 NEUTRON ACER TENDL-2023 LIBRARY; T=0.K
angular distribution for (n,n*6)

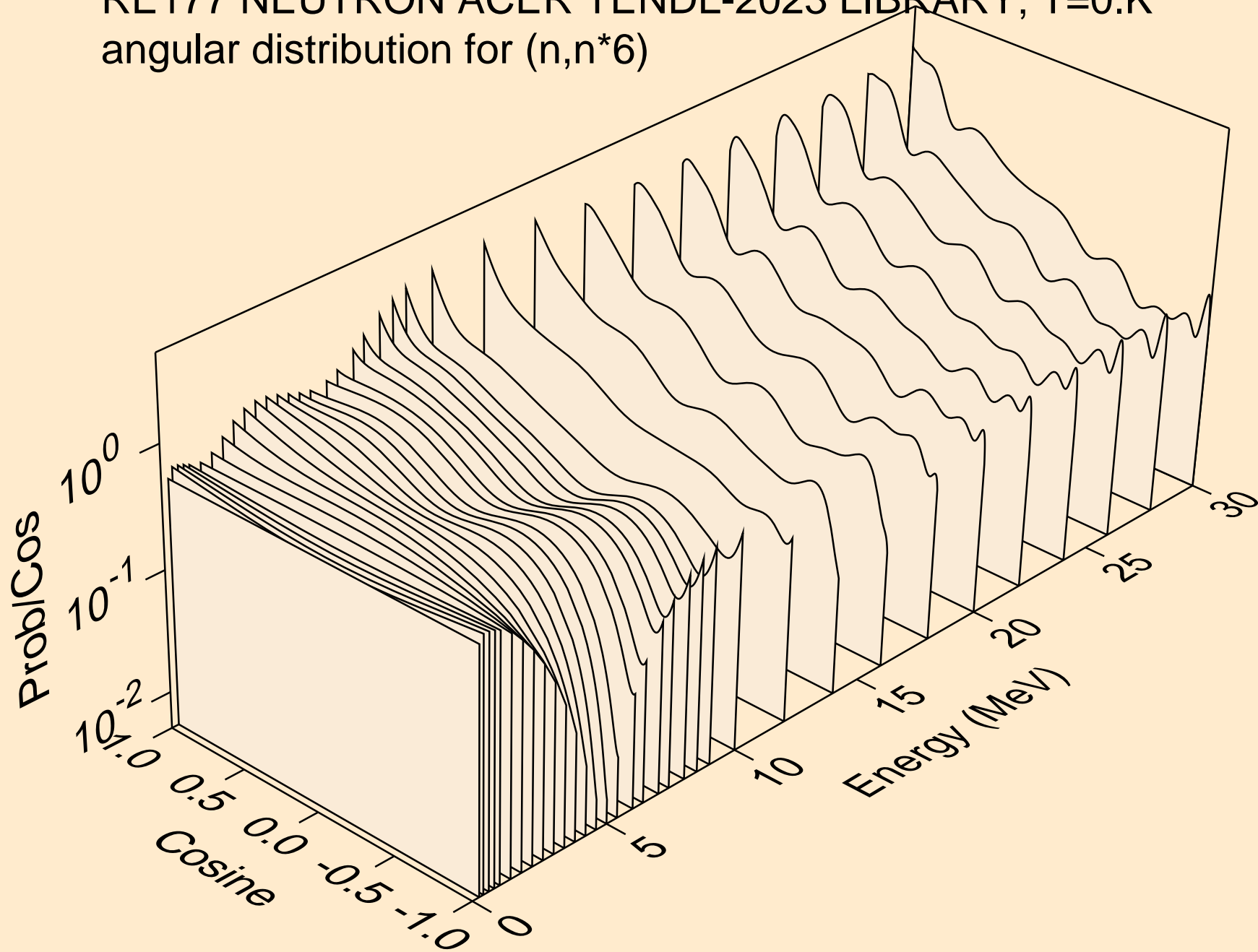

RE177 NEUTRON ACER TENDL-2023 LIBRARY; T=0.K
angular distribution for (n,n*7)

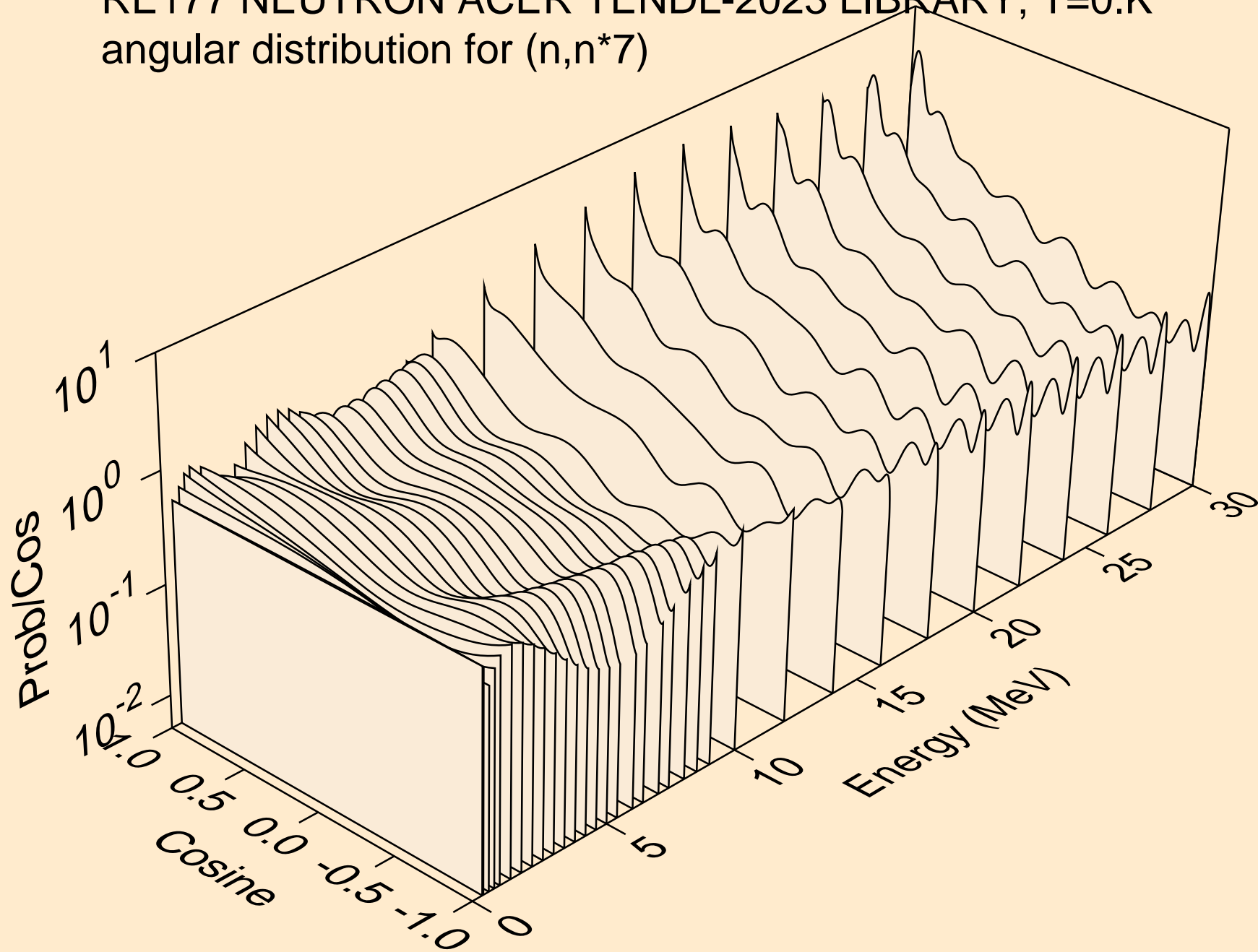

RE177 NEUTRON ACER TENDL-2023 LIBRARY; T=0.K
angular distribution for (n,n*8)

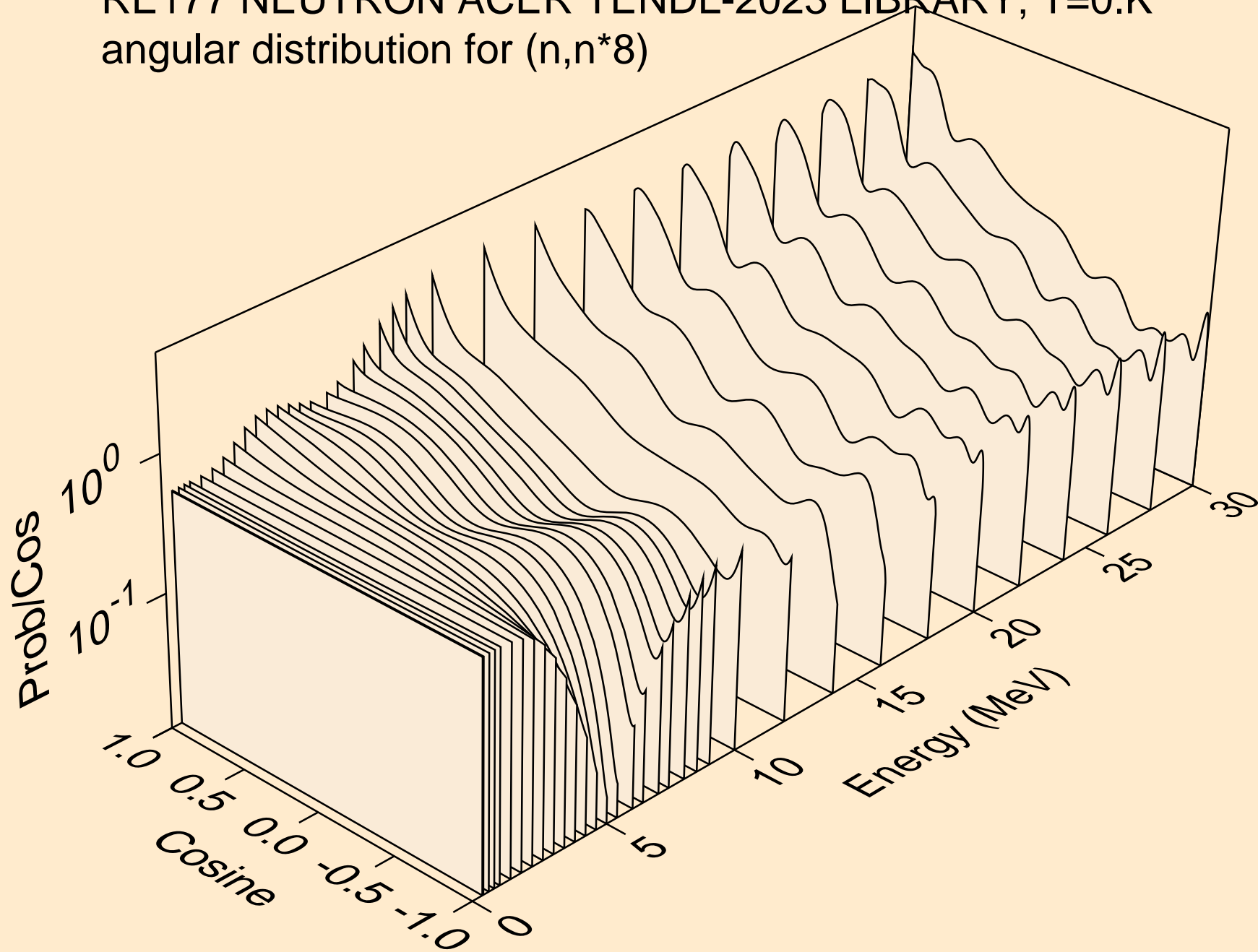

RE177 NEUTRON ACER TENDL-2023 LIBRARY; T=0.K
angular distribution for (n,n*9)

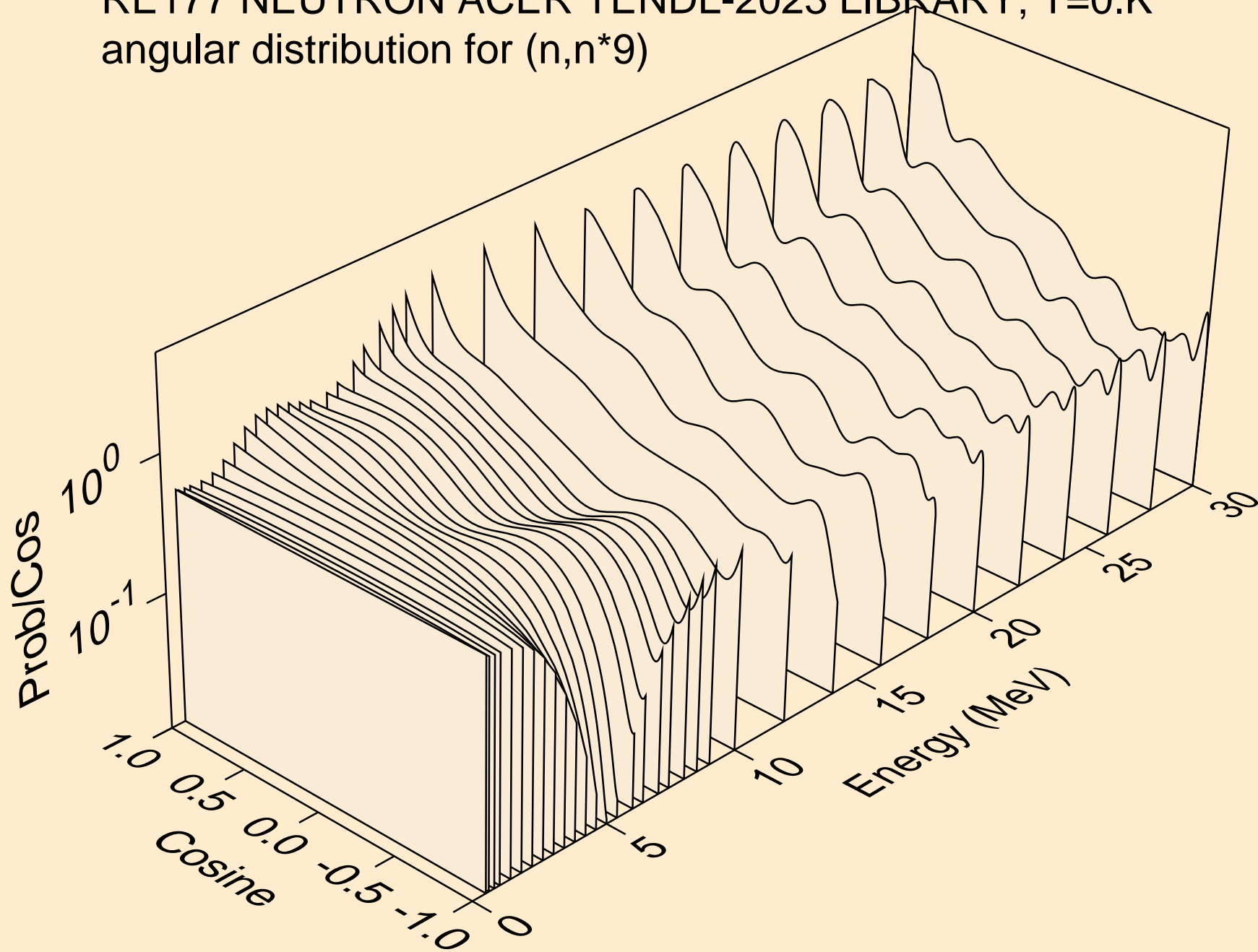

RE177 NEUTRON ACER TENDL-2023 LIBRARY; T=0.K
angular distribution for (n,n*10)

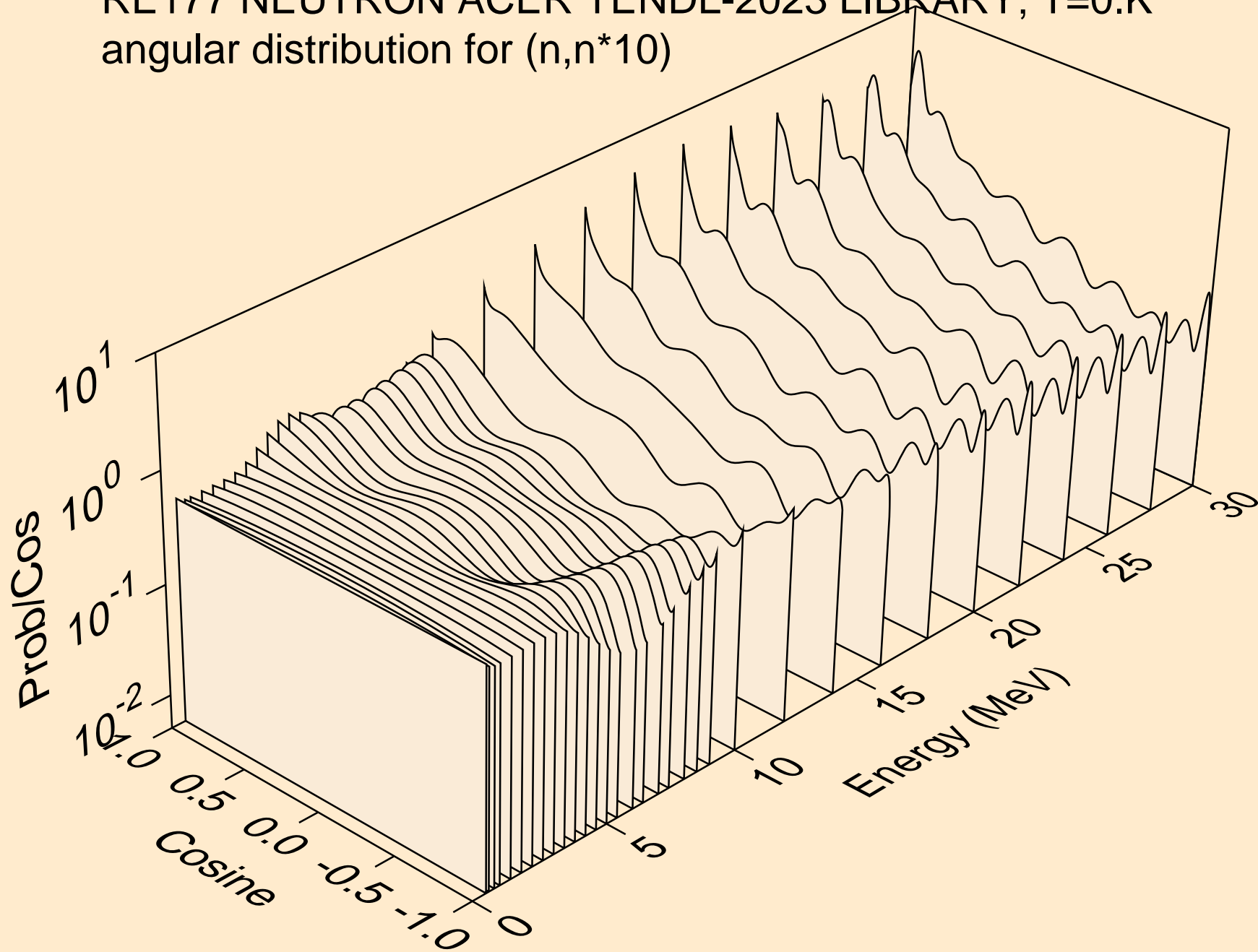

RE177 NEUTRON ACER TENDL-2023 LIBRARY; T=0.K
angular distribution for (n,n*11)

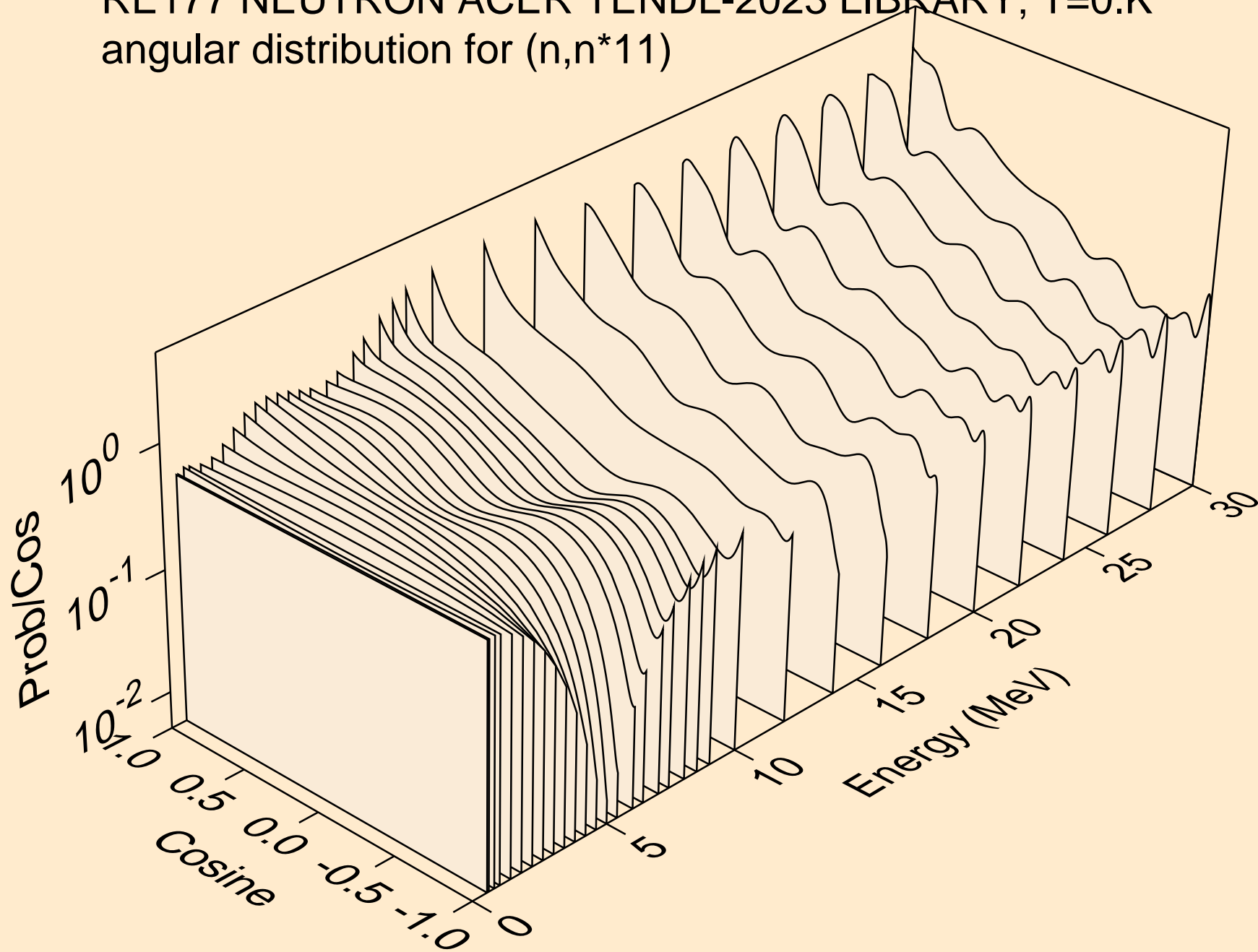

RE177 NEUTRON ACER TENDL-2023 LIBRARY; T=0.K
angular distribution for (n,n*12)

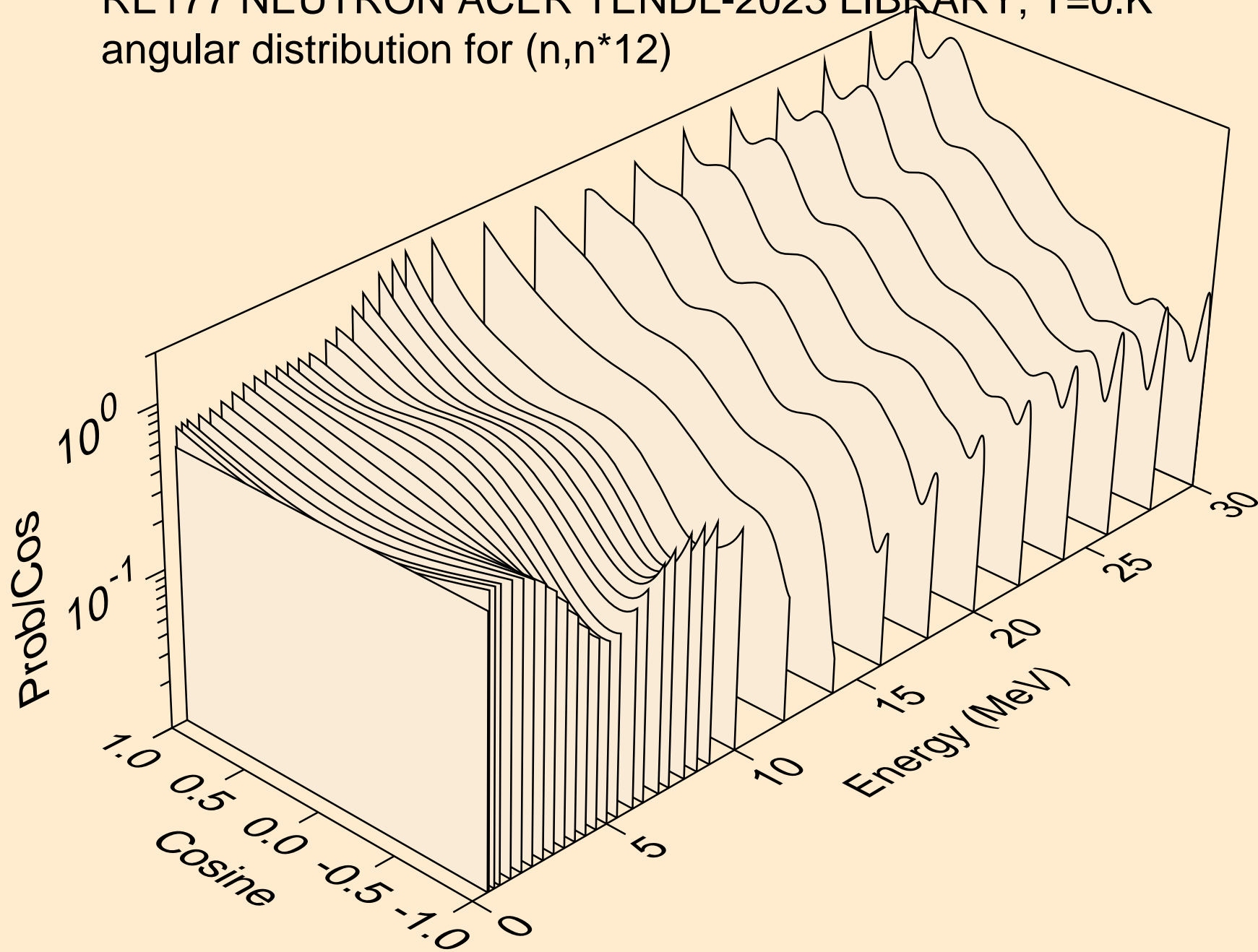

RE177 NEUTRON ACER TENDL-2023 LIBRARY; T=0.K
angular distribution for (n,n*13)

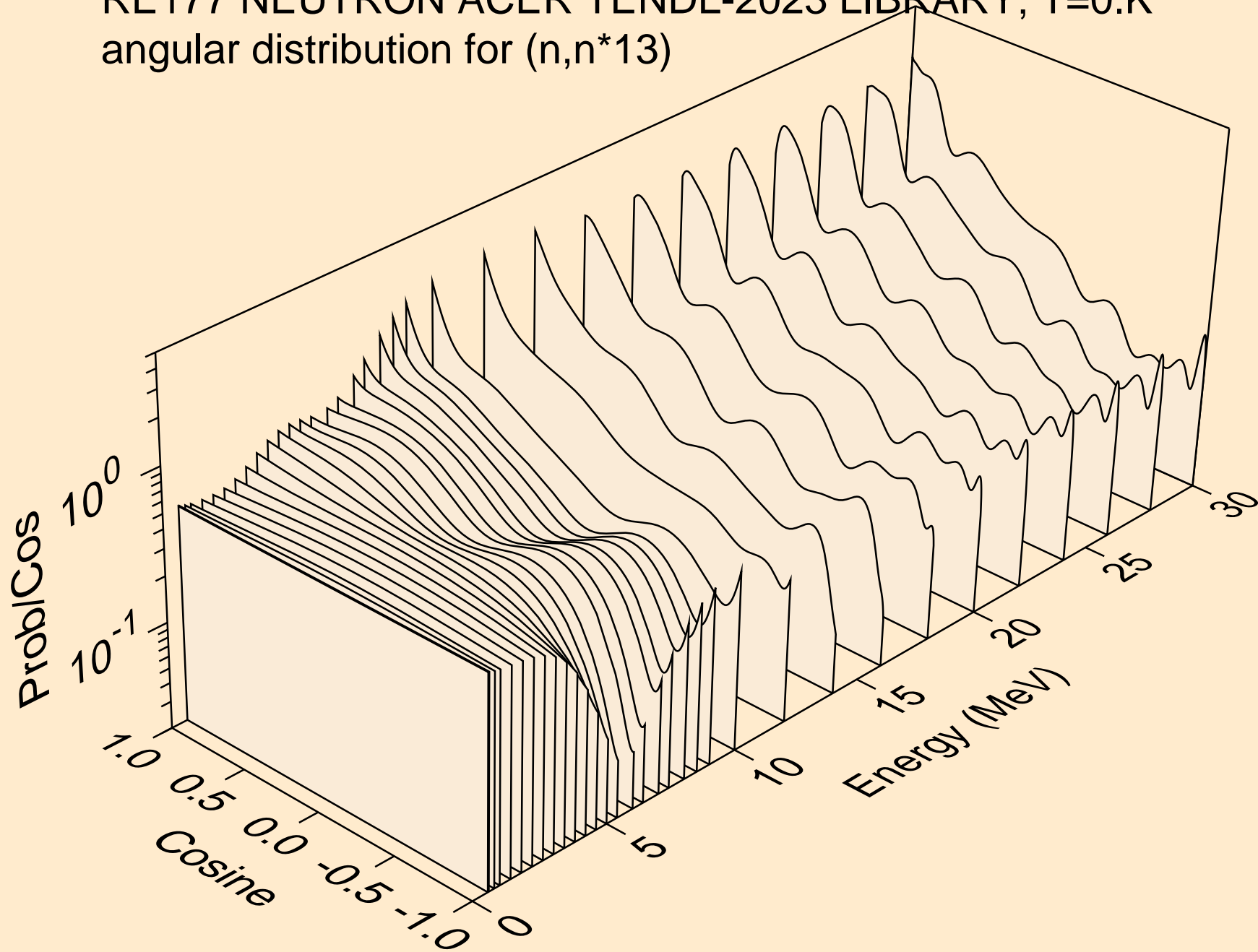

RE177 NEUTRON ACER TENDL-2023 LIBRARY; T=0.K
angular distribution for (n,n*14)

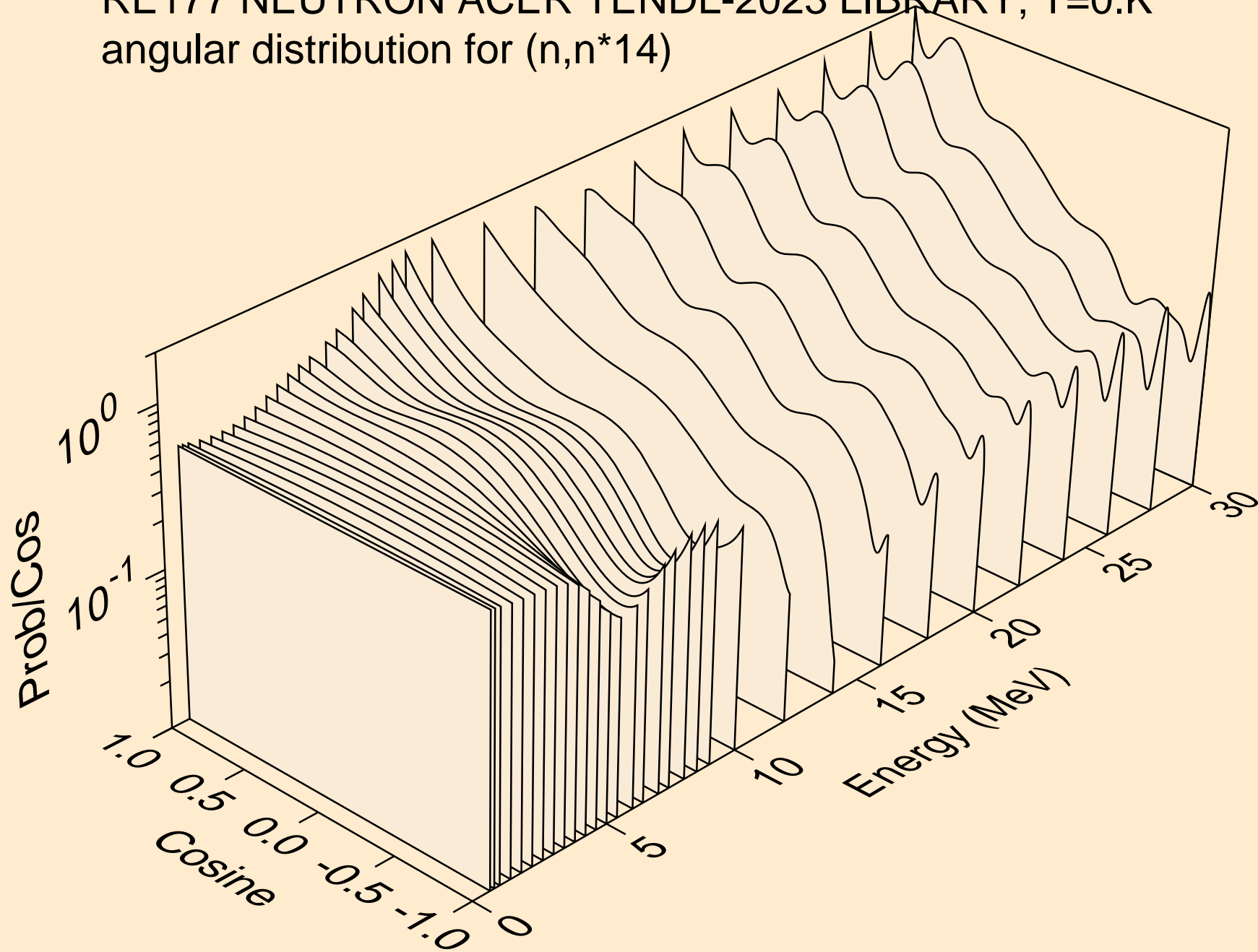

RE177 NEUTRON ACER TENDL-2023 LIBRARY; T=0.K
angular distribution for (n,n*15)

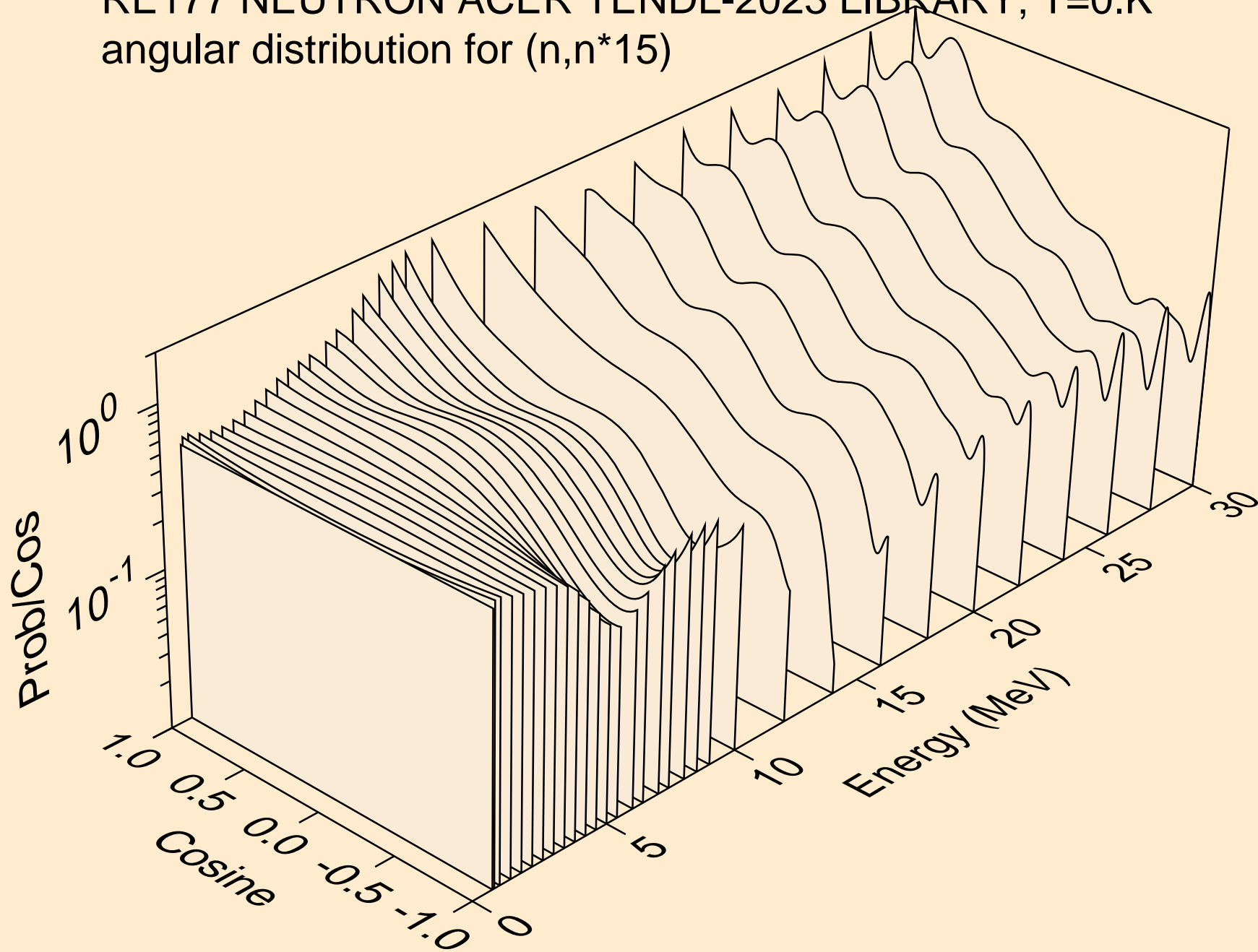

RE177 NEUTRON ACER TENDL-2023 LIBRARY; T=0.K
angular distribution for (n,n*16)

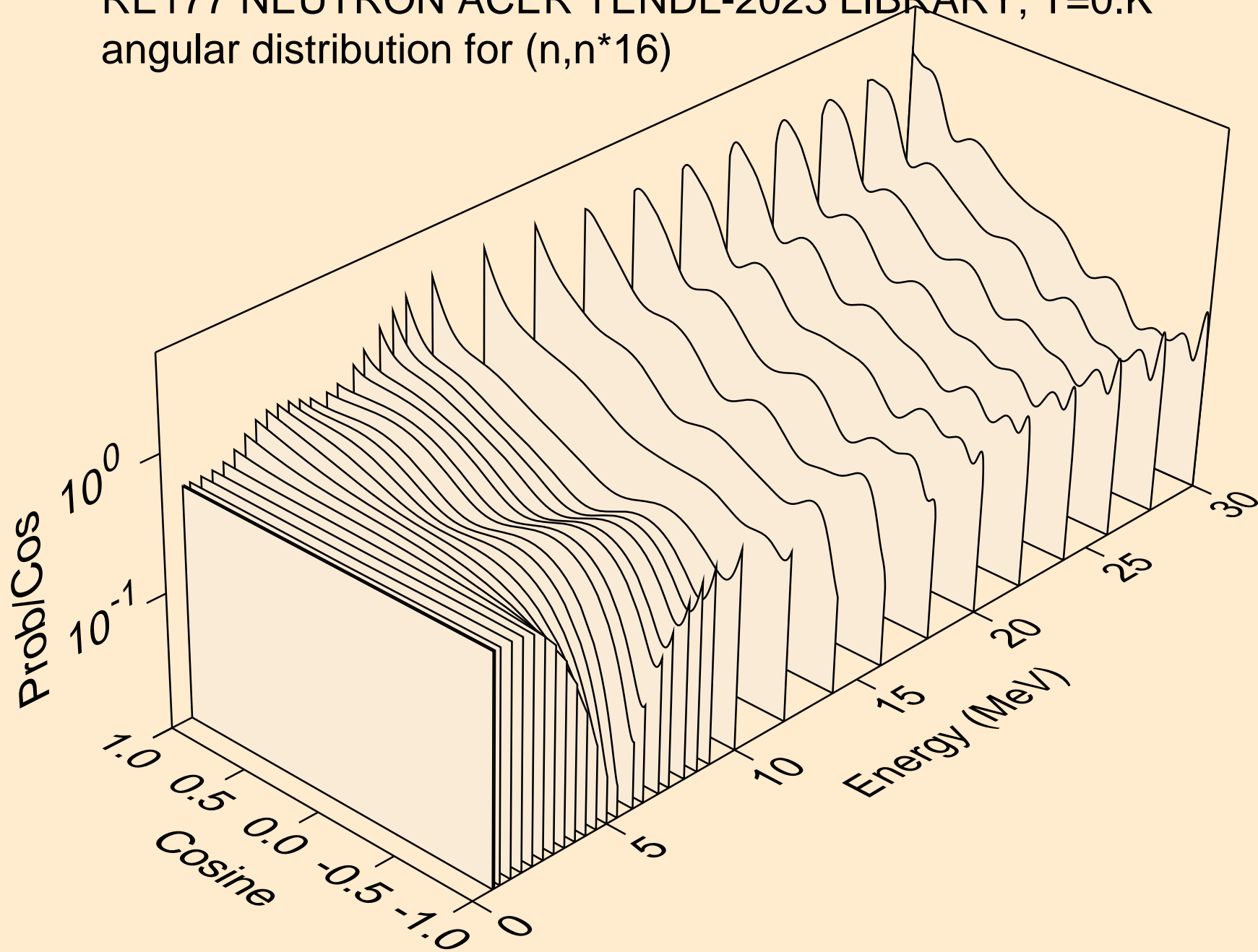

RE177 NEUTRON ACER TENDL-2023 LIBRARY; T=0.K
angular distribution for (n,n*17)

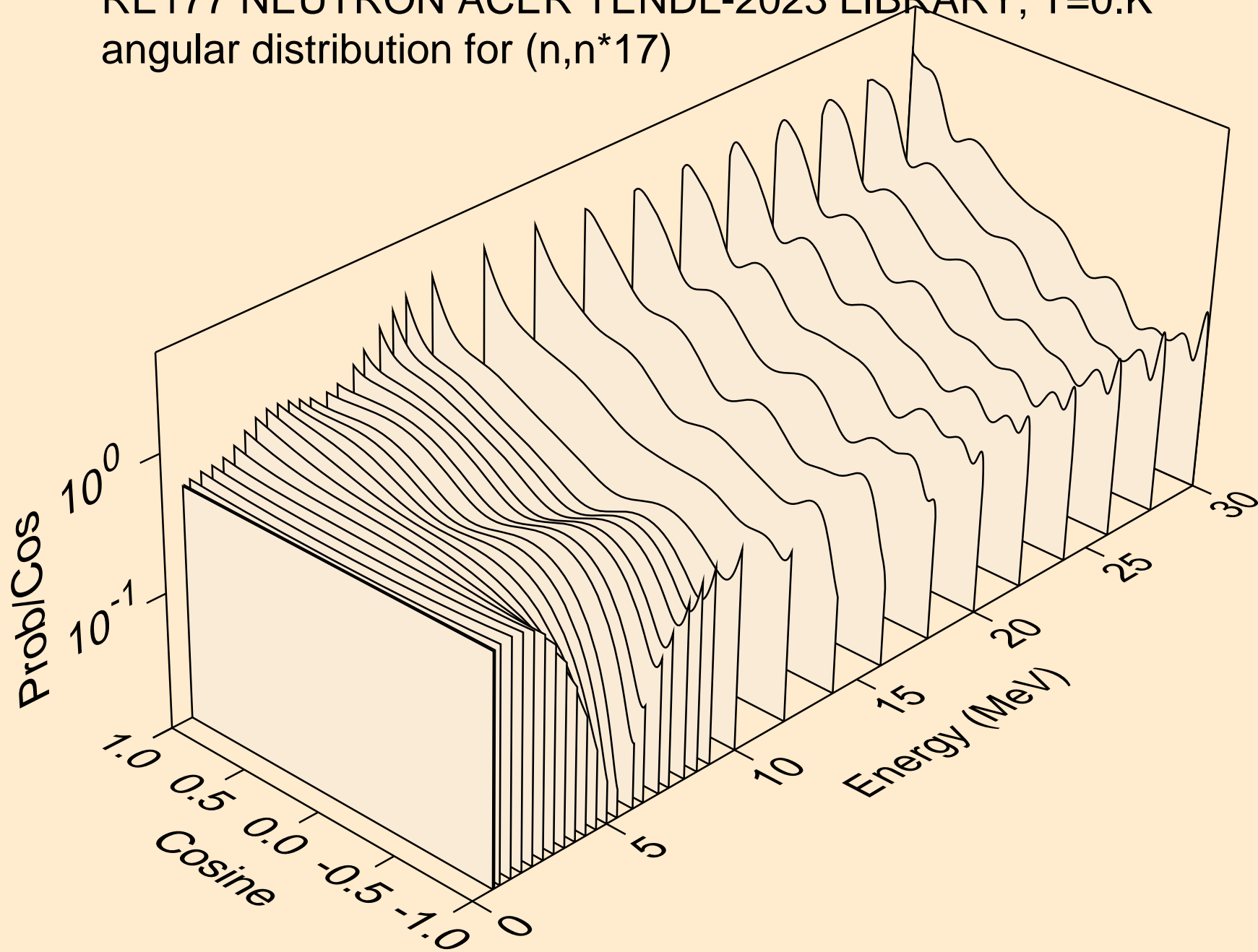

RE177 NEUTRON ACER TENDL-2023 LIBRARY; T=0.K
angular distribution for (n,n*18)

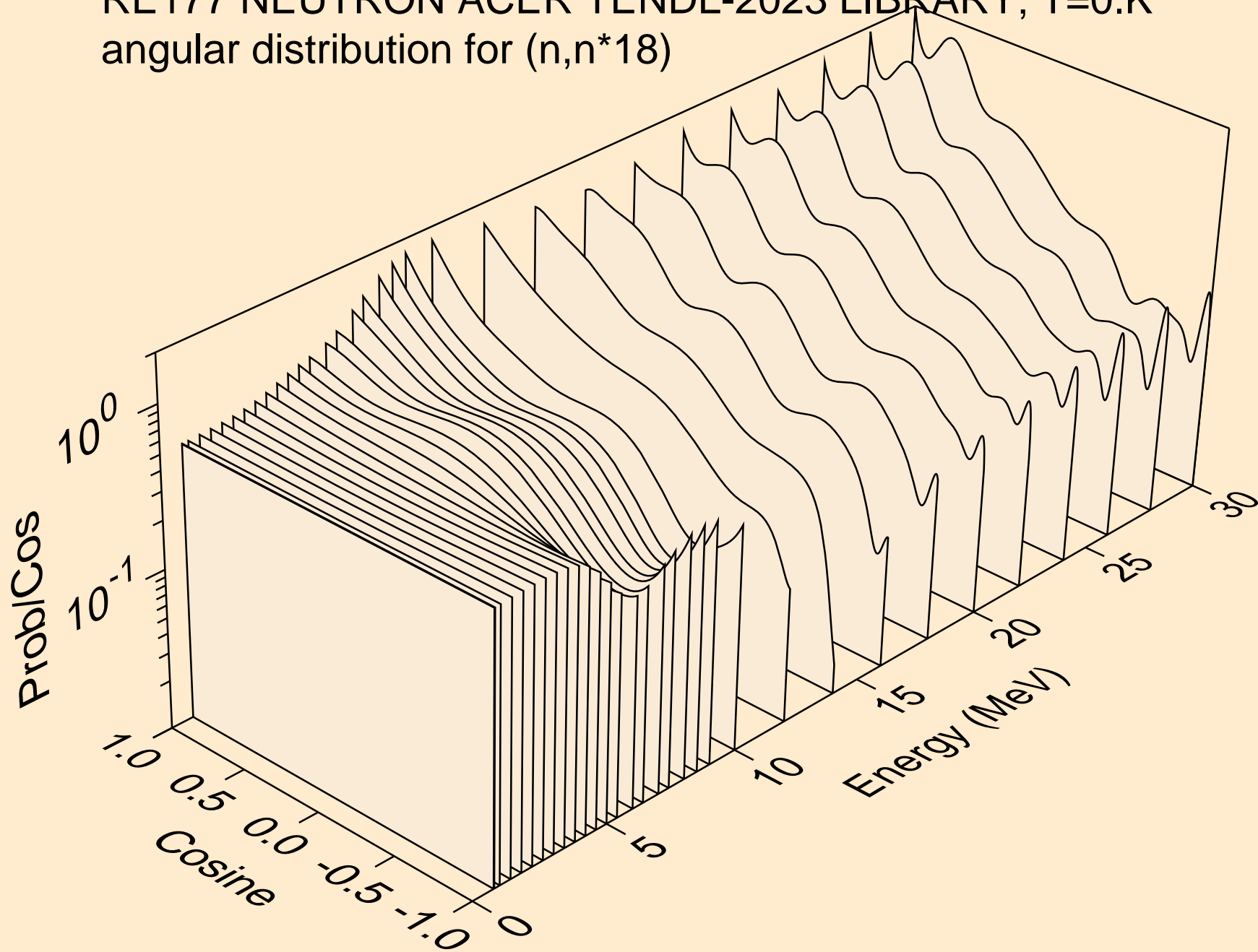

RE177 NEUTRON ACER TENDL-2023 LIBRARY; T=0.K
Neutron emission for (n,x)

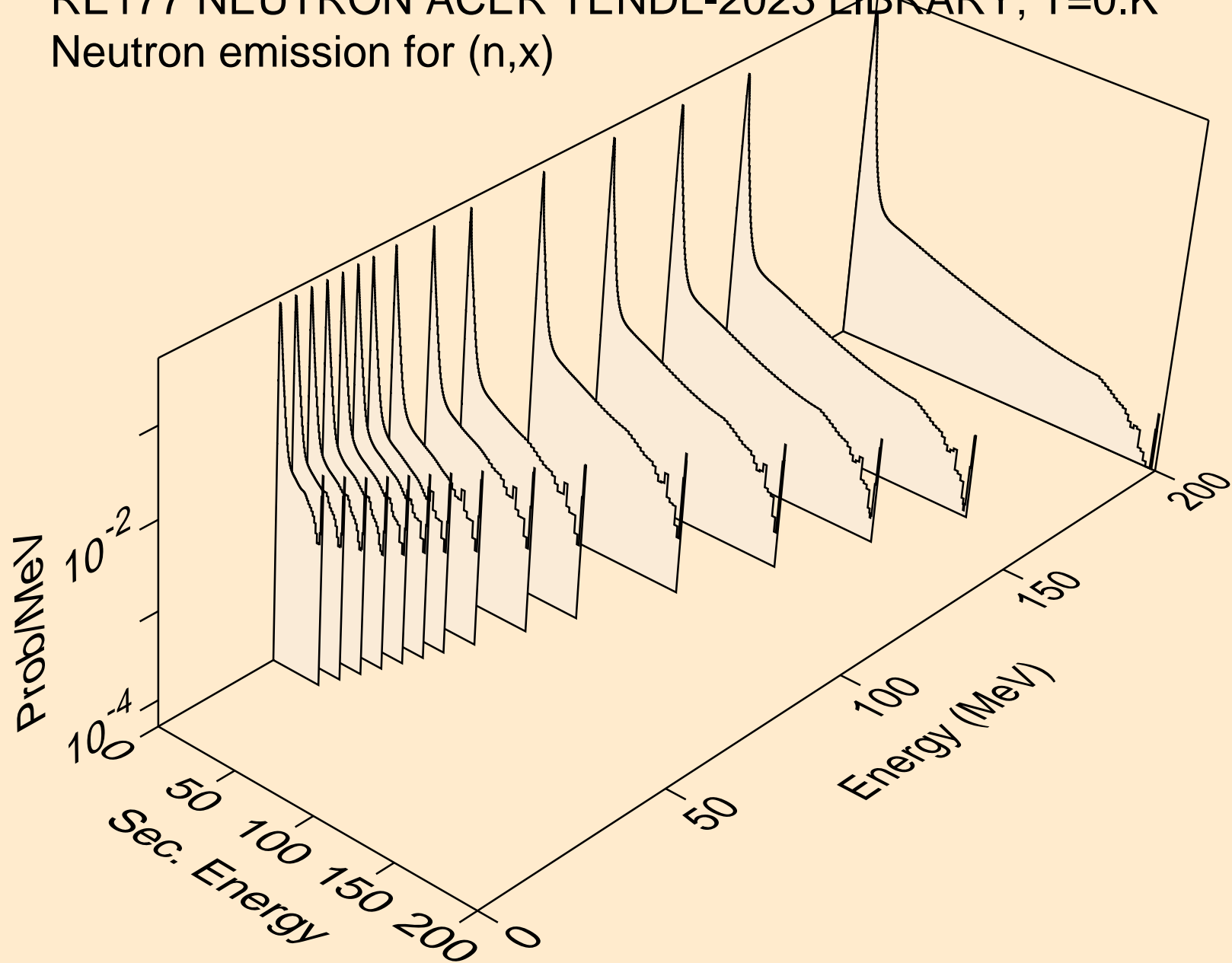

RE177 NEUTRON ACER TENDL-2023 LIBRARY; T=0.K
Neutron emission for (n,2nd)

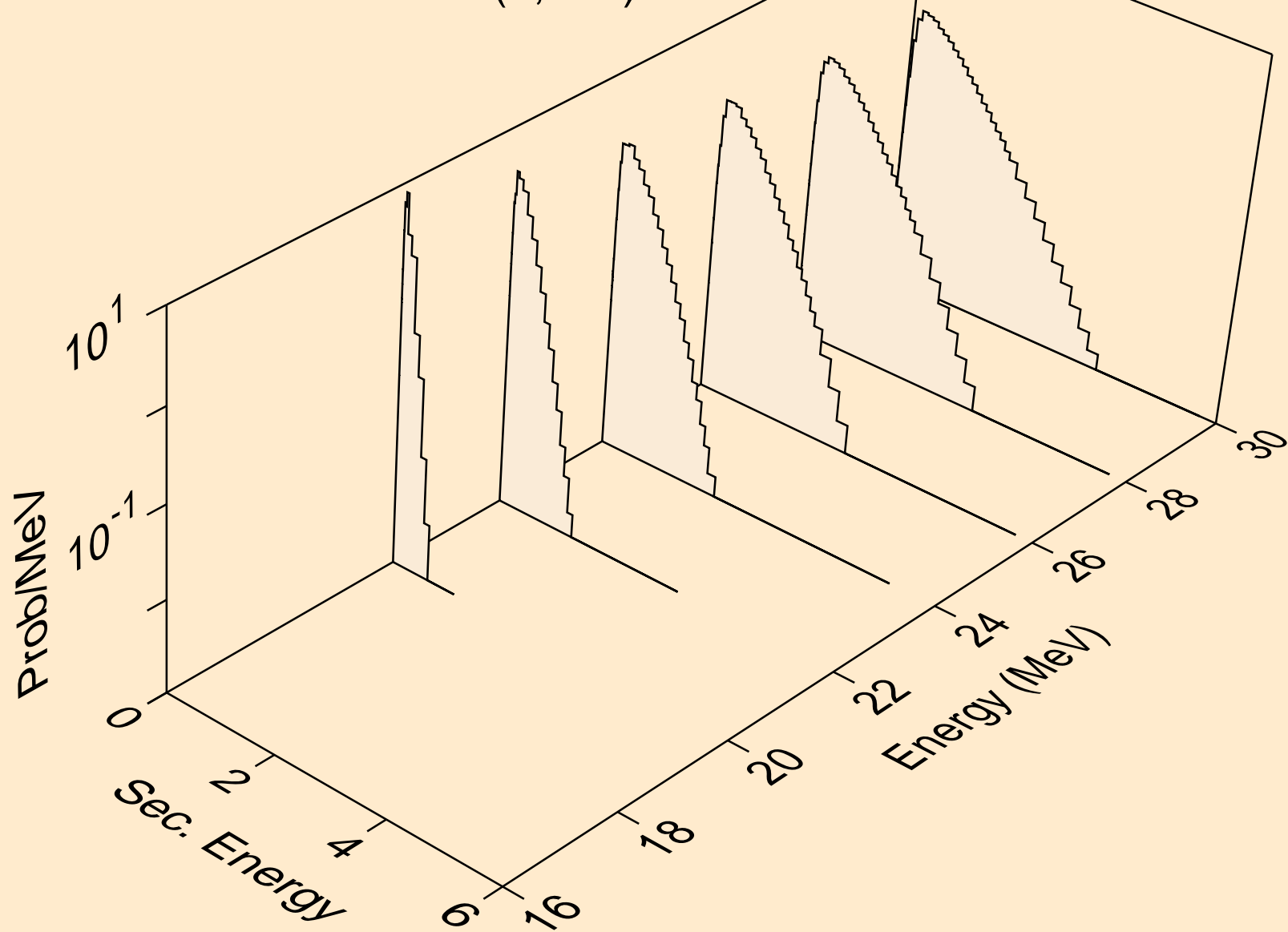

RE177 NEUTRON ACER TENDL-2023 LIBRARY; T=0.K
Neutron emission for (n,2n)

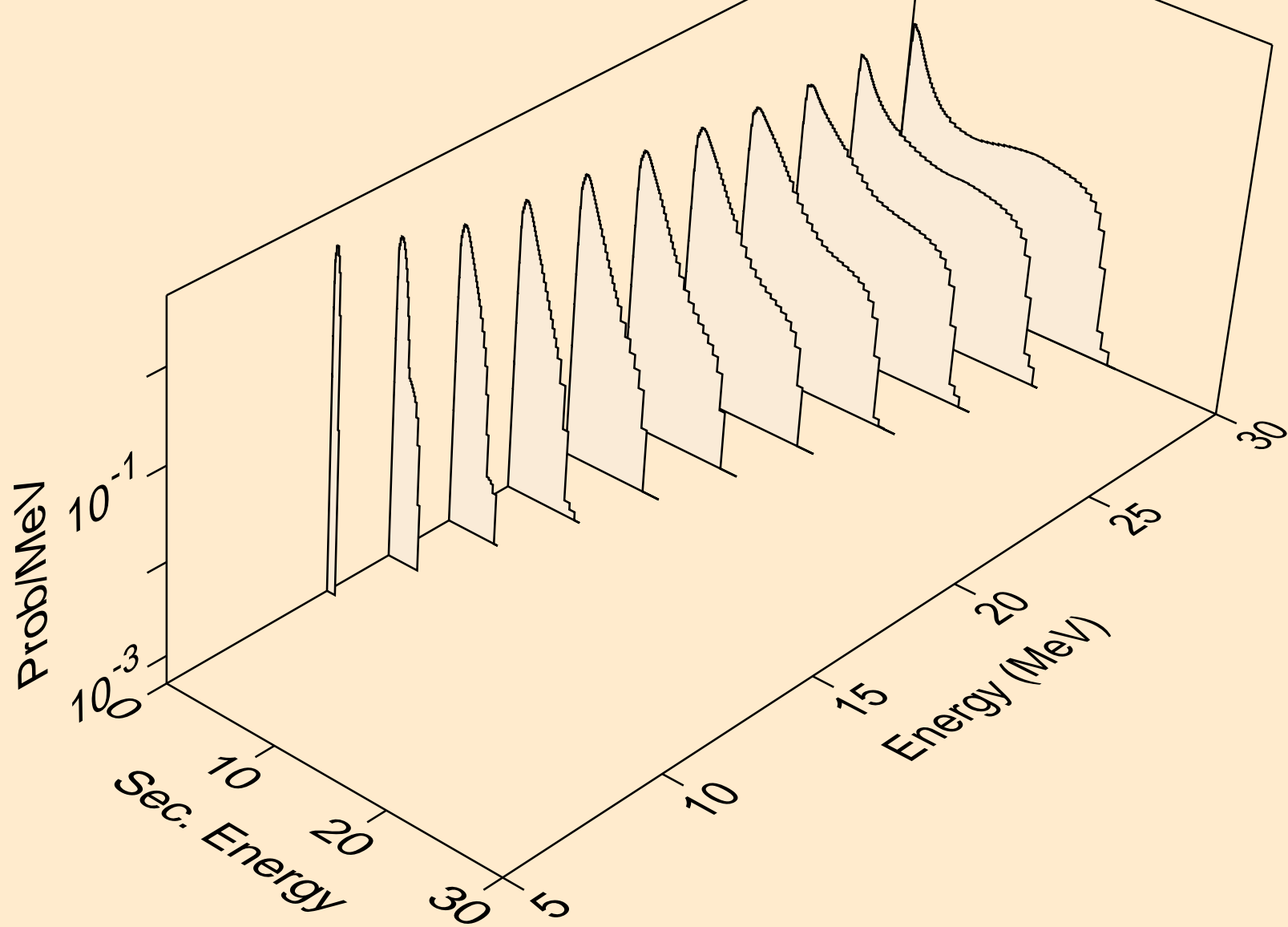

RE177 NEUTRON ACER TENDL-2023 LIBRARY; T=0.K
Neutron emission for (n,3n)

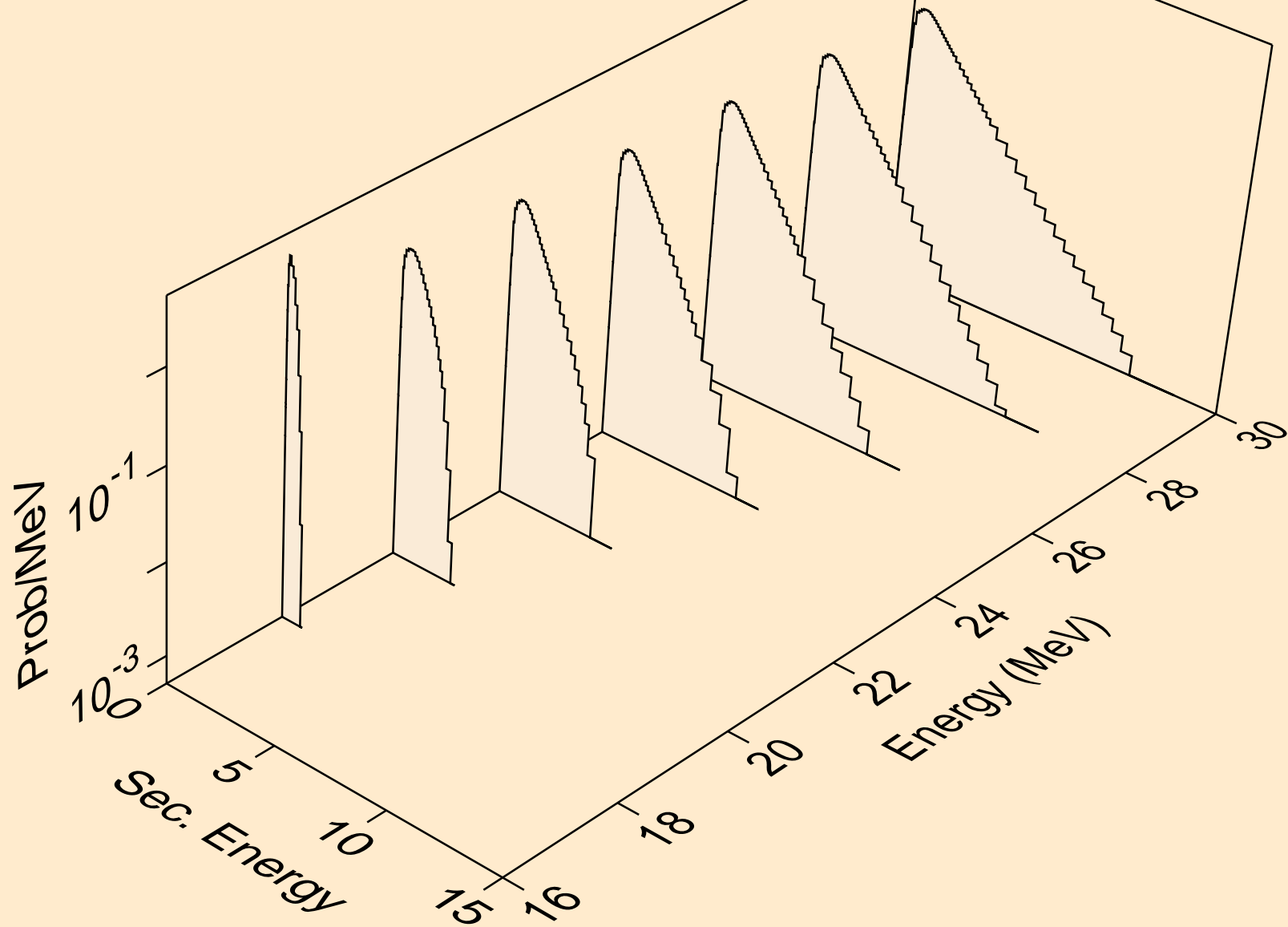

RE177 NEUTRON ACER TENDL-2023 LIBRARY; T=0.K
Neutron emission for (n,n*)a

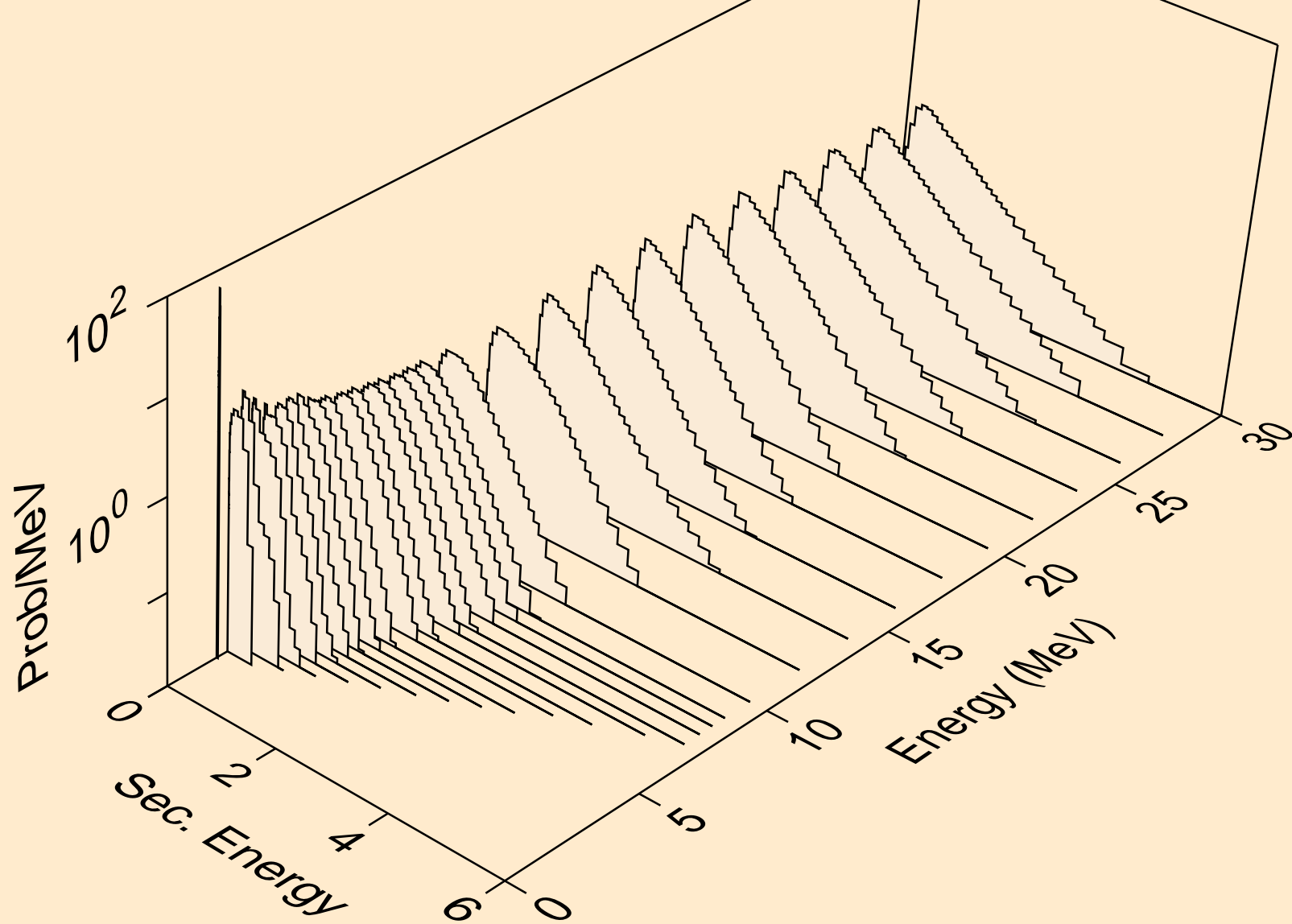

RE177 NEUTRON ACER TENDL-2023 LIBRARY; T=0.K
Neutron emission for (n,2n)a

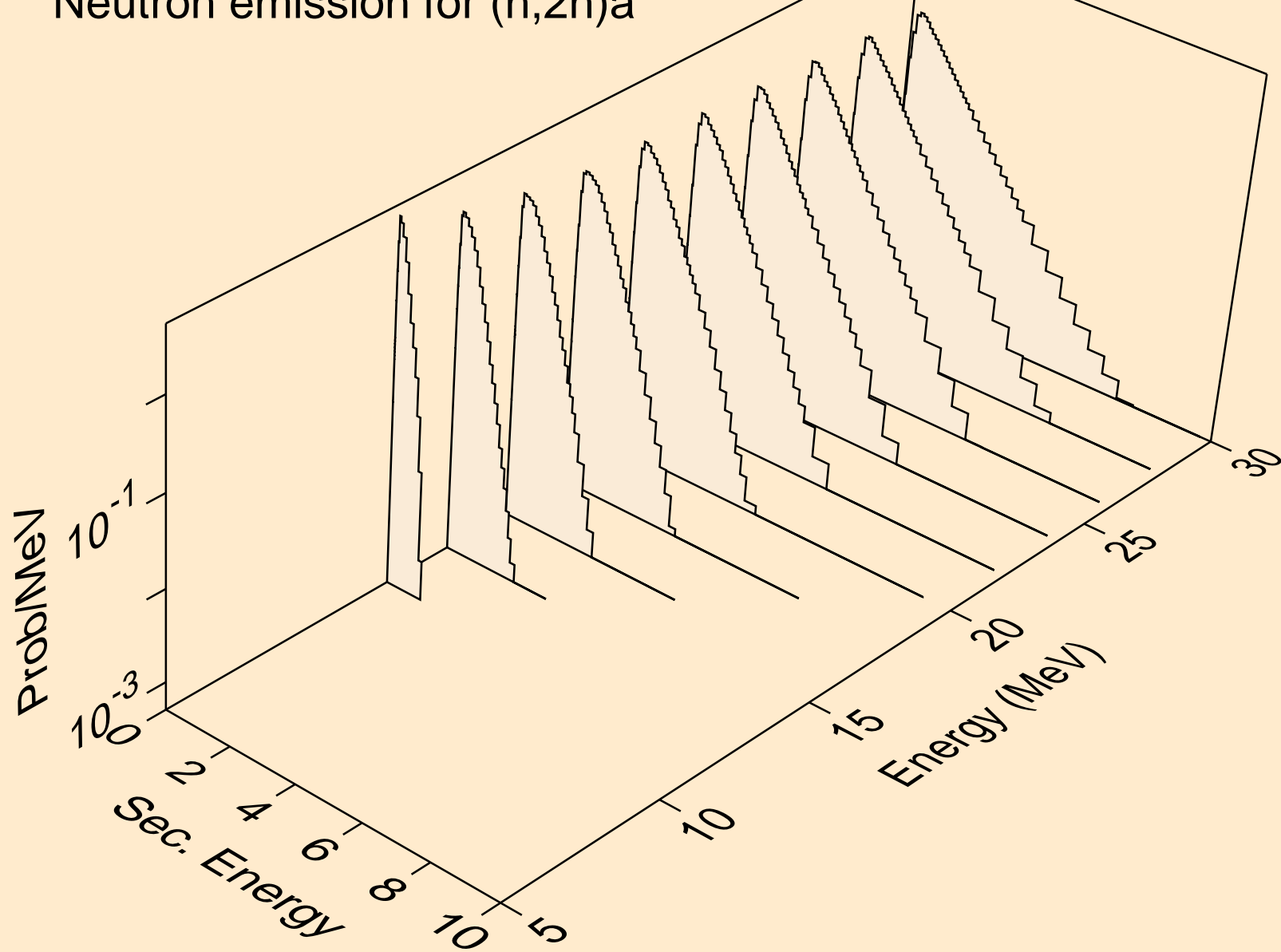

RE177 NEUTRON ACER TENDL-2023 LIBRARY; T=0.K
Neutron emission for (n,3n)a

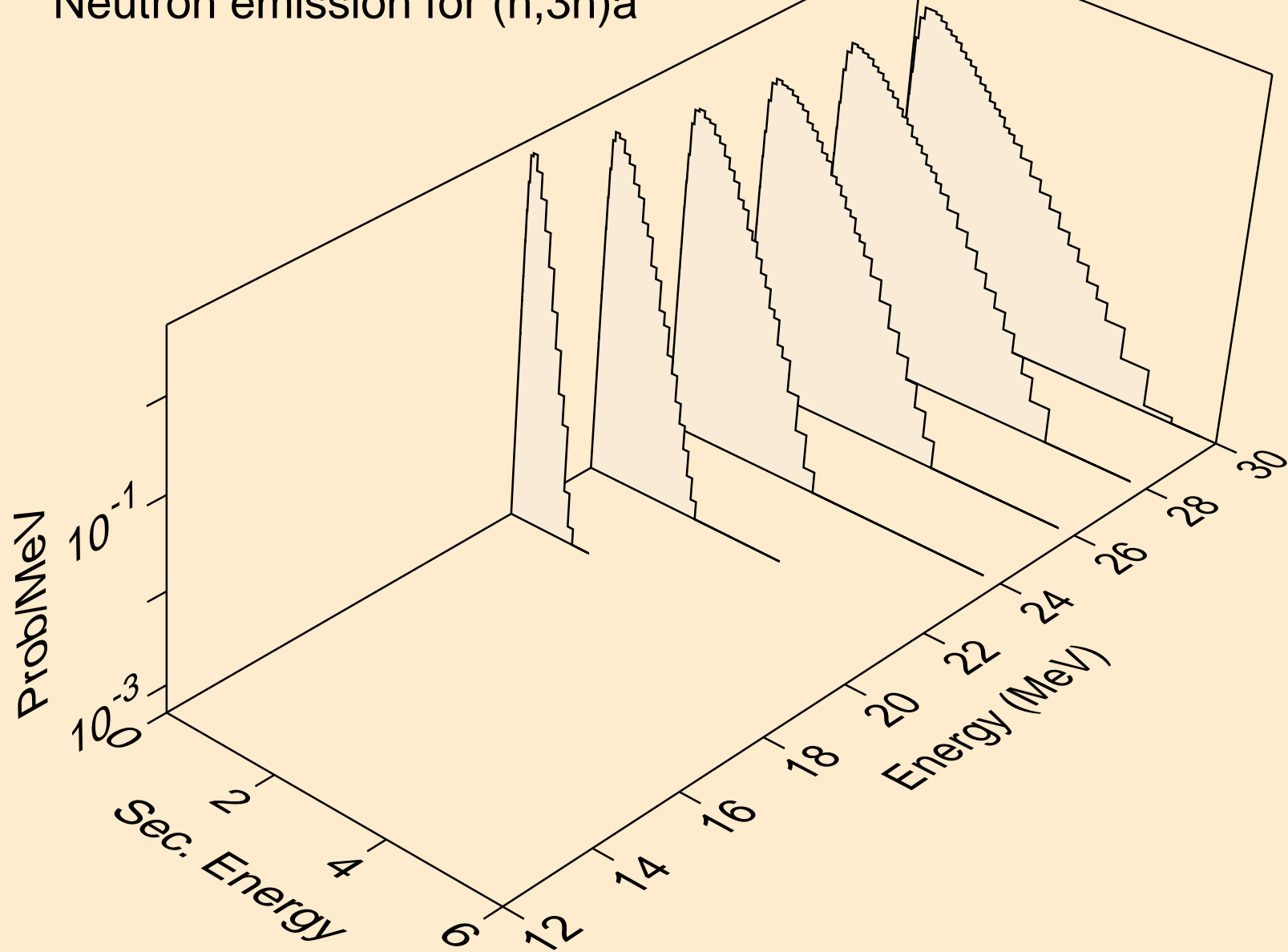

RE177 NEUTRON ACER TENDL-2023 LIBRARY; T=0.K
Neutron emission for (n,n*)p

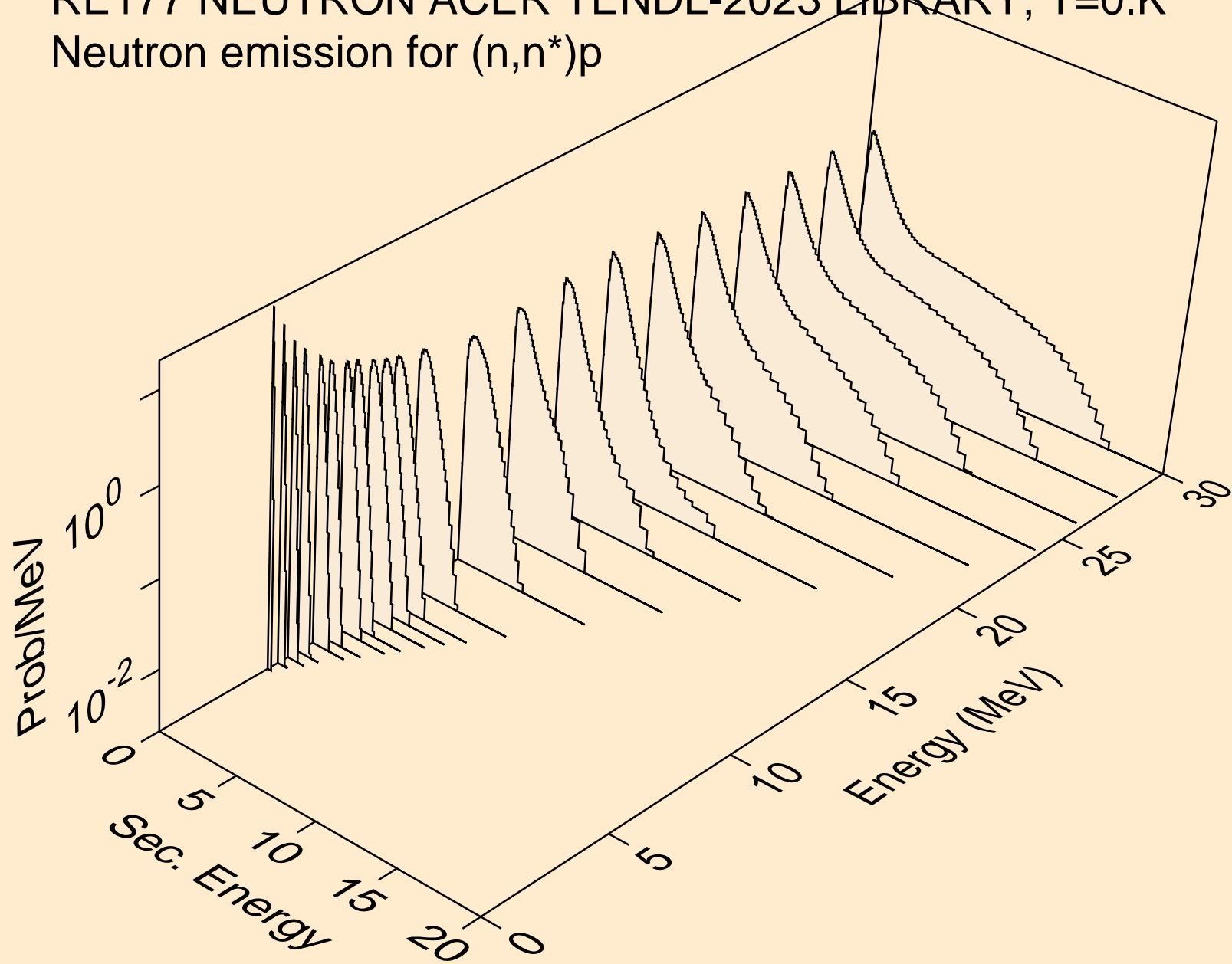

RE177 NEUTRON ACER TENDL-2023 LIBRARY; T=0.K
Neutron emission for (n,n*)2a

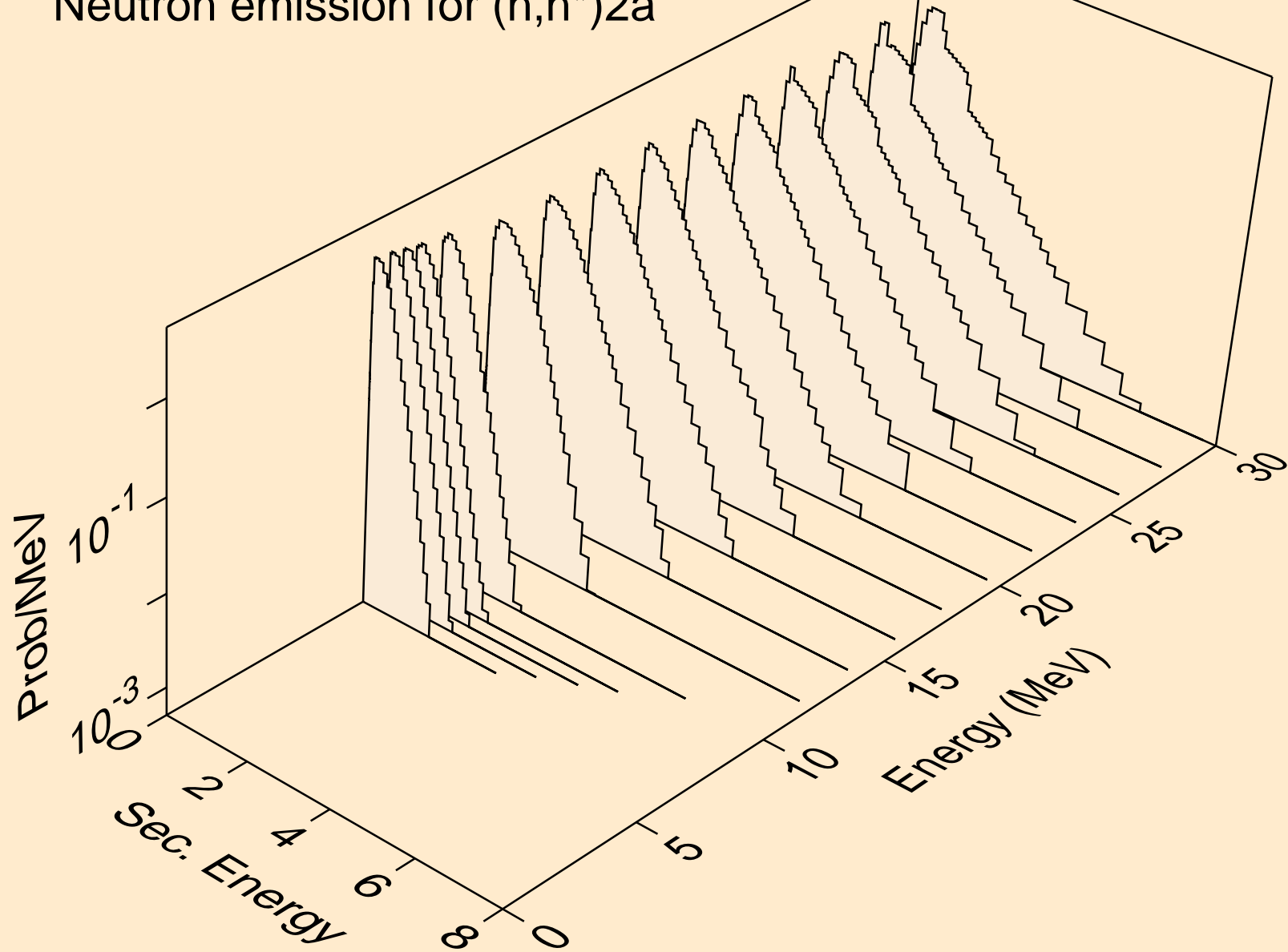

RE177 NEUTRON ACER TENDL-2023 LIBRARY; T=0.K
Neutron emission for (n,2n)2a

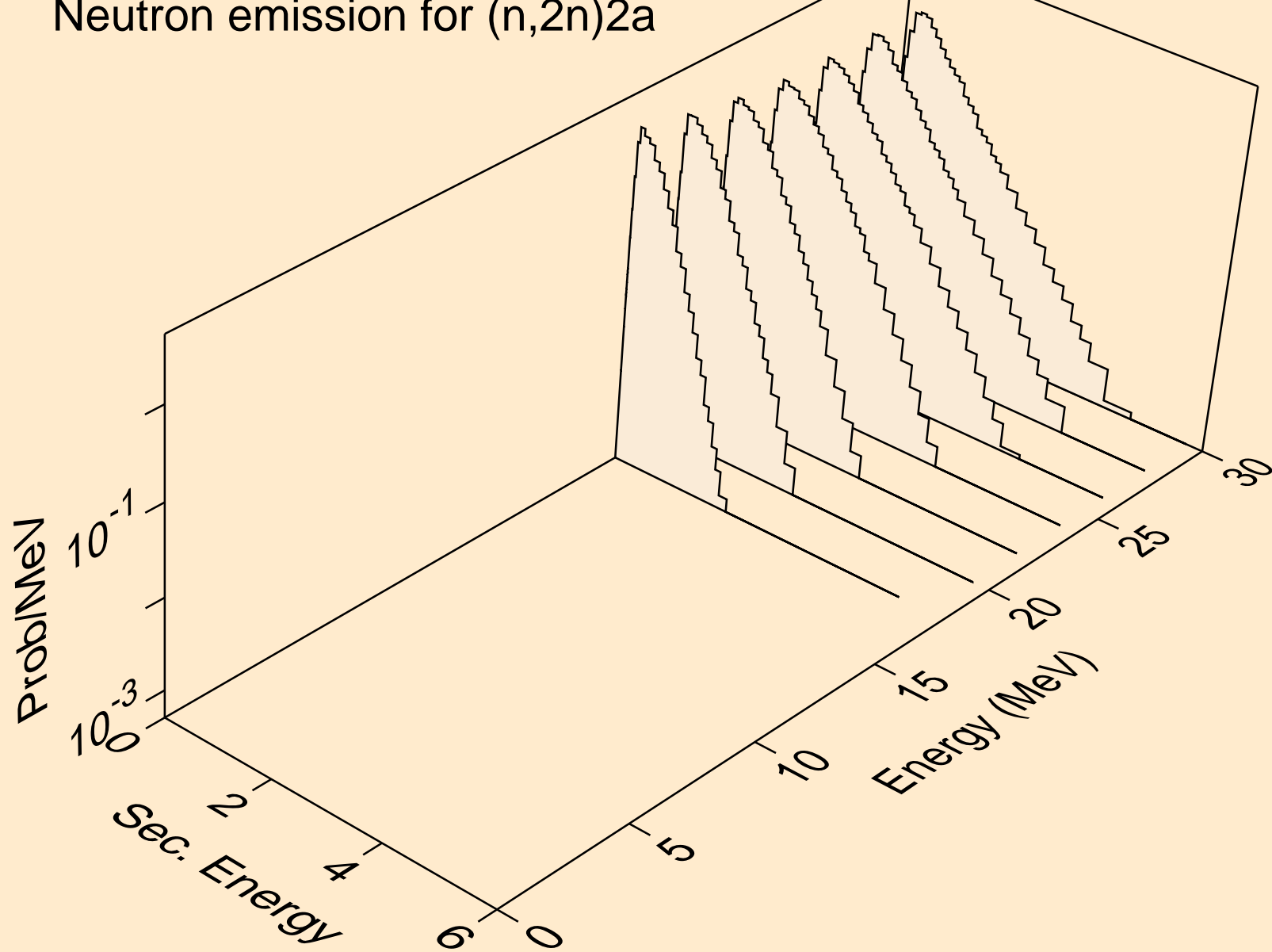

RE177 NEUTRON ACER TENDL-2023 LIBRARY; T=0.K
Neutron emission for (n,n*)d

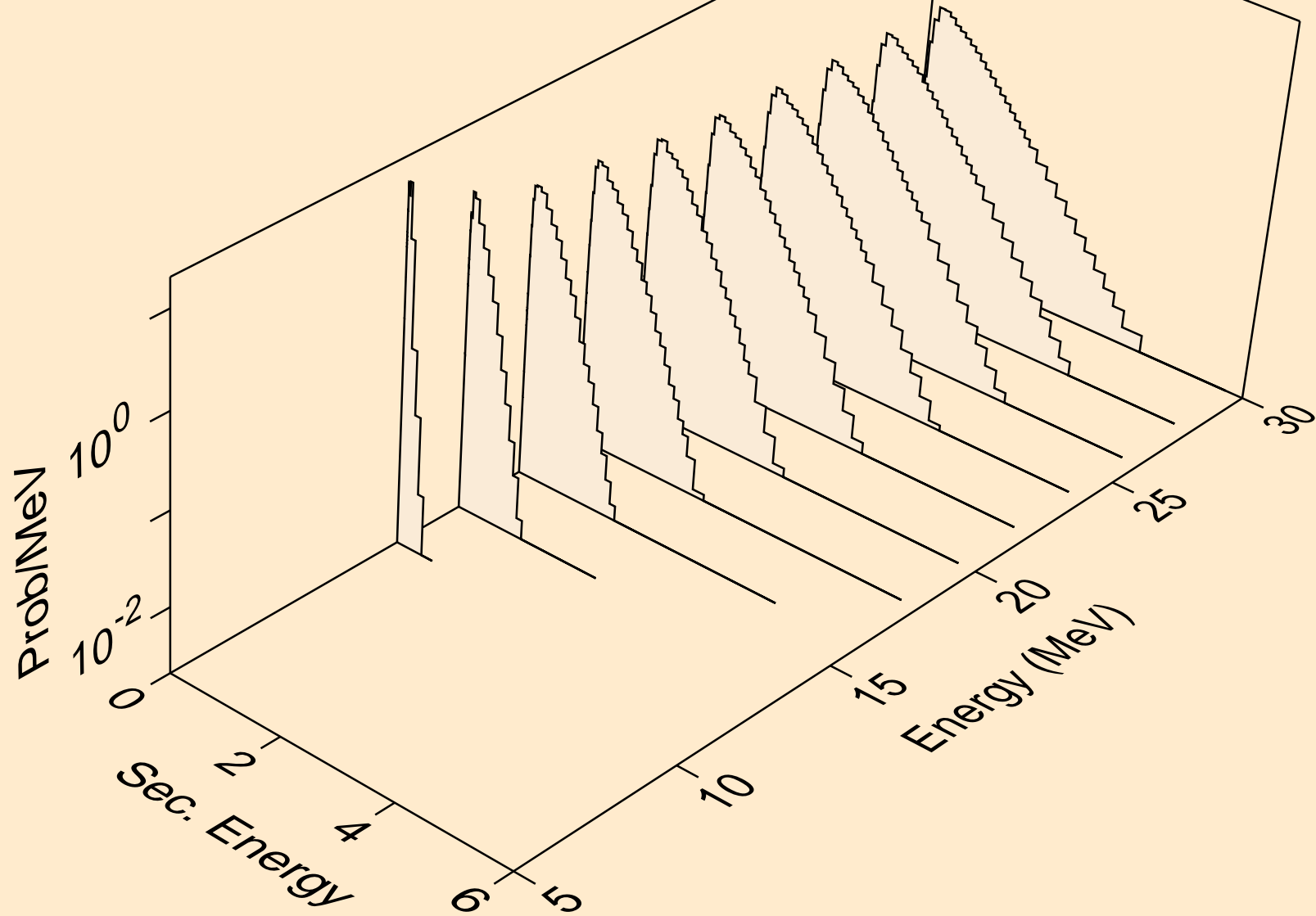

RE177 NEUTRON ACER TENDL-2023 LIBRARY; T=0.K
Neutron emission for (n,n*)t

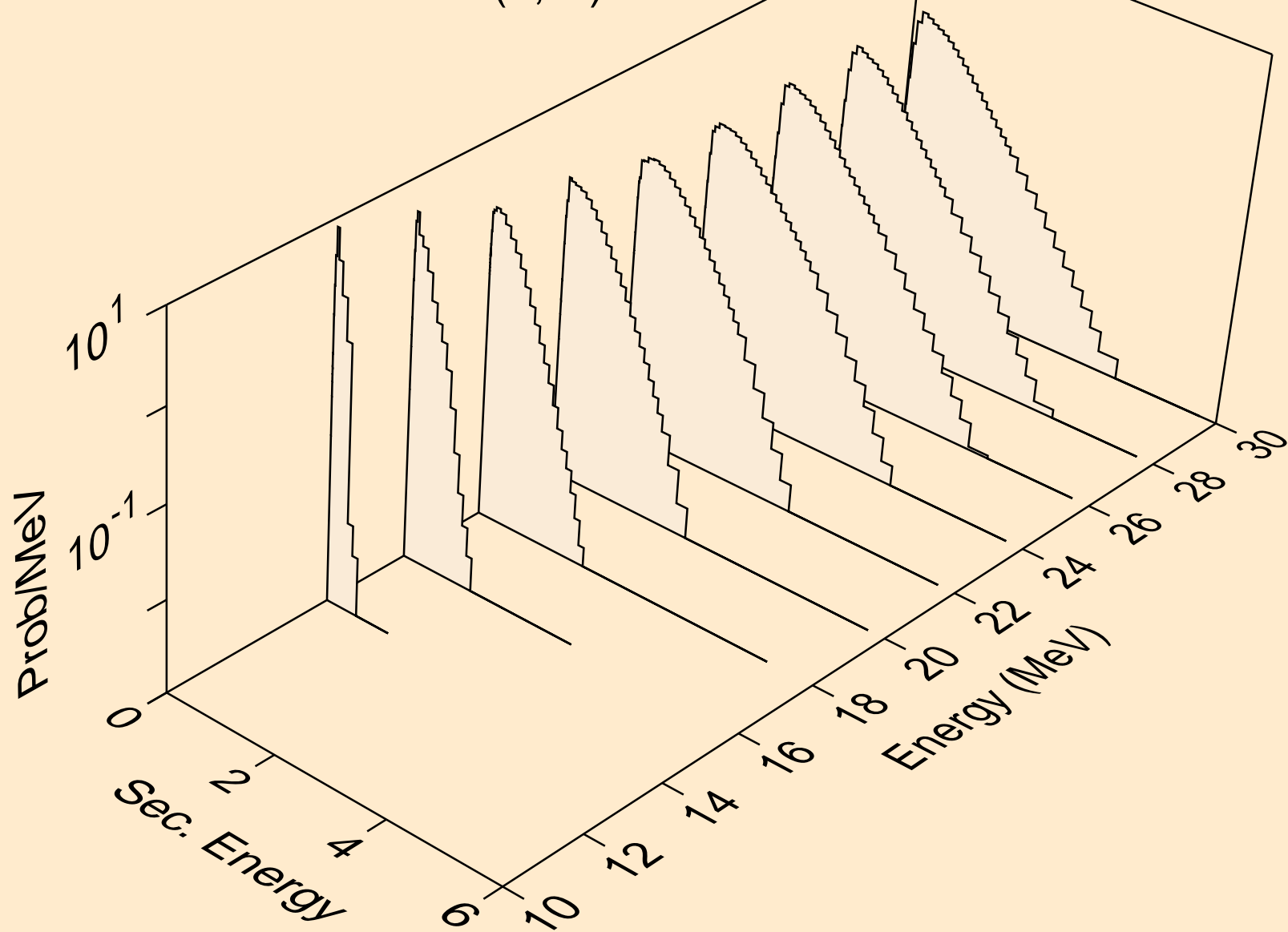

RE177 NEUTRON ACER TENDL-2023 LIBRARY; T=0.K
Neutron emission for (n,n*)he3

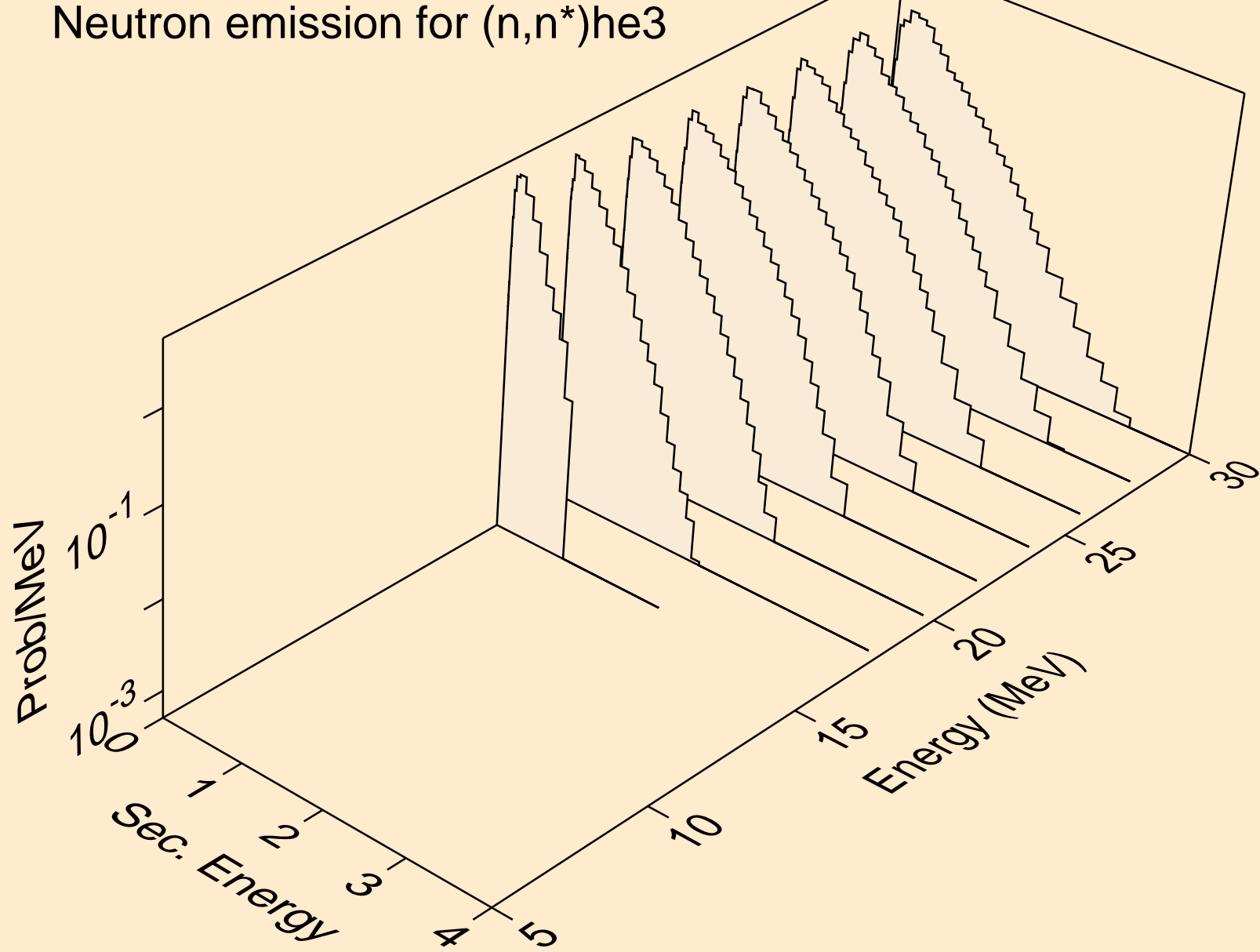

RE177 NEUTRON ACER TENDL-2023 LIBRARY; T=0.K
Neutron emission for (n,4n)

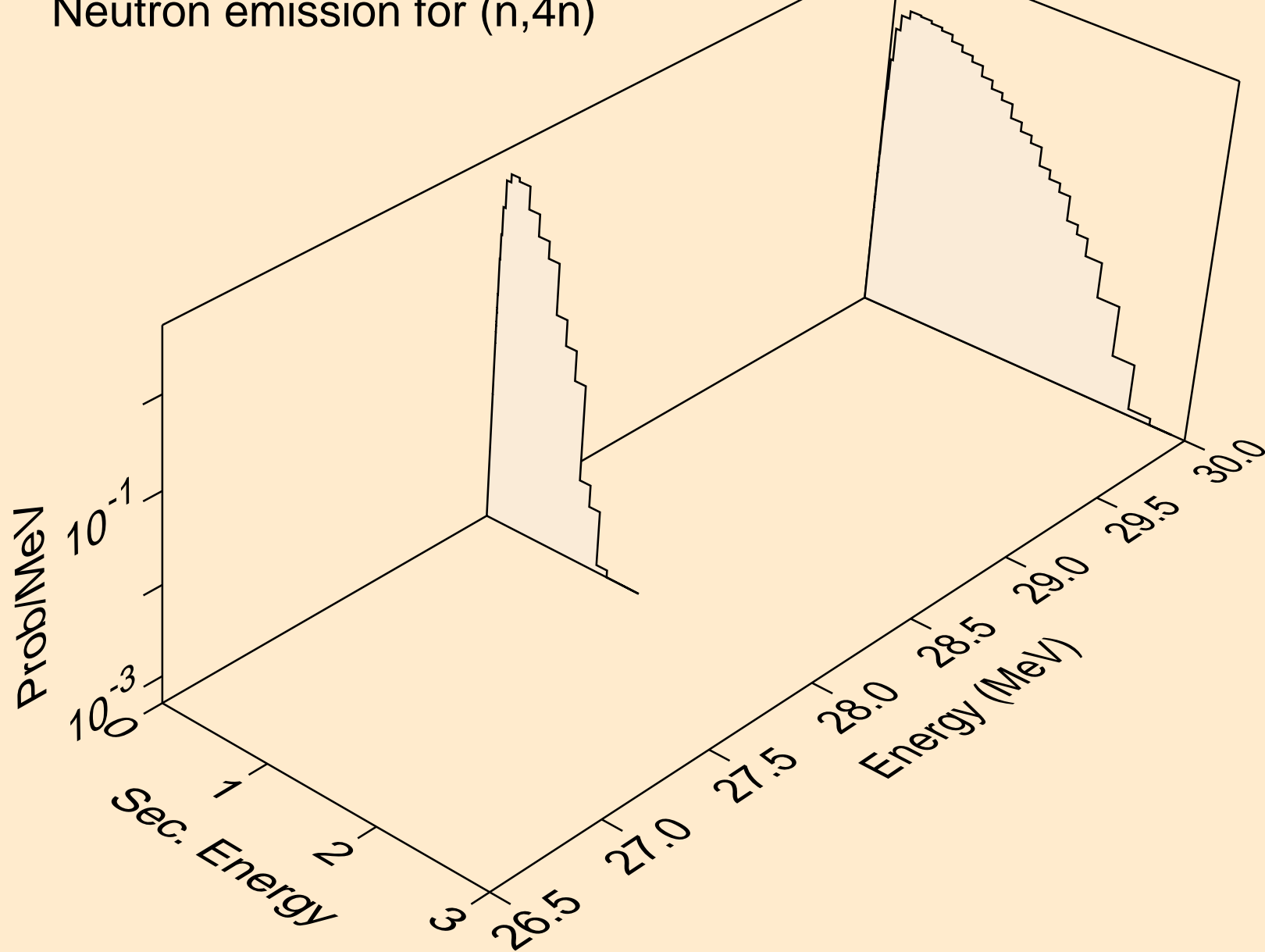

RE177 NEUTRON ACER TENDL-2023 LIBRARY; T=0.K
Neutron emission for (n,2np)

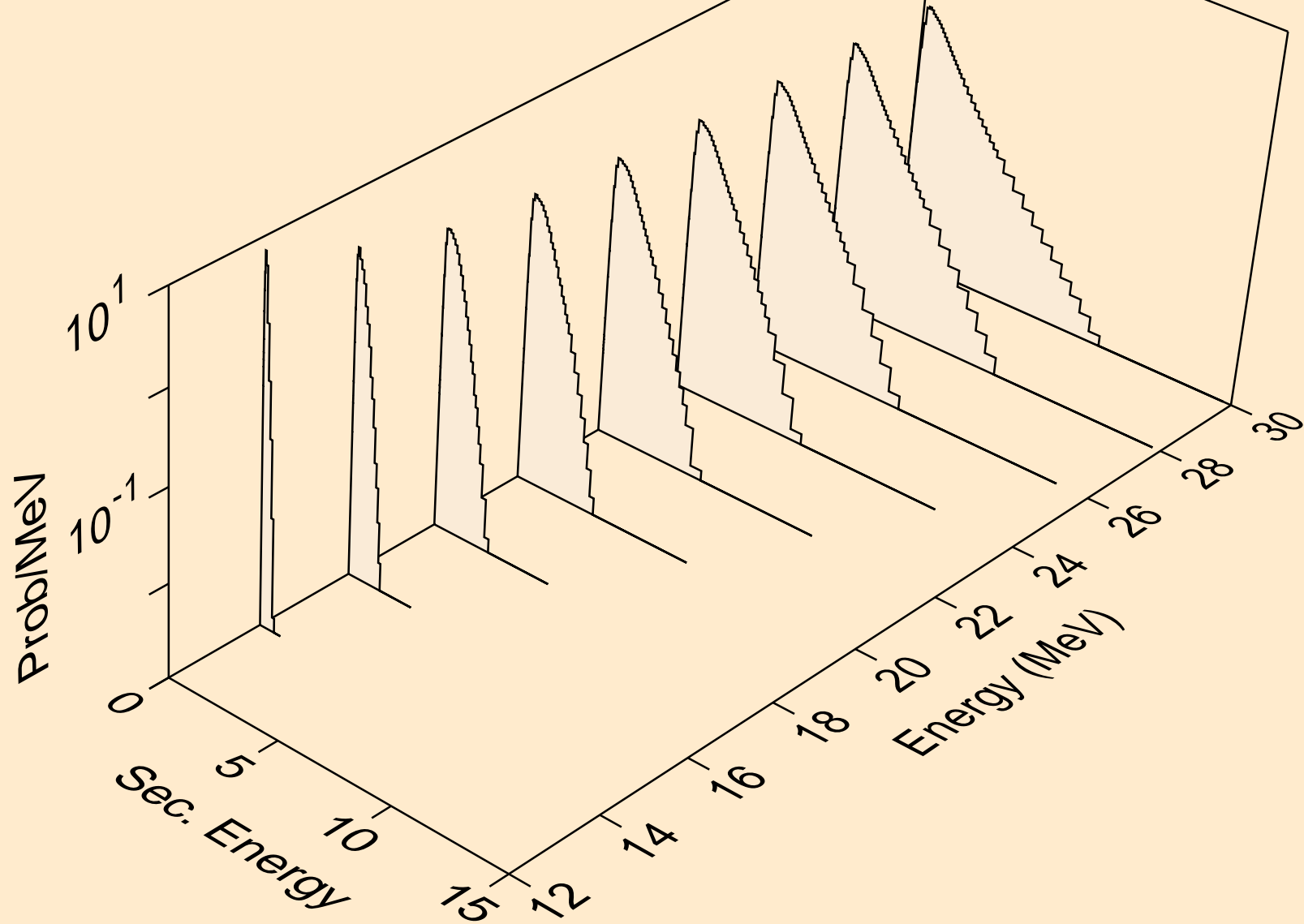

RE177 NEUTRON ACER TENDL-2023 LIBRARY; T=0.K
Neutron emission for (n,3np)

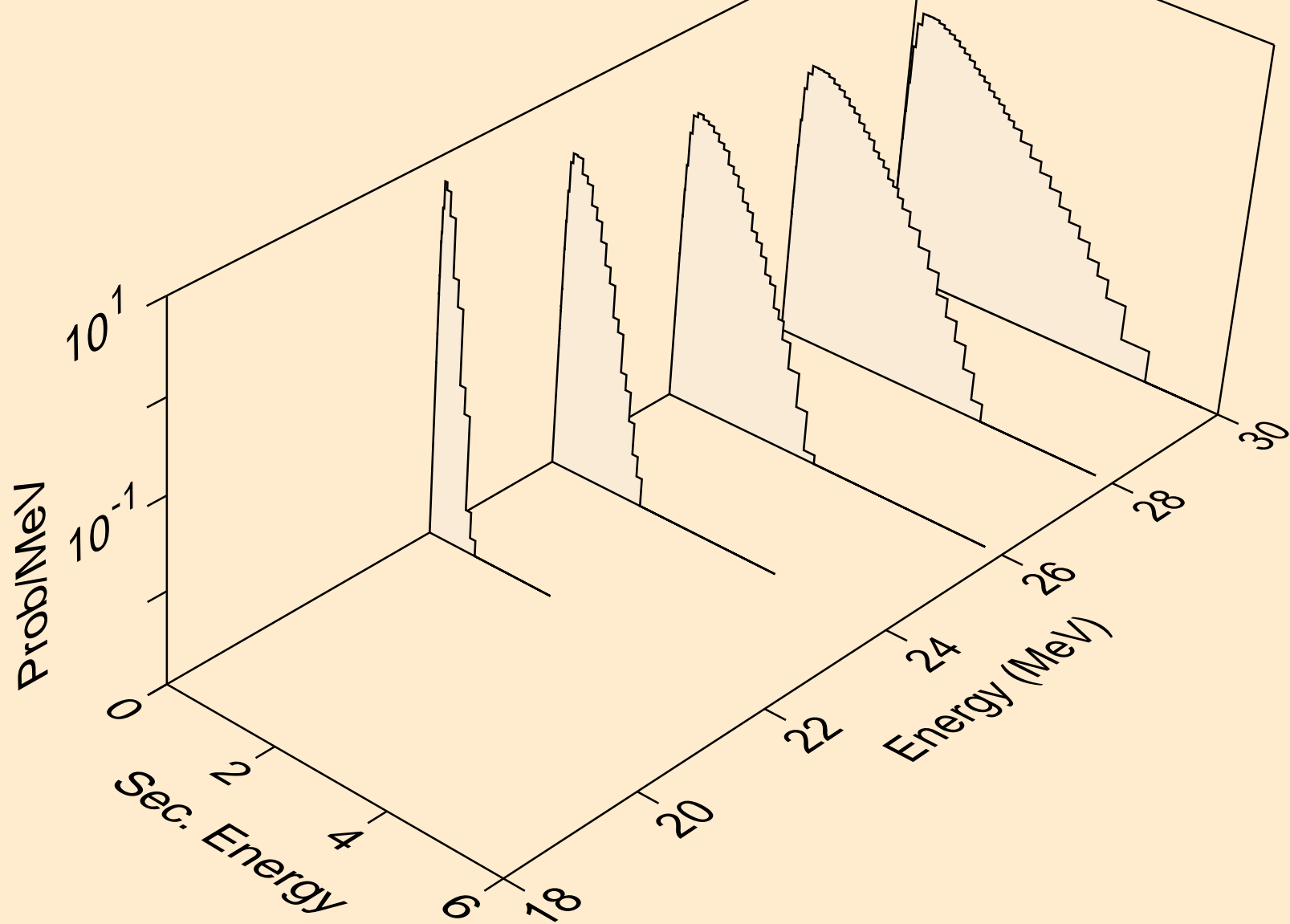

RE177 NEUTRON ACER TENDL-2023 LIBRARY; T=0.K
Neutron emission for (n,n2p)

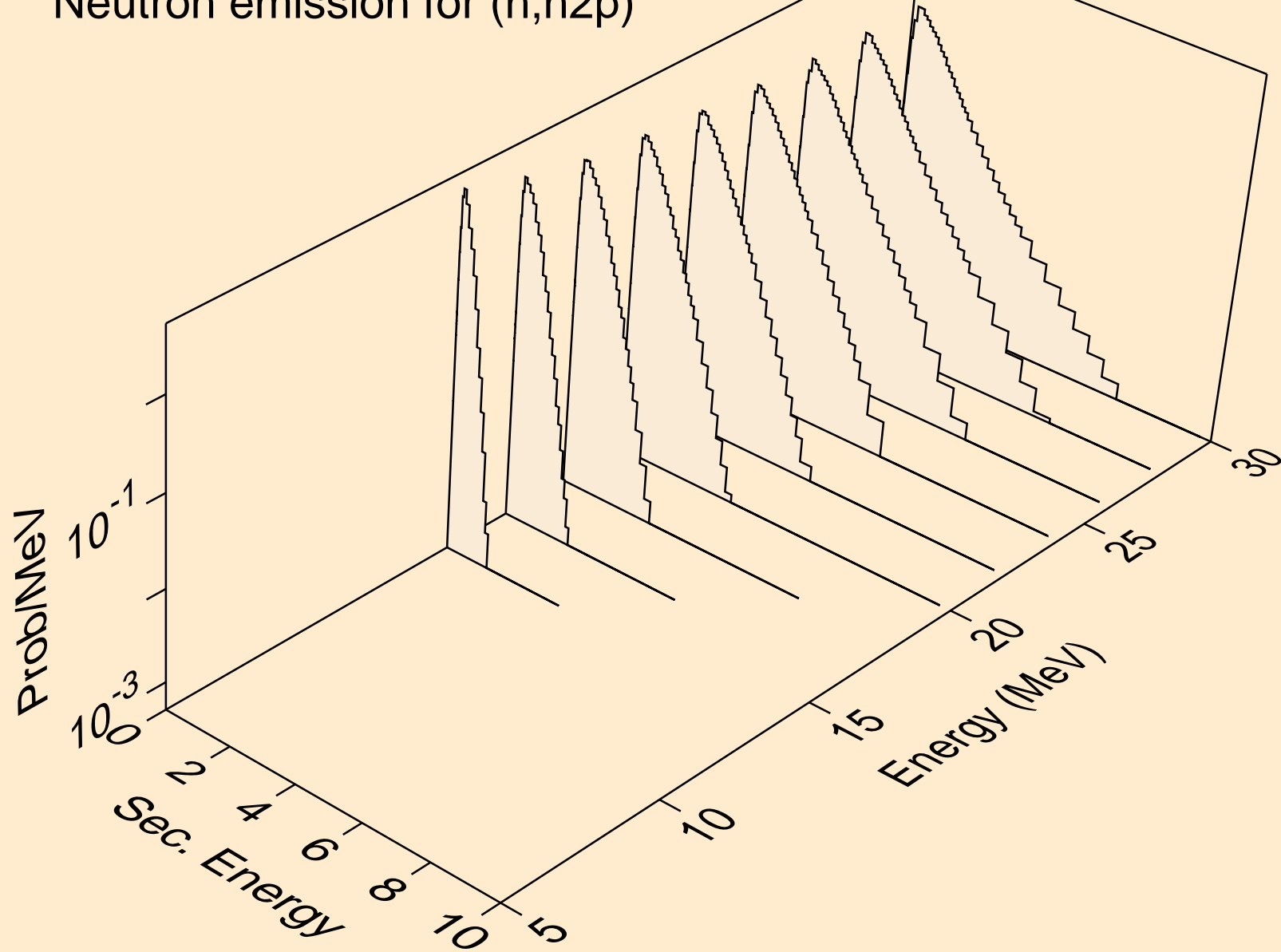

RE177 NEUTRON ACER TENDL-2023 LIBRARY; T=0.K
Neutron emission for (n,npa)

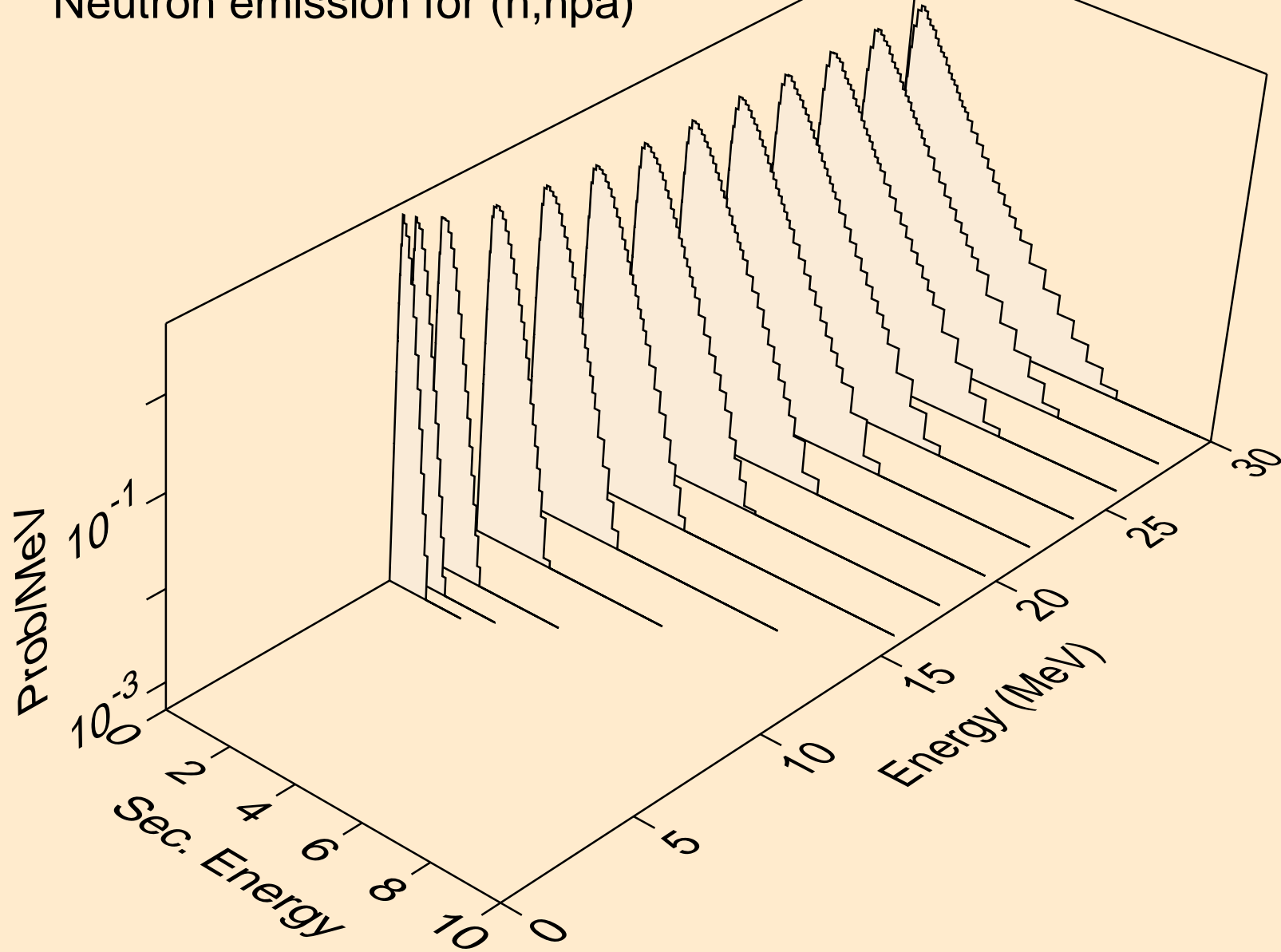

RE177 NEUTRON ACER TENDL-2023 LIBRARY; T=0.K
Neutron emission for (n,n*c)

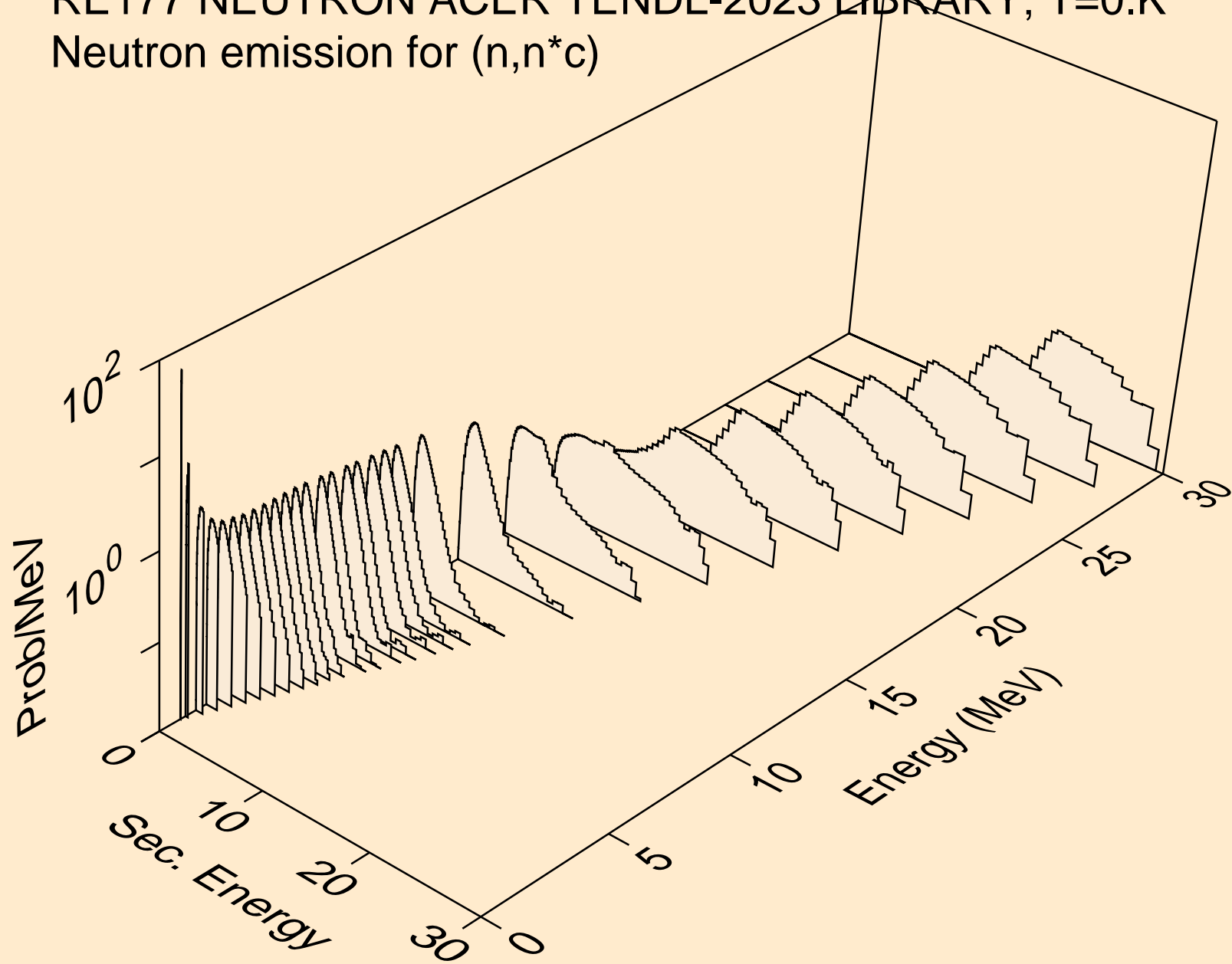

RE177 NEUTRON ACER TENDL-2023 LIBRARY; T=0.K
Photon emission for (n,x)

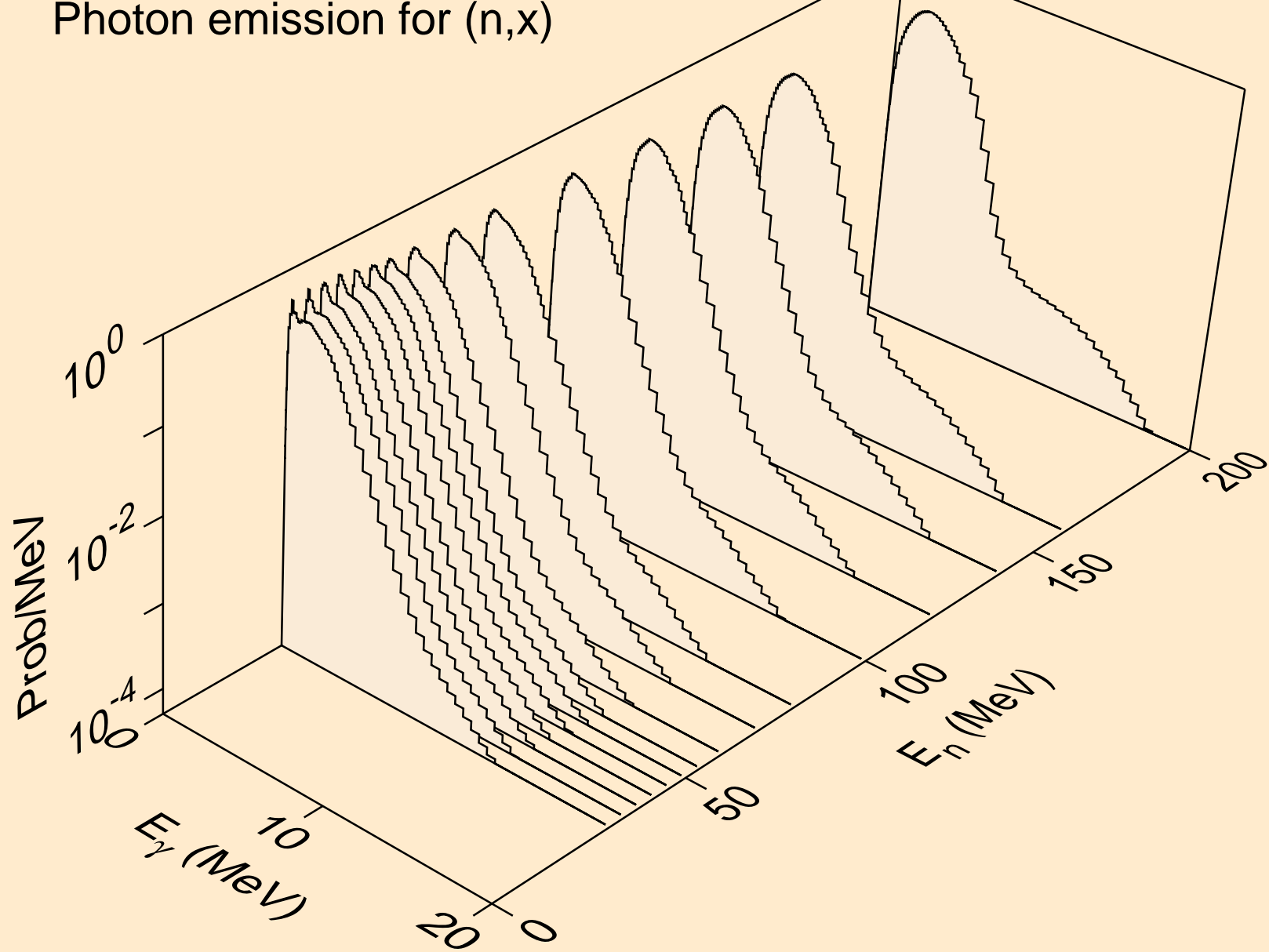

RE177 NEUTRON ACER TENDL-2023 LIBRARY; T=0.K
Photon emission for (n,2nd)

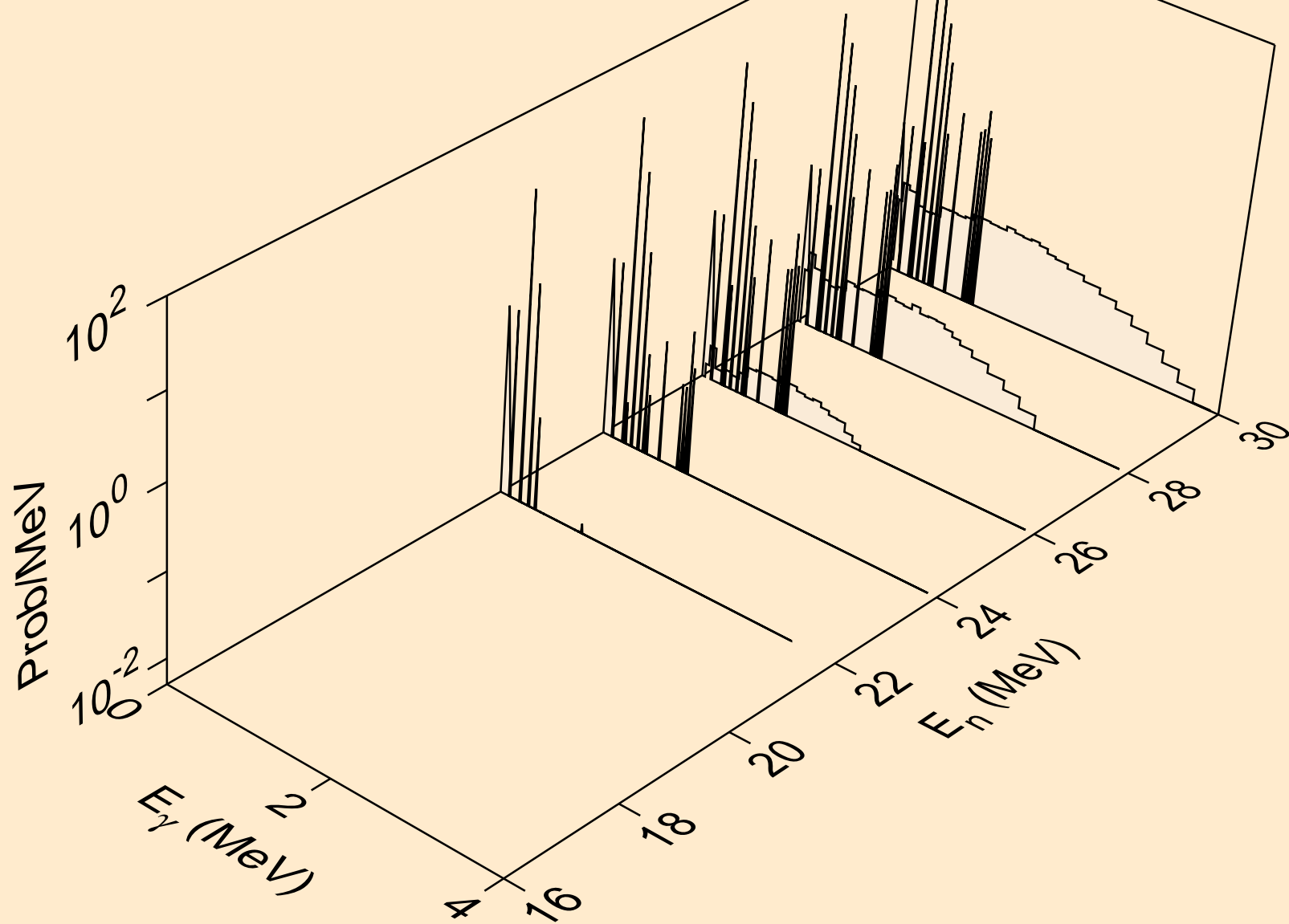

RE177 NEUTRON ACER TENDL-2023 LIBRARY; T=0.K
Photon emission for (n,2n)

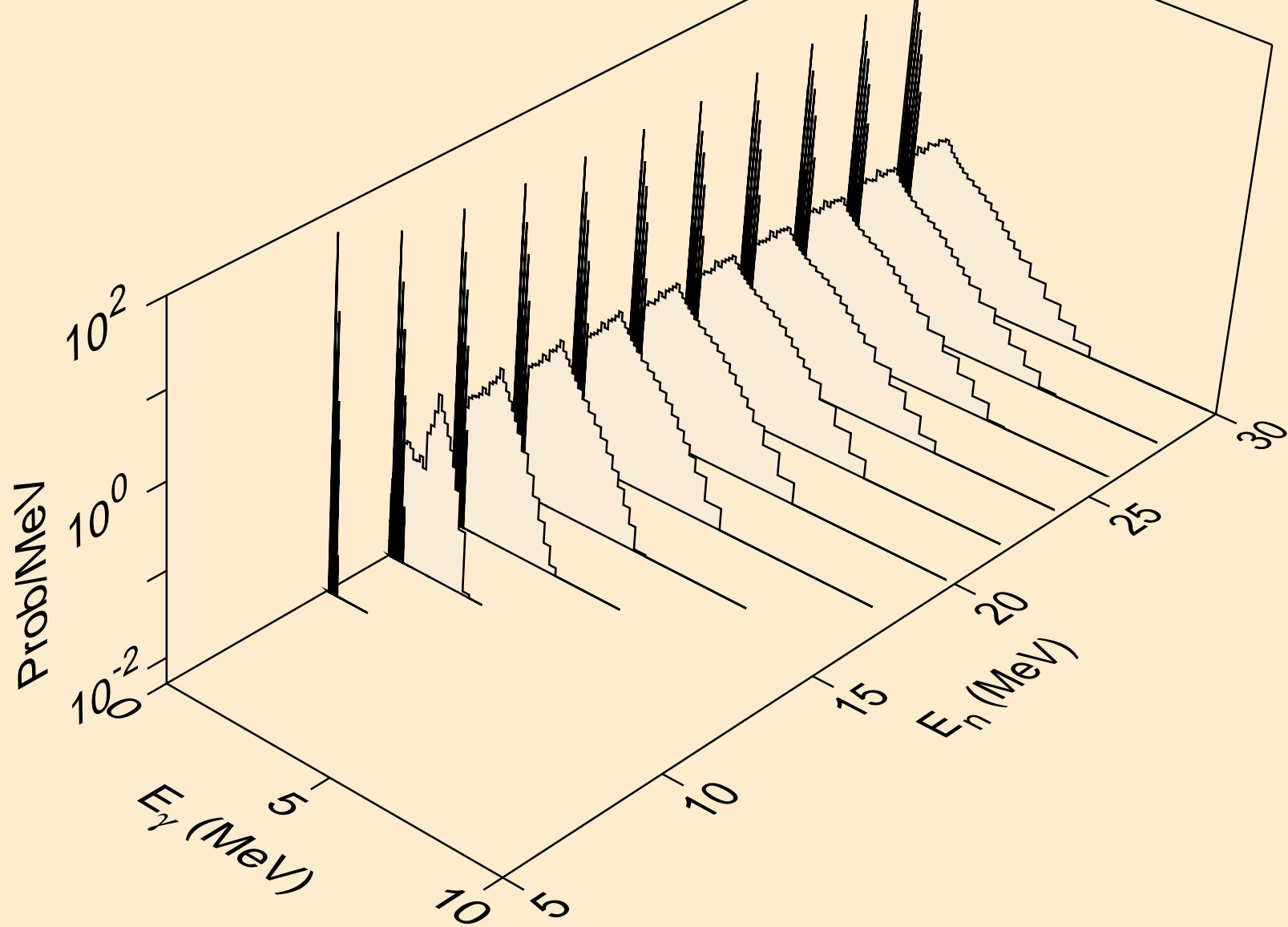

RE177 NEUTRON ACER TENDL-2023 LIBRARY; T=0.K
Photon emission for (n,3n)

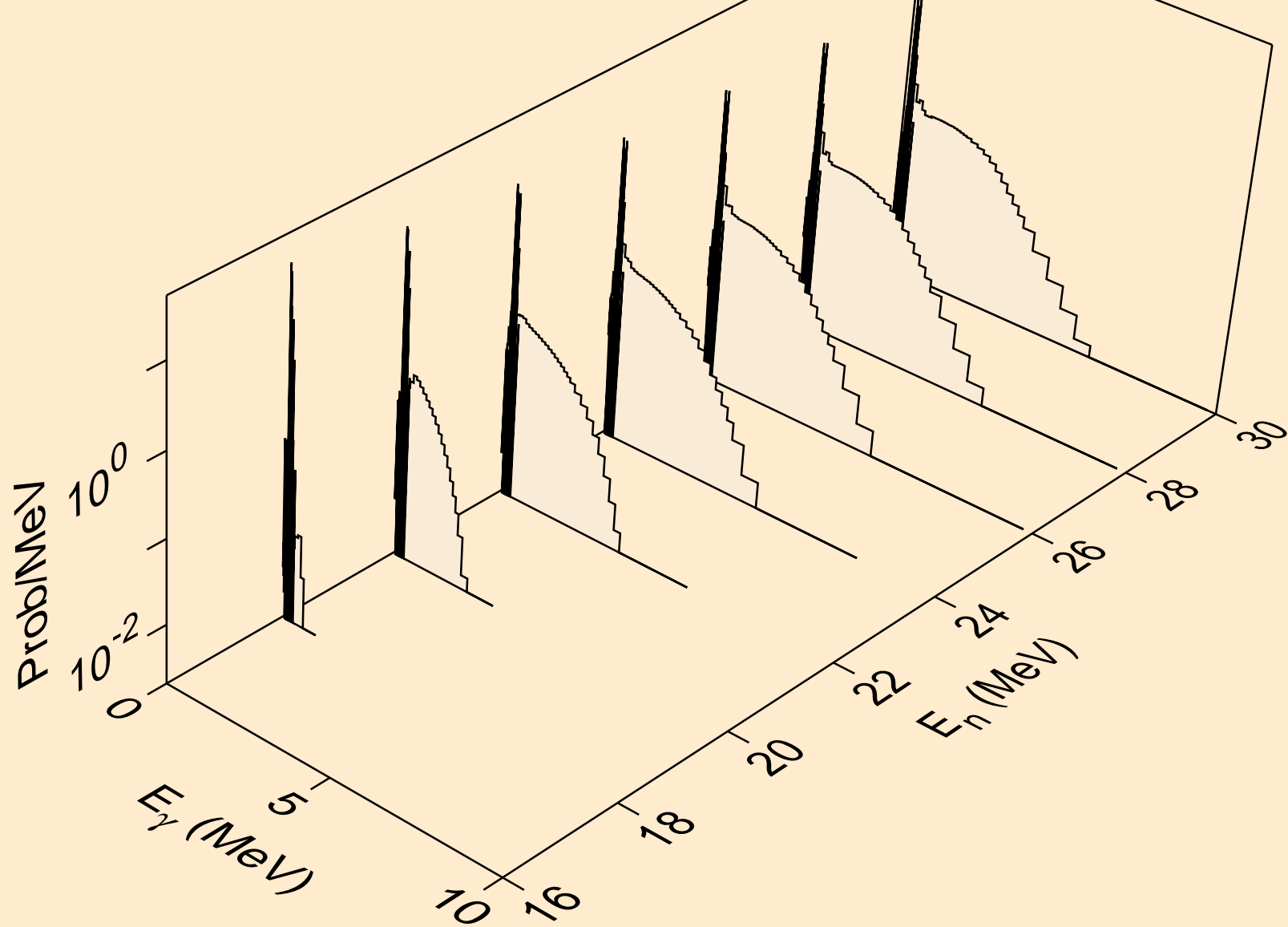

RE177 NEUTRON ACER TENDL-2023 LIBRARY; T=0.K
Photon emission for (n,n*)a

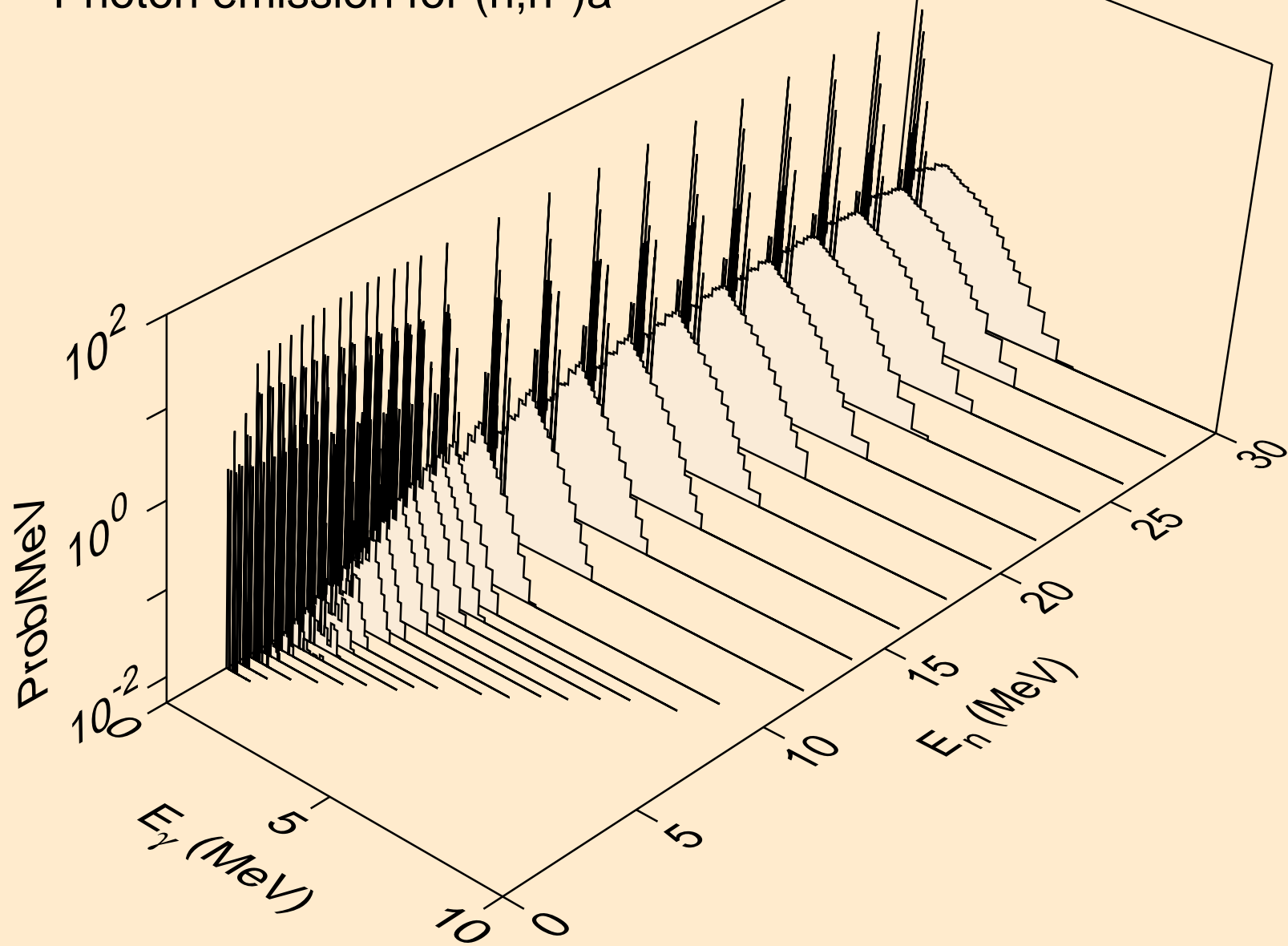

RE177 NEUTRON ACER TENDL-2023 LIBRARY; T=0.K
Photon emission for (n,2n)a

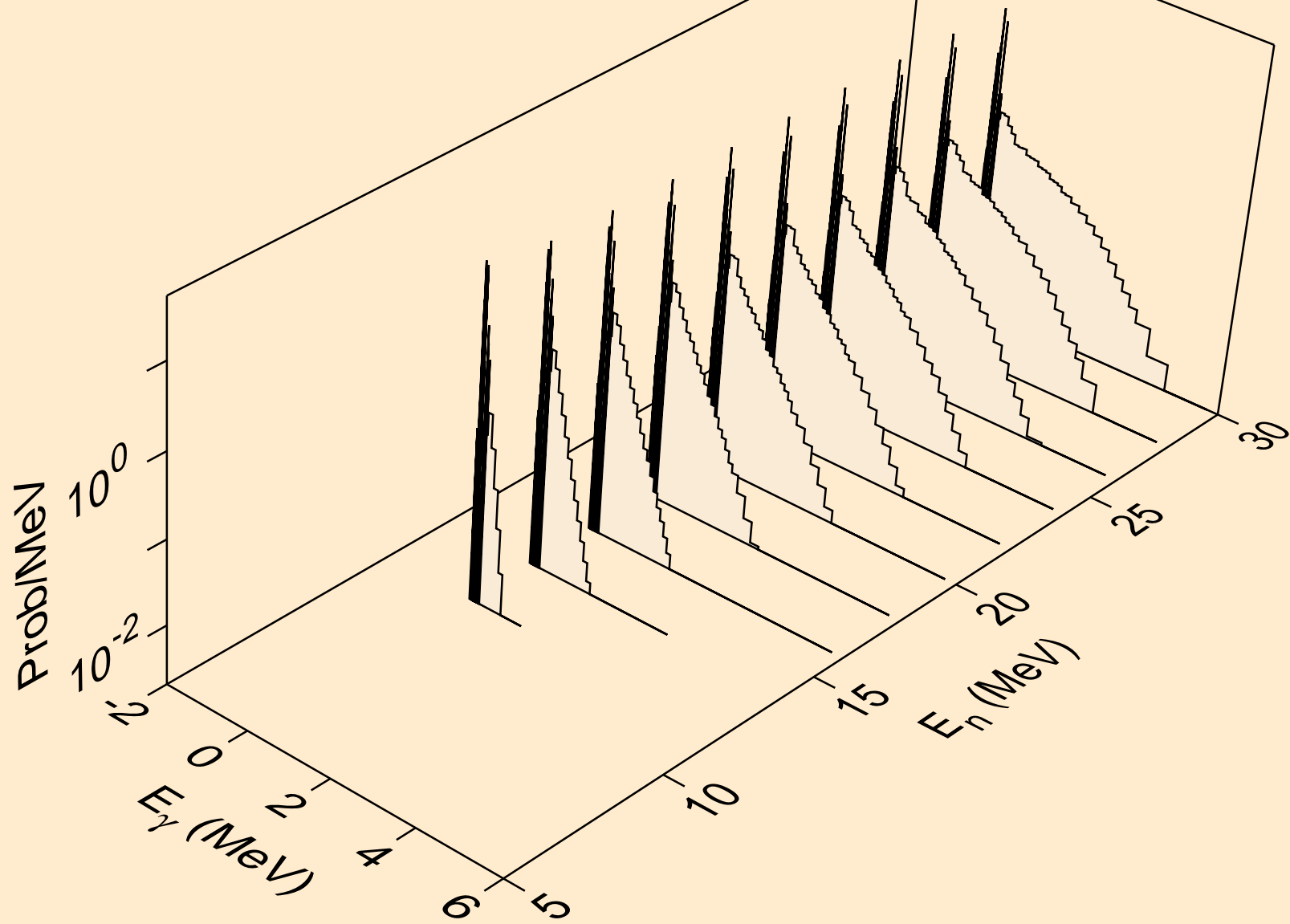

RE177 NEUTRON ACER TENDL-2023 LIBRARY; T=0.K
Photon emission for (n,3n)a

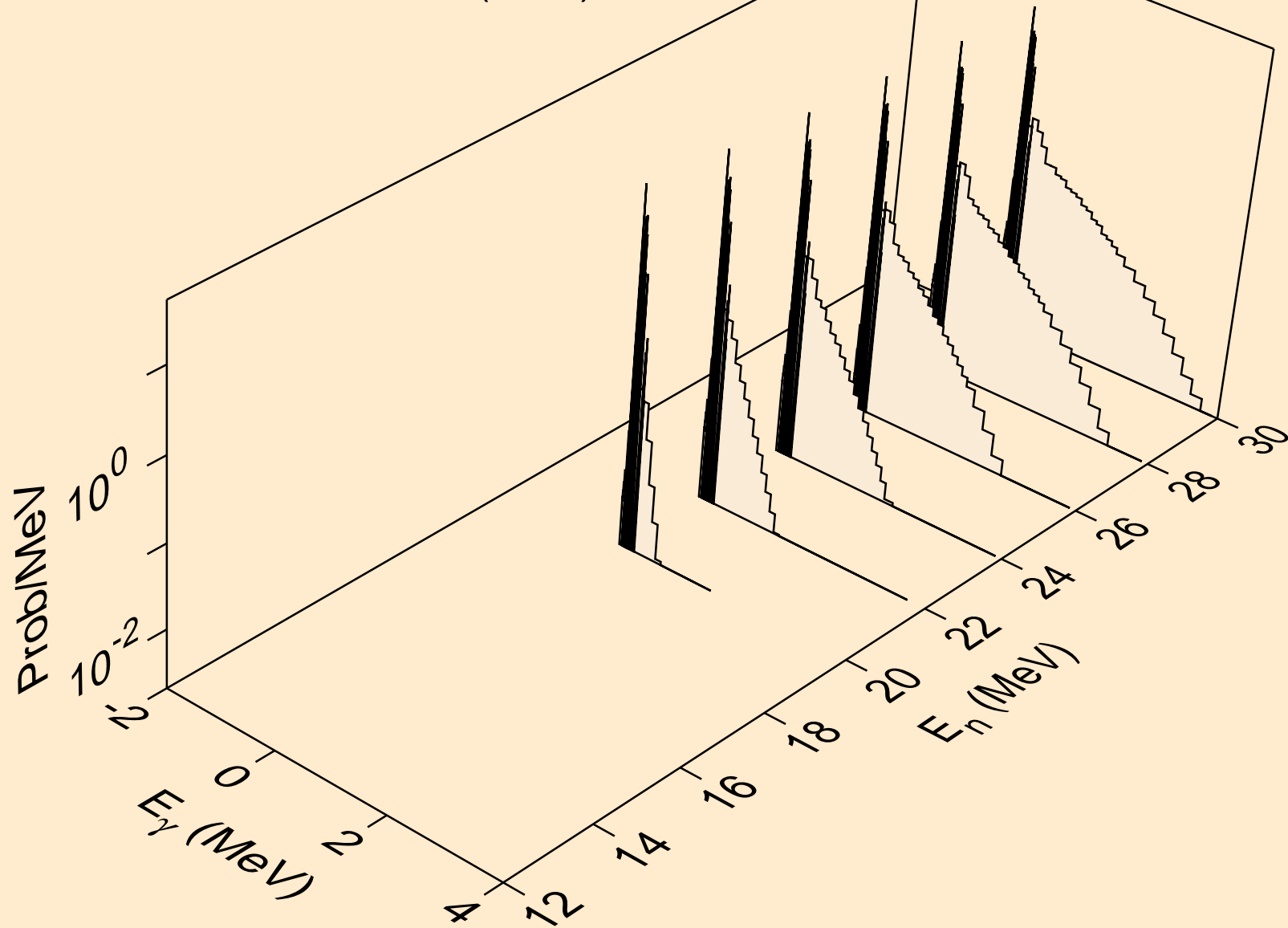

RE177 NEUTRON ACER TENDL-2023 LIBRARY; T=0.K
Photon emission for (n,n*)p

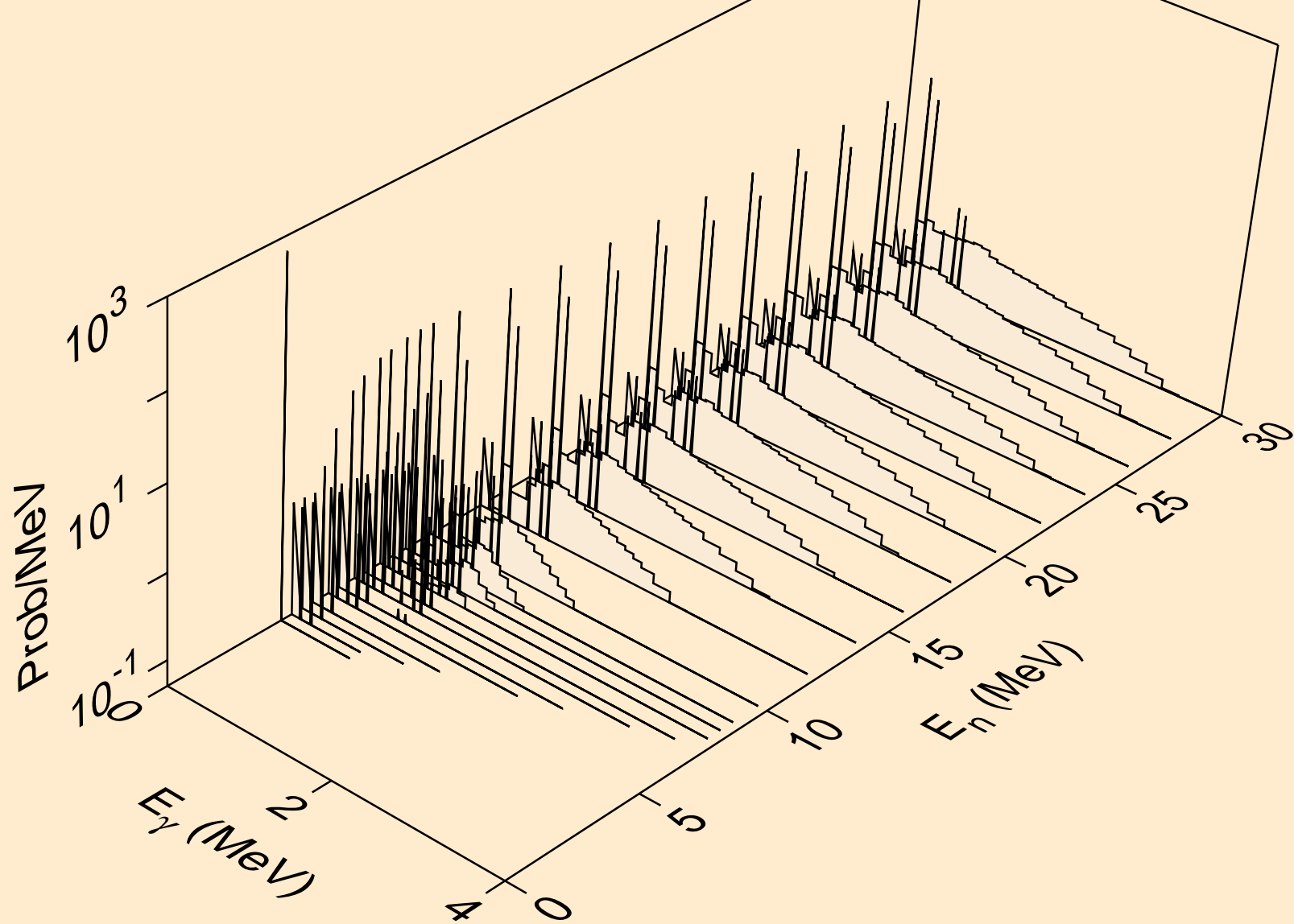

RE177 NEUTRON ACER TENDL-2023 LIBRARY; T=0.K
Photon emission for (n,n*)2a

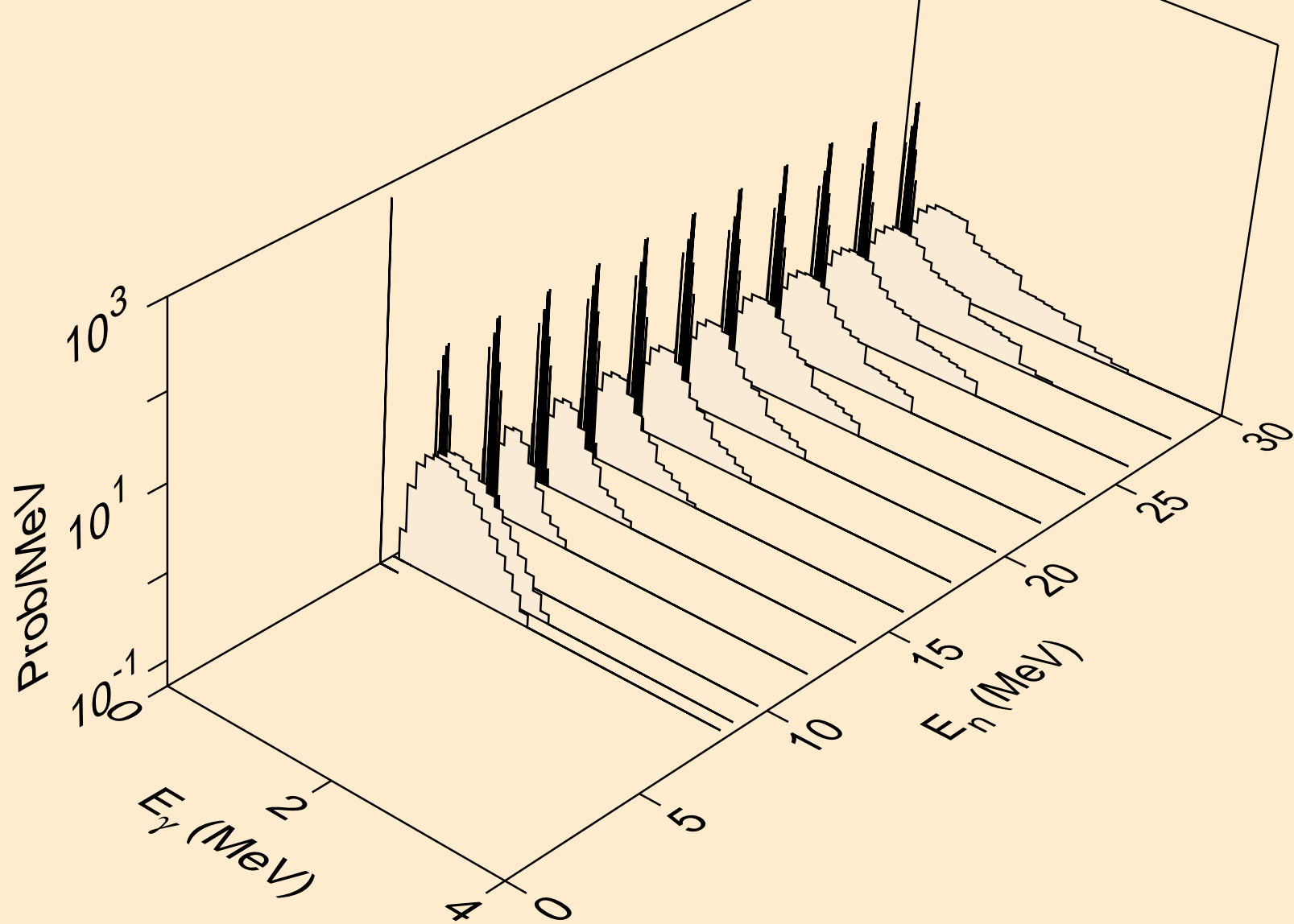

RE177 NEUTRON ACER TENDL-2023 LIBRARY; T=0.K
Photon emission for (n,2n)2a

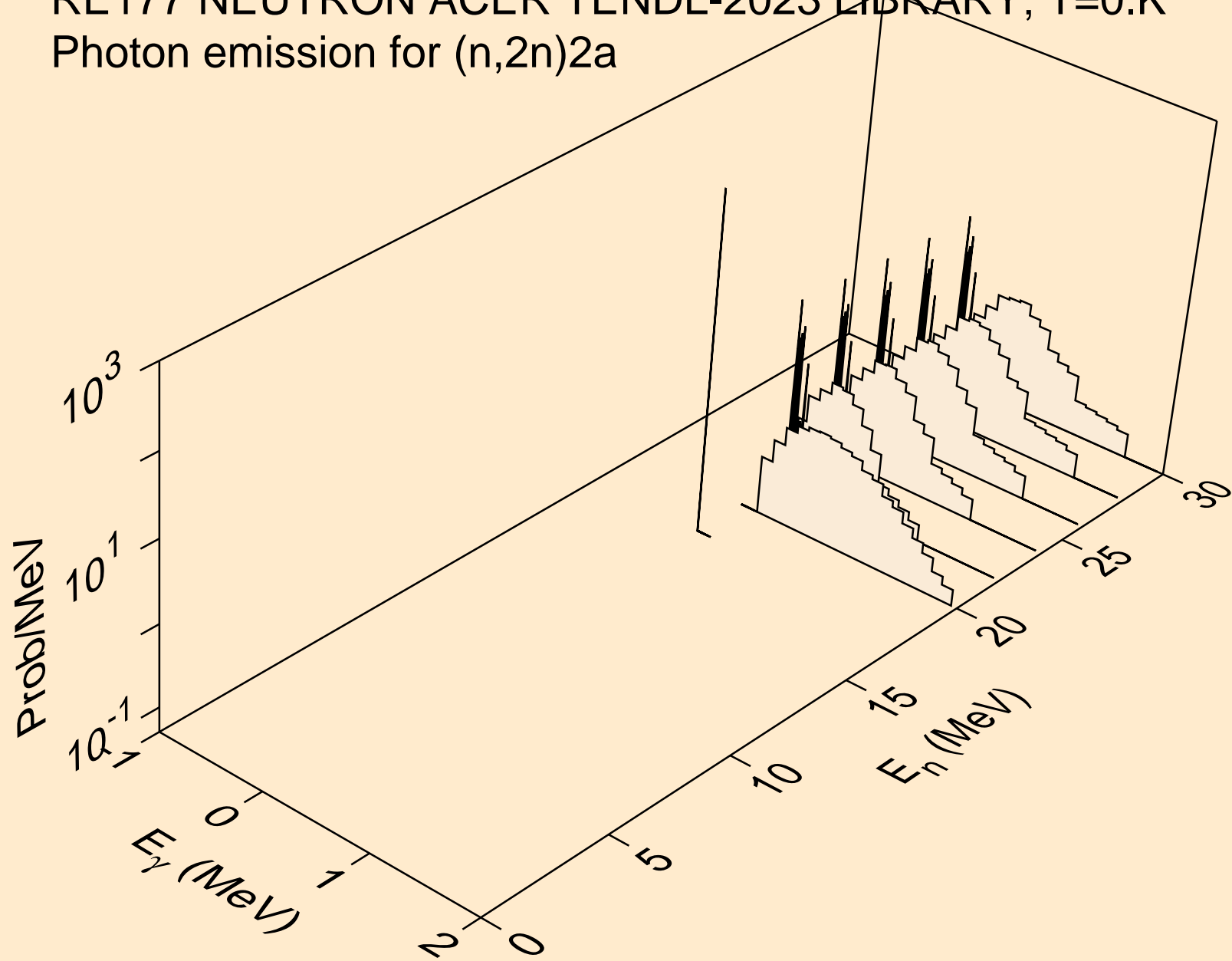

RE177 NEUTRON ACER TENDL-2023 LIBRARY; T=0.K
Photon emission for (n,n*)d

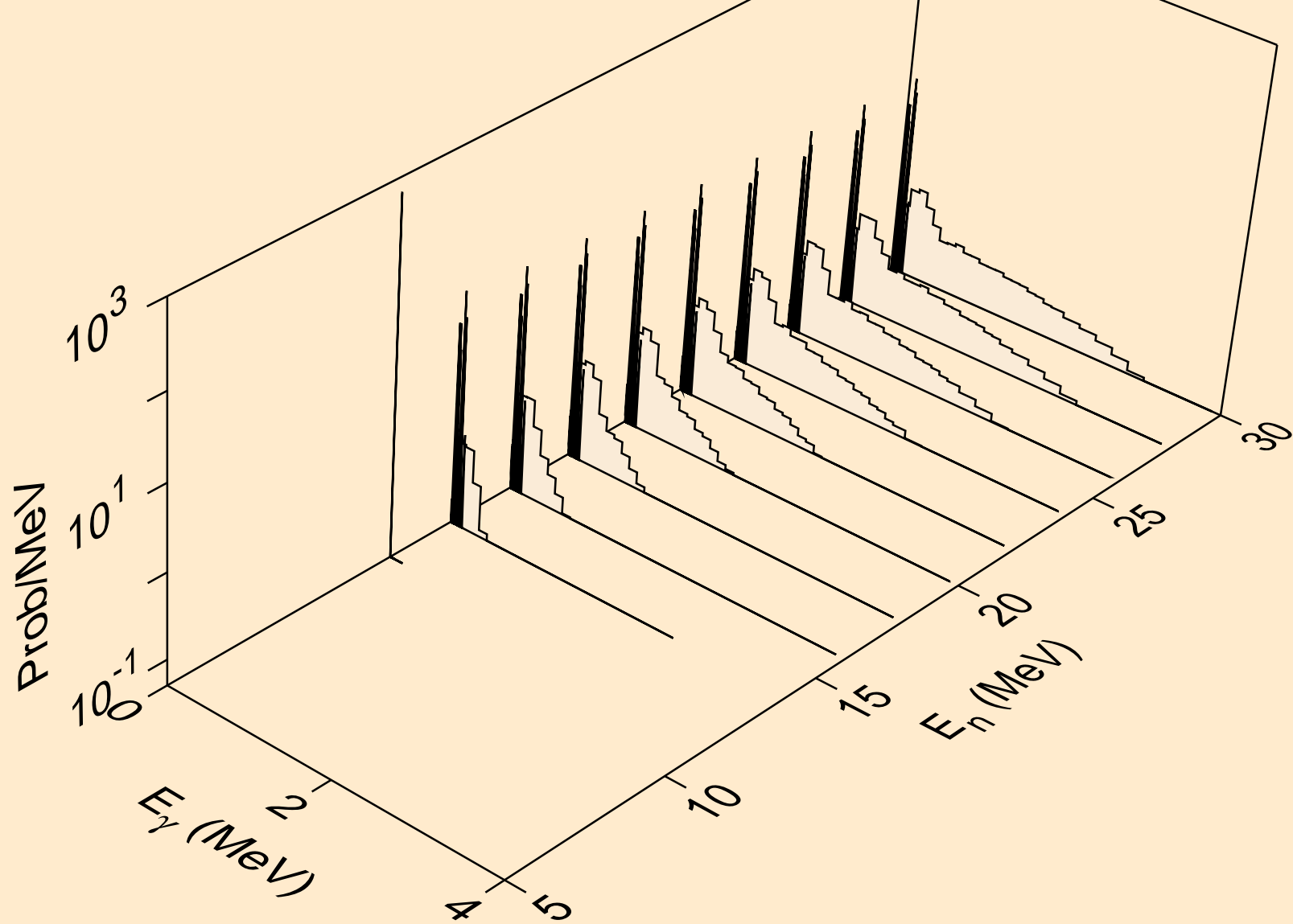

RE177 NEUTRON ACER TENDL-2023 LIBRARY; T=0.K
Photon emission for (n,n*)t

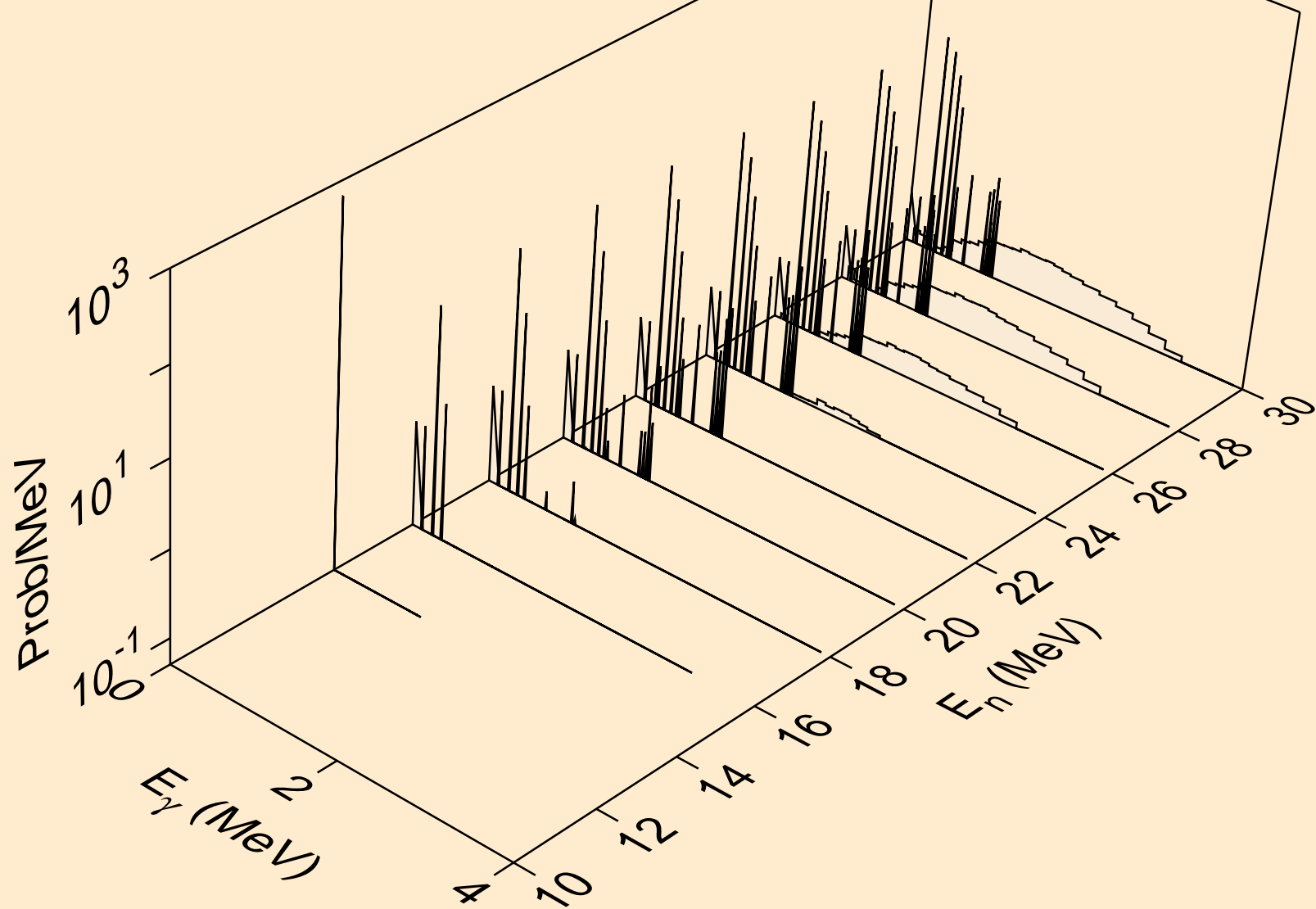

RE177 NEUTRON ACER TENDL-2023 LIBRARY; T=0.K
Photon emission for (n,n*)he3

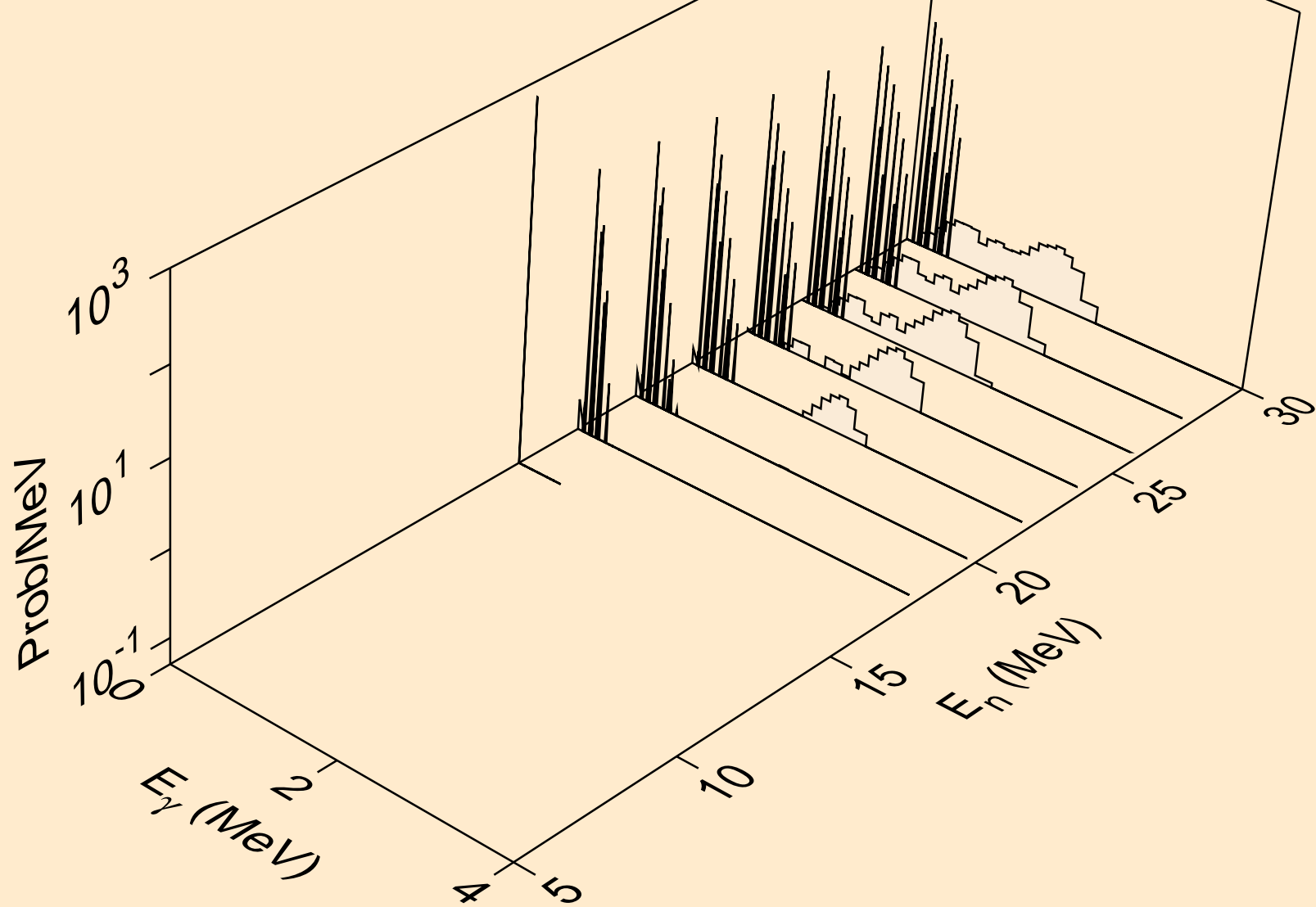

RE177 NEUTRON ACER TENDL-2023 LIBRARY; T=0.K
Photon emission for (n,4n)

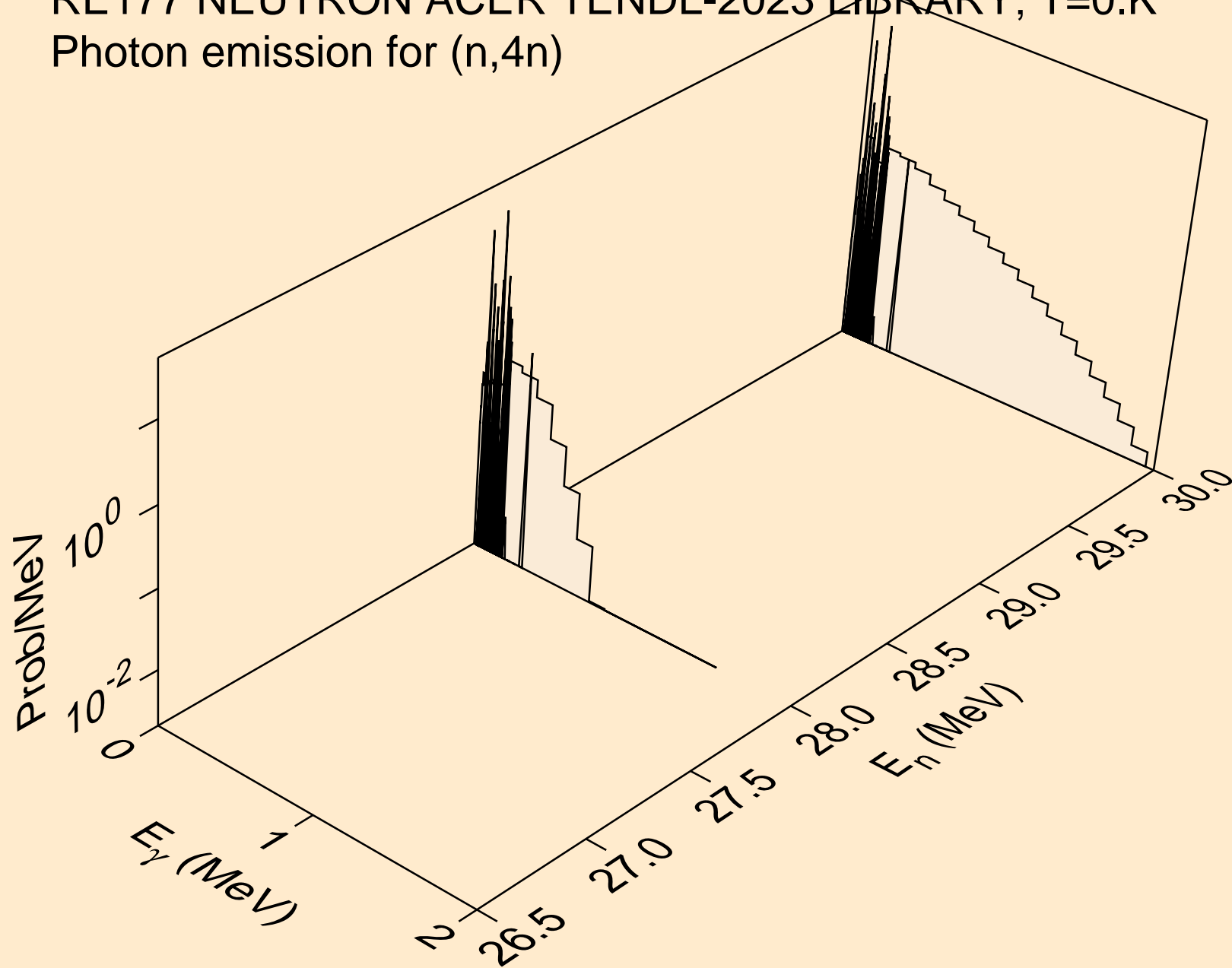

RE177 NEUTRON ACER TENDL-2023 LIBRARY; T=0.K
Photon emission for (n,2np)

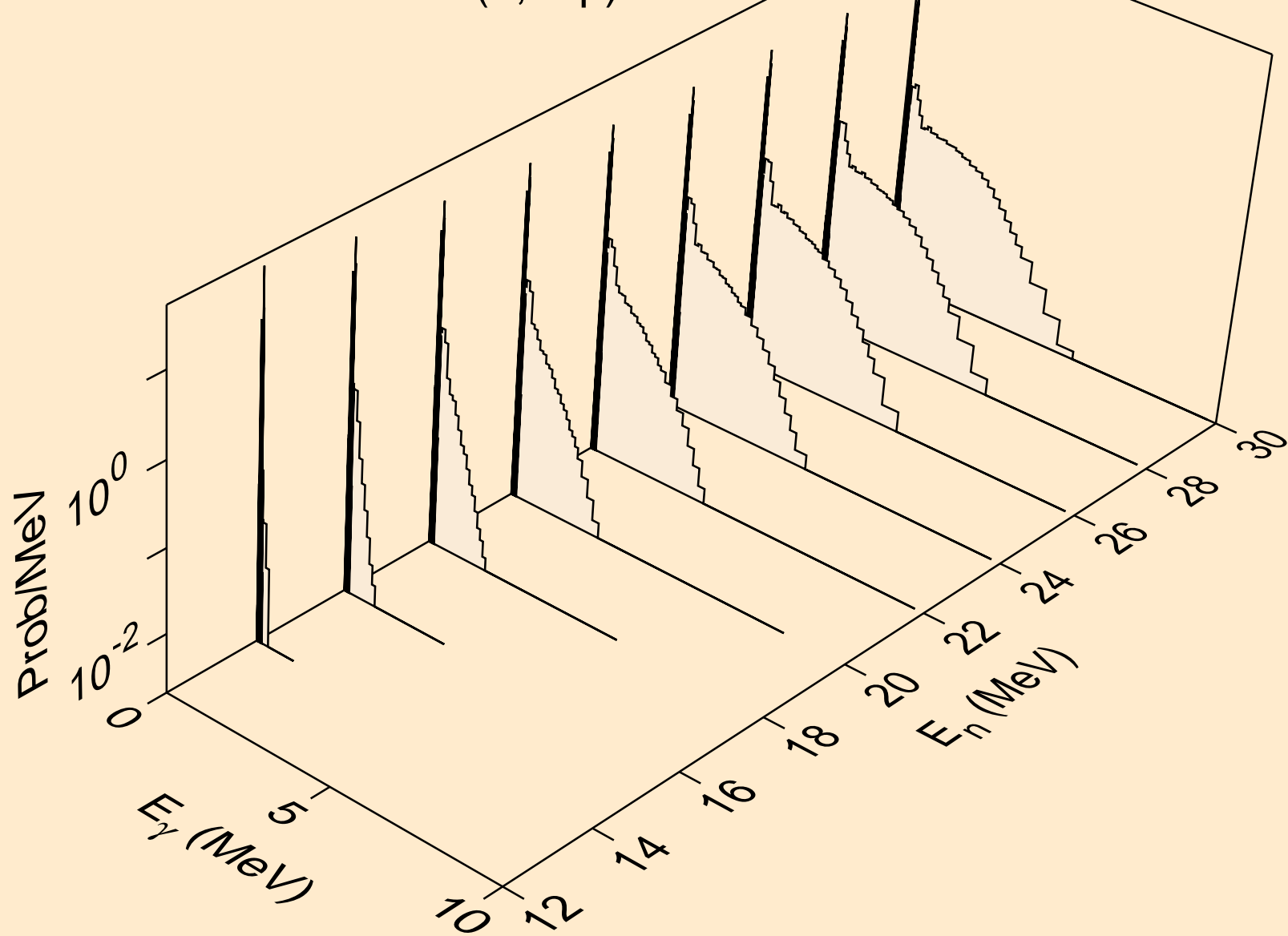

RE177 NEUTRON ACER TENDL-2023 LIBRARY; T=0.K
Photon emission for (n,3np)

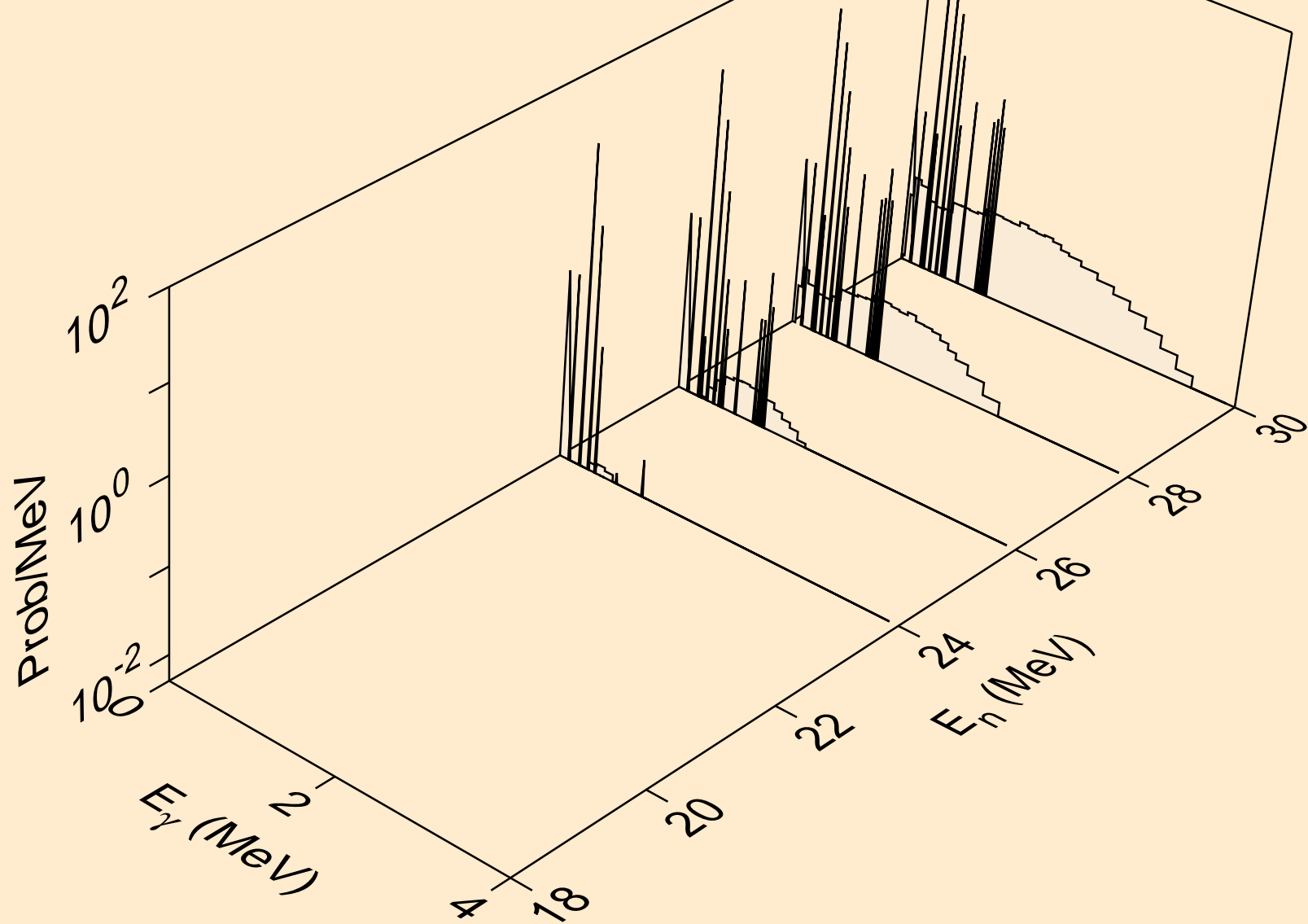

RE177 NEUTRON ACER TENDL-2023 LIBRARY; T=0.K
Photon emission for (n,n2p)

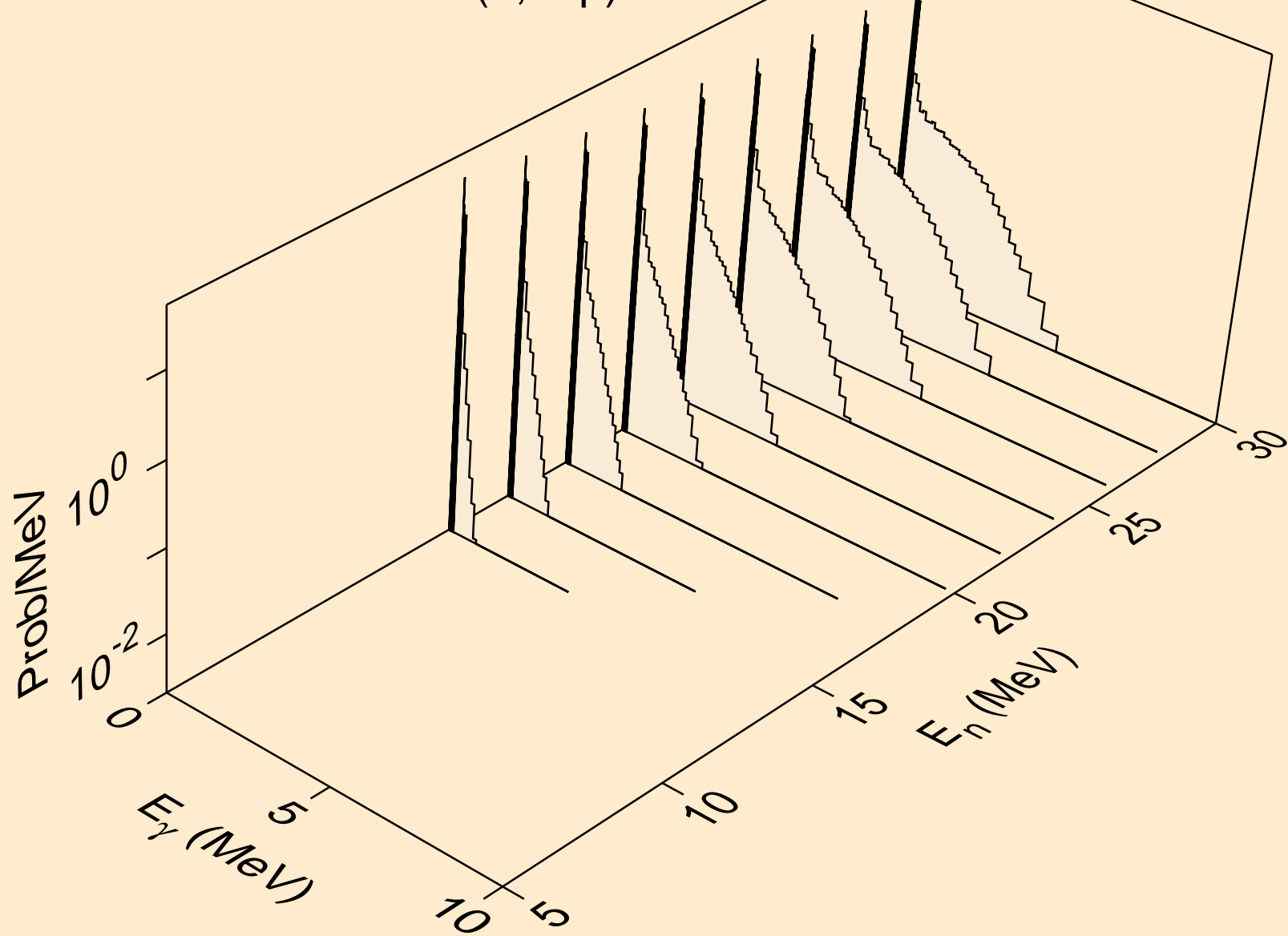

RE177 NEUTRON ACER TENDL-2023 LIBRARY; T=0.K
Photon emission for (n,npa)

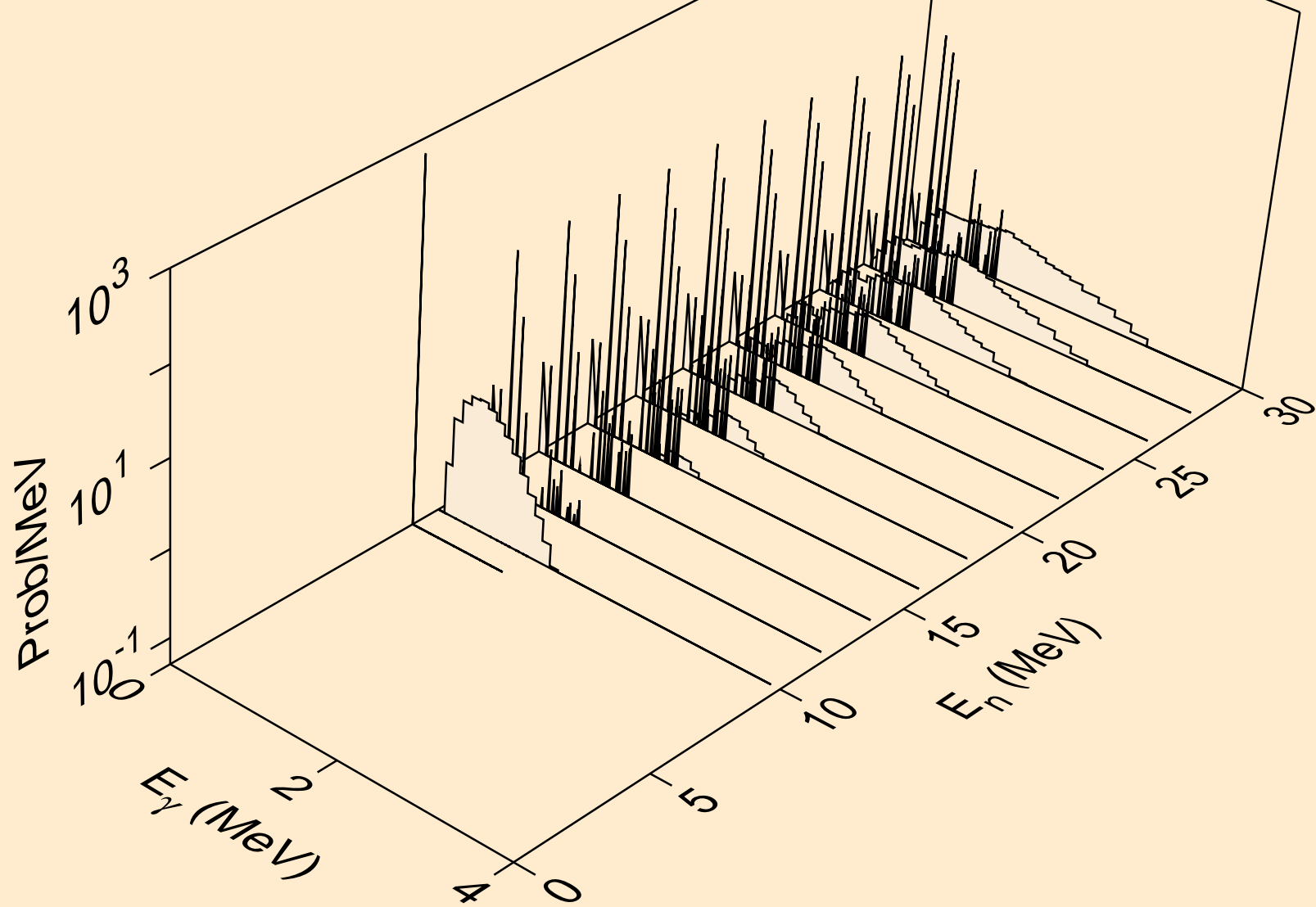

RE177 NEUTRON ACER TENDL-2023 LIBRARY; T=0.K
Photon emission for (n,n*c)

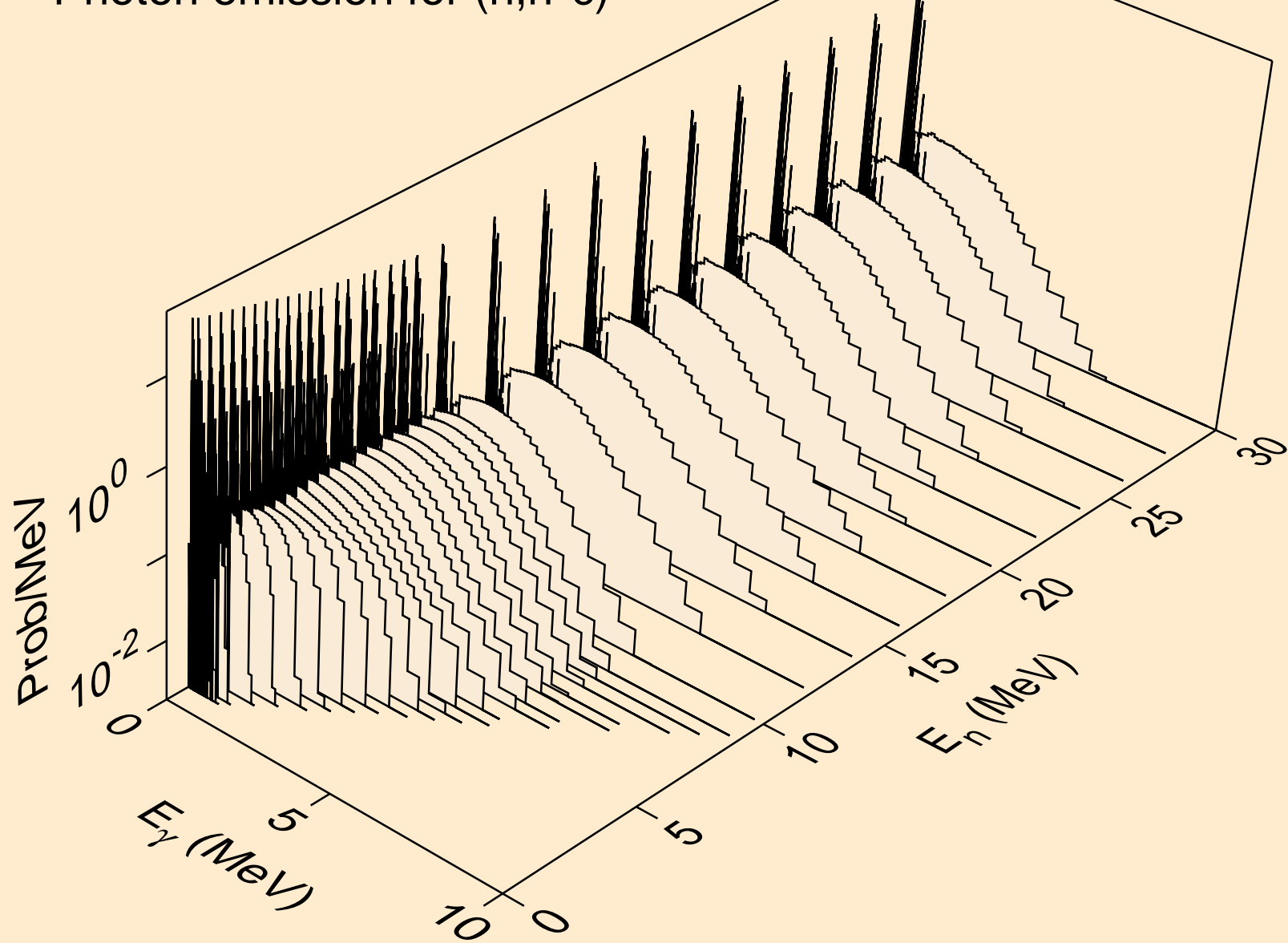

RE177 NEUTRON ACER TENDL-2023 LIBRARY; T=0.K
Photon emission for (n,gma)

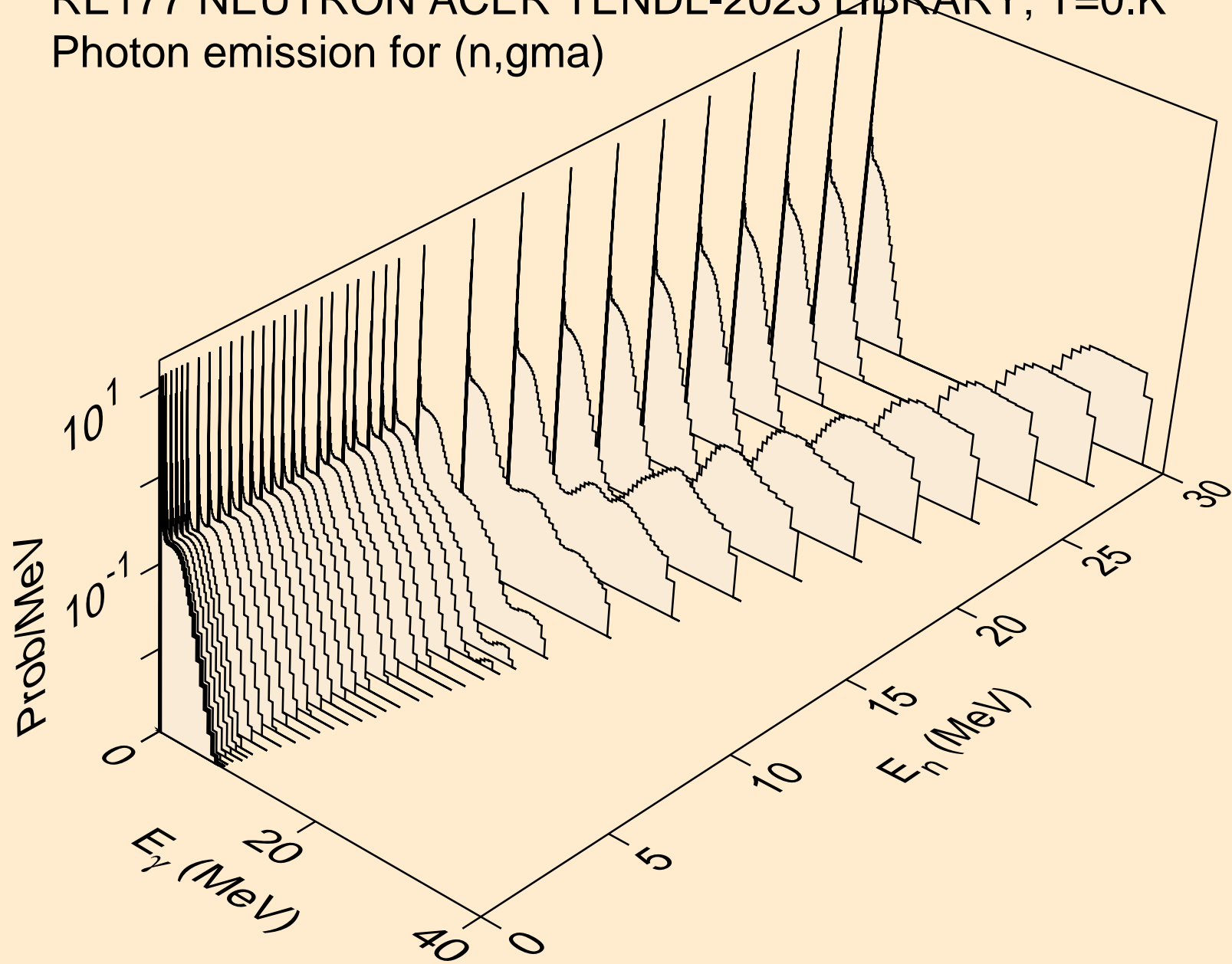

RE177 NEUTRON ACER TENDL-2023 LIBRARY; T=0.K
Photon emission for (n,p)

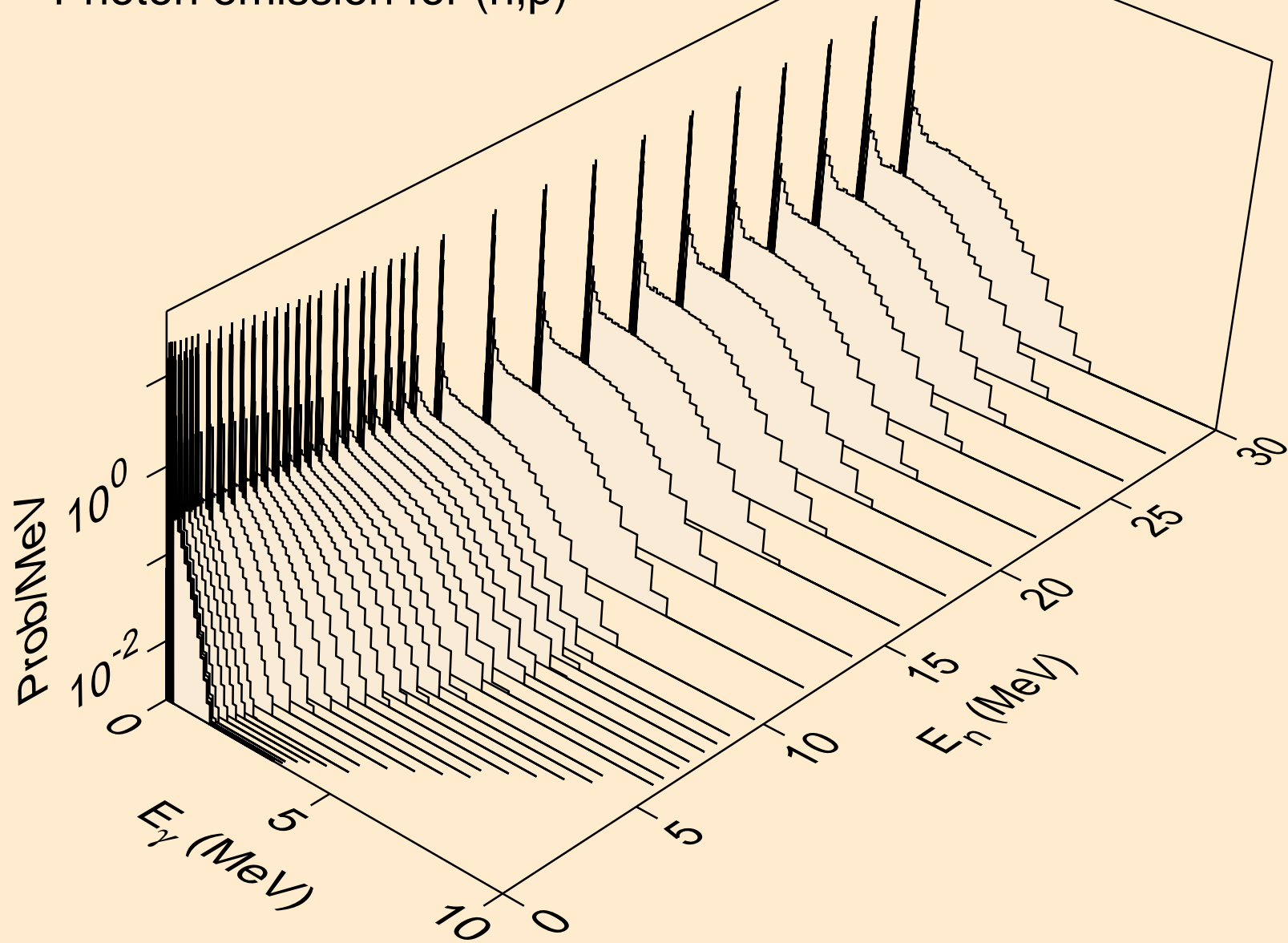

RE177 NEUTRON ACER TENDL-2023 LIBRARY; T=0.K
Photon emission for (n,d)

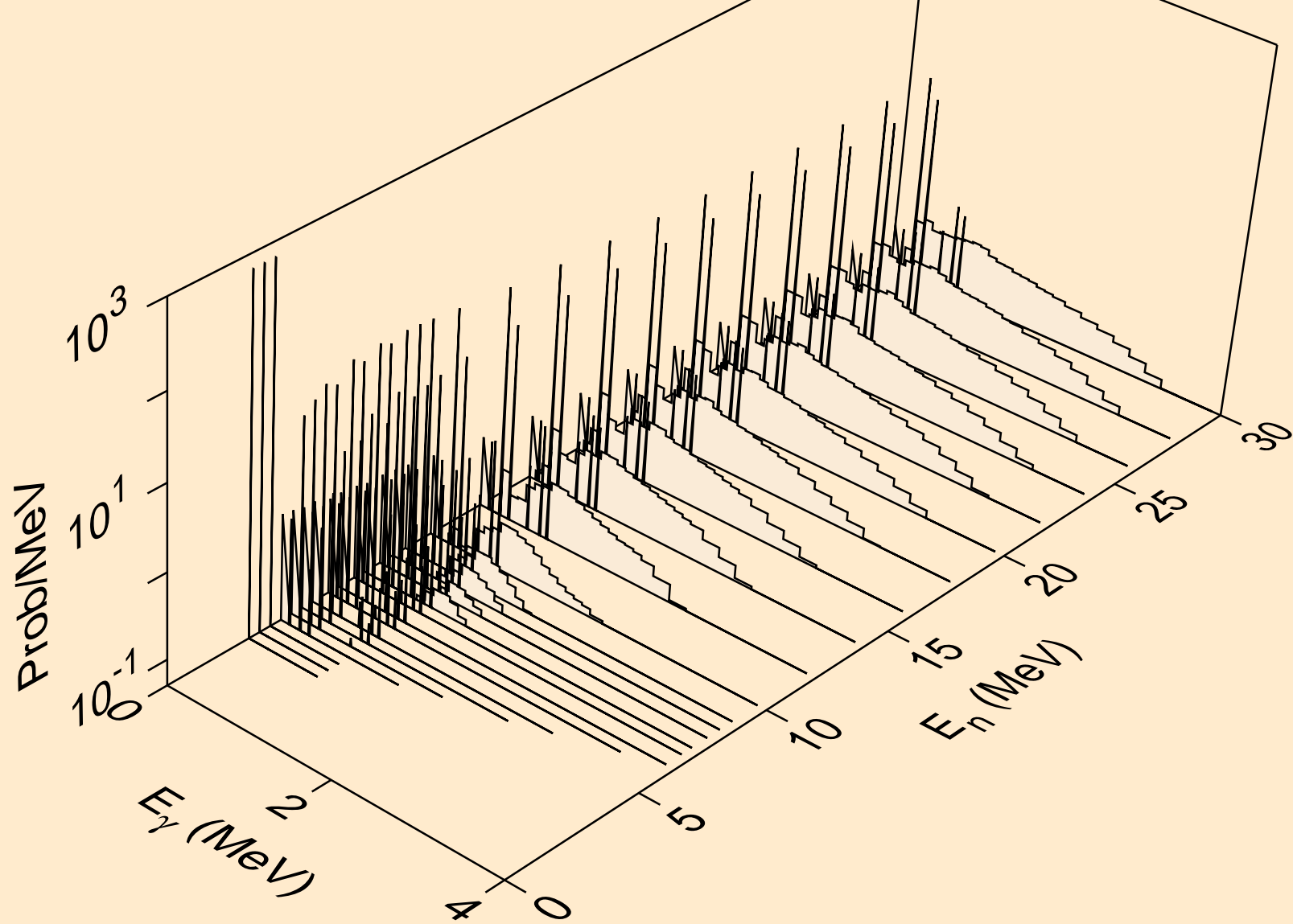

RE177 NEUTRON ACER TENDL-2023 LIBRARY; T=0.K
Photon emission for (n,t)

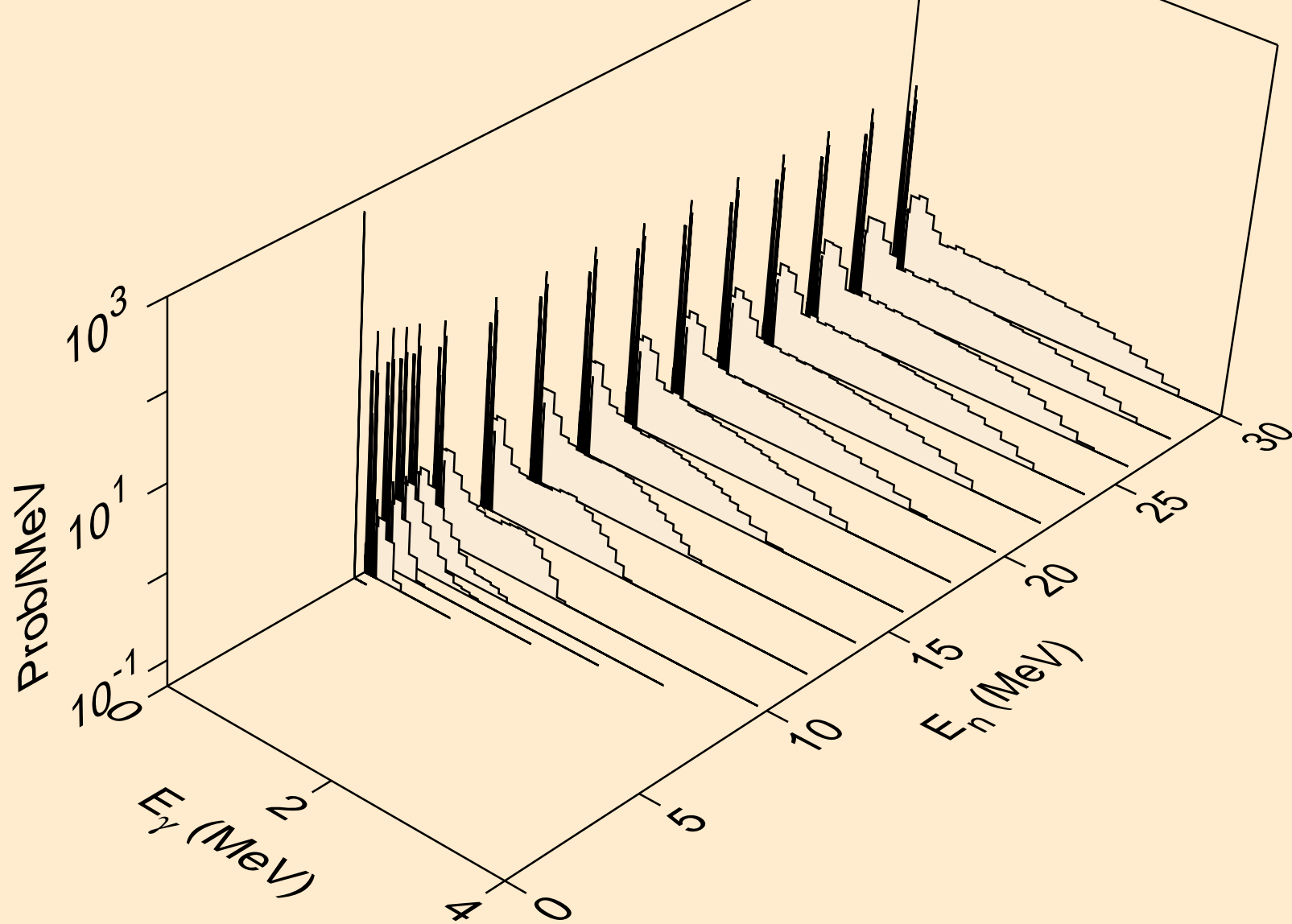

RE177 NEUTRON ACER TENDL-2023 LIBRARY; T=0.K
Photon emission for (n,he3)

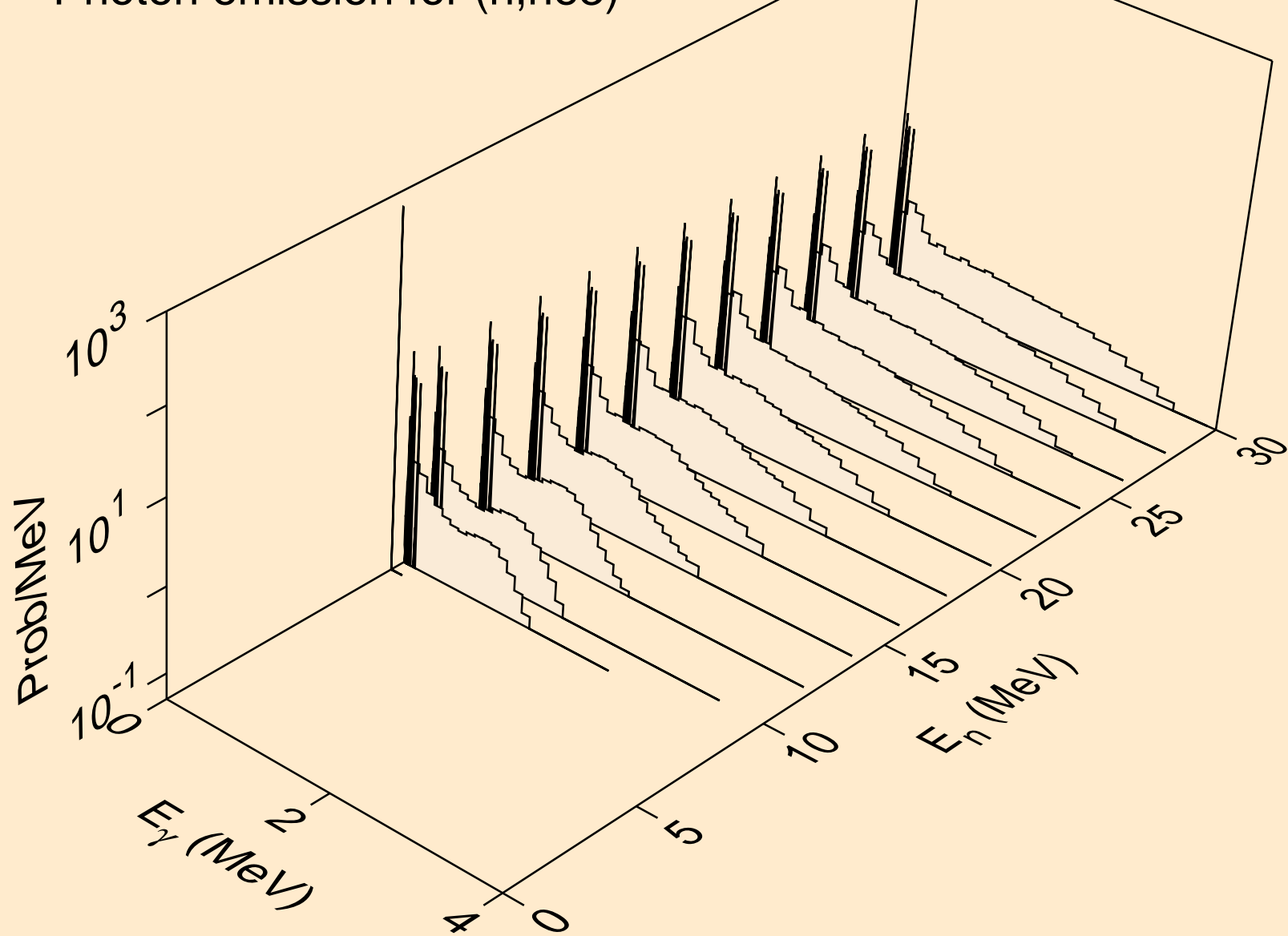

RE177 NEUTRON ACER TENDL-2023 LIBRARY; T=0.K
Photon emission for (n,a)

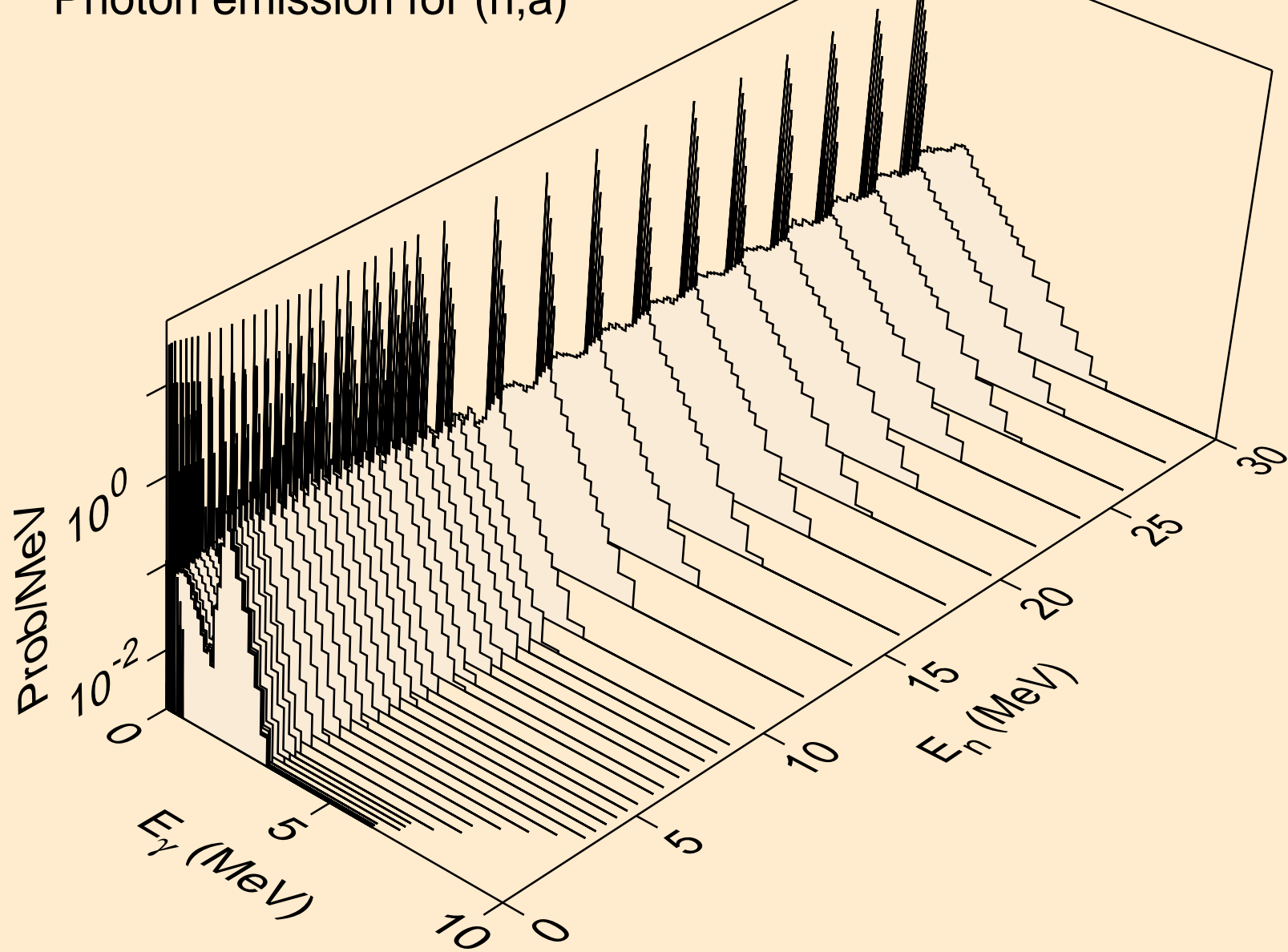

RE177 NEUTRON ACER TENDL-2023 LIBRARY; T=0.K
Photon emission for (n,2a)

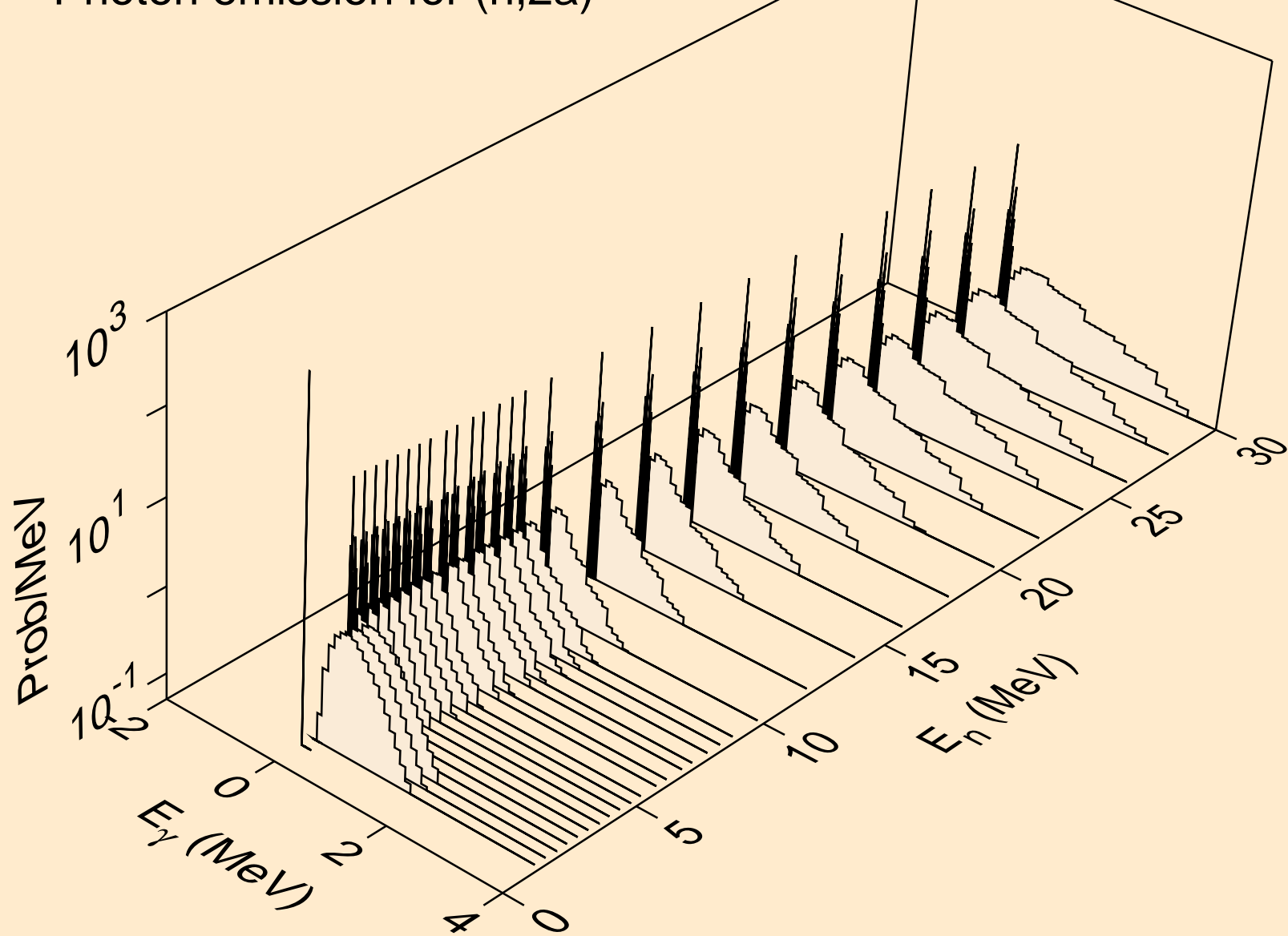

RE177 NEUTRON ACER TENDL-2023 LIBRARY; T=0.K
Photon emission for (n,2p)

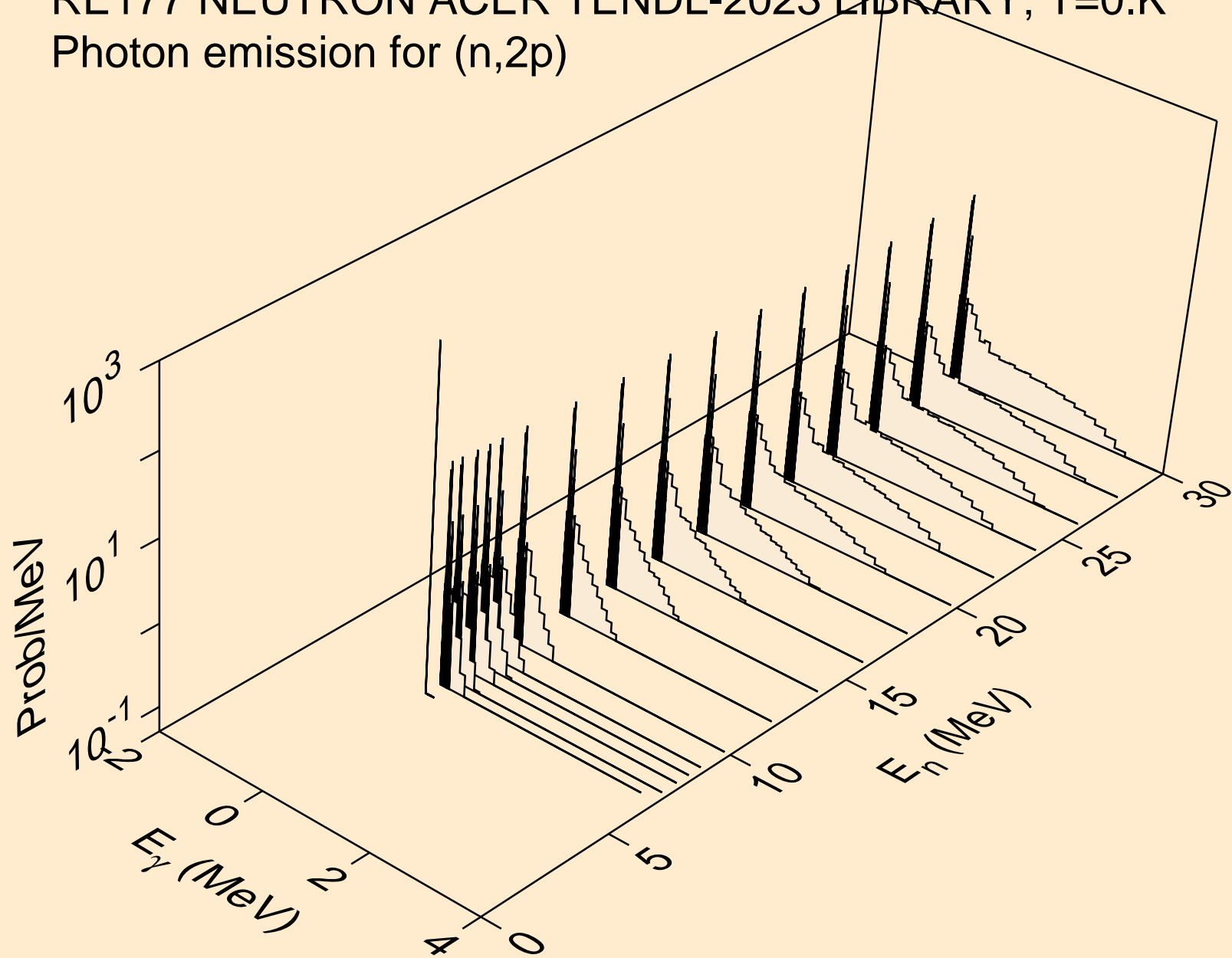

RE177 NEUTRON ACER TENDL-2023 LIBRARY; T=0.K
Photon emission for (n,p)

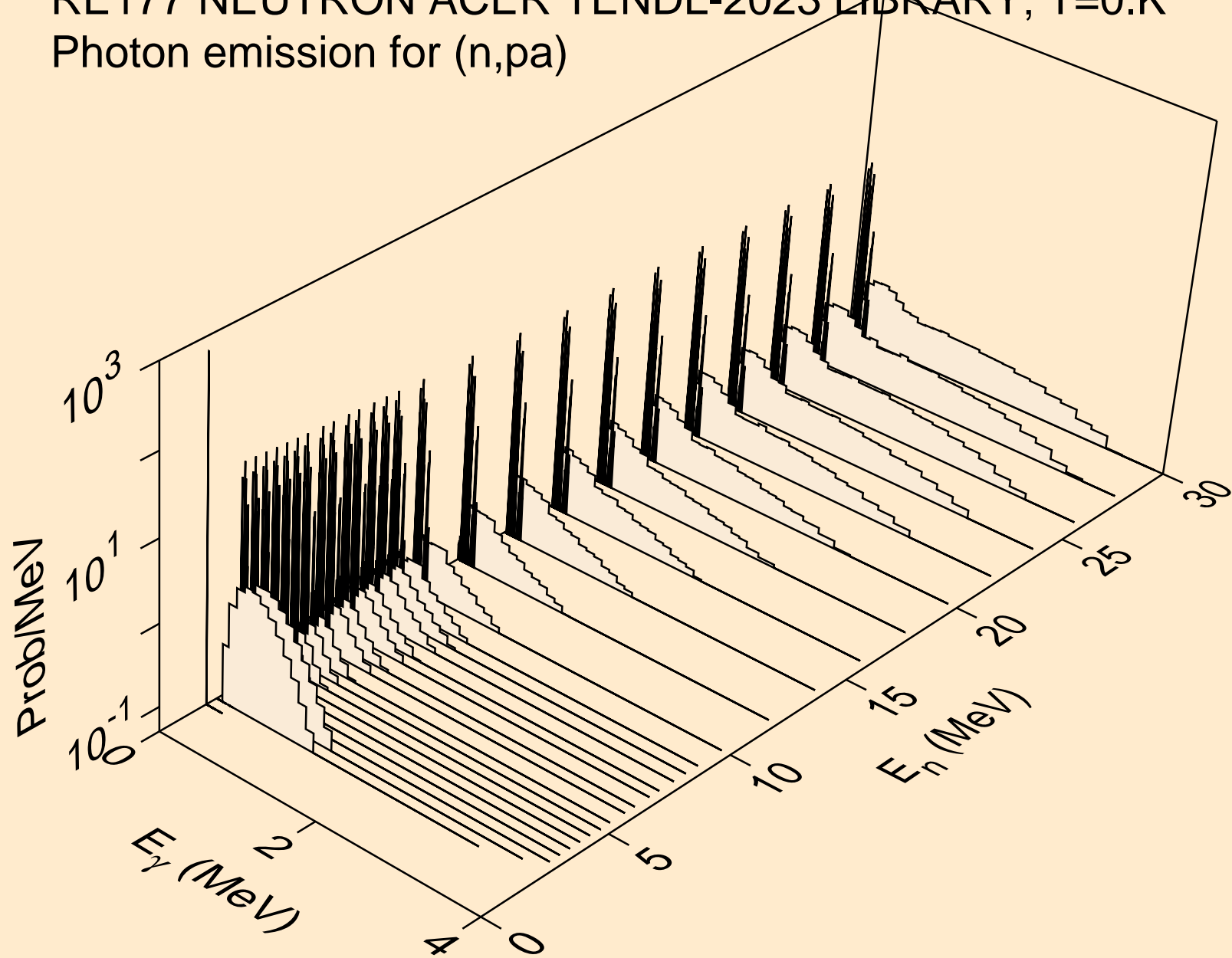

RE177 NEUTRON ACER TENDL-2023 LIBRARY; T=0.K
Photon emission for (n,pd)

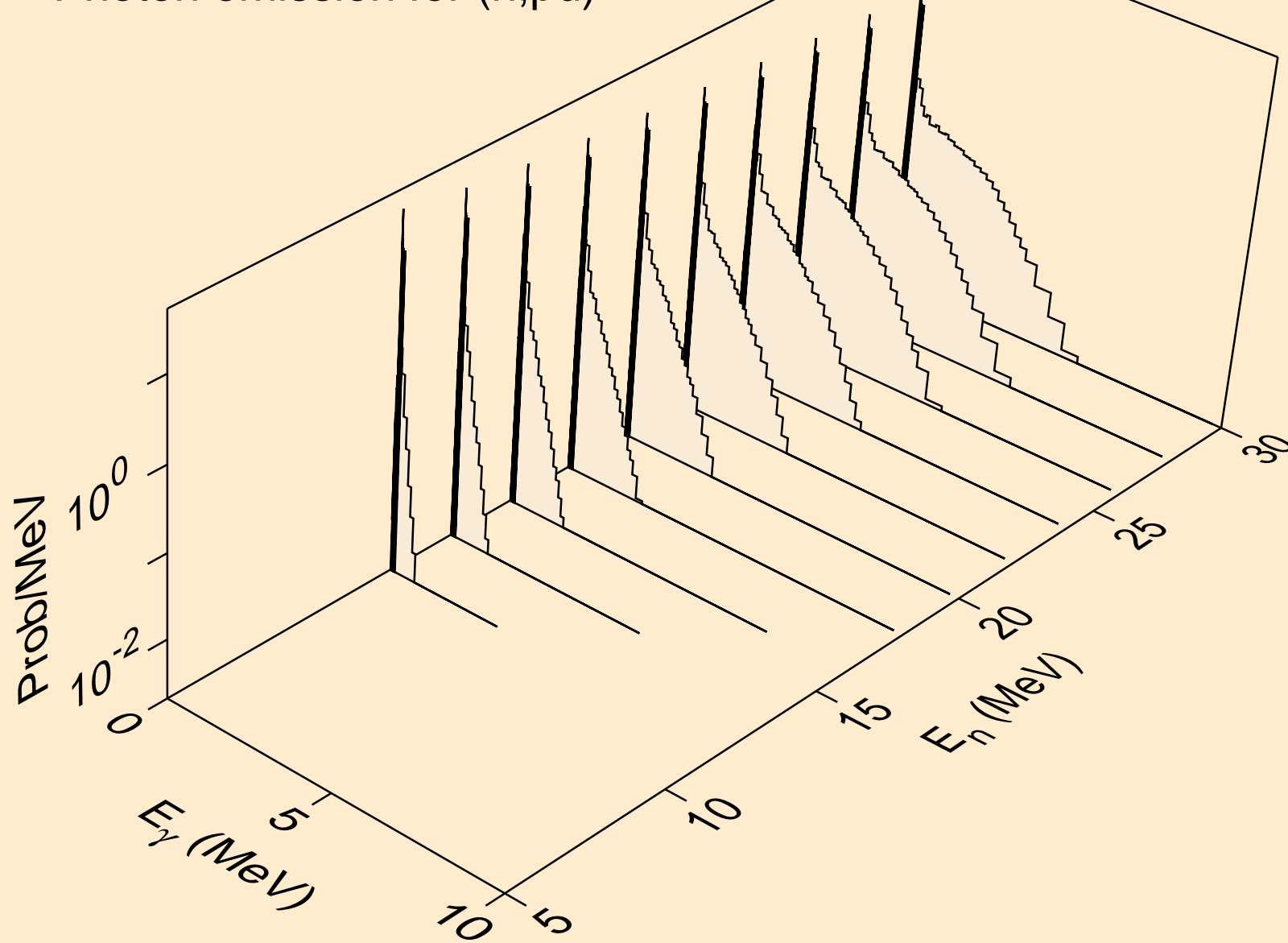

RE177 NEUTRON ACER TENDL-2023 LIBRARY; T=0.K
Photon emission for (n,pt)

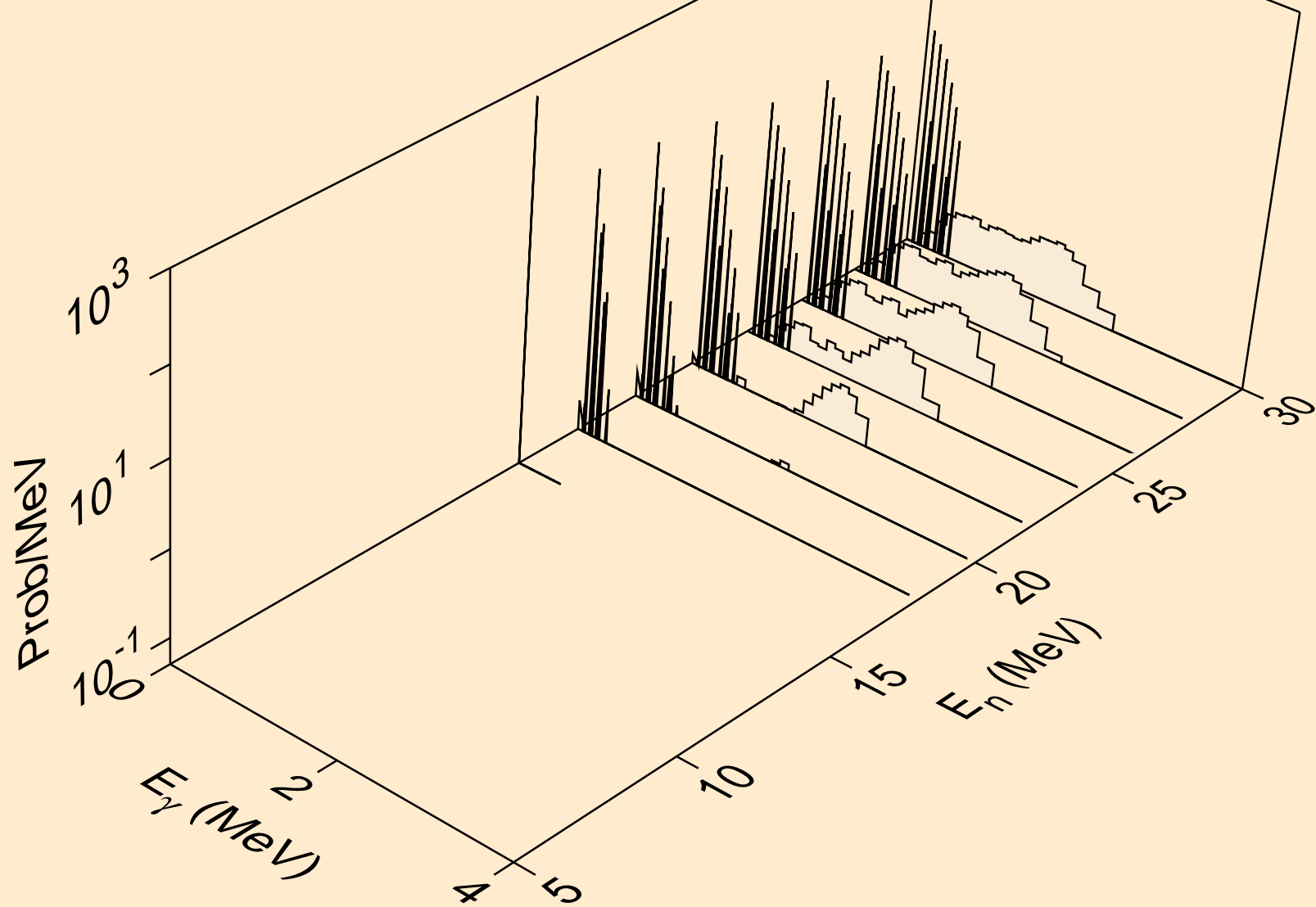

RE177 NEUTRON ACER TENDL-2023 LIBRARY; T=0.K
Photon emission for (n,da)

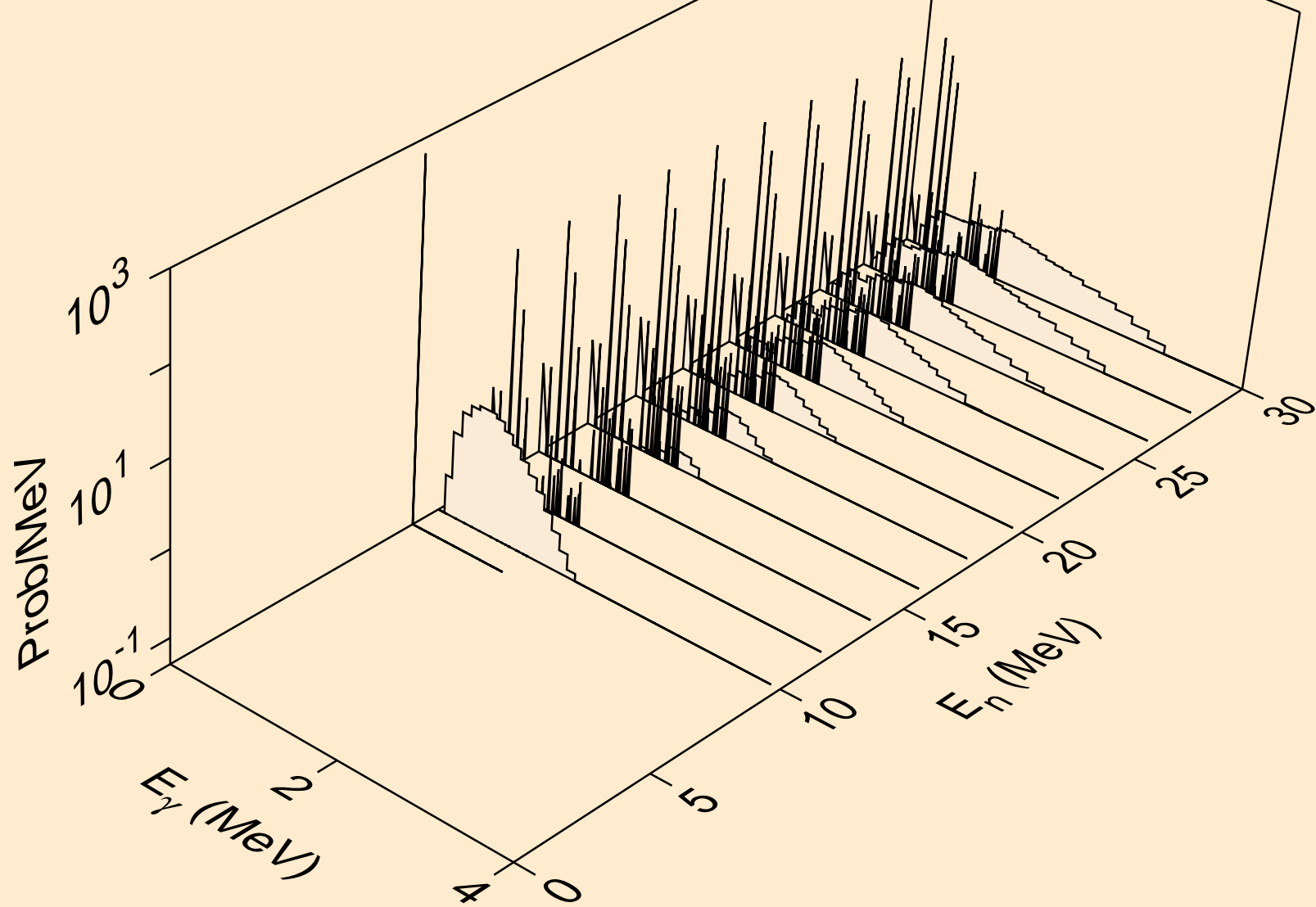

RE177 NEUTRON ACER TENDL-2023 LIBRARY; T=0.K
thermal capture photon spectrum

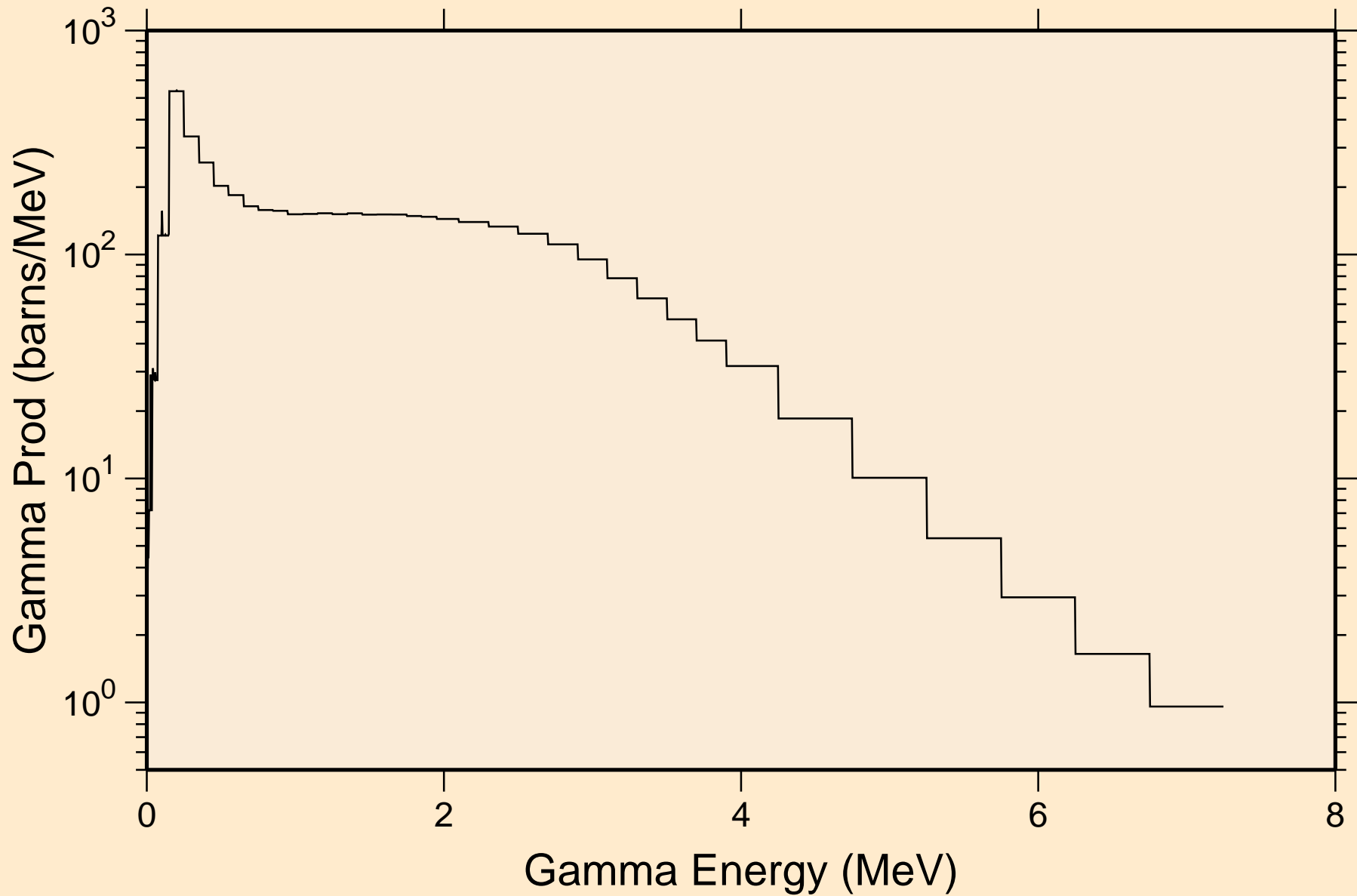

RE177 NEUTRON ACER TENDL-2023 LIBRARY; T=0.K
14 MeV photon spectrum

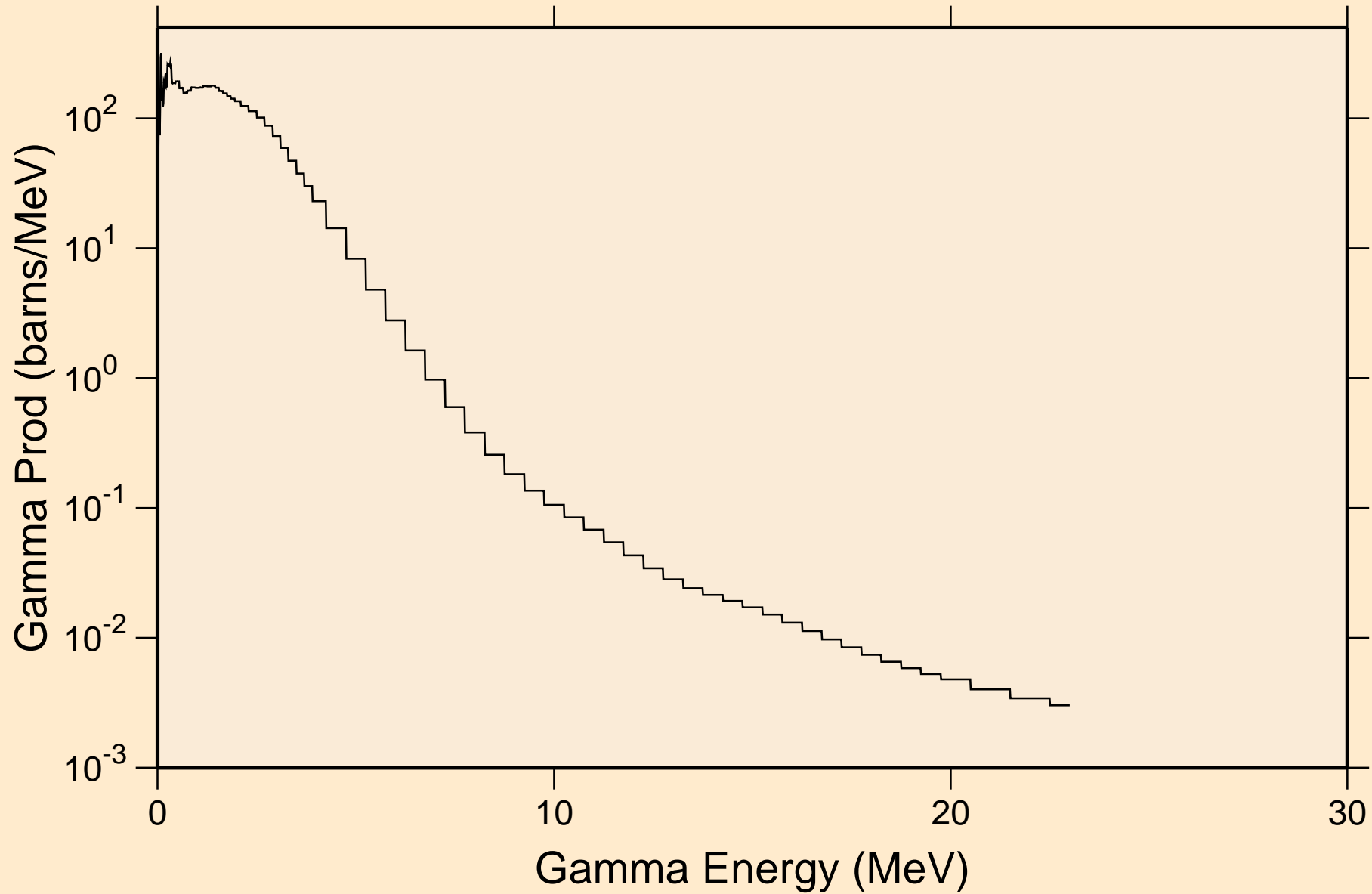

RE177 NEUTRON ACER TENDL-2023 LIBRARY; T=0.K
Particle heating contributions

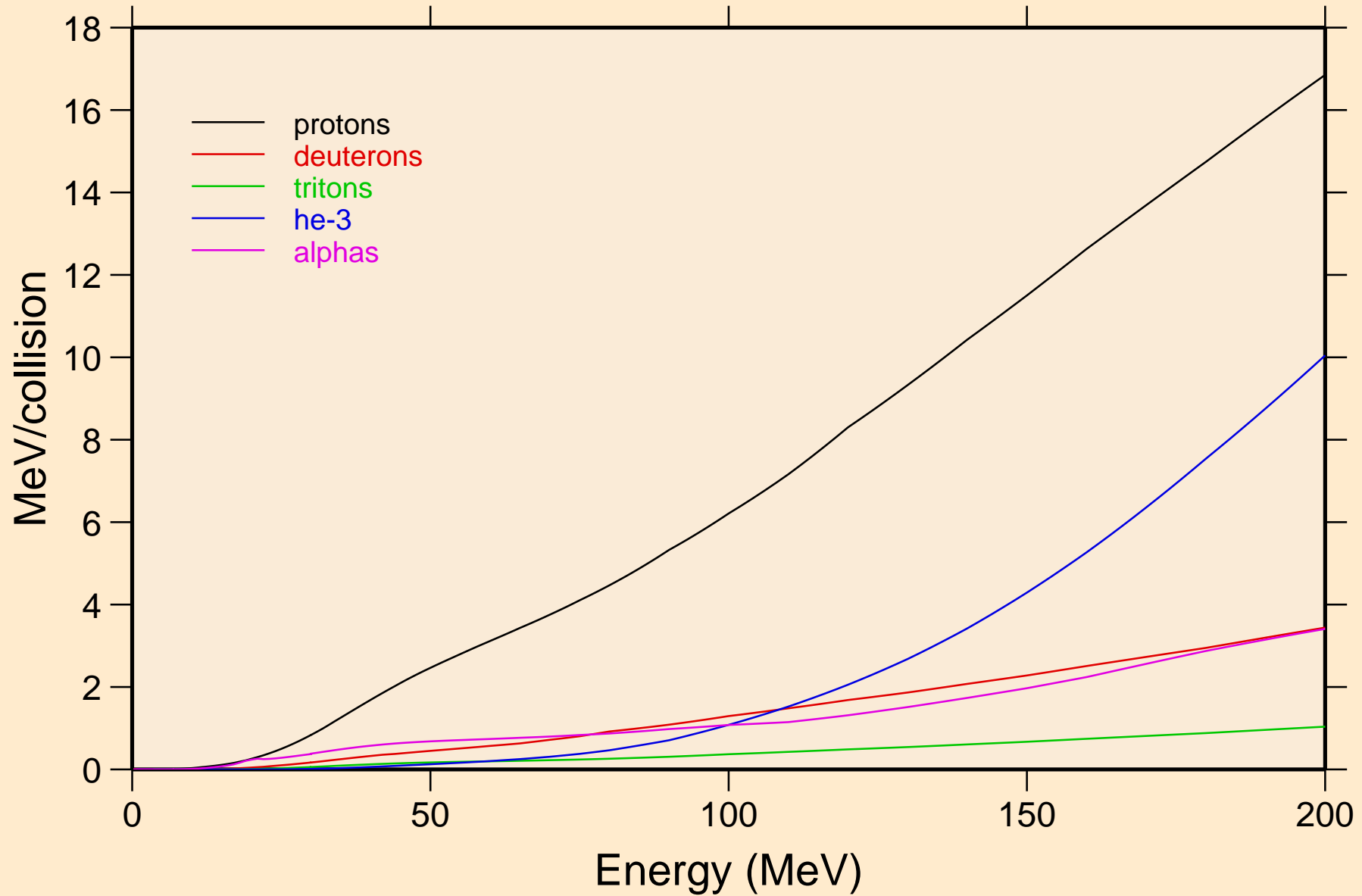

RE177 NEUTRON ACER TENDL-2023 LIBRARY; T=0.K
Recoil Heating

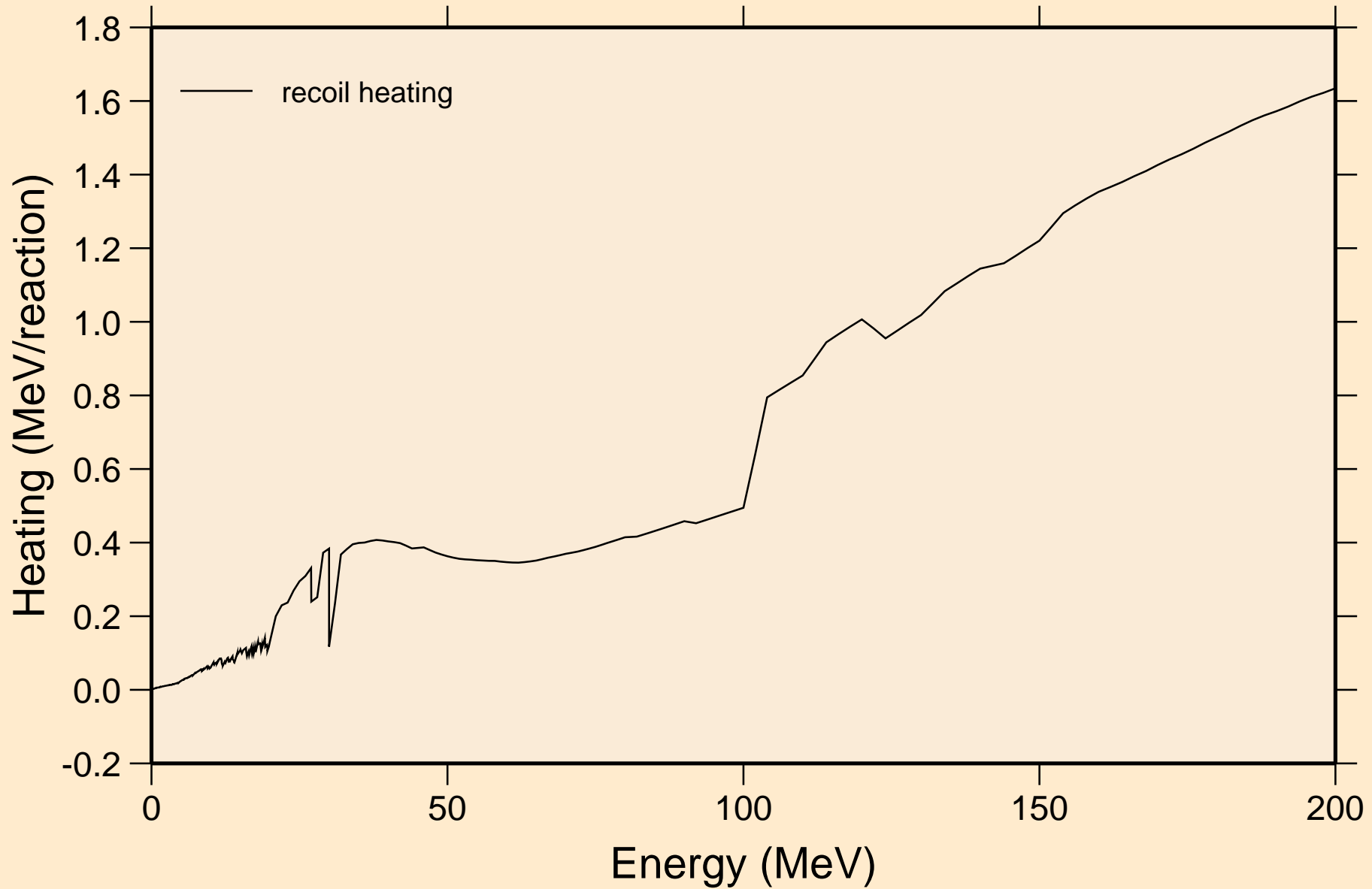

RE177 NEUTRON ACER TENDL-2023 LIBRARY; T=0.K
Particle production cross sections

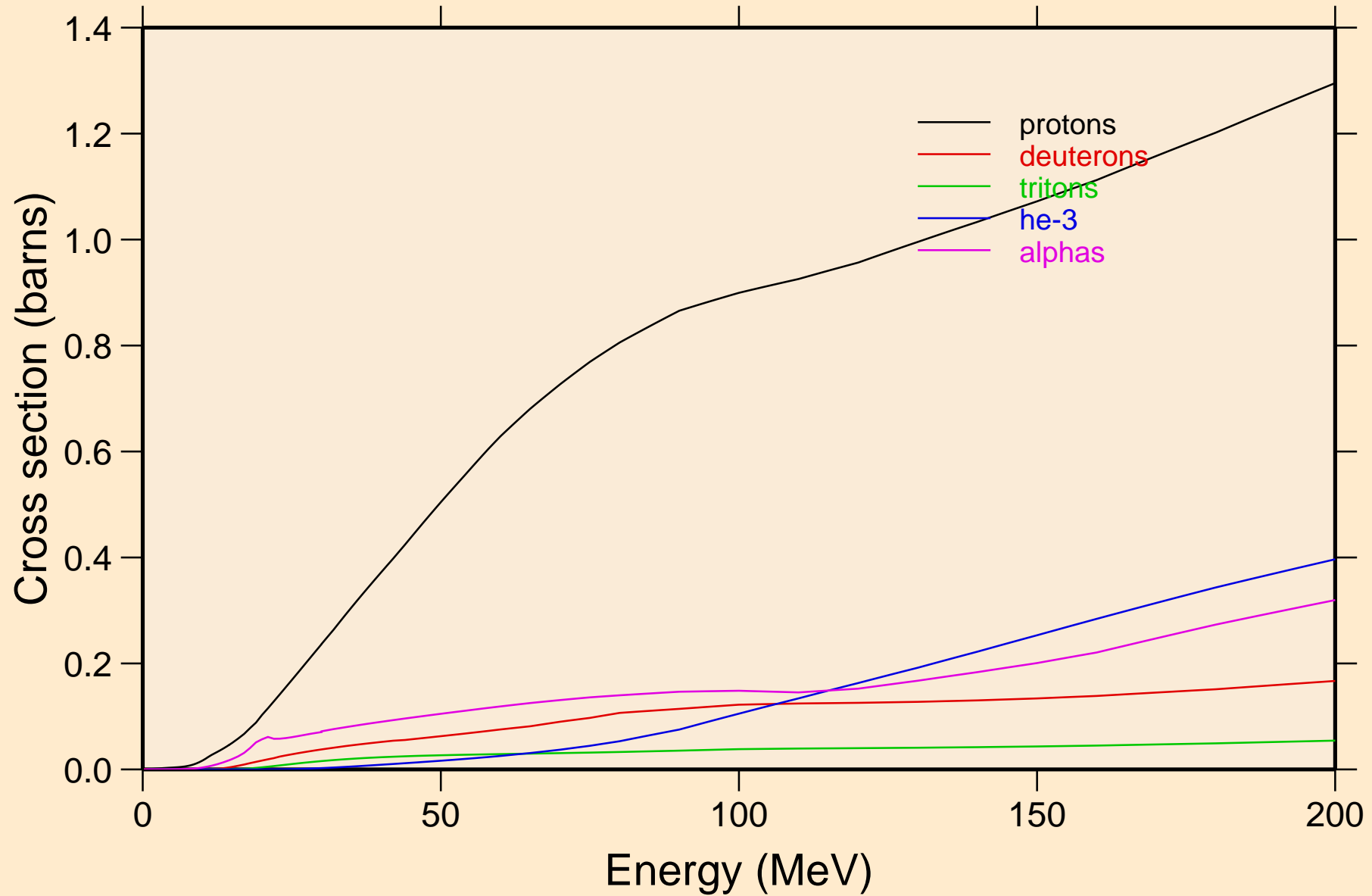

RE177 NEUTRON ACER TENDL-2023 LIBRARY; T=0.K
protons from (n,x)

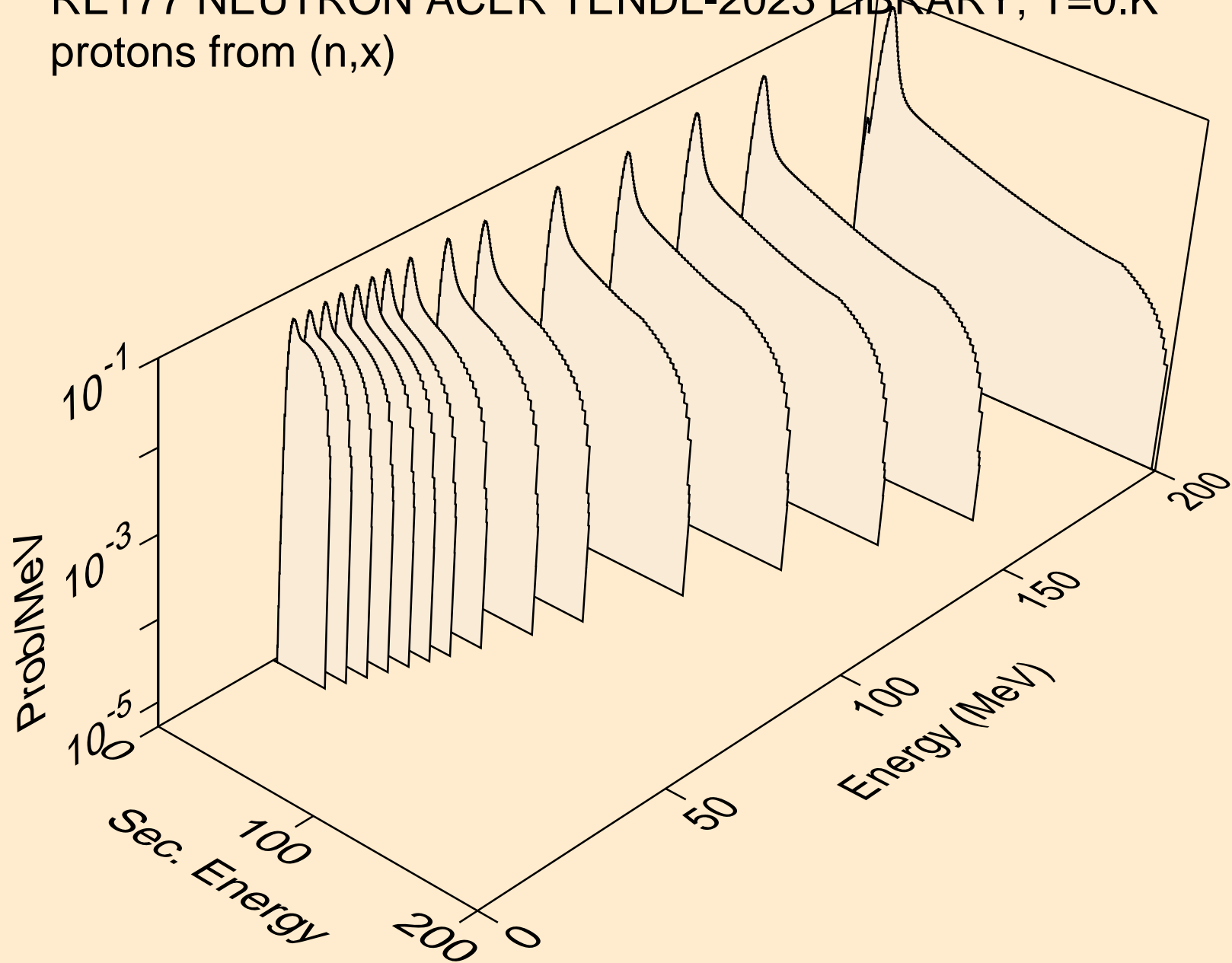

RE177 NEUTRON ACER TENDL-2023 LIBRARY; T=0.K
protons from (n,n*)p

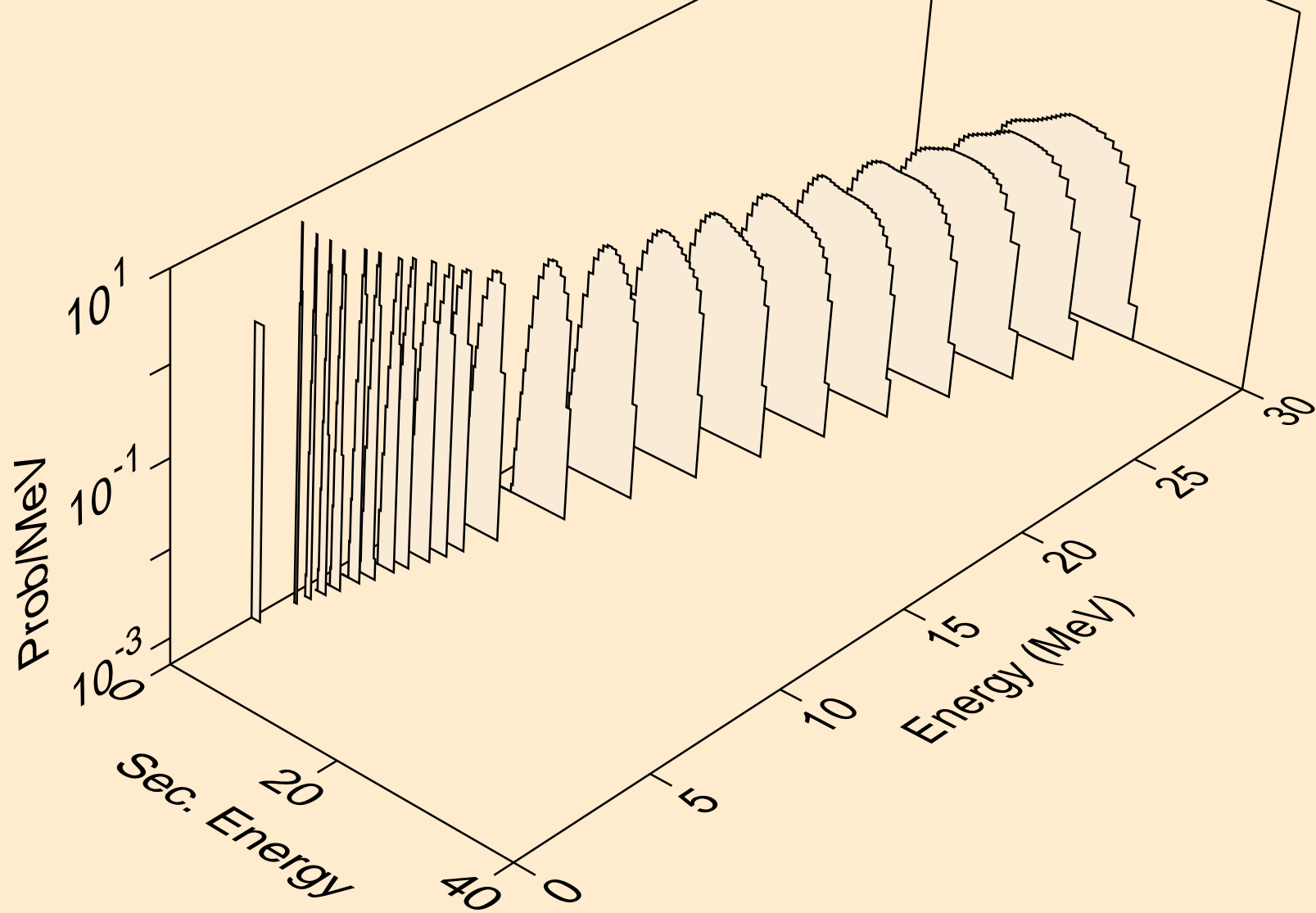

RE177 NEUTRON ACER TENDL-2023 LIBRARY; T=0.K
protons from (n,2np)

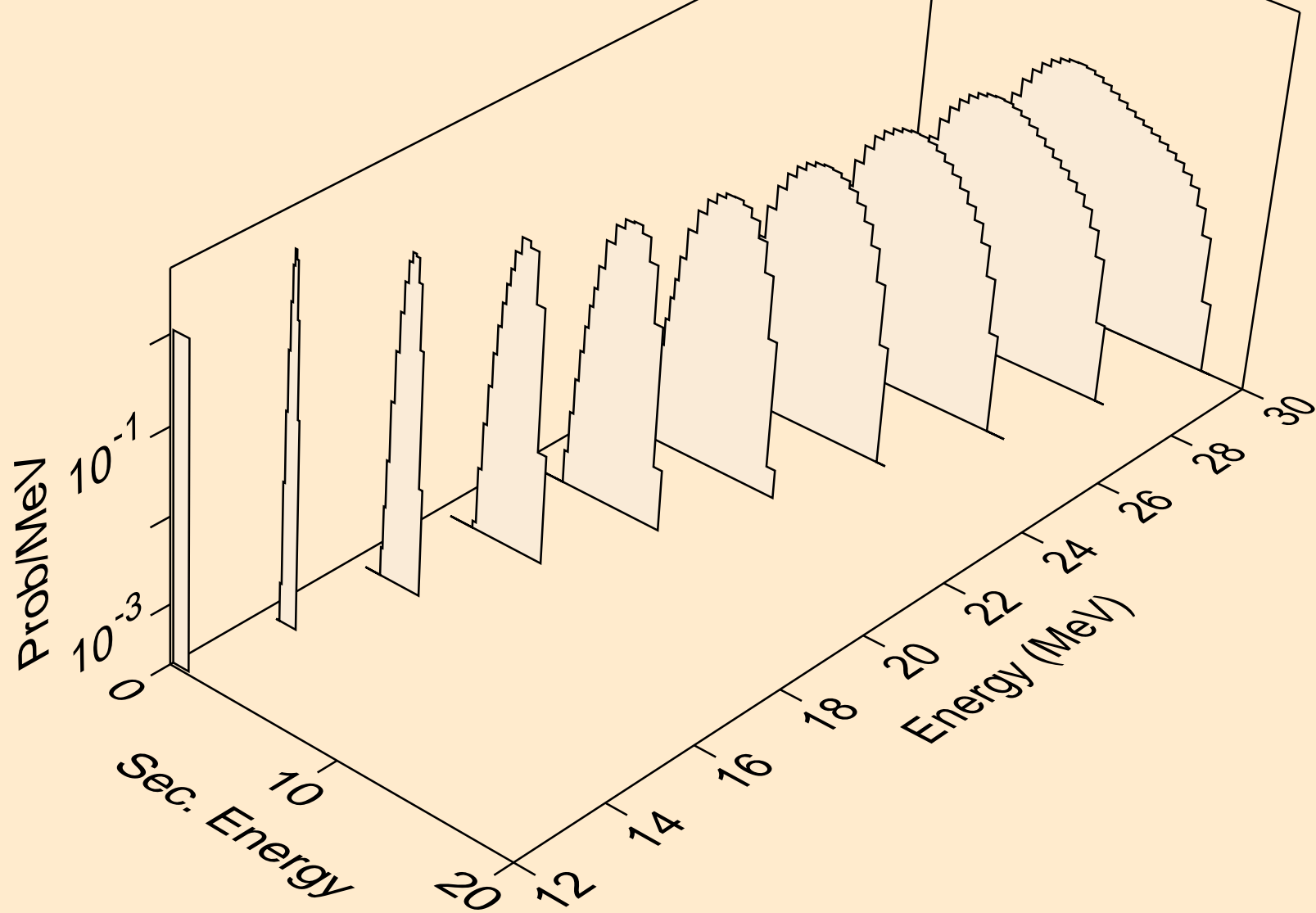

RE177 NEUTRON ACER TENDL-2023 LIBRARY; T=0.K
protons from (n,3np)

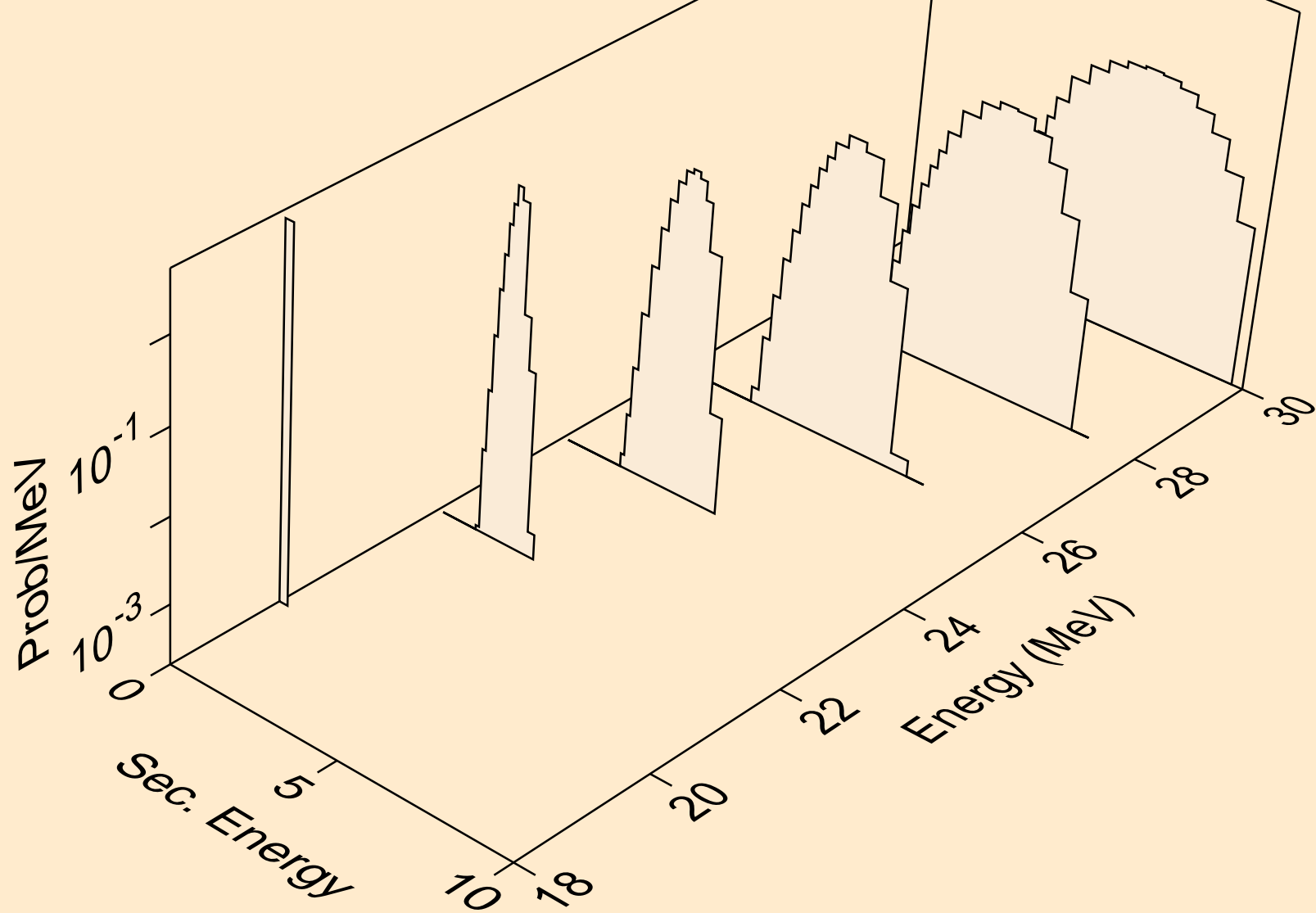

RE177 NEUTRON ACER TENDL-2023 LIBRARY; T=0.K
protons from (n,n2p)

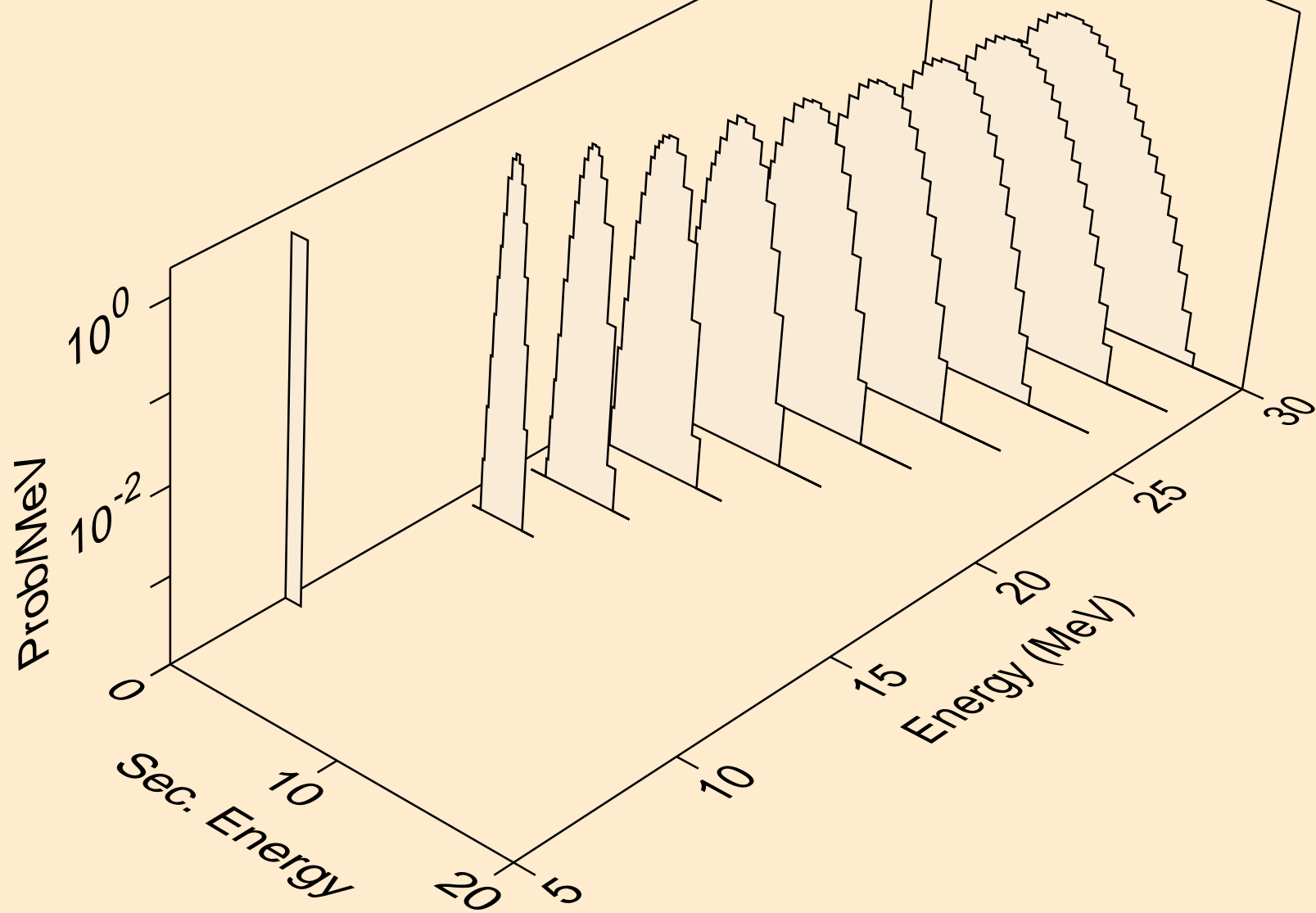

RE177 NEUTRON ACER TENDL-2023 LIBRARY; T=0.K
protons from (n,npa)

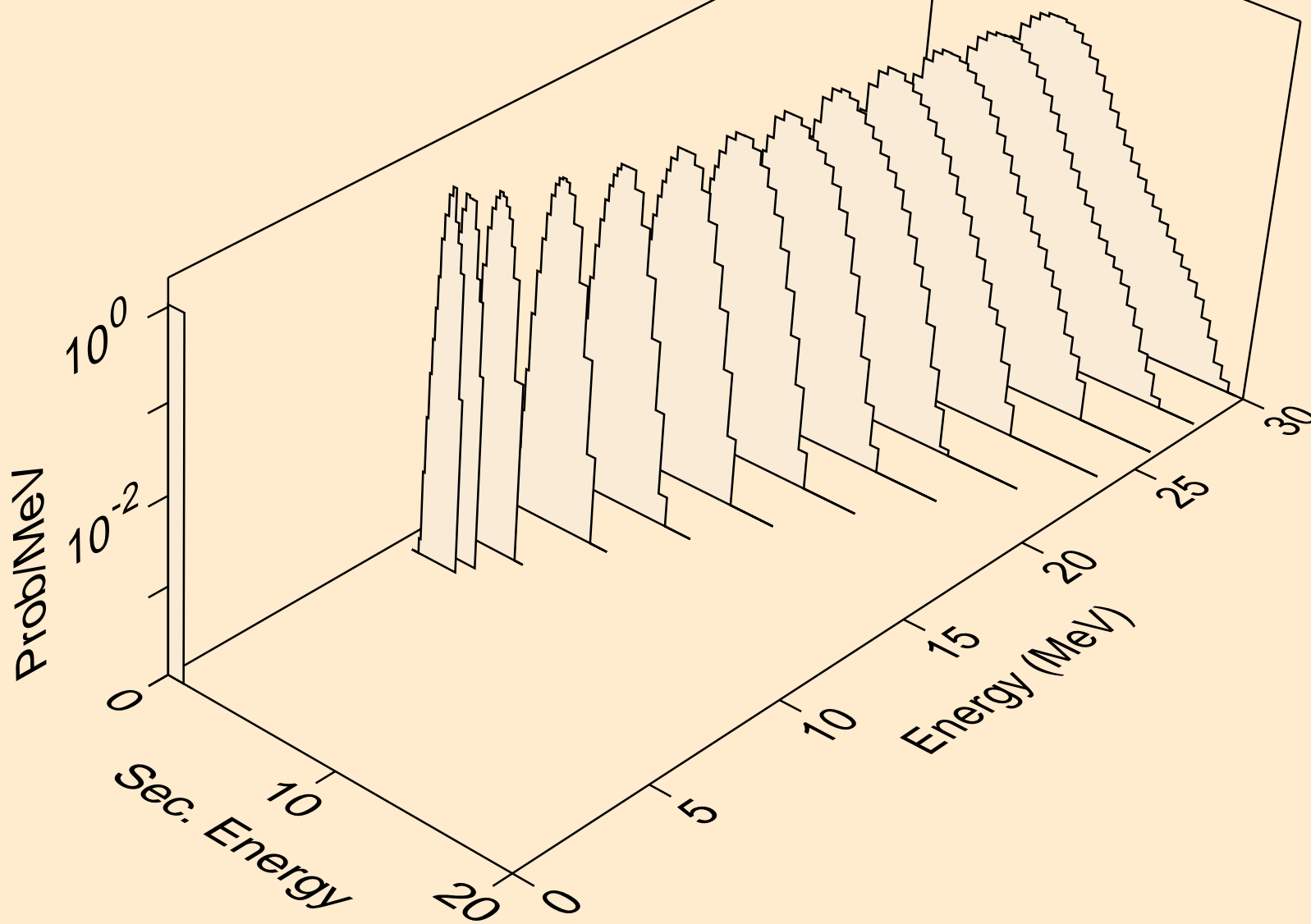

RE177 NEUTRON ACER TENDL-2023 LIBRARY; T=0.K
protons from (n,p)

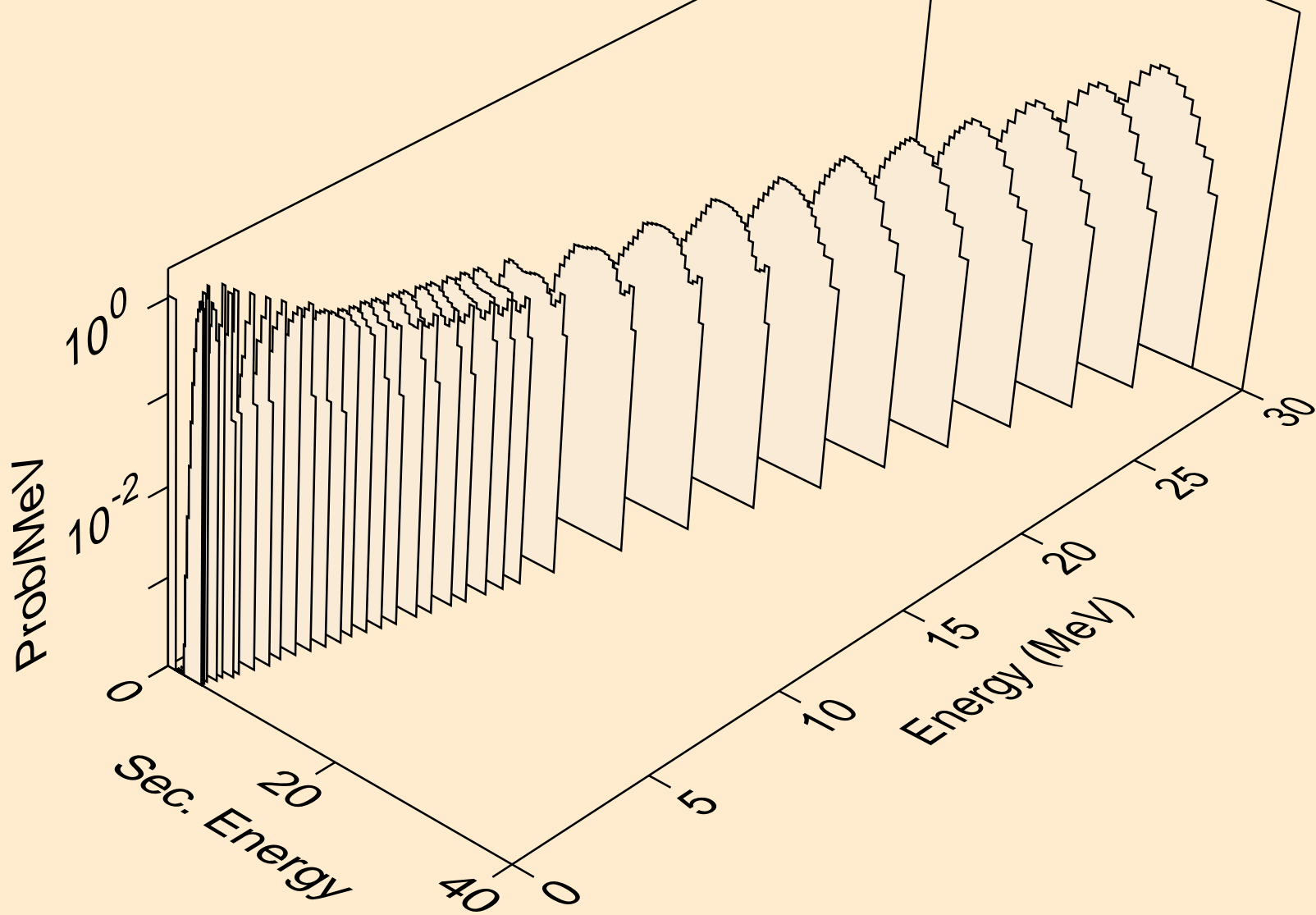

RE177 NEUTRON ACER TENDL-2023 LIBRARY; T=0.K
protons from (n,2p)

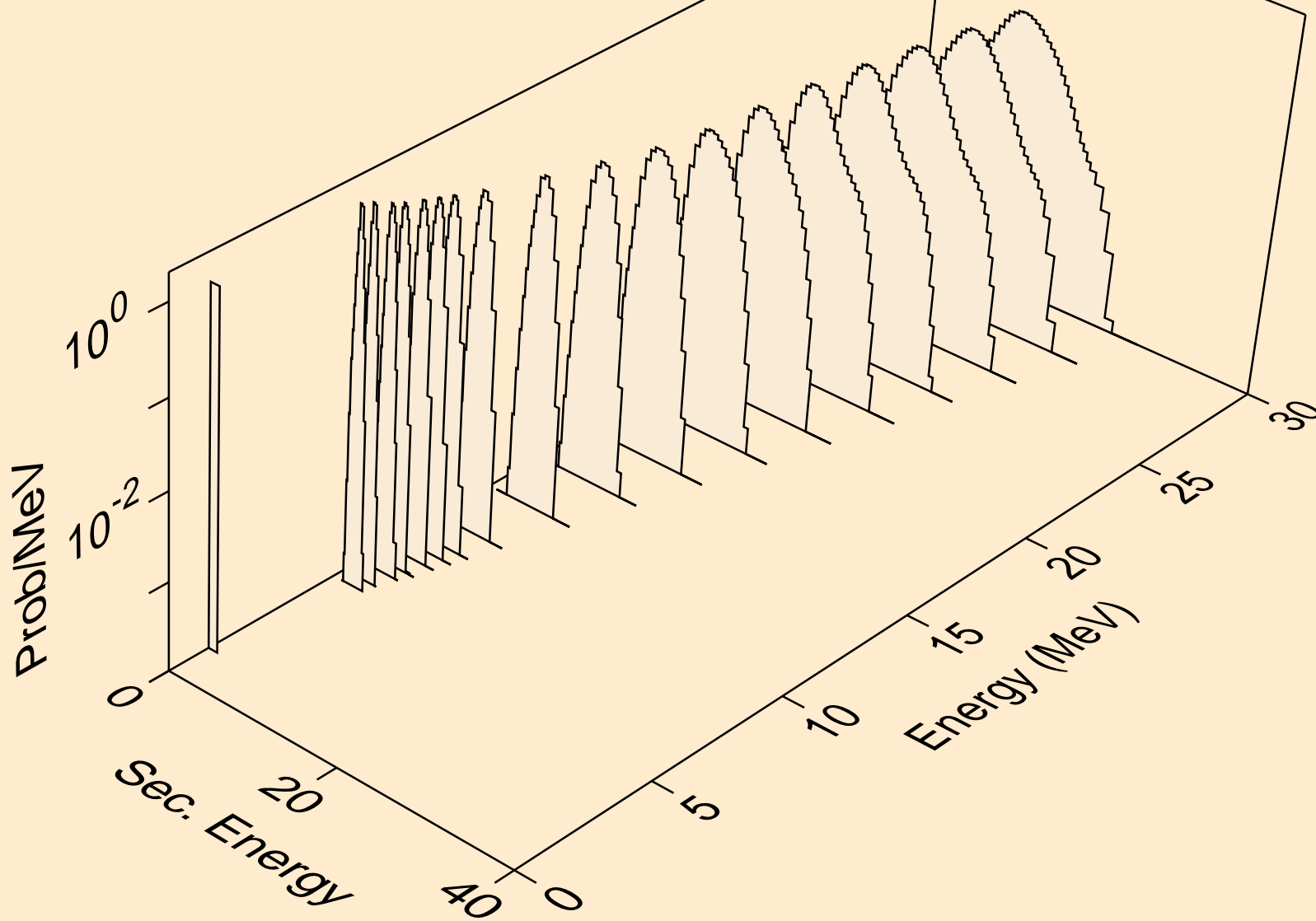

RE177 NEUTRON ACER TENDL-2023 LIBRARY; T=0.K
protons from (n,p)

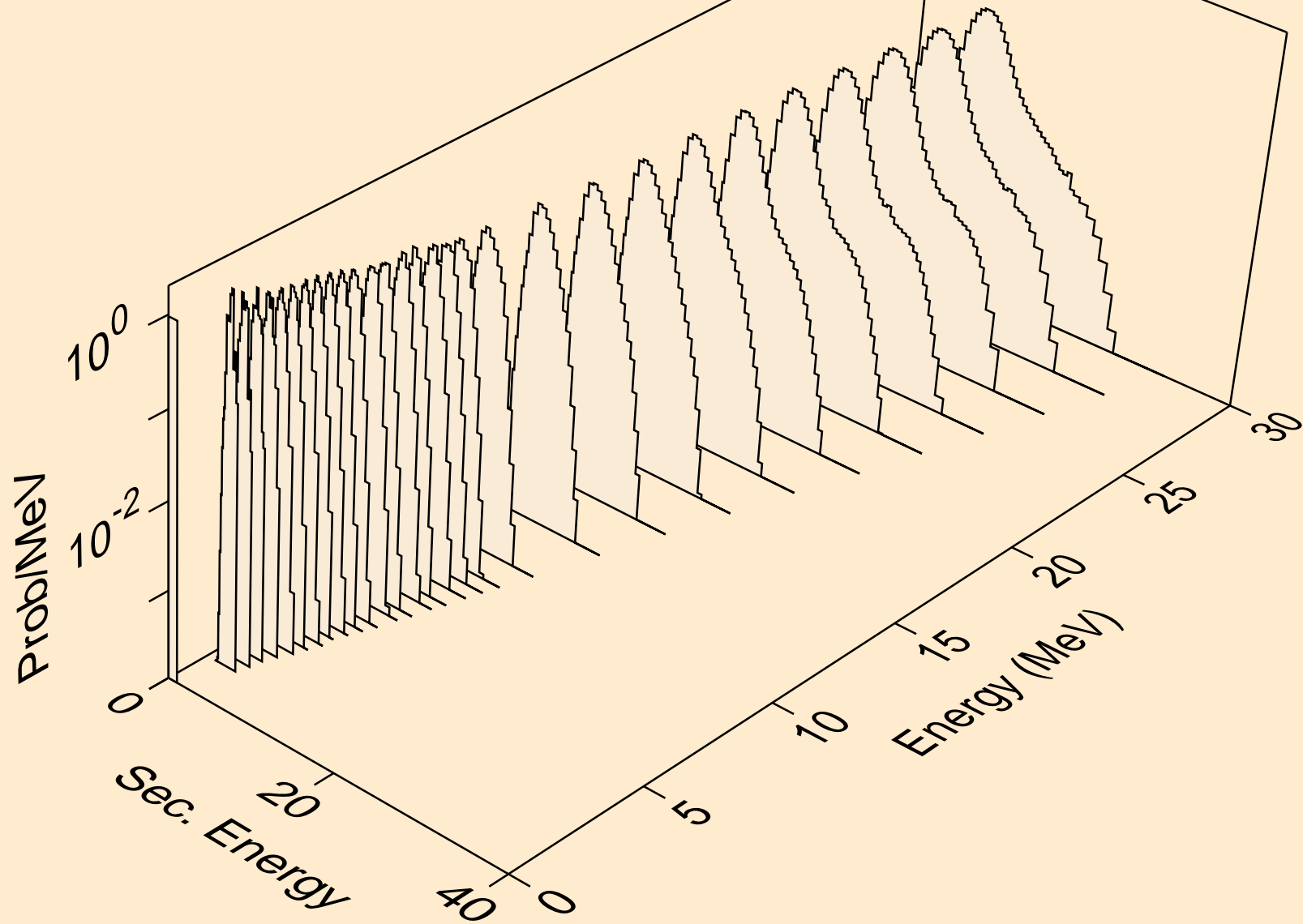

RE177 NEUTRON ACER TENDL-2023 LIBRARY; T=0.K
protons from (n,pd)

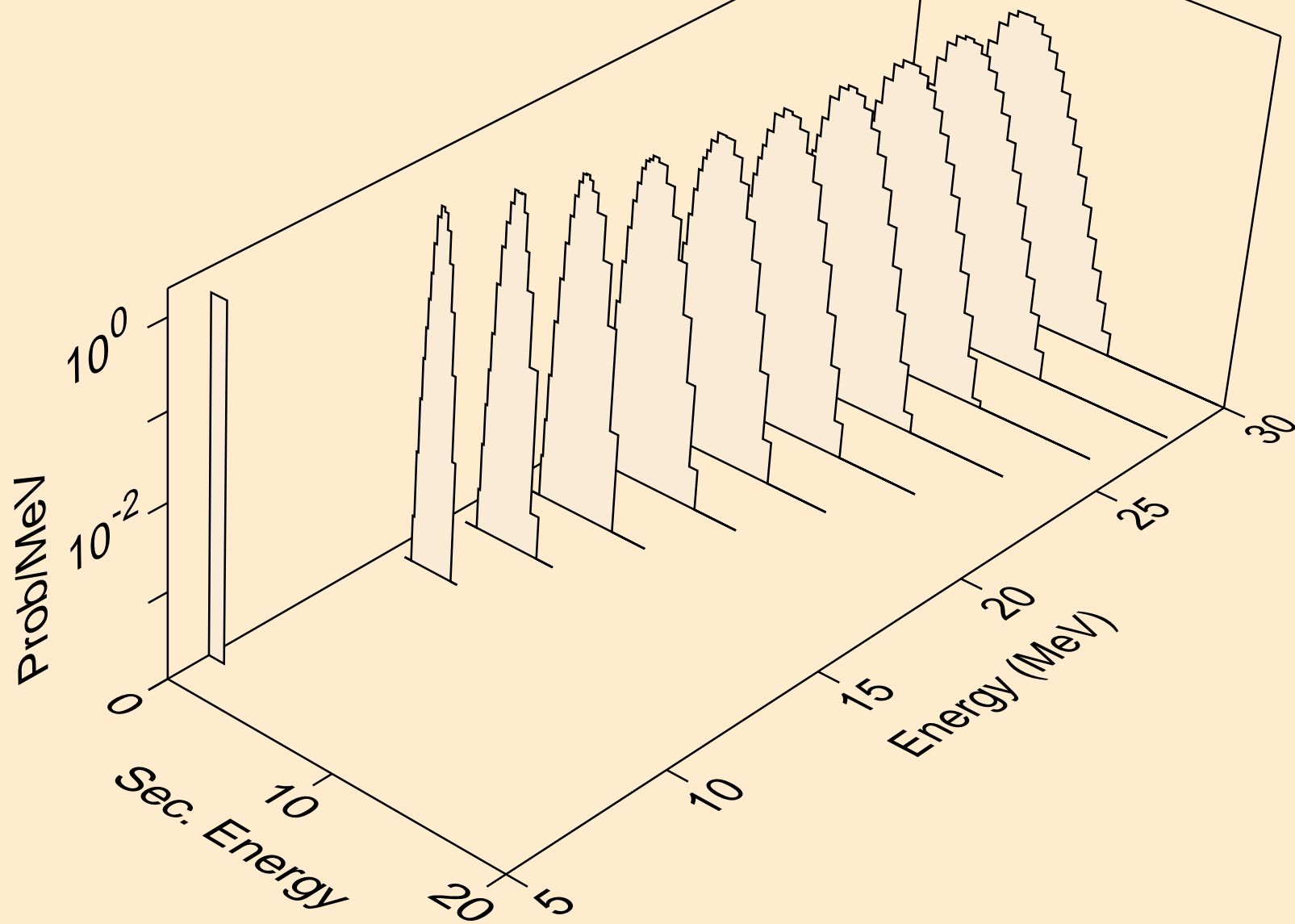

RE177 NEUTRON ACER TENDL-2023 LIBRARY; T=0.K
protons from (n,pt)

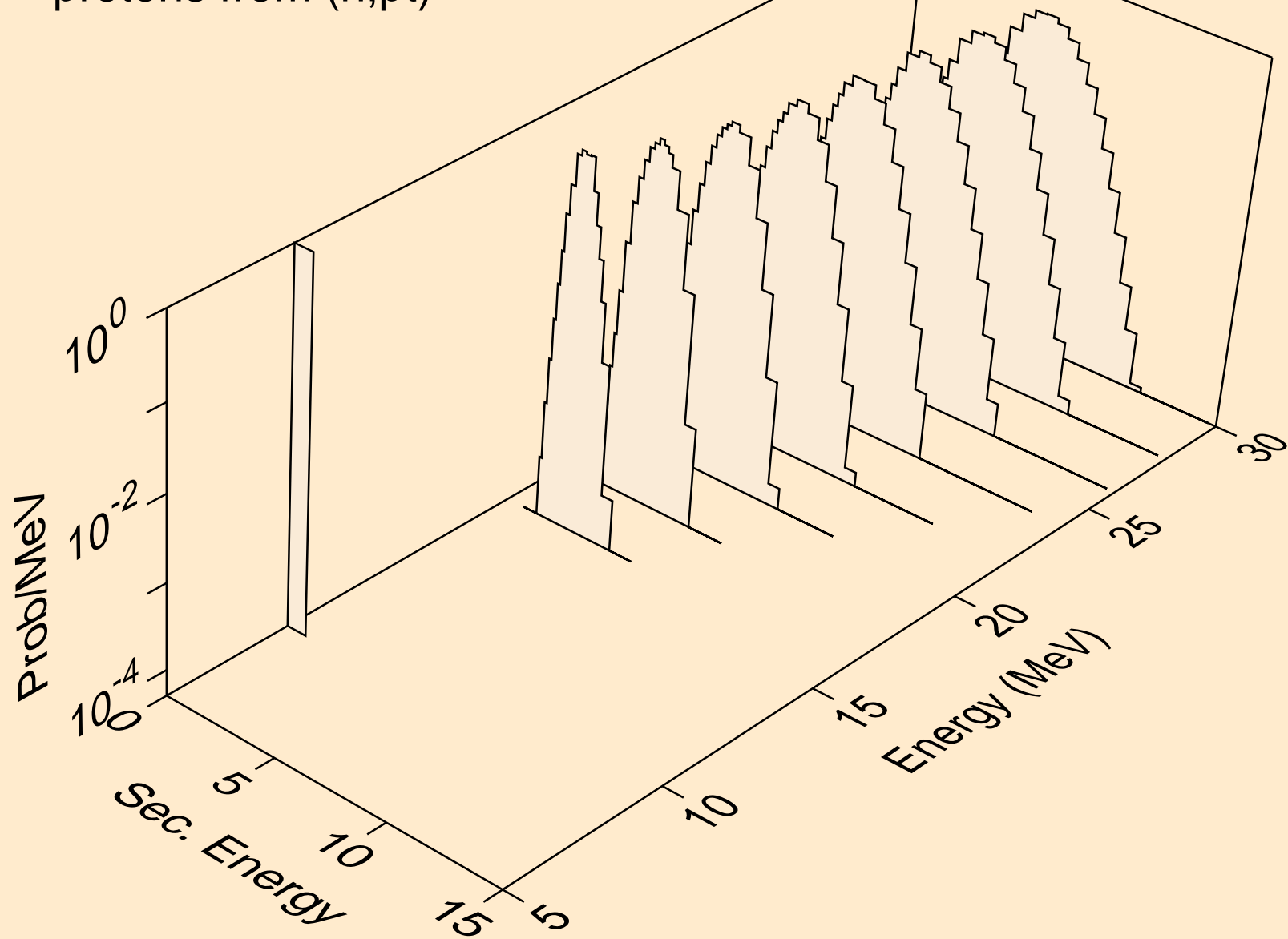

RE177 NEUTRON ACER TENDL-2023 LIBRARY; T=0.K
deuterons from (n,x)

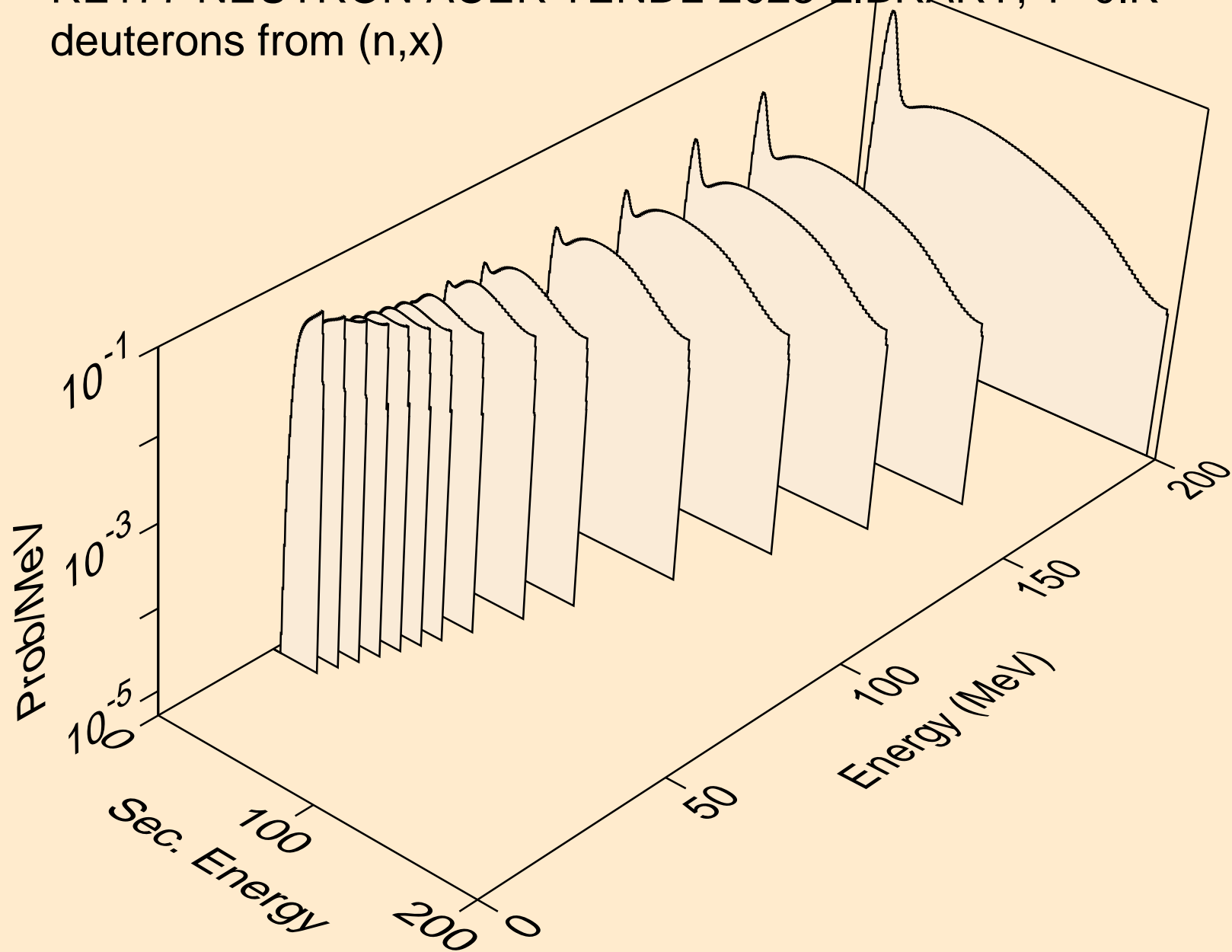

RE177 NEUTRON ACER TENDL-2023 LIBRARY; T=0.K
deuterons from (n,2nd)

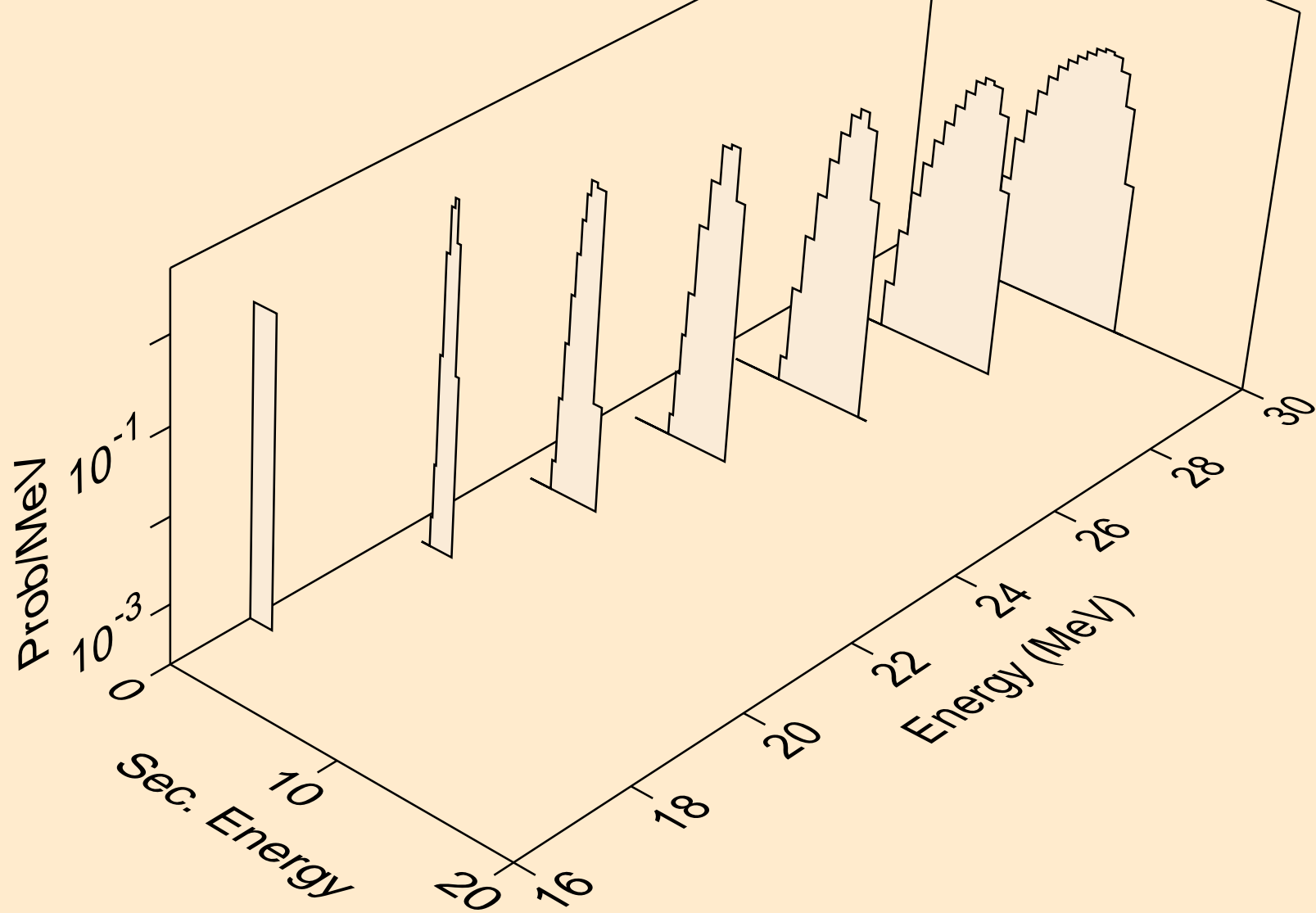

RE177 NEUTRON ACER TENDL-2023 LIBRARY; T=0.K
deuterons from (n,n*)d

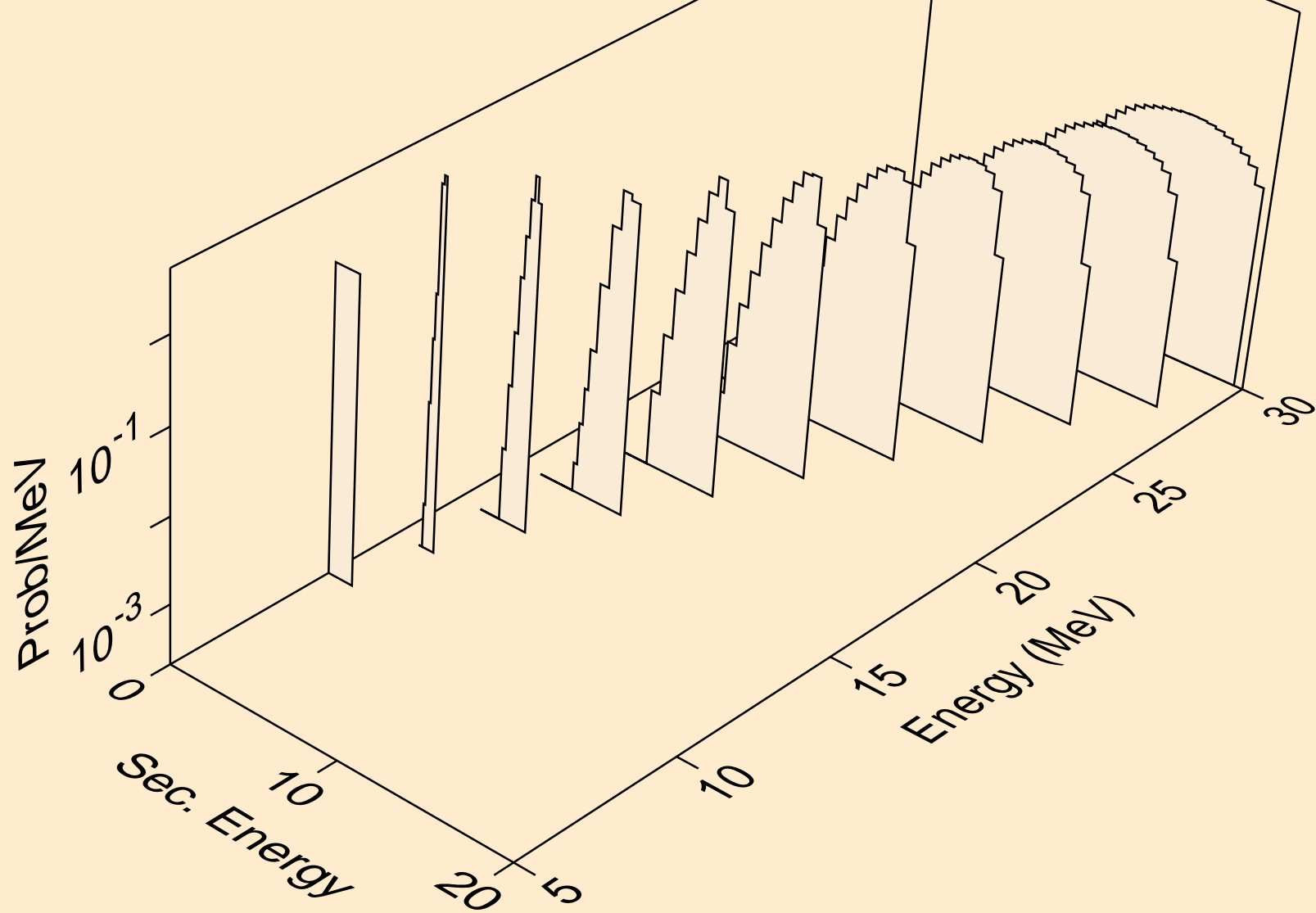

RE177 NEUTRON ACER TENDL-2023 LIBRARY; T=0.K
deuterons from (n,d)

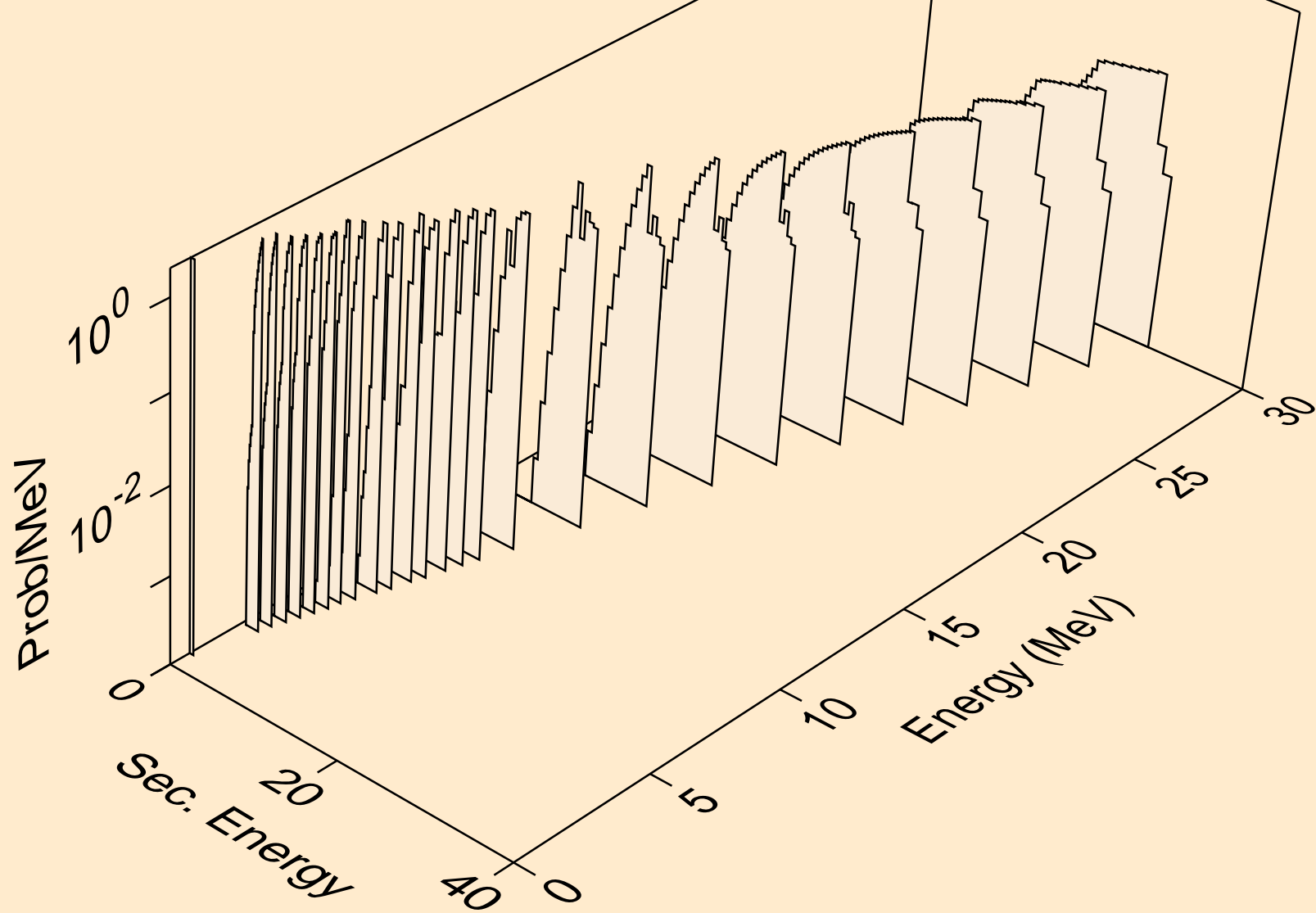

RE177 NEUTRON ACER TENDL-2023 LIBRARY; T=0.K
deuterons from (n,pd)

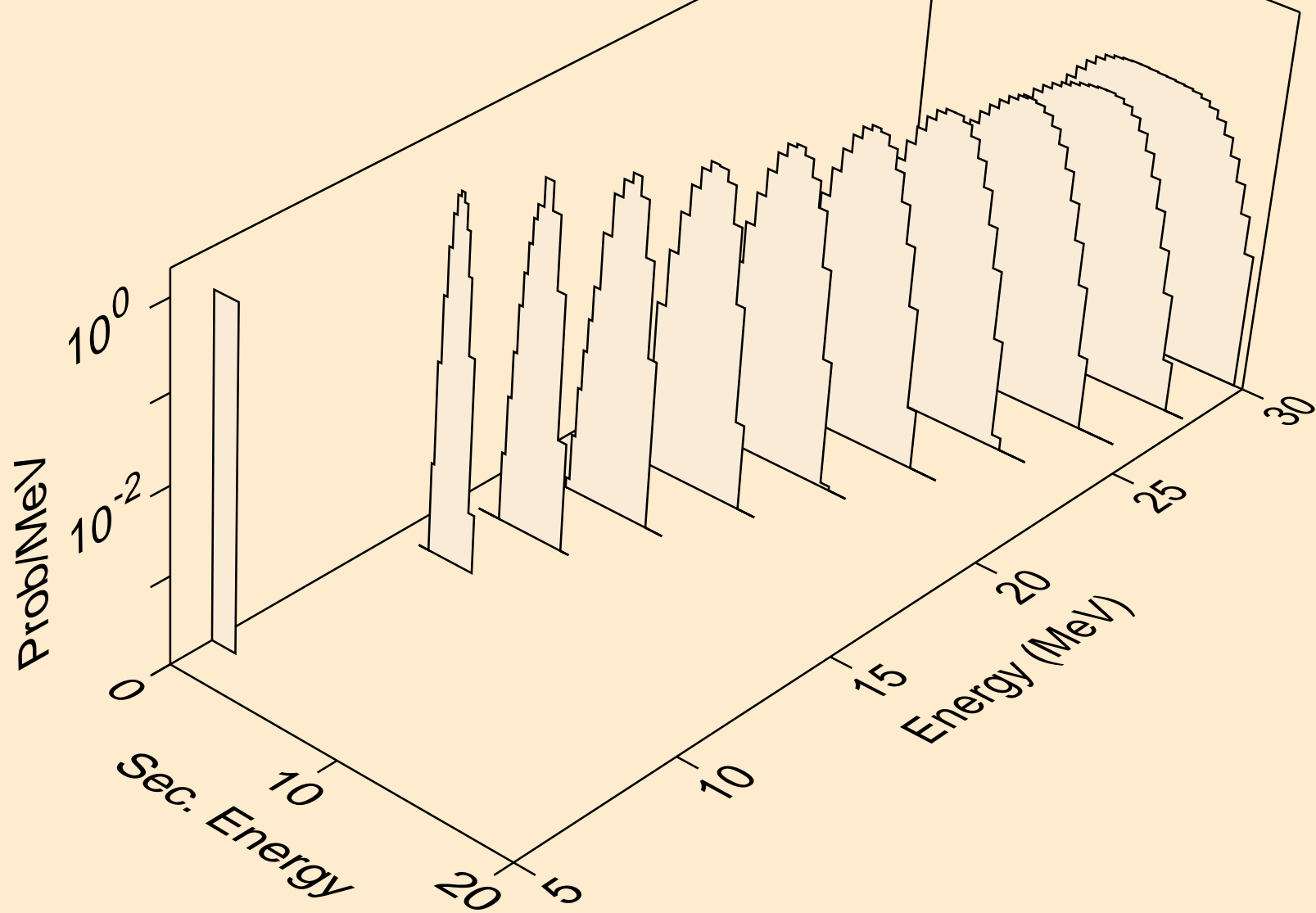

RE177 NEUTRON ACER TENDL-2023 LIBRARY; T=0.K
deuterons from (n,da)

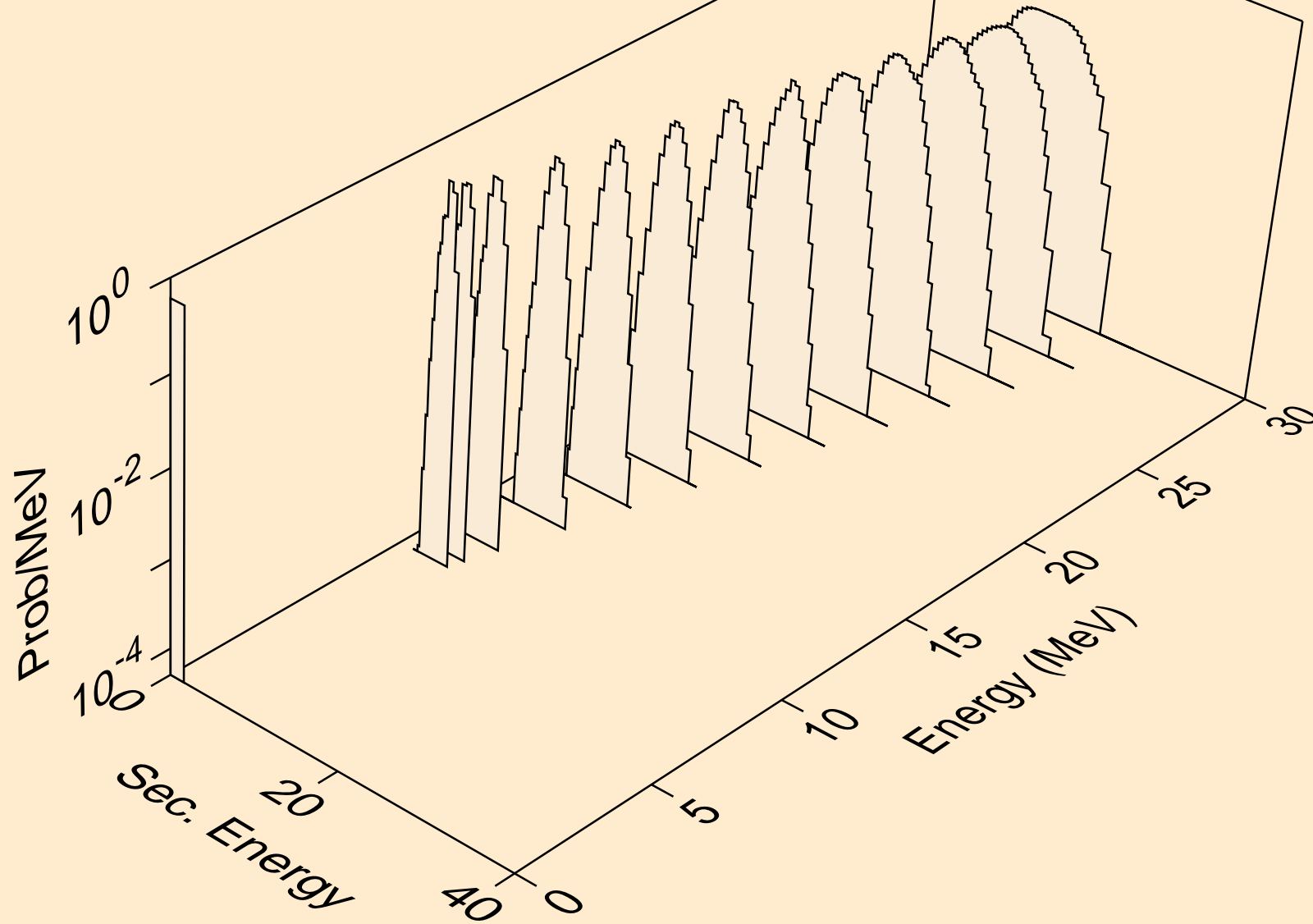

RE177 NEUTRON ACER TENDL-2023 LIBRARY; T=0.K
tritons from (n,x)

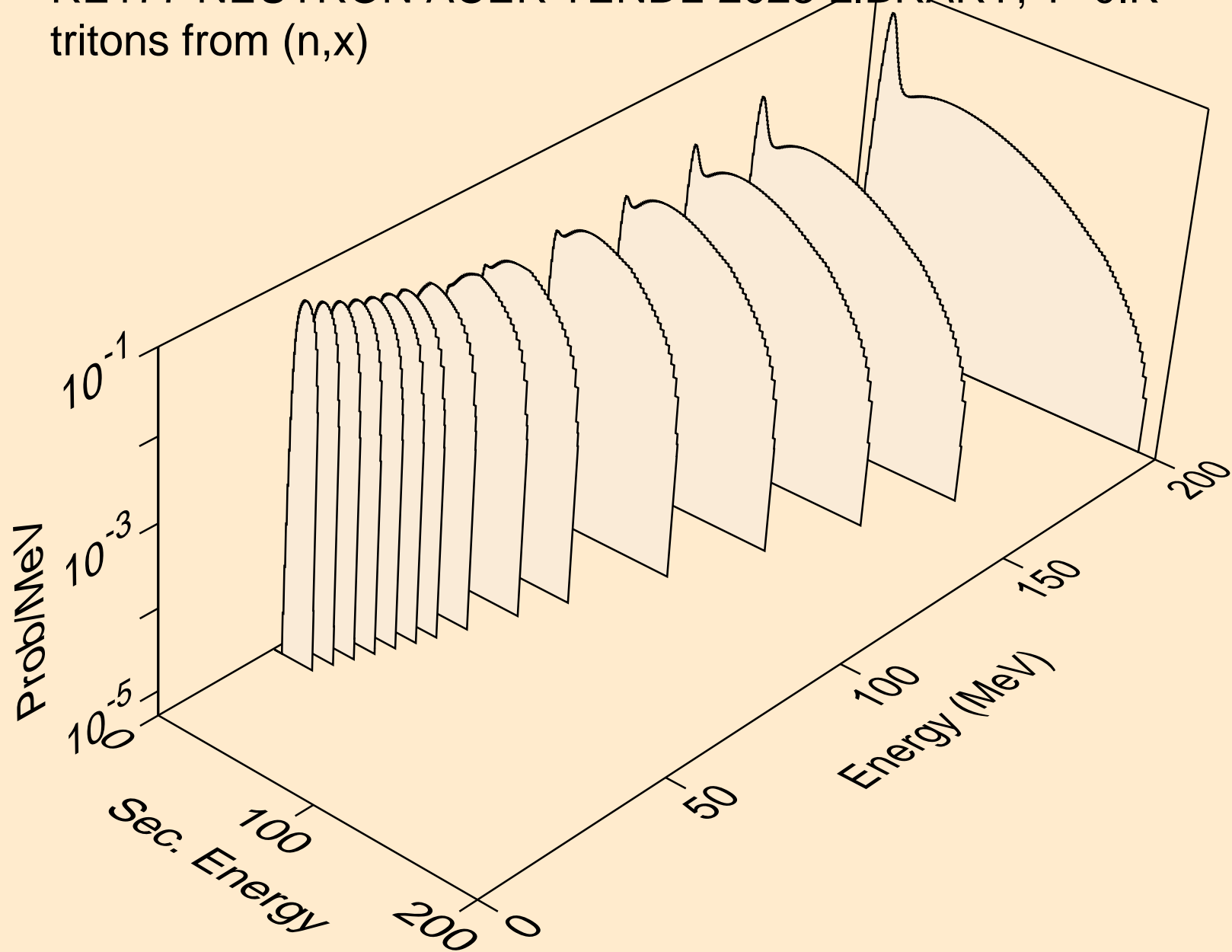

RE177 NEUTRON ACER TENDL-2023 LIBRARY; T=0.K
tritons from (n,n*)t

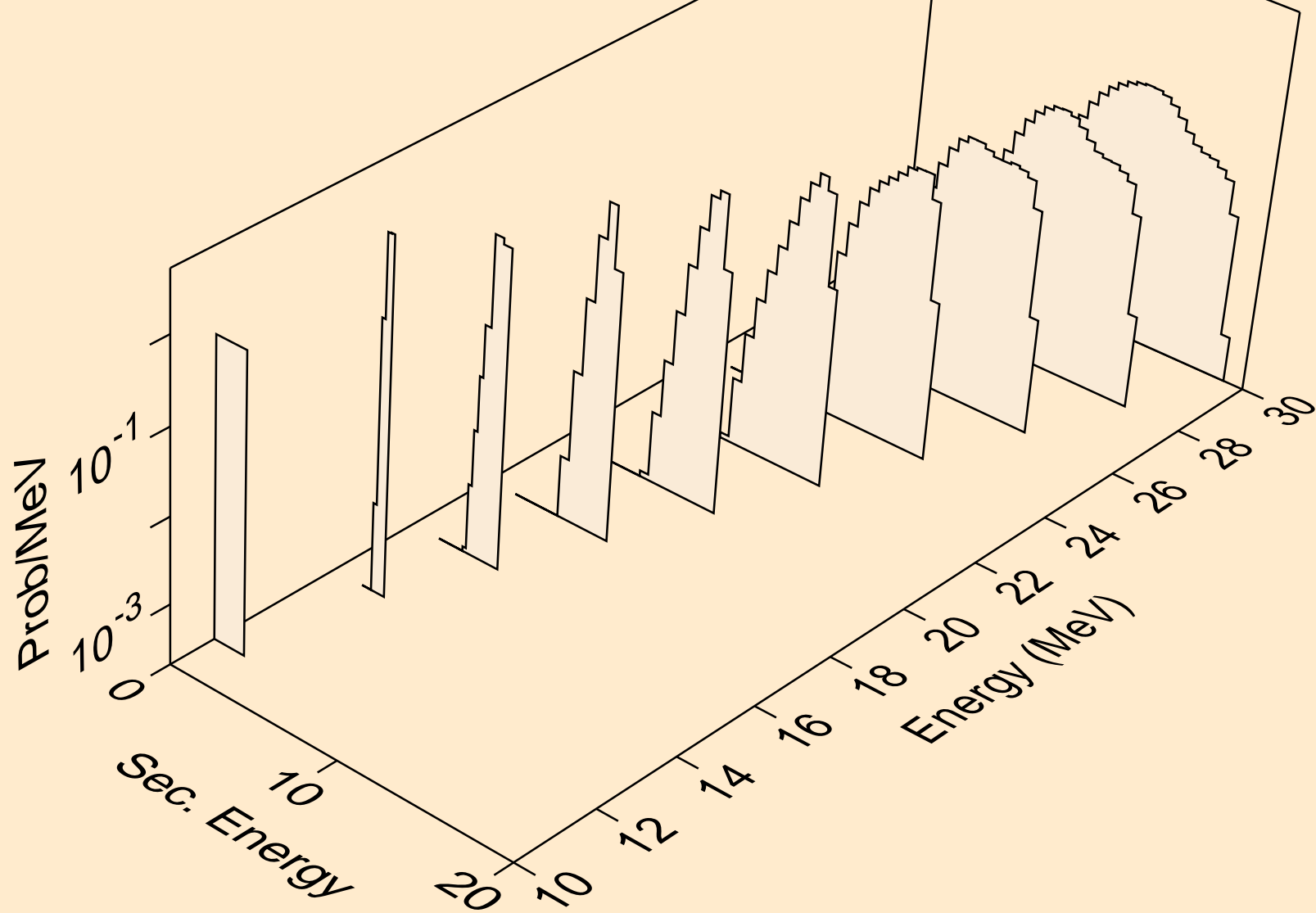

RE177 NEUTRON ACER TENDL-2023 LIBRARY; T=0.K
tritons from (n,t)

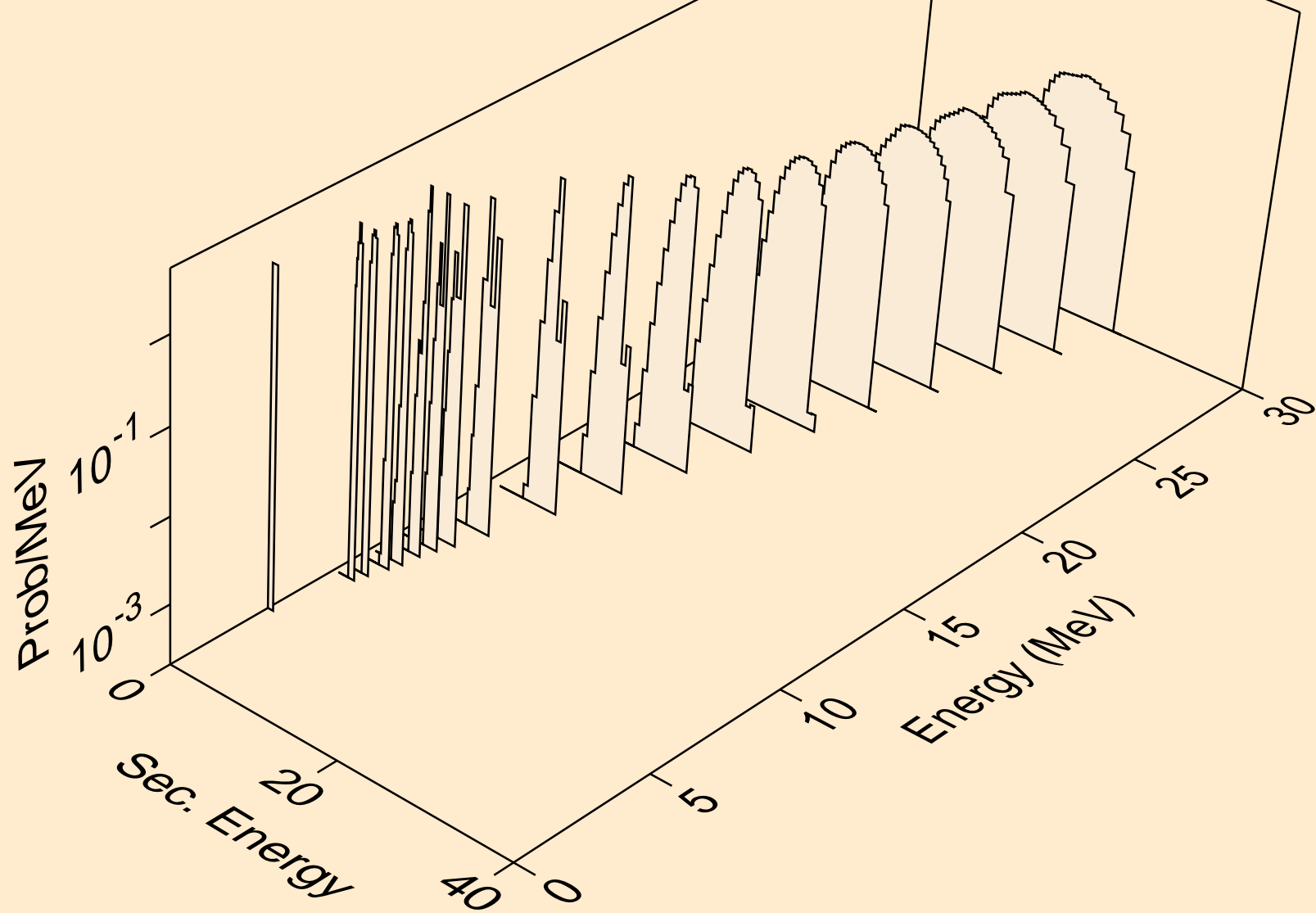

RE177 NEUTRON ACER TENDL-2023 LIBRARY; T=0.K
tritons from (n,pt)

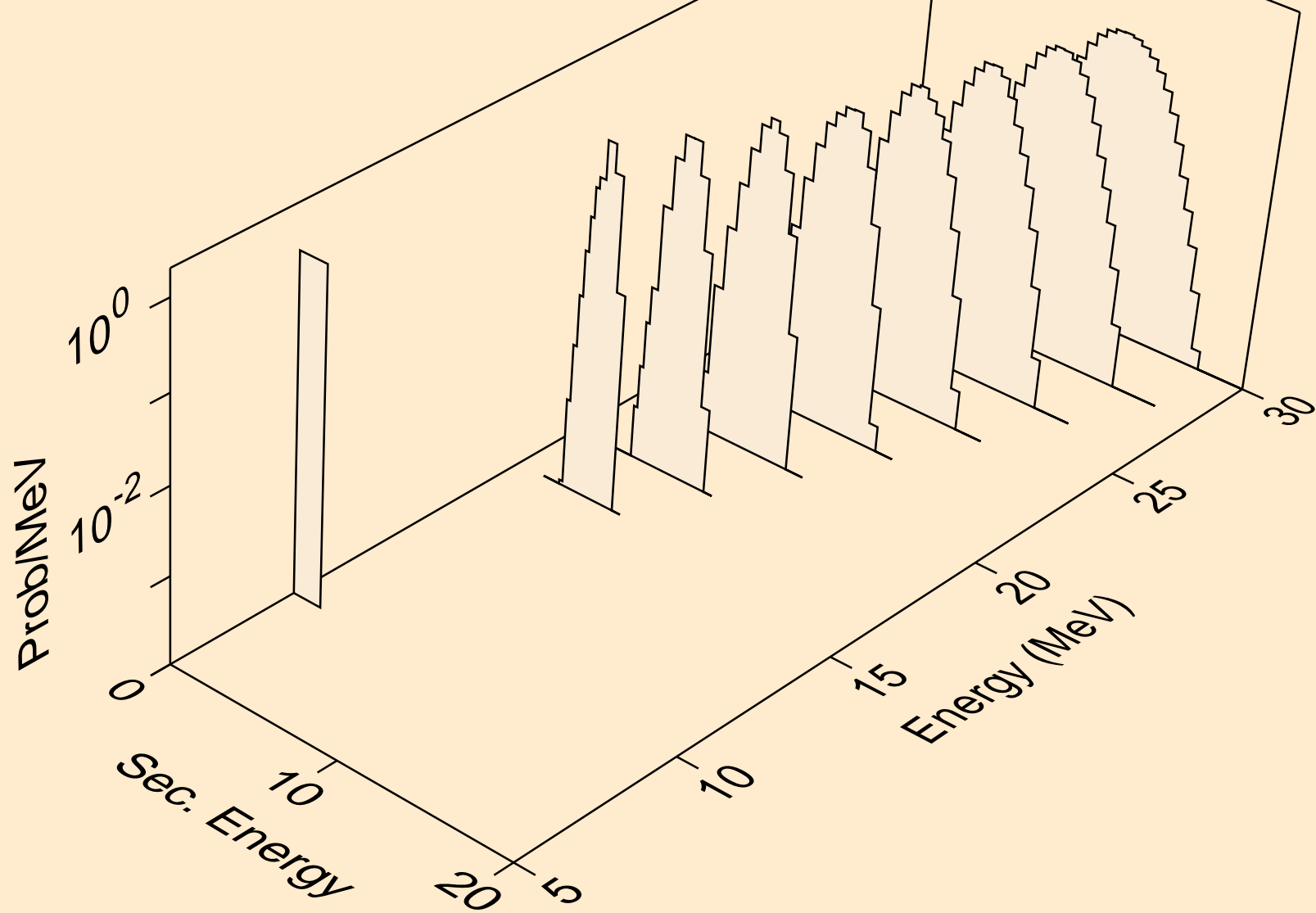

RE177 NEUTRON ACER TENDL-2023 LIBRARY; T=0.K
he3s from (n,x)

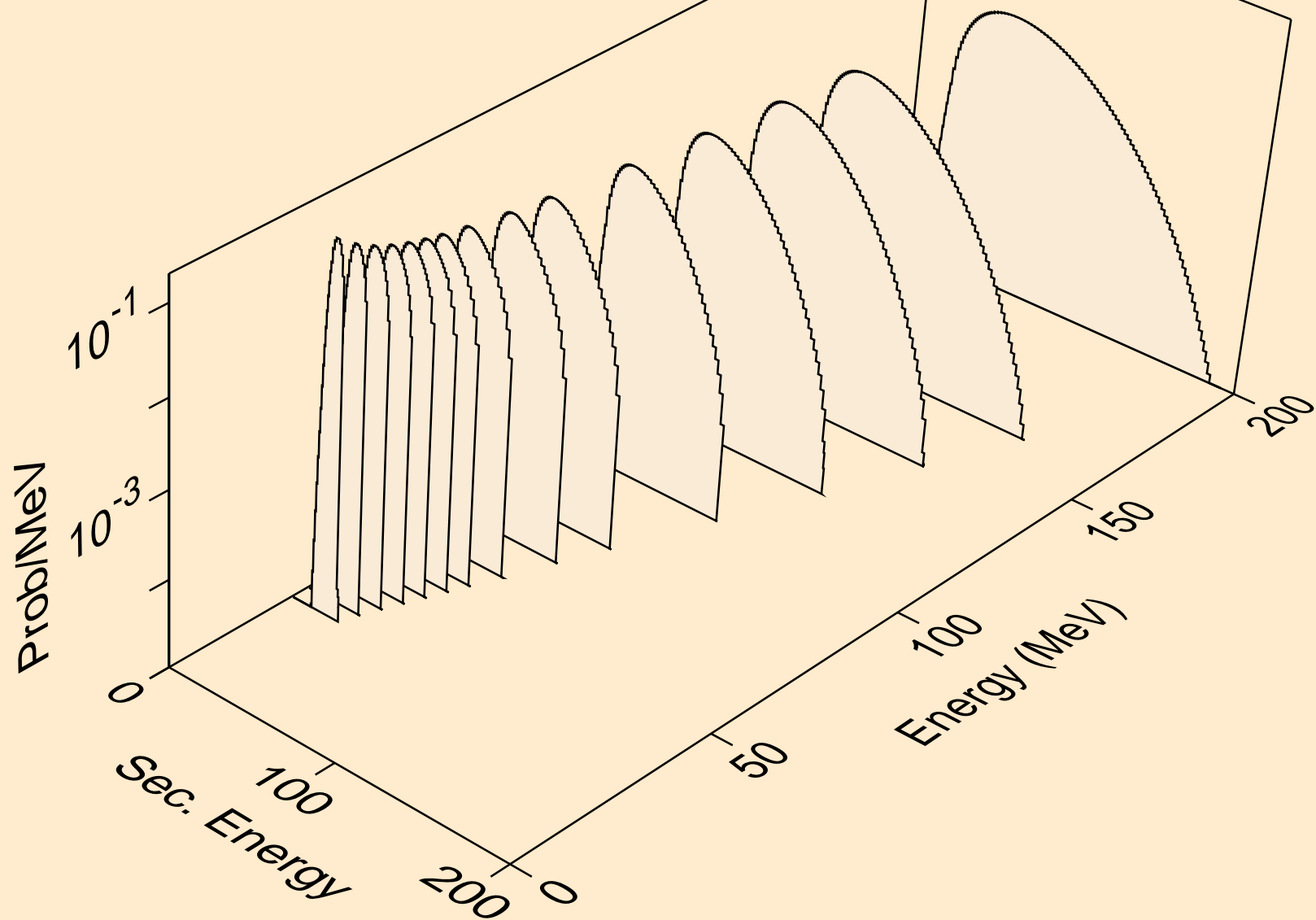

RE177 NEUTRON ACER TENDL-2023 LIBRARY; T=0.K
he3s from (n,n*)he3

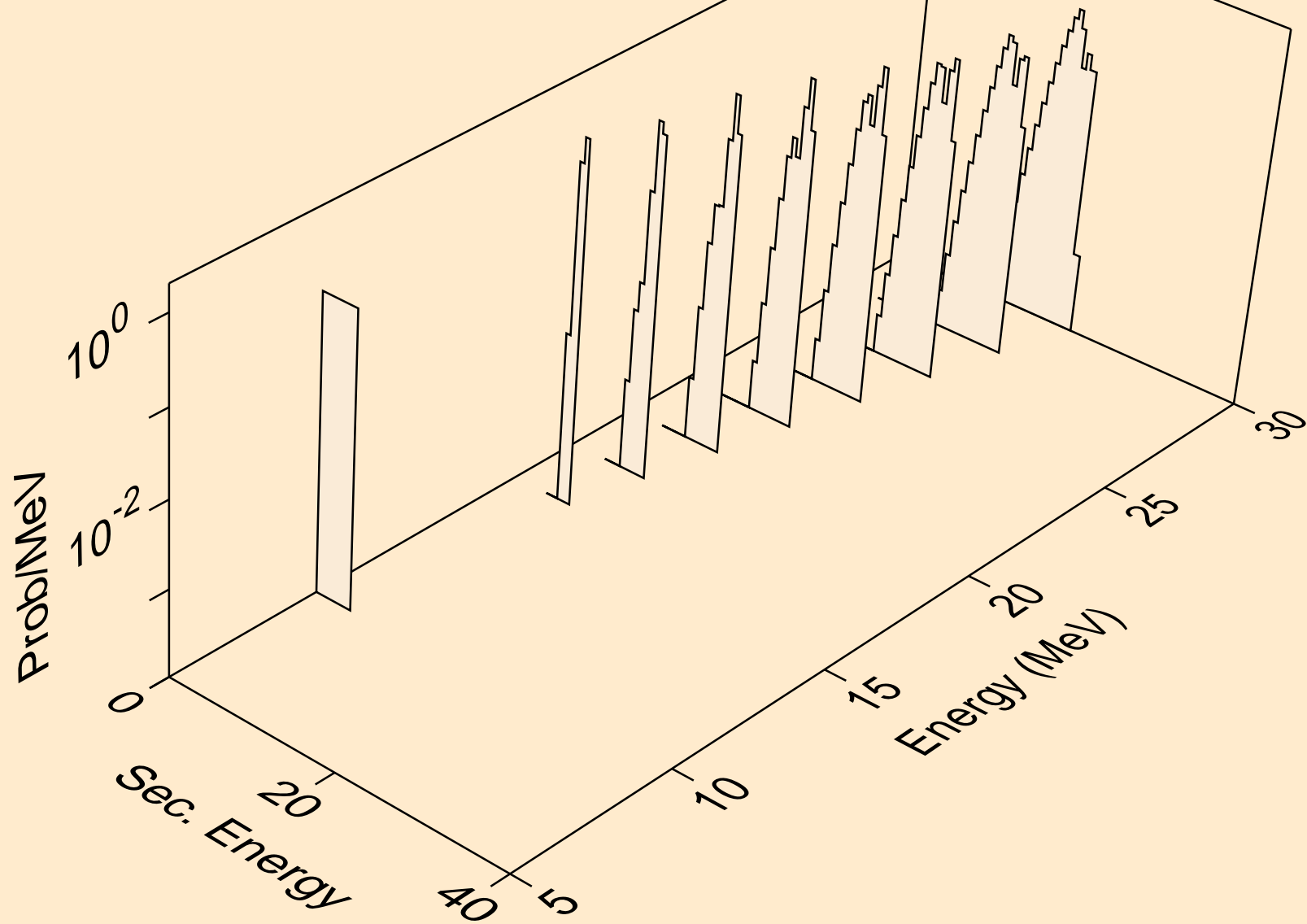

RE177 NEUTRON ACER TENDL-2023 LIBRARY; T=0.K
he3s from (n,he3)

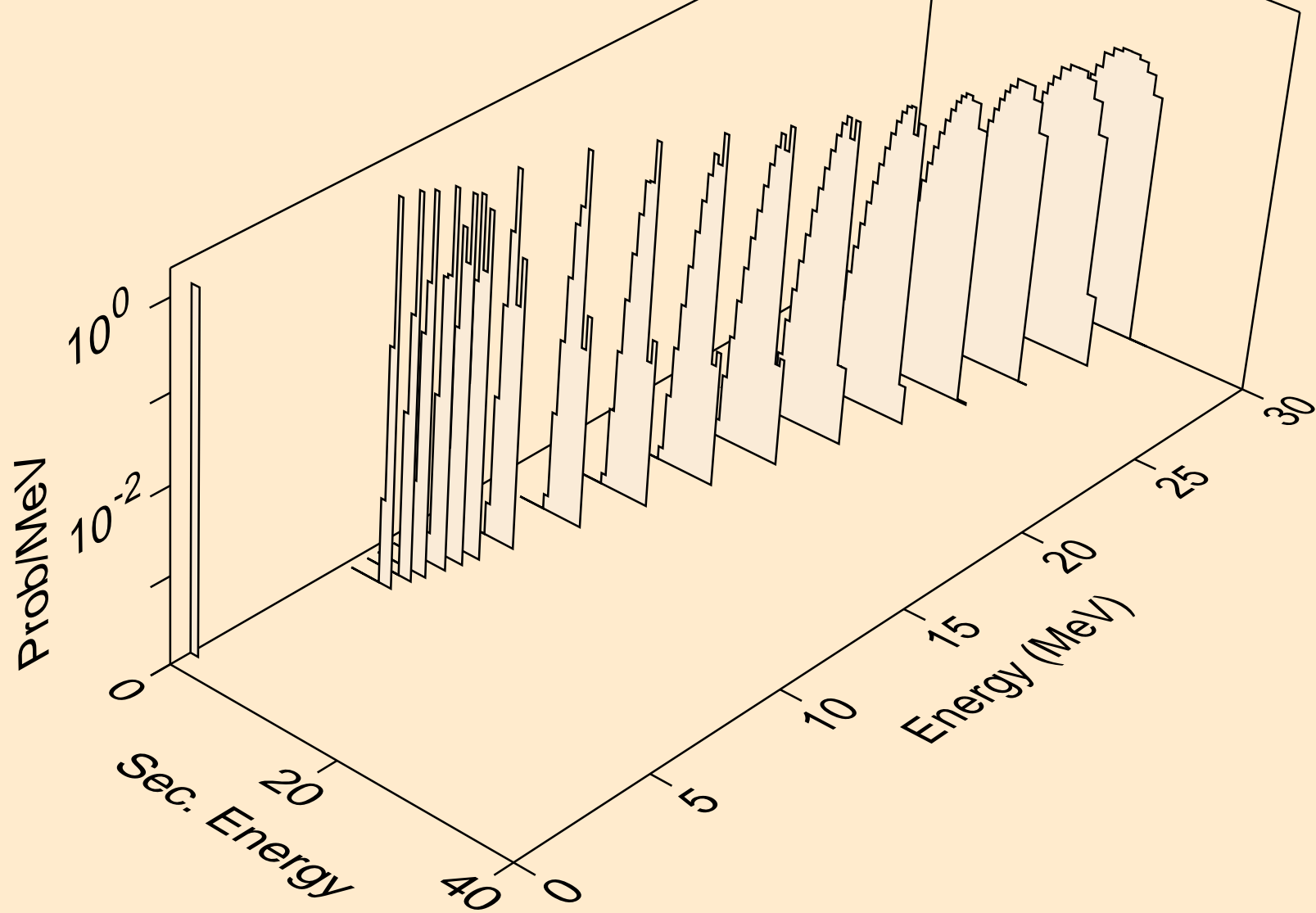

RE177 NEUTRON ACER TENDL-2023 LIBRARY; T=0.K
alphas from (n,x)

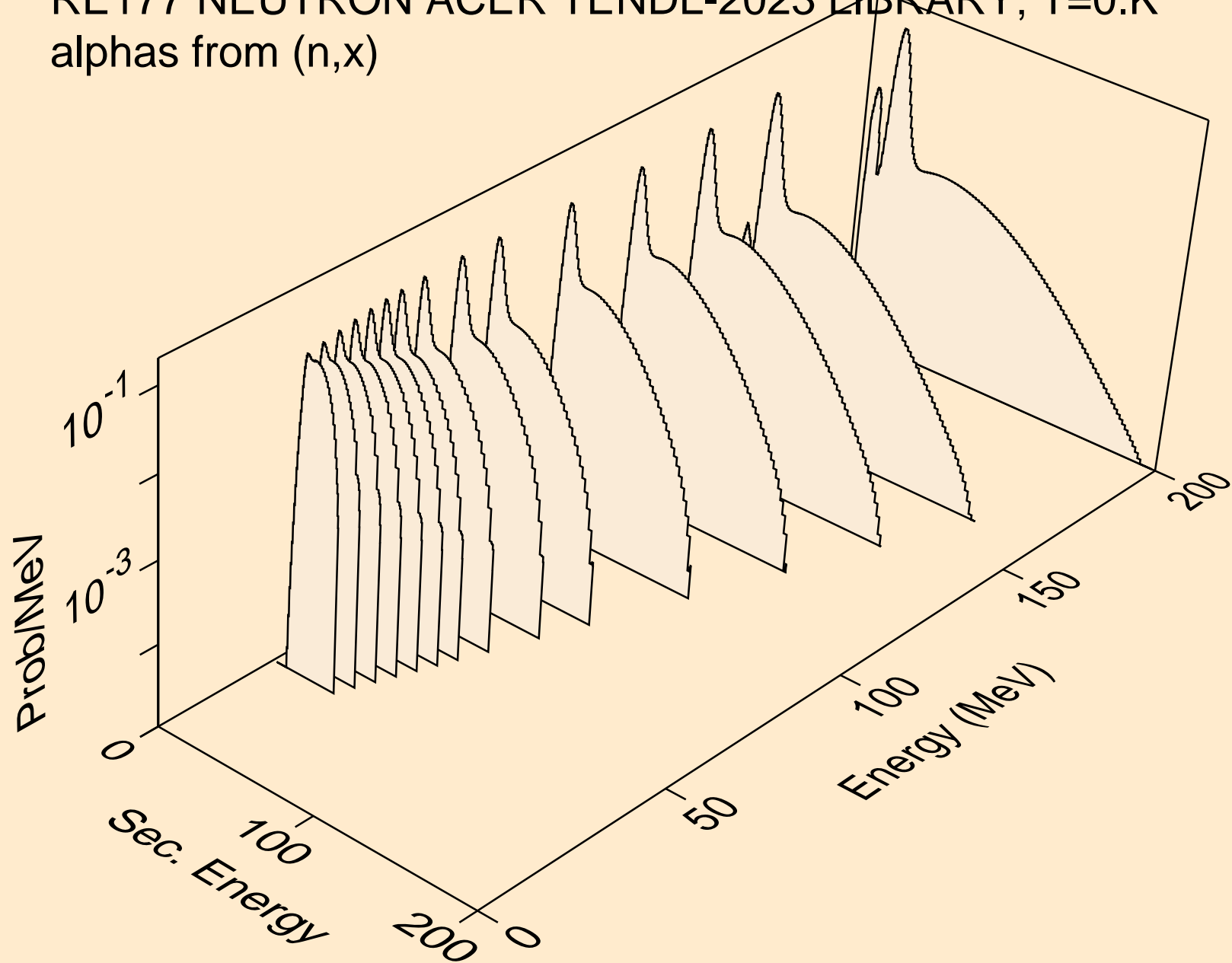

RE177 NEUTRON ACER TENDL-2023 LIBRARY; T=0.K
alphas from (n,n*)a

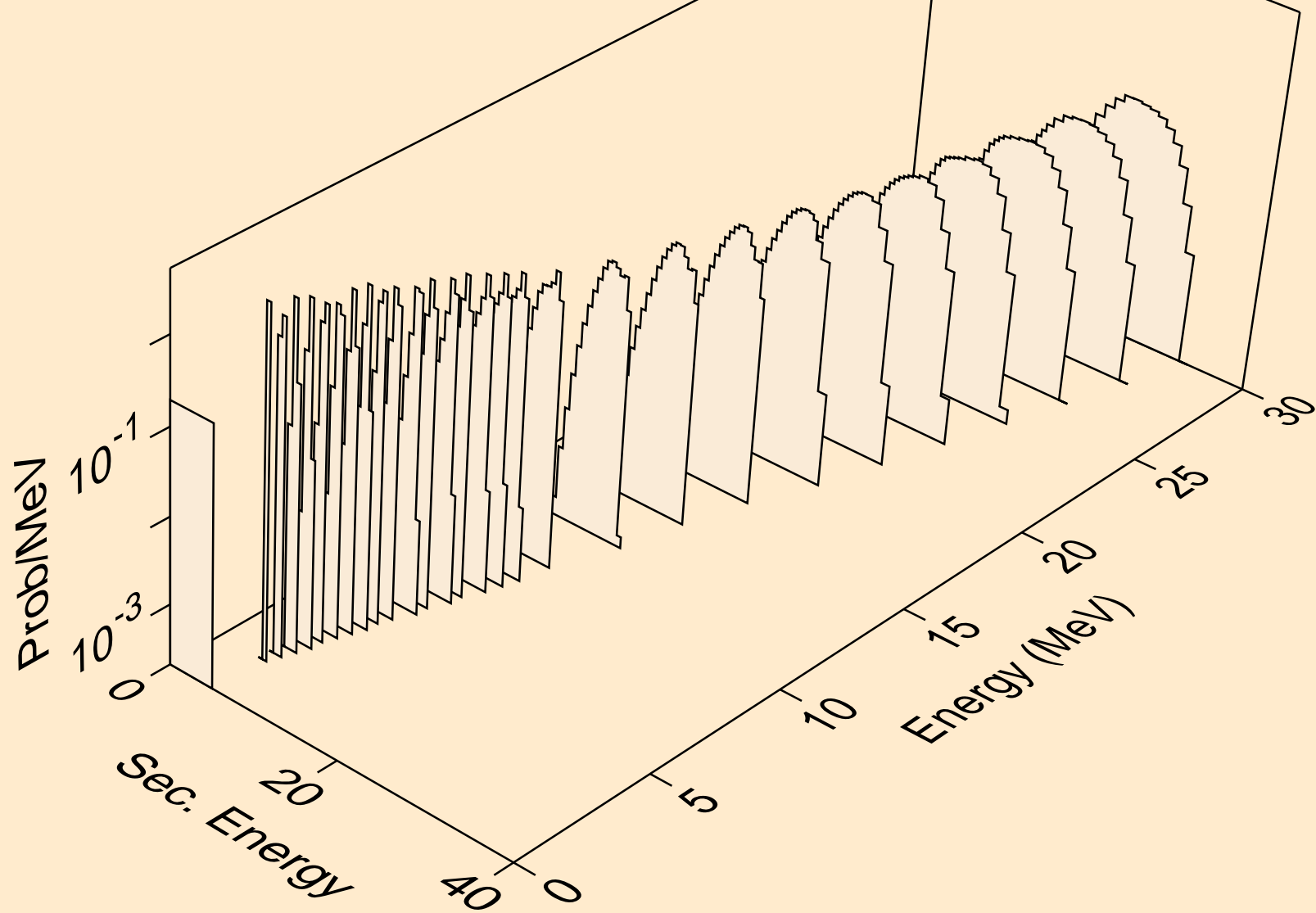

RE177 NEUTRON ACER TENDL-2023 LIBRARY; T=0.K
alphas from (n,2n)a

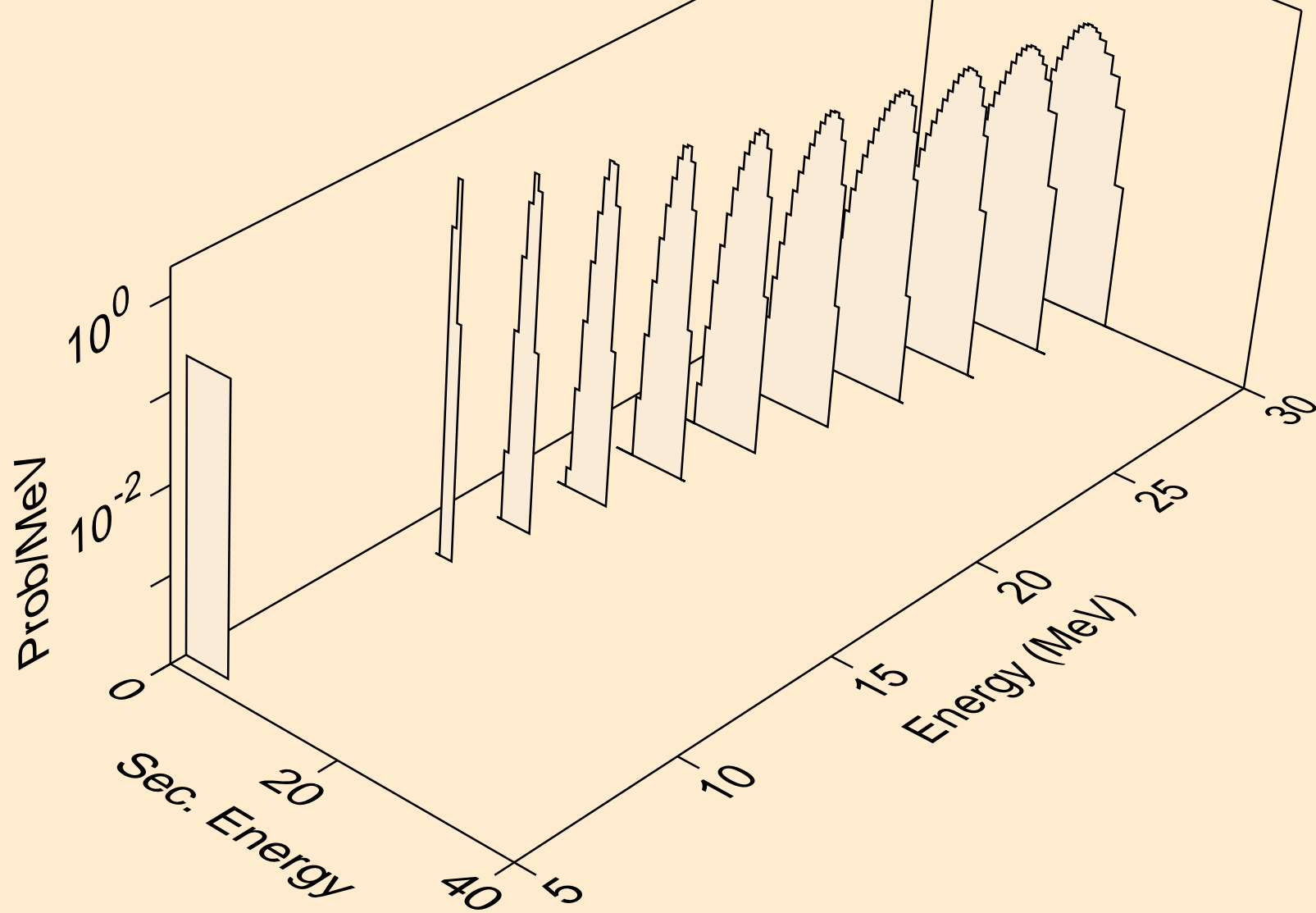

RE177 NEUTRON ACER TENDL-2023 LIBRARY; T=0.K
alphas from (n,3n)a

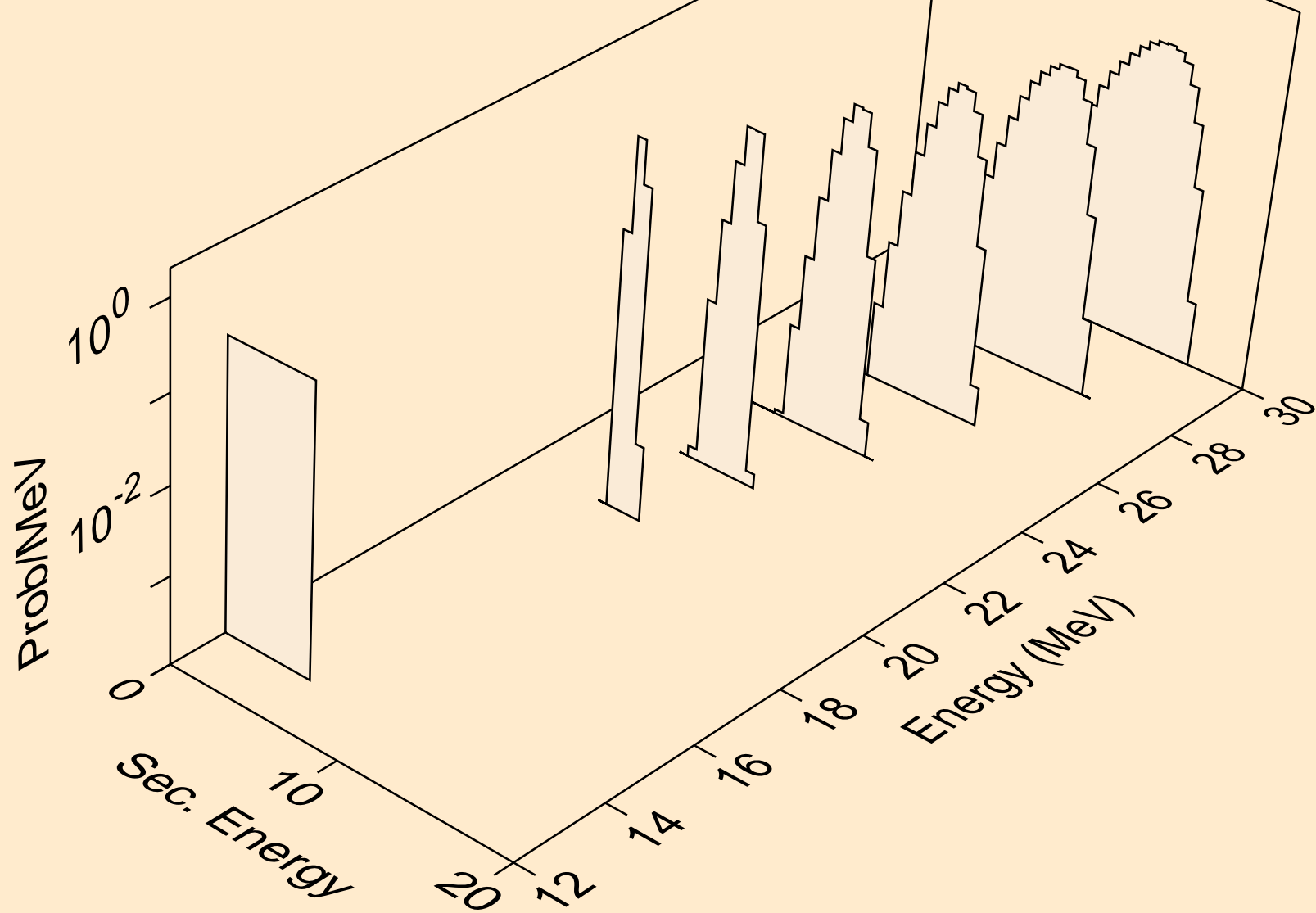

RE177 NEUTRON ACER TENDL-2023 LIBRARY; T=0.K
alphas from (n,n*)2a

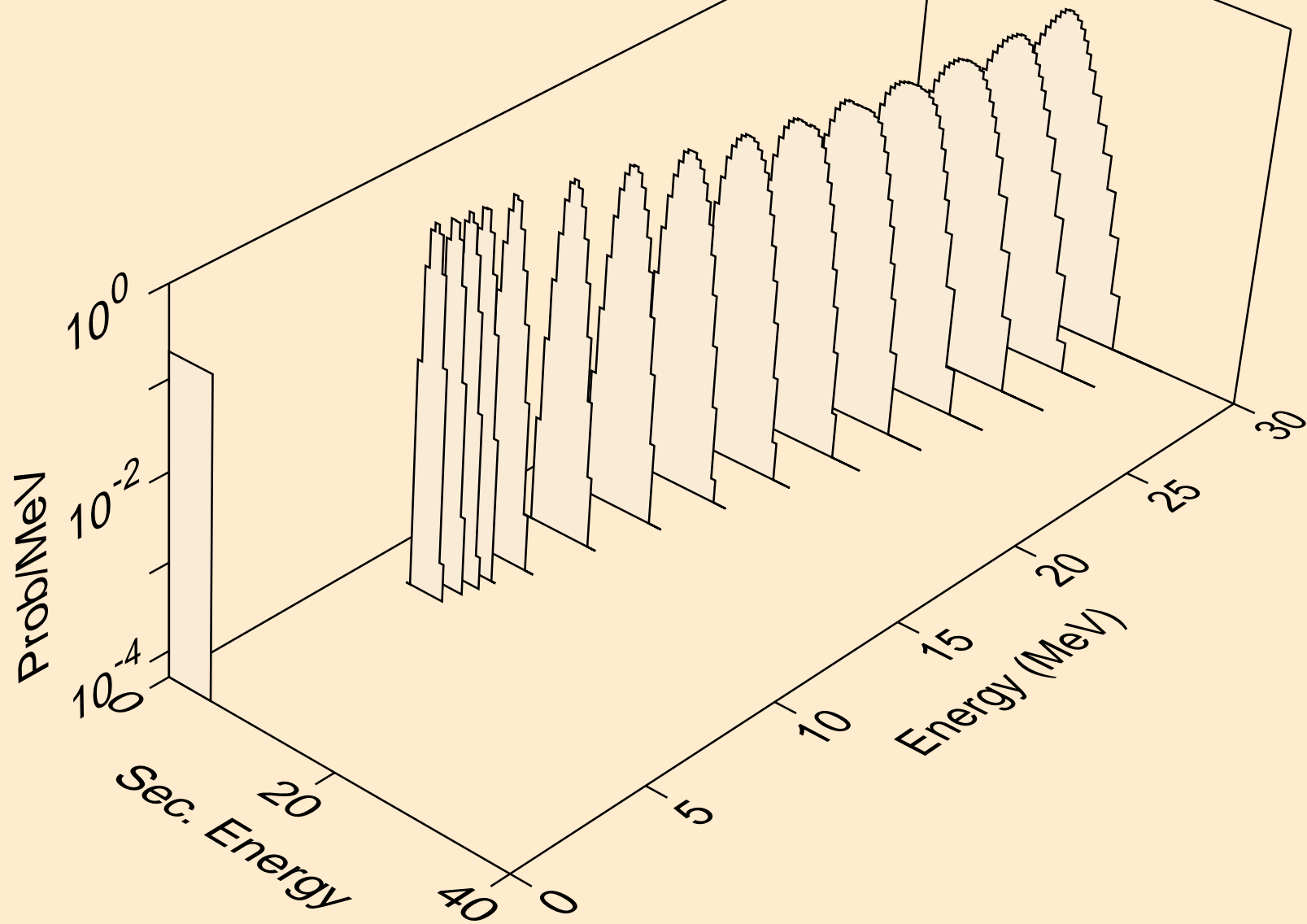

RE177 NEUTRON ACER TENDL-2023 LIBRARY; T=0.K
alphas from (n,2n)2a

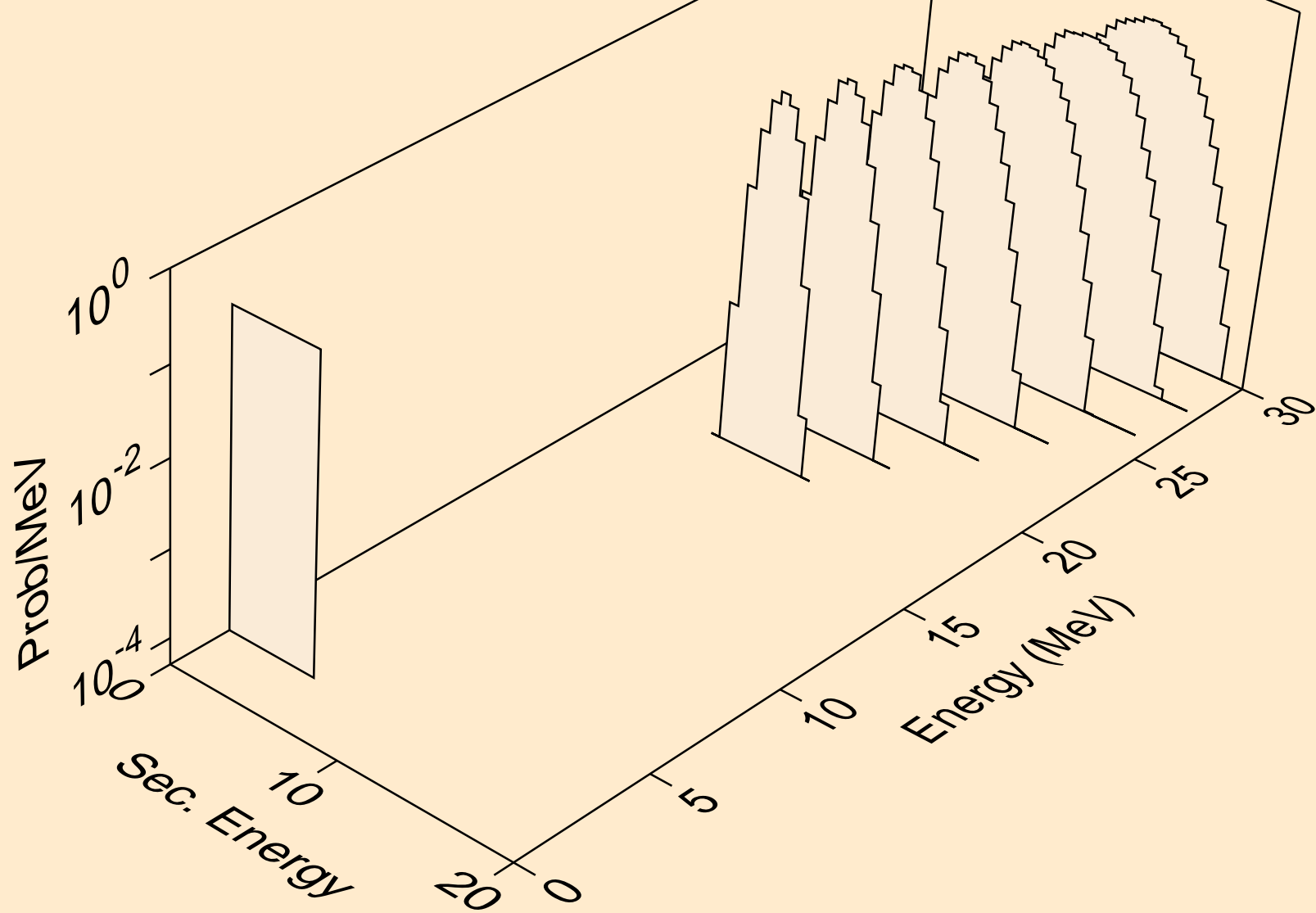

RE177 NEUTRON ACER TENDL-2023 LIBRARY; T=0.K
alphas from (n,npa)

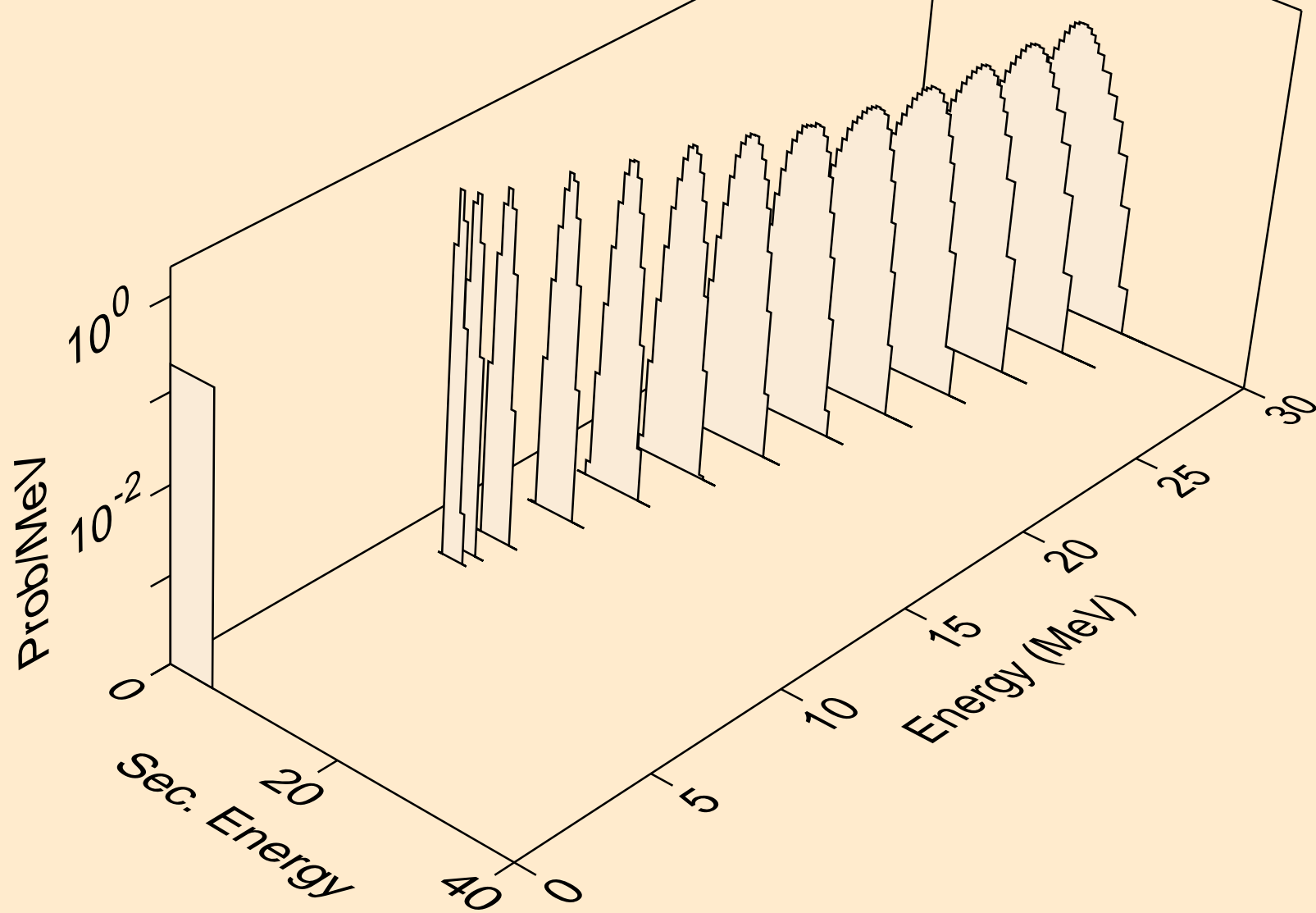

RE177 NEUTRON ACER TENDL-2023 LIBRARY; T=0.K
alphas from (n,a)

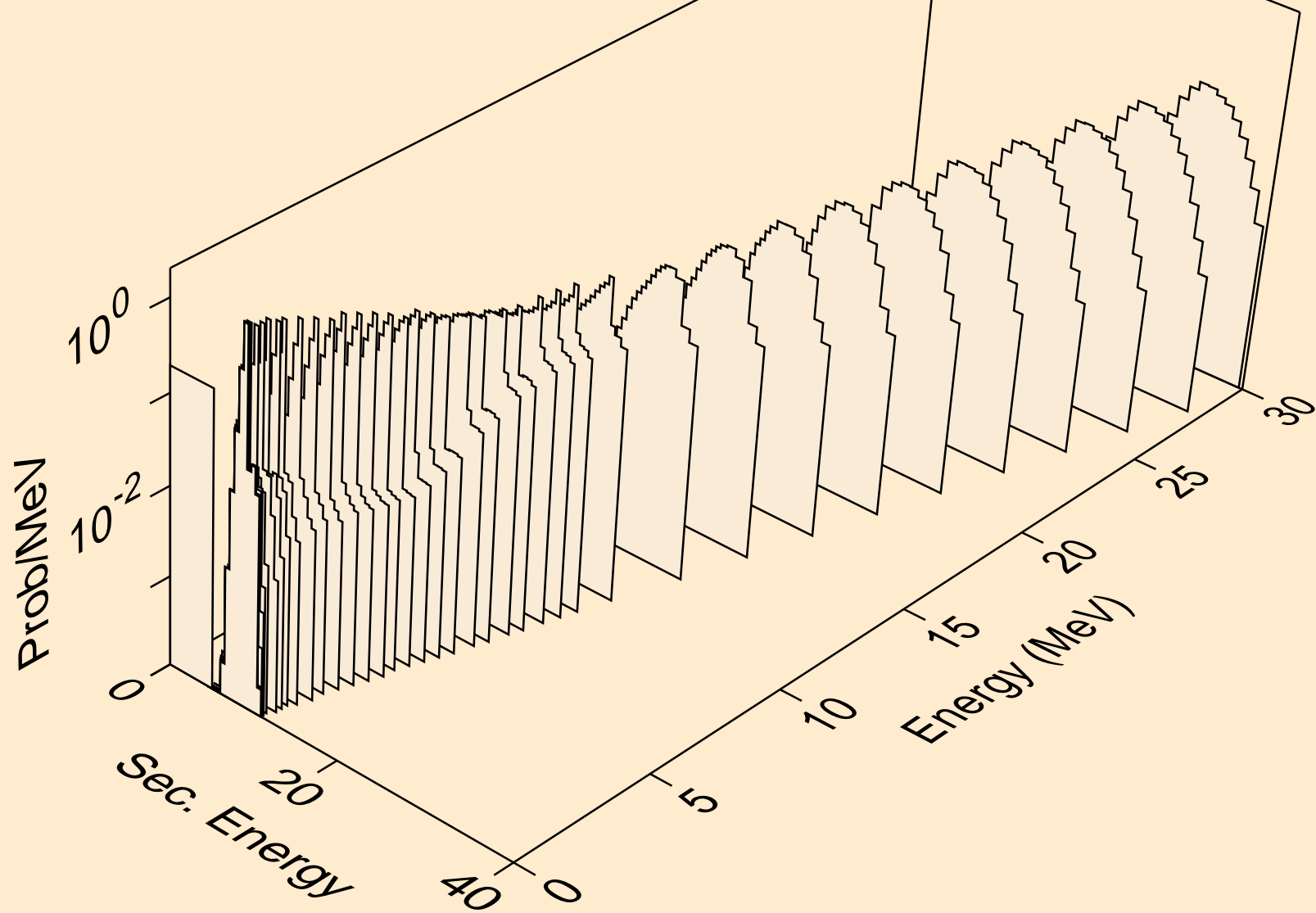

RE177 NEUTRON ACER TENDL-2023 LIBRARY; T=0.K
alphas from (n,2a)

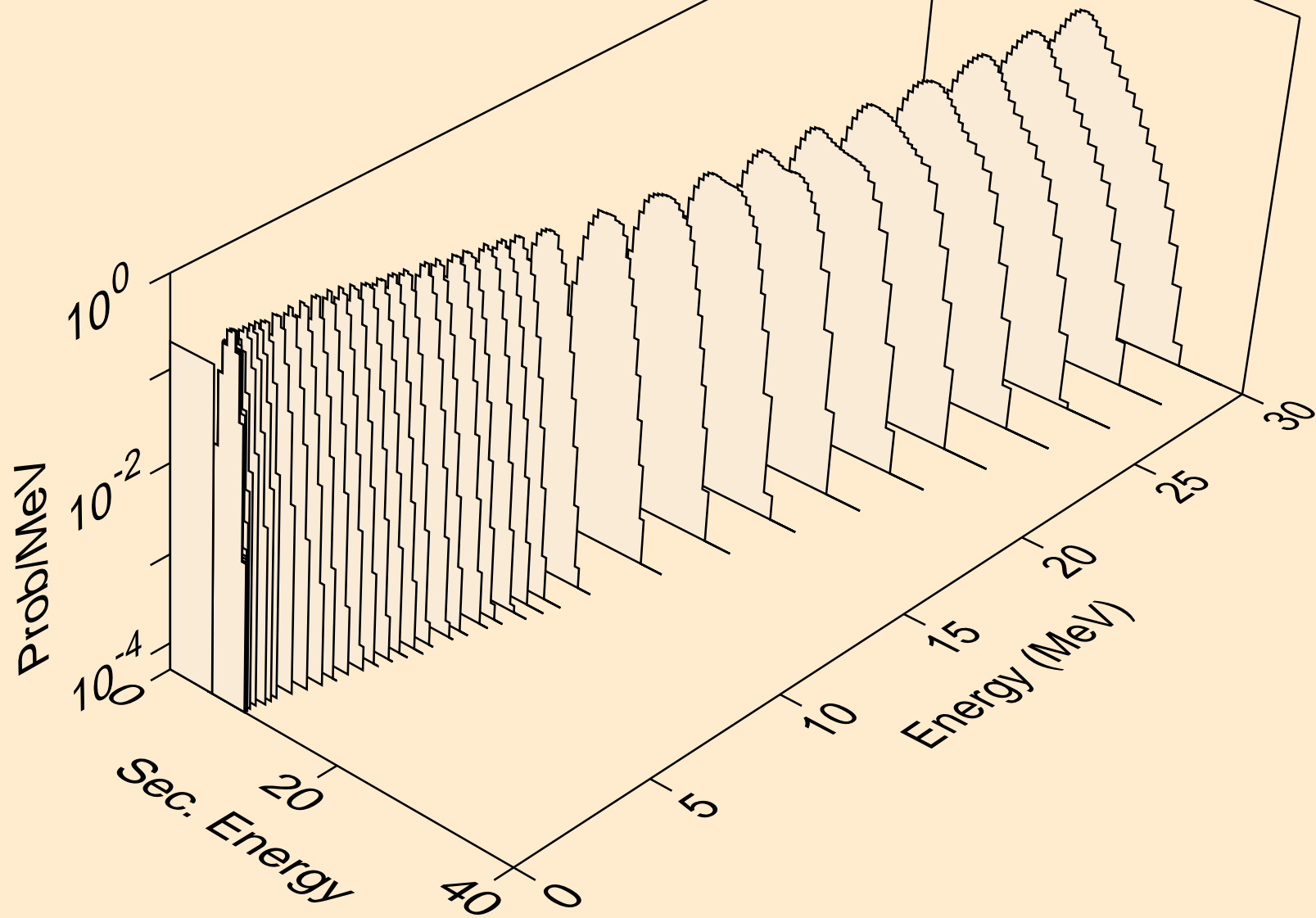

RE177 NEUTRON ACER TENDL-2023 LIBRARY; T=0.K
alphas from (n,pa)

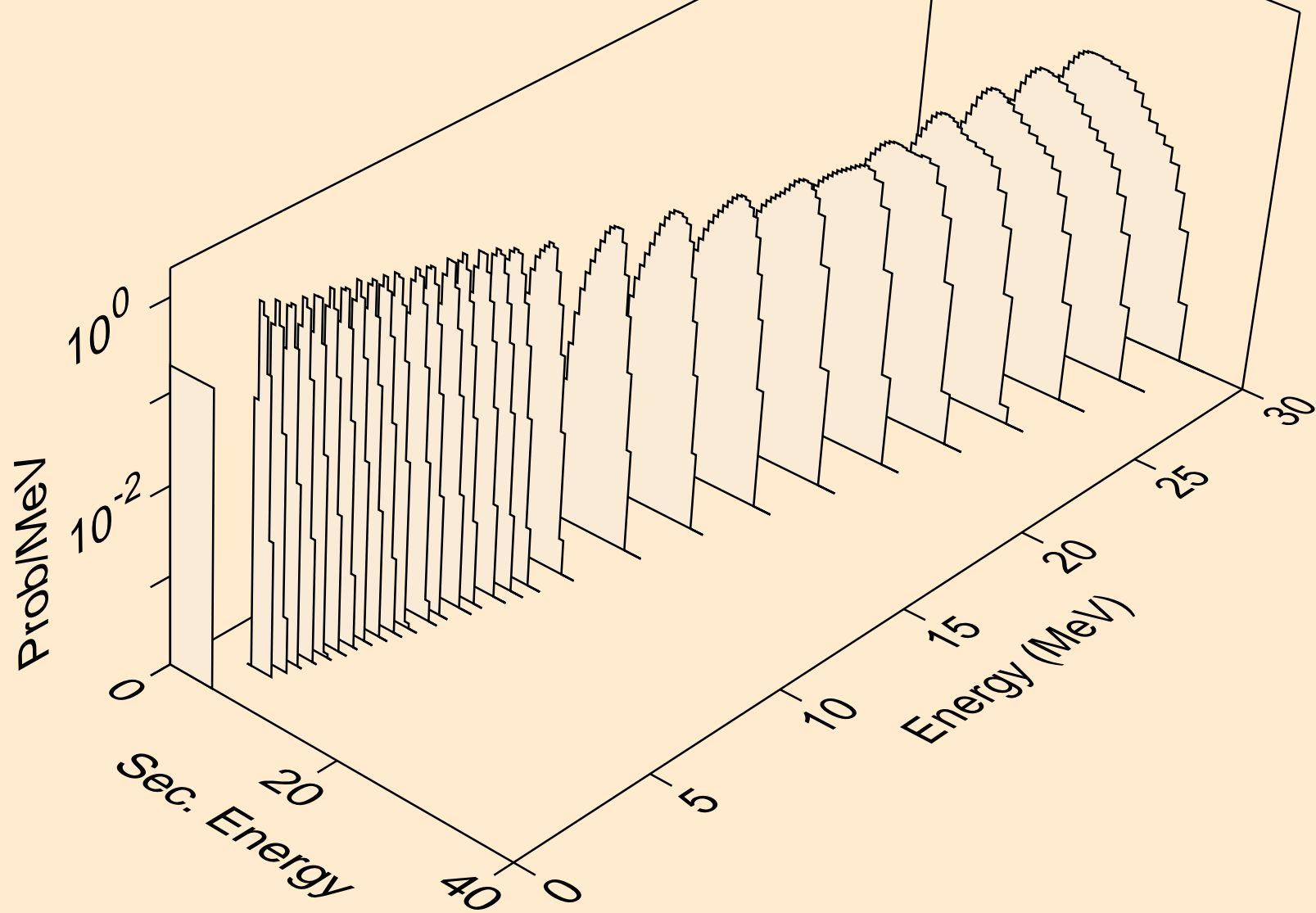

RE177 NEUTRON ACER TENDL-2023 LIBRARY; T=0.K
alphas from (n,da)

