

RH101 NEUTRON ACER TENDL-2023 LIBRARY; T=0.K

Principal cross sections

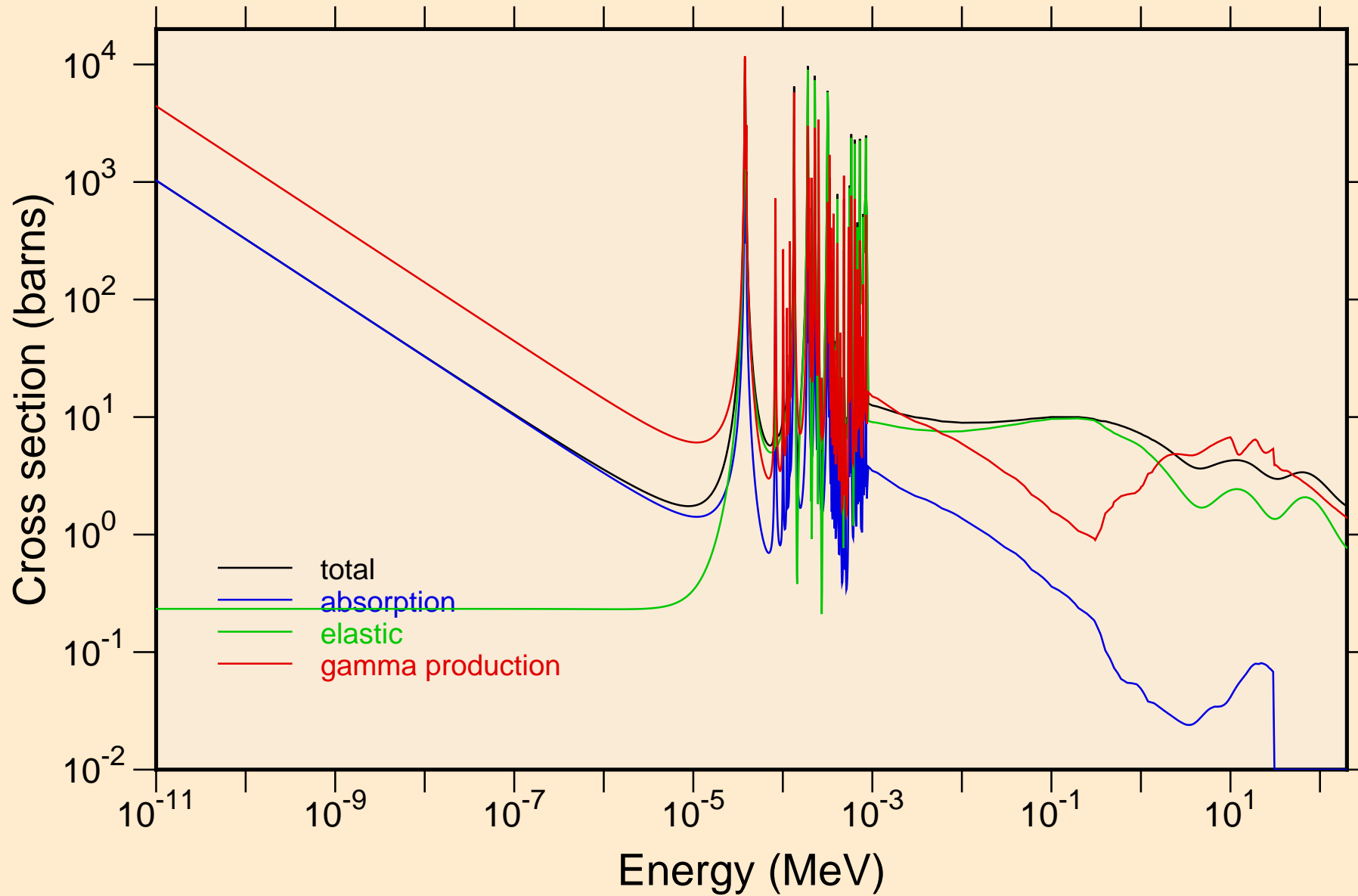

RH101 NEUTRON ACER TENDL-2023 LIBRARY; T=0.K
resonance total cross section

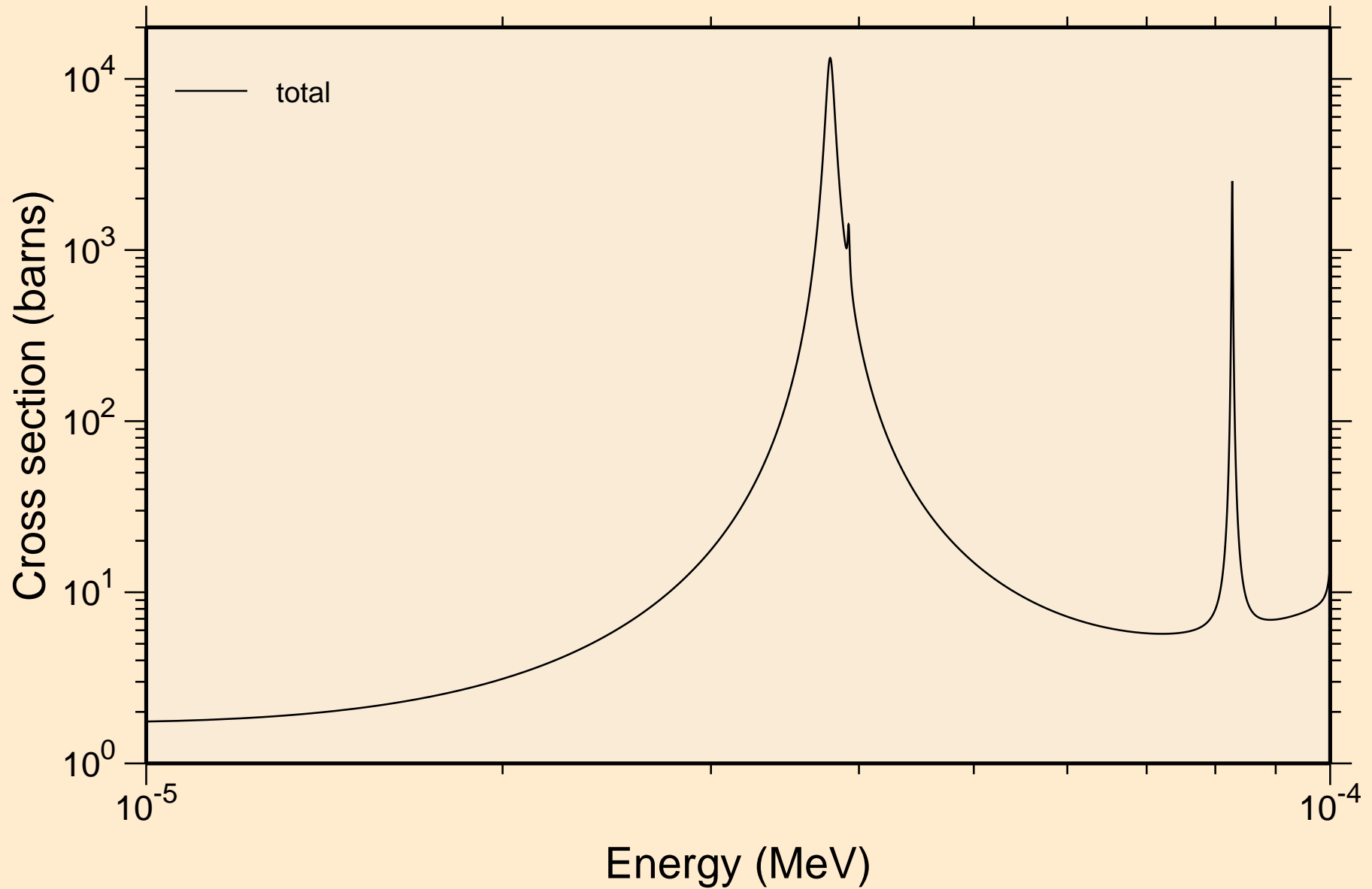

RH101 NEUTRON ACER TENDL-2023 LIBRARY; T=0.K
resonance total cross section

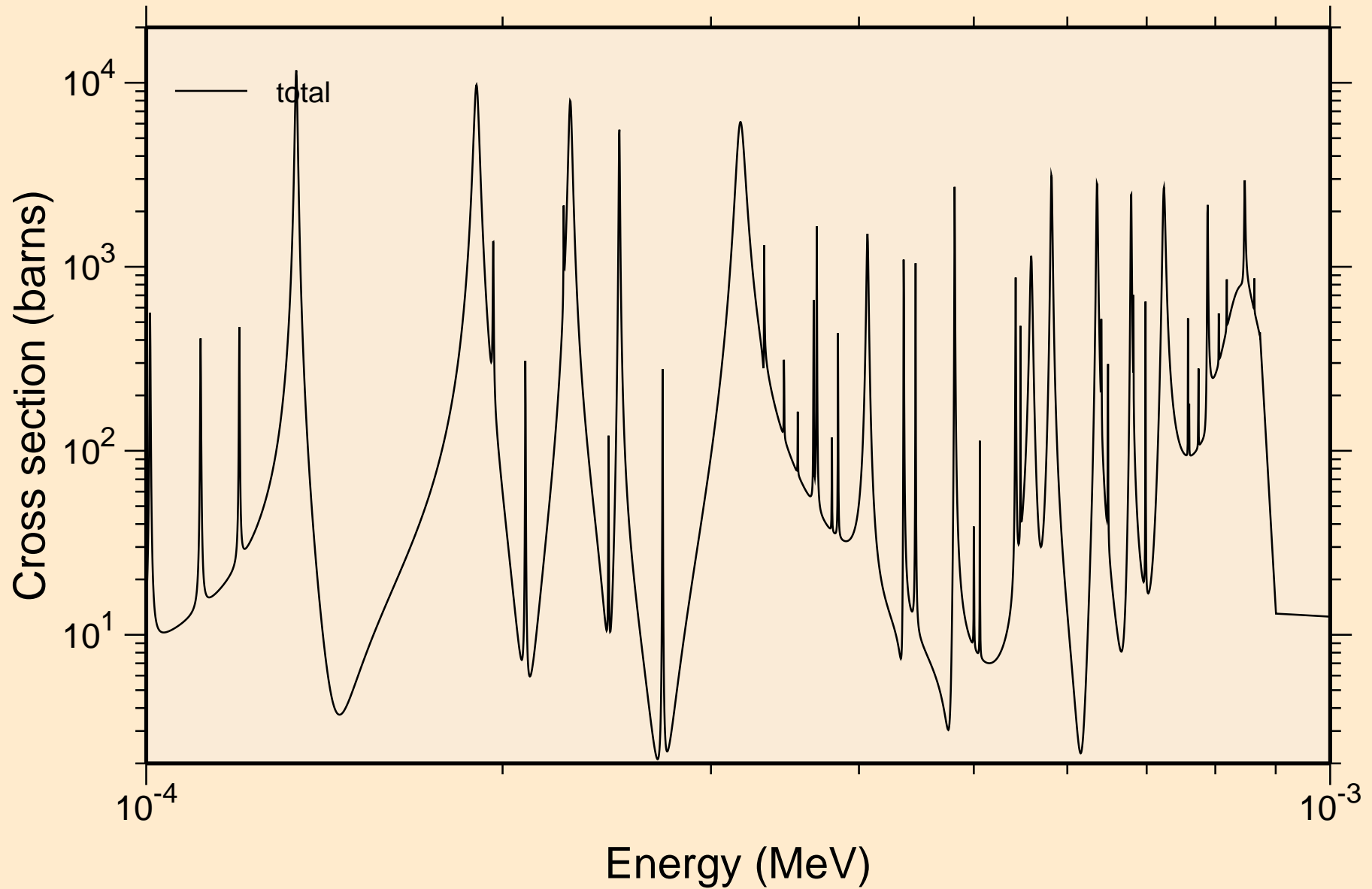

RH101 NEUTRON ACER TENDL-2023 LIBRARY; T=0.K
resonance total cross section

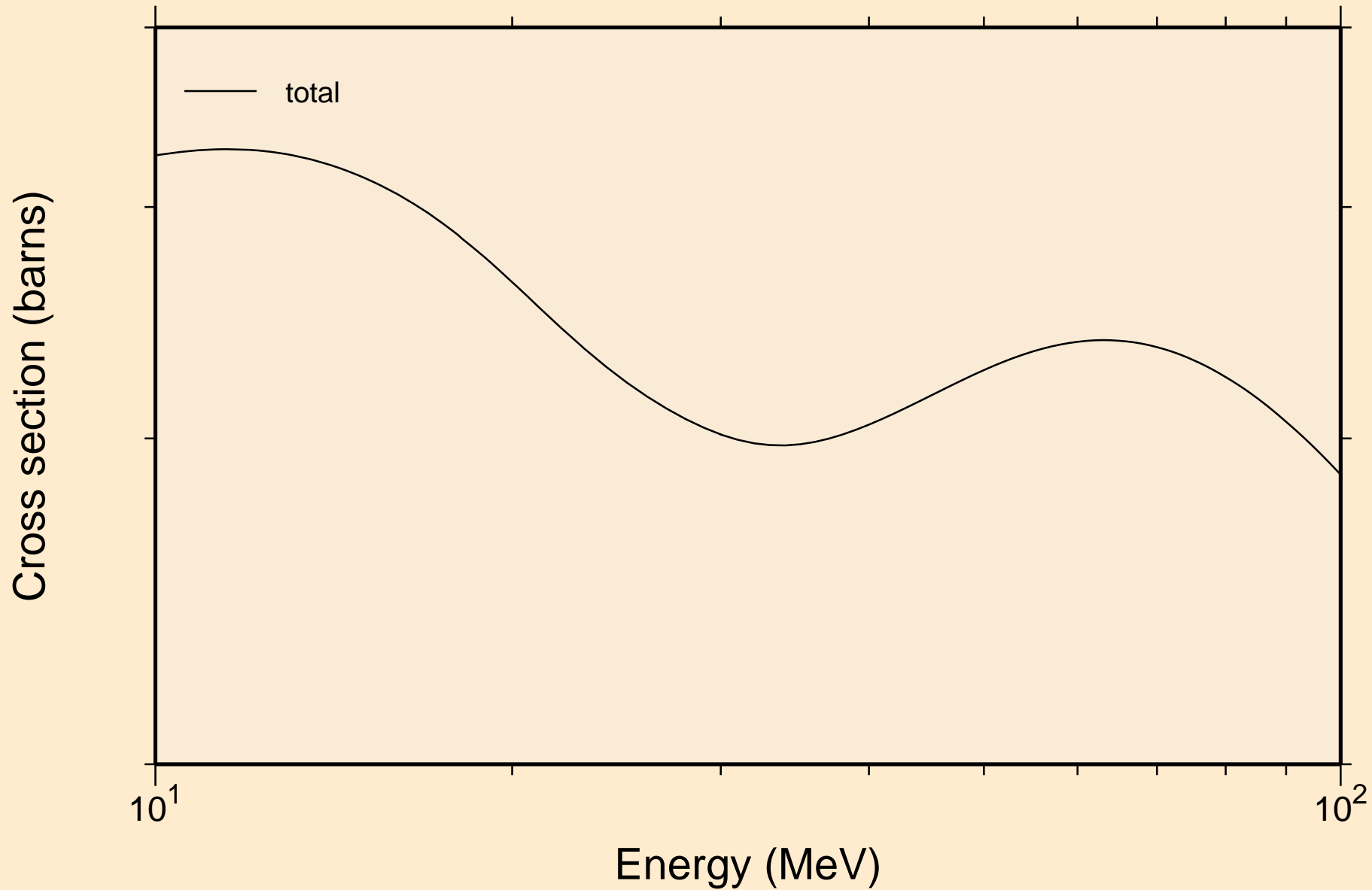

RH101 NEUTRON ACER TENDL-2023 LIBRARY; T=0.K
resonance absorption cross sections

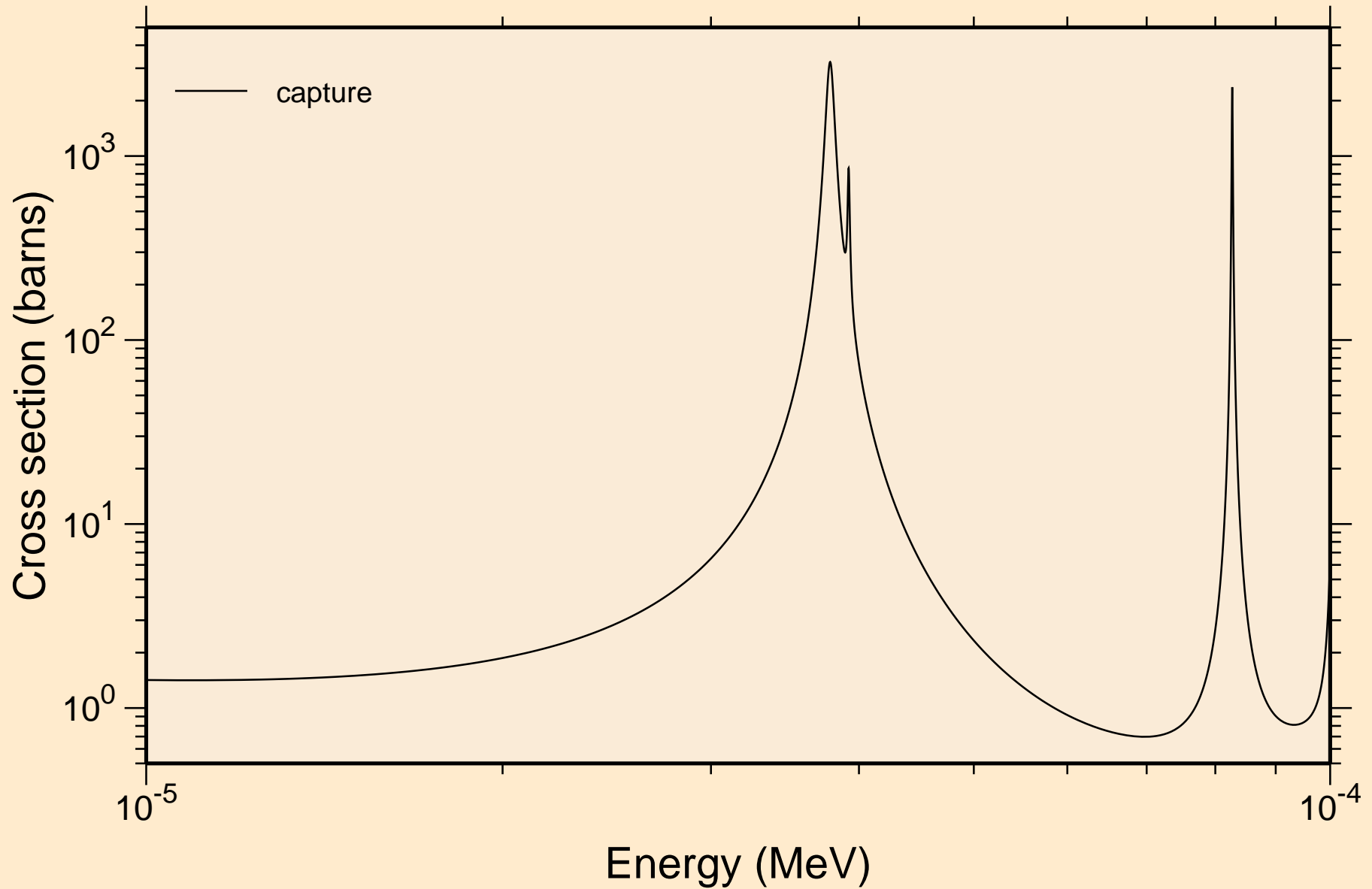

RH101 NEUTRON ACER TENDL-2023 LIBRARY; T=0.K
resonance absorption cross sections

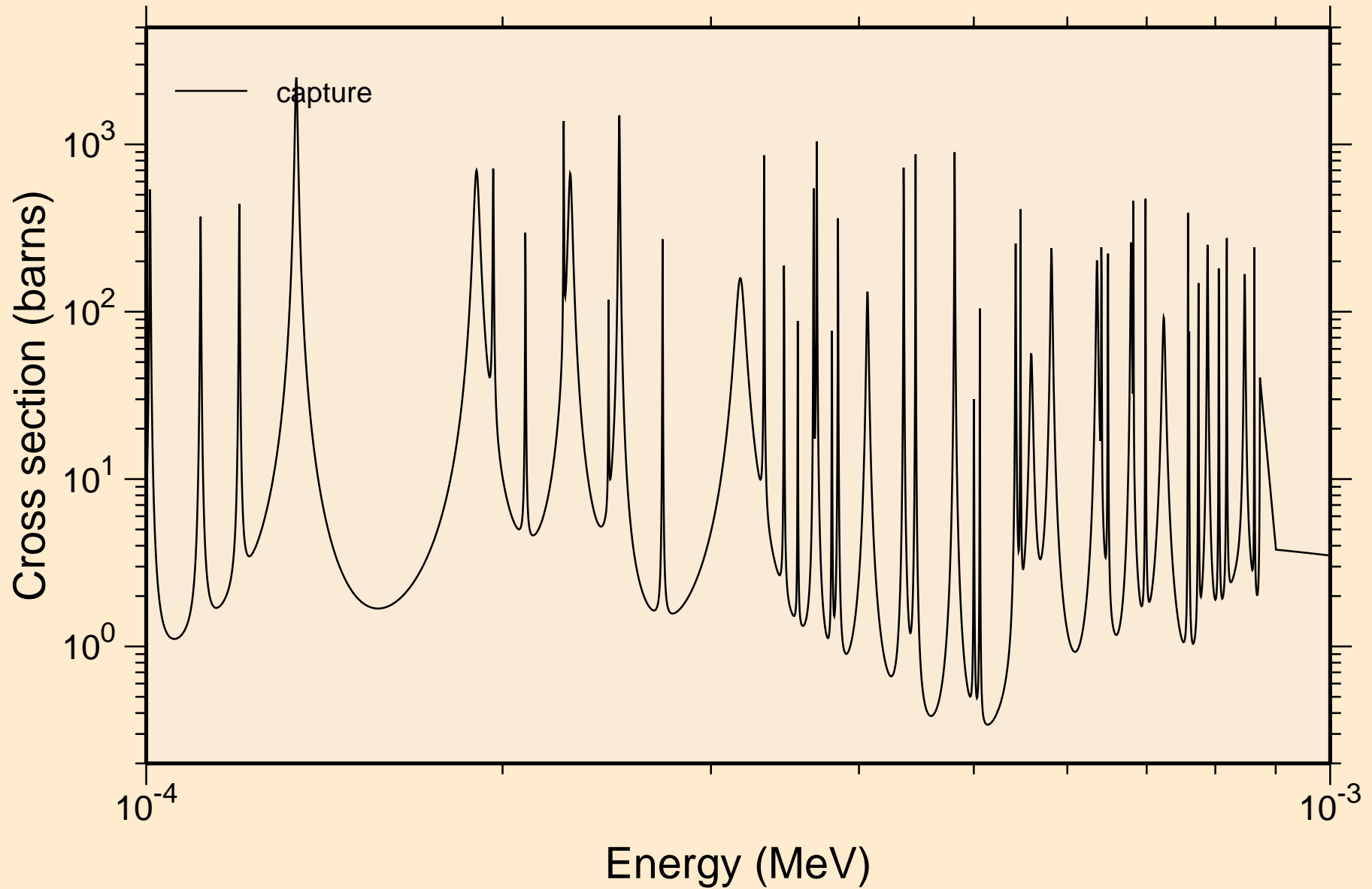

RH101 NEUTRON ACER TENDL-2023 LIBRARY; T=0.K
resonance absorption cross sections

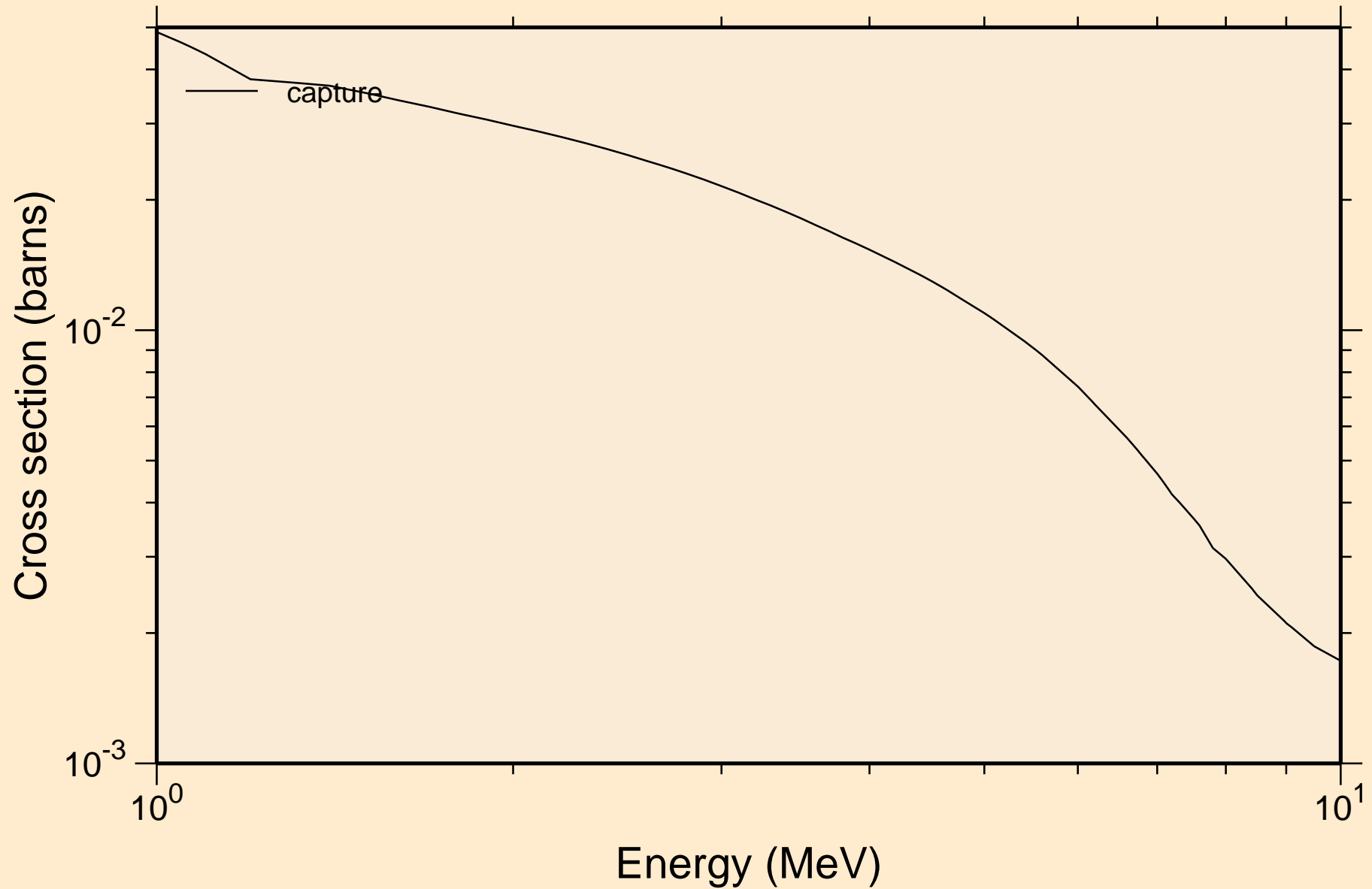

RH101 NEUTRON ACER TENDL-2023 LIBRARY; T=0.K
Heating

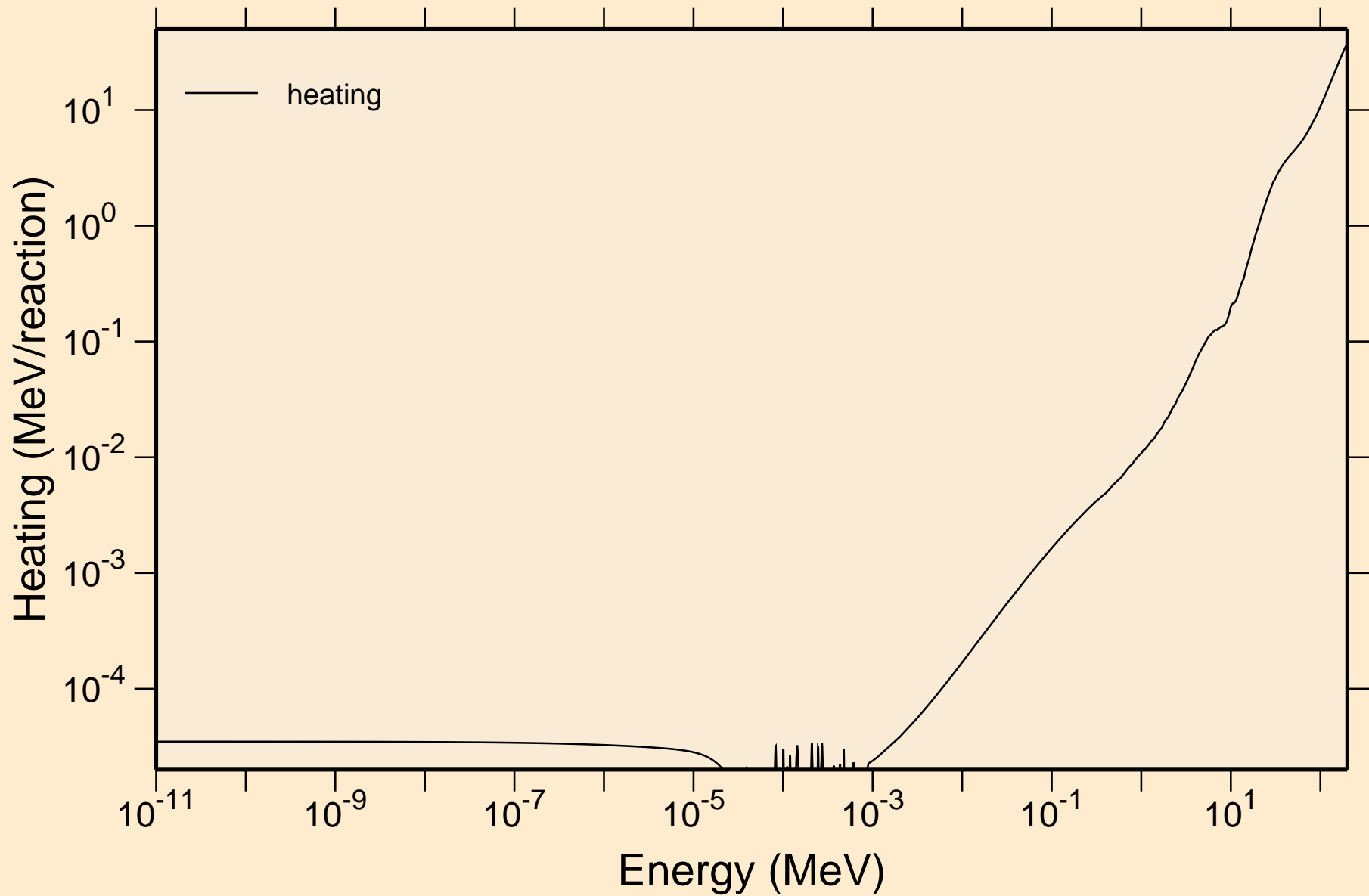

RH101 NEUTRON ACER TENDL-2023 LIBRARY; T=0.K

Damage

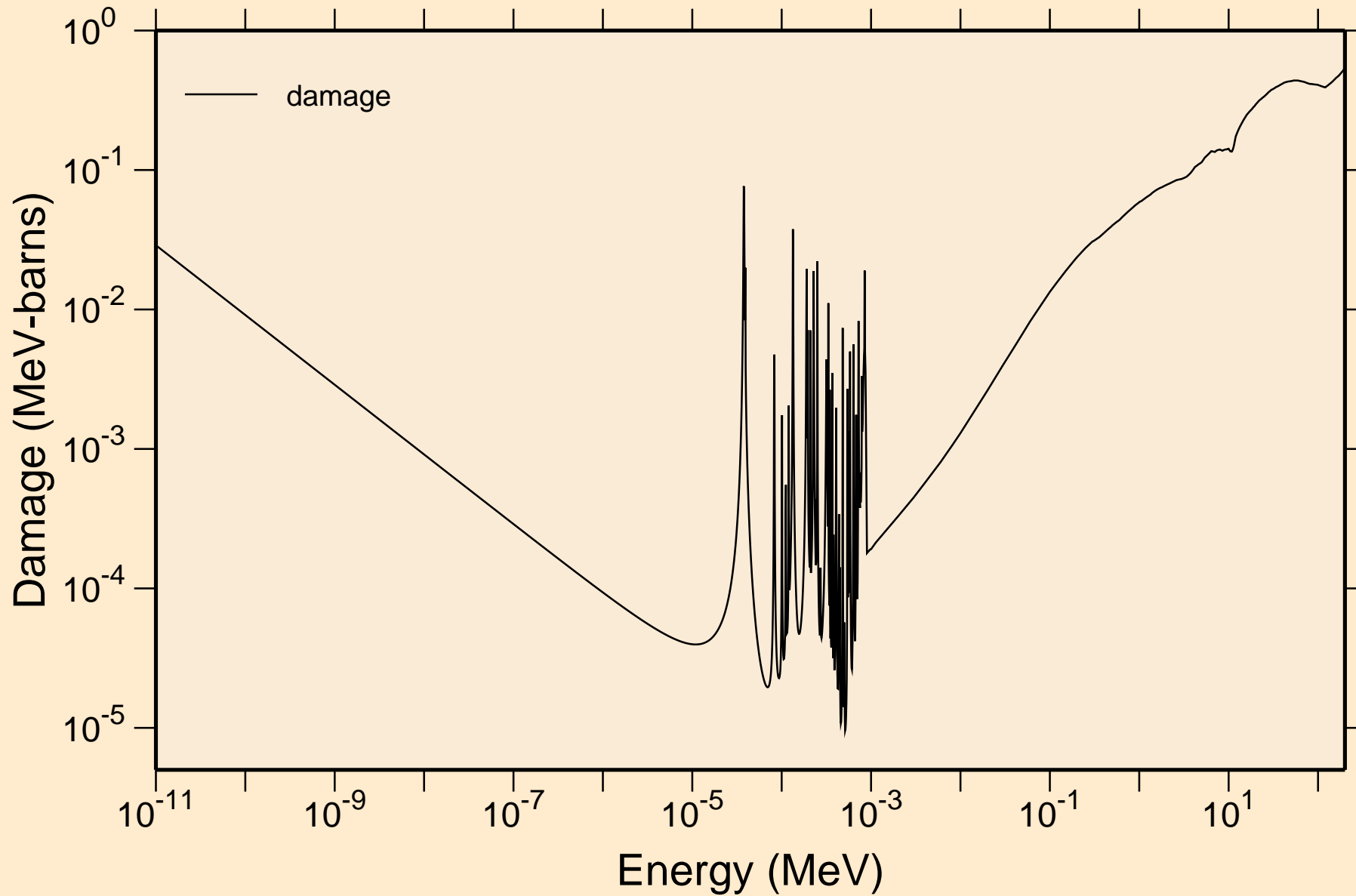

RH101 NEUTRON ACER TENDL-2023 LIBRARY; T=0.K

Non-threshold reactions

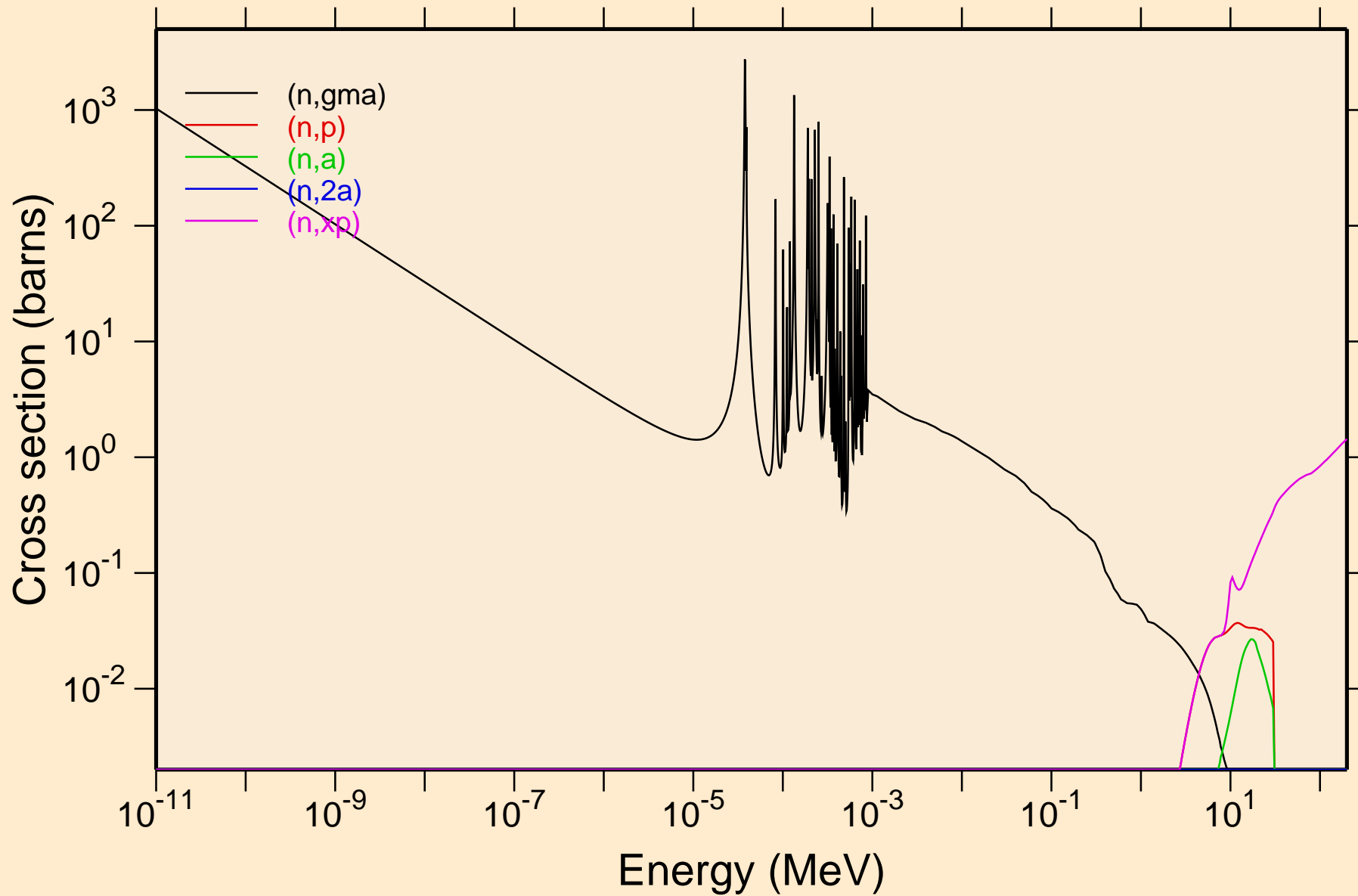

RH101 NEUTRON ACER TENDL-2023 LIBRARY; T=0.K
Non-threshold reactions

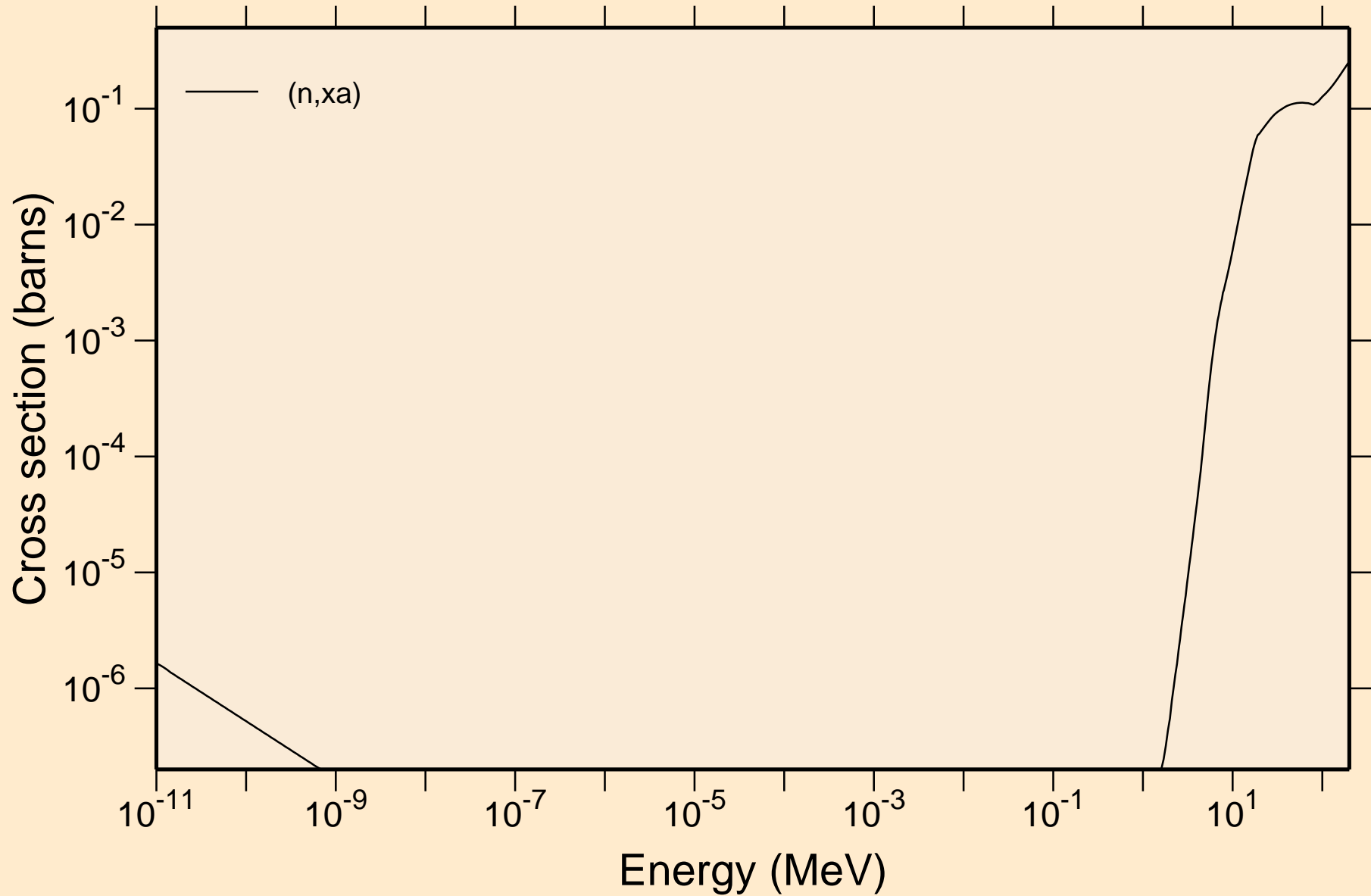

RH101 NEUTRON ACER TENDL-2023 LIBRARY; T=0.K

Principal cross sections

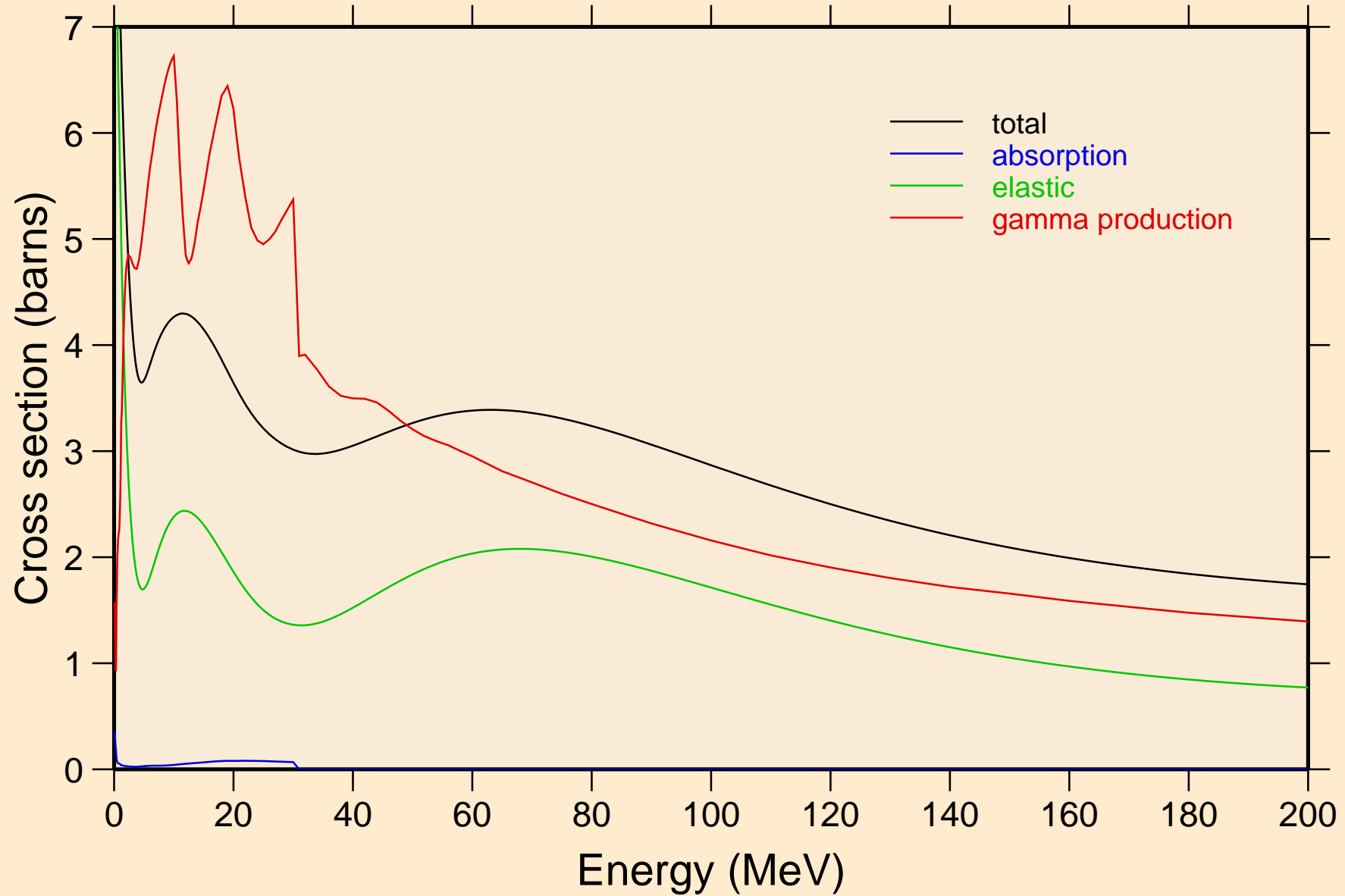

RH101 NEUTRON ACER TENDL-2023 LIBRARY; T=0.K

Heating

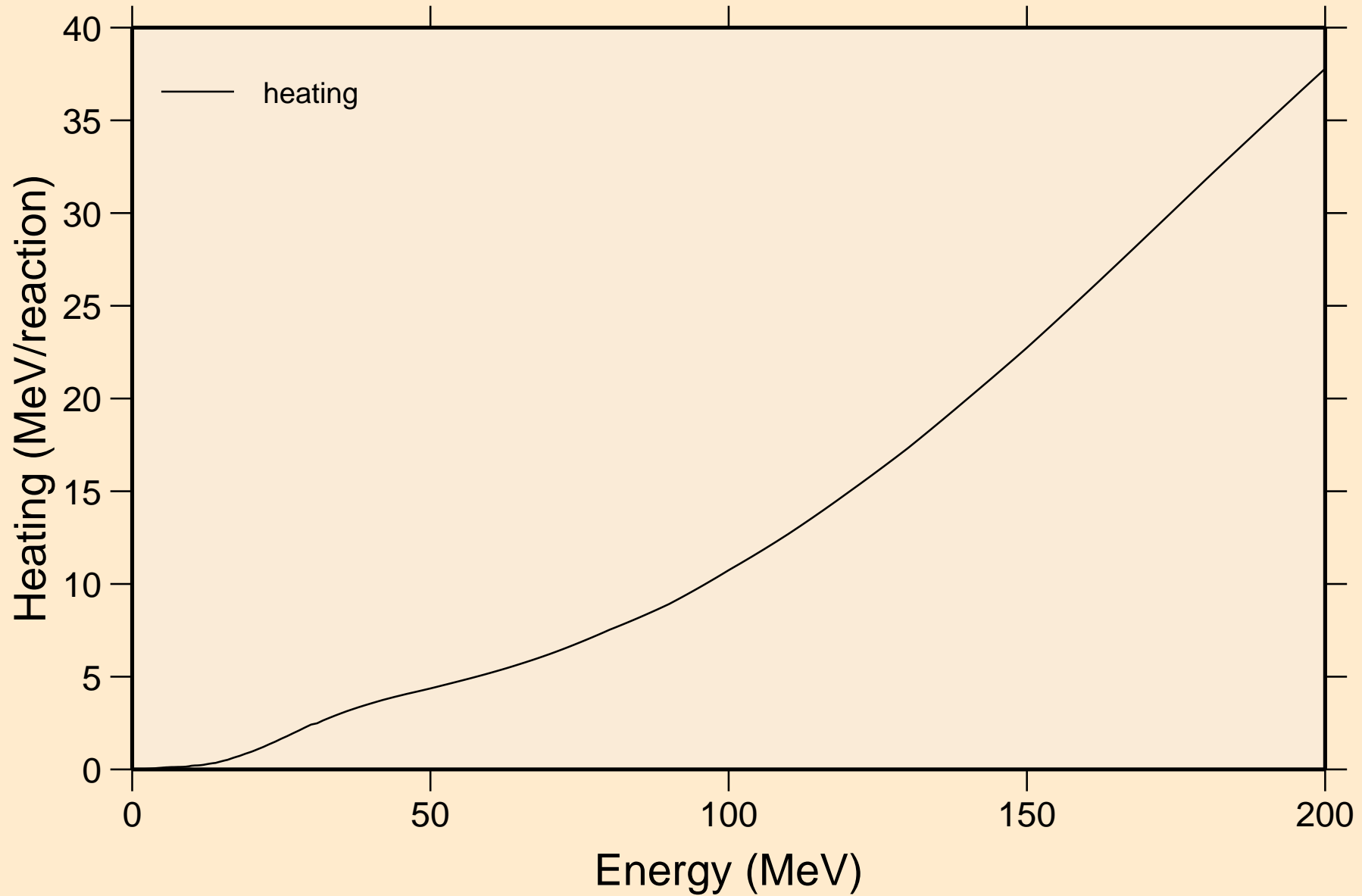

RH101 NEUTRON ACER TENDL-2023 LIBRARY; T=0.K
Damage

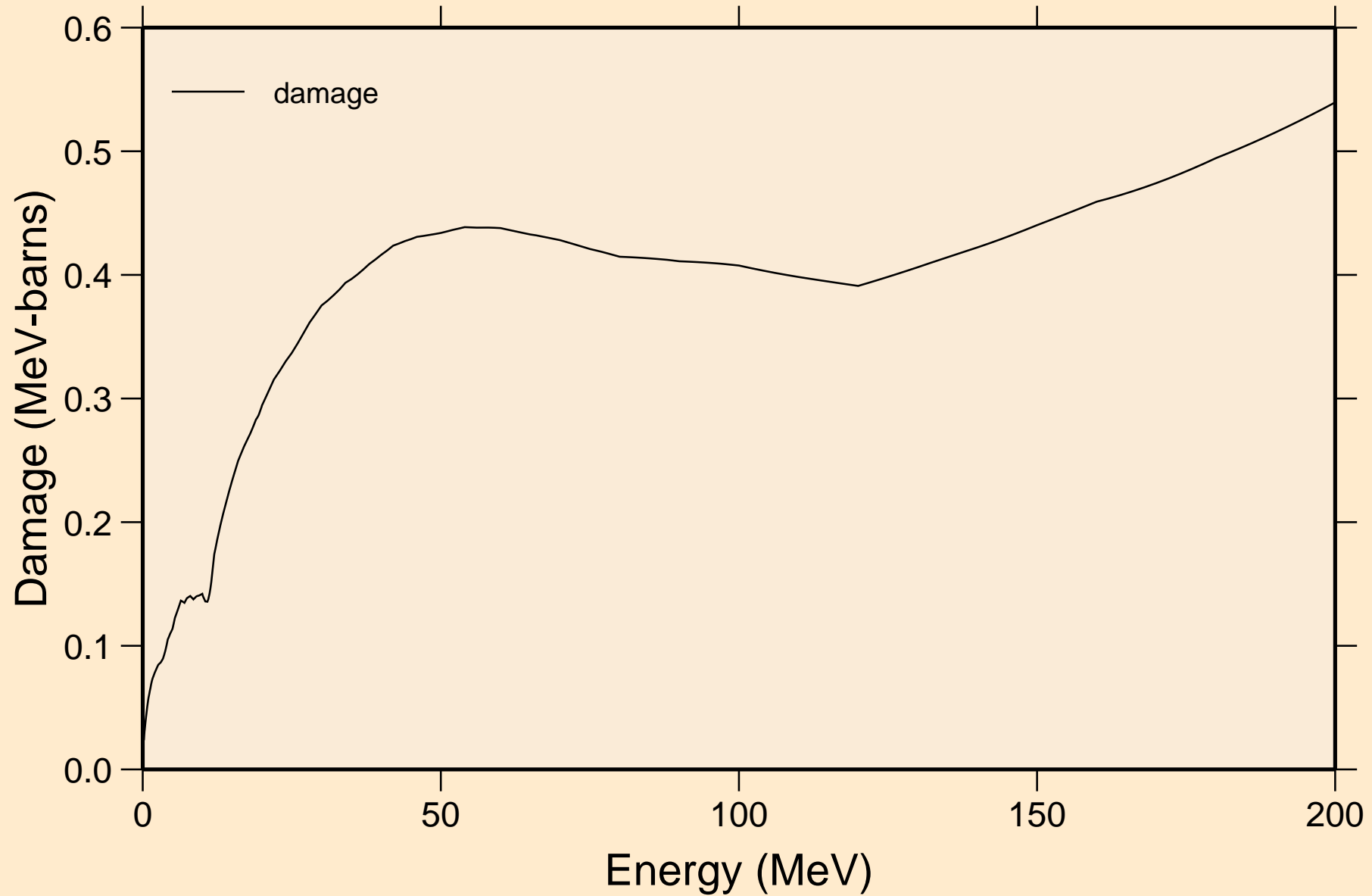

RH101 NEUTRON ACER TENDL-2023 LIBRARY; T=0.K

Non-threshold reactions

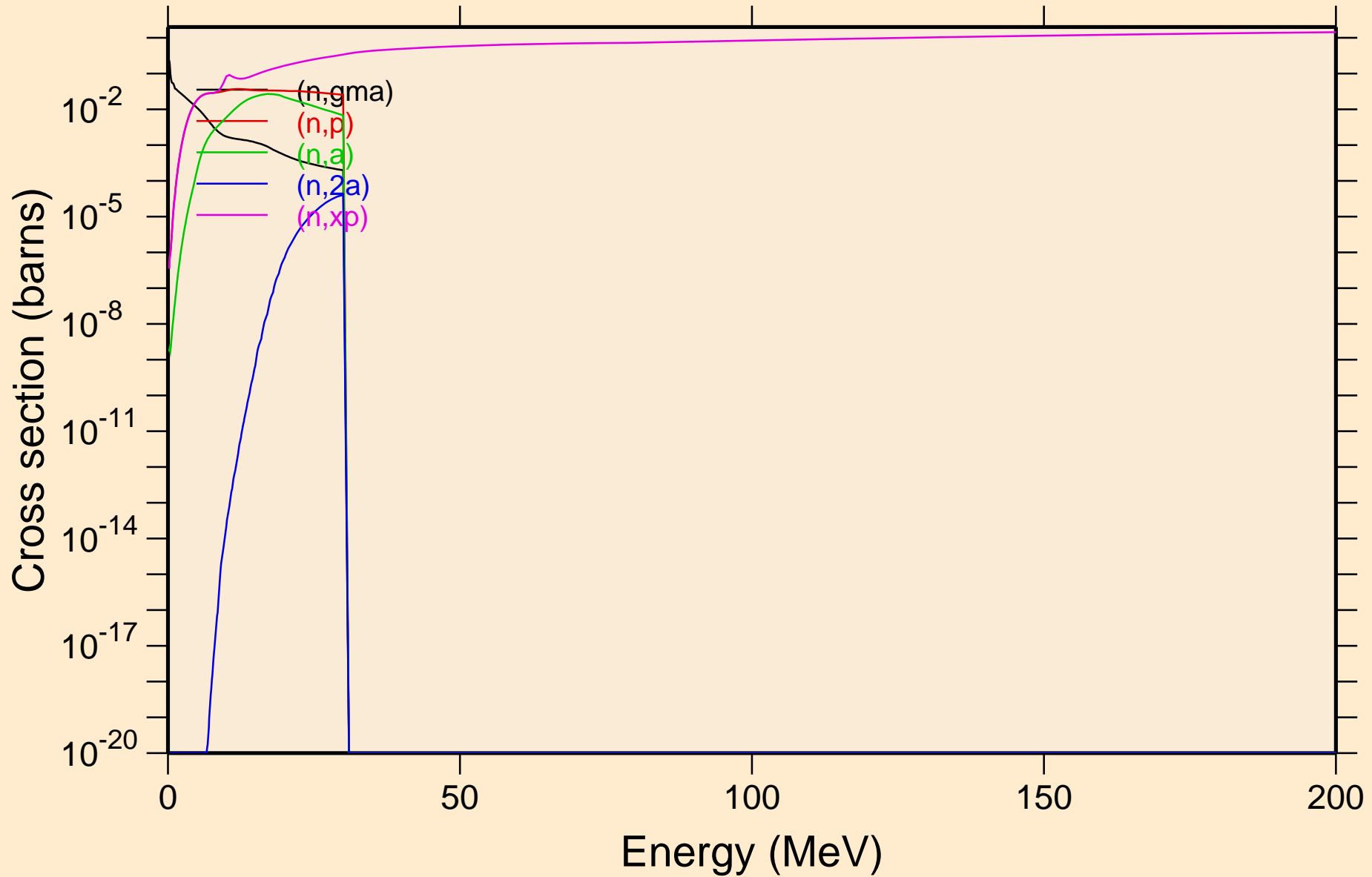

RH101 NEUTRON ACER TENDL-2023 LIBRARY; T=0.K
Non-threshold reactions

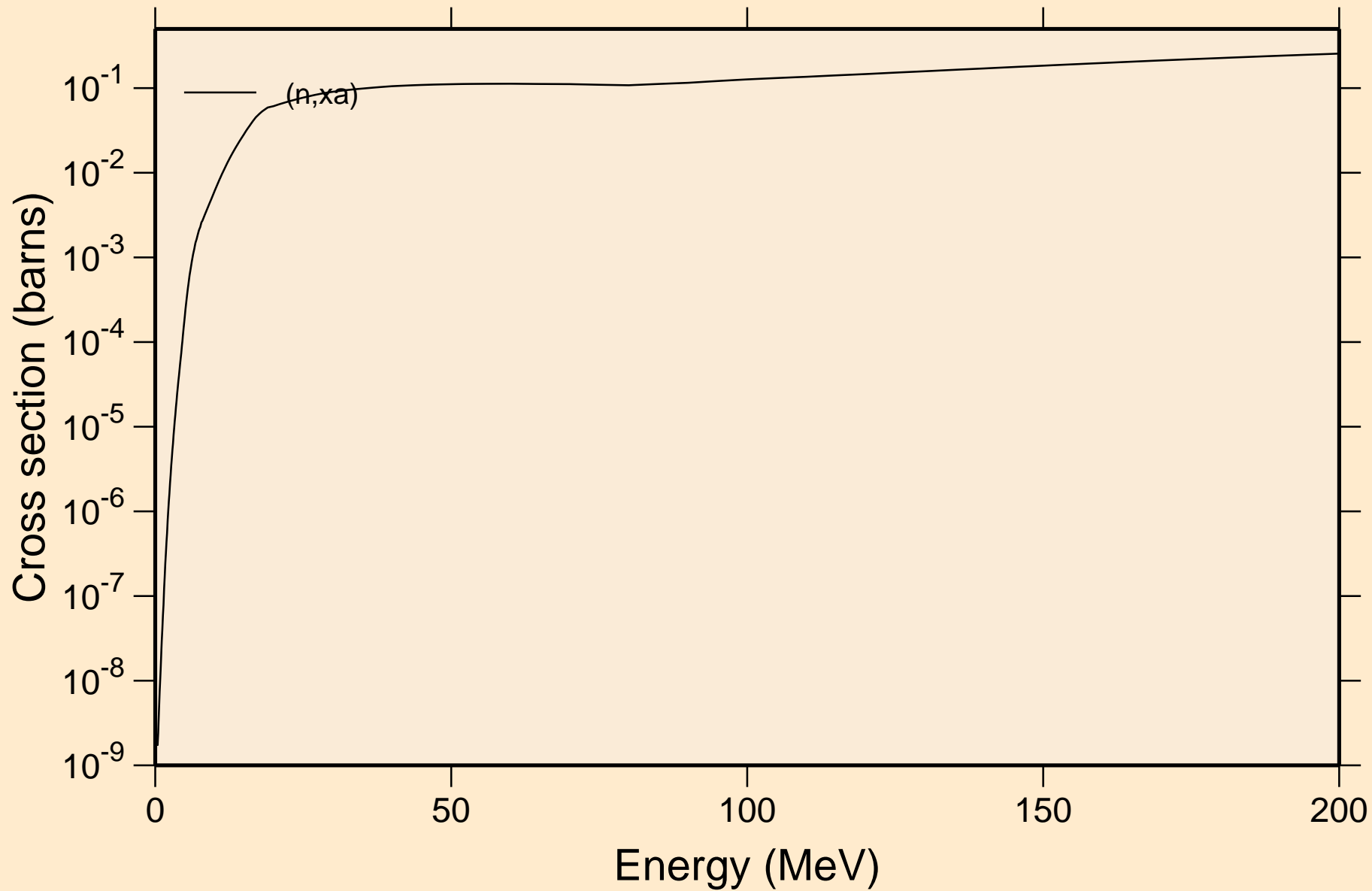

RH101 NEUTRON ACER TENDL-2023 LIBRARY; T=0.K
Inelastic levels

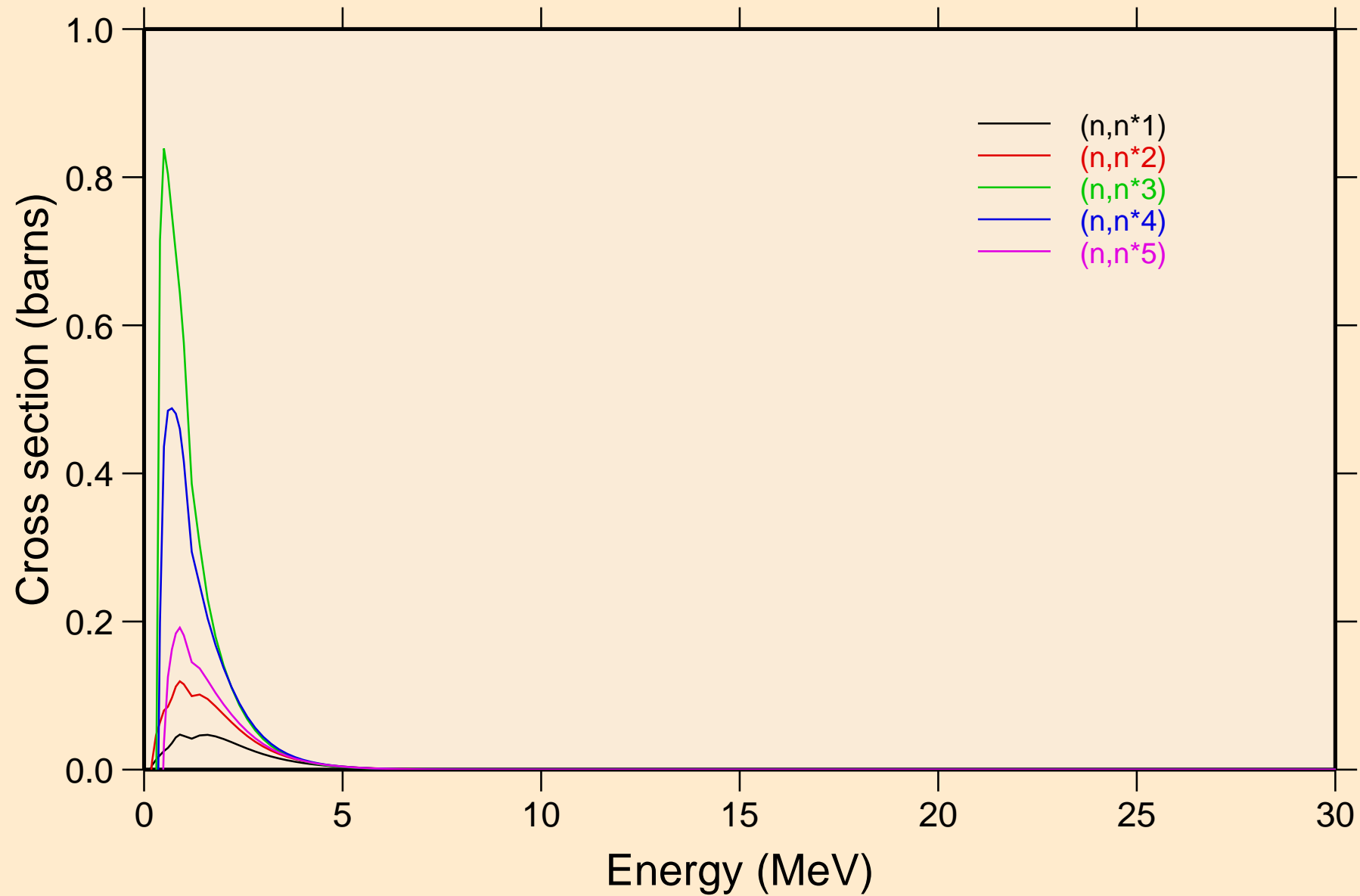

RH101 NEUTRON ACER TENDL-2023 LIBRARY; T=0.K
Inelastic levels

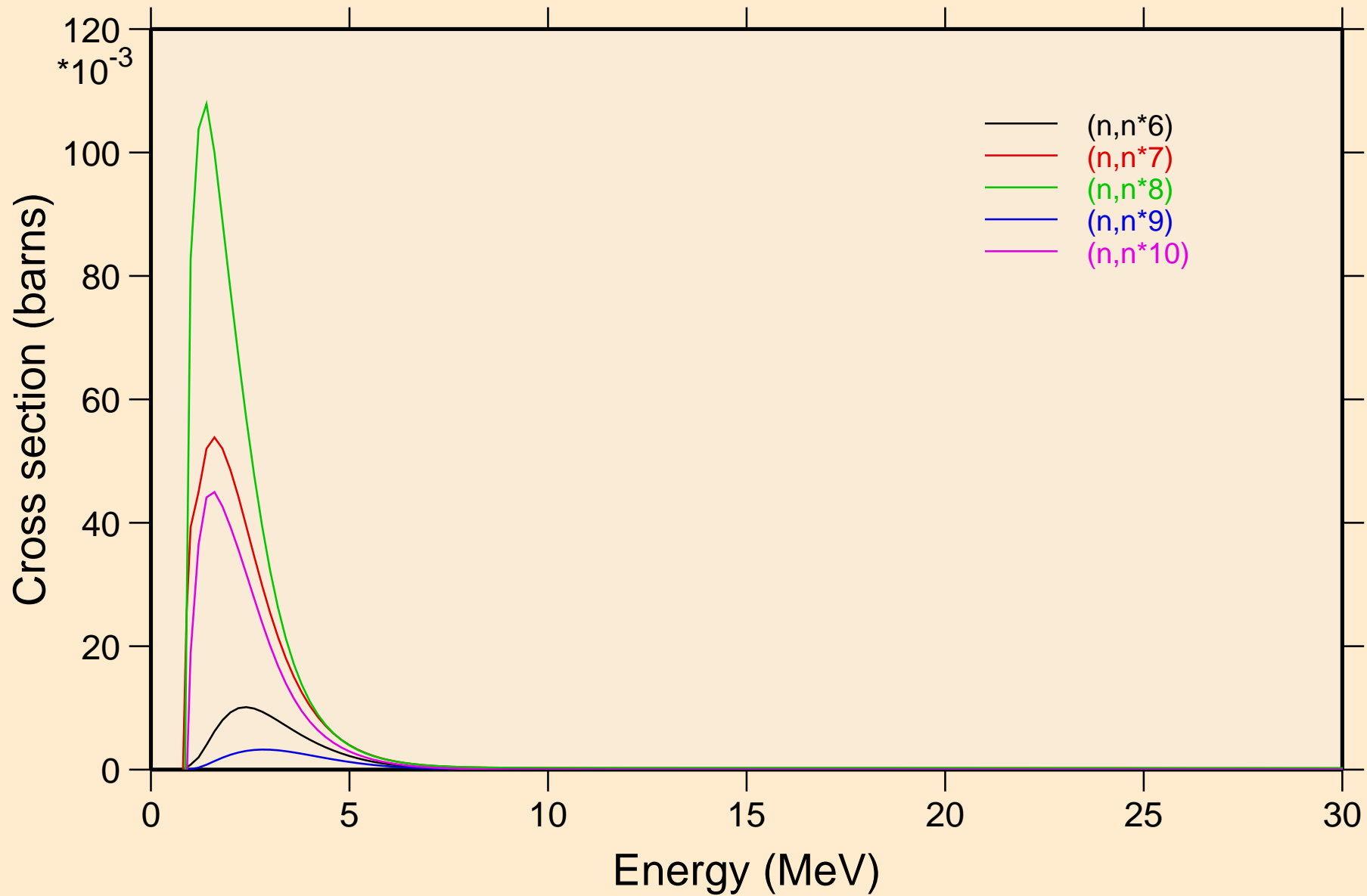

RH101 NEUTRON ACER TENDL-2023 LIBRARY; T=0.K
Inelastic levels

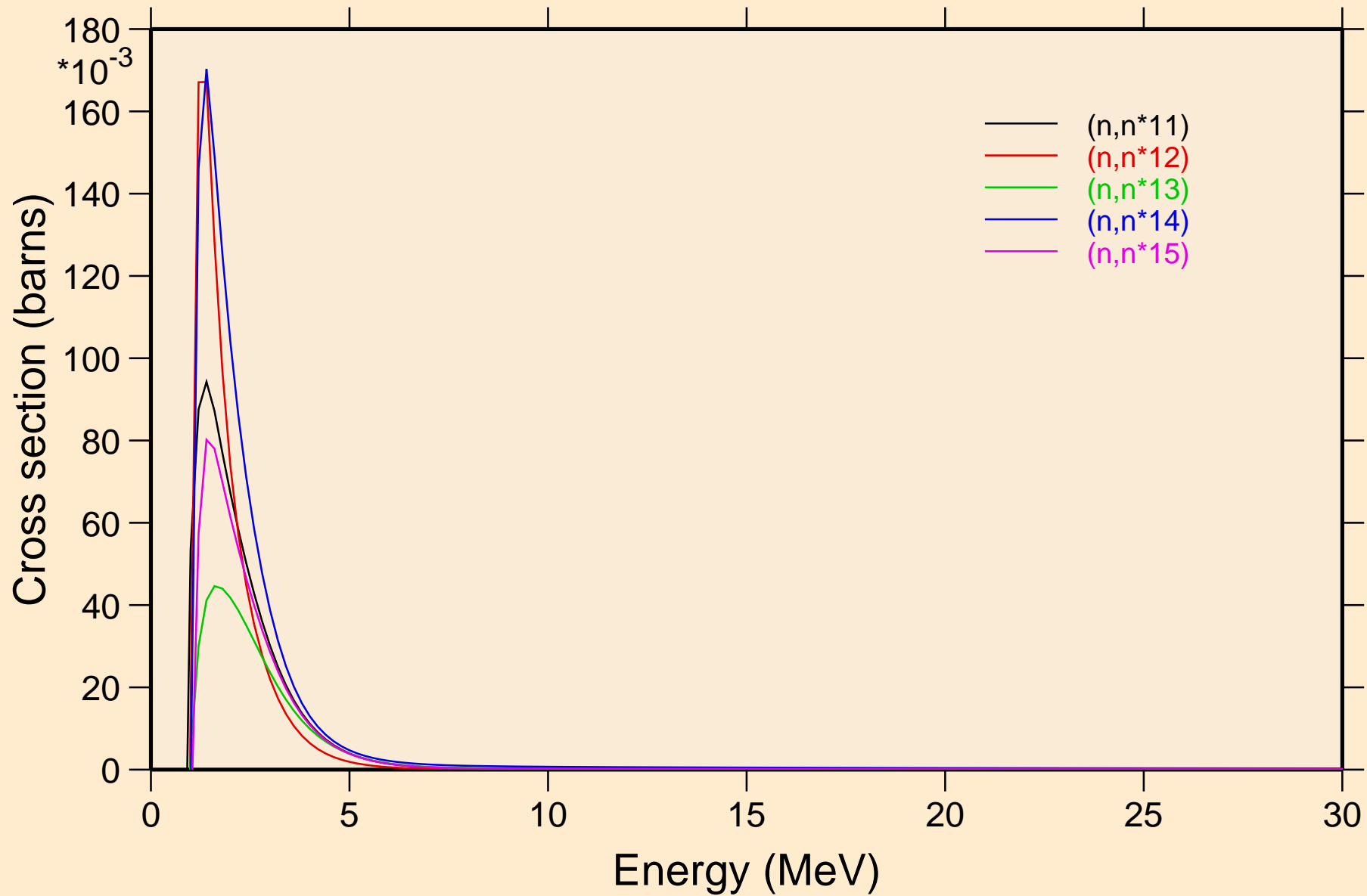

RH101 NEUTRON ACER TENDL-2023 LIBRARY; T=0.K
Inelastic levels

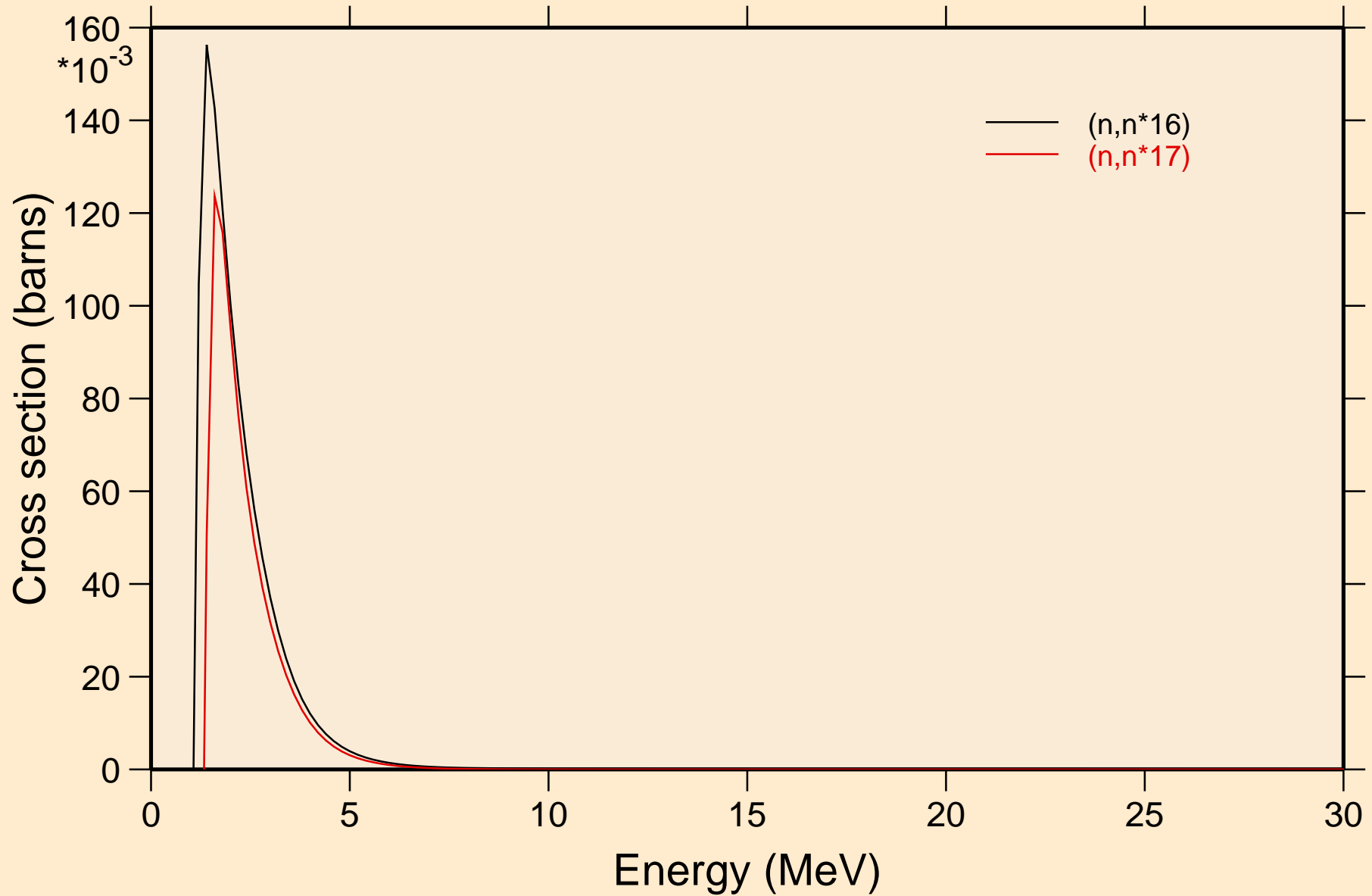

RH101 NEUTRON ACER TENDL-2023 LIBRARY; T=0.K
Threshold reactions

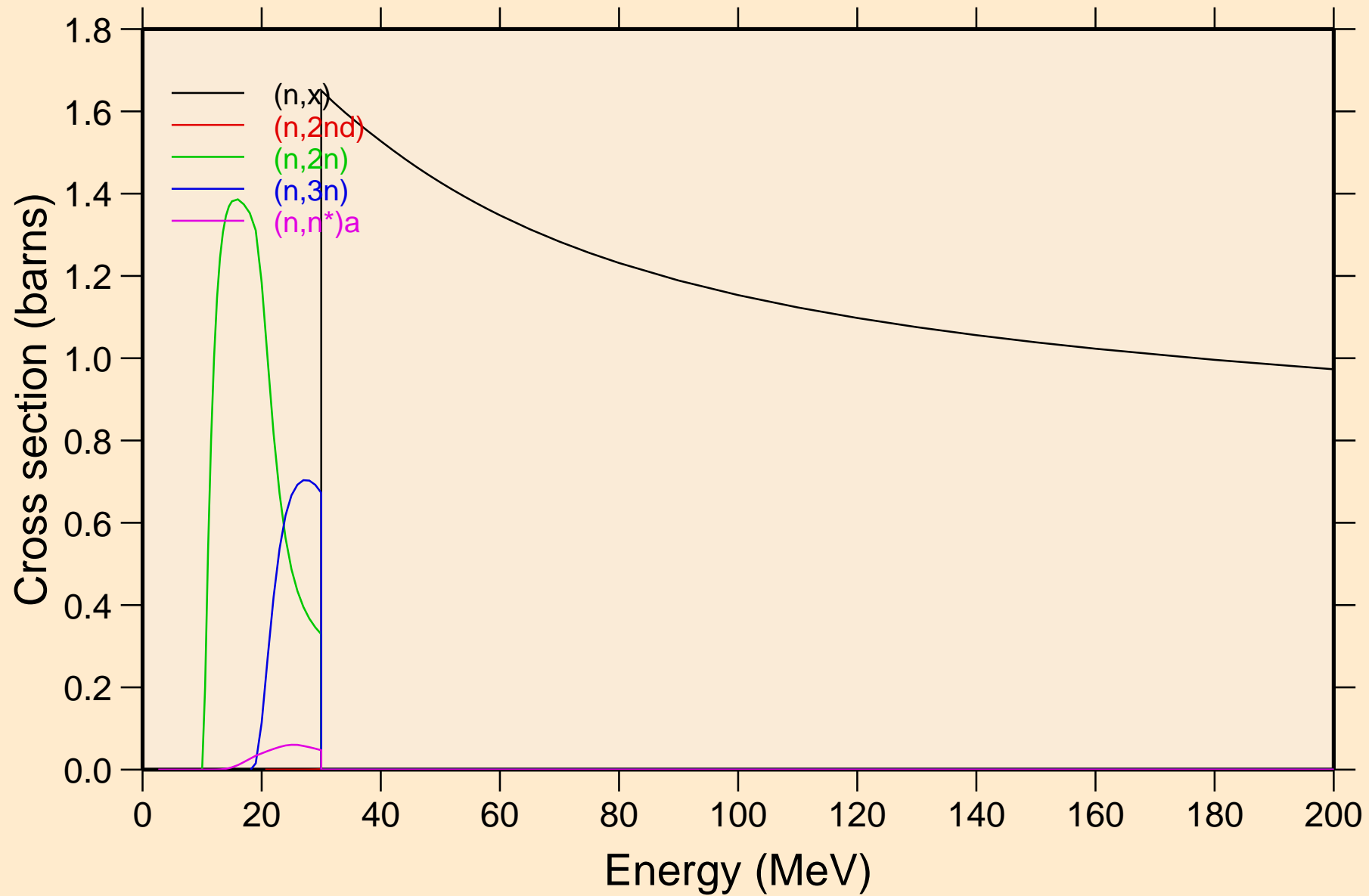

RH101 NEUTRON ACER TENDL-2023 LIBRARY; T=0.K

Threshold reactions

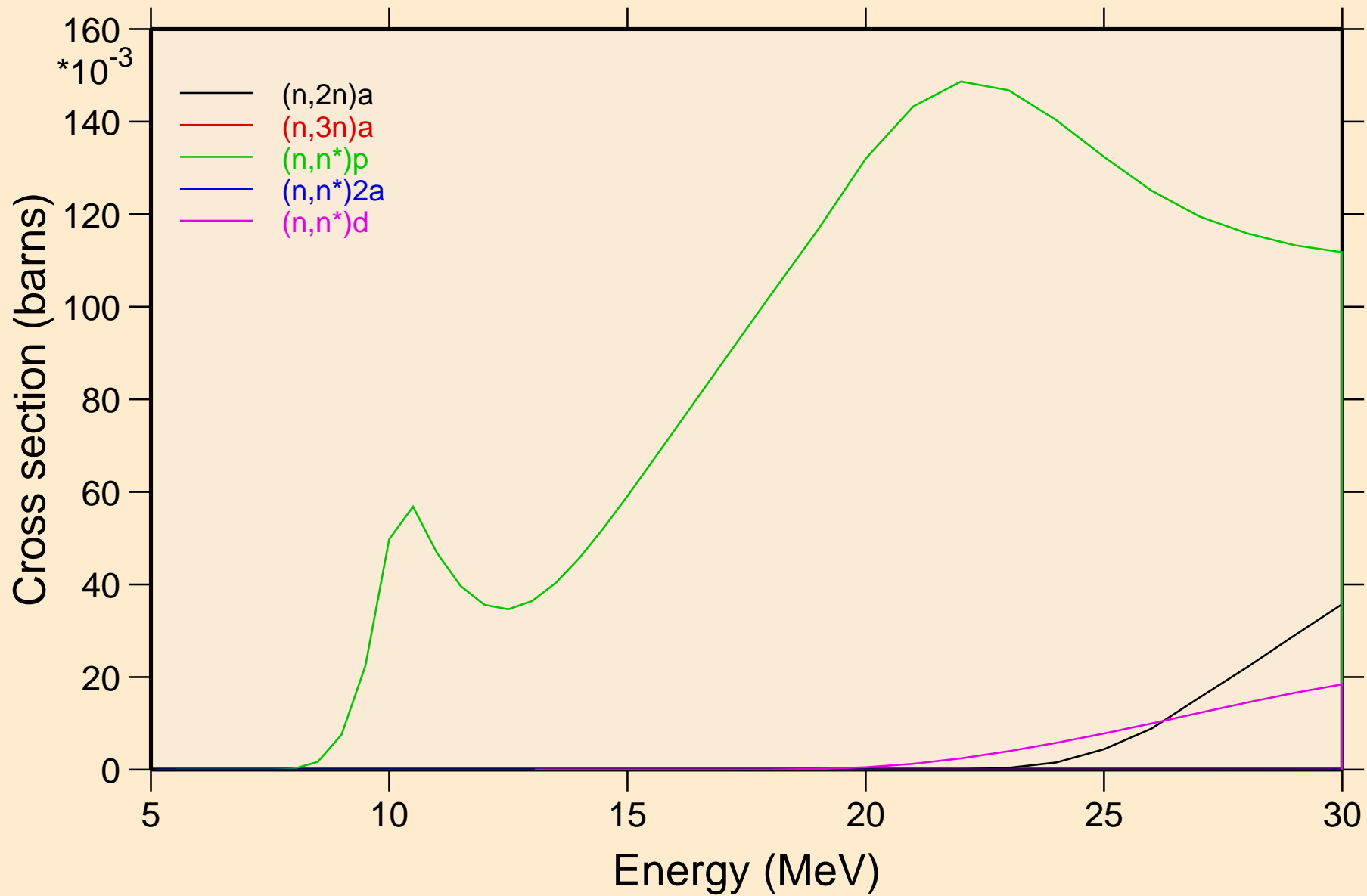

RH101 NEUTRON ACER TENDL-2023 LIBRARY; T=0.K

Threshold reactions

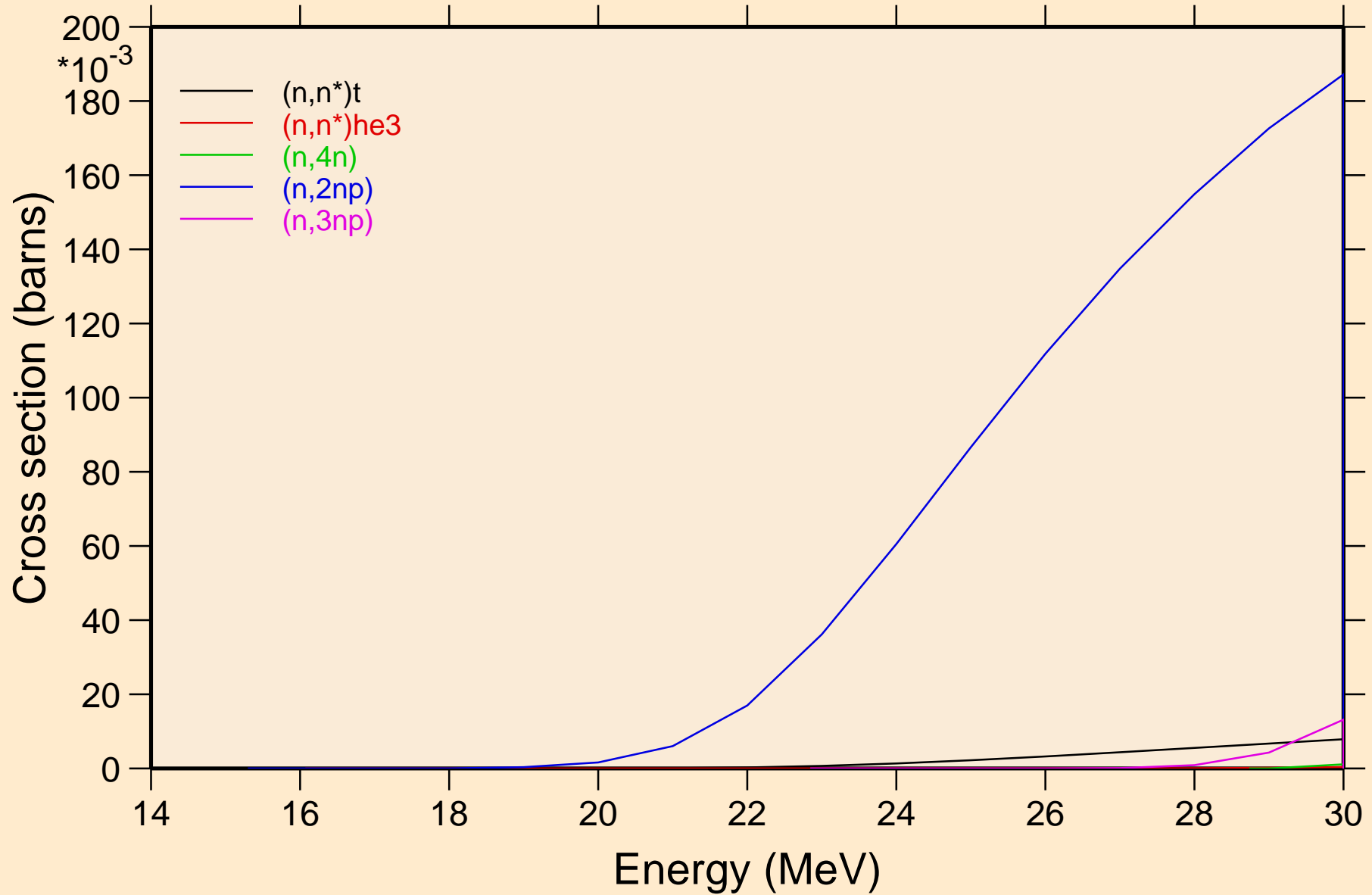

RH101 NEUTRON ACER TENDL-2023 LIBRARY; T=0.K
Threshold reactions

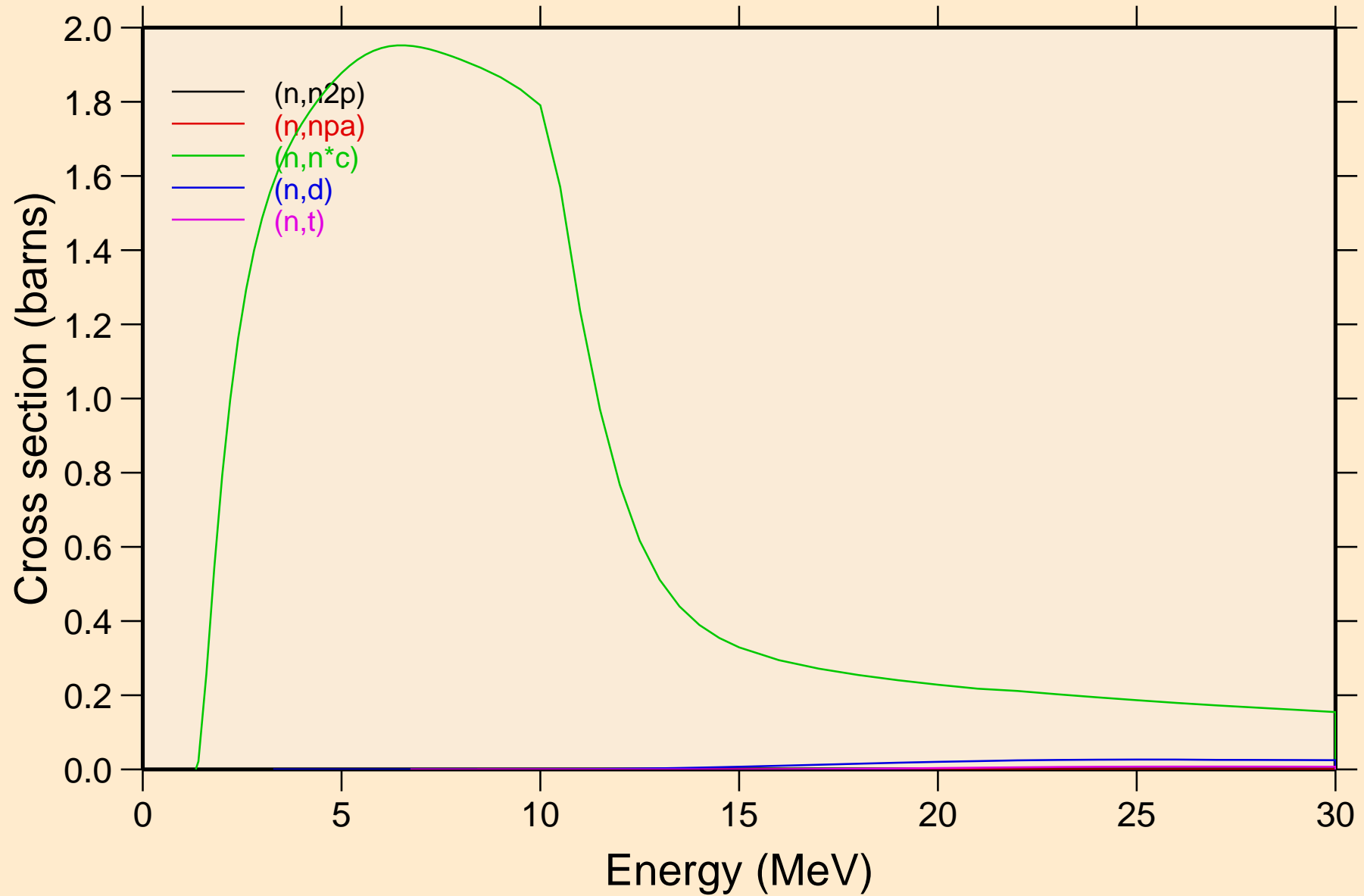

RH101 NEUTRON ACER TENDL-2023 LIBRARY; T=0.K
Threshold reactions

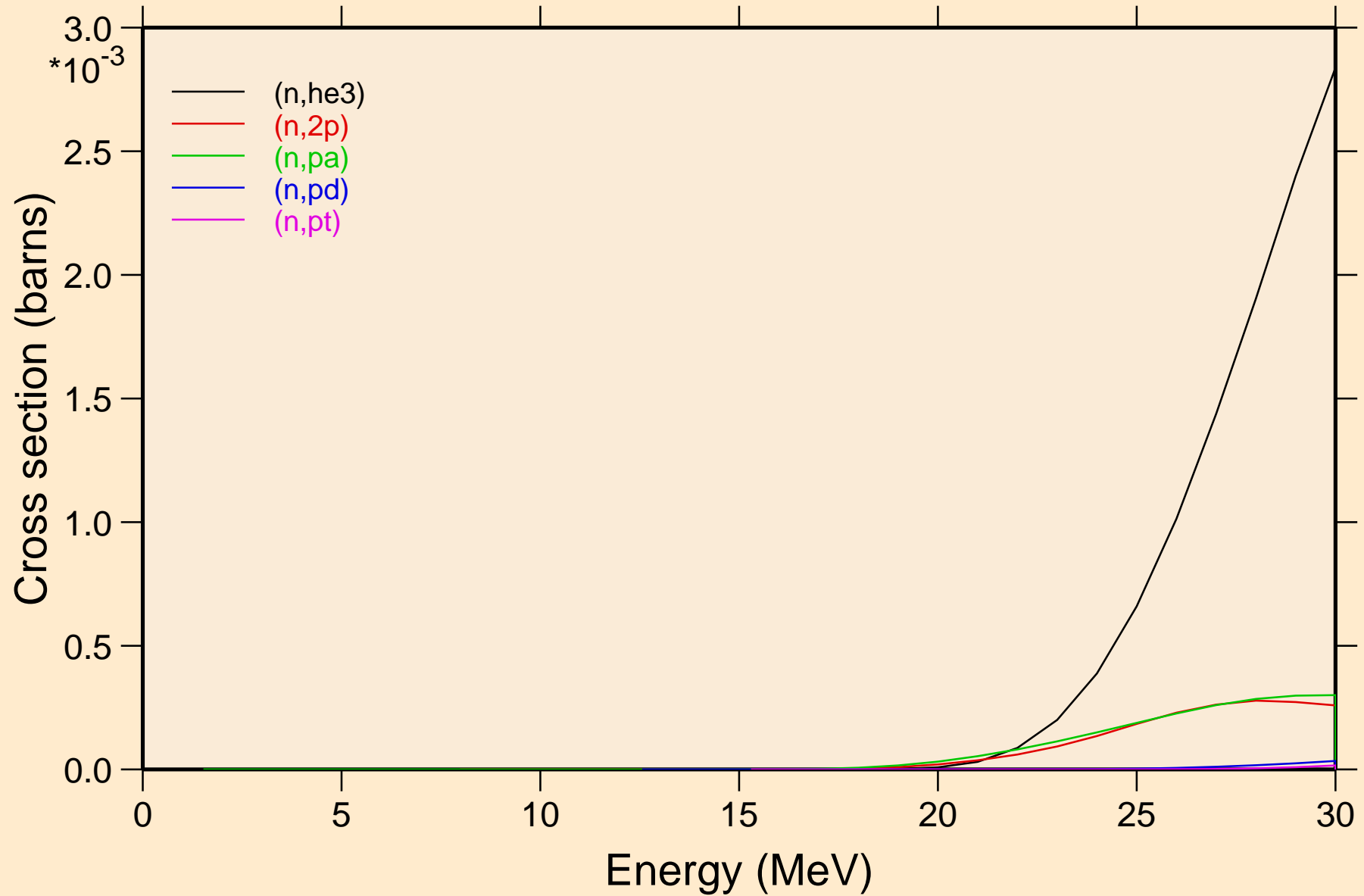

RH101 NEUTRON ACER TENDL-2023 LIBRARY; T=0.K
Threshold reactions

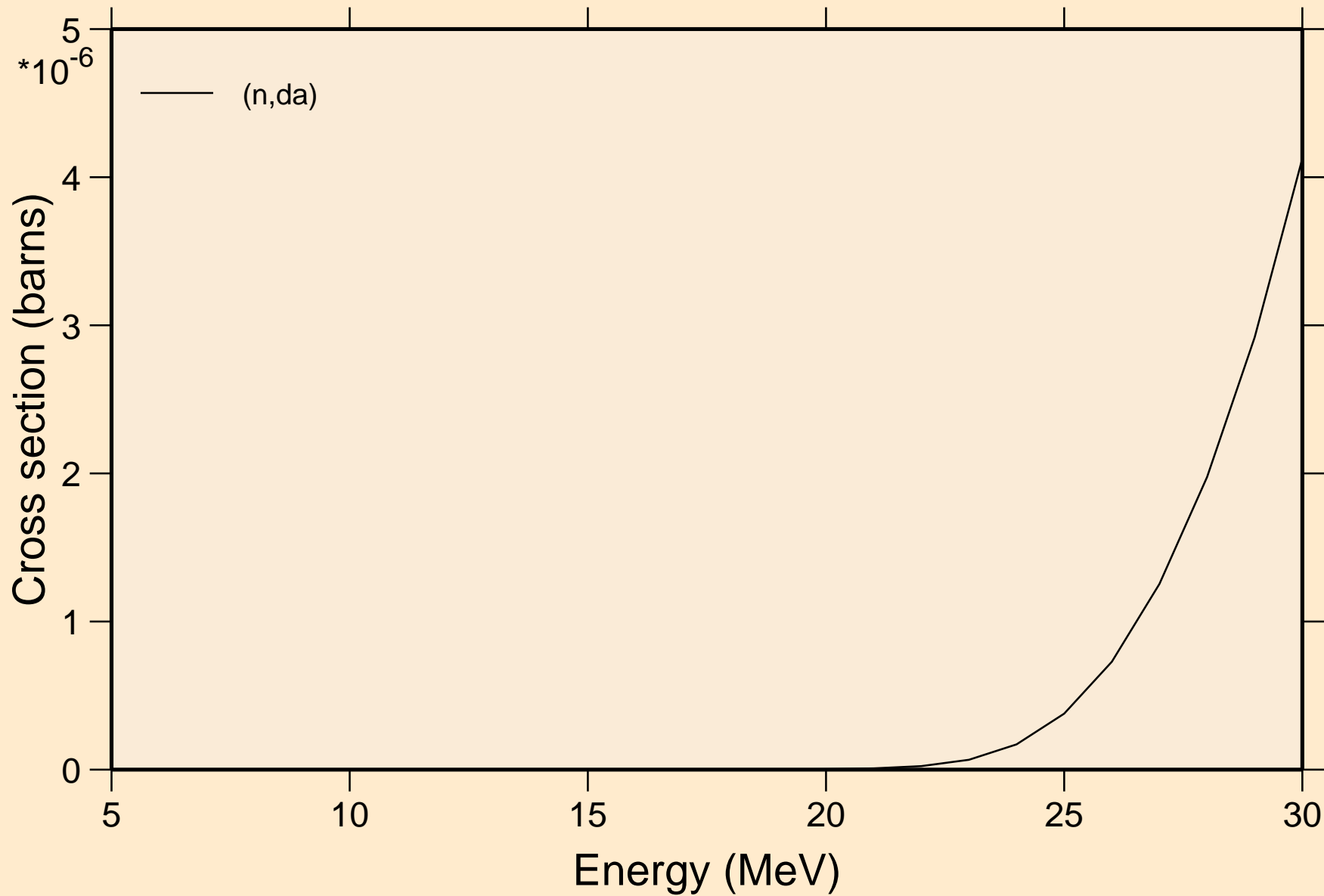

RH101 NEUTRON ACER TENDL-2023 LIBRARY; T=0.K
Threshold reactions

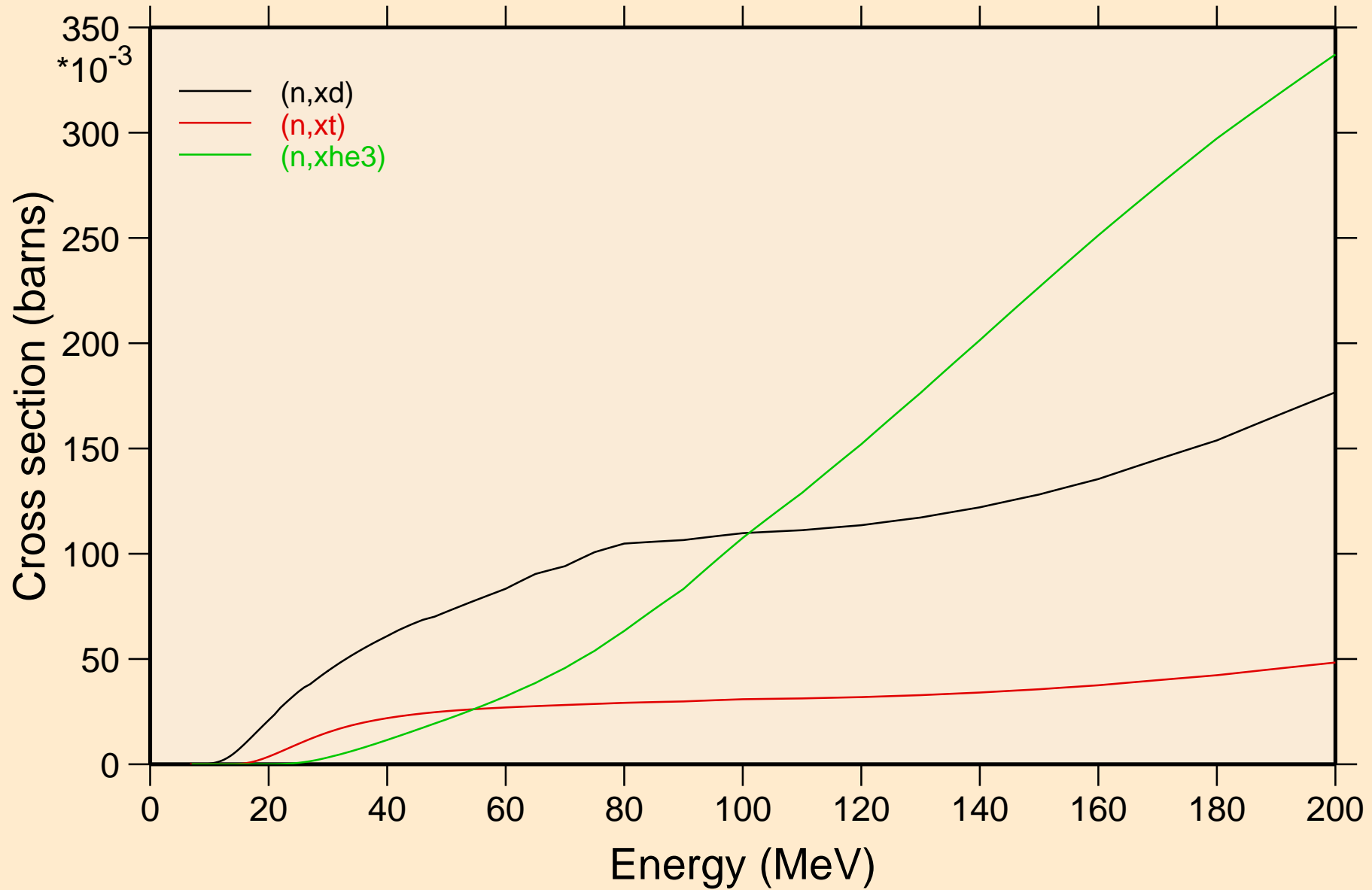

RH101 NEUTRON ACER TENDL-2023 LIBRARY; T=0.K
angular distribution for elastic

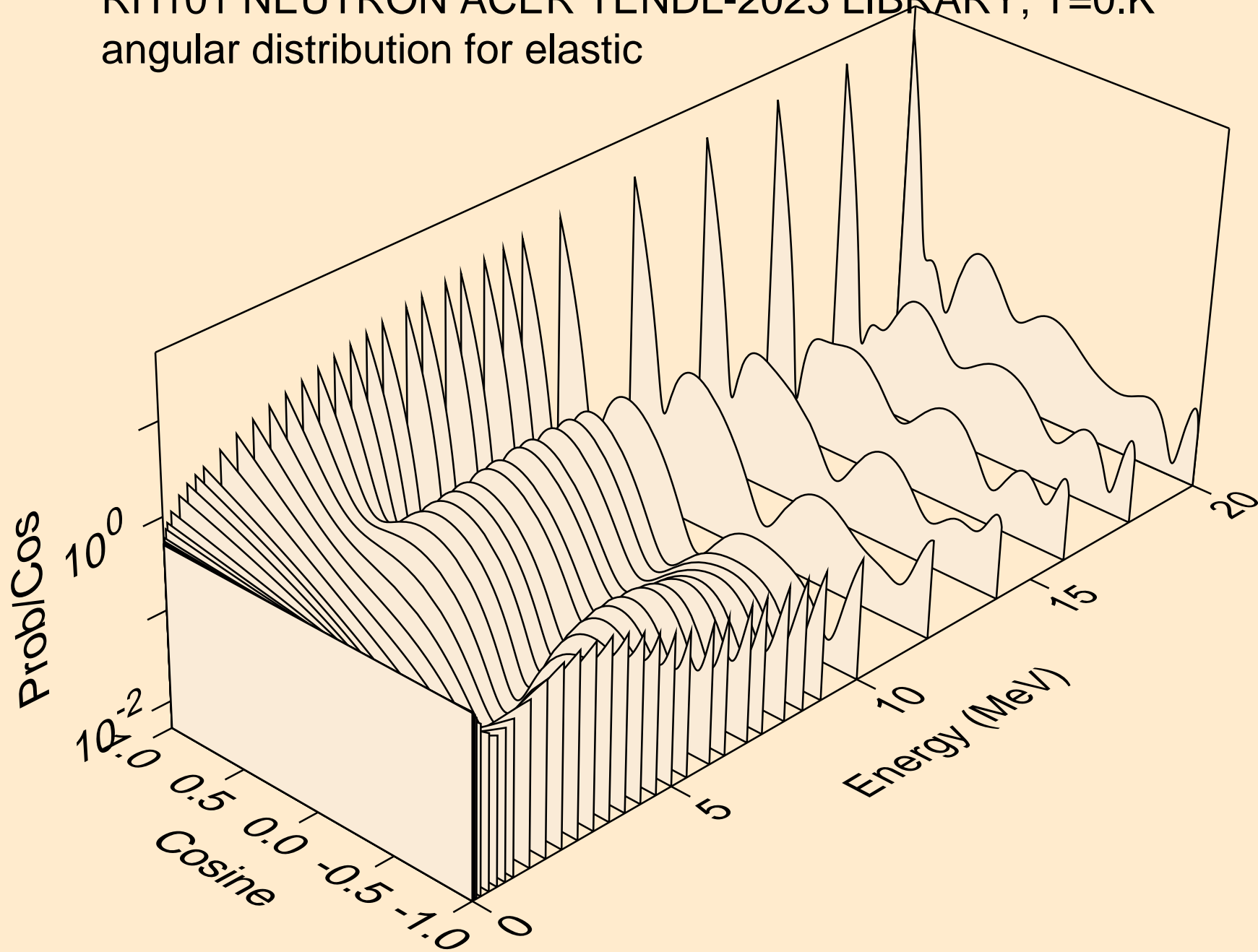

RH101 NEUTRON ACER TENDL-2023 LIBRARY; T=0.K
angular distribution for elastic

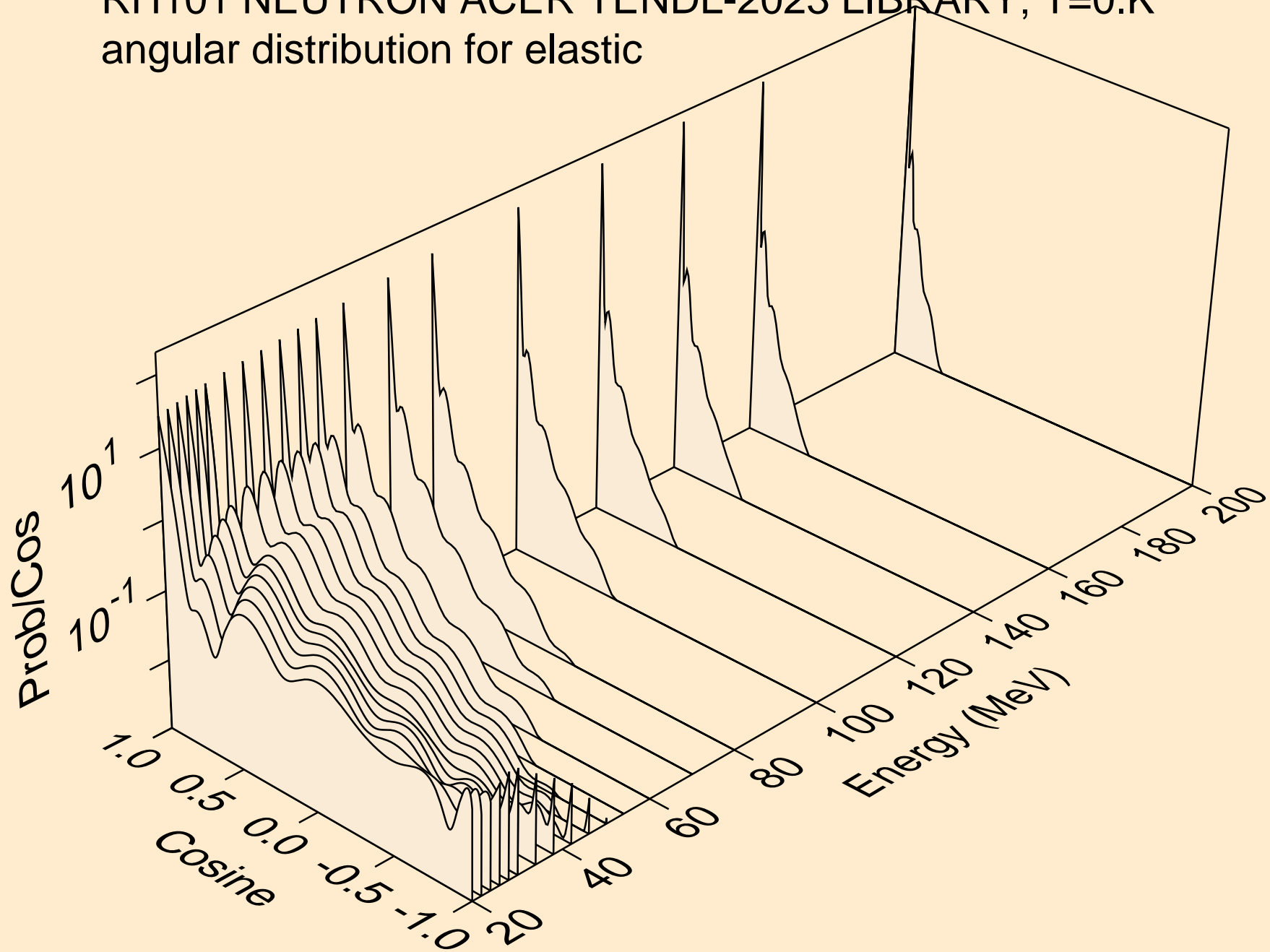

RH101 NEUTRON ACER TENDL-2023 LIBRARY; T=0.K
angular distribution for (n,n*1)

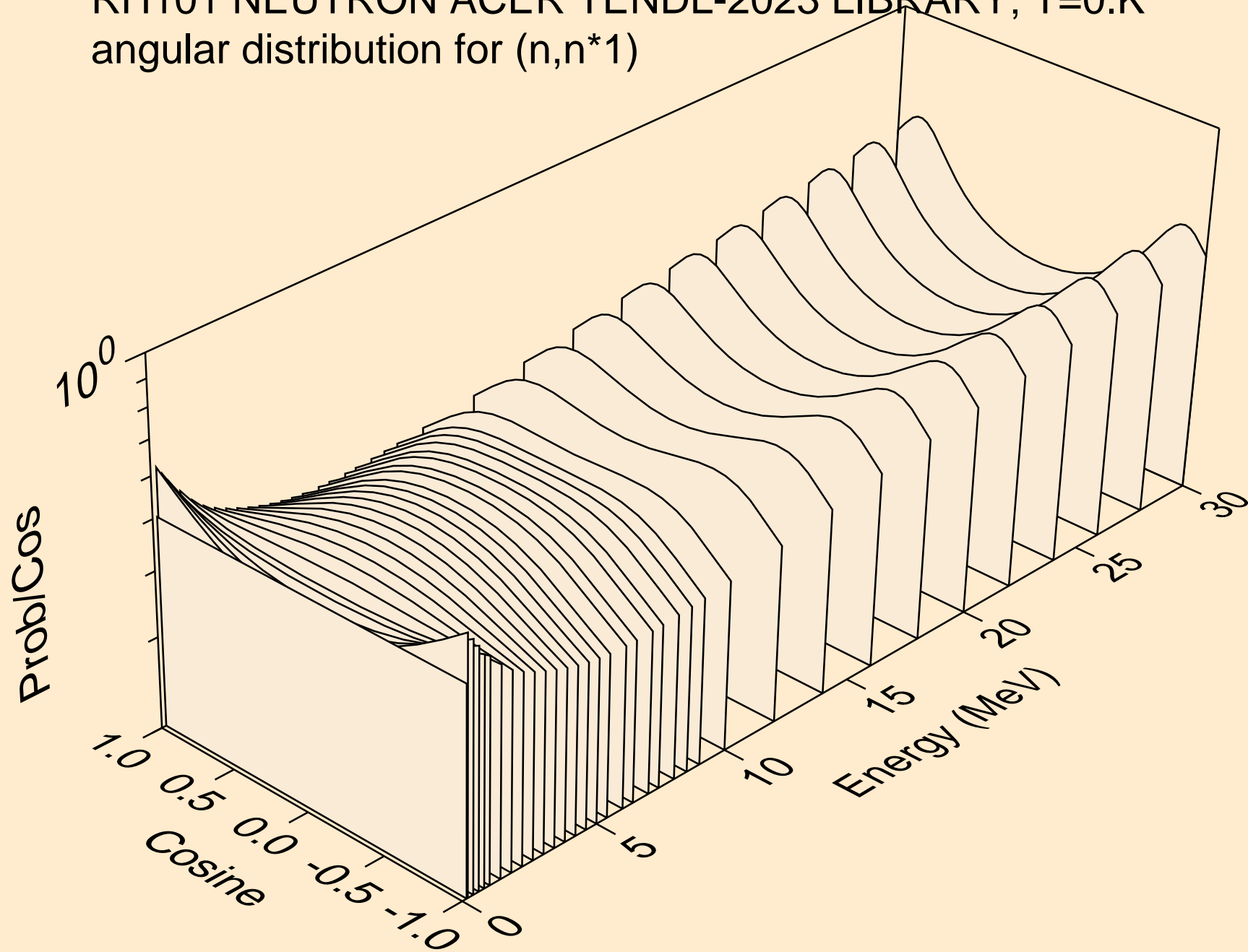

RH101 NEUTRON ACER TENDL-2023 LIBRARY; T=0.K
angular distribution for (n,n*2)

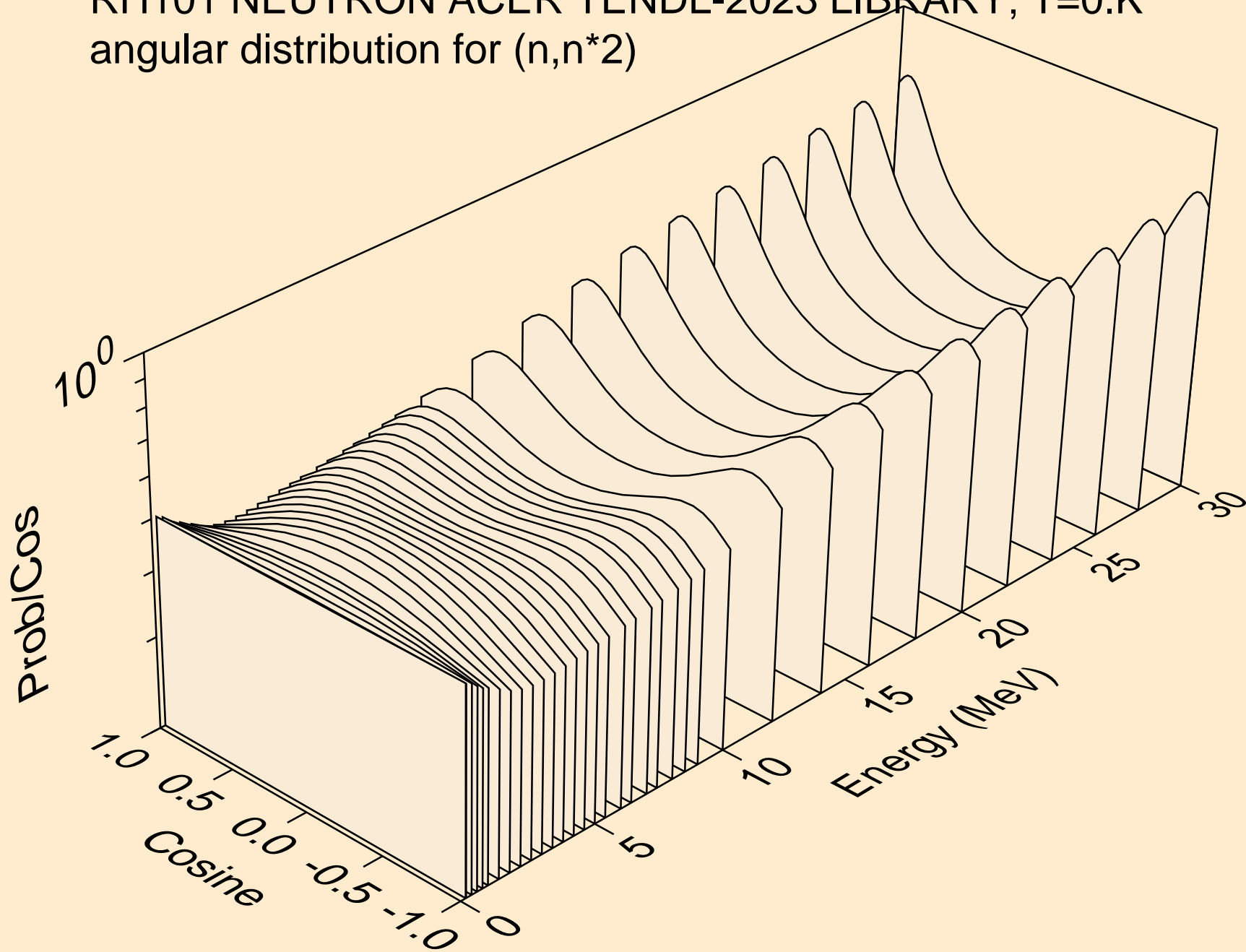

RH101 NEUTRON ACER TENDL-2023 LIBRARY; T=0.K
angular distribution for (n,n*3)

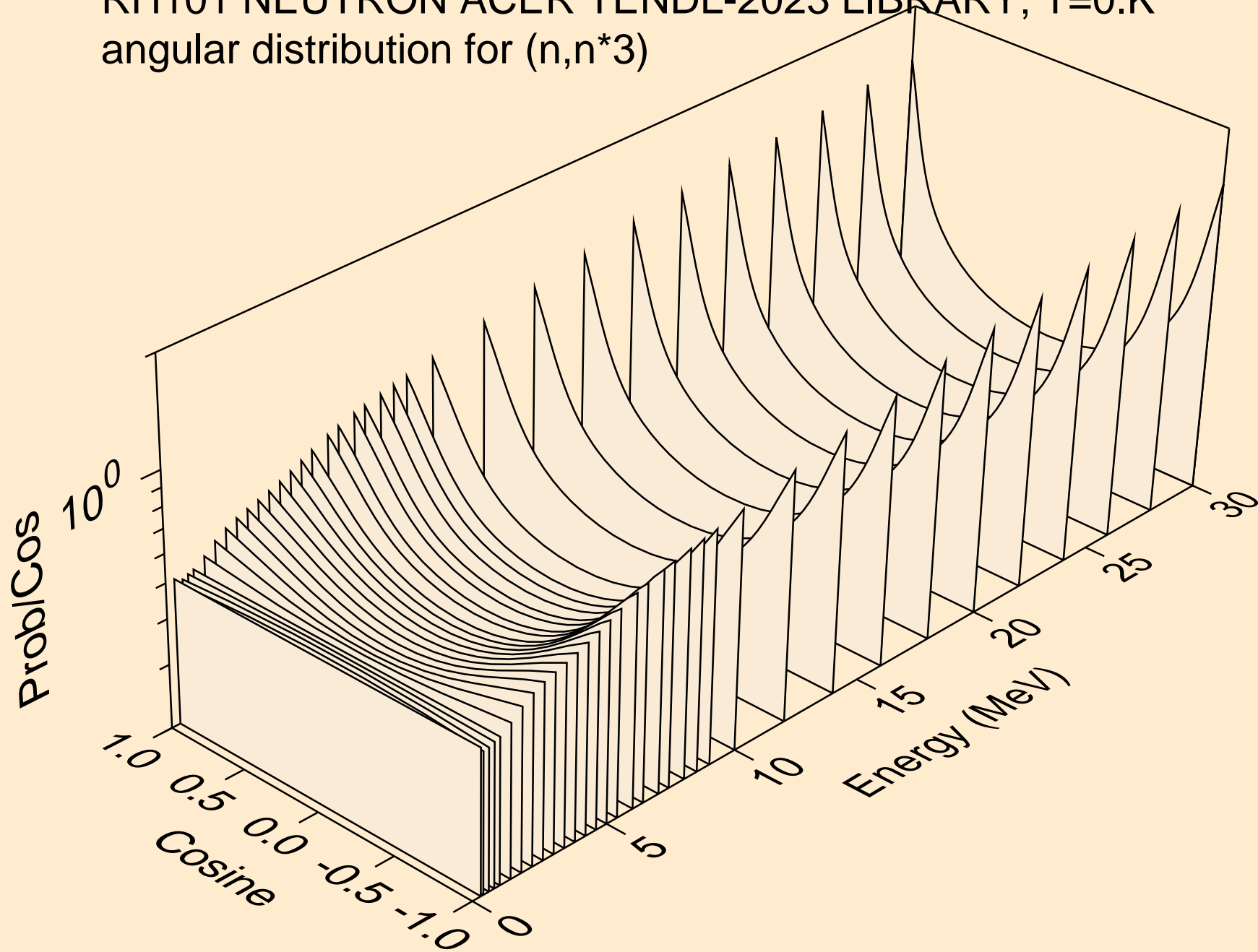

RH101 NEUTRON ACER TENDL-2023 LIBRARY; T=0.K
angular distribution for (n,n*4)

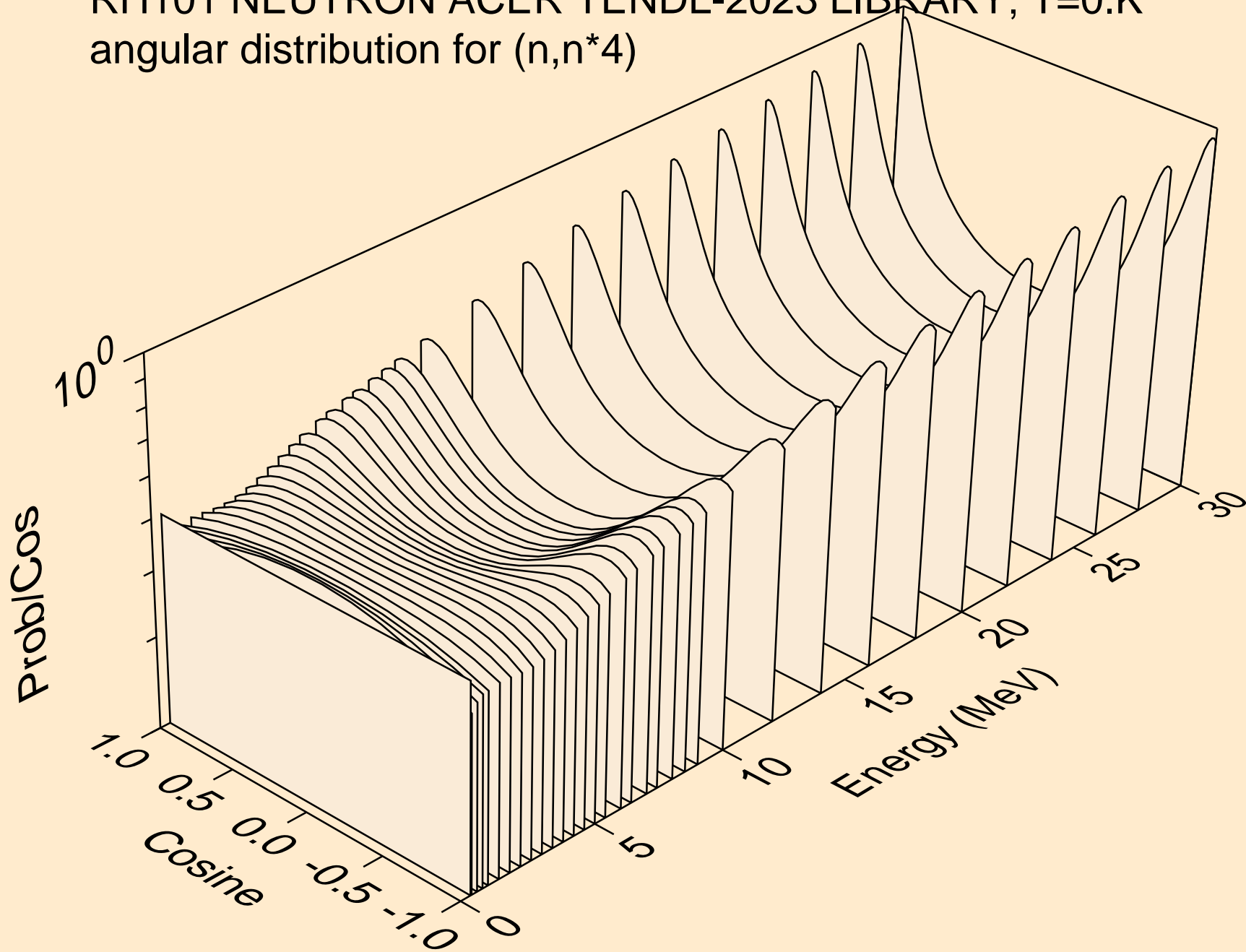

RH101 NEUTRON ACER TENDL-2023 LIBRARY; T=0.K
angular distribution for (n,n*5)

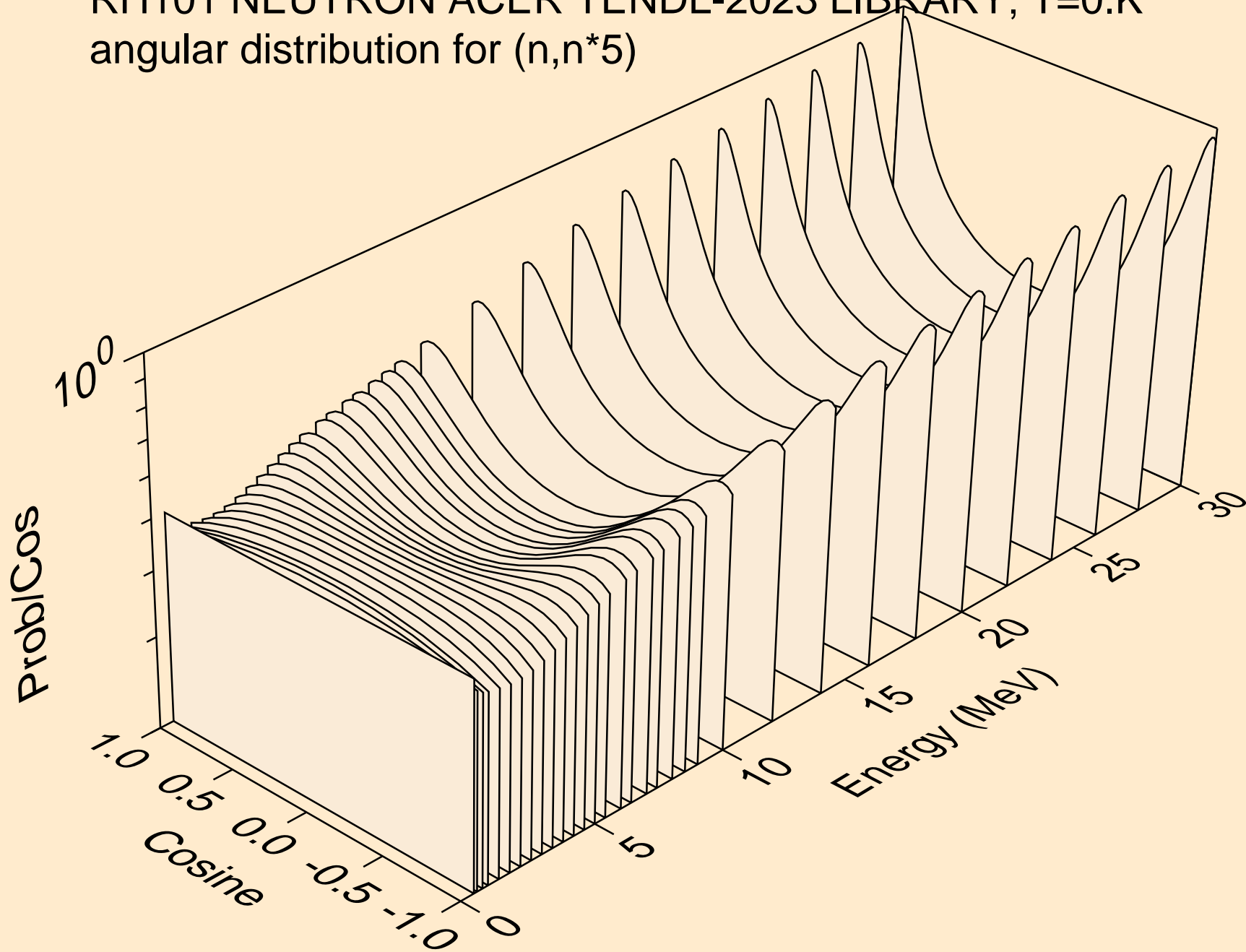

RH101 NEUTRON ACER TENDL-2023 LIBRARY; T=0.K
angular distribution for (n,n*6)

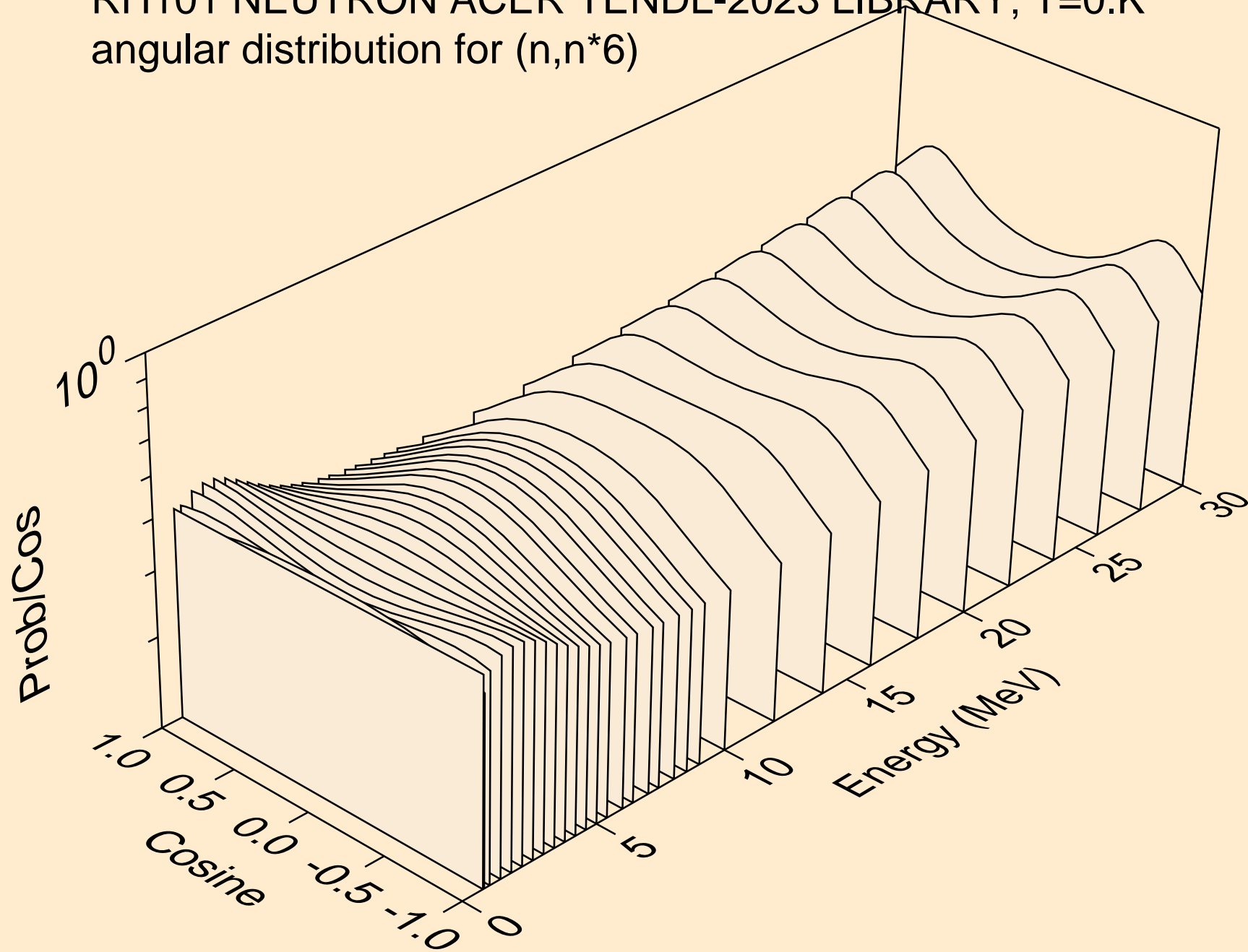

RH101 NEUTRON ACER TENDL-2023 LIBRARY; T=0.K
angular distribution for (n,n*7)

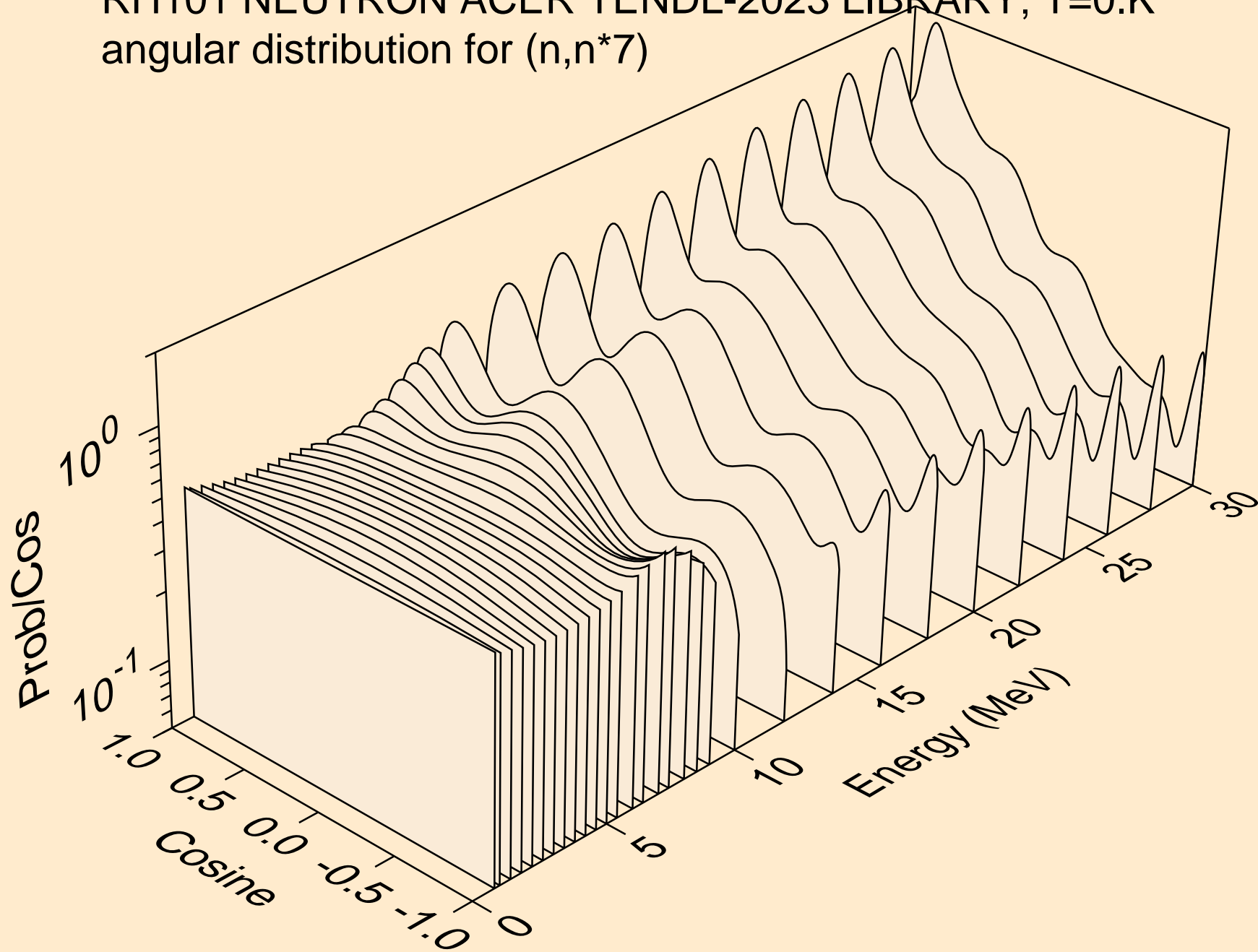

RH101 NEUTRON ACER TENDL-2023 LIBRARY; T=0.K
angular distribution for (n,n*8)

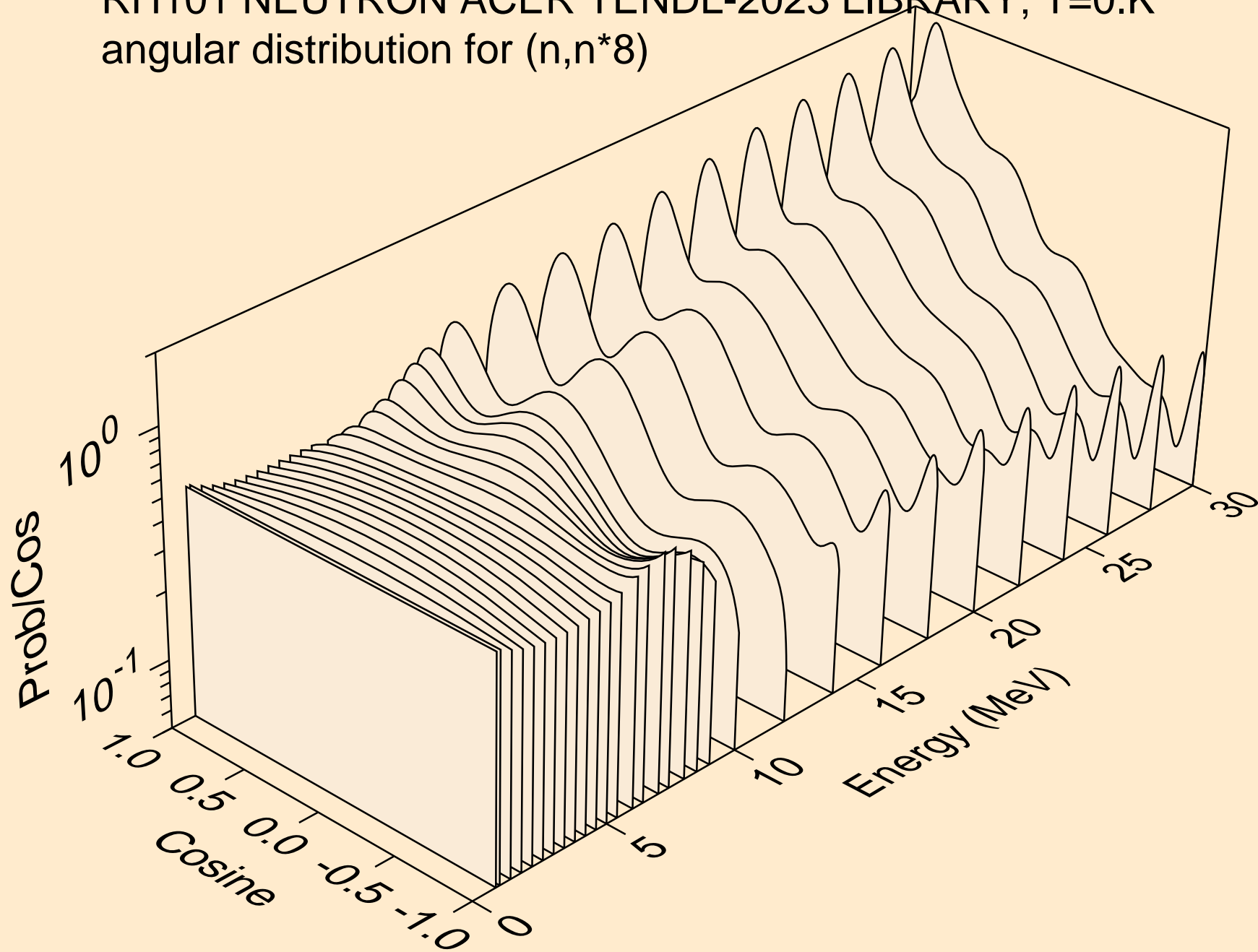

RH101 NEUTRON ACER TENDL-2023 LIBRARY; T=0.K
angular distribution for (n,n*9)

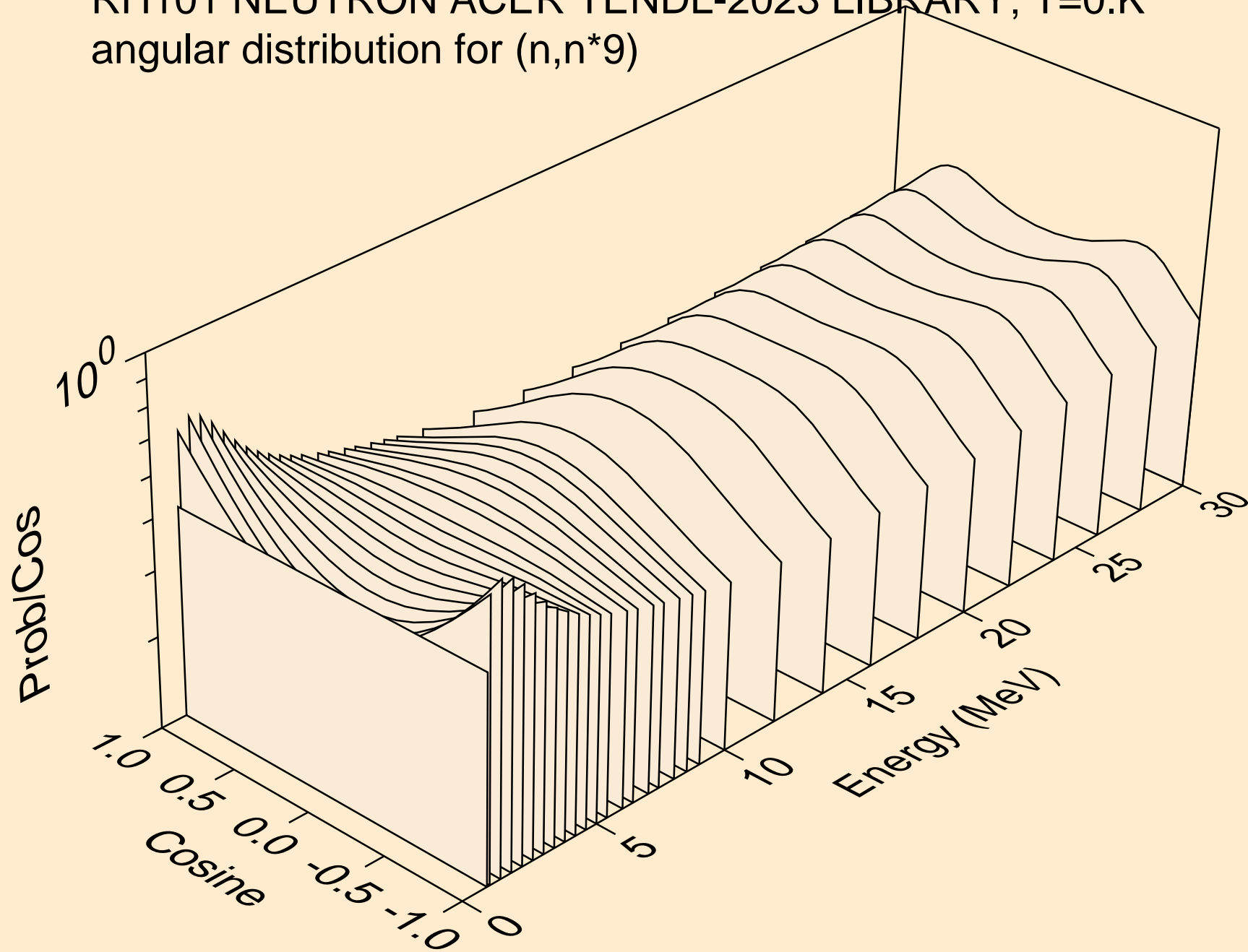

RH101 NEUTRON ACER TENDL-2023 LIBRARY; T=0.K
angular distribution for (n,n*10)

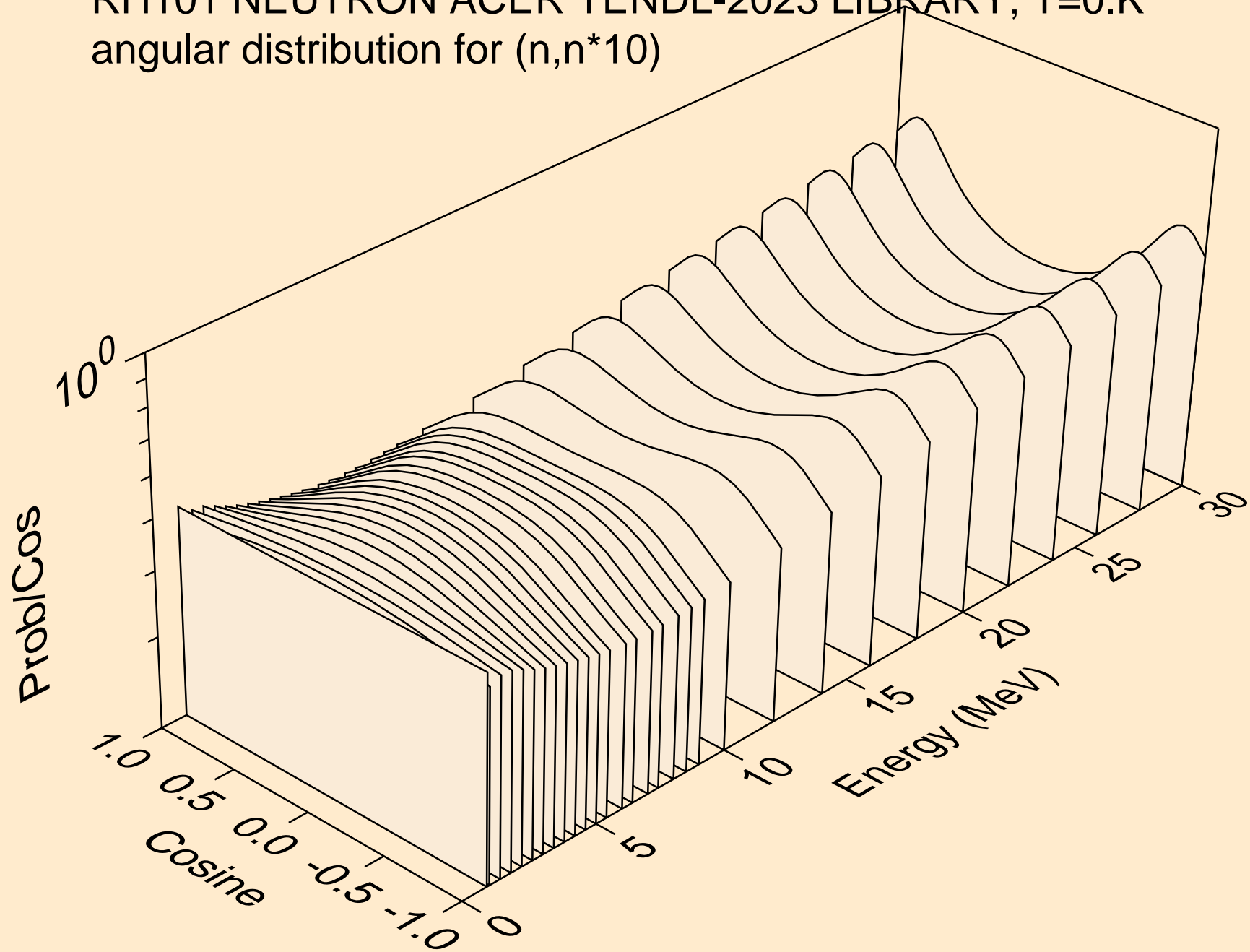

RH101 NEUTRON ACER TENDL-2023 LIBRARY; T=0.K
angular distribution for (n,n*11)

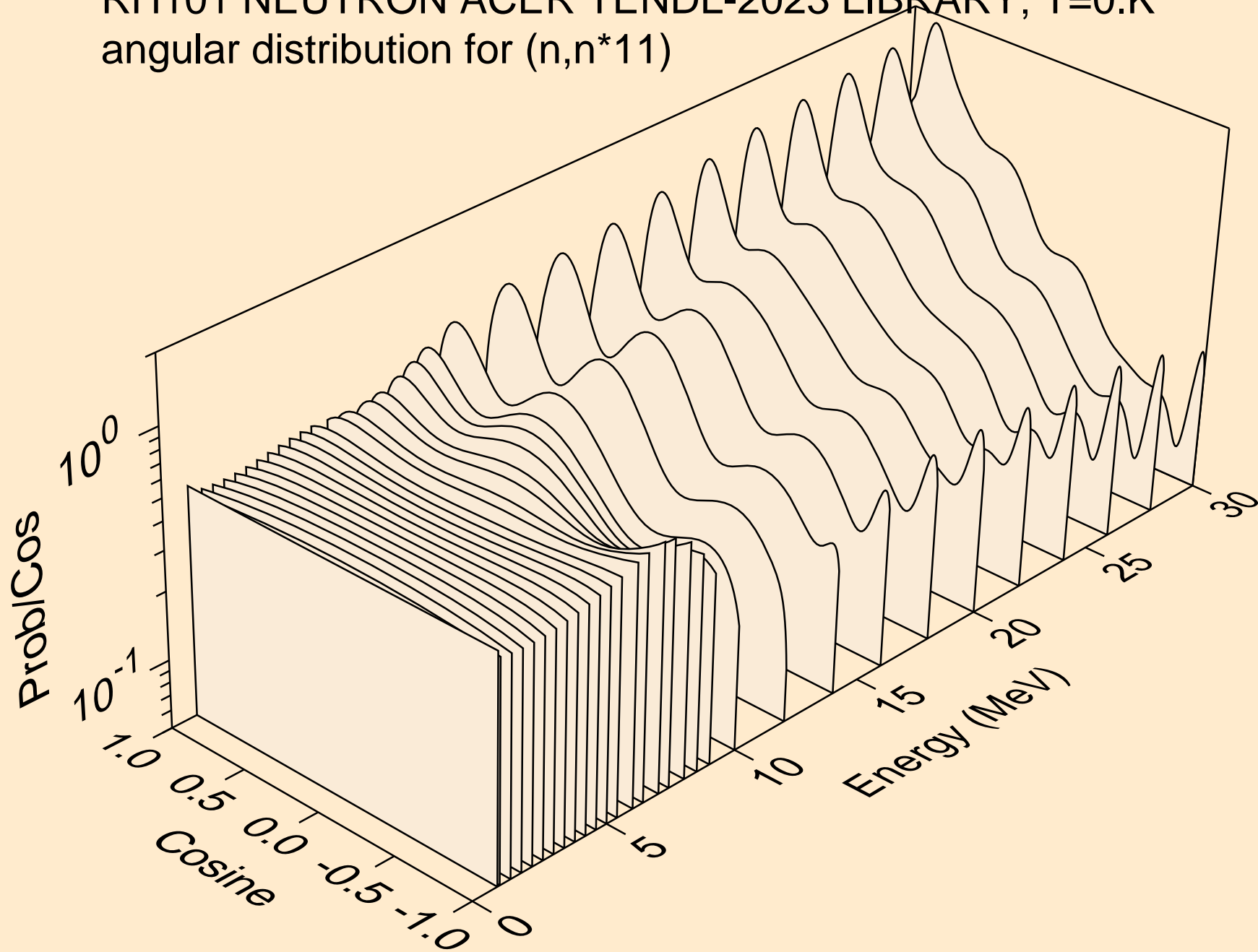

RH101 NEUTRON ACER TENDL-2023 LIBRARY; T=0.K
angular distribution for (n,n*12)

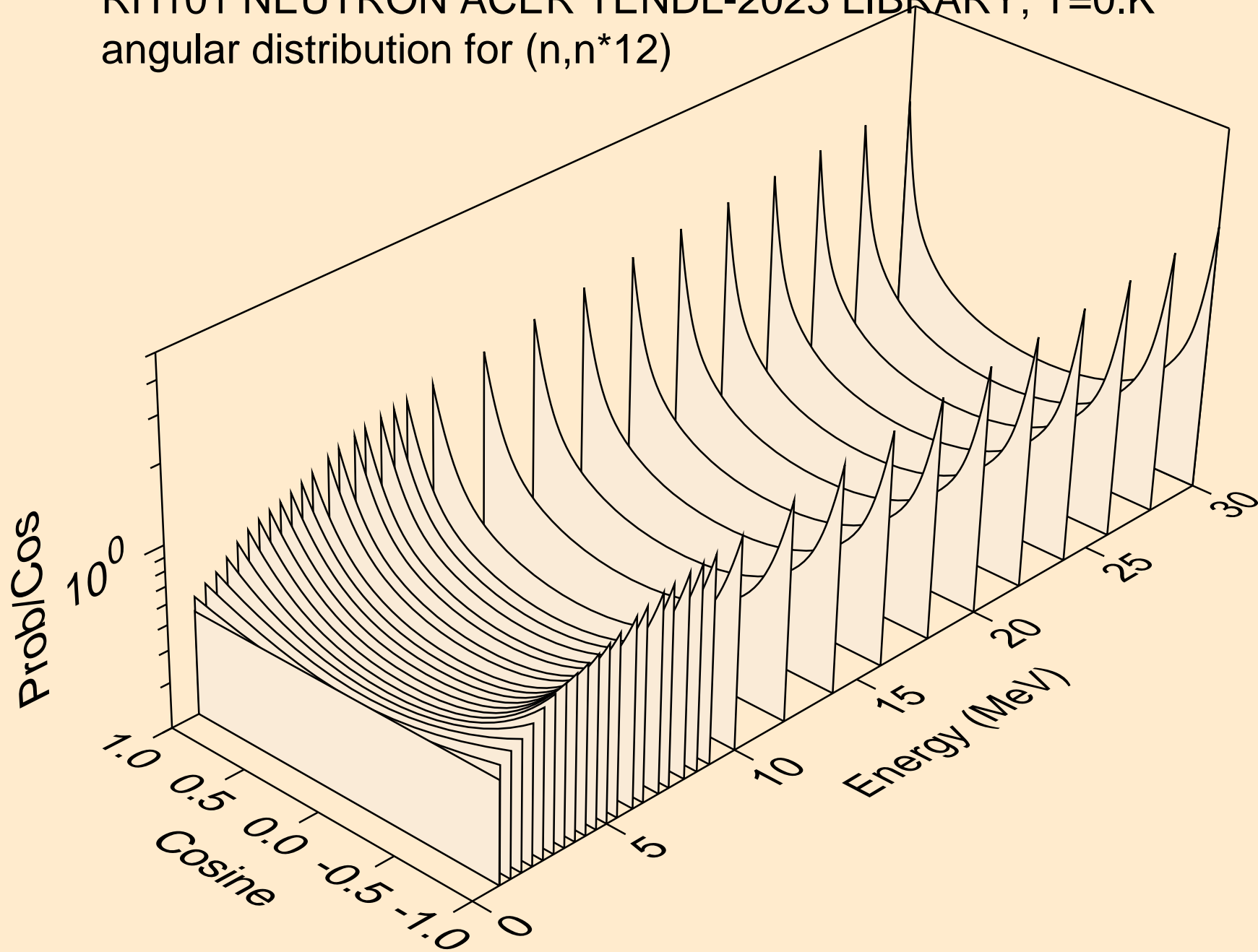

RH101 NEUTRON ACER TENDL-2023 LIBRARY; T=0.K
angular distribution for (n,n*13)

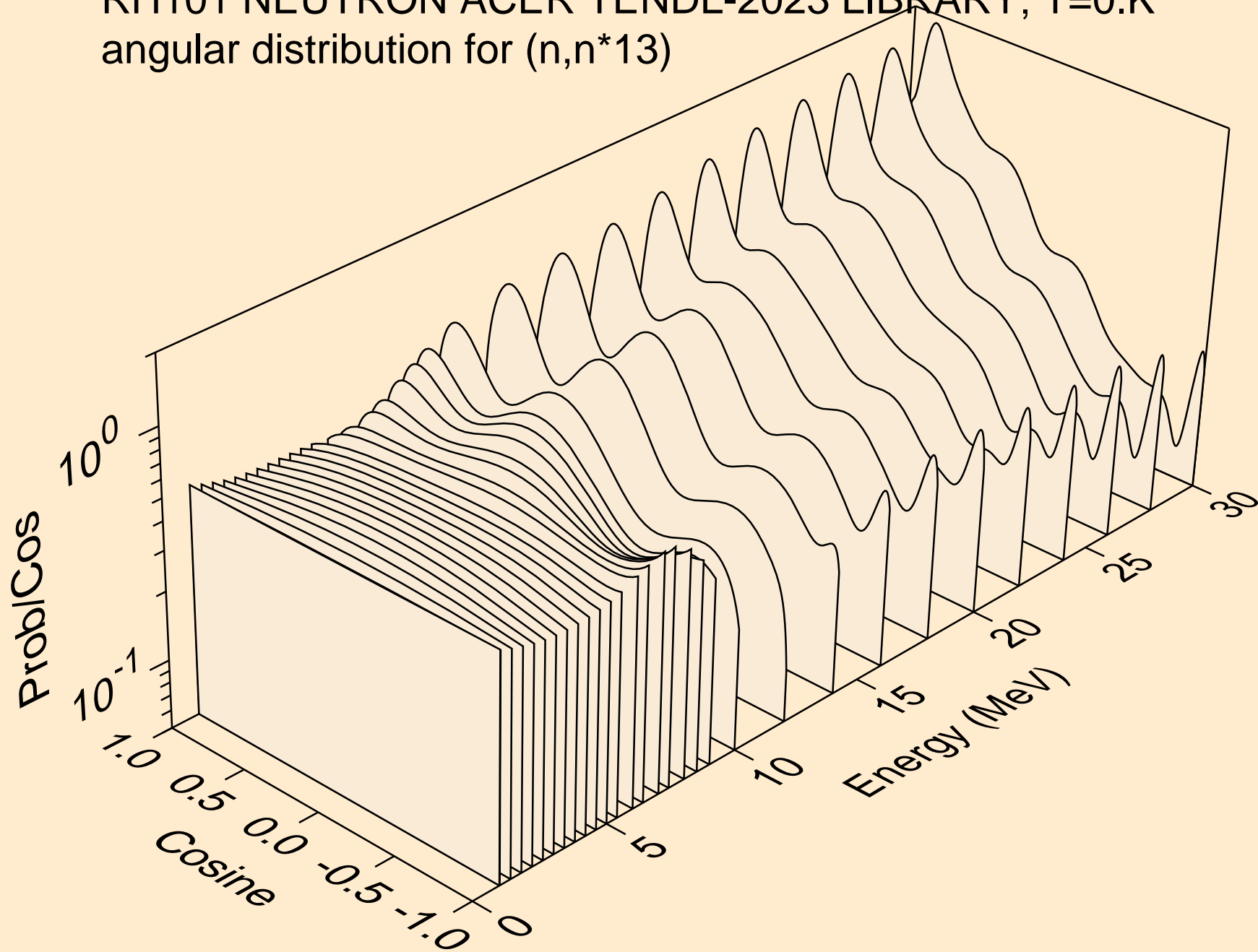

RH101 NEUTRON ACER TENDL-2023 LIBRARY; T=0.K
angular distribution for (n,n*14)

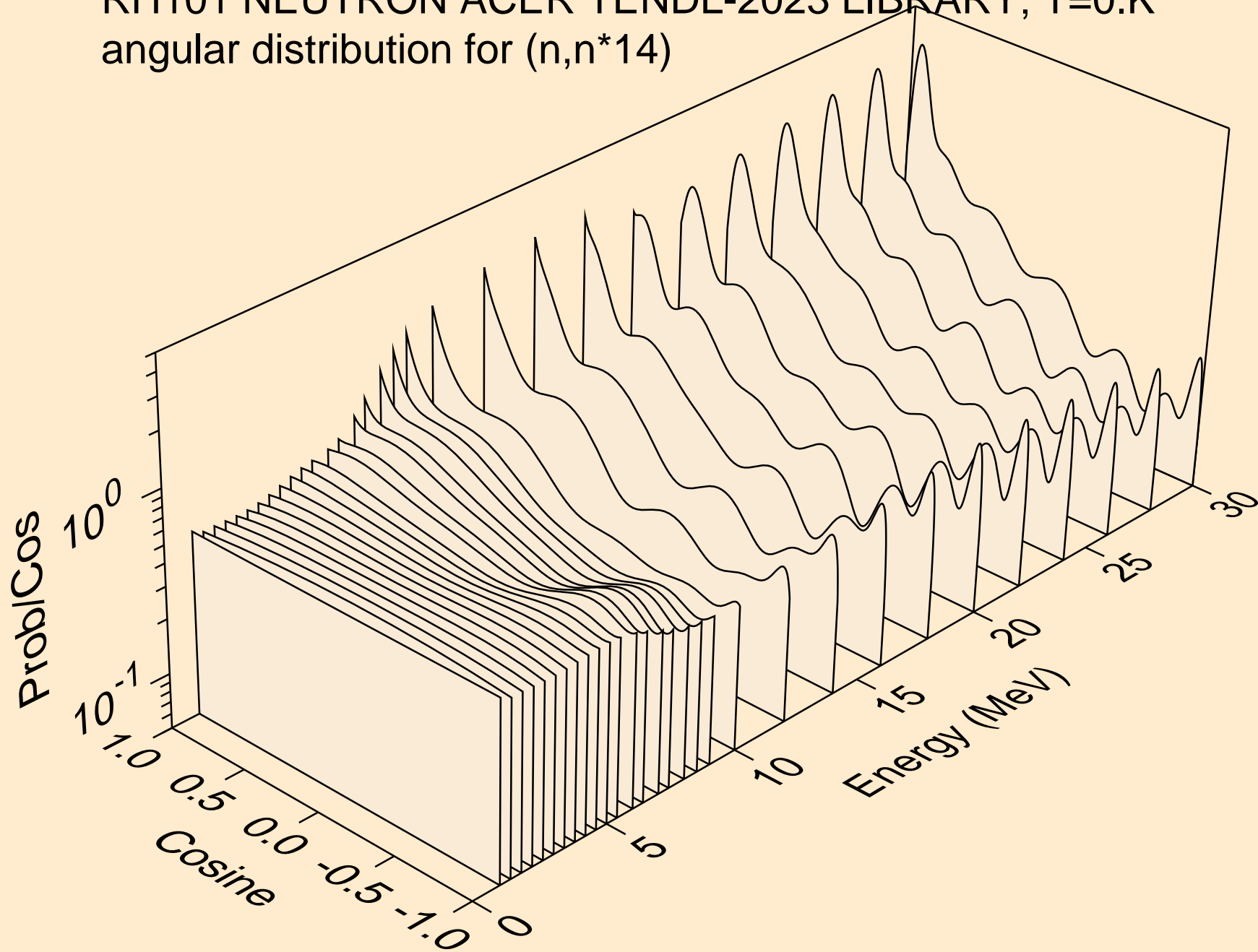

RH101 NEUTRON ACER TENDL-2023 LIBRARY; T=0.K
angular distribution for (n,n*15)

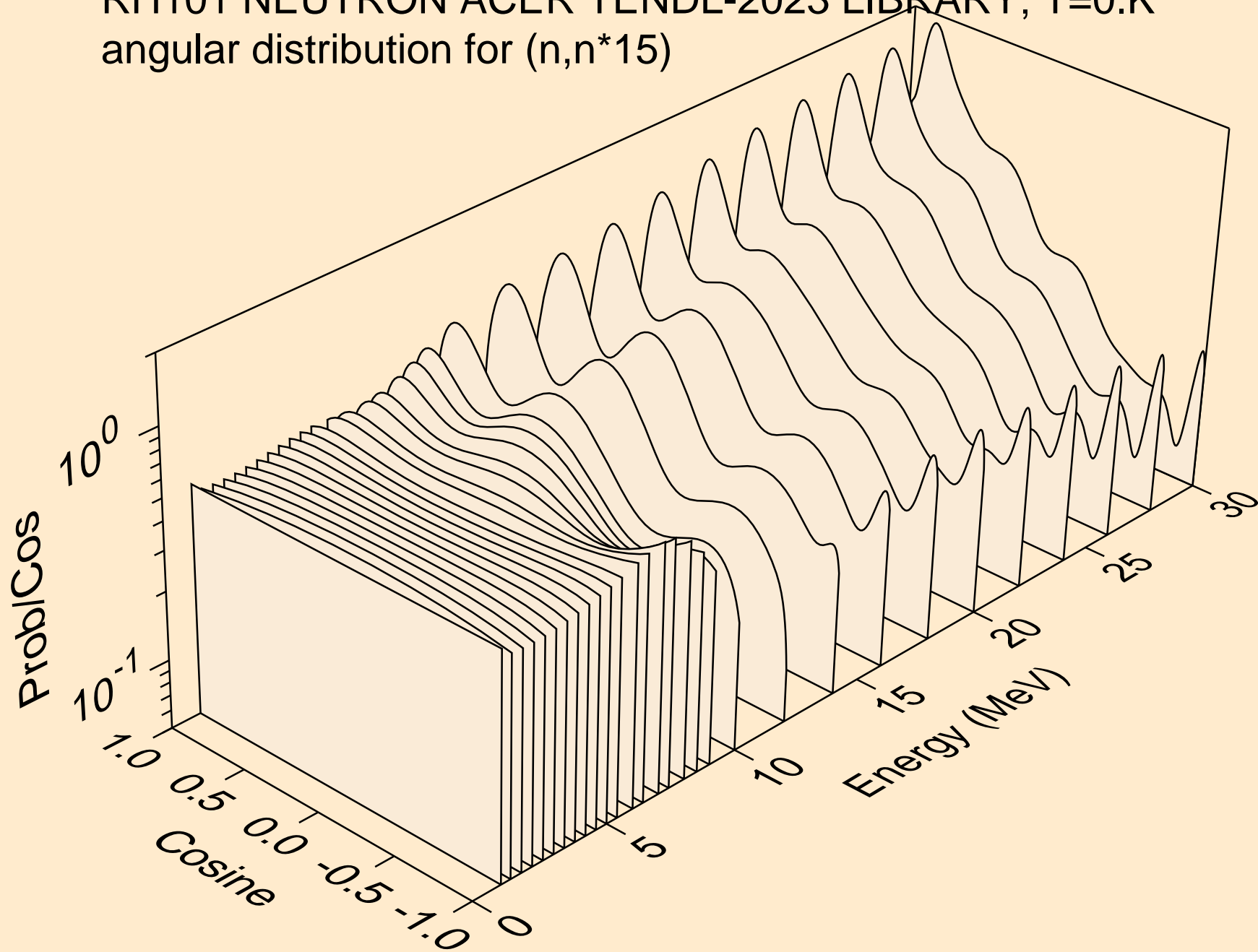

RH101 NEUTRON ACER TENDL-2023 LIBRARY; T=0.K
angular distribution for (n,n*16)

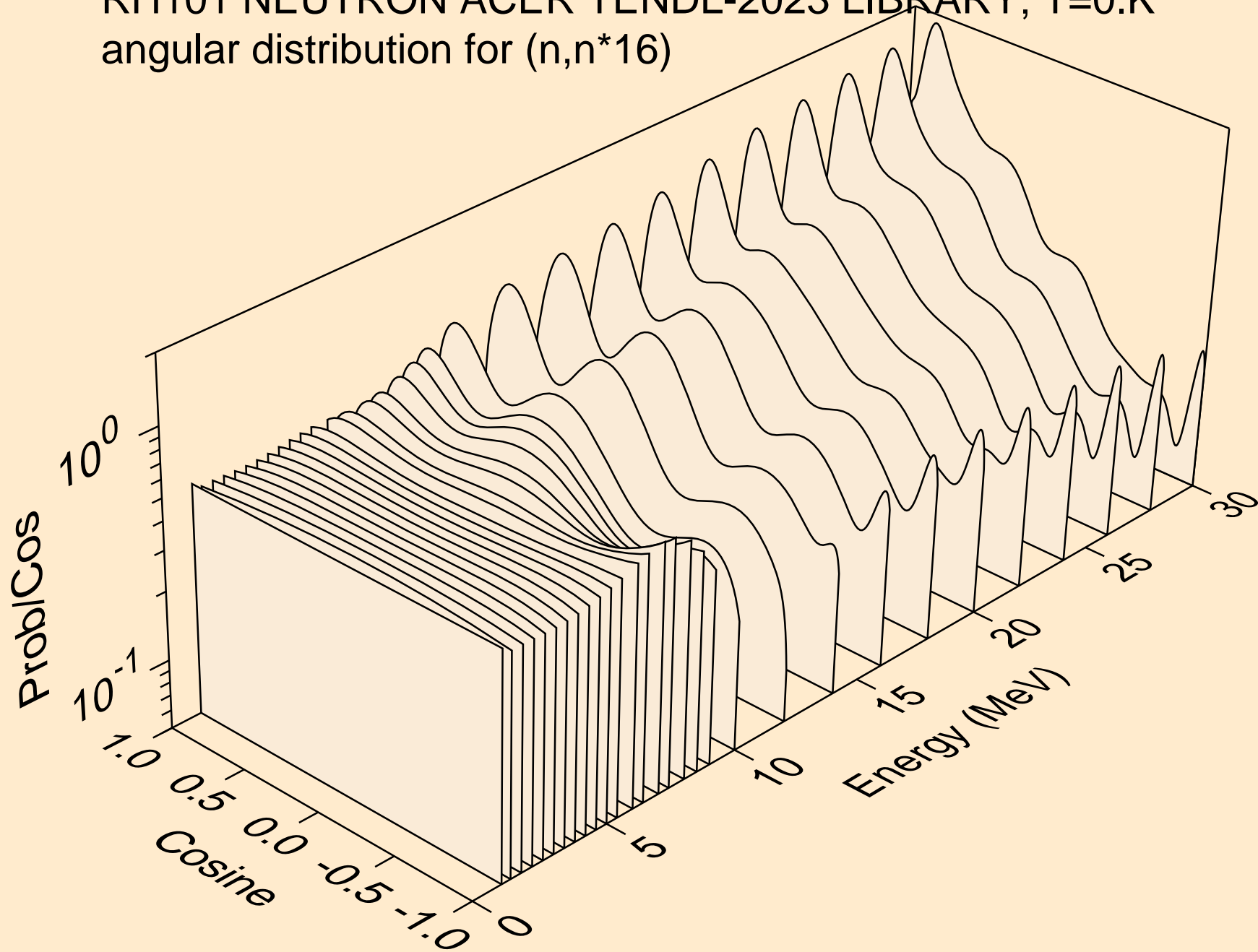

RH101 NEUTRON ACER TENDL-2023 LIBRARY; T=0.K
angular distribution for (n,n*17)

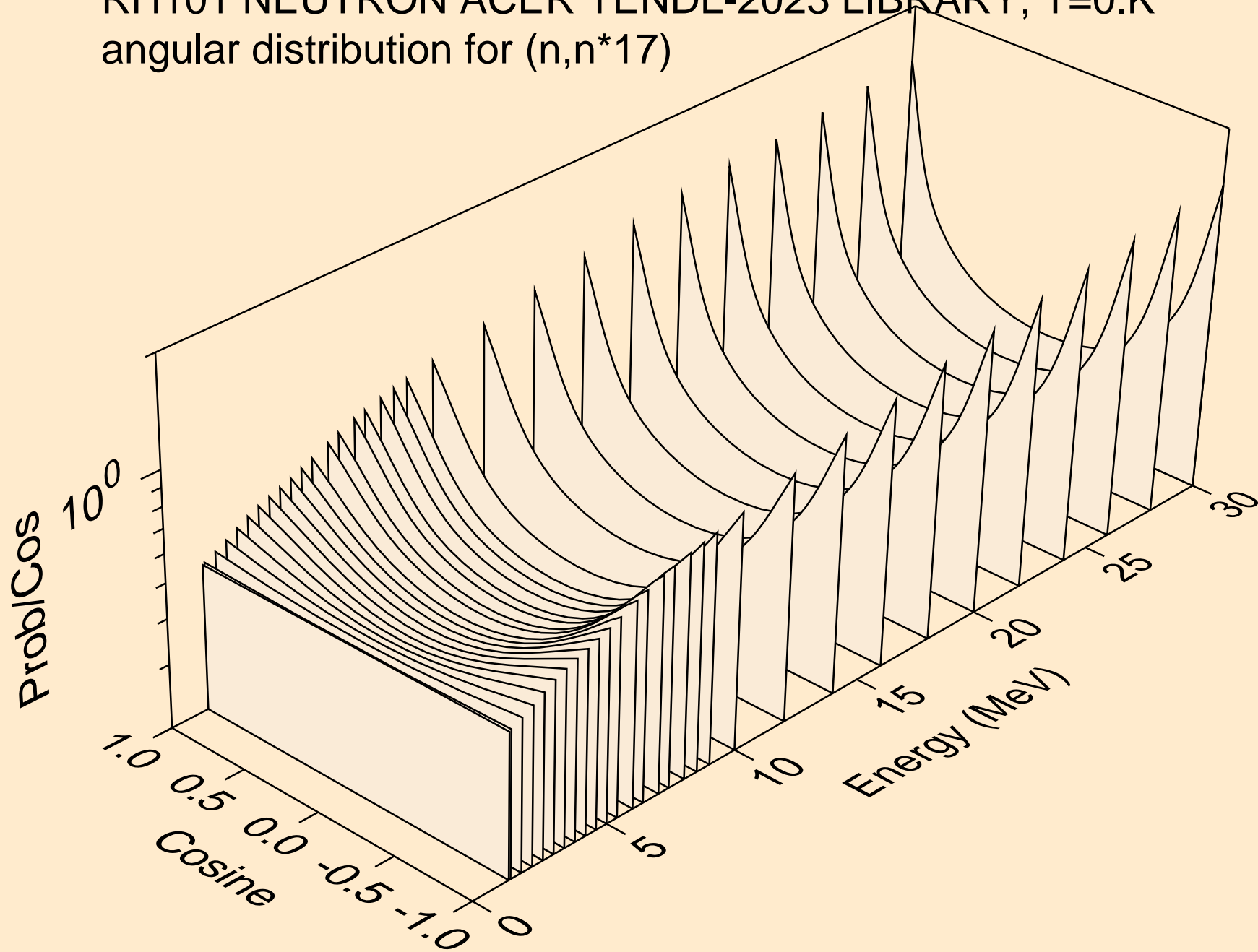

RH101 NEUTRON ACER TENDL-2023 LIBRARY; T=0.K
Neutron emission for (n,x)

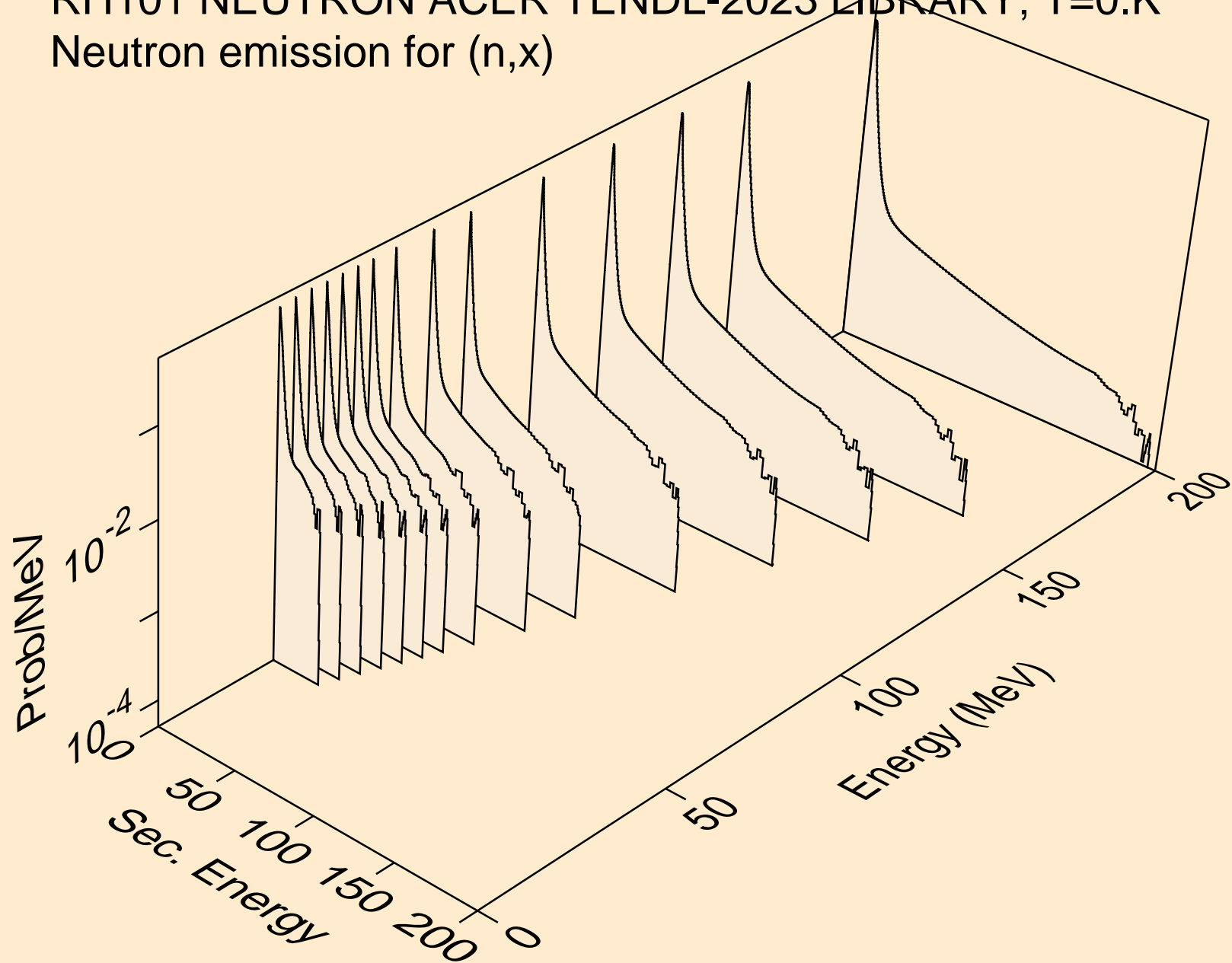

RH101 NEUTRON ACER TENDL-2023 LIBRARY; T=0.K
Neutron emission for (n,2nd)

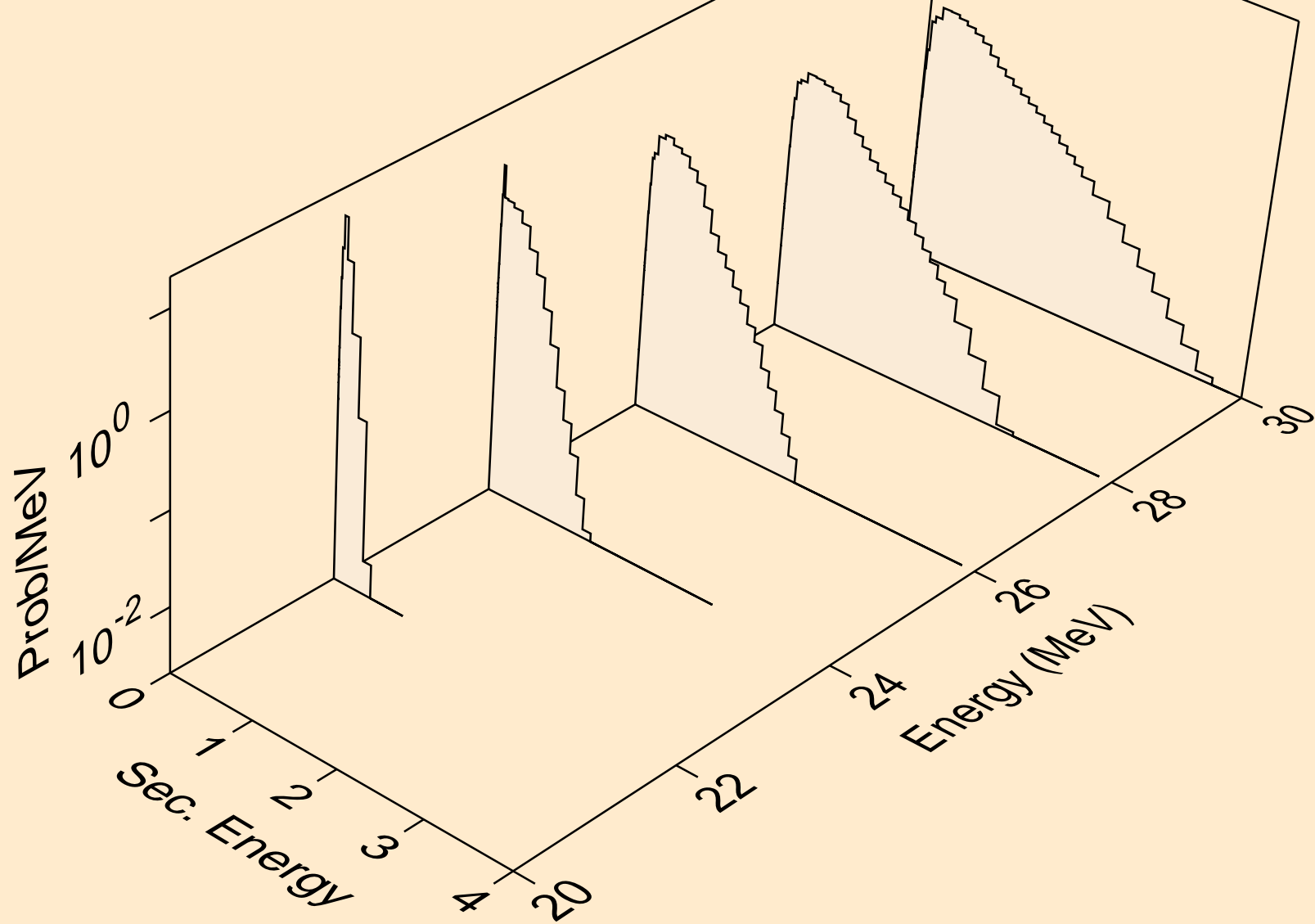

RH101 NEUTRON ACER TENDL-2023 LIBRARY; T=0.K
Neutron emission for (n,2n)

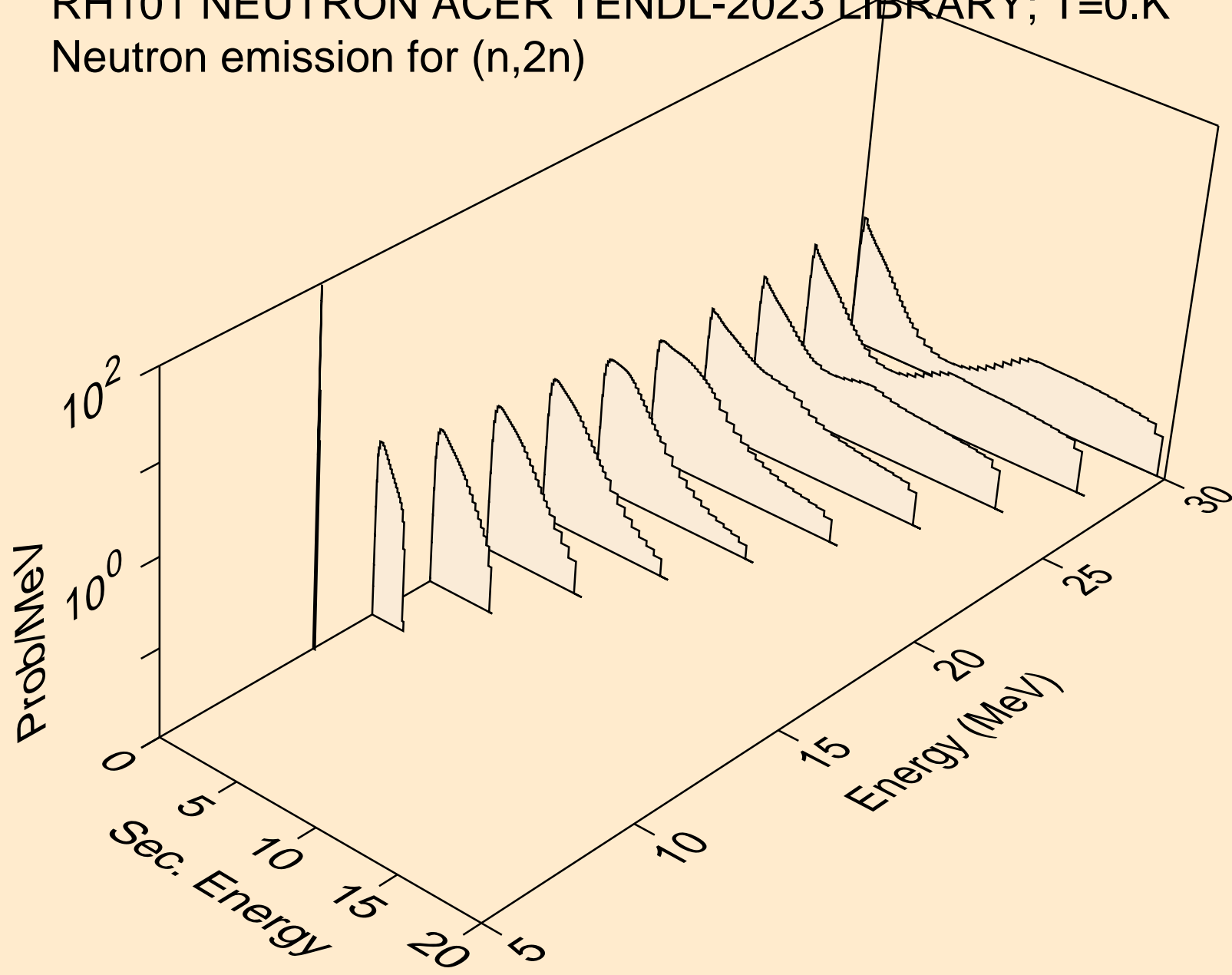

RH101 NEUTRON ACER TENDL-2023 LIBRARY; T=0.K
Neutron emission for (n,3n)

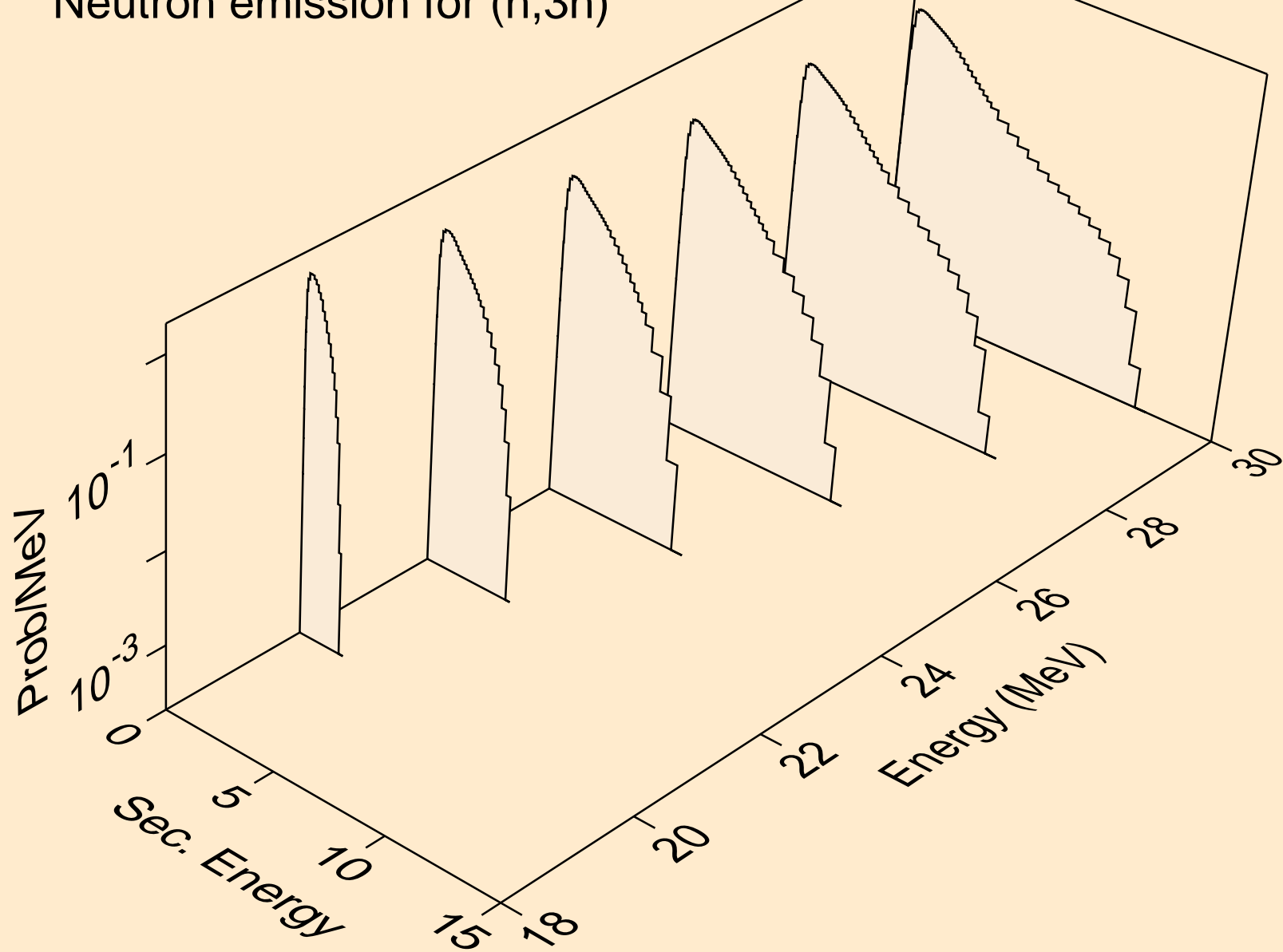

RH101 NEUTRON ACER TENDL-2023 LIBRARY; T=0.K
Neutron emission for (n,n*)a

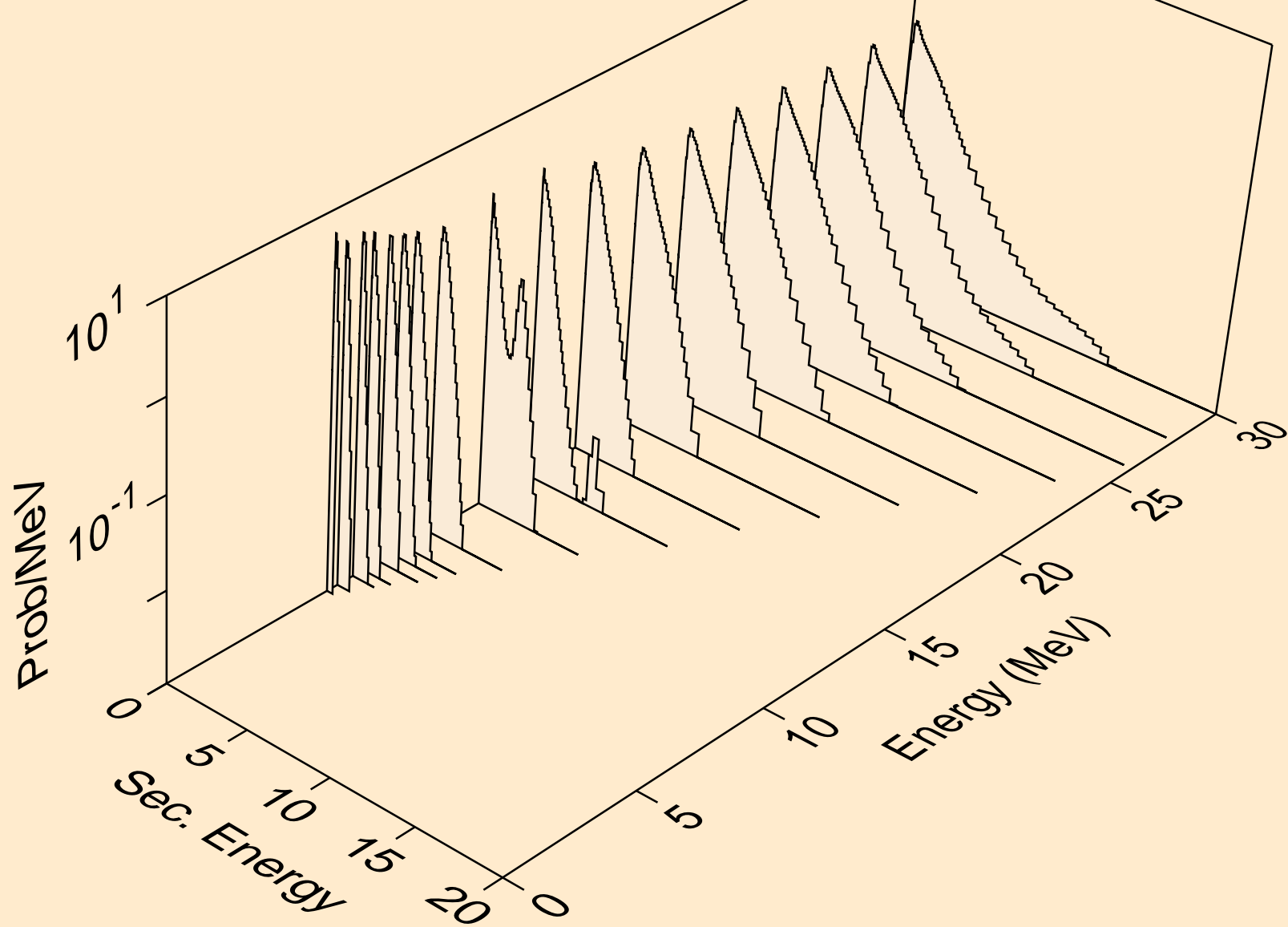

RH101 NEUTRON ACER TENDL-2023 LIBRARY; T=0.K
Neutron emission for (n,2n)a

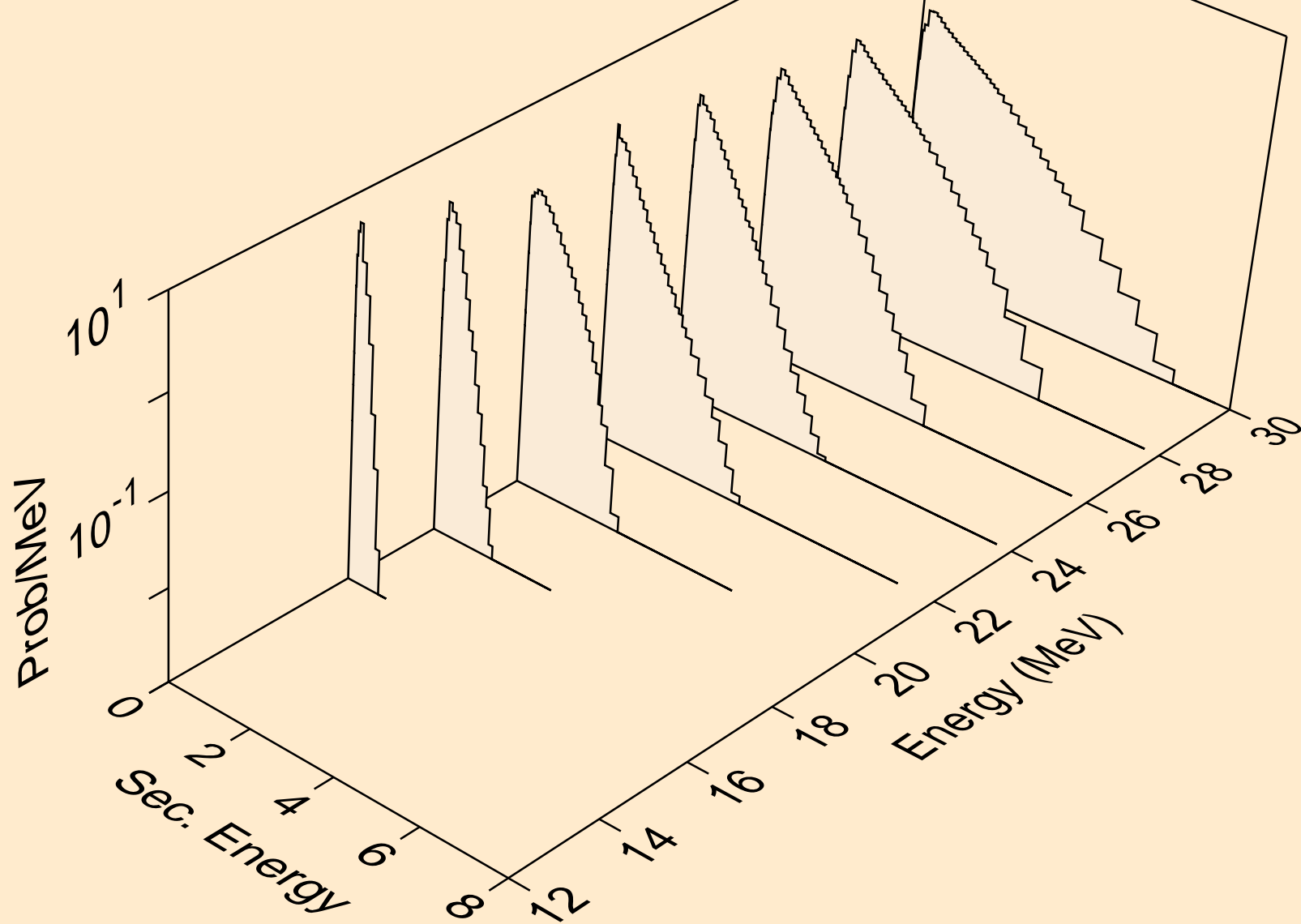

RH101 NEUTRON ACER TENDL-2023 LIBRARY; T=0.K
Neutron emission for (n,3n)a

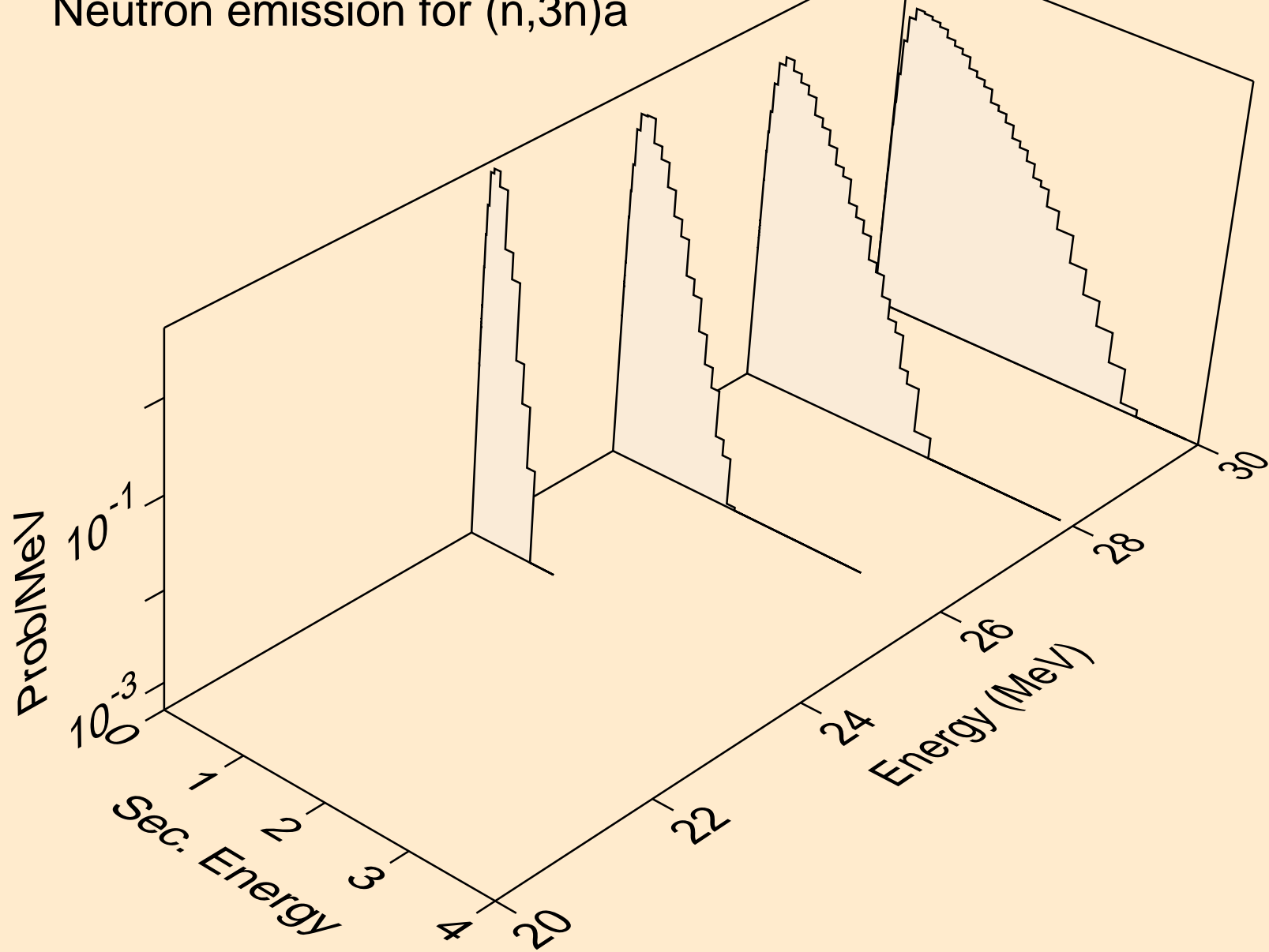

RH101 NEUTRON ACER TENDL-2023 LIBRARY; T=0.K
Neutron emission for (n,n*)p

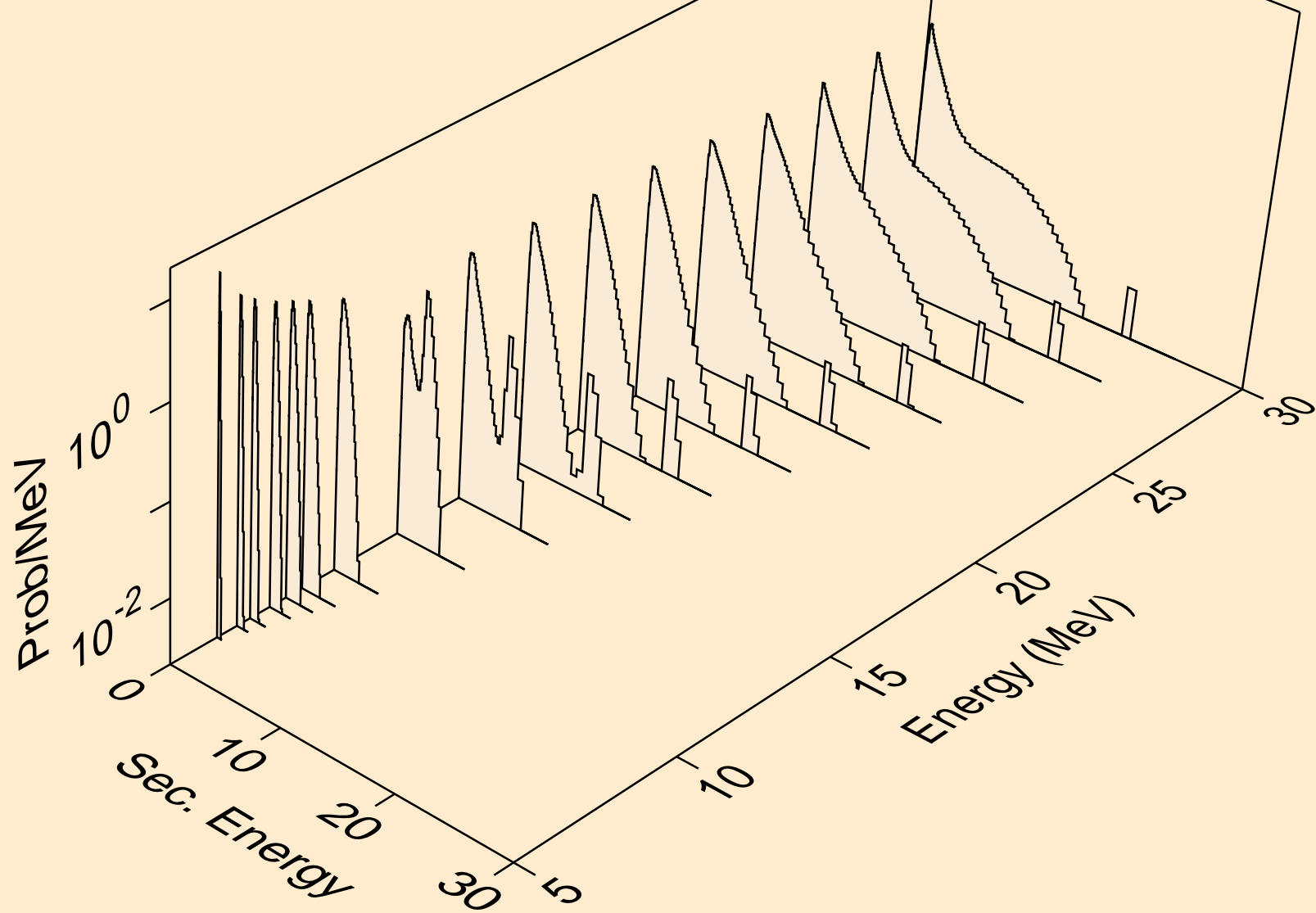

RH101 NEUTRON ACER TENDL-2023 LIBRARY; T=0.K
Neutron emission for (n,n*)2a

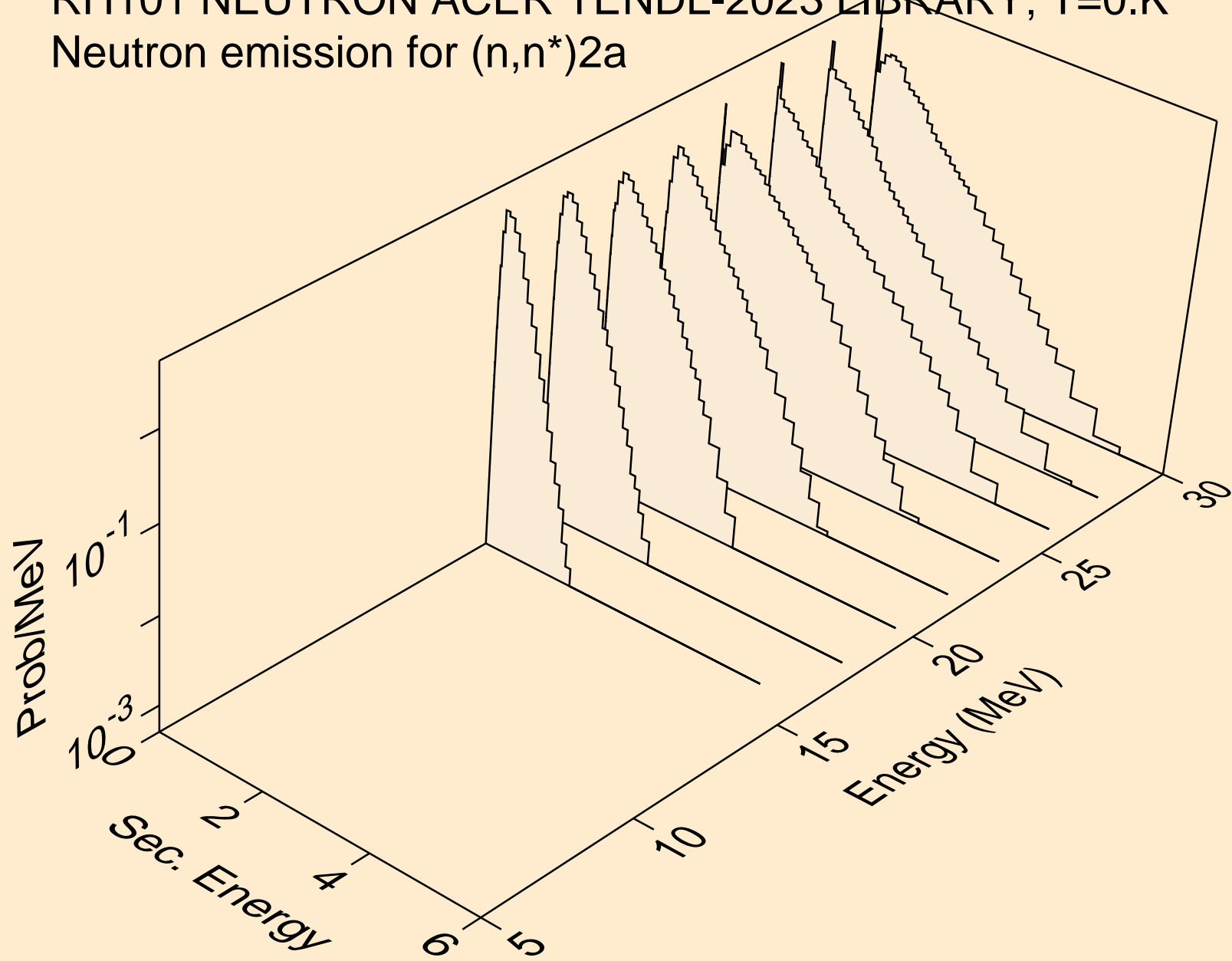

RH101 NEUTRON ACER TENDL-2023 LIBRARY; T=0.K
Neutron emission for (n,n*)d

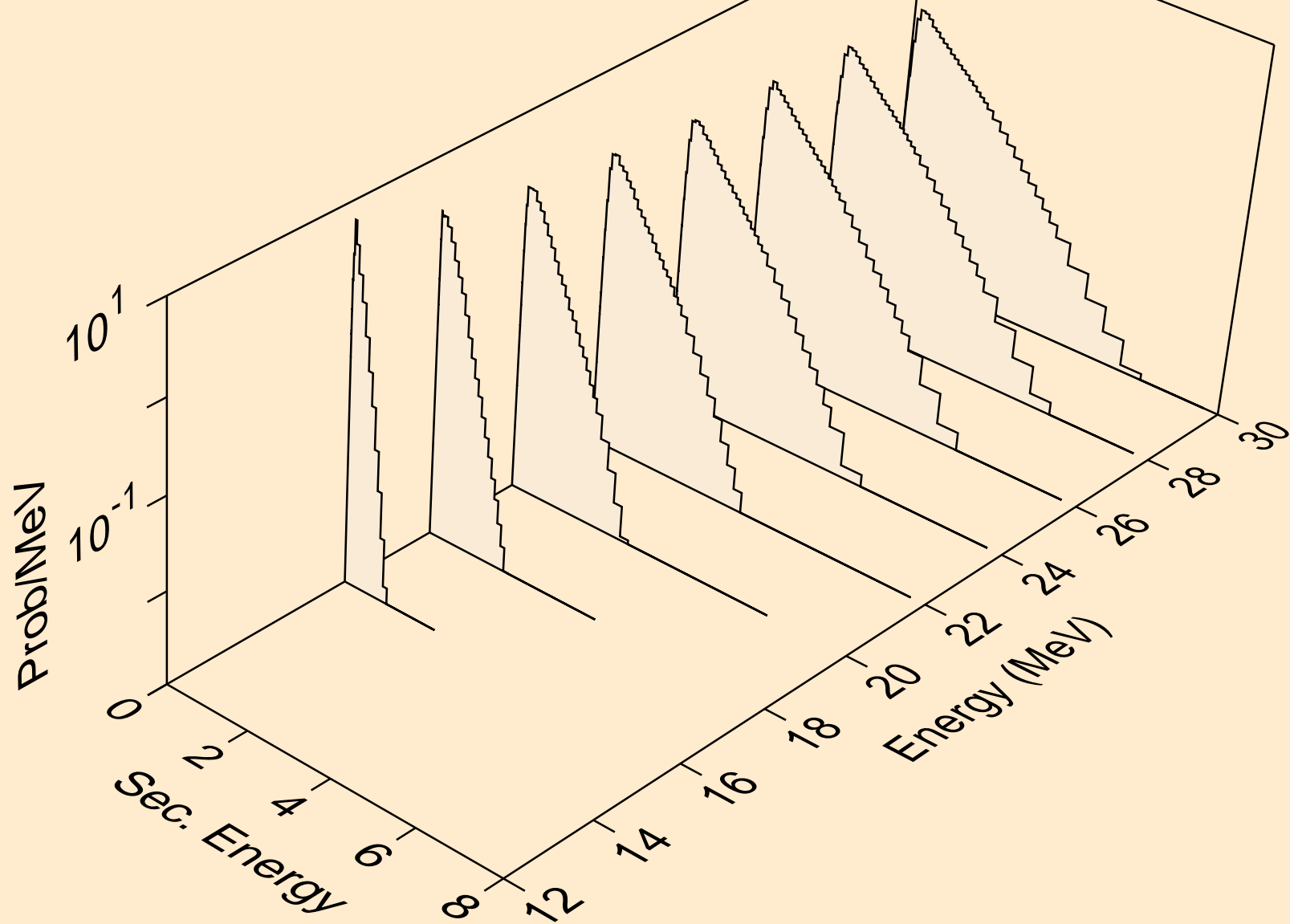

RH101 NEUTRON ACER TENDL-2023 LIBRARY; T=0.K
Neutron emission for (n,n*)t

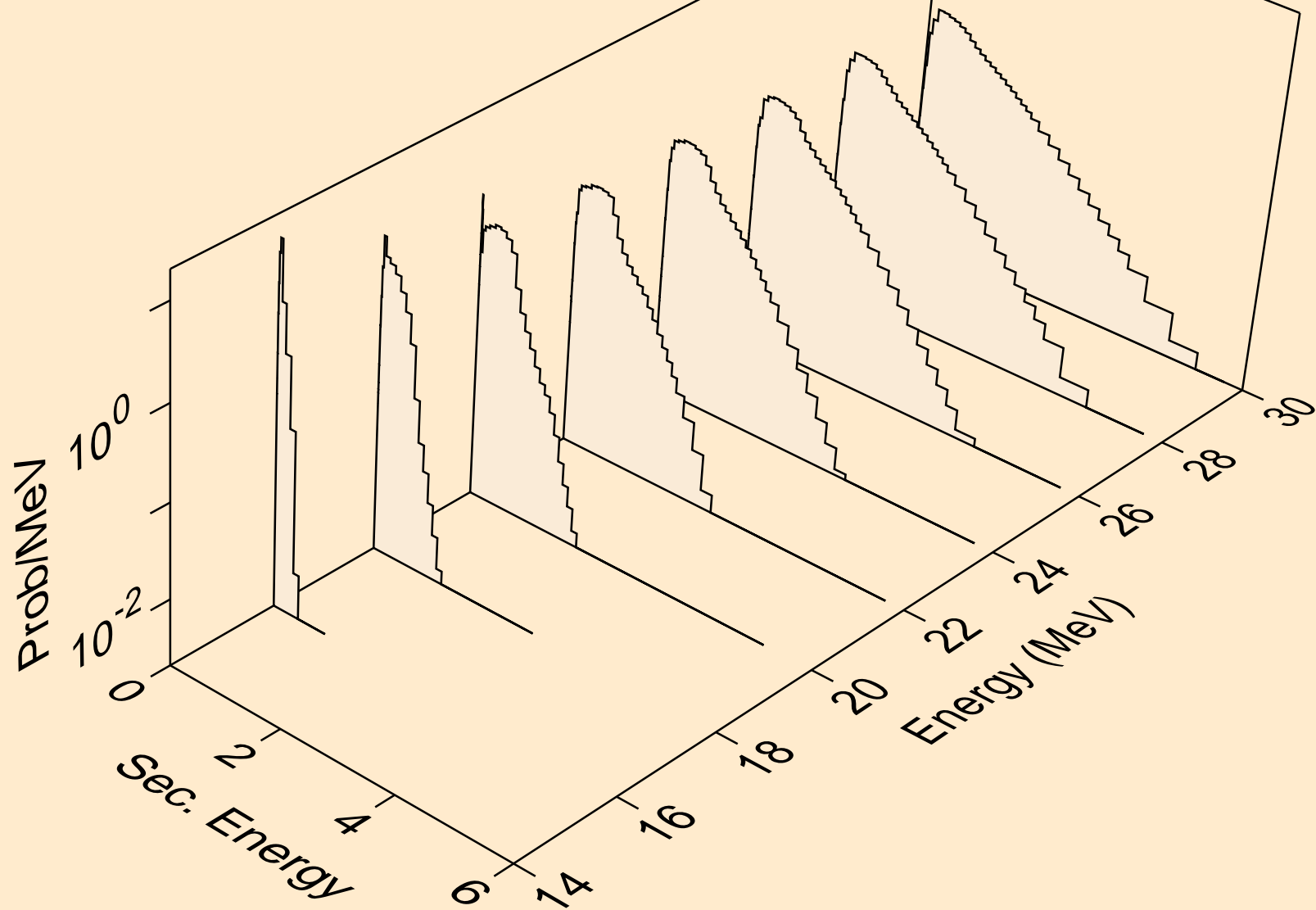

RH101 NEUTRON ACER TENDL-2023 LIBRARY; T=0.K
Neutron emission for (n,n*)he3

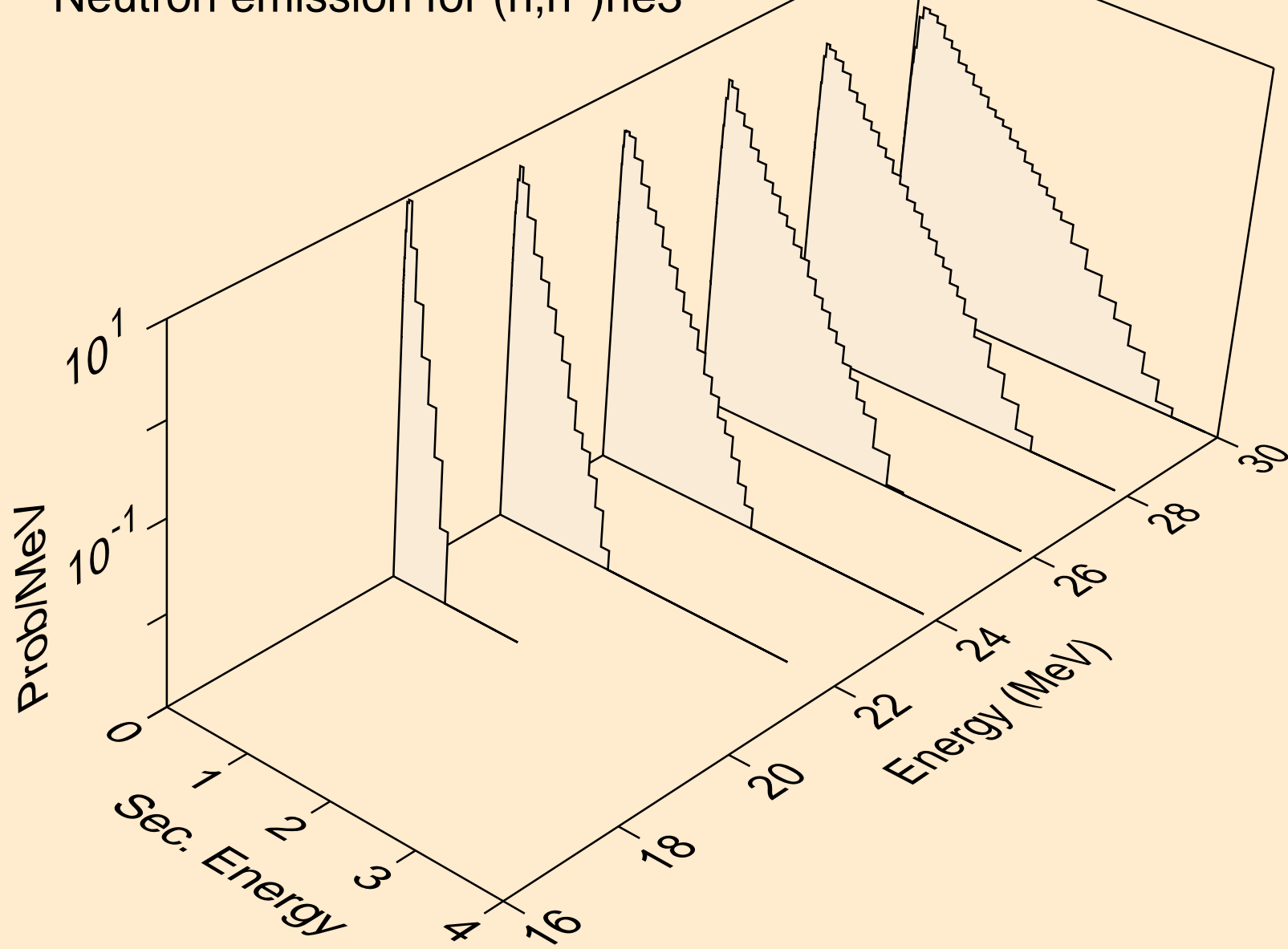

RH101 NEUTRON ACER TENDL-2023 LIBRARY; T=0.K
Neutron emission for (n,4n)

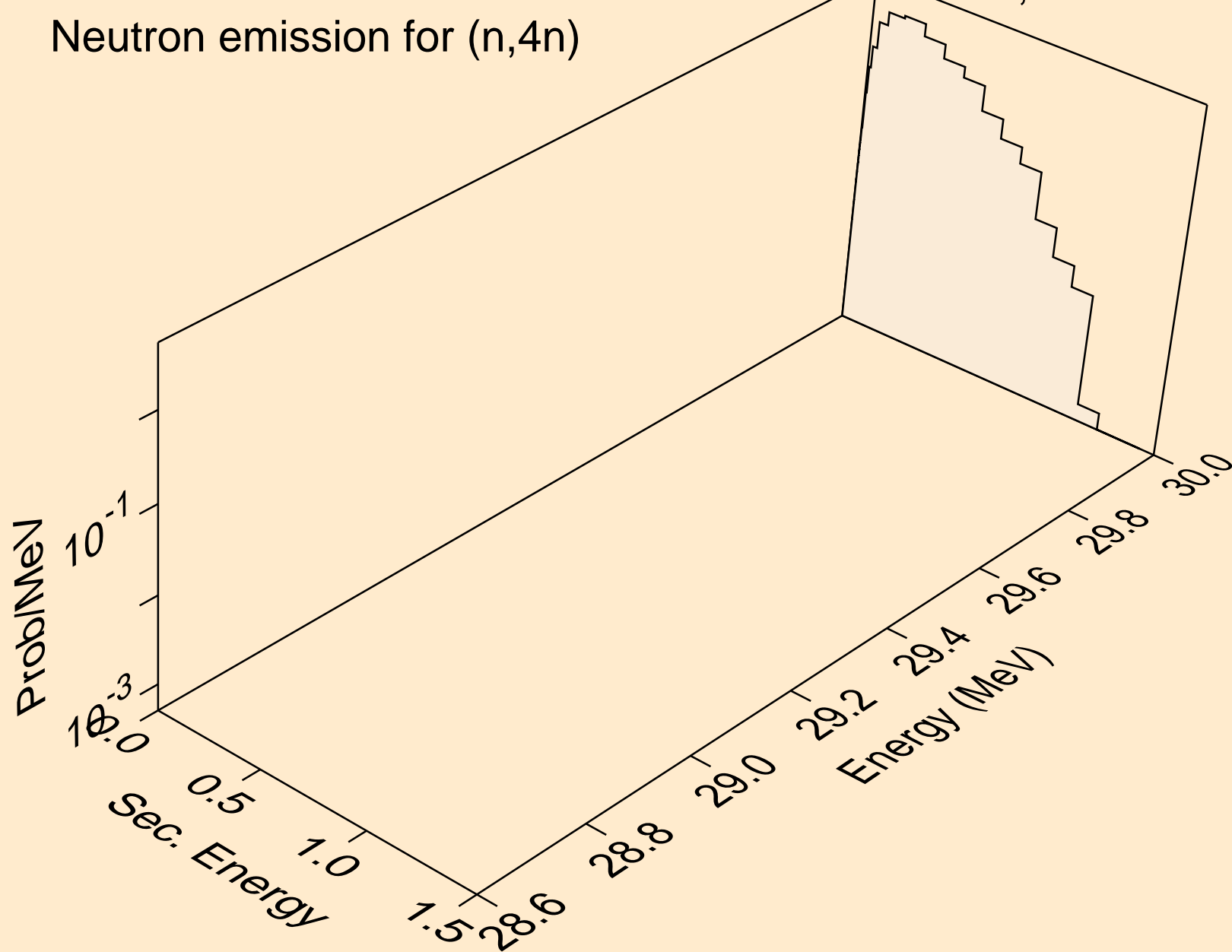

RH101 NEUTRON ACER TENDL-2023 LIBRARY; T=0.K
Neutron emission for (n,2np)

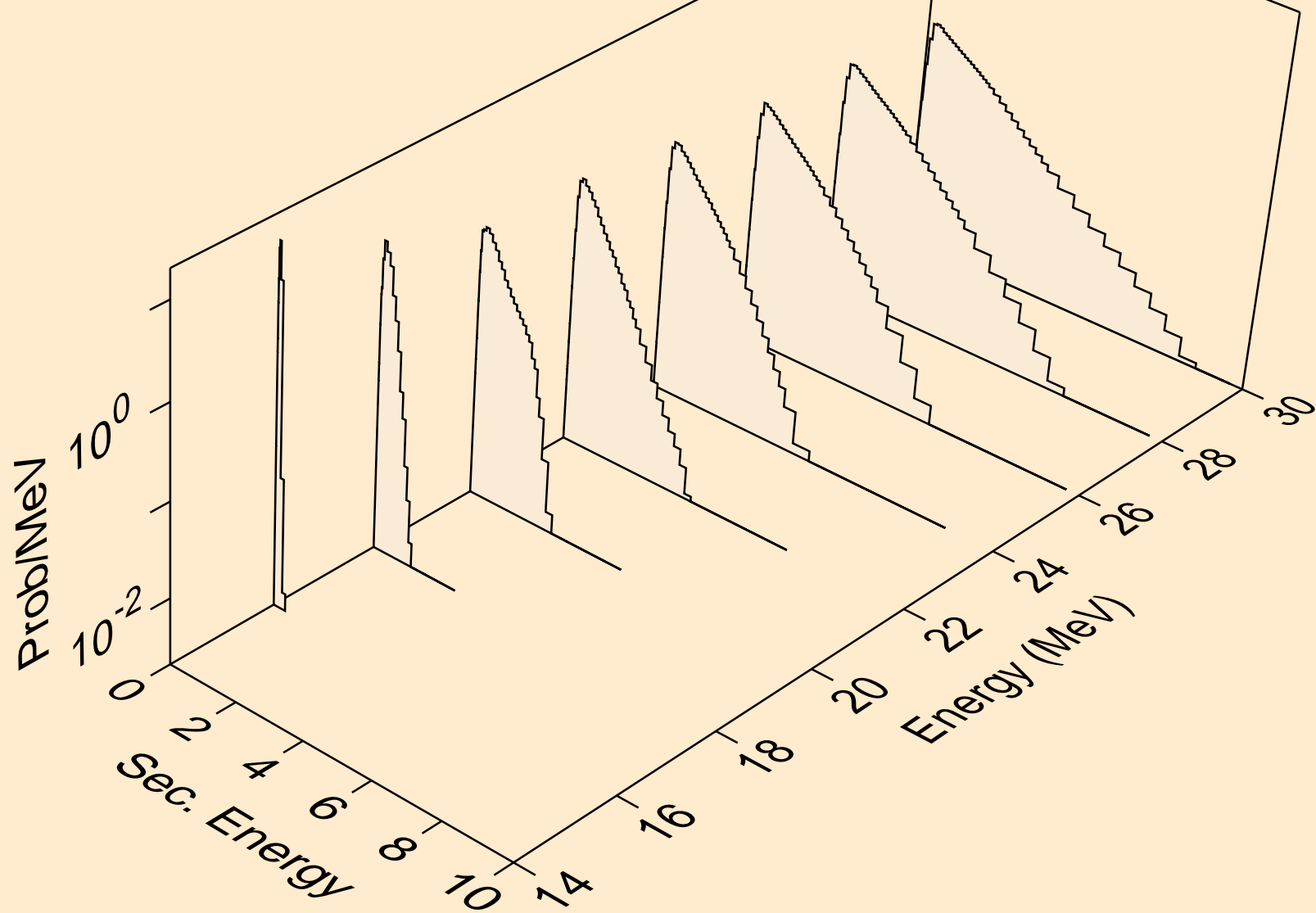

RH101 NEUTRON ACER TENDL-2023 LIBRARY; T=0.K
Neutron emission for (n,3np)

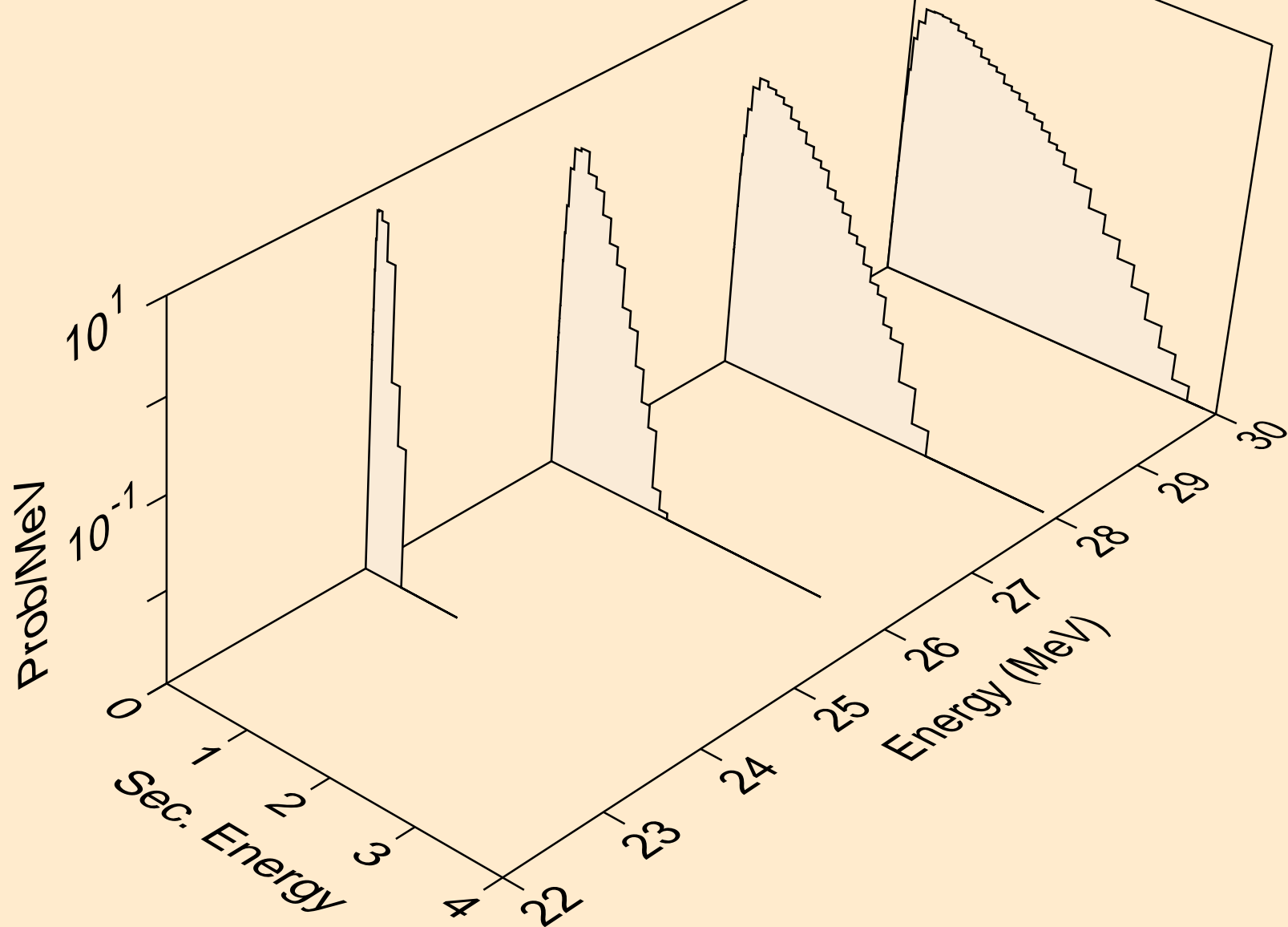

RH101 NEUTRON ACER TENDL-2023 LIBRARY; T=0.K
Neutron emission for (n,n2p)

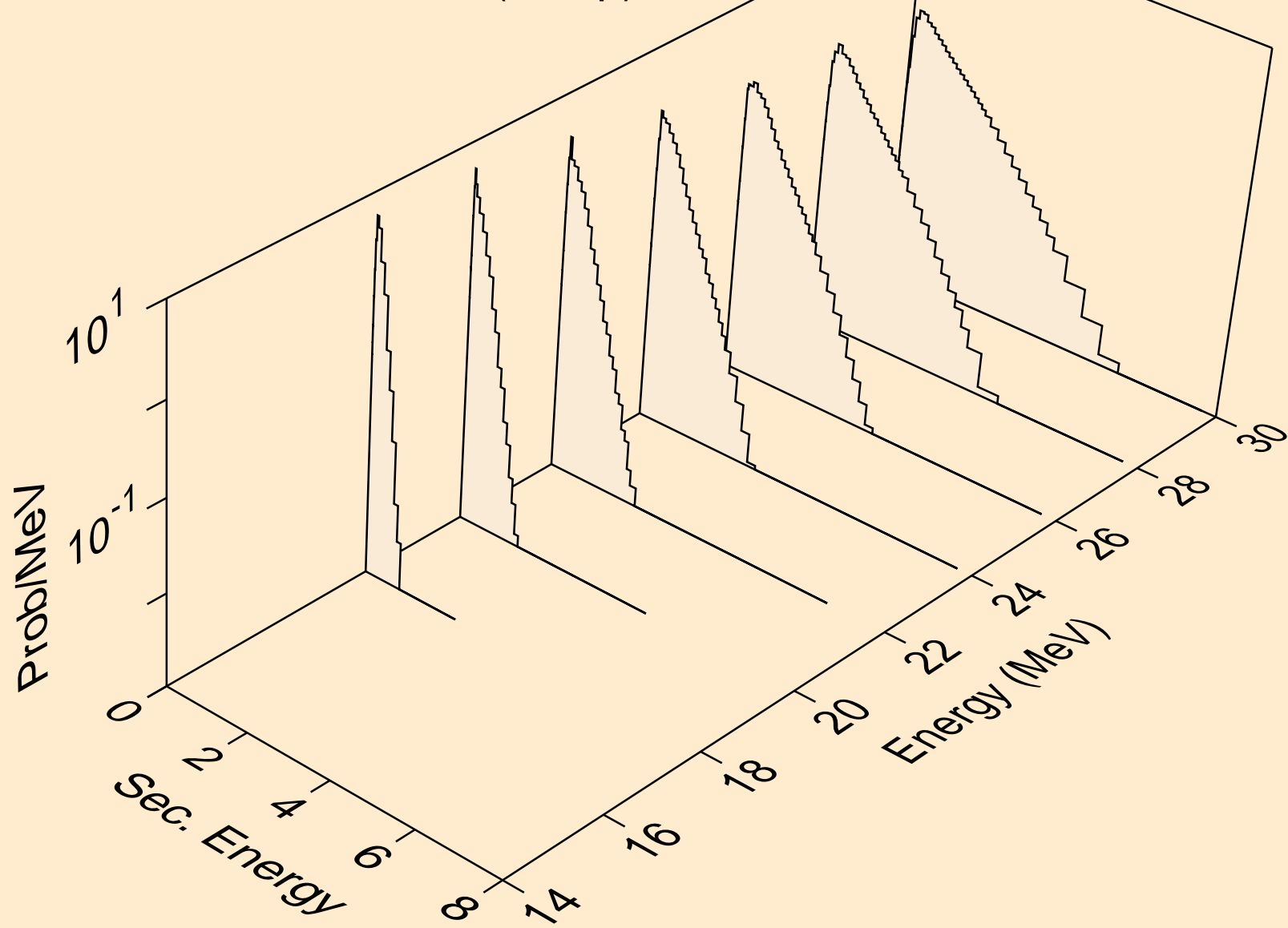

RH101 NEUTRON ACER TENDL-2023 LIBRARY; T=0.K
Neutron emission for (n,npa)

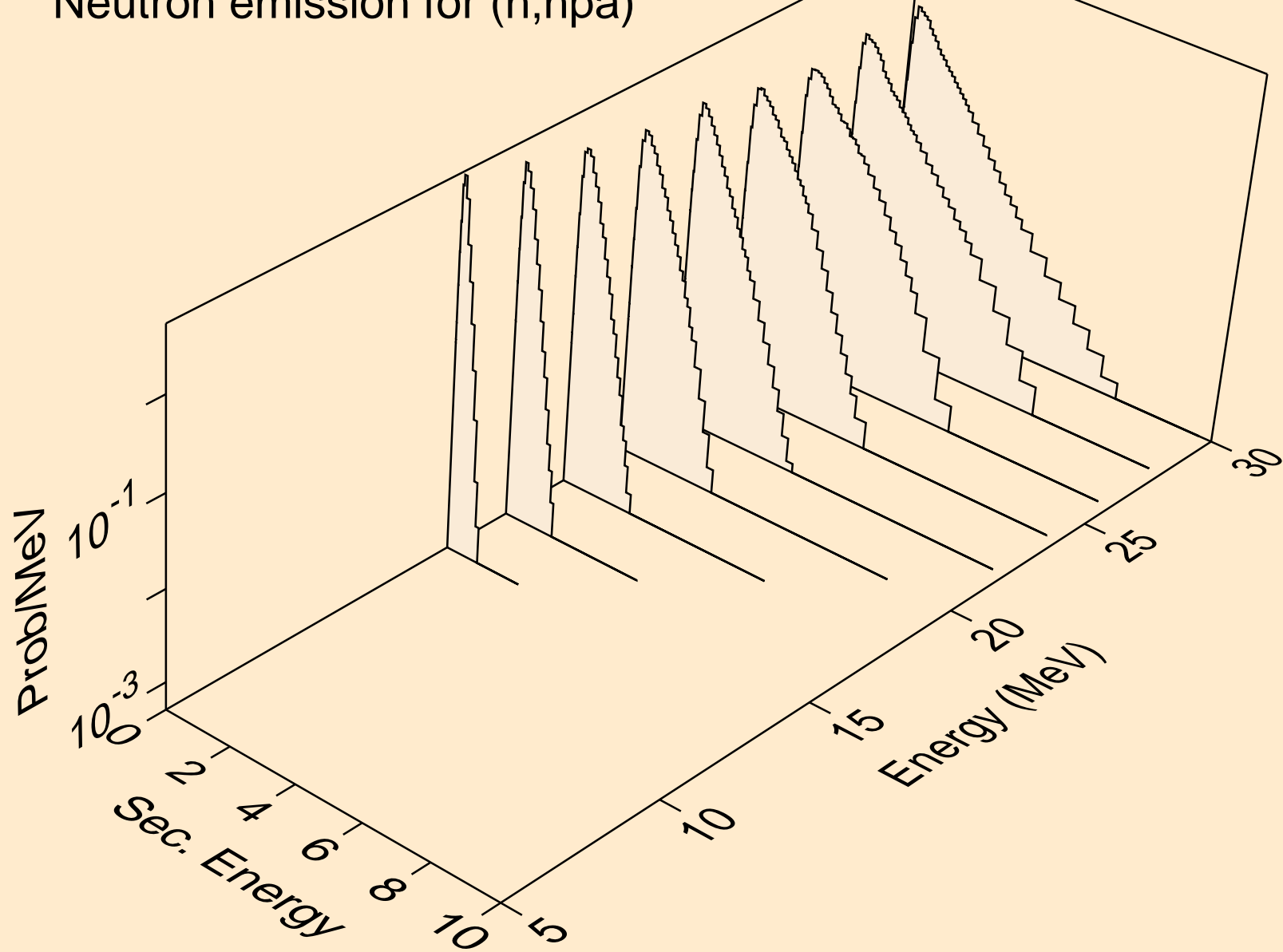

RH101 NEUTRON ACER TENDL-2023 LIBRARY; T=0.K
Neutron emission for (n,n*c)

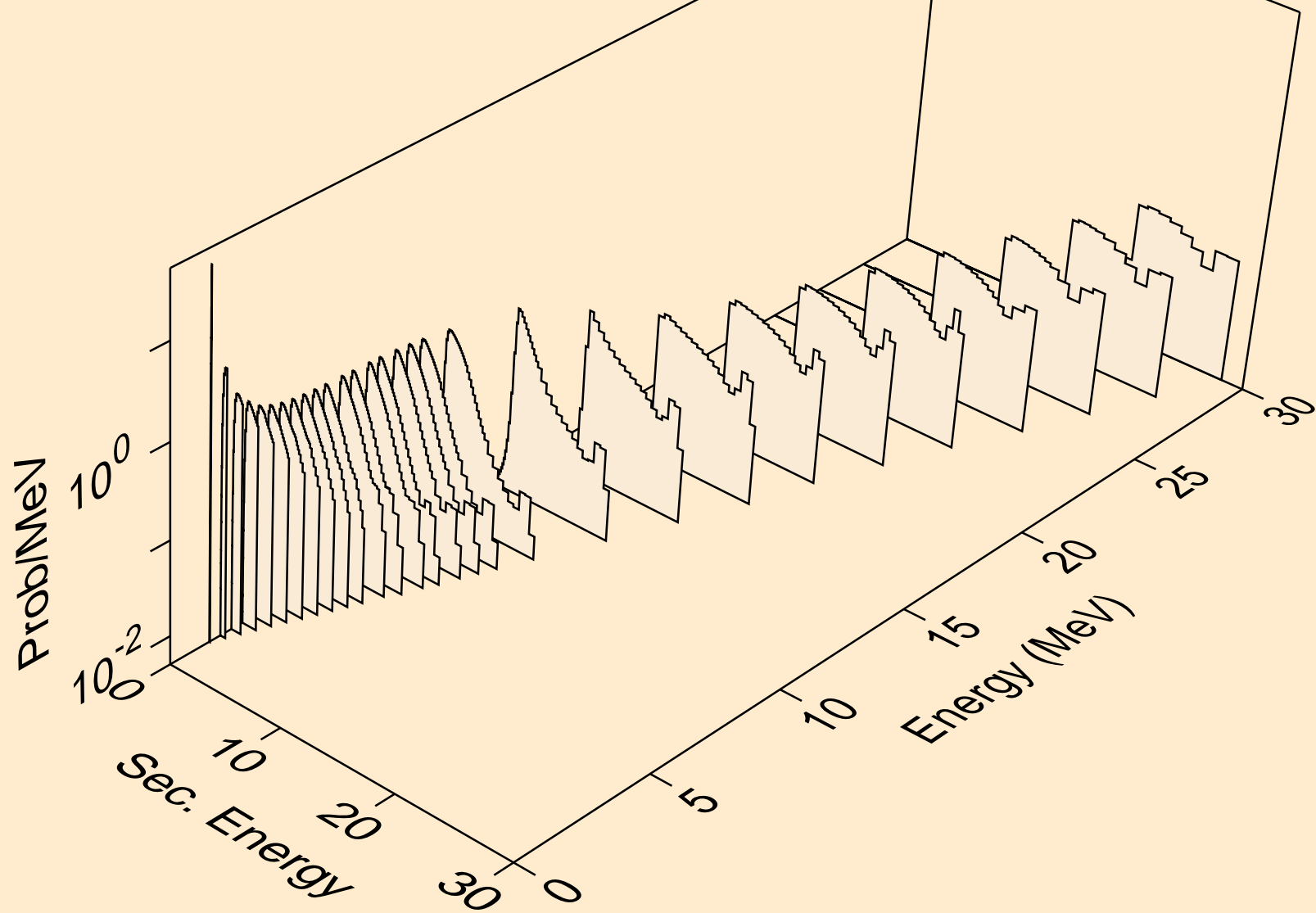

RH101 NEUTRON ACER TENDL-2023 LIBRARY; T=0.K
Photon emission for (n,x)

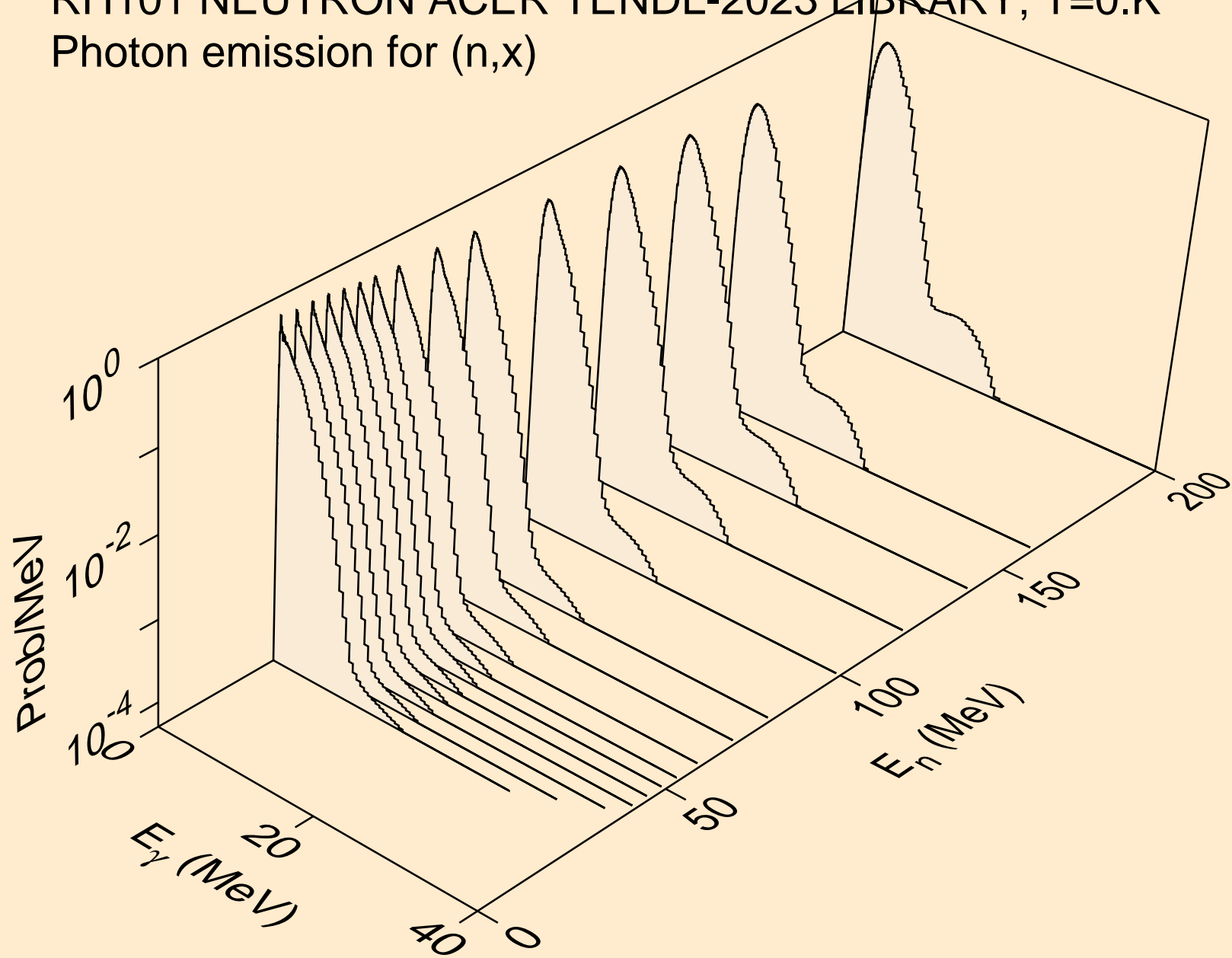

RH101 NEUTRON ACER TENDL-2023 LIBRARY; T=0.K
Photon emission for (n,2nd)

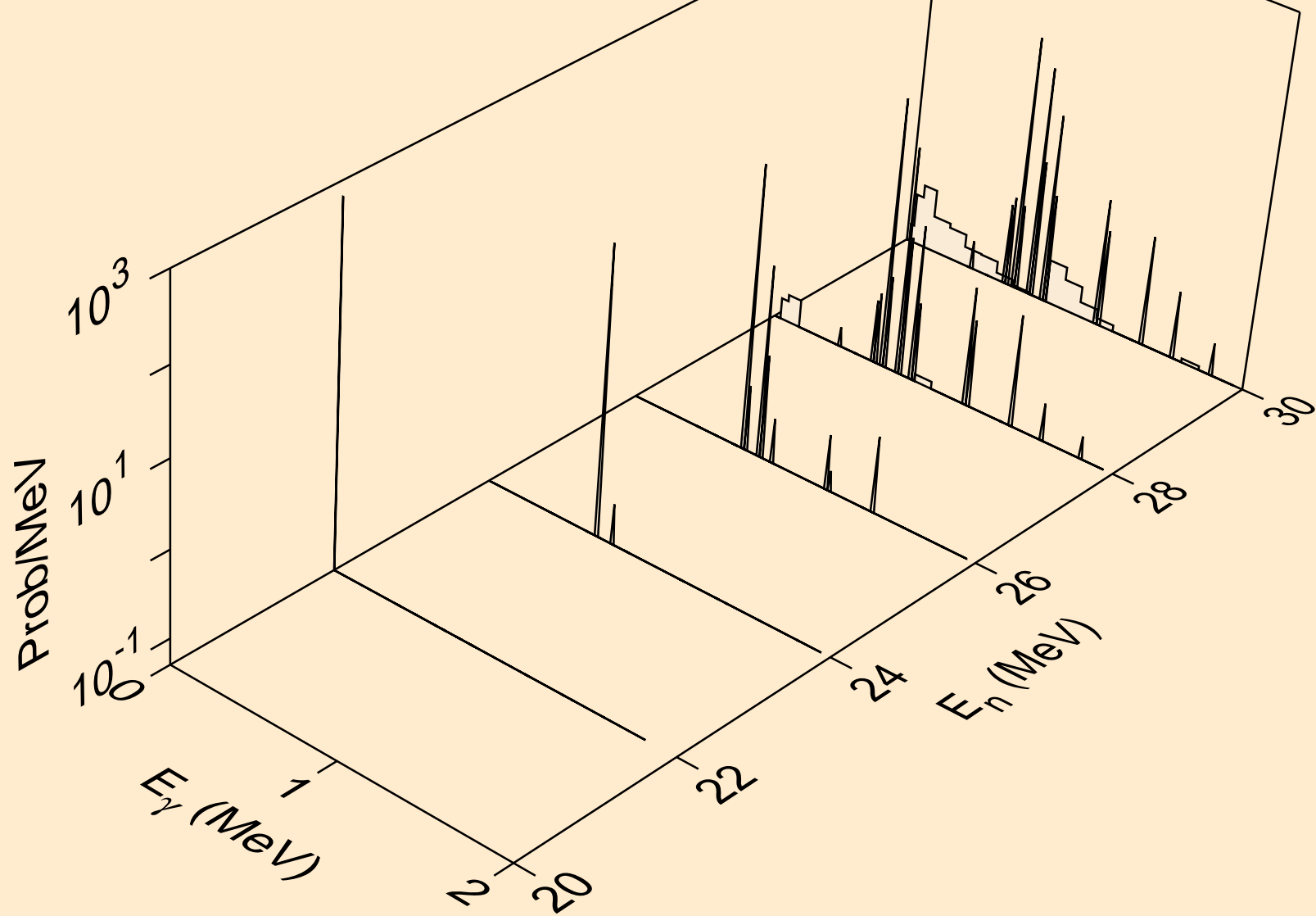

RH101 NEUTRON ACER TENDL-2023 LIBRARY; T=0.K
Photon emission for (n,2n)

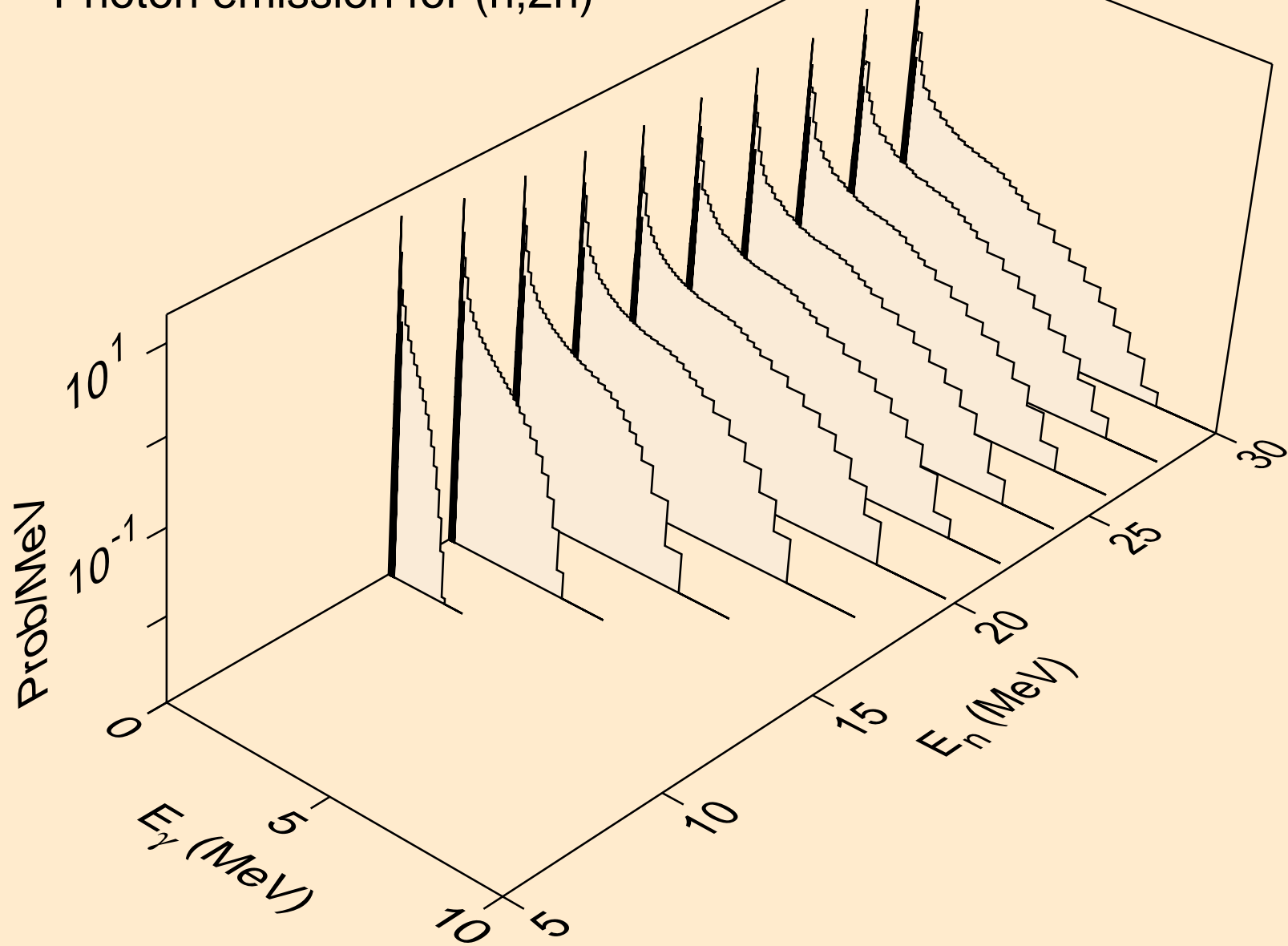

RH101 NEUTRON ACER TENDL-2023 LIBRARY; T=0.K
Photon emission for (n,3n)

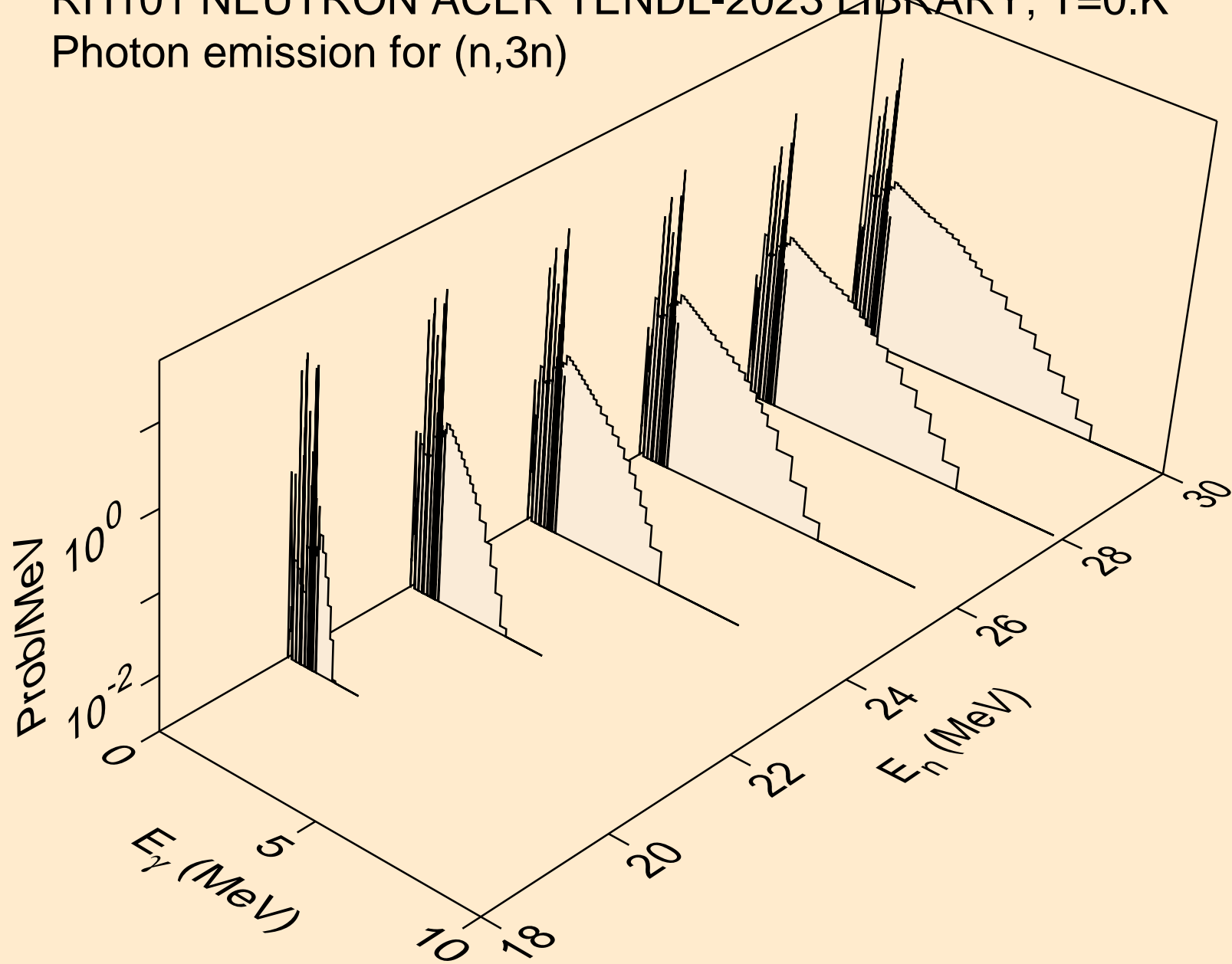

RH101 NEUTRON ACER TENDL-2023 LIBRARY; T=0.K
Photon emission for (n,n*)a

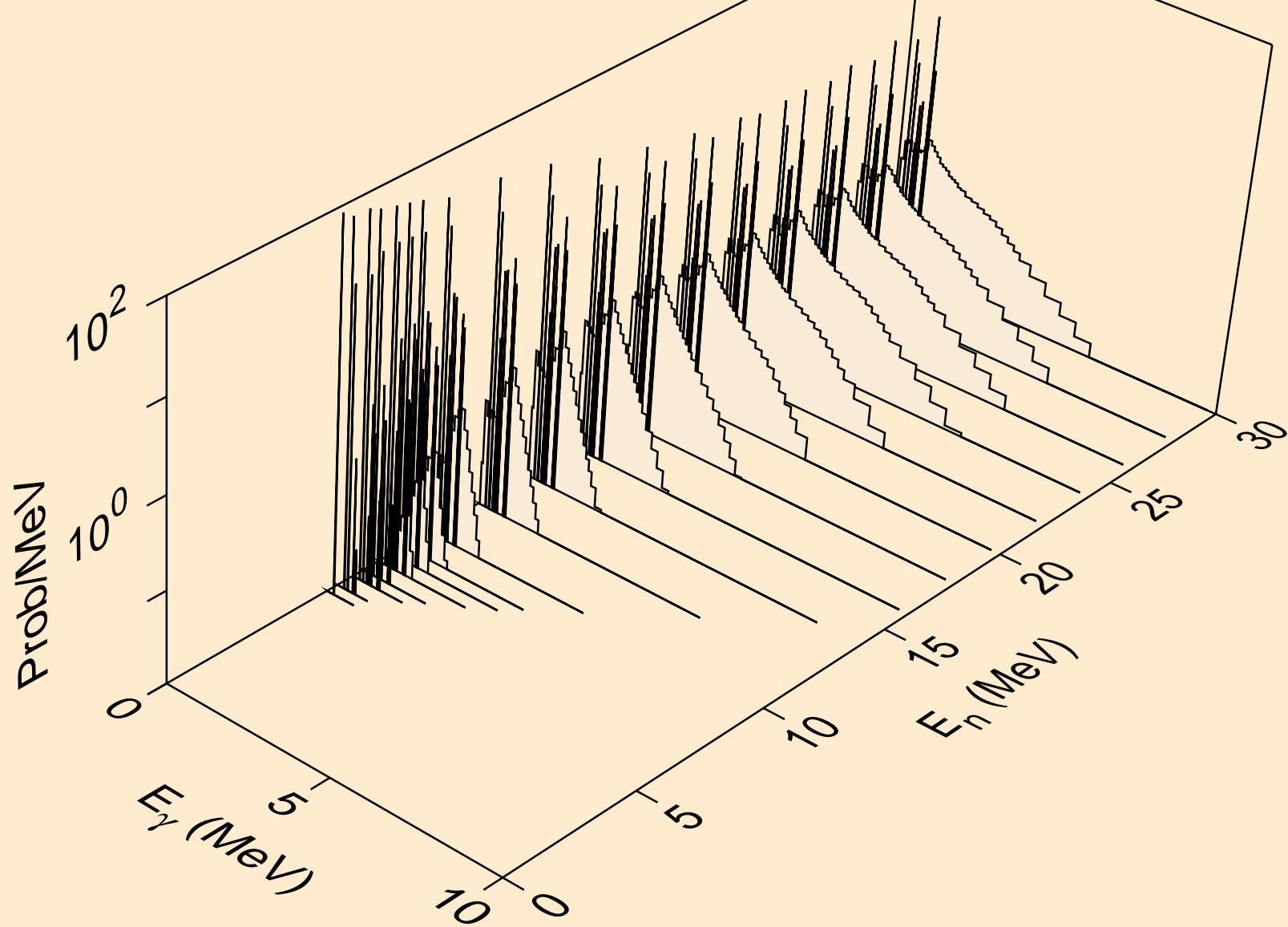

RH101 NEUTRON ACER TENDL-2023 LIBRARY; T=0.K
Photon emission for (n,2n)a

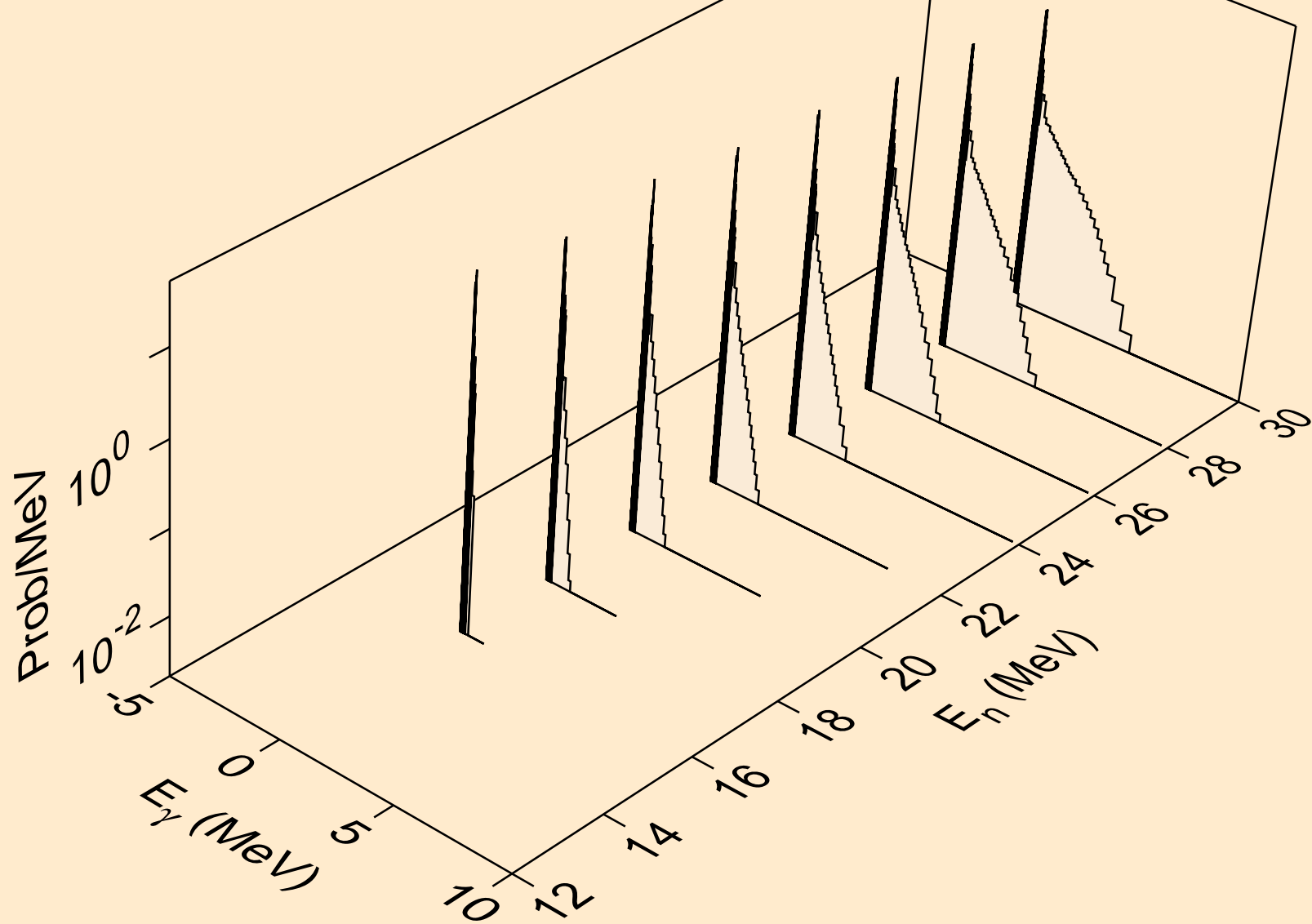

RH101 NEUTRON ACER TENDL-2023 LIBRARY; T=0.K
Photon emission for (n,3n)a

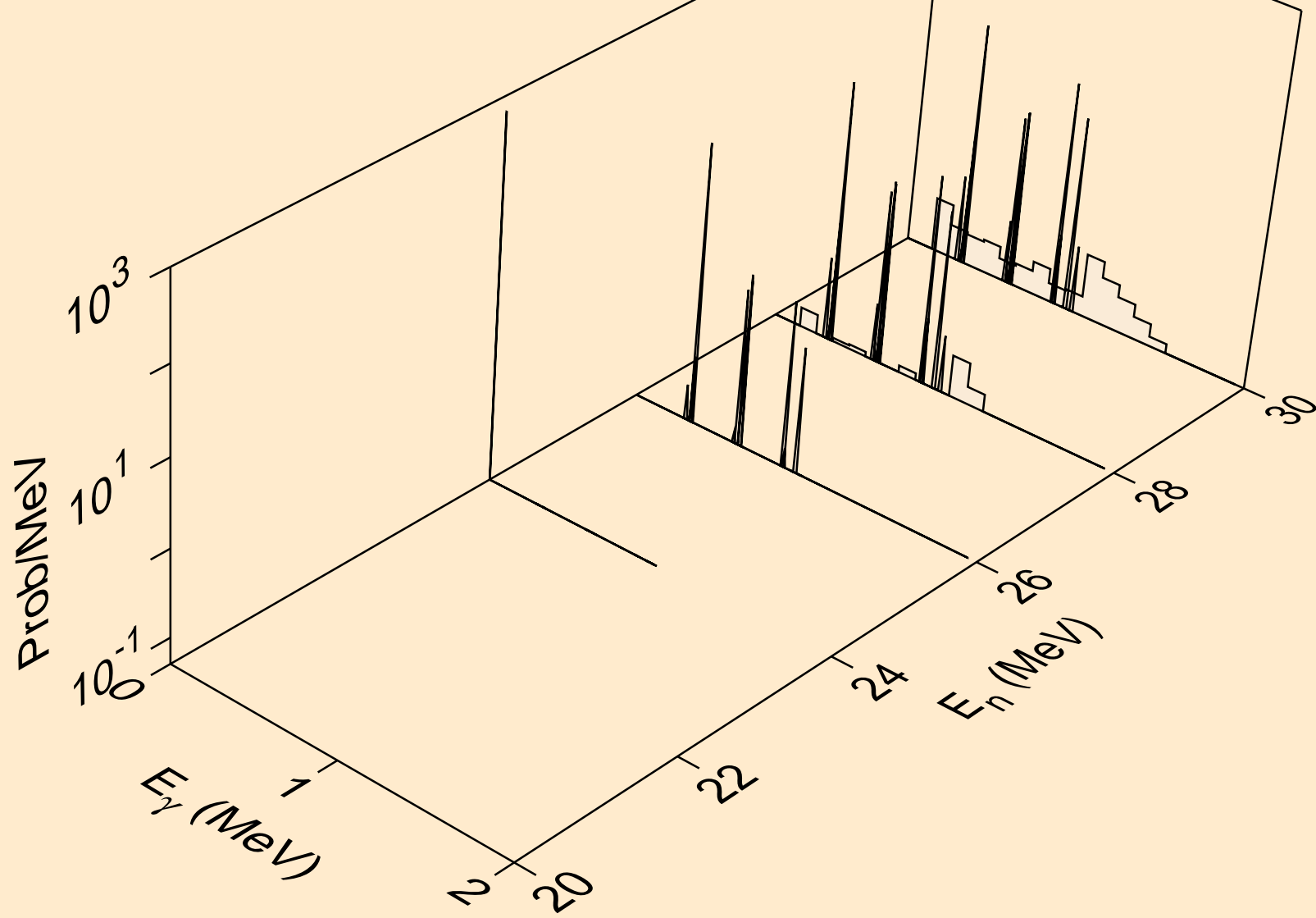

RH101 NEUTRON ACER TENDL-2023 LIBRARY; T=0.K
Photon emission for (n,n*)p

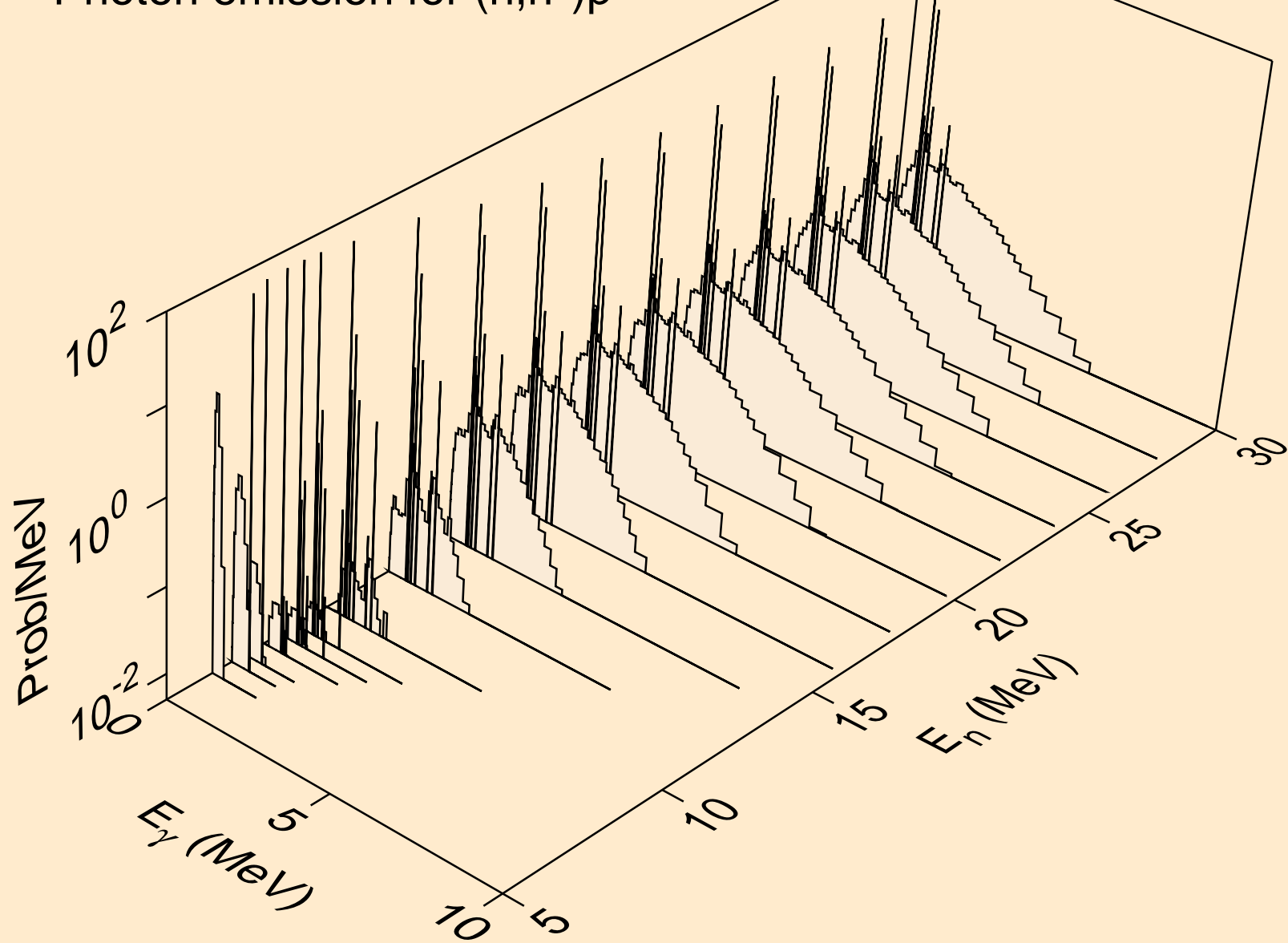

RH101 NEUTRON ACER TENDL-2023 LIBRARY; T=0.K
Photon emission for (n,n*)2a

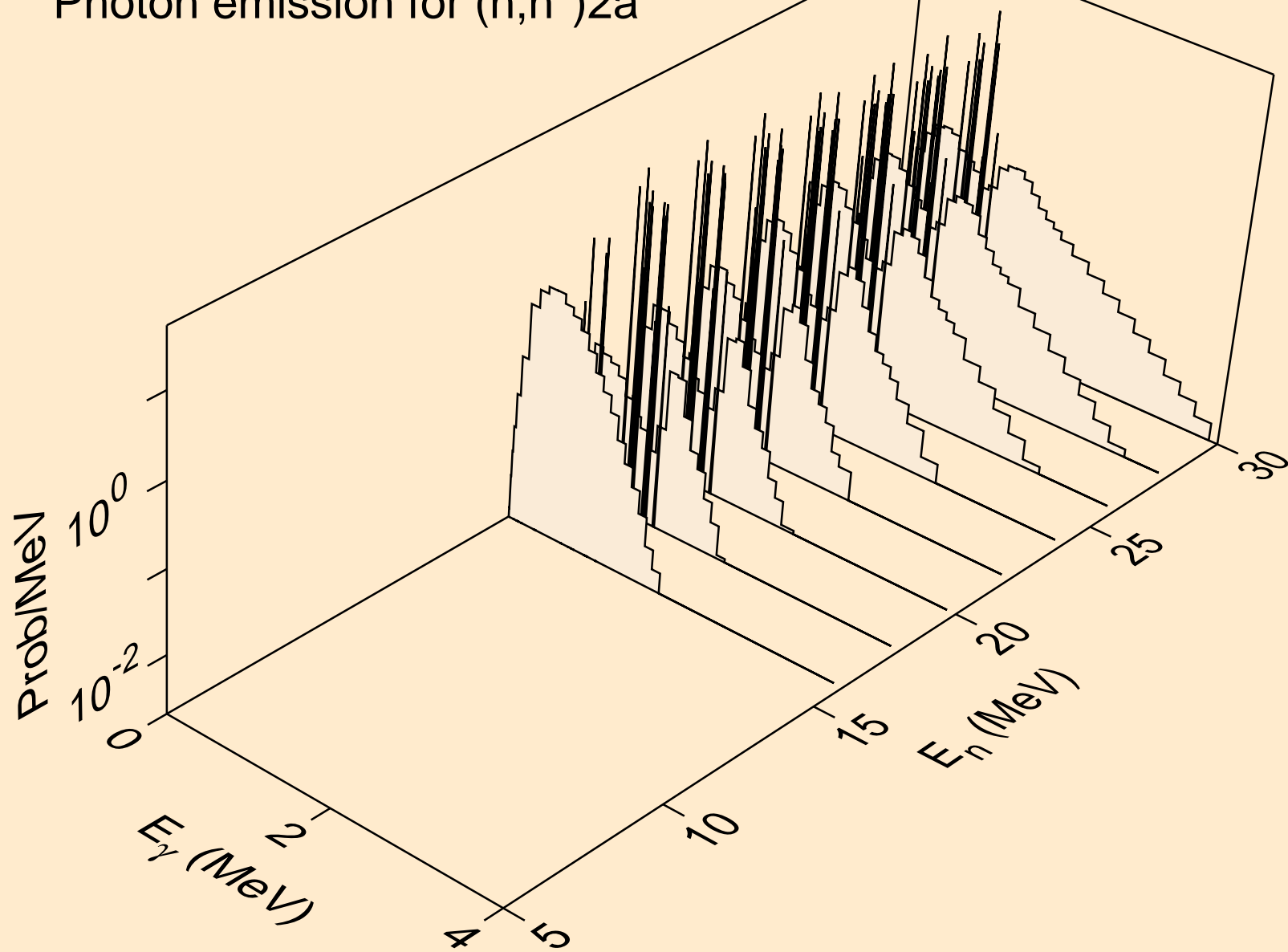

RH101 NEUTRON ACER TENDL-2023 LIBRARY; T=0.K
Photon emission for (n,n*)d

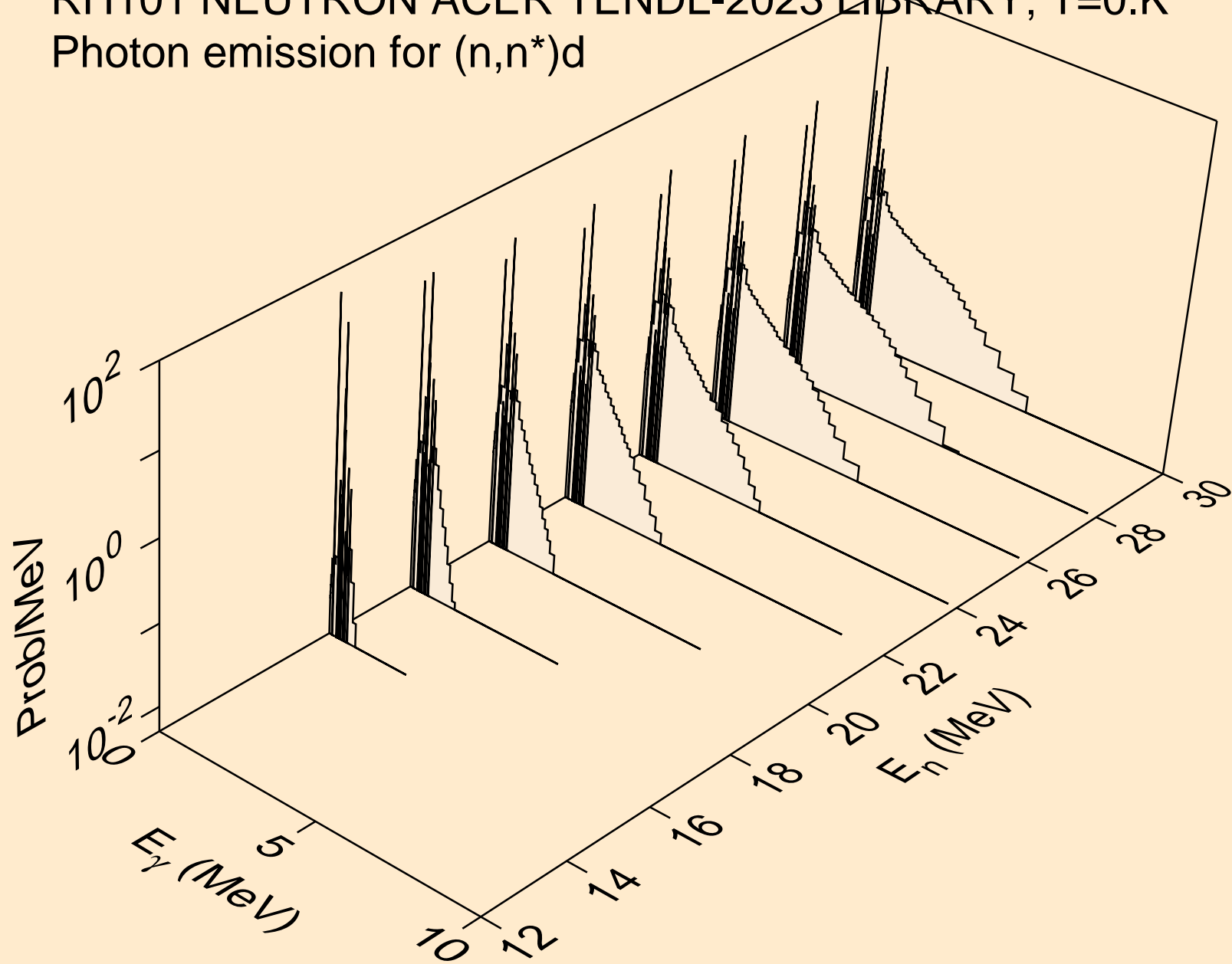

RH101 NEUTRON ACER TENDL-2023 LIBRARY; T=0.K
Photon emission for (n,n*)t

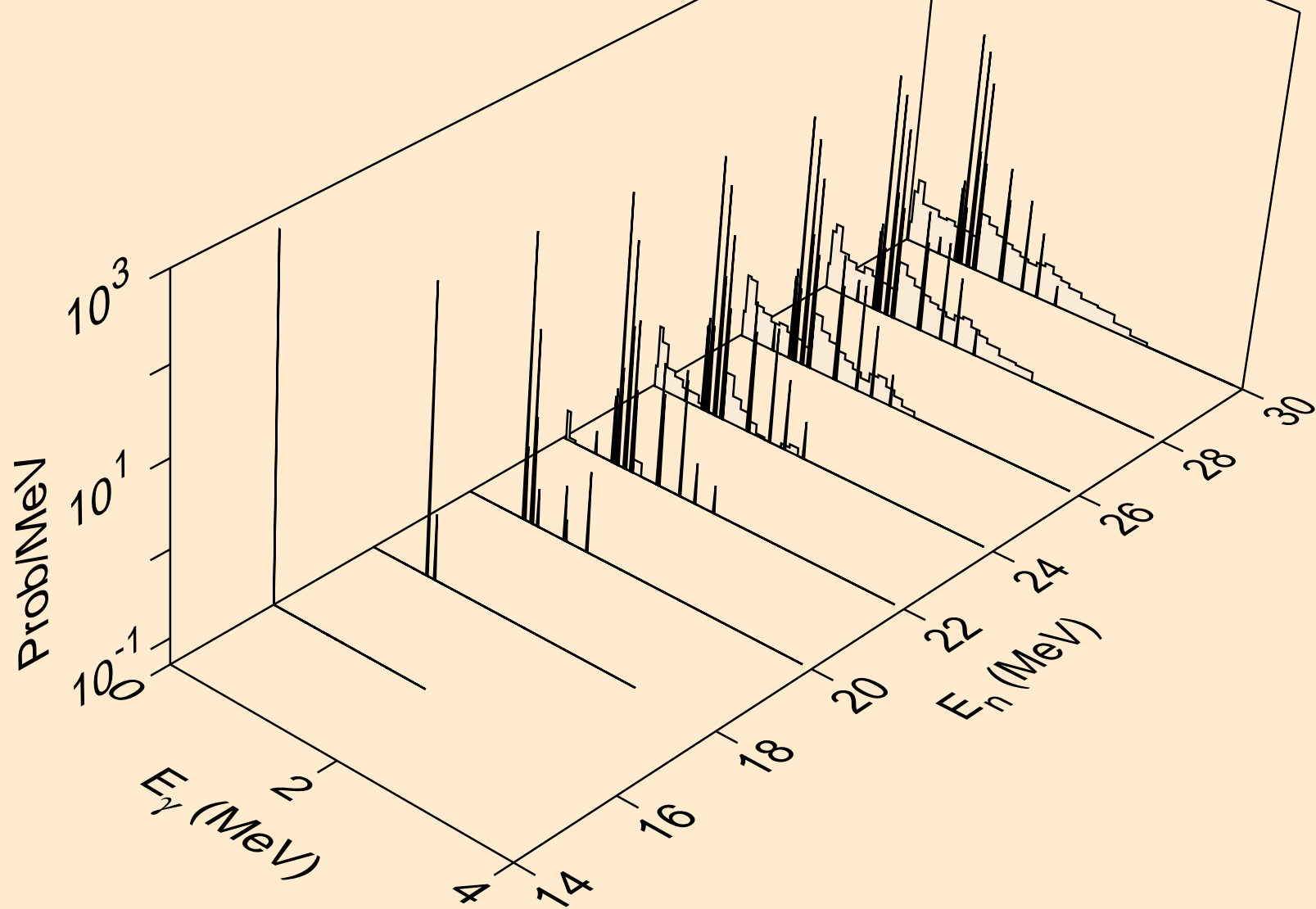

RH101 NEUTRON ACER TENDL-2023 LIBRARY; T=0.K
Photon emission for (n,n*)he3

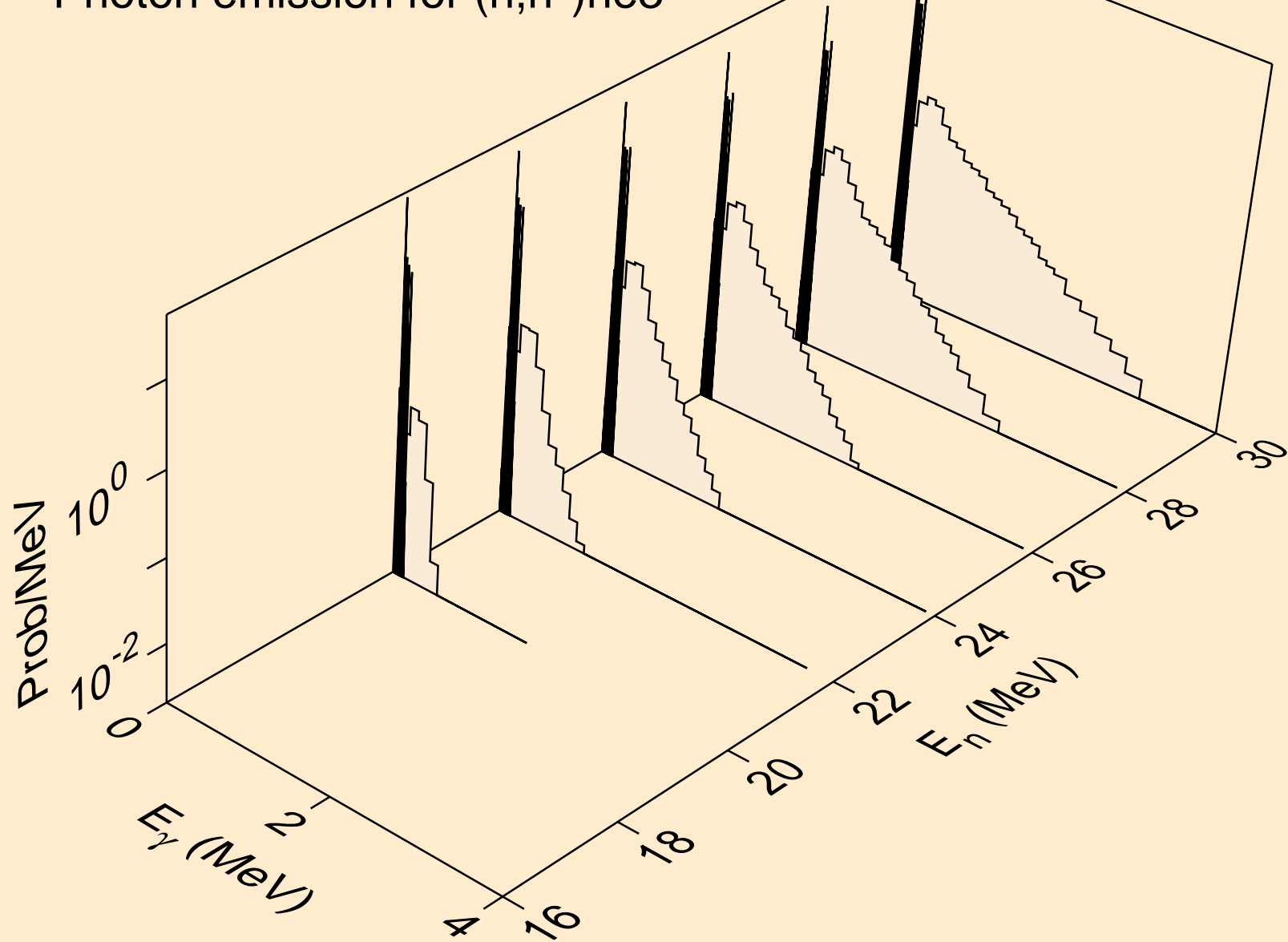

RH101 NEUTRON ACER TENDL-2023 LIBRARY; T=0.K
Photon emission for (n,4n)

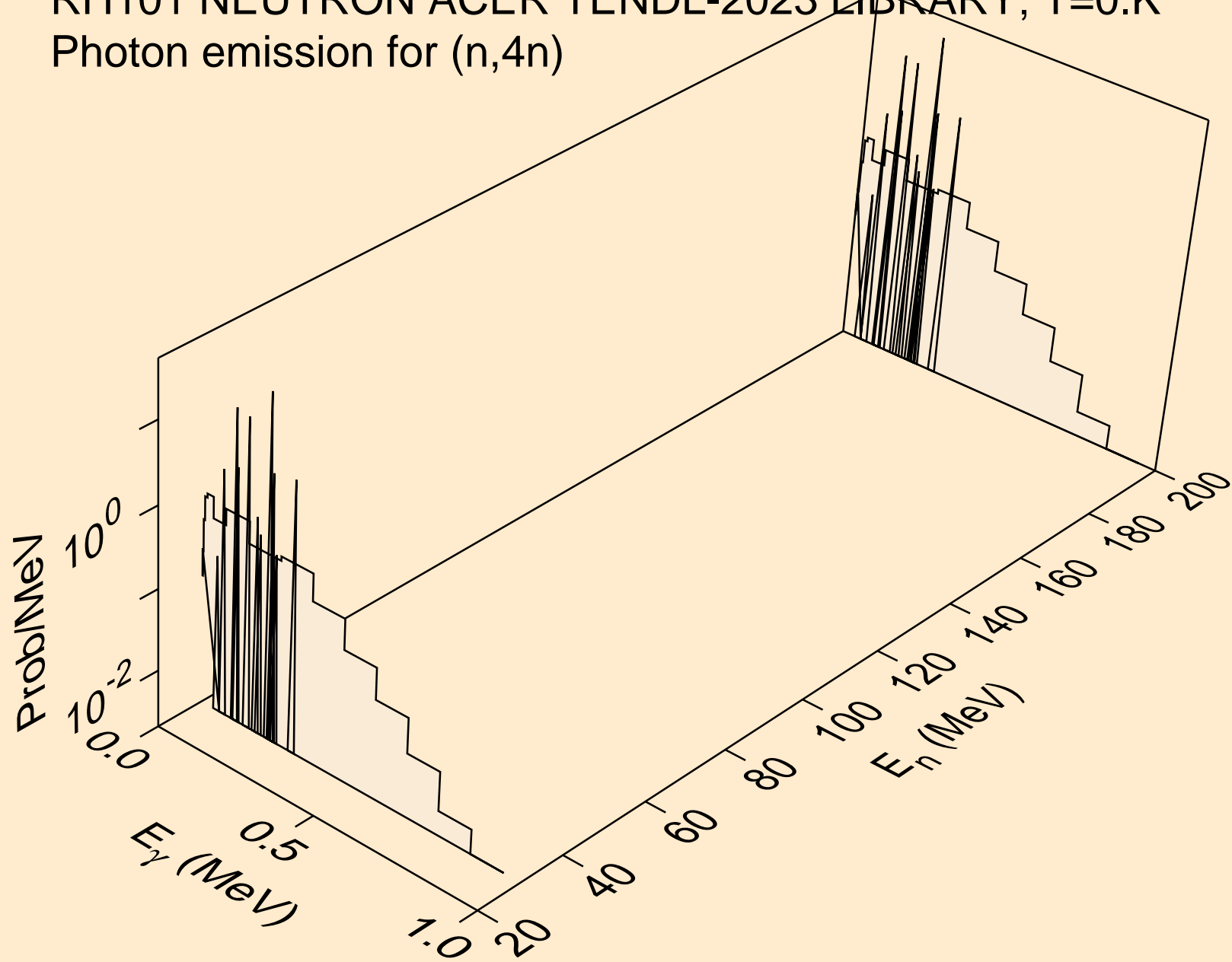

RH101 NEUTRON ACER TENDL-2023 LIBRARY; T=0.K
Photon emission for (n,2np)

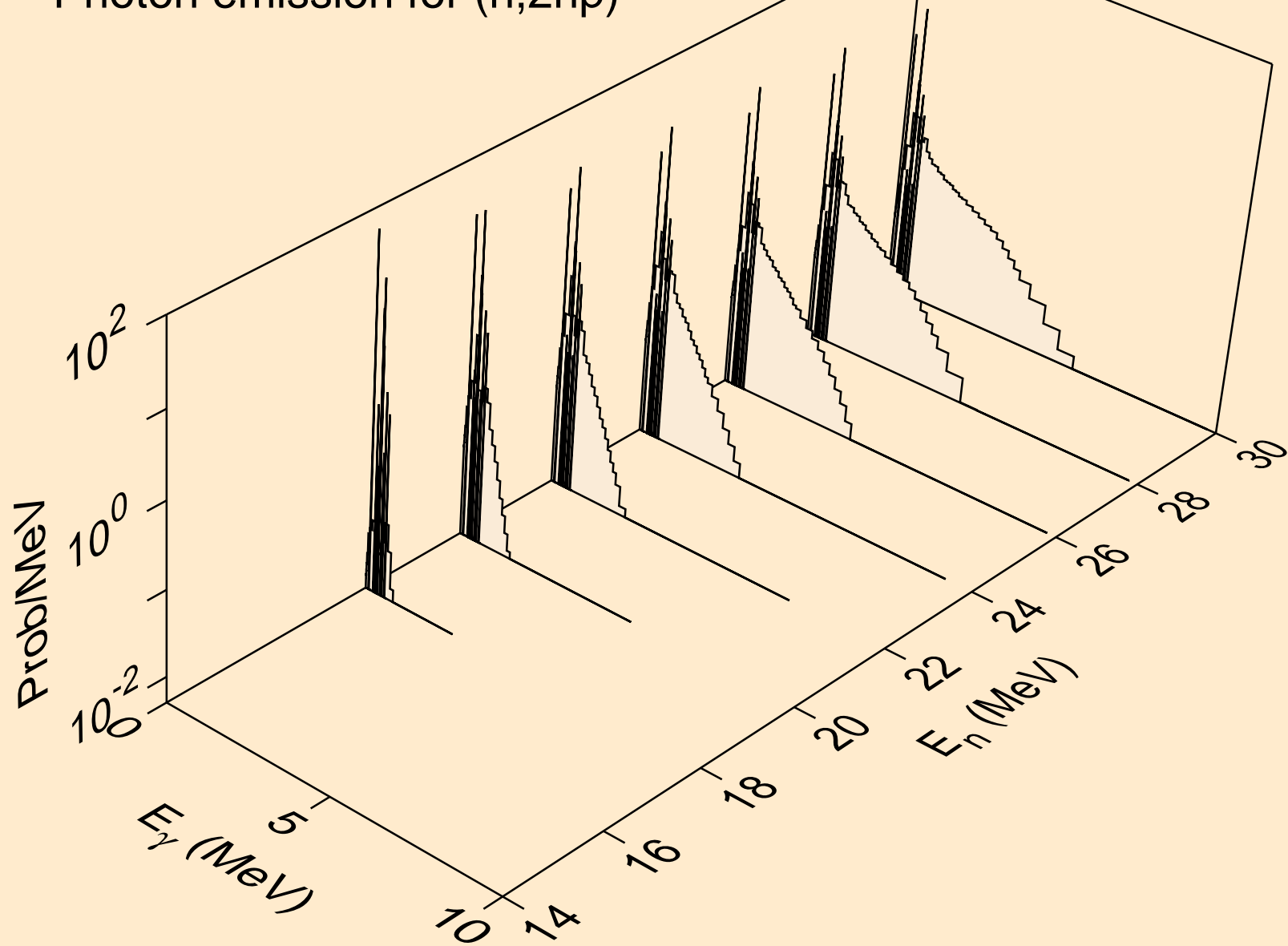

RH101 NEUTRON ACER TENDL-2023 LIBRARY; T=0.K
Photon emission for (n,3np)

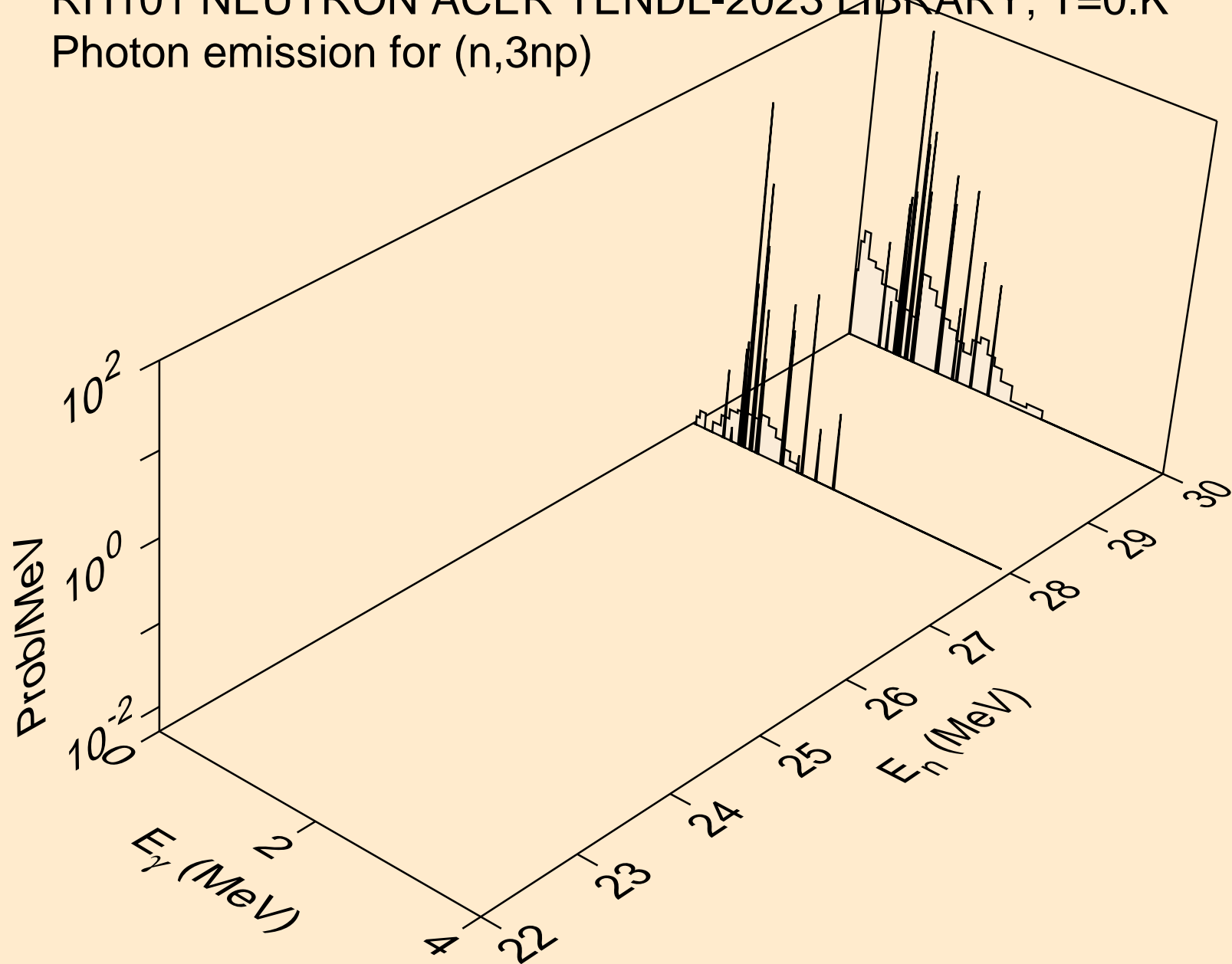

RH101 NEUTRON ACER TENDL-2023 LIBRARY; T=0.K
Photon emission for (n,n2p)

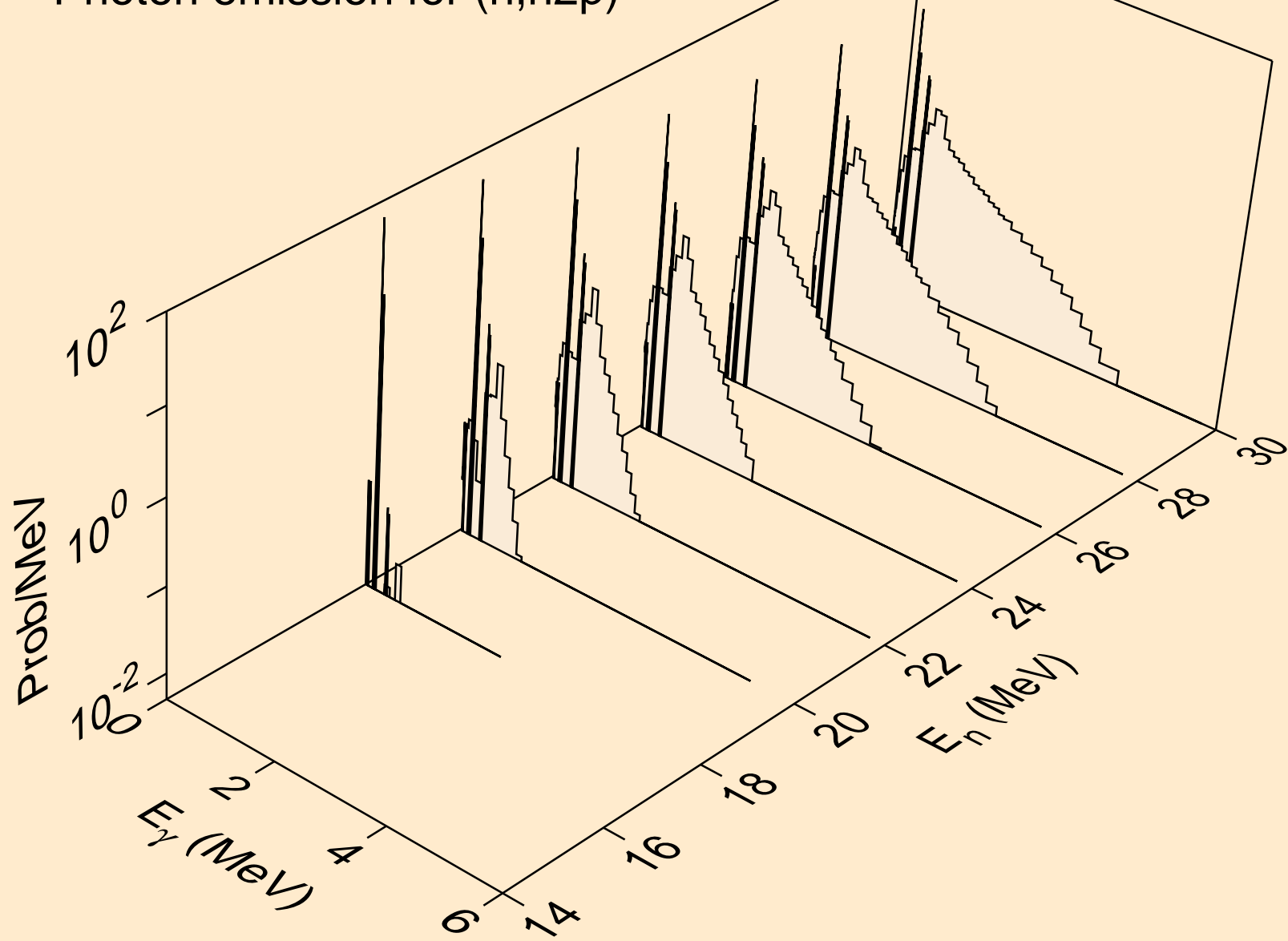

RH101 NEUTRON ACER TENDL-2023 LIBRARY; T=0.K
Photon emission for (n,npa)

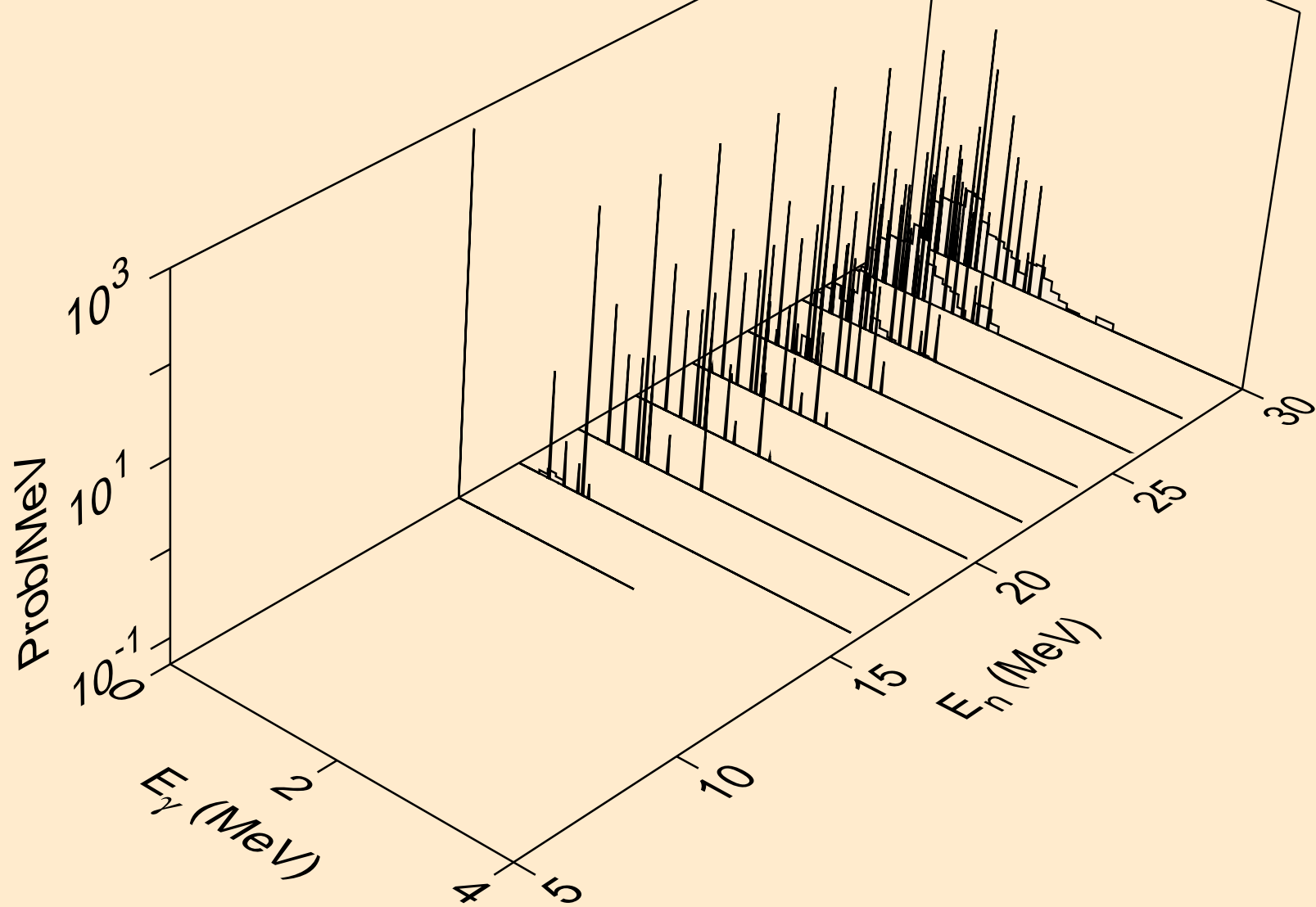

RH101 NEUTRON ACER TENDL-2023 LIBRARY; T=0.K
Photon emission for (n,n*c)

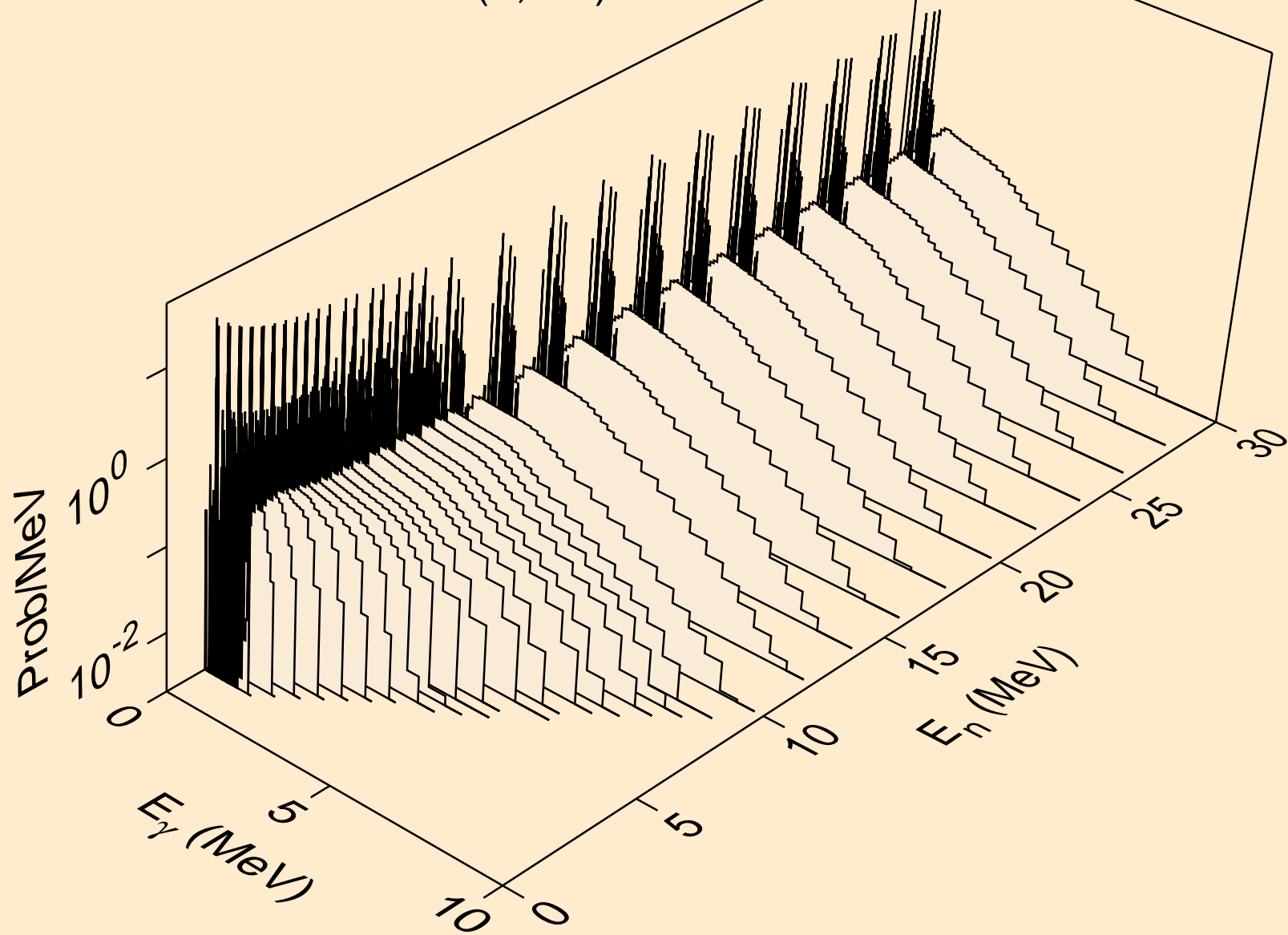

RH101 NEUTRON ACER TENDL-2023 LIBRARY; T=0.K
Photon emission for (n,gma)

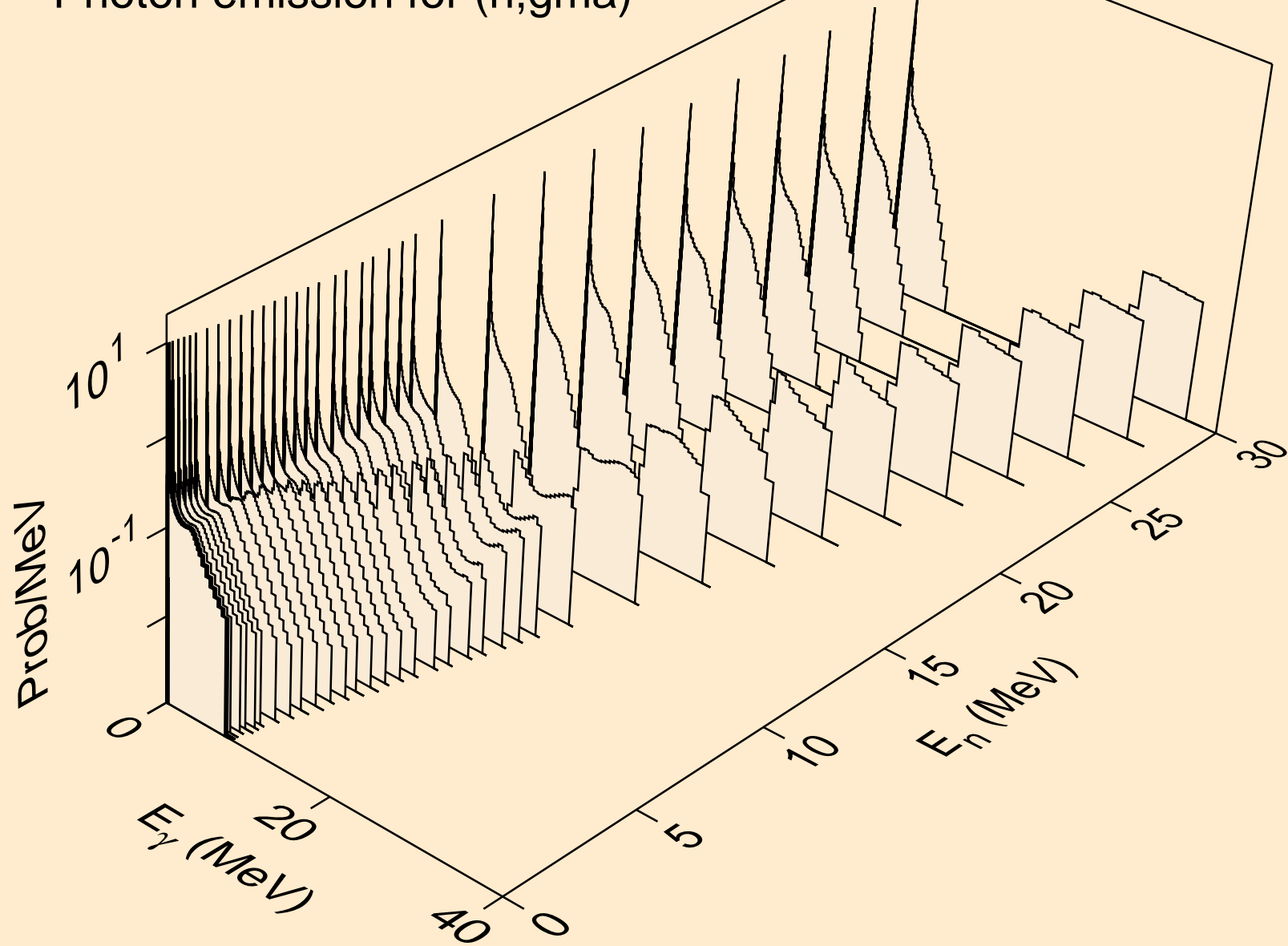

RH101 NEUTRON ACER TENDL-2023 LIBRARY; T=0.K
Photon emission for (n,p)

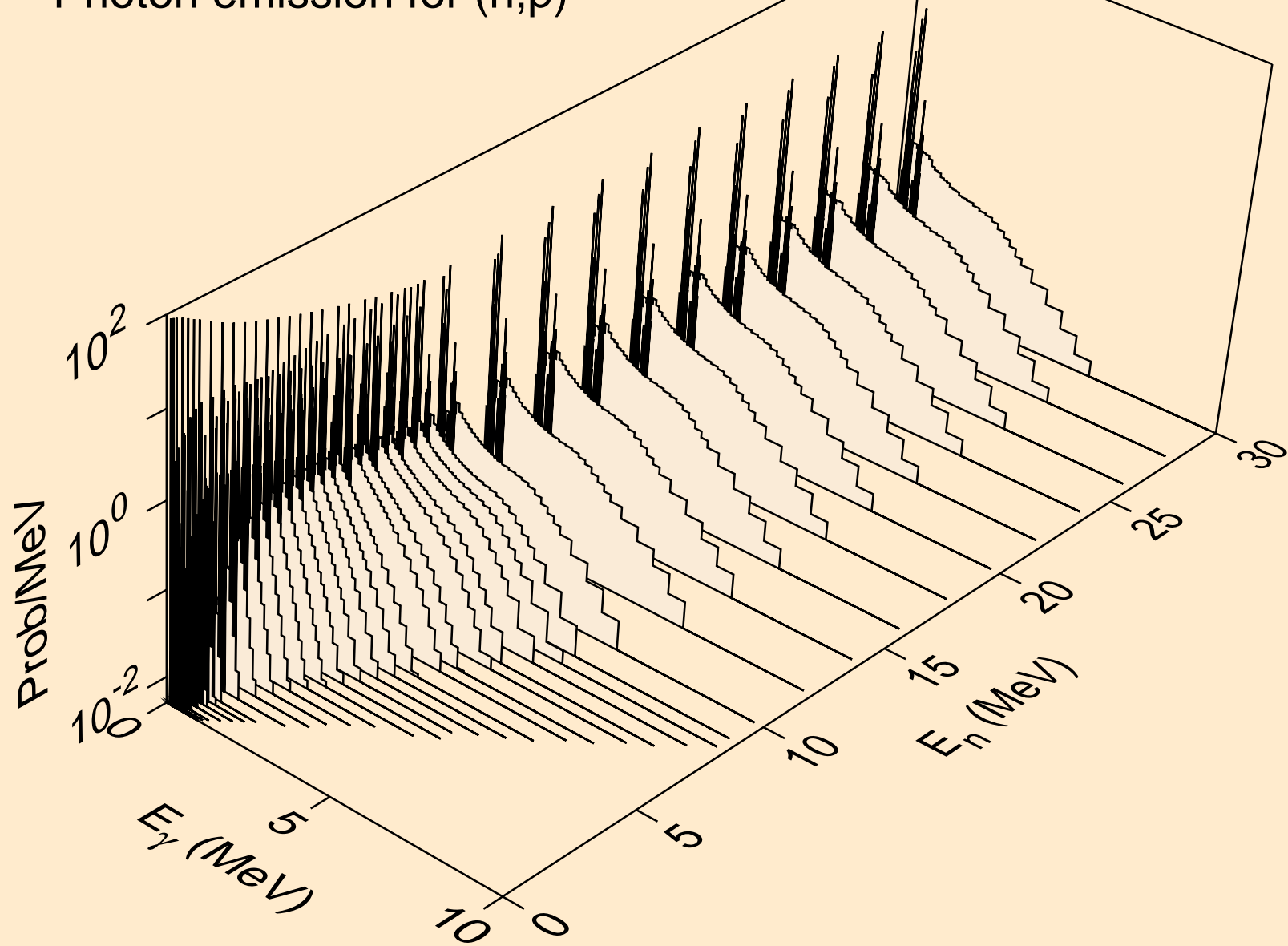

RH101 NEUTRON ACER TENDL-2023 LIBRARY; T=0.K
Photon emission for (n,d)

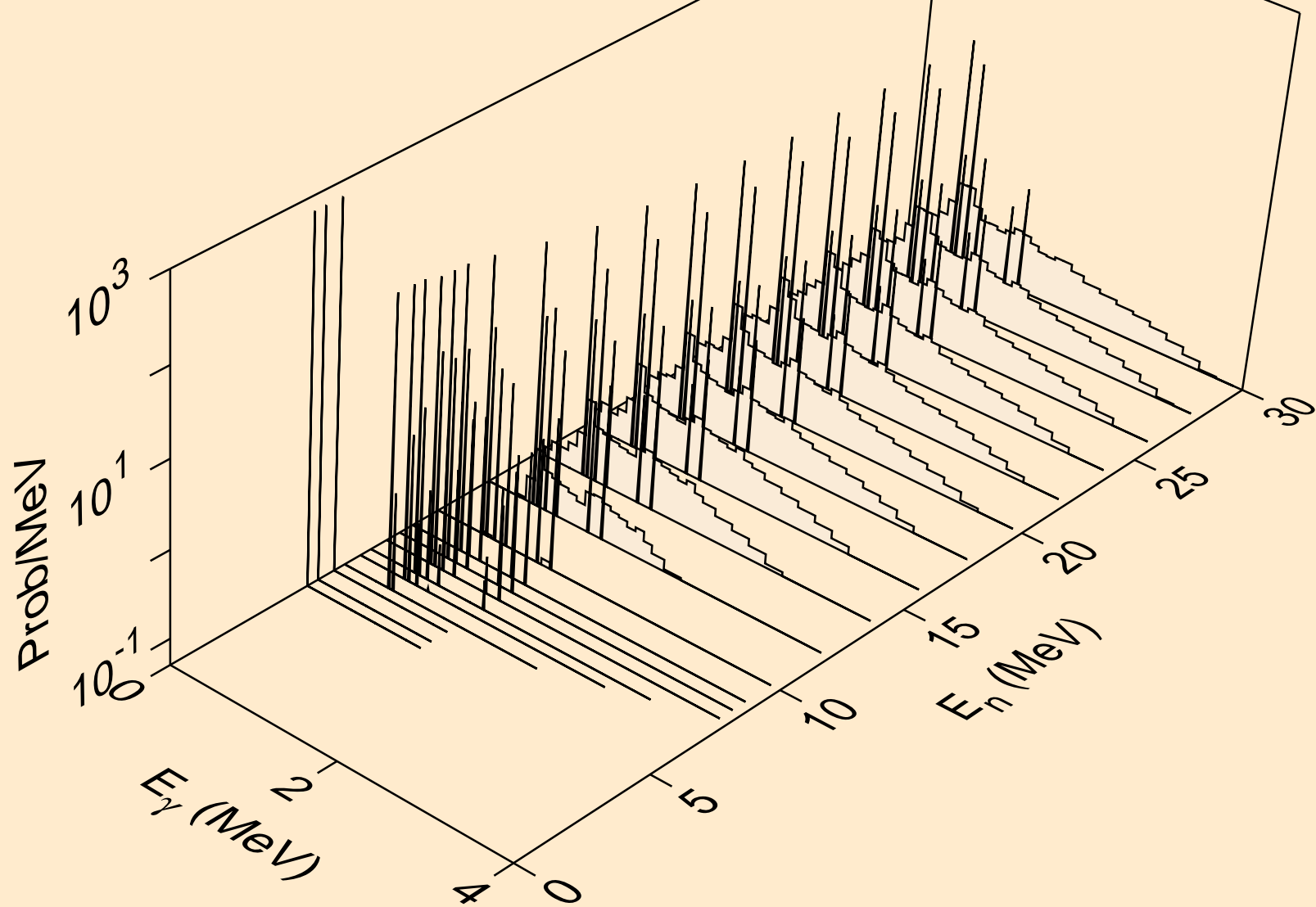

RH101 NEUTRON ACER TENDL-2023 LIBRARY; T=0.K
Photon emission for (n,t)

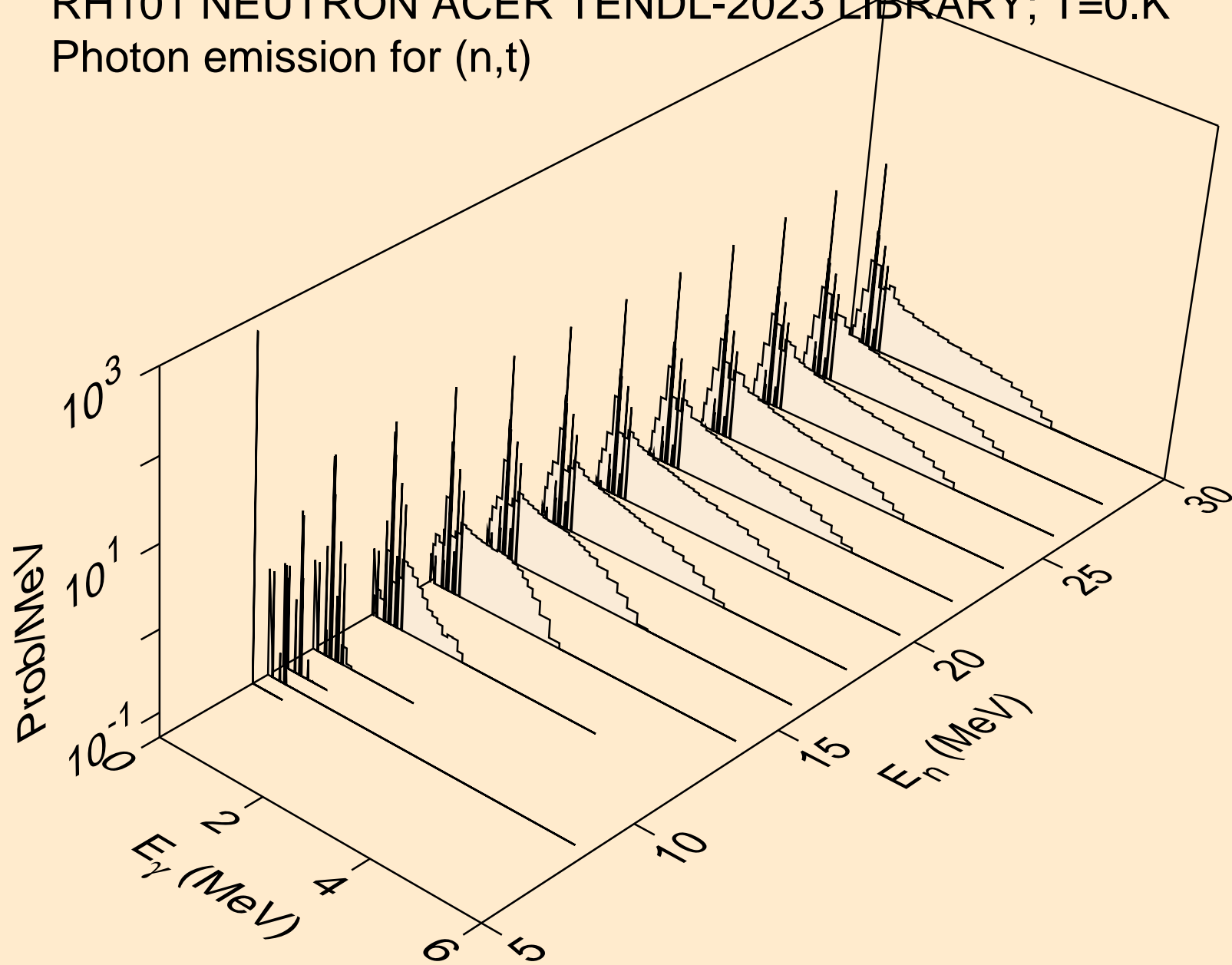

RH101 NEUTRON ACER TENDL-2023 LIBRARY; T=0.K
Photon emission for (n,he3)

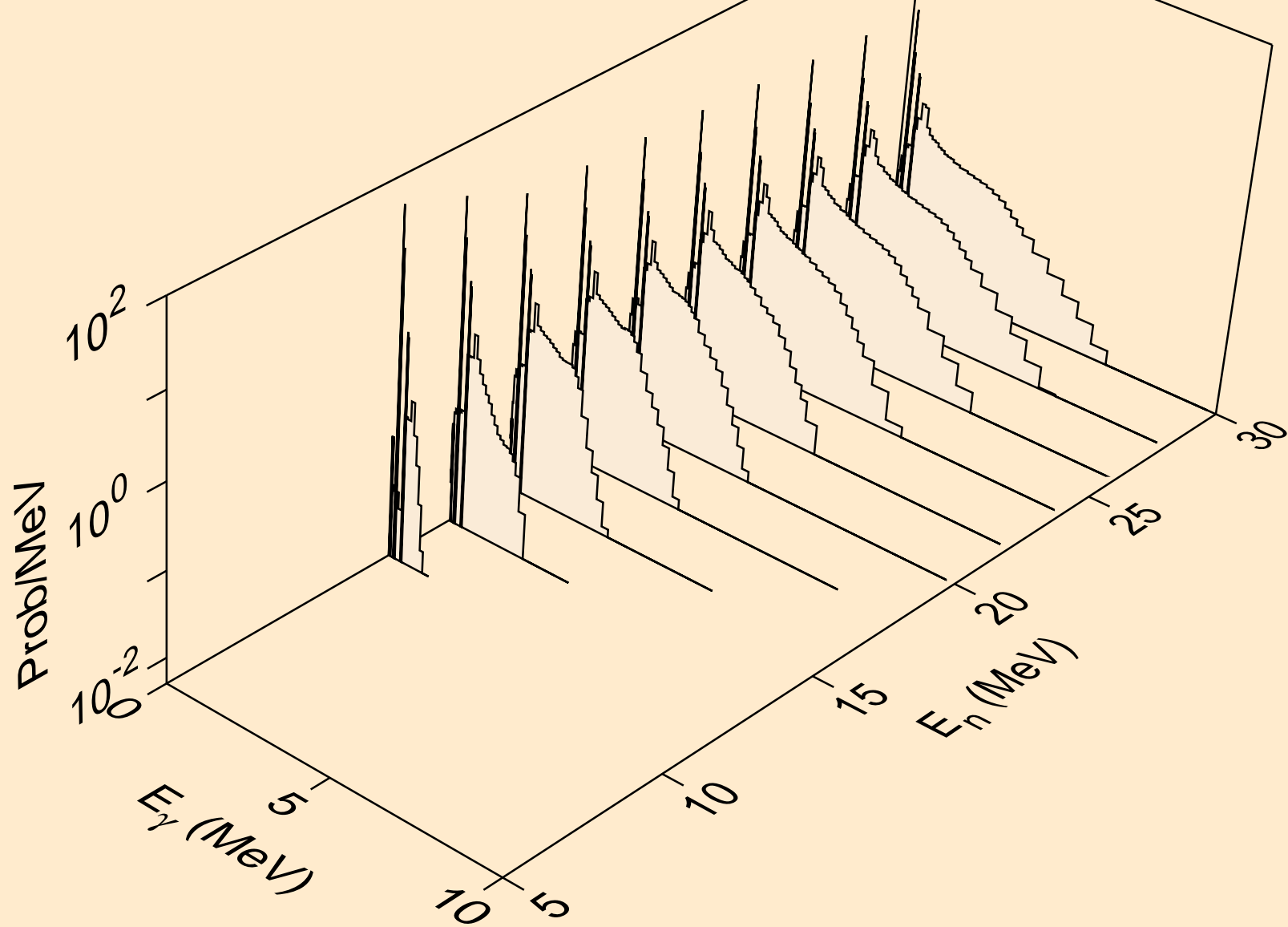

RH101 NEUTRON ACER TENDL-2023 LIBRARY; T=0.K
Photon emission for (n,a)

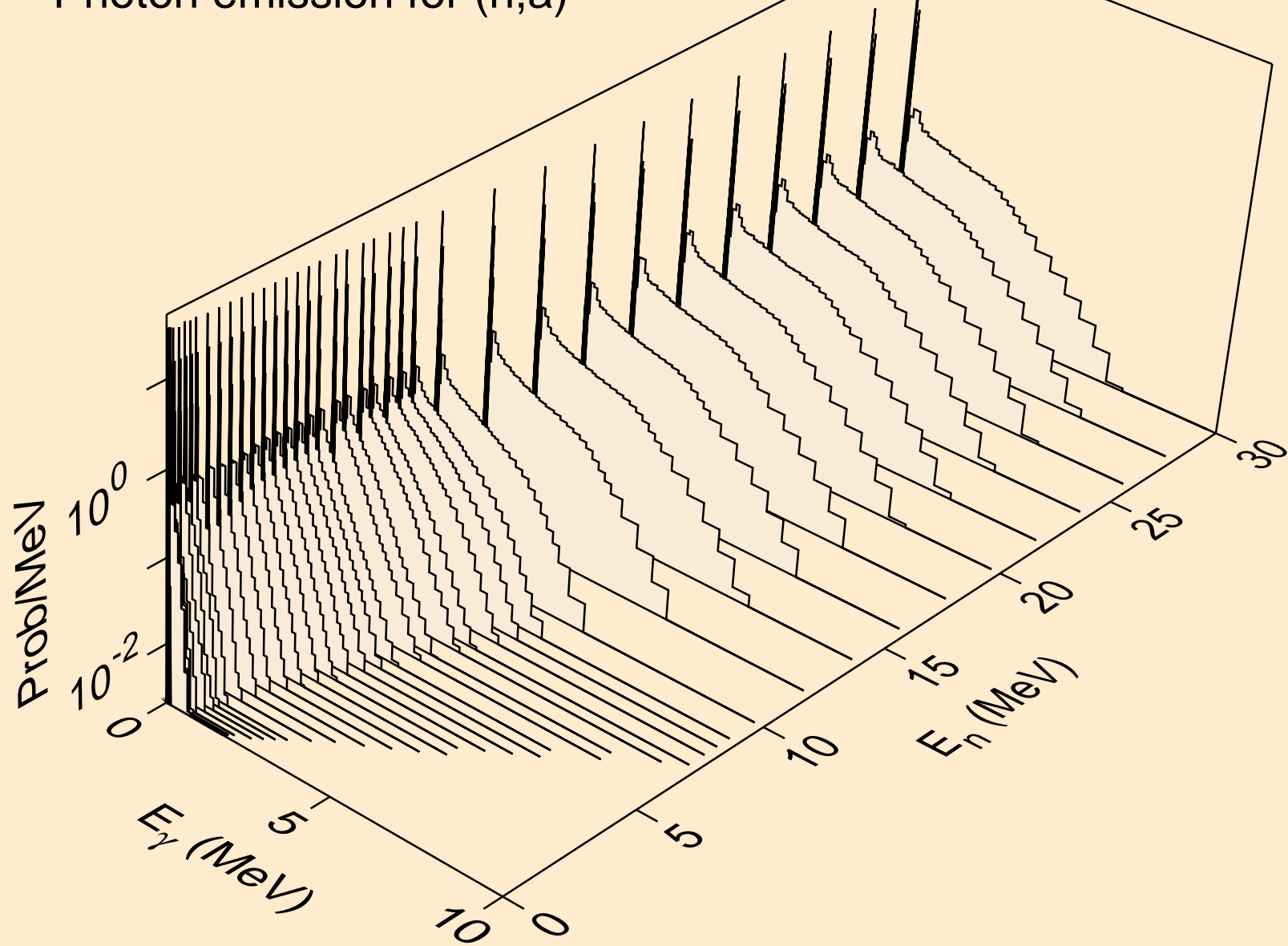

RH101 NEUTRON ACER TENDL-2023 LIBRARY; T=0.K
Photon emission for (n,2a)

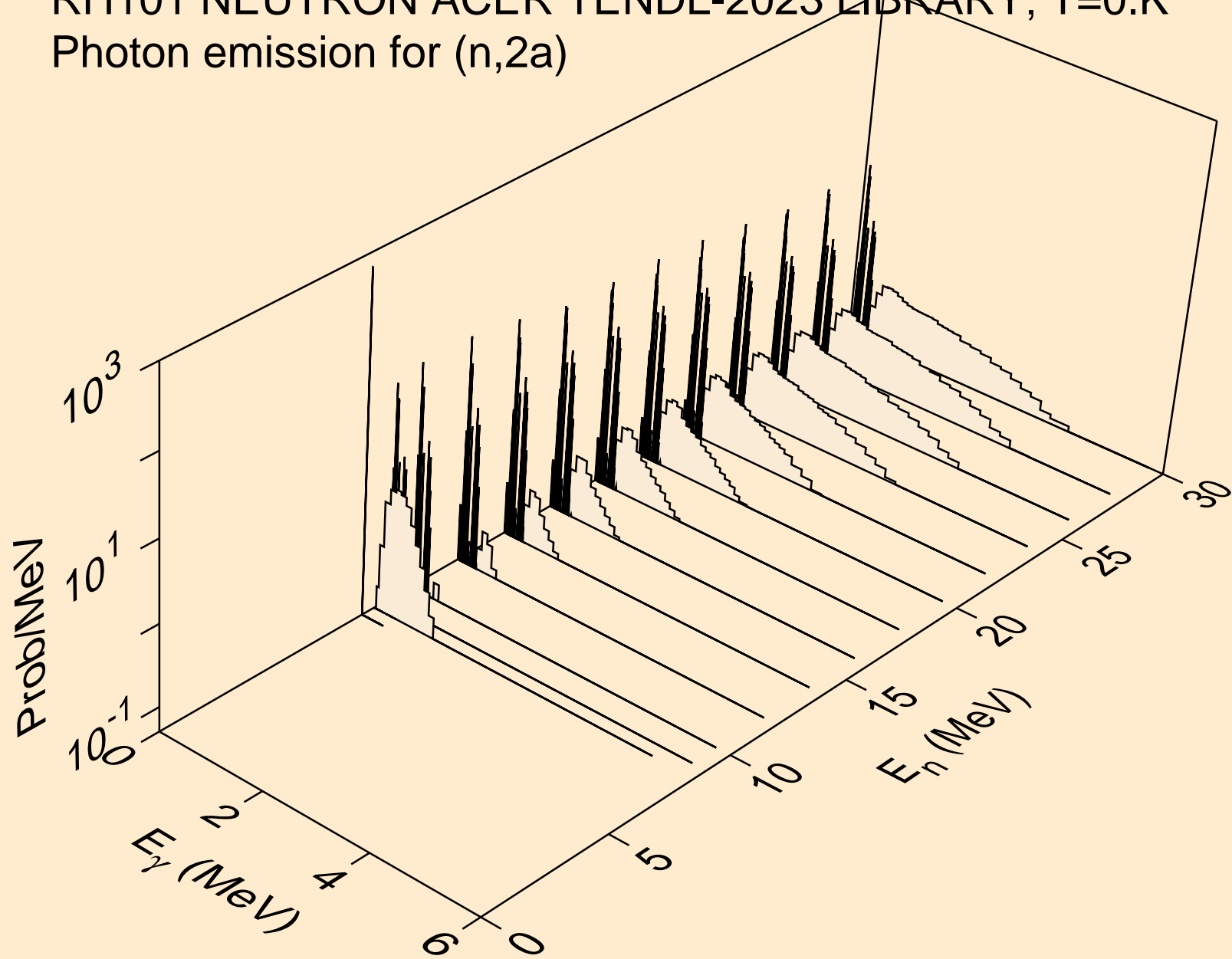

RH101 NEUTRON ACER TENDL-2023 LIBRARY; T=0.K
Photon emission for (n,2p)

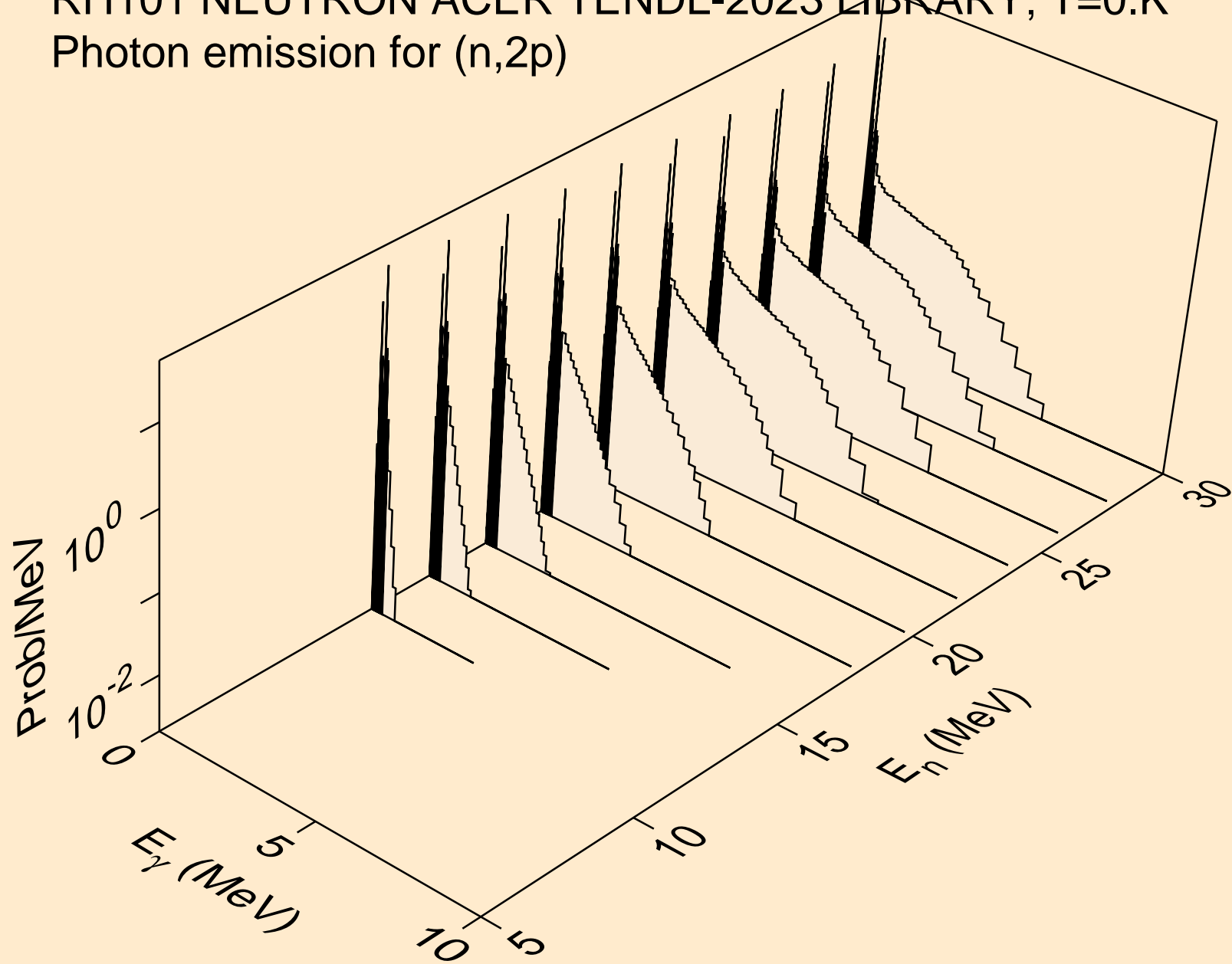

RH101 NEUTRON ACER TENDL-2023 LIBRARY; T=0.K
Photon emission for (n,p)

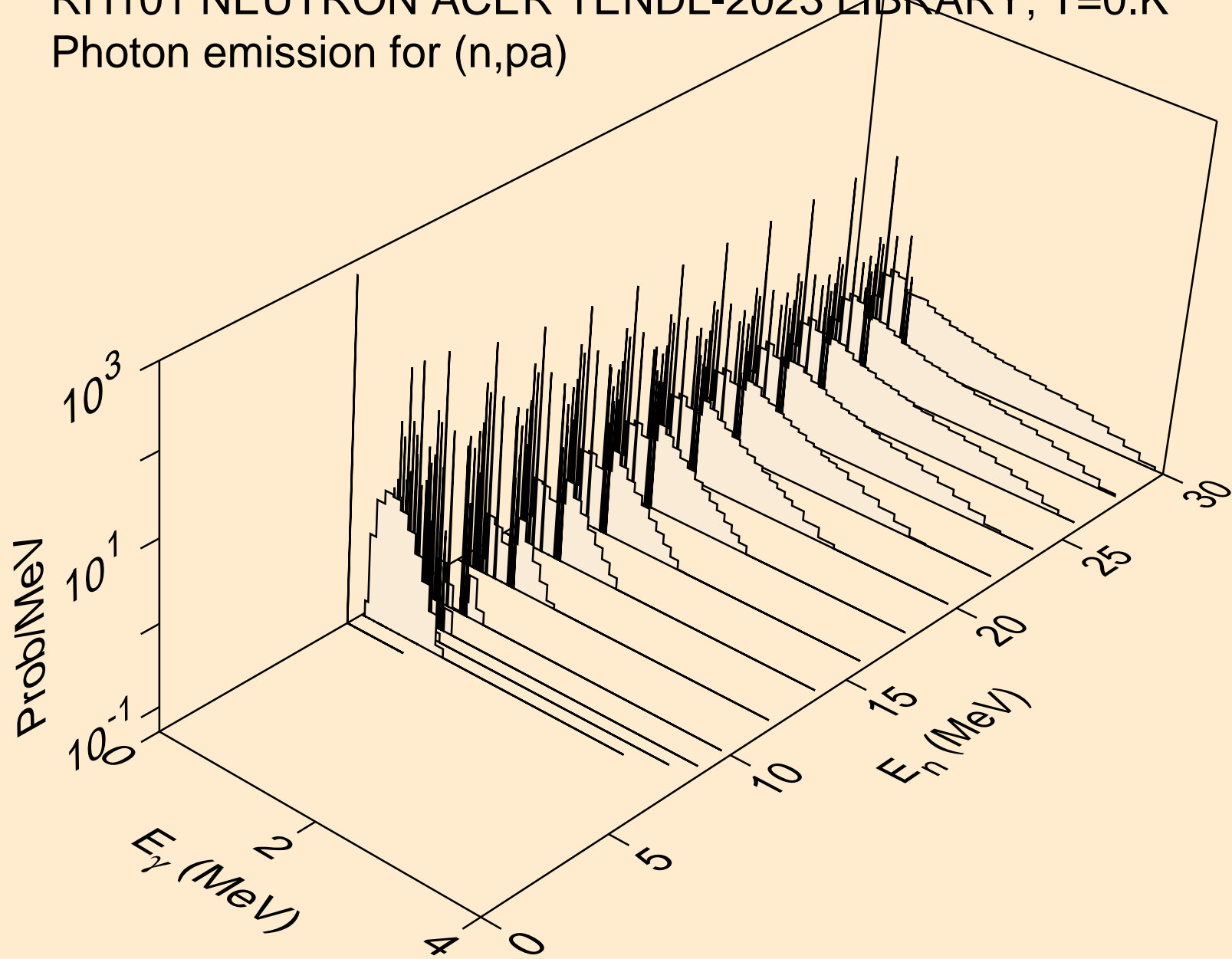

RH101 NEUTRON ACER TENDL-2023 LIBRARY; T=0.K
Photon emission for (n,pd)

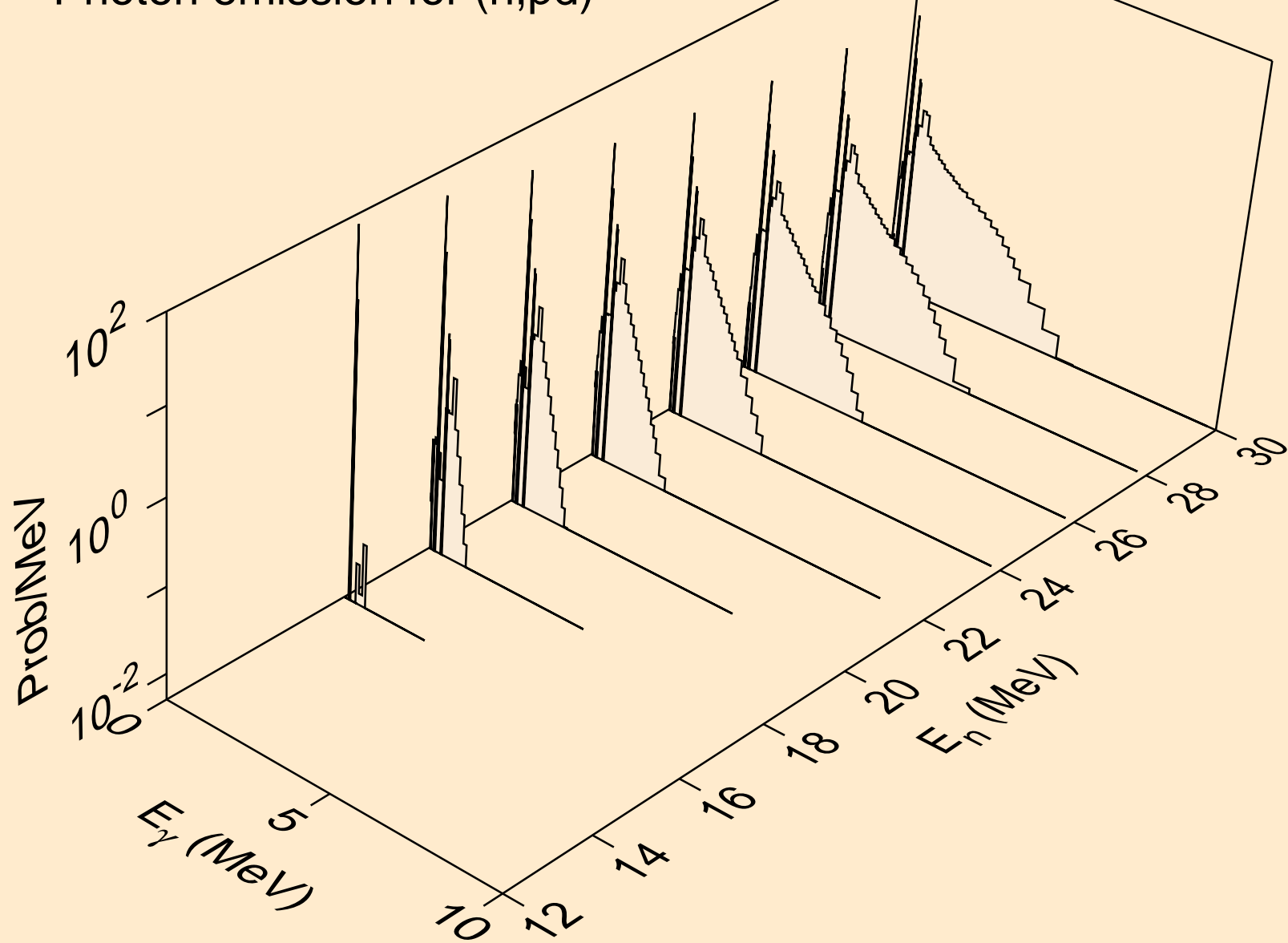

RH101 NEUTRON ACER TENDL-2023 LIBRARY; T=0.K
Photon emission for (n,pt)

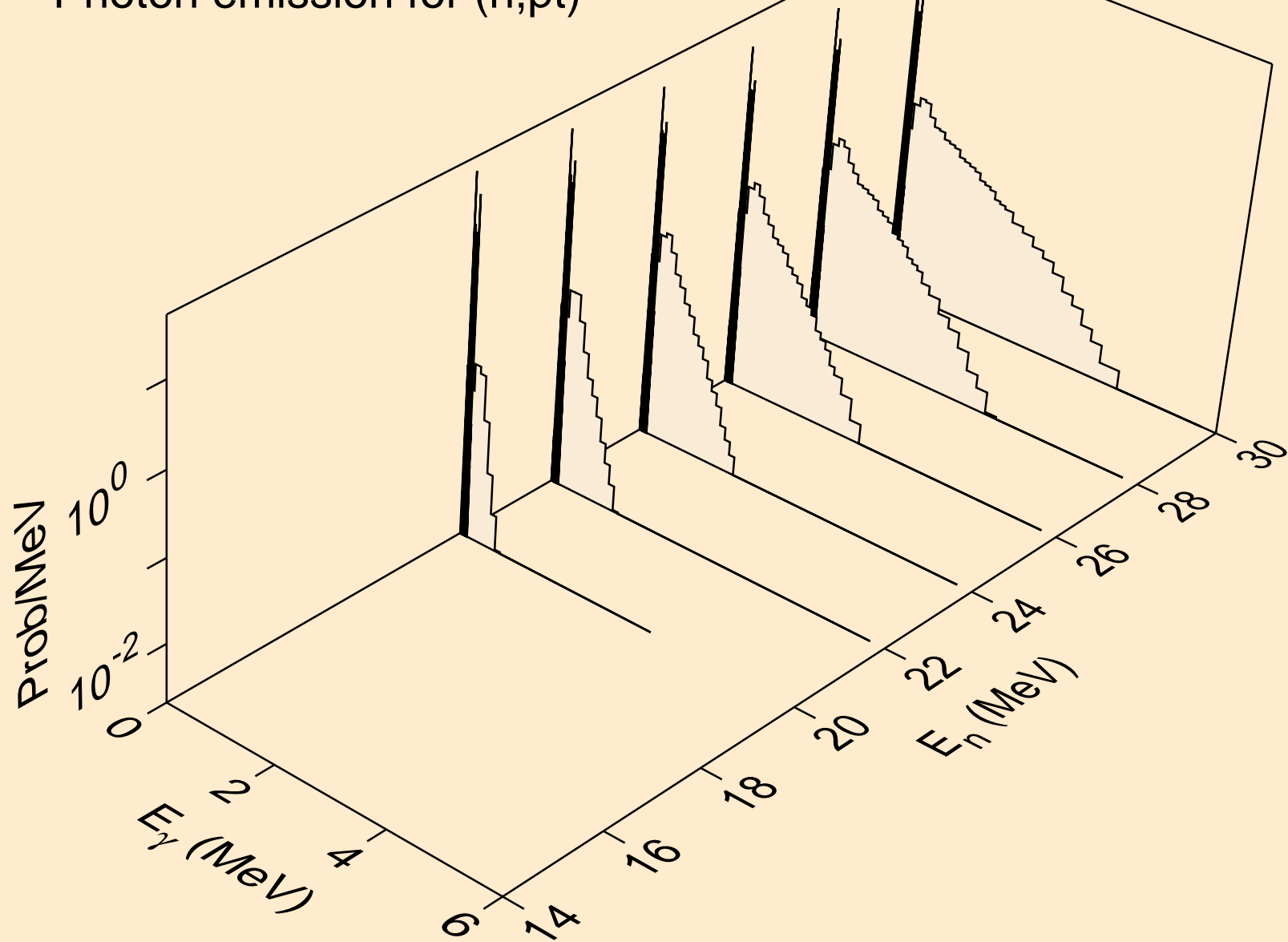

RH101 NEUTRON ACER TENDL-2023 LIBRARY; T=0.K
Photon emission for (n,da)

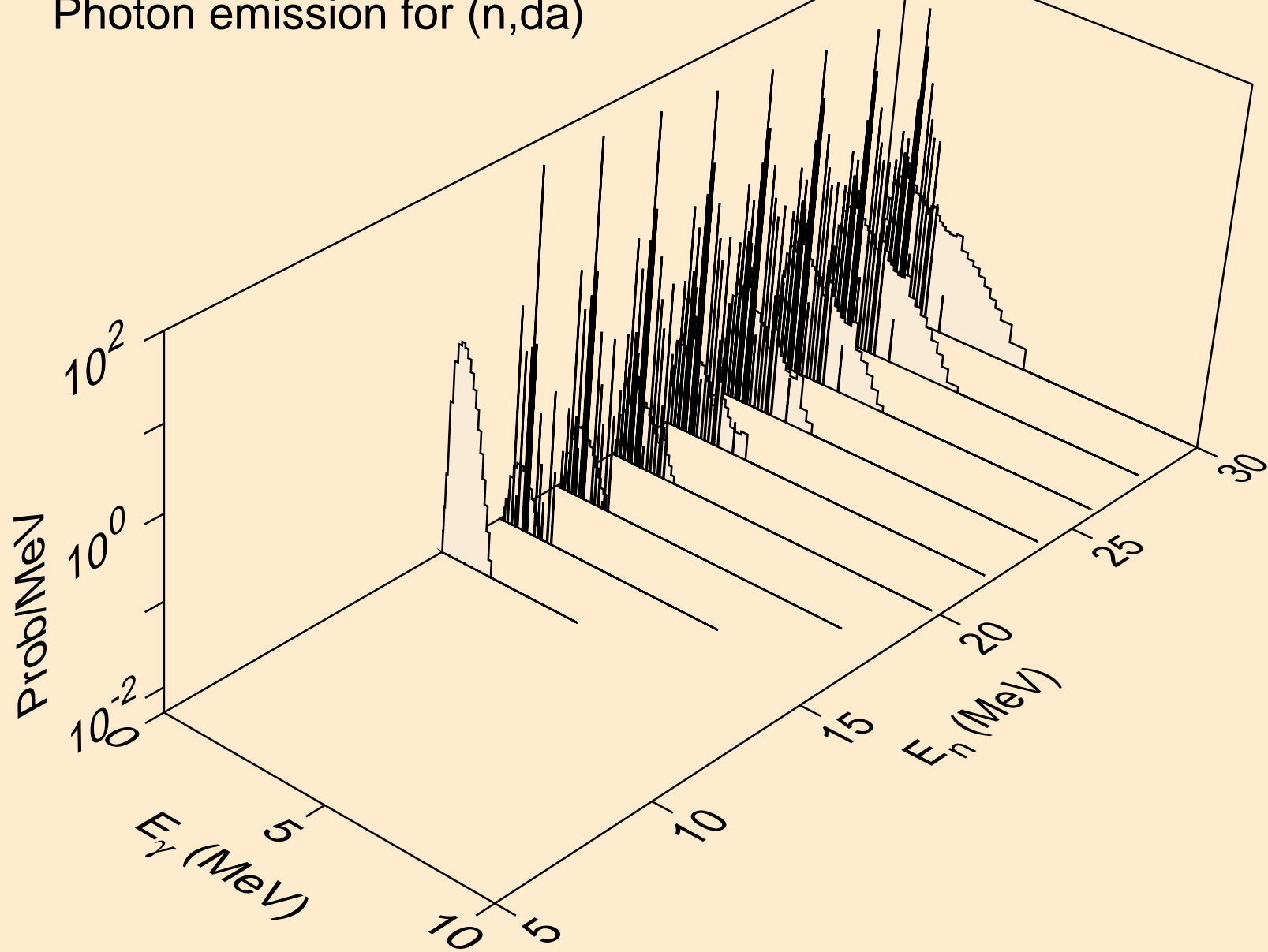

RH101 NEUTRON ACER TENDL-2023 LIBRARY; T=0.K
thermal capture photon spectrum

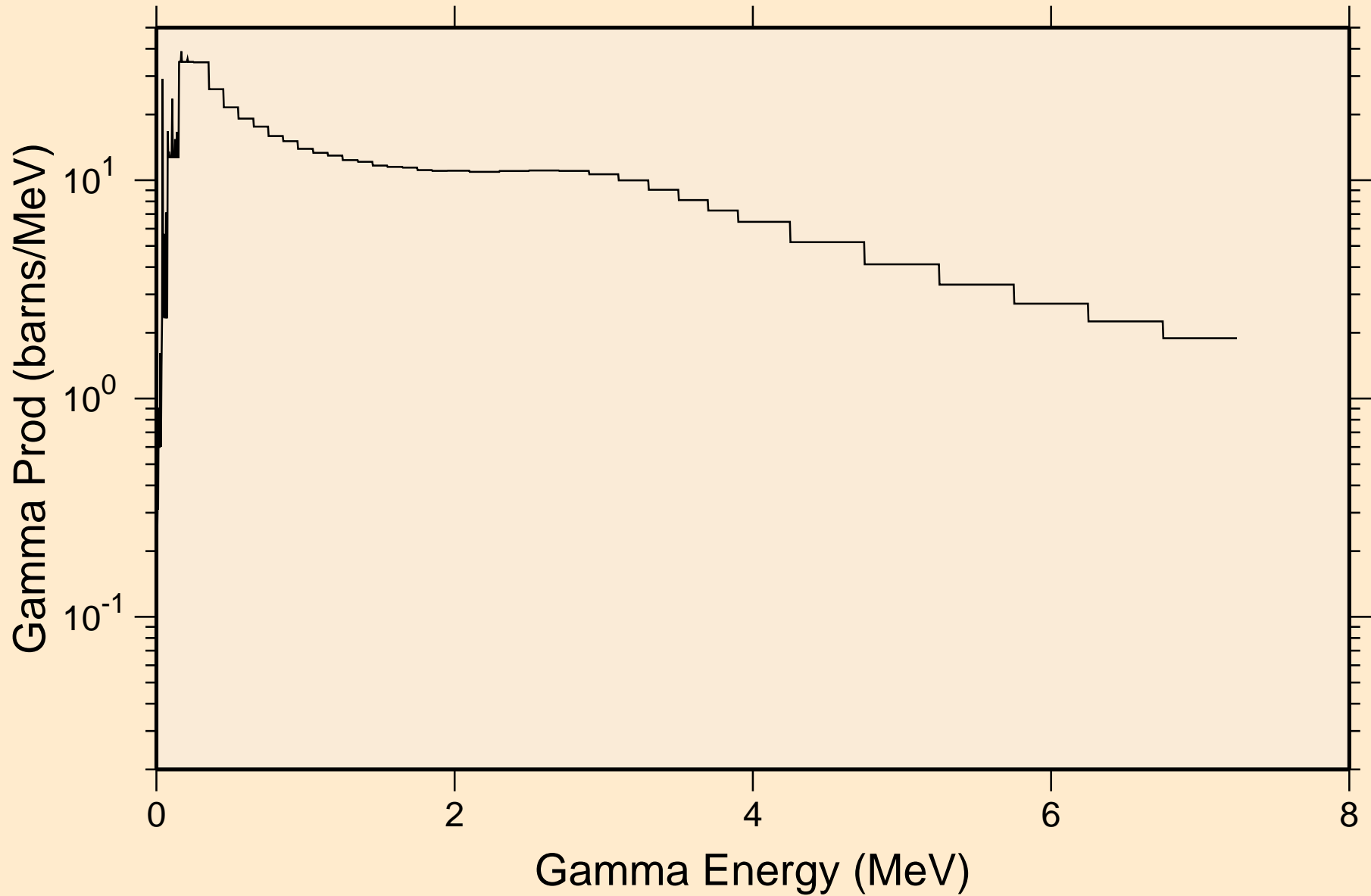

RH101 NEUTRON ACER TENDL-2023 LIBRARY; T=0.K
14 MeV photon spectrum

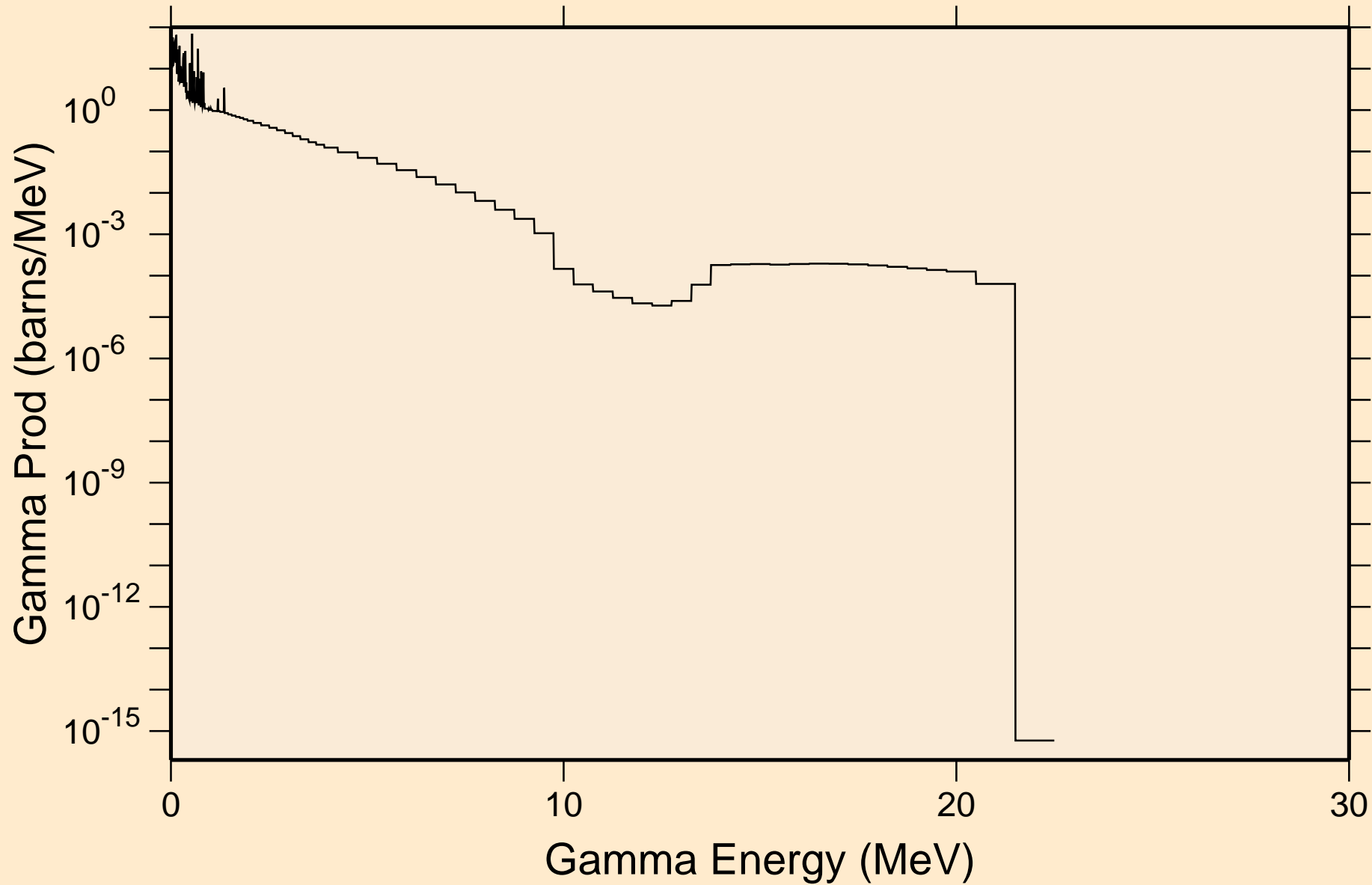

RH101 NEUTRON ACER TENDL-2023 LIBRARY; T=0.K

Particle heating contributions

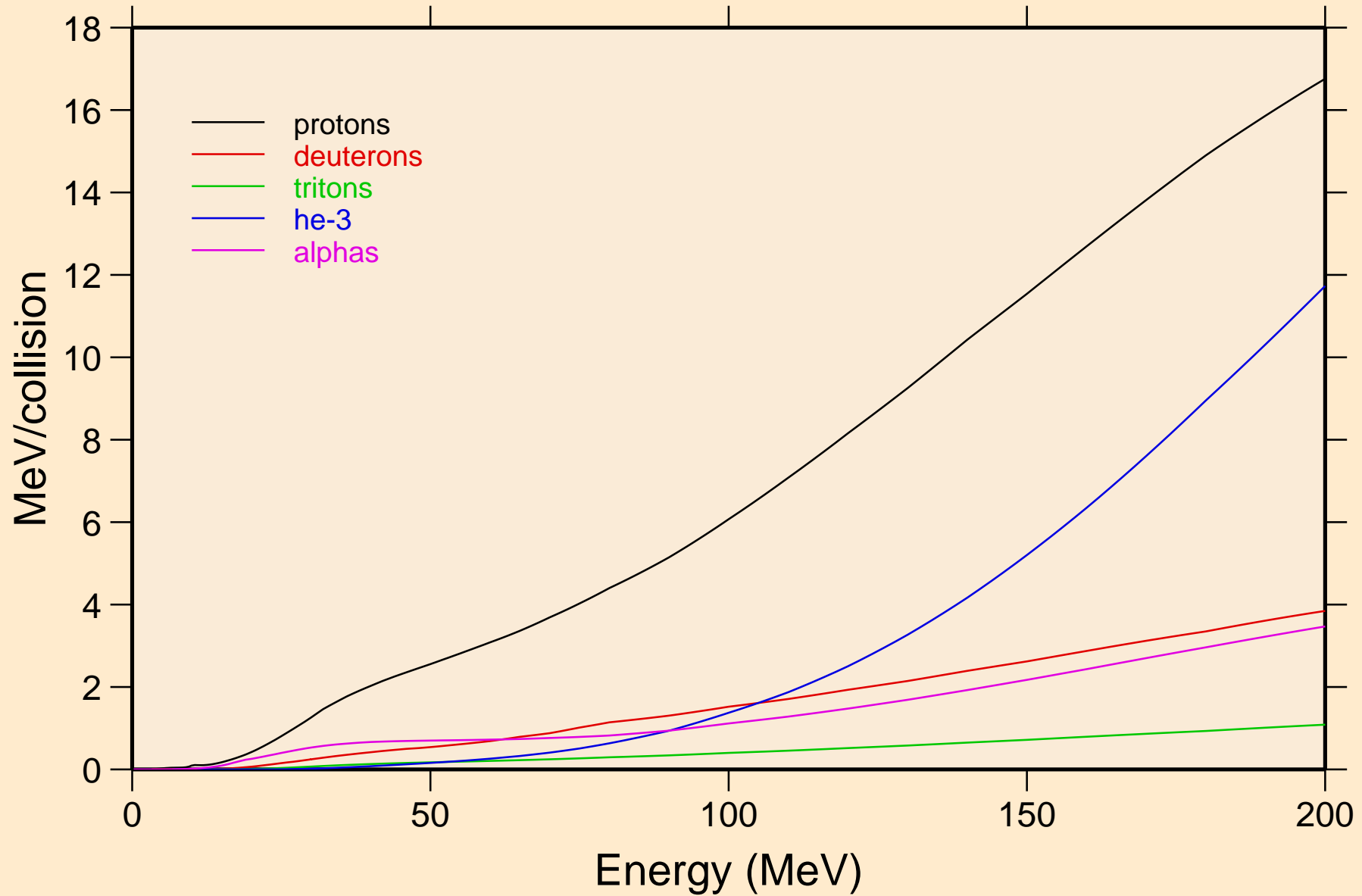

RH101 NEUTRON ACER TENDL-2023 LIBRARY; T=0.K
Recoil Heating

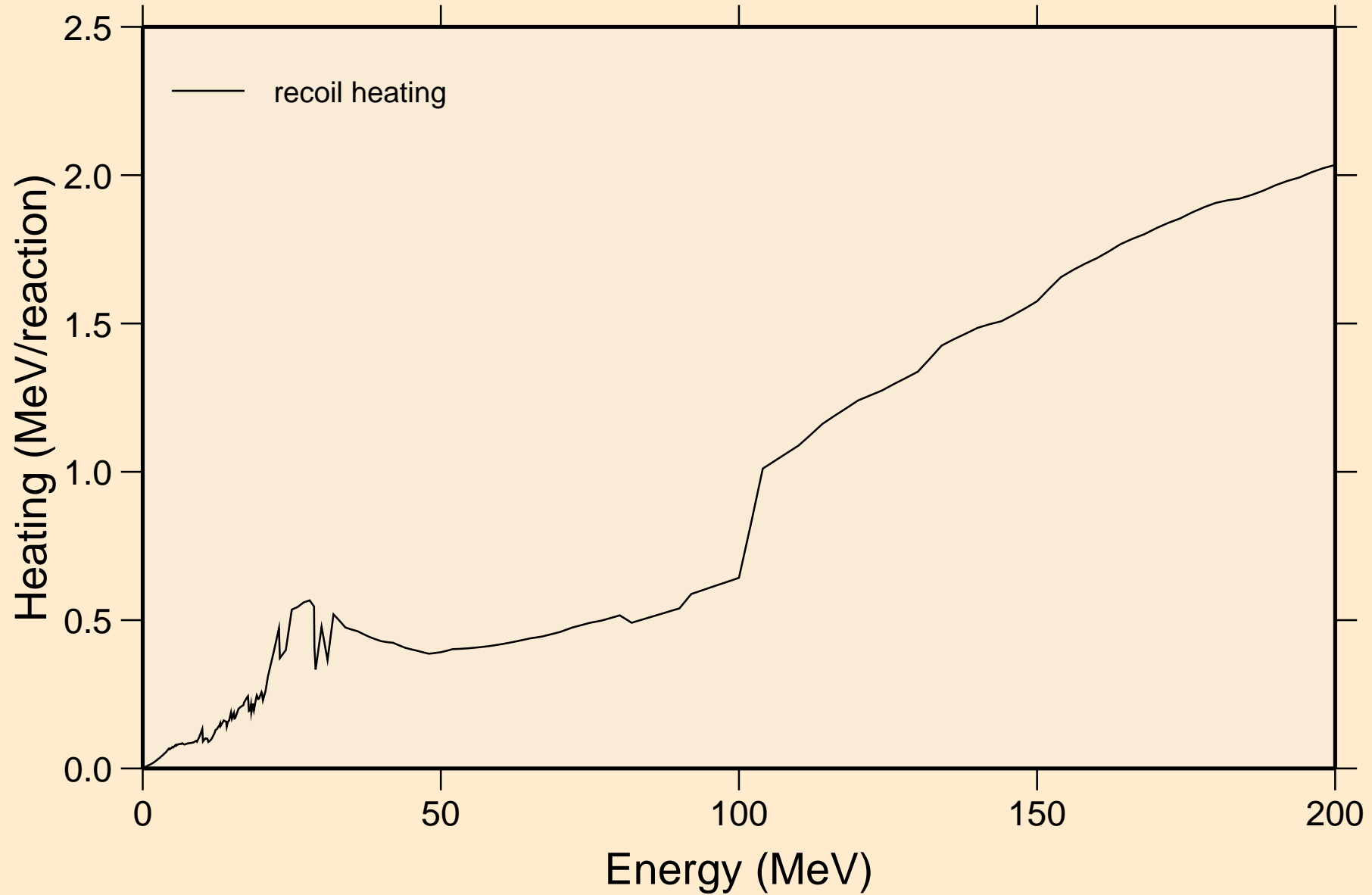

RH101 NEUTRON ACER TENDL-2023 LIBRARY; T=0.K

Particle production cross sections

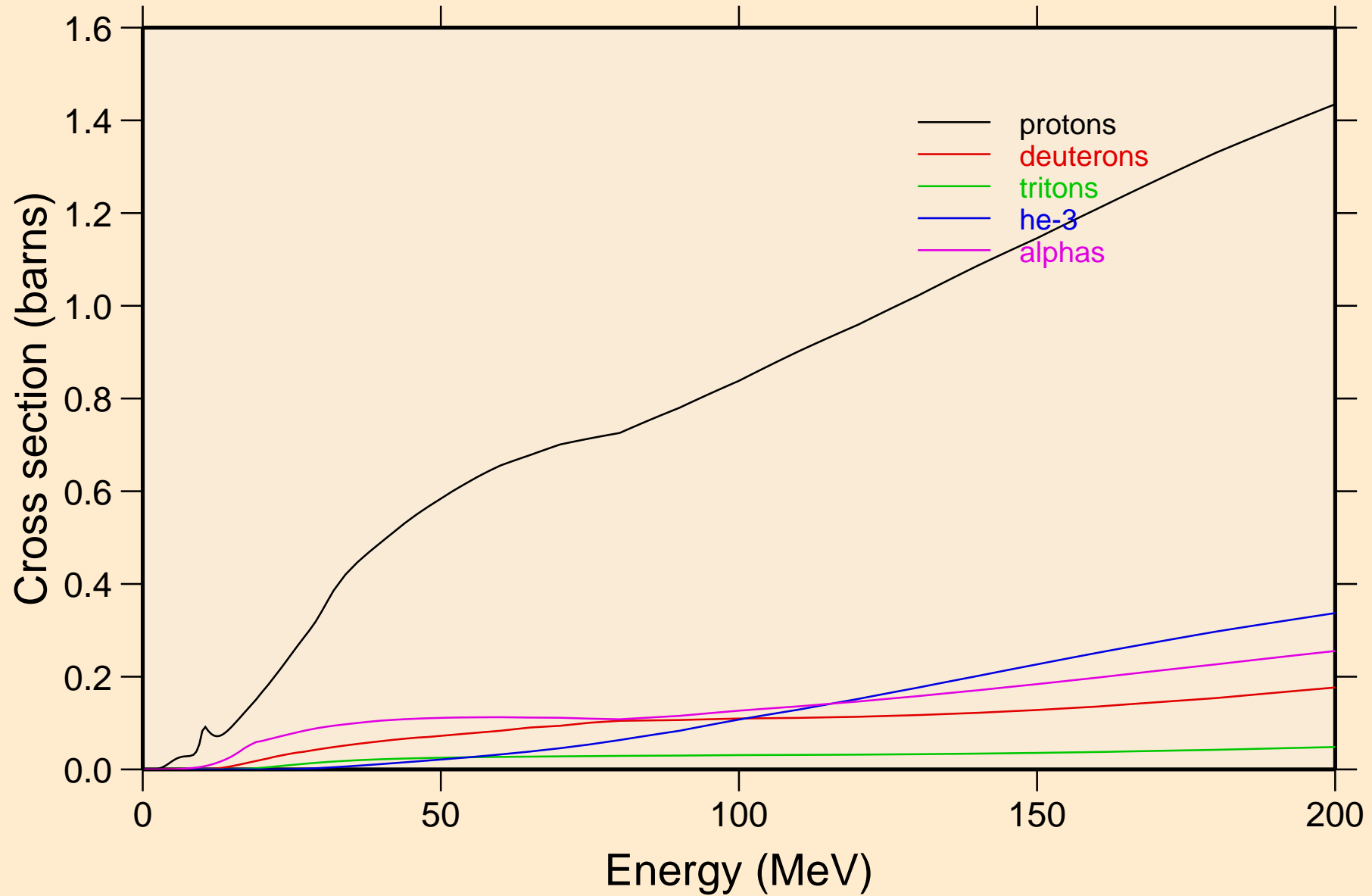

RH101 NEUTRON ACER TENDL-2023 LIBRARY; T=0.K
protons from (n,x)

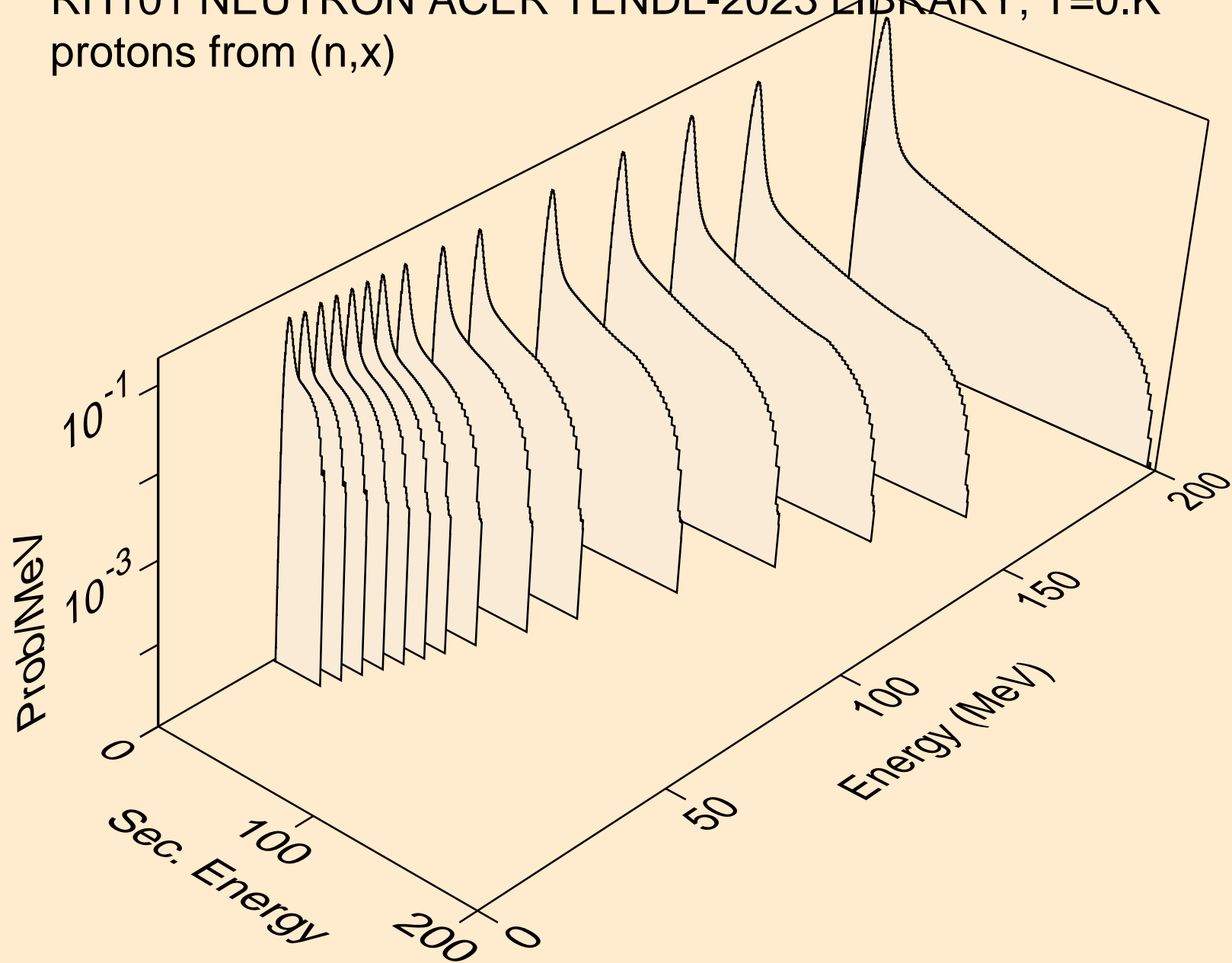

RH101 NEUTRON ACER TENDL-2023 LIBRARY; T=0.K
protons from (n,n*)p

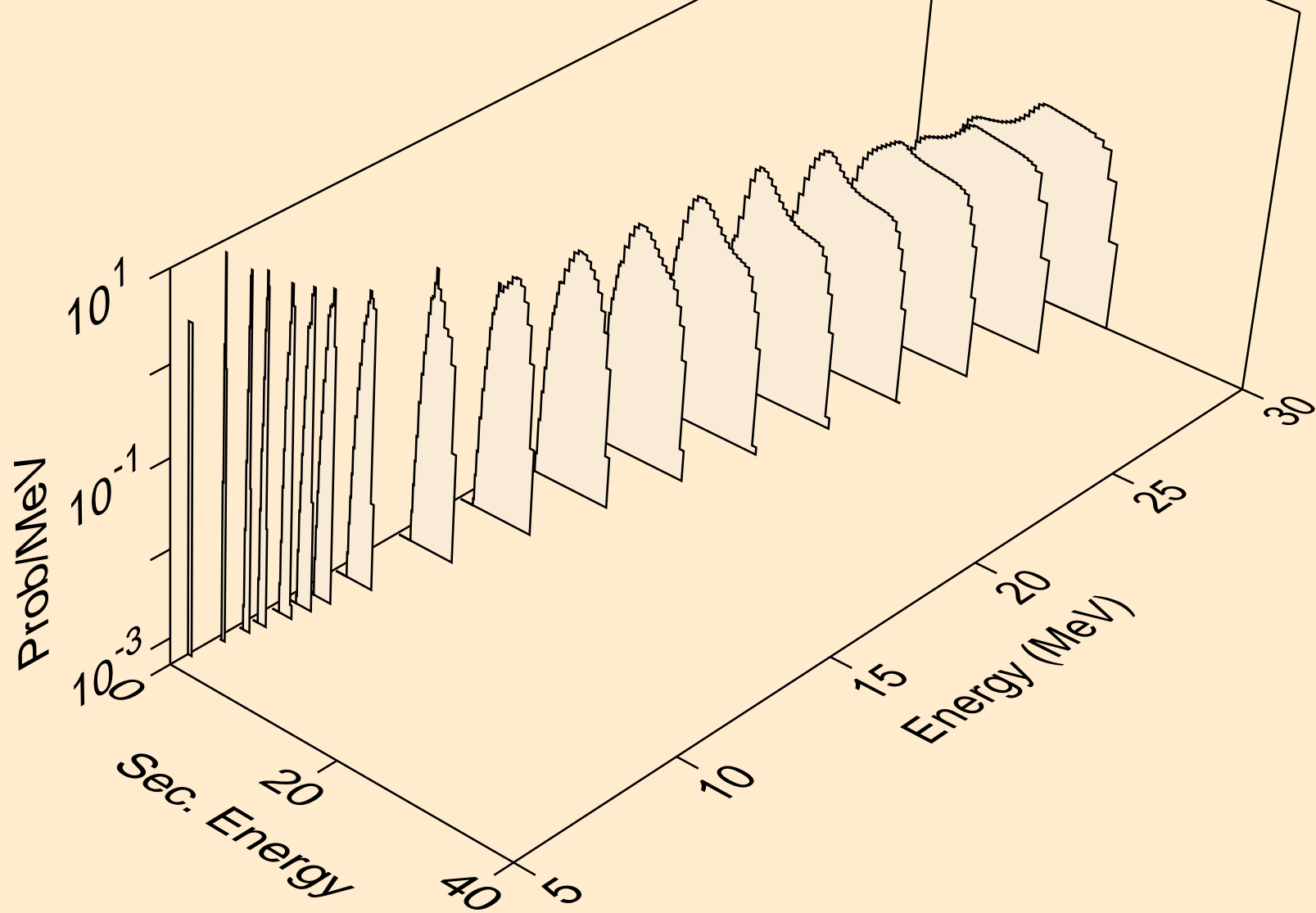

RH101 NEUTRON ACER TENDL-2023 LIBRARY; T=0.K
protons from (n,2np)

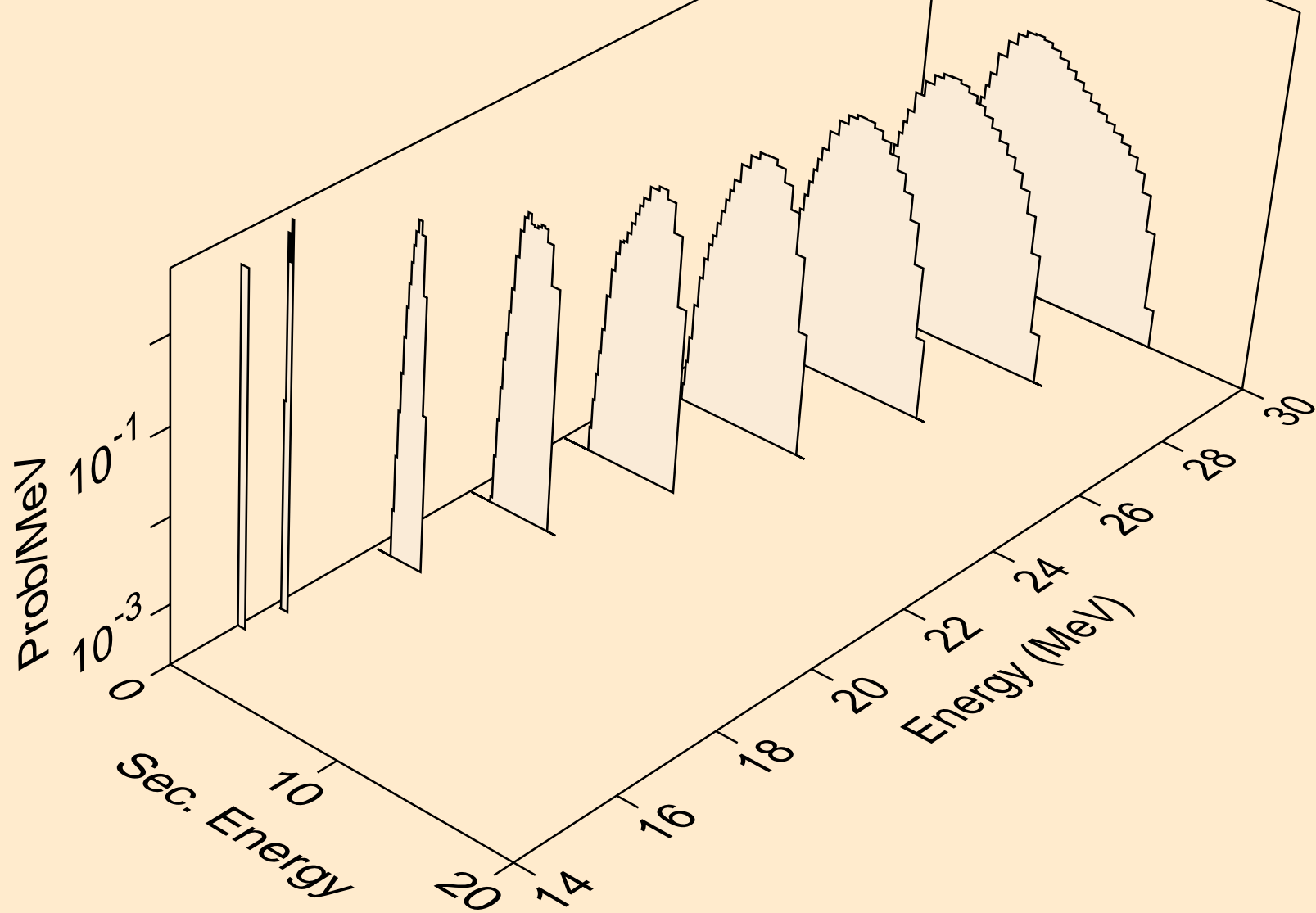

RH101 NEUTRON ACER TENDL-2023 LIBRARY; T=0.K
protons from (n,3np)

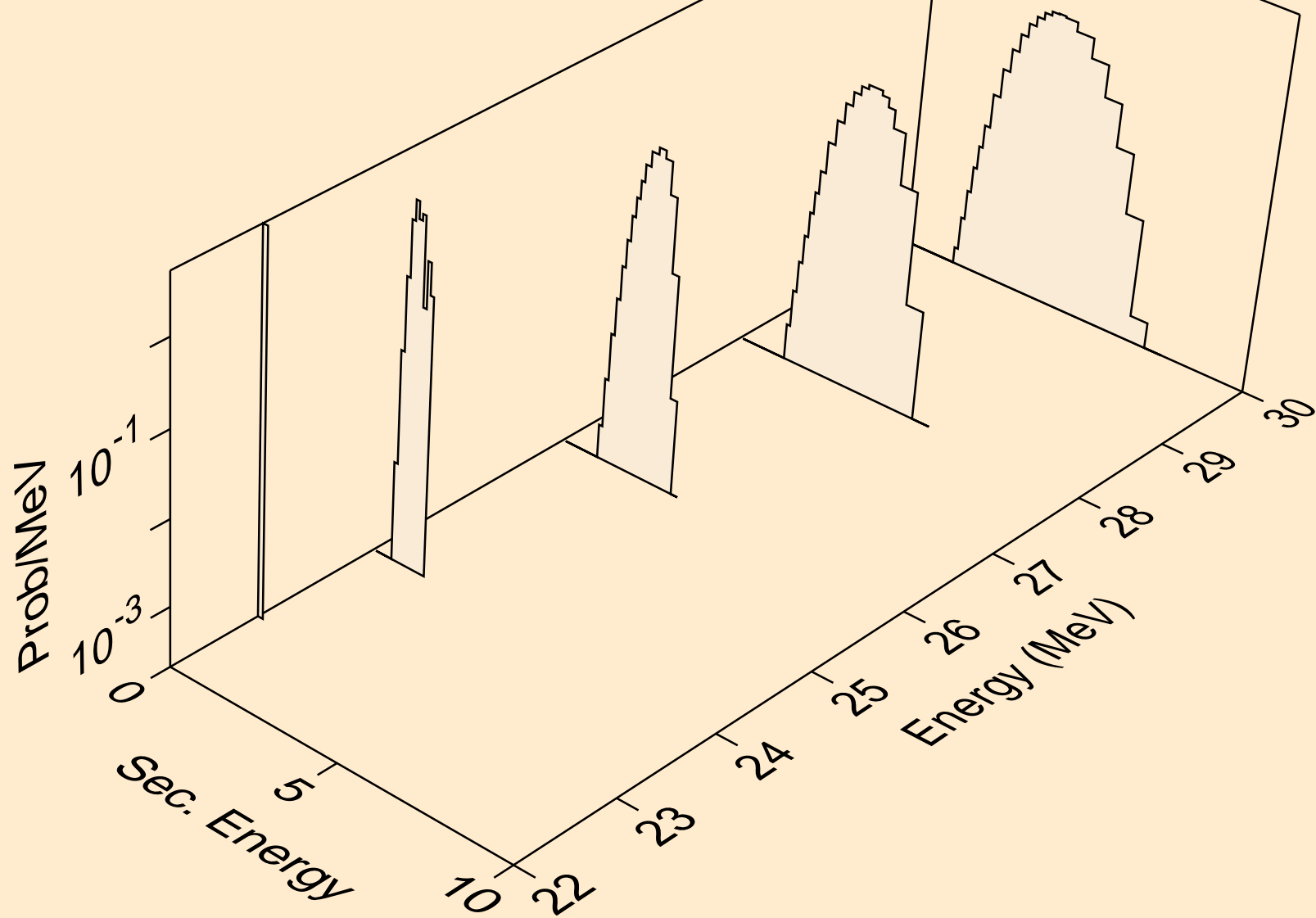

RH101 NEUTRON ACER TENDL-2023 LIBRARY; T=0.K
protons from (n,n2p)

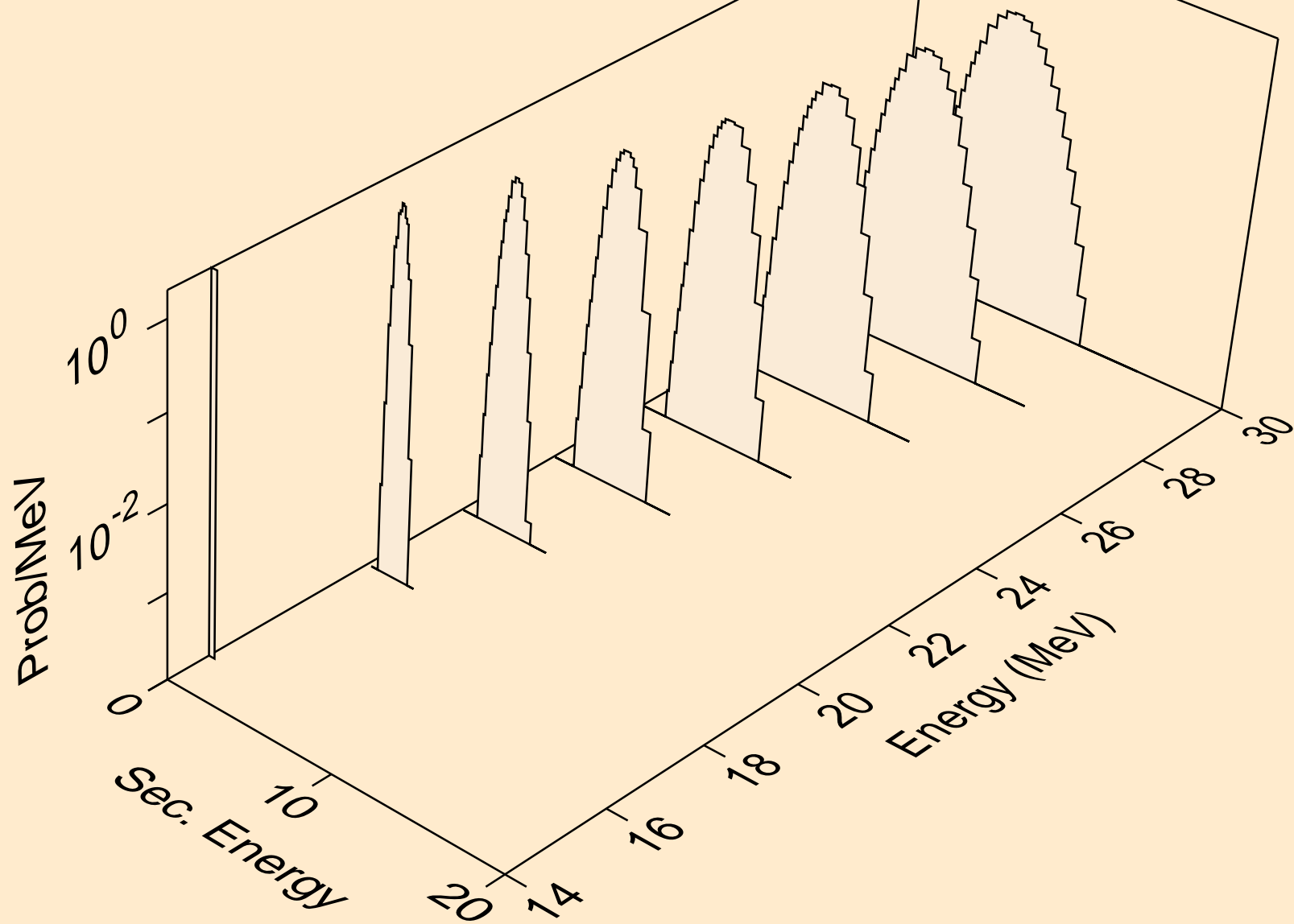

RH101 NEUTRON ACER TENDL-2023 LIBRARY; T=0.K
protons from (n,npa)

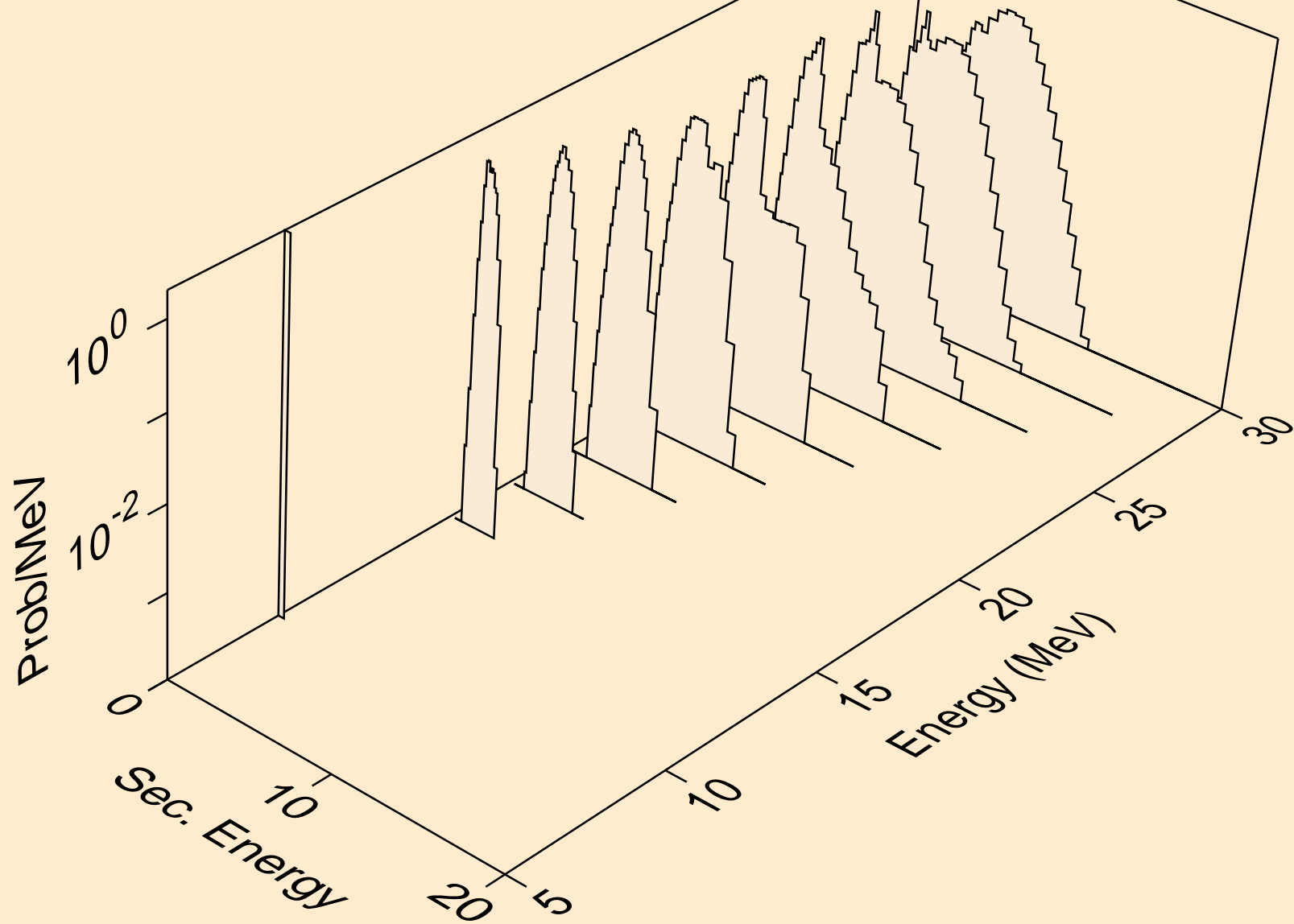

RH101 NEUTRON ACER TENDL-2023 LIBRARY; T=0.K
protons from (n,p)

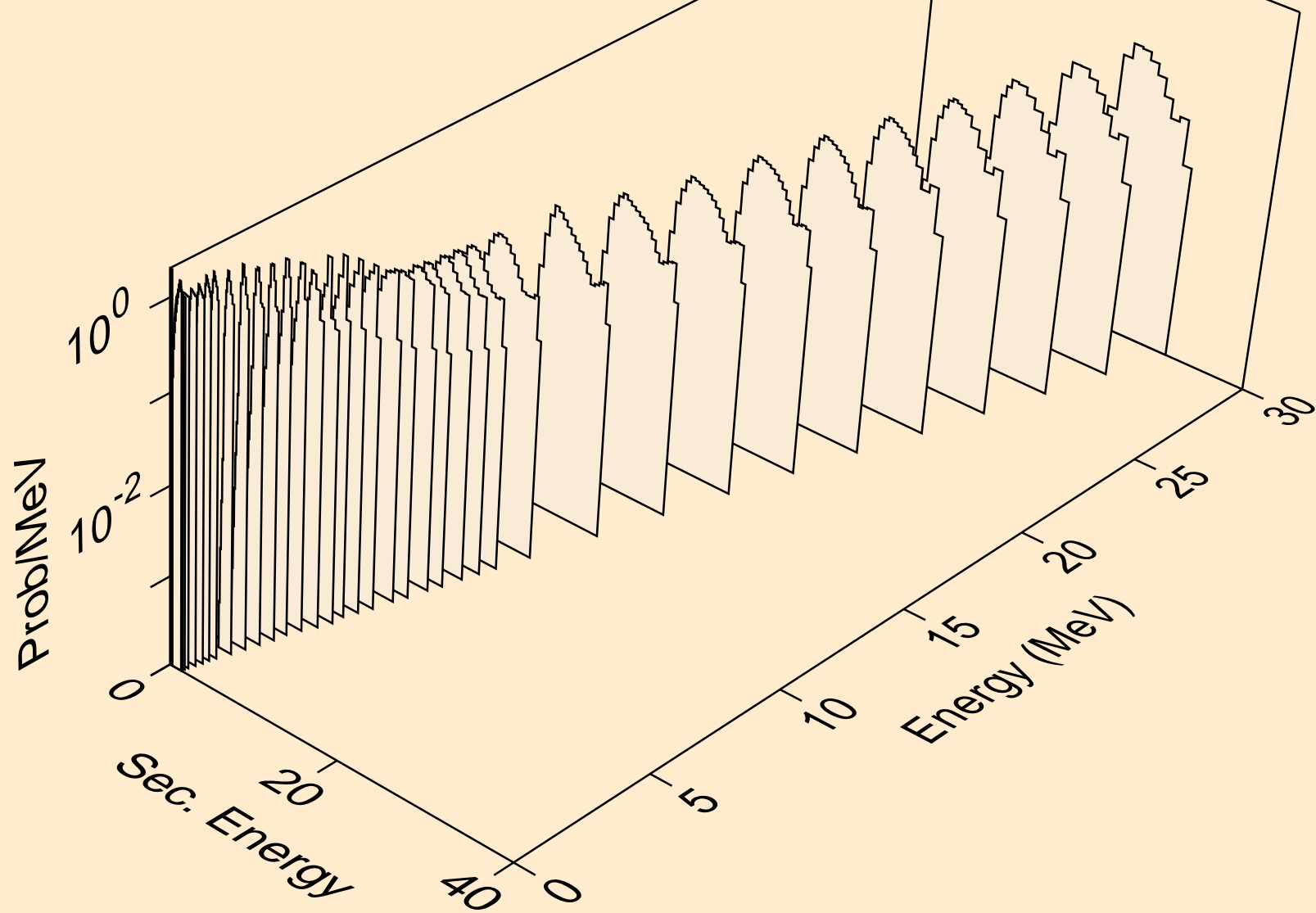

RH101 NEUTRON ACER TENDL-2023 LIBRARY; T=0.K
protons from (n,2p)

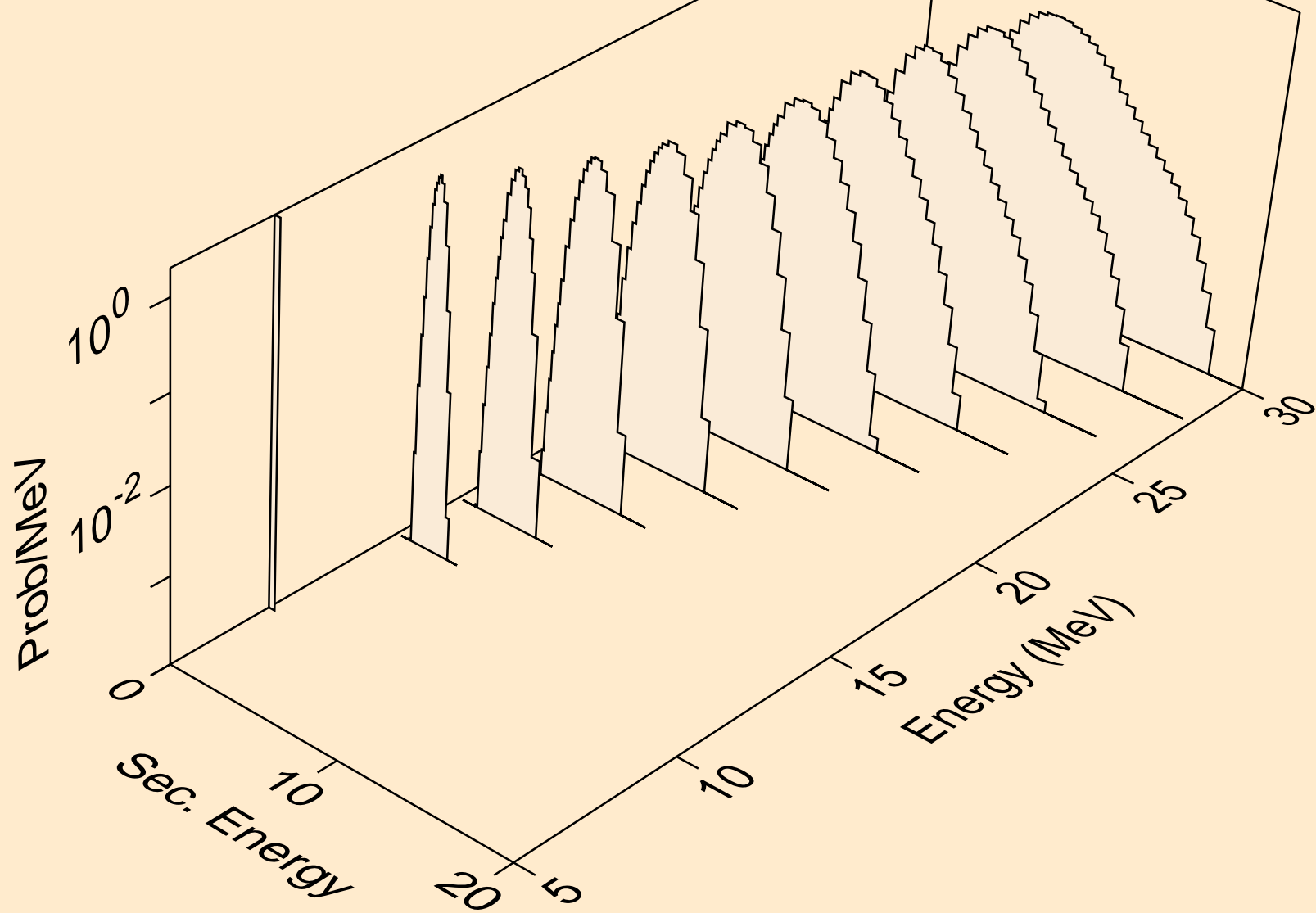

RH101 NEUTRON ACER TENDL-2023 LIBRARY; T=0.K
protons from (n,p)

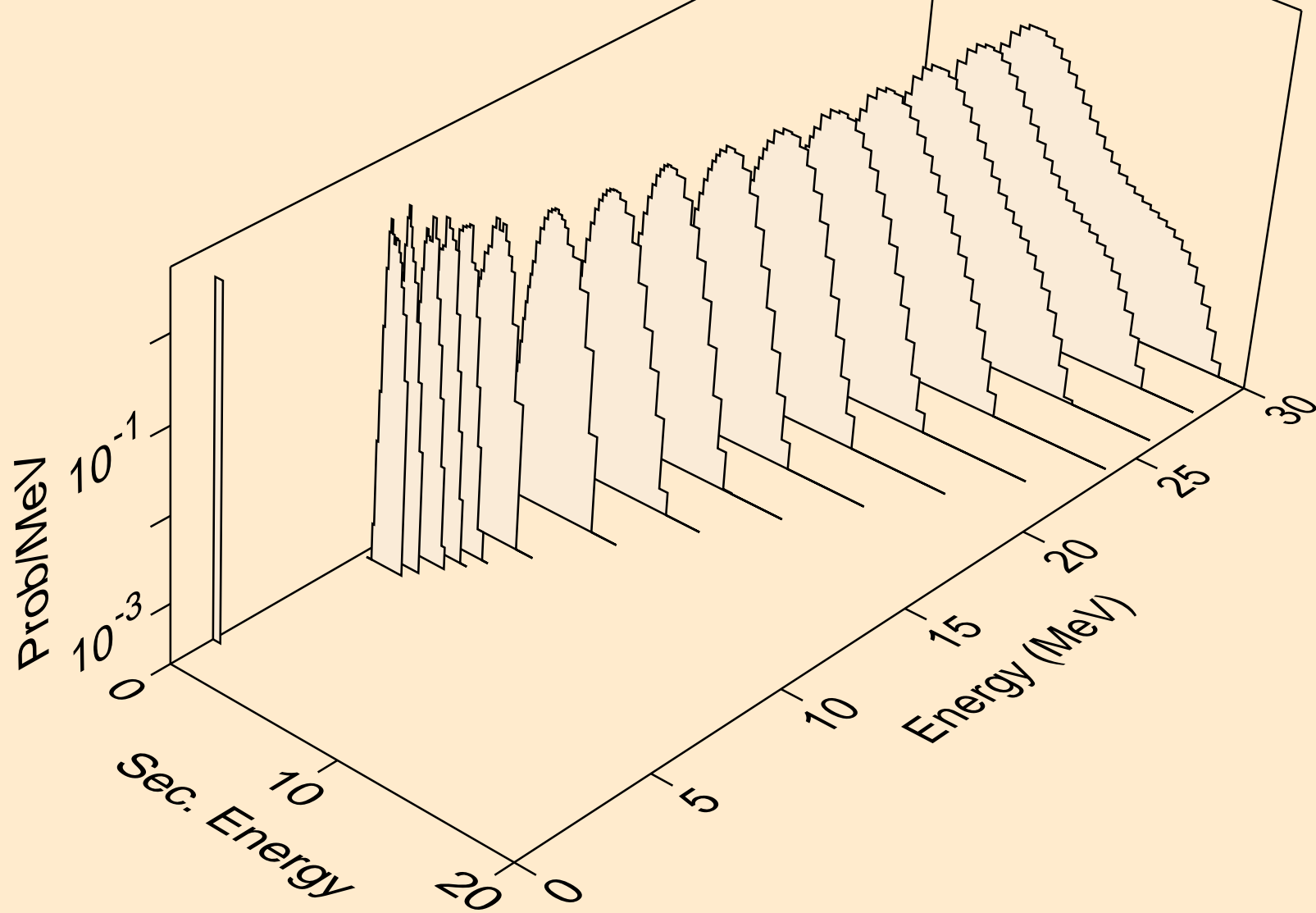

RH101 NEUTRON ACER TENDL-2023 LIBRARY; T=0.K
protons from (n,pd)

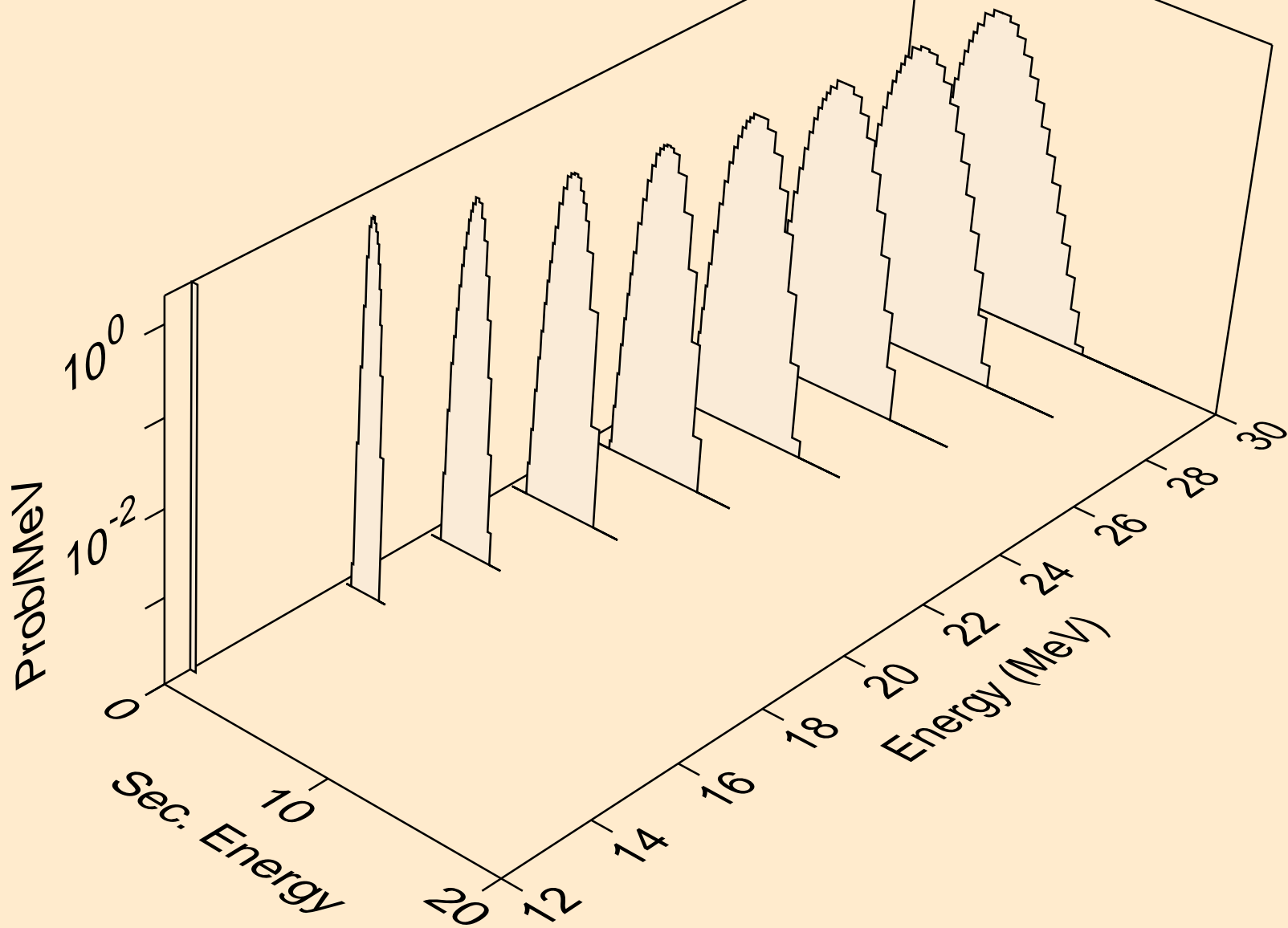

RH101 NEUTRON ACER TENDL-2023 LIBRARY; T=0.K
protons from (n,pt)

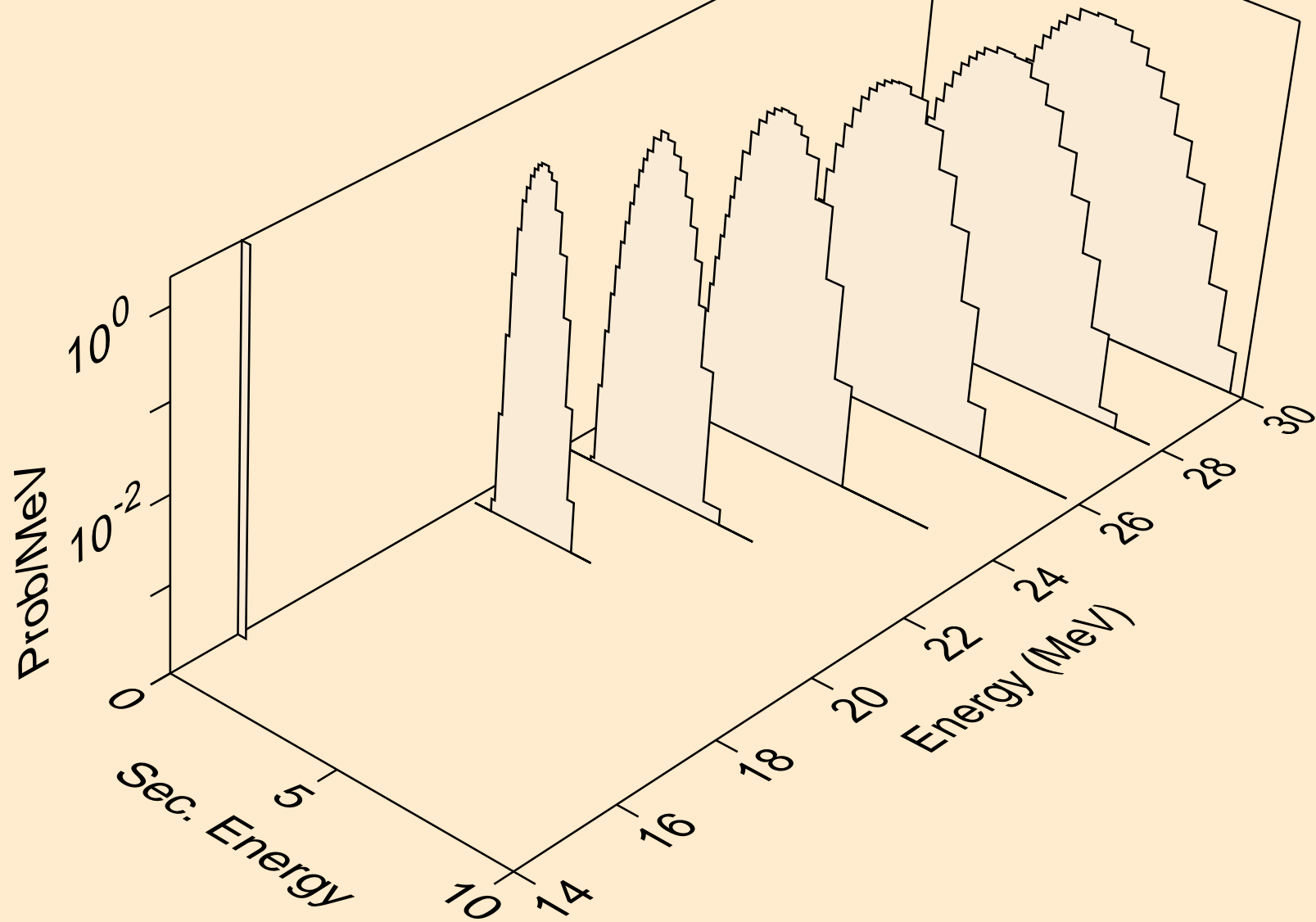

RH101 NEUTRON ACER TENDL-2023 LIBRARY; T=0.K
deuterons from (n,x)

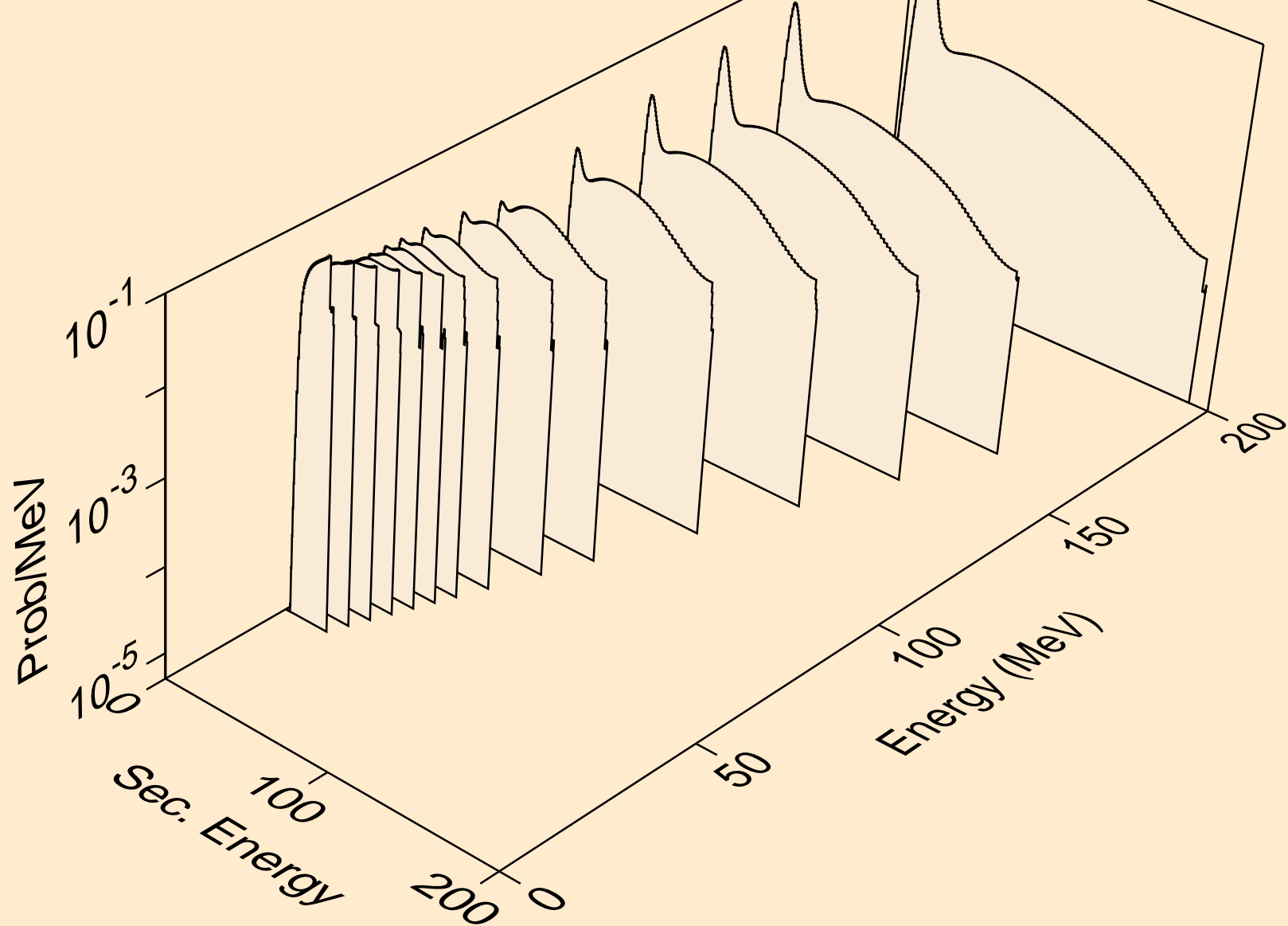

RH101 NEUTRON ACER TENDL-2023 LIBRARY; T=0.K
deuterons from (n,2nd)

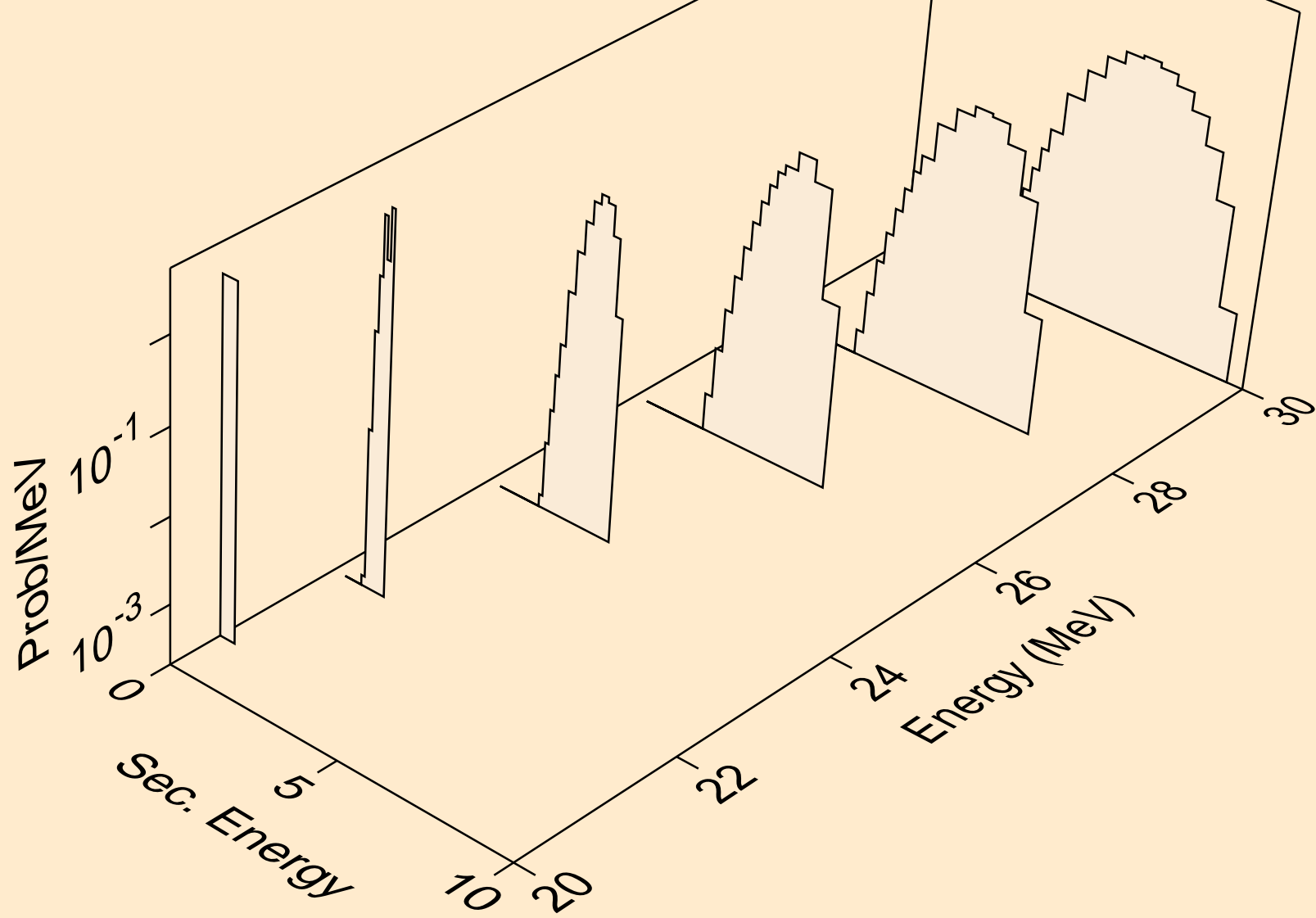

RH101 NEUTRON ACER TENDL-2023 LIBRARY; T=0.K
deuterons from (n,n*)d

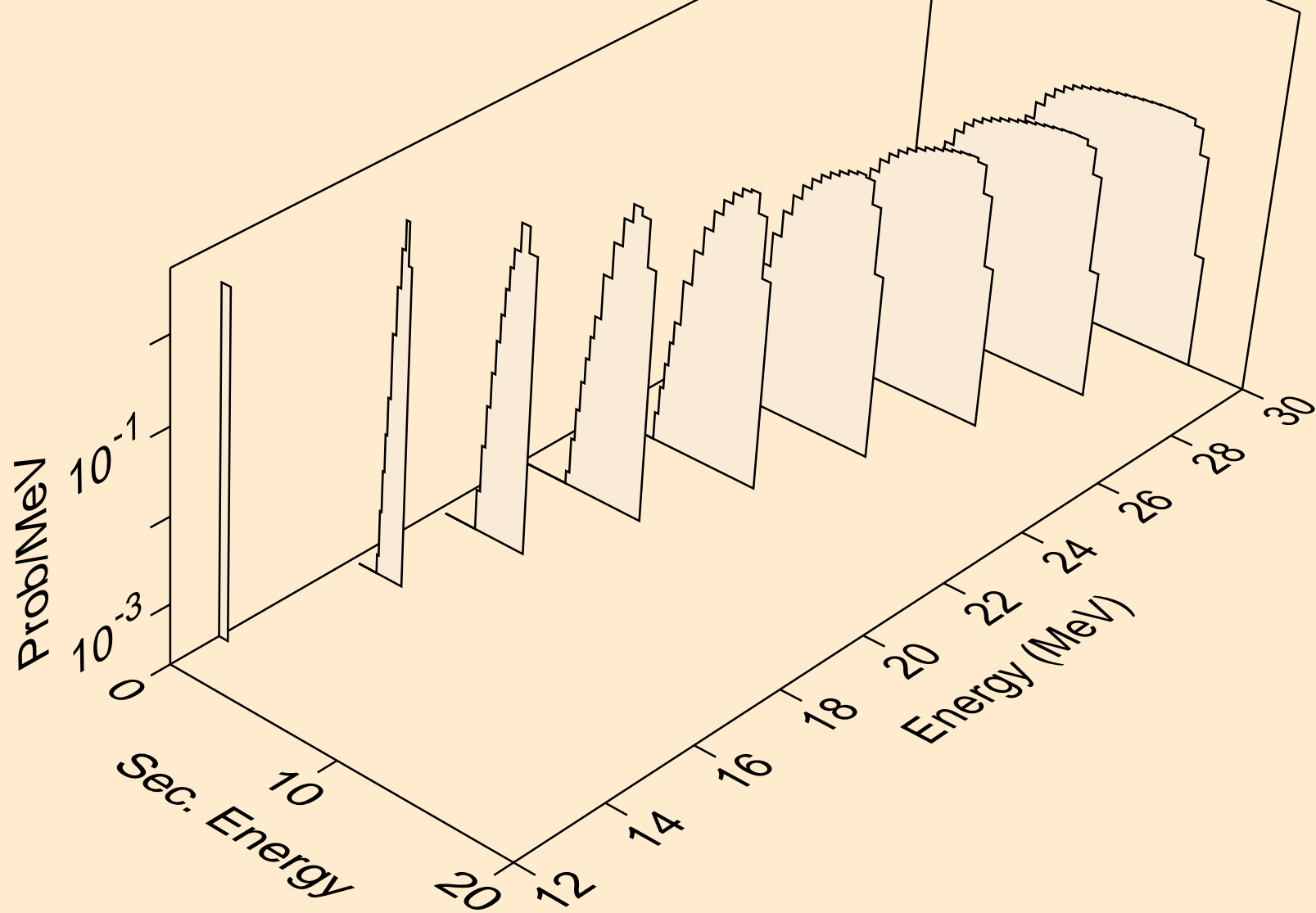

RH101 NEUTRON ACER TENDL-2023 LIBRARY; T=0.K
deuterons from (n,d)

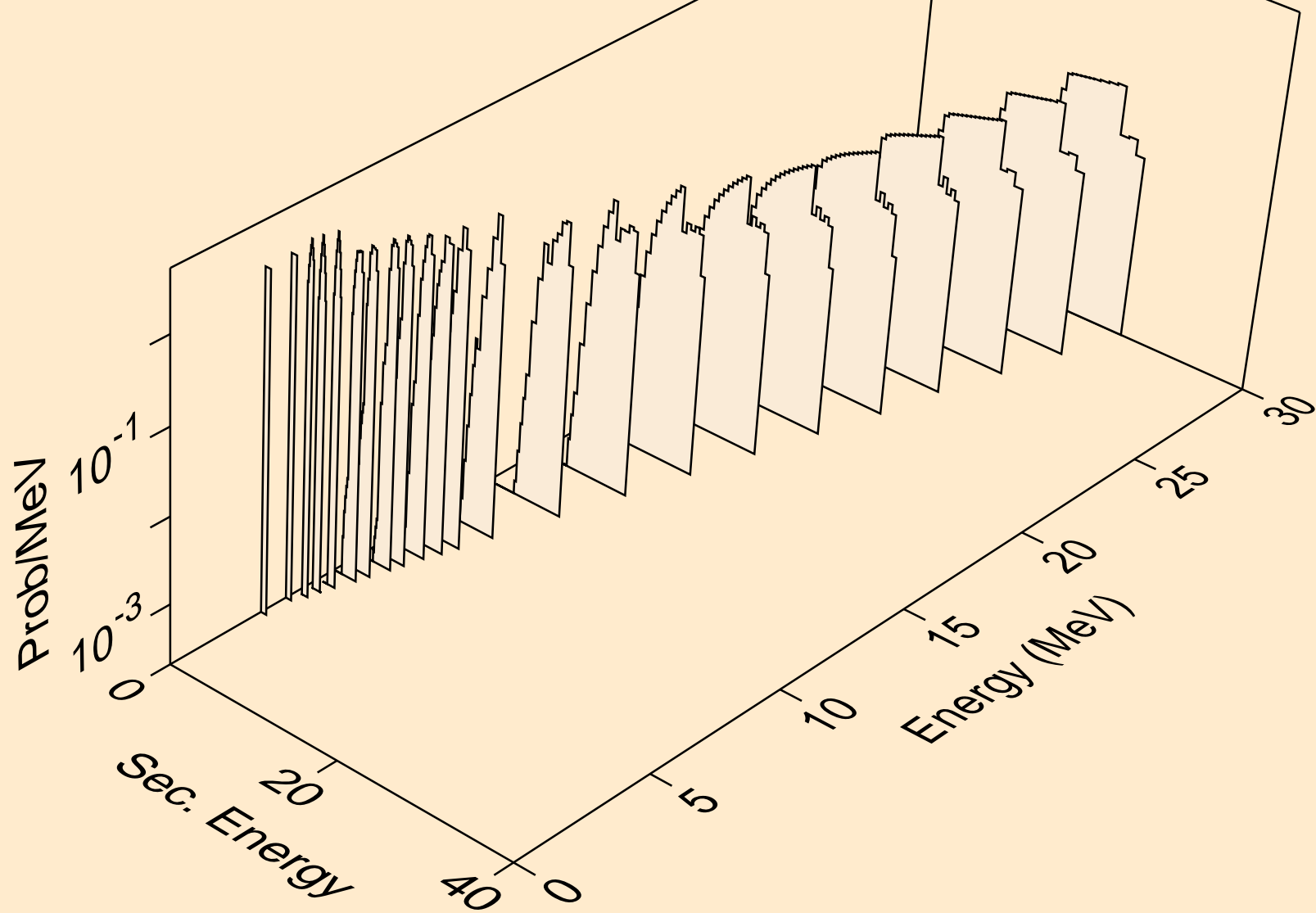

RH101 NEUTRON ACER TENDL-2023 LIBRARY; T=0.K
deuterons from (n,pd)

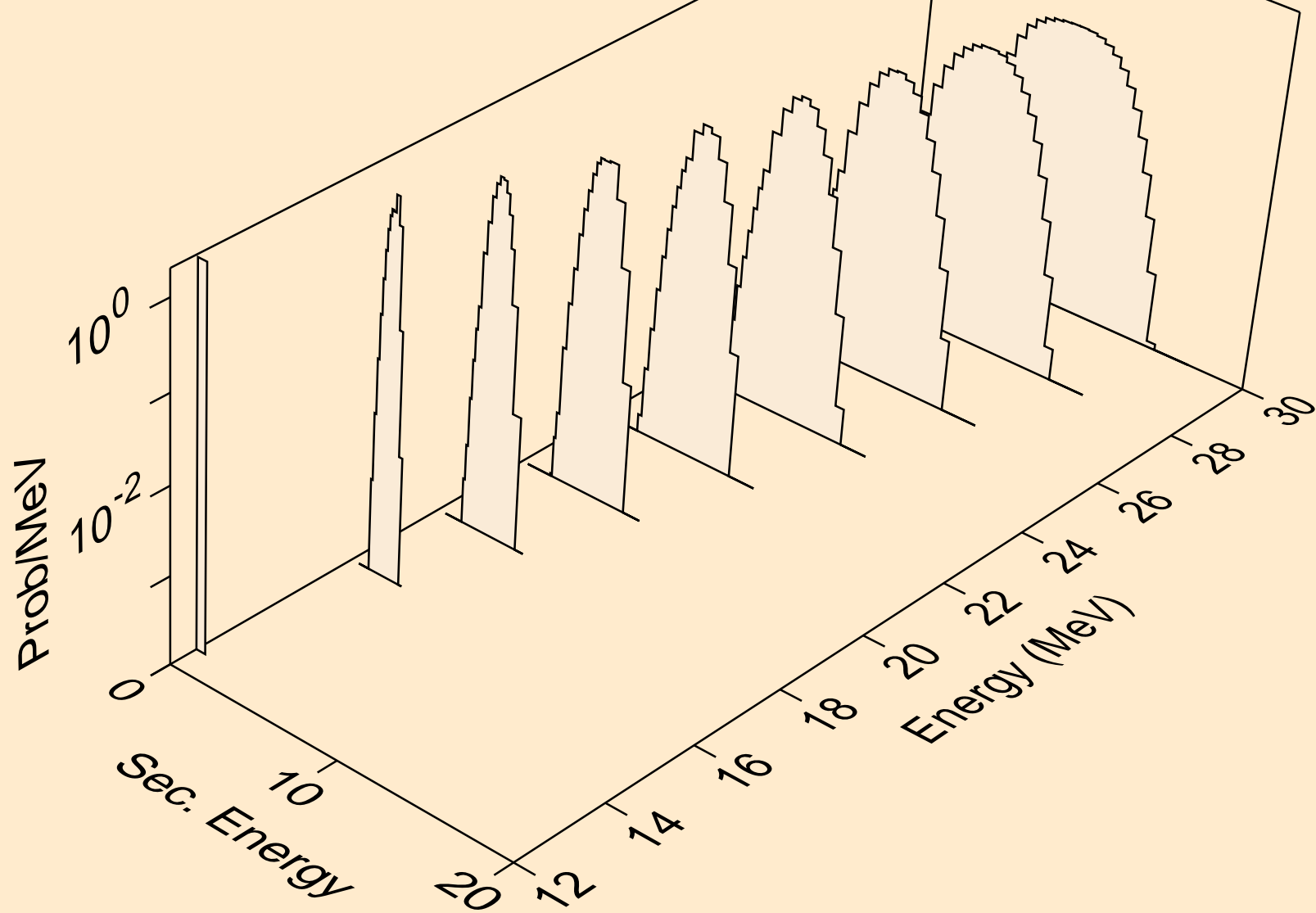

RH101 NEUTRON ACER TENDL-2023 LIBRARY; T=0.K
deuterons from (n,da)

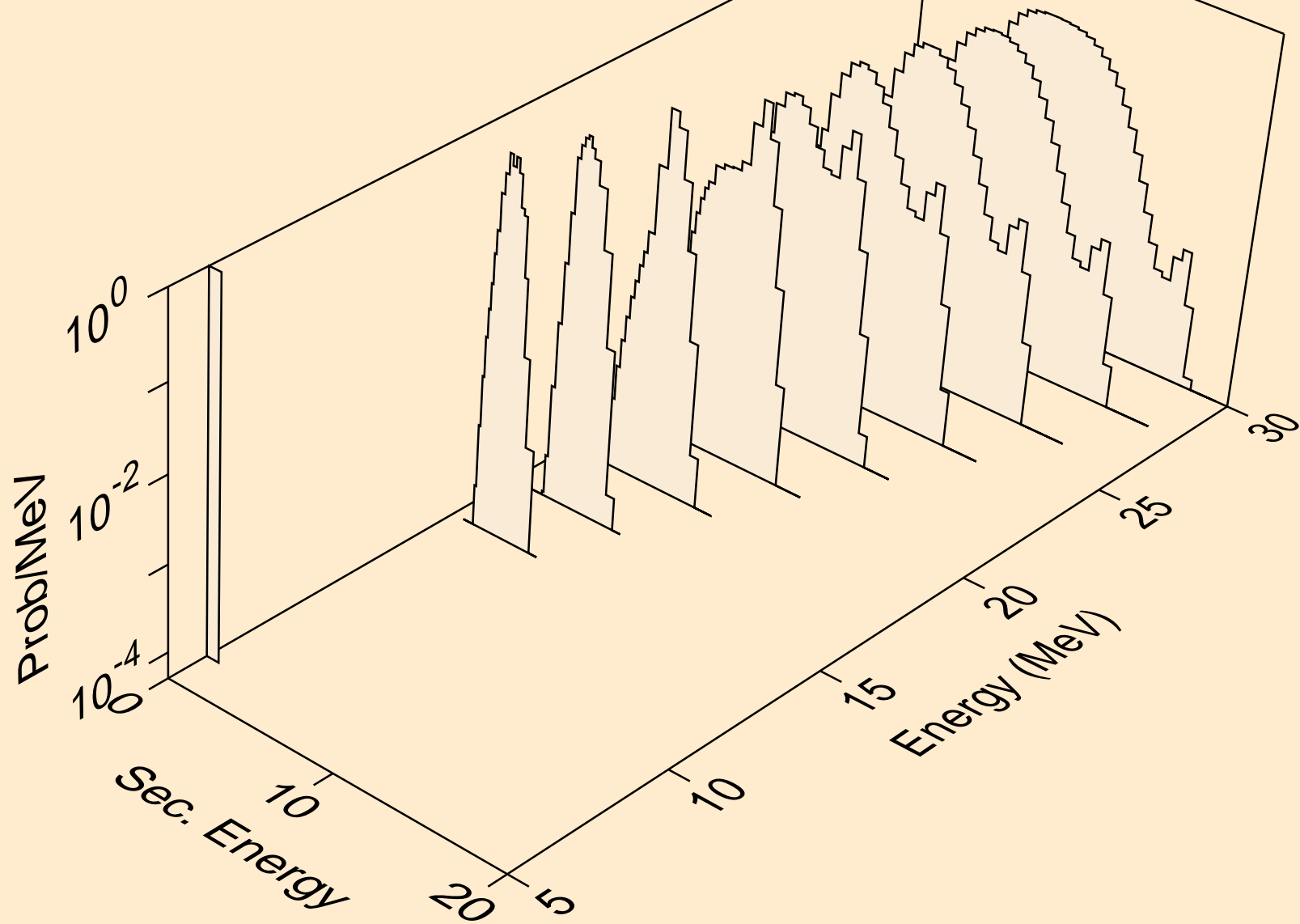

RH101 NEUTRON ACER TENDL-2023 LIBRARY; T=0.K
tritons from (n,x)

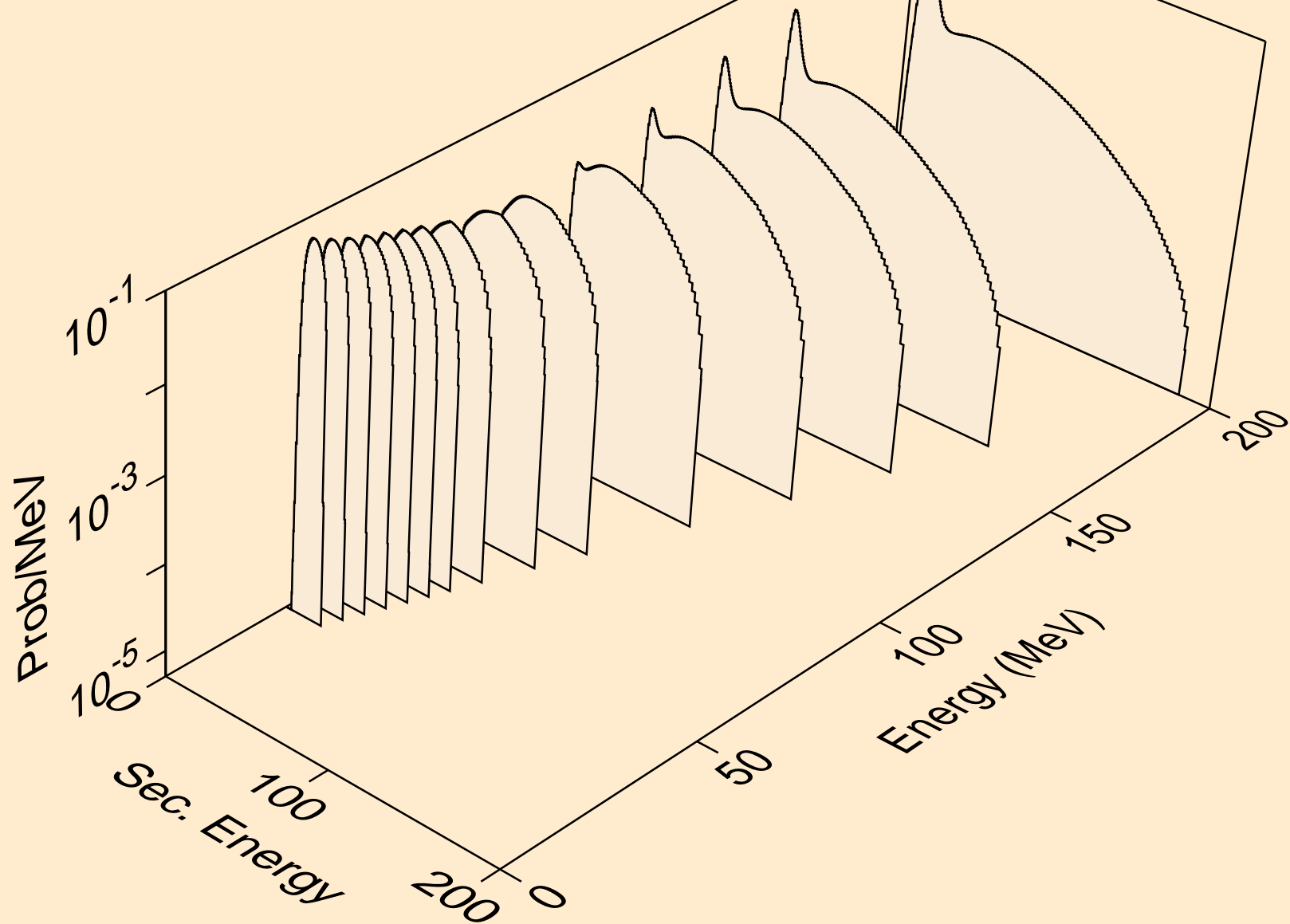

RH101 NEUTRON ACER TENDL-2023 LIBRARY; T=0.K
tritons from (n,n*)t

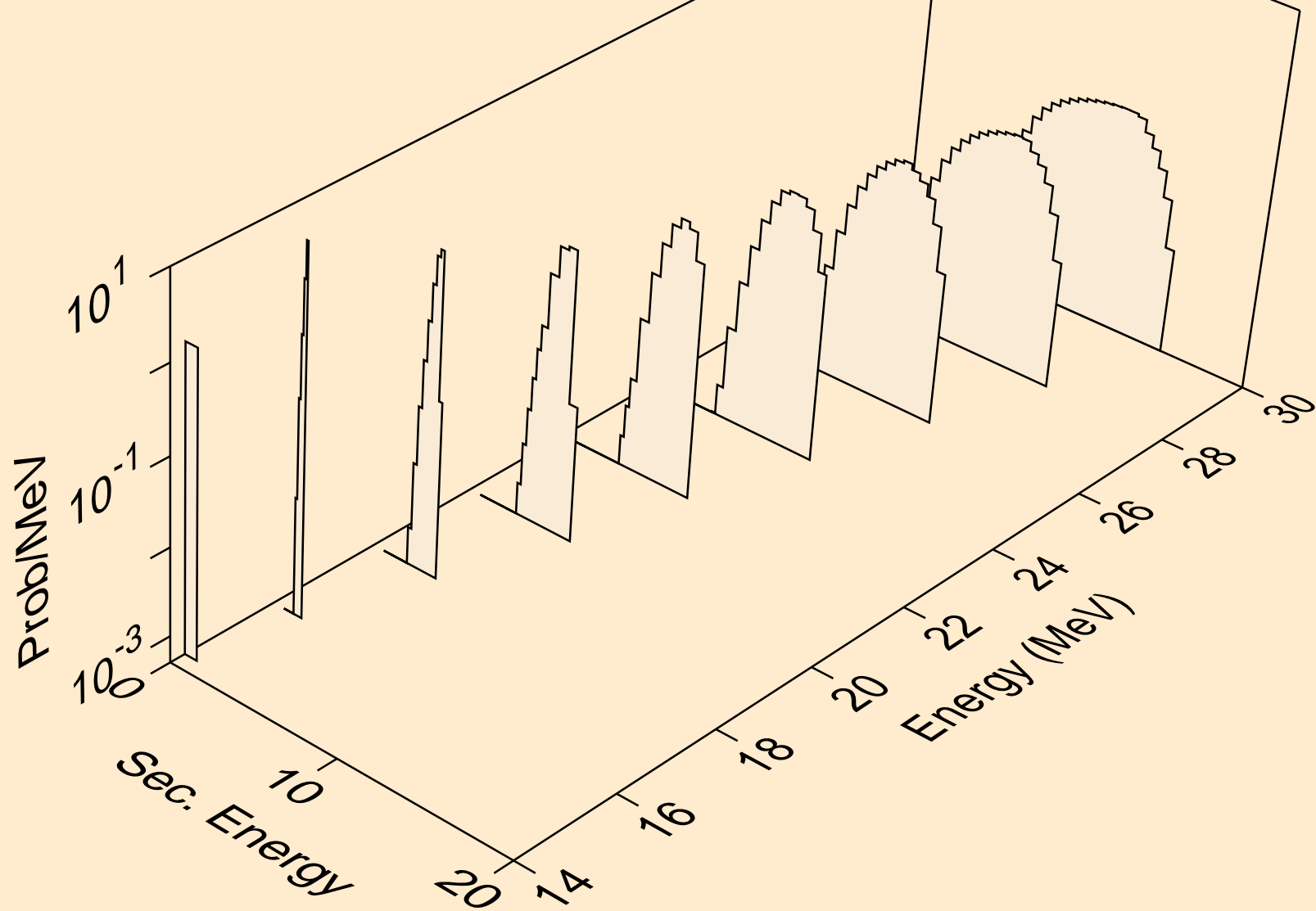

RH101 NEUTRON ACER TENDL-2023 LIBRARY; T=0.K
tritons from (n,t)

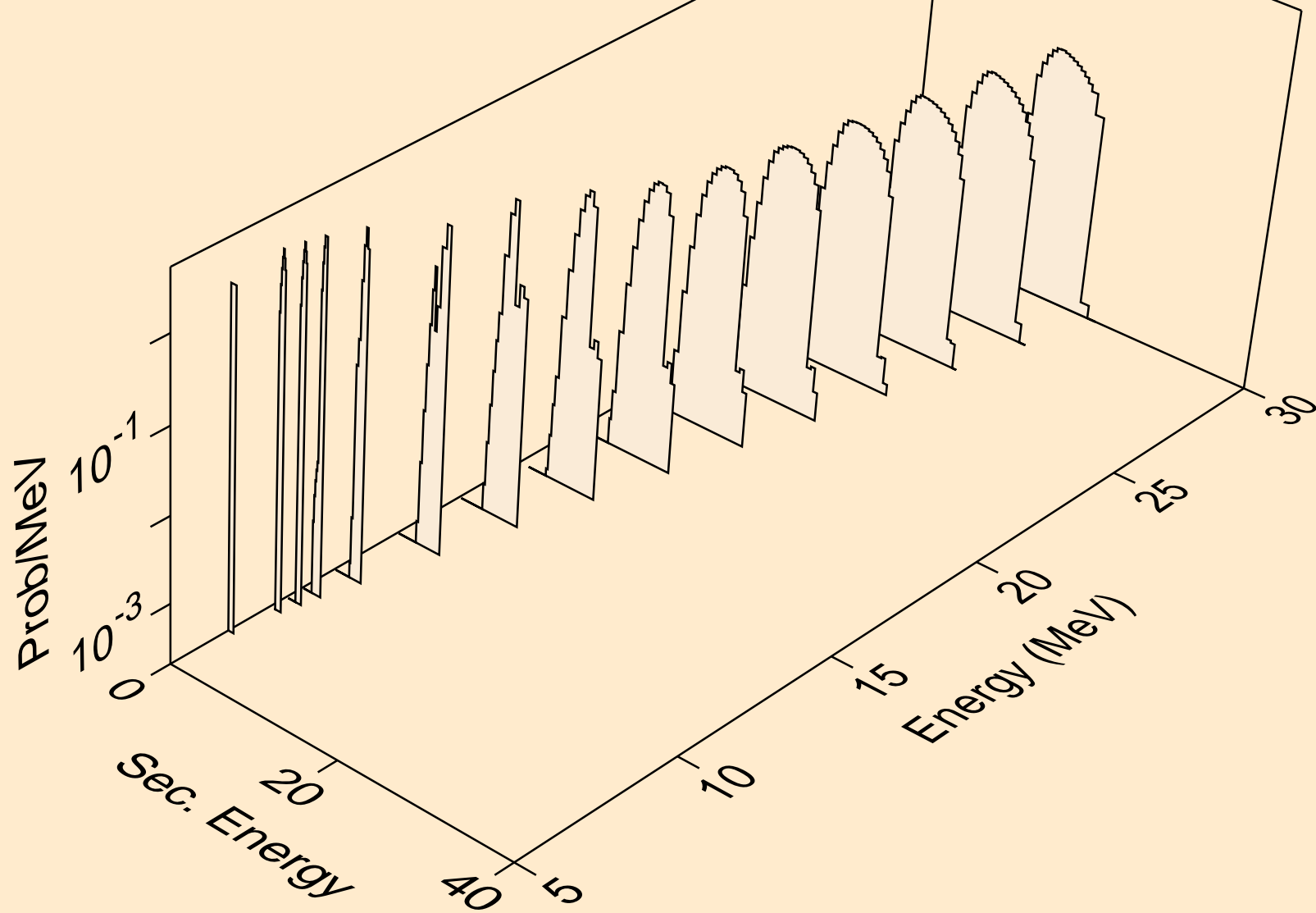

RH101 NEUTRON ACER TENDL-2023 LIBRARY; T=0.K
tritons from (n,pt)

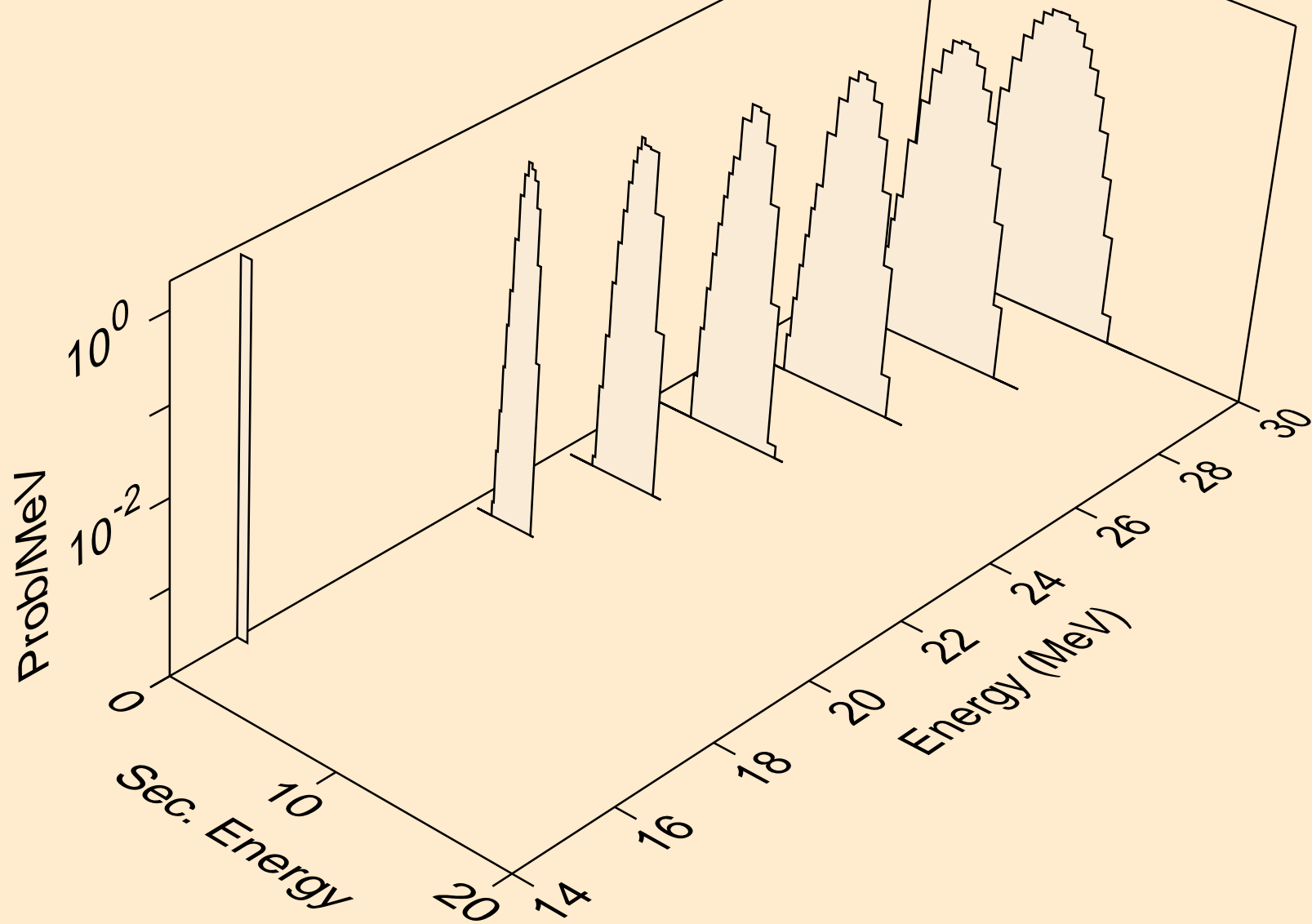

RH101 NEUTRON ACER TENDL-2023 LIBRARY; T=0.K
he3s from (n,x)

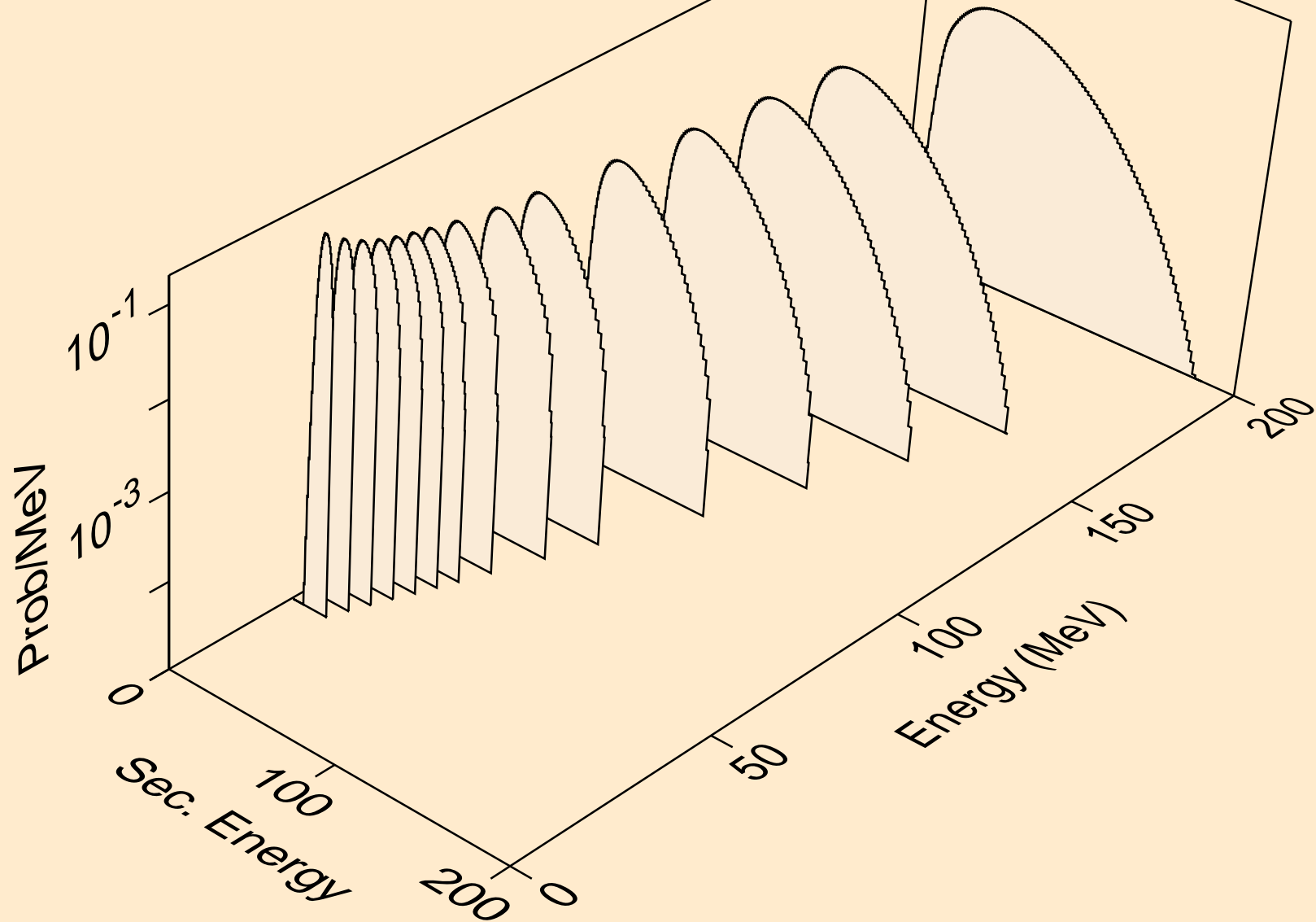

RH101 NEUTRON ACER TENDL-2023 LIBRARY; T=0.K
he3s from (n,n*)he3

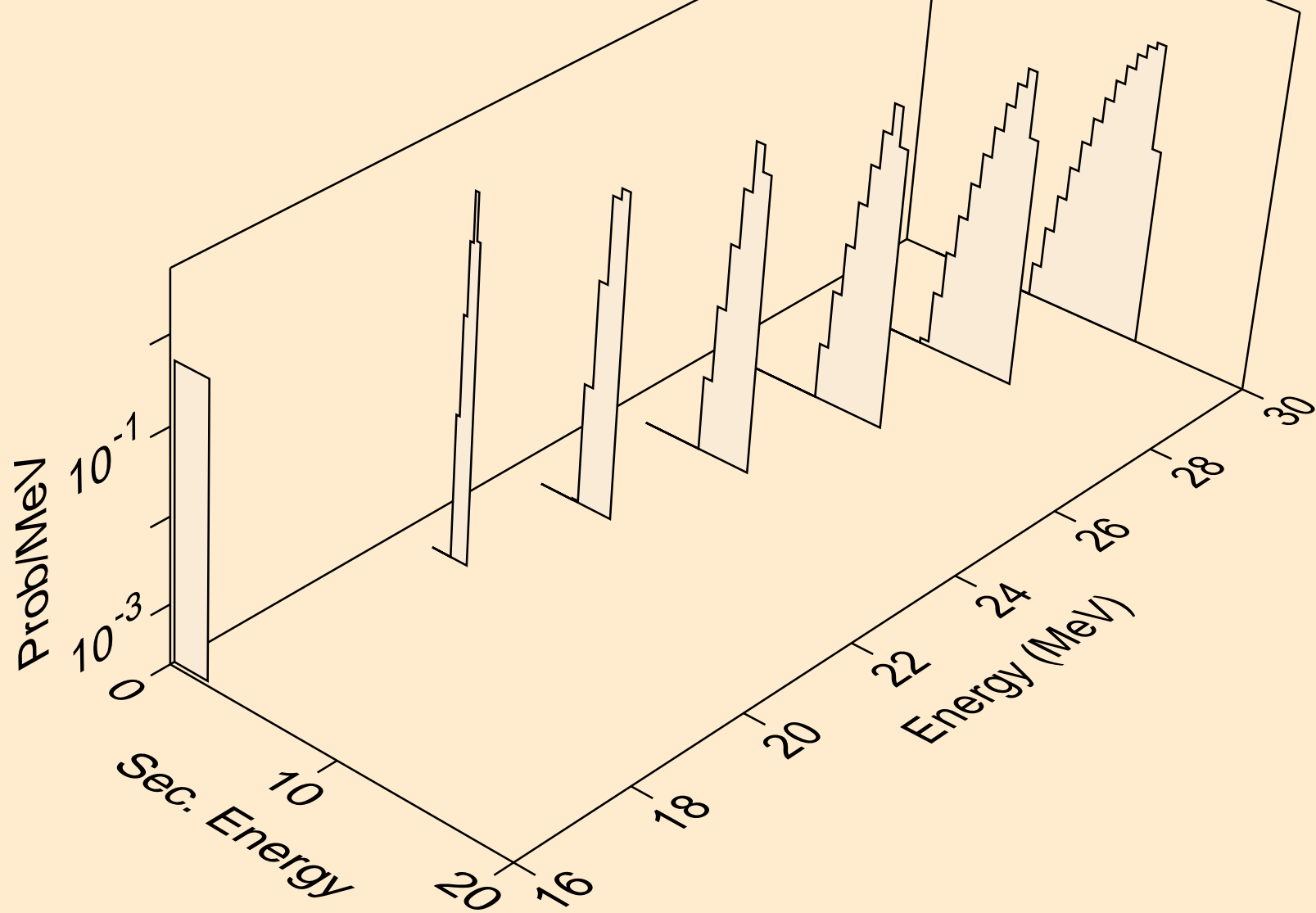

RH101 NEUTRON ACER TENDL-2023 LIBRARY; T=0.K
he3s from (n,he3)

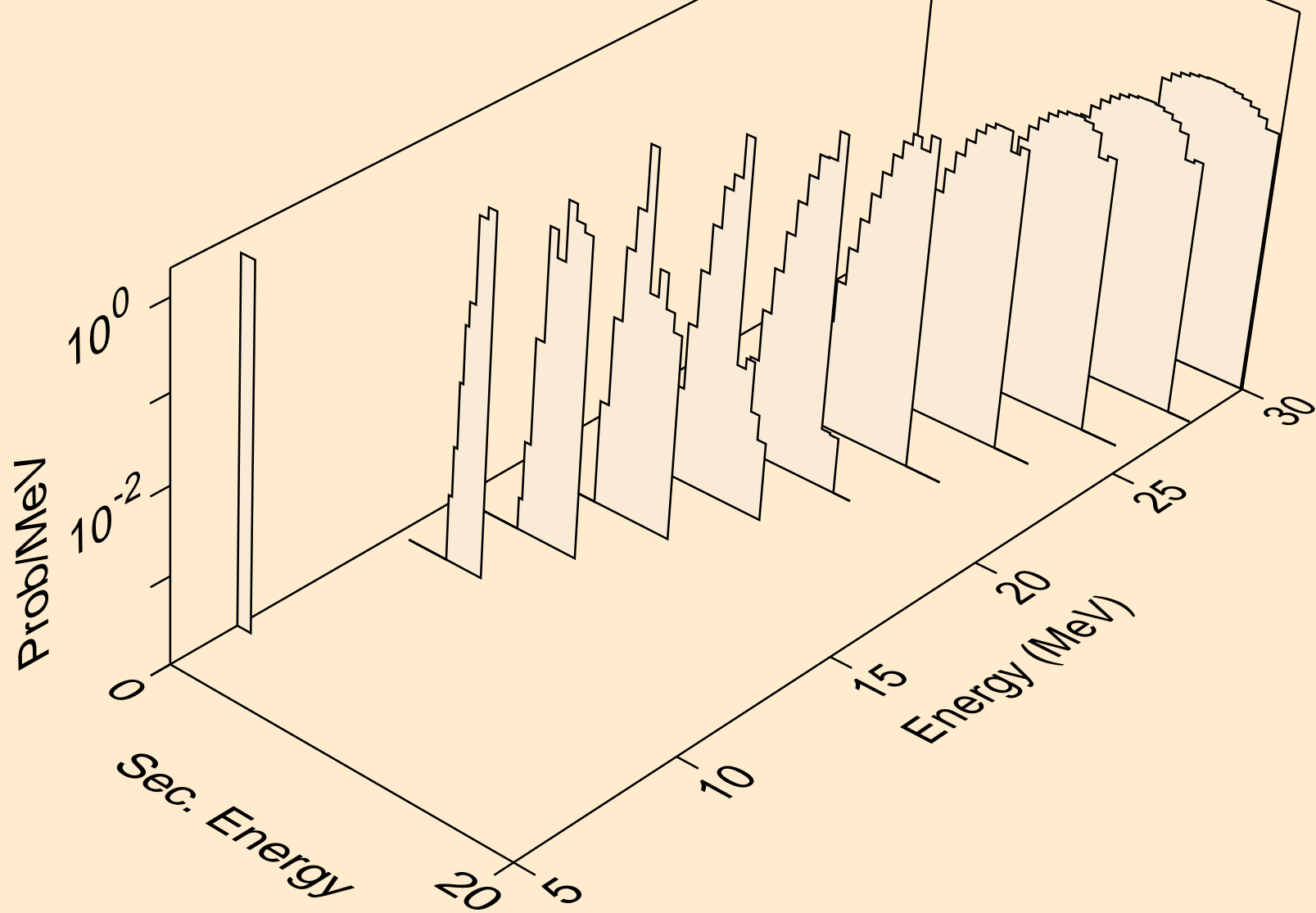

RH101 NEUTRON ACER TENDL-2023 LIBRARY; T=0.K
alphas from (n,x)

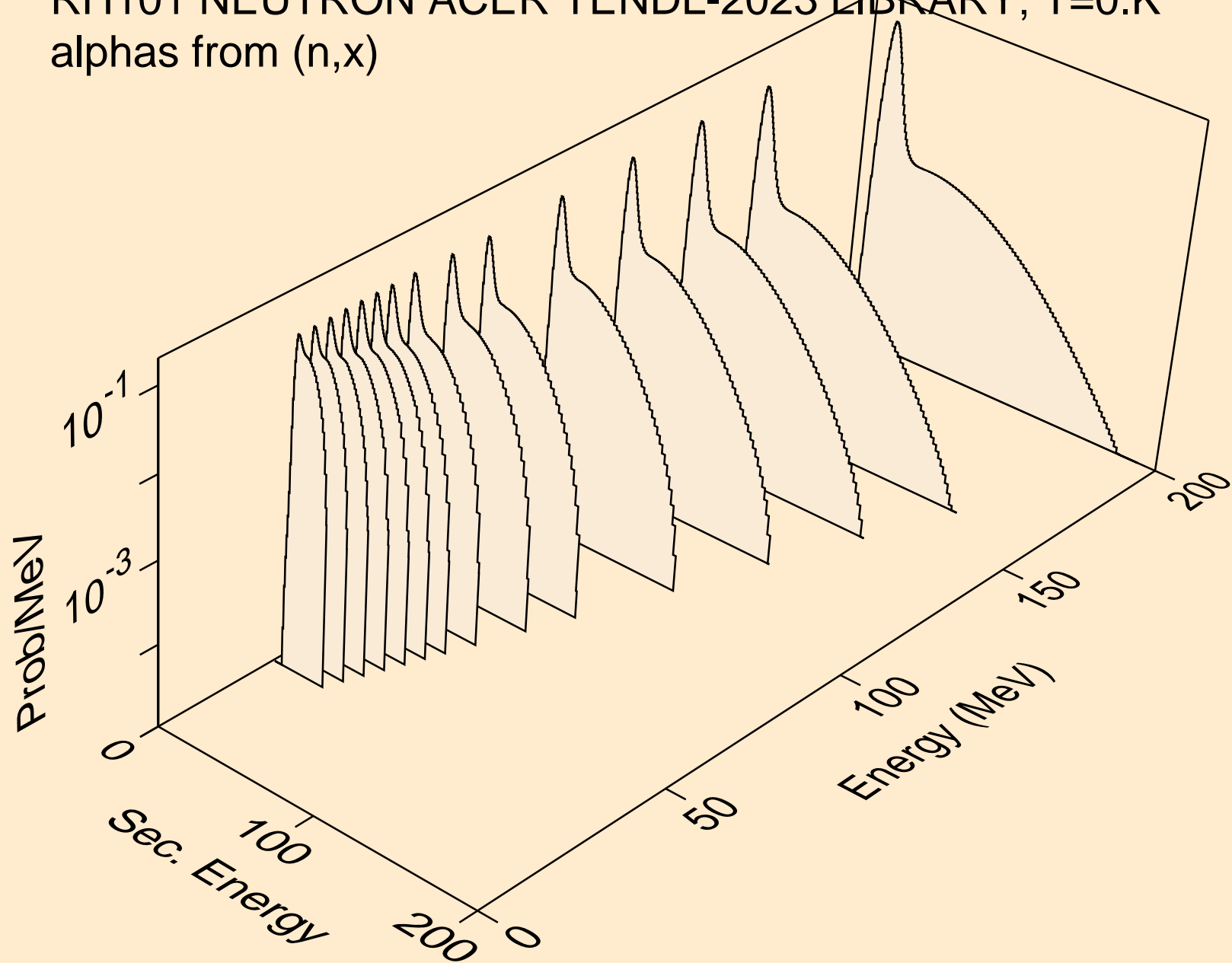

RH101 NEUTRON ACER TENDL-2023 LIBRARY; T=0.K
alphas from (n,n*)a

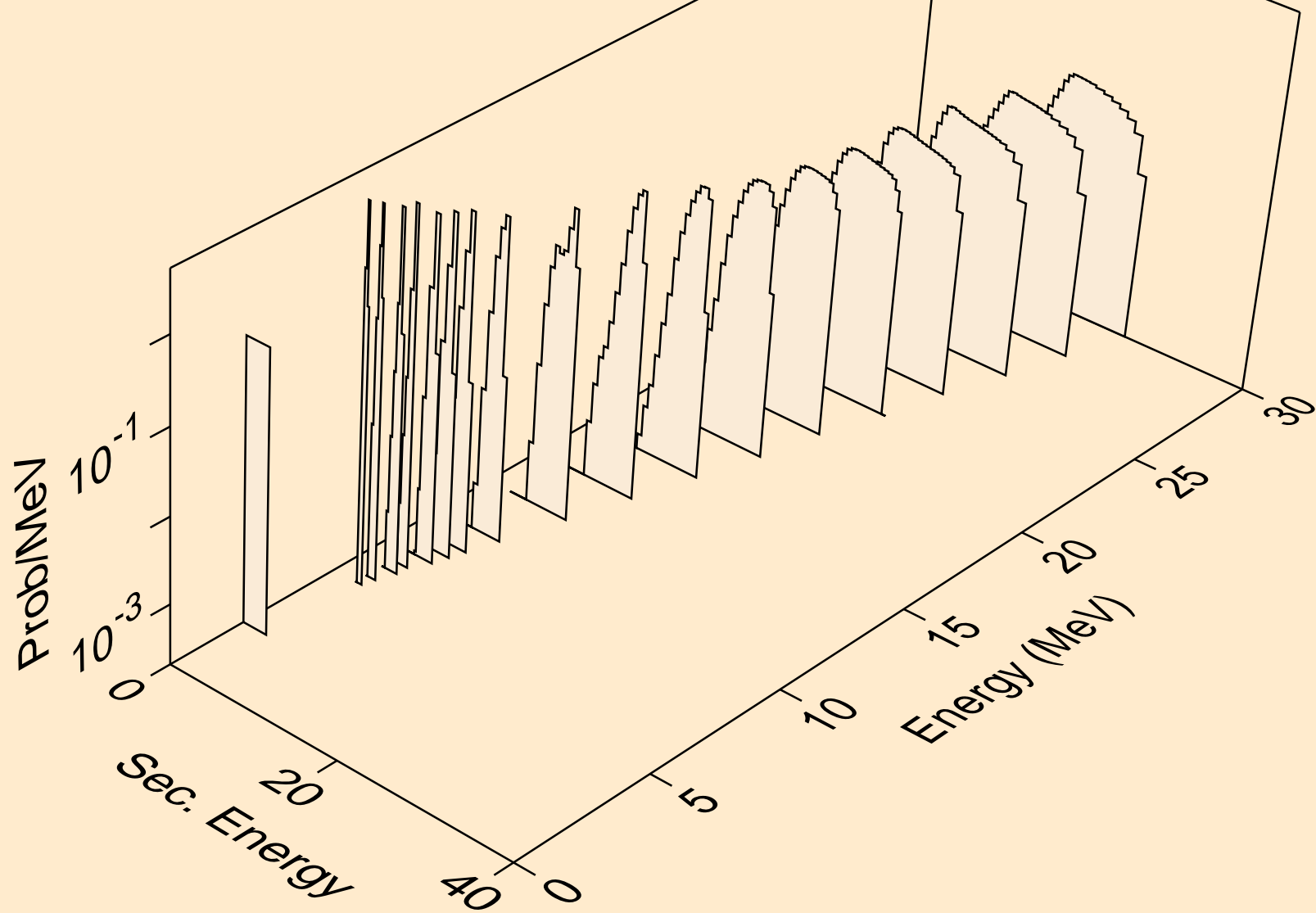

RH101 NEUTRON ACER TENDL-2023 LIBRARY; T=0.K
alphas from (n,2n)a

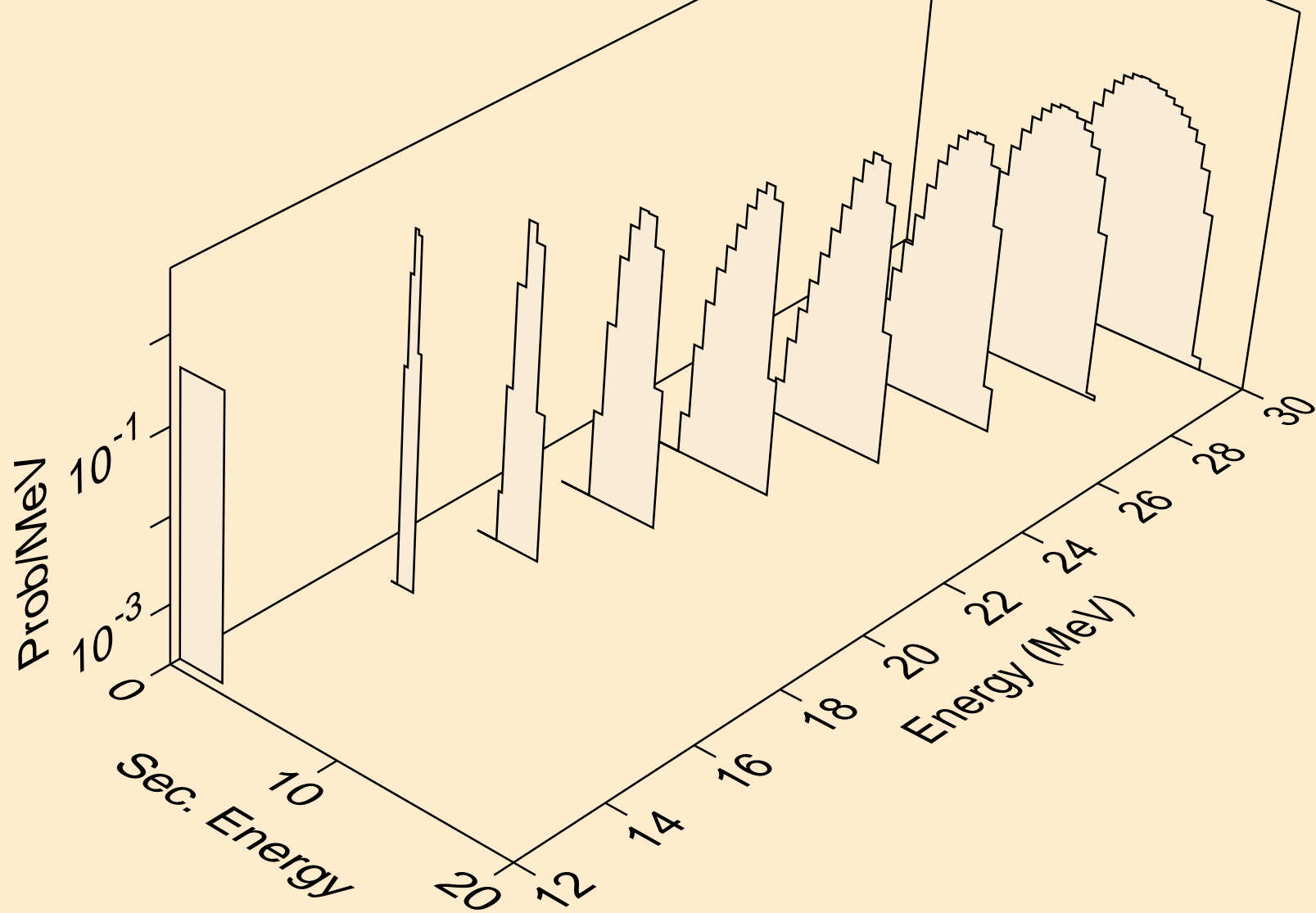

RH101 NEUTRON ACER TENDL-2023 LIBRARY; T=0.K
alphas from (n,3n)a

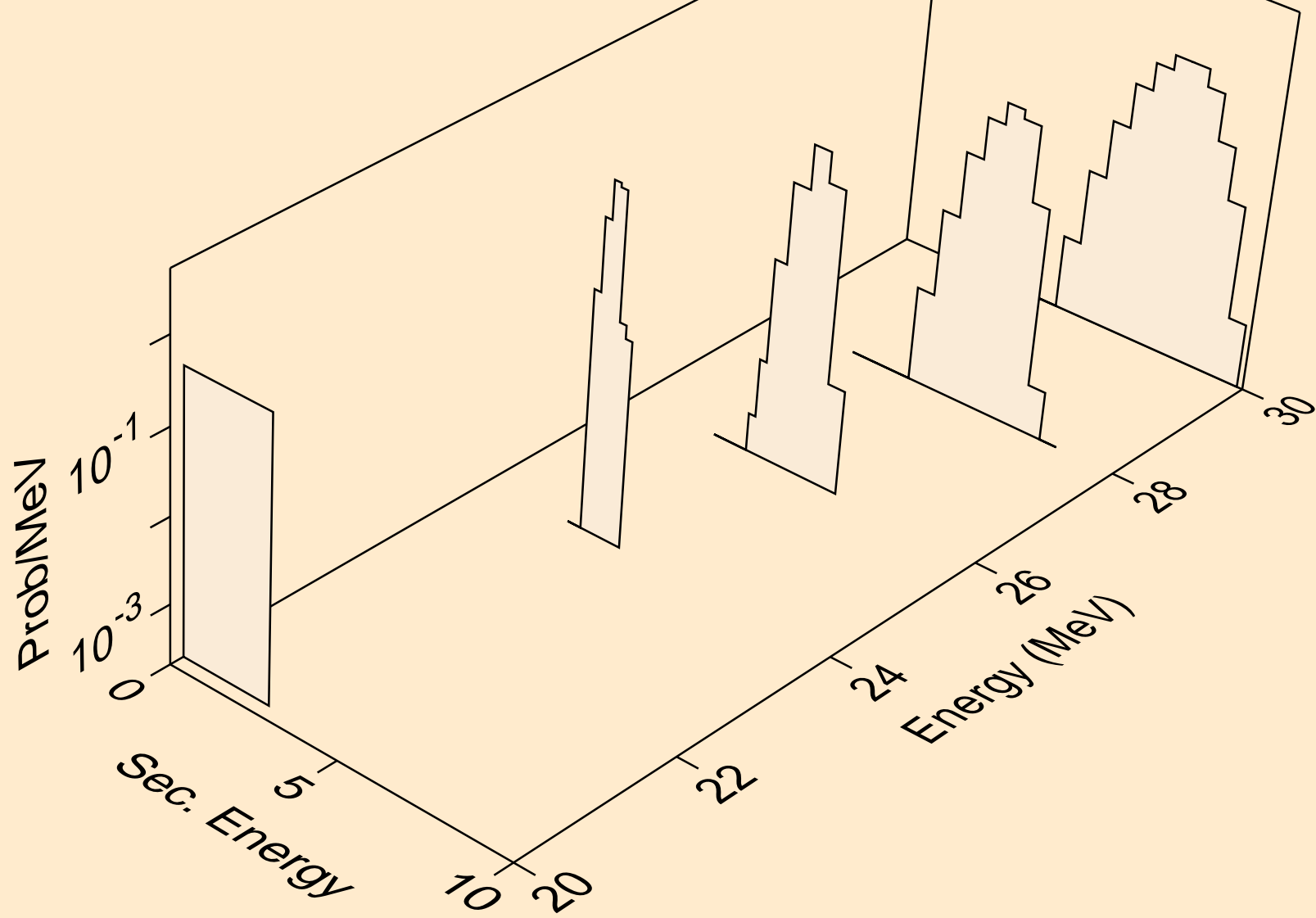

RH101 NEUTRON ACER TENDL-2023 LIBRARY; T=0.K
alphas from (n,n*)2a

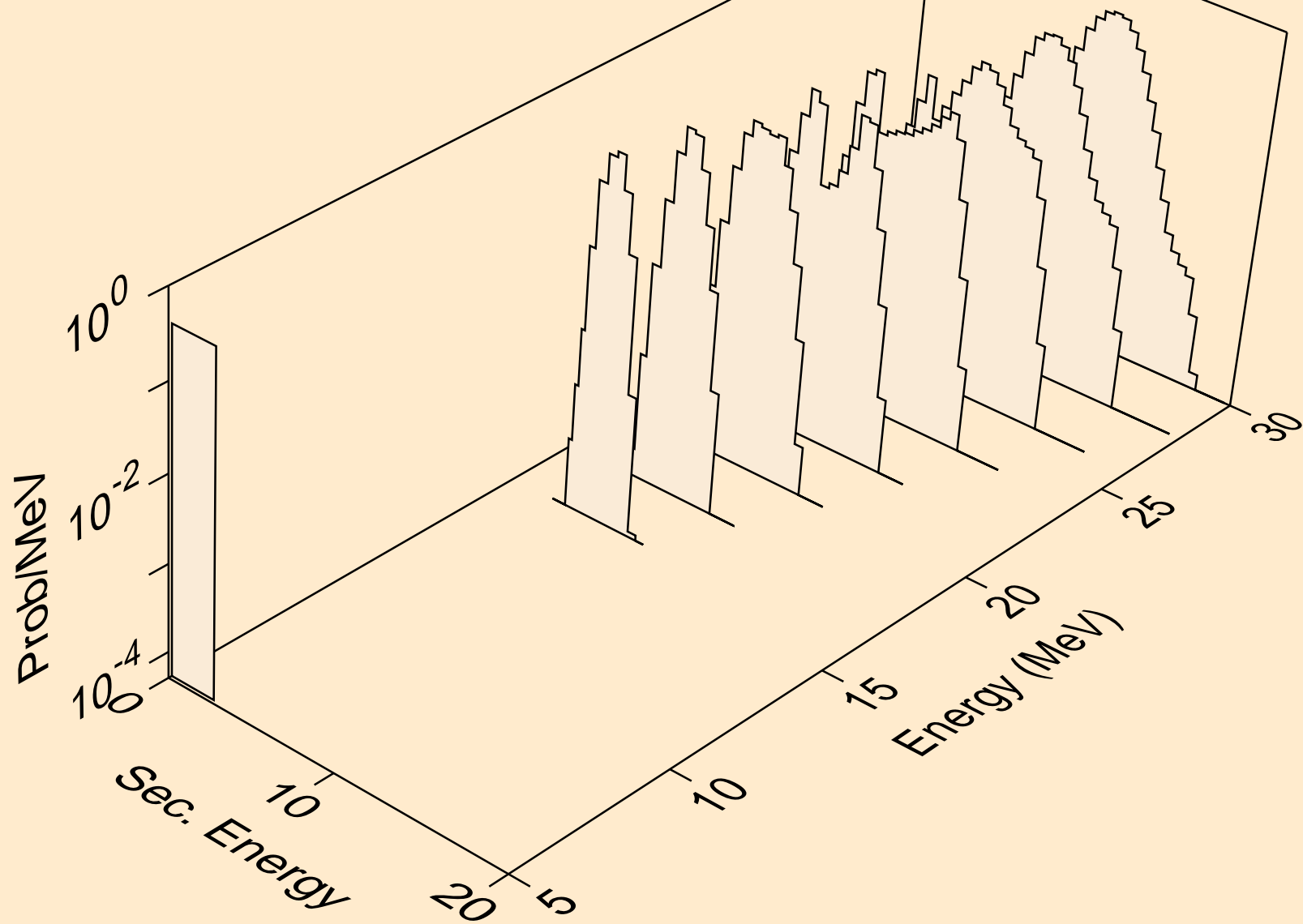

RH101 NEUTRON ACER TENDL-2023 LIBRARY; T=0.K
alphas from (n,npa)

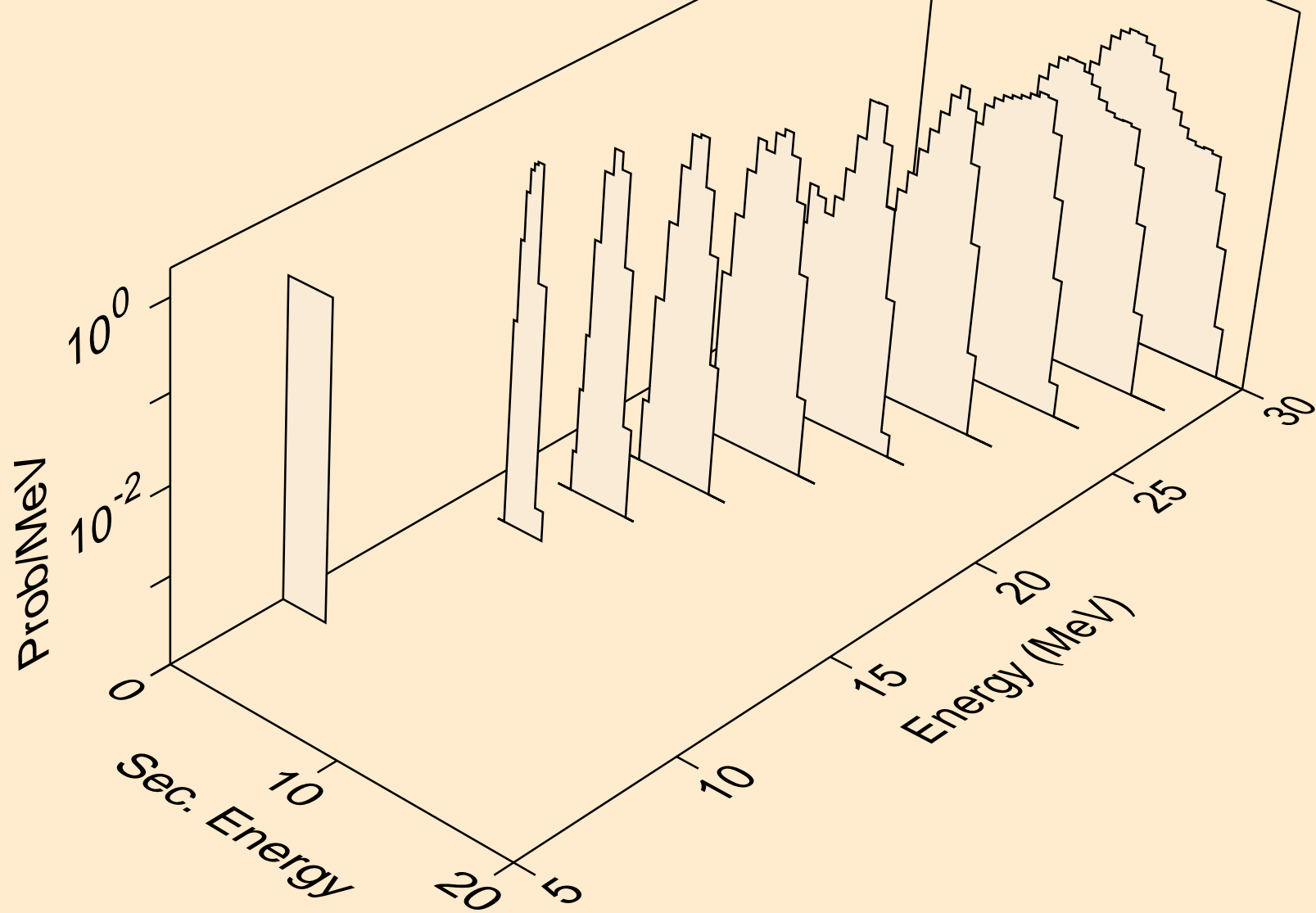

RH101 NEUTRON ACER TENDL-2023 LIBRARY; T=0.K
alphas from (n,a)

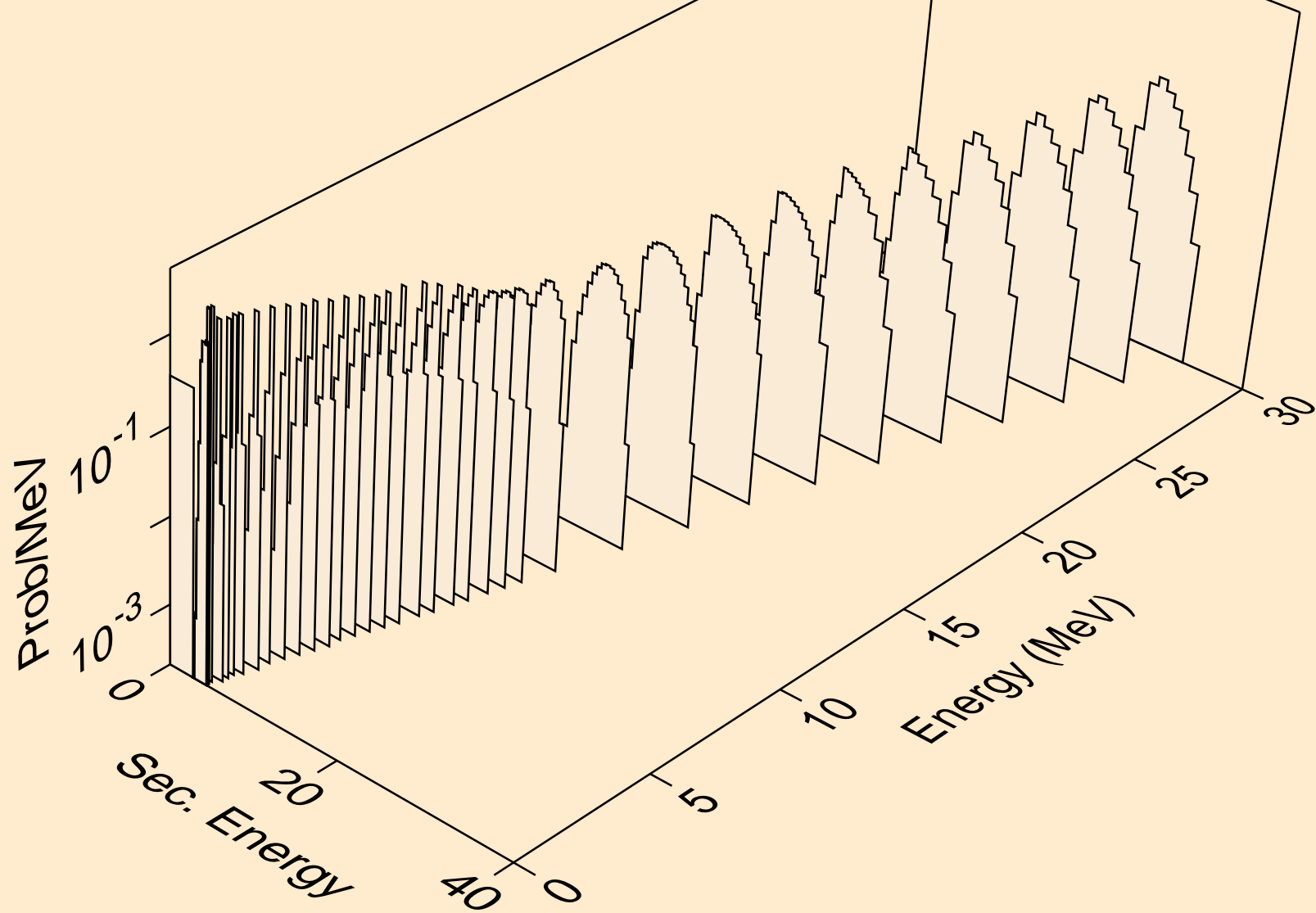

RH101 NEUTRON ACER TENDL-2023 LIBRARY; T=0.K
alphas from (n,2a)

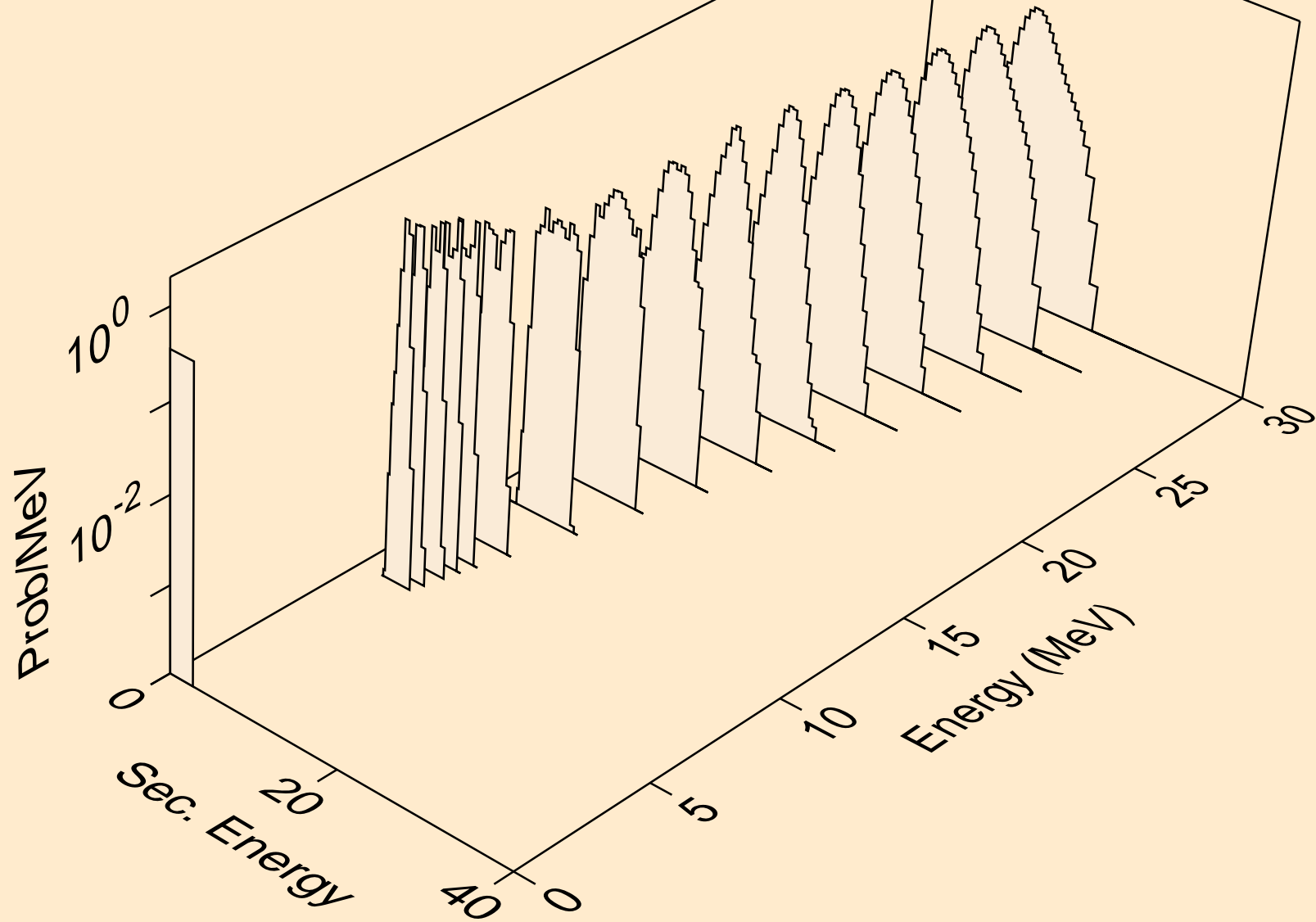

RH101 NEUTRON ACER TENDL-2023 LIBRARY; T=0.K
alphas from (n,pa)

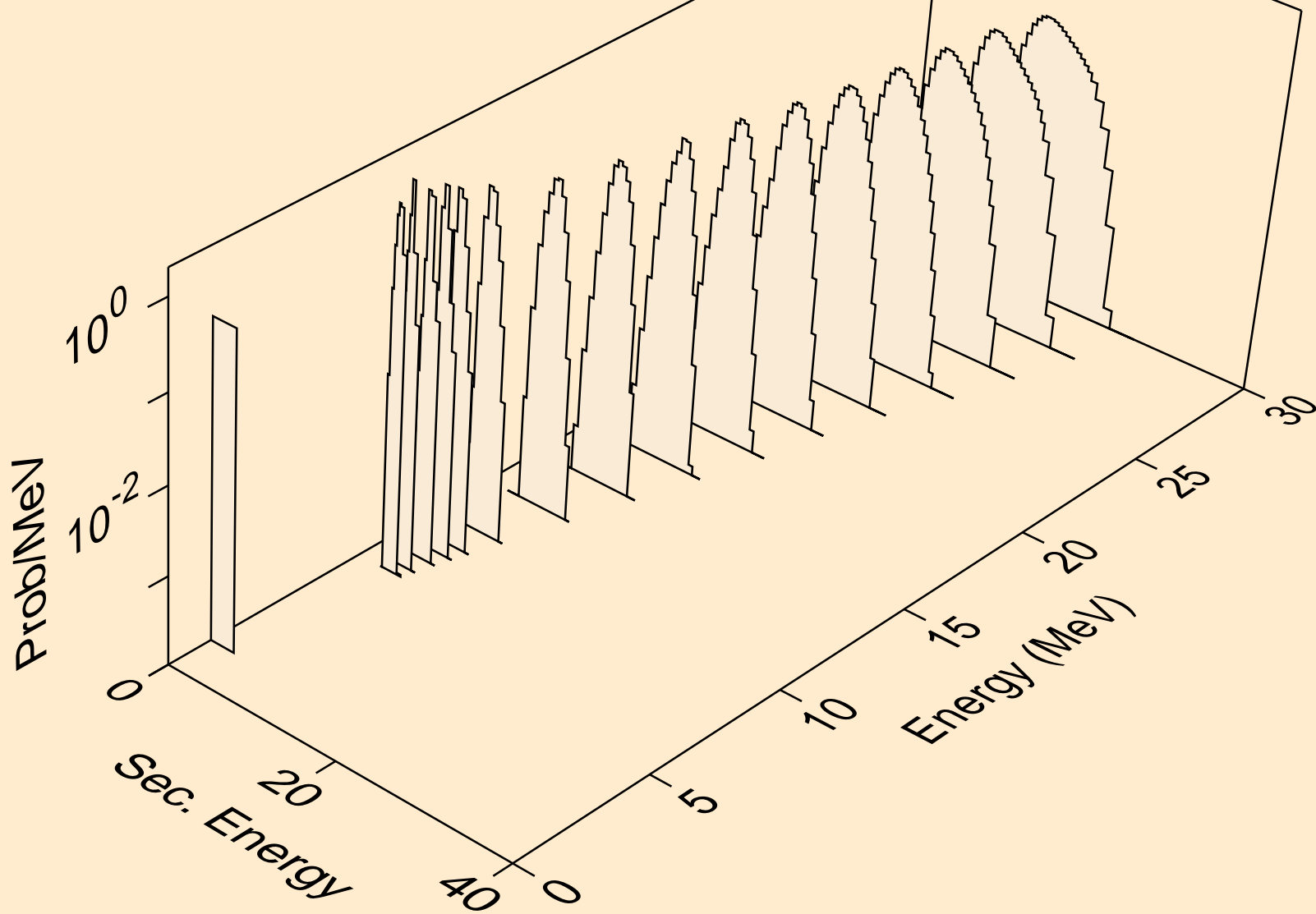

RH101 NEUTRON ACER TENDL-2023 LIBRARY; T=0.K
alphas from (n,da)

