

RN205M NEUTRON ACER TENDL-2023 LIBRARY; T=0.K
Principal cross sections

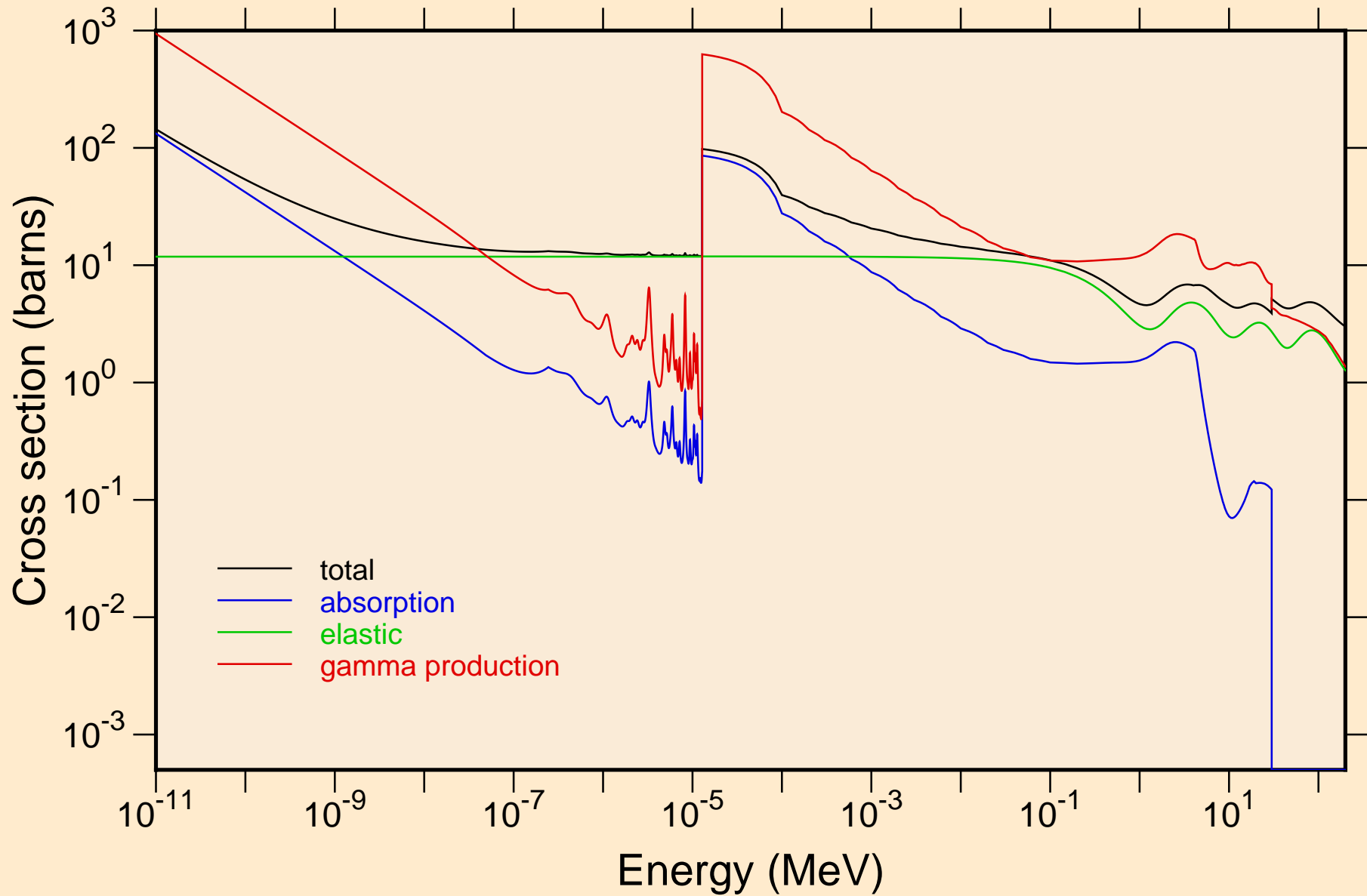

RN205M NEUTRON ACER TENDL-2023 LIBRARY; T=0.K
resonance total cross section

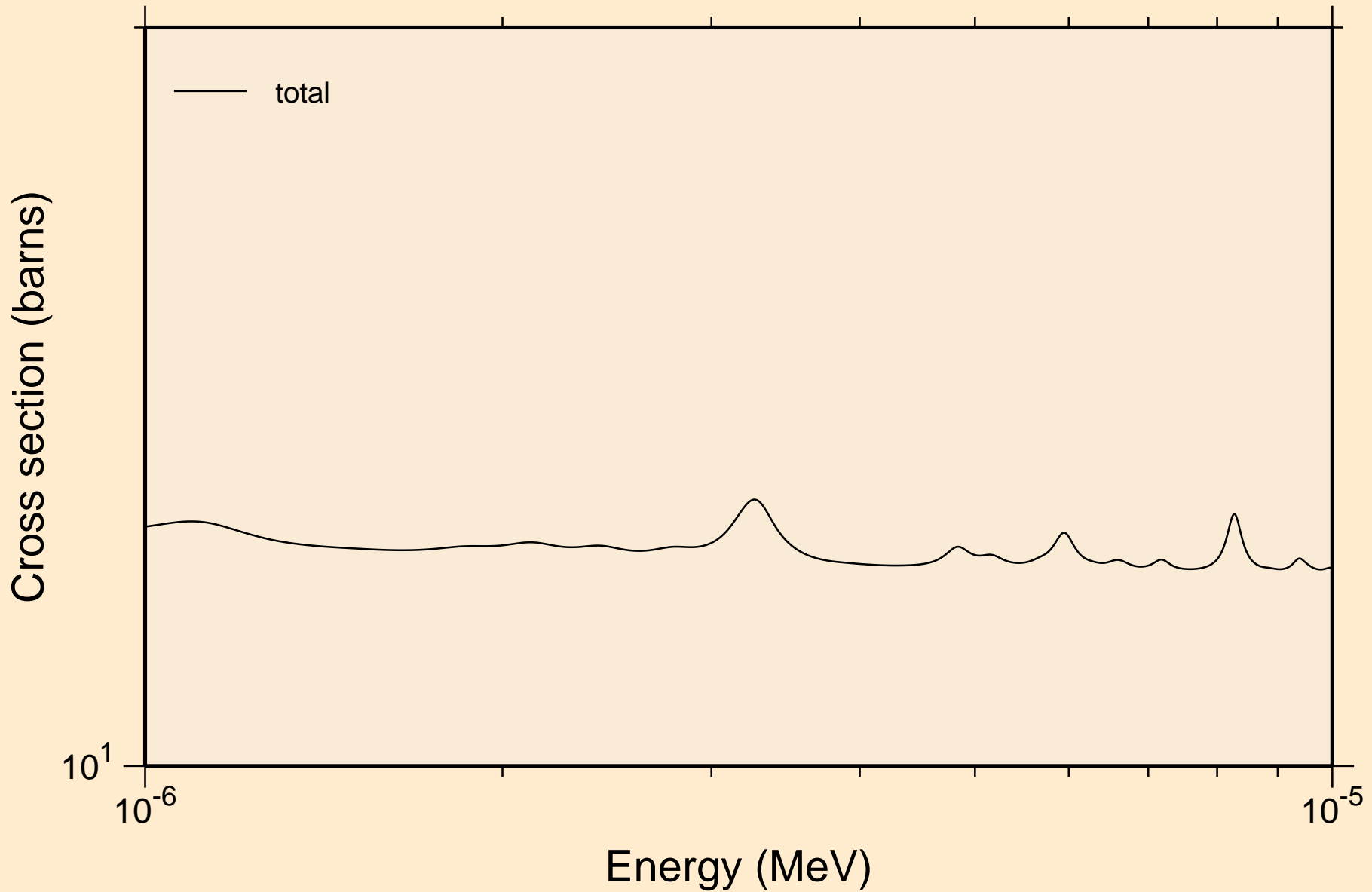

RN205M NEUTRON ACER TENDL-2023 LIBRARY; T=0.K
resonance total cross section

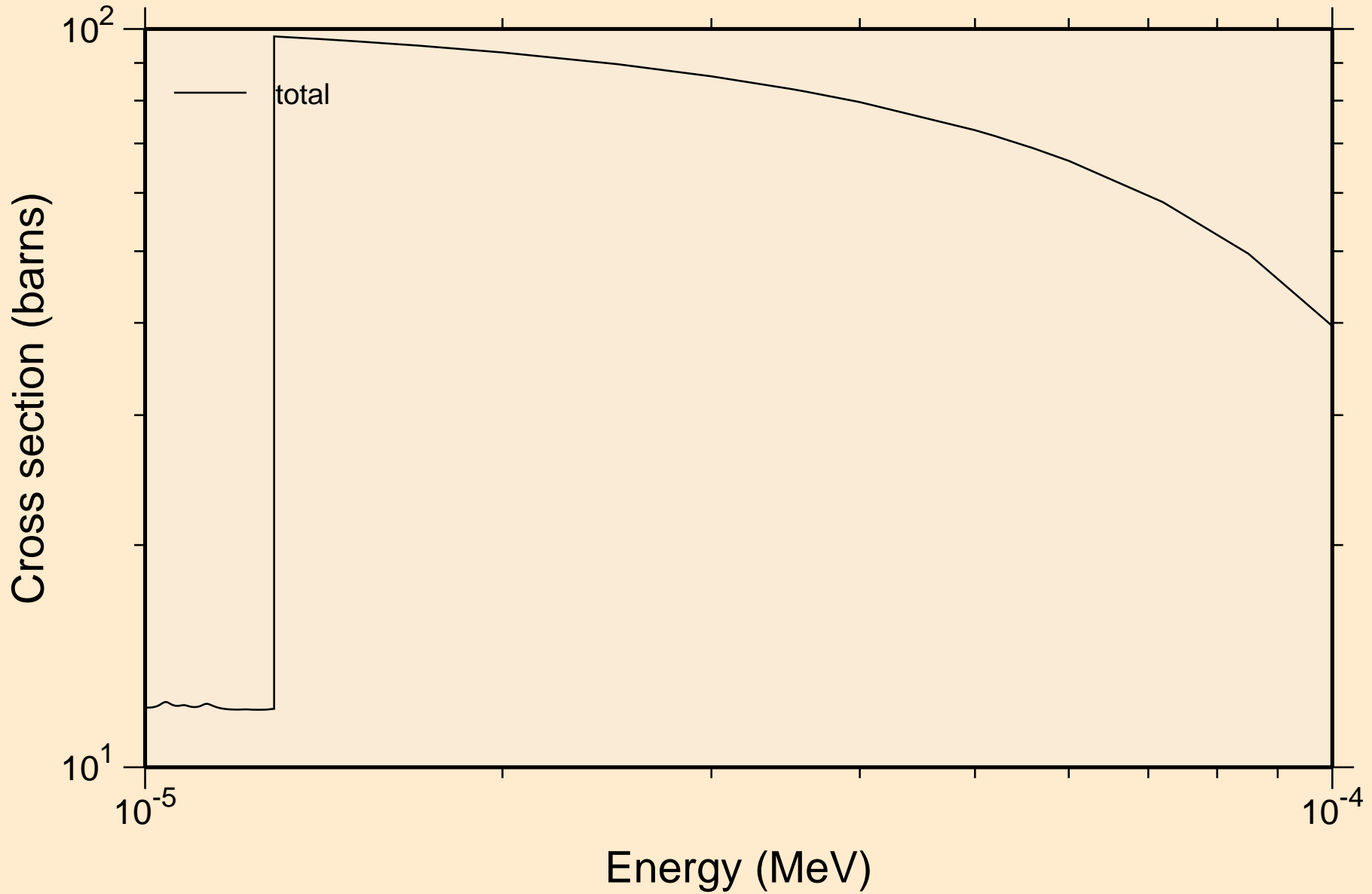

RN205M NEUTRON ACER TENDL-2023 LIBRARY; T=0.K
resonance total cross section

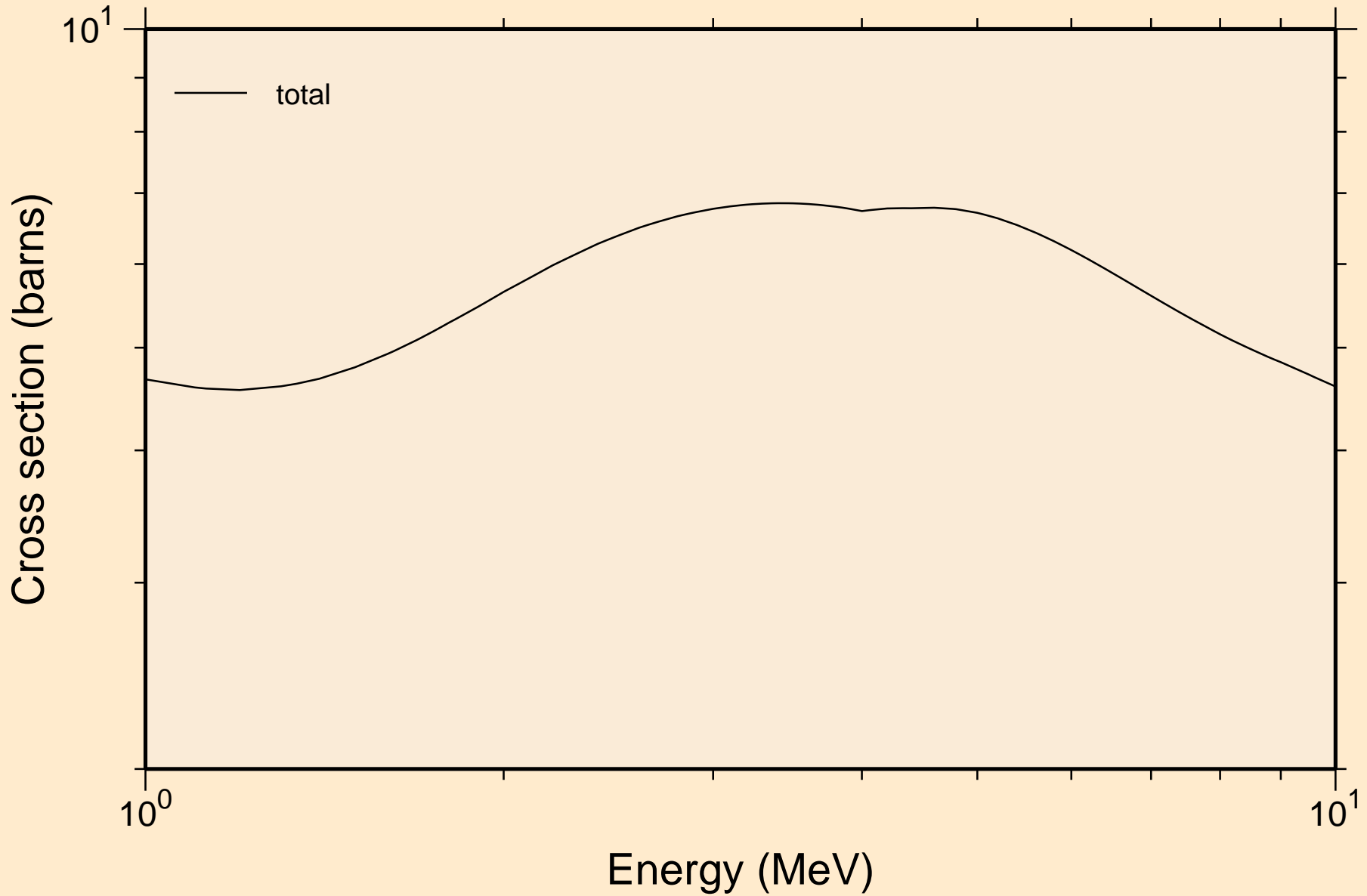

RN205M NEUTRON ACER TENDL-2023 LIBRARY; T=0.K
resonance absorption cross sections

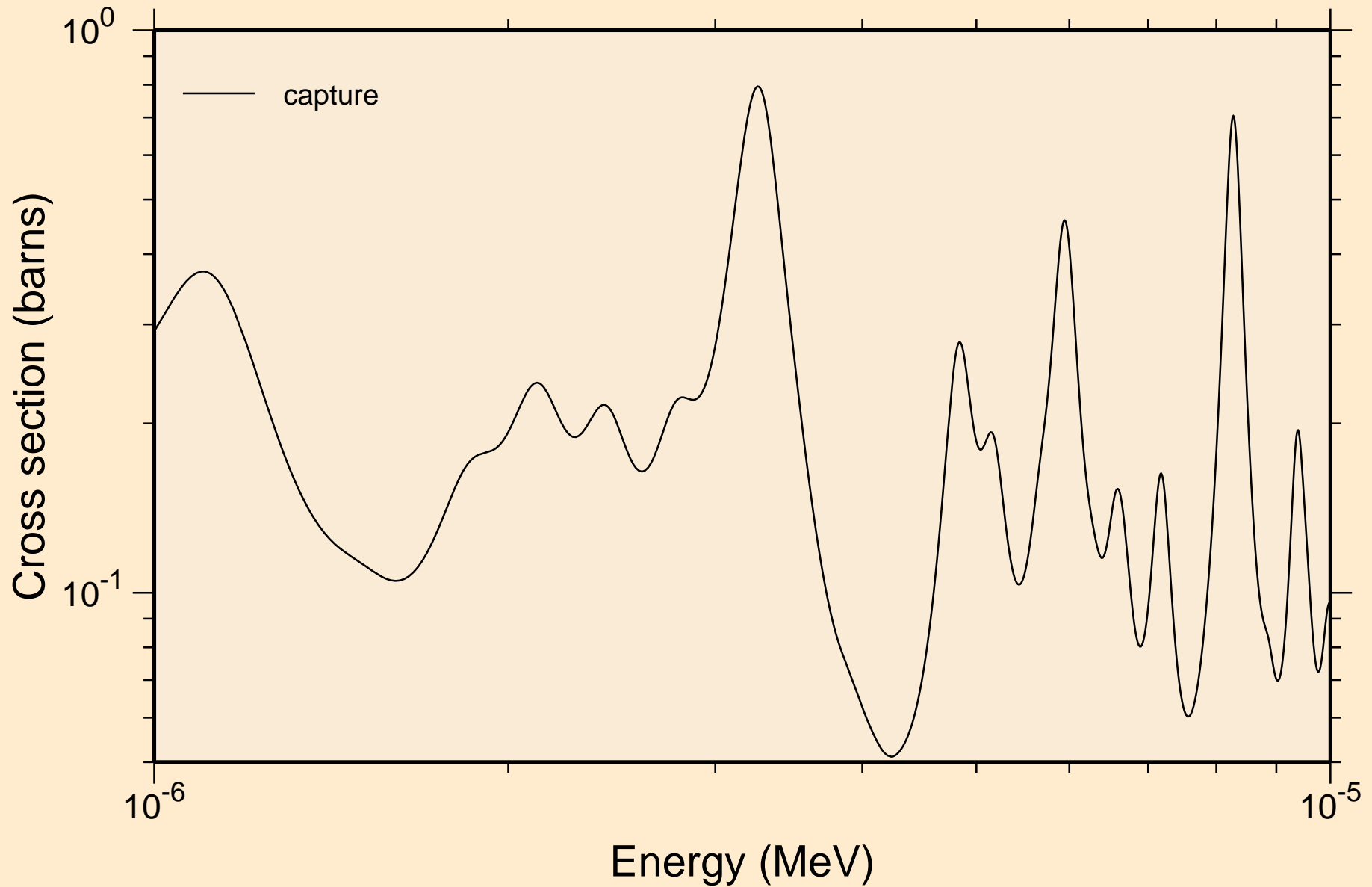

RN205M NEUTRON ACER TENDL-2023 LIBRARY; T=0.K
resonance absorption cross sections

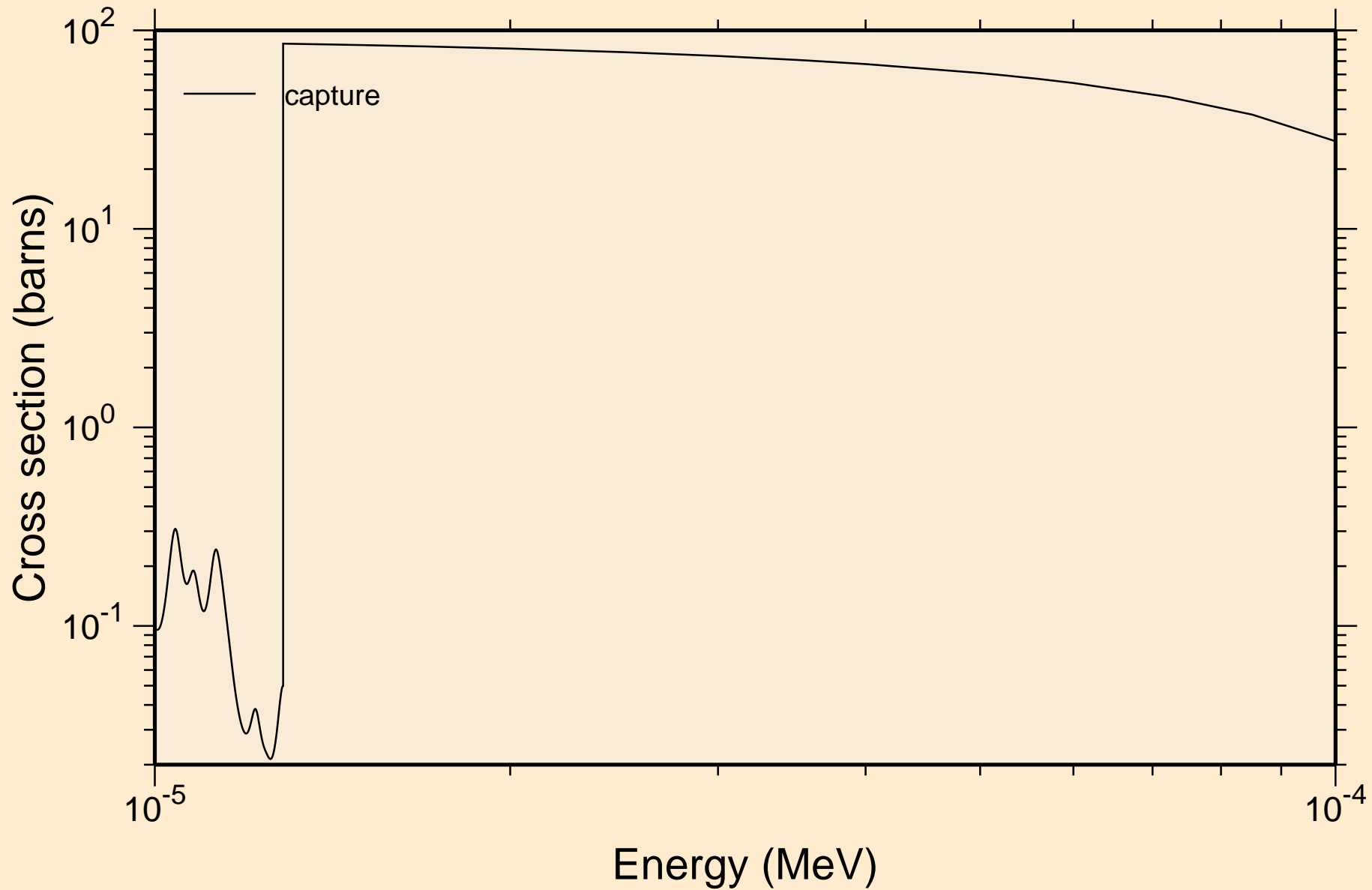

RN205M NEUTRON ACER TENDL-2023 LIBRARY; T=0.K
resonance absorption cross sections

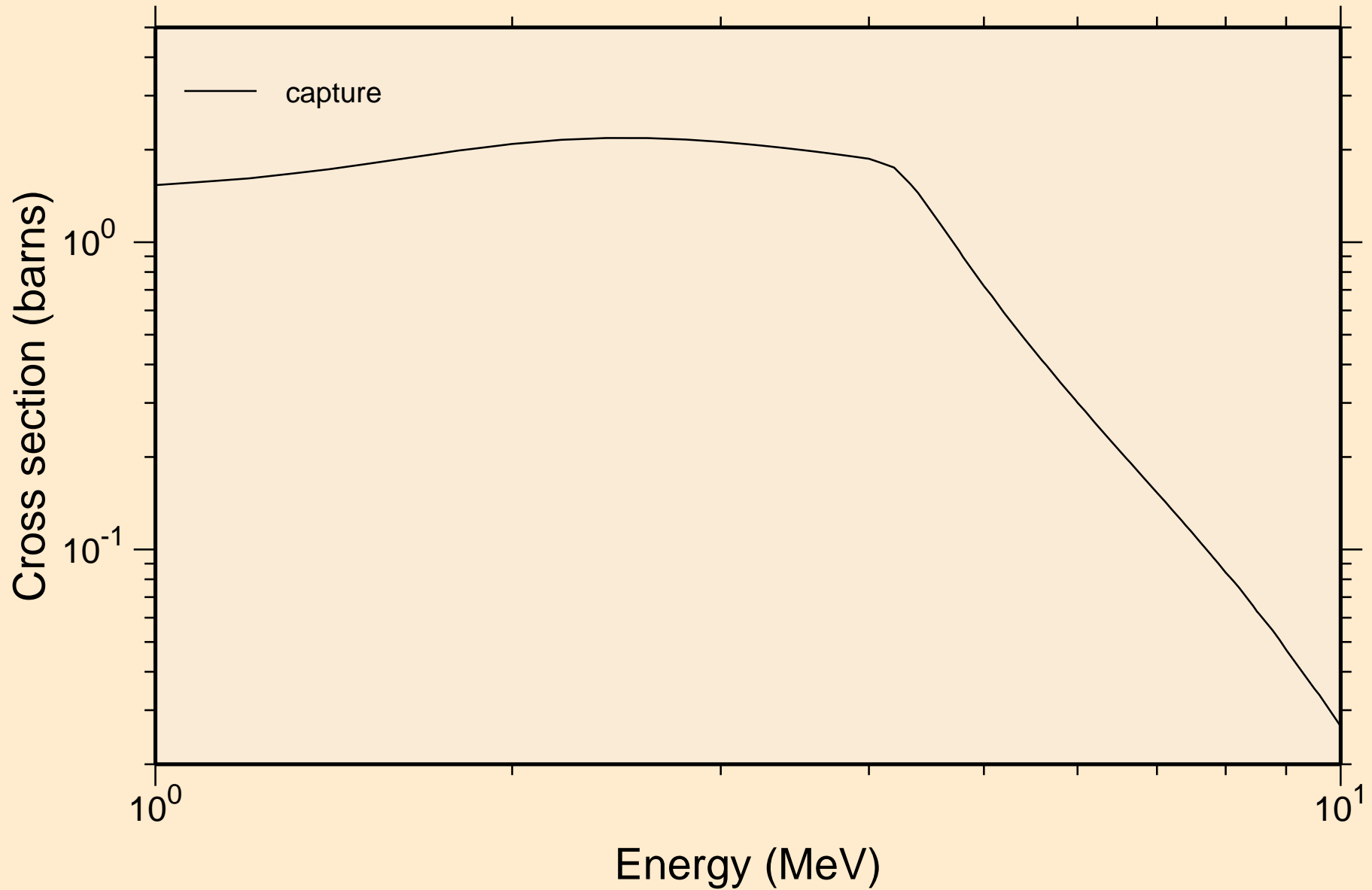

RN205M NEUTRON ACER TENDL-2023 LIBRARY; T=0.K

Heating

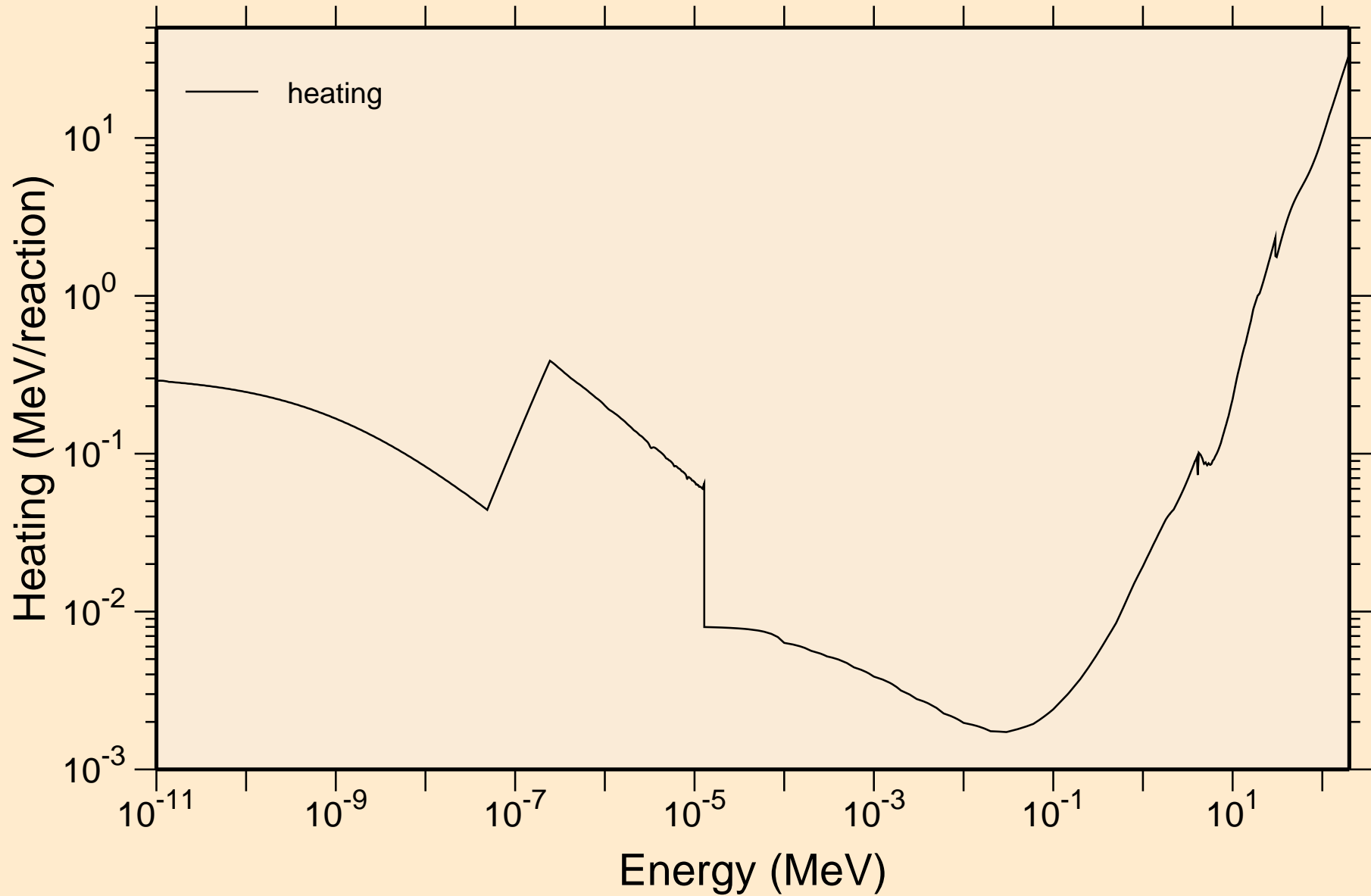

RN205M NEUTRON ACER TENDL-2023 LIBRARY; T=0.K
Damage

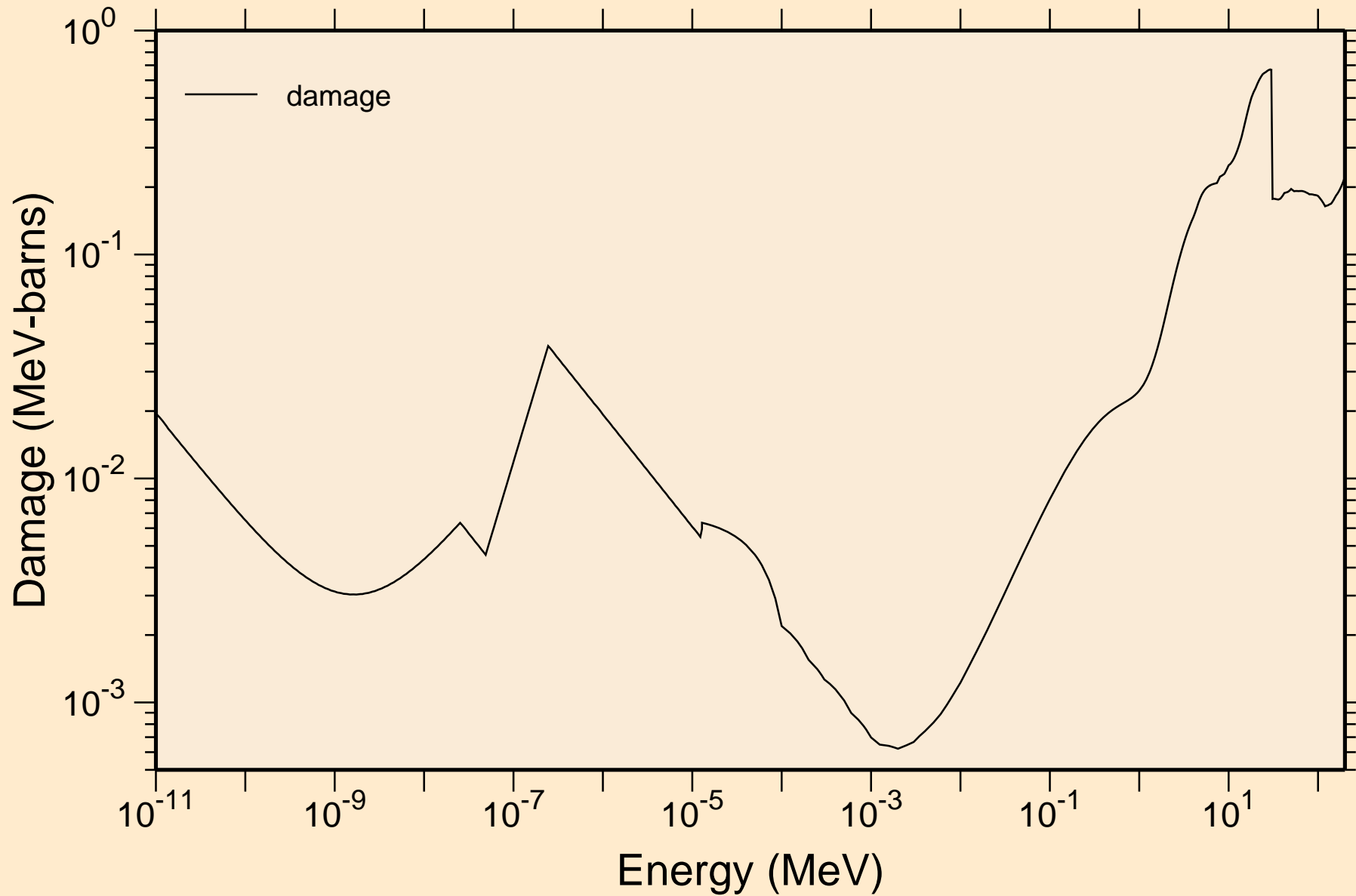

RN205M NEUTRON ACER TENDL-2023 LIBRARY; T=0.K

Non-threshold reactions

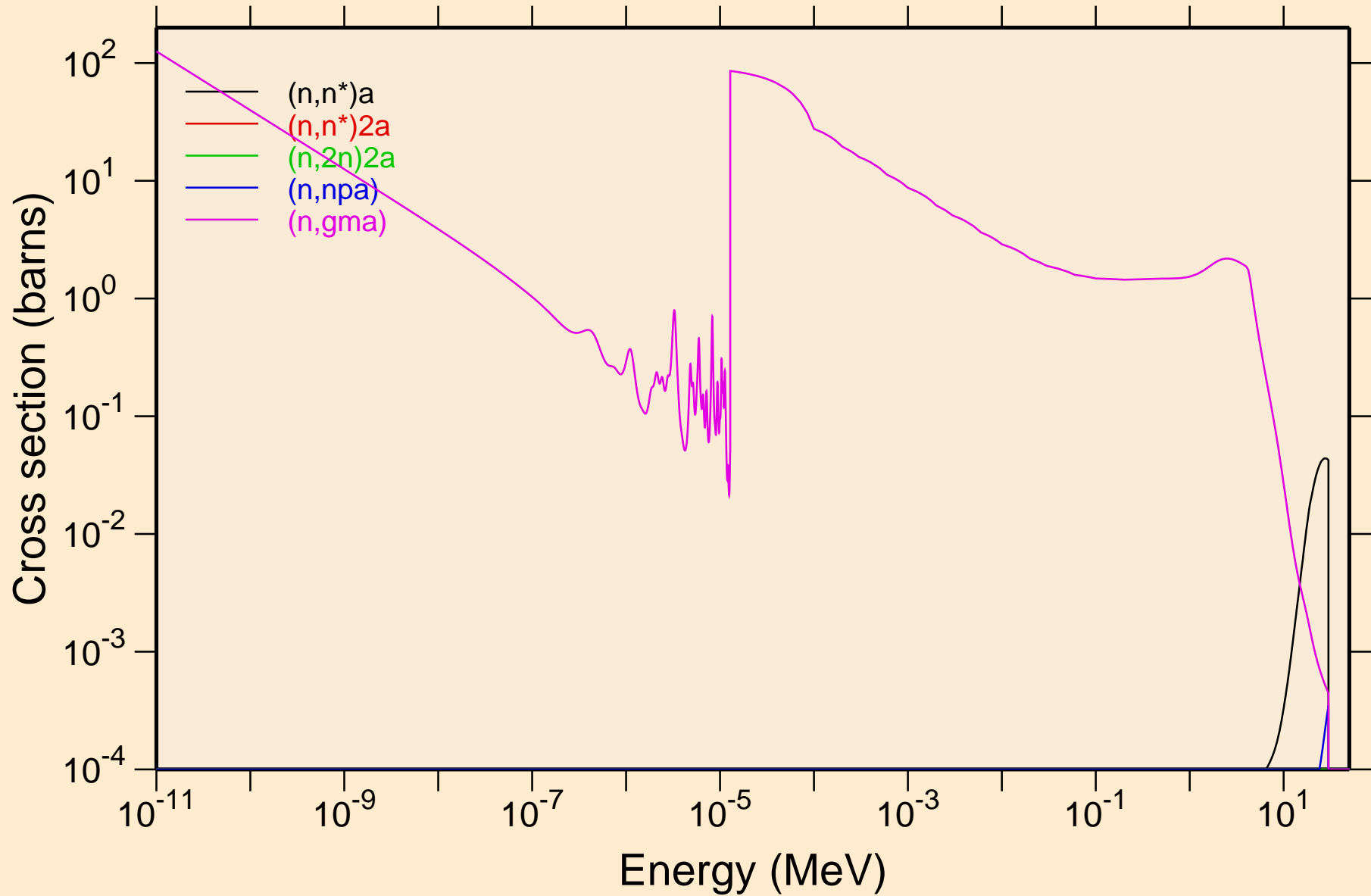

RN205M NEUTRON ACER TENDL-2023 LIBRARY; T=0.K
Non-threshold reactions

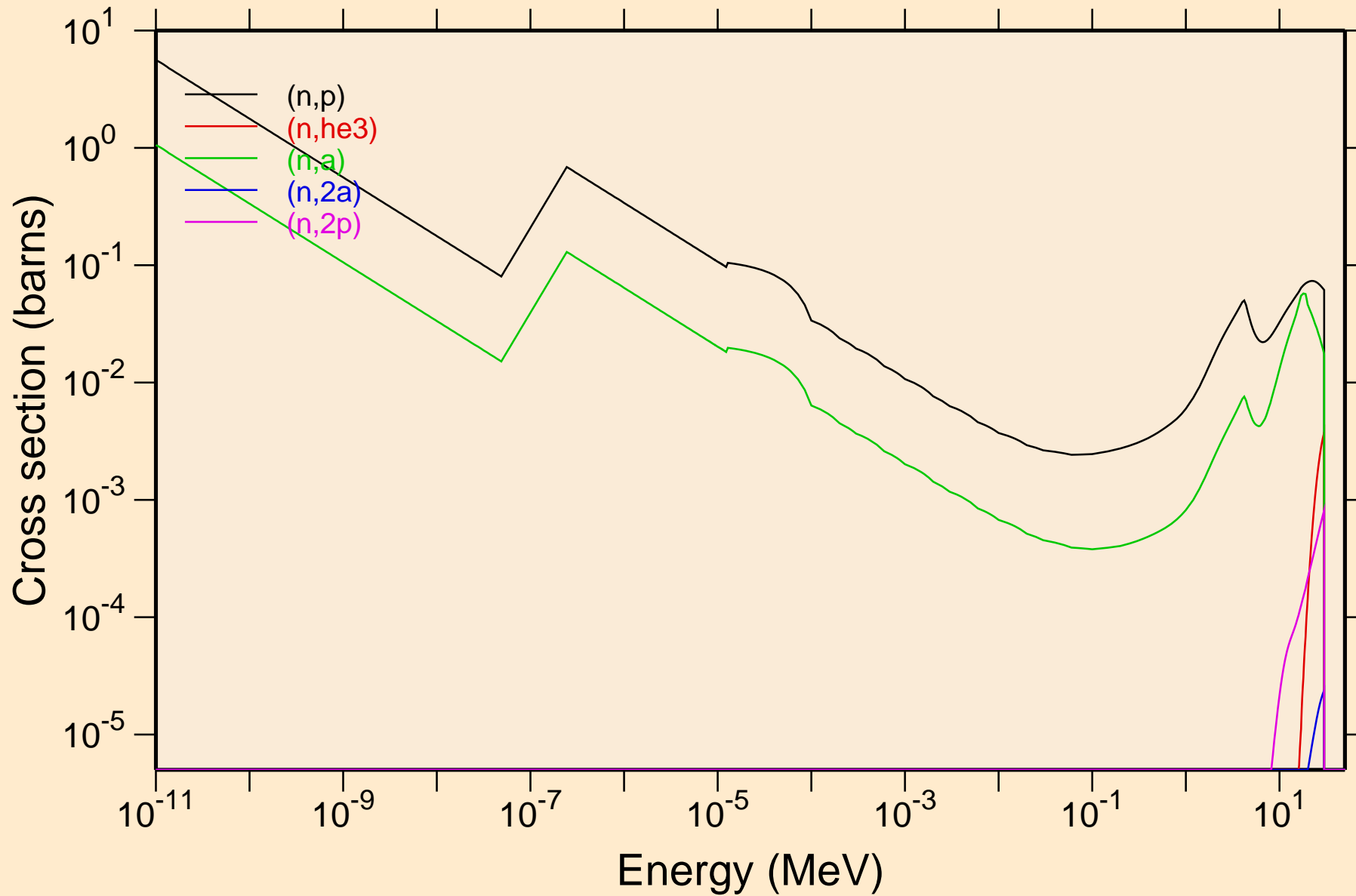

RN205M NEUTRON ACER TENDL-2023 LIBRARY; T=0.K

Non-threshold reactions

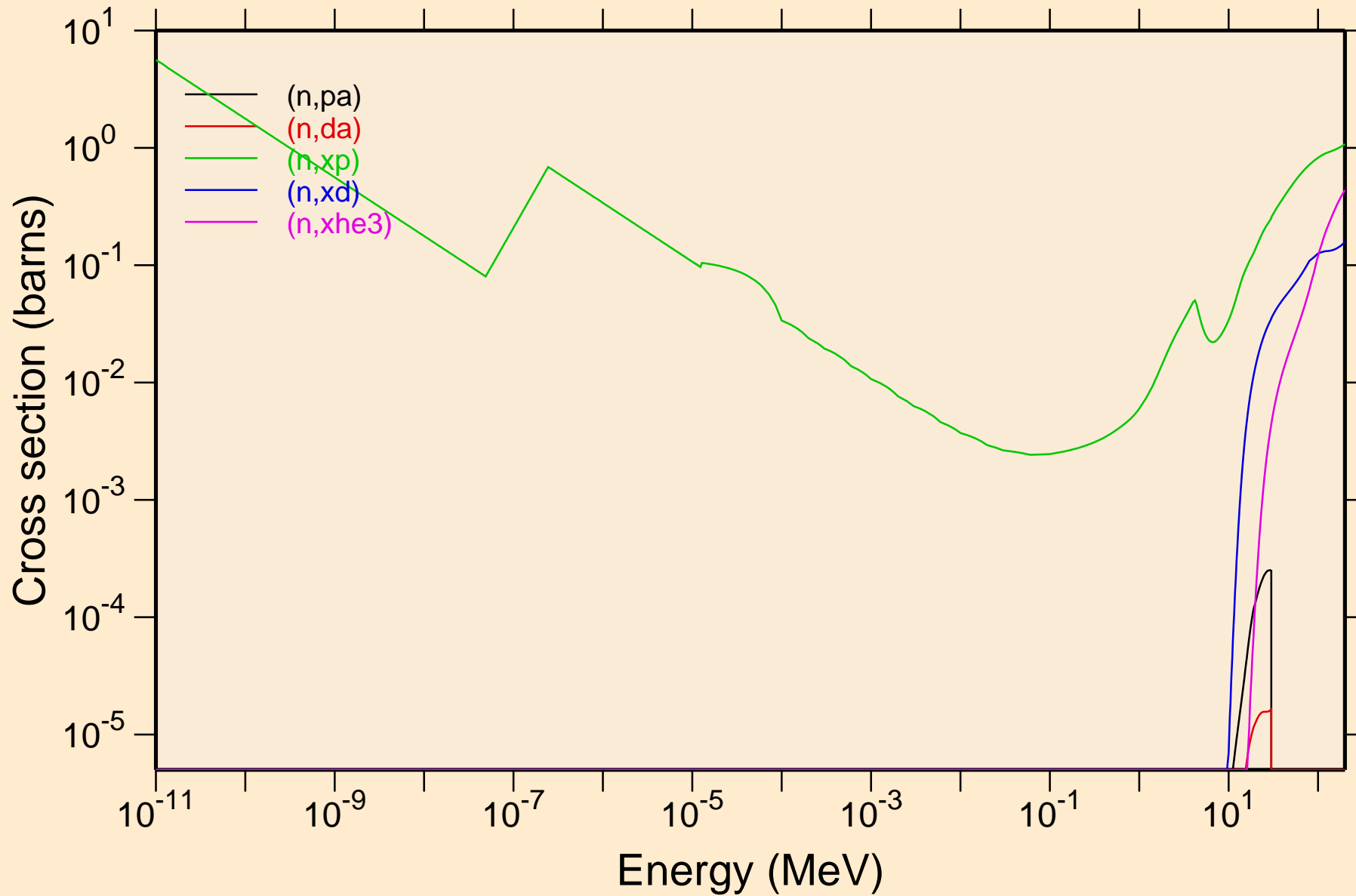

RN205M NEUTRON ACER TENDL-2023 LIBRARY; T=0.K
Non-threshold reactions

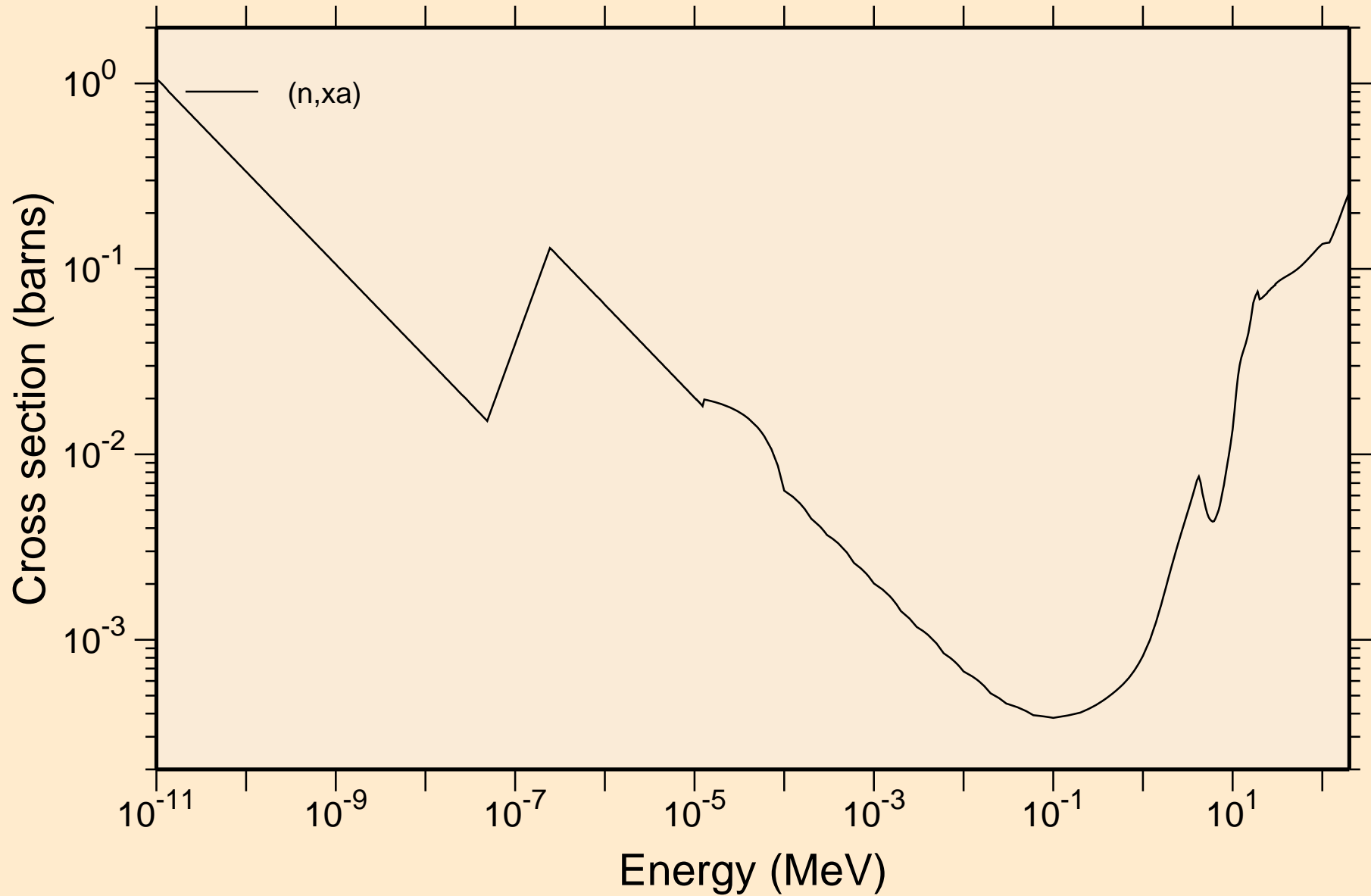

RN205M NEUTRON ACER TENDL-2023 LIBRARY; T=0.K

Principal cross sections

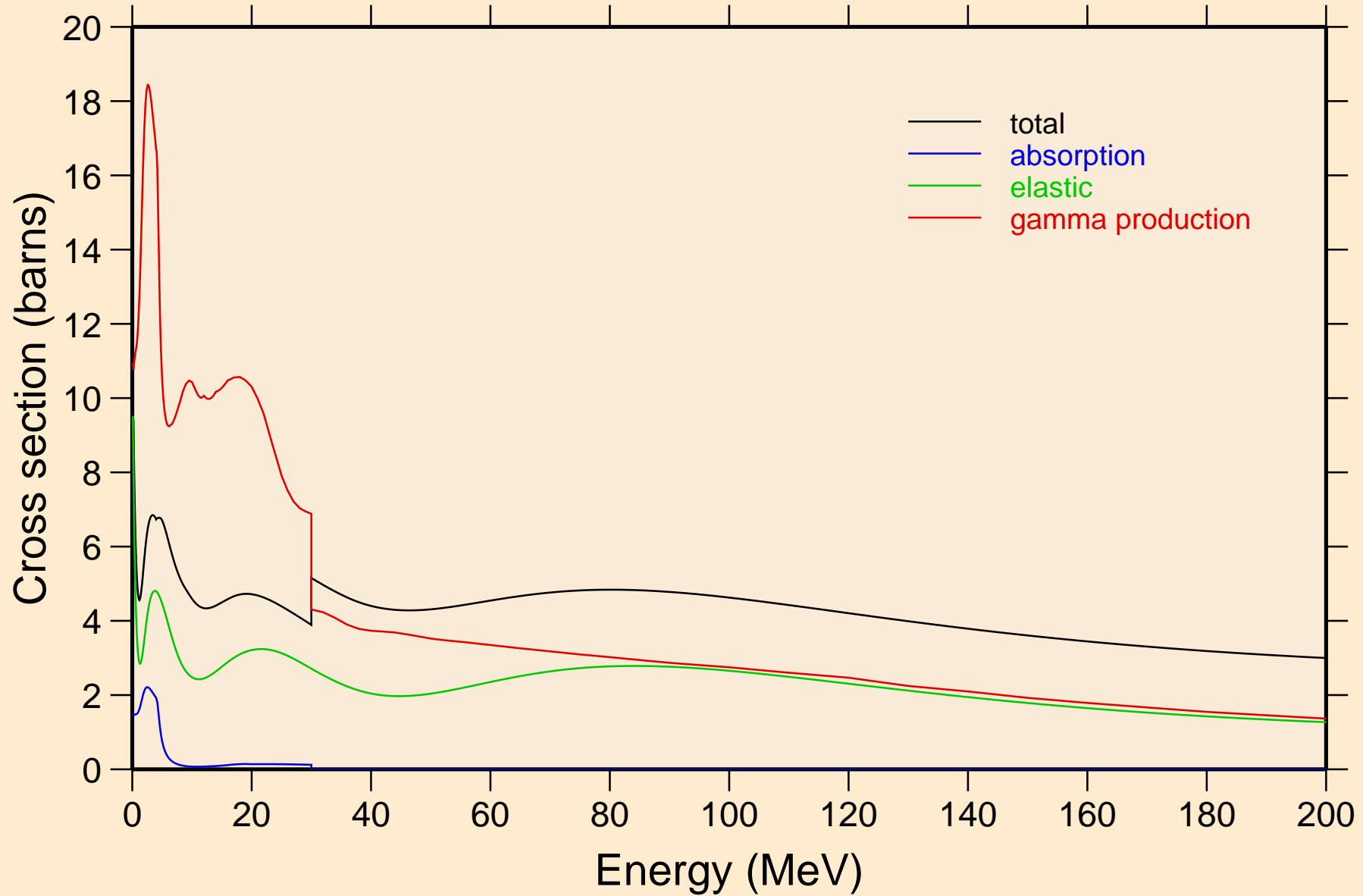

RN205M NEUTRON ACER TENDL-2023 LIBRARY; T=0.K

Heating

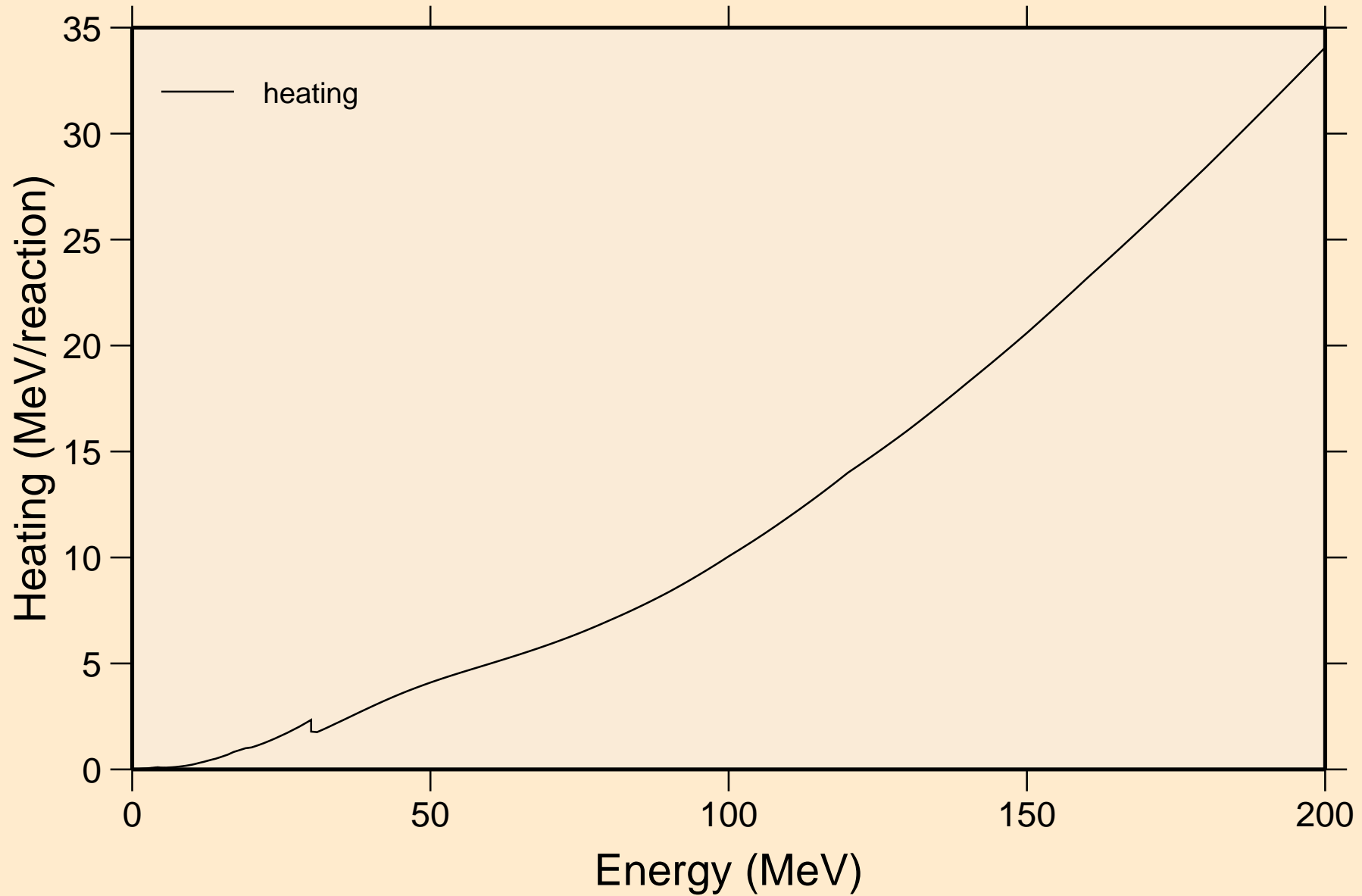

RN205M NEUTRON ACER TENDL-2023 LIBRARY; T=0.K

Damage

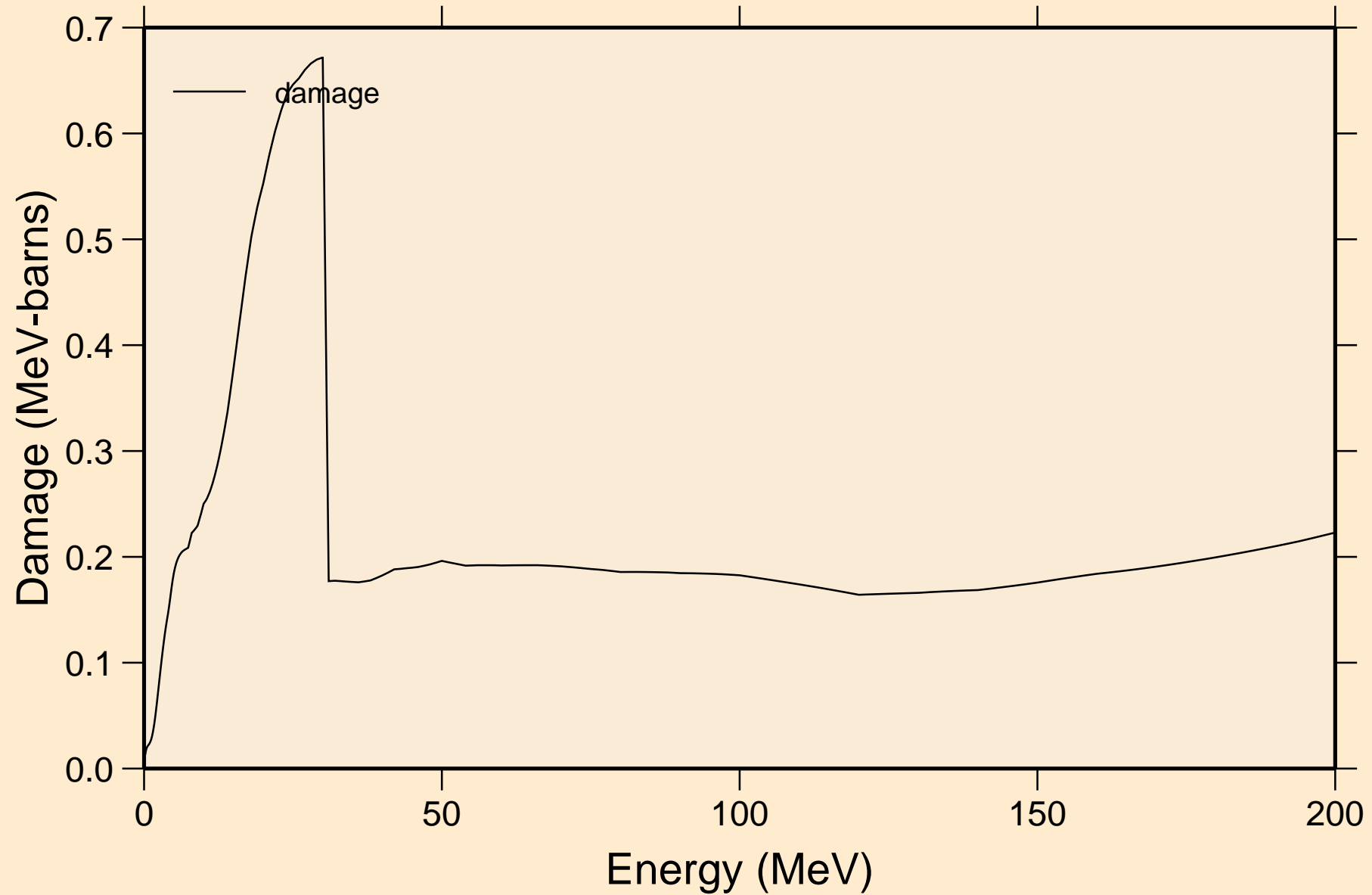

RN205M NEUTRON ACER TENDL-2023 LIBRARY; T=0.K

Non-threshold reactions

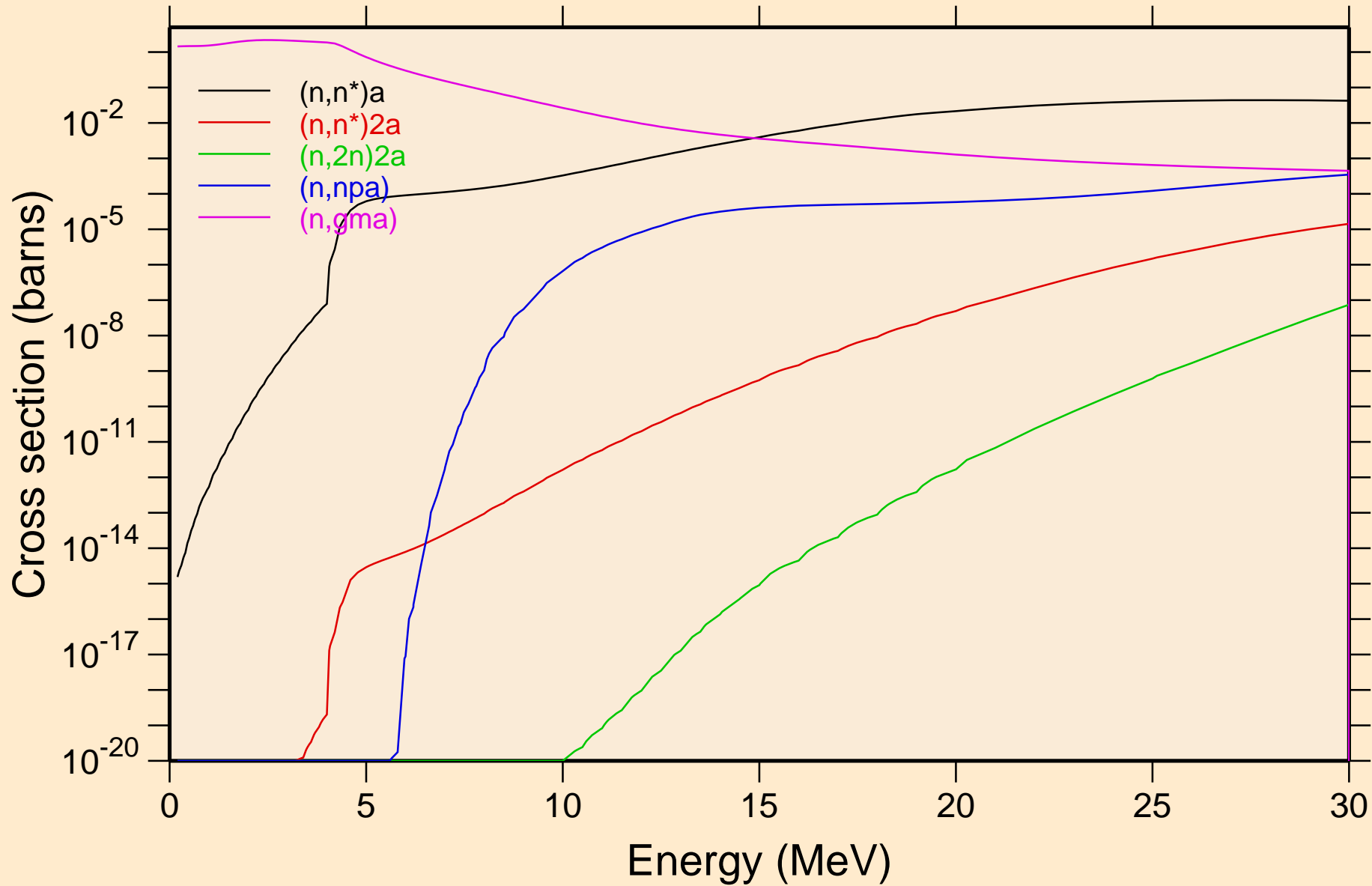

RN205M NEUTRON ACER TENDL-2023 LIBRARY; T=0.K
Non-threshold reactions

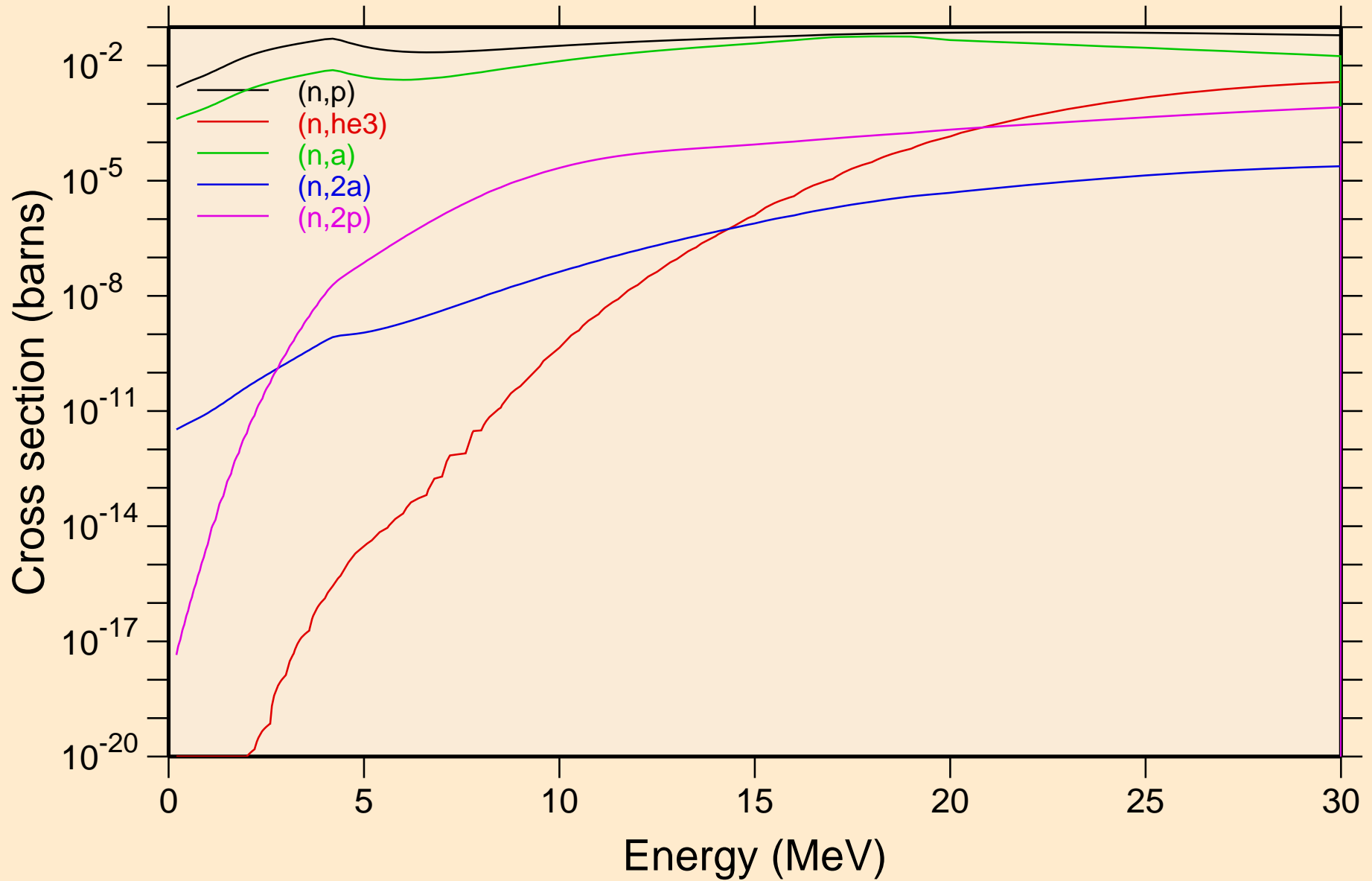

RN205M NEUTRON ACER TENDL-2023 LIBRARY; T=0.K

Non-threshold reactions

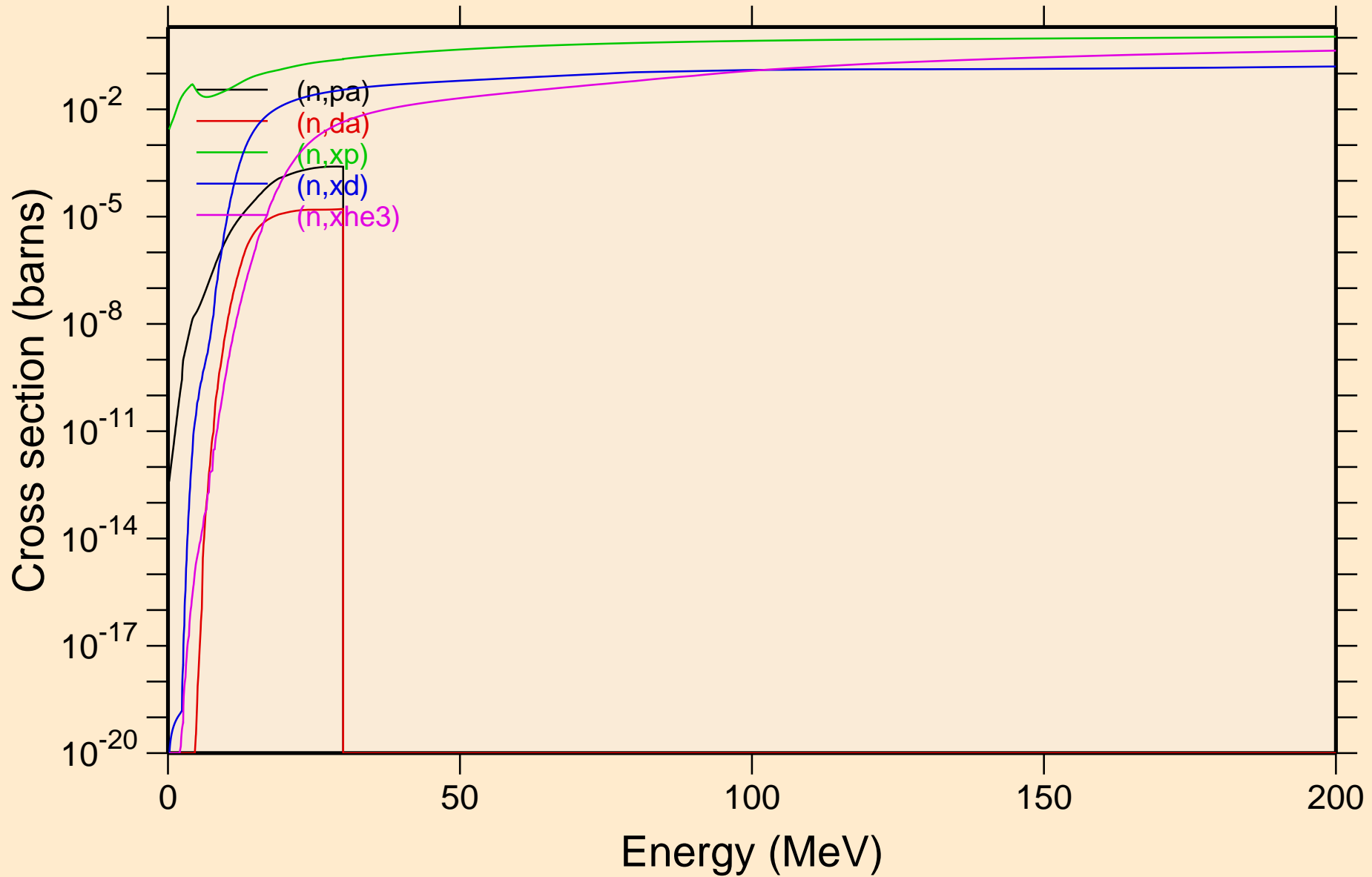

RN205M NEUTRON ACER TENDL-2023 LIBRARY; T=0.K
Non-threshold reactions

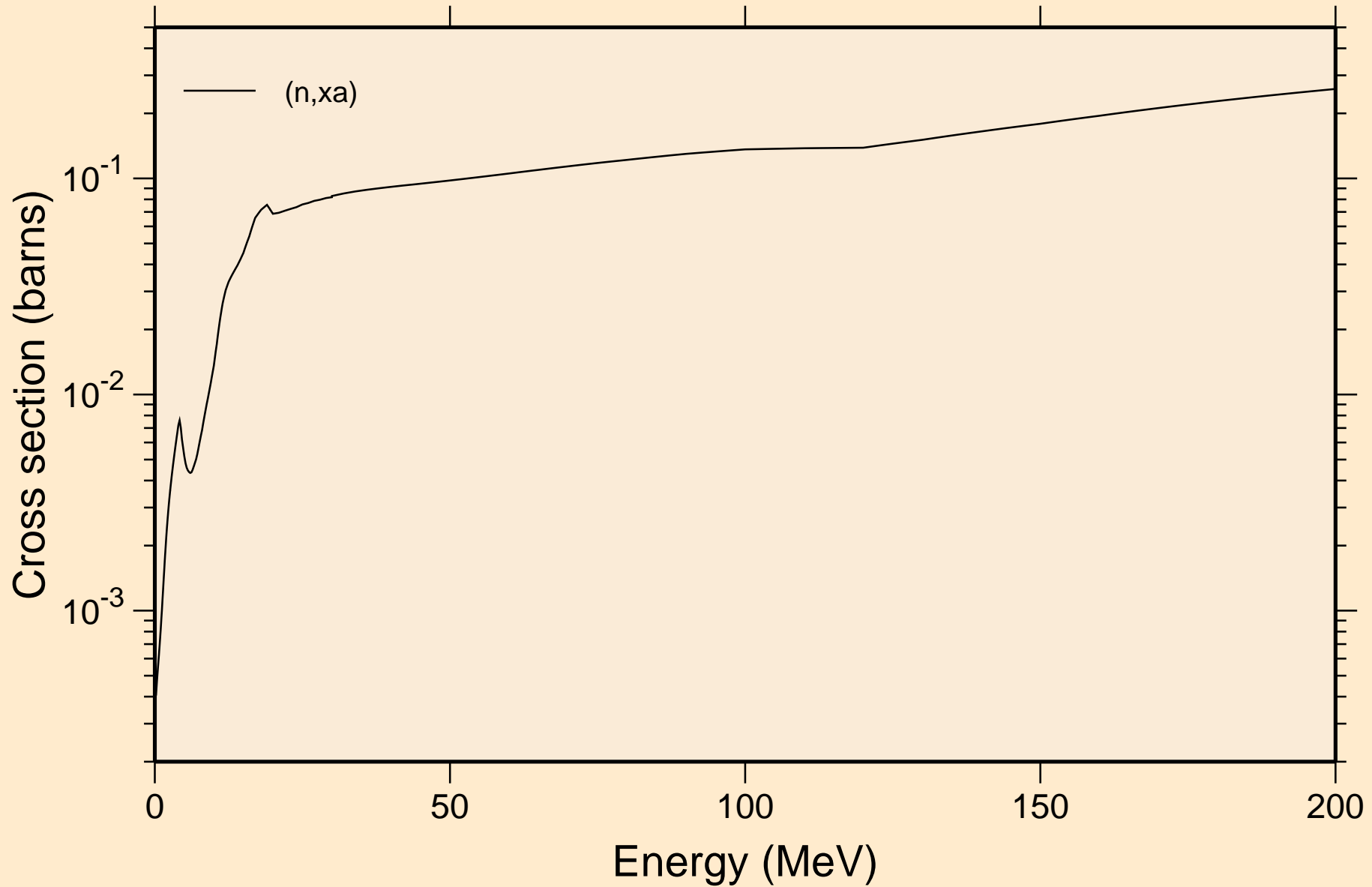

RN205M NEUTRON ACER TENDL-2023 LIBRARY; T=0.K
Inelastic levels

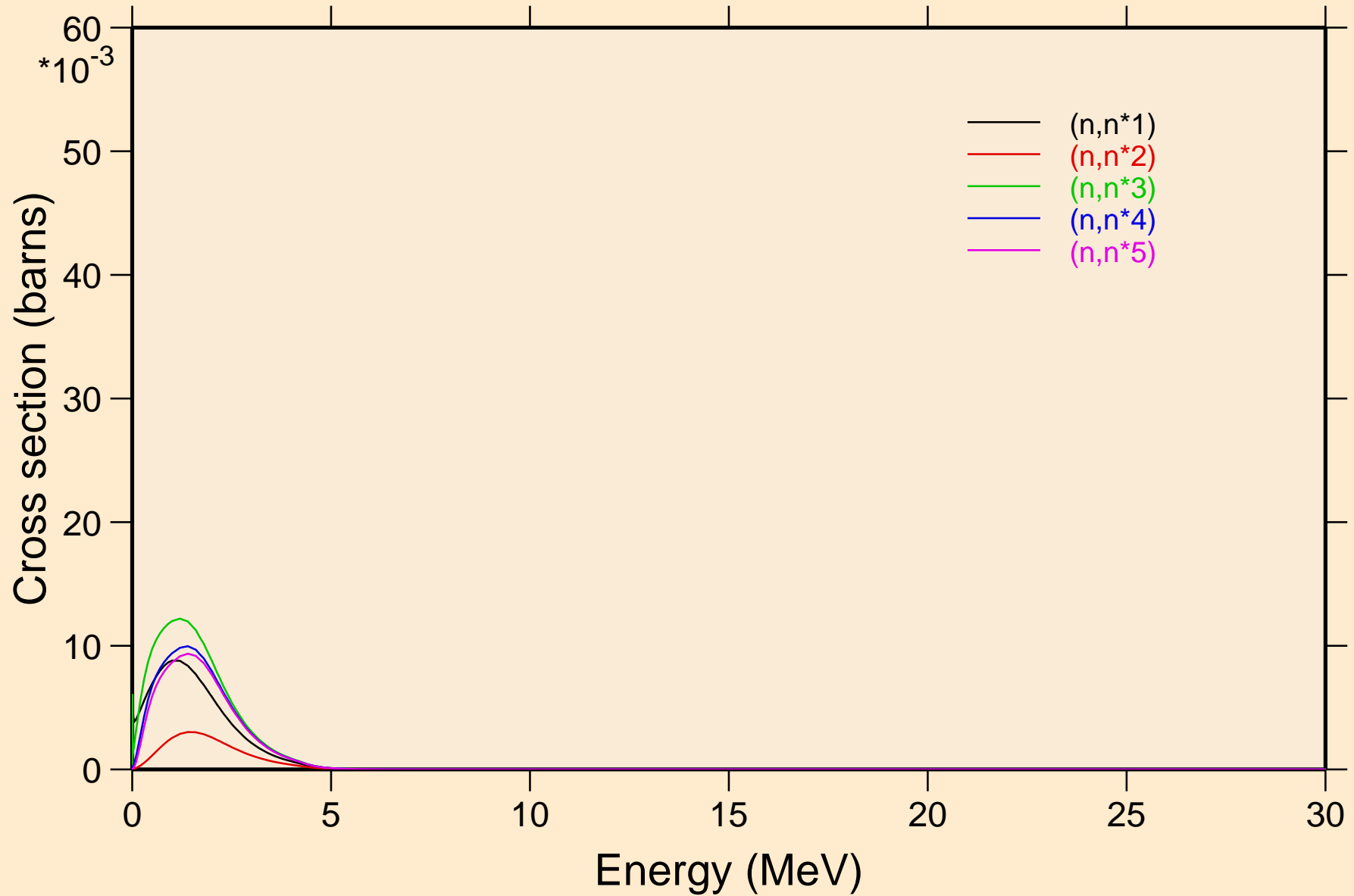

RN205M NEUTRON ACER TENDL-2023 LIBRARY; T=0.K
Inelastic levels

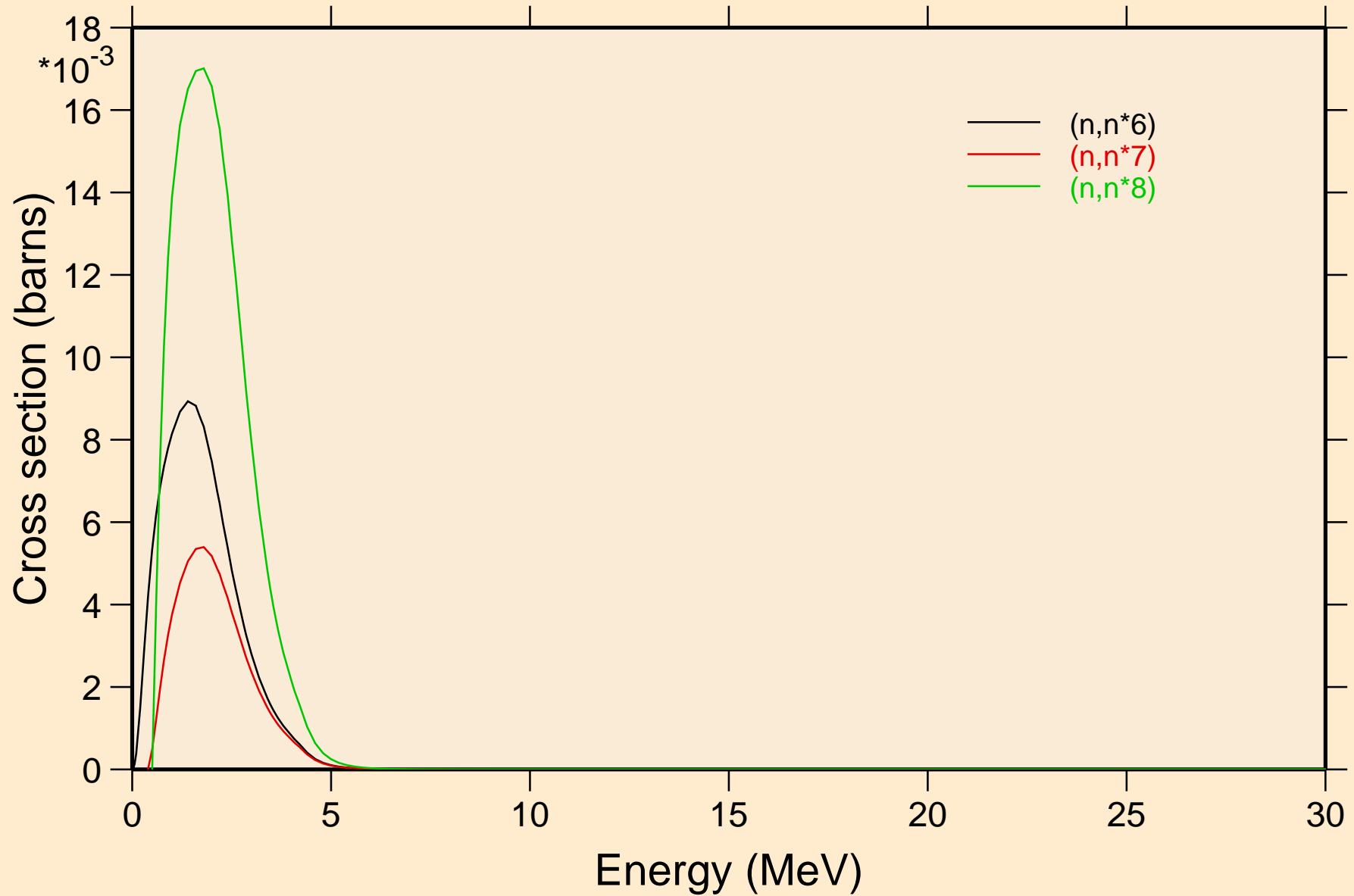

RN205M NEUTRON ACER TENDL-2023 LIBRARY; T=0.K

Threshold reactions

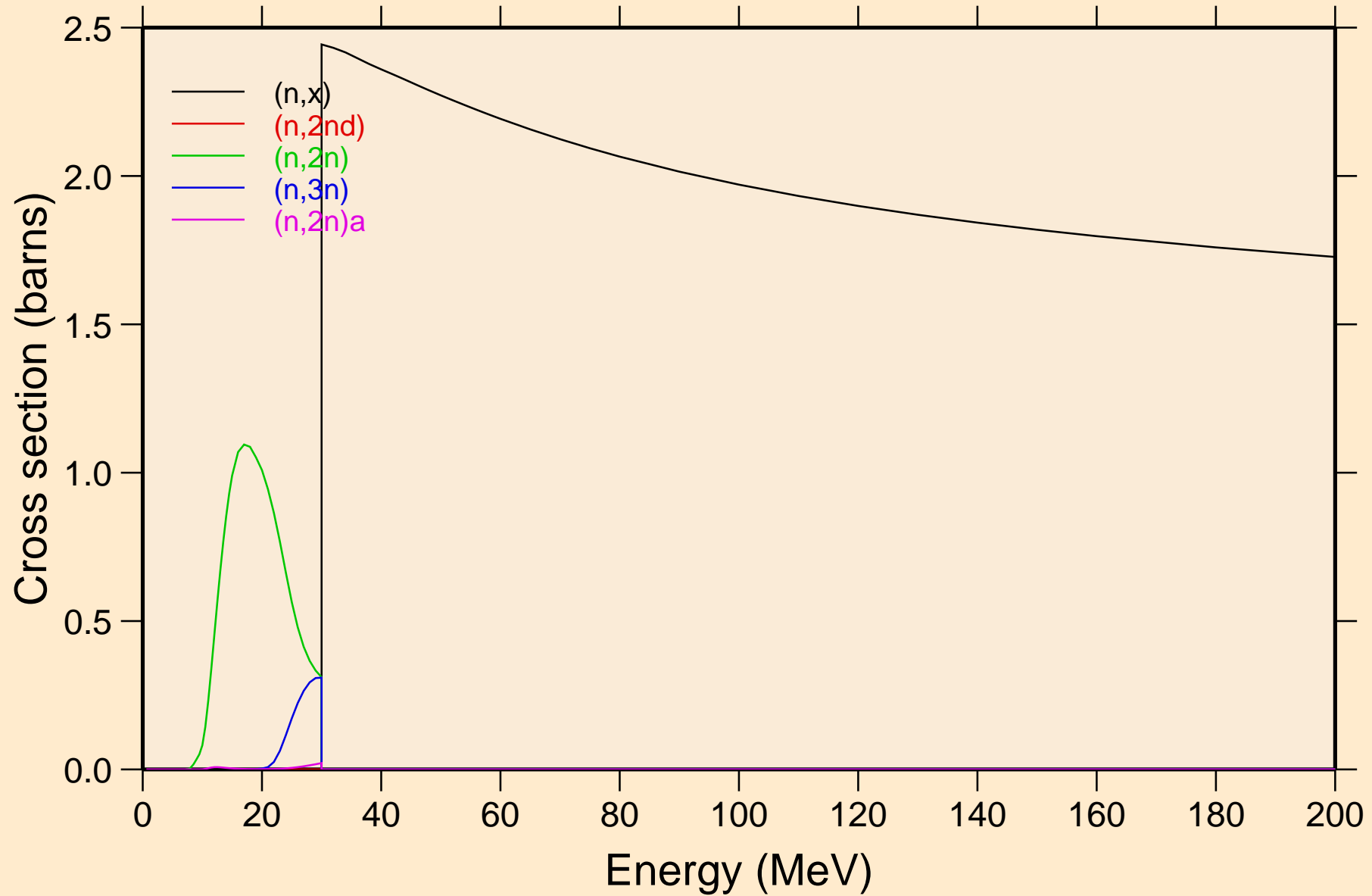

RN205M NEUTRON ACER TENDL-2023 LIBRARY; T=0.K
Threshold reactions

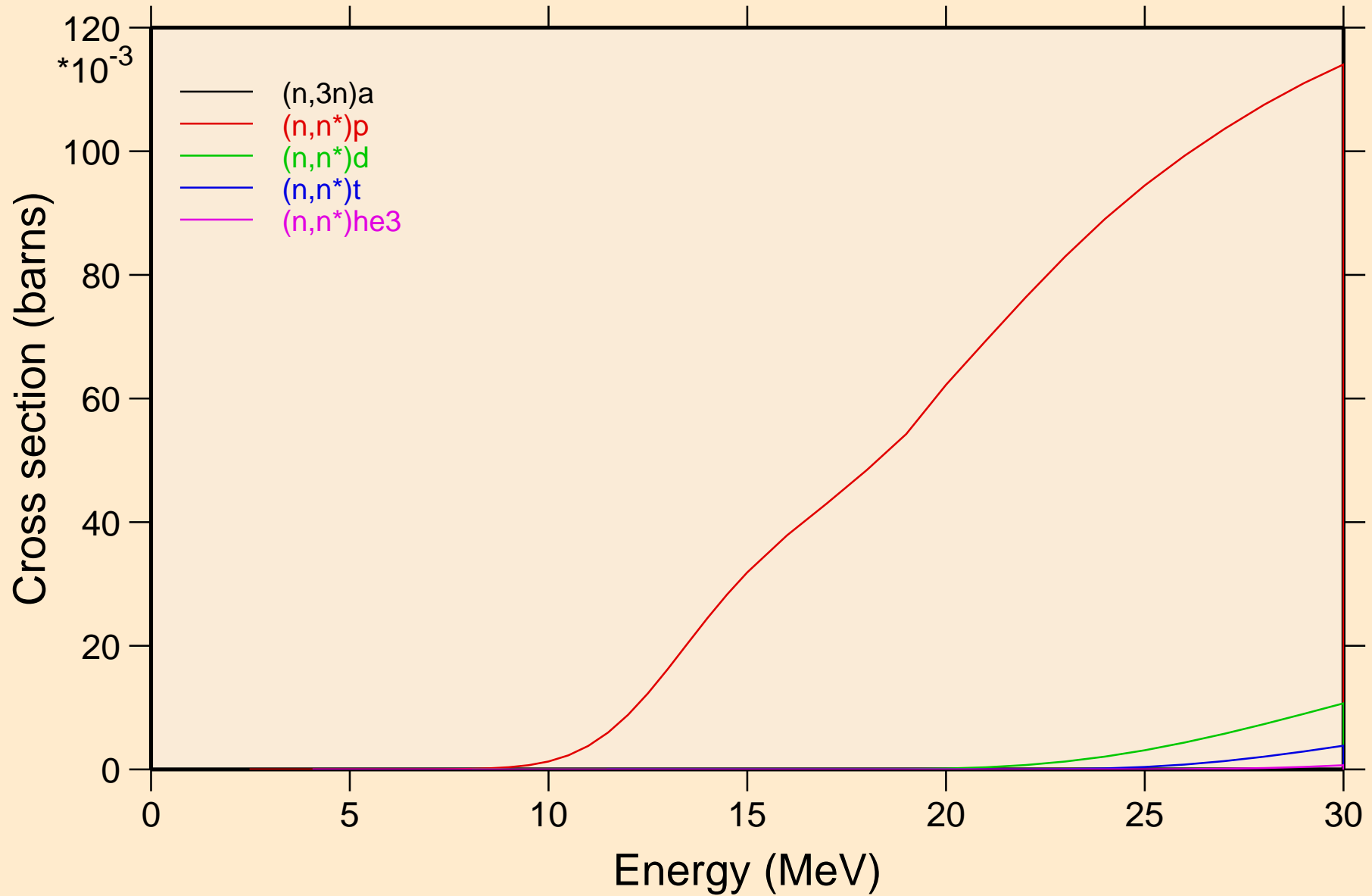

RN205M NEUTRON ACER TENDL-2023 LIBRARY; T=0.K
Threshold reactions

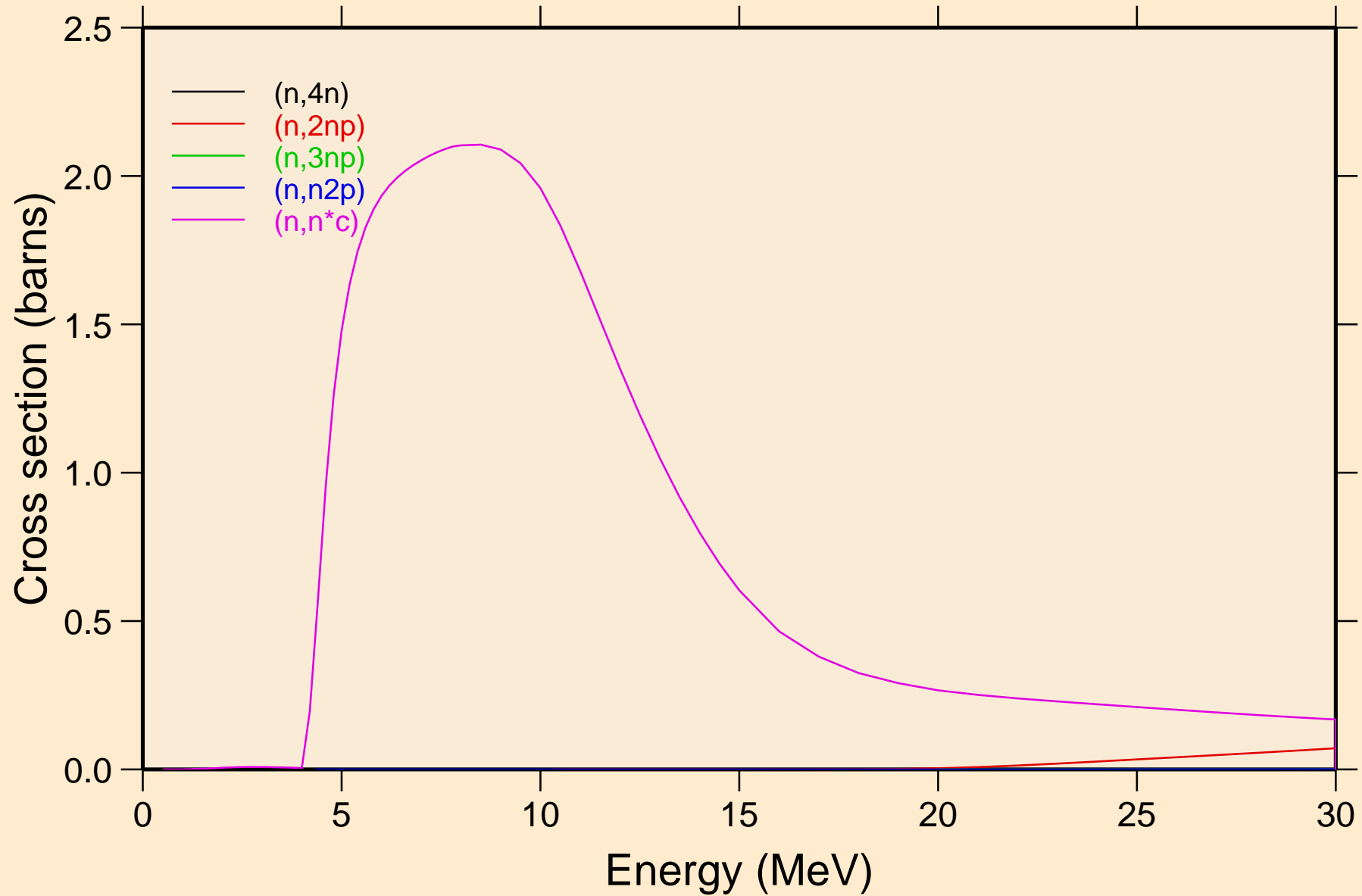

RN205M NEUTRON ACER TENDL-2023 LIBRARY; T=0.K

Threshold reactions

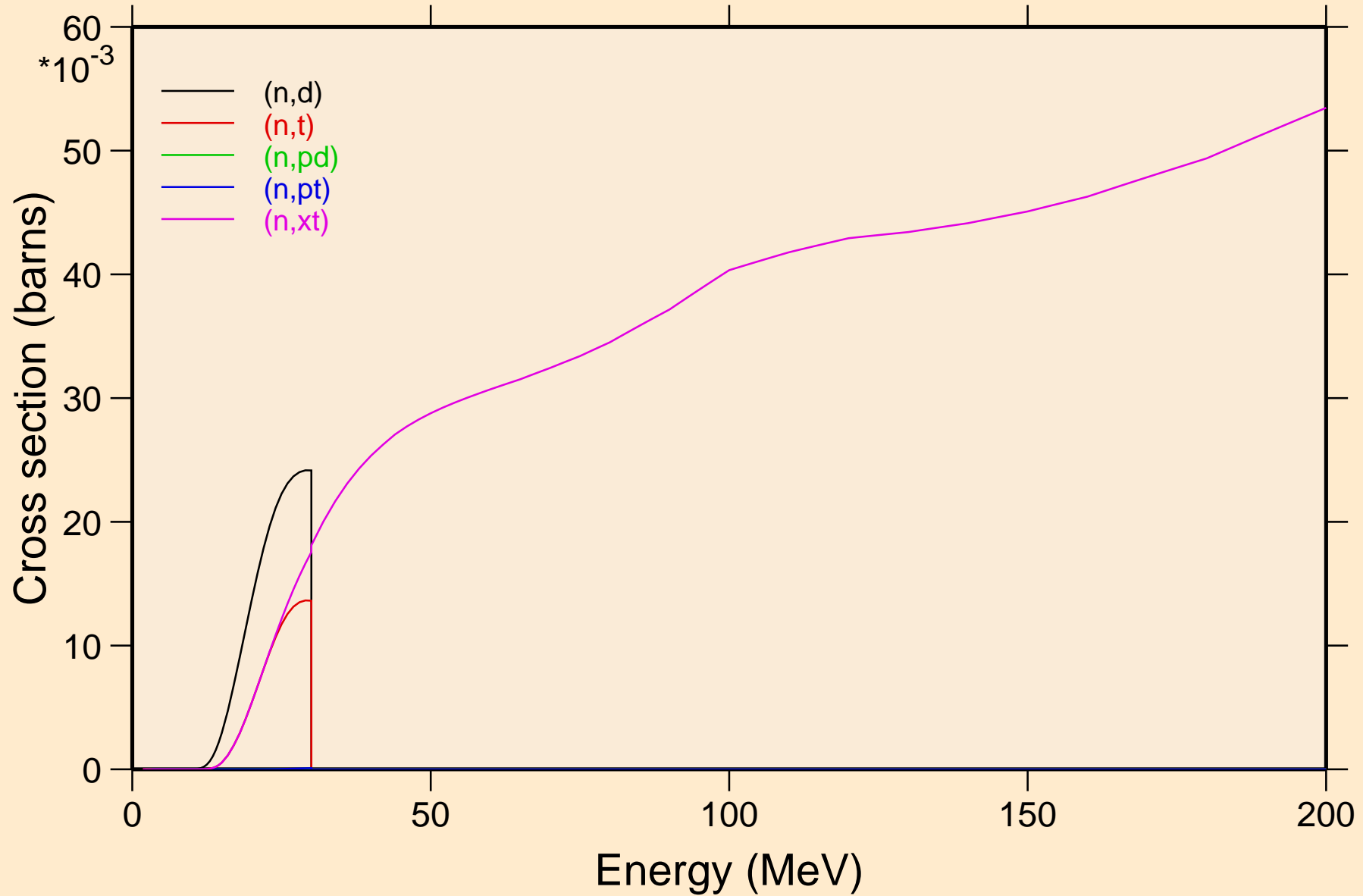

RN205M NEUTRON ACER TENDL-2023 LIBRARY; T=0.K
angular distribution for elastic

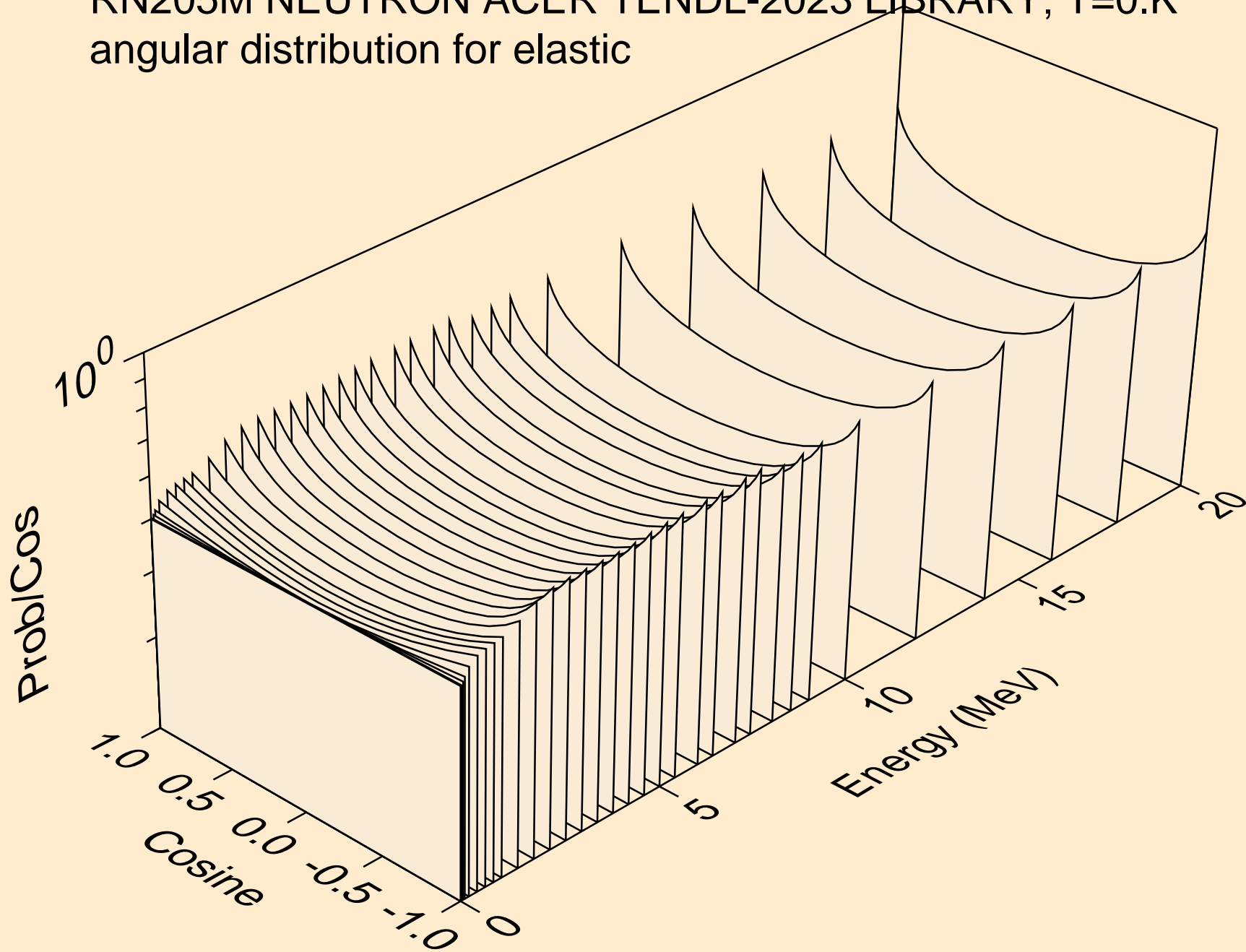

RN205M NEUTRON ACER TENDL-2023 LIBRARY; T=0.K
angular distribution for elastic

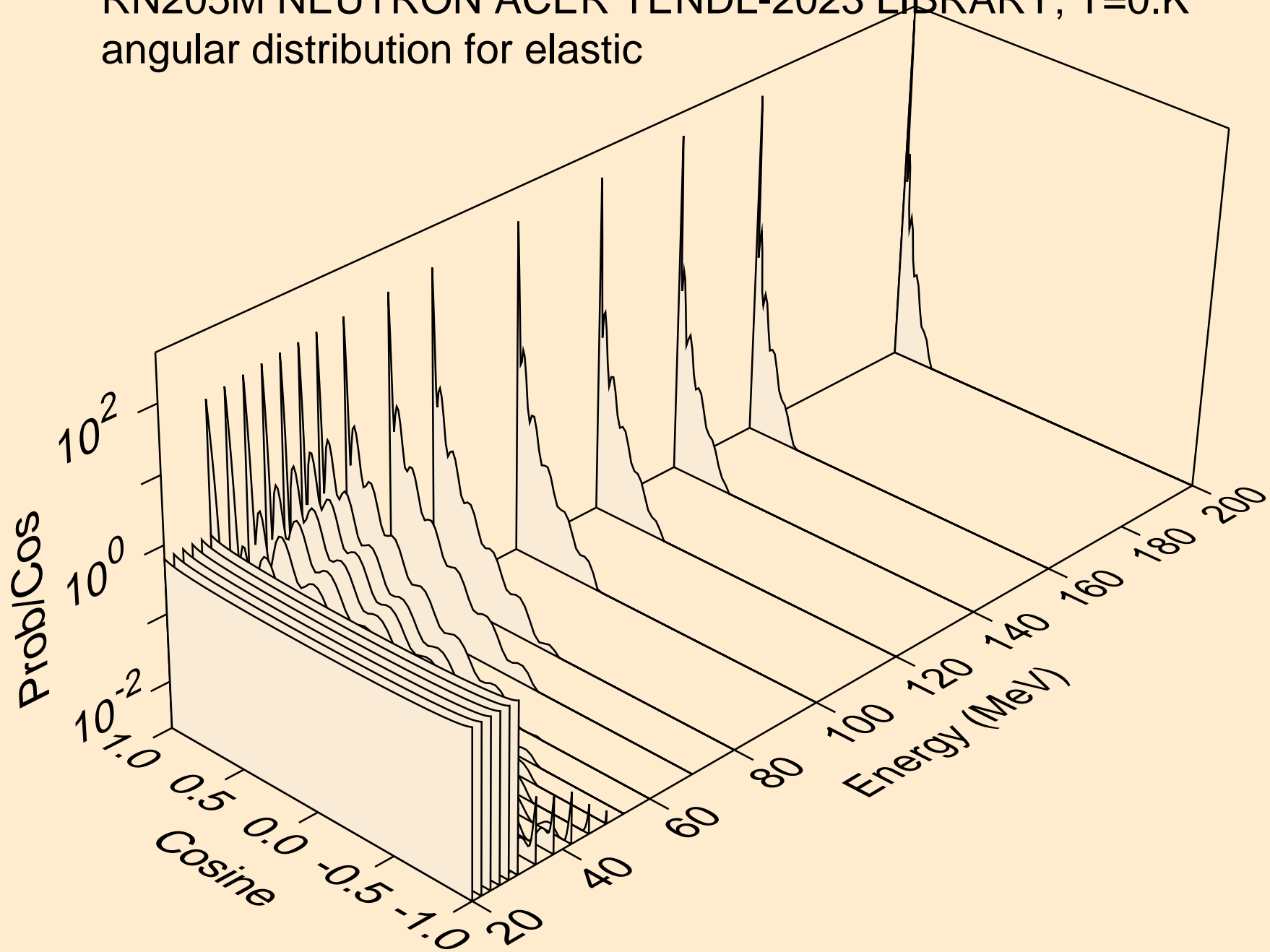

RN205M NEUTRON ACER TENDL-2023 LIBRARY; T=0.K
angular distribution for (n,n*1)

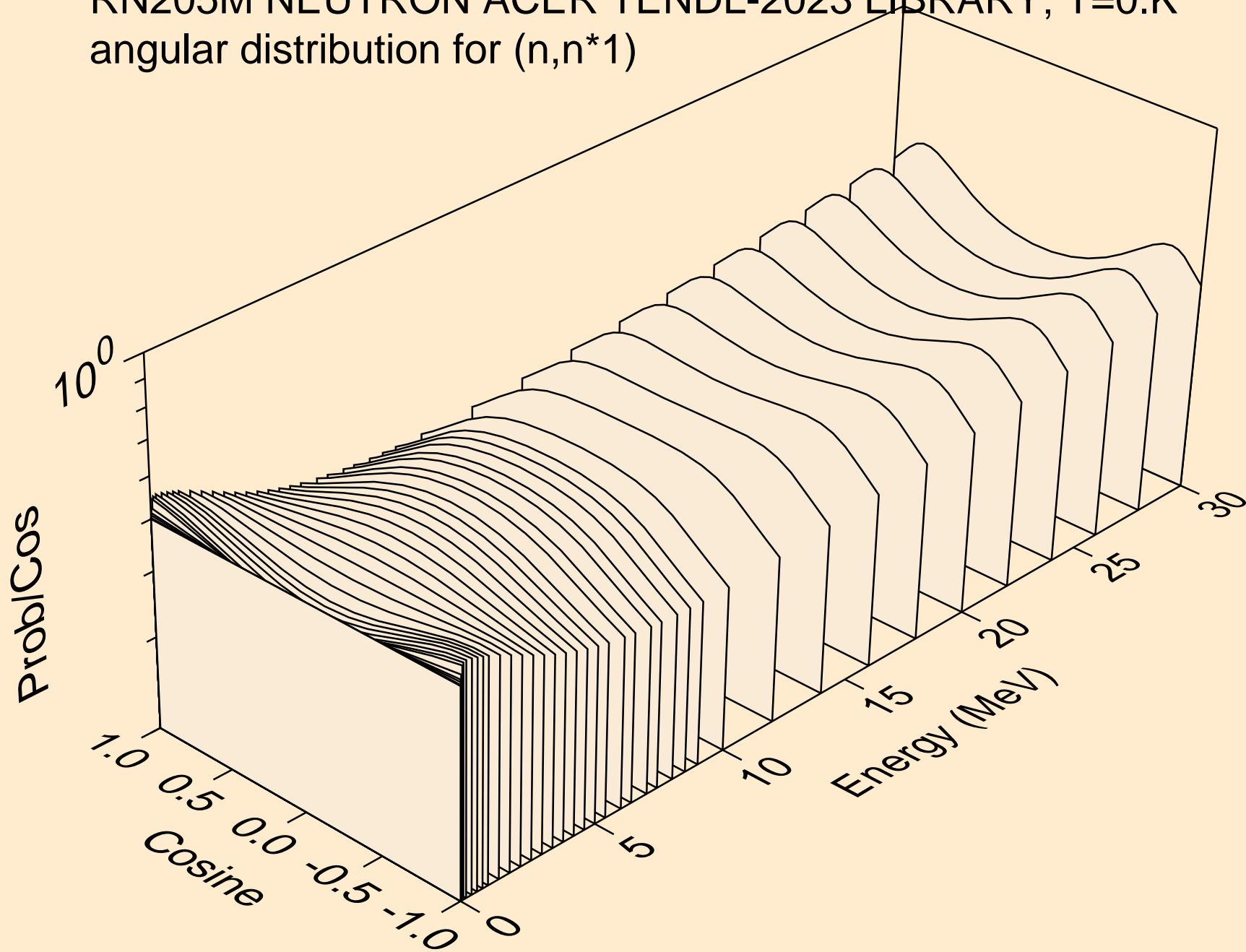

RN205M NEUTRON ACER TENDL-2023 LIBRARY; T=0.K
angular distribution for (n,n*2)

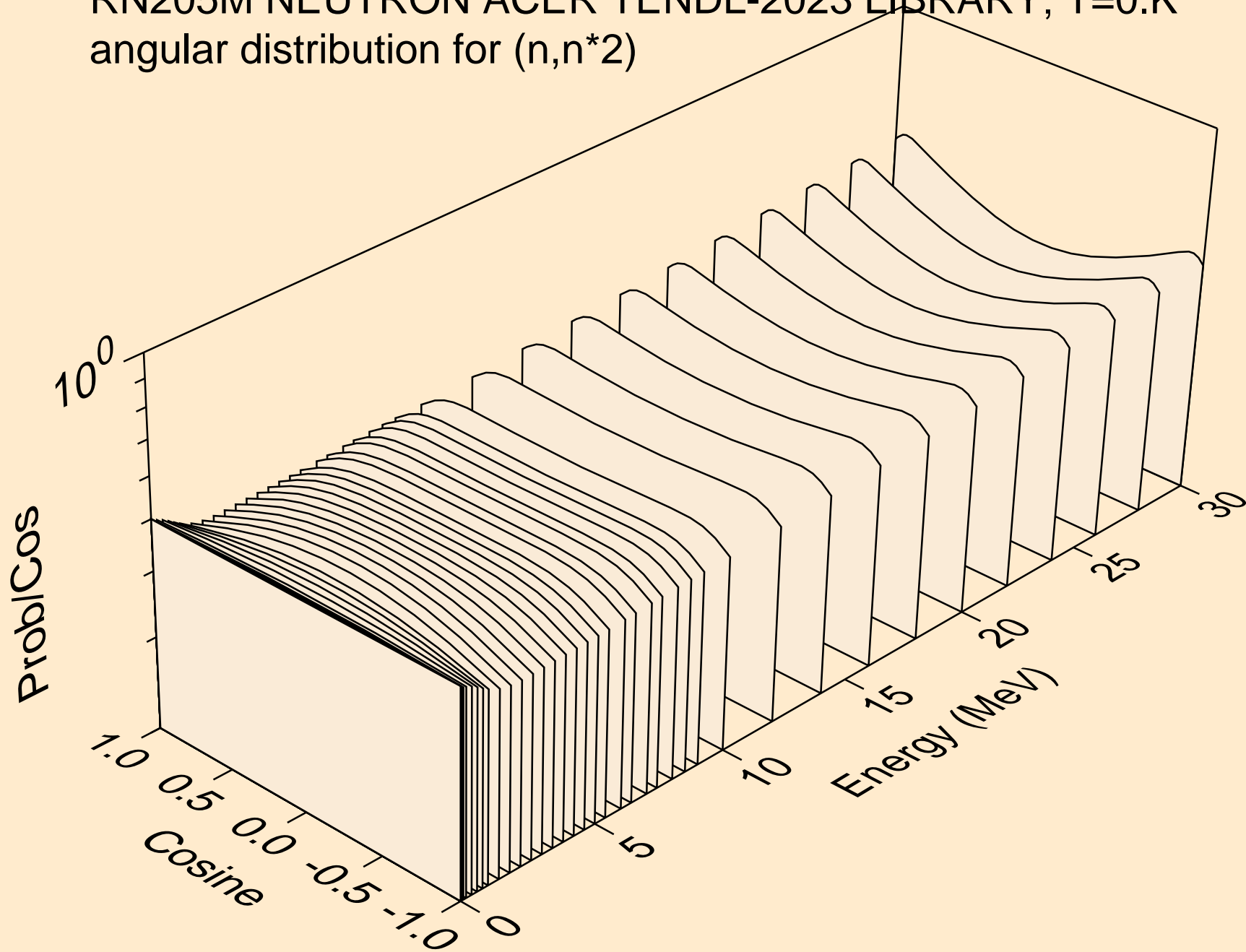

RN205M NEUTRON ACER TENDL-2023 LIBRARY; T=0.K
angular distribution for (n,n*3)

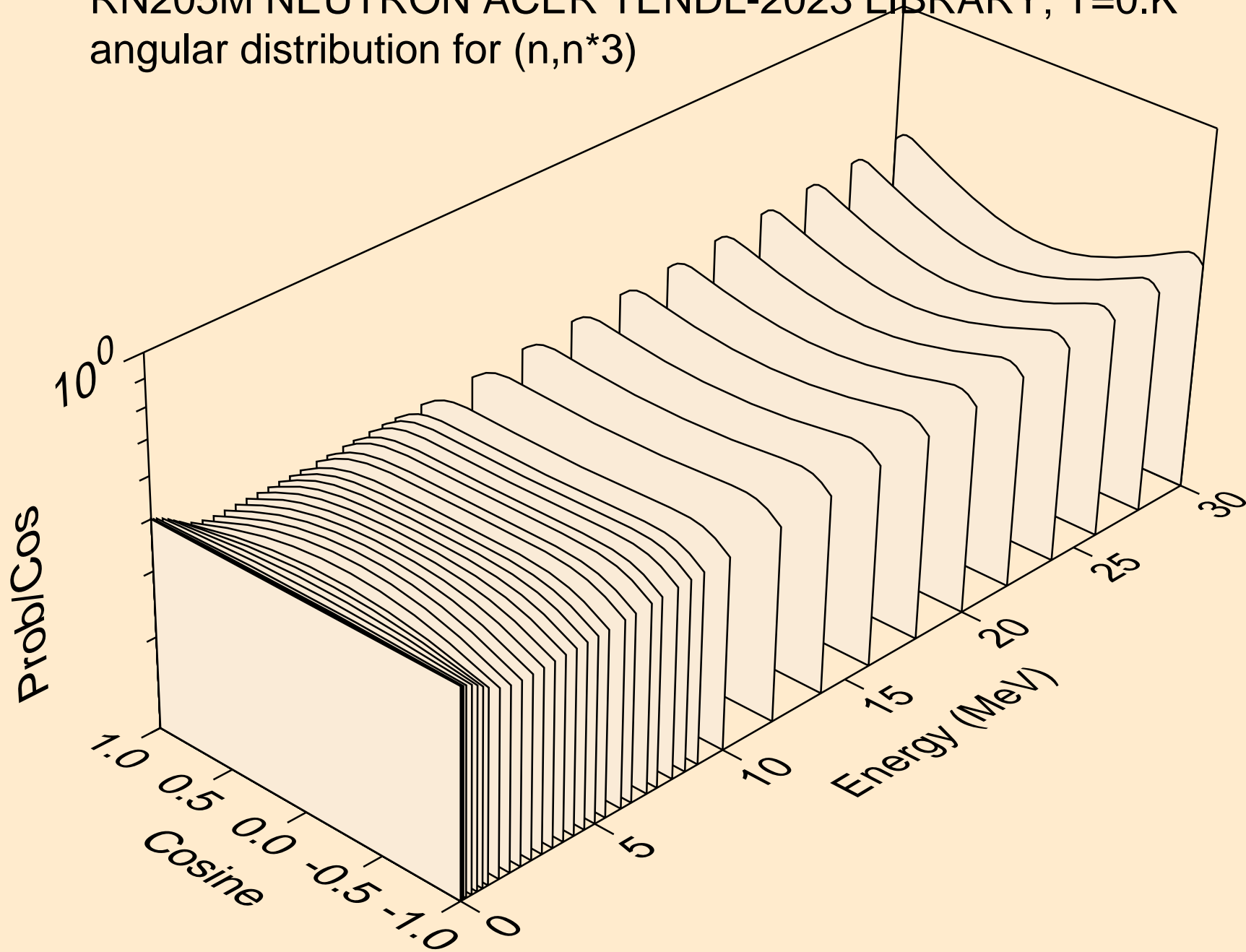

RN205M NEUTRON ACER TENDL-2023 LIBRARY; T=0.K
angular distribution for (n,n*4)

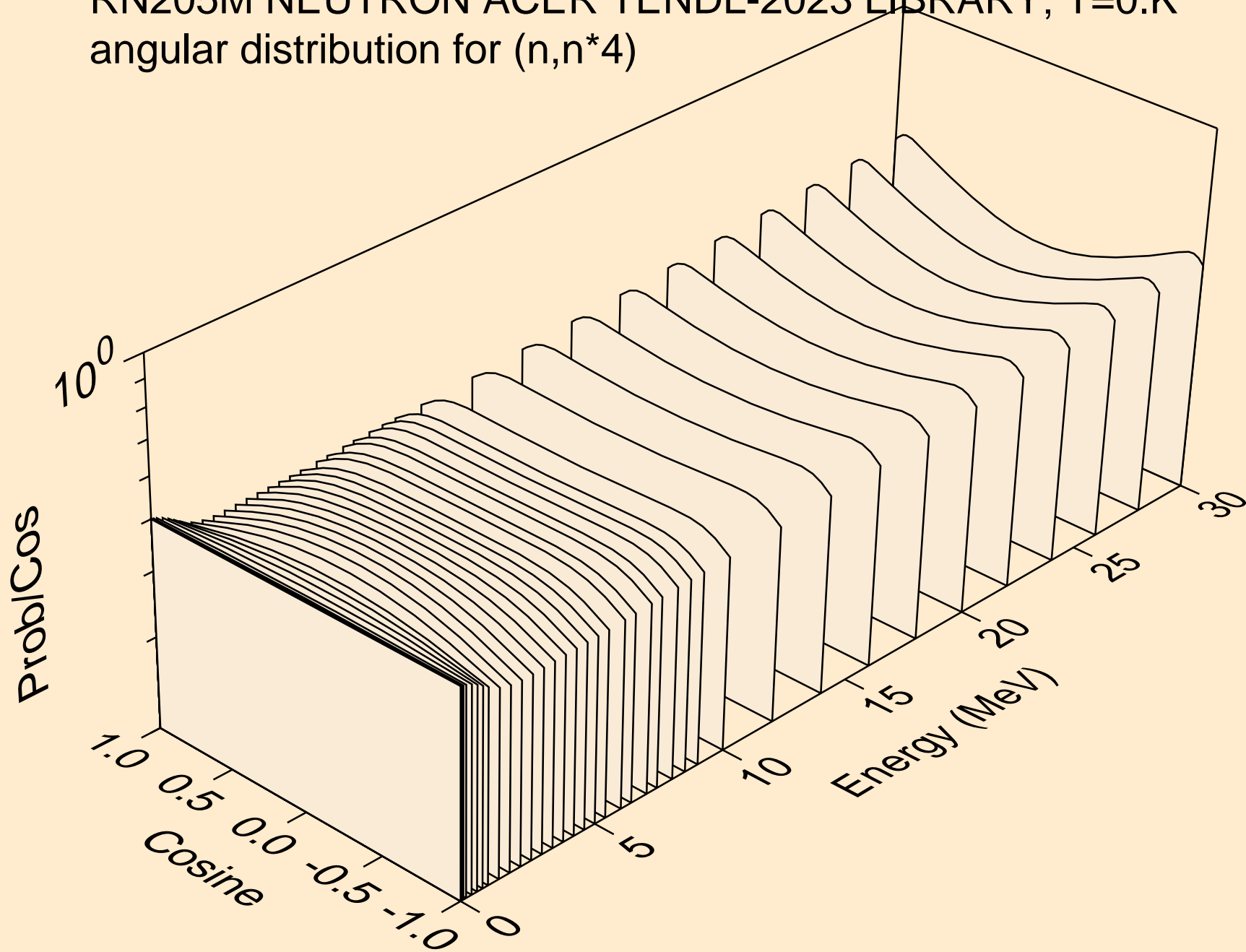

RN205M NEUTRON ACER TENDL-2023 LIBRARY; T=0.K
angular distribution for (n,n*5)

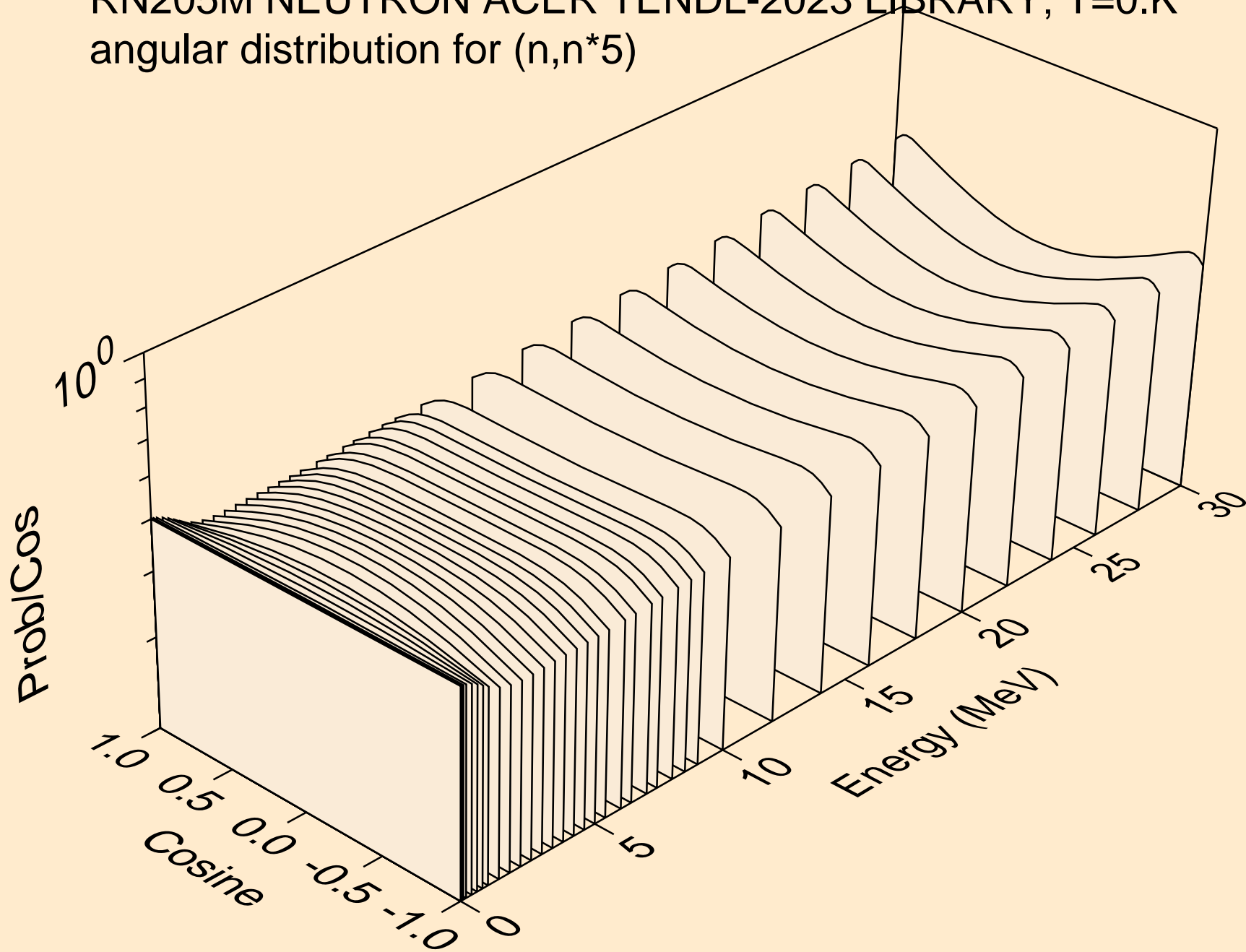

RN205M NEUTRON ACER TENDL-2023 LIBRARY; T=0.K
angular distribution for (n,n*6)

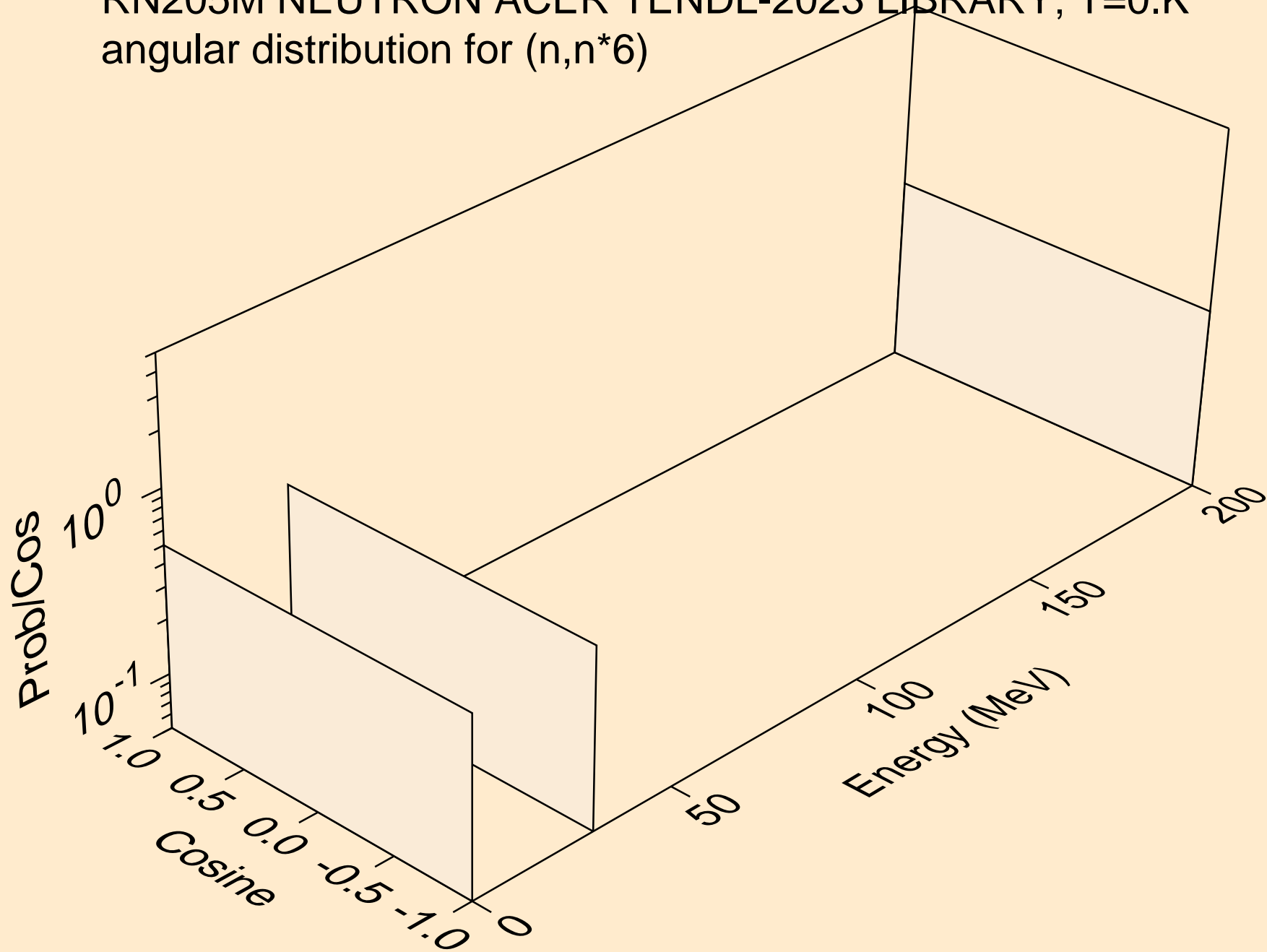

RN205M NEUTRON ACER TENDL-2023 LIBRARY; T=0.K
angular distribution for (n,n*7)

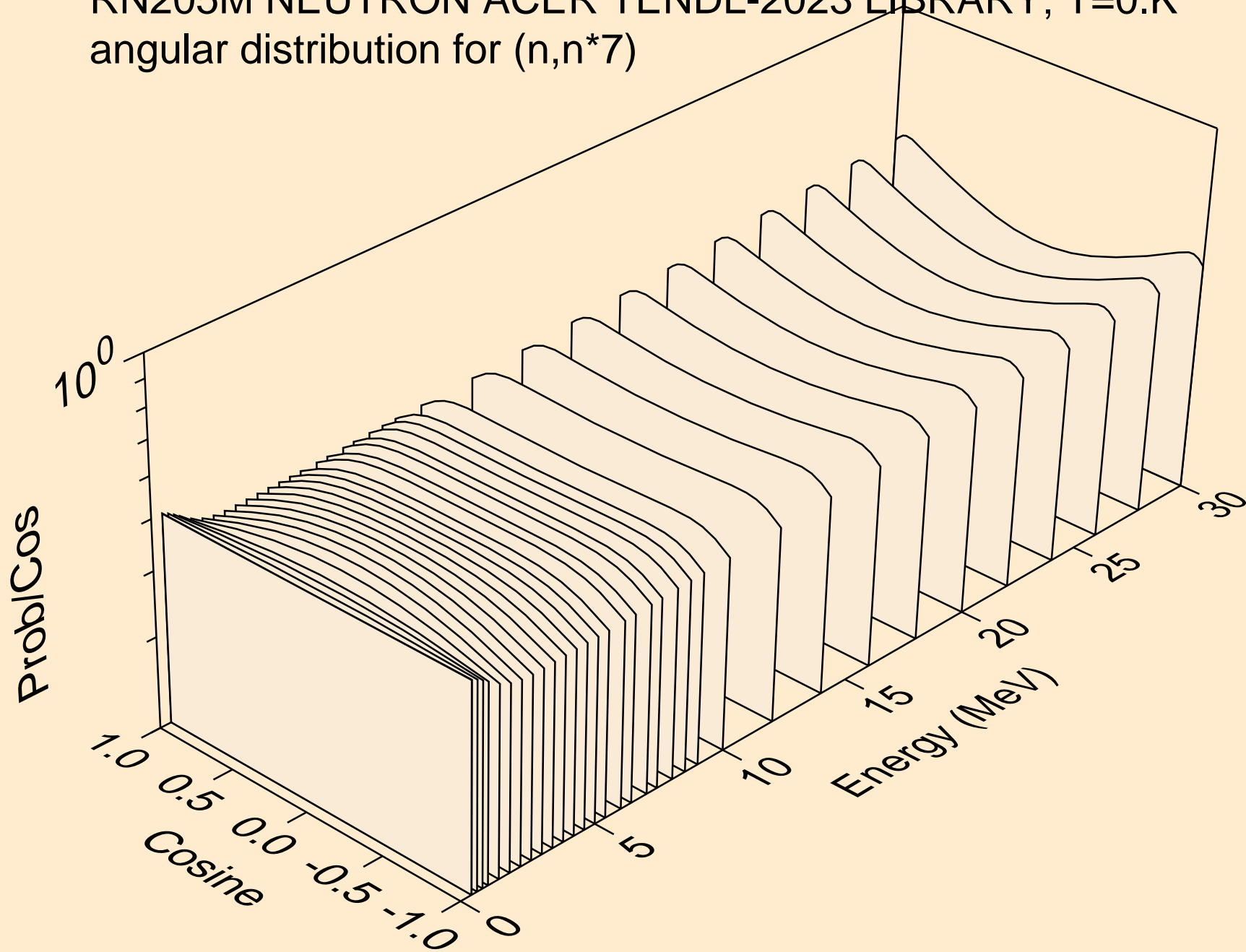

RN205M NEUTRON ACER TENDL-2023 LIBRARY; T=0.K
angular distribution for (n,n*8)

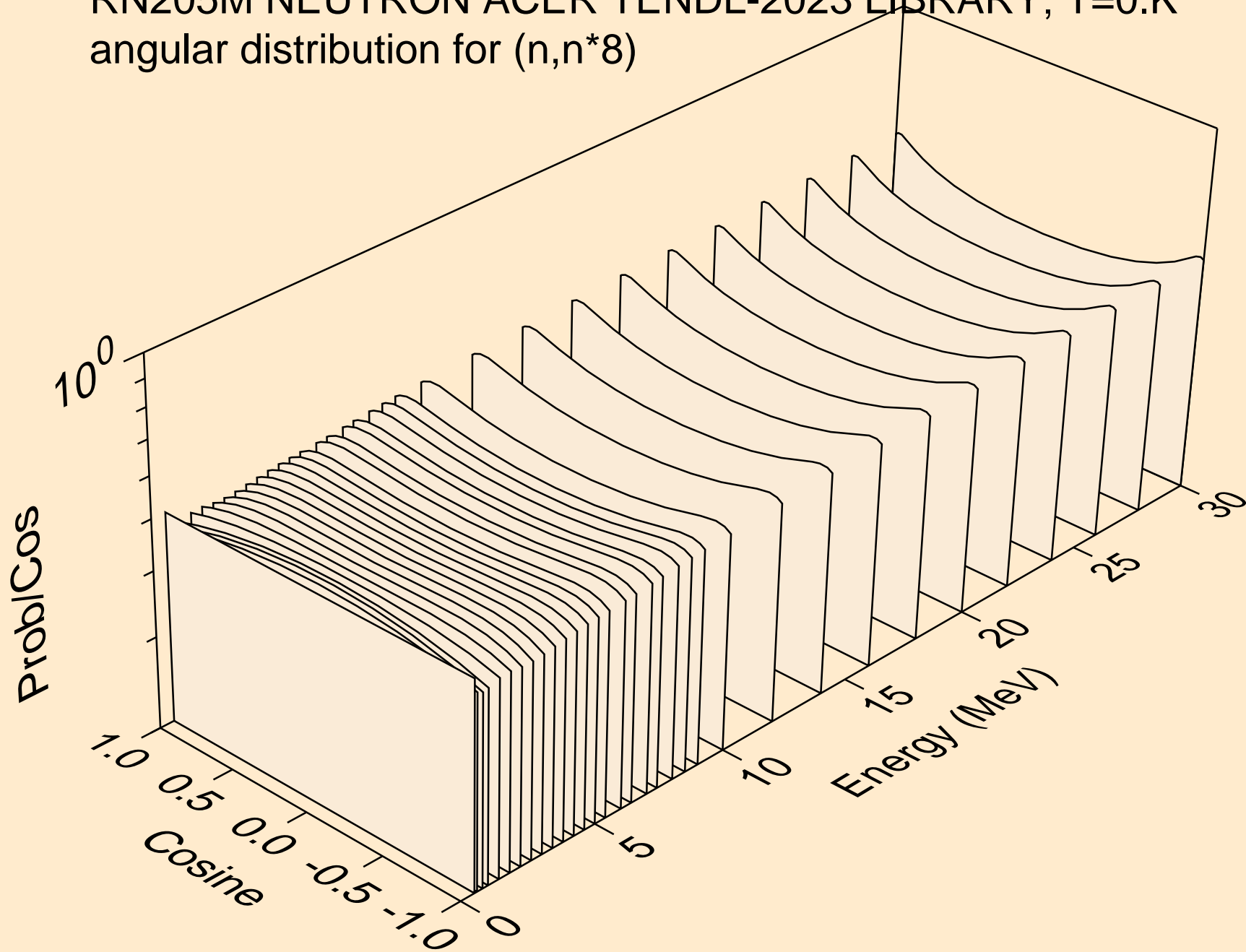

RN205M NEUTRON ACER TENDL-2023 LIBRARY; T=0.K
Neutron emission for (n,x)

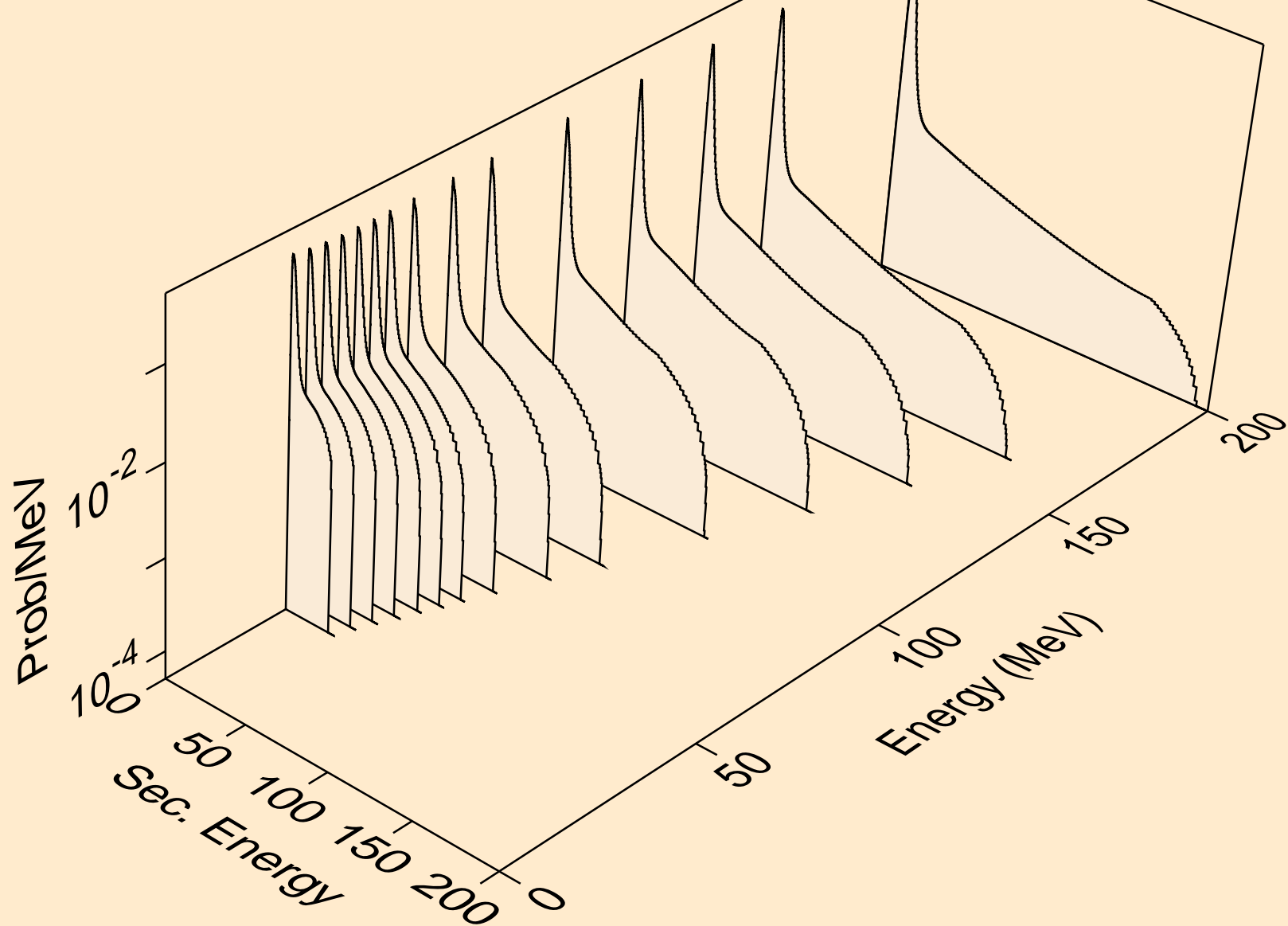

RN205M NEUTRON ACER TENDL-2023 LIBRARY; T=0.K
Neutron emission for (n,2nd)

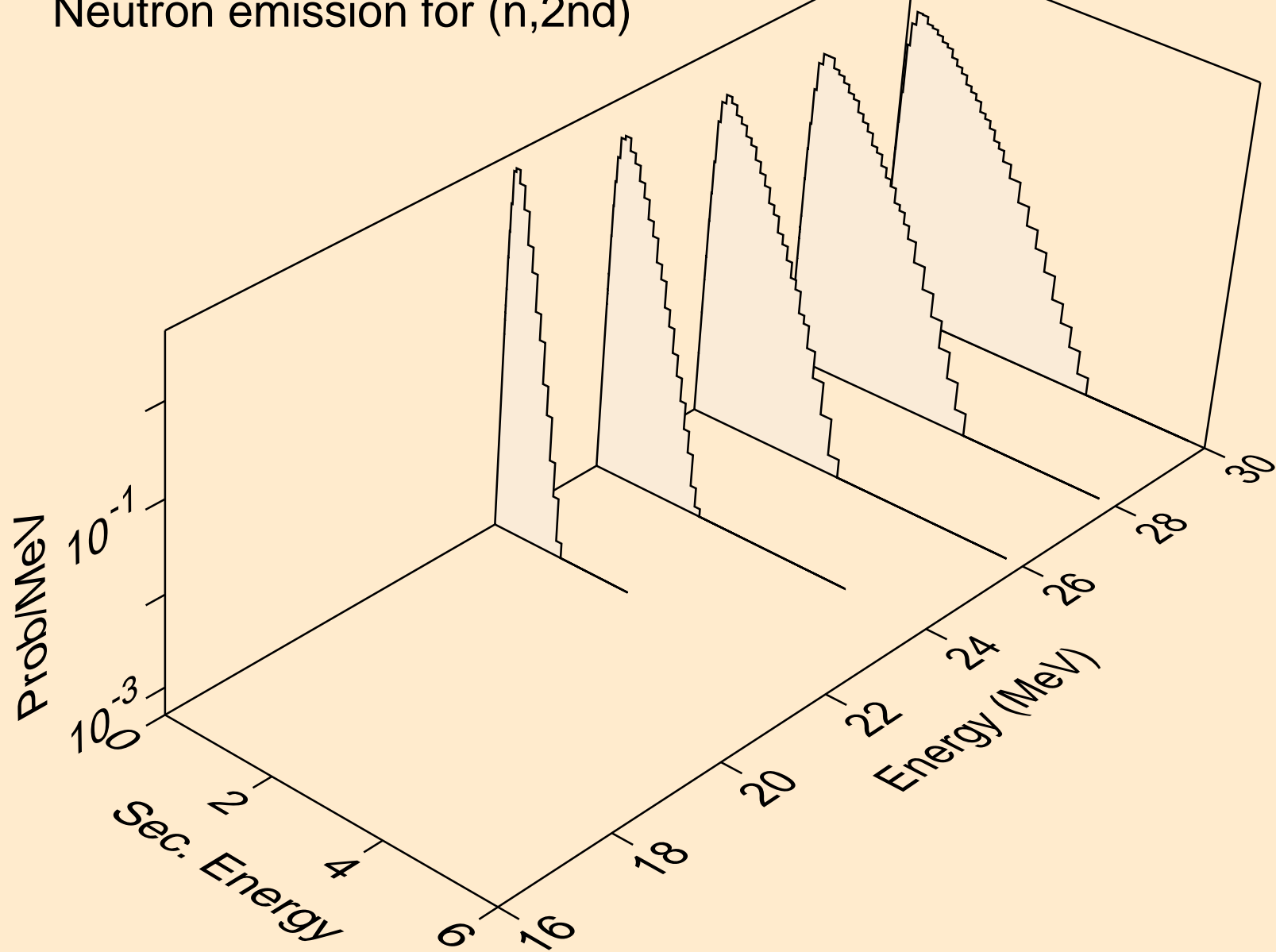

RN205M NEUTRON ACER TENDL-2023 LIBRARY; T=0.K
Neutron emission for (n,2n)

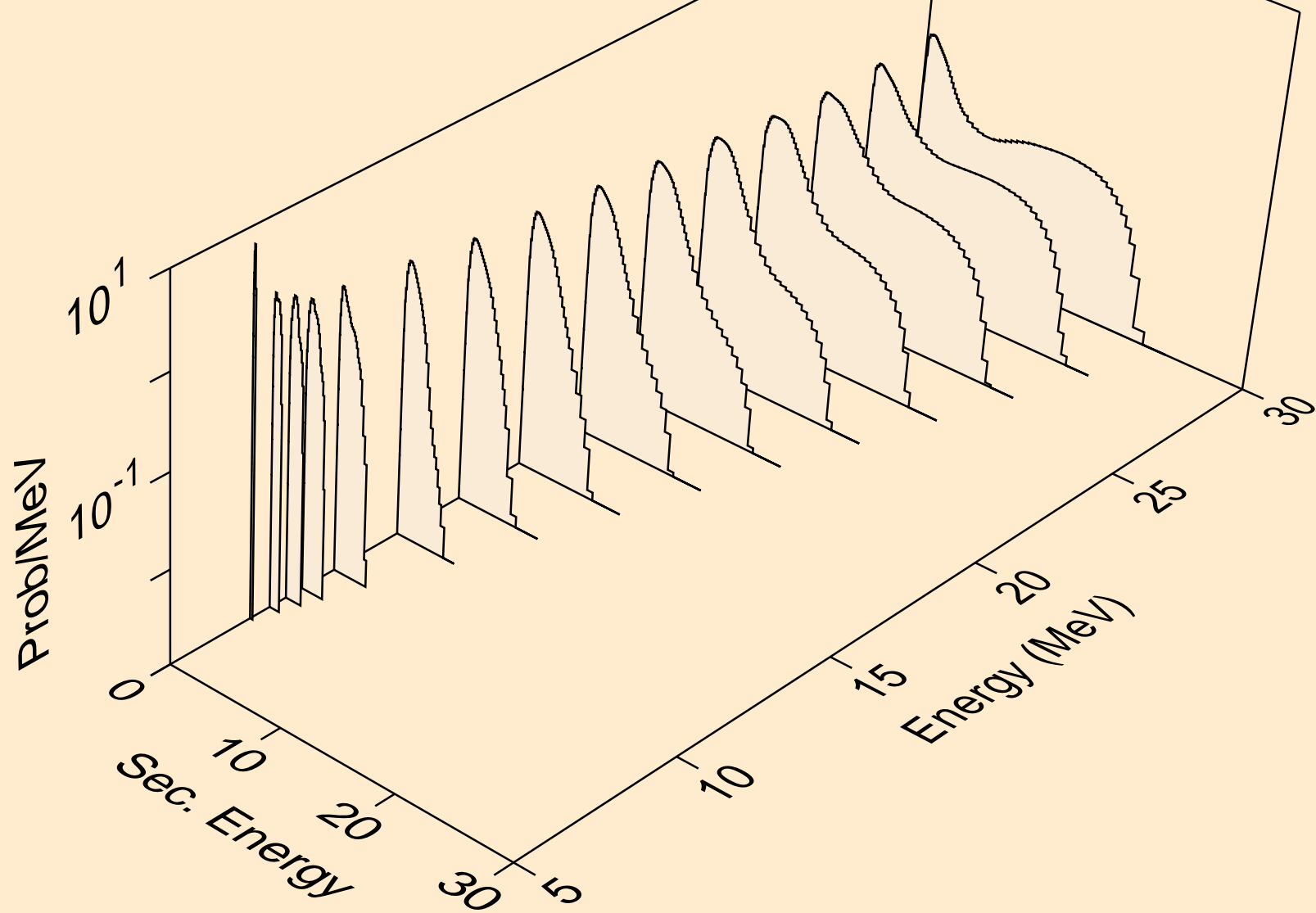

RN205M NEUTRON ACER TENDL-2023 LIBRARY; T=0.K
Neutron emission for (n,3n)

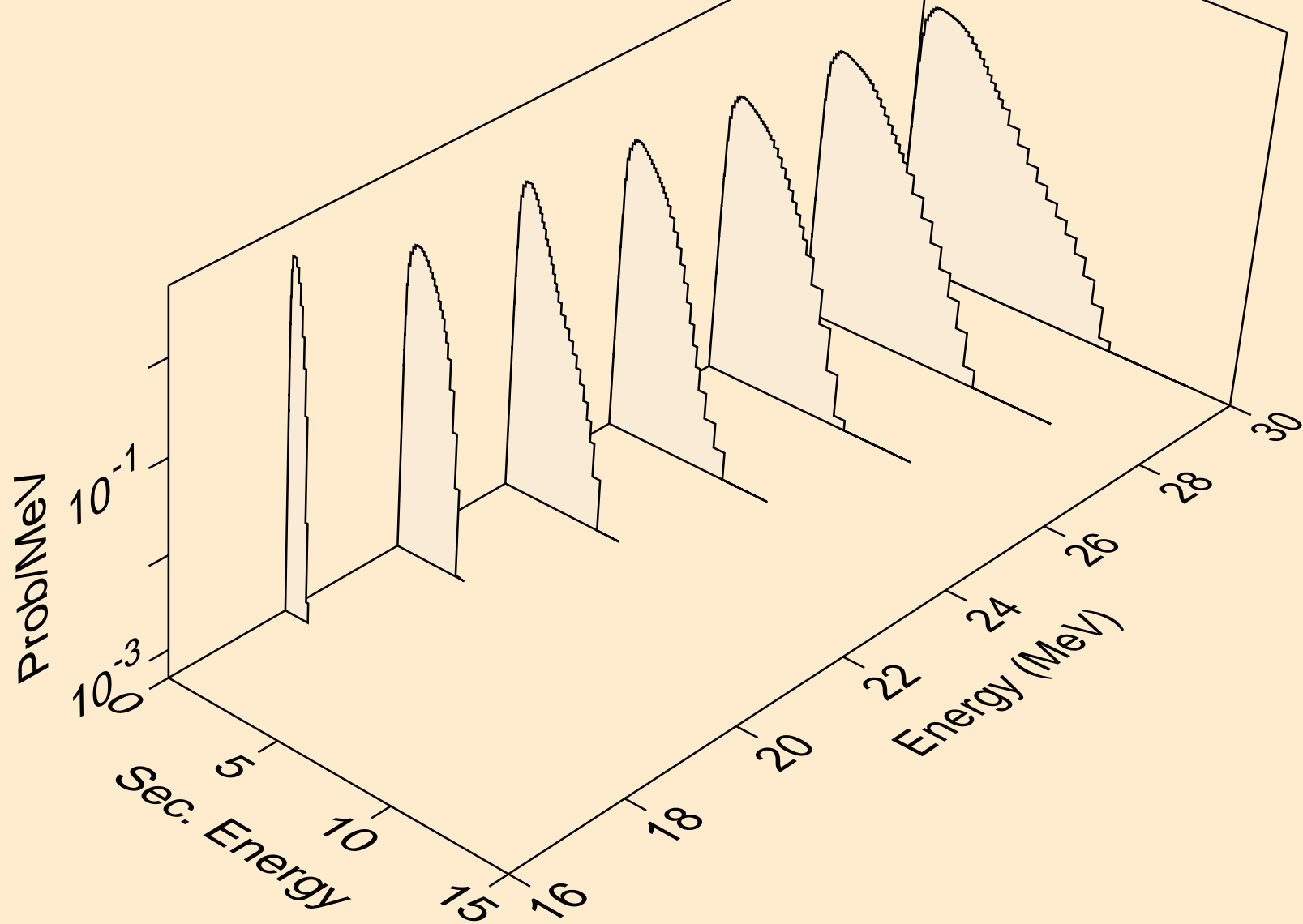

RN205M NEUTRON ACER TENDL-2023 LIBRARY; T=0.K
Neutron emission for (n,n*)a

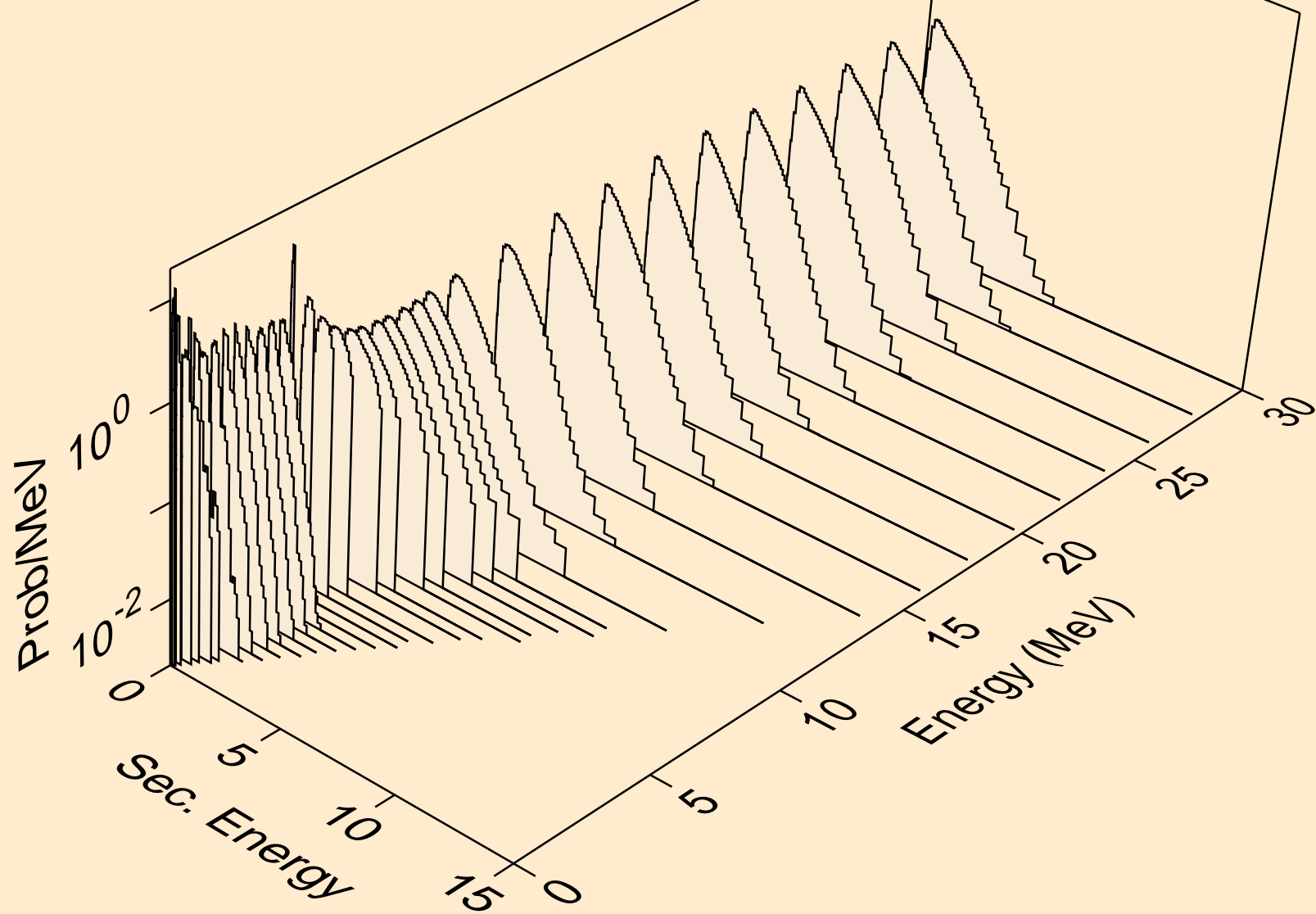

RN205M NEUTRON ACER TENDL-2023 LIBRARY; T=0.K
Neutron emission for (n,2n)a

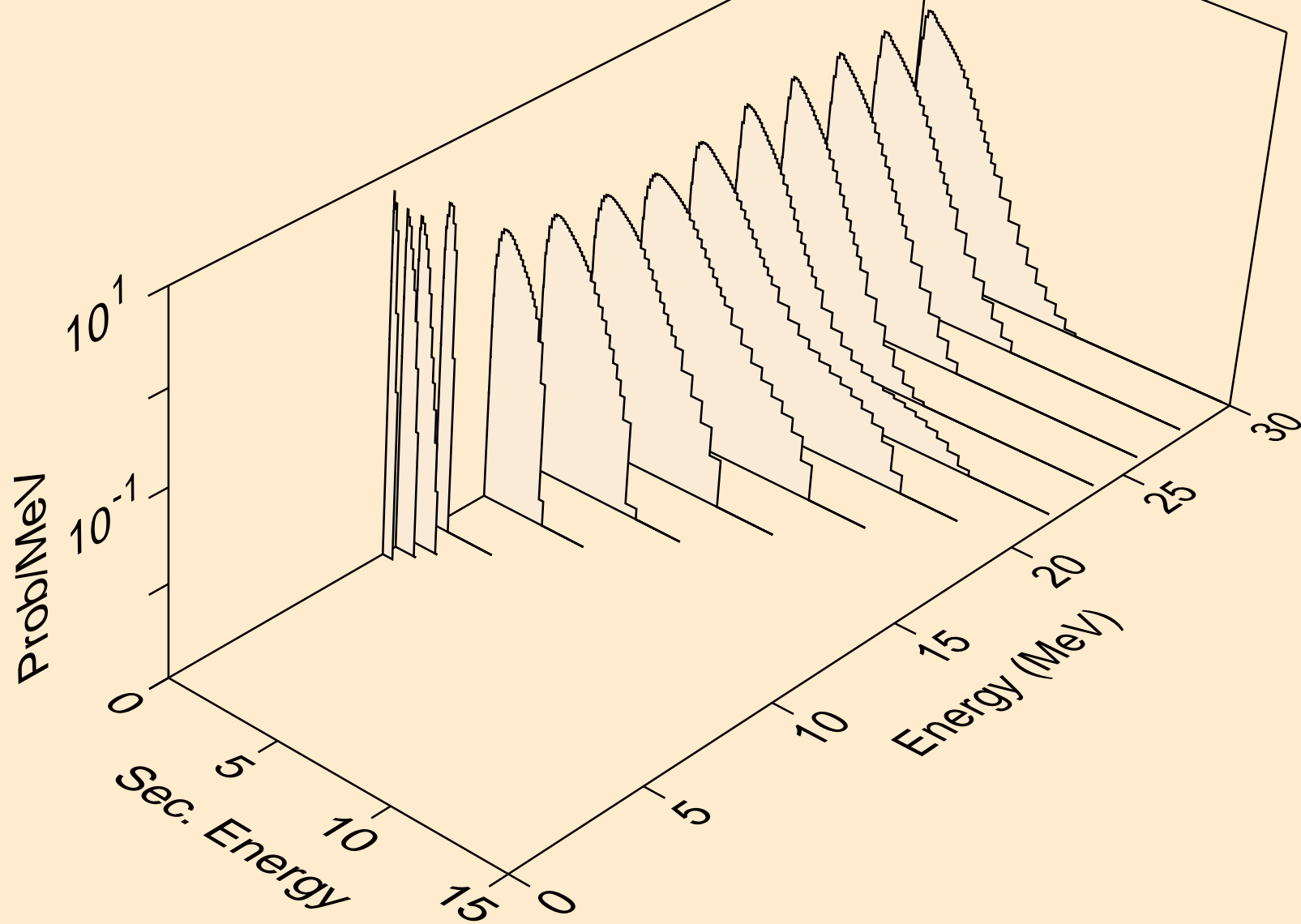

RN205M NEUTRON ACER TENDL-2023 LIBRARY; T=0.K
Neutron emission for (n,3n)a

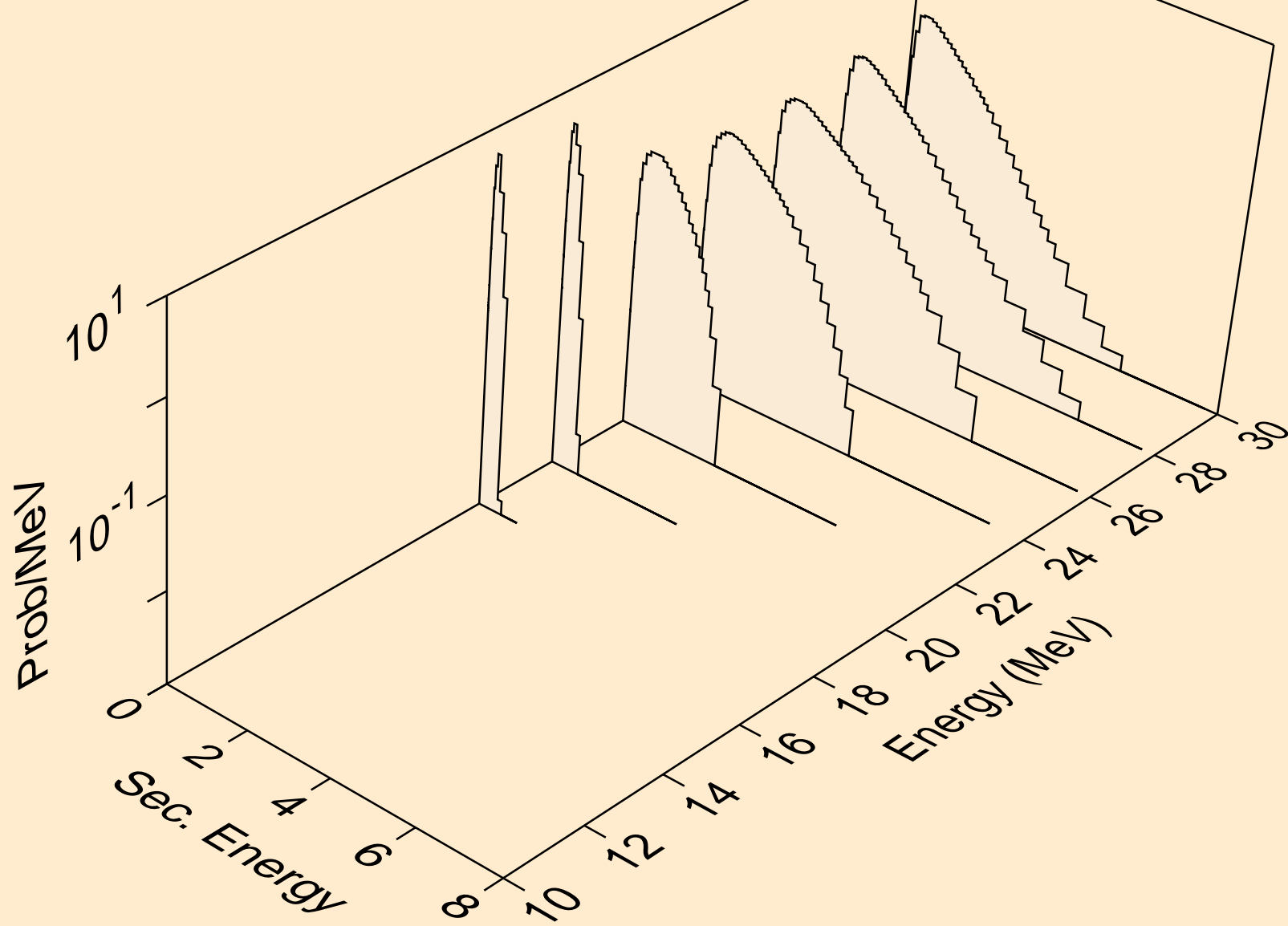

RN205M NEUTRON ACER TENDL-2023 LIBRARY; T=0.K
Neutron emission for (n,n*)p

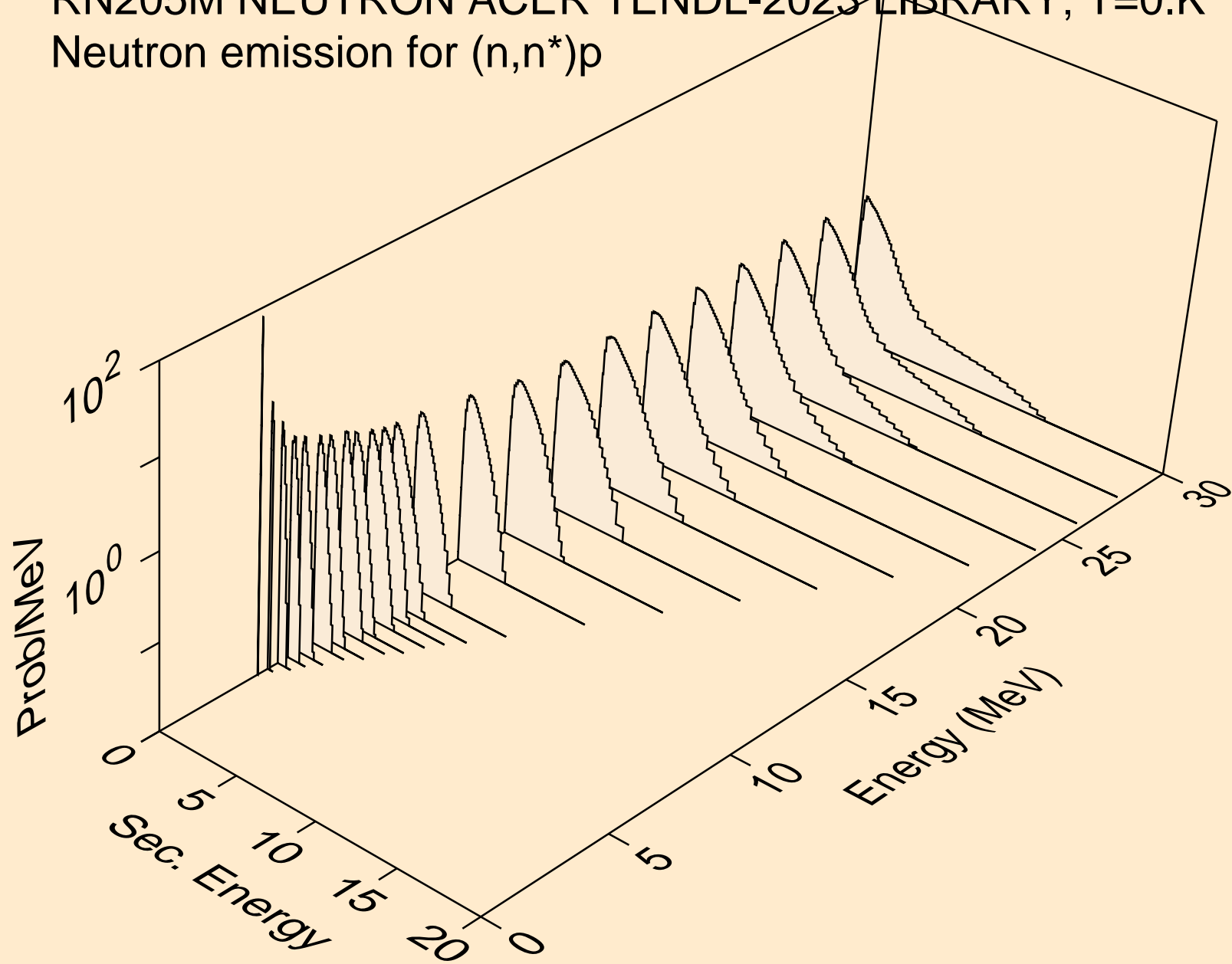

RN205M NEUTRON ACER TENDL-2023 LIBRARY; T=0.K
Neutron emission for (n,n*)2a

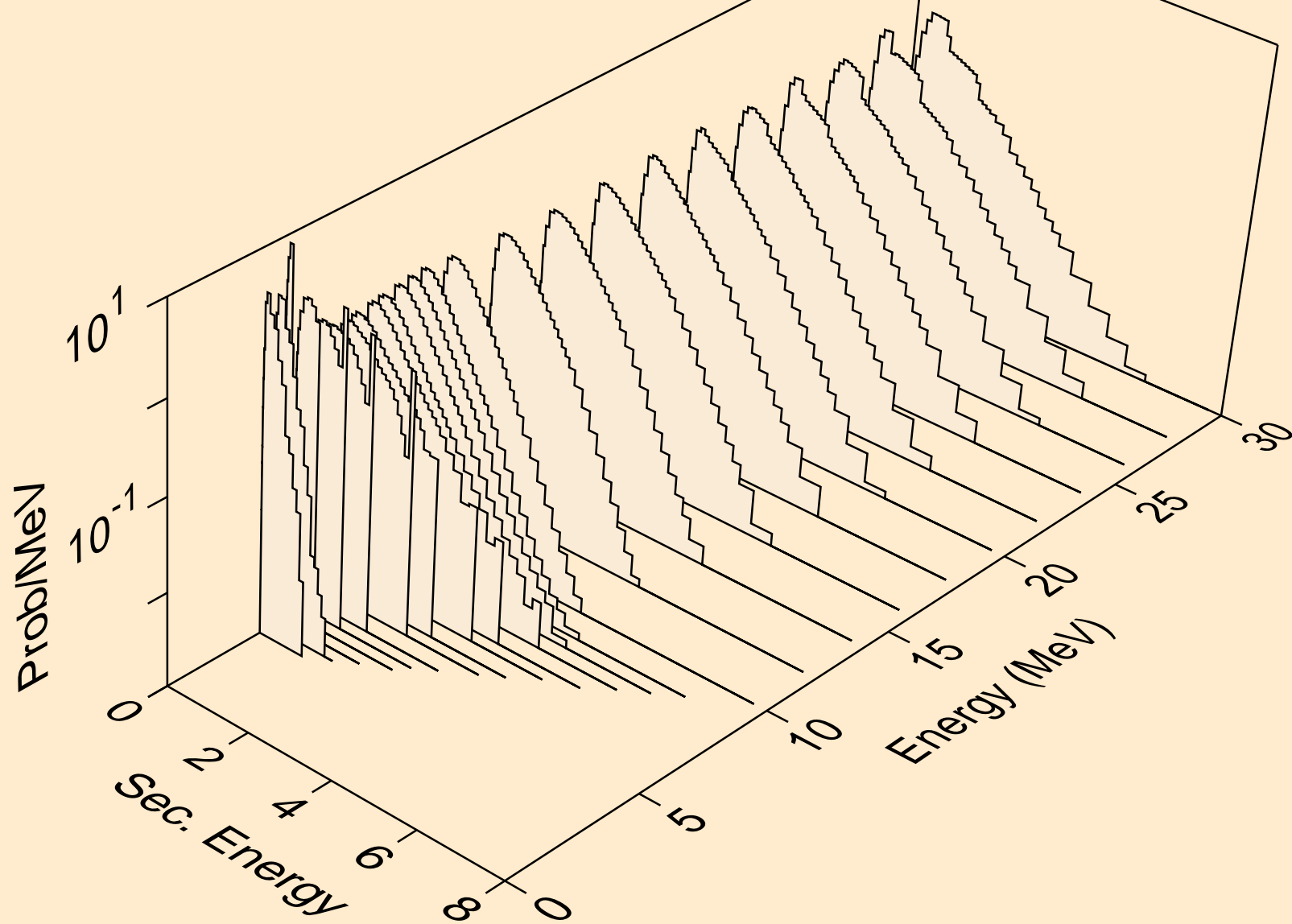

RN205M NEUTRON ACER TENDL-2023 LIBRARY; T=0.K
Neutron emission for (n,2n)2a

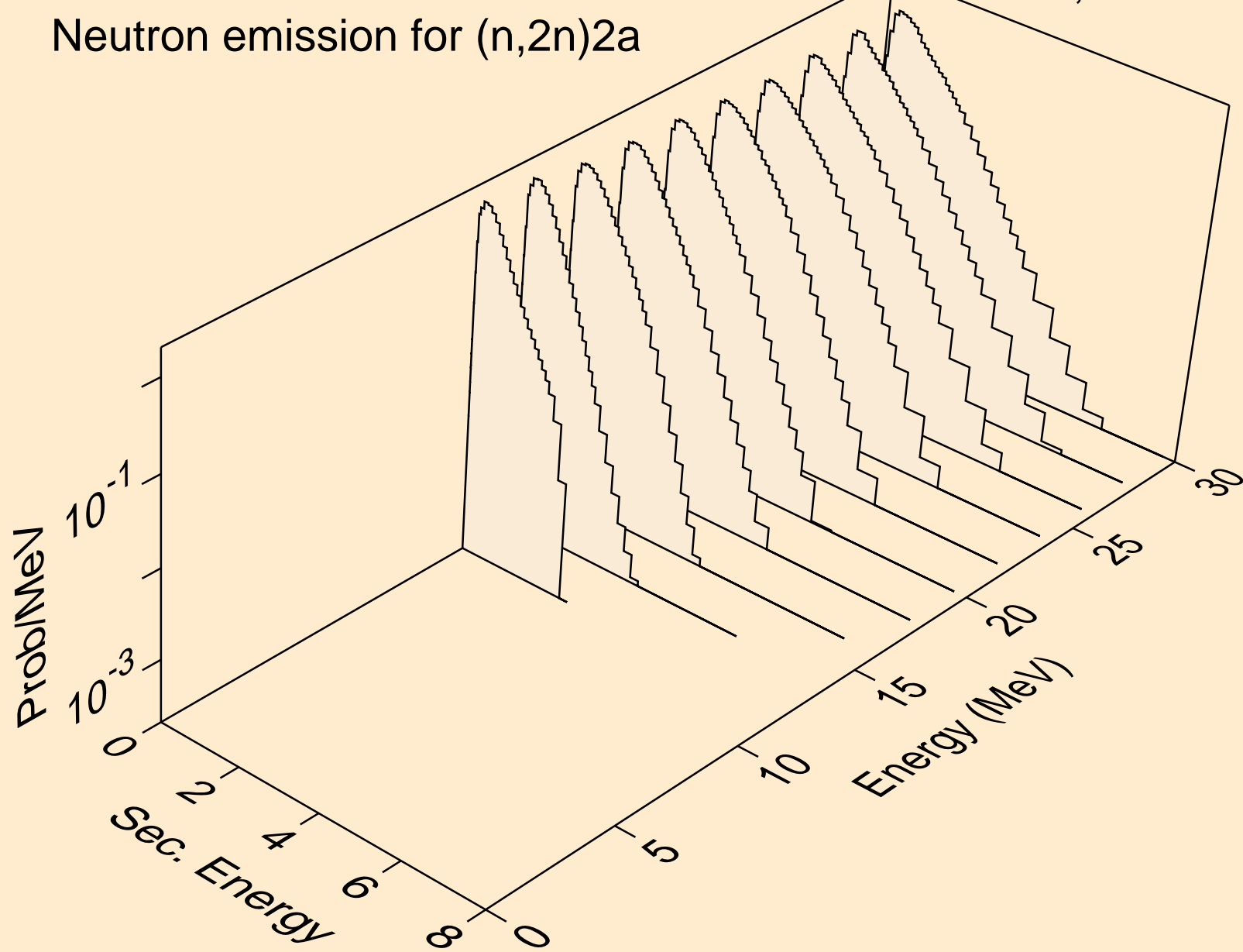

RN205M NEUTRON ACER TENDL-2023 LIBRARY; T=0.K
Neutron emission for (n,n*)d

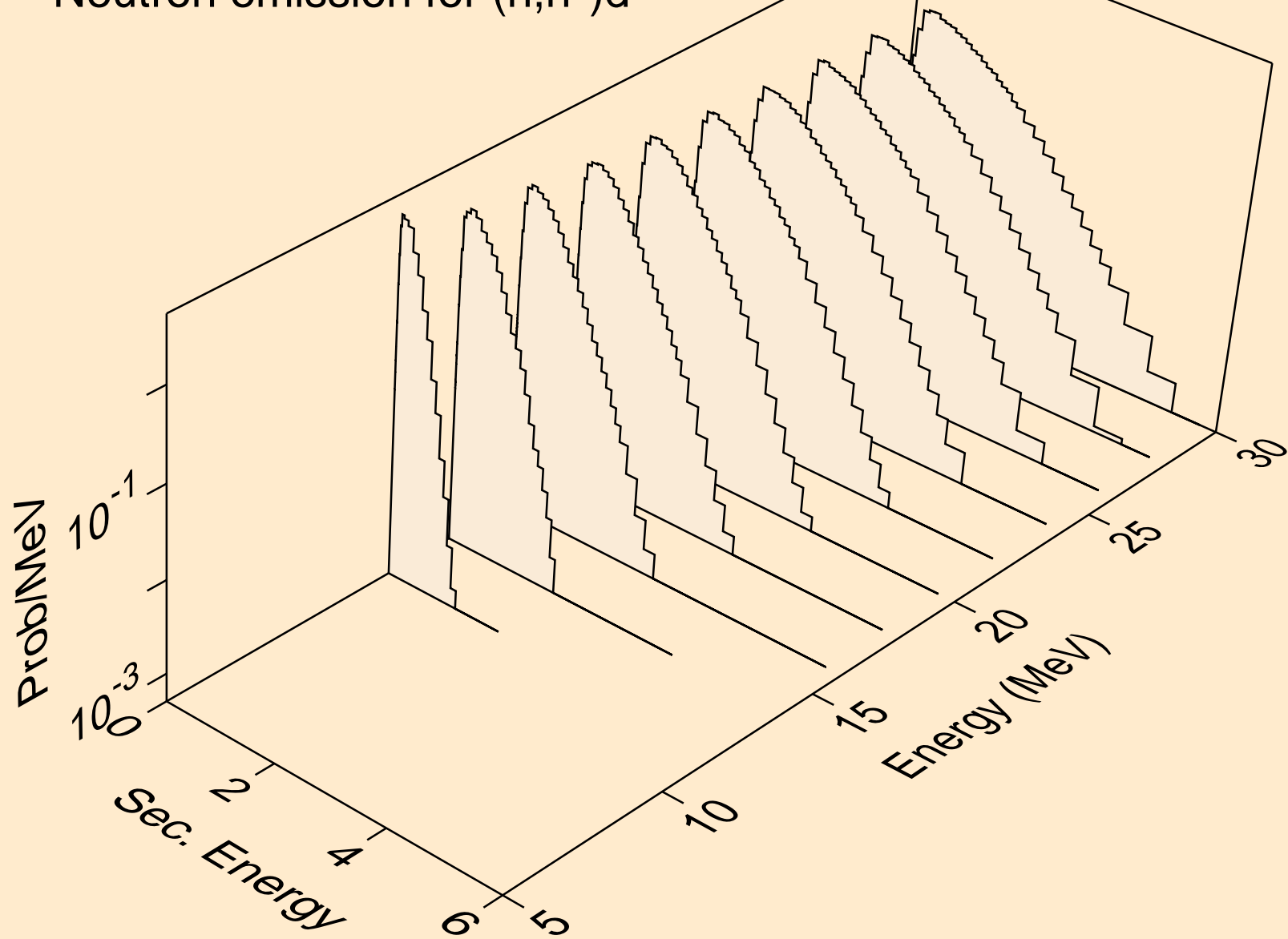

RN205M NEUTRON ACER TENDL-2023 LIBRARY; T=0.K
Neutron emission for (n,n*)t

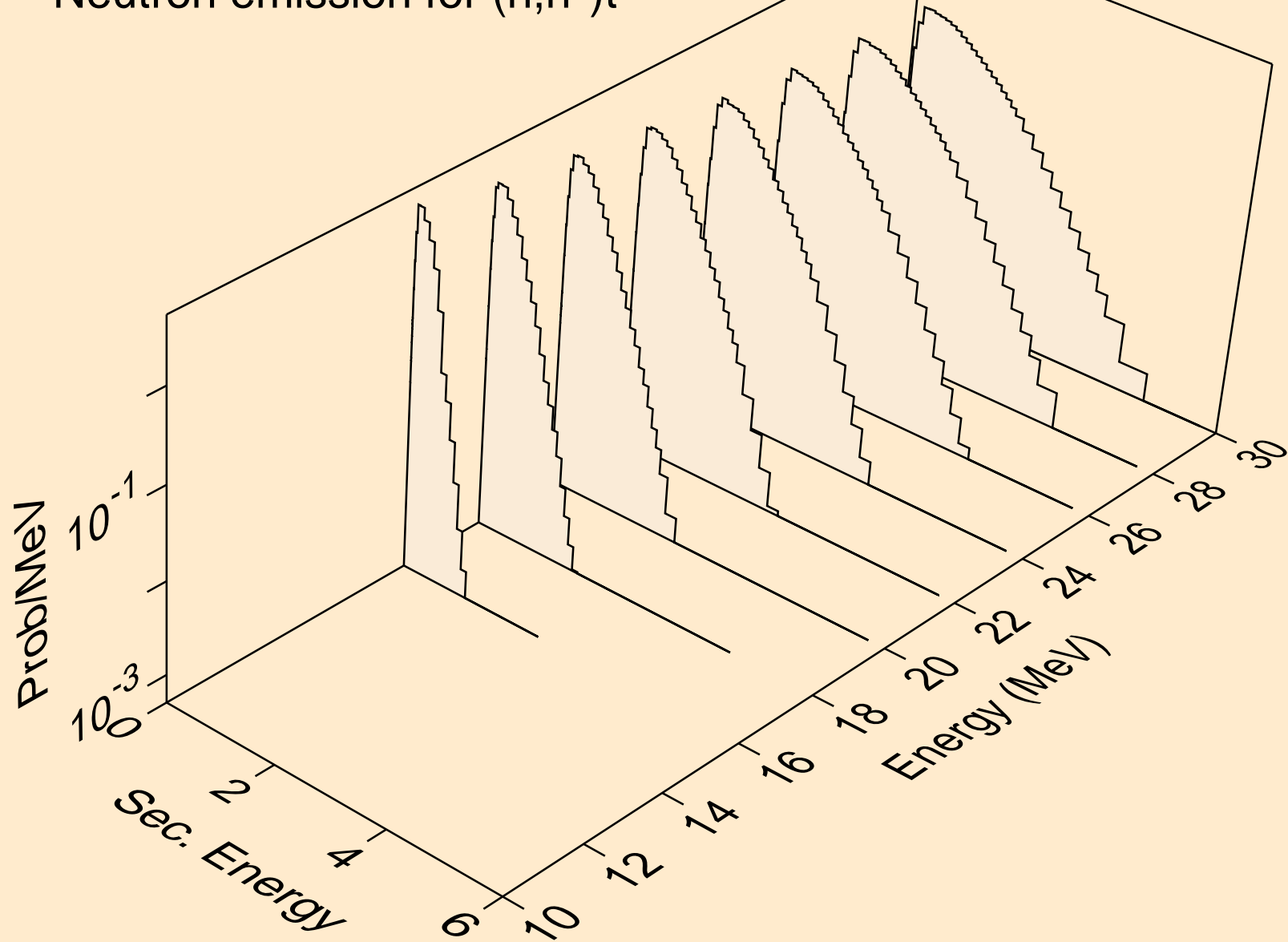

RN205M NEUTRON ACER TENDL-2023 LIBRARY; T=0.K
Neutron emission for (n,n*)he3

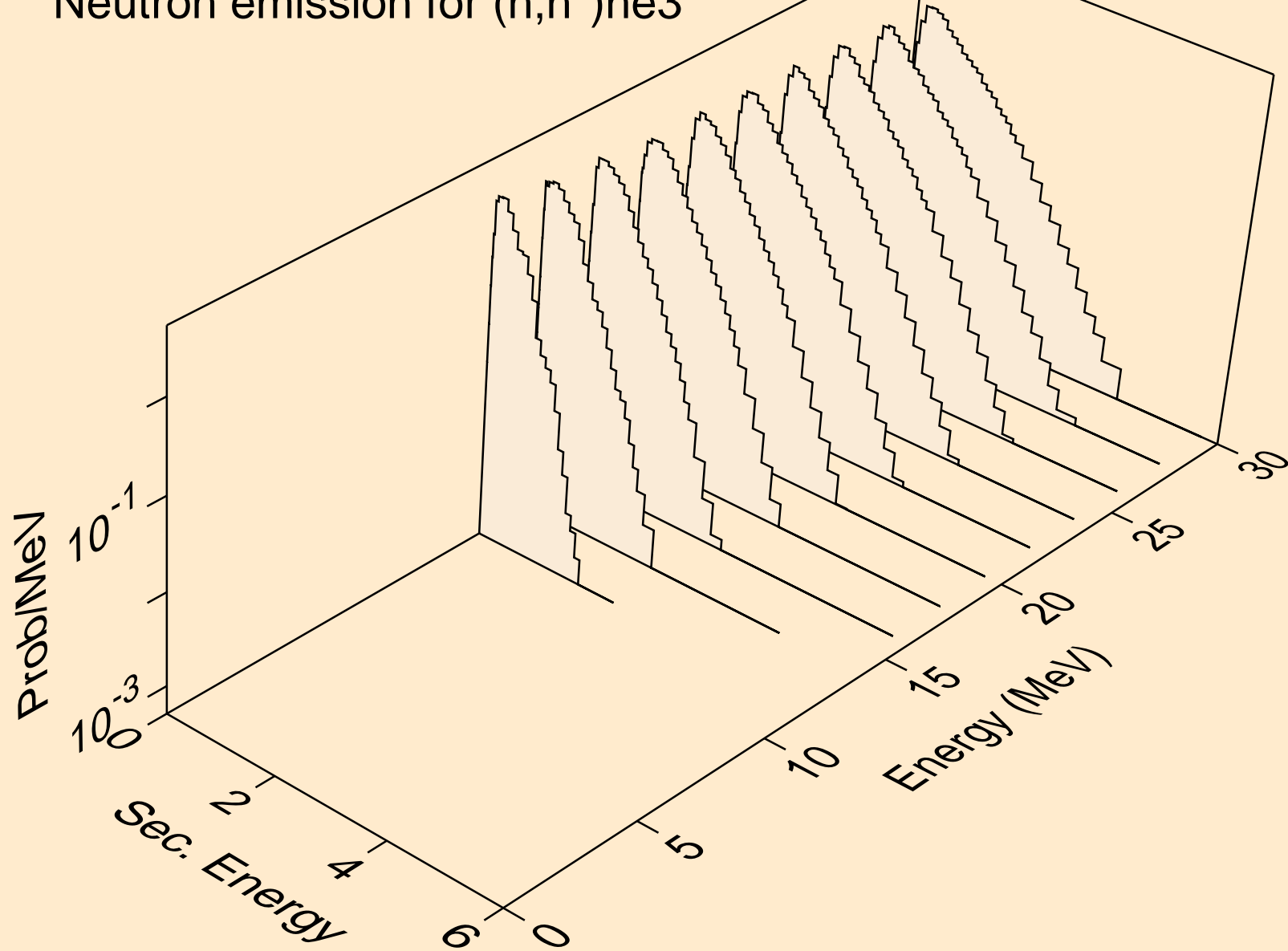

RN205M NEUTRON ACER TENDL-2023 LIBRARY; T=0.K
Neutron emission for (n,4n)

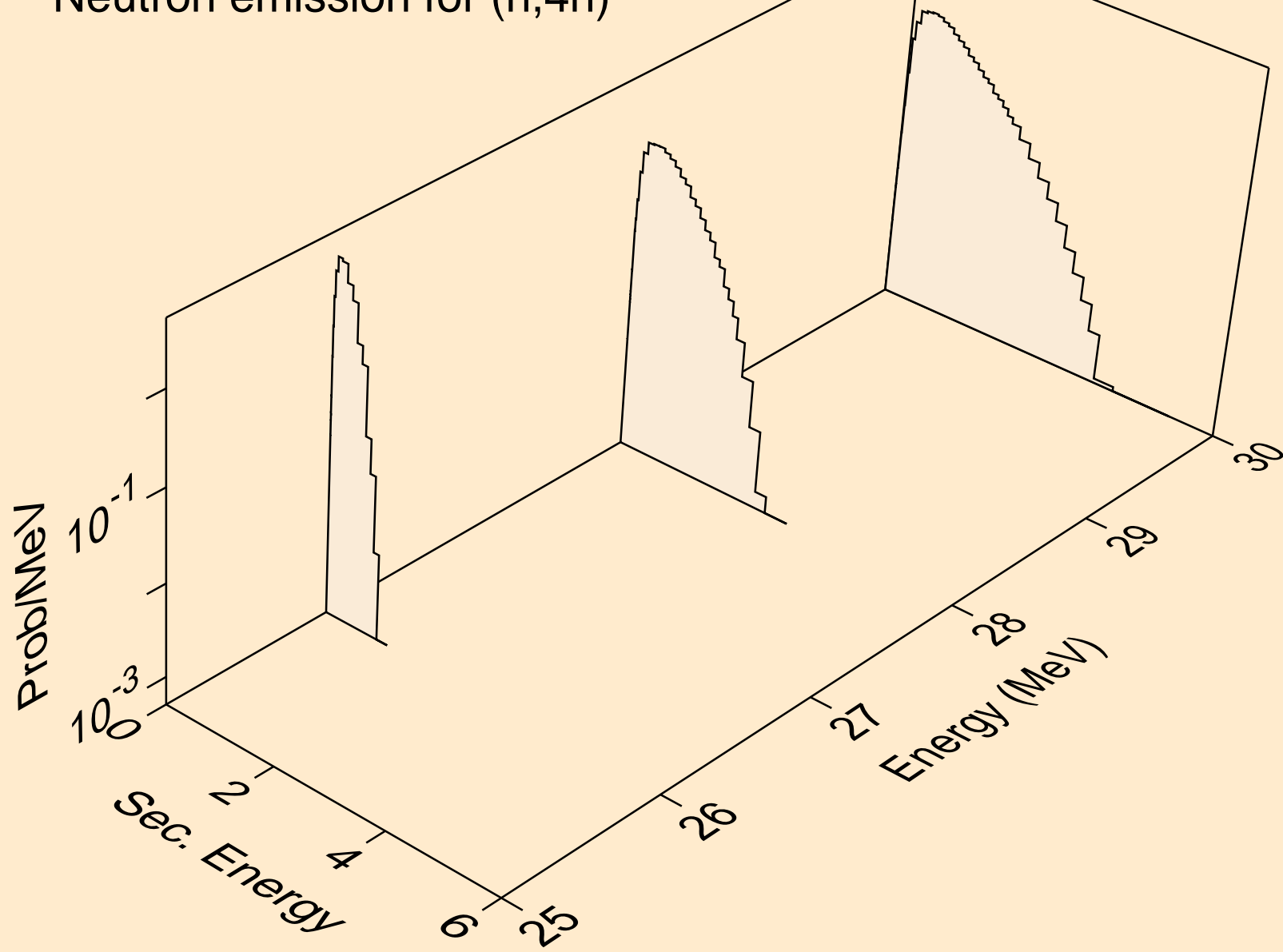

RN205M NEUTRON ACER TENDL-2023 LIBRARY; T=0.K
Neutron emission for (n,2np)

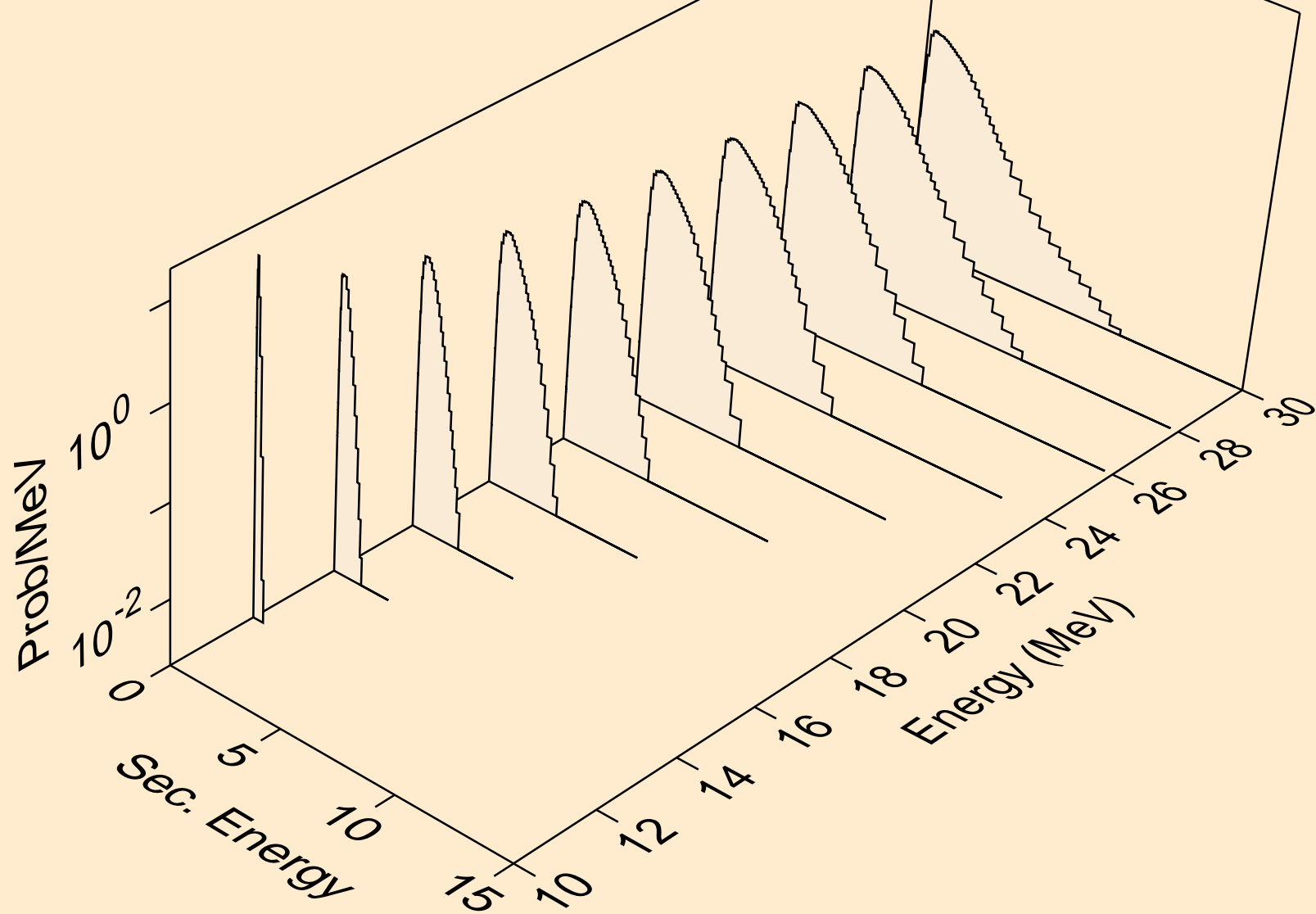

RN205M NEUTRON ACER TENDL-2023 LIBRARY; T=0.K
Neutron emission for (n,3np)

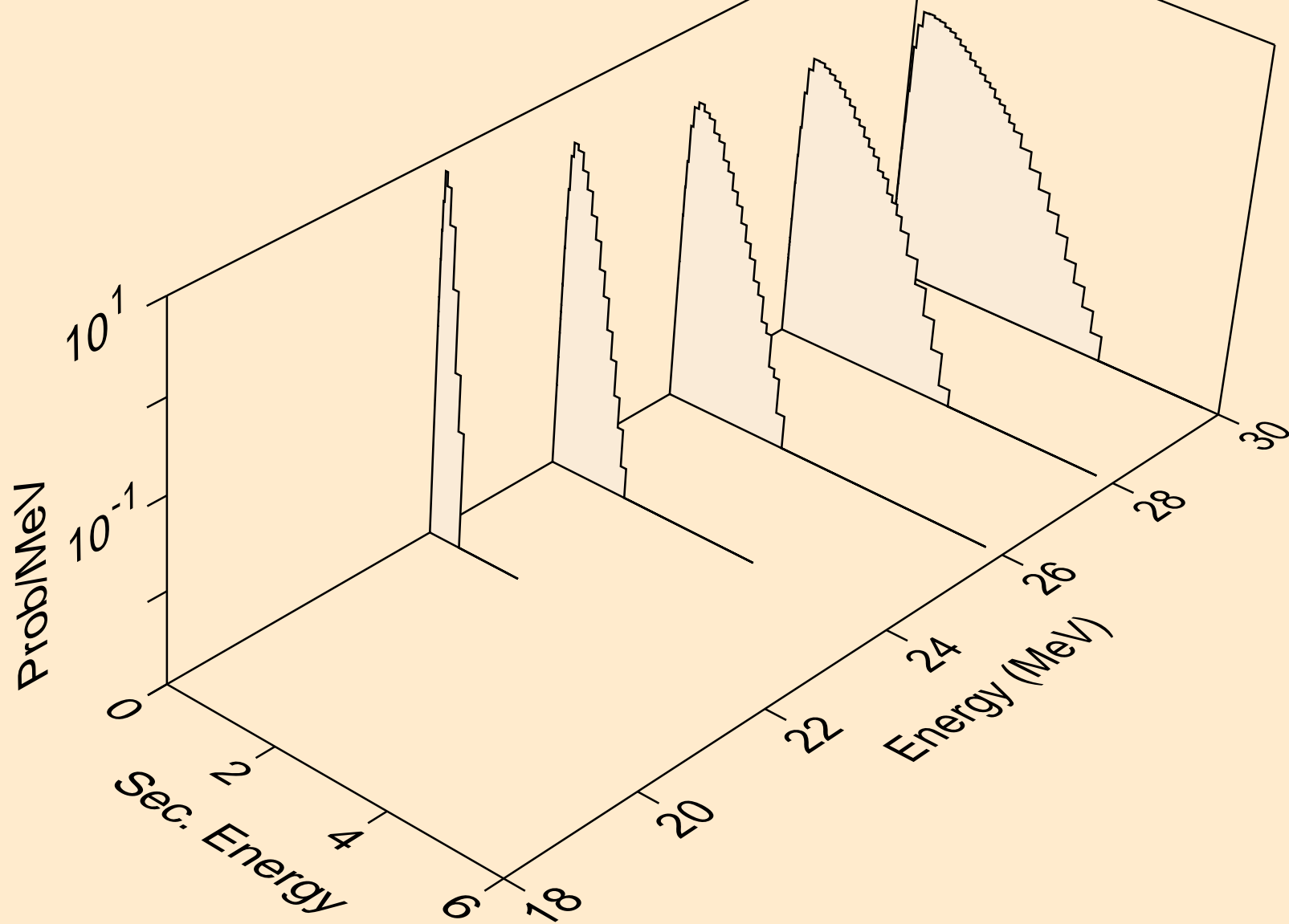

RN205M NEUTRON ACER TENDL-2023 LIBRARY; T=0.K
Neutron emission for (n,n2p)

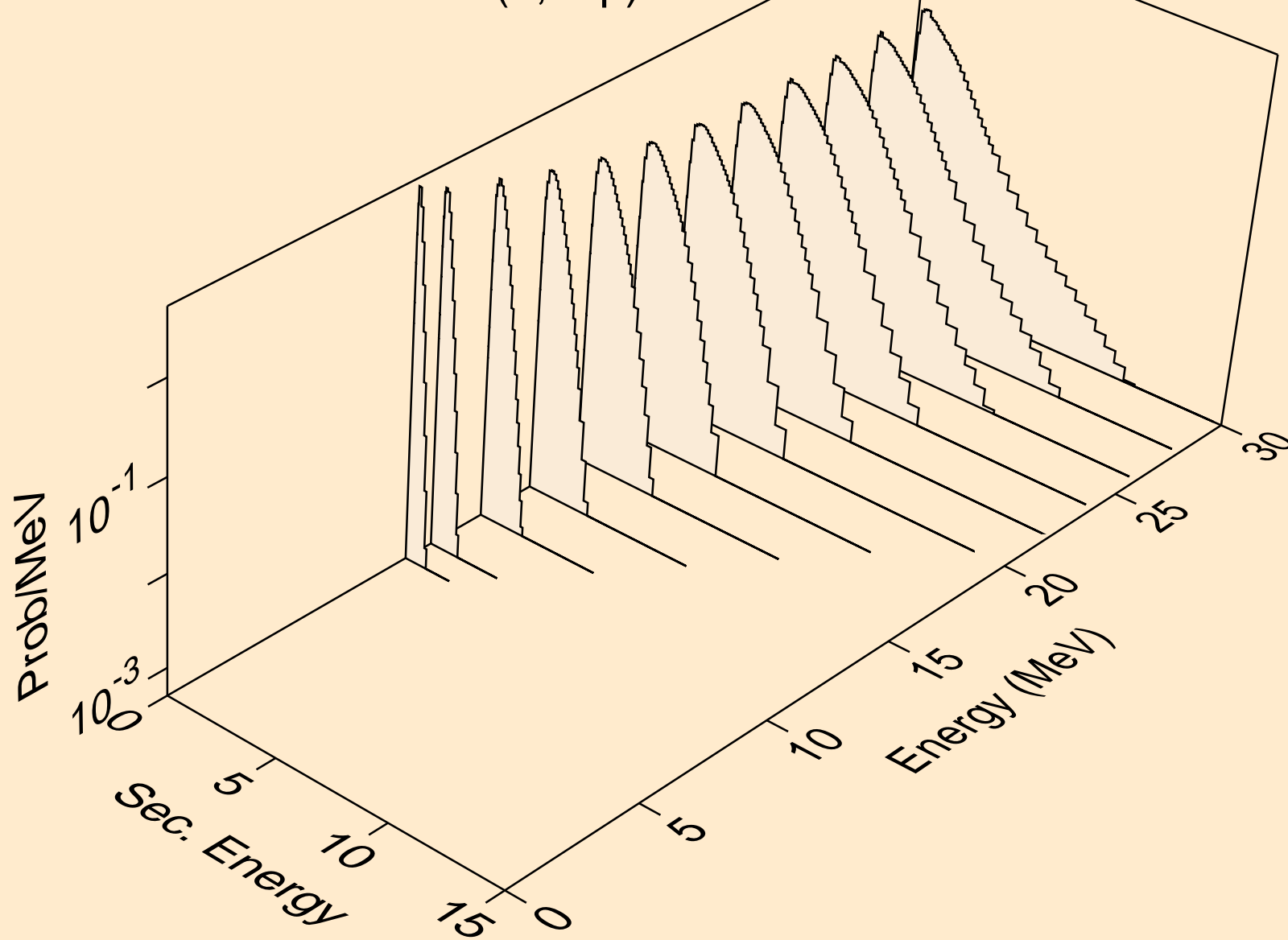

RN205M NEUTRON ACER TENDL-2023 LIBRARY; T=0.K
Neutron emission for (n,npa)

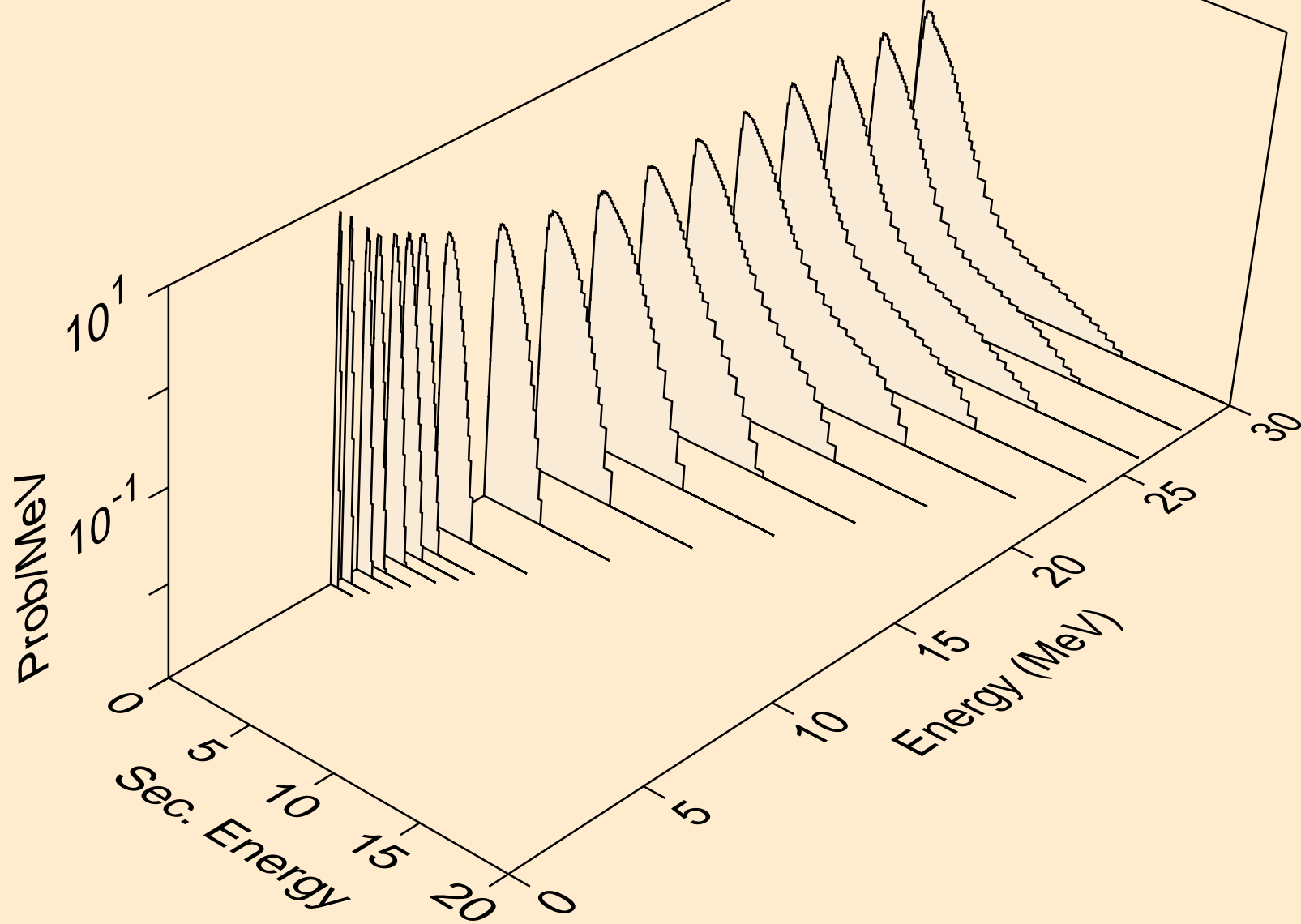

RN205M NEUTRON ACER TENDL-2023 LIBRARY; T=0.K
Neutron emission for (n,n*c)

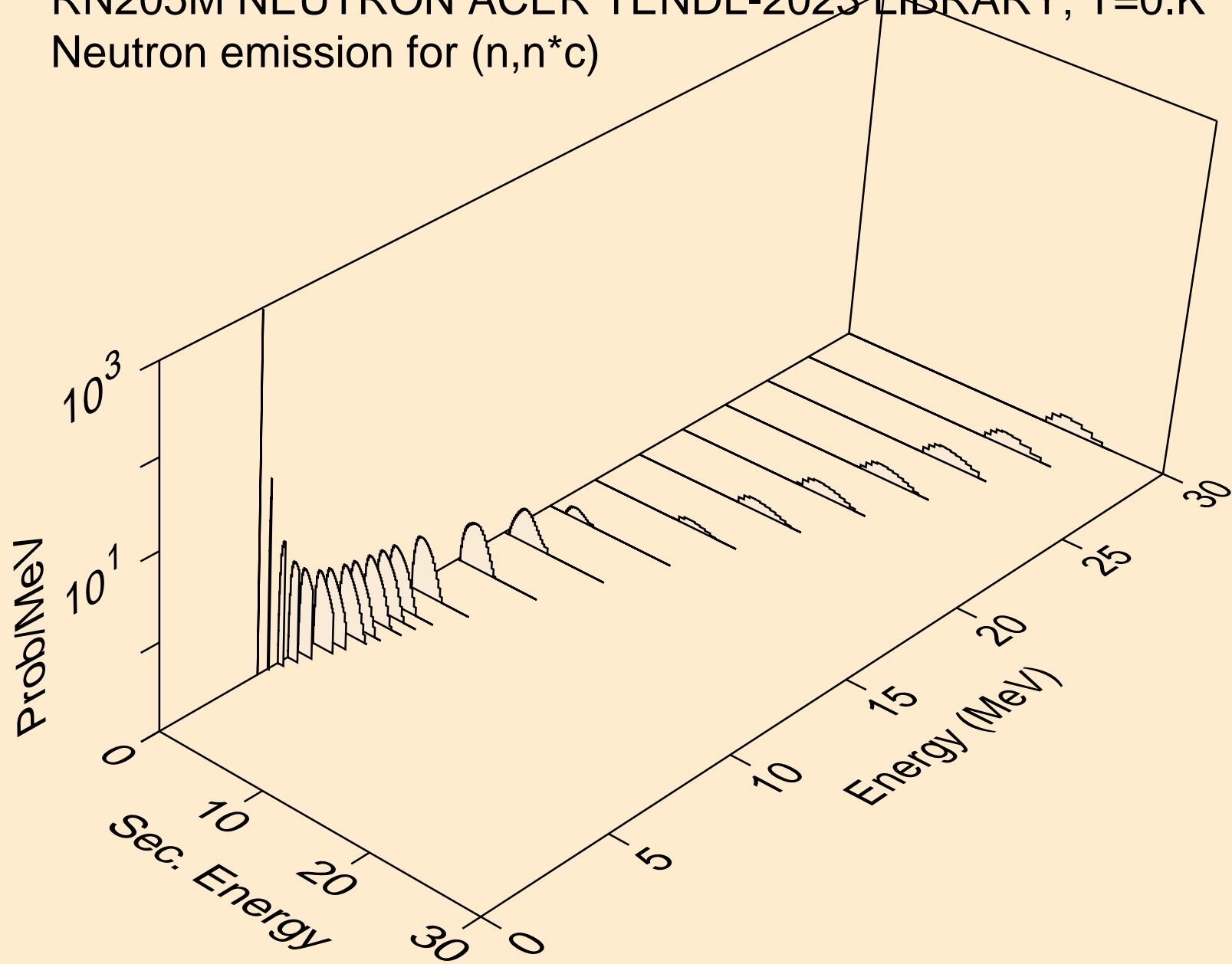

RN205M NEUTRON ACER TENDL-2023 LIBRARY; T=0.K
Photon emission for (n,x)

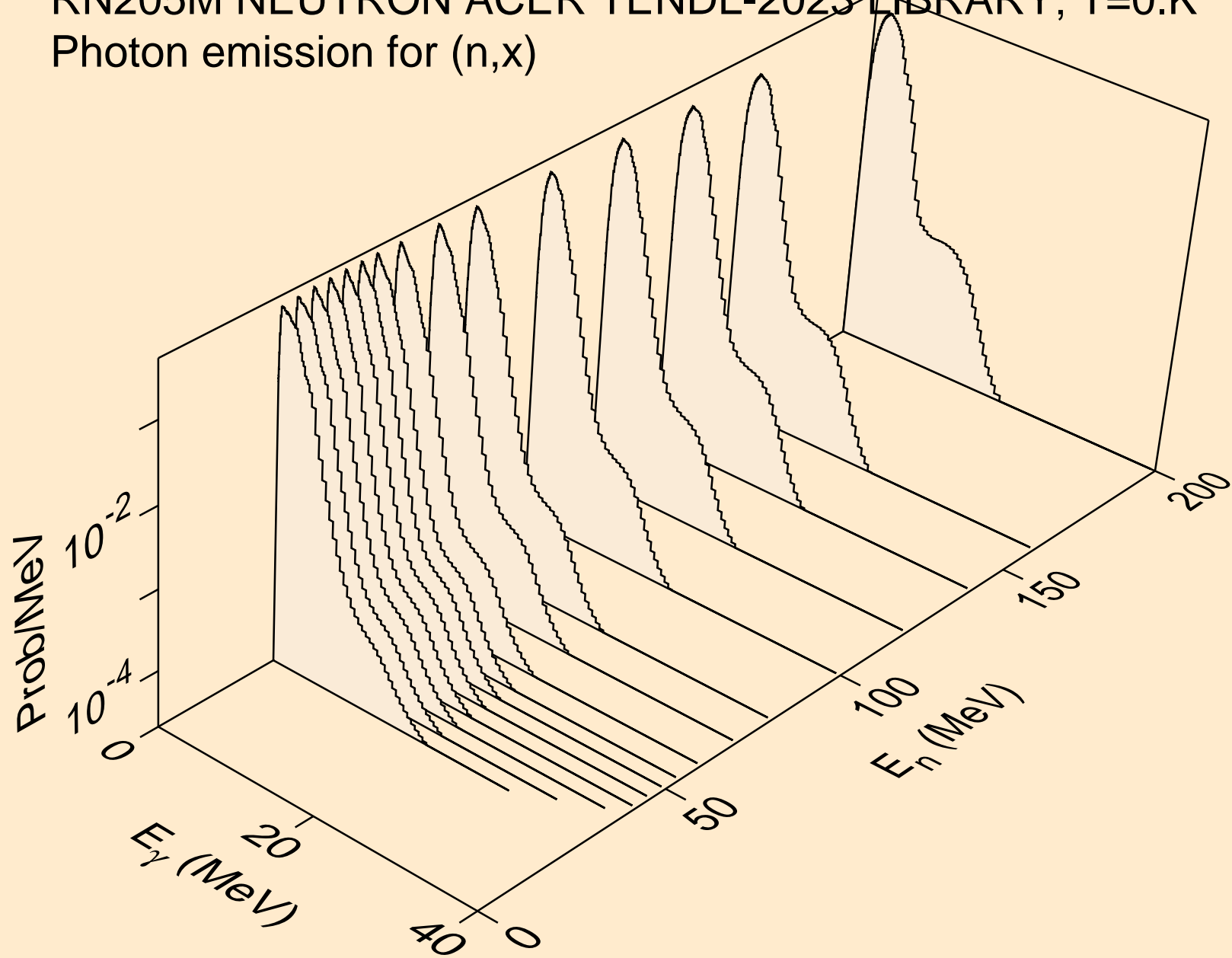

RN205M NEUTRON ACER TENDL-2023 LIBRARY; T=0.K
Photon emission for (n,2nd)

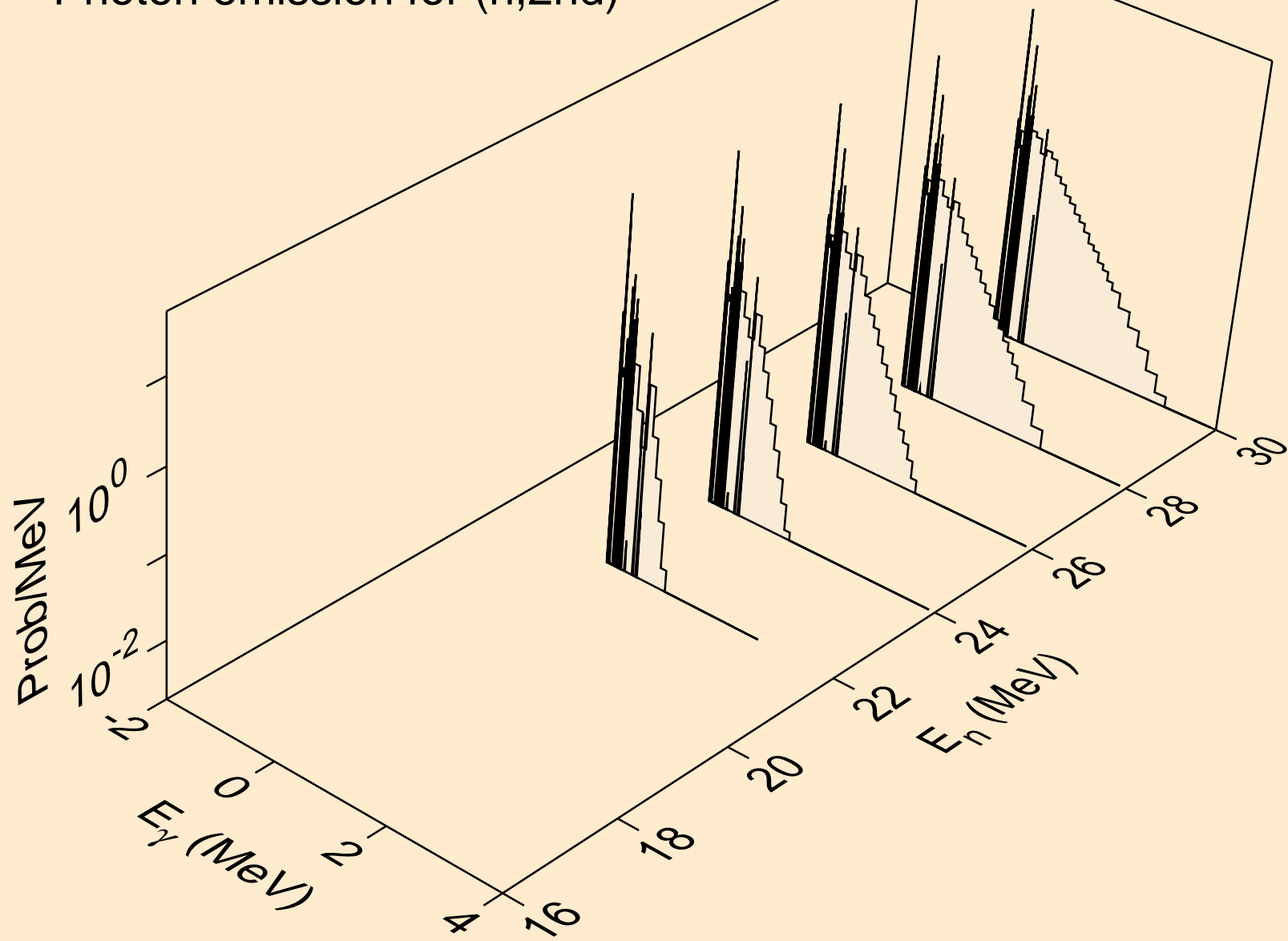

RN205M NEUTRON ACER TENDL-2023 LIBRARY; T=0.K
Photon emission for (n,2n)

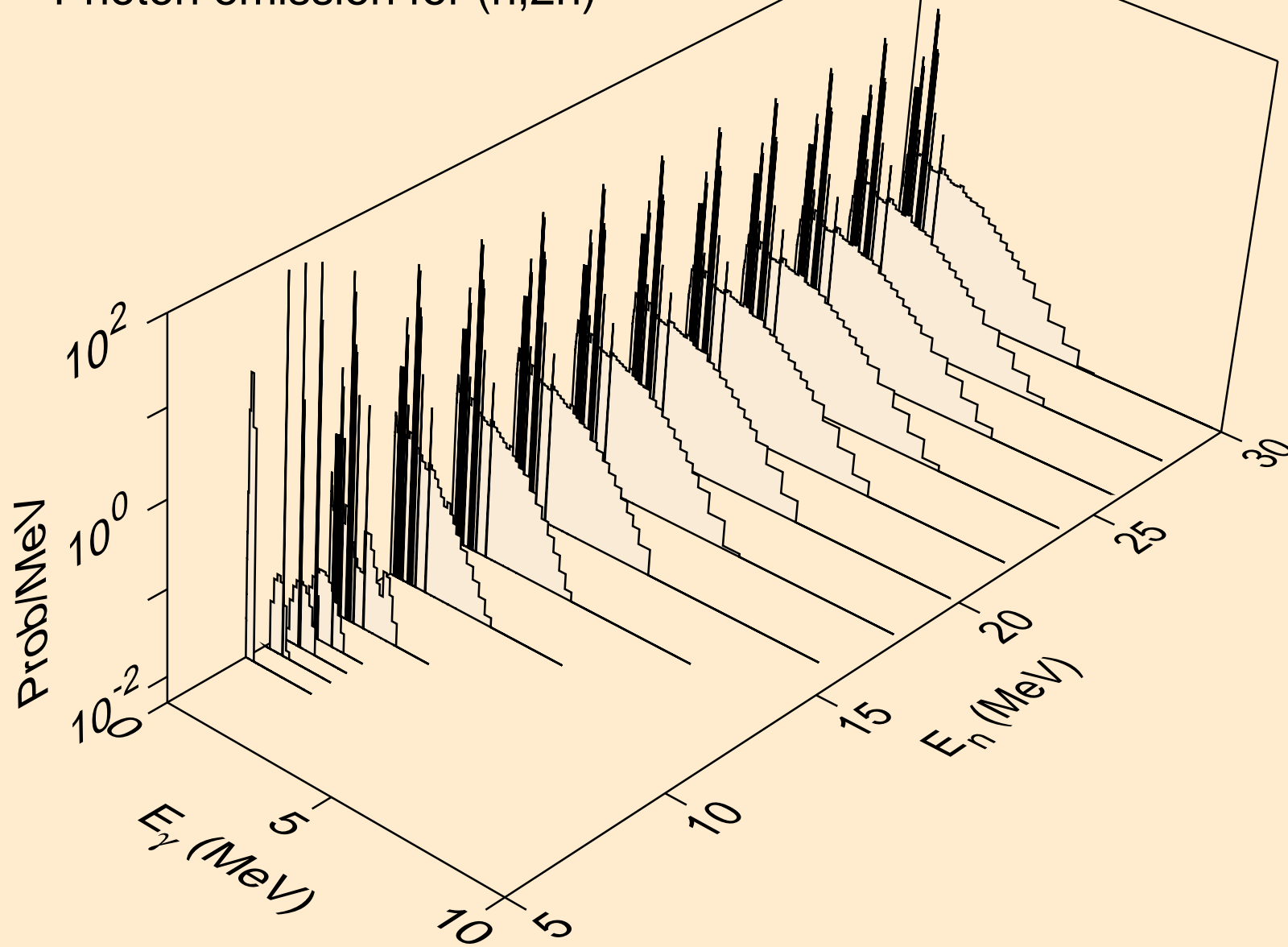

RN205M NEUTRON ACER TENDL-2023 LIBRARY; T=0.K
Photon emission for (n,3n)

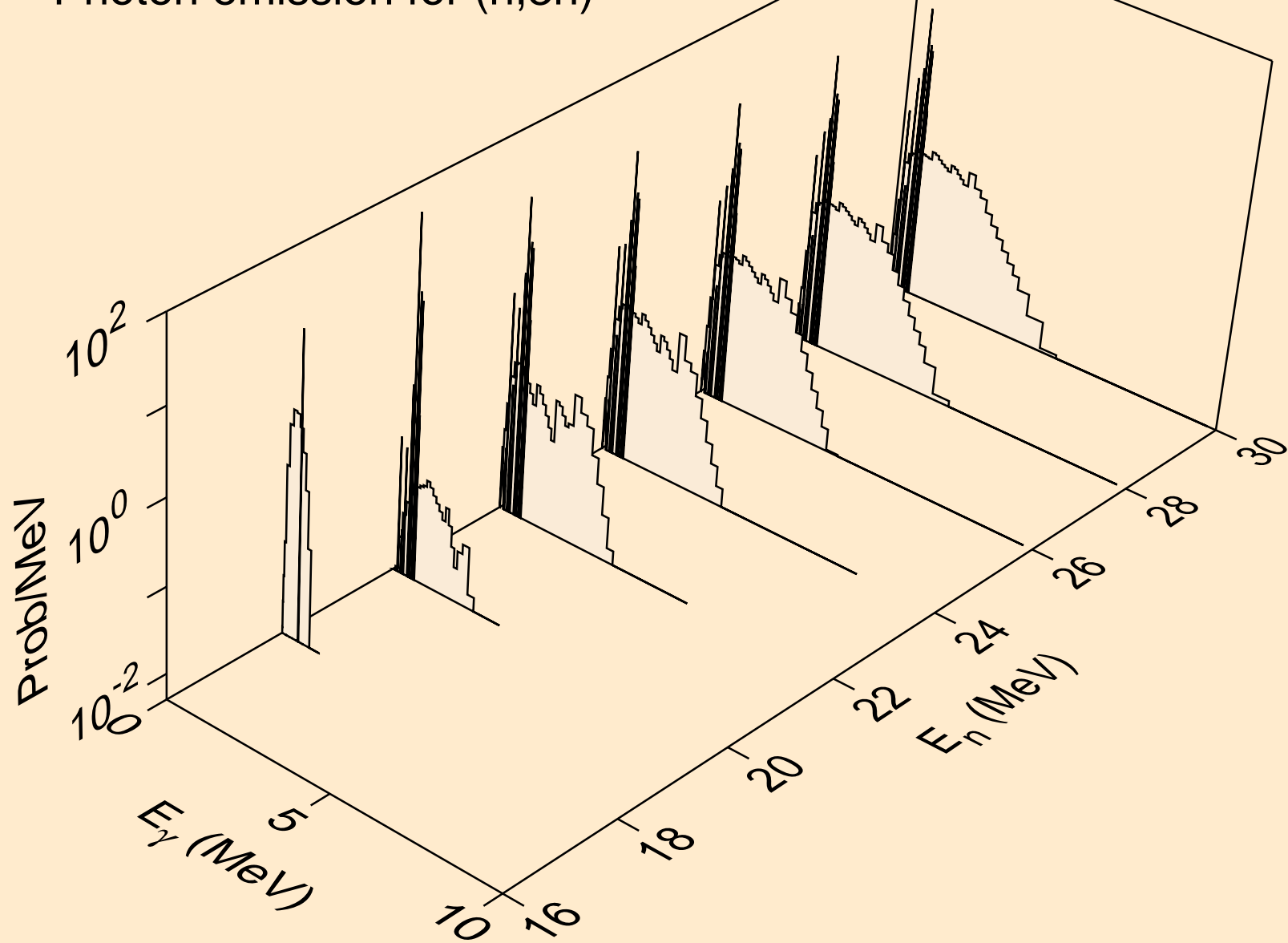

RN205M NEUTRON ACER TENDL-2023 LIBRARY; T=0.K
Photon emission for (n,n*)a

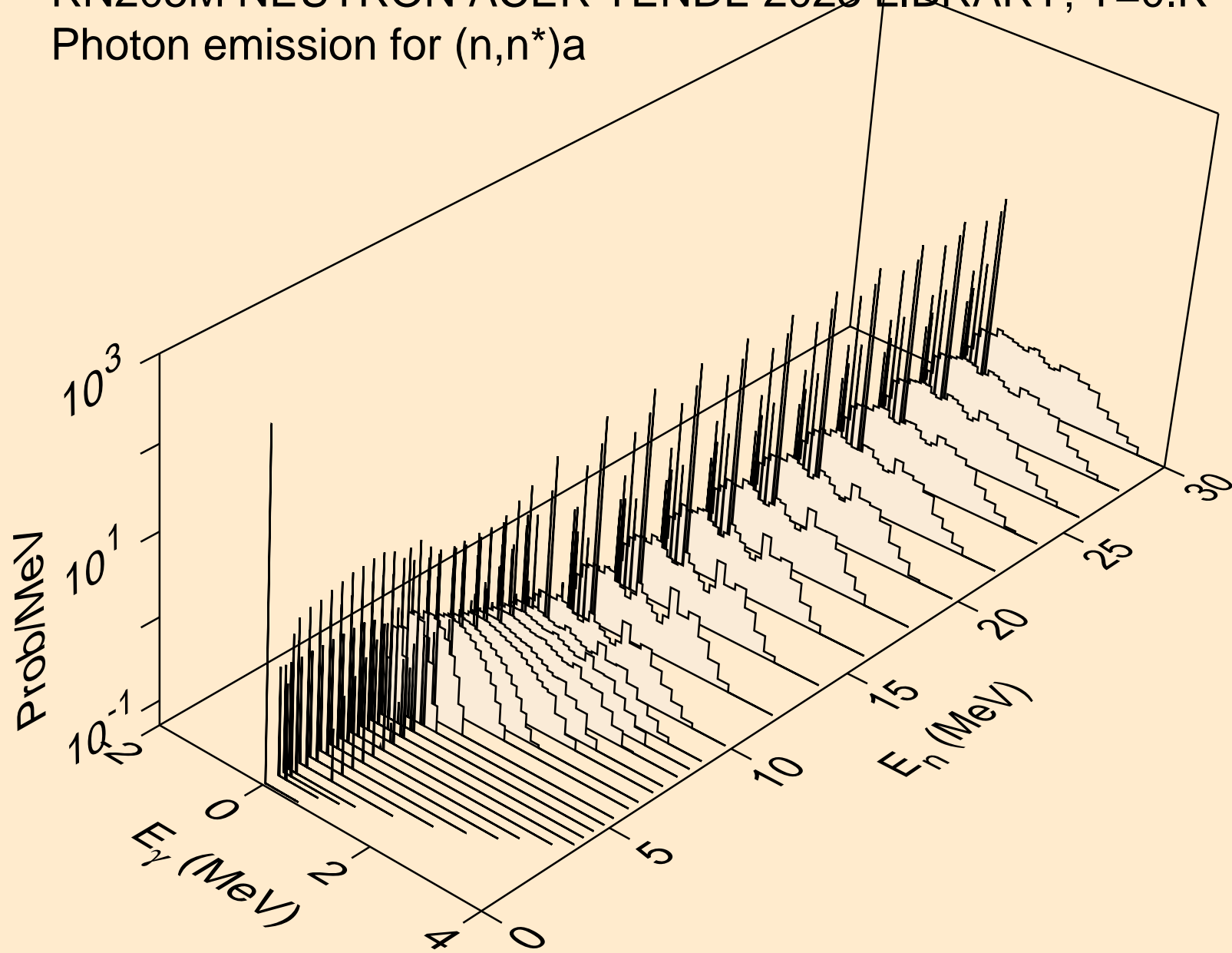

RN205M NEUTRON ACER TENDL-2023 LIBRARY; T=0.K
Photon emission for (n,2n)a

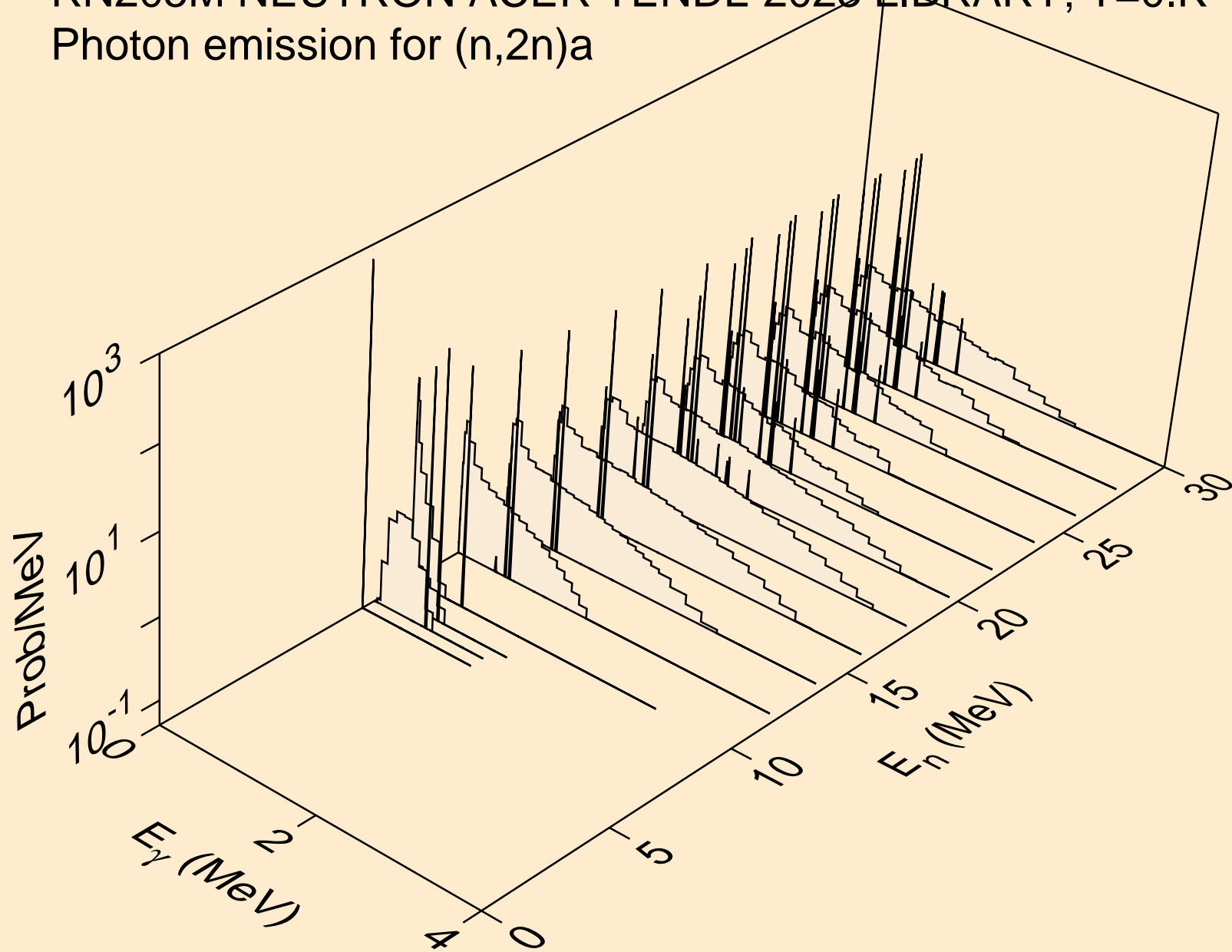

RN205M NEUTRON ACER TENDL-2023 LIBRARY; T=0.K
Photon emission for (n,3n)a

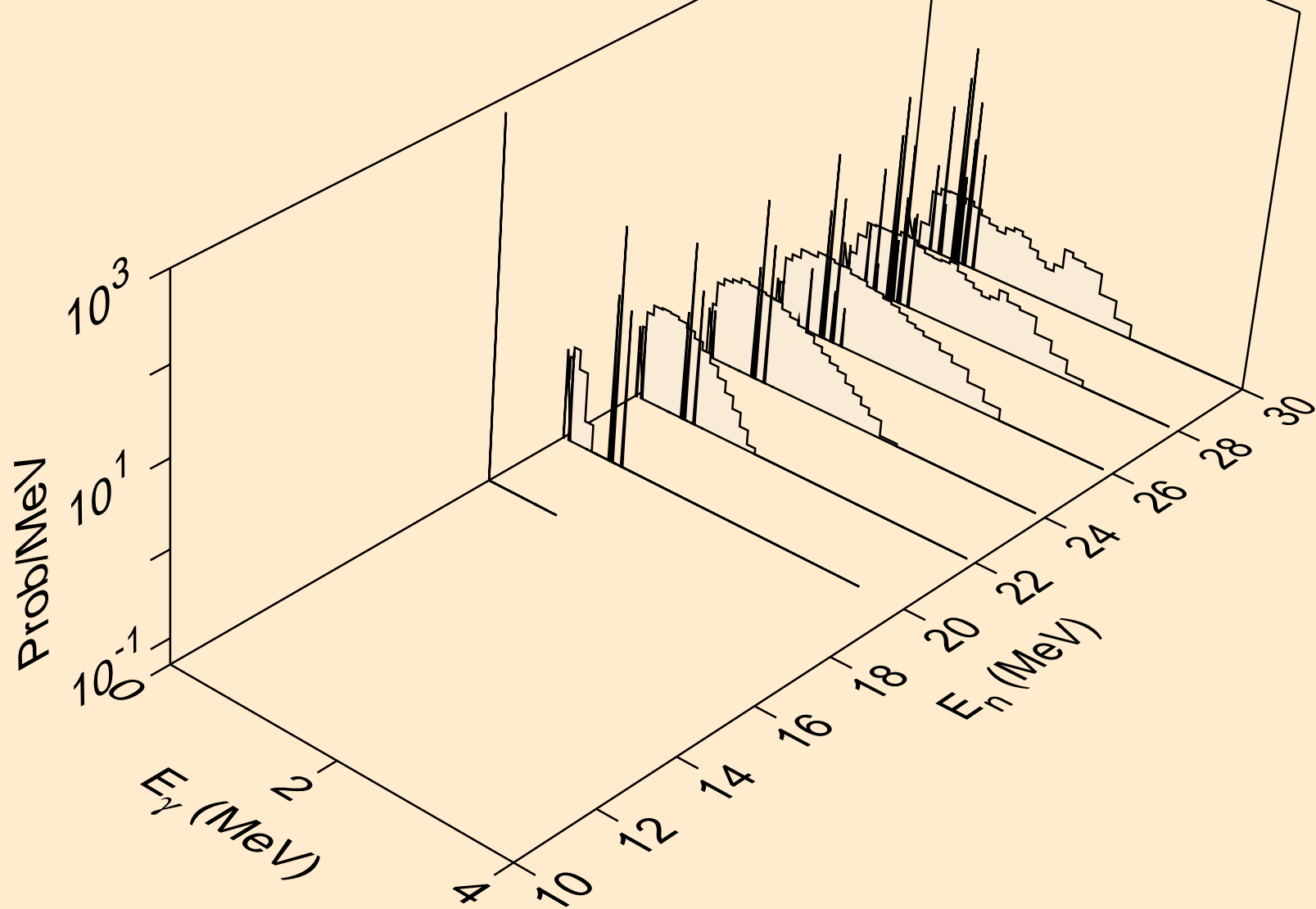

RN205M NEUTRON ACER TENDL-2023 LIBRARY; T=0.K
Photon emission for (n,n*)p

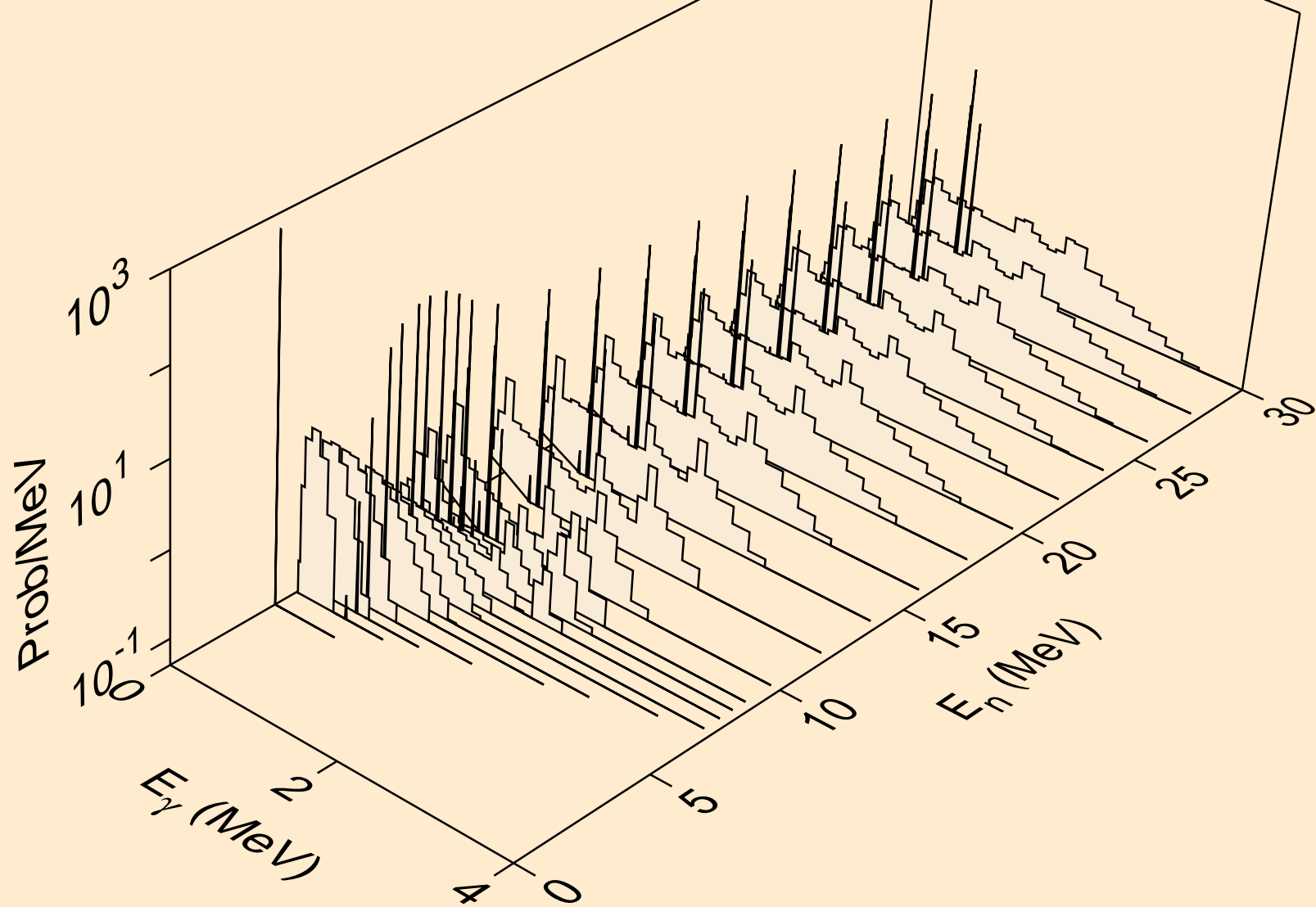

RN205M NEUTRON ACER TENDL-2023 LIBRARY; T=0.K
Photon emission for (n,n*)2a

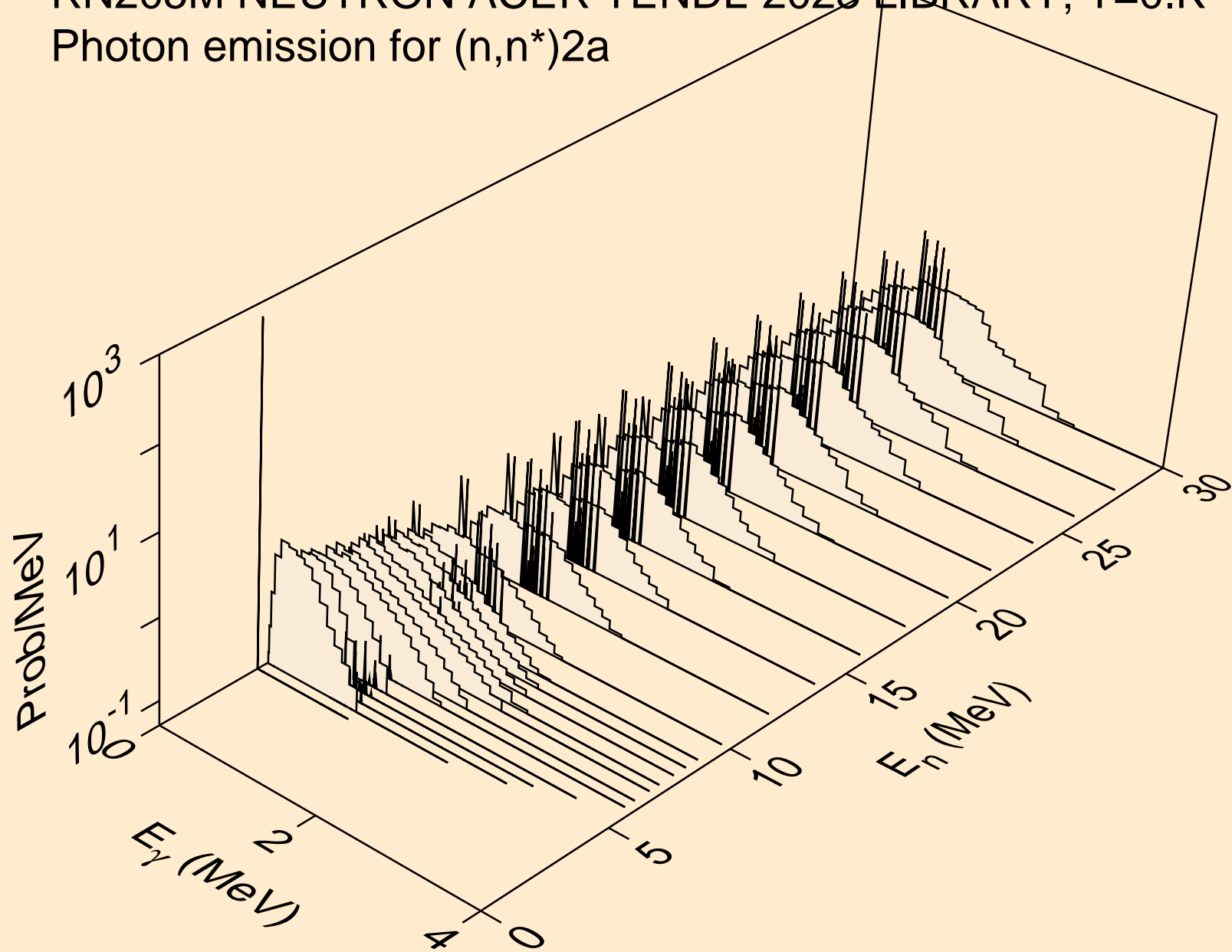

RN205M NEUTRON ACER TENDL-2023 LIBRARY; T=0.K
Photon emission for (n,2n)2a

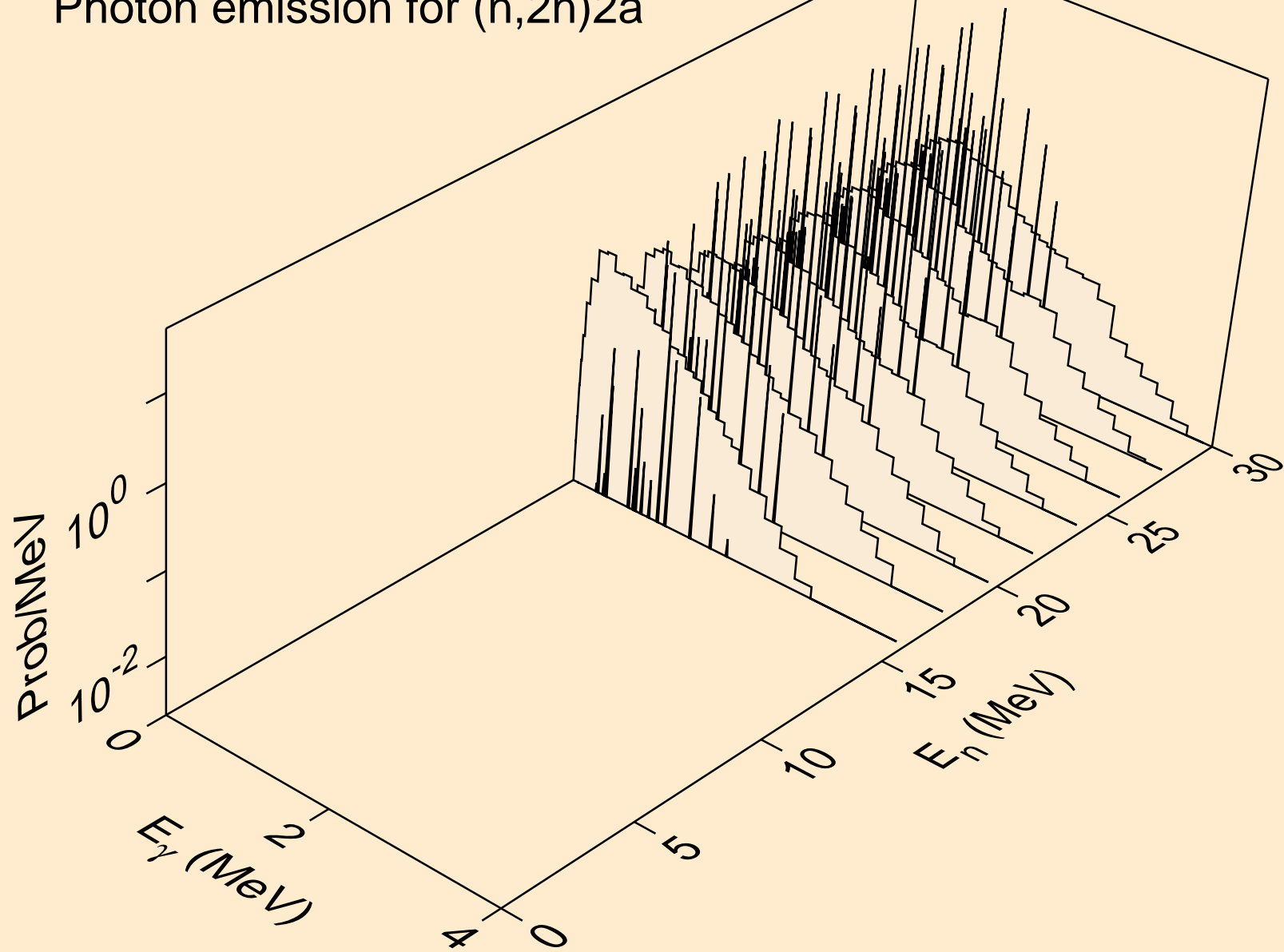

RN205M NEUTRON ACER TENDL-2023 LIBRARY; T=0.K
Photon emission for (n,n*)d

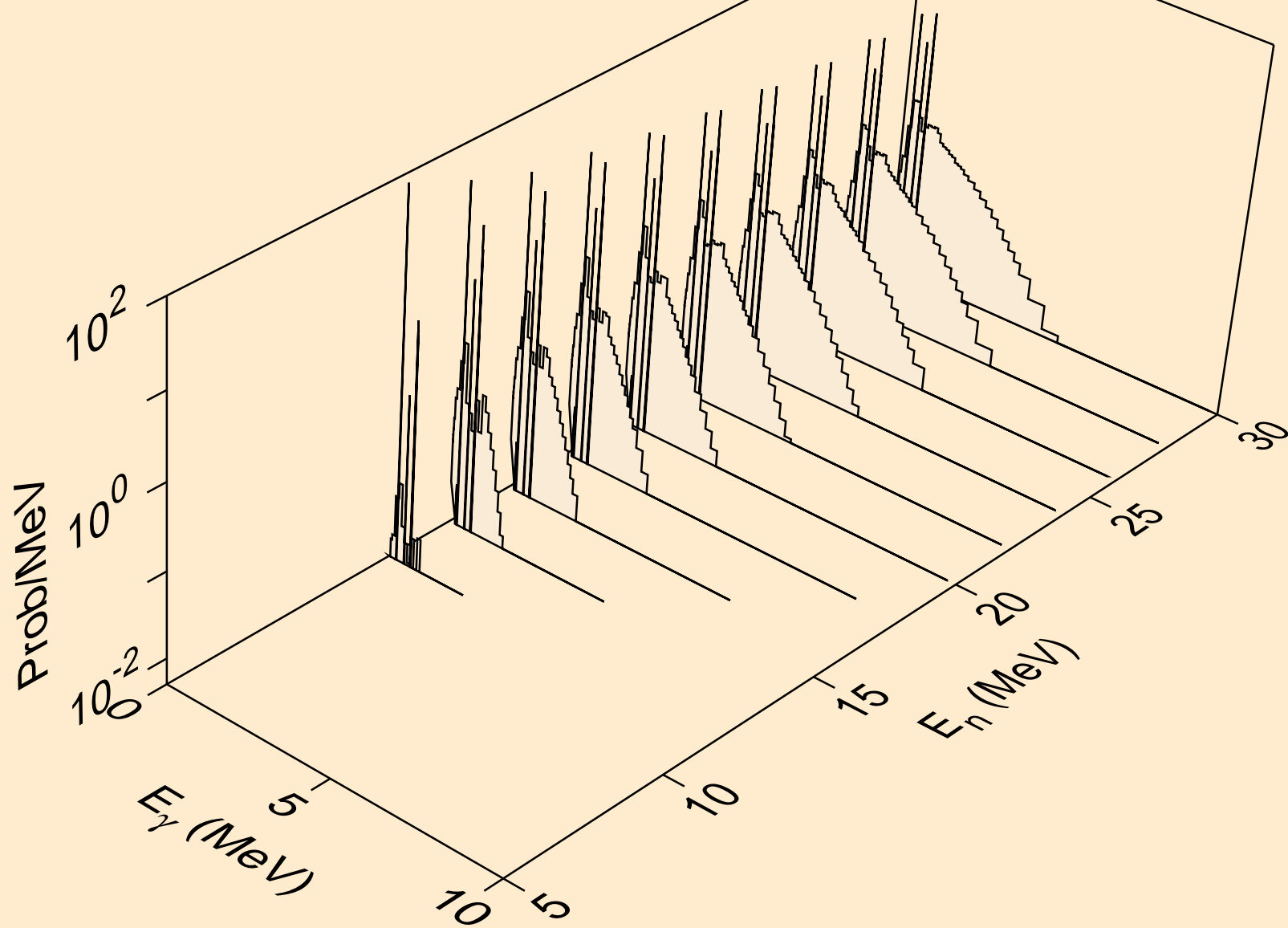

RN205M NEUTRON ACER TENDL-2023 LIBRARY; T=0.K
Photon emission for (n,n*)t

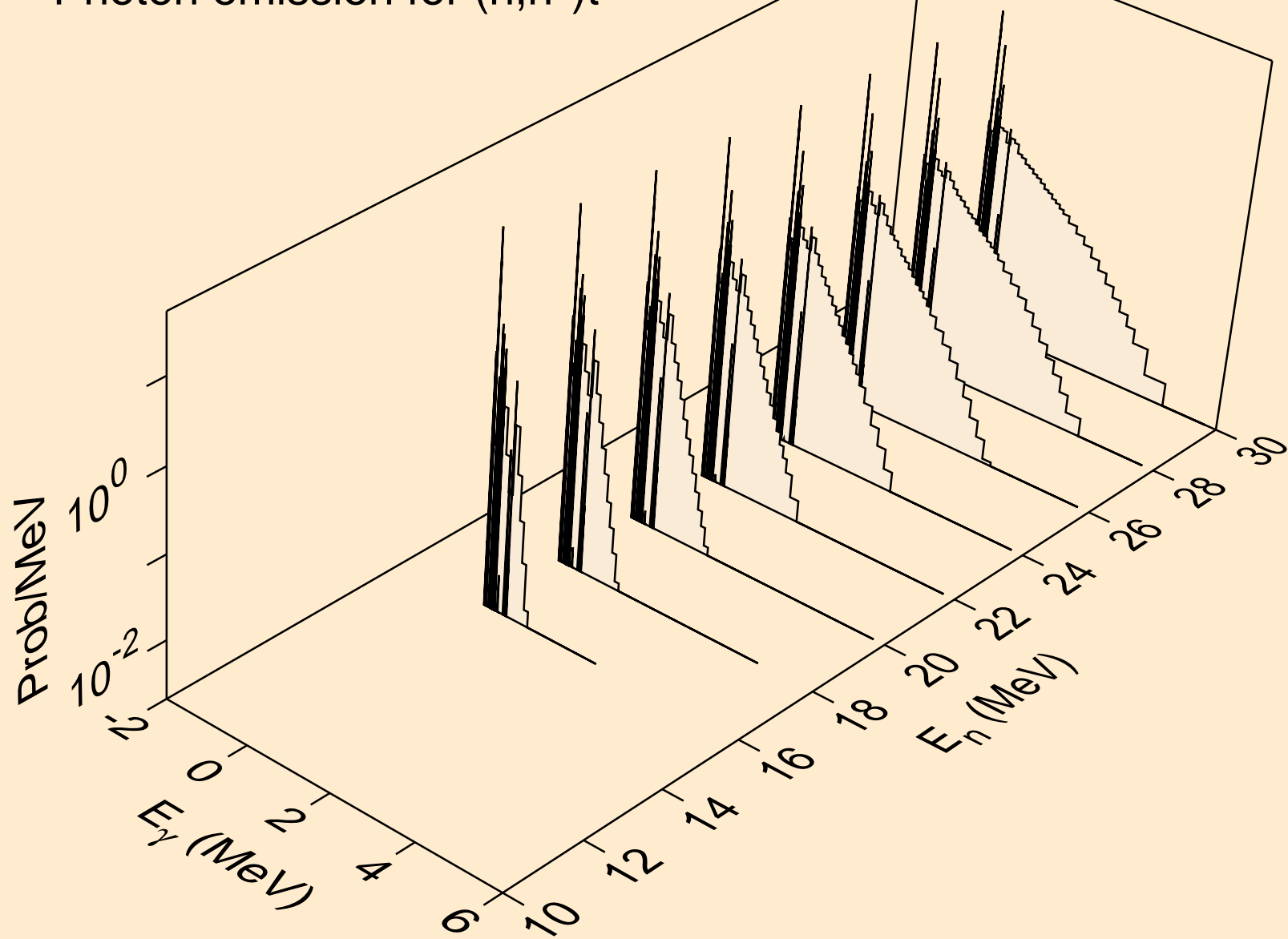

RN205M NEUTRON ACER TENDL-2023 LIBRARY; T=0.K
Photon emission for (n,n*)he3

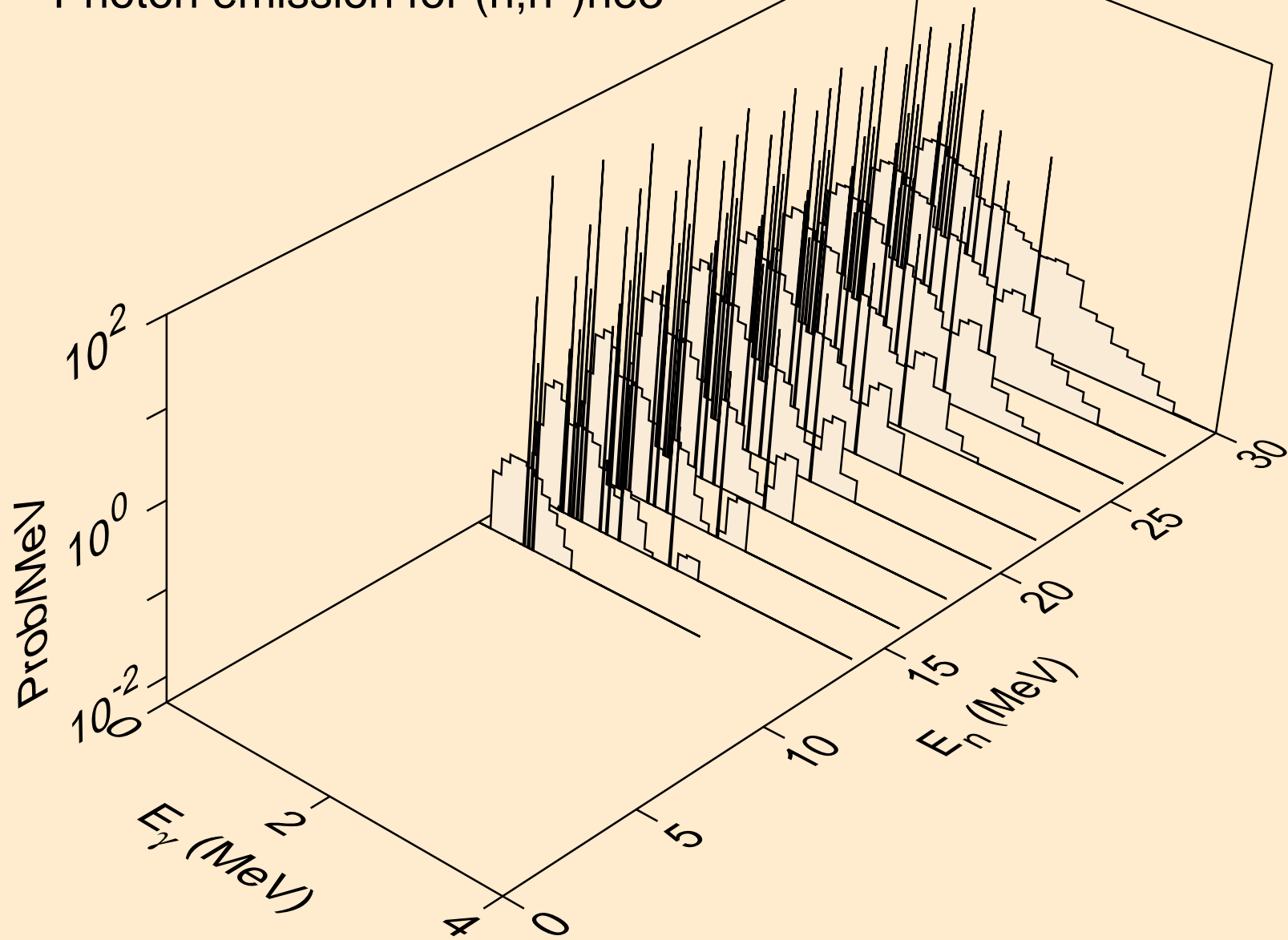

RN205M NEUTRON ACER TENDL-2023 LIBRARY; T=0.K
Photon emission for (n,4n)

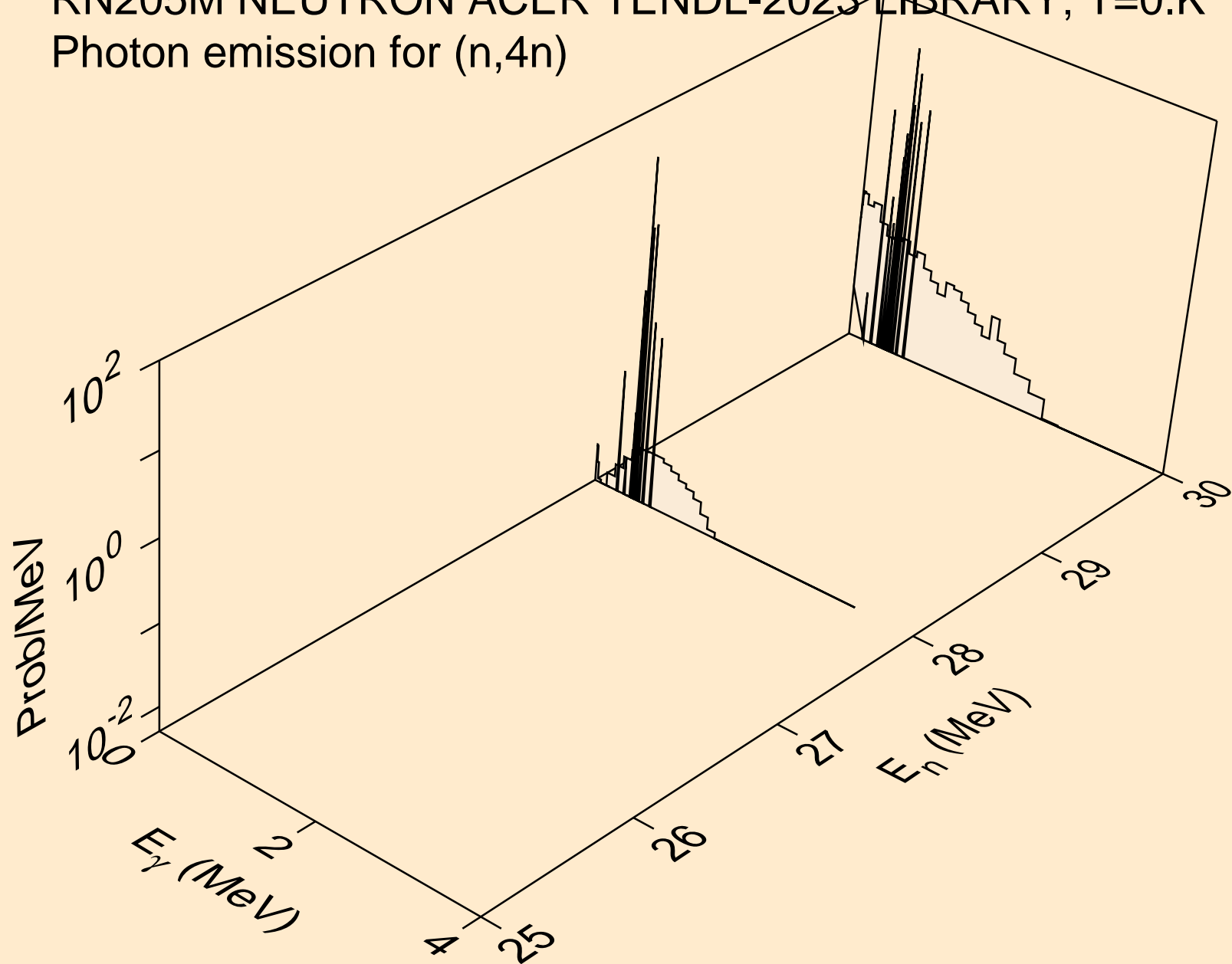

RN205M NEUTRON ACER TENDL-2023 LIBRARY; T=0.K
Photon emission for (n,2np)

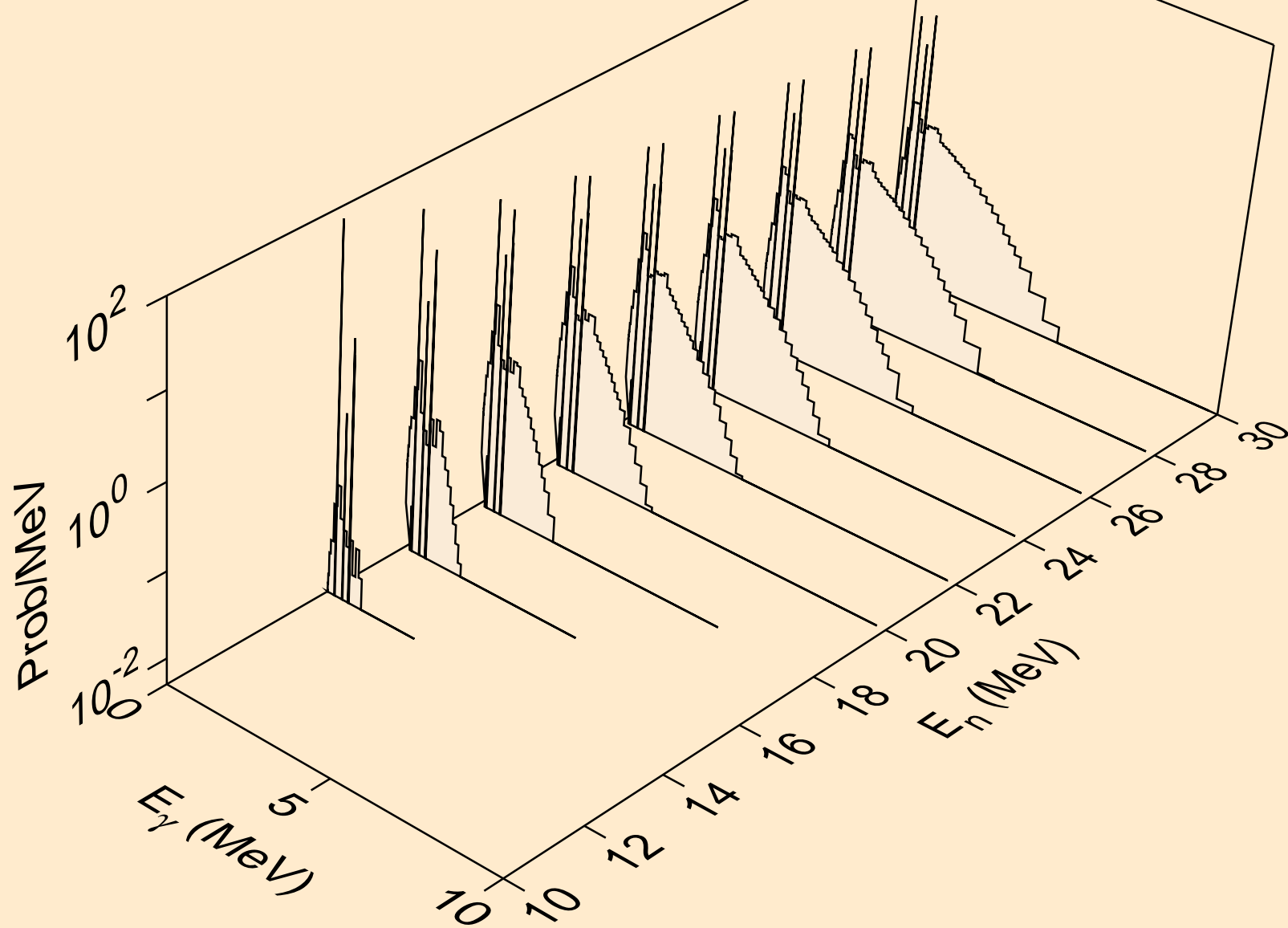

RN205M NEUTRON ACER TENDL-2023 LIBRARY; T=0.K
Photon emission for (n,3np)

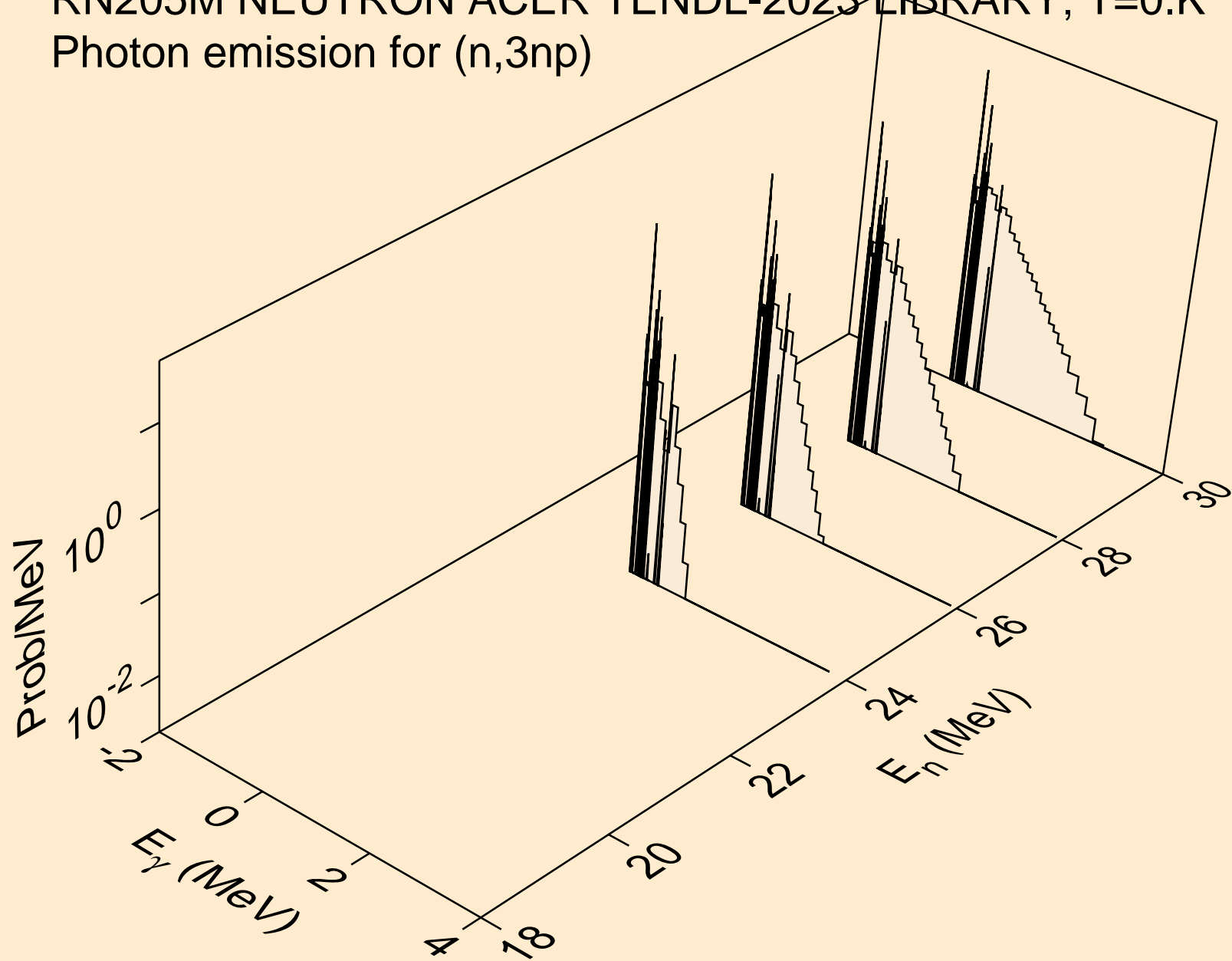

RN205M NEUTRON ACER TENDL-2023 LIBRARY; T=0.K
Photon emission for (n,n2p)

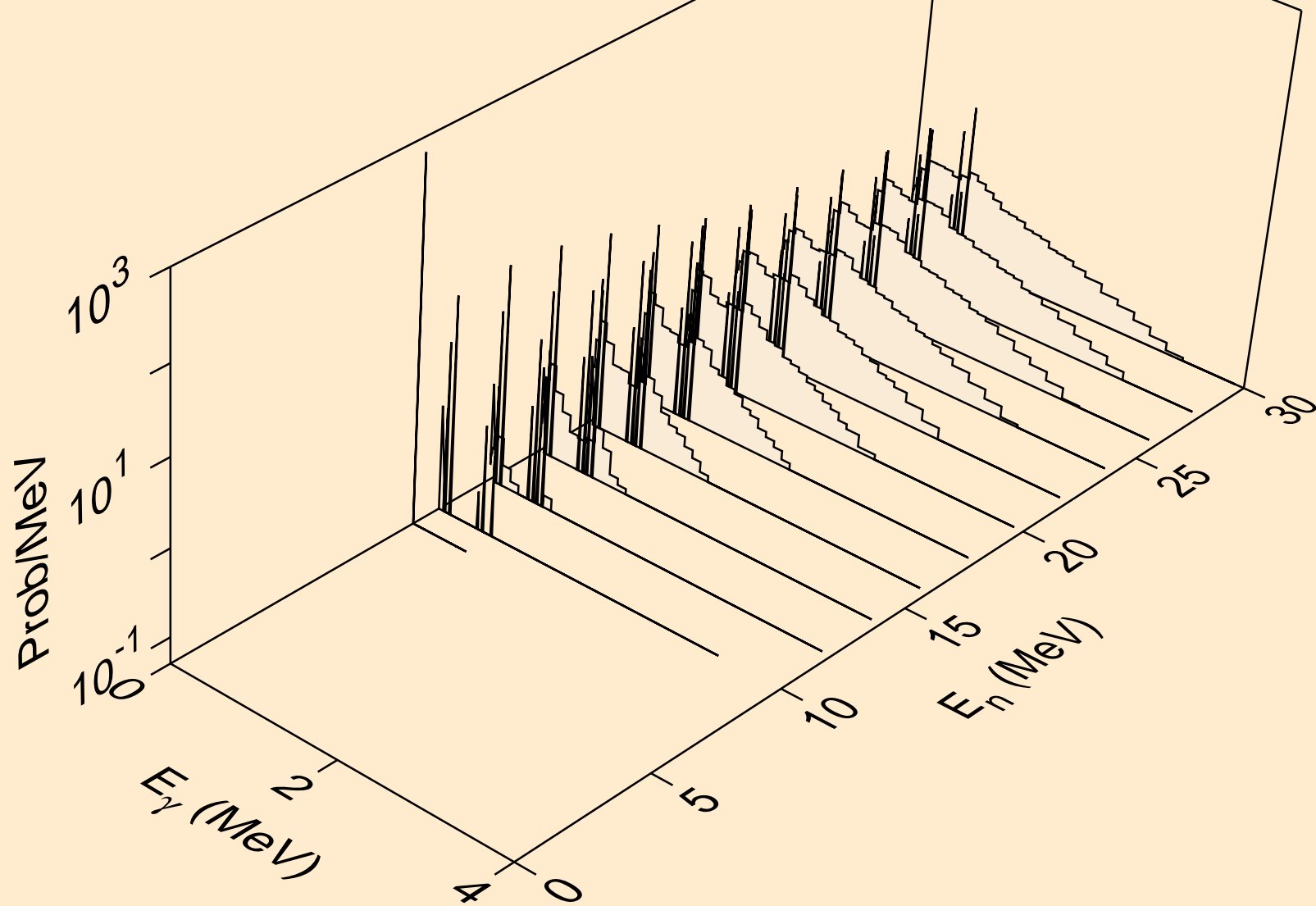

RN205M NEUTRON ACER TENDL-2023 LIBRARY; T=0.K
Photon emission for (n,npa)

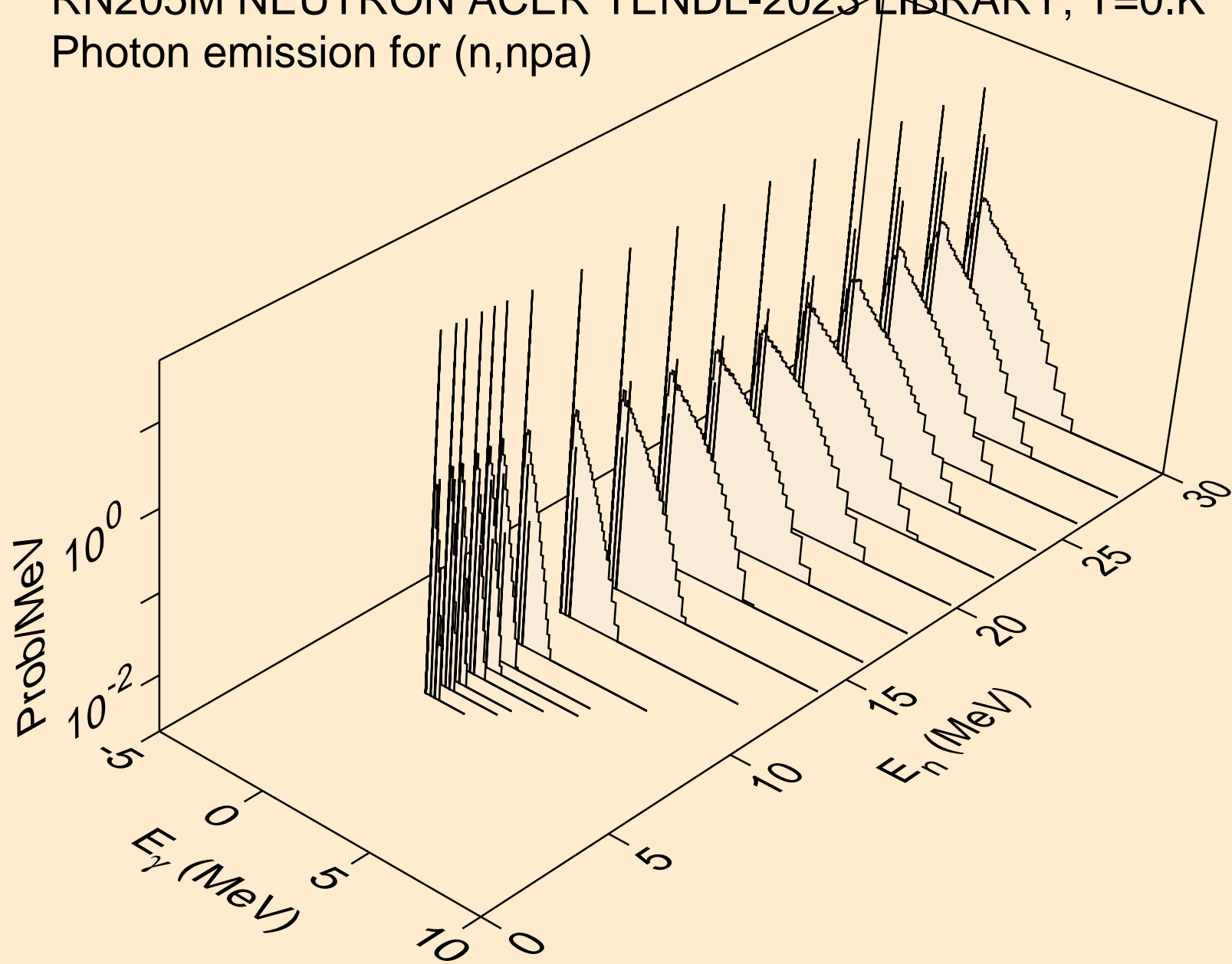

RN205M NEUTRON ACER TENDL-2023 LIBRARY; T=0.K
Photon emission for (n,n*1)

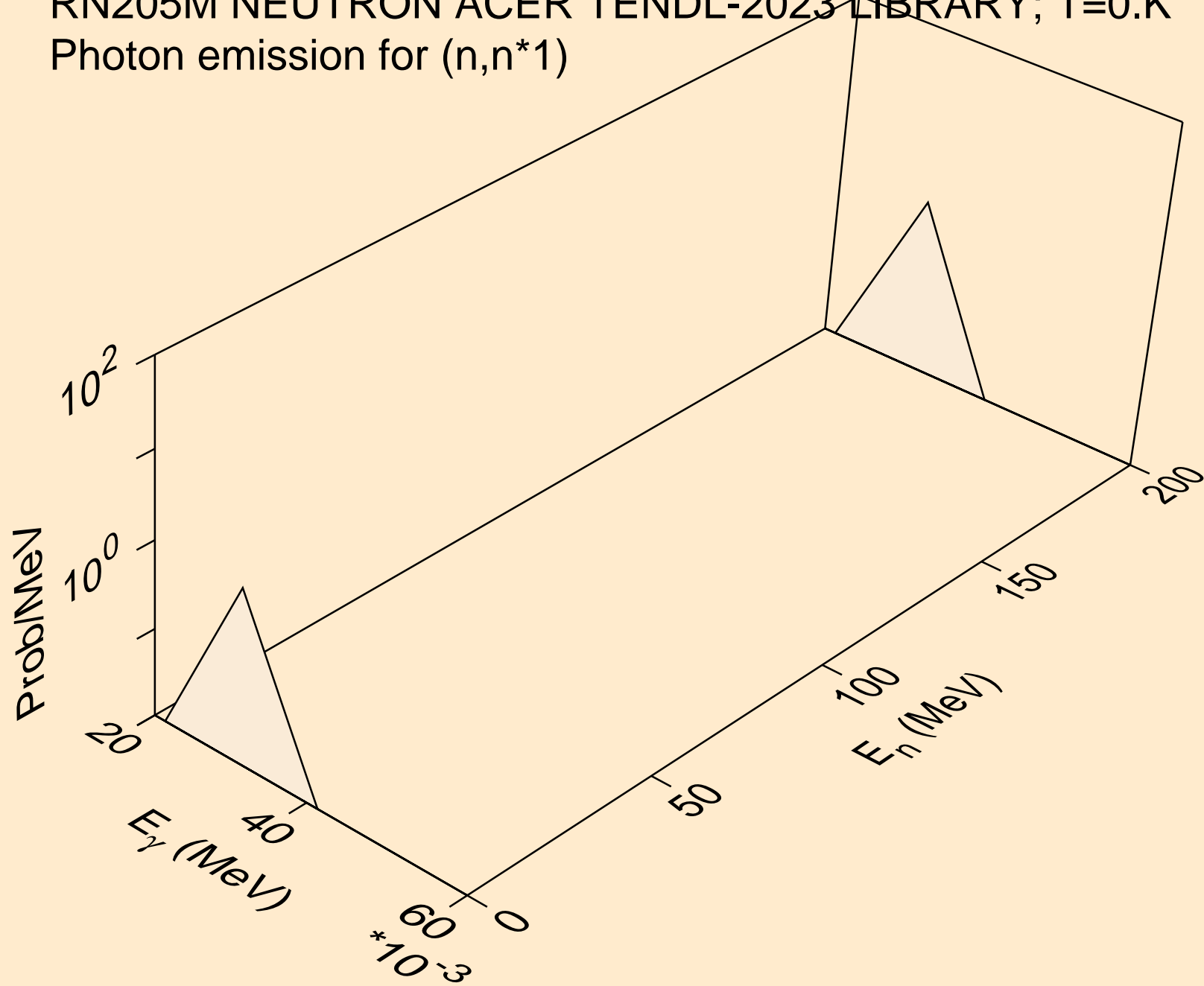

RN205M NEUTRON ACER TENDL-2023 LIBRARY; T=0.K
Photon emission for (n,n*2)

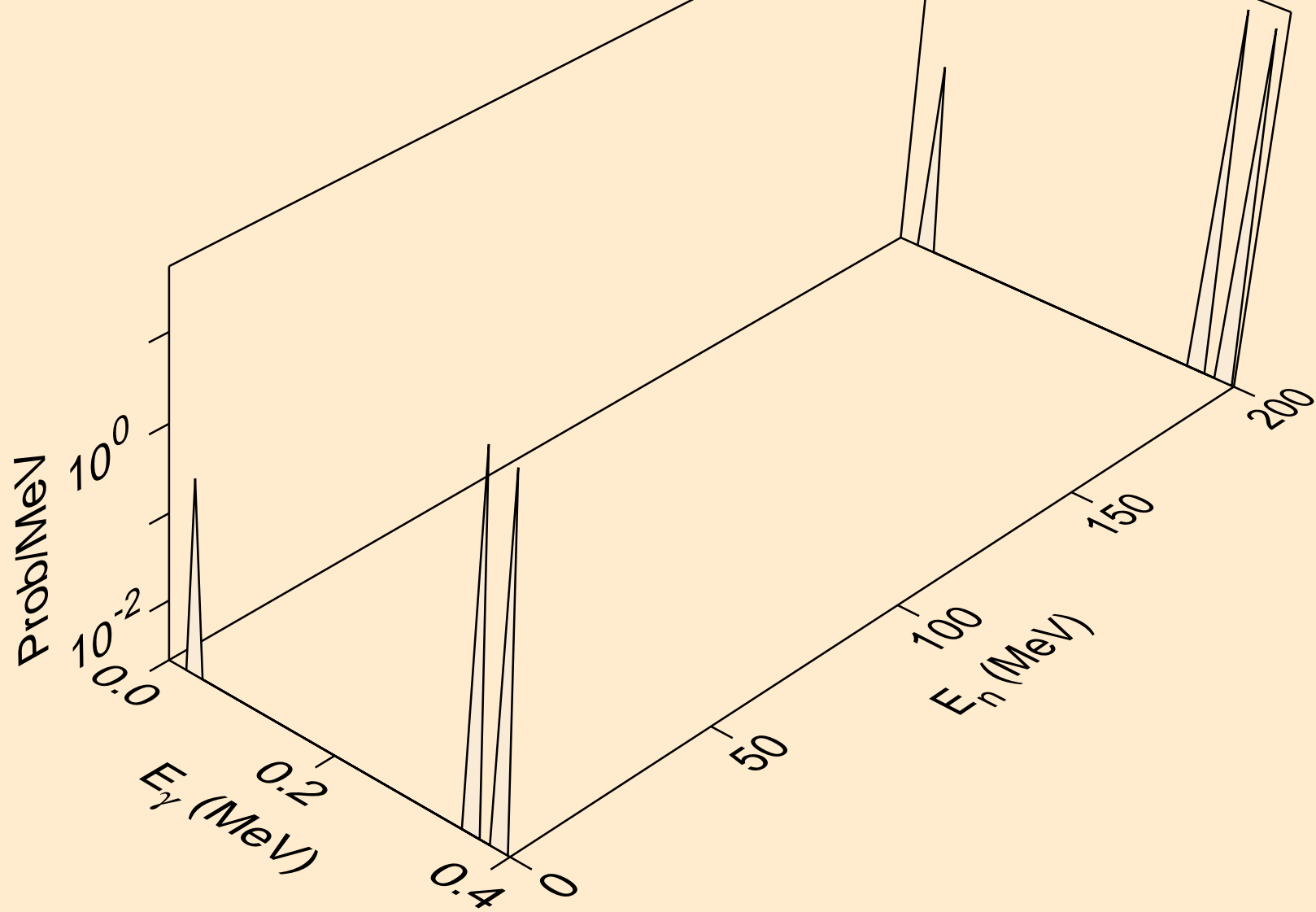

RN205M NEUTRON ACER TENDL-2023 LIBRARY; T=0.K
Photon emission for (n,n*3)

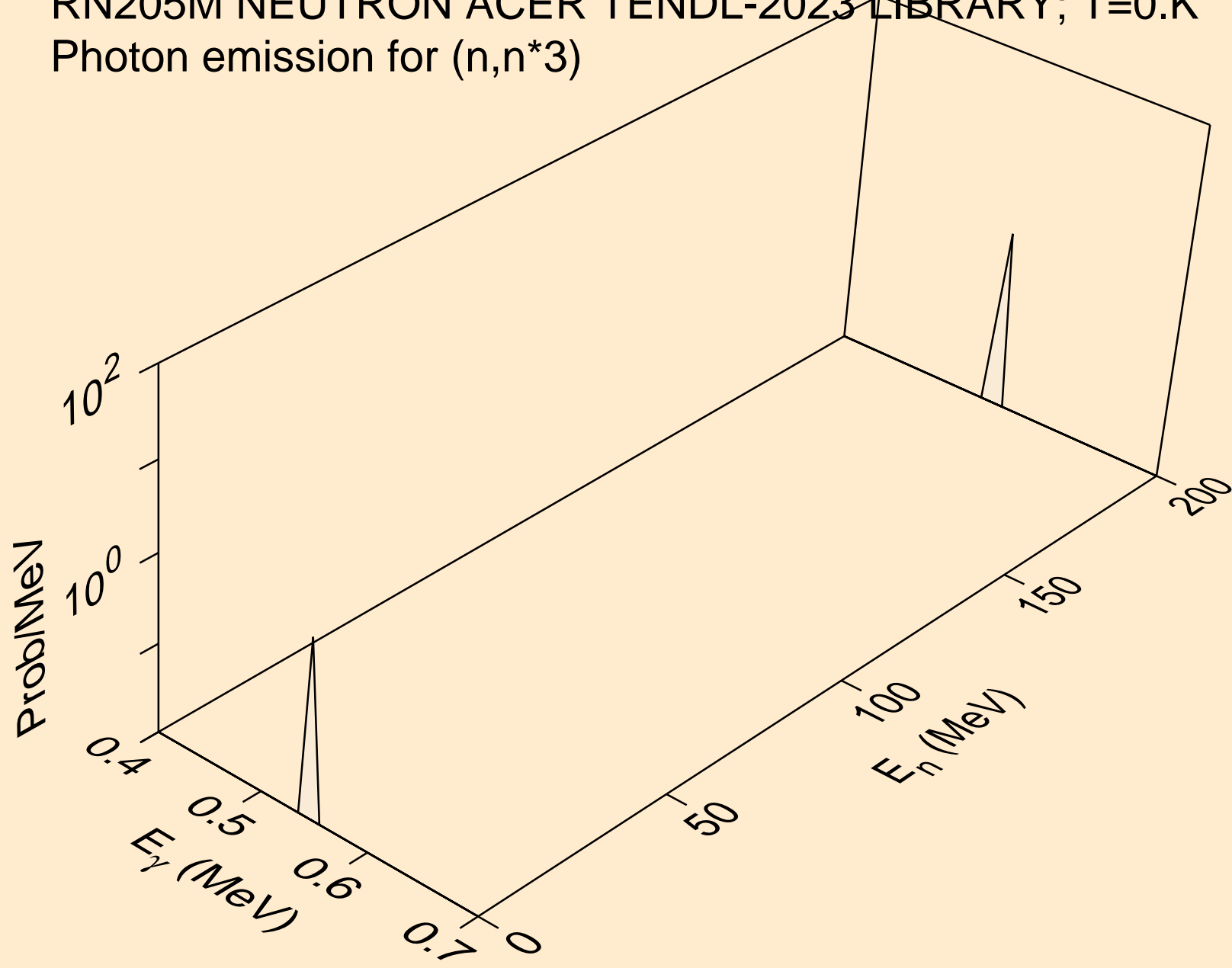

RN205M NEUTRON ACER TENDL-2023 LIBRARY; T=0.K
Photon emission for (n,n*4)

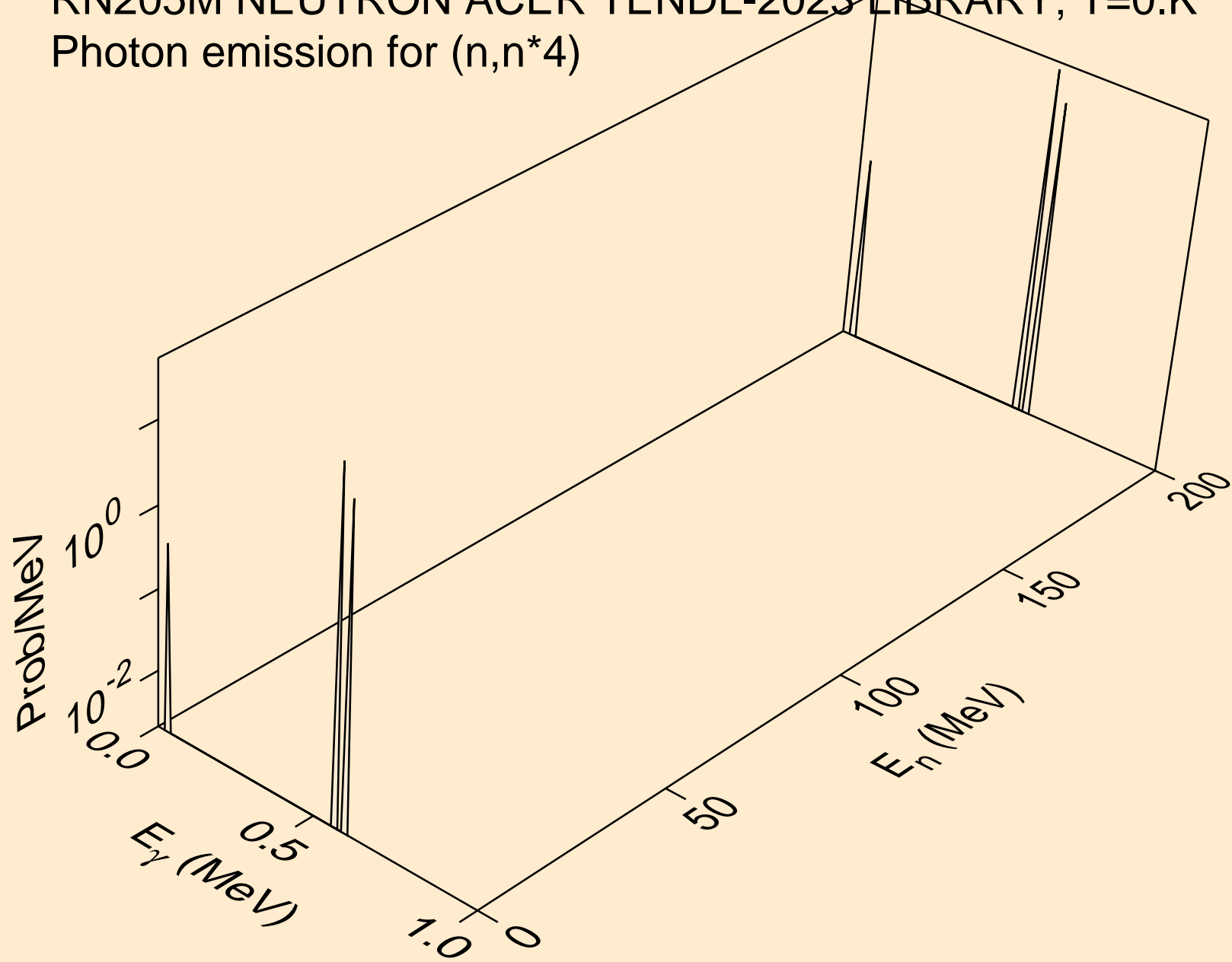

RN205M NEUTRON ACER TENDL-2023 LIBRARY; T=0.K
Photon emission for (n,n*5)

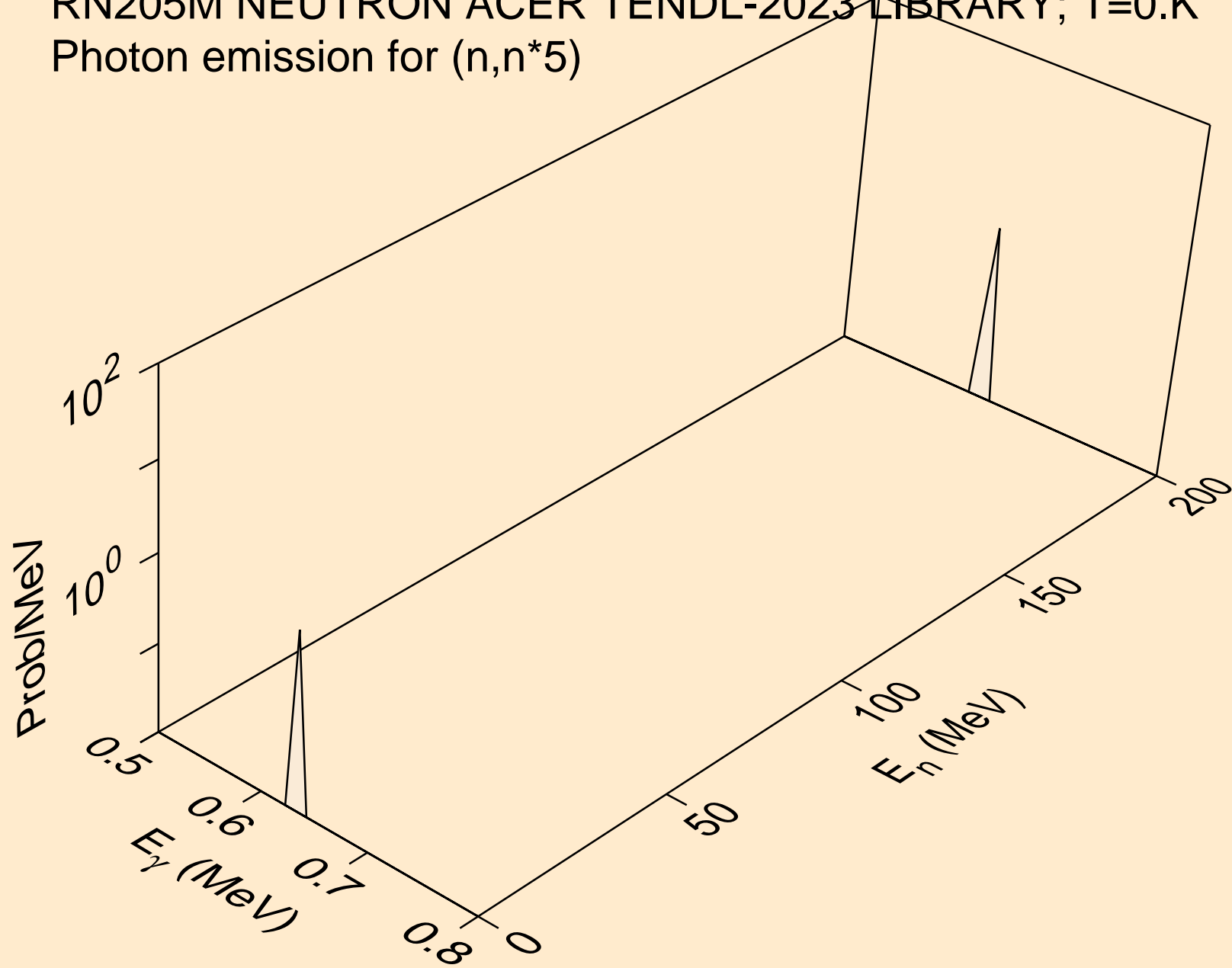

RN205M NEUTRON ACER TENDL-2023 LIBRARY; T=0.K
Photon emission for (n,n*7)

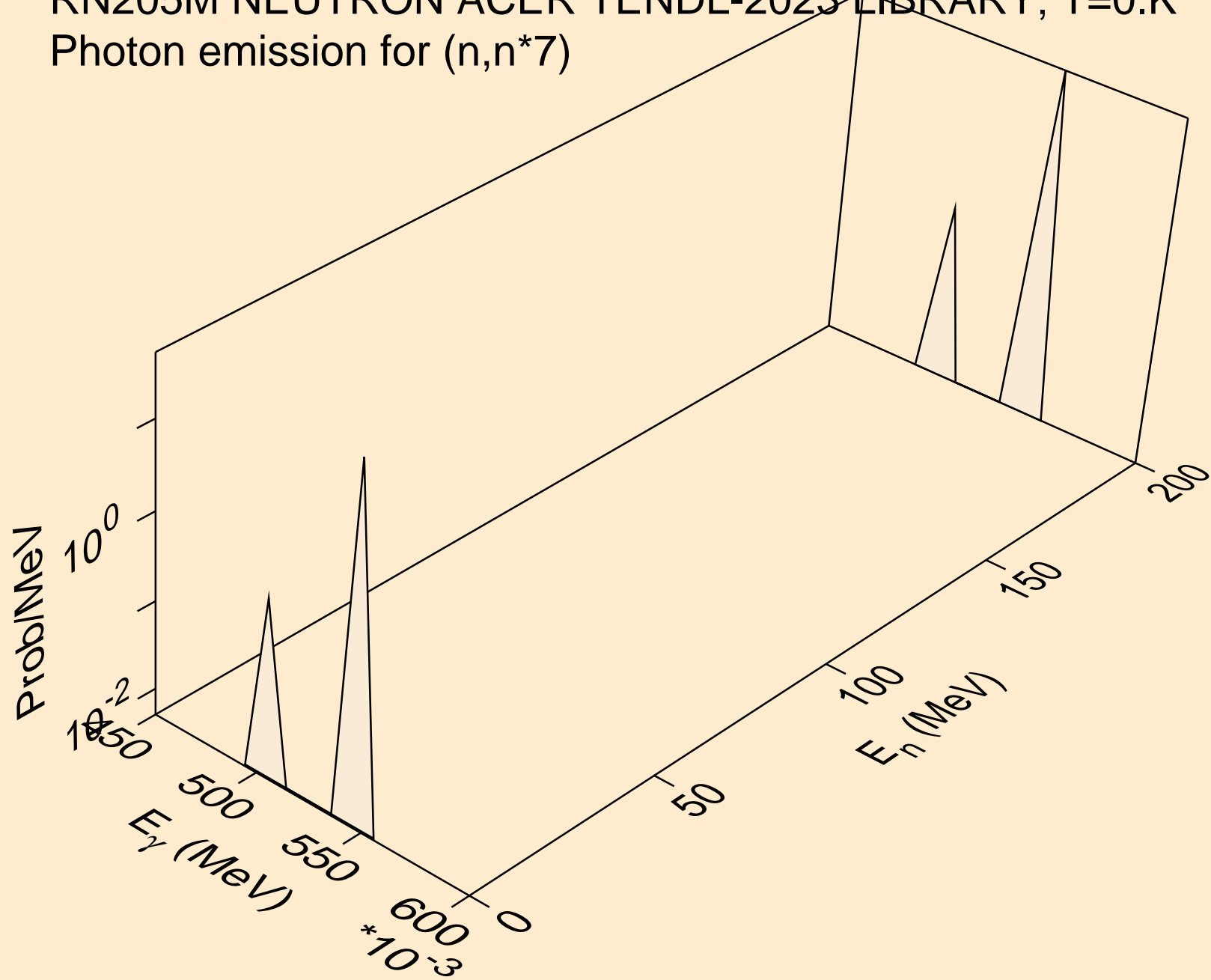

RN205M NEUTRON ACER TENDL-2023 LIBRARY; T=0.K
Photon emission for (n,n*8)

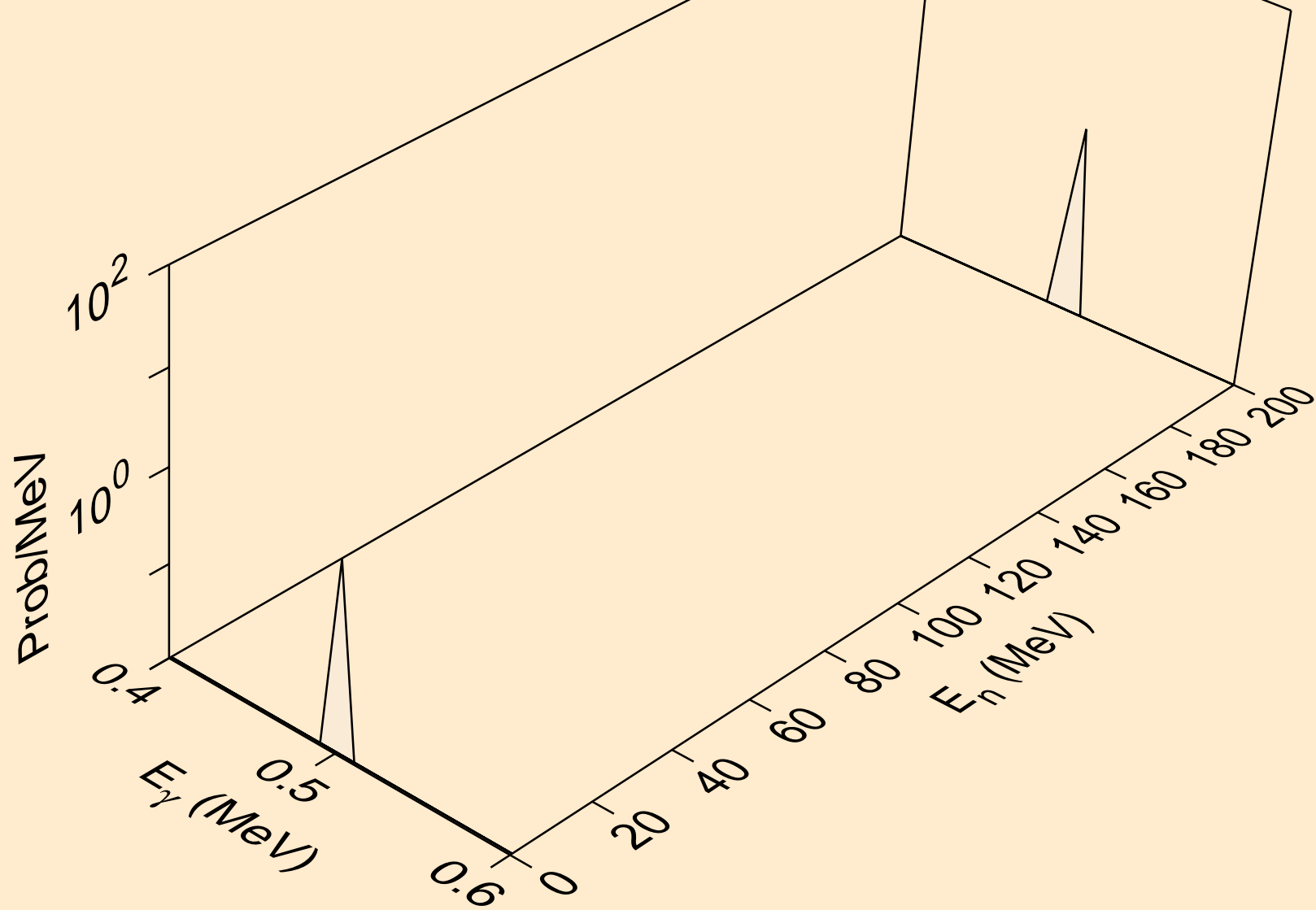

RN205M NEUTRON ACER TENDL-2023 LIBRARY; T=0.K
Photon emission for (n,n*c)

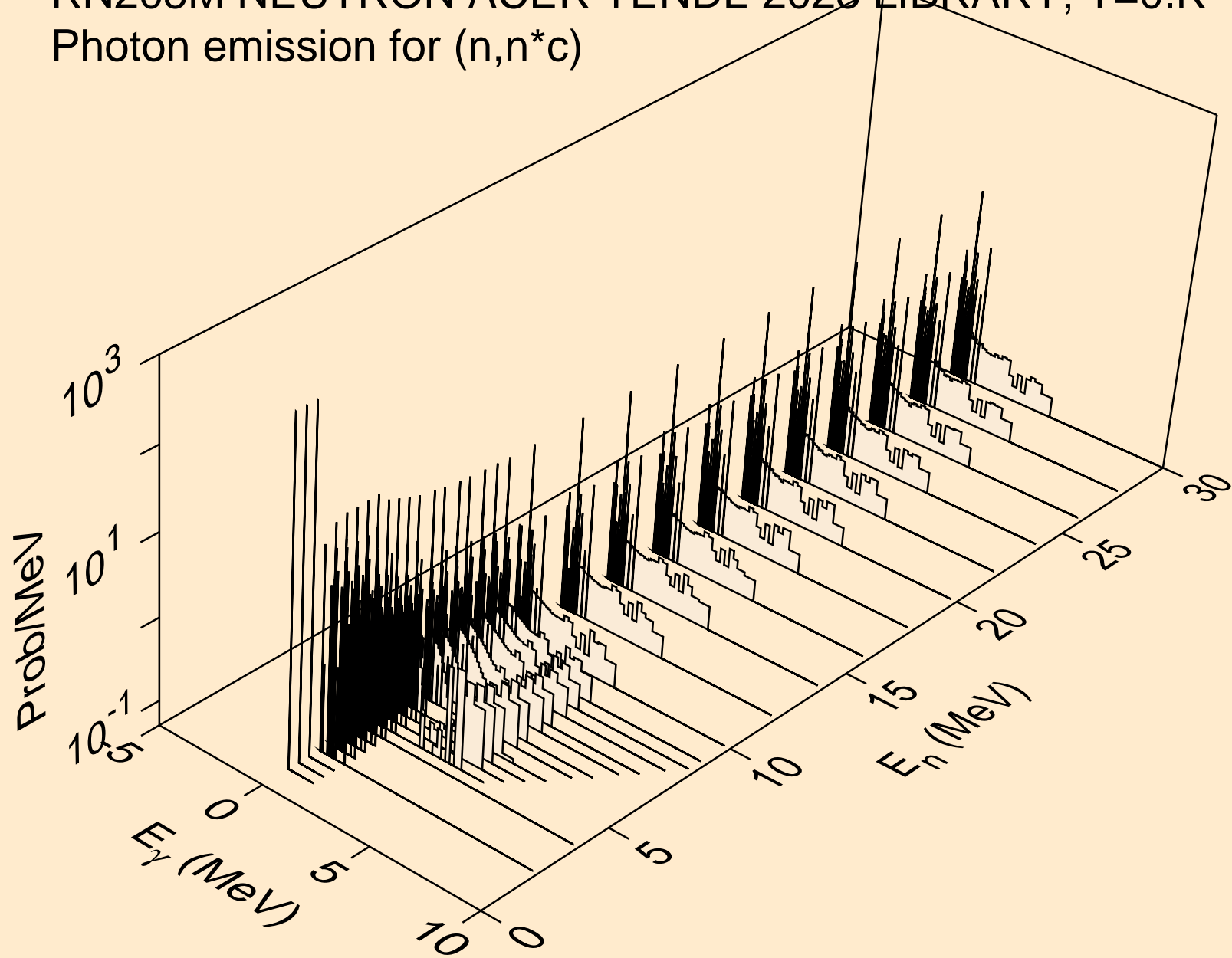

RN205M NEUTRON ACER TENDL-2023 LIBRARY; T=0.K
Photon emission for (n,gma)

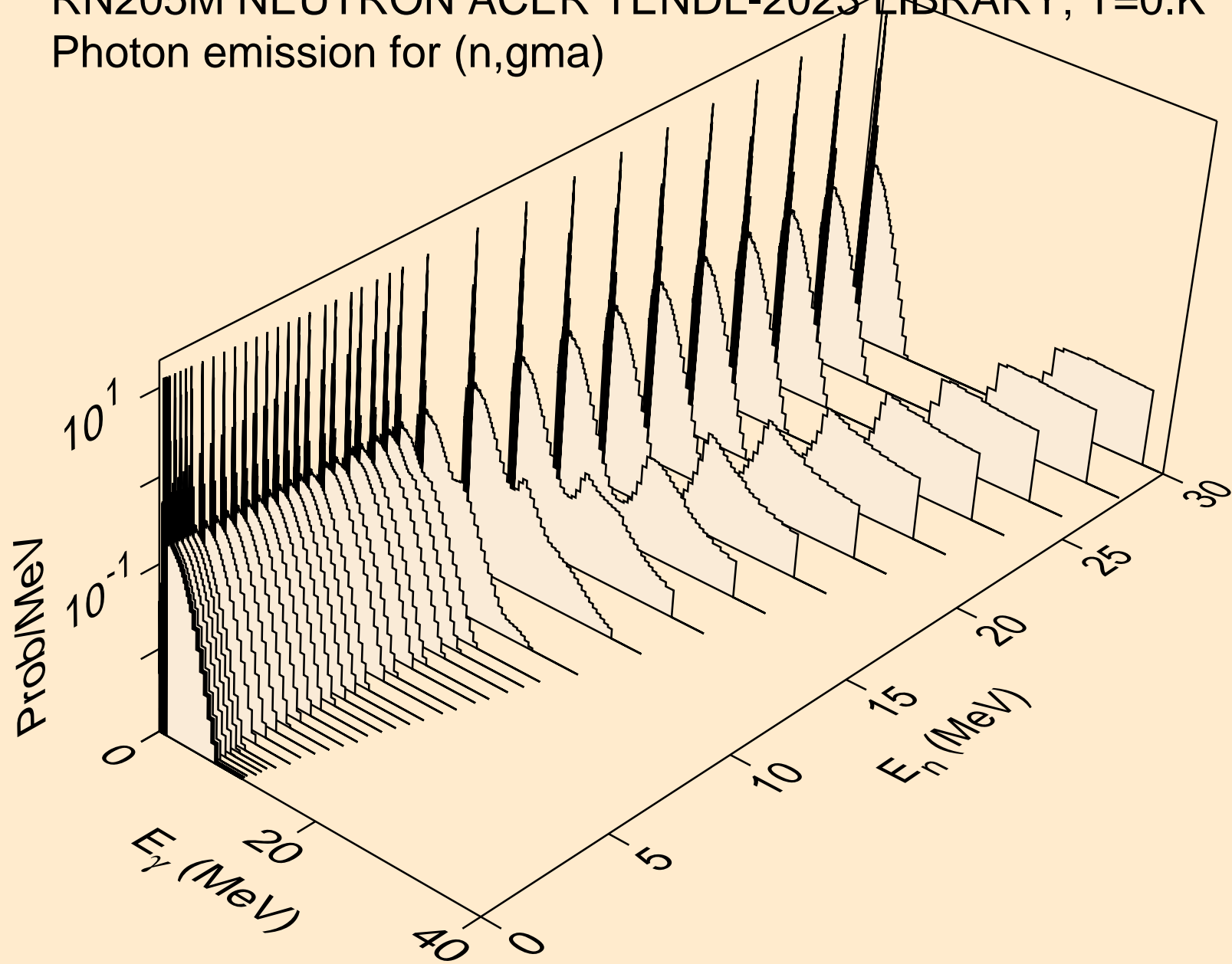

RN205M NEUTRON ACER TENDL-2023 LIBRARY; T=0.K
Photon emission for (n,p)

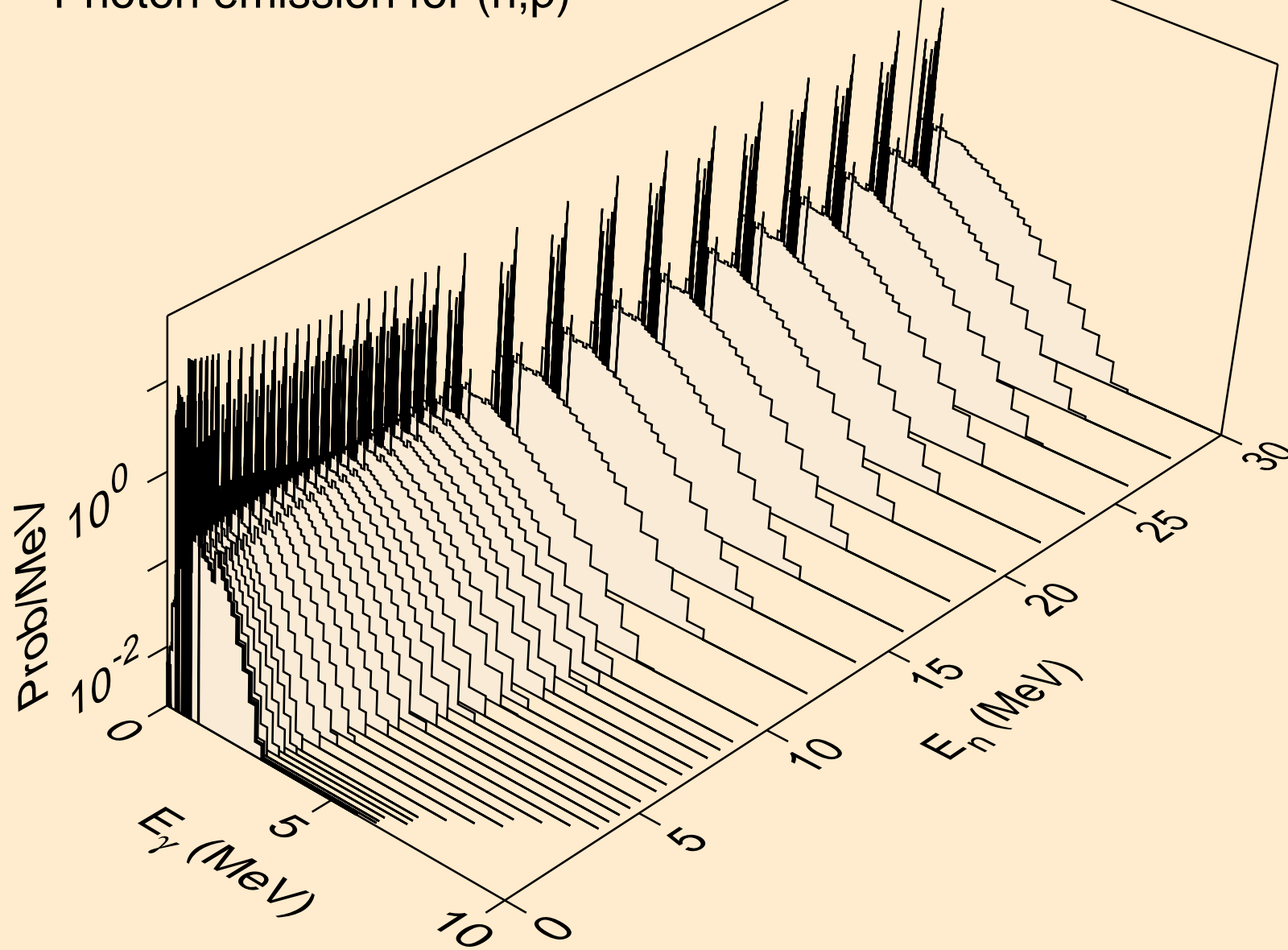

RN205M NEUTRON ACER TENDL-2023 LIBRARY; T=0.K
Photon emission for (n,d)

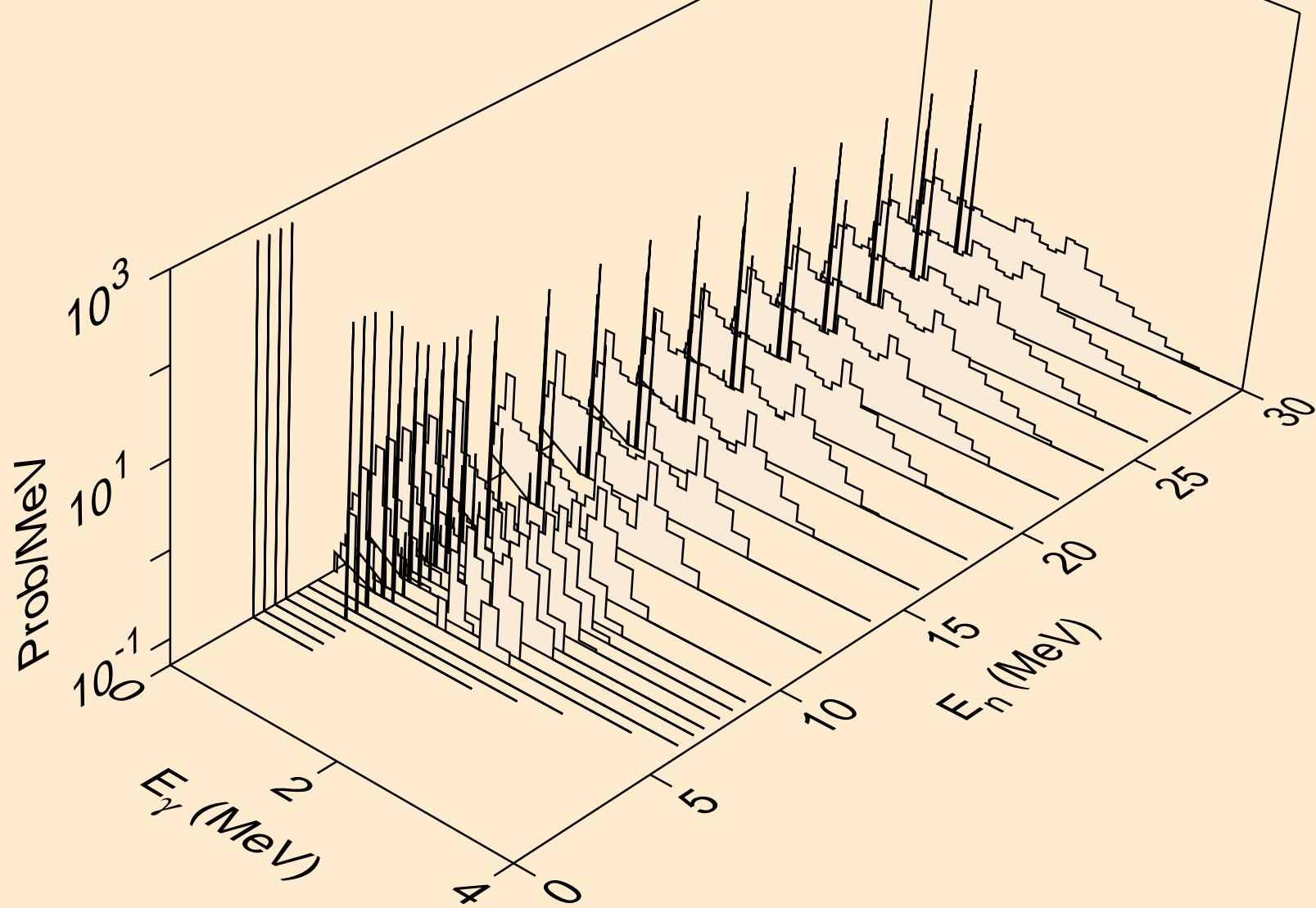

RN205M NEUTRON ACER TENDL-2023 LIBRARY; T=0.K
Photon emission for (n,t)

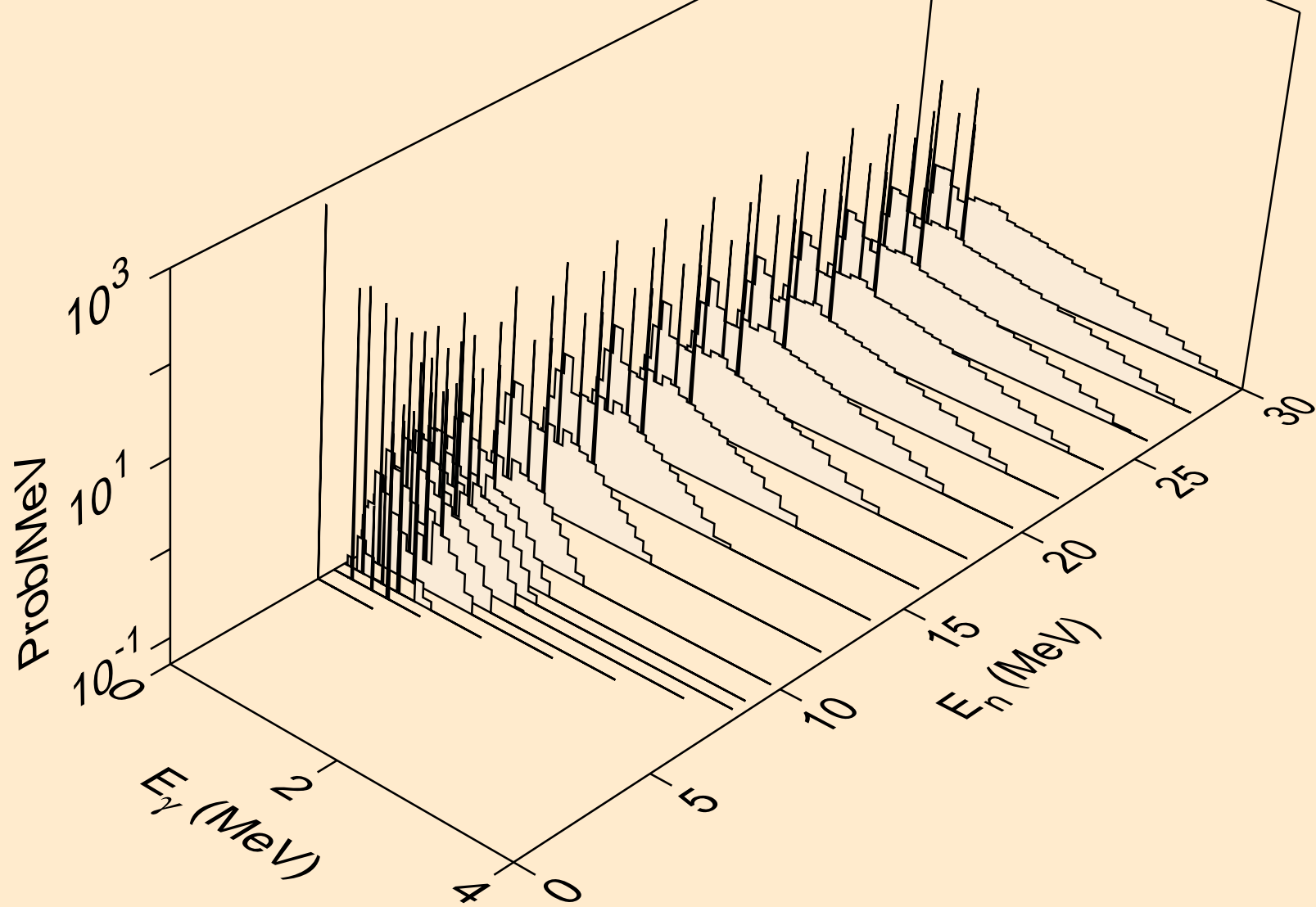

RN205M NEUTRON ACER TENDL-2023 LIBRARY; T=0.K
Photon emission for (n,he3)

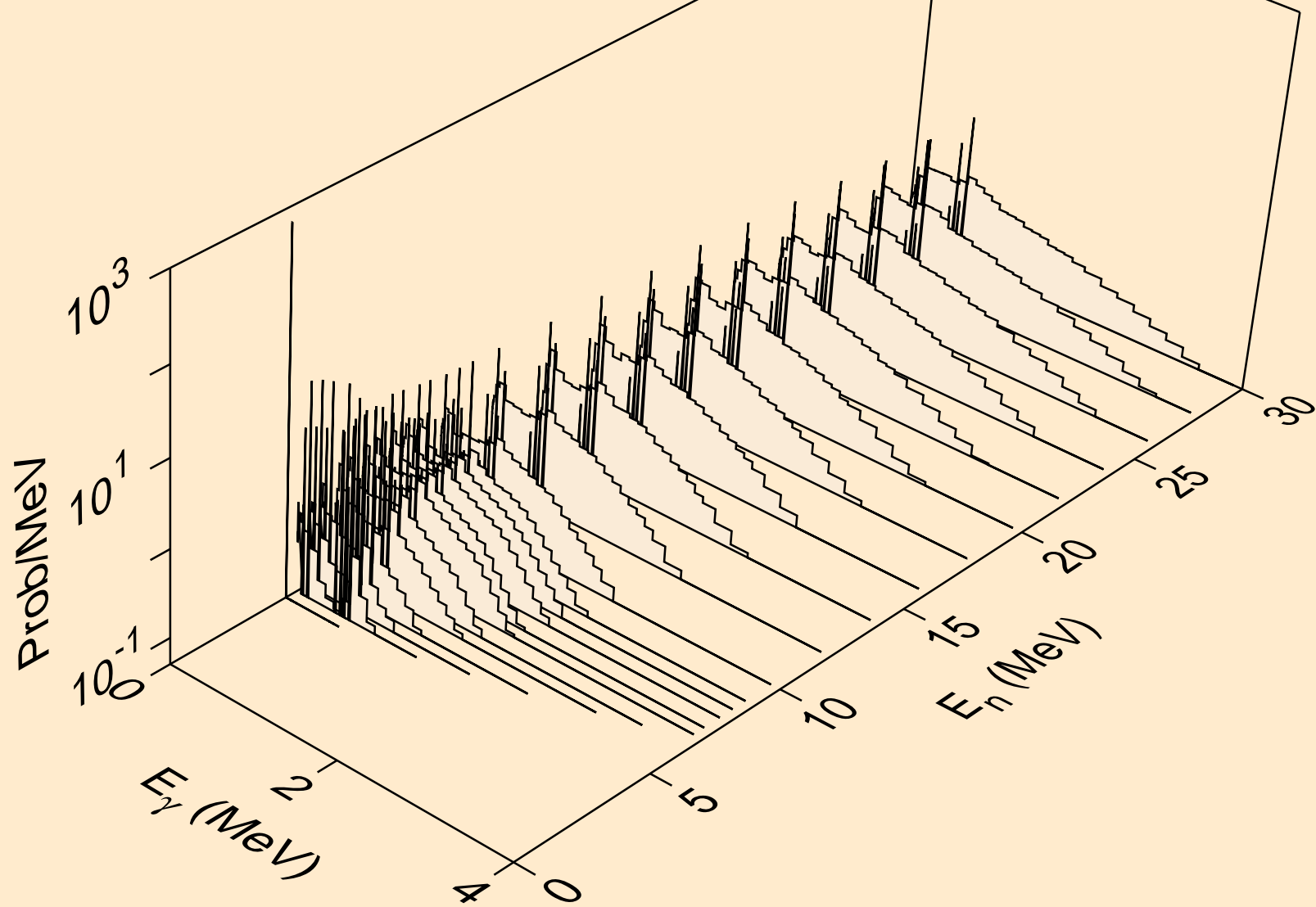

RN205M NEUTRON ACER TENDL-2023 LIBRARY; T=0.K
Photon emission for (n,a)

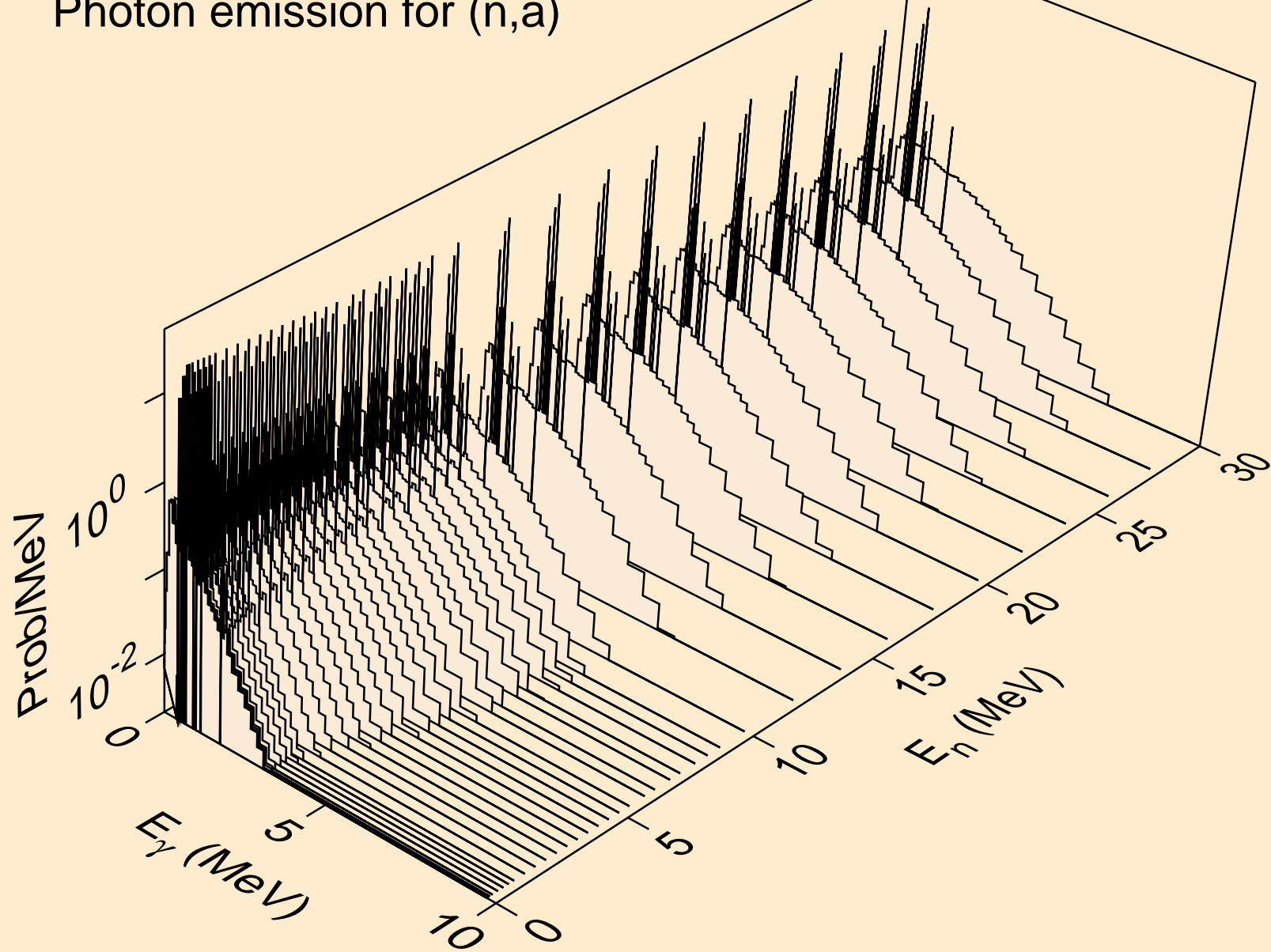

RN205M NEUTRON ACER TENDL-2023 LIBRARY; T=0.K
Photon emission for (n,2a)

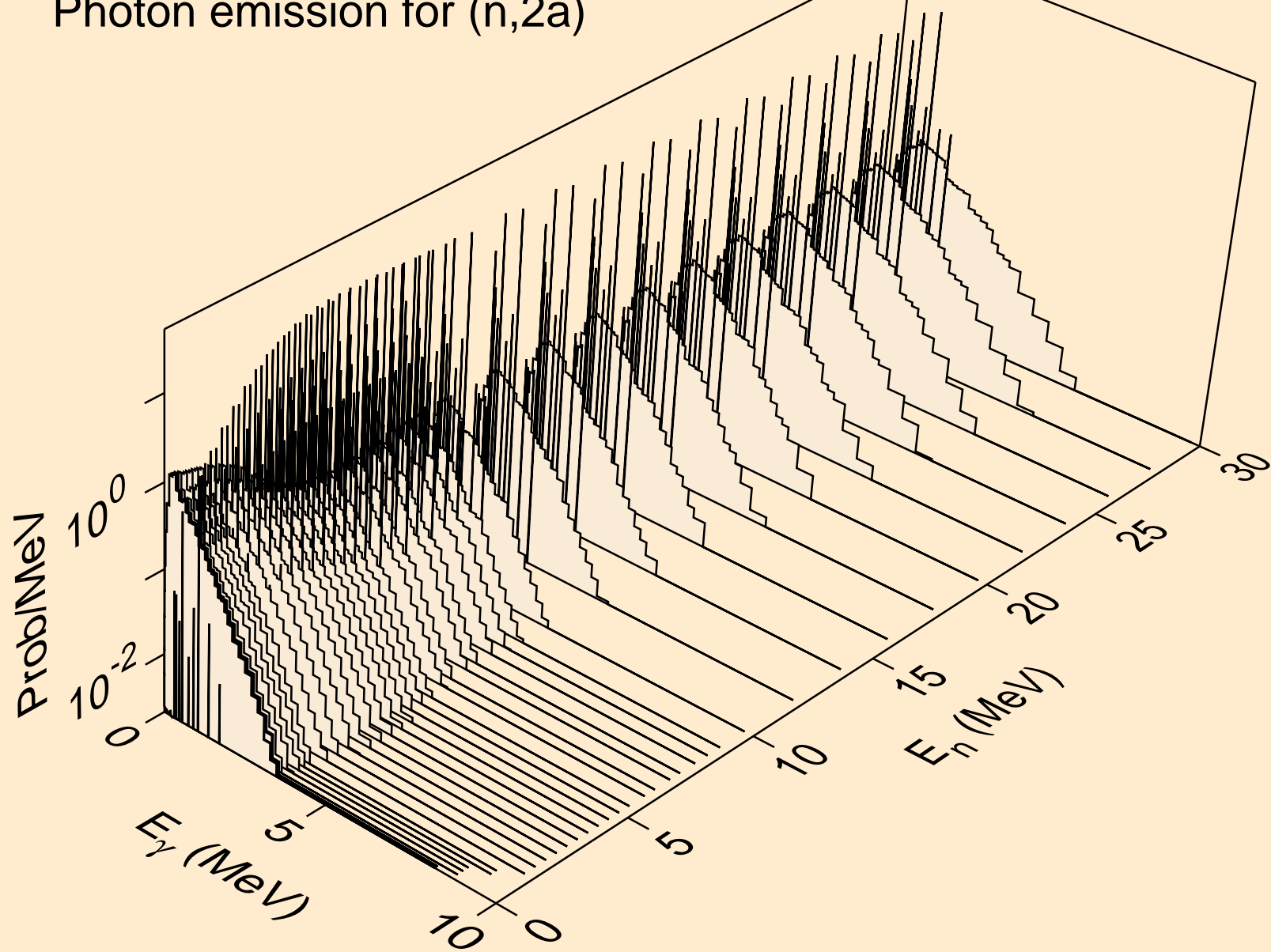

RN205M NEUTRON ACER TENDL-2023 LIBRARY; T=0.K
Photon emission for (n,2p)

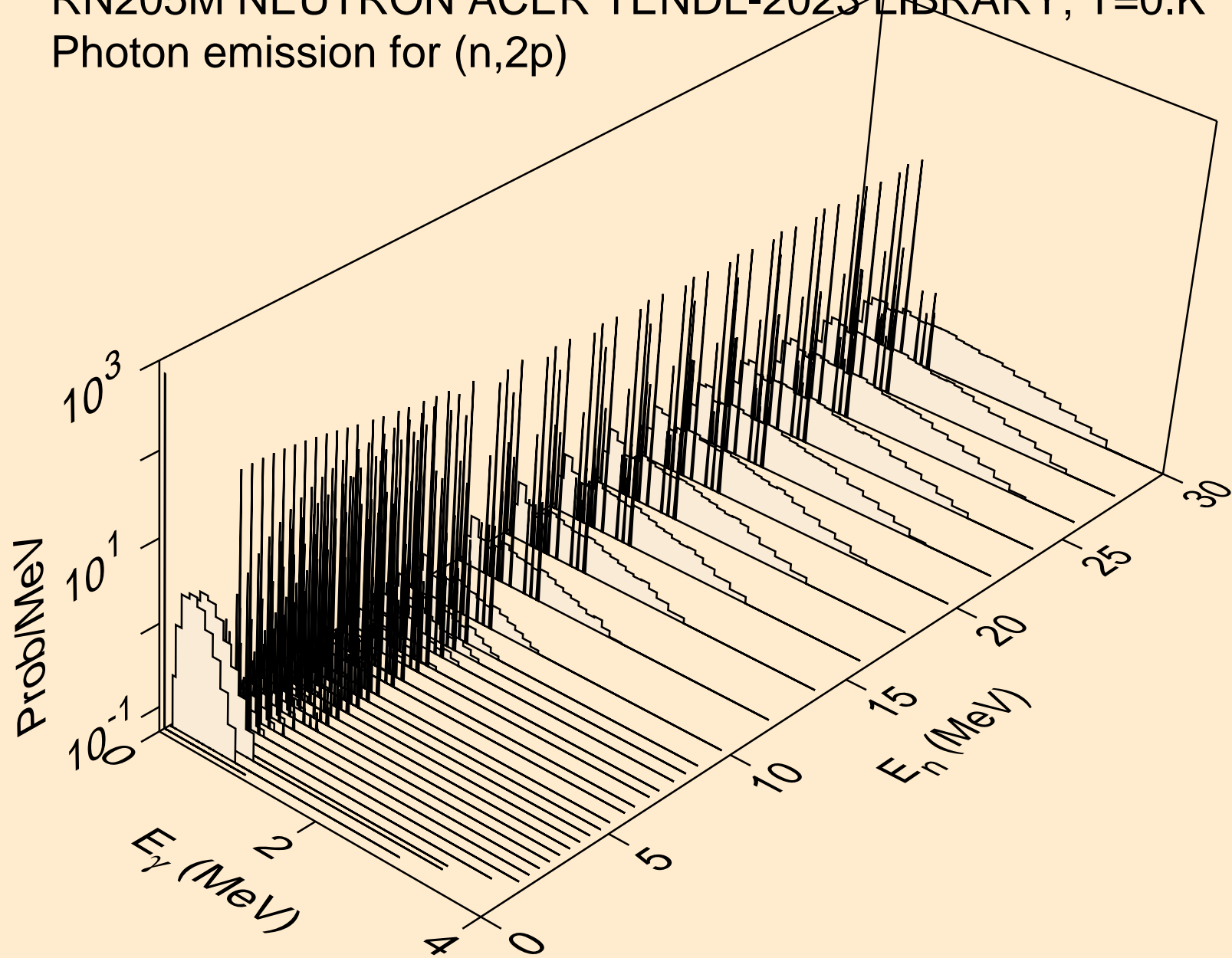

RN205M NEUTRON ACER TENDL-2023 LIBRARY; T=0.K
Photon emission for (n,p α)

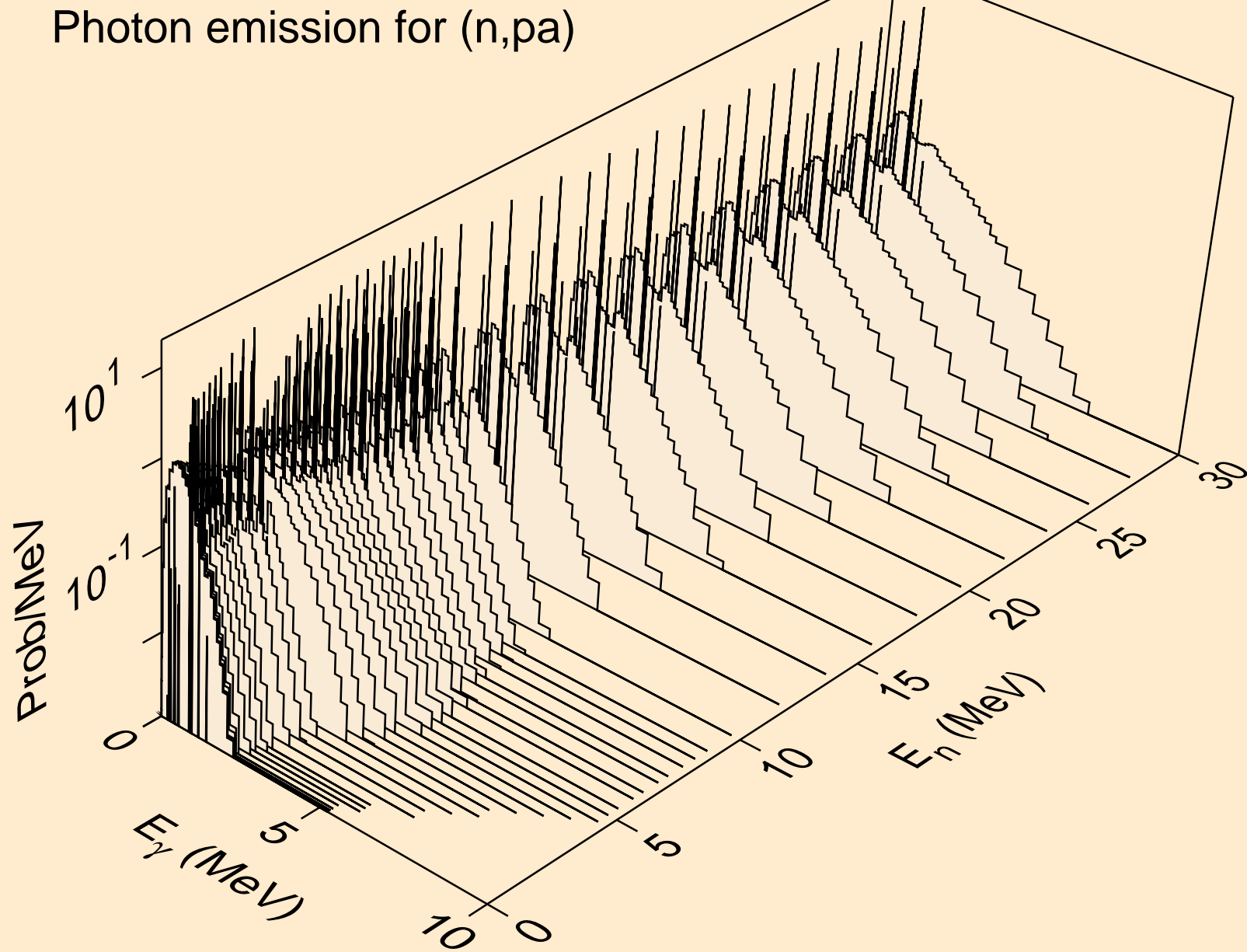

RN205M NEUTRON ACER TENDL-2023 LIBRARY; T=0.K
Photon emission for (n,pd)

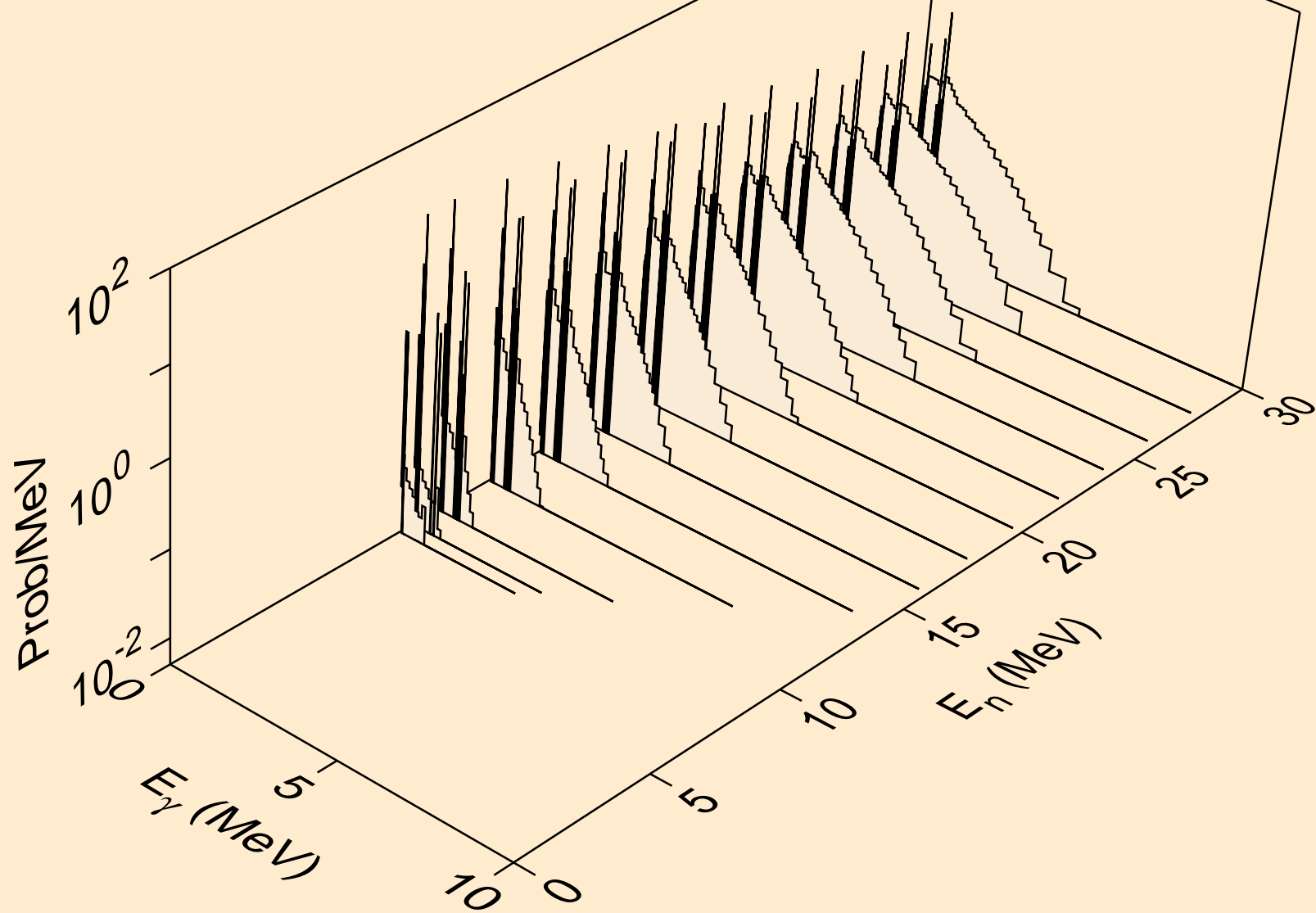

RN205M NEUTRON ACER TENDL-2023 LIBRARY; T=0.K
Photon emission for (n,pt)

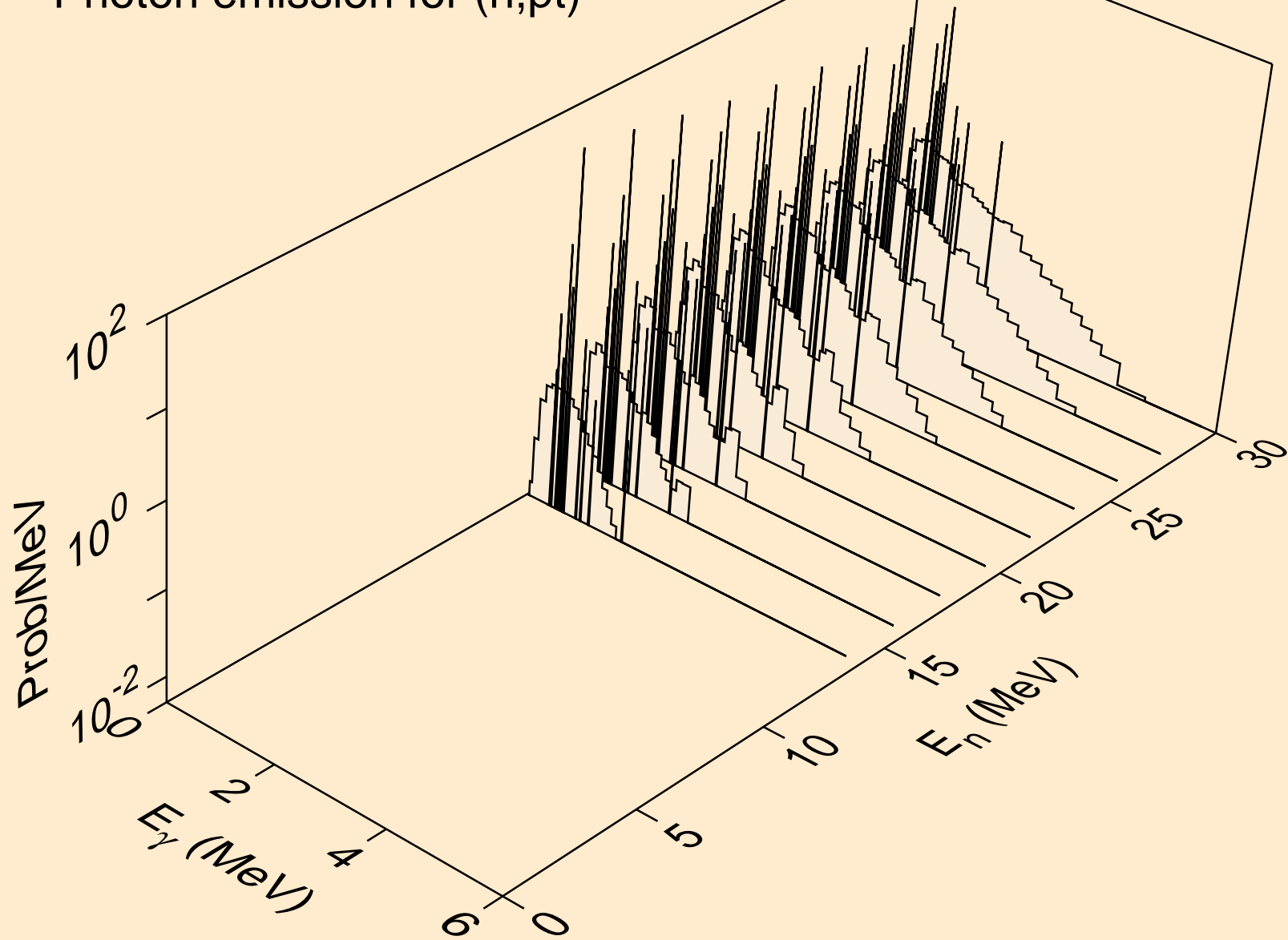

RN205M NEUTRON ACER TENDL-2023 LIBRARY; T=0.K
Photon emission for (n,da)

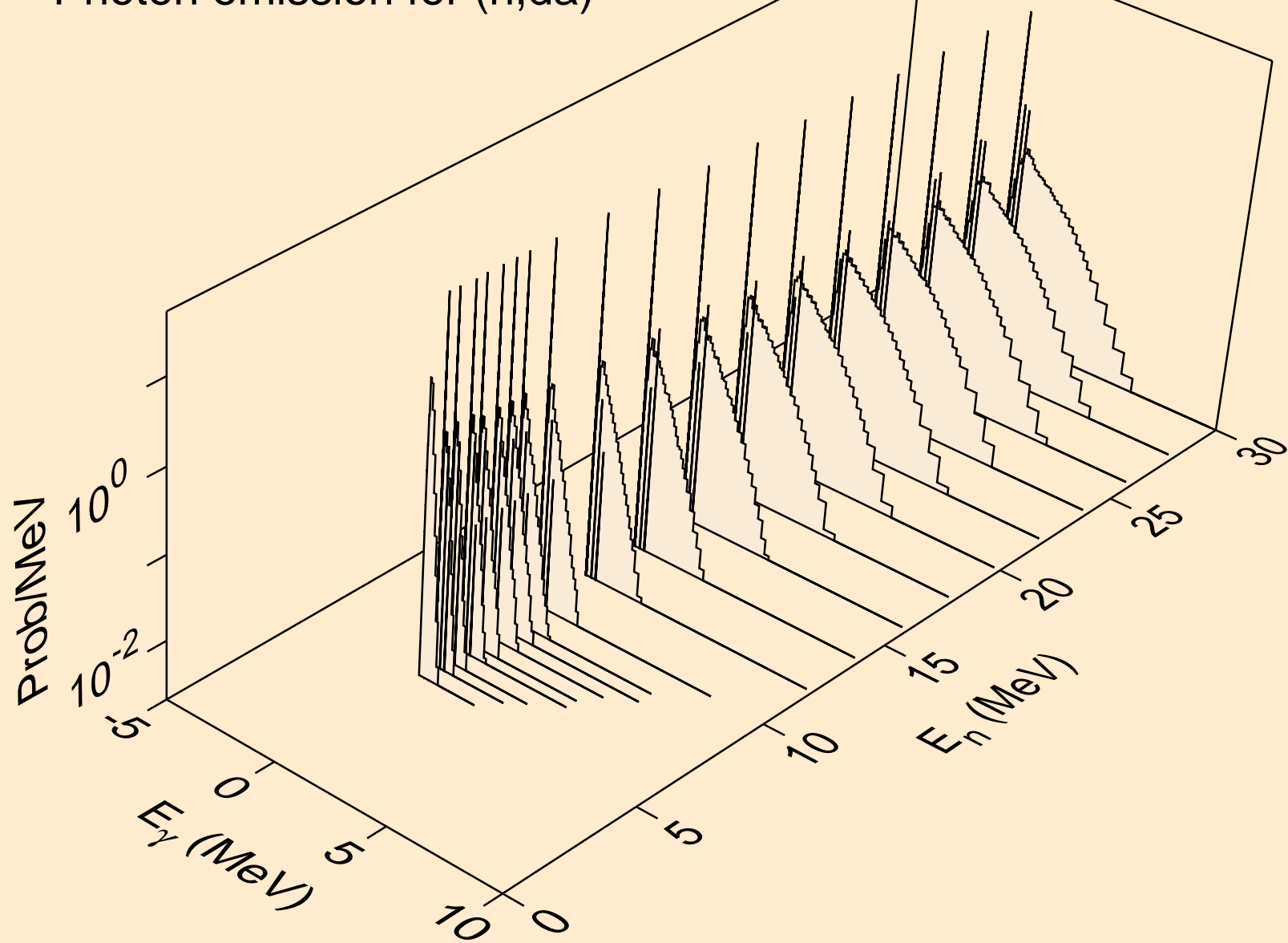

RN205M NEUTRON ACER TENDL-2023 LIBRARY; T=0.K
thermal capture photon spectrum

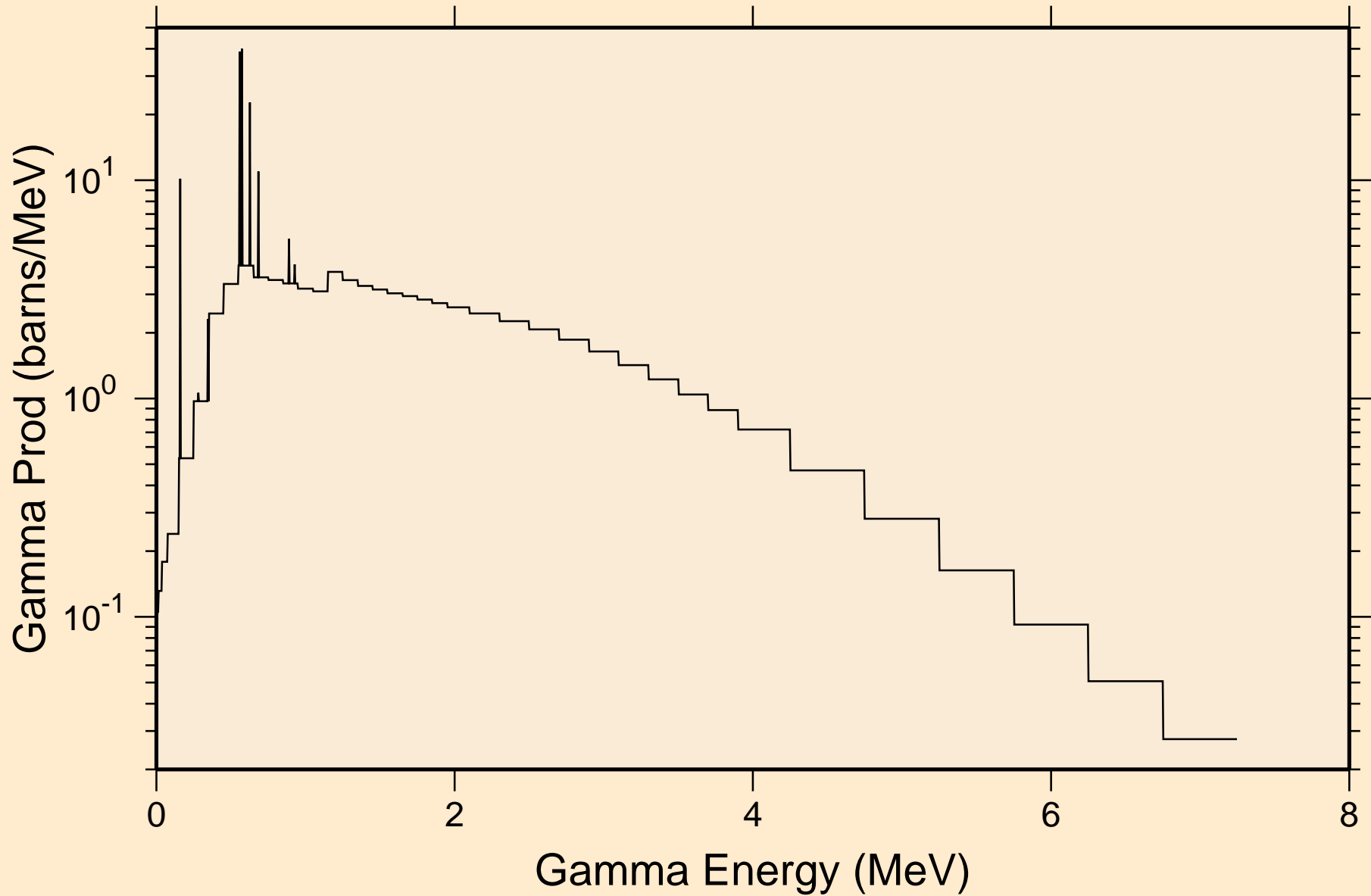

RN205M NEUTRON ACER TENDL-2023 LIBRARY; T=0.K
14 MeV photon spectrum

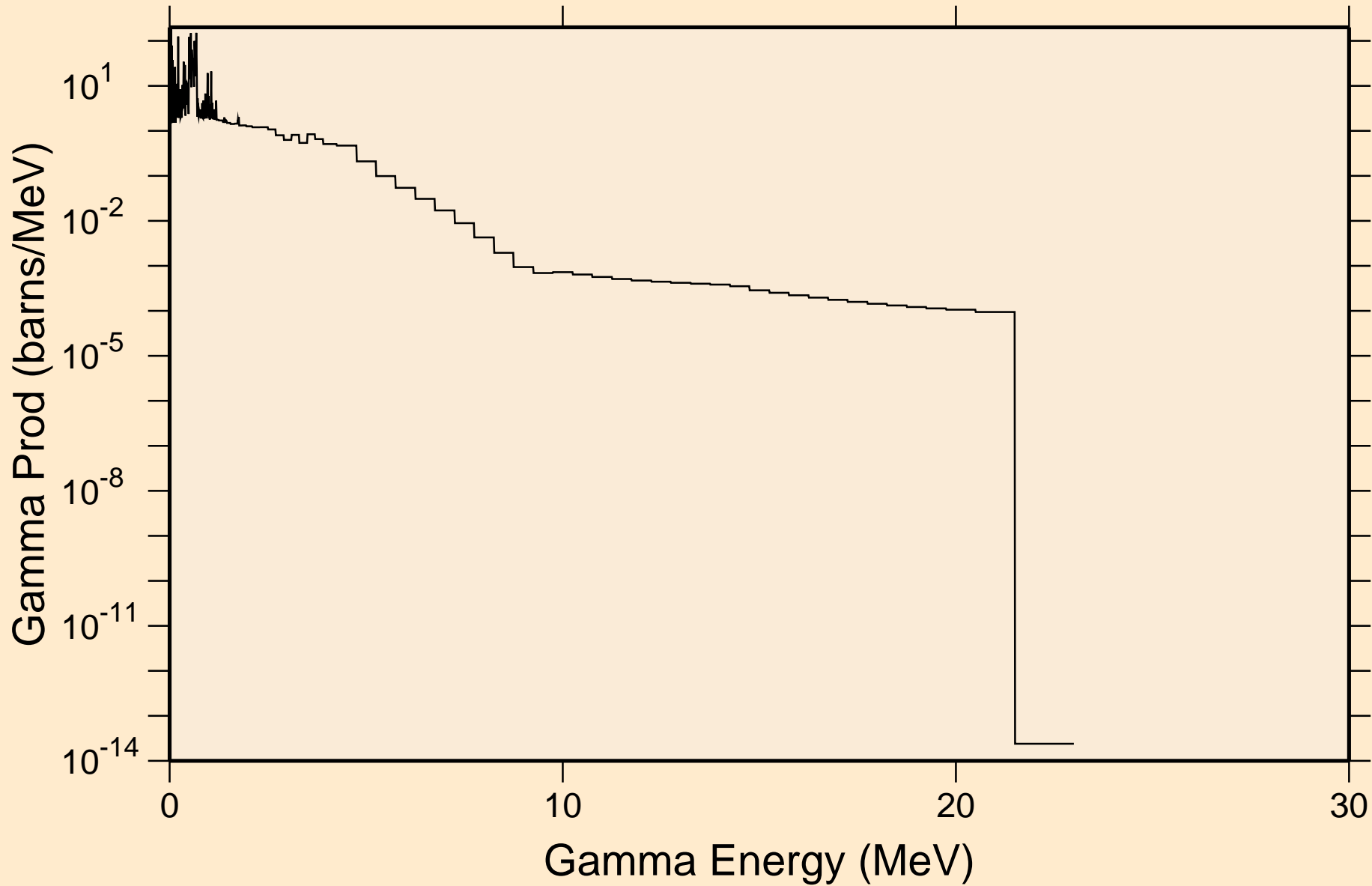

RN205M NEUTRON ACER TENDL-2023 LIBRARY; T=0.K

Particle heating contributions

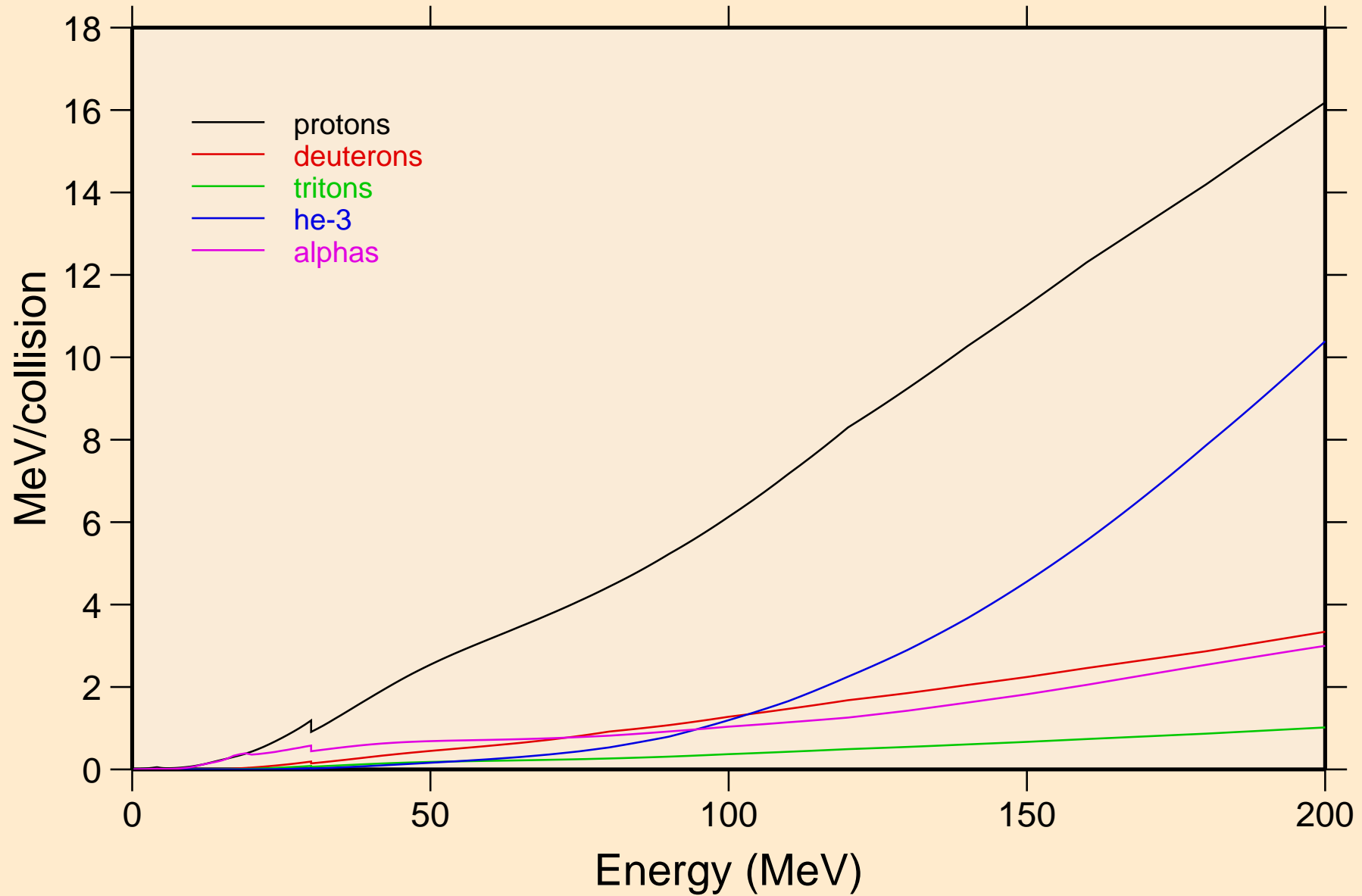

RN205M NEUTRON ACER TENDL-2023 LIBRARY; T=0.K
Recoil Heating

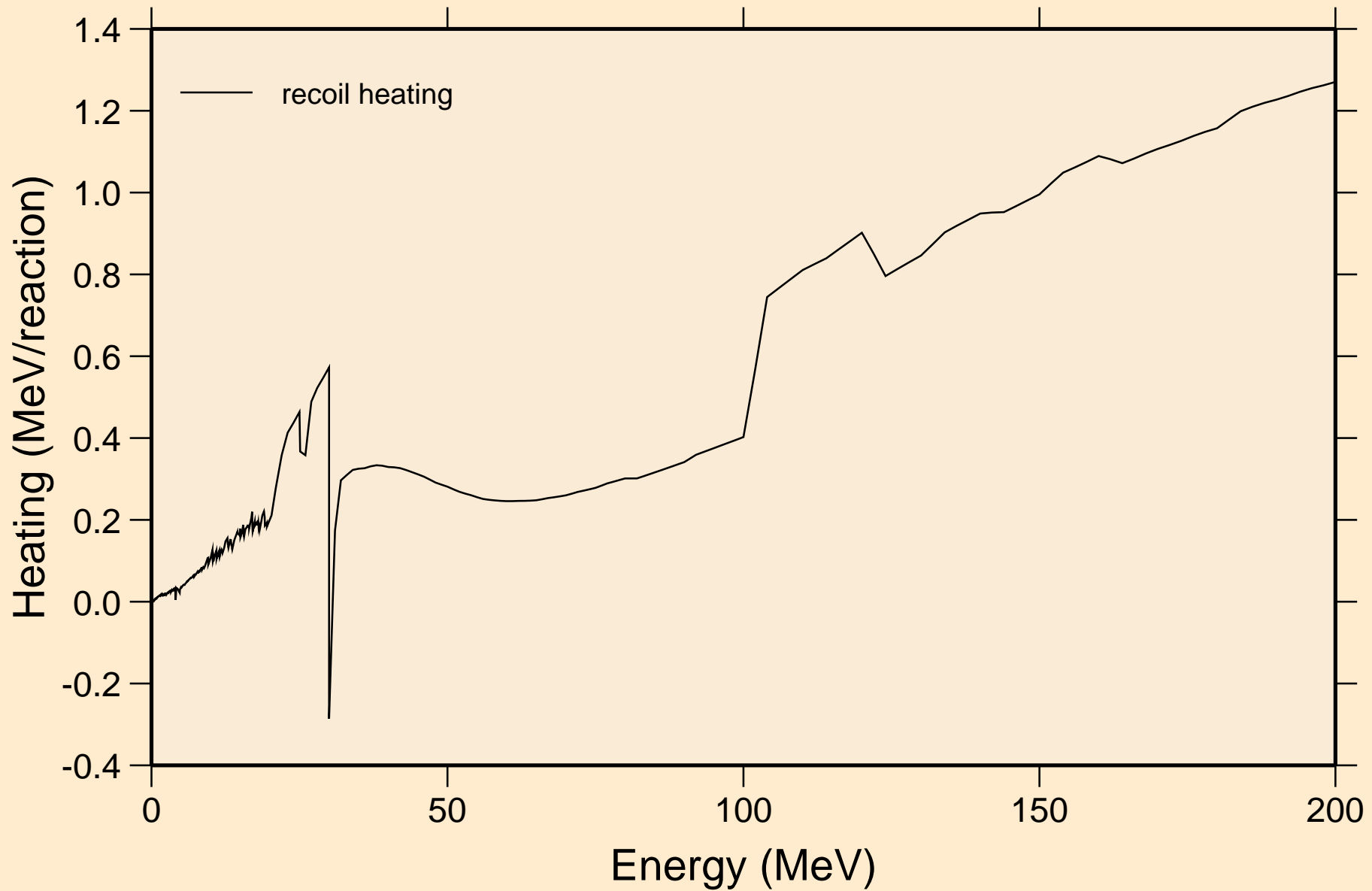

RN205M NEUTRON ACER TENDL-2023 LIBRARY; T=0.K
Particle production cross sections

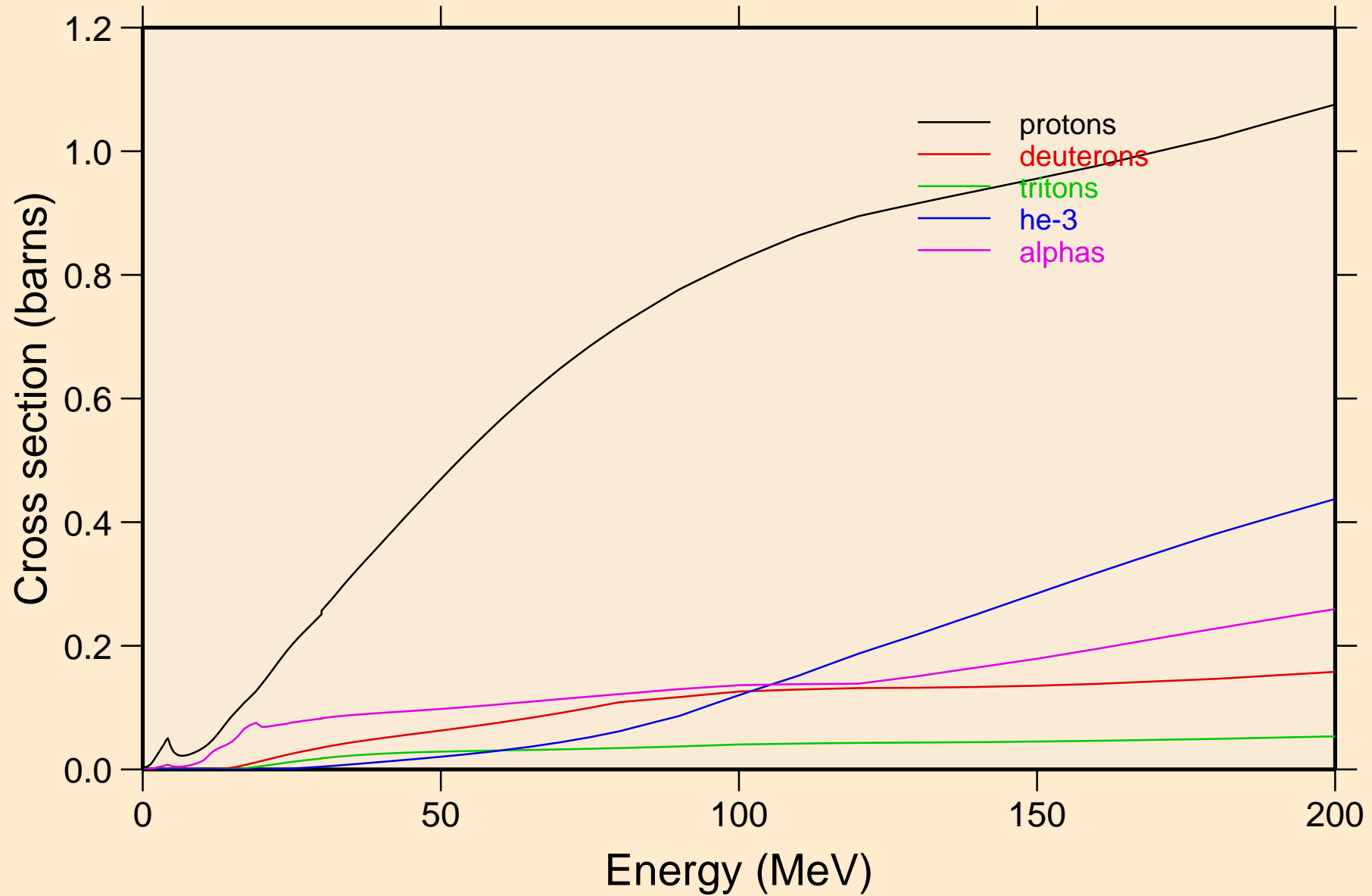

RN205M NEUTRON ACER TENDL-2023 LIBRARY; T=0.K
protons from (n,x)

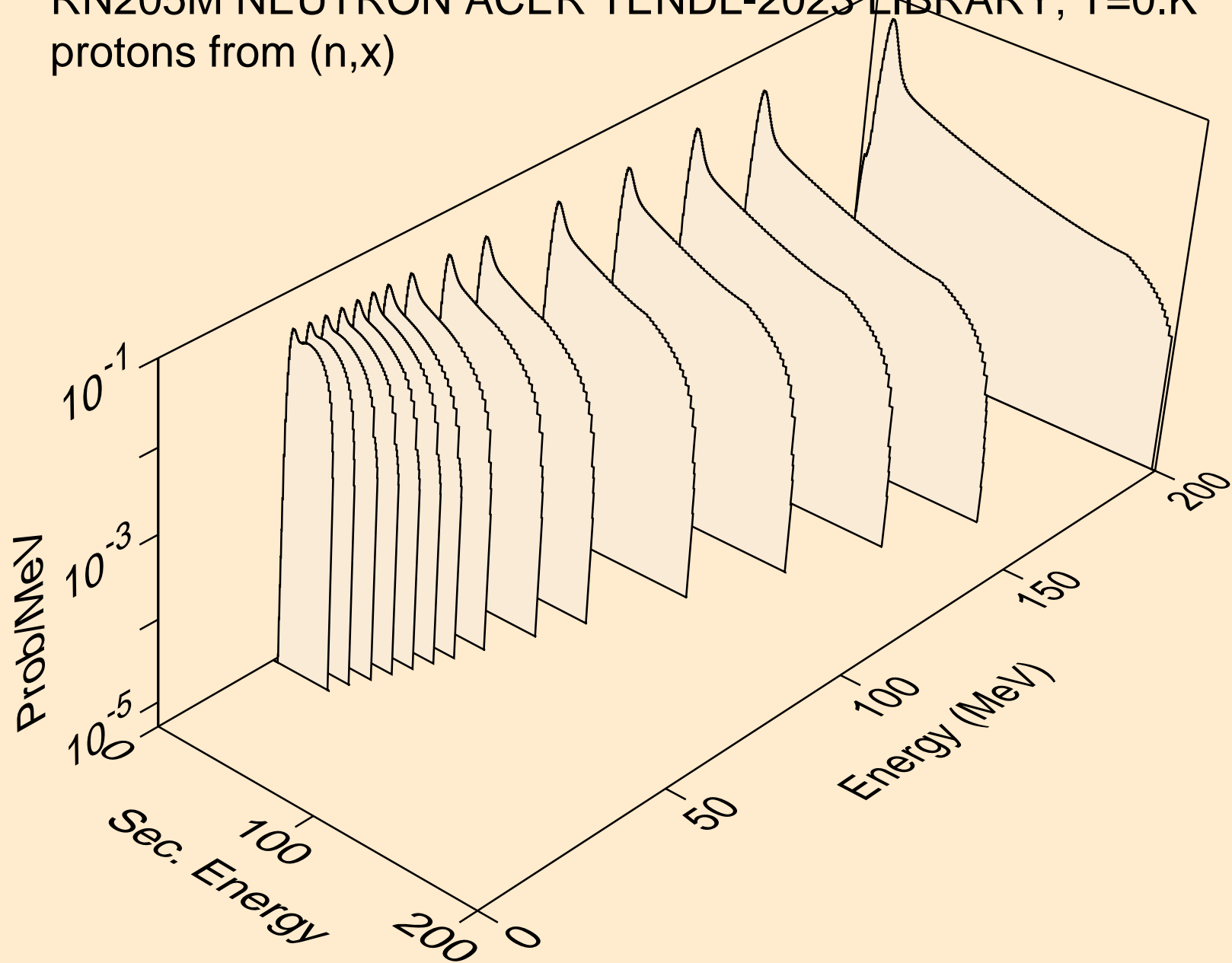

RN205M NEUTRON ACER TENDL-2023 LIBRARY; T=0.K
protons from (n,n*)p

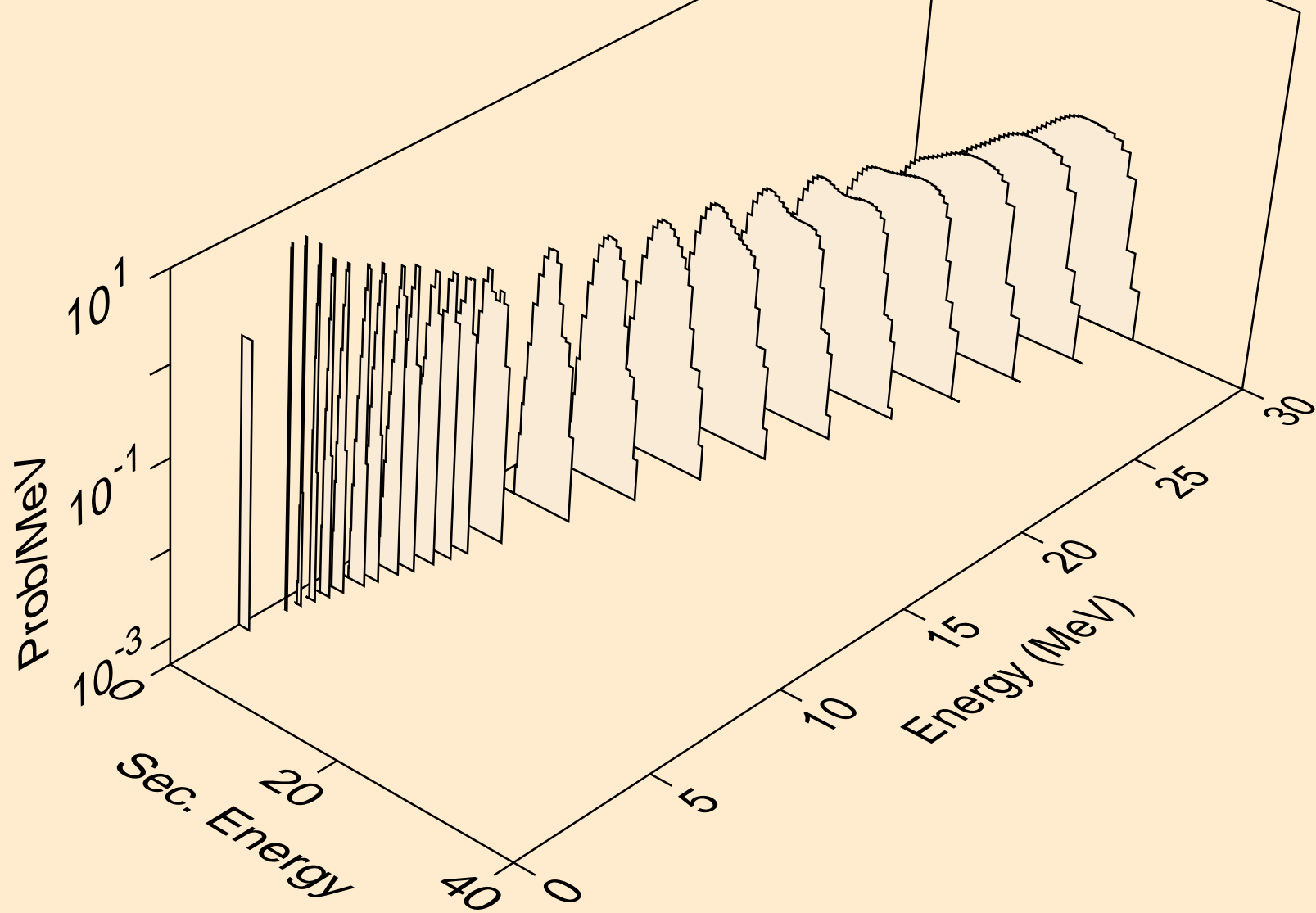

RN205M NEUTRON ACER TENDL-2023 LIBRARY; T=0.K
protons from (n,2np)

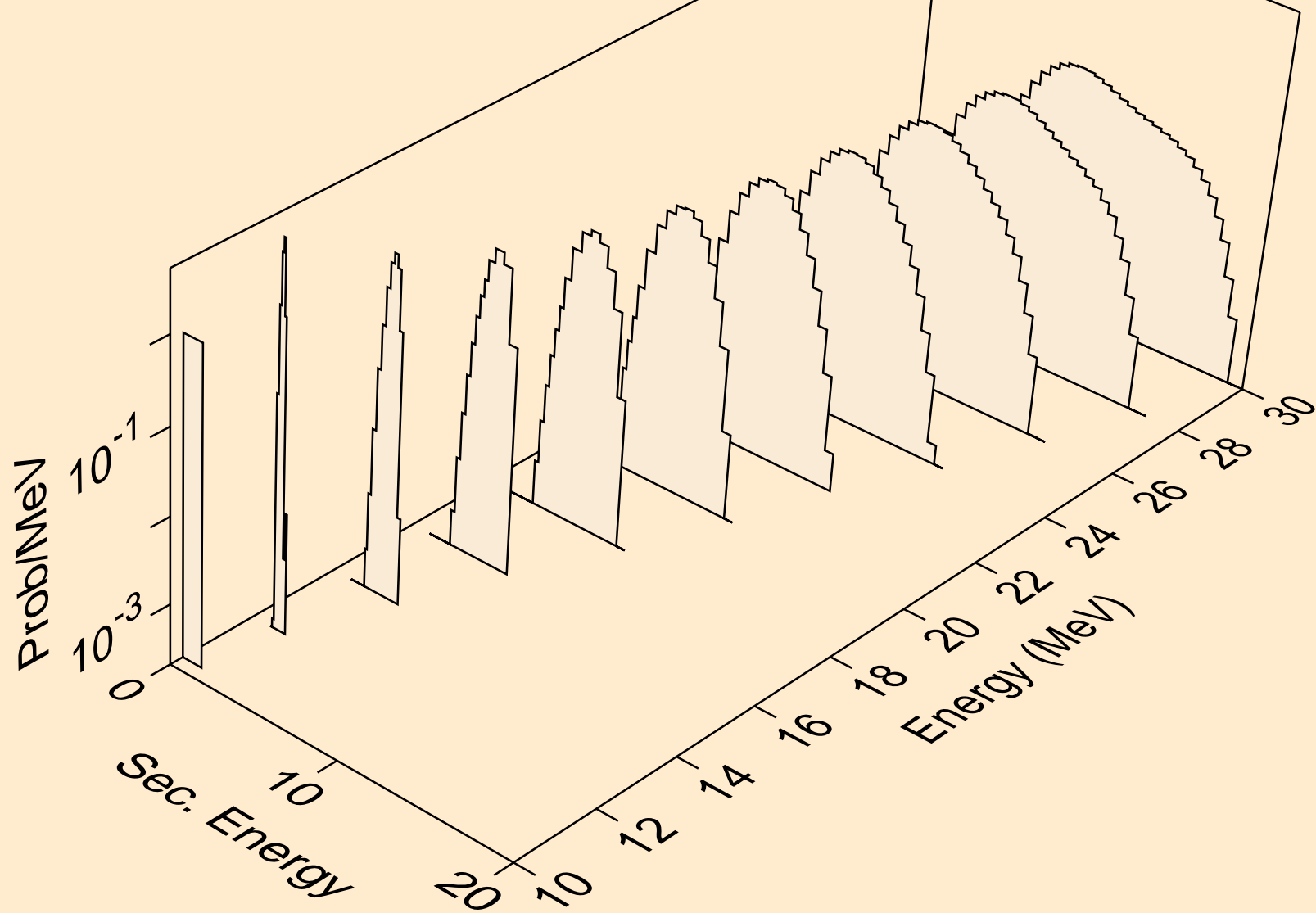

RN205M NEUTRON ACER TENDL-2023 LIBRARY; T=0.K
protons from (n,3np)

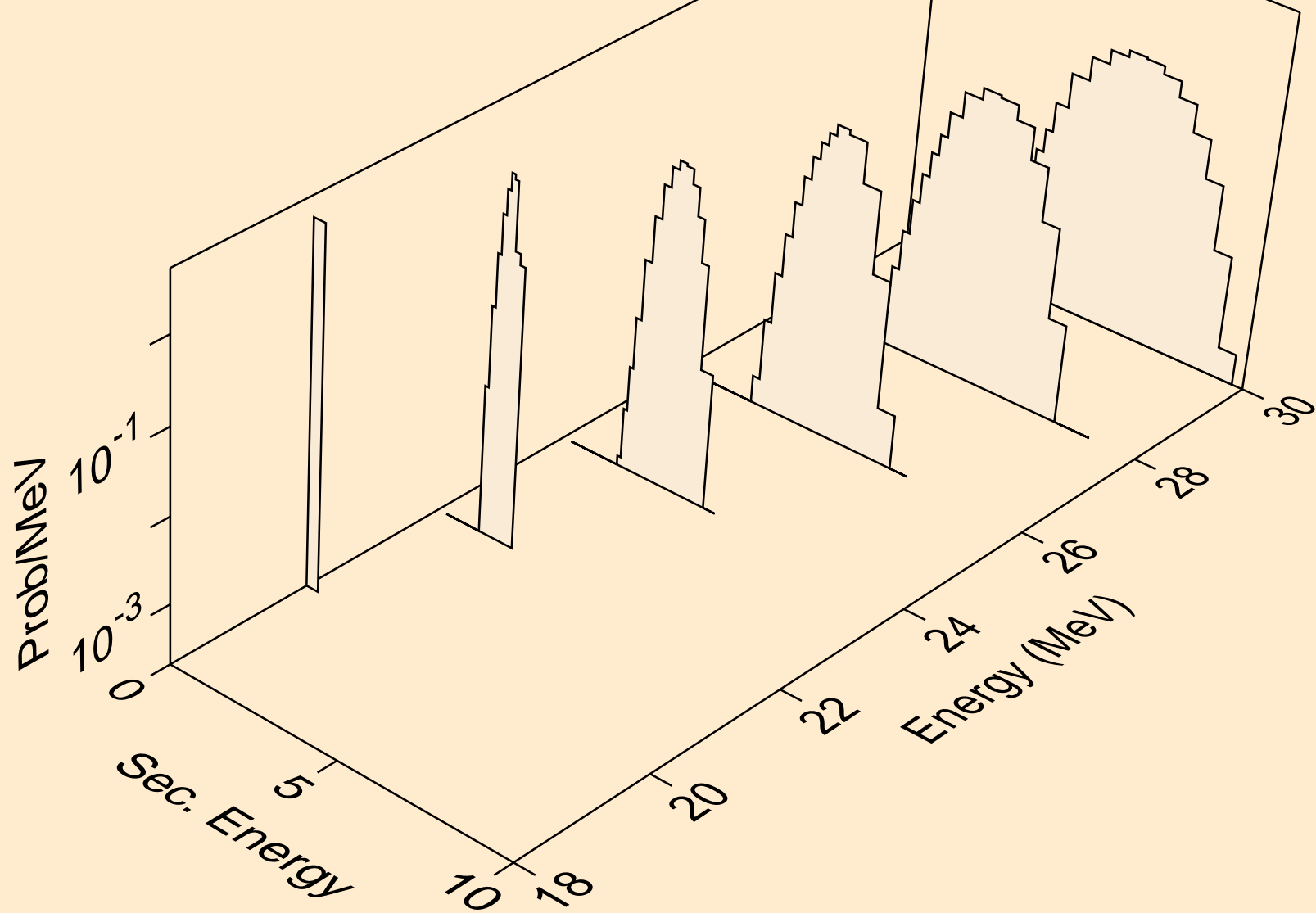

RN205M NEUTRON ACER TENDL-2023 LIBRARY; T=0.K
protons from (n,n2p)

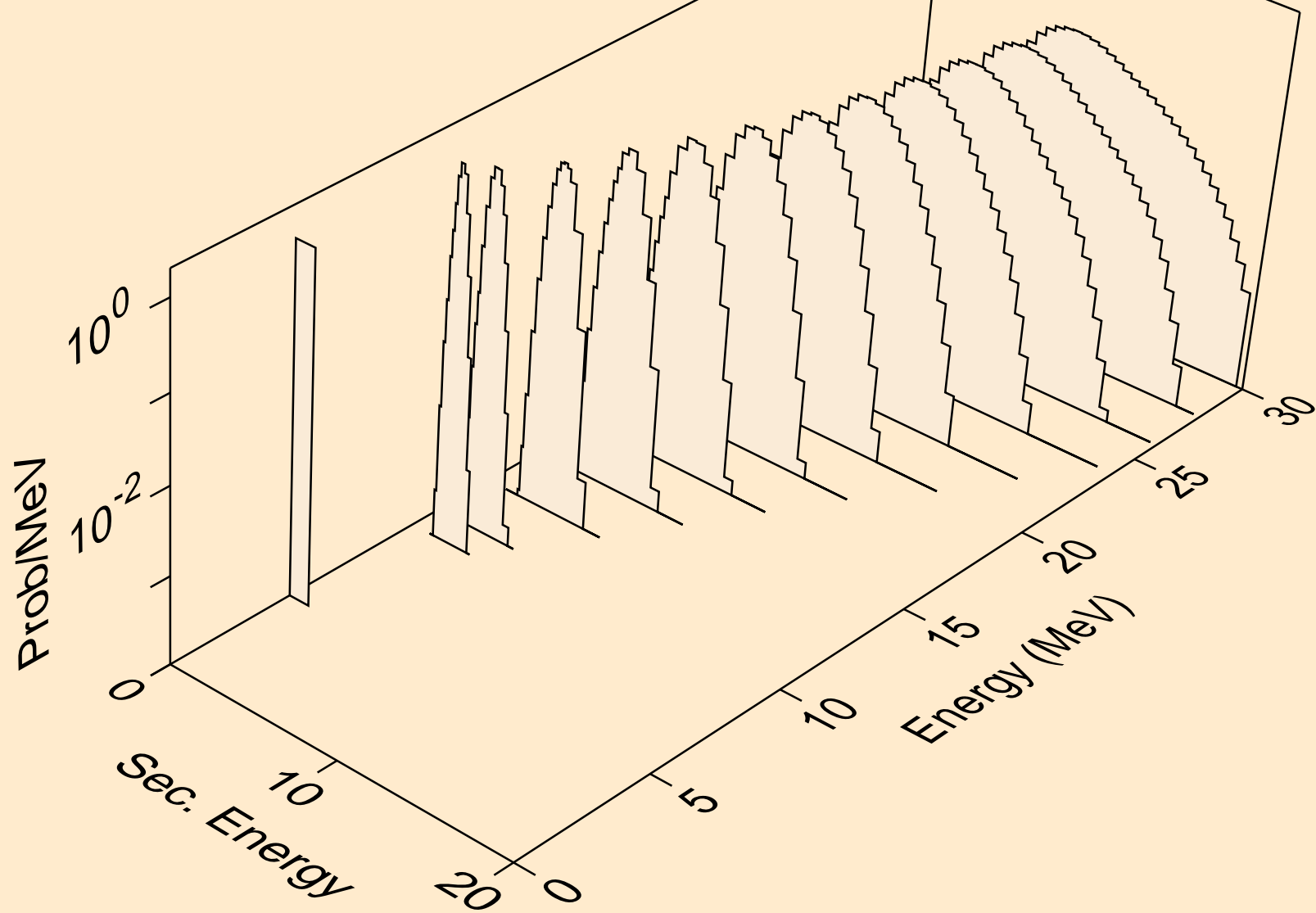

RN205M NEUTRON ACER TENDL-2023 LIBRARY; T=0.K
protons from (n,npa)

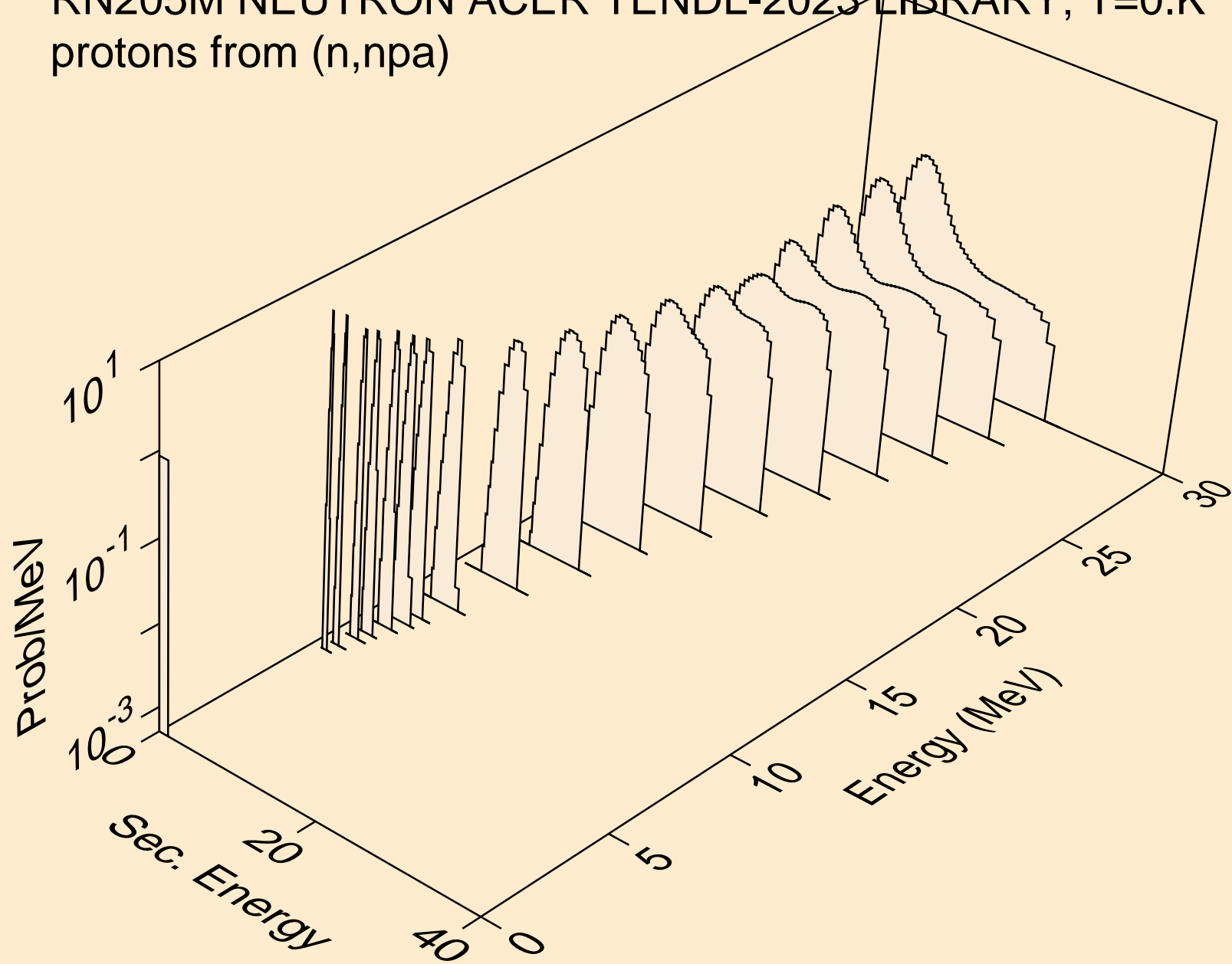

RN205M NEUTRON ACER TENDL-2023 LIBRARY; T=0.K
protons from (n,p)

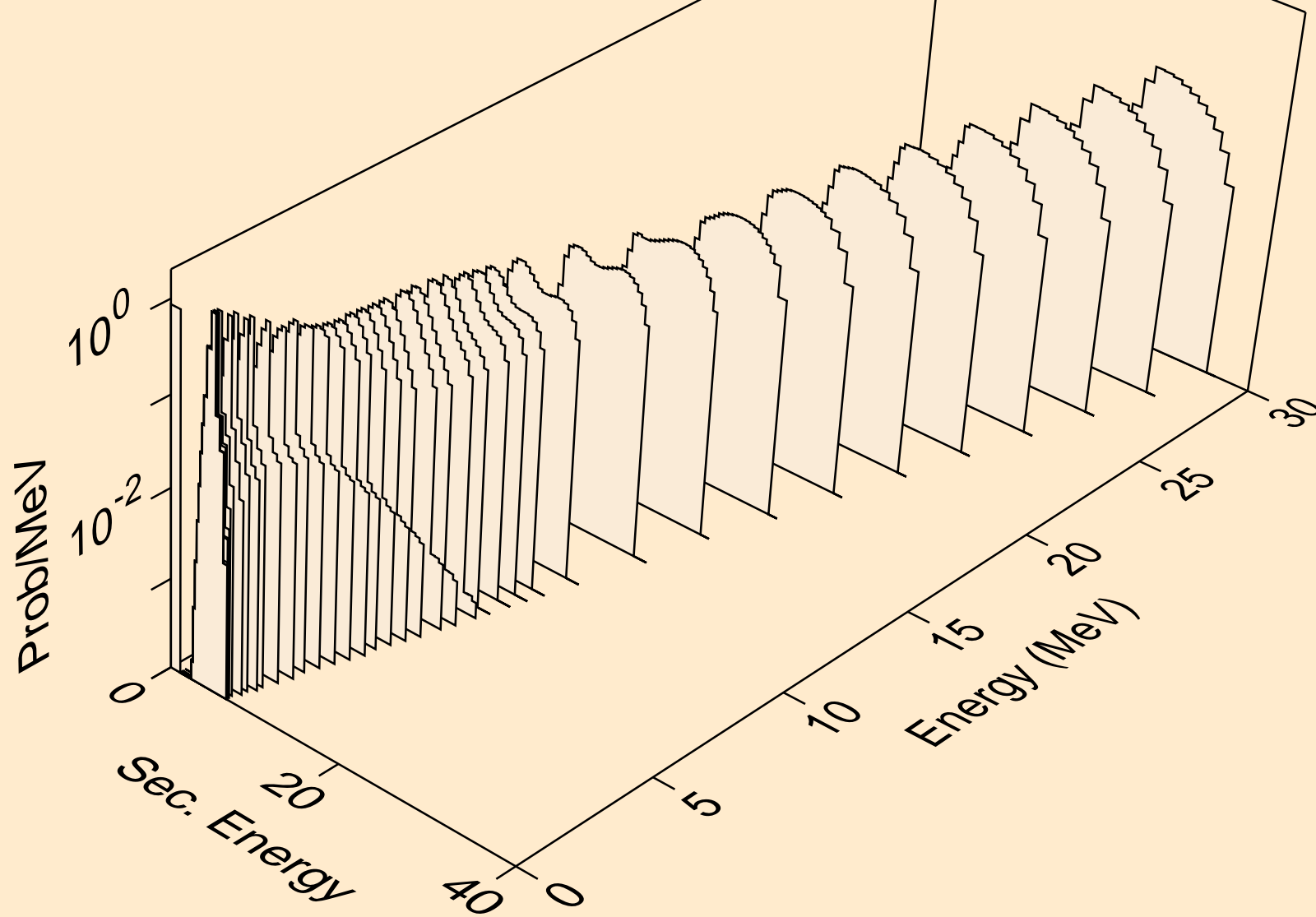

RN205M NEUTRON ACER TENDL-2023 LIBRARY; T=0.K
protons from (n,2p)

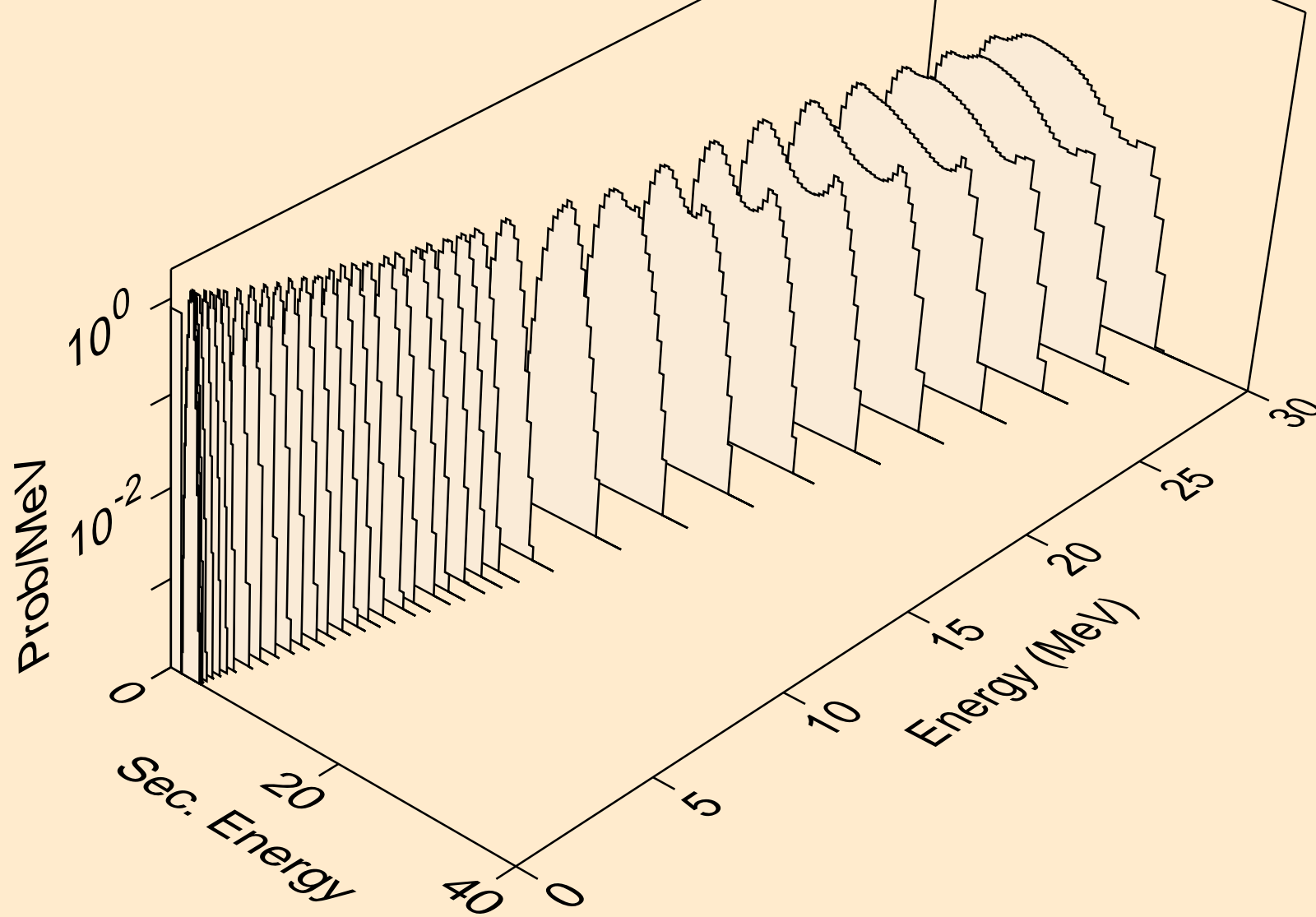

RN205M NEUTRON ACER TENDL-2023 LIBRARY; T=0.K
protons from (n,p)

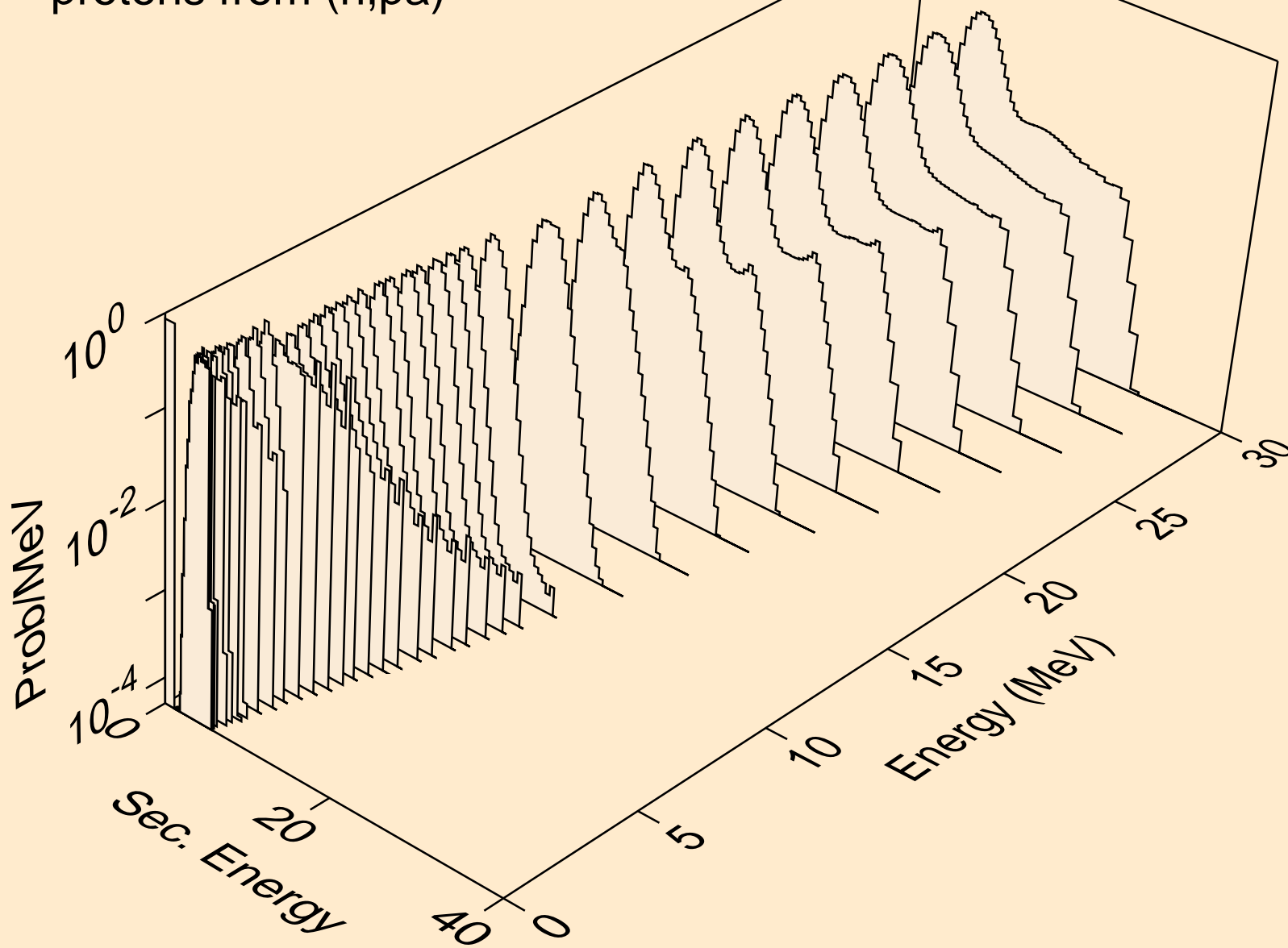

RN205M NEUTRON ACER TENDL-2023 LIBRARY; T=0.K
protons from (n,pd)

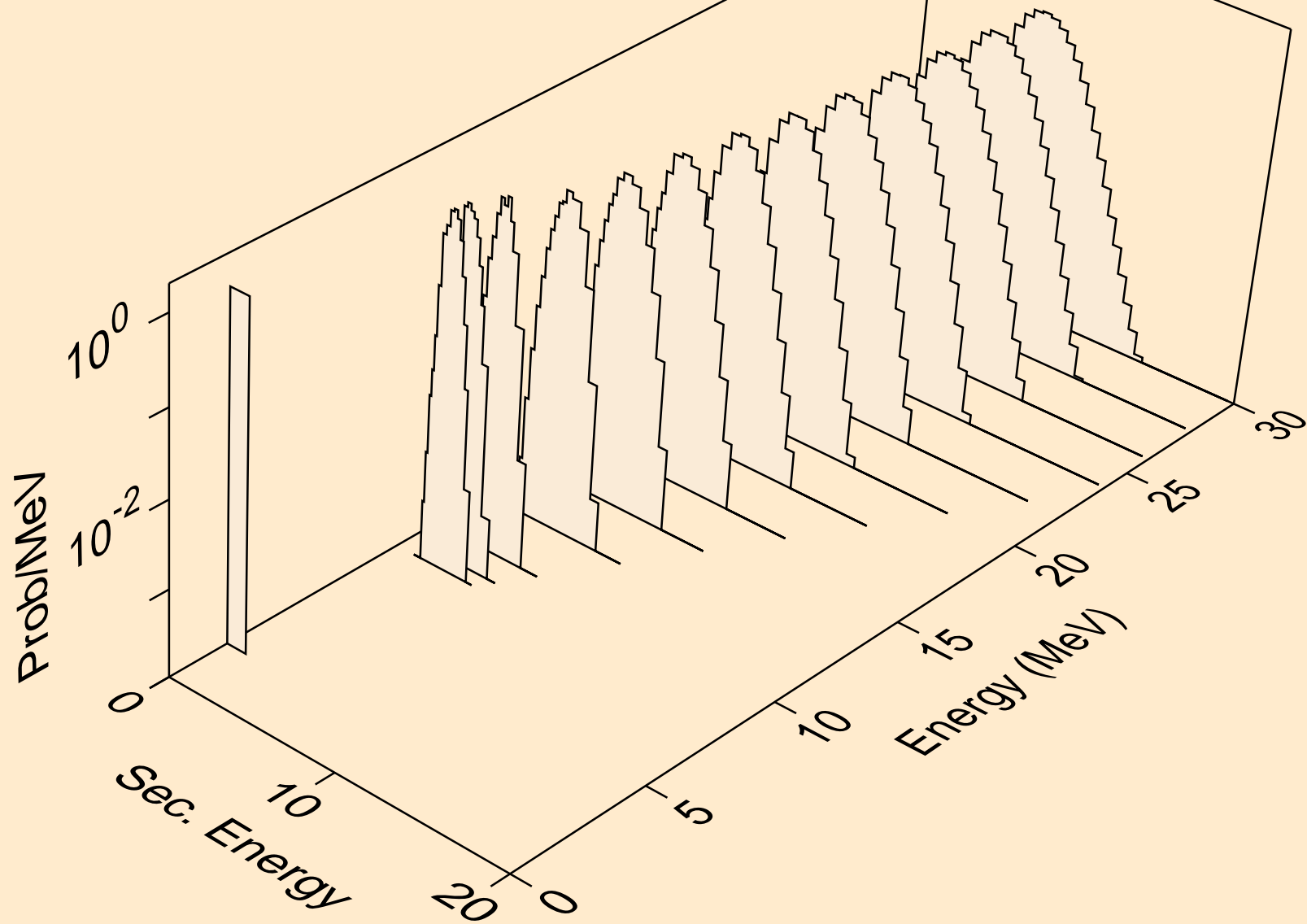

RN205M NEUTRON ACER TENDL-2023 LIBRARY; T=0.K
protons from (n,pt)

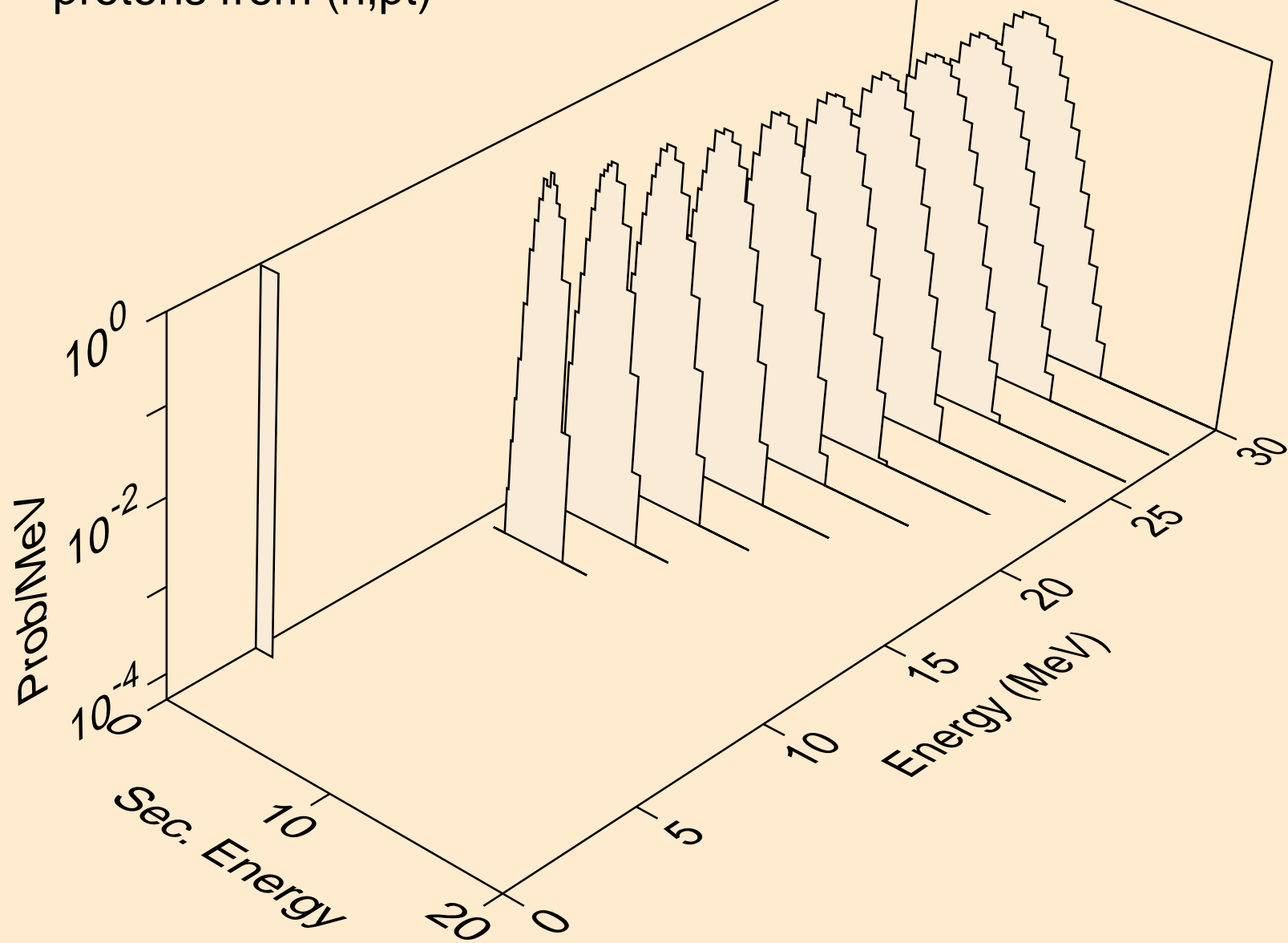

RN205M NEUTRON ACER TENDL-2023 LIBRARY; T=0.K
deuterons from (n,x)

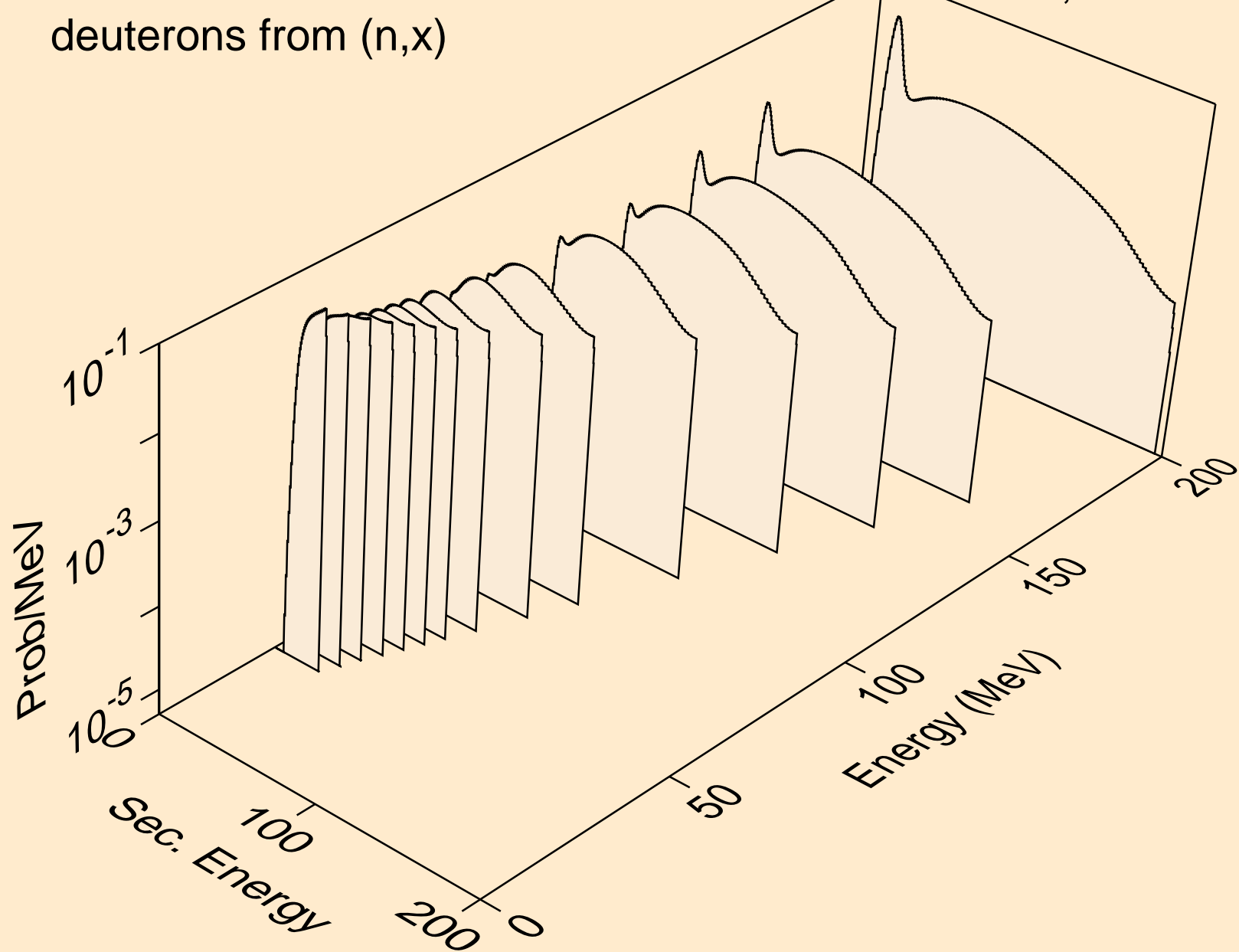

RN205M NEUTRON ACER TENDL-2023 LIBRARY; T=0.K
deuterons from (n,2nd)

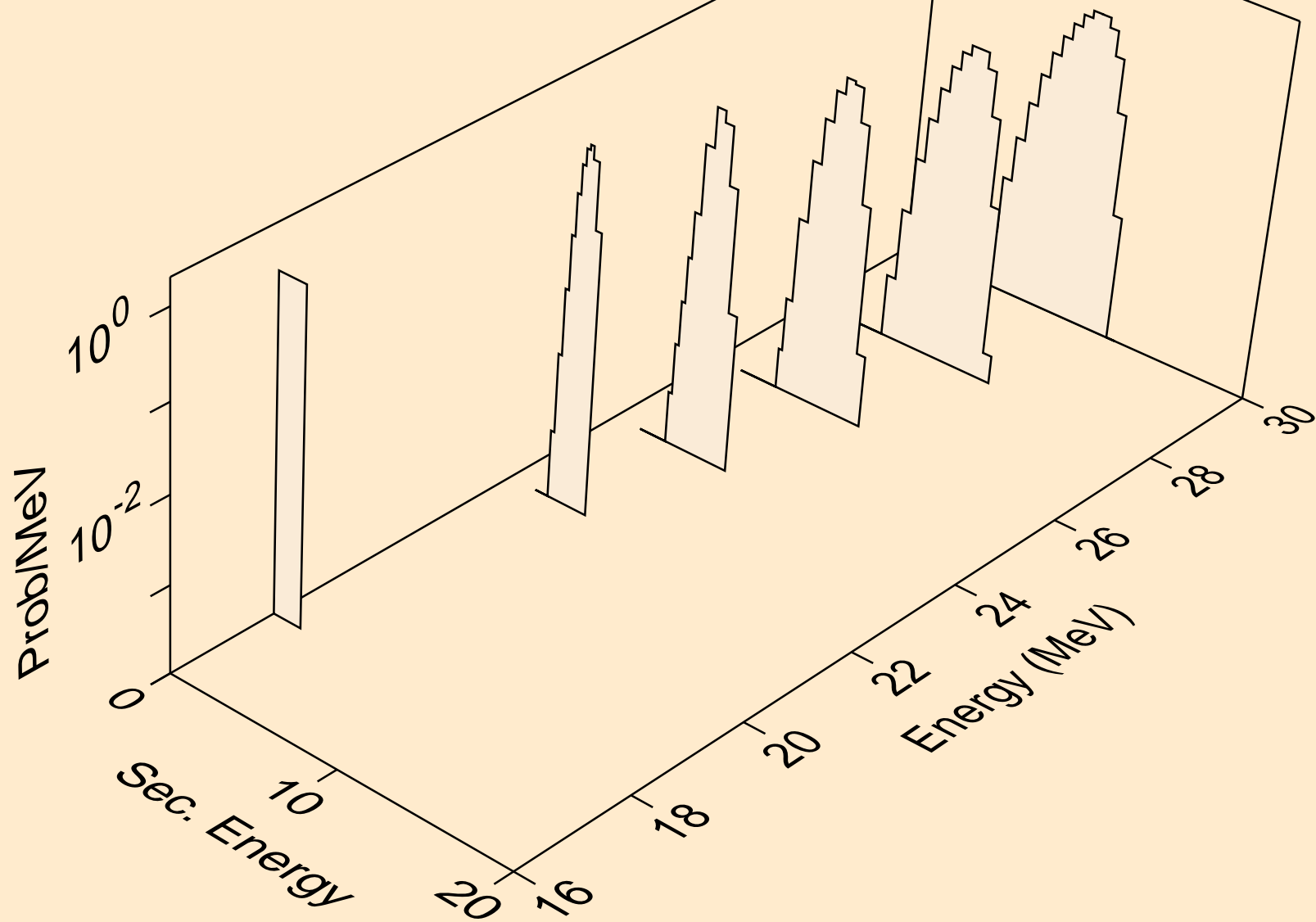

RN205M NEUTRON ACER TENDL-2023 LIBRARY; T=0.K
deuterons from (n,n*)d

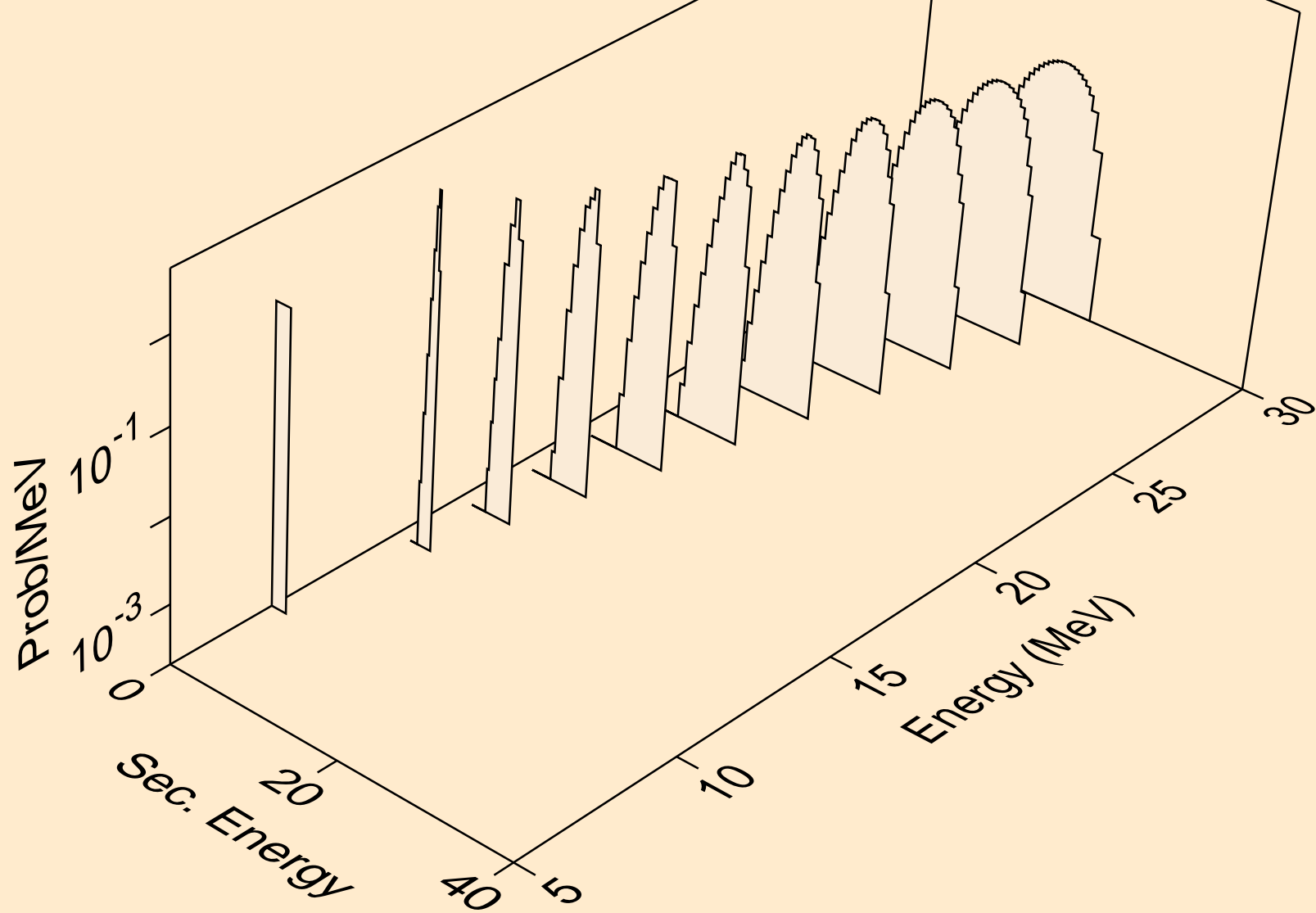

RN205M NEUTRON ACER TENDL-2023 LIBRARY; T=0.K
deuterons from (n,d)

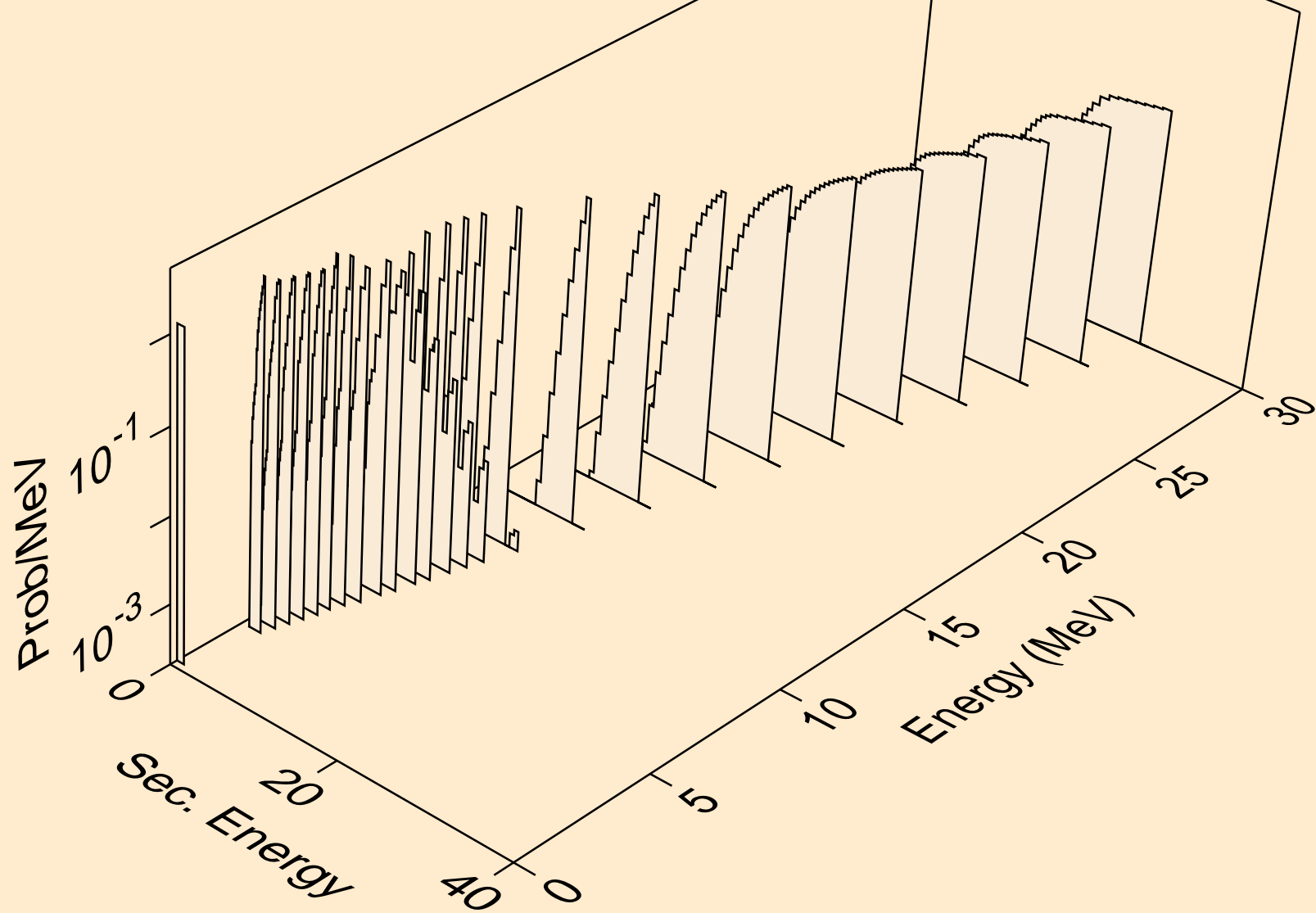

RN205M NEUTRON ACER TENDL-2023 LIBRARY; T=0.K
deuterons from (n,pd)

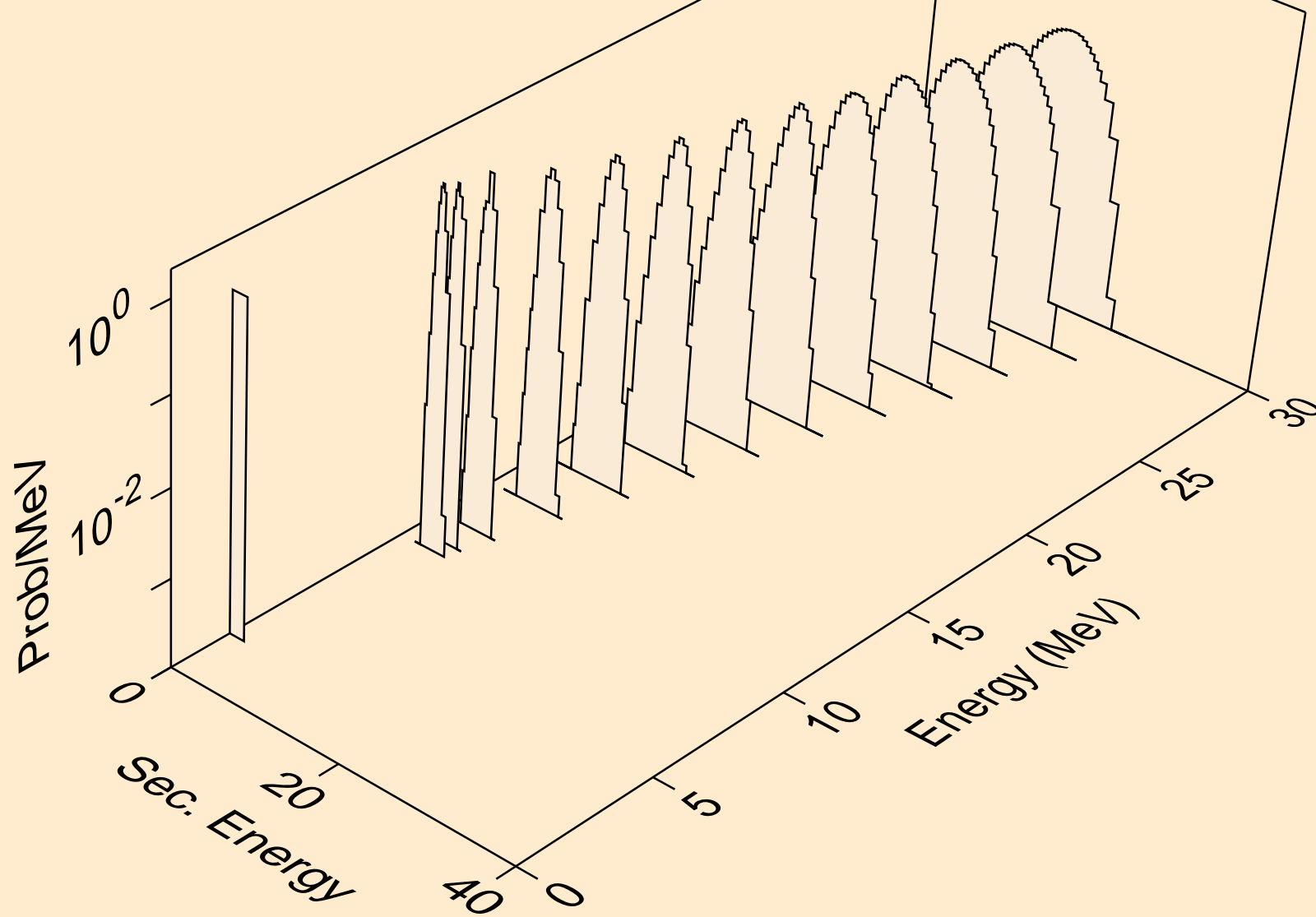

RN205M NEUTRON ACER TENDL-2023 LIBRARY; T=0.K
deuterons from (n,da)

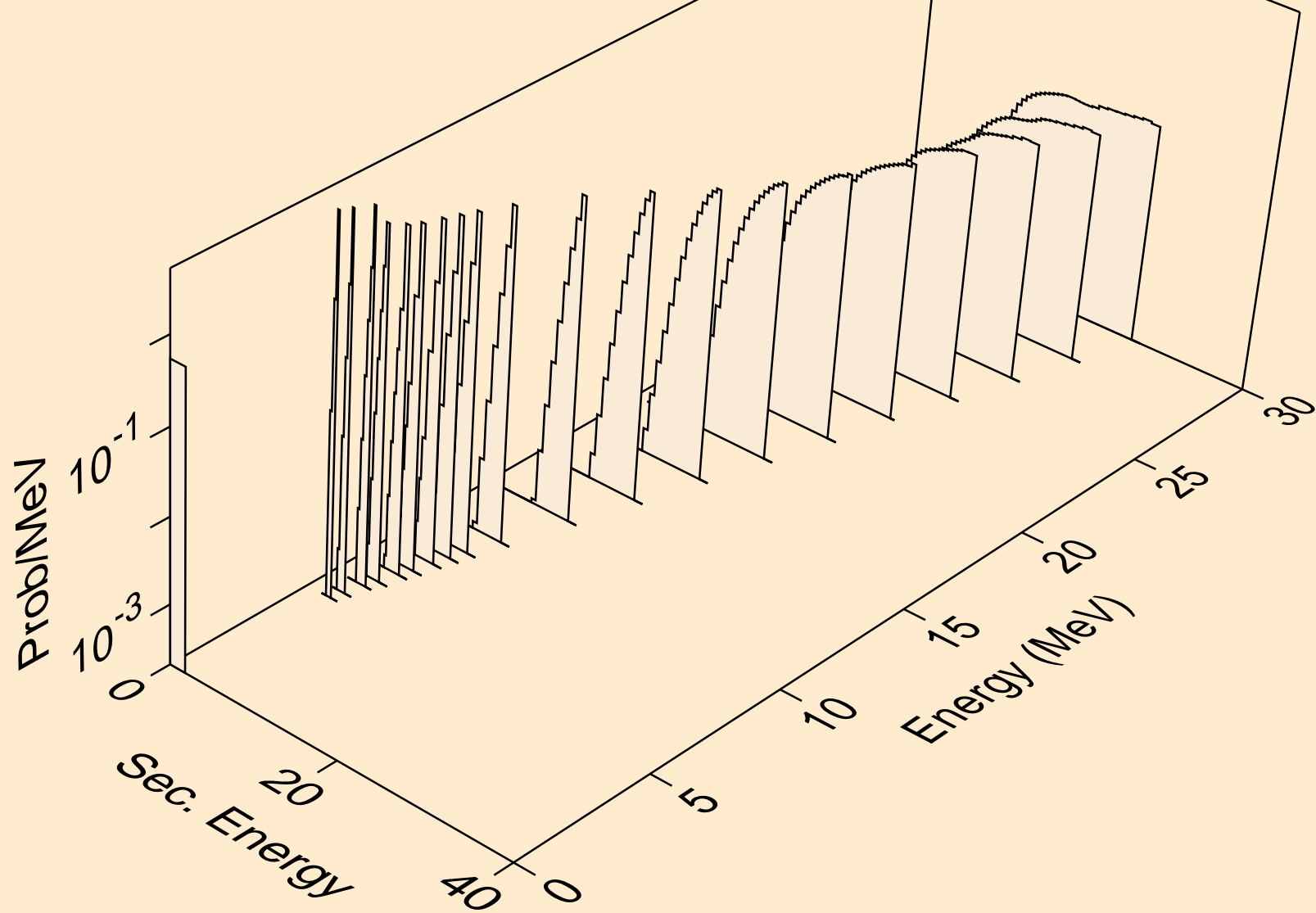

RN205M NEUTRON ACER TENDL-2023 LIBRARY; T=0.K
tritons from (n,x)

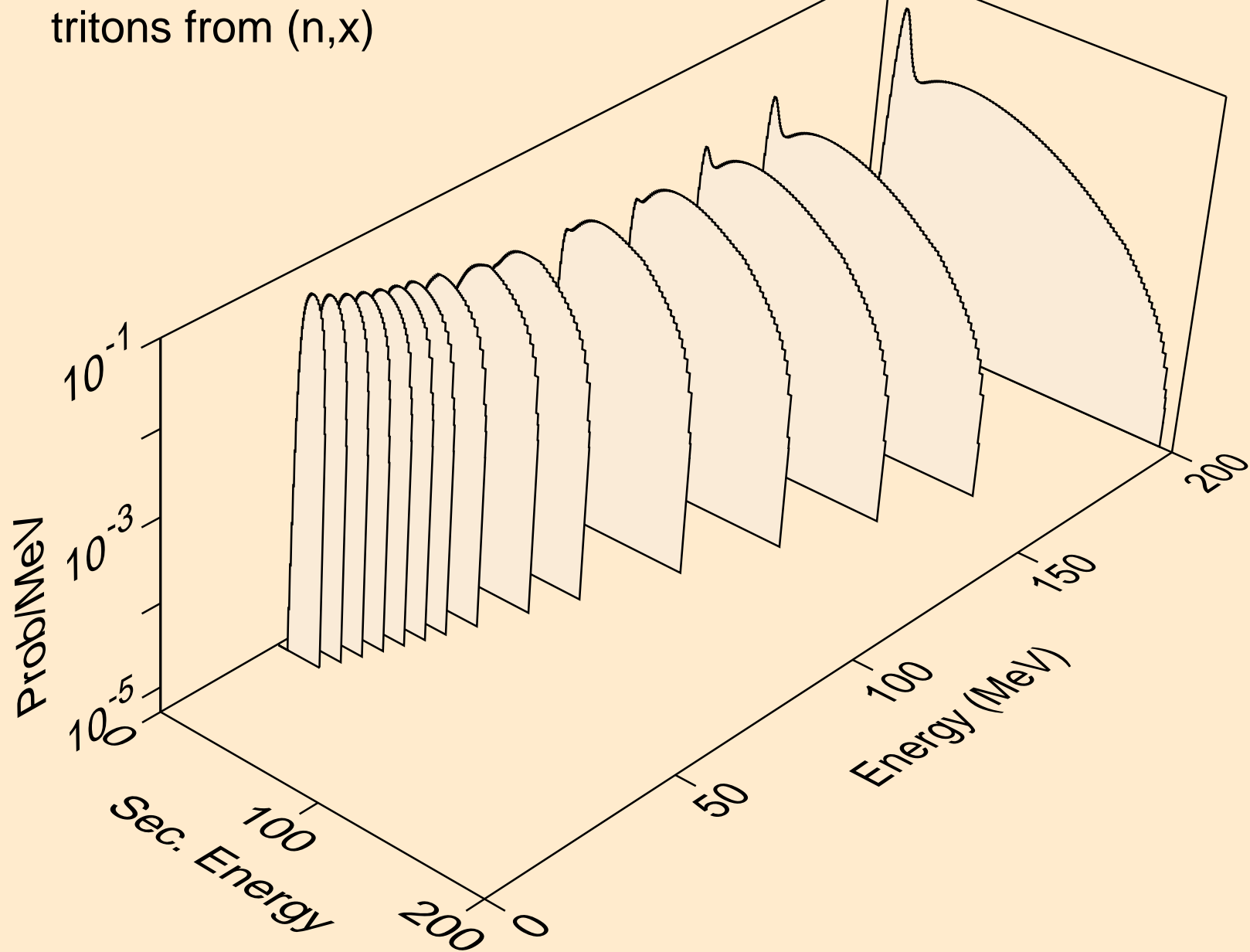

RN205M NEUTRON ACER TENDL-2023 LIBRARY; T=0.K
tritons from (n,n*)t

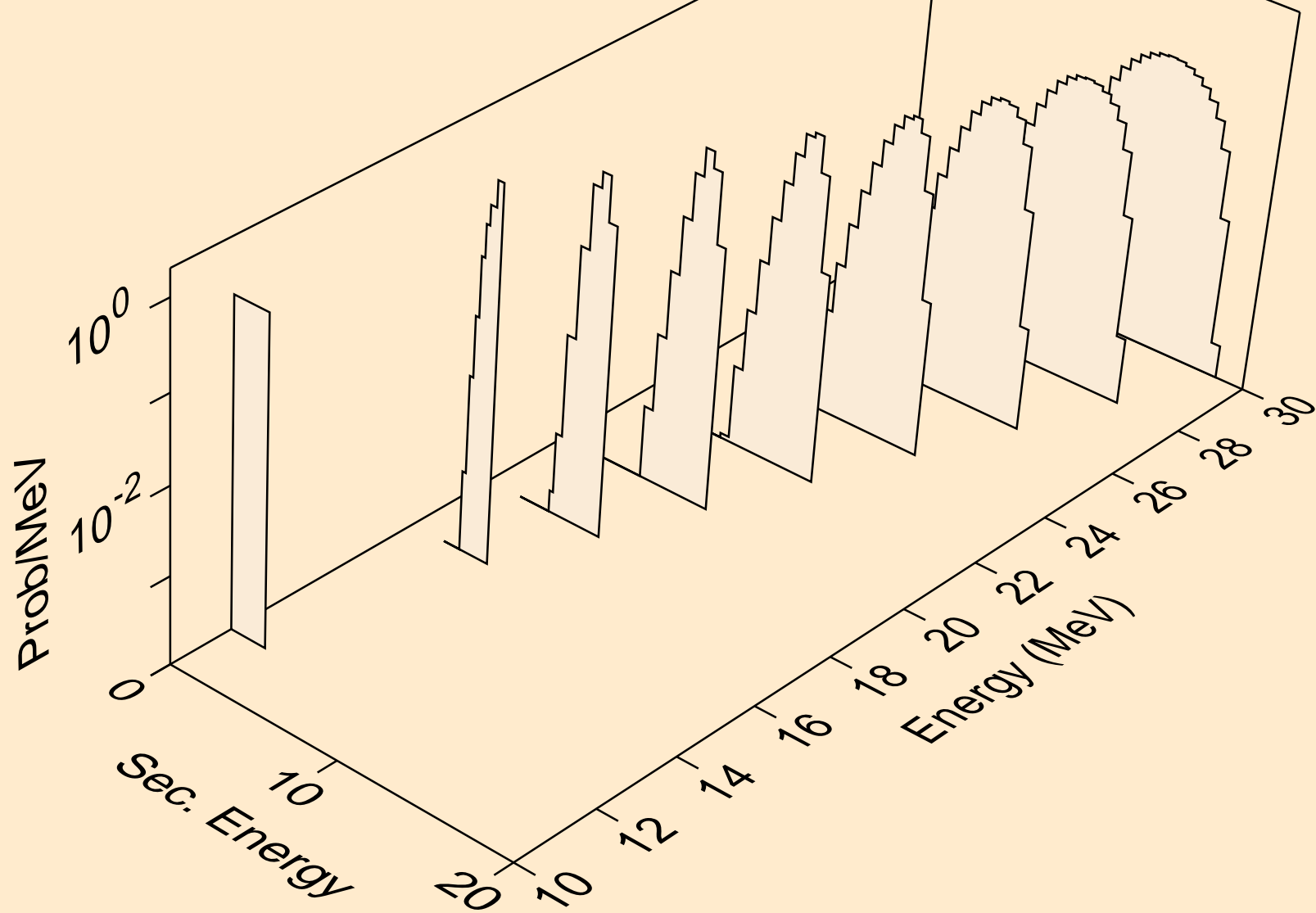

RN205M NEUTRON ACER TENDL-2023 LIBRARY; T=0.K
tritons from (n,t)

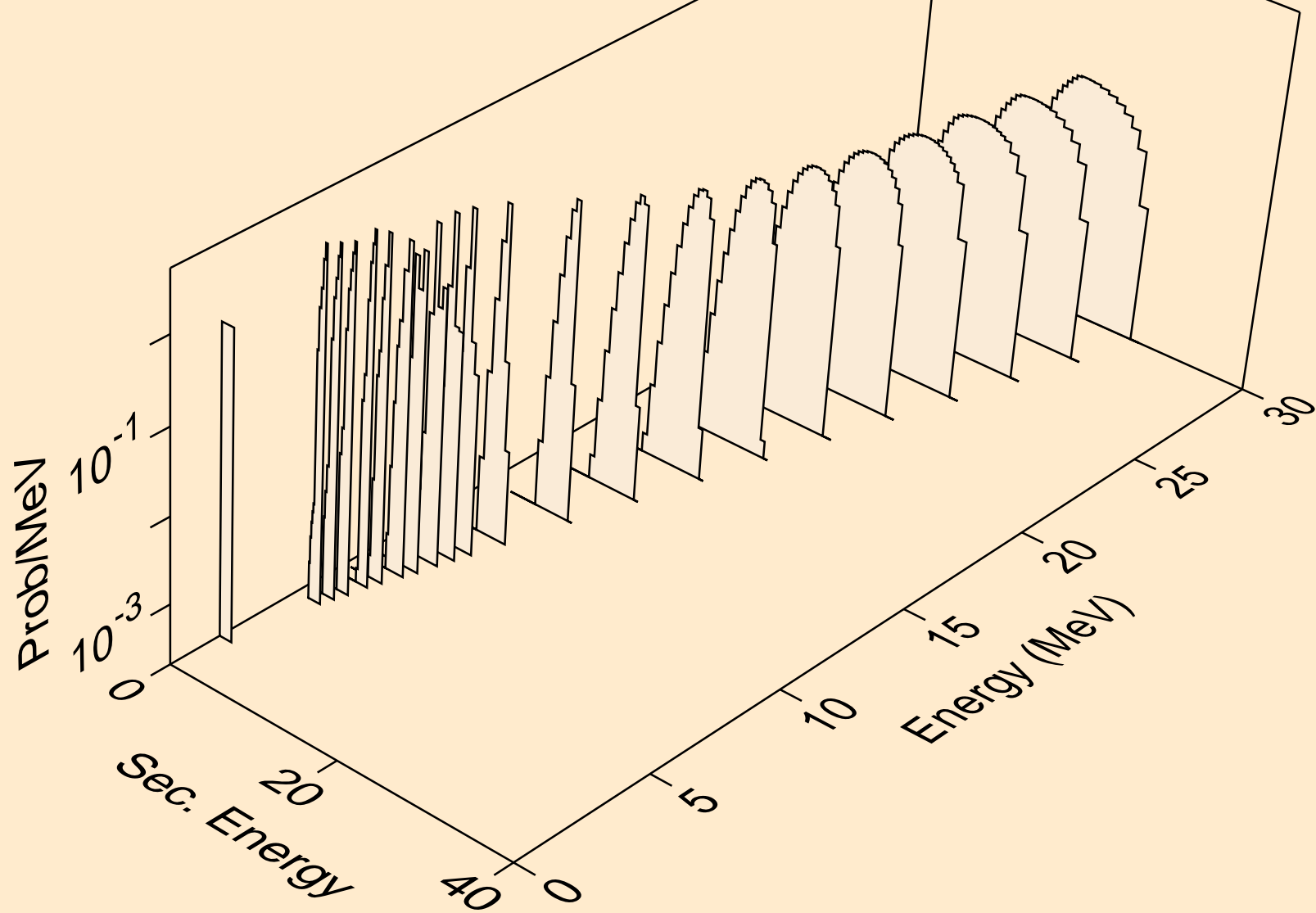

RN205M NEUTRON ACER TENDL-2023 LIBRARY; T=0.K
tritons from (n,pt)

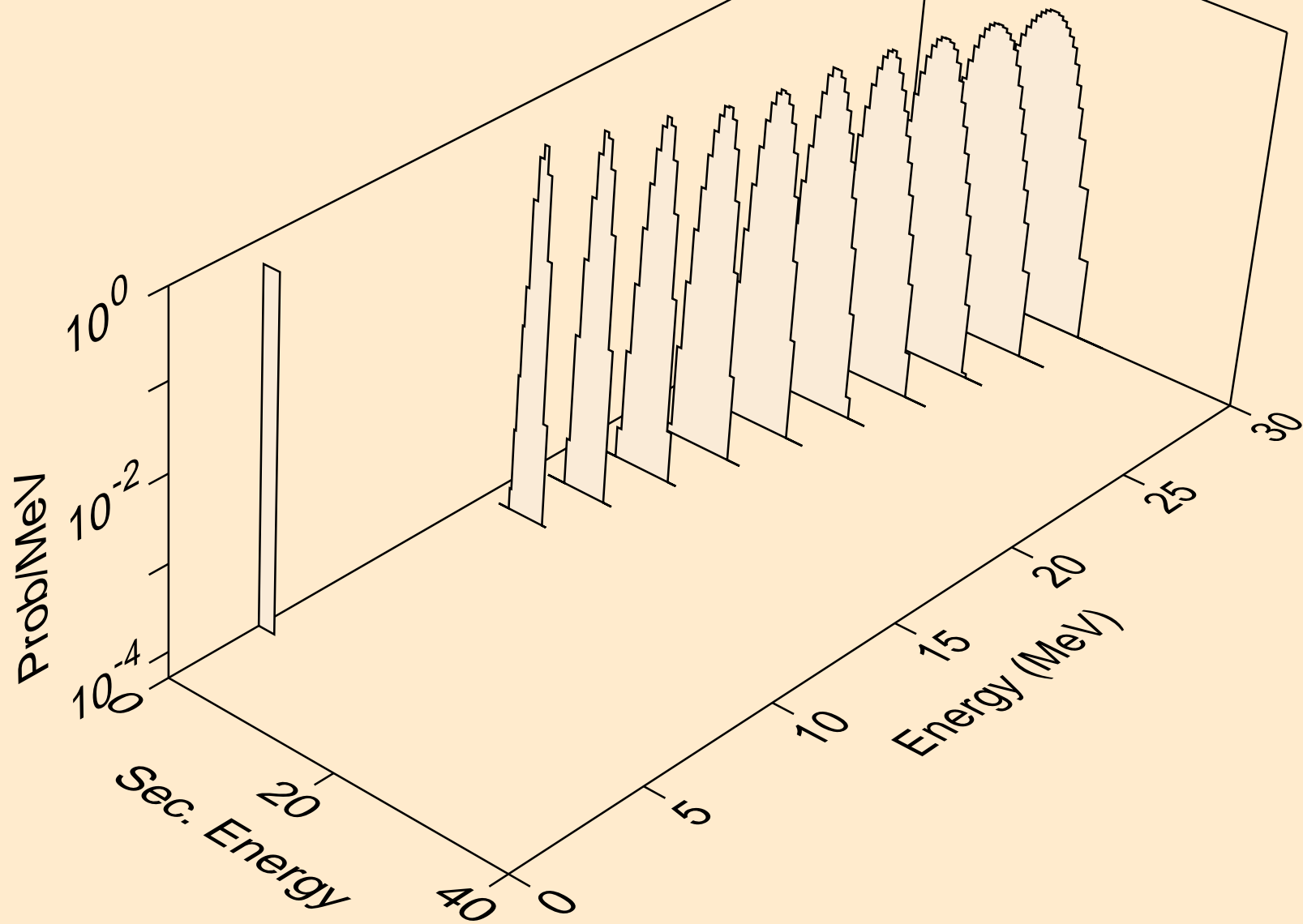

RN205M NEUTRON ACER TENDL-2023 LIBRARY; T=0.K
he3s from (n,x)

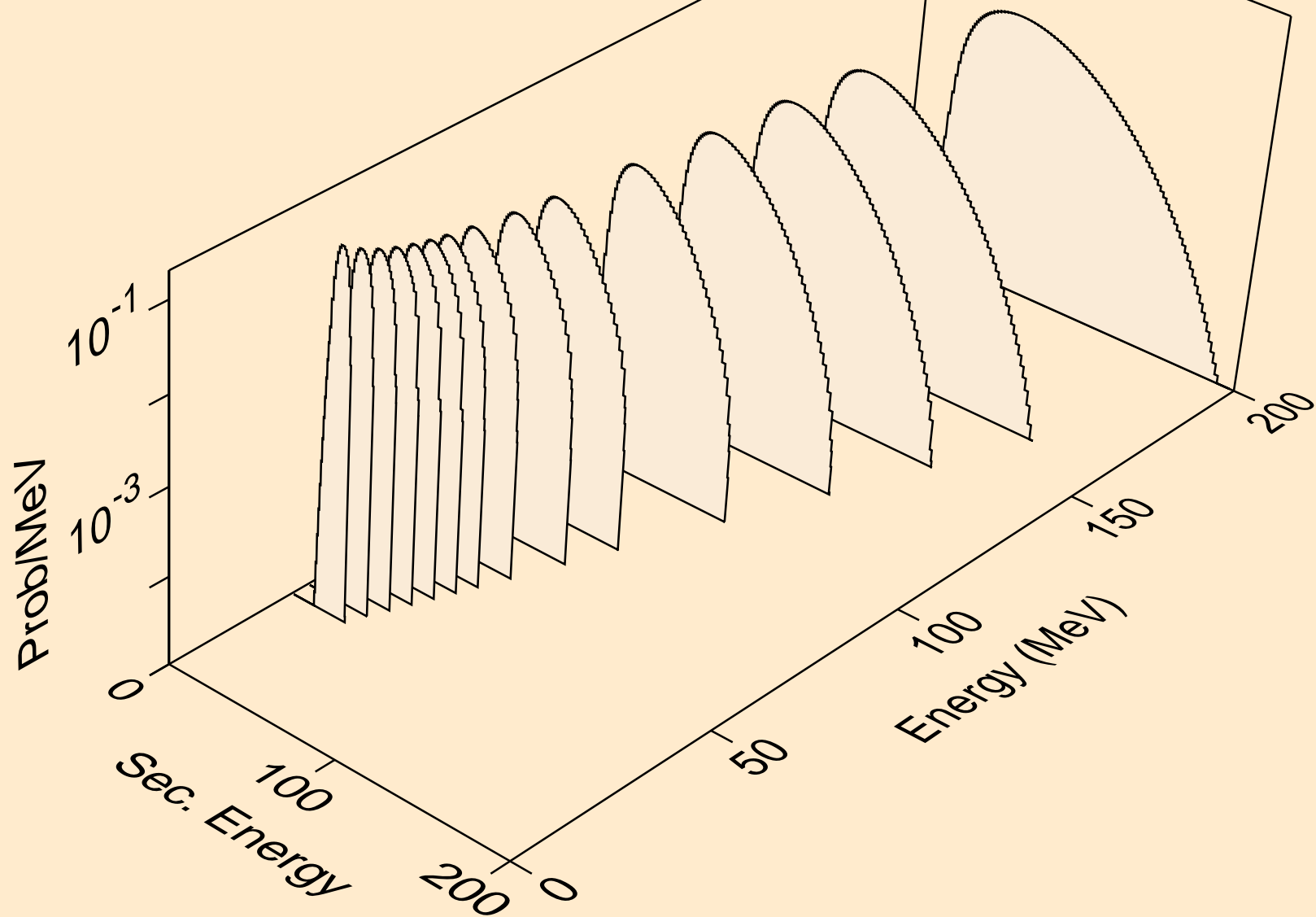

RN205M NEUTRON ACER TENDL-2023 LIBRARY; T=0.K
he3s from (n,n*)he3

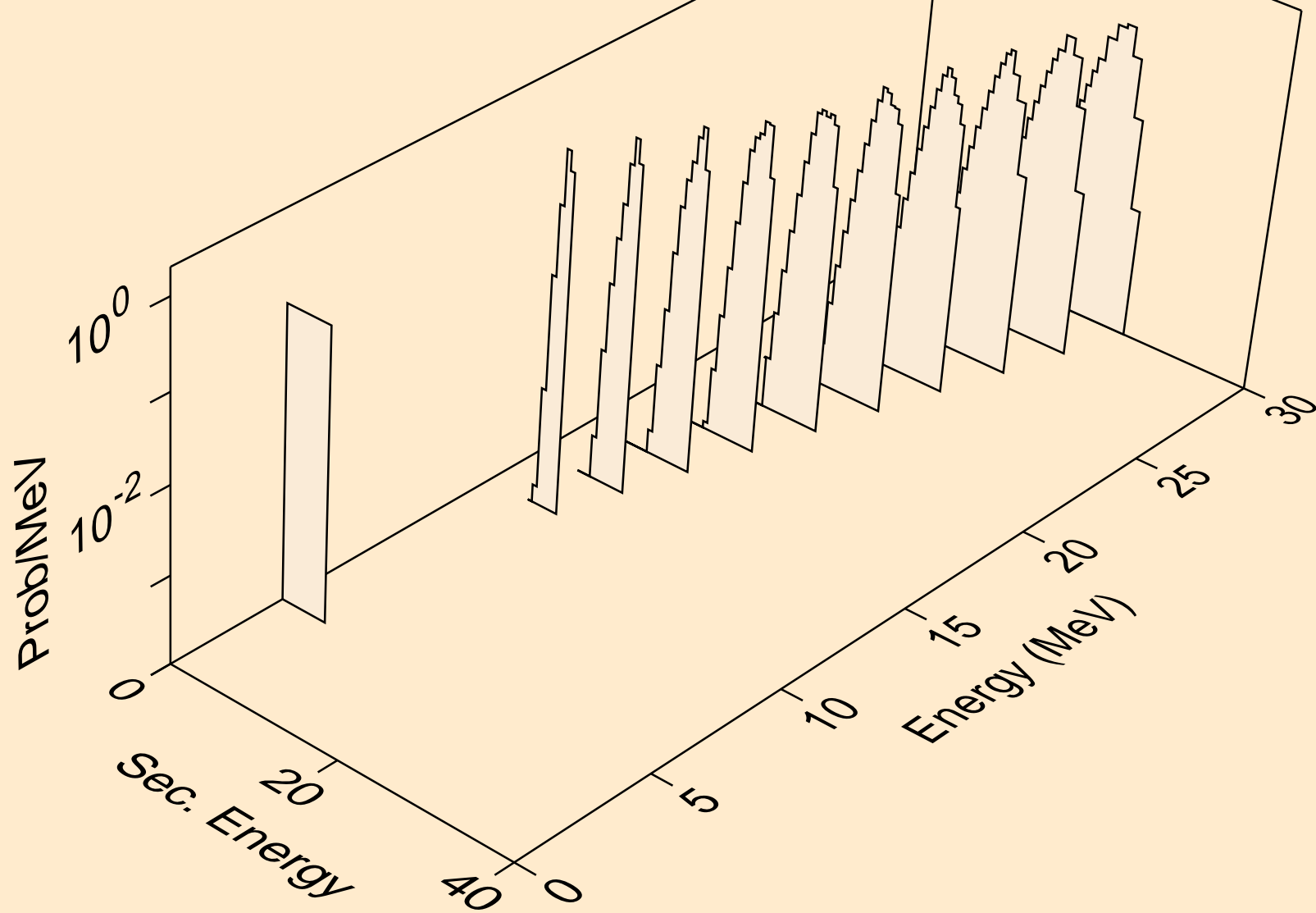

RN205M NEUTRON ACER TENDL-2023 LIBRARY; T=0.K
he3s from (n,he3)

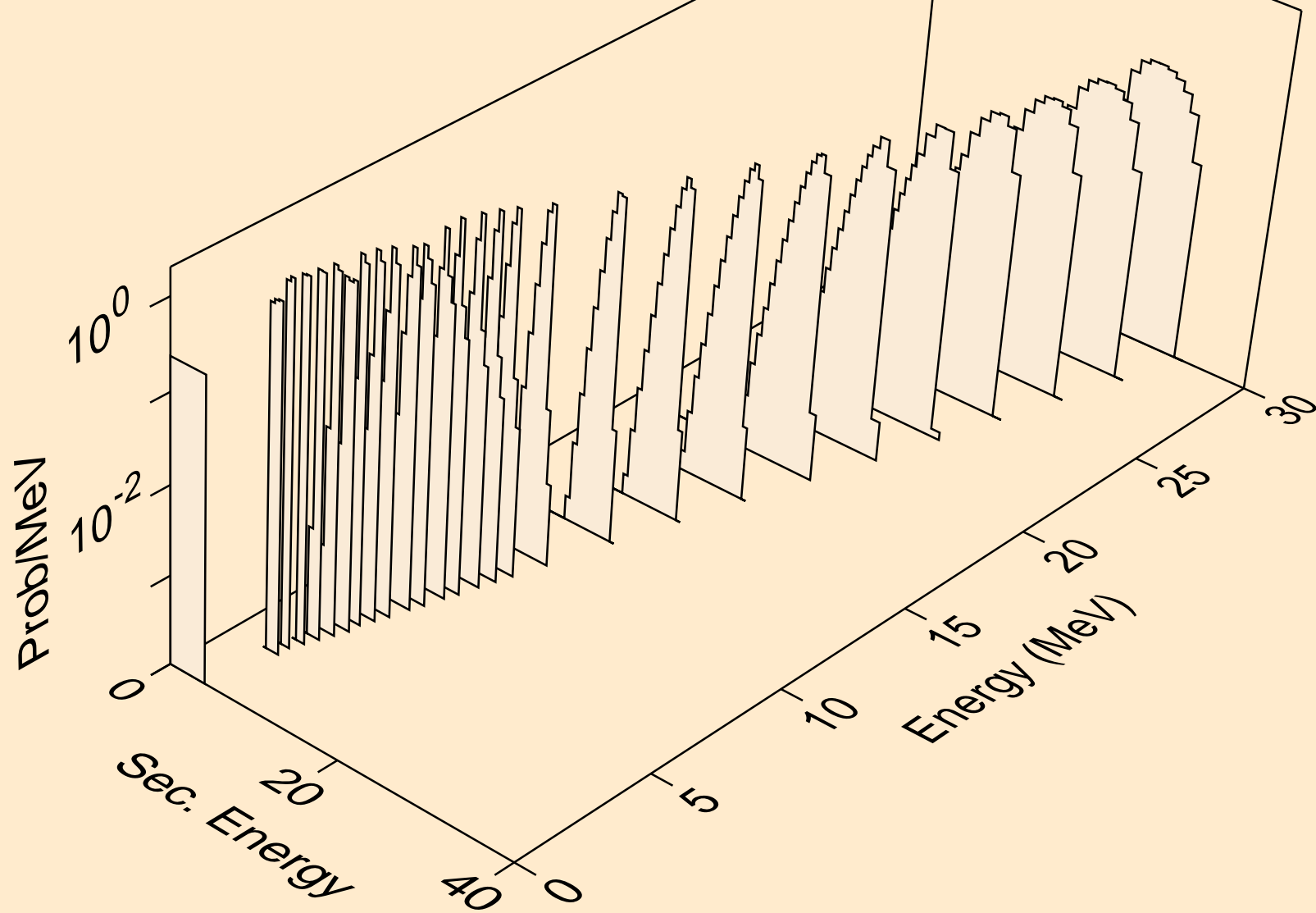

RN205M NEUTRON ACER TENDL-2023 LIBRARY; T=0.K
alphas from (n,x)

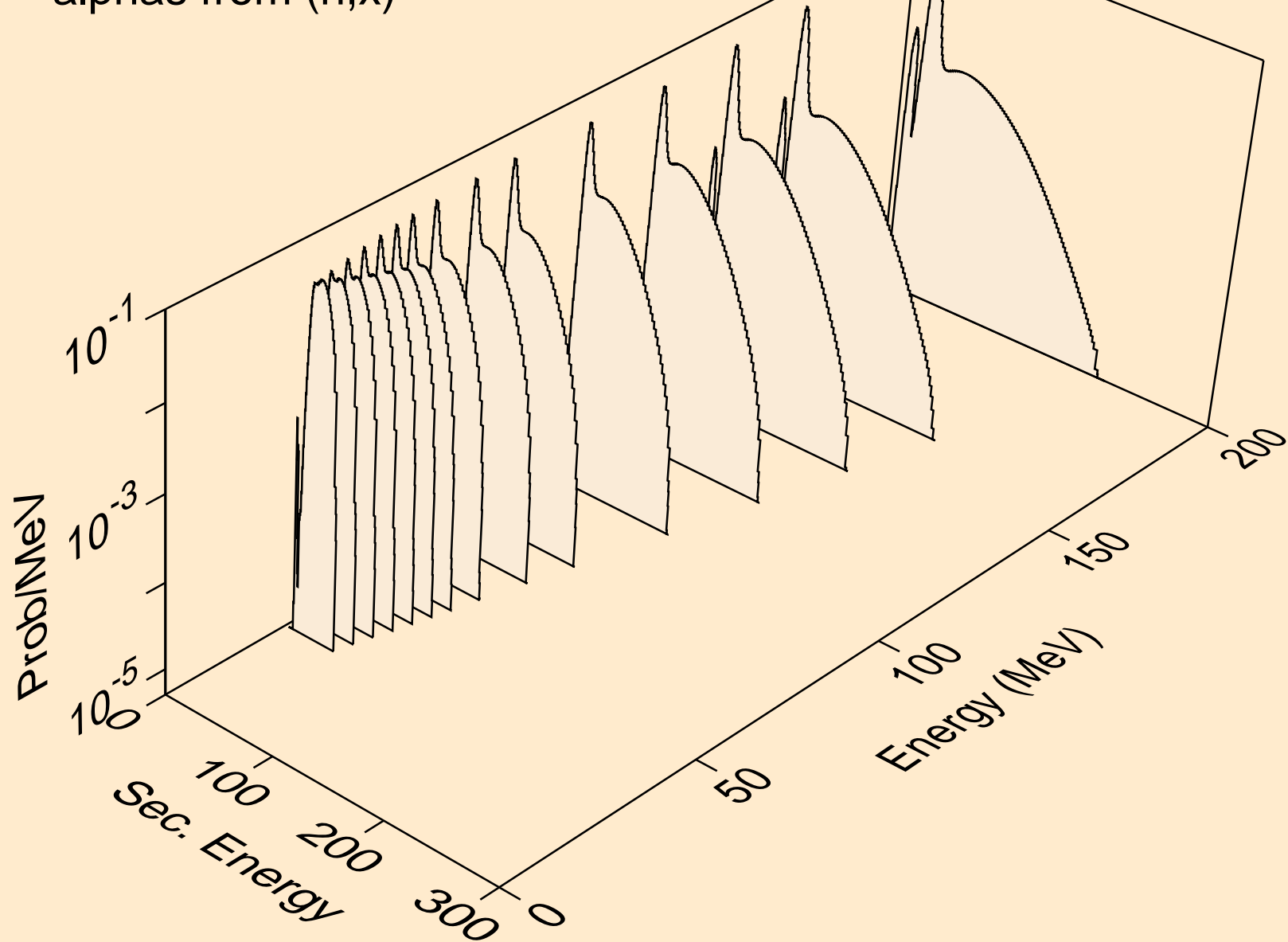

RN205M NEUTRON ACER TENDL-2023 LIBRARY; T=0.K
alphas from (n,n*)a

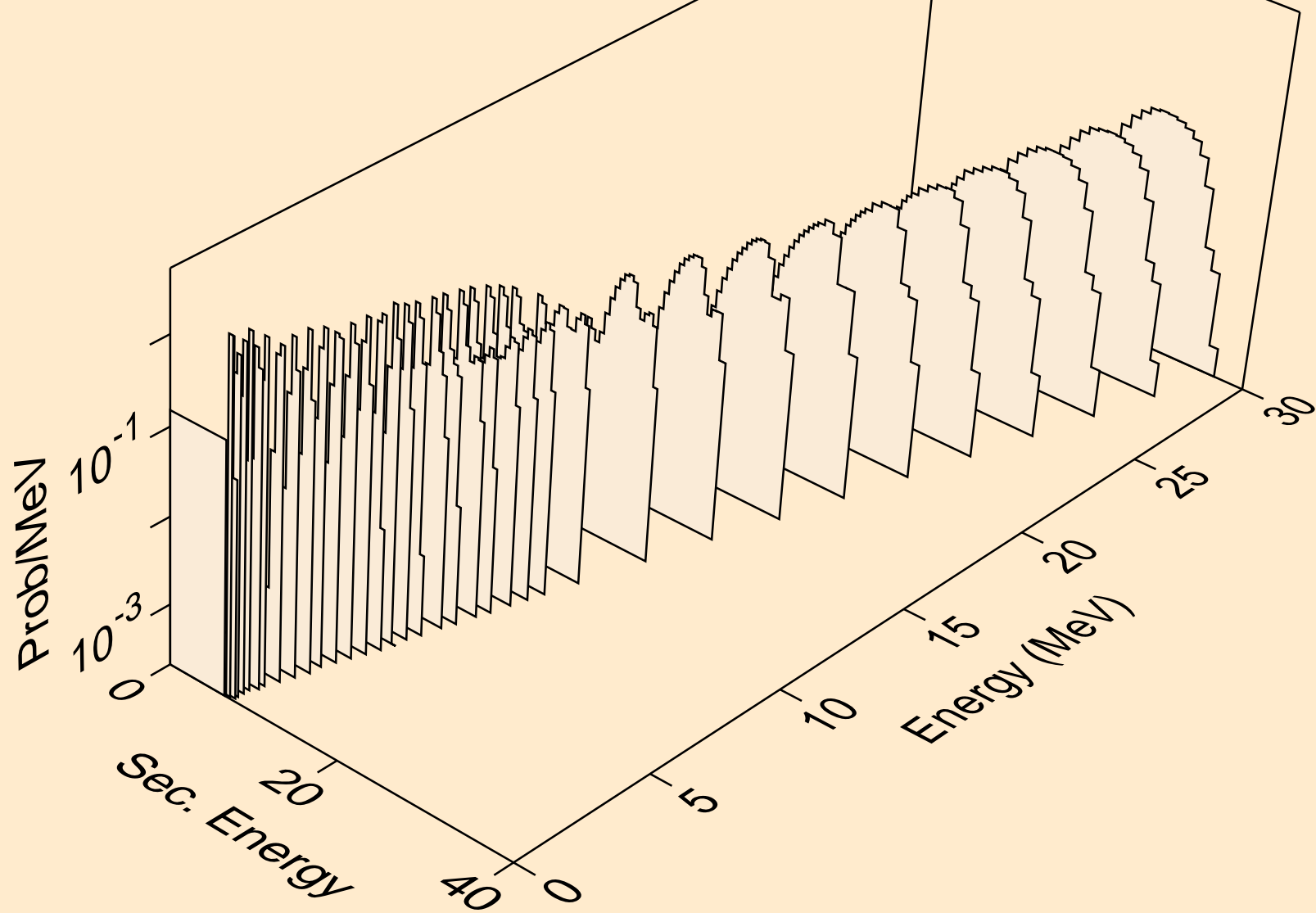

RN205M NEUTRON ACER TENDL-2023 LIBRARY; T=0.K
alphas from (n,2n)a

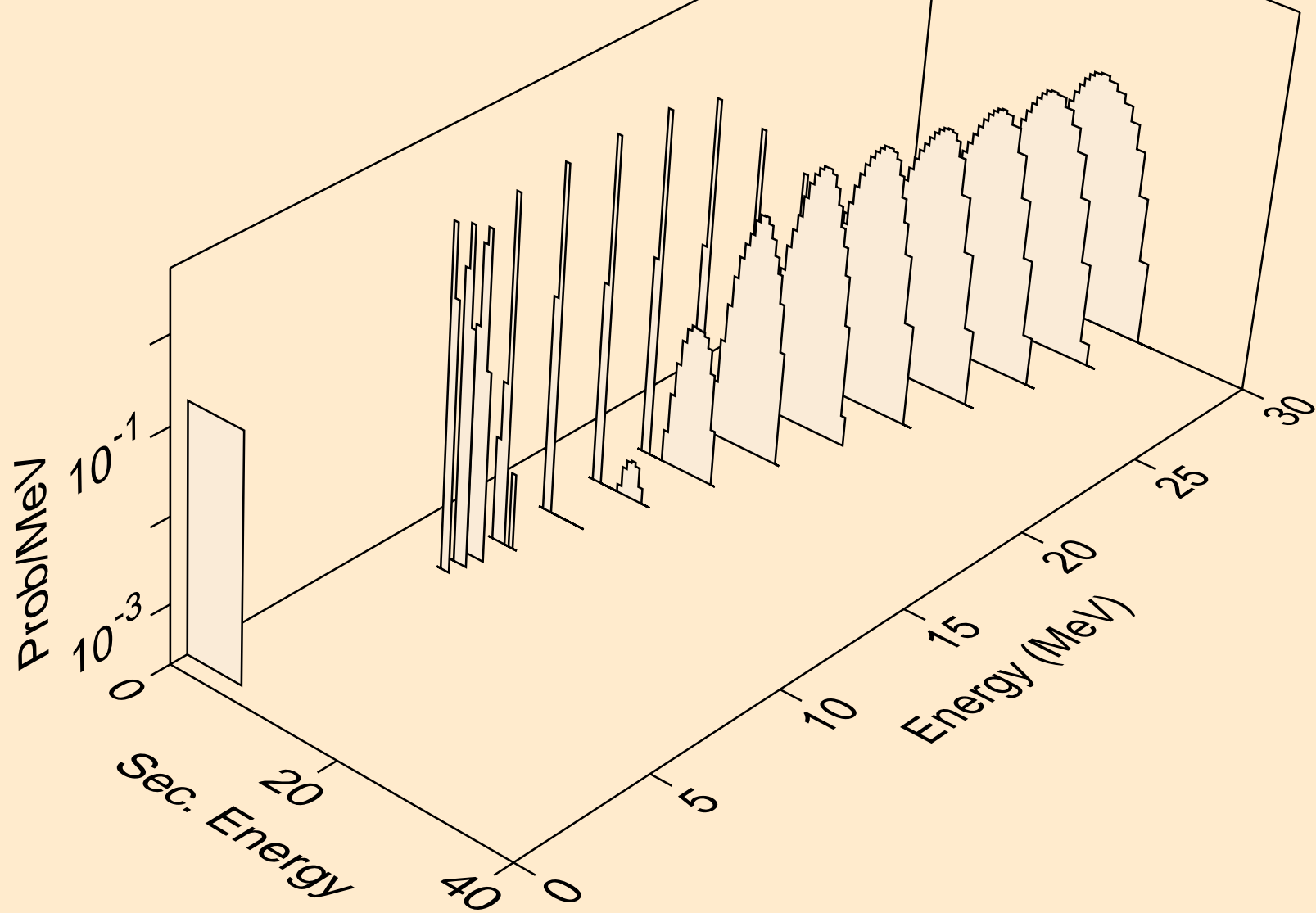

RN205M NEUTRON ACER TENDL-2023 LIBRARY; T=0.K
alphas from (n,3n)a

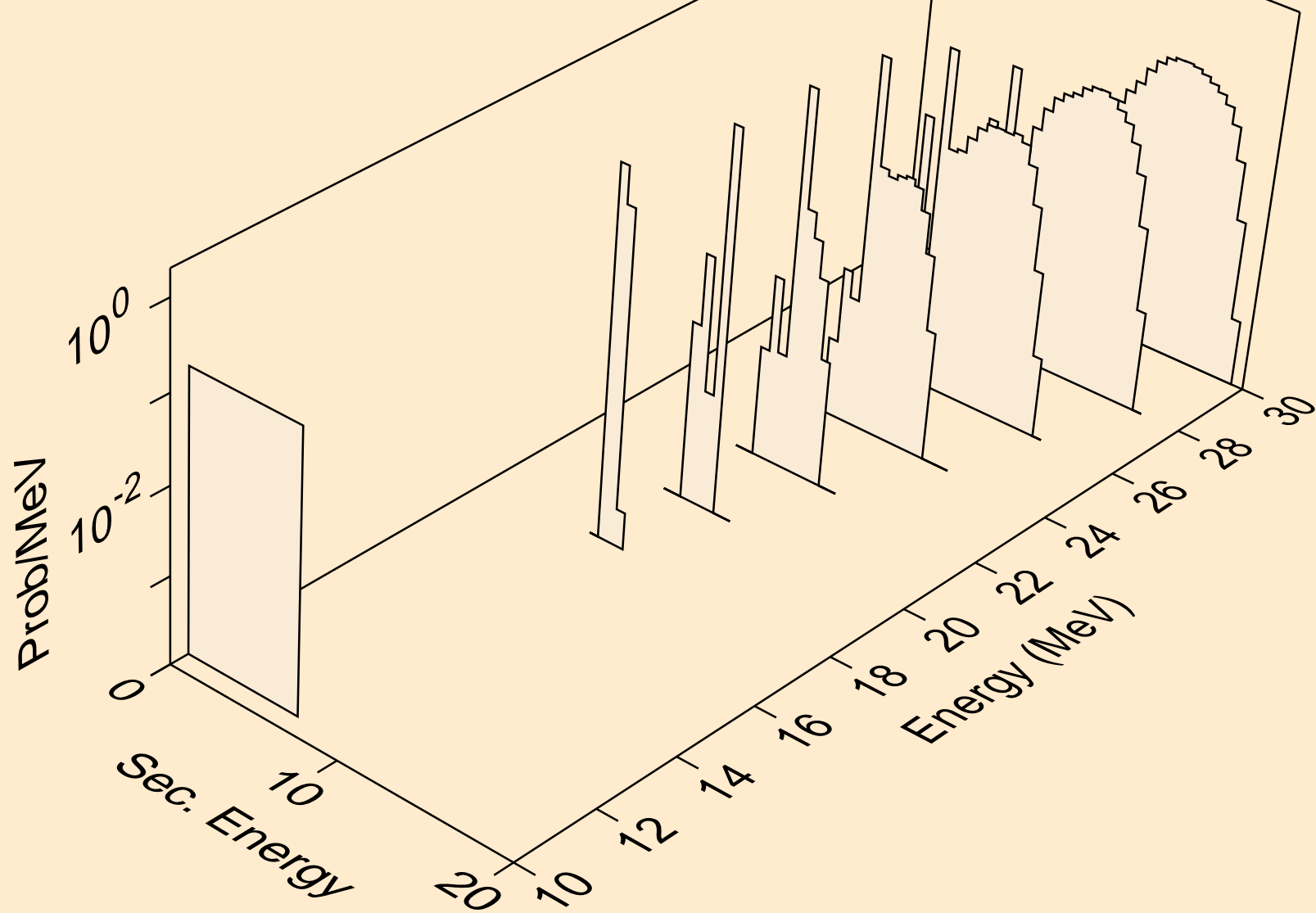

RN205M NEUTRON ACER TENDL-2023 LIBRARY; T=0.K
alphas from (n,n*)2a

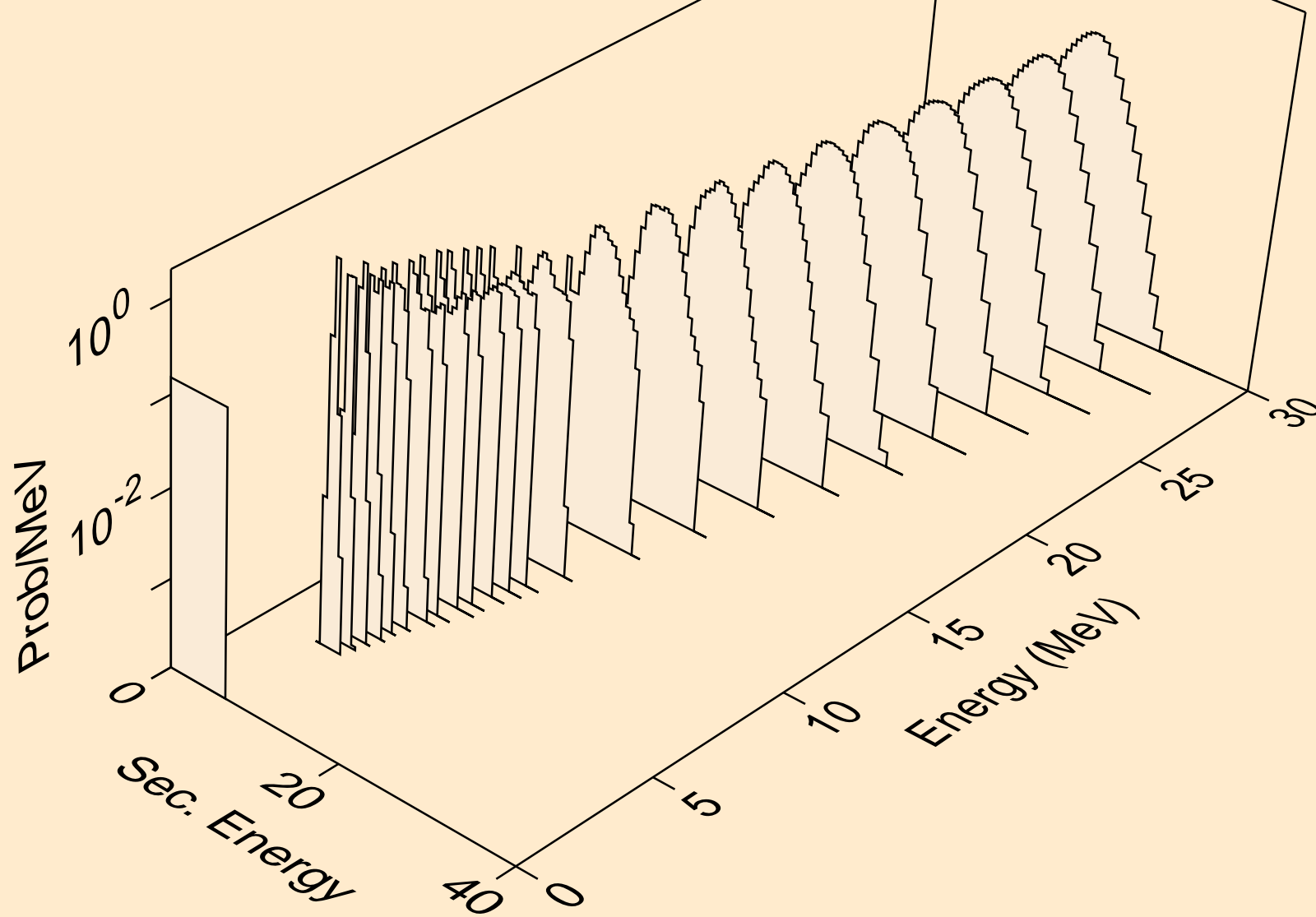

RN205M NEUTRON ACER TENDL-2023 LIBRARY; T=0.K
alphas from (n,2n)2a

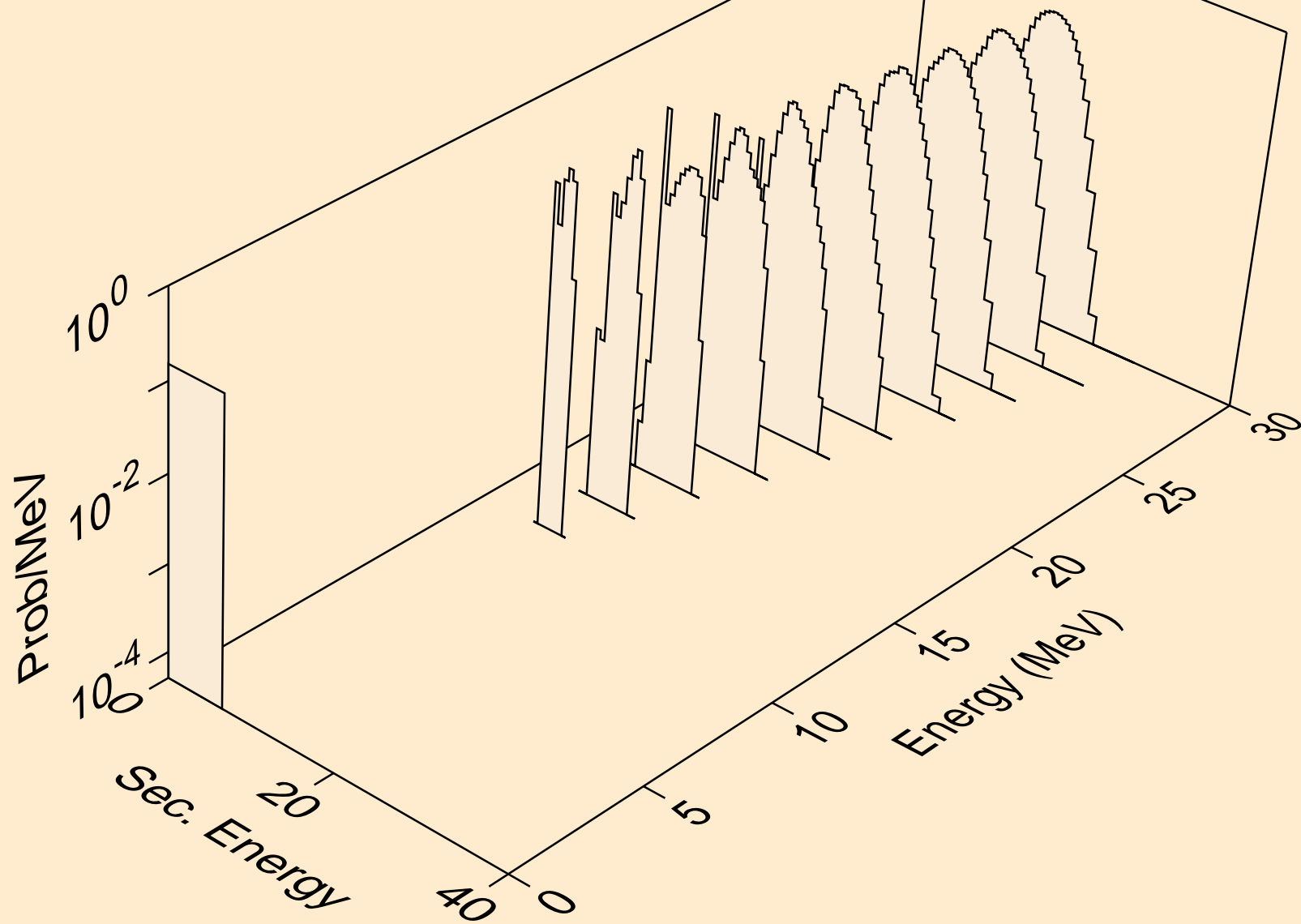

RN205M NEUTRON ACER TENDL-2023 LIBRARY; T=0.K
alphas from (n,npa)

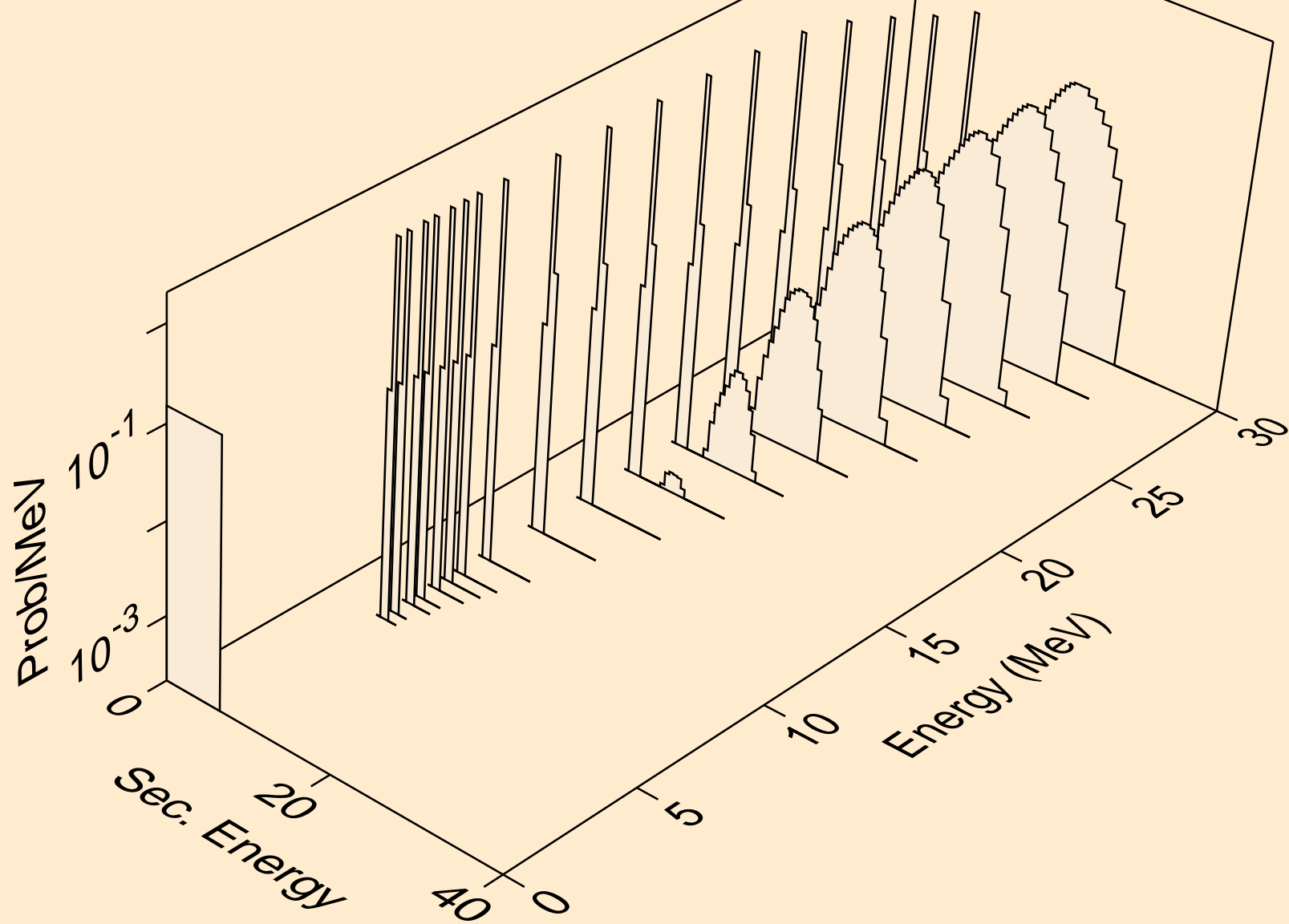

RN205M NEUTRON ACER TENDL-2023 LIBRARY; T=0.K
alphas from (n,a)

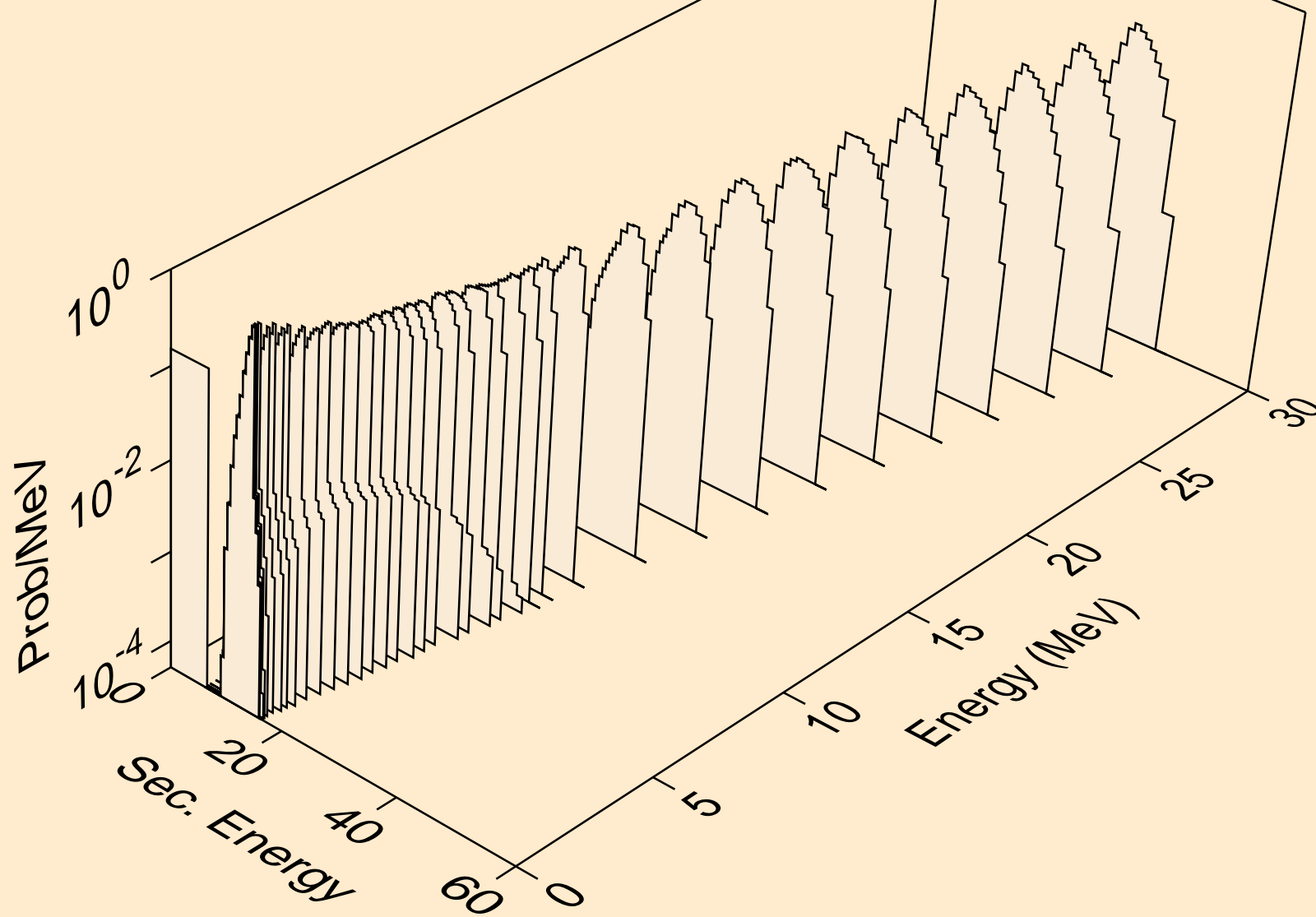

RN205M NEUTRON ACER TENDL-2023 LIBRARY; T=0.K
alphas from (n,2a)

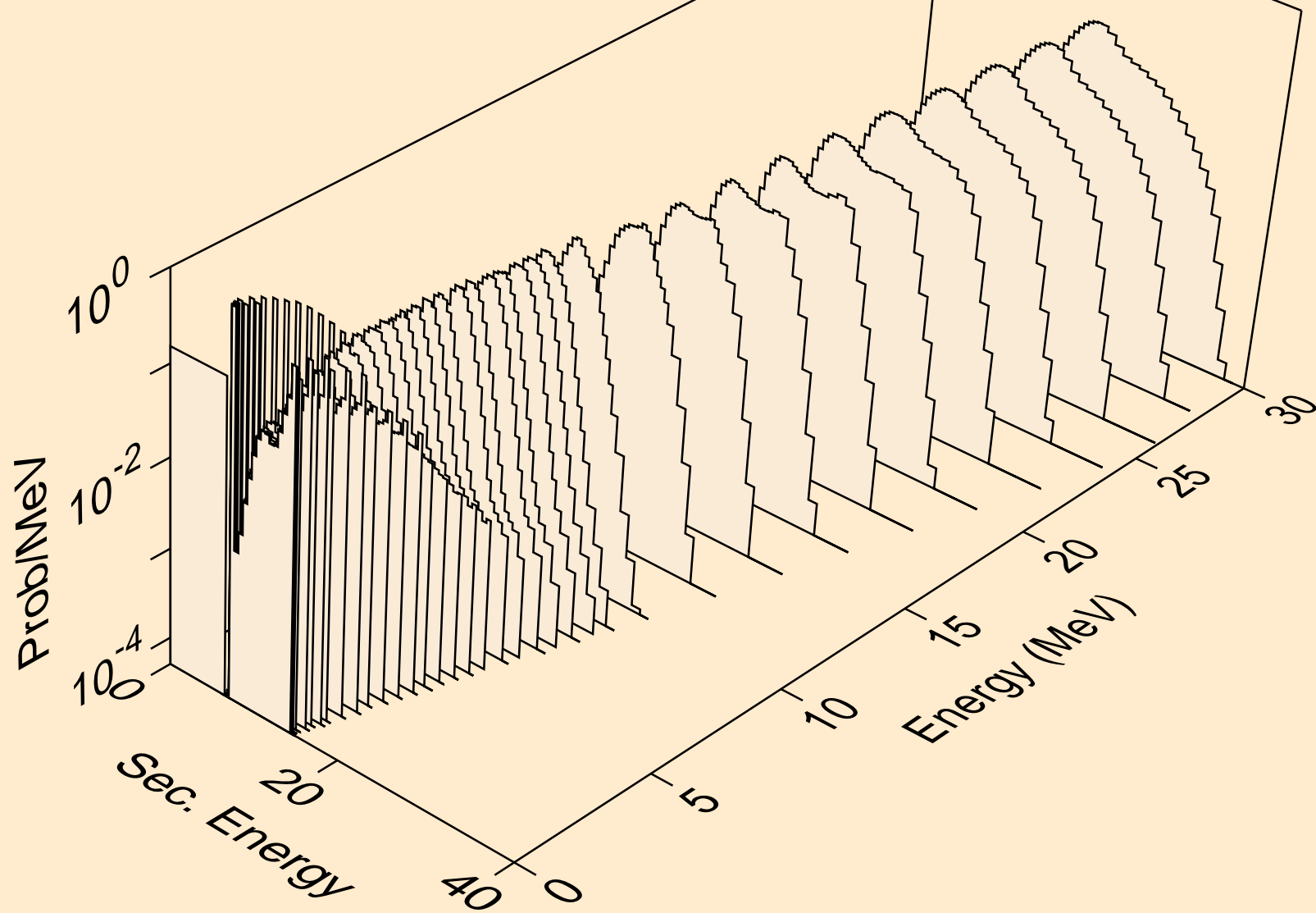

RN205M NEUTRON ACER TENDL-2023 LIBRARY; T=0.K
alphas from (n,pa)

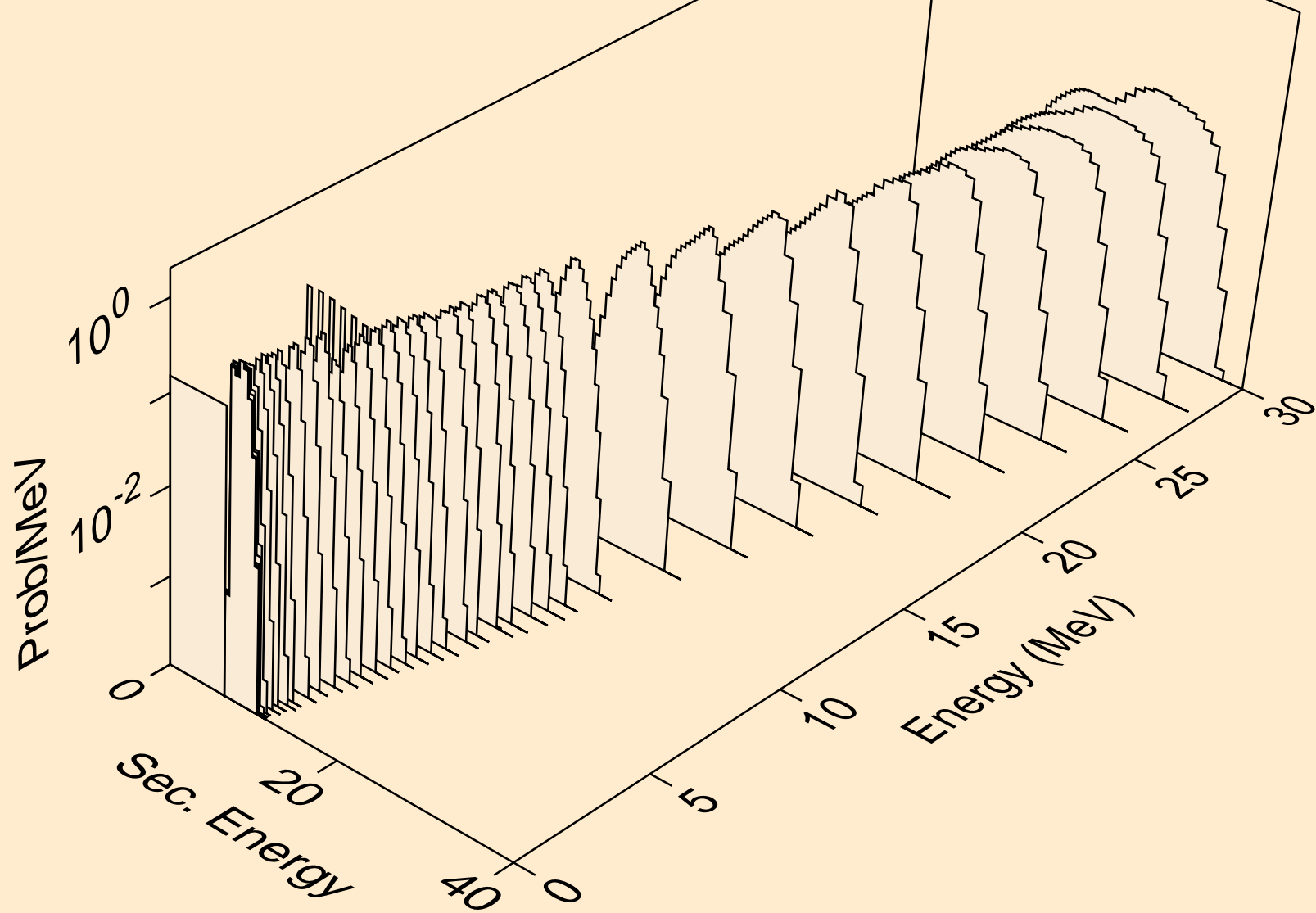

RN205M NEUTRON ACER TENDL-2023 LIBRARY; T=0.K
alphas from (n,da)

