

RU091 NEUTRON ACER TENDL-2023 LIBRARY; T=0.K  
Principal cross sections

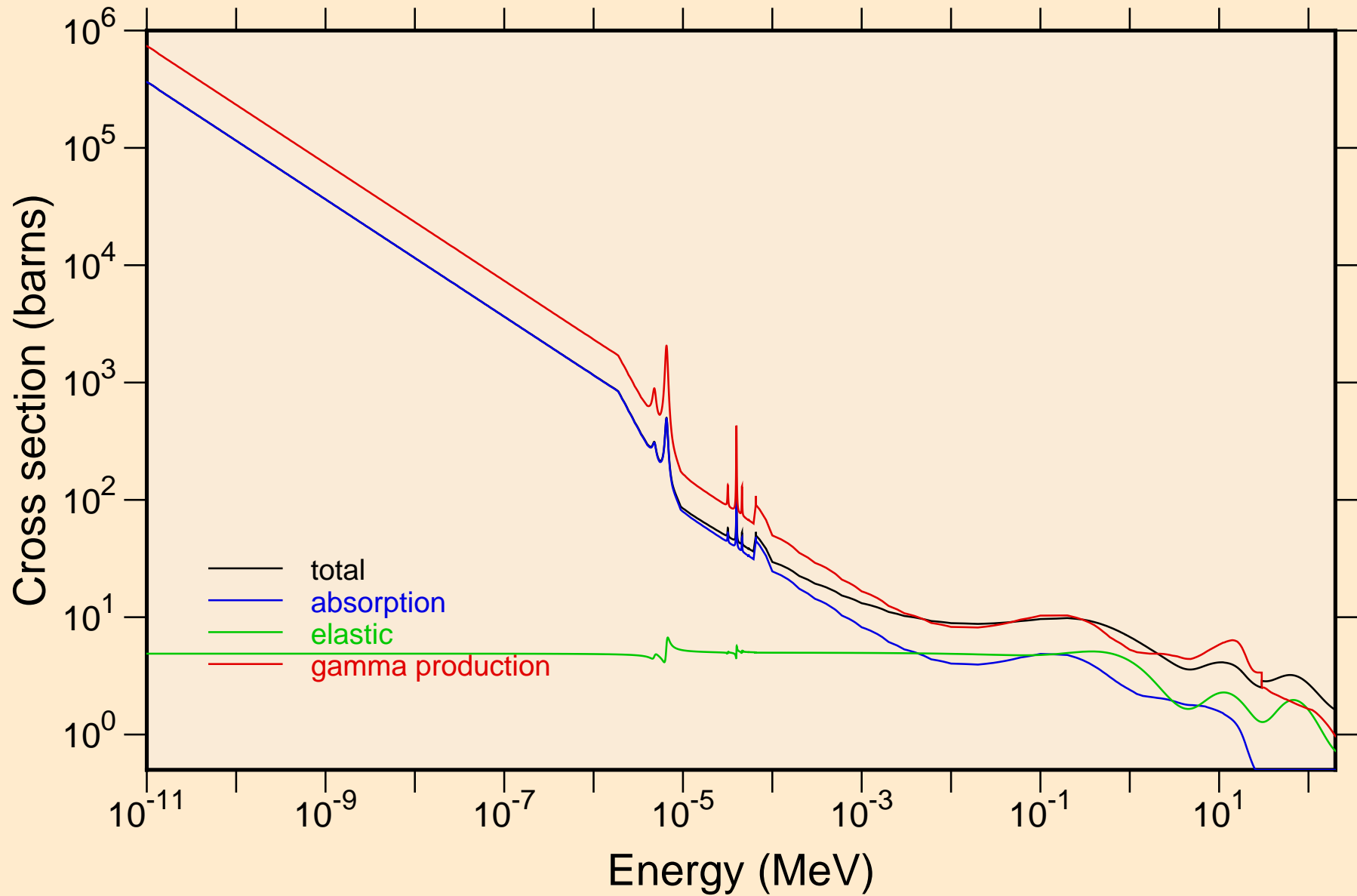

RU091 NEUTRON ACER TENDL-2023 LIBRARY; T=0.K  
resonance total cross section

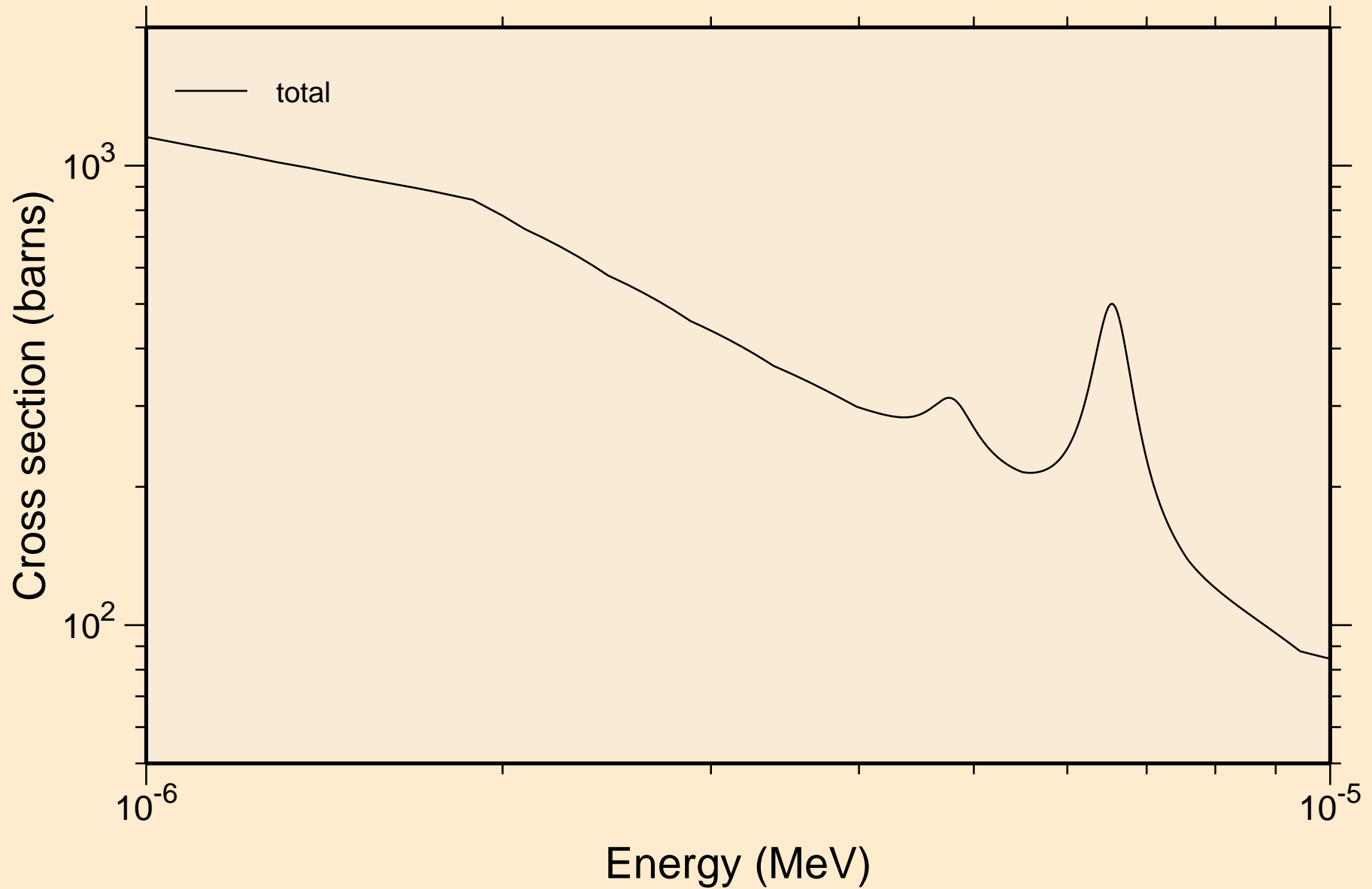

RU091 NEUTRON ACER TENDL-2023 LIBRARY; T=0.K  
resonance total cross section

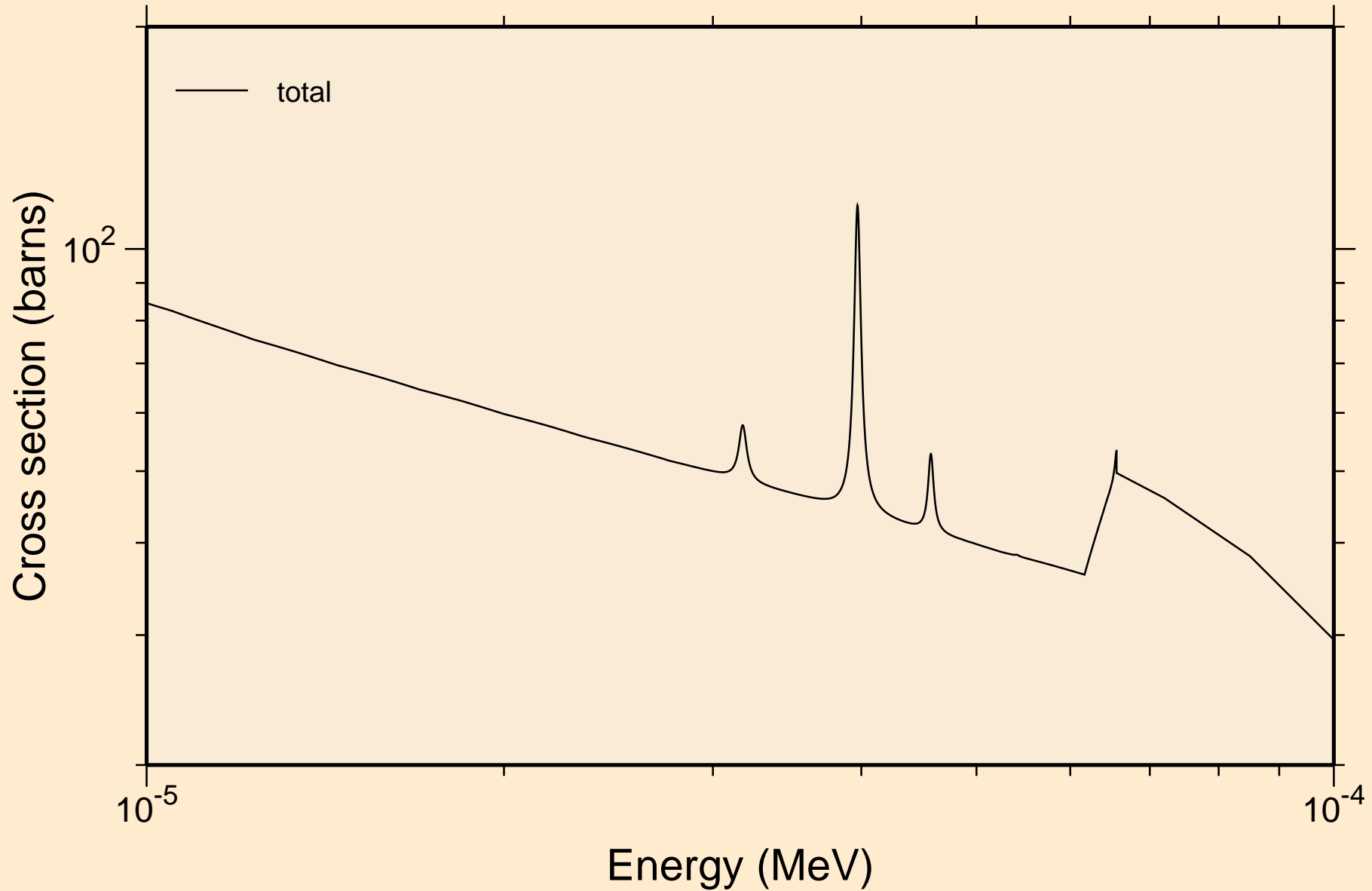

RU091 NEUTRON ACER TENDL-2023 LIBRARY; T=0.K  
resonance total cross section

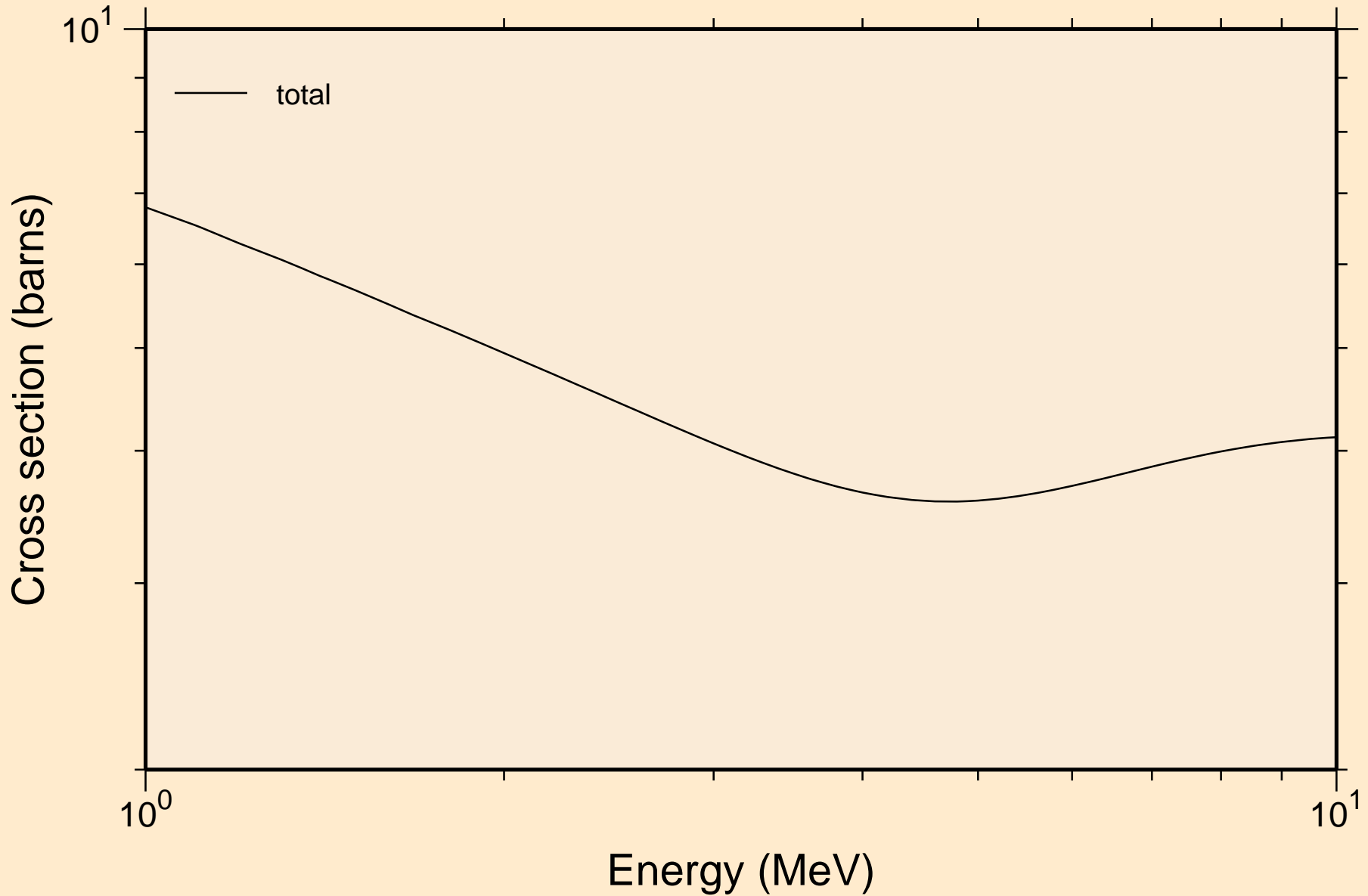

RU091 NEUTRON ACER TENDL-2023 LIBRARY; T=0.K  
resonance absorption cross sections

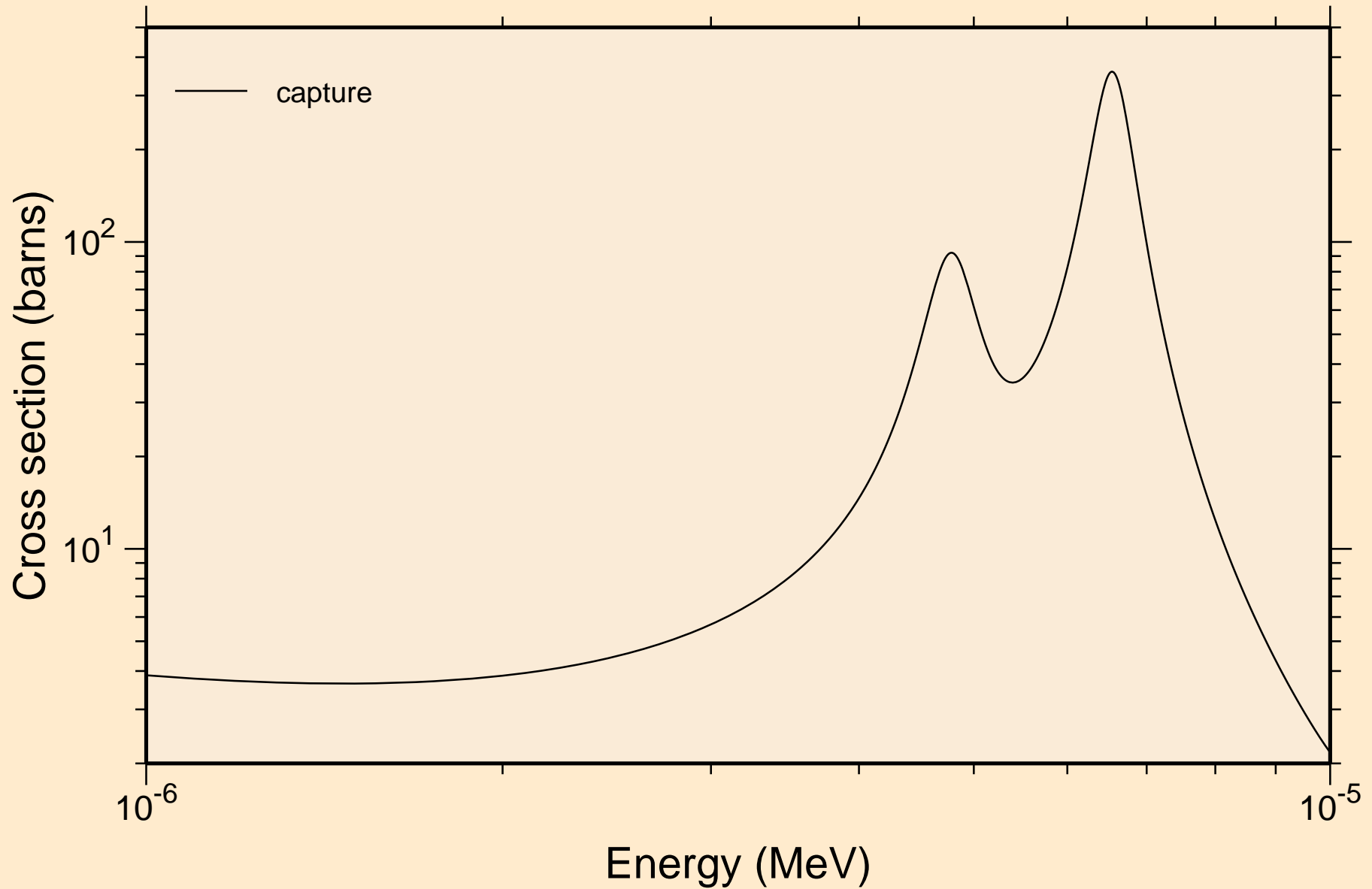

RU091 NEUTRON ACER TENDL-2023 LIBRARY; T=0.K  
resonance absorption cross sections

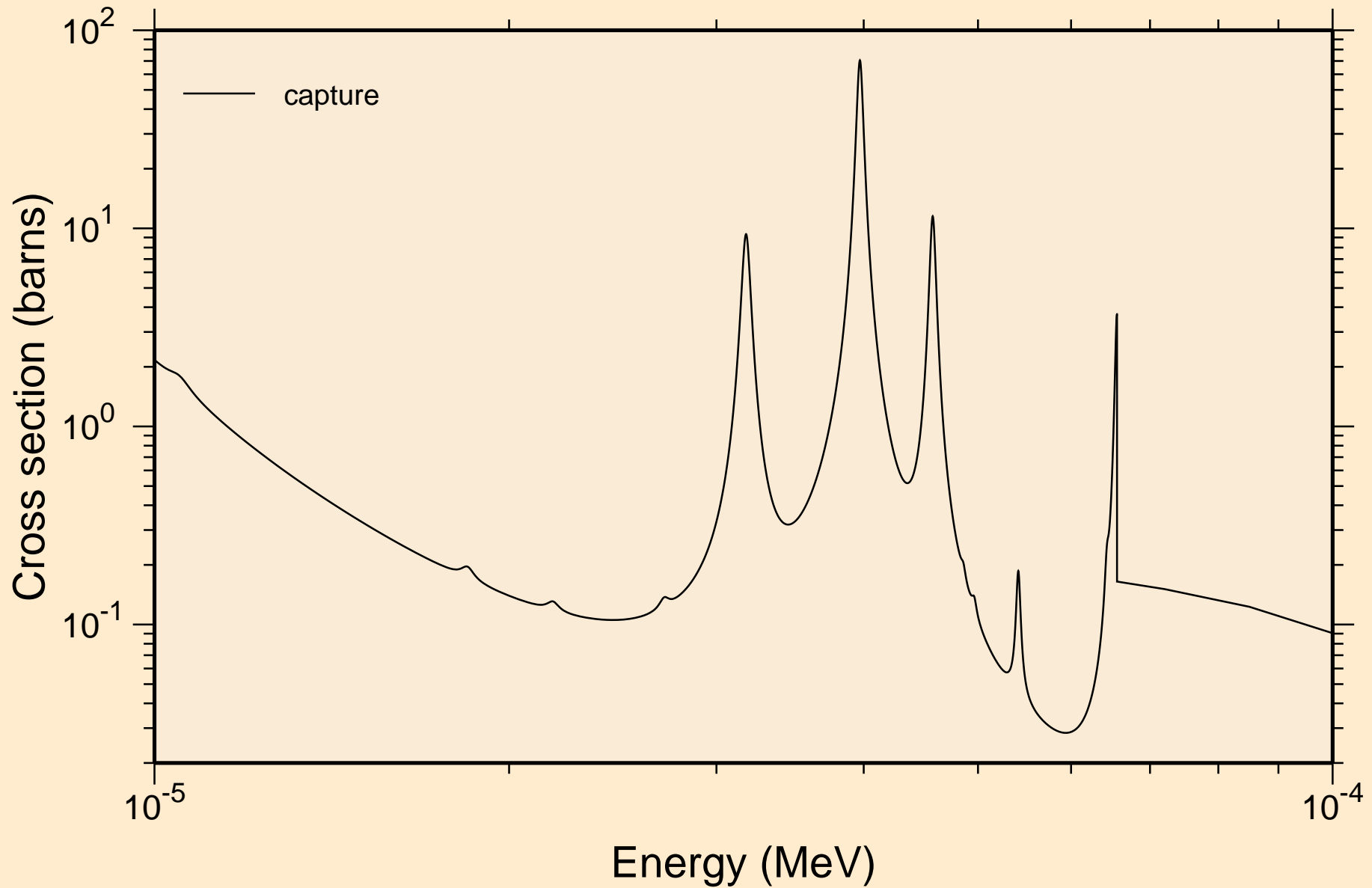

RU091 NEUTRON ACER TENDL-2023 LIBRARY; T=0.K  
resonance absorption cross sections

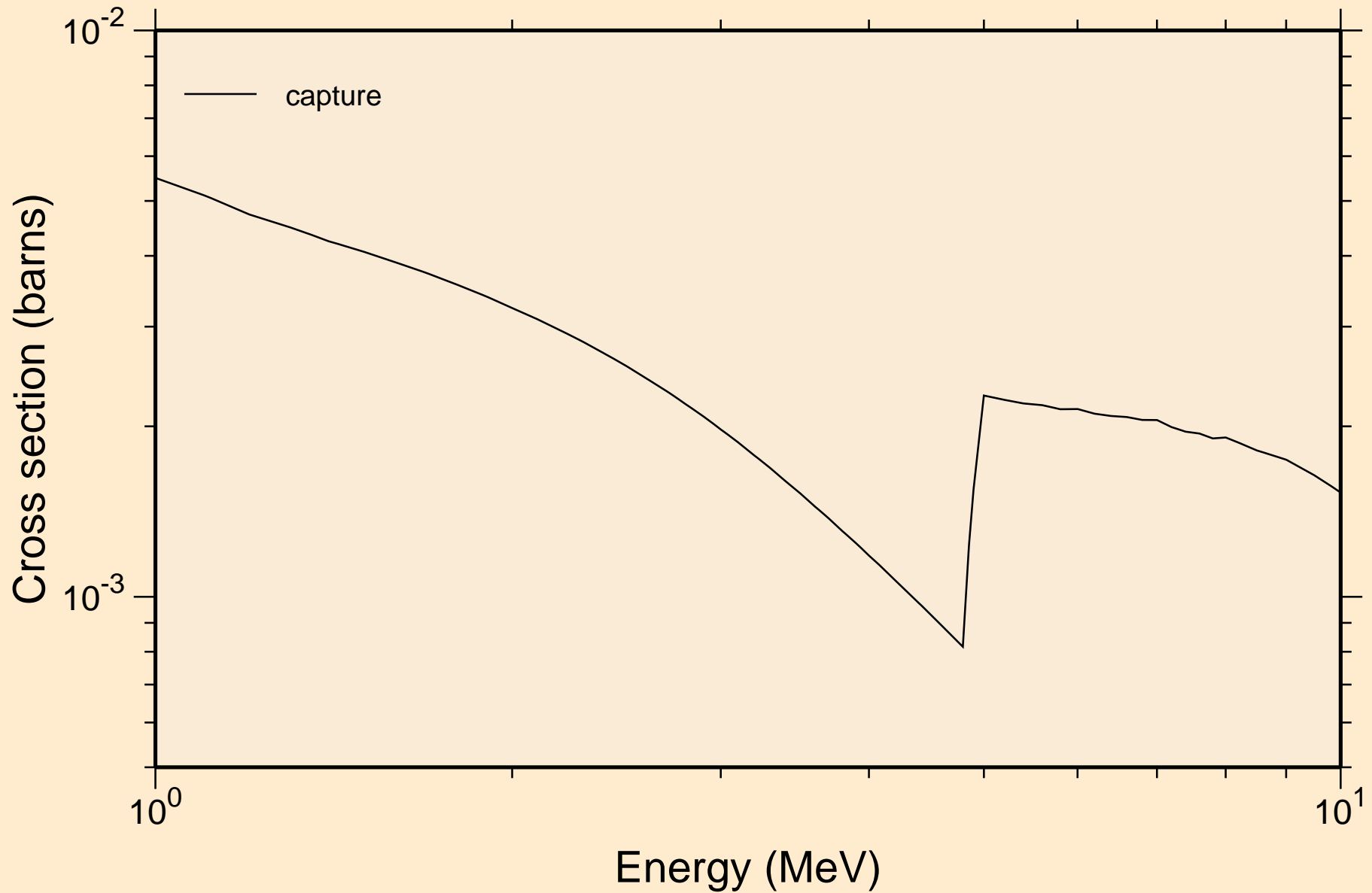

# RU091 NEUTRON ACER TENDL-2023 LIBRARY; T=0.K

## Heating

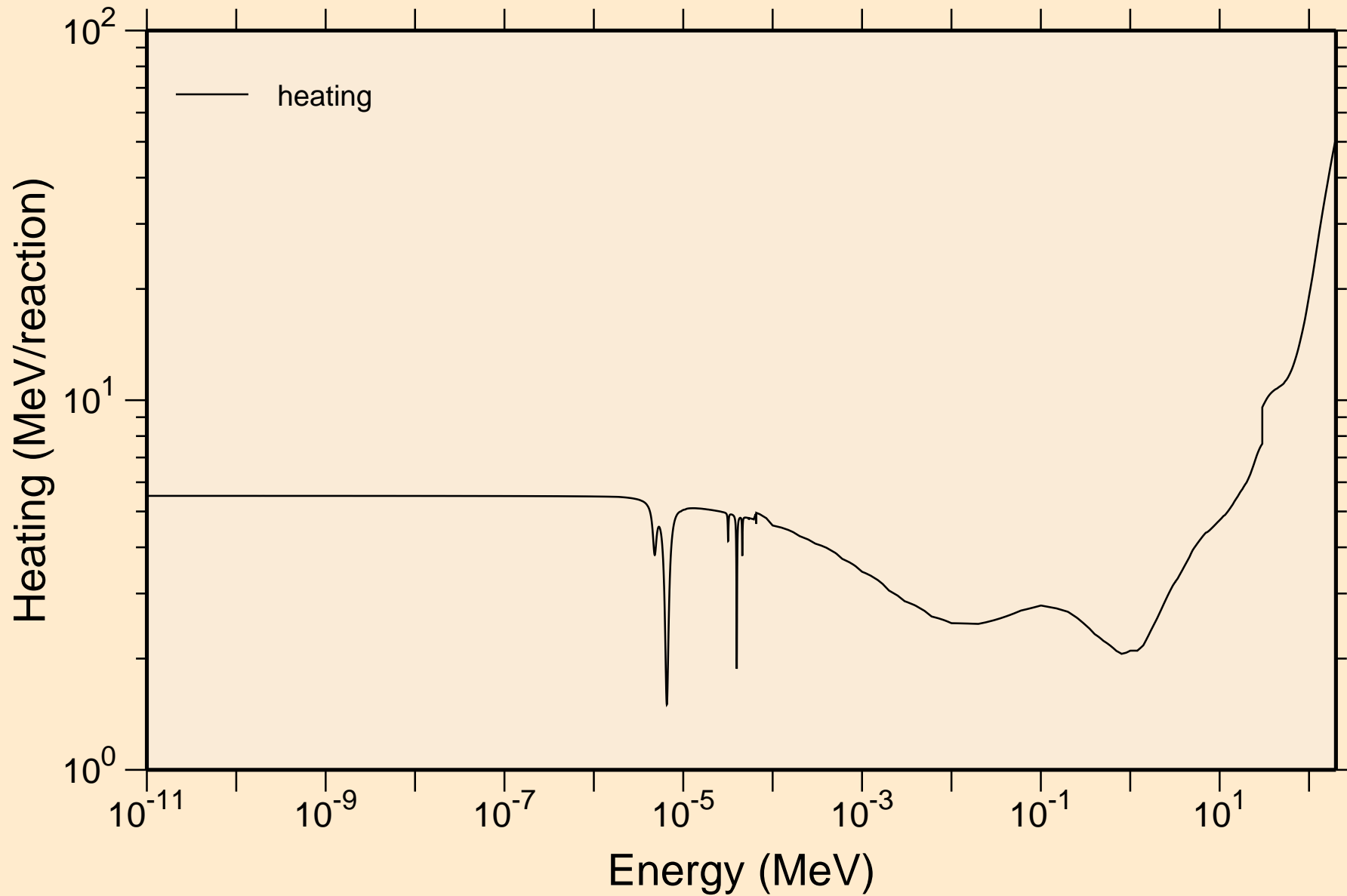



# RU091 NEUTRON ACER TENDL-2023 LIBRARY; T=0.K

## Damage

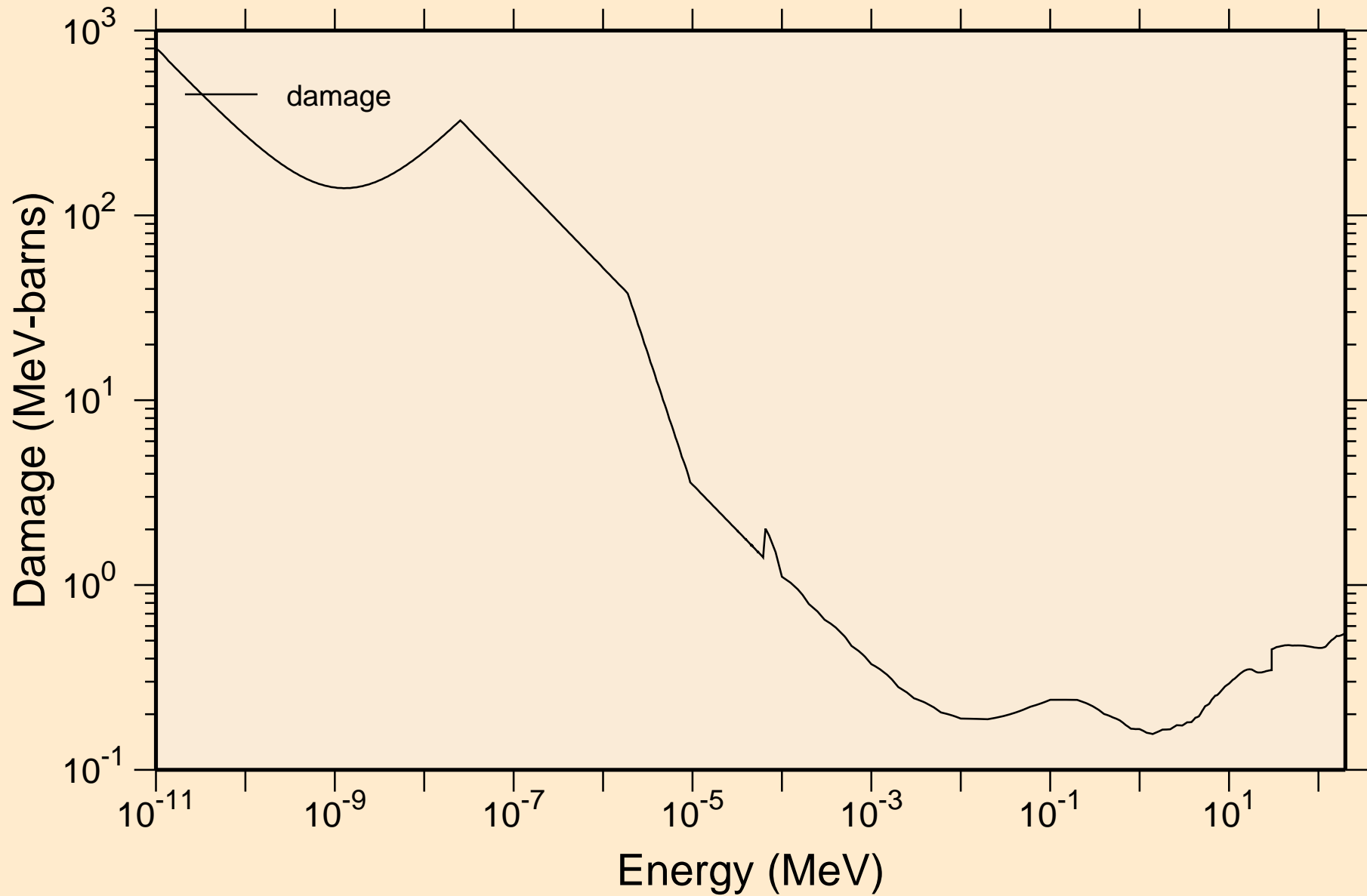

RU091 NEUTRON ACER TENDL-2023 LIBRARY; T=0.K  
Non-threshold reactions

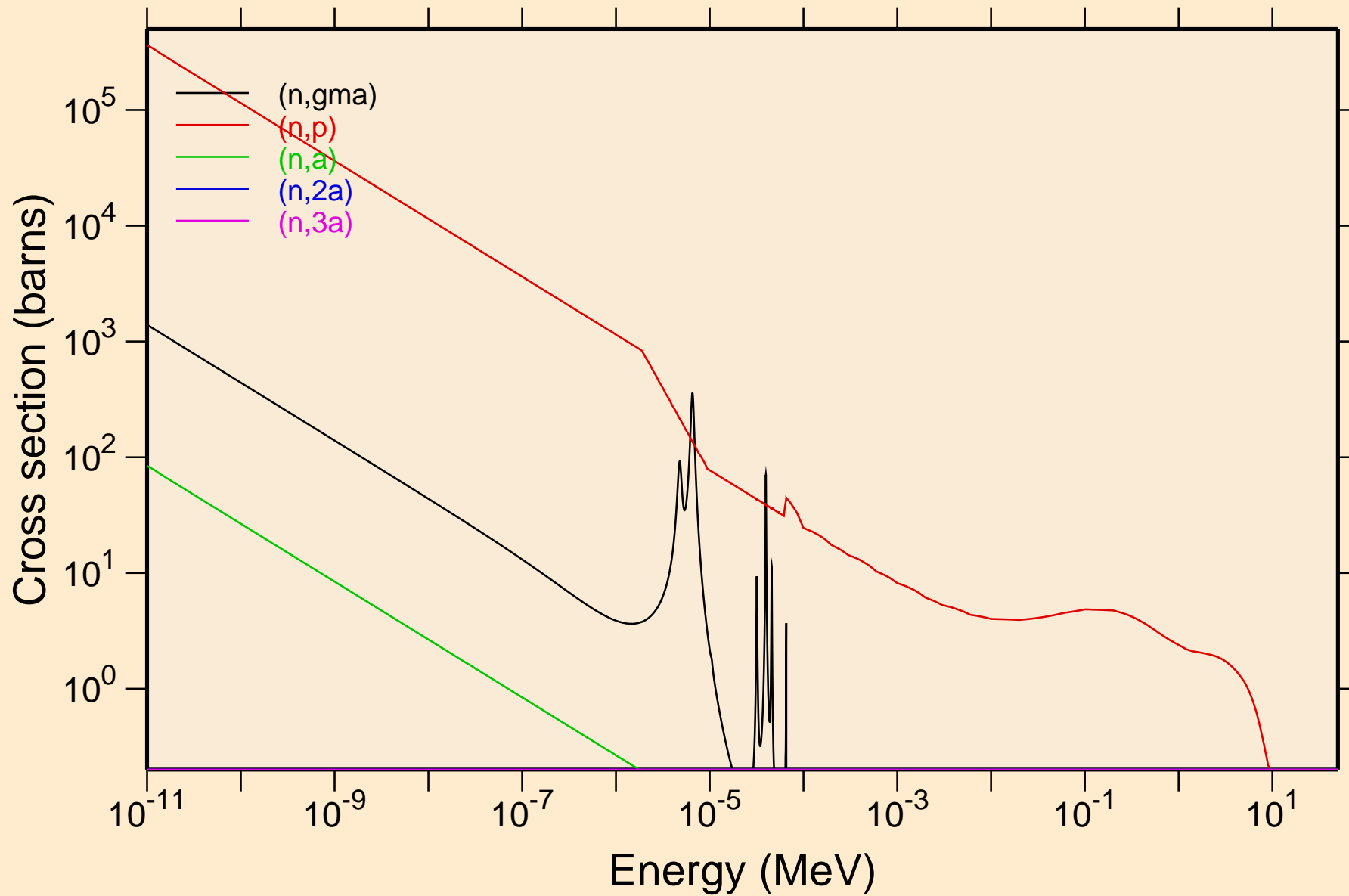

RU091 NEUTRON ACER TENDL-2023 LIBRARY; T=0.K  
Non-threshold reactions

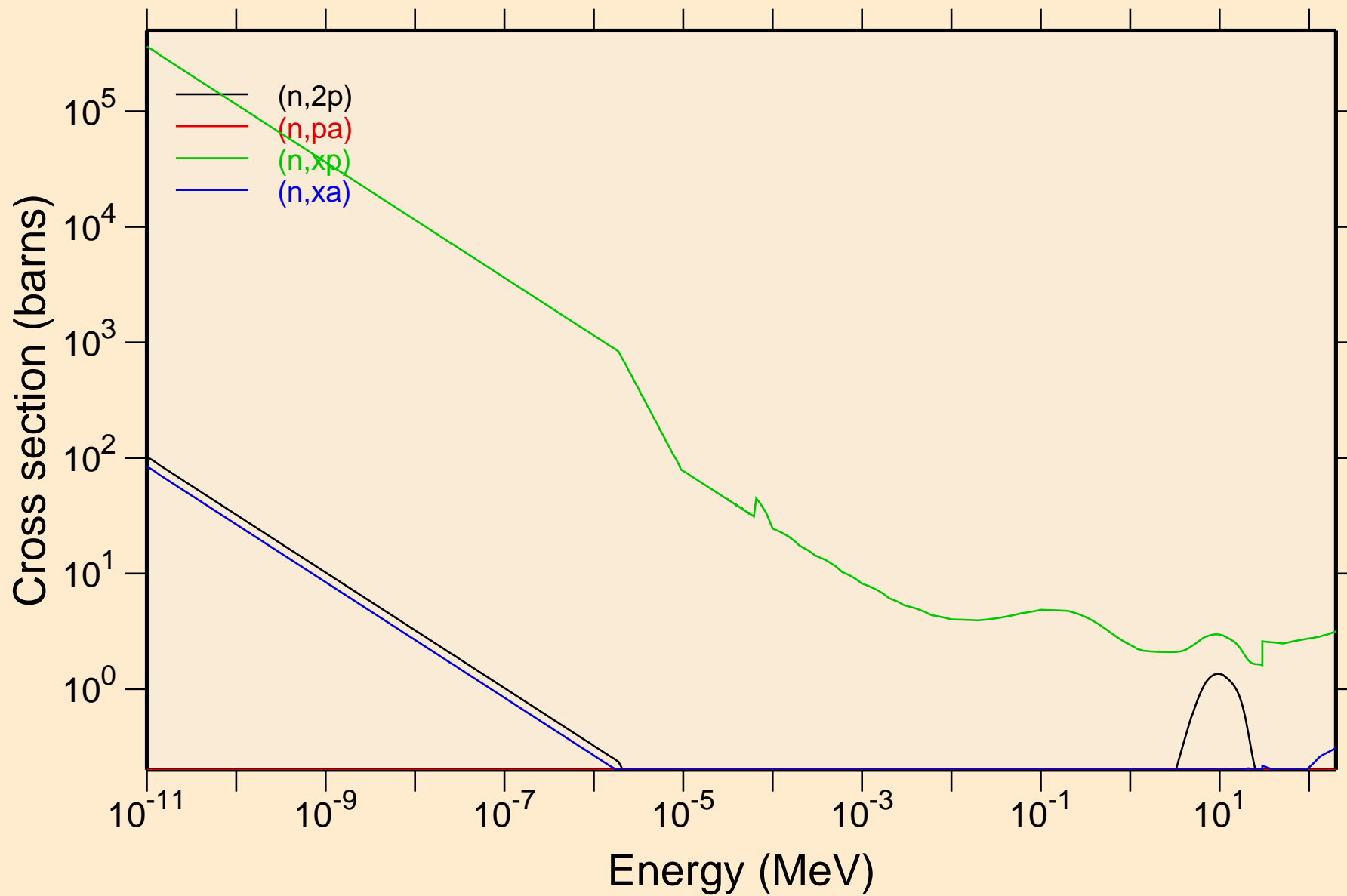

# RU091 NEUTRON ACER TENDL-2023 LIBRARY; T=0.K

## Principal cross sections

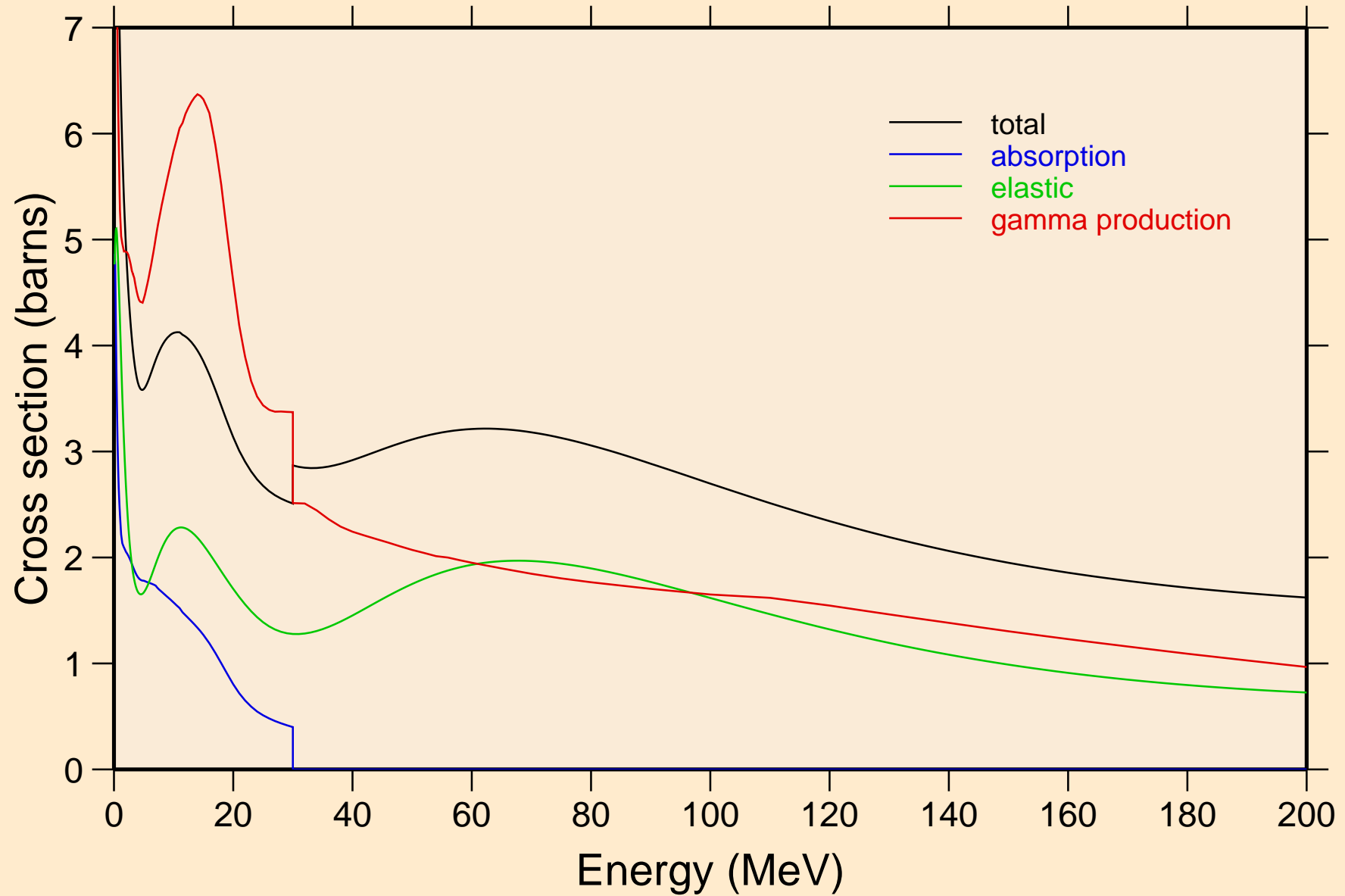

# RU091 NEUTRON ACER TENDL-2023 LIBRARY; T=0.K

## Heating

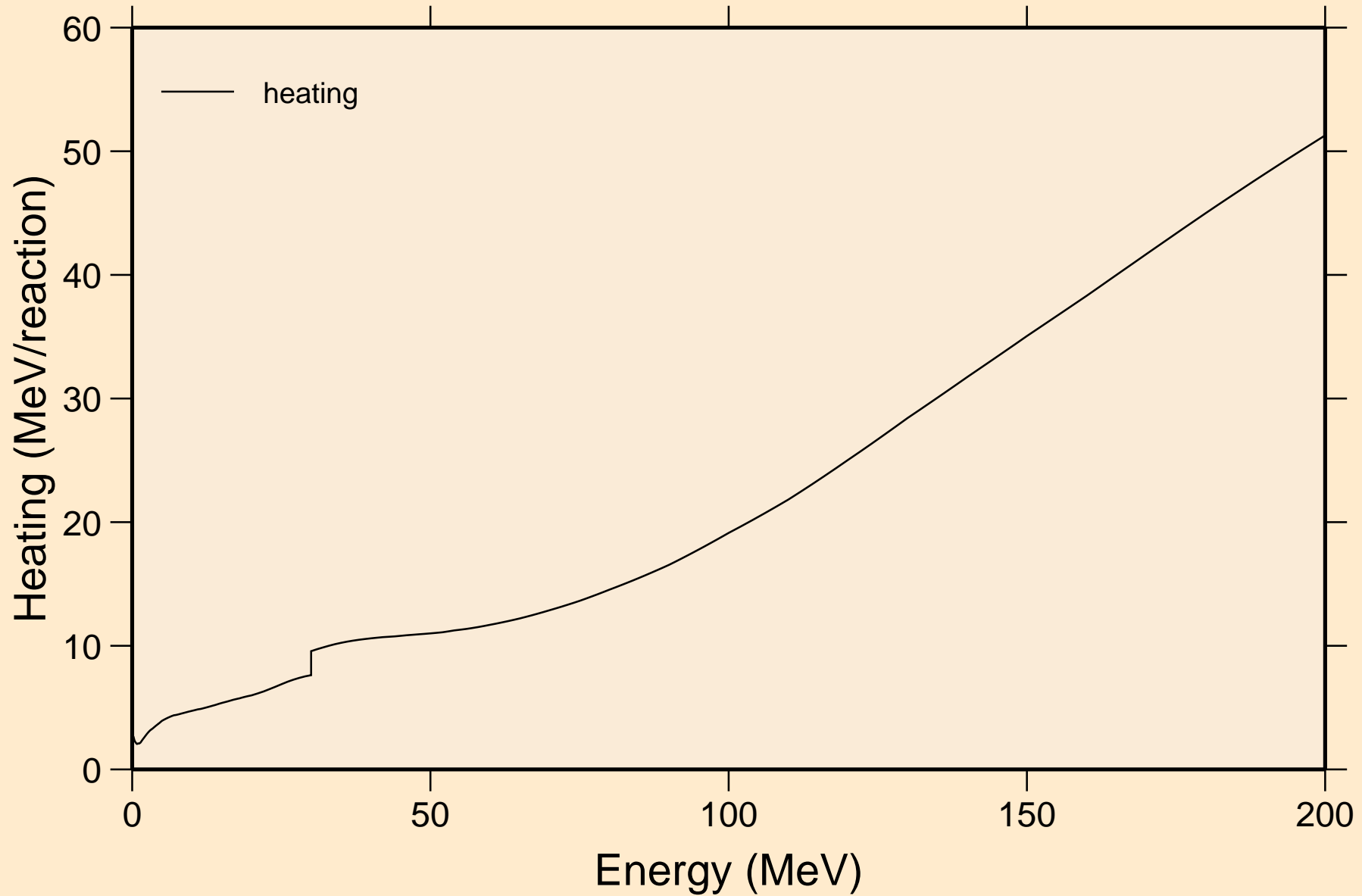

RU091 NEUTRON ACER TENDL-2023 LIBRARY; T=0.K  
Damage

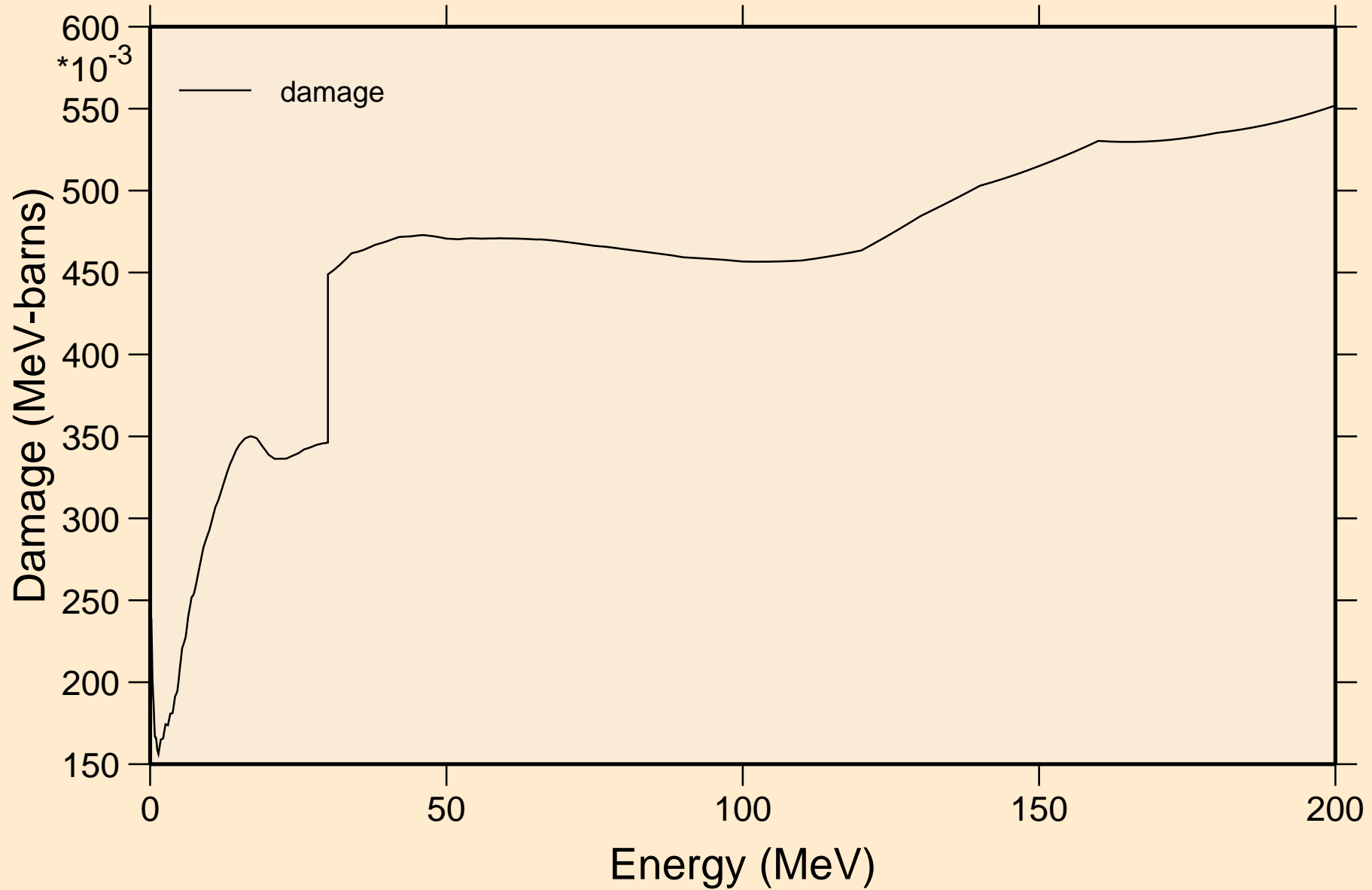

RU091 NEUTRON ACER TENDL-2023 LIBRARY; T=0.K  
Non-threshold reactions

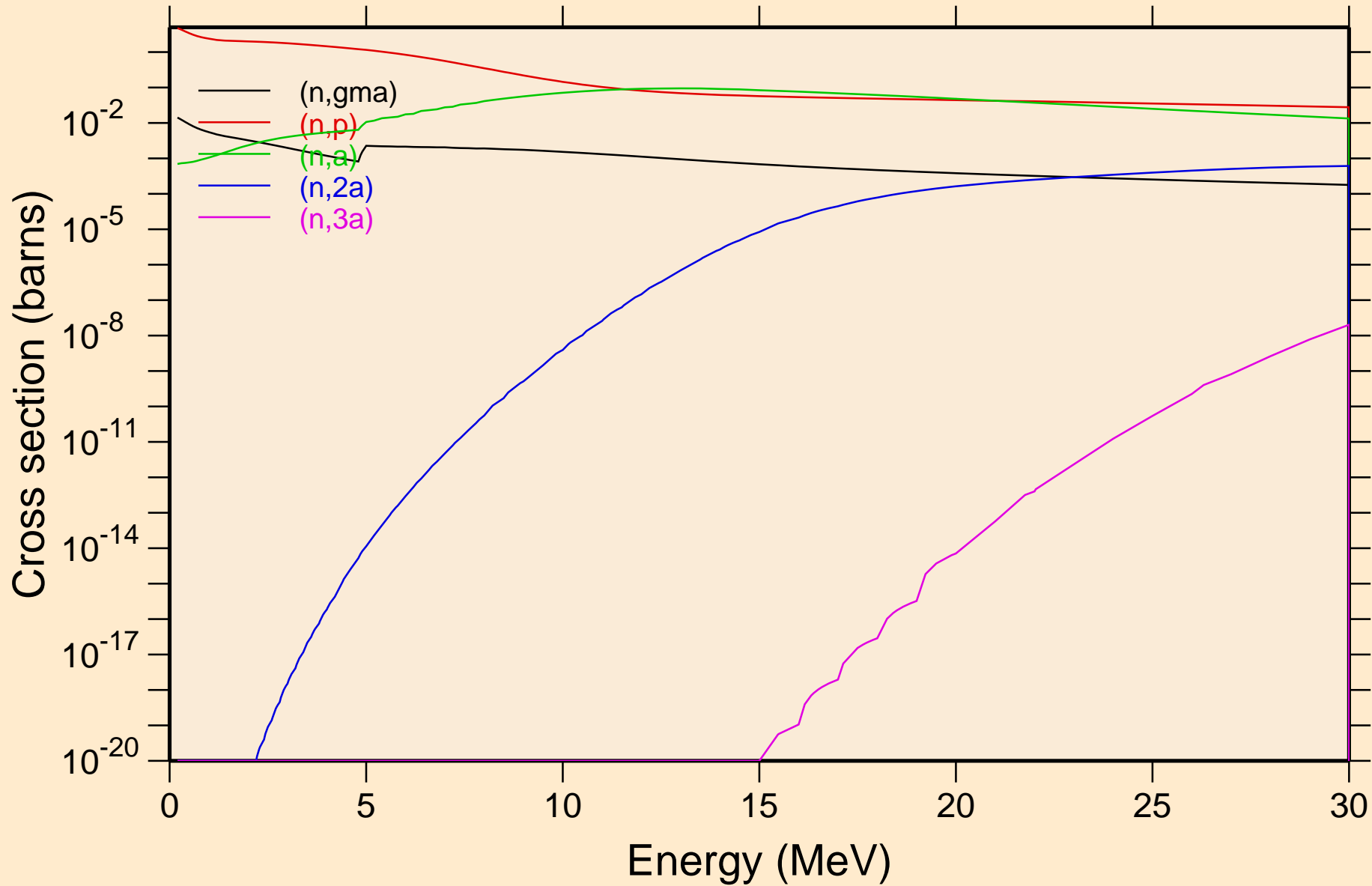

RU091 NEUTRON ACER TENDL-2023 LIBRARY; T=0.K  
Non-threshold reactions

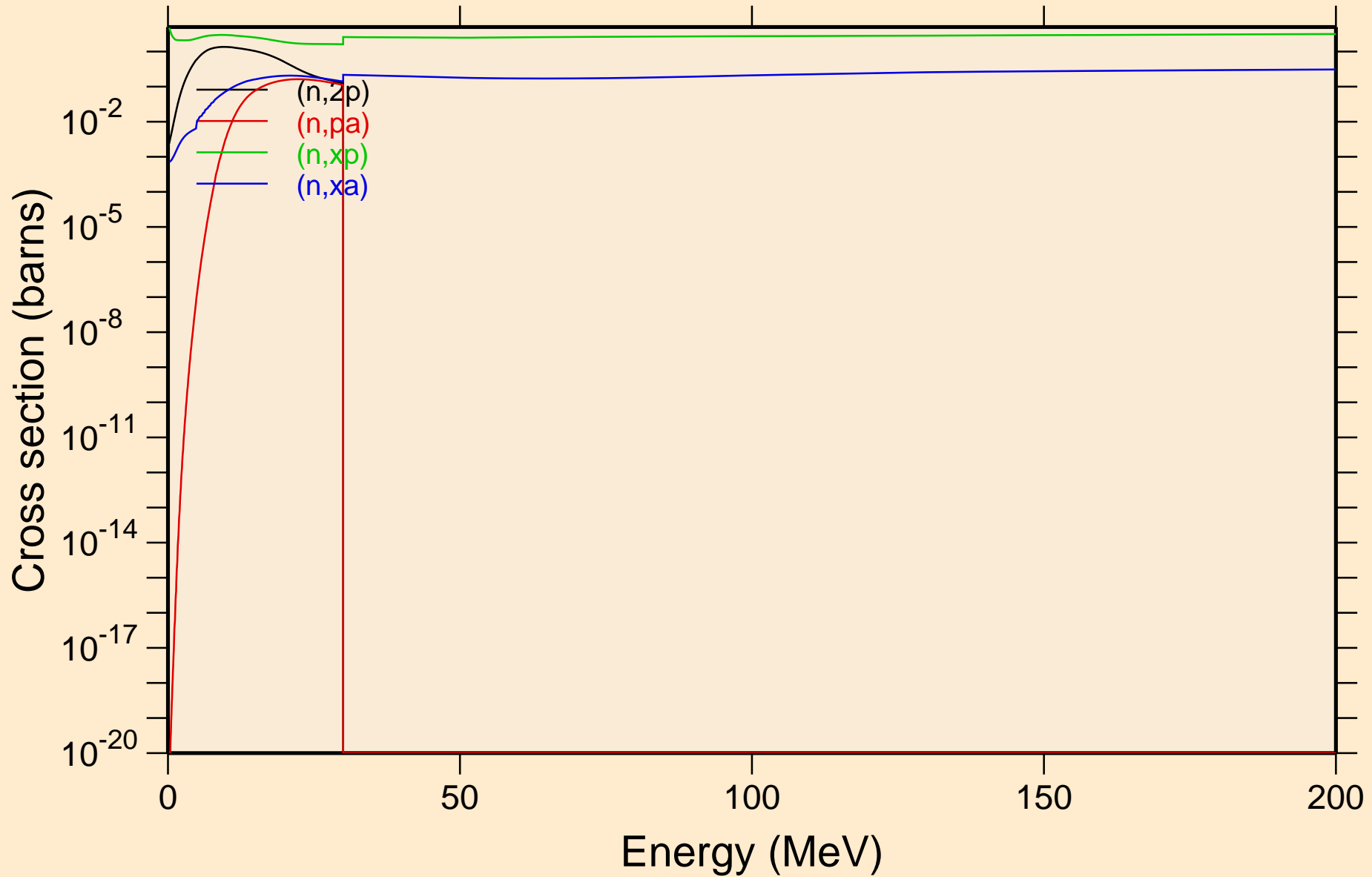



RU091 NEUTRON ACER TENDL-2023 LIBRARY; T=0.K  
Inelastic levels

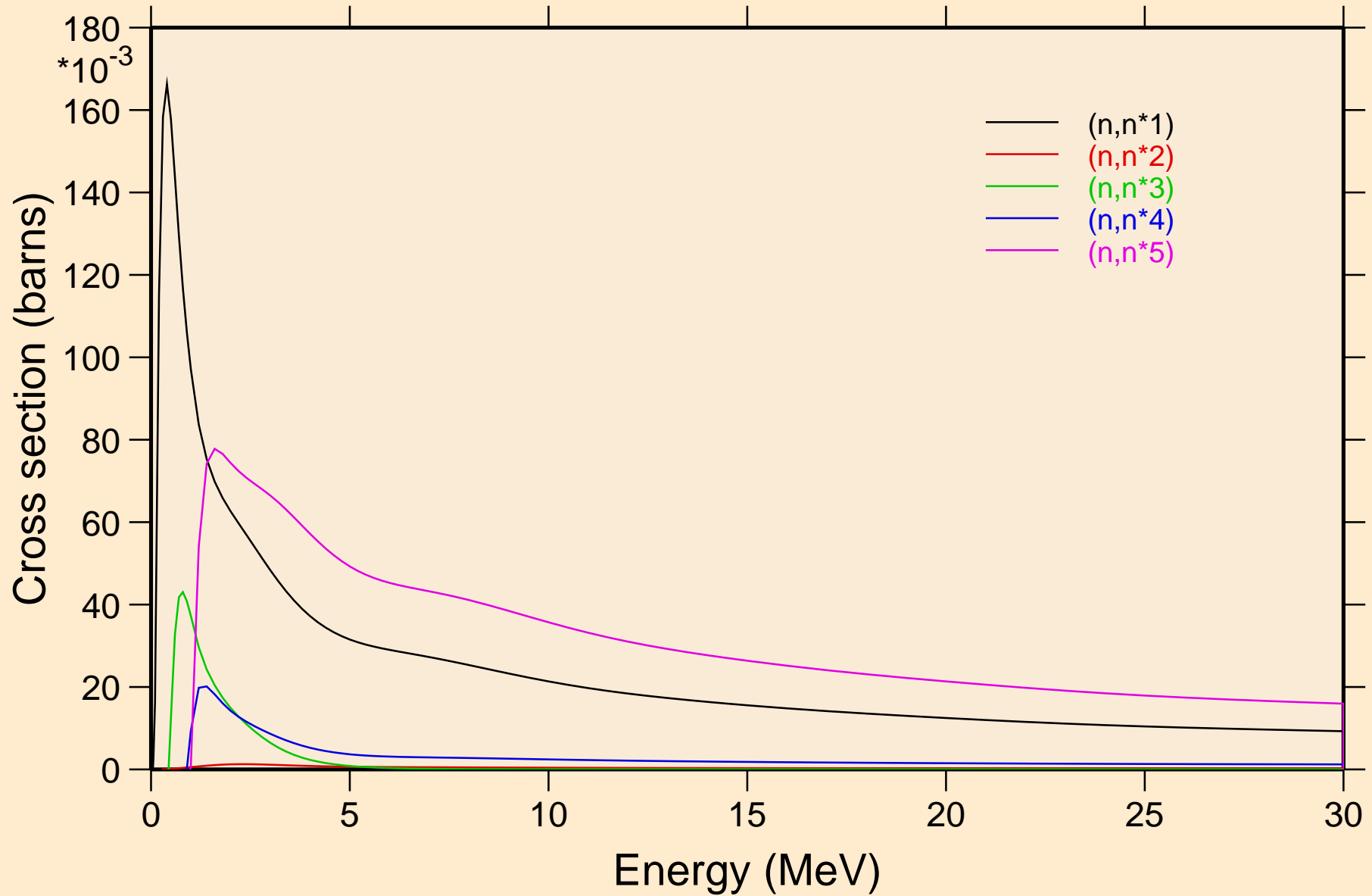

RU091 NEUTRON ACER TENDL-2023 LIBRARY; T=0.K  
Inelastic levels

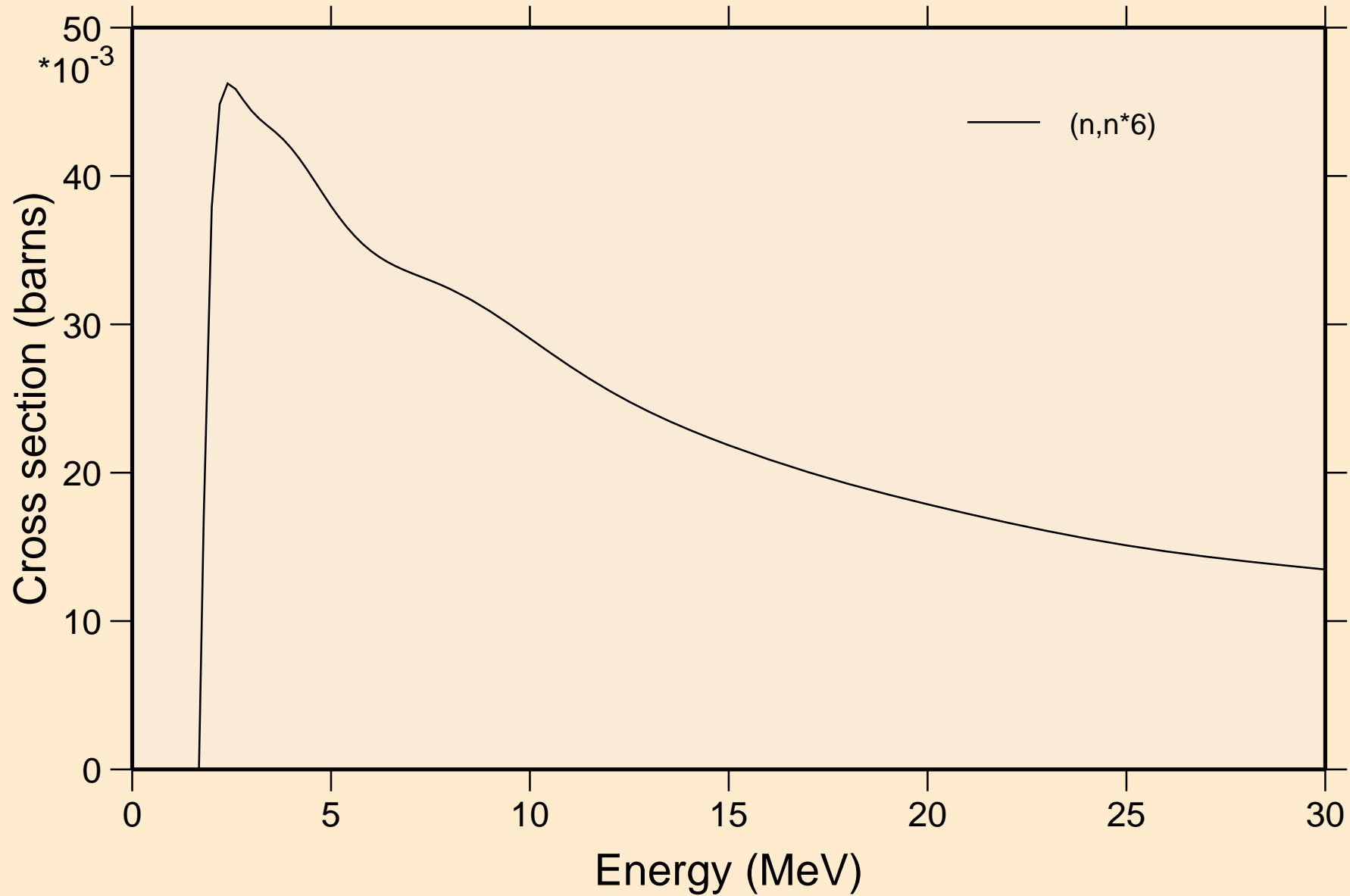

RU091 NEUTRON ACER TENDL-2023 LIBRARY; T=0.K  
Threshold reactions

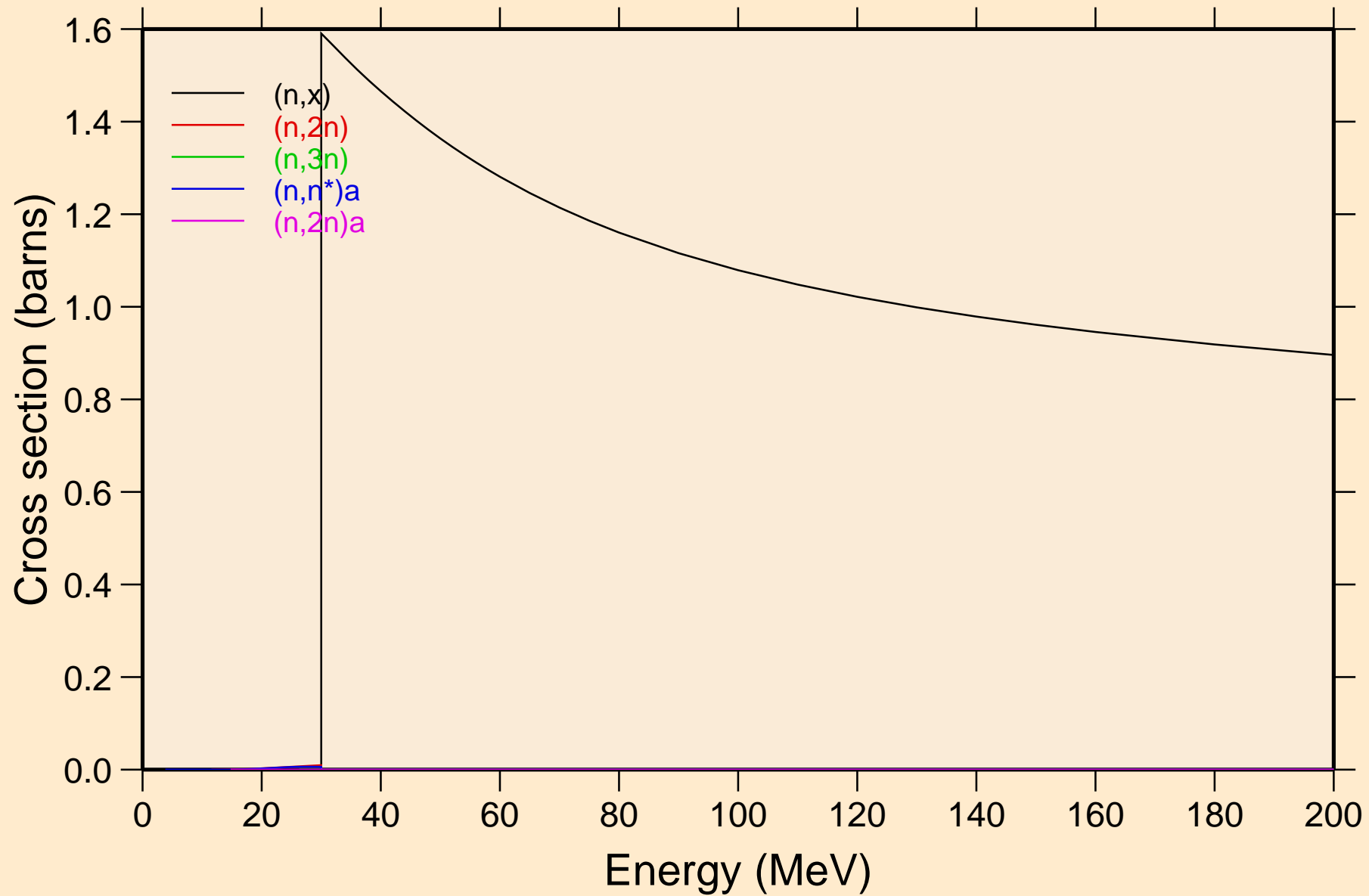

RU091 NEUTRON ACER TENDL-2023 LIBRARY; T=0.K  
Threshold reactions

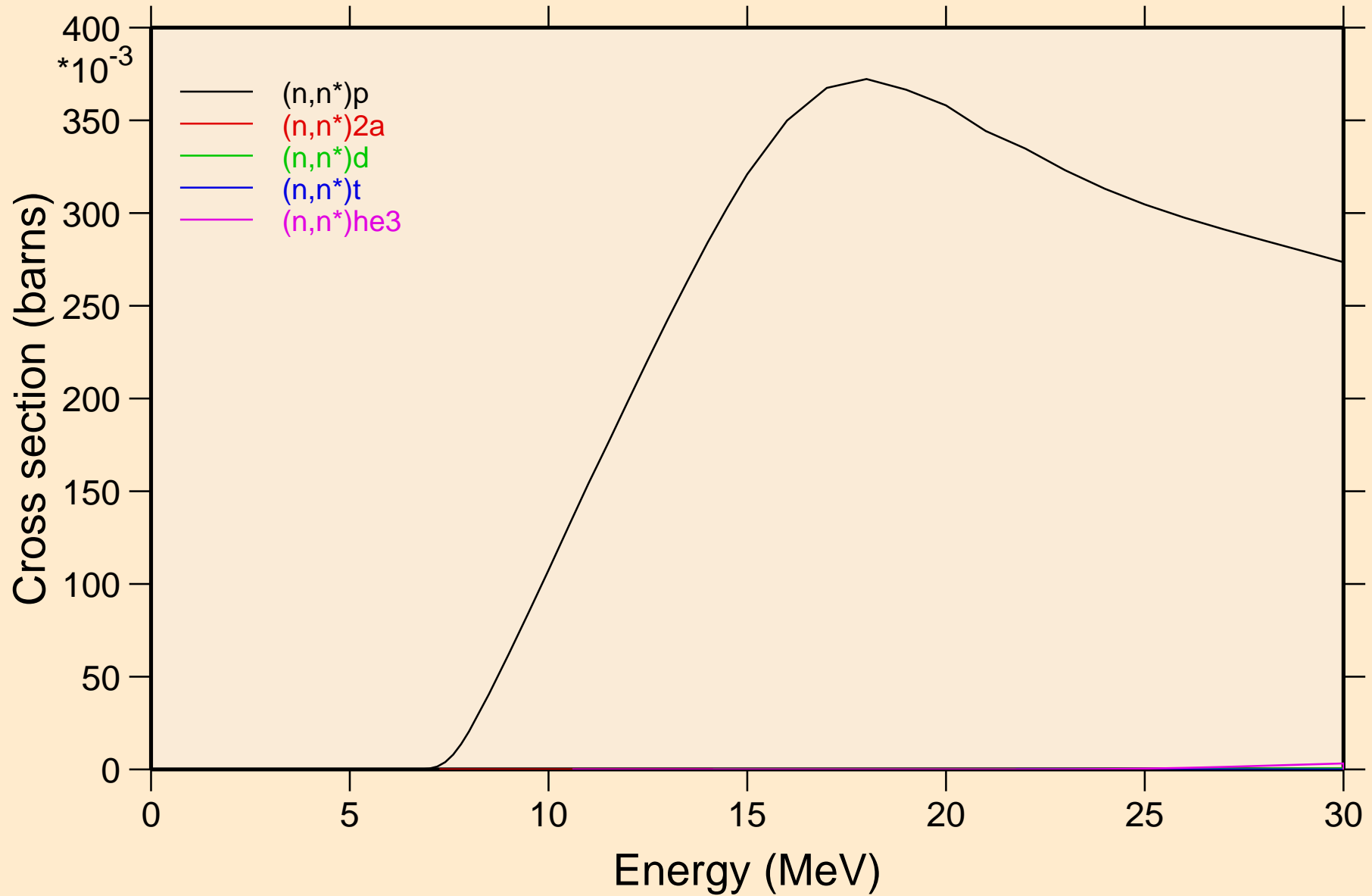

RU091 NEUTRON ACER TENDL-2023 LIBRARY; T=0.K  
Threshold reactions

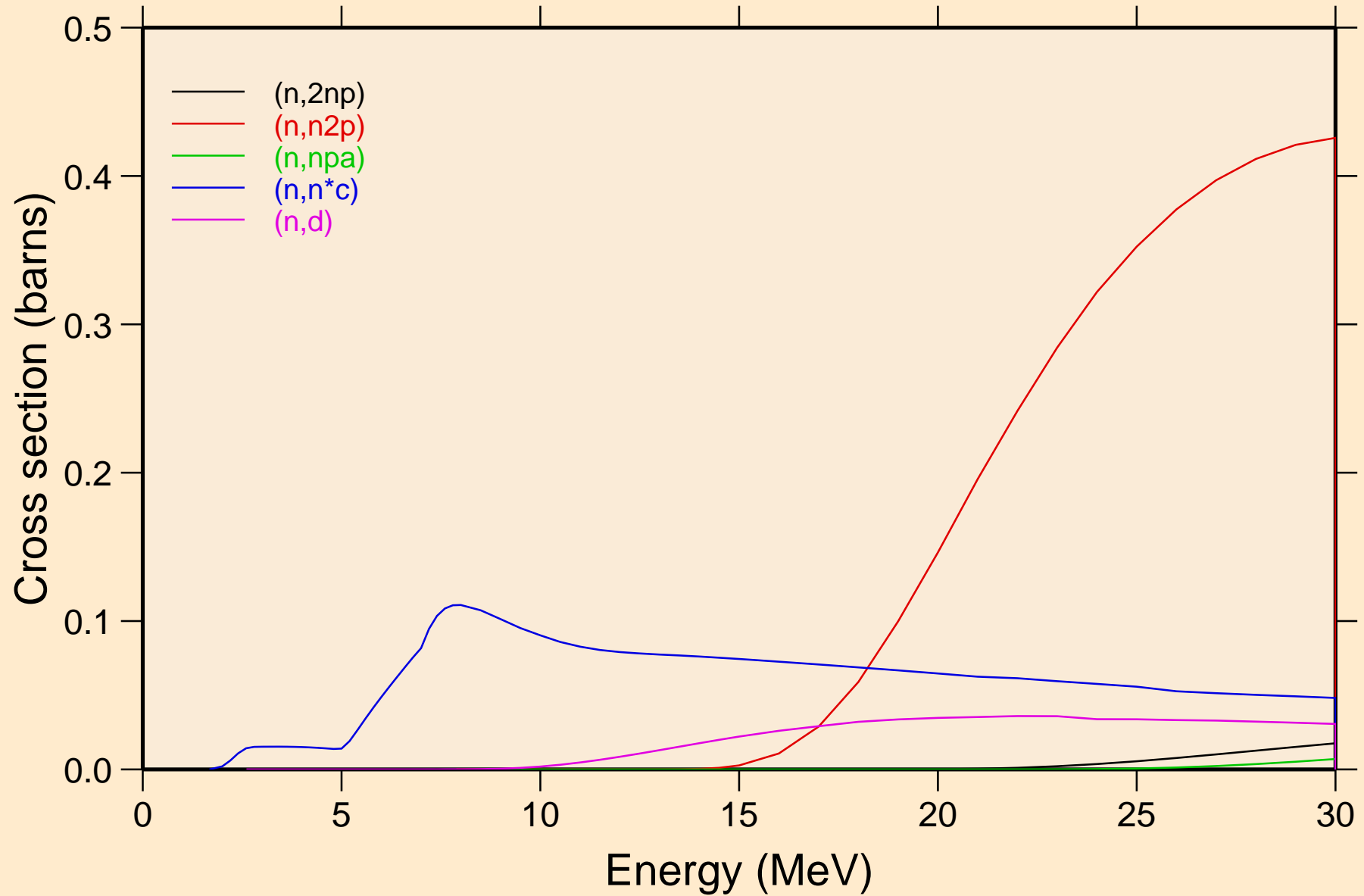

RU091 NEUTRON ACER TENDL-2023 LIBRARY; T=0.K  
Threshold reactions

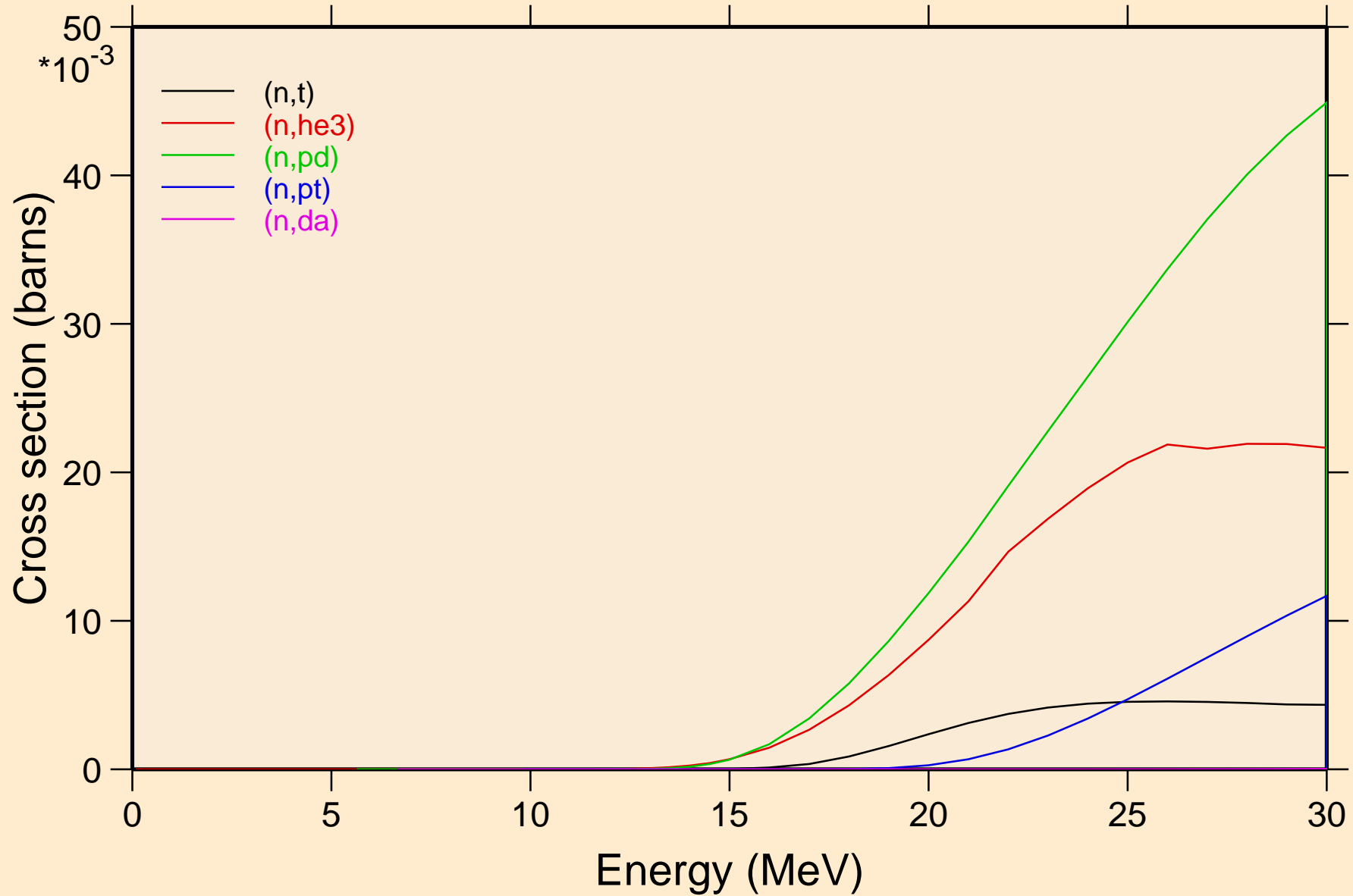

RU091 NEUTRON ACER TENDL-2023 LIBRARY; T=0.K  
Threshold reactions

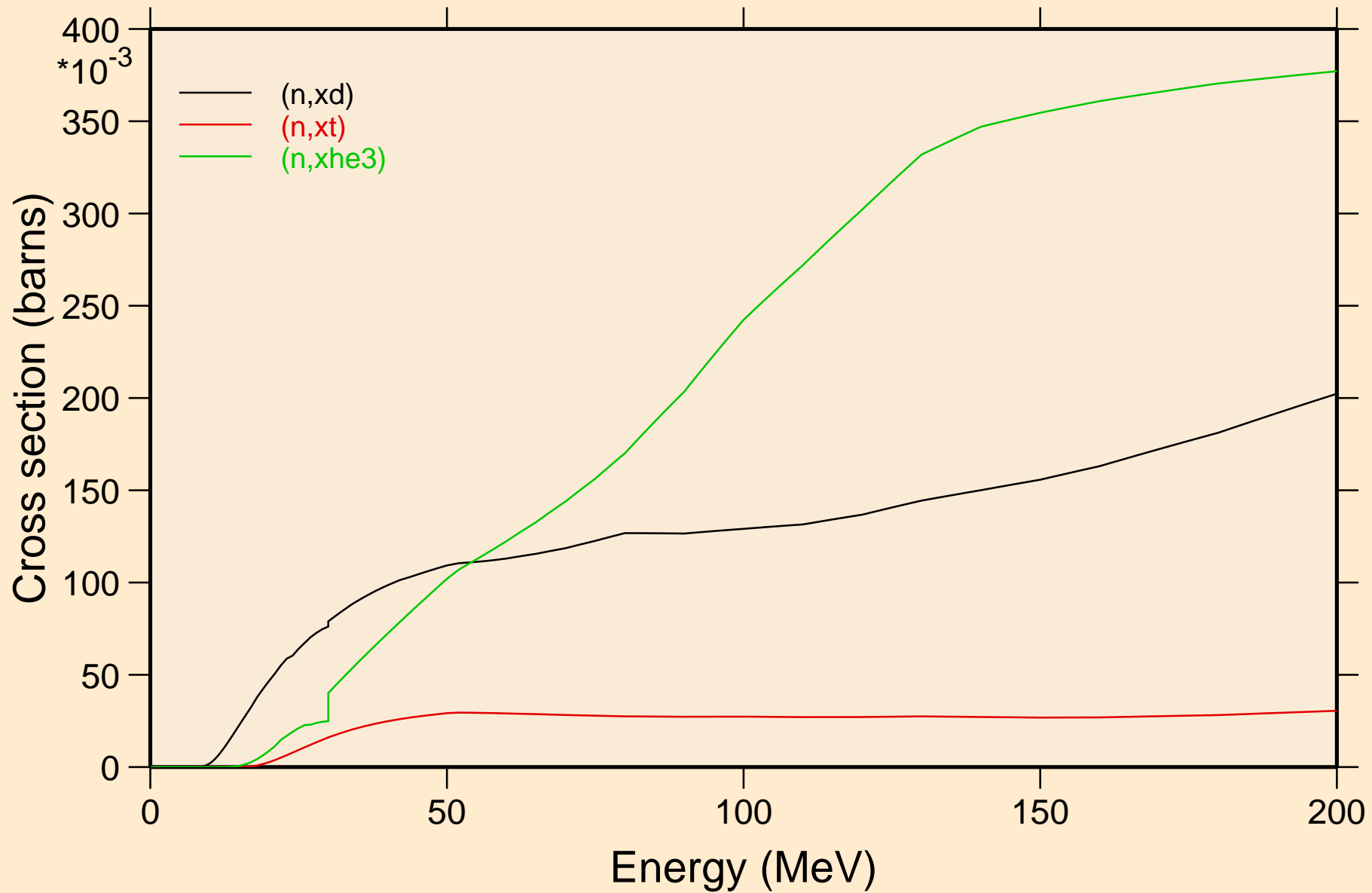

RU091 NEUTRON ACER TENDL-2023 LIBRARY; T=0.K  
angular distribution for elastic

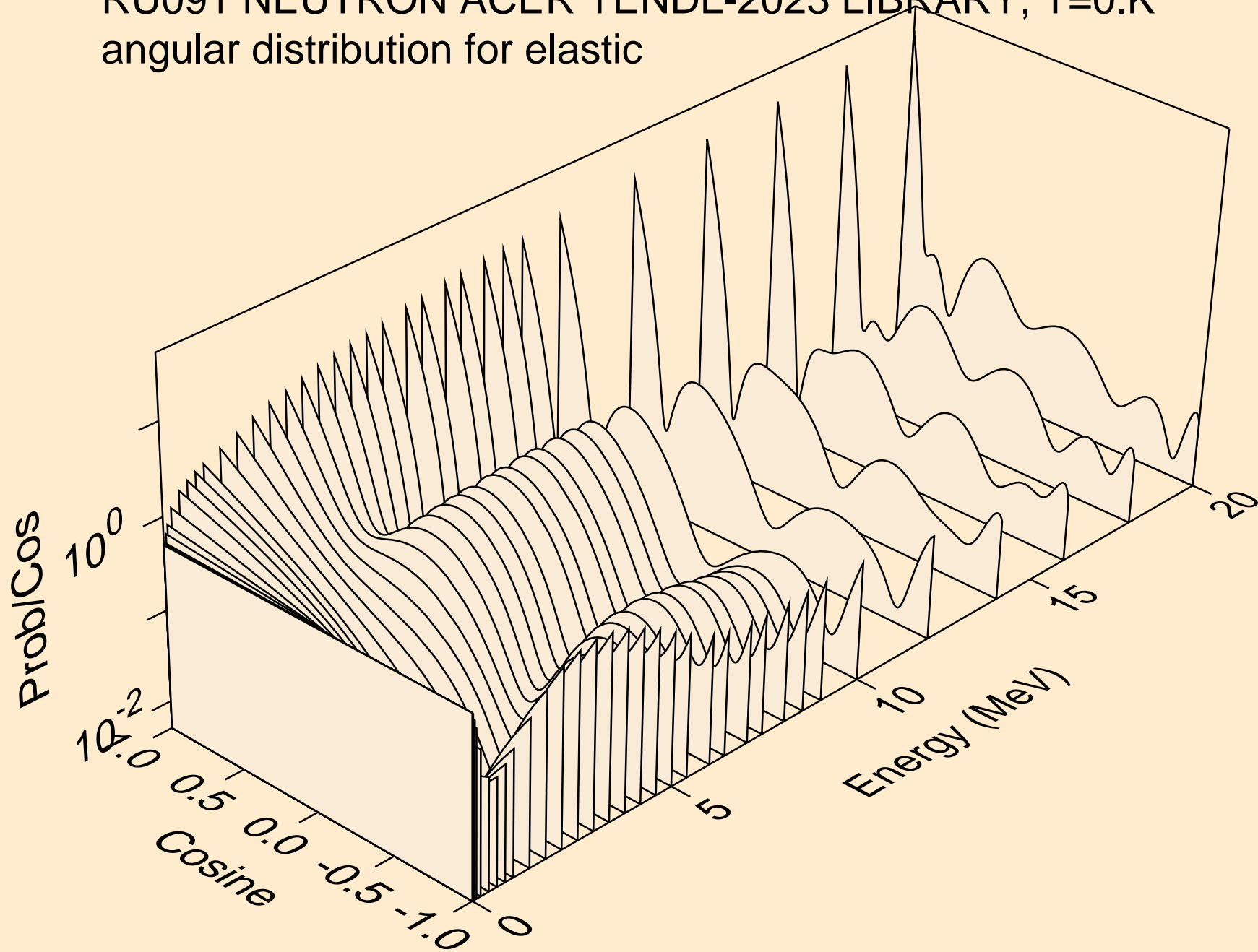



RU091 NEUTRON ACER TENDL-2023 LIBRARY; T=0.K  
angular distribution for elastic

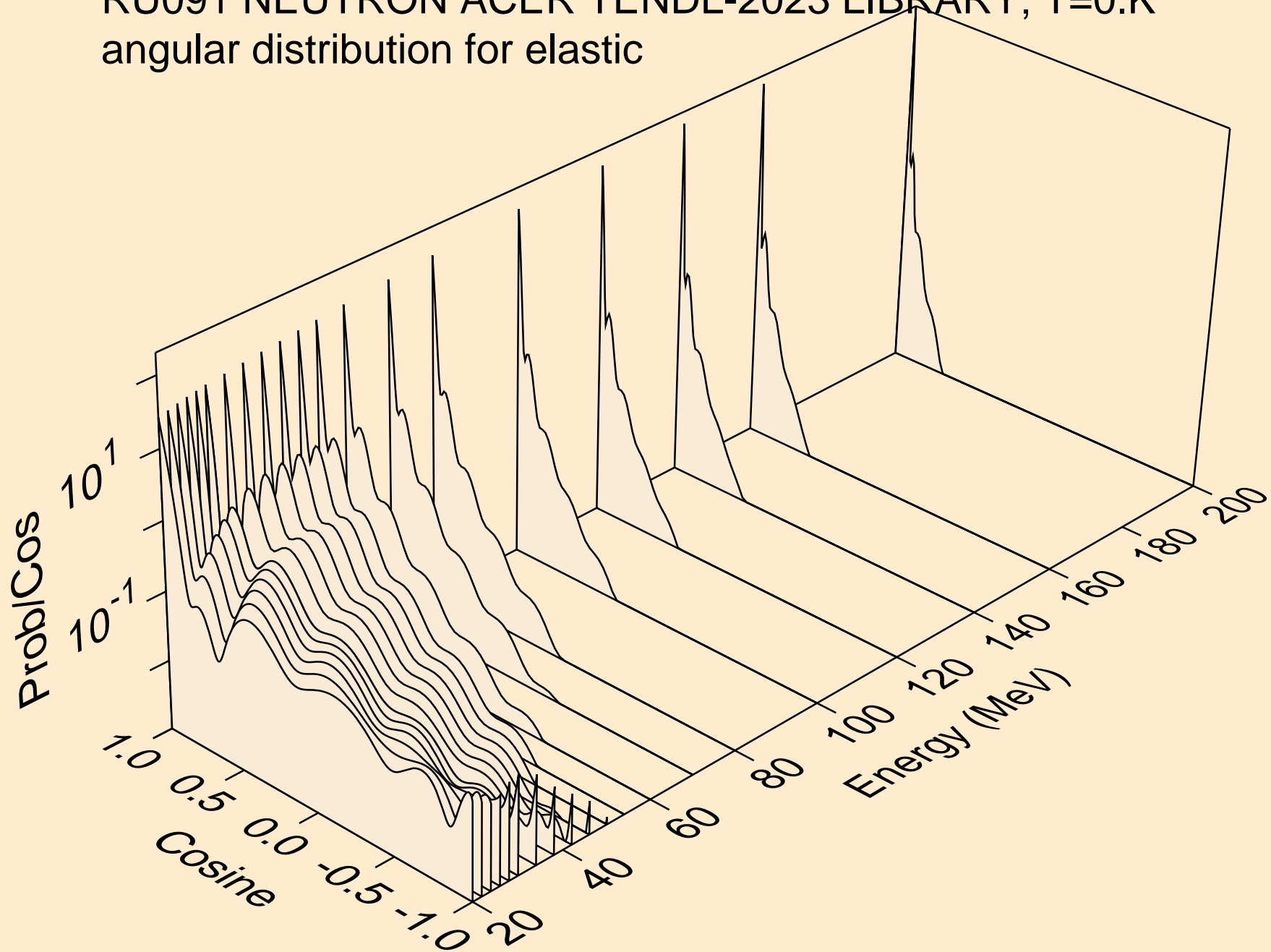

RU091 NEUTRON ACER TENDL-2023 LIBRARY; T=0.K  
angular distribution for (n,n\*1)

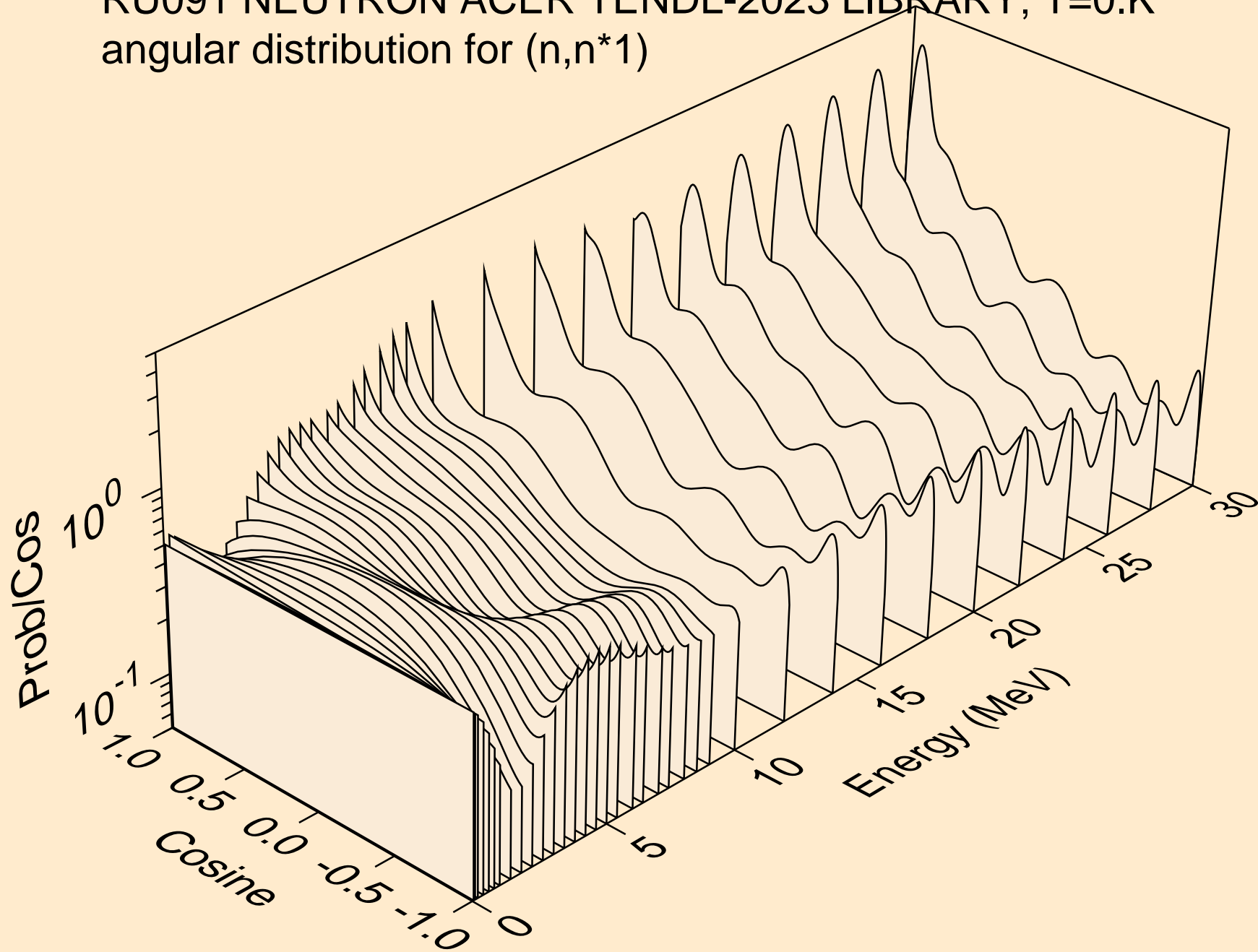

RU091 NEUTRON ACER TENDL-2023 LIBRARY; T=0.K  
angular distribution for (n,n\*2)

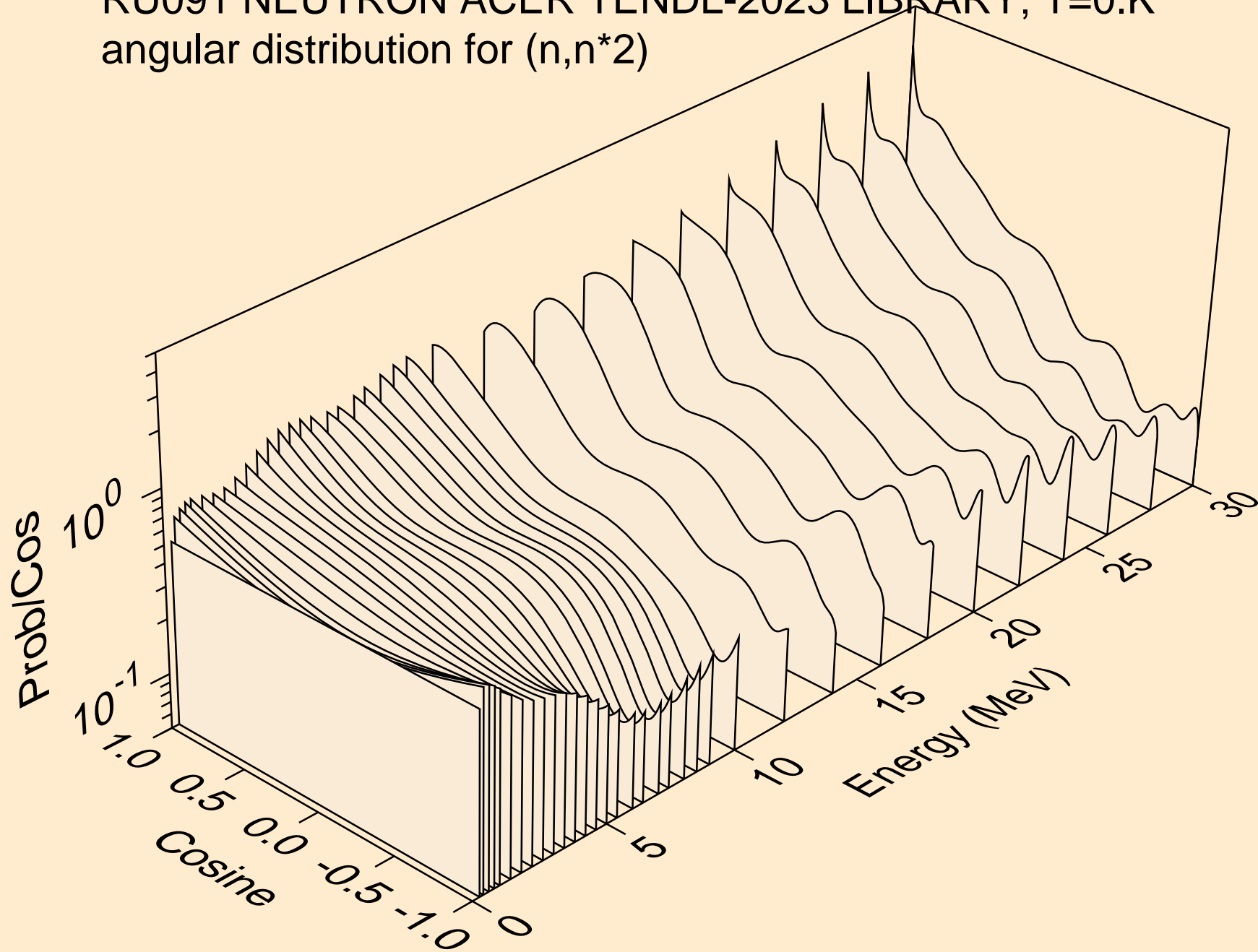

RU091 NEUTRON ACER TENDL-2023 LIBRARY; T=0.K  
angular distribution for (n,n\*3)

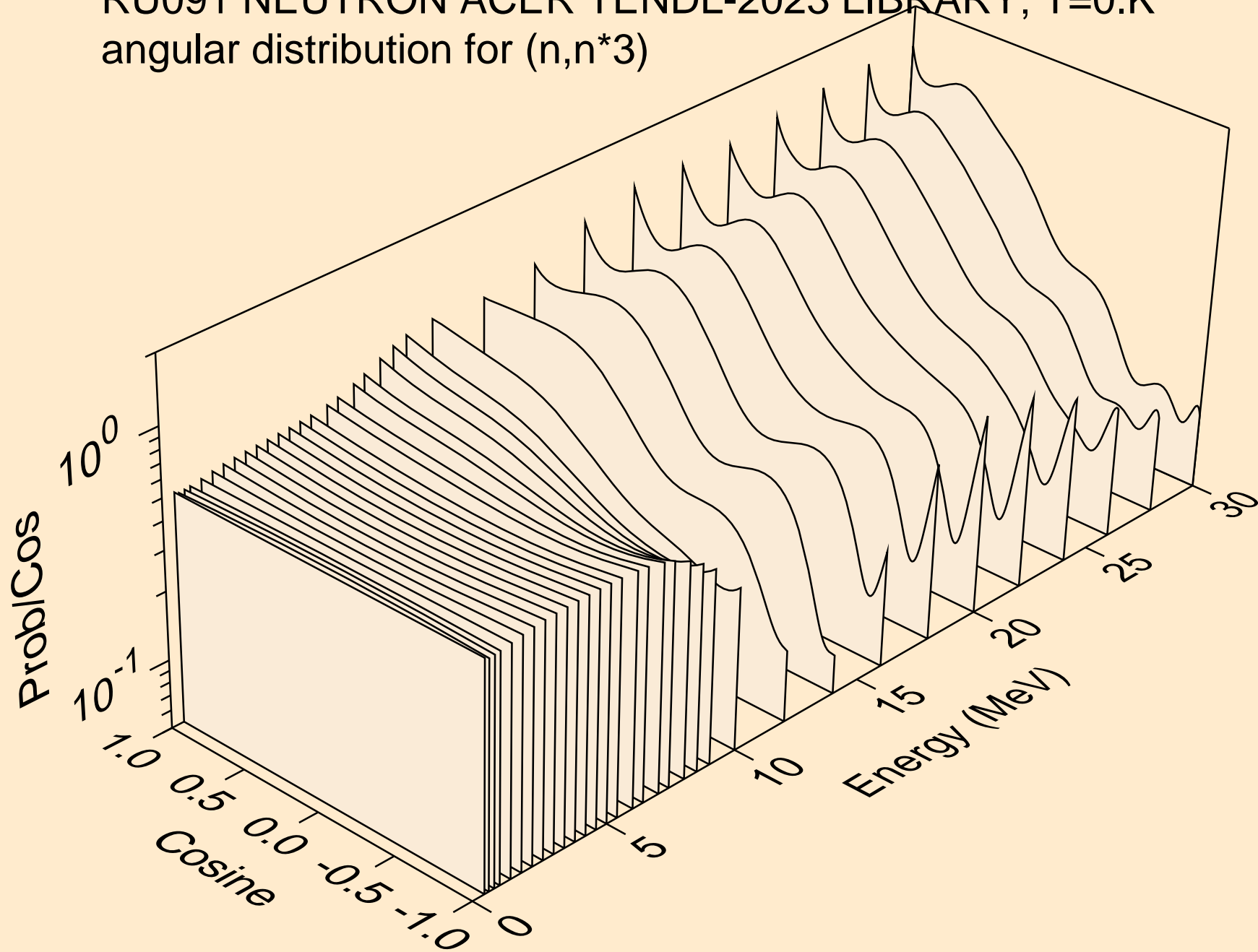

RU091 NEUTRON ACER TENDL-2023 LIBRARY; T=0.K  
angular distribution for (n,n\*4)

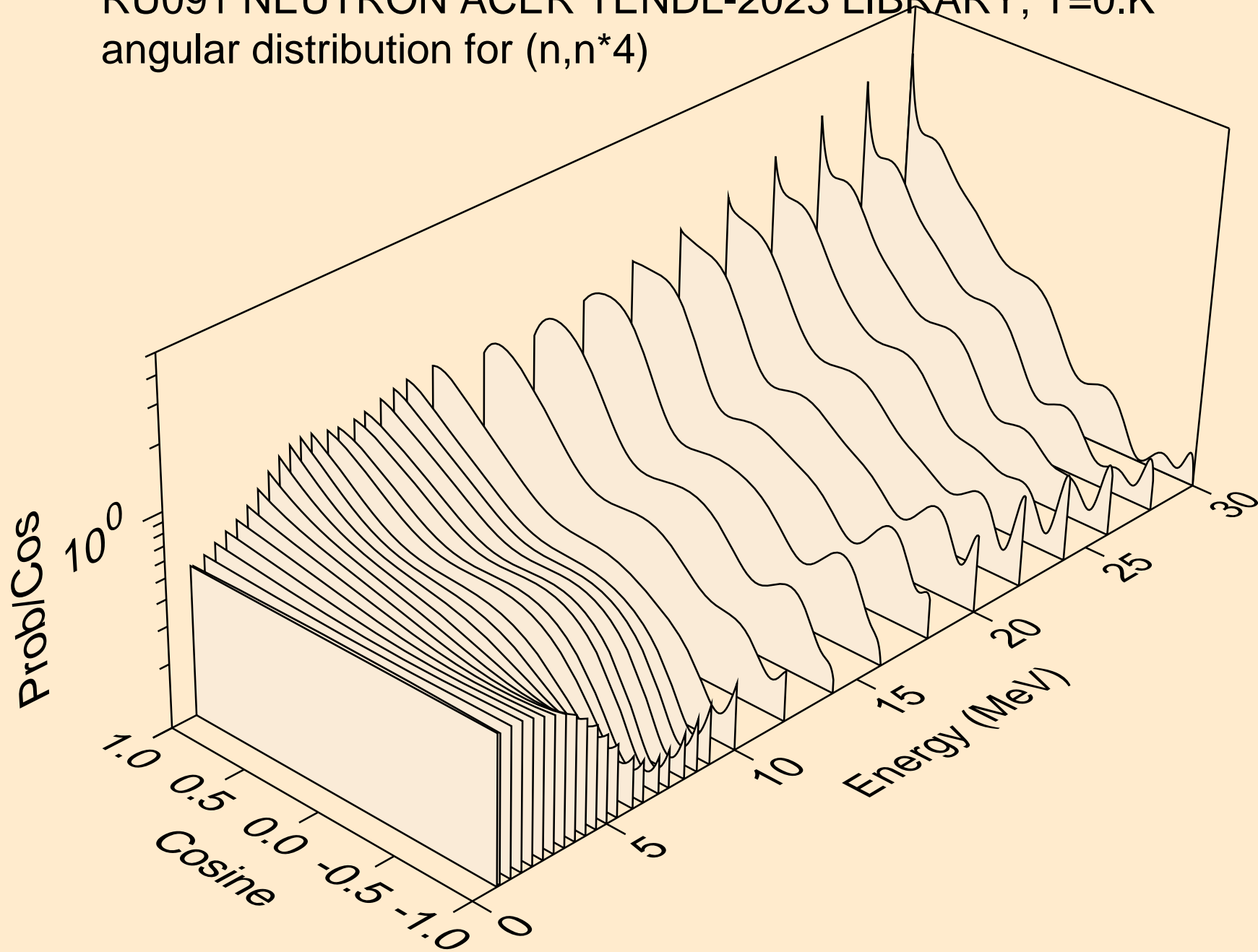

RU091 NEUTRON ACER TENDL-2023 LIBRARY; T=0.K  
angular distribution for (n,n\*5)

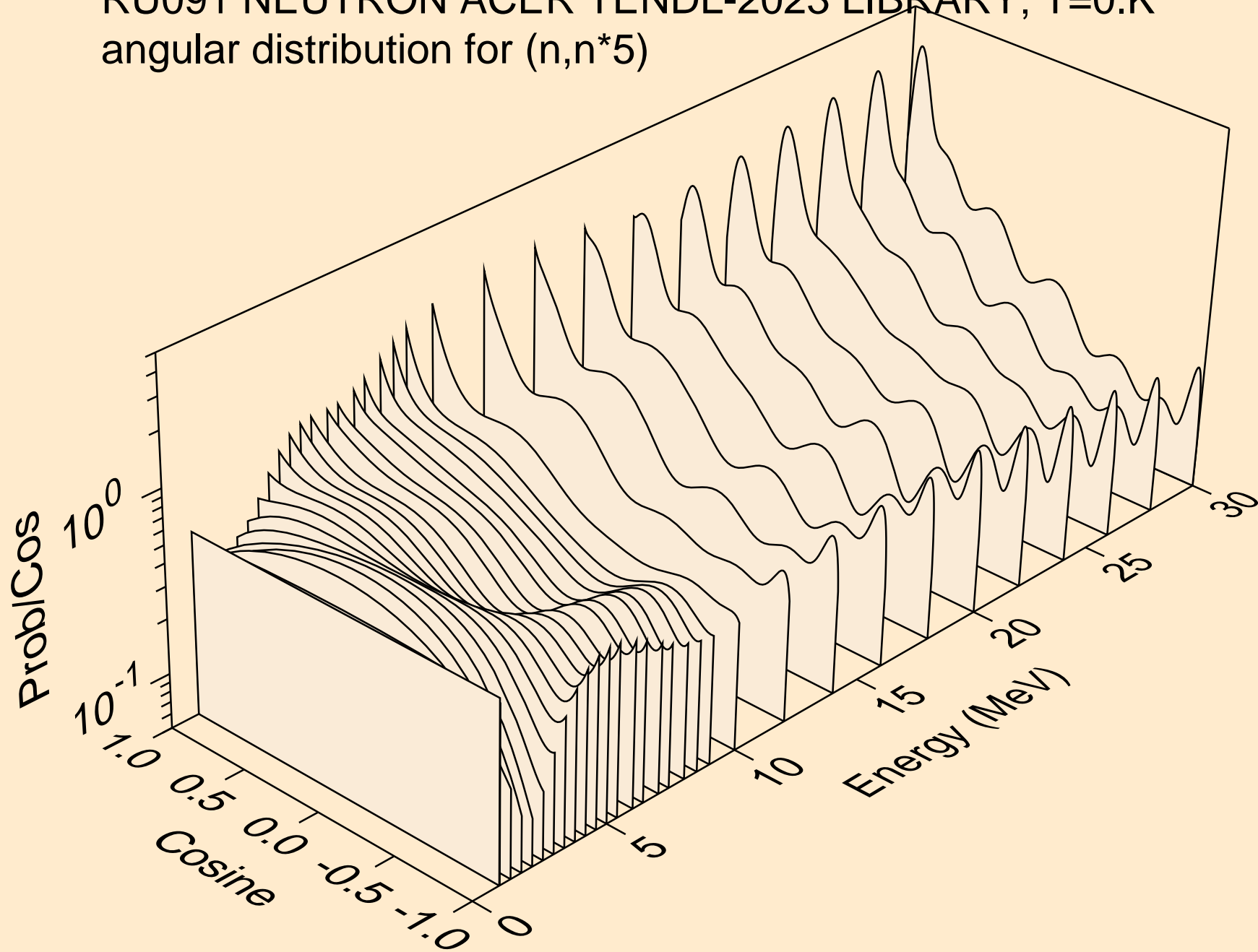

RU091 NEUTRON ACER TENDL-2023 LIBRARY; T=0.K  
angular distribution for (n,n\*6)

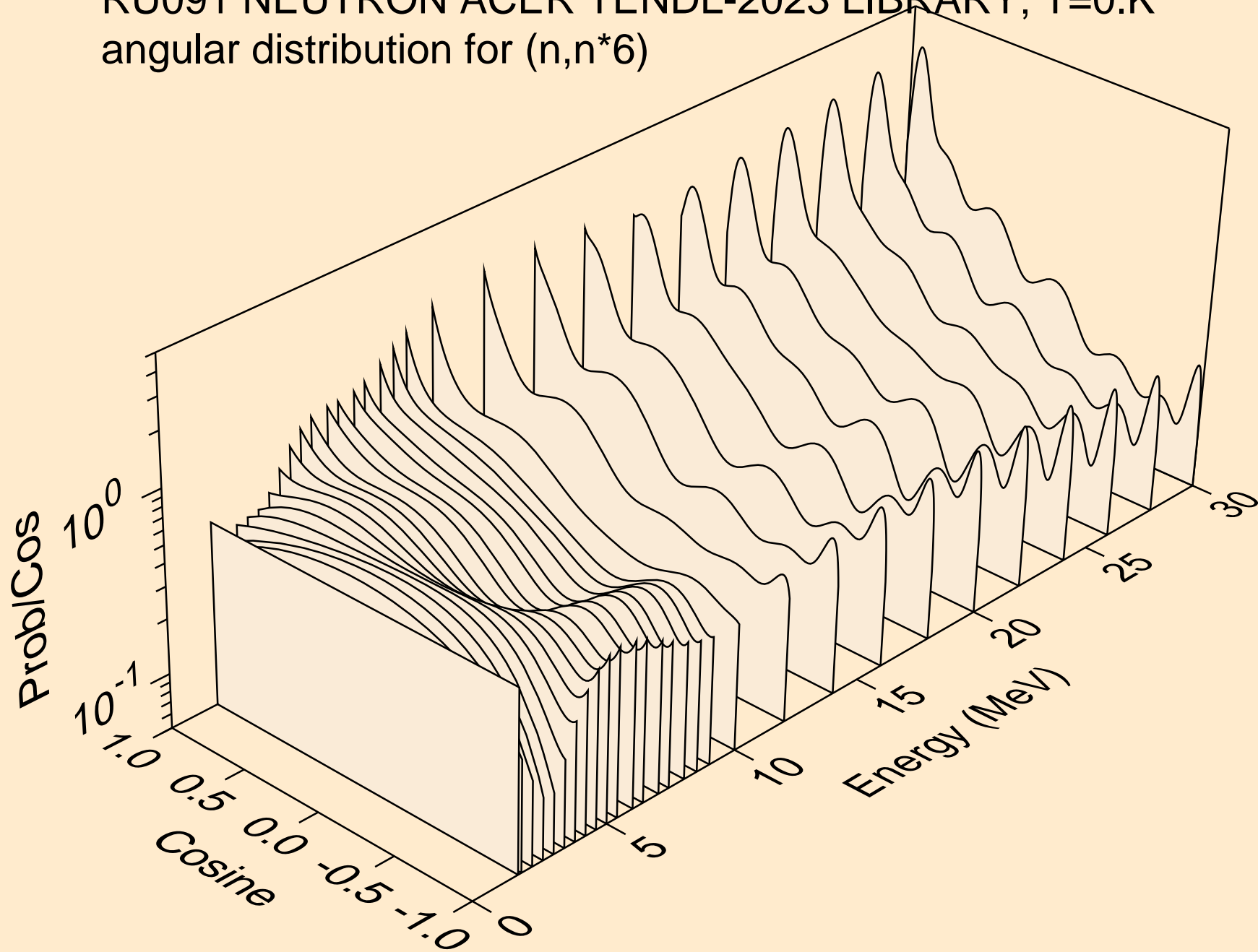

RU091 NEUTRON ACER TENDL-2023 LIBRARY; T=0.K  
Neutron emission for (n,x)

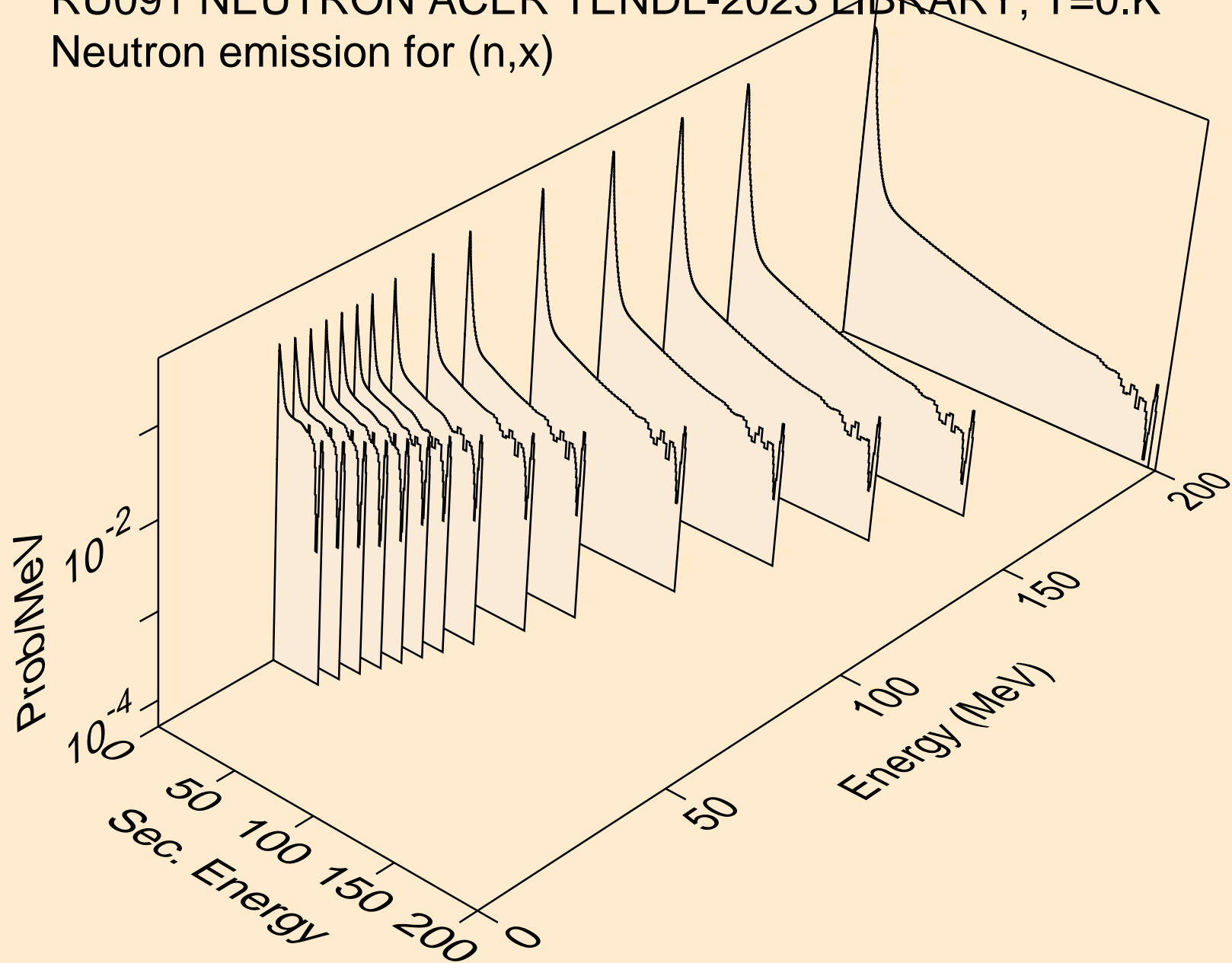



RU091 NEUTRON ACER TENDL-2023 LIBRARY; T=0.K  
Neutron emission for (n,2n)

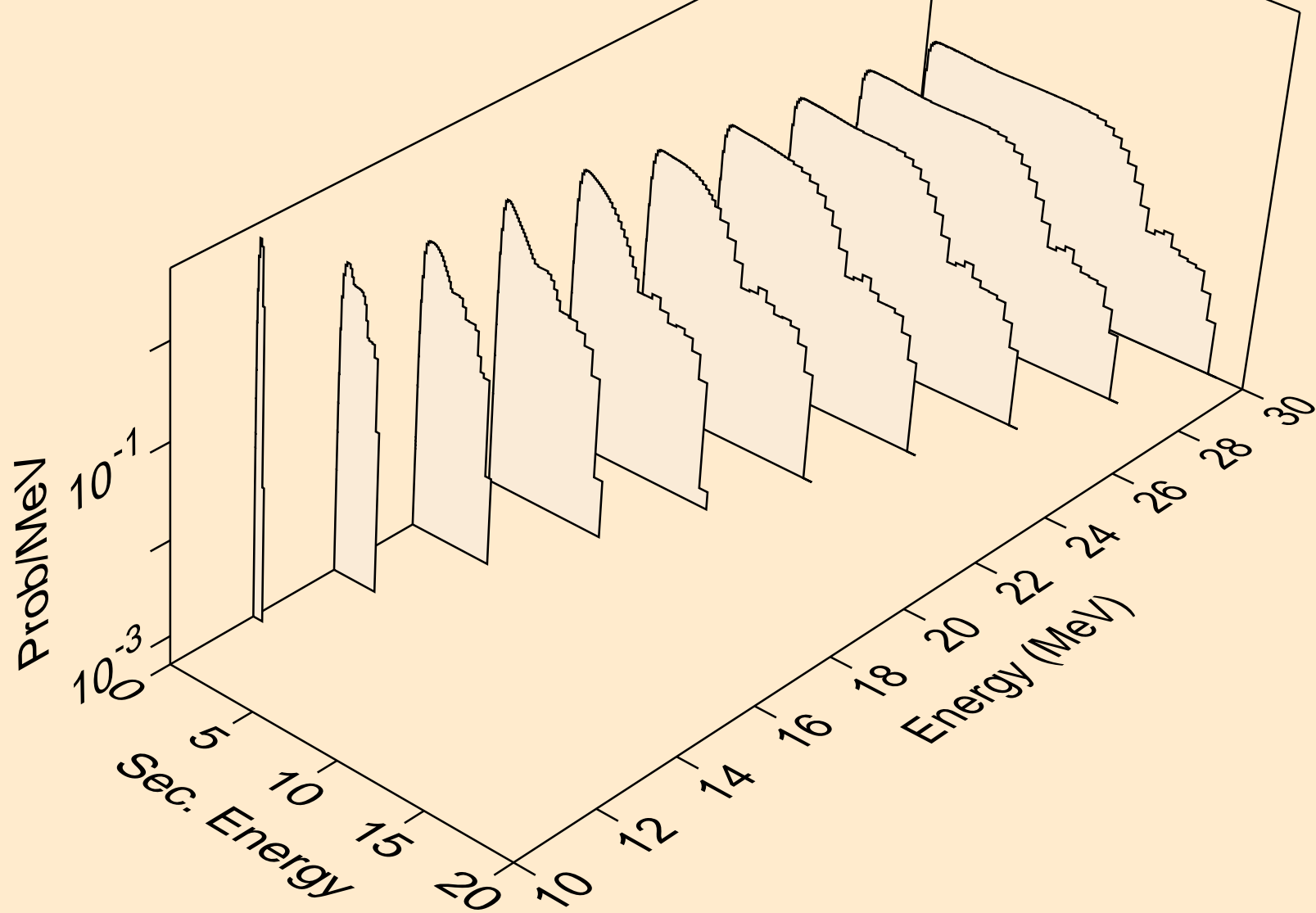

RU091 NEUTRON ACER TENDL-2023 LIBRARY; T=0.K  
Neutron emission for (n,3n)

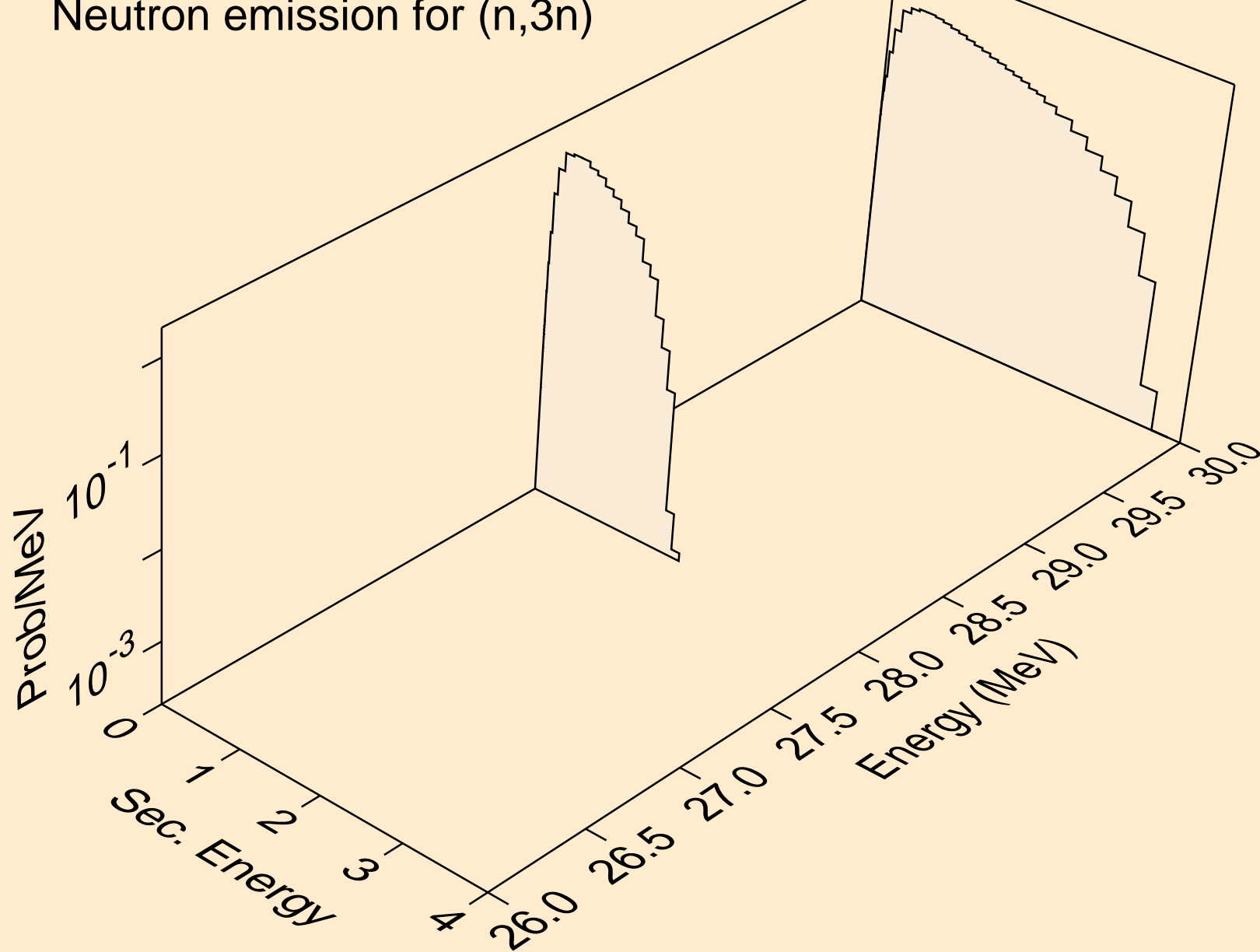

RU091 NEUTRON ACER TENDL-2023 LIBRARY; T=0.K  
Neutron emission for (n,n\*)a

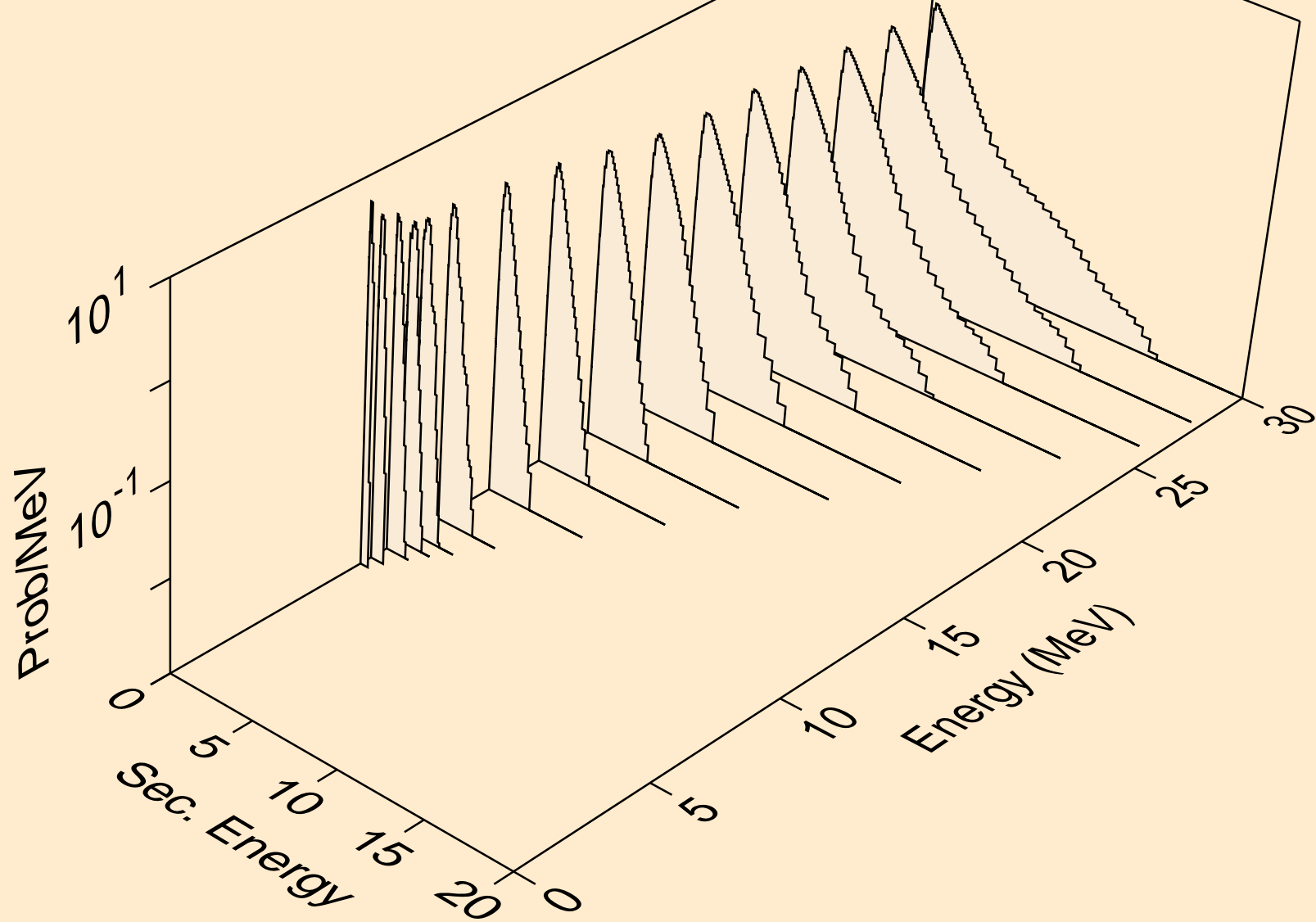

RU091 NEUTRON ACER TENDL-2023 LIBRARY; T=0.K  
Neutron emission for (n,2n)<sub>a</sub>

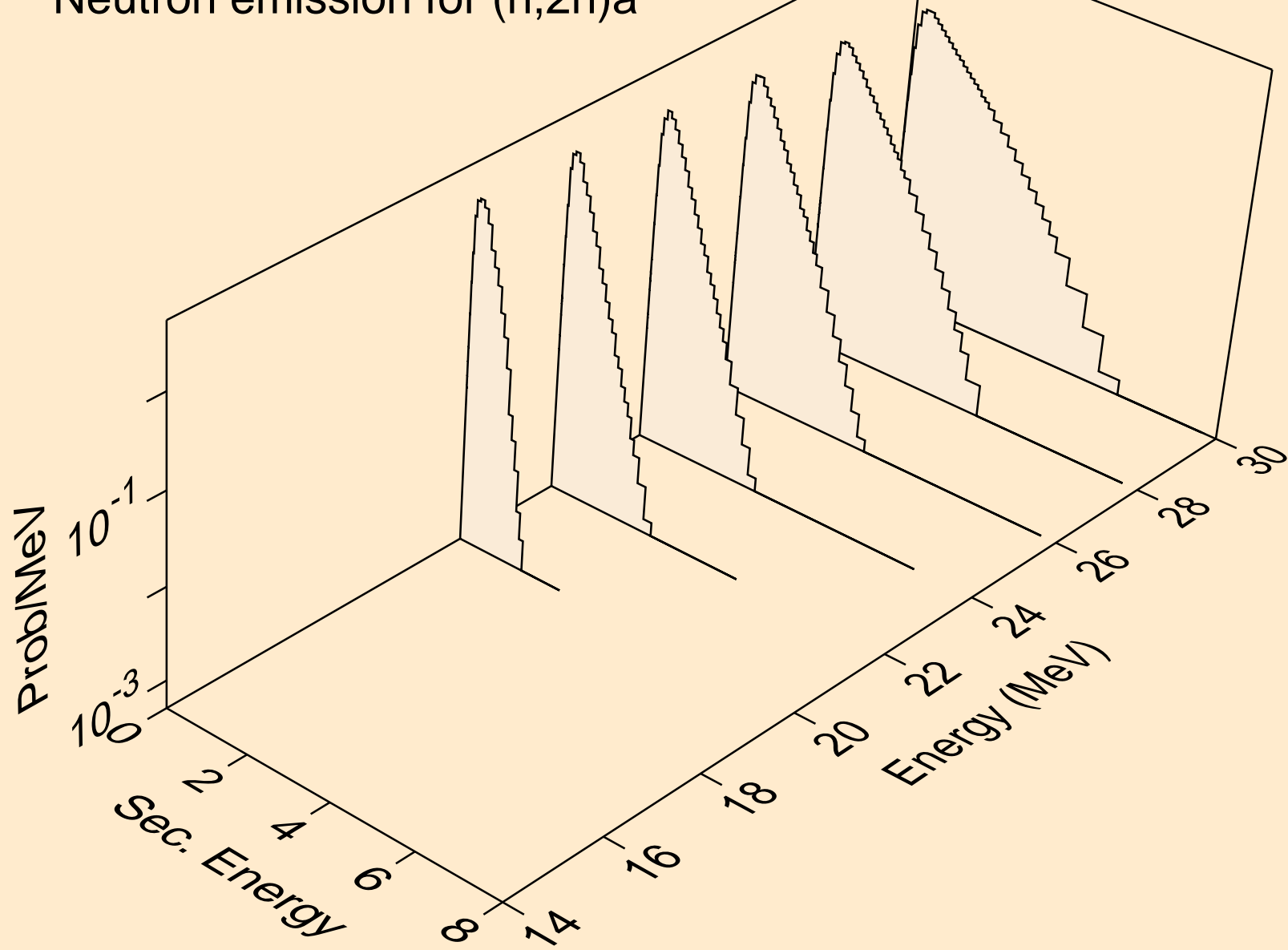

RU091 NEUTRON ACER TENDL-2023 LIBRARY; T=0.K  
Neutron emission for (n,n\*)p

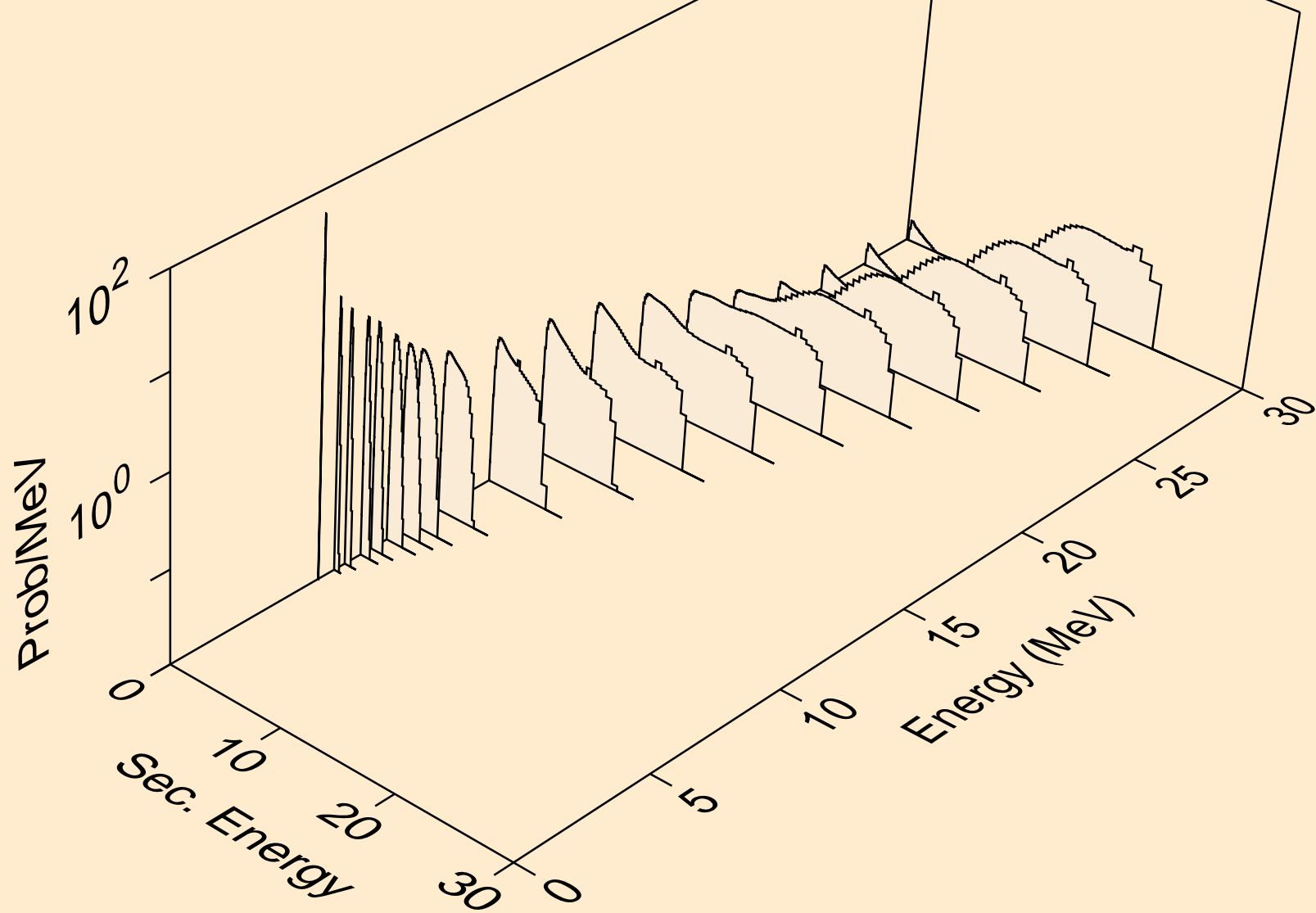

RU091 NEUTRON ACER TENDL-2023 LIBRARY; T=0.K  
Neutron emission for (n,n\*)2a

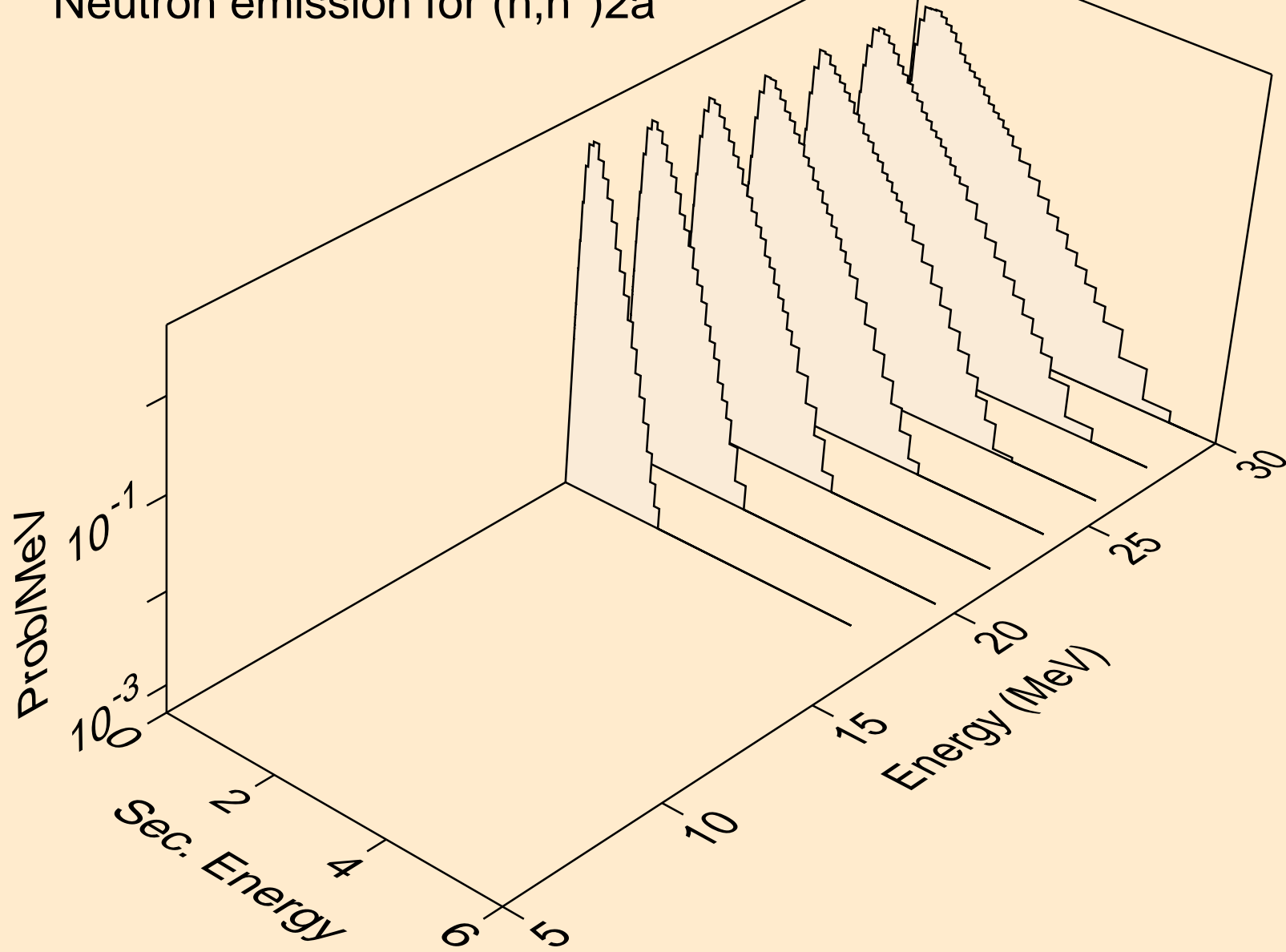

RU091 NEUTRON ACER TENDL-2023 LIBRARY; T=0.K  
Neutron emission for (n,n\*)d

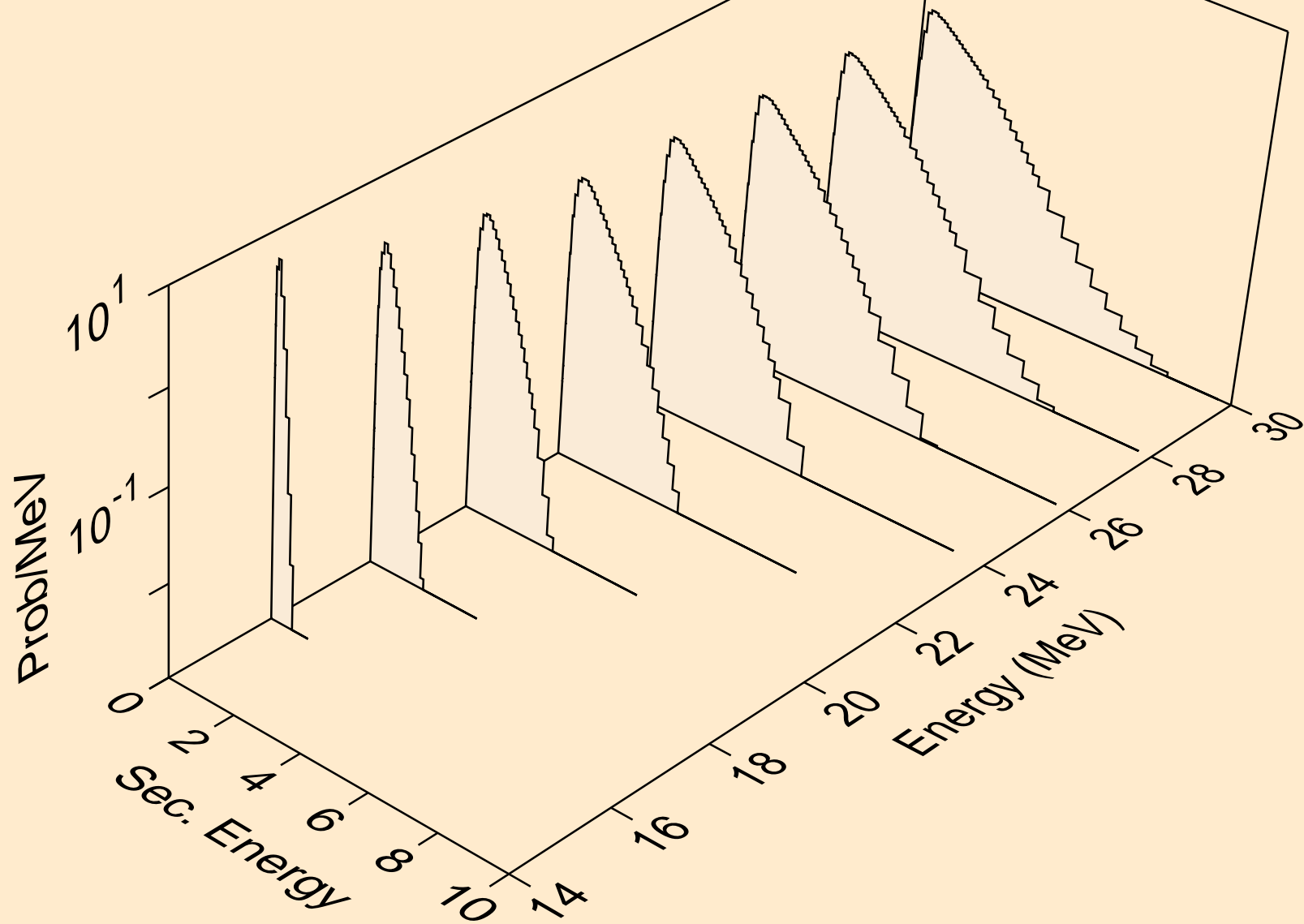

RU091 NEUTRON ACER TENDL-2023 LIBRARY; T=0.K  
Neutron emission for (n,n\*)t

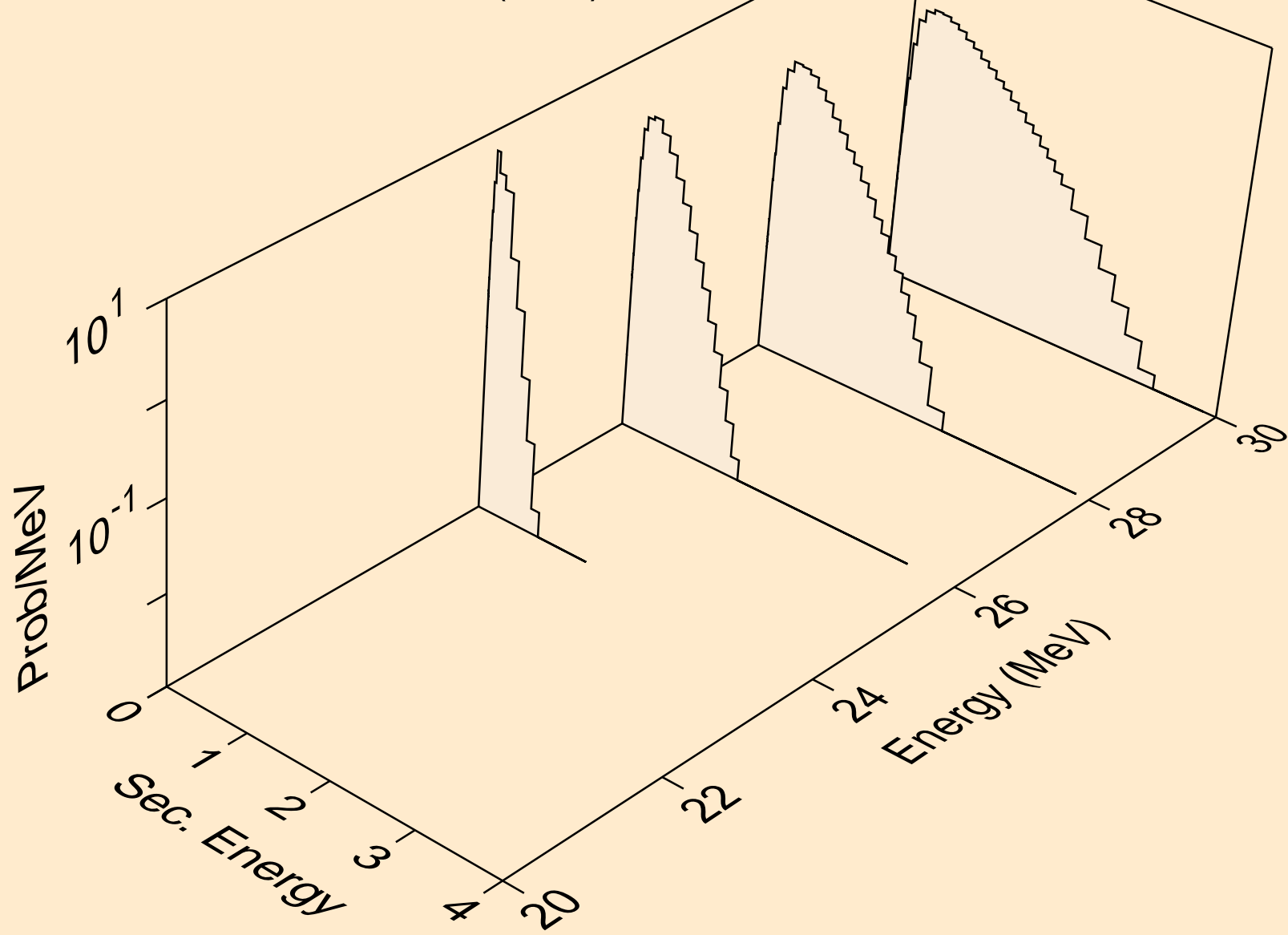



RU091 NEUTRON ACER TENDL-2023 LIBRARY; T=0.K  
Neutron emission for (n,n\*)he3

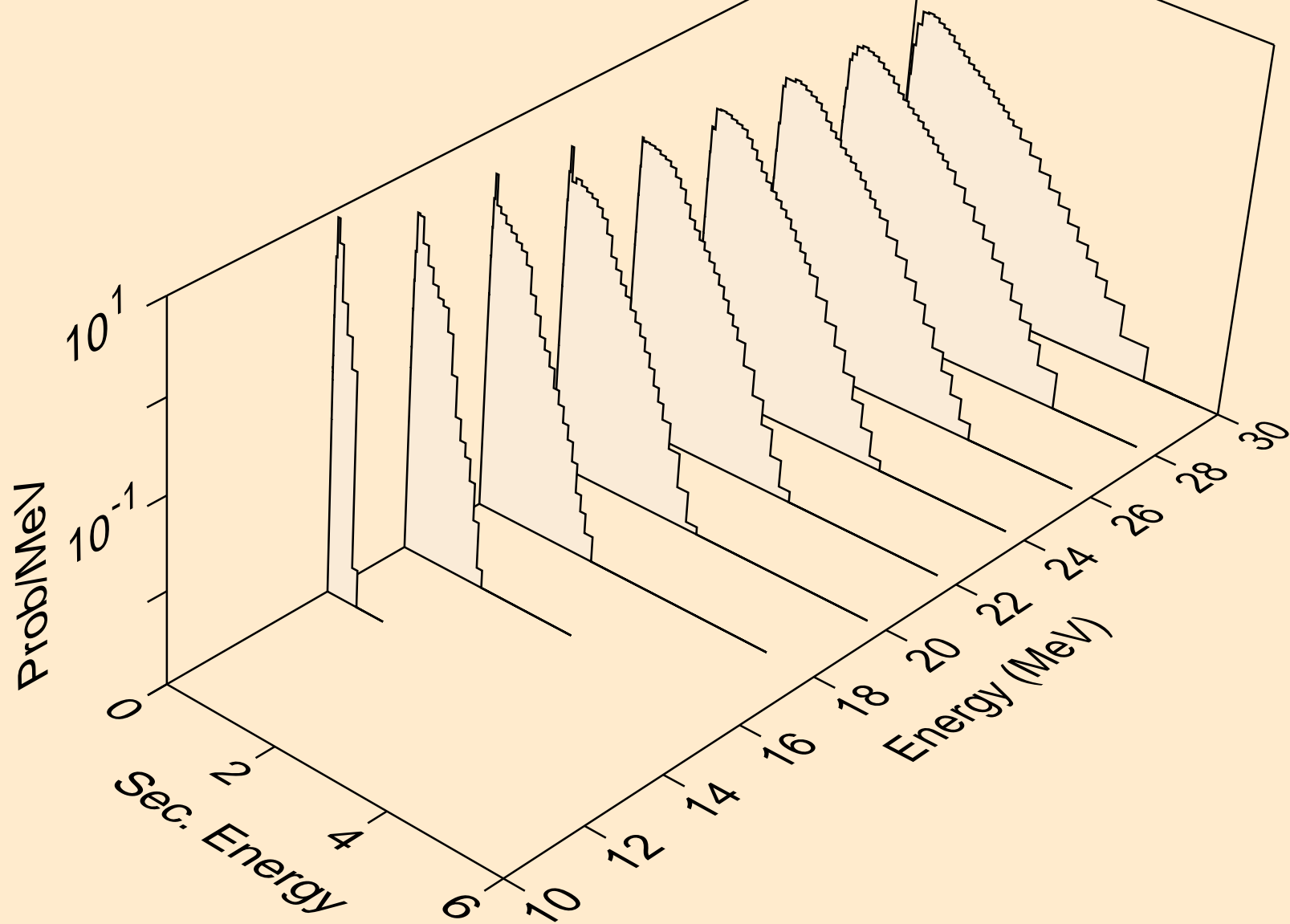

RU091 NEUTRON ACER TENDL-2023 LIBRARY; T=0.K  
Neutron emission for (n,2np)

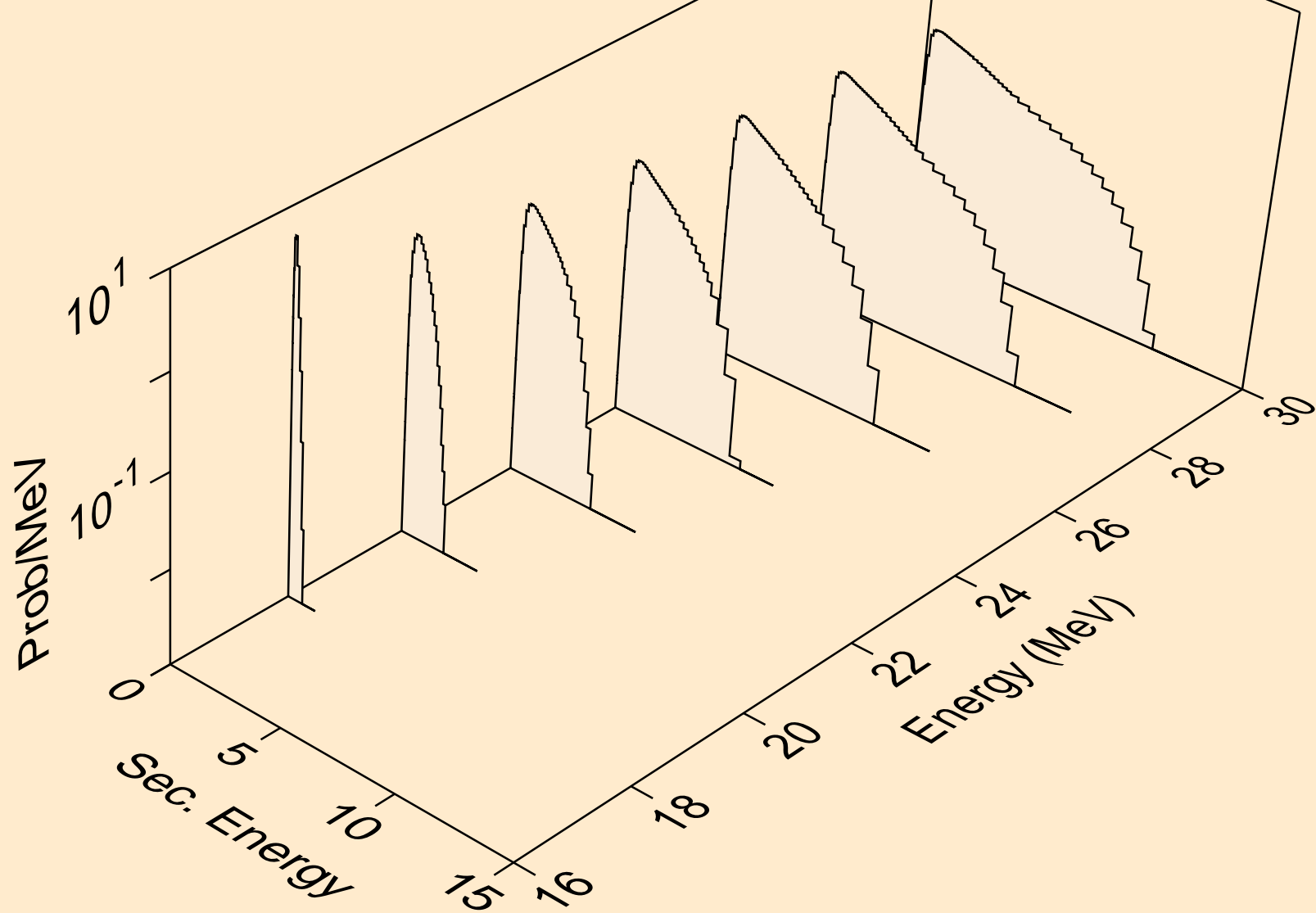

RU091 NEUTRON ACER TENDL-2023 LIBRARY; T=0.K  
Neutron emission for (n,n2p)

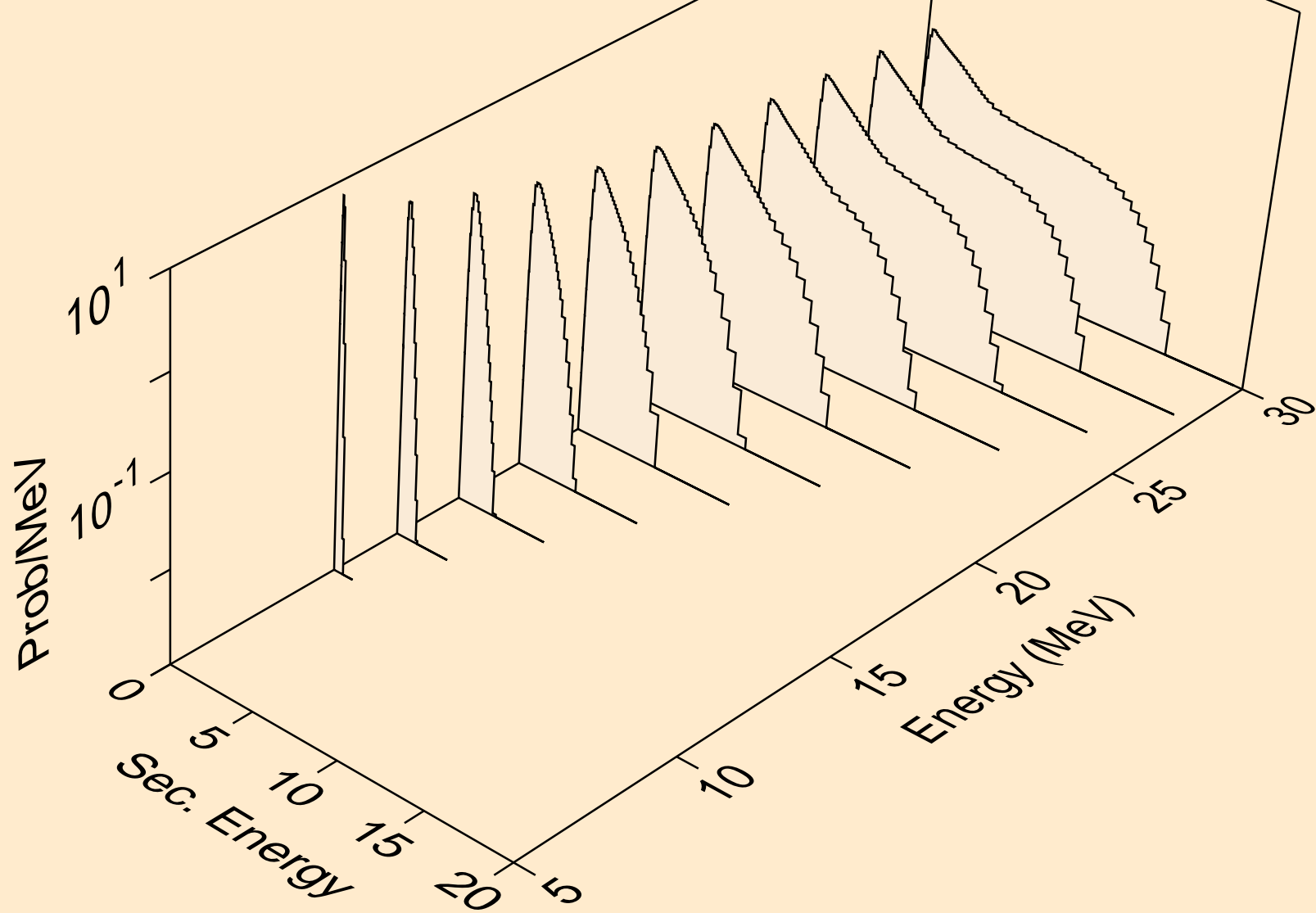

RU091 NEUTRON ACER TENDL-2023 LIBRARY; T=0.K  
Neutron emission for (n,npa)

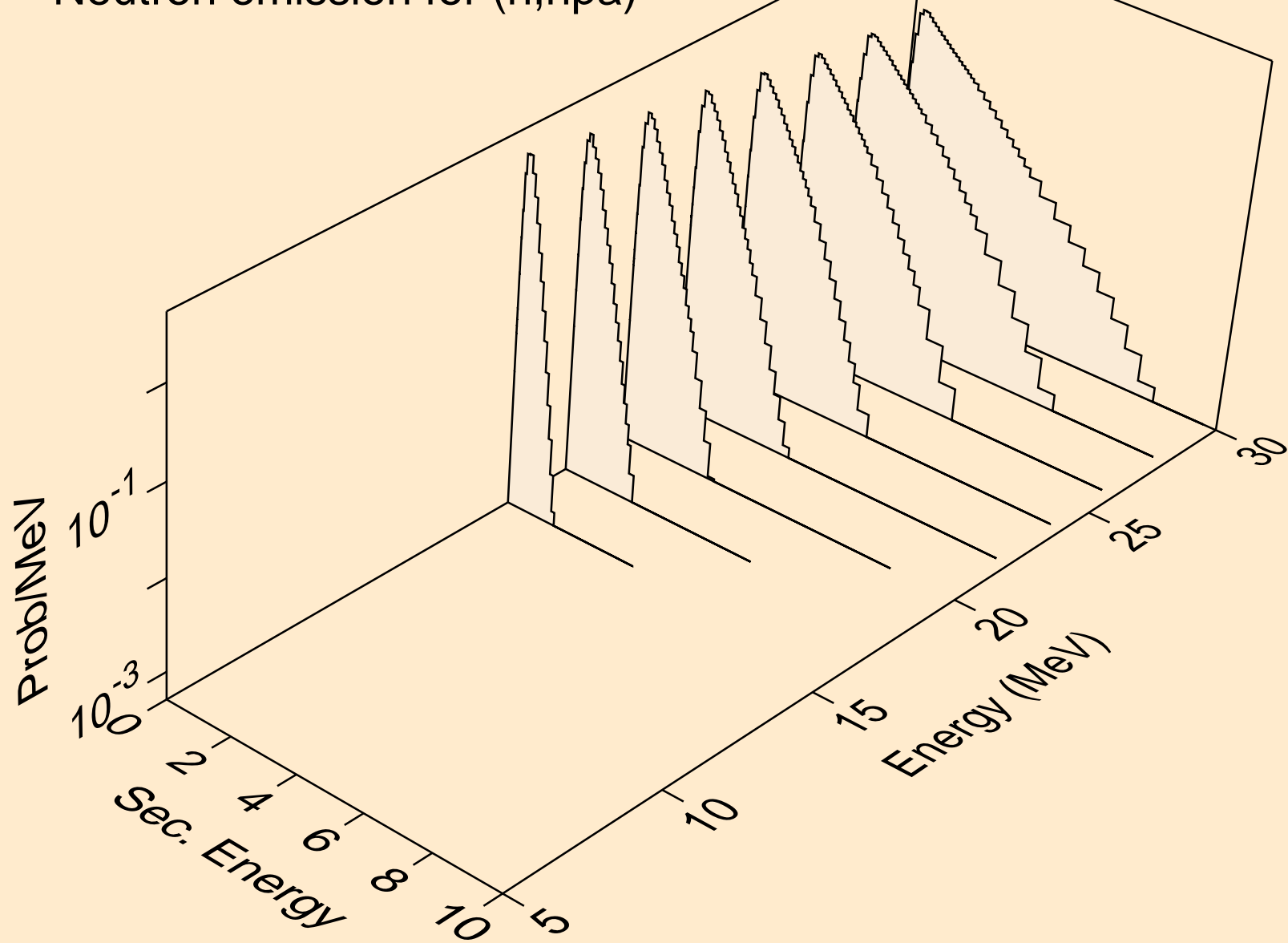

RU091 NEUTRON ACER TENDL-2023 LIBRARY; T=0.K  
Neutron emission for (n,n\*c)

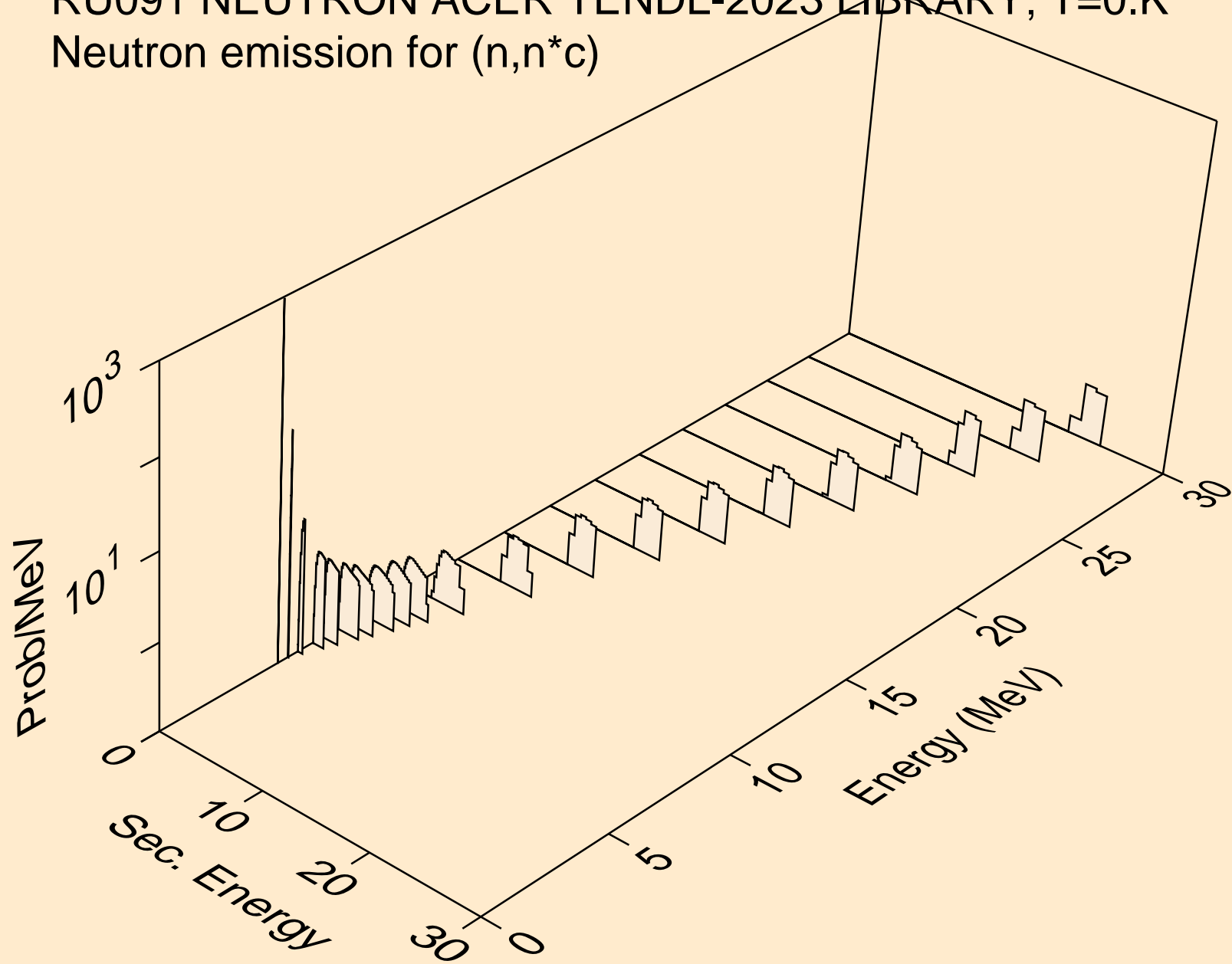

RU091 NEUTRON ACER TENDL-2023 LIBRARY; T=0.K  
Photon emission for (n,x)

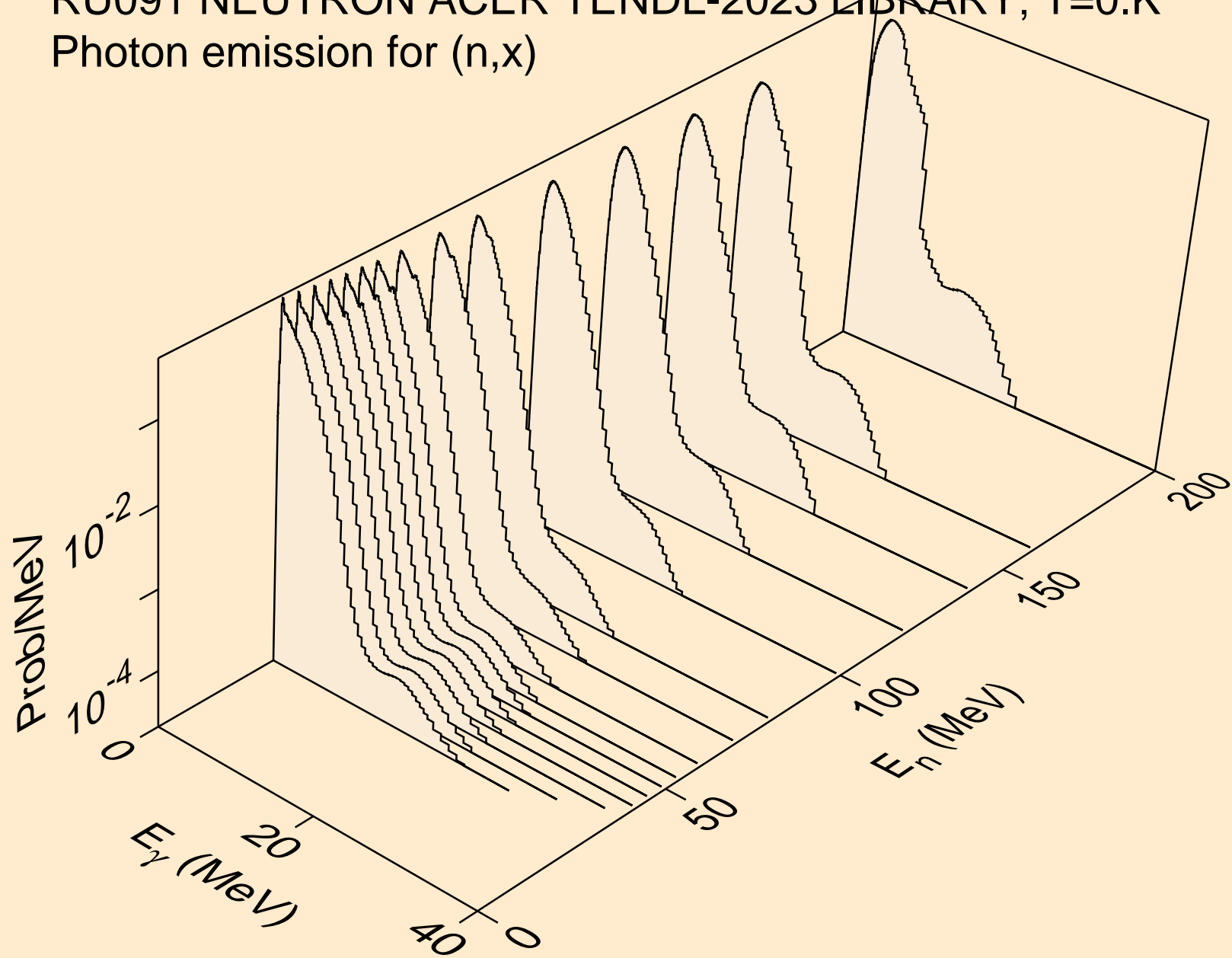

RU091 NEUTRON ACER TENDL-2023 LIBRARY; T=0.K  
Photon emission for (n,2n)

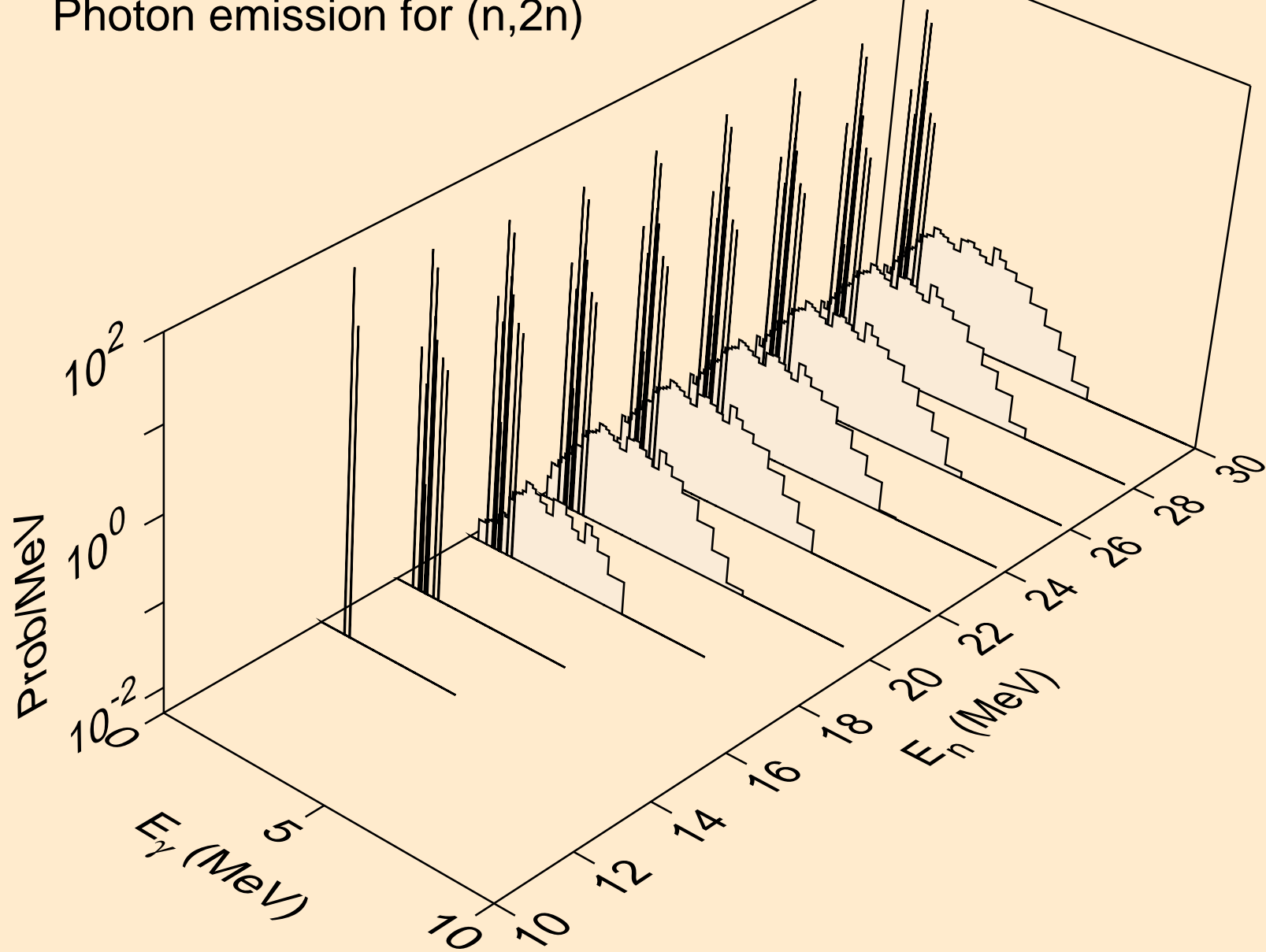

RU091 NEUTRON ACER TENDL-2023 LIBRARY; T=0.K  
Photon emission for (n,3n)

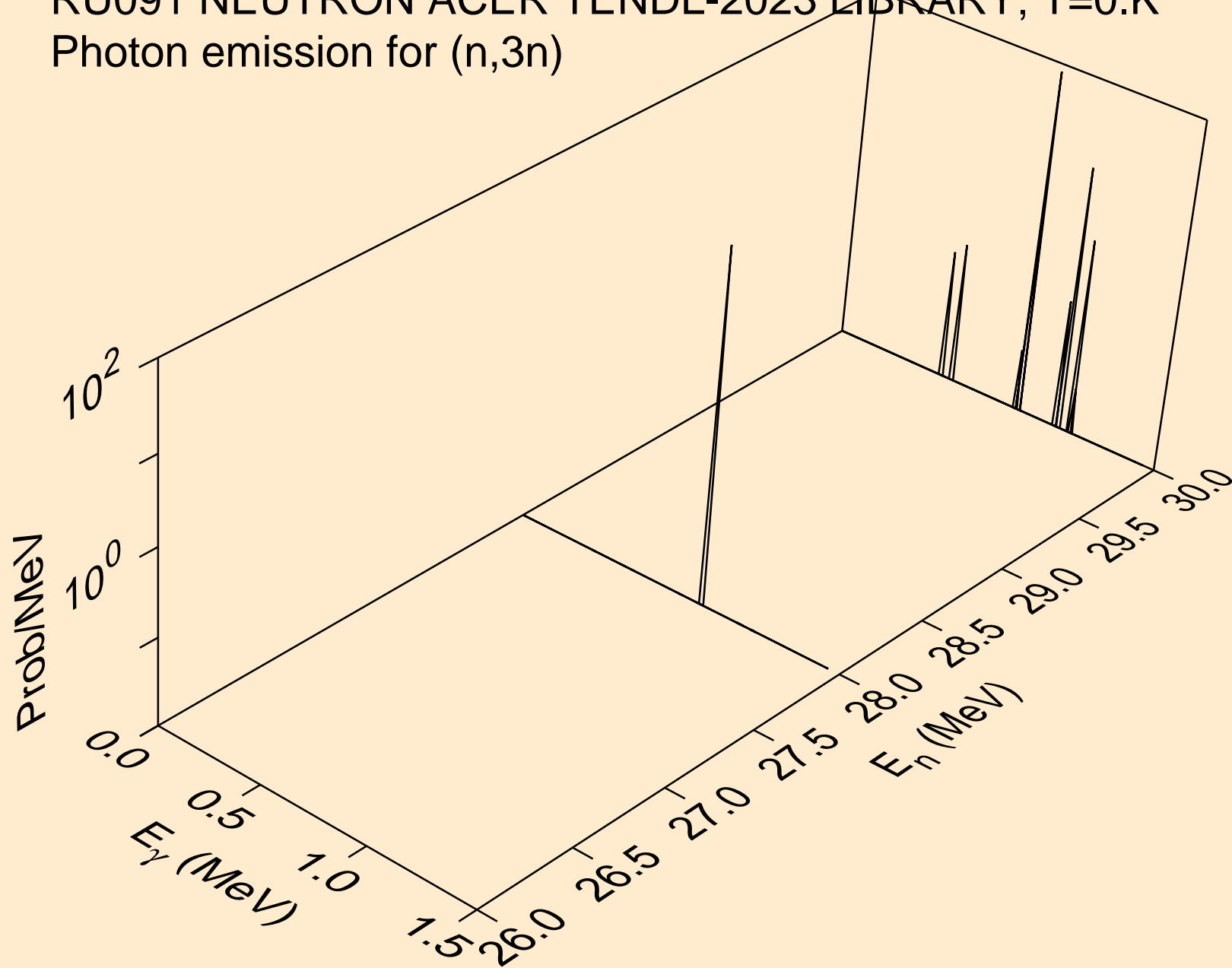



RU091 NEUTRON ACER TENDL-2023 LIBRARY; T=0.K  
Photon emission for (n,n\*)a

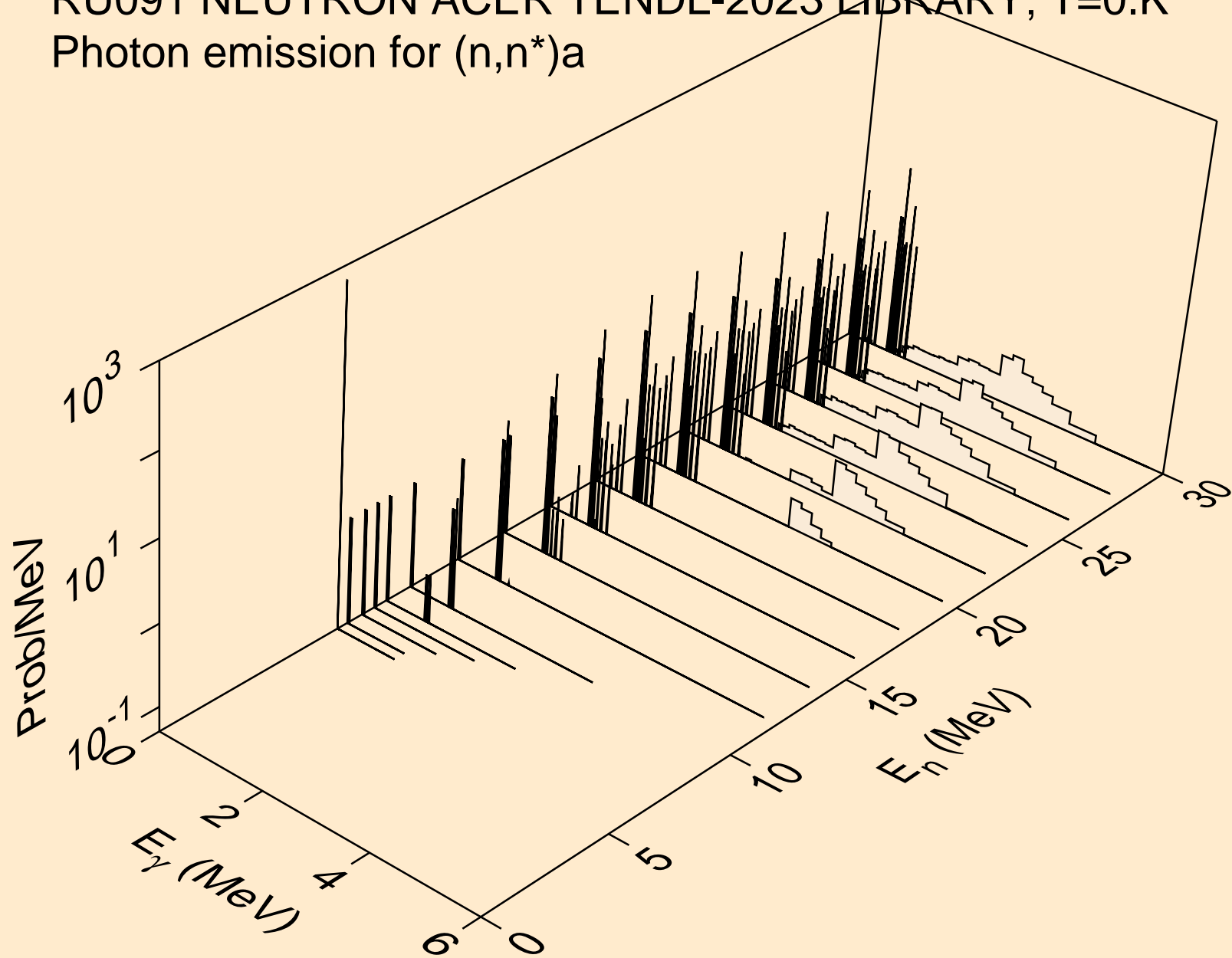

RU091 NEUTRON ACER TENDL-2023 LIBRARY; T=0.K  
Photon emission for (n,2n)a

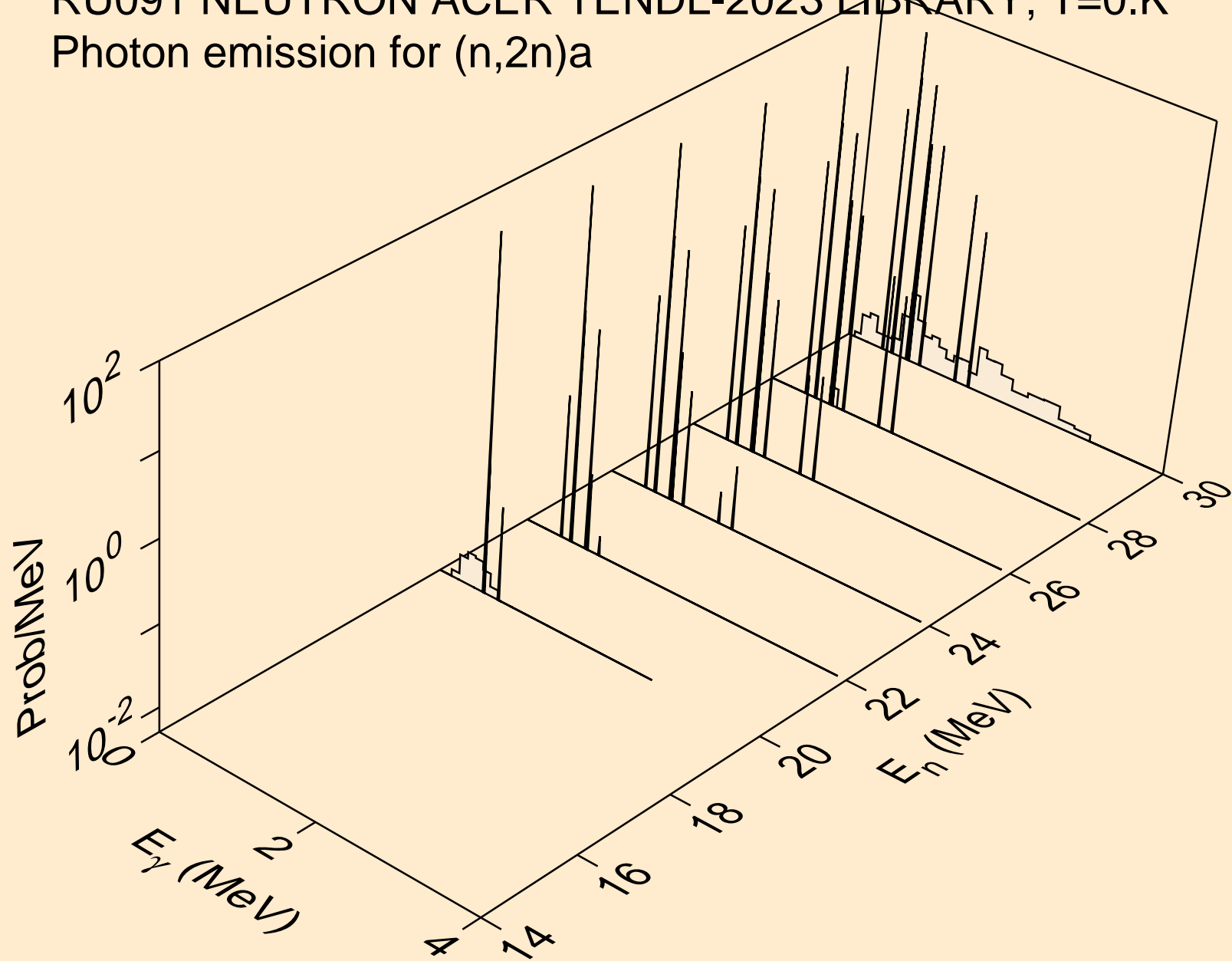

RU091 NEUTRON ACER TENDL-2023 LIBRARY; T=0.K  
Photon emission for (n,n\*)p

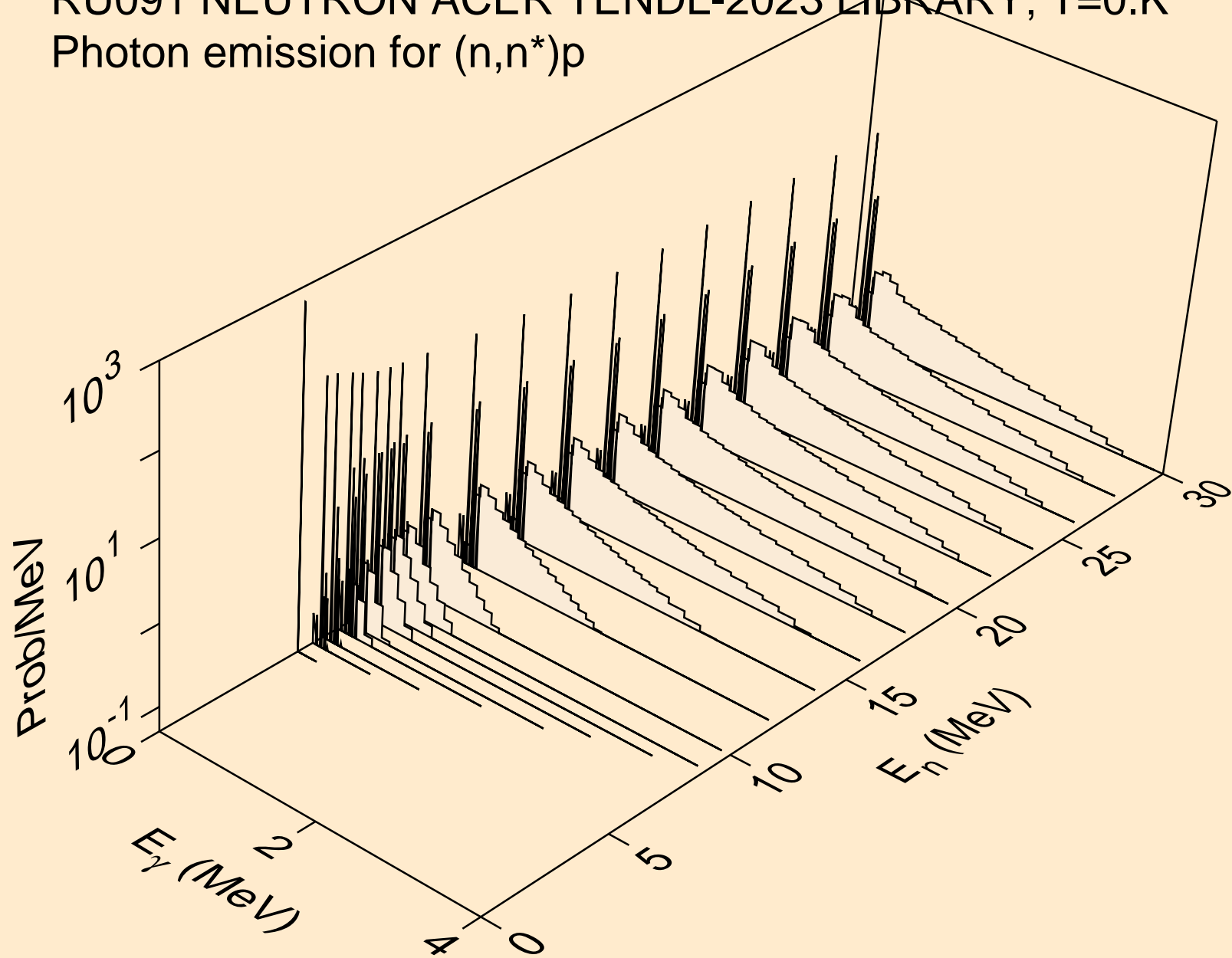

RU091 NEUTRON ACER TENDL-2023 LIBRARY; T=0.K  
Photon emission for (n,n\*)2a

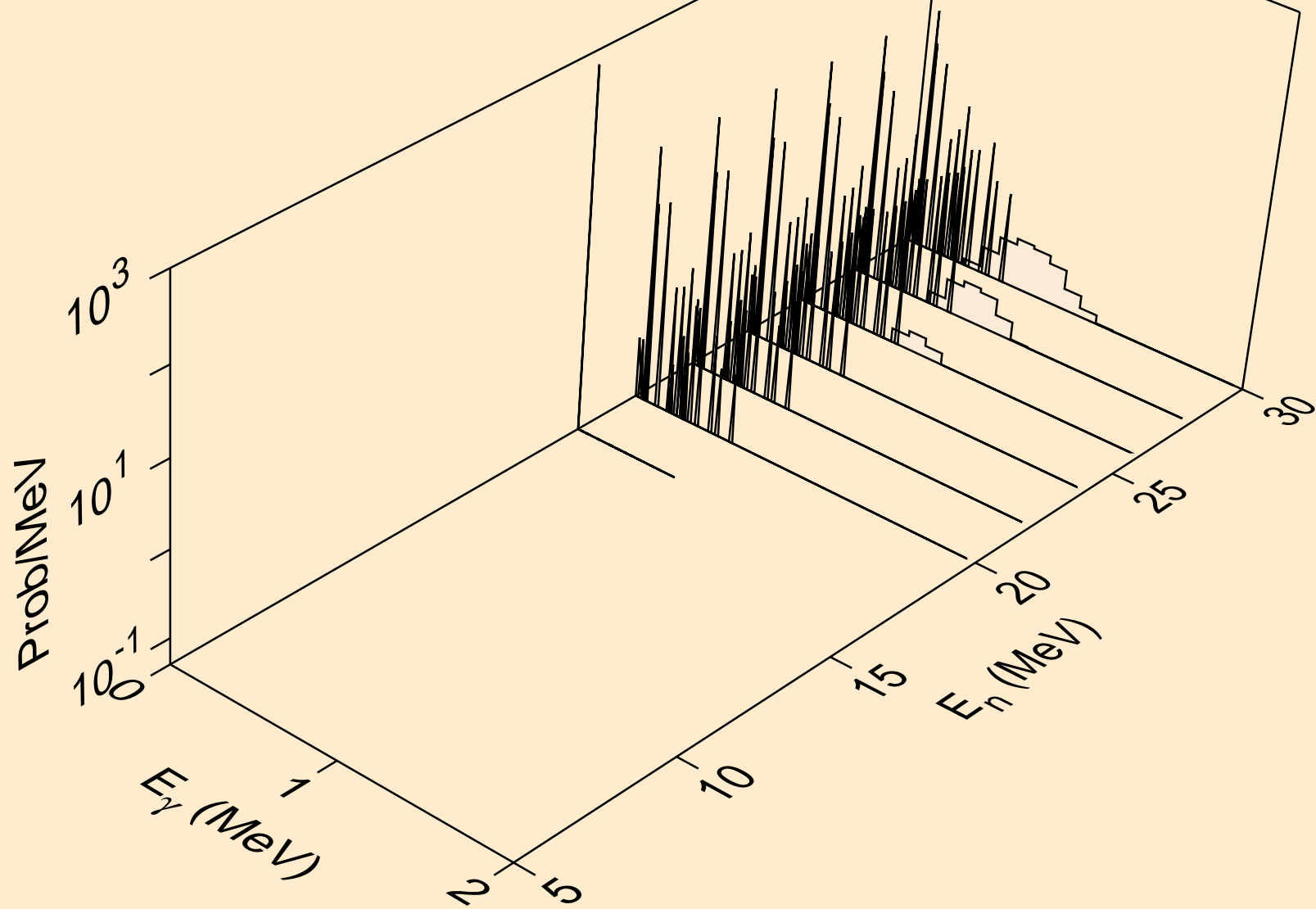

RU091 NEUTRON ACER TENDL-2023 LIBRARY; T=0.K  
Photon emission for (n,n\*)d

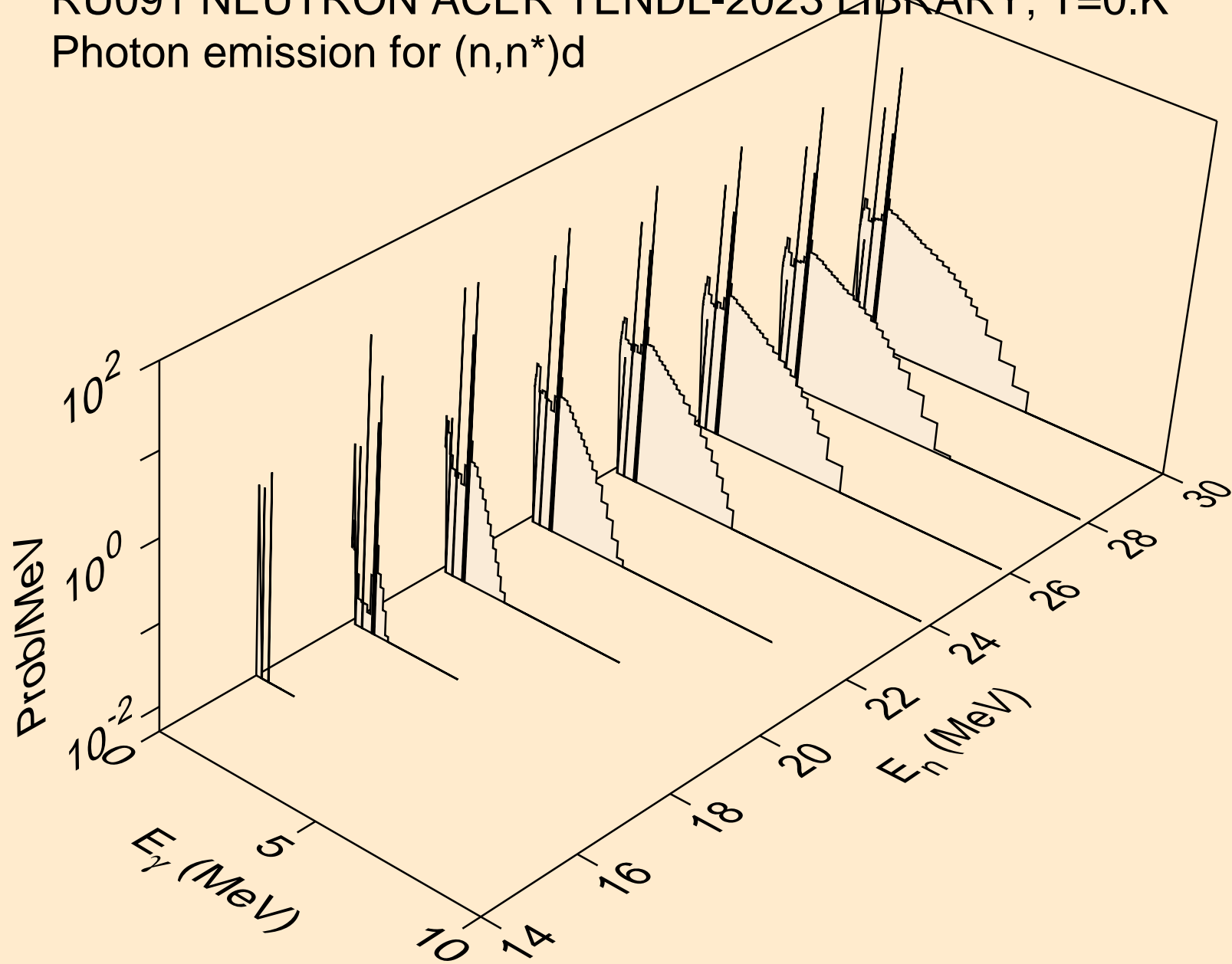

RU091 NEUTRON ACER TENDL-2023 LIBRARY; T=0.K  
Photon emission for (n,n\*)t

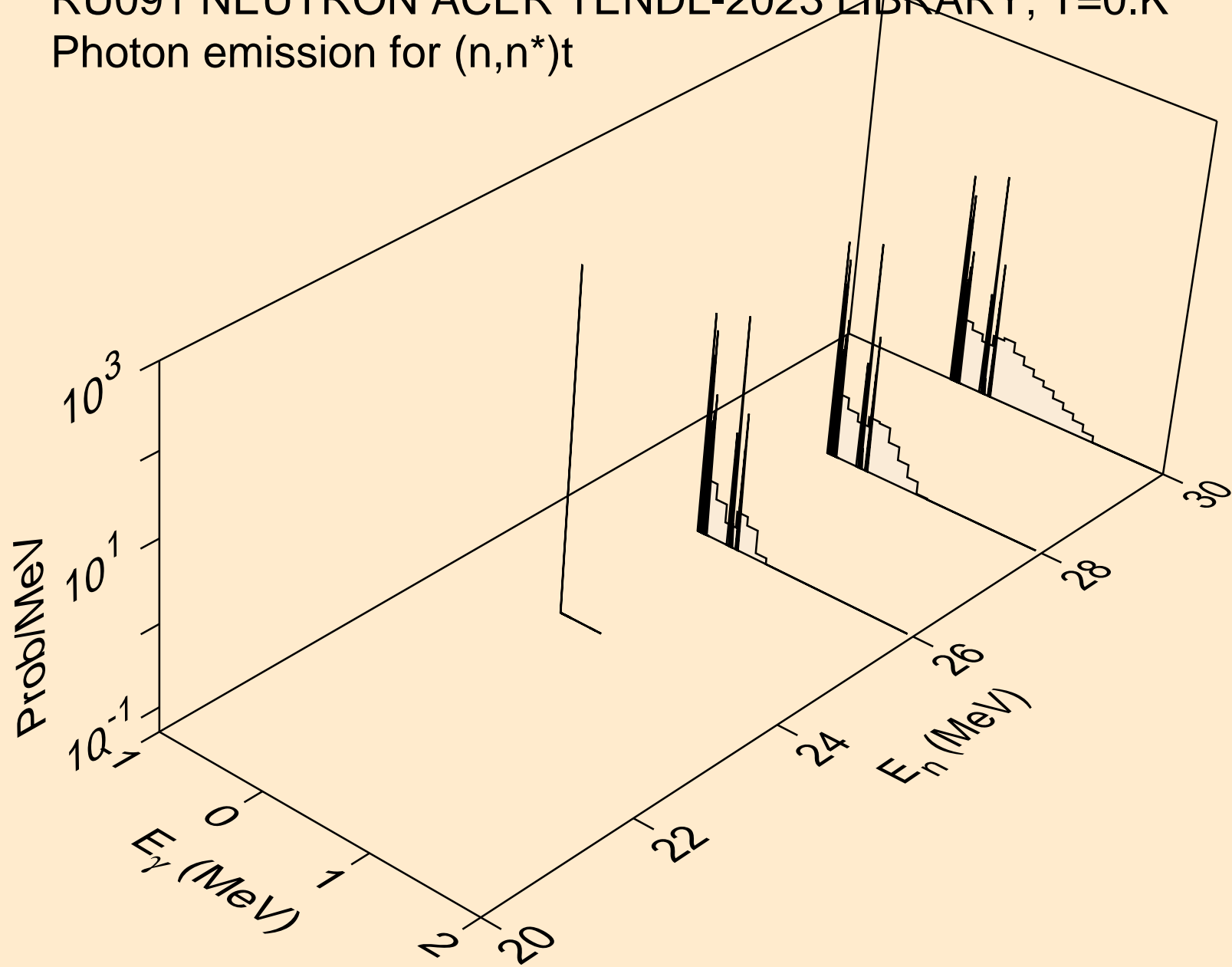

RU091 NEUTRON ACER TENDL-2023 LIBRARY; T=0.K  
Photon emission for (n,n\*)he3

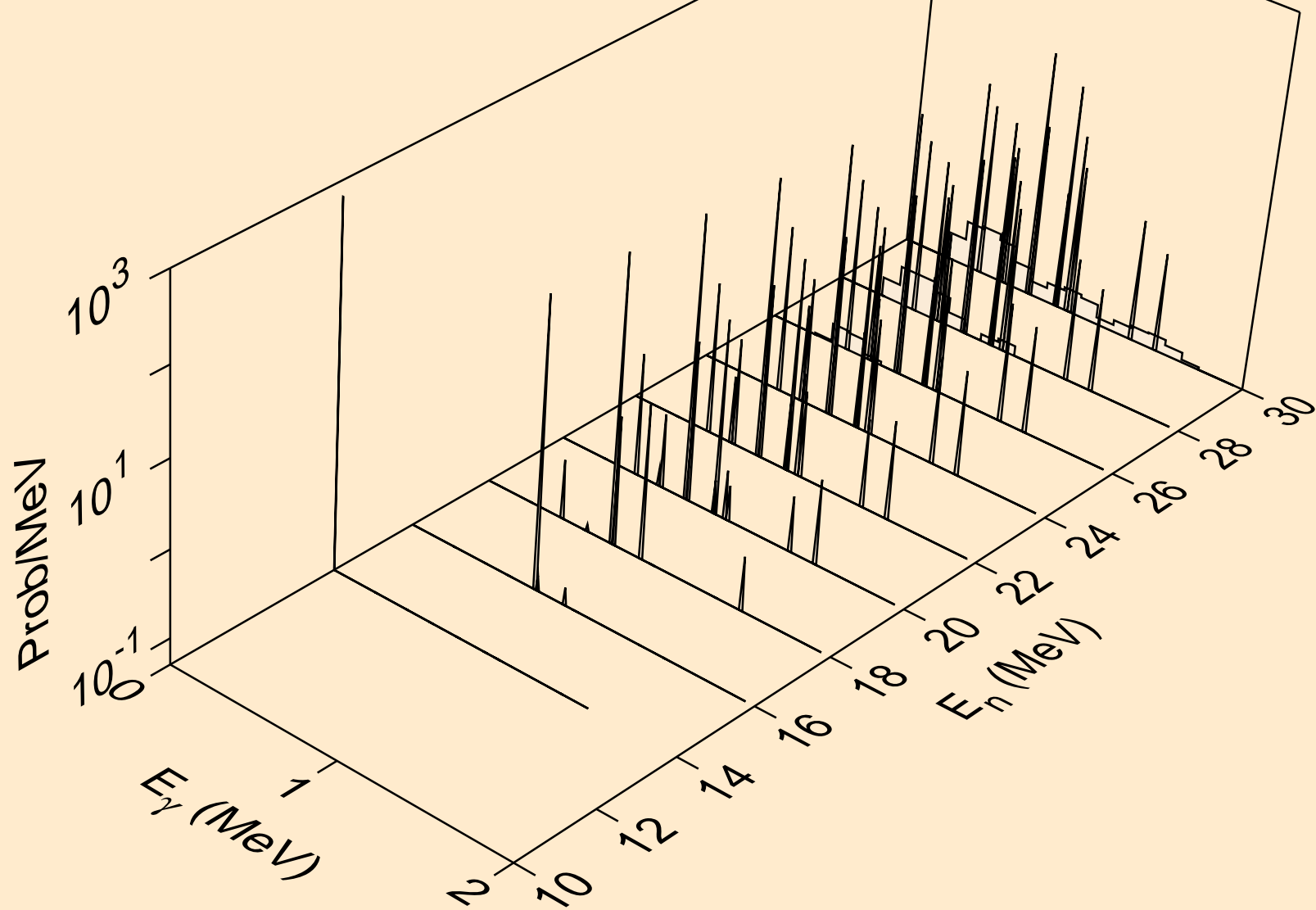

RU091 NEUTRON ACER TENDL-2023 LIBRARY; T=0.K  
Photon emission for (n,2np)

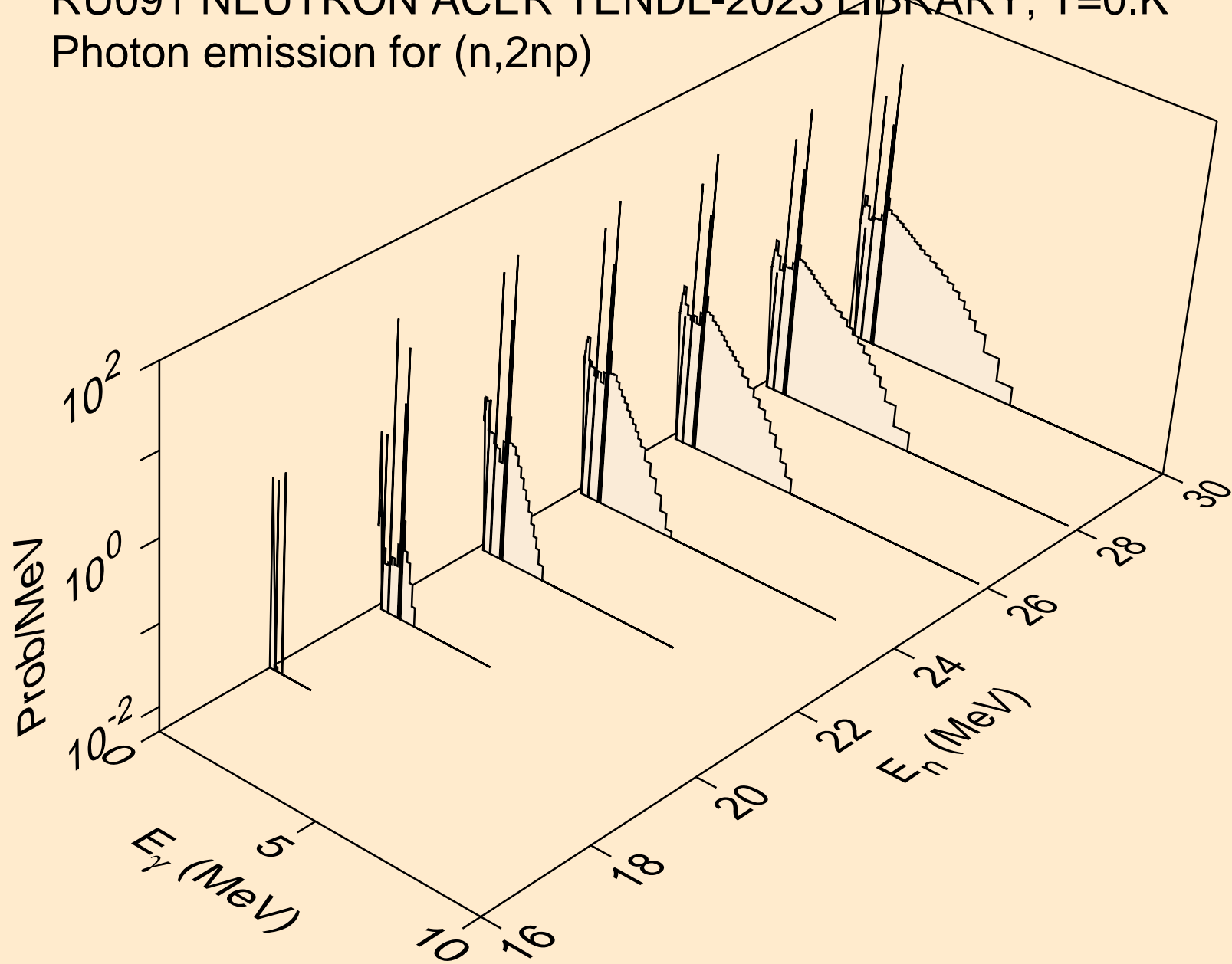



RU091 NEUTRON ACER TENDL-2023 LIBRARY; T=0.K  
Photon emission for (n,n2p)

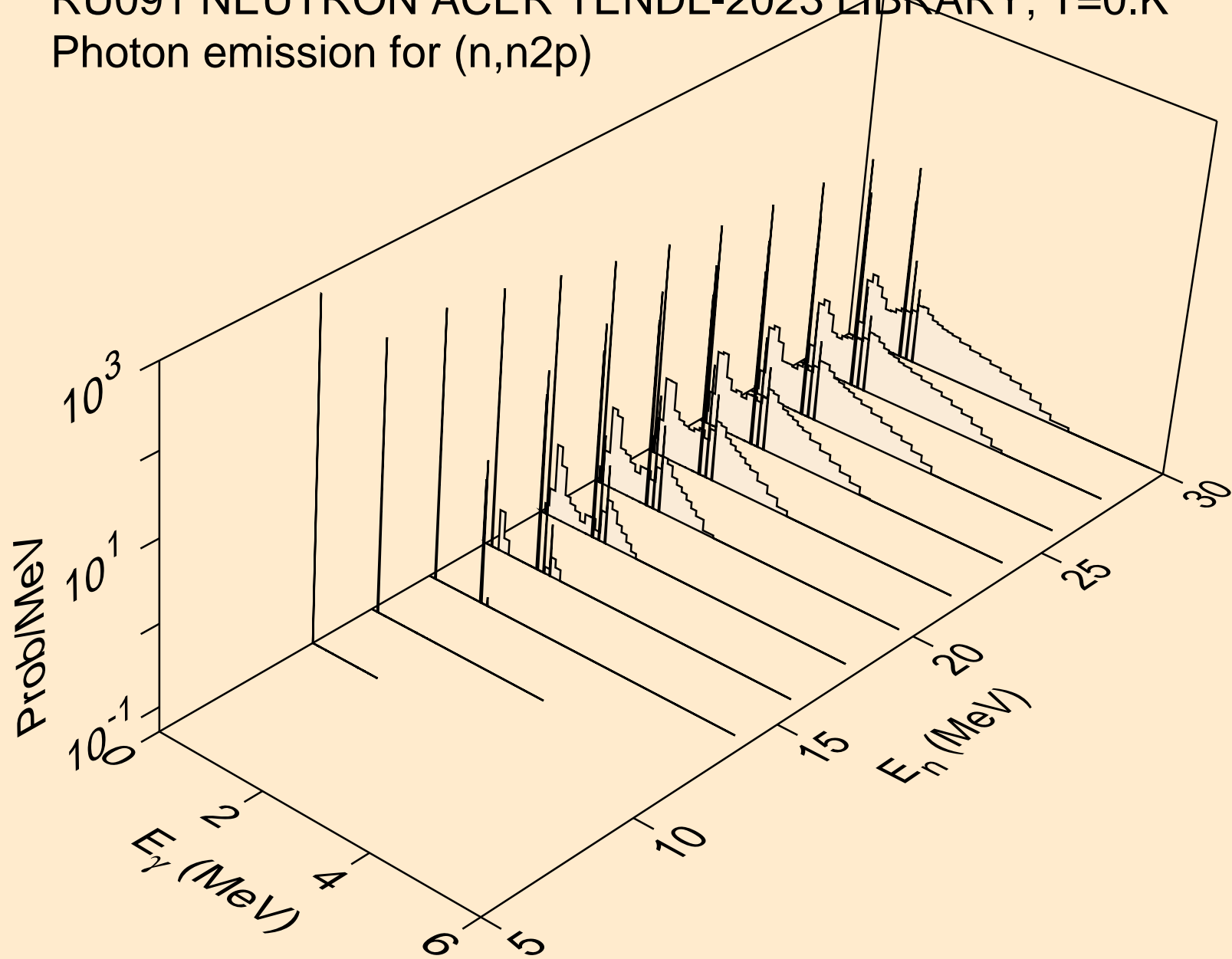

RU091 NEUTRON ACER TENDL-2023 LIBRARY; T=0.K  
Photon emission for (n,npa)

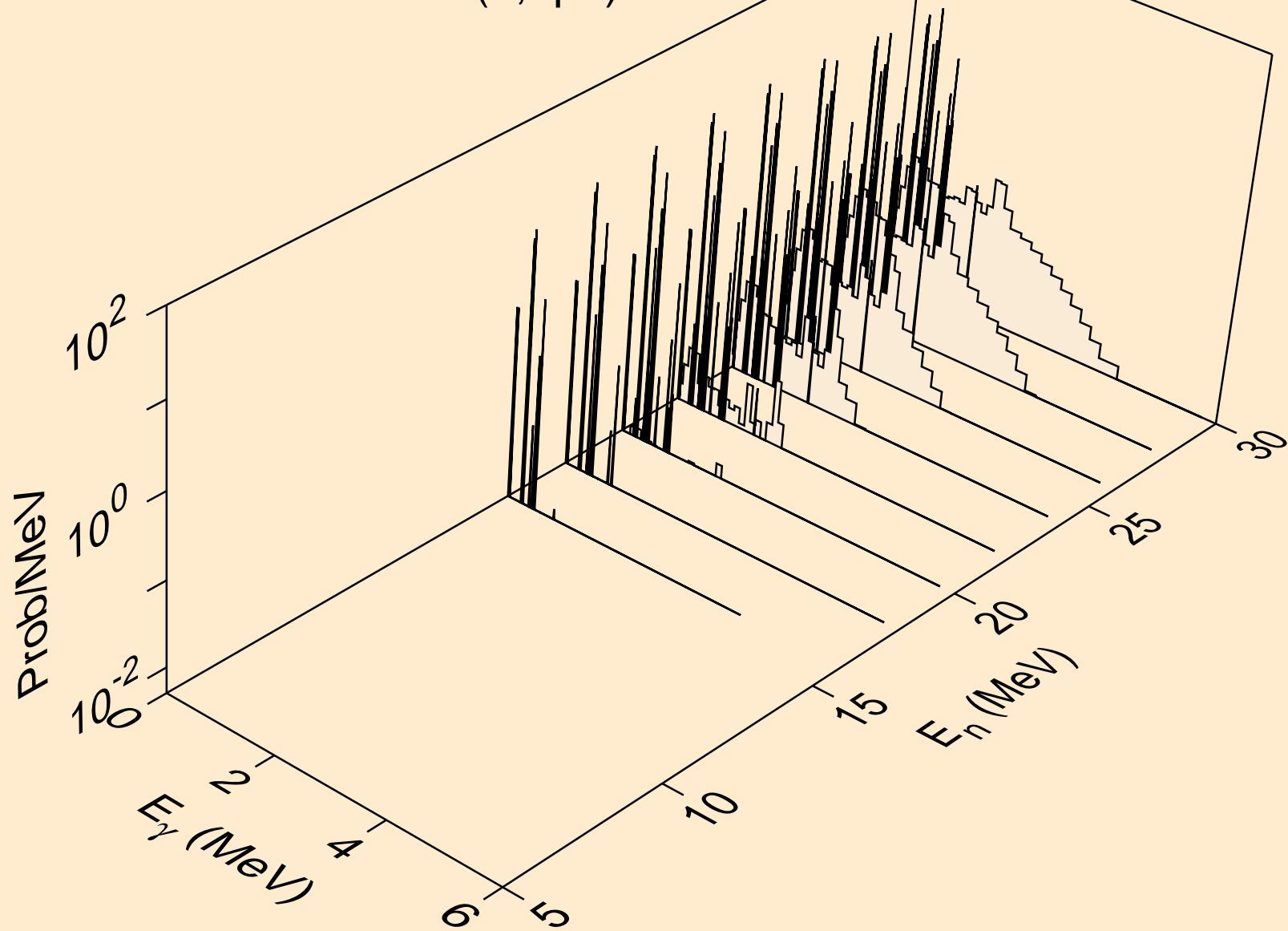

RU091 NEUTRON ACER TENDL-2023 LIBRARY; T=0.K  
Photon emission for (n,n\*c)

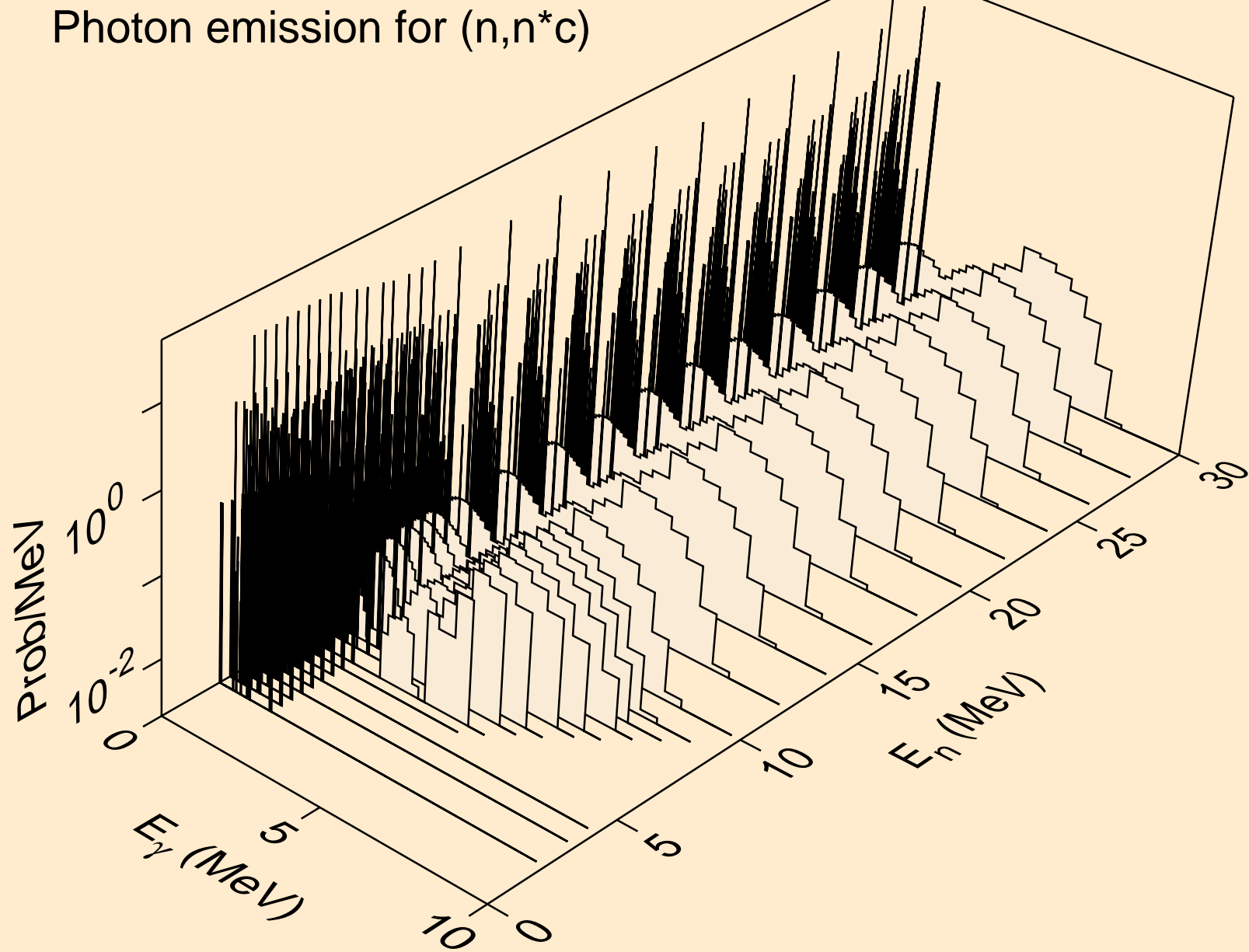

RU091 NEUTRON ACER TENDL-2023 LIBRARY; T=0.K  
Photon emission for (n,gma)

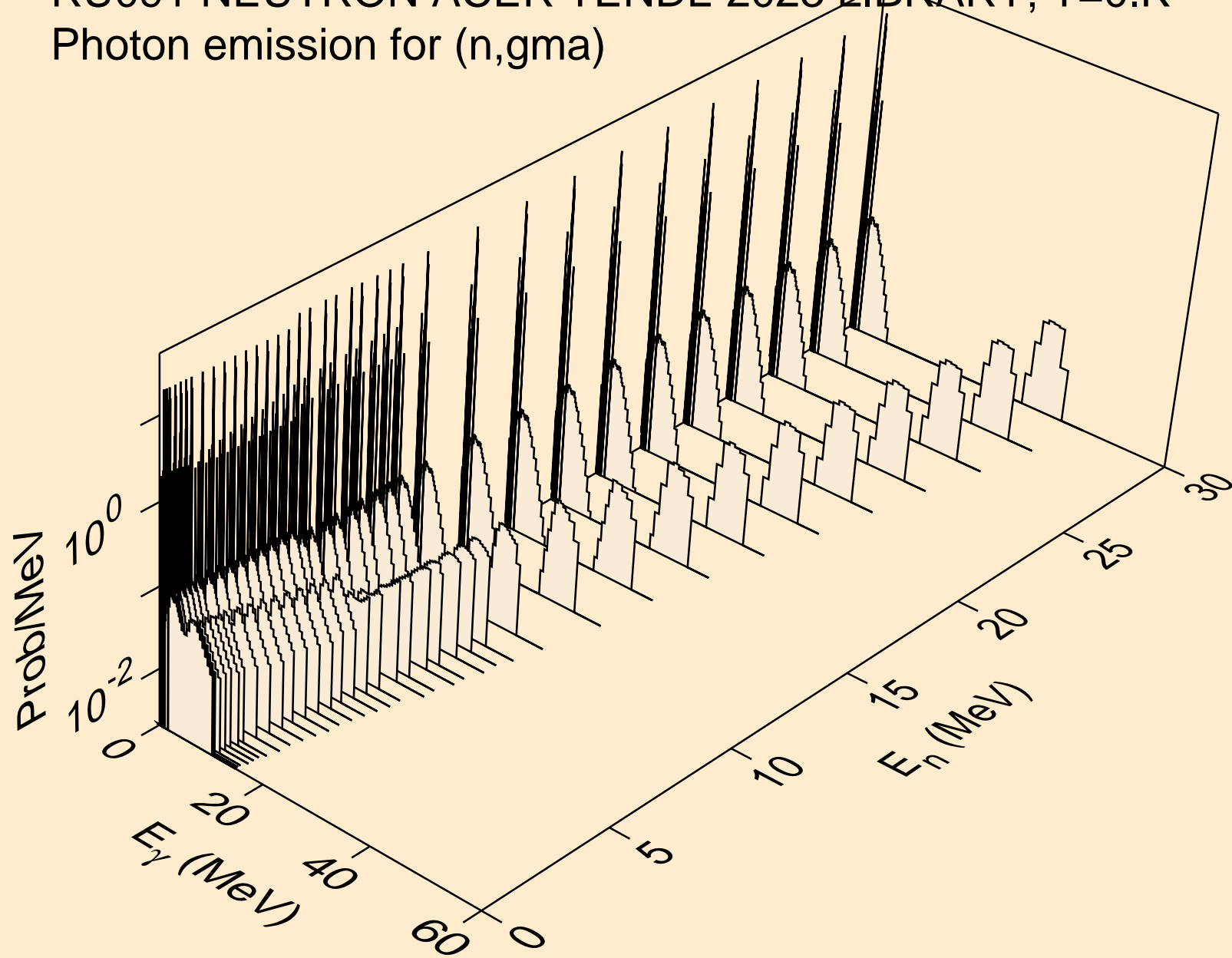

RU091 NEUTRON ACER TENDL-2023 LIBRARY; T=0.K  
Photon emission for (n,p)

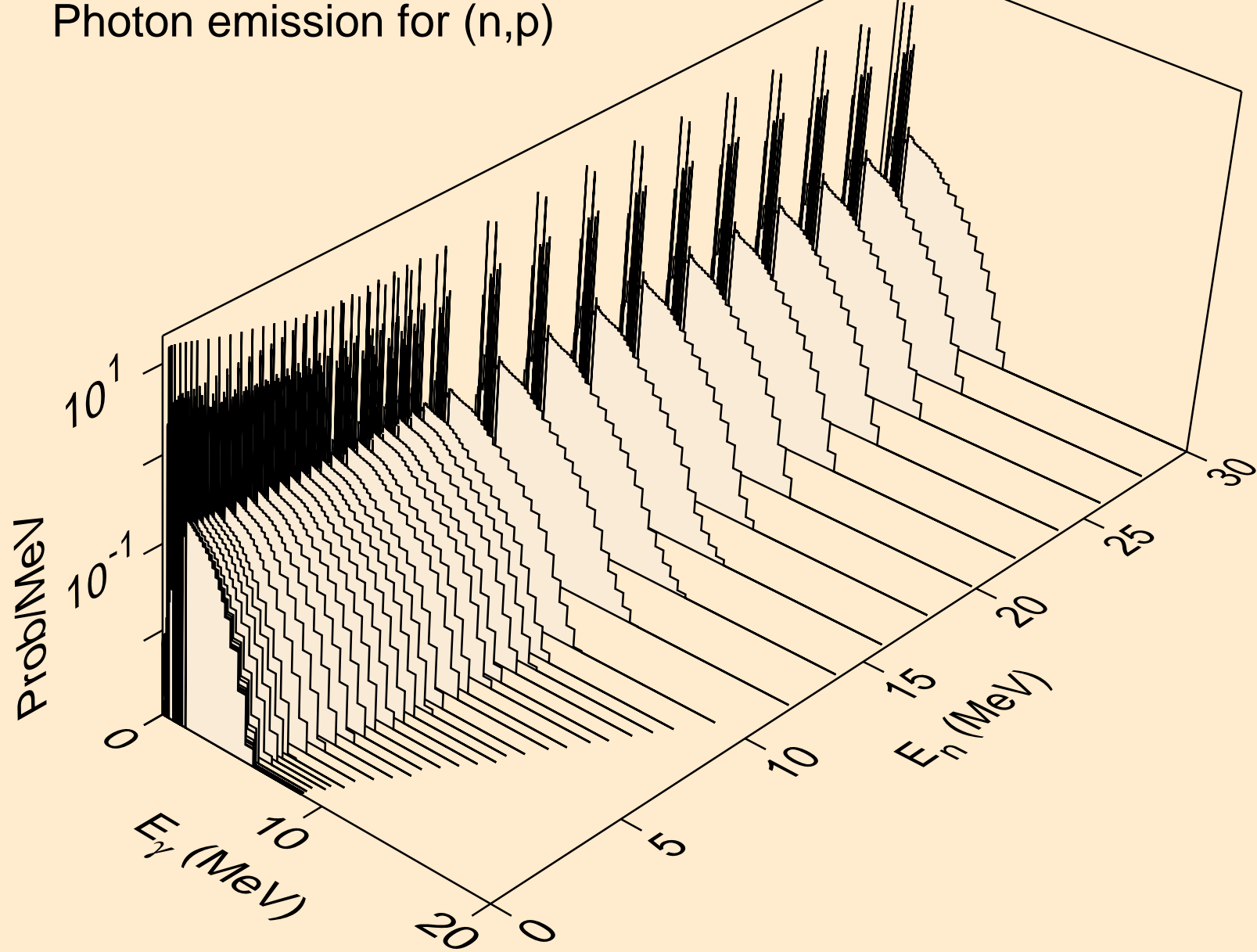

RU091 NEUTRON ACER TENDL-2023 LIBRARY; T=0.K  
Photon emission for (n,d)

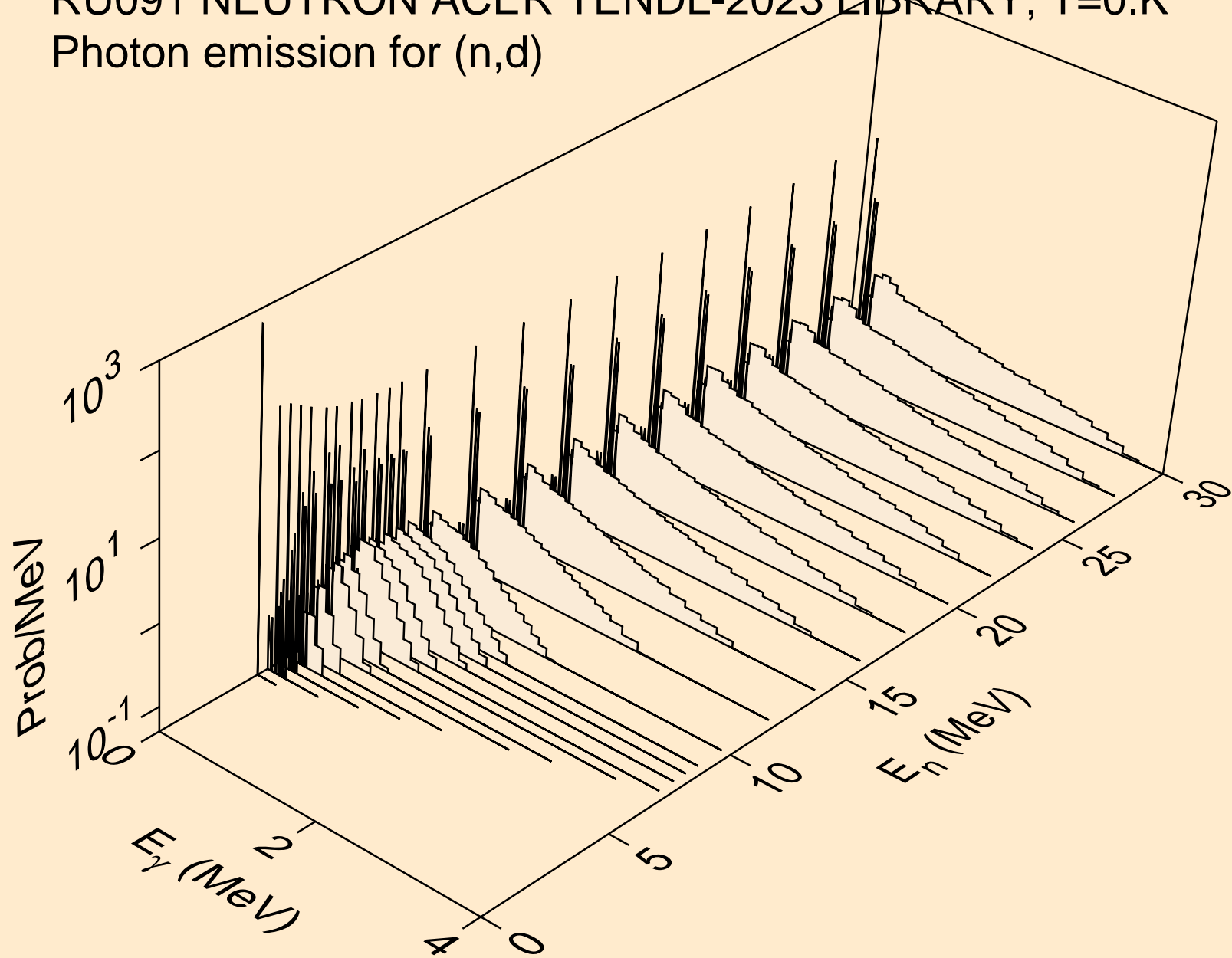

RU091 NEUTRON ACER TENDL-2023 LIBRARY; T=0.K  
Photon emission for (n,t)

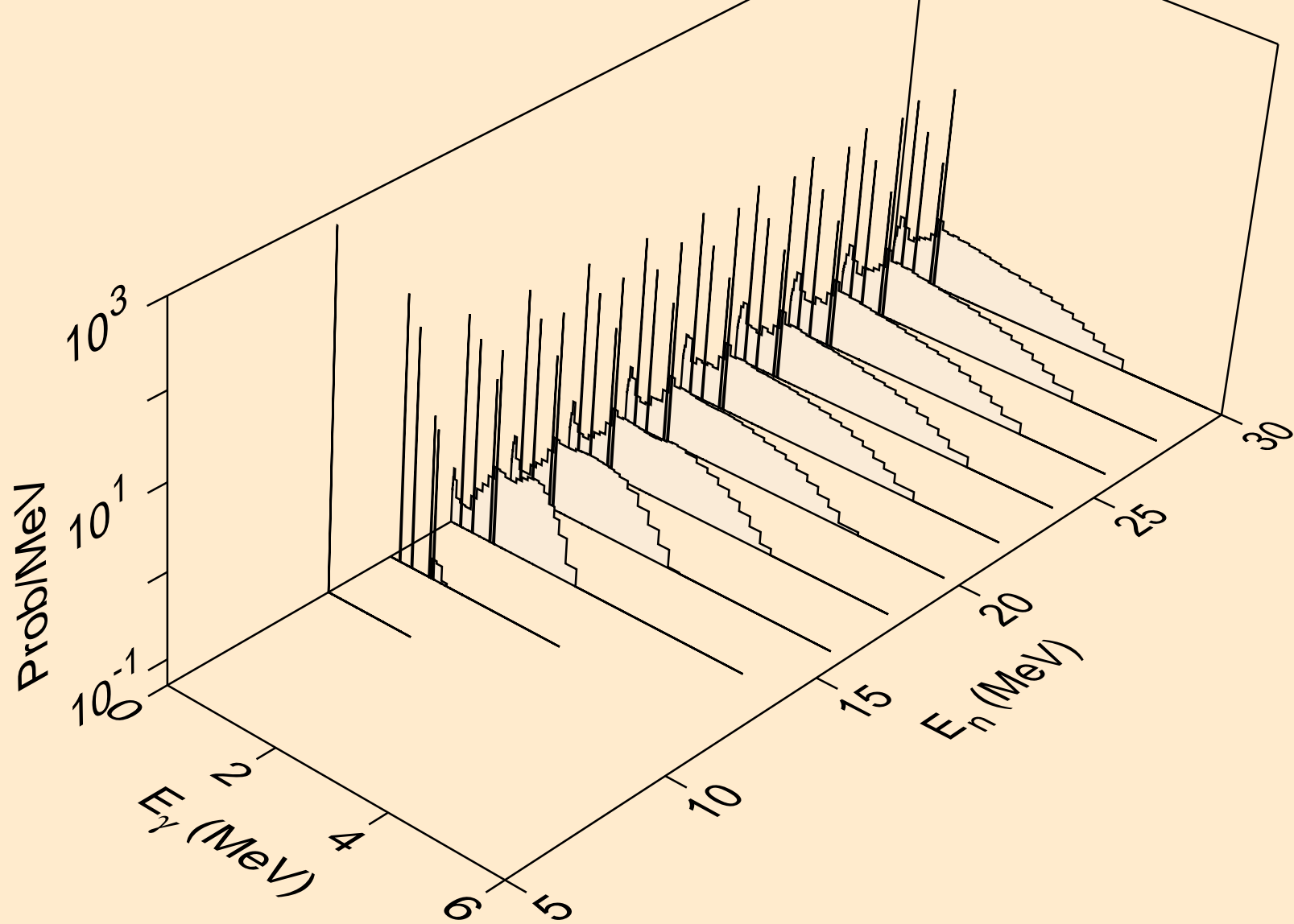

RU091 NEUTRON ACER TENDL-2023 LIBRARY; T=0.K  
Photon emission for (n,he3)

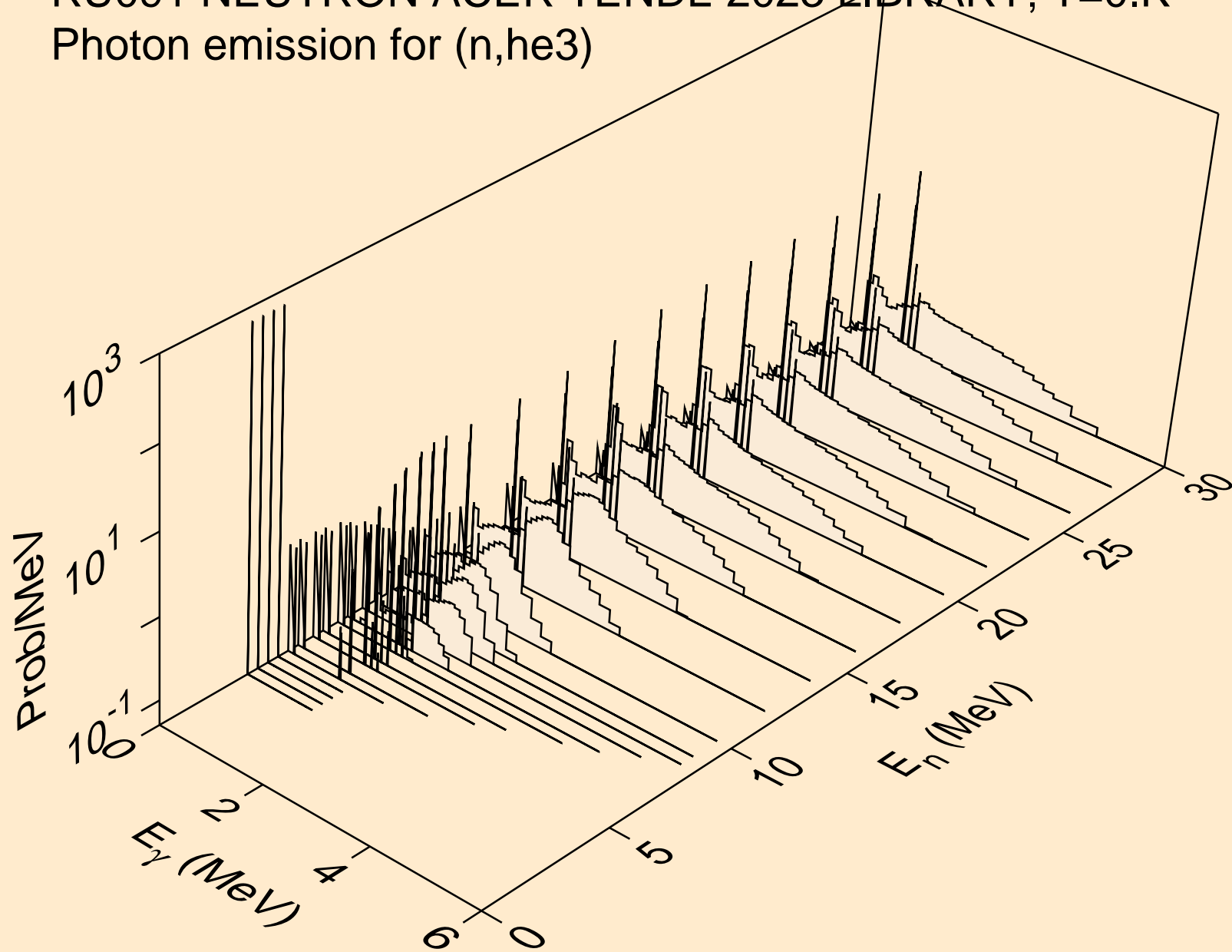



RU091 NEUTRON ACER TENDL-2023 LIBRARY; T=0.K  
Photon emission for (n,a)

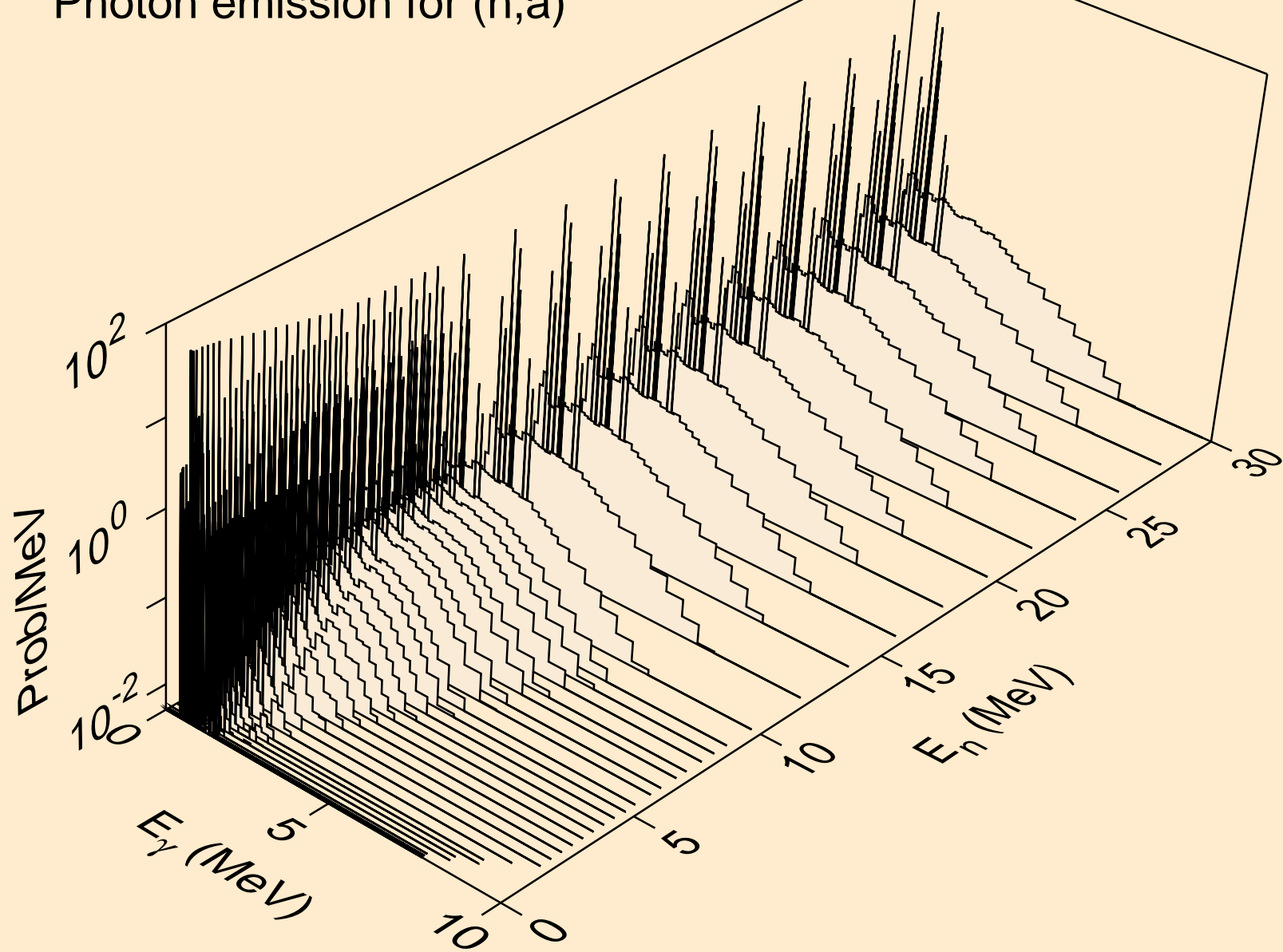

RU091 NEUTRON ACER TENDL-2023 LIBRARY; T=0.K  
Photon emission for (n,2a)

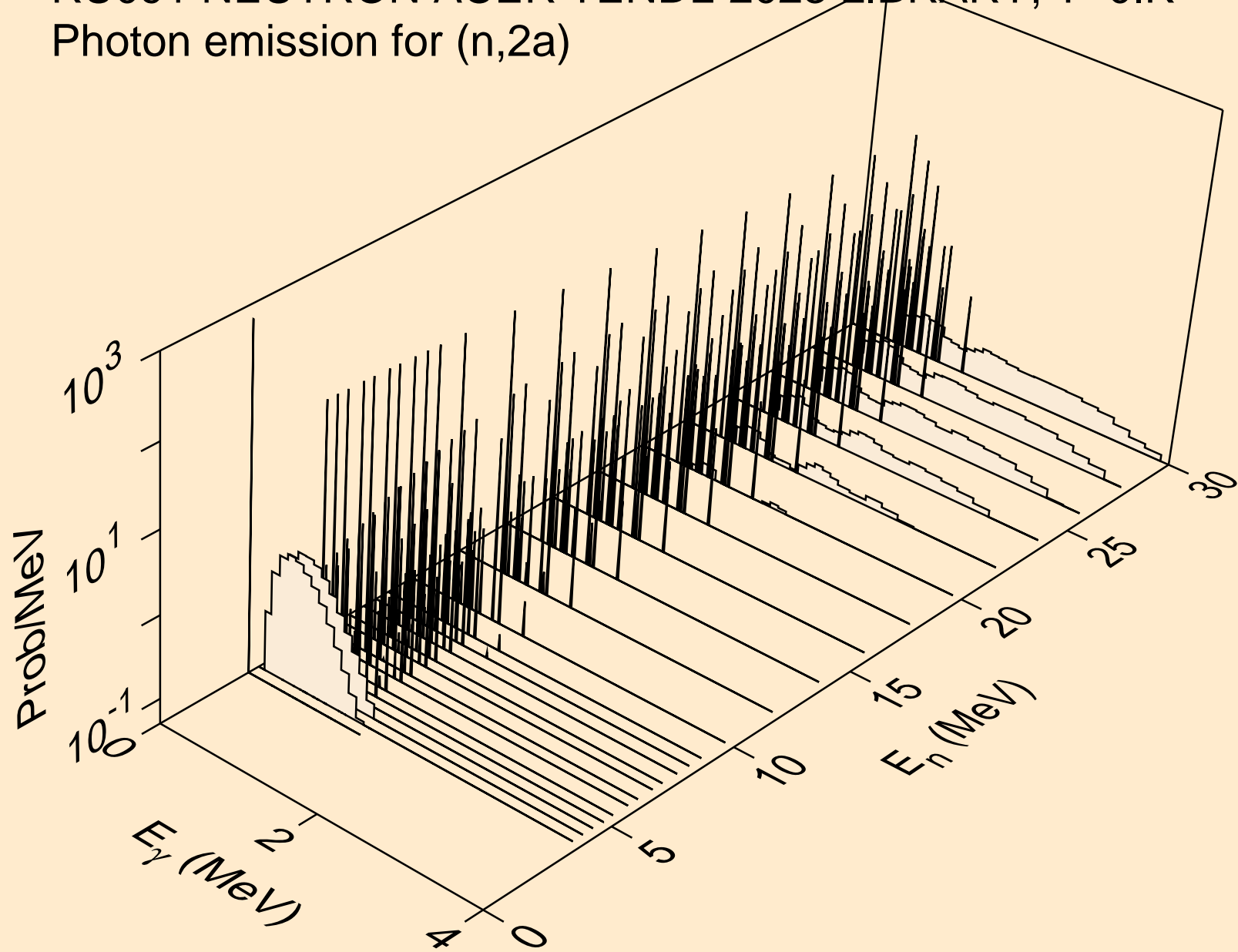

RU091 NEUTRON ACER TENDL-2023 LIBRARY; T=0.K  
Photon emission for (n,3a)

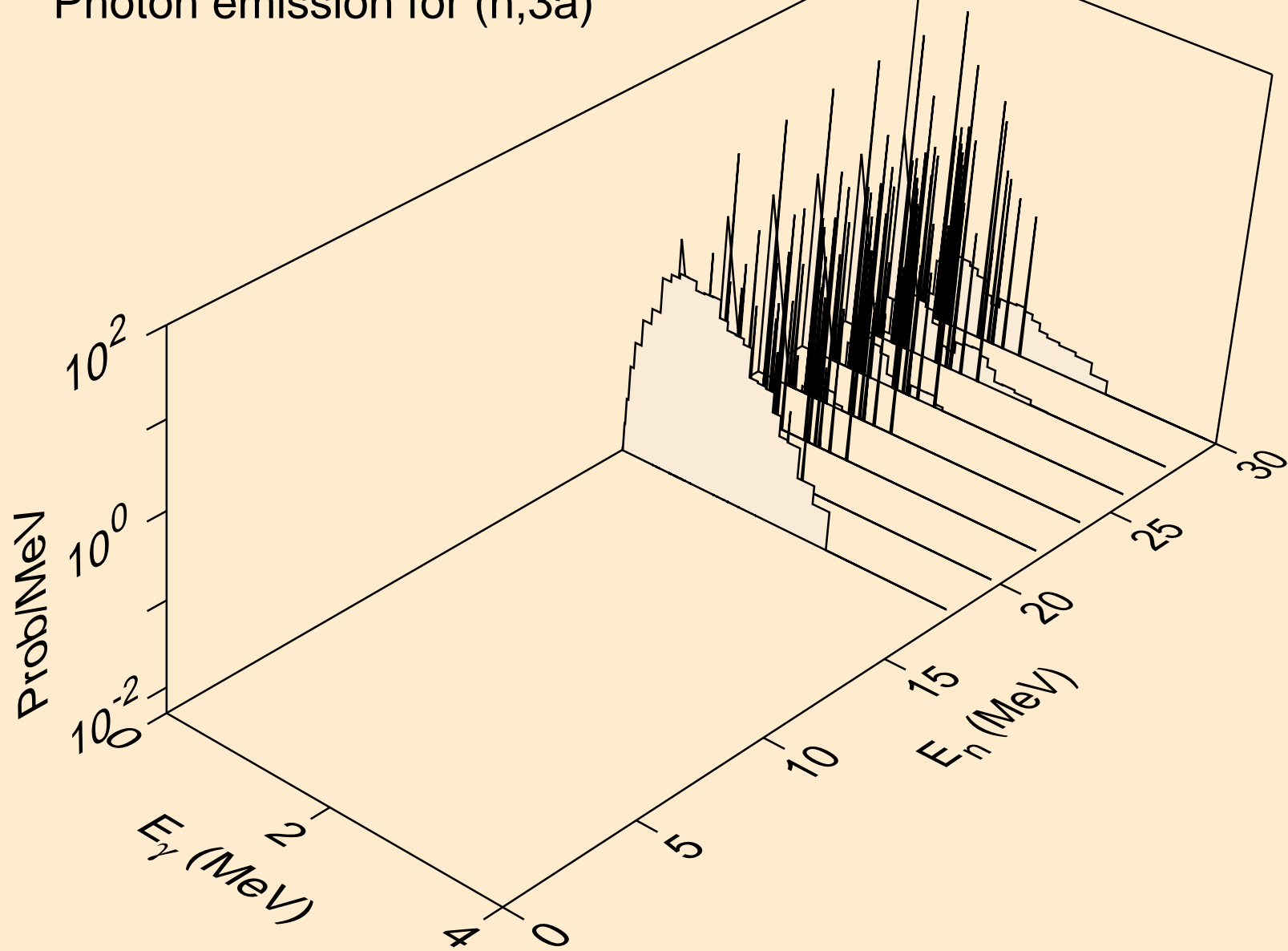

RU091 NEUTRON ACER TENDL-2023 LIBRARY; T=0.K  
Photon emission for (n,2p)

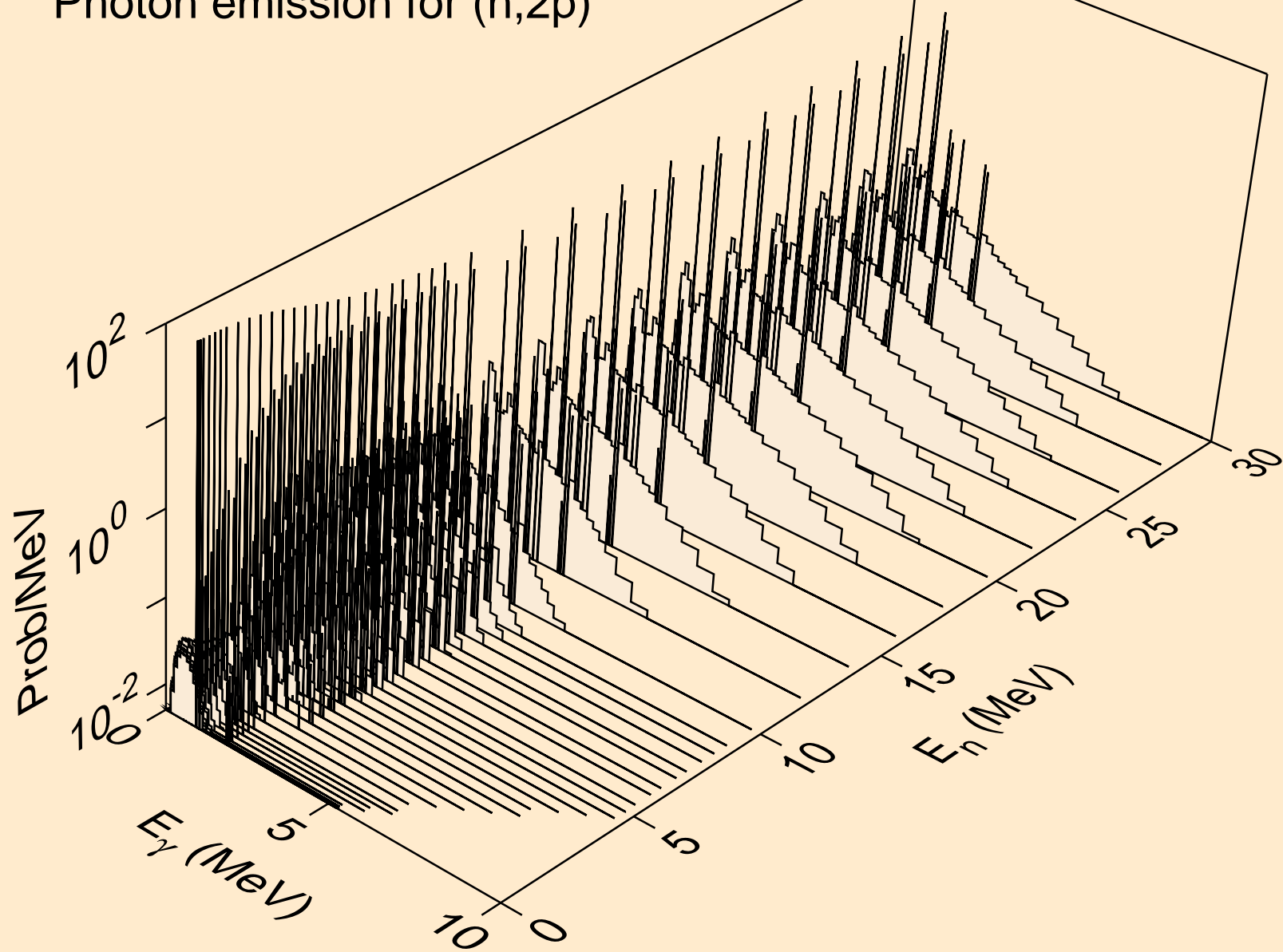

RU091 NEUTRON ACER TENDL-2023 LIBRARY; T=0.K  
Photon emission for (n,p $\alpha$ )

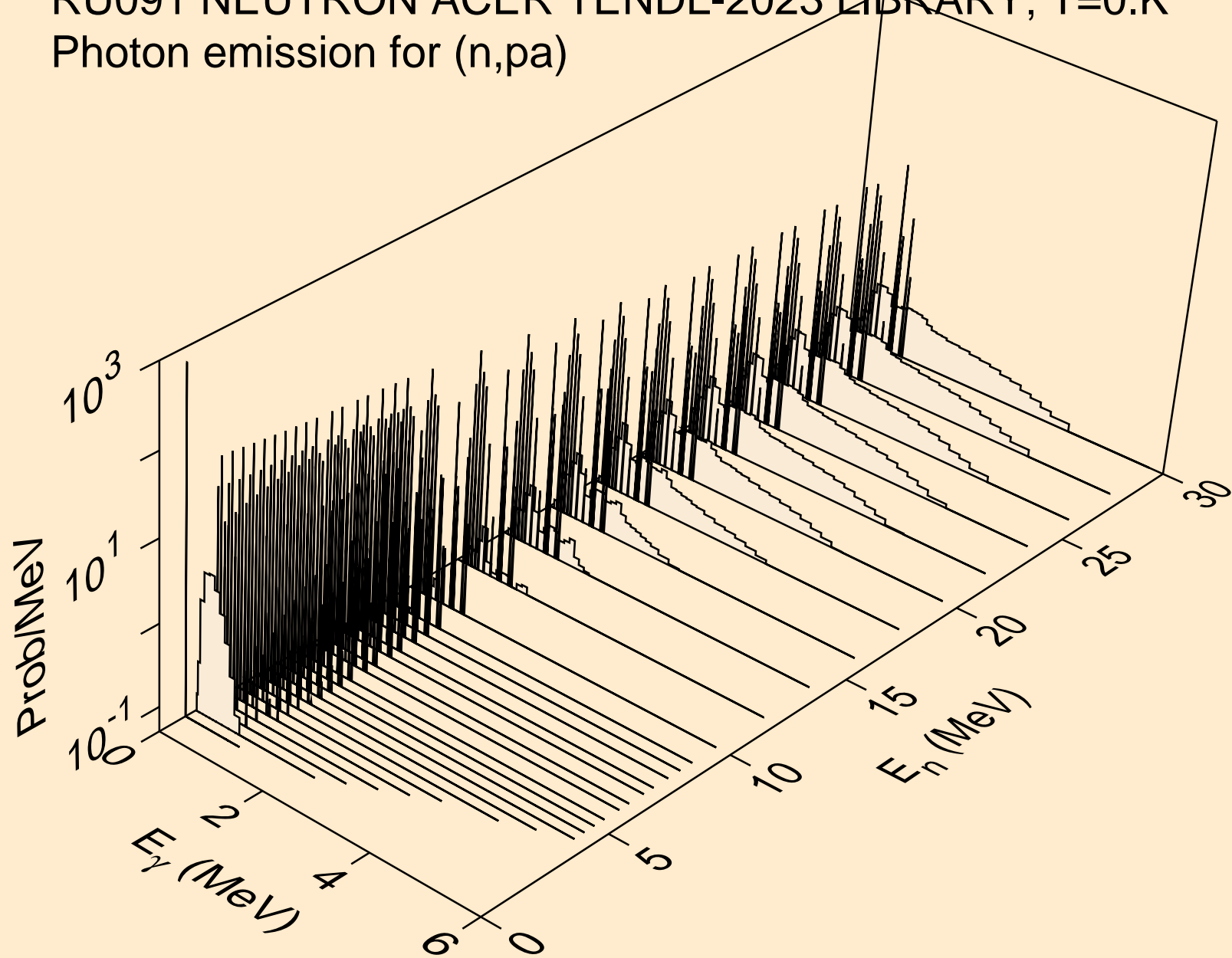

RU091 NEUTRON ACER TENDL-2023 LIBRARY; T=0.K  
Photon emission for (n,pd)

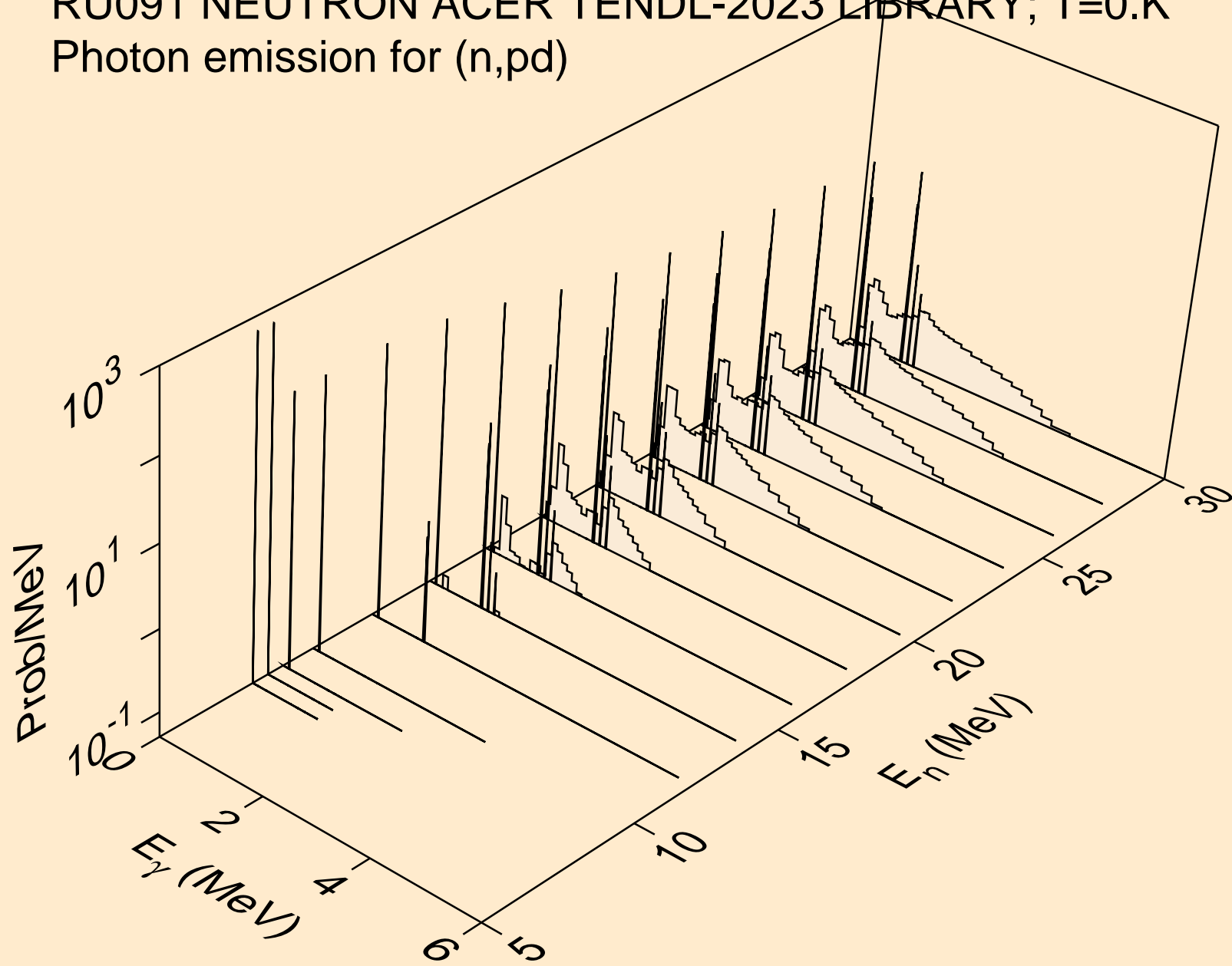

RU091 NEUTRON ACER TENDL-2023 LIBRARY; T=0.K  
Photon emission for (n,pt)

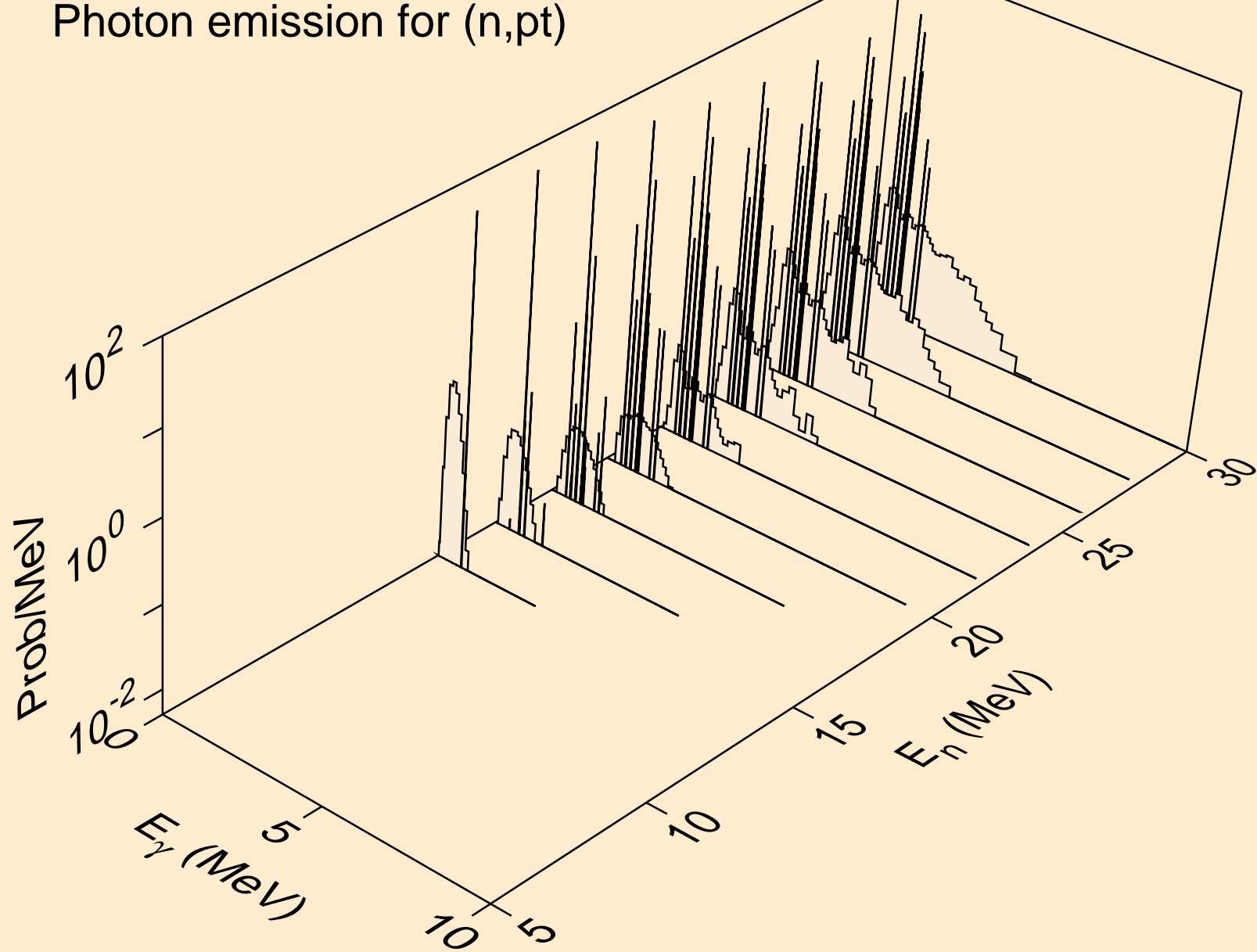

RU091 NEUTRON ACER TENDL-2023 LIBRARY; T=0.K  
Photon emission for (n,da)

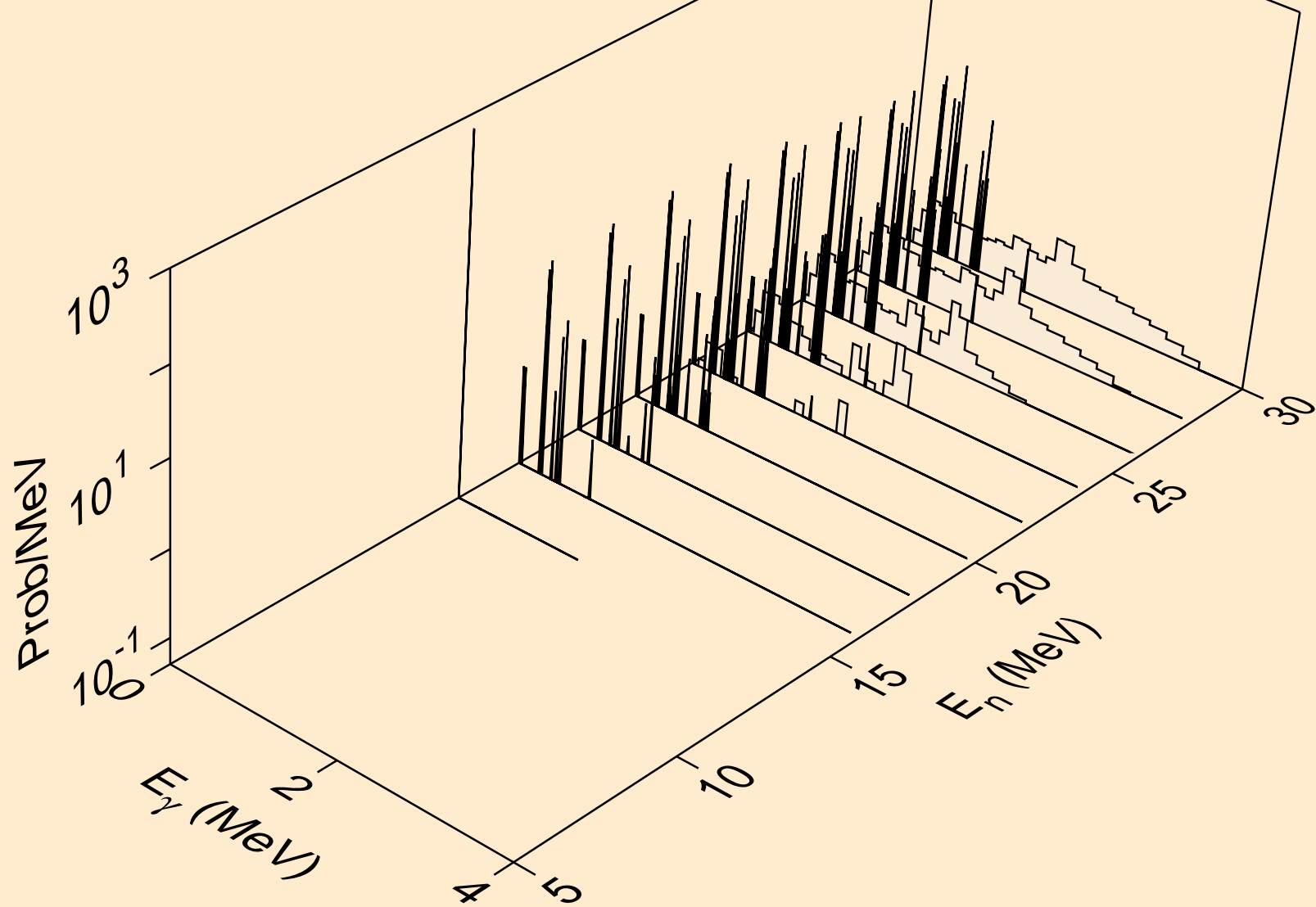



RU091 NEUTRON ACER TENDL-2023 LIBRARY; T=0.K  
thermal capture photon spectrum

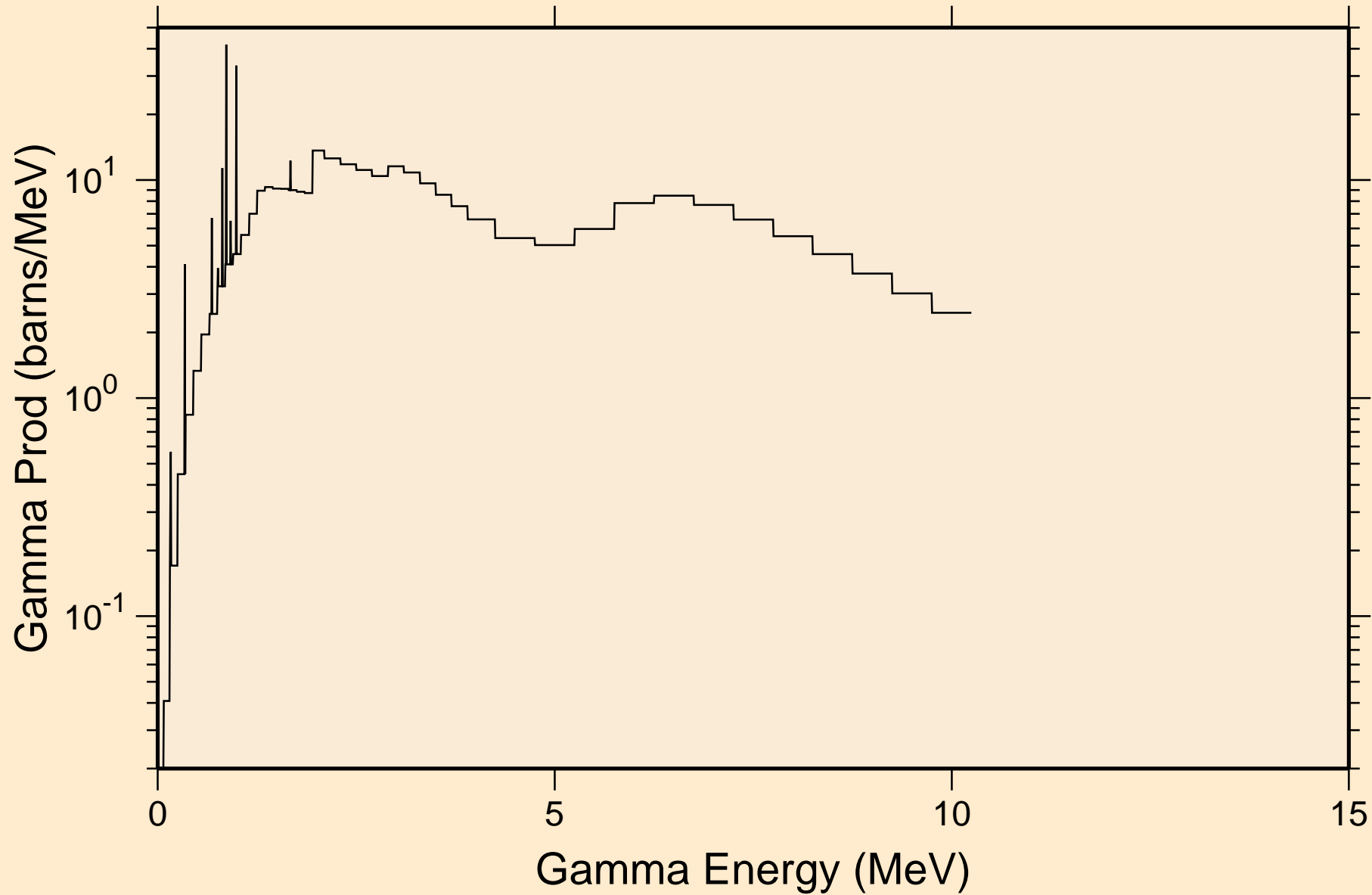

RU091 NEUTRON ACER TENDL-2023 LIBRARY; T=0.K  
14 MeV photon spectrum

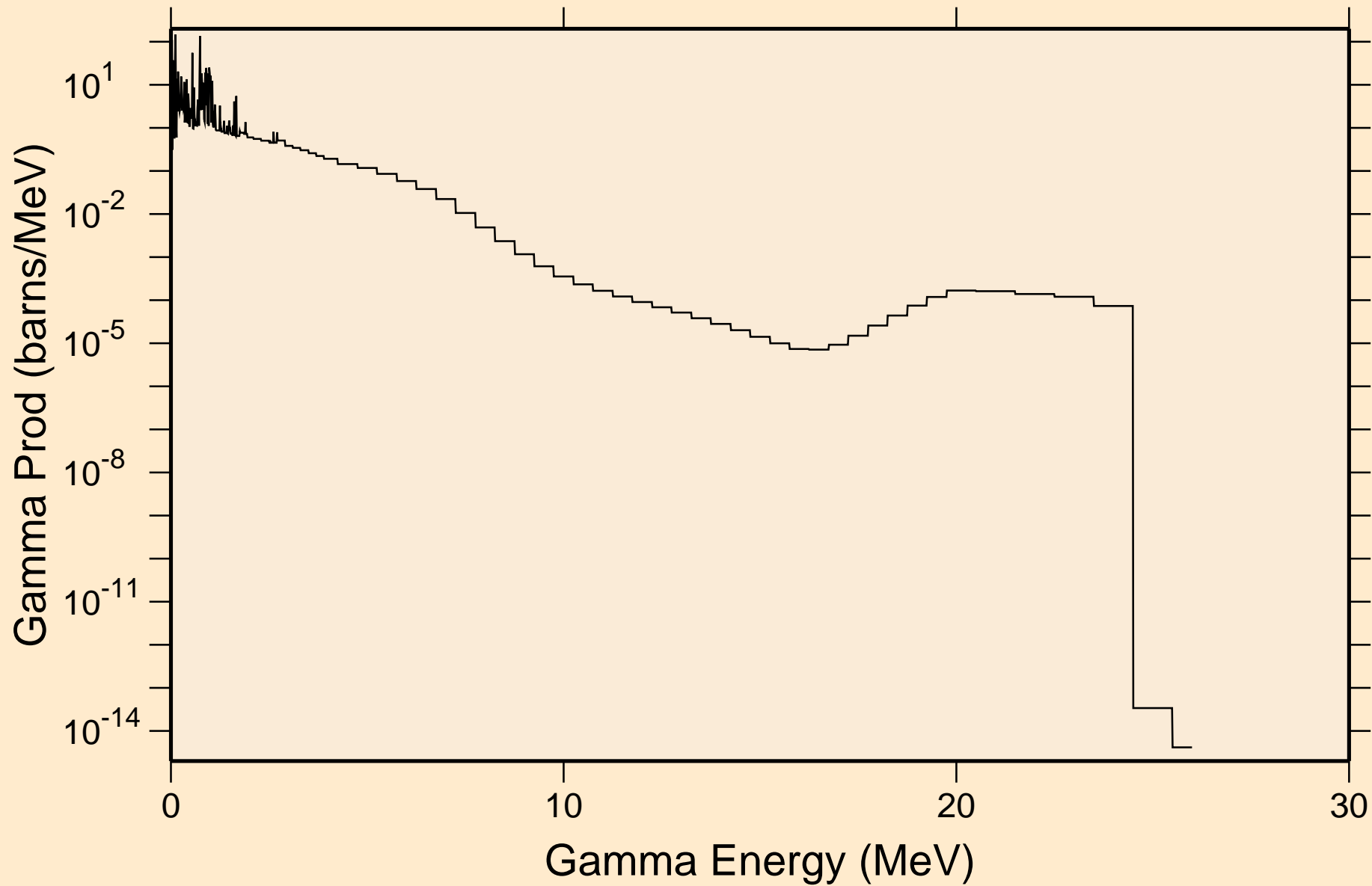

RU091 NEUTRON ACER TENDL-2023 LIBRARY; T=0.K  
Particle heating contributions

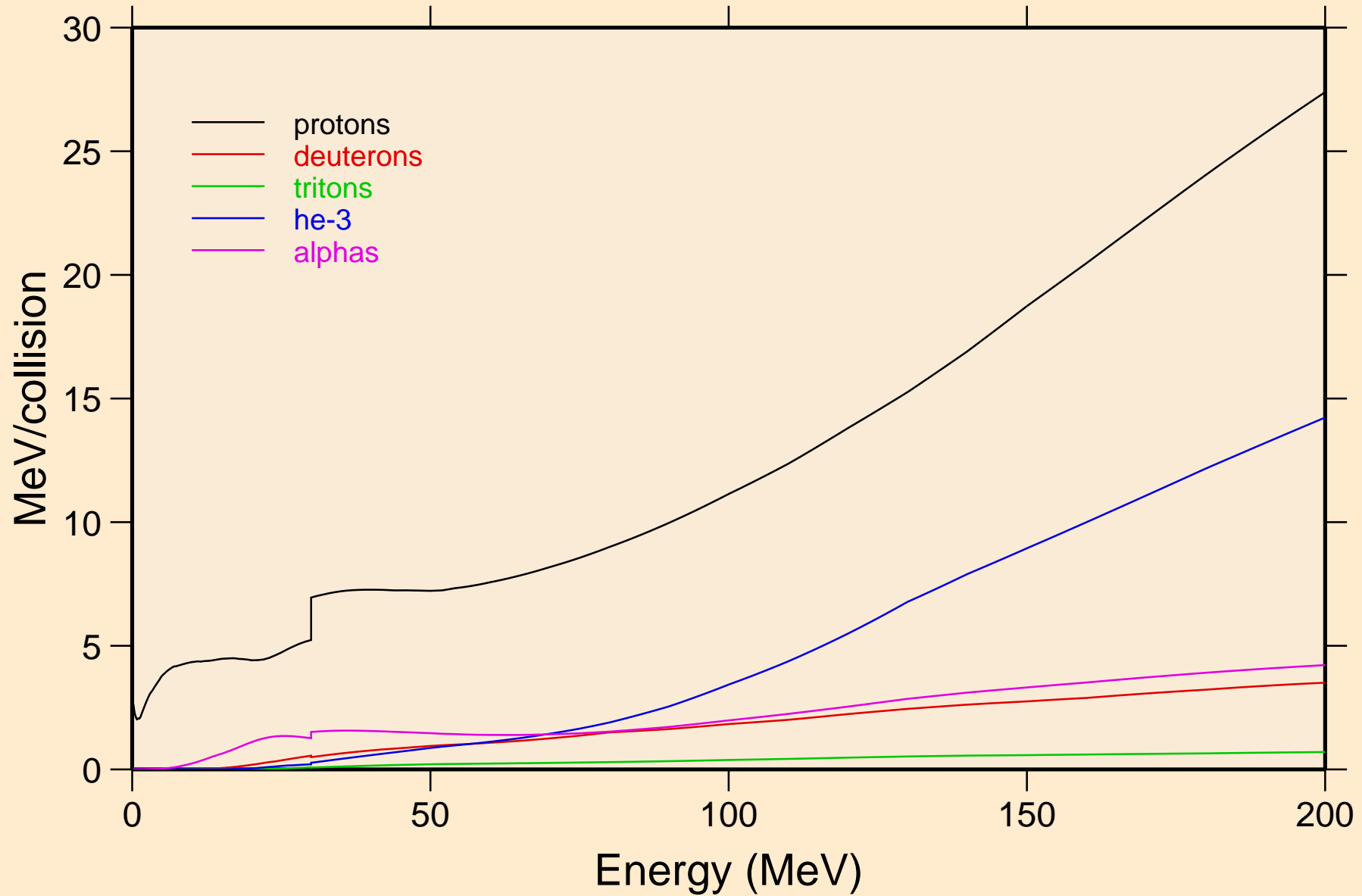

RU091 NEUTRON ACER TENDL-2023 LIBRARY; T=0.K  
Recoil Heating

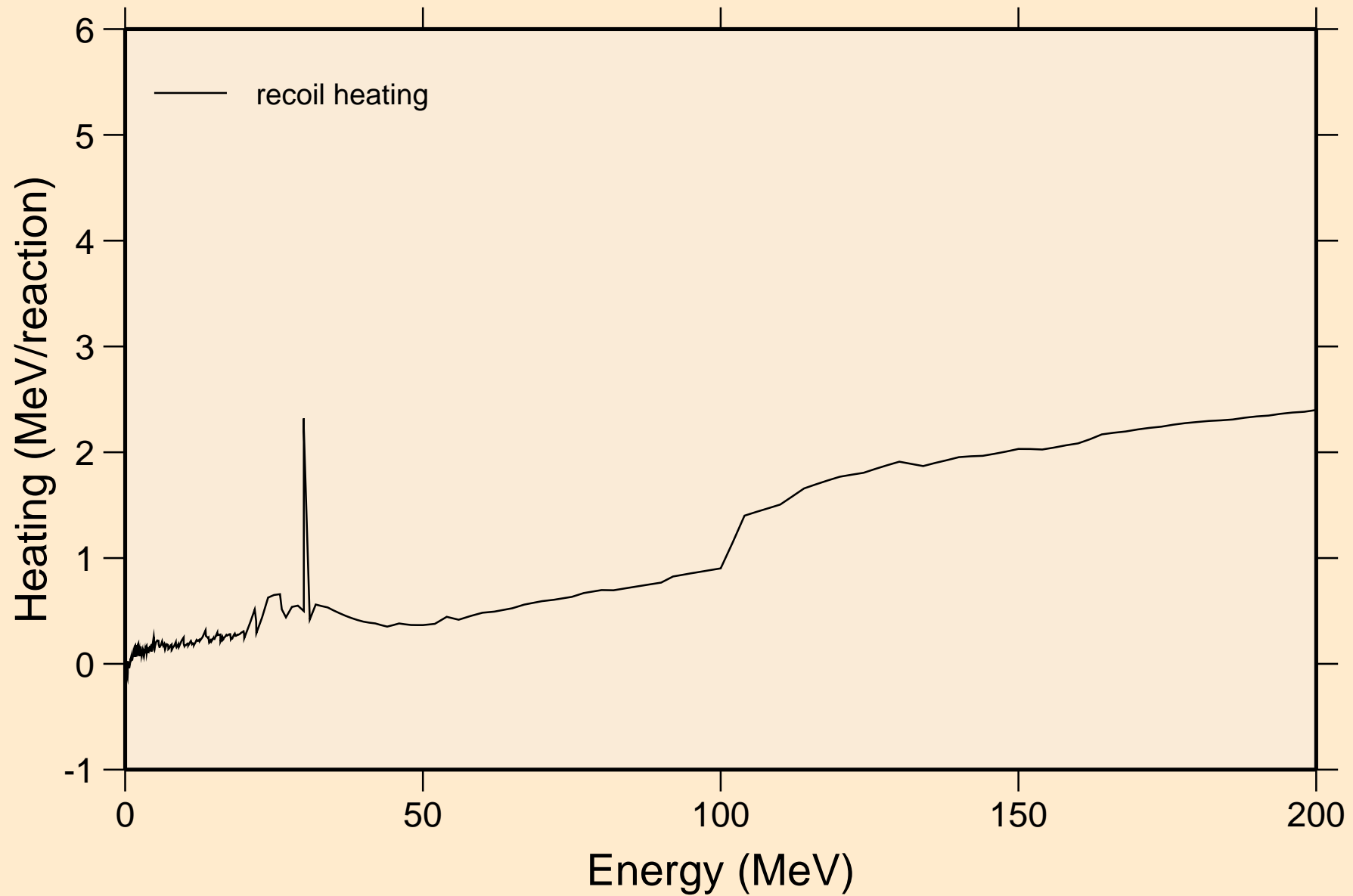

RU091 NEUTRON ACER TENDL-2023 LIBRARY; T=0.K  
Particle production cross sections

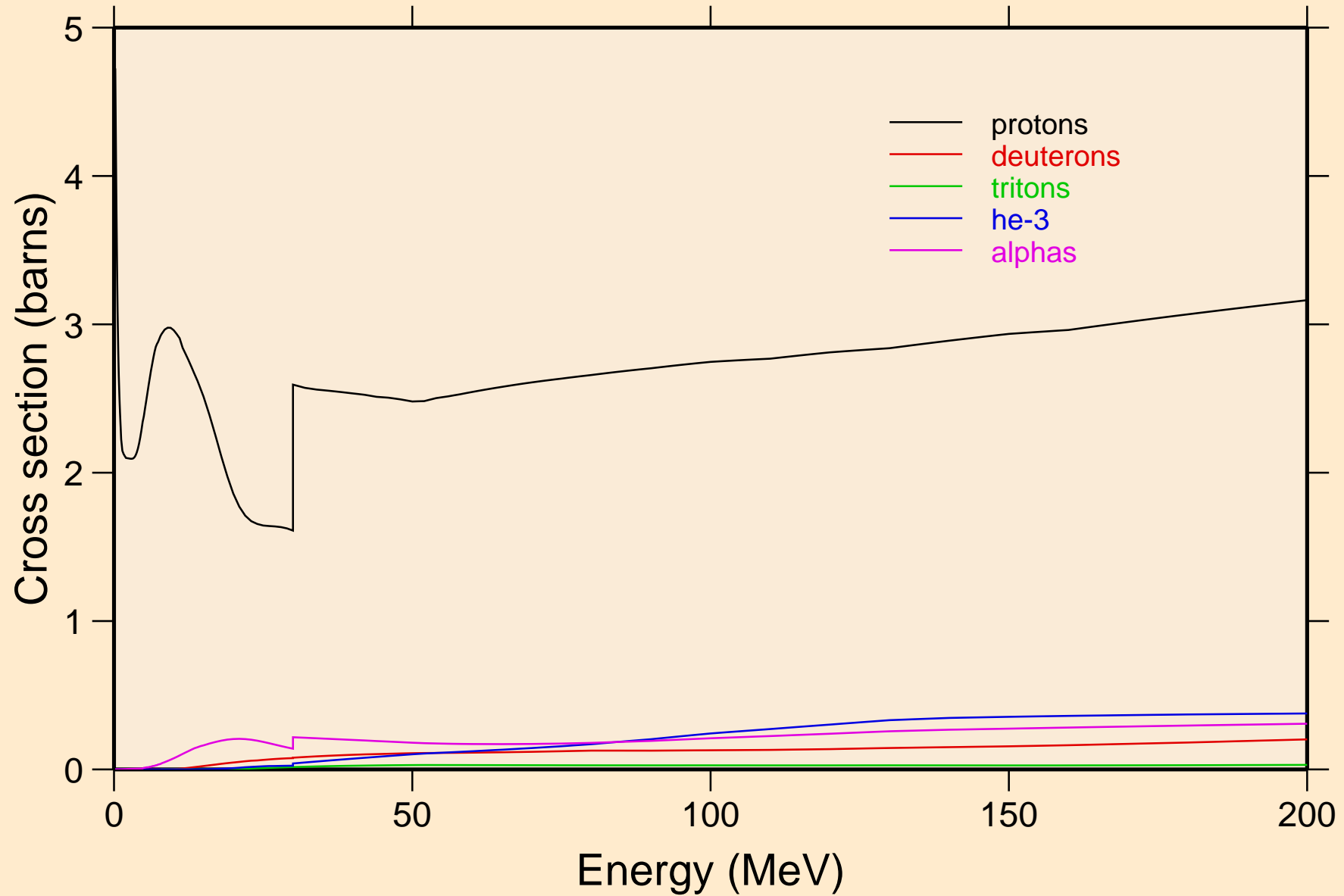

RU091 NEUTRON ACER TENDL-2023 LIBRARY; T=0.K  
protons from (n,x)

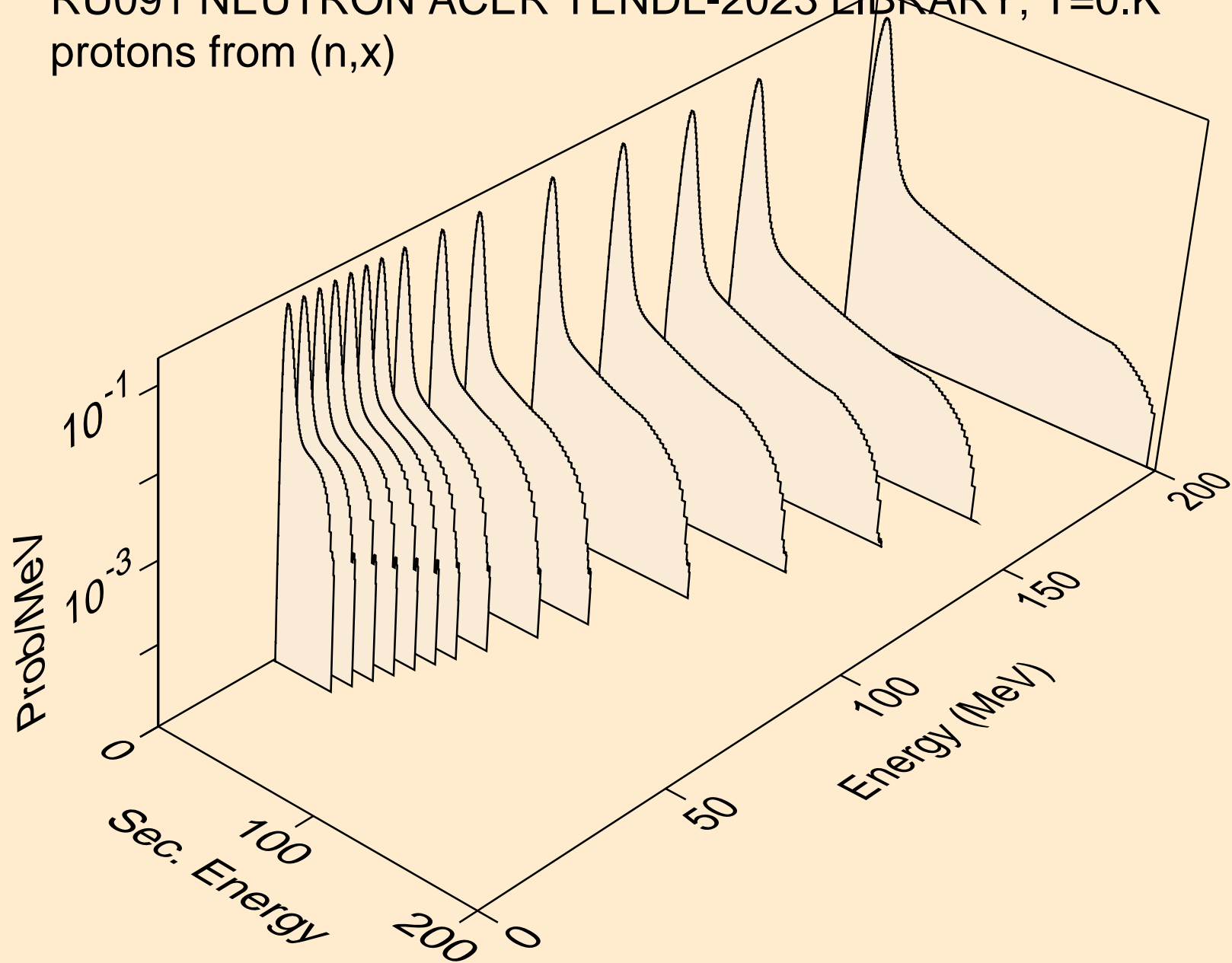

RU091 NEUTRON ACER TENDL-2023 LIBRARY; T=0.K  
protons from (n,n\*)p

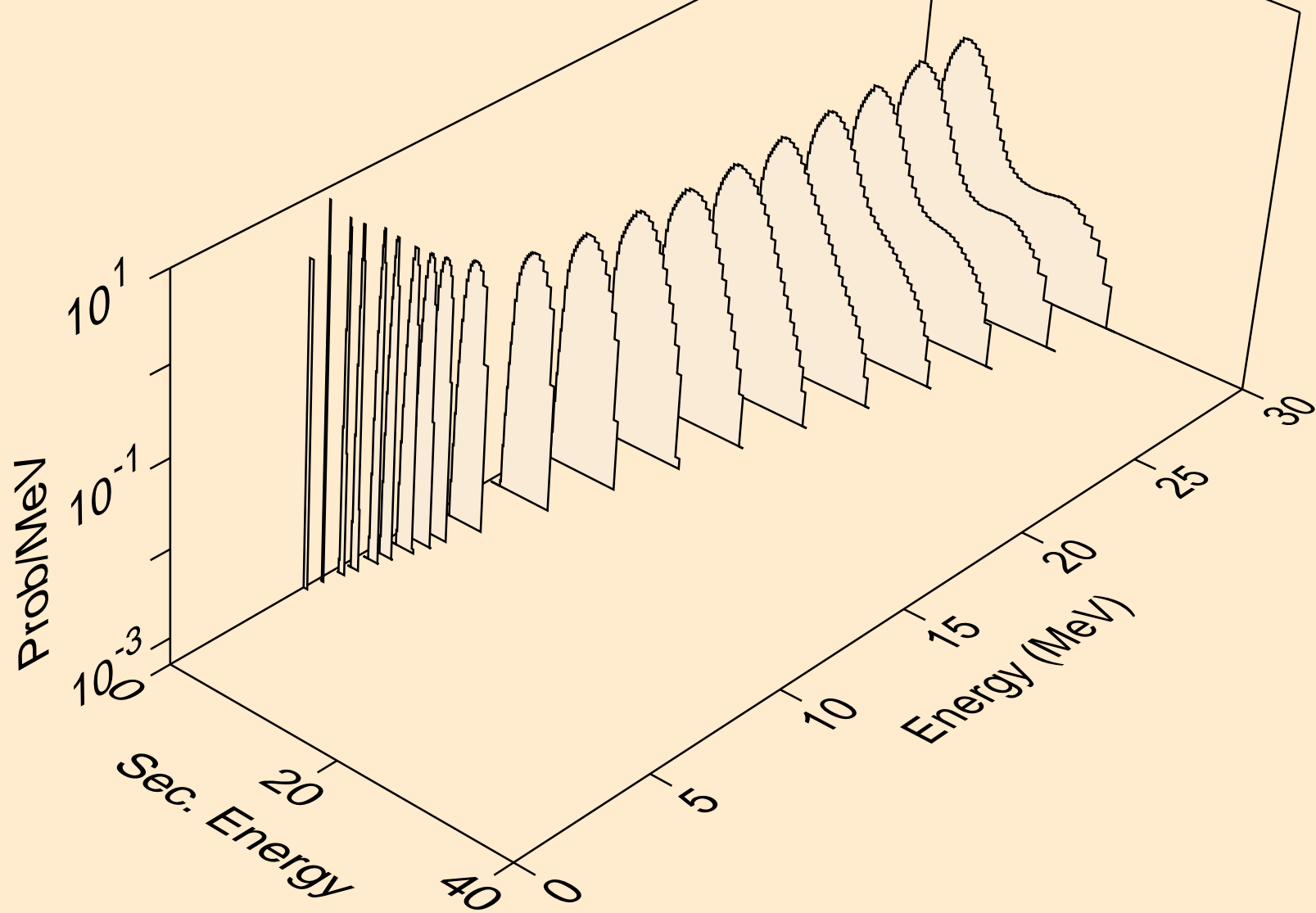

RU091 NEUTRON ACER TENDL-2023 LIBRARY; T=0.K  
protons from (n,2np)

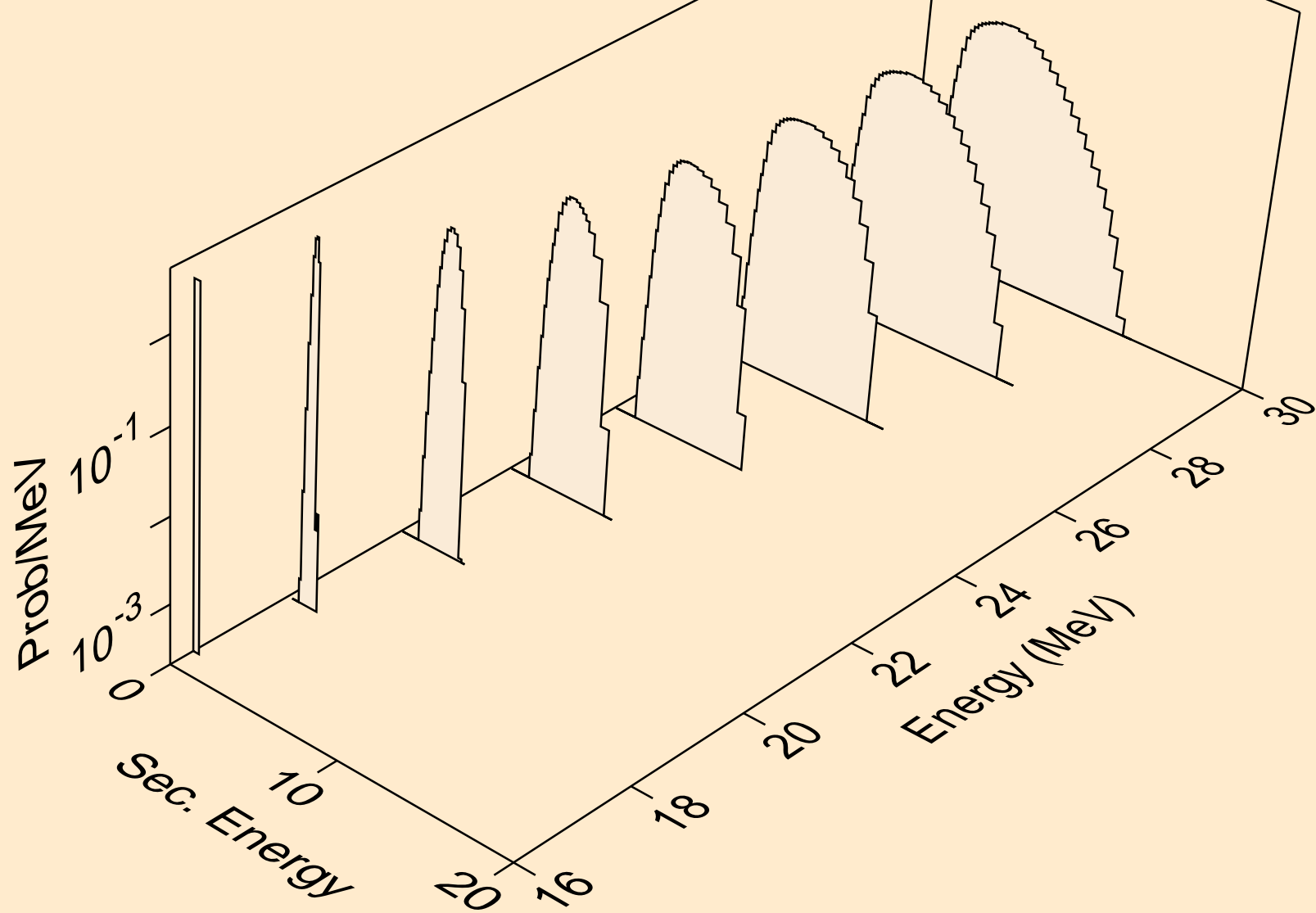



RU091 NEUTRON ACER TENDL-2023 LIBRARY; T=0.K  
protons from (n,n2p)

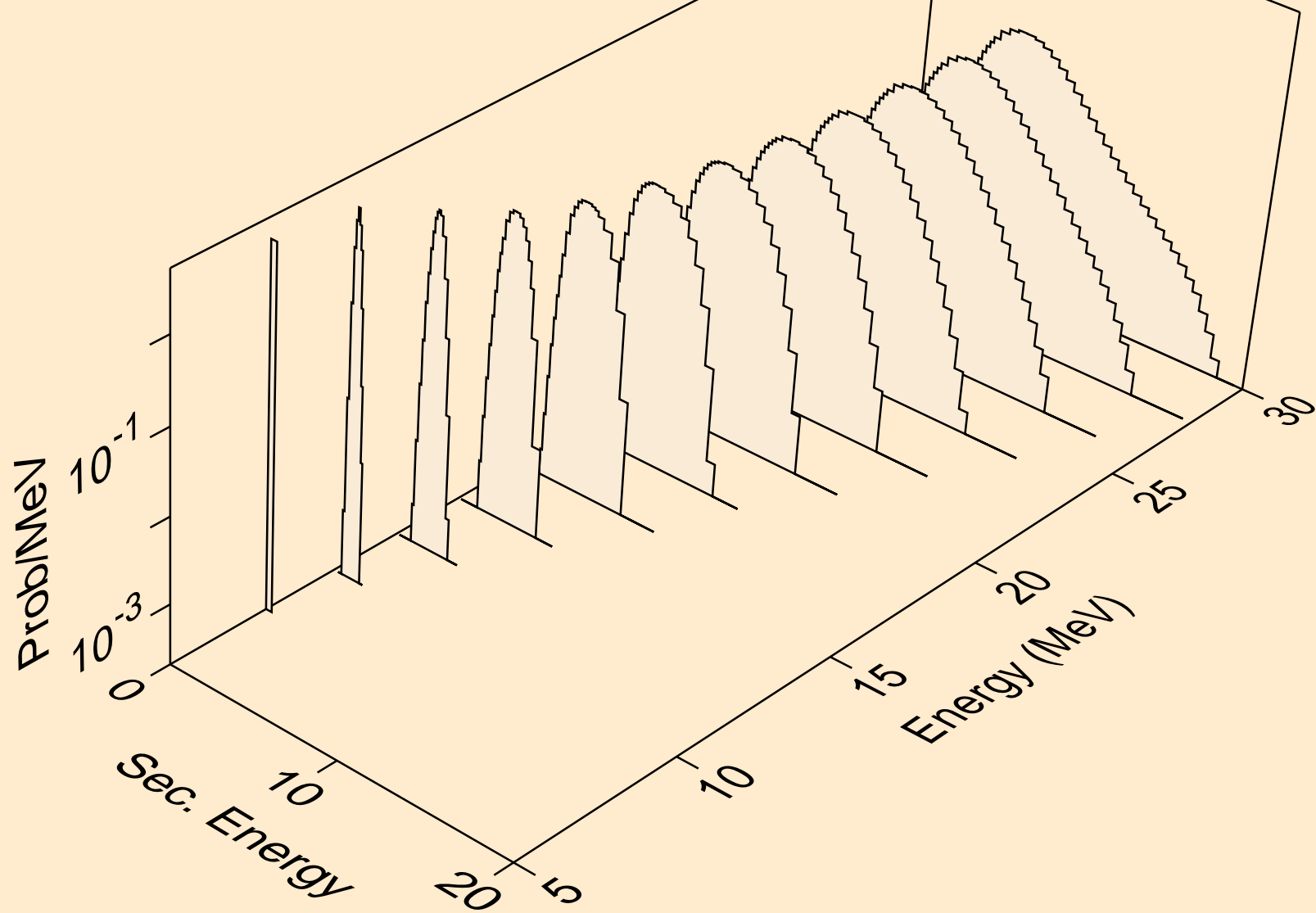

RU091 NEUTRON ACER TENDL-2023 LIBRARY; T=0.K  
protons from (n,npa)

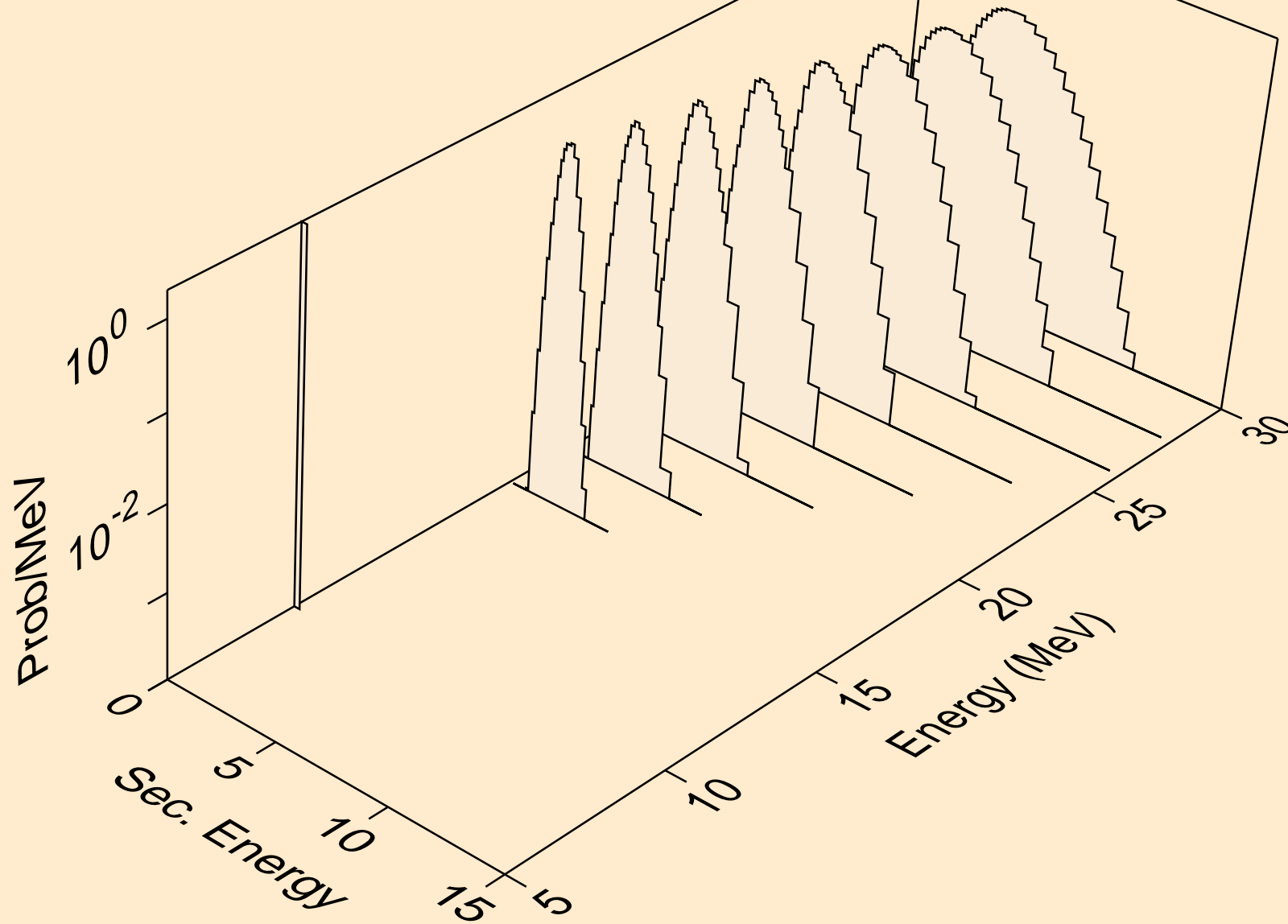

RU091 NEUTRON ACER TENDL-2023 LIBRARY; T=0.K  
protons from (n,p)

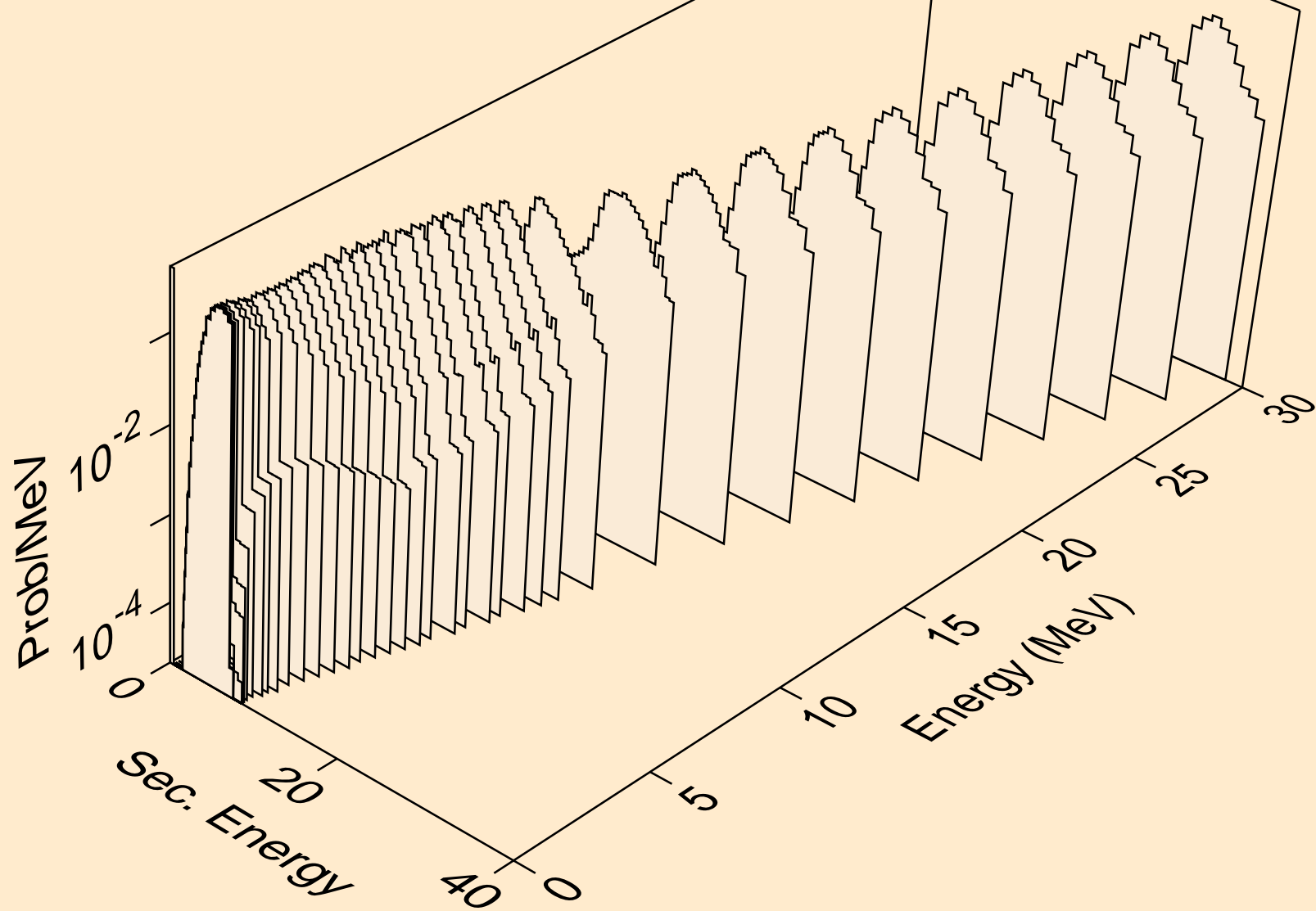

RU091 NEUTRON ACER TENDL-2023 LIBRARY; T=0.K  
protons from (n,2p)

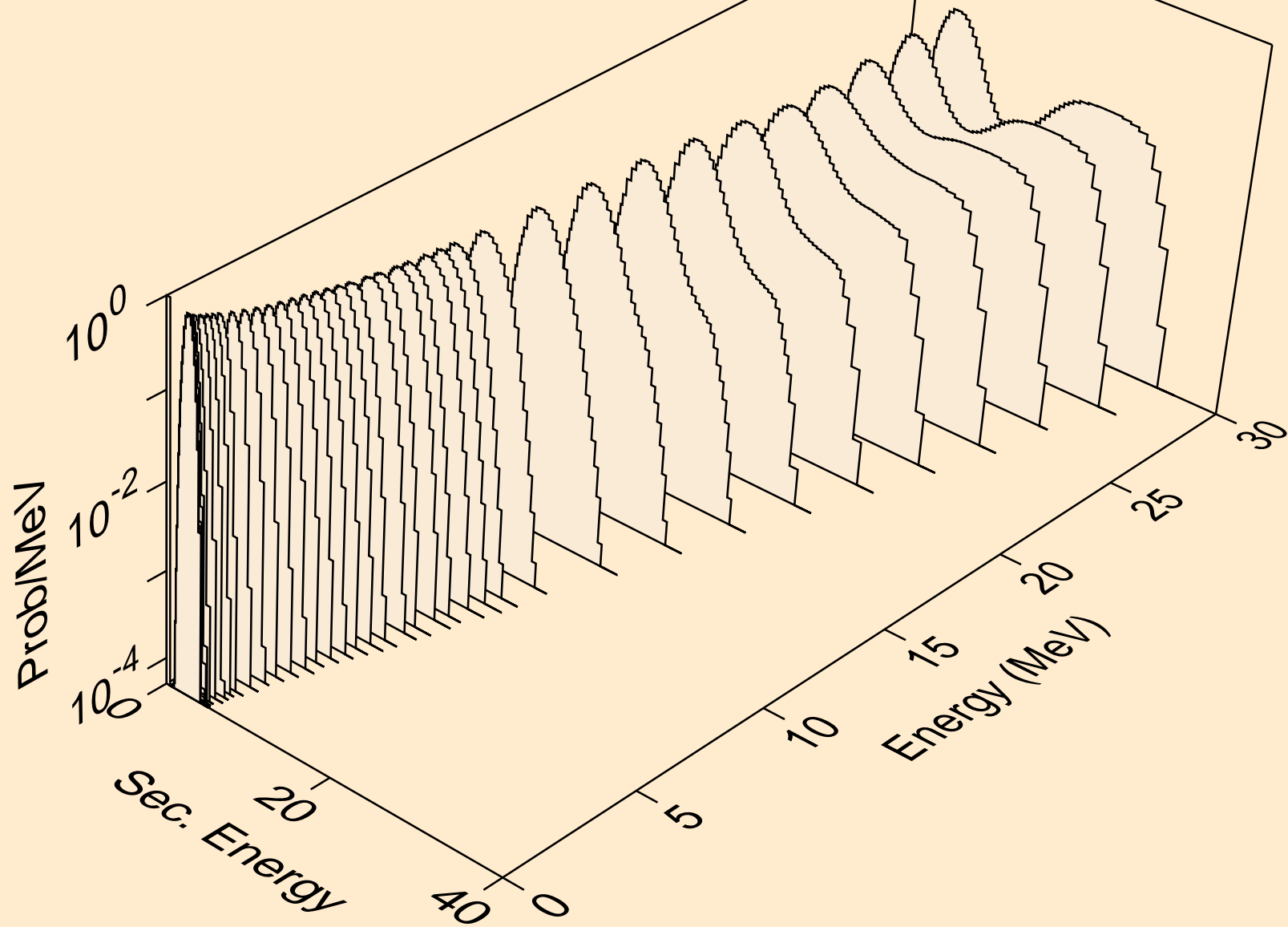

RU091 NEUTRON ACER TENDL-2023 LIBRARY; T=0.K  
protons from (n,p)

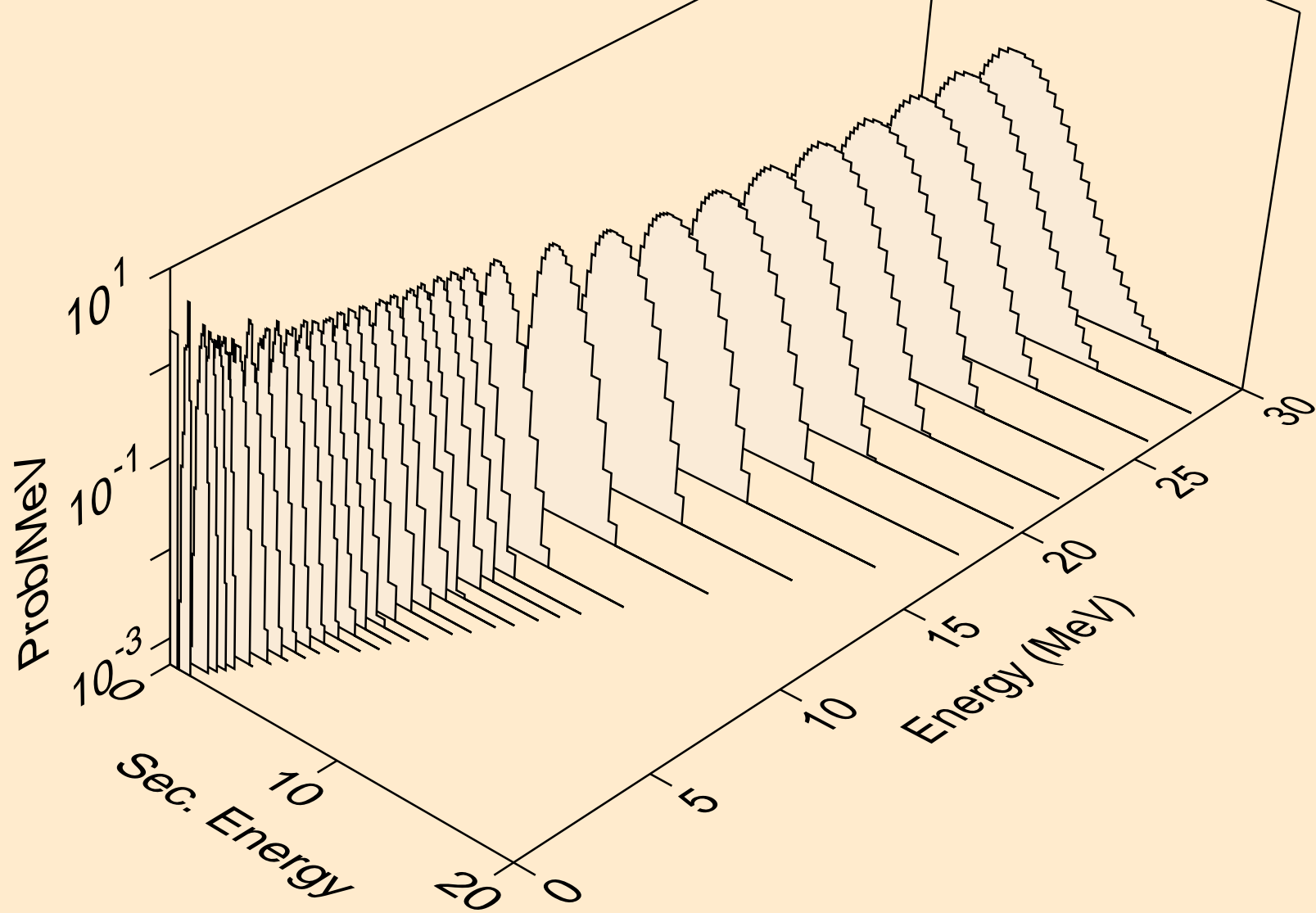

RU091 NEUTRON ACER TENDL-2023 LIBRARY; T=0.K  
protons from (n,pd)

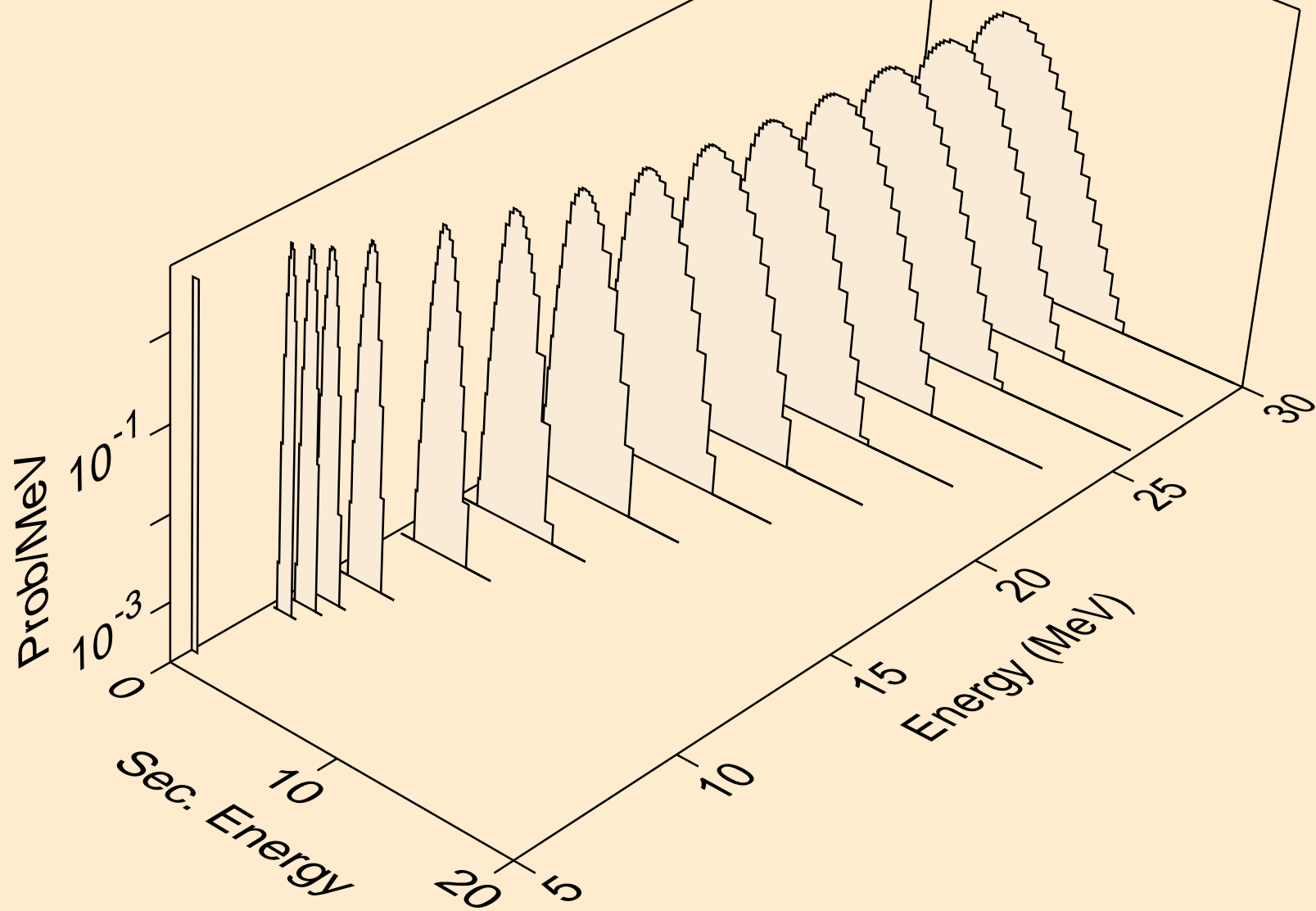

RU091 NEUTRON ACER TENDL-2023 LIBRARY; T=0.K  
protons from (n,pt)

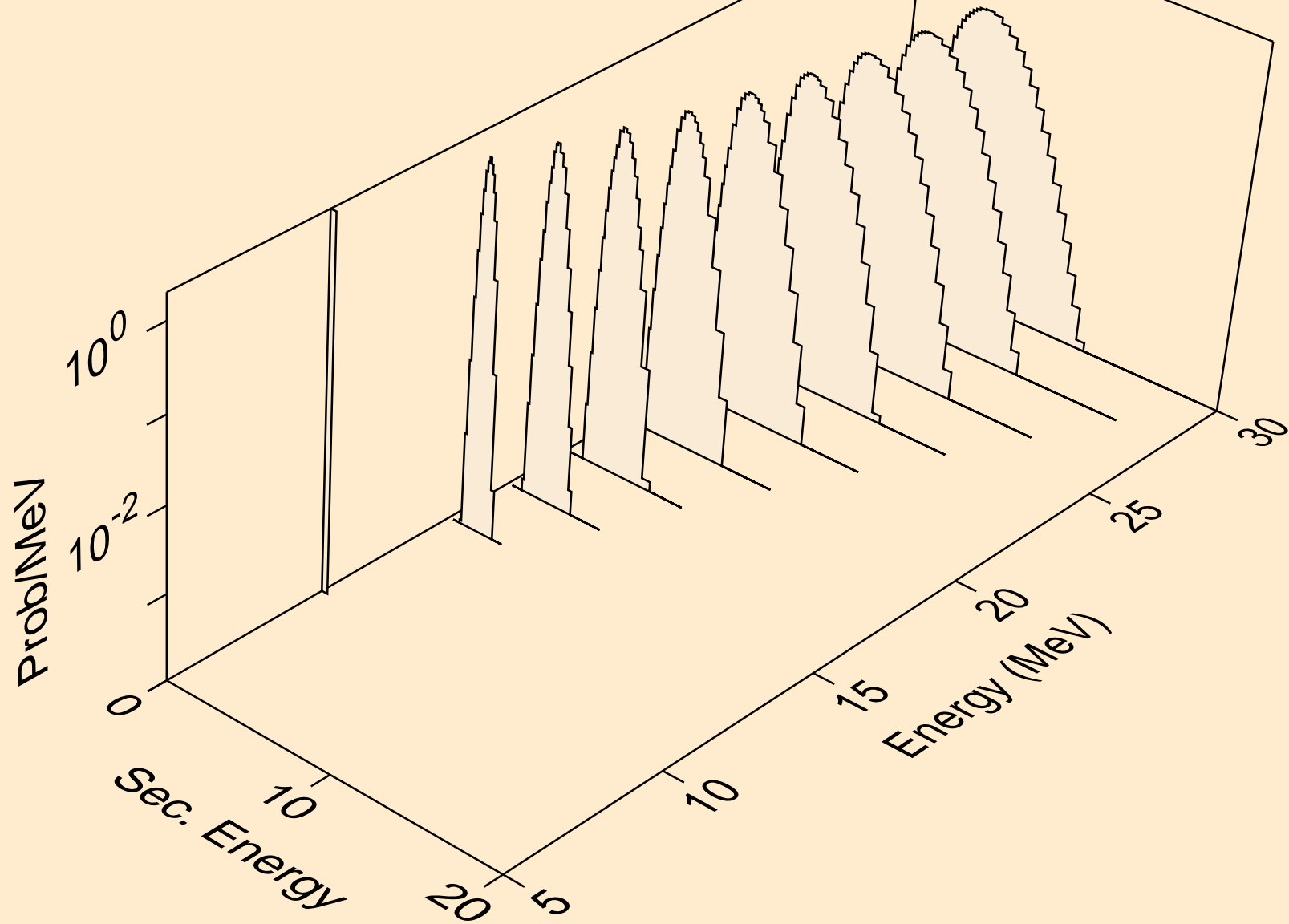

RU091 NEUTRON ACER TENDL-2023 LIBRARY; T=0.K  
deuterons from (n,x)

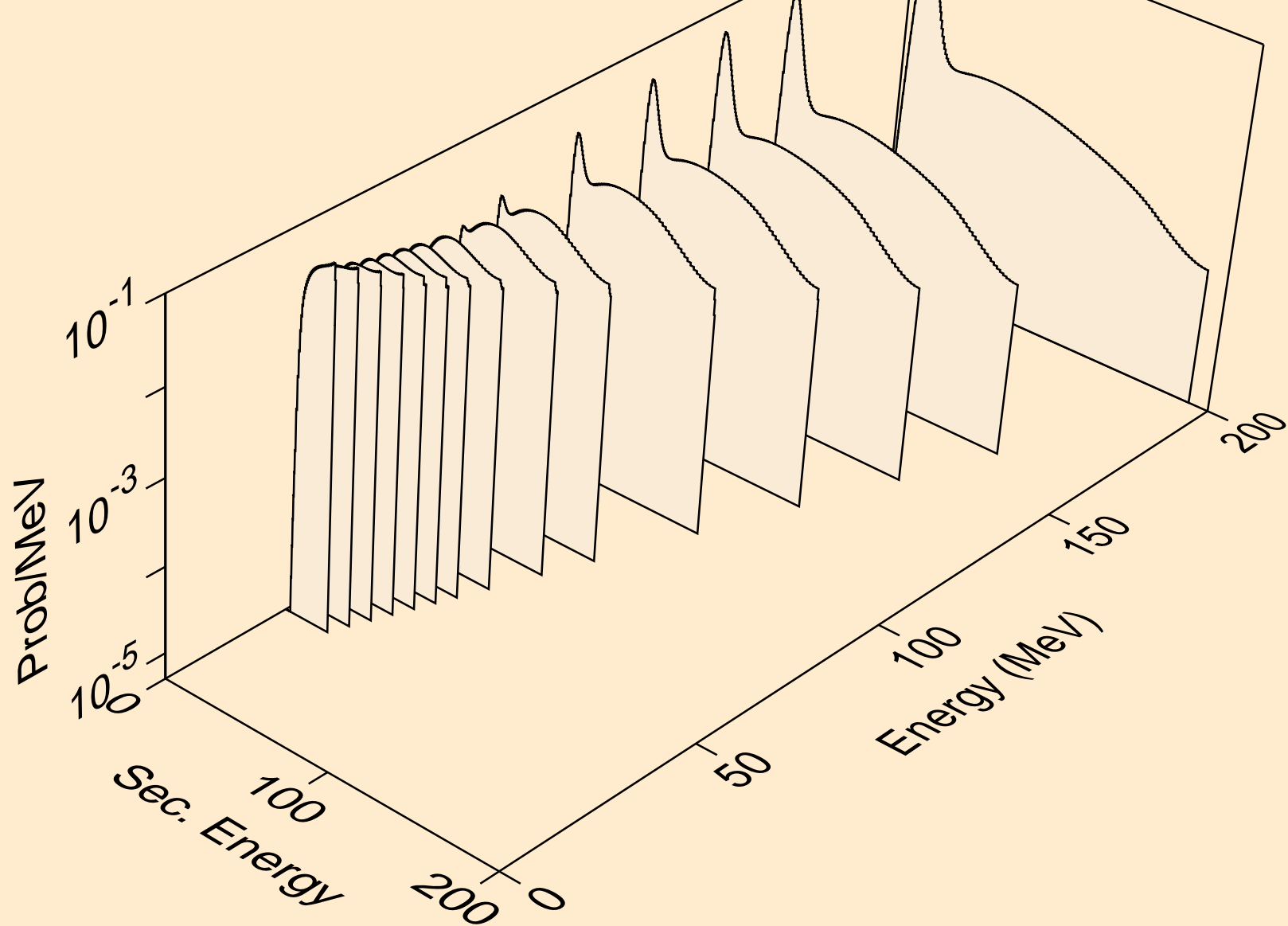



RU091 NEUTRON ACER TENDL-2023 LIBRARY; T=0.K  
deuterons from (n,n\*)d

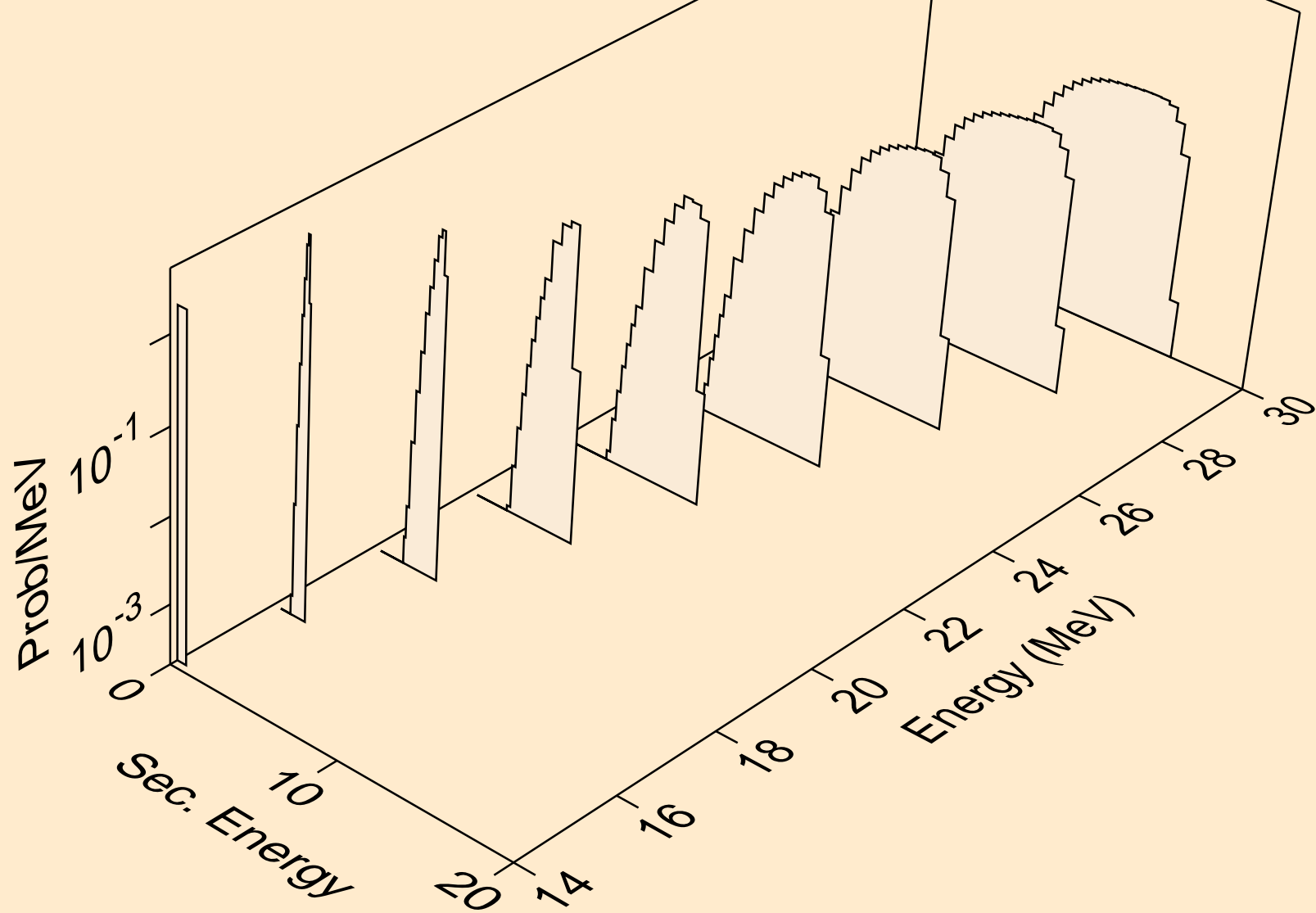

RU091 NEUTRON ACER TENDL-2023 LIBRARY; T=0.K  
deuterons from (n,d)

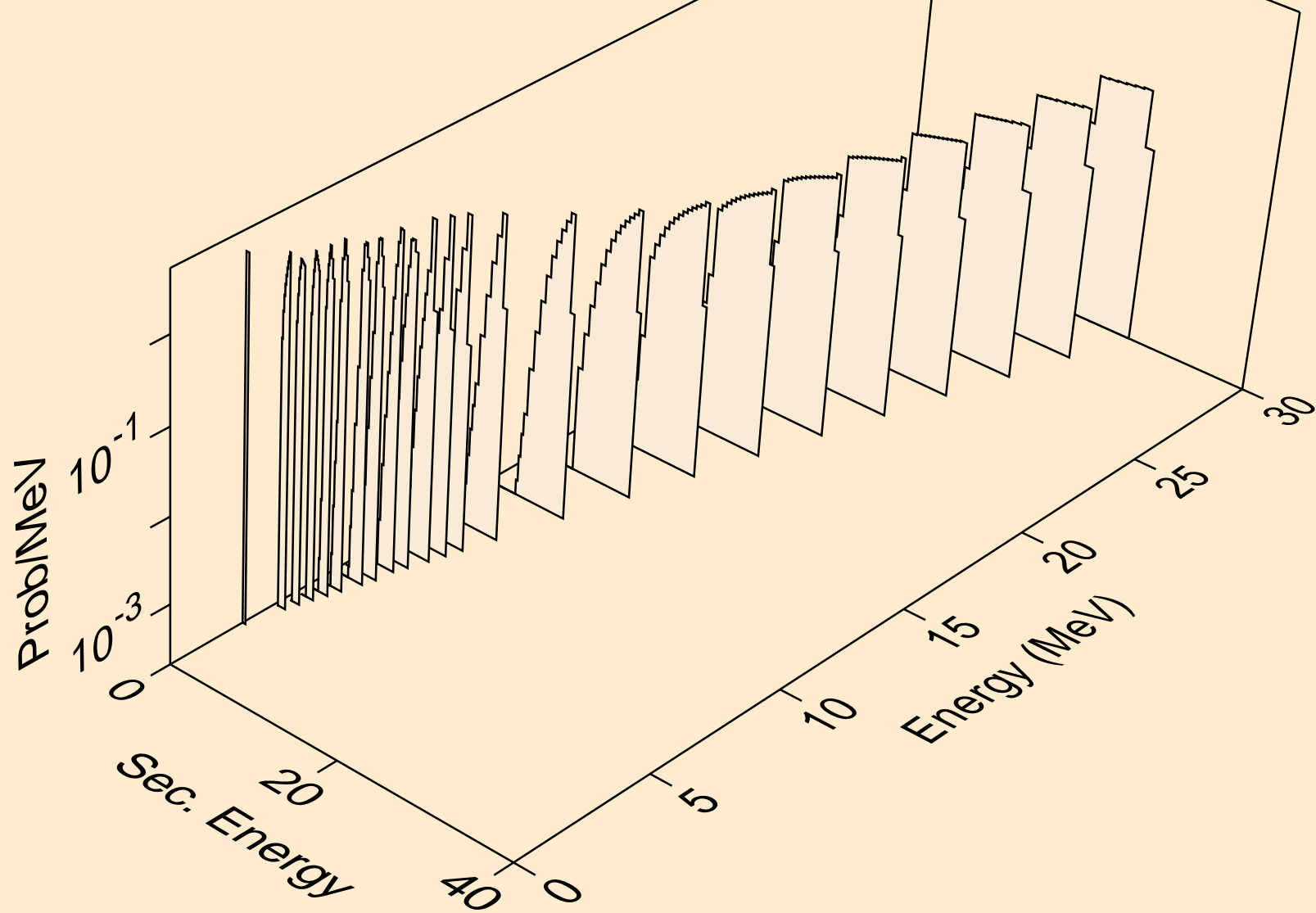

RU091 NEUTRON ACER TENDL-2023 LIBRARY; T=0.K  
deuterons from (n,pd)

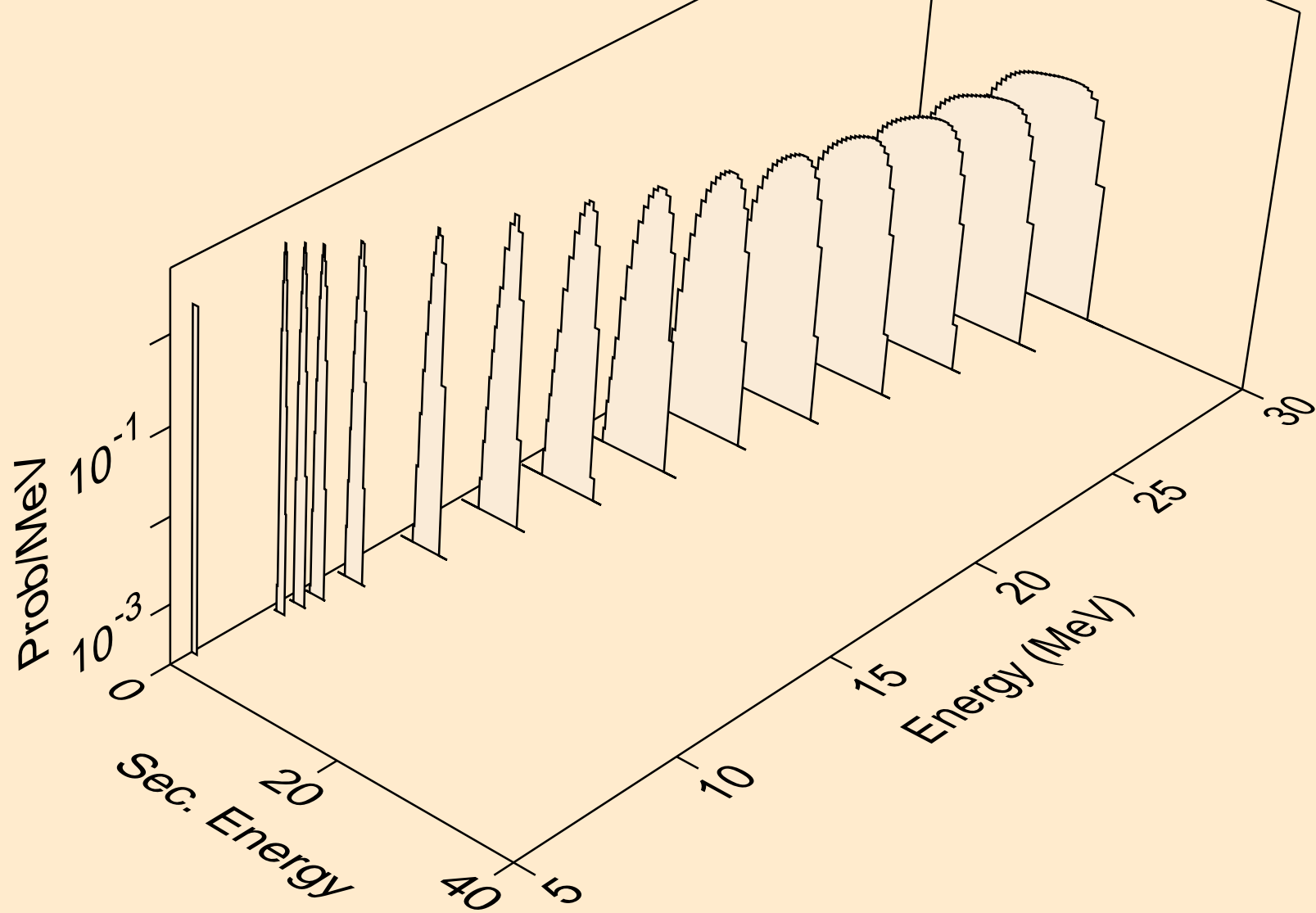

RU091 NEUTRON ACER TENDL-2023 LIBRARY; T=0.K  
deuterons from (n,da)

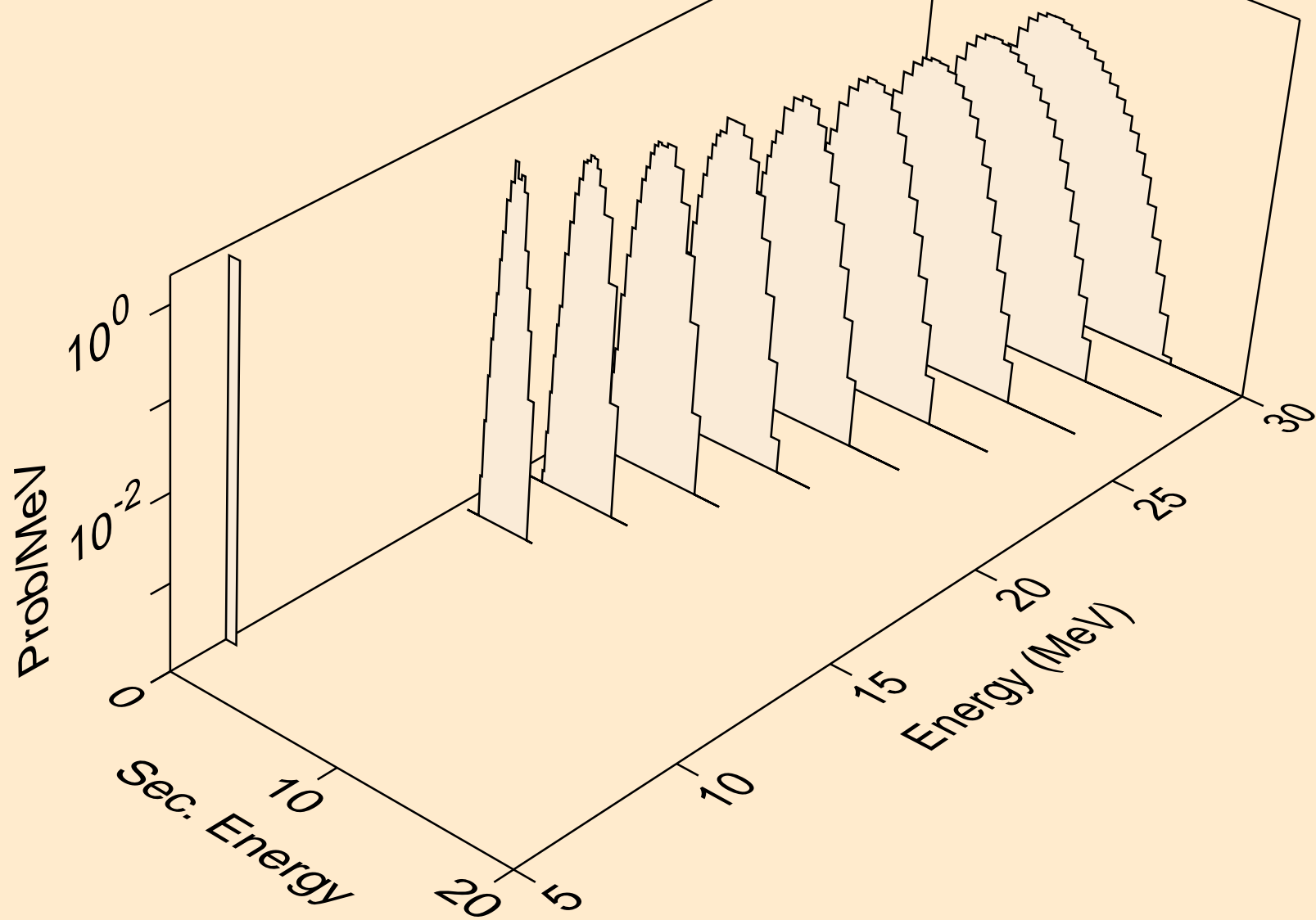

RU091 NEUTRON ACER TENDL-2023 LIBRARY; T=0.K  
tritons from (n,x)

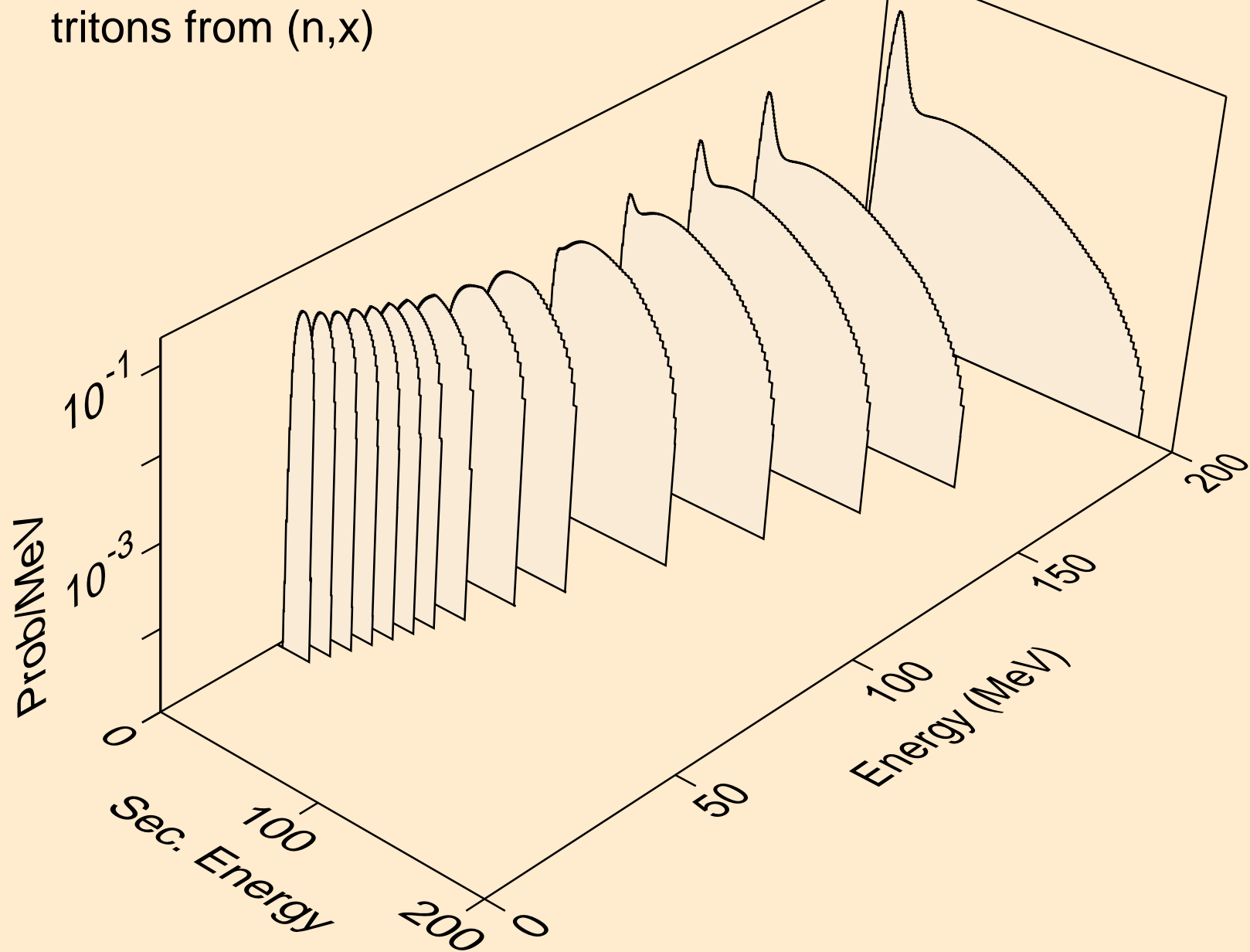

RU091 NEUTRON ACER TENDL-2023 LIBRARY; T=0.K  
tritons from (n,n\*)t

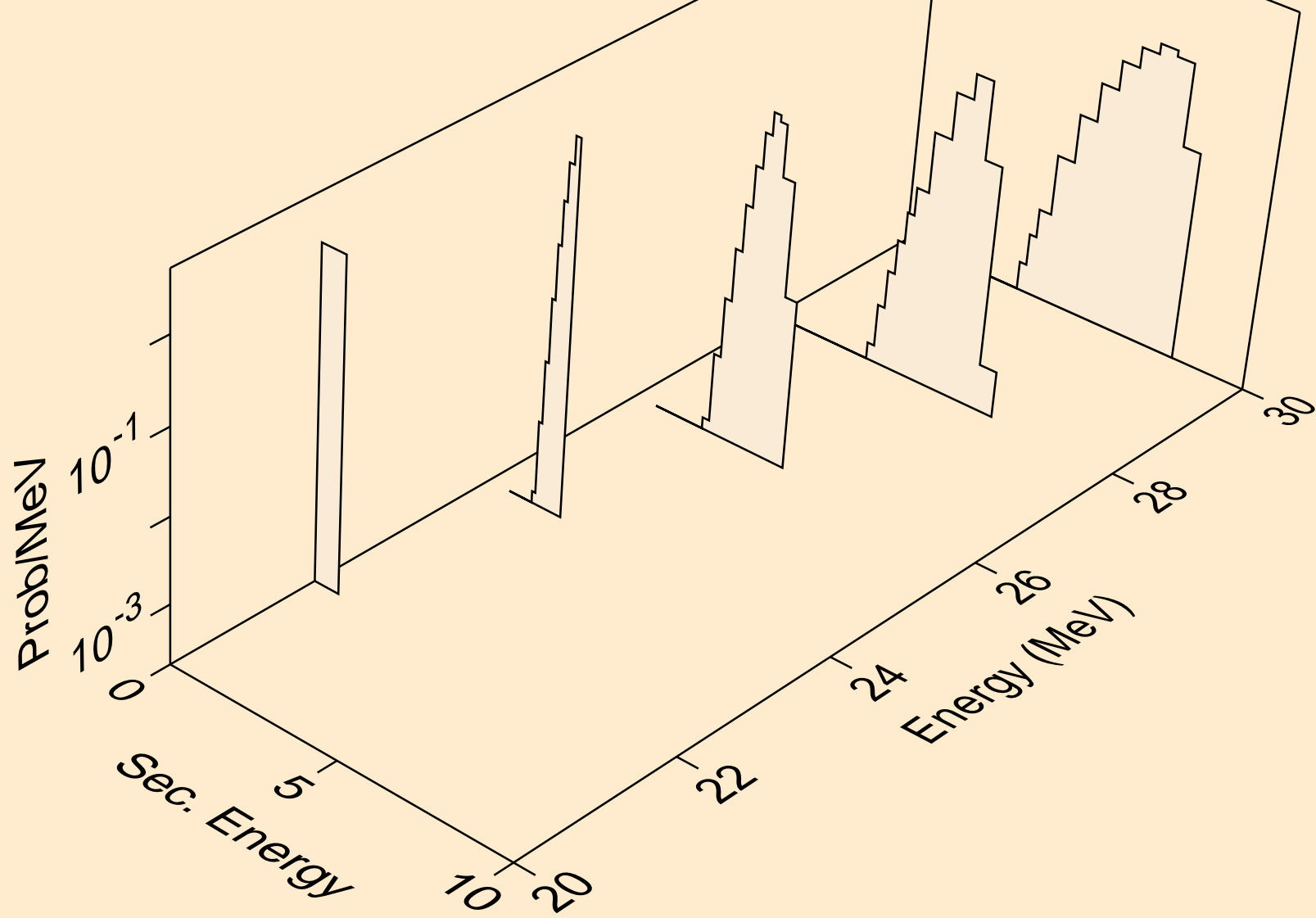

RU091 NEUTRON ACER TENDL-2023 LIBRARY; T=0.K  
tritons from (n,t)

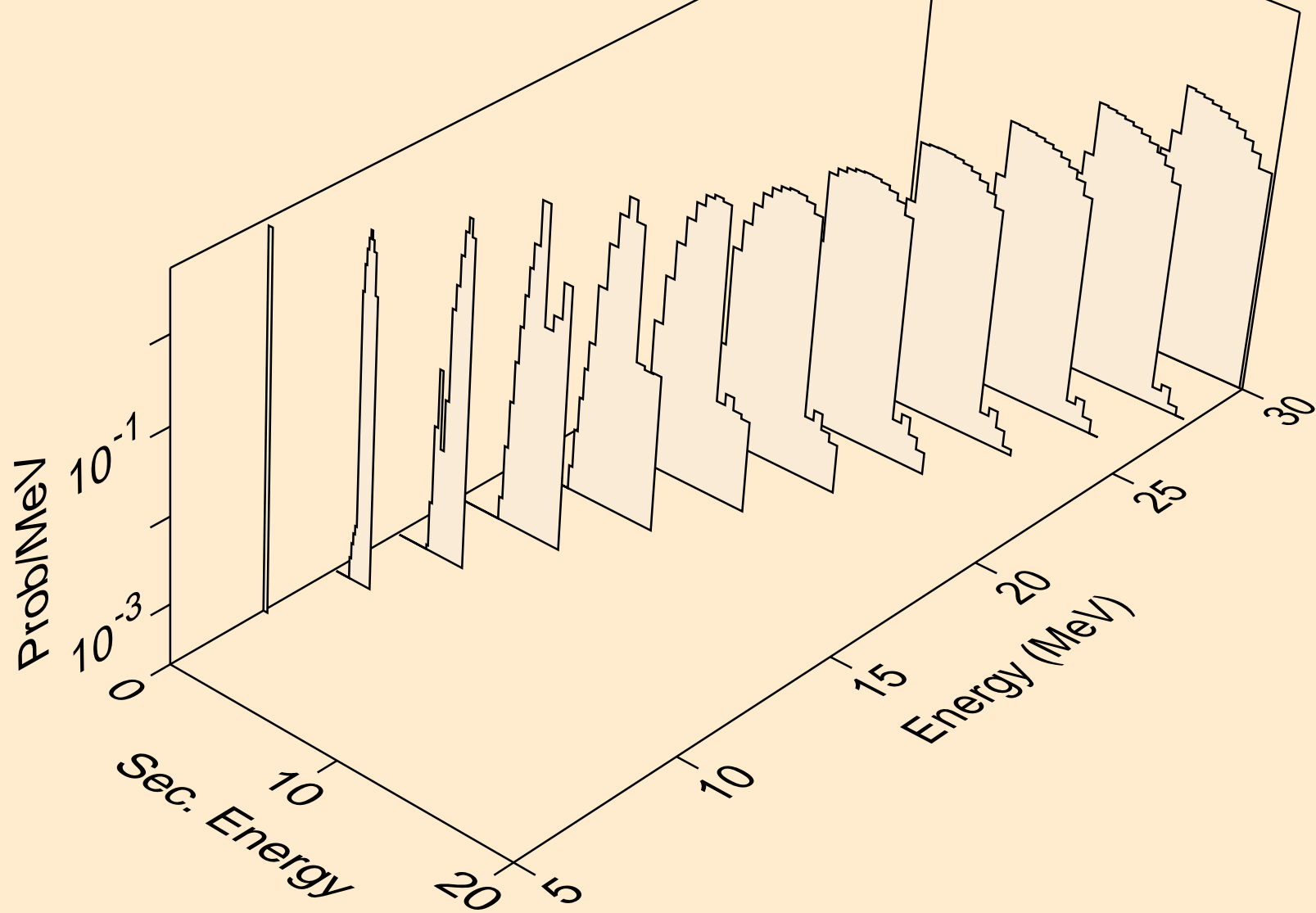

RU091 NEUTRON ACER TENDL-2023 LIBRARY; T=0.K  
tritons from (n,pt)

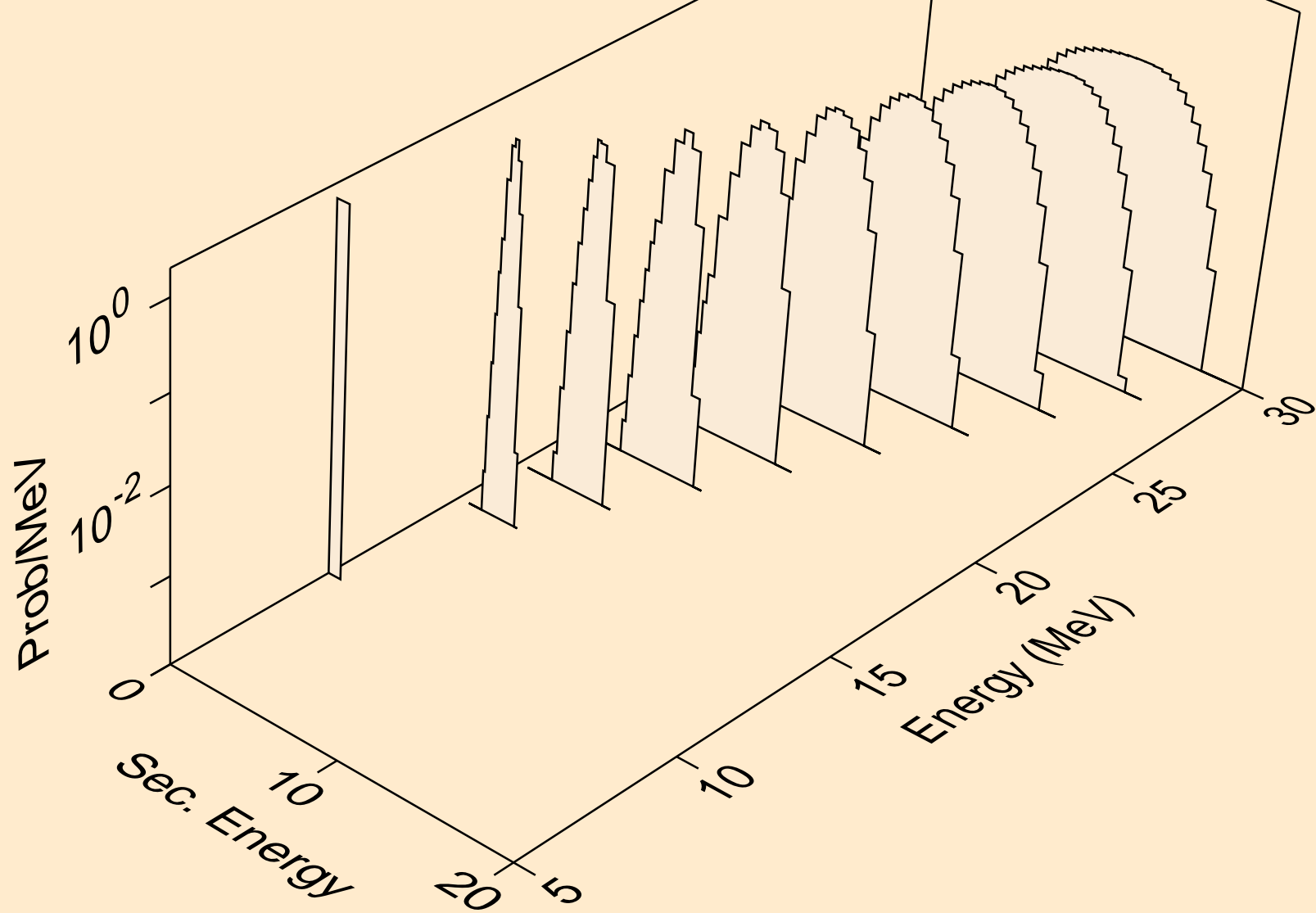



RU091 NEUTRON ACER TENDL-2023 LIBRARY; T=0.K  
he3s from (n,x)

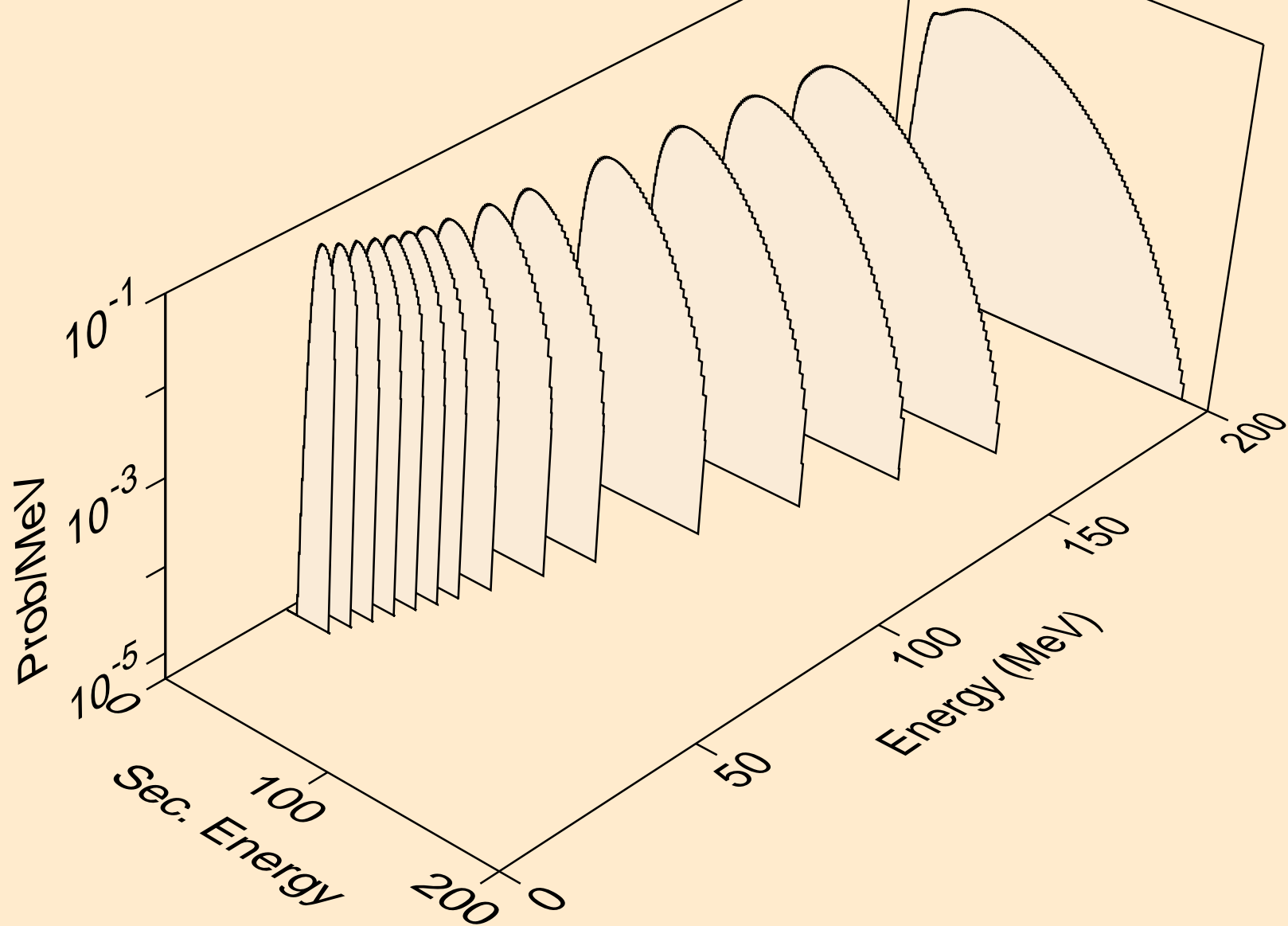

RU091 NEUTRON ACER TENDL-2023 LIBRARY; T=0.K  
he3s from (n,n\*)he3

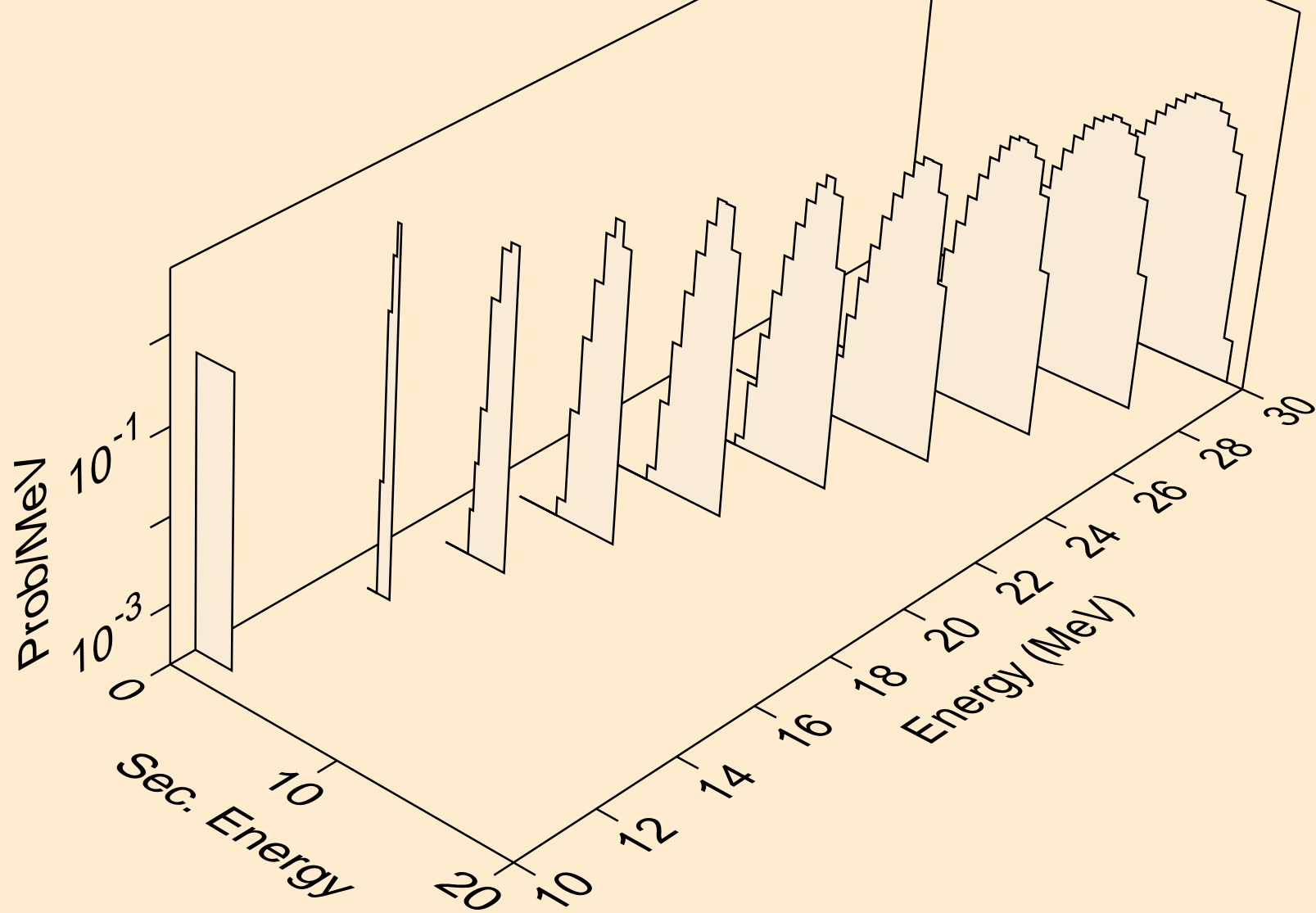

RU091 NEUTRON ACER TENDL-2023 LIBRARY; T=0.K  
he3s from (n,he3)

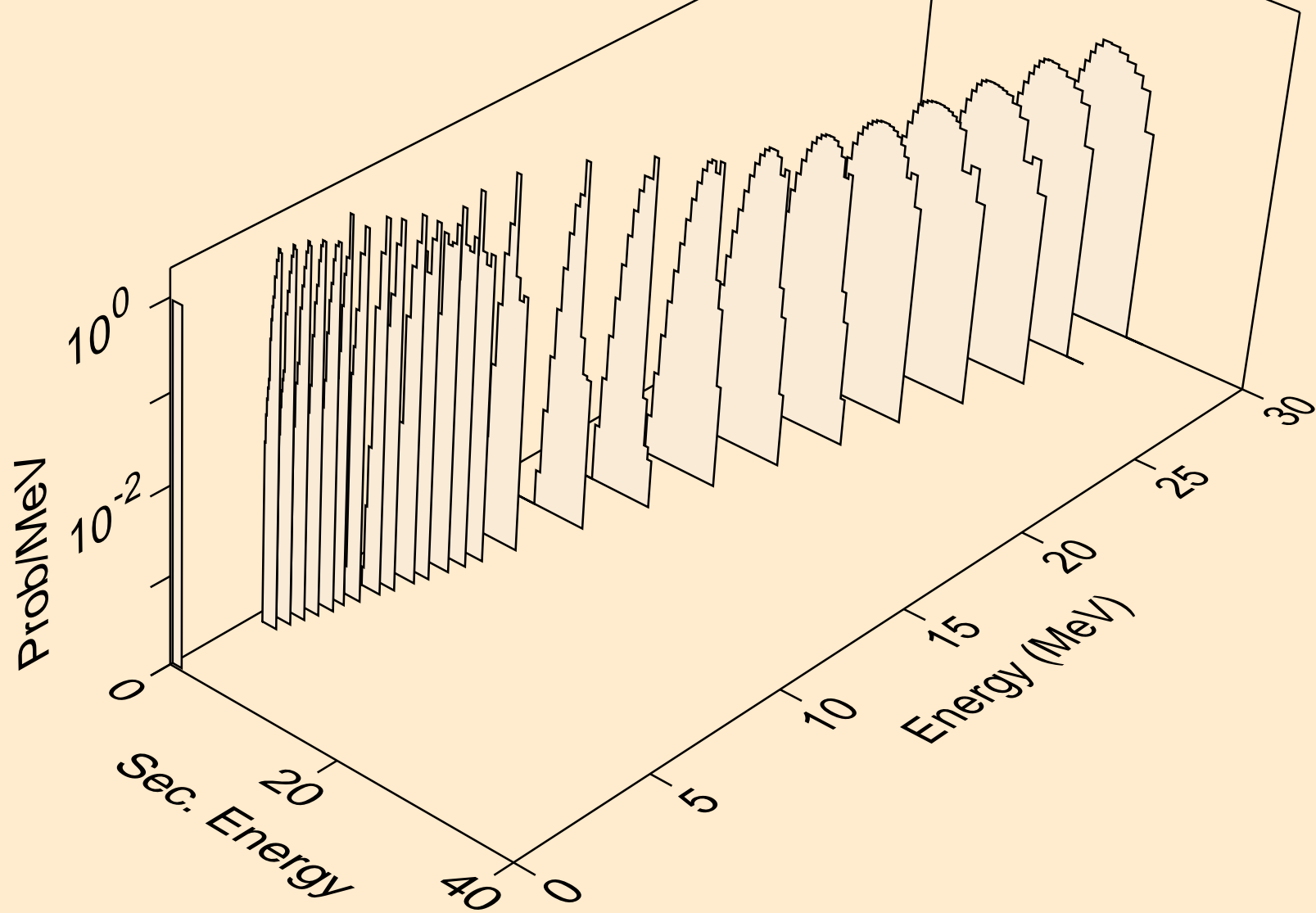

RU091 NEUTRON ACER TENDL-2023 LIBRARY; T=0.K  
alphas from (n,x)

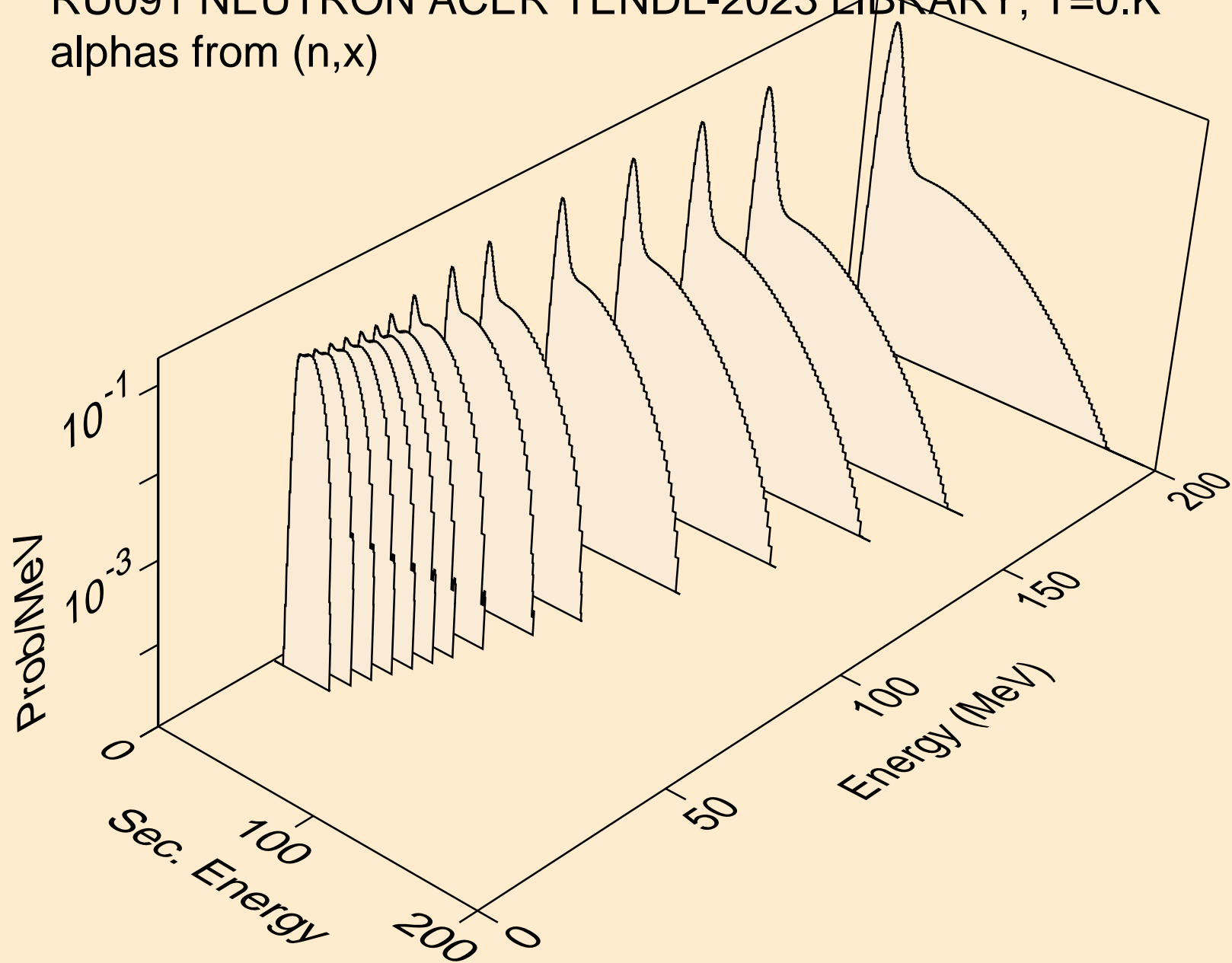

RU091 NEUTRON ACER TENDL-2023 LIBRARY; T=0.K  
alphas from (n,n\*)a

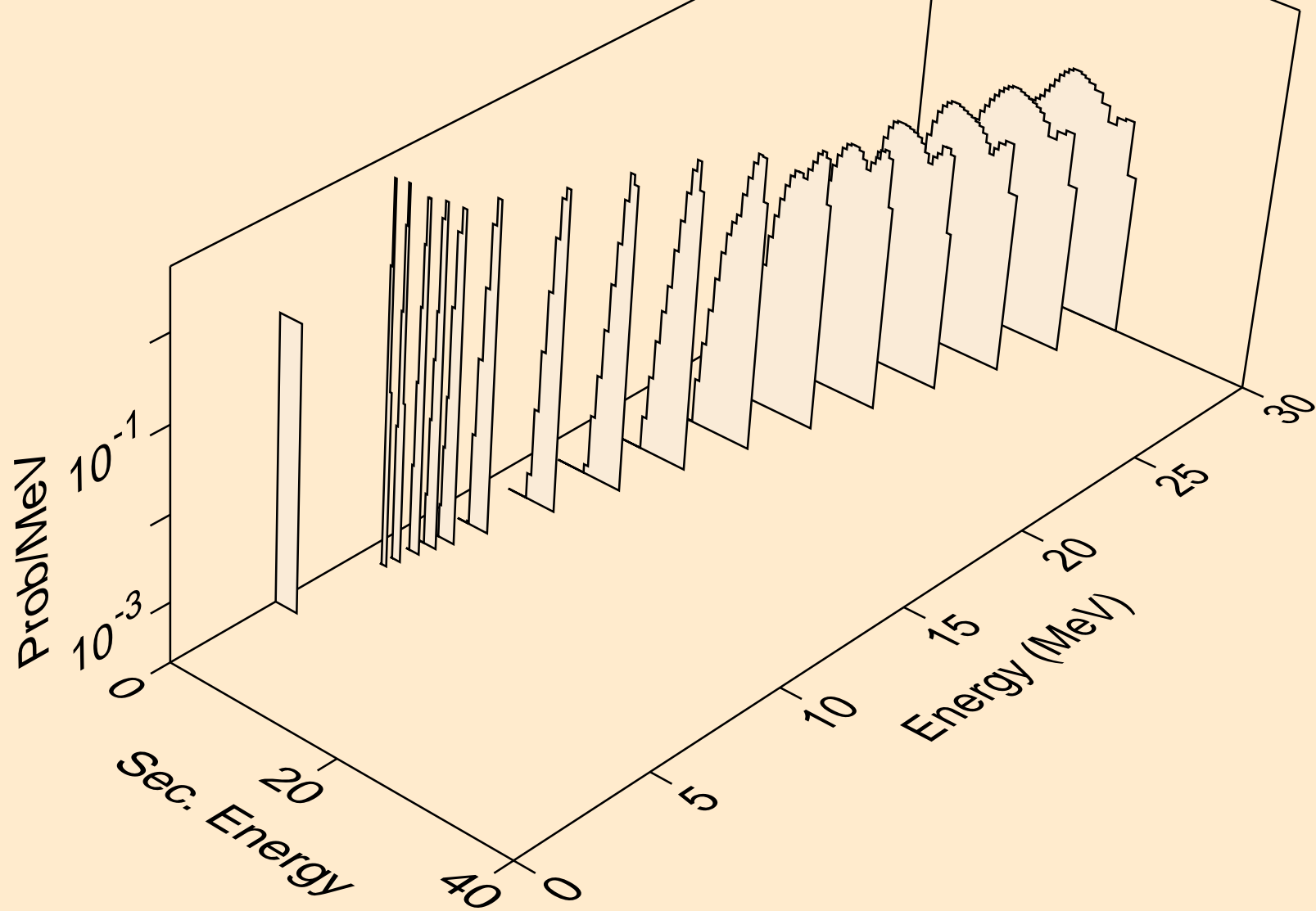

RU091 NEUTRON ACER TENDL-2023 LIBRARY; T=0.K  
alphas from (n,2n)a

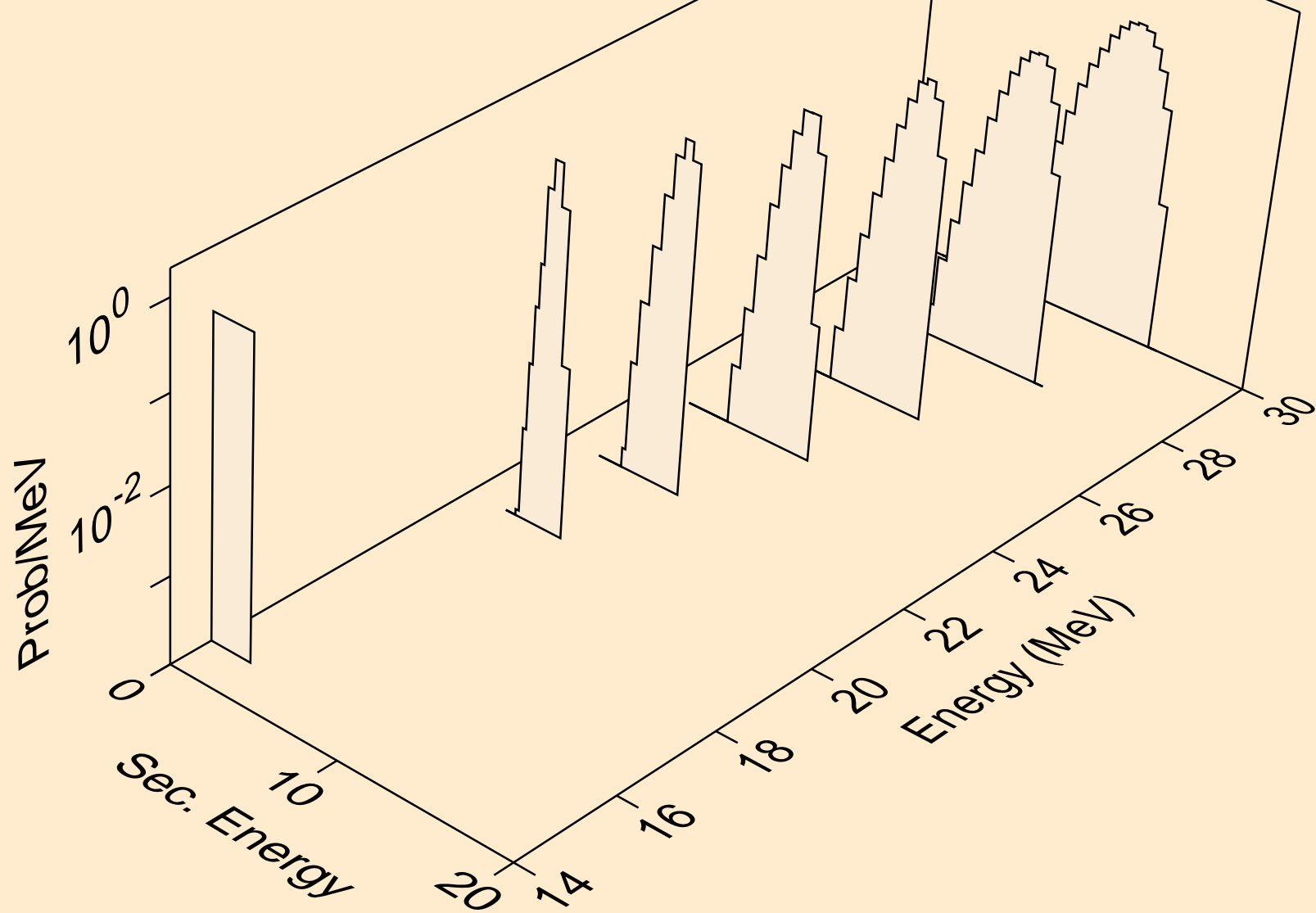

RU091 NEUTRON ACER TENDL-2023 LIBRARY; T=0.K  
alphas from (n,n\*)2a

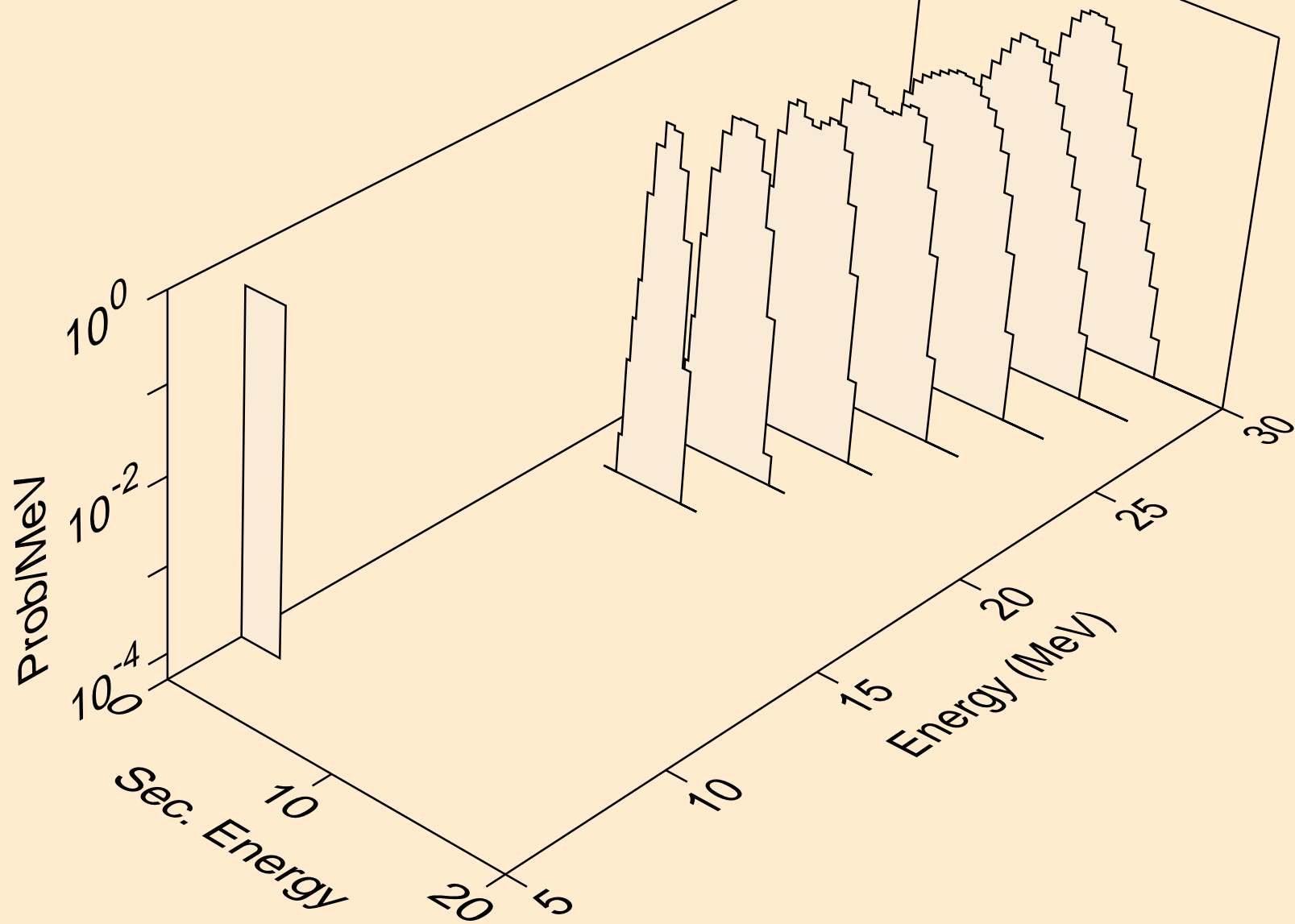

RU091 NEUTRON ACER TENDL-2023 LIBRARY; T=0.K  
alphas from (n,npa)

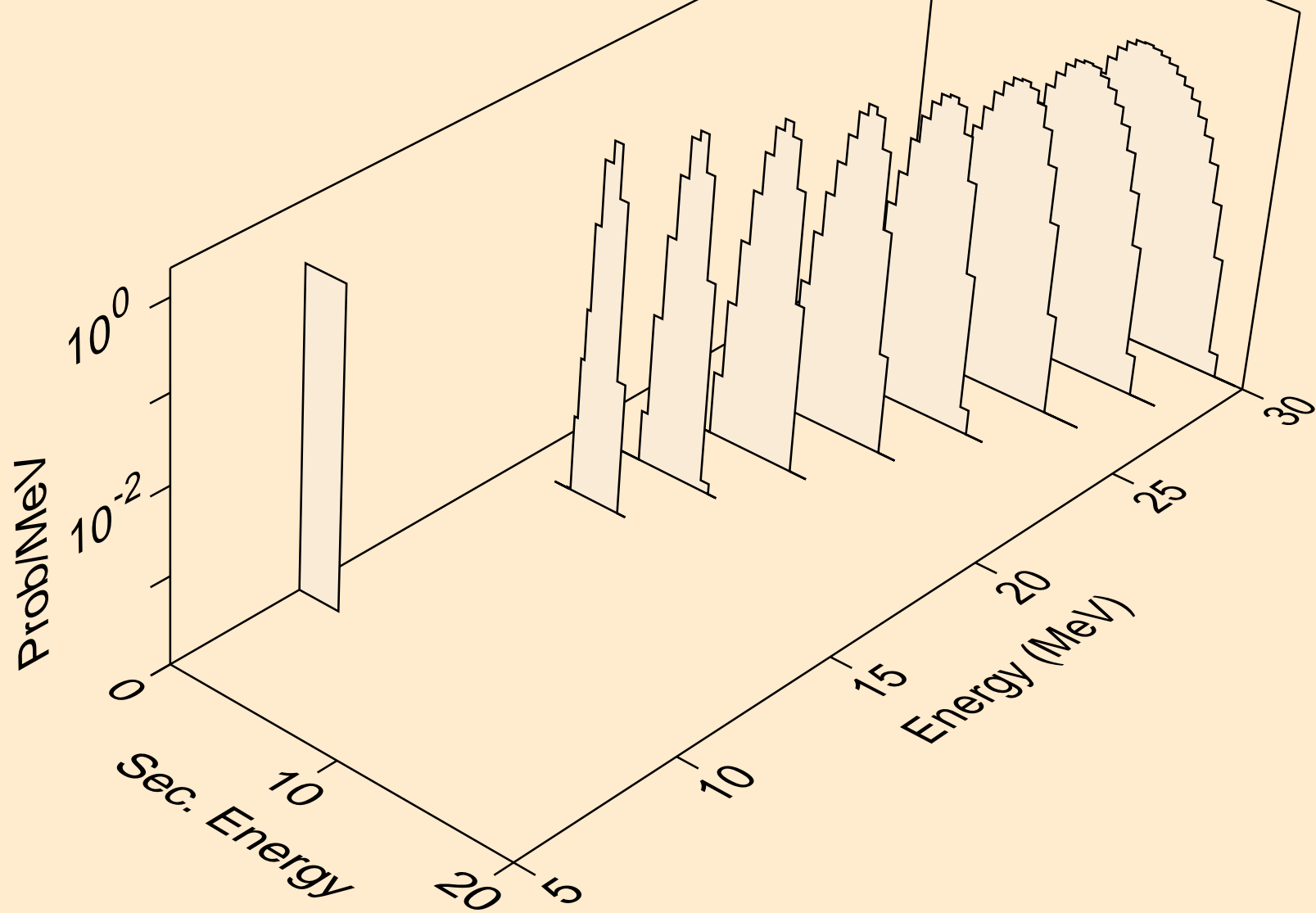



RU091 NEUTRON ACER TENDL-2023 LIBRARY; T=0.K  
alphas from (n,a)

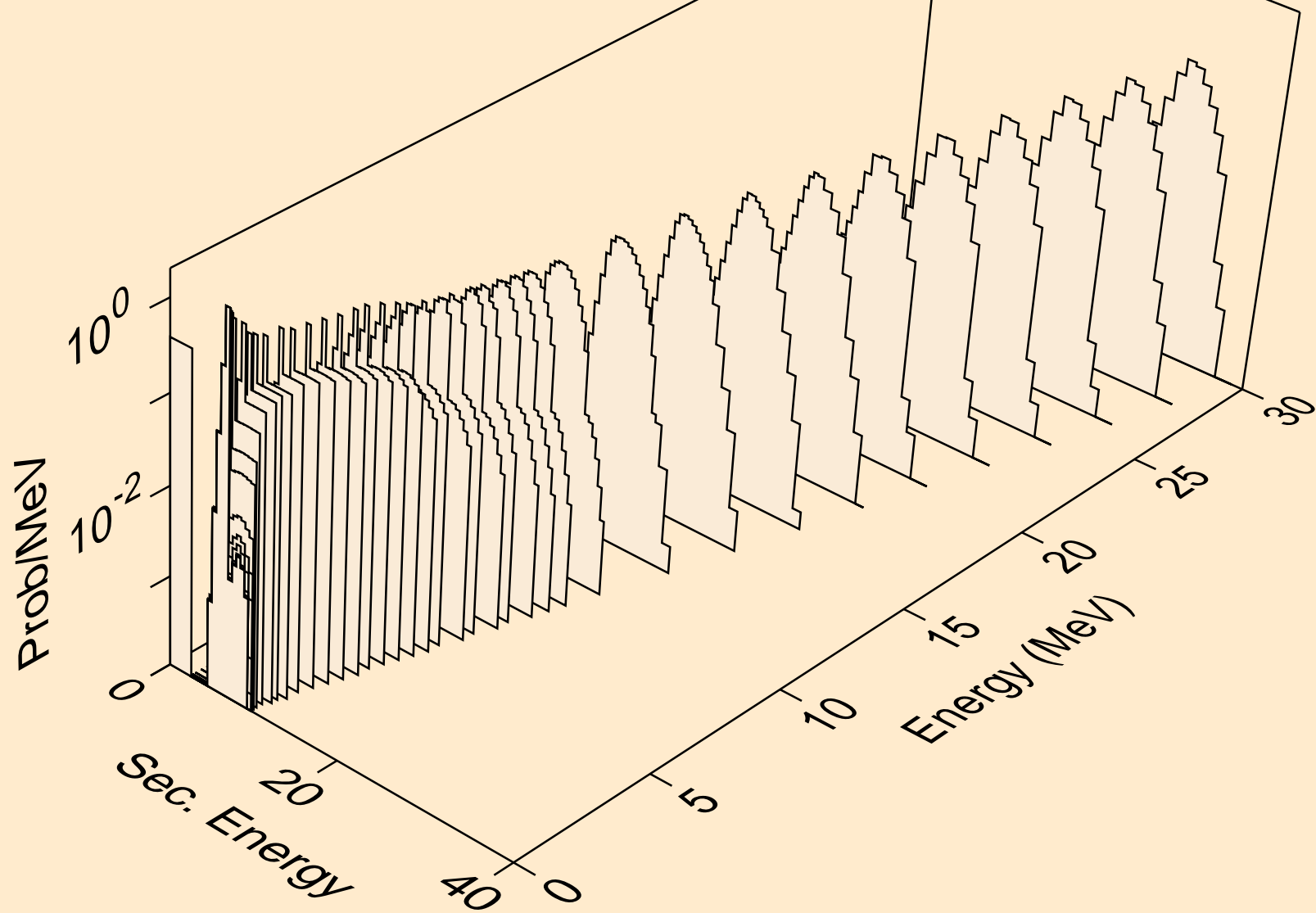

RU091 NEUTRON ACER TENDL-2023 LIBRARY; T=0.K  
alphas from (n,2a)

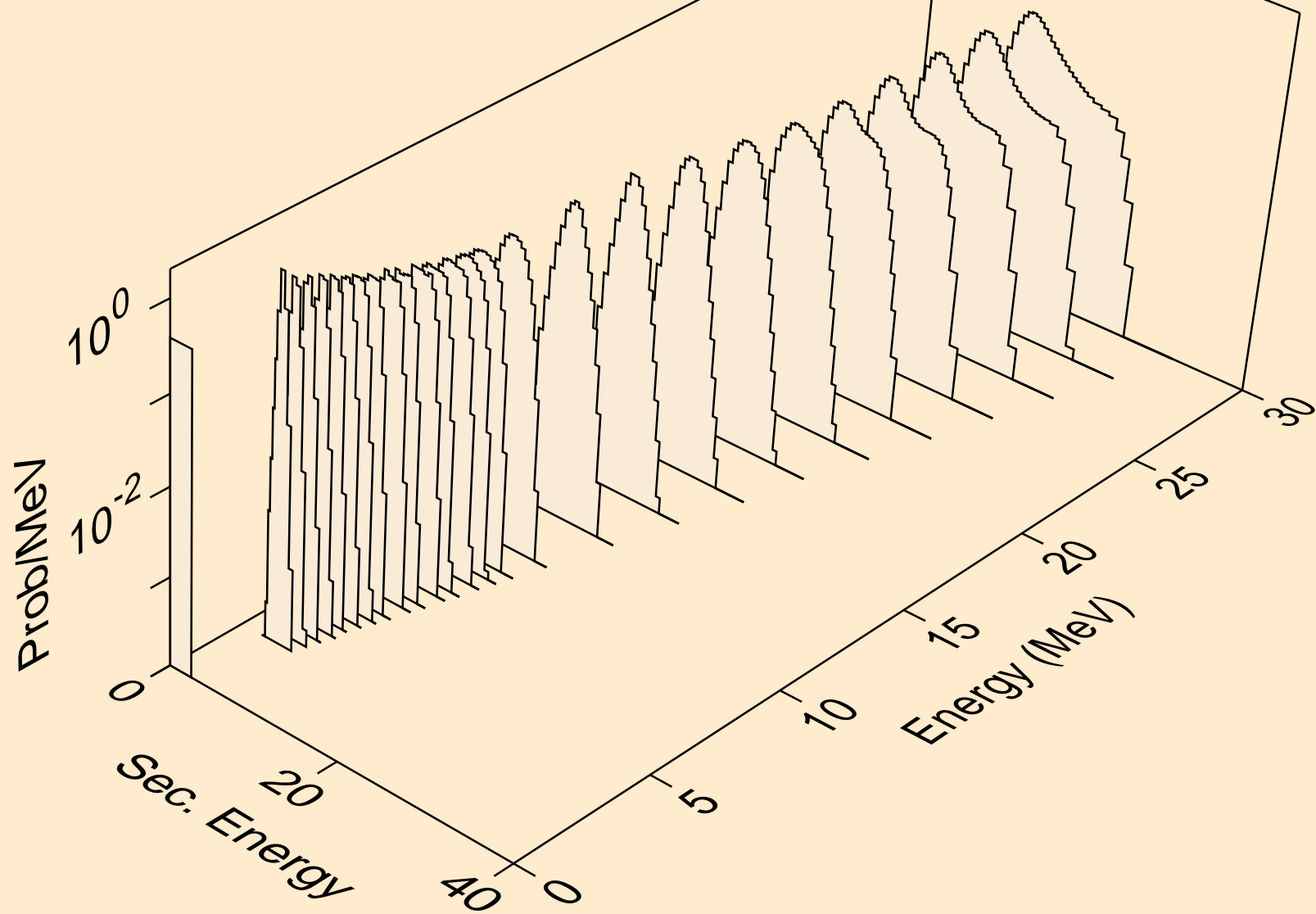

RU091 NEUTRON ACER TENDL-2023 LIBRARY; T=0.K  
alphas from (n,3a)

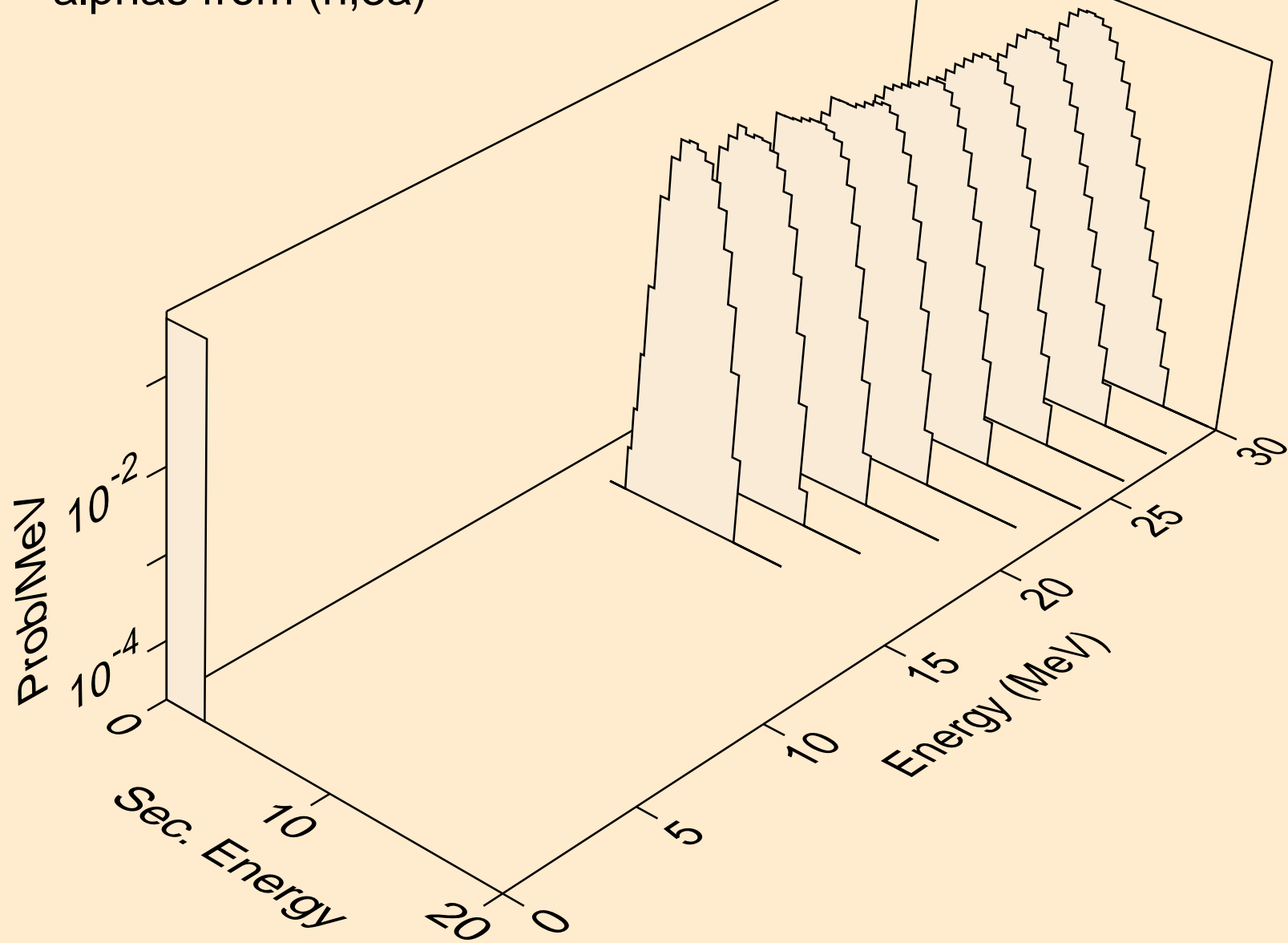

RU091 NEUTRON ACER TENDL-2023 LIBRARY; T=0.K  
alphas from (n,pa)

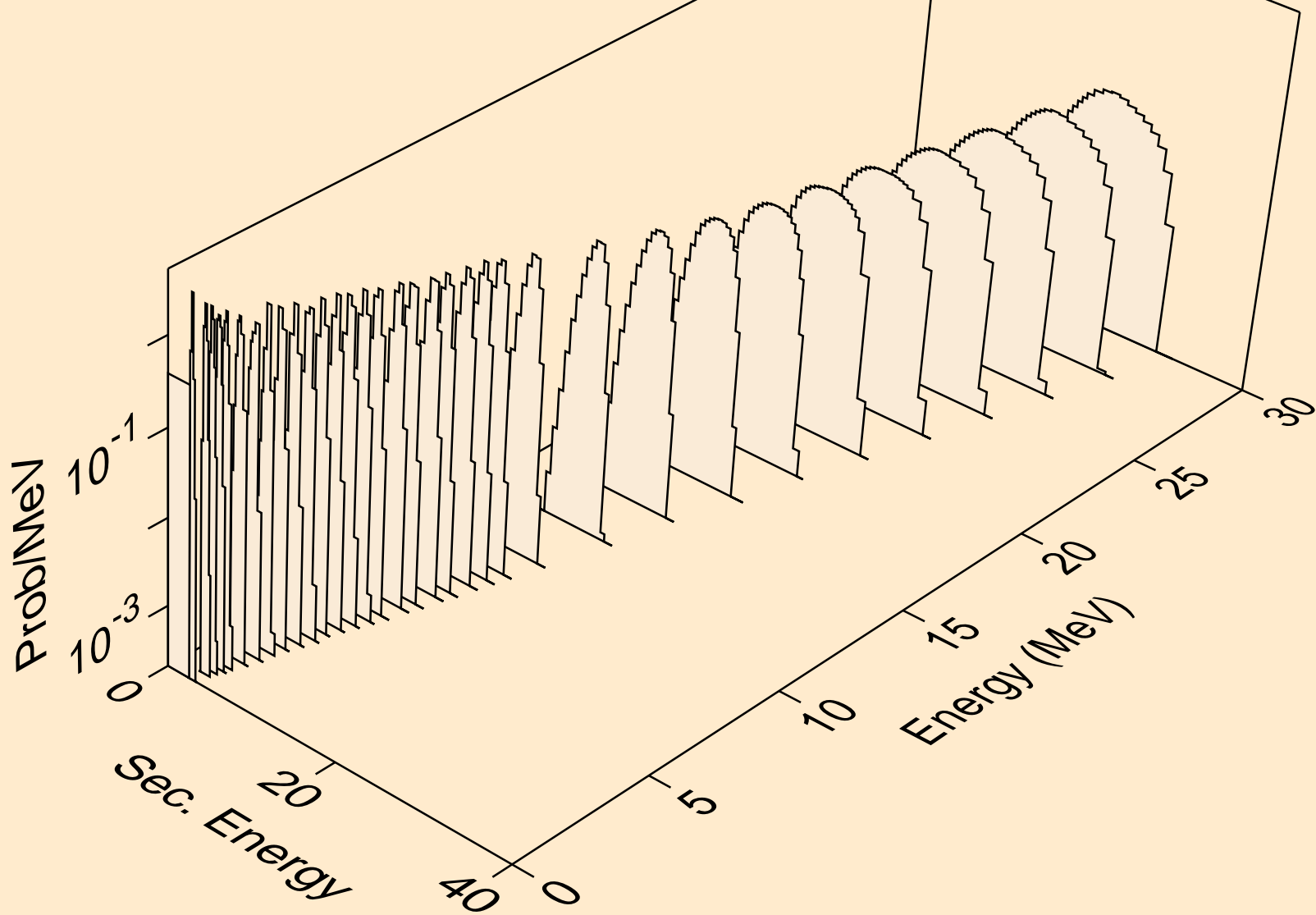

RU091 NEUTRON ACER TENDL-2023 LIBRARY; T=0.K  
alphas from (n,da)

