

S032 NEUTRON ACER TENDL-2023 LIBRARY; T=0.K

Principal cross sections

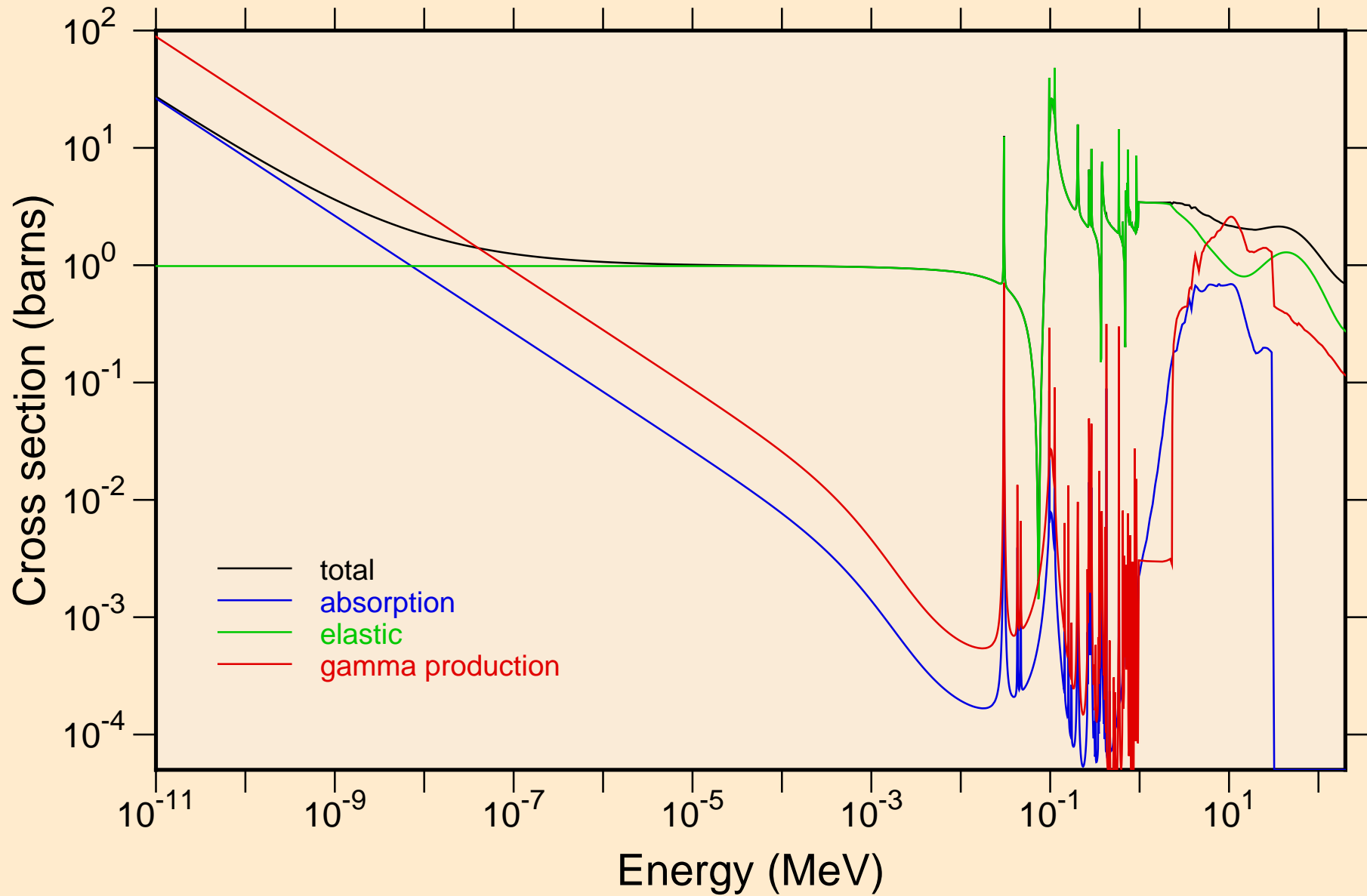

S032 NEUTRON ACER TENDL-2023 LIBRARY; T=0.K
resonance total cross section

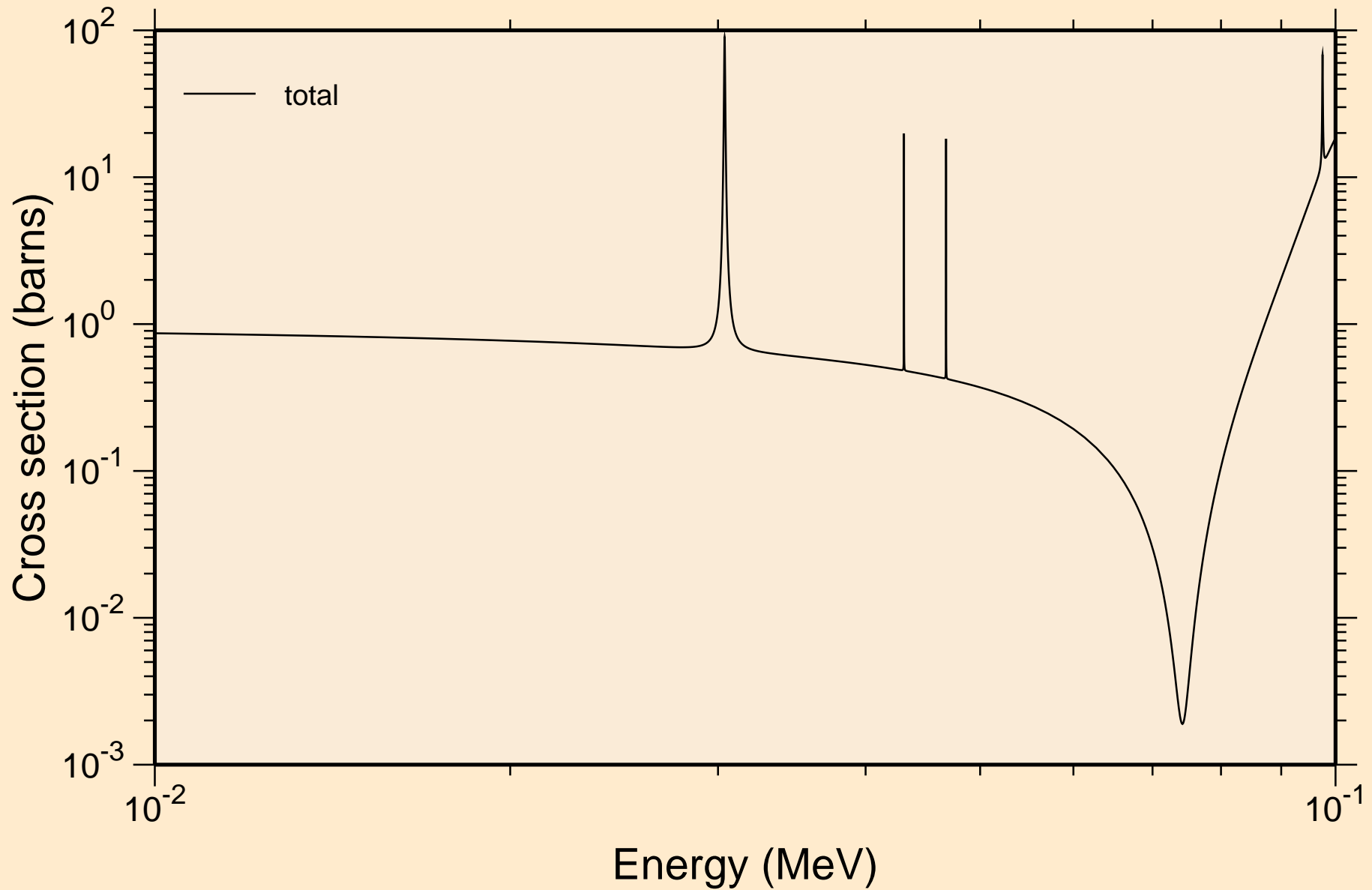

S032 NEUTRON ACER TENDL-2023 LIBRARY; T=0.K
resonance total cross section

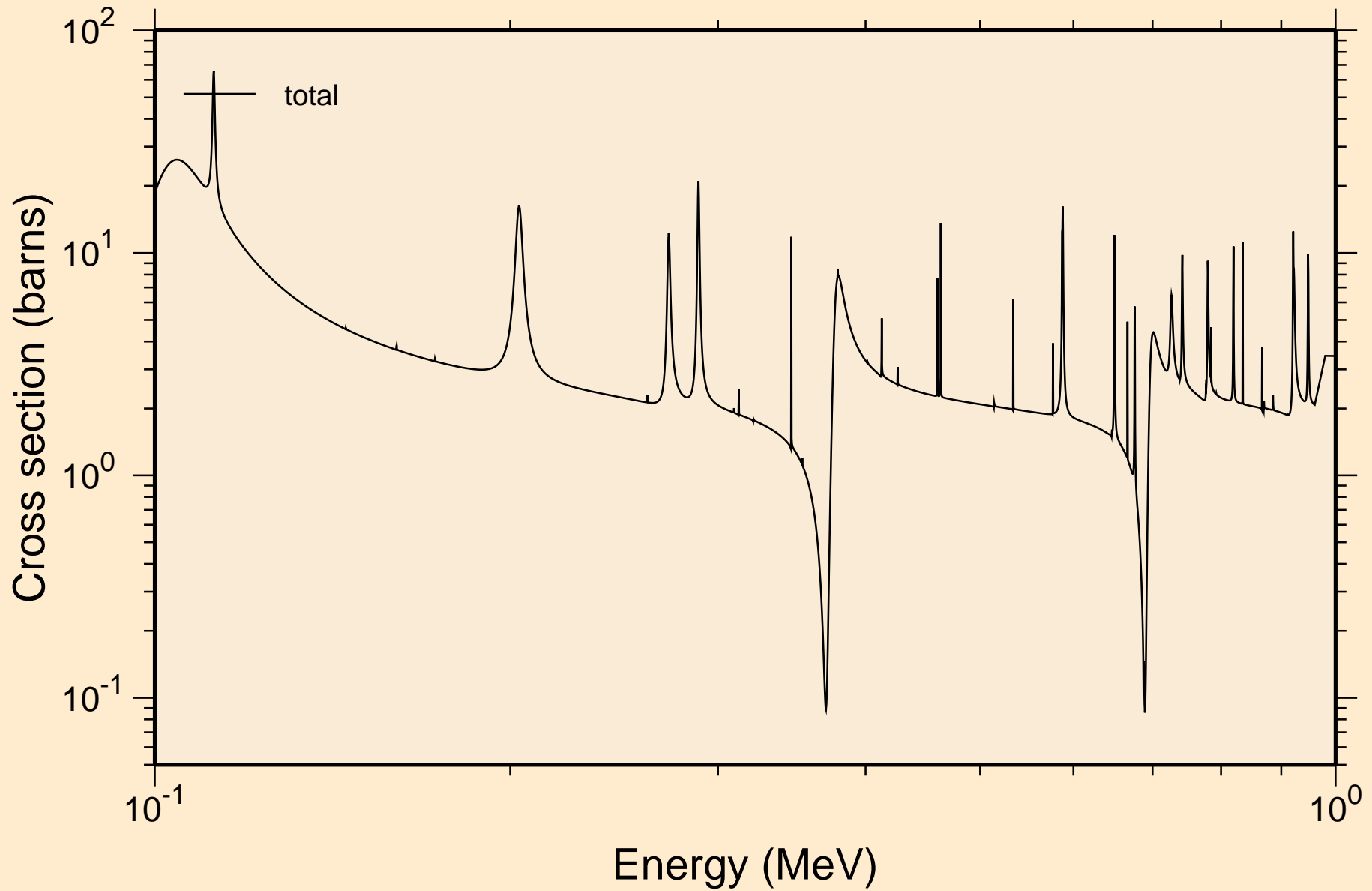

S032 NEUTRON ACER TENDL-2023 LIBRARY; T=0.K
resonance total cross section

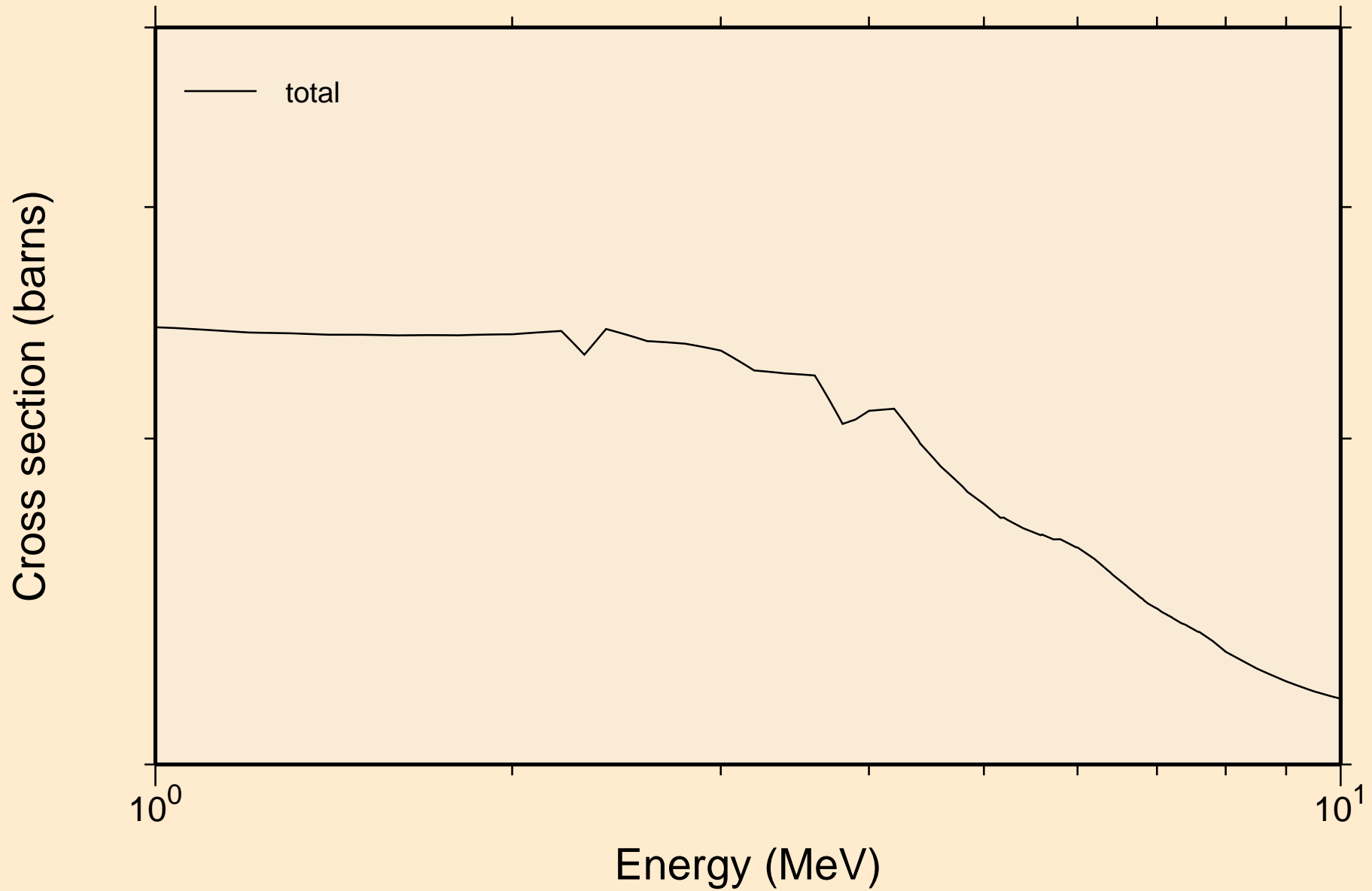

S032 NEUTRON ACER TENDL-2023 LIBRARY; T=0.K
resonance absorption cross sections

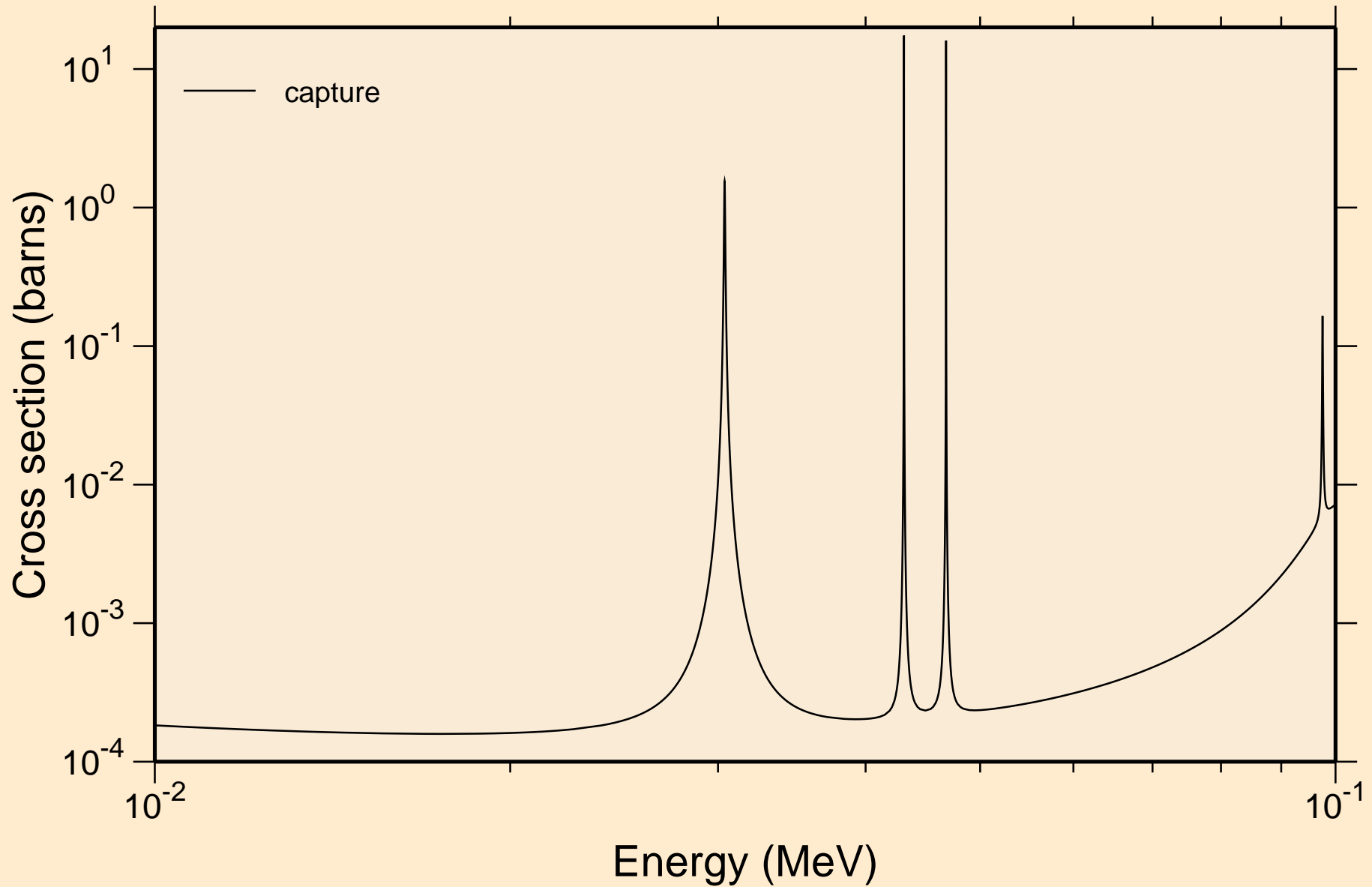

S032 NEUTRON ACER TENDL-2023 LIBRARY; T=0.K
resonance absorption cross sections

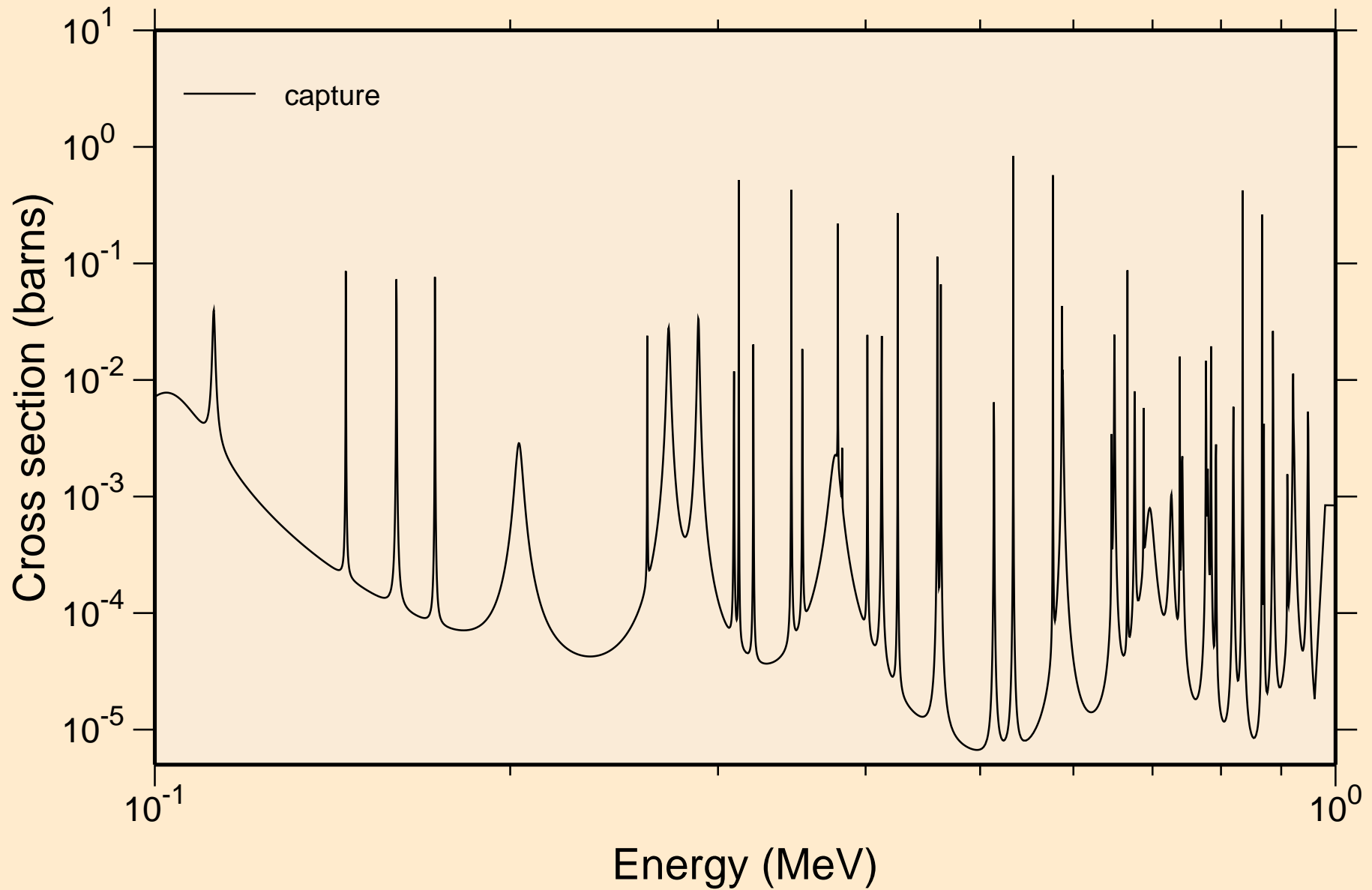

S032 NEUTRON ACER TENDL-2023 LIBRARY; T=0.K
resonance absorption cross sections

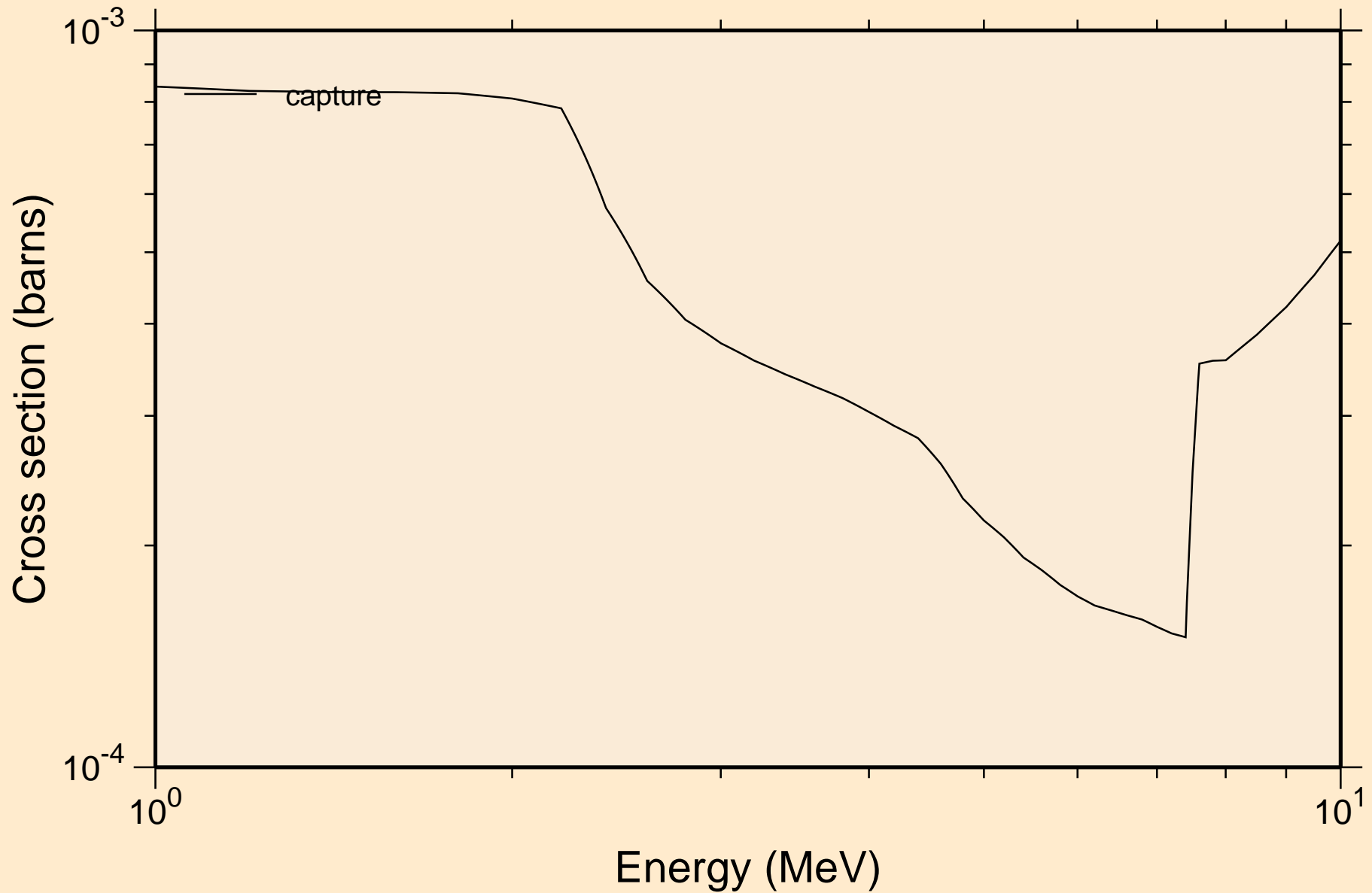

S032 NEUTRON ACER TENDL-2023 LIBRARY; T=0.K

Heating

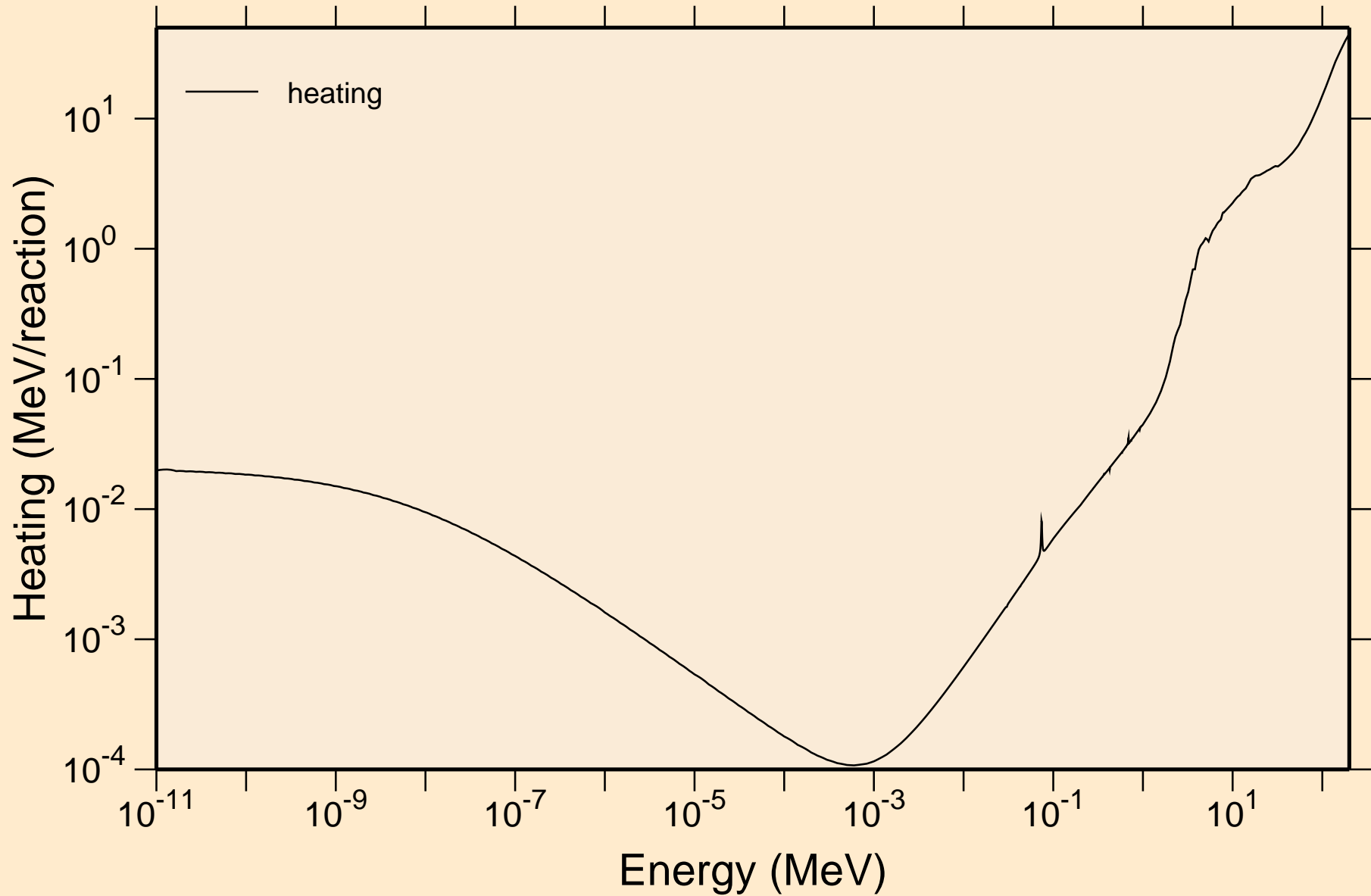

S032 NEUTRON ACER TENDL-2023 LIBRARY; T=0.K
Damage

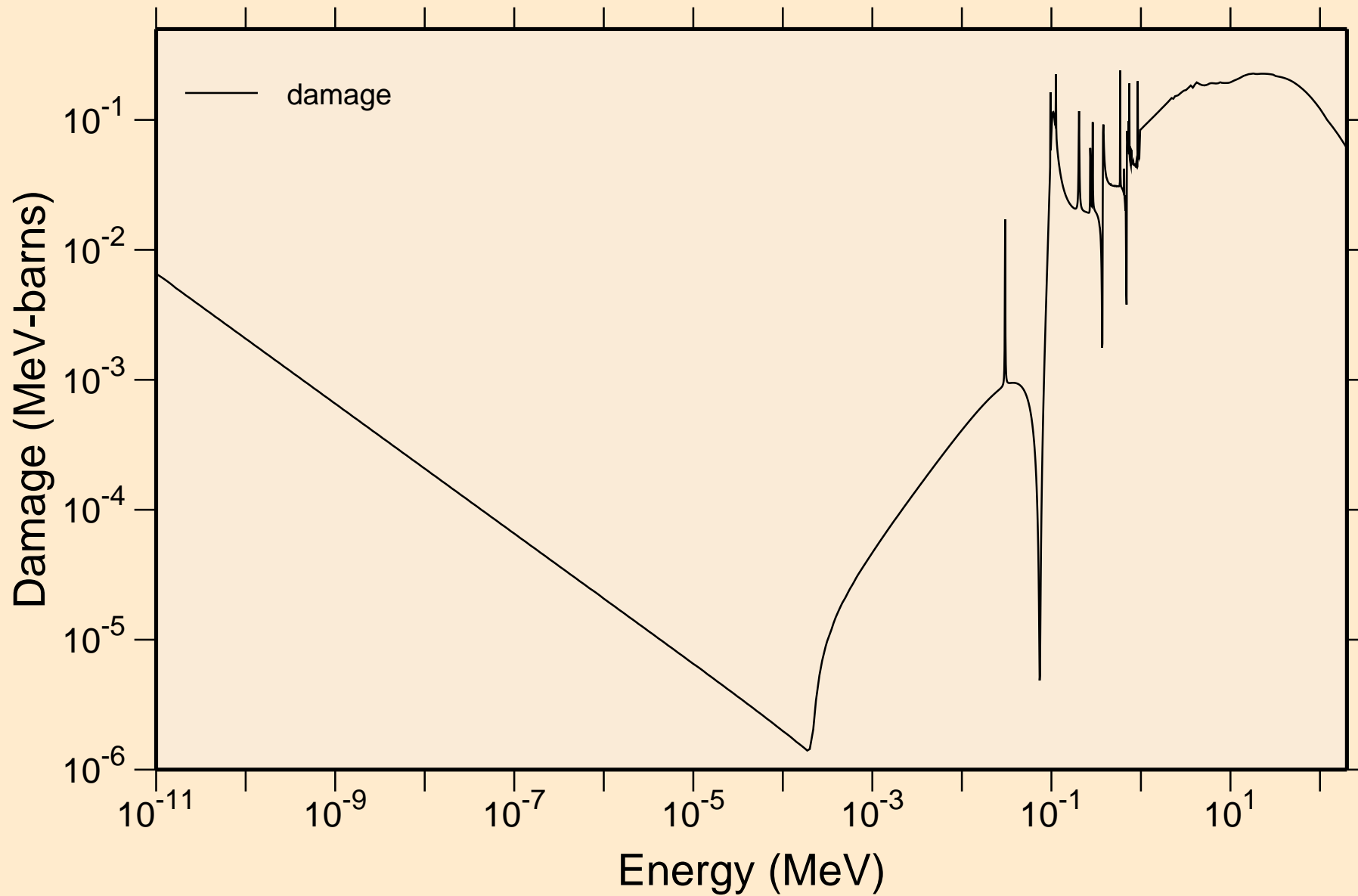

S032 NEUTRON ACER TENDL-2023 LIBRARY; T=0.K
Non-threshold reactions

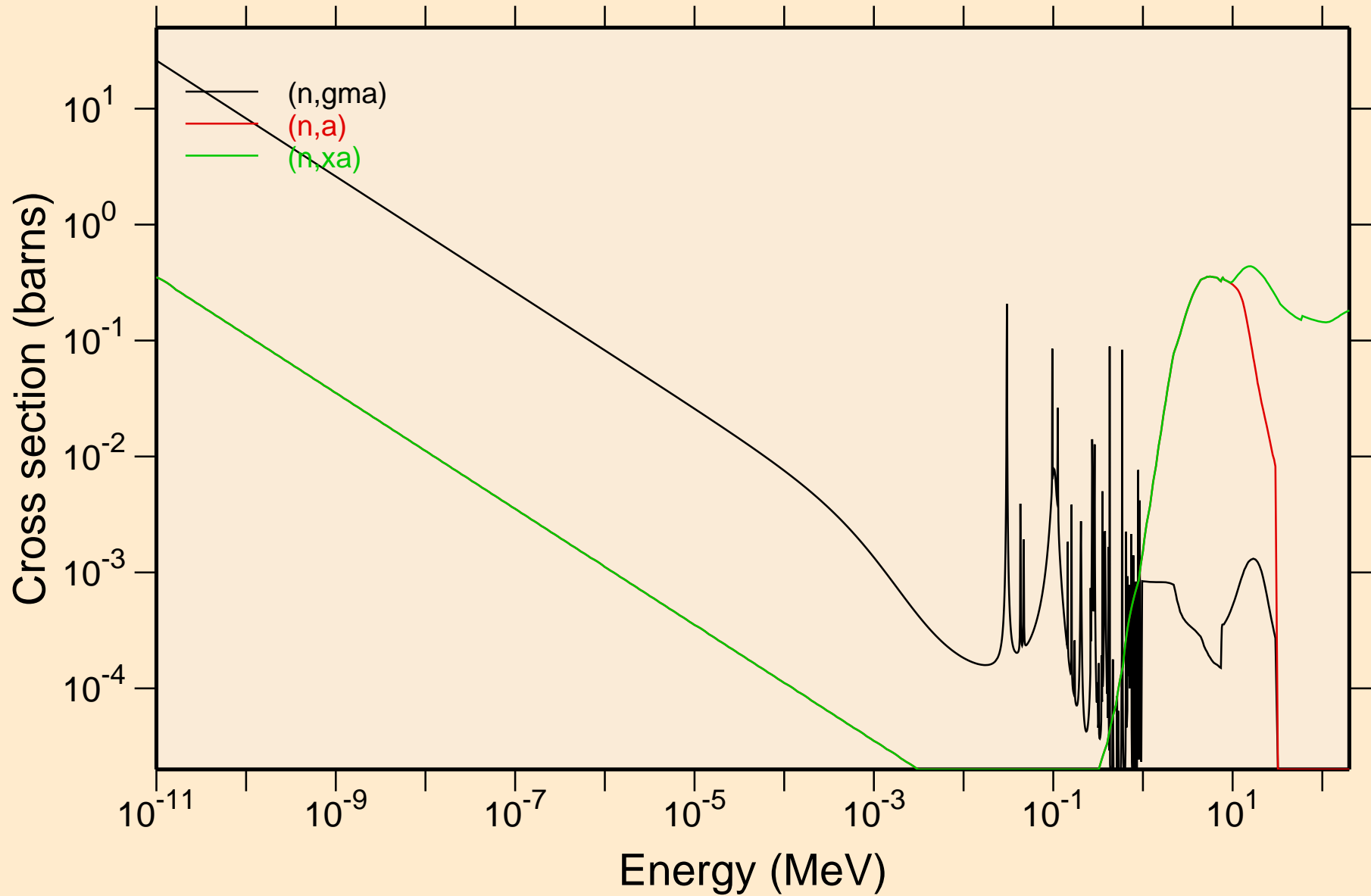

S032 NEUTRON ACER TENDL-2023 LIBRARY; T=0.K

Principal cross sections

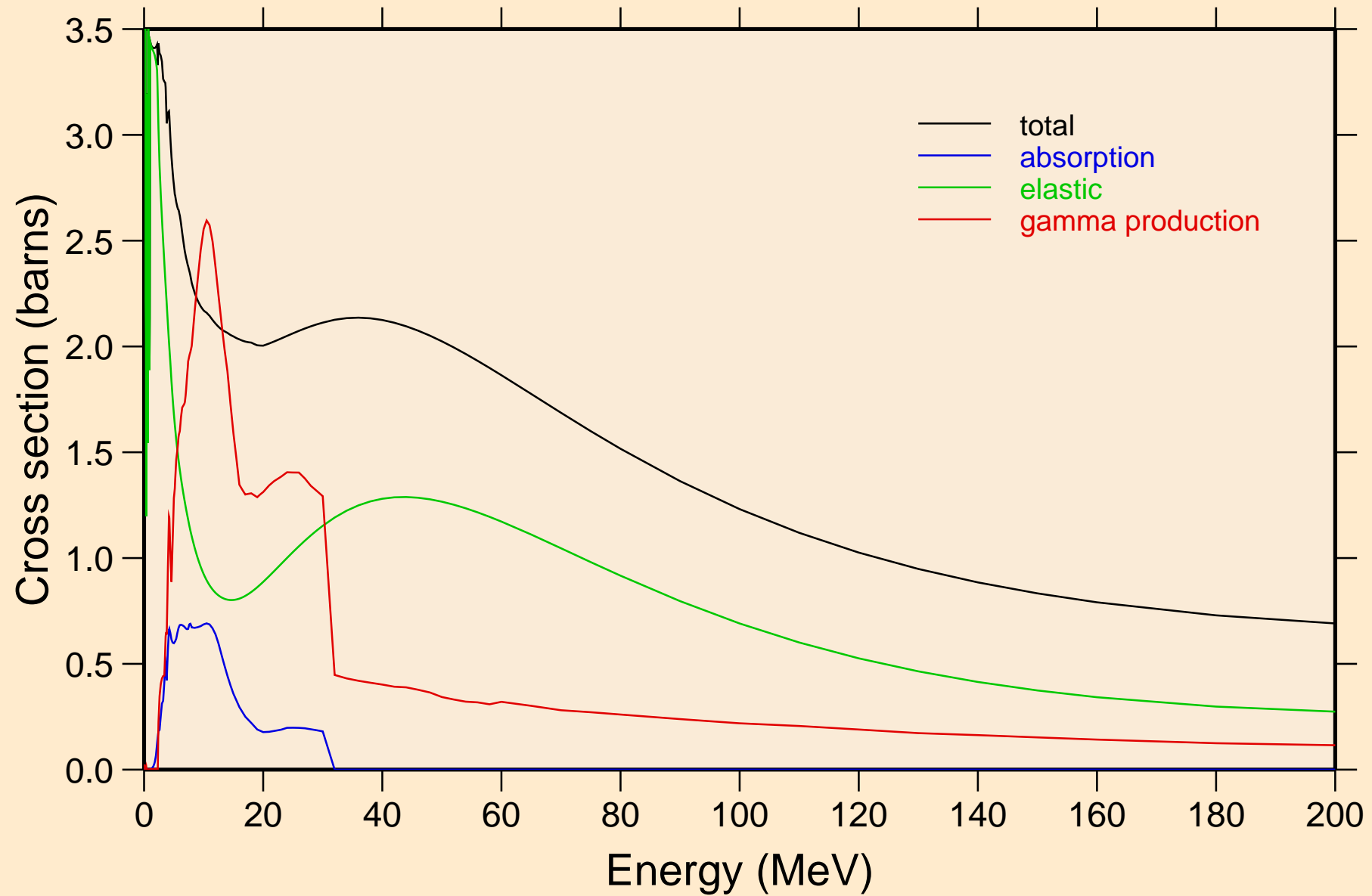

S032 NEUTRON ACER TENDL-2023 LIBRARY; T=0.K

Heating

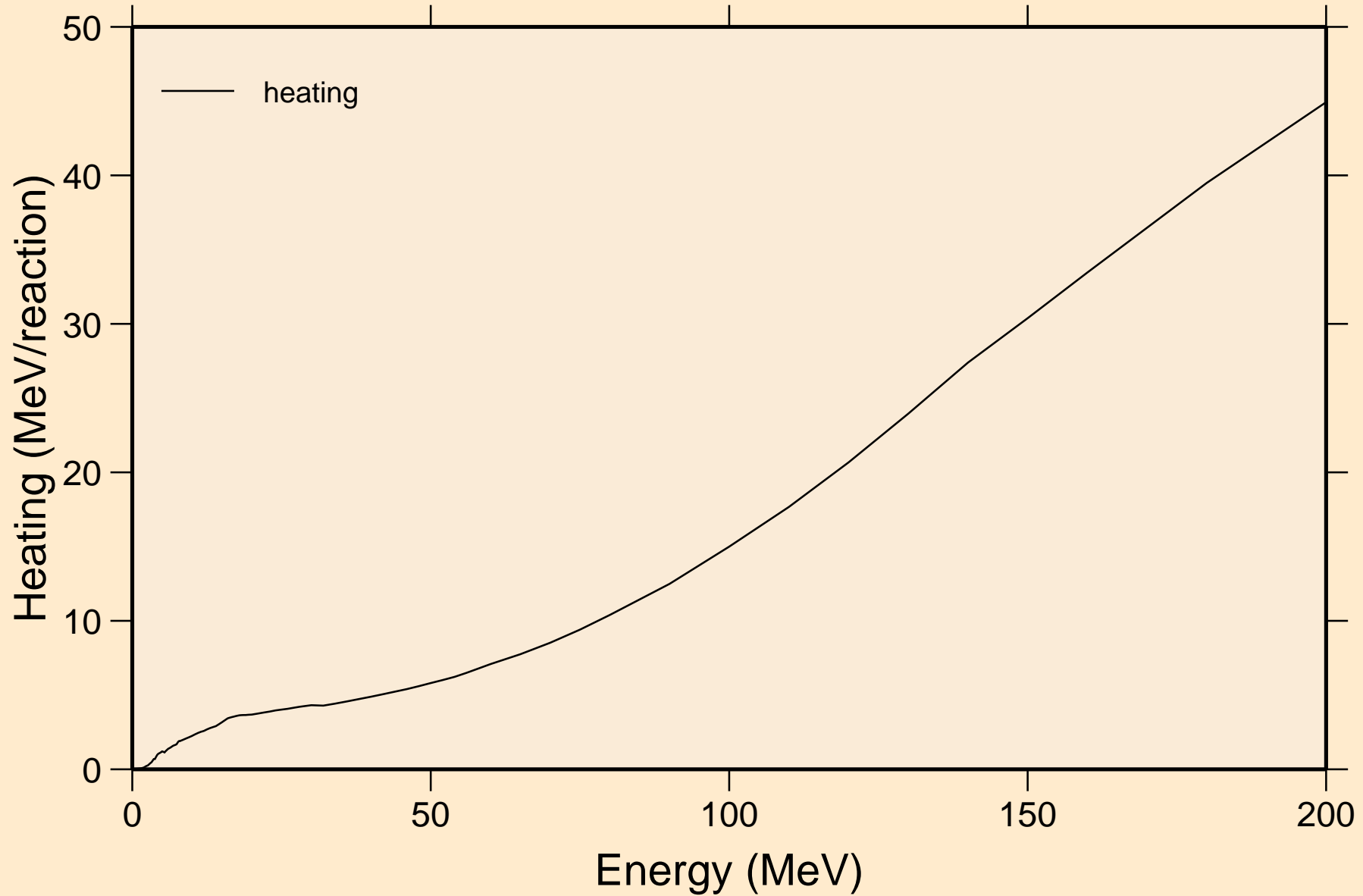

S032 NEUTRON ACER TENDL-2023 LIBRARY; T=0.K

Damage

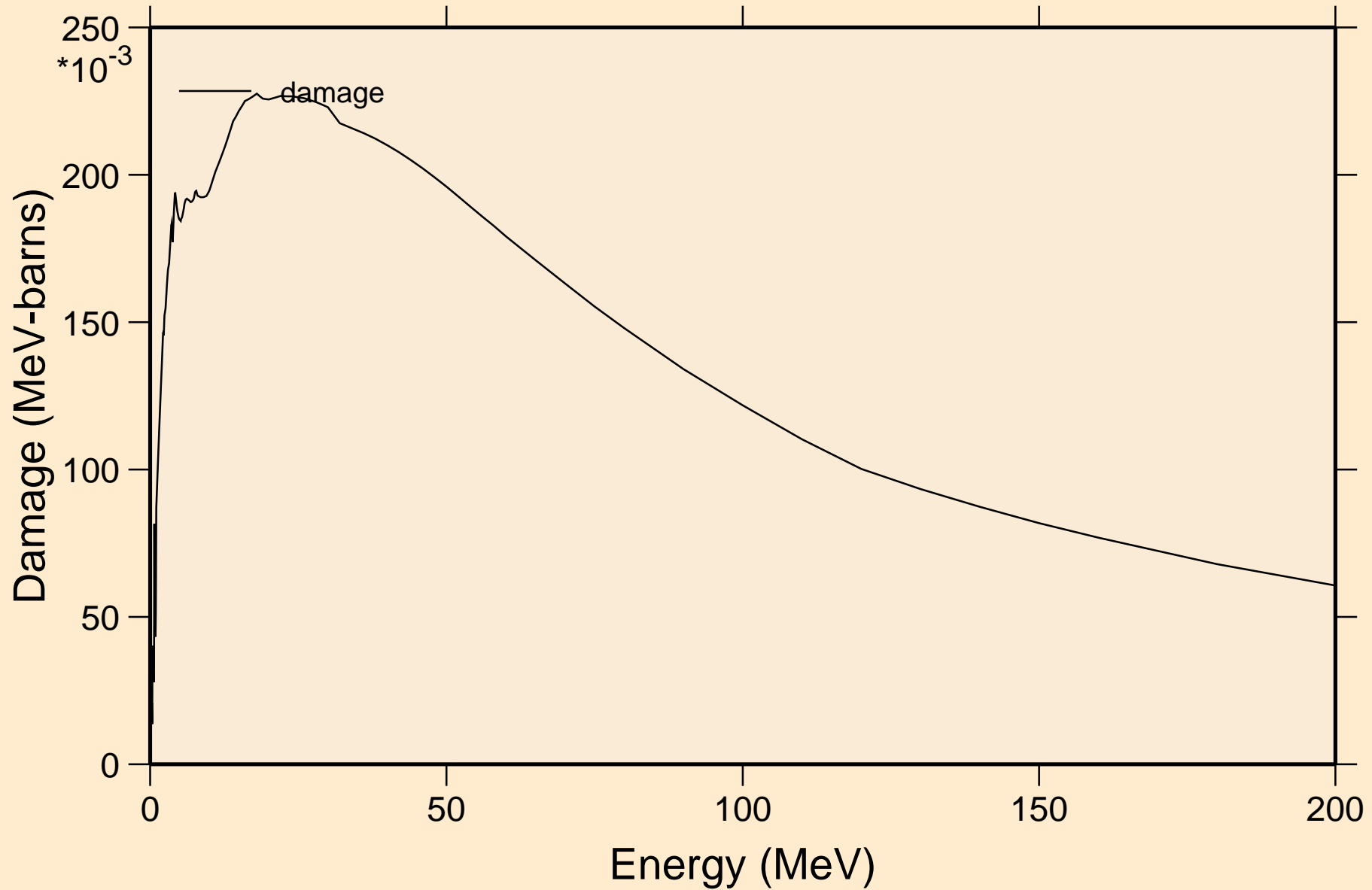

S032 NEUTRON ACER TENDL-2023 LIBRARY; T=0.K
Non-threshold reactions

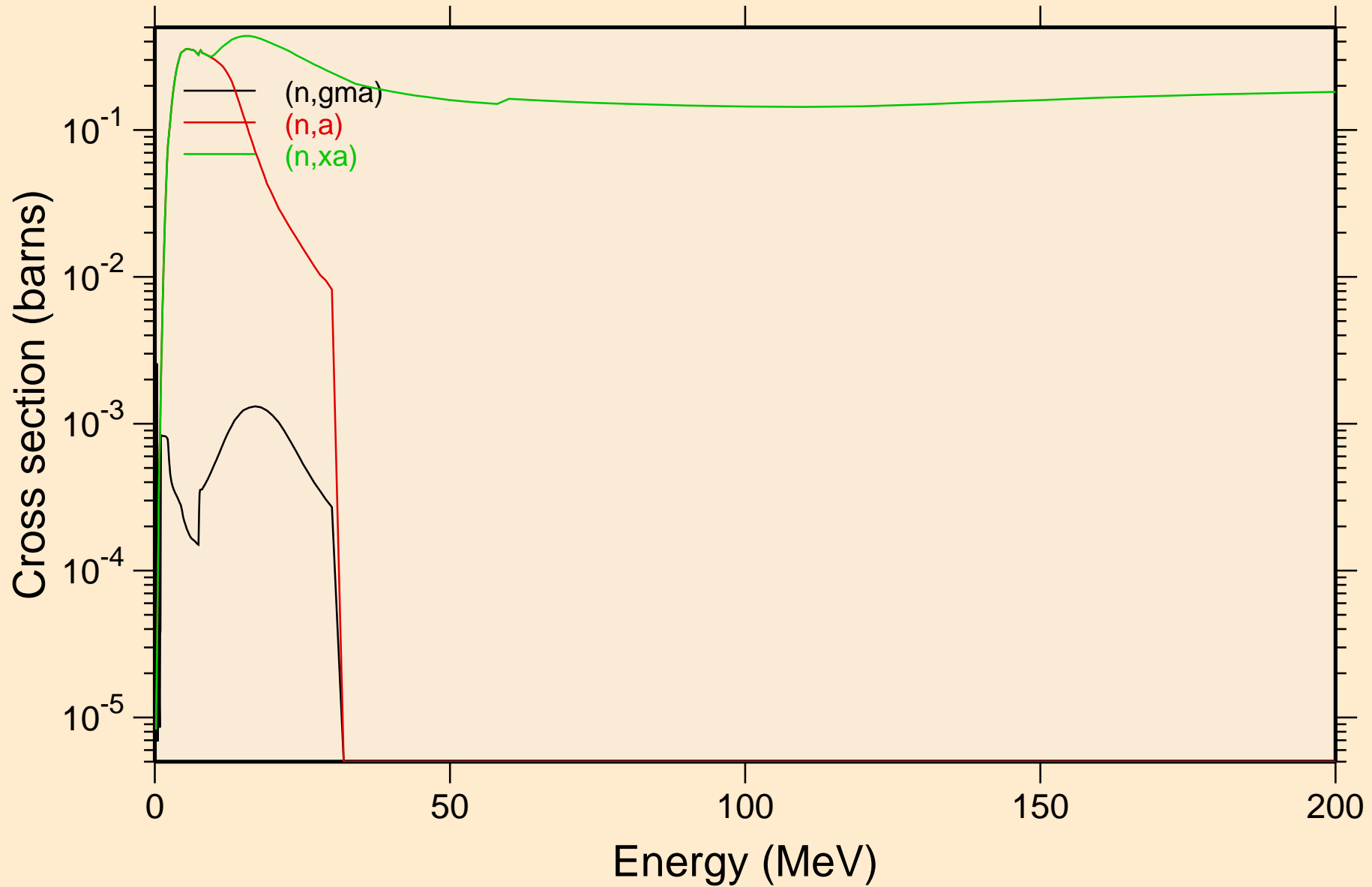

S032 NEUTRON ACER TENDL-2023 LIBRARY; T=0.K
Inelastic levels

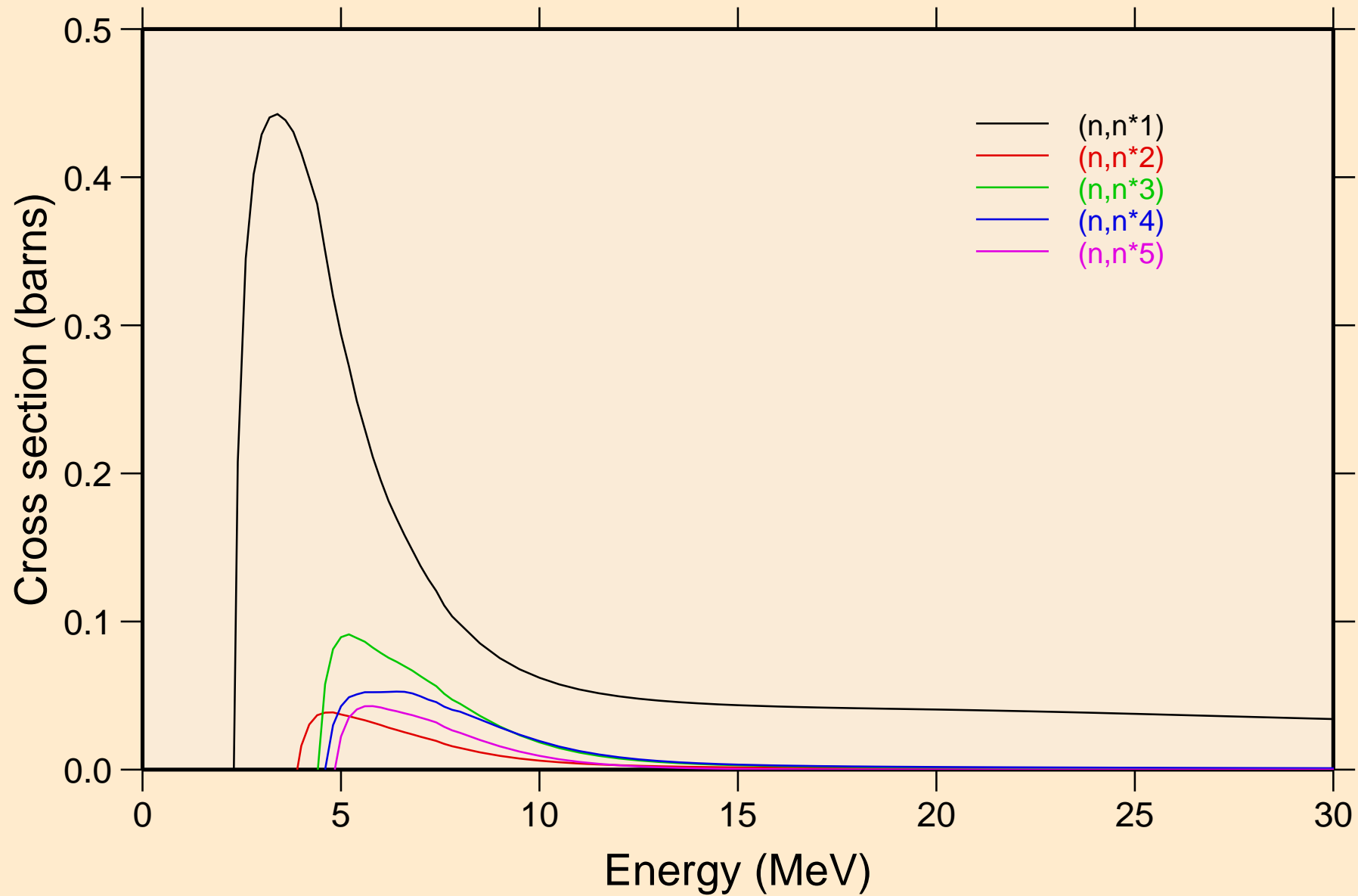

S032 NEUTRON ACER TENDL-2023 LIBRARY; T=0.K
Inelastic levels

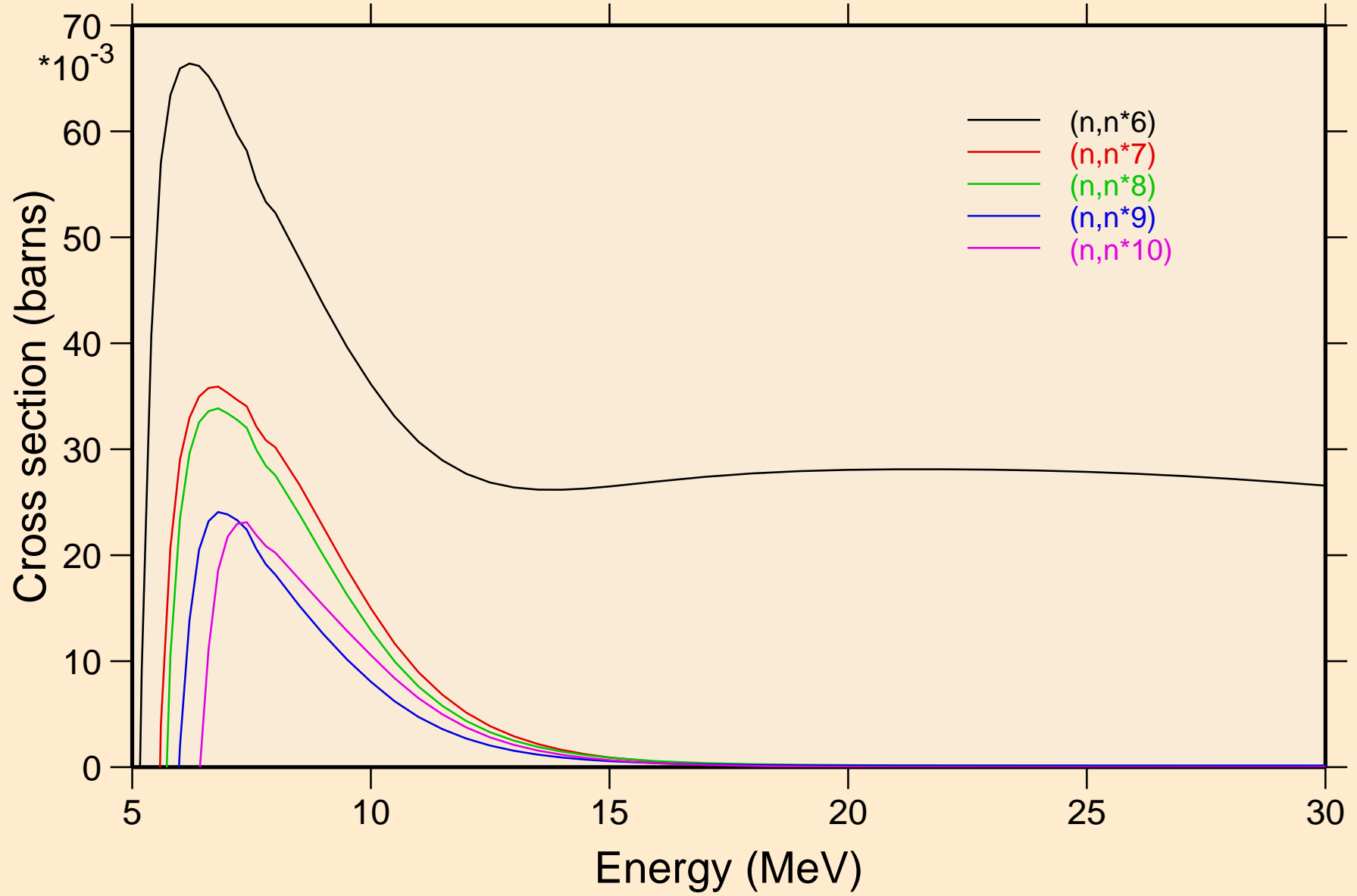

S032 NEUTRON ACER TENDL-2023 LIBRARY; T=0.K
Inelastic levels

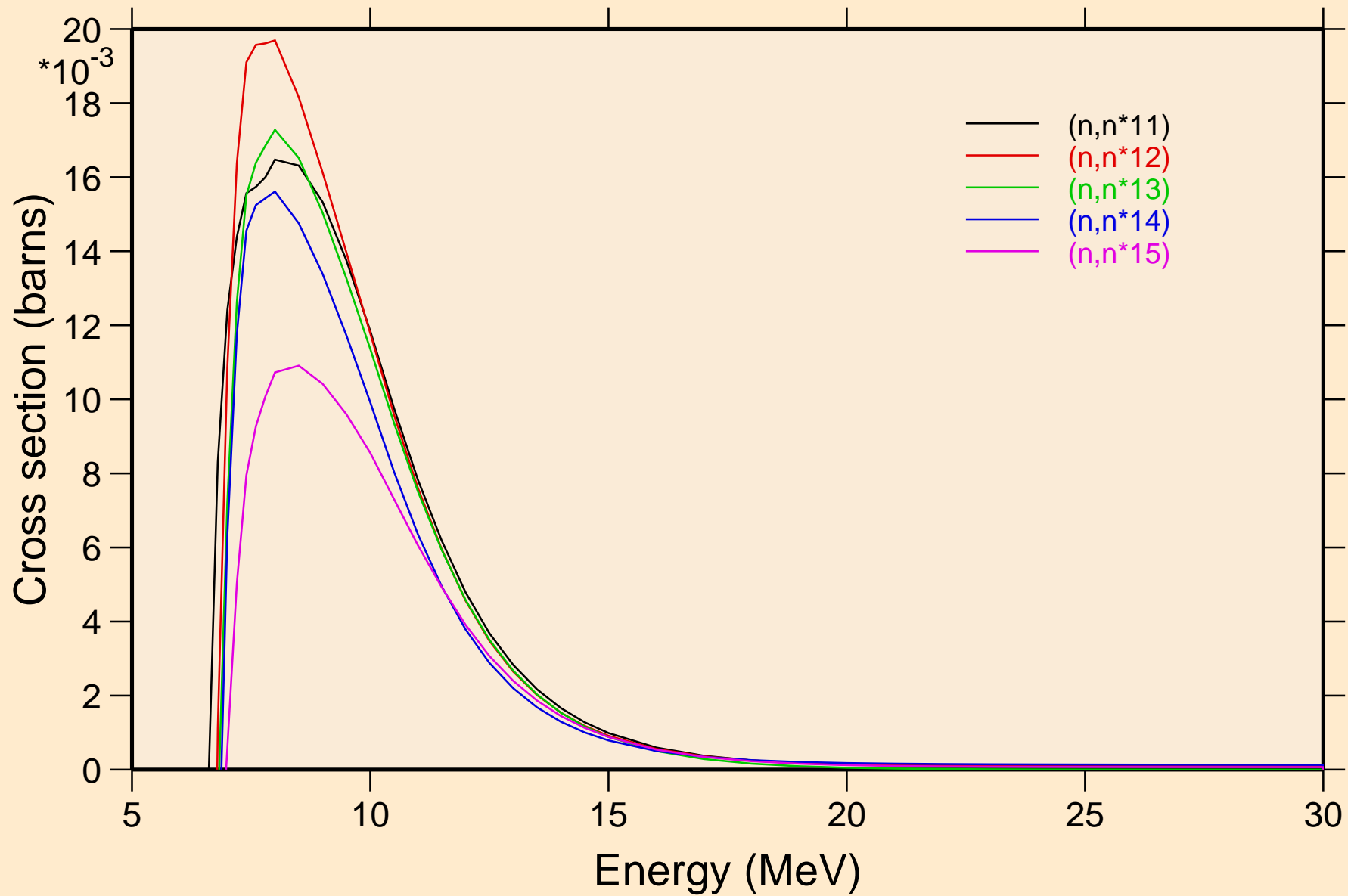

S032 NEUTRON ACER TENDL-2023 LIBRARY; T=0.K
Inelastic levels

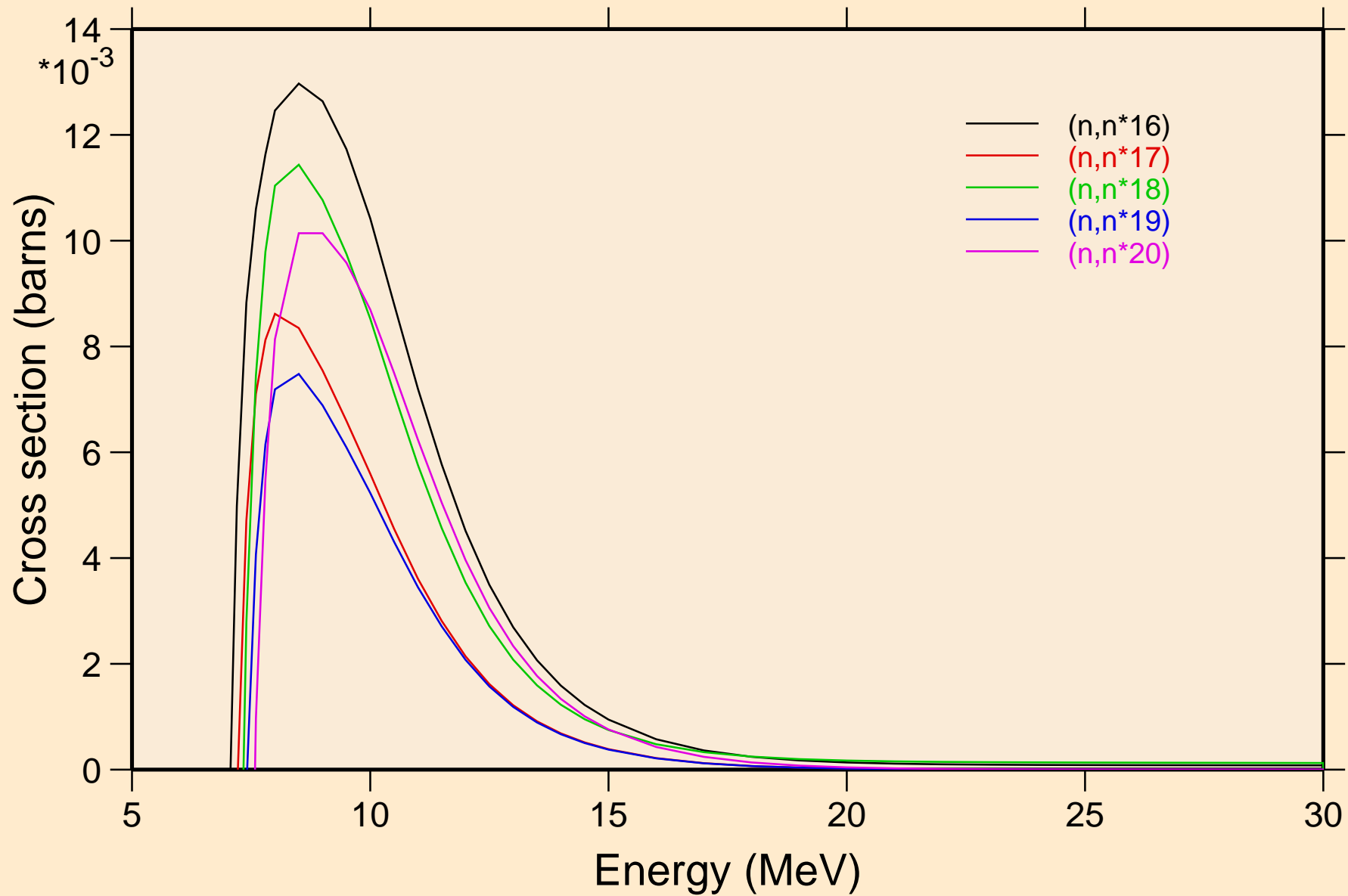

S032 NEUTRON ACER TENDL-2023 LIBRARY; T=0.K

Threshold reactions

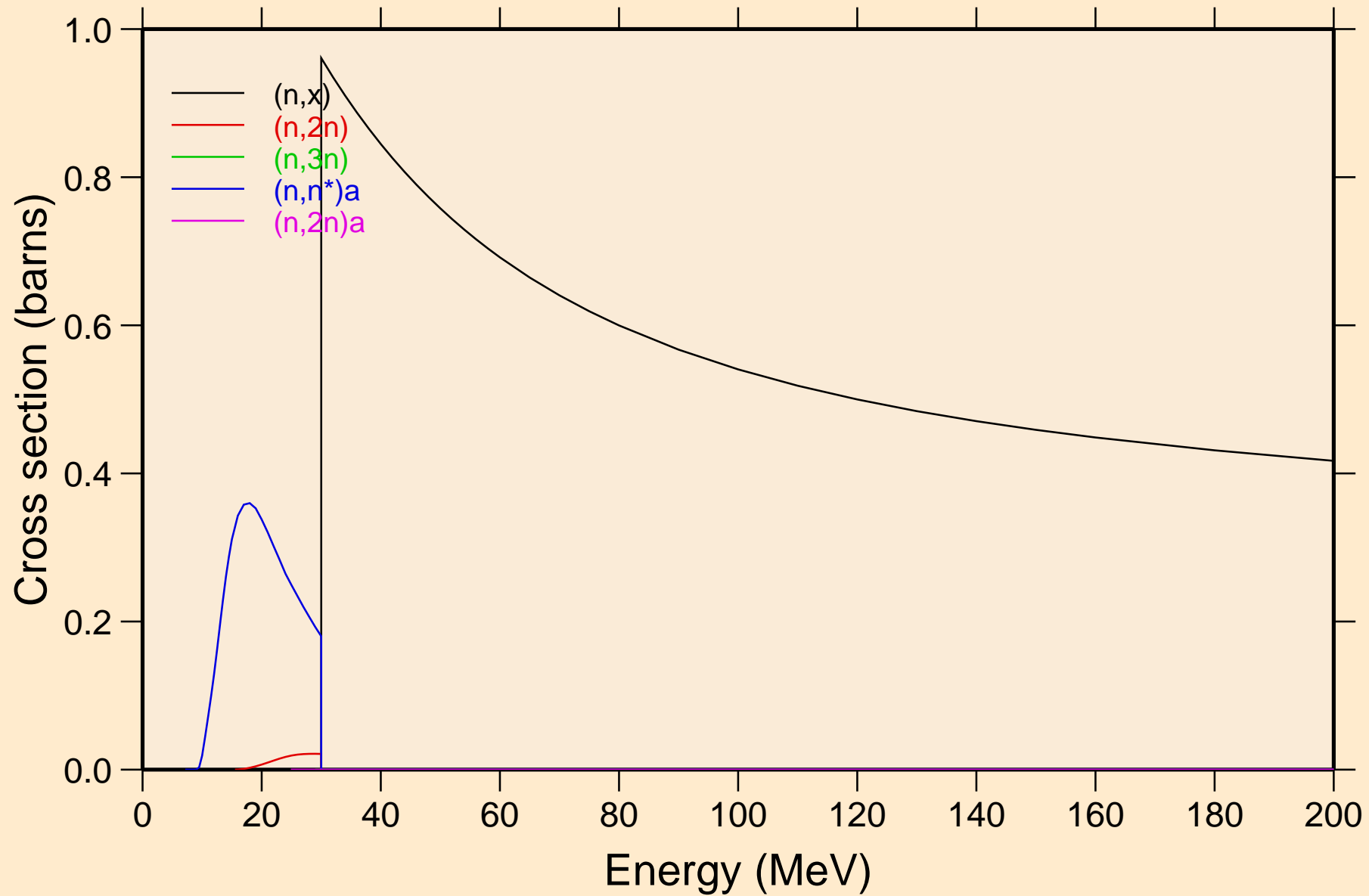

S032 NEUTRON ACER TENDL-2023 LIBRARY; T=0.K

Threshold reactions

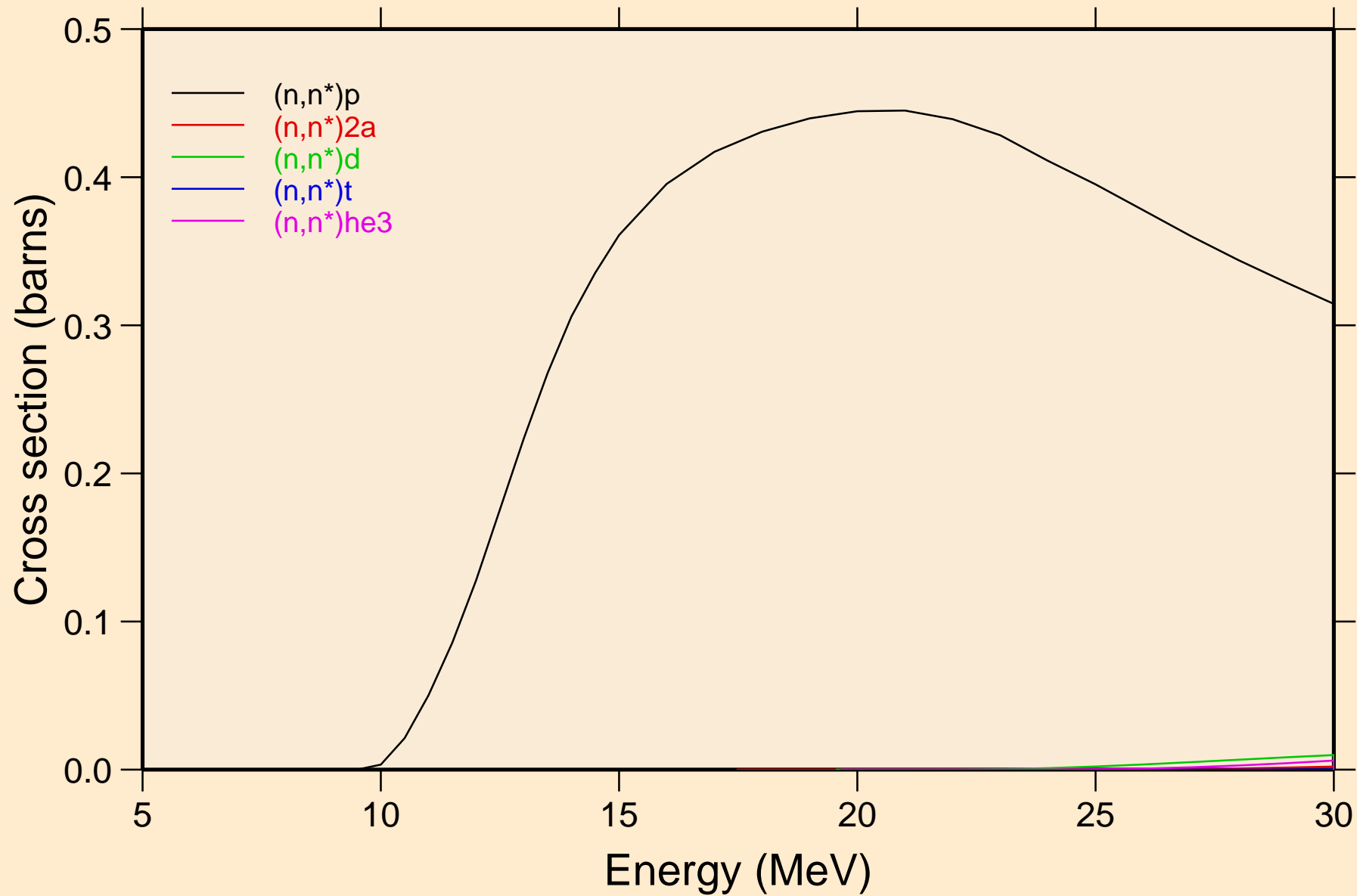

S032 NEUTRON ACER TENDL-2023 LIBRARY; T=0.K

Threshold reactions

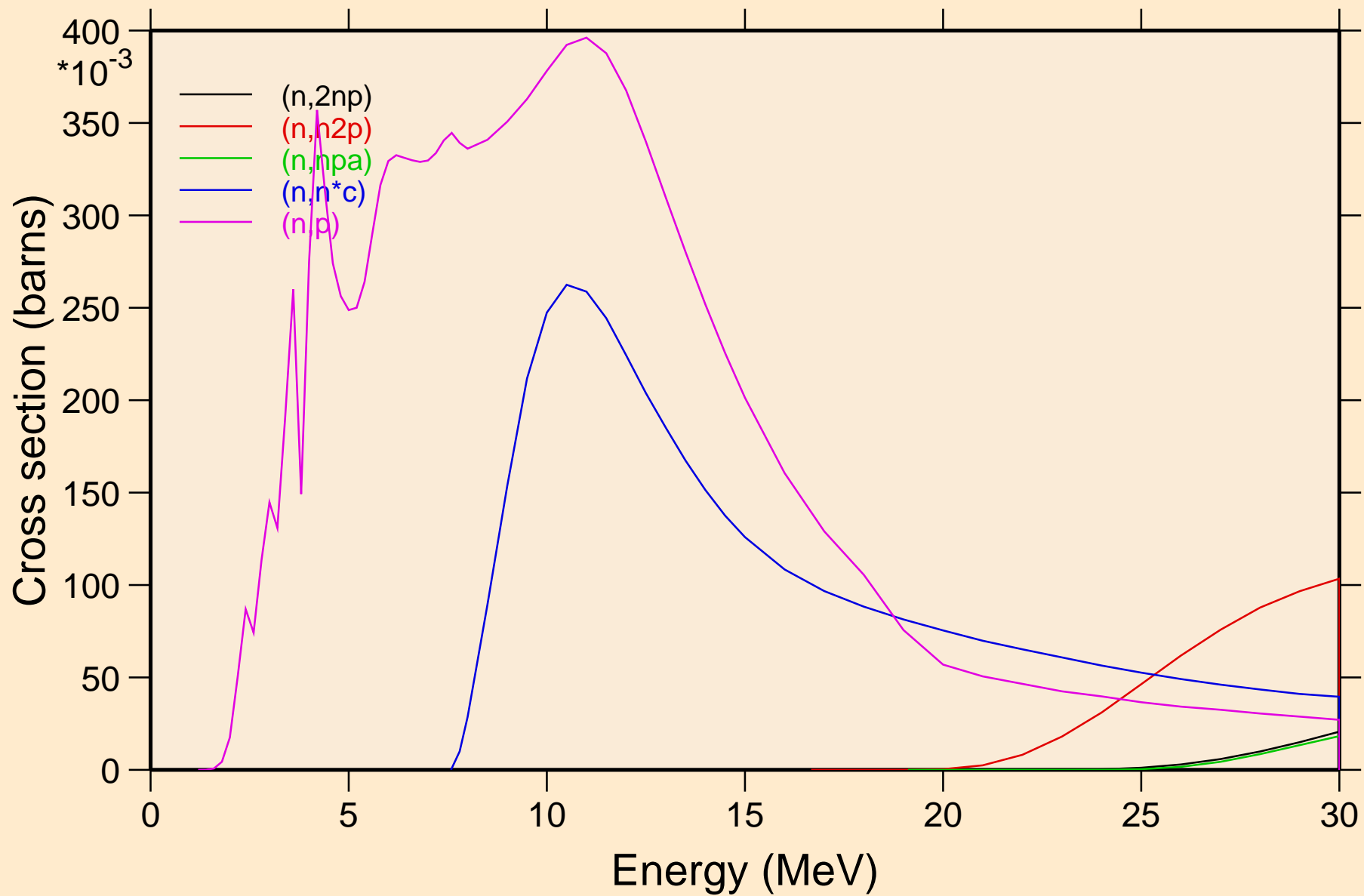

S032 NEUTRON ACER TENDL-2023 LIBRARY; T=0.K

Threshold reactions

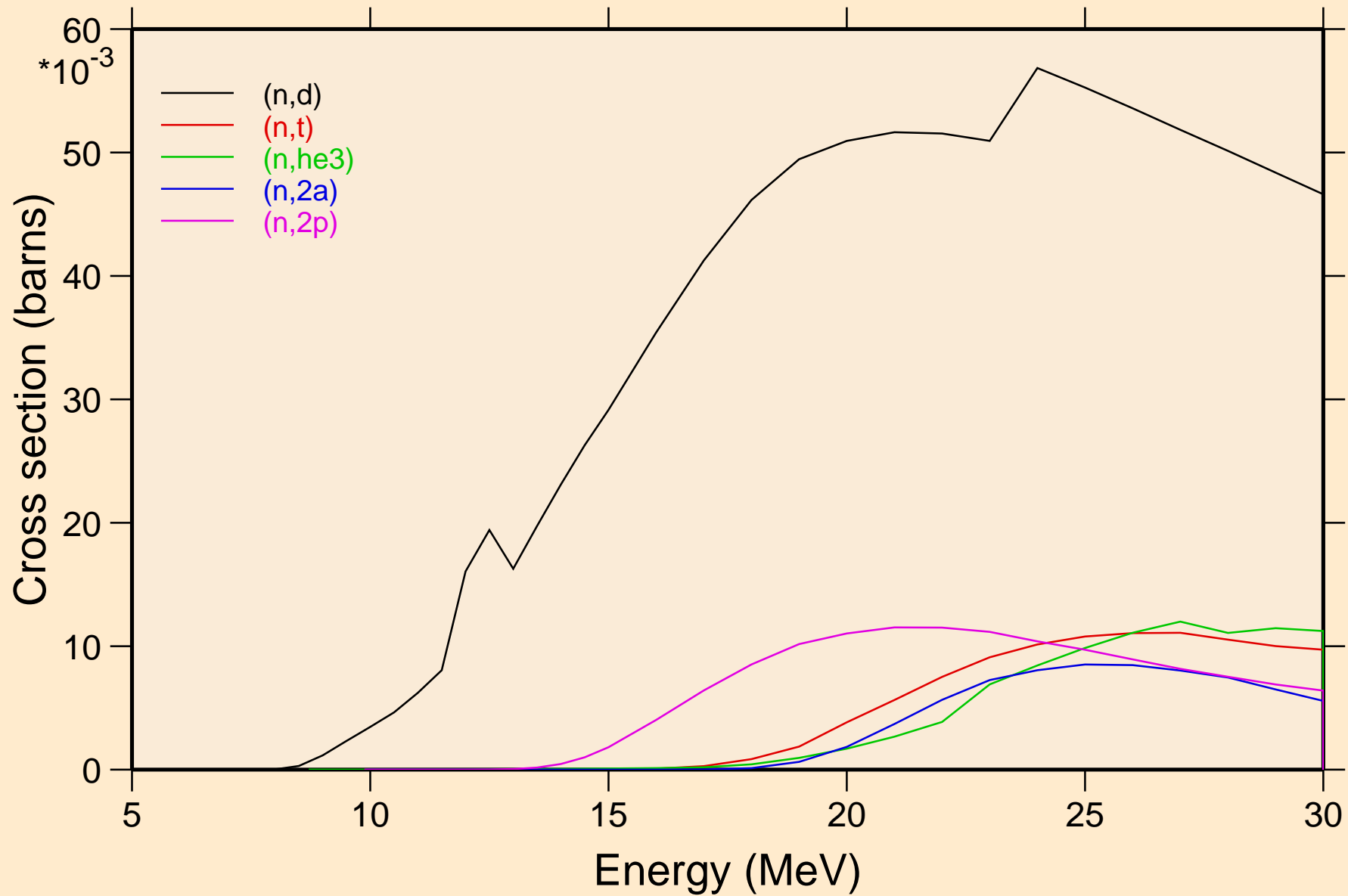

S032 NEUTRON ACER TENDL-2023 LIBRARY; T=0.K
Threshold reactions

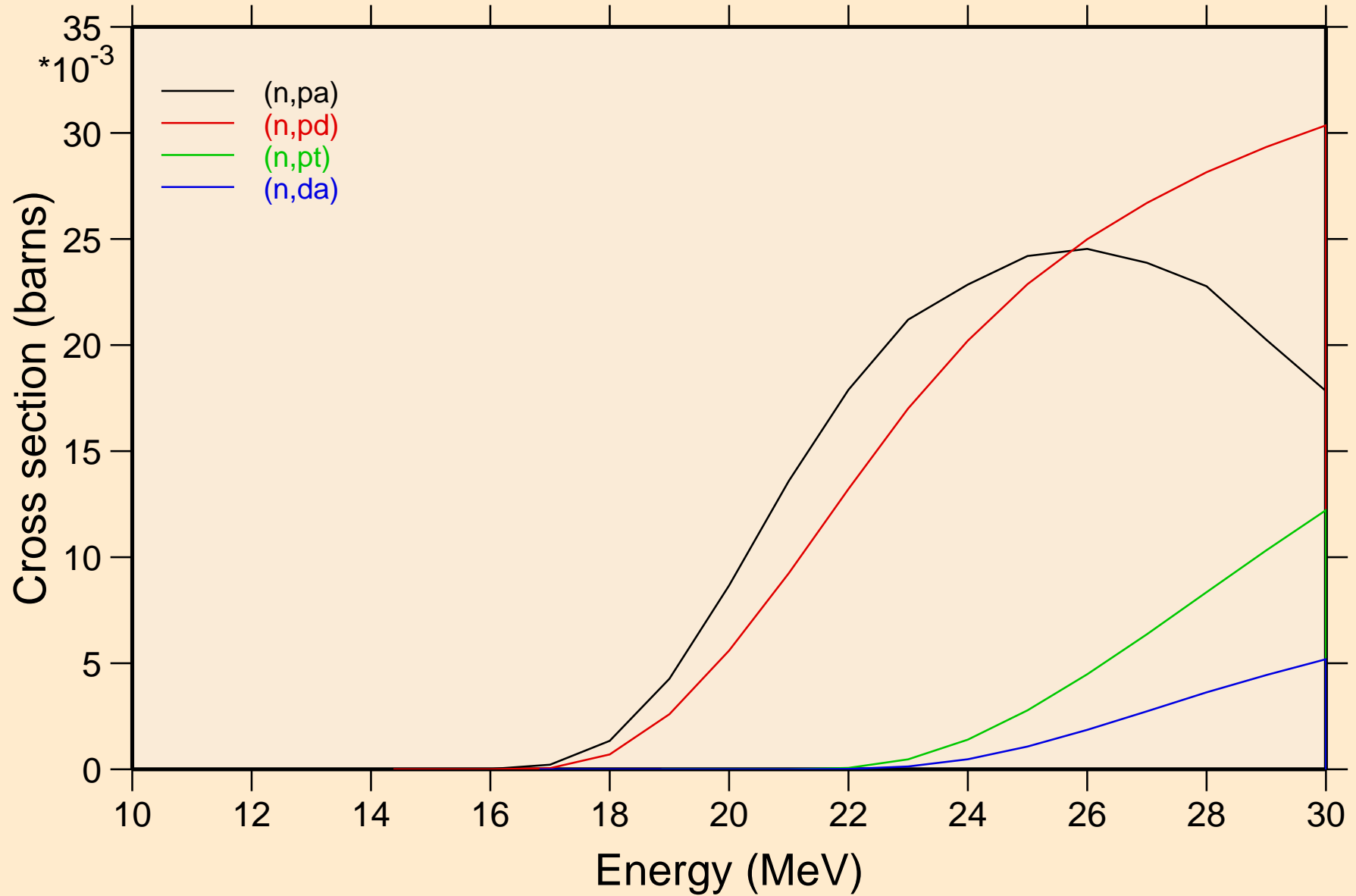

S032 NEUTRON ACER TENDL-2023 LIBRARY; T=0.K

Threshold reactions

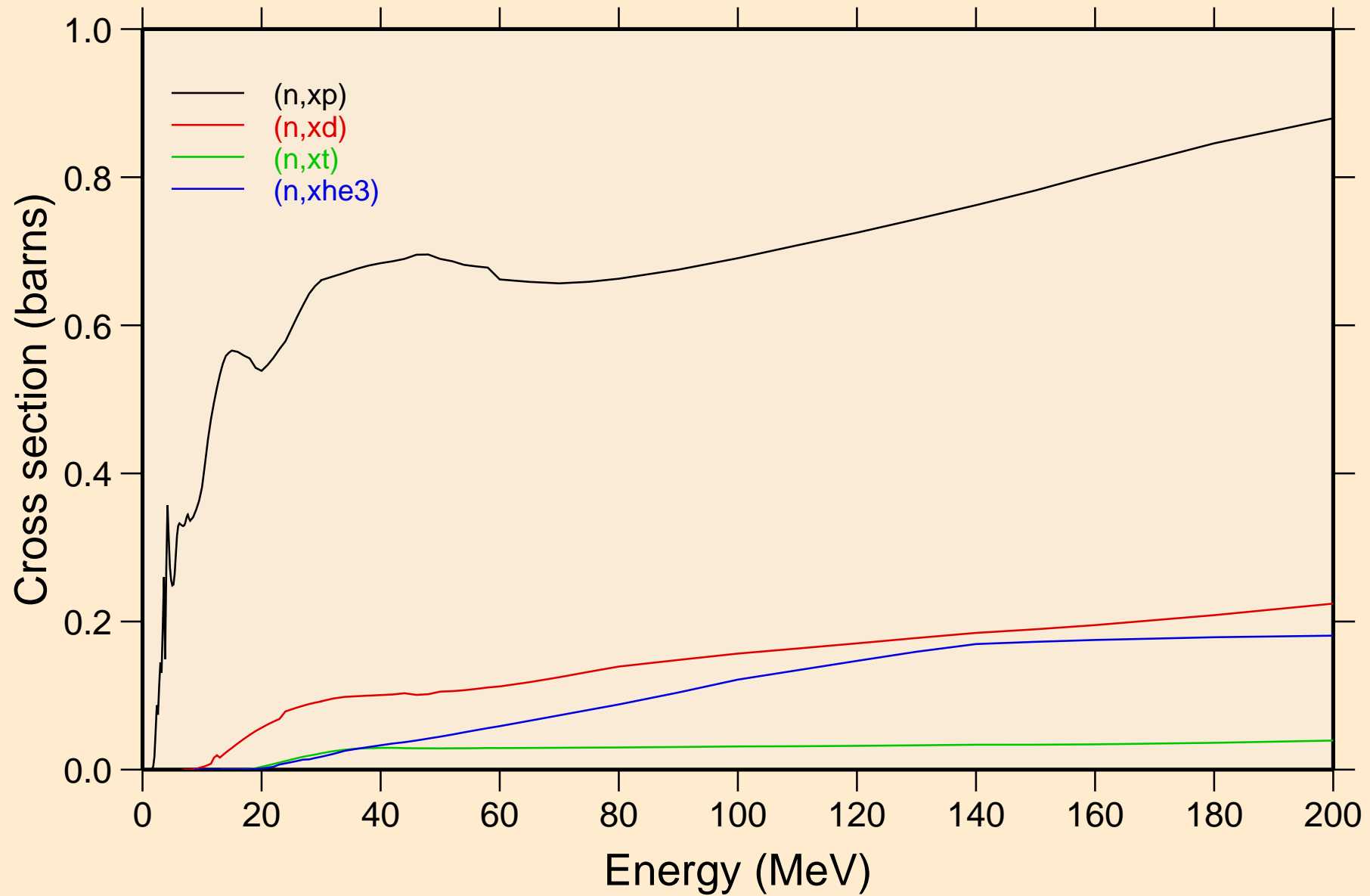

S032 NEUTRON ACER TENDL-2023 LIBRARY; T=0.K
angular distribution for elastic

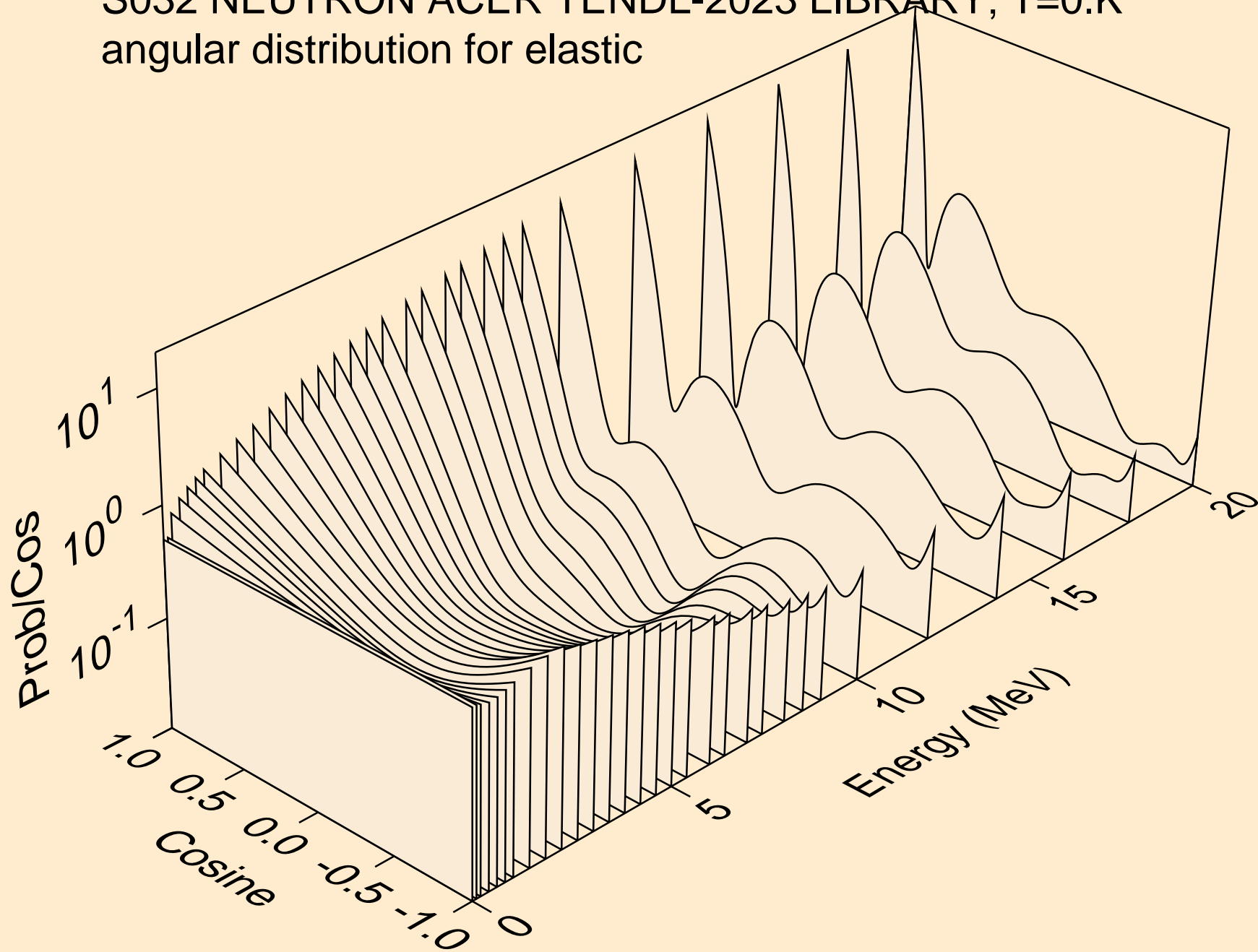

S032 NEUTRON ACER TENDL-2023 LIBRARY; T=0.K
angular distribution for elastic

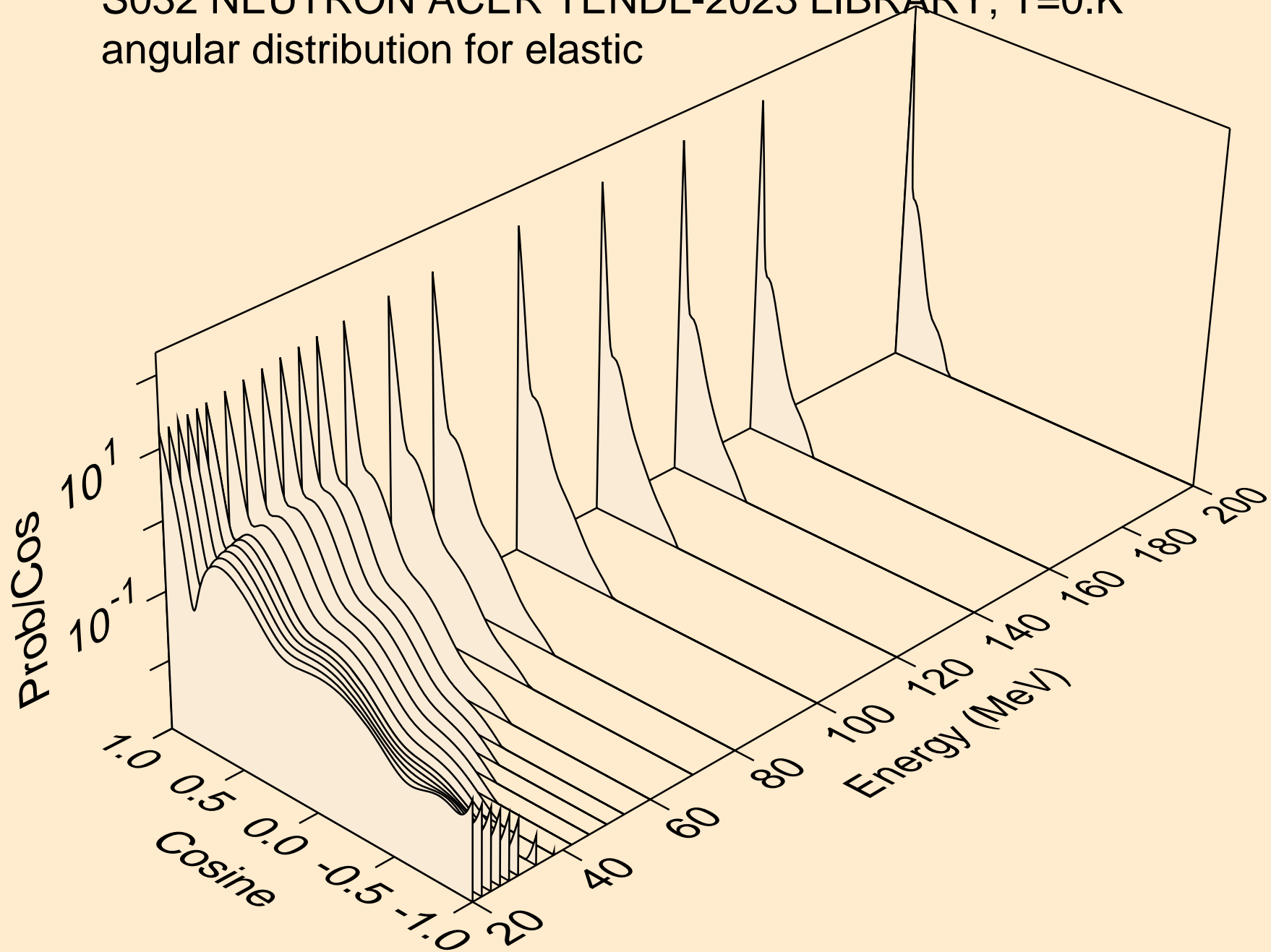

S032 NEUTRON ACER TENDL-2023 LIBRARY; T=0.K
angular distribution for (n,n*1)

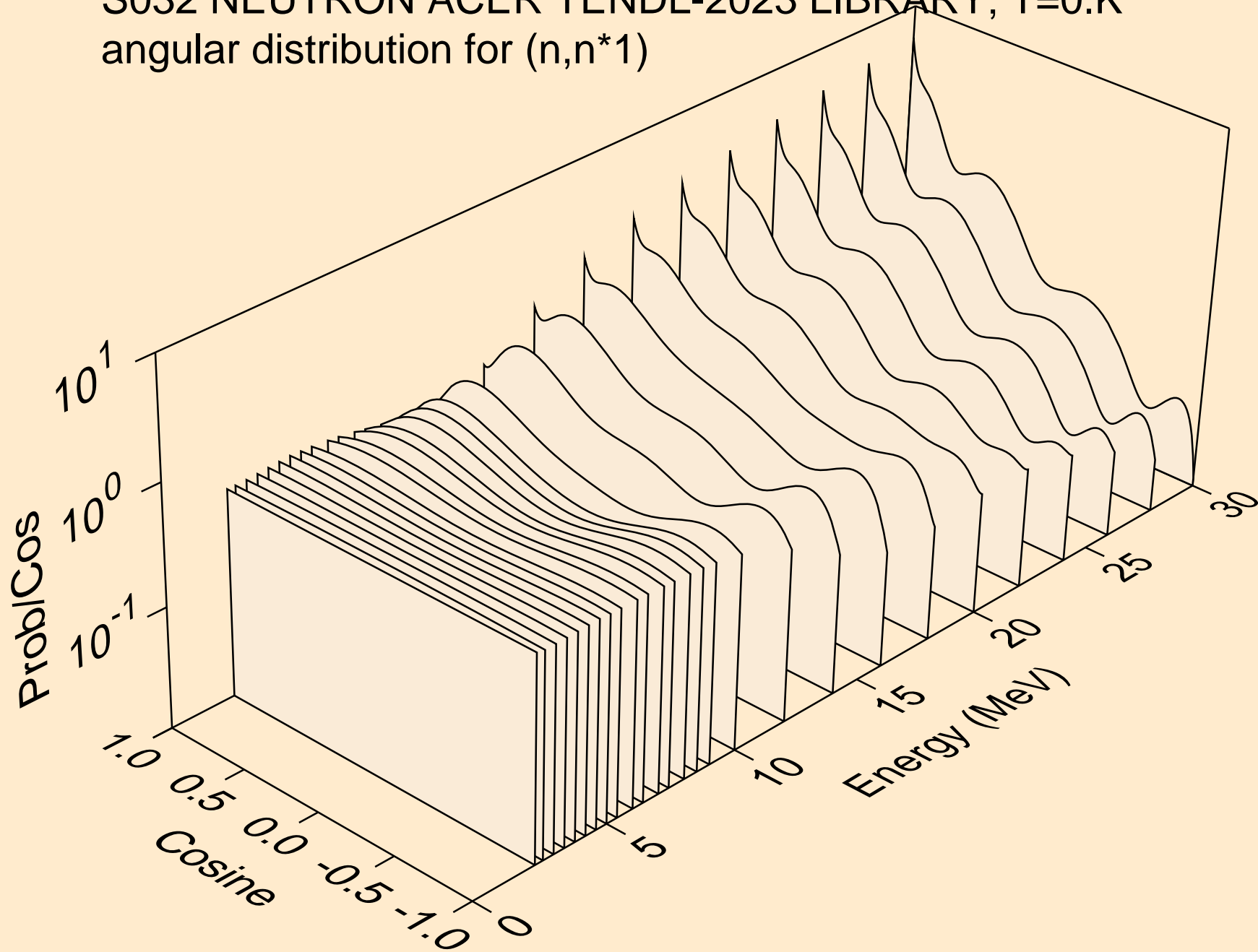

S032 NEUTRON ACER TENDL-2023 LIBRARY; T=0.K
angular distribution for (n,n*2)

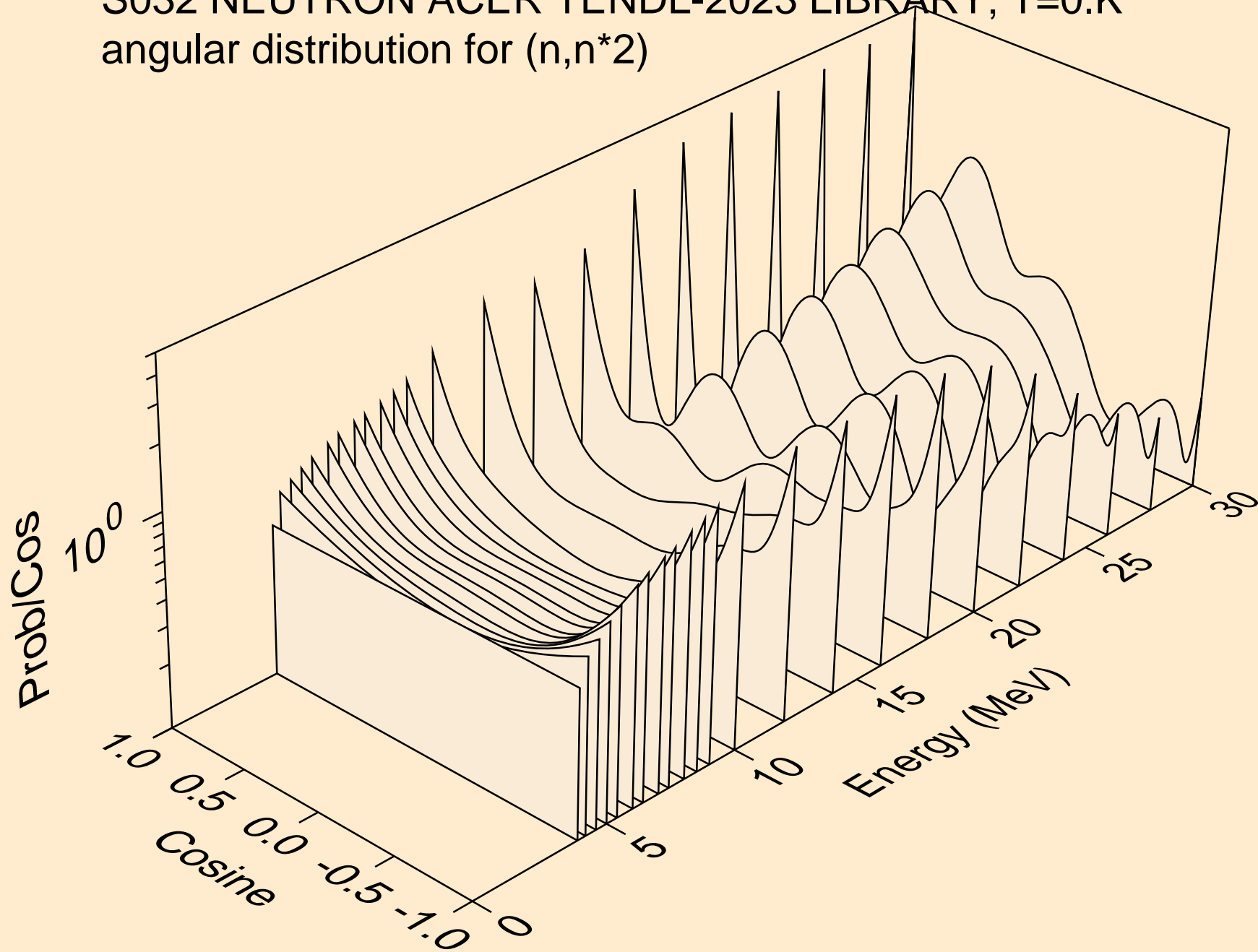

S032 NEUTRON ACER TENDL-2023 LIBRARY; T=0.K
angular distribution for (n,n*3)

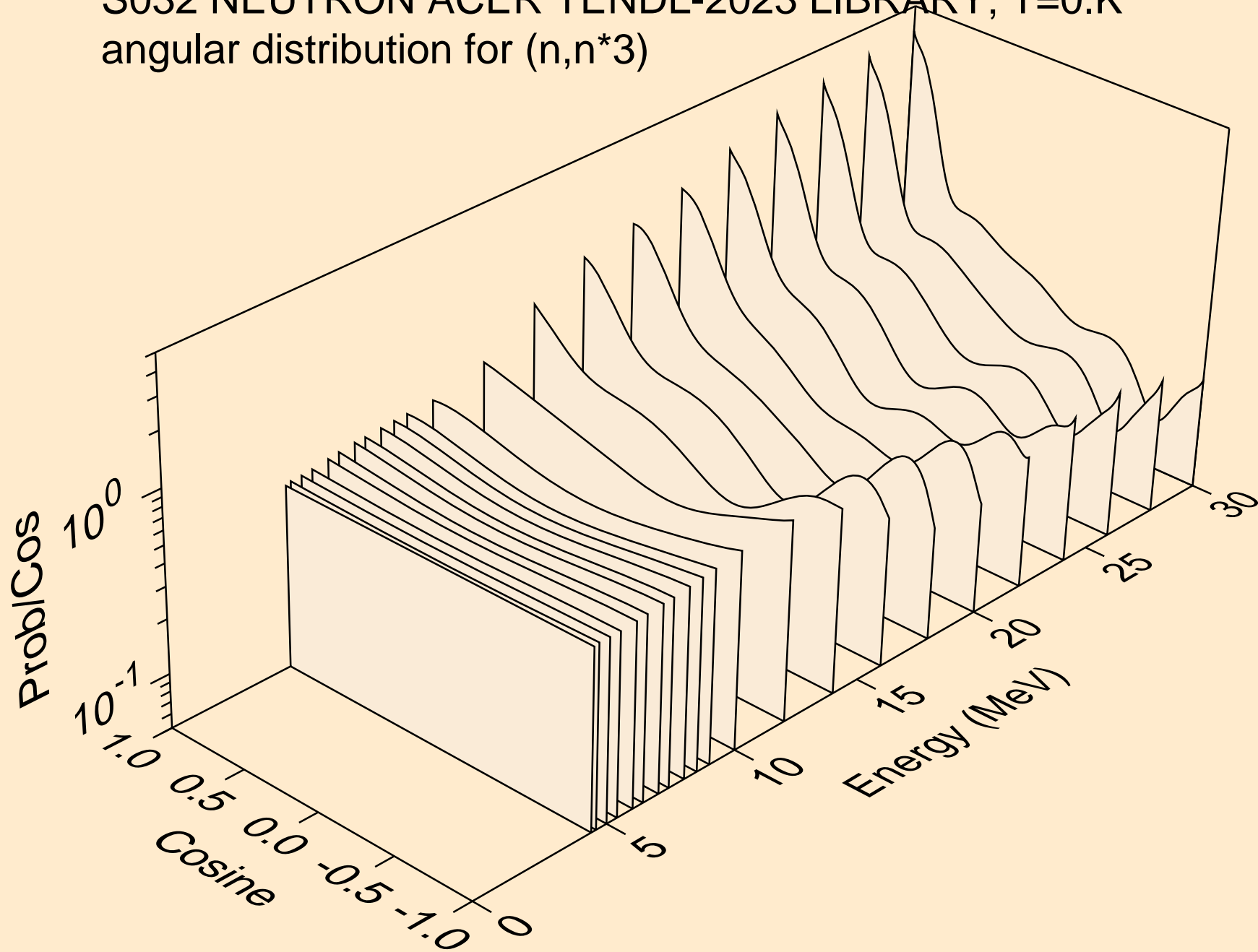

S032 NEUTRON ACER TENDL-2023 LIBRARY; T=0.K
angular distribution for (n,n*4)

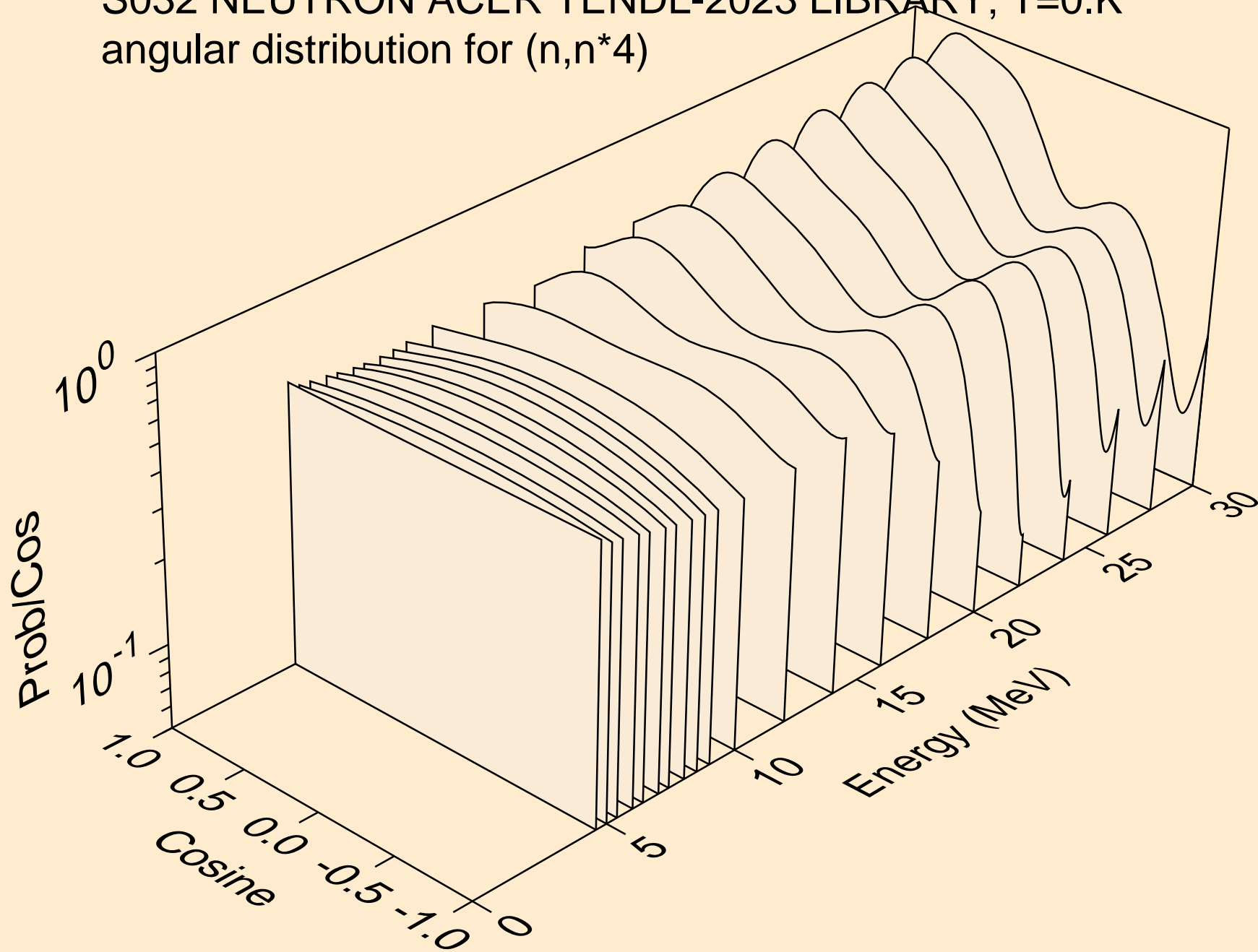

S032 NEUTRON ACER TENDL-2023 LIBRARY; T=0.K
angular distribution for (n,n*5)

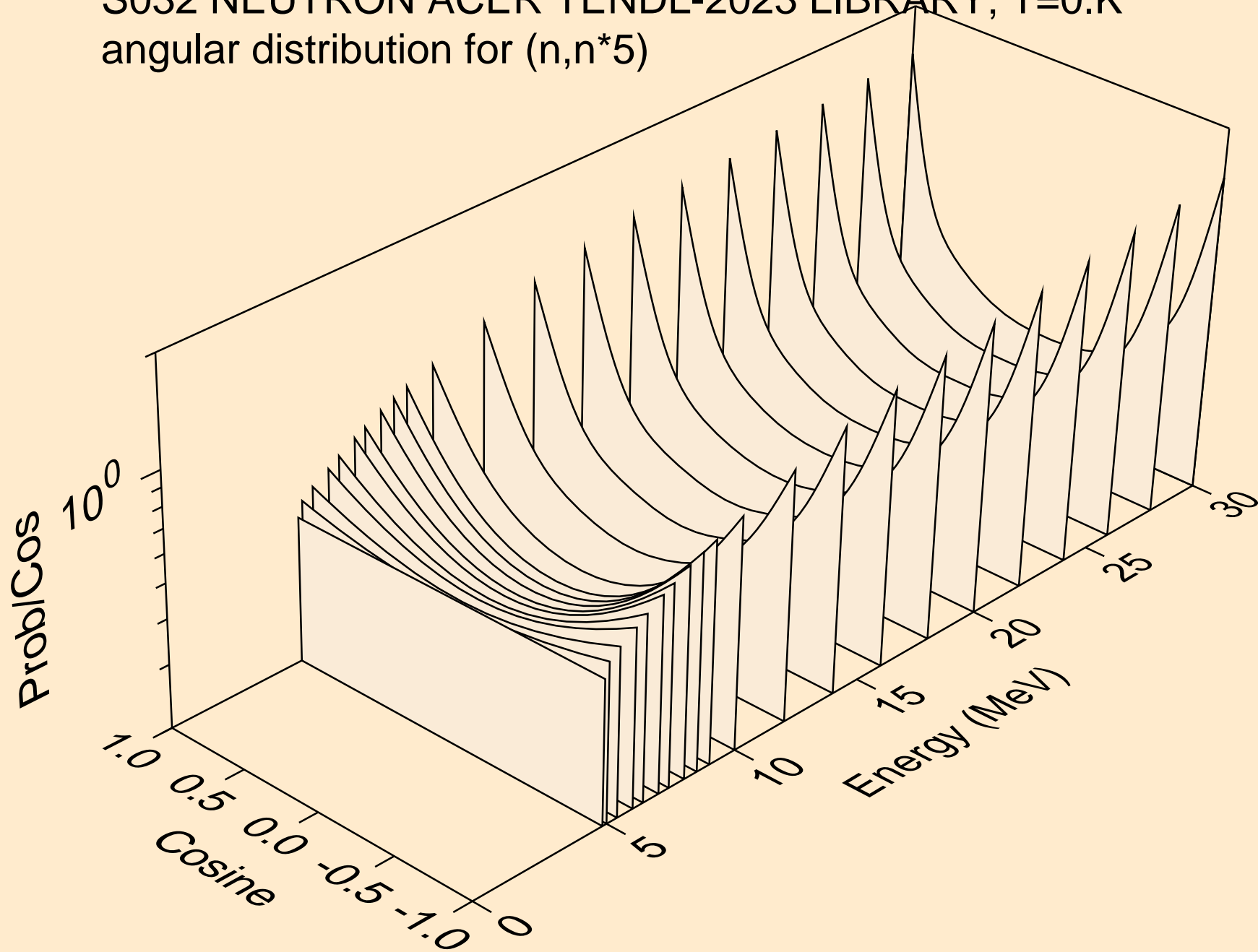

S032 NEUTRON ACER TENDL-2023 LIBRARY; T=0.K
angular distribution for (n,n*6)

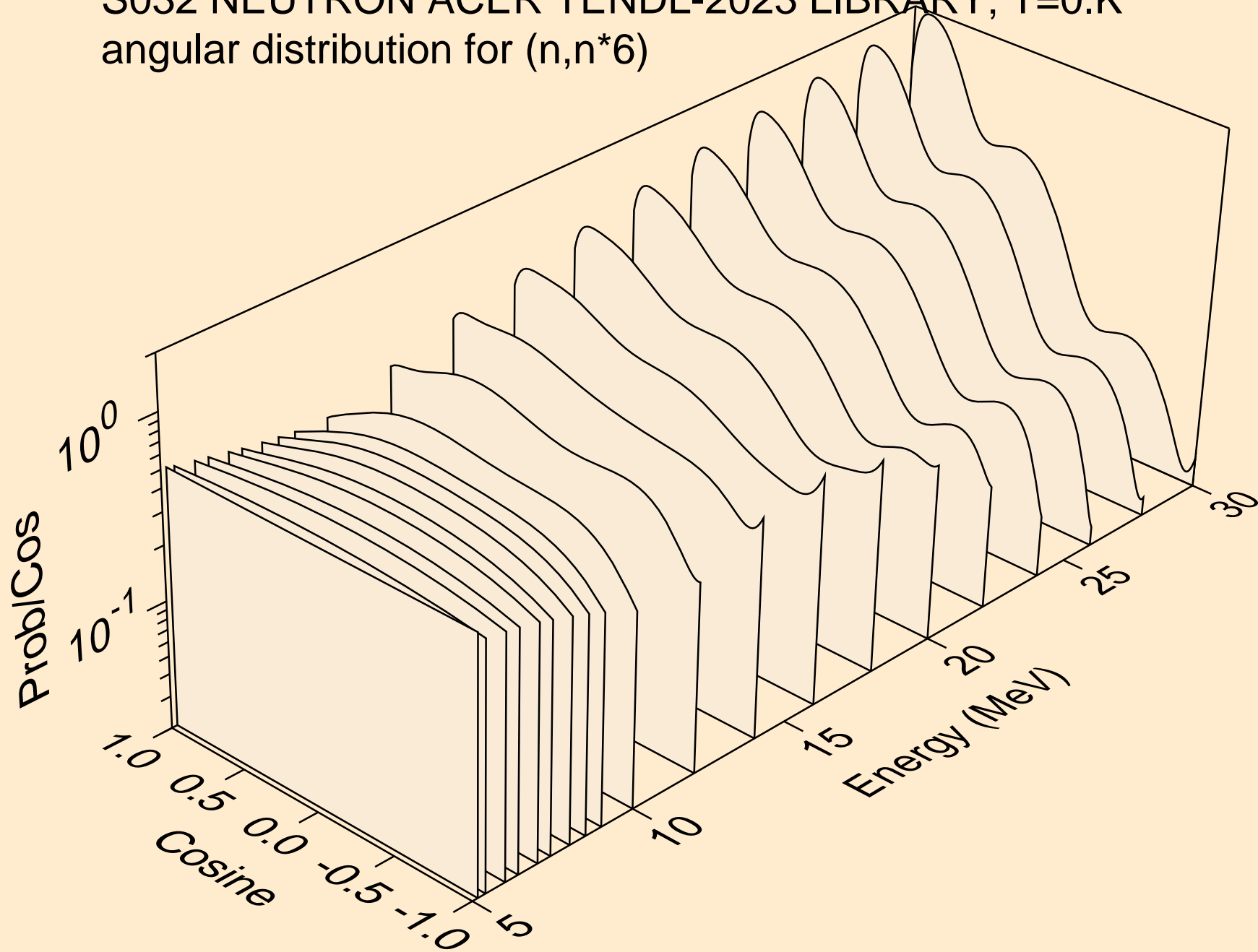

S032 NEUTRON ACER TENDL-2023 LIBRARY; T=0.K
angular distribution for (n,n*7)

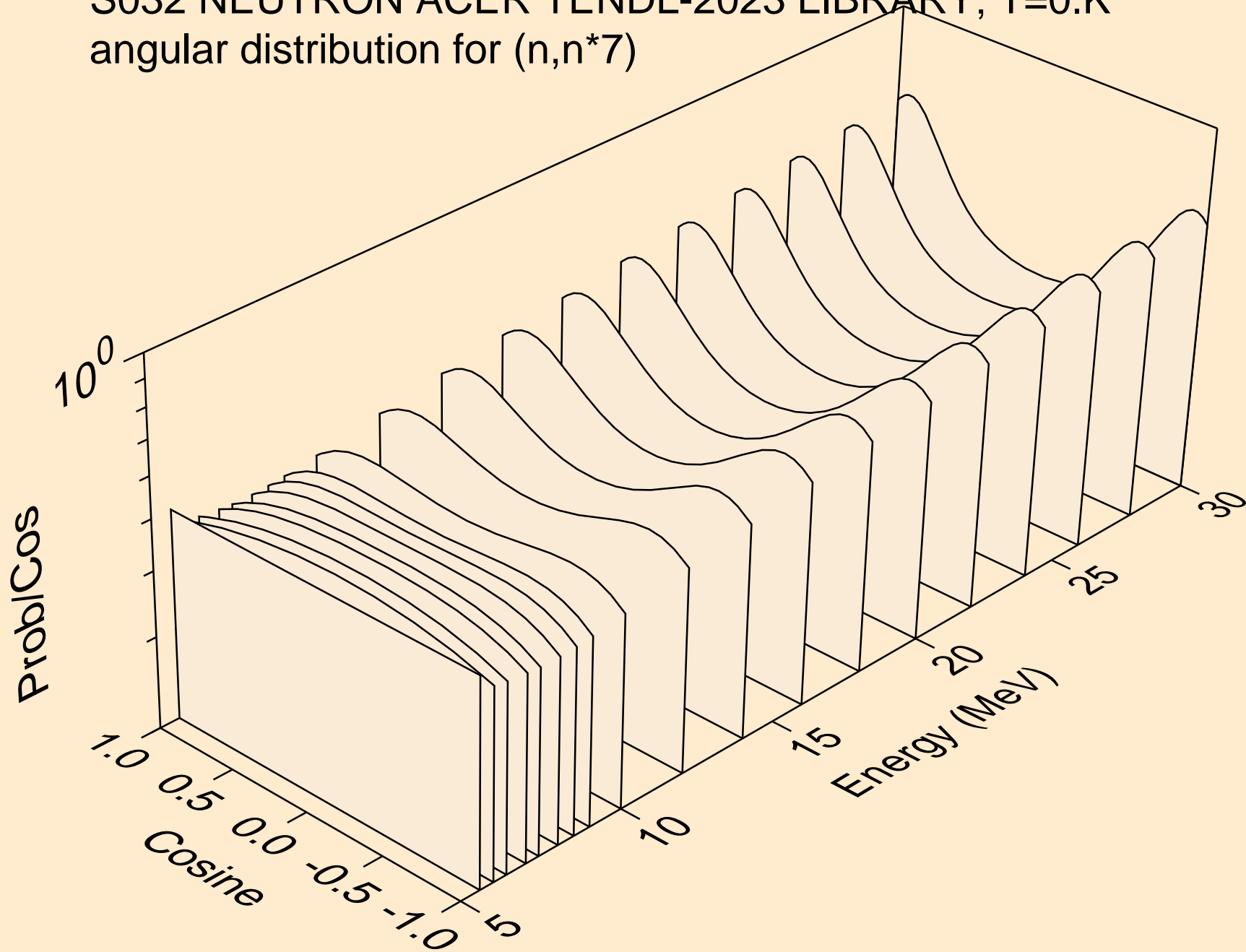

S032 NEUTRON ACER TENDL-2023 LIBRARY; T=0.K
angular distribution for (n,n*8)

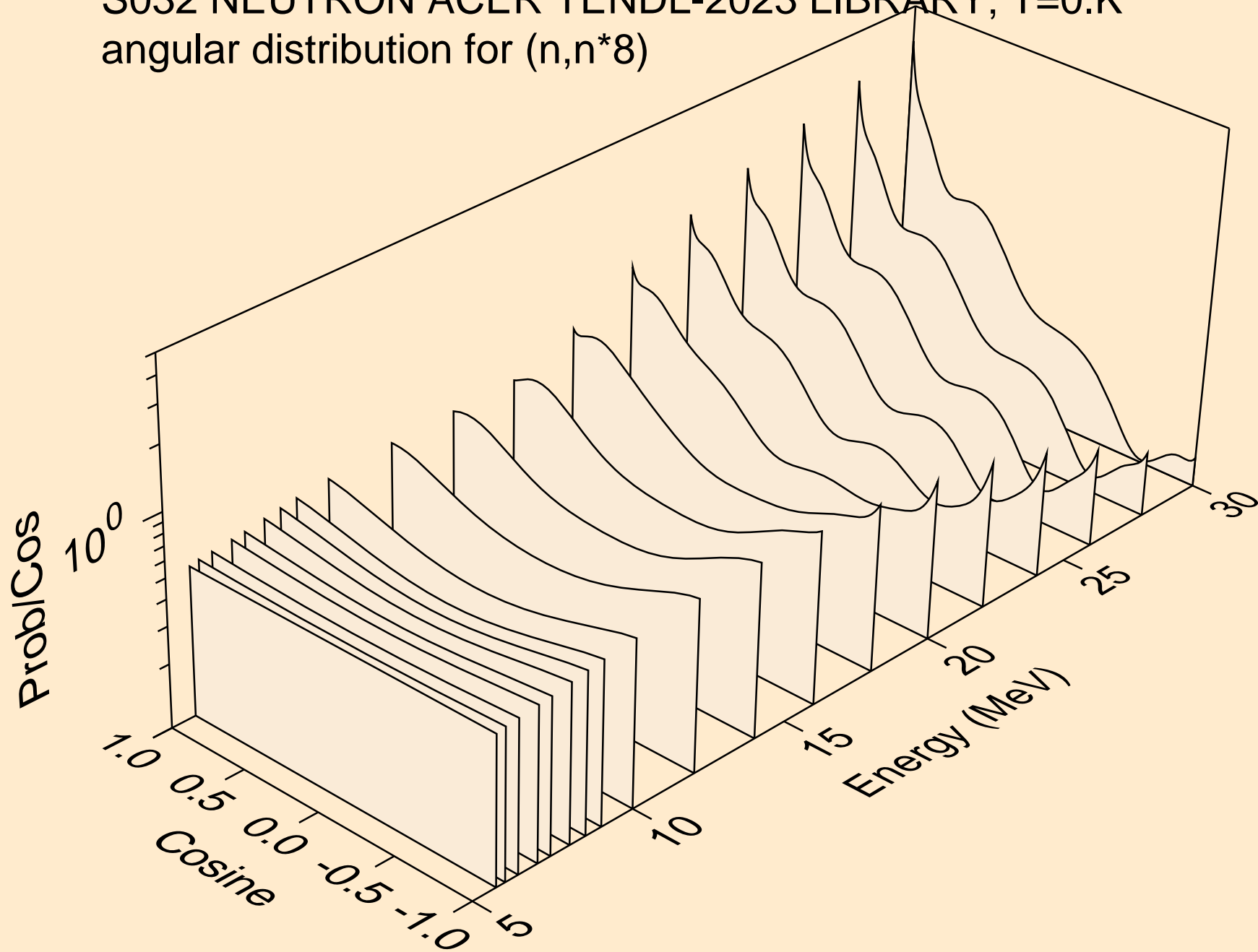

S032 NEUTRON ACER TENDL-2023 LIBRARY; T=0.K
angular distribution for (n,n*9)

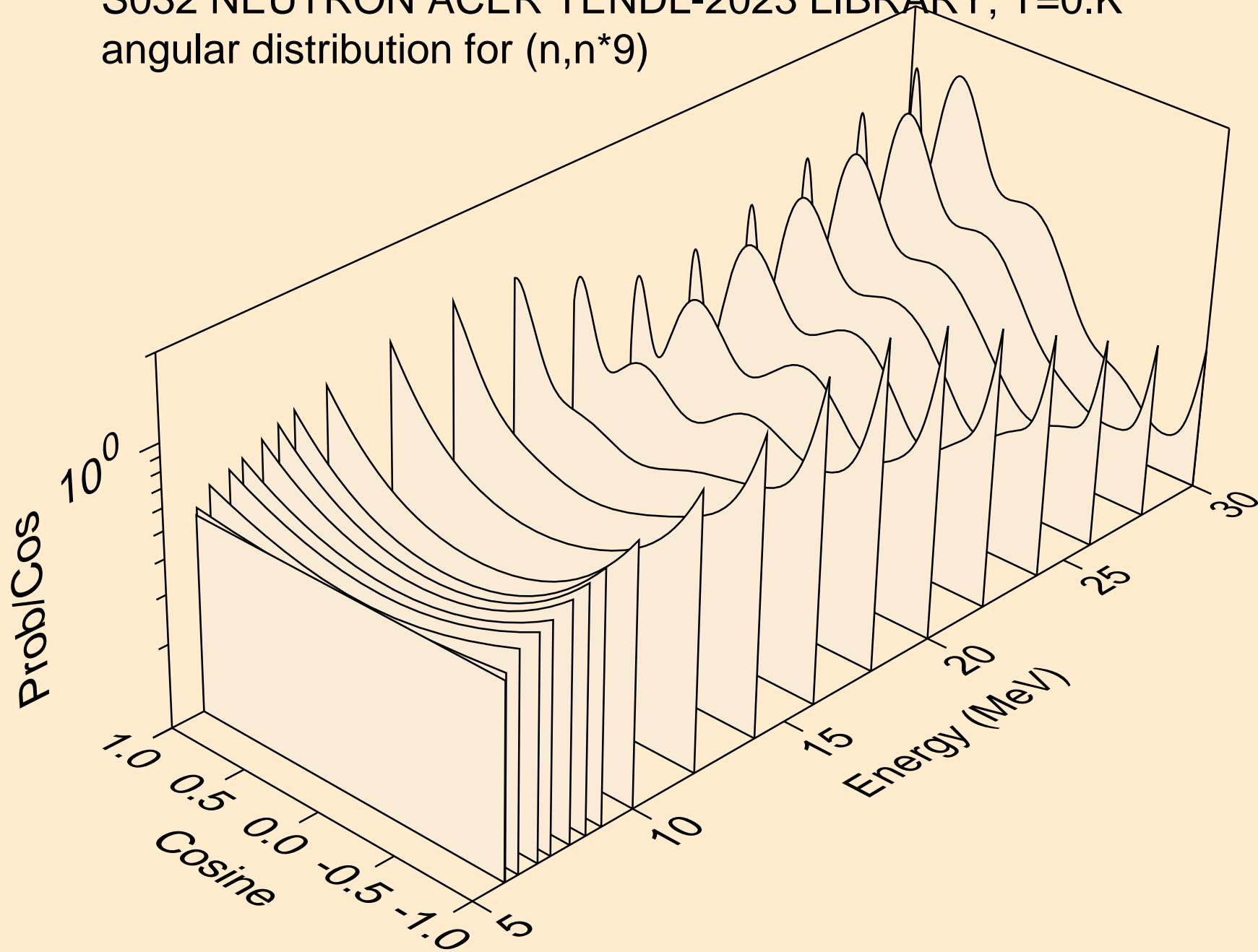

S032 NEUTRON ACER TENDL-2023 LIBRARY; T=0.K
angular distribution for (n,n*10)

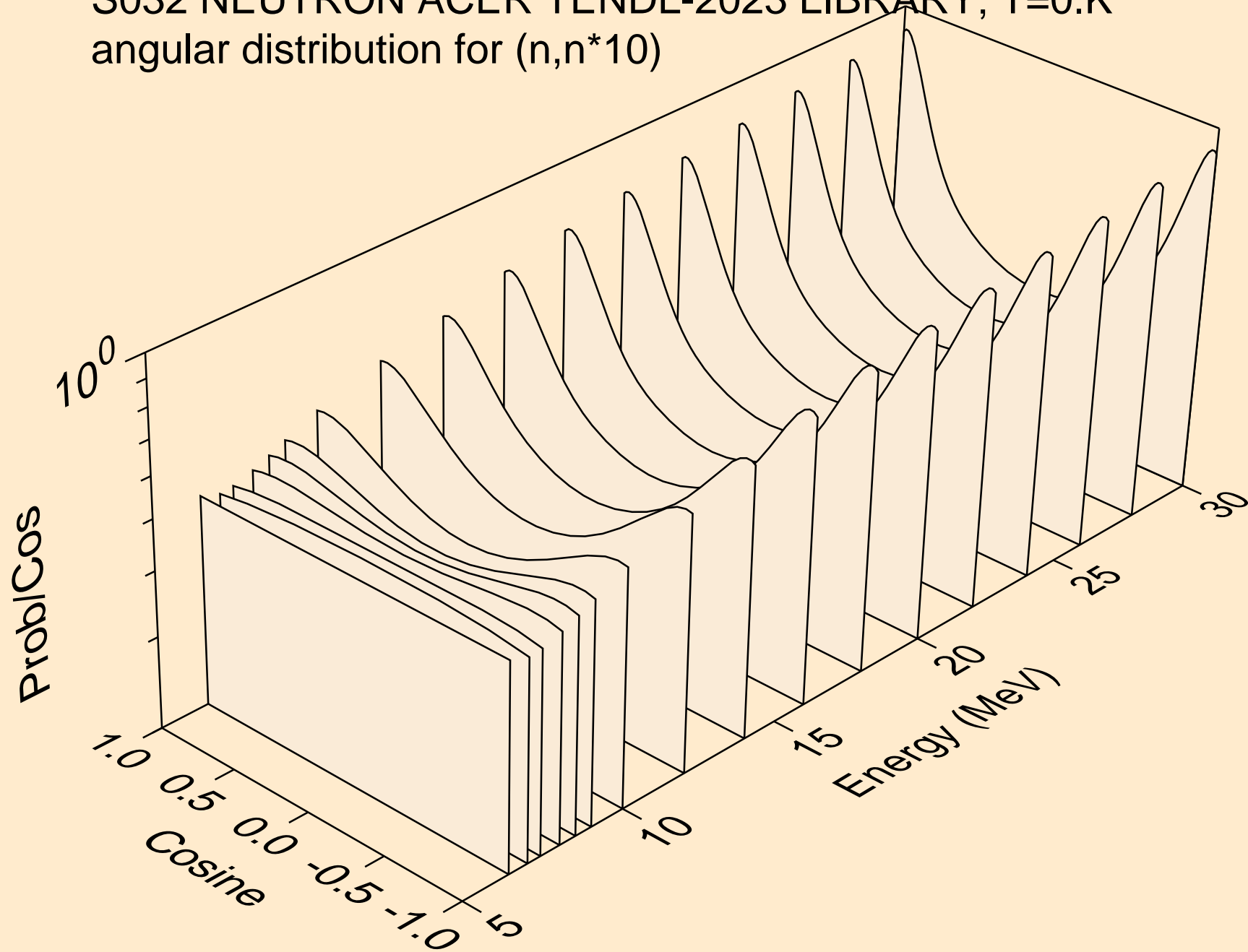

S032 NEUTRON ACER TENDL-2023 LIBRARY; T=0.K
angular distribution for (n,n*11)

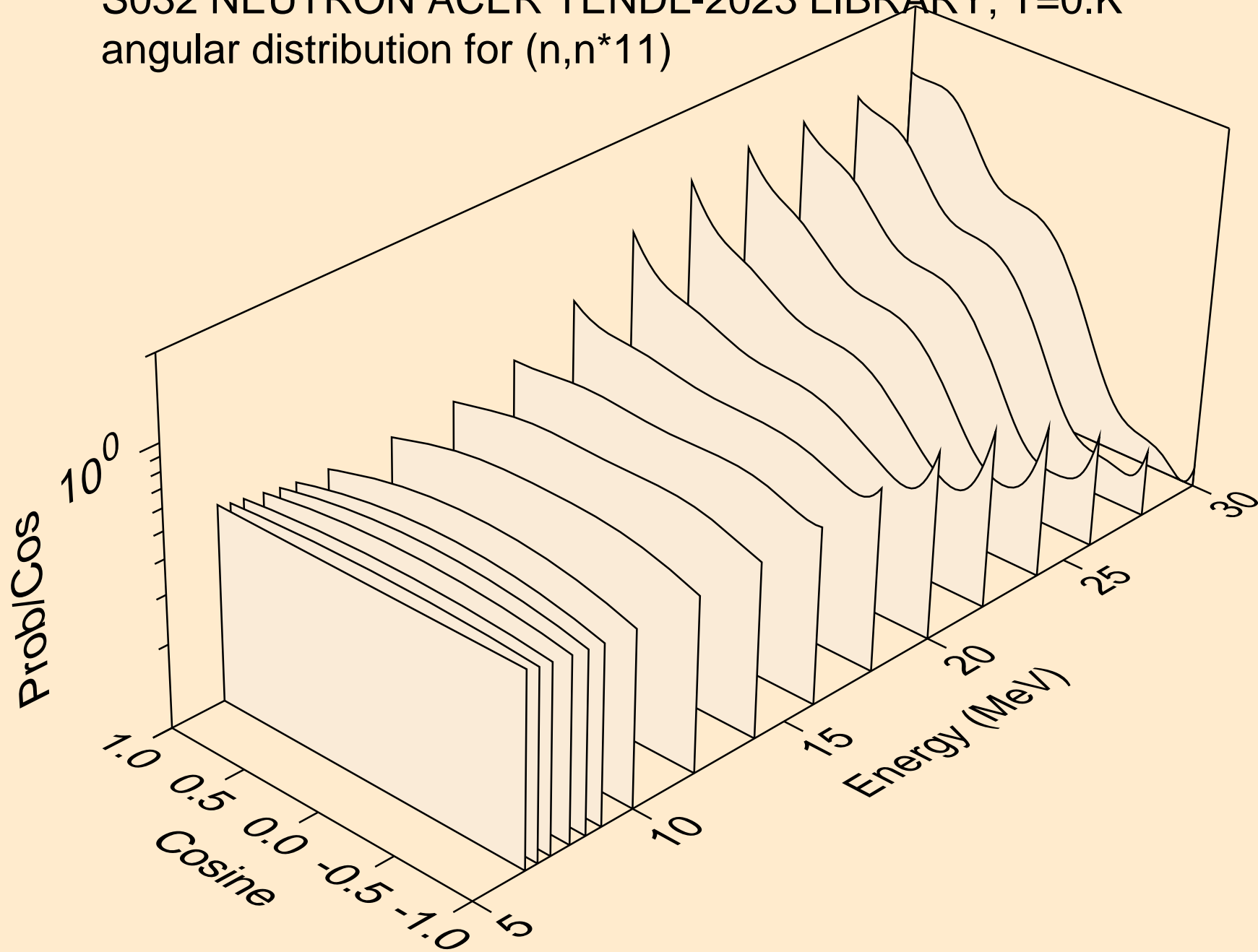

S032 NEUTRON ACER TENDL-2023 LIBRARY; T=0.K
angular distribution for (n,n*12)

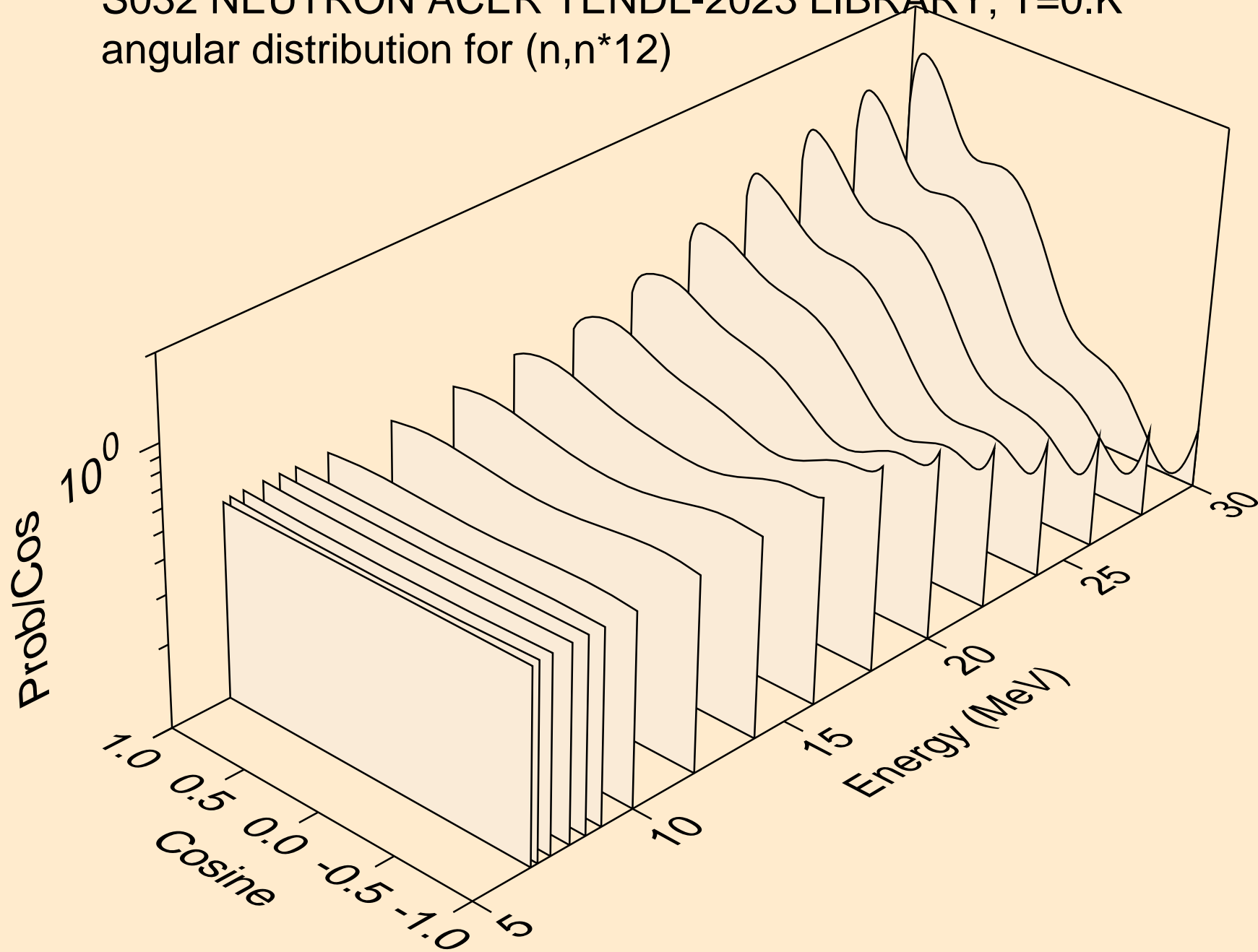

S032 NEUTRON ACER TENDL-2023 LIBRARY; T=0.K
angular distribution for (n,n*13)

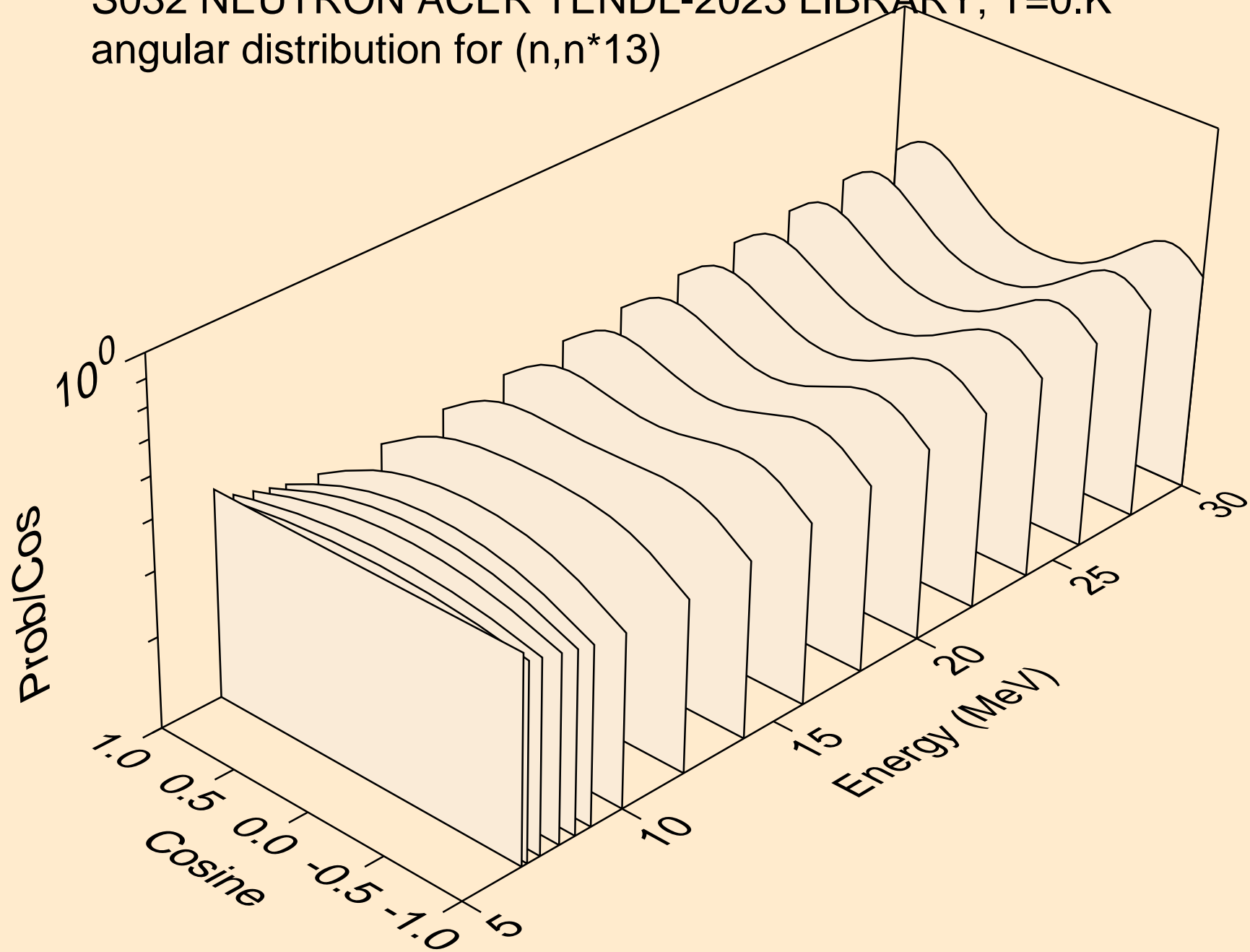

S032 NEUTRON ACER TENDL-2023 LIBRARY; T=0.K
angular distribution for (n,n*14)

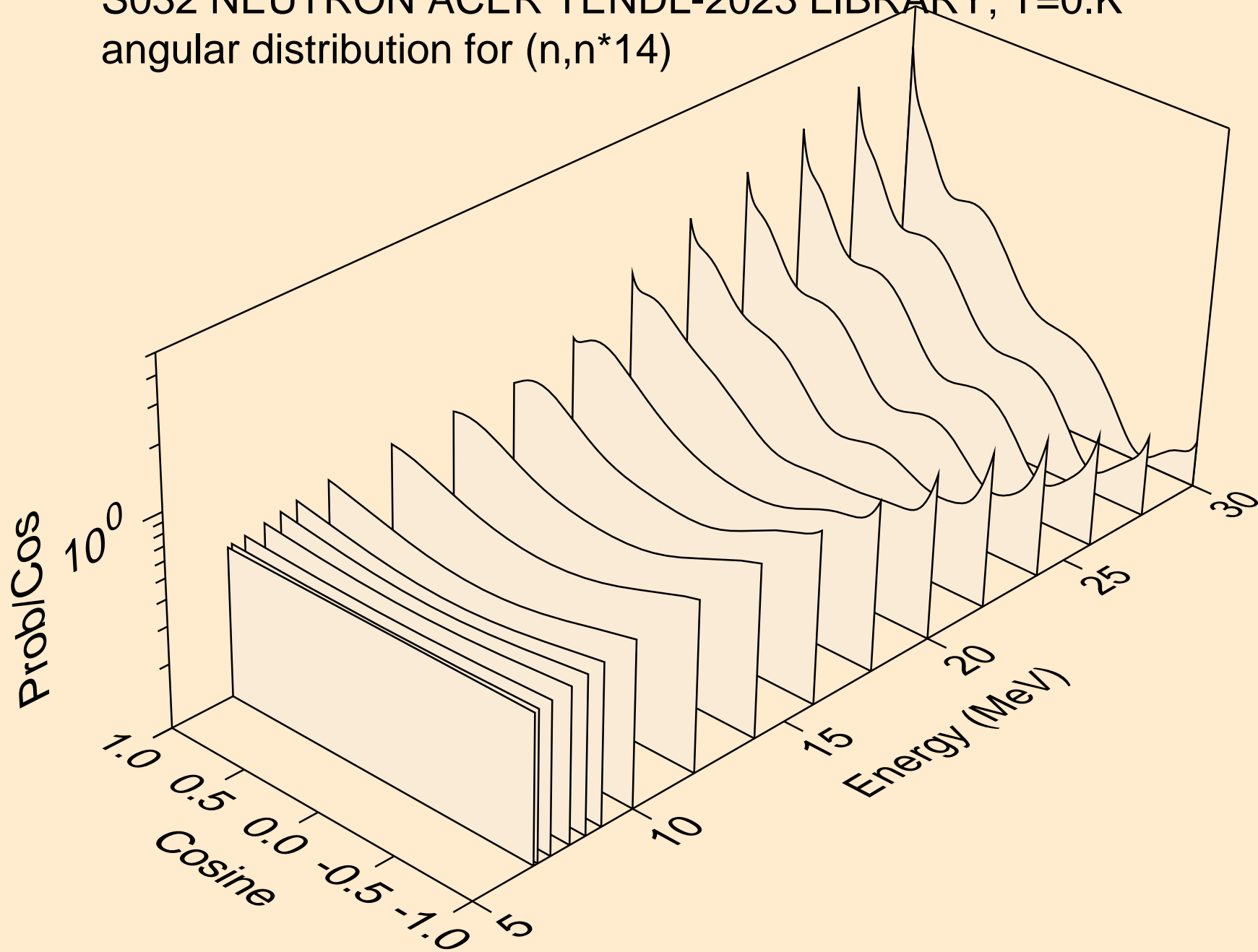

S032 NEUTRON ACER TENDL-2023 LIBRARY; T=0.K
angular distribution for (n,n*15)

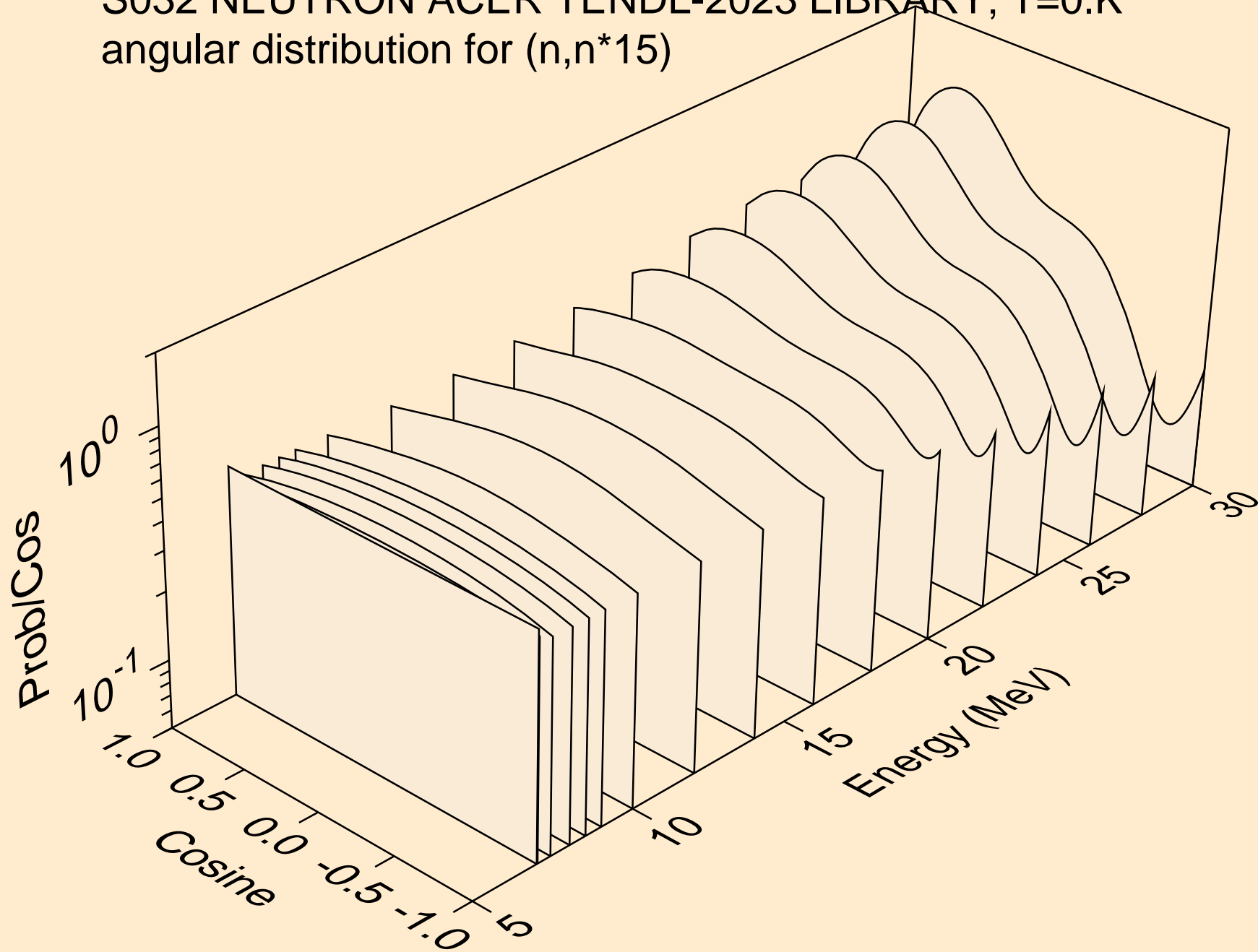

S032 NEUTRON ACER TENDL-2023 LIBRARY; T=0.K
angular distribution for (n,n*16)

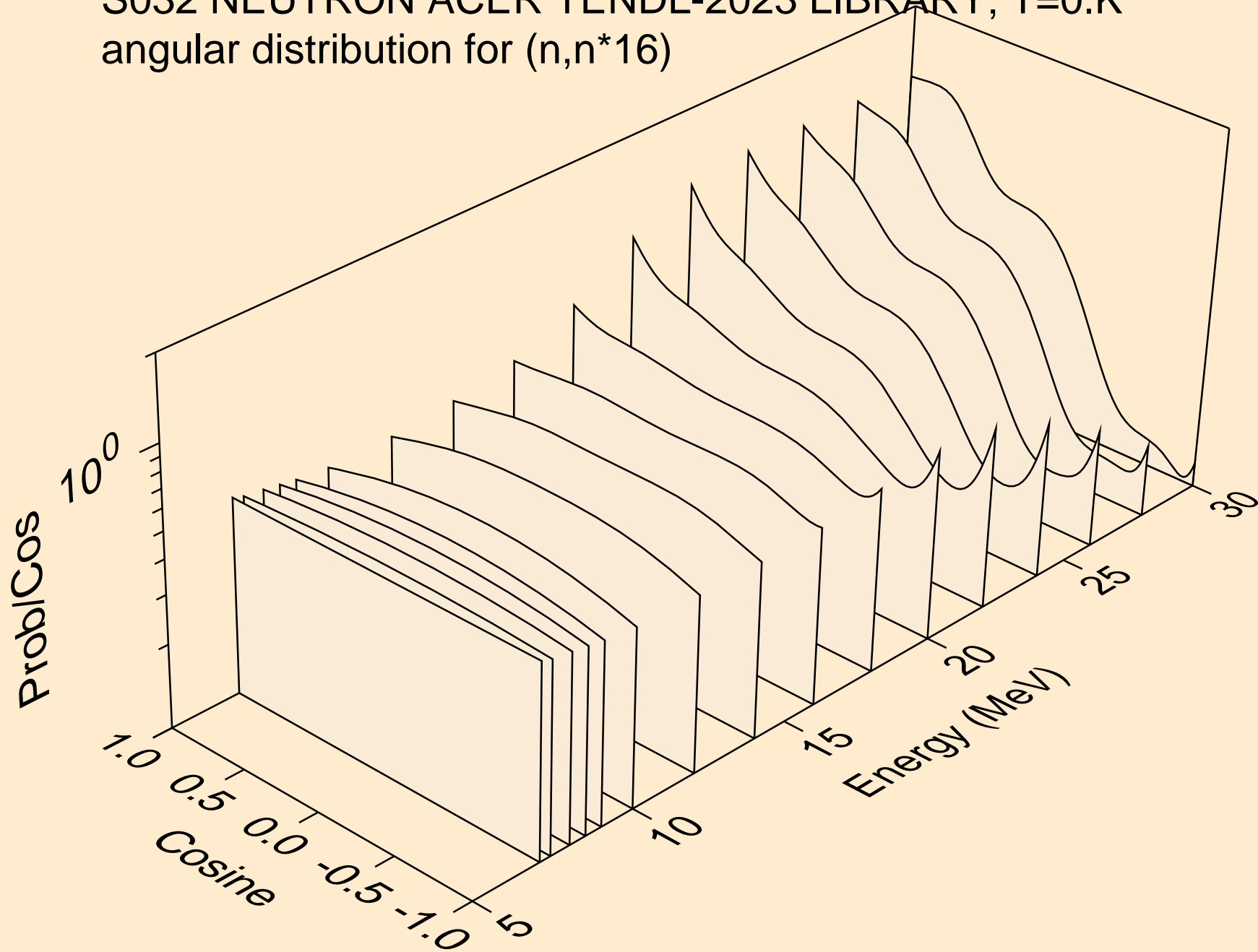

S032 NEUTRON ACER TENDL-2023 LIBRARY; T=0.K
angular distribution for (n,n*17)

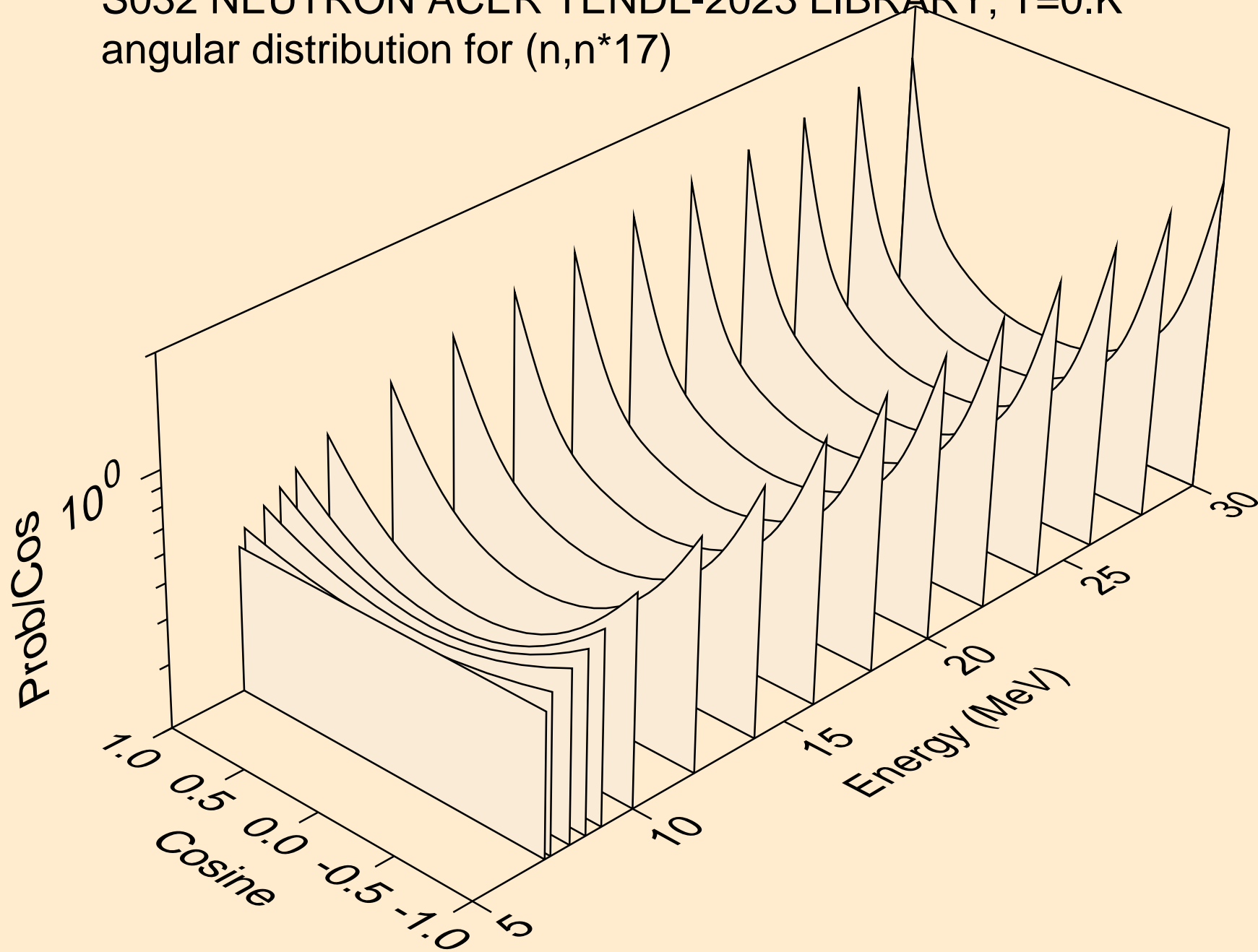

S032 NEUTRON ACER TENDL-2023 LIBRARY; T=0.K
angular distribution for (n,n*18)

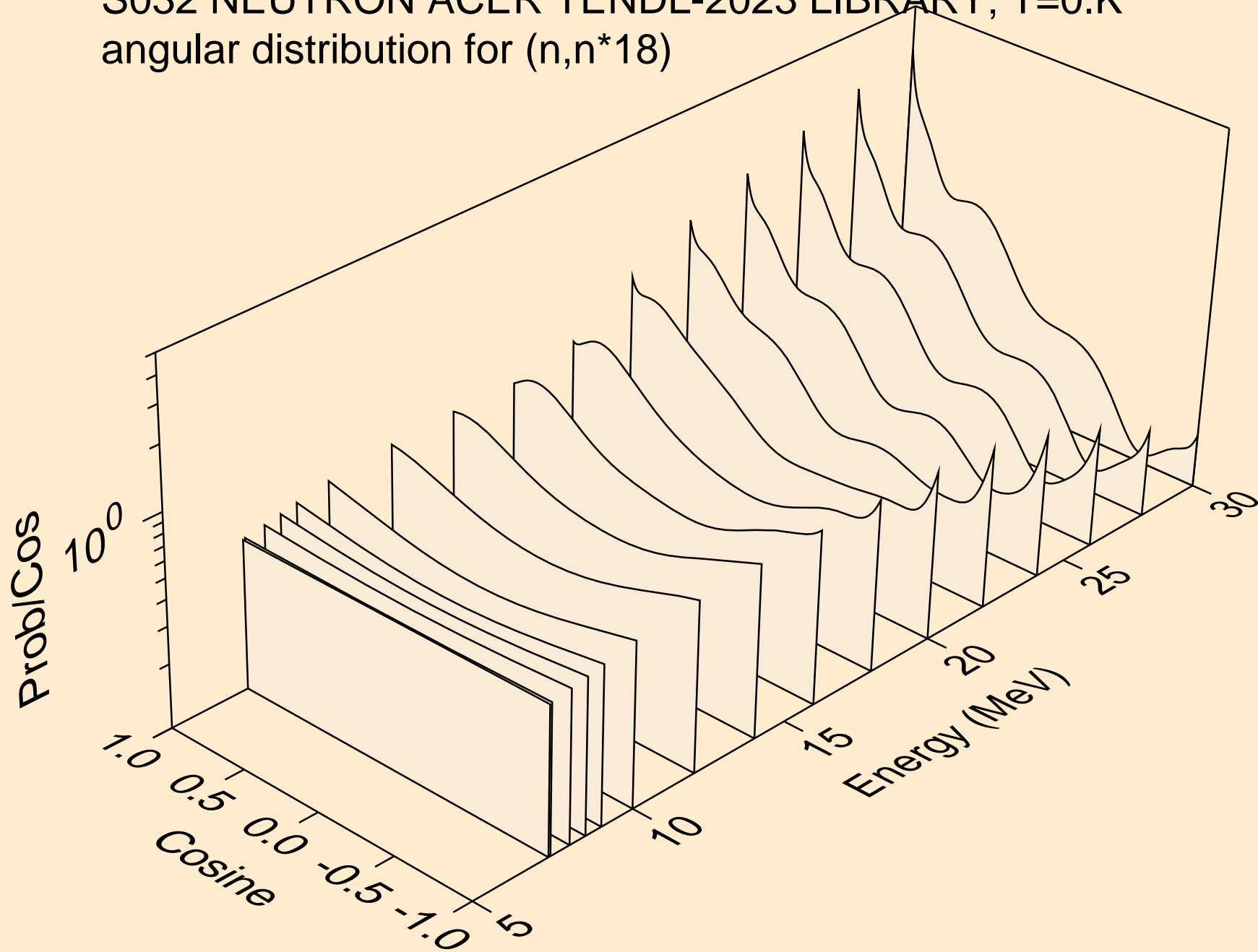

S032 NEUTRON ACER TENDL-2023 LIBRARY; T=0.K
angular distribution for (n,n*19)

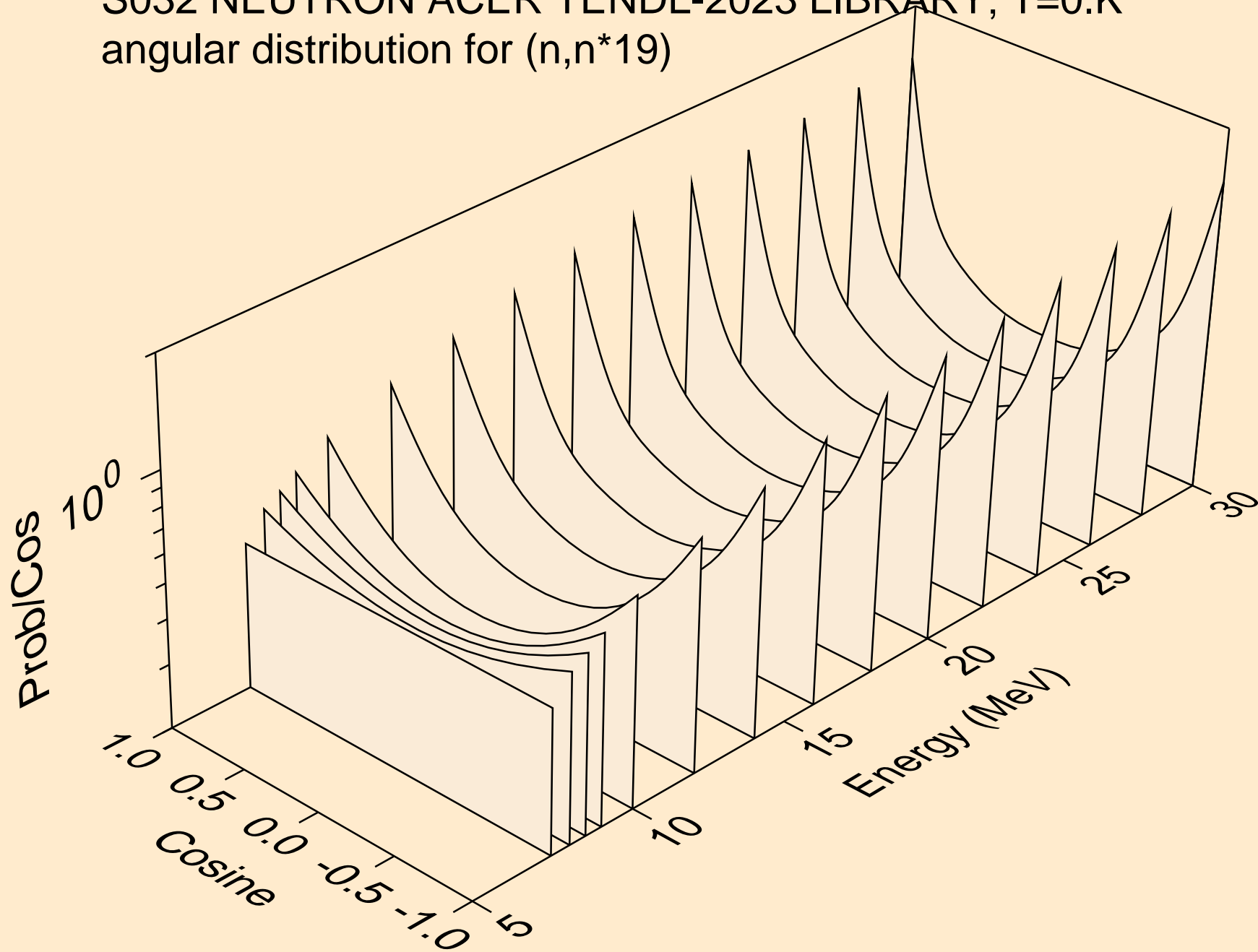

S032 NEUTRON ACER TENDL-2023 LIBRARY; T=0.K
angular distribution for (n,n*20)

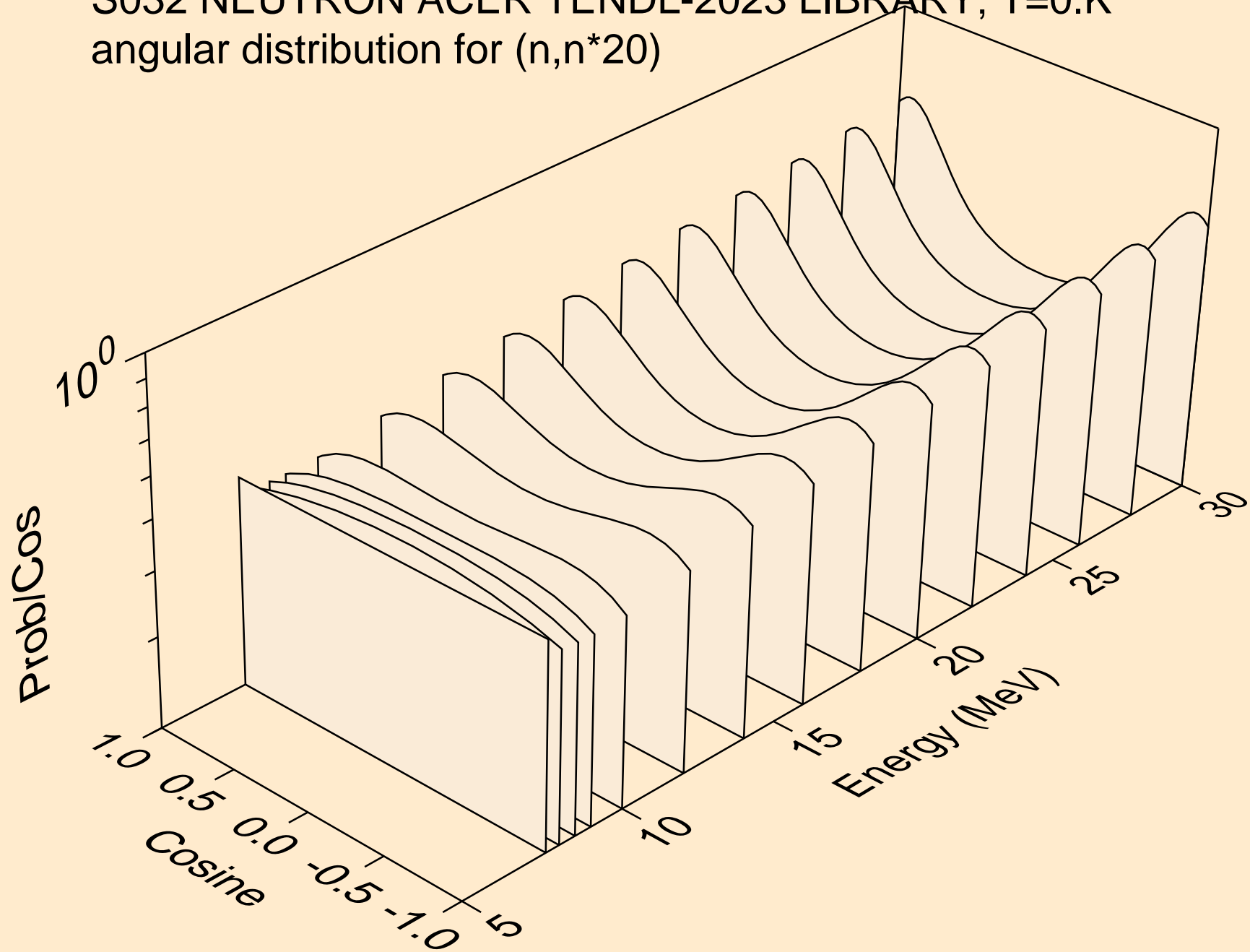

S032 NEUTRON ACER TENDL-2023 LIBRARY; T=0.K
Neutron emission for (n,x)

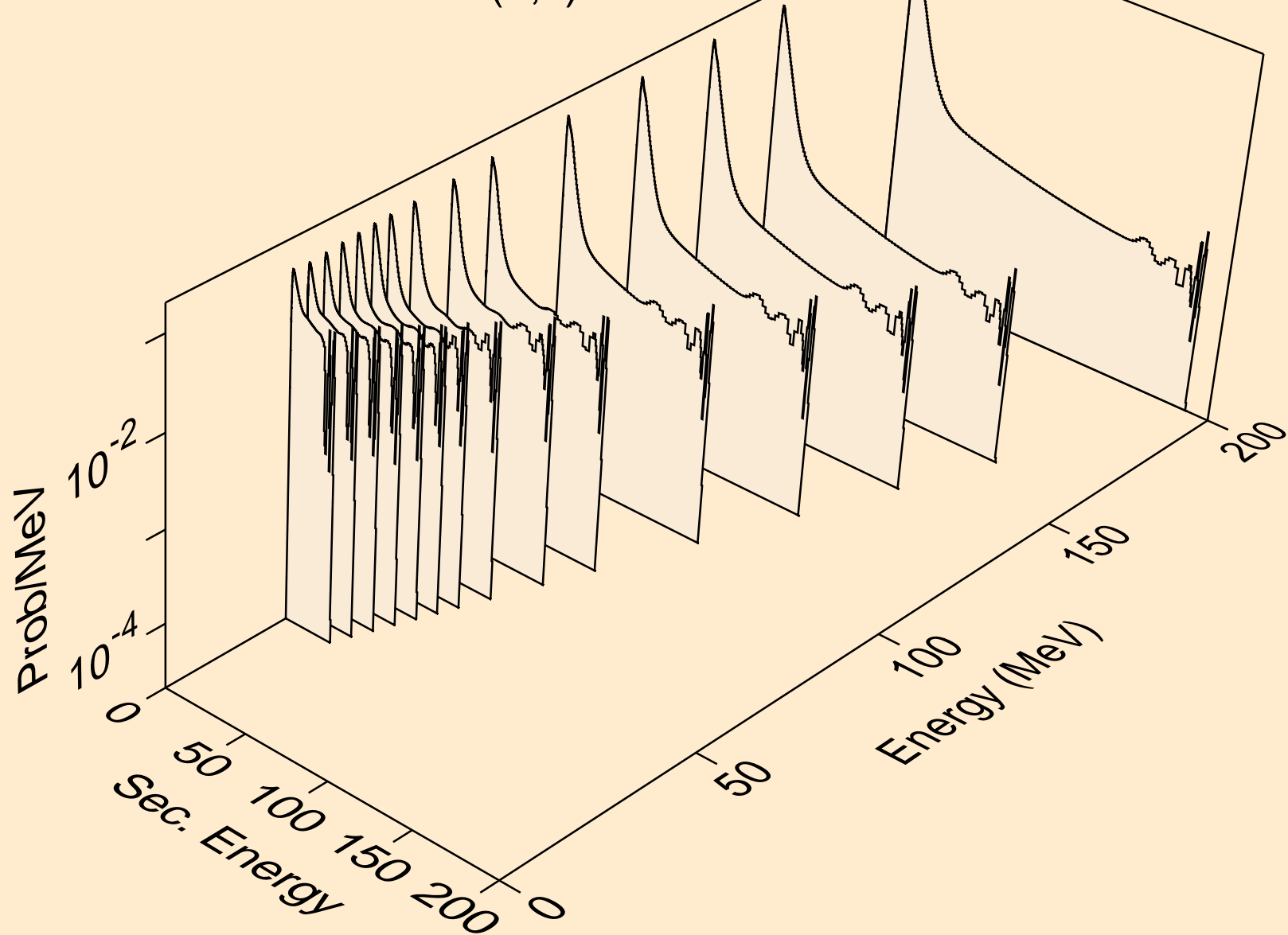

S032 NEUTRON ACER TENDL-2023 LIBRARY; T=0.K
Neutron emission for (n,2n)

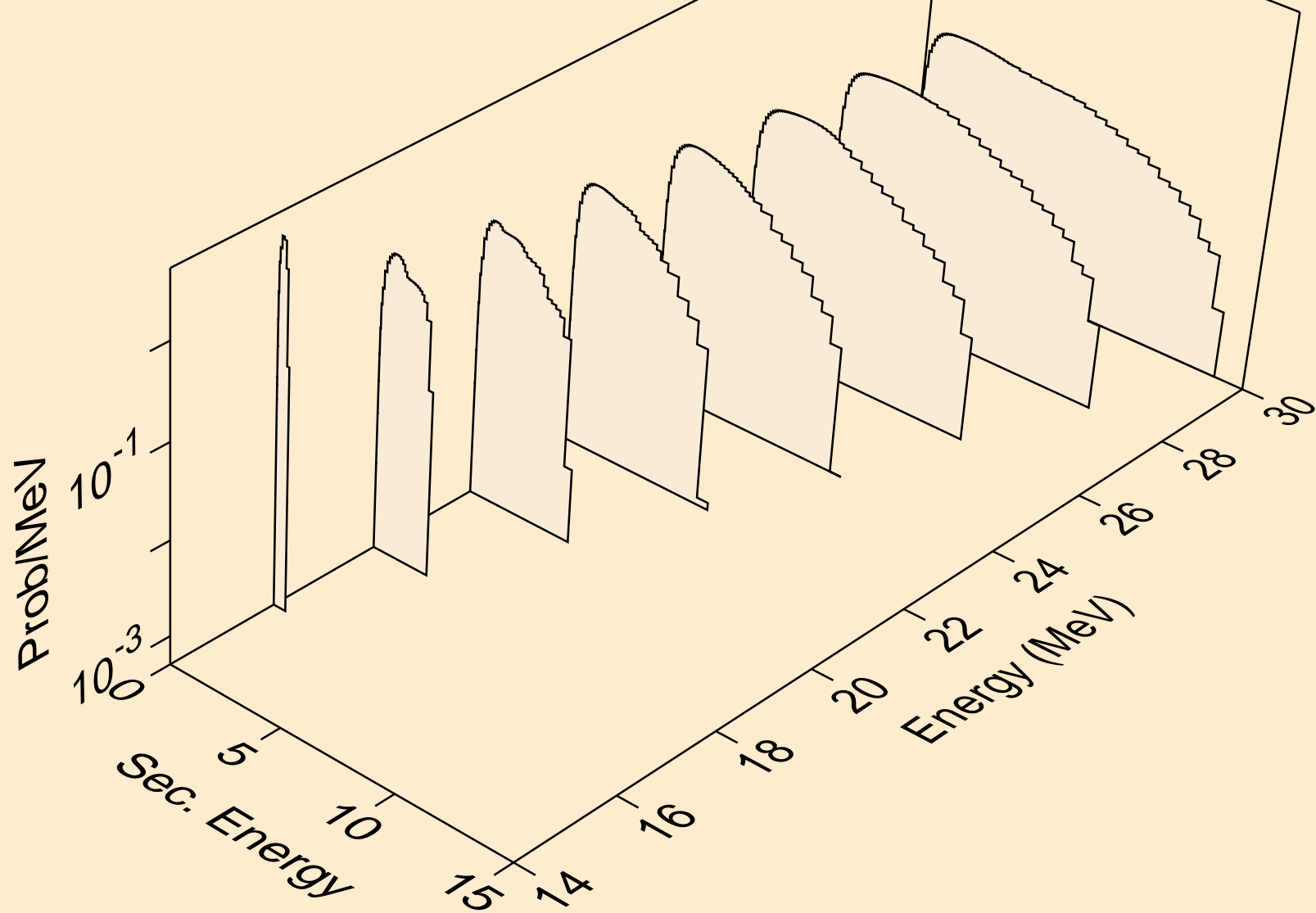

S032 NEUTRON ACER TENDL-2023 LIBRARY; T=0.K
Neutron emission for (n,3n)

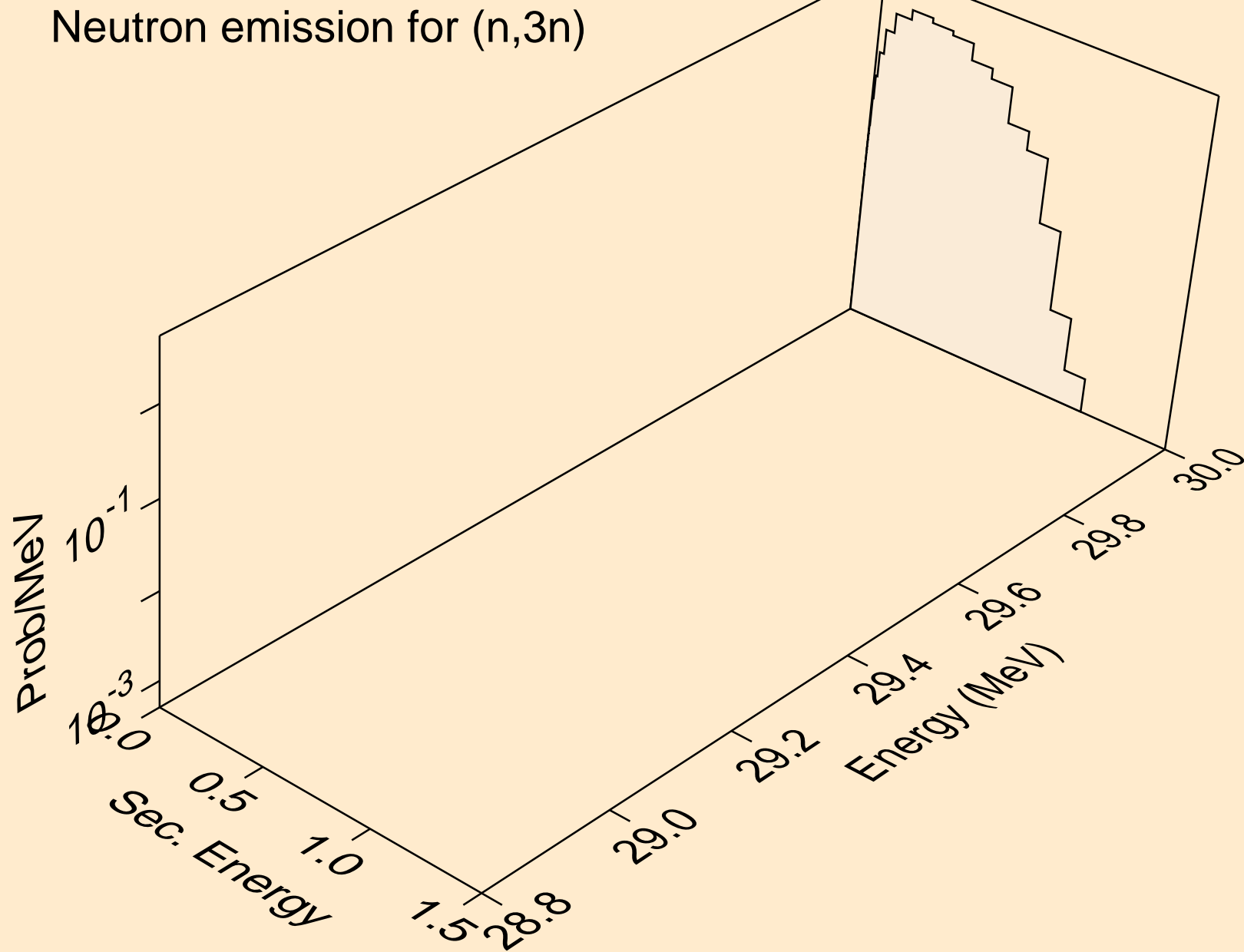

S032 NEUTRON ACER TENDL-2023 LIBRARY; T=0.K
Neutron emission for (n,n*)a

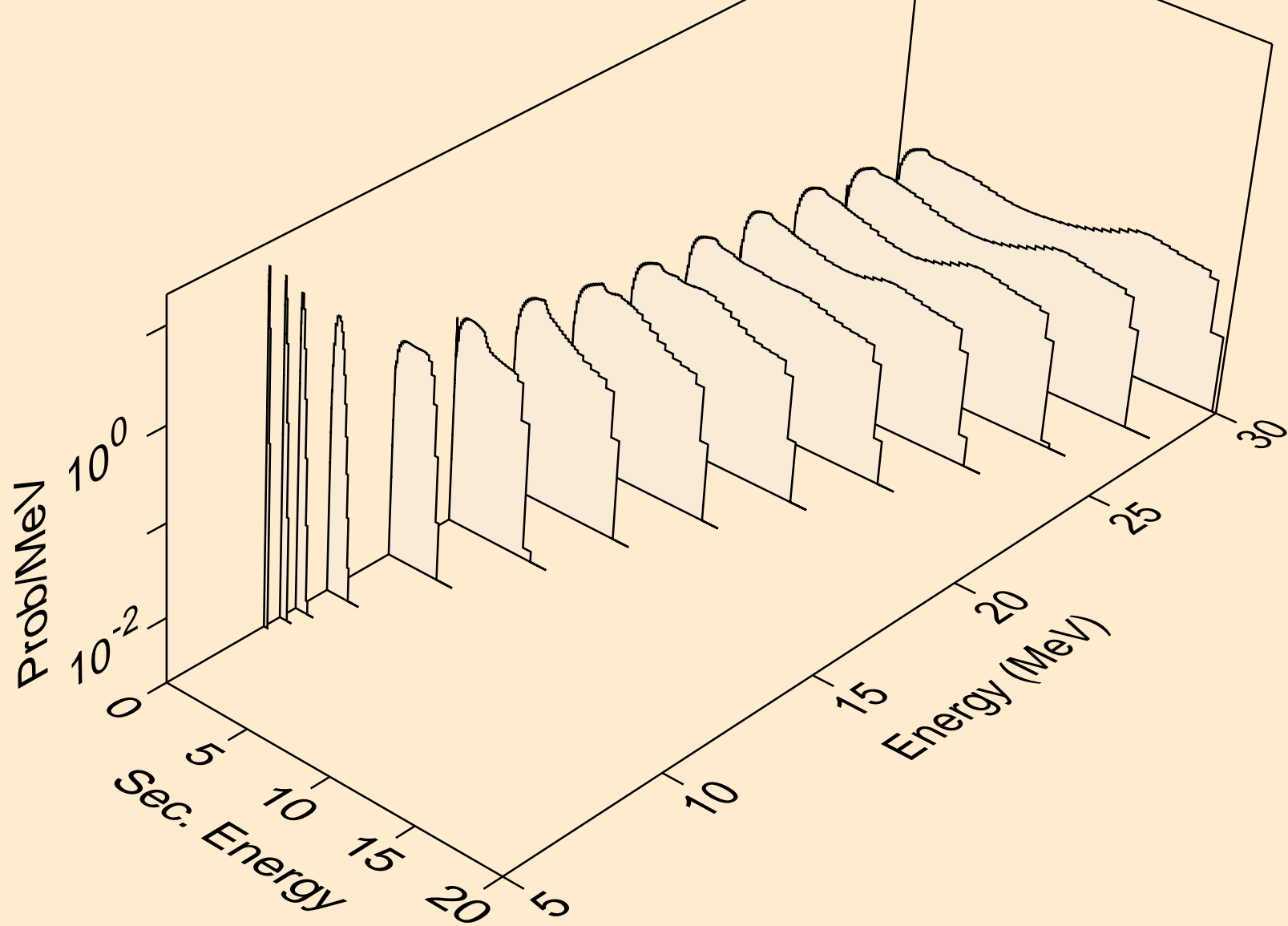

S032 NEUTRON ACER TENDL-2023 LIBRARY; T=0.K
Neutron emission for (n,2n)a

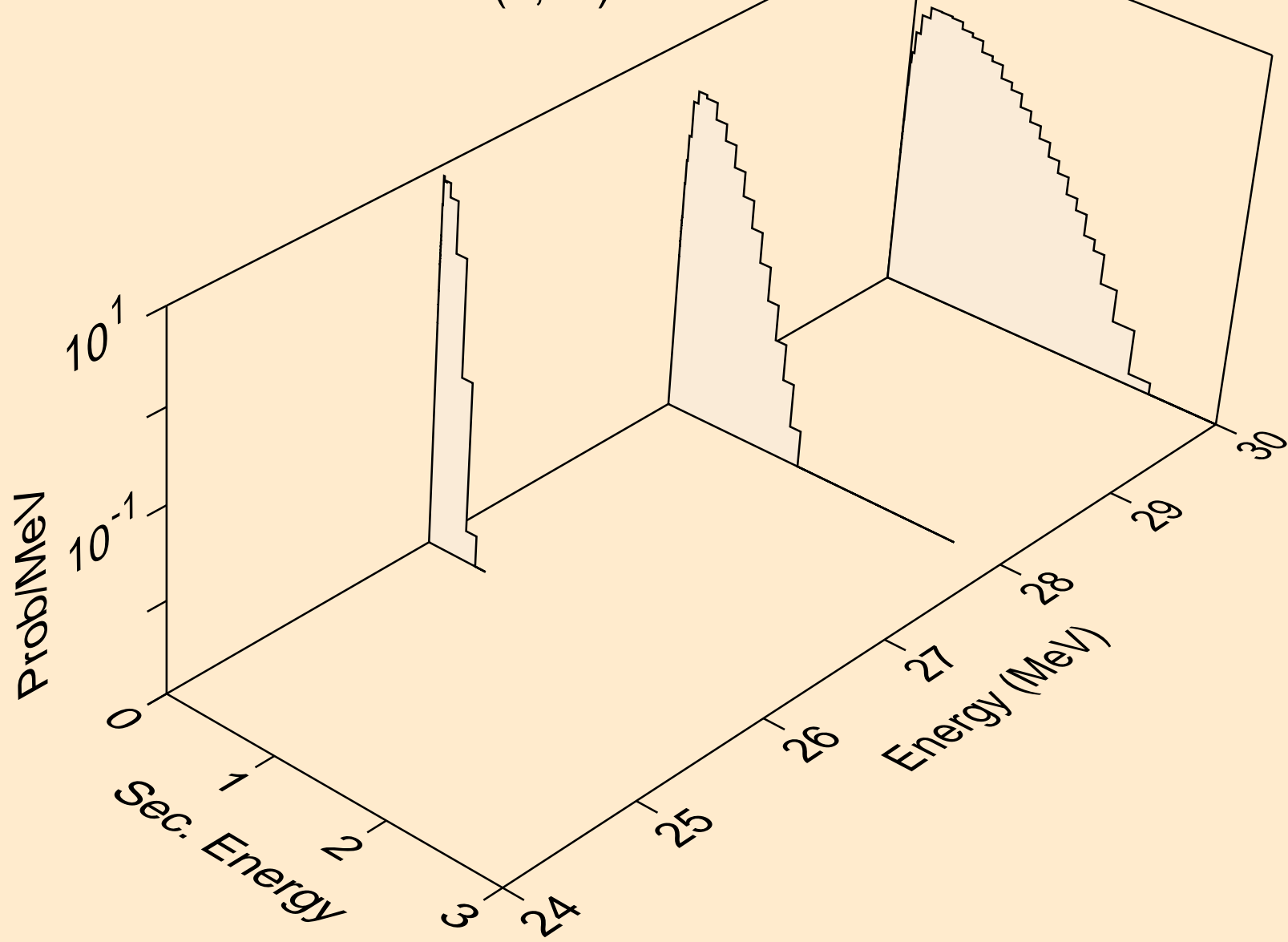

S032 NEUTRON ACER TENDL-2023 LIBRARY; T=0.K
Neutron emission for (n,n*)p

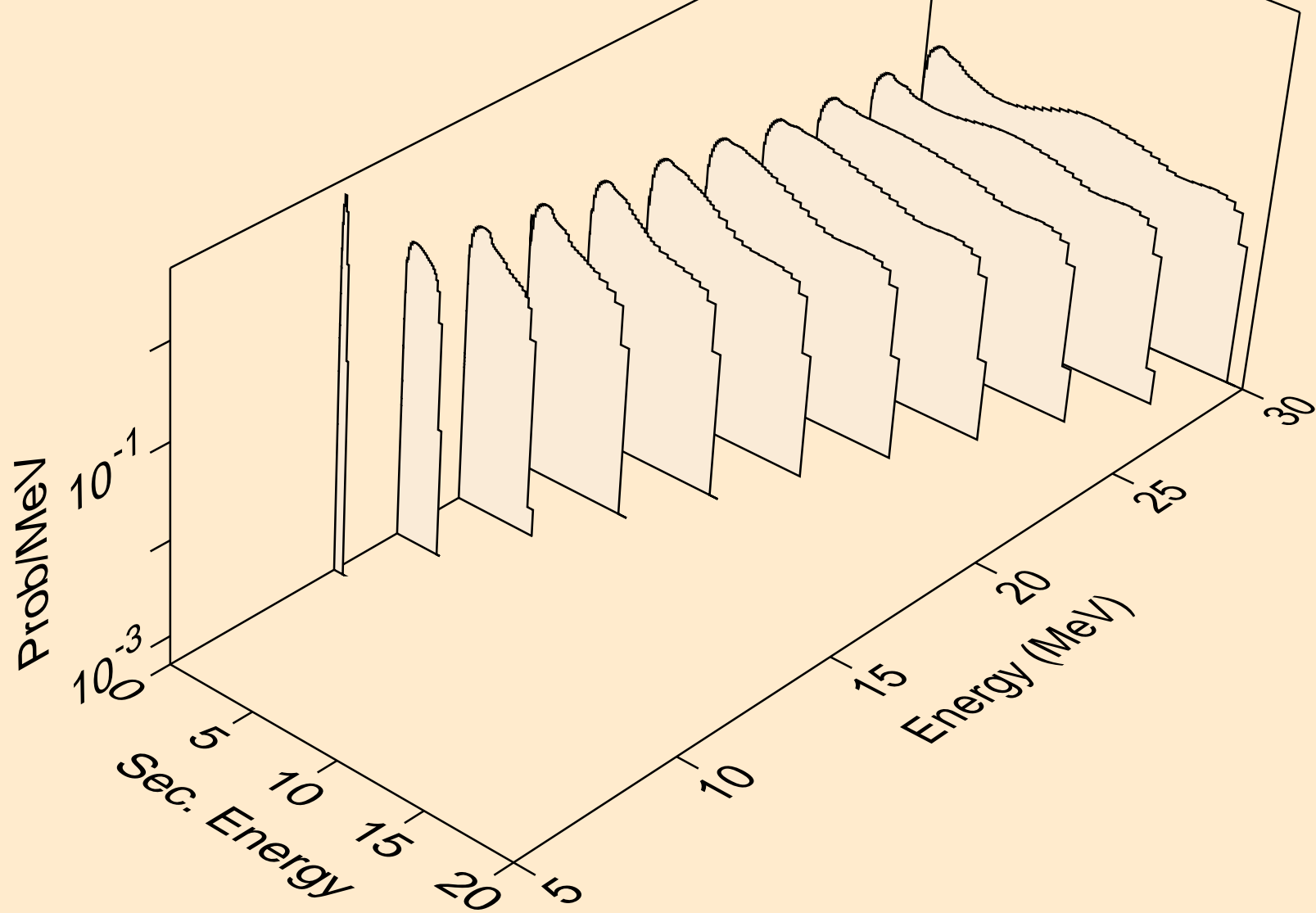

S032 NEUTRON ACER TENDL-2023 LIBRARY; T=0.K
Neutron emission for (n,n*)2a

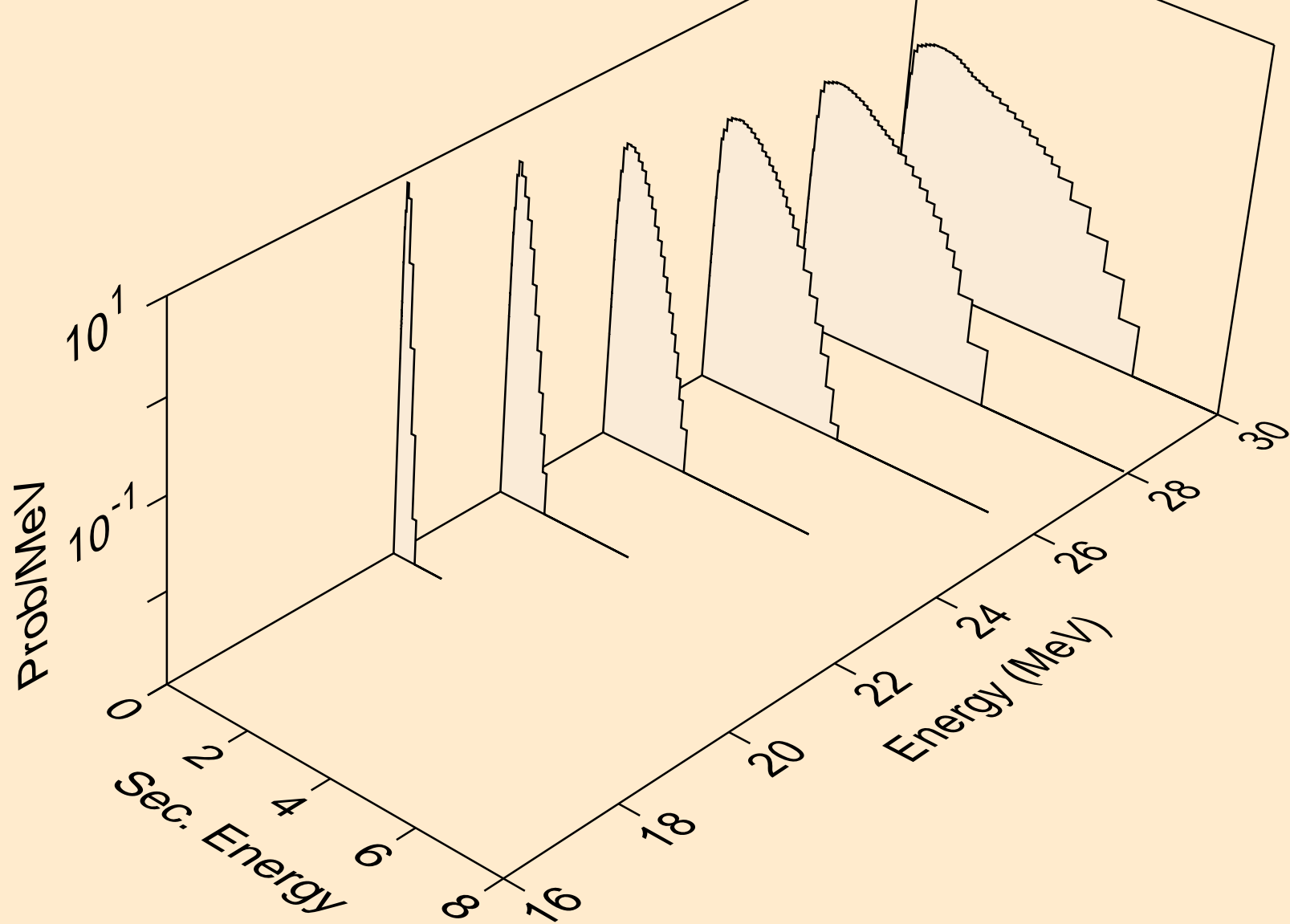

S032 NEUTRON ACER TENDL-2023 LIBRARY; T=0.K
Neutron emission for (n,n*)d

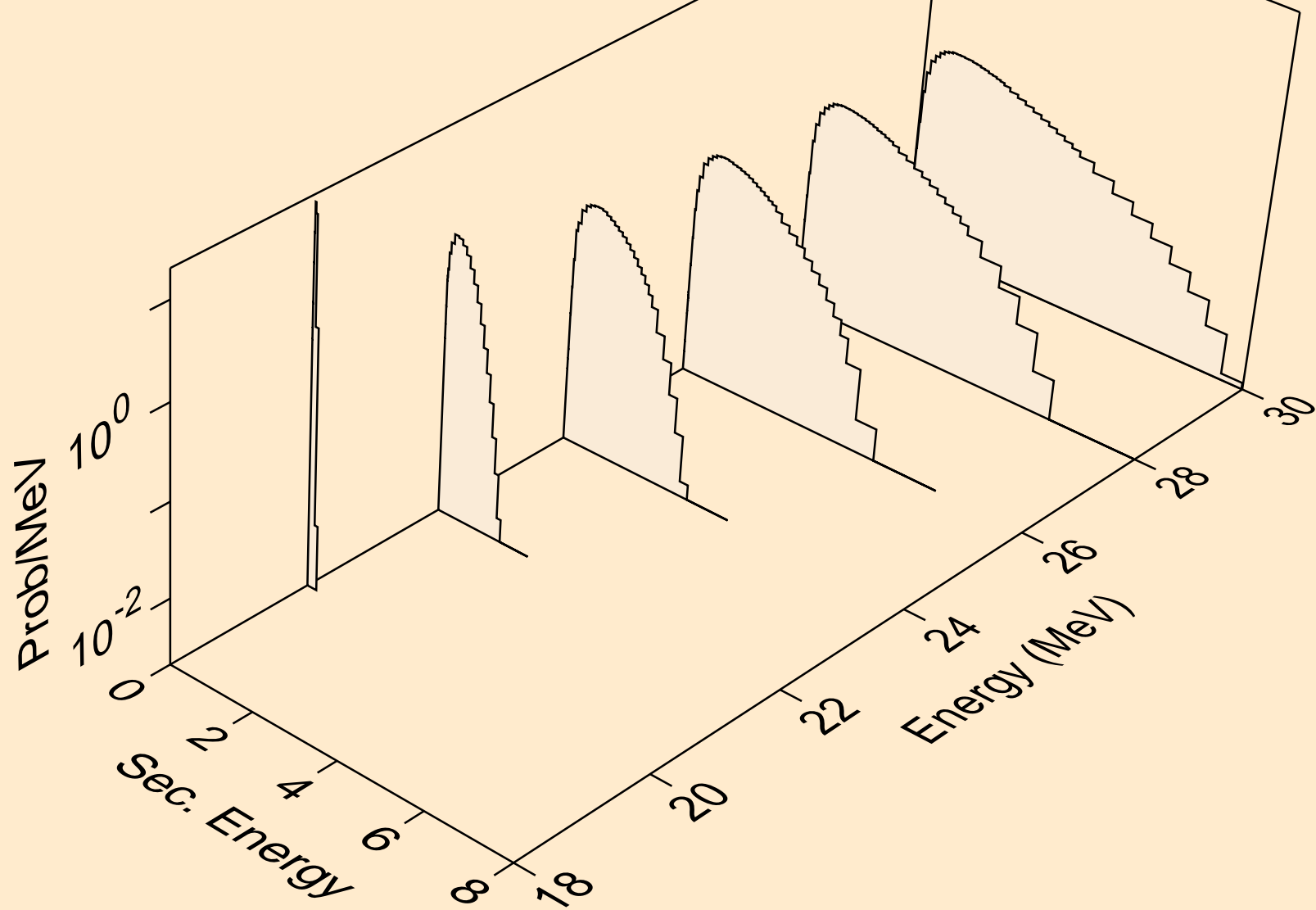

S032 NEUTRON ACER TENDL-2023 LIBRARY; T=0.K
Neutron emission for (n,n*)t

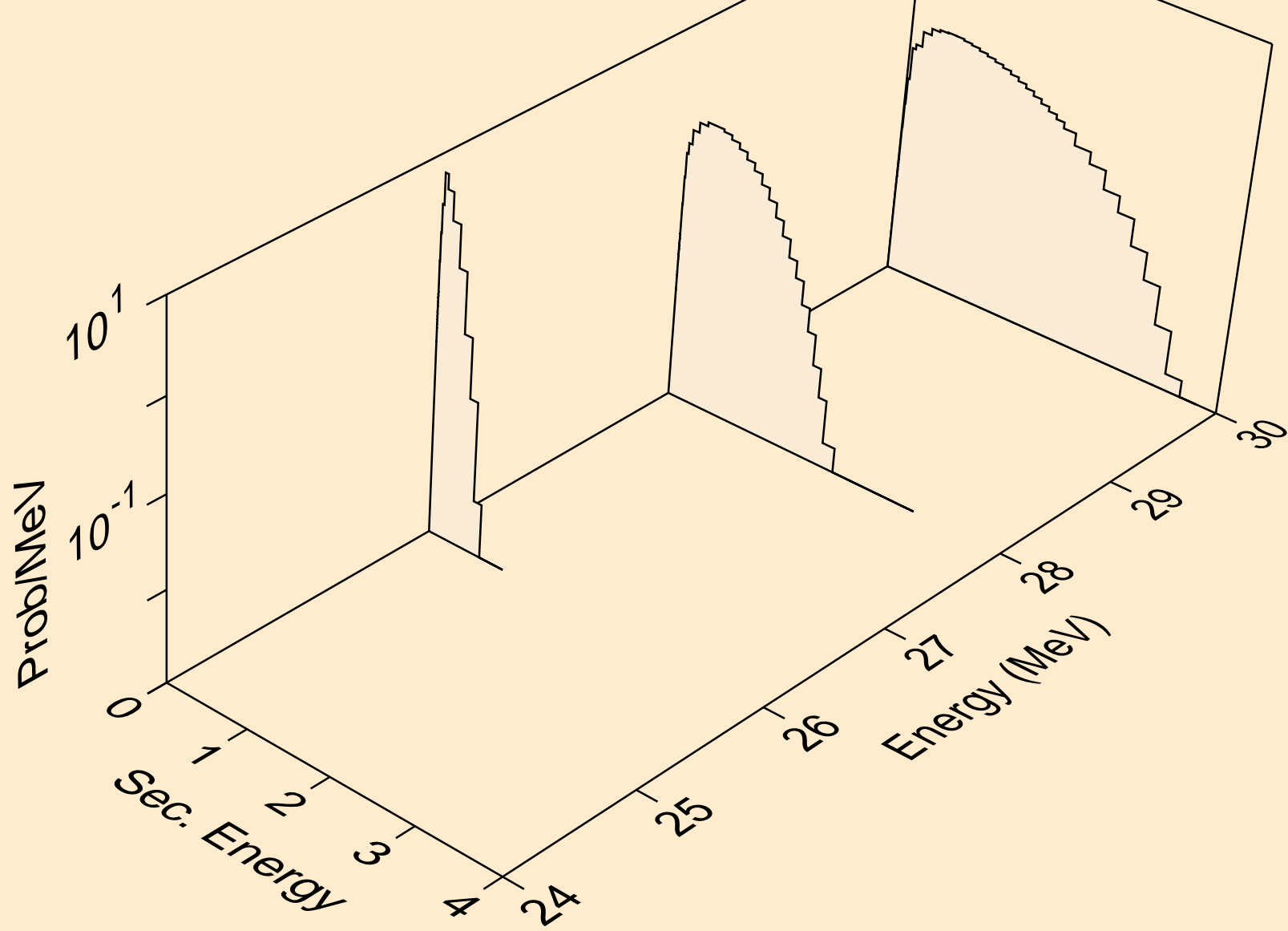

S032 NEUTRON ACER TENDL-2023 LIBRARY; T=0.K
Neutron emission for (n,n*)he3

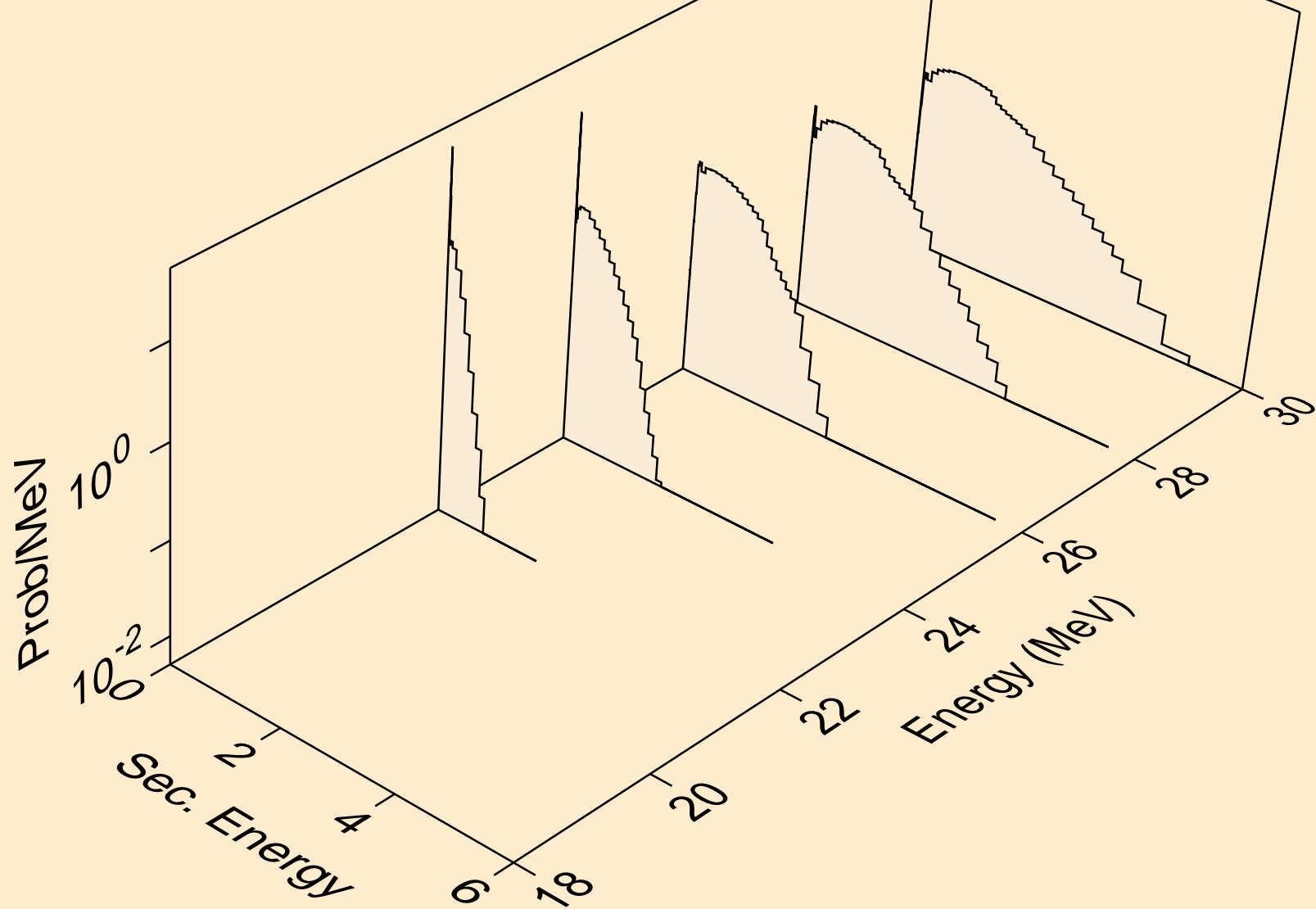

S032 NEUTRON ACER TENDL-2023 LIBRARY; T=0.K
Neutron emission for (n,2np)

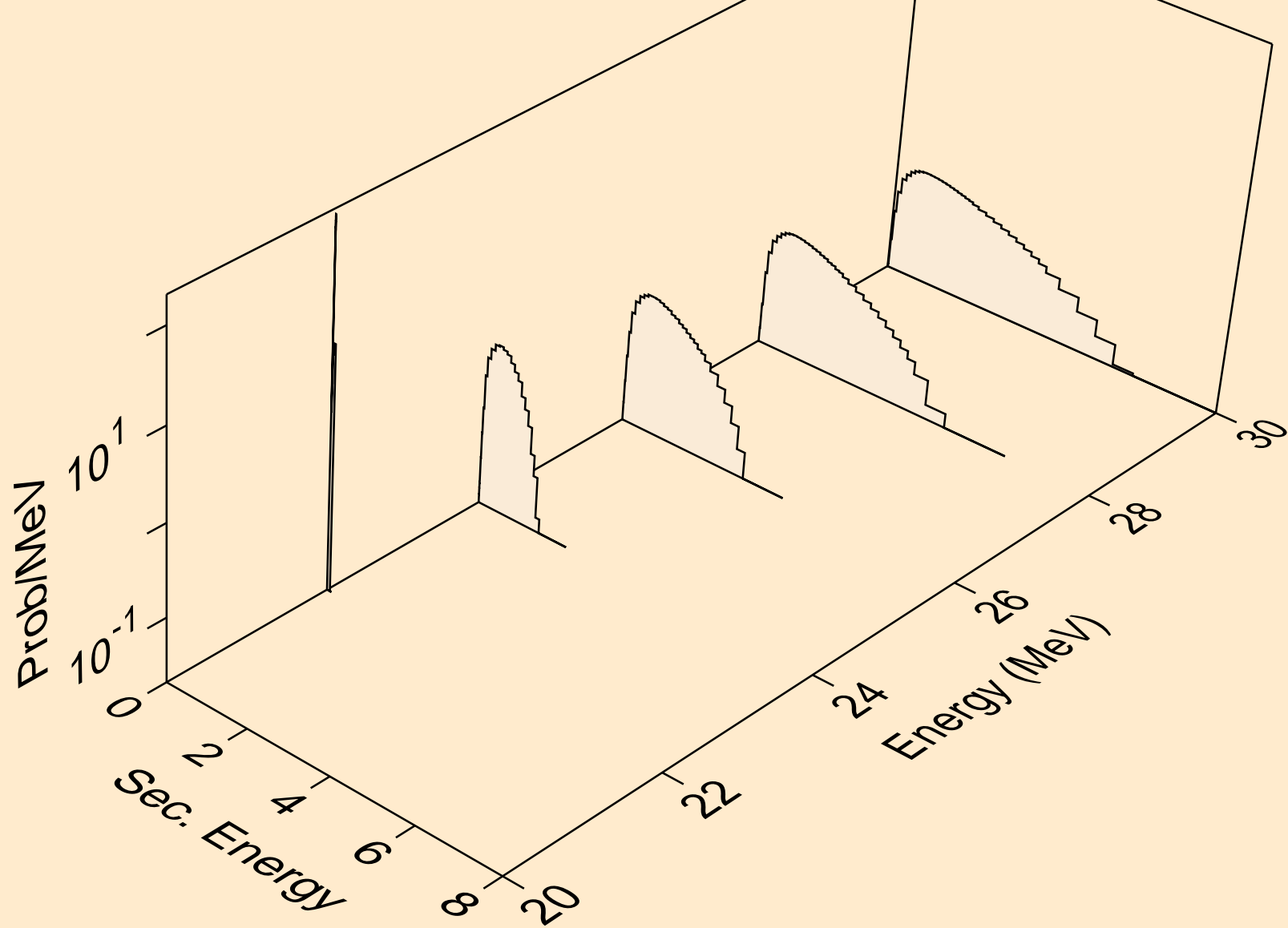

S032 NEUTRON ACER TENDL-2023 LIBRARY; T=0.K
Neutron emission for (n,n2p)

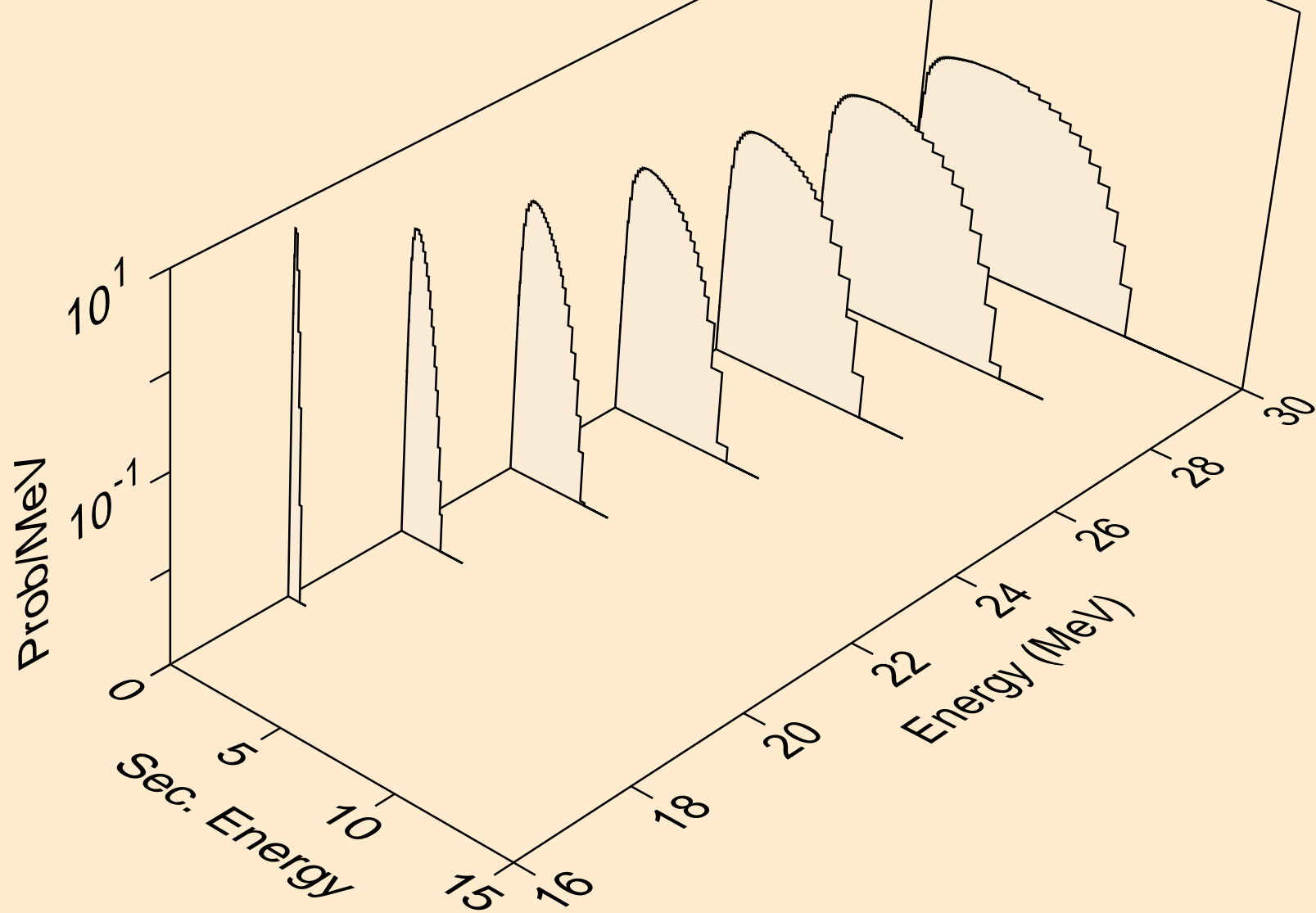

S032 NEUTRON ACER TENDL-2023 LIBRARY; T=0.K
Neutron emission for (n,npa)

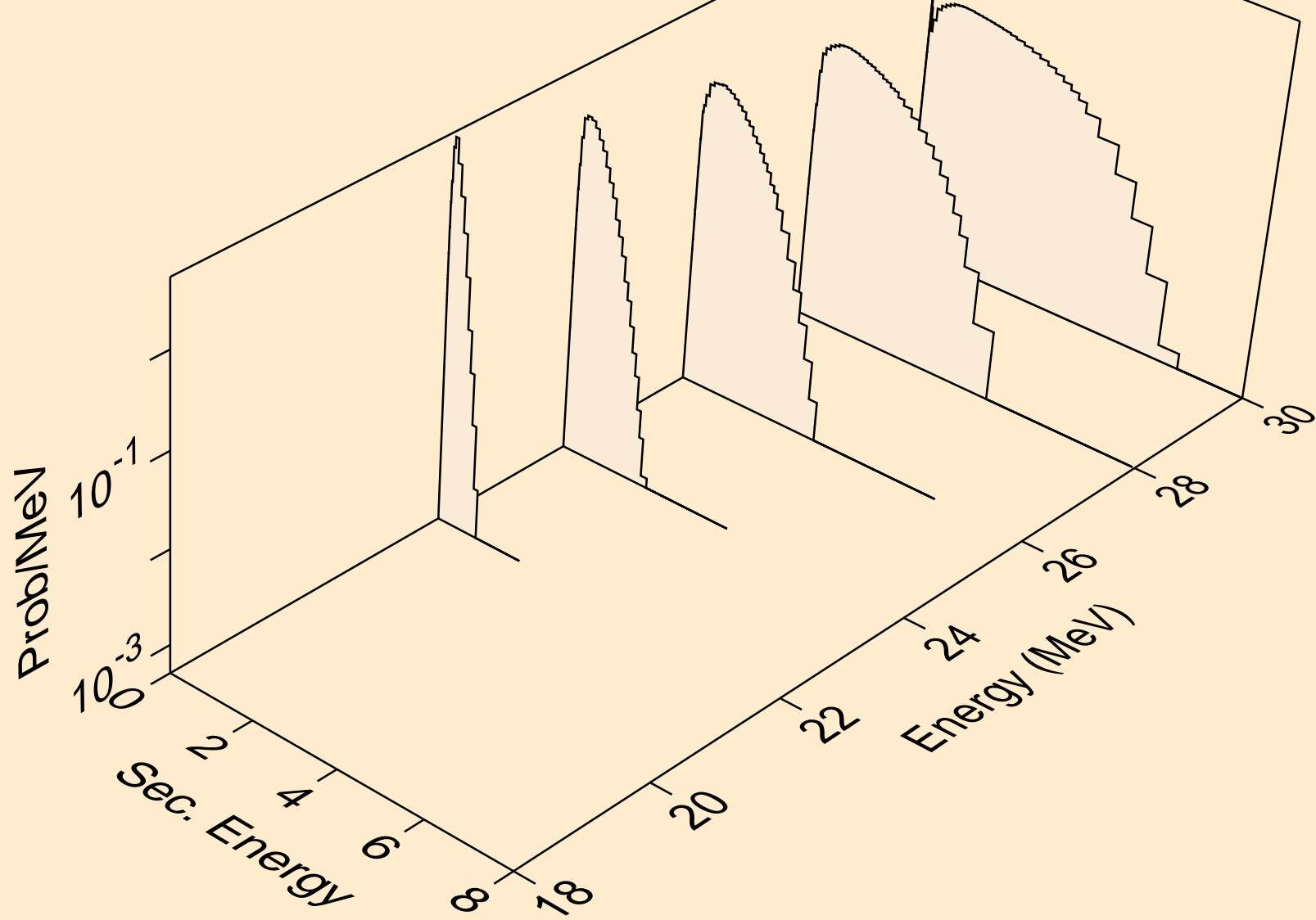

S032 NEUTRON ACER TENDL-2023 LIBRARY; T=0.K
Neutron emission for (n,n*c)

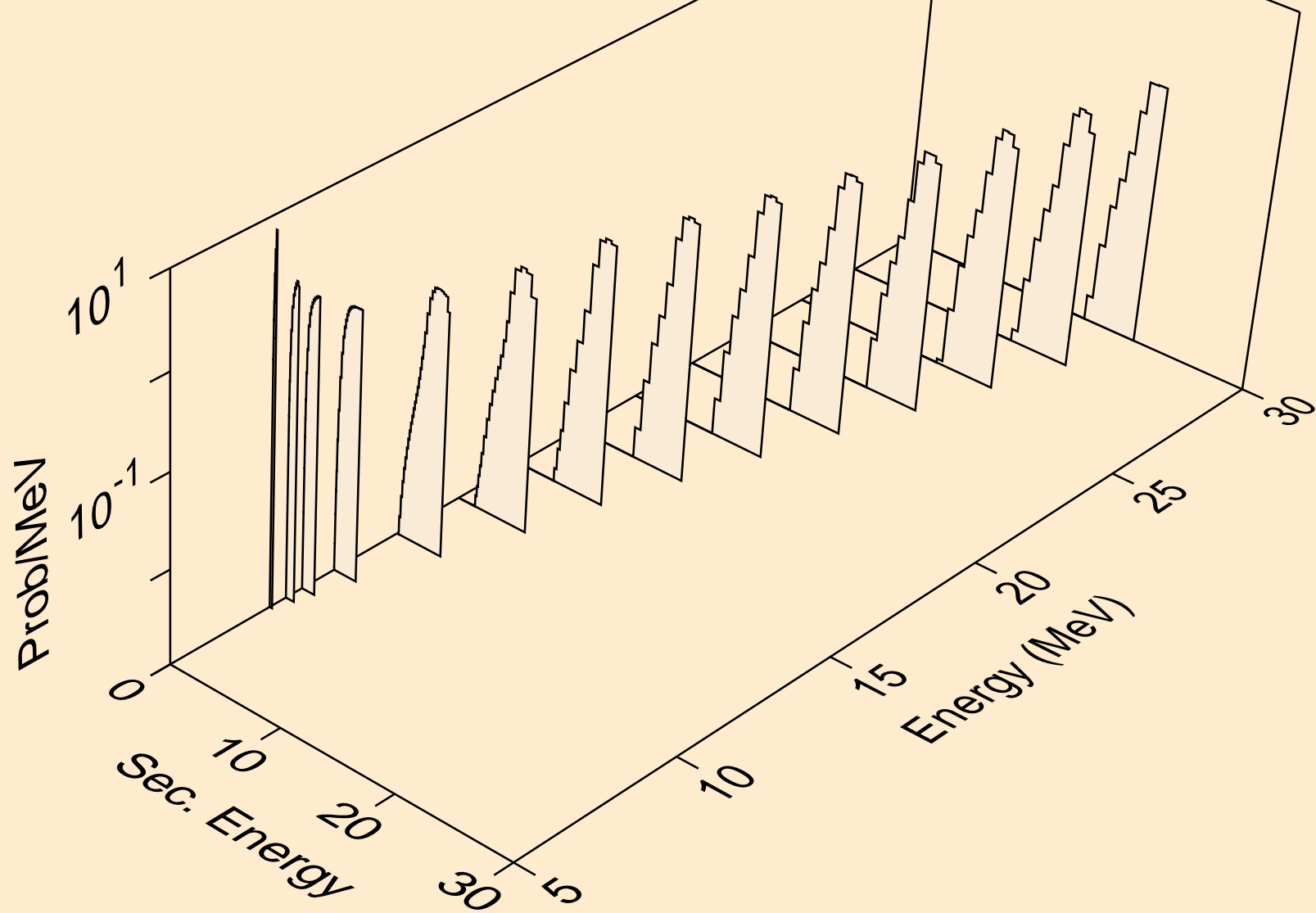

S032 NEUTRON ACER TENDL-2023 LIBRARY; T=0.K
Photon emission for (n,x)

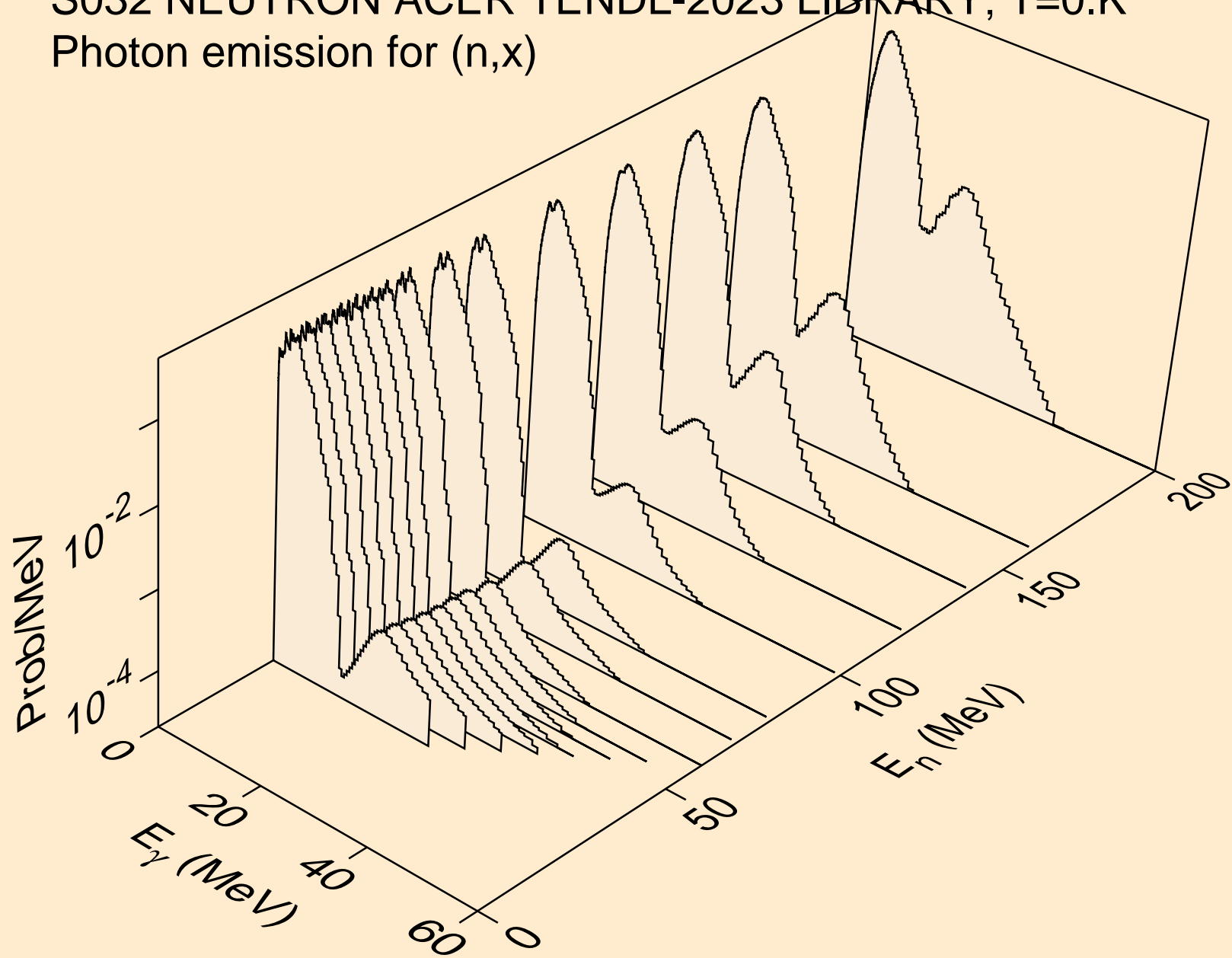

S032 NEUTRON ACER TENDL-2023 LIBRARY; T=0.K
Photon emission for (n,2n)

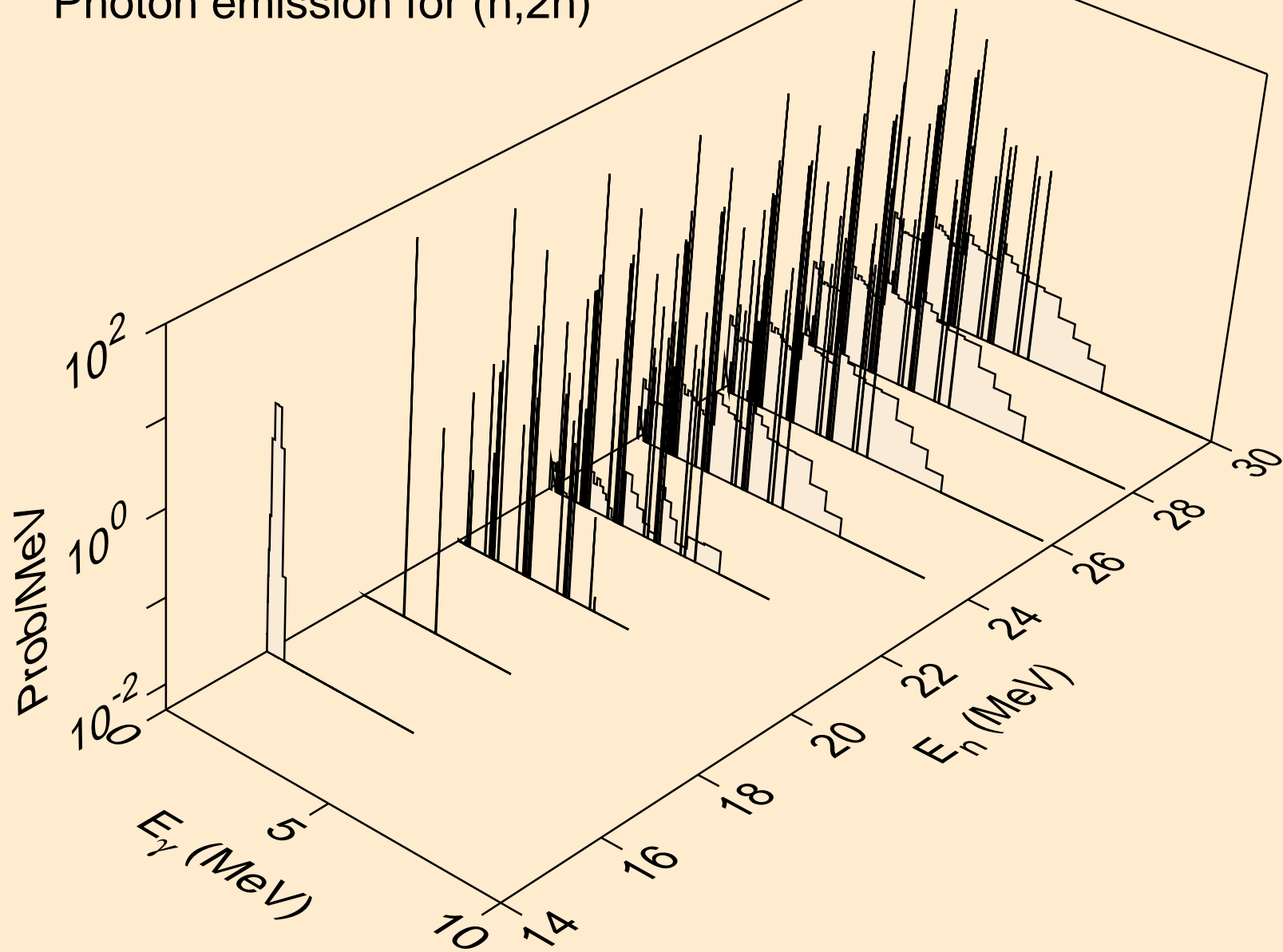

S032 NEUTRON ACER TENDL-2023 LIBRARY; T=0.K
Photon emission for (n,3n)

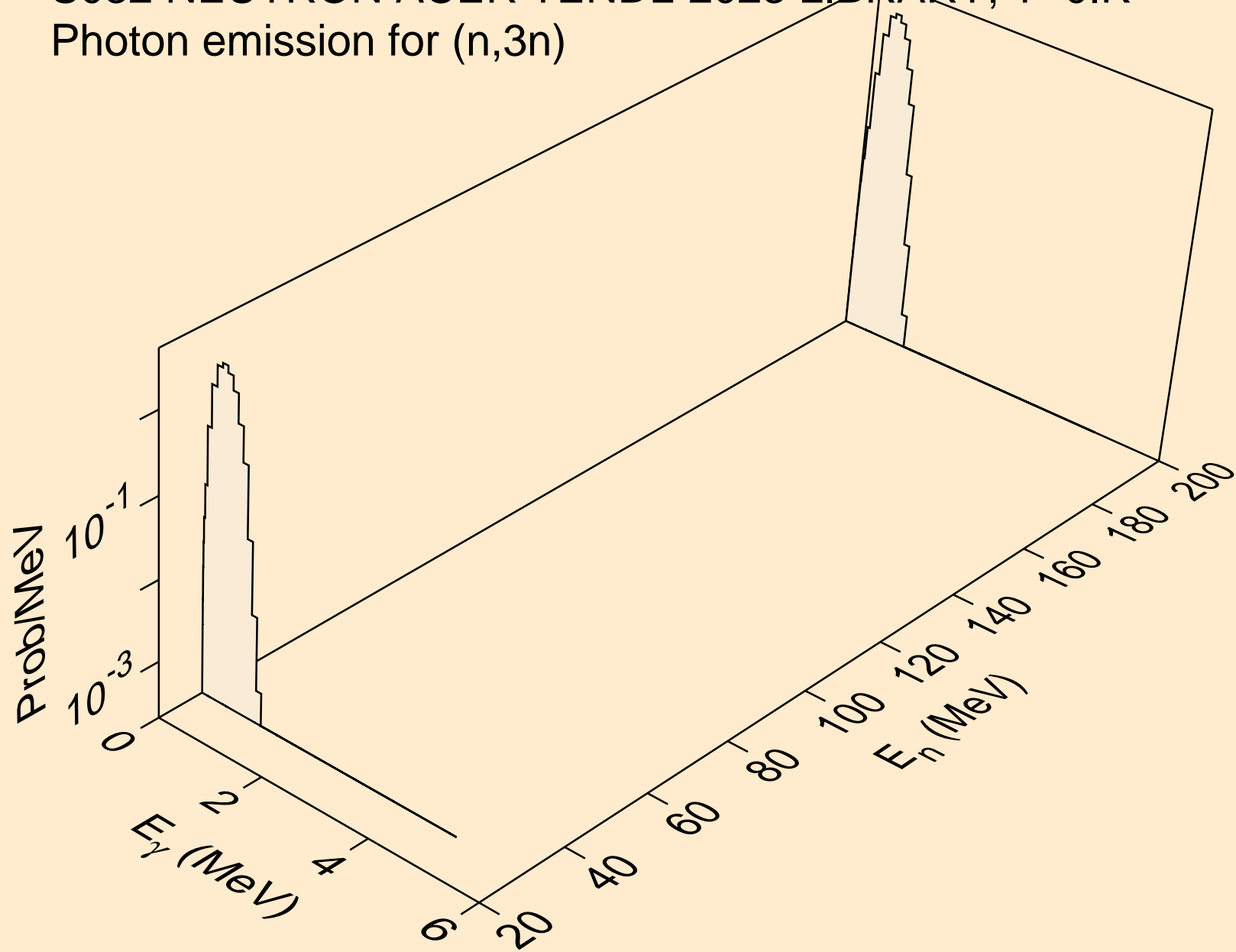

S032 NEUTRON ACER TENDL-2023 LIBRARY; T=0.K
Photon emission for (n,n*)a

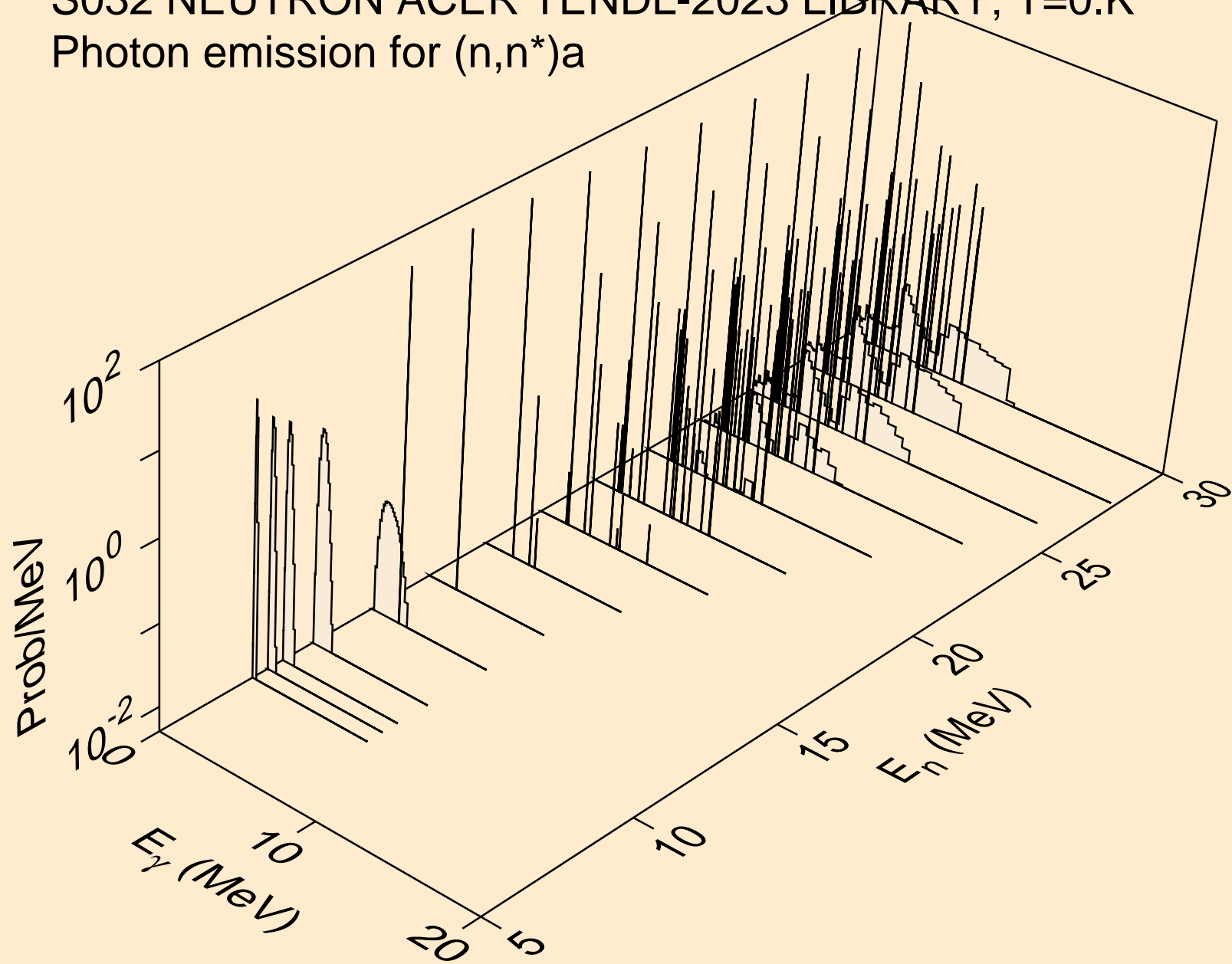

S032 NEUTRON ACER TENDL-2023 LIBRARY; T=0.K
Photon emission for (n,2n)a

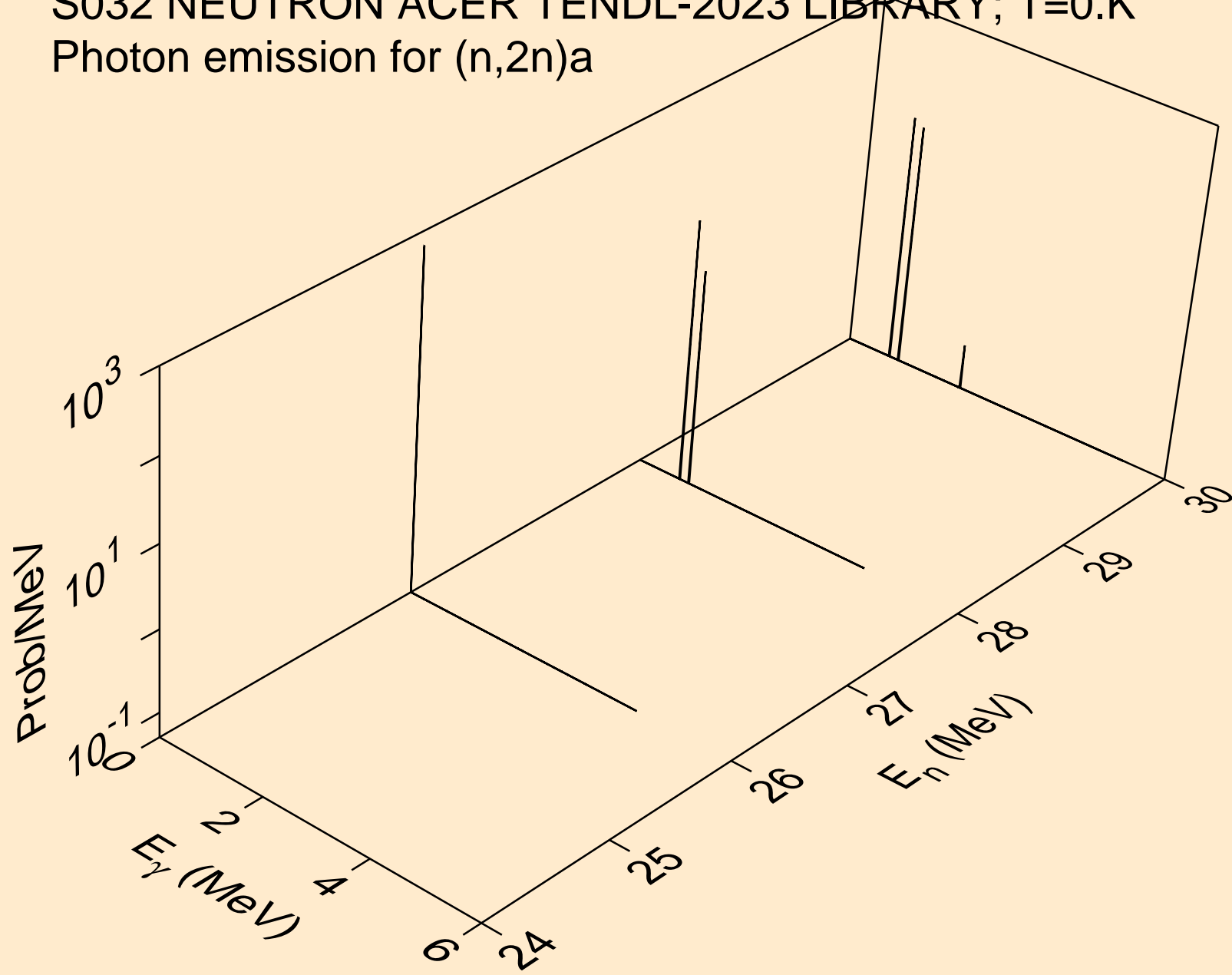

S032 NEUTRON ACER TENDL-2023 LIBRARY; T=0.K
Photon emission for (n,n*)p

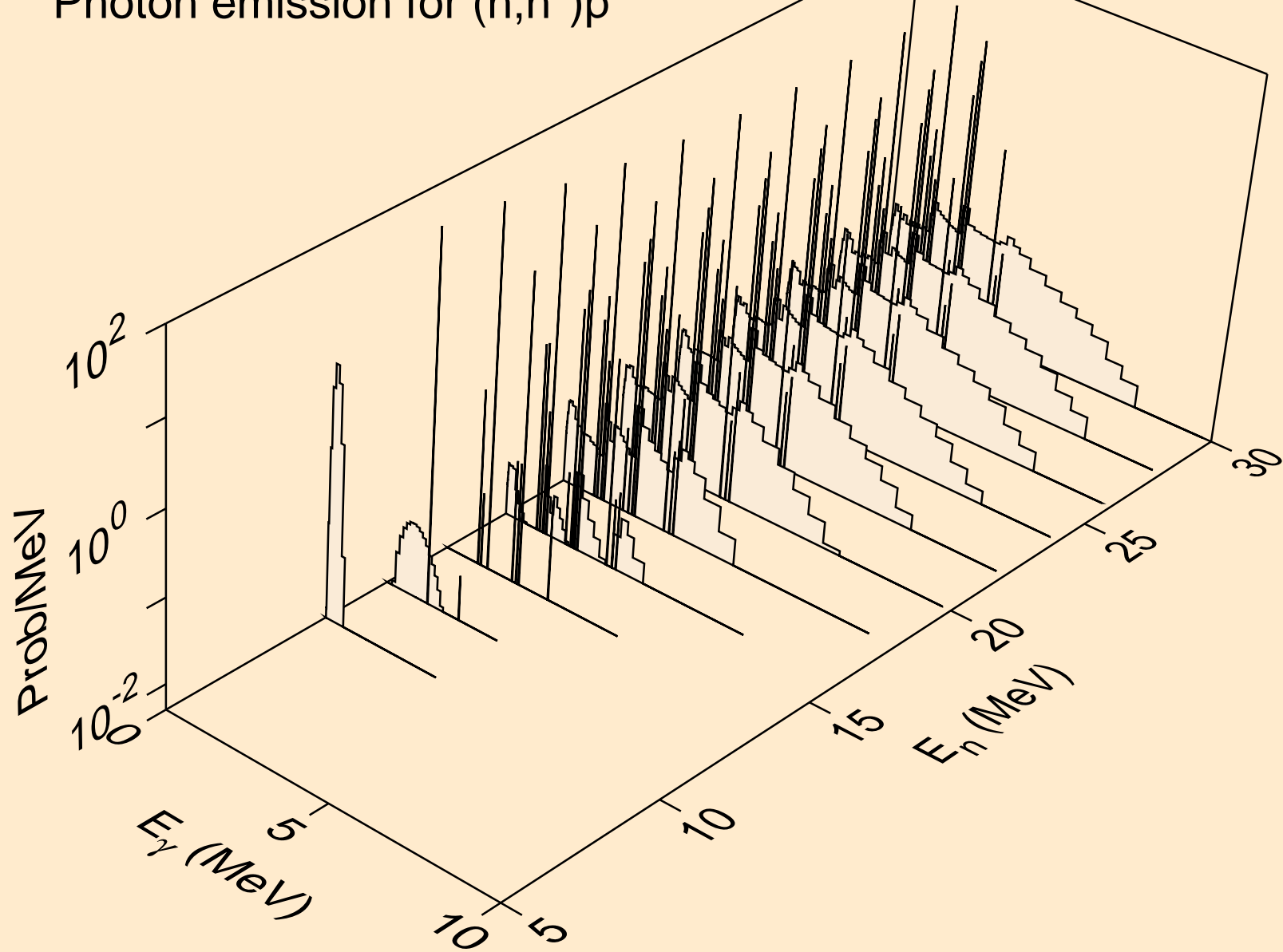

S032 NEUTRON ACER TENDL-2023 LIBRARY; T=0.K
Photon emission for (n,n*)2a

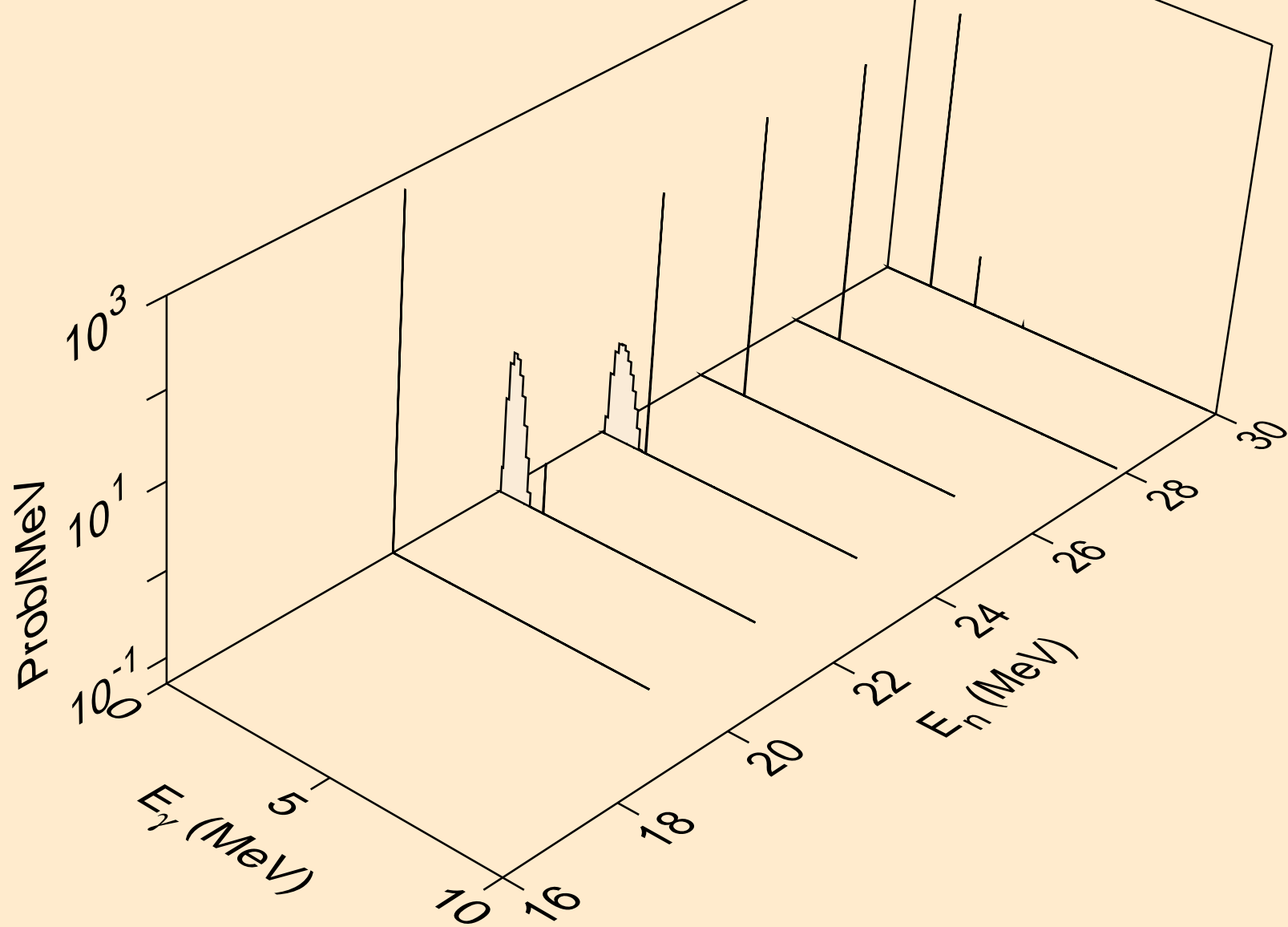

S032 NEUTRON ACER TENDL-2023 LIBRARY; T=0.K
Photon emission for (n,n*)d

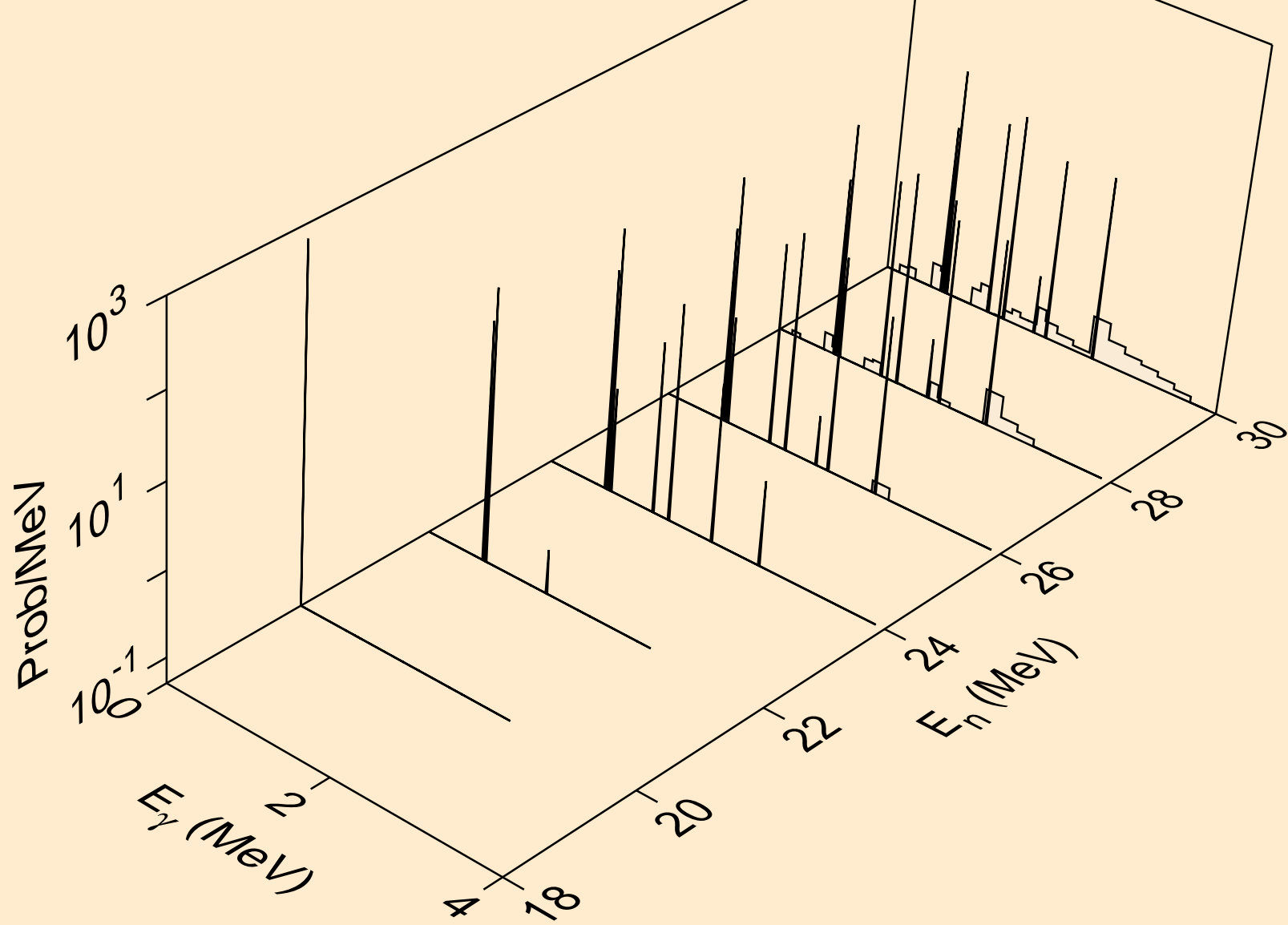

S032 NEUTRON ACER TENDL-2023 LIBRARY; T=0.K
Photon emission for (n,n*)t

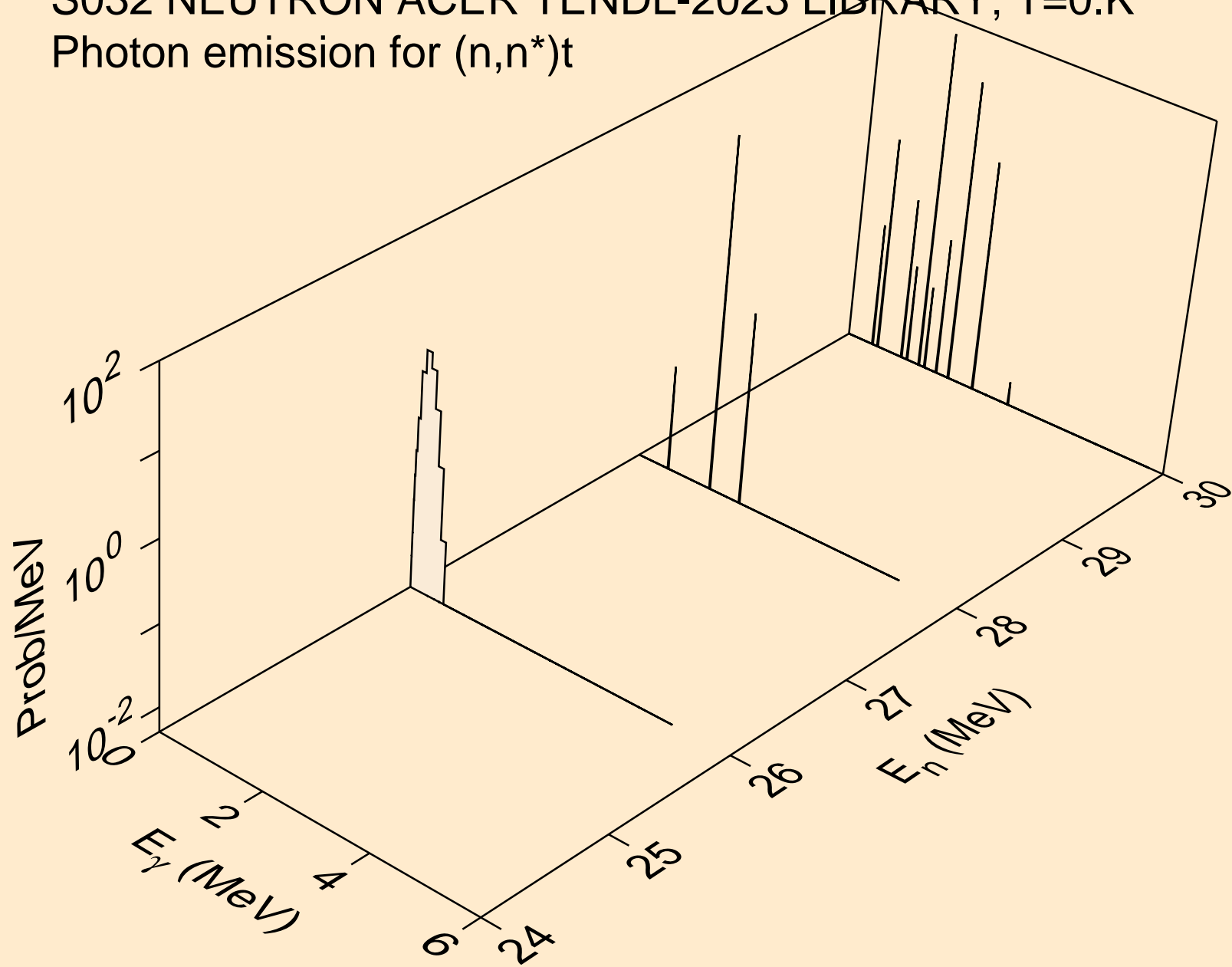

S032 NEUTRON ACER TENDL-2023 LIBRARY; T=0.K
Photon emission for (n,n*)he3

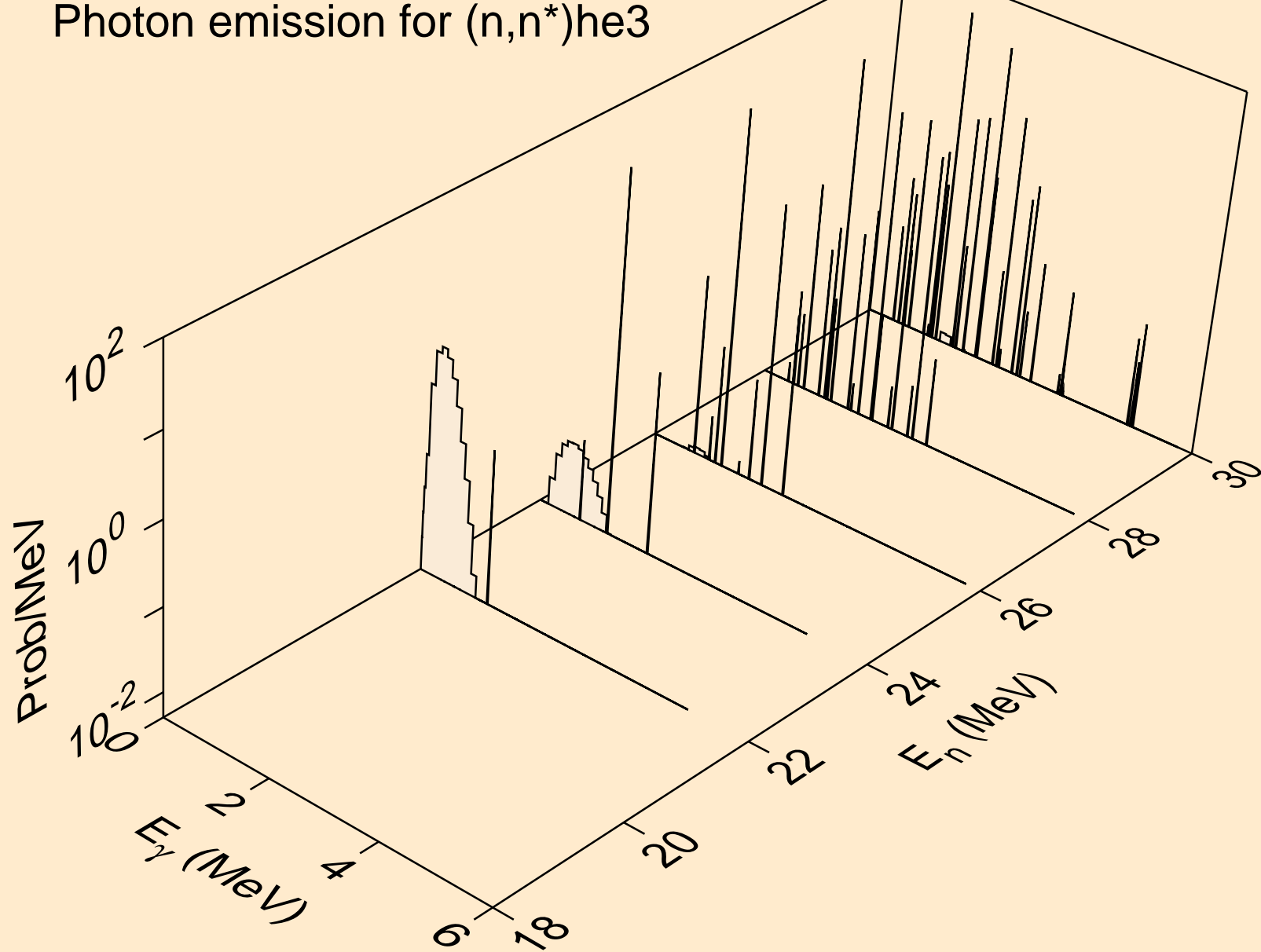

S032 NEUTRON ACER TENDL-2023 LIBRARY; T=0.K
Photon emission for (n,2np)

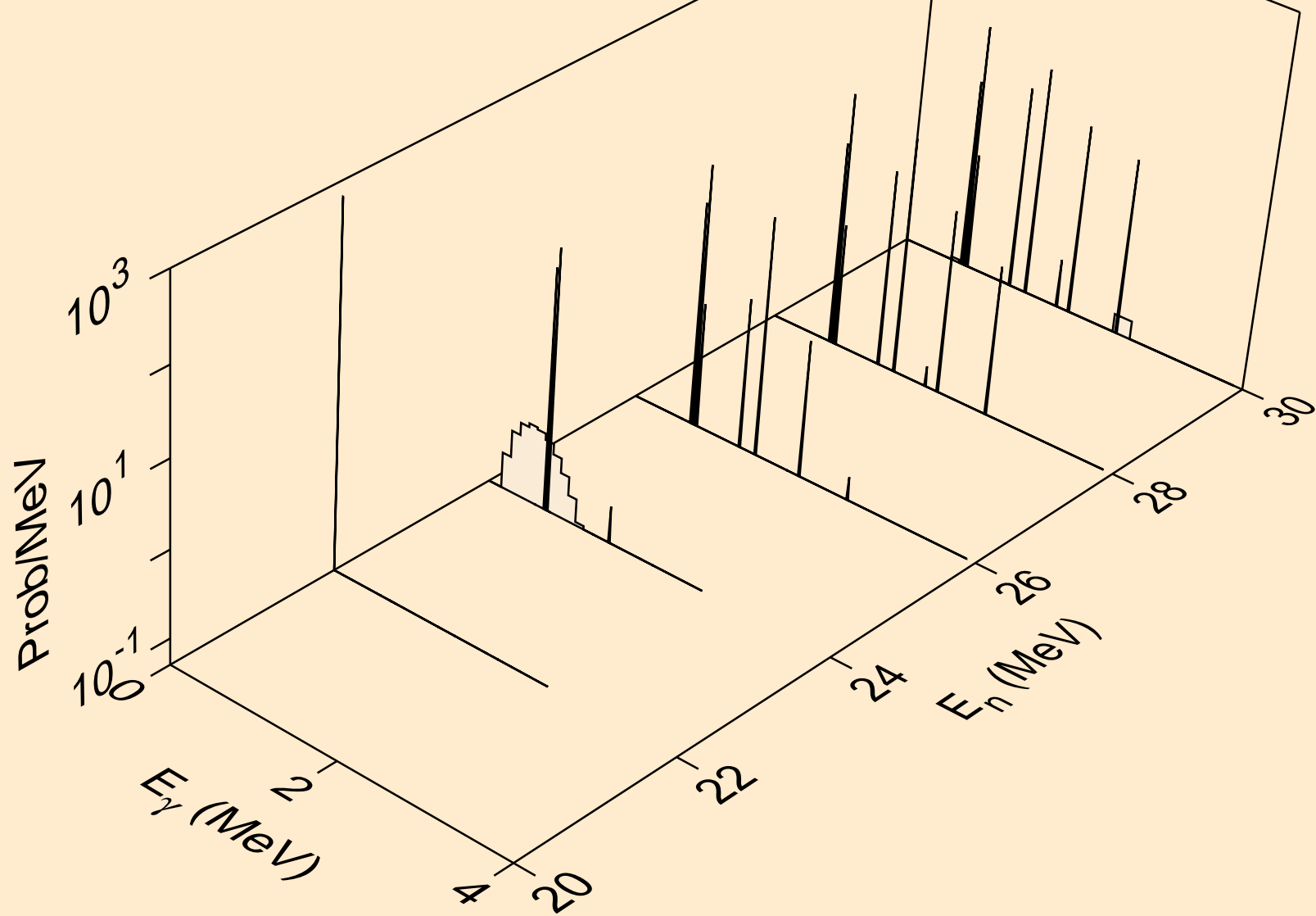

S032 NEUTRON ACER TENDL-2023 LIBRARY; T=0.K
Photon emission for (n,n2p)

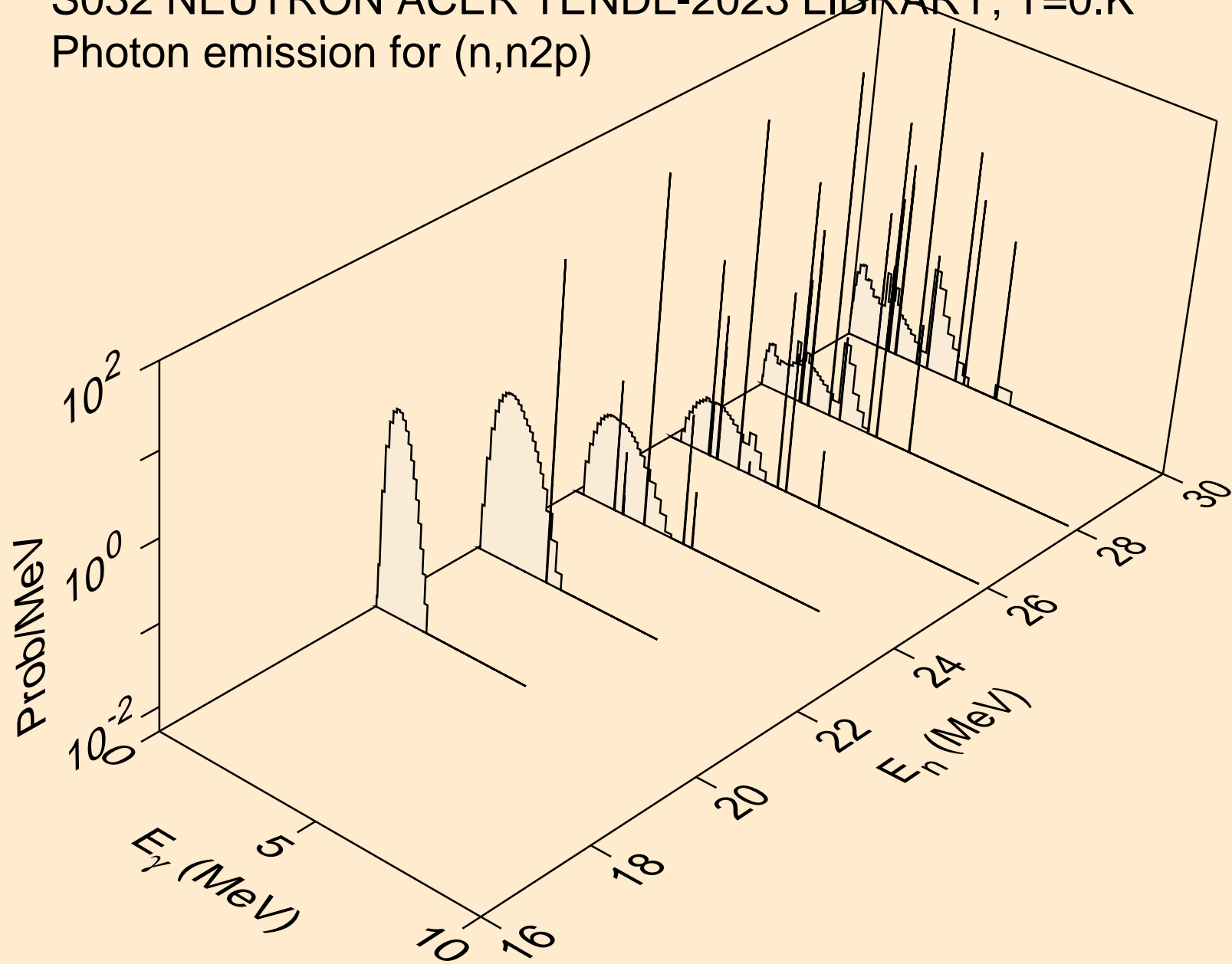

S032 NEUTRON ACER TENDL-2023 LIBRARY; T=0.K
Photon emission for (n,npa)

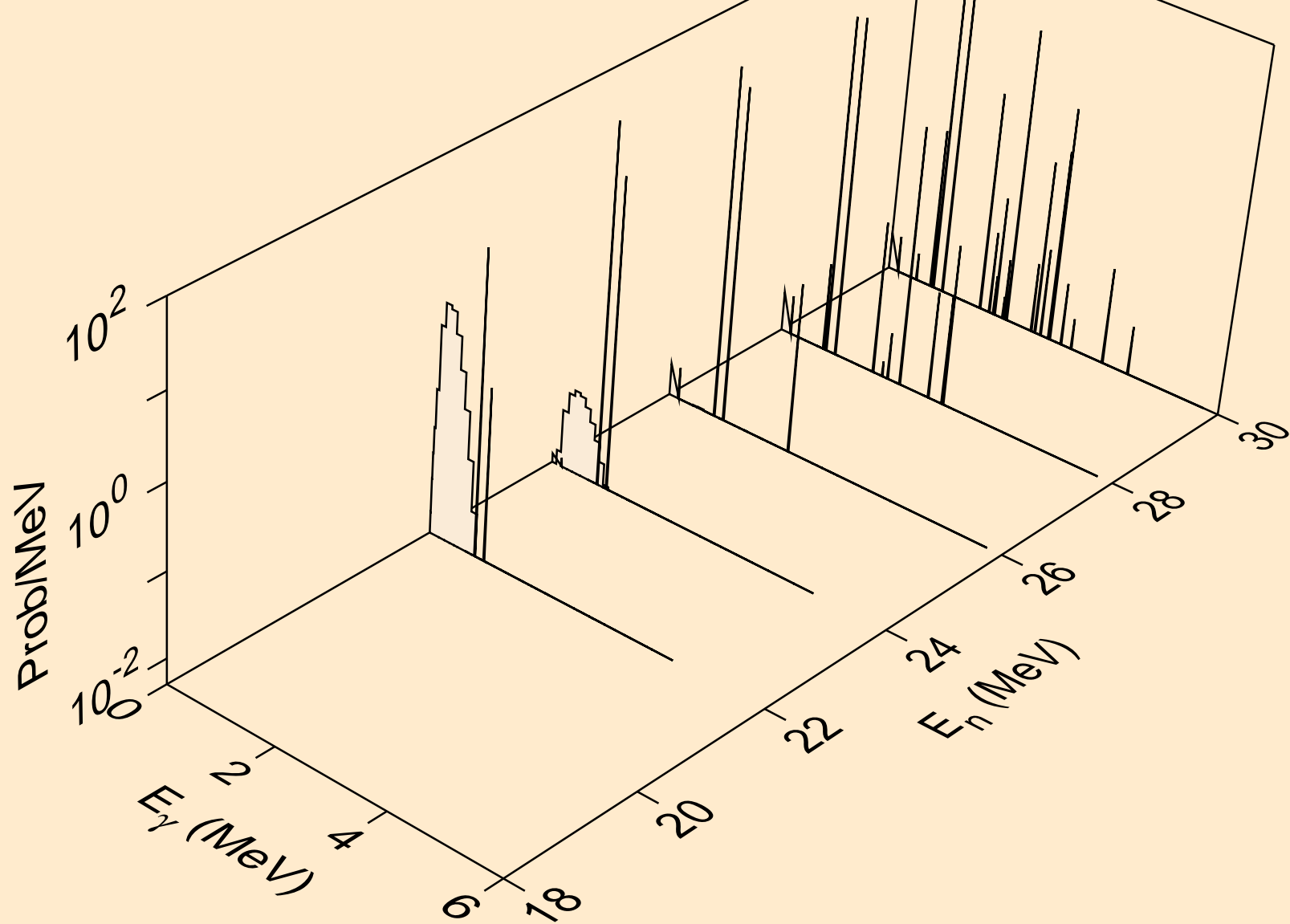

S032 NEUTRON ACER TENDL-2023 LIBRARY; T=0.K
Photon emission for (n,n*c)

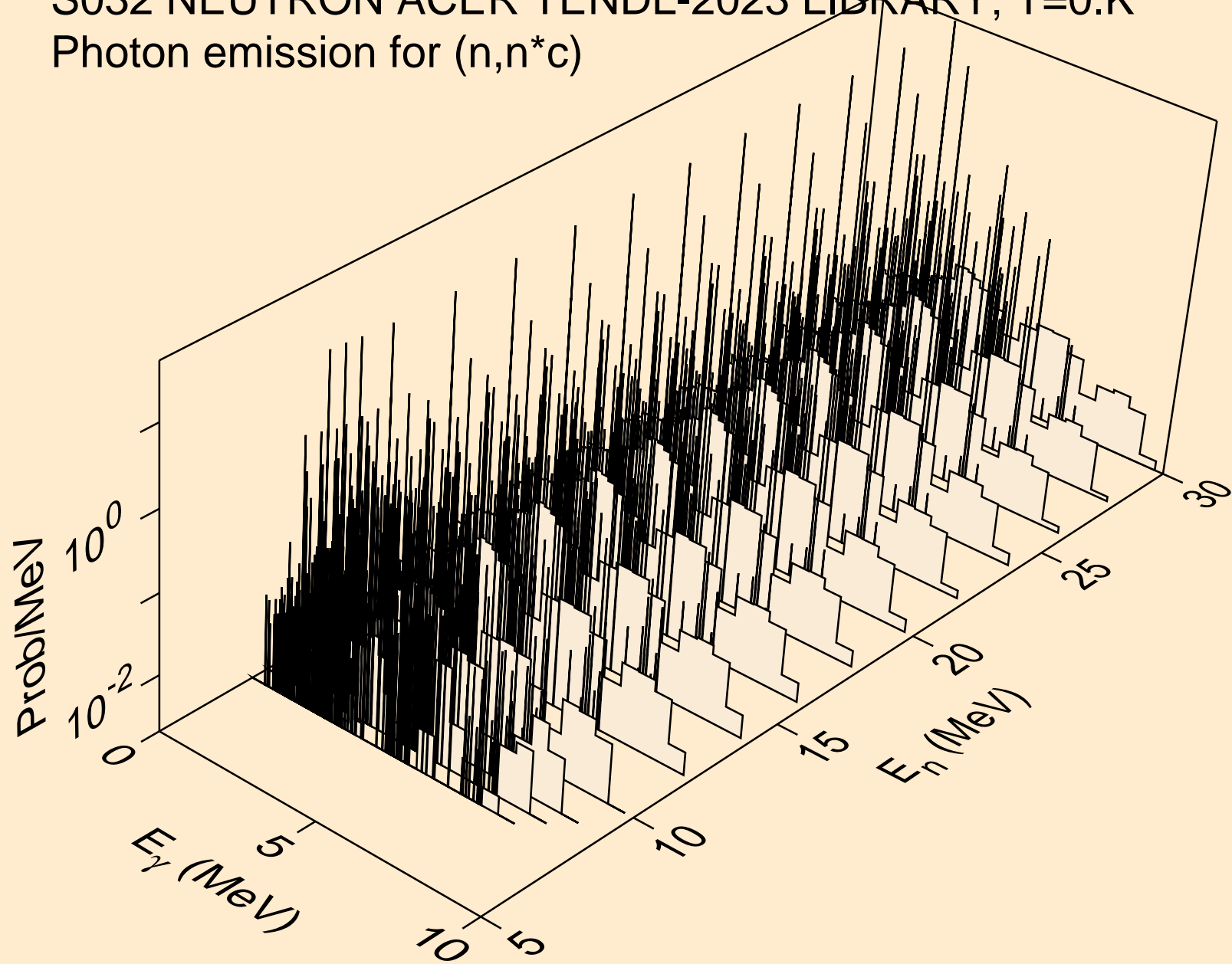

S032 NEUTRON ACER TENDL-2023 LIBRARY; T=0.K
Photon emission for (n,gma)

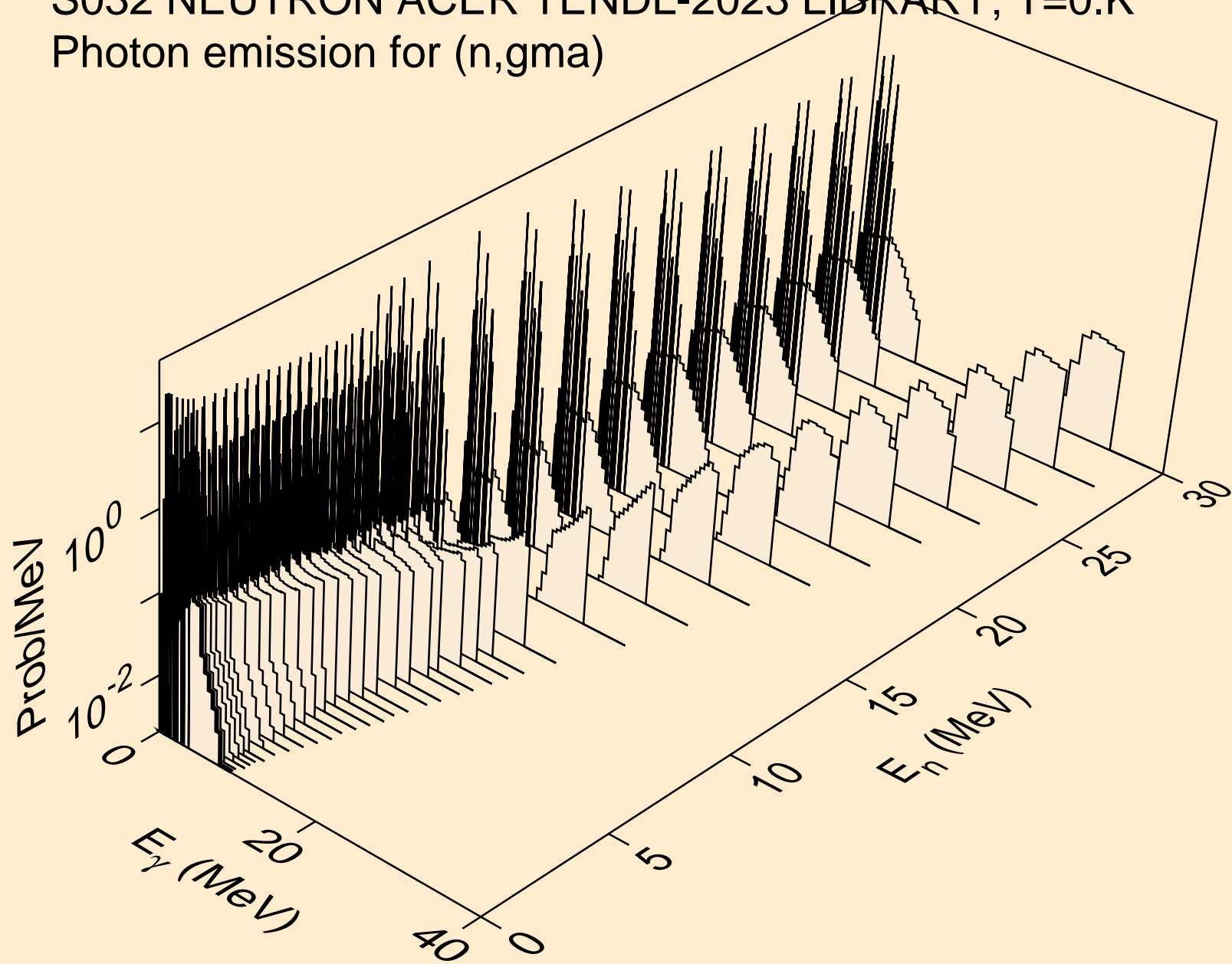

S032 NEUTRON ACER TENDL-2023 LIBRARY; T=0.K
Photon emission for (n,p)

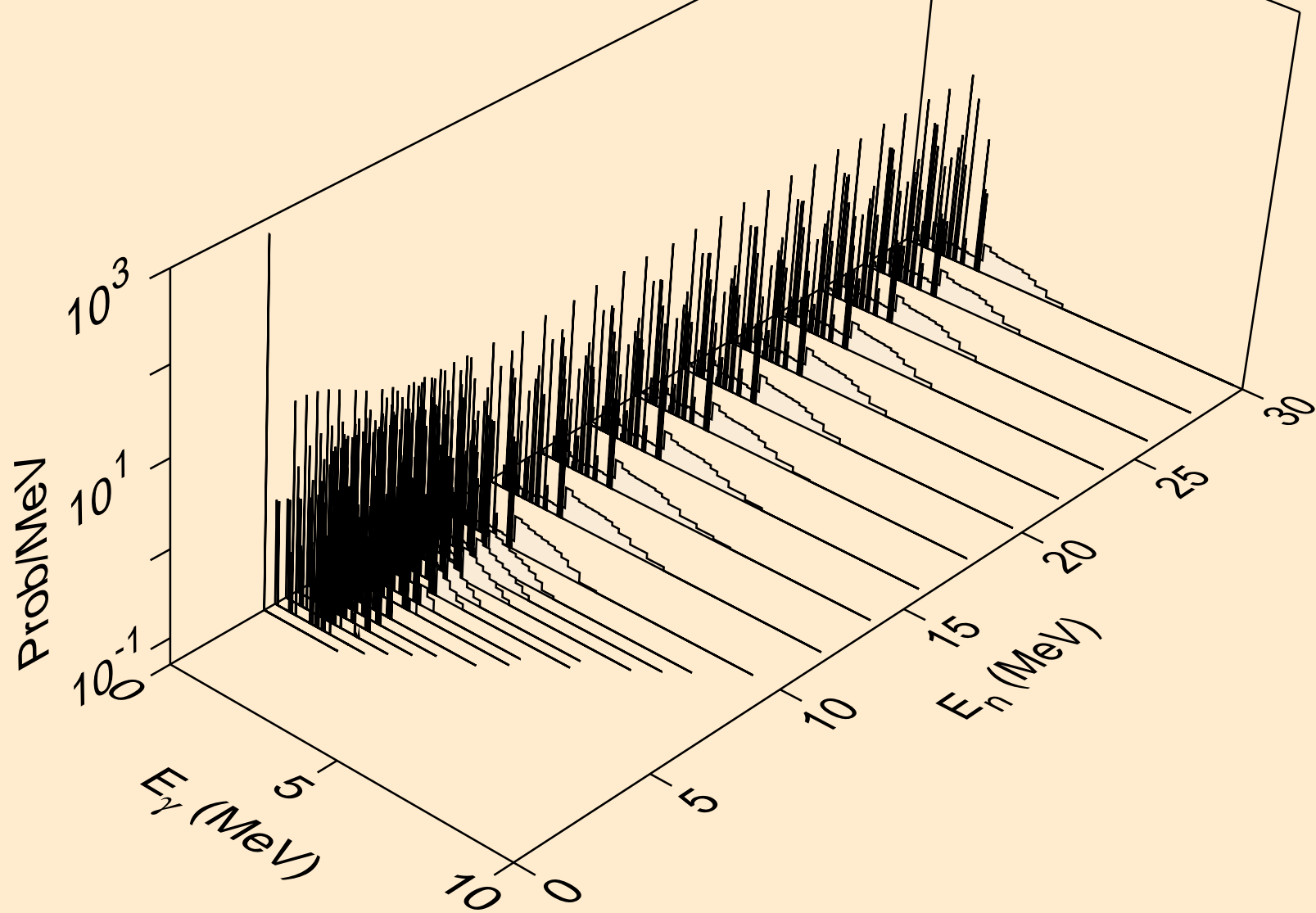

S032 NEUTRON ACER TENDL-2023 LIBRARY; T=0.K
Photon emission for (n,d)

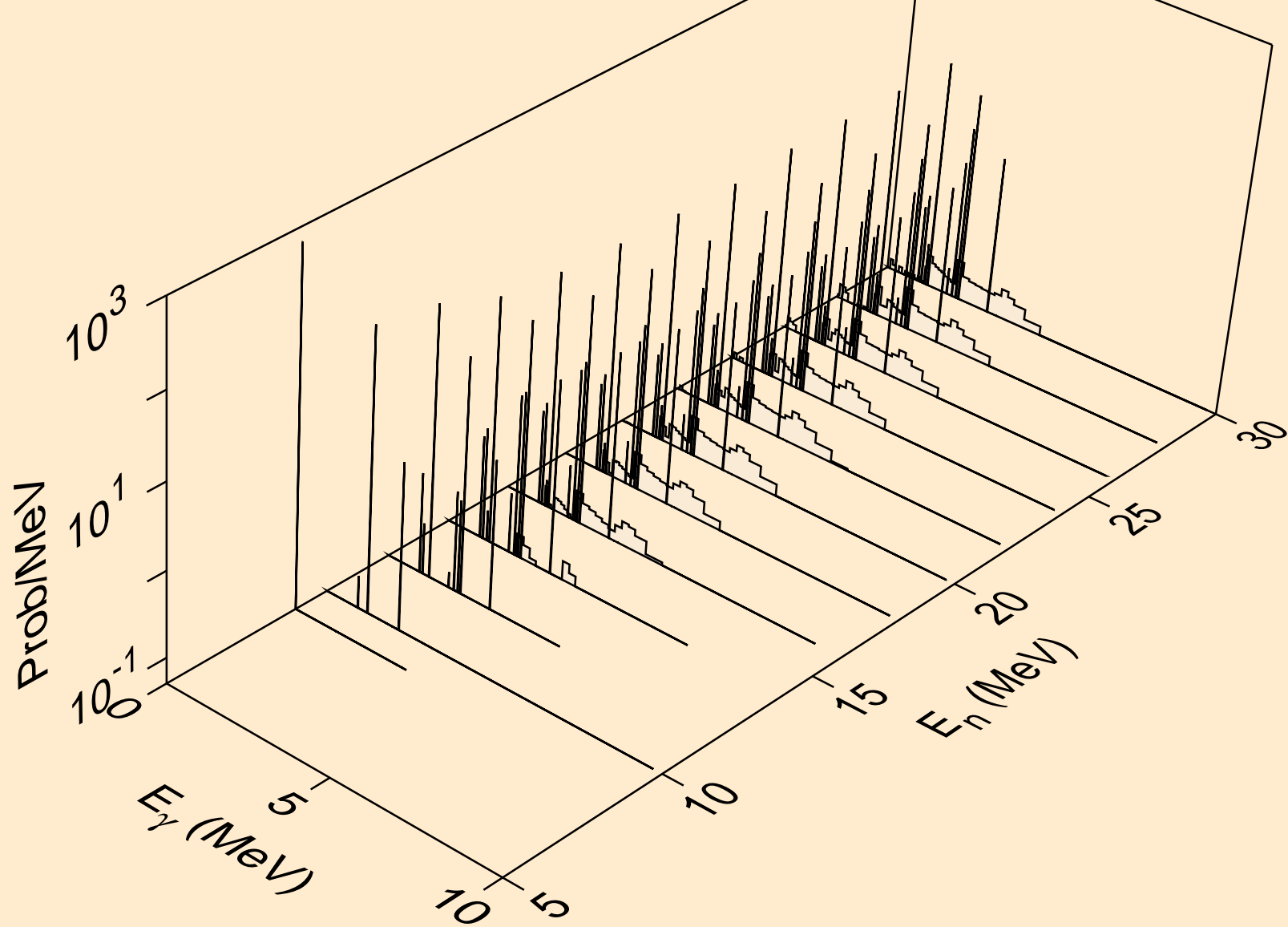

S032 NEUTRON ACER TENDL-2023 LIBRARY; T=0.K
Photon emission for (n,t)

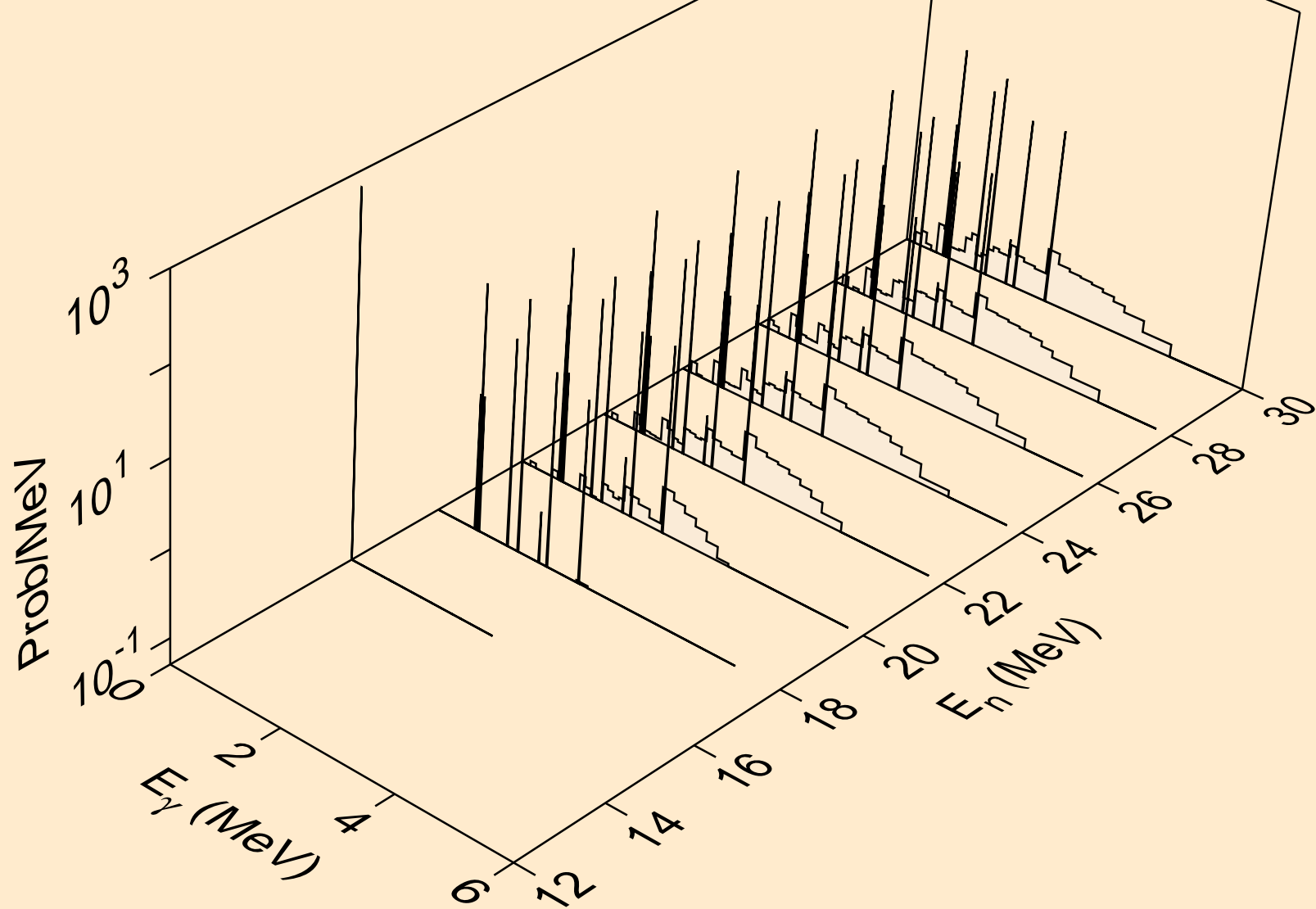

S032 NEUTRON ACER TENDL-2023 LIBRARY; T=0.K
Photon emission for (n,he3)

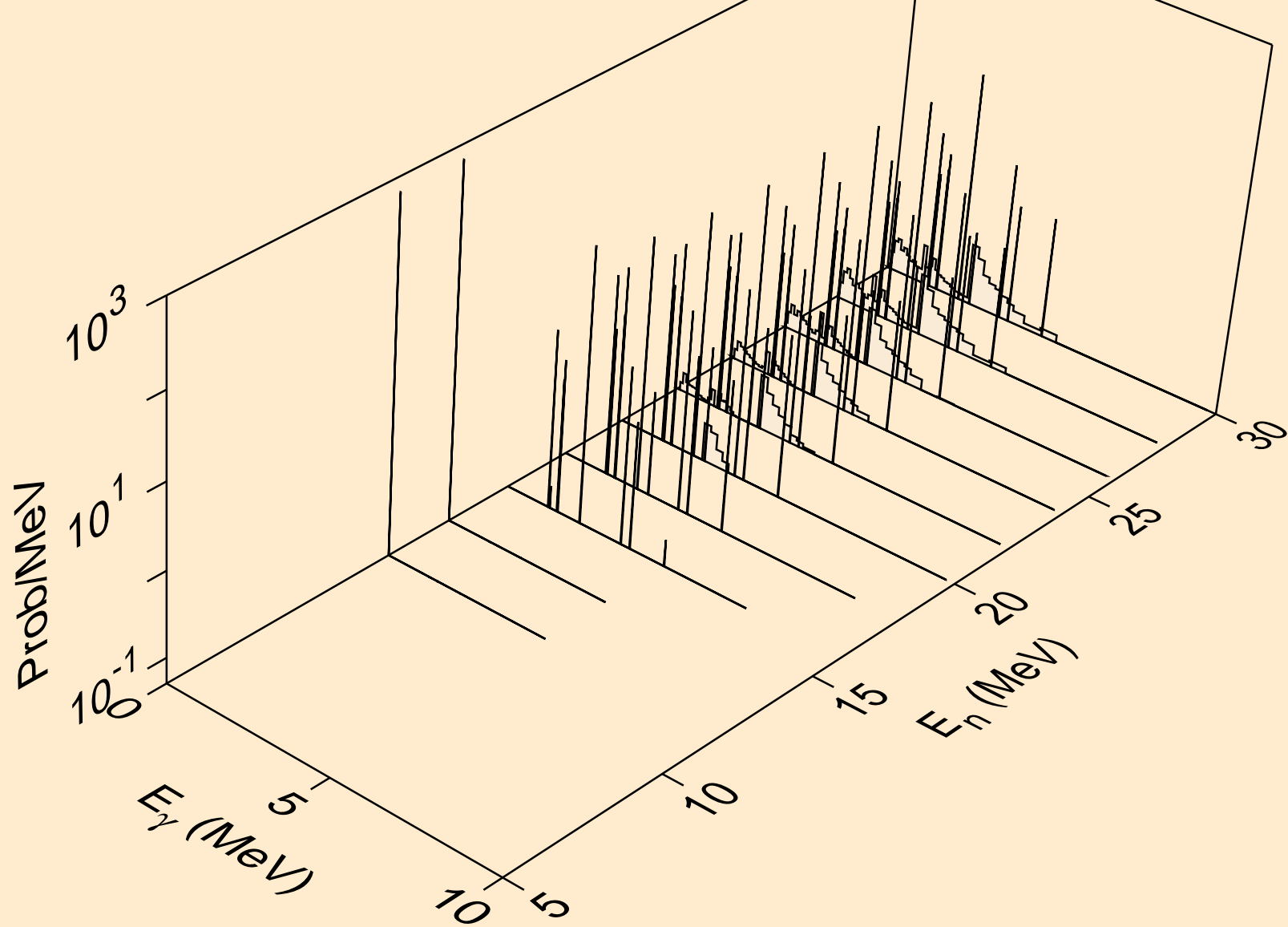

S032 NEUTRON ACER TENDL-2023 LIBRARY; T=0.K
Photon emission for (n,a)

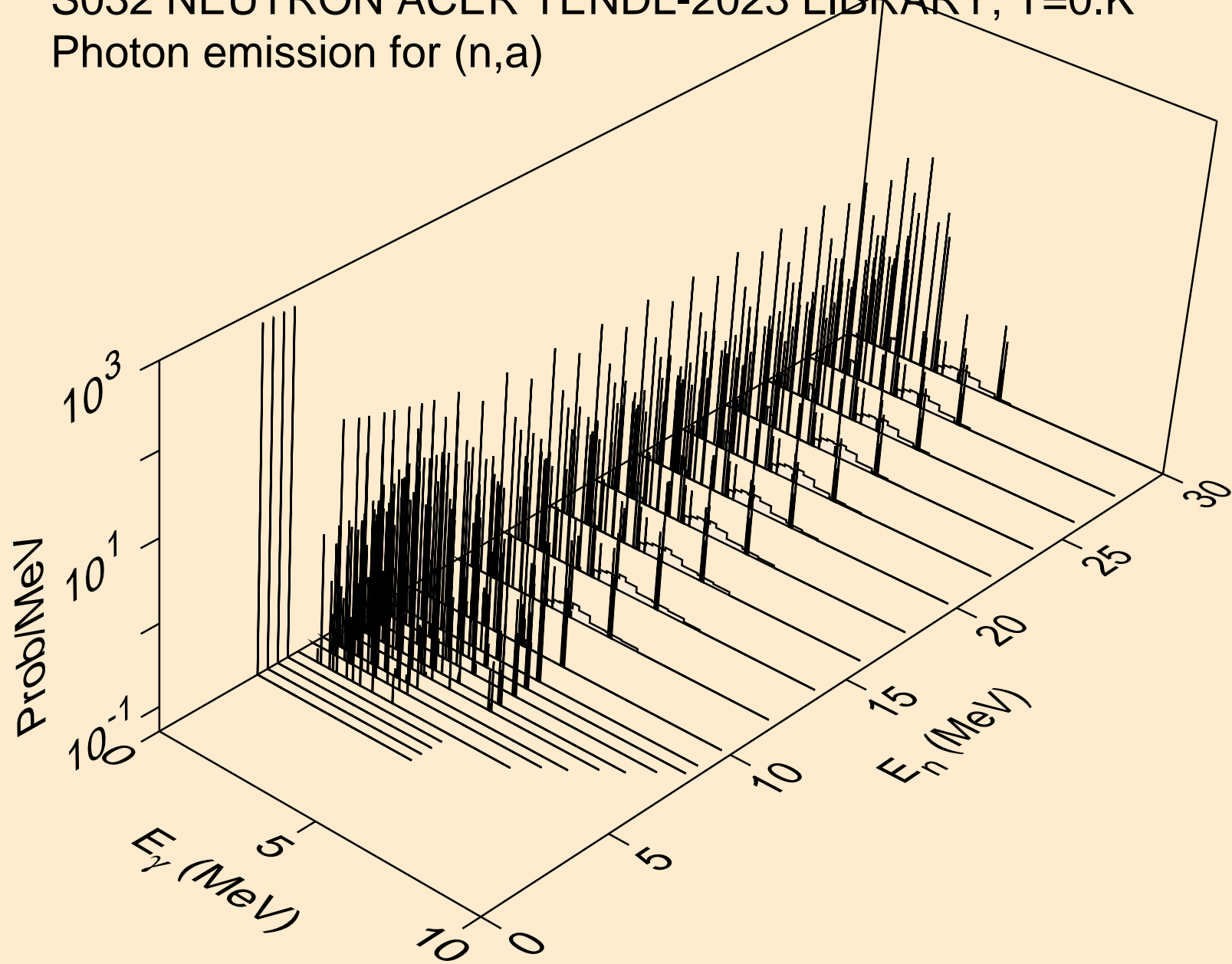

S032 NEUTRON ACER TENDL-2023 LIBRARY; T=0.K
Photon emission for (n,2a)

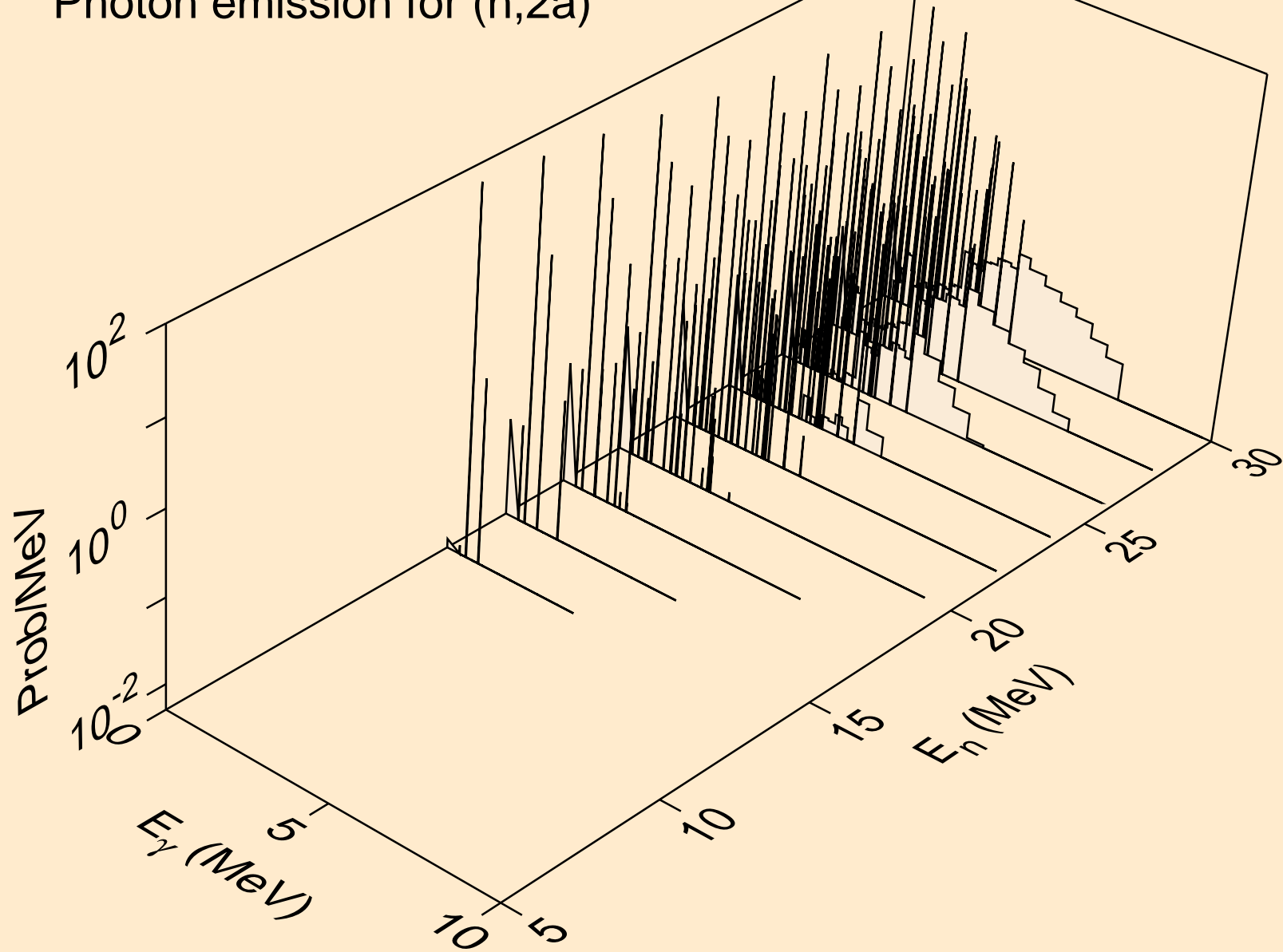

S032 NEUTRON ACER TENDL-2023 LIBRARY; T=0.K
Photon emission for (n,2p)

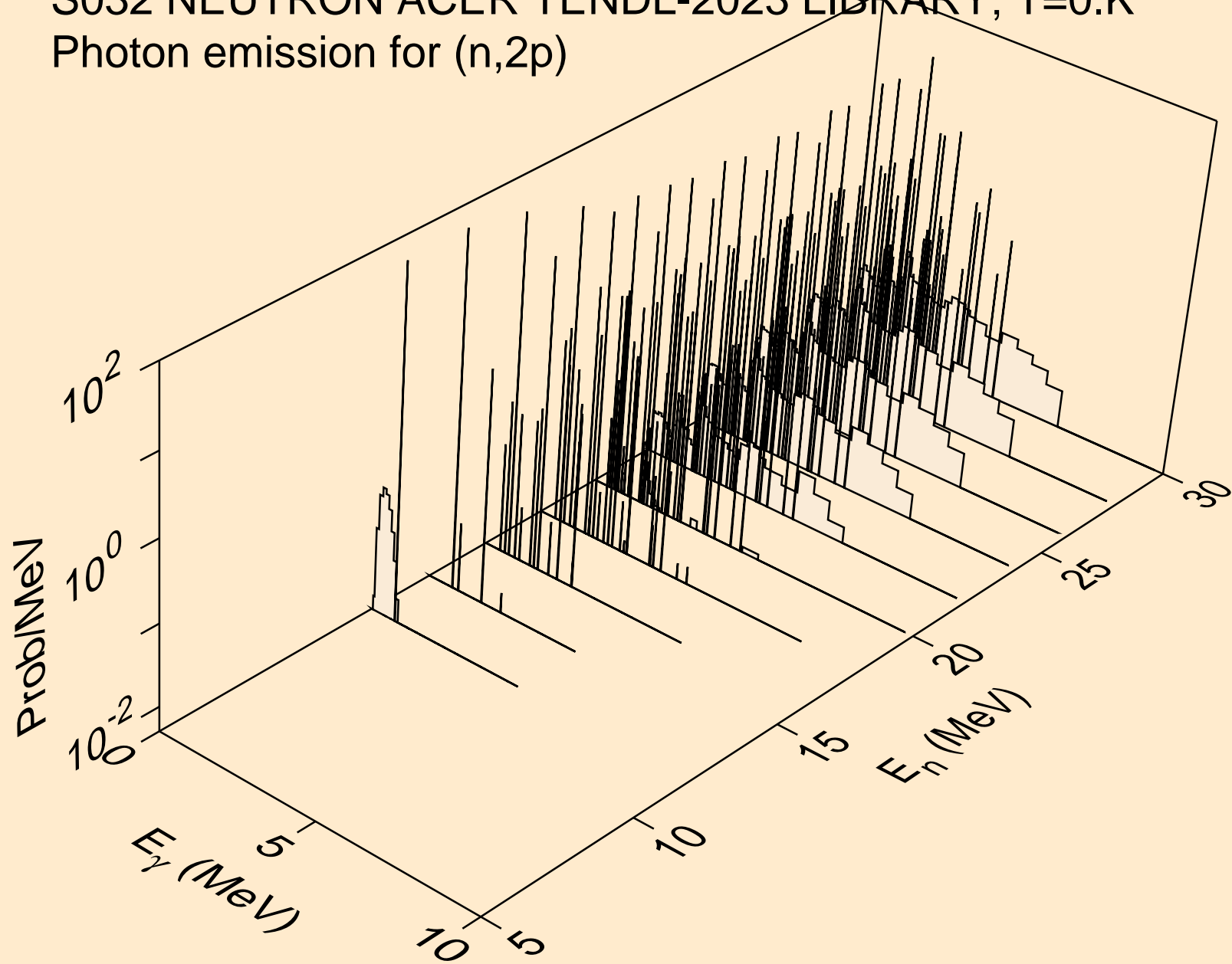

S032 NEUTRON ACER TENDL-2023 LIBRARY; T=0.K
Photon emission for (n,p α)

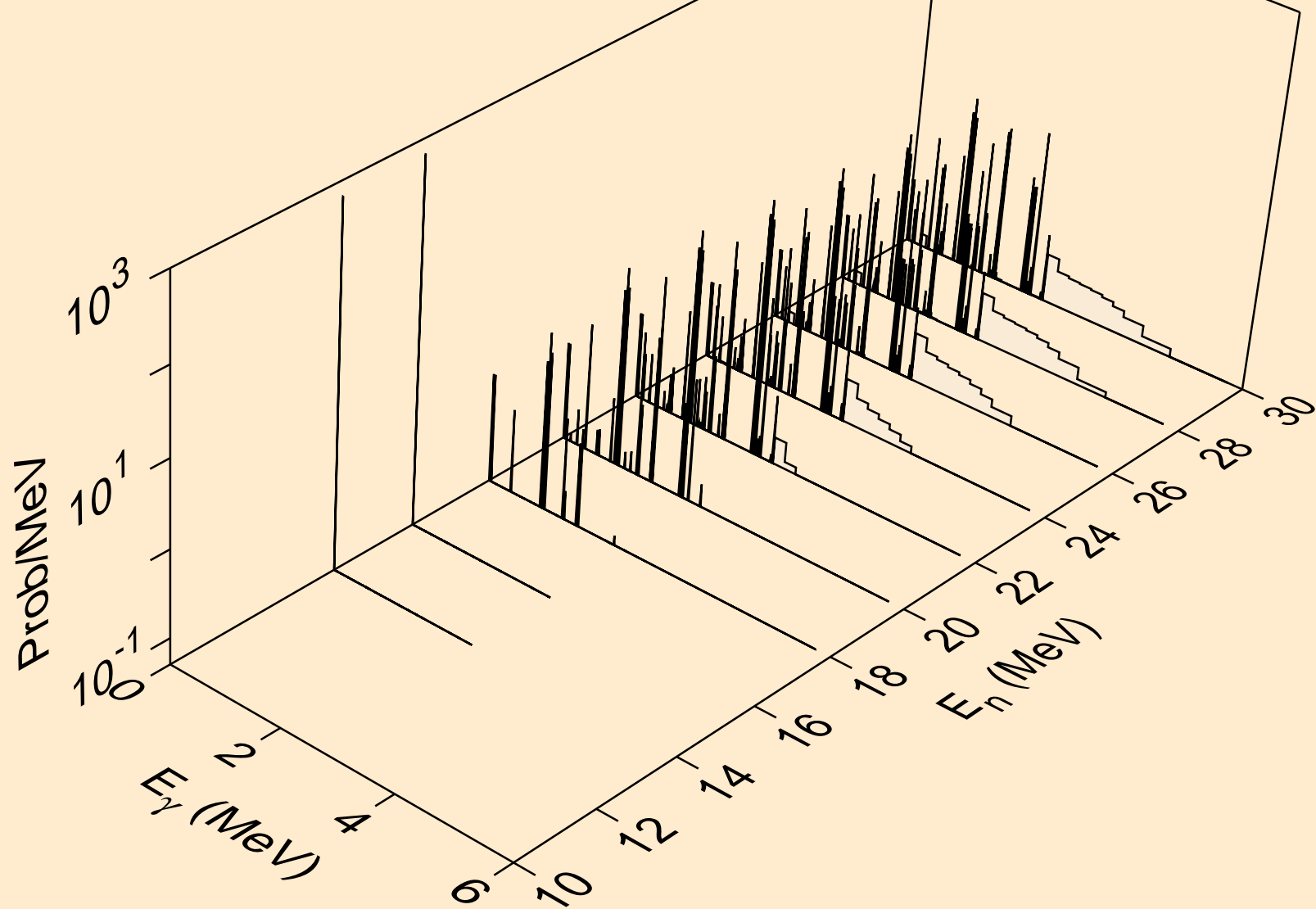

S032 NEUTRON ACER TENDL-2023 LIBRARY; T=0.K
Photon emission for (n,pd)

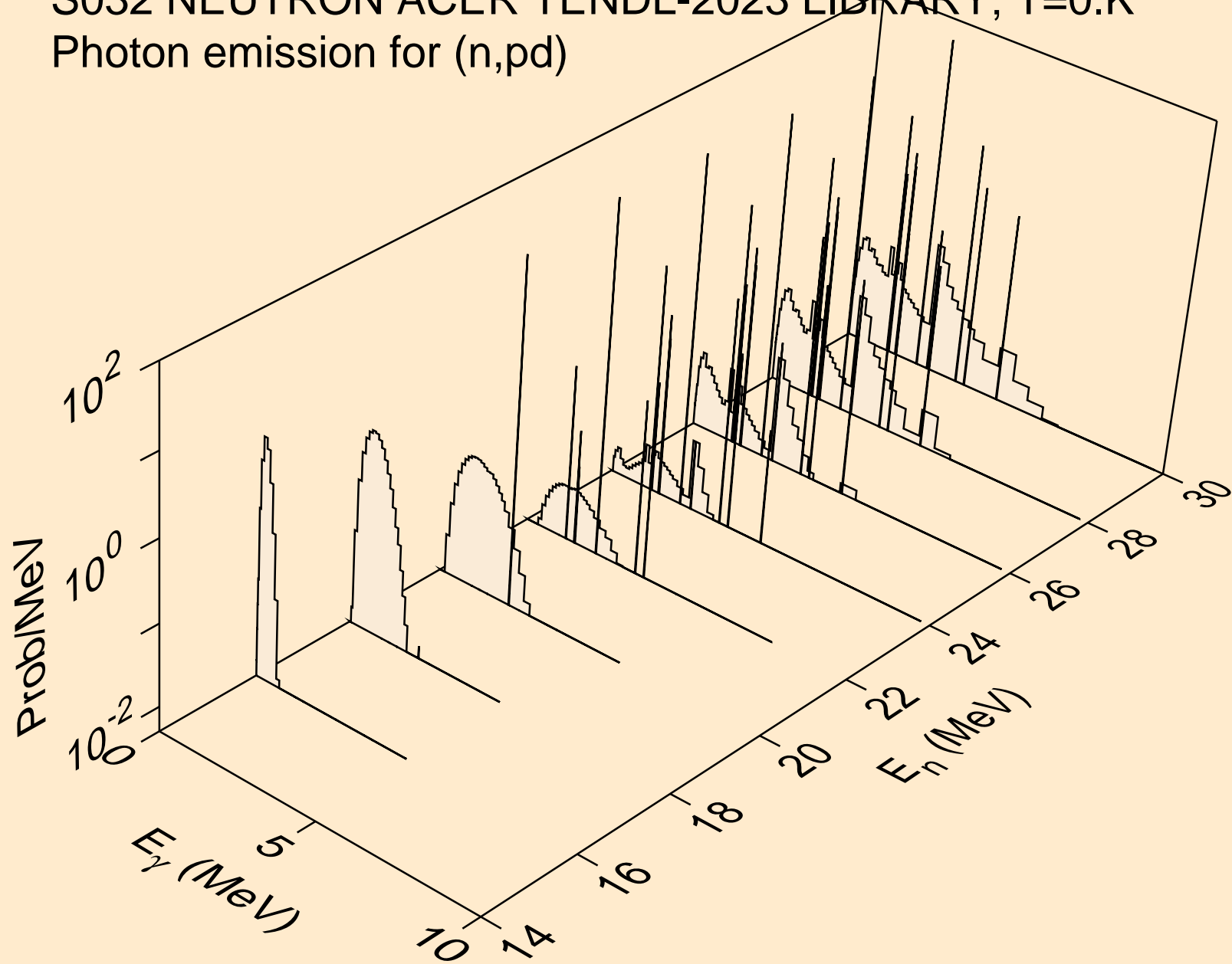

S032 NEUTRON ACER TENDL-2023 LIBRARY; T=0.K
Photon emission for (n,pt)

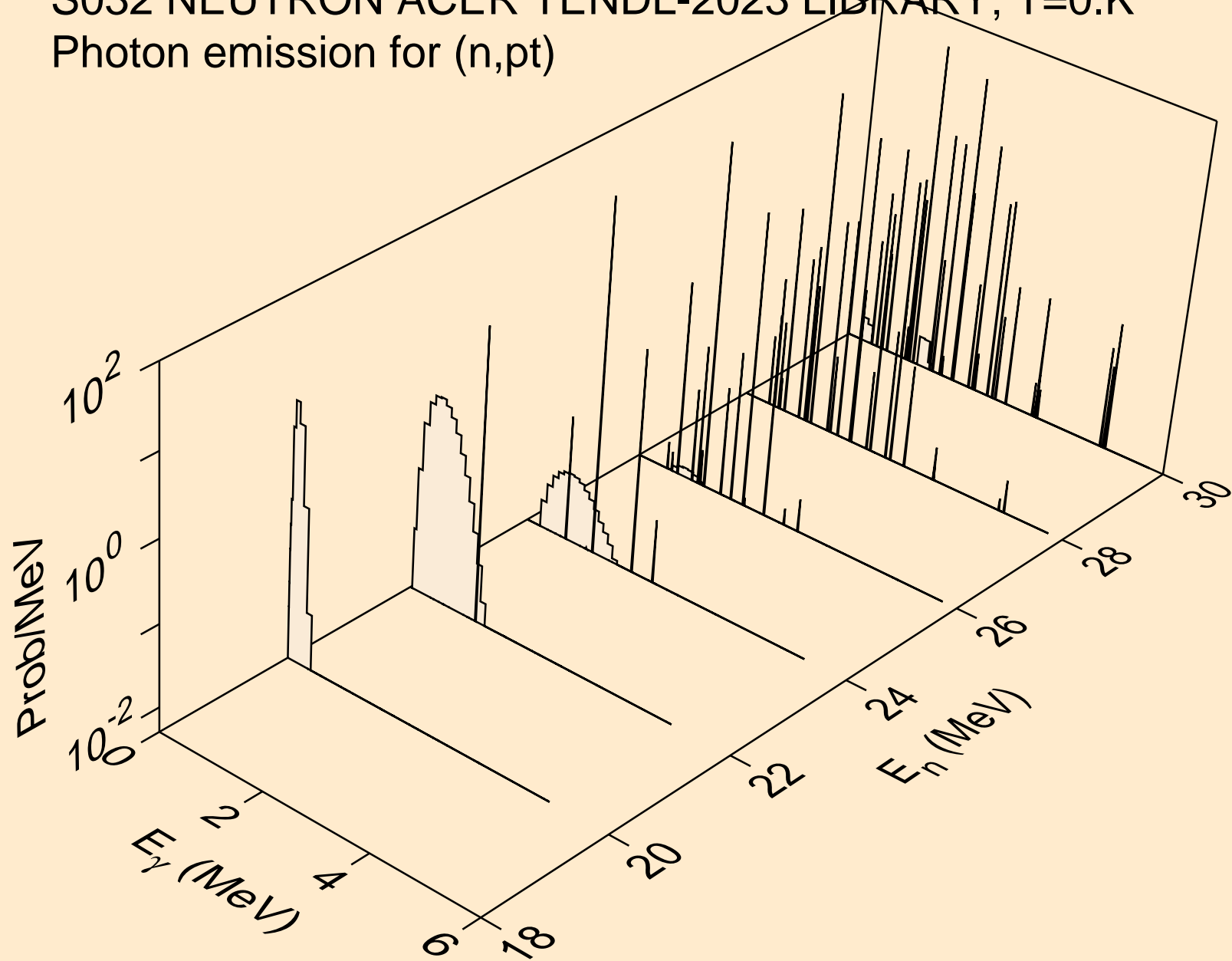

S032 NEUTRON ACER TENDL-2023 LIBRARY; T=0.K
Photon emission for (n,da)

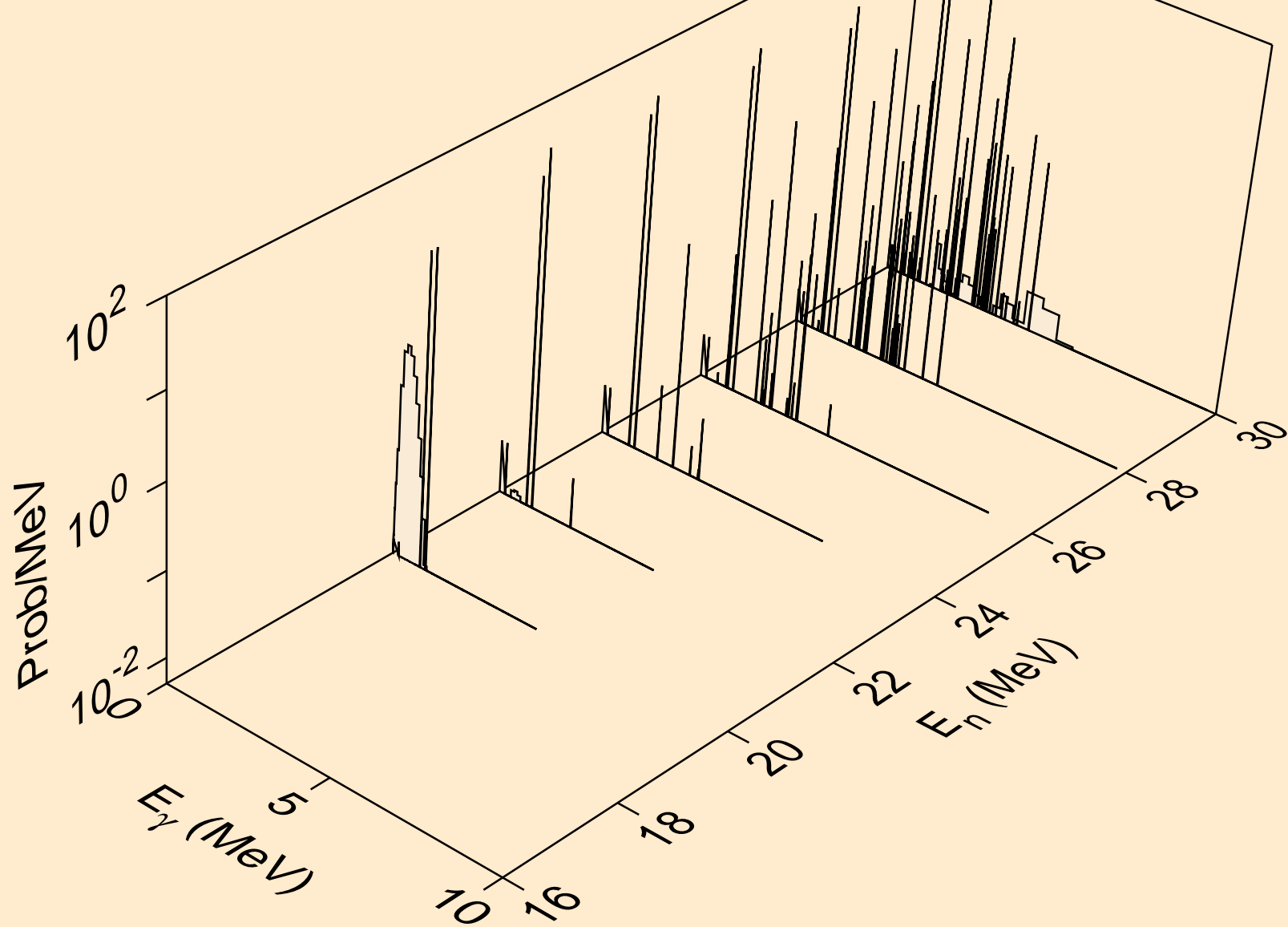

S032 NEUTRON ACER TENDL-2023 LIBRARY; T=0.K
thermal capture photon spectrum

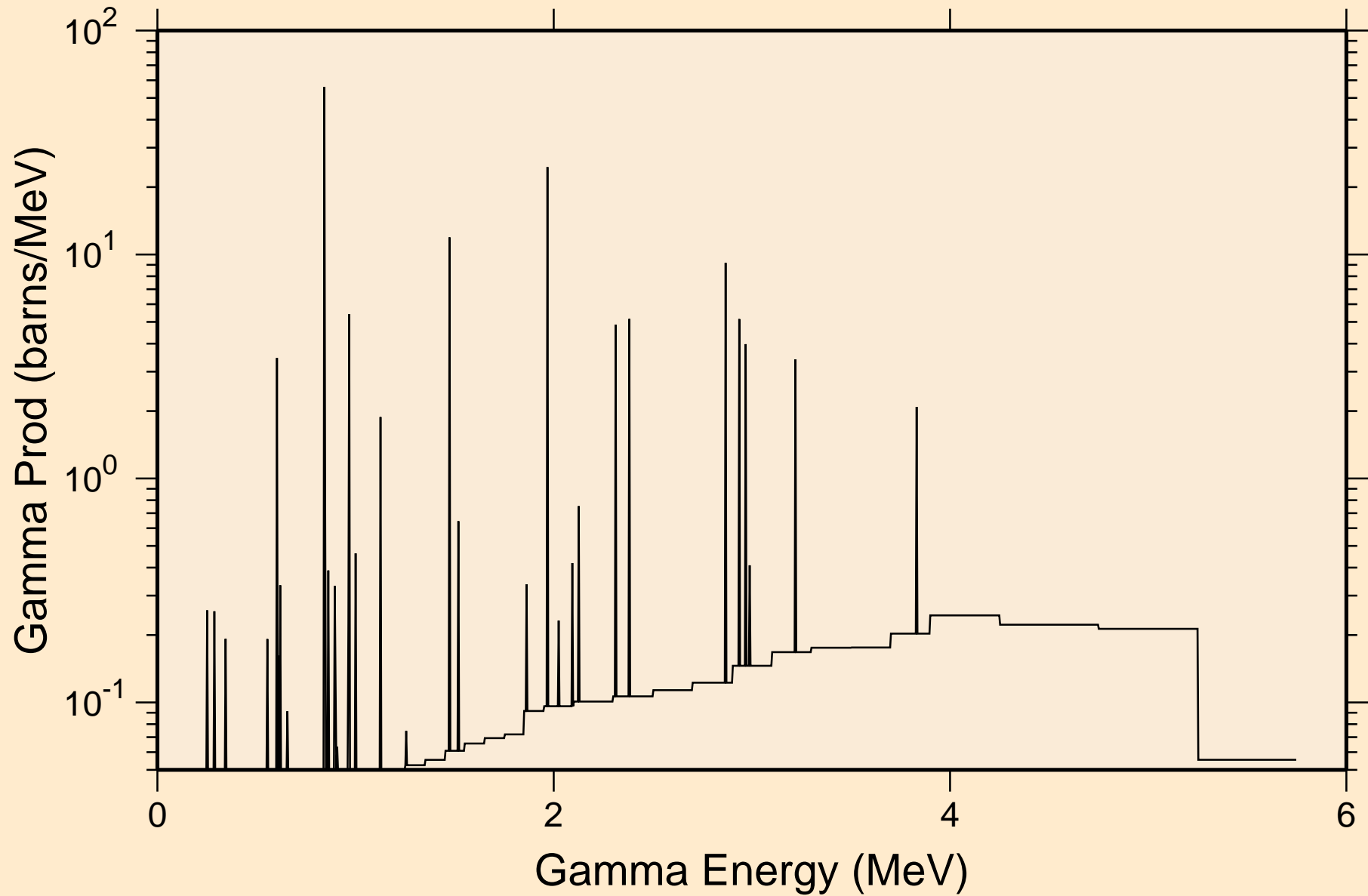

S032 NEUTRON ACER TENDL-2023 LIBRARY; T=0.K
14 MeV photon spectrum

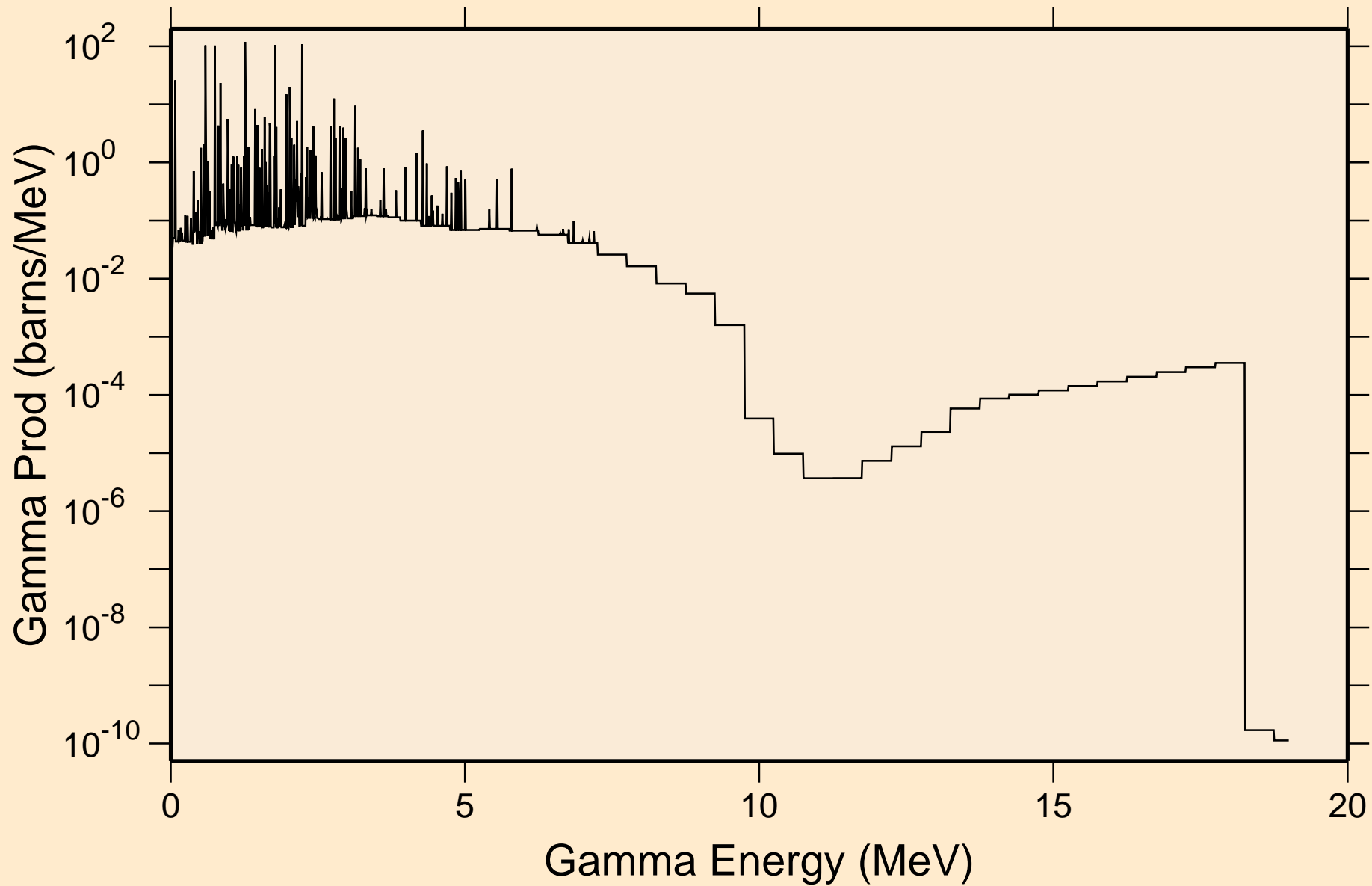

S032 NEUTRON ACER TENDL-2023 LIBRARY; T=0.K
Particle heating contributions

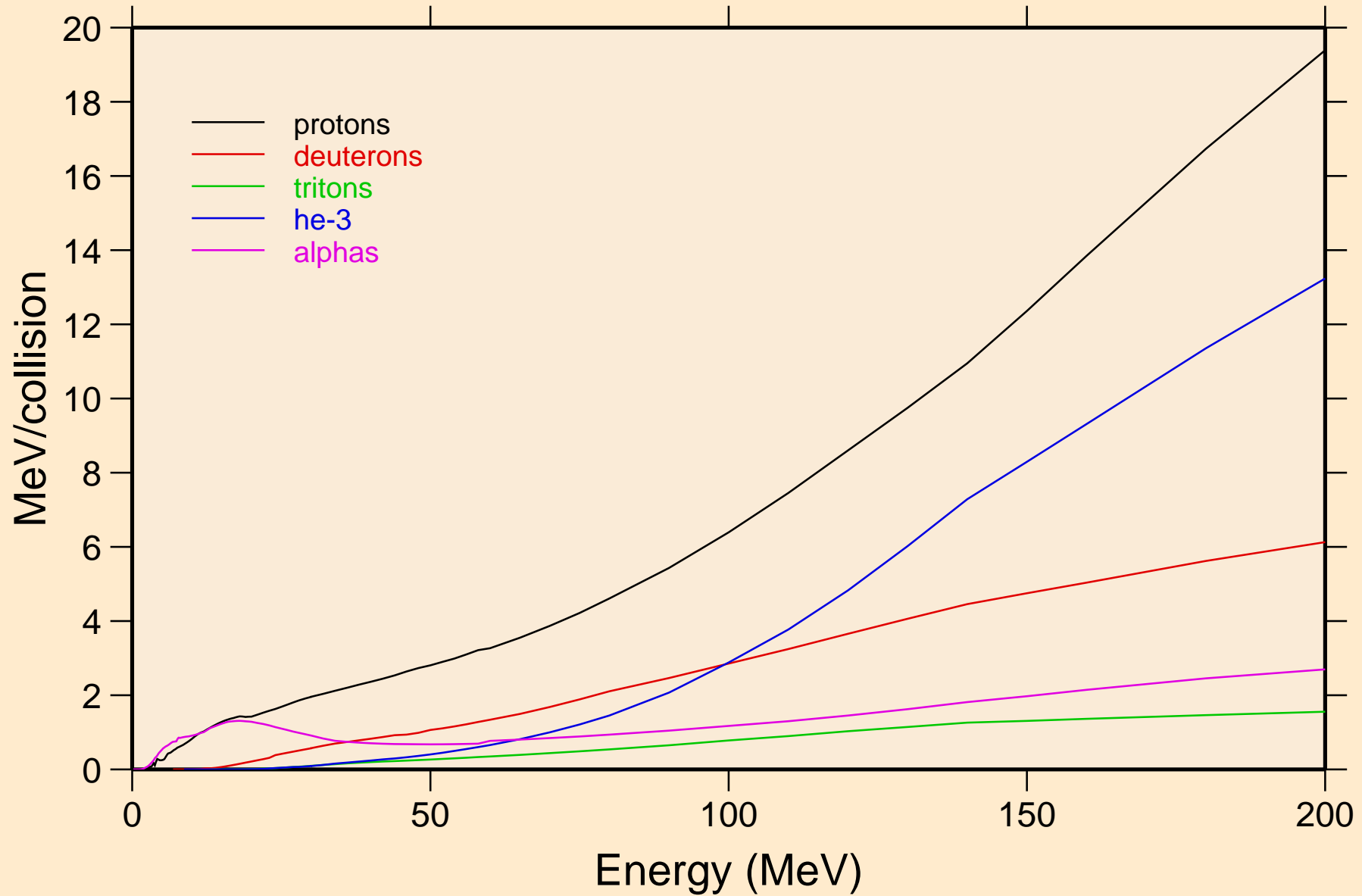

S032 NEUTRON ACER TENDL-2023 LIBRARY; T=0.K

Recoil Heating

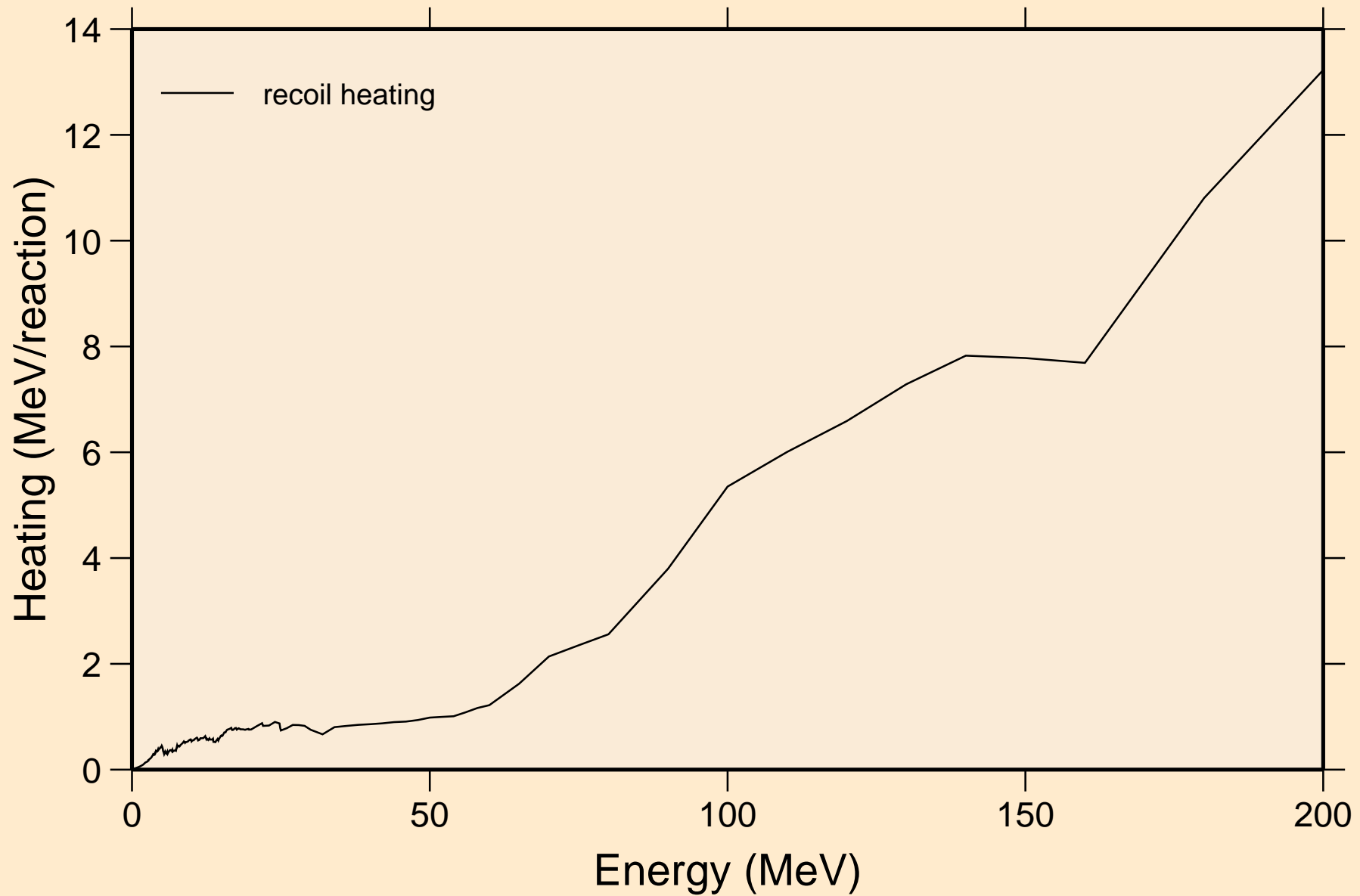

S032 NEUTRON ACER TENDL-2023 LIBRARY; T=0.K

Particle production cross sections

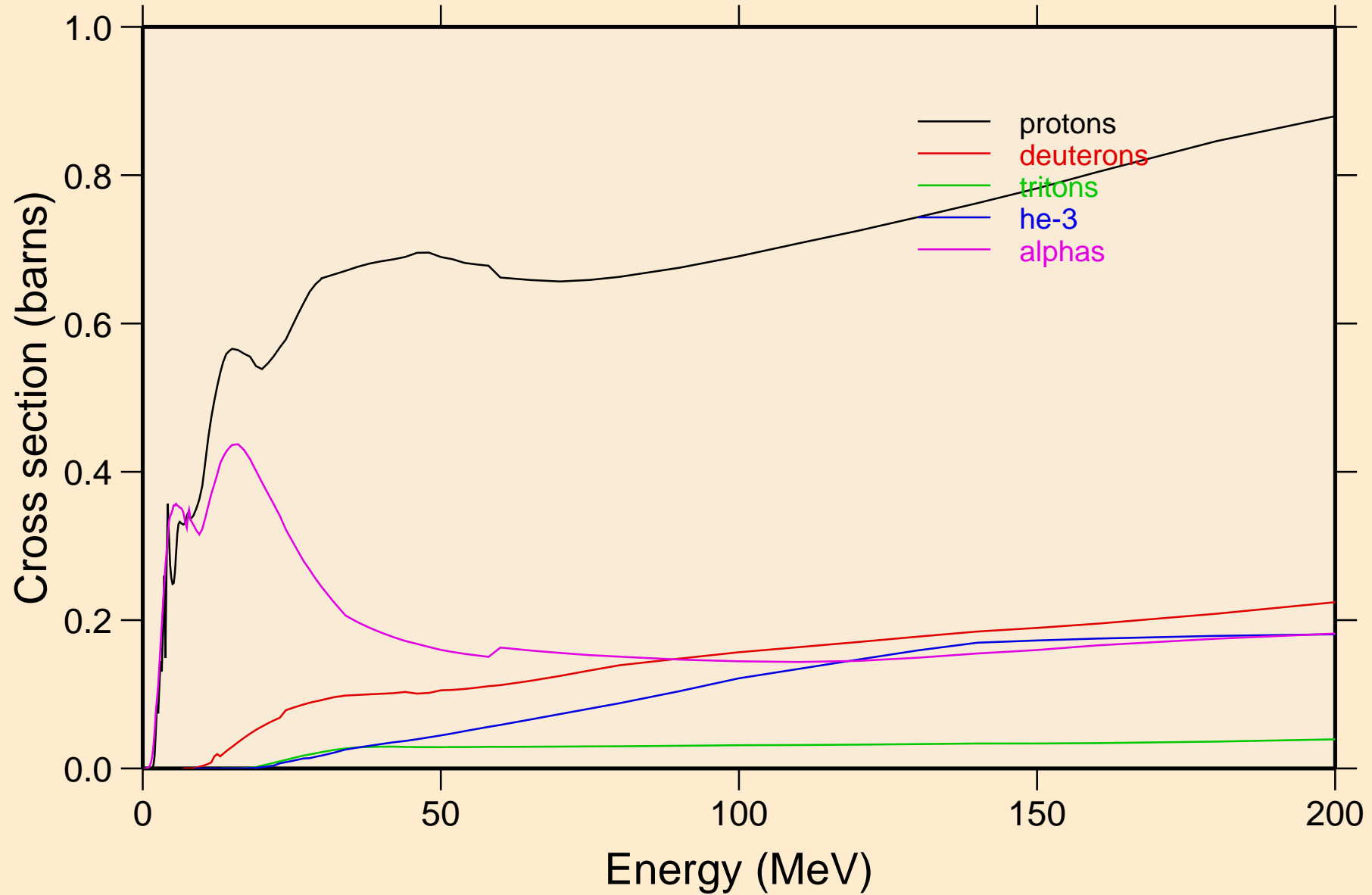

S032 NEUTRON ACER TENDL-2023 LIBRARY; T=0.K
protons from (n,x)

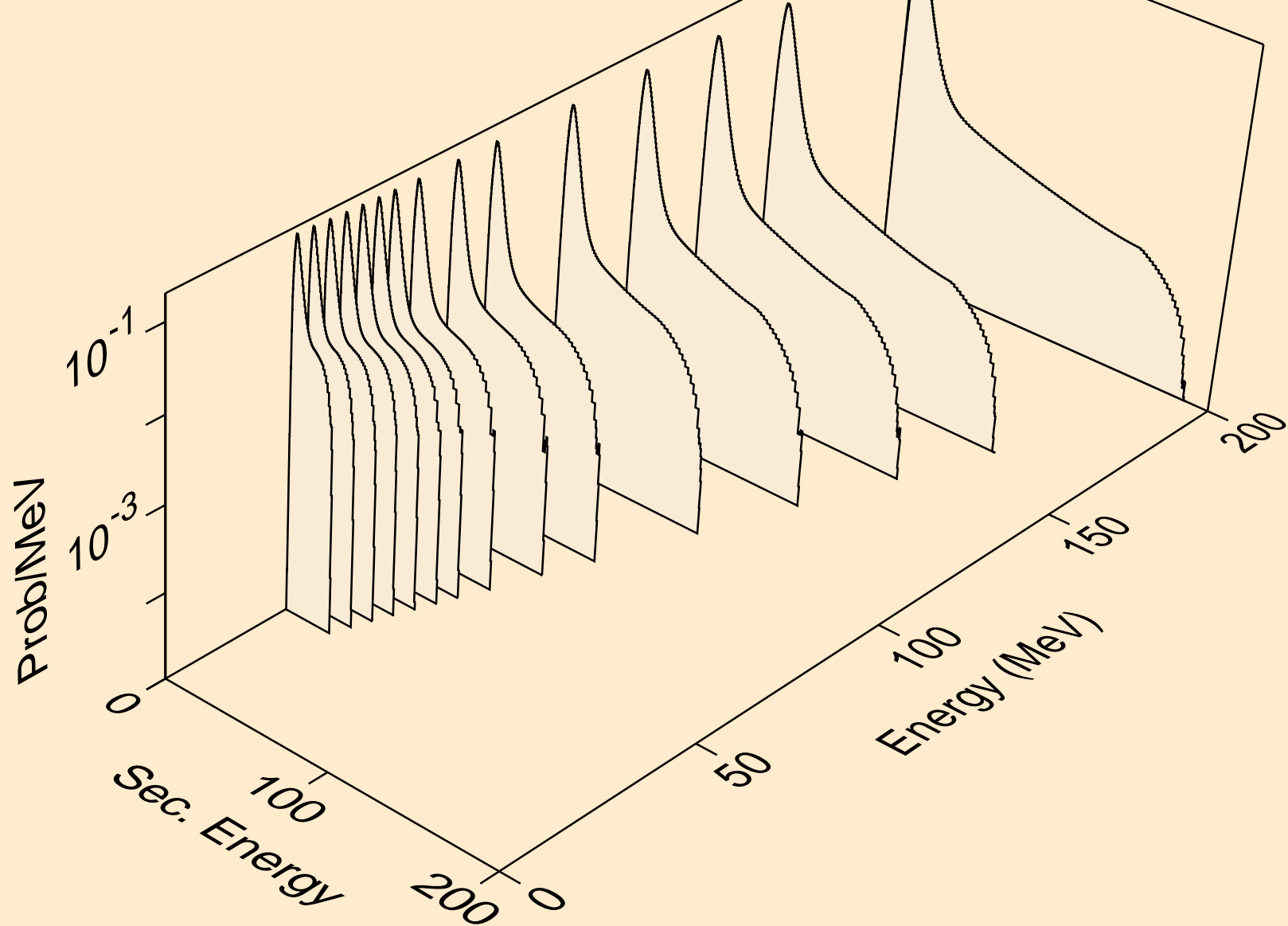

S032 NEUTRON ACER TENDL-2023 LIBRARY; T=0.K
protons from (n,n*)p

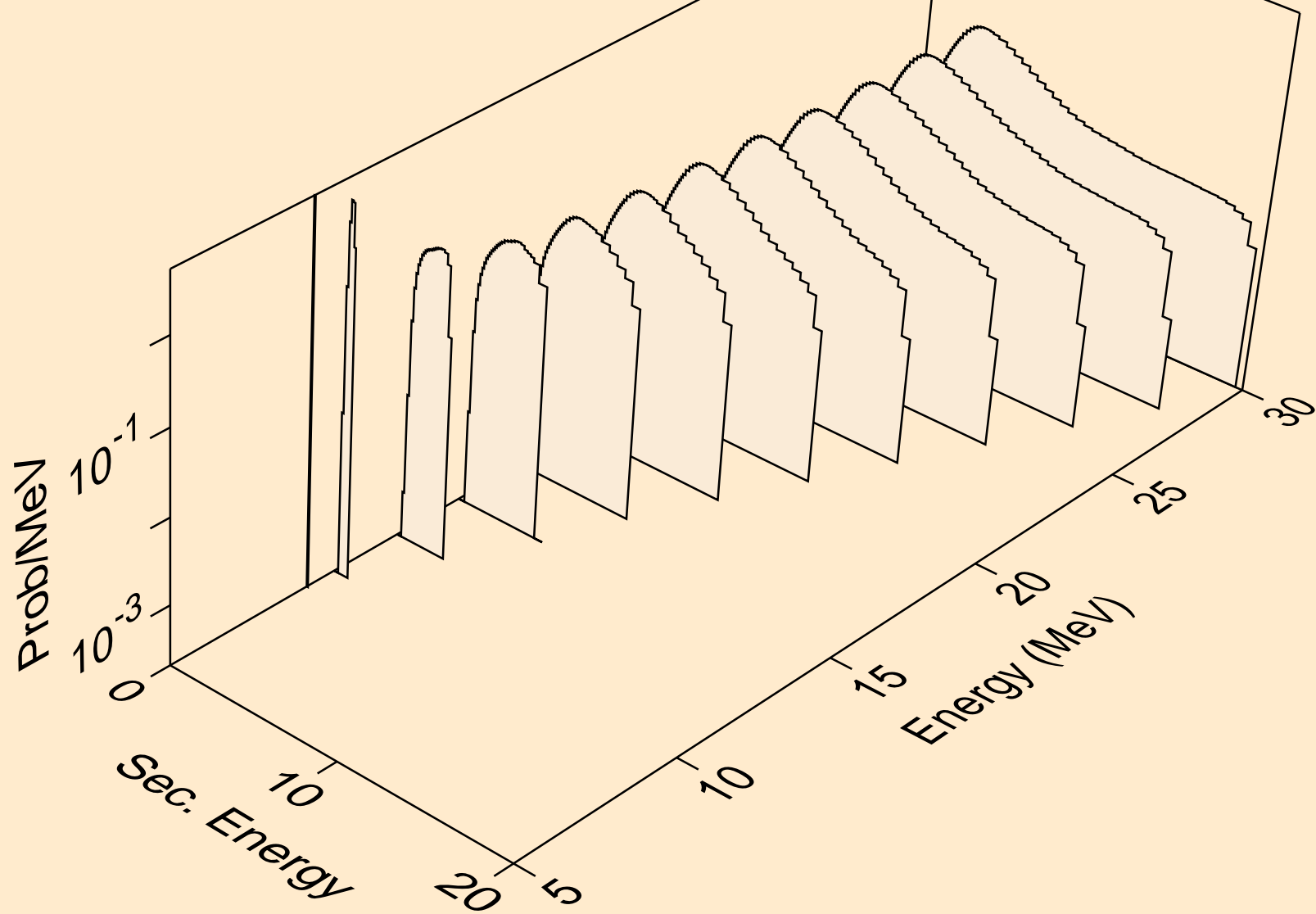

S032 NEUTRON ACER TENDL-2023 LIBRARY; T=0.K
protons from (n,2np)

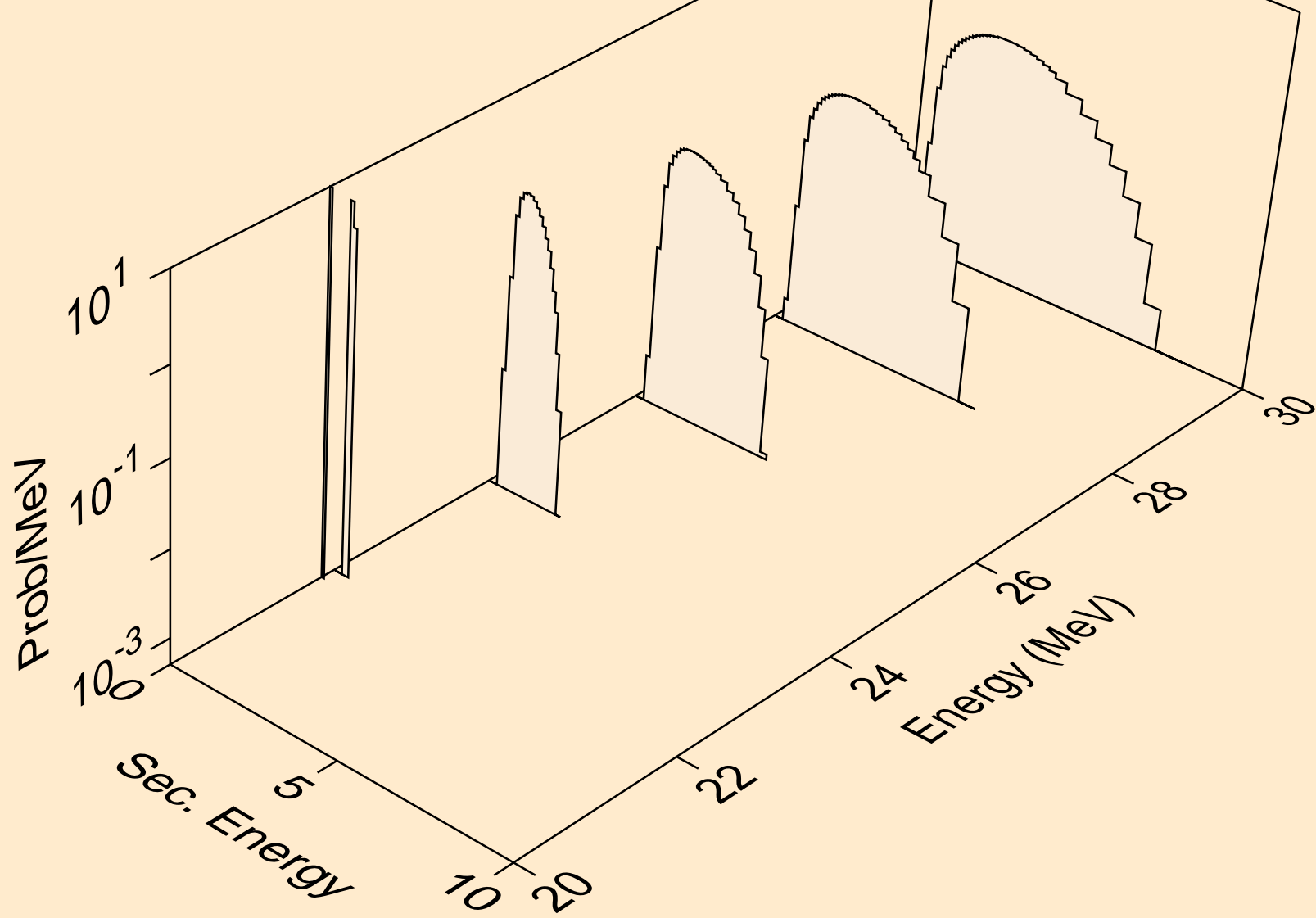

S032 NEUTRON ACER TENDL-2023 LIBRARY; T=0.K
protons from (n,n2p)

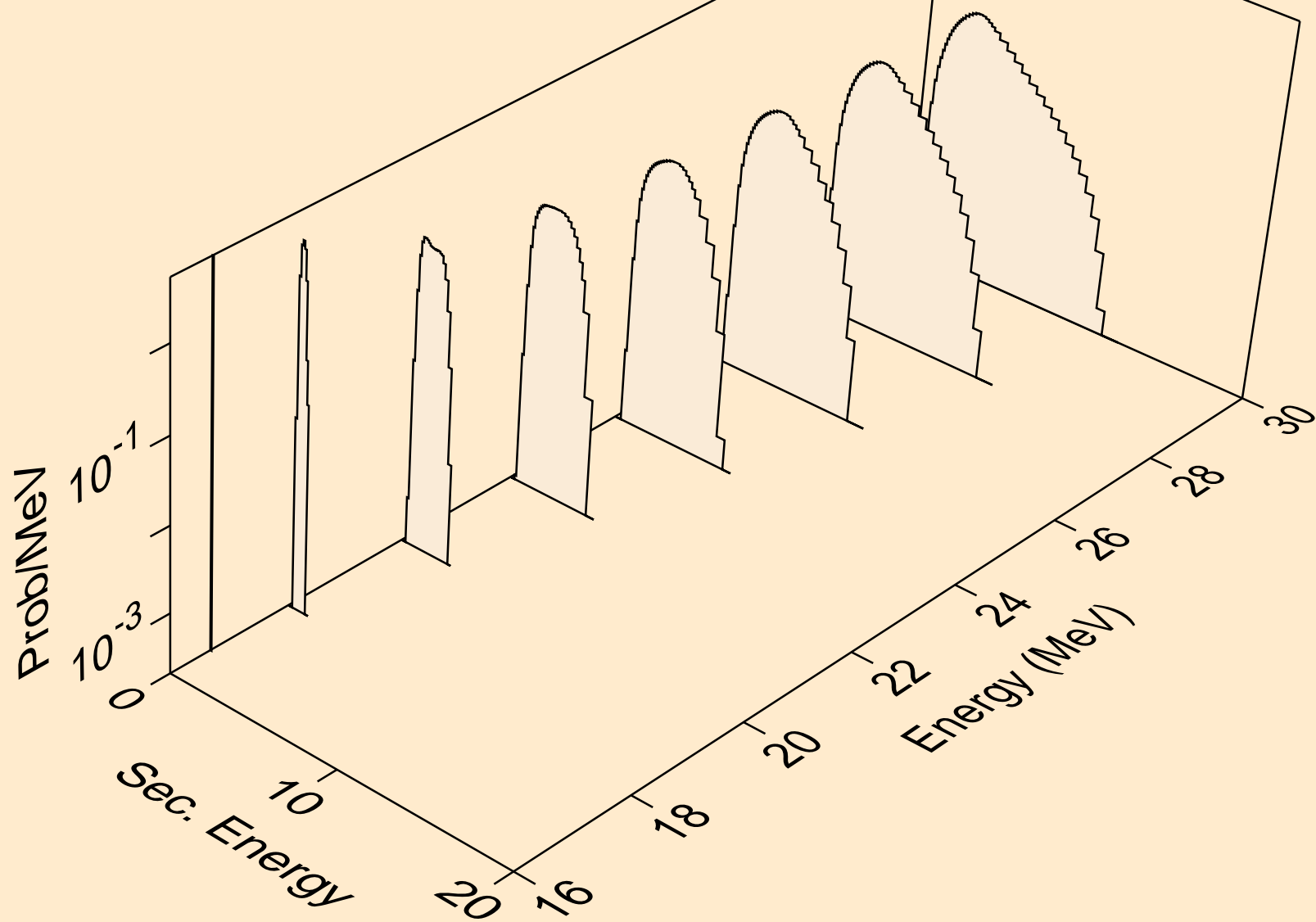

S032 NEUTRON ACER TENDL-2023 LIBRARY; T=0.K
protons from (n,npa)

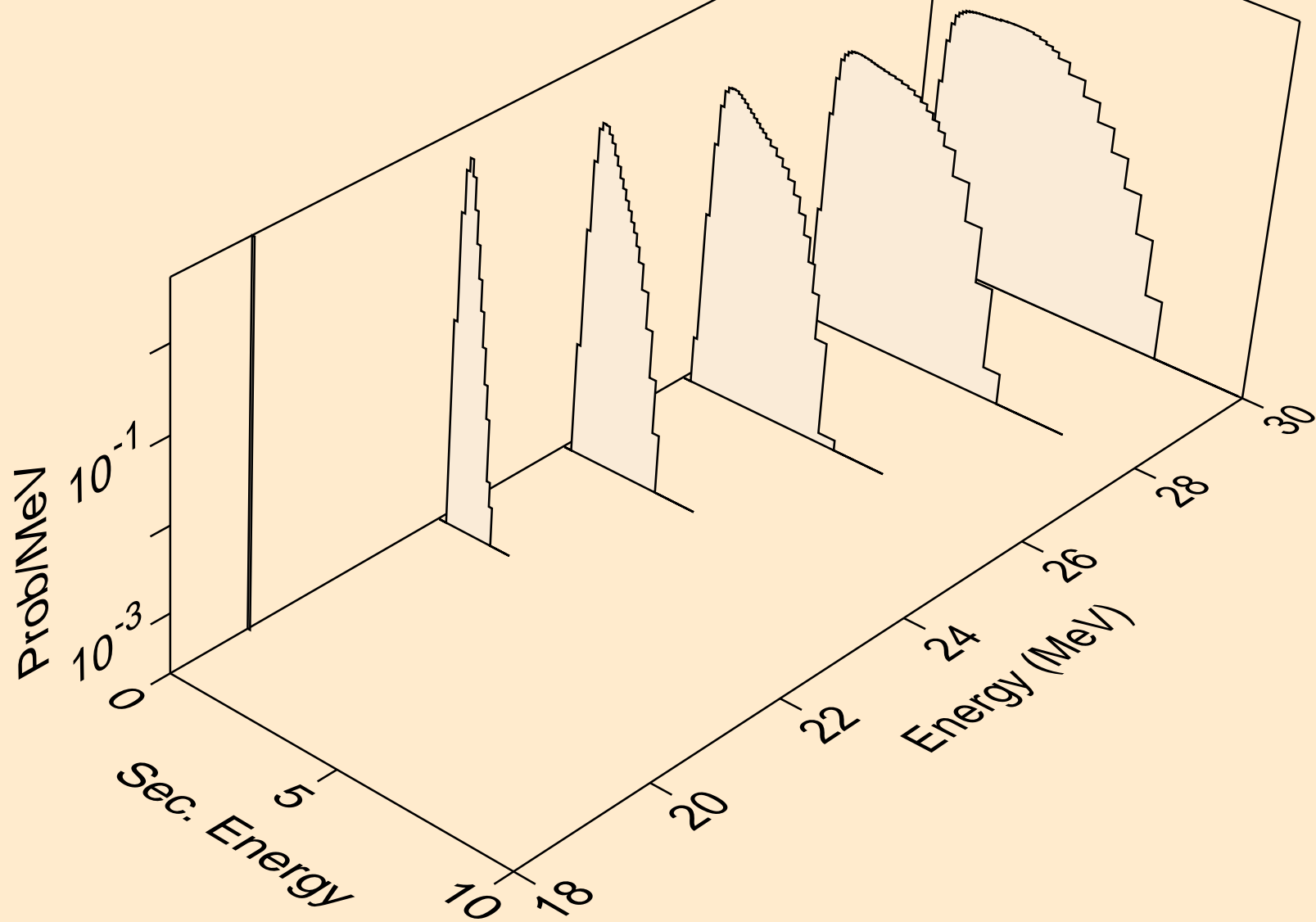

S032 NEUTRON ACER TENDL-2023 LIBRARY; T=0.K
protons from (n,p)

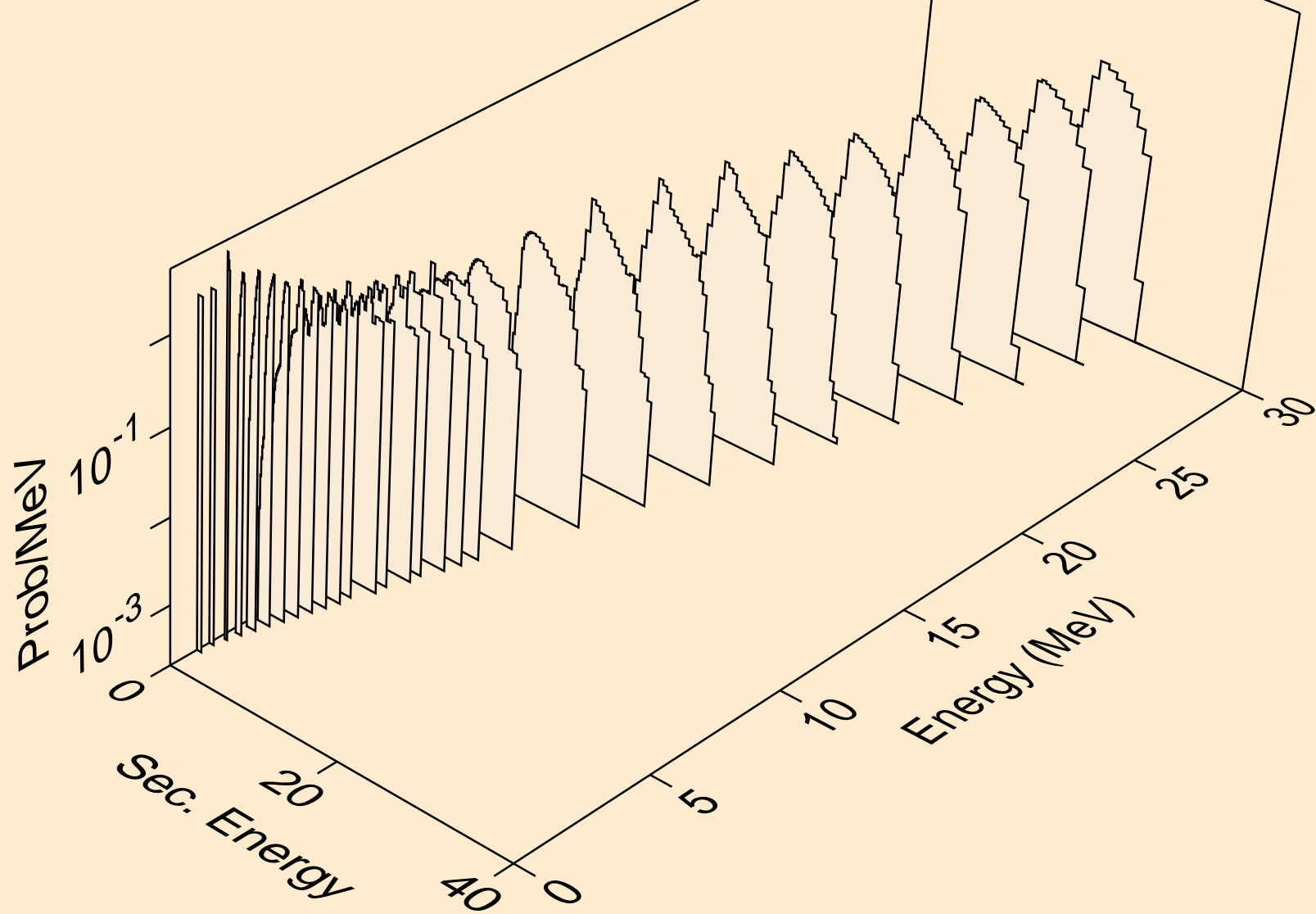

S032 NEUTRON ACER TENDL-2023 LIBRARY; T=0.K
protons from (n,2p)

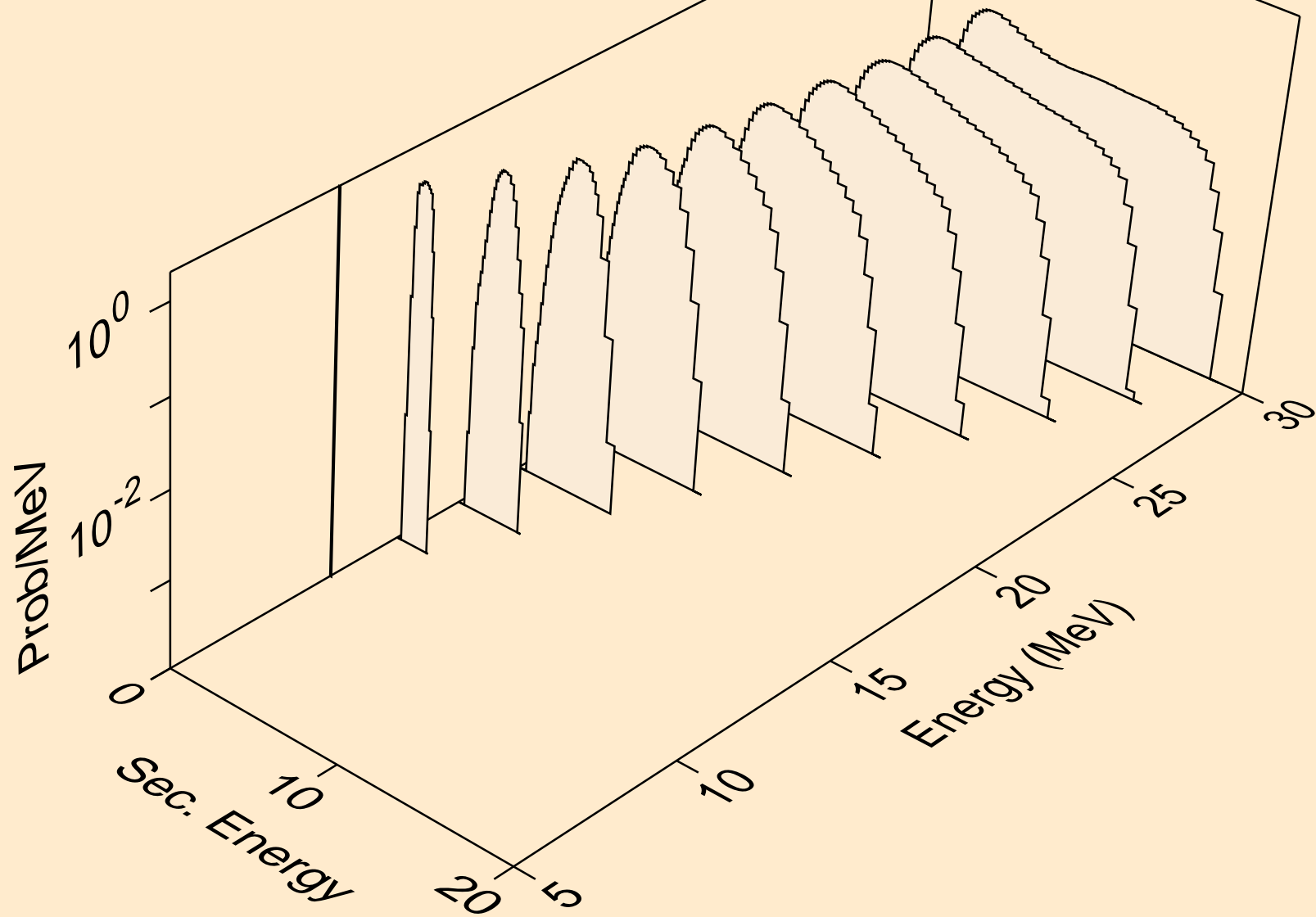

S032 NEUTRON ACER TENDL-2023 LIBRARY; T=0.K
protons from (n,pa)

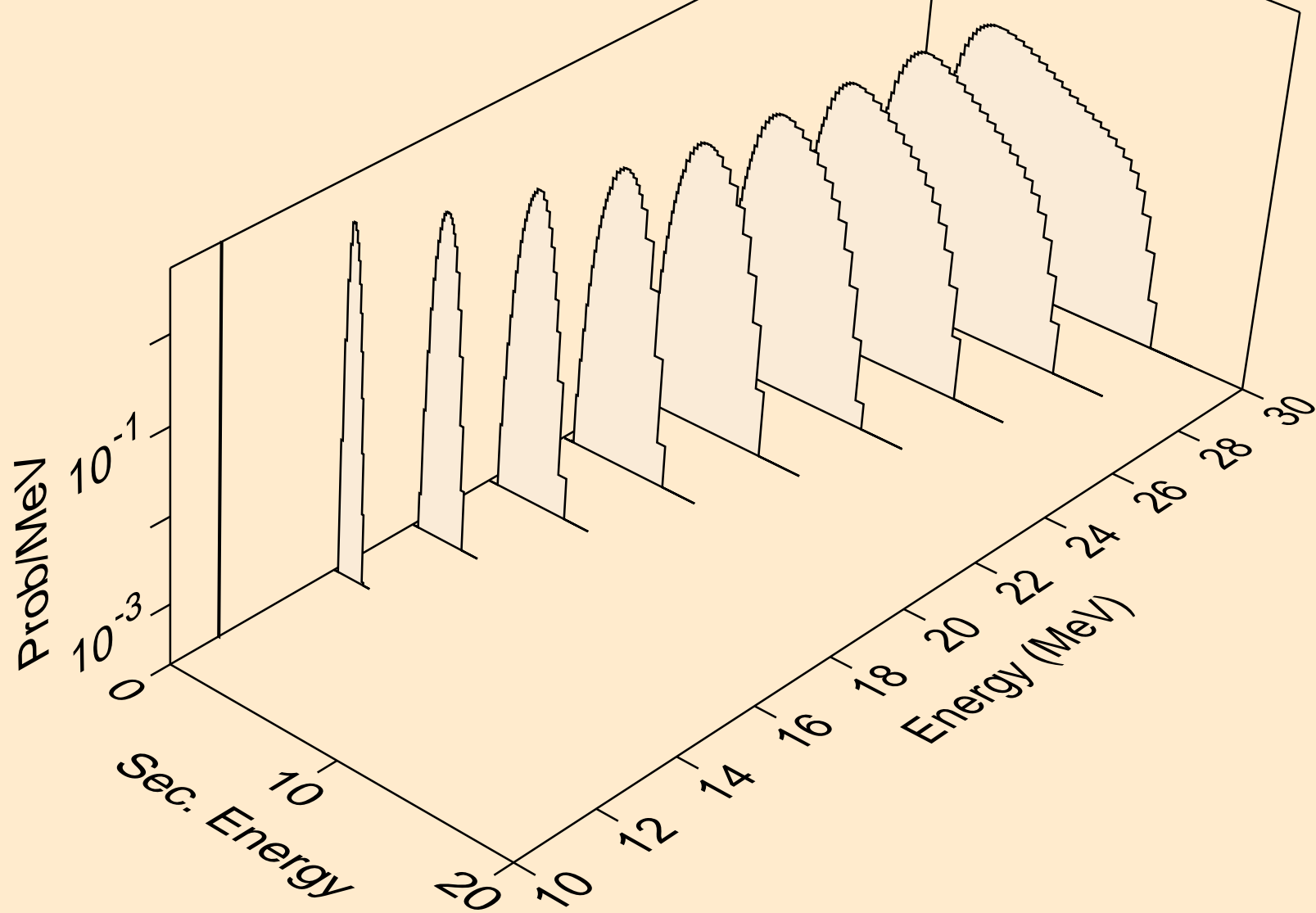

S032 NEUTRON ACER TENDL-2023 LIBRARY; T=0.K
protons from (n,pd)

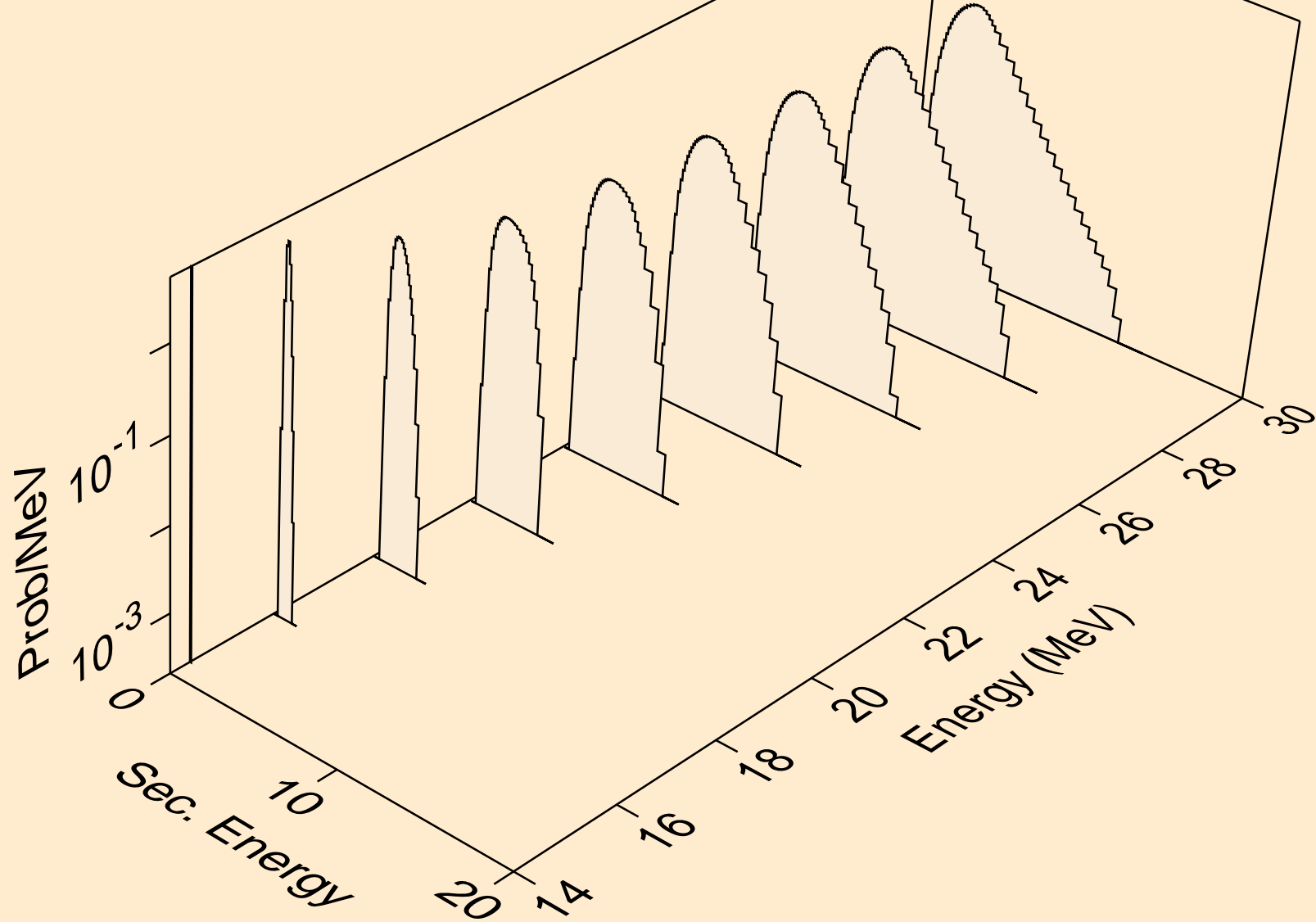

S032 NEUTRON ACER TENDL-2023 LIBRARY; T=0.K
protons from (n,pt)

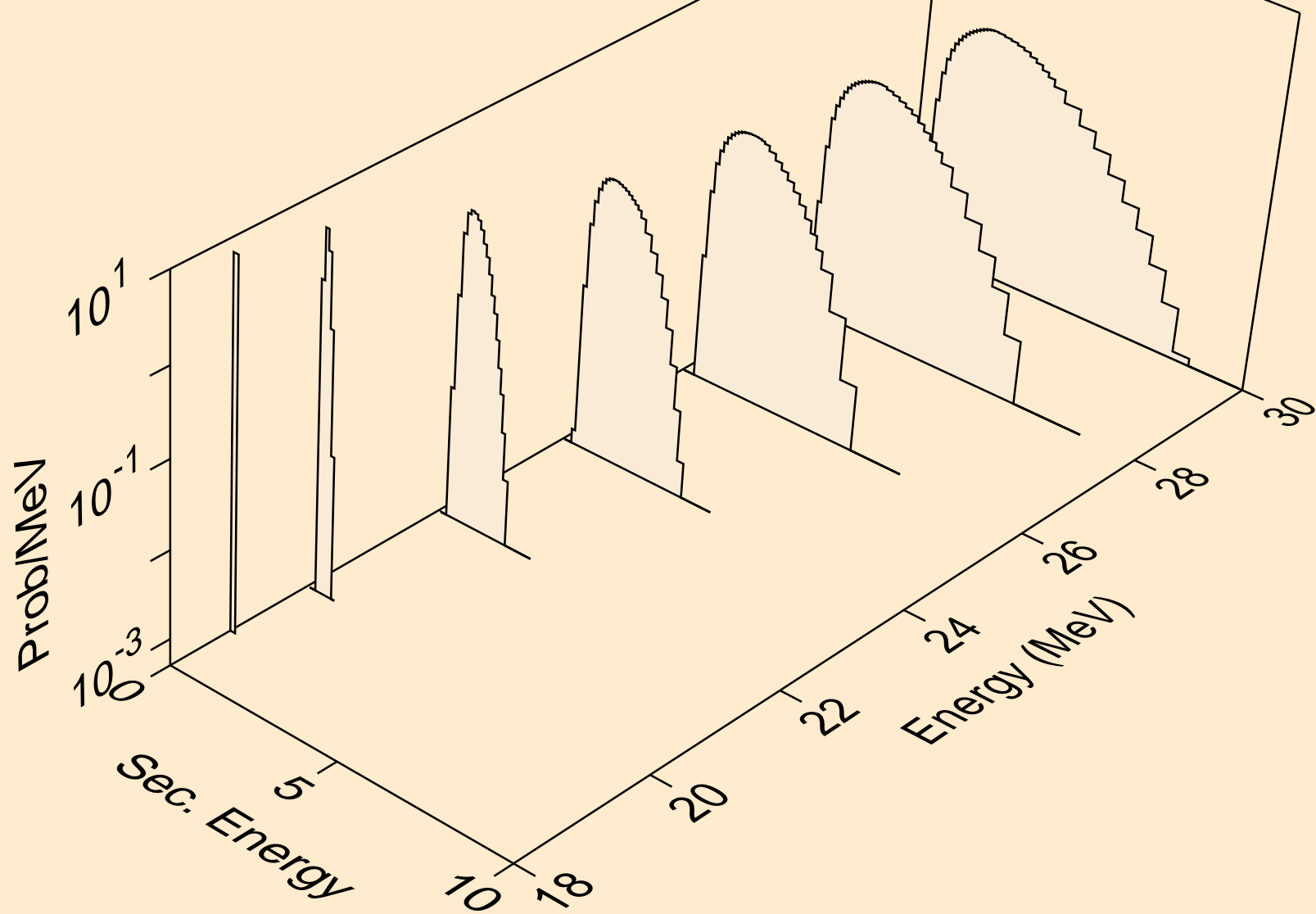

S032 NEUTRON ACER TENDL-2023 LIBRARY; T=0.K
deuterons from (n,x)

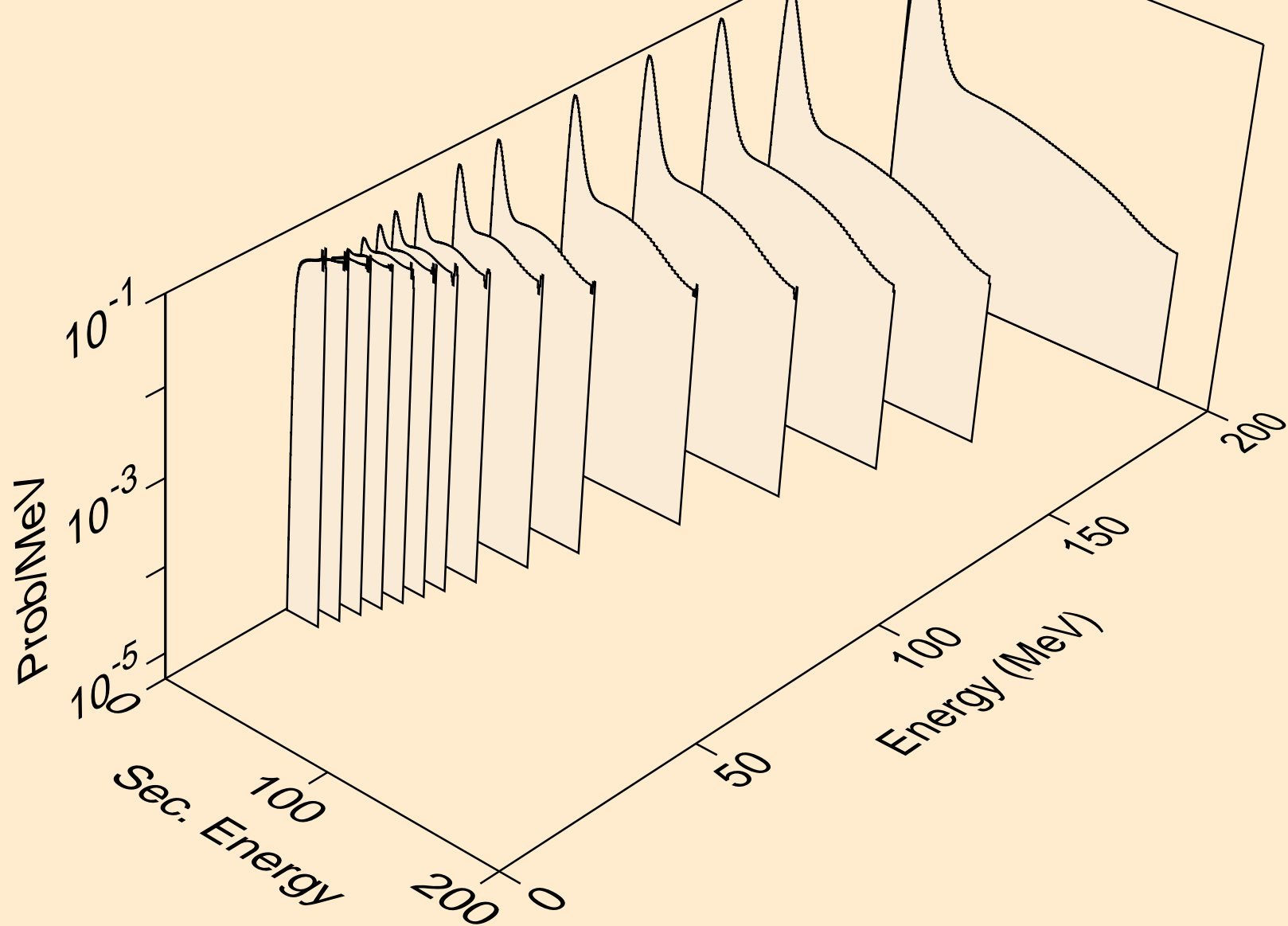

S032 NEUTRON ACER TENDL-2023 LIBRARY; T=0.K
deuterons from (n,n*)d

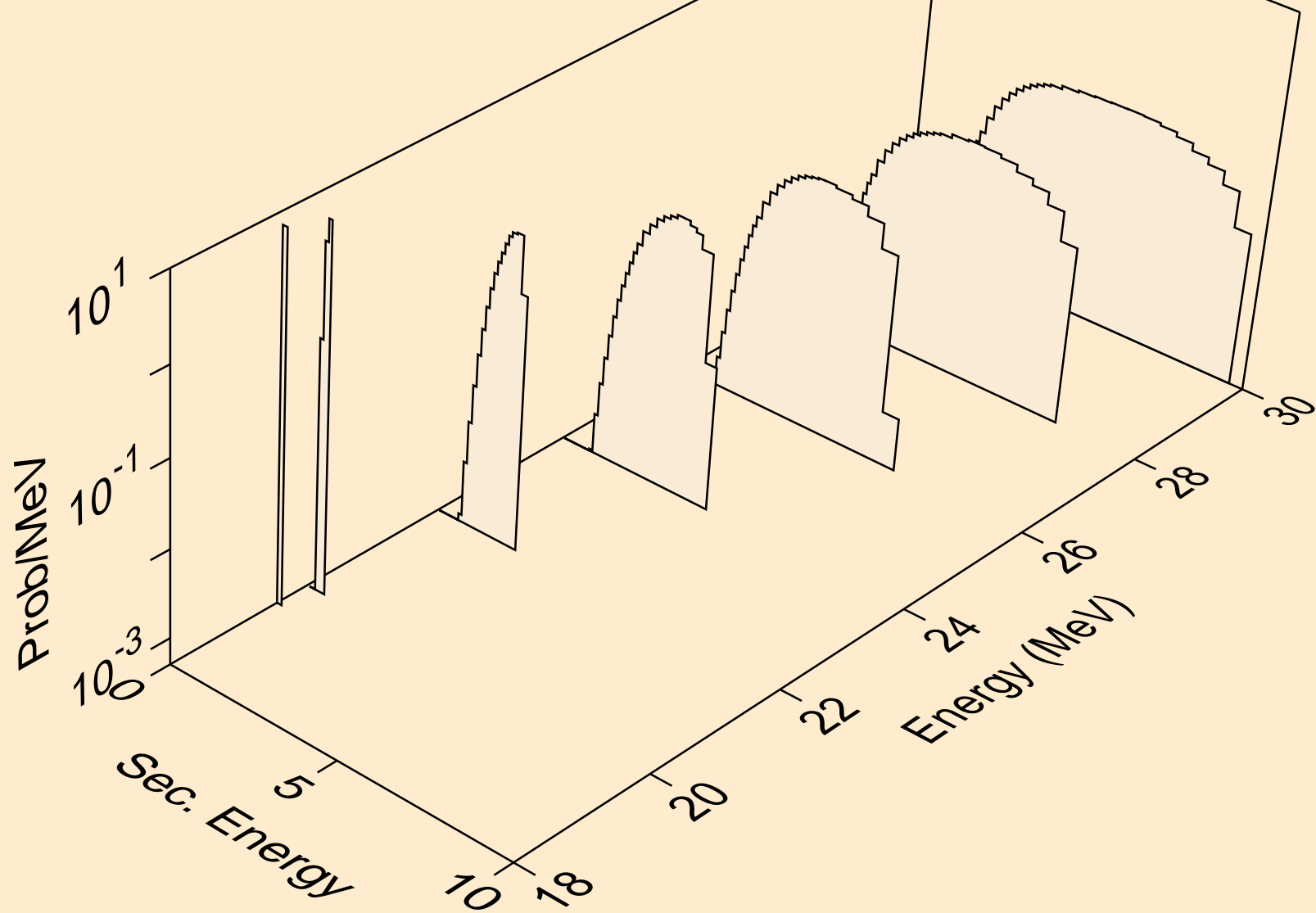

S032 NEUTRON ACER TENDL-2023 LIBRARY; T=0.K
deuterons from (n,d)

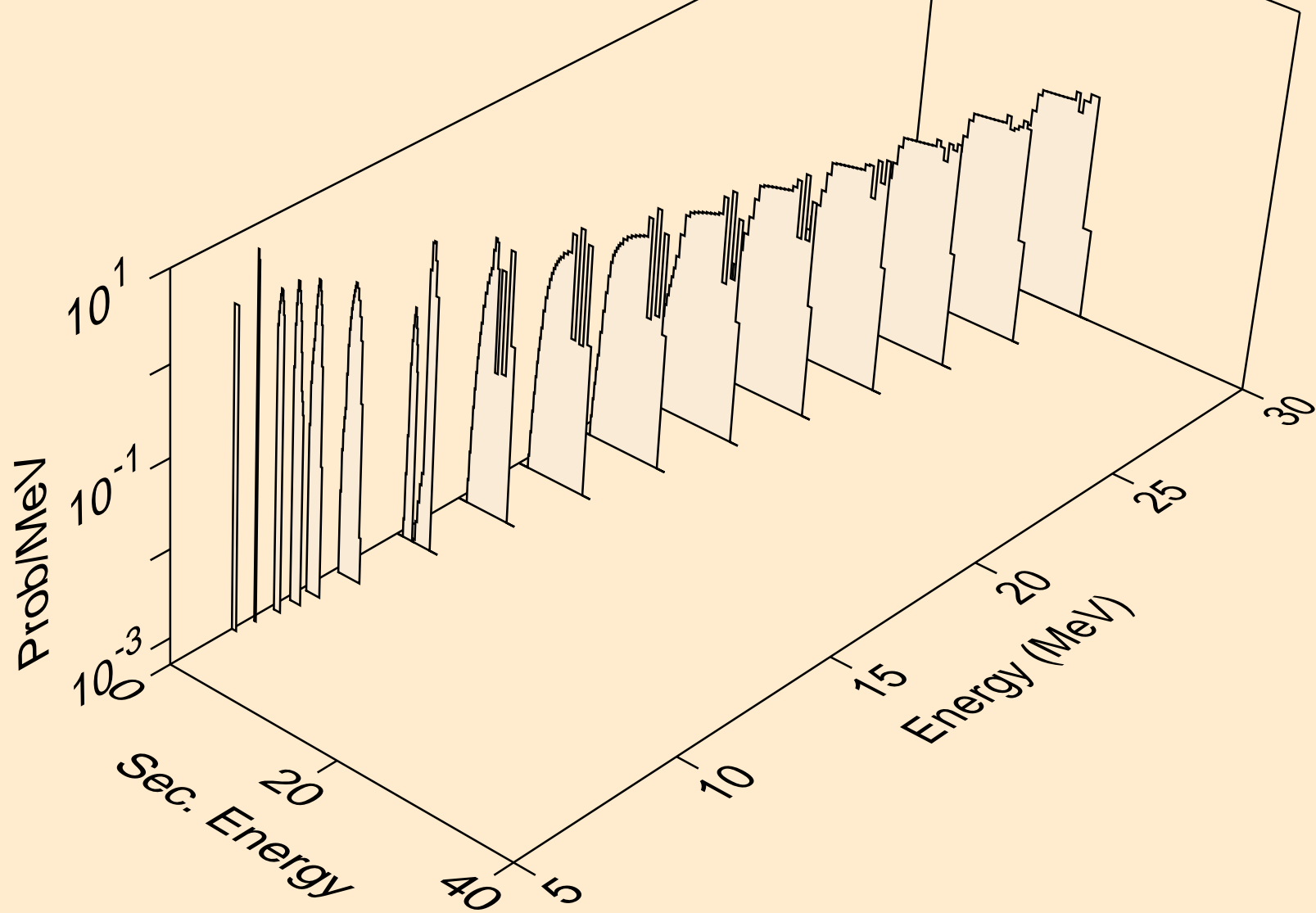

S032 NEUTRON ACER TENDL-2023 LIBRARY; T=0.K
deuterons from (n,pd)

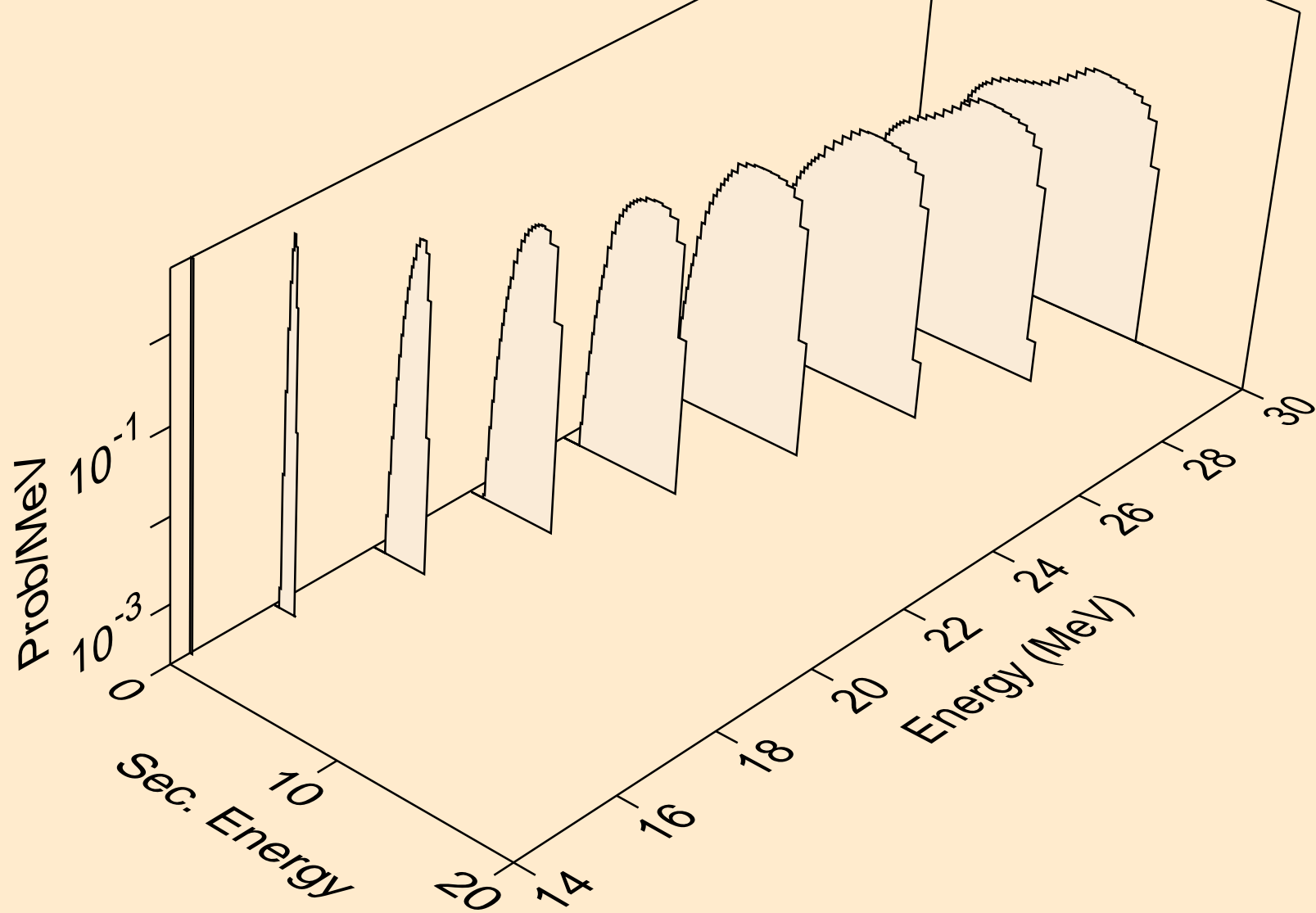

S032 NEUTRON ACER TENDL-2023 LIBRARY; T=0.K
deuterons from (n,da)

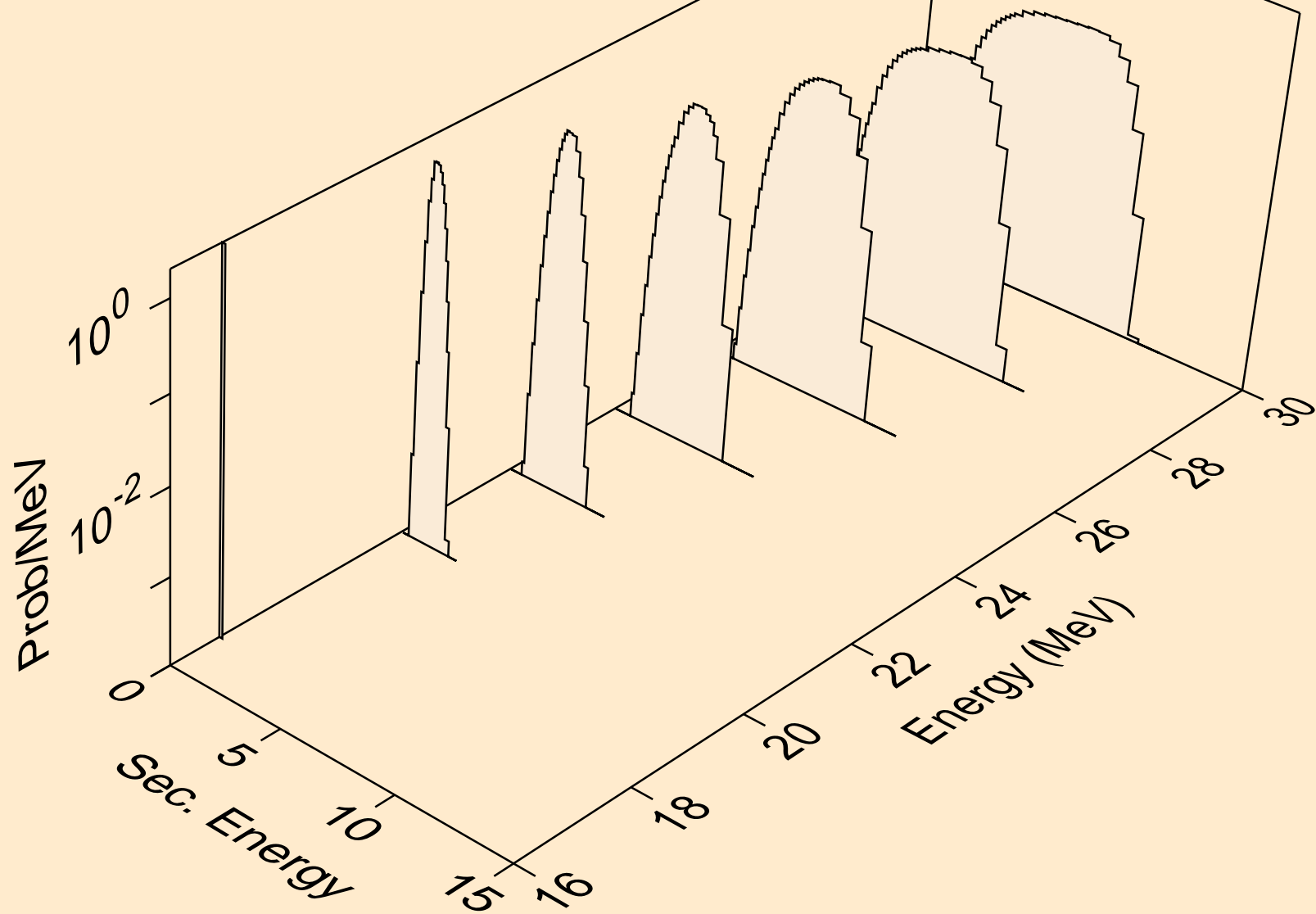

S032 NEUTRON ACER TENDL-2023 LIBRARY; T=0.K
tritons from (n,x)

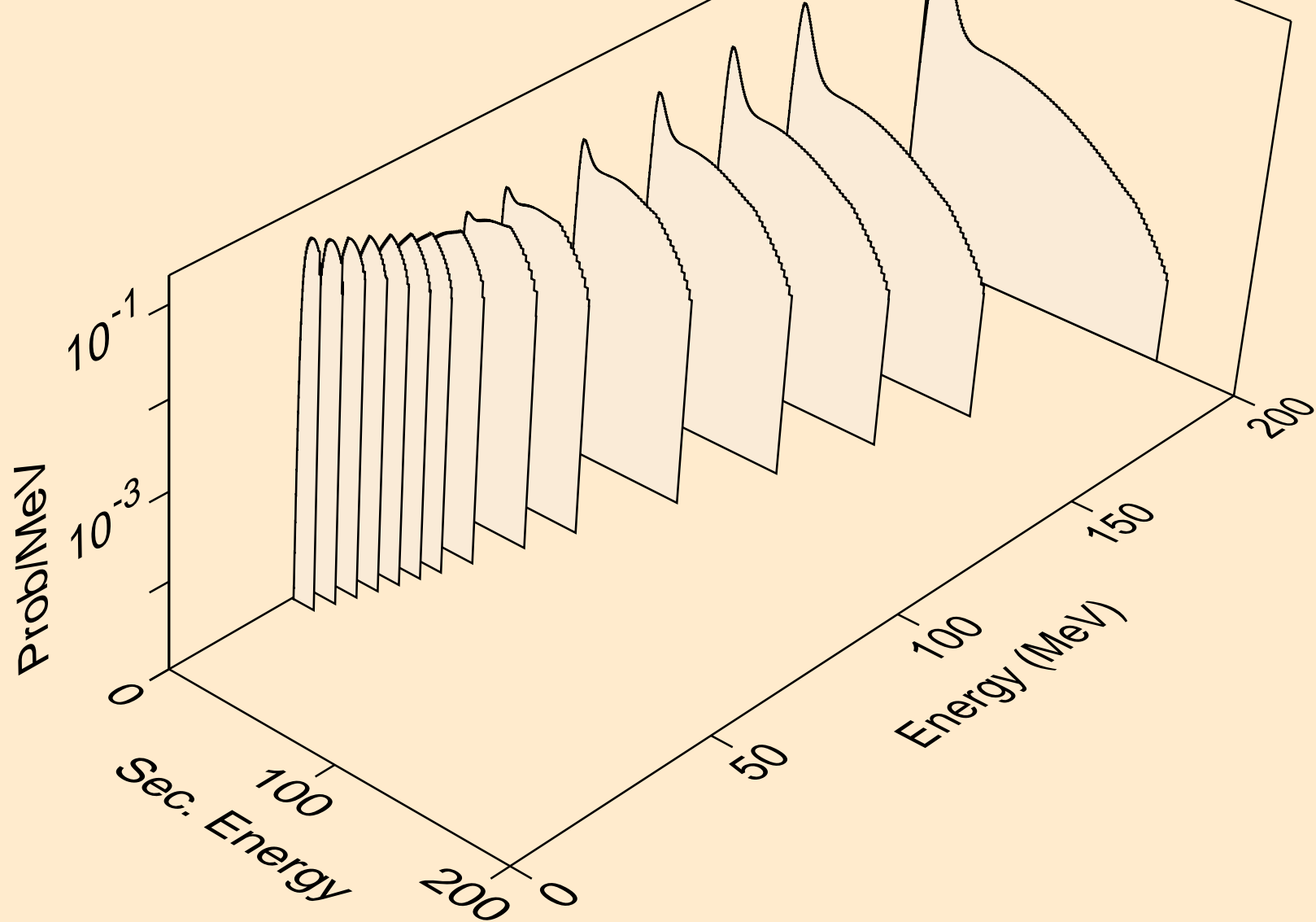

S032 NEUTRON ACER TENDL-2023 LIBRARY; T=0.K
tritons from (n,n*)t

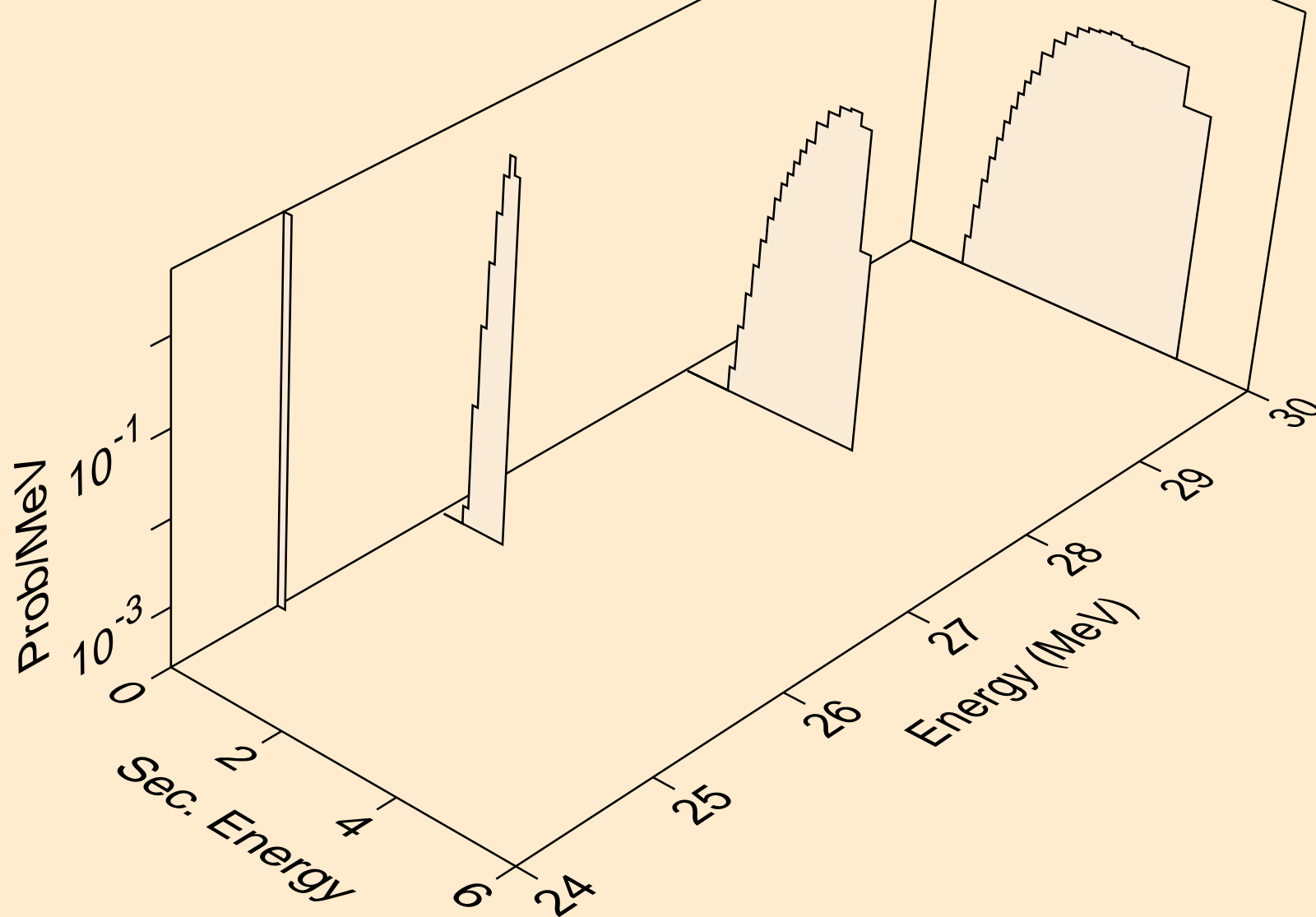

S032 NEUTRON ACER TENDL-2023 LIBRARY; T=0.K
tritons from (n,t)

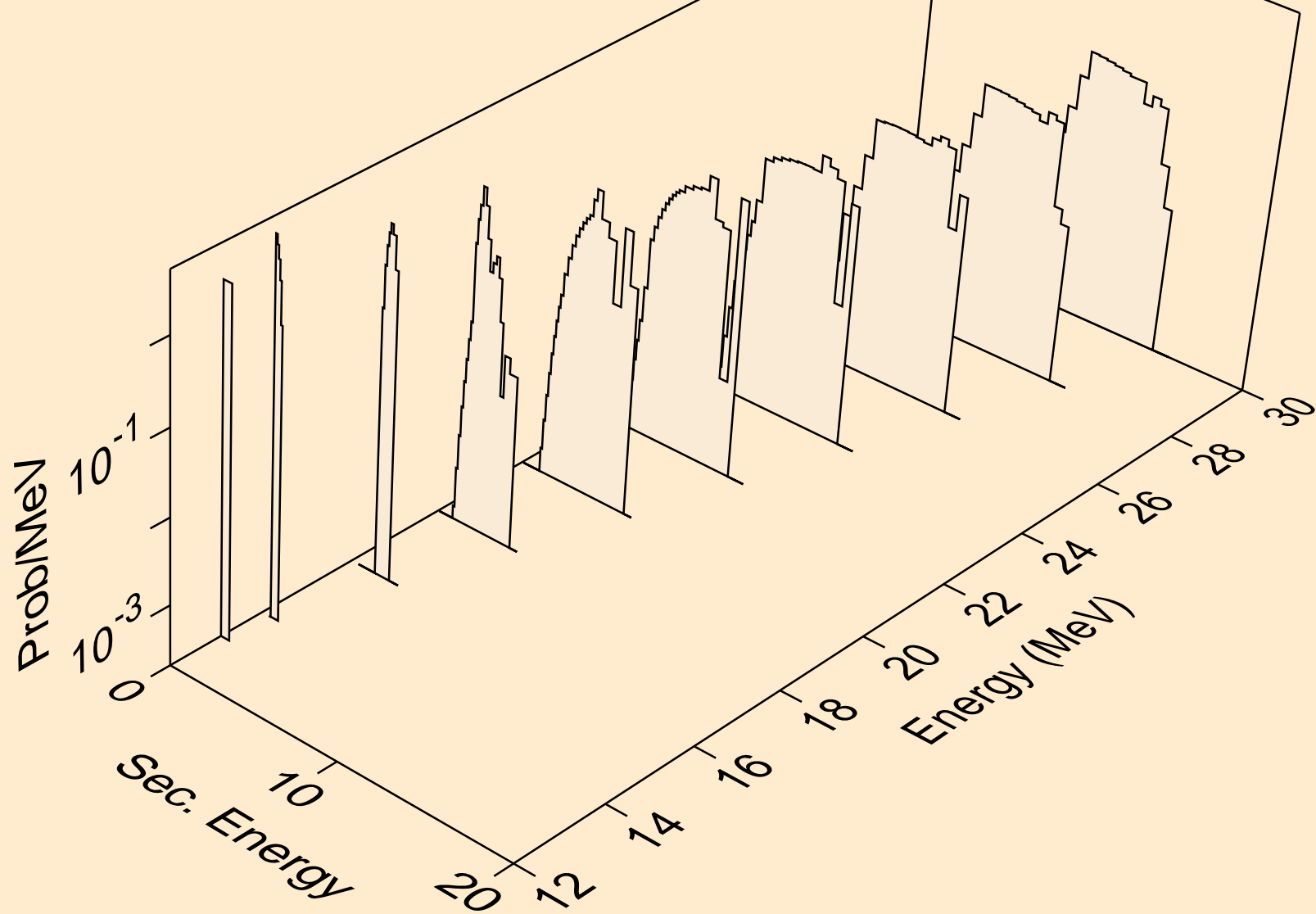

S032 NEUTRON ACER TENDL-2023 LIBRARY; T=0.K
tritons from (n,pt)

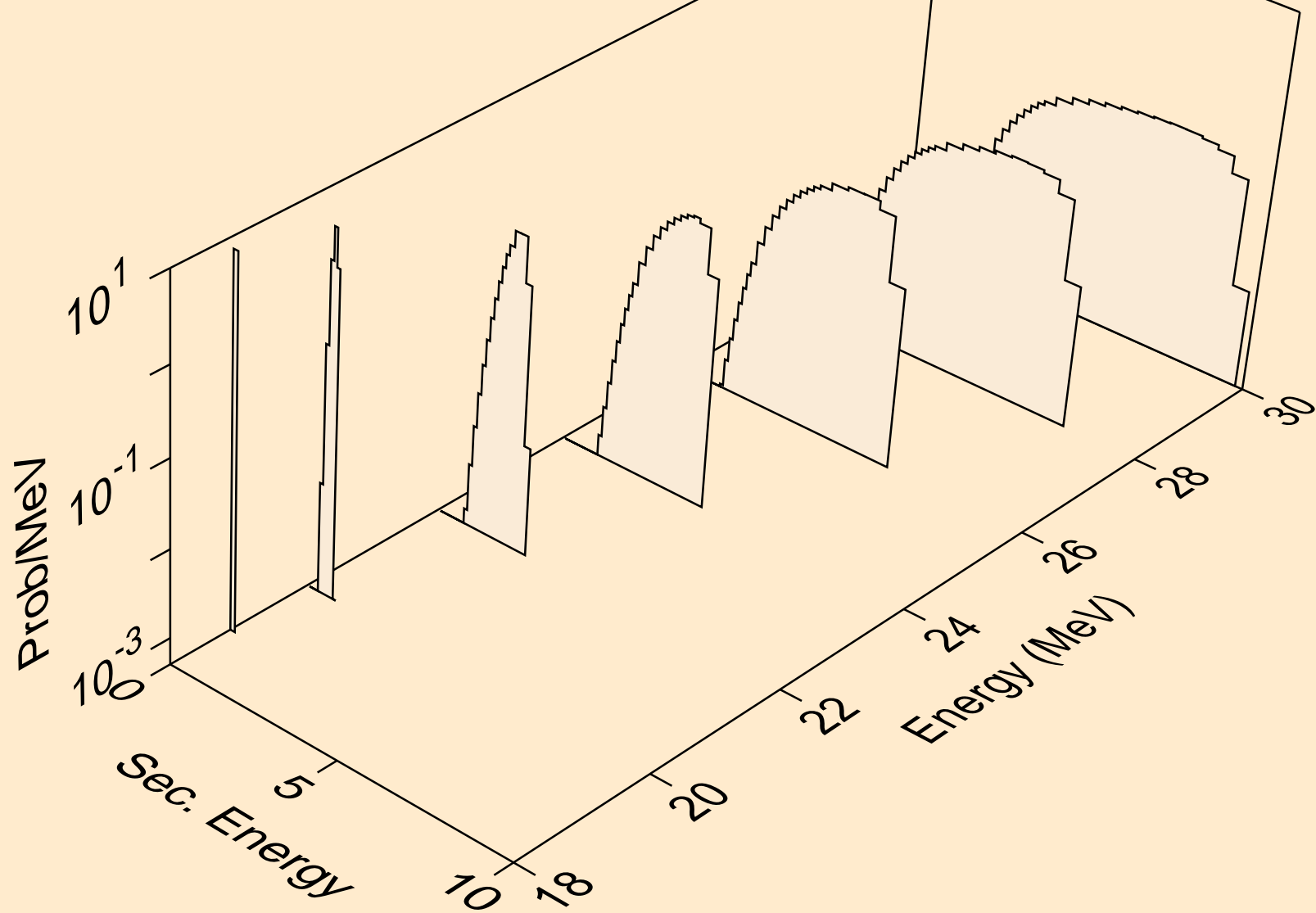

S032 NEUTRON ACER TENDL-2023 LIBRARY; T=0.K
he3s from (n,x)

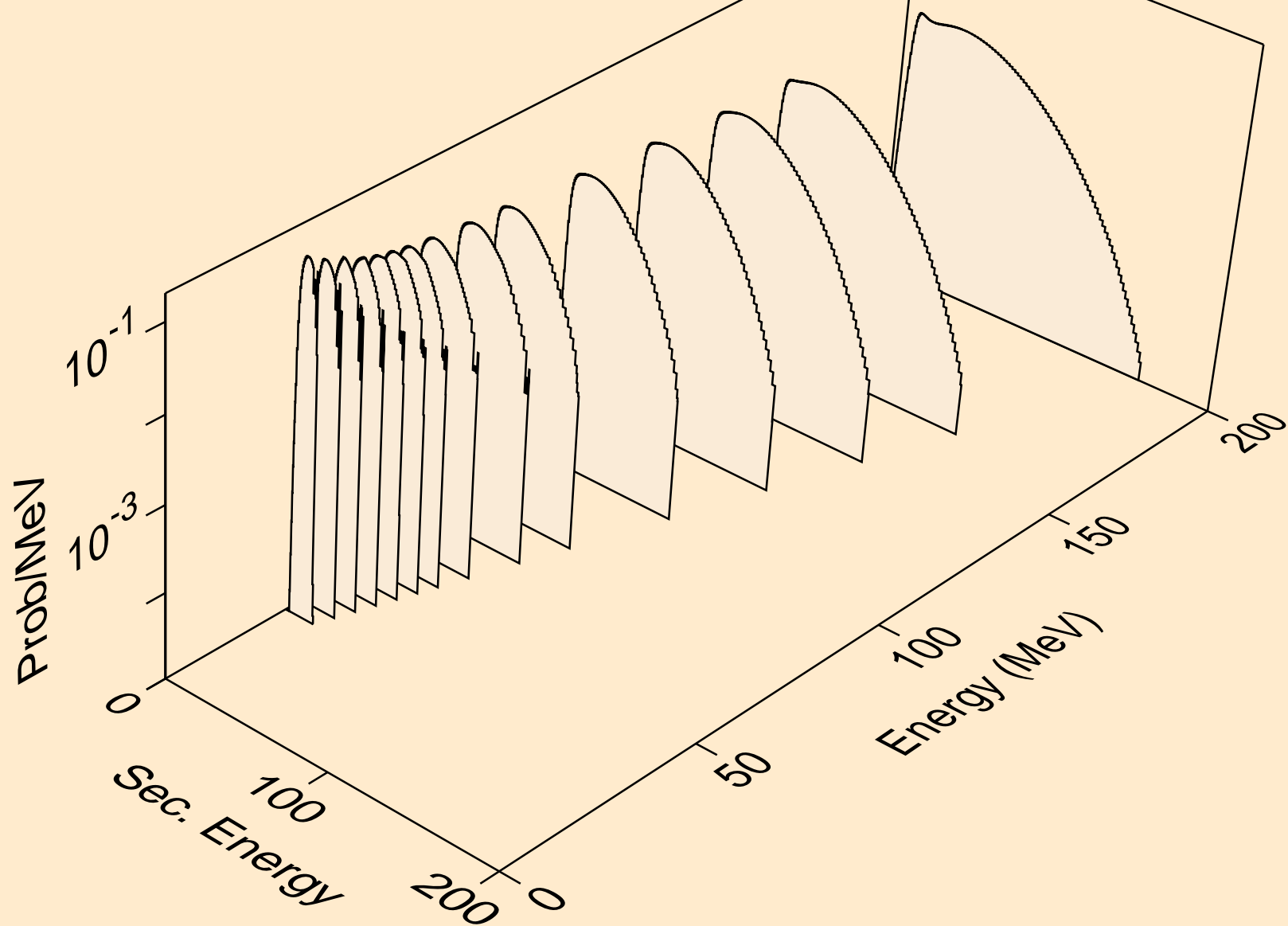

S032 NEUTRON ACER TENDL-2023 LIBRARY; T=0.K
he3s from (n,n*)he3

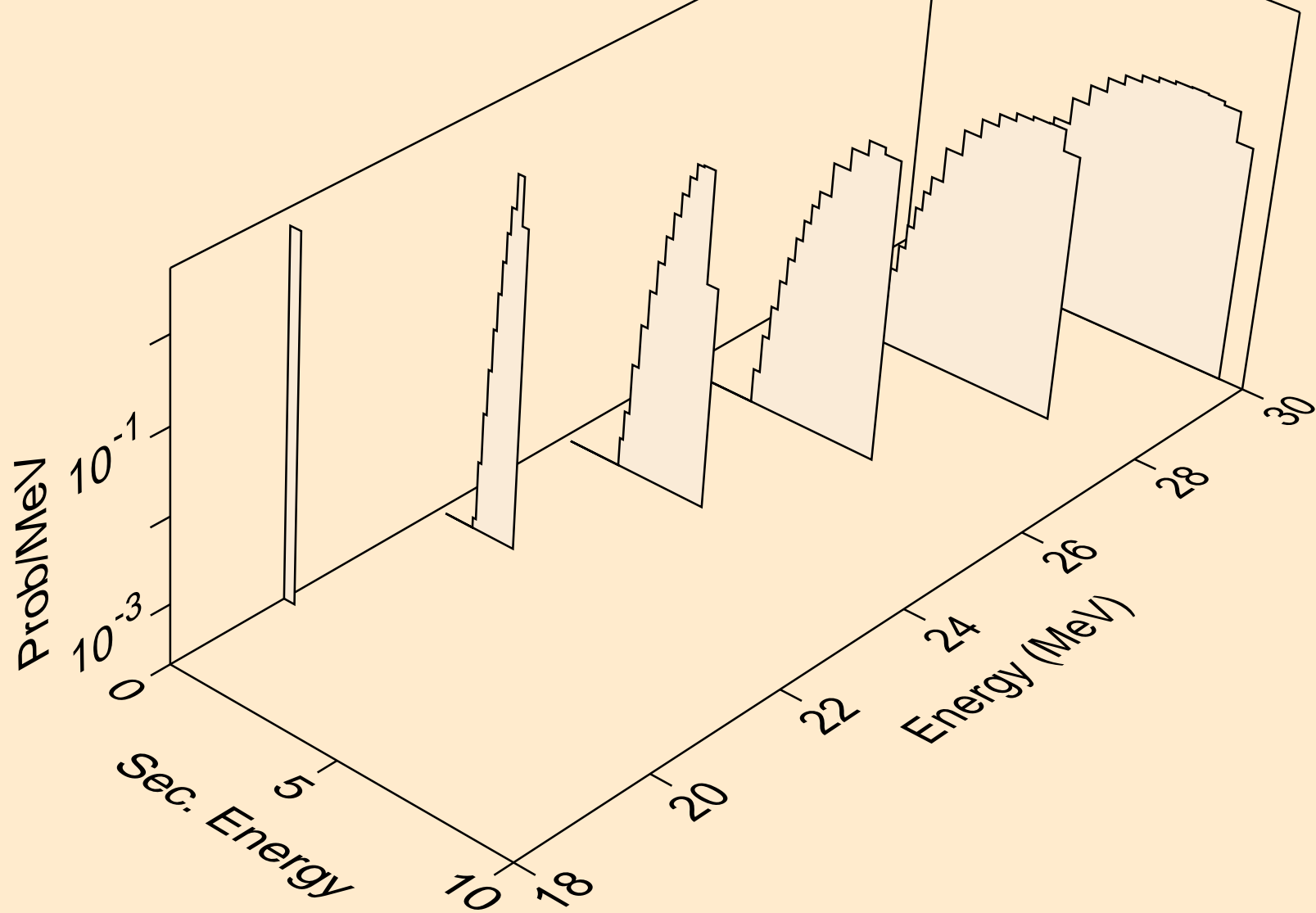

S032 NEUTRON ACER TENDL-2023 LIBRARY; T=0.K
he3s from (n,he3)

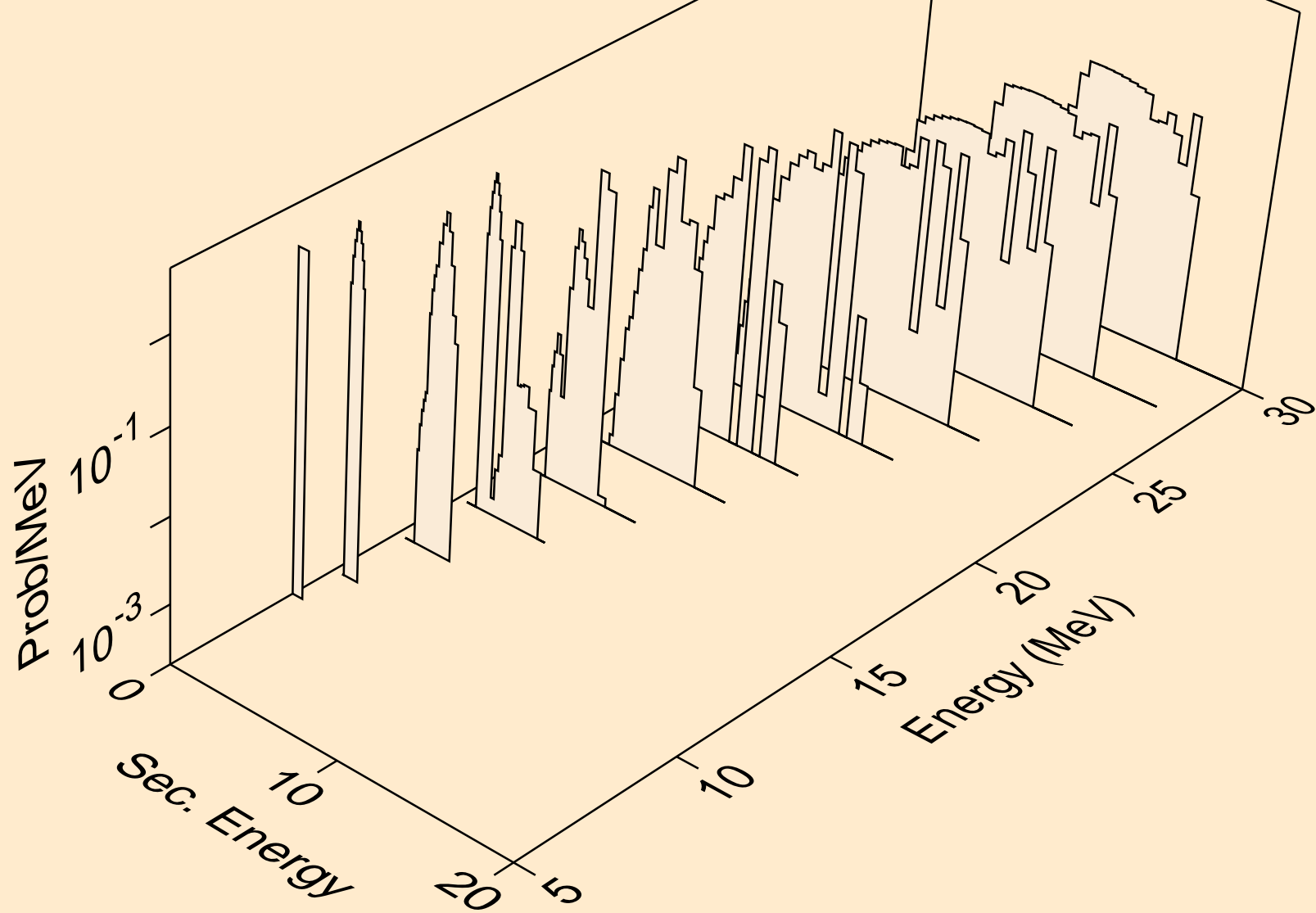

S032 NEUTRON ACER TENDL-2023 LIBRARY; T=0.K
alphas from (n,x)

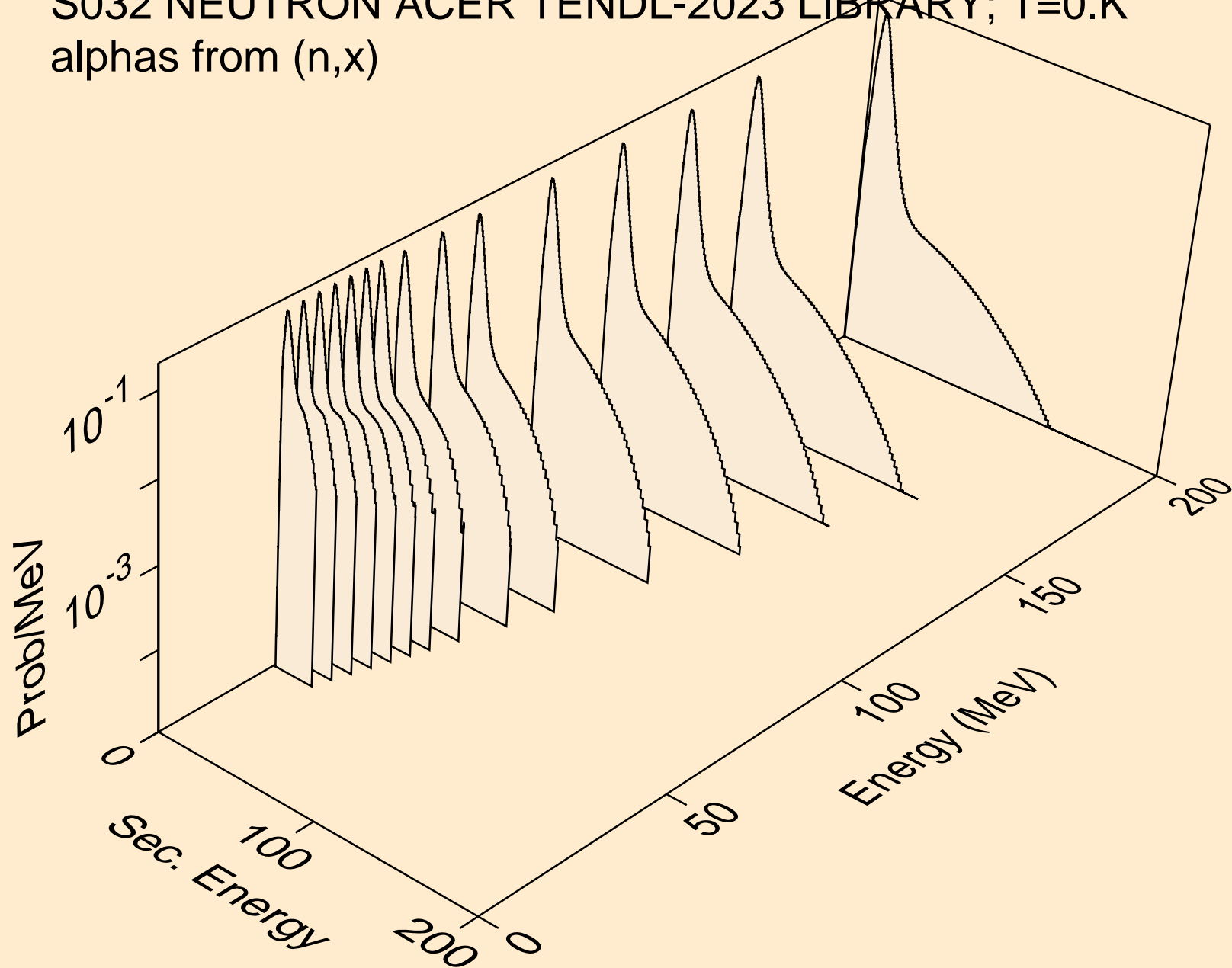

S032 NEUTRON ACER TENDL-2023 LIBRARY; T=0.K
alphas from (n,n*)a

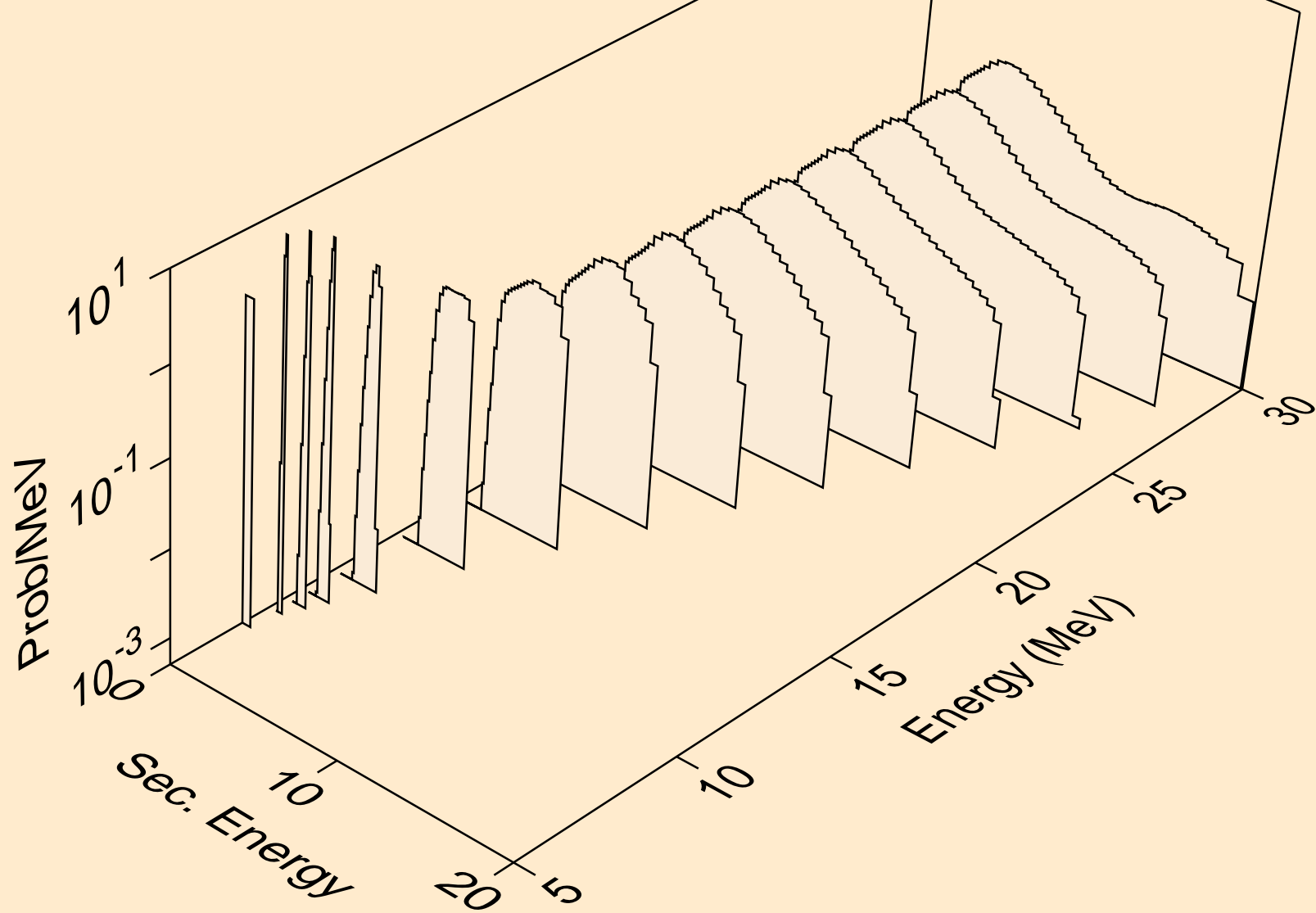

S032 NEUTRON ACER TENDL-2023 LIBRARY; T=0.K
alphas from (n,2n)a

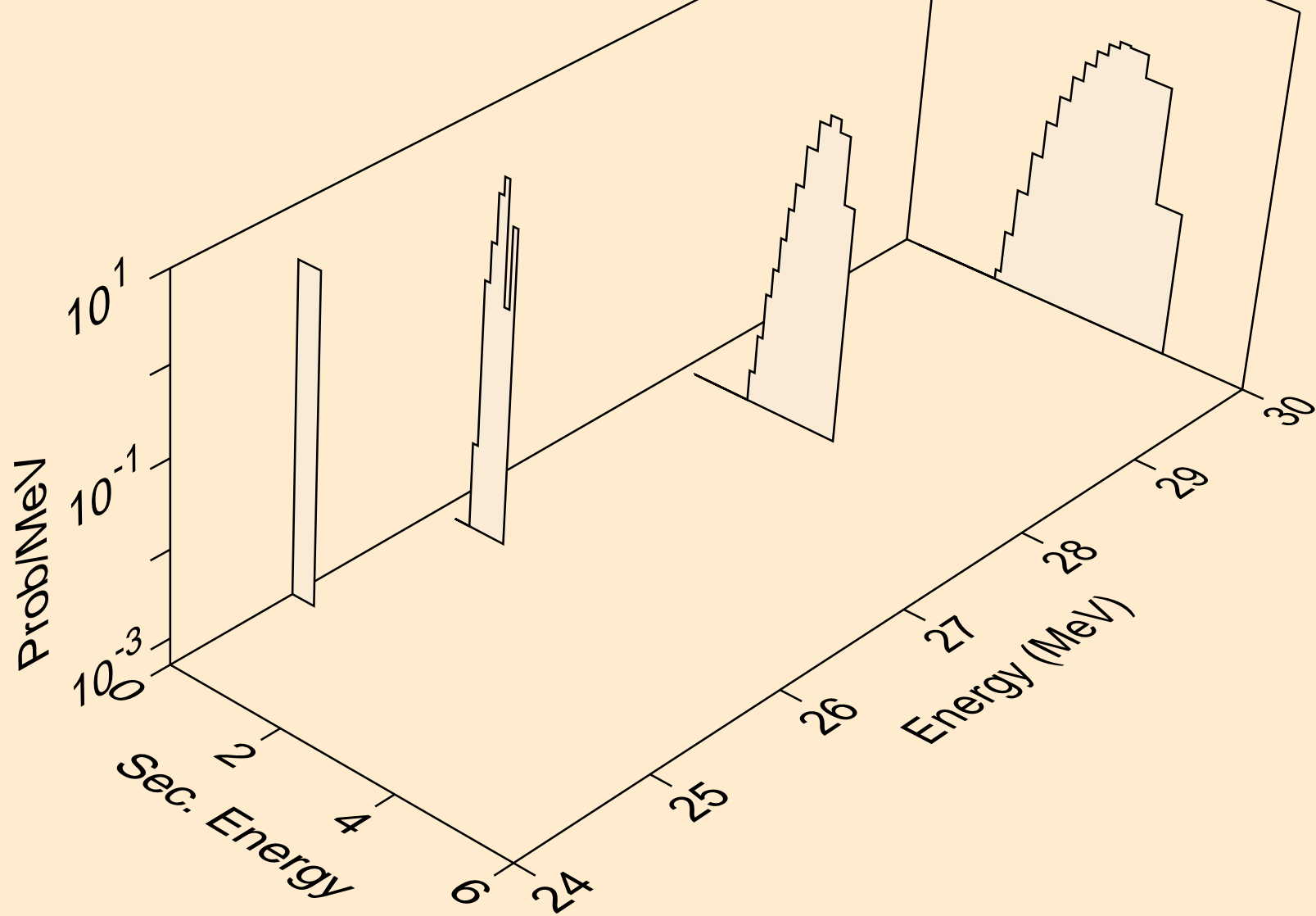

S032 NEUTRON ACER TENDL-2023 LIBRARY; T=0.K
alphas from (n,n*)2a

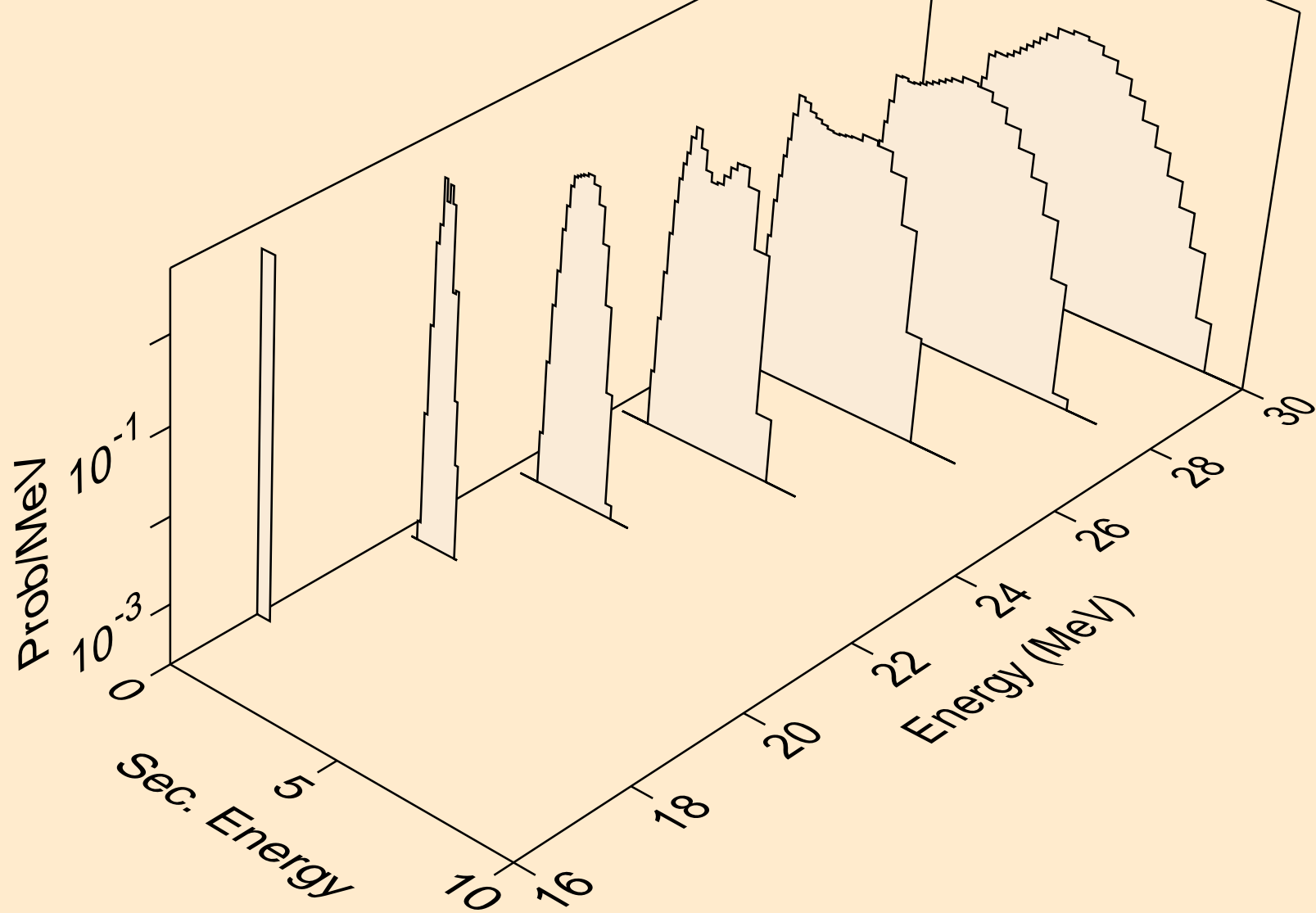

S032 NEUTRON ACER TENDL-2023 LIBRARY; T=0.K
alphas from (n,npa)

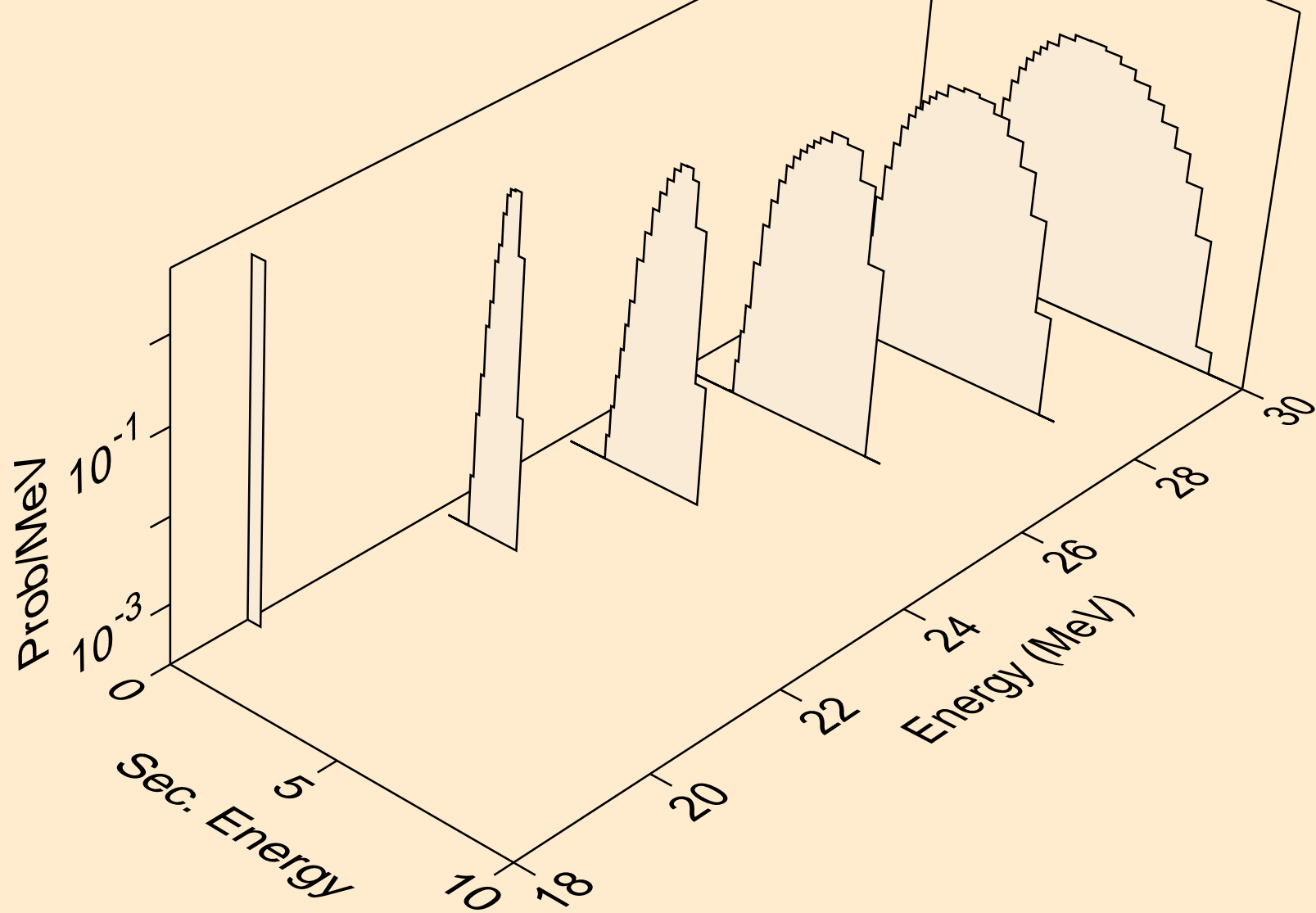

S032 NEUTRON ACER TENDL-2023 LIBRARY; T=0.K
alphas from (n,a)

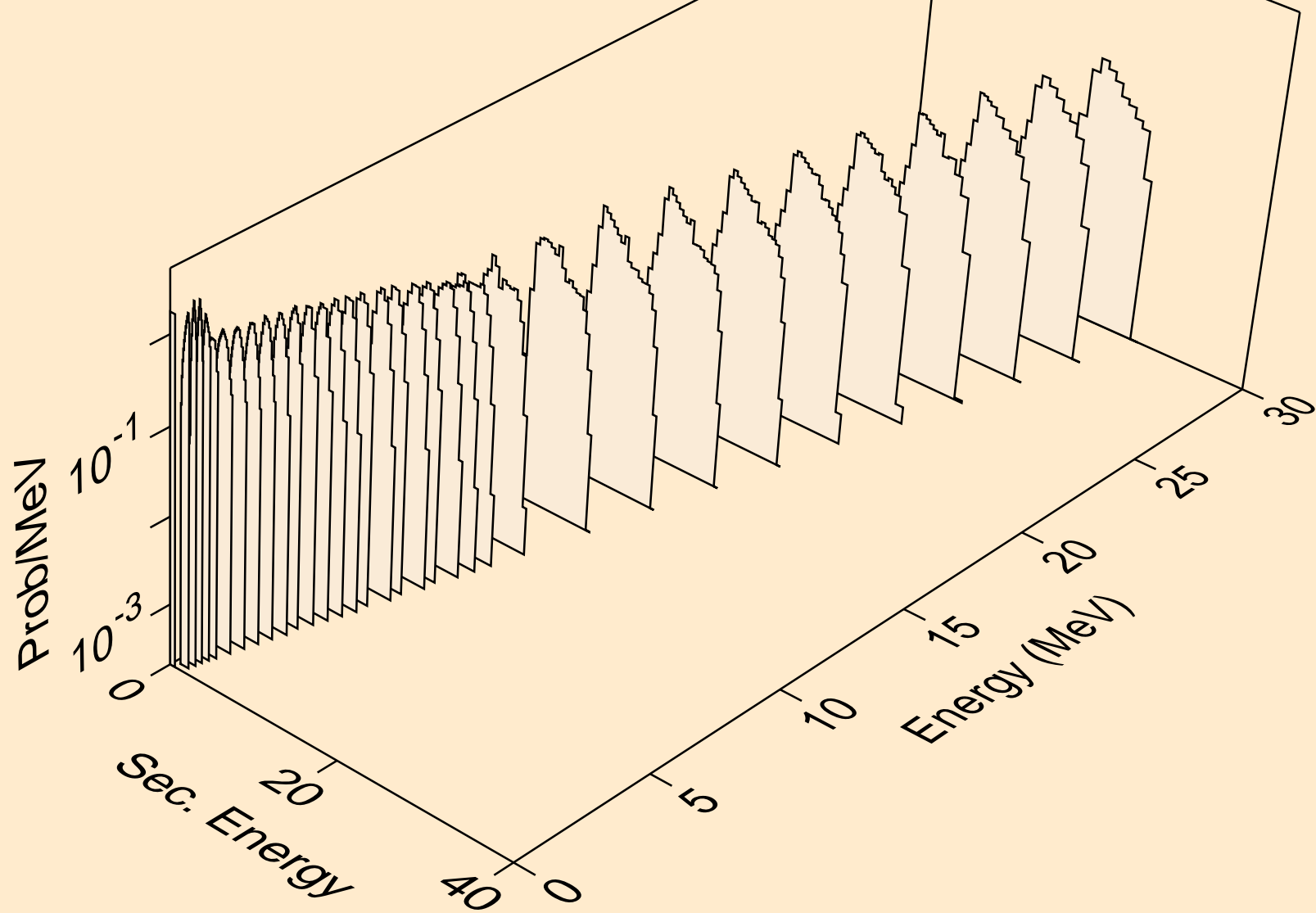

S032 NEUTRON ACER TENDL-2023 LIBRARY; T=0.K
alphas from (n,2a)

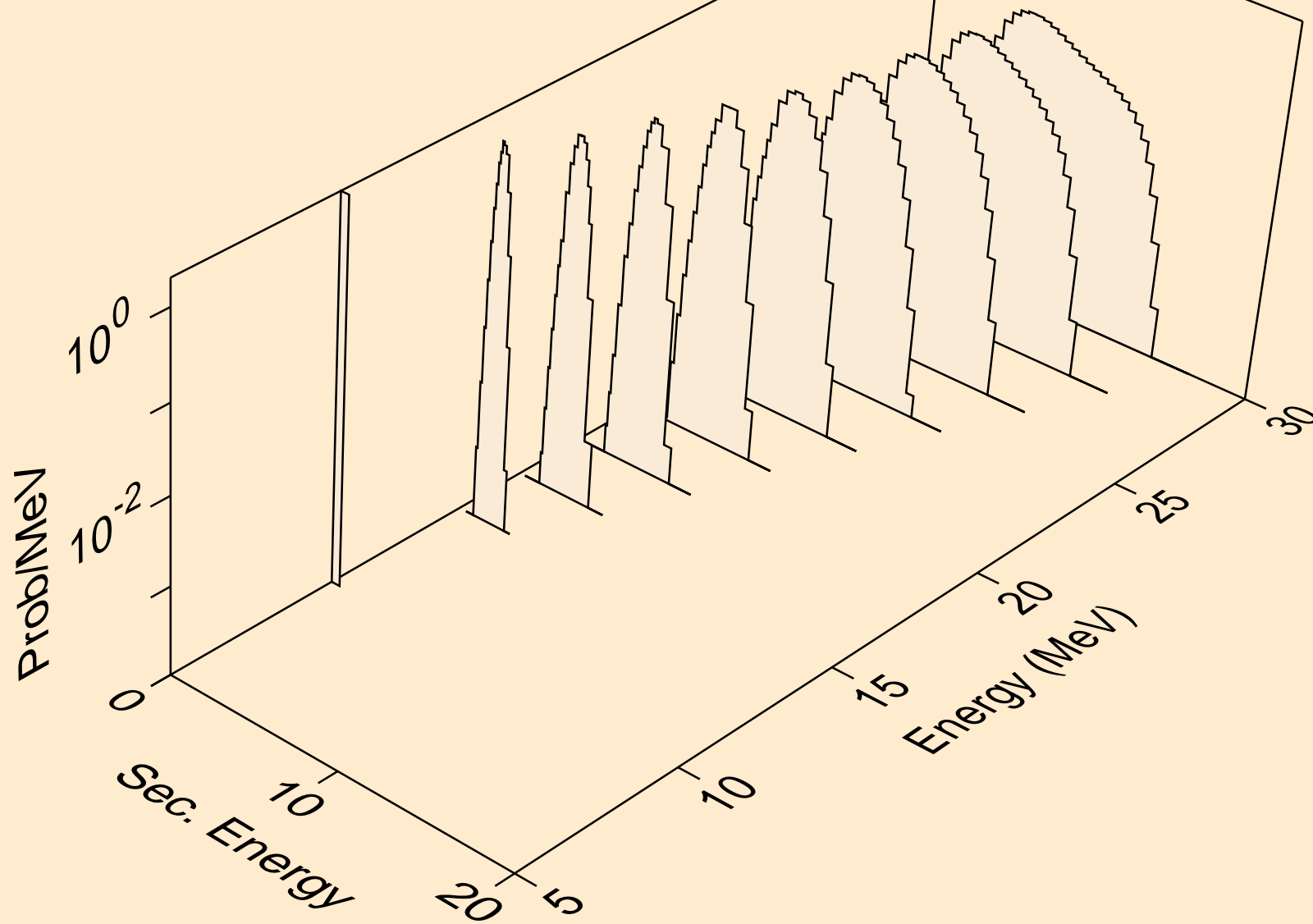

S032 NEUTRON ACER TENDL-2023 LIBRARY; T=0.K
alphas from (n,pa)

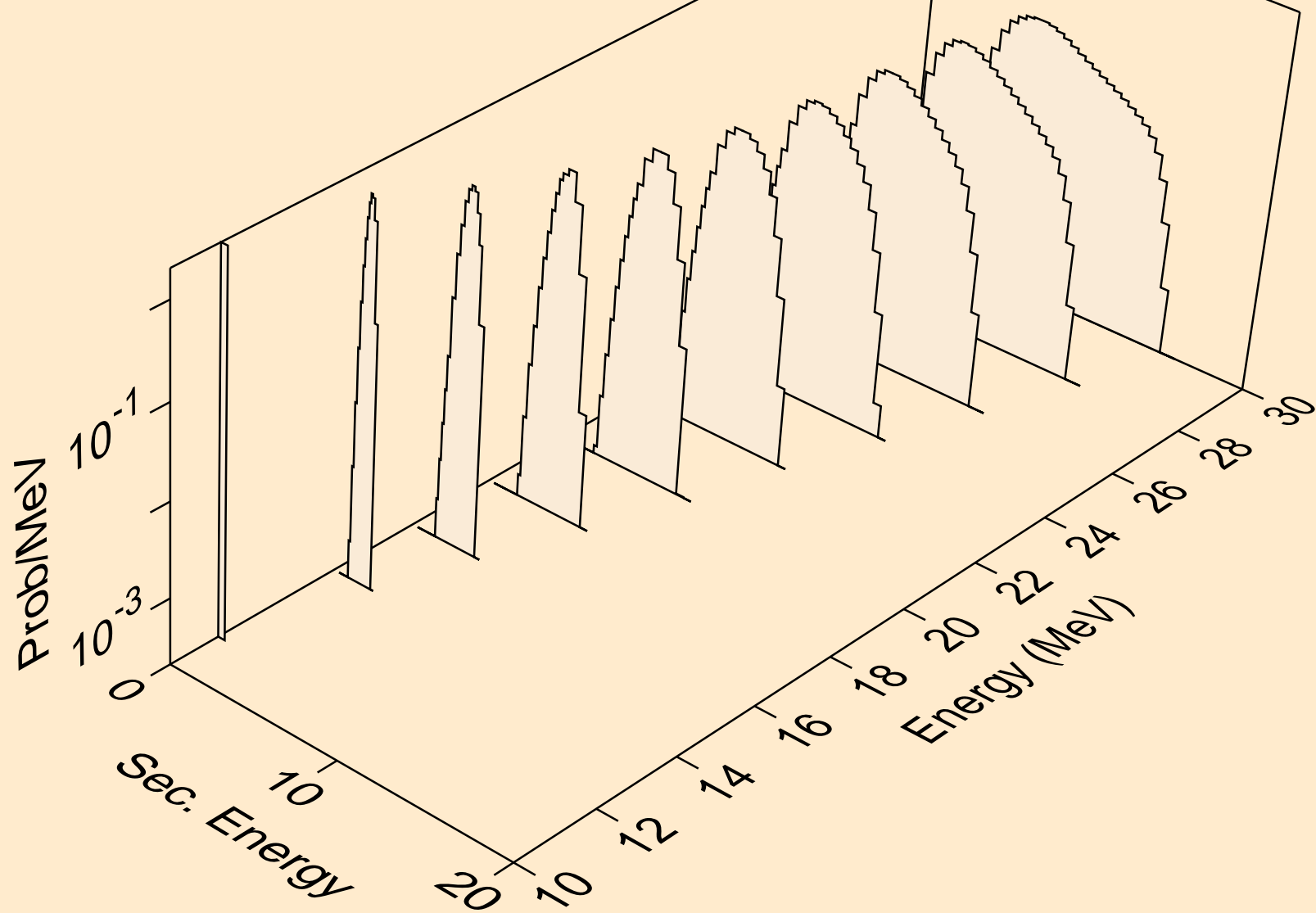

S032 NEUTRON ACER TENDL-2023 LIBRARY; T=0.K
alphas from (n,da)

