

# S036 NEUTRON ACER TENDL-2023 LIBRARY; T=0.K

## Principal cross sections

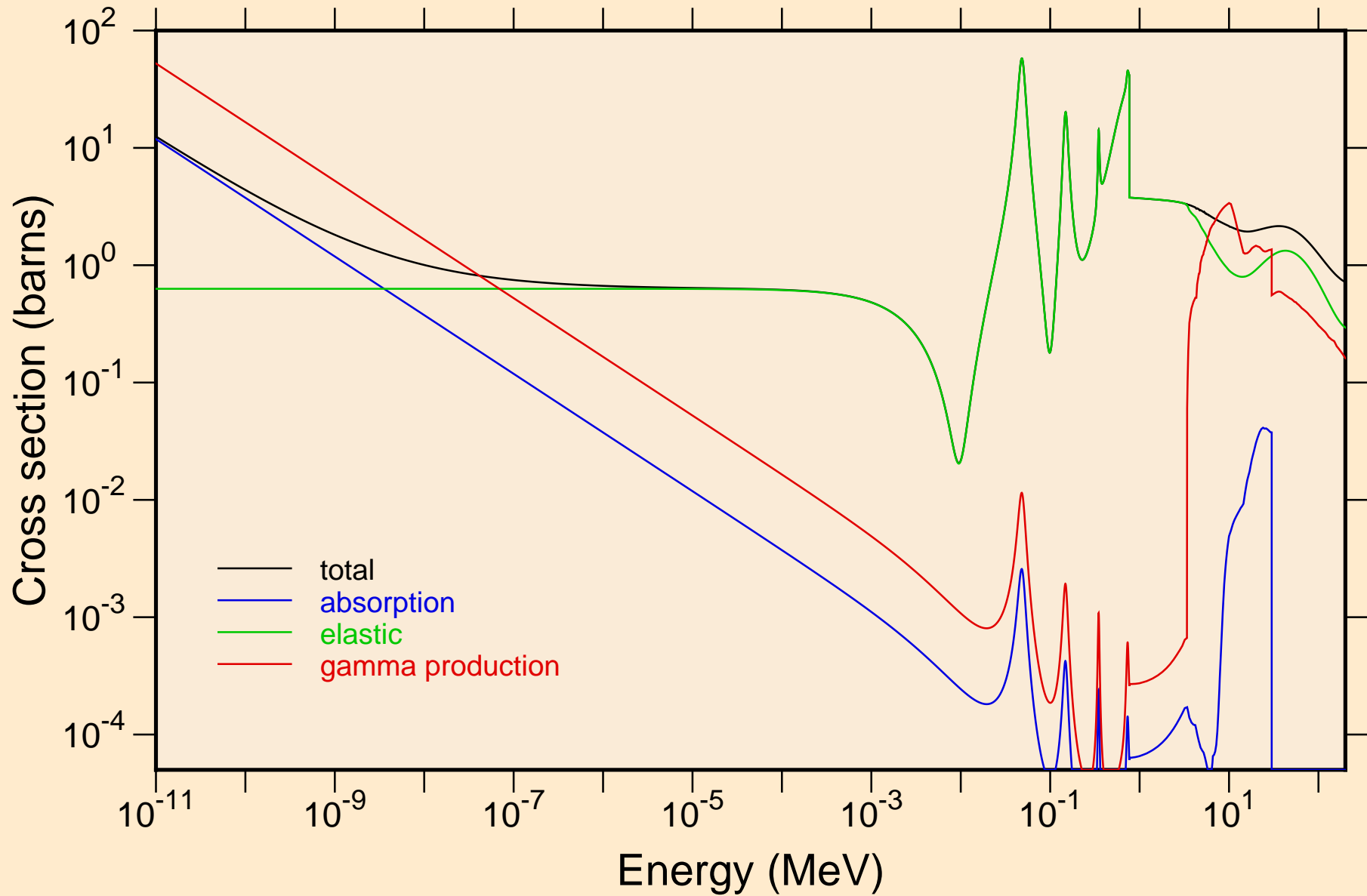

# S036 NEUTRON ACER TENDL-2023 LIBRARY; T=0.K

## Heating

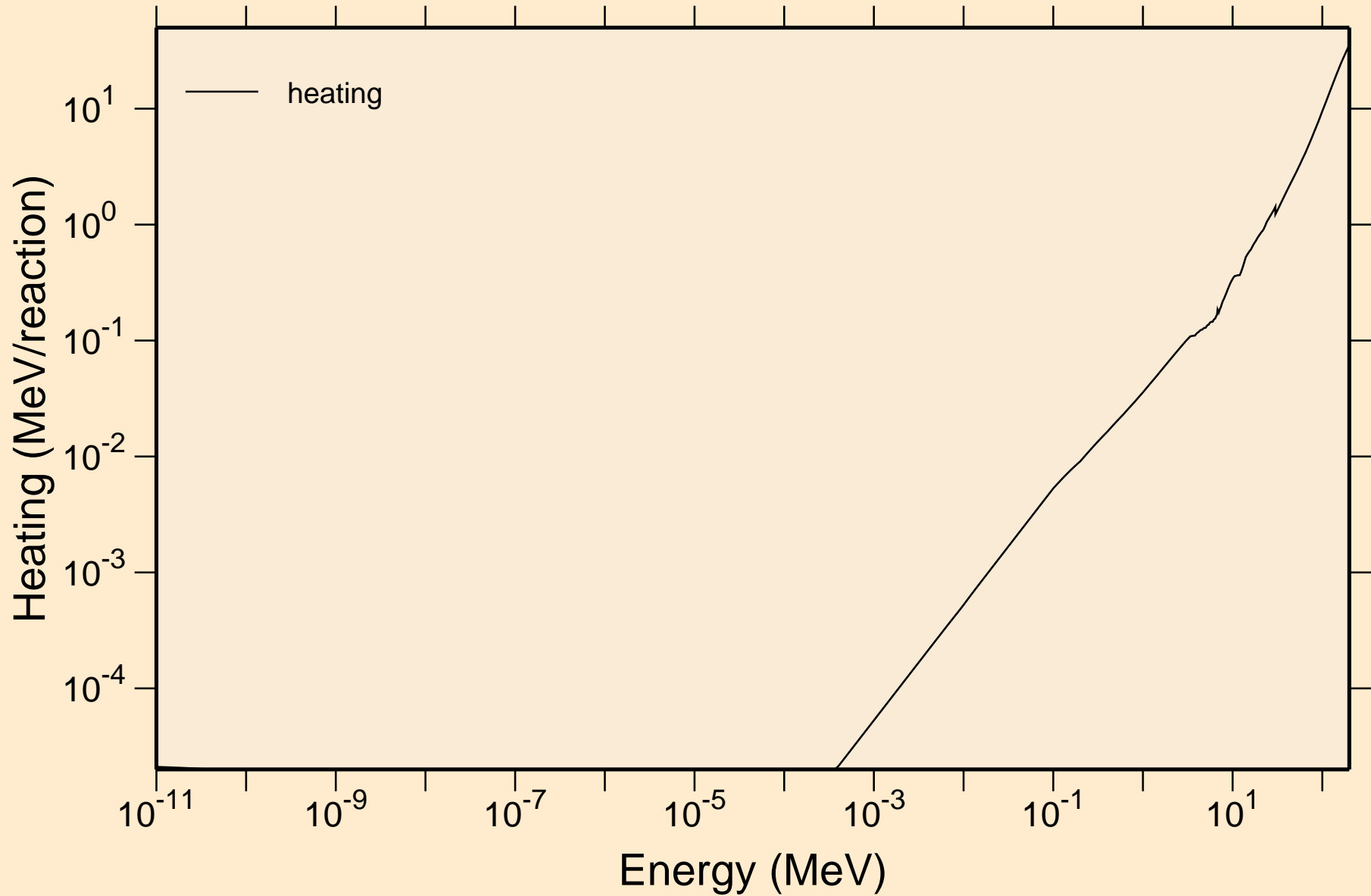

# S036 NEUTRON ACER TENDL-2023 LIBRARY; T=0.K

## Damage

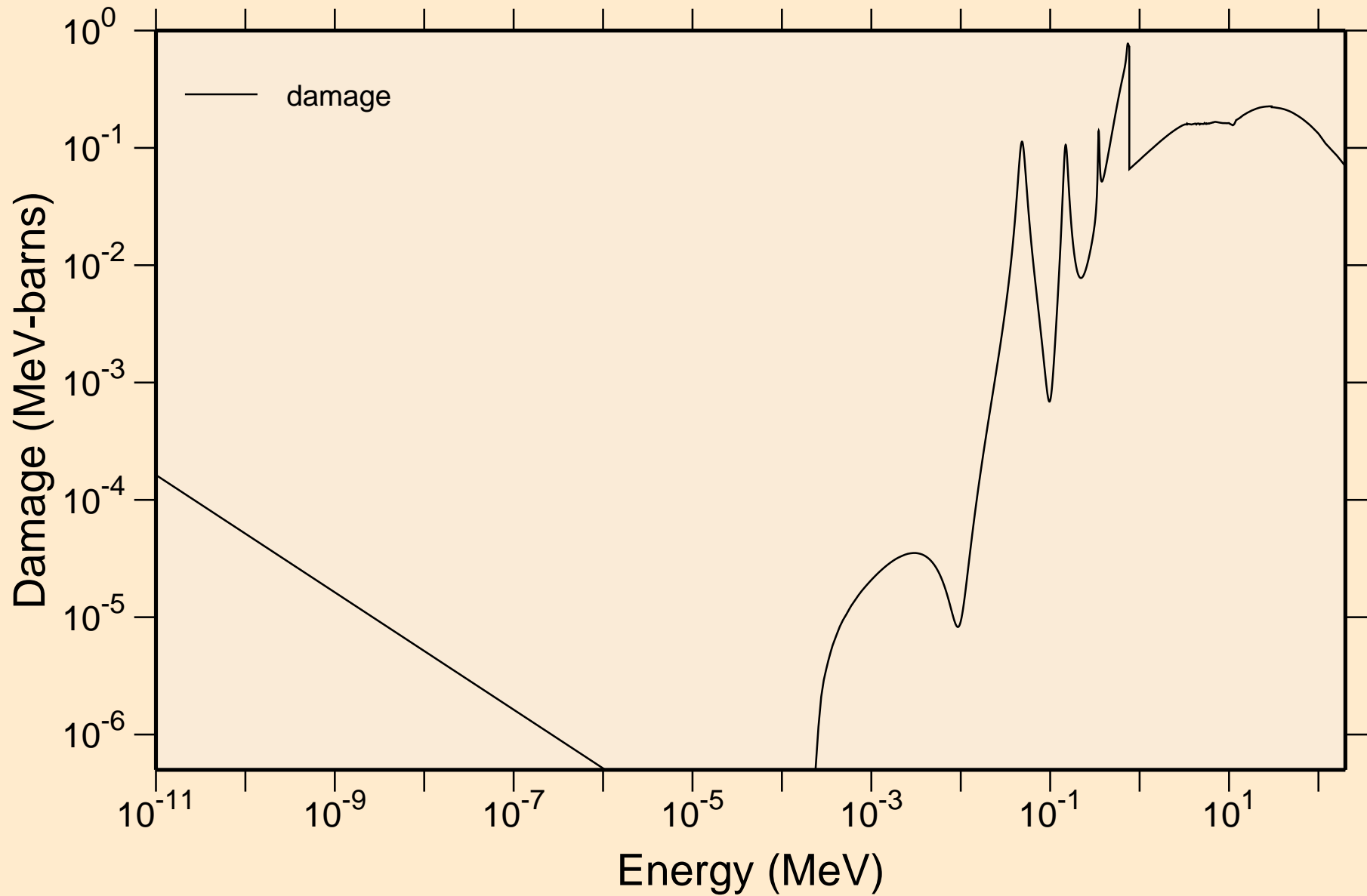

S036 NEUTRON ACER TENDL-2023 LIBRARY; T=0.K  
Non-threshold reactions

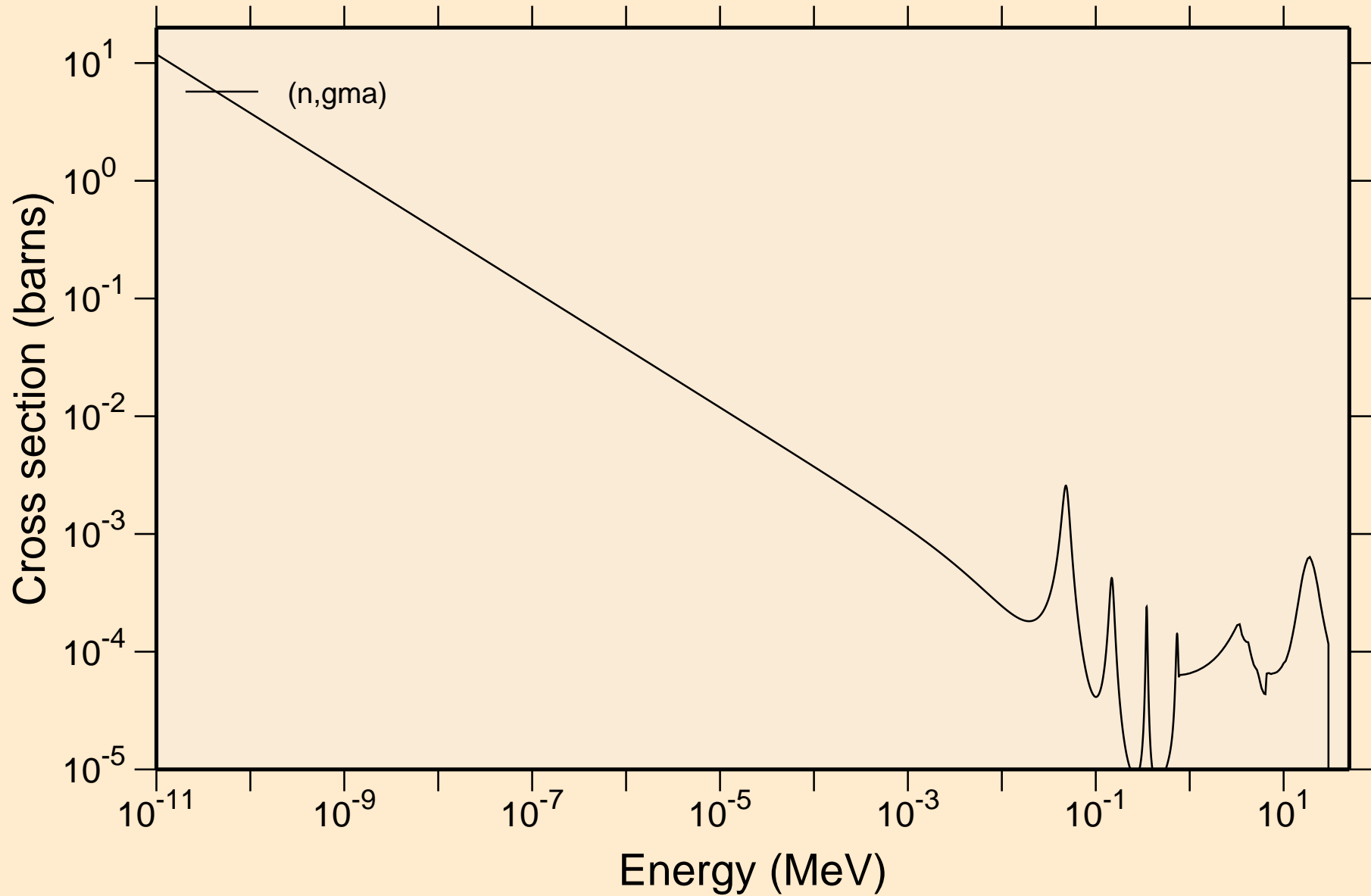

# S036 NEUTRON ACER TENDL-2023 LIBRARY; T=0.K

## Principal cross sections

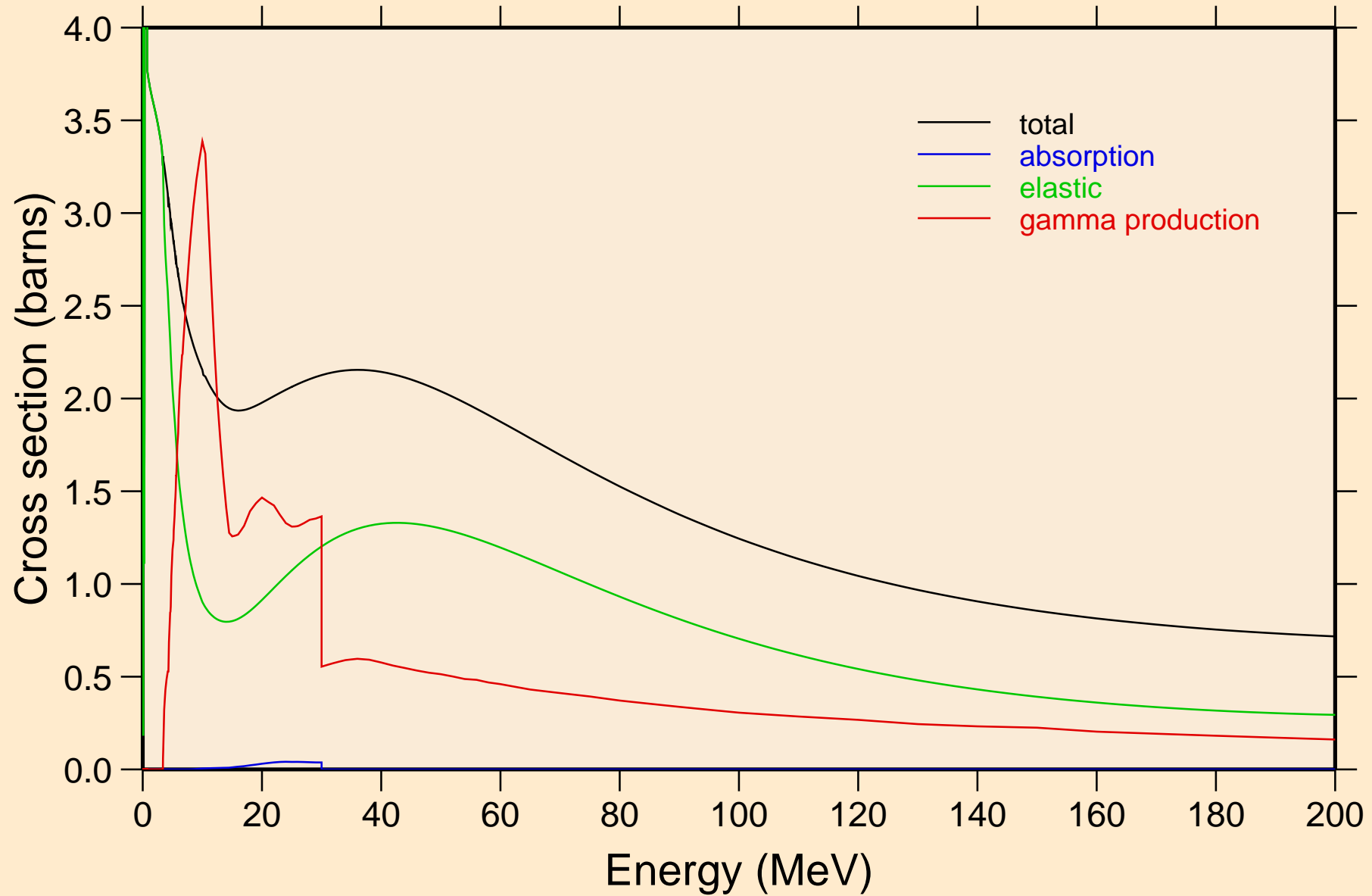

# S036 NEUTRON ACER TENDL-2023 LIBRARY; T=0.K

## Heating

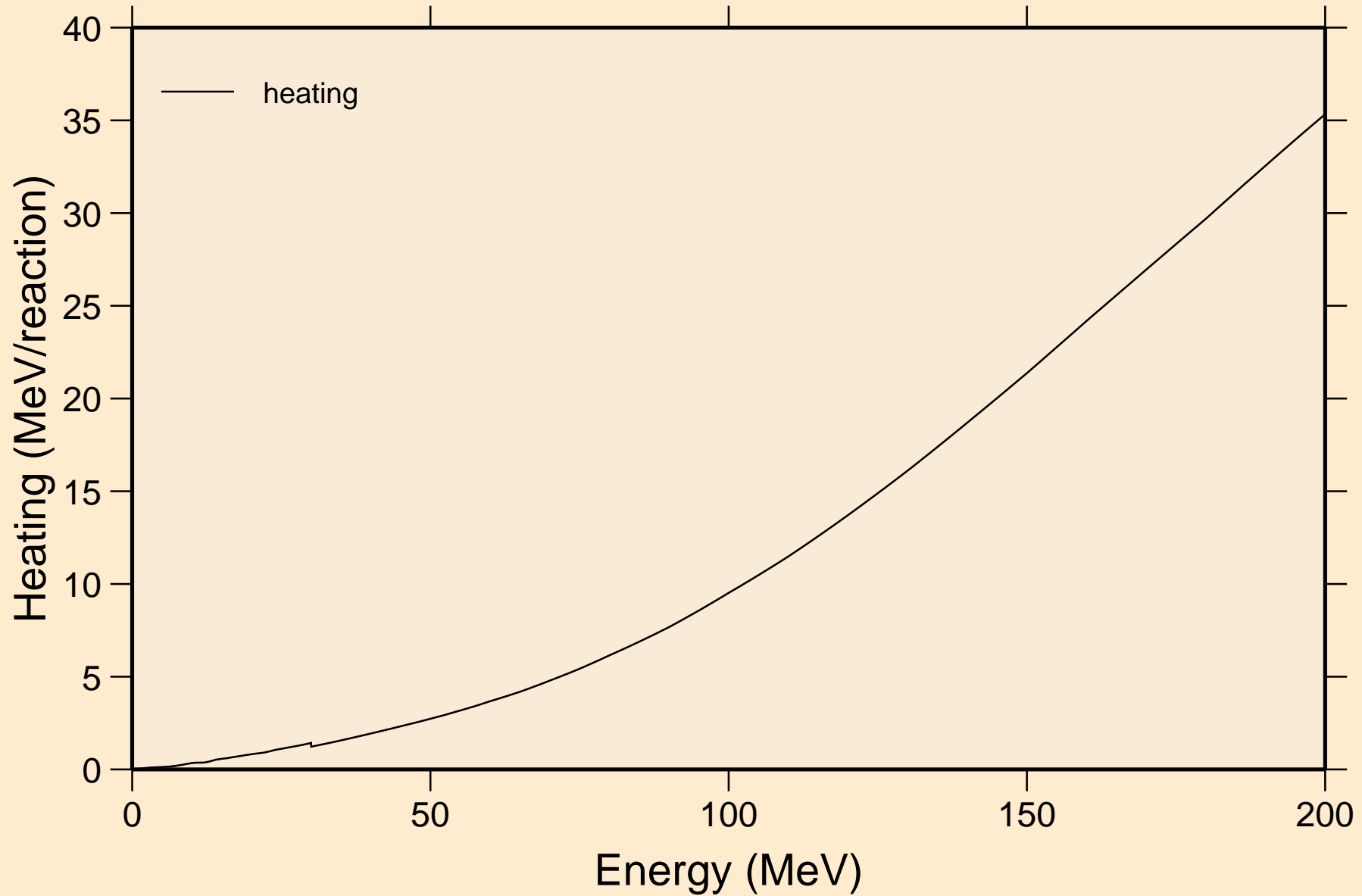

# S036 NEUTRON ACER TENDL-2023 LIBRARY; T=0.K

## Damage

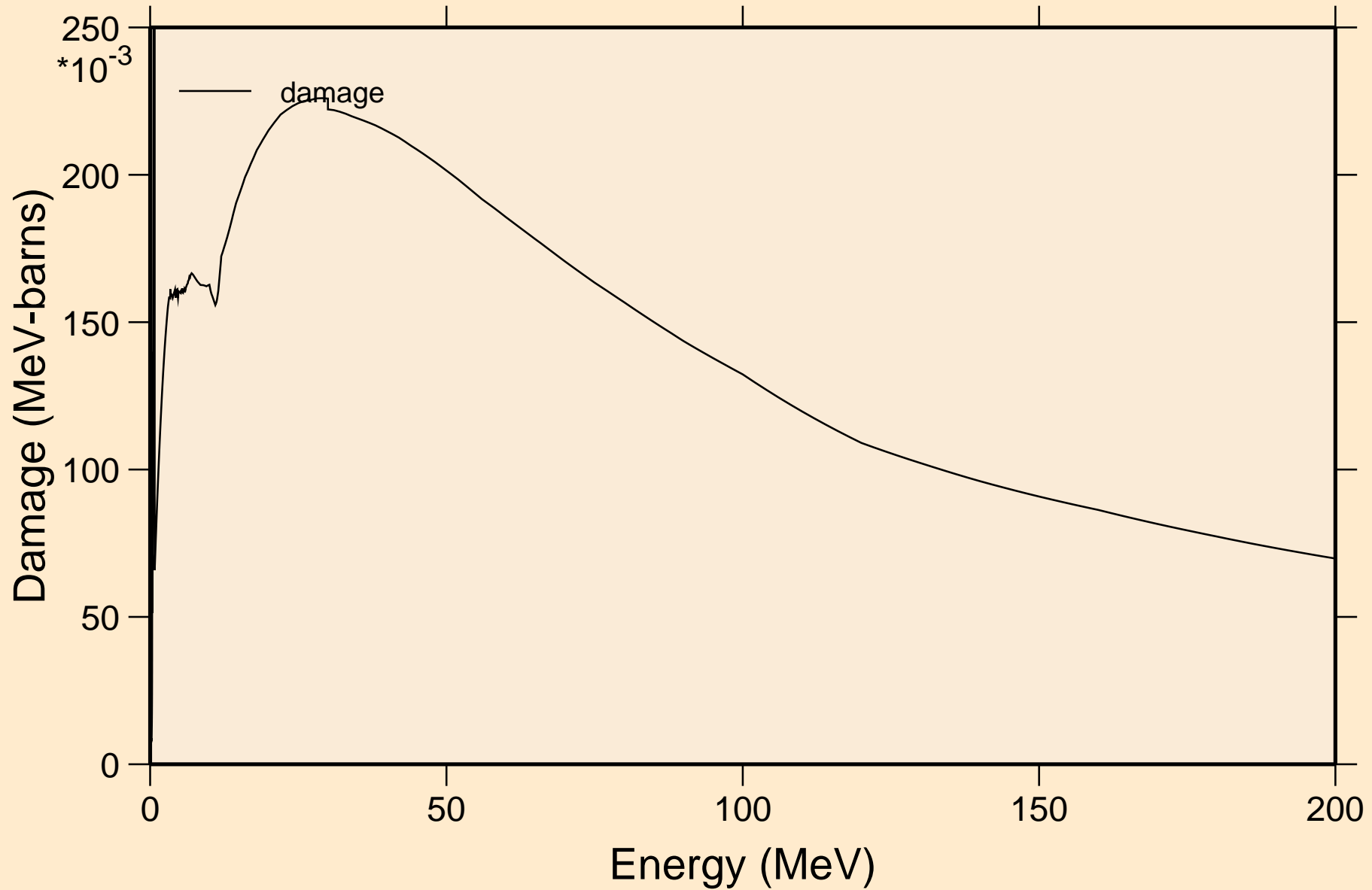

S036 NEUTRON ACER TENDL-2023 LIBRARY; T=0.K  
Non-threshold reactions

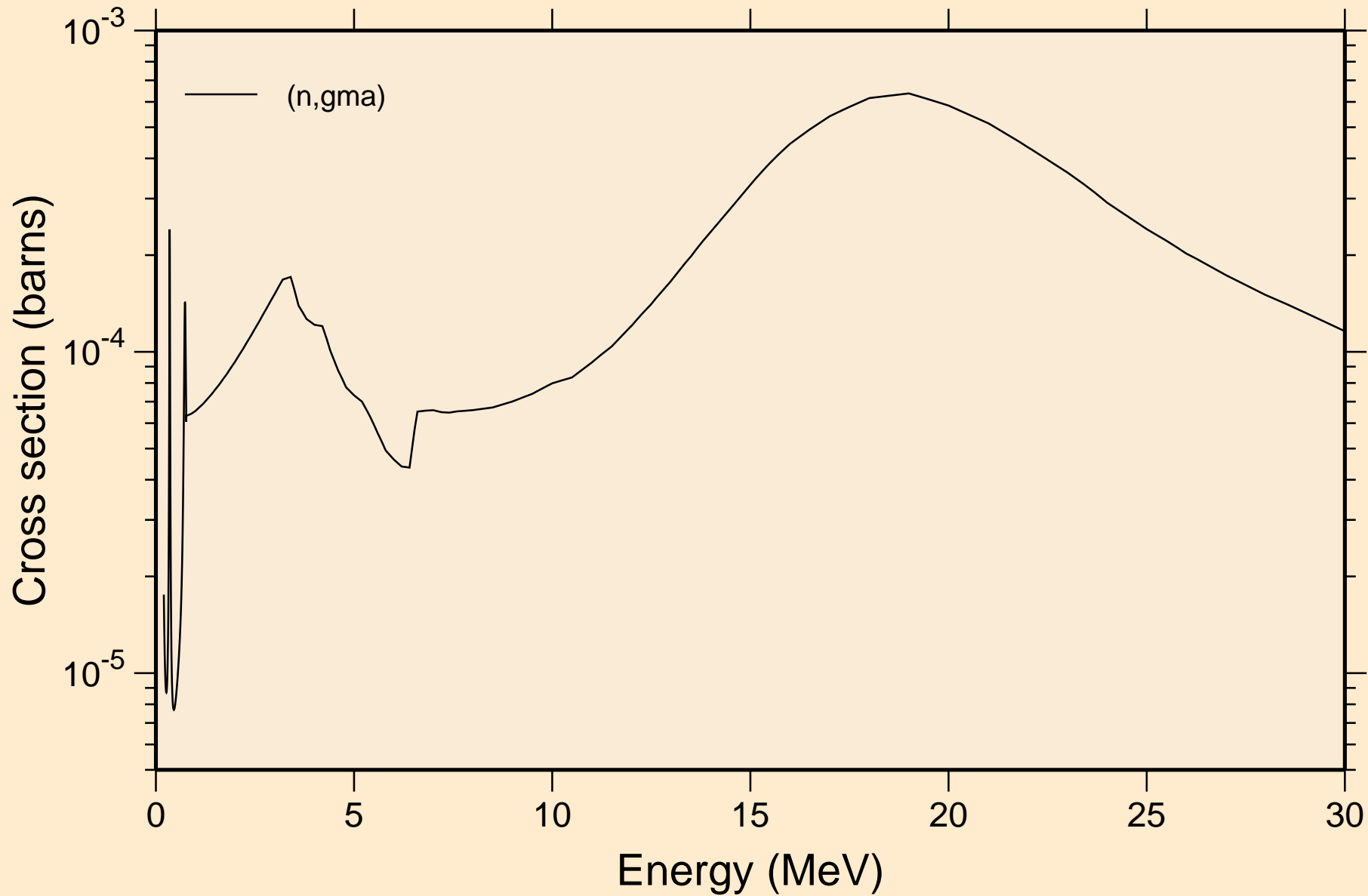



S036 NEUTRON ACER TENDL-2023 LIBRARY; T=0.K  
Inelastic levels

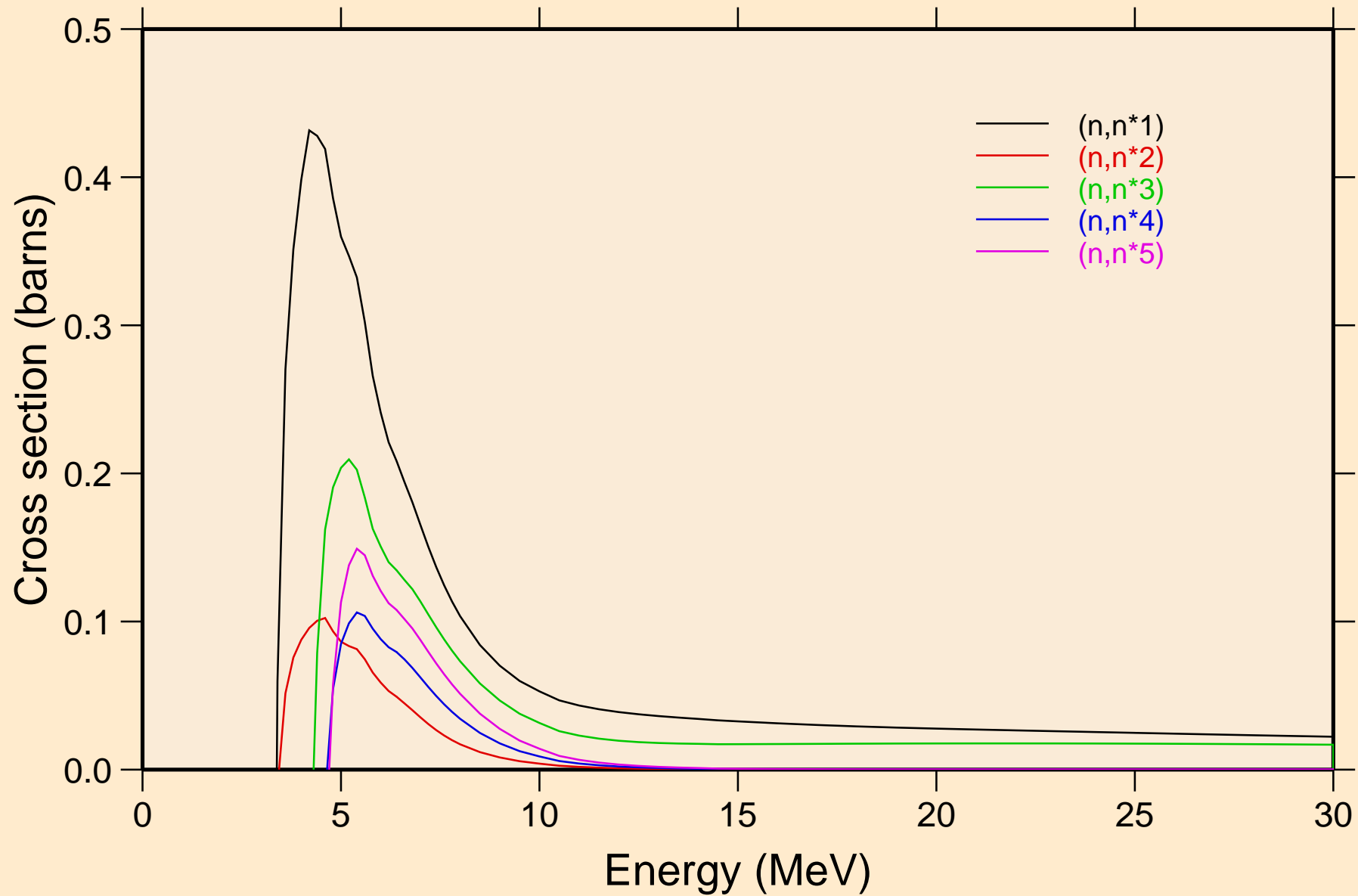

S036 NEUTRON ACER TENDL-2023 LIBRARY; T=0.K  
Inelastic levels

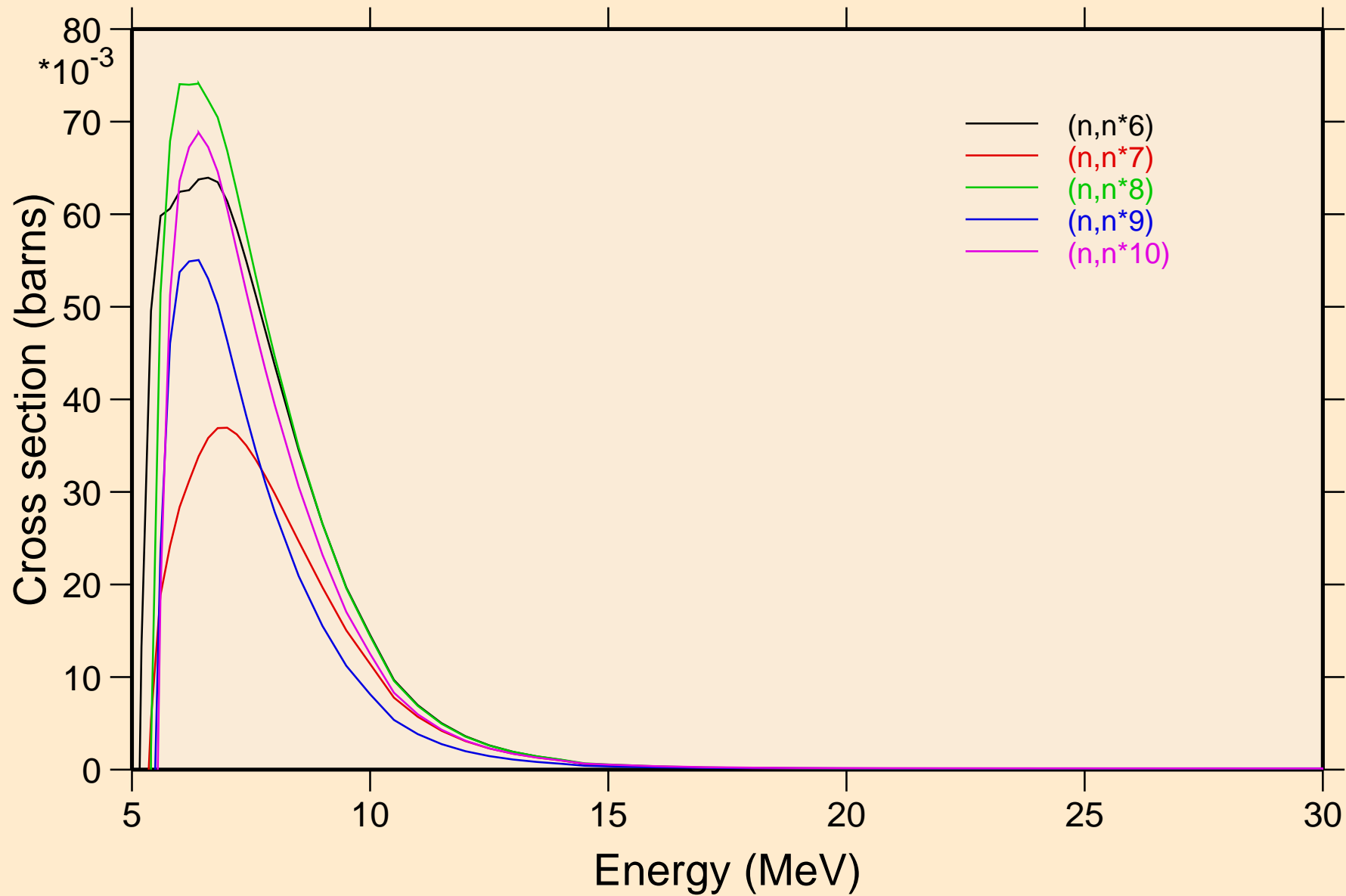

S036 NEUTRON ACER TENDL-2023 LIBRARY; T=0.K  
Inelastic levels

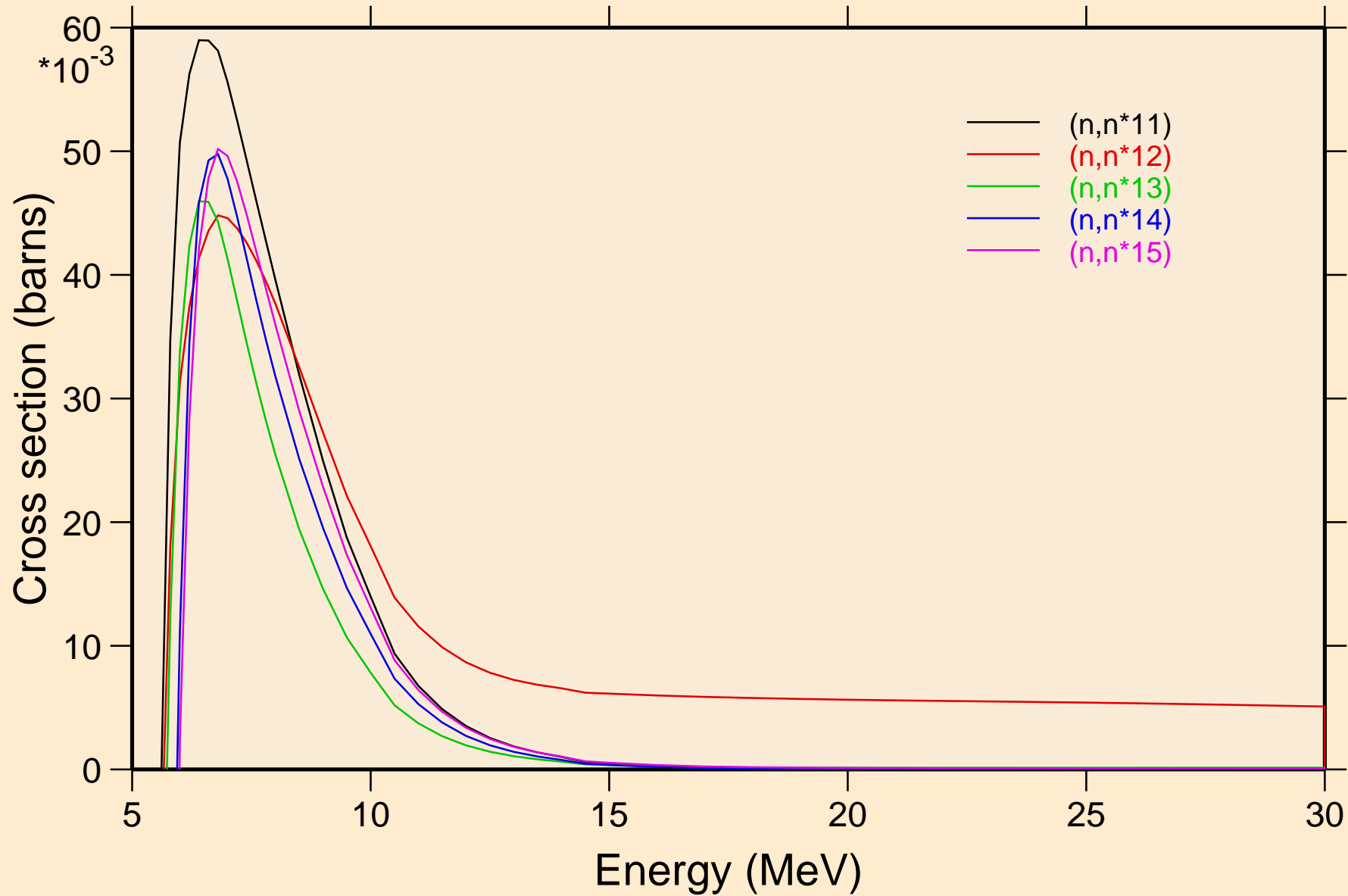

S036 NEUTRON ACER TENDL-2023 LIBRARY; T=0.K  
Inelastic levels

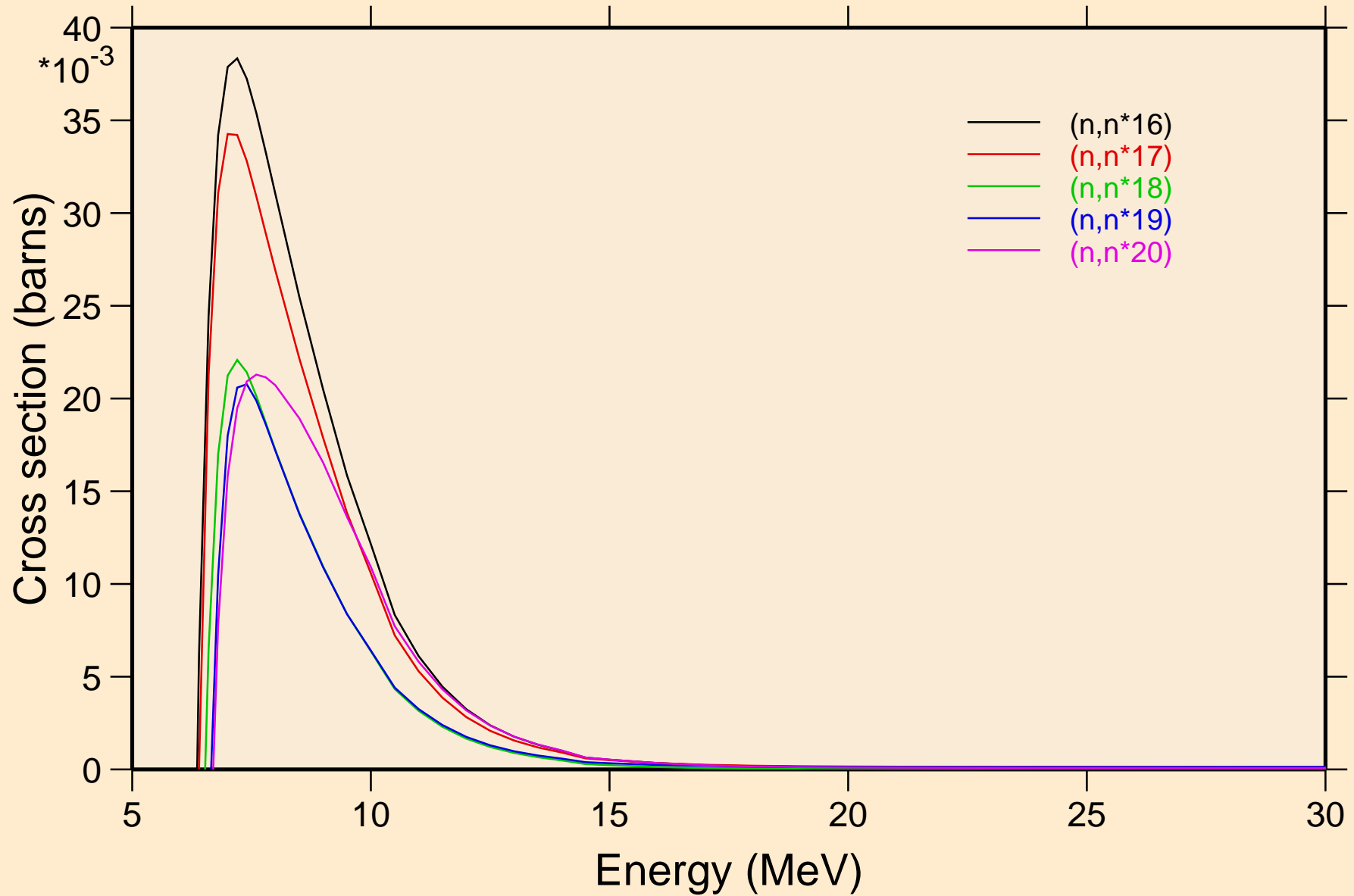

S036 NEUTRON ACER TENDL-2023 LIBRARY; T=0.K  
Threshold reactions

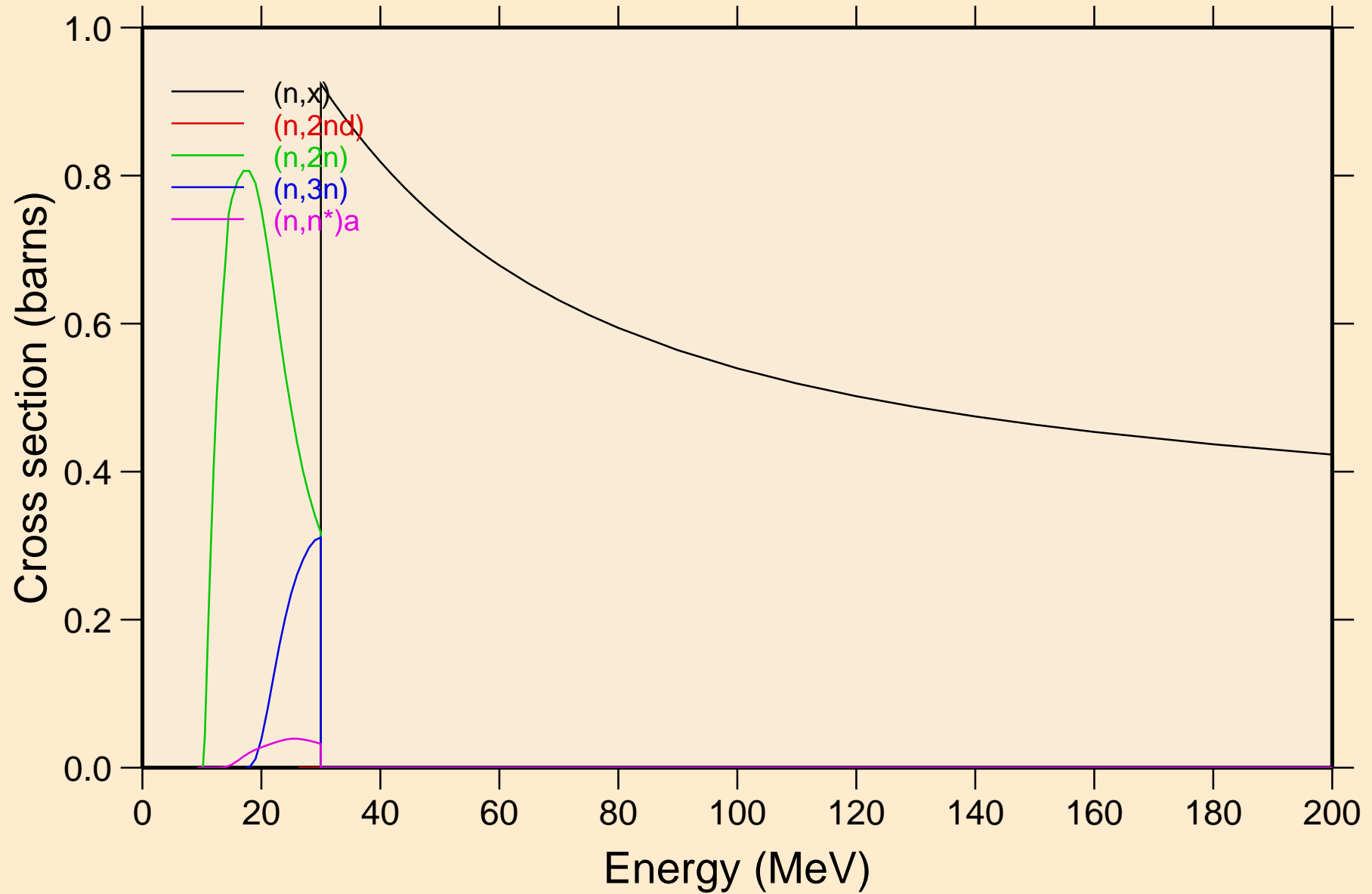

S036 NEUTRON ACER TENDL-2023 LIBRARY; T=0.K  
Threshold reactions

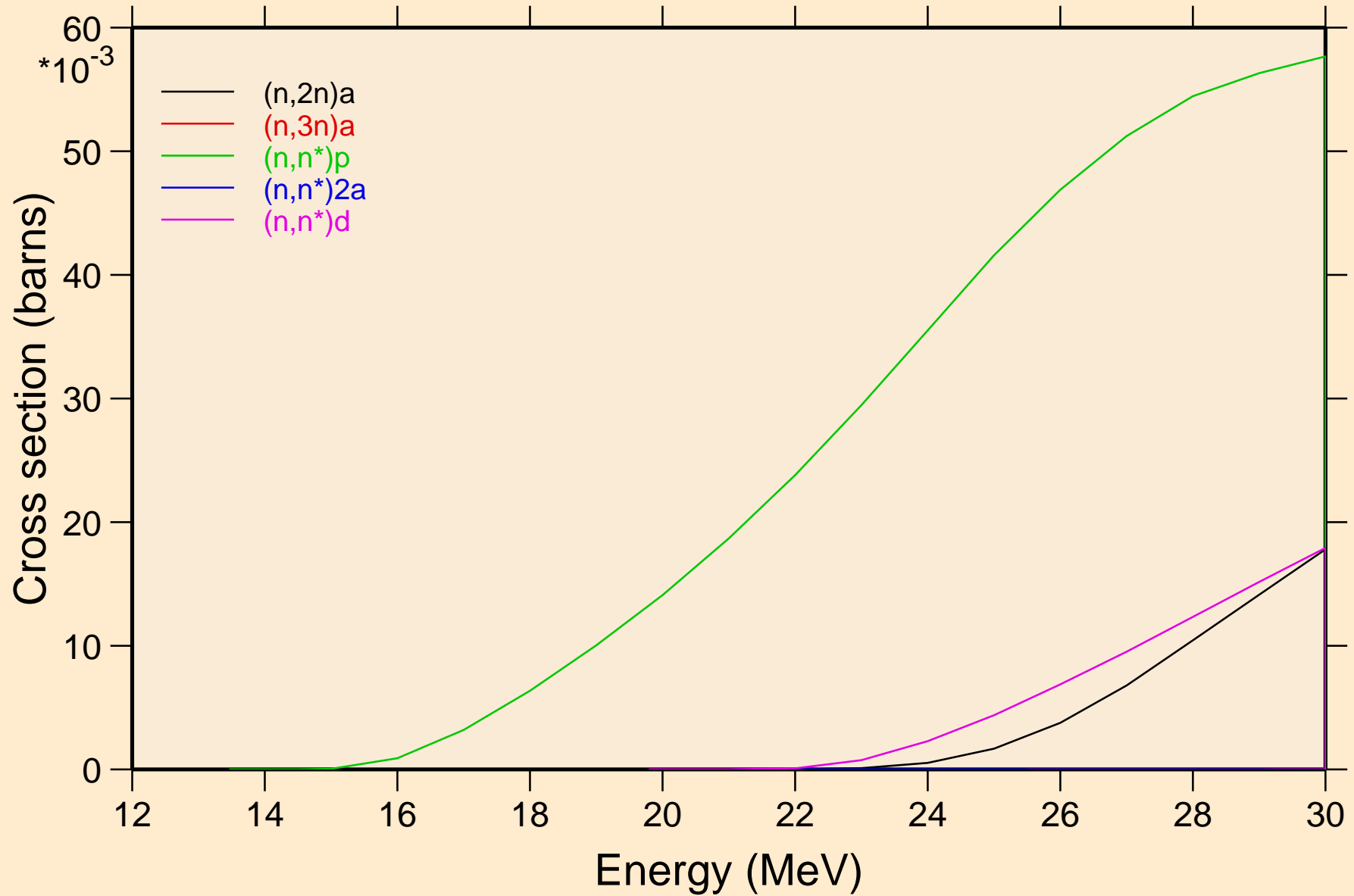

# S036 NEUTRON ACER TENDL-2023 LIBRARY; T=0.K

## Threshold reactions

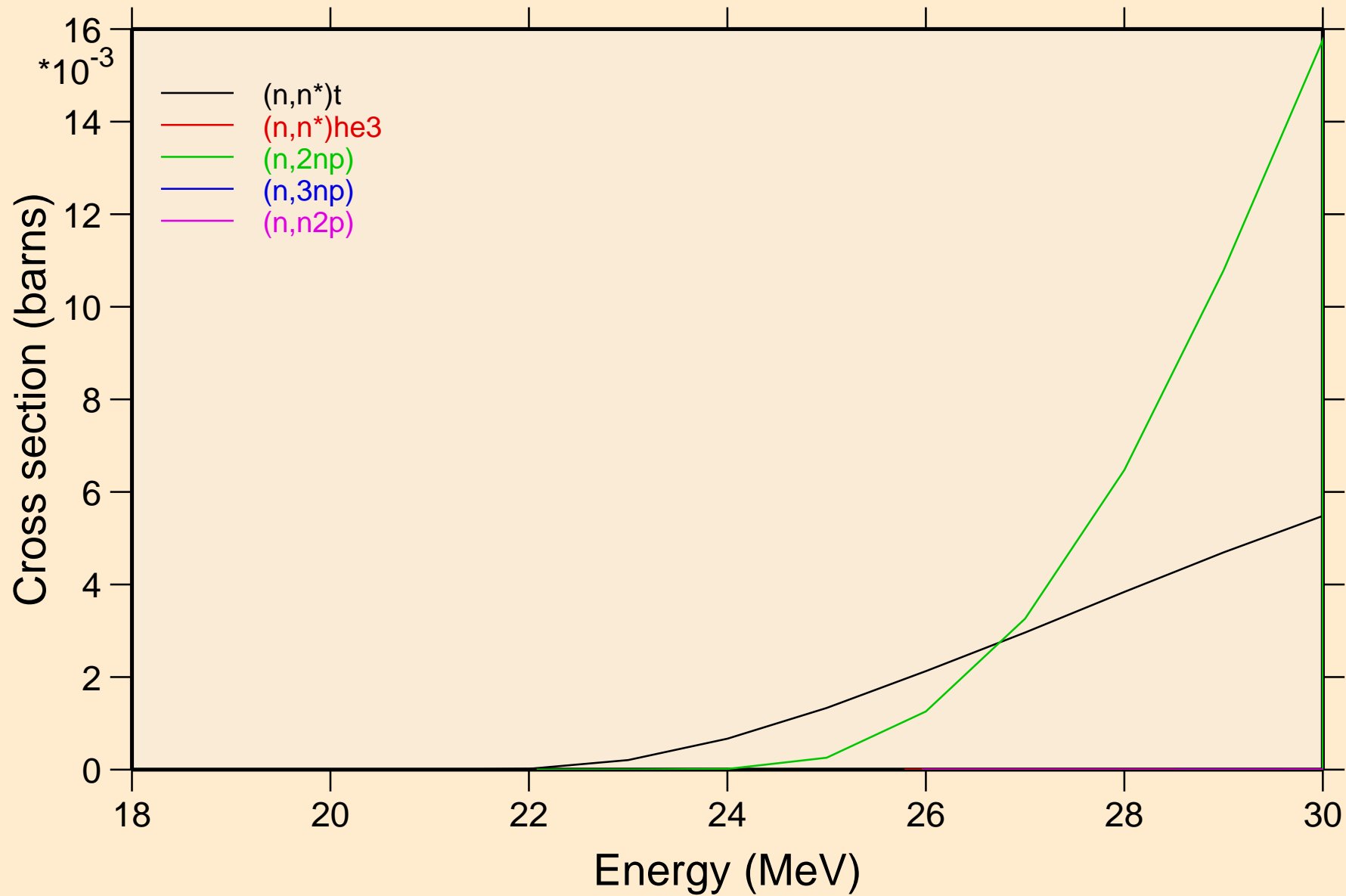

# S036 NEUTRON ACER TENDL-2023 LIBRARY; T=0.K

## Threshold reactions

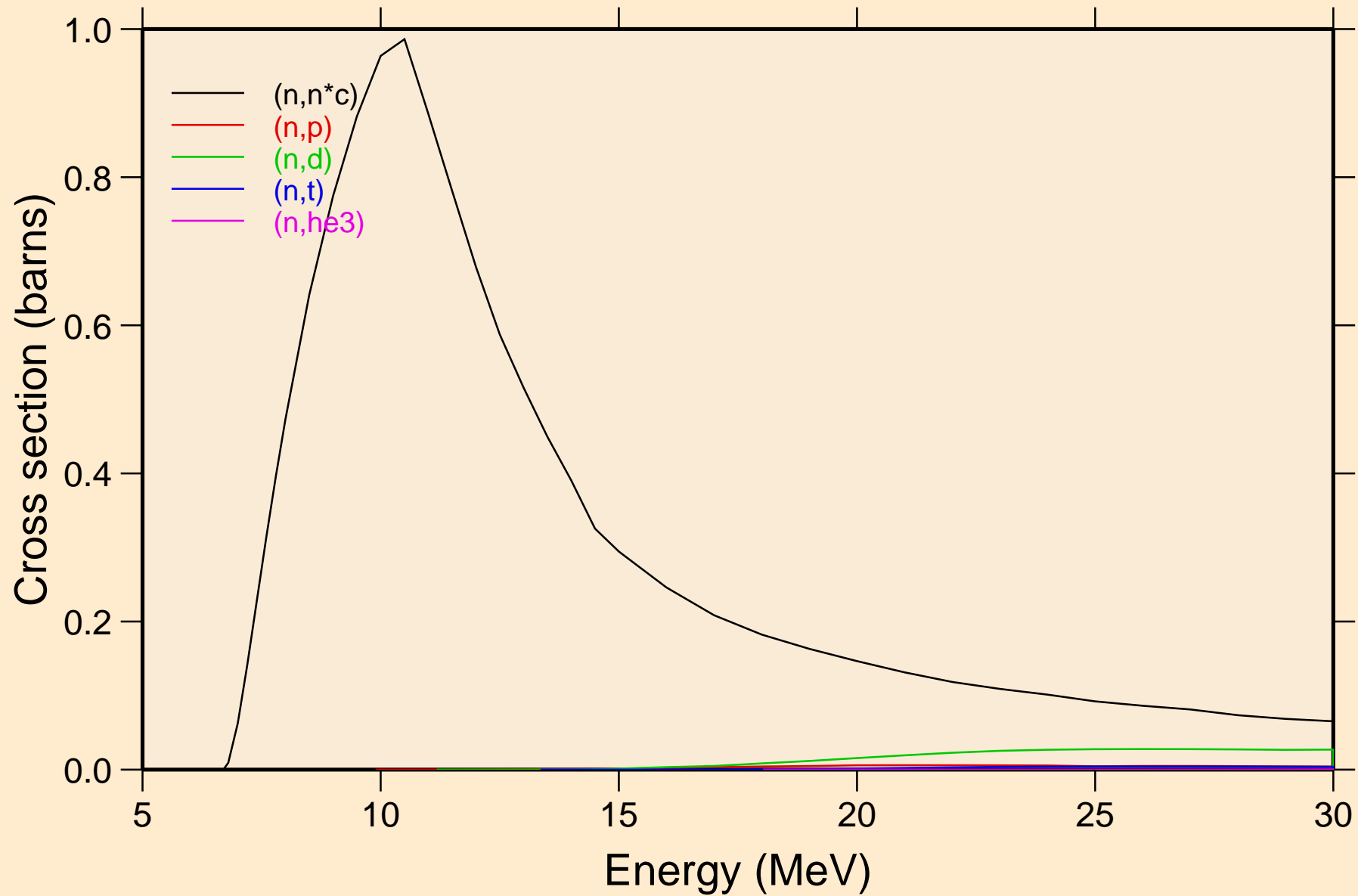



# S036 NEUTRON ACER TENDL-2023 LIBRARY; T=0.K

## Threshold reactions

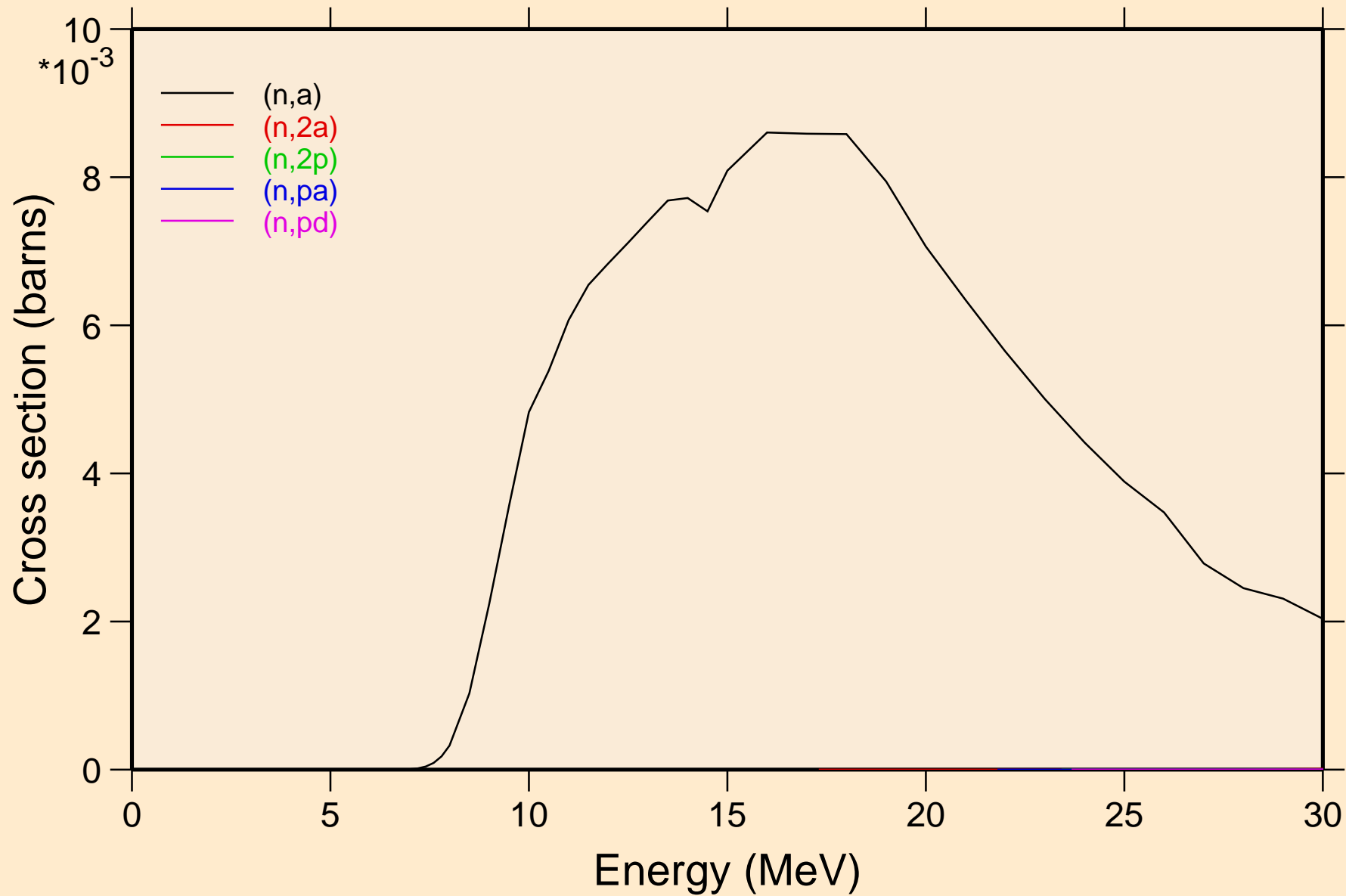

S036 NEUTRON ACER TENDL-2023 LIBRARY; T=0.K  
Threshold reactions

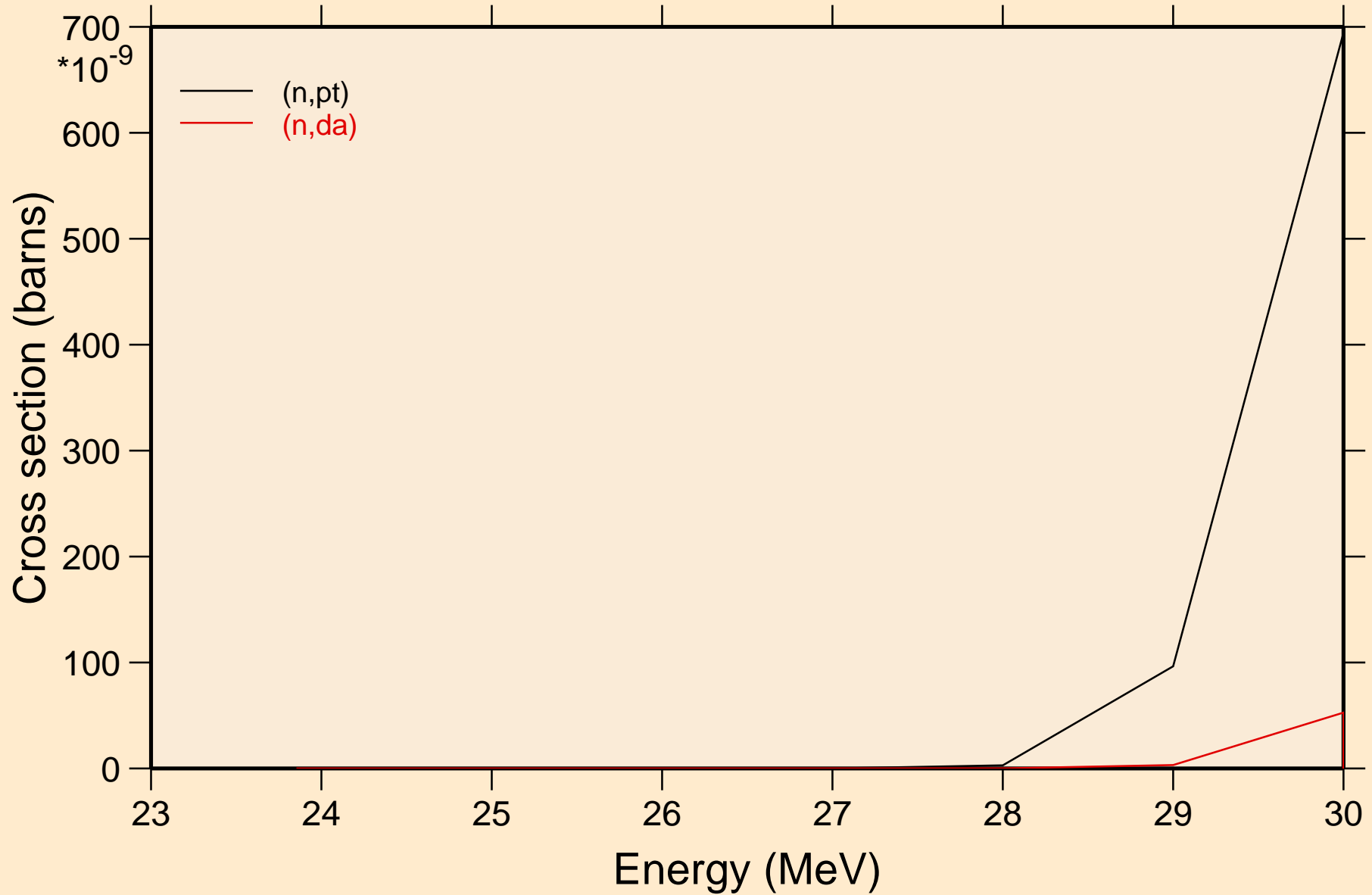

S036 NEUTRON ACER TENDL-2023 LIBRARY; T=0.K  
Threshold reactions

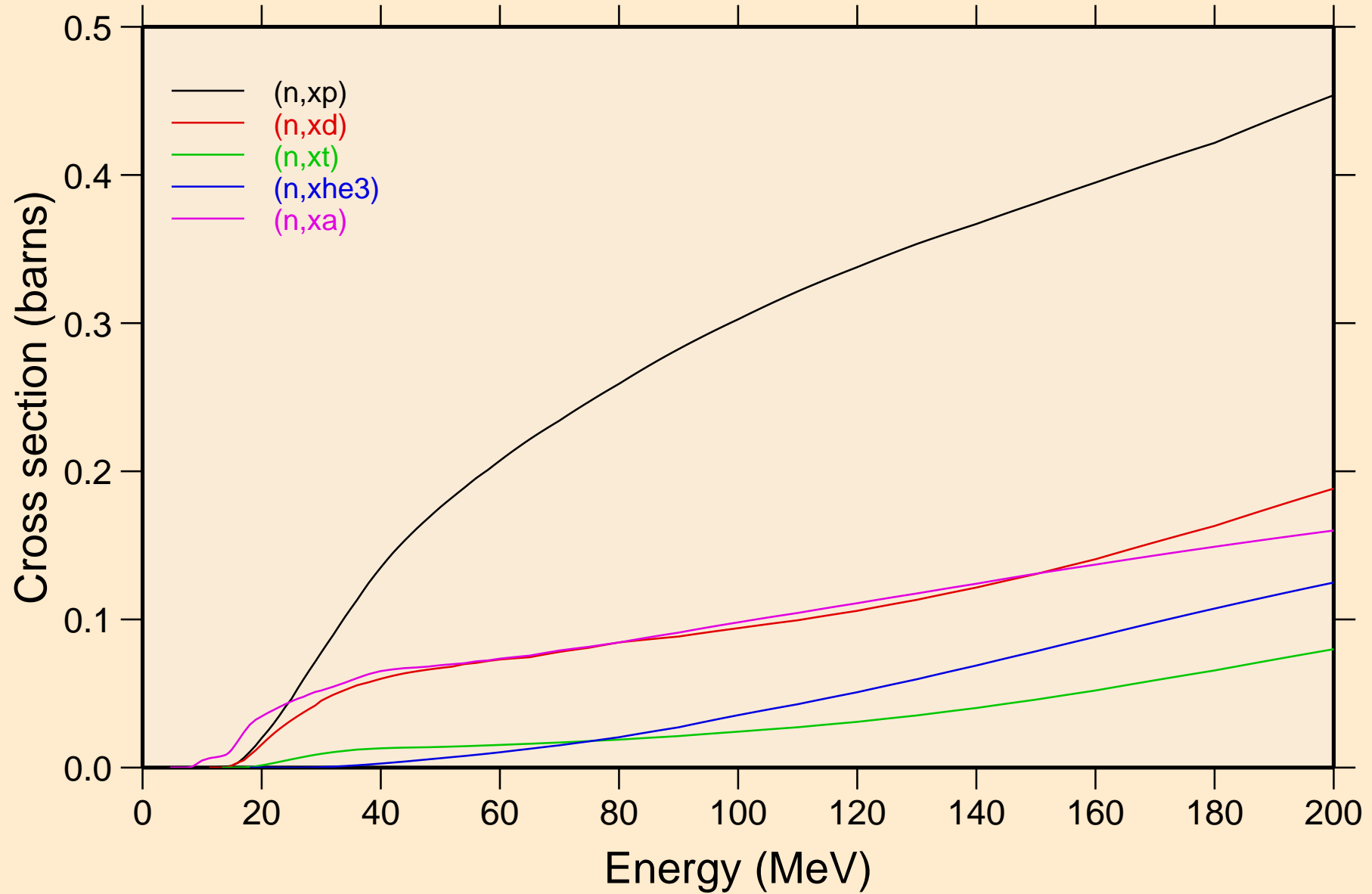

S036 NEUTRON ACER TENDL-2023 LIBRARY; T=0.K  
angular distribution for elastic

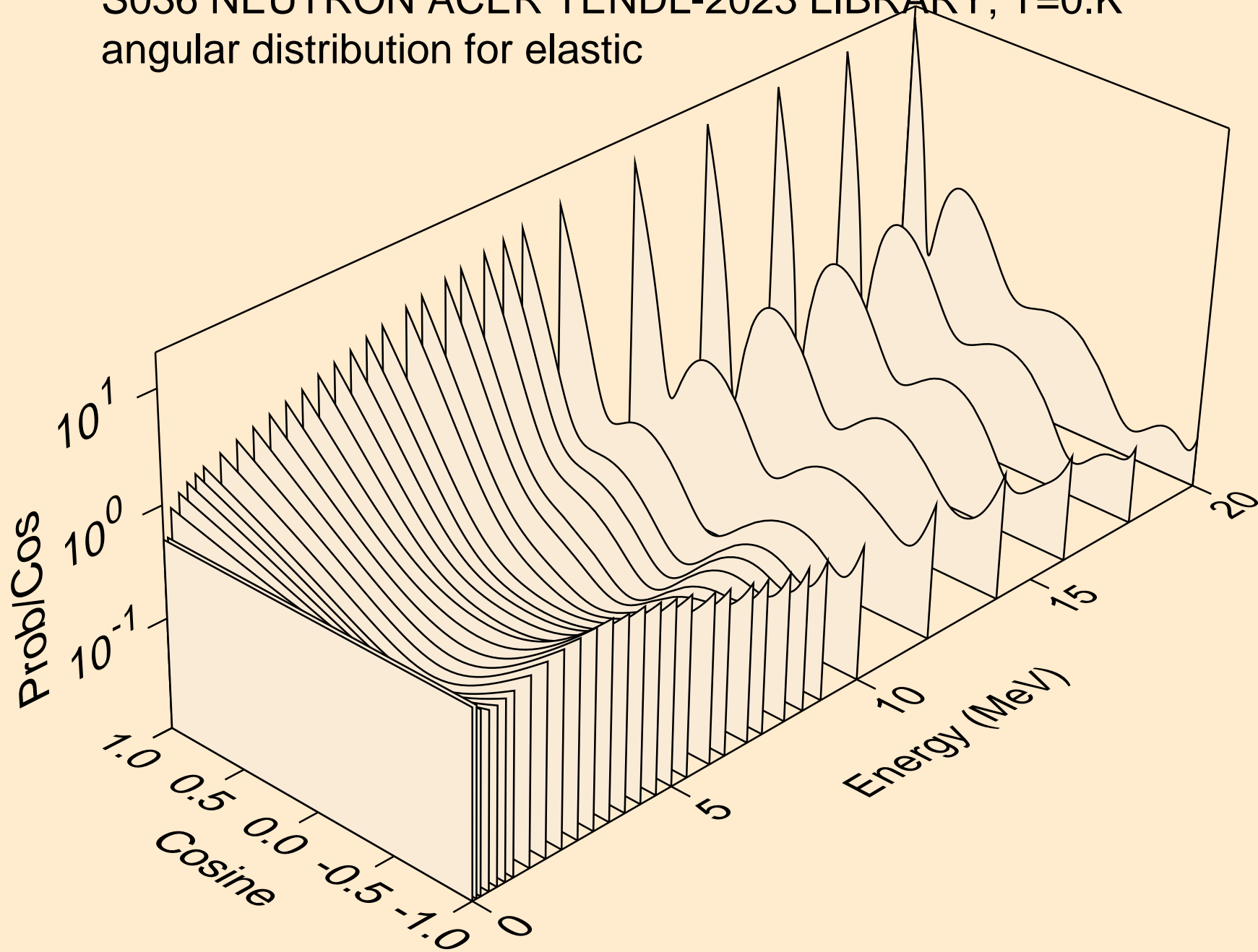

S036 NEUTRON ACER TENDL-2023 LIBRARY; T=0.K  
angular distribution for elastic

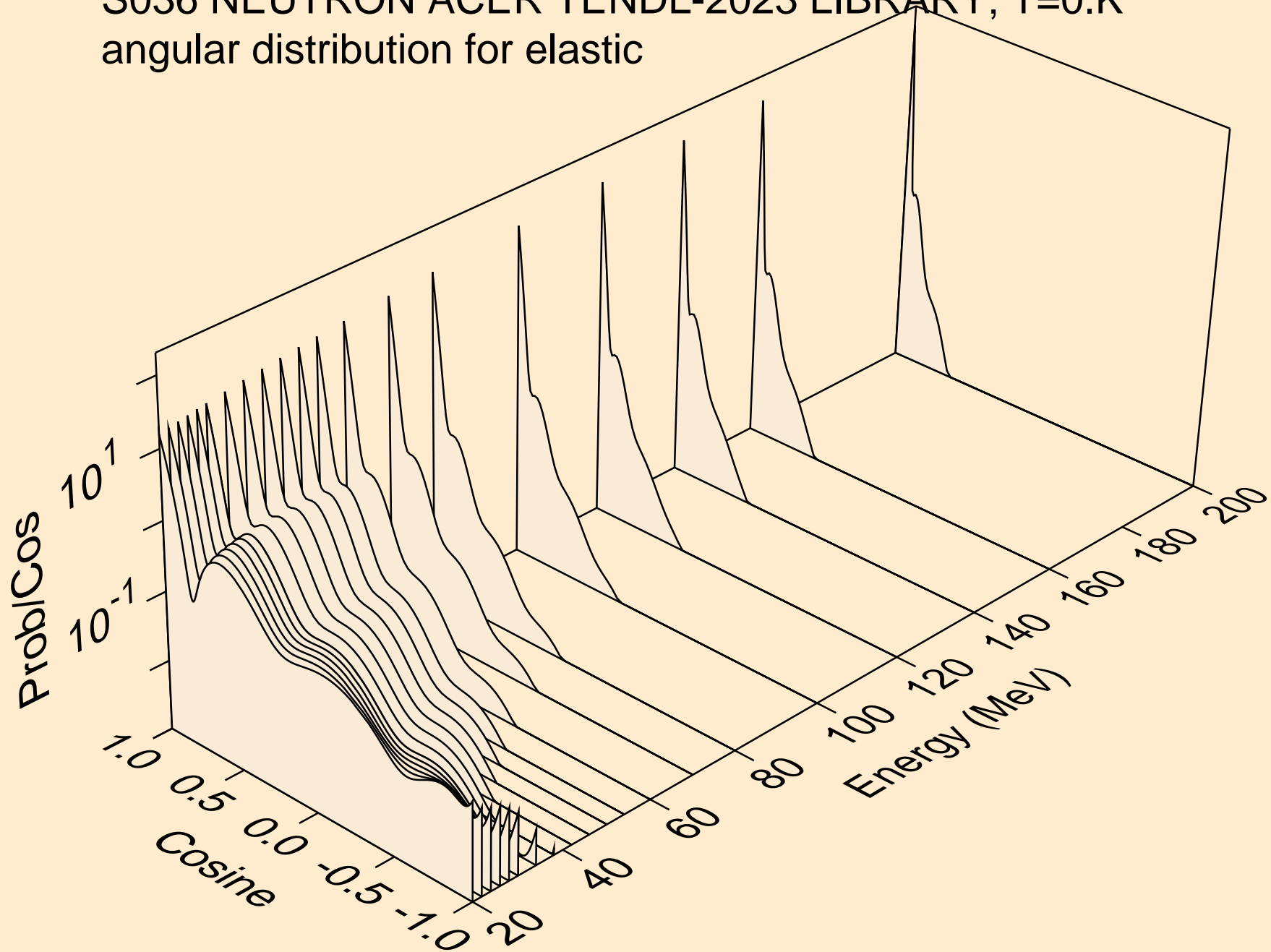

S036 NEUTRON ACER TENDL-2023 LIBRARY; T=0.K  
angular distribution for (n,n\*1)

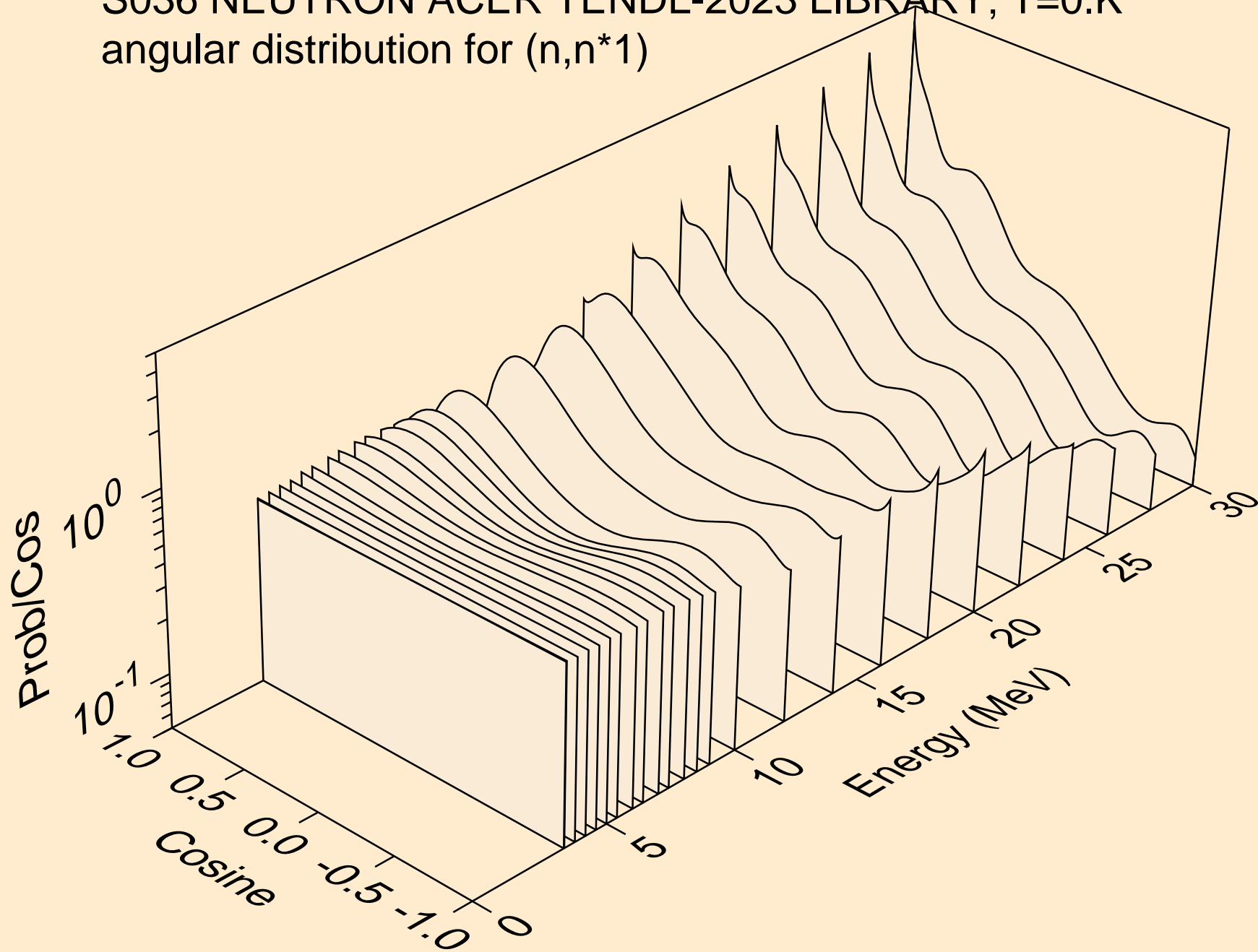

S036 NEUTRON ACER TENDL-2023 LIBRARY; T=0.K  
angular distribution for (n,n\*2)

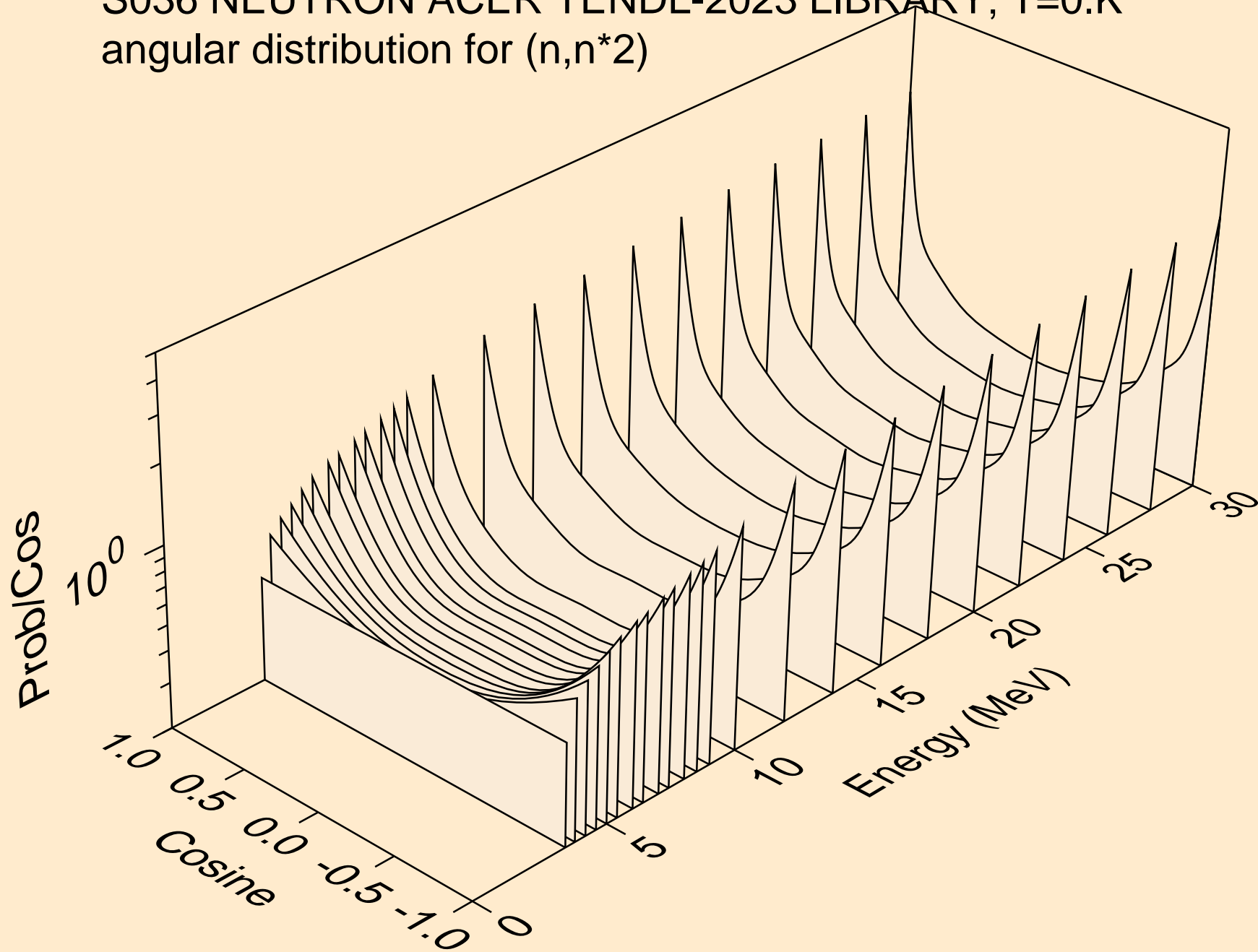

S036 NEUTRON ACER TENDL-2023 LIBRARY; T=0.K  
angular distribution for (n,n\*3)

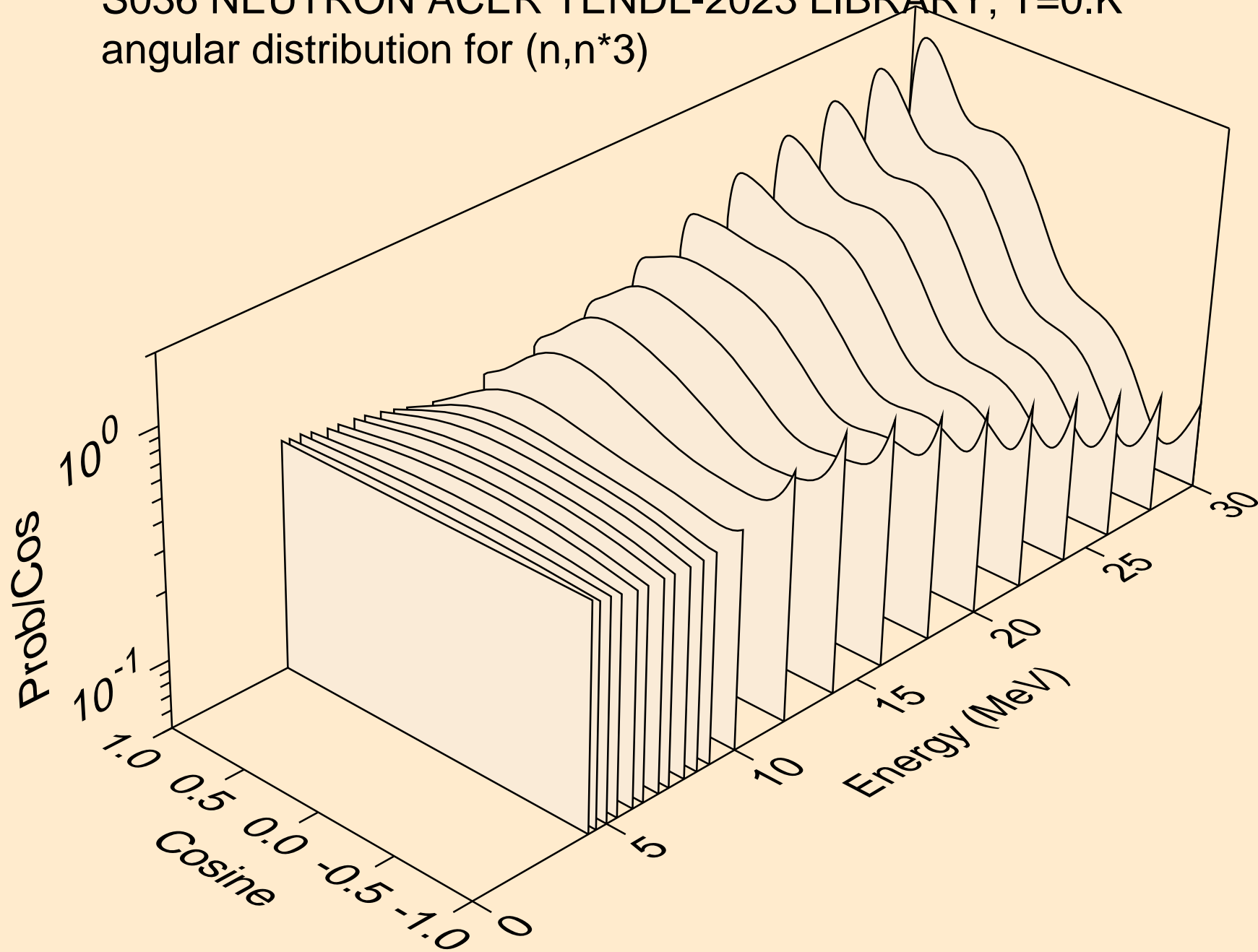



S036 NEUTRON ACER TENDL-2023 LIBRARY; T=0.K  
angular distribution for (n,n\*4)

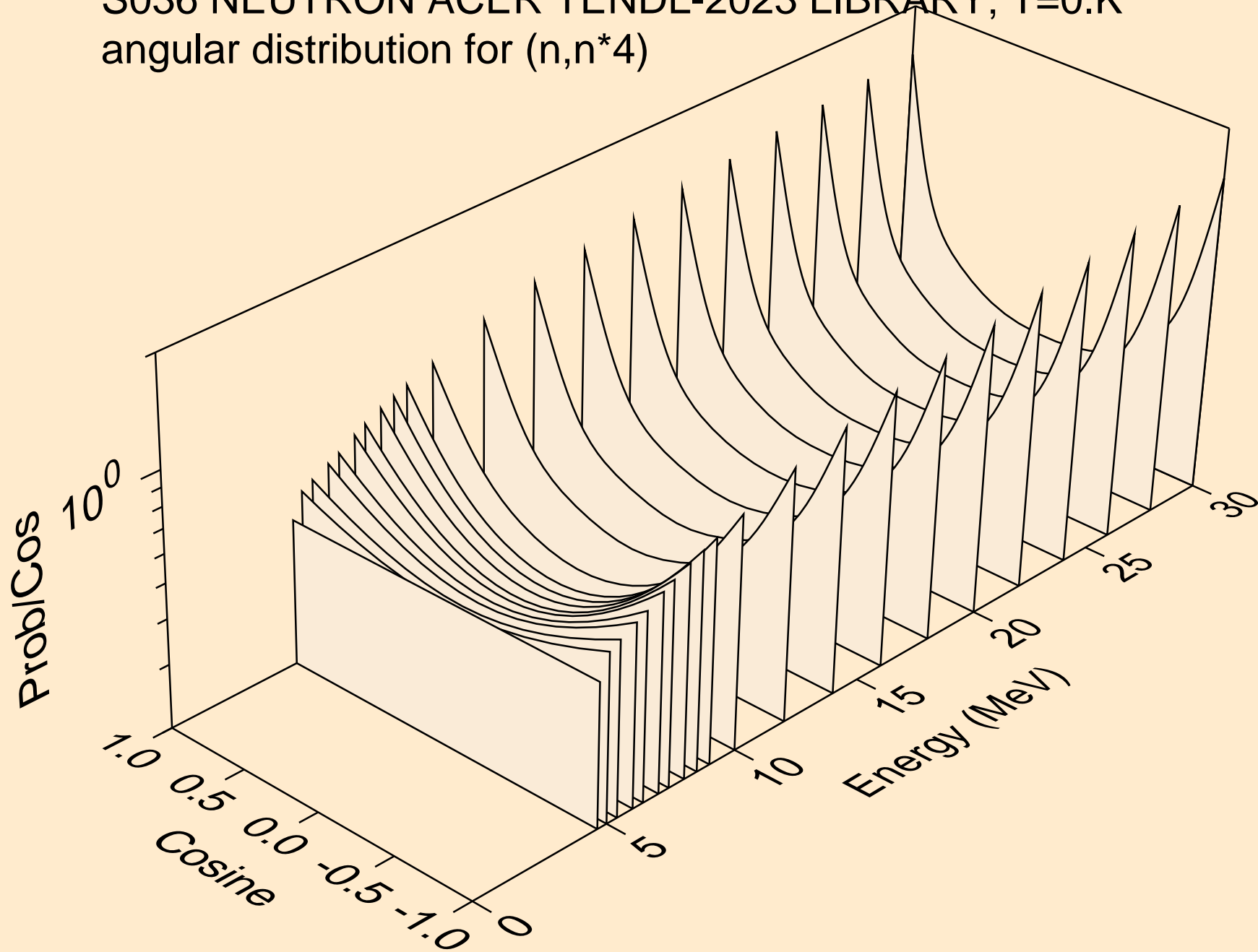

S036 NEUTRON ACER TENDL-2023 LIBRARY; T=0.K  
angular distribution for (n,n\*5)

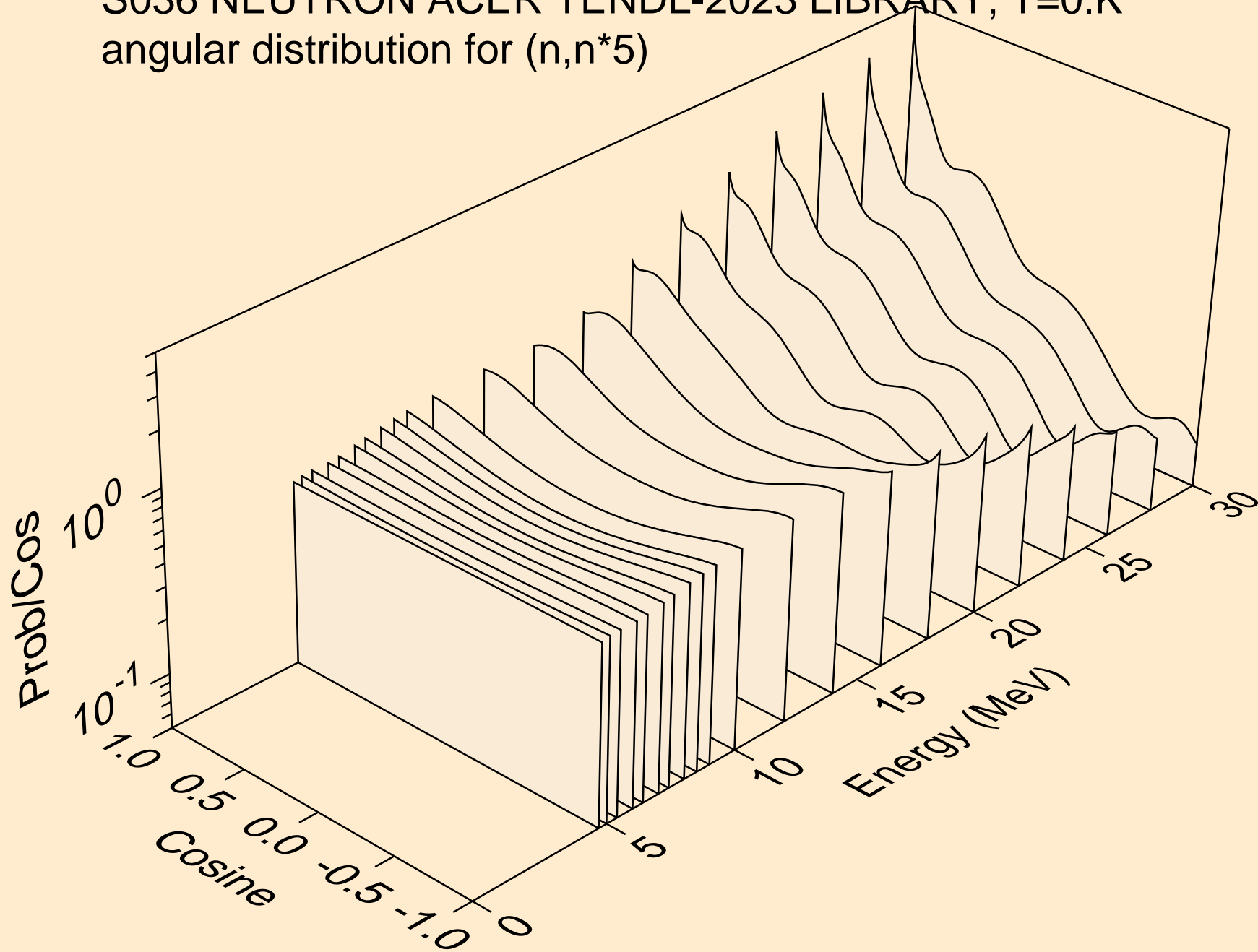

S036 NEUTRON ACER TENDL-2023 LIBRARY; T=0.K  
angular distribution for (n,n\*6)

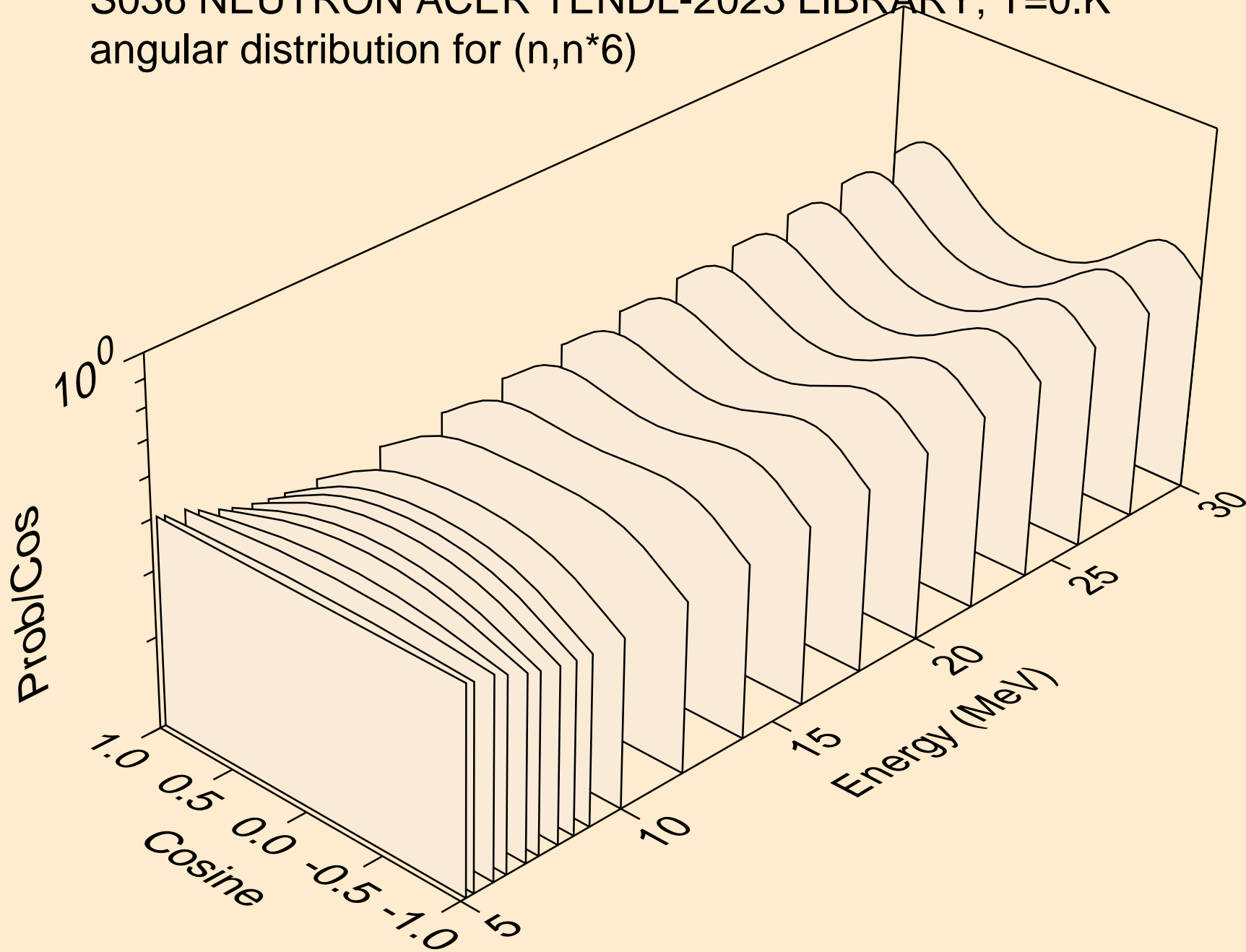

S036 NEUTRON ACER TENDL-2023 LIBRARY; T=0.K  
angular distribution for (n,n\*7)

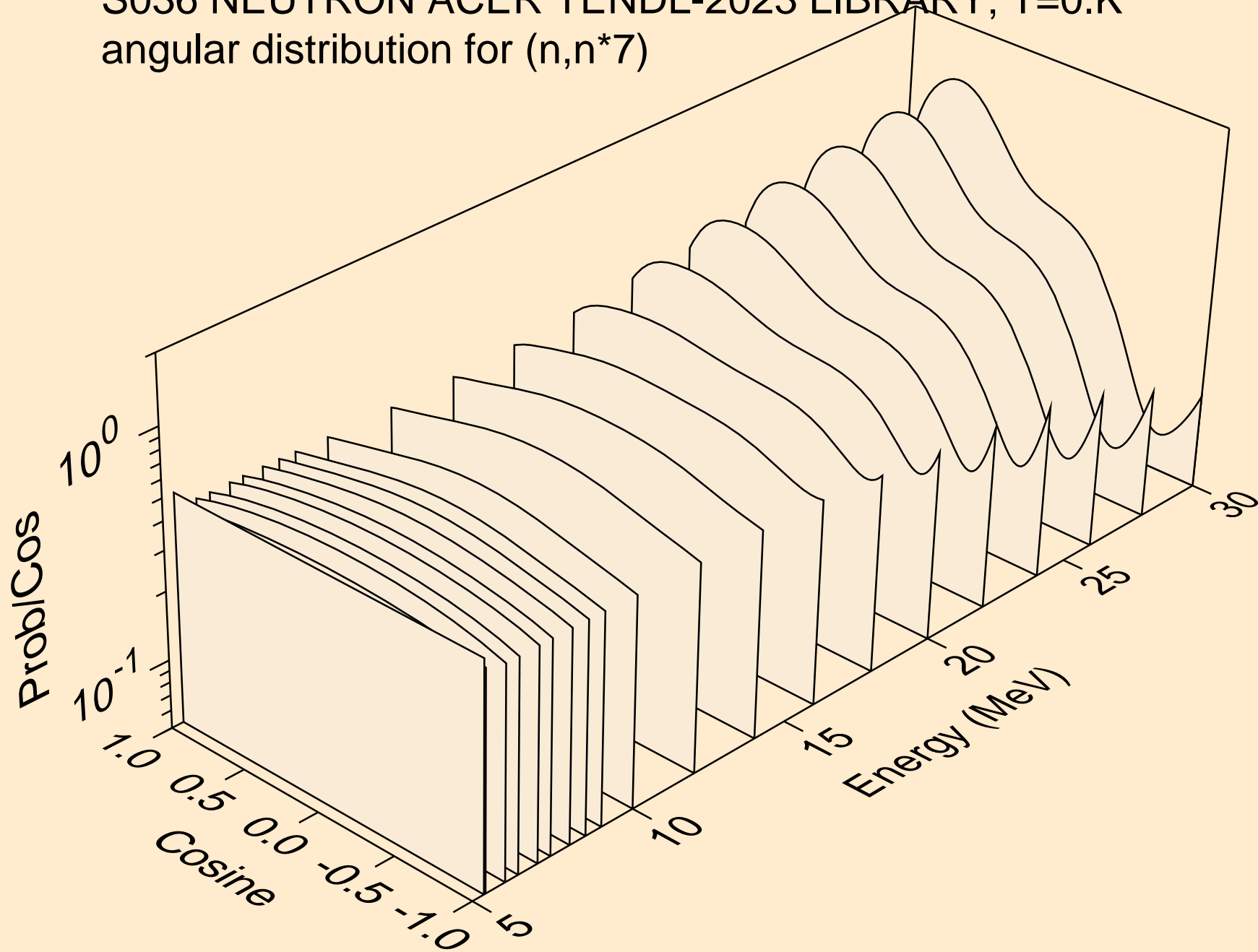

S036 NEUTRON ACER TENDL-2023 LIBRARY; T=0.K  
angular distribution for (n,n\*8)

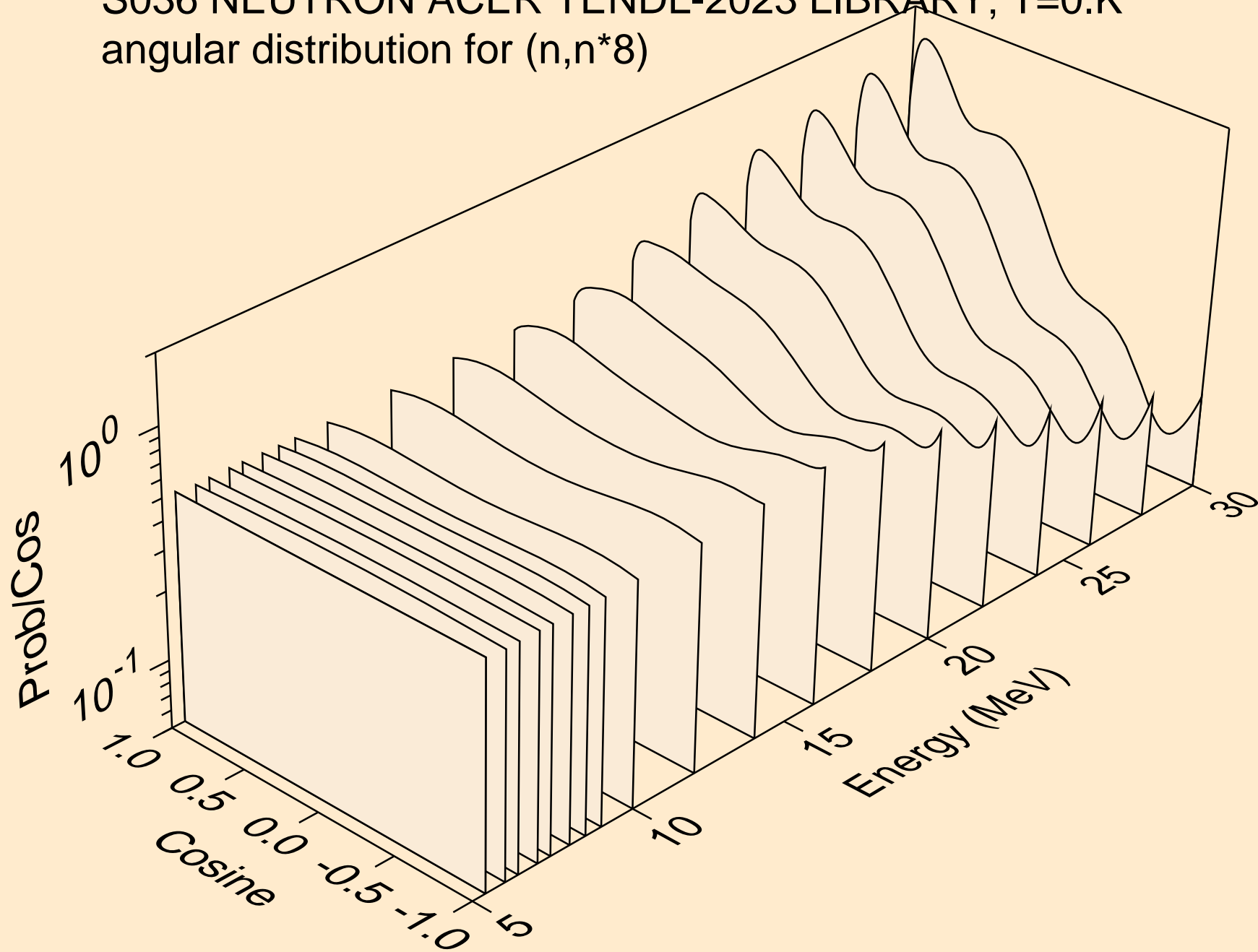

S036 NEUTRON ACER TENDL-2023 LIBRARY; T=0.K  
angular distribution for (n,n\*9)

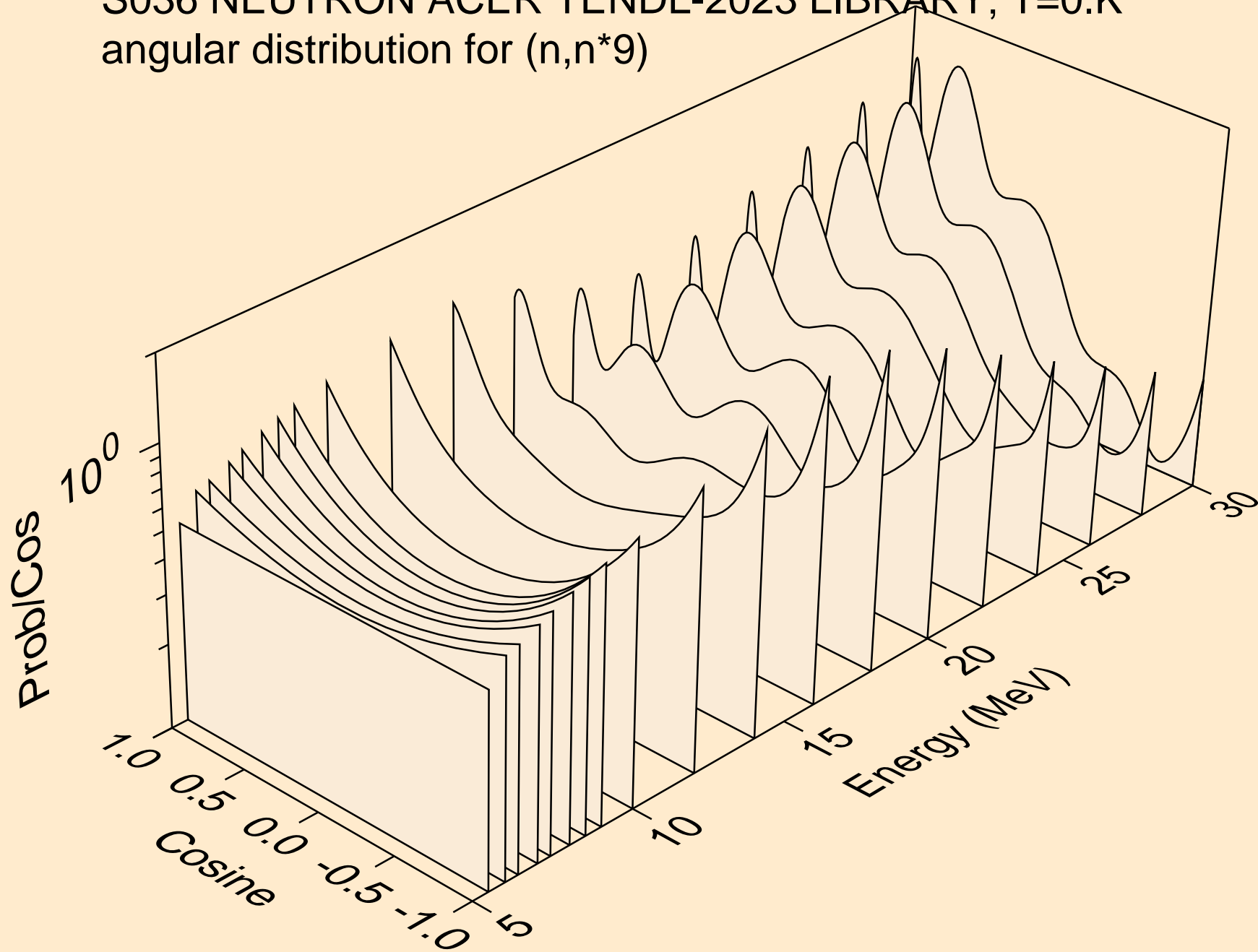

S036 NEUTRON ACER TENDL-2023 LIBRARY; T=0.K  
angular distribution for (n,n\*10)

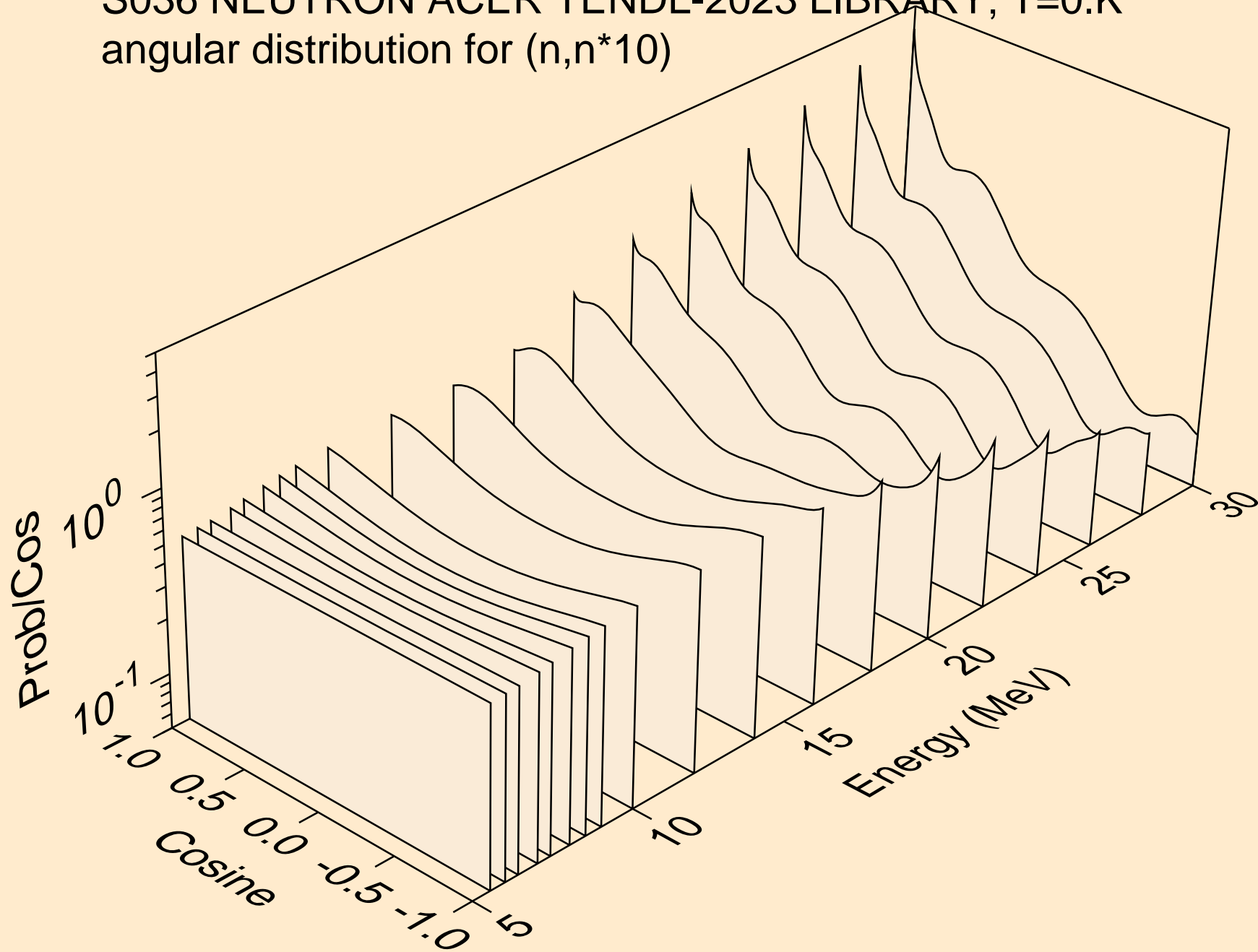

S036 NEUTRON ACER TENDL-2023 LIBRARY; T=0.K  
angular distribution for (n,n\*11)

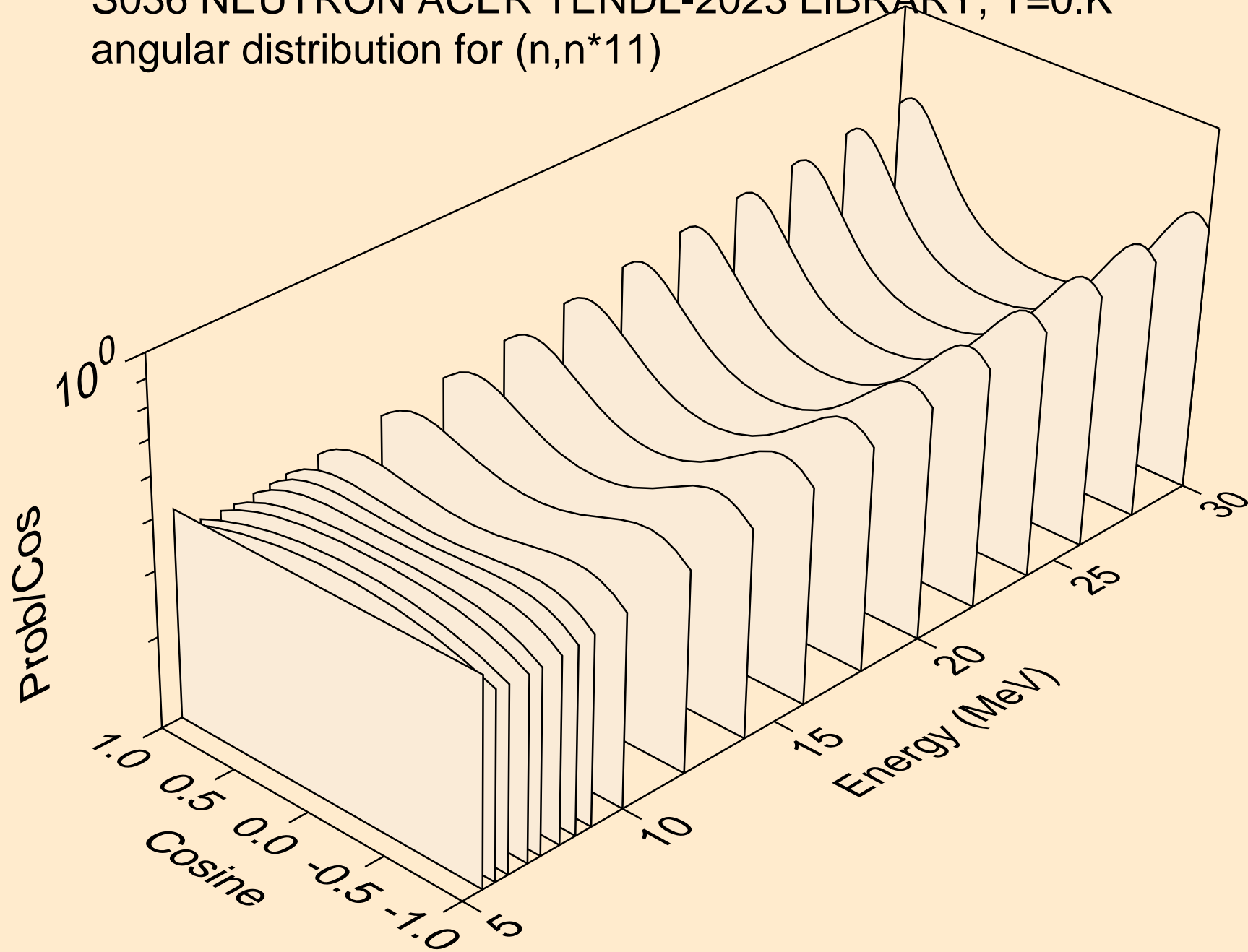



S036 NEUTRON ACER TENDL-2023 LIBRARY; T=0.K  
angular distribution for (n,n\*12)

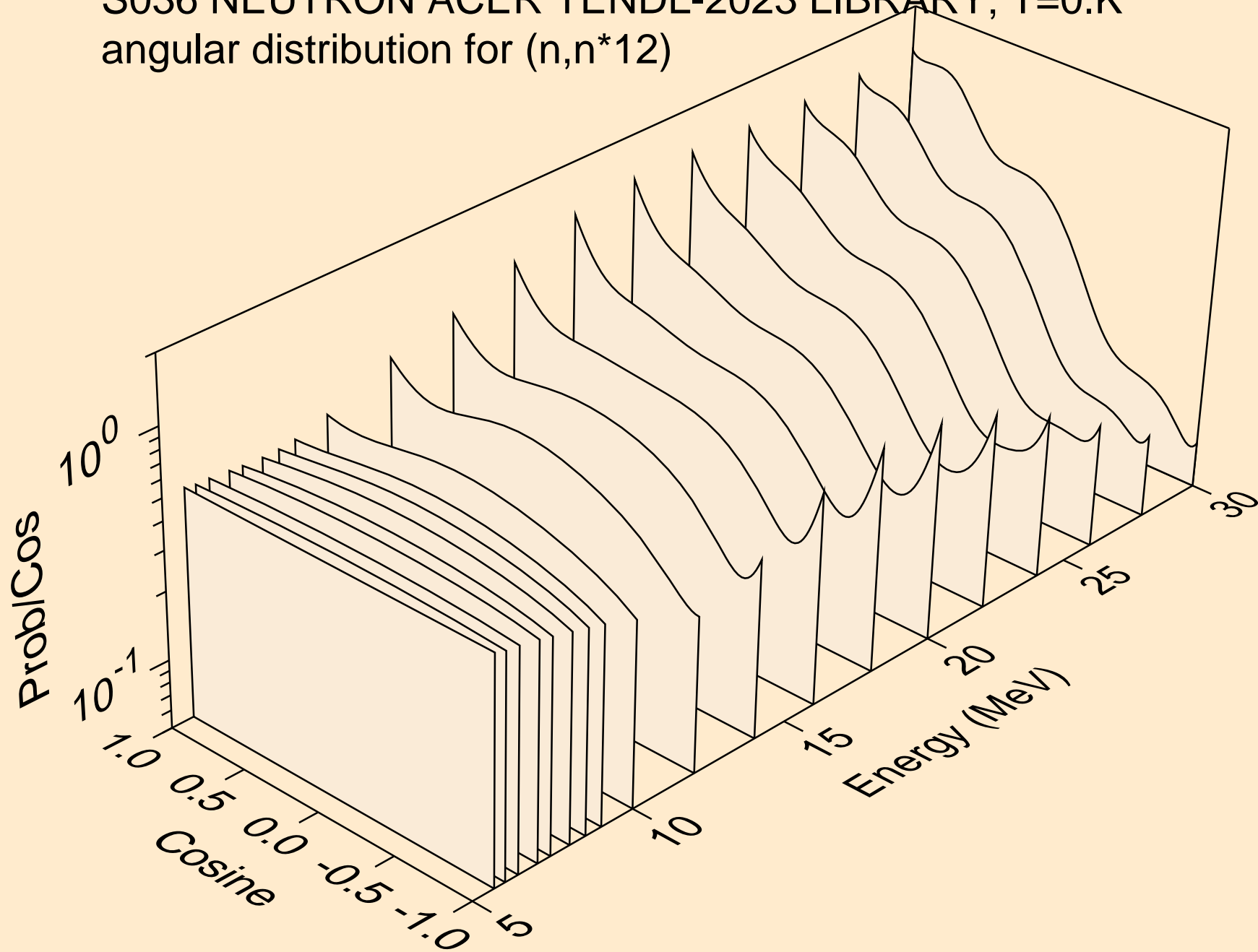

S036 NEUTRON ACER TENDL-2023 LIBRARY; T=0.K  
angular distribution for (n,n\*13)

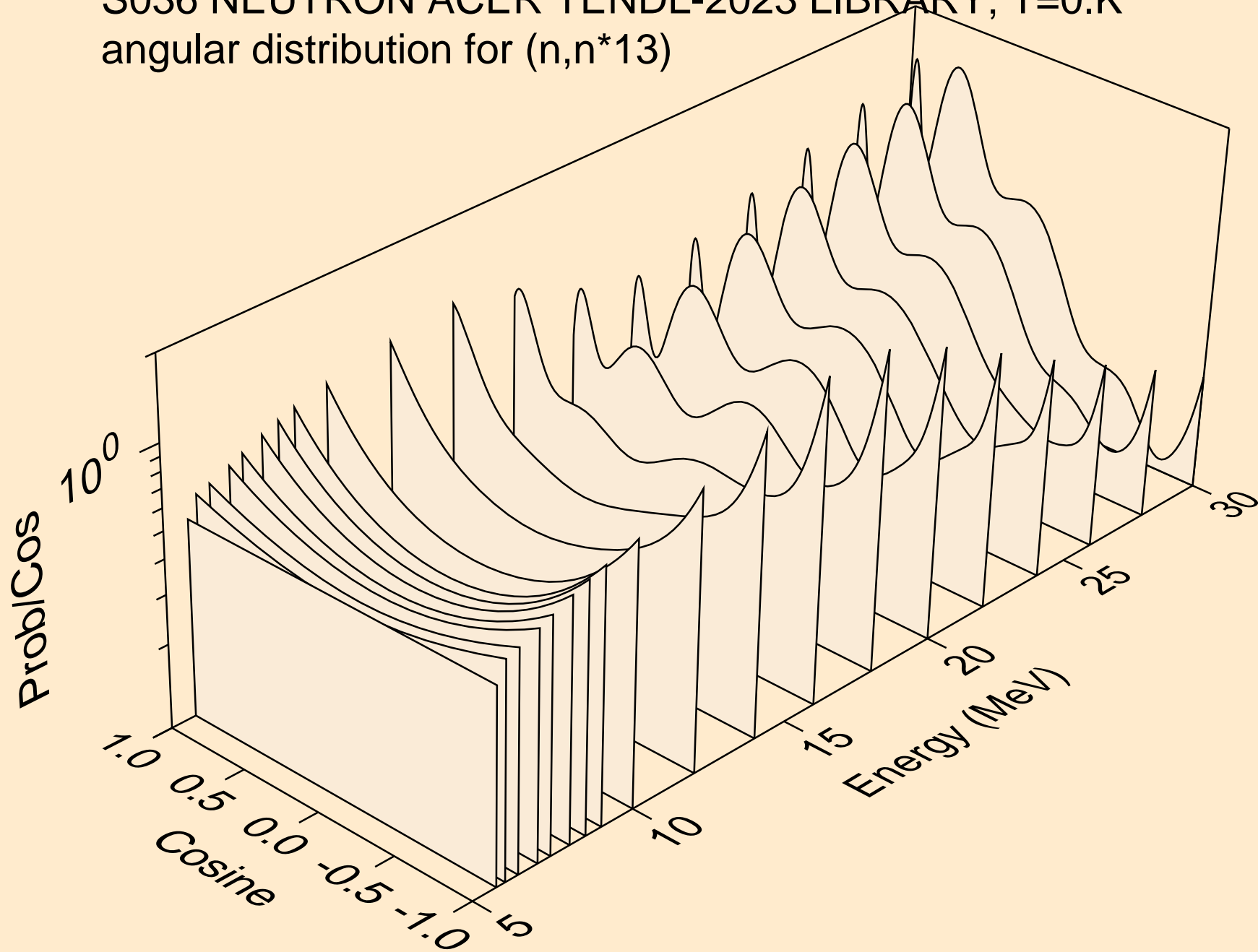

S036 NEUTRON ACER TENDL-2023 LIBRARY; T=0.K  
angular distribution for (n,n\*14)

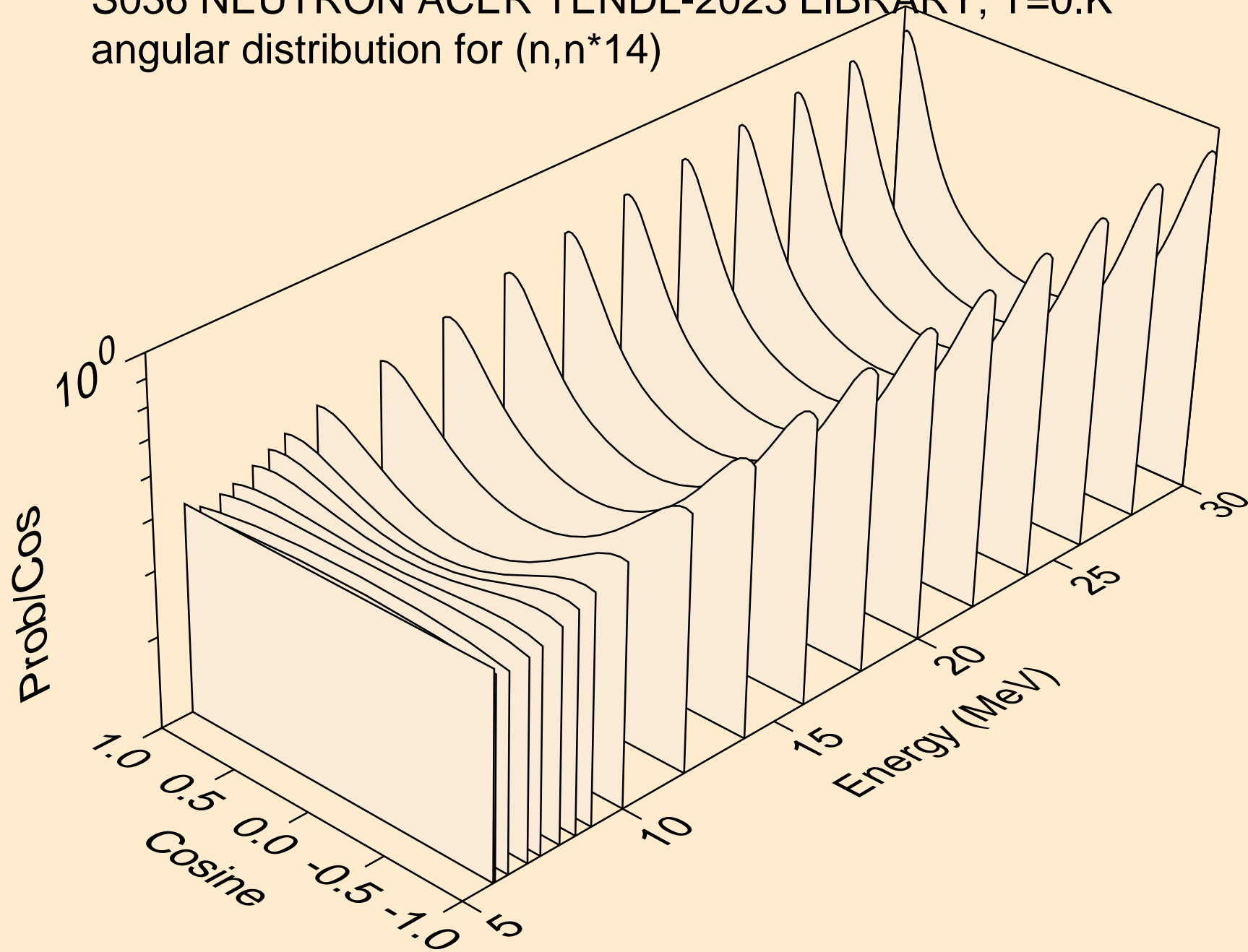

S036 NEUTRON ACER TENDL-2023 LIBRARY; T=0.K  
angular distribution for (n,n\*15)

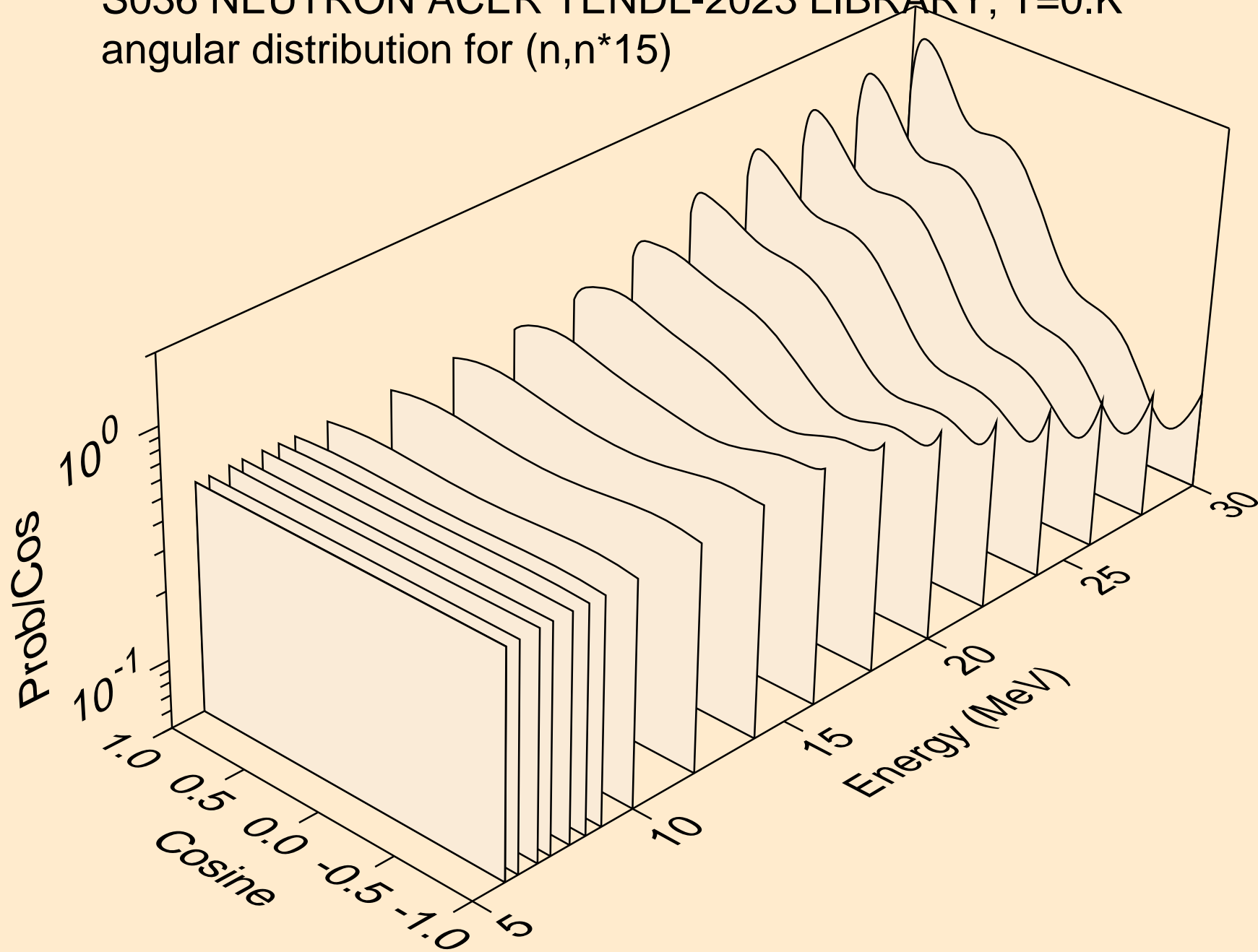

S036 NEUTRON ACER TENDL-2023 LIBRARY; T=0.K  
angular distribution for (n,n\*16)

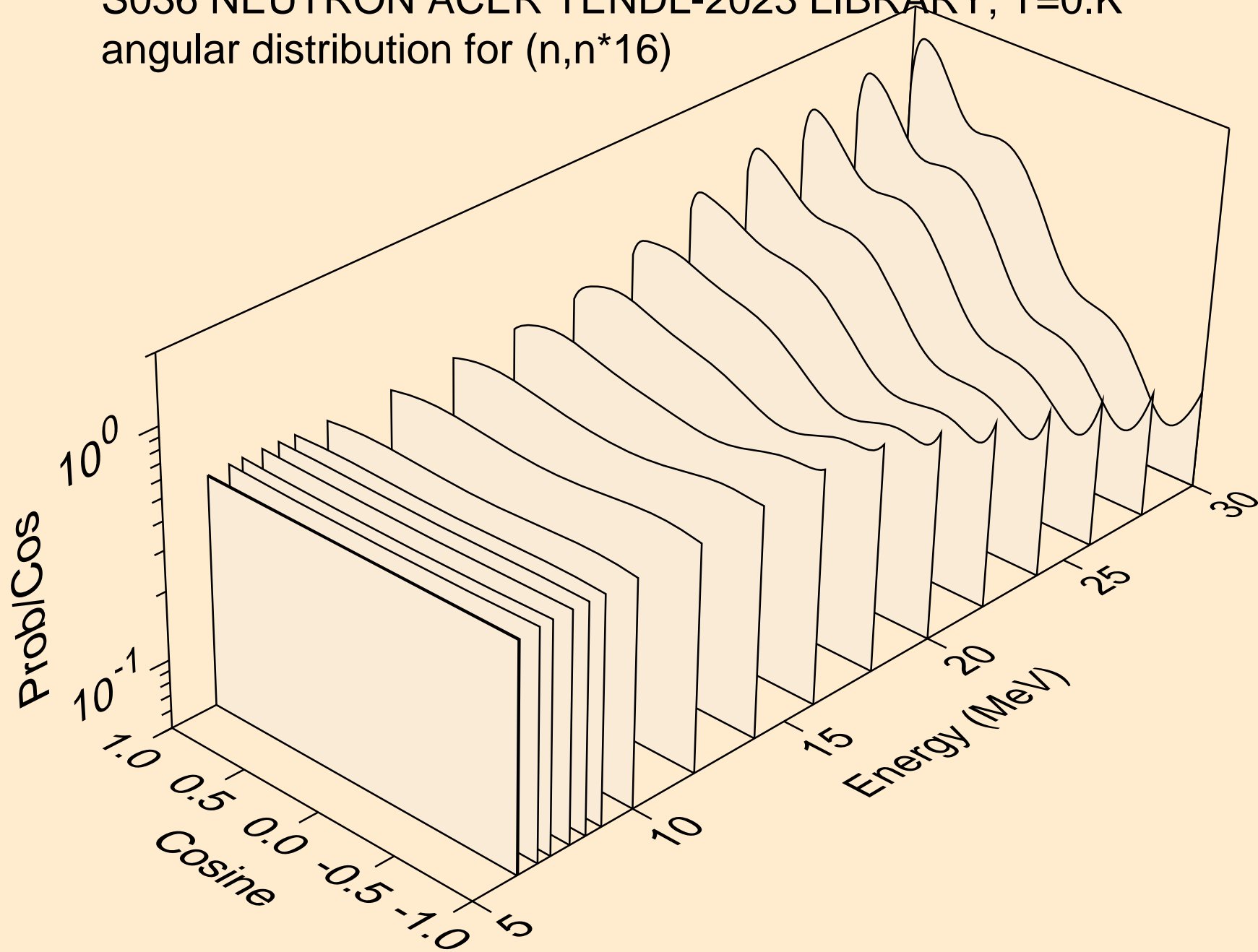

S036 NEUTRON ACER TENDL-2023 LIBRARY; T=0.K  
angular distribution for (n,n\*17)

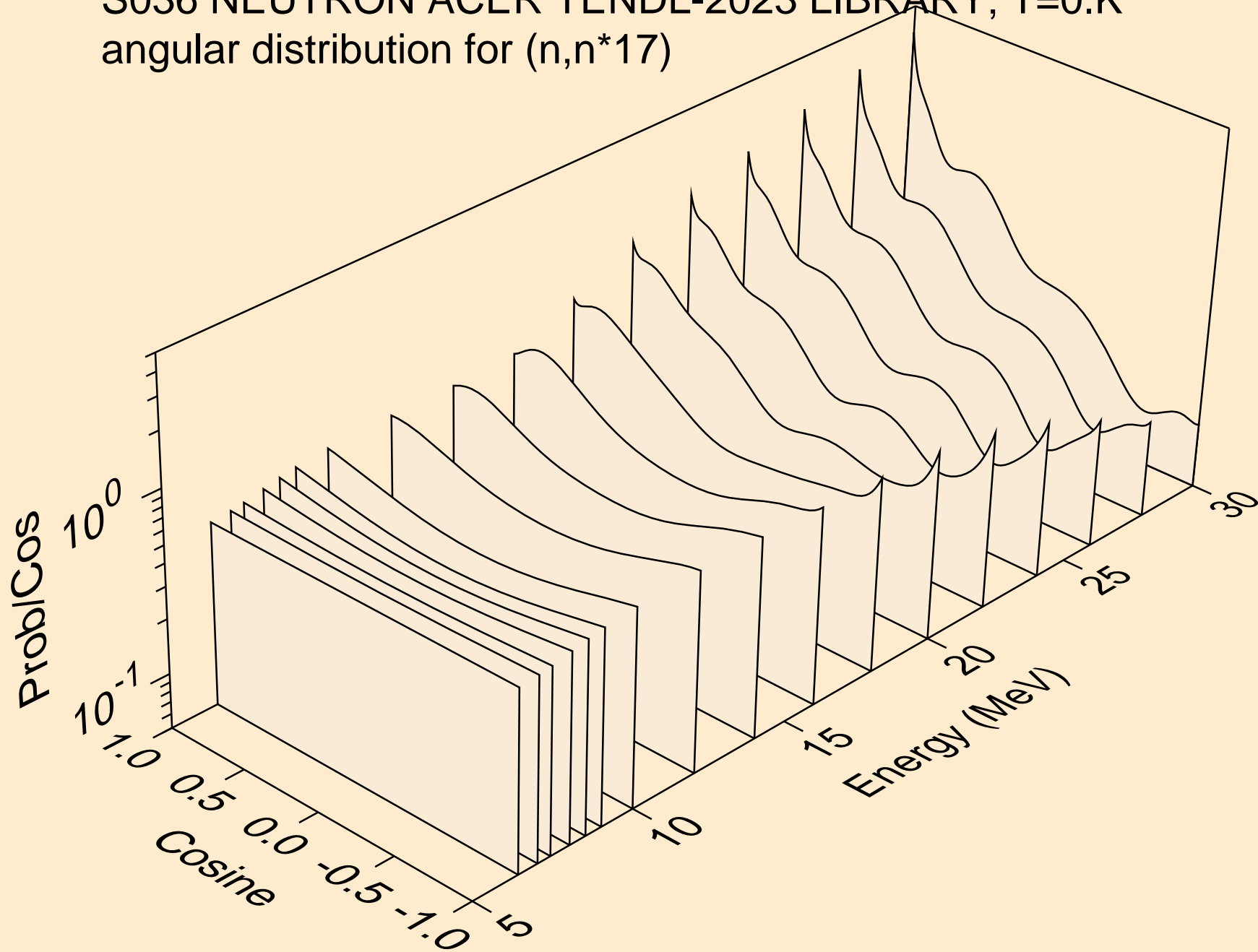

S036 NEUTRON ACER TENDL-2023 LIBRARY; T=0.K  
angular distribution for (n,n\*18)

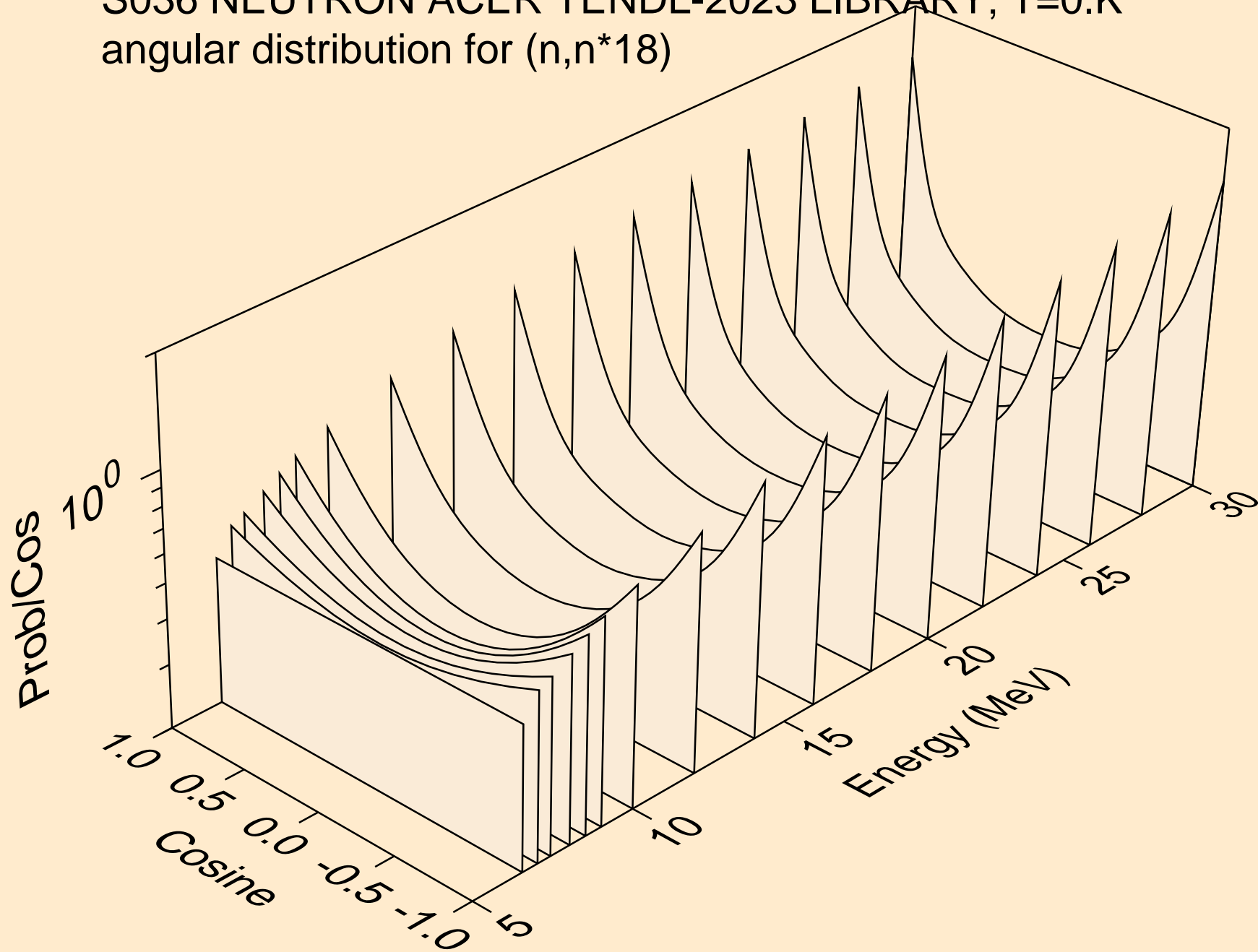

S036 NEUTRON ACER TENDL-2023 LIBRARY; T=0.K  
angular distribution for (n,n\*19)

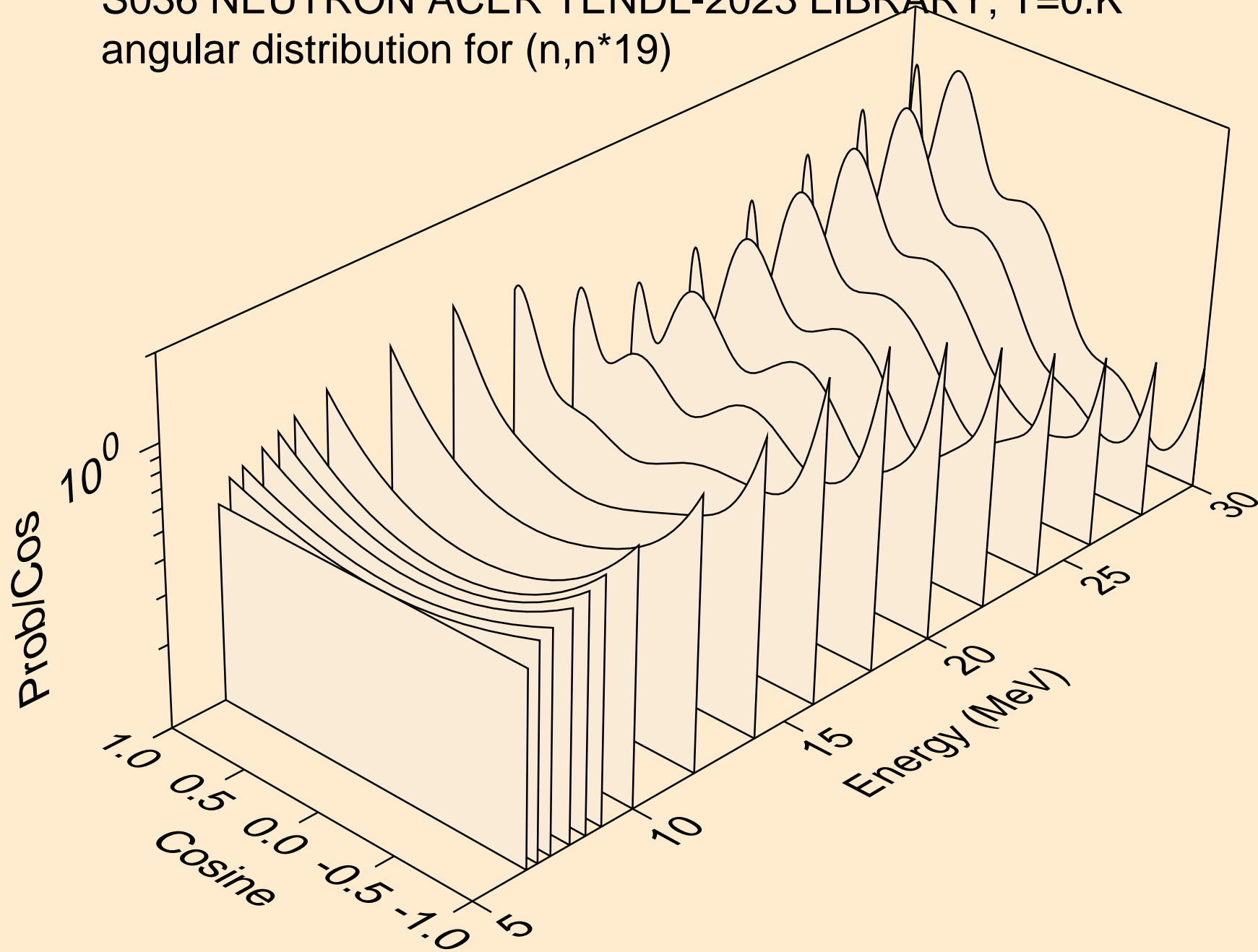



S036 NEUTRON ACER TENDL-2023 LIBRARY; T=0.K  
angular distribution for (n,n\*20)

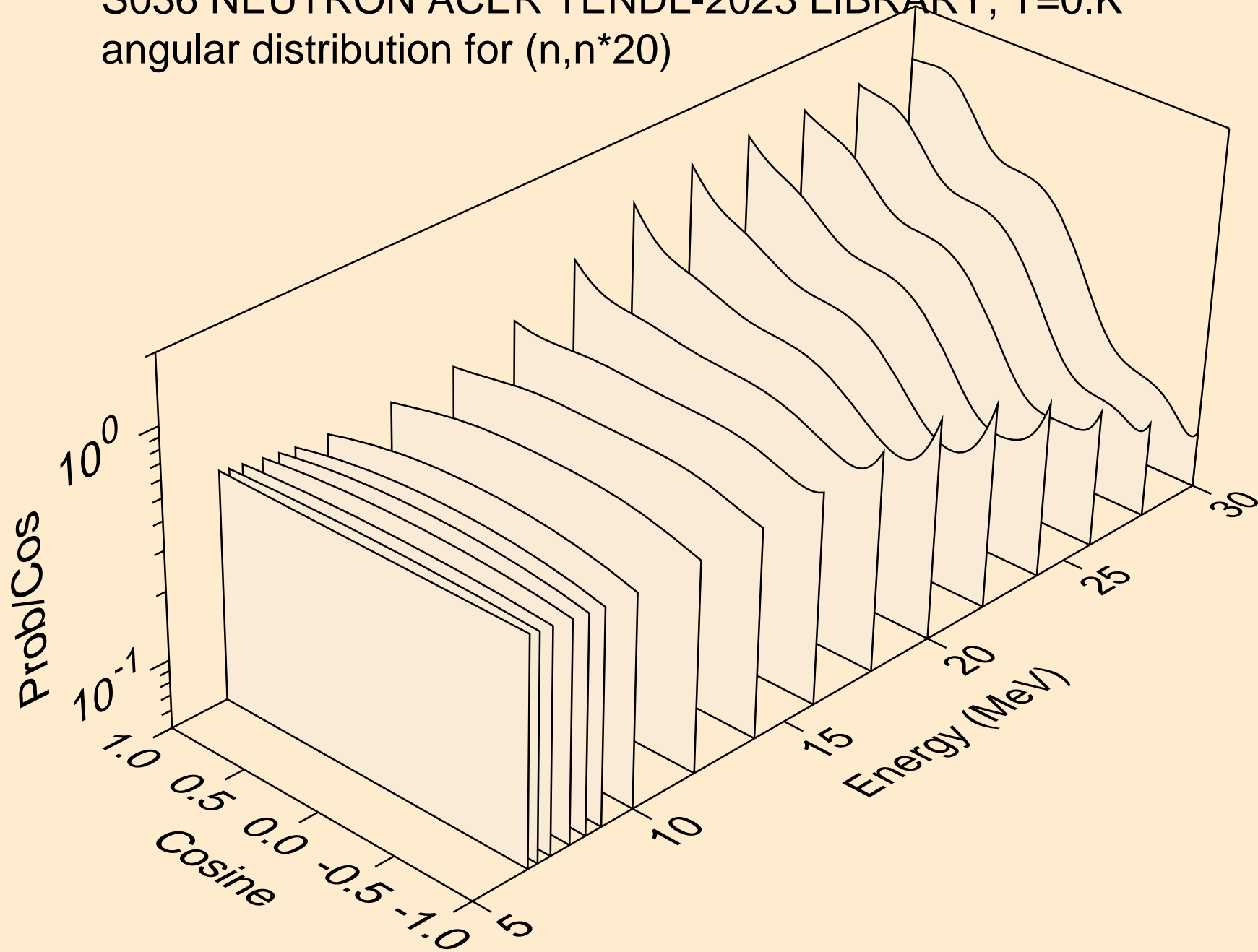

S036 NEUTRON ACER TENDL-2023 LIBRARY; T=0.K  
Neutron emission for (n,x)

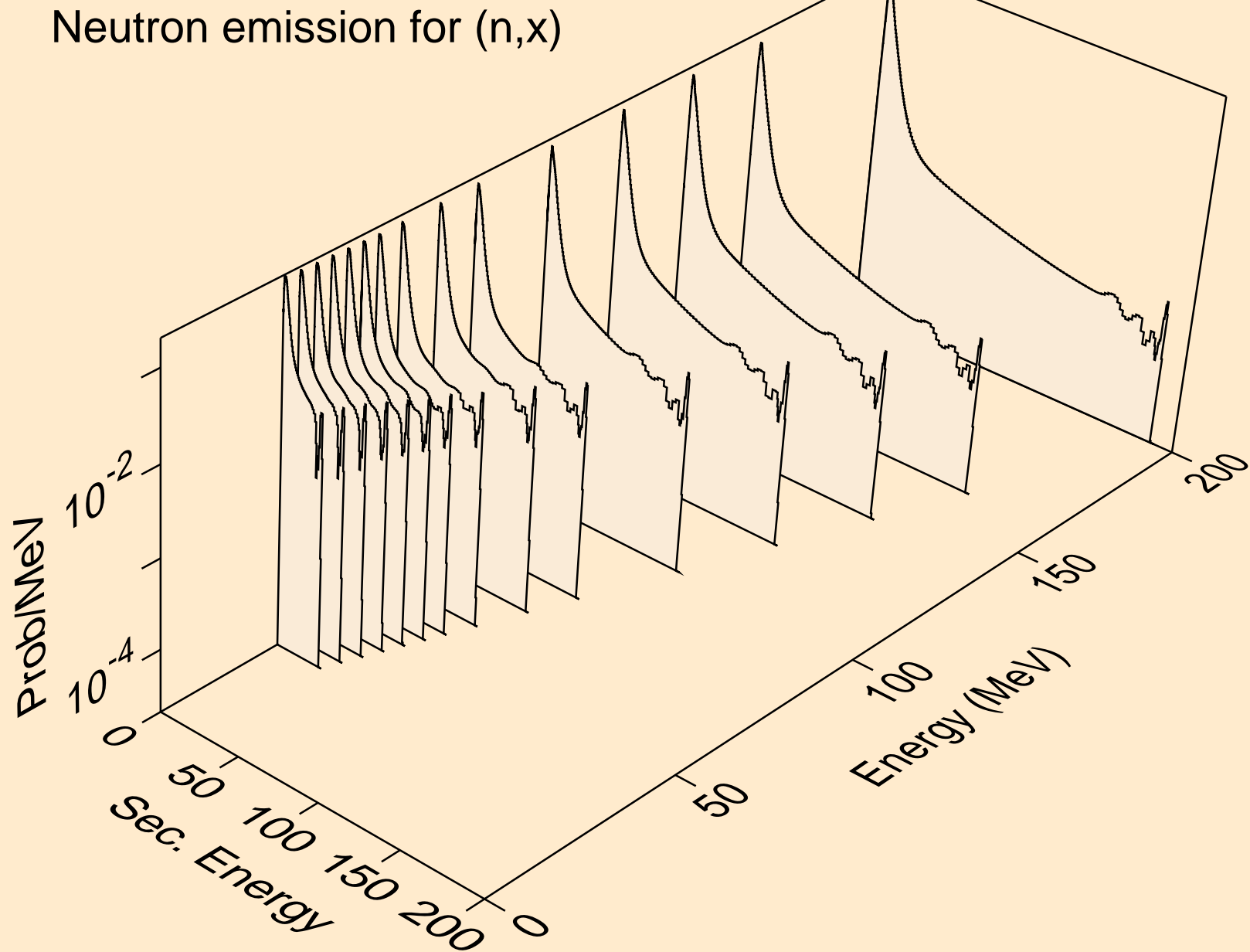

S036 NEUTRON ACER TENDL-2023 LIBRARY; T=0.K  
Neutron emission for (n,2nd)

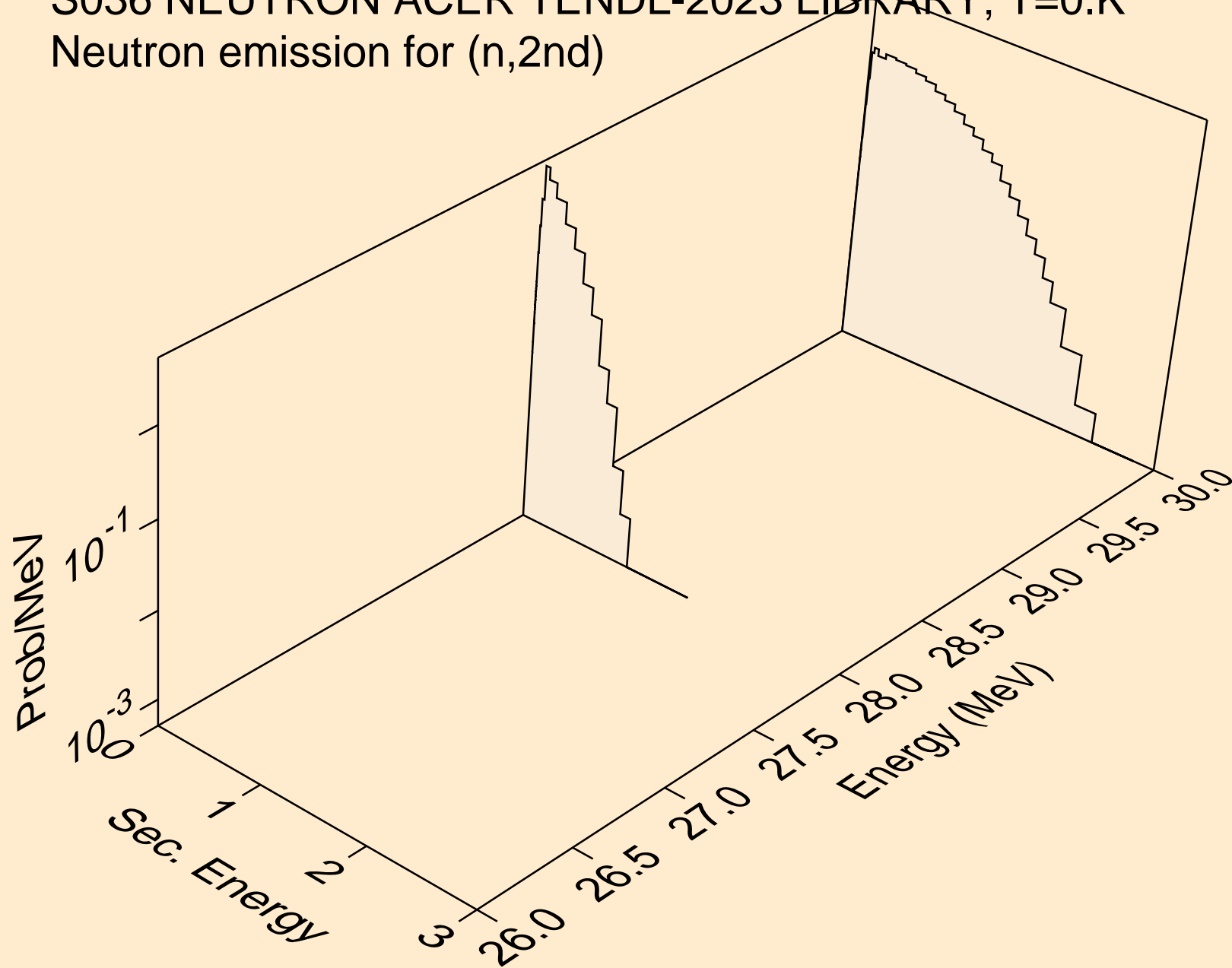

S036 NEUTRON ACER TENDL-2023 LIBRARY; T=0.K  
Neutron emission for (n,2n)

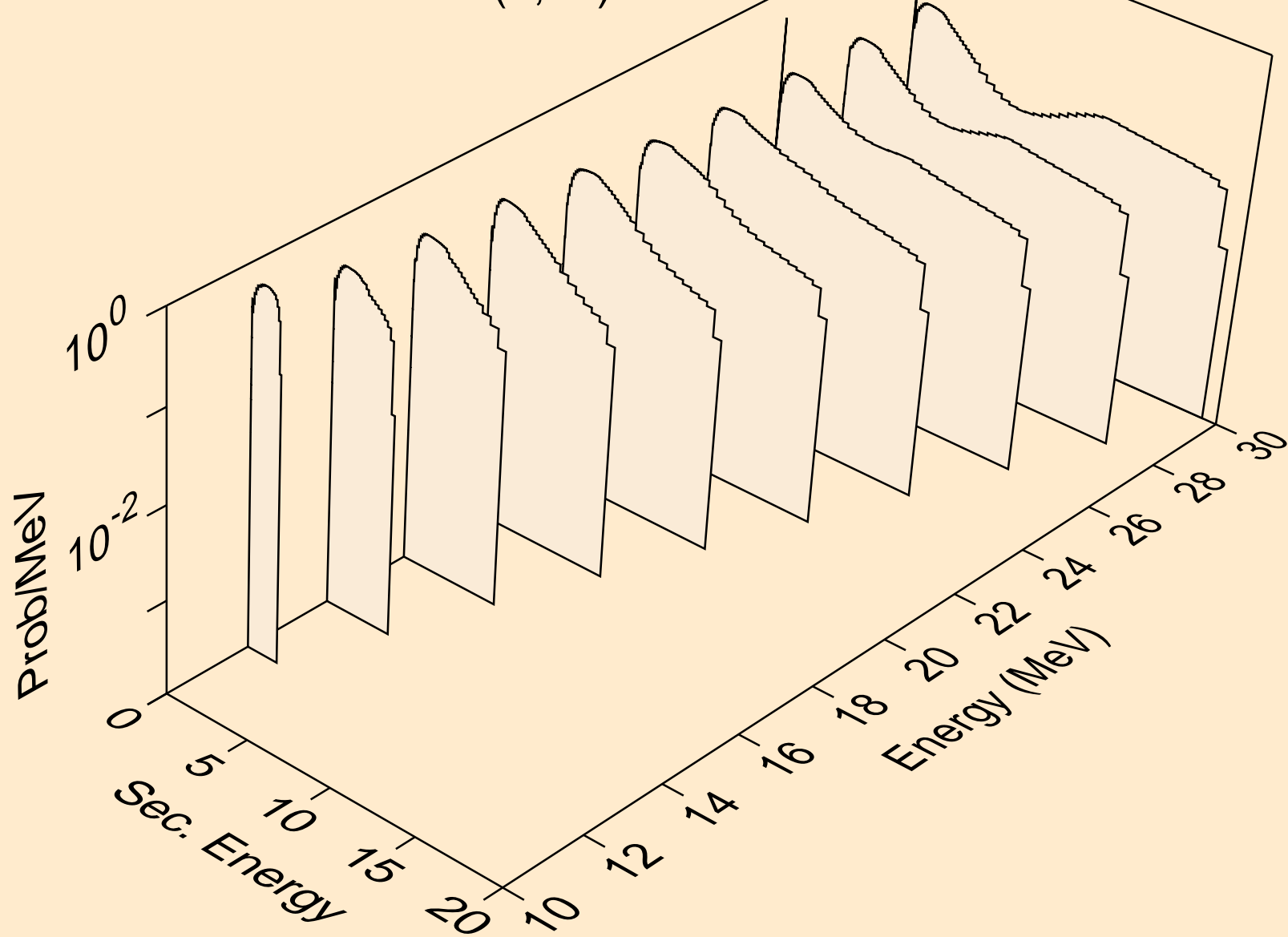

S036 NEUTRON ACER TENDL-2023 LIBRARY; T=0.K  
Neutron emission for (n,3n)

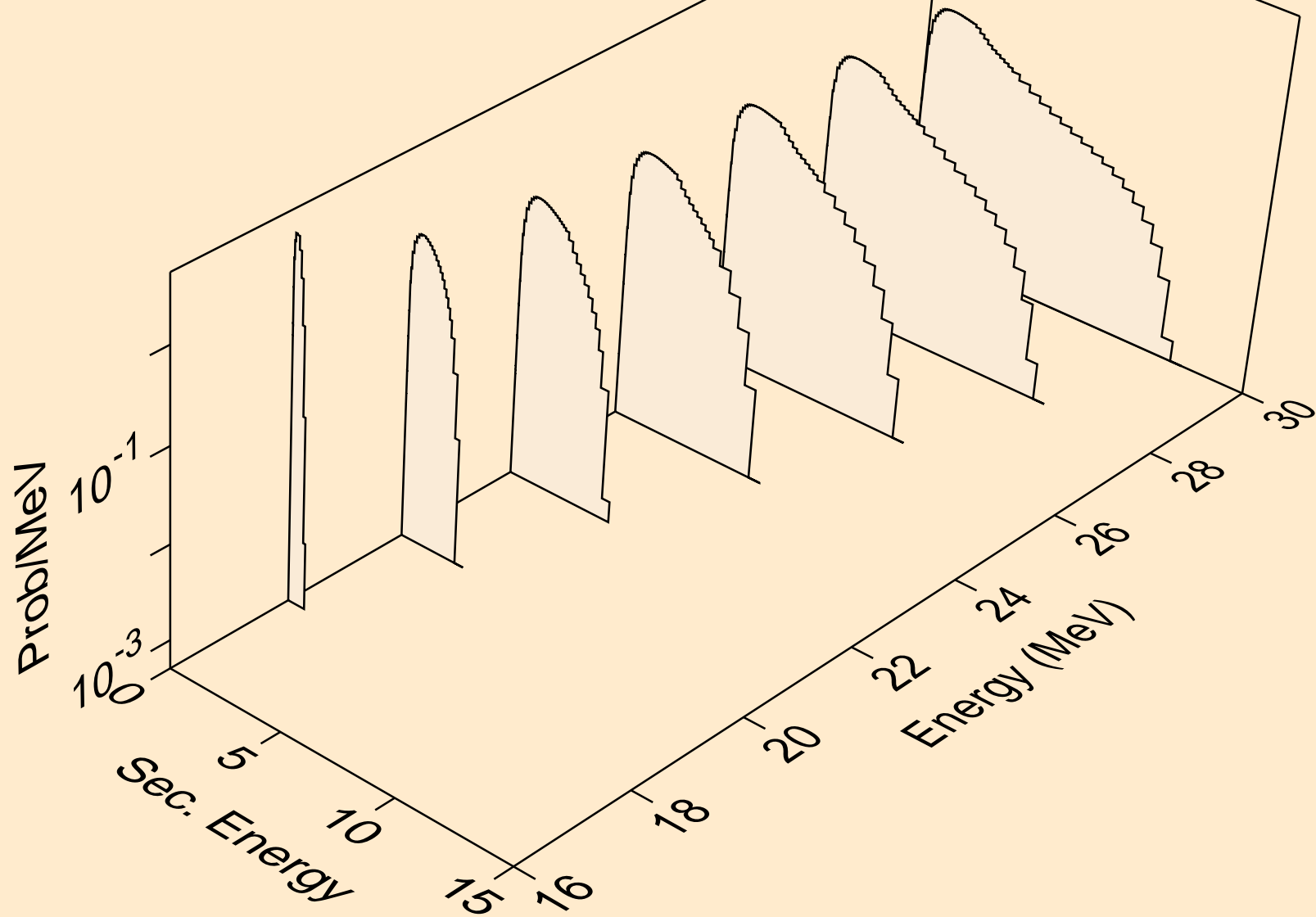

S036 NEUTRON ACER TENDL-2023 LIBRARY; T=0.K  
Neutron emission for (n,n\*)a

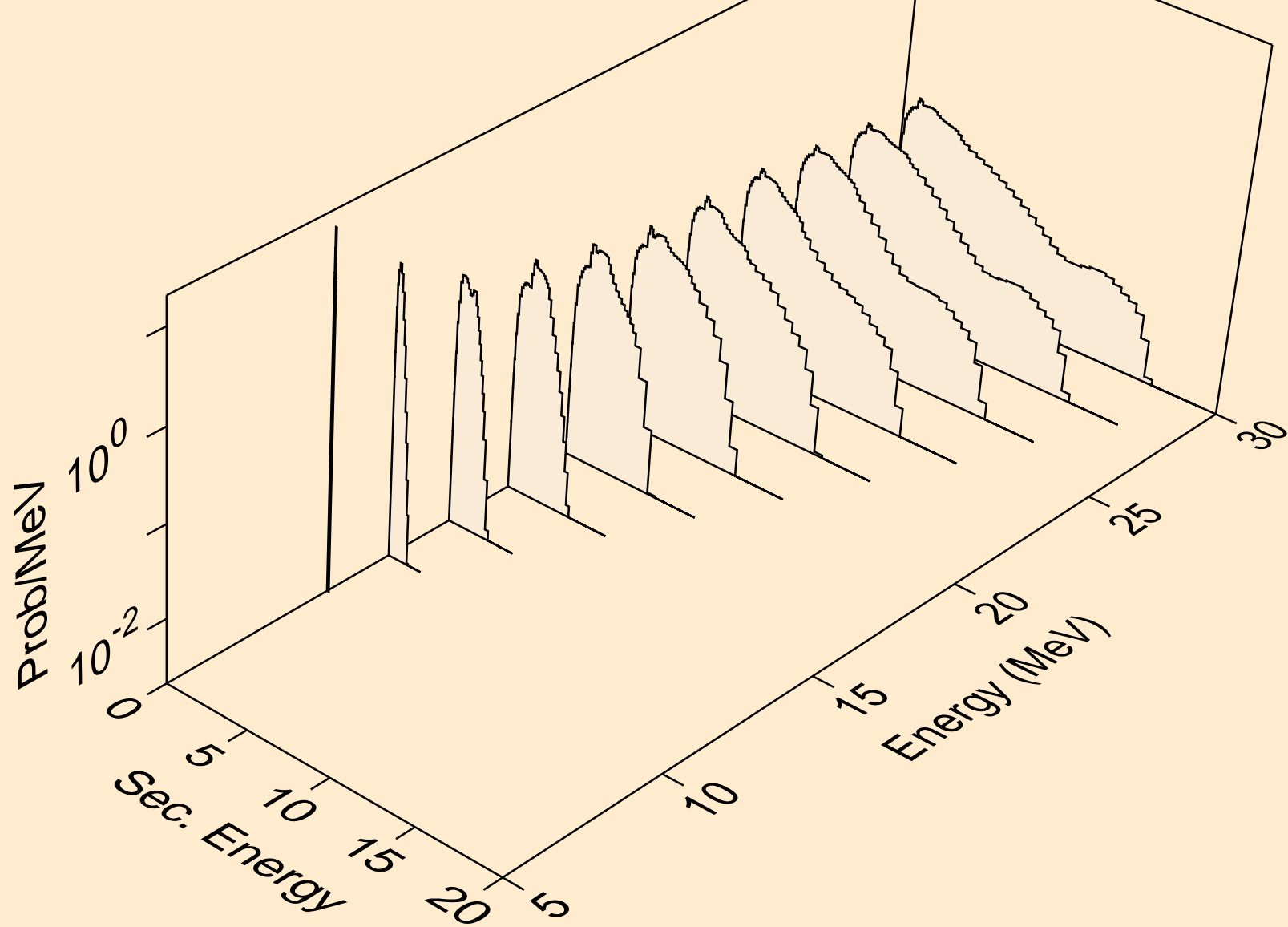

S036 NEUTRON ACER TENDL-2023 LIBRARY; T=0.K  
Neutron emission for (n,2n)a

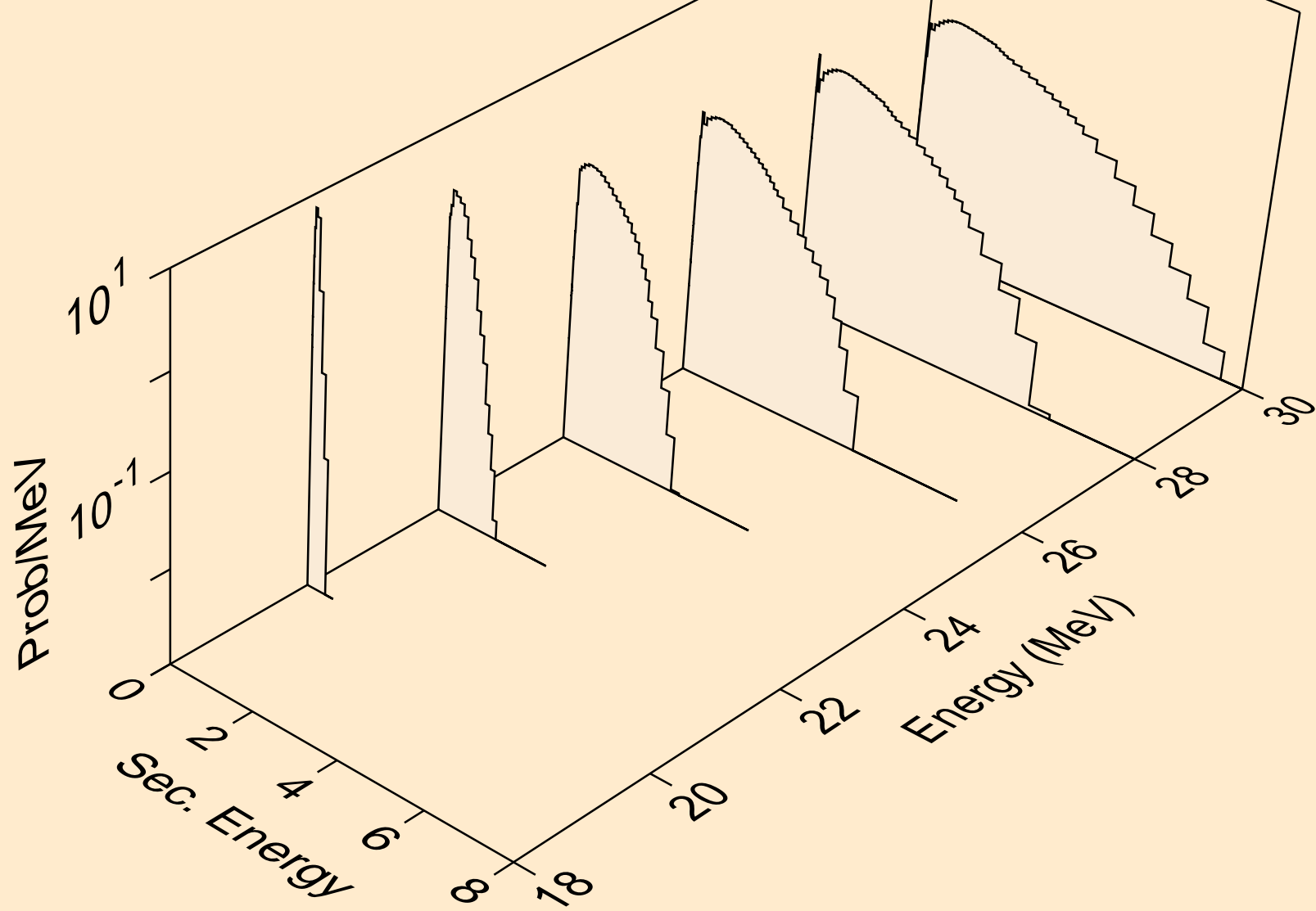

S036 NEUTRON ACER TENDL-2023 LIBRARY; T=0.K  
Neutron emission for (n,3n)a

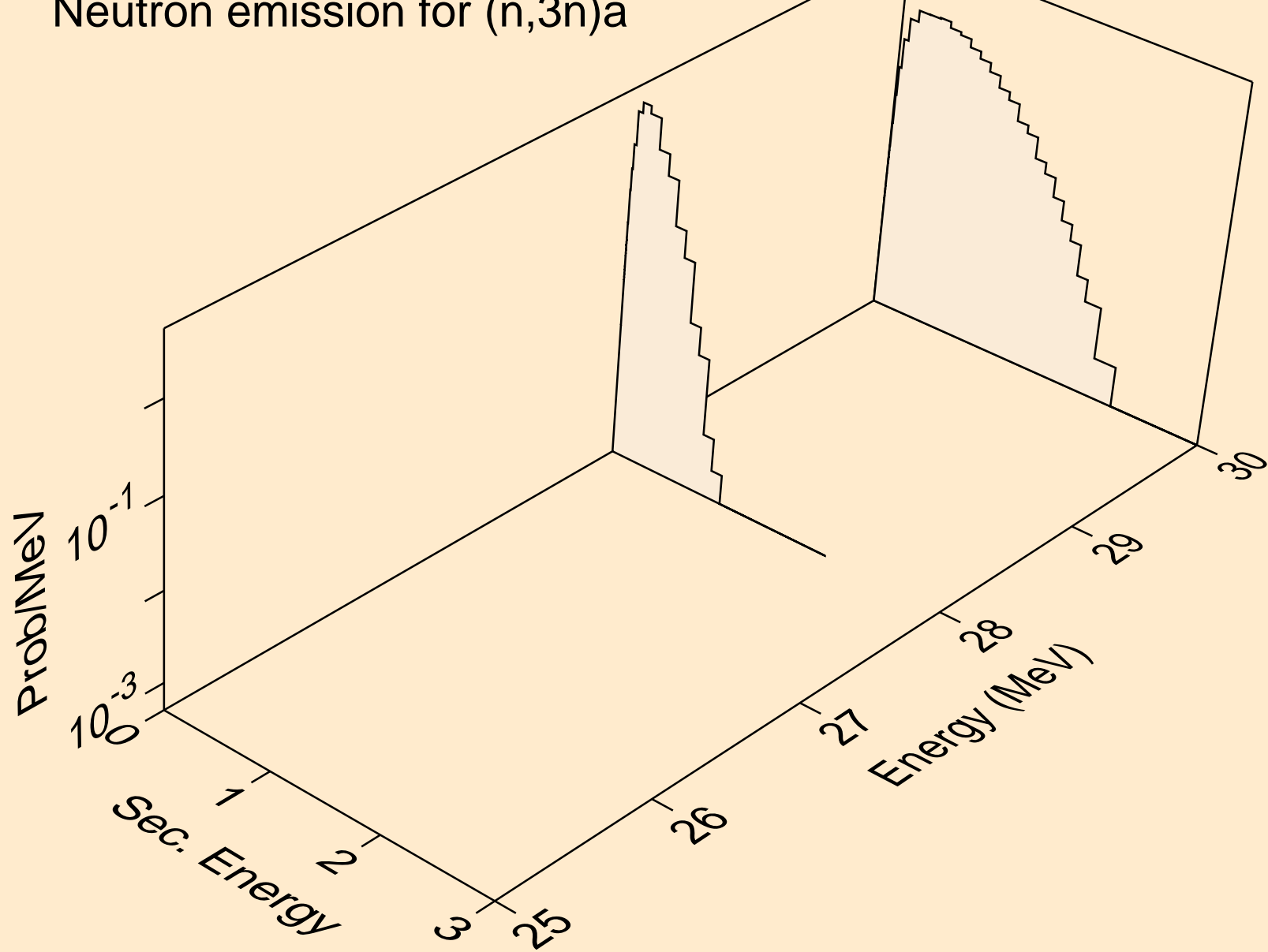



S036 NEUTRON ACER TENDL-2023 LIBRARY; T=0.K  
Neutron emission for (n,n\*)p

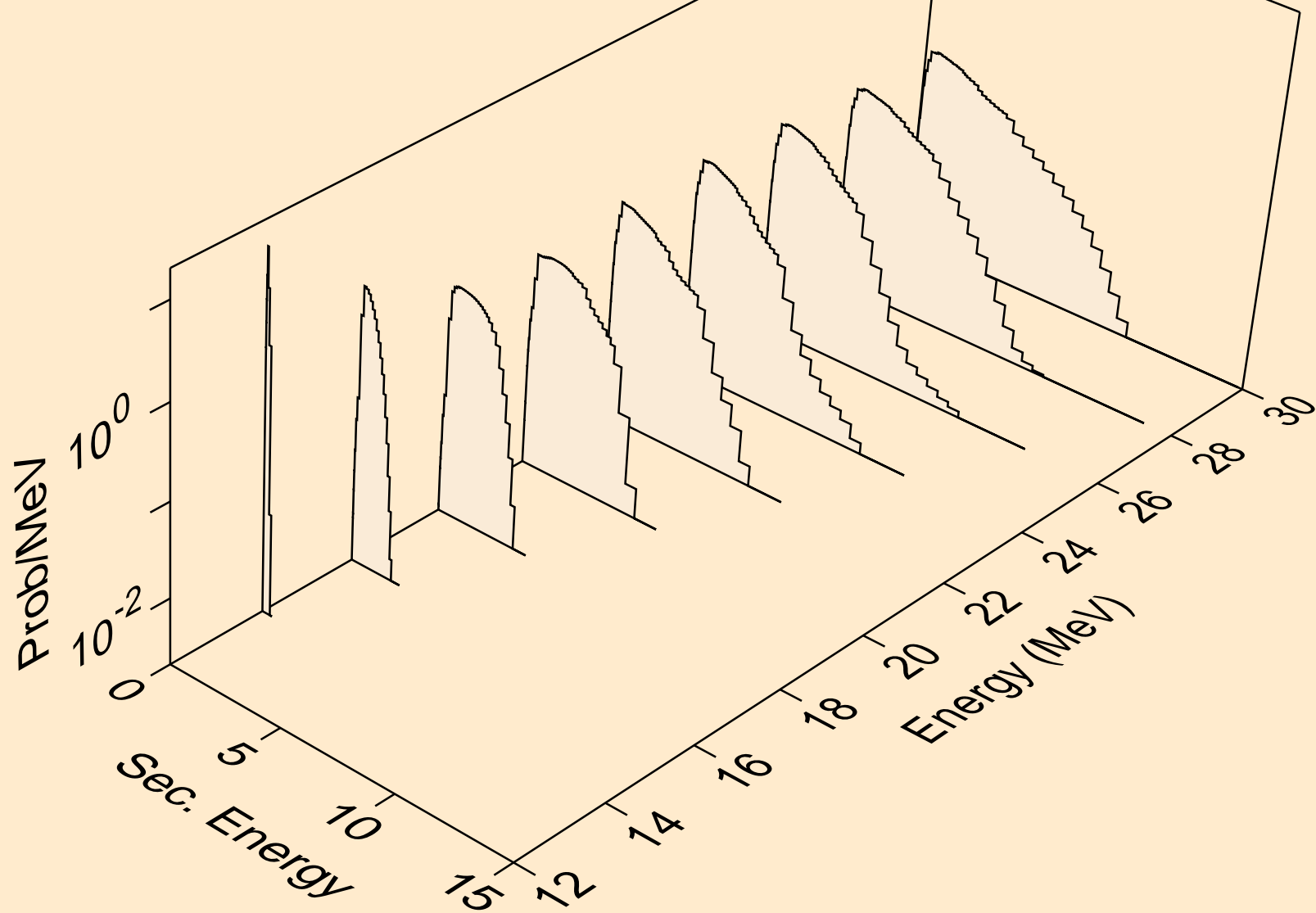

S036 NEUTRON ACER TENDL-2023 LIBRARY; T=0.K  
Neutron emission for (n,n\*)2a

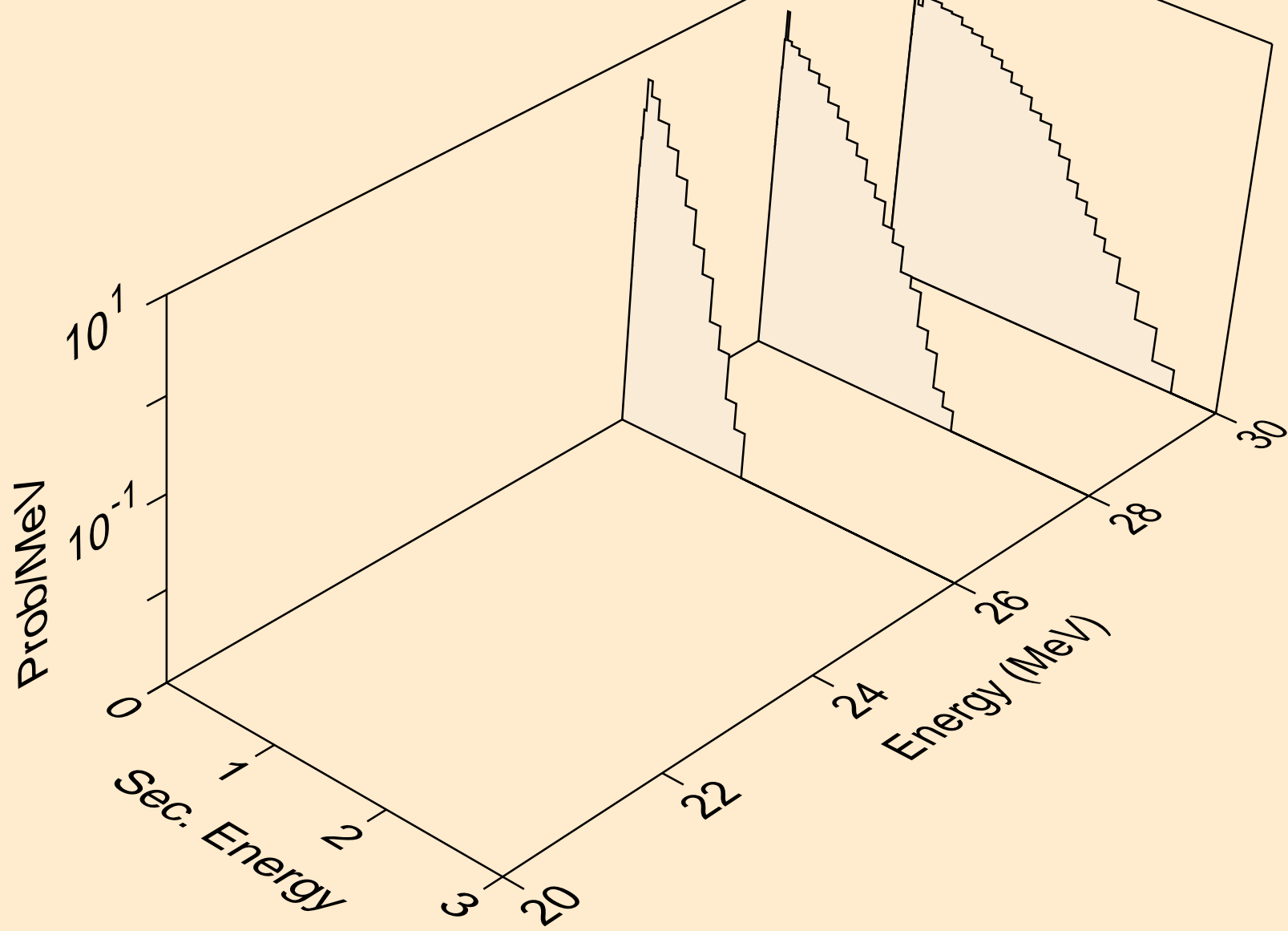

S036 NEUTRON ACER TENDL-2023 LIBRARY; T=0.K  
Neutron emission for (n,n\*)d

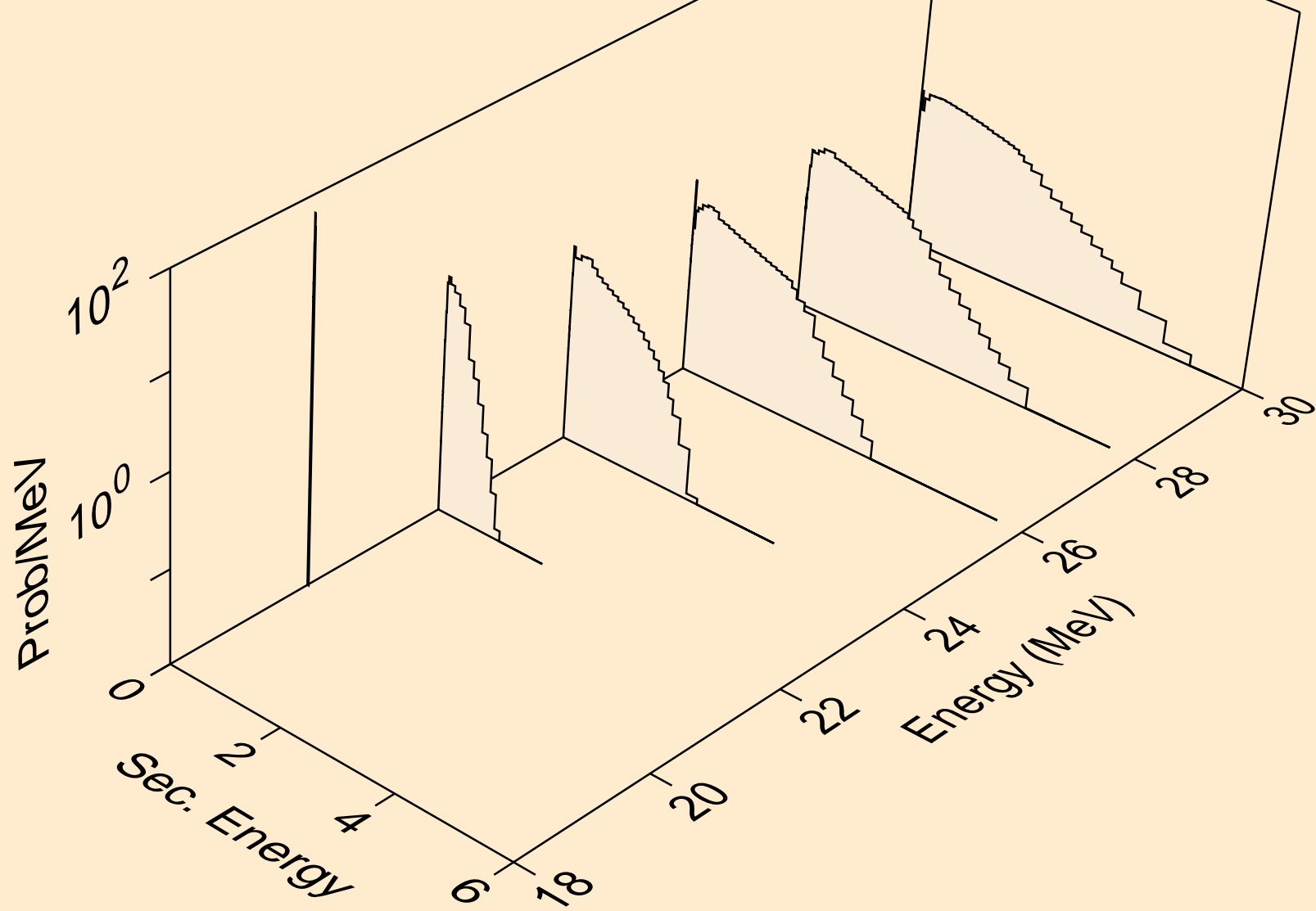

S036 NEUTRON ACER TENDL-2023 LIBRARY; T=0.K  
Neutron emission for (n,n\*)t

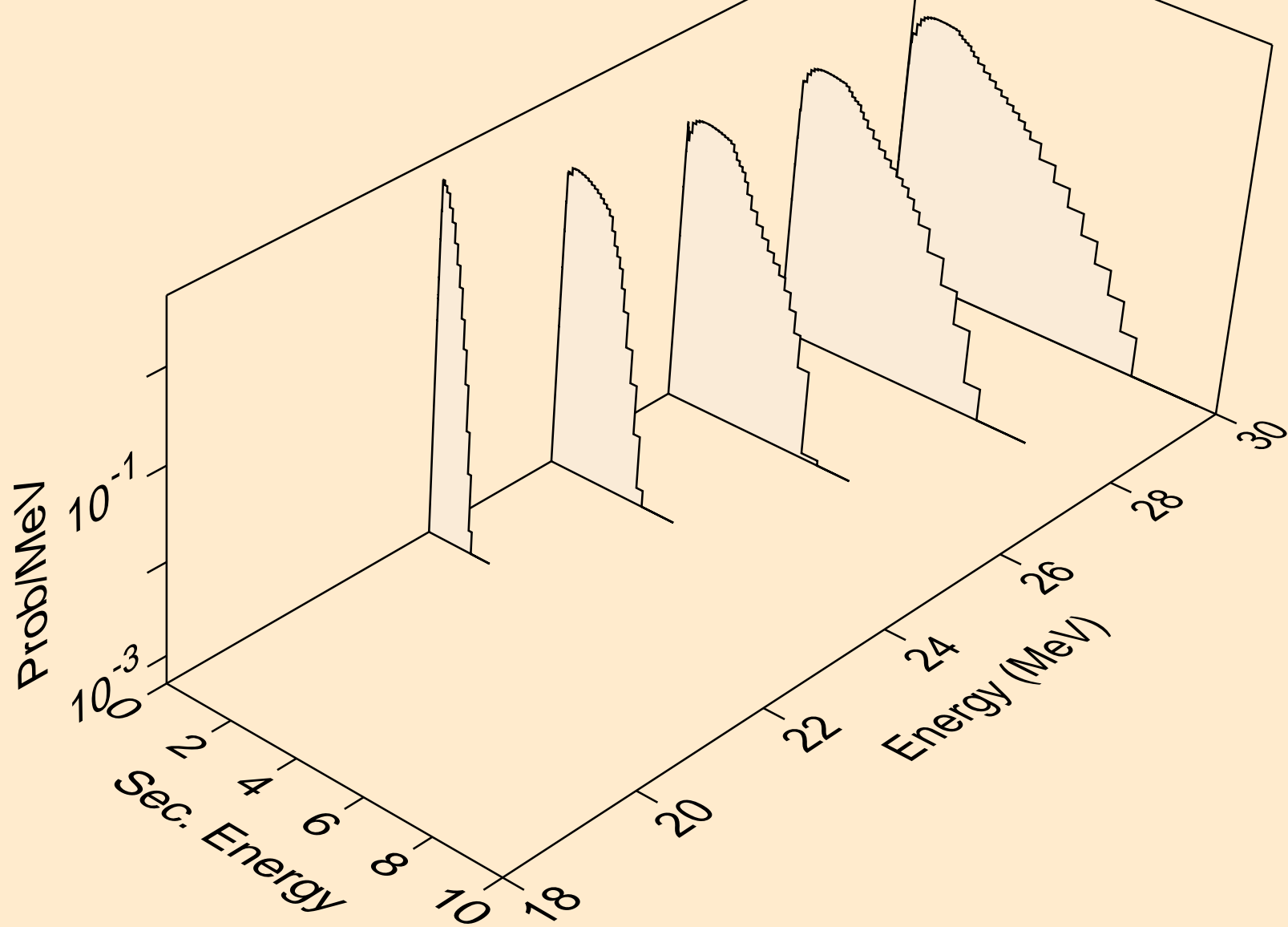

S036 NEUTRON ACER TENDL-2023 LIBRARY; T=0.K  
Neutron emission for (n,n\*)he3

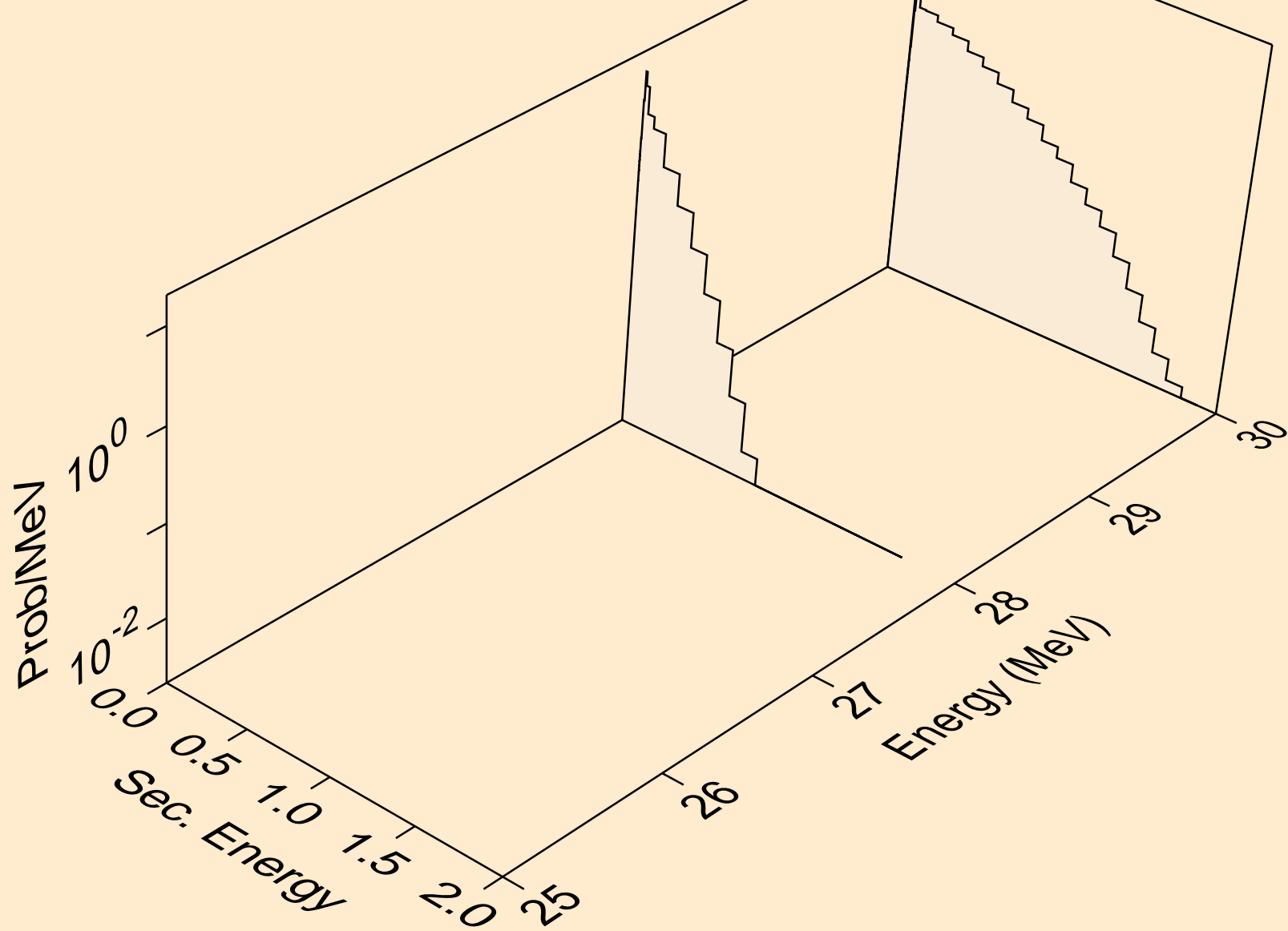

S036 NEUTRON ACER TENDL-2023 LIBRARY; T=0.K  
Neutron emission for (n,2np)

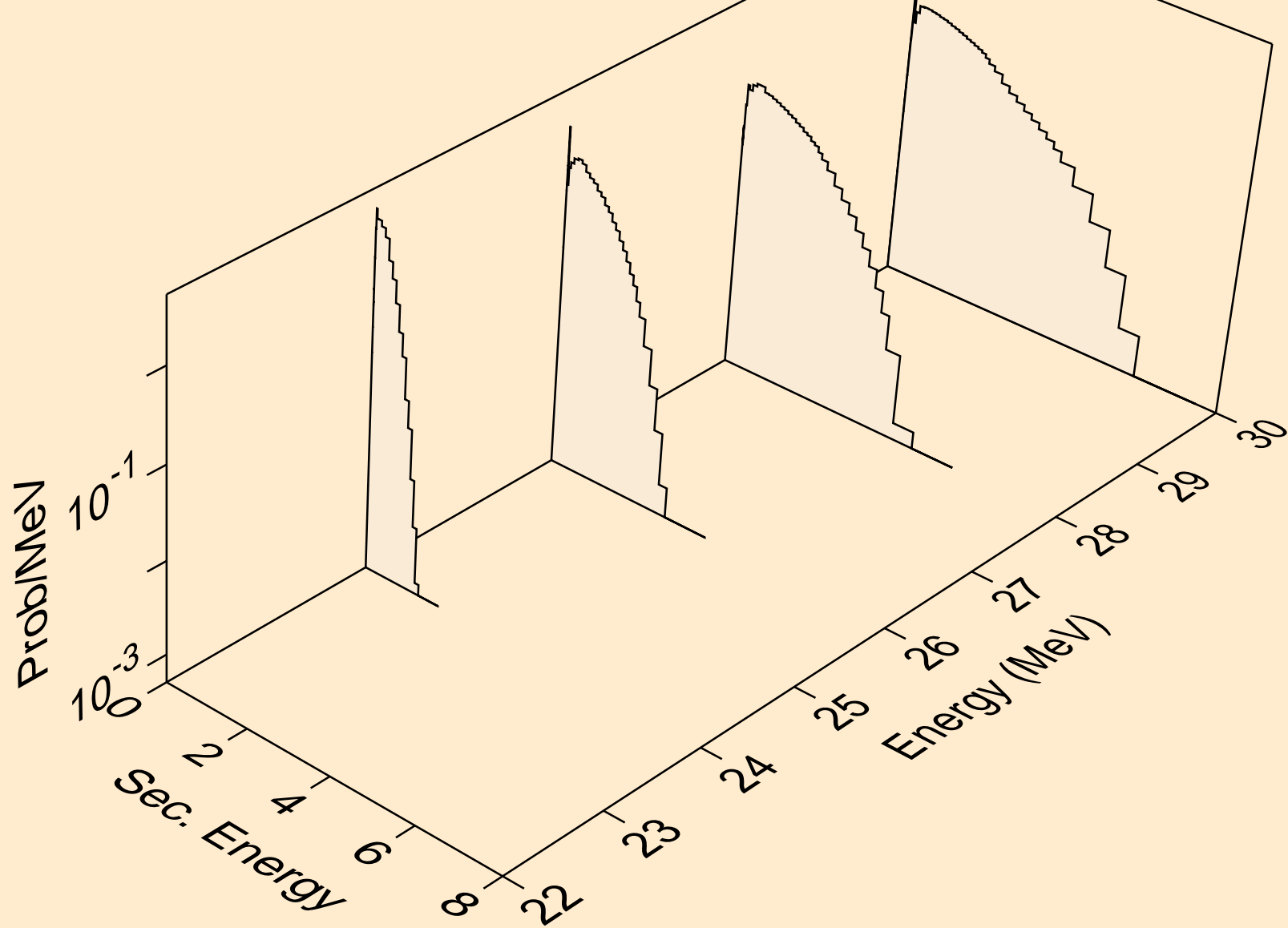

S036 NEUTRON ACER TENDL-2023 LIBRARY; T=0.K  
Neutron emission for (n,3np)

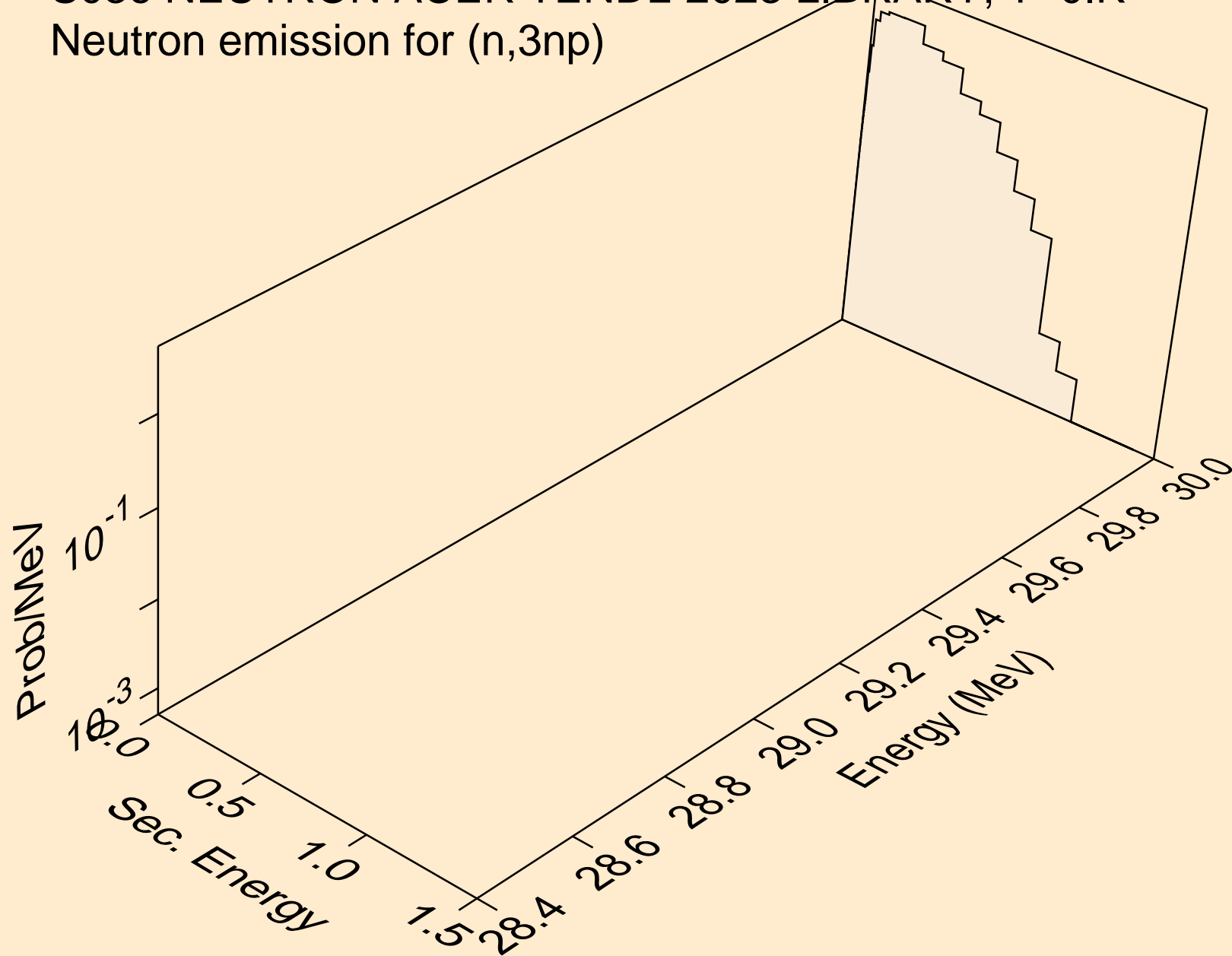

S036 NEUTRON ACER TENDL-2023 LIBRARY; T=0.K  
Neutron emission for (n,n2p)

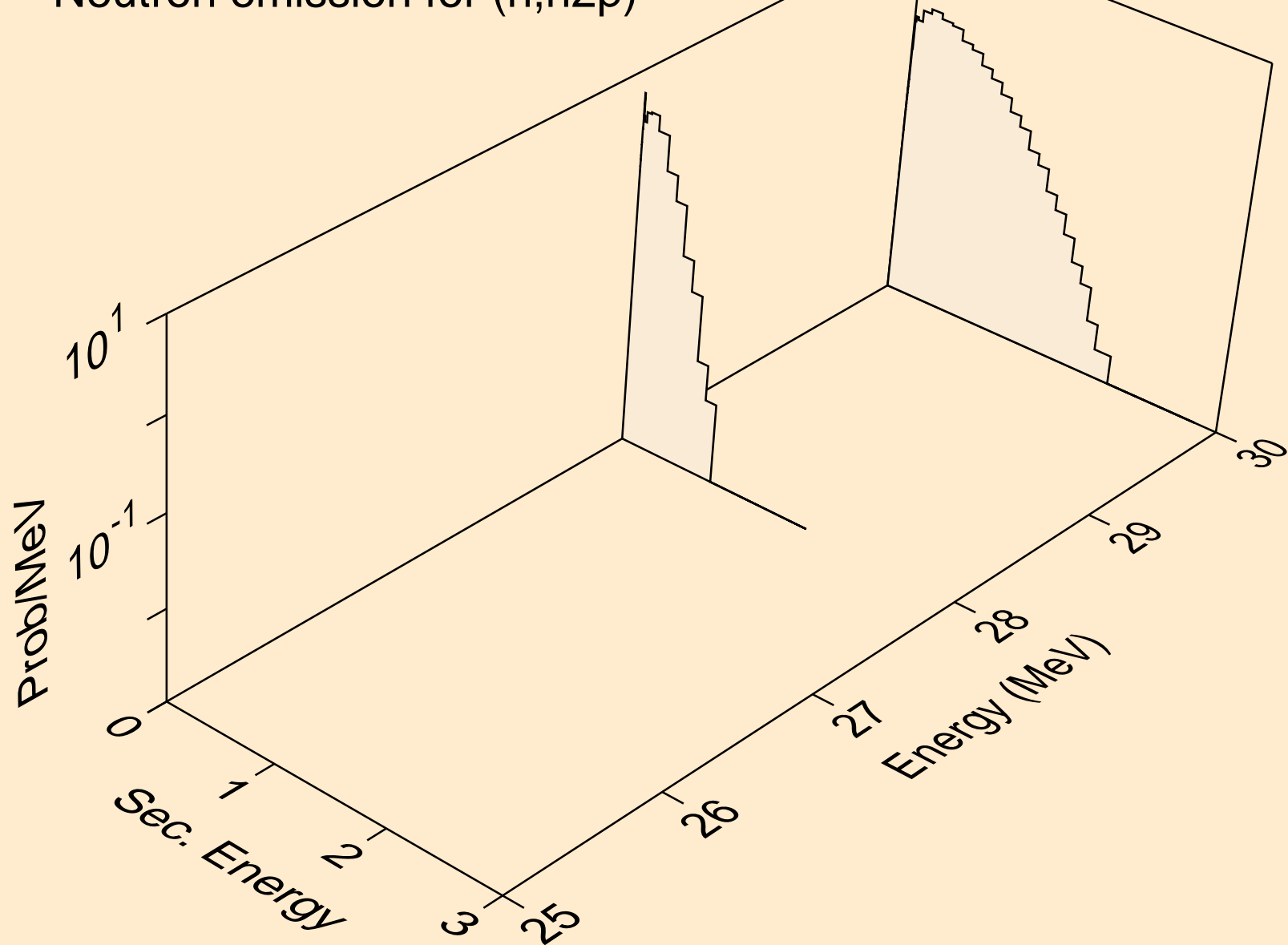



S036 NEUTRON ACER TENDL-2023 LIBRARY; T=0.K  
Neutron emission for (n,n\*c)

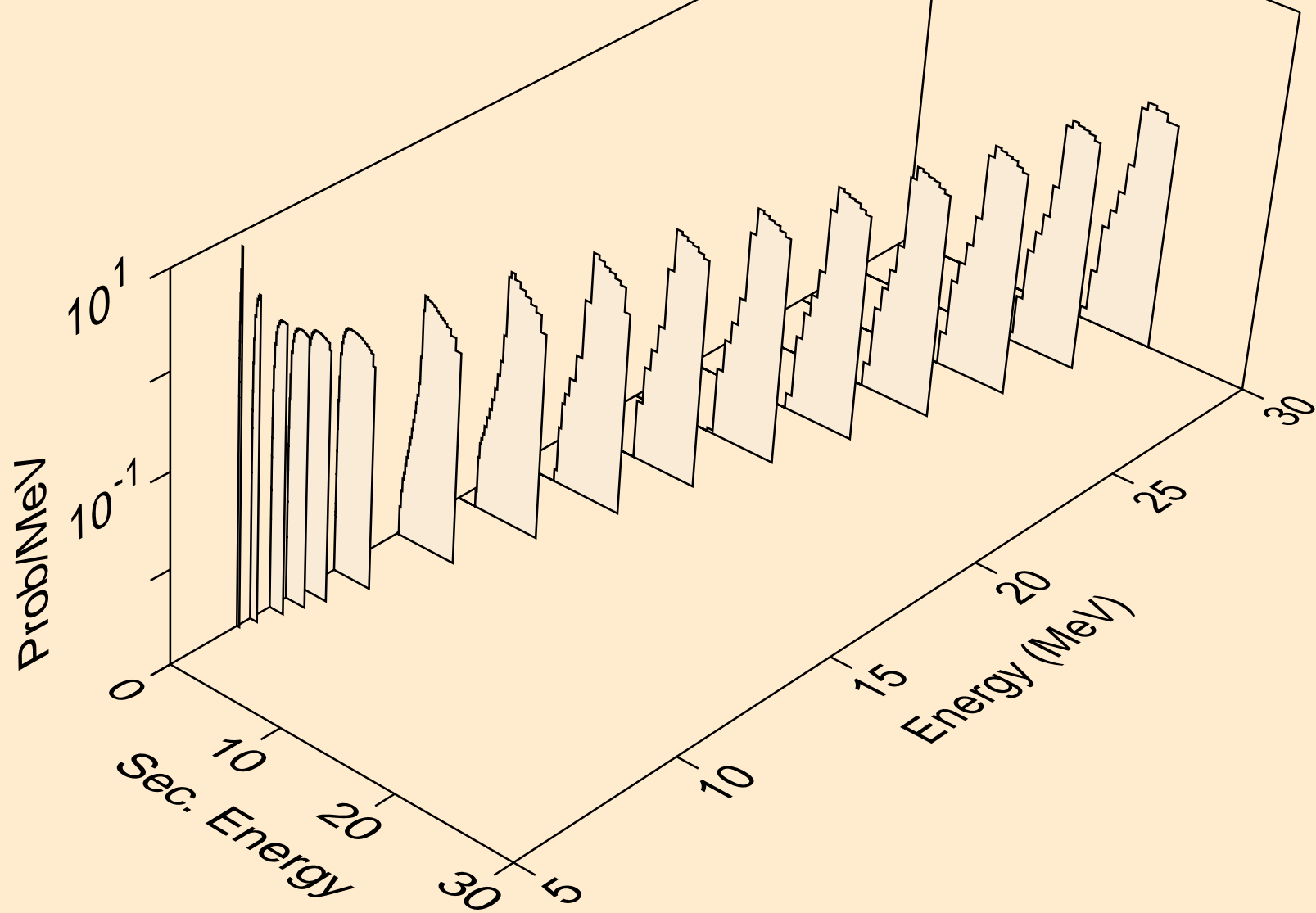

S036 NEUTRON ACER TENDL-2023 LIBRARY; T=0.K  
Photon emission for (n,x)

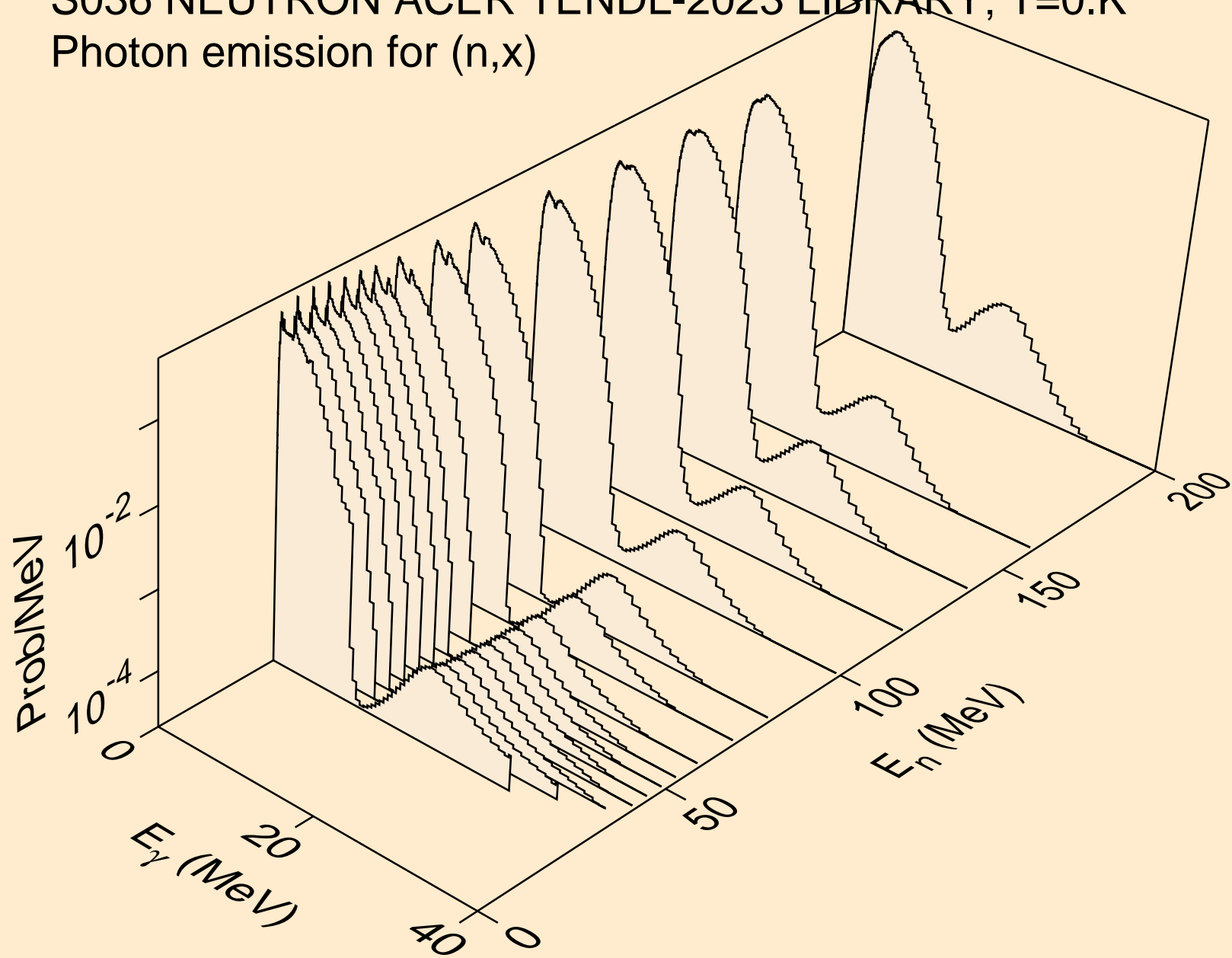

S036 NEUTRON ACER TENDL-2023 LIBRARY; T=0.K  
Photon emission for (n,2nd)

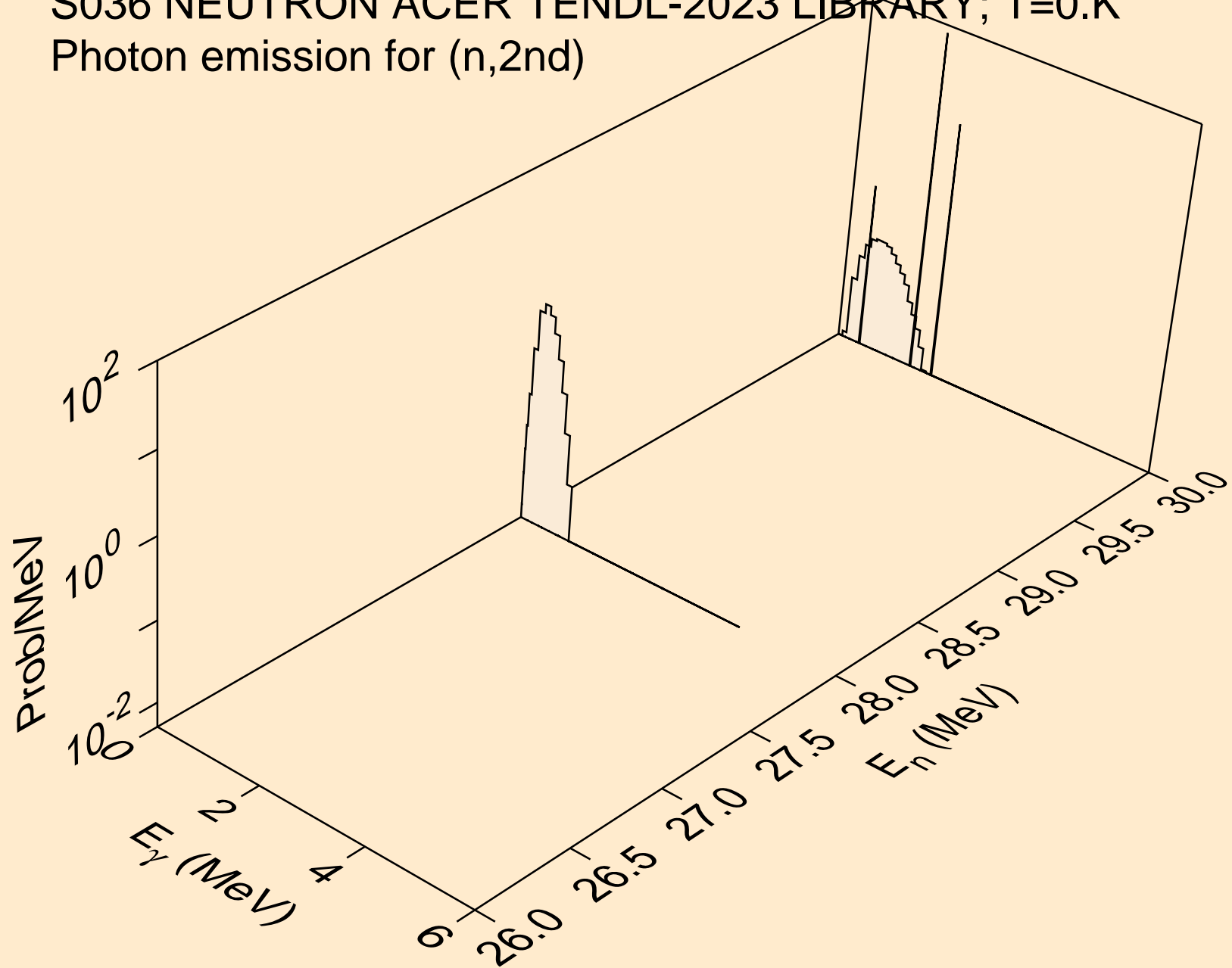

S036 NEUTRON ACER TENDL-2023 LIBRARY; T=0.K  
Photon emission for (n,2n)

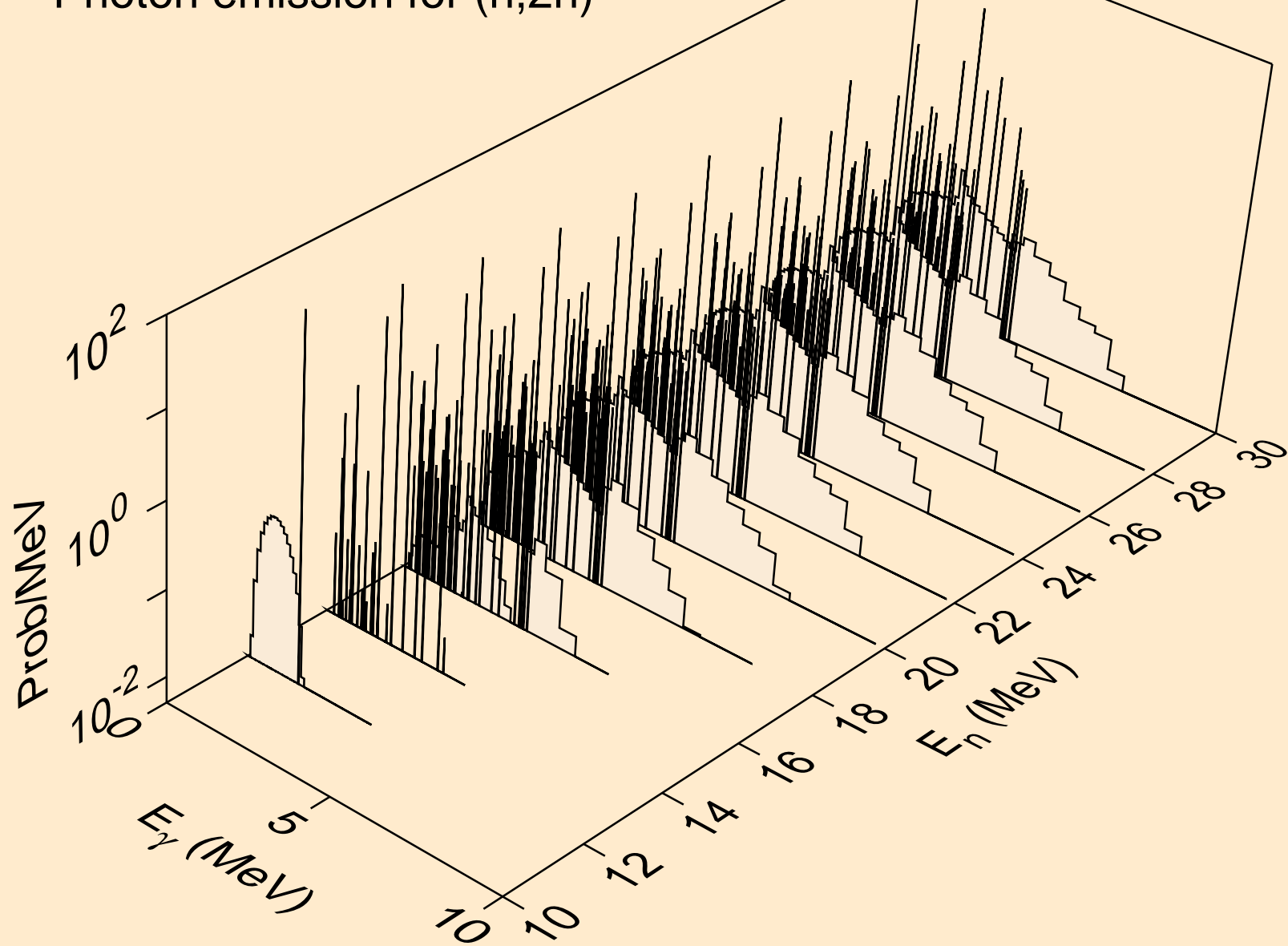

S036 NEUTRON ACER TENDL-2023 LIBRARY; T=0.K  
Photon emission for (n,3n)

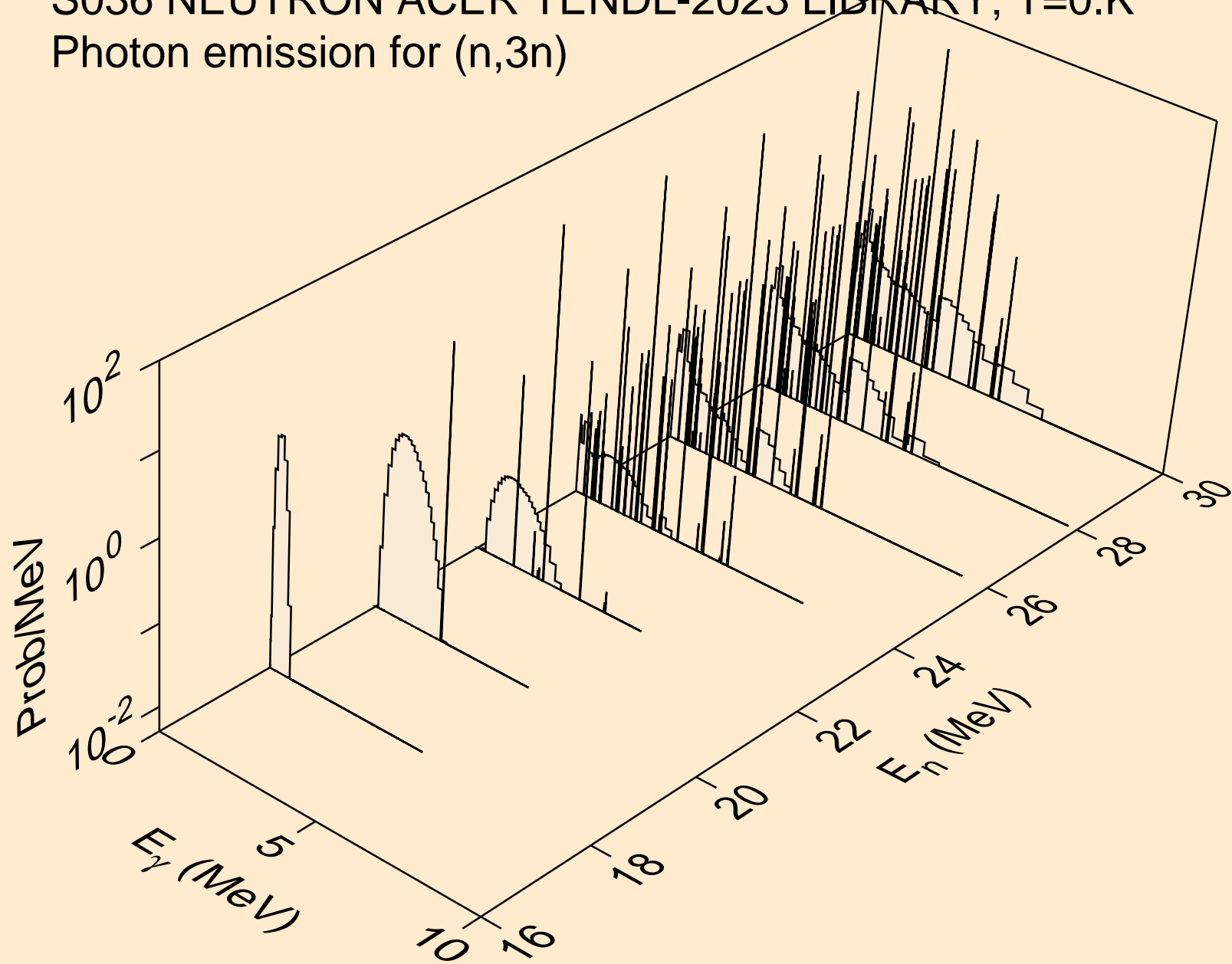

S036 NEUTRON ACER TENDL-2023 LIBRARY; T=0.K  
Photon emission for (n,n\*)a

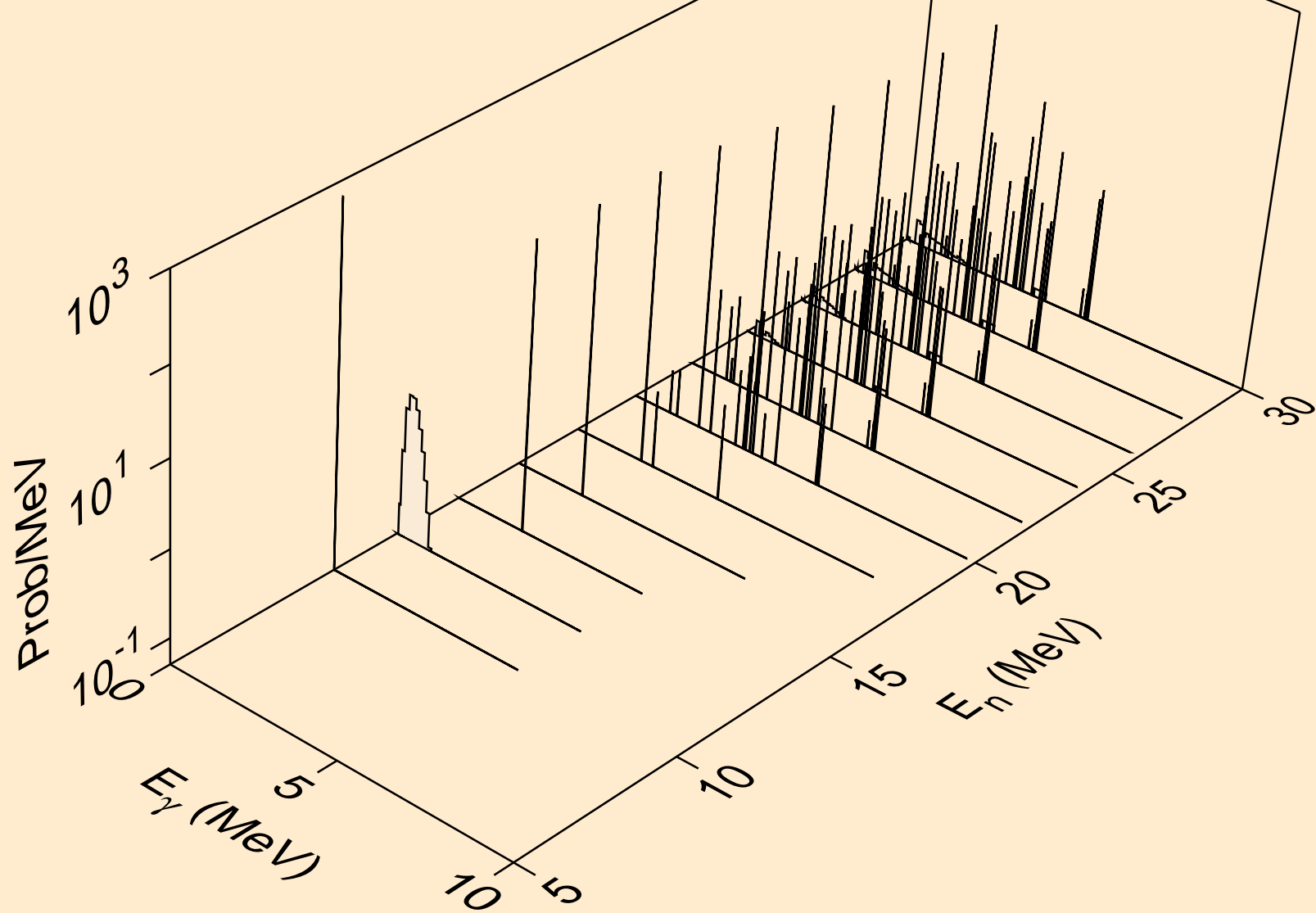

S036 NEUTRON ACER TENDL-2023 LIBRARY; T=0.K  
Photon emission for (n,2n)a

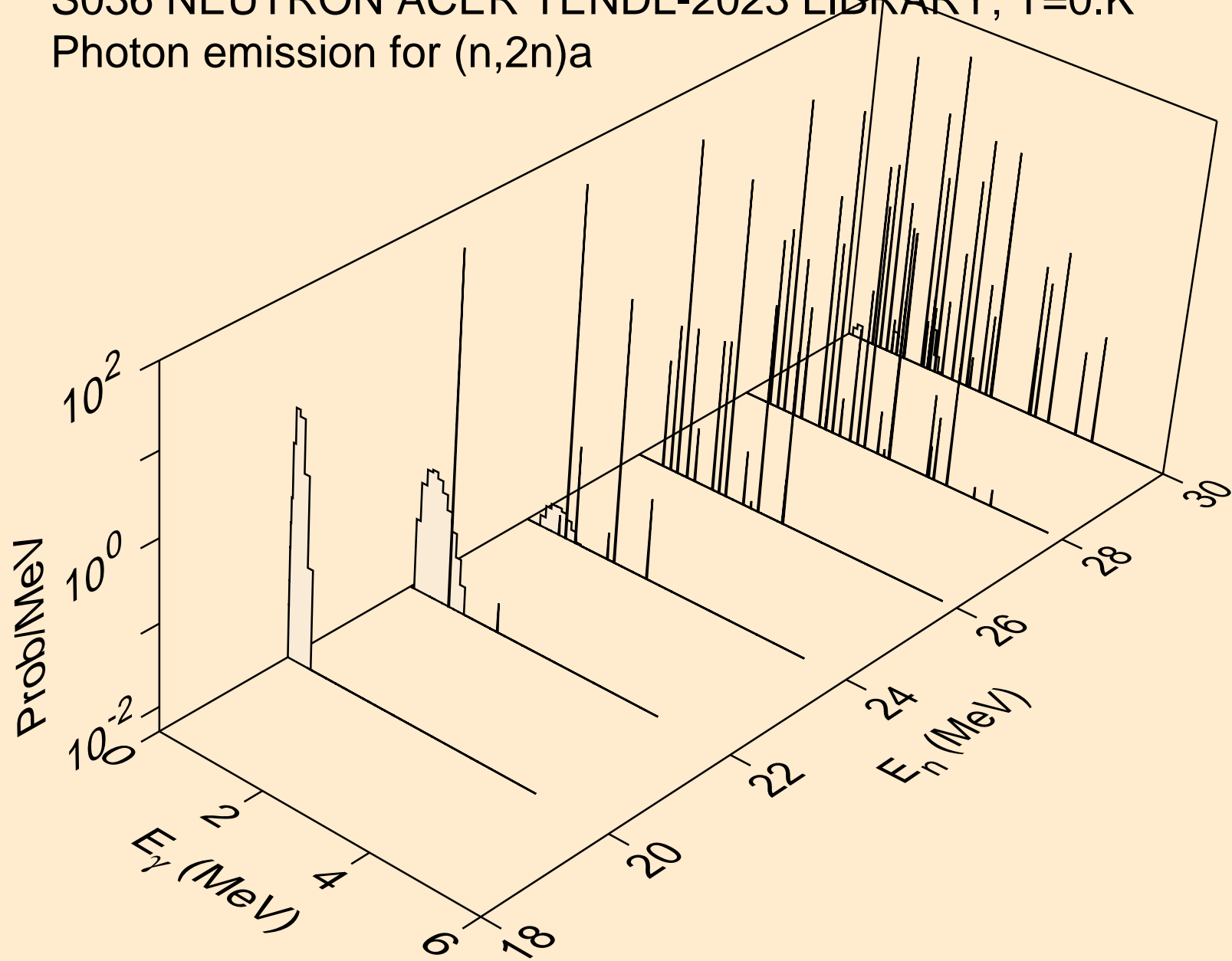

S036 NEUTRON ACER TENDL-2023 LIBRARY; T=0.K  
Photon emission for (n,3n)a

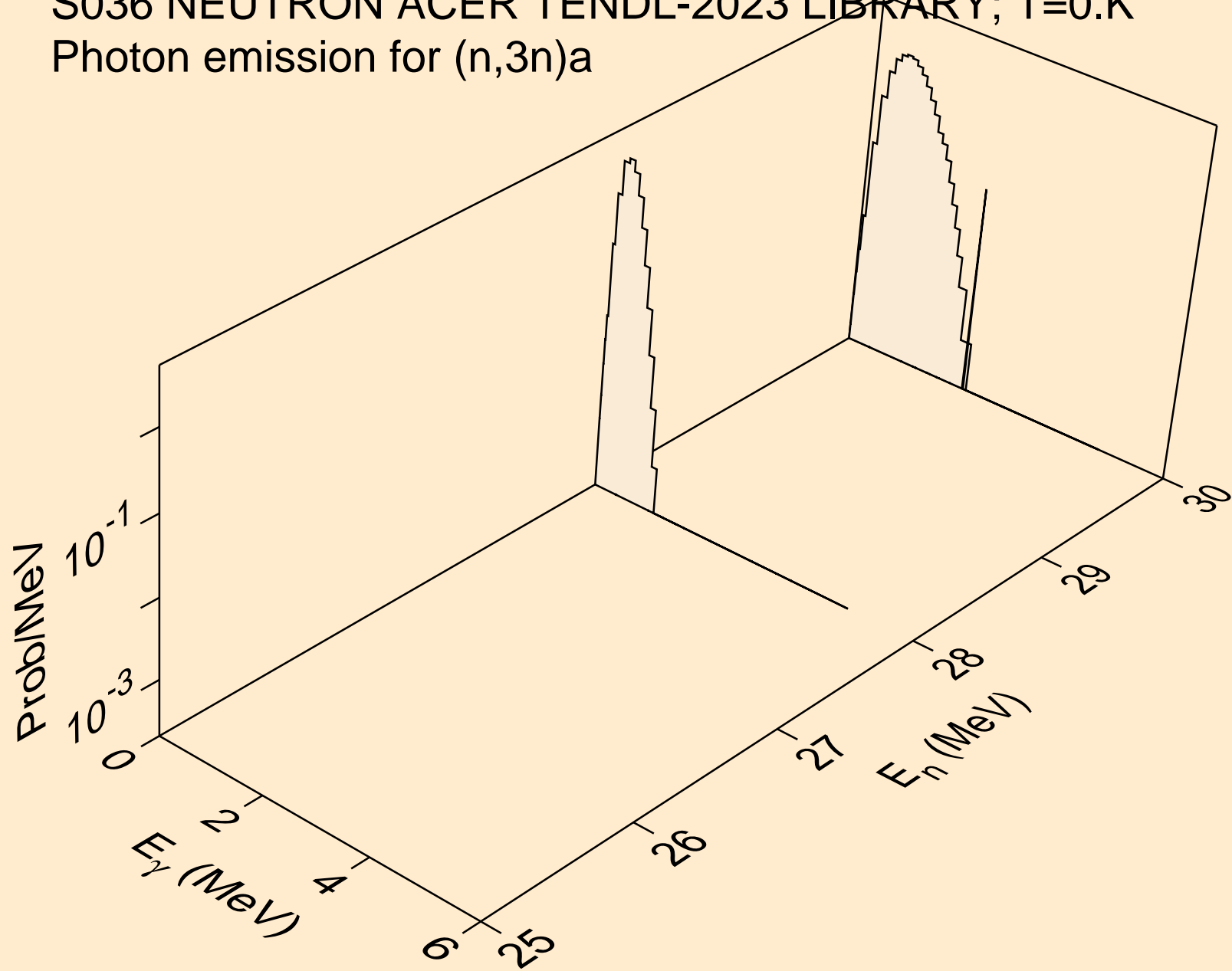



S036 NEUTRON ACER TENDL-2023 LIBRARY; T=0.K  
Photon emission for (n,n\*)p

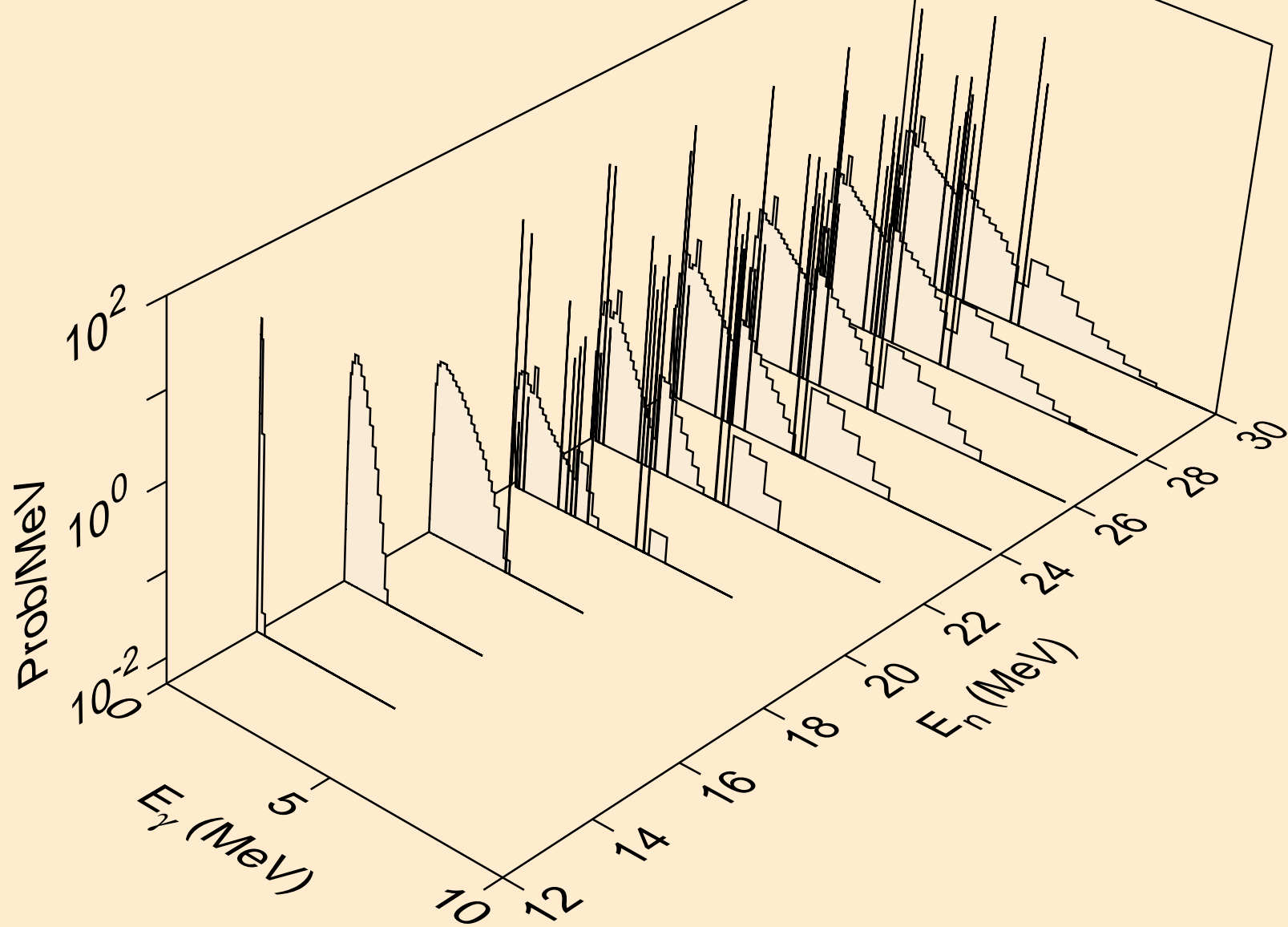

S036 NEUTRON ACER TENDL-2023 LIBRARY; T=0.K  
Photon emission for (n,n\*)2a

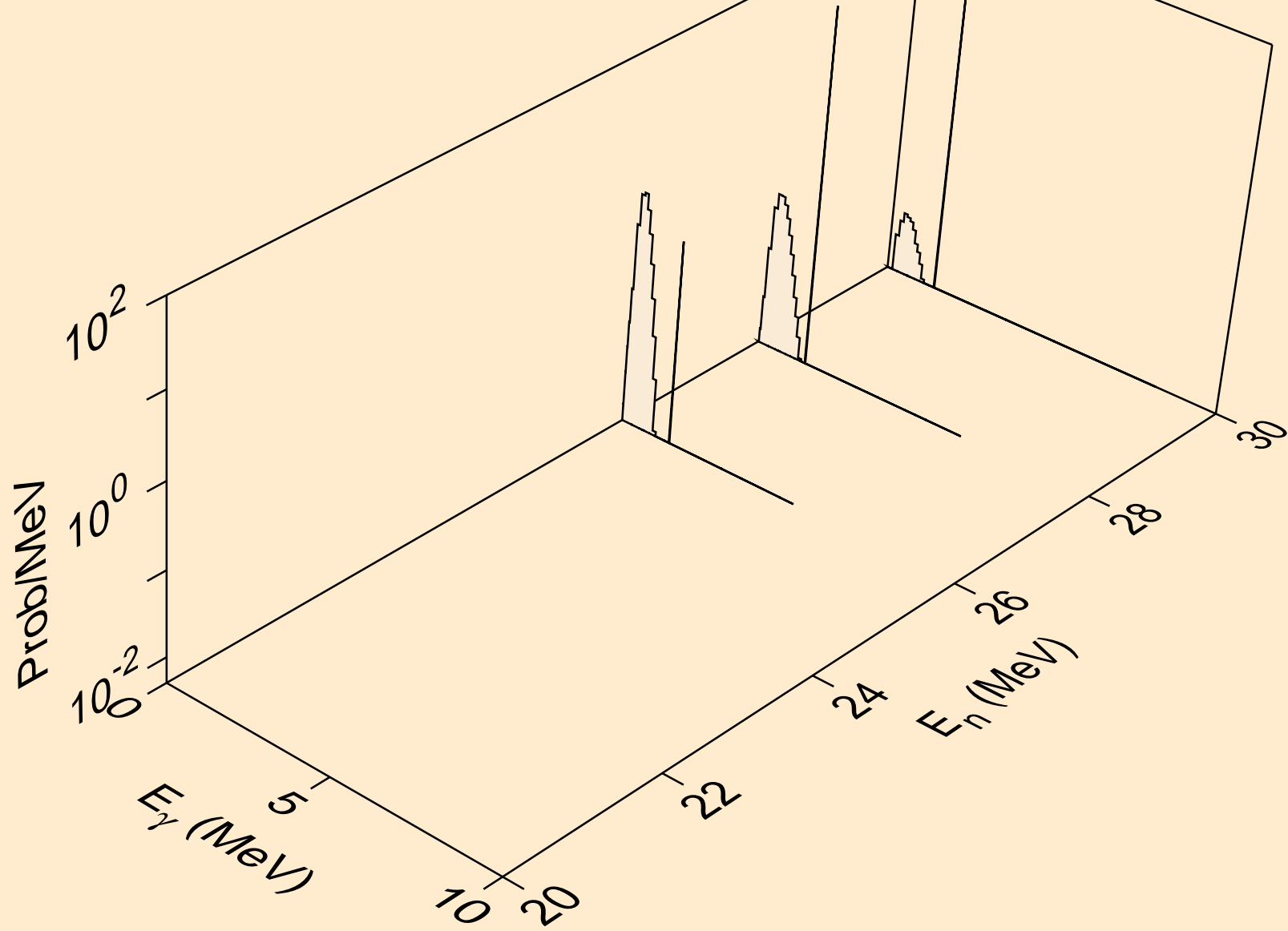

S036 NEUTRON ACER TENDL-2023 LIBRARY; T=0.K  
Photon emission for (n,n\*)d

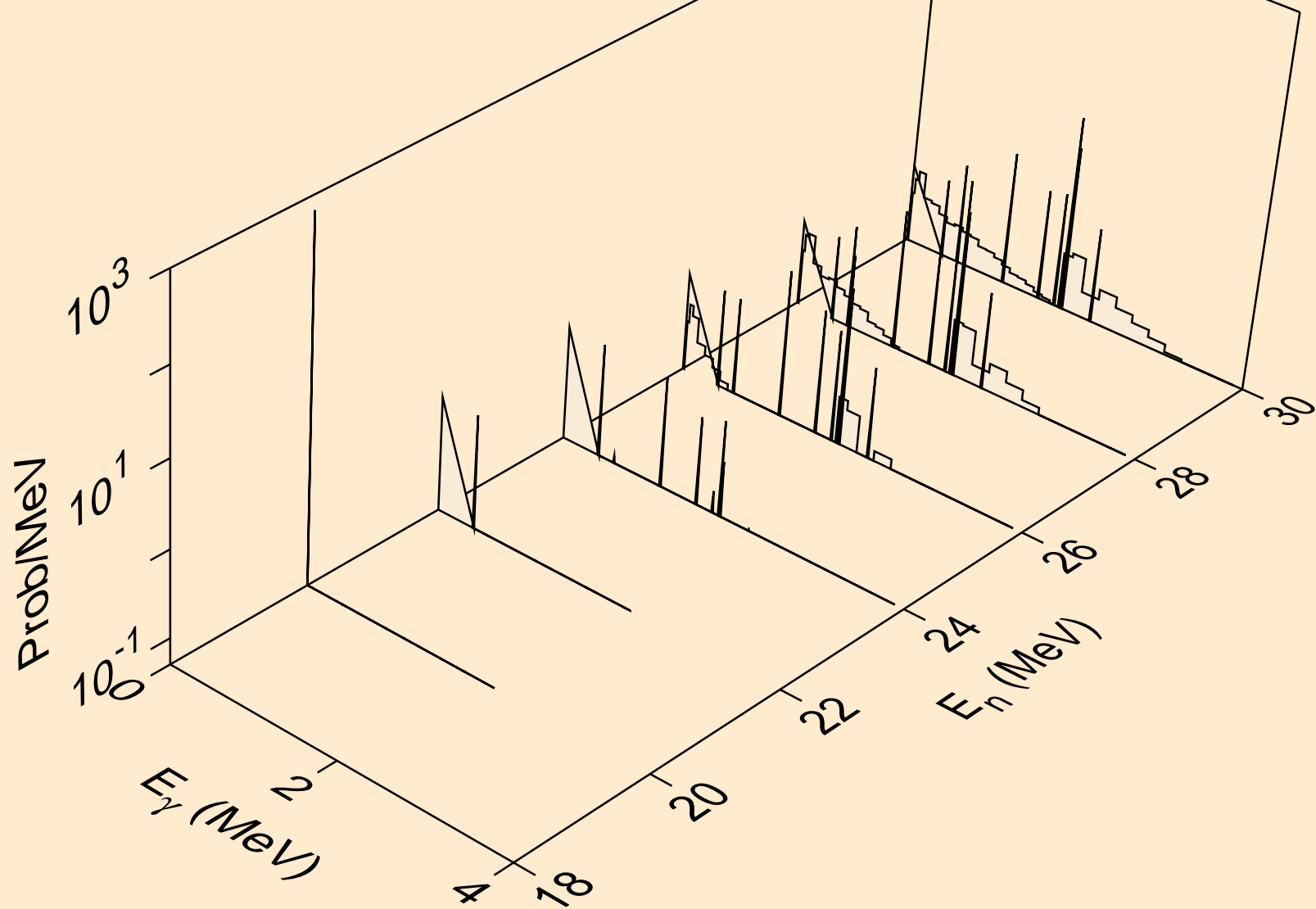

S036 NEUTRON ACER TENDL-2023 LIBRARY; T=0.K  
Photon emission for (n,n\*)t

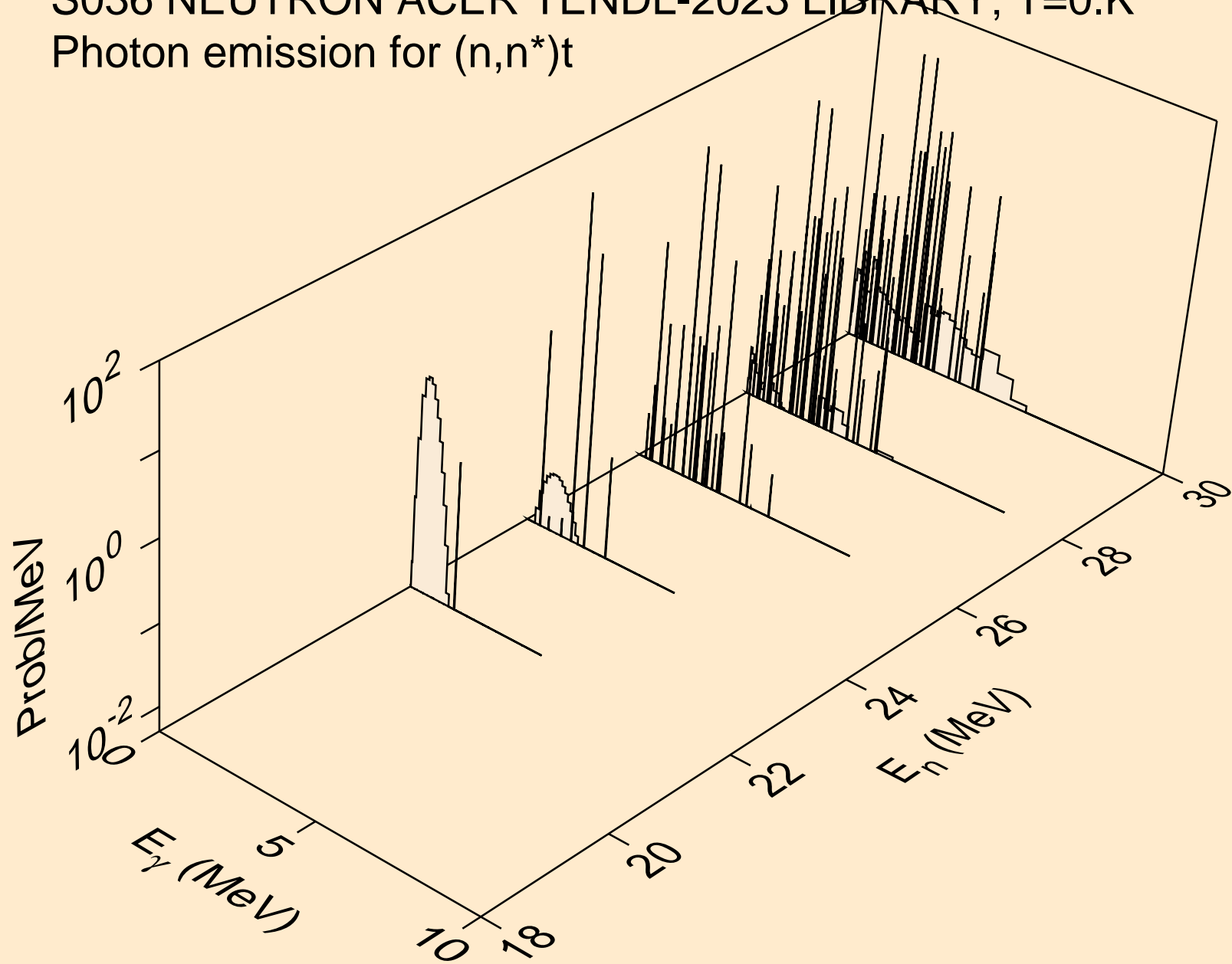

S036 NEUTRON ACER TENDL-2023 LIBRARY; T=0.K  
Photon emission for (n,n\*)he3

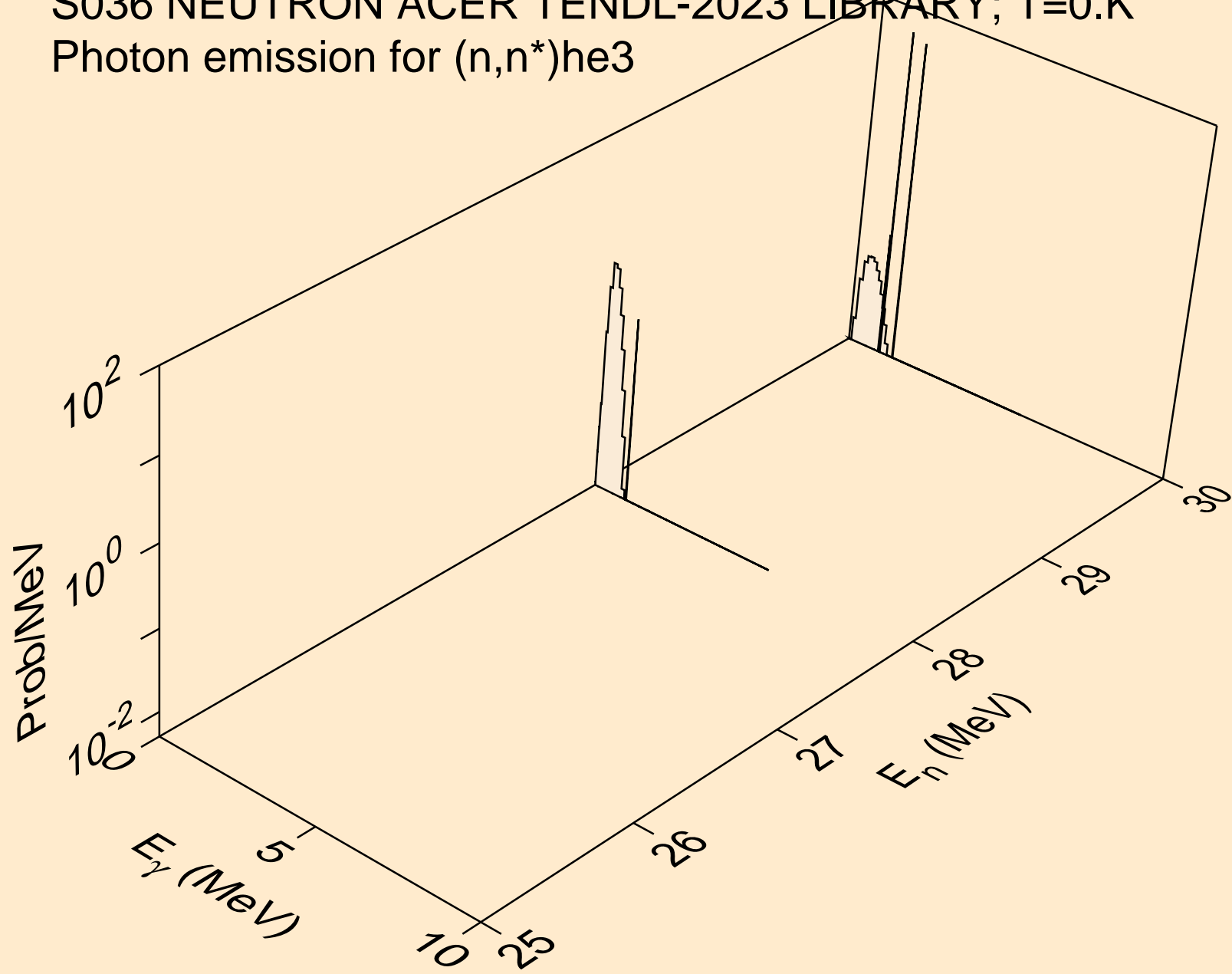

S036 NEUTRON ACER TENDL-2023 LIBRARY; T=0.K  
Photon emission for (n,2np)

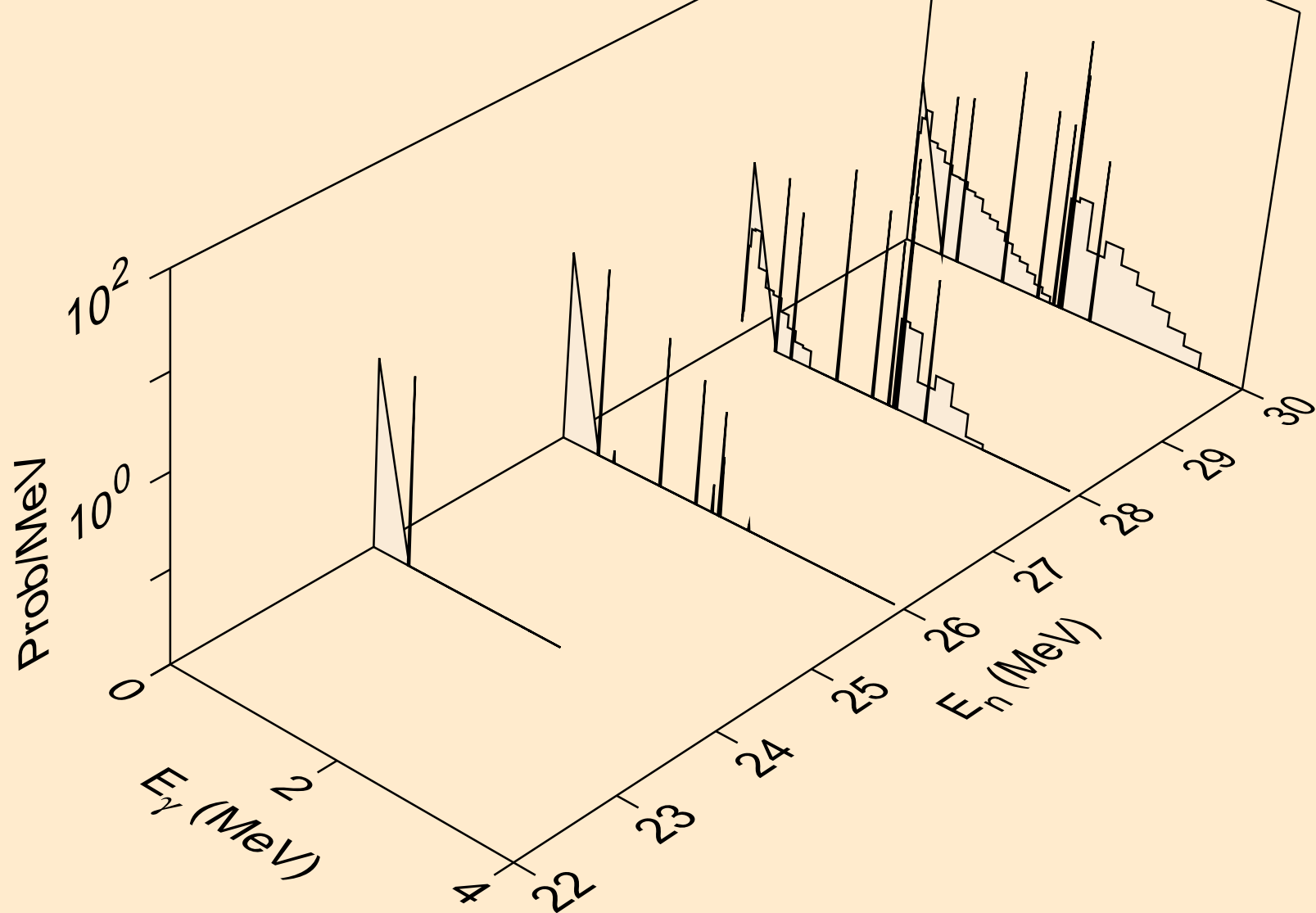

S036 NEUTRON ACER TENDL-2023 LIBRARY; T=0.K  
Photon emission for (n,3np)

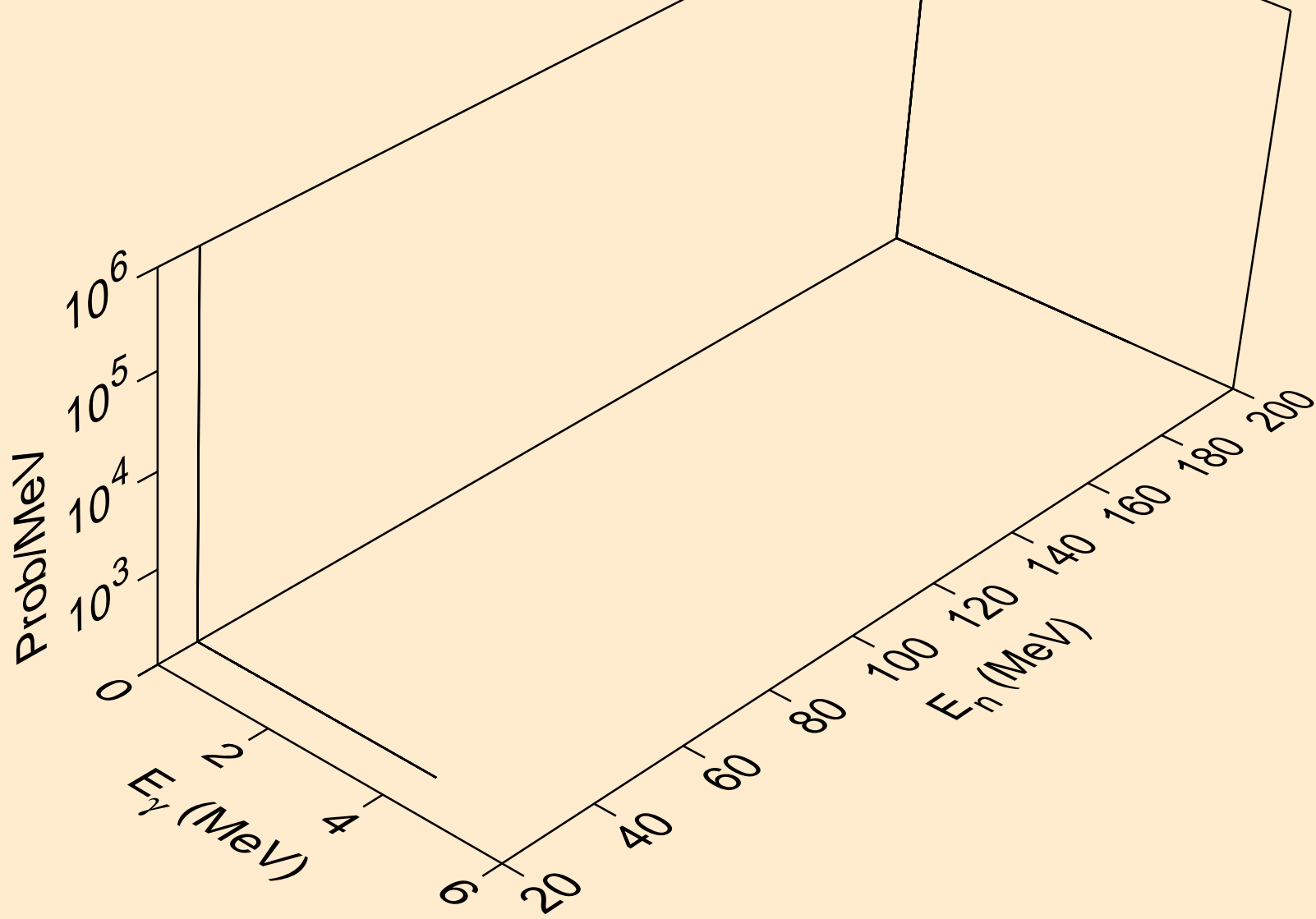

S036 NEUTRON ACER TENDL-2023 LIBRARY; T=0.K  
Photon emission for (n,n2p)

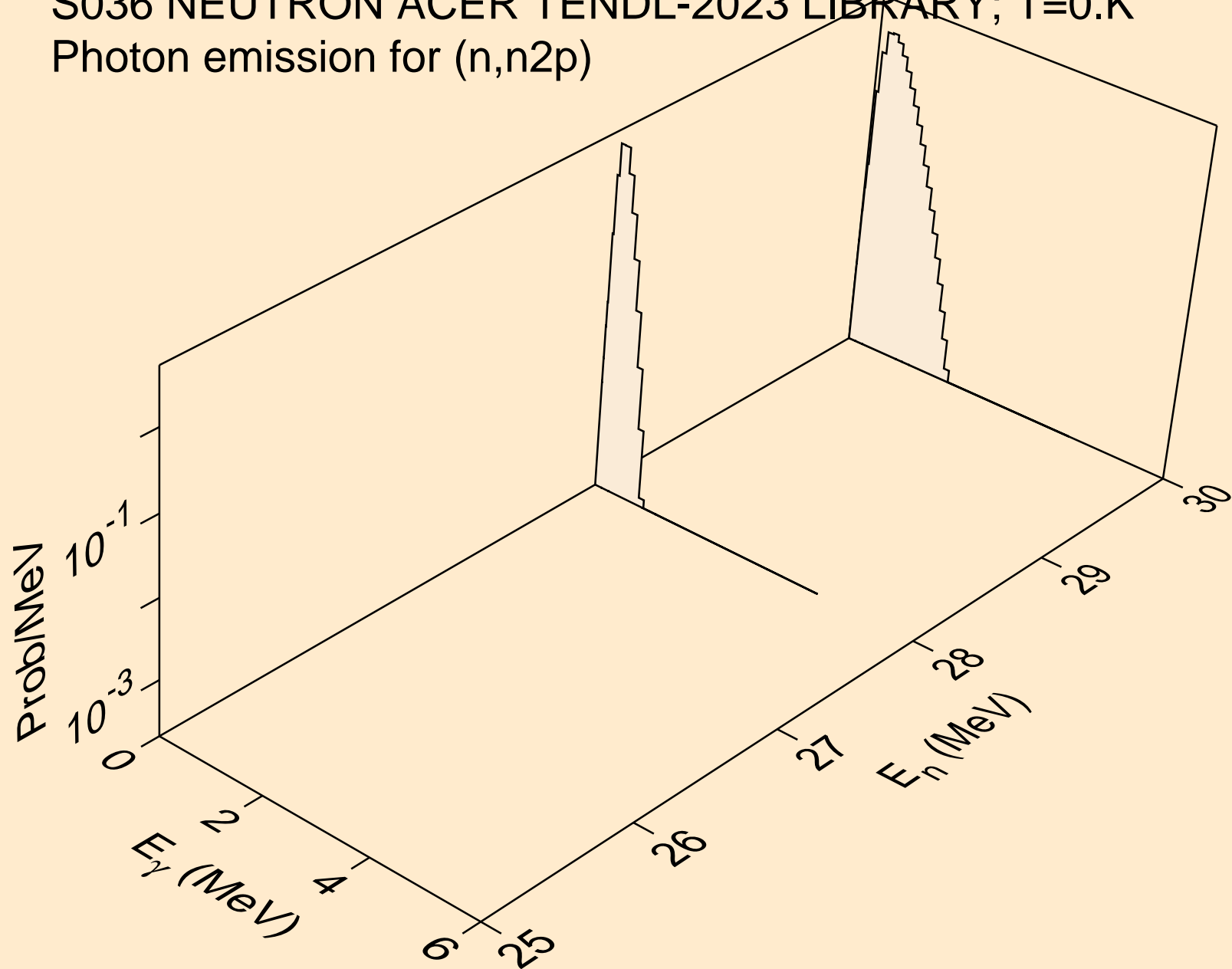



S036 NEUTRON ACER TENDL-2023 LIBRARY; T=0.K  
Photon emission for (n,n\*c)

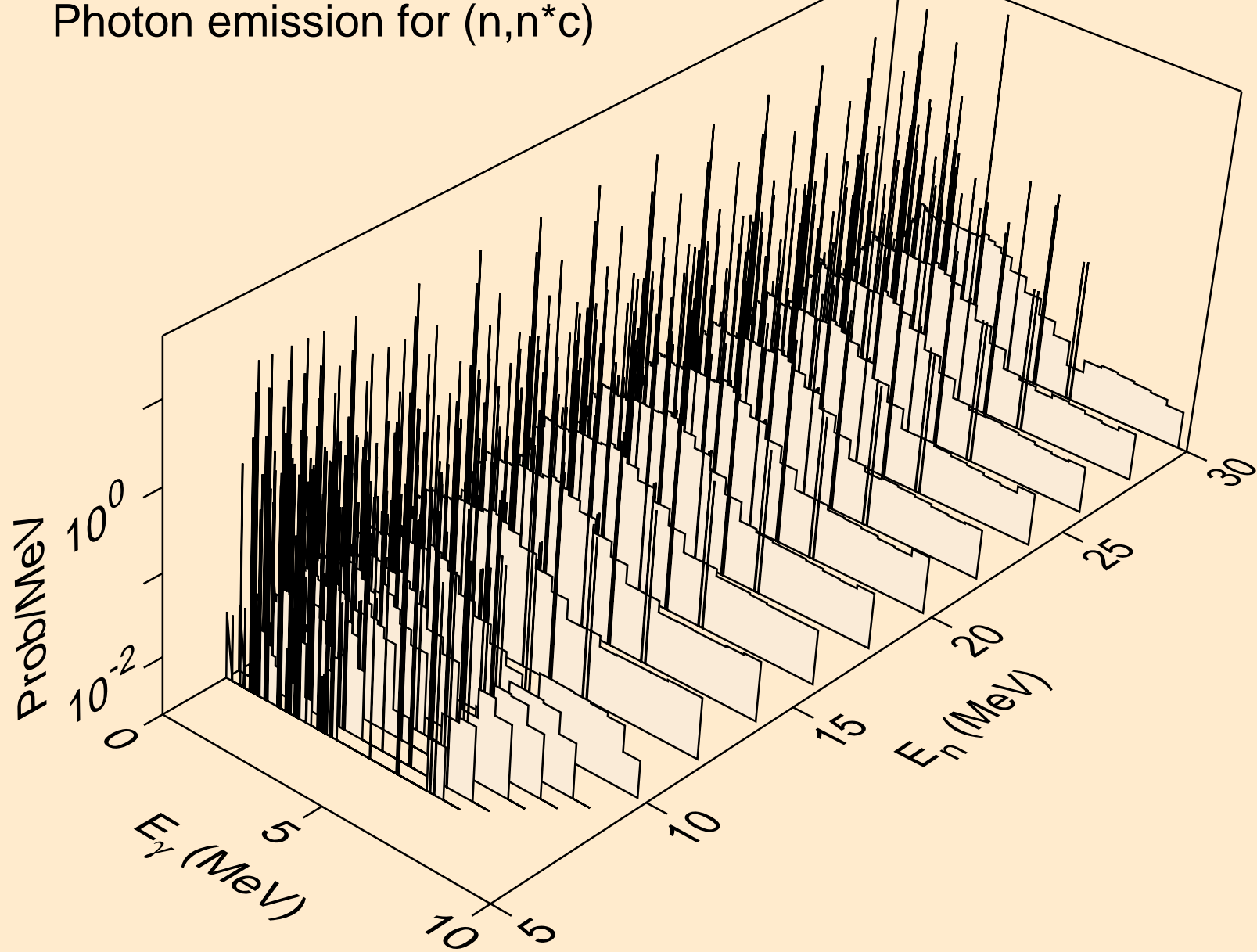

S036 NEUTRON ACER TENDL-2023 LIBRARY; T=0.K  
Photon emission for (n,gma)

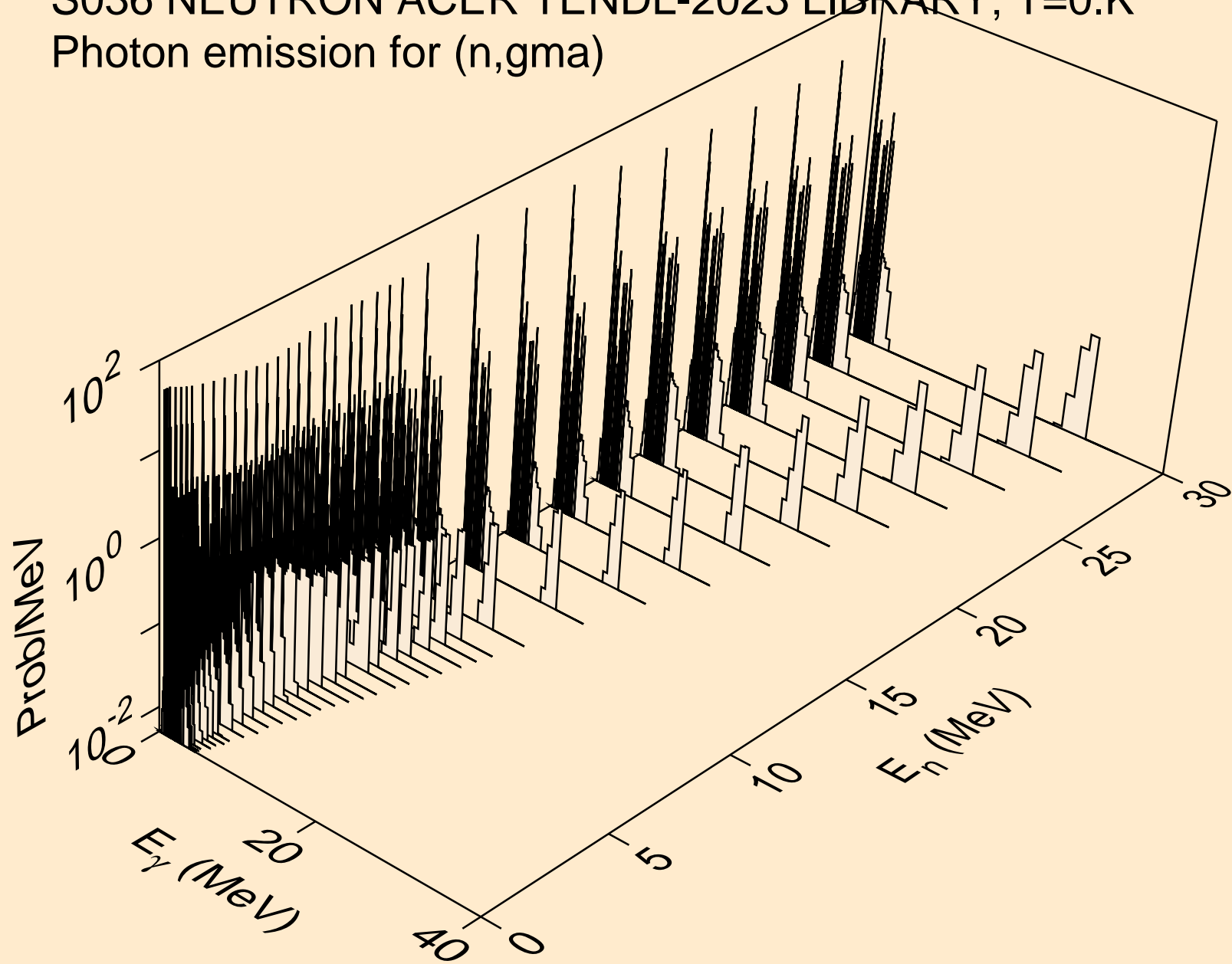

S036 NEUTRON ACER TENDL-2023 LIBRARY; T=0.K  
Photon emission for (n,p)

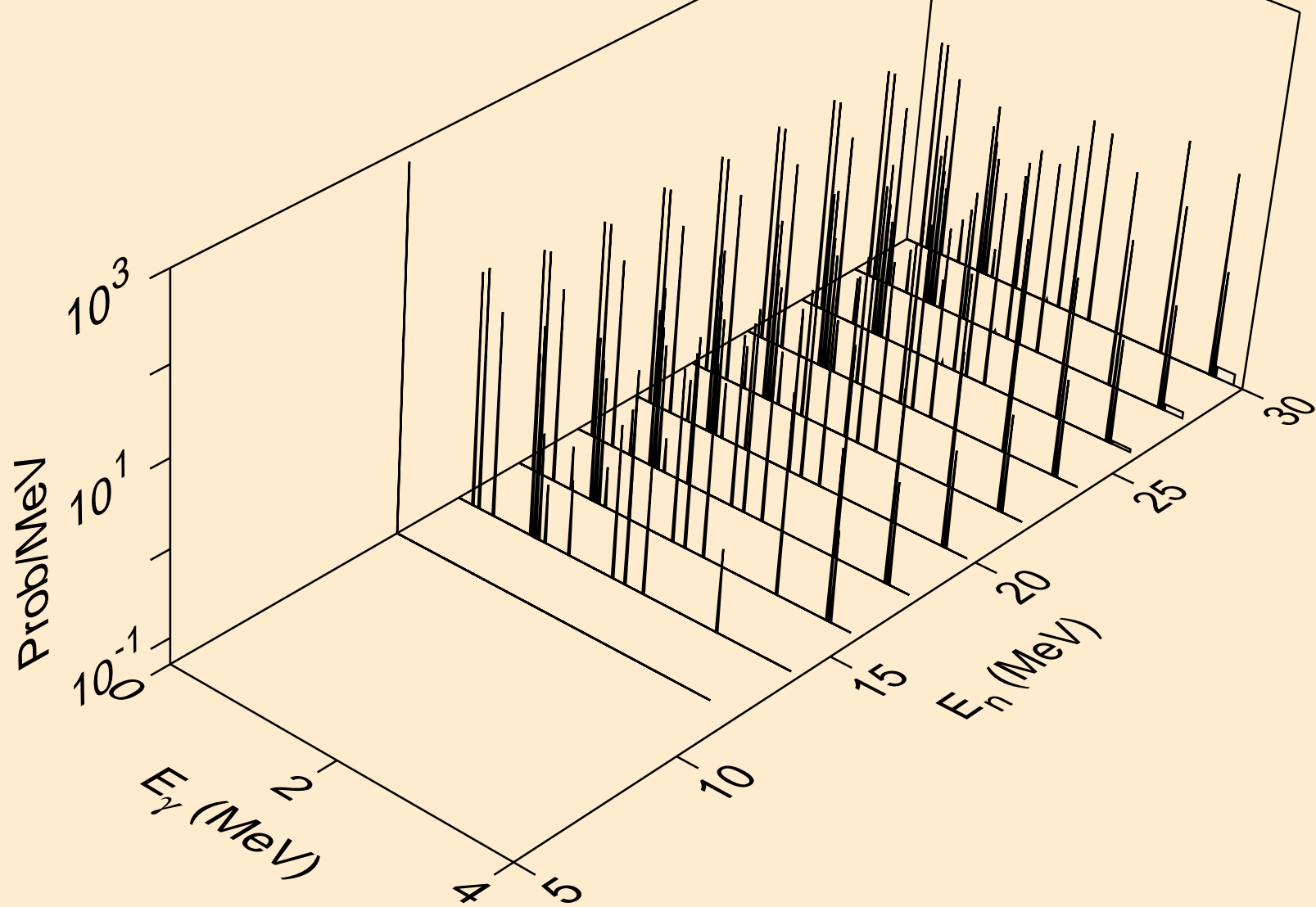

S036 NEUTRON ACER TENDL-2023 LIBRARY; T=0.K  
Photon emission for (n,d)

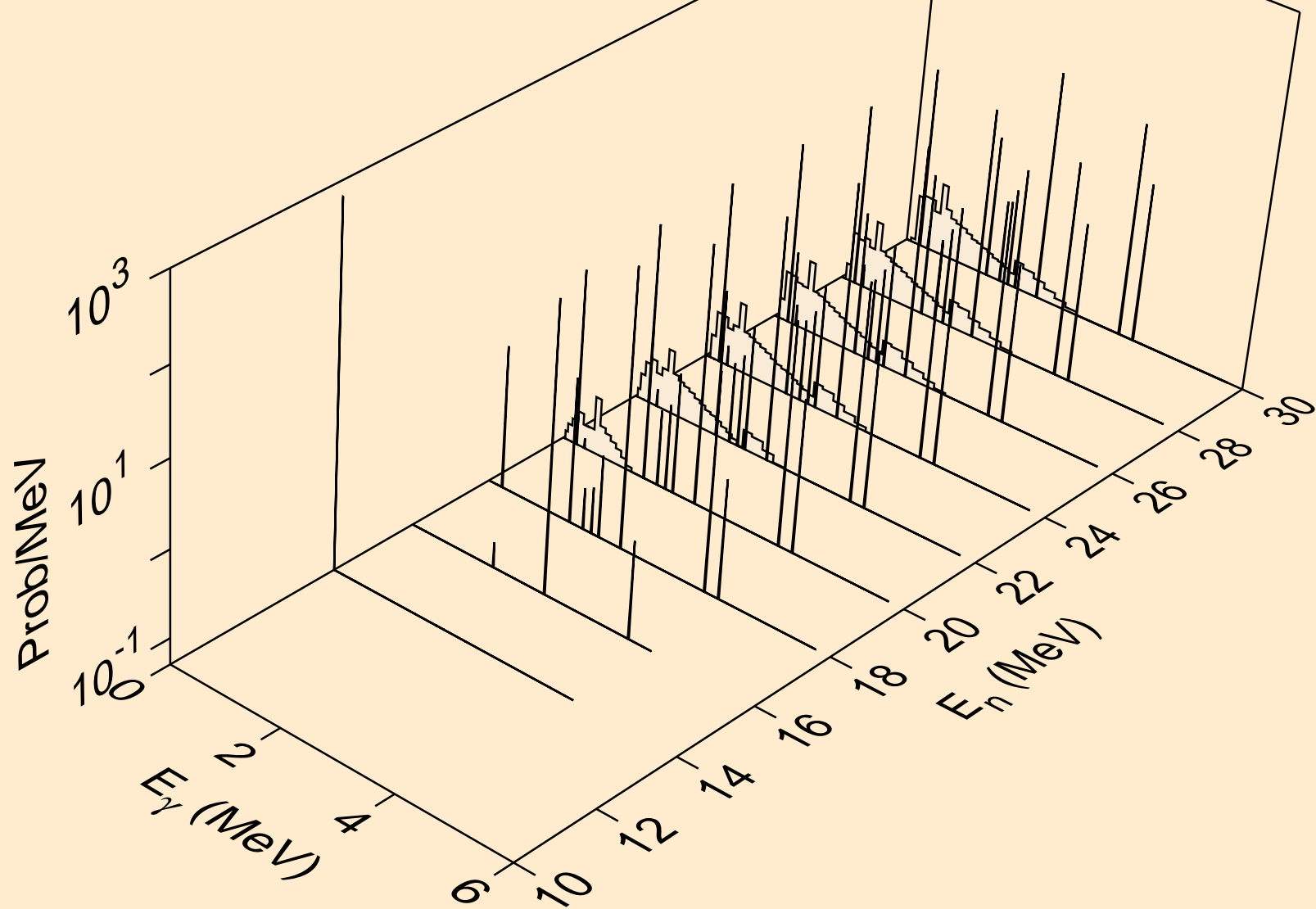

S036 NEUTRON ACER TENDL-2023 LIBRARY; T=0.K  
Photon emission for (n,t)

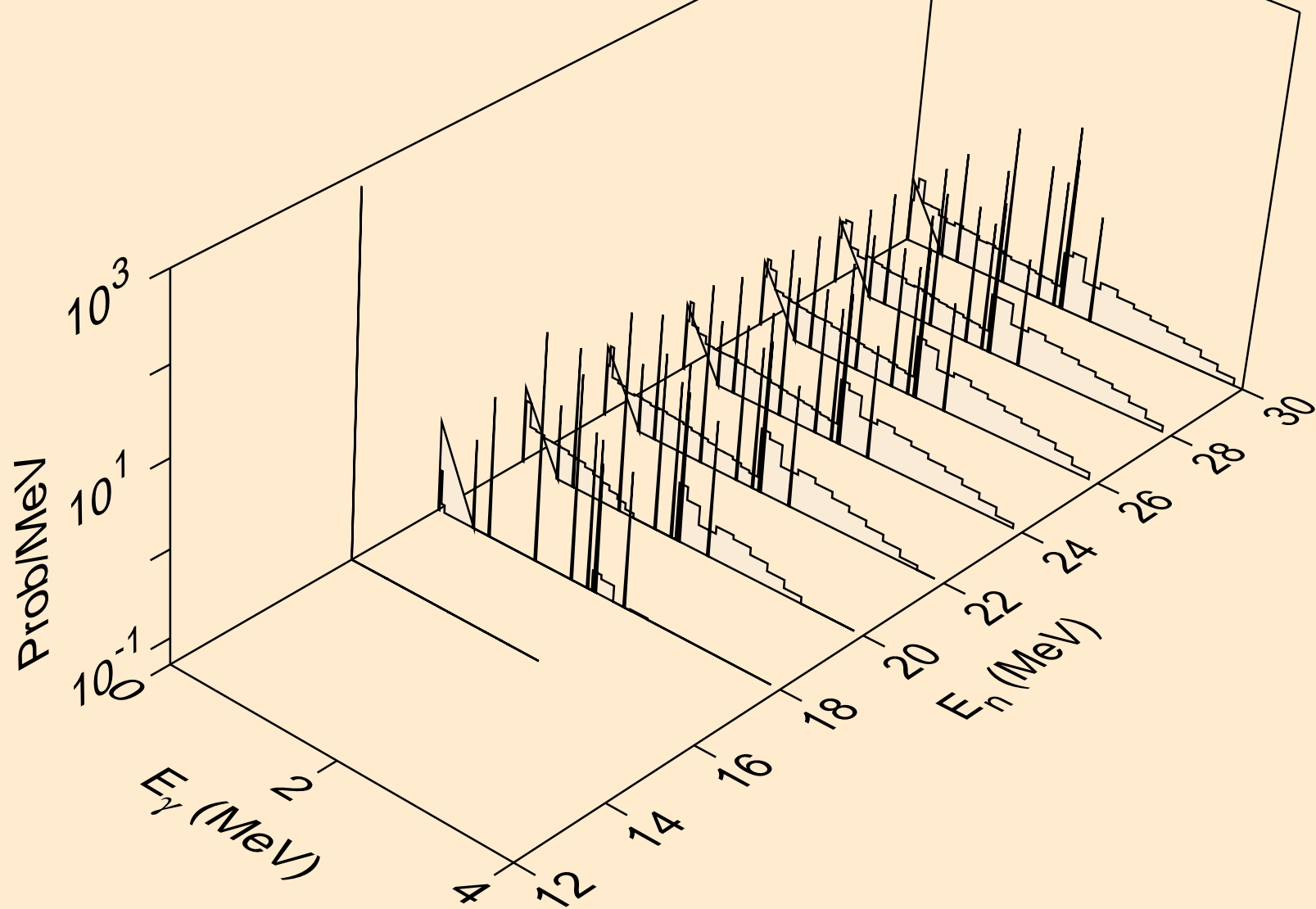

S036 NEUTRON ACER TENDL-2023 LIBRARY; T=0.K  
Photon emission for (n,he3)

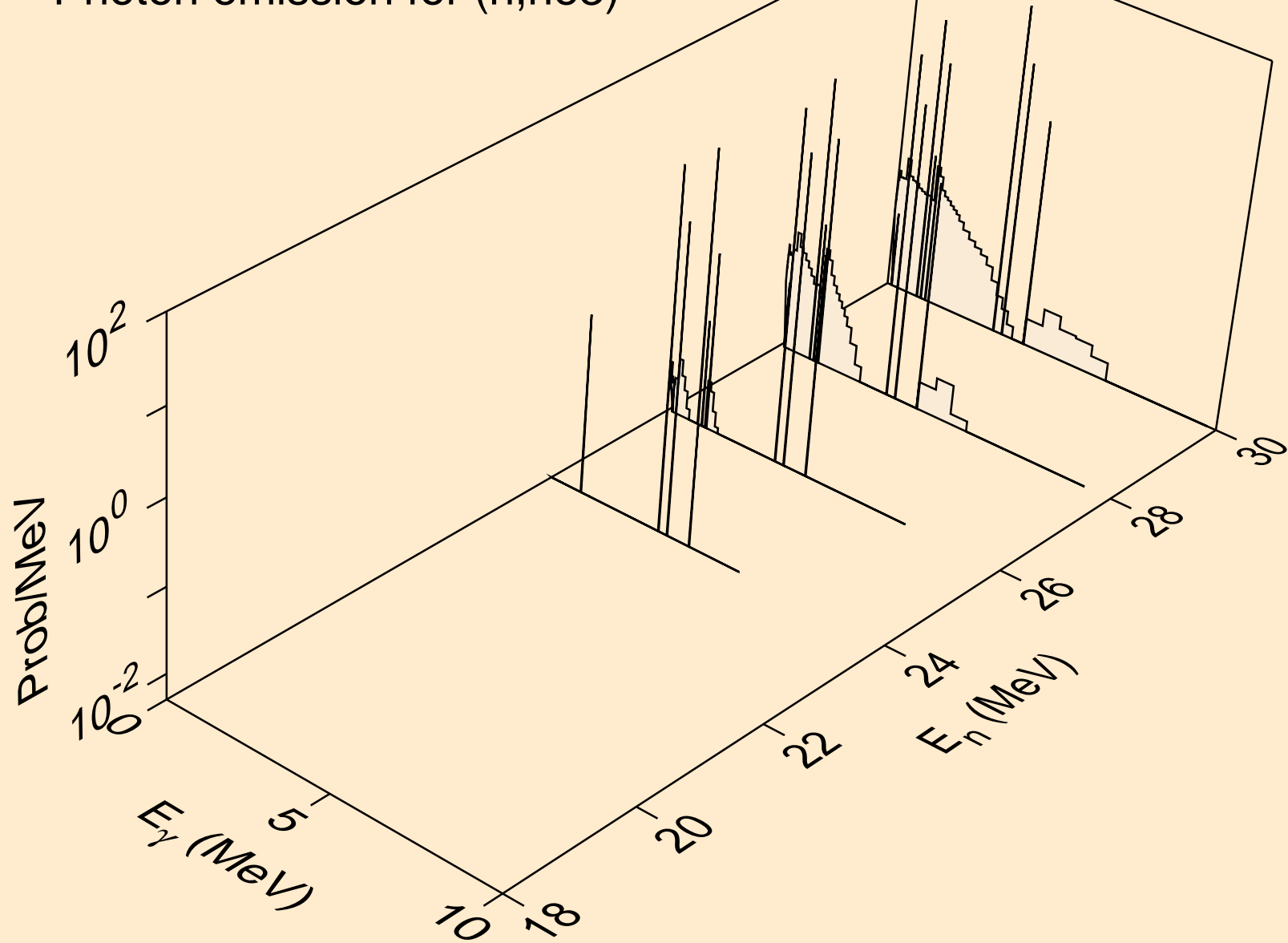

S036 NEUTRON ACER TENDL-2023 LIBRARY; T=0.K  
Photon emission for (n,a)

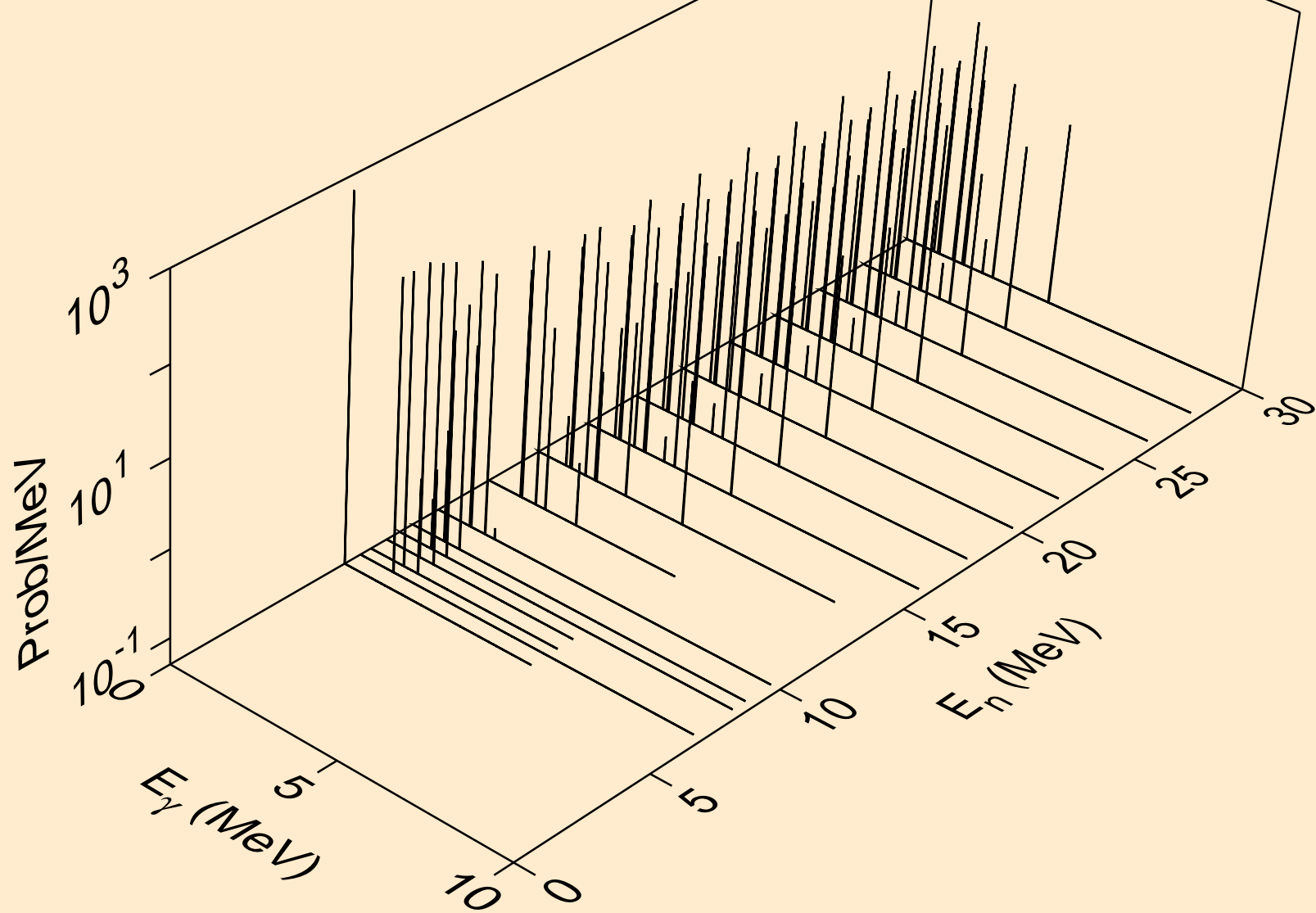

S036 NEUTRON ACER TENDL-2023 LIBRARY; T=0.K  
Photon emission for (n,2a)

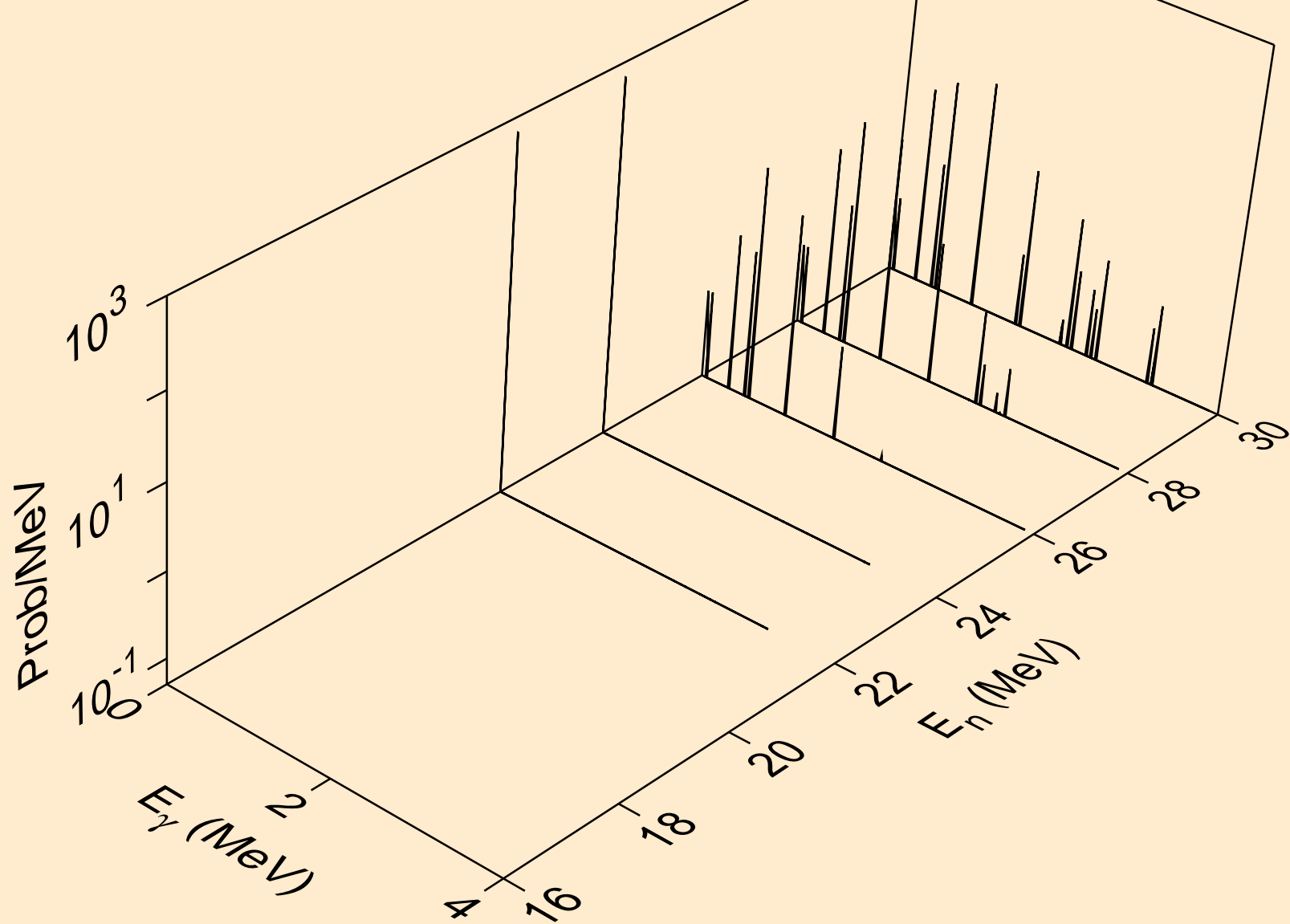



S036 NEUTRON ACER TENDL-2023 LIBRARY; T=0.K  
Photon emission for (n,2p)

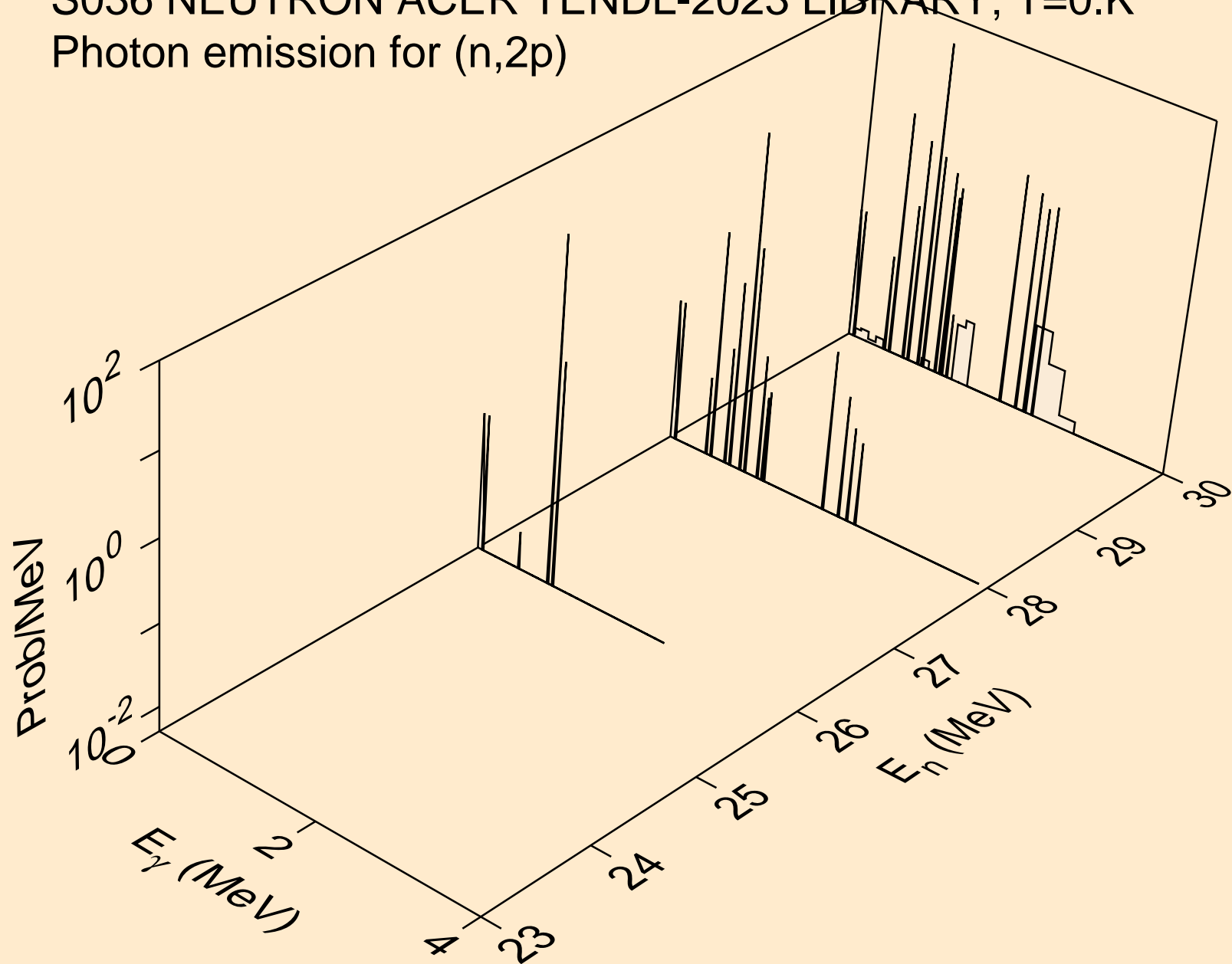

S036 NEUTRON ACER TENDL-2023 LIBRARY; T=0.K  
Photon emission for (n,pa)

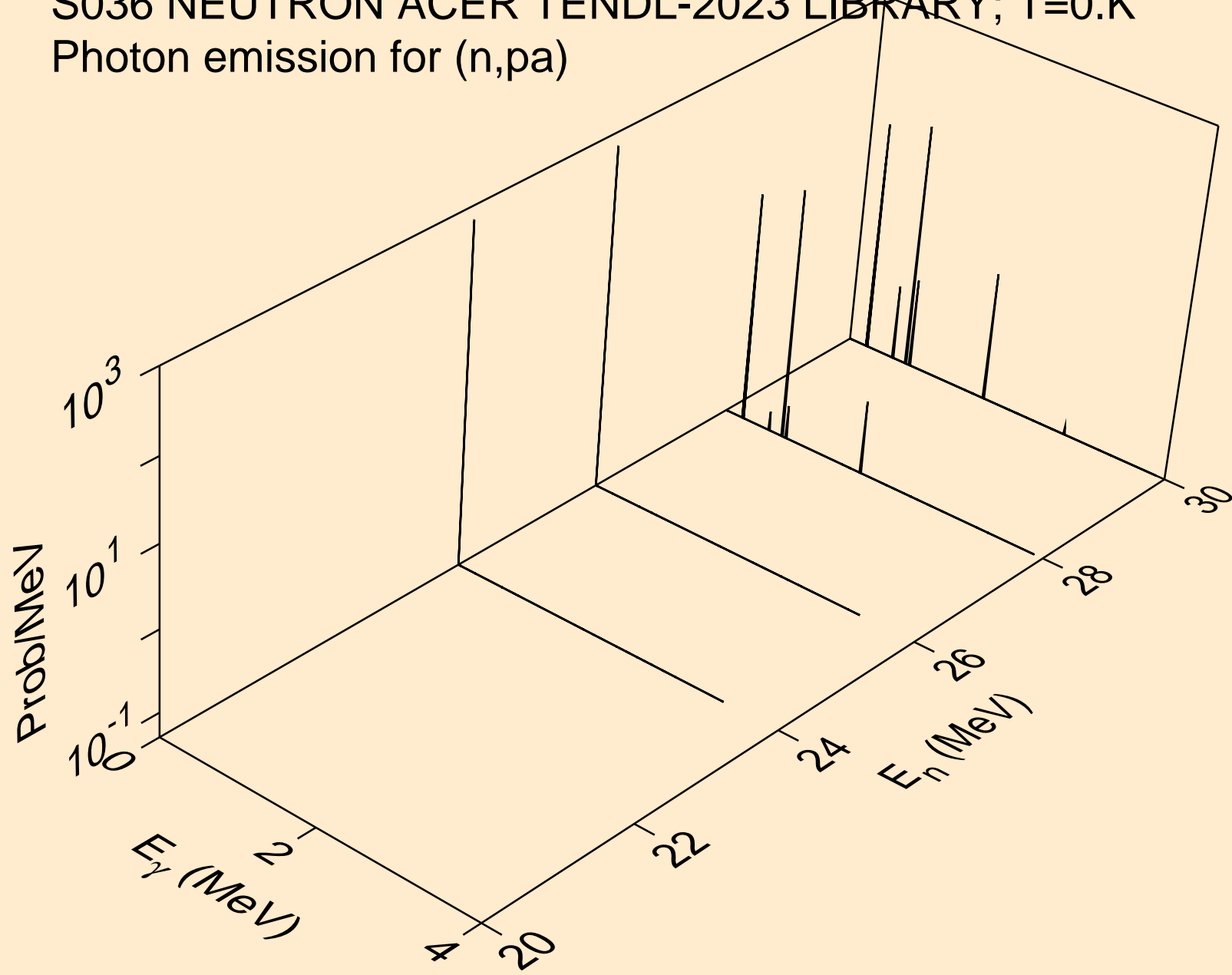

S036 NEUTRON ACER TENDL-2023 LIBRARY; T=0.K  
Photon emission for (n,pd)

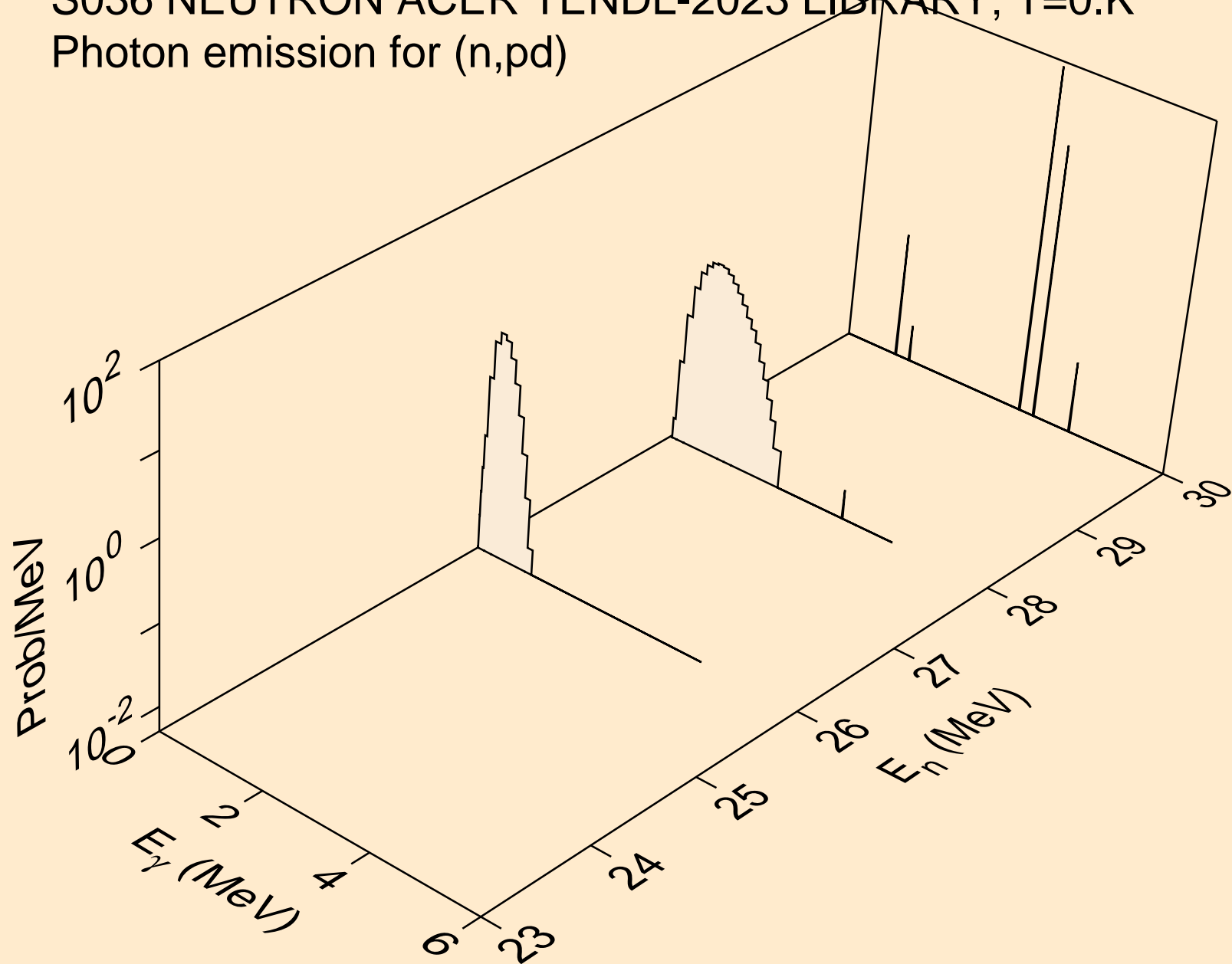

S036 NEUTRON ACER TENDL-2023 LIBRARY; T=0.K  
Photon emission for (n,pt)

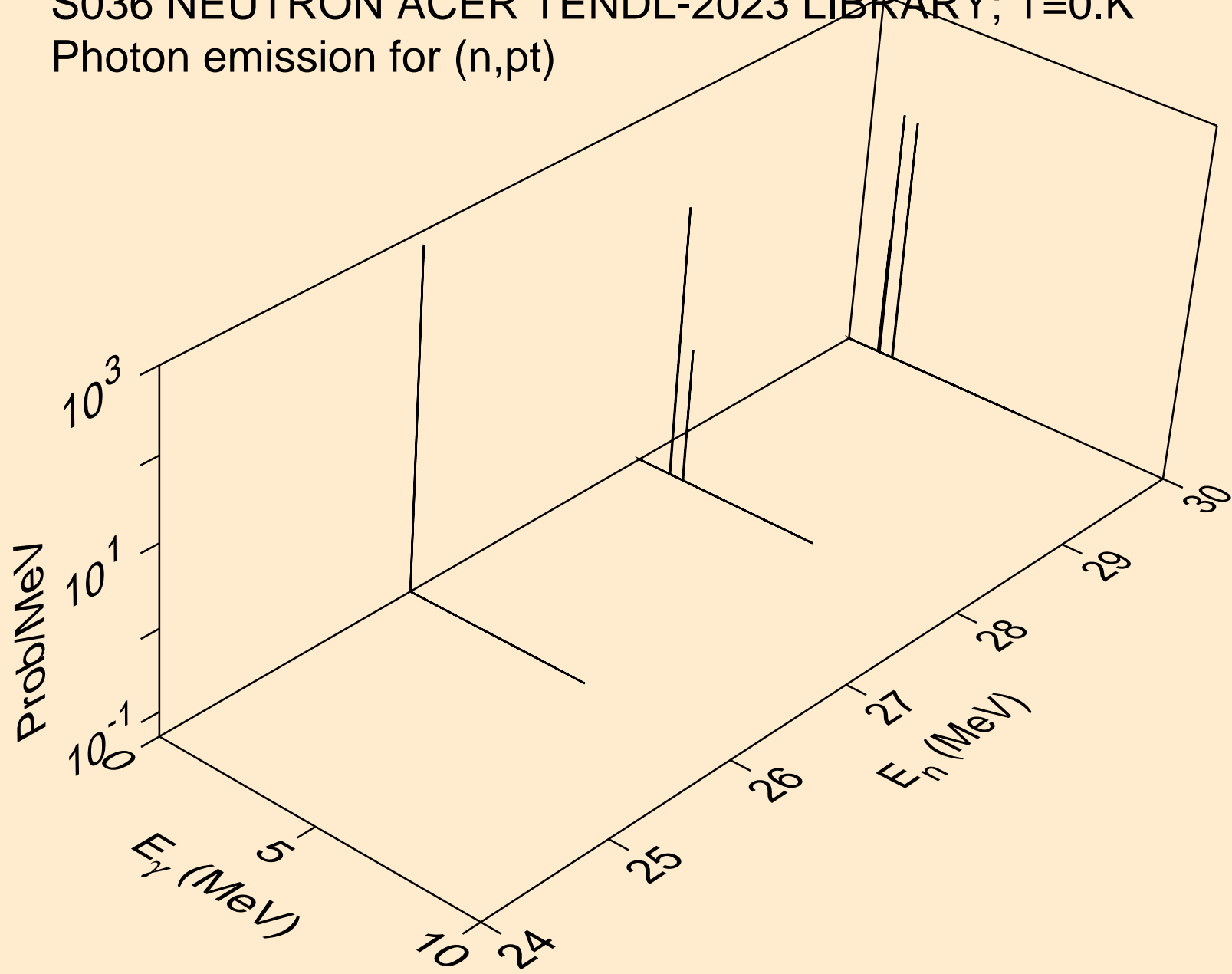

S036 NEUTRON ACER TENDL-2023 LIBRARY; T=0.K  
Photon emission for (n,da)

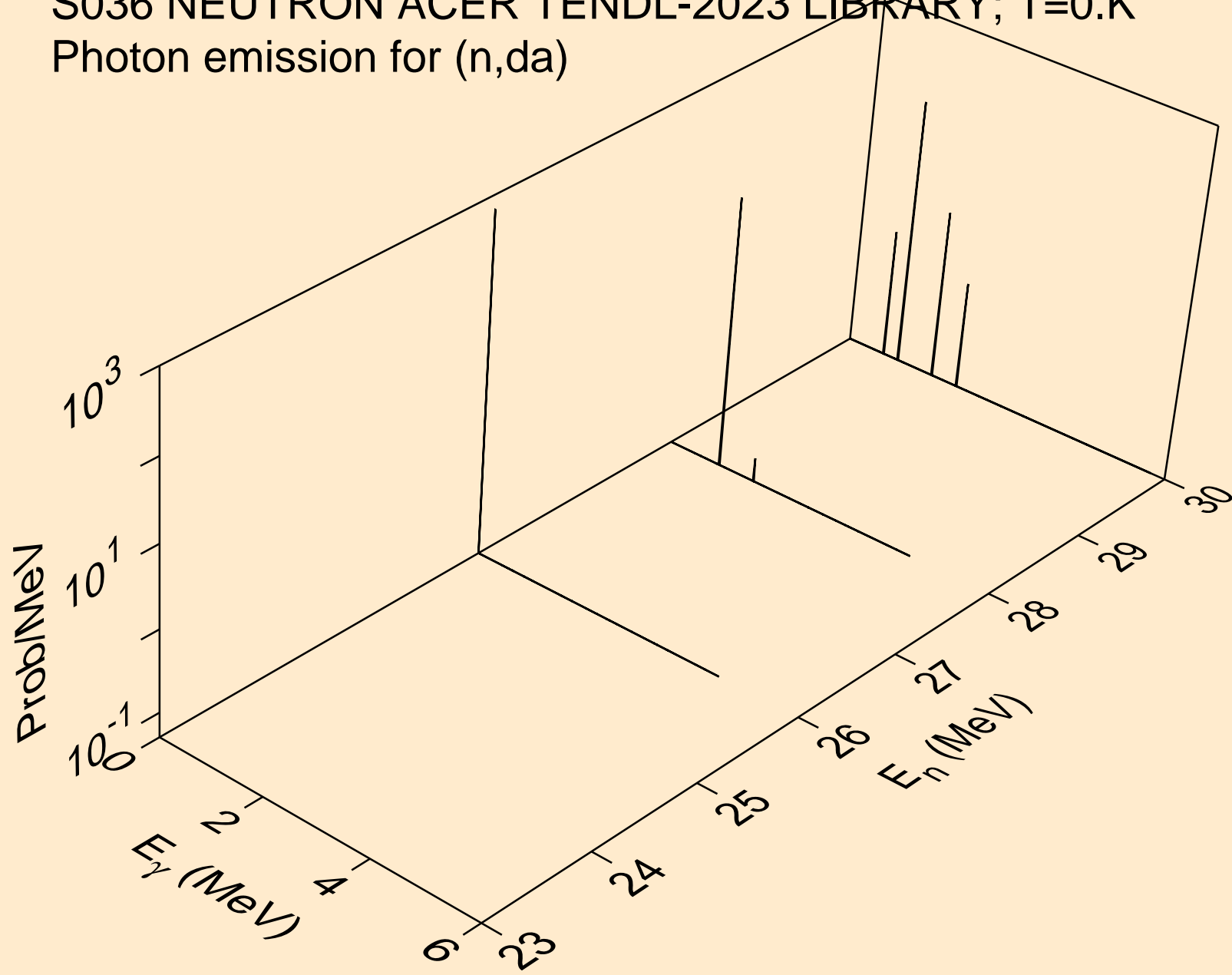

S036 NEUTRON ACER TENDL-2023 LIBRARY; T=0.K  
thermal capture photon spectrum

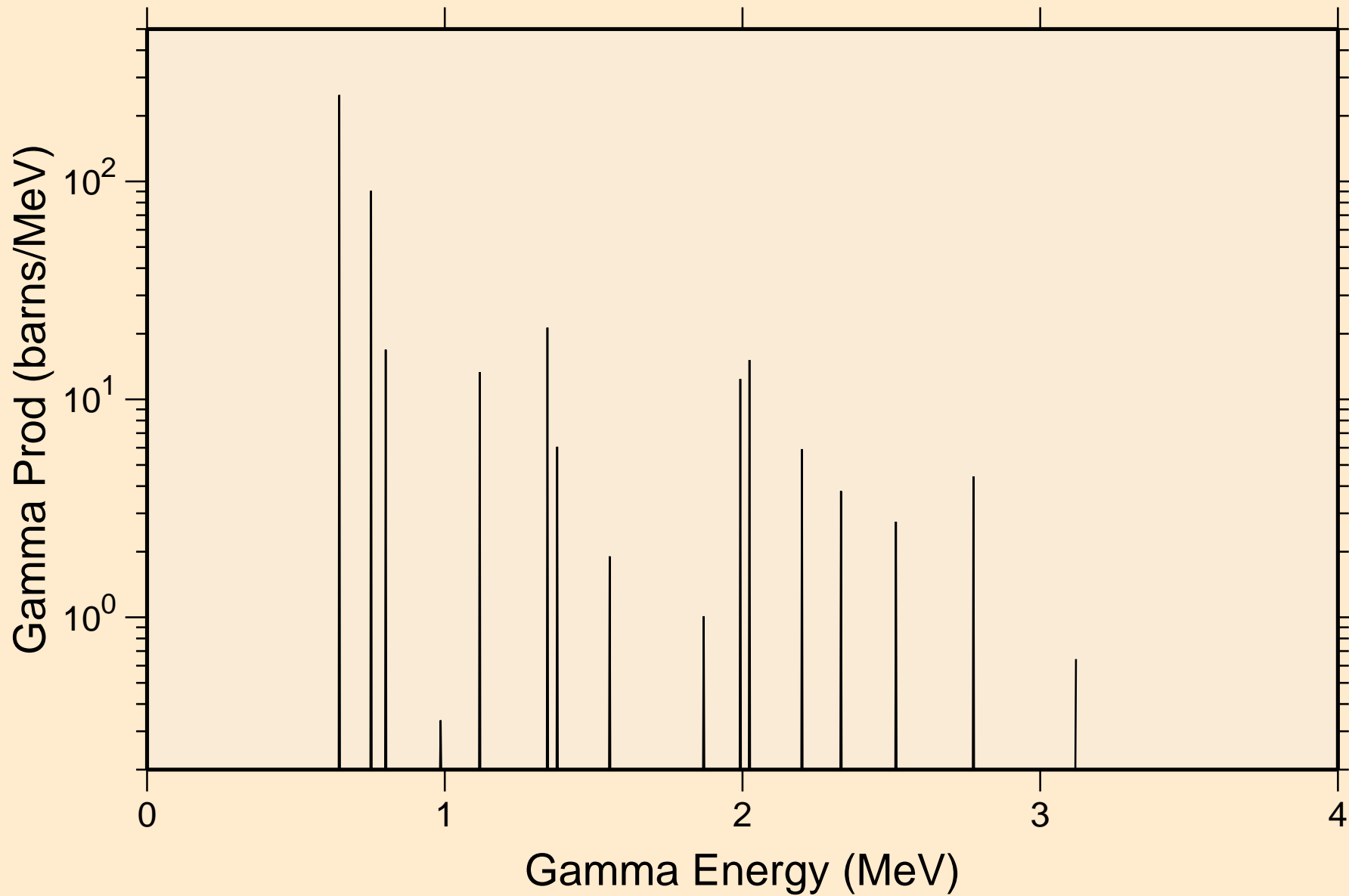

S036 NEUTRON ACER TENDL-2023 LIBRARY; T=0.K  
14 MeV photon spectrum

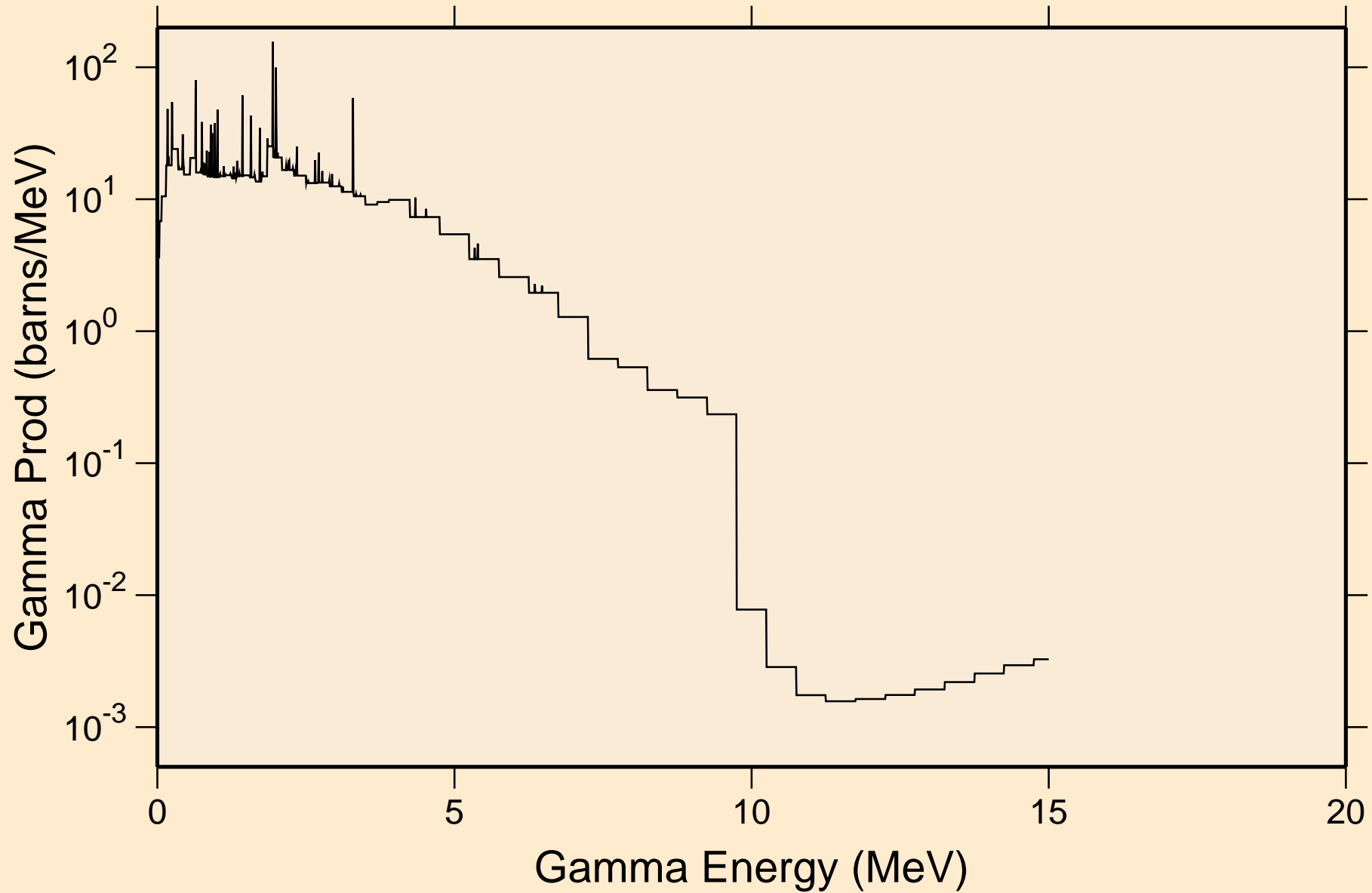

# S036 NEUTRON ACER TENDL-2023 LIBRARY; T=0.K

## Particle heating contributions

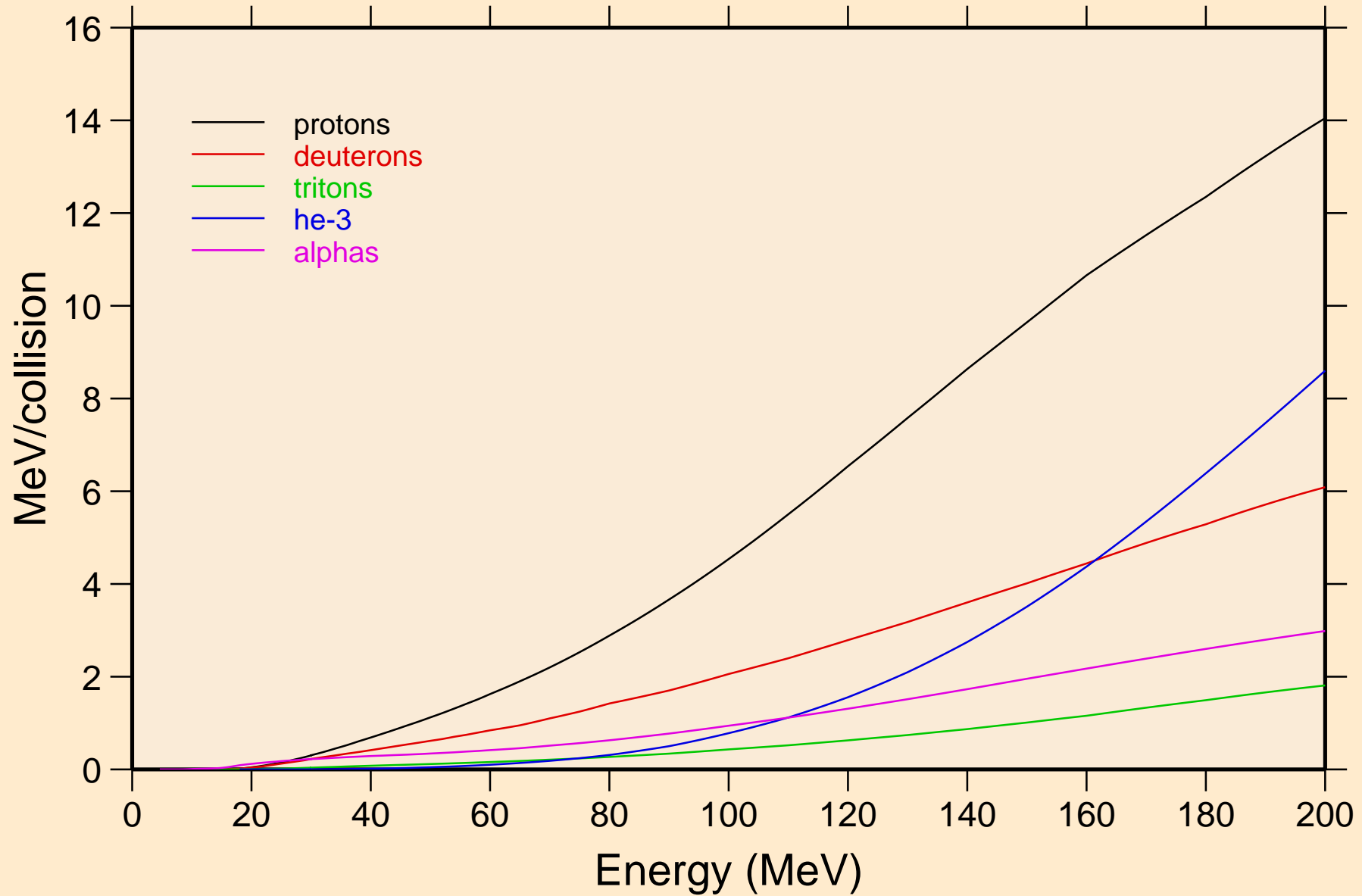



S036 NEUTRON ACER TENDL-2023 LIBRARY; T=0.K  
Recoil Heating

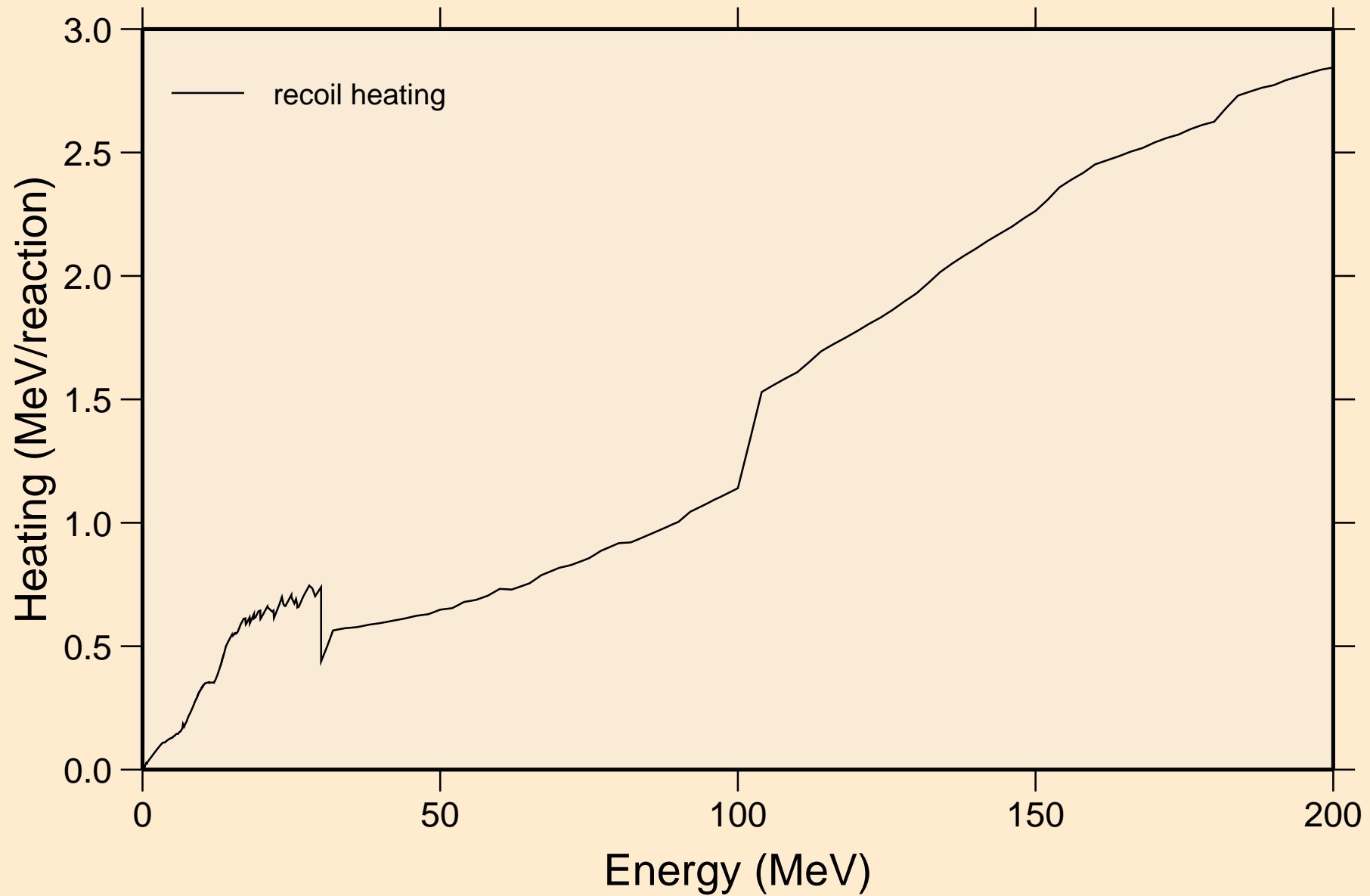

# S036 NEUTRON ACER TENDL-2023 LIBRARY; T=0.K

## Particle production cross sections

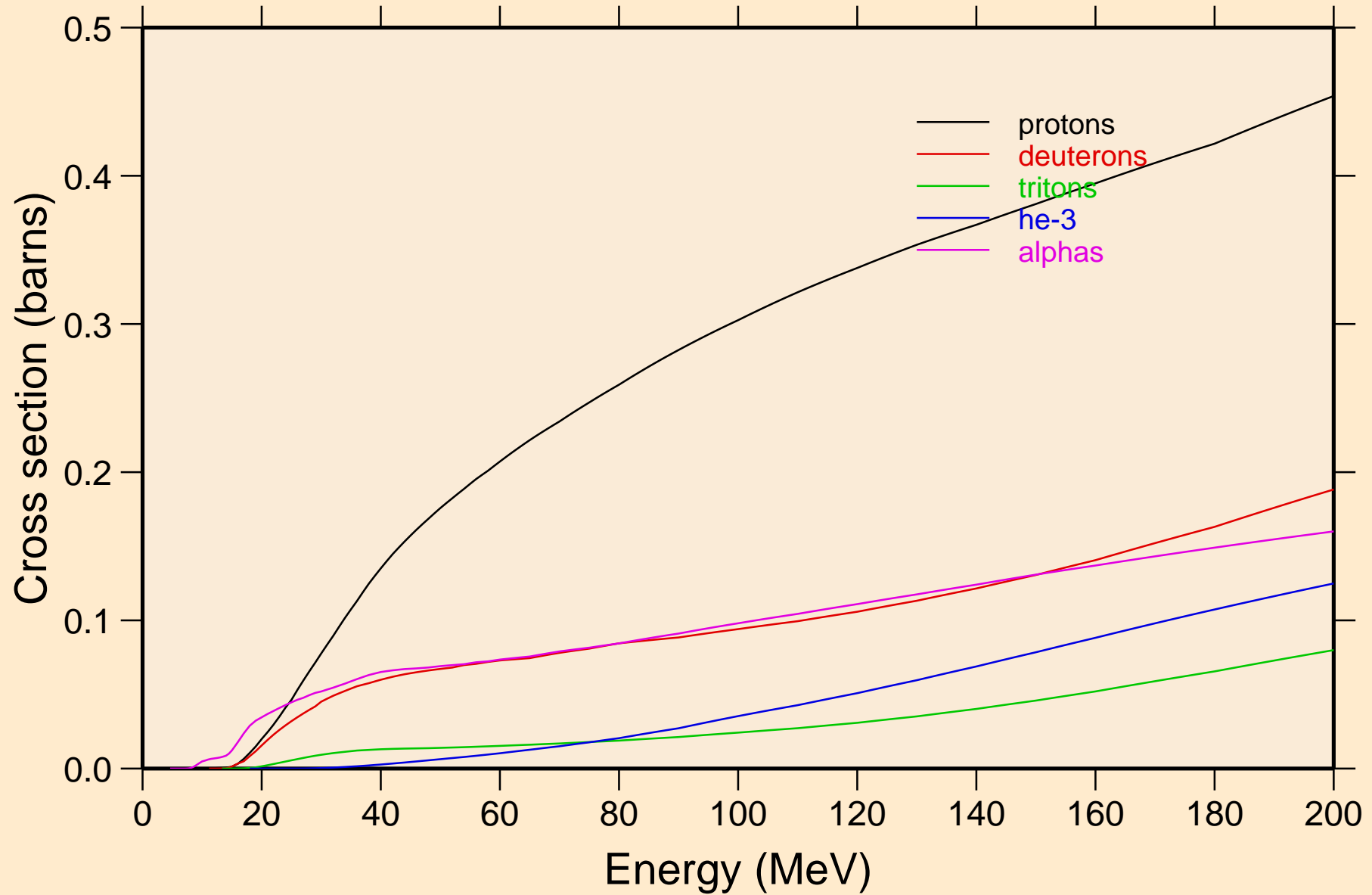

S036 NEUTRON ACER TENDL-2023 LIBRARY; T=0.K  
protons from (n,x)

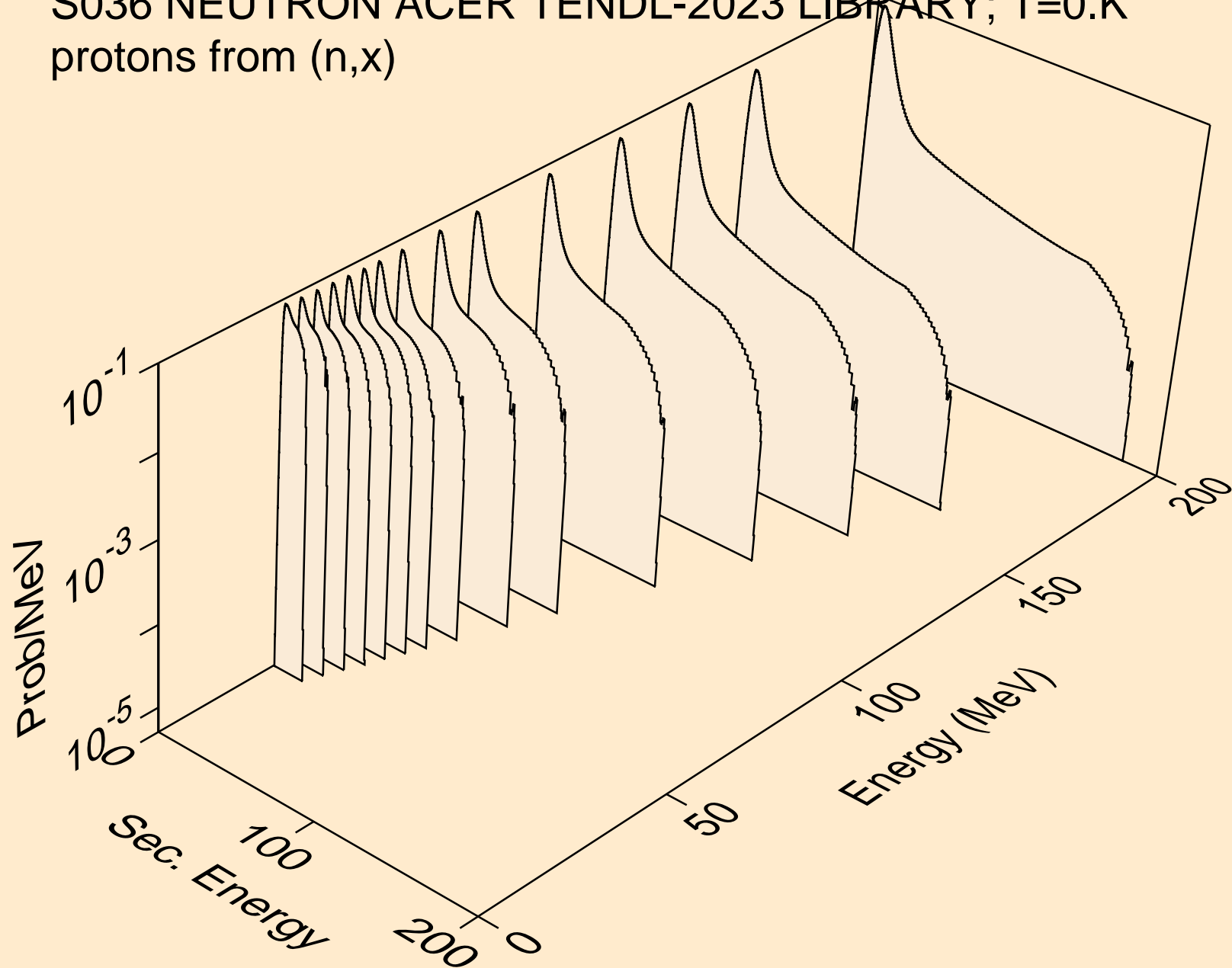

S036 NEUTRON ACER TENDL-2023 LIBRARY; T=0.K  
protons from (n,n\*)p

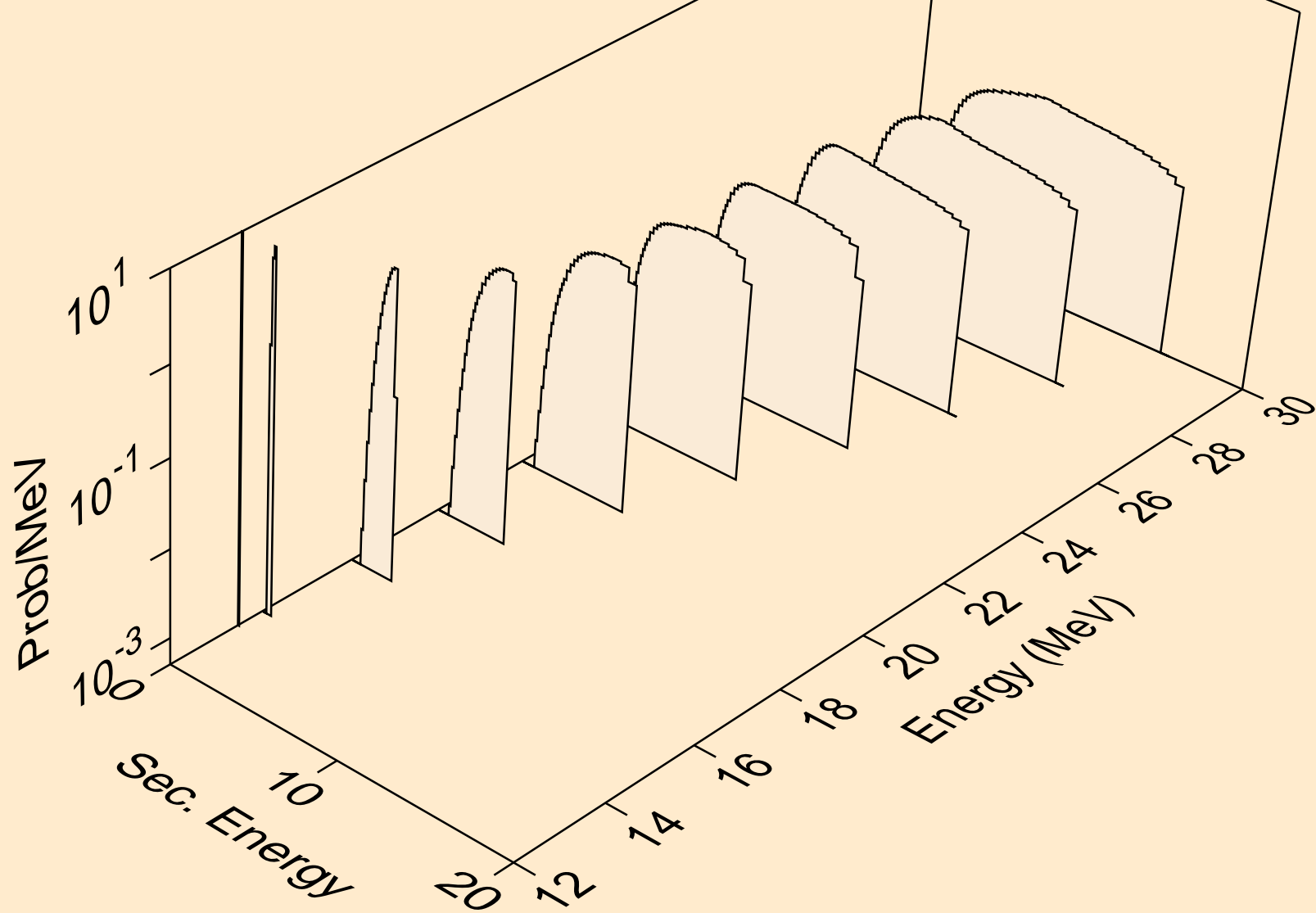

S036 NEUTRON ACER TENDL-2023 LIBRARY; T=0.K  
protons from (n,2np)

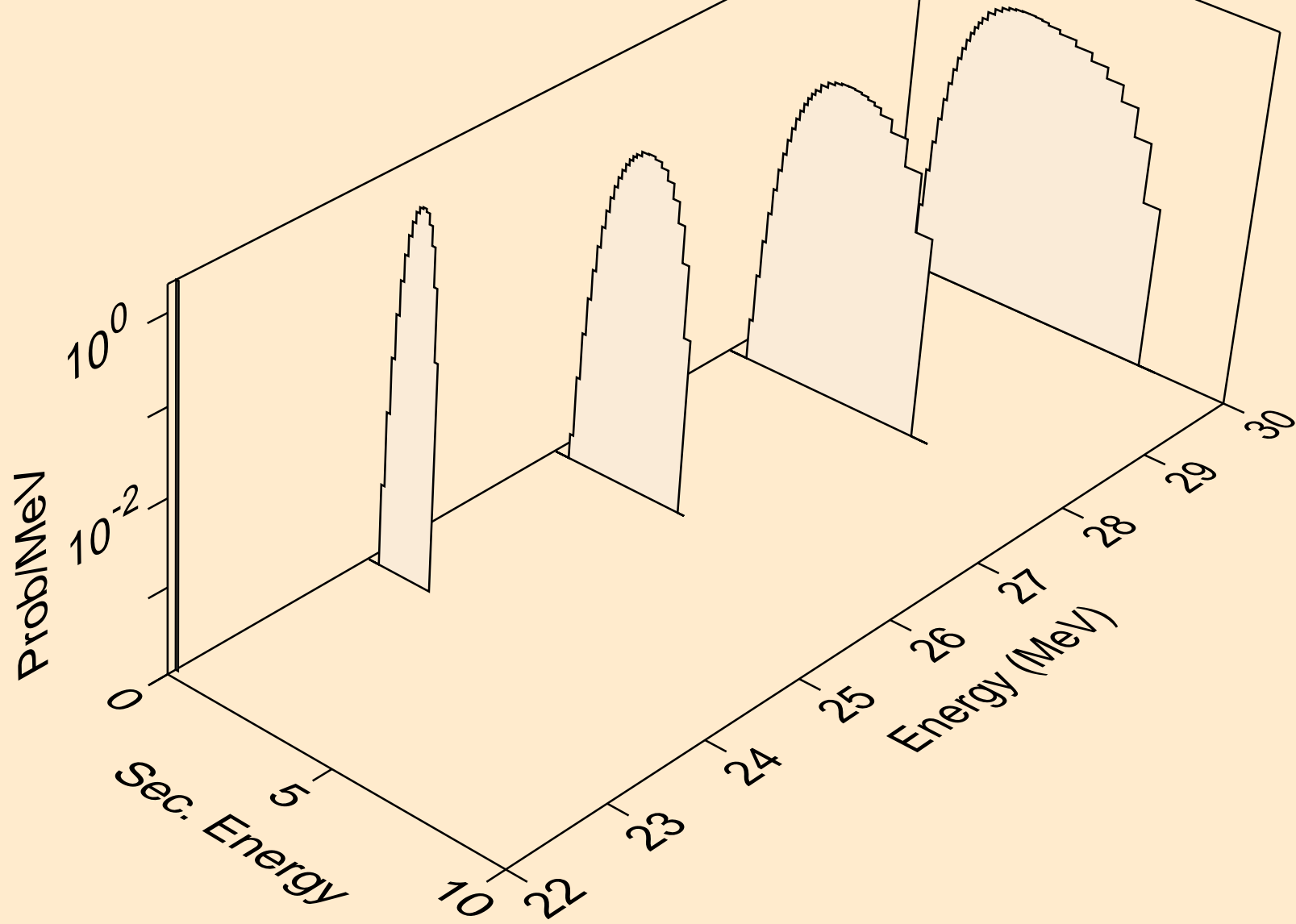

S036 NEUTRON ACER TENDL-2023 LIBRARY; T=0.K  
protons from (n,3np)

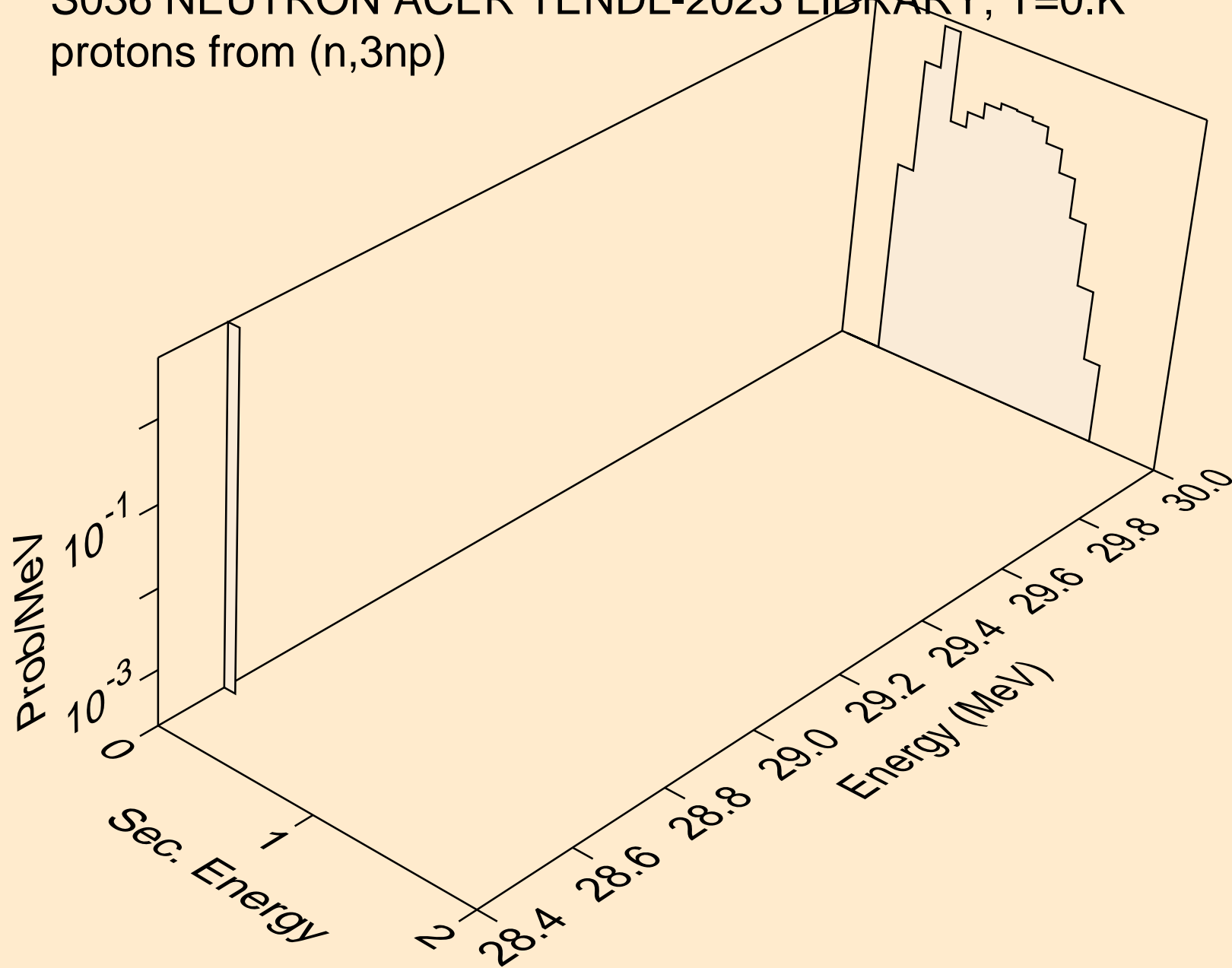

S036 NEUTRON ACER TENDL-2023 LIBRARY; T=0.K  
protons from (n,n2p)

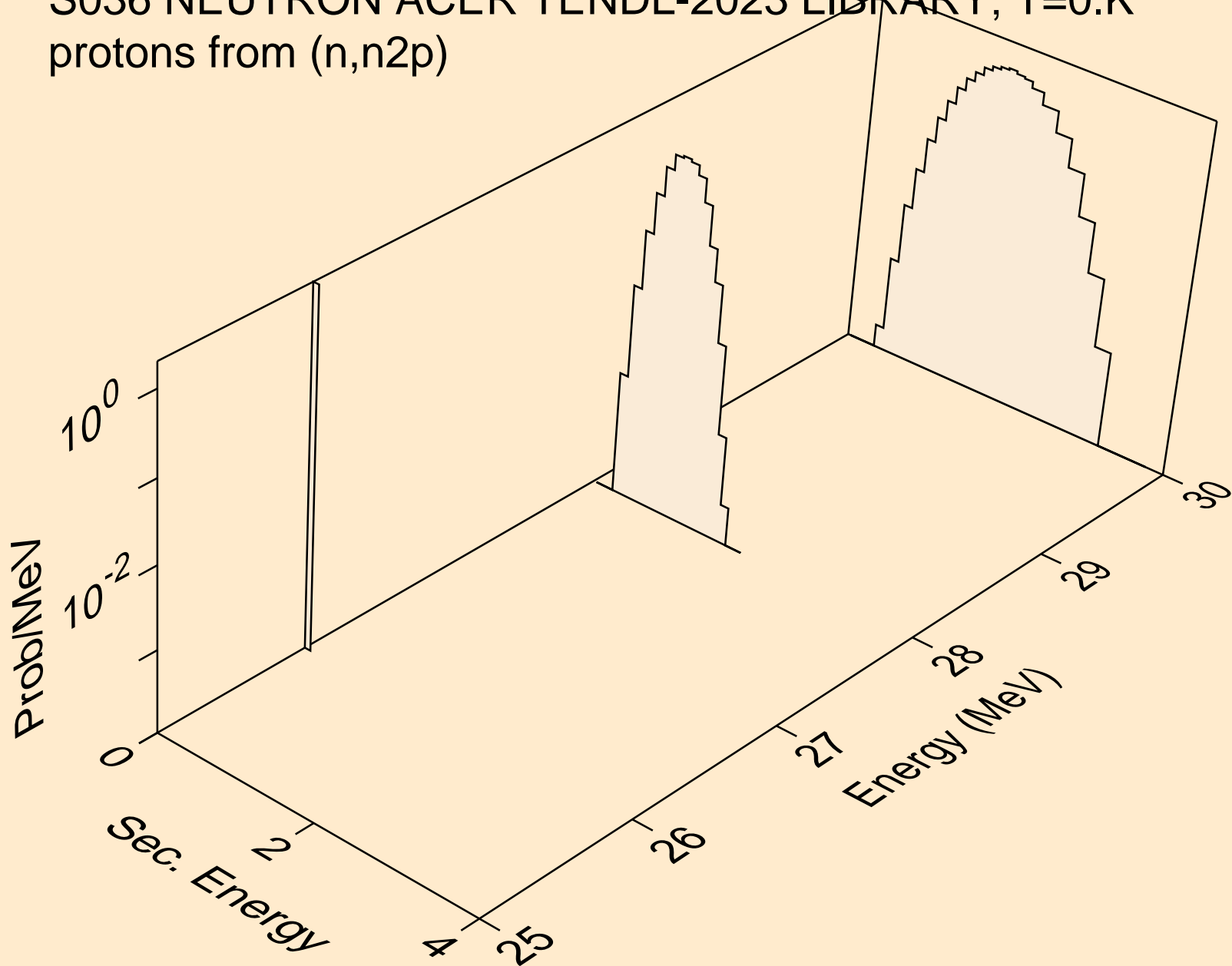

S036 NEUTRON ACER TENDL-2023 LIBRARY; T=0.K  
protons from (n,p)

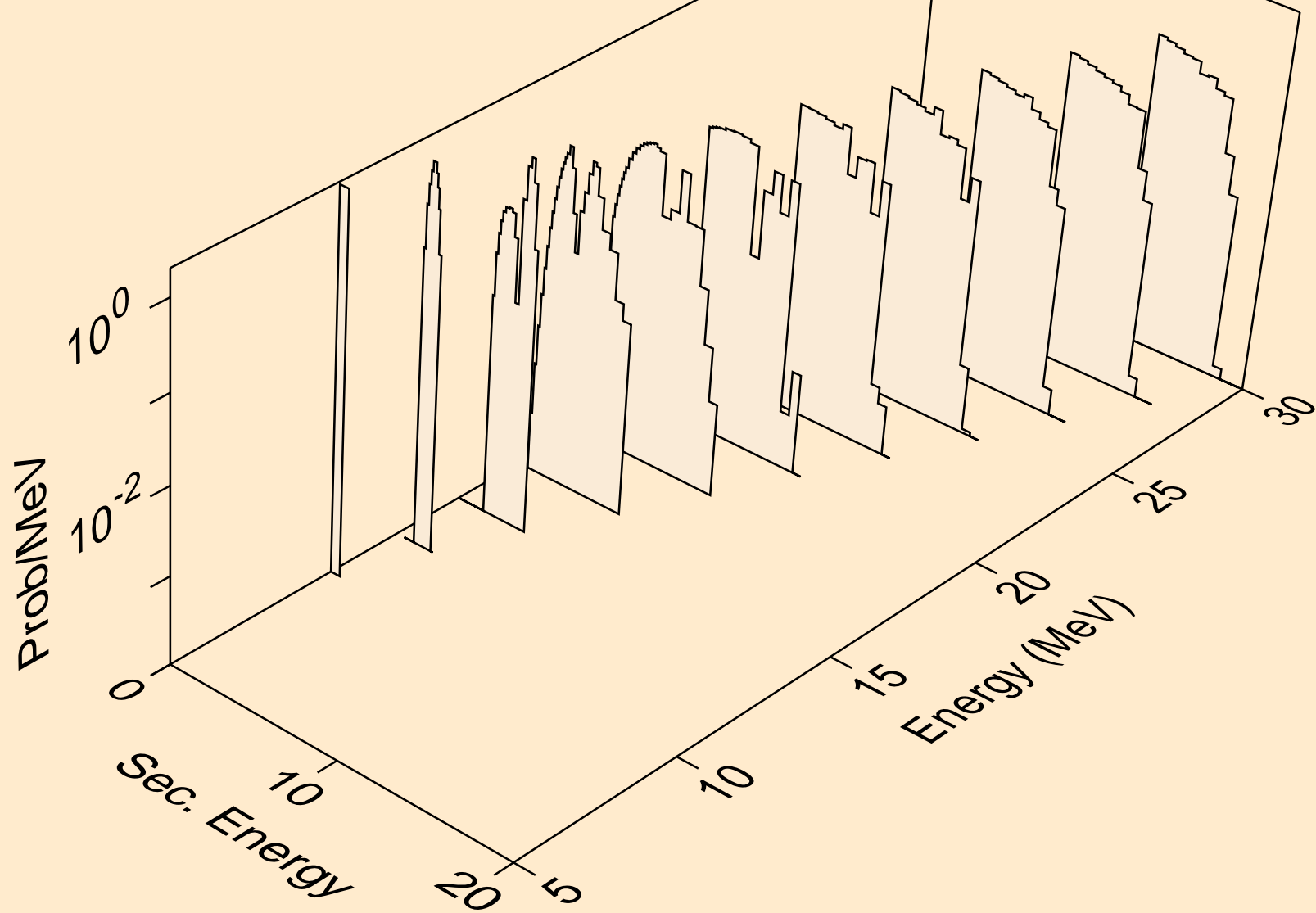



S036 NEUTRON ACER TENDL-2023 LIBRARY; T=0.K  
protons from (n,2p)

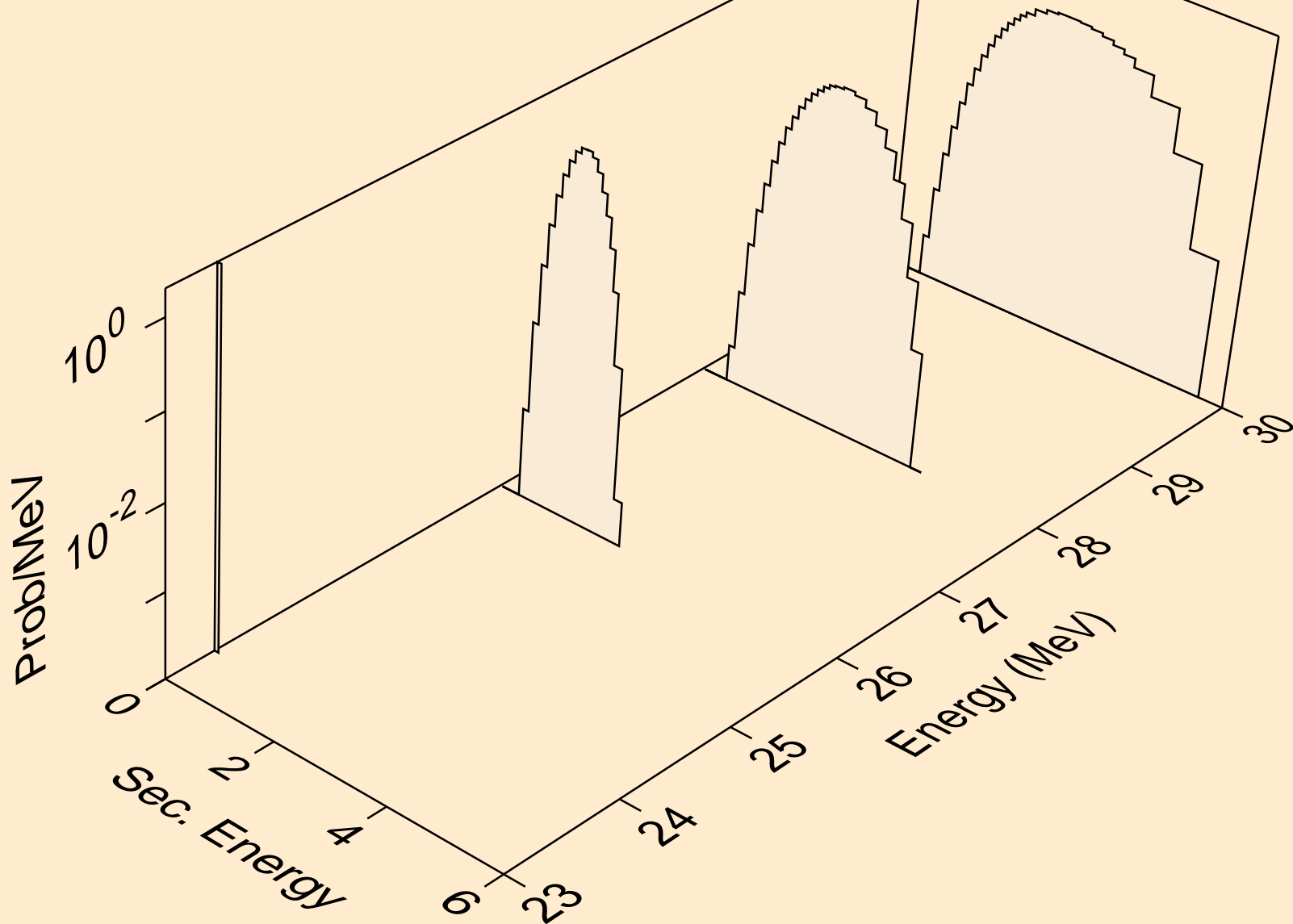

S036 NEUTRON ACER TENDL-2023 LIBRARY; T=0.K  
protons from (n,pa)

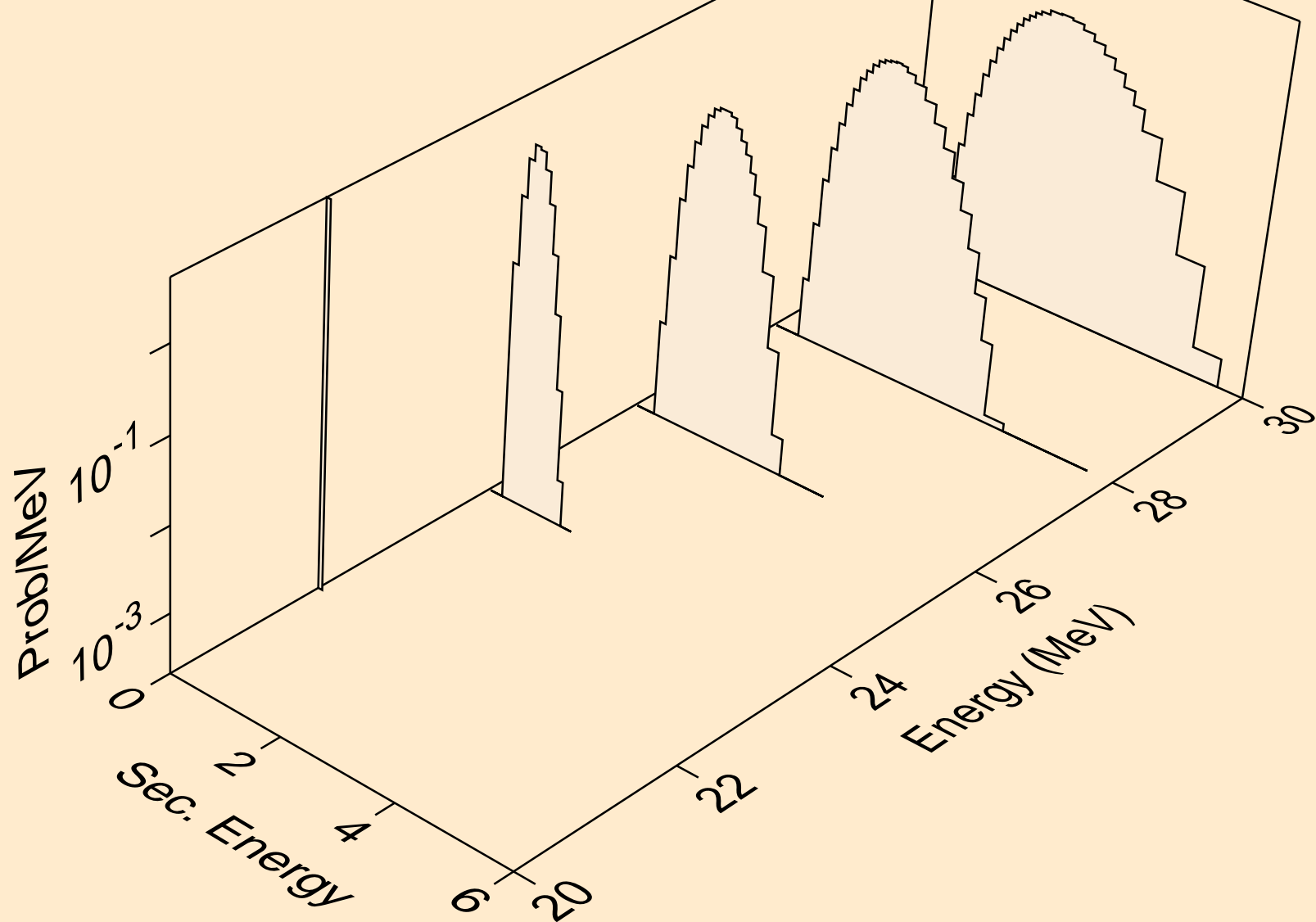

S036 NEUTRON ACER TENDL-2023 LIBRARY; T=0.K  
protons from (n,pd)

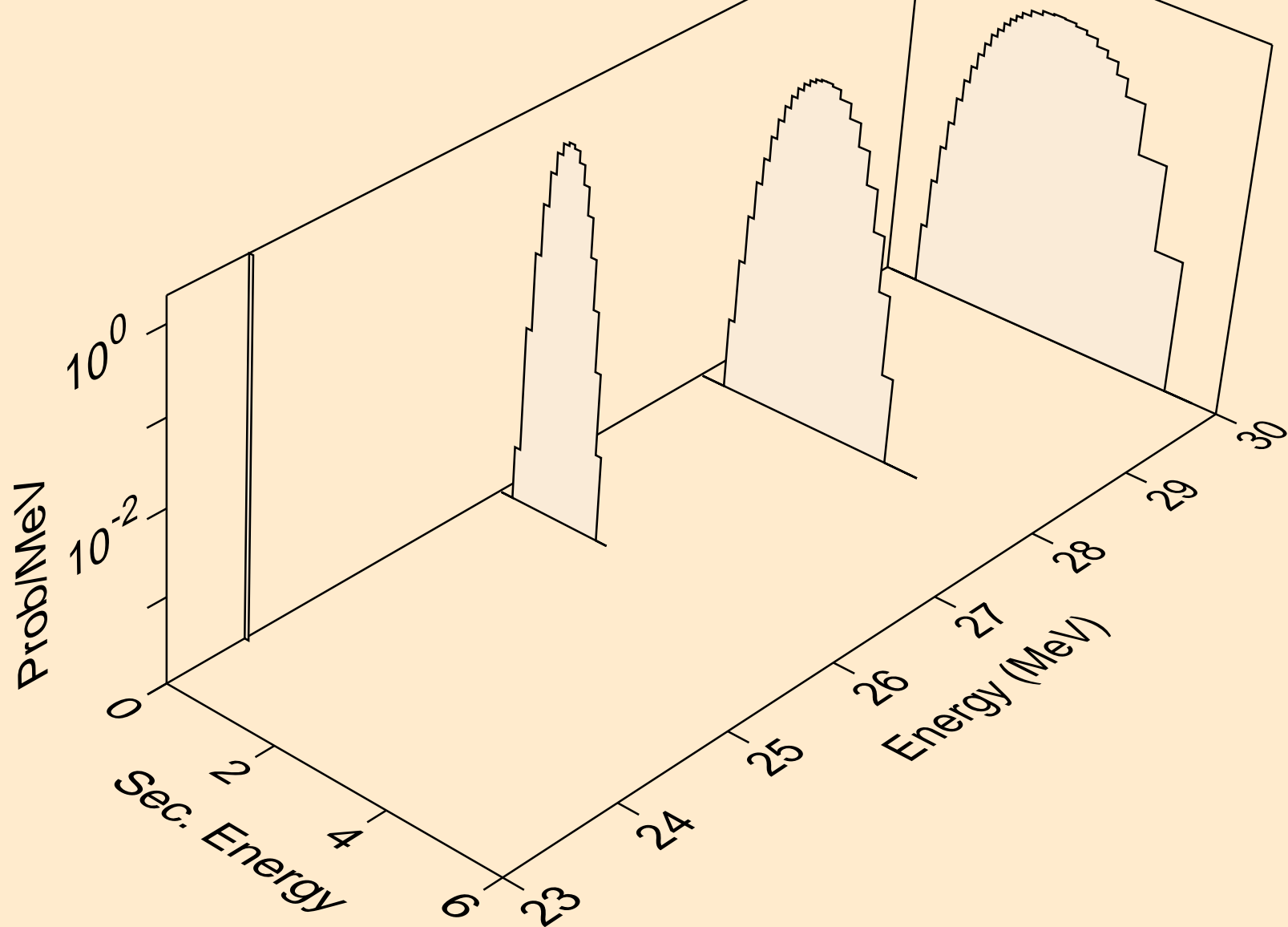

S036 NEUTRON ACER TENDL-2023 LIBRARY; T=0.K  
protons from (n,pt)

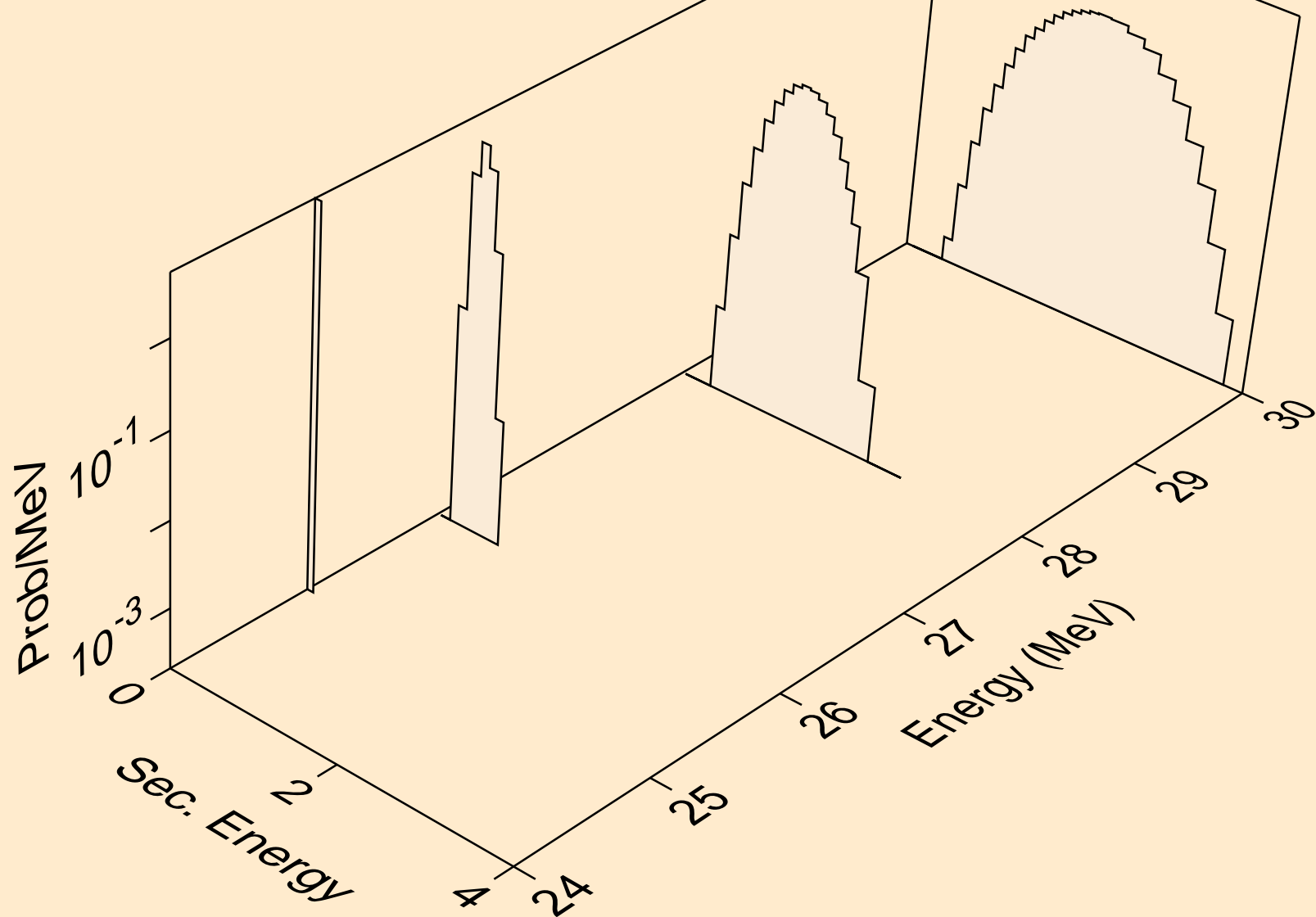

S036 NEUTRON ACER TENDL-2023 LIBRARY; T=0.K  
deuterons from (n,x)

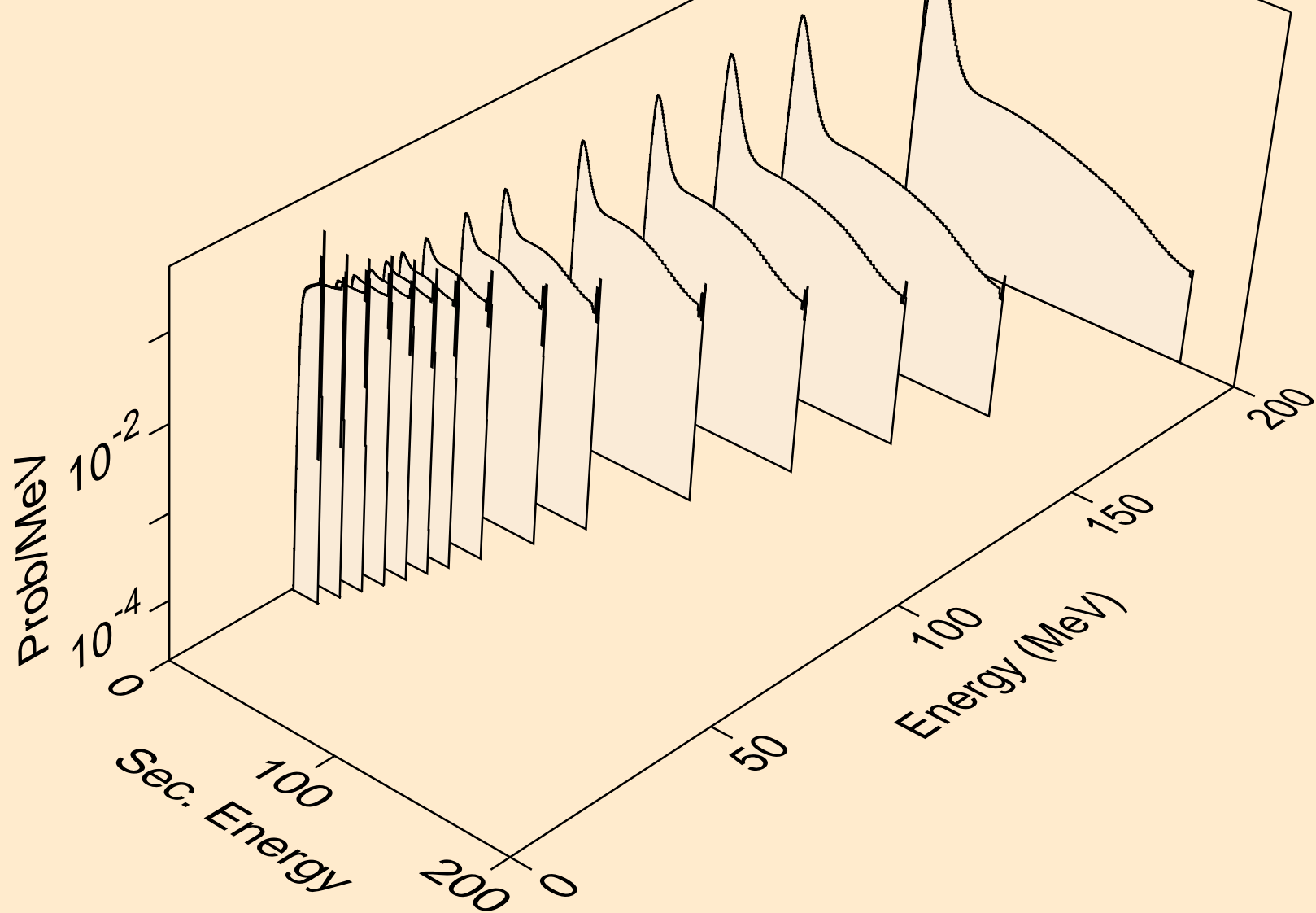

S036 NEUTRON ACER TENDL-2023 LIBRARY; T=0.K  
deuterons from (n,2nd)

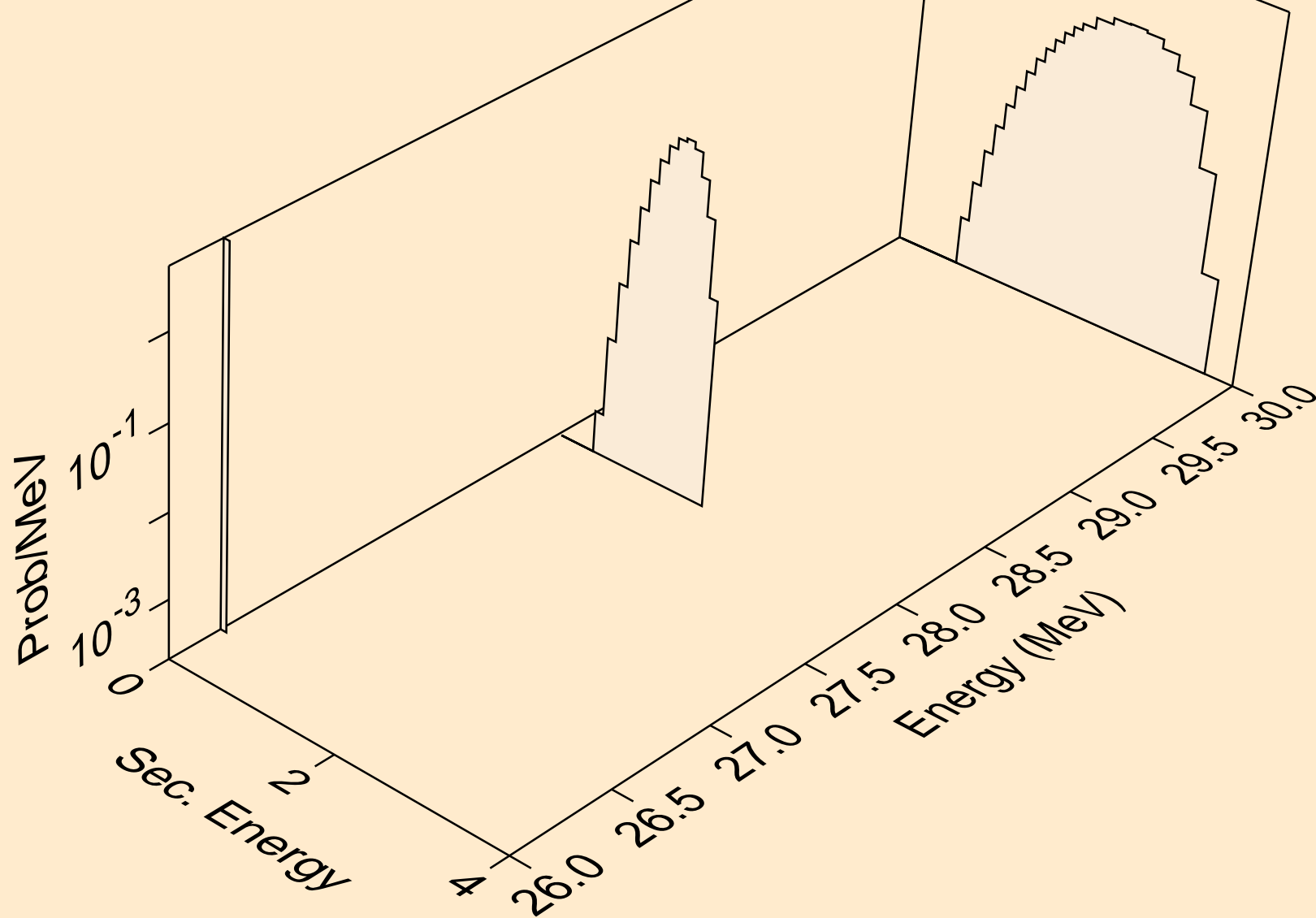

S036 NEUTRON ACER TENDL-2023 LIBRARY; T=0.K  
deuterons from (n,n\*)d

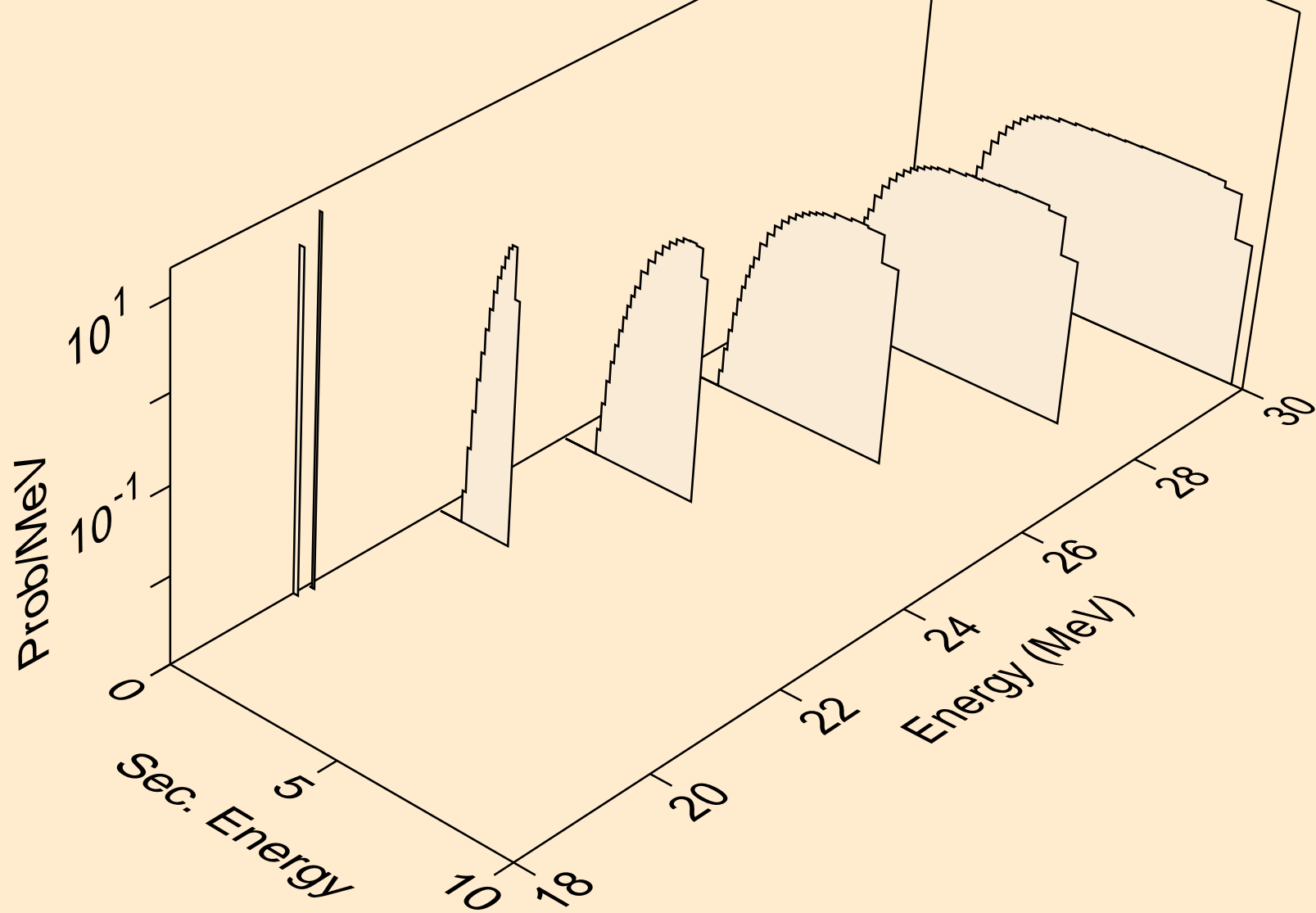

S036 NEUTRON ACER TENDL-2023 LIBRARY; T=0.K  
deuterons from (n,d)

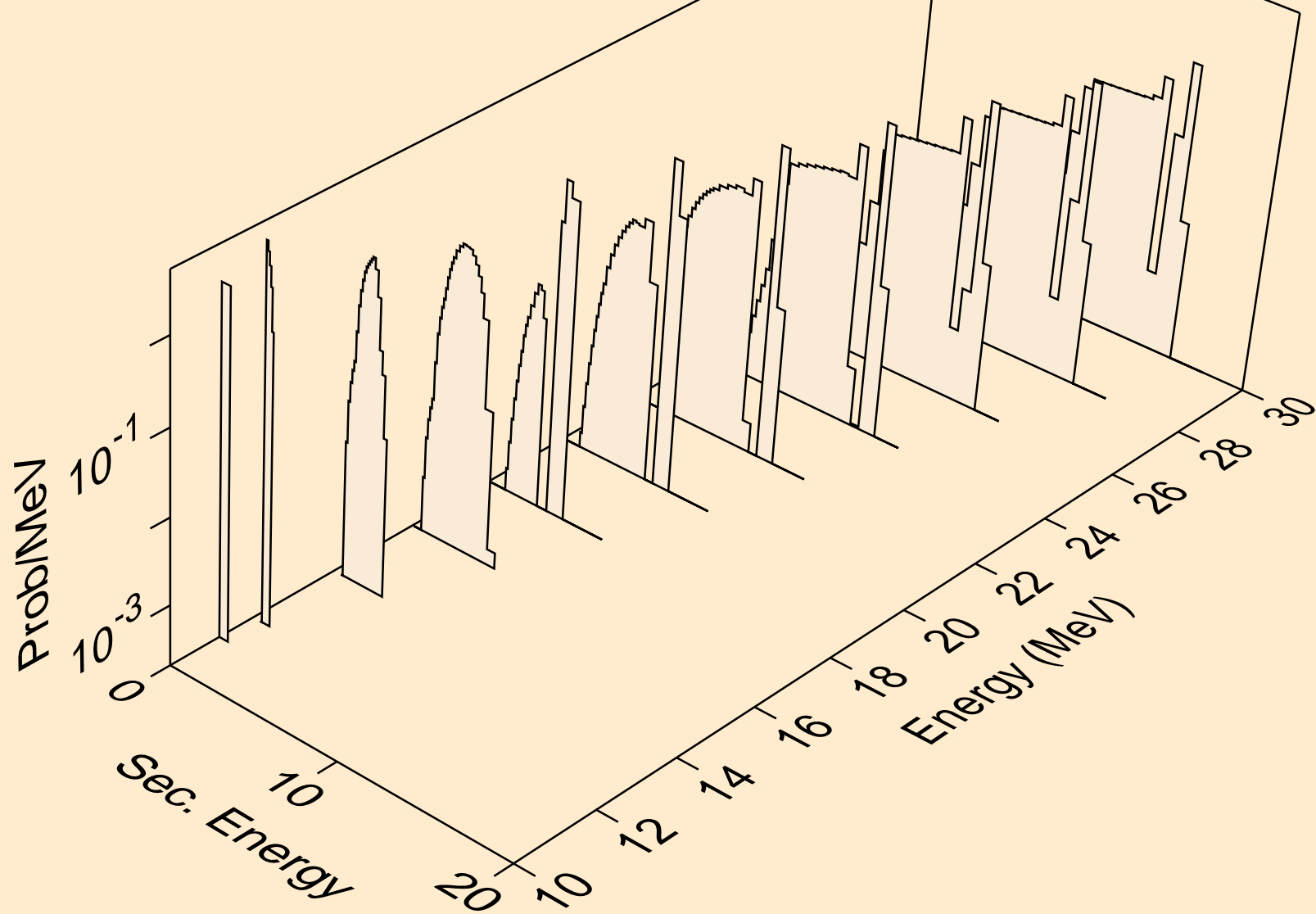



S036 NEUTRON ACER TENDL-2023 LIBRARY; T=0.K  
deuterons from (n,pd)

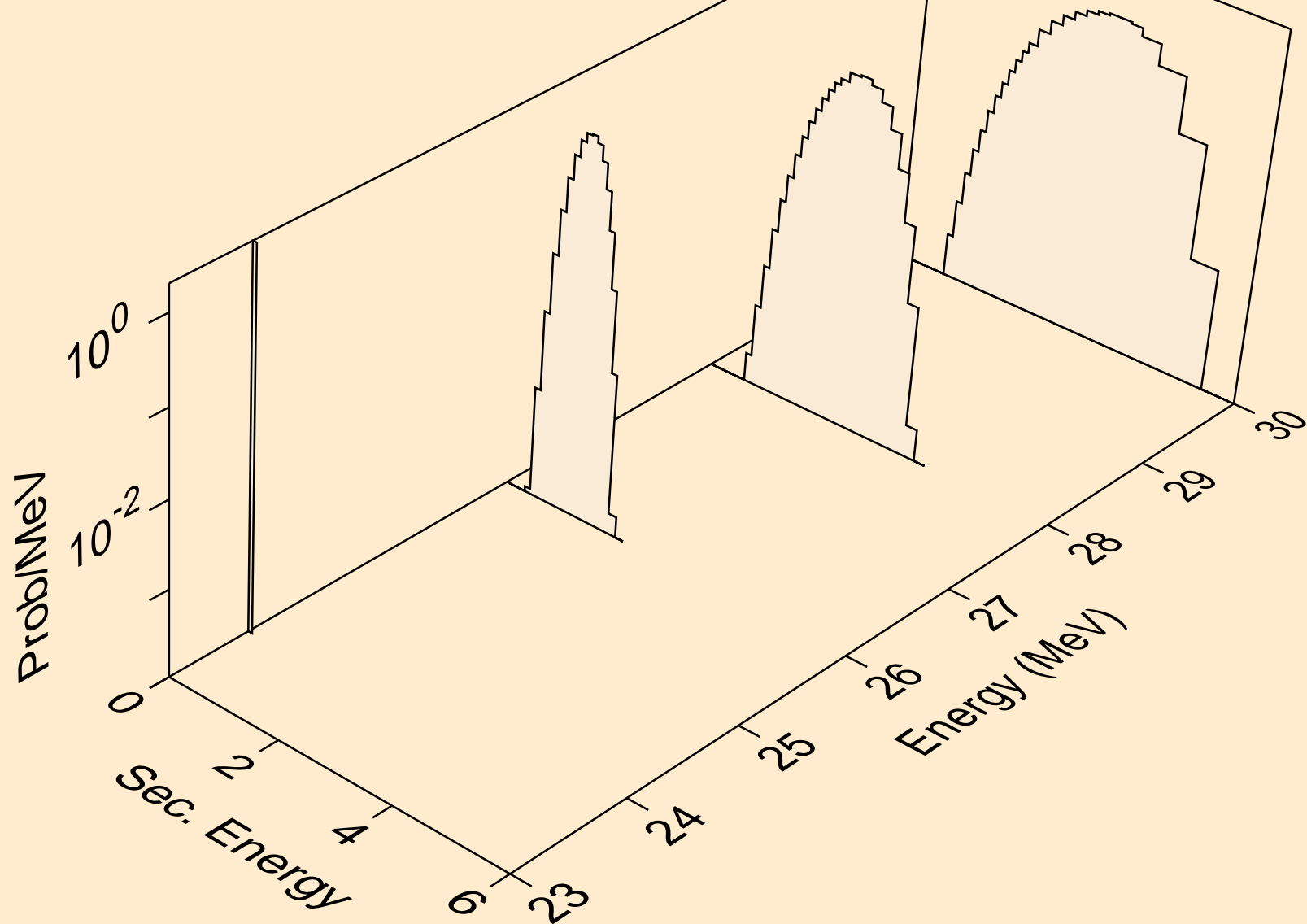

S036 NEUTRON ACER TENDL-2023 LIBRARY; T=0.K  
deuterons from (n,da)

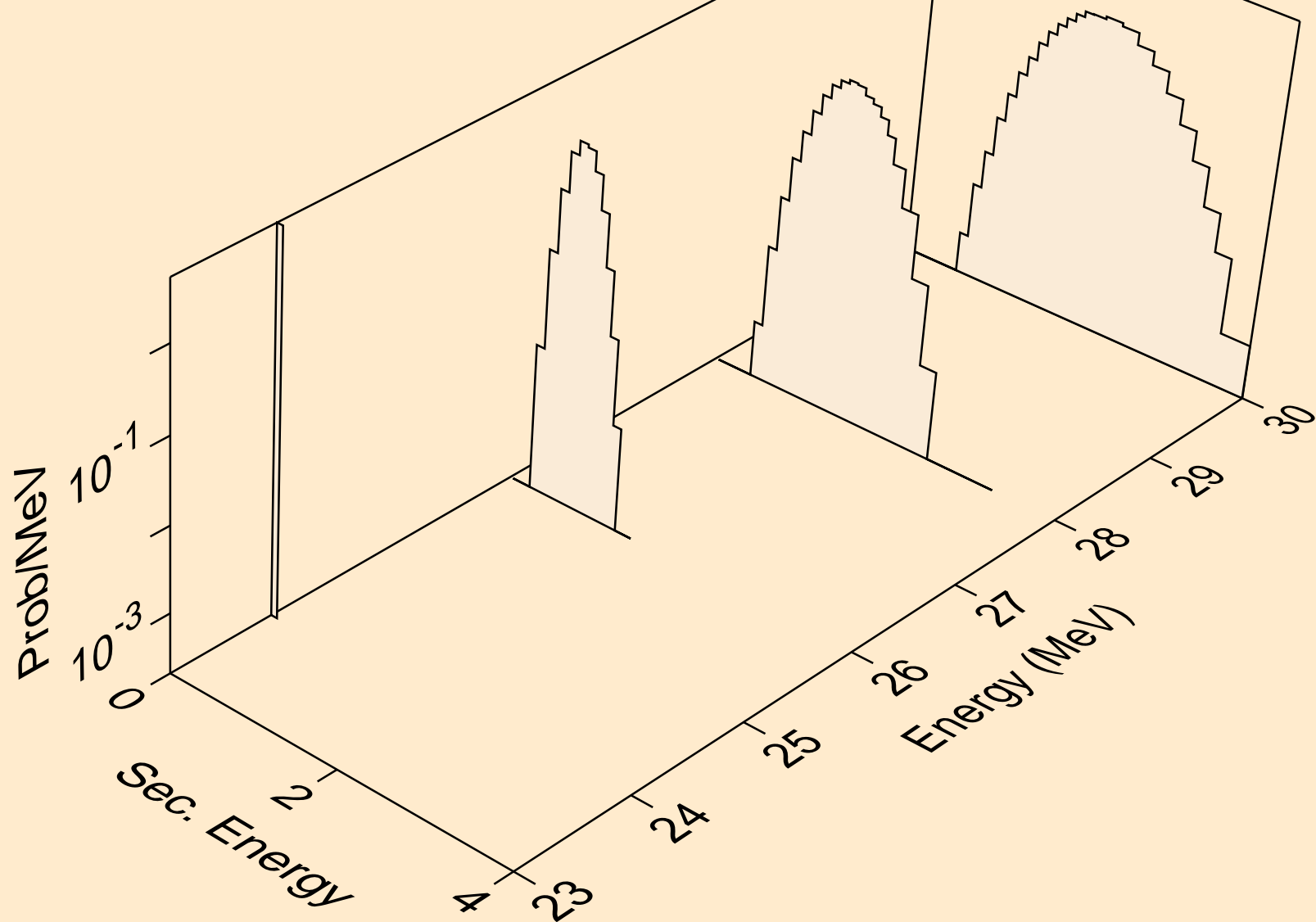

S036 NEUTRON ACER TENDL-2023 LIBRARY; T=0.K  
tritons from (n,x)

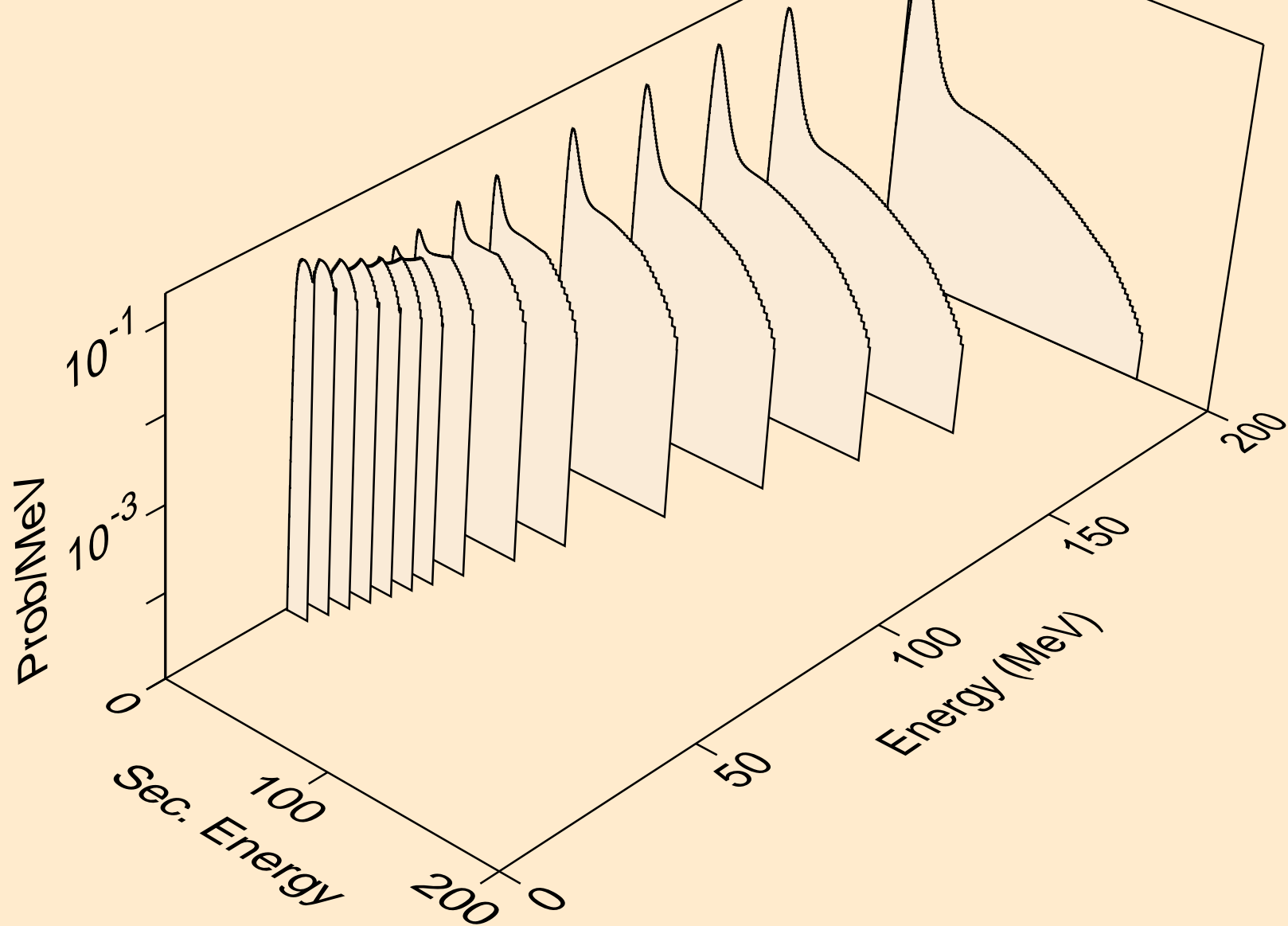

S036 NEUTRON ACER TENDL-2023 LIBRARY; T=0.K  
tritons from (n,n\*)t

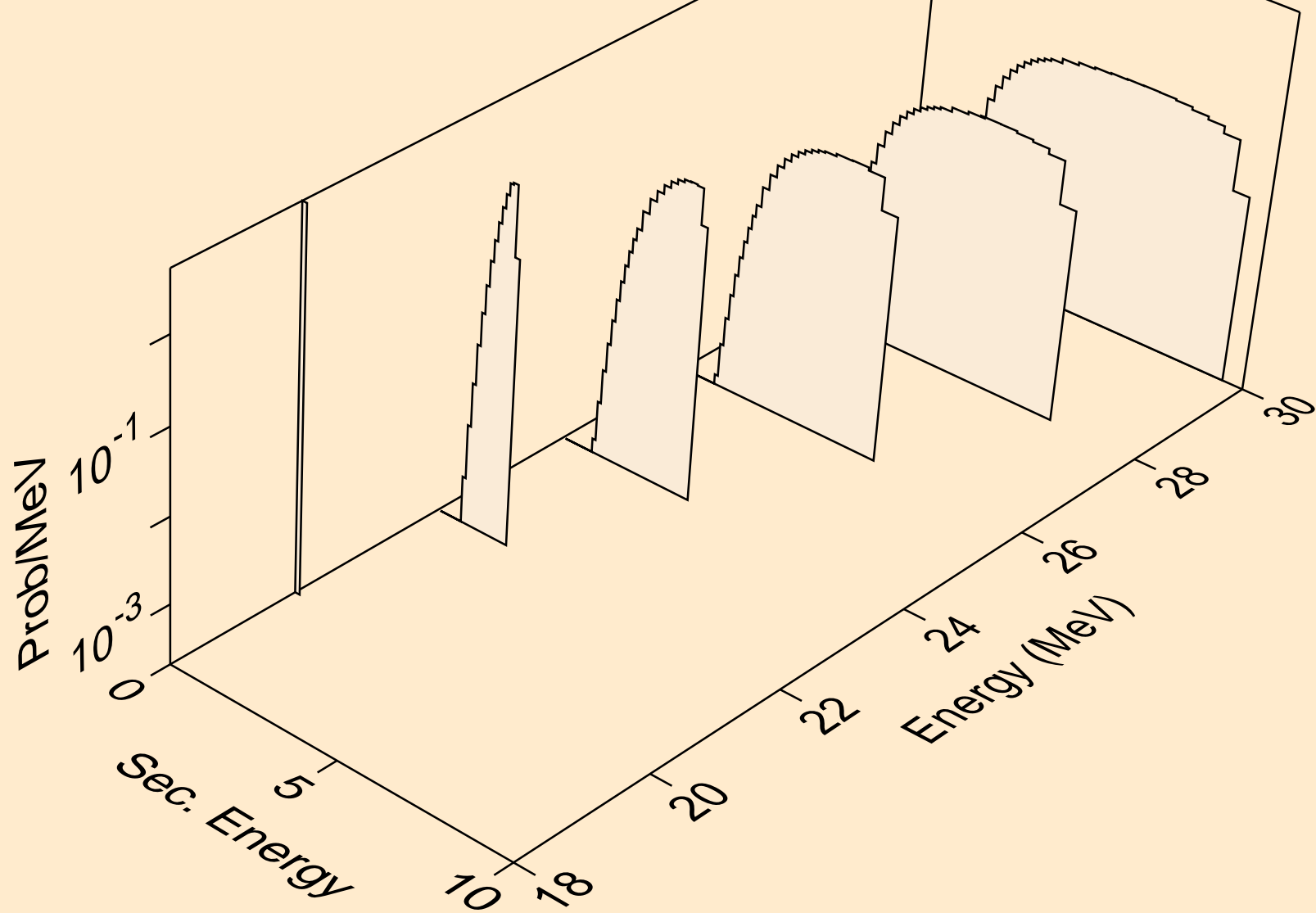

S036 NEUTRON ACER TENDL-2023 LIBRARY; T=0.K  
tritons from (n,t)

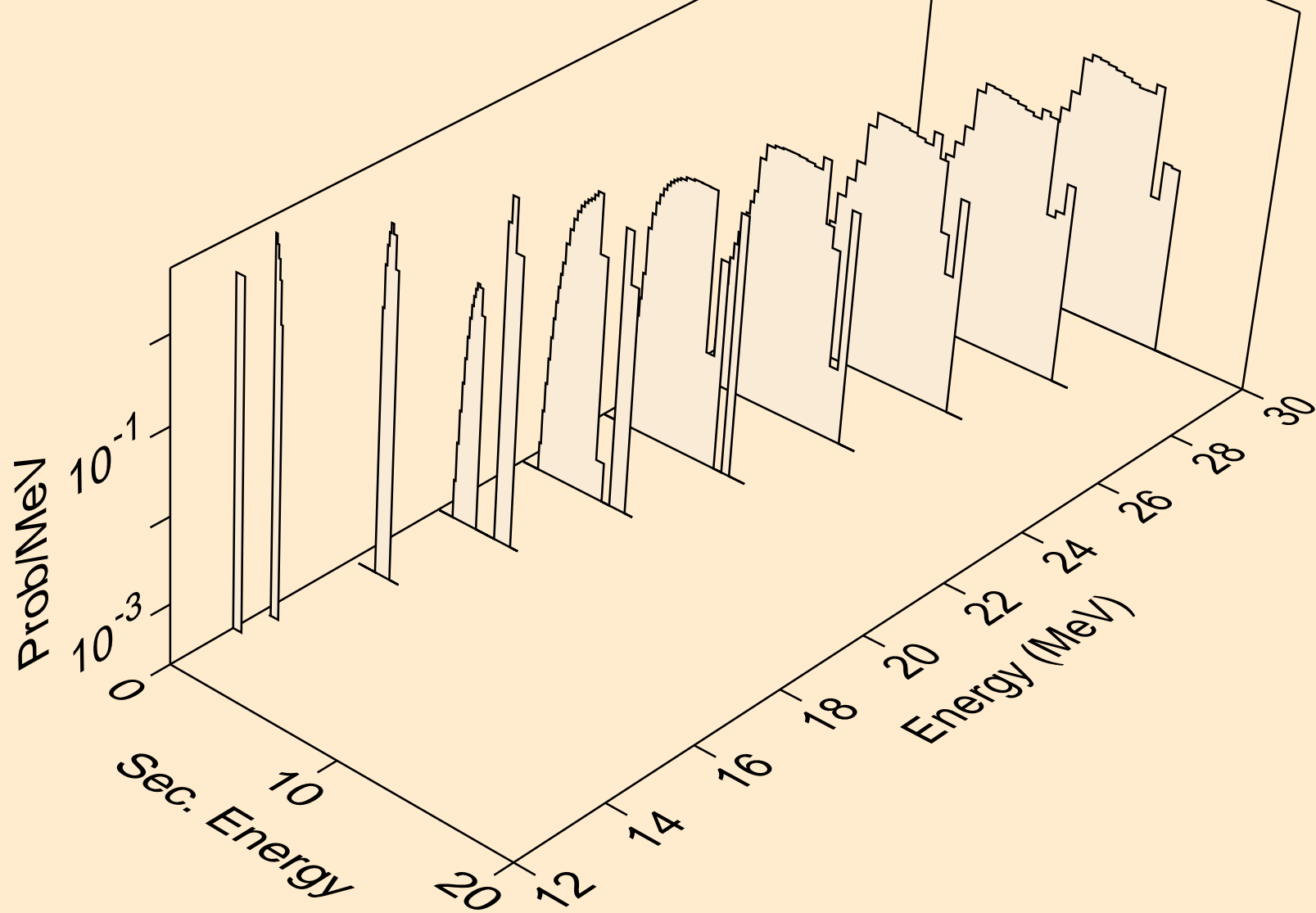

S036 NEUTRON ACER TENDL-2023 LIBRARY; T=0.K  
tritons from (n,pt)

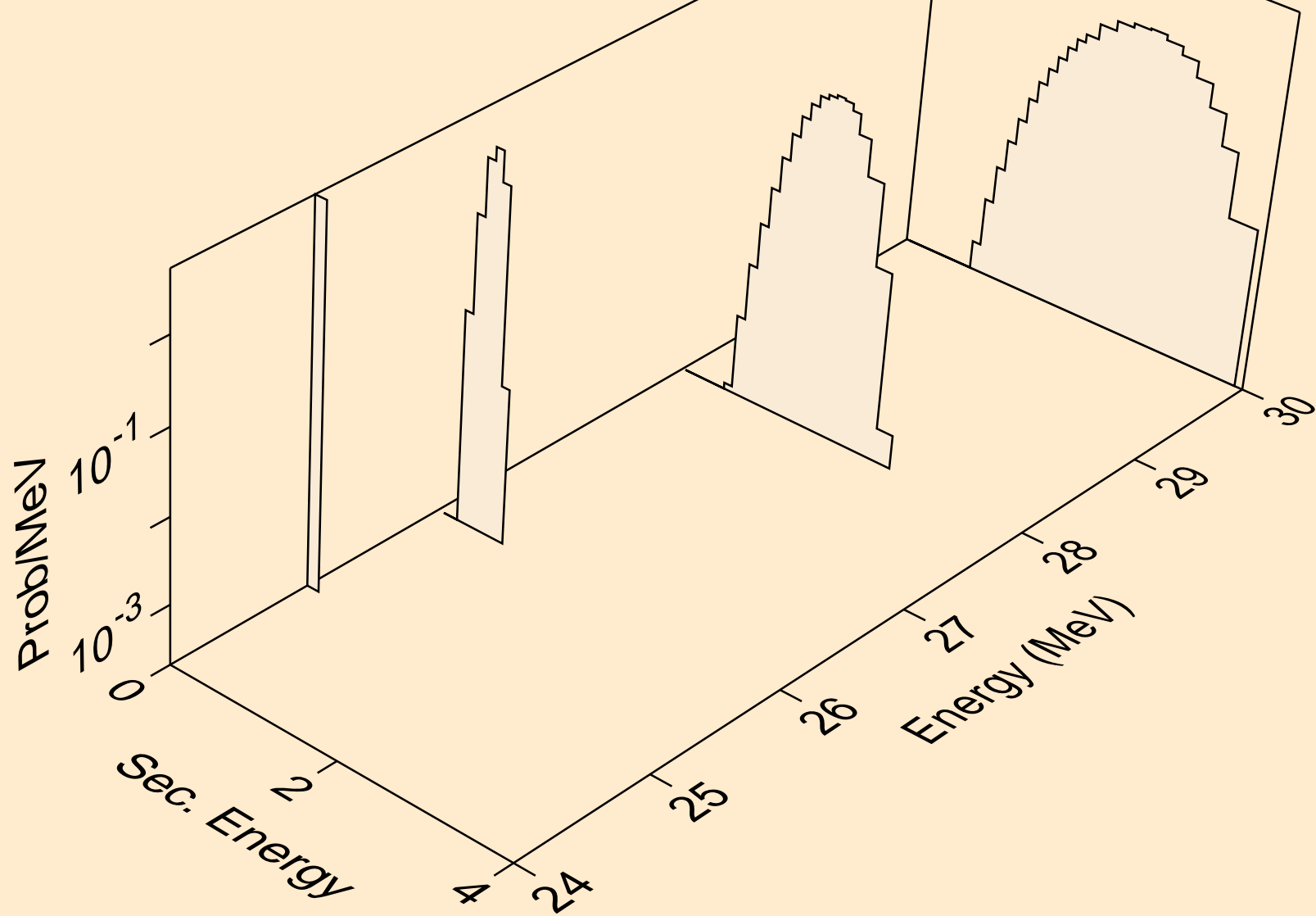

S036 NEUTRON ACER TENDL-2023 LIBRARY; T=0.K  
he3s from (n,x)

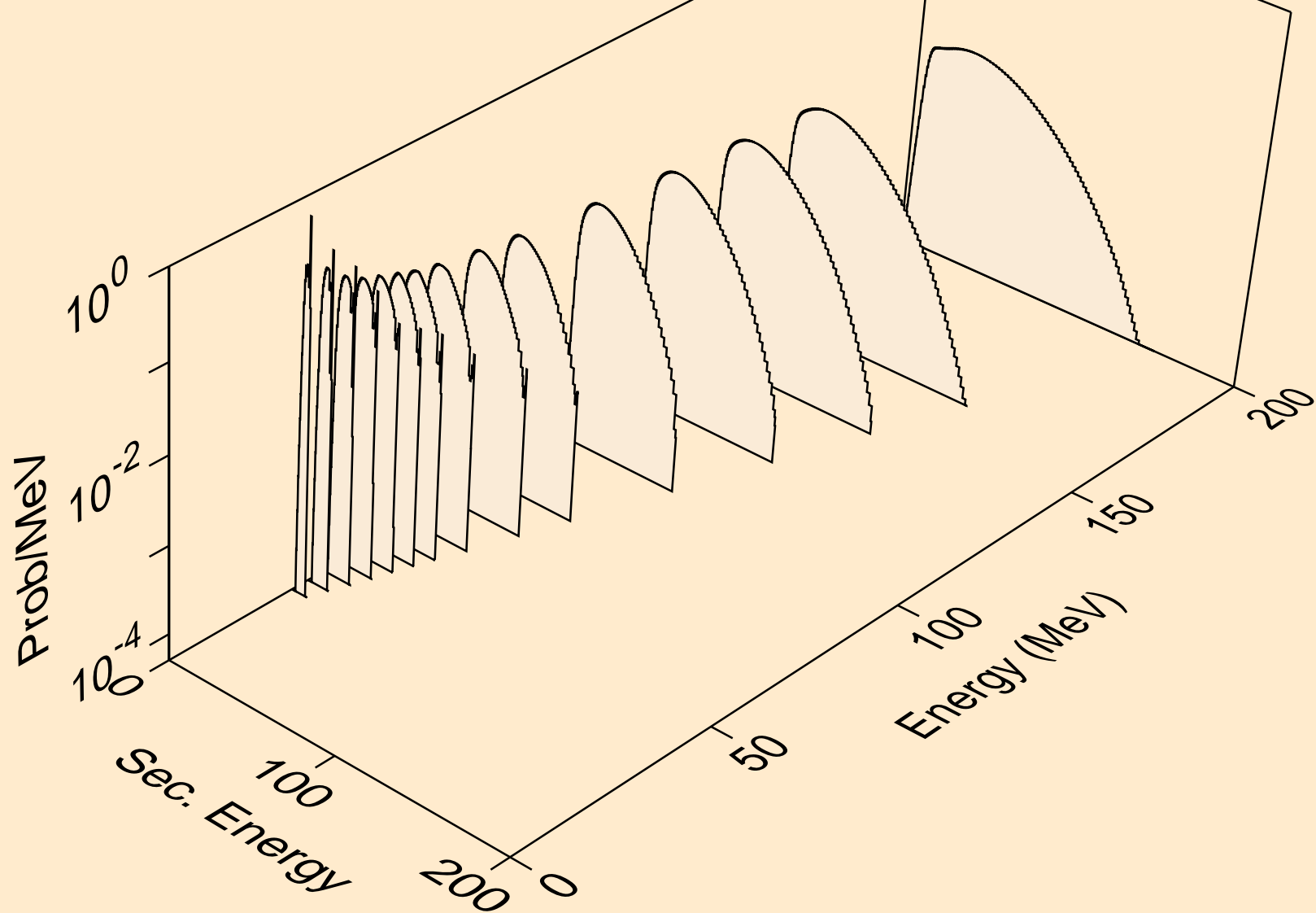

S036 NEUTRON ACER TENDL-2023 LIBRARY; T=0.K  
he3s from (n,n\*)he3

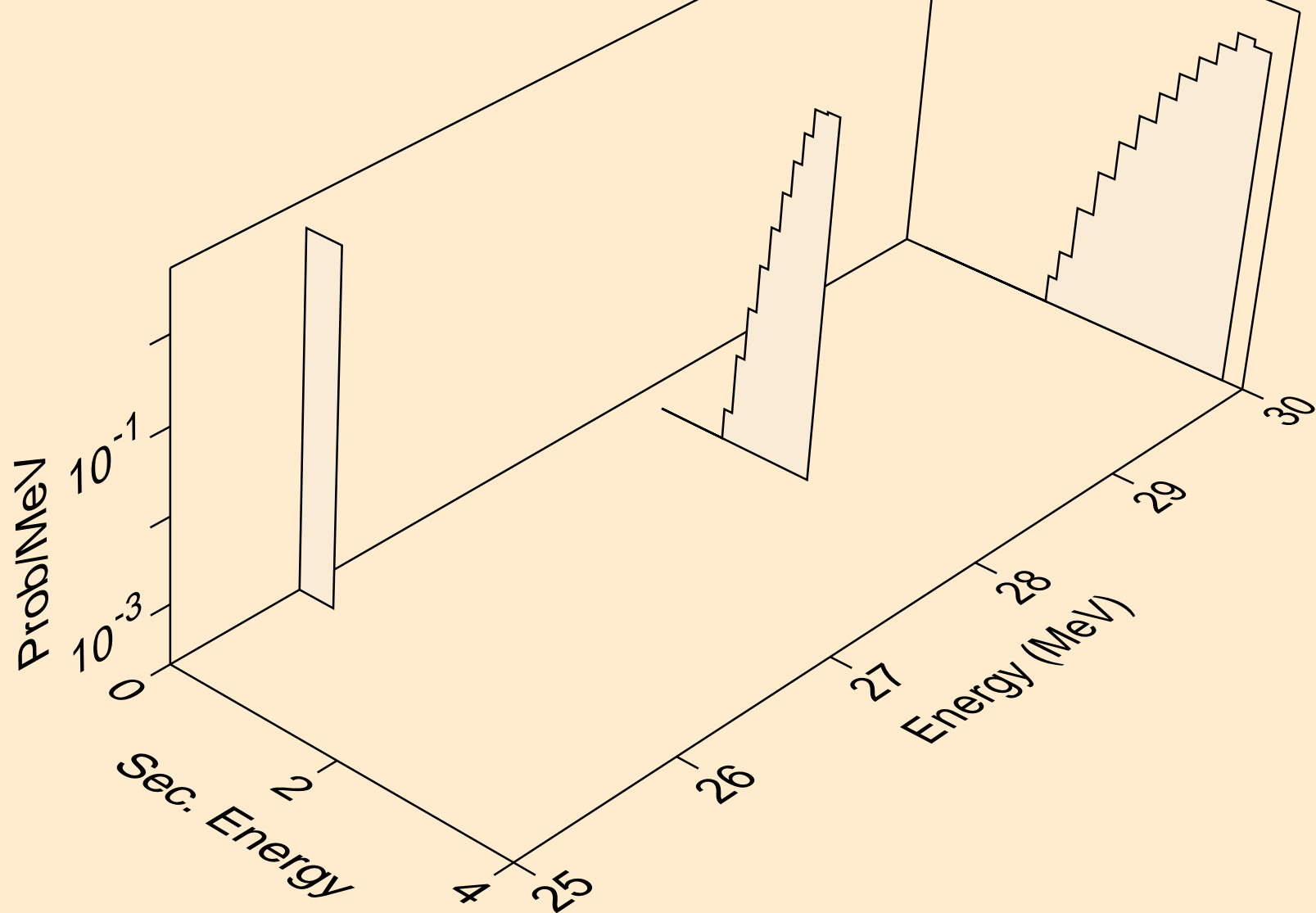



S036 NEUTRON ACER TENDL-2023 LIBRARY; T=0.K  
he3s from (n,he3)

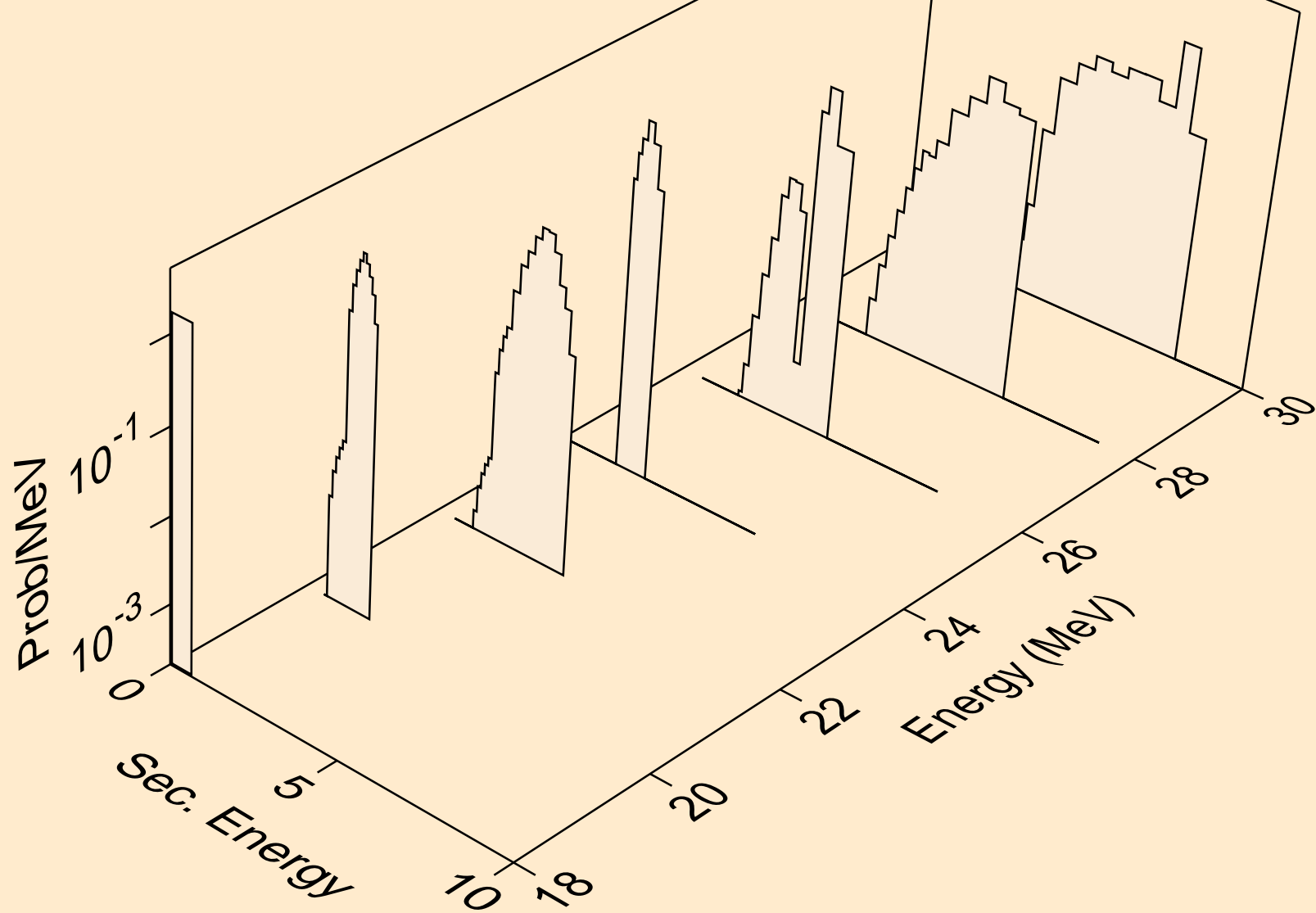

S036 NEUTRON ACER TENDL-2023 LIBRARY; T=0.K  
alphas from (n,x)

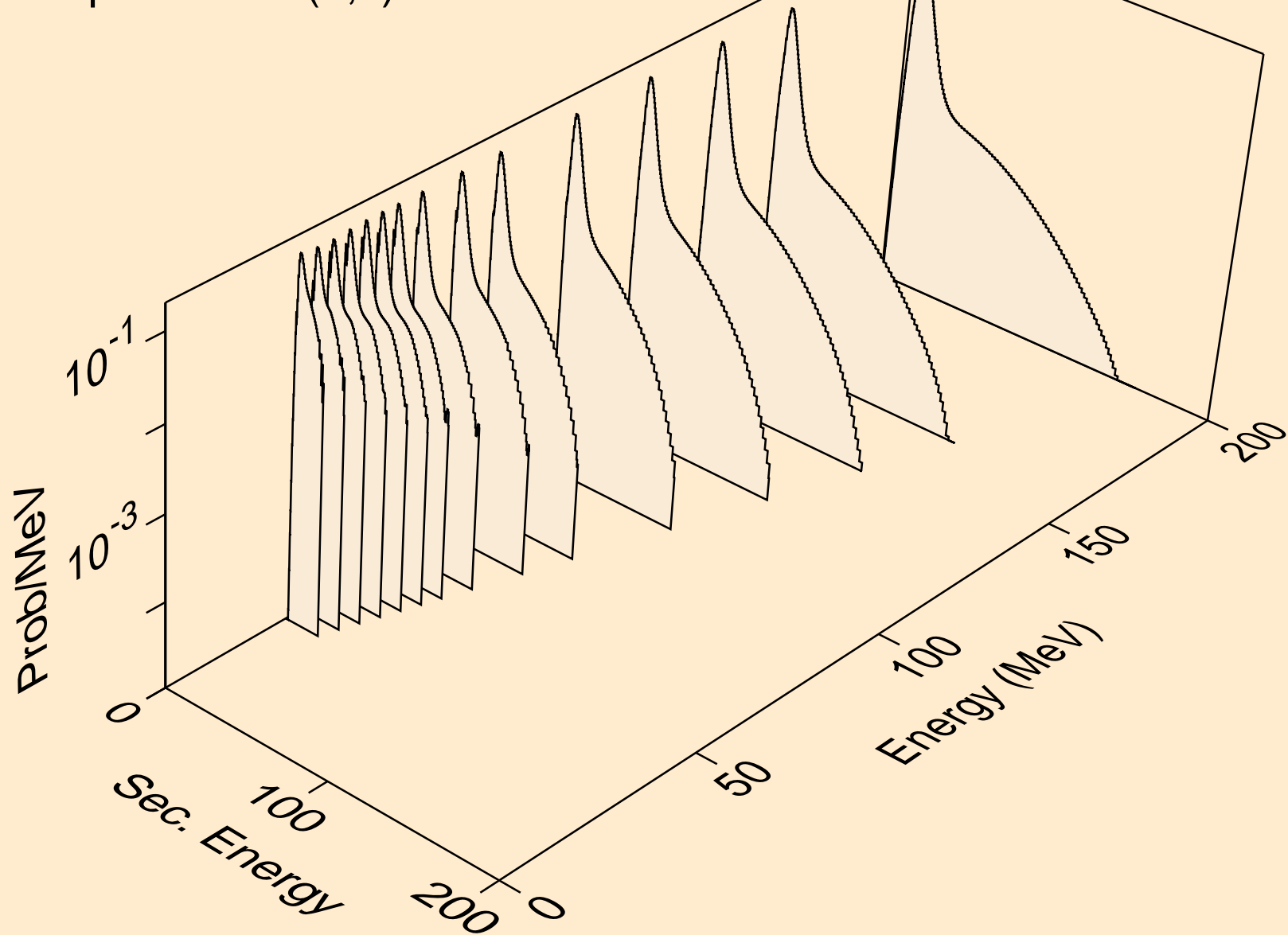

S036 NEUTRON ACER TENDL-2023 LIBRARY; T=0.K  
alphas from (n,n\*)a

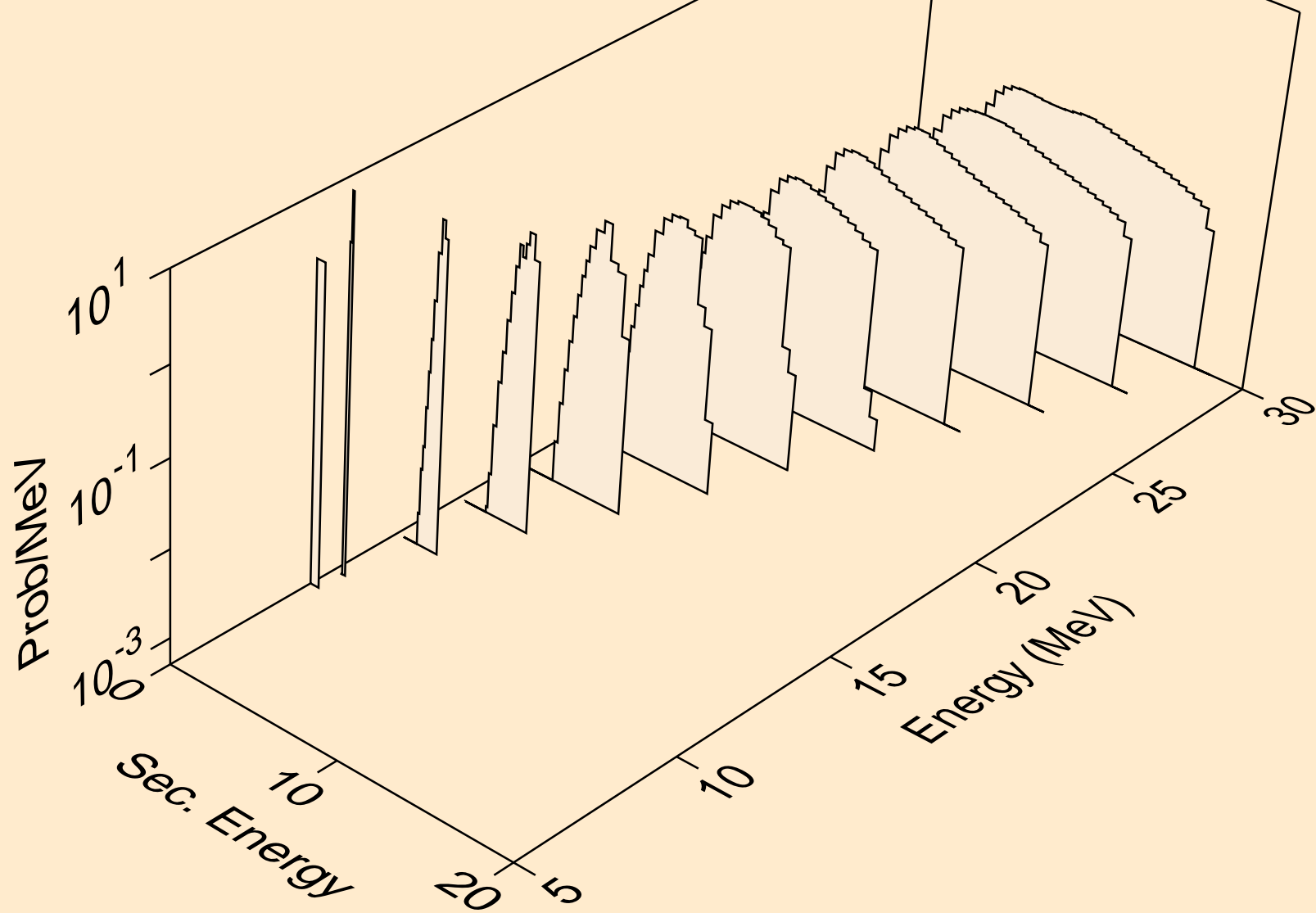

S036 NEUTRON ACER TENDL-2023 LIBRARY; T=0.K  
alphas from (n,2n)a

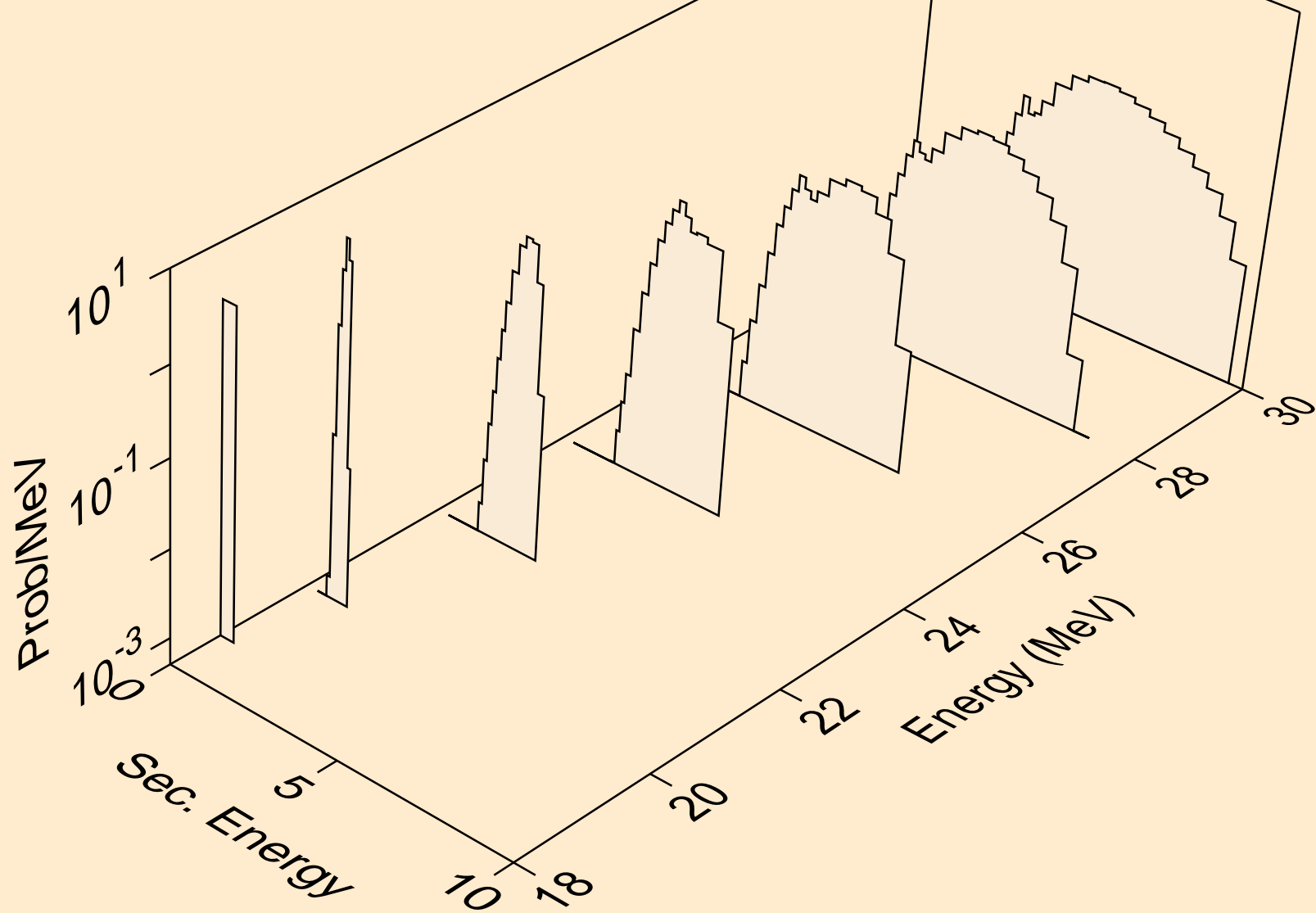

S036 NEUTRON ACER TENDL-2023 LIBRARY; T=0.K  
alphas from (n,3n)a

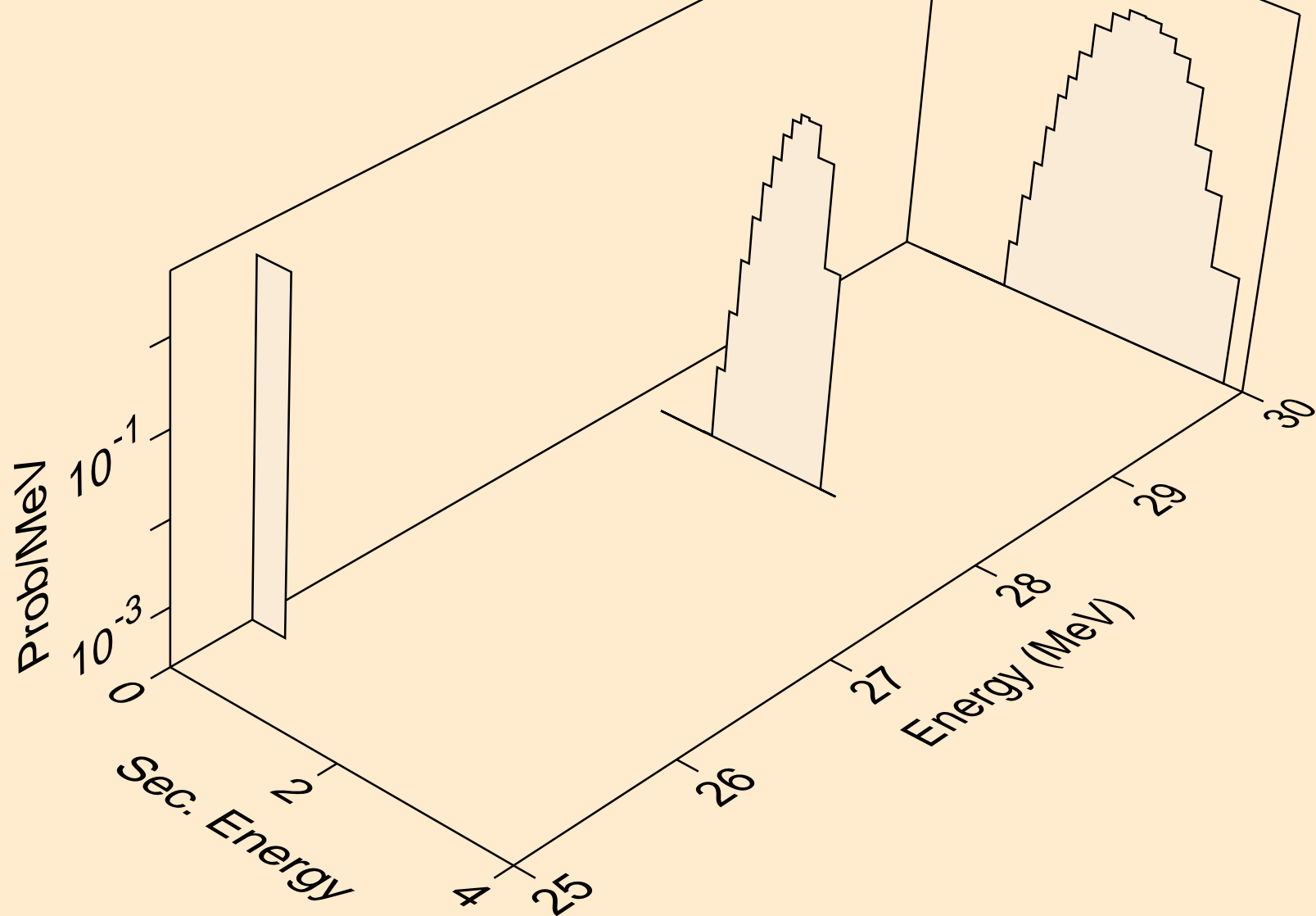

S036 NEUTRON ACER TENDL-2023 LIBRARY; T=0.K  
alphas from (n,n\*)2a

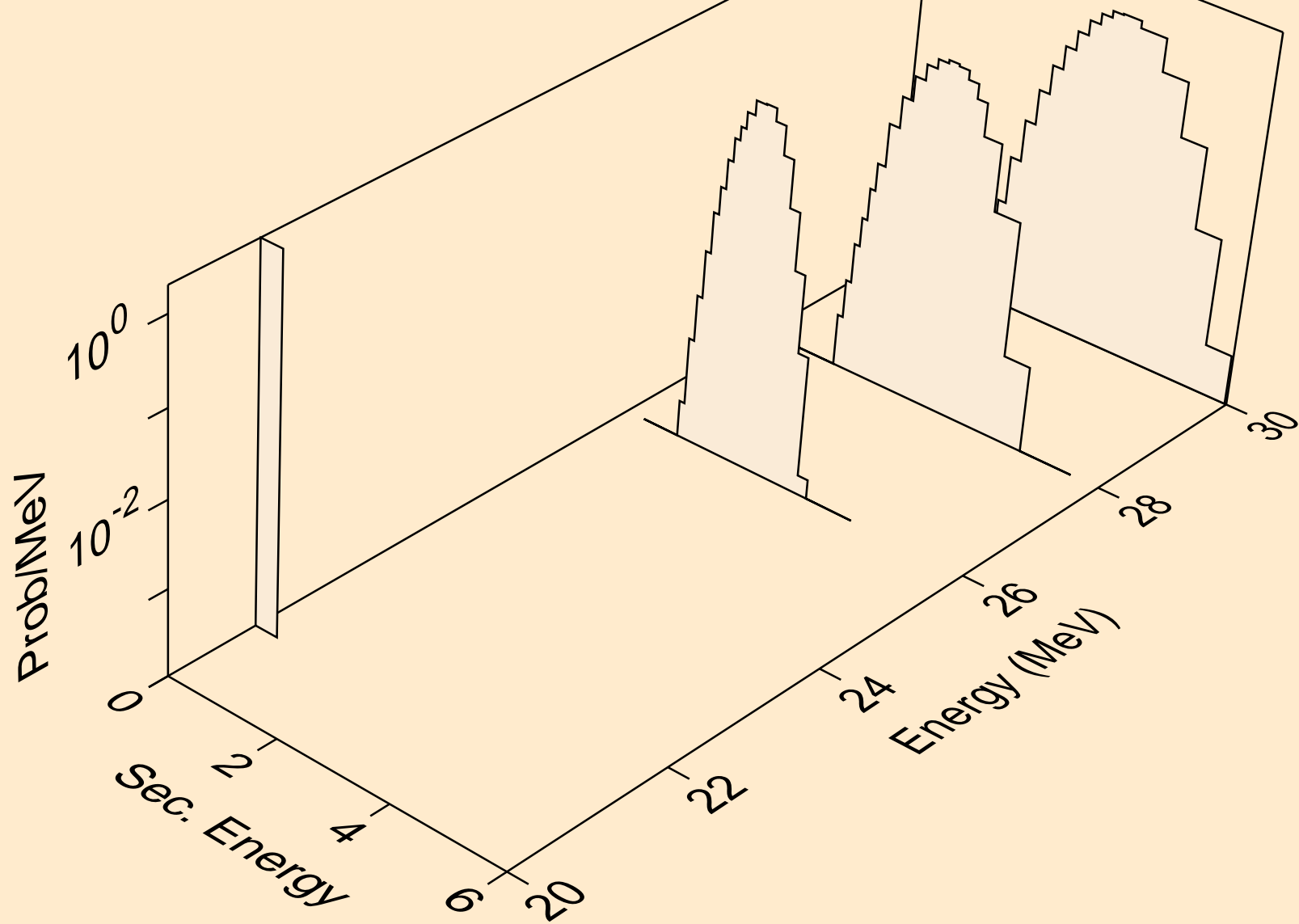

S036 NEUTRON ACER TENDL-2023 LIBRARY; T=0.K  
alphas from (n,a)

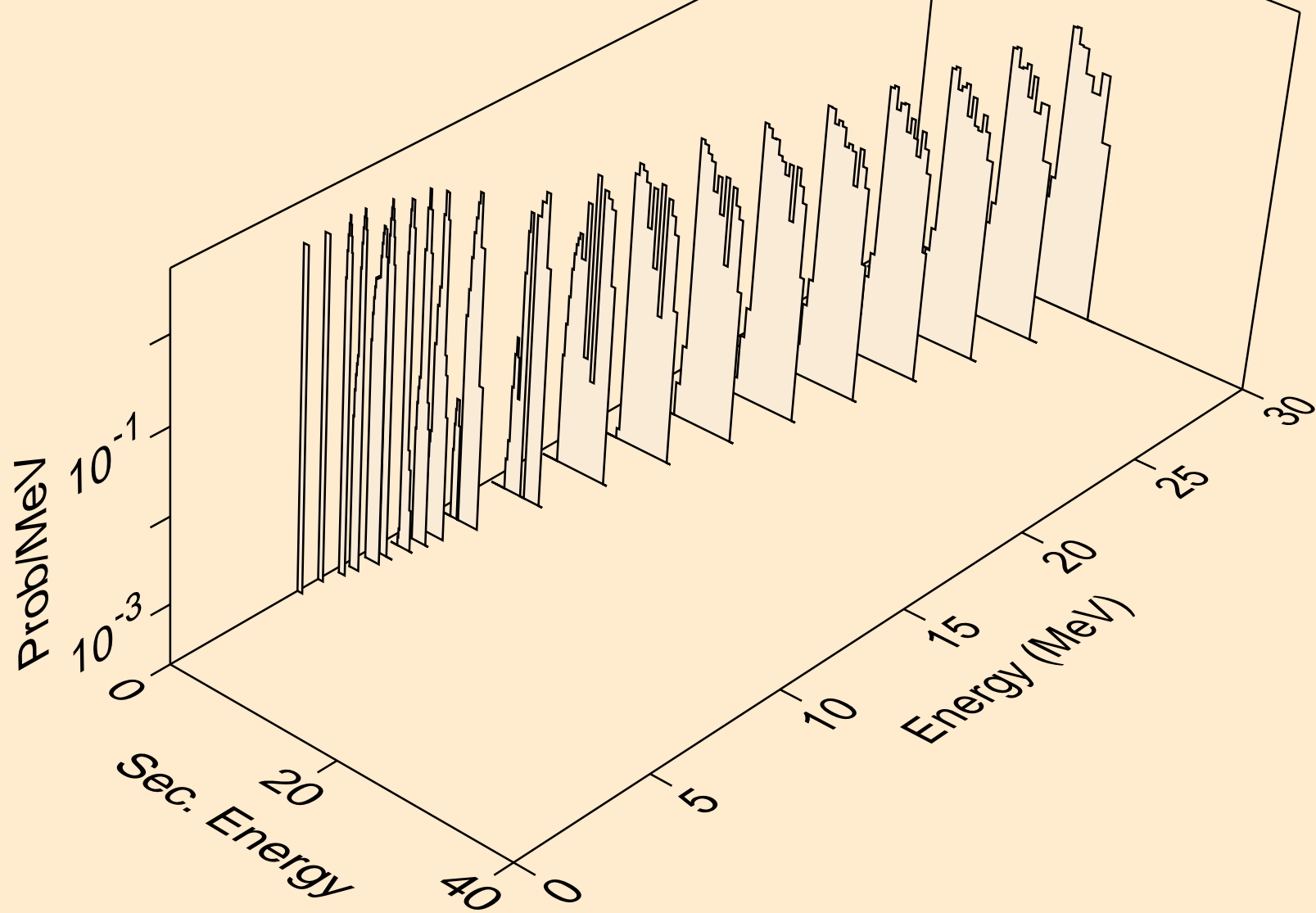

S036 NEUTRON ACER TENDL-2023 LIBRARY; T=0.K  
alphas from (n,2a)

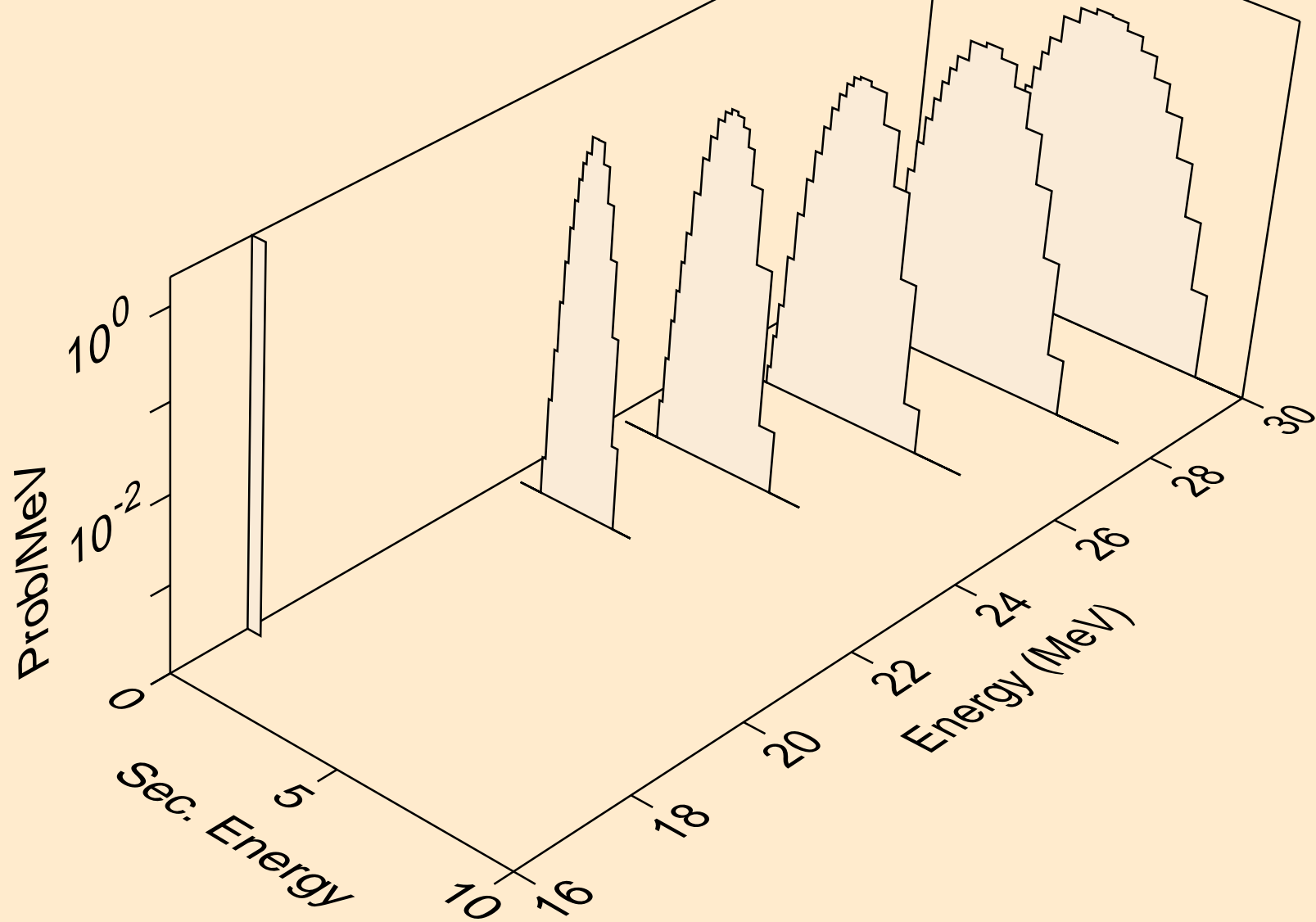



S036 NEUTRON ACER TENDL-2023 LIBRARY; T=0.K  
alphas from (n,pa)

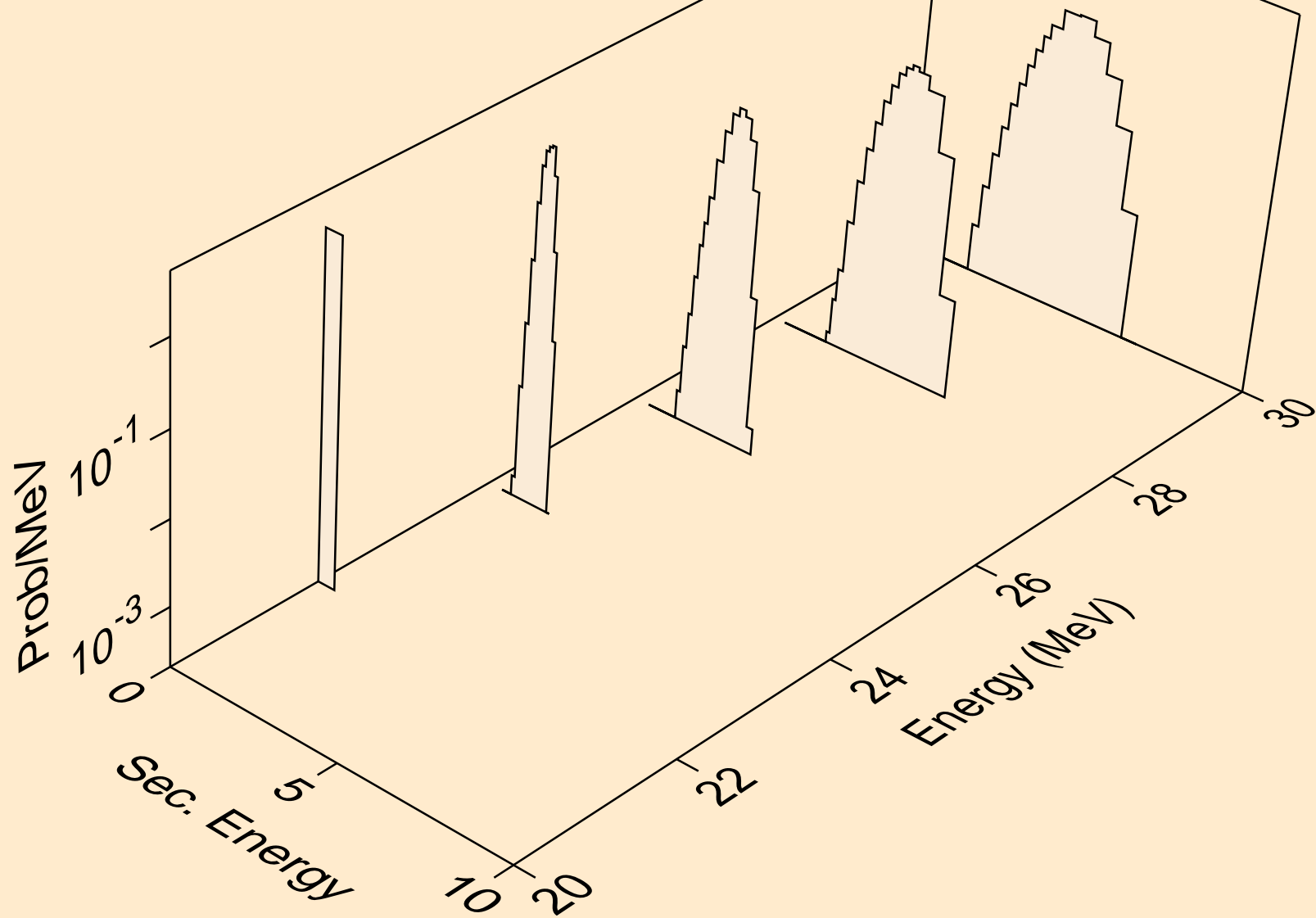

S036 NEUTRON ACER TENDL-2023 LIBRARY; T=0.K  
alphas from (n,da)

