

# SB105 NEUTRON ACER TENDL-2023 LIBRARY; T=0.K

## Principal cross sections

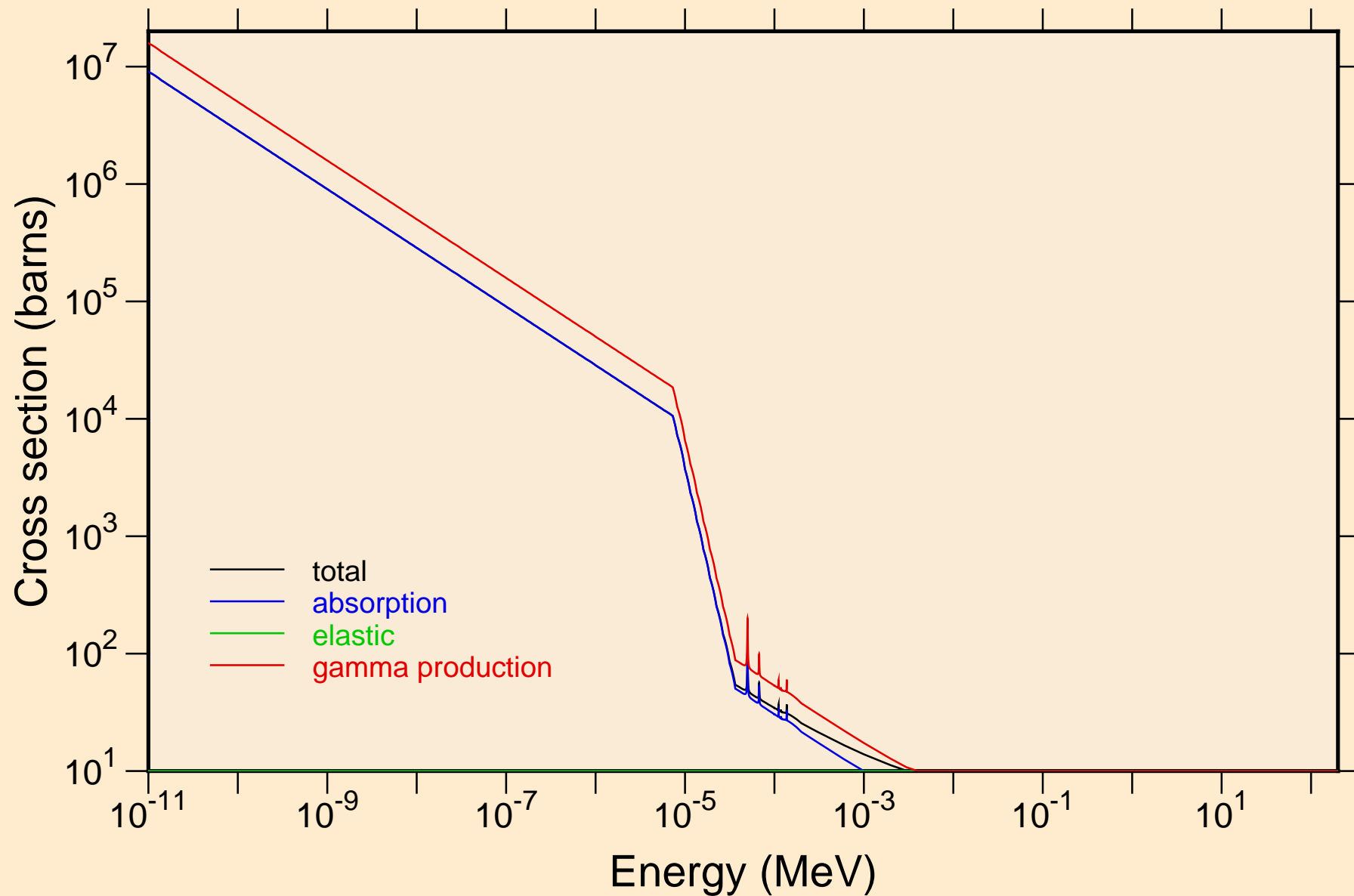

SB105 NEUTRON ACER TENDL-2023 LIBRARY; T=0.K  
resonance total cross section

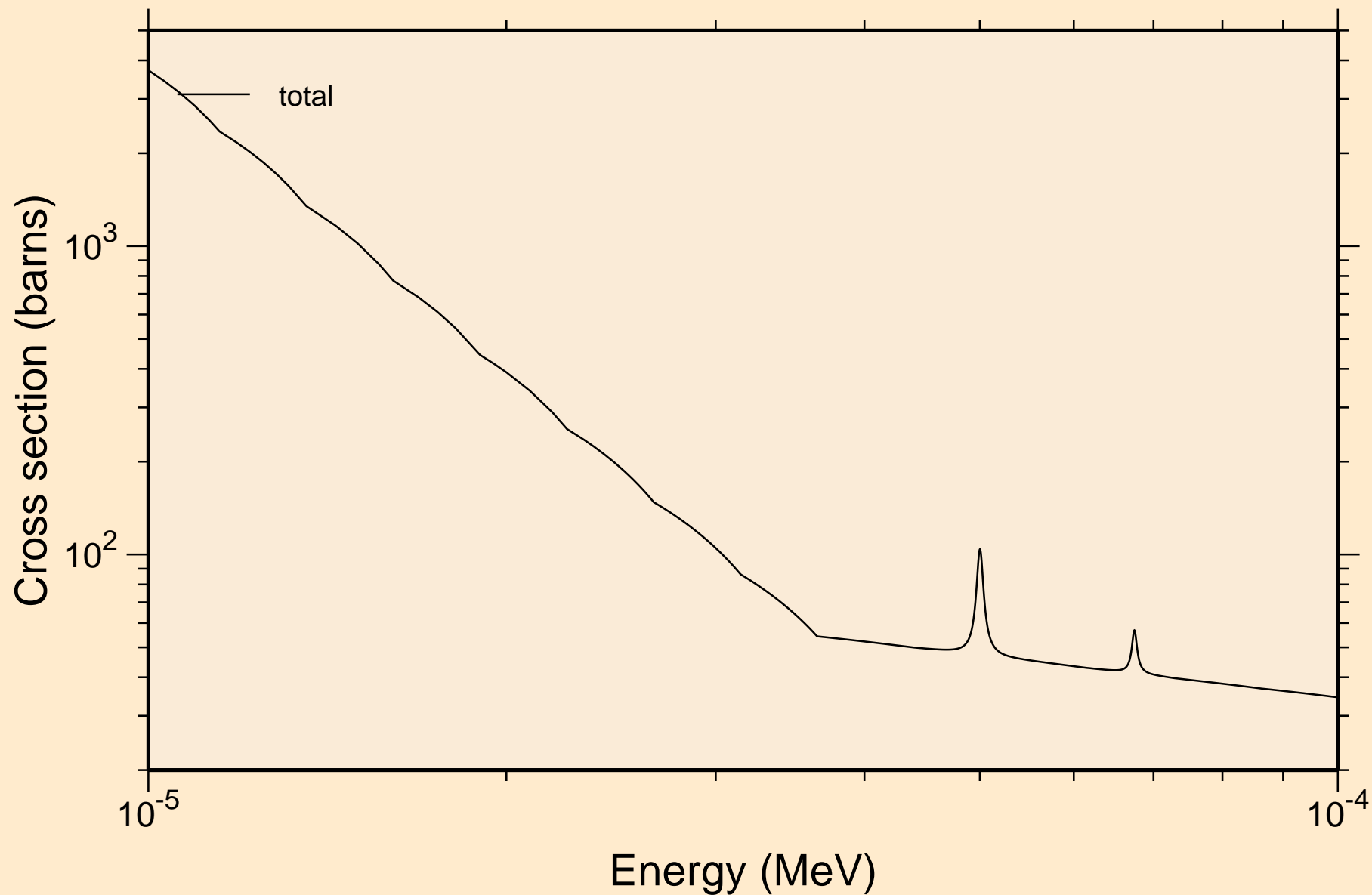

SB105 NEUTRON ACER TENDL-2023 LIBRARY; T=0.K  
resonance total cross section

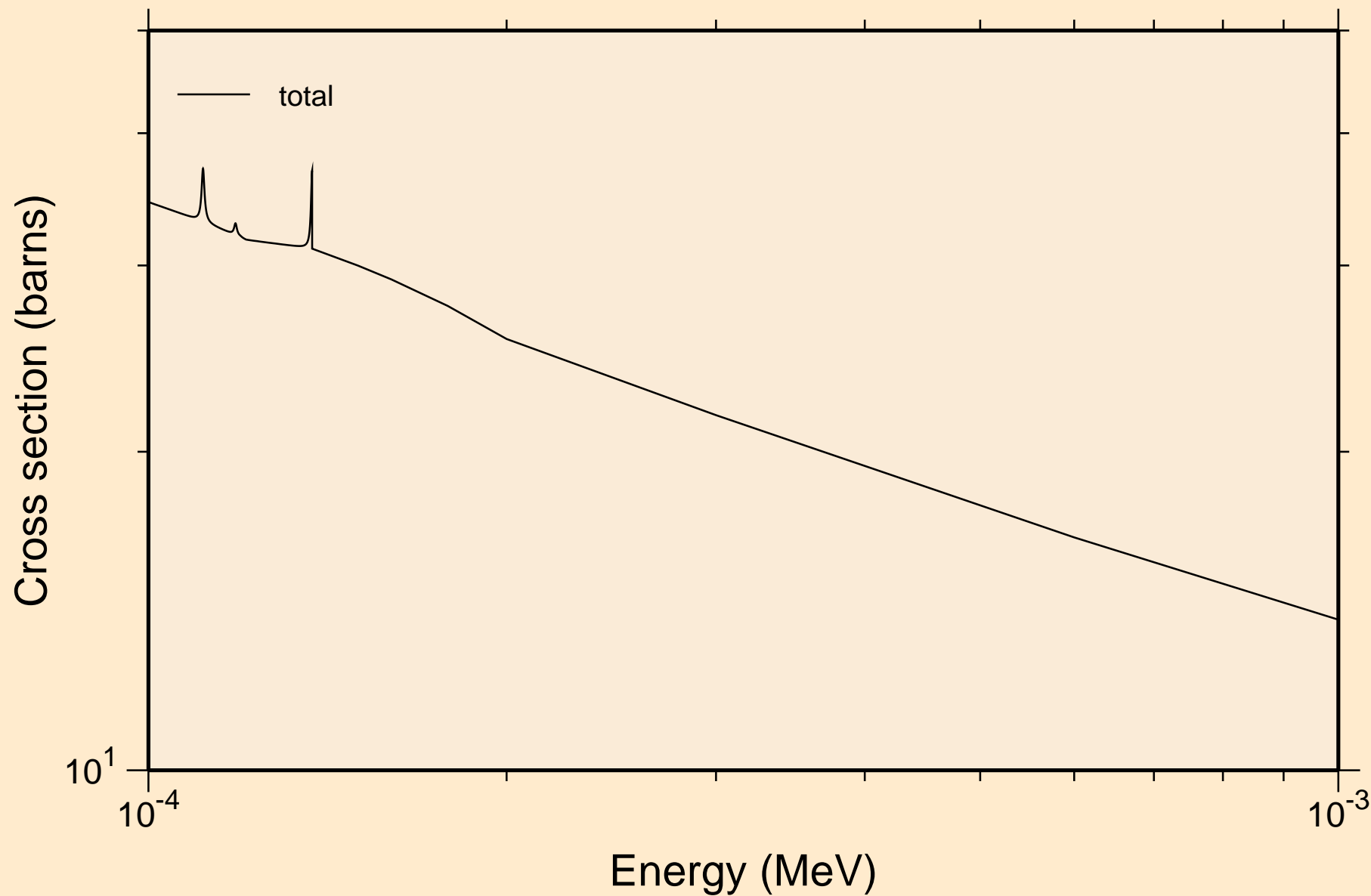

SB105 NEUTRON ACER TENDL-2023 LIBRARY; T=0.K  
resonance total cross section

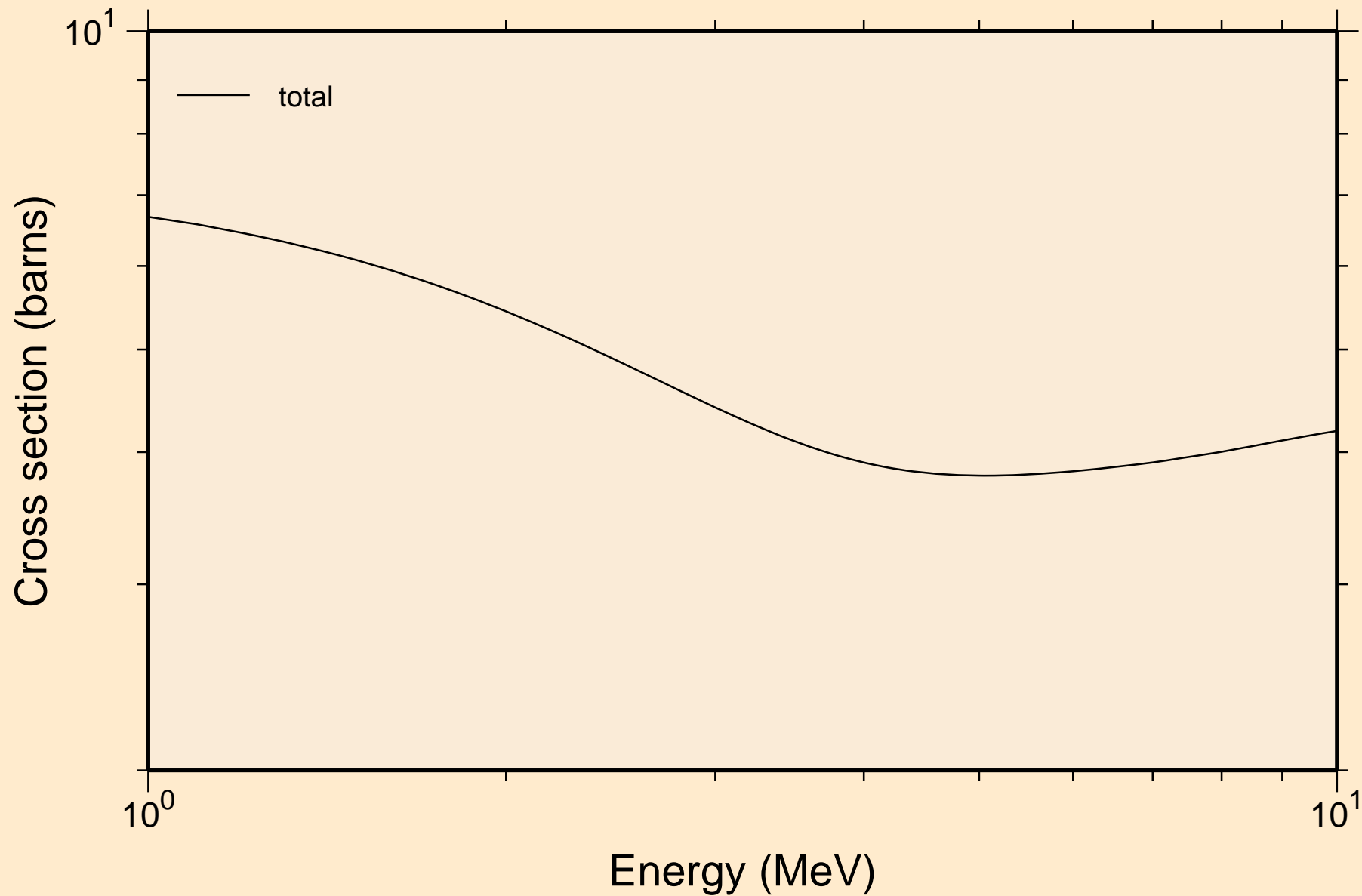

SB105 NEUTRON ACER TENDL-2023 LIBRARY; T=0.K  
resonance absorption cross sections

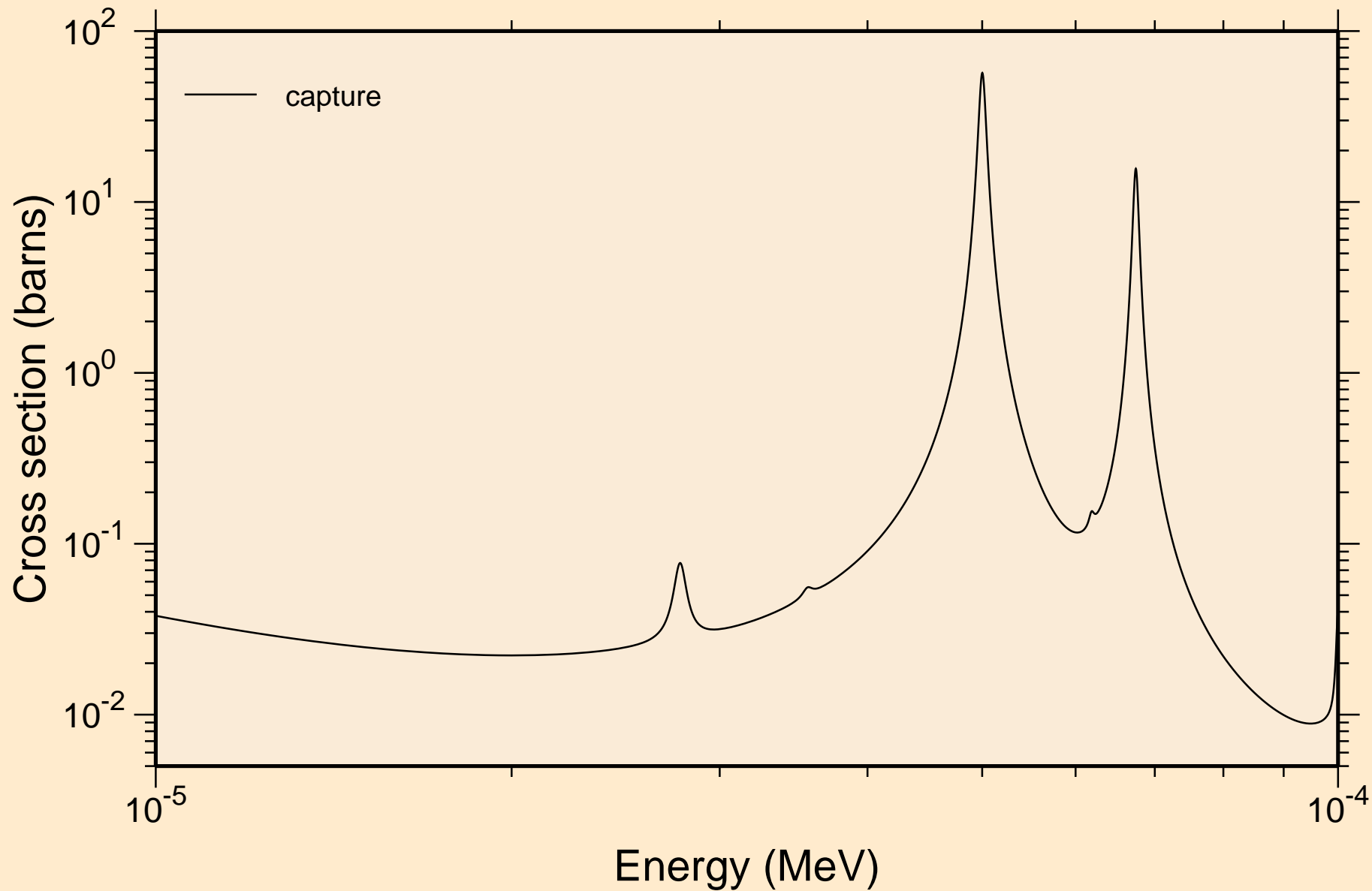

SB105 NEUTRON ACER TENDL-2023 LIBRARY; T=0.K  
resonance absorption cross sections

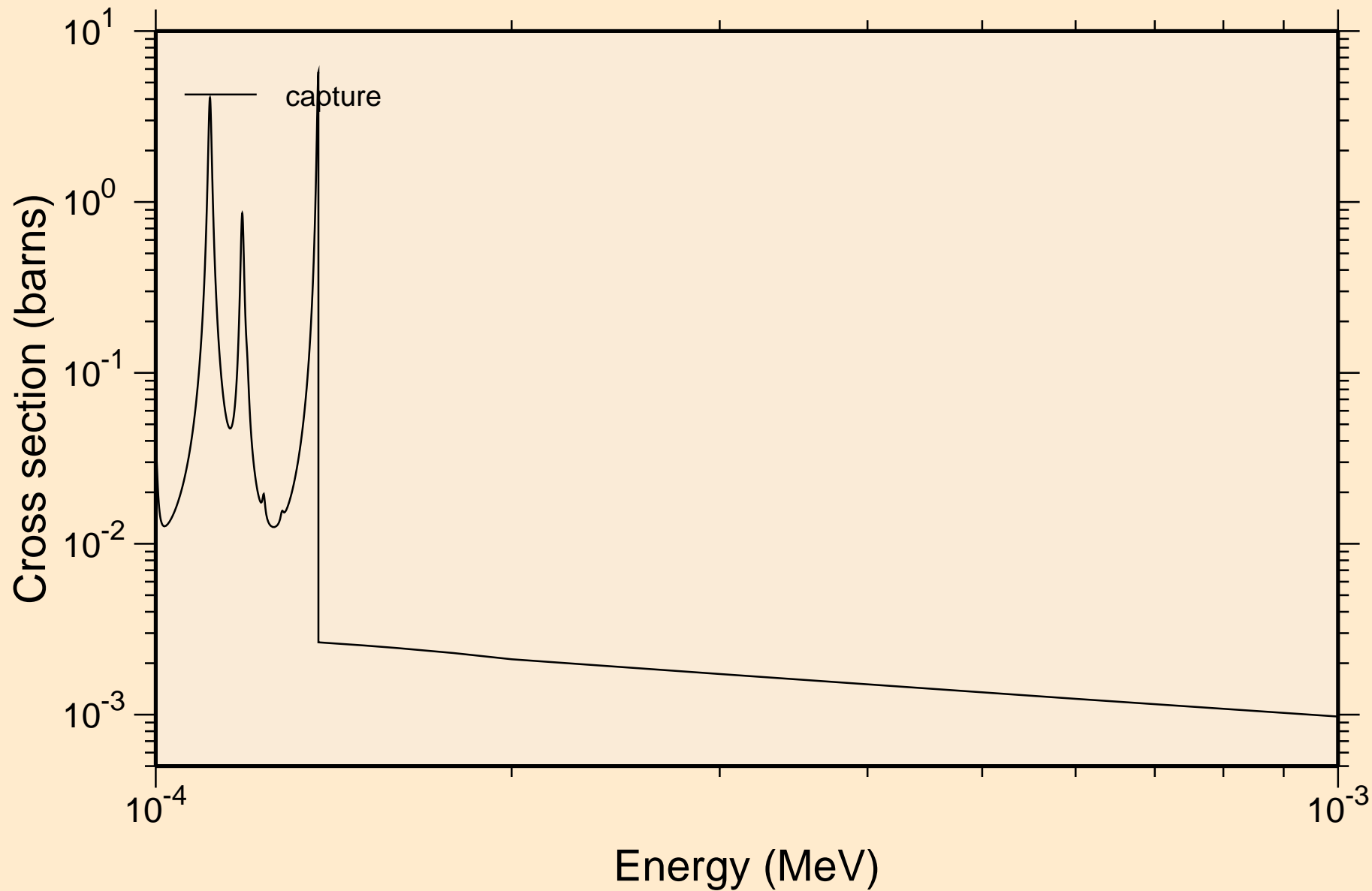

SB105 NEUTRON ACER TENDL-2023 LIBRARY; T=0.K  
resonance absorption cross sections

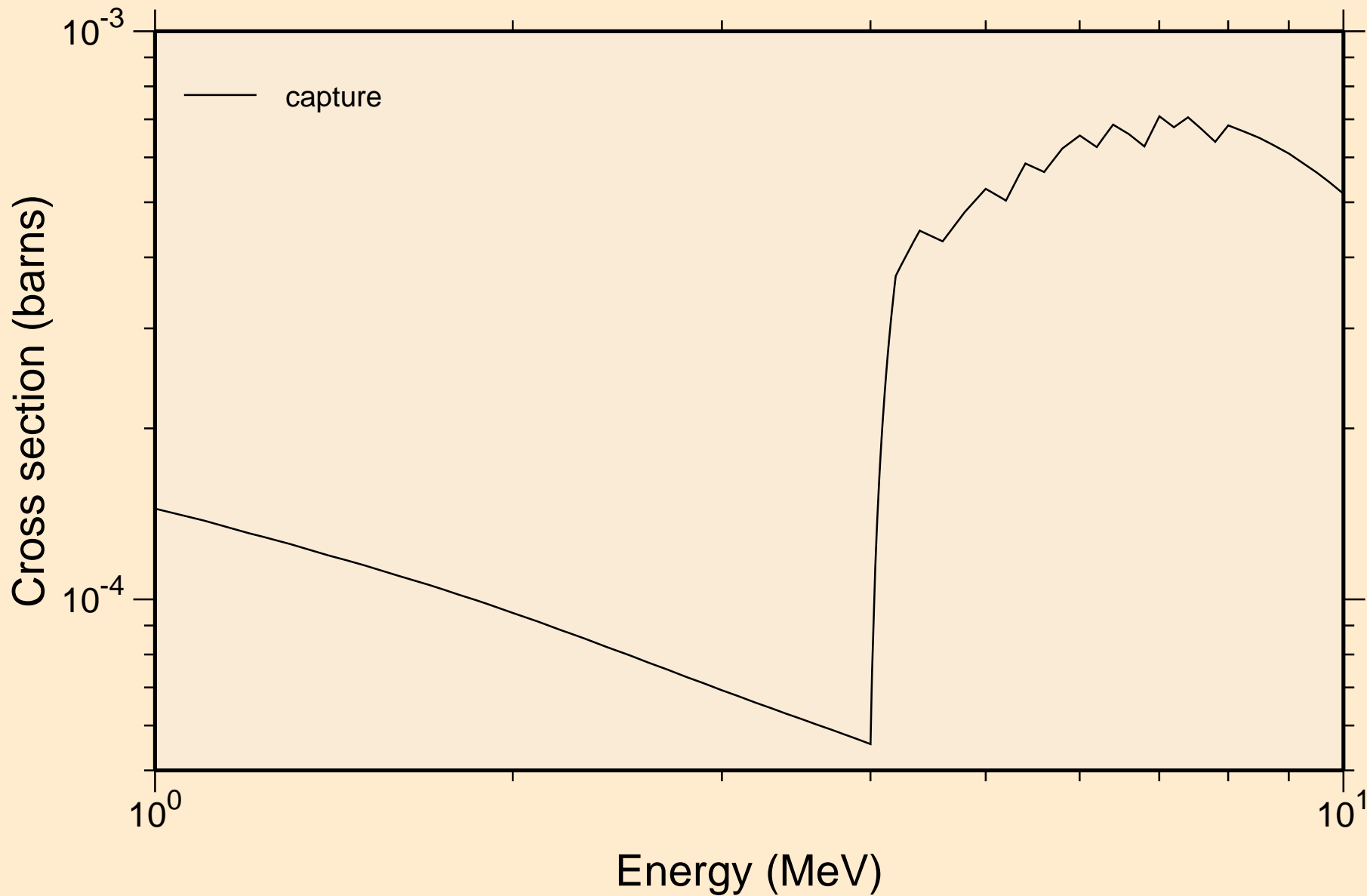

# SB105 NEUTRON ACER TENDL-2023 LIBRARY; T=0.K

## Heating

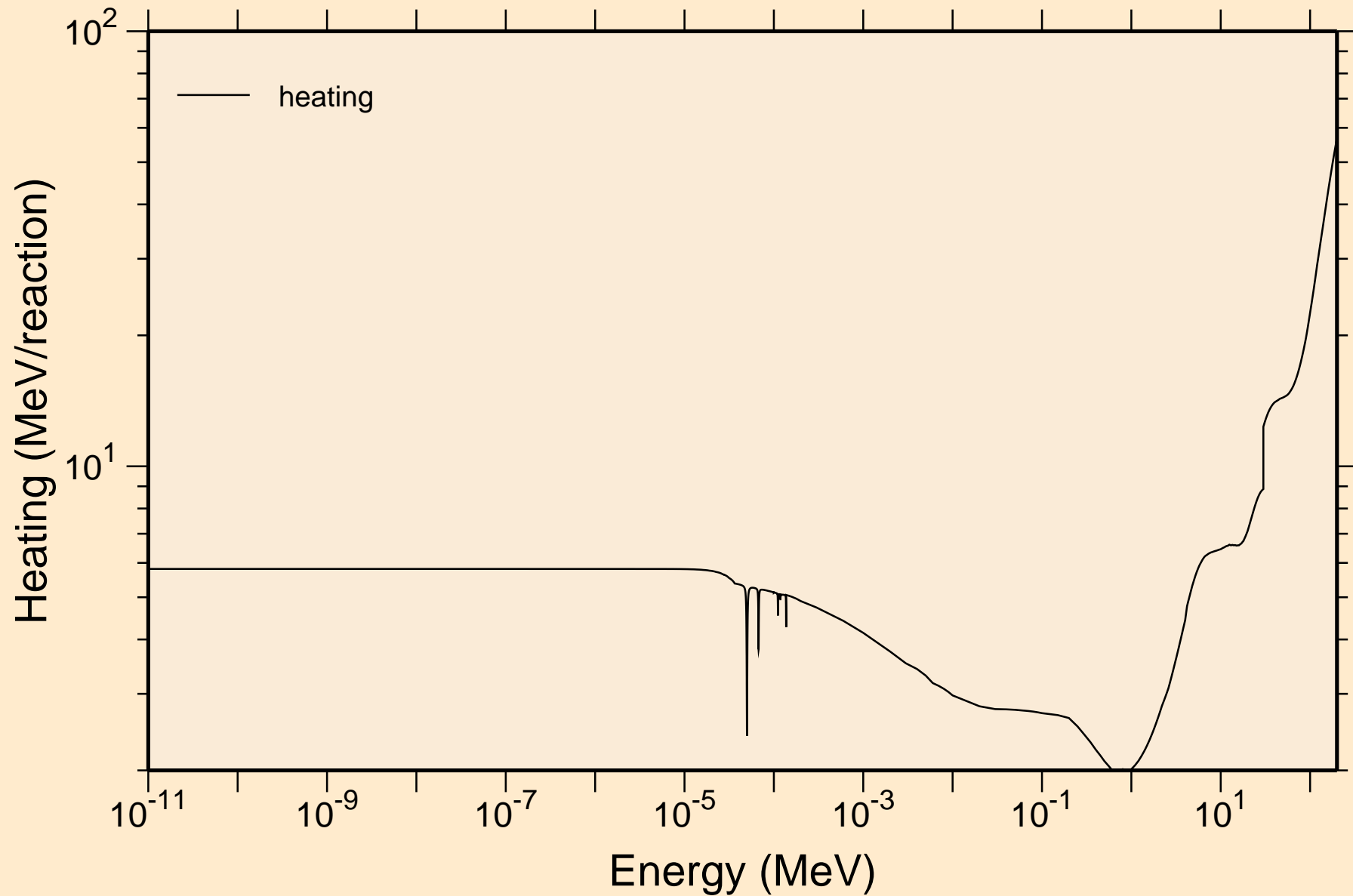



# SB105 NEUTRON ACER TENDL-2023 LIBRARY; T=0.K

## Damage

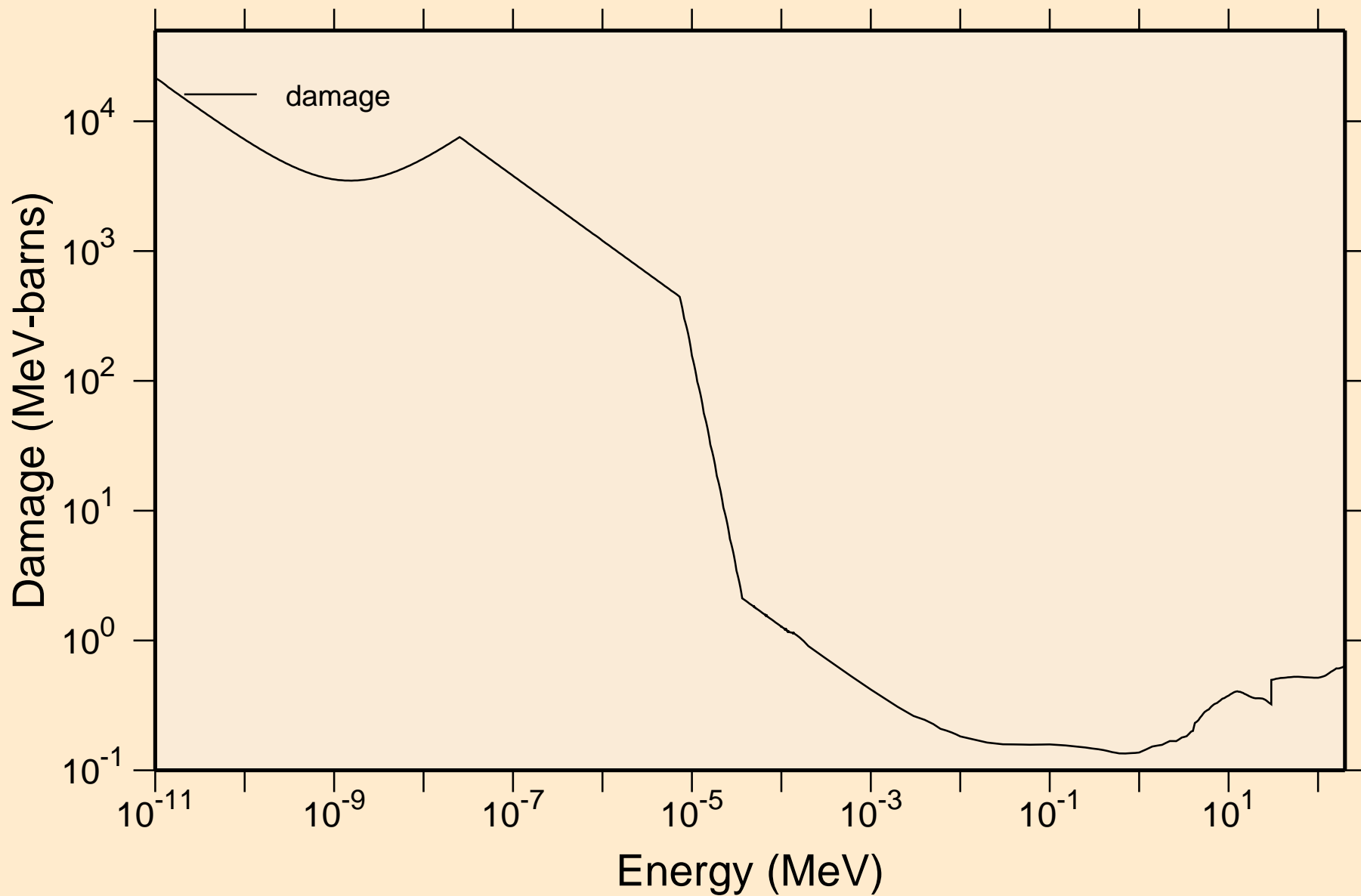

# SB105 NEUTRON ACER TENDL-2023 LIBRARY; T=0.K

## Non-threshold reactions

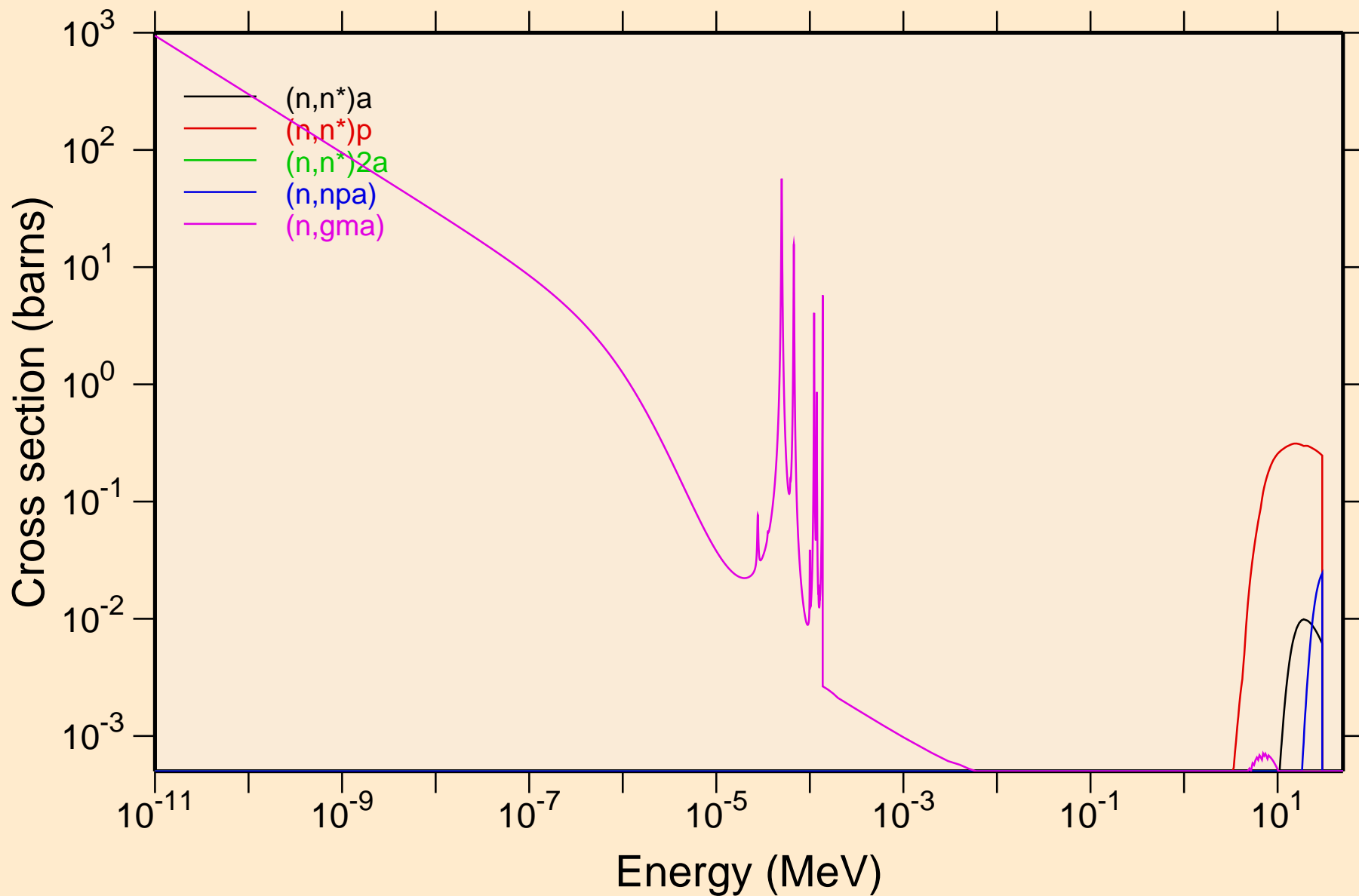



SB105 NEUTRON ACER TENDL-2023 LIBRARY; T=0.K  
Non-threshold reactions

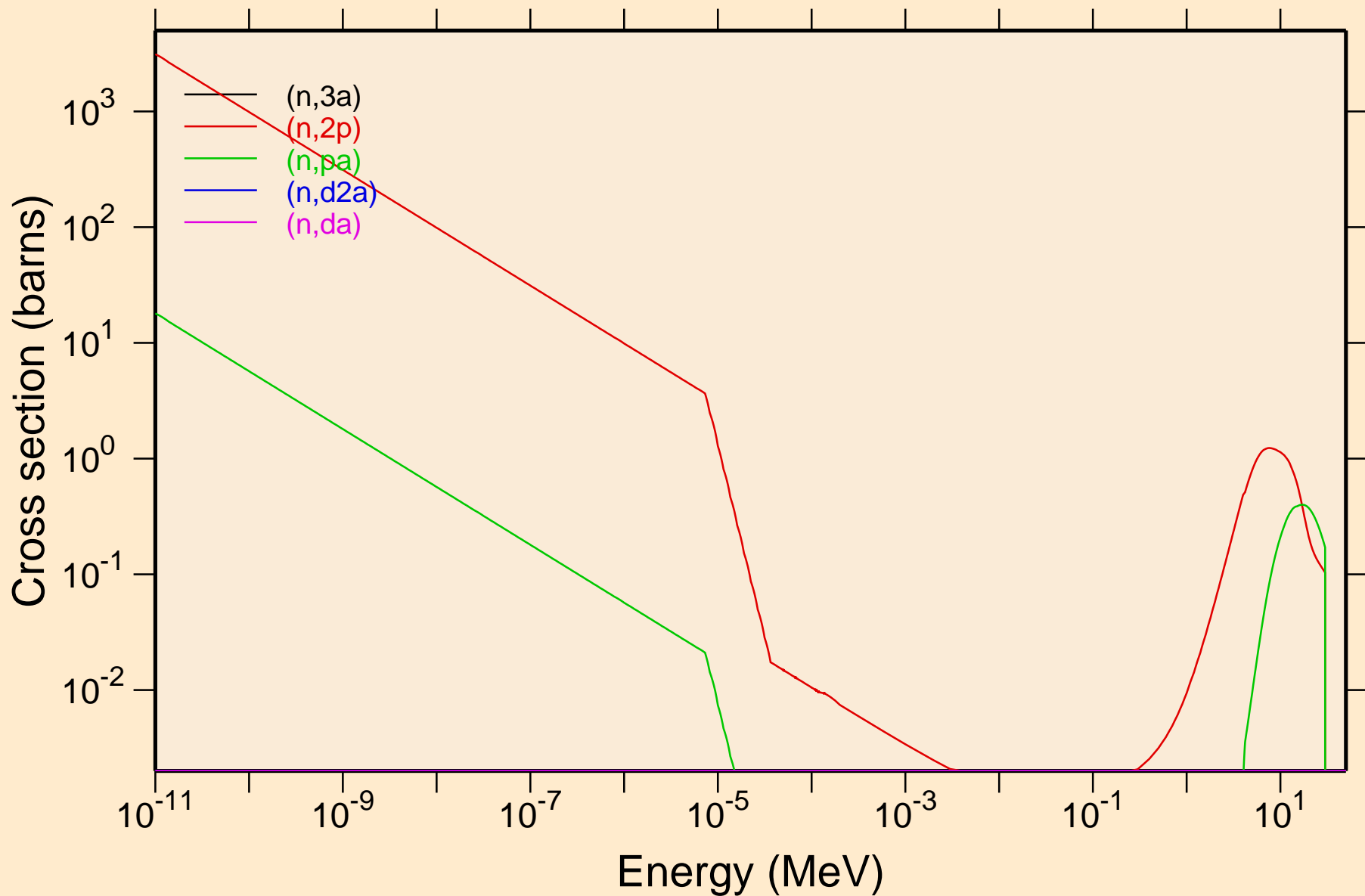

# SB105 NEUTRON ACER TENDL-2023 LIBRARY; T=0.K

## Non-threshold reactions

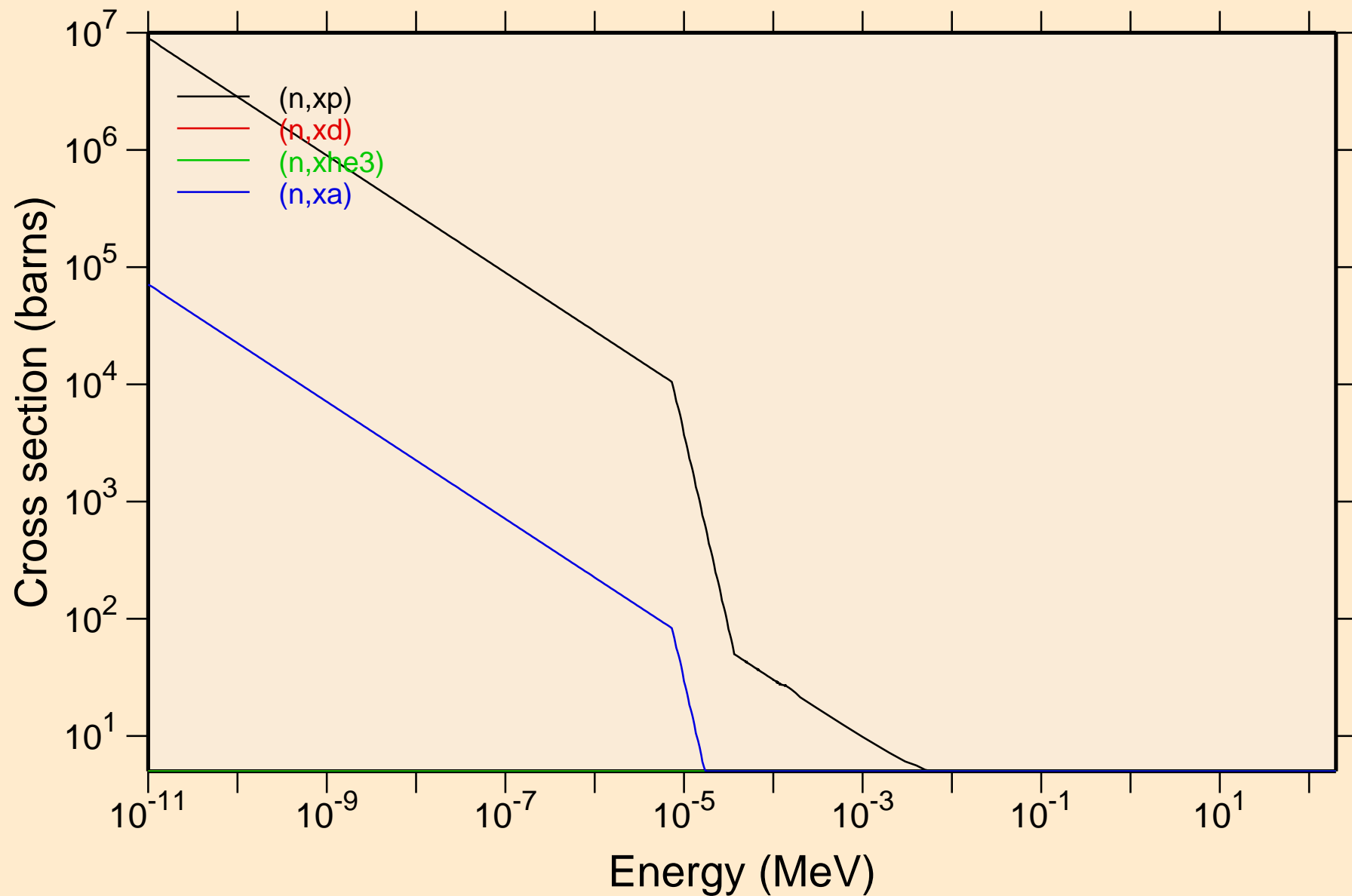

# SB105 NEUTRON ACER TENDL-2023 LIBRARY; T=0.K

## Principal cross sections

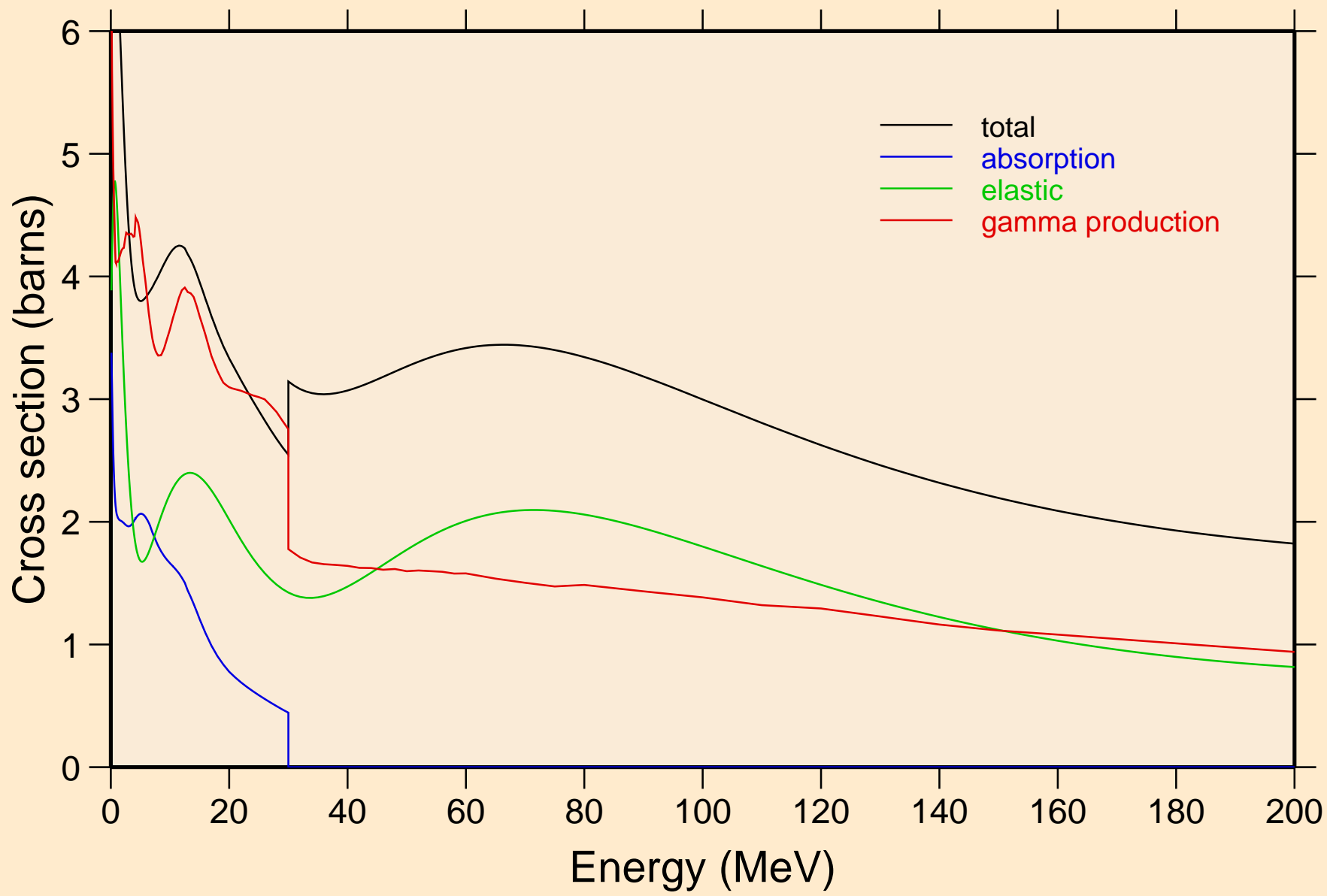

# SB105 NEUTRON ACER TENDL-2023 LIBRARY; T=0.K

## Heating

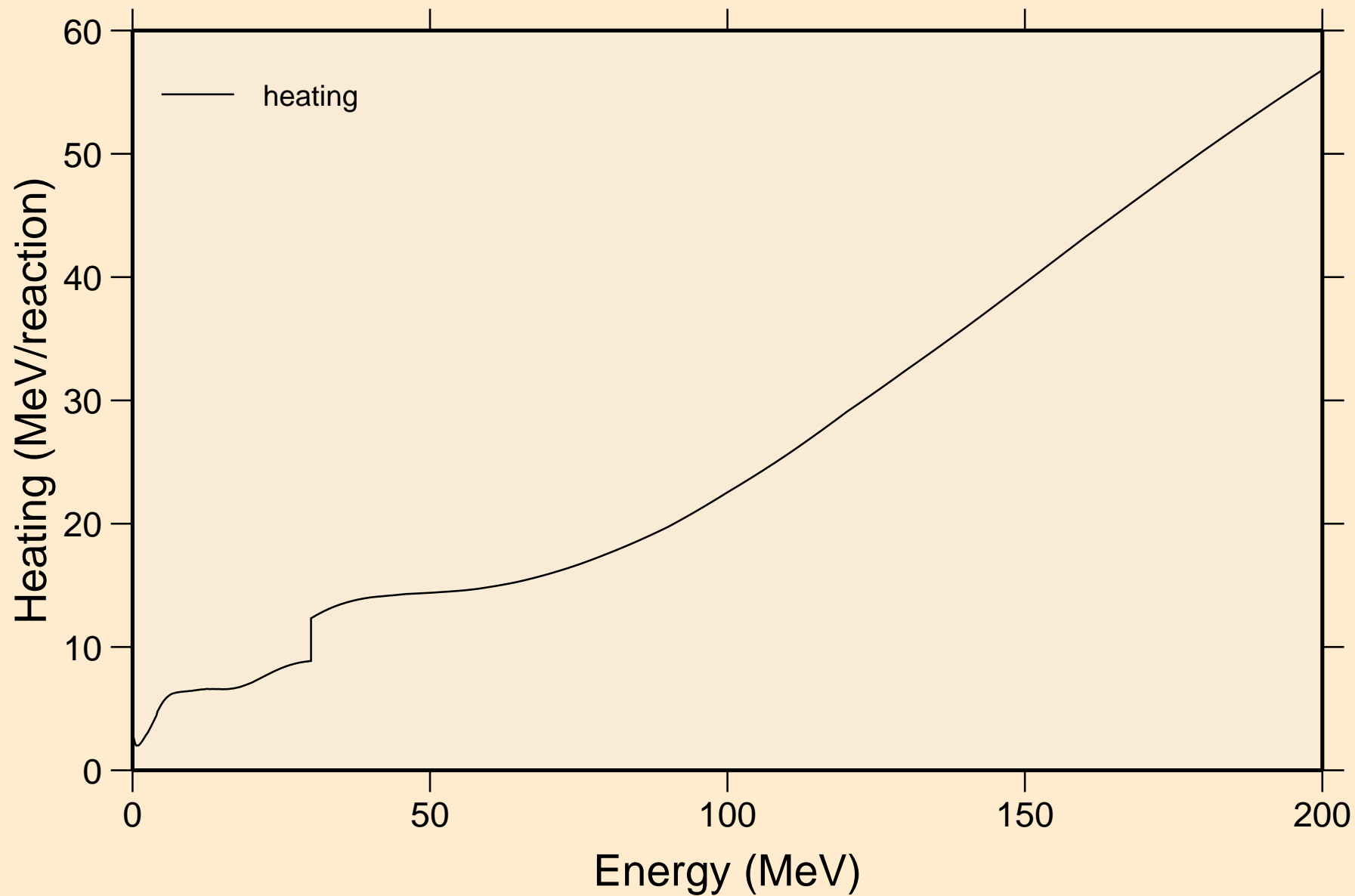

# SB105 NEUTRON ACER TENDL-2023 LIBRARY; T=0.K

## Damage

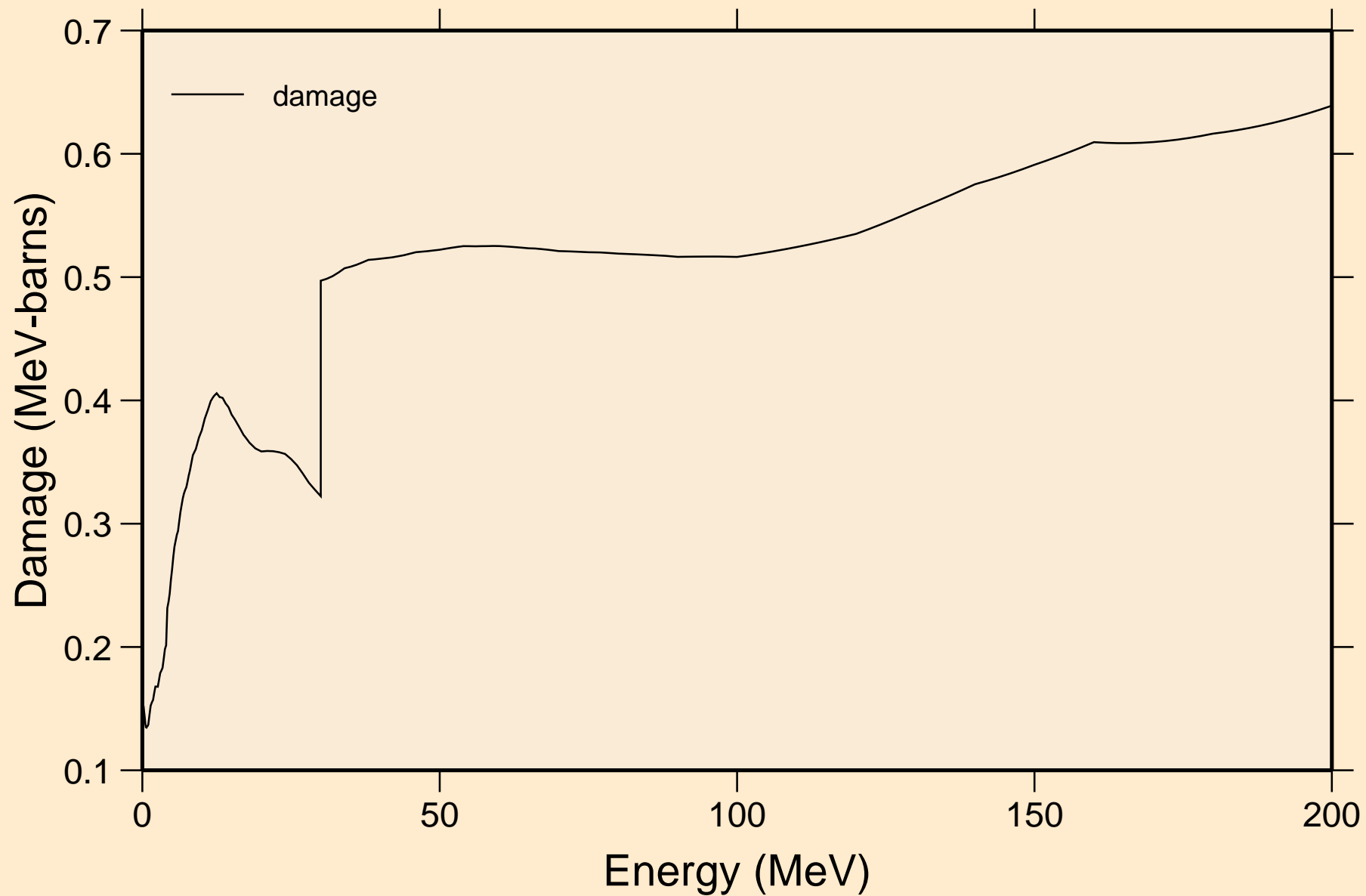



# SB105 NEUTRON ACER TENDL-2023 LIBRARY; T=0.K

## Non-threshold reactions

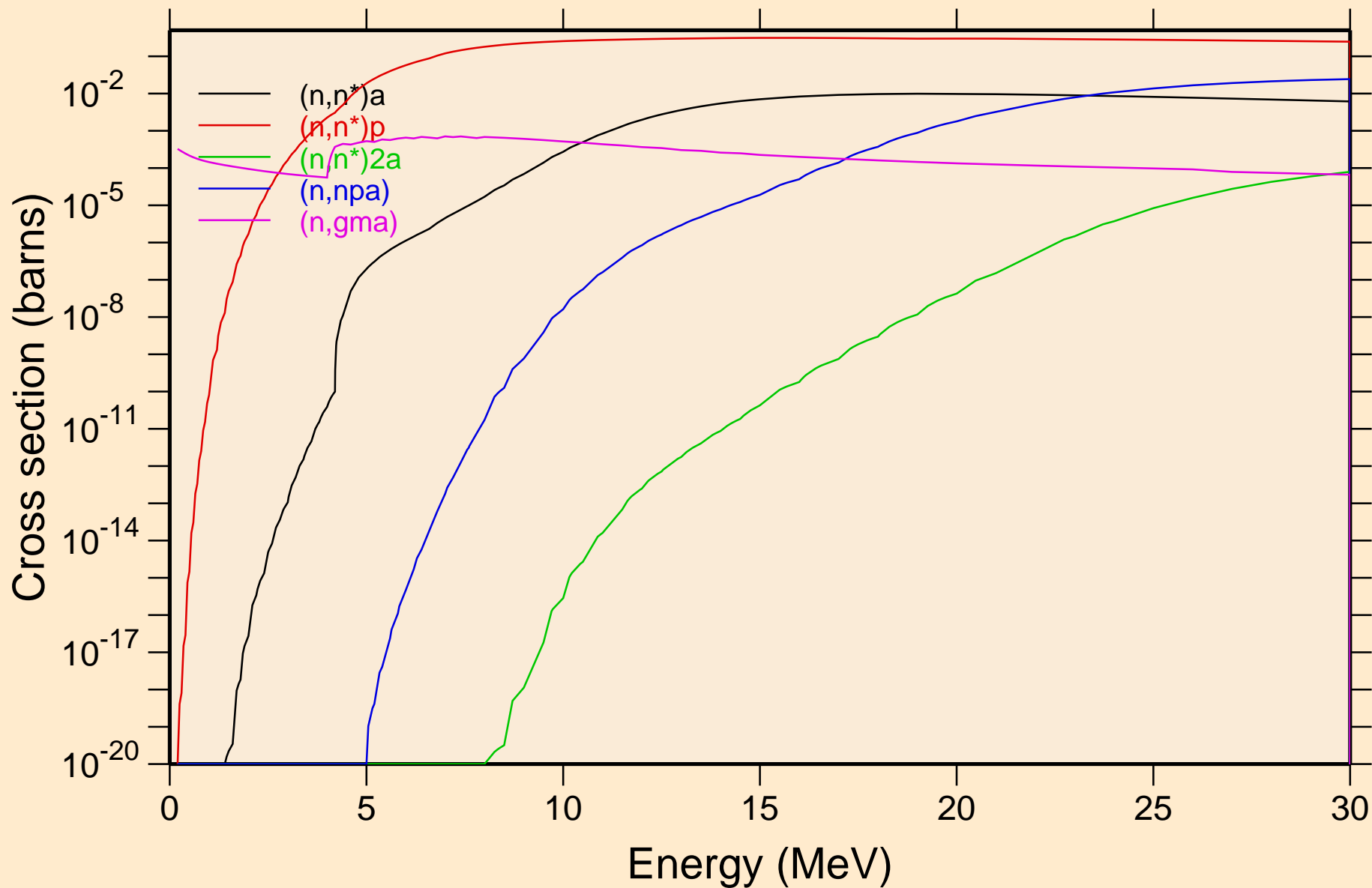

SB105 NEUTRON ACER TENDL-2023 LIBRARY; T=0.K  
Non-threshold reactions

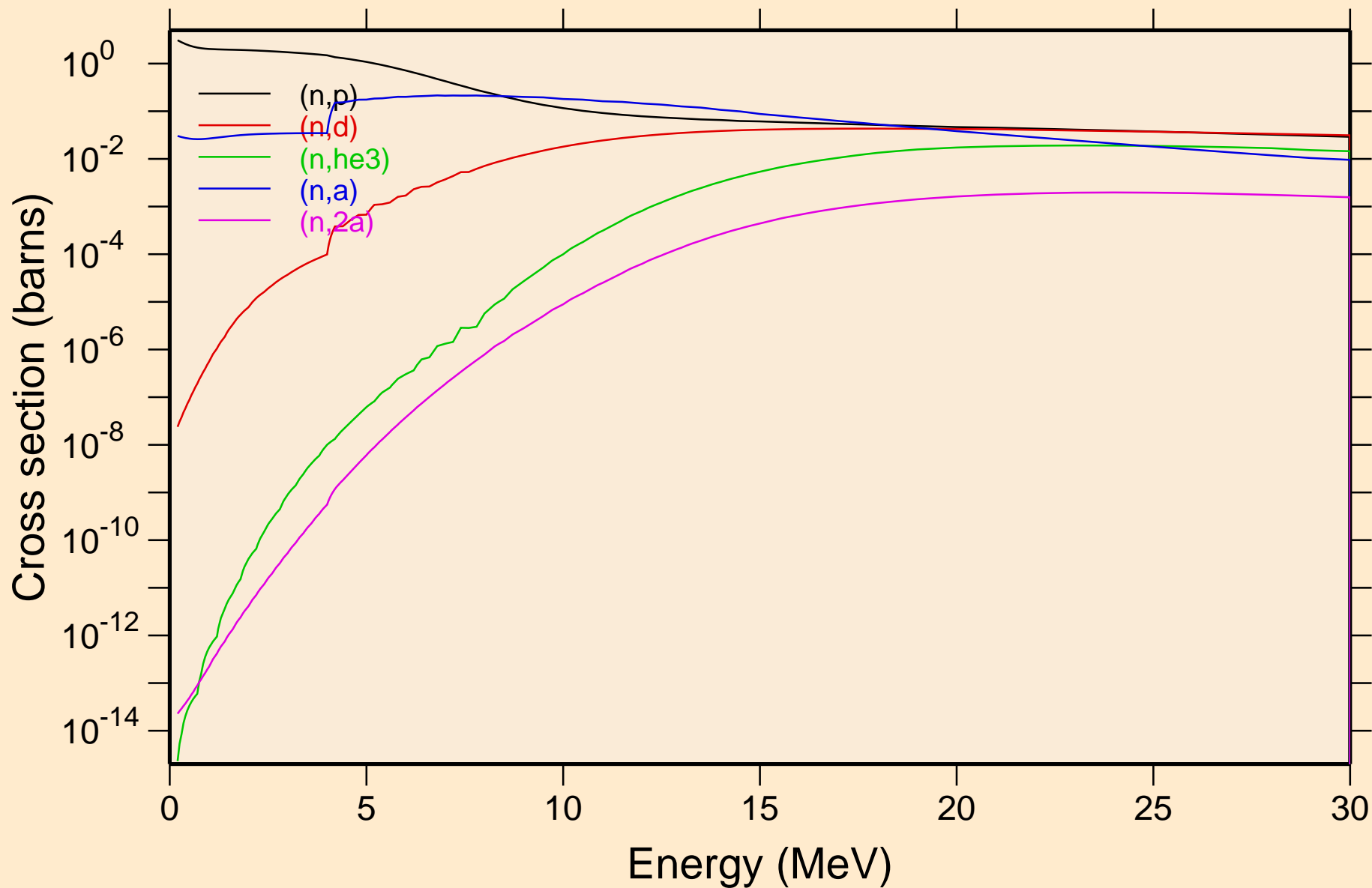

# SB105 NEUTRON ACER TENDL-2023 LIBRARY; T=0.K

## Non-threshold reactions

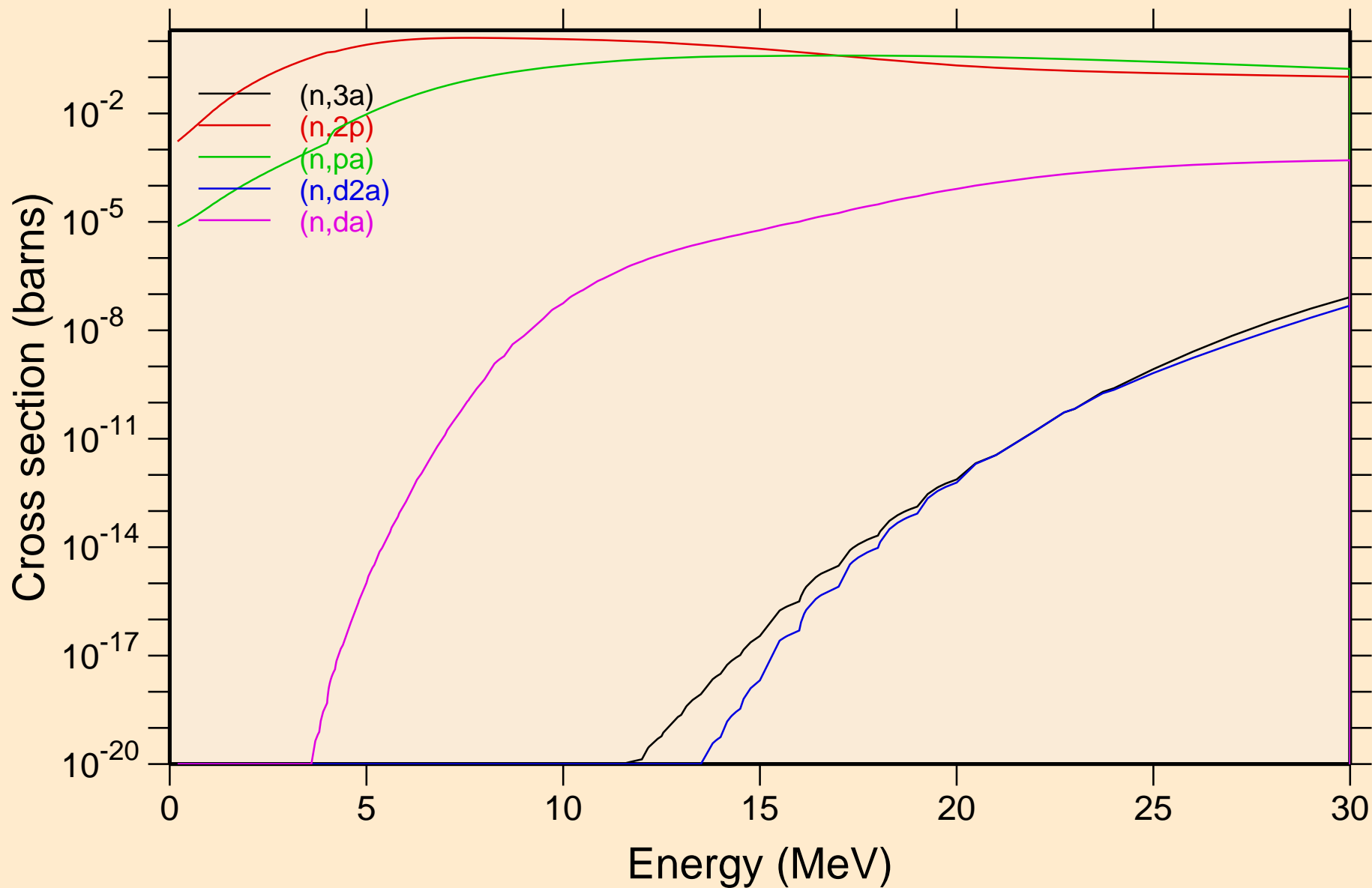

SB105 NEUTRON ACER TENDL-2023 LIBRARY; T=0.K  
Non-threshold reactions

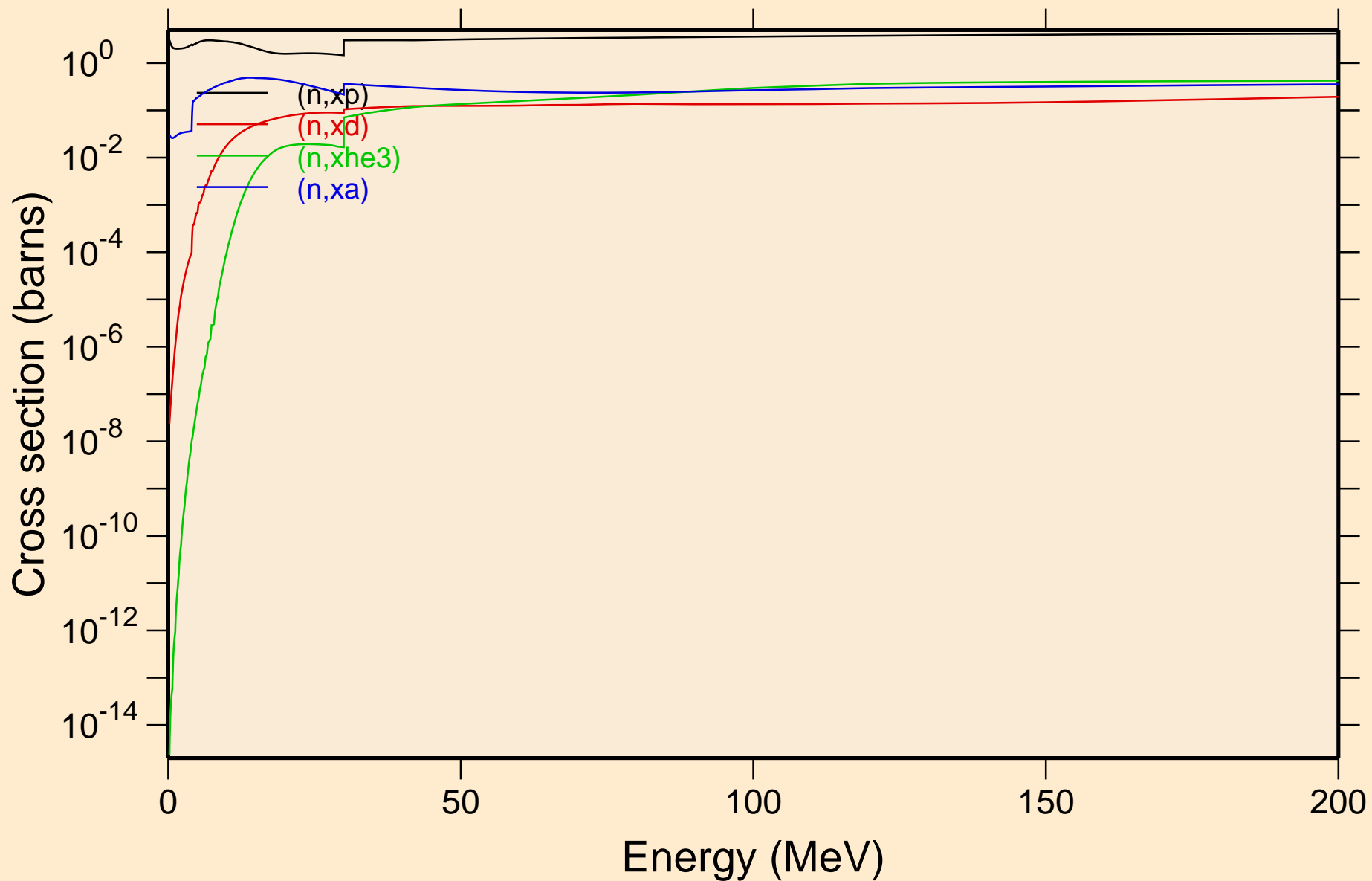

SB105 NEUTRON ACER TENDL-2023 LIBRARY; T=0.K  
Inelastic levels

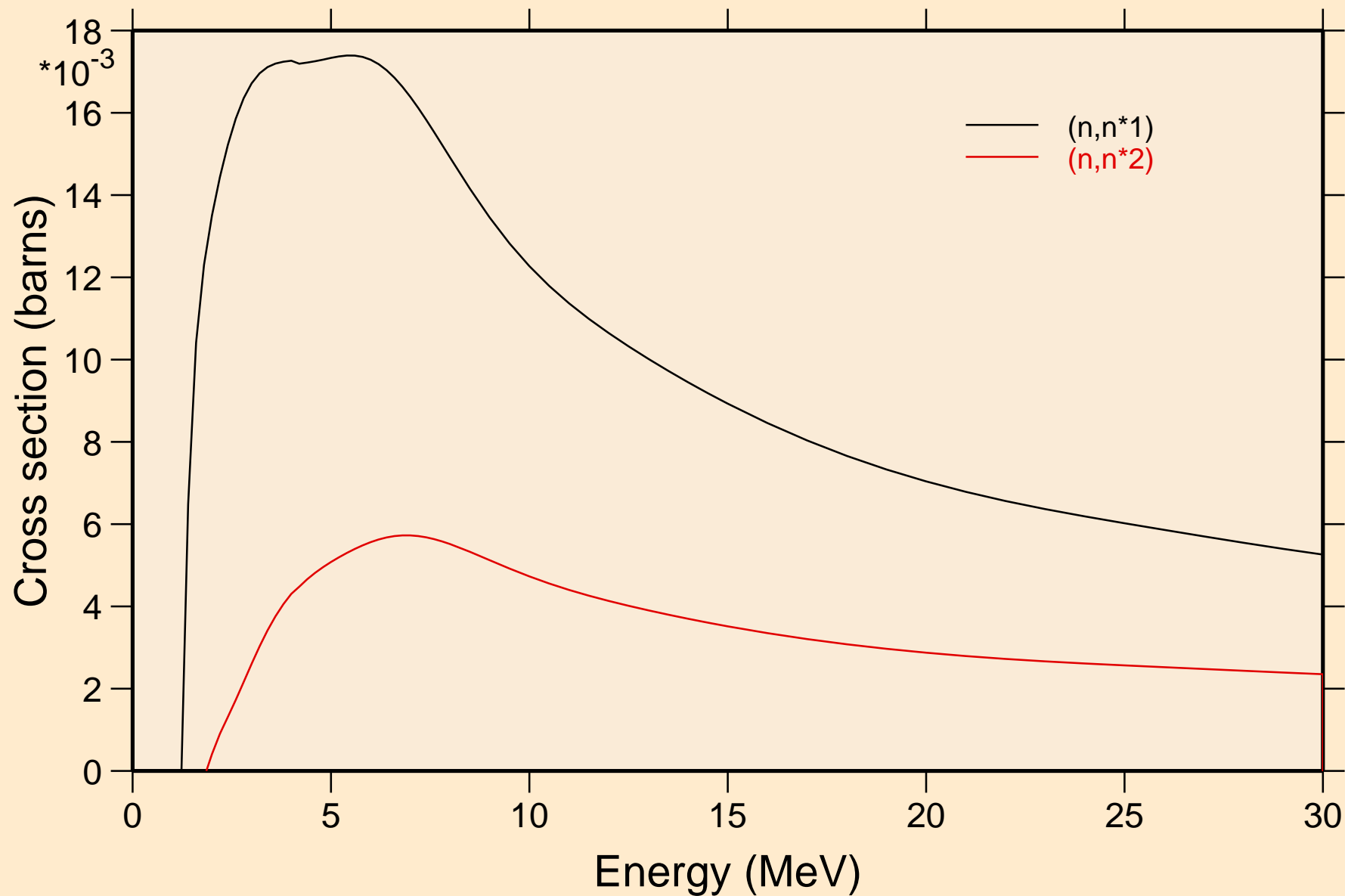

# SB105 NEUTRON ACER TENDL-2023 LIBRARY; T=0.K

## Threshold reactions

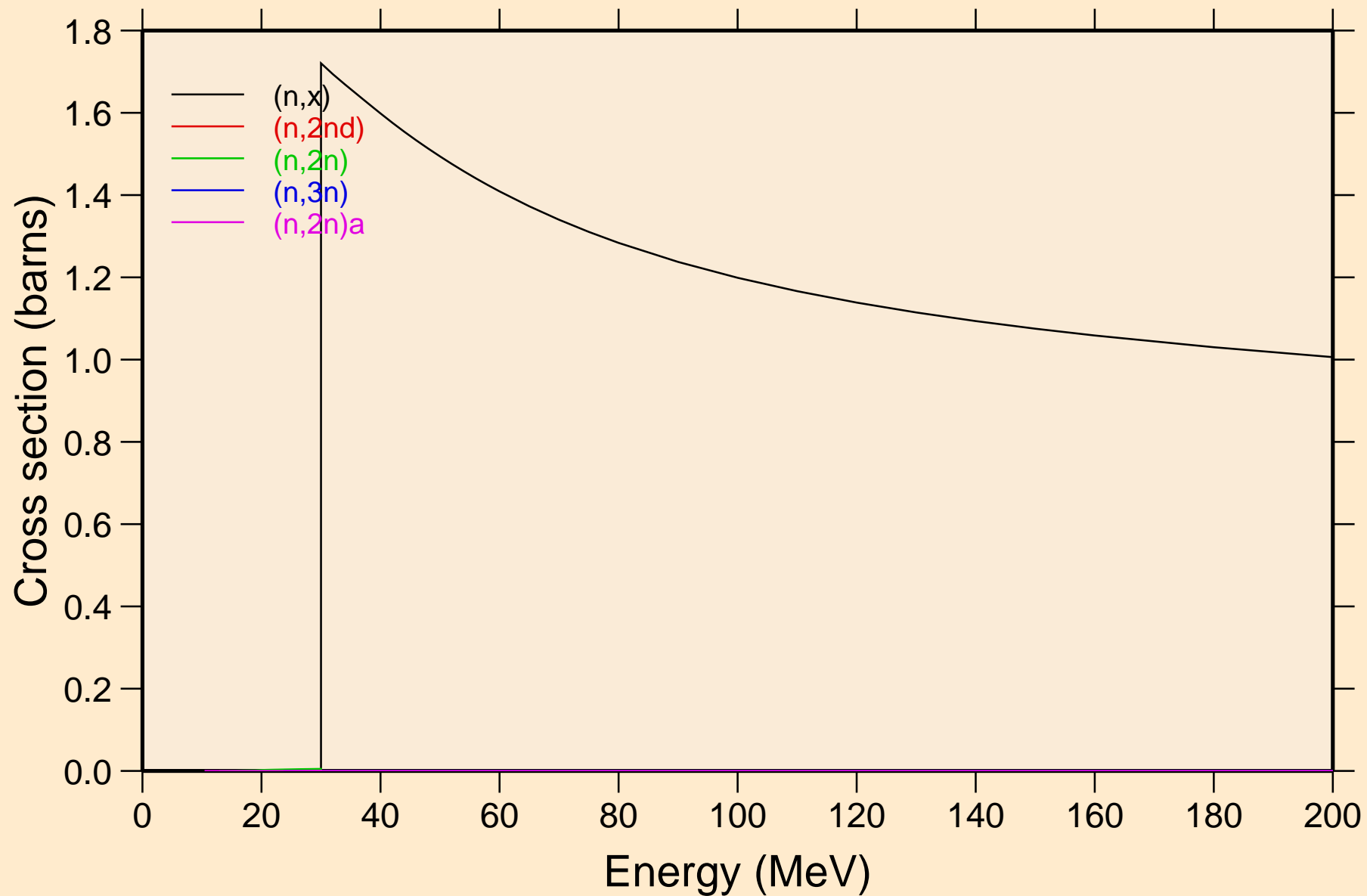

# SB105 NEUTRON ACER TENDL-2023 LIBRARY; T=0.K

## Threshold reactions

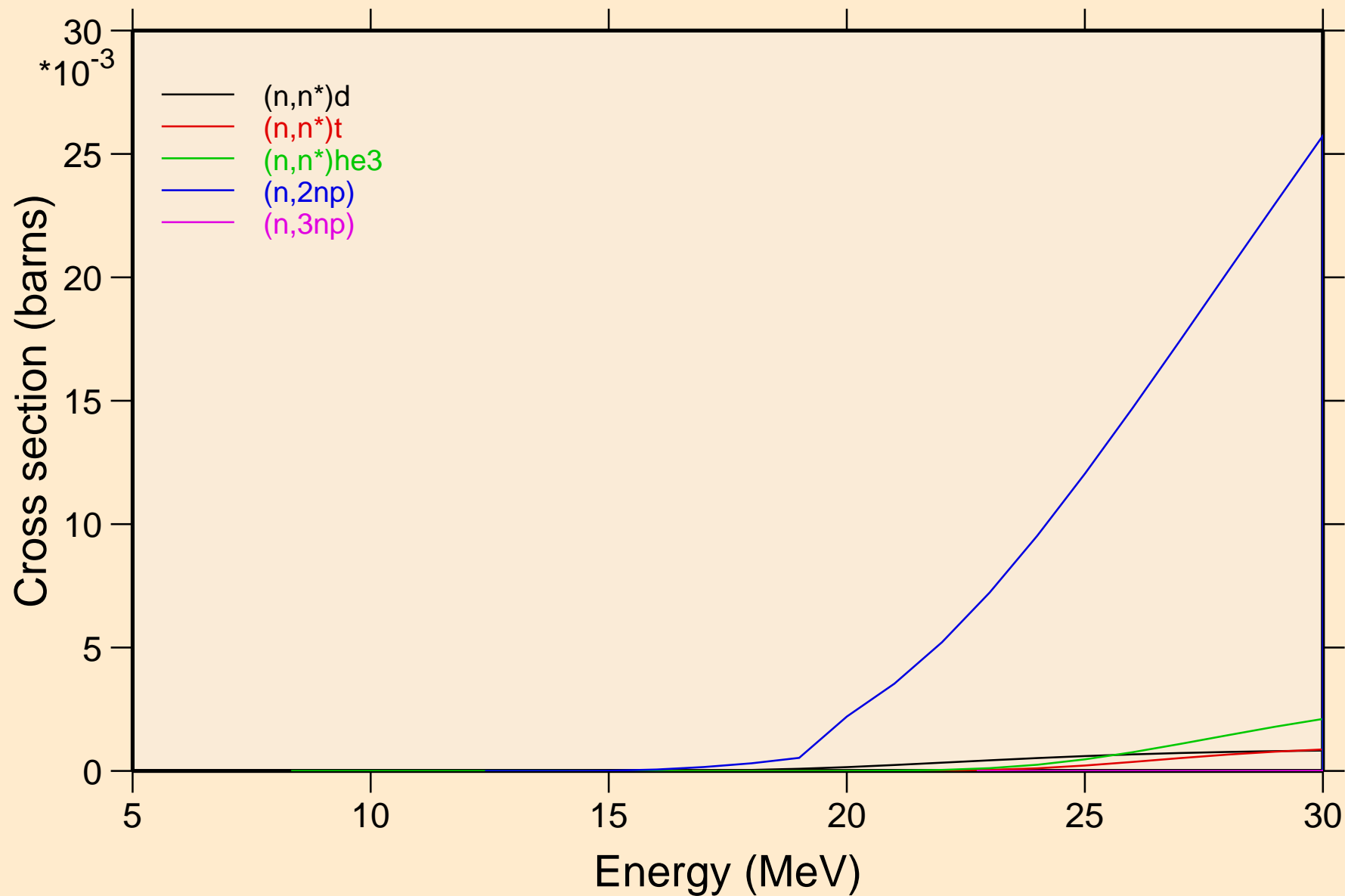

# SB105 NEUTRON ACER TENDL-2023 LIBRARY; T=0.K

## Threshold reactions

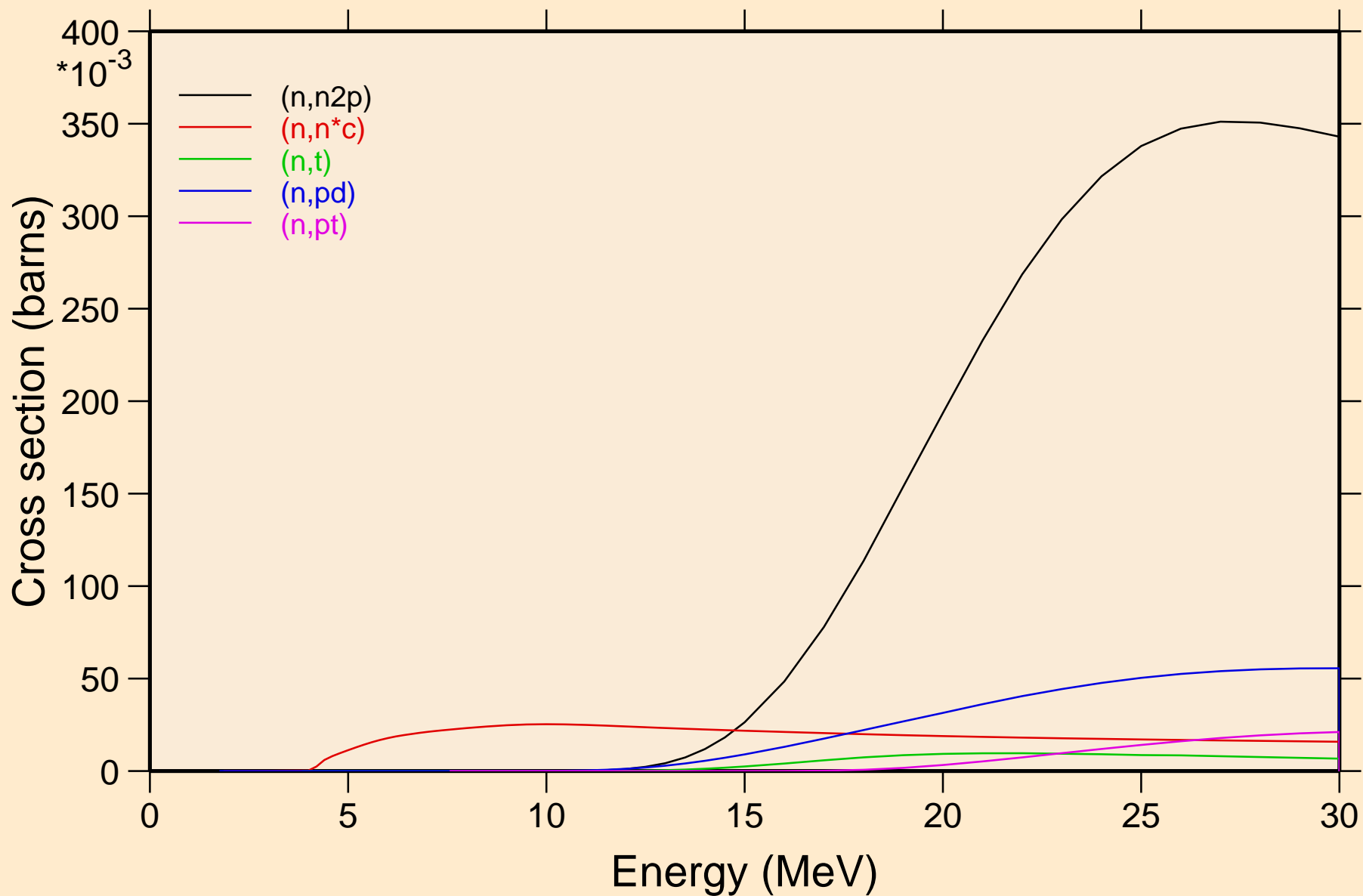



SB105 NEUTRON ACER TENDL-2023 LIBRARY; T=0.K  
Threshold reactions

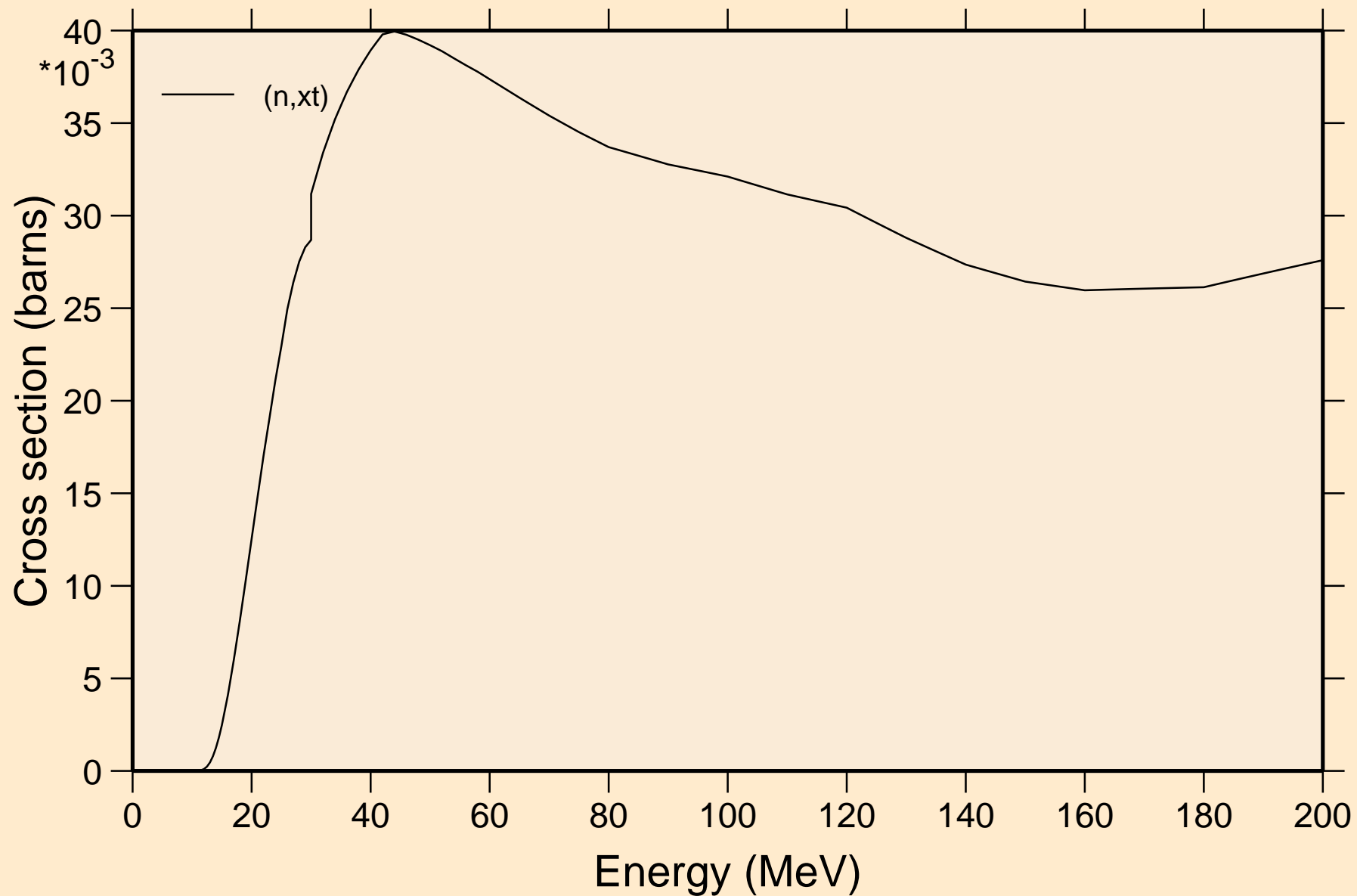

SB105 NEUTRON ACER TENDL-2023 LIBRARY; T=0.K  
angular distribution for elastic

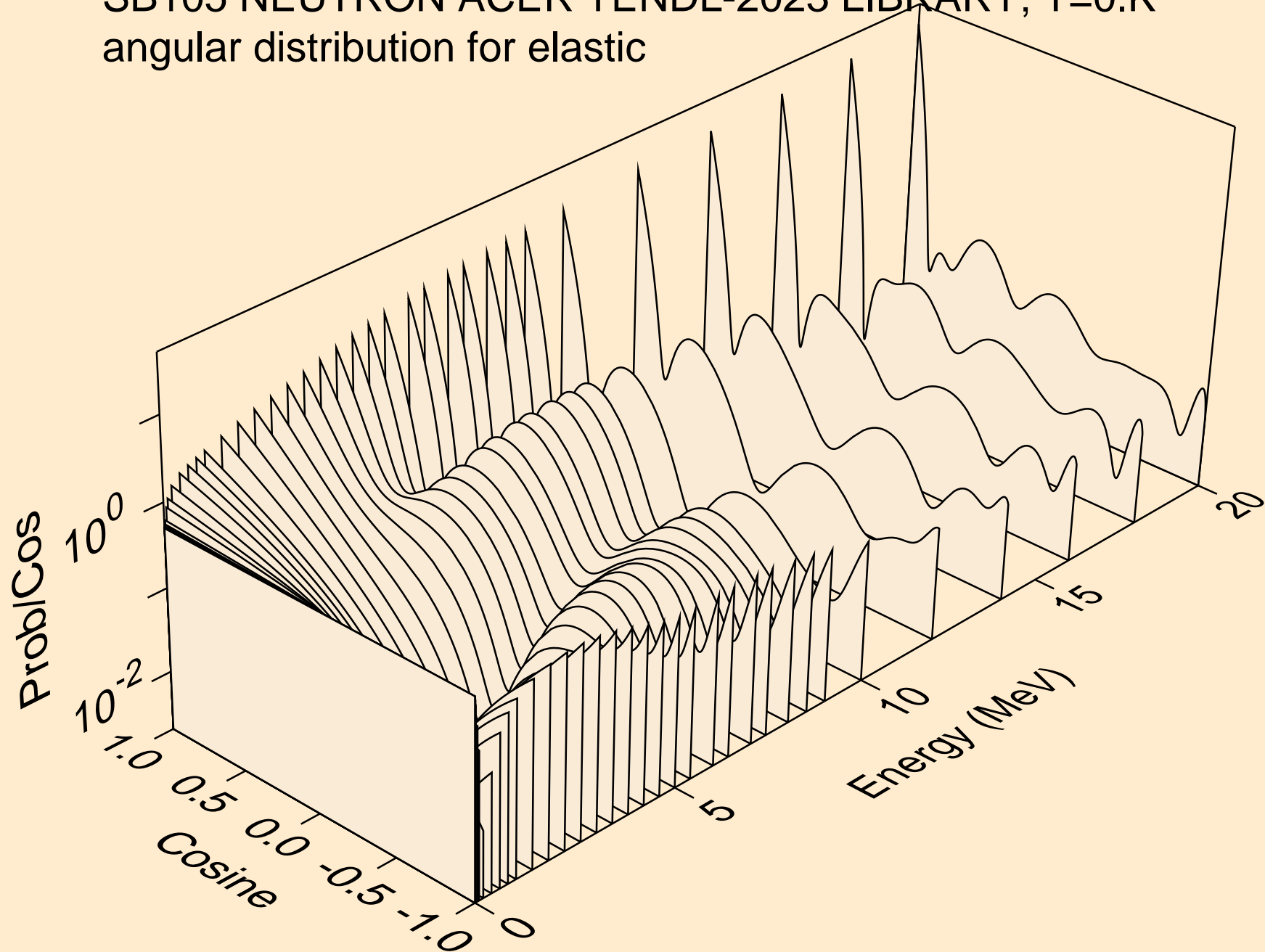

SB105 NEUTRON ACER TENDL-2023 LIBRARY; T=0.K  
angular distribution for elastic

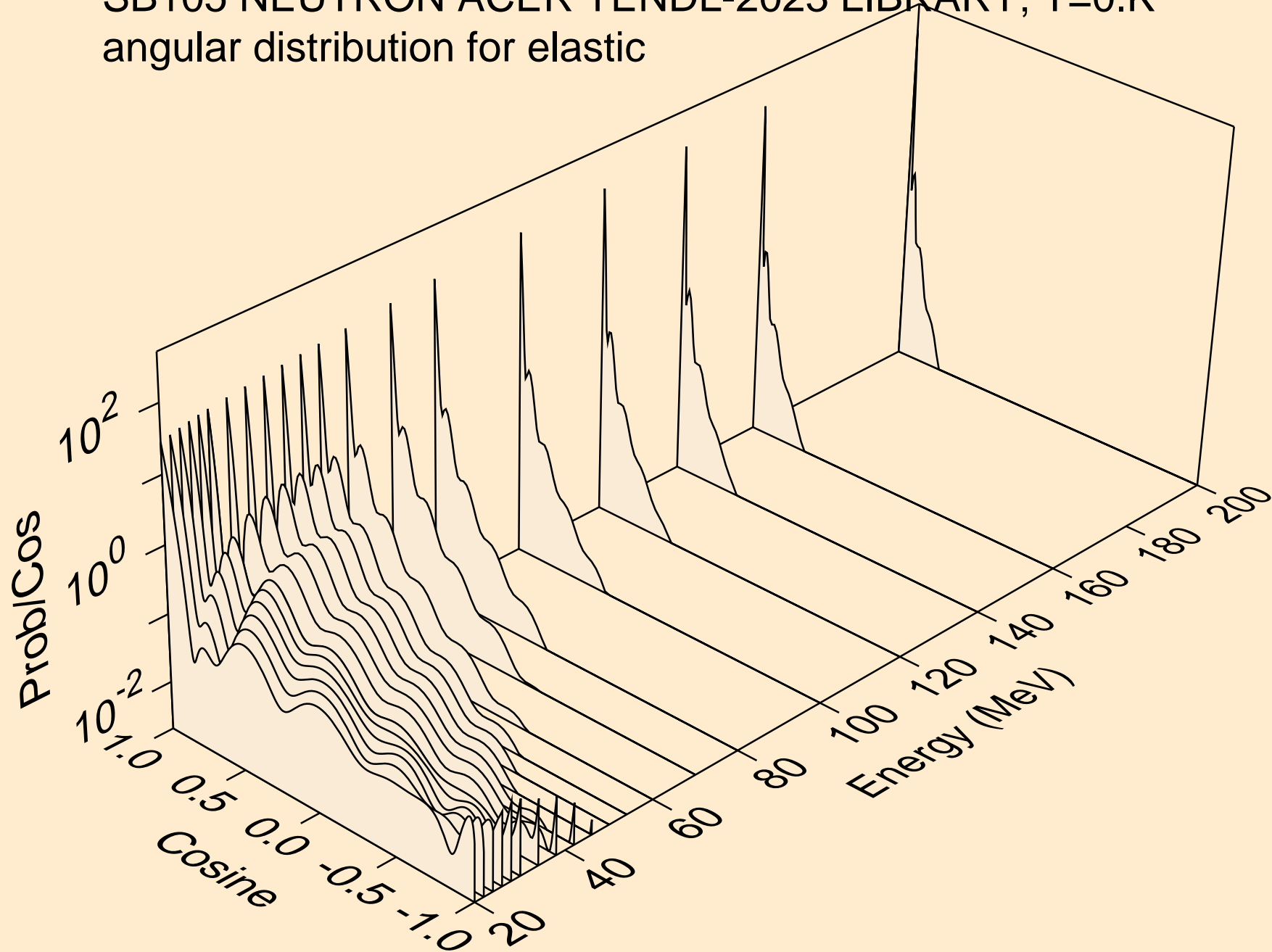

SB105 NEUTRON ACER TENDL-2023 LIBRARY; T=0.K  
angular distribution for (n,n\*1)

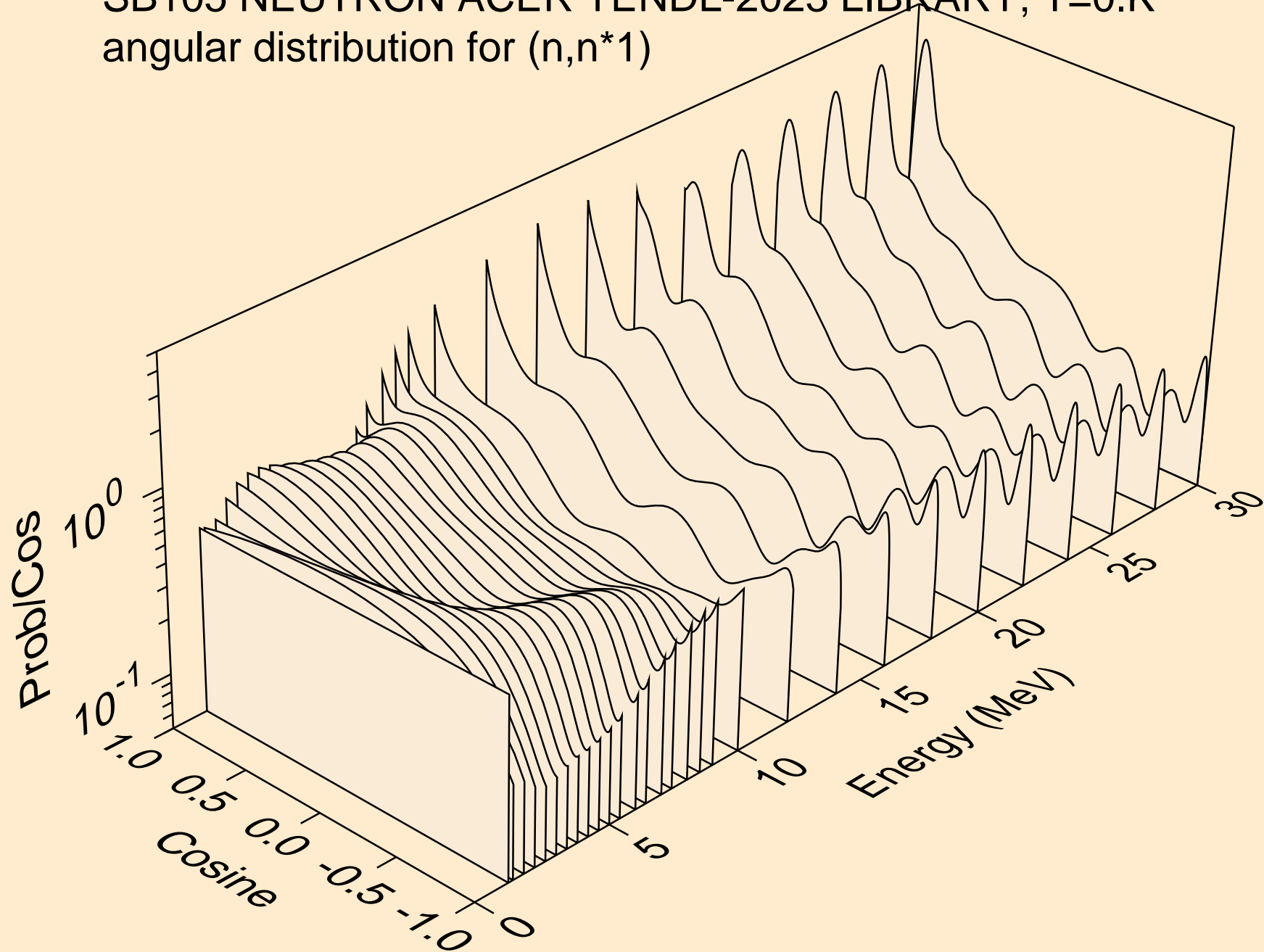

SB105 NEUTRON ACER TENDL-2023 LIBRARY; T=0.K  
angular distribution for (n,n\*2)

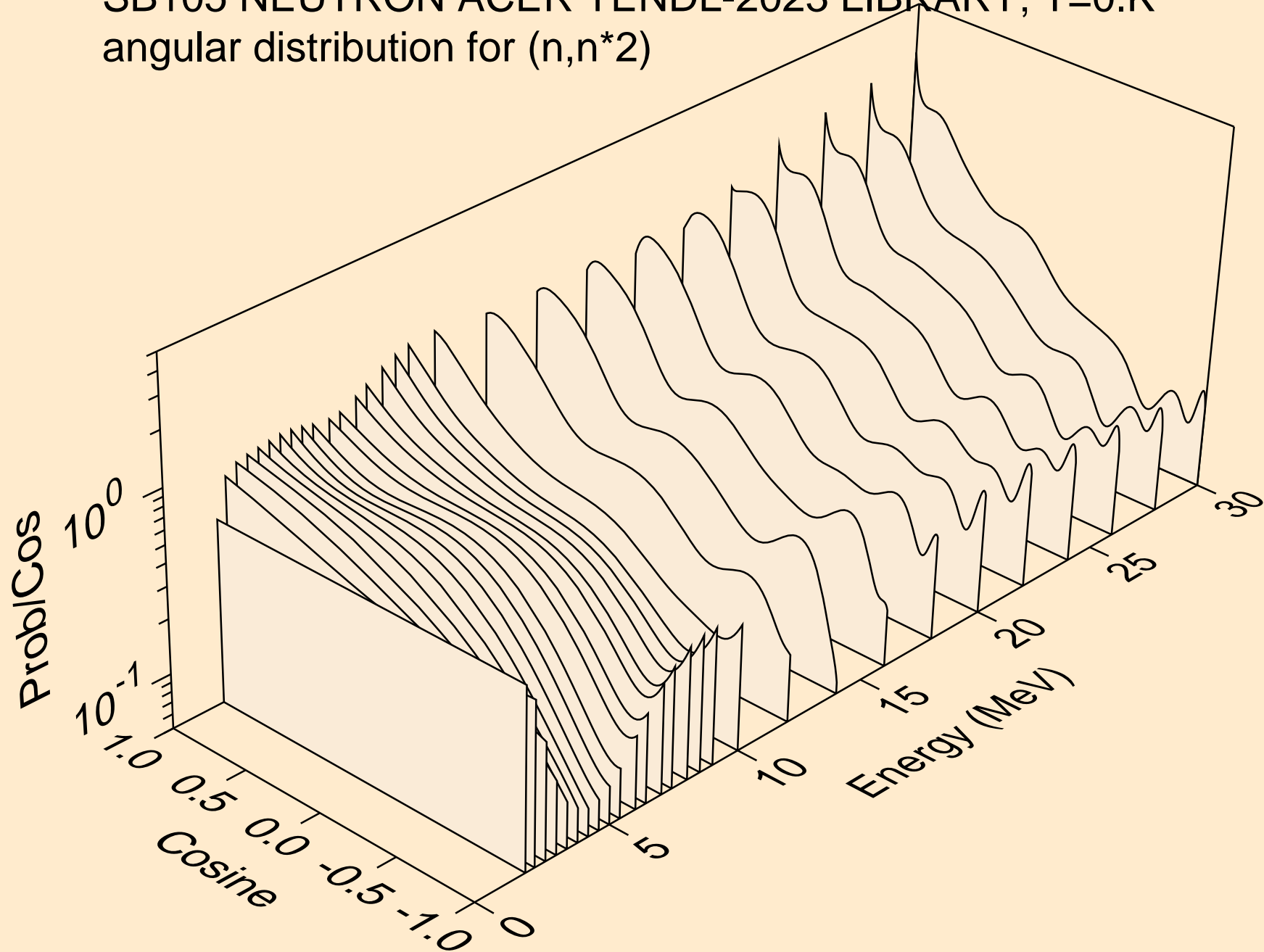

SB105 NEUTRON ACER TENDL-2023 LIBRARY; T=0.K  
Neutron emission for (n,x)

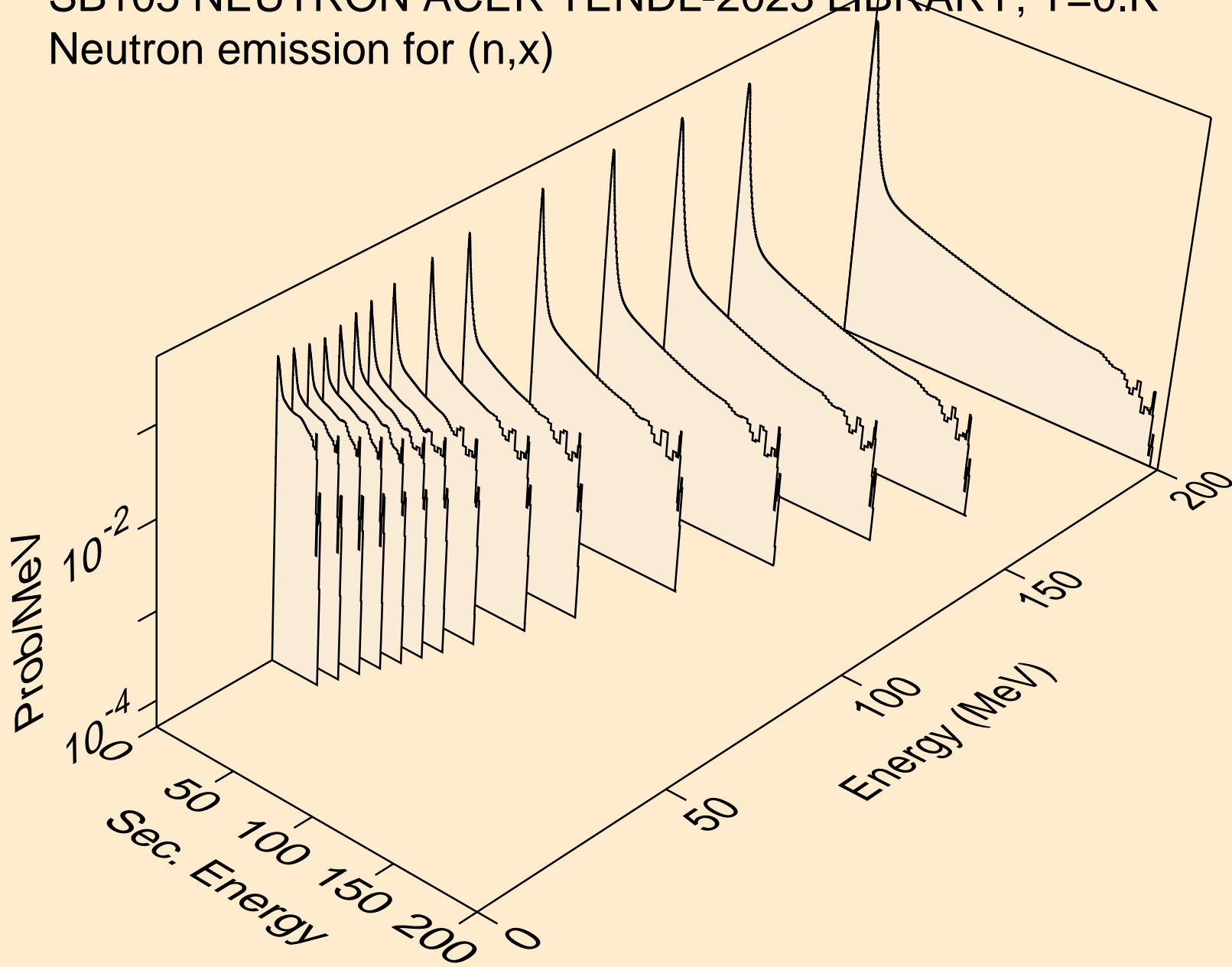

SB105 NEUTRON ACER TENDL-2023 LIBRARY; T=0.K  
Neutron emission for (n,2nd)

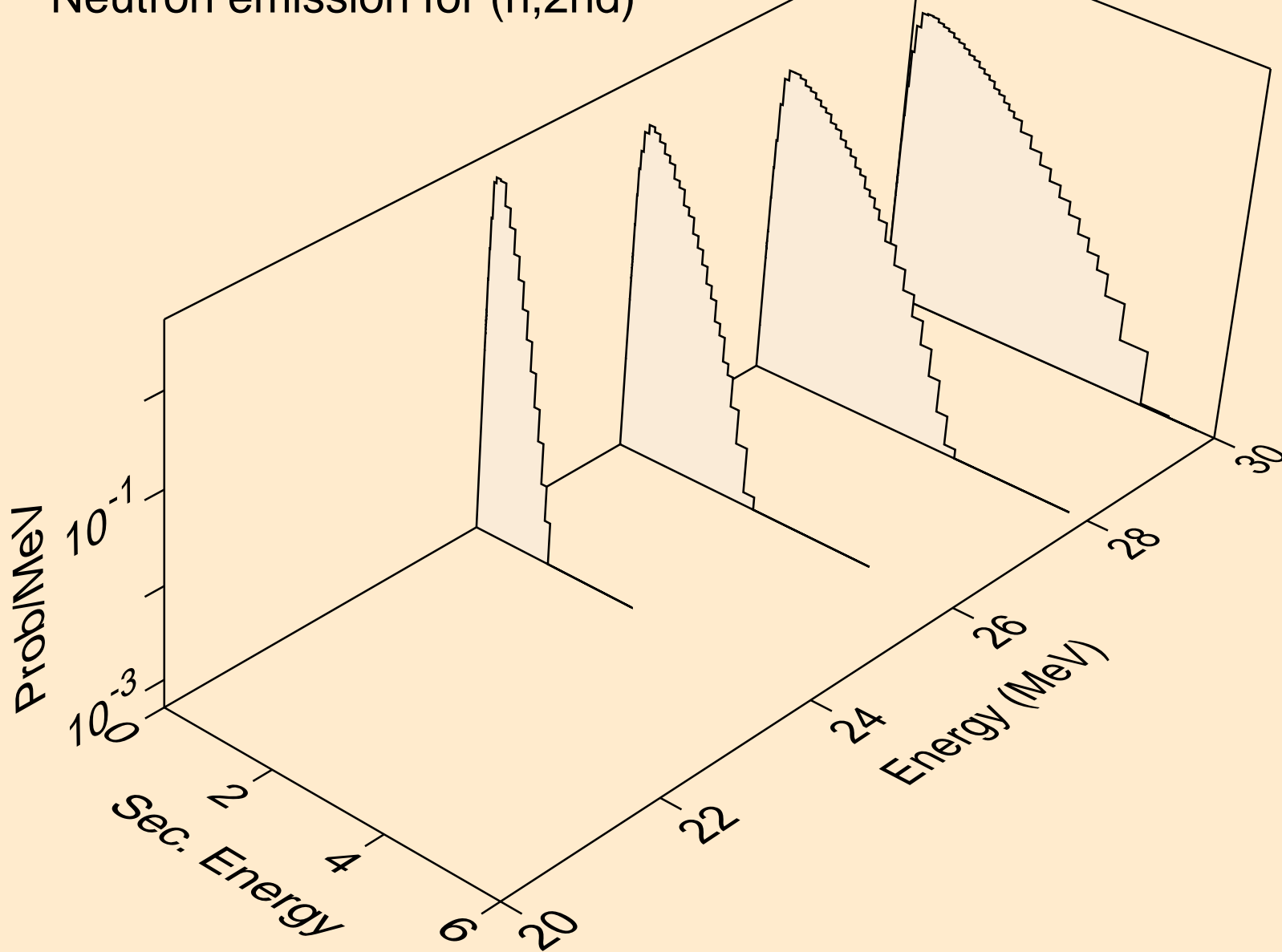

SB105 NEUTRON ACER TENDL-2023 LIBRARY; T=0.K  
Neutron emission for (n,2n)

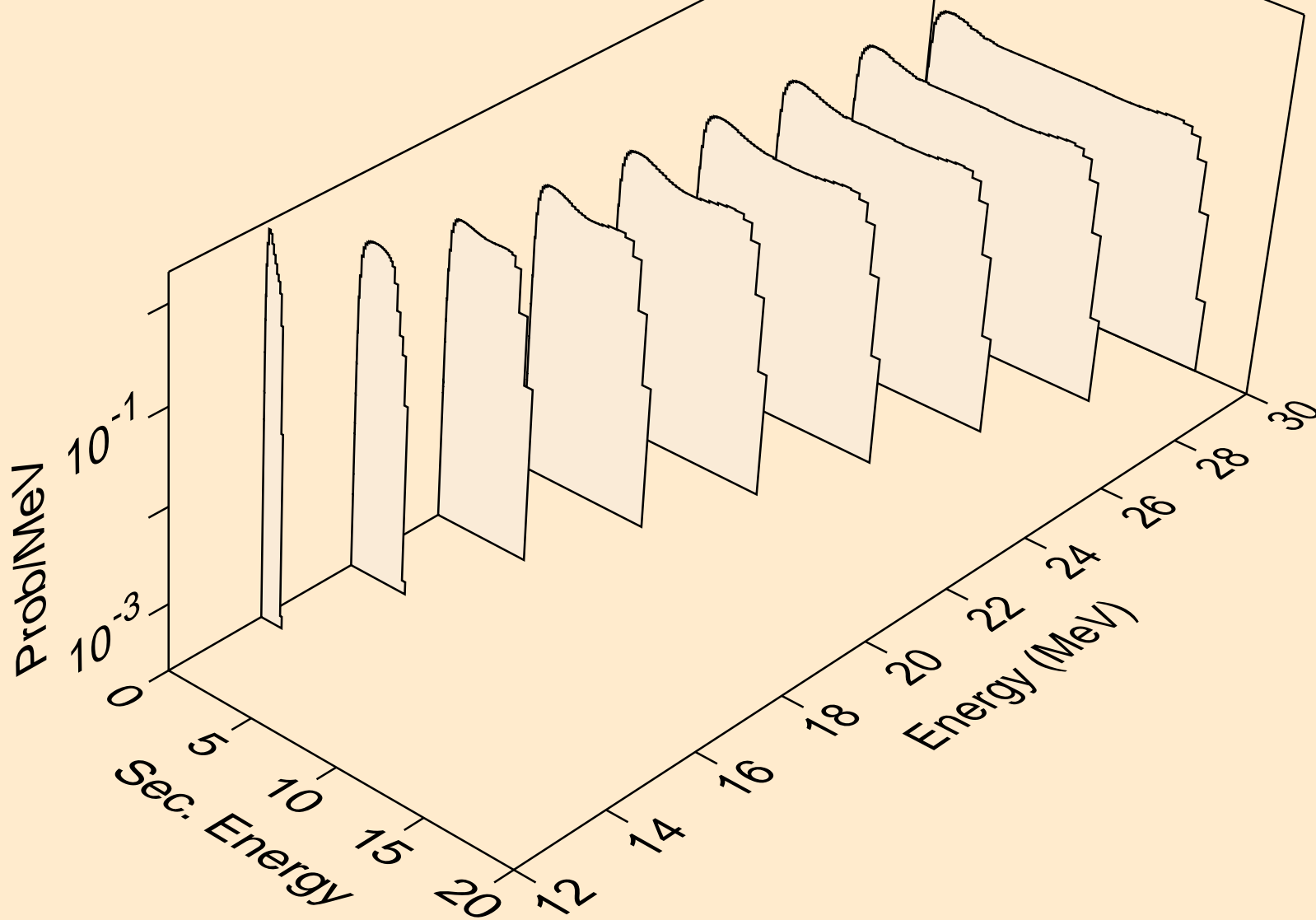



SB105 NEUTRON ACER TENDL-2023 LIBRARY; T=0.K  
Neutron emission for (n,3n)

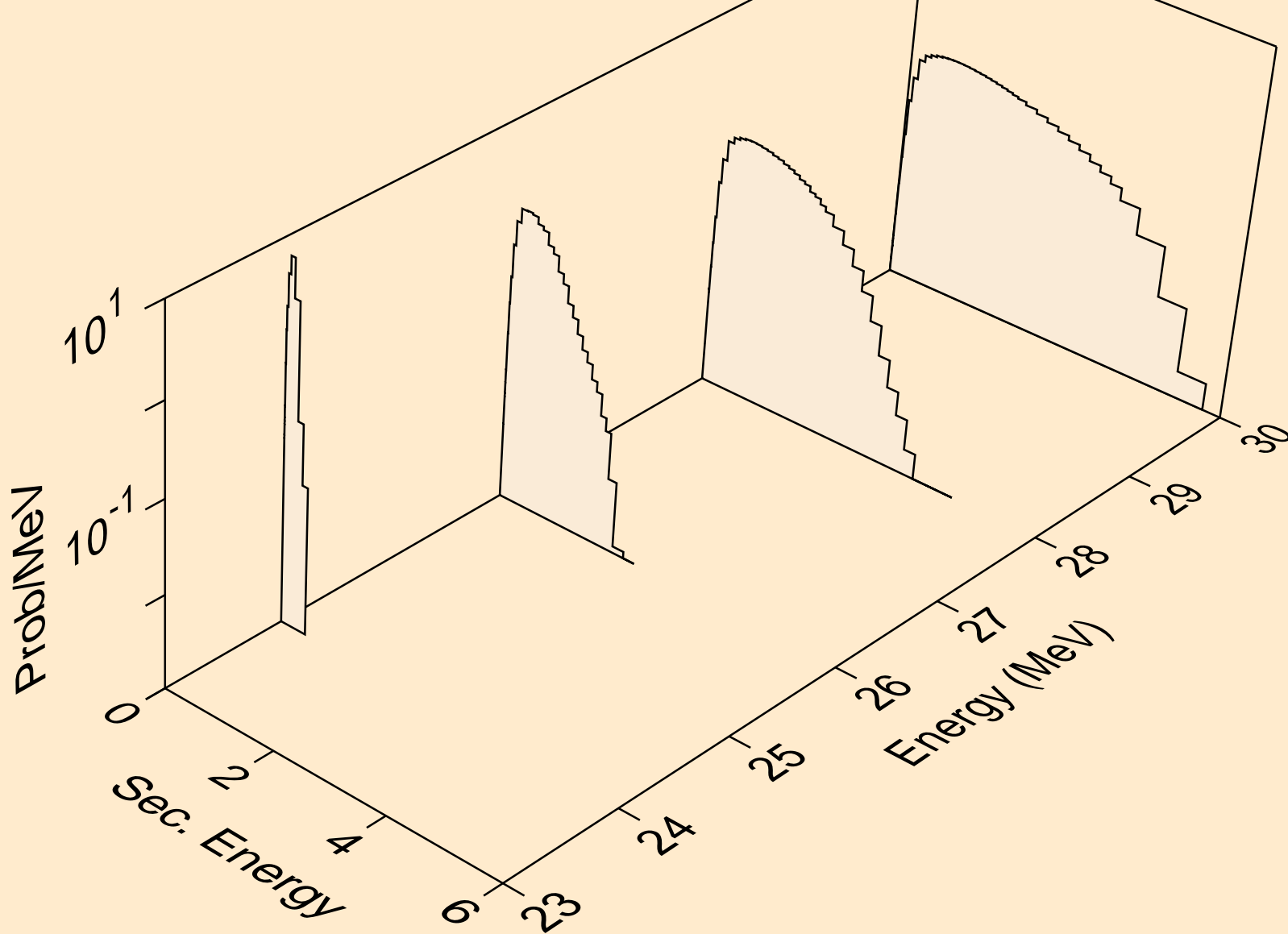

SB105 NEUTRON ACER TENDL-2023 LIBRARY; T=0.K  
Neutron emission for (n,n\*)a

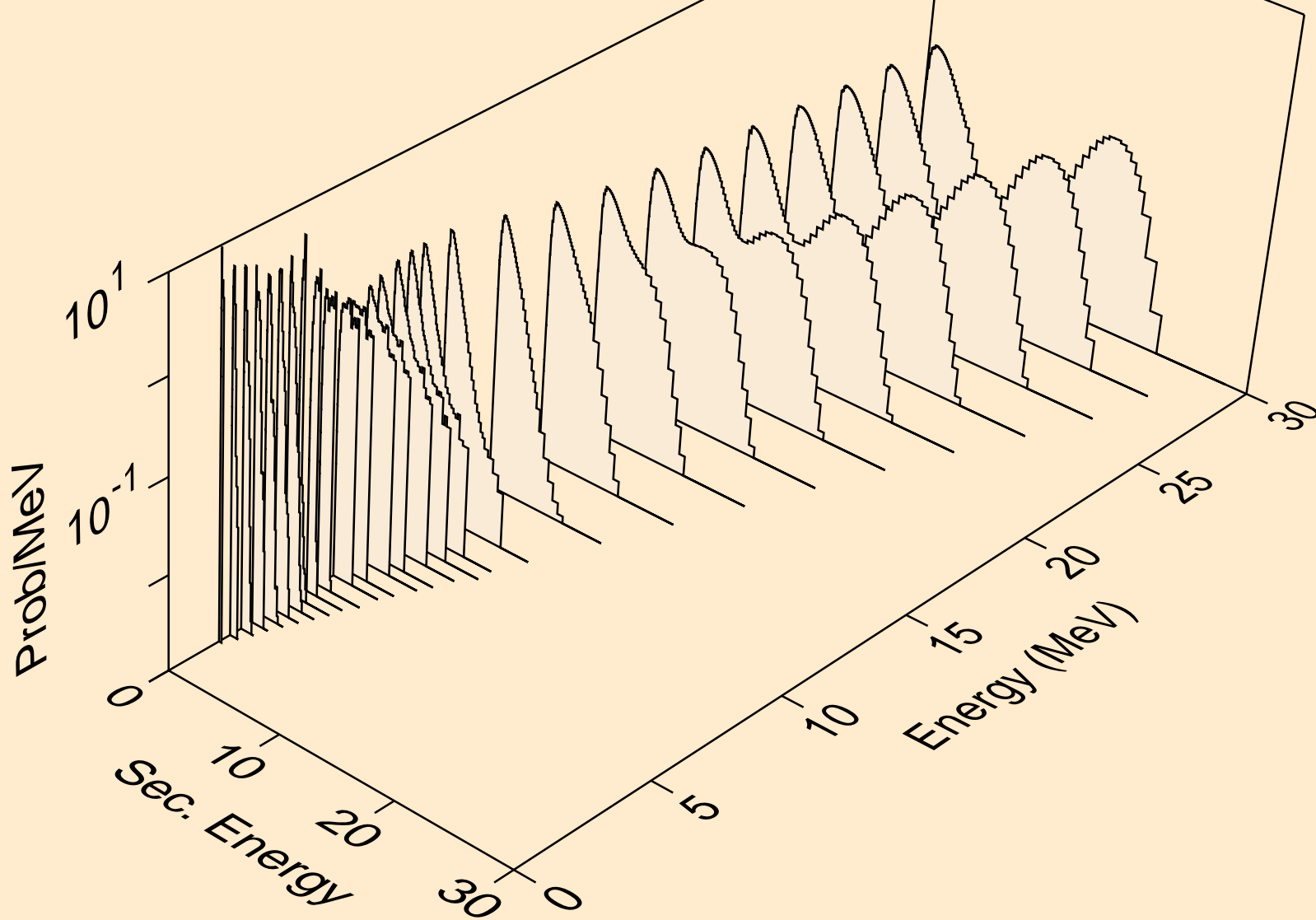

SB105 NEUTRON ACER TENDL-2023 LIBRARY; T=0.K  
Neutron emission for (n,2n)a

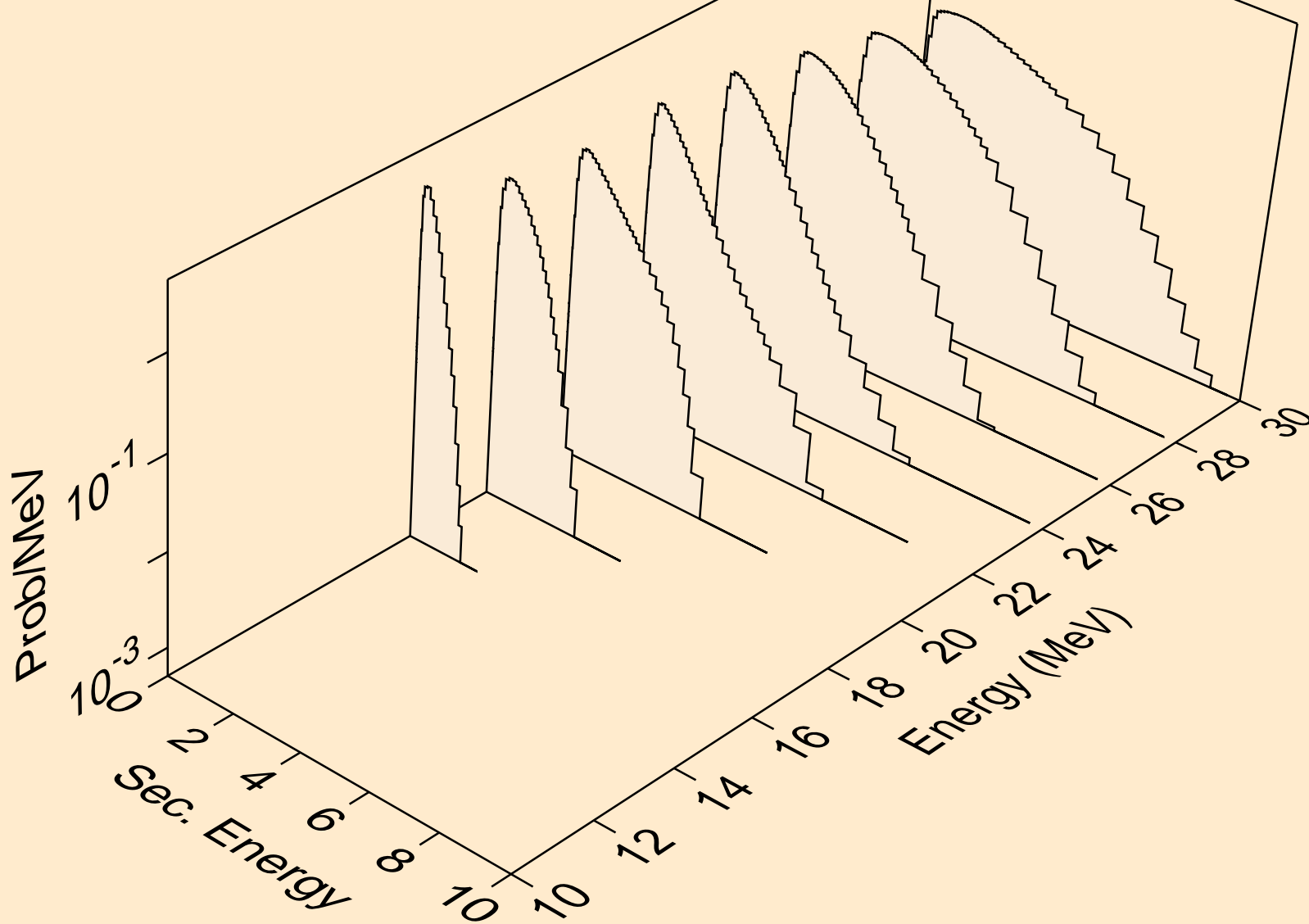

SB105 NEUTRON ACER TENDL-2023 LIBRARY; T=0.K  
Neutron emission for (n,n\*)p

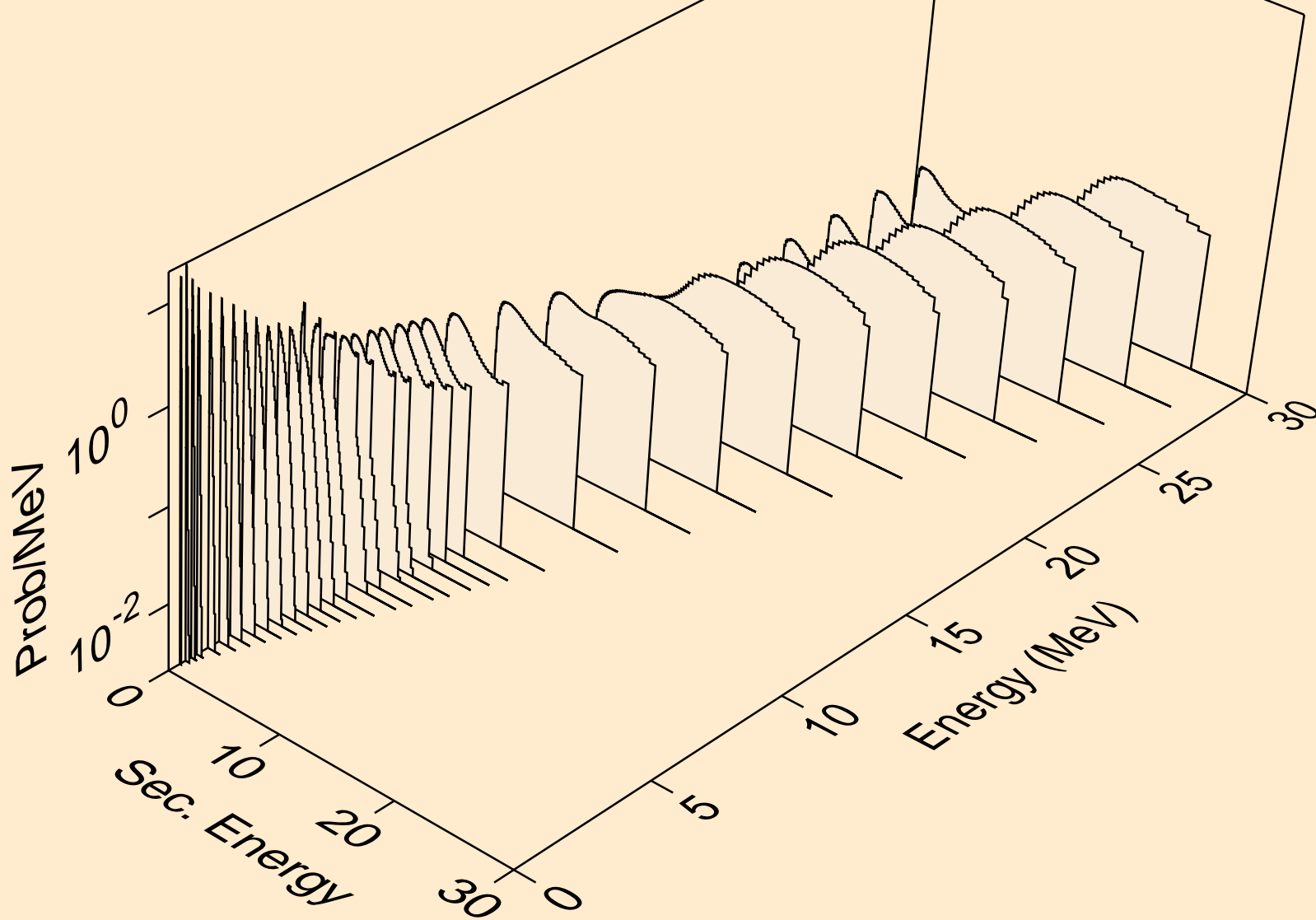

SB105 NEUTRON ACER TENDL-2023 LIBRARY; T=0.K  
Neutron emission for (n,n\*)2a

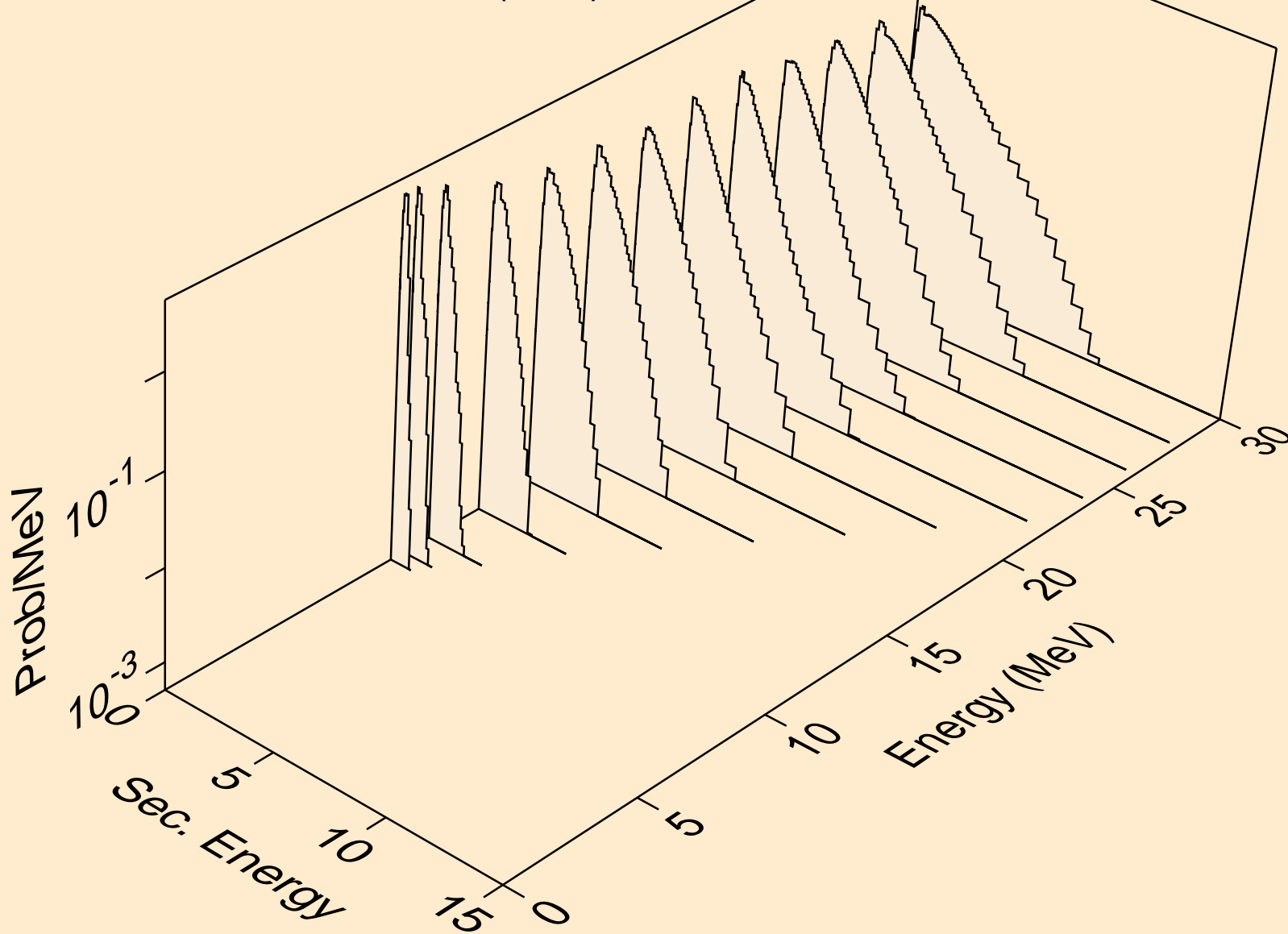

SB105 NEUTRON ACER TENDL-2023 LIBRARY; T=0.K  
Neutron emission for (n,n\*)d

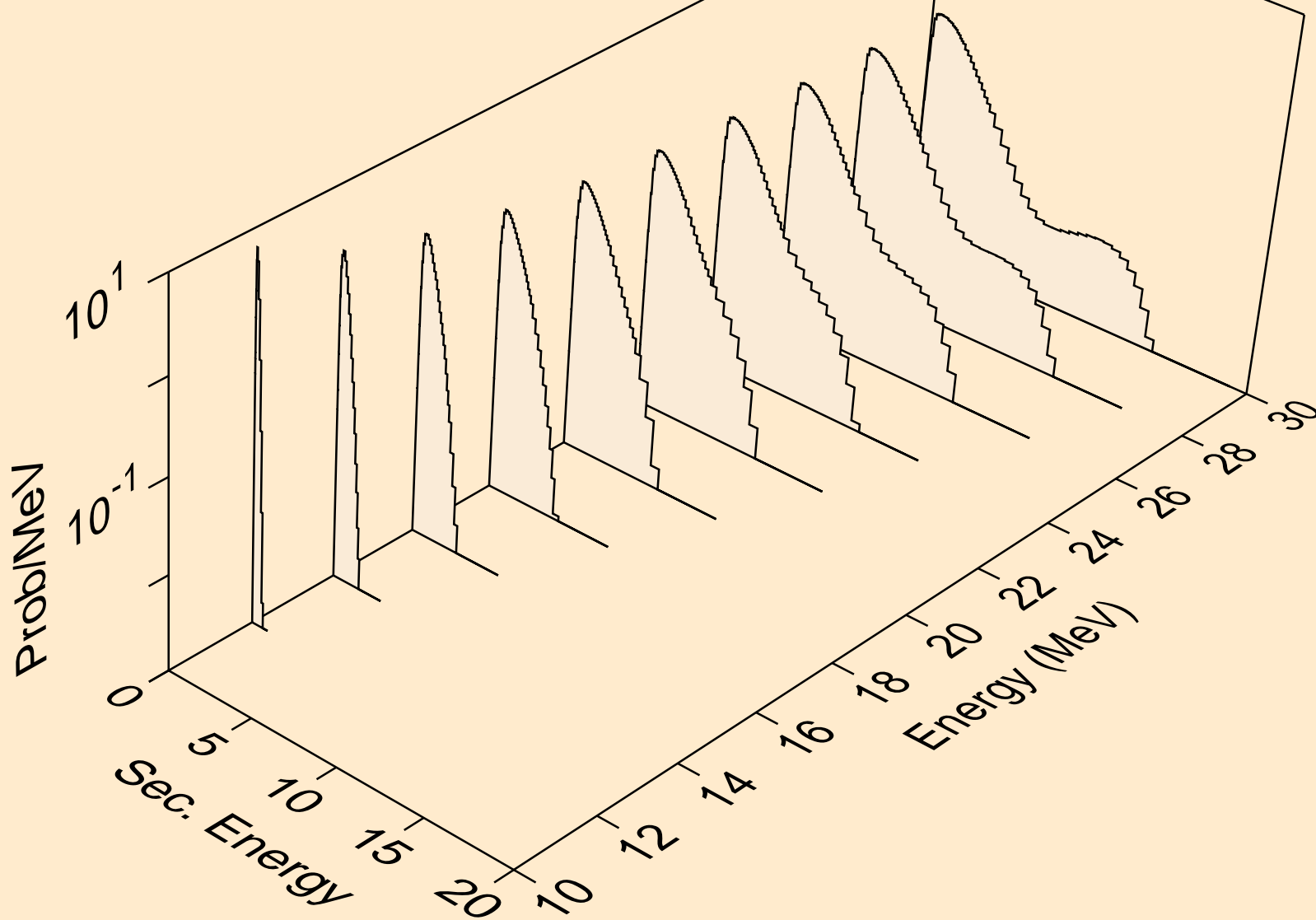

SB105 NEUTRON ACER TENDL-2023 LIBRARY; T=0.K  
Neutron emission for (n,n\*)t

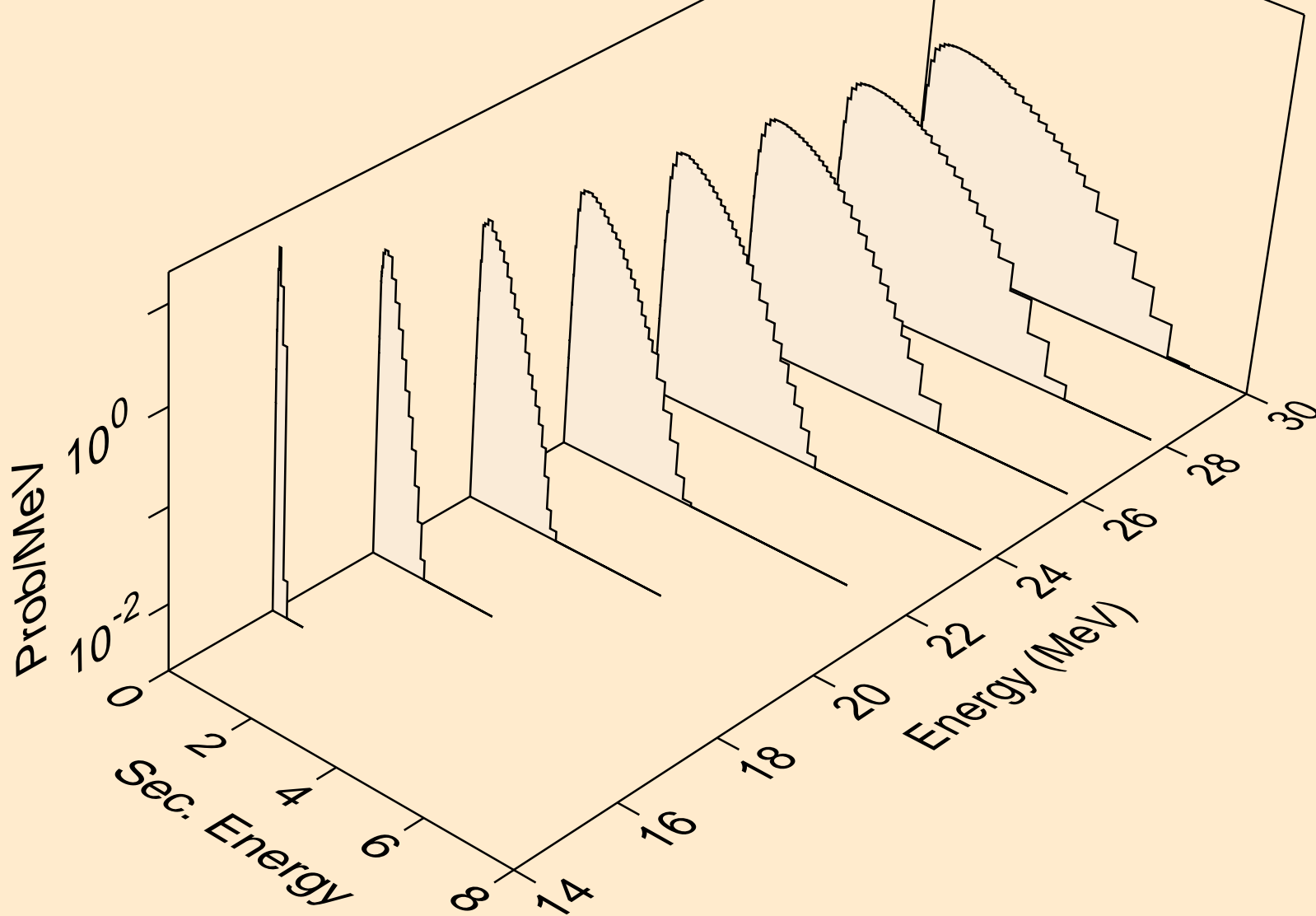

SB105 NEUTRON ACER TENDL-2023 LIBRARY; T=0.K  
Neutron emission for (n,n\*)he3

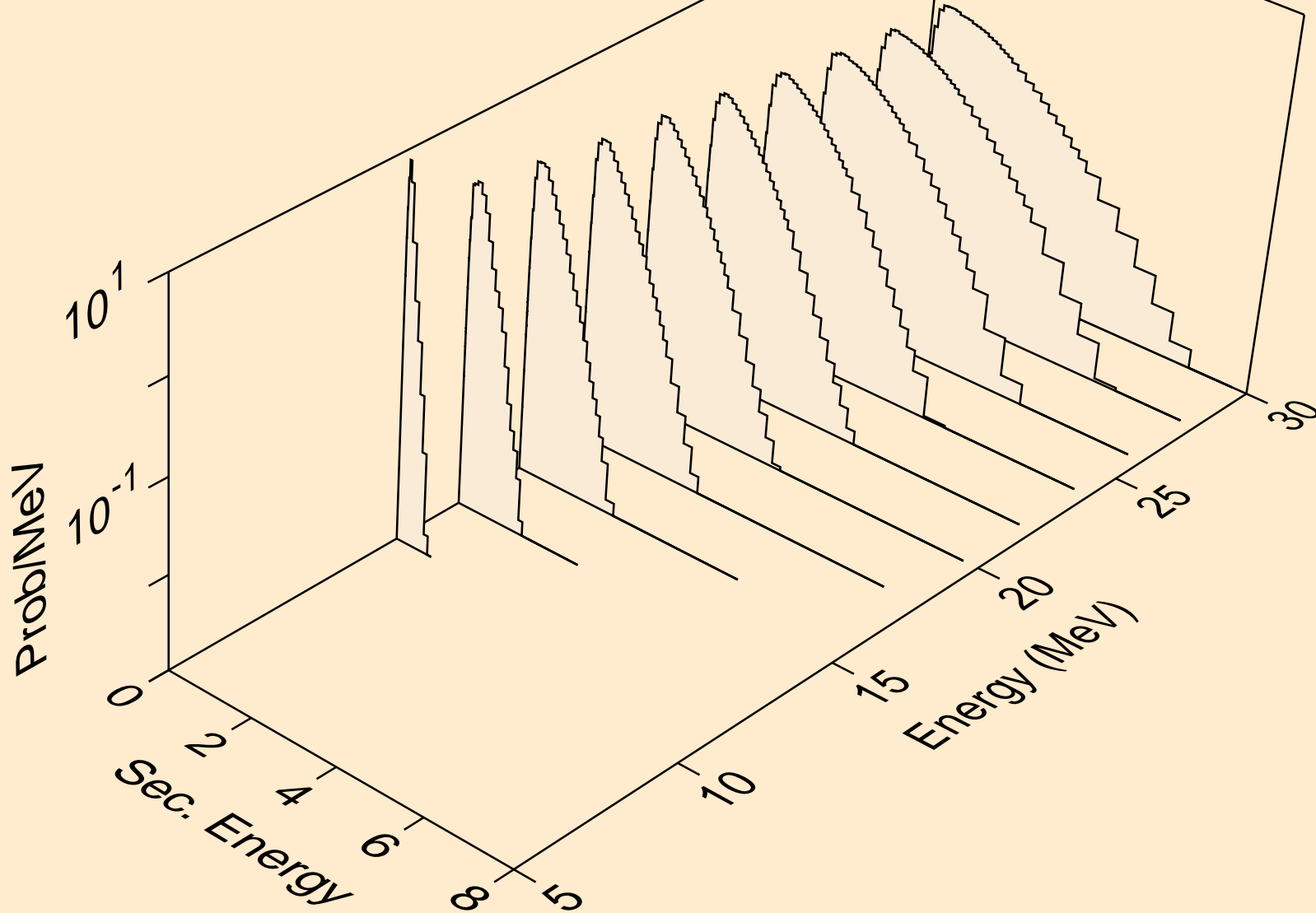



SB105 NEUTRON ACER TENDL-2023 LIBRARY; T=0.K  
Neutron emission for (n,2np)

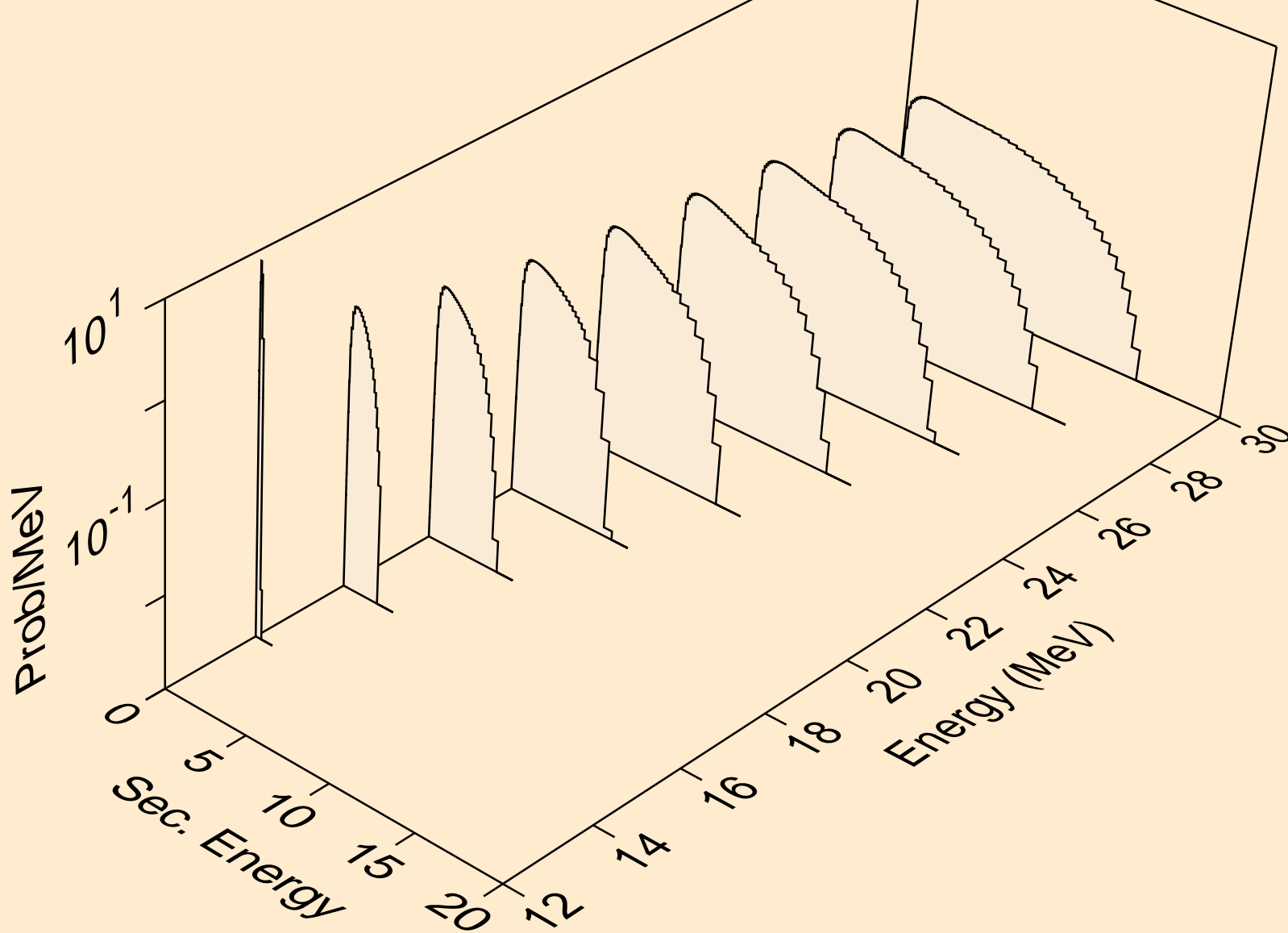

SB105 NEUTRON ACER TENDL-2023 LIBRARY; T=0.K  
Neutron emission for (n,3np)

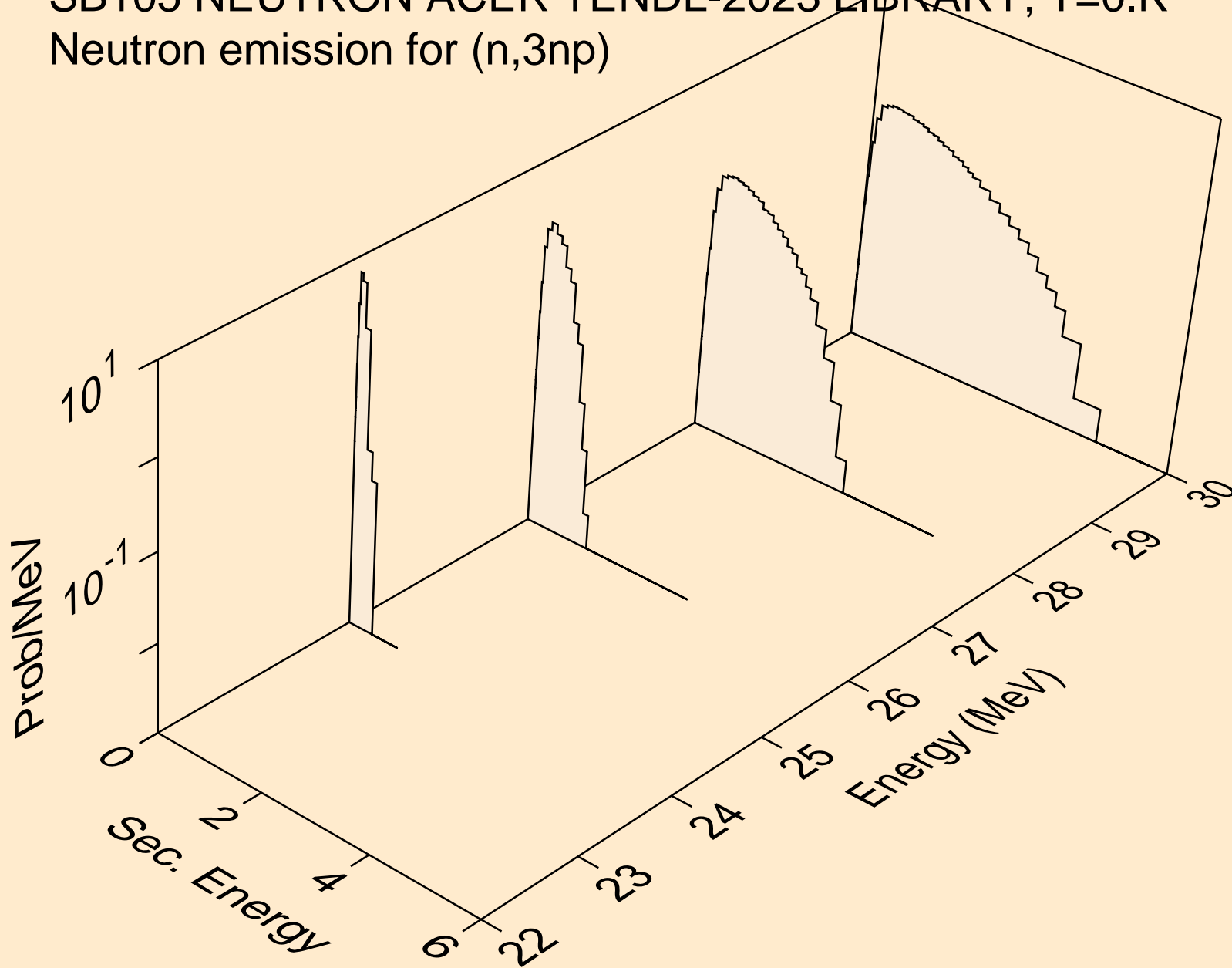

SB105 NEUTRON ACER TENDL-2023 LIBRARY; T=0.K  
Neutron emission for (n,n2p)

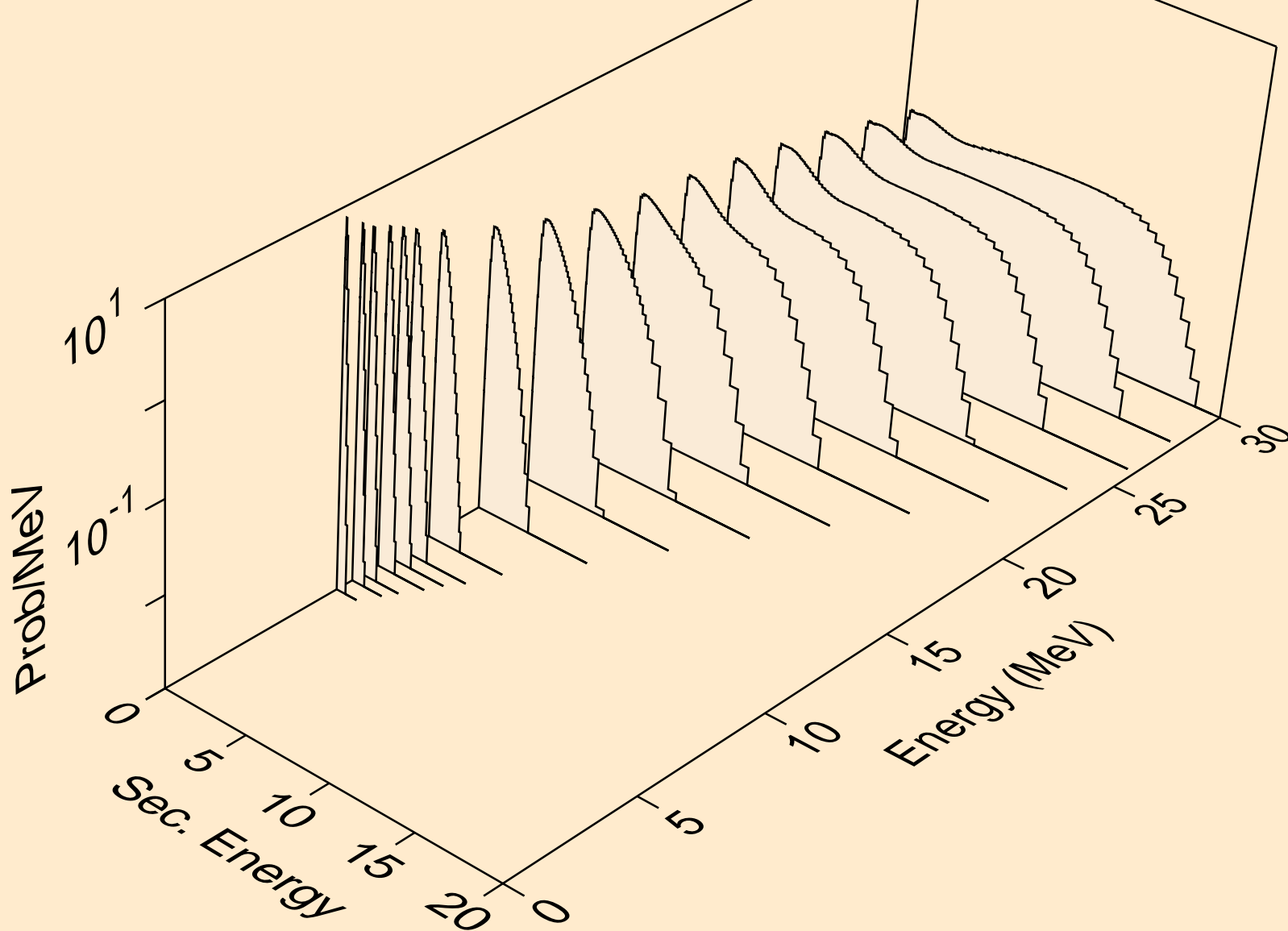

SB105 NEUTRON ACER TENDL-2023 LIBRARY; T=0.K  
Neutron emission for (n,npa)

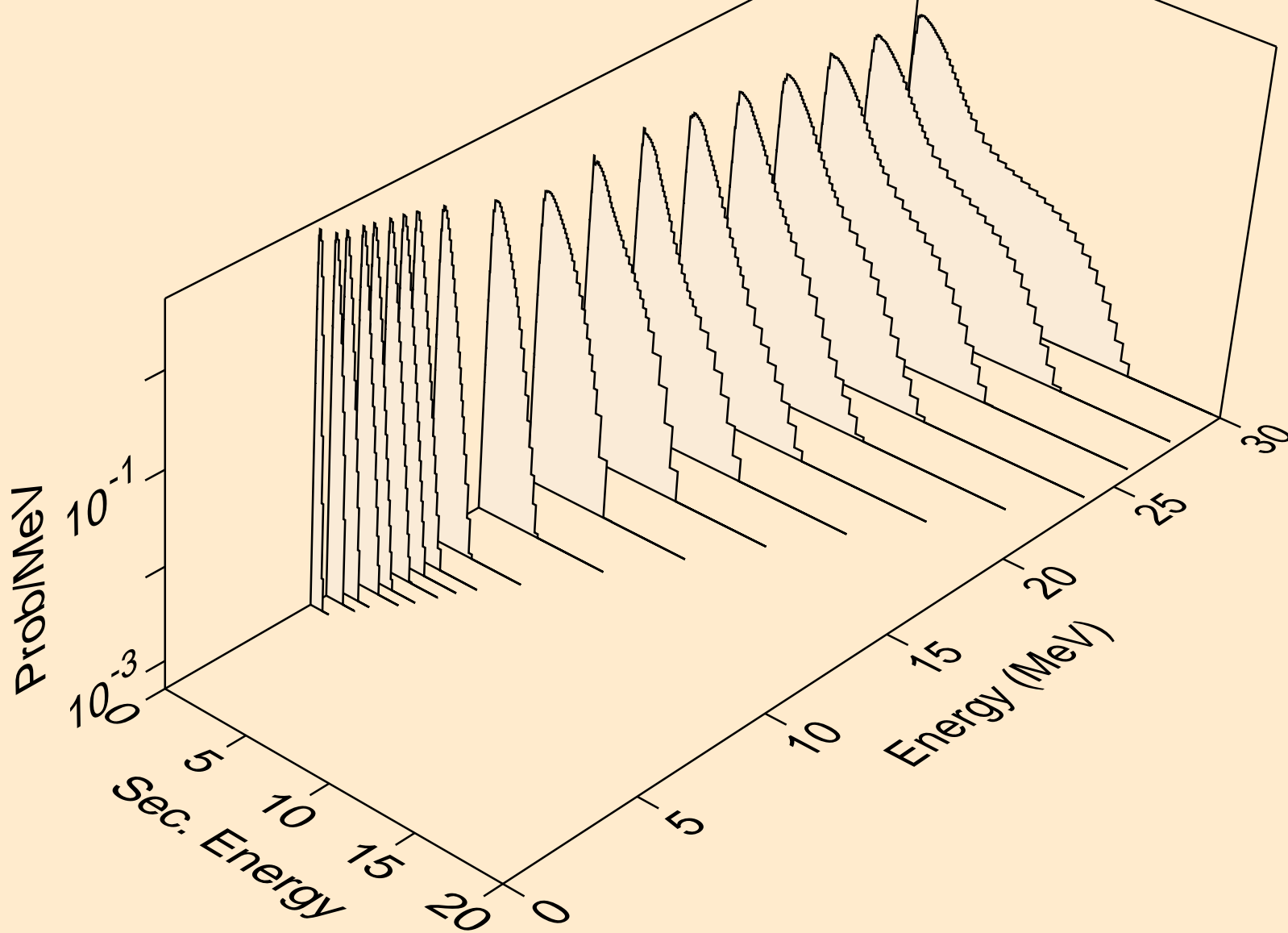

SB105 NEUTRON ACER TENDL-2023 LIBRARY; T=0.K  
Neutron emission for (n,n\*c)

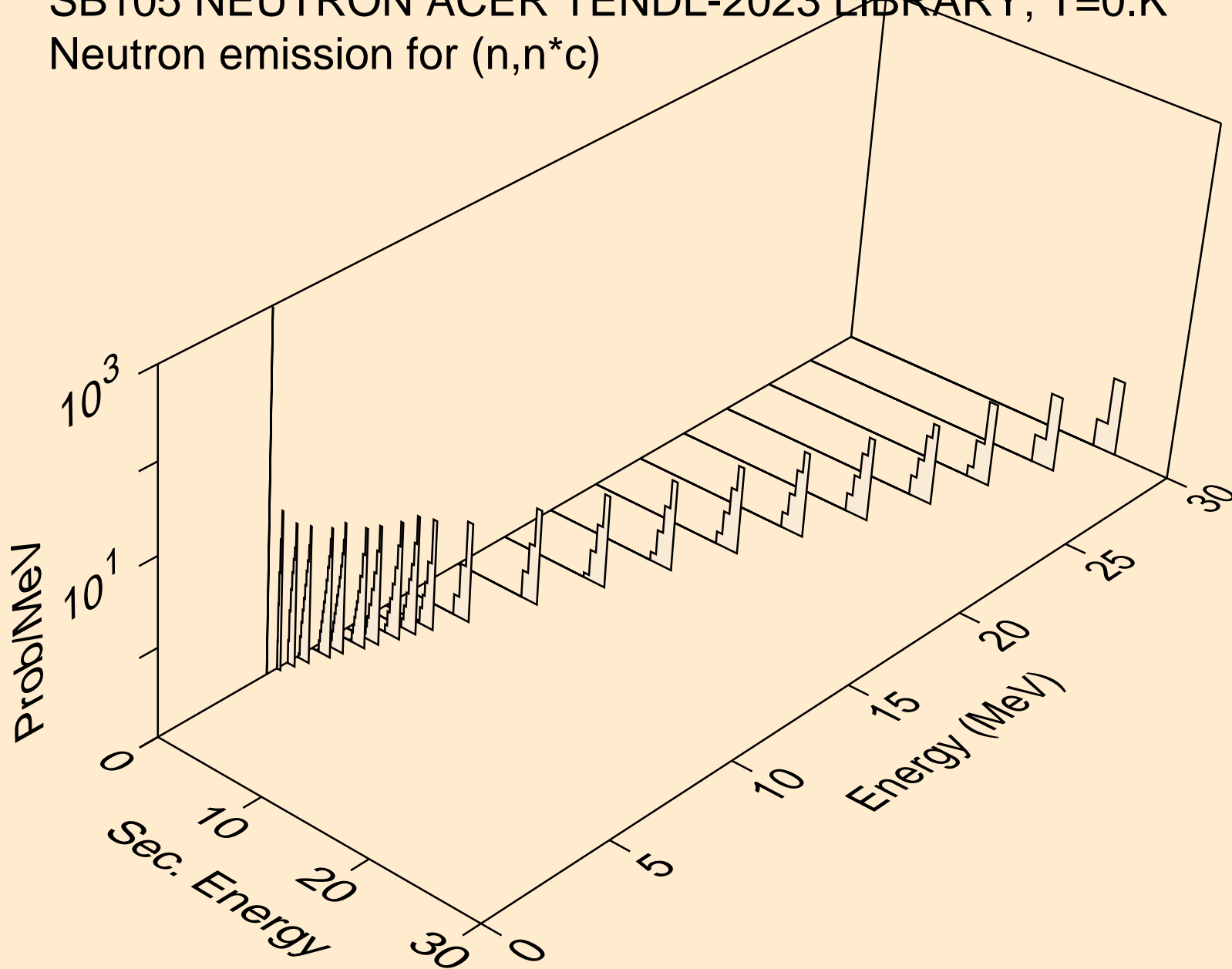

SB105 NEUTRON ACER TENDL-2023 LIBRARY; T=0.K  
Photon emission for (n,x)

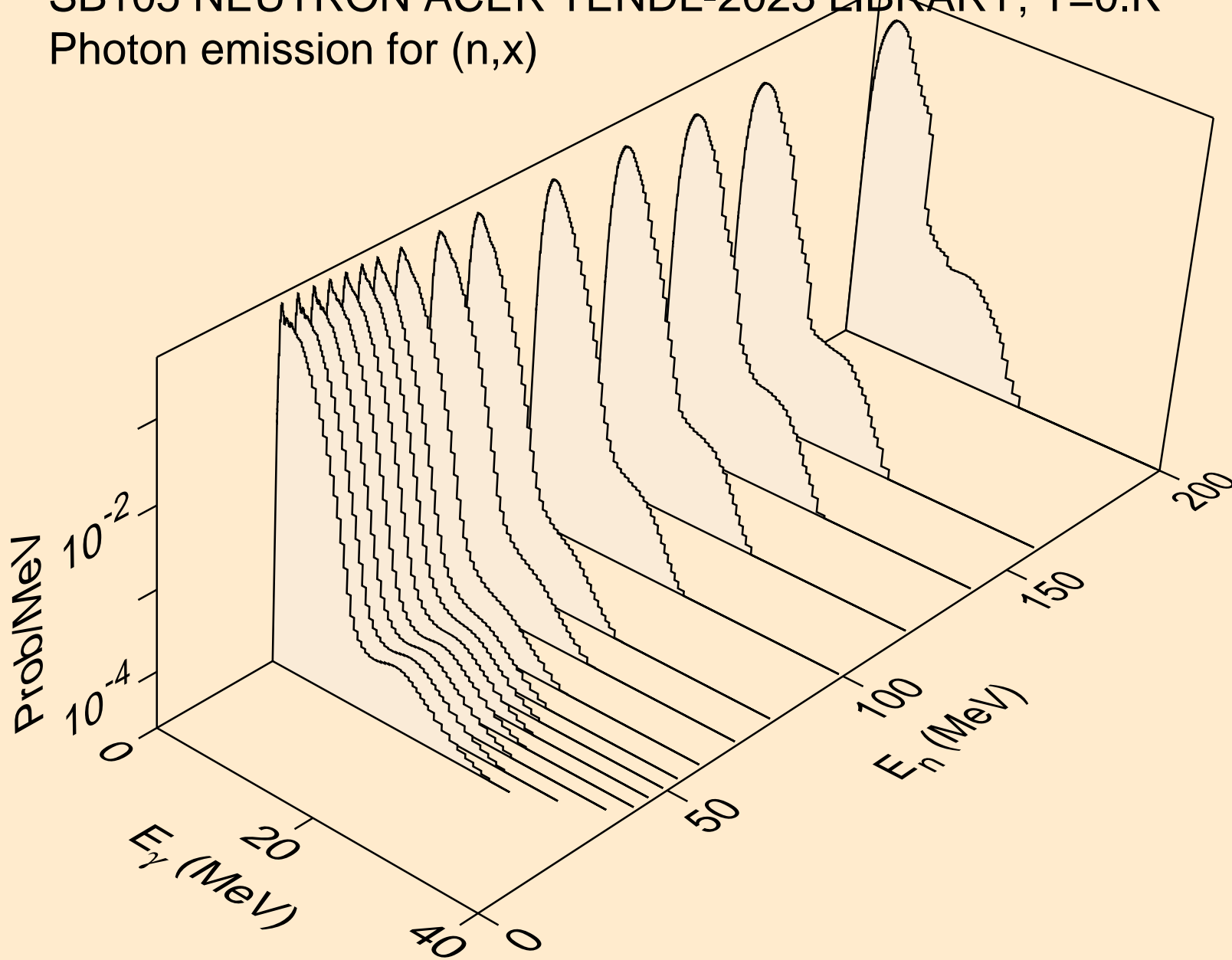

SB105 NEUTRON ACER TENDL-2023 LIBRARY; T=0.K  
Photon emission for (n,2nd)

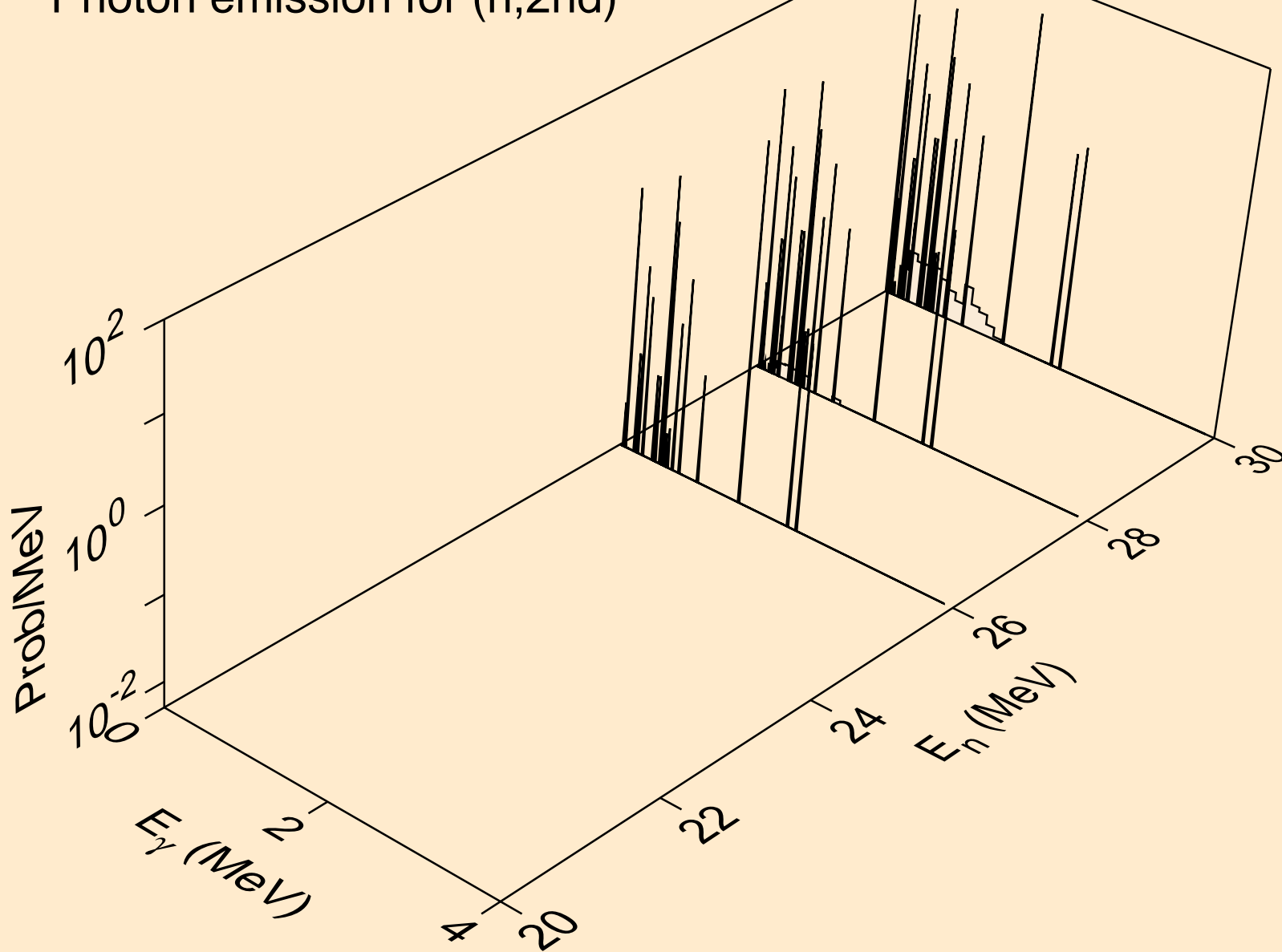

SB105 NEUTRON ACER TENDL-2023 LIBRARY; T=0.K  
Photon emission for (n,2n)

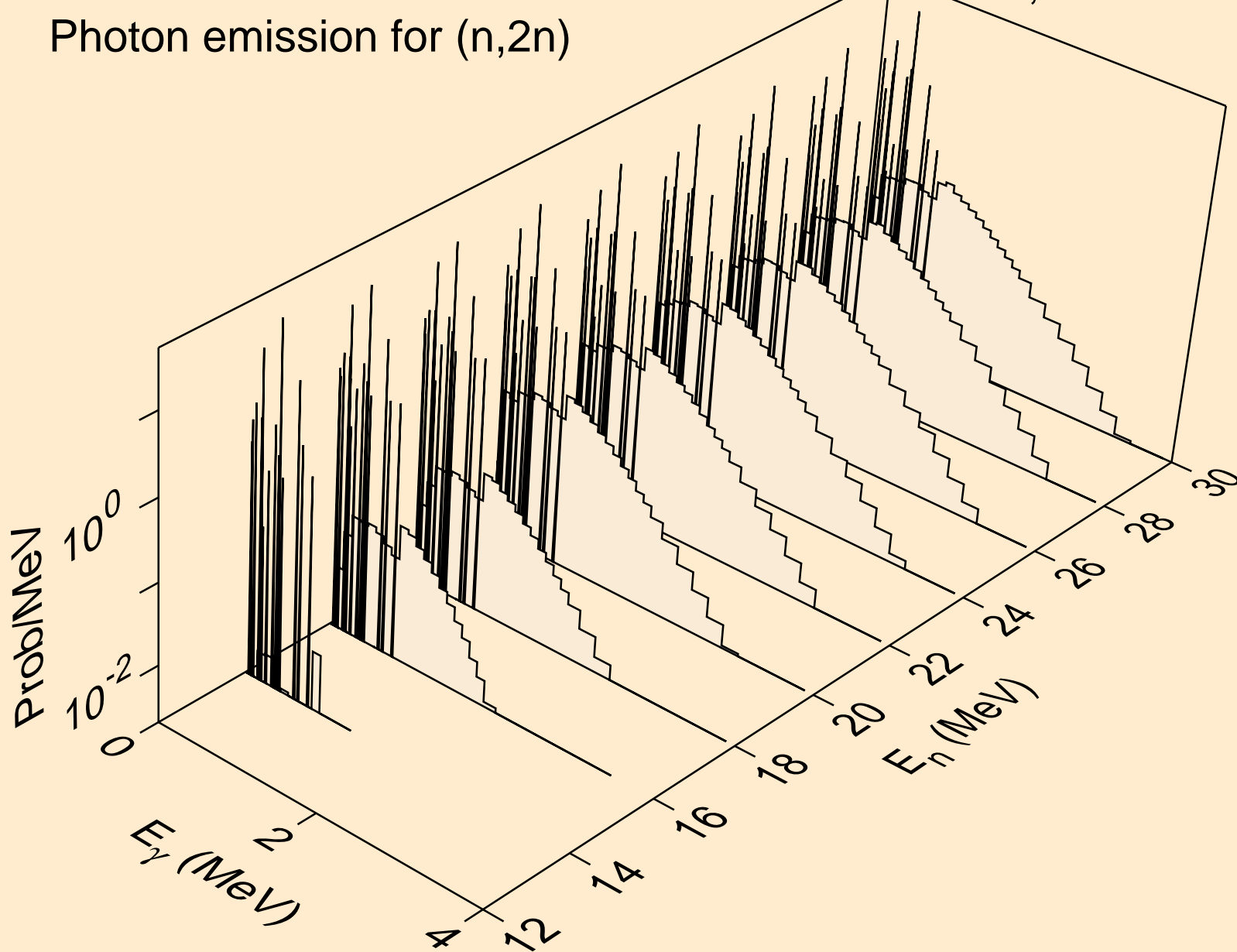



SB105 NEUTRON ACER TENDL-2023 LIBRARY; T=0.K  
Photon emission for (n,3n)

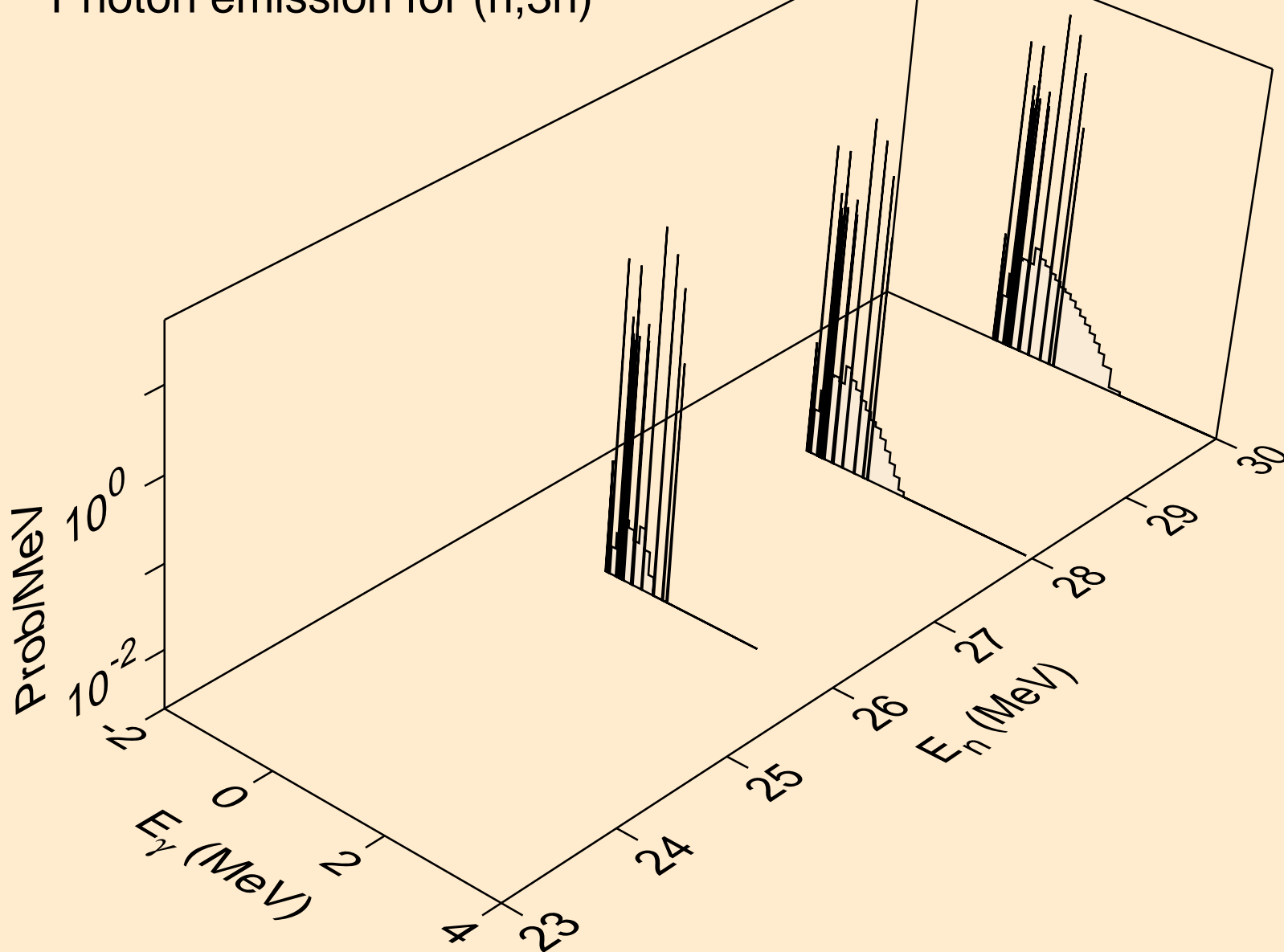

SB105 NEUTRON ACER TENDL-2023 LIBRARY; T=0.K  
Photon emission for (n,n\*)a

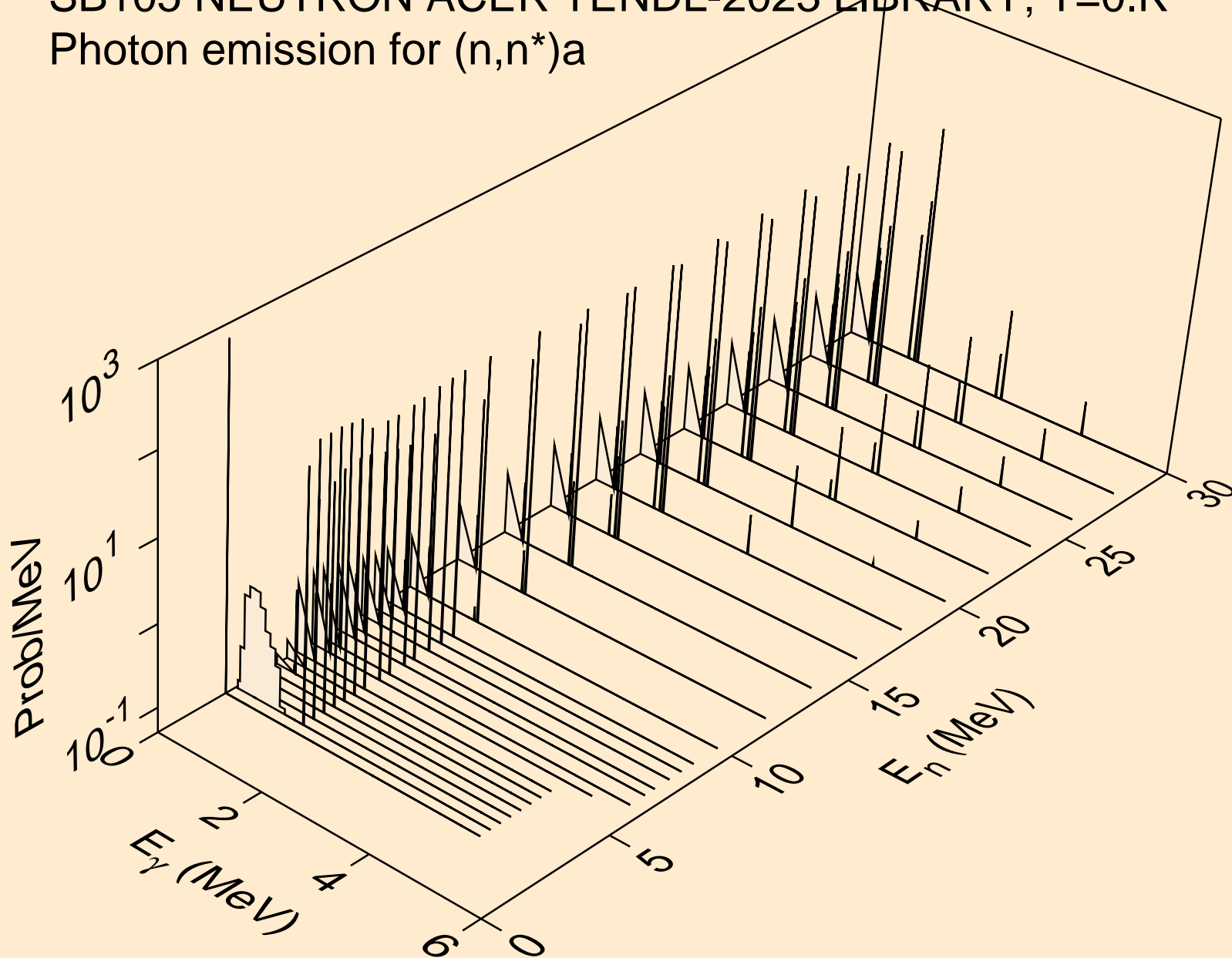

SB105 NEUTRON ACER TENDL-2023 LIBRARY; T=0.K  
Photon emission for (n,2n)a

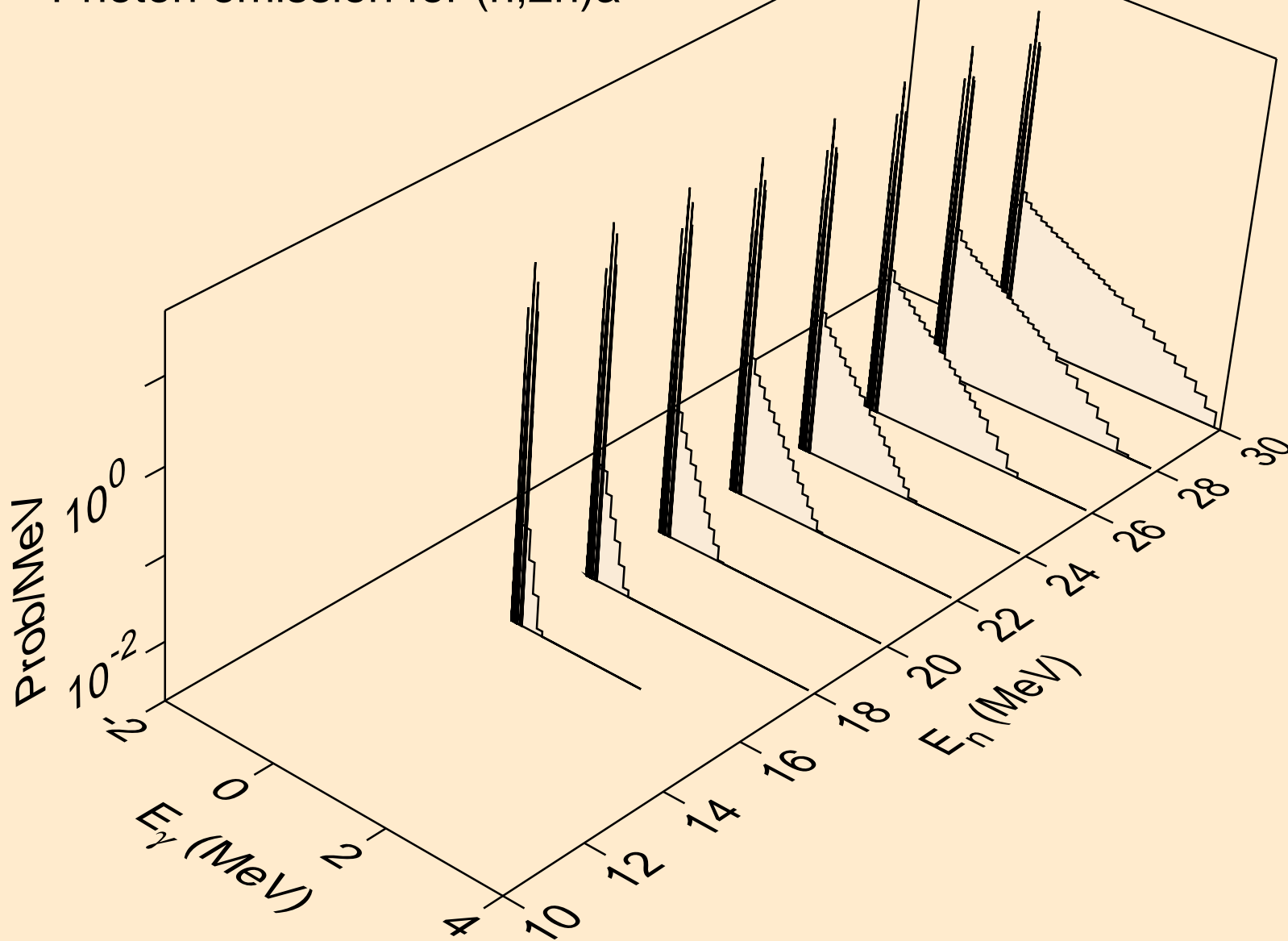

SB105 NEUTRON ACER TENDL-2023 LIBRARY; T=0.K  
Photon emission for (n,n\*)p

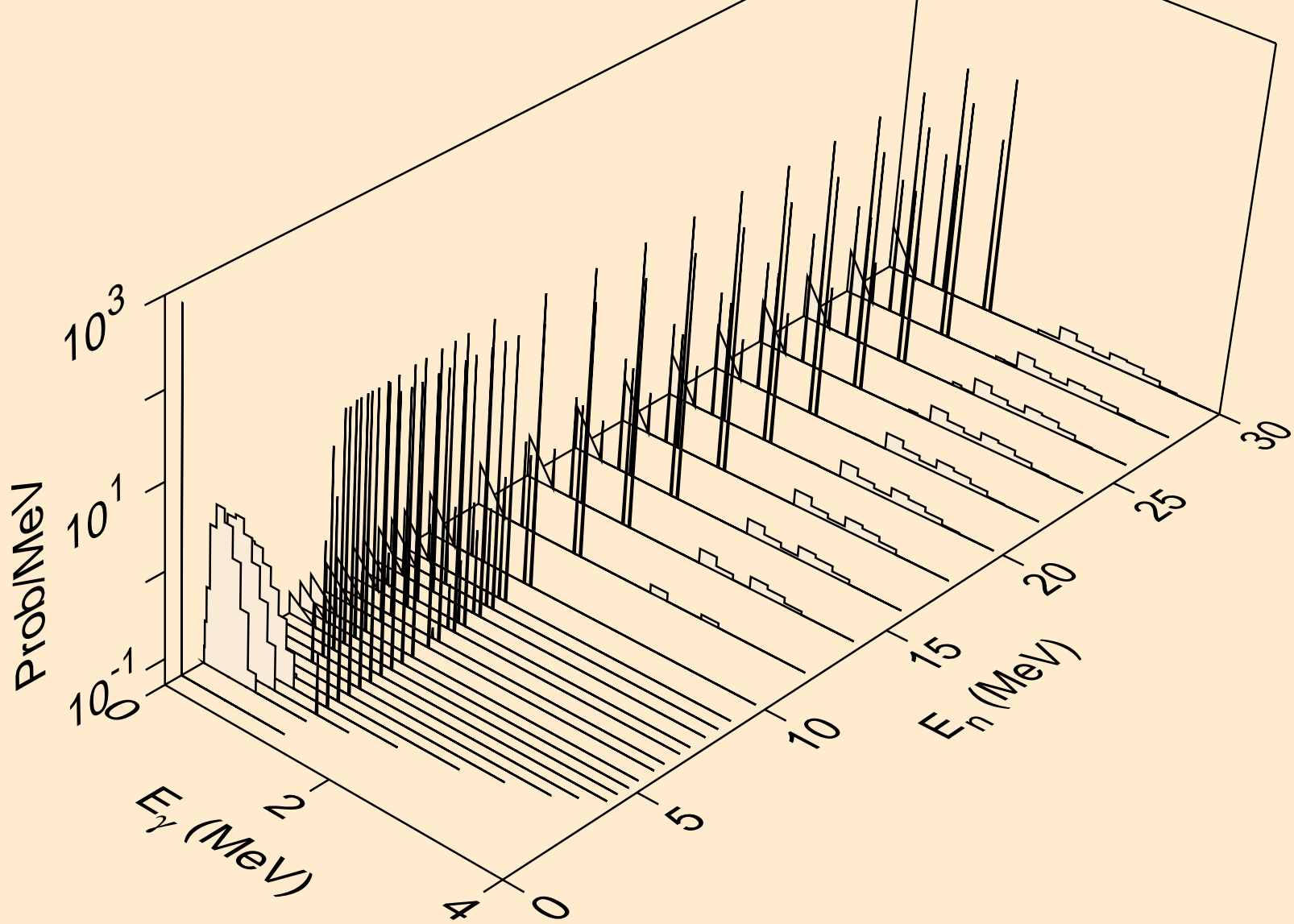

SB105 NEUTRON ACER TENDL-2023 LIBRARY; T=0.K  
Photon emission for (n,n\*)2a

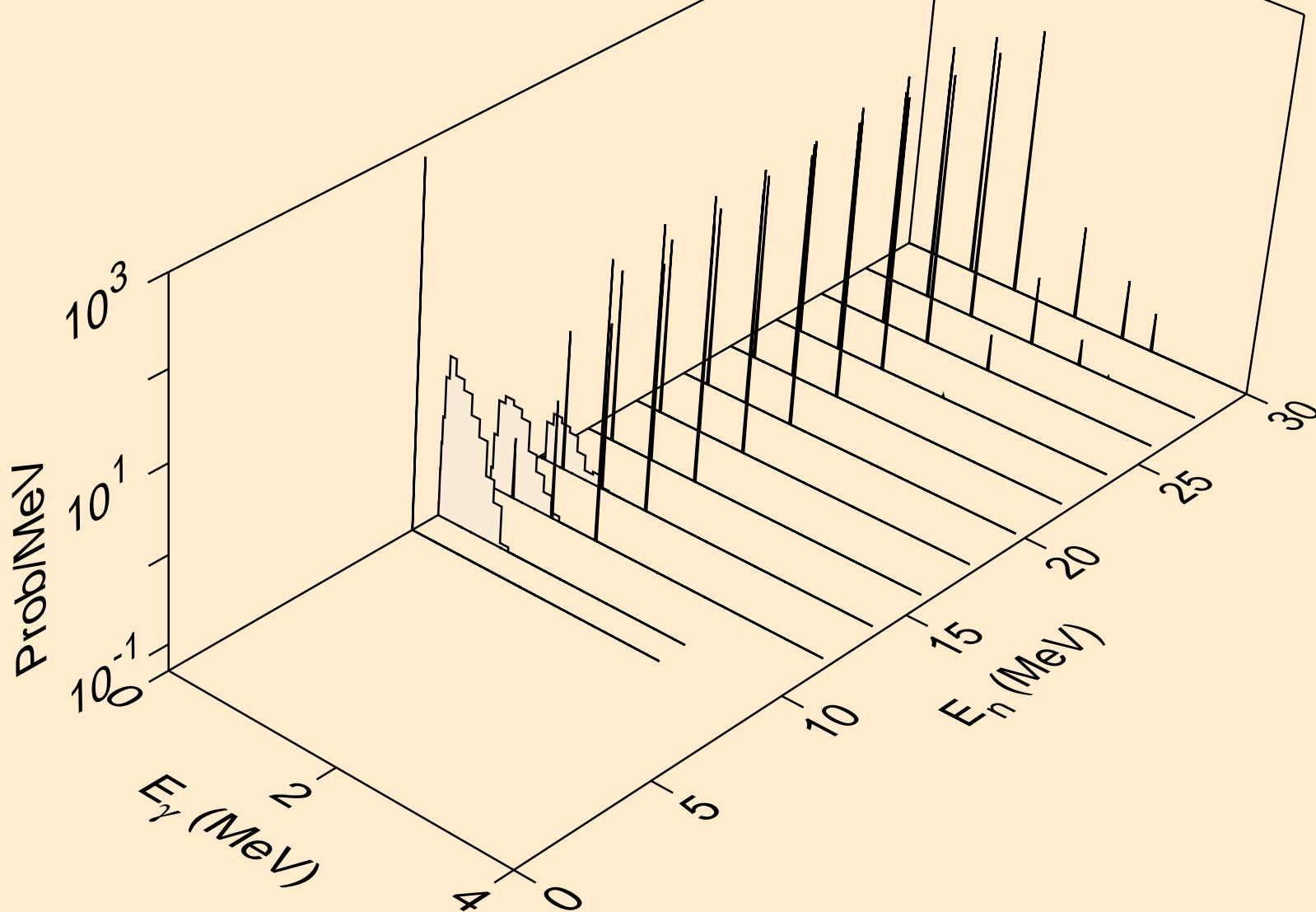

SB105 NEUTRON ACER TENDL-2023 LIBRARY; T=0.K  
Photon emission for (n,n\*)d

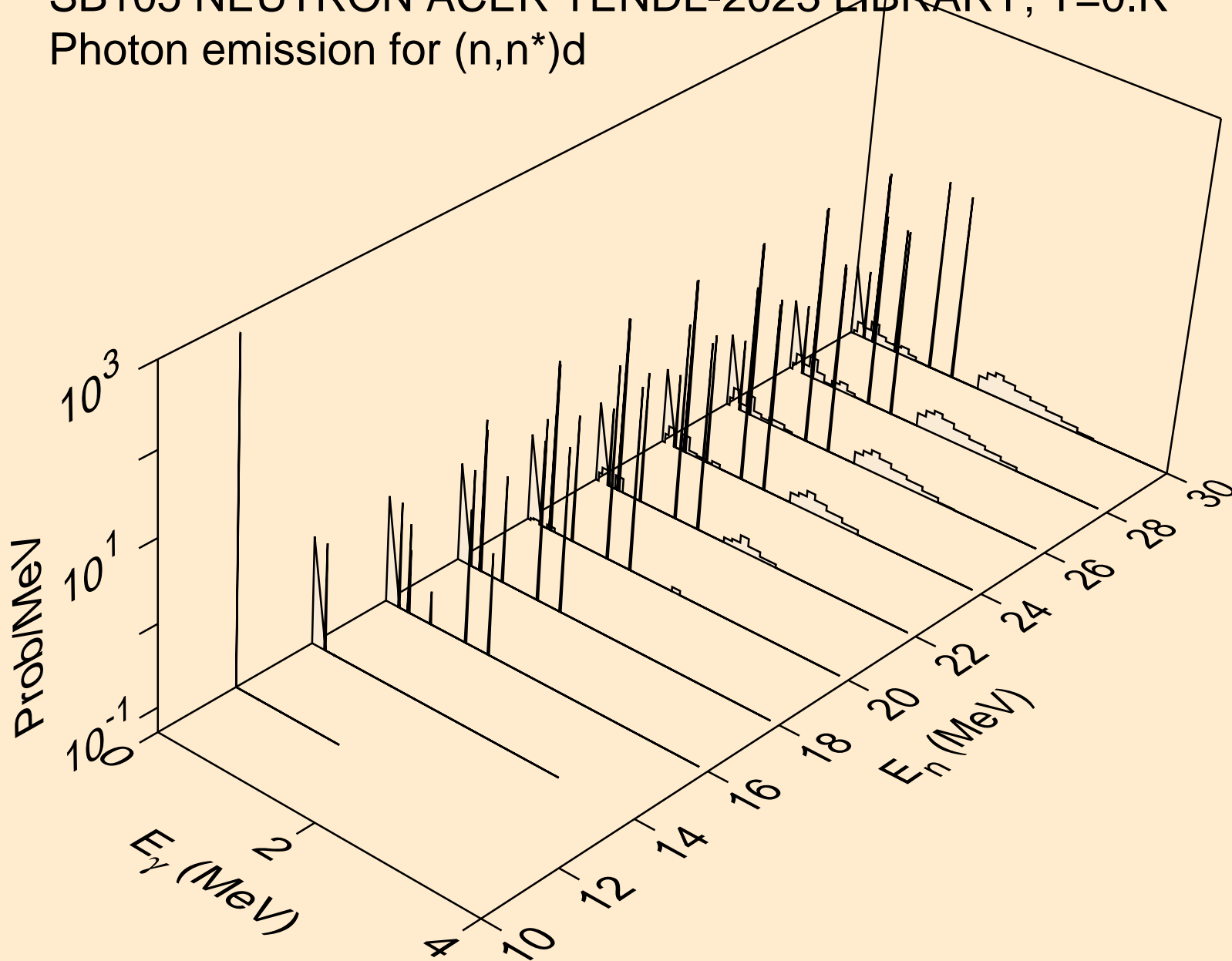

SB105 NEUTRON ACER TENDL-2023 LIBRARY; T=0.K  
Photon emission for (n,n\*)t

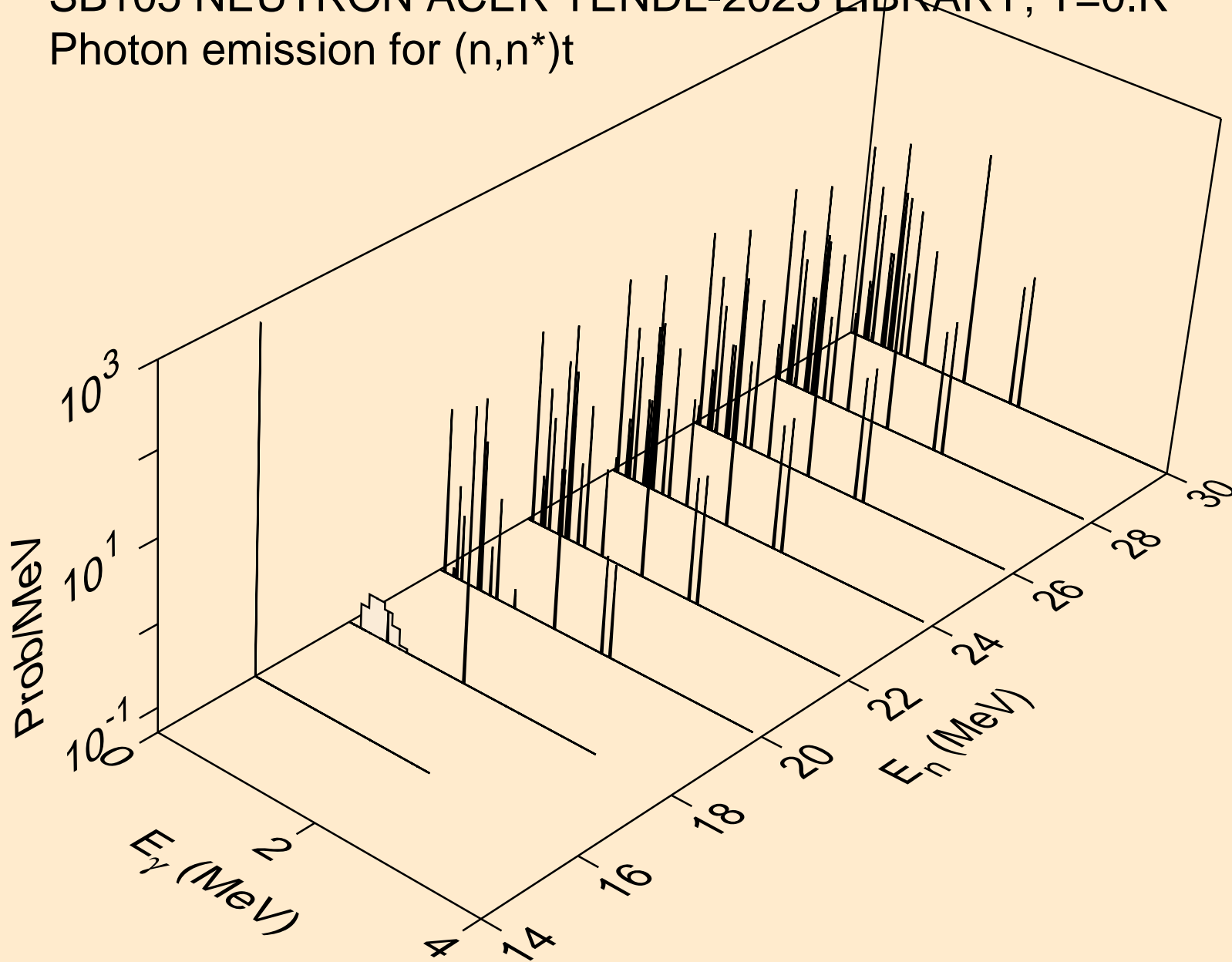

SB105 NEUTRON ACER TENDL-2023 LIBRARY; T=0.K  
Photon emission for (n,n\*)he3

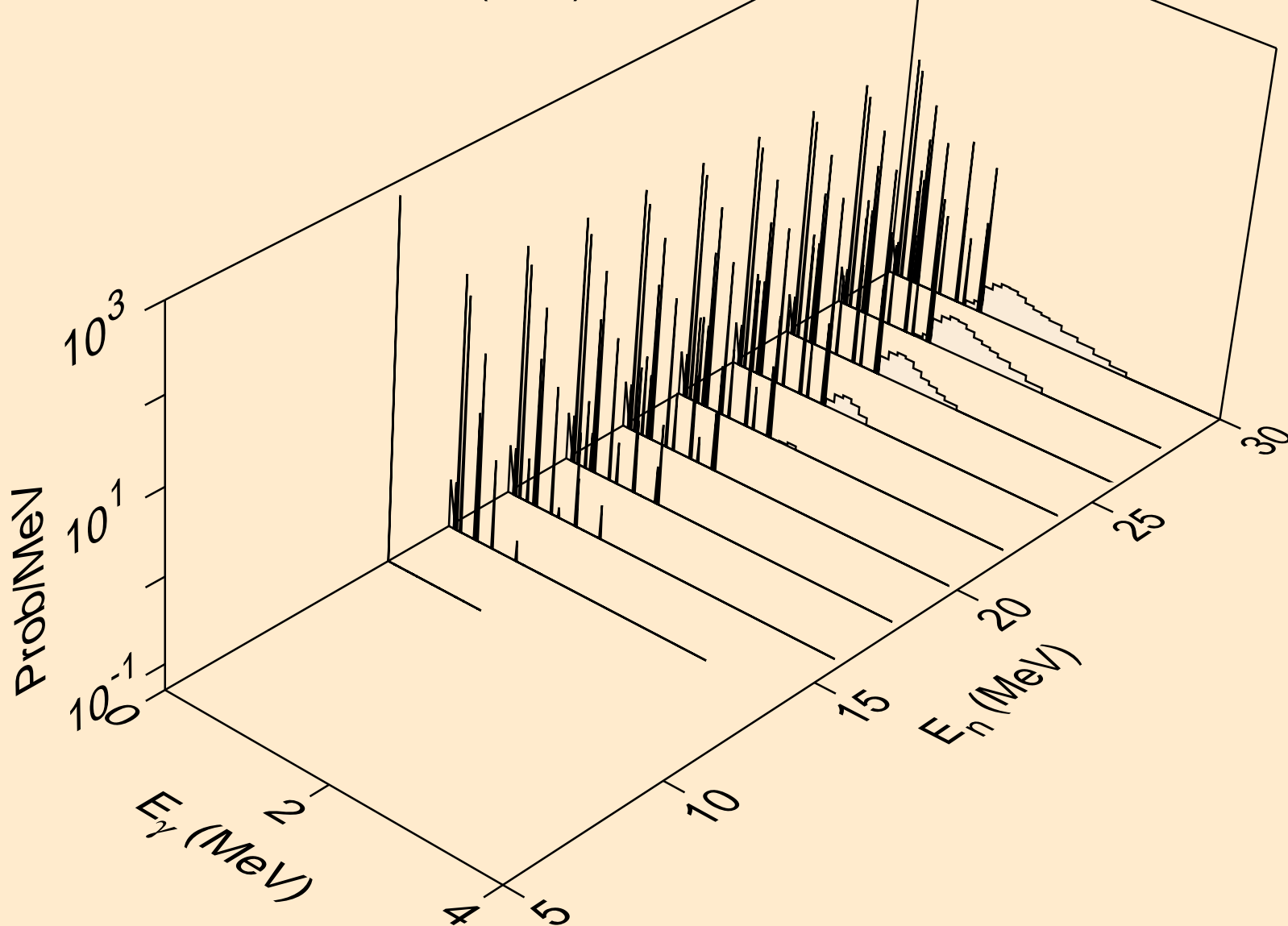



SB105 NEUTRON ACER TENDL-2023 LIBRARY; T=0.K  
Photon emission for (n,2np)

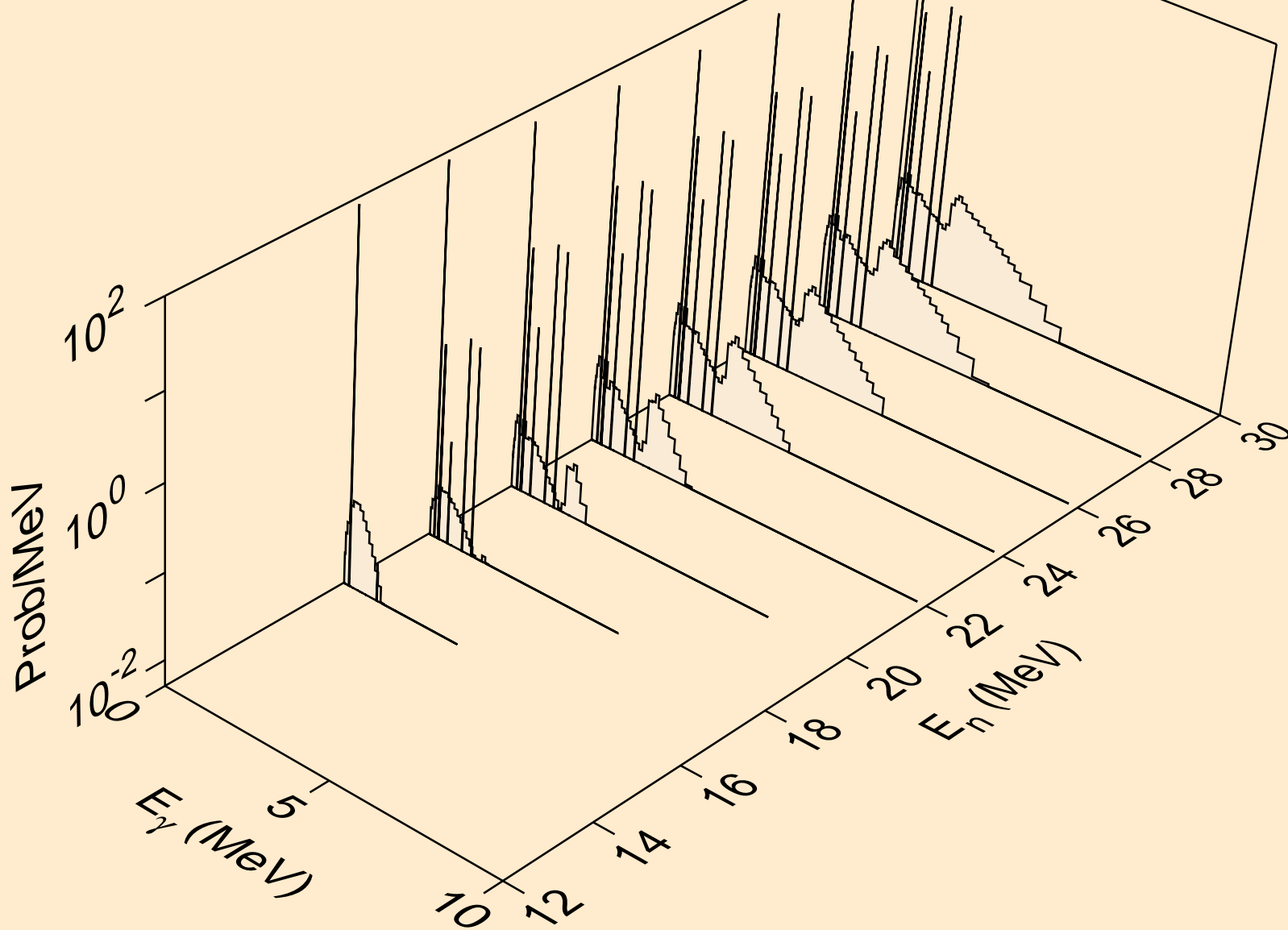

SB105 NEUTRON ACER TENDL-2023 LIBRARY; T=0.K  
Photon emission for (n,3np)

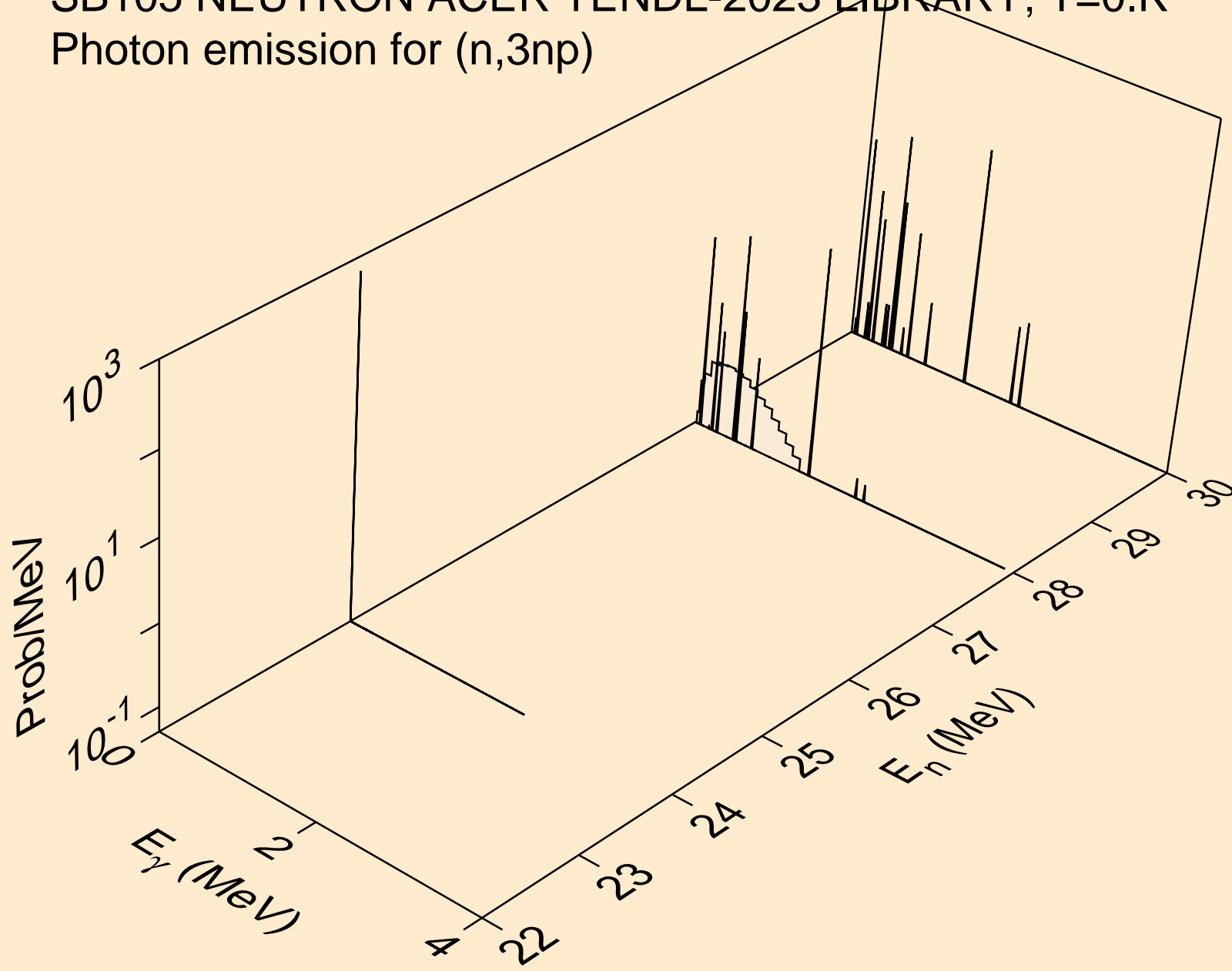

SB105 NEUTRON ACER TENDL-2023 LIBRARY; T=0.K  
Photon emission for (n,n2p)

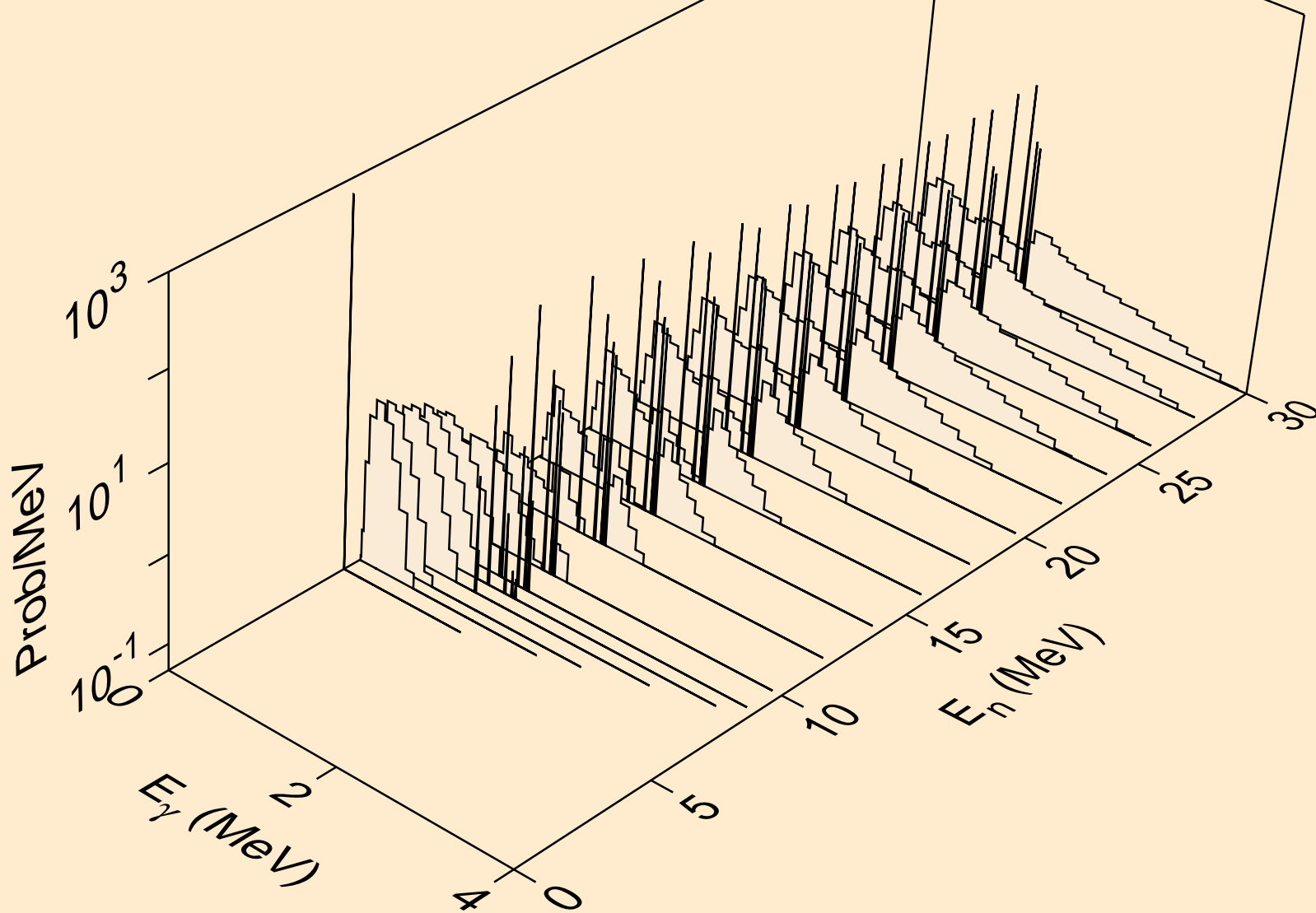

SB105 NEUTRON ACER TENDL-2023 LIBRARY; T=0.K  
Photon emission for (n,npa)

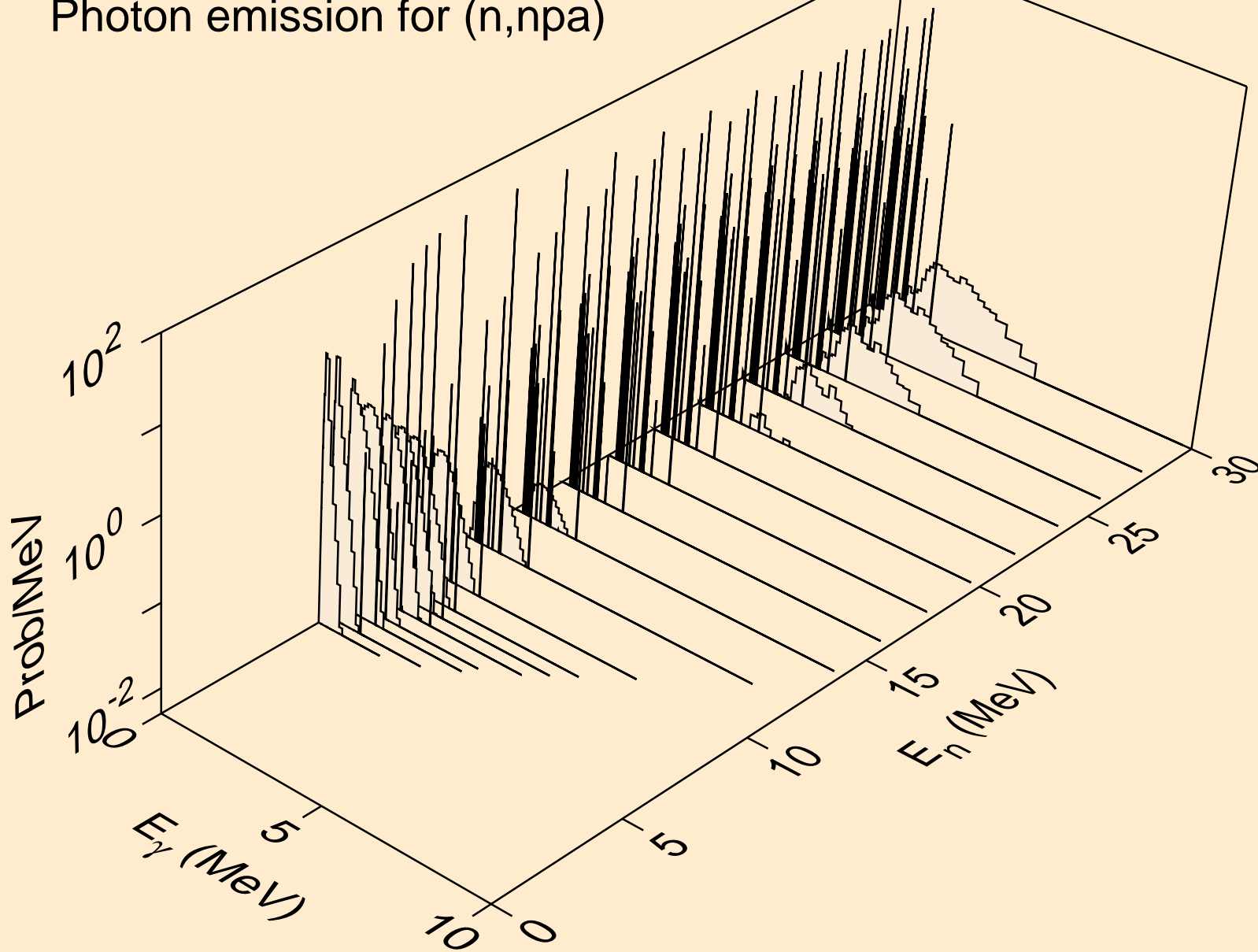

SB105 NEUTRON ACER TENDL-2023 LIBRARY; T=0.K  
Photon emission for (n,n\*c)

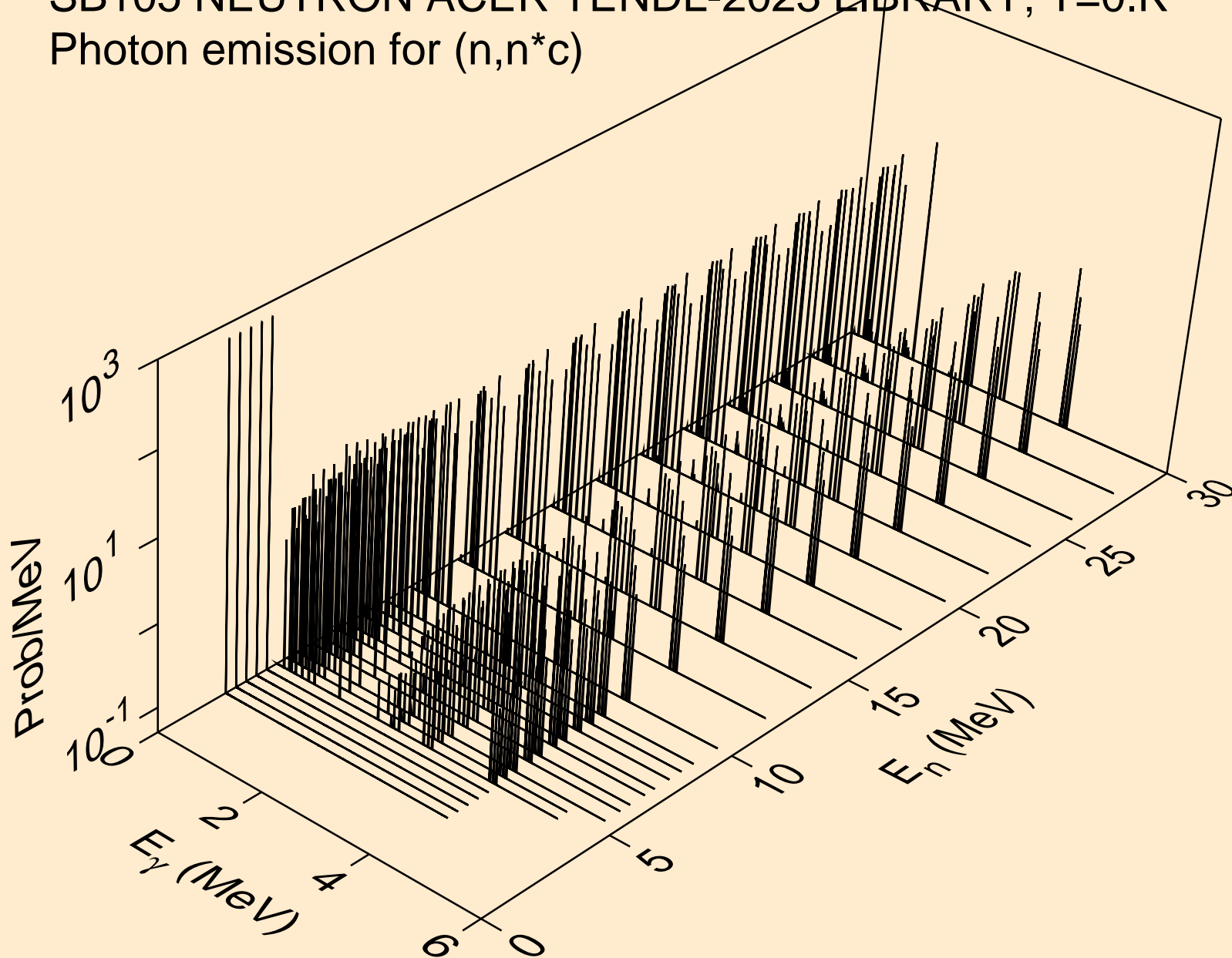

SB105 NEUTRON ACER TENDL-2023 LIBRARY; T=0.K  
Photon emission for (n,gma)

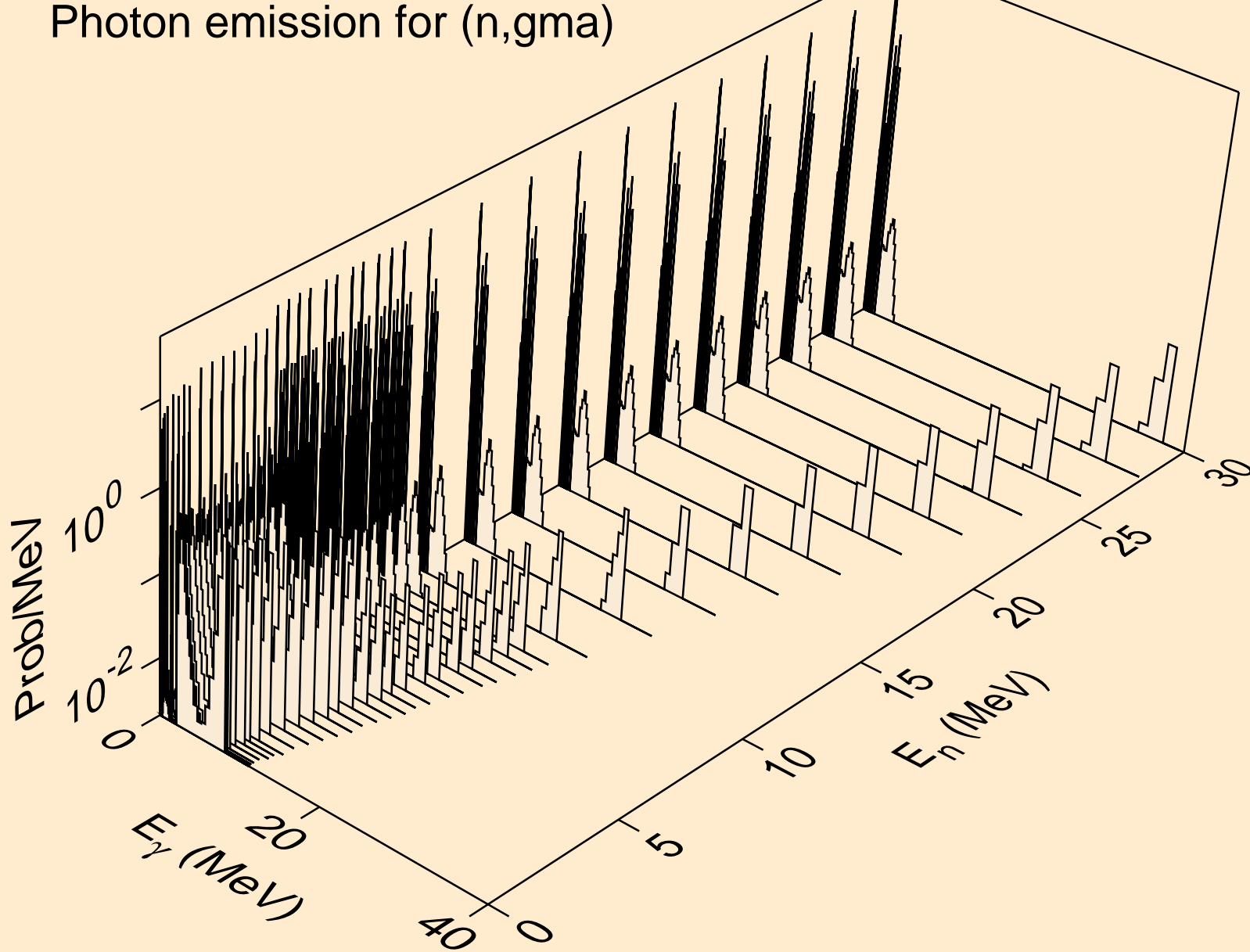

SB105 NEUTRON ACER TENDL-2023 LIBRARY; T=0.K  
Photon emission for (n,p)

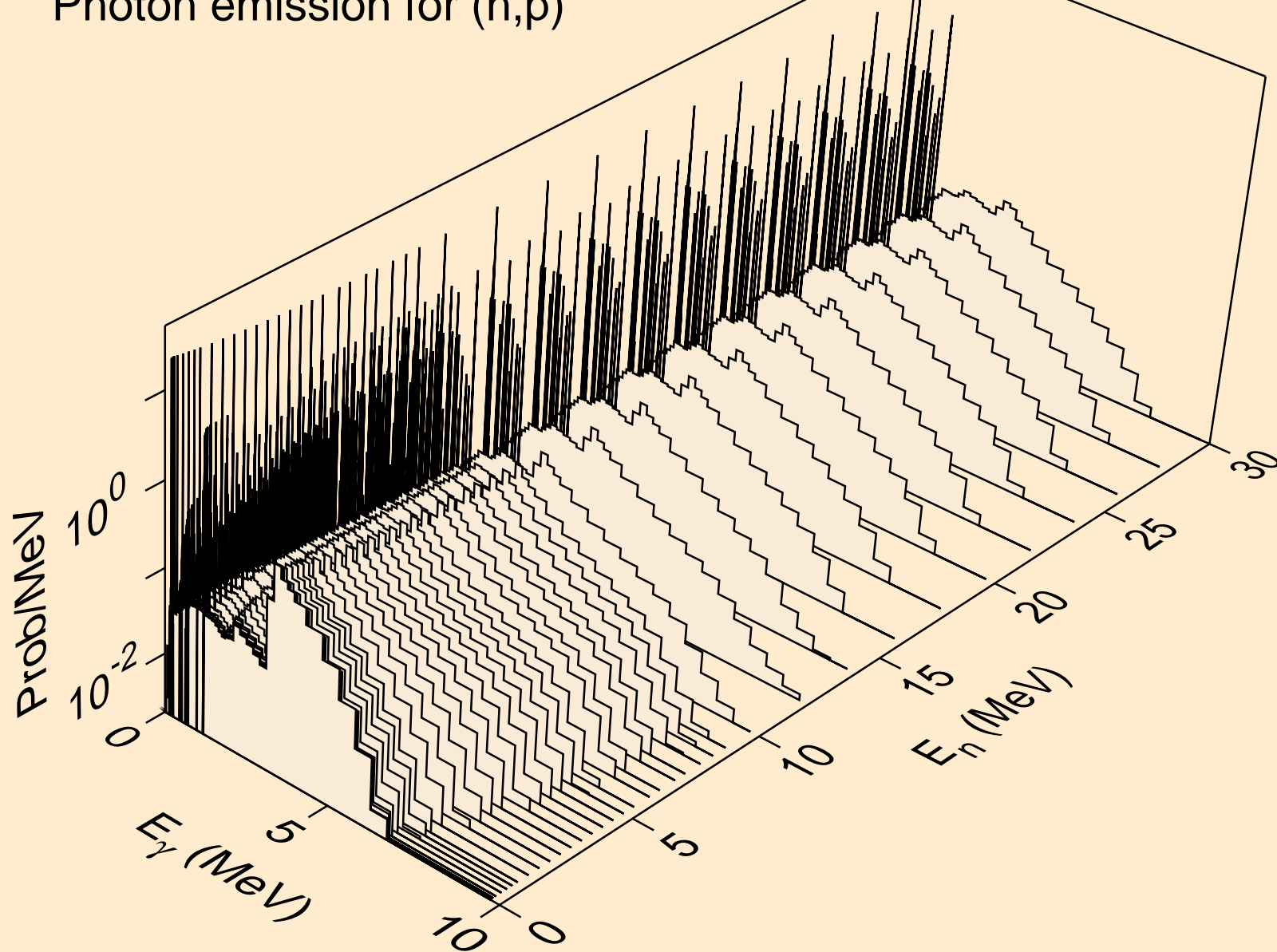

SB105 NEUTRON ACER TENDL-2023 LIBRARY; T=0.K  
Photon emission for (n,d)

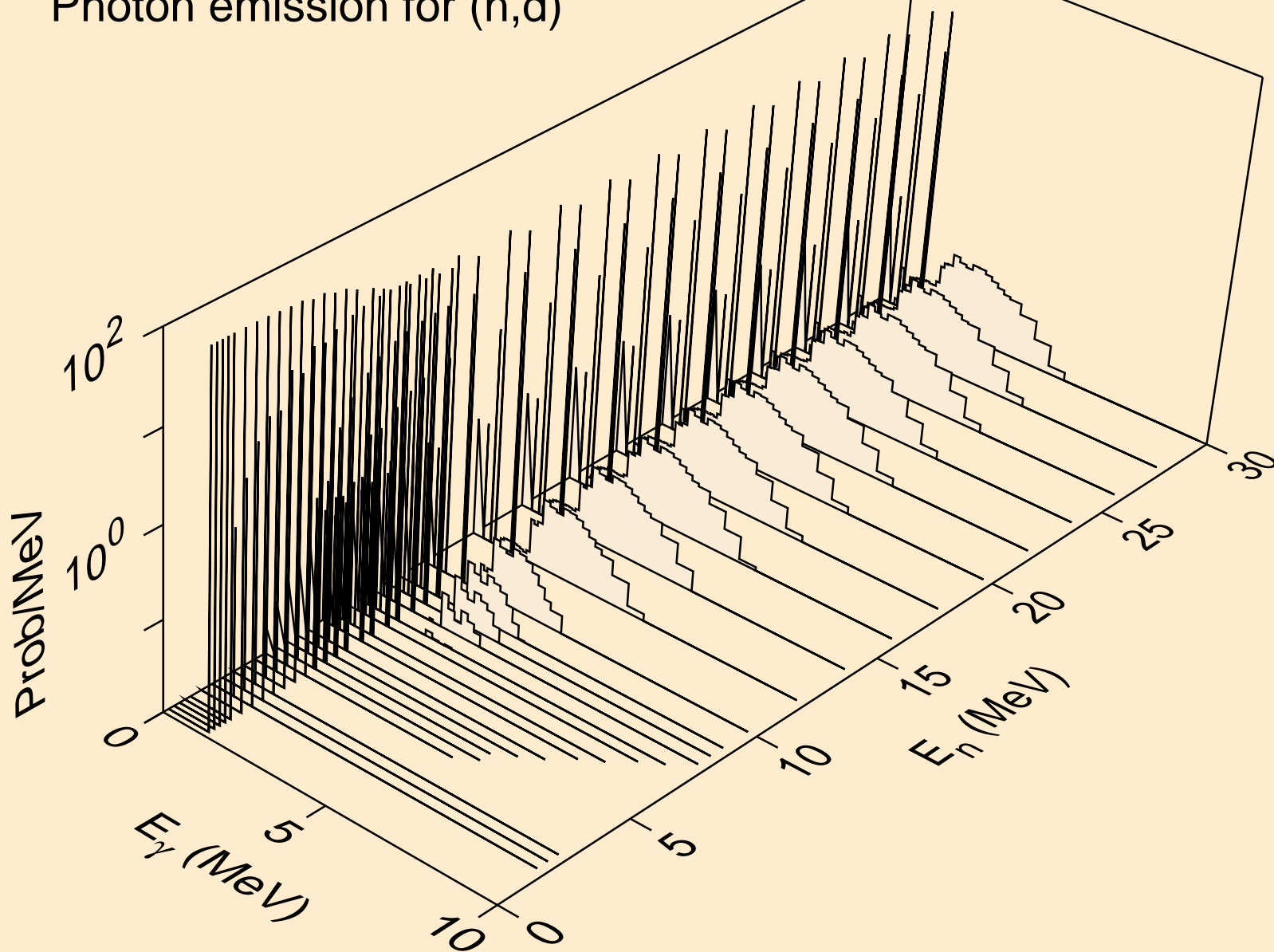



SB105 NEUTRON ACER TENDL-2023 LIBRARY; T=0.K  
Photon emission for (n,t)

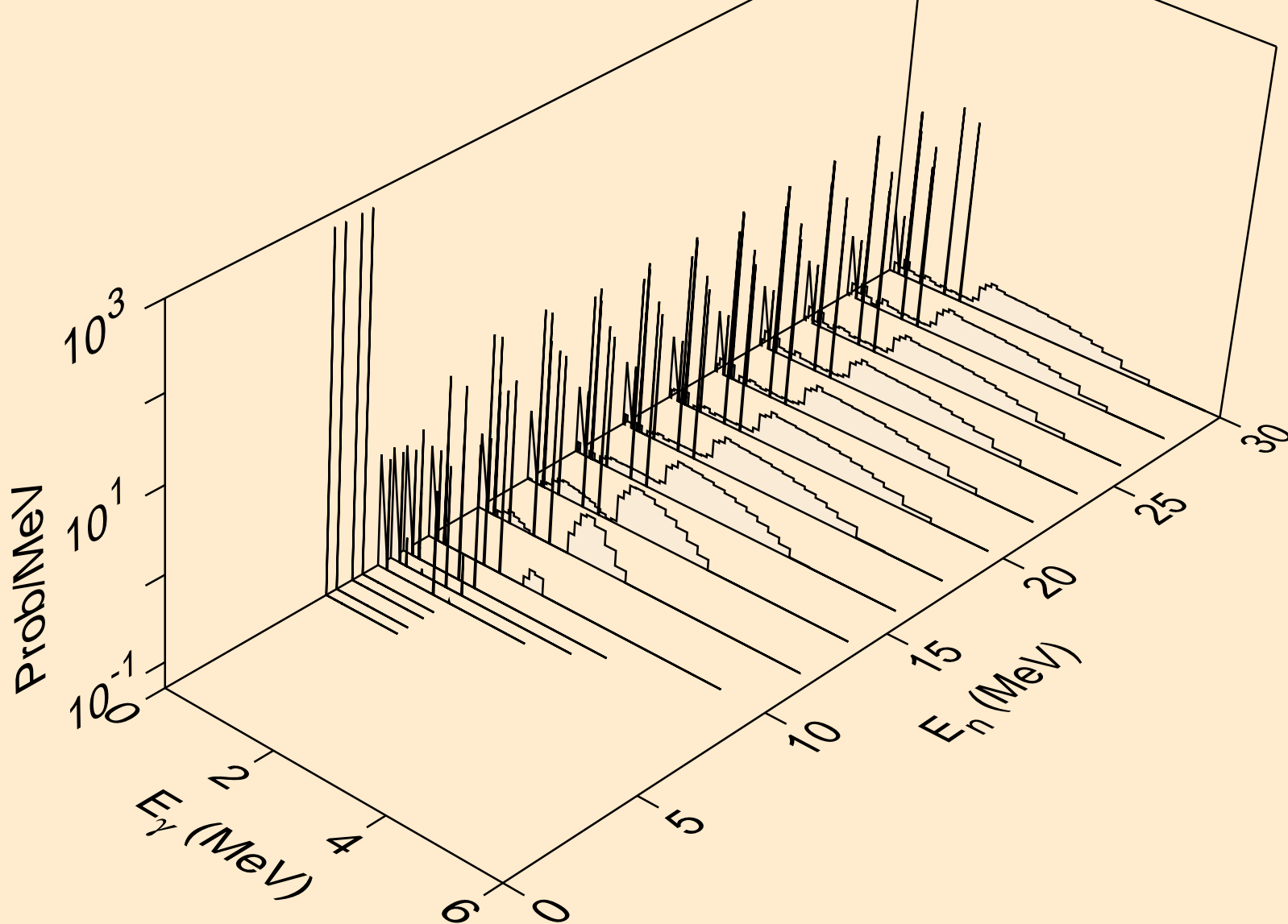

SB105 NEUTRON ACER TENDL-2023 LIBRARY; T=0.K  
Photon emission for (n,he3)

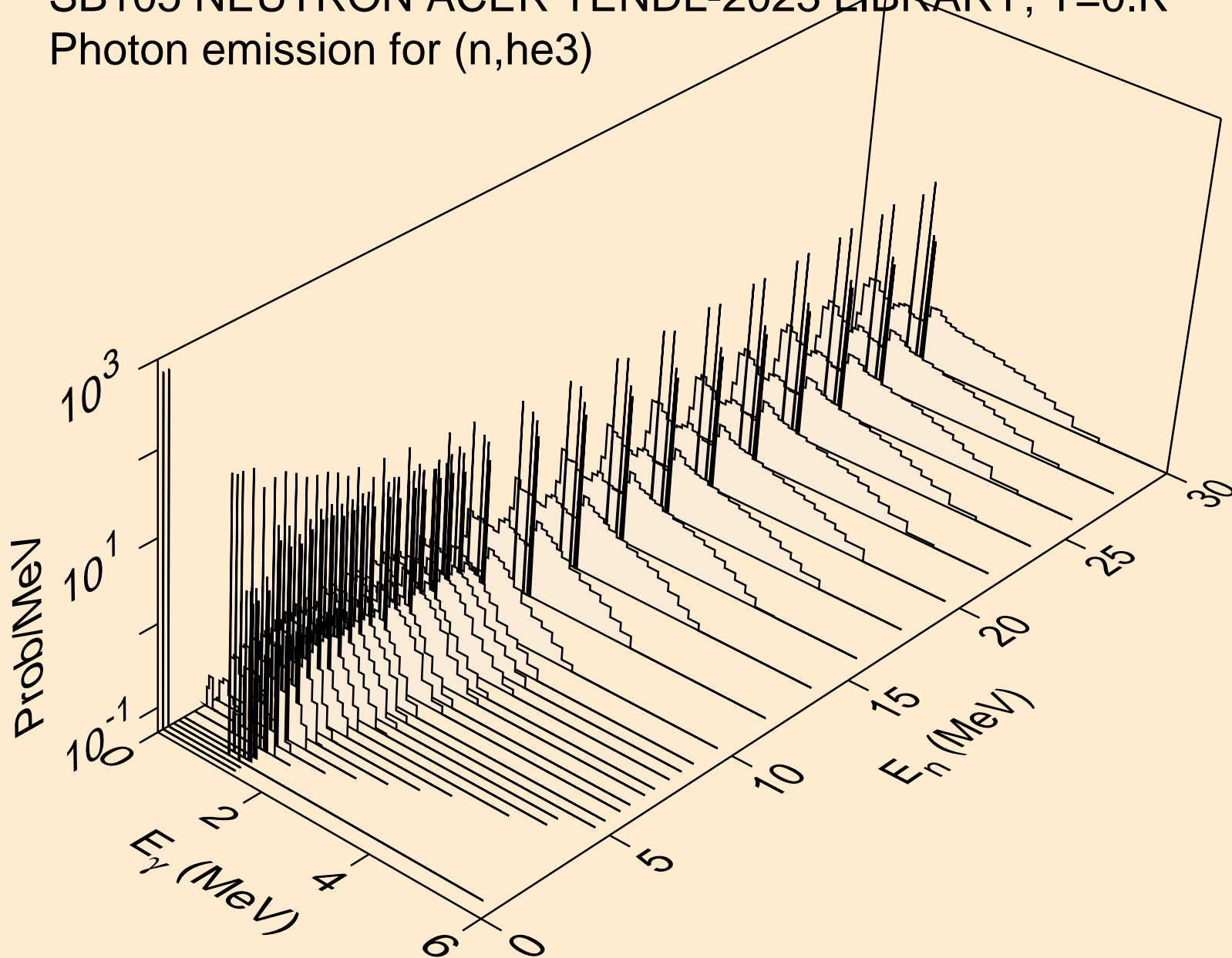

SB105 NEUTRON ACER TENDL-2023 LIBRARY; T=0.K  
Photon emission for (n,a)

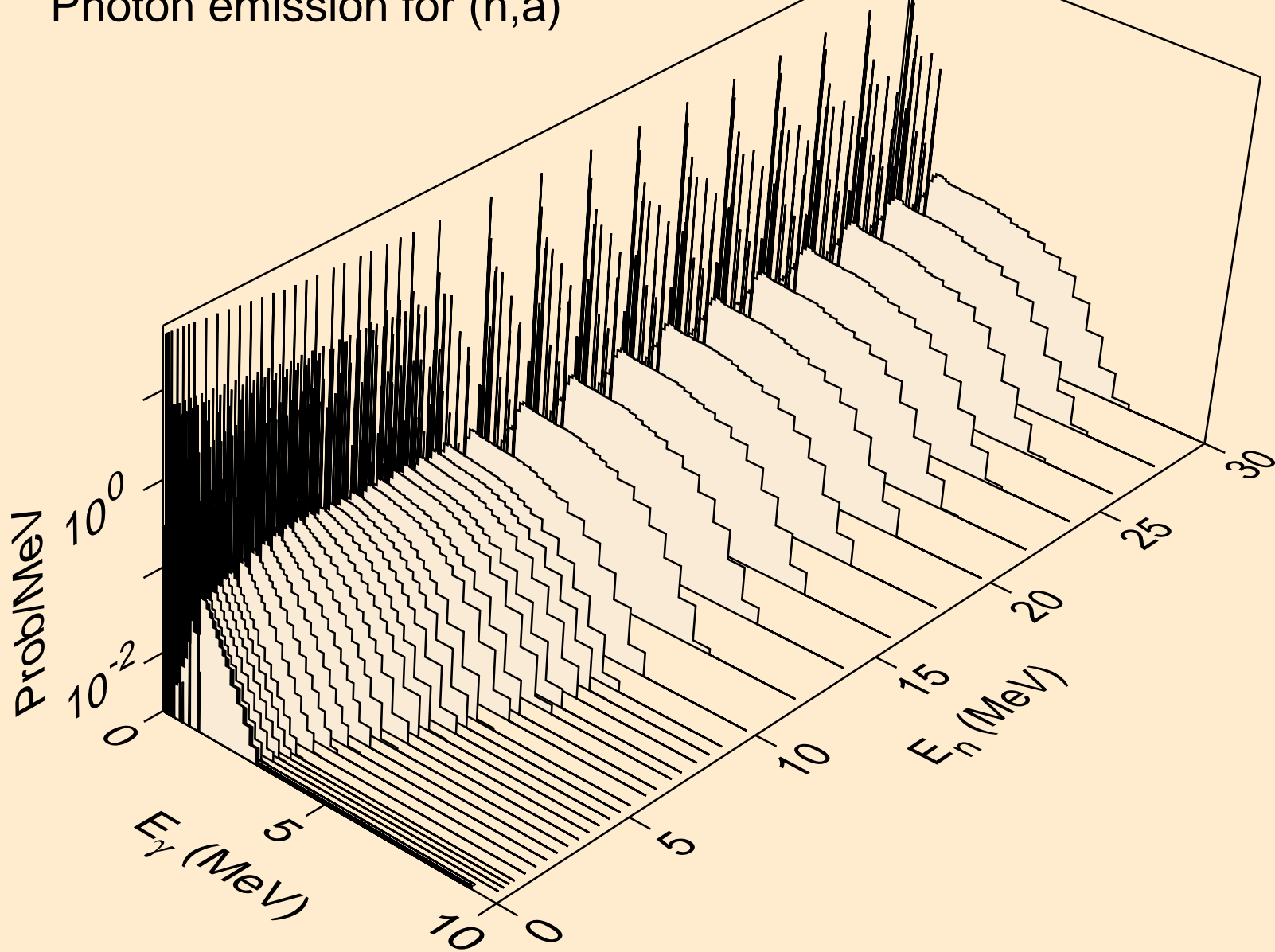

SB105 NEUTRON ACER TENDL-2023 LIBRARY; T=0.K  
Photon emission for (n,2a)

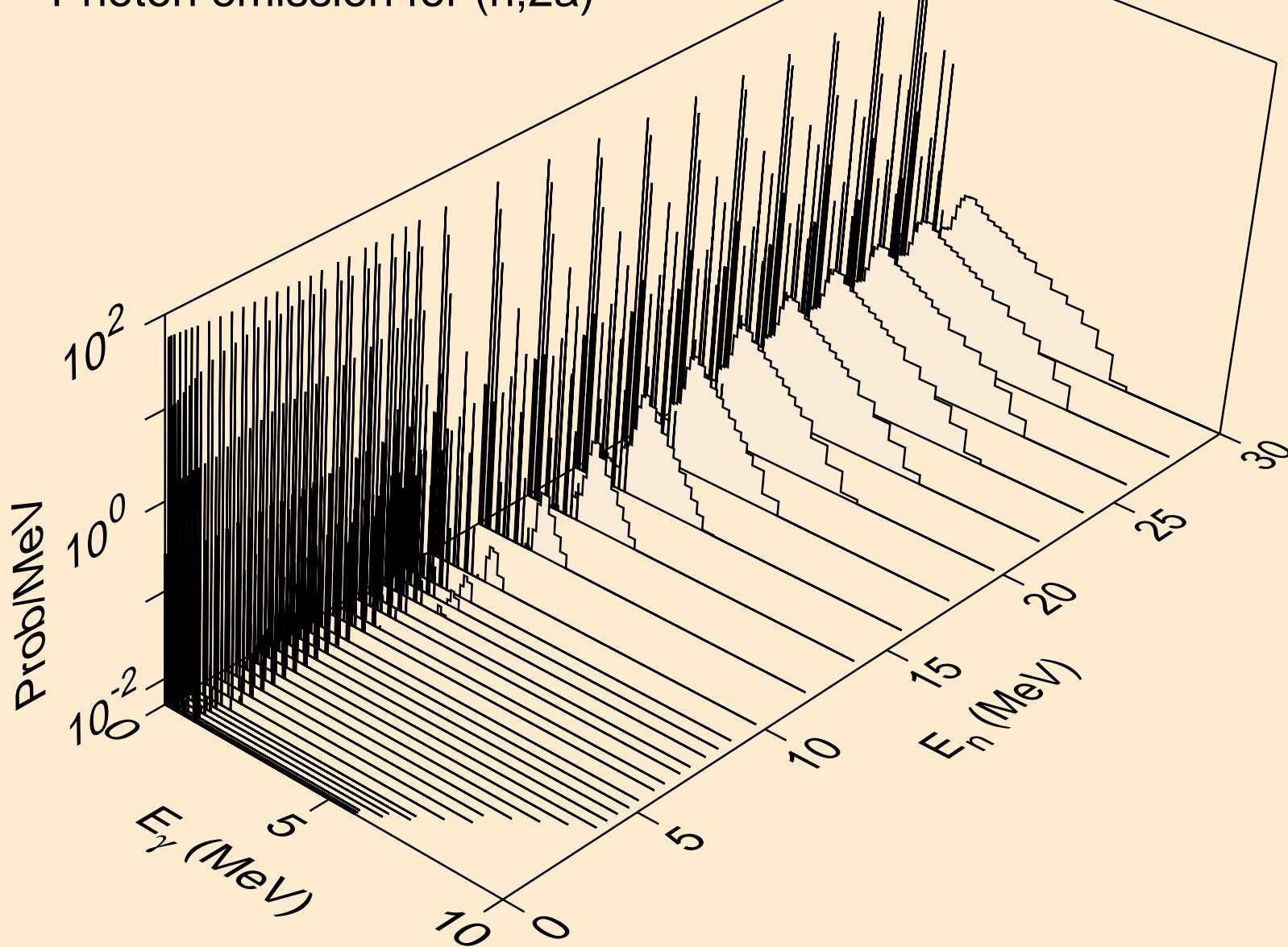

SB105 NEUTRON ACER TENDL-2023 LIBRARY; T=0.K  
Photon emission for (n,3a)

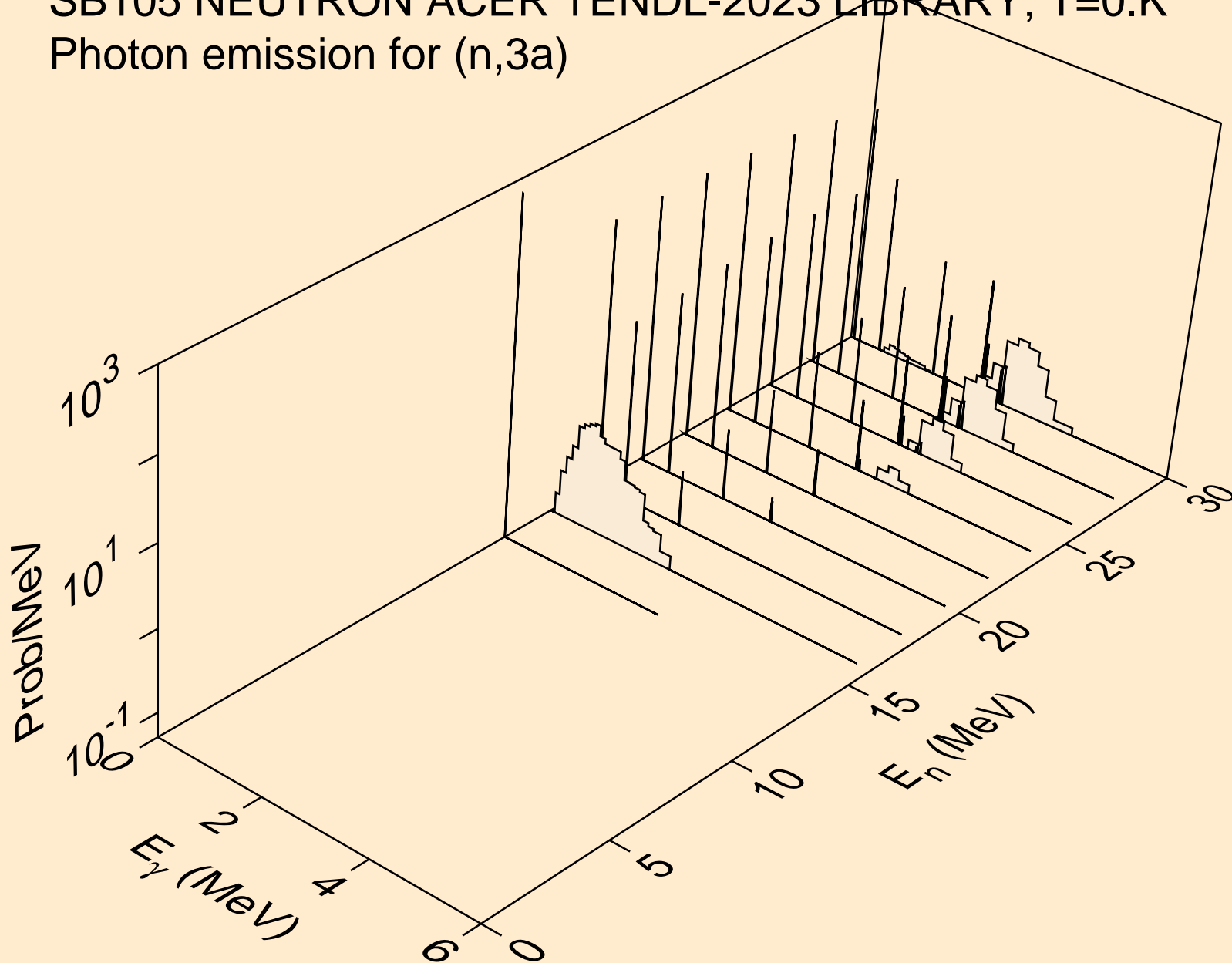

SB105 NEUTRON ACER TENDL-2023 LIBRARY; T=0.K  
Photon emission for (n,2p)

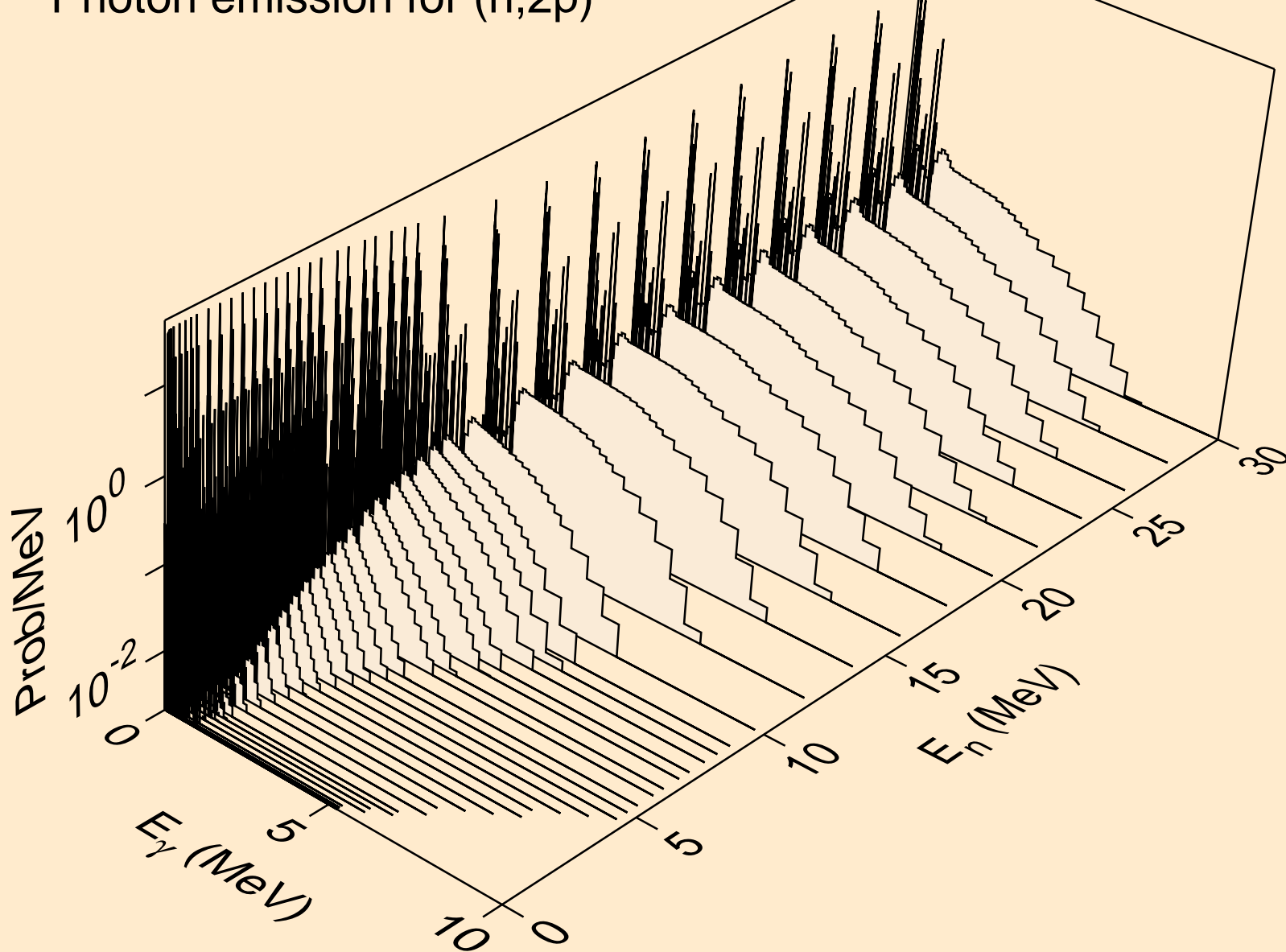

SB105 NEUTRON ACER TENDL-2023 LIBRARY; T=0.K  
Photon emission for (n,p $\alpha$ )

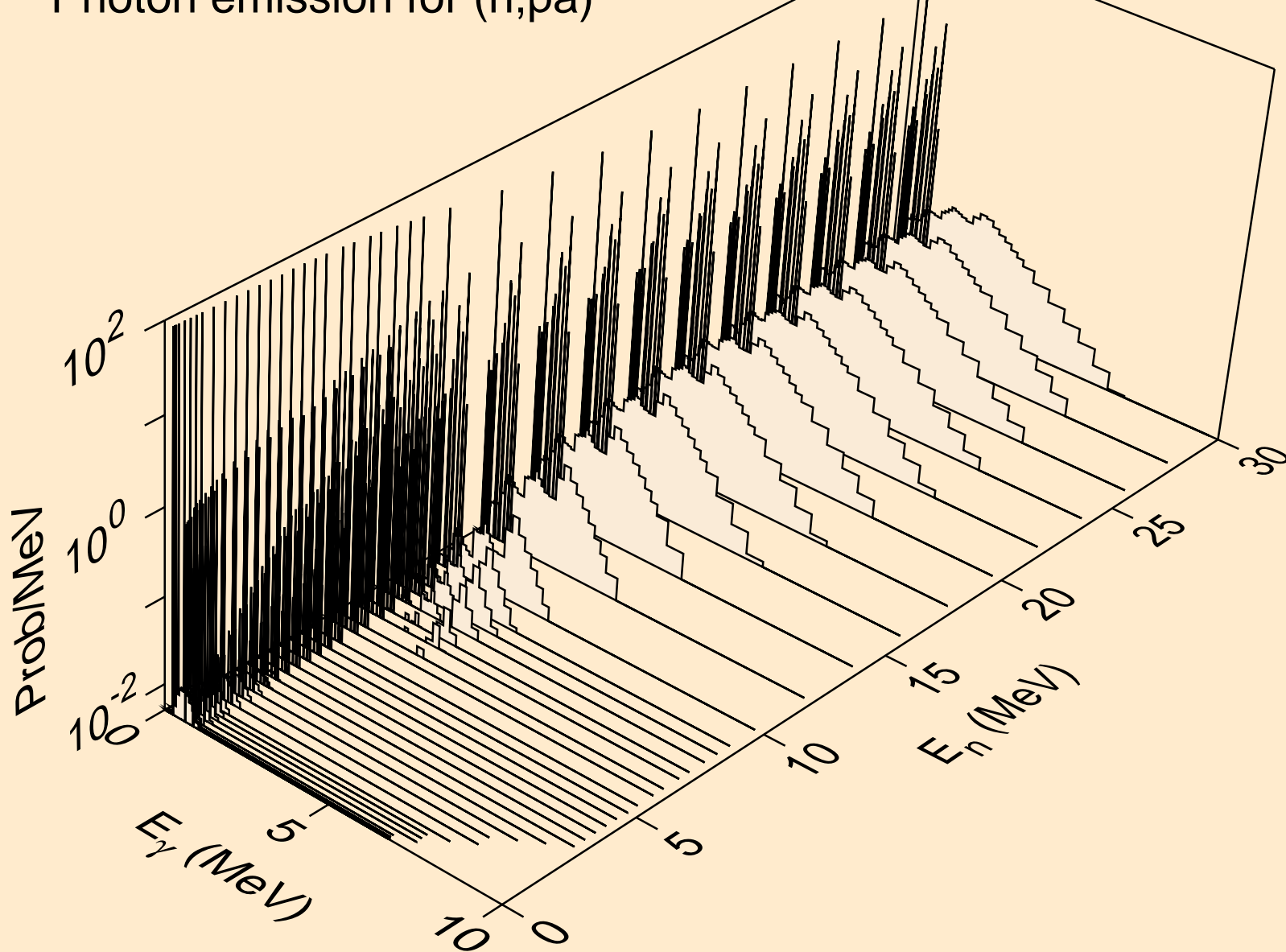

SB105 NEUTRON ACER TENDL-2023 LIBRARY; T=0.K  
Photon emission for (n,d2a)

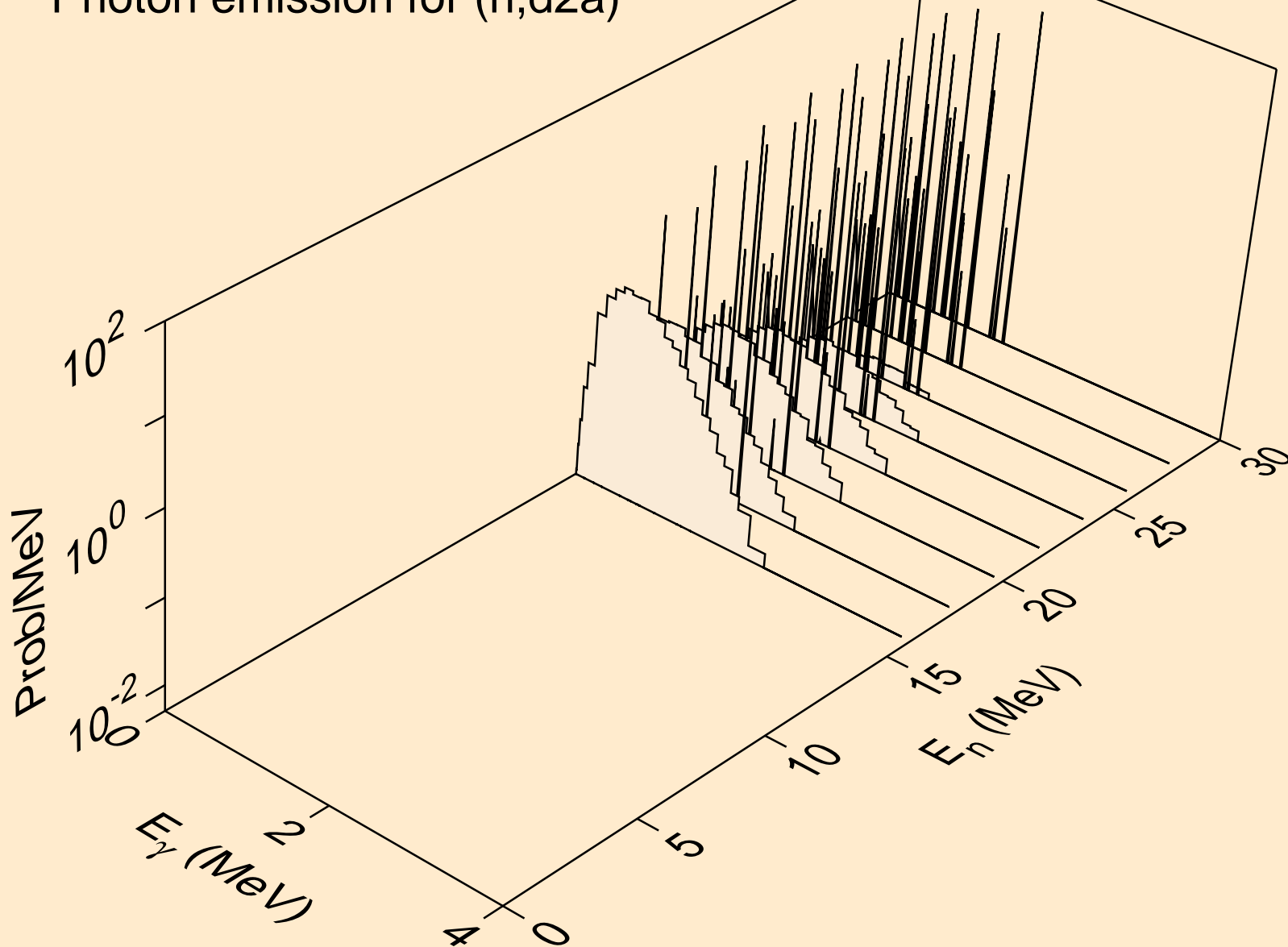



SB105 NEUTRON ACER TENDL-2023 LIBRARY; T=0.K  
Photon emission for (n,pd)

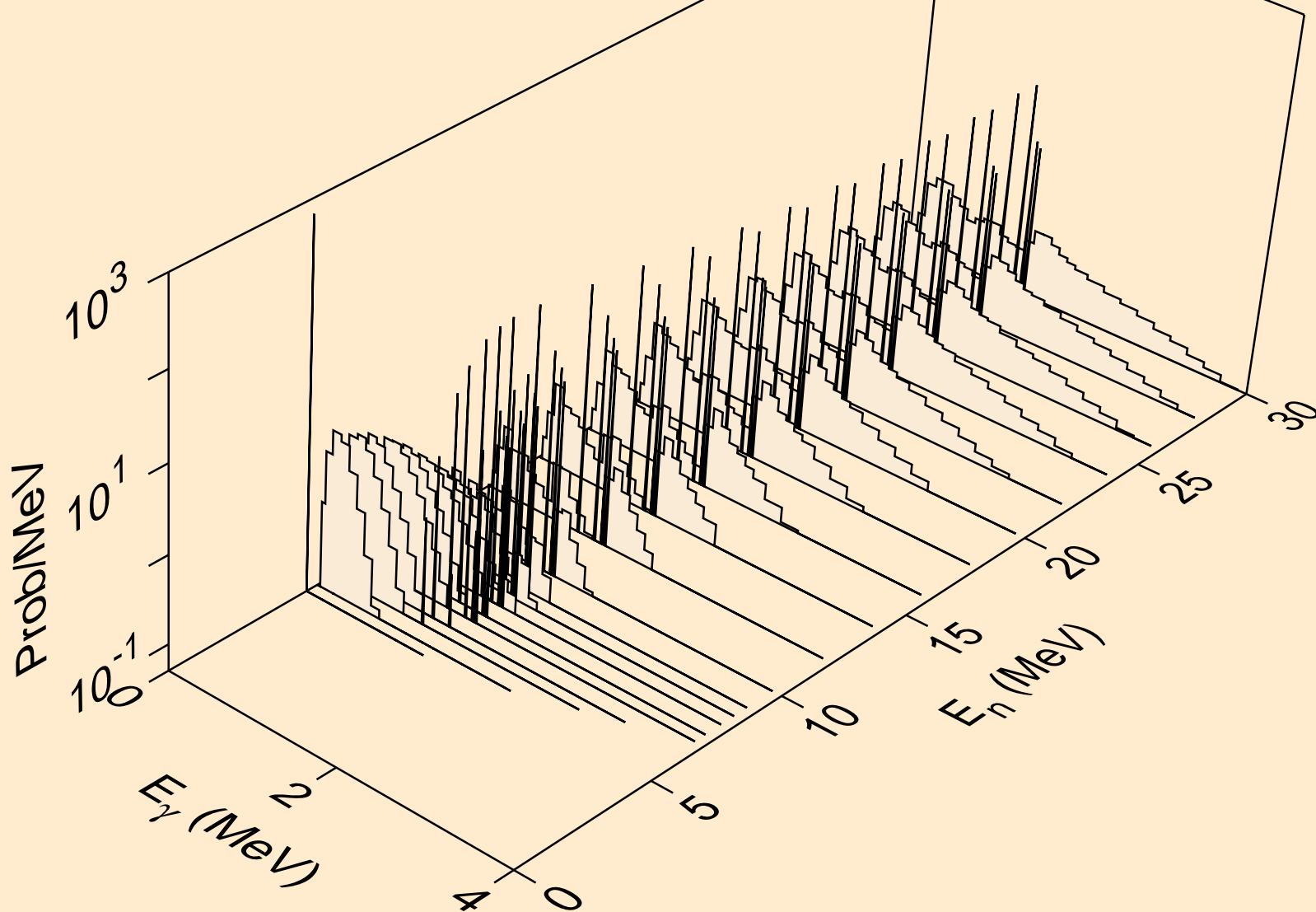

SB105 NEUTRON ACER TENDL-2023 LIBRARY; T=0.K  
Photon emission for (n,pt)

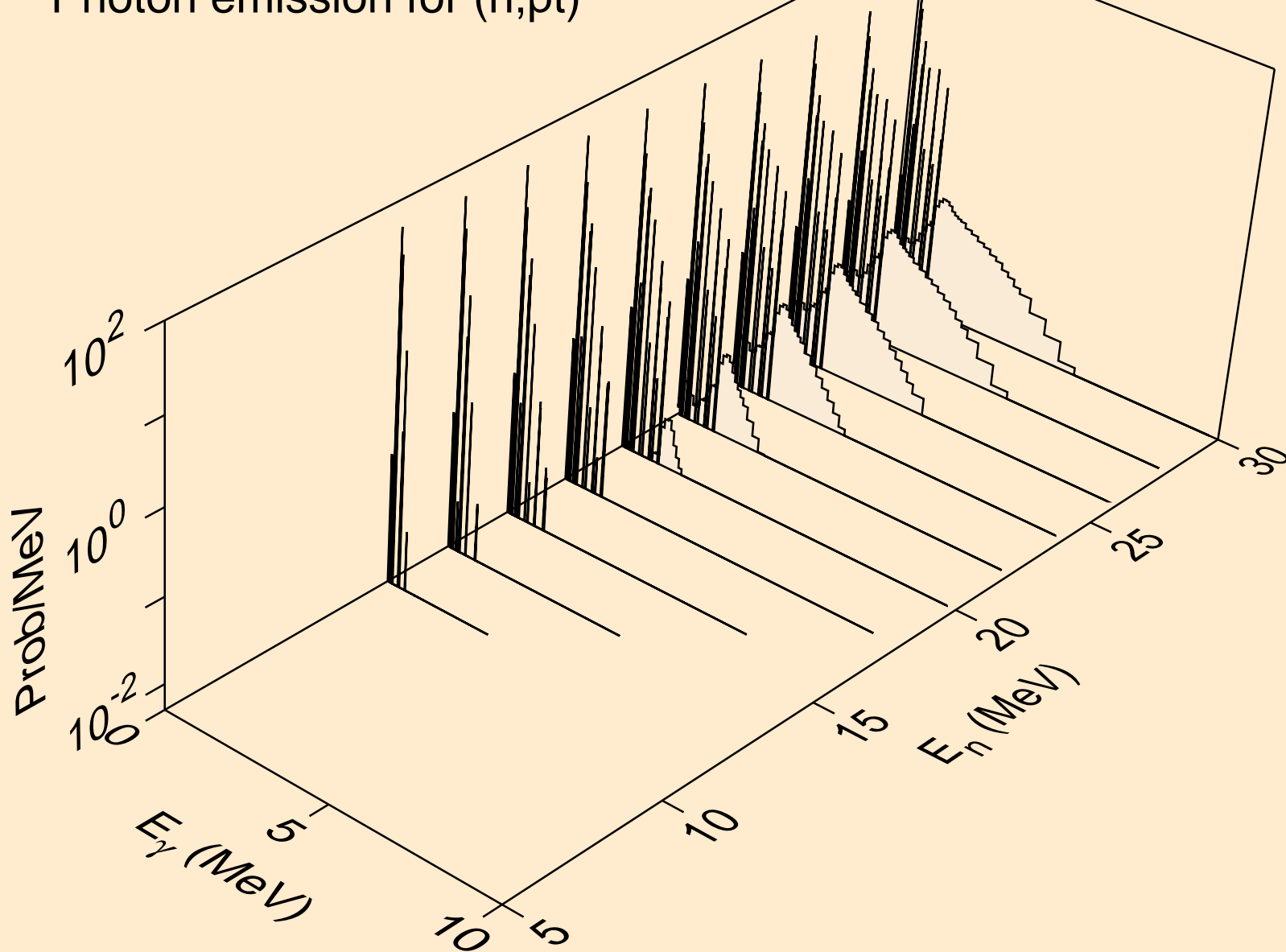

SB105 NEUTRON ACER TENDL-2023 LIBRARY; T=0.K  
Photon emission for (n,da)

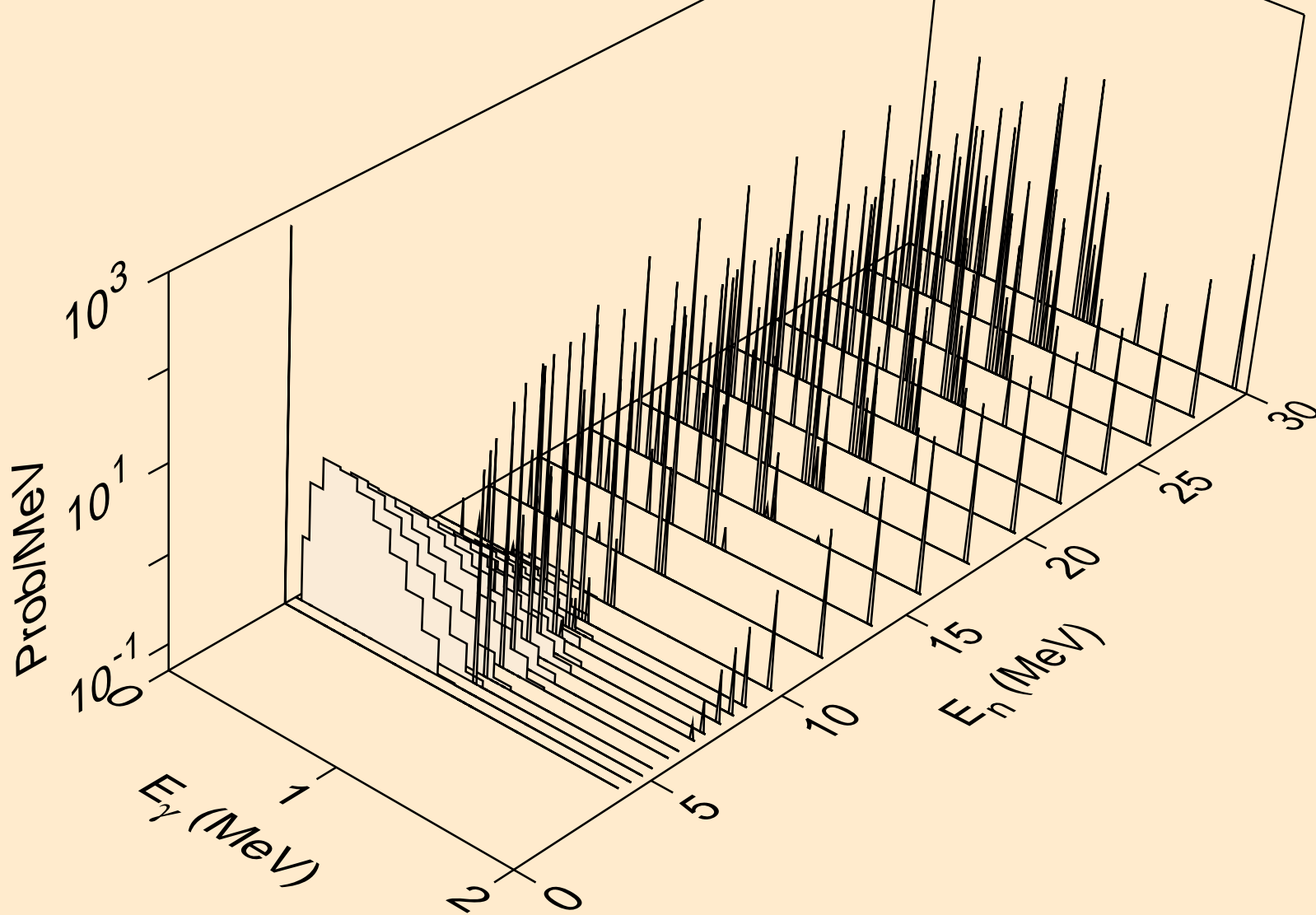

SB105 NEUTRON ACER TENDL-2023 LIBRARY; T=0.K  
thermal capture photon spectrum

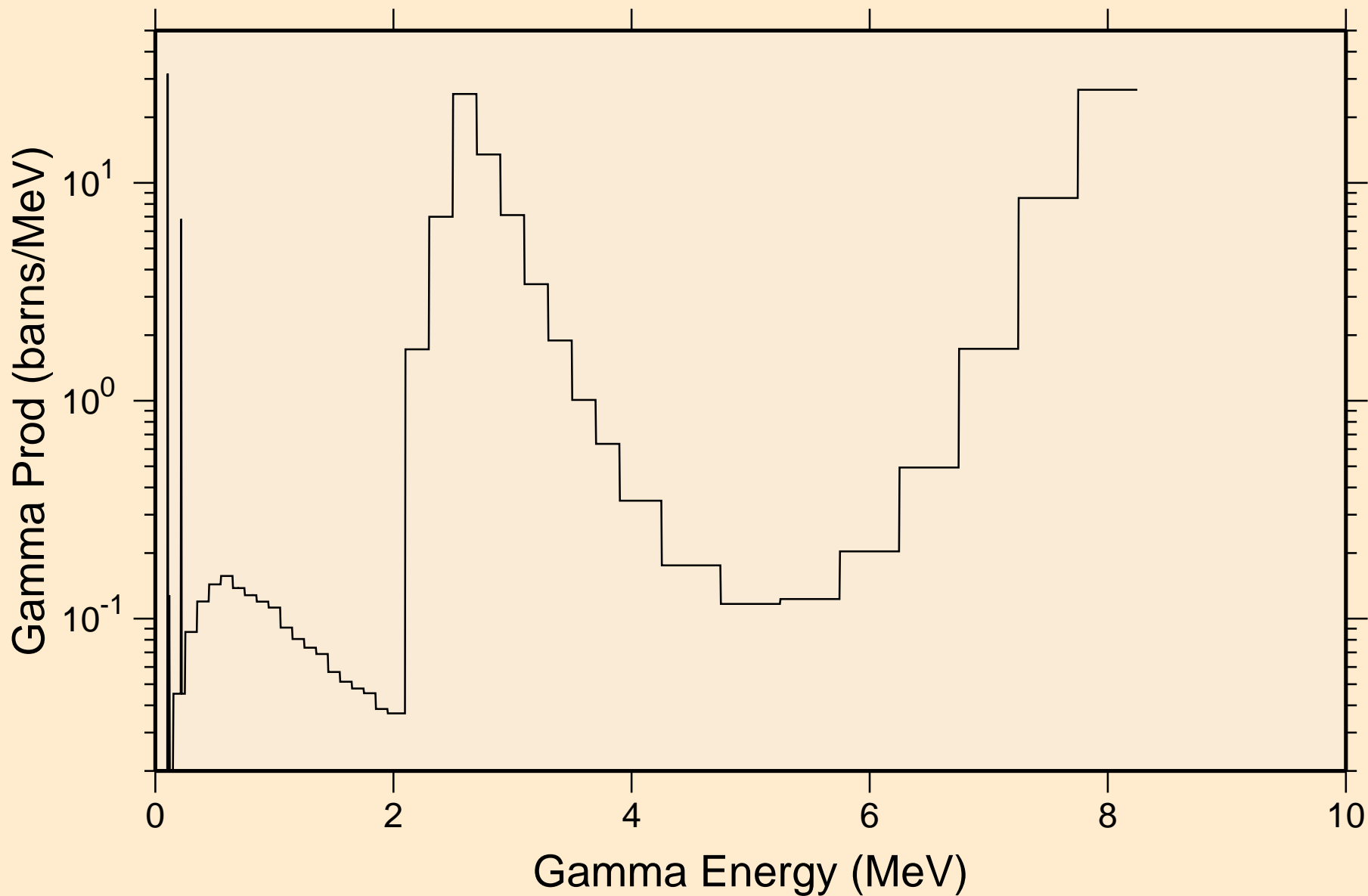

SB105 NEUTRON ACER TENDL-2023 LIBRARY; T=0.K  
14 MeV photon spectrum

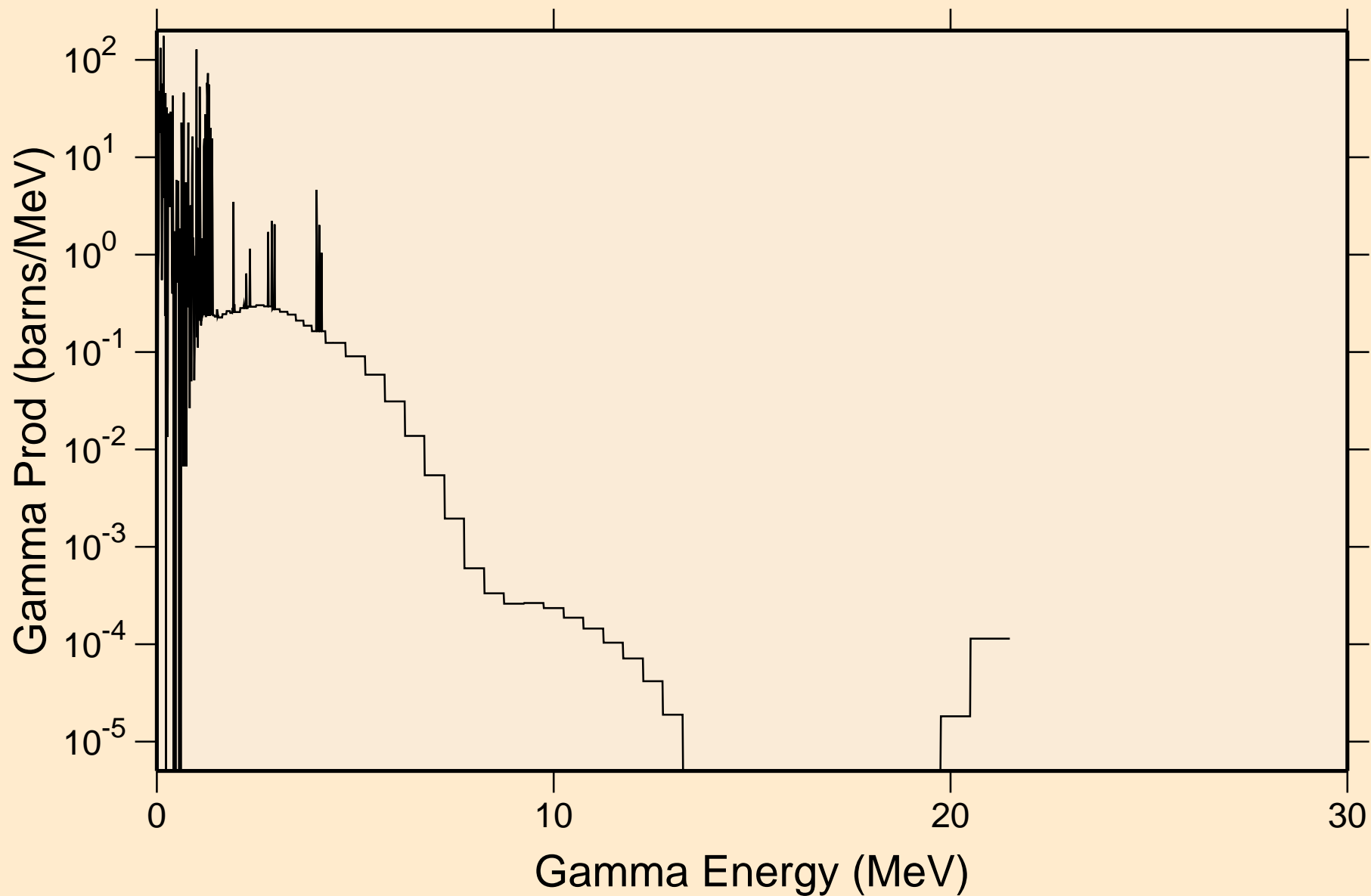

# SB105 NEUTRON ACER TENDL-2023 LIBRARY; T=0.K

## Particle heating contributions

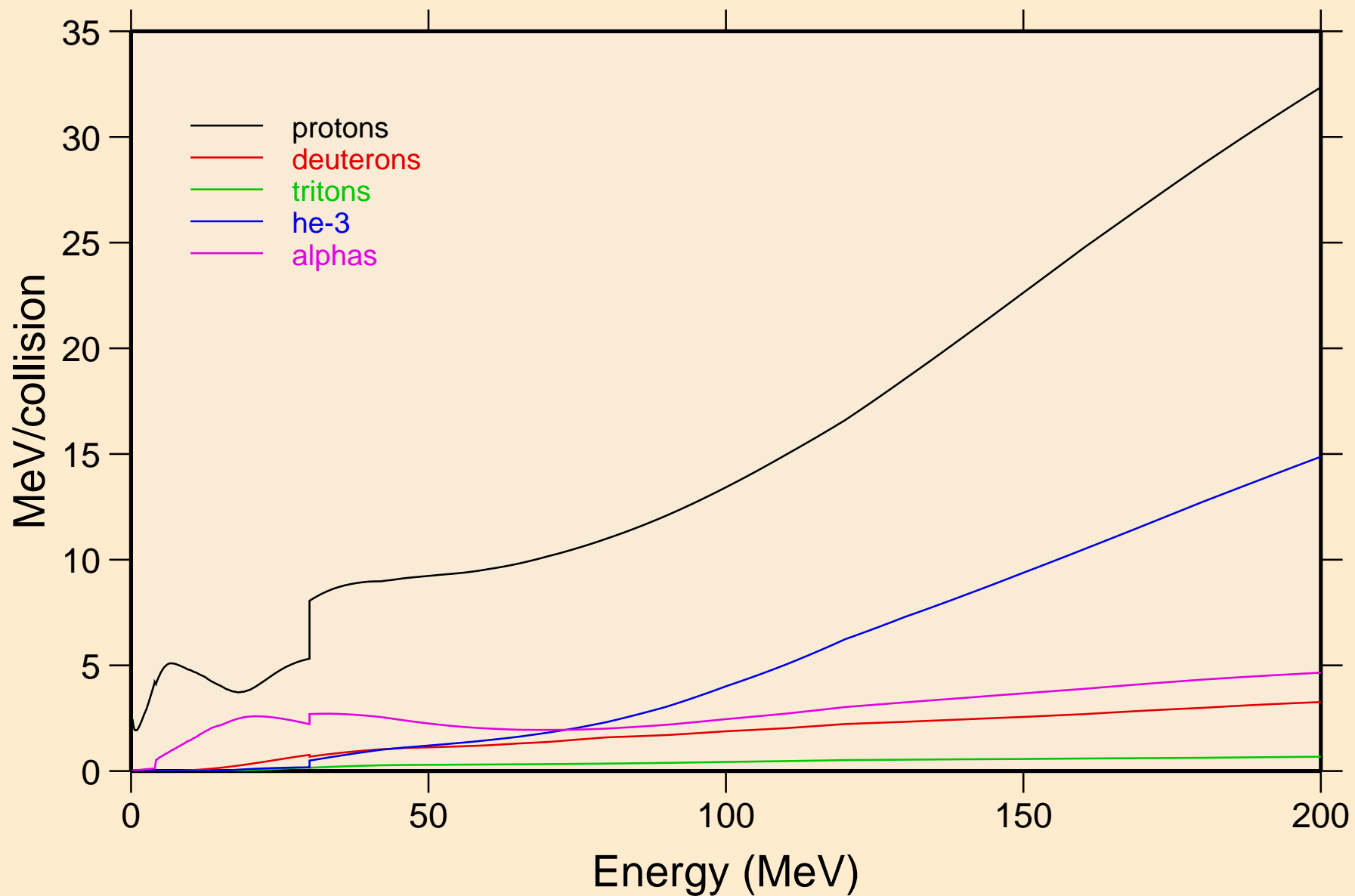

SB105 NEUTRON ACER TENDL-2023 LIBRARY; T=0.K  
Recoil Heating

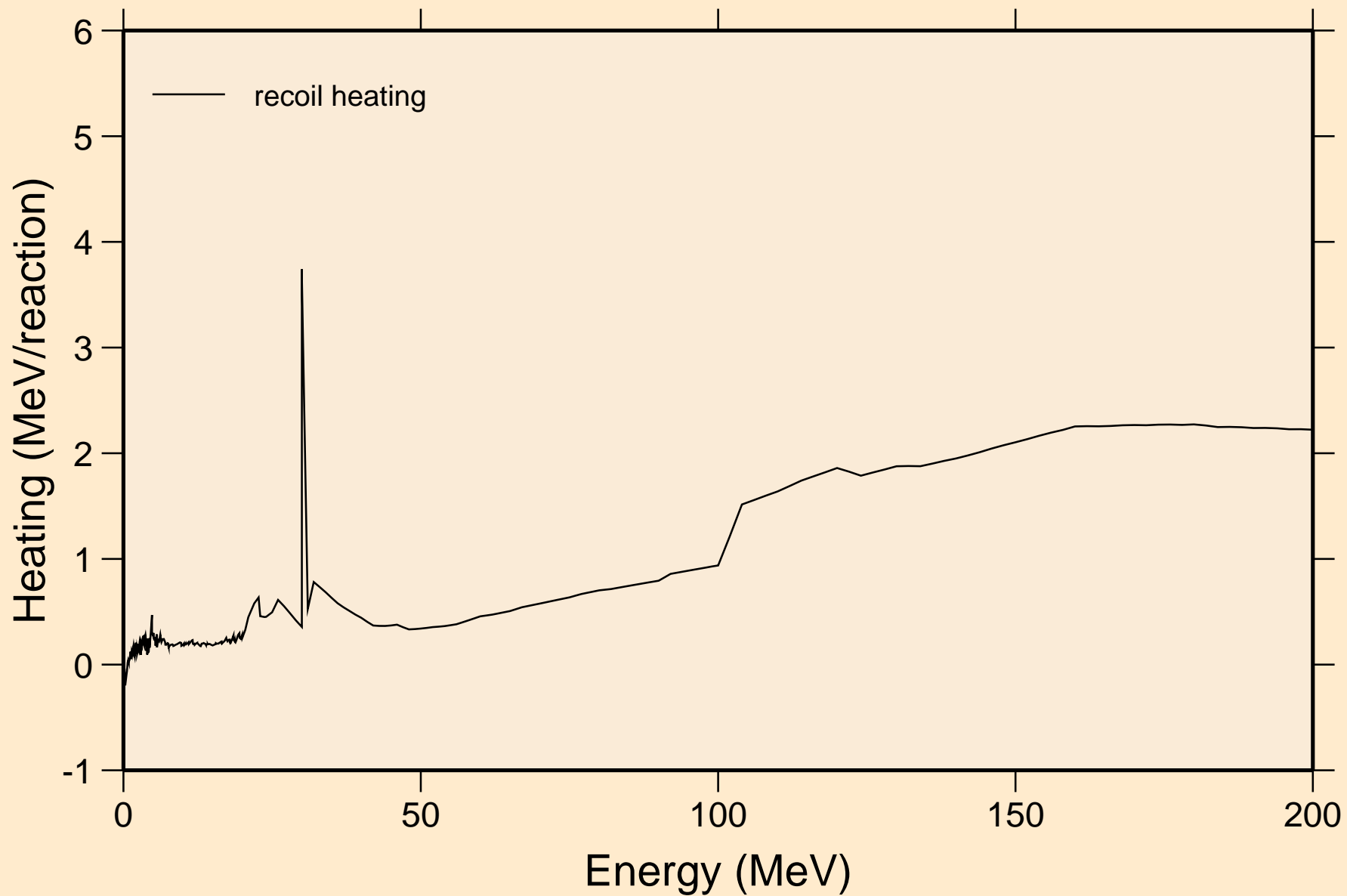

# SB105 NEUTRON ACER TENDL-2023 LIBRARY; T=0.K

## Particle production cross sections

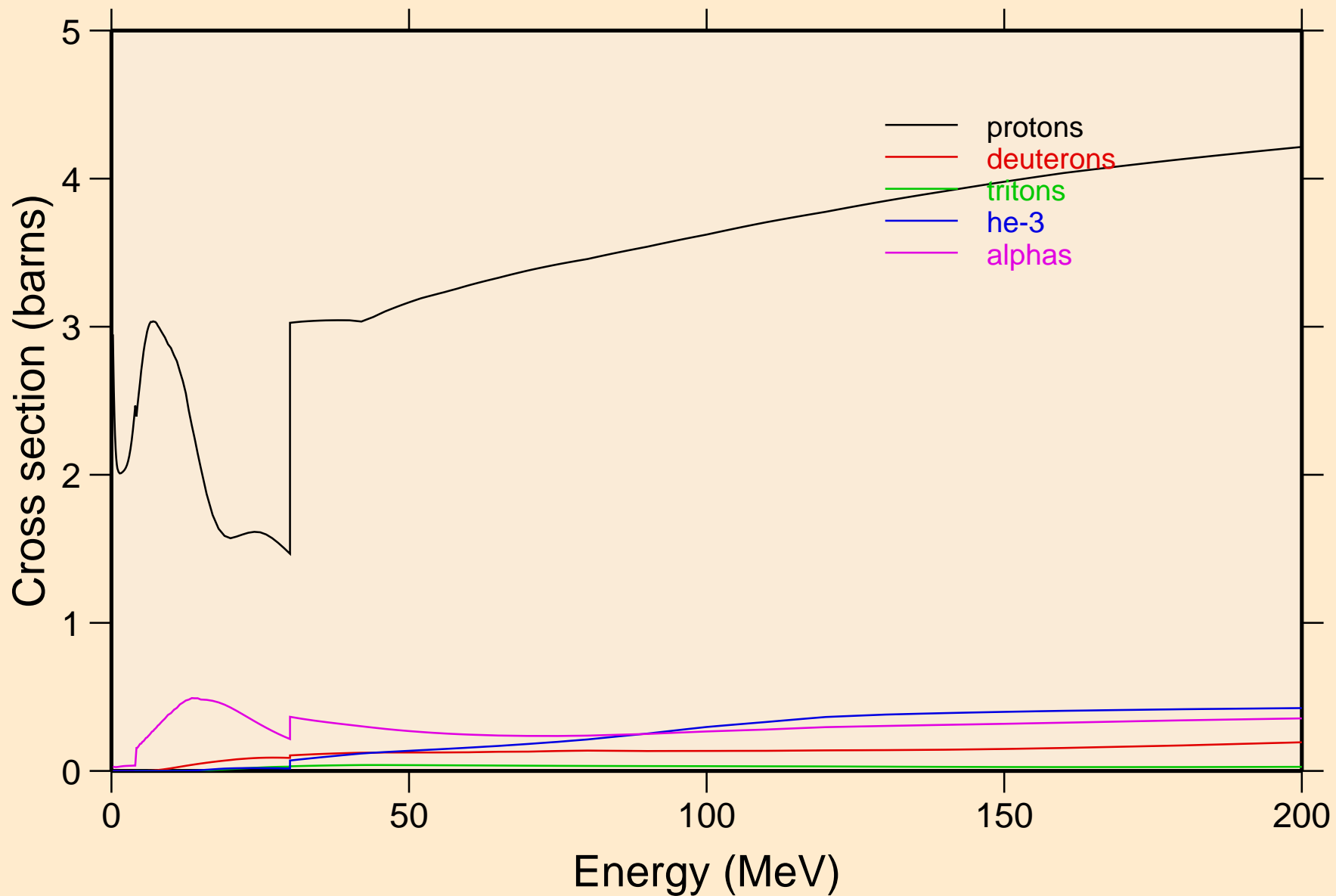



SB105 NEUTRON ACER TENDL-2023 LIBRARY; T=0.K  
protons from (n,x)

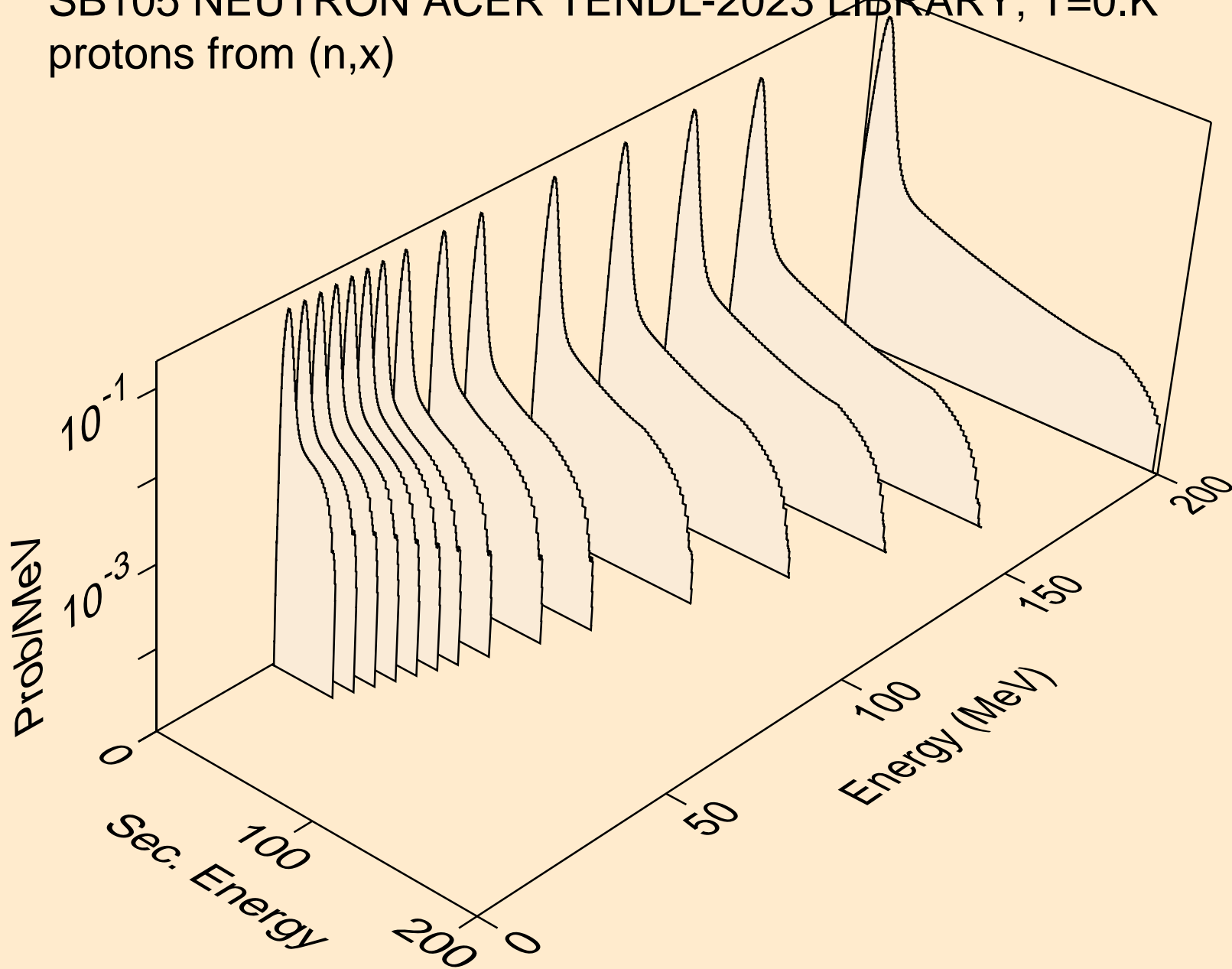

SB105 NEUTRON ACER TENDL-2023 LIBRARY; T=0.K  
protons from (n,n\*)p

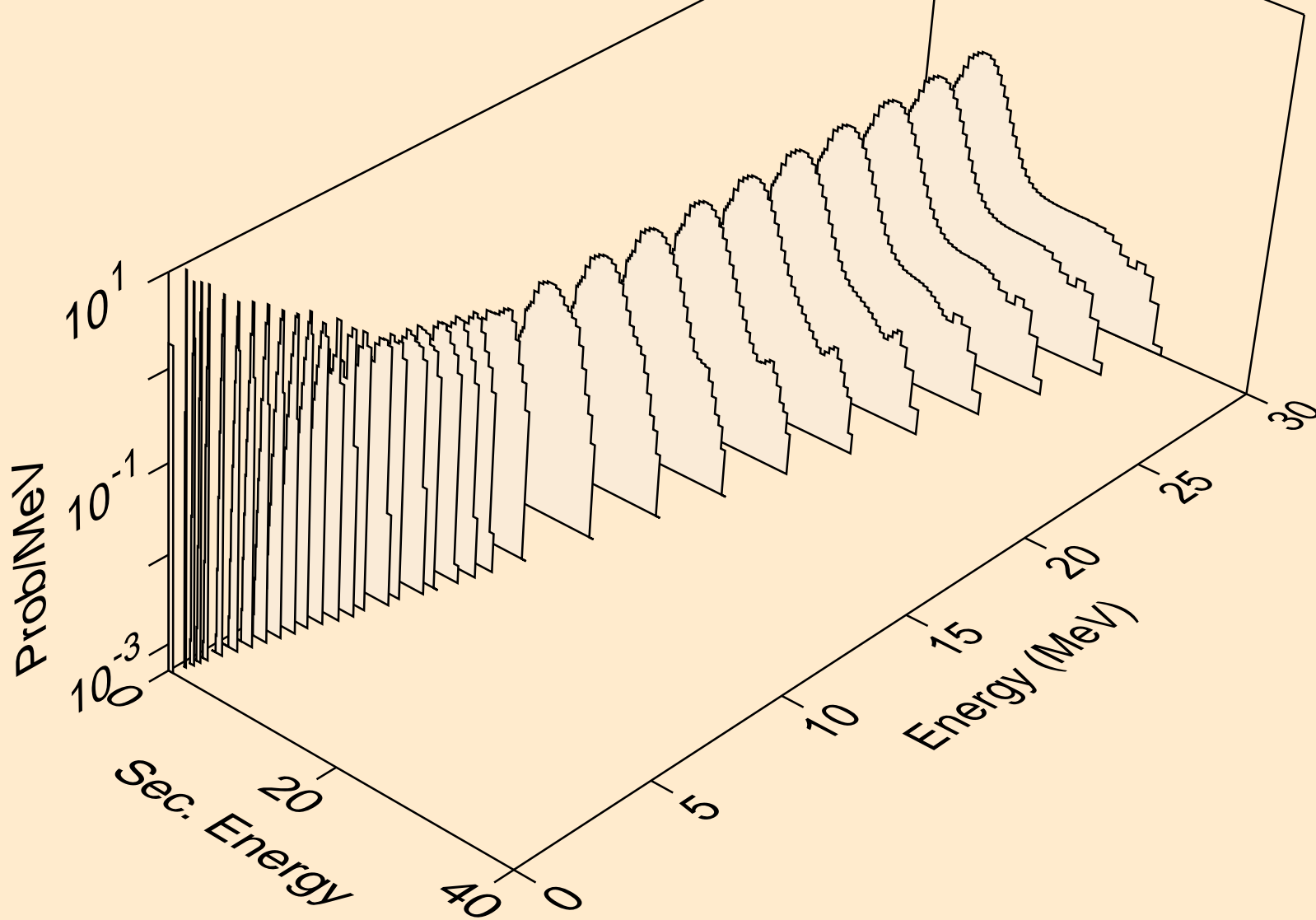

SB105 NEUTRON ACER TENDL-2023 LIBRARY; T=0.K  
protons from (n,2np)

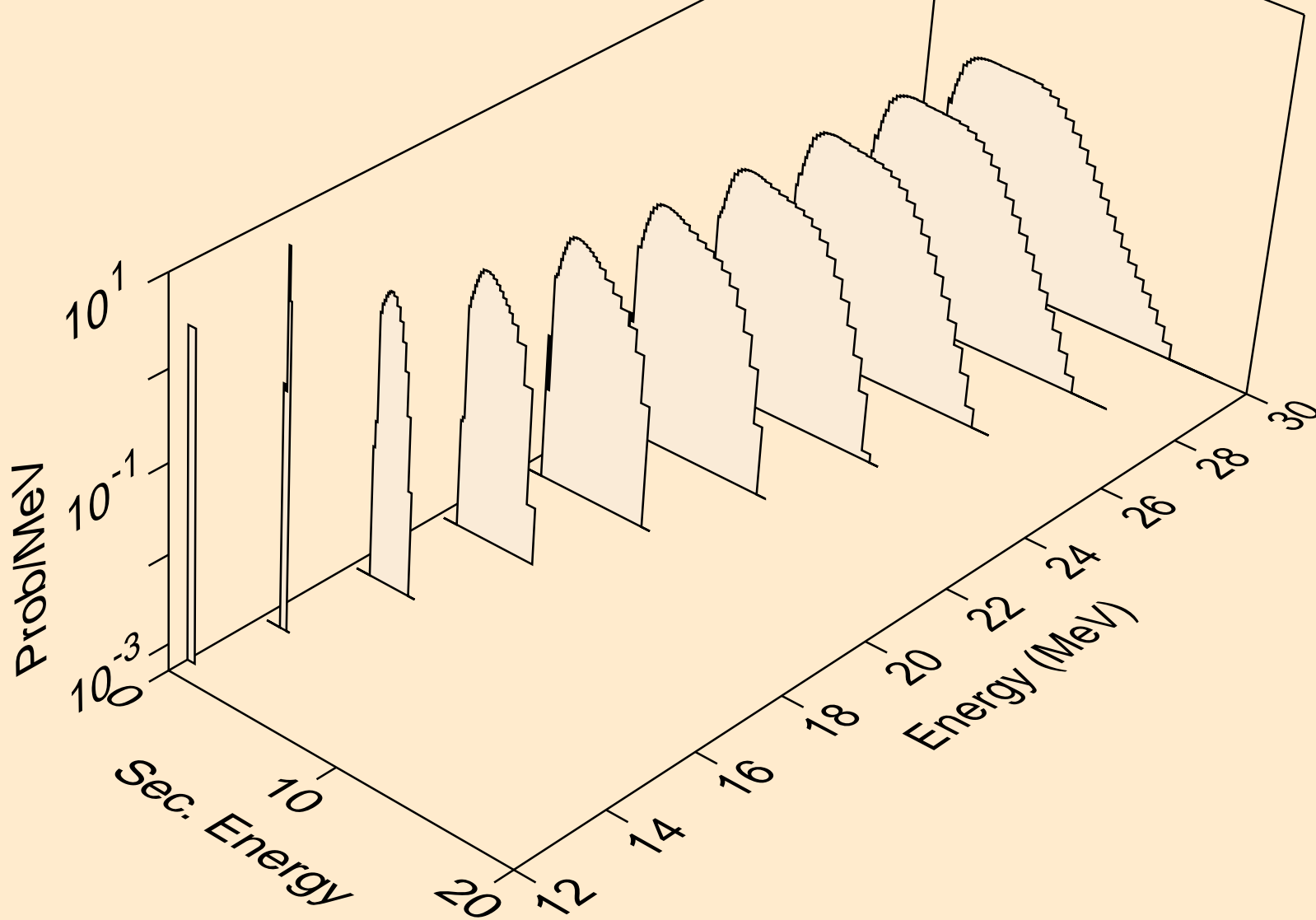

SB105 NEUTRON ACER TENDL-2023 LIBRARY; T=0.K  
protons from (n,3np)

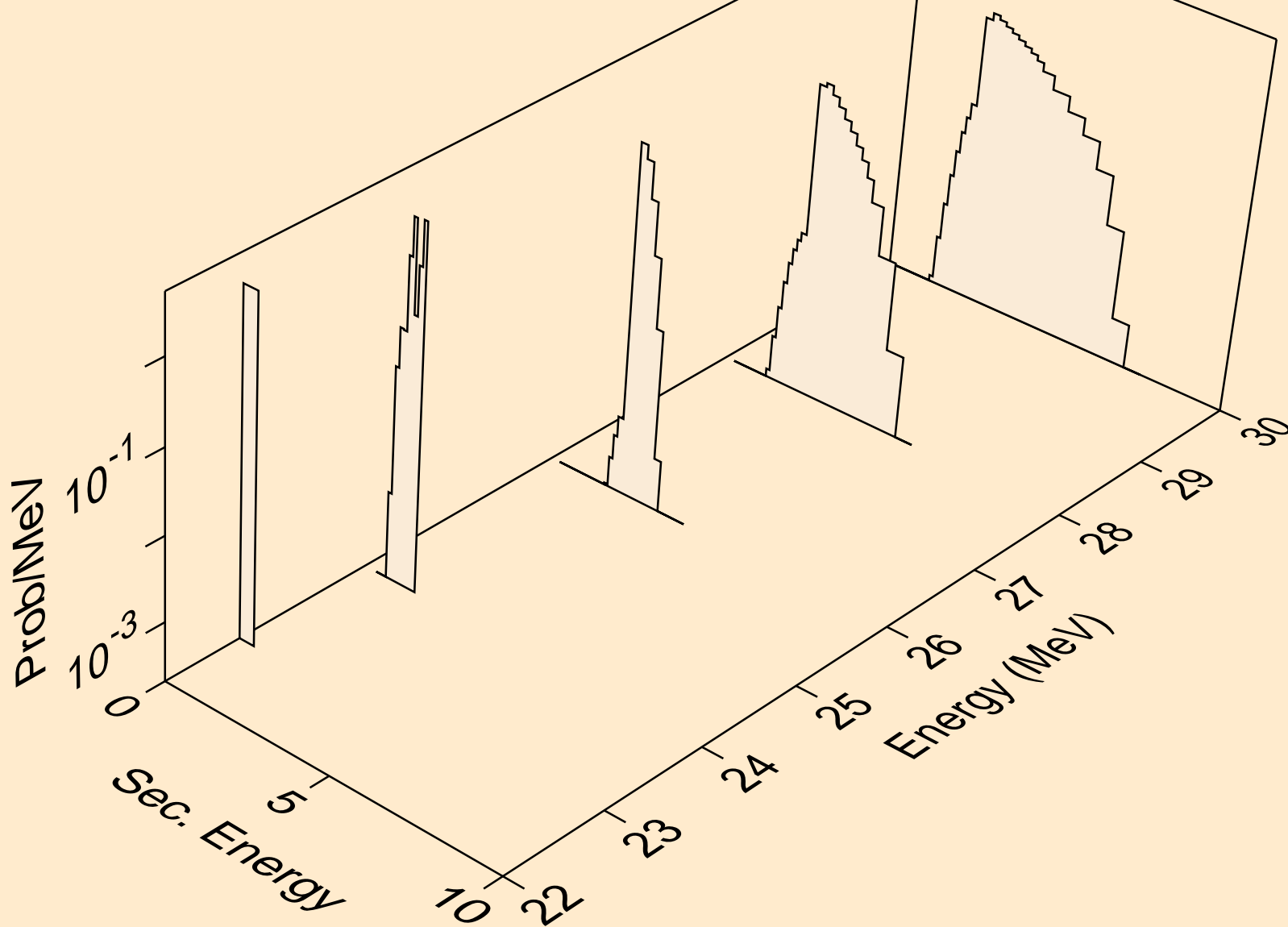

SB105 NEUTRON ACER TENDL-2023 LIBRARY; T=0.K  
protons from (n,n2p)

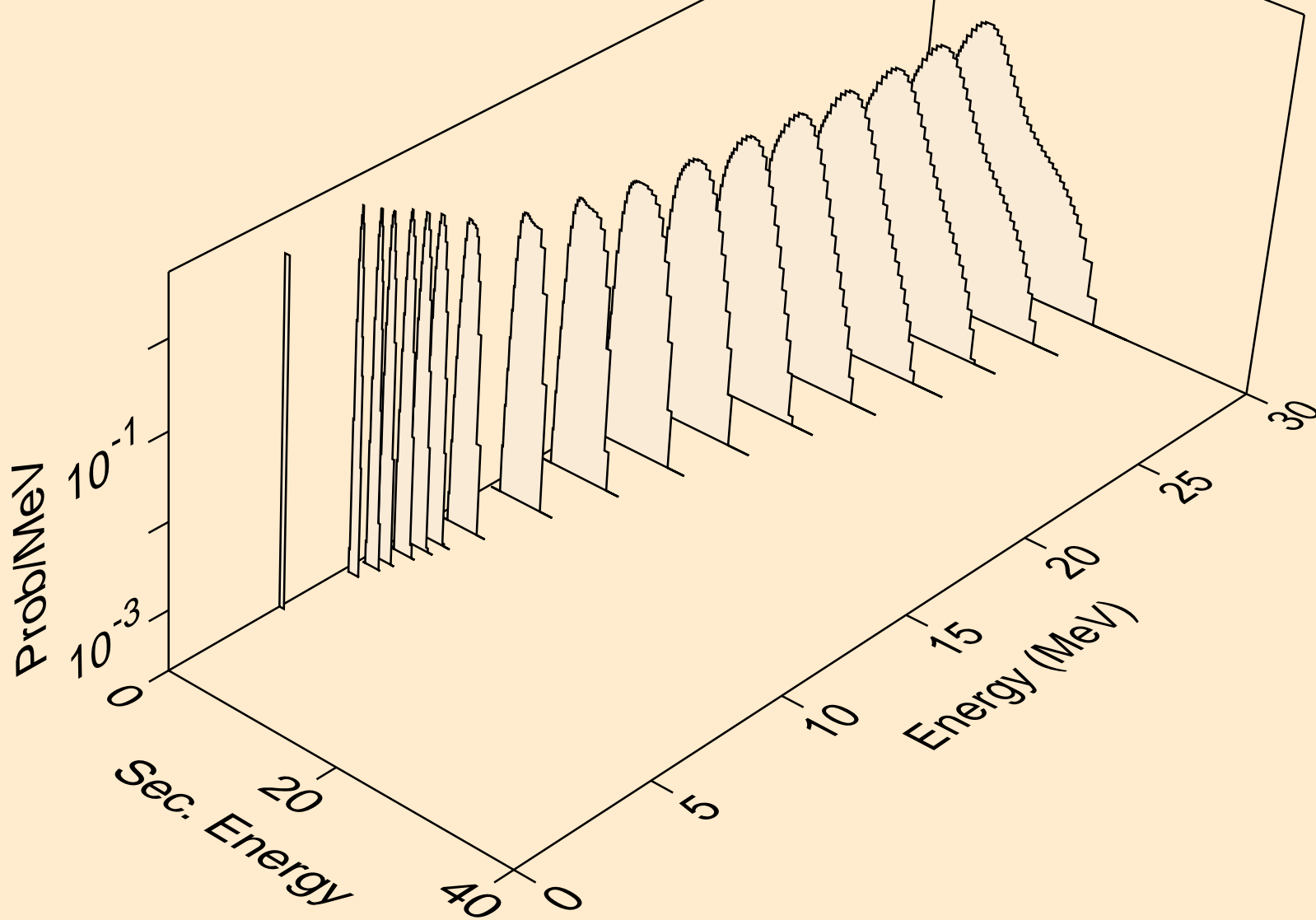

SB105 NEUTRON ACER TENDL-2023 LIBRARY; T=0.K  
protons from (n,npa)

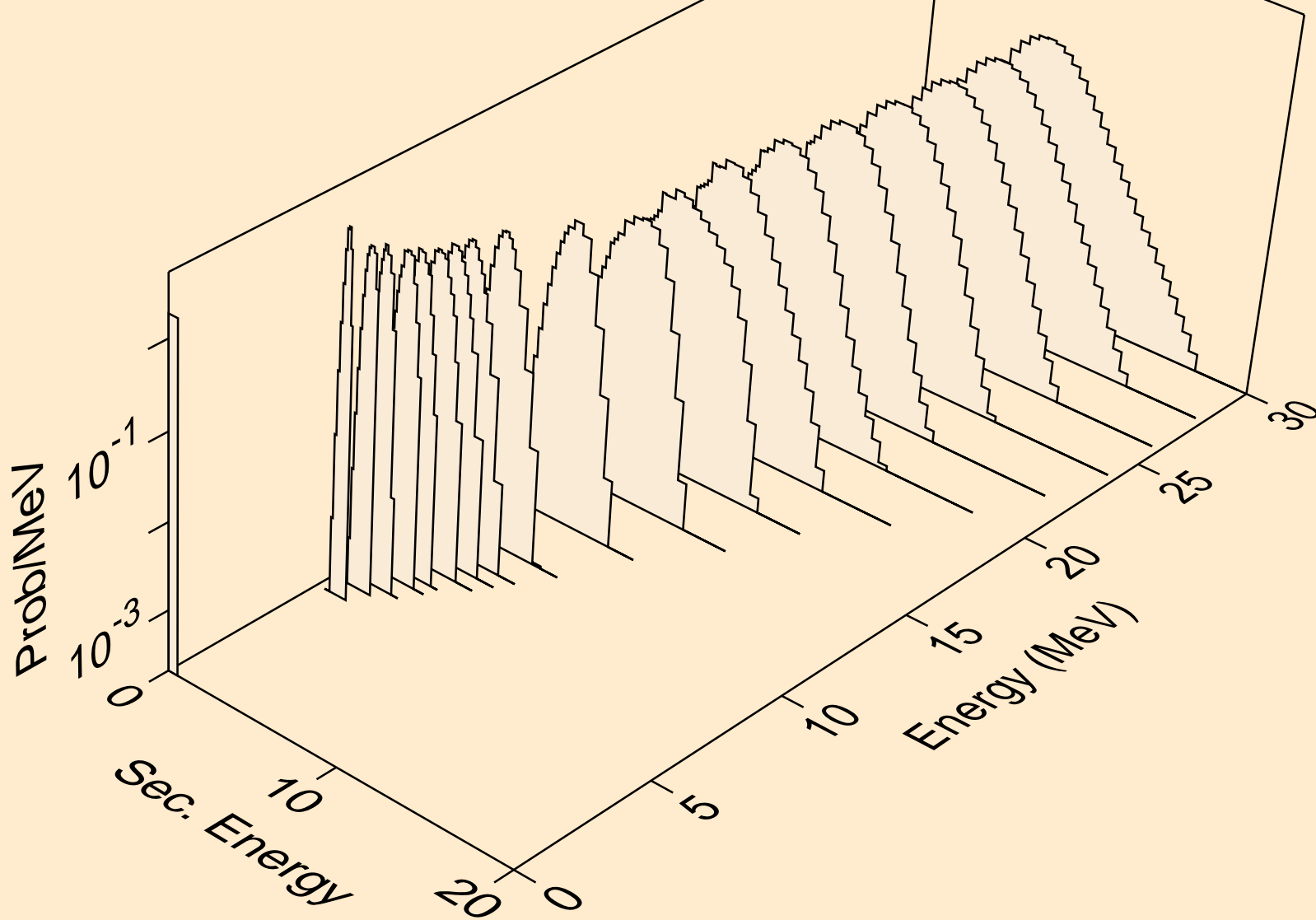

SB105 NEUTRON ACER TENDL-2023 LIBRARY; T=0.K  
protons from (n,p)

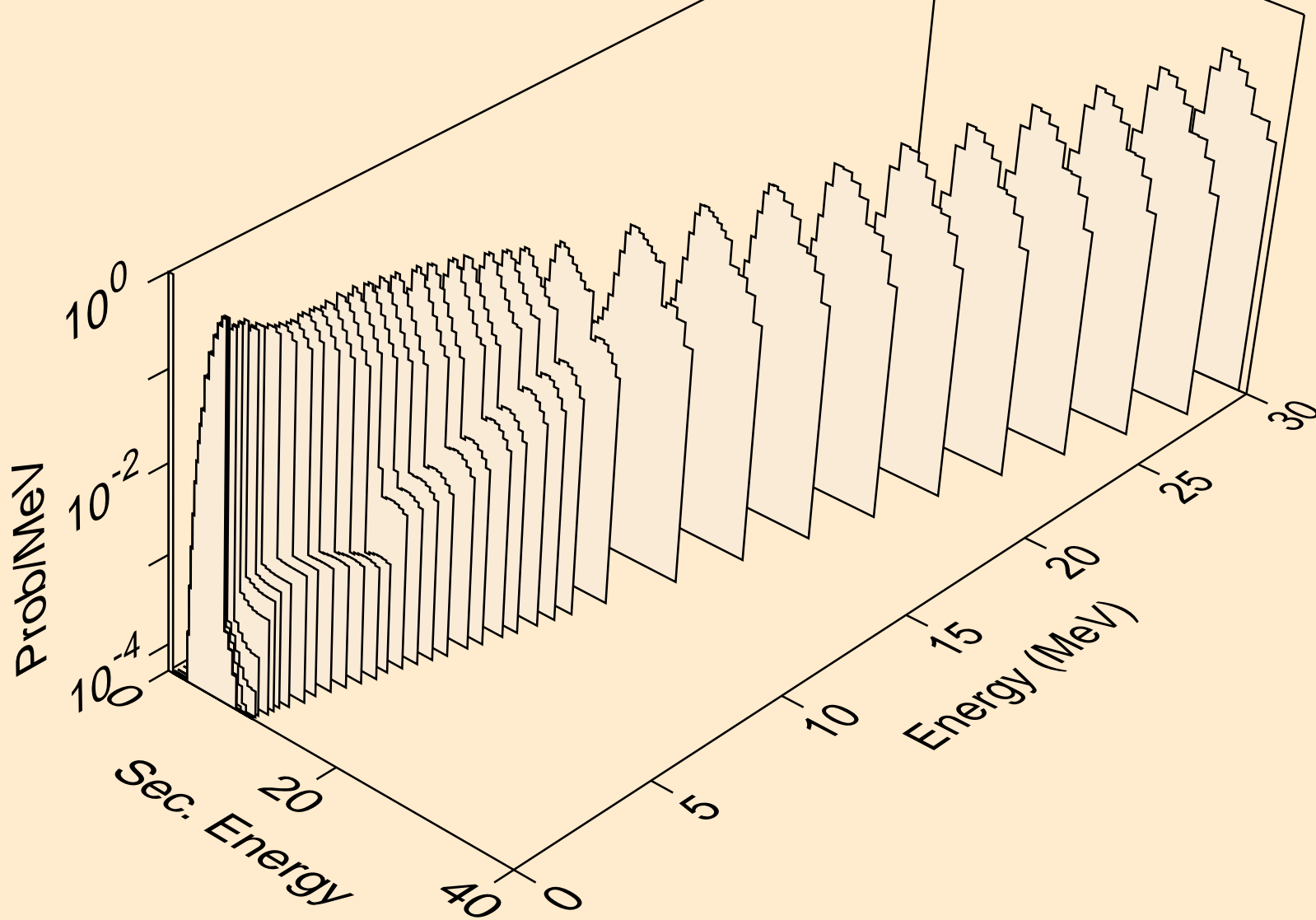

SB105 NEUTRON ACER TENDL-2023 LIBRARY; T=0.K  
protons from (n,2p)

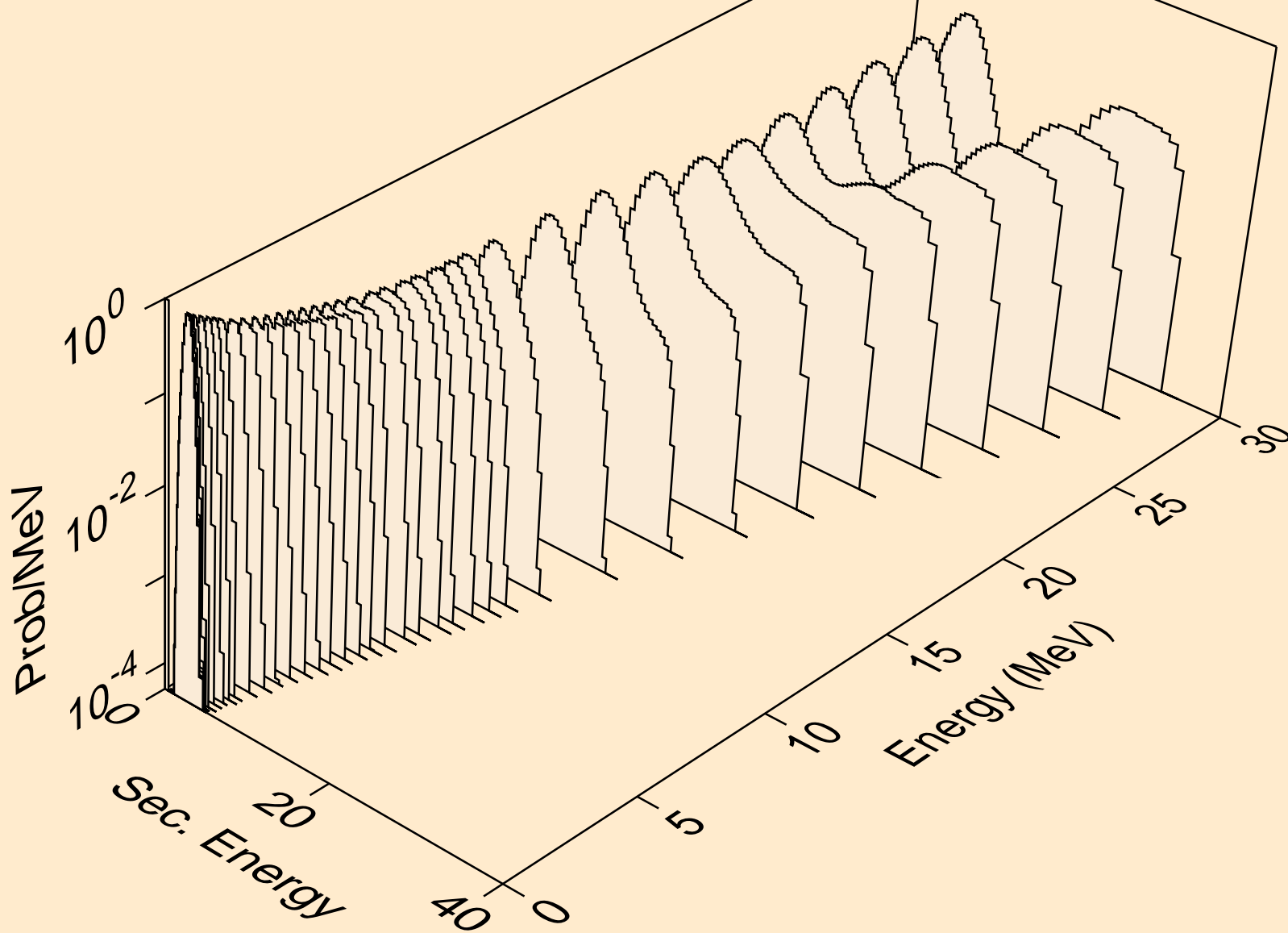



SB105 NEUTRON ACER TENDL-2023 LIBRARY; T=0.K  
protons from (n,p)

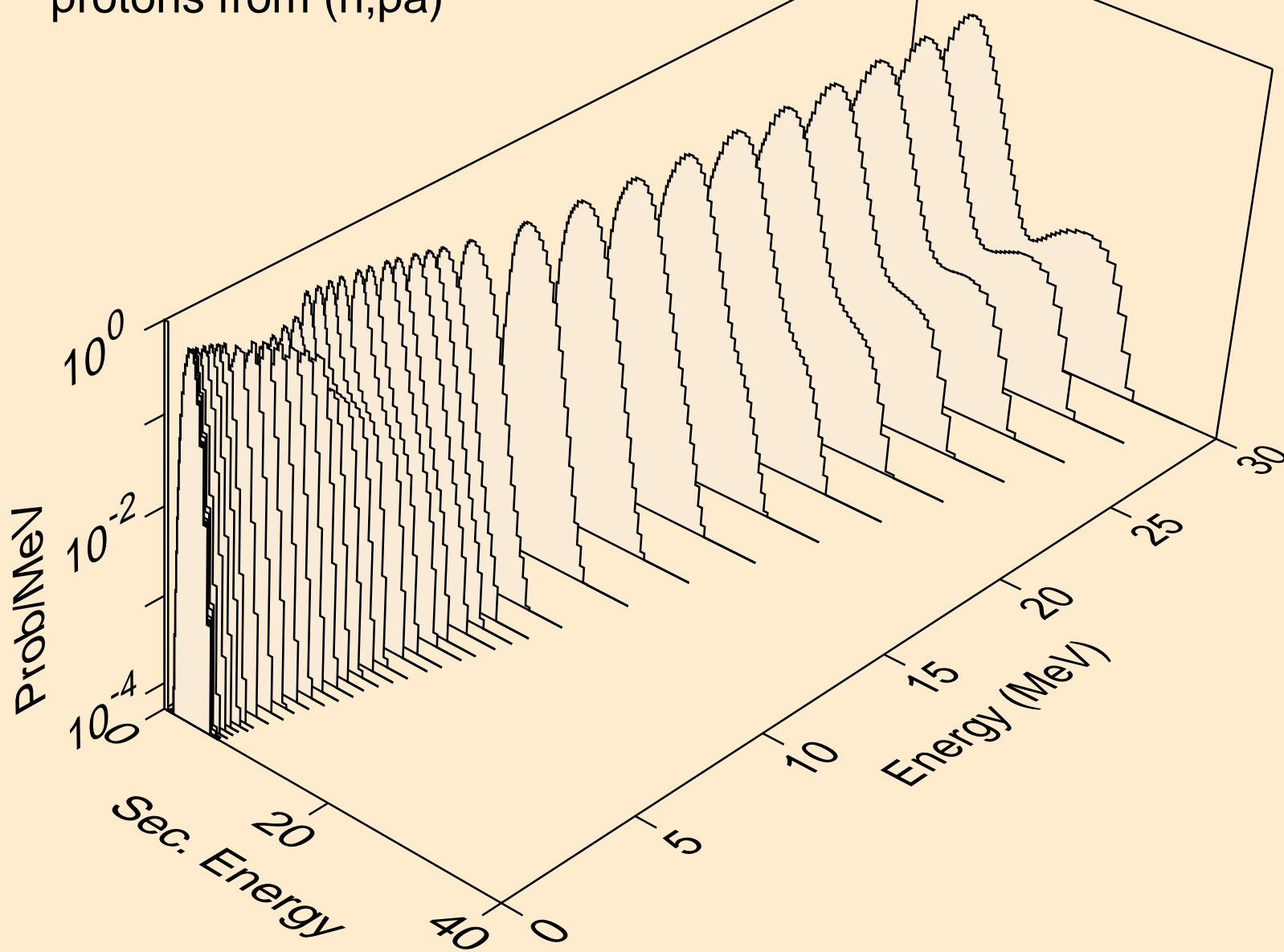

SB105 NEUTRON ACER TENDL-2023 LIBRARY; T=0.K  
protons from (n,pd)

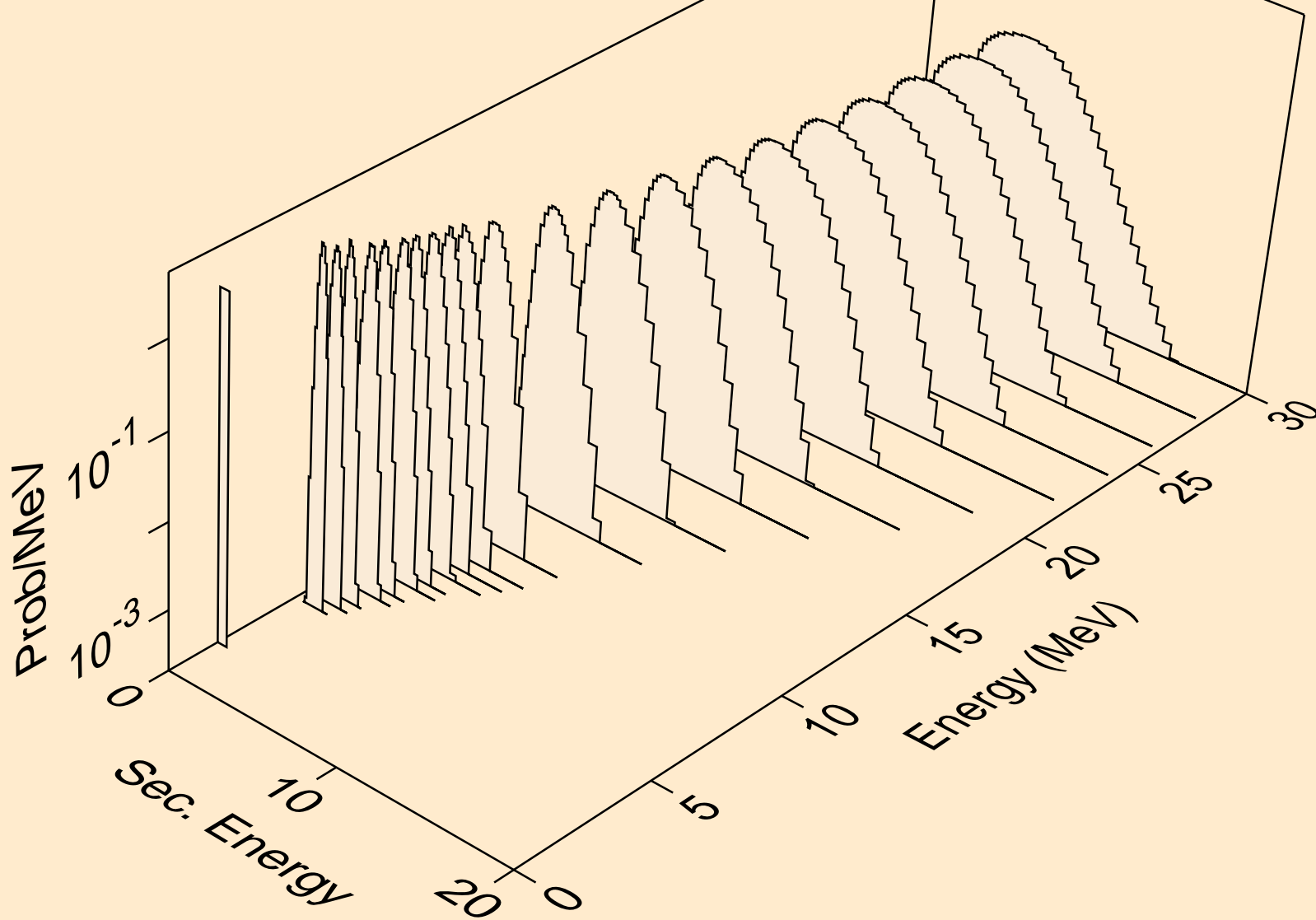

SB105 NEUTRON ACER TENDL-2023 LIBRARY; T=0.K  
protons from (n,pt)

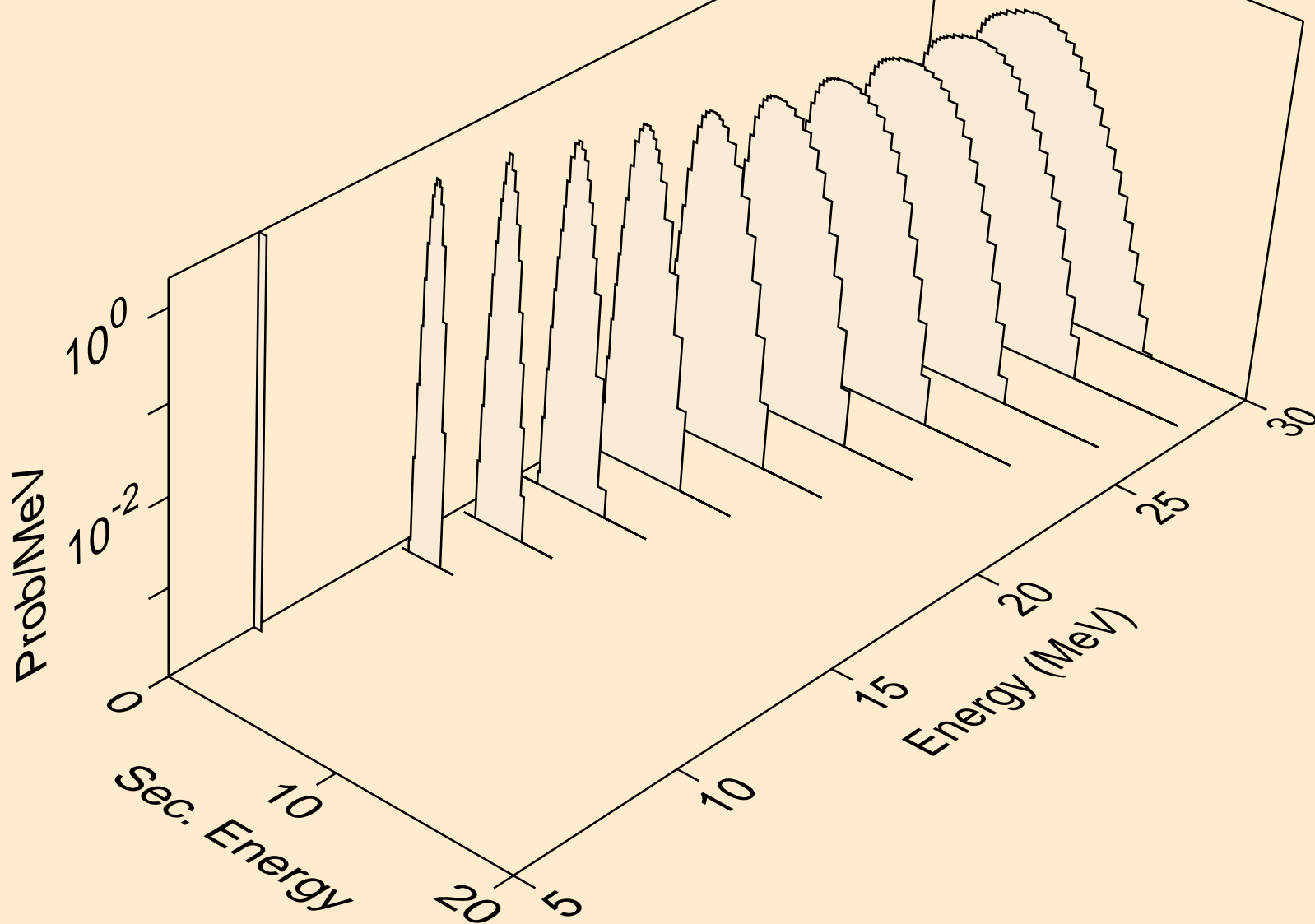

SB105 NEUTRON ACER TENDL-2023 LIBRARY; T=0.K  
deuterons from (n,x)

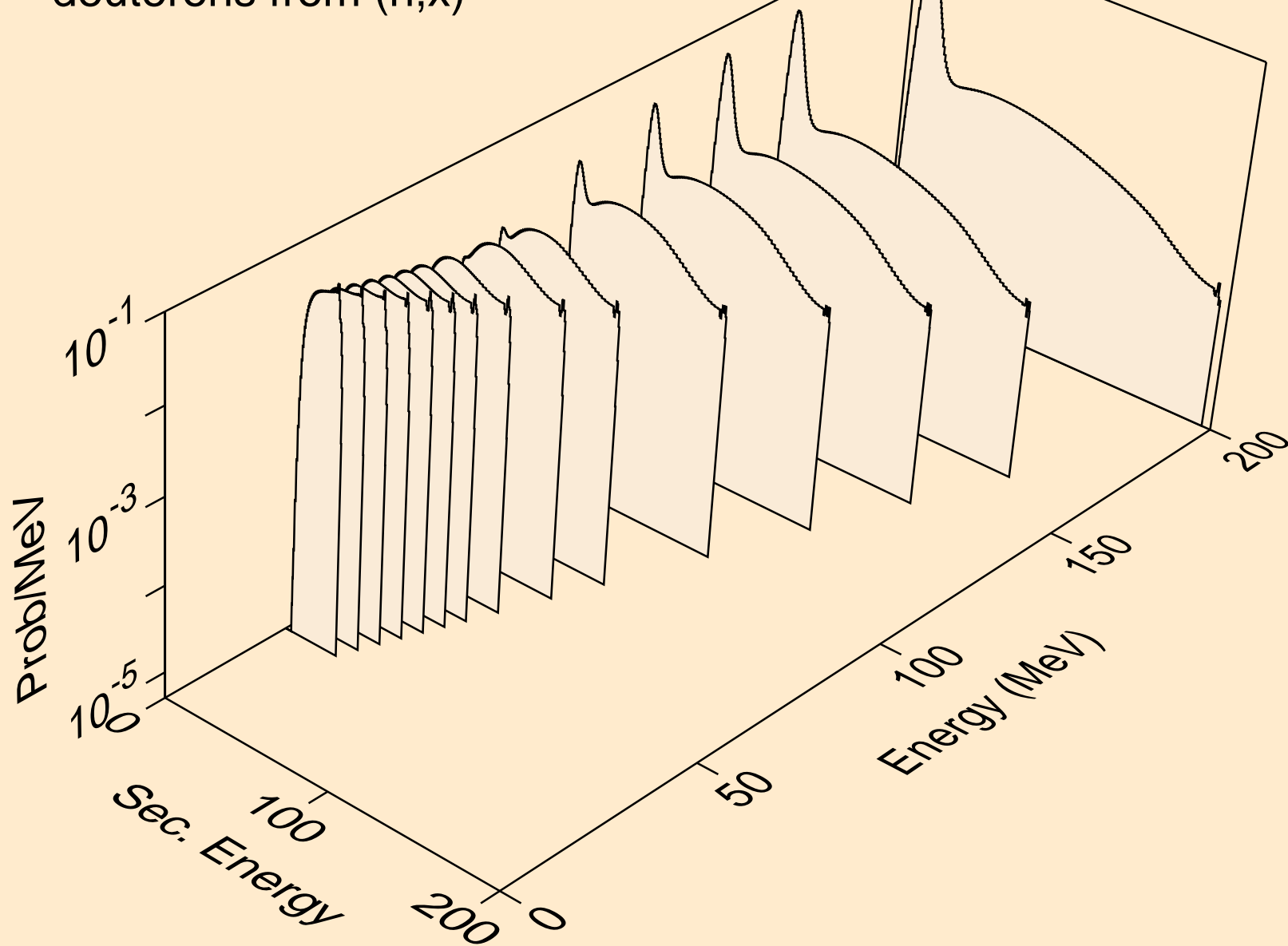

SB105 NEUTRON ACER TENDL-2023 LIBRARY; T=0.K  
deuterons from (n,2nd)

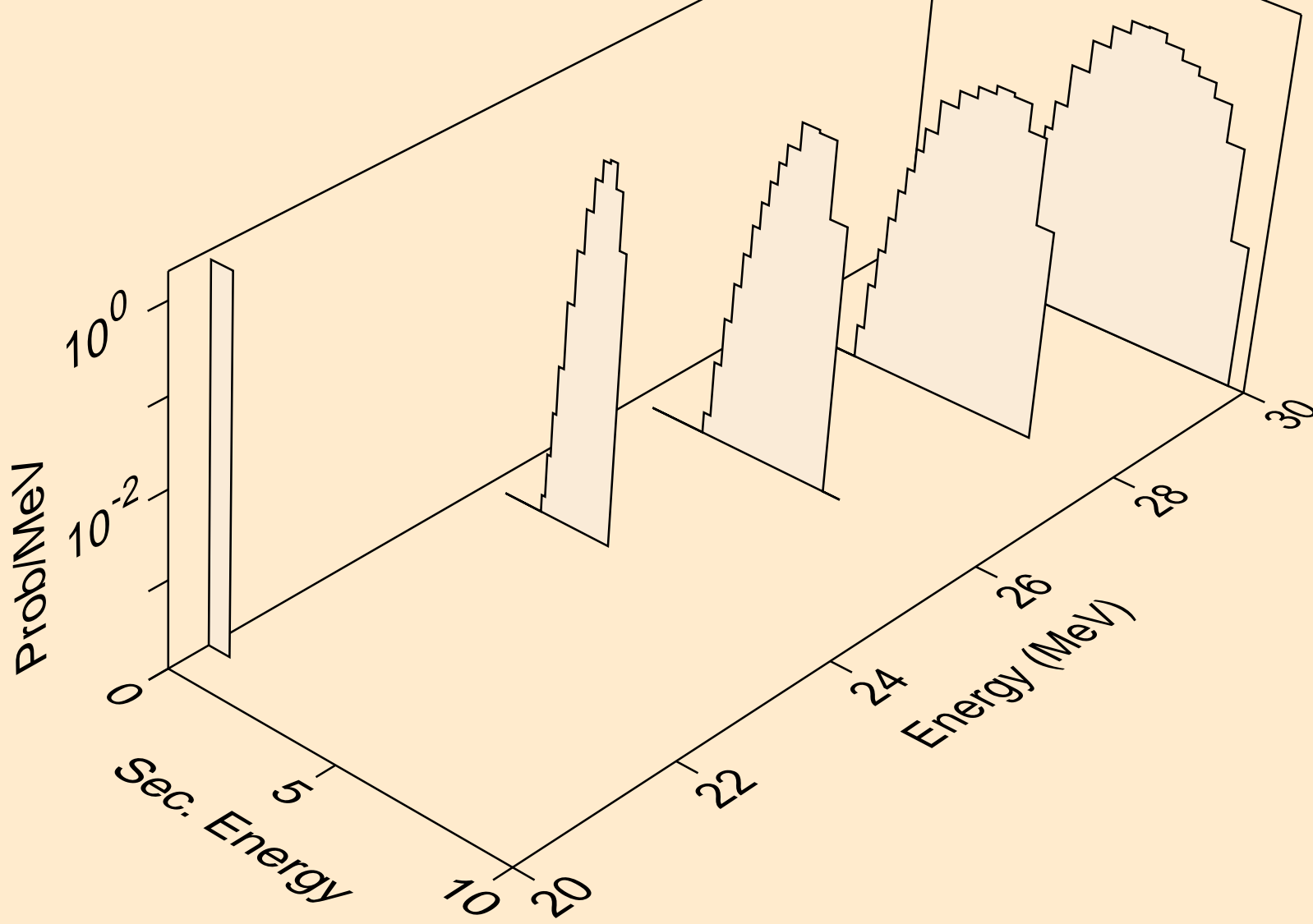

SB105 NEUTRON ACER TENDL-2023 LIBRARY; T=0.K  
deuterons from (n,n\*)d

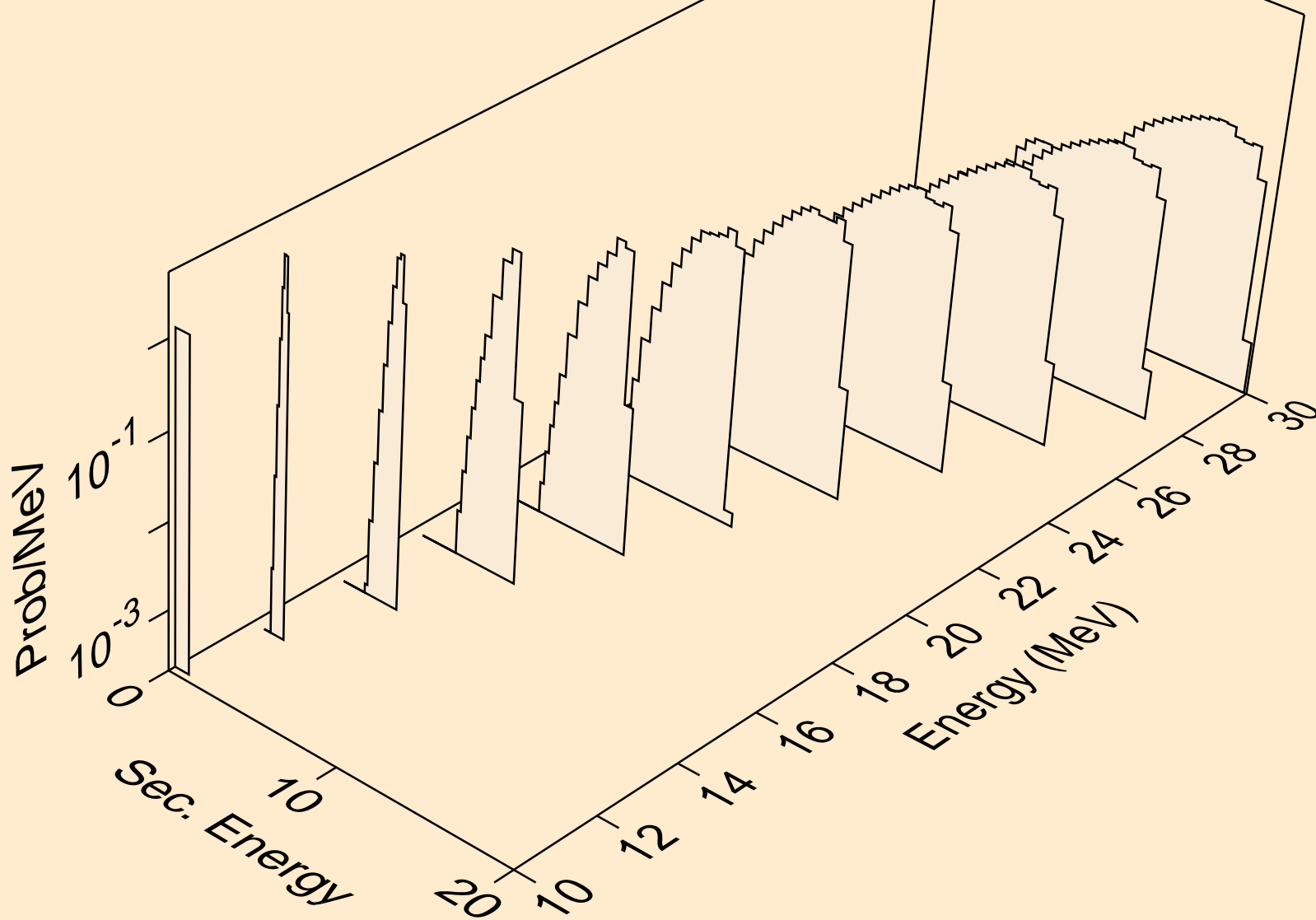

SB105 NEUTRON ACER TENDL-2023 LIBRARY; T=0.K  
deuterons from (n,d)

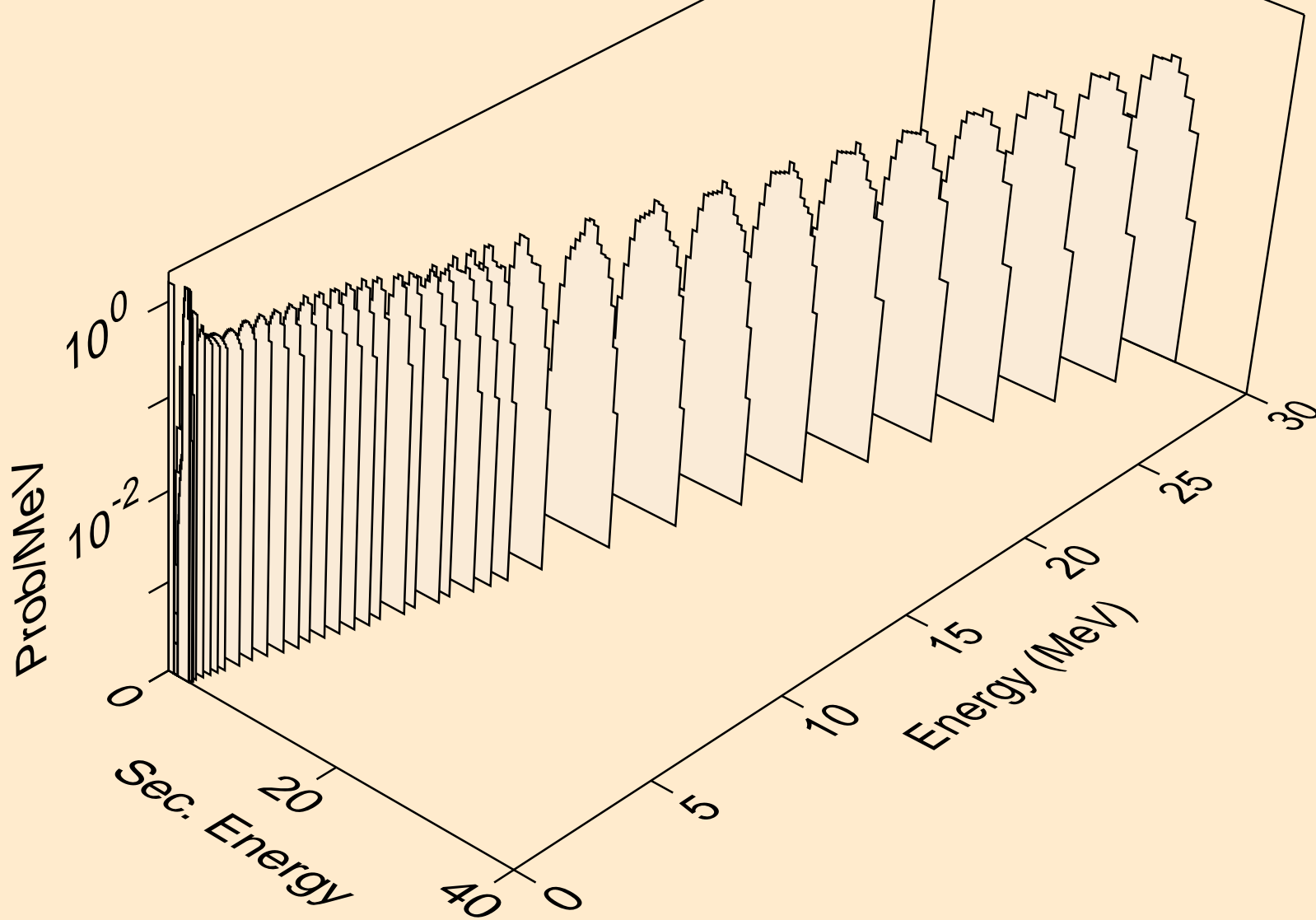

SB105 NEUTRON ACER TENDL-2023 LIBRARY; T=0.K  
deuterons from (n,d2a)

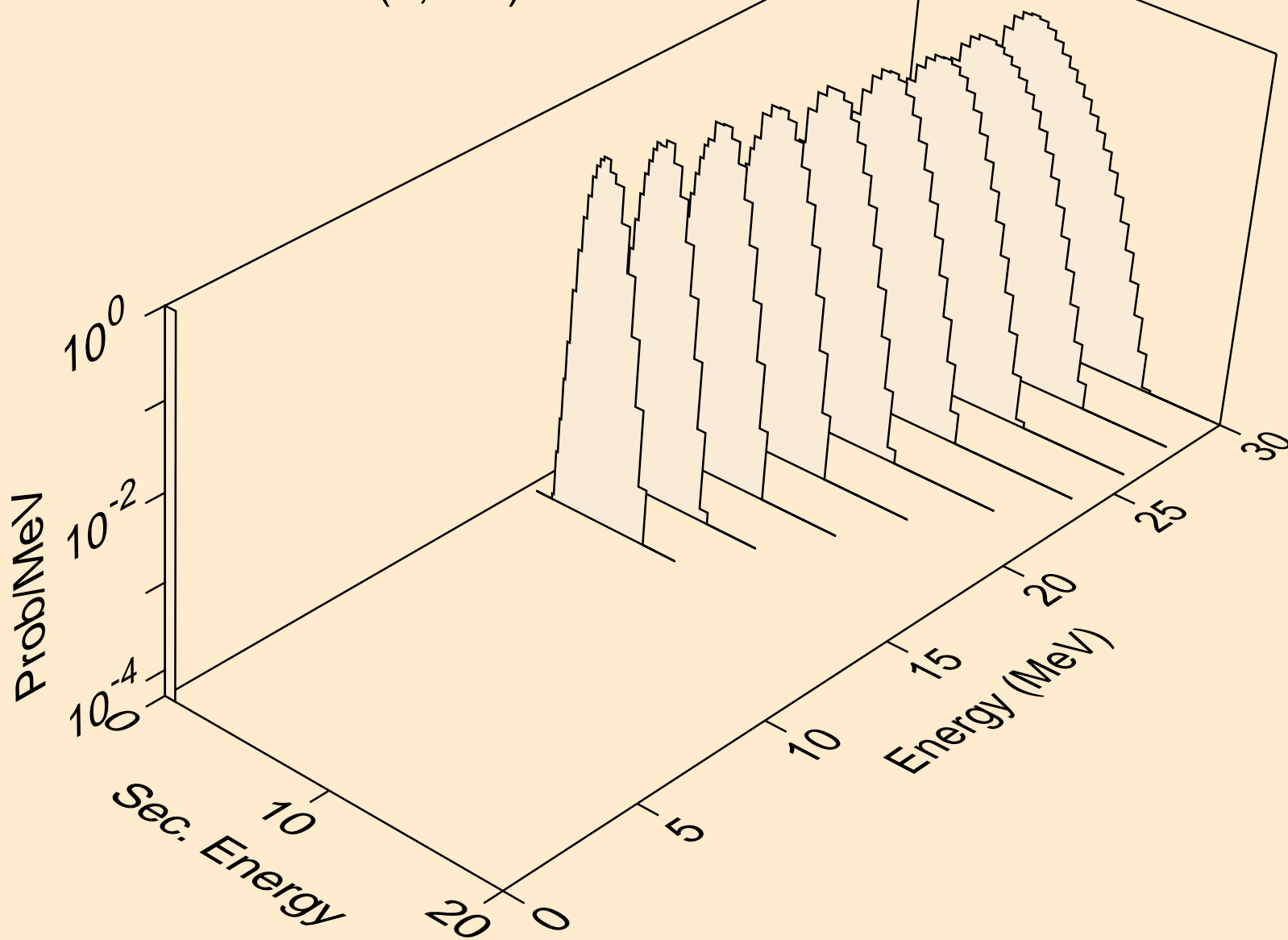



SB105 NEUTRON ACER TENDL-2023 LIBRARY; T=0.K  
deuterons from (n,pd)

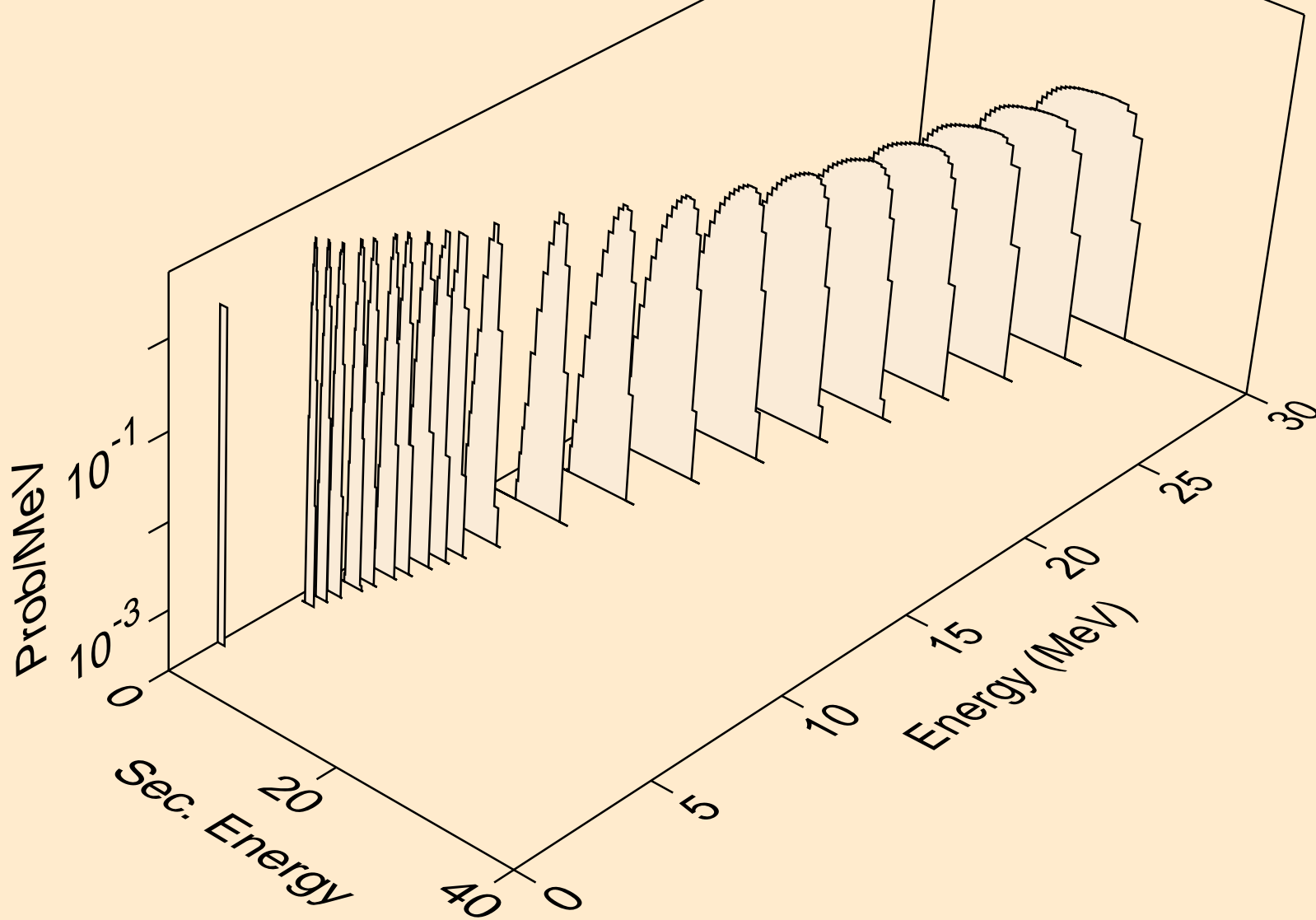

SB105 NEUTRON ACER TENDL-2023 LIBRARY; T=0.K  
deuterons from (n,da)

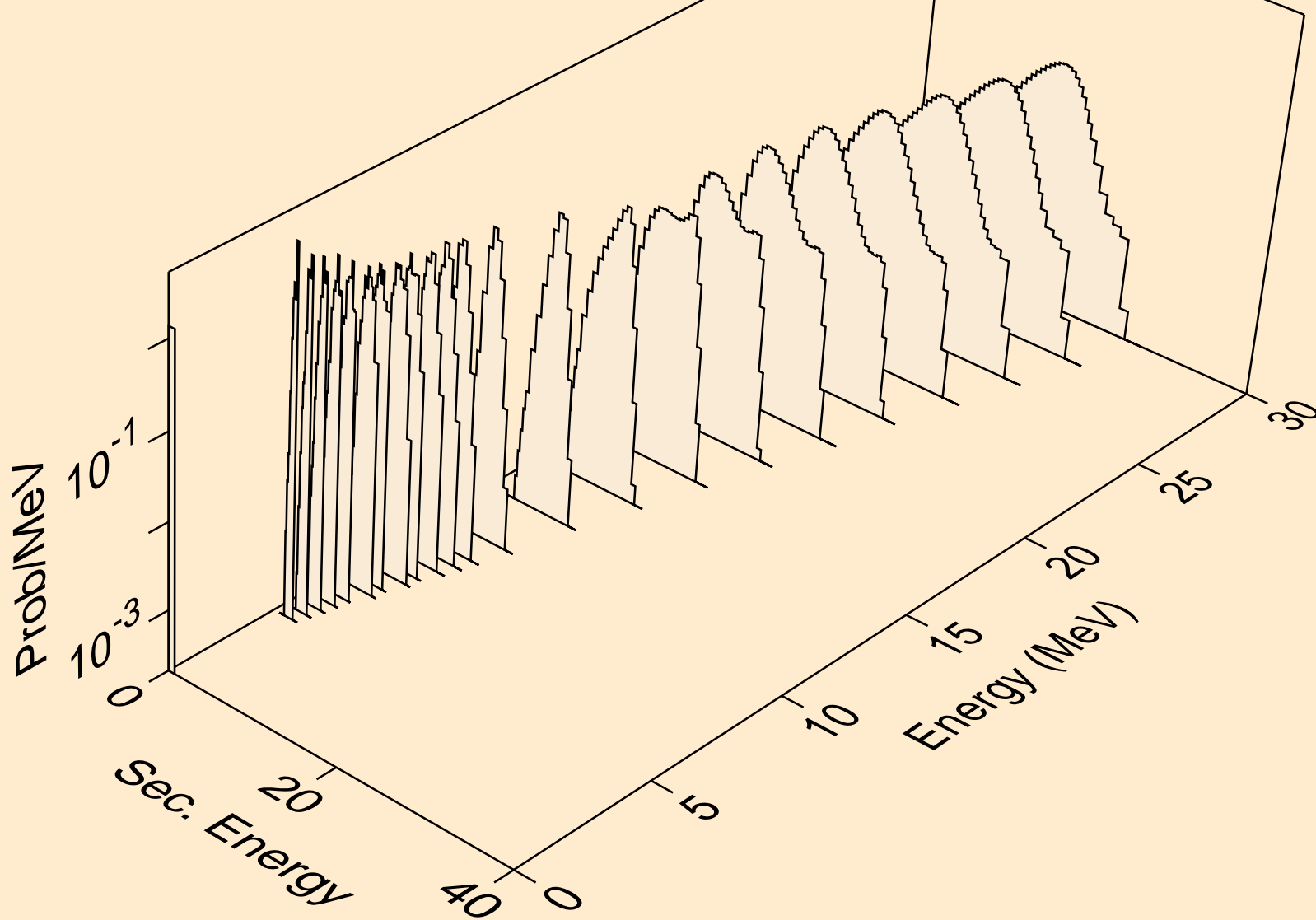

SB105 NEUTRON ACER TENDL-2023 LIBRARY; T=0.K  
tritons from (n,x)

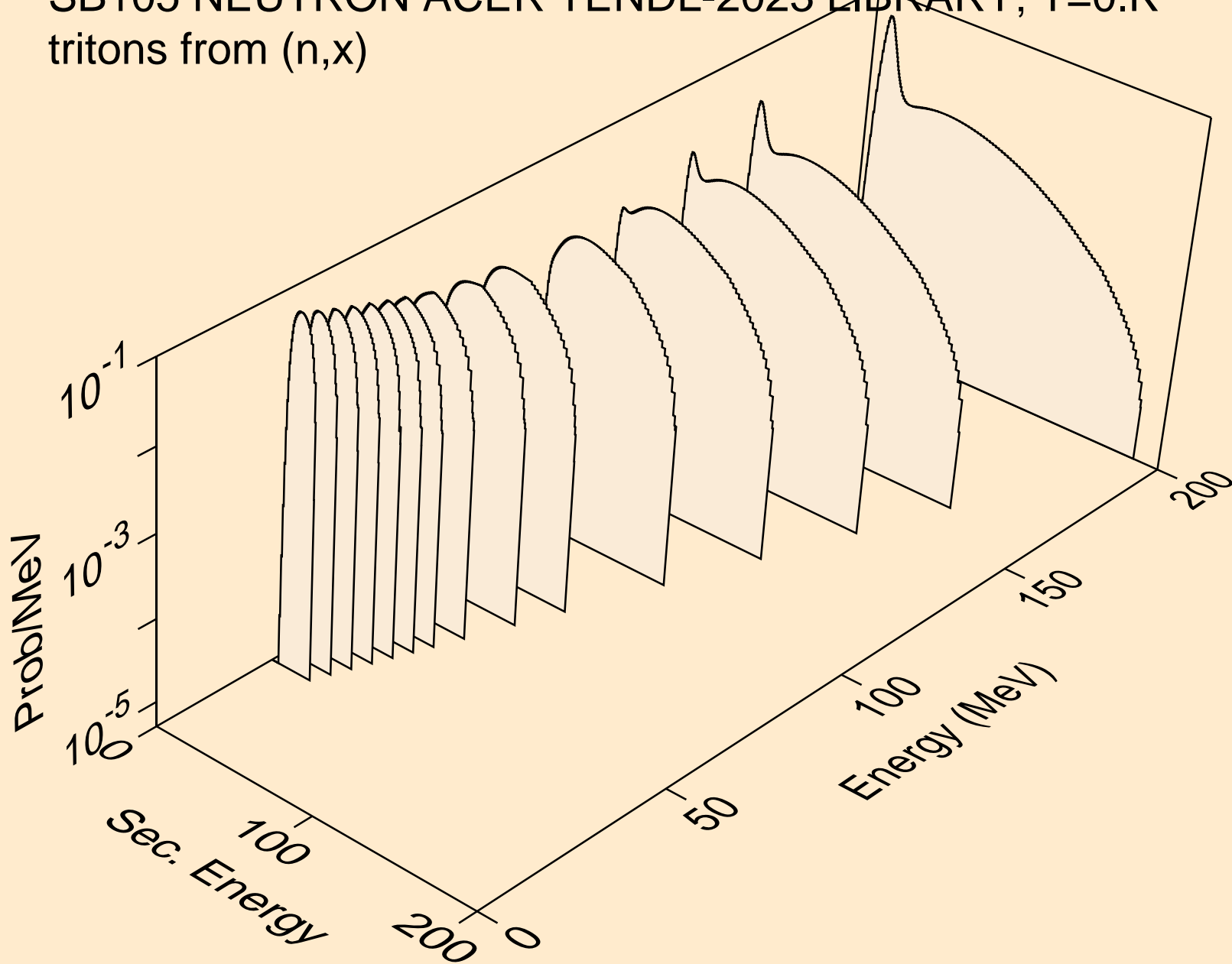

SB105 NEUTRON ACER TENDL-2023 LIBRARY; T=0.K  
tritons from (n,n\*)t

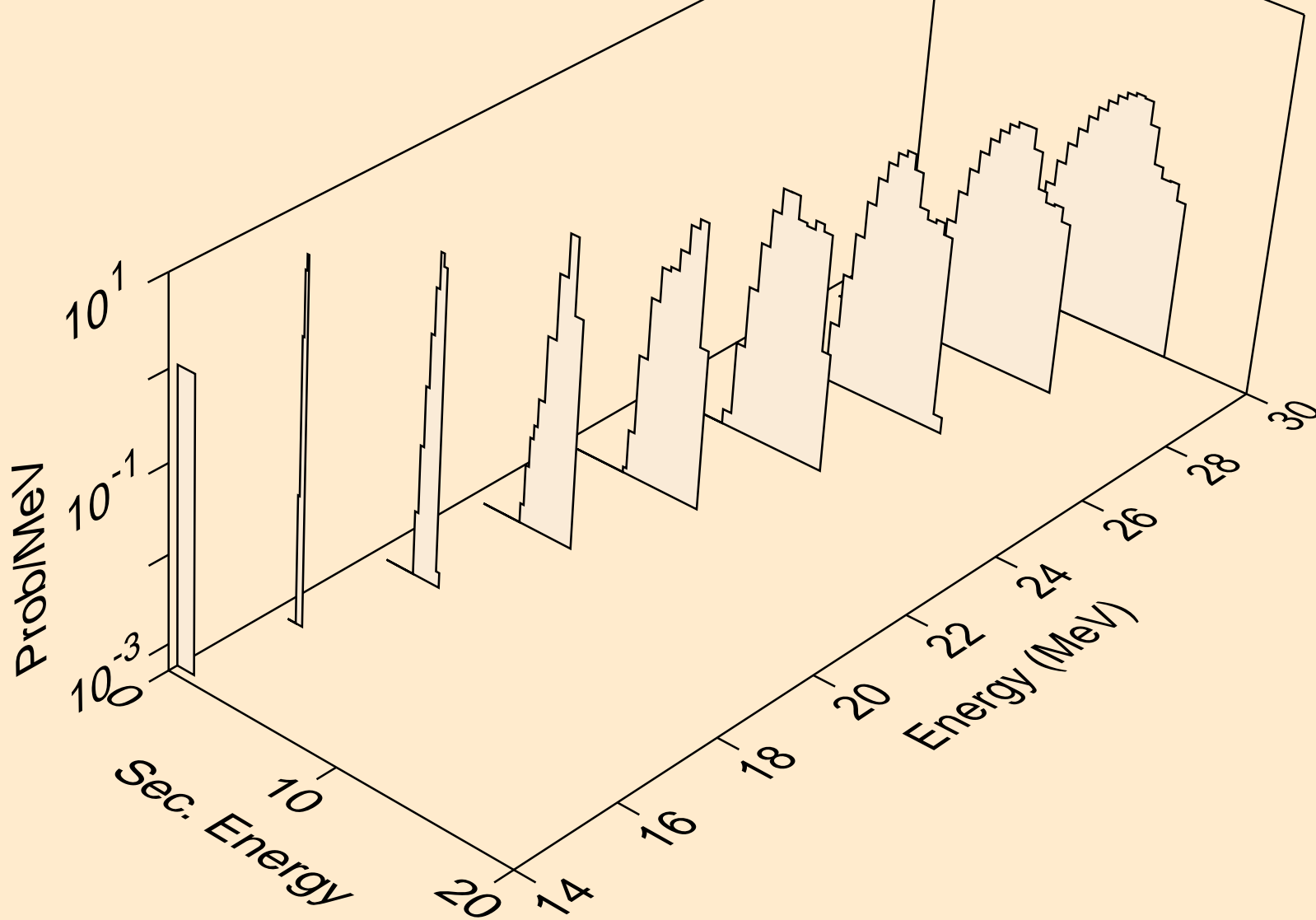

SB105 NEUTRON ACER TENDL-2023 LIBRARY; T=0.K  
tritons from (n,t)

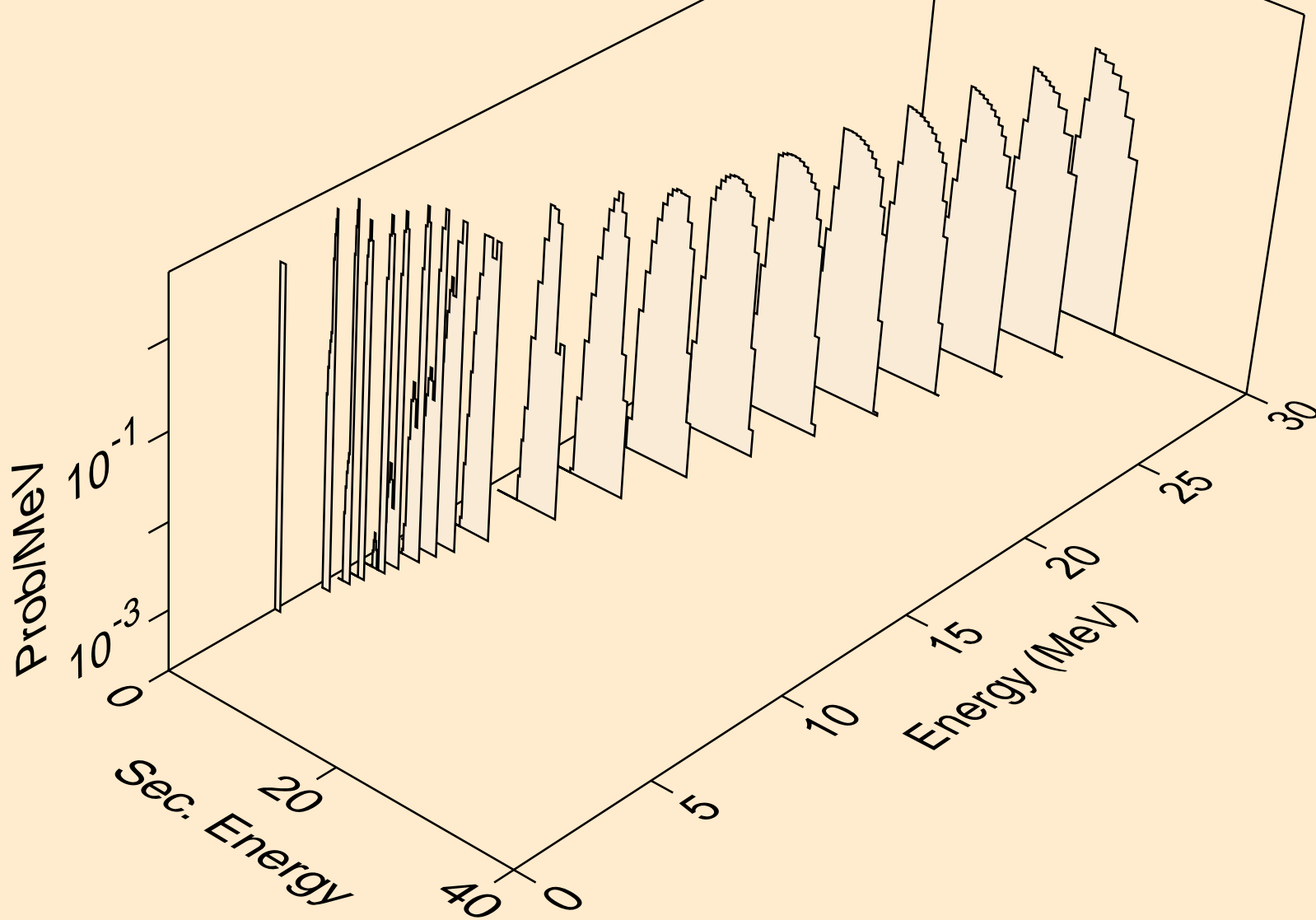

SB105 NEUTRON ACER TENDL-2023 LIBRARY; T=0.K  
tritons from (n,pt)

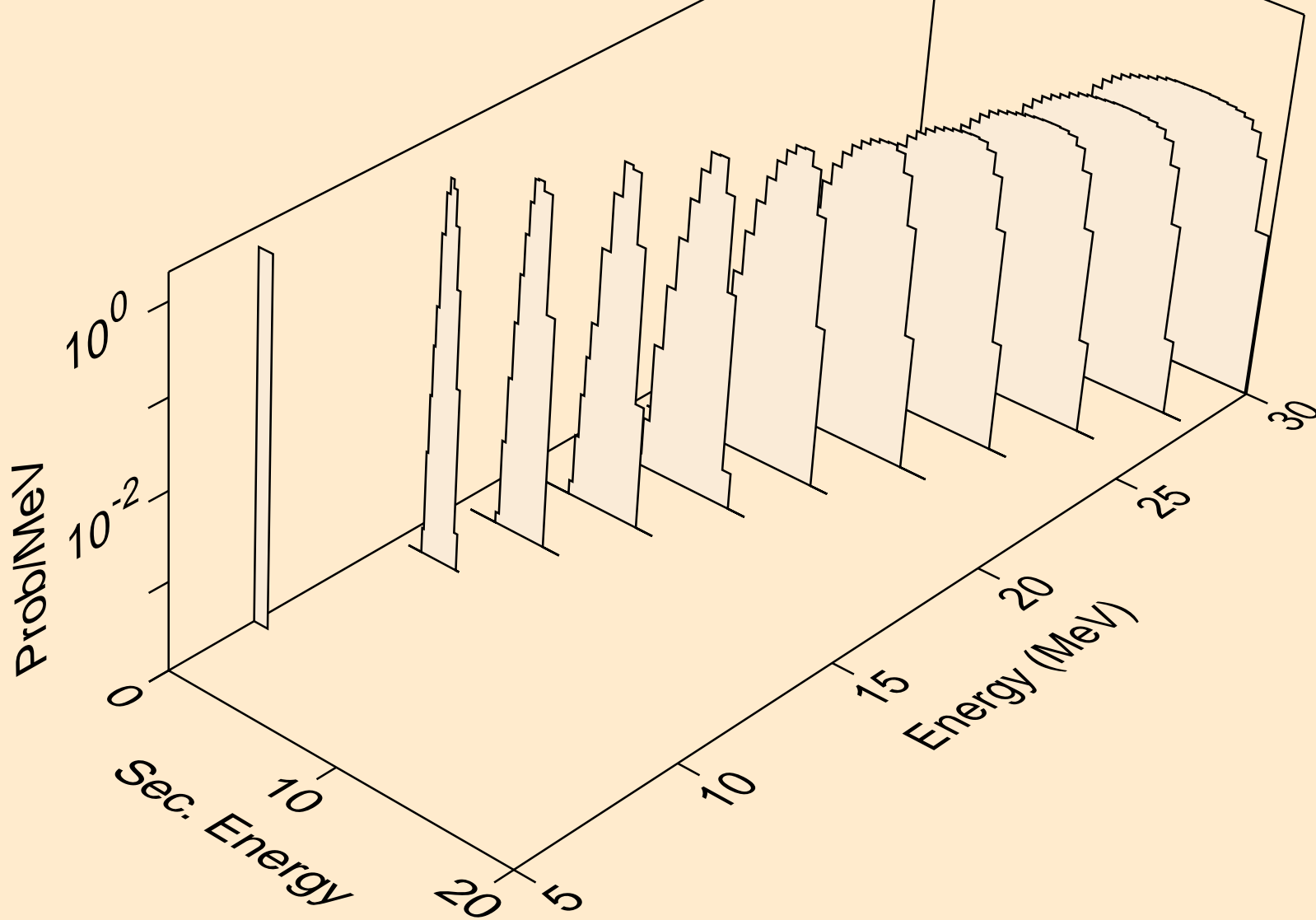

SB105 NEUTRON ACER TENDL-2023 LIBRARY; T=0.K  
he3s from (n,x)

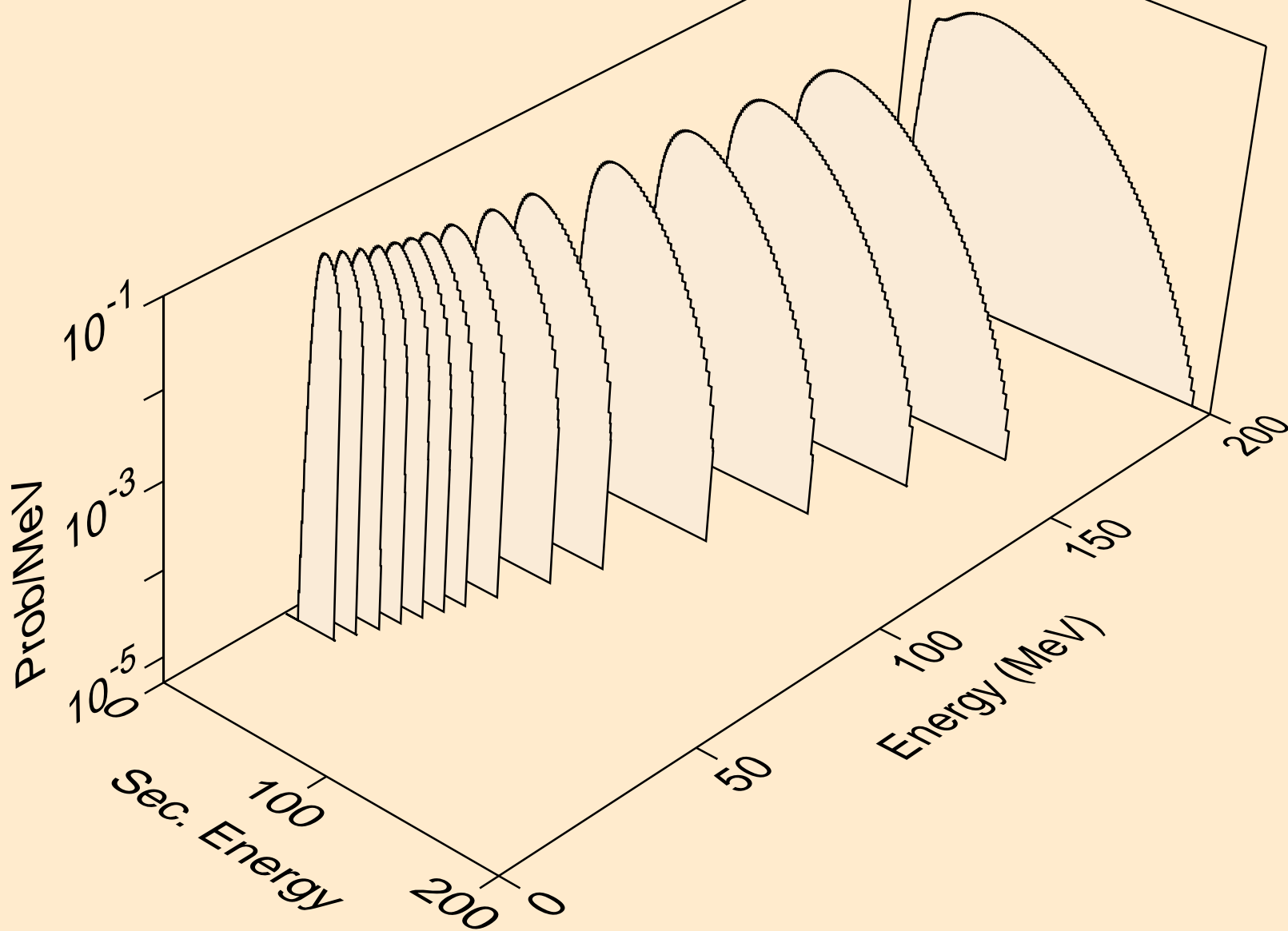

SB105 NEUTRON ACER TENDL-2023 LIBRARY; T=0.K  
he3s from (n,n\*)he3

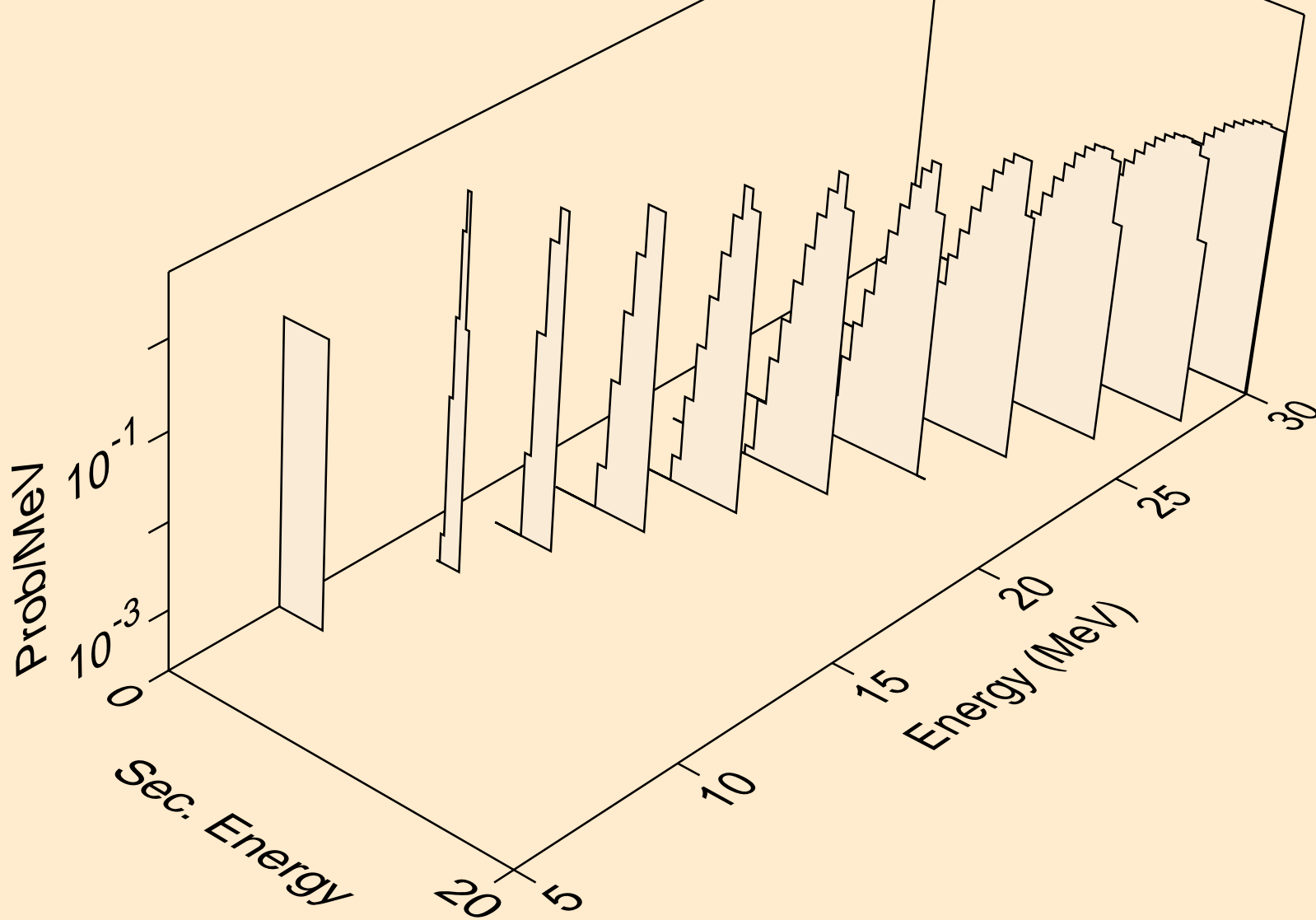



SB105 NEUTRON ACER TENDL-2023 LIBRARY; T=0.K  
he3s from (n,he3)

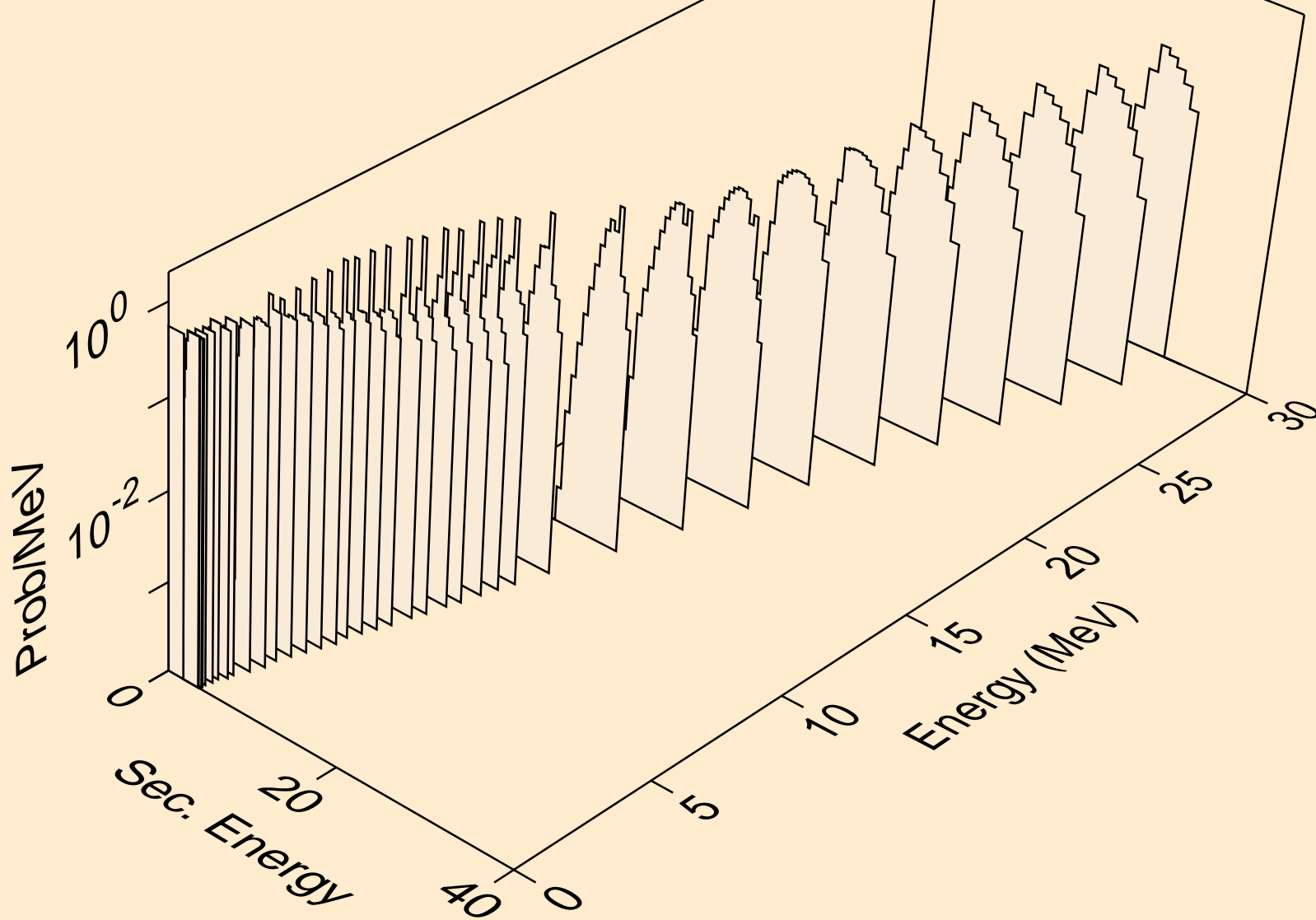

SB105 NEUTRON ACER TENDL-2023 LIBRARY; T=0.K  
alphas from (n,x)

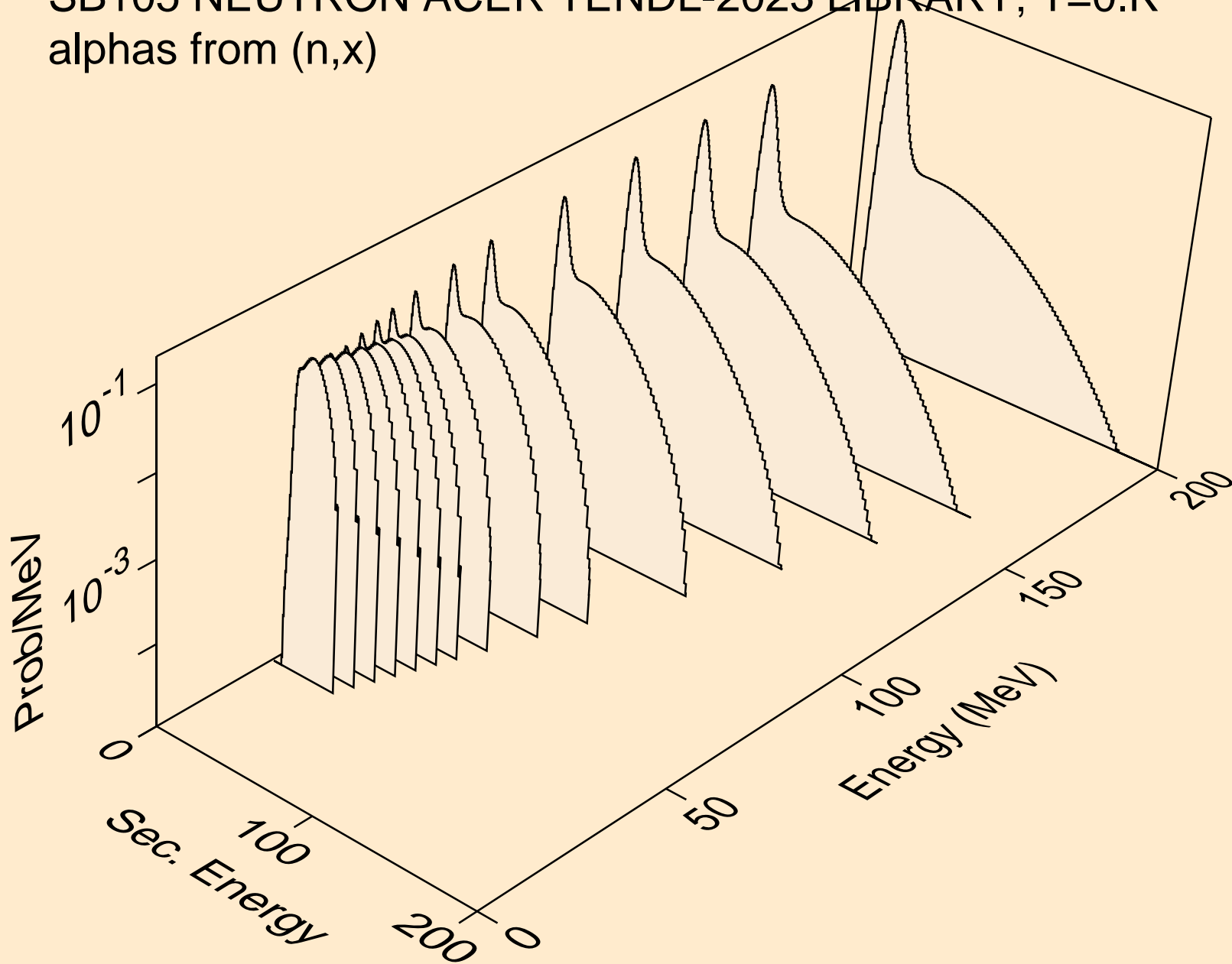

SB105 NEUTRON ACER TENDL-2023 LIBRARY; T=0.K  
alphas from (n,n\*)a

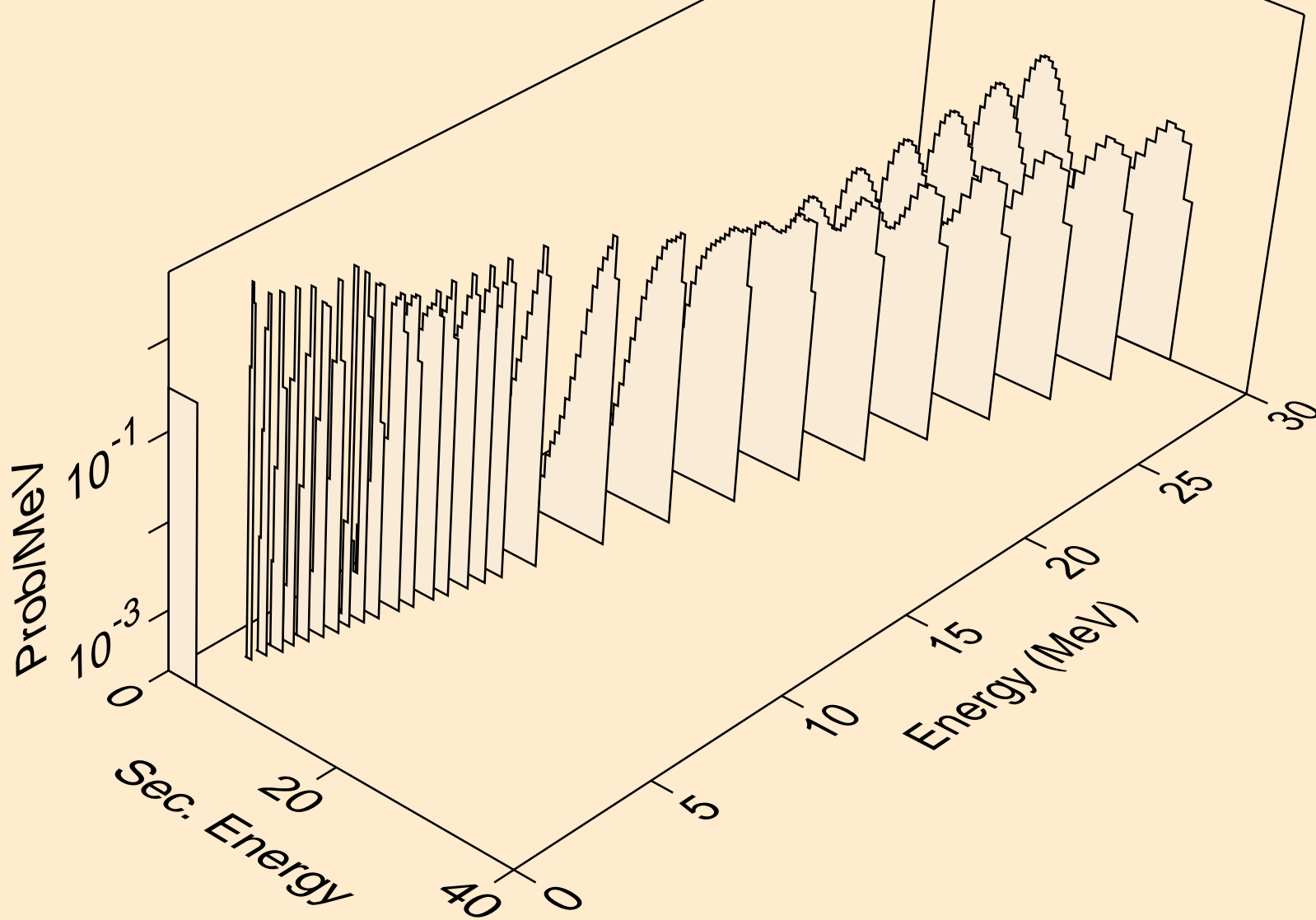

SB105 NEUTRON ACER TENDL-2023 LIBRARY; T=0.K  
alphas from (n,2n)a

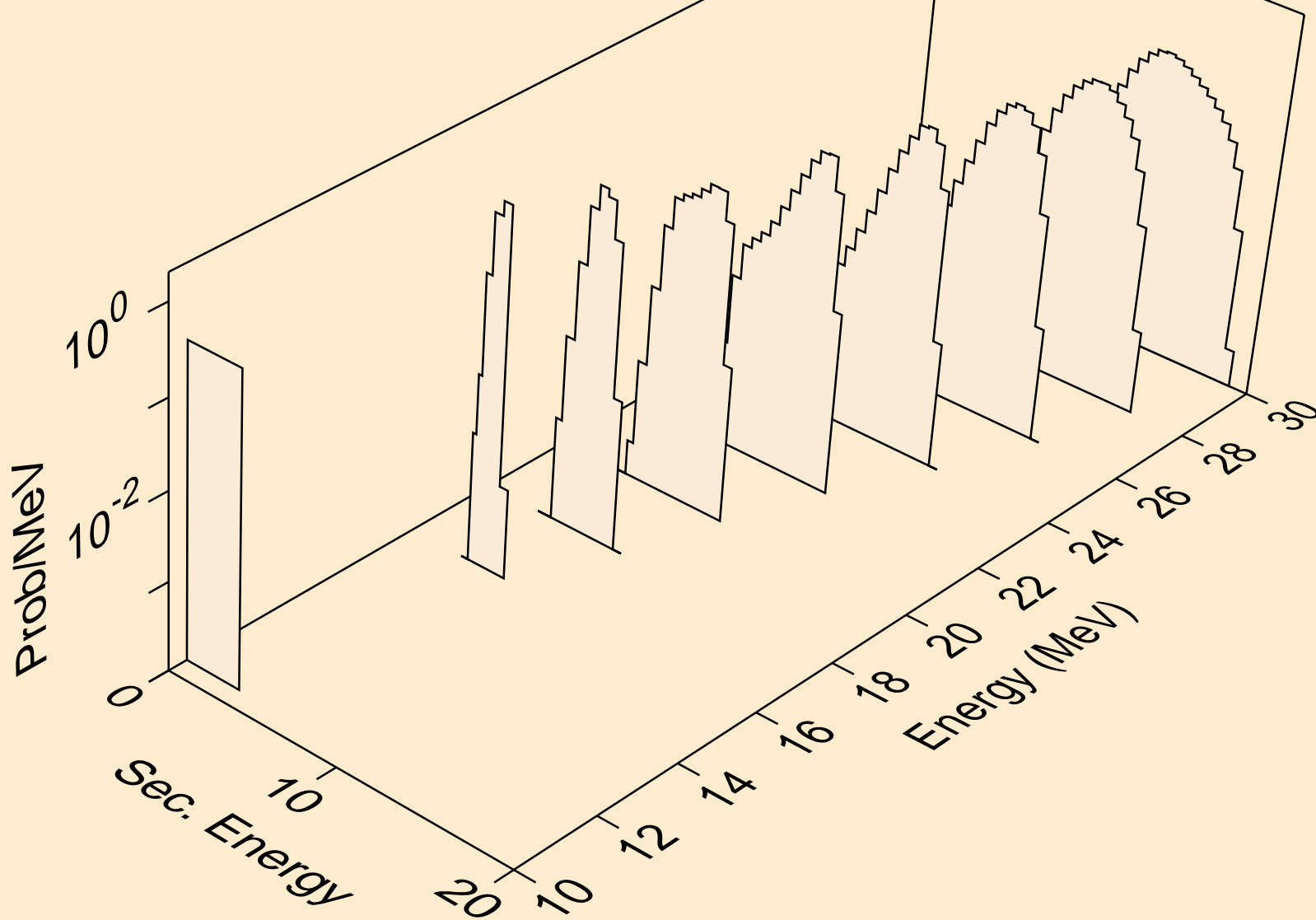

SB105 NEUTRON ACER TENDL-2023 LIBRARY; T=0.K  
alphas from (n,n\*)2a

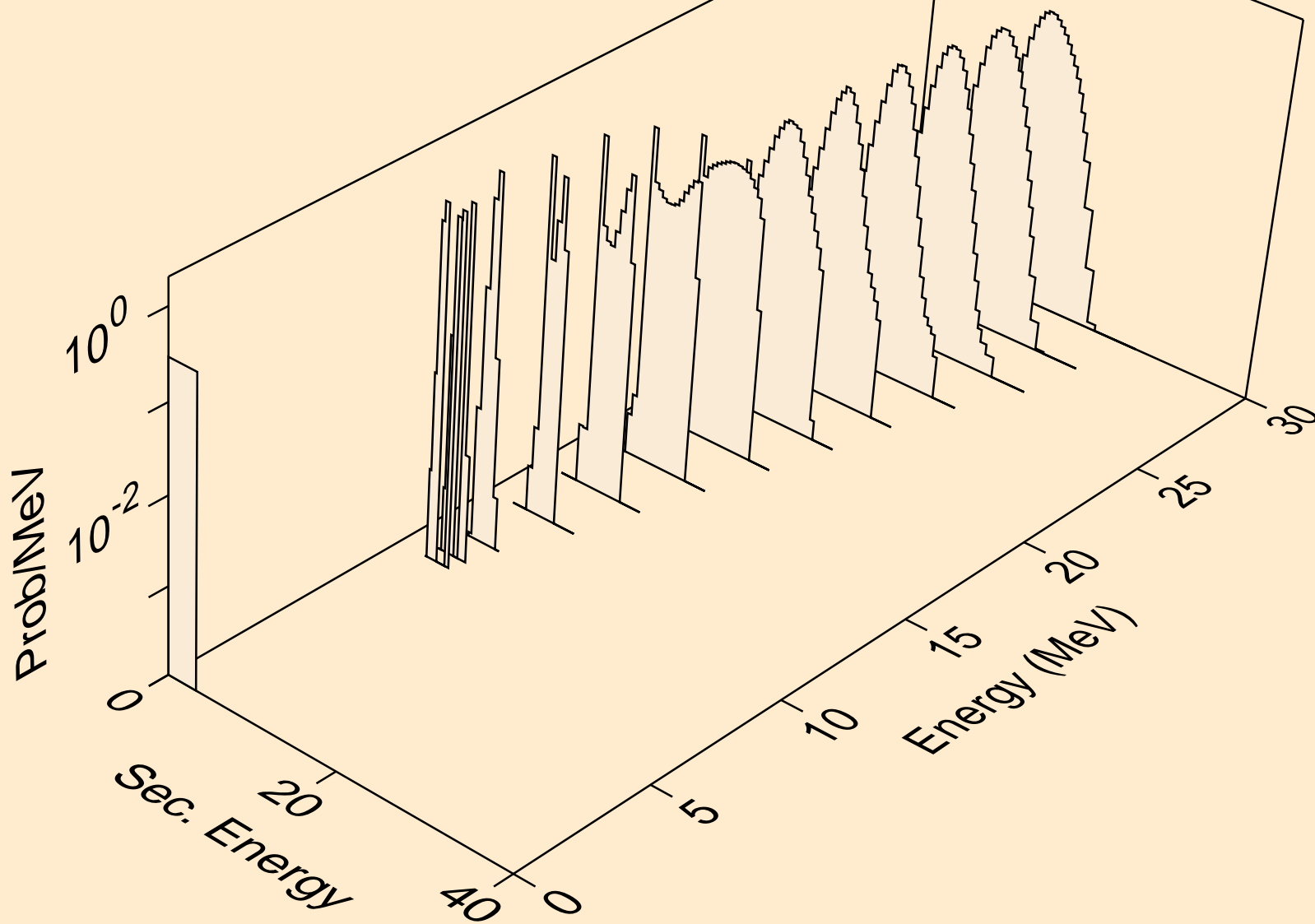

SB105 NEUTRON ACER TENDL-2023 LIBRARY; T=0.K  
alphas from (n,npa)

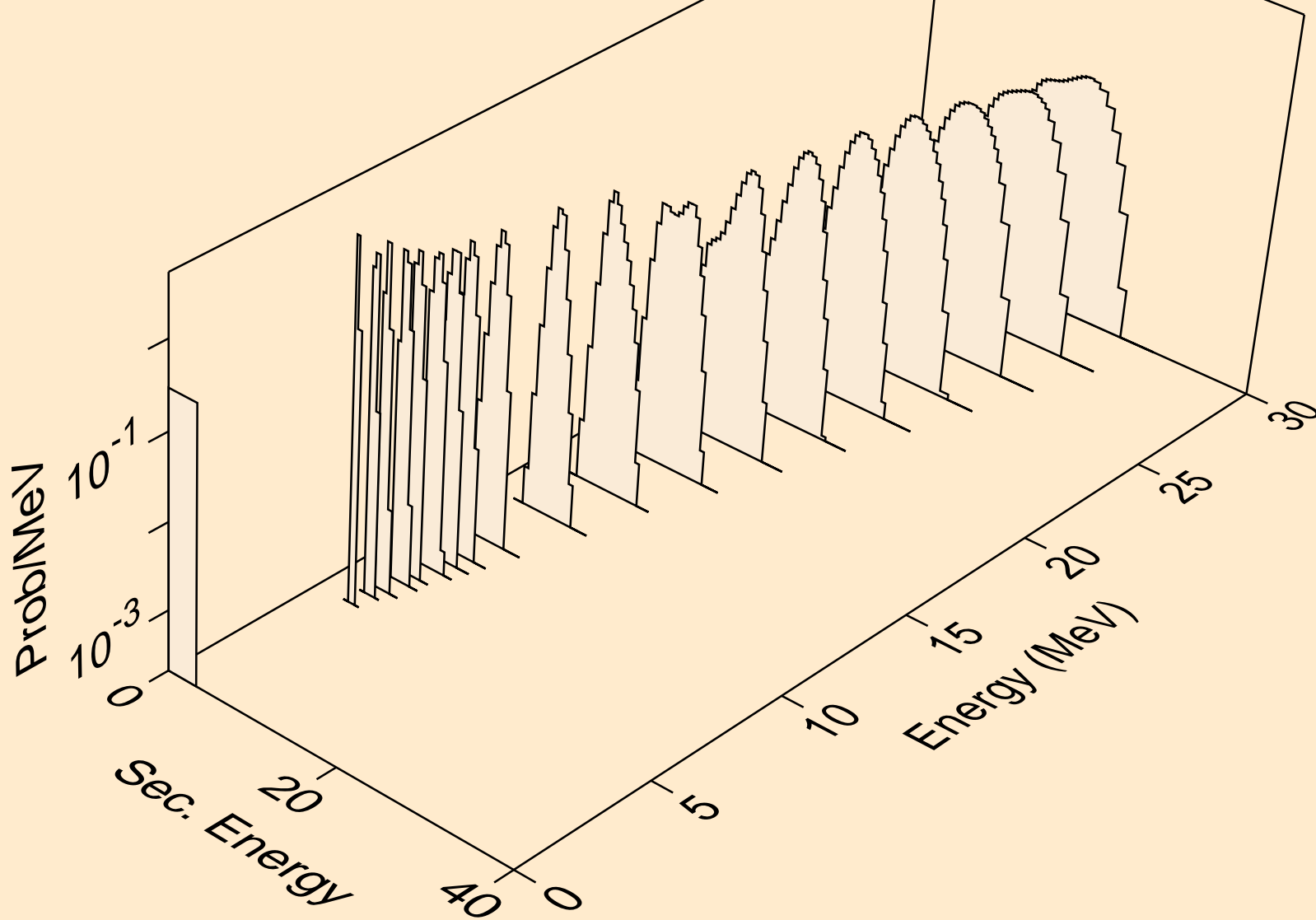

SB105 NEUTRON ACER TENDL-2023 LIBRARY; T=0.K  
alphas from (n,a)

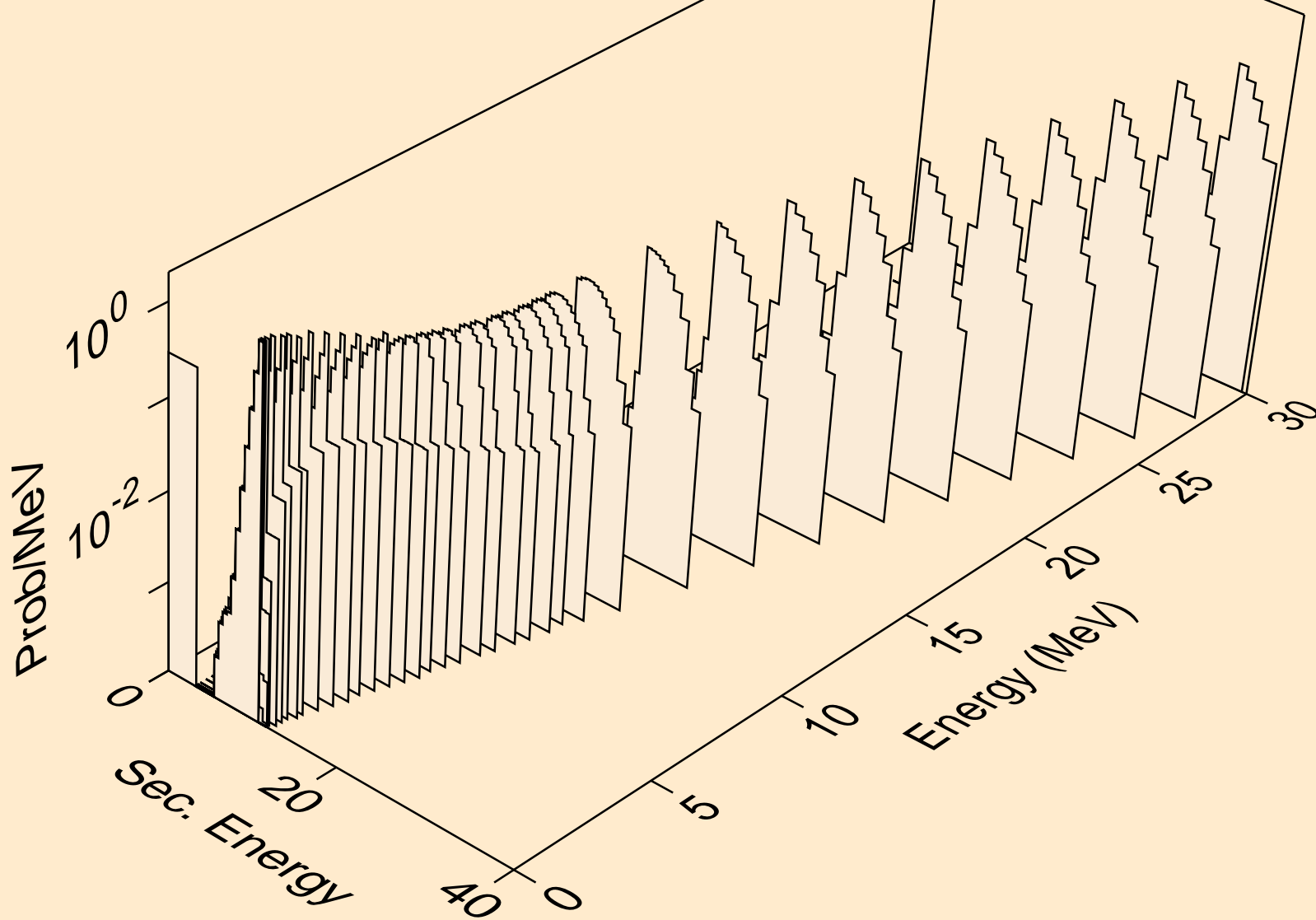

SB105 NEUTRON ACER TENDL-2023 LIBRARY; T=0.K  
alphas from (n,2a)

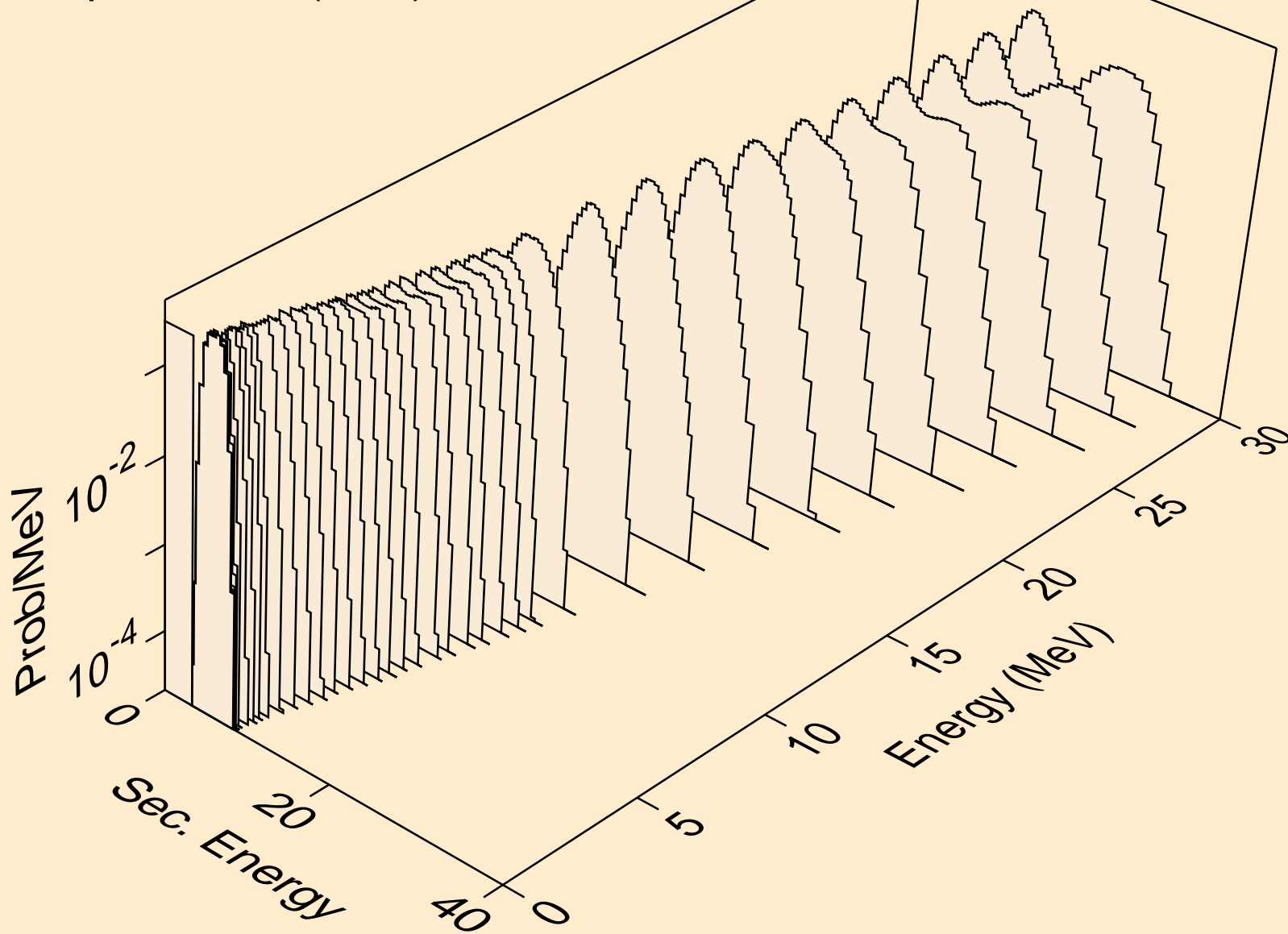



SB105 NEUTRON ACER TENDL-2023 LIBRARY; T=0.K  
alphas from (n,3a)

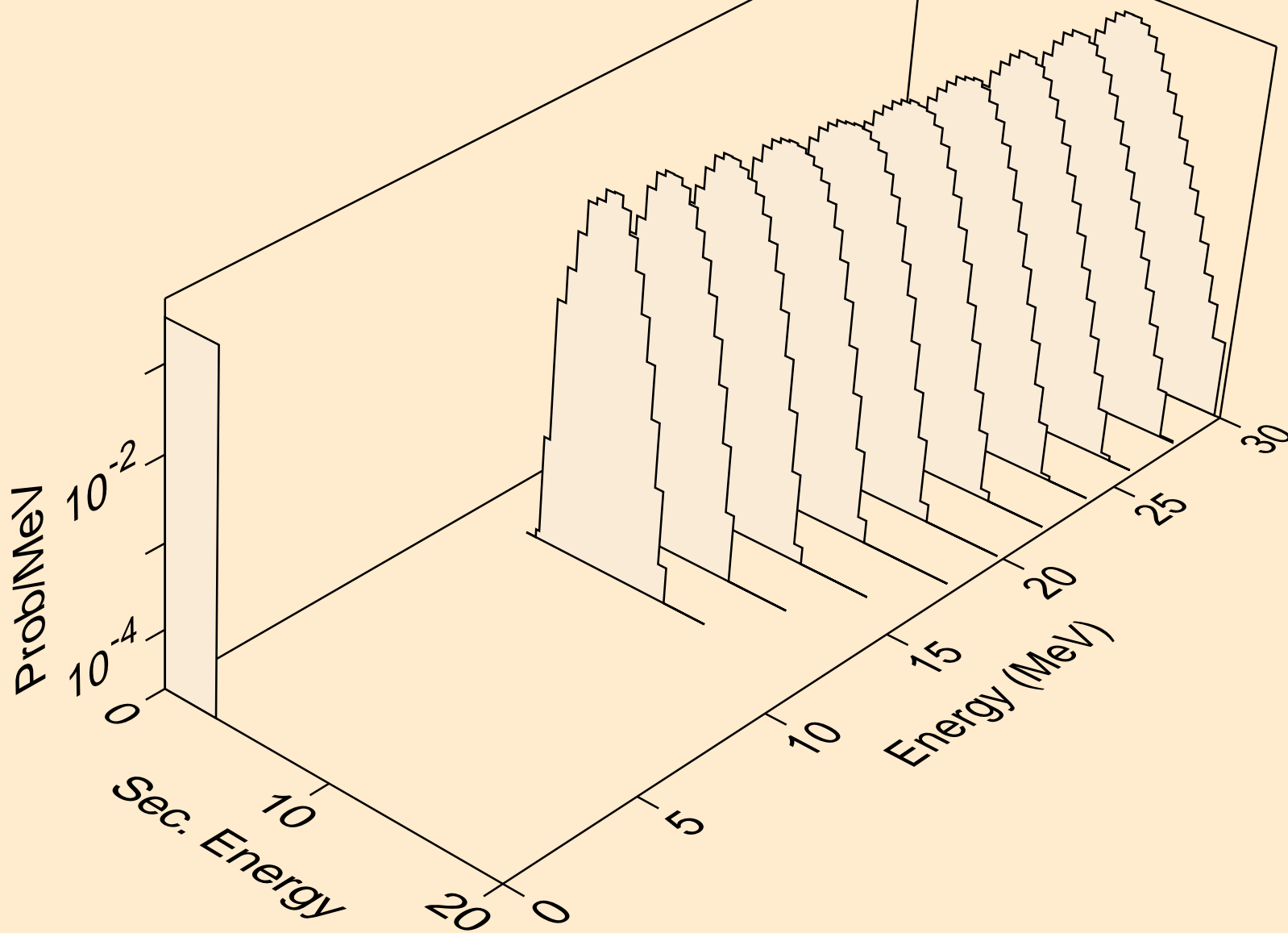

SB105 NEUTRON ACER TENDL-2023 LIBRARY; T=0.K  
alphas from (n,pa)

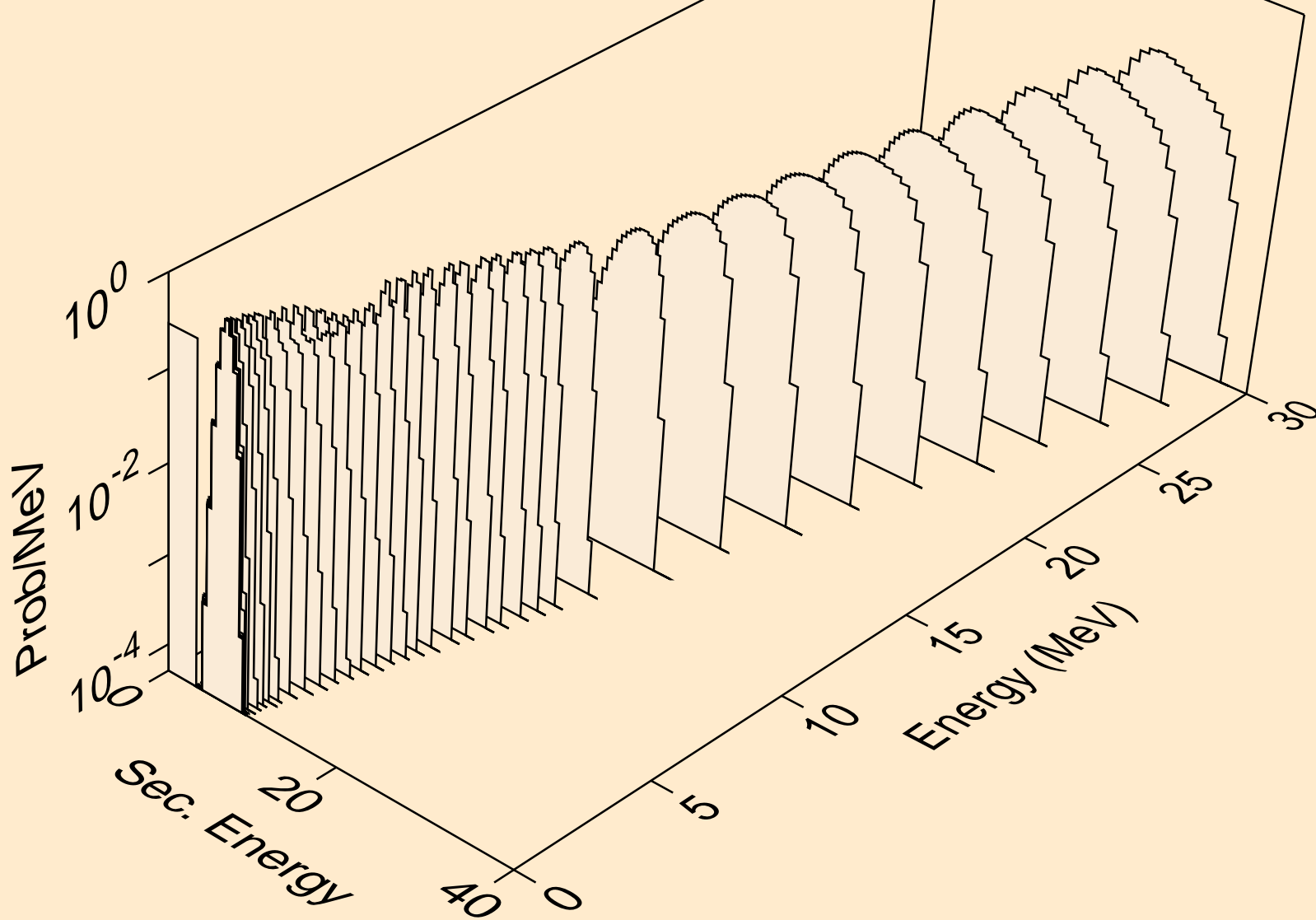

SB105 NEUTRON ACER TENDL-2023 LIBRARY; T=0.K  
alphas from (n,d2a)

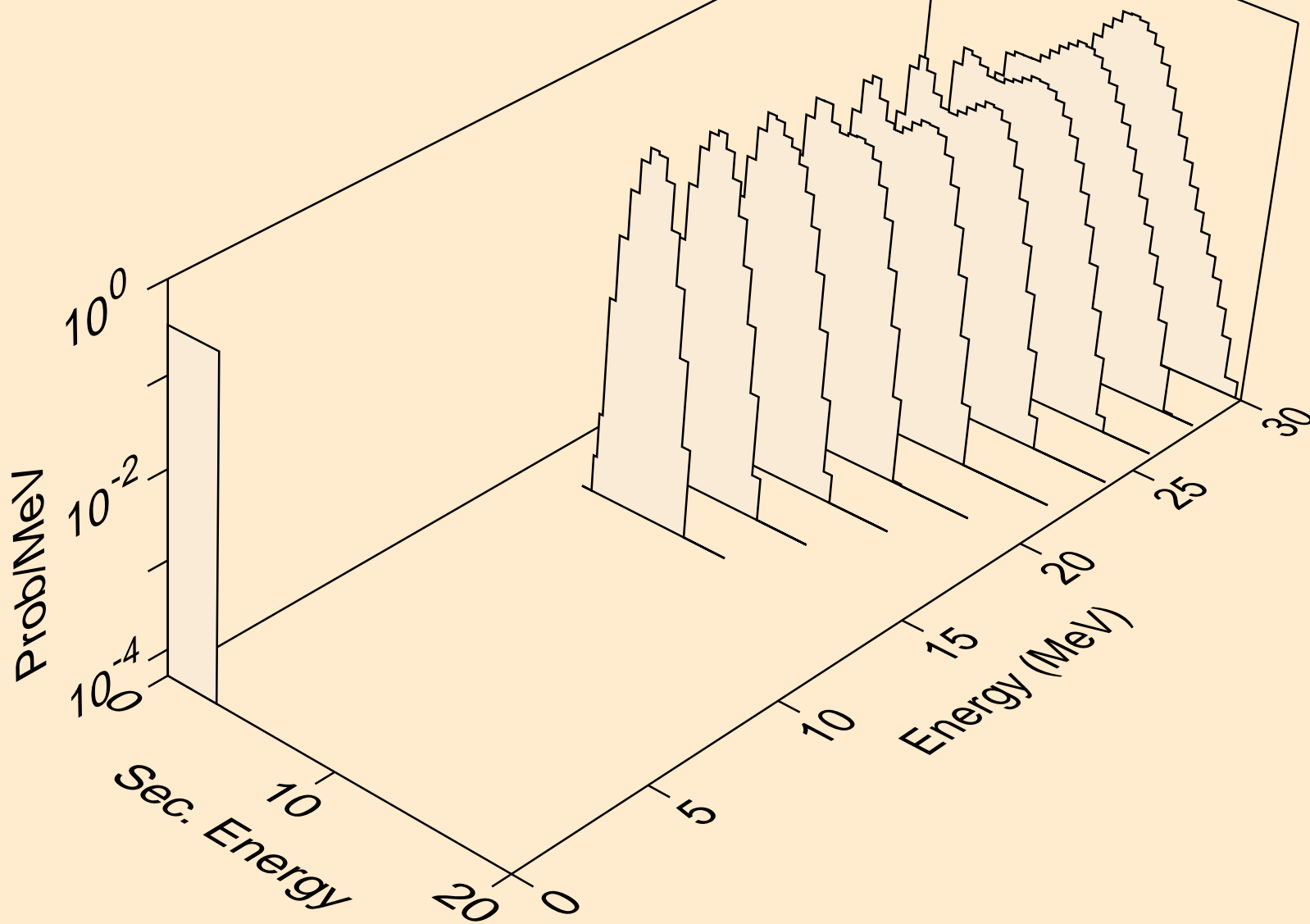

SB105 NEUTRON ACER TENDL-2023 LIBRARY; T=0.K  
alphas from (n,da)

