

SC044M NEUTRON ACER TENDL-2023 LIBRARY; T=0.K

Principal cross sections

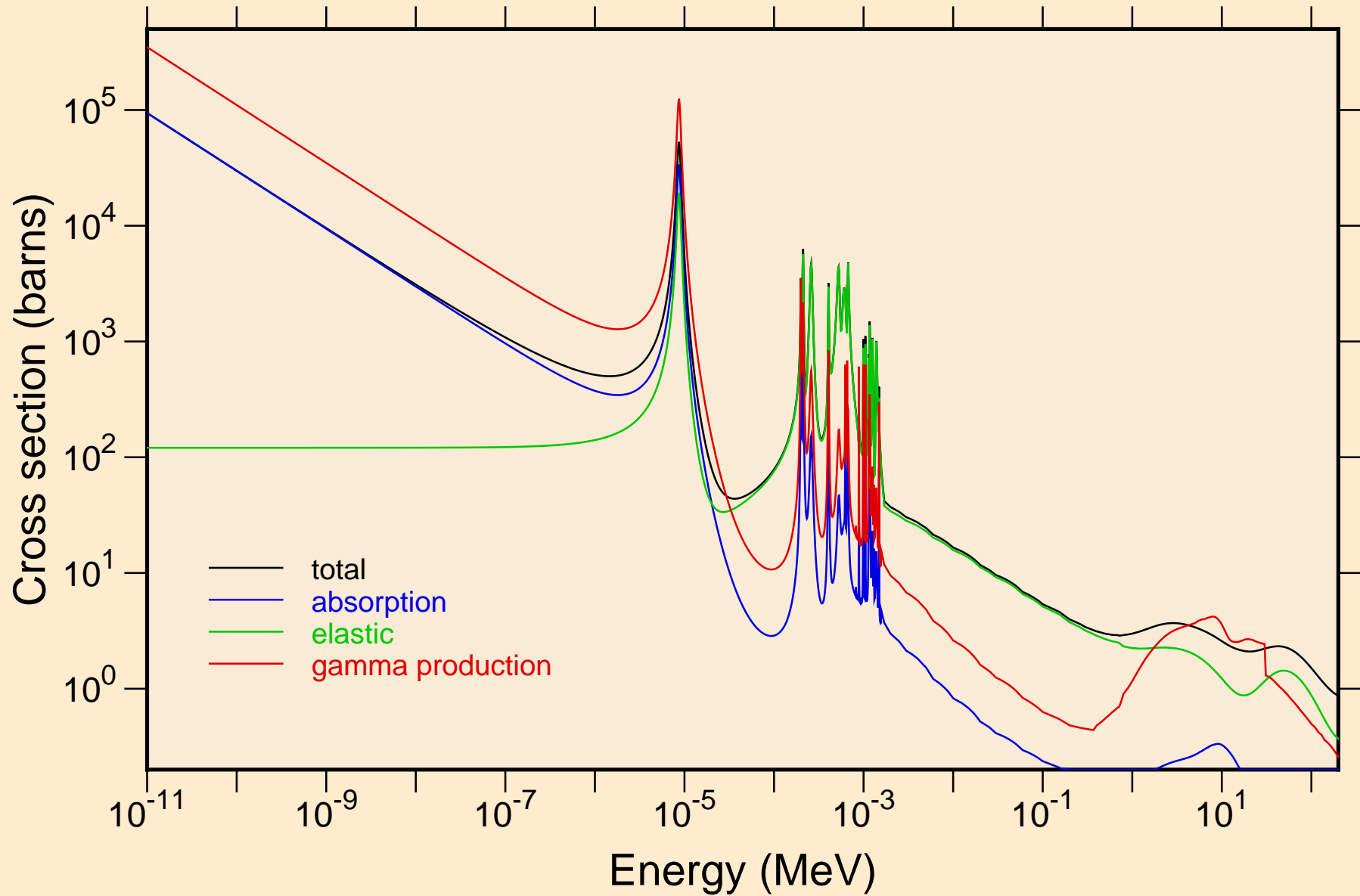

SC044M NEUTRON ACER TENDL-2023 LIBRARY; T=0.K
resonance total cross section

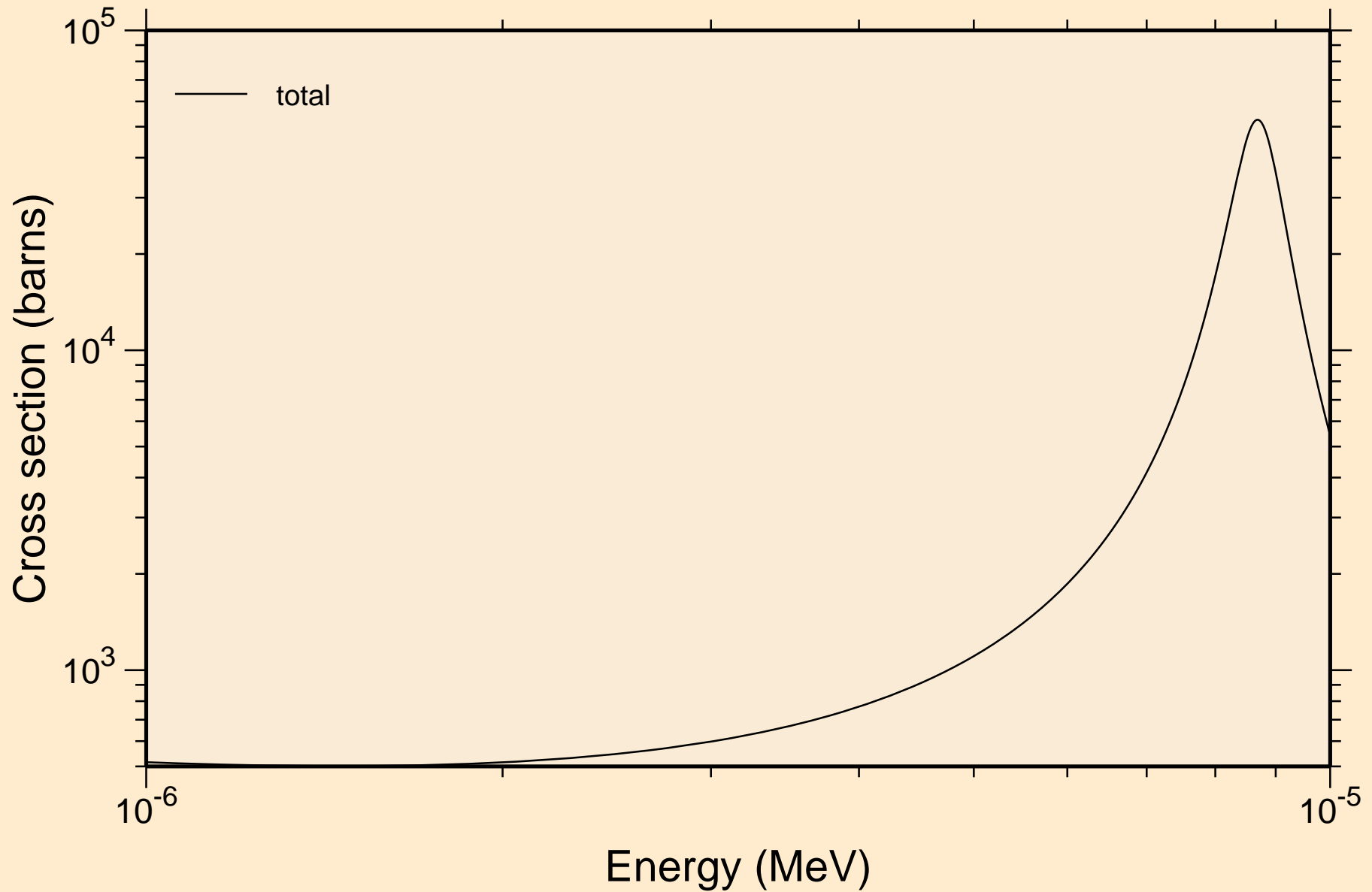

SC044M NEUTRON ACER TENDL-2023 LIBRARY; T=0.K
resonance total cross section

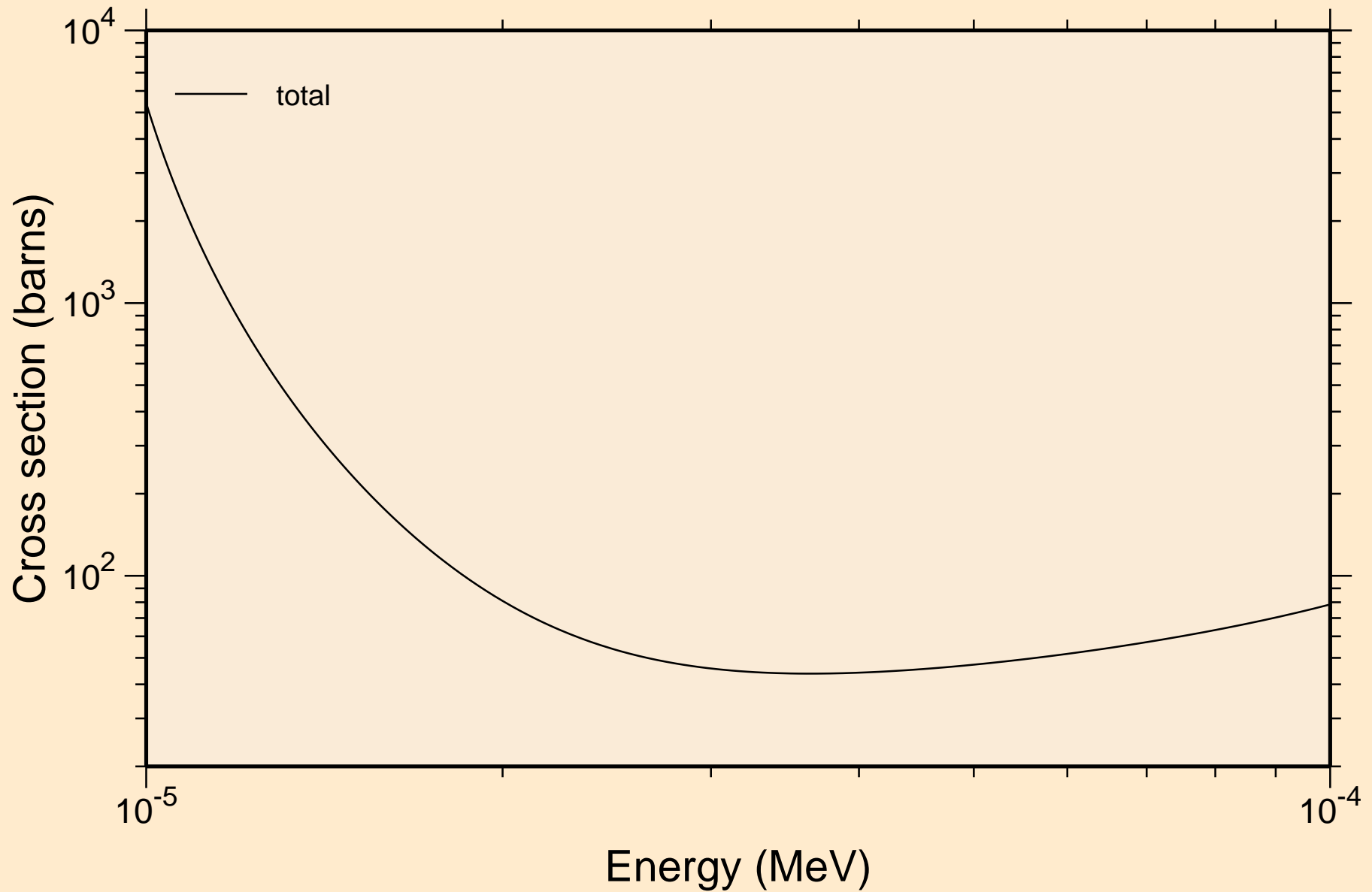

SC044M NEUTRON ACER TENDL-2023 LIBRARY; T=0.K
resonance total cross section

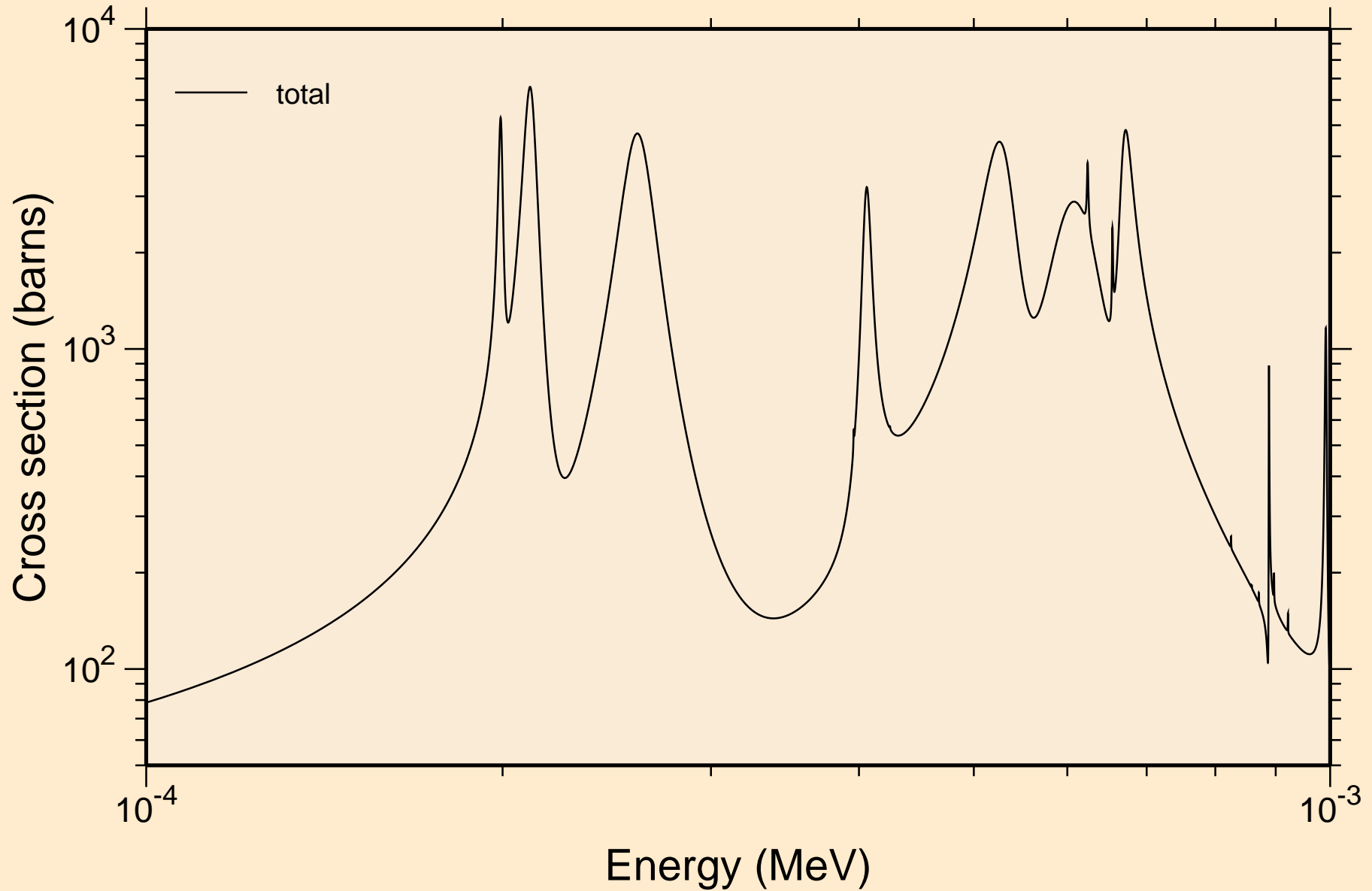

SC044M NEUTRON ACER TENDL-2023 LIBRARY; T=0.K
resonance total cross section

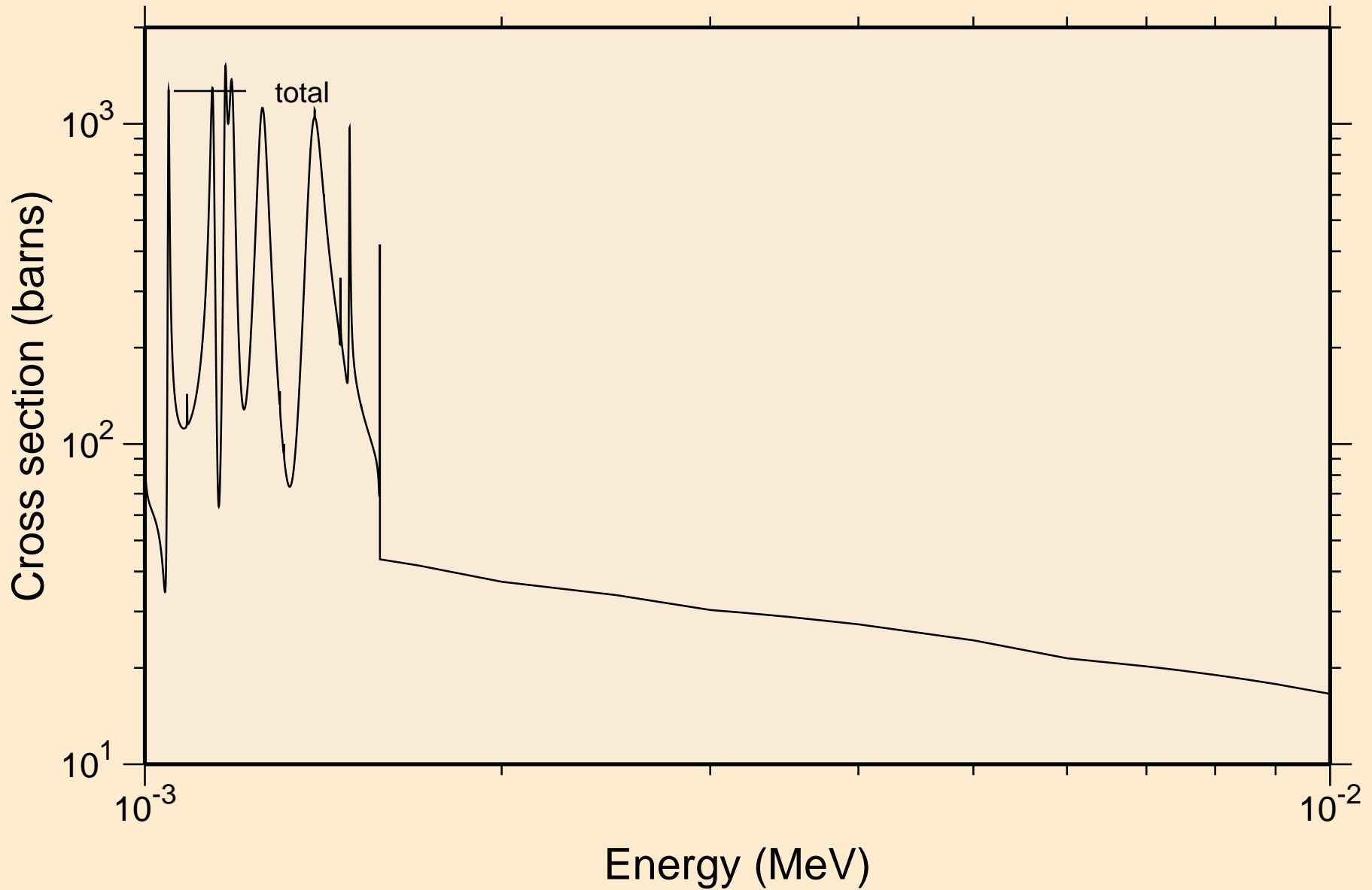

SC044M NEUTRON ACER TENDL-2023 LIBRARY; T=0.K
resonance total cross section

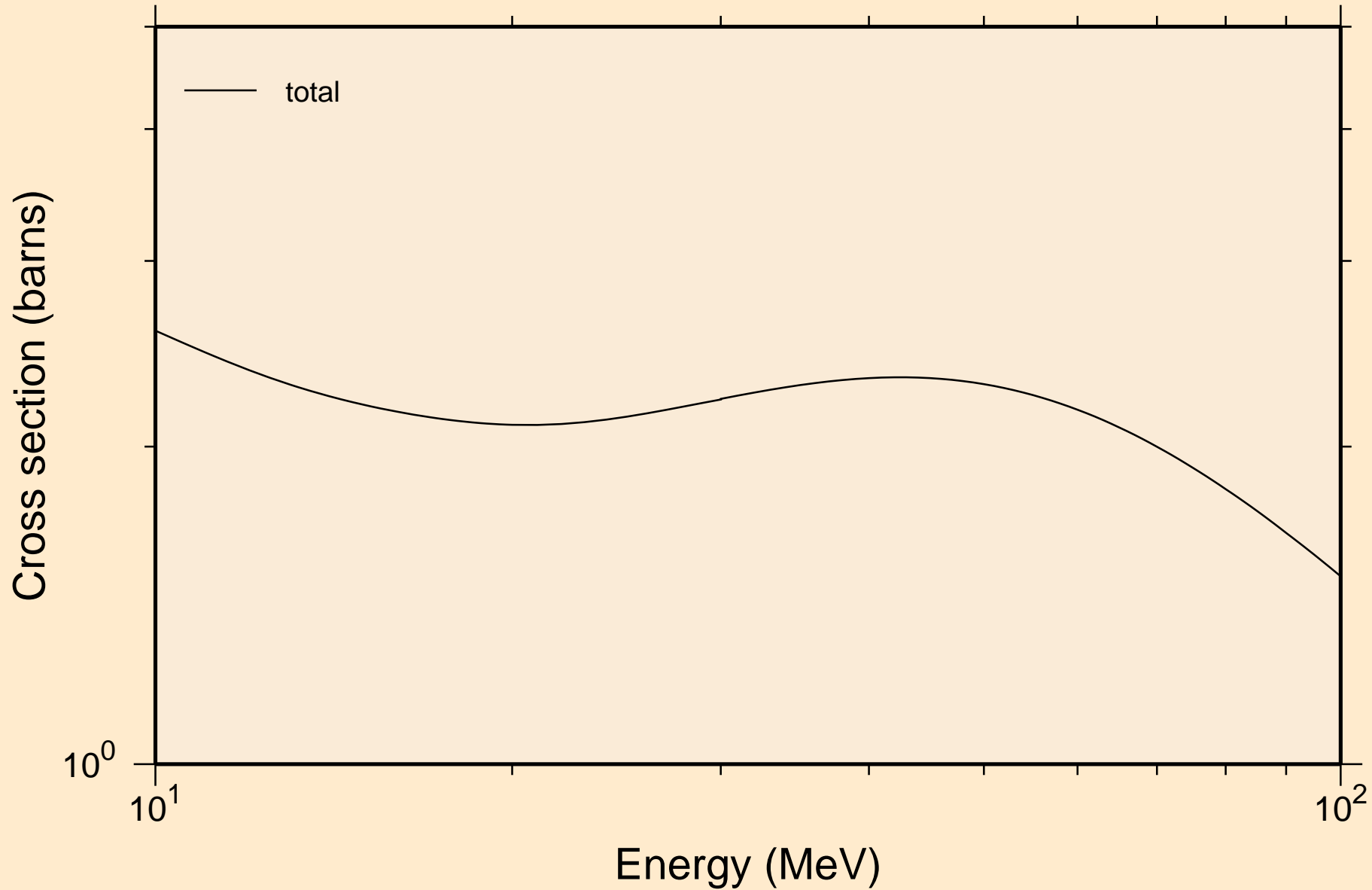

SC044M NEUTRON ACER TENDL-2023 LIBRARY; T=0.K
resonance absorption cross sections

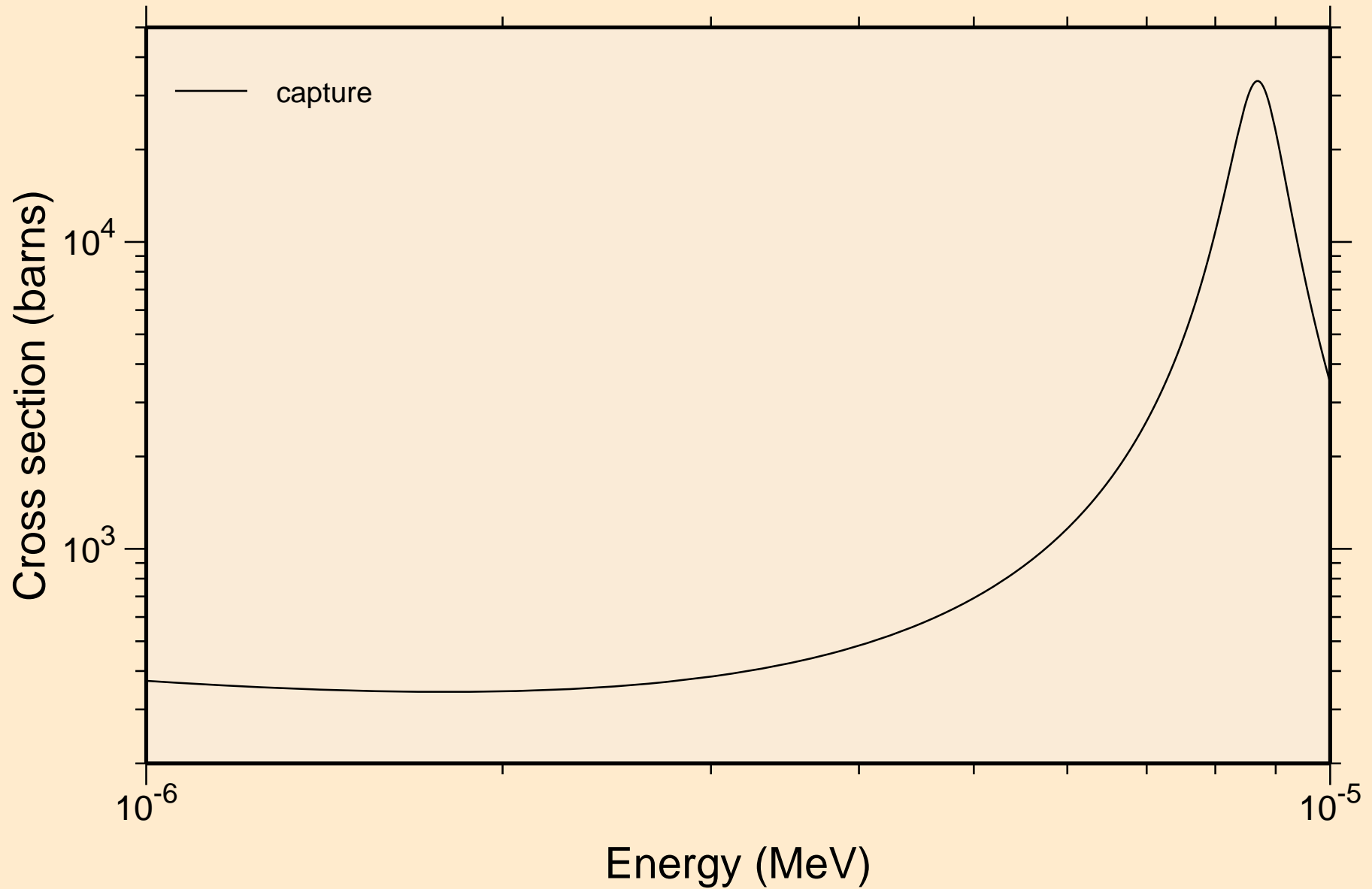

SC044M NEUTRON ACER TENDL-2023 LIBRARY; T=0.K
resonance absorption cross sections

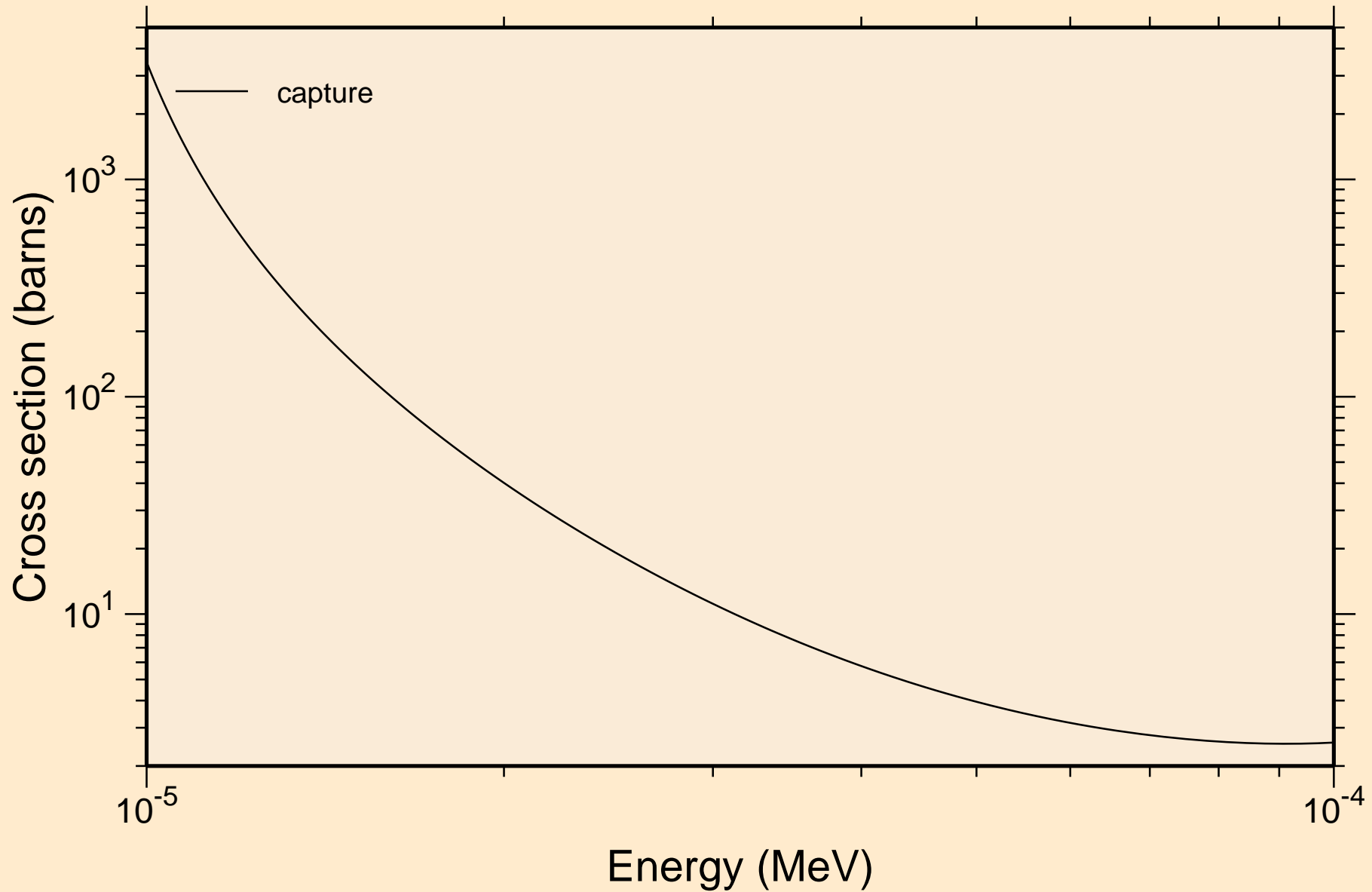

SC044M NEUTRON ACER TENDL-2023 LIBRARY; T=0.K
resonance absorption cross sections

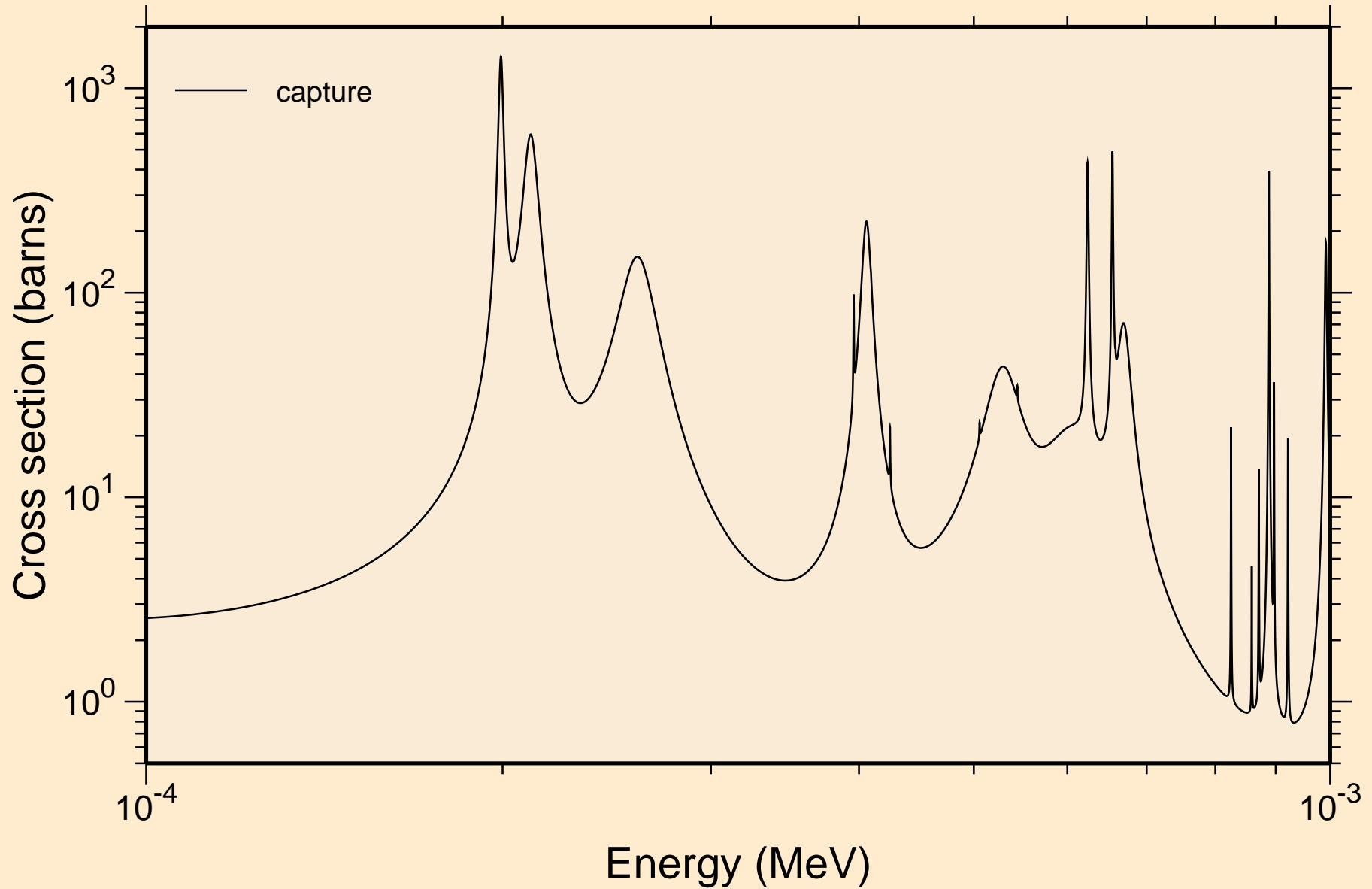

SC044M NEUTRON ACER TENDL-2023 LIBRARY; T=0.K
resonance absorption cross sections

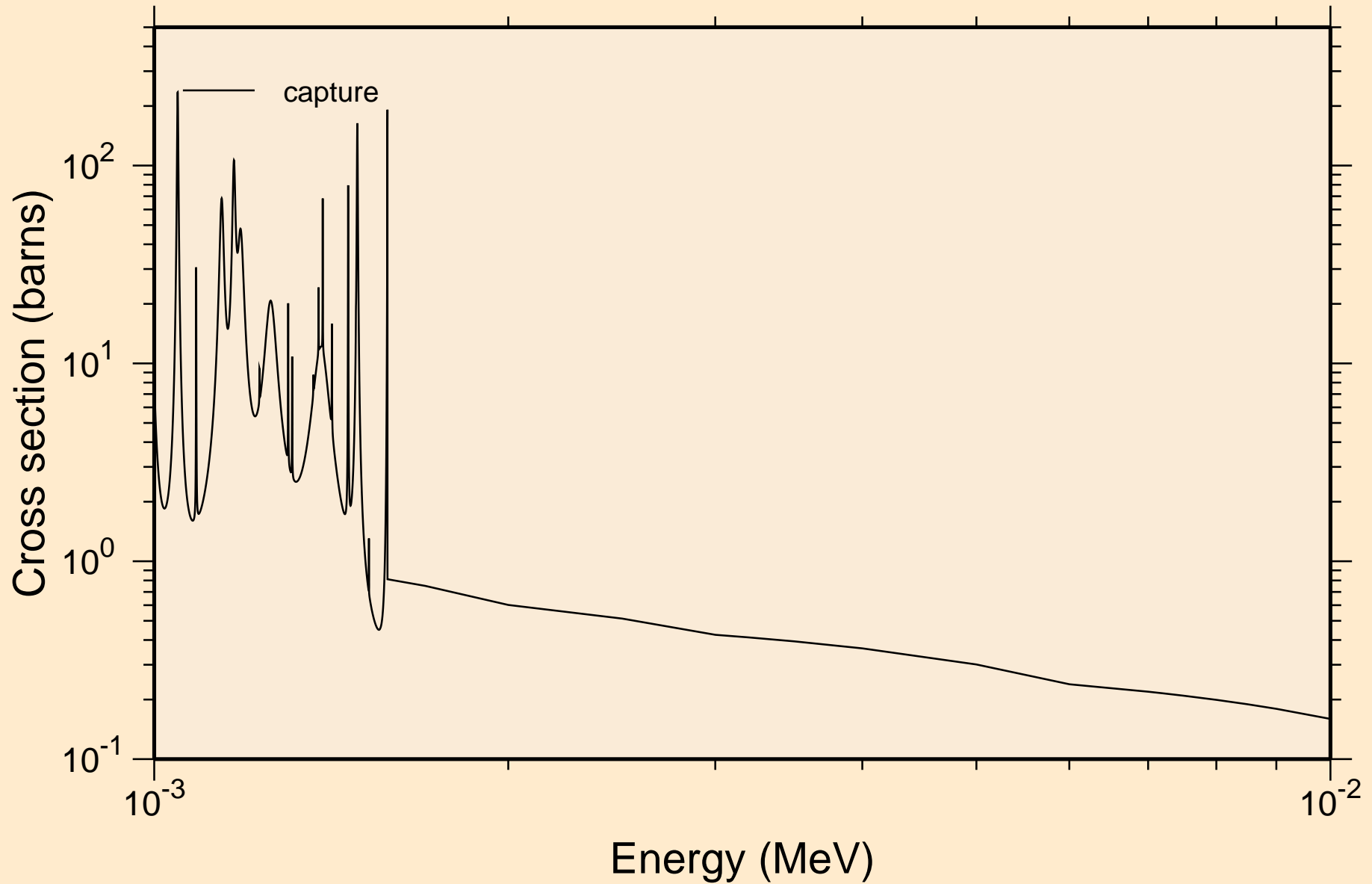

SC044M NEUTRON ACER TENDL-2023 LIBRARY; T=0.K
resonance absorption cross sections

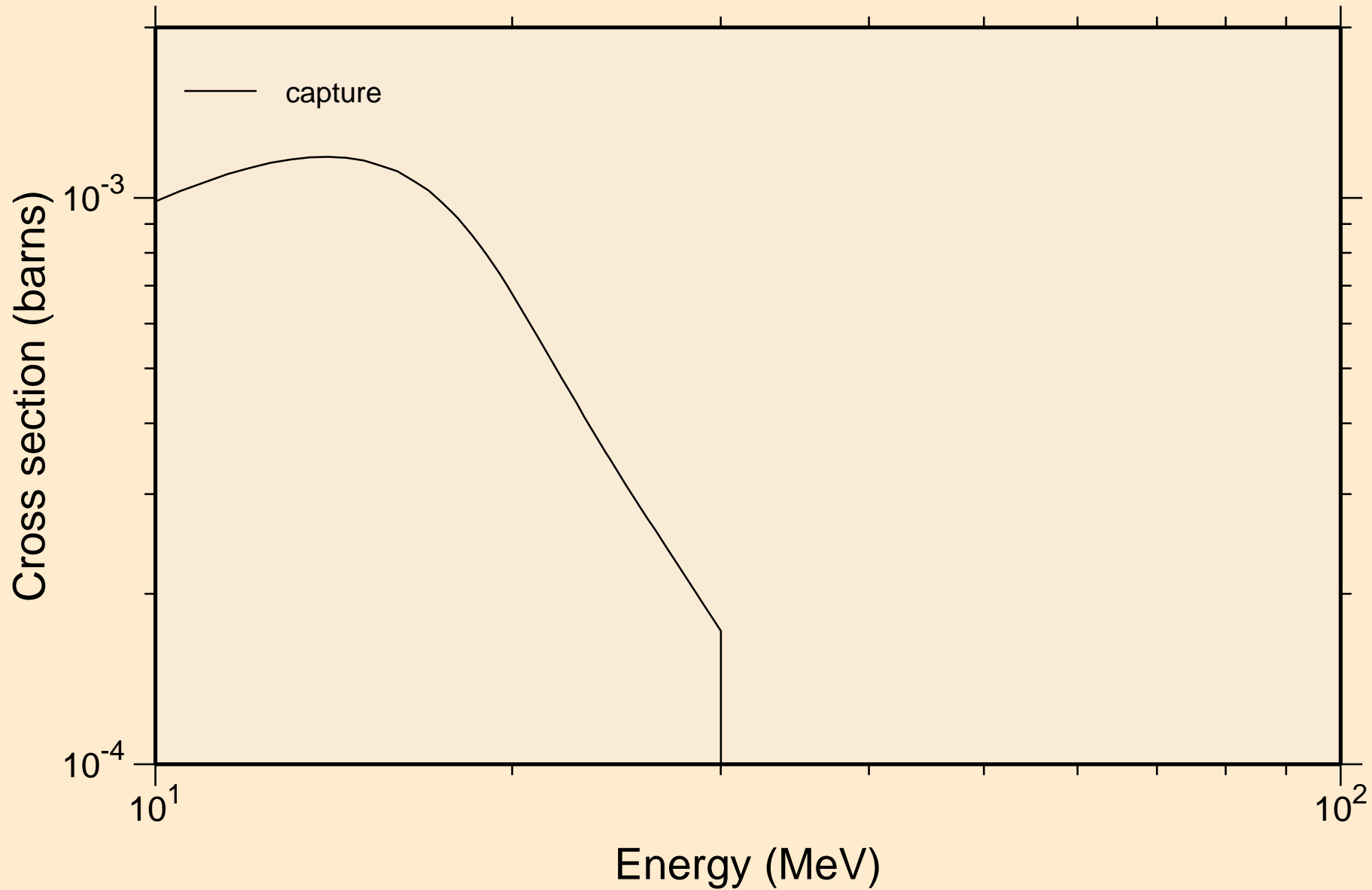

SC044M NEUTRON ACER TENDL-2023 LIBRARY; T=0.K

Heating

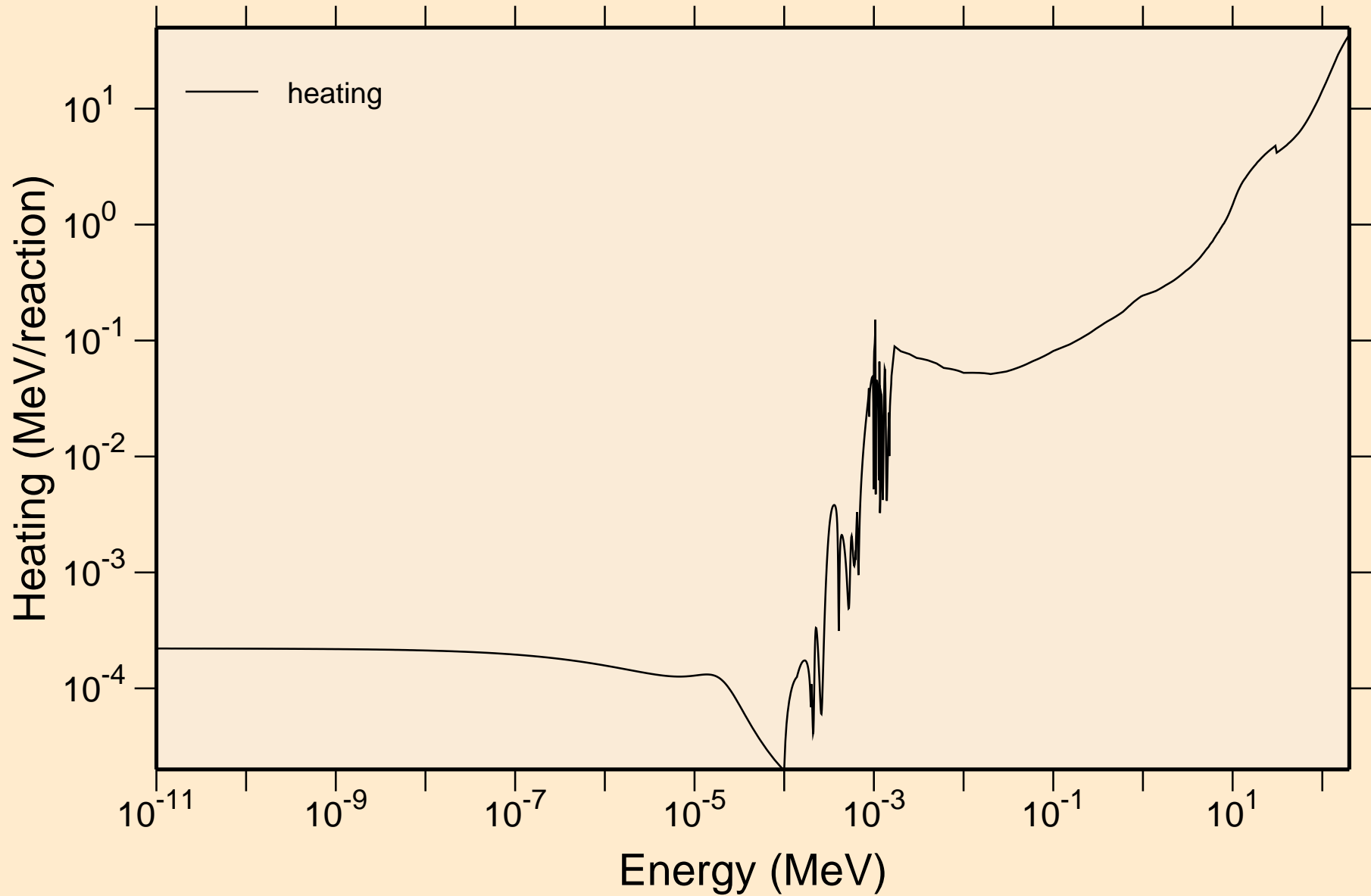

SC044M NEUTRON ACER TENDL-2023 LIBRARY; T=0.K

Damage

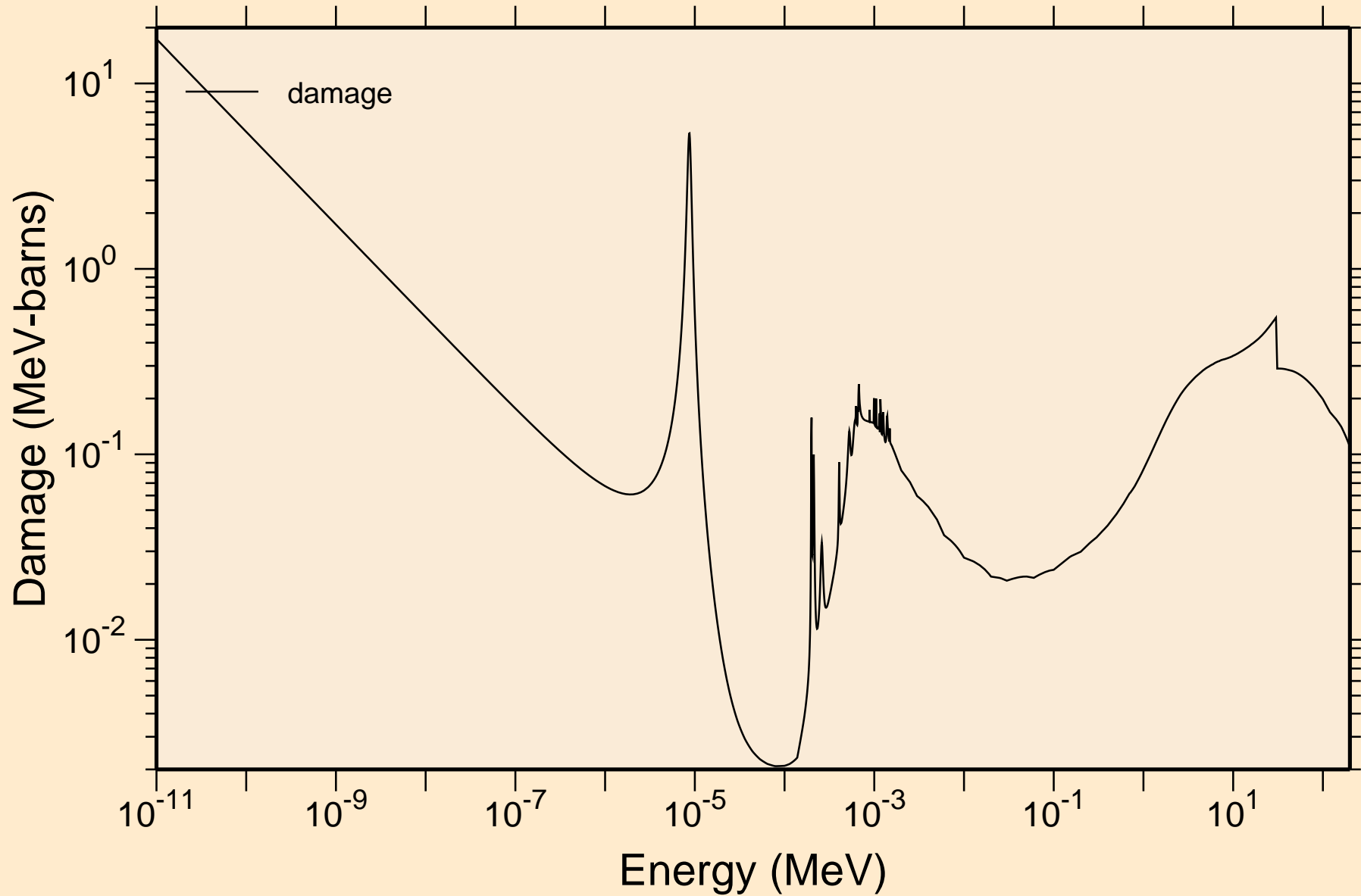

SC044M NEUTRON ACER TENDL-2023 LIBRARY; T=0.K

Non-threshold reactions

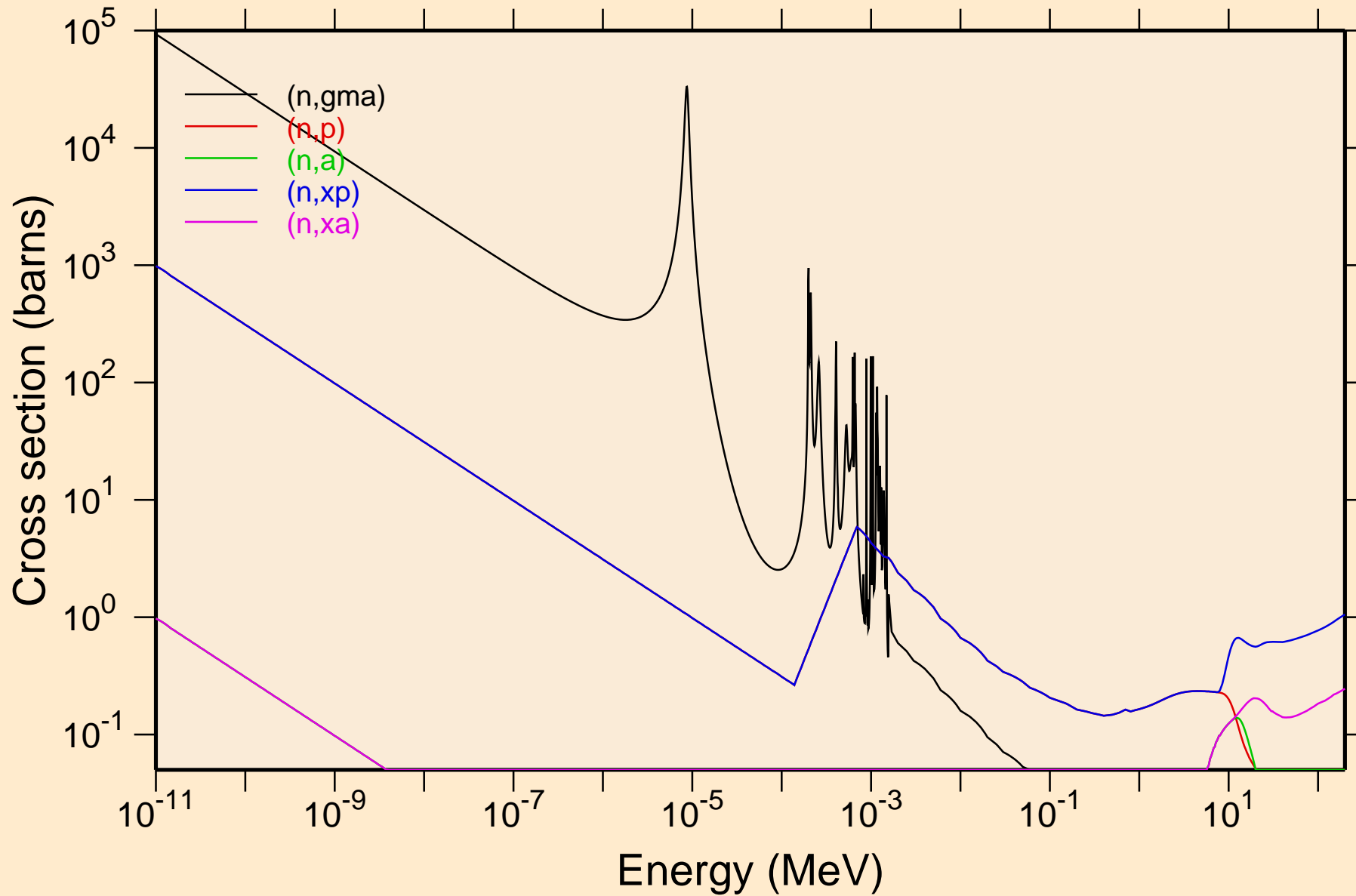

SC044M NEUTRON ACER TENDL-2023 LIBRARY; T=0.K

Principal cross sections

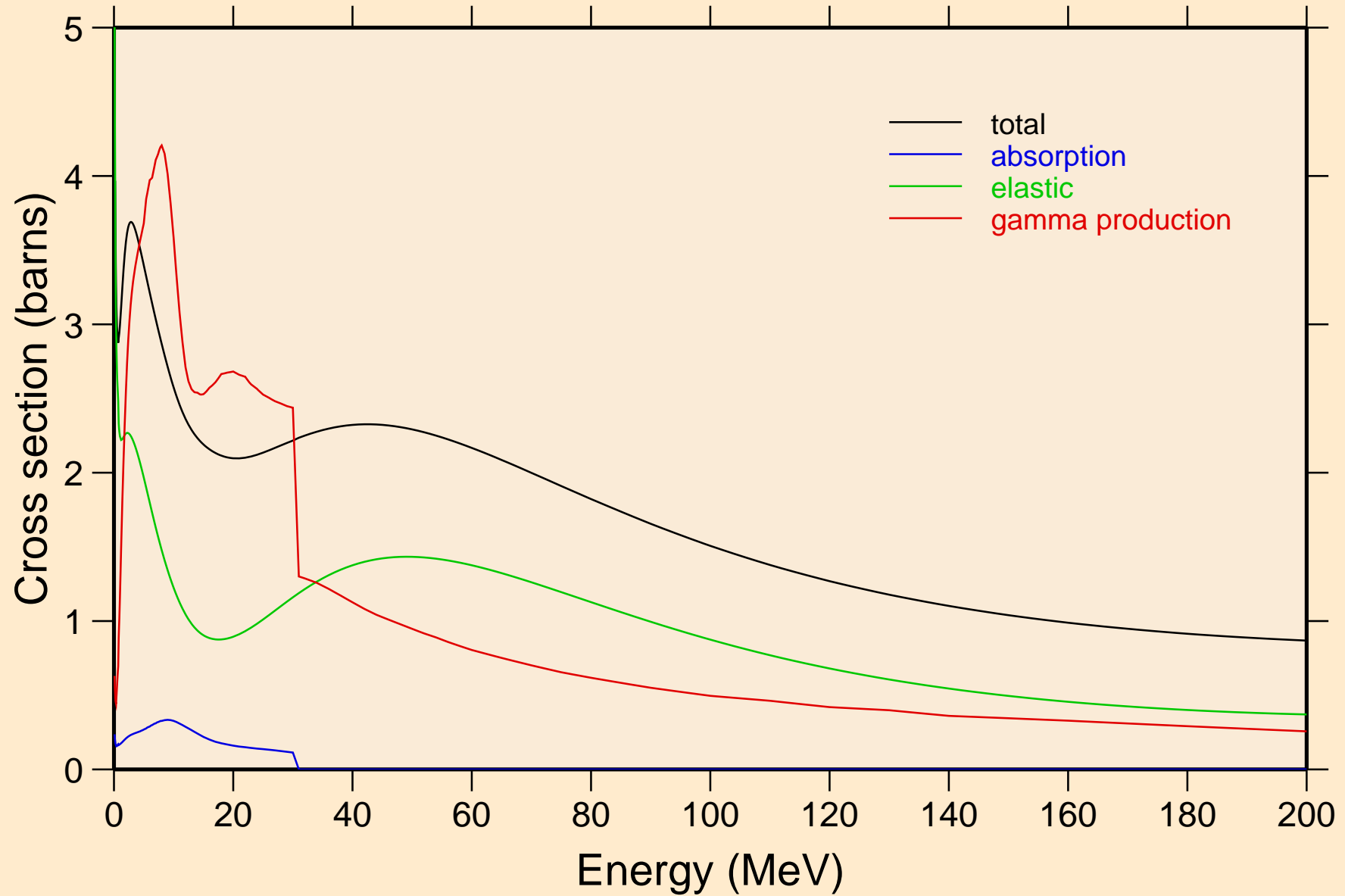

SC044M NEUTRON ACER TENDL-2023 LIBRARY; T=0.K

Heating

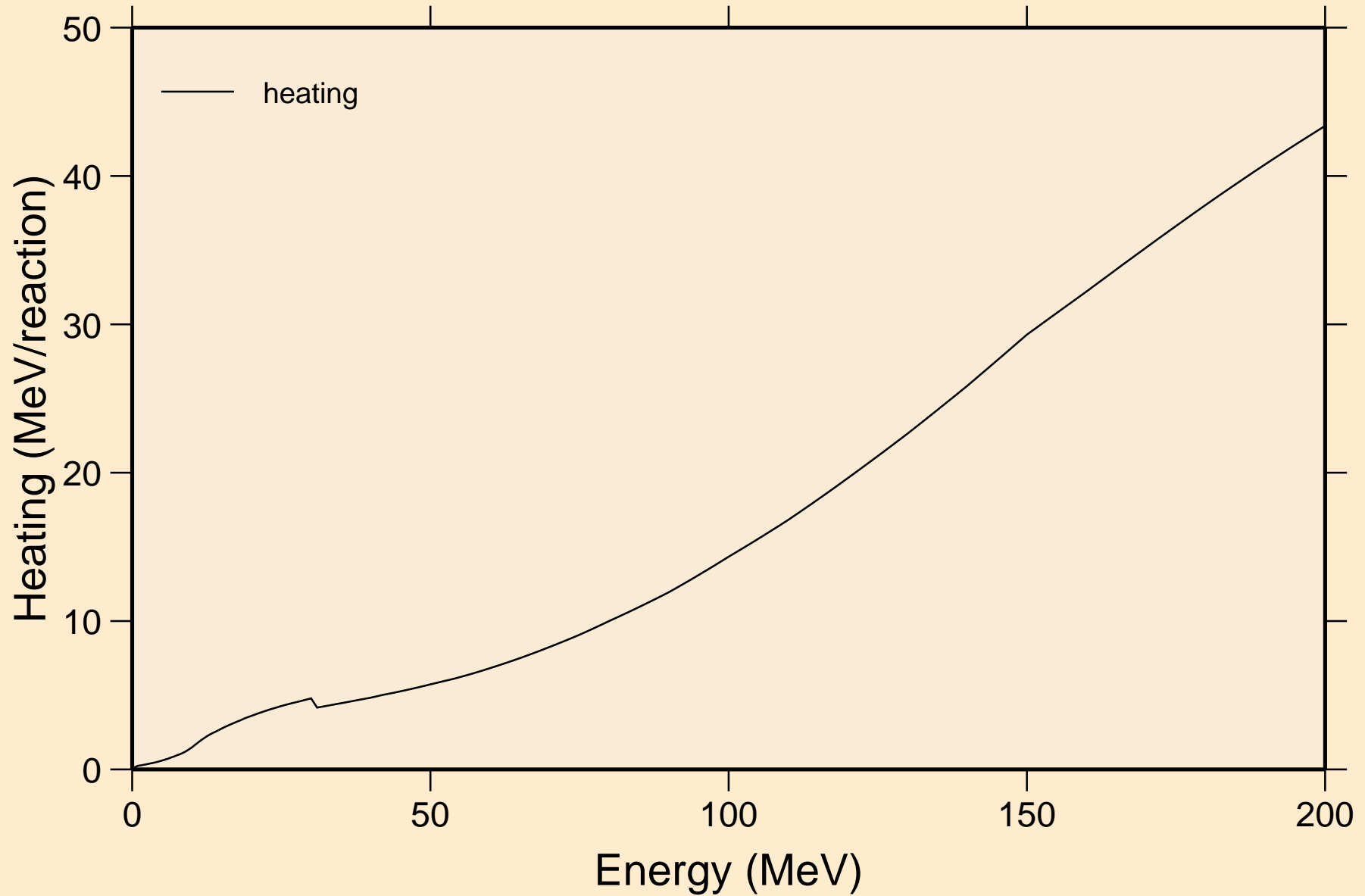

SC044M NEUTRON ACER TENDL-2023 LIBRARY; T=0.K
Damage

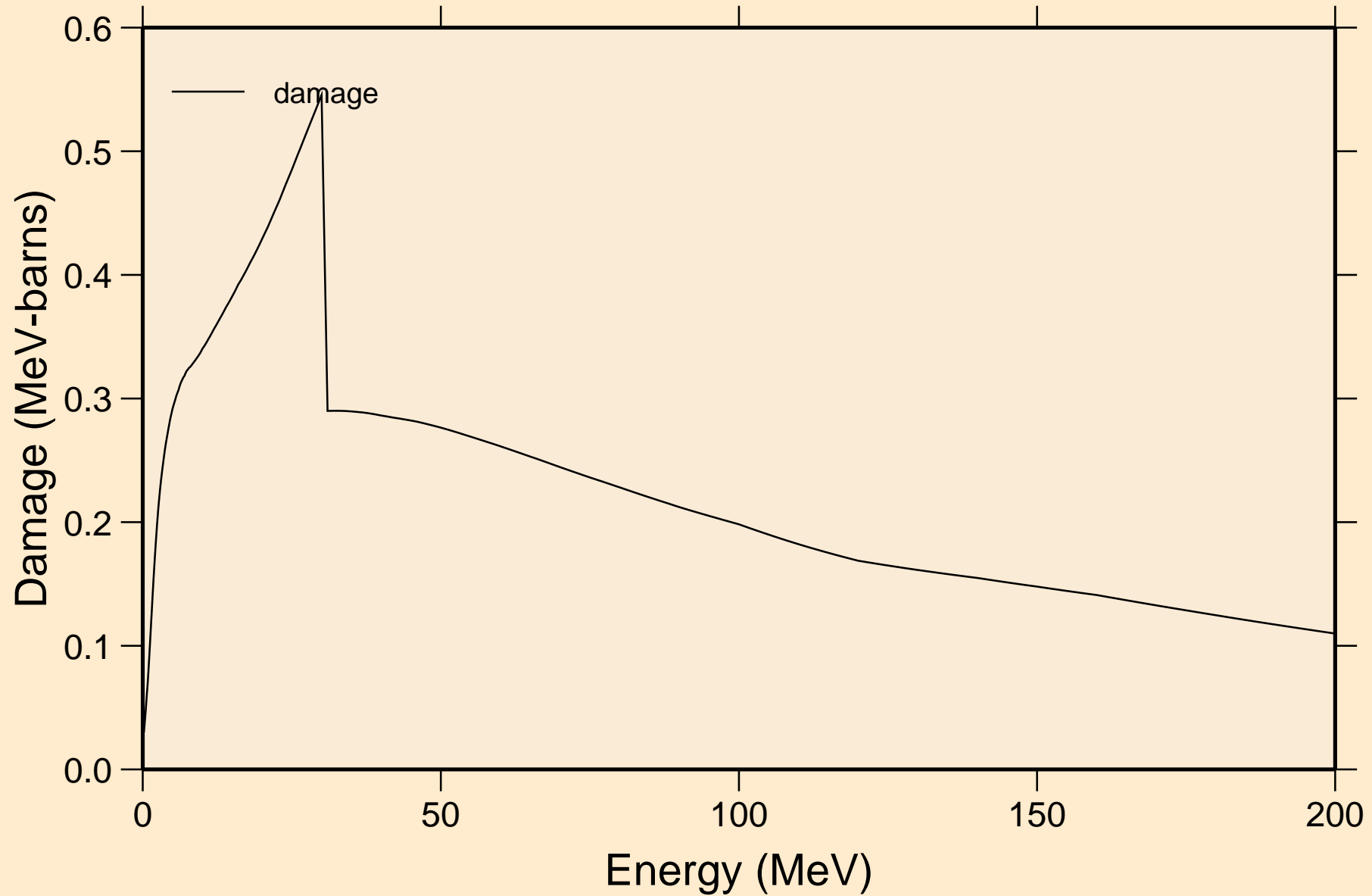

SC044M NEUTRON ACER TENDL-2023 LIBRARY; T=0.K
Non-threshold reactions

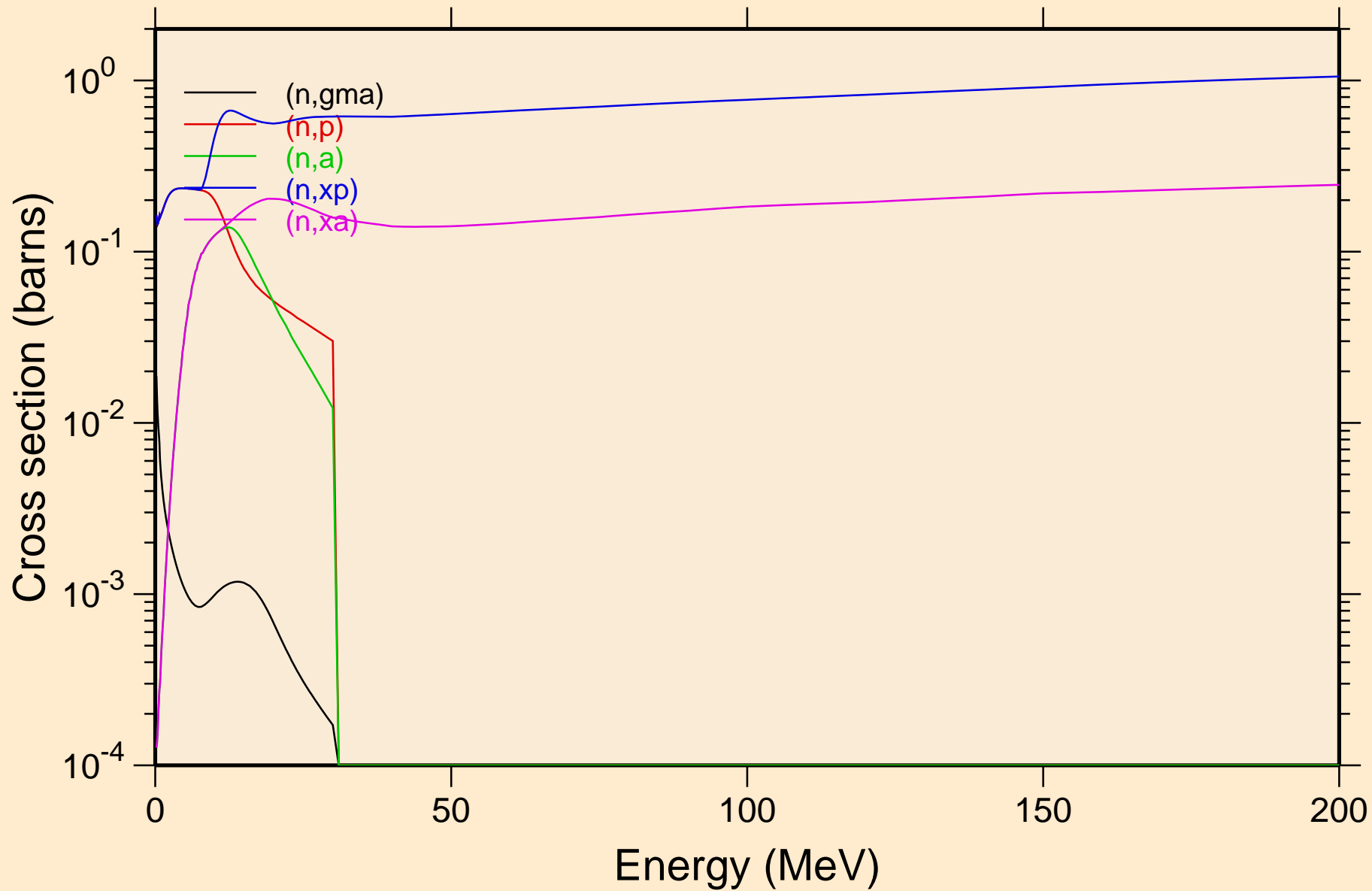

SC044M NEUTRON ACER TENDL-2023 LIBRARY; T=0.K
Inelastic levels

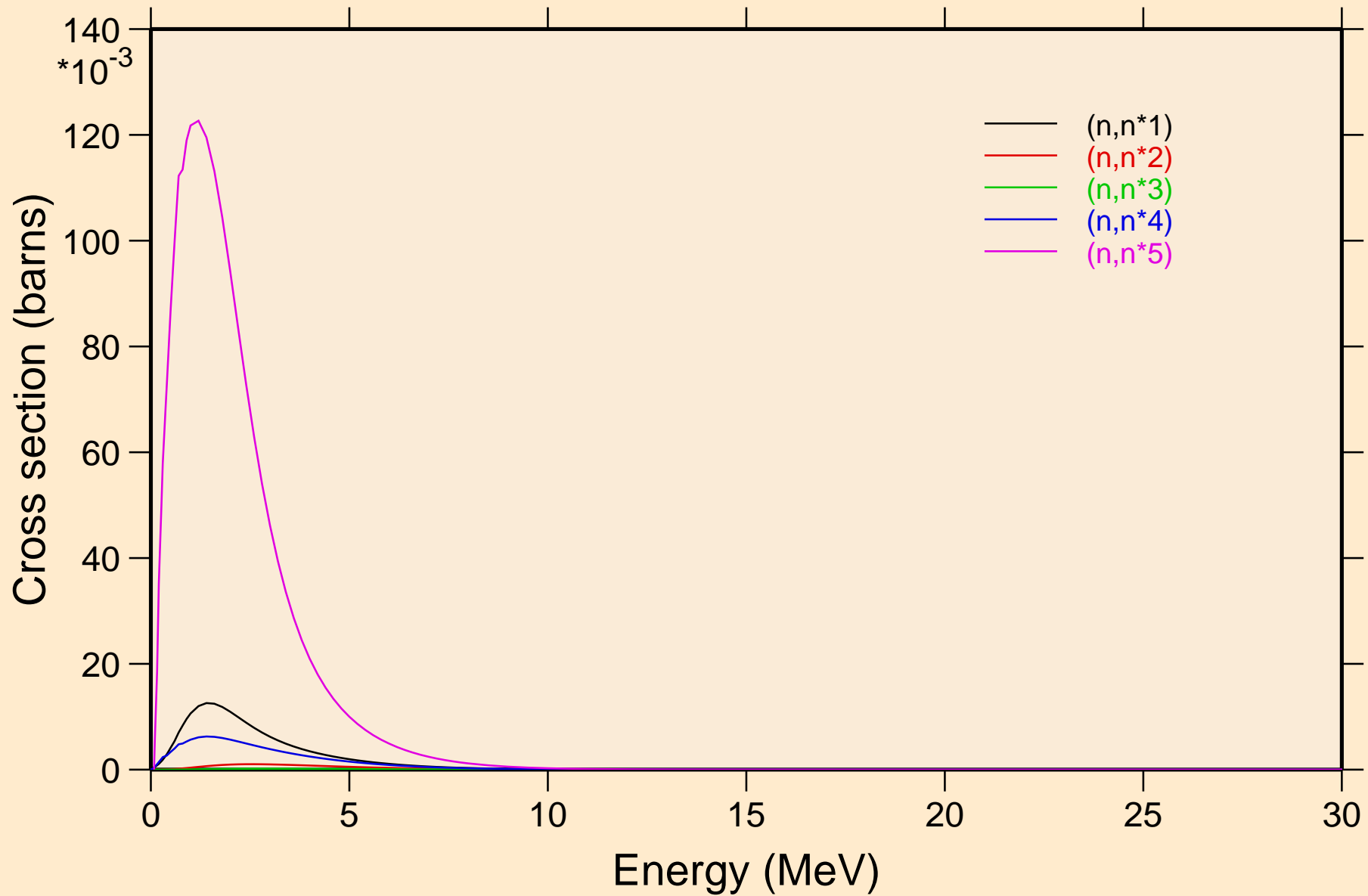

SC044M NEUTRON ACER TENDL-2023 LIBRARY; T=0.K
Inelastic levels

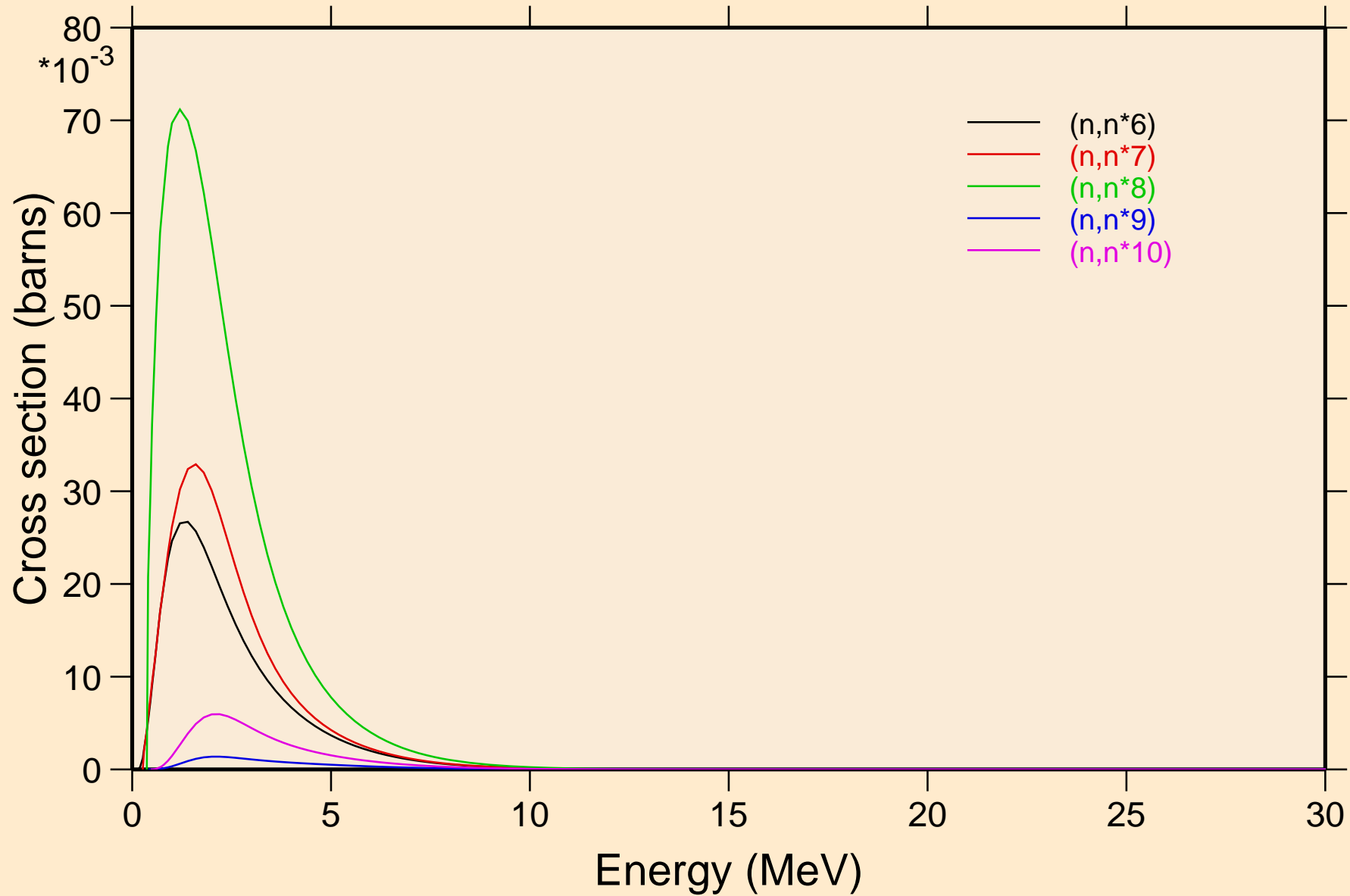

SC044M NEUTRON ACER TENDL-2023 LIBRARY; T=0.K
Inelastic levels

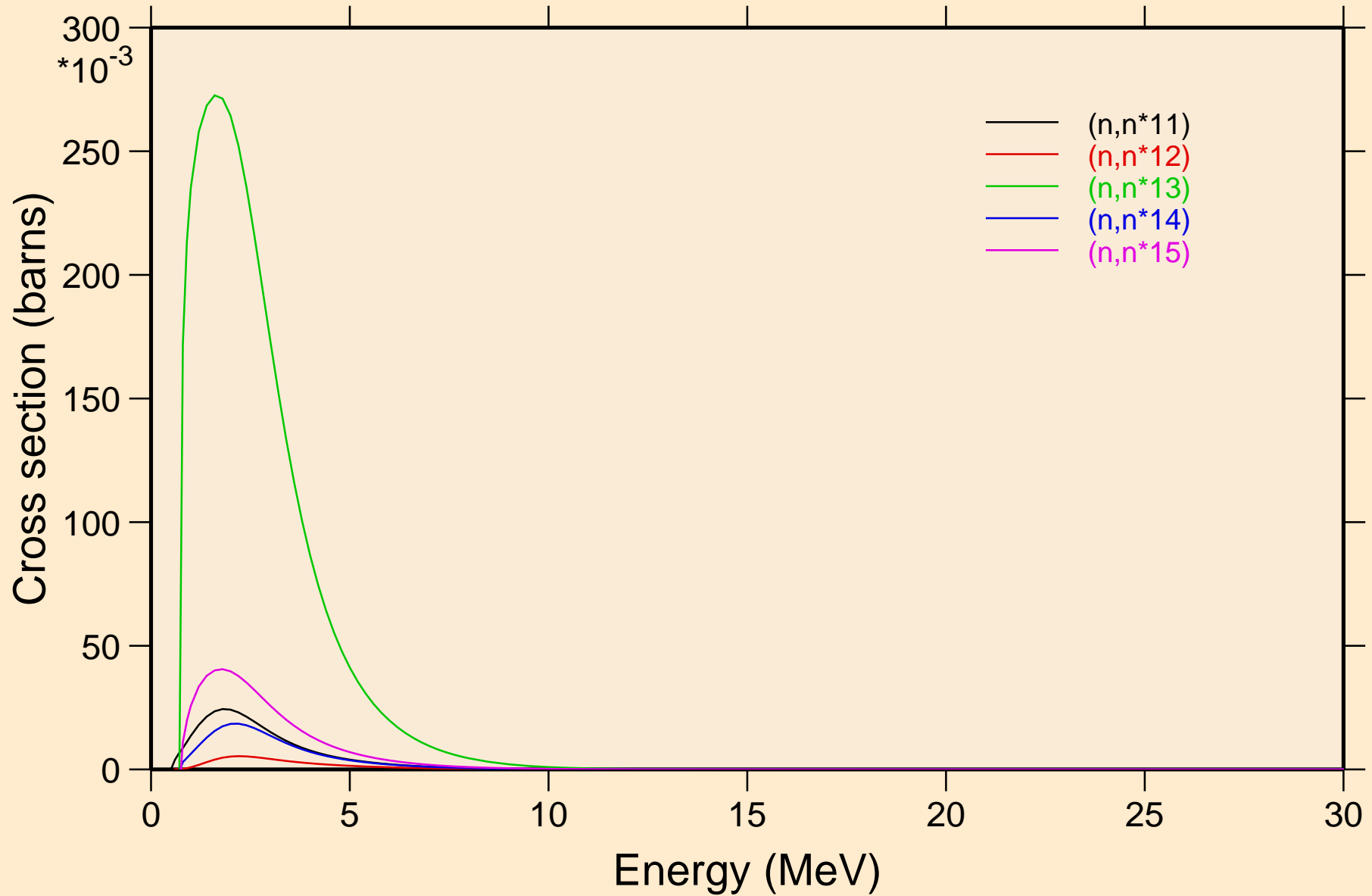

SC044M NEUTRON ACER TENDL-2023 LIBRARY; T=0.K
Inelastic levels

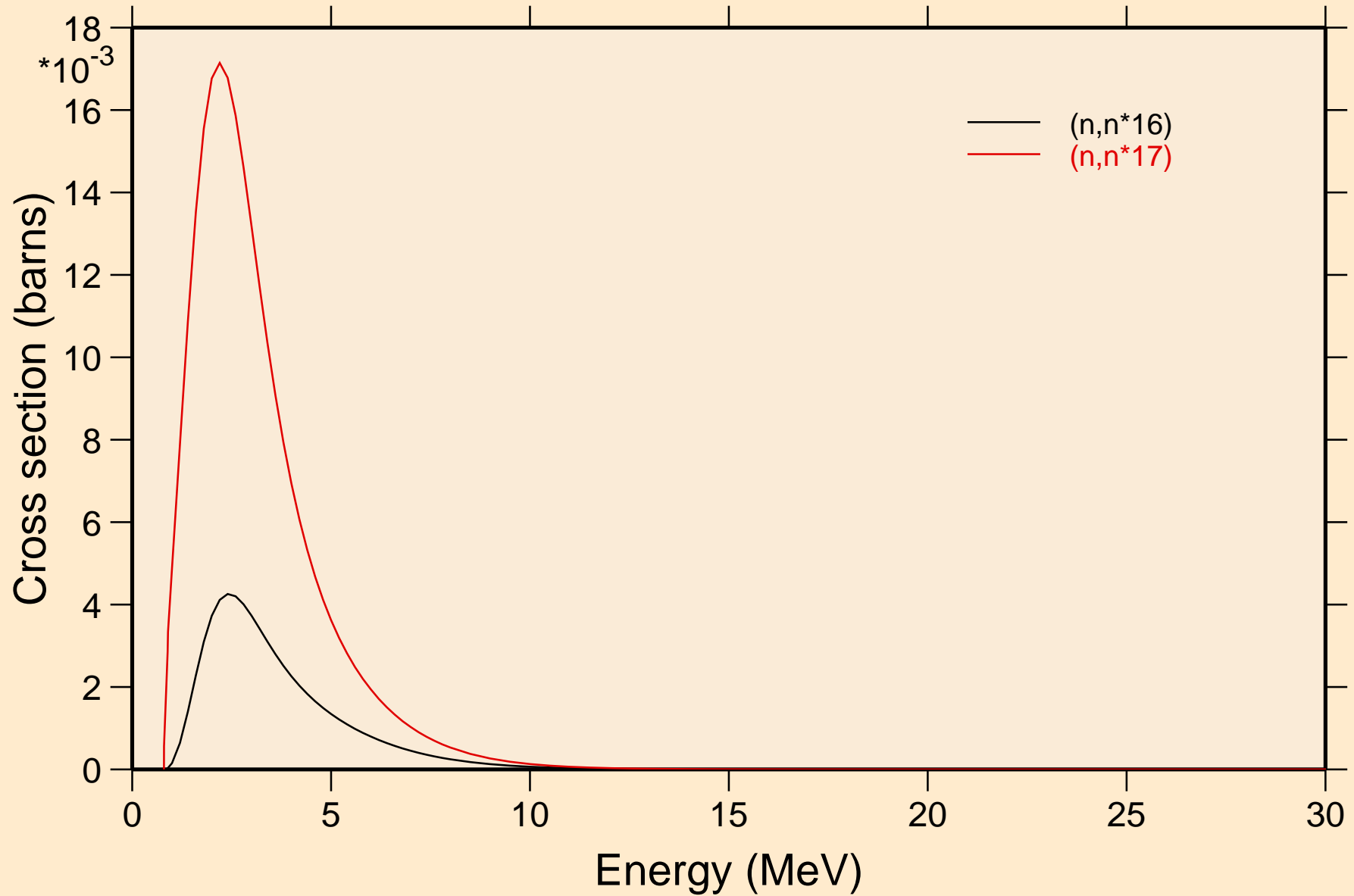

SC044M NEUTRON ACER TENDL-2023 LIBRARY; T=0.K

Threshold reactions

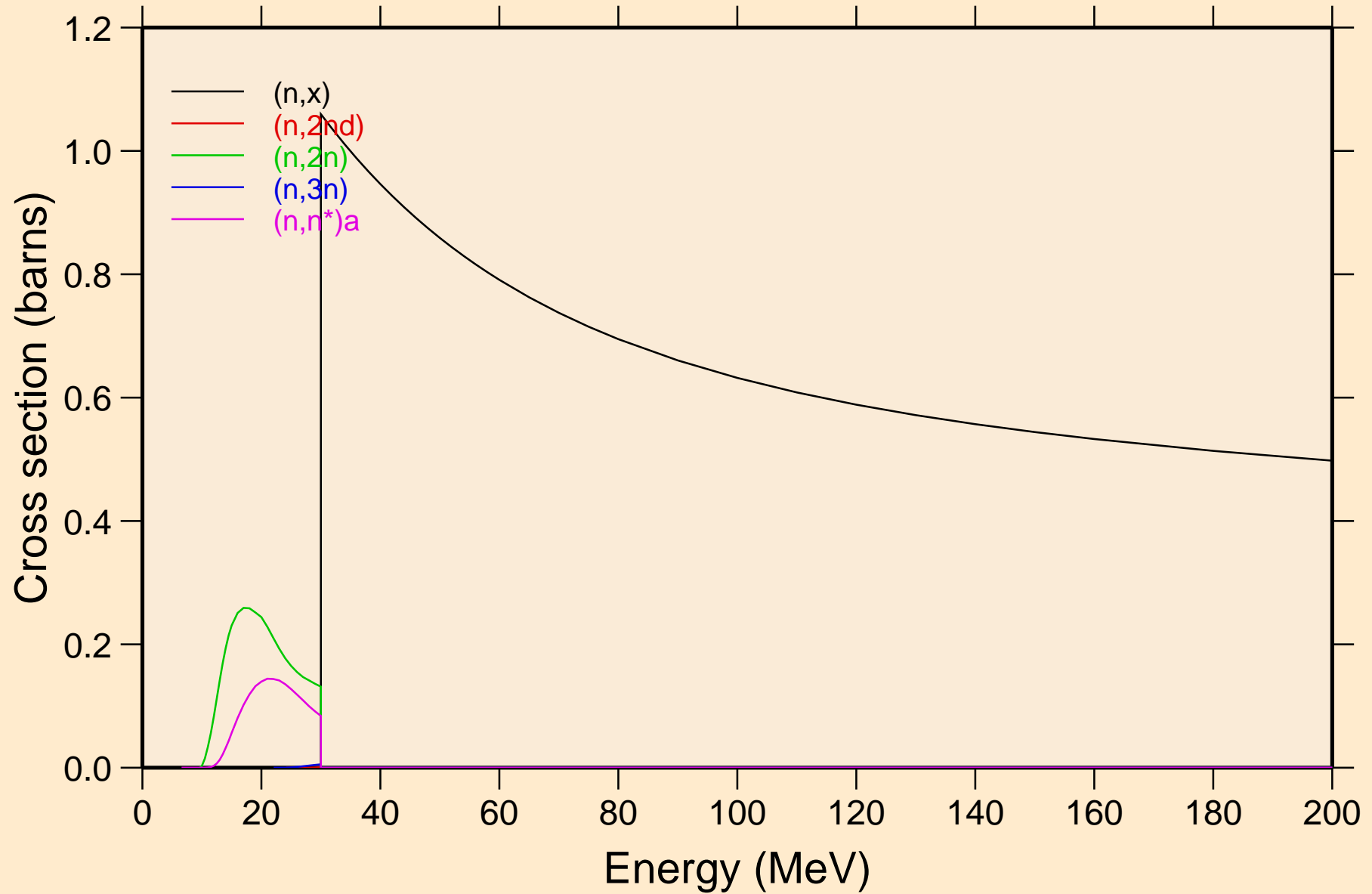

SC044M NEUTRON ACER TENDL-2023 LIBRARY; T=0.K

Threshold reactions

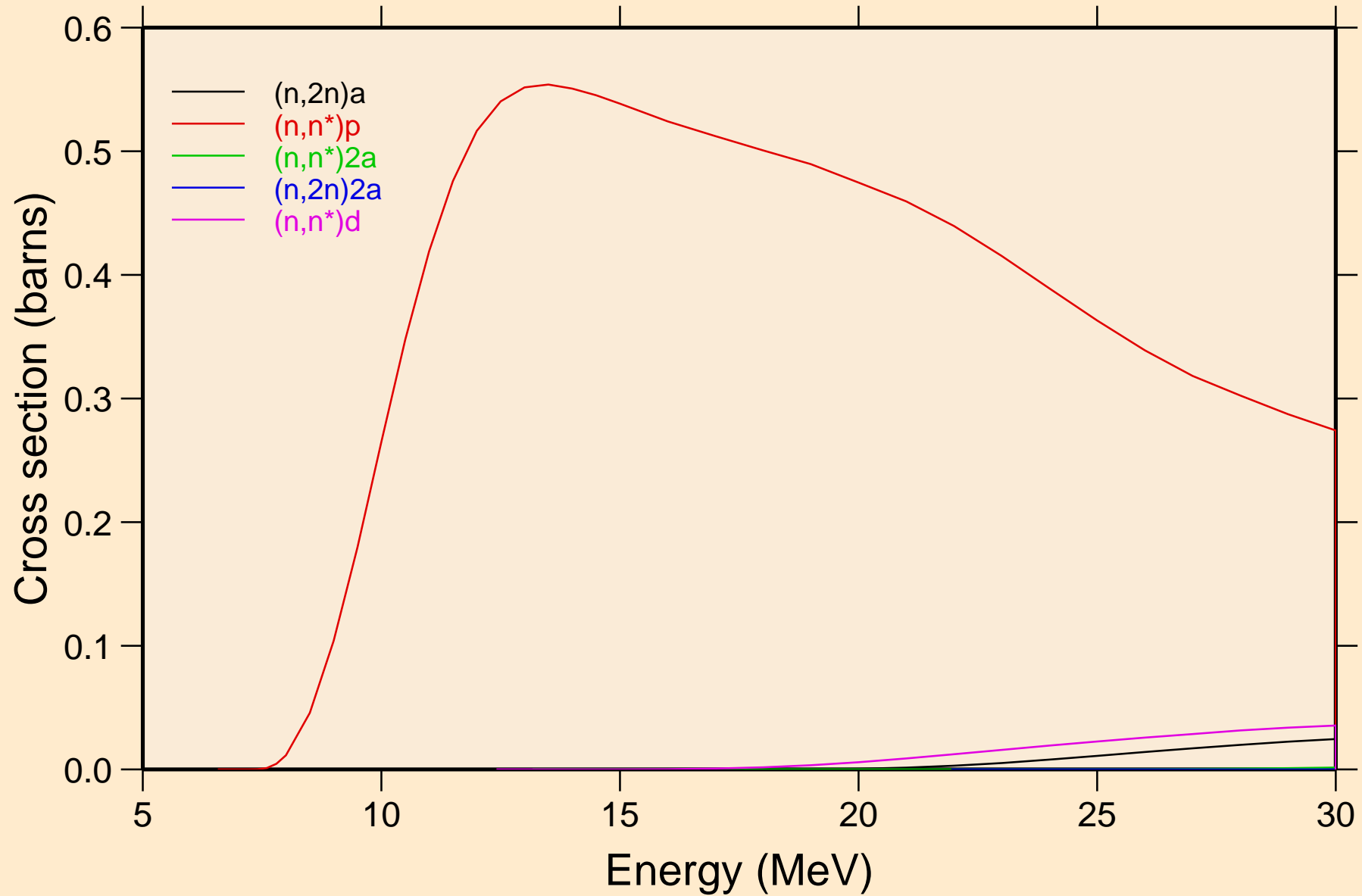

SC044M NEUTRON ACER TENDL-2023 LIBRARY; T=0.K

Threshold reactions

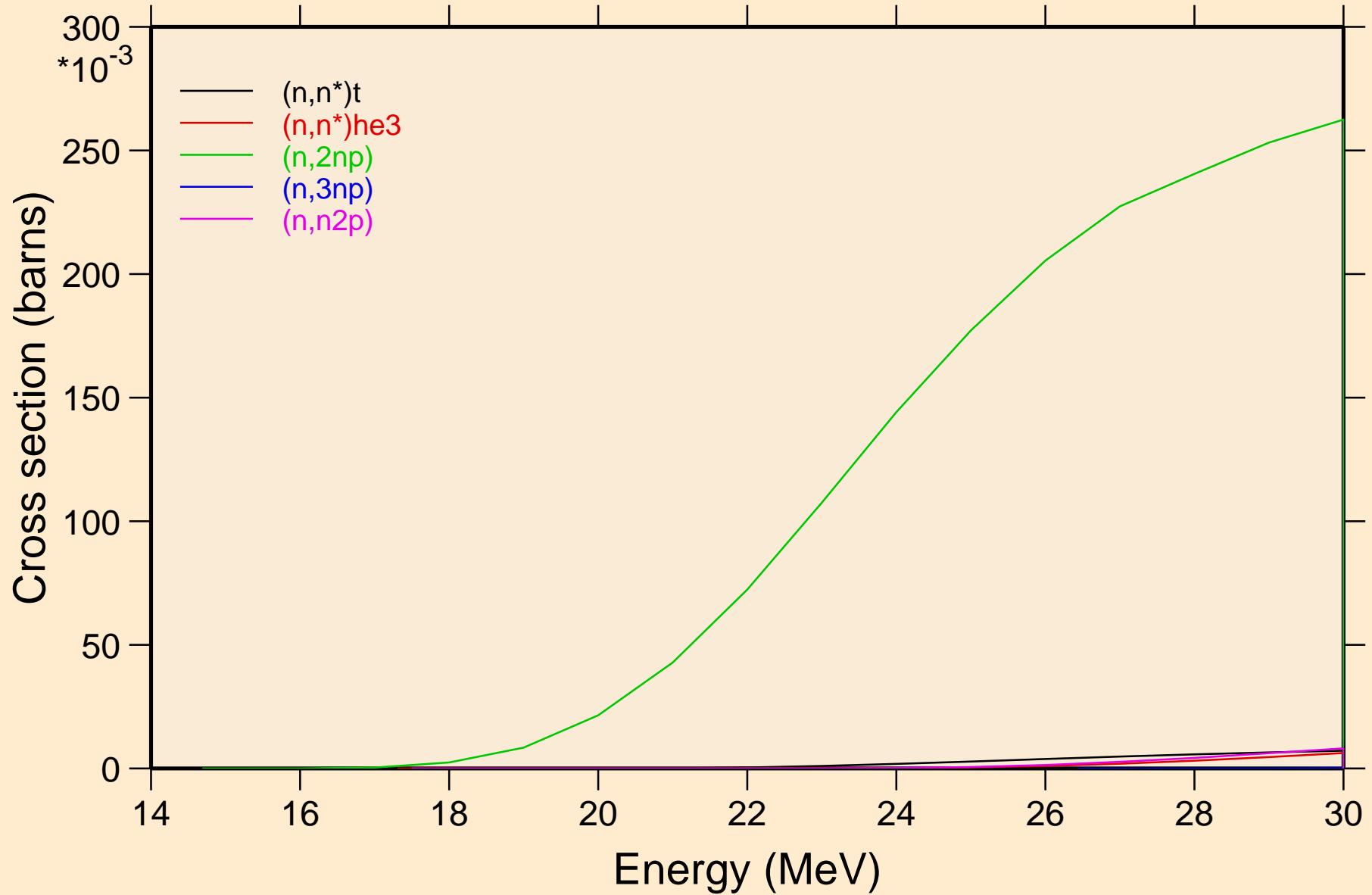

SC044M NEUTRON ACER TENDL-2023 LIBRARY; T=0.K

Threshold reactions

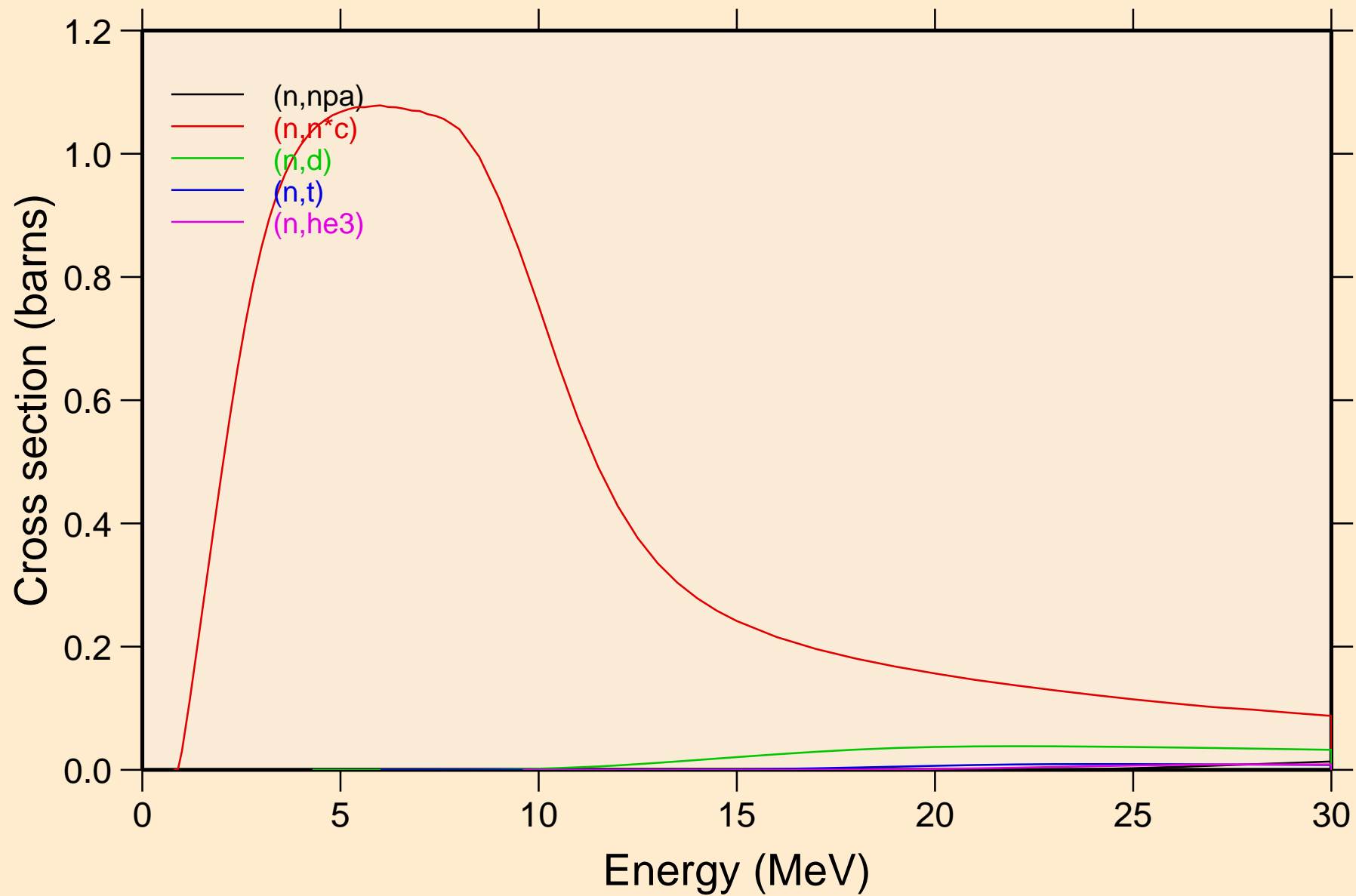

SC044M NEUTRON ACER TENDL-2023 LIBRARY; T=0.K
Threshold reactions

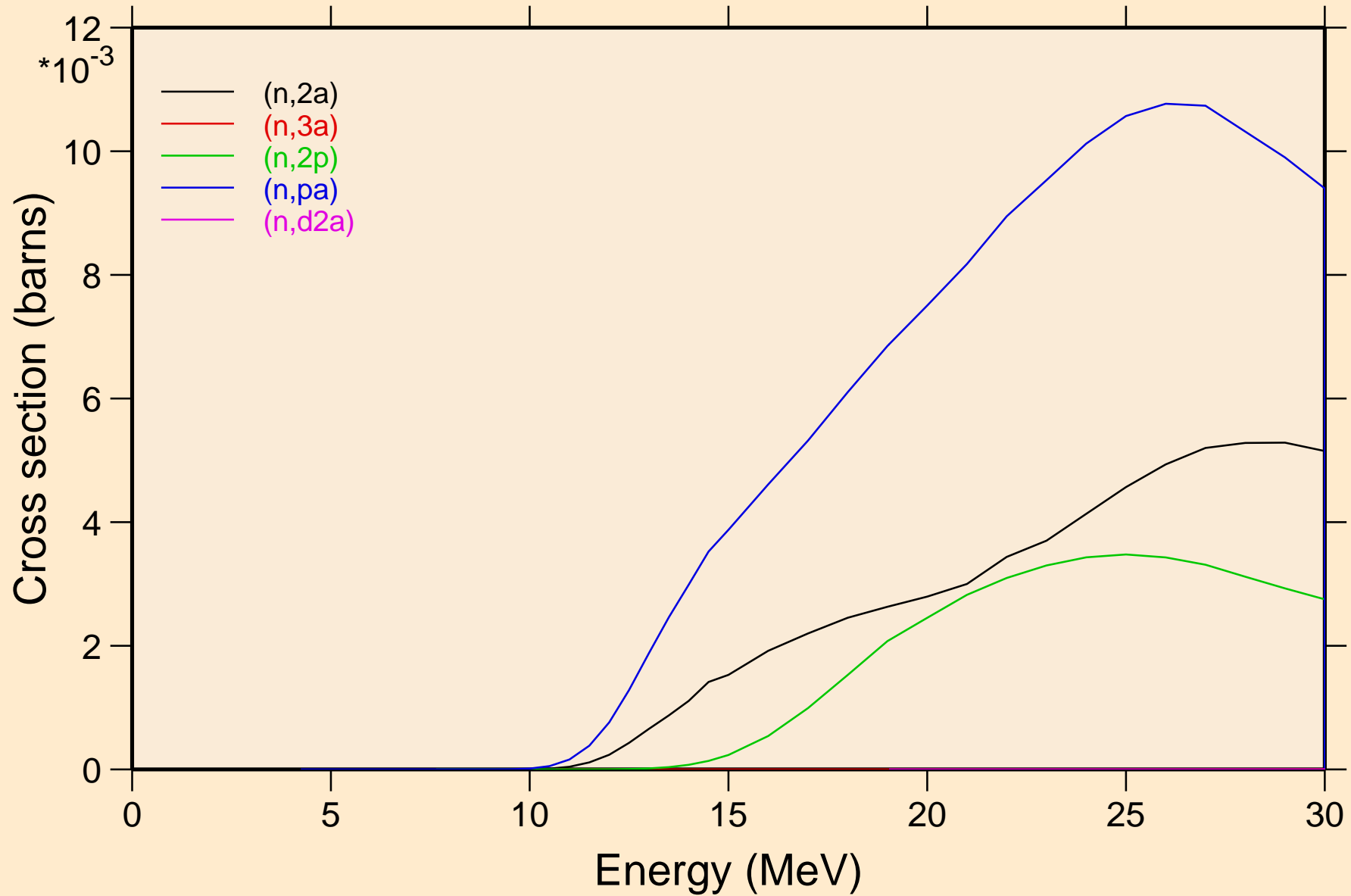

SC044M NEUTRON ACER TENDL-2023 LIBRARY; T=0.K
Threshold reactions

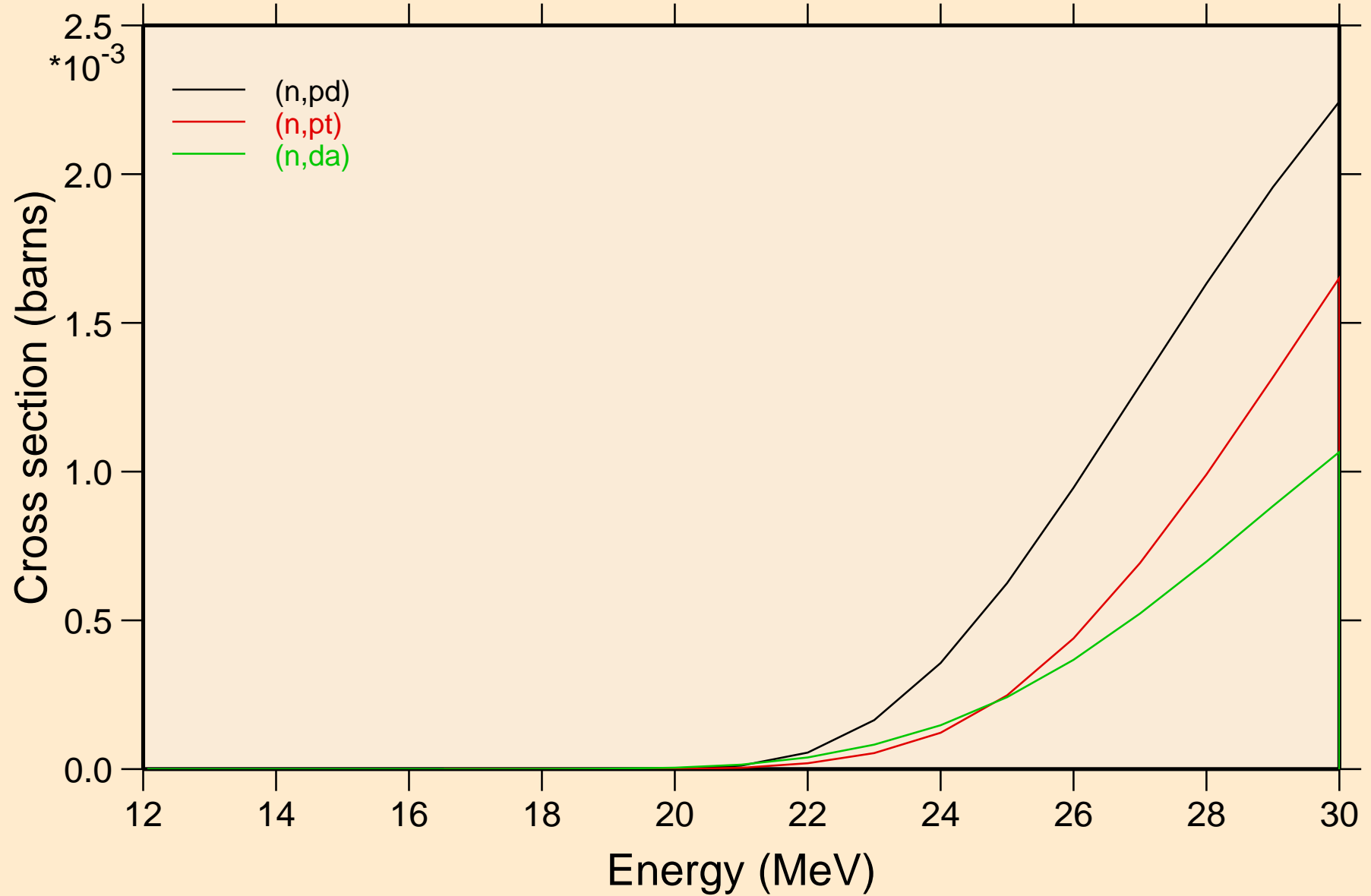

SC044M NEUTRON ACER TENDL-2023 LIBRARY; T=0.K

Threshold reactions

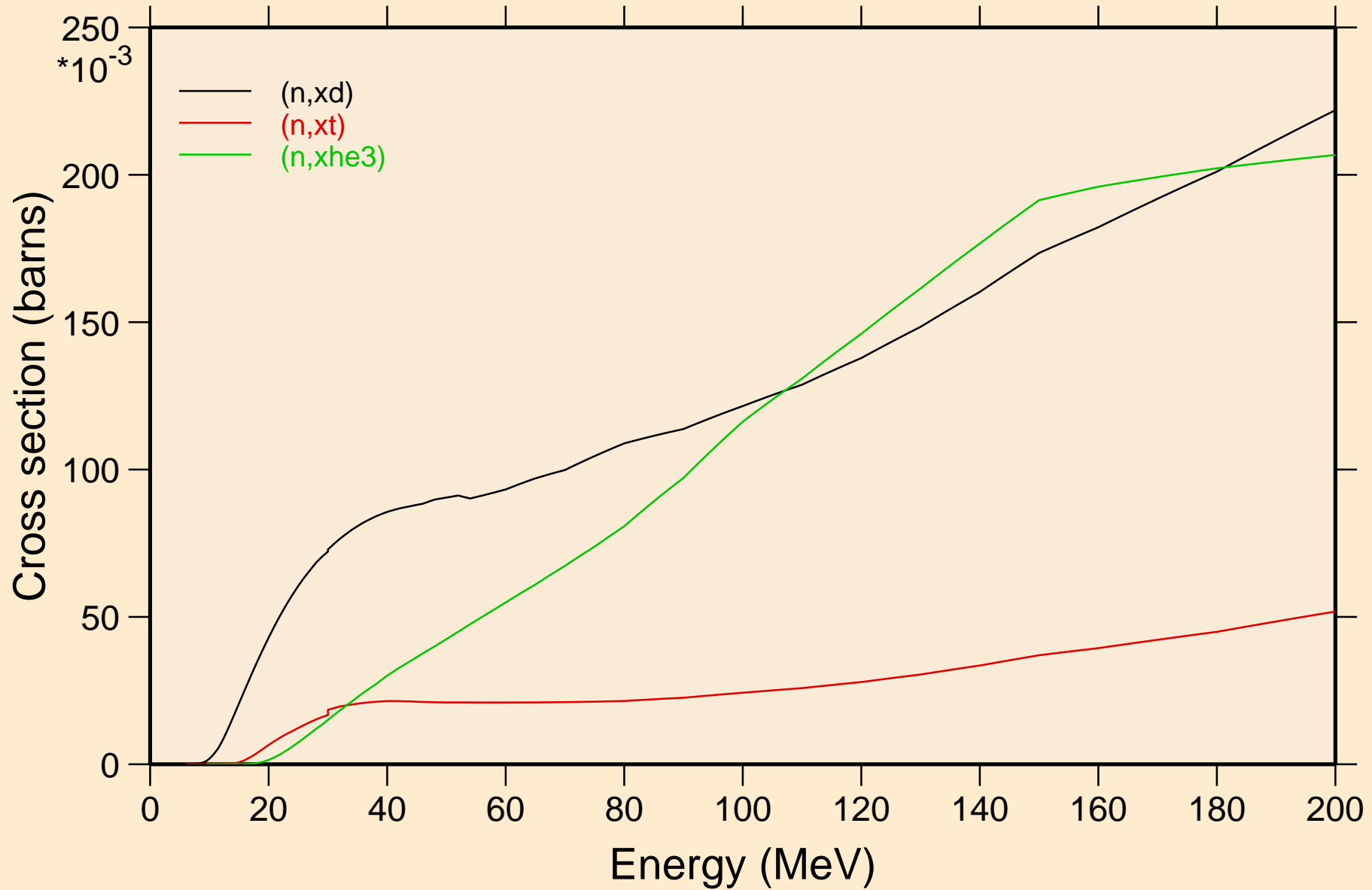

SC044M NEUTRON ACER TENDL-2023 LIBRARY; T=0.K
angular distribution for elastic

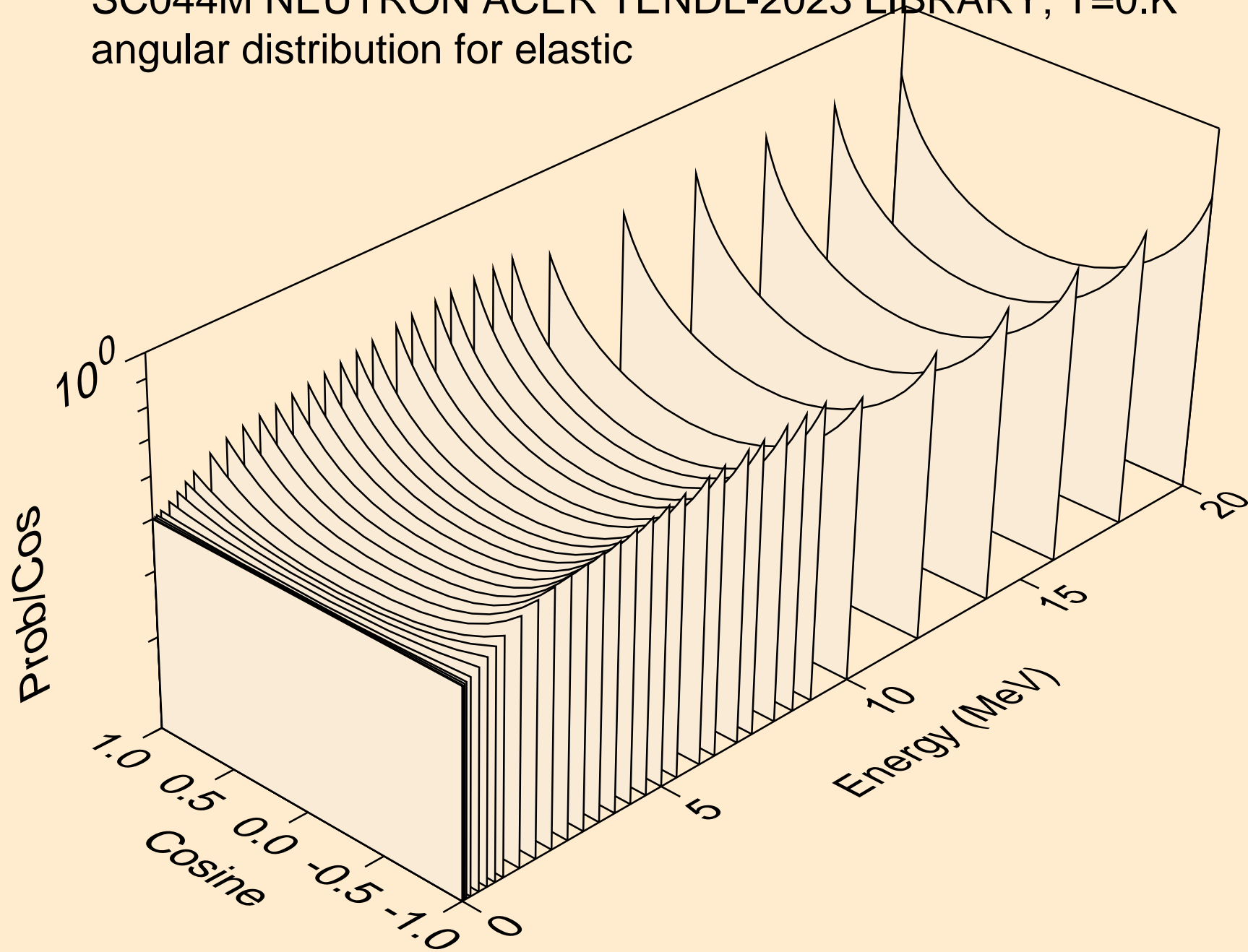

SC044M NEUTRON ACER TENDL-2023 LIBRARY; T=0.K
angular distribution for elastic

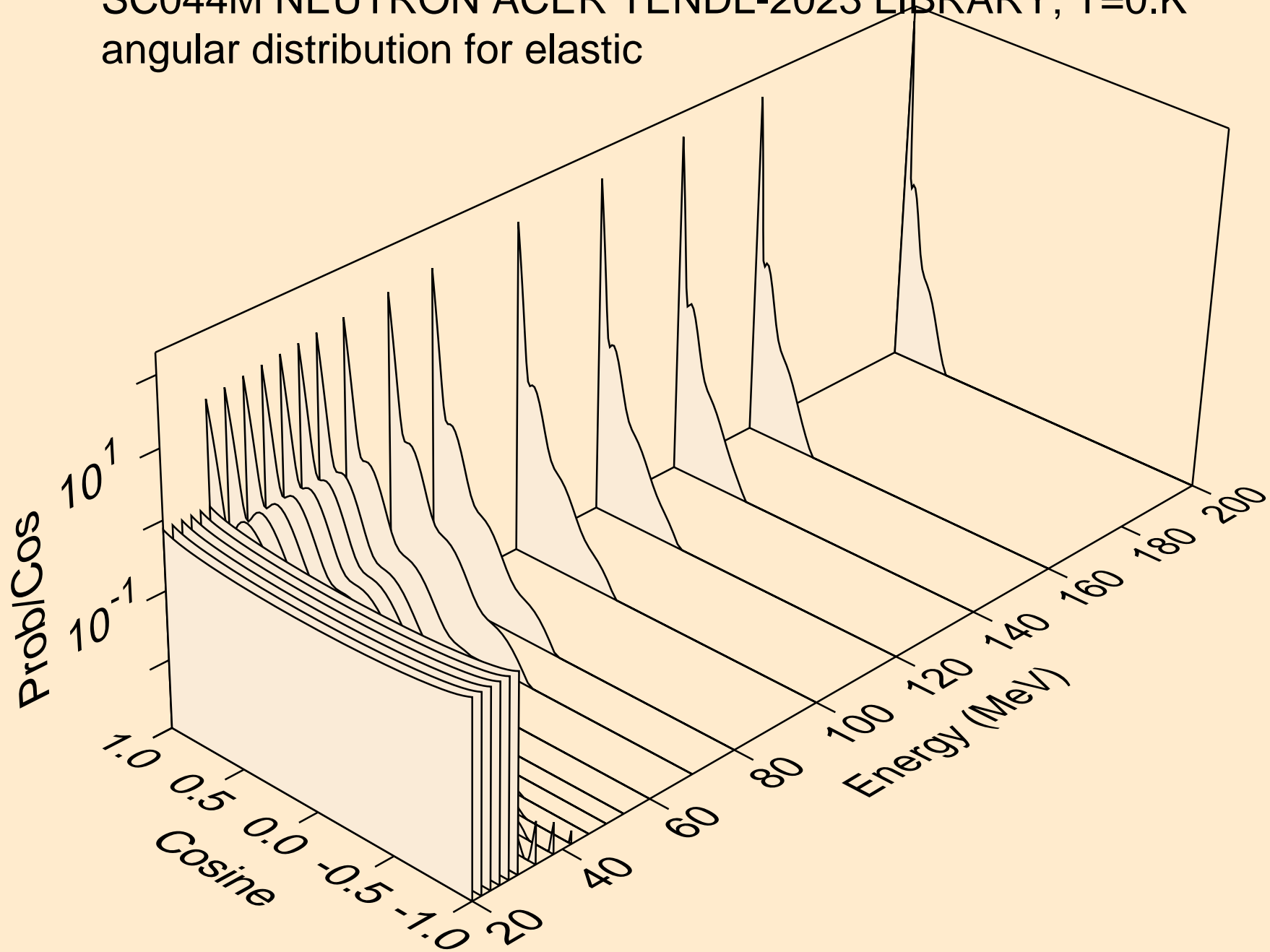

SC044M NEUTRON ACER TENDL-2023 LIBRARY; T=0.K
angular distribution for (n,n*1)

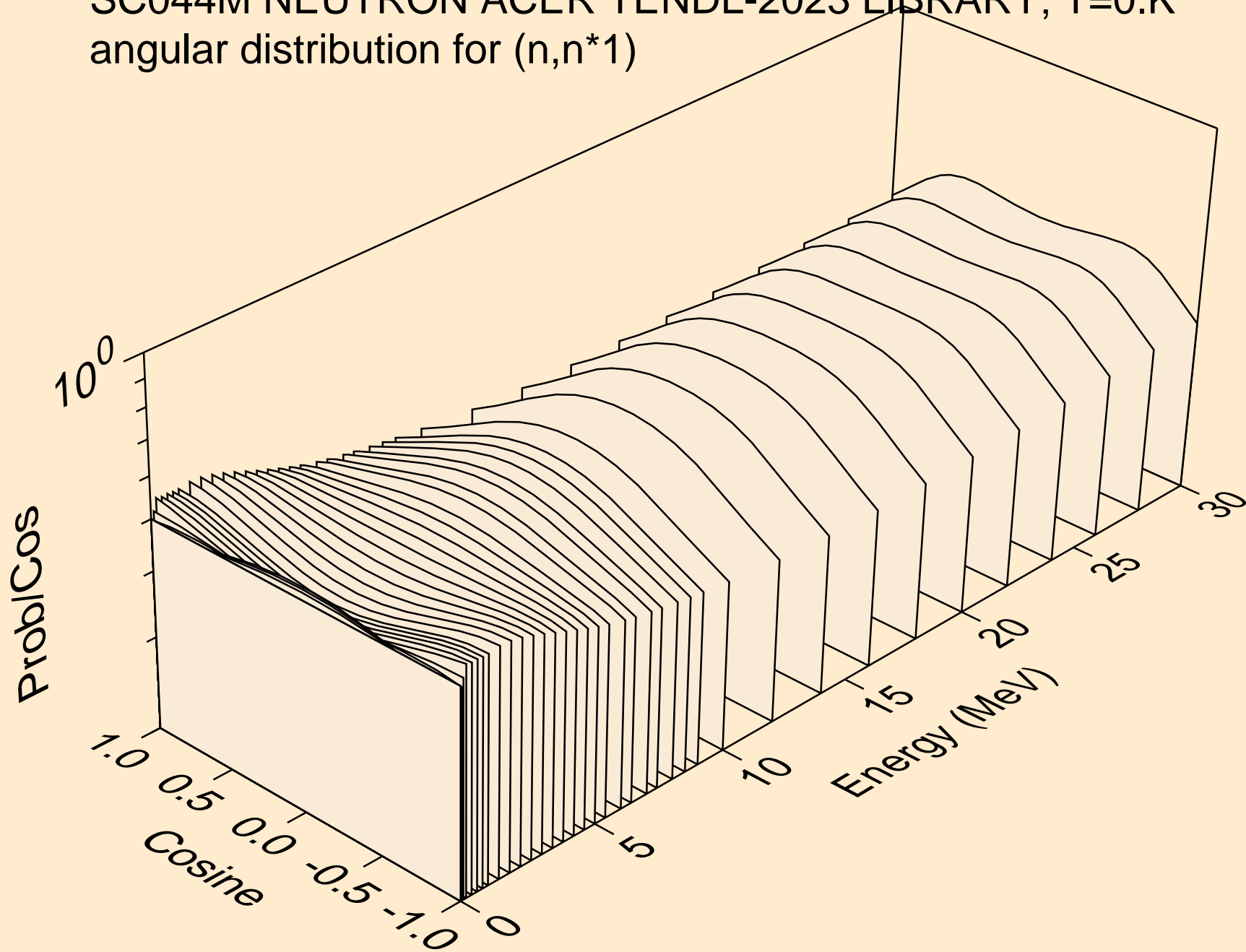

SC044M NEUTRON ACER TENDL-2023 LIBRARY; T=0.K
angular distribution for (n,n*2)

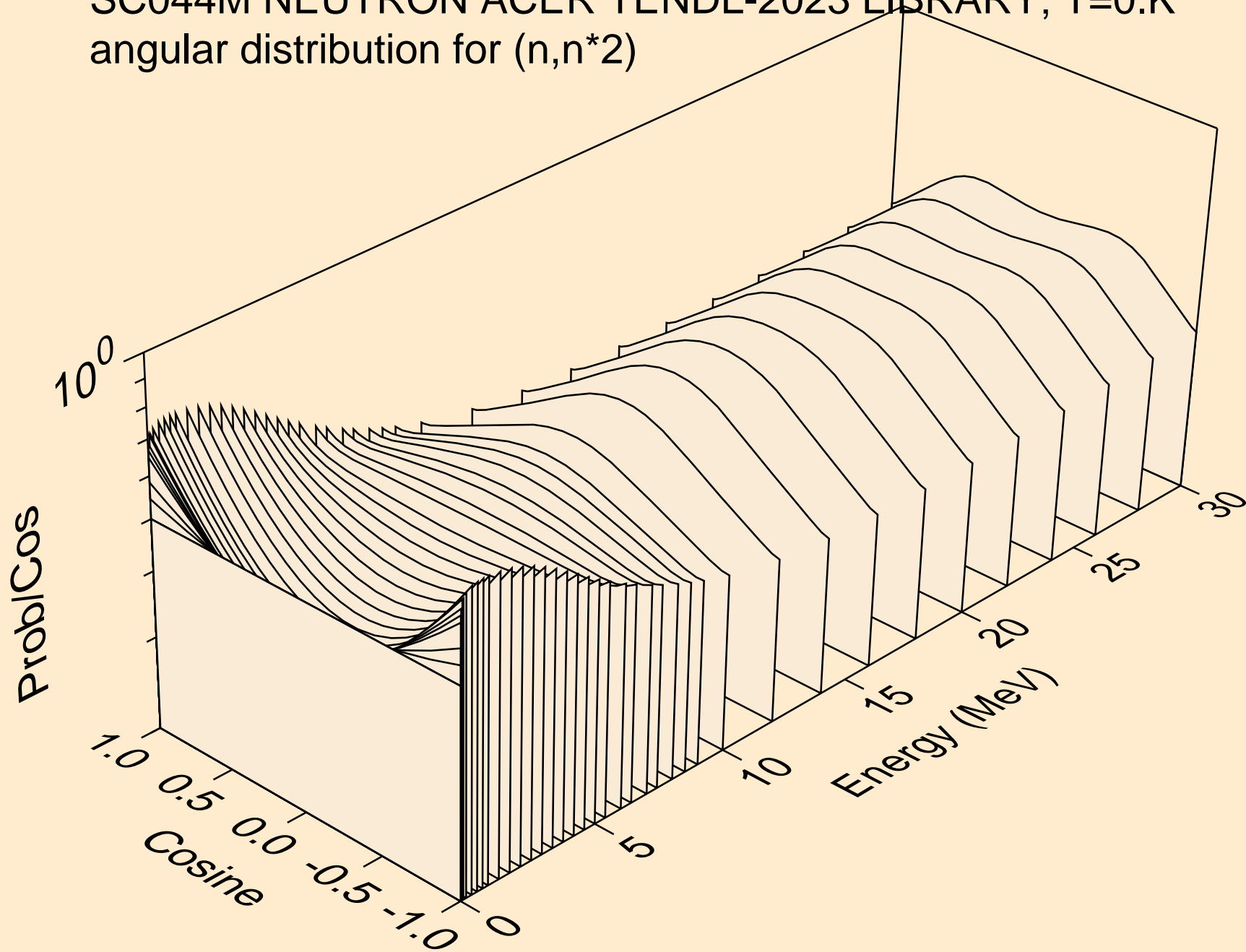

SC044M NEUTRON ACER TENDL-2023 LIBRARY; T=0.K
angular distribution for (n,n*3)

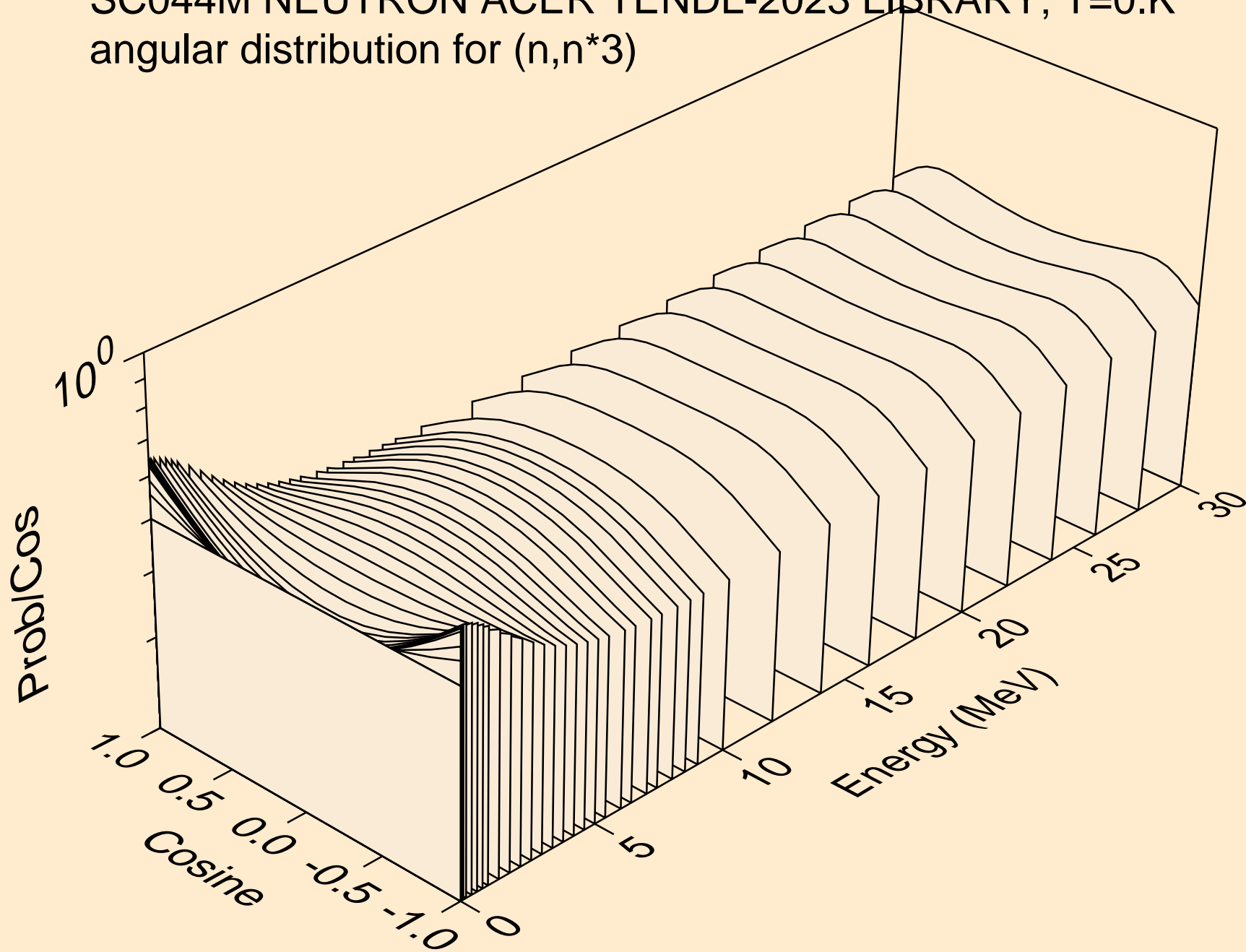

SC044M NEUTRON ACER TENDL-2023 LIBRARY; T=0.K
angular distribution for (n,n*4)

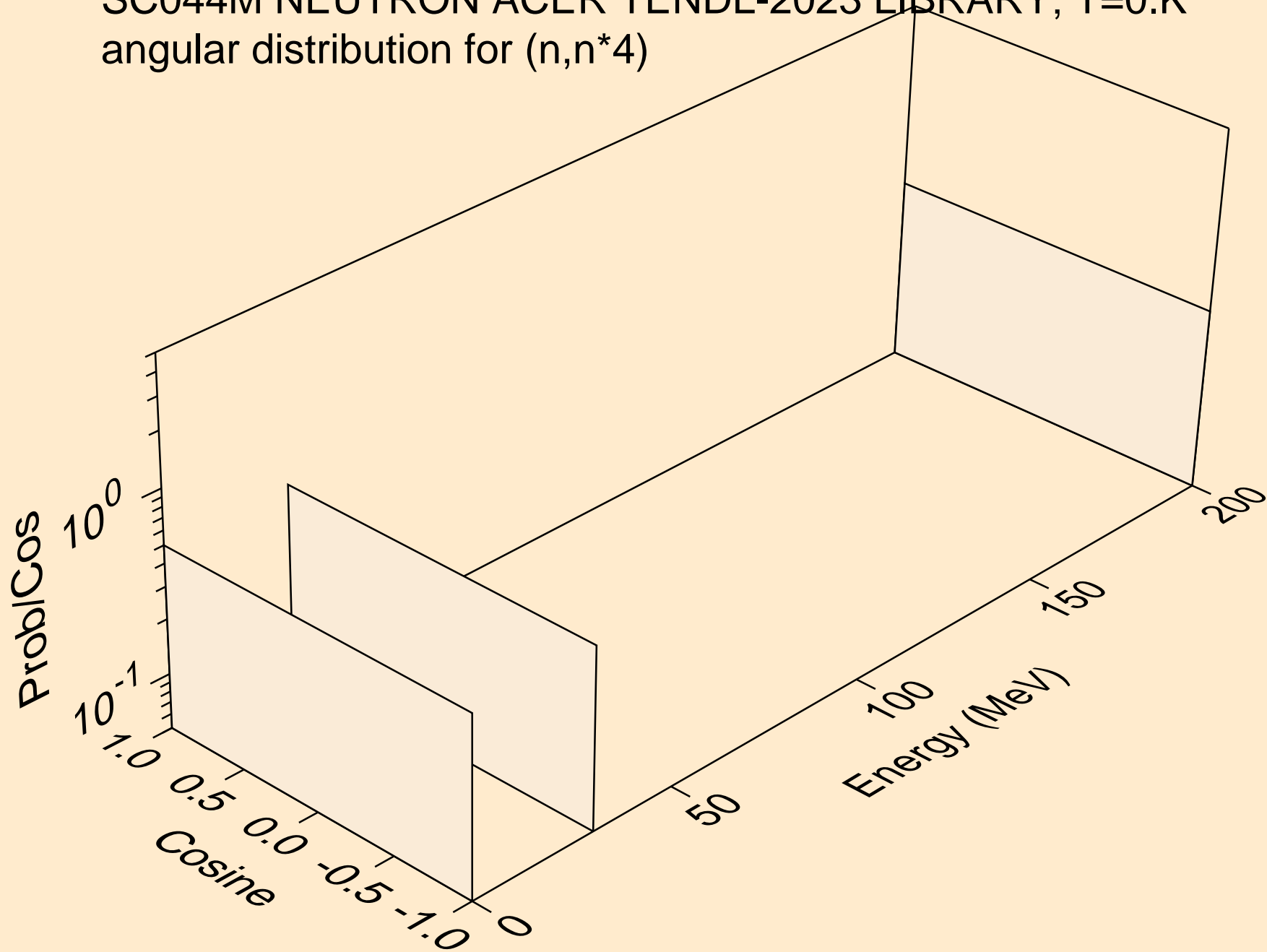

SC044M NEUTRON ACER TENDL-2023 LIBRARY; T=0.K
angular distribution for (n,n*5)

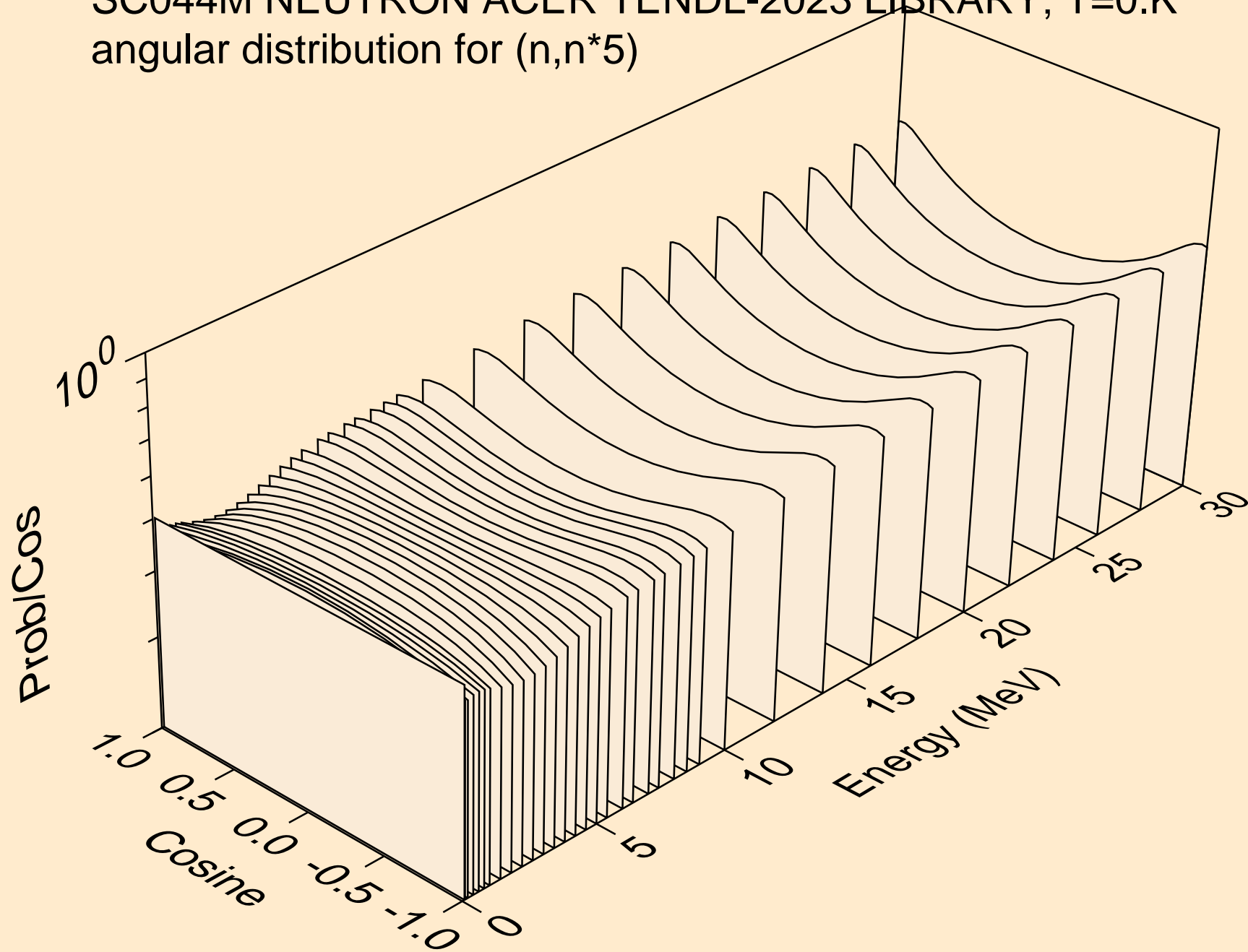

SC044M NEUTRON ACER TENDL-2023 LIBRARY; T=0.K
angular distribution for (n,n*6)

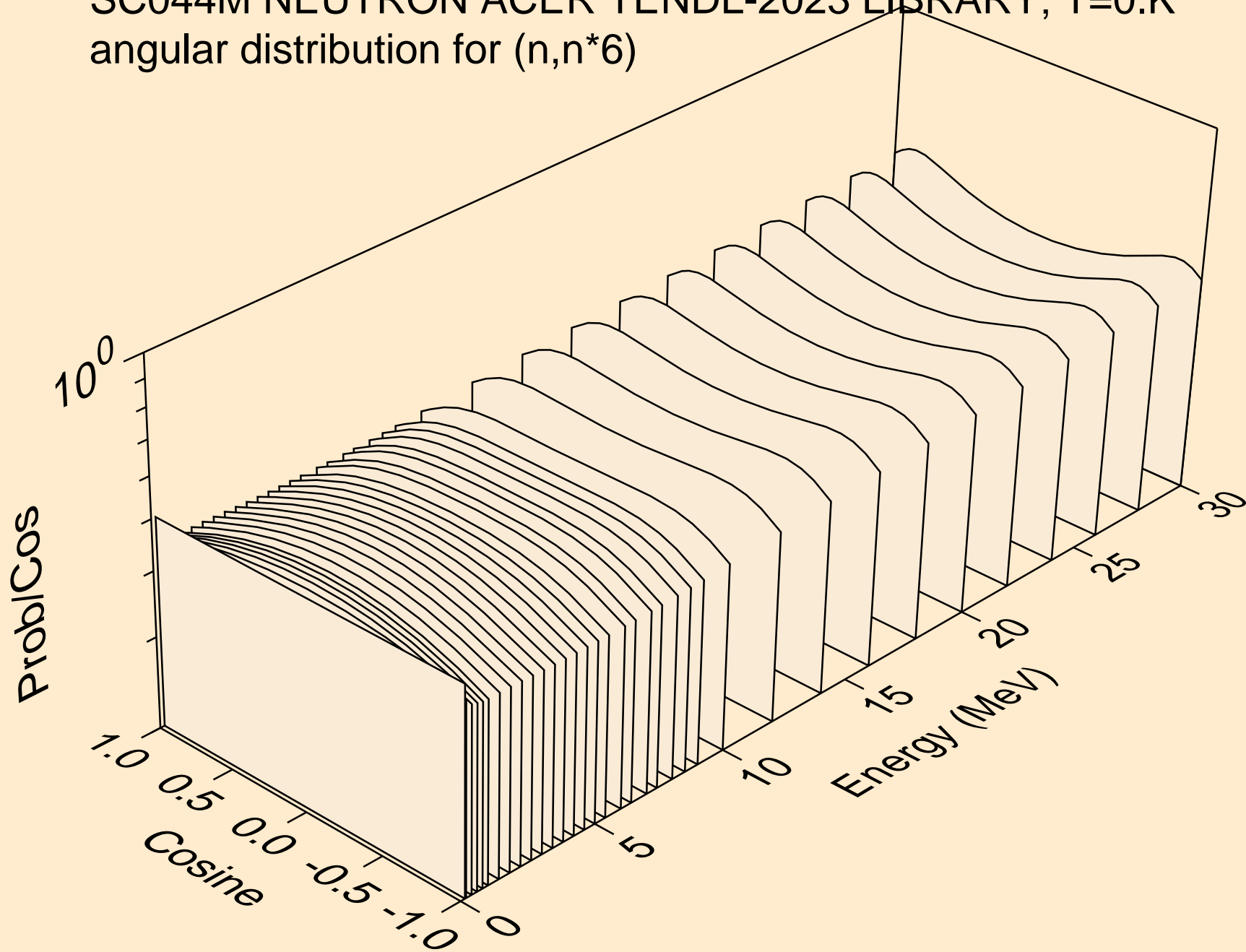

SC044M NEUTRON ACER TENDL-2023 LIBRARY; T=0.K
angular distribution for (n,n*7)

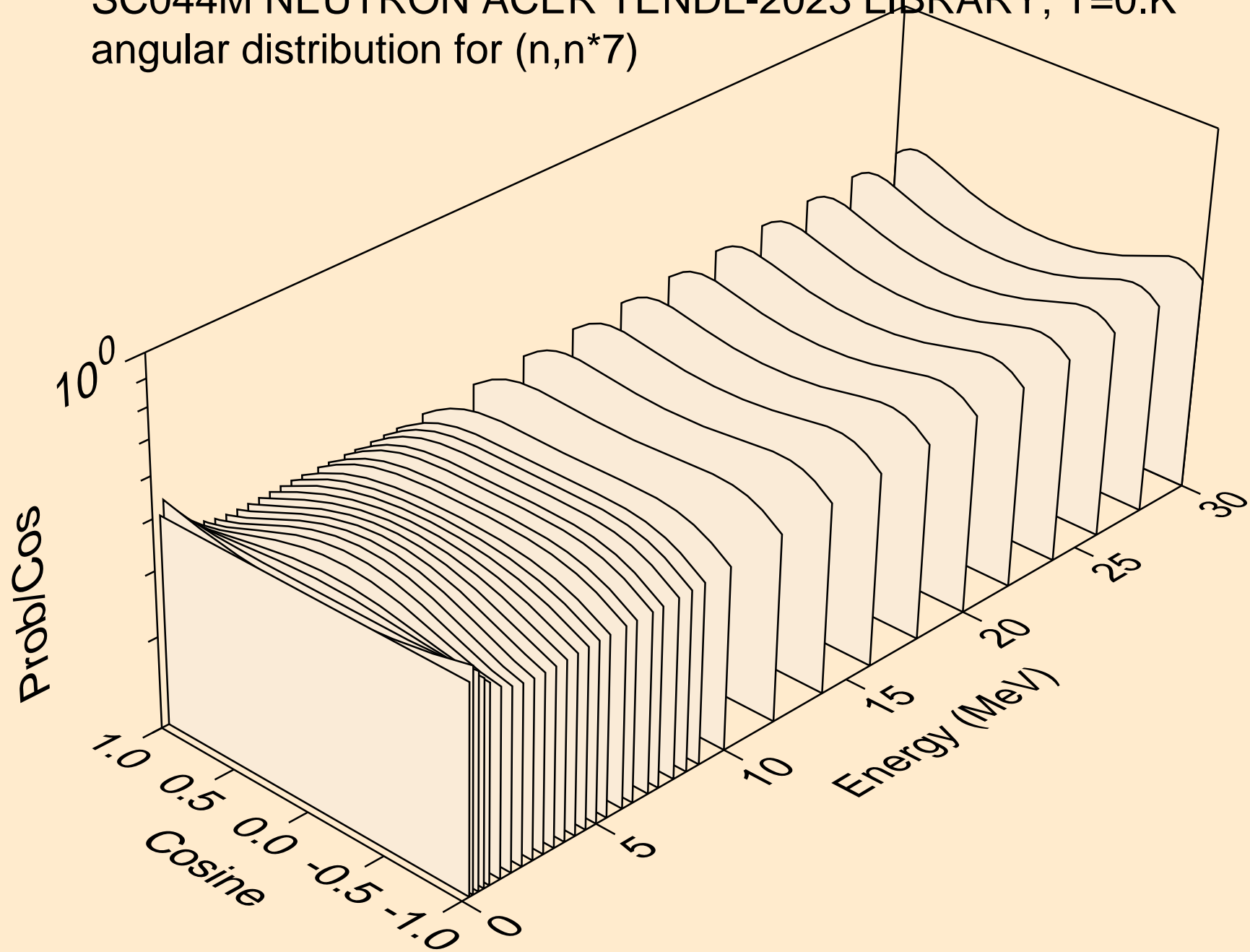

SC044M NEUTRON ACER TENDL-2023 LIBRARY; T=0.K
angular distribution for (n,n*8)

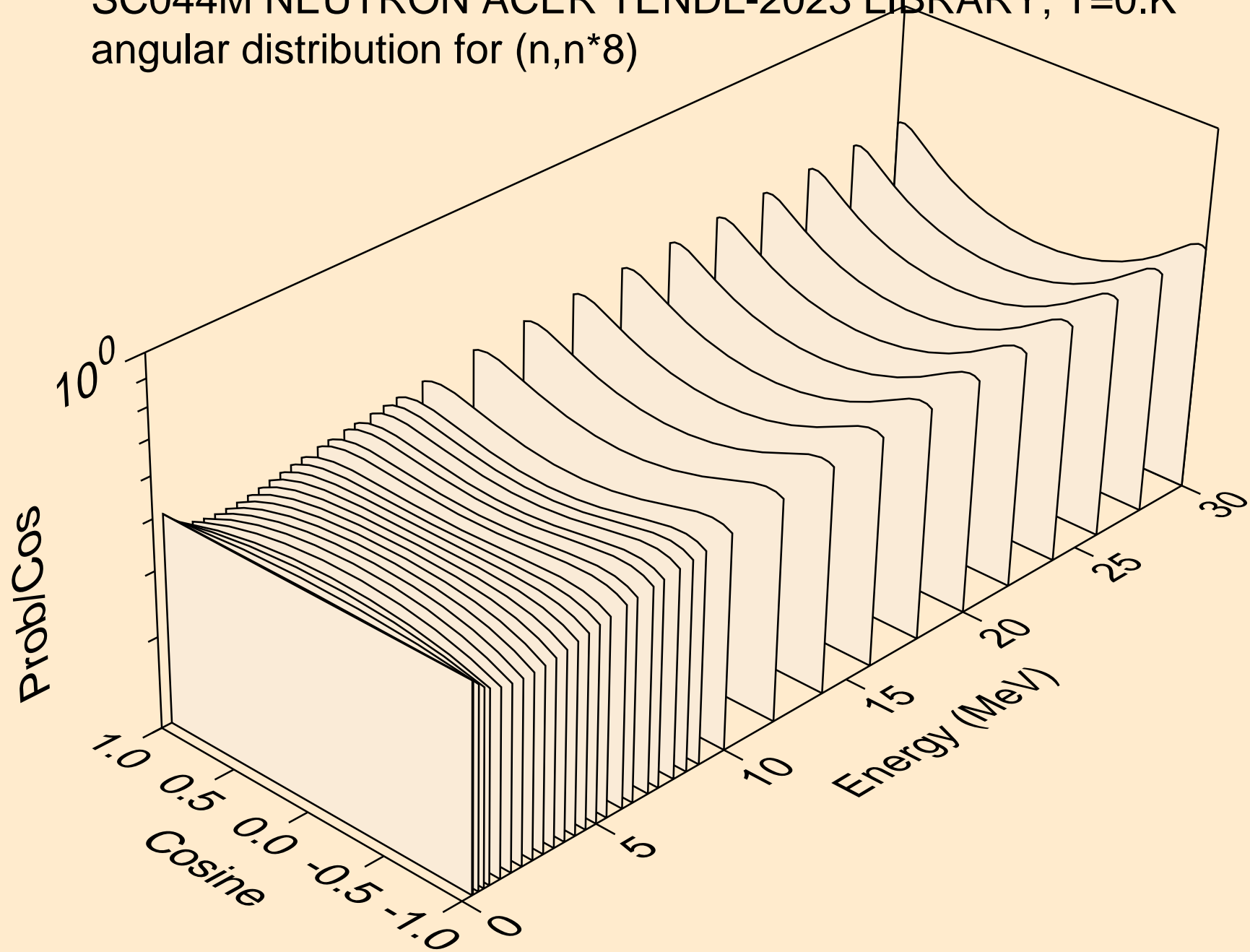

SC044M NEUTRON ACER TENDL-2023 LIBRARY; T=0.K
angular distribution for (n,n*9)

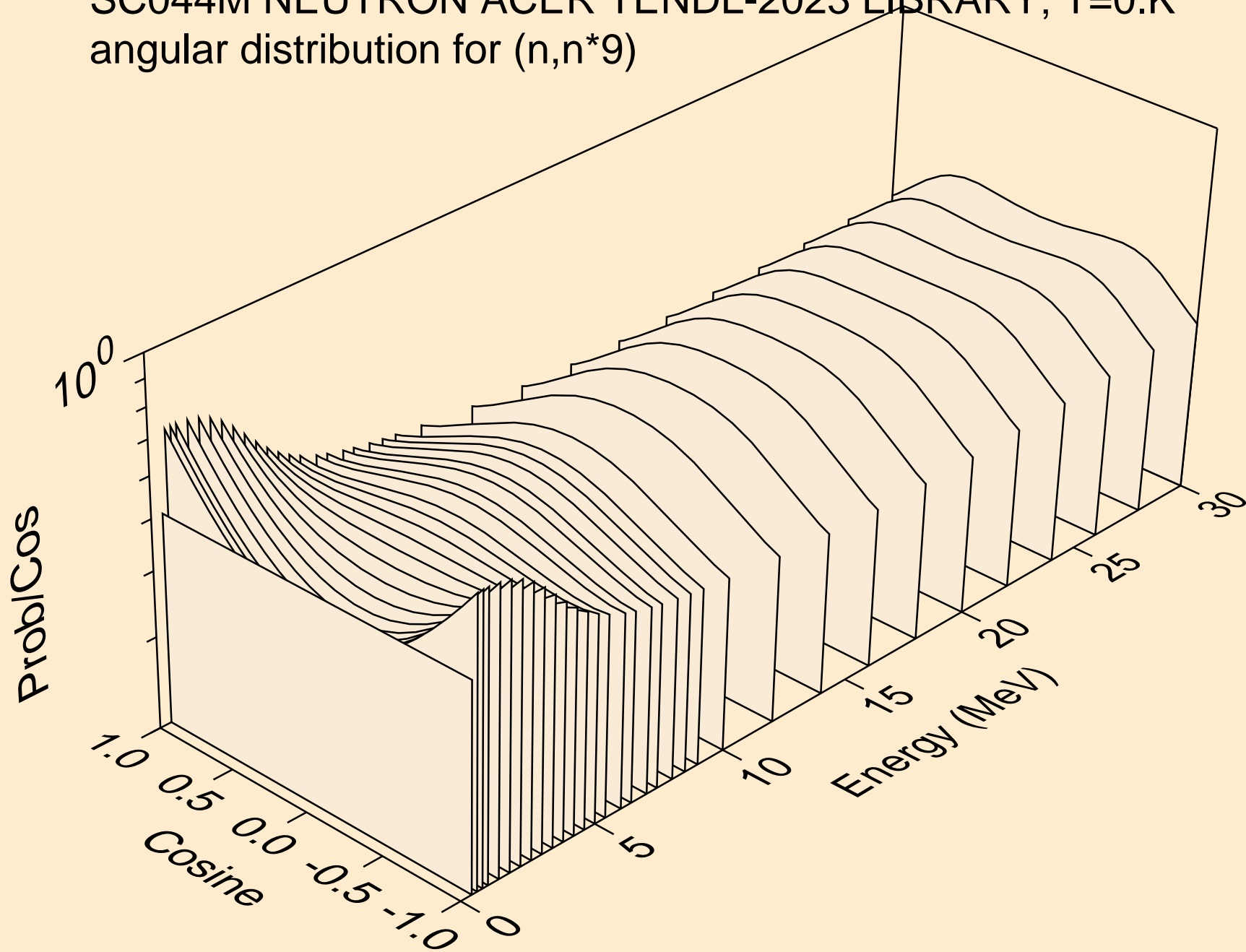

SC044M NEUTRON ACER TENDL-2023 LIBRARY; T=0.K
angular distribution for (n,n*10)

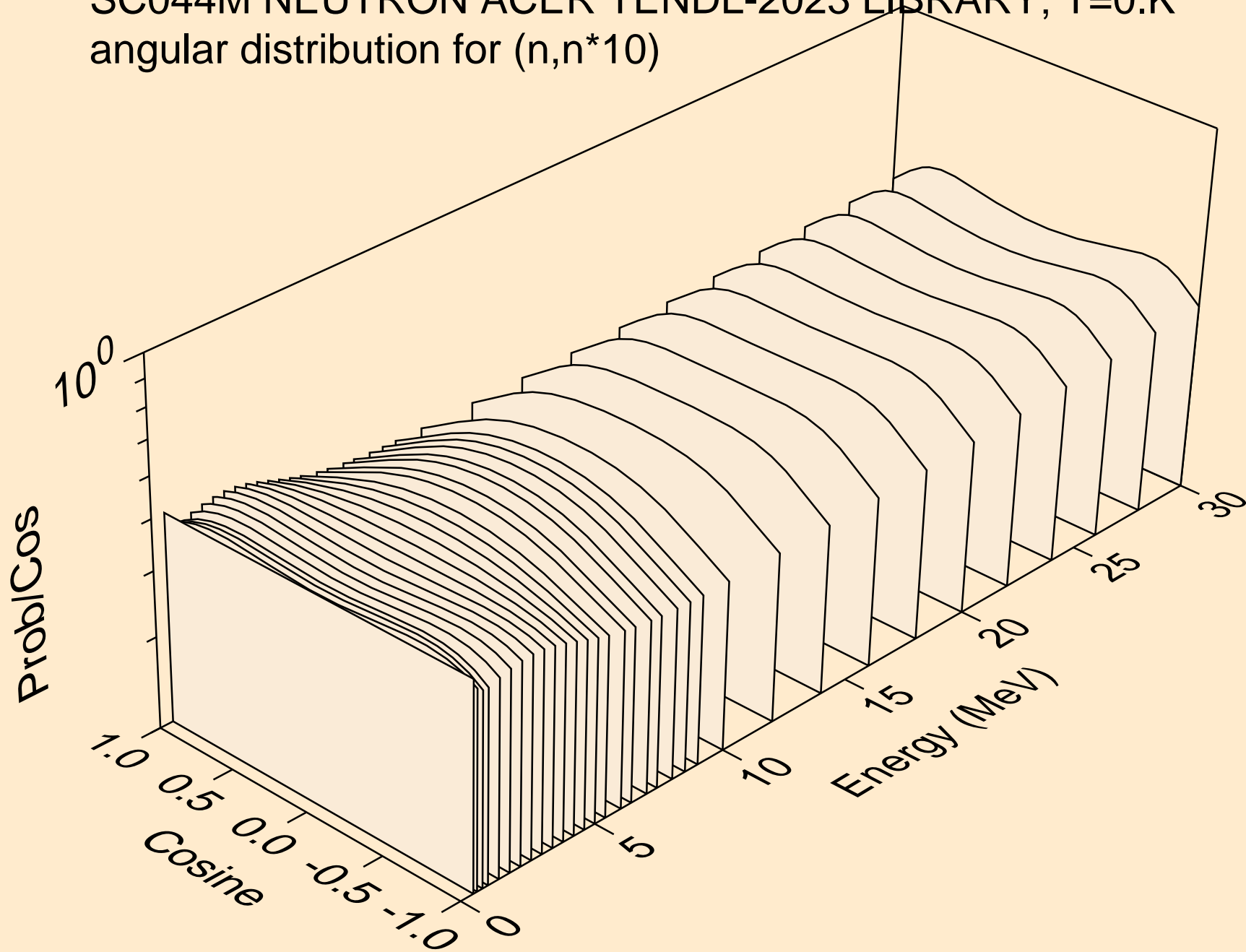

SC044M NEUTRON ACER TENDL-2023 LIBRARY; T=0.K
angular distribution for (n,n*11)

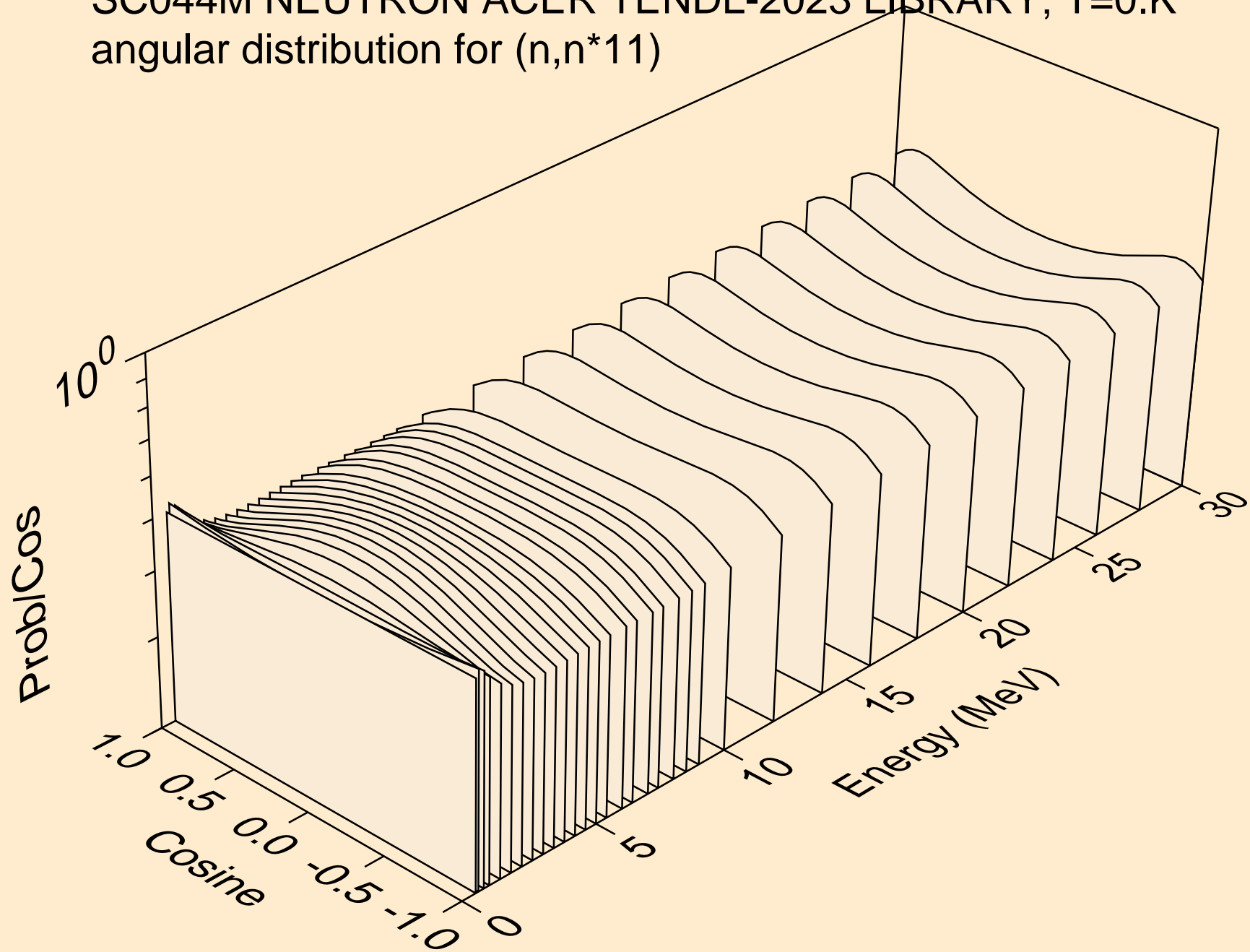

SC044M NEUTRON ACER TENDL-2023 LIBRARY; T=0.K
angular distribution for (n,n*12)

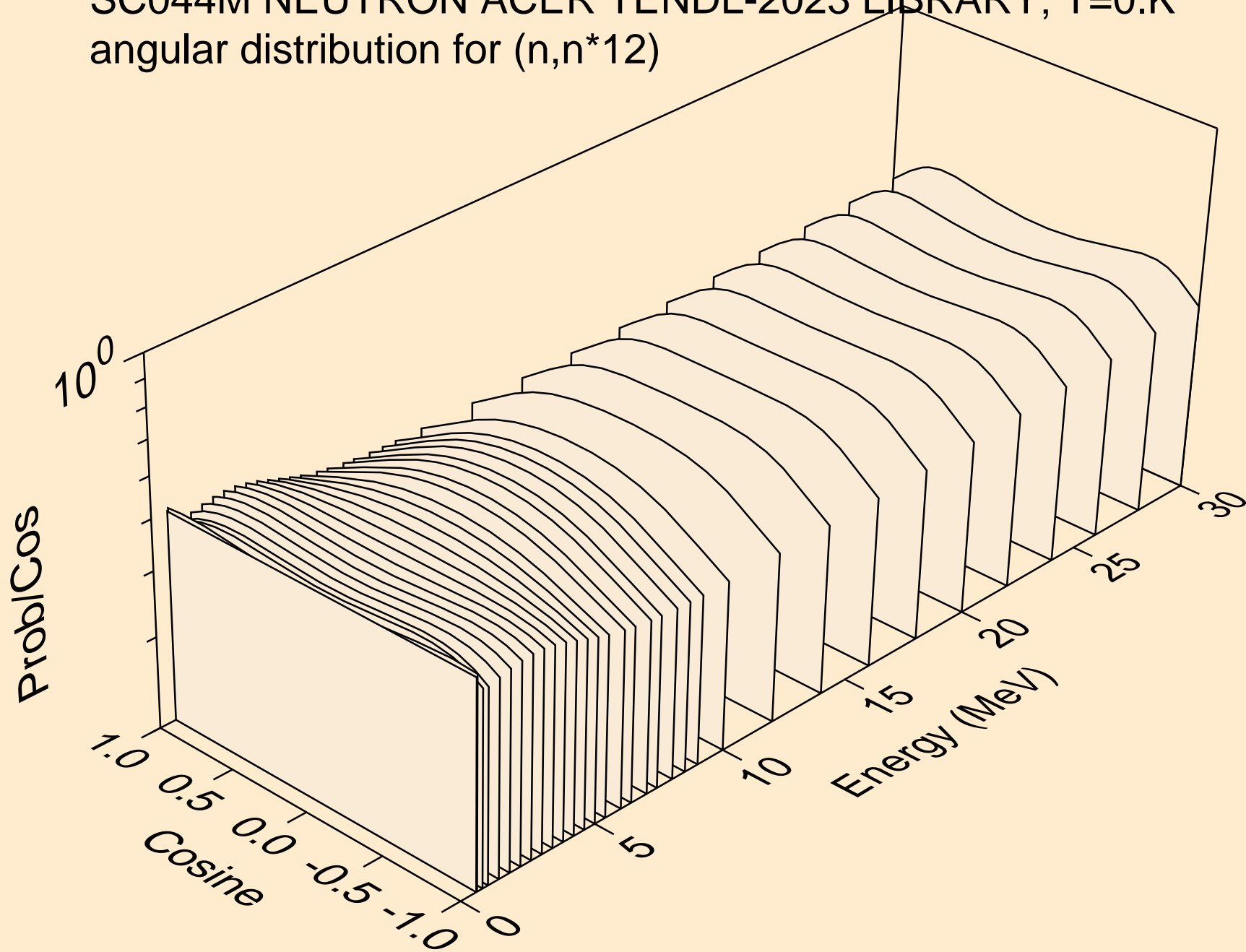

SC044M NEUTRON ACER TENDL-2023 LIBRARY; T=0.K
angular distribution for (n,n*13)

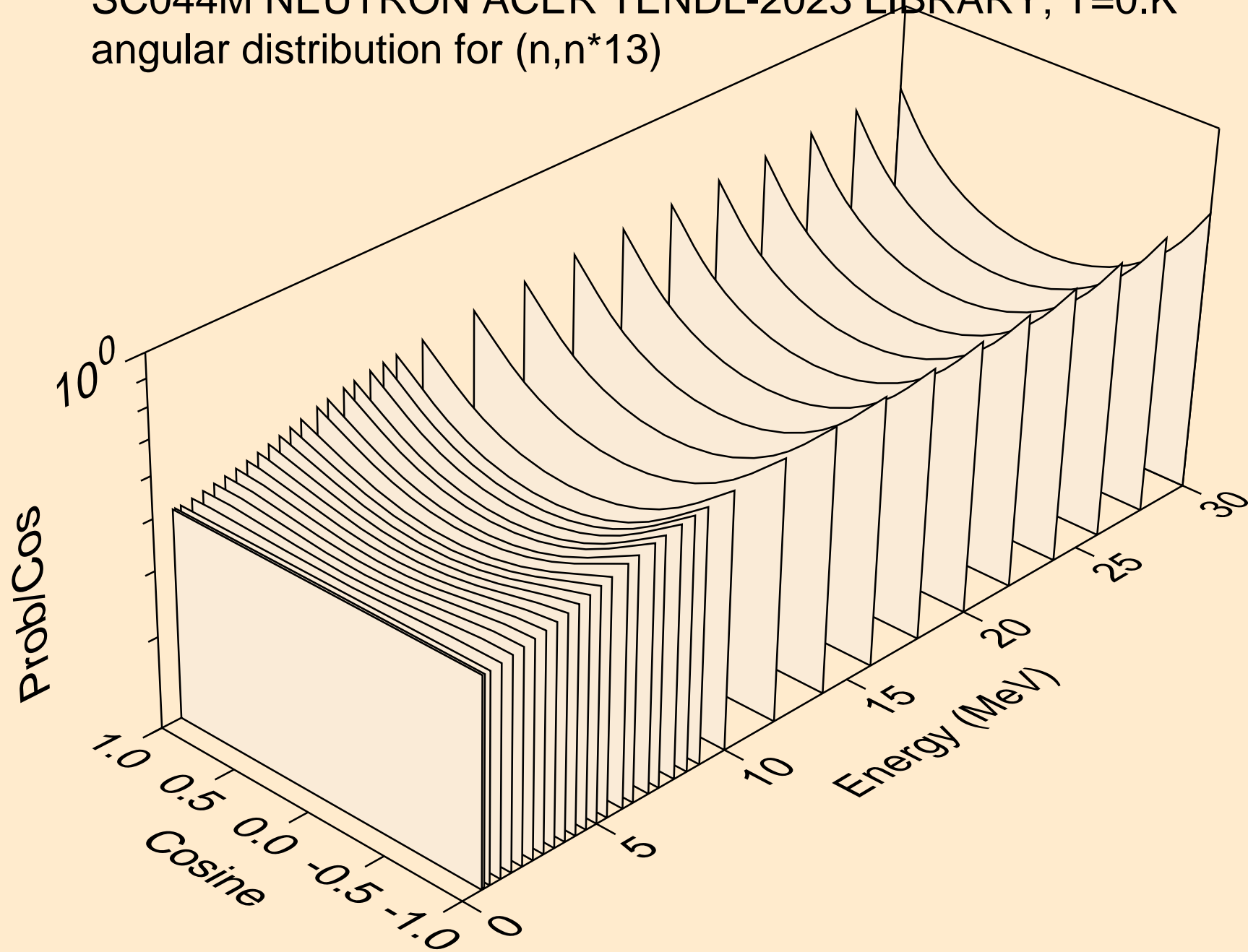

SC044M NEUTRON ACER TENDL-2023 LIBRARY; T=0.K
angular distribution for (n,n*14)

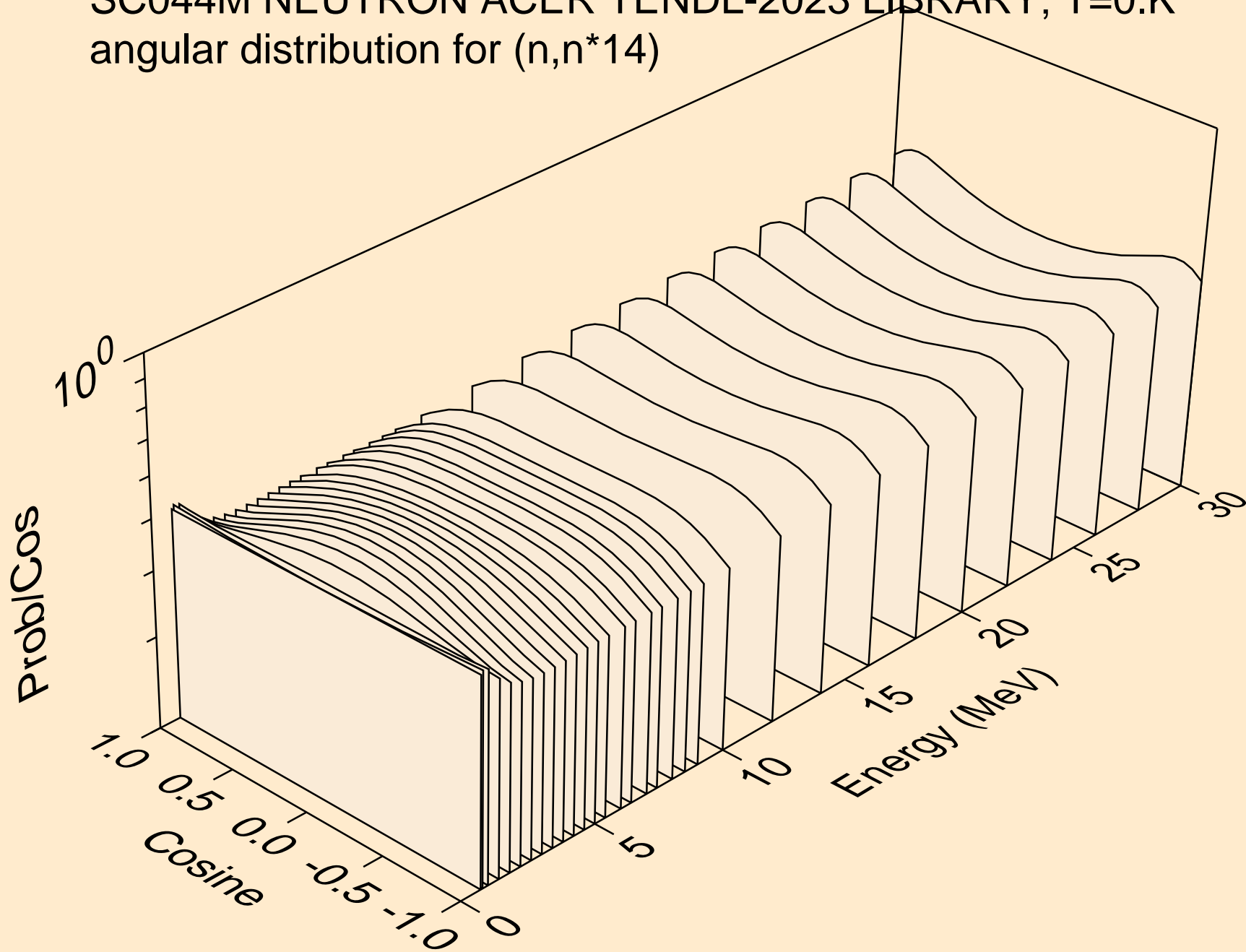

SC044M NEUTRON ACER TENDL-2023 LIBRARY; T=0.K
angular distribution for (n,n*15)

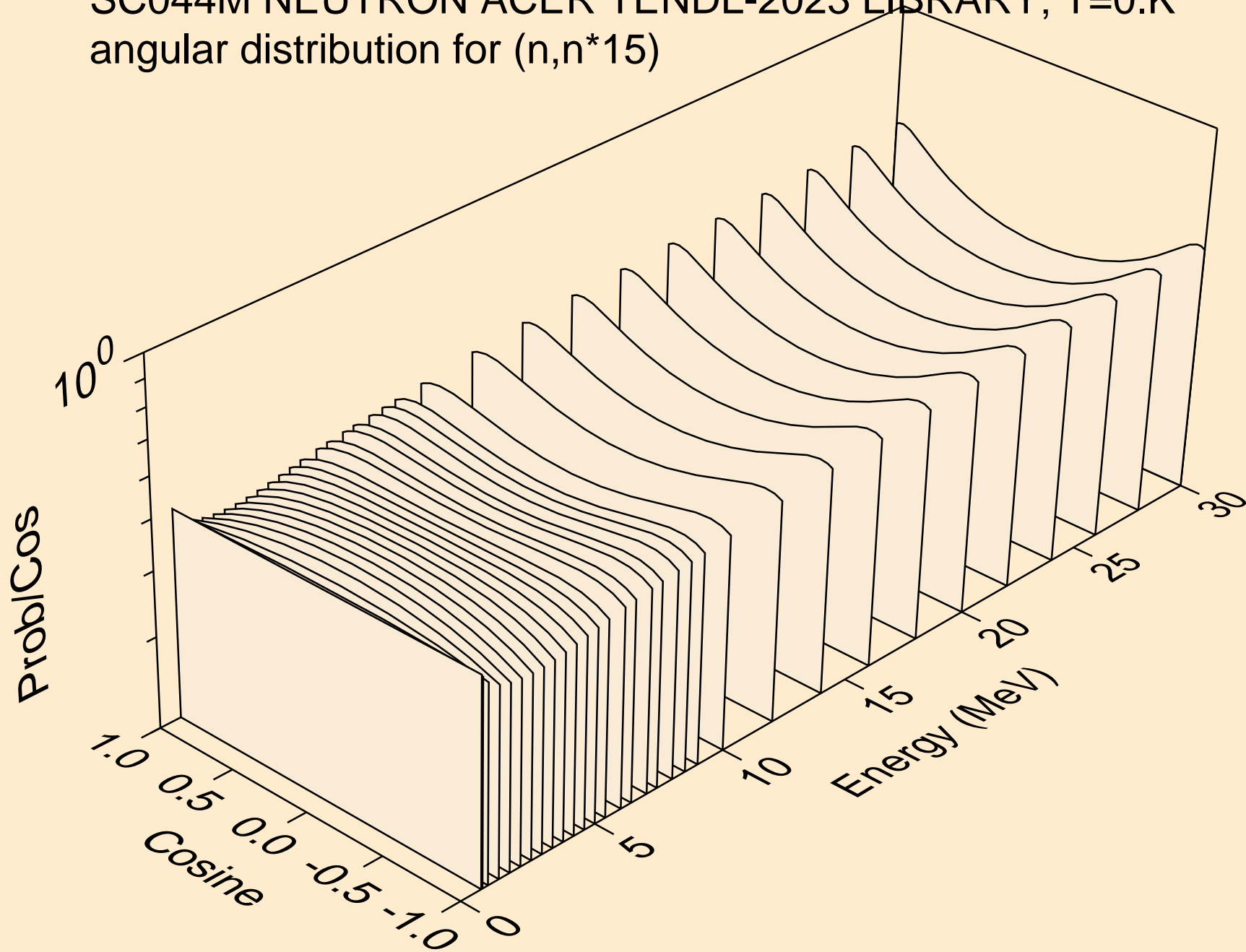

SC044M NEUTRON ACER TENDL-2023 LIBRARY; T=0.K
angular distribution for (n,n*16)

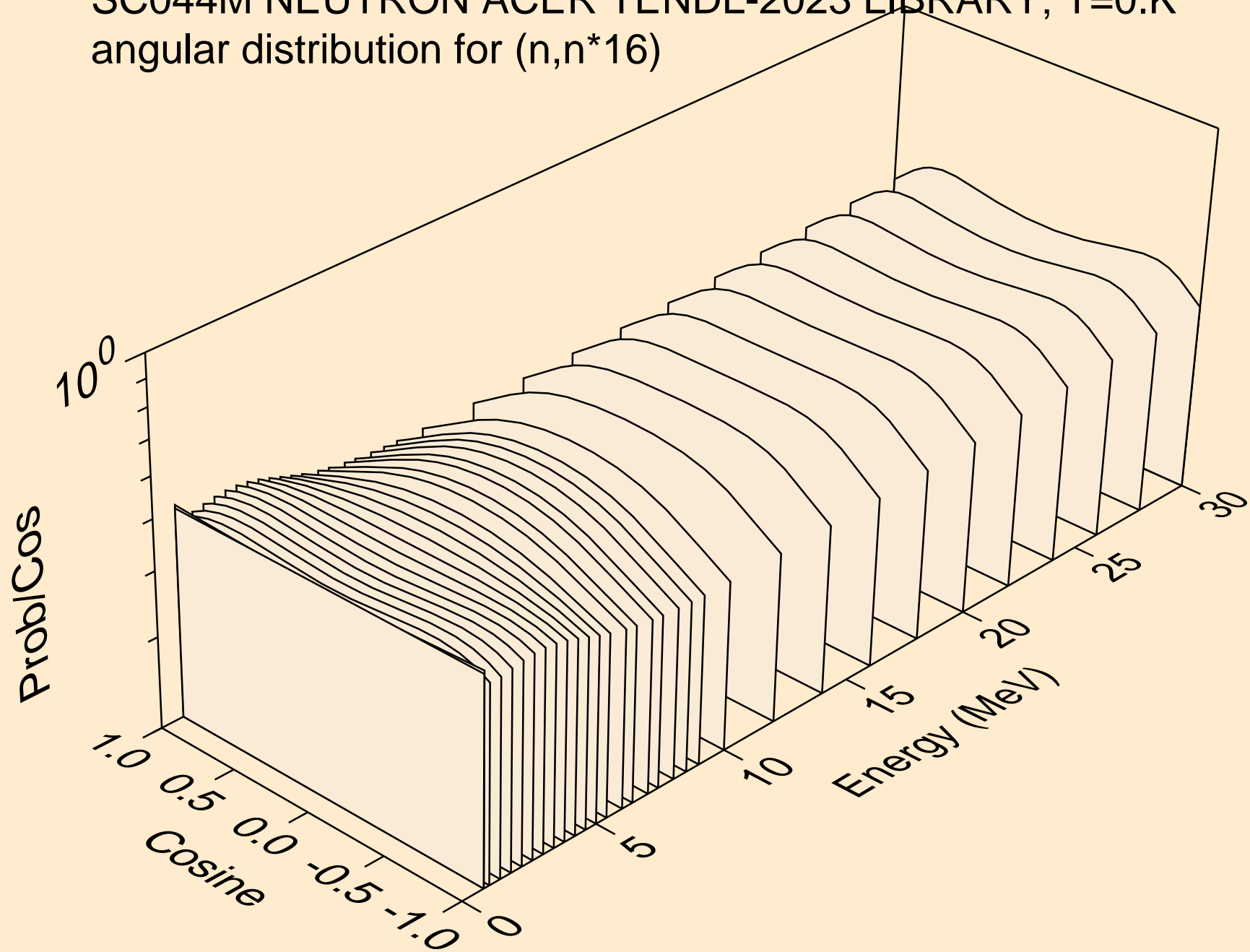

SC044M NEUTRON ACER TENDL-2023 LIBRARY; T=0.K
angular distribution for (n,n*17)

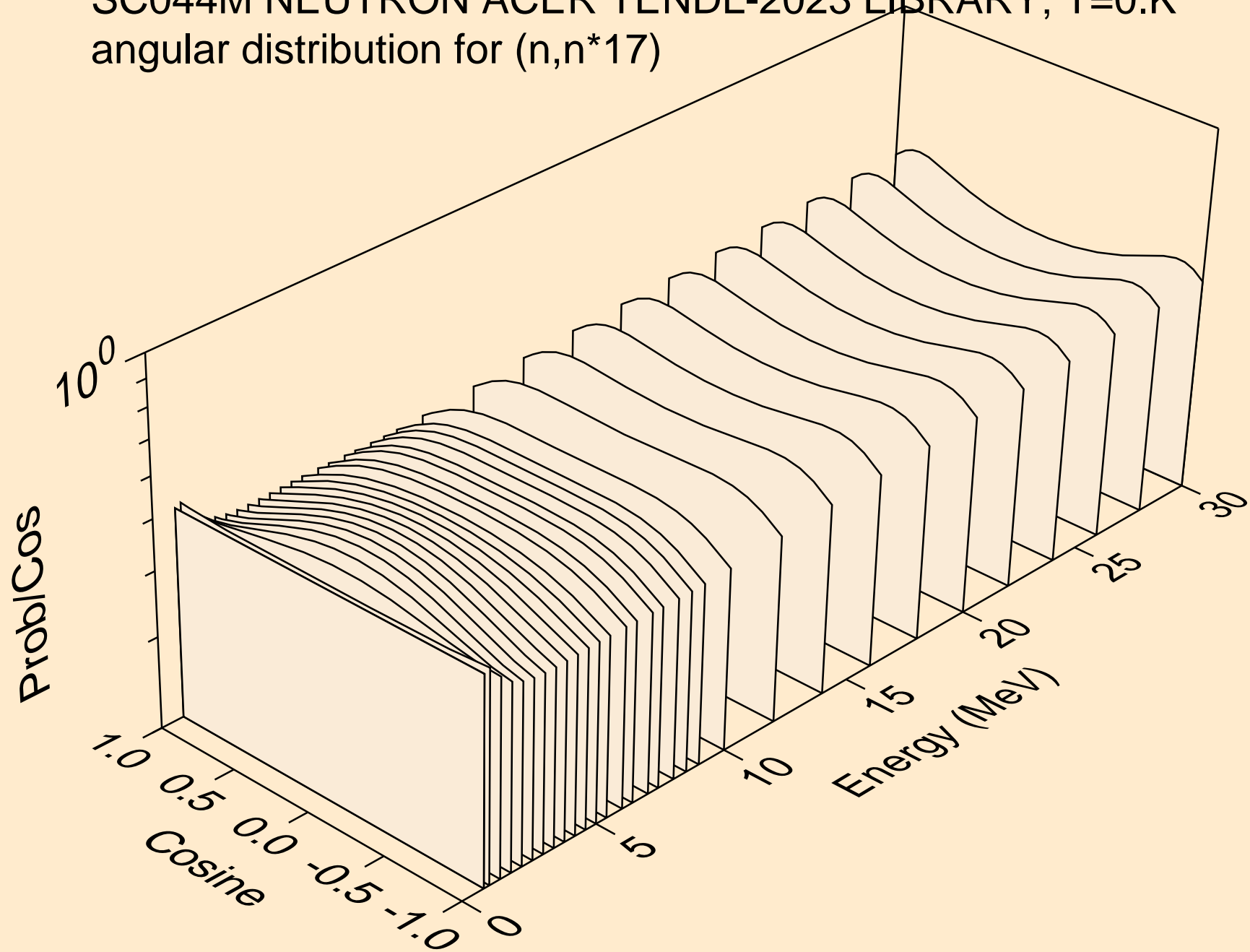

SC044M NEUTRON ACER TENDL-2023 LIBRARY; T=0.K
Neutron emission for (n,x)

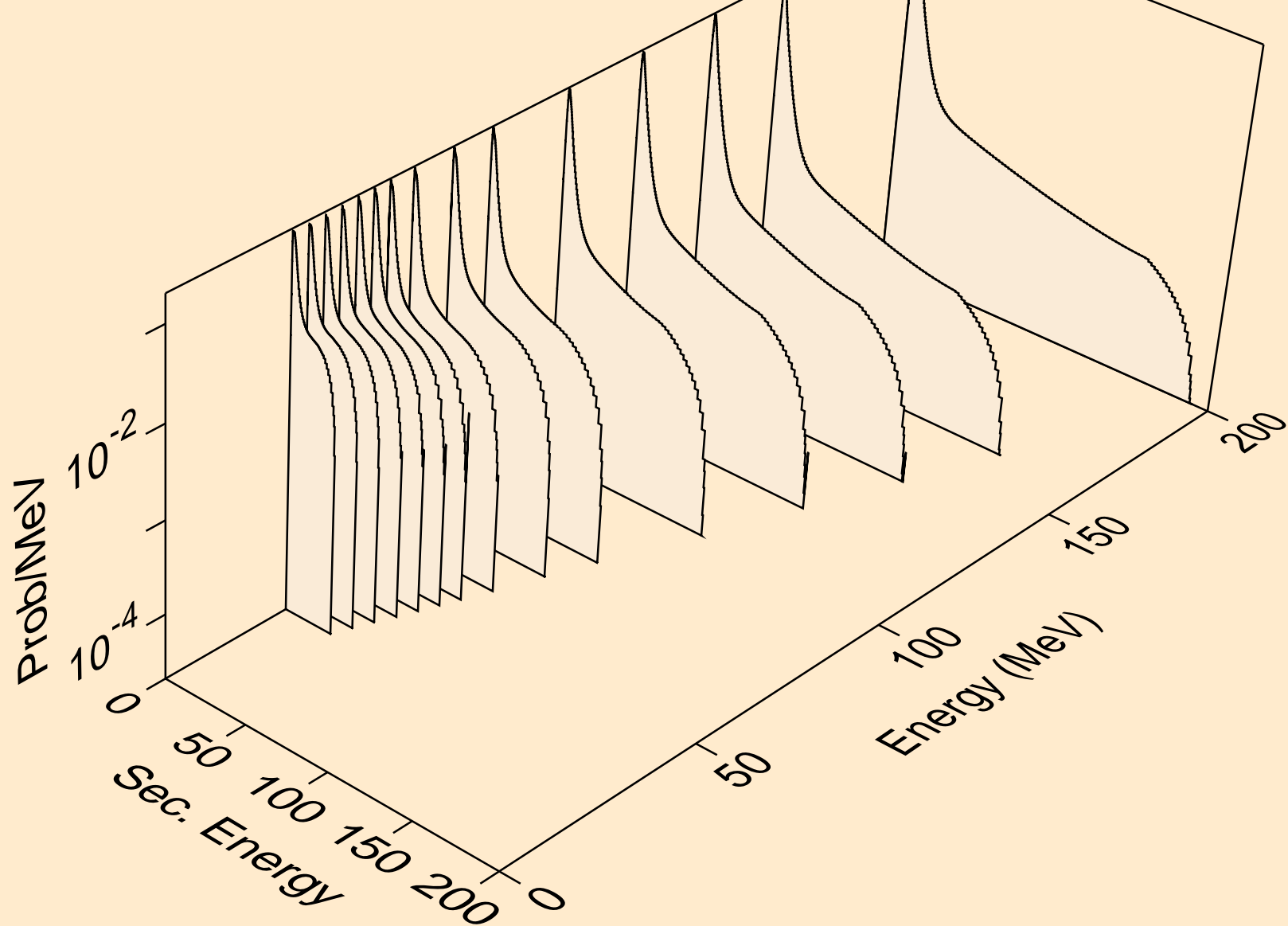

SC044M NEUTRON ACER TENDL-2023 LIBRARY; T=0.K
Neutron emission for (n,2nd)

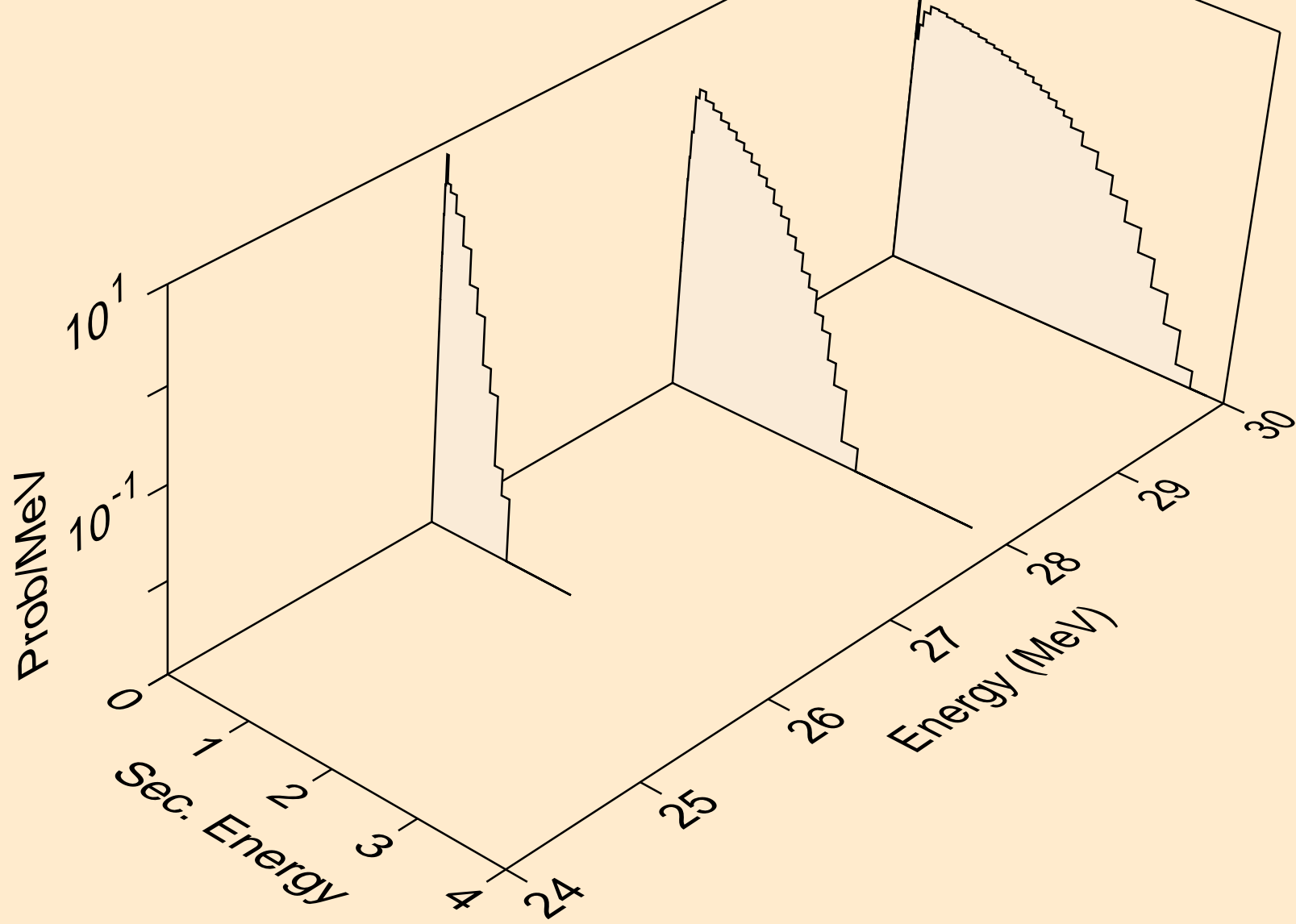

SC044M NEUTRON ACER TENDL-2023 LIBRARY; T=0.K
Neutron emission for (n,2n)

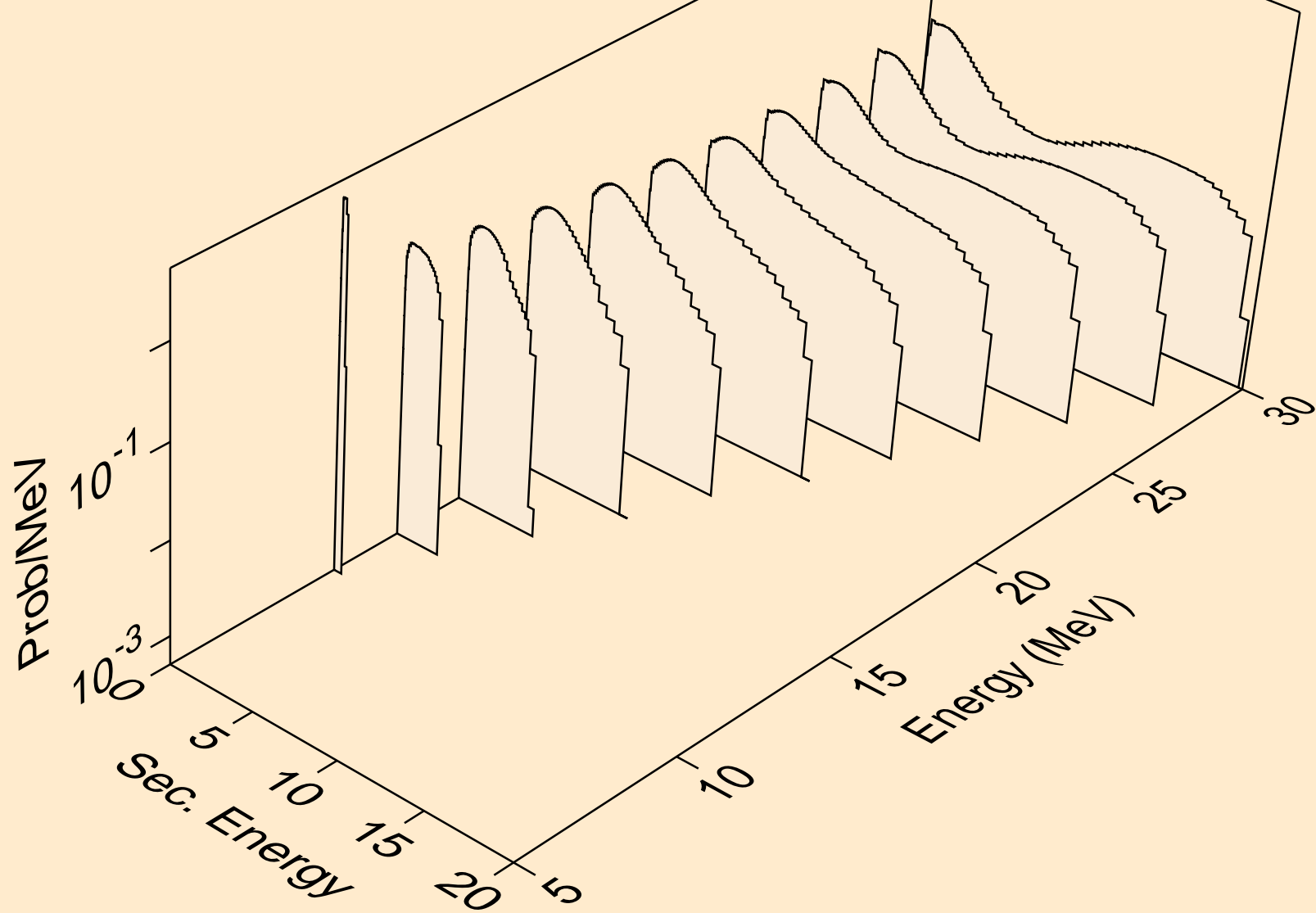

SC044M NEUTRON ACER TENDL-2023 LIBRARY; T=0.K
Neutron emission for (n,3n)

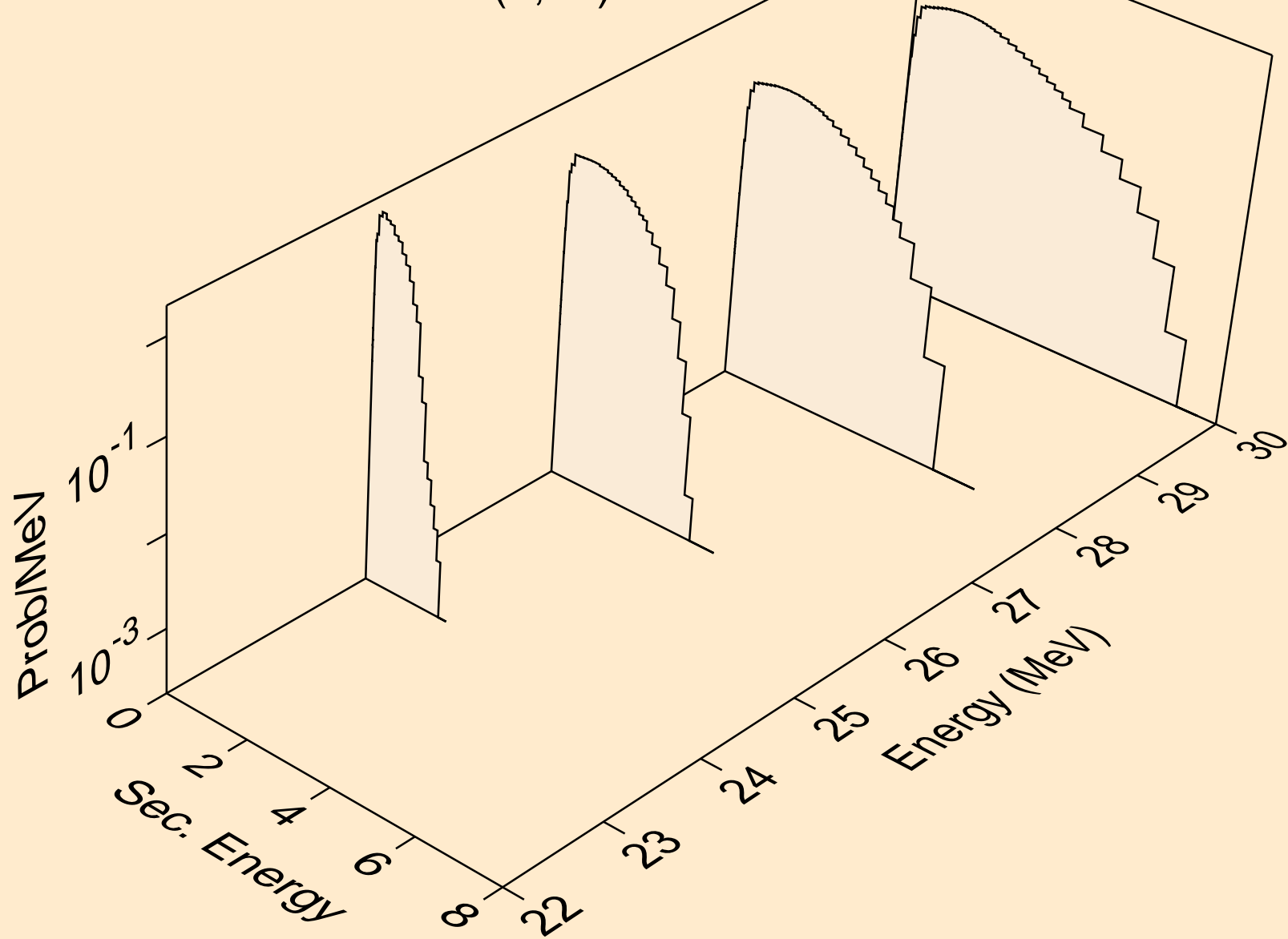

SC044M NEUTRON ACER TENDL-2023 LIBRARY; T=0.K
Neutron emission for (n,n*)a

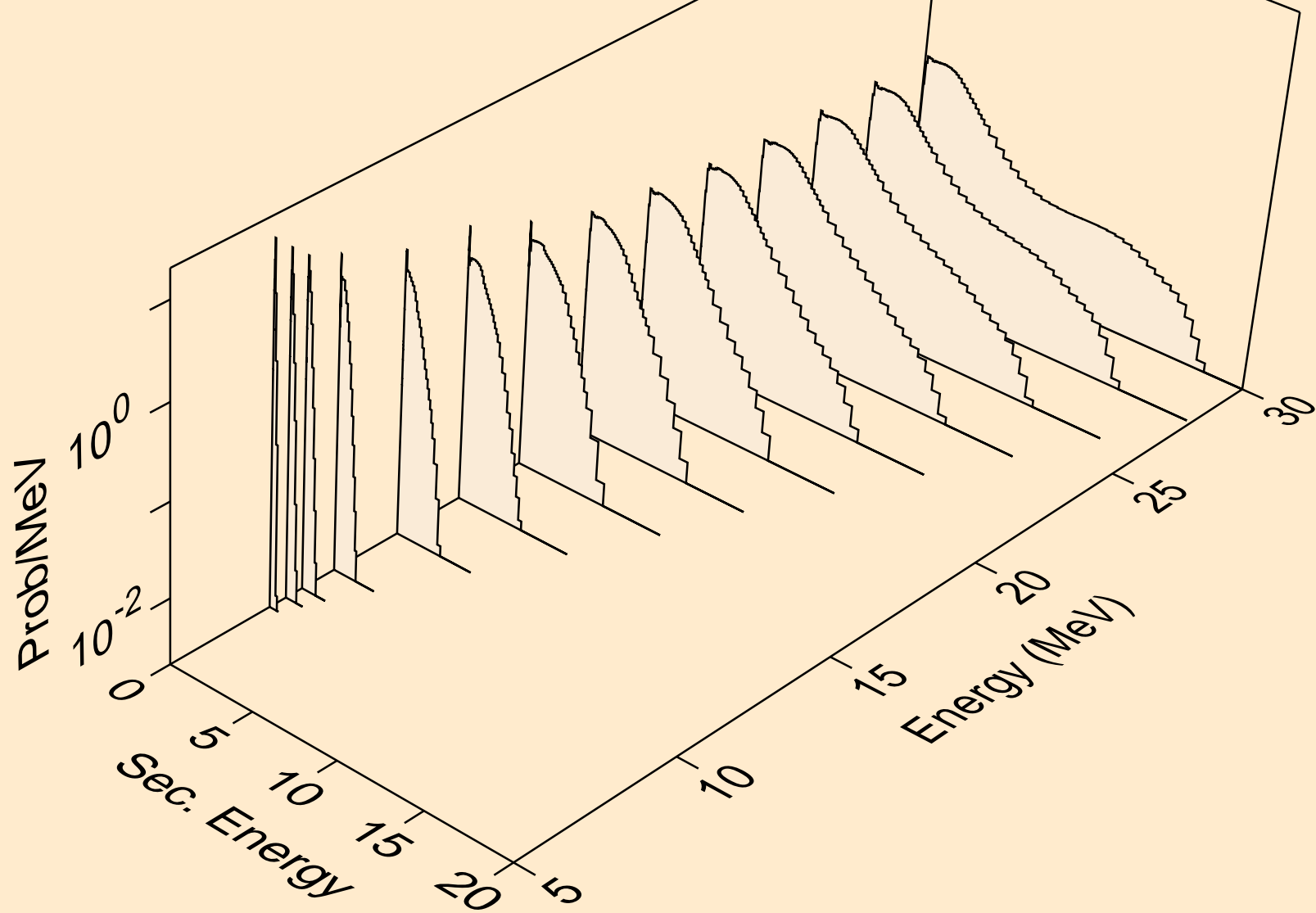

SC044M NEUTRON ACER TENDL-2023 LIBRARY; T=0.K
Neutron emission for (n,2n)a

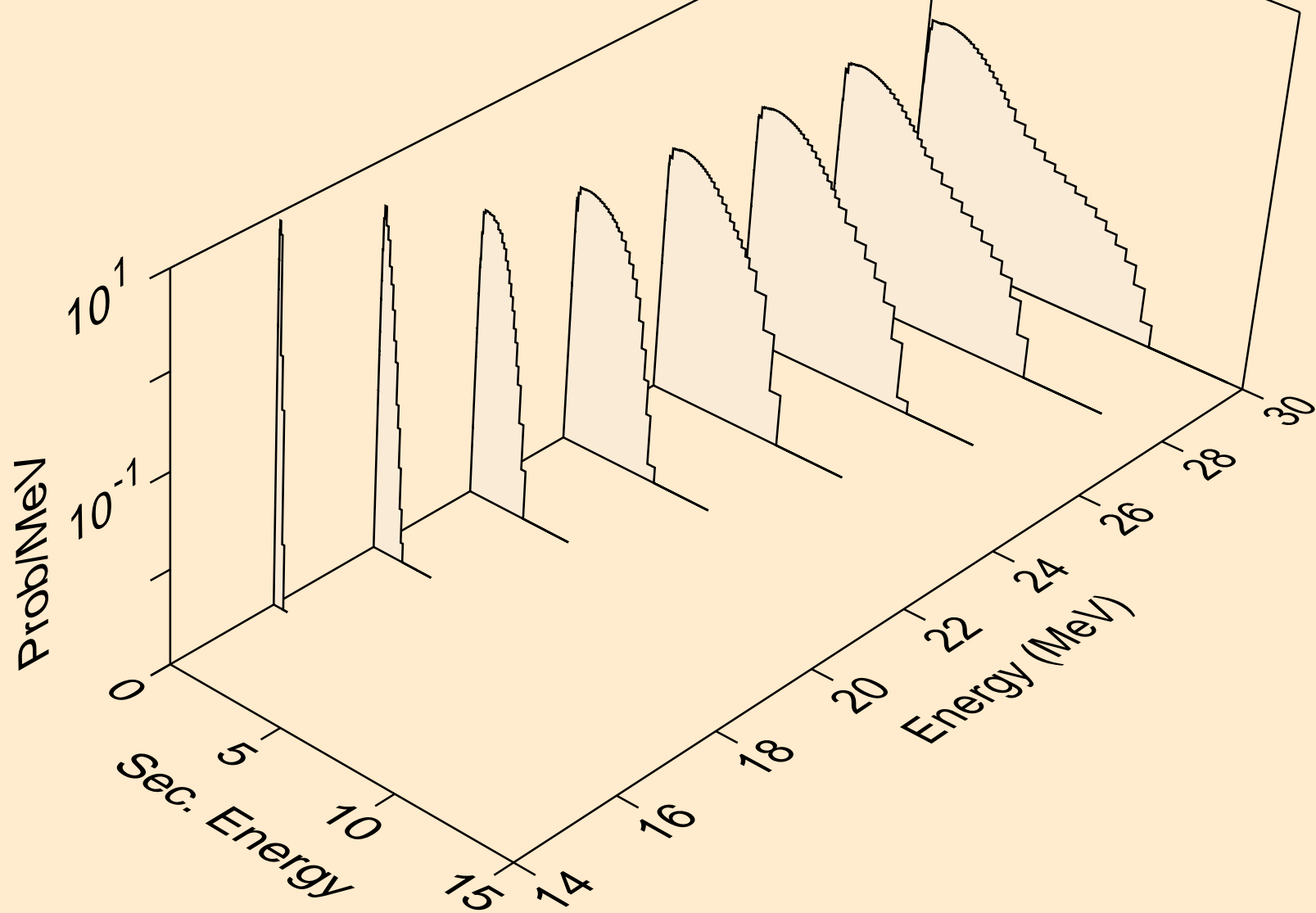

SC044M NEUTRON ACER TENDL-2023 LIBRARY; T=0.K
Neutron emission for (n,n*)p

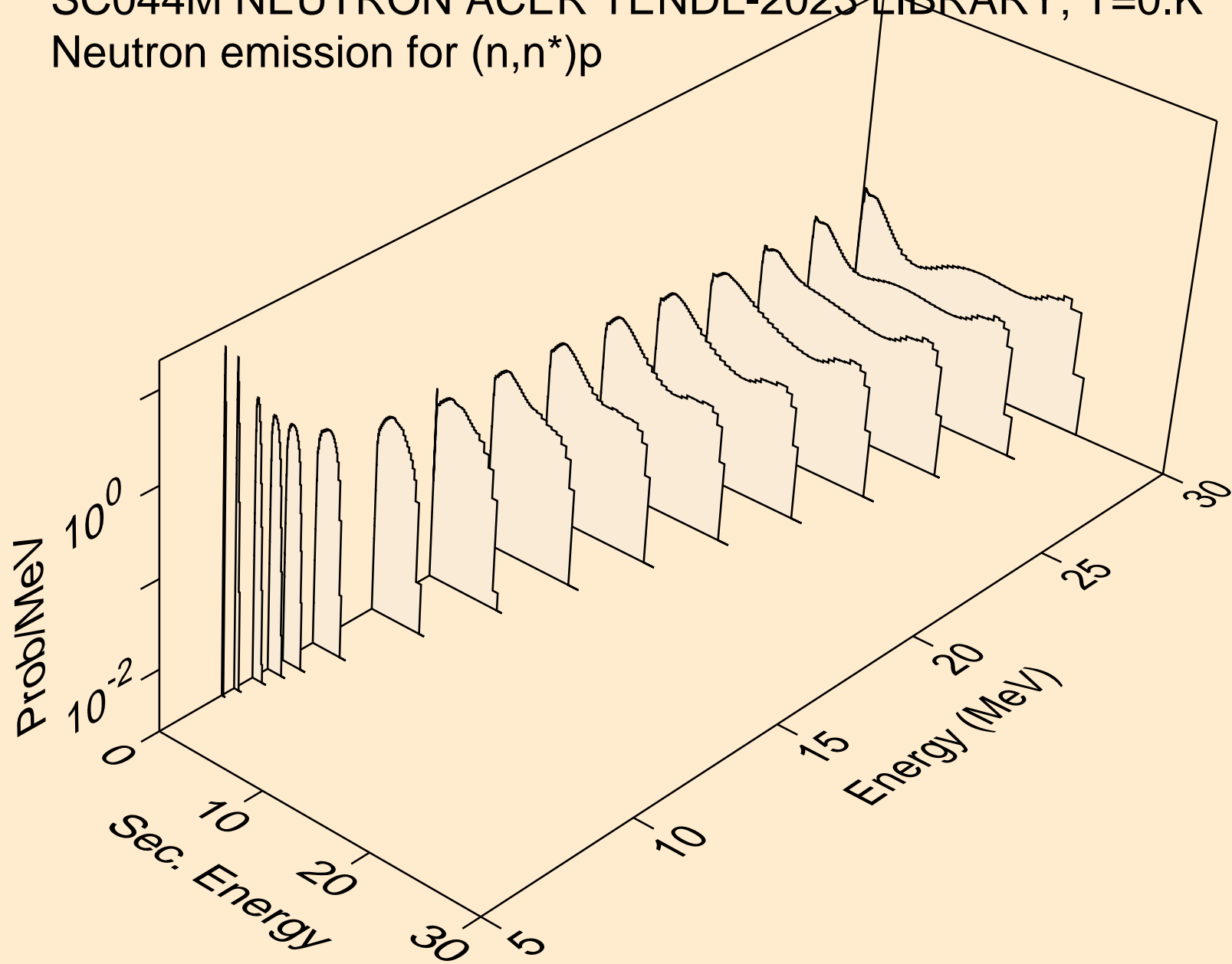

SC044M NEUTRON ACER TENDL-2023 LIBRARY; T=0.K
Neutron emission for (n,n*)2a

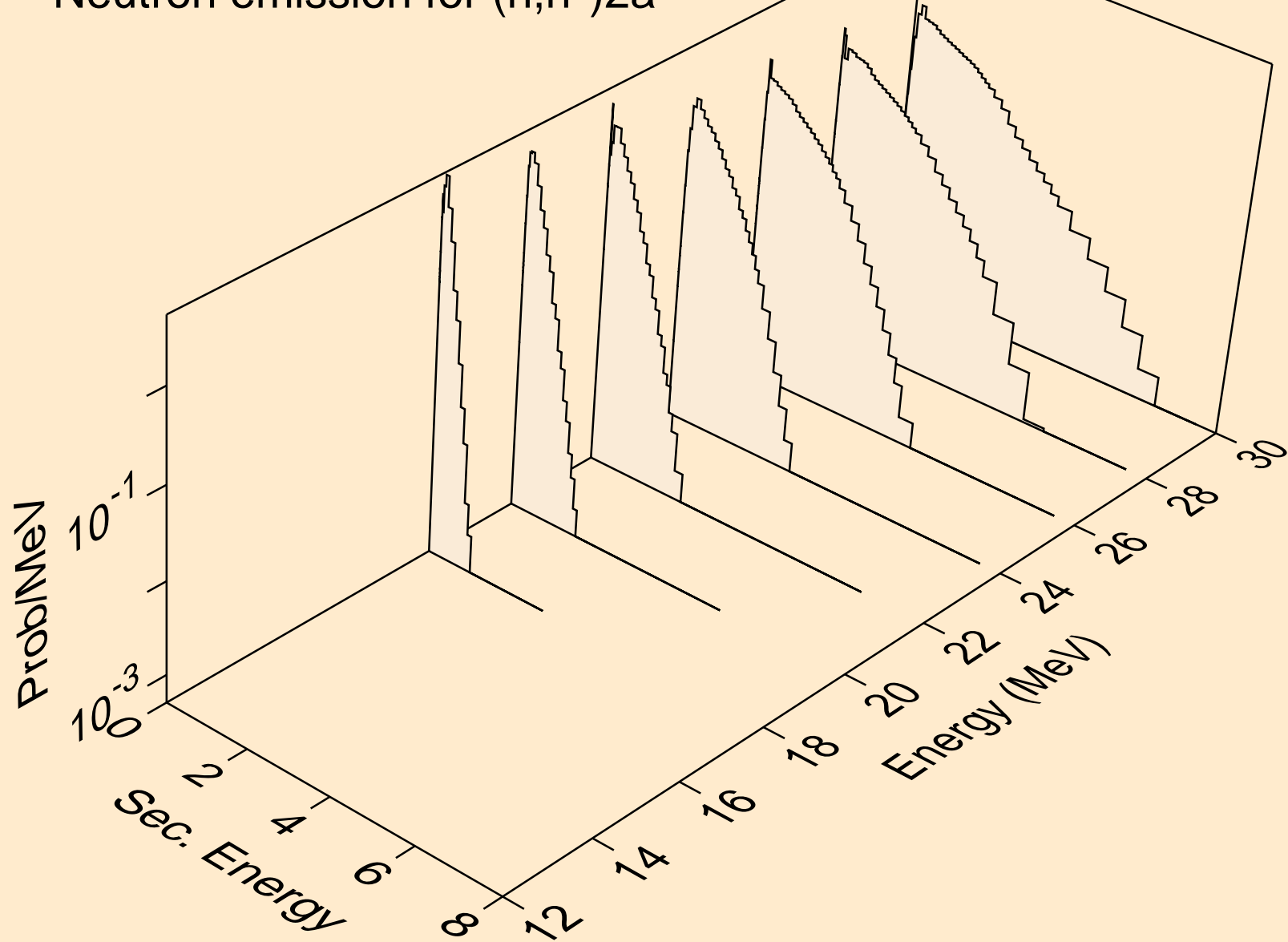

SC044M NEUTRON ACER TENDL-2023 LIBRARY; T=0.K
Neutron emission for (n,2n)2a

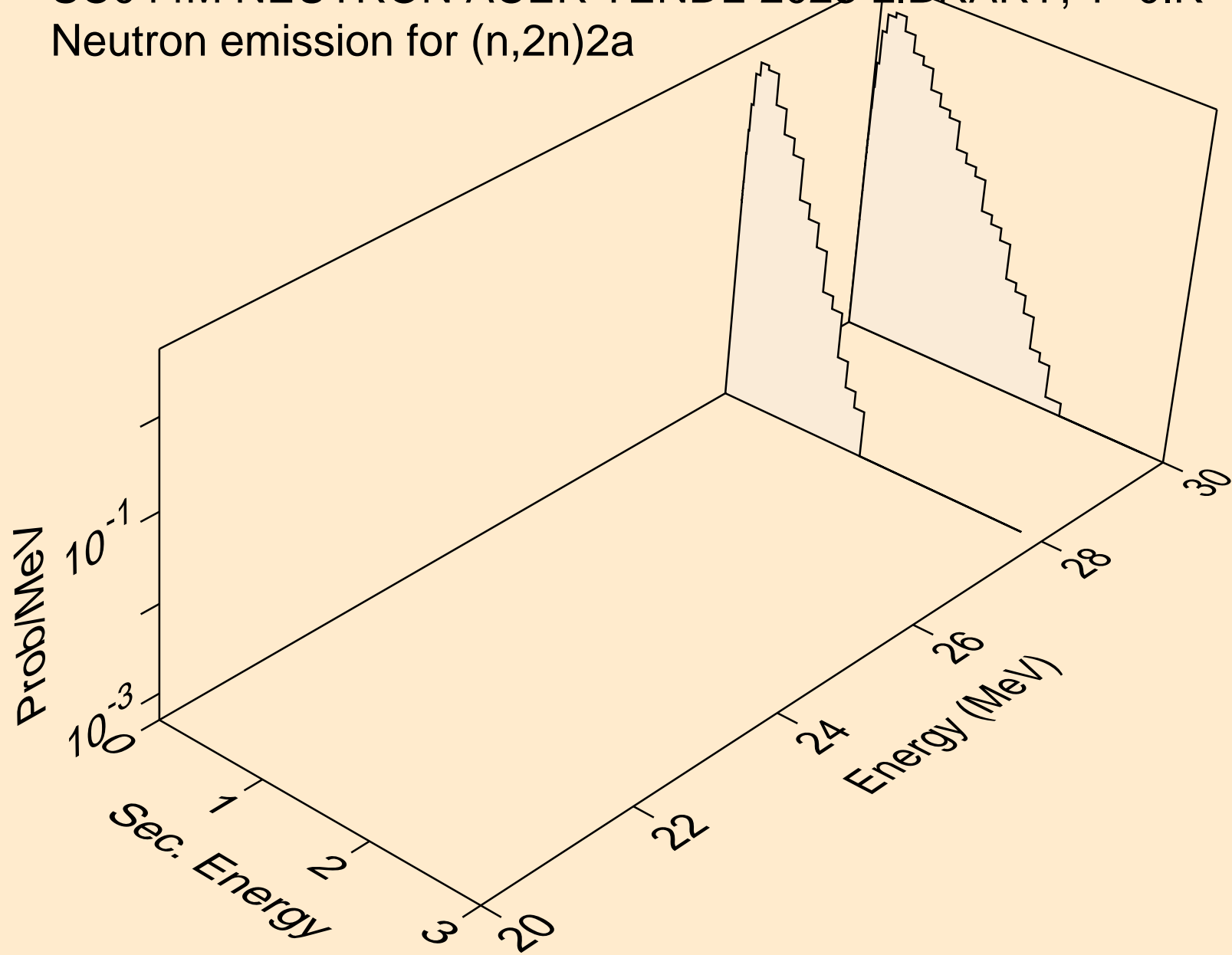

SC044M NEUTRON ACER TENDL-2023 LIBRARY; T=0.K
Neutron emission for (n,n*)d

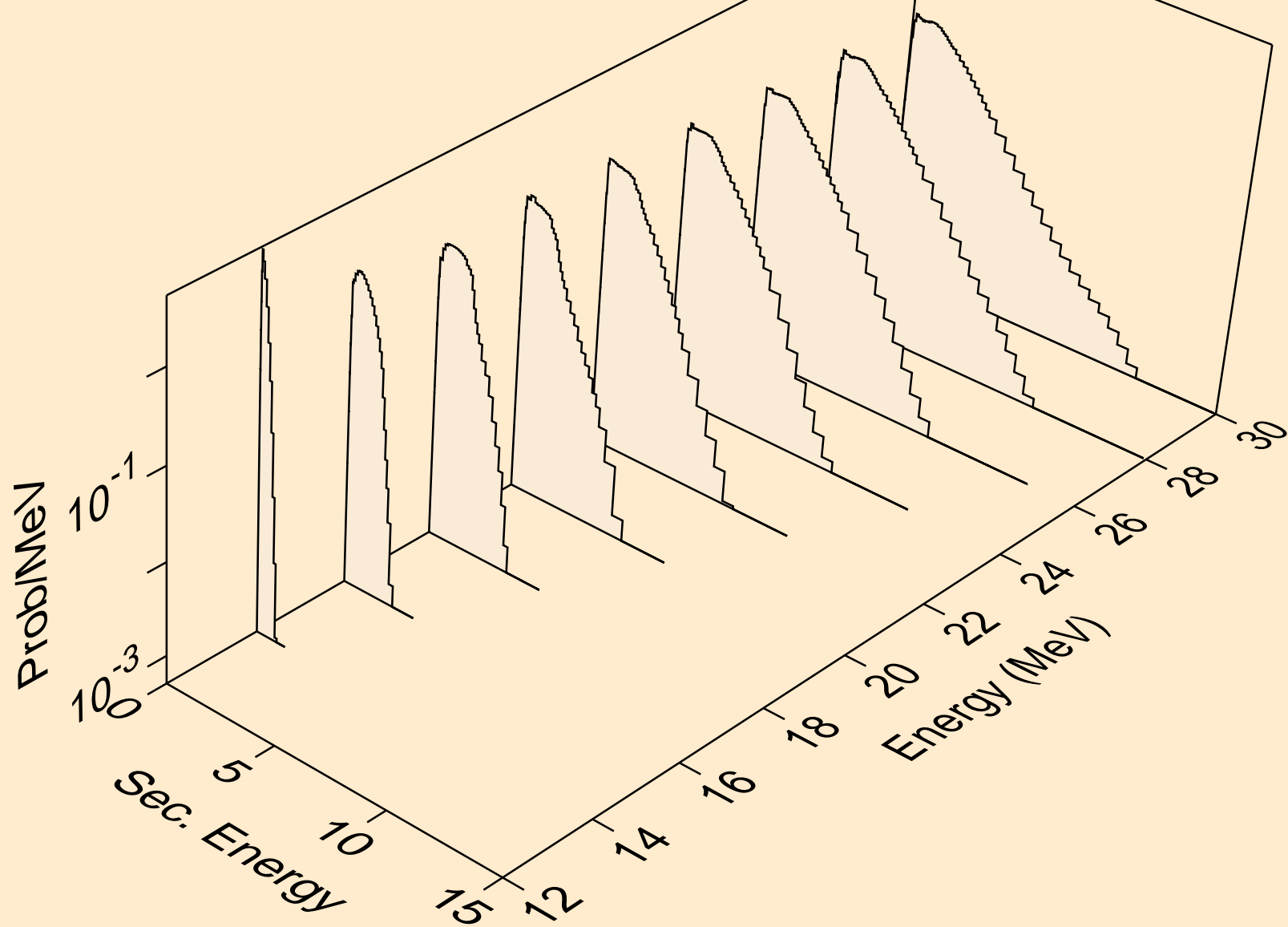

SC044M NEUTRON ACER TENDL-2023 LIBRARY; T=0.K
Neutron emission for (n,n*)t

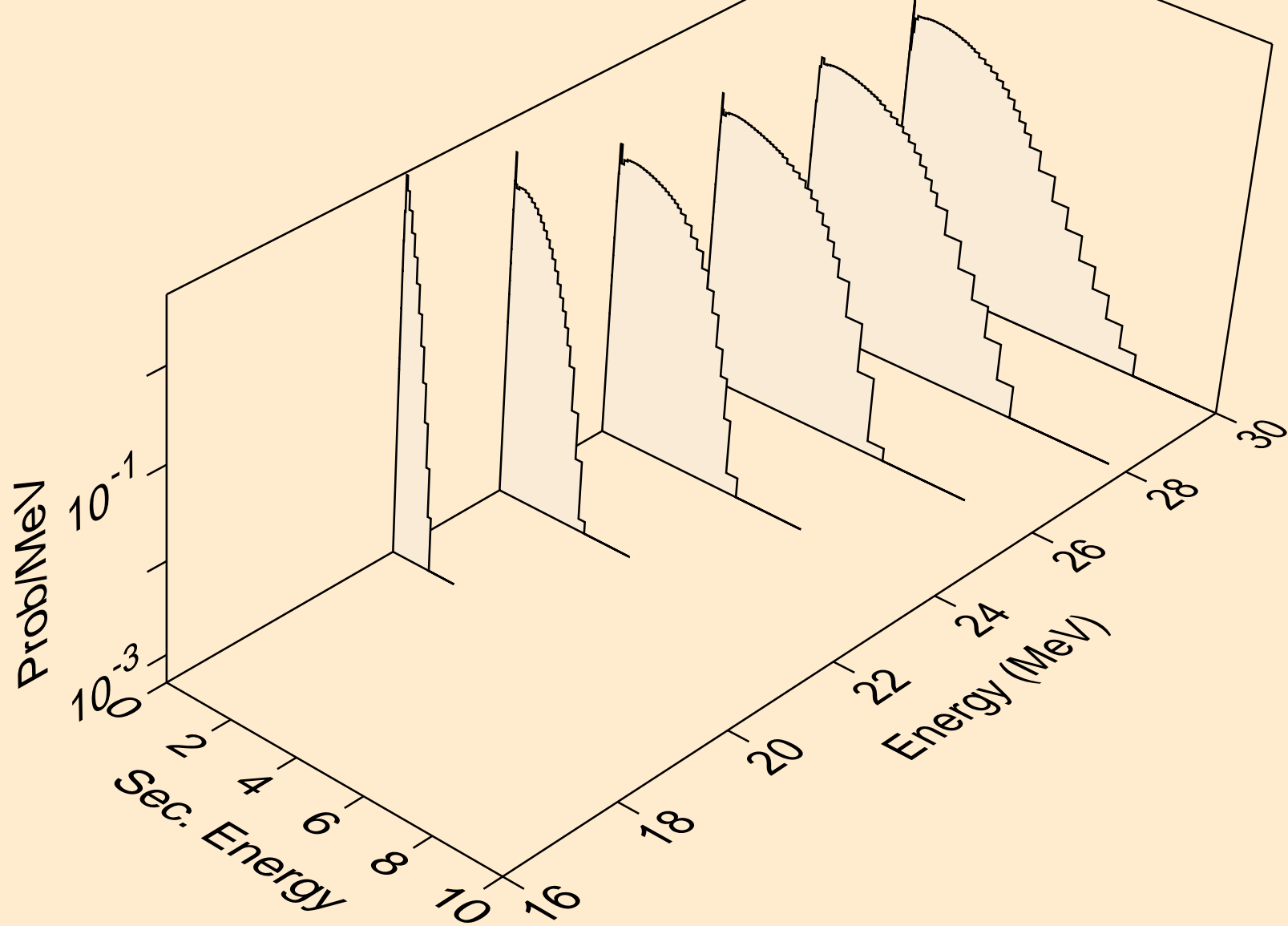

SC044M NEUTRON ACER TENDL-2023 LIBRARY; T=0.K
Neutron emission for (n,n*)he3

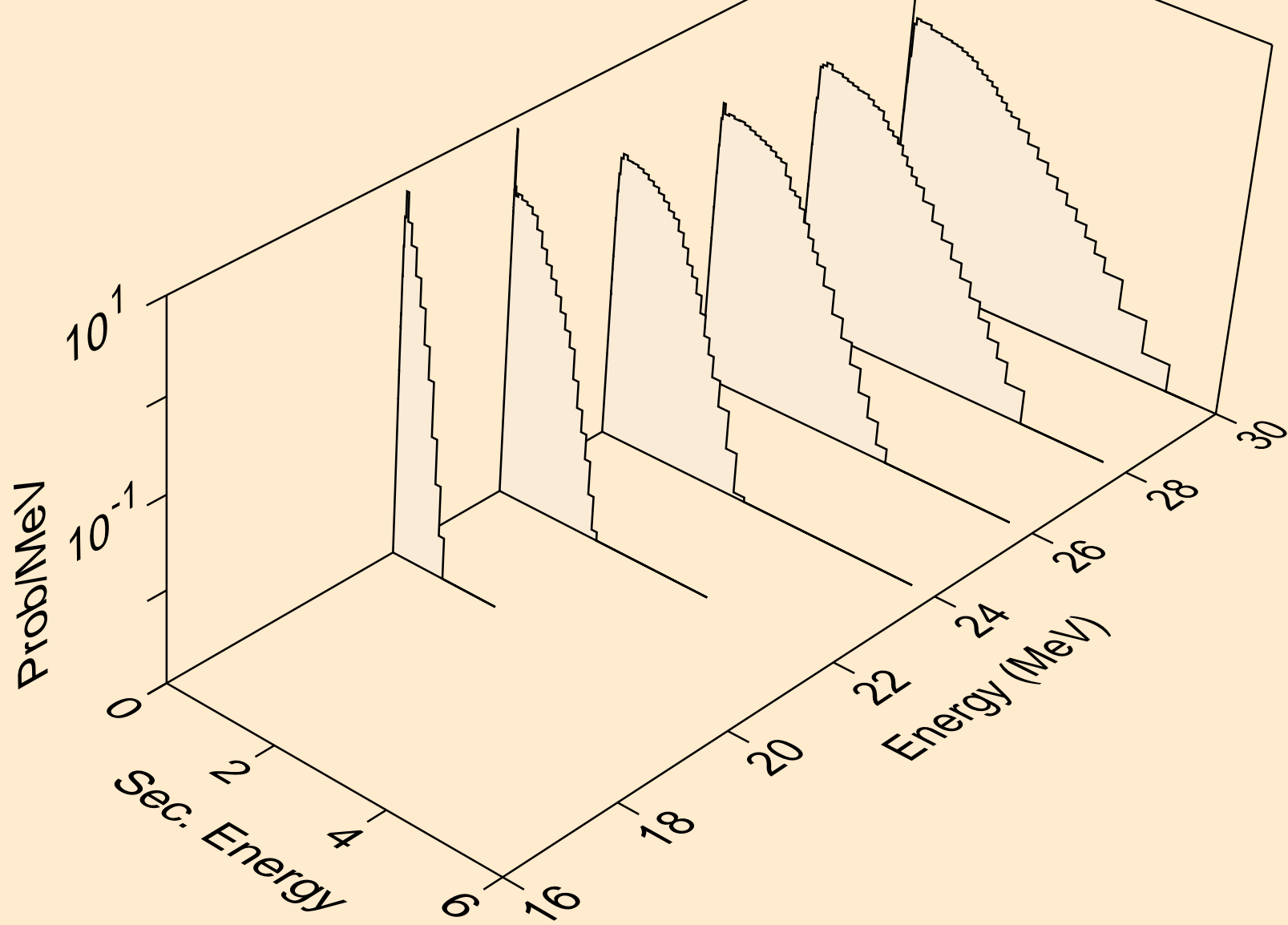

SC044M NEUTRON ACER TENDL-2023 LIBRARY; T=0.K
Neutron emission for (n,2np)

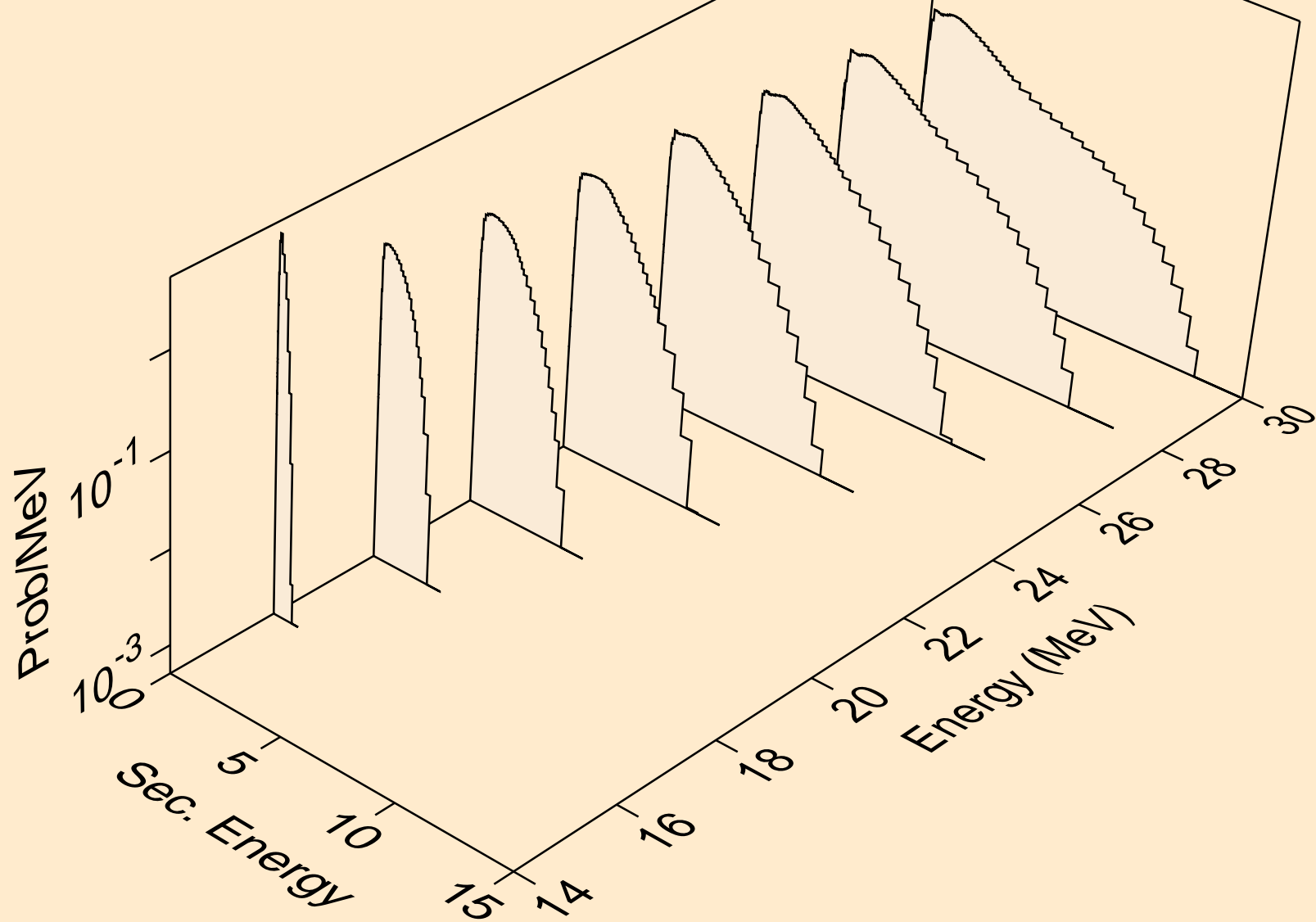

SC044M NEUTRON ACER TENDL-2023 LIBRARY; T=0.K
Neutron emission for (n,3np)

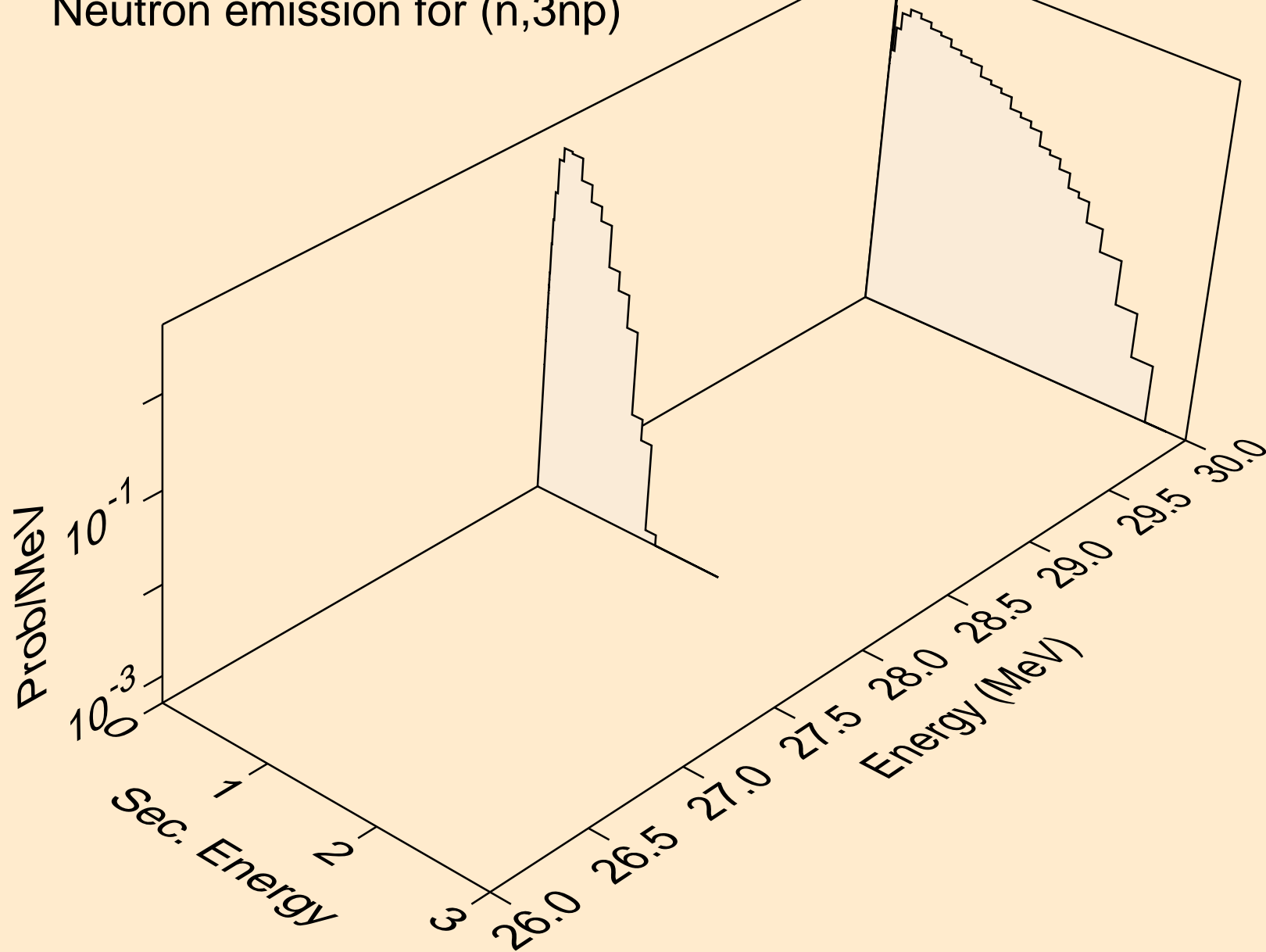

SC044M NEUTRON ACER TENDL-2023 LIBRARY; T=0.K
Neutron emission for (n,n2p)

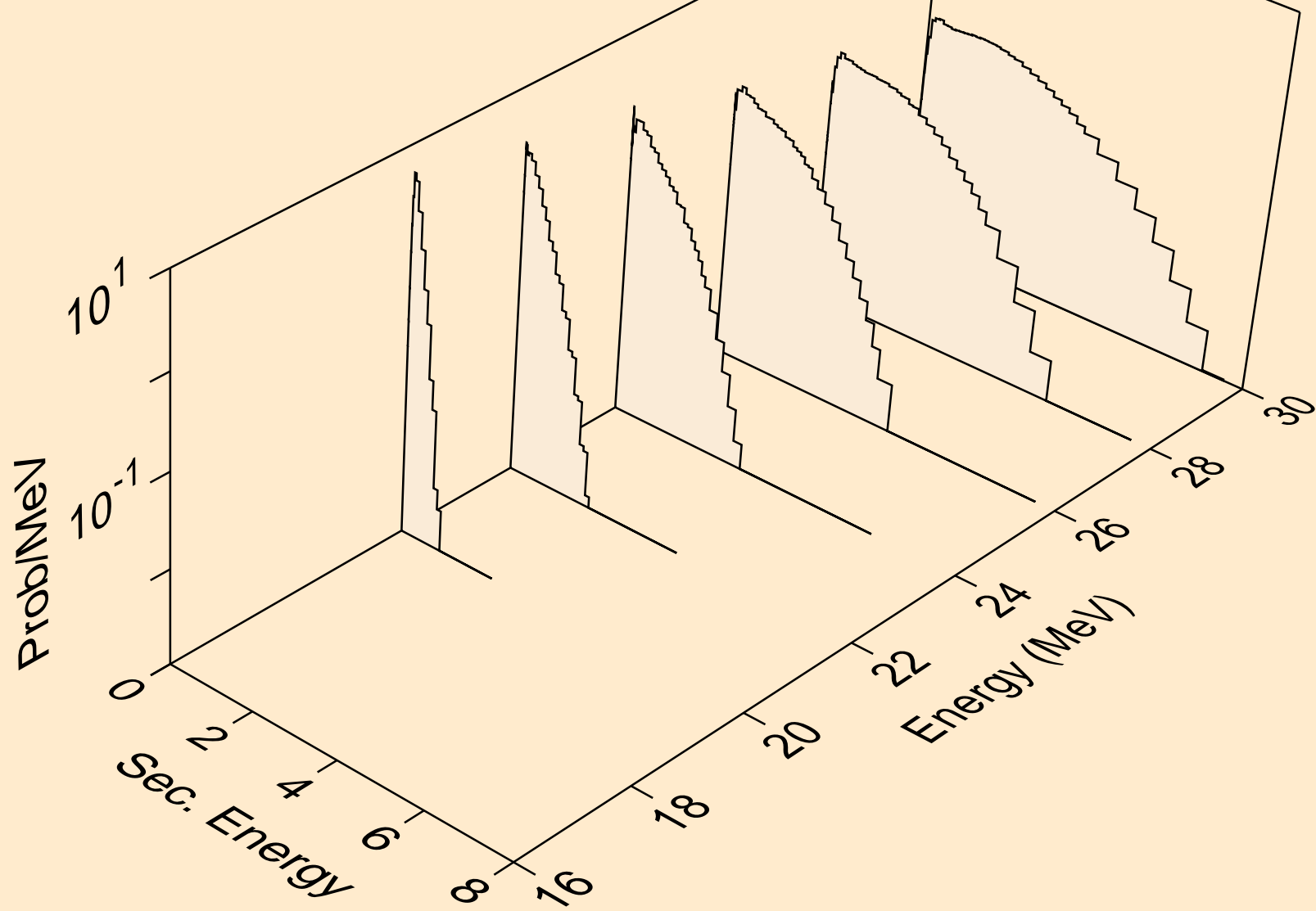

SC044M NEUTRON ACER TENDL-2023 LIBRARY; T=0.K
Neutron emission for (n,npa)

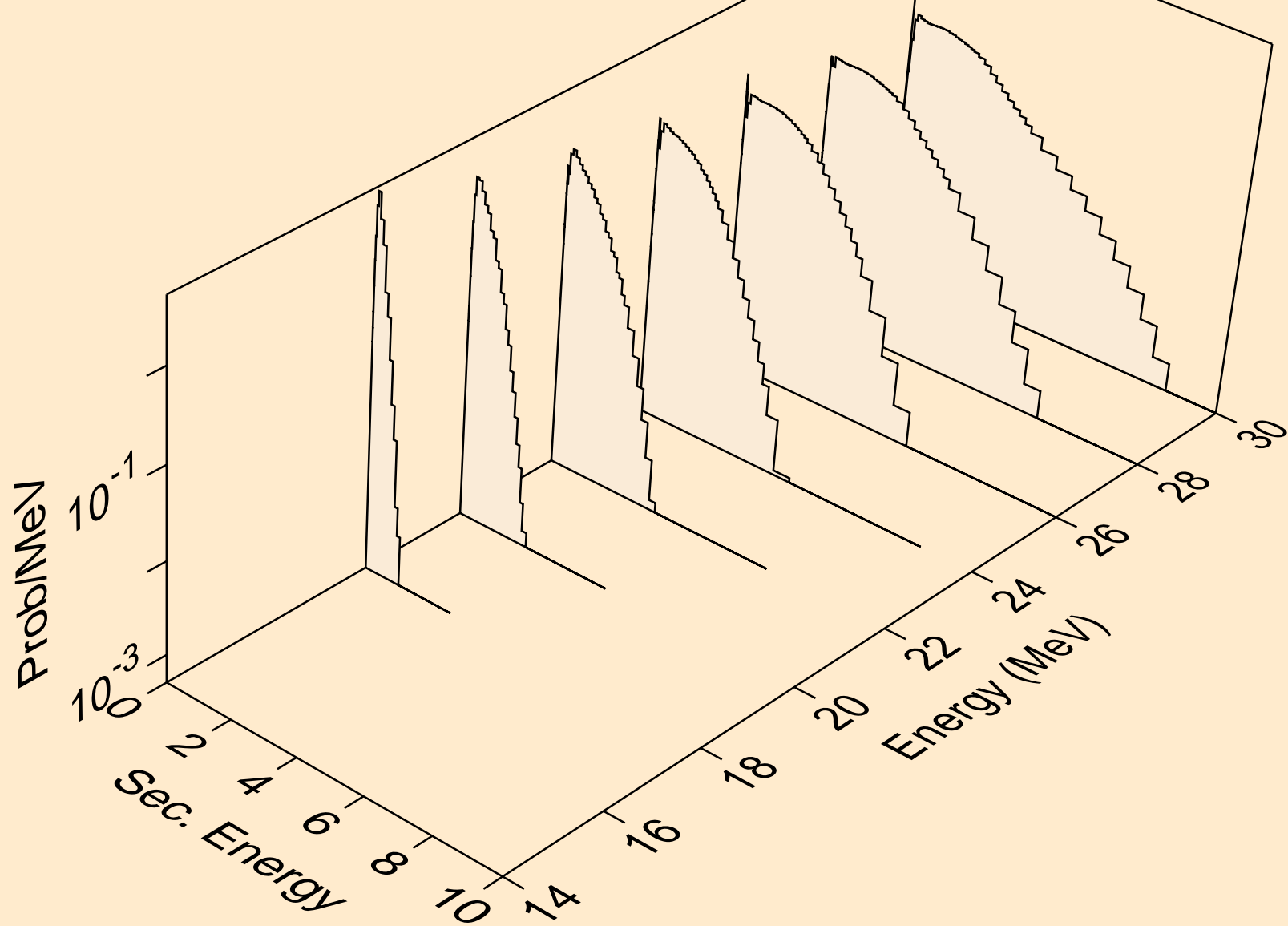

SC044M NEUTRON ACER TENDL-2023 LIBRARY; T=0.K
Neutron emission for (n,n*c)

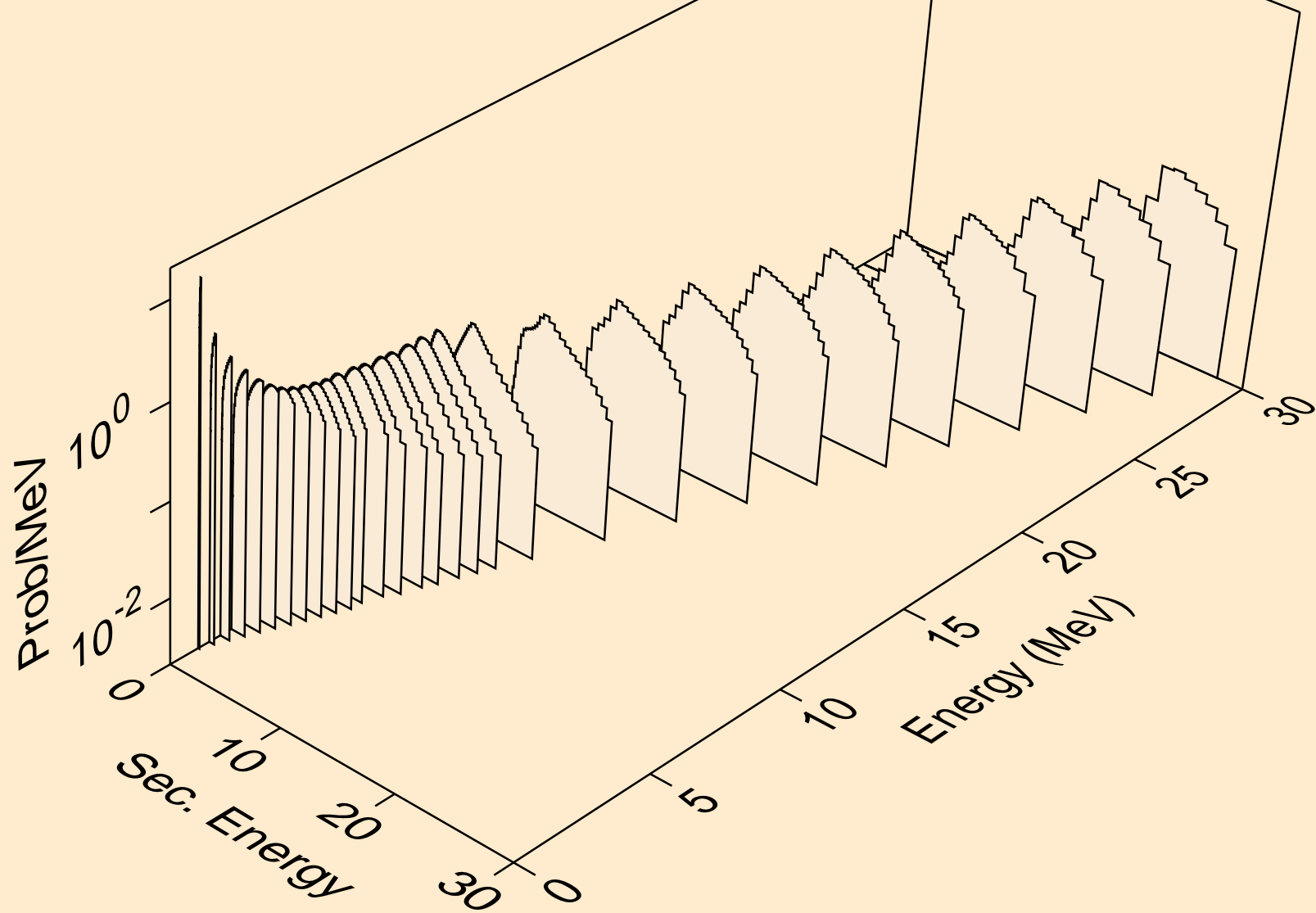

SC044M NEUTRON ACER TENDL-2023 LIBRARY; T=0.K
Photon emission for (n,x)

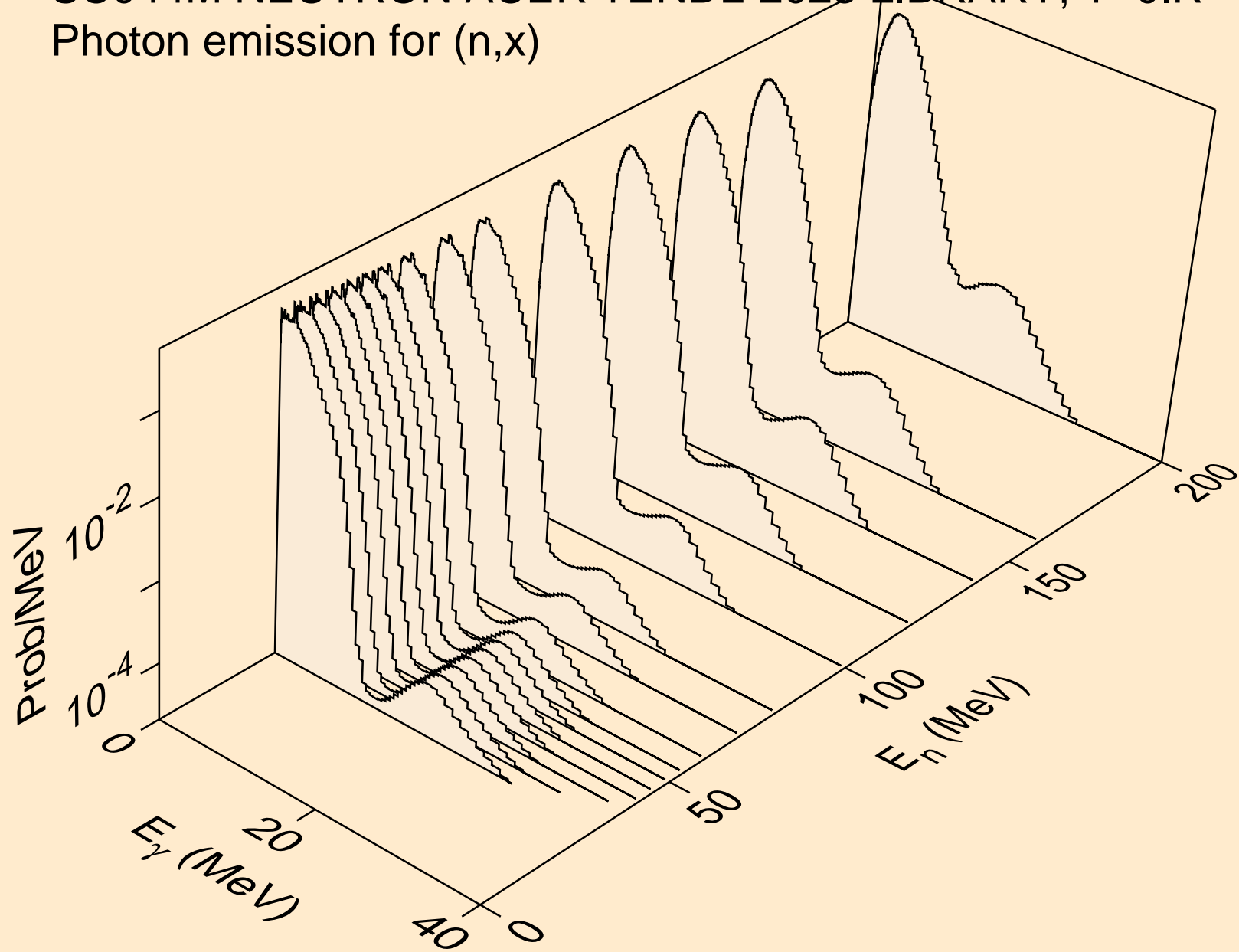

SC044M NEUTRON ACER TENDL-2023 LIBRARY; T=0.K
Photon emission for (n,2nd)

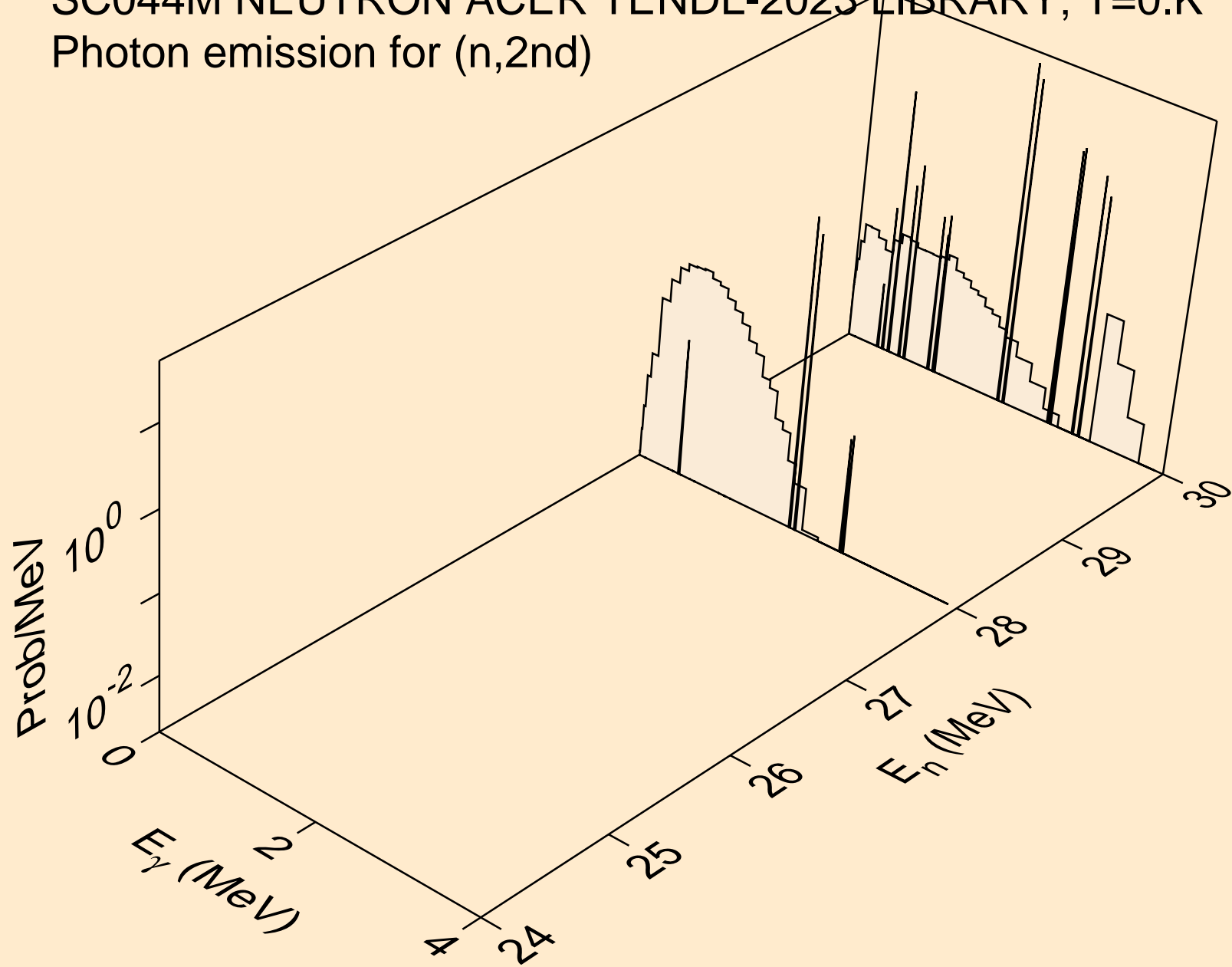

SC044M NEUTRON ACER TENDL-2023 LIBRARY; T=0.K
Photon emission for (n,2n)

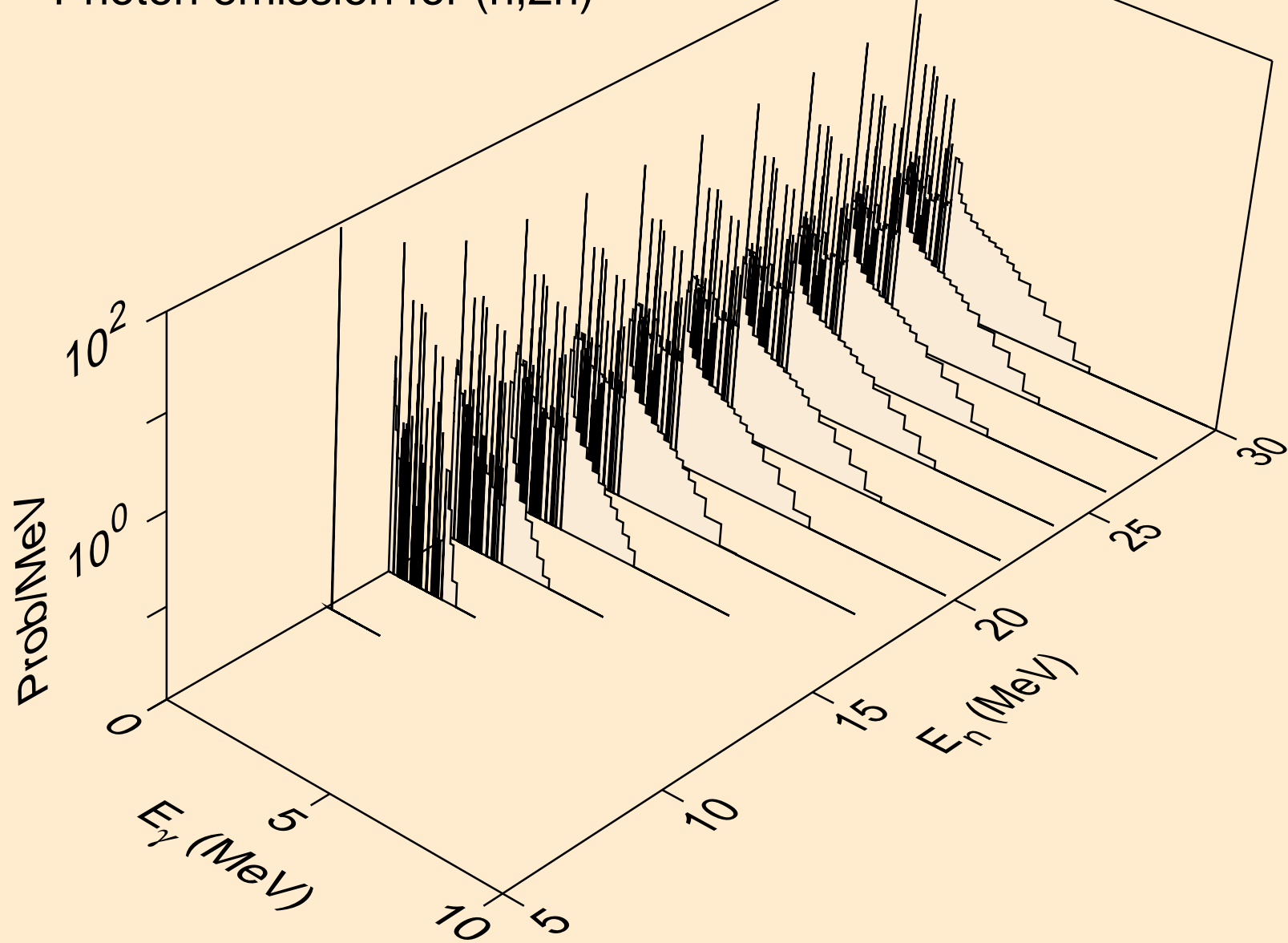

SC044M NEUTRON ACER TENDL-2023 LIBRARY; T=0.K
Photon emission for (n,3n)

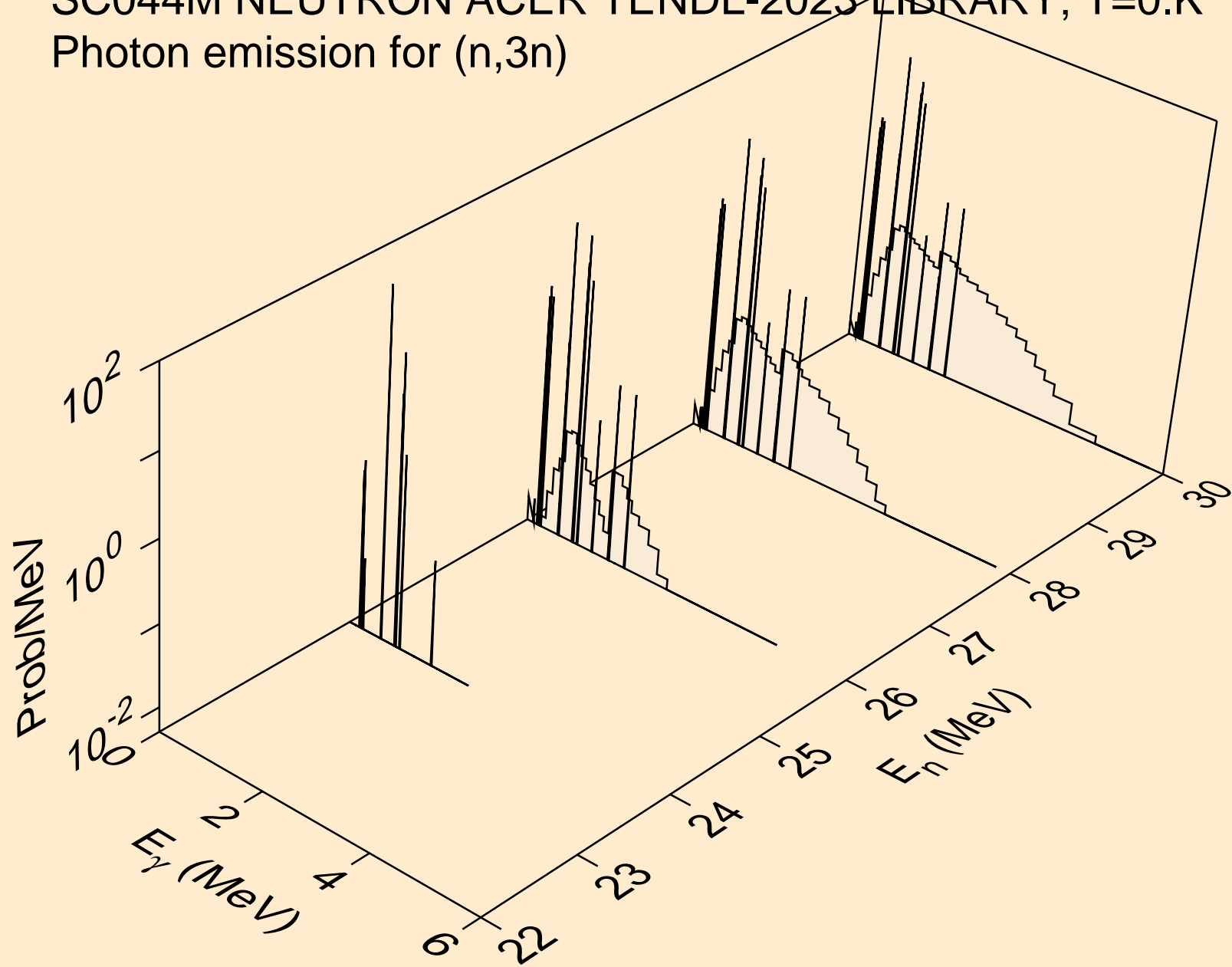

SC044M NEUTRON ACER TENDL-2023 LIBRARY; T=0.K
Photon emission for (n,n*)a

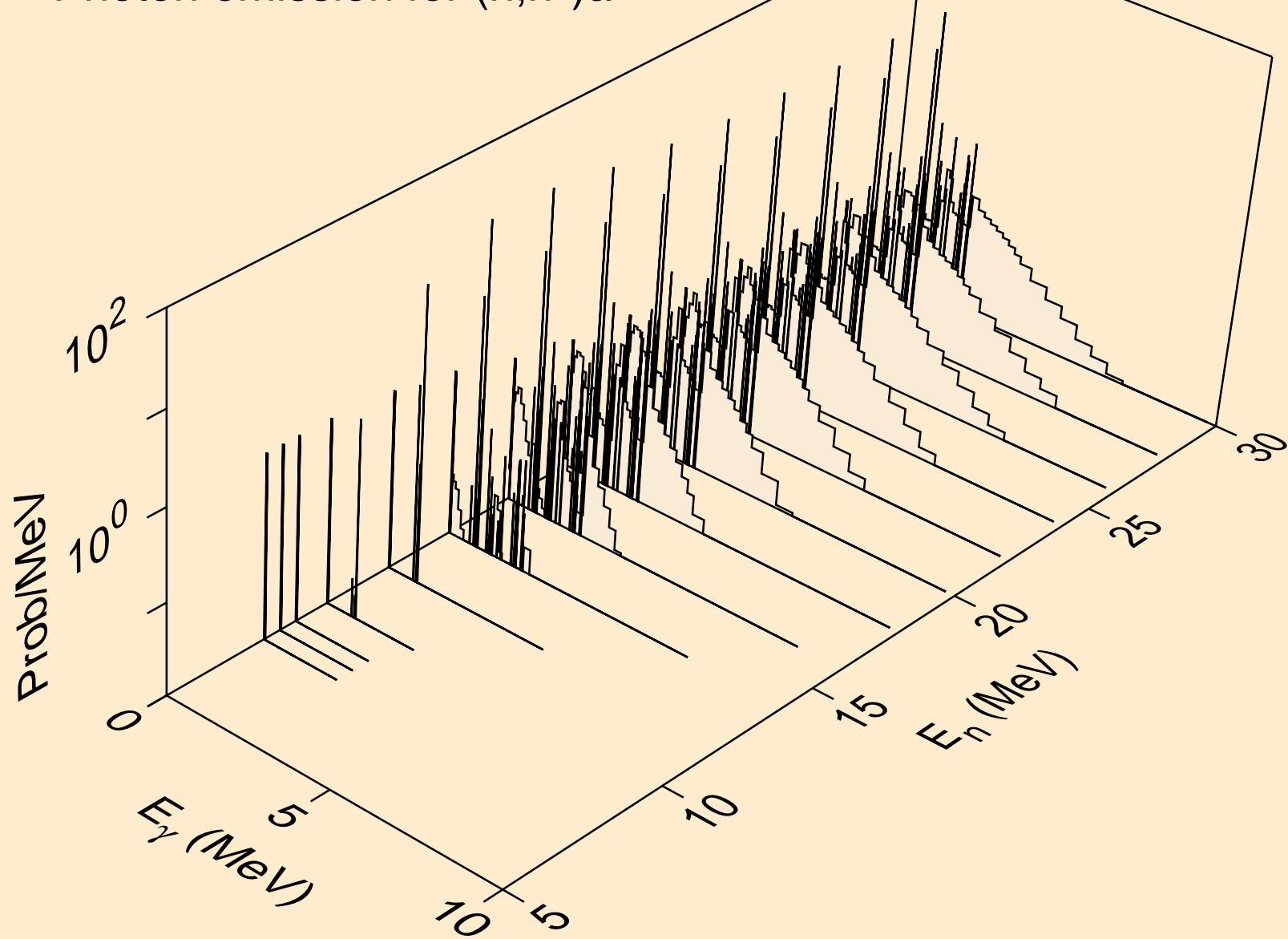

SC044M NEUTRON ACER TENDL-2023 LIBRARY; T=0.K
Photon emission for (n,2n)a

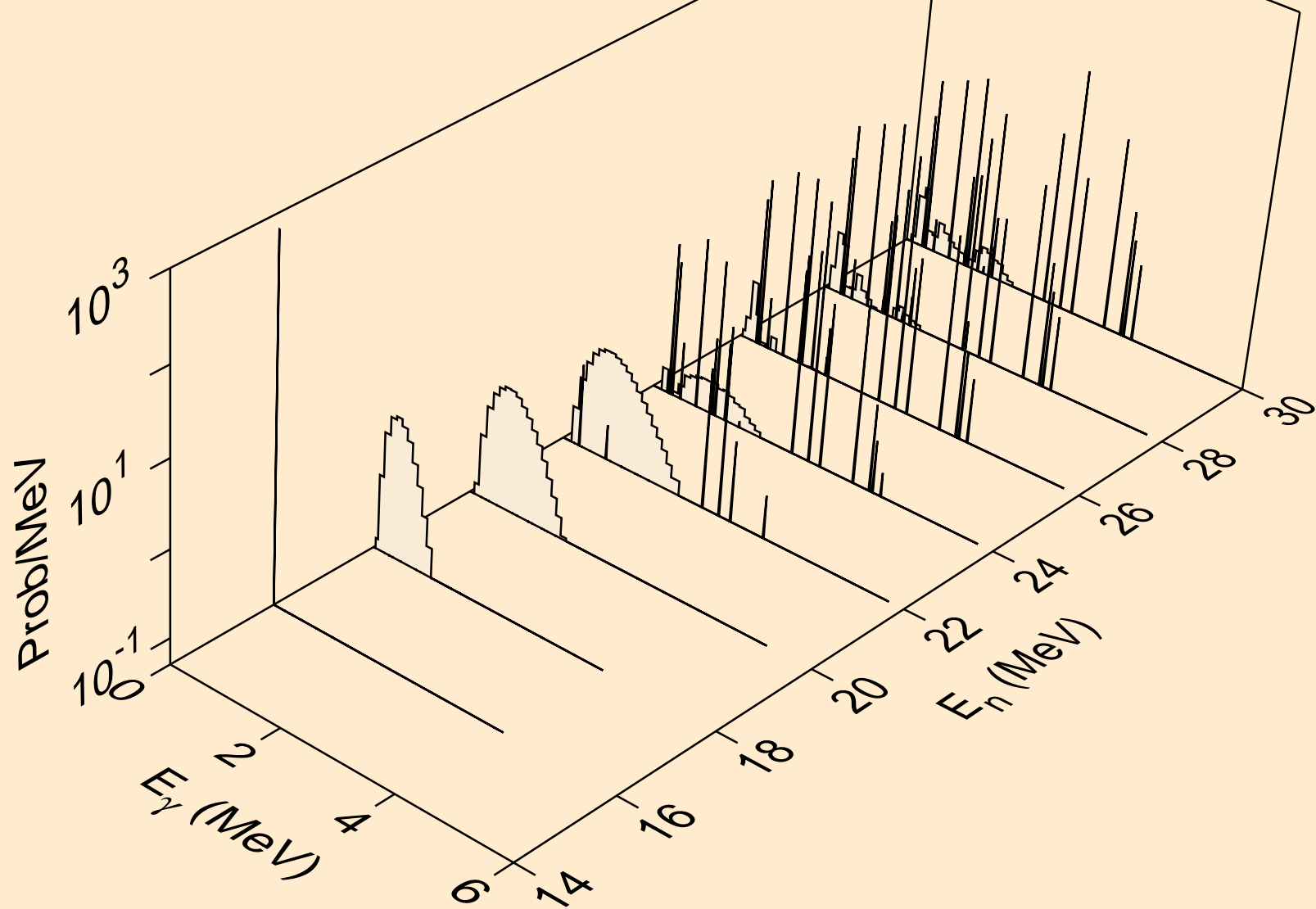

SC044M NEUTRON ACER TENDL-2023 LIBRARY; T=0.K
Photon emission for (n,n*)p

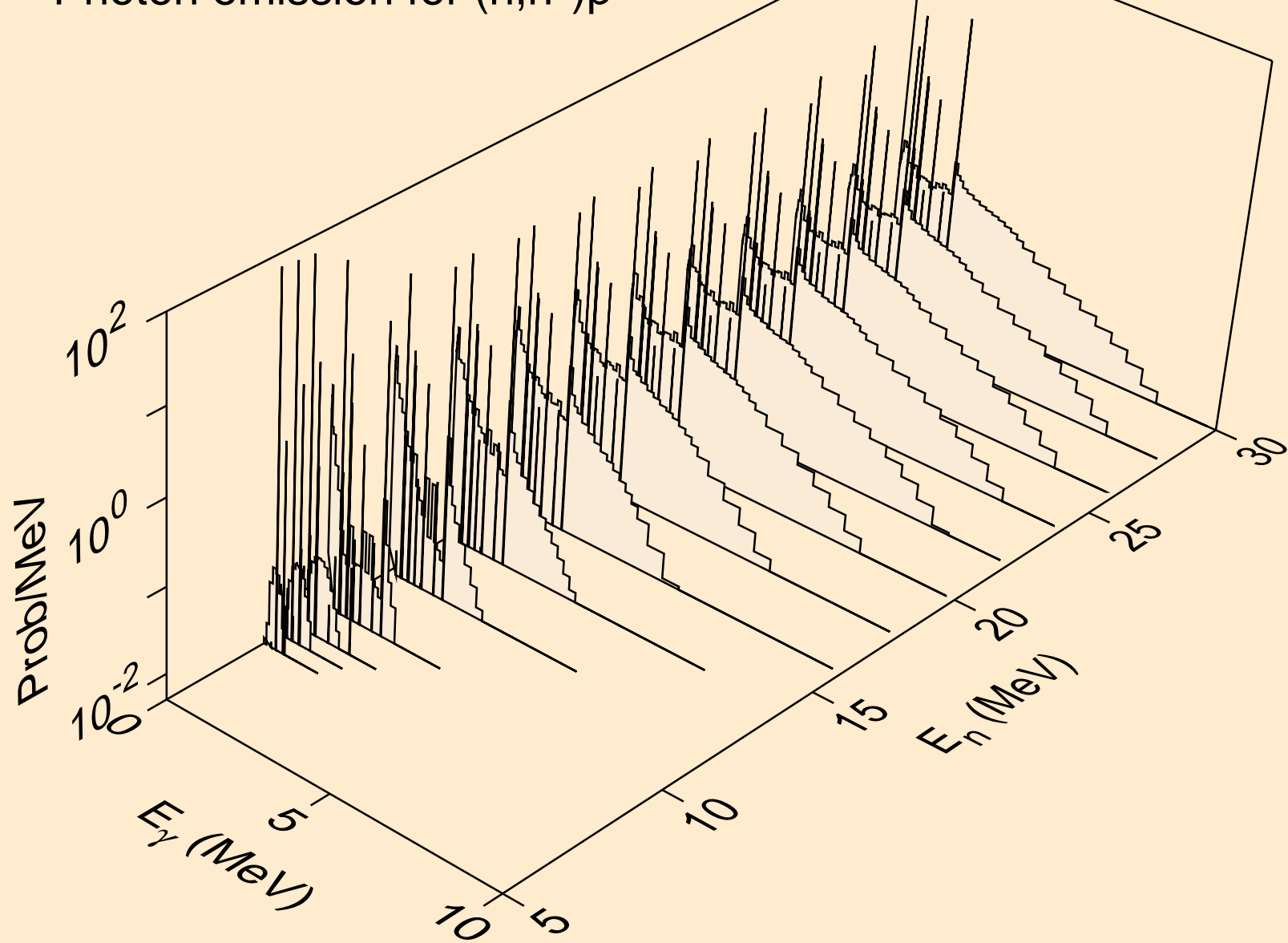

SC044M NEUTRON ACER TENDL-2023 LIBRARY; T=0.K
Photon emission for (n,n*)2a

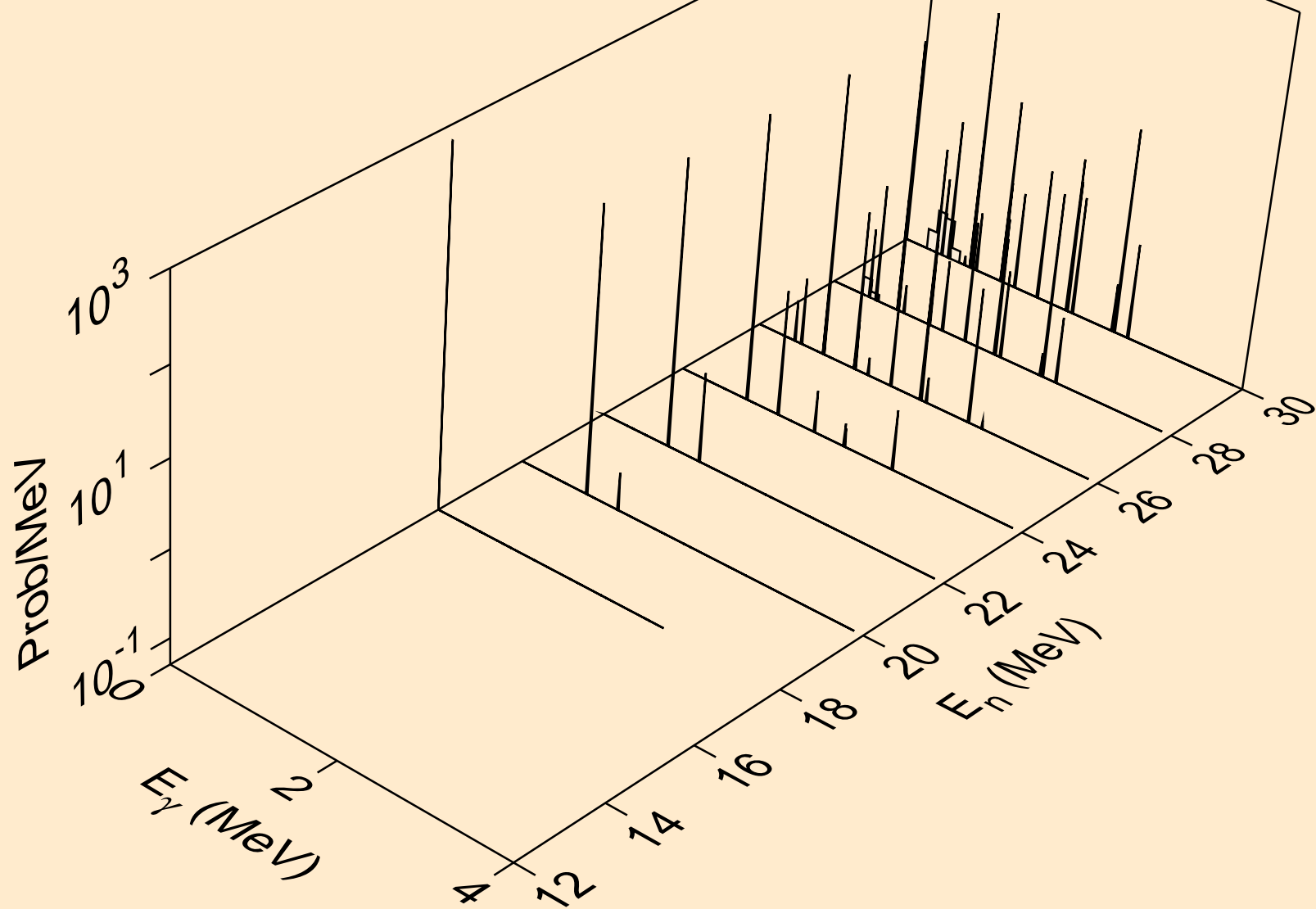

SC044M NEUTRON ACER TENDL-2023 LIBRARY; T=0.K
Photon emission for (n,2n)2a

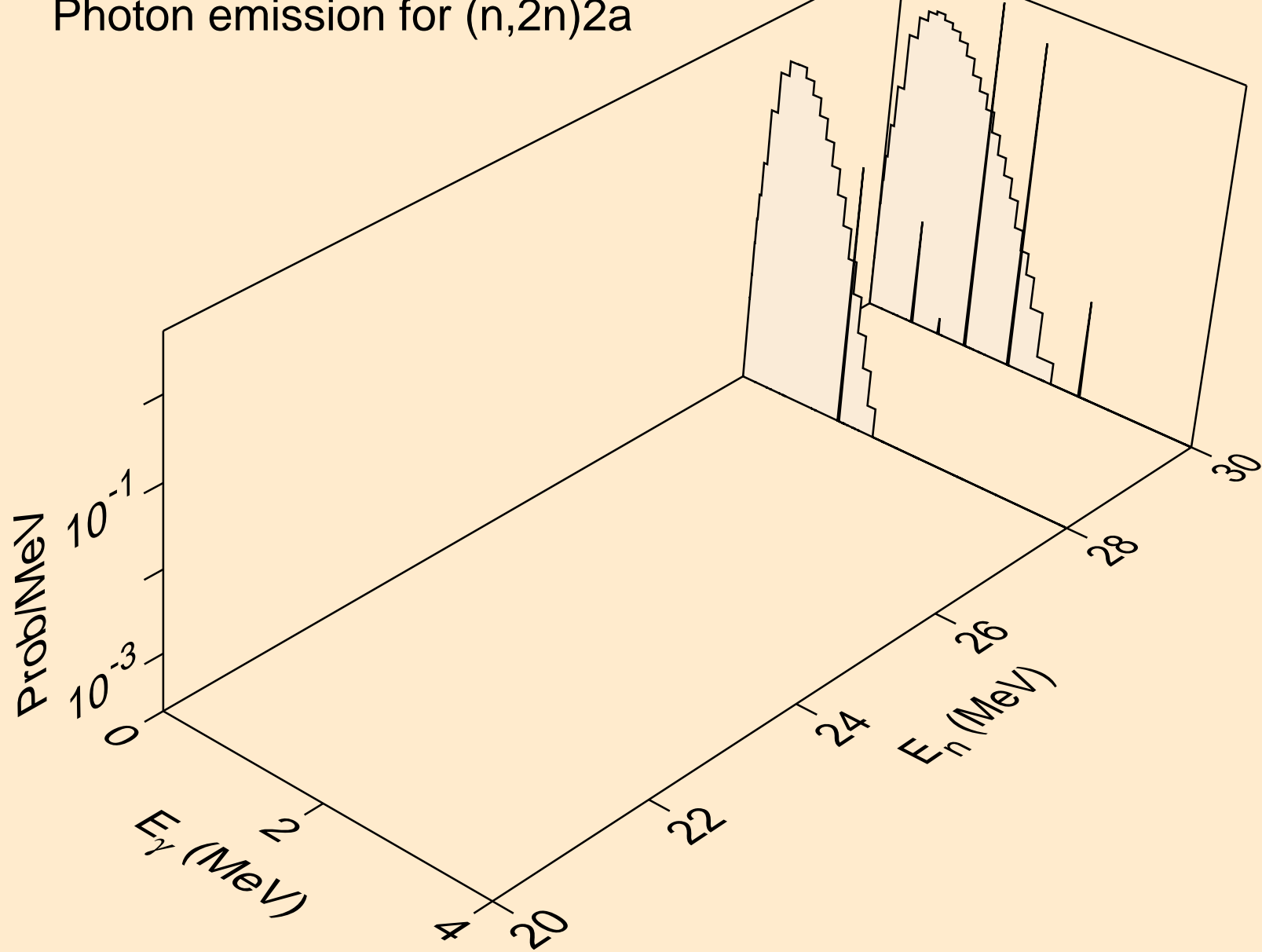

SC044M NEUTRON ACER TENDL-2023 LIBRARY; T=0.K
Photon emission for (n,n*)d

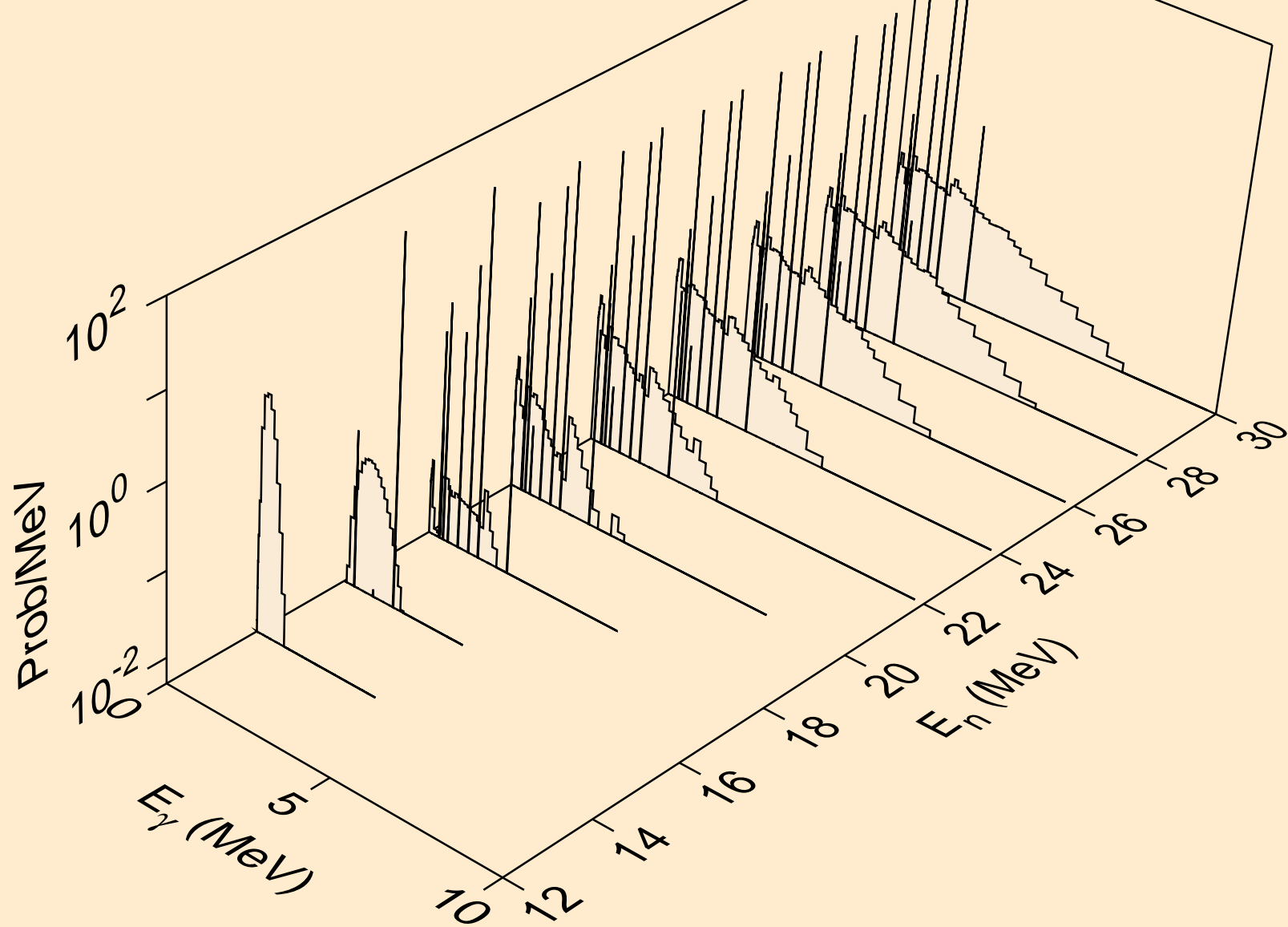

SC044M NEUTRON ACER TENDL-2023 LIBRARY; T=0.K
Photon emission for (n,n*)t

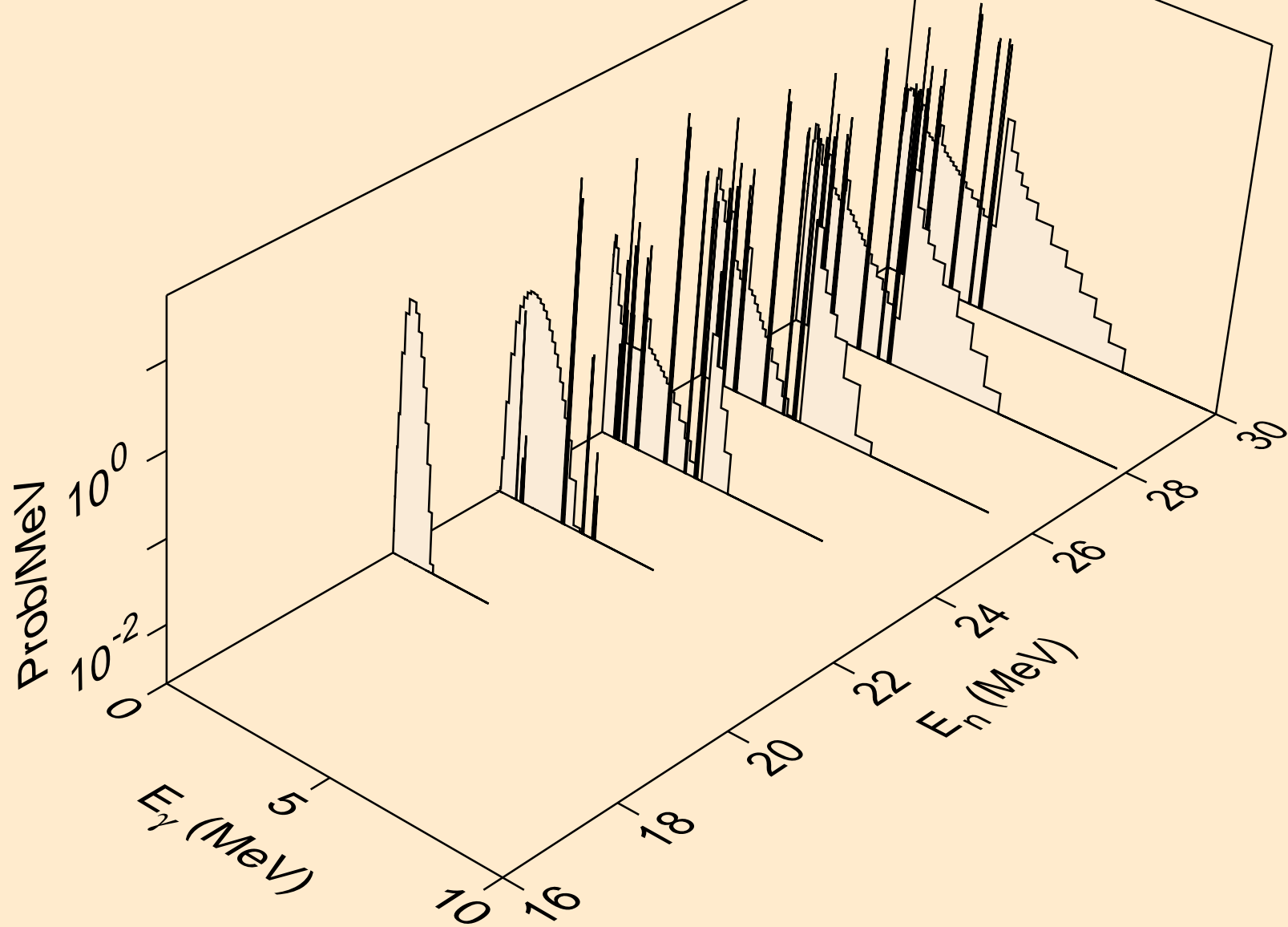

SC044M NEUTRON ACER TENDL-2023 LIBRARY; T=0.K
Photon emission for (n,n*)he3

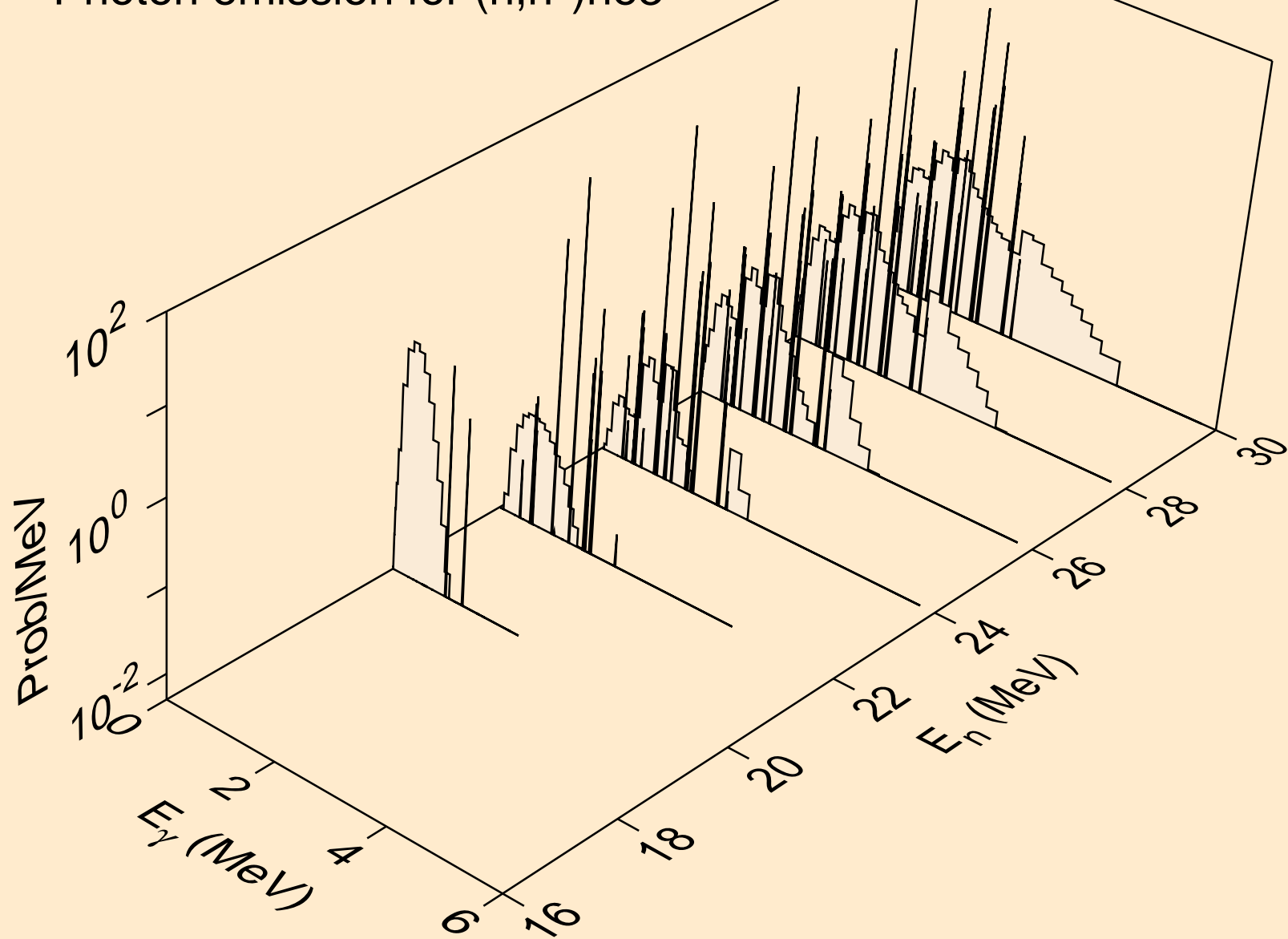

SC044M NEUTRON ACER TENDL-2023 LIBRARY; T=0.K
Photon emission for (n,2np)

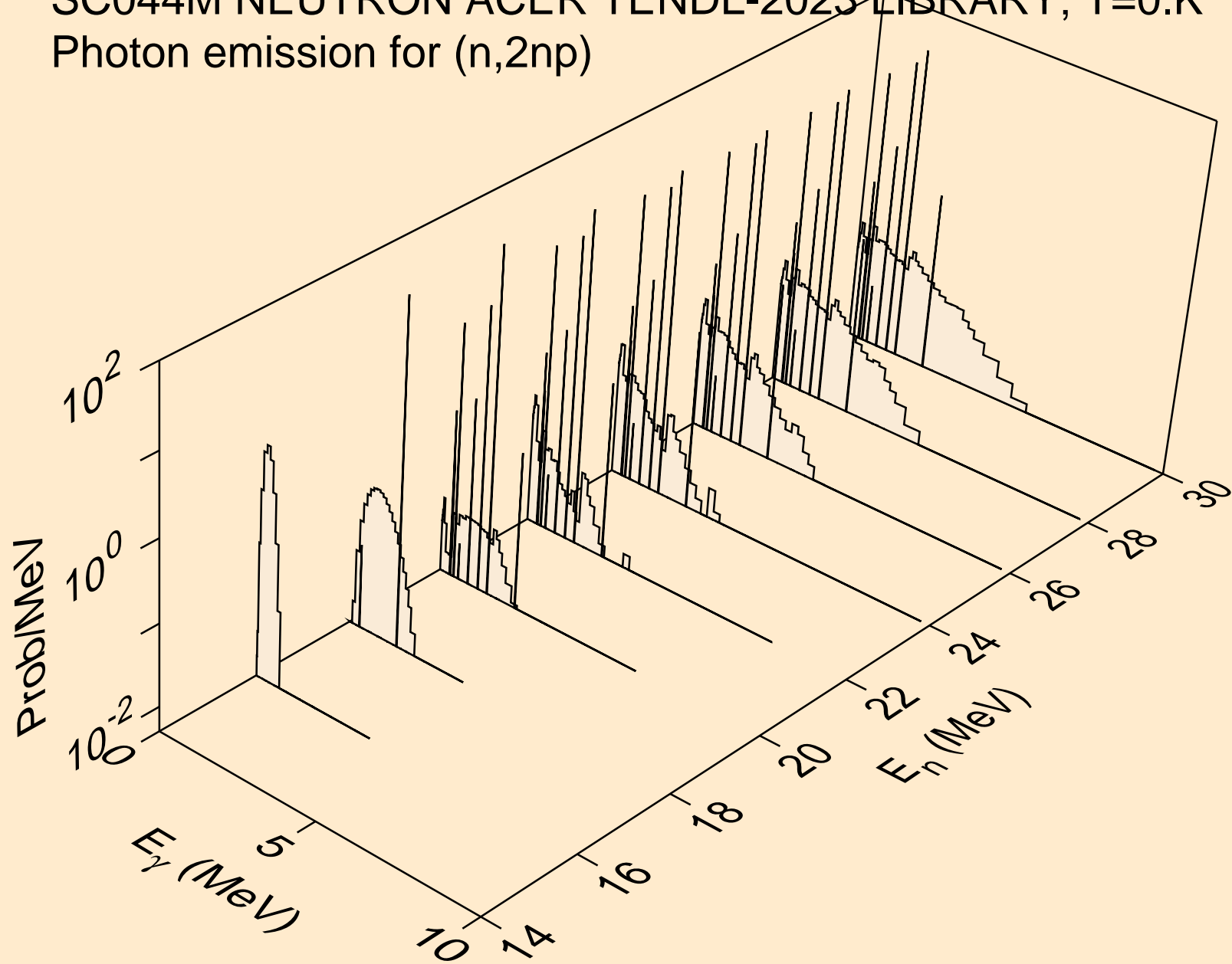

SC044M NEUTRON ACER TENDL-2023 LIBRARY; T=0.K
Photon emission for (n,3np)

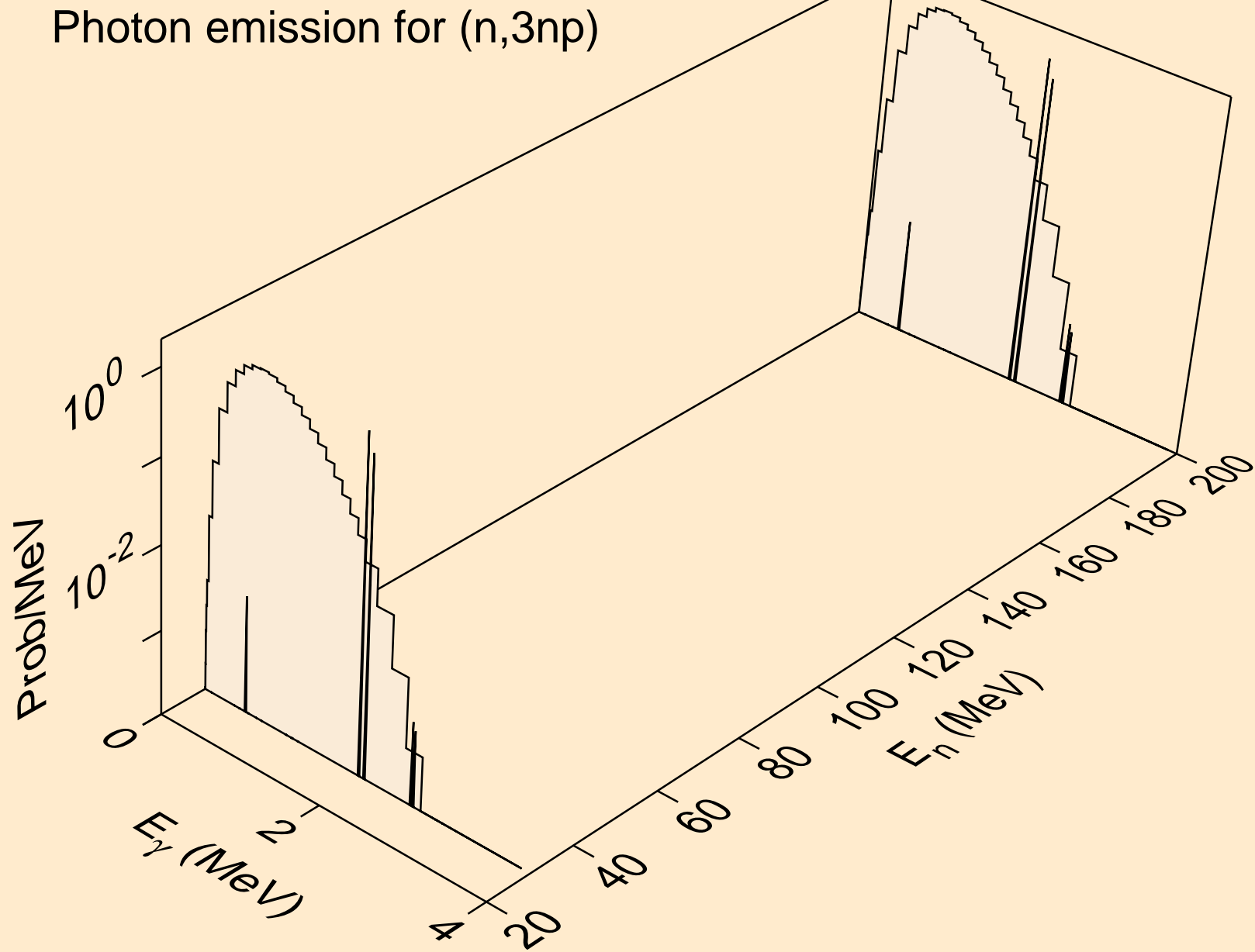

SC044M NEUTRON ACER TENDL-2023 LIBRARY; T=0.K
Photon emission for (n,n2p)

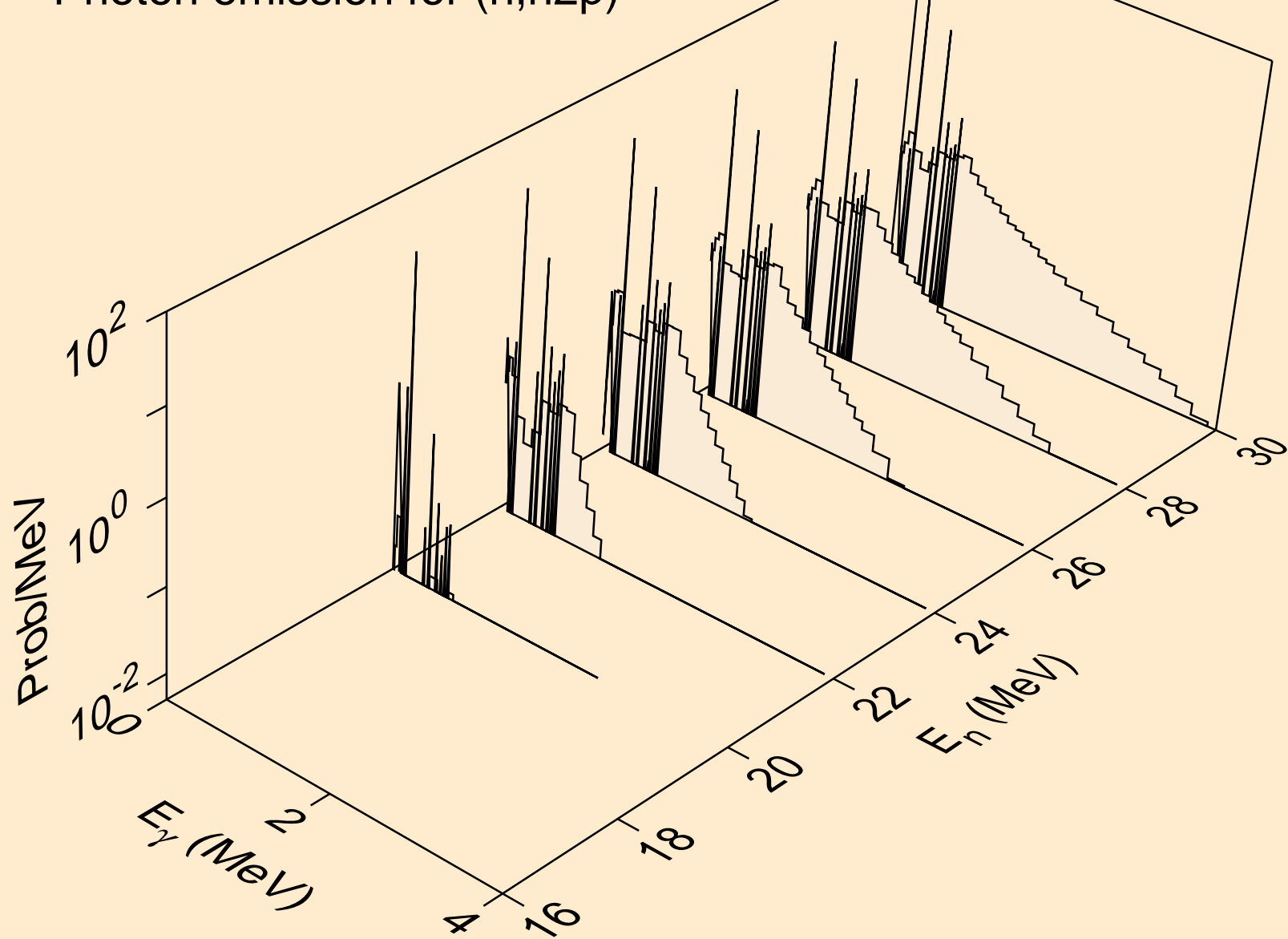

SC044M NEUTRON ACER TENDL-2023 LIBRARY; T=0.K
Photon emission for (n,npa)

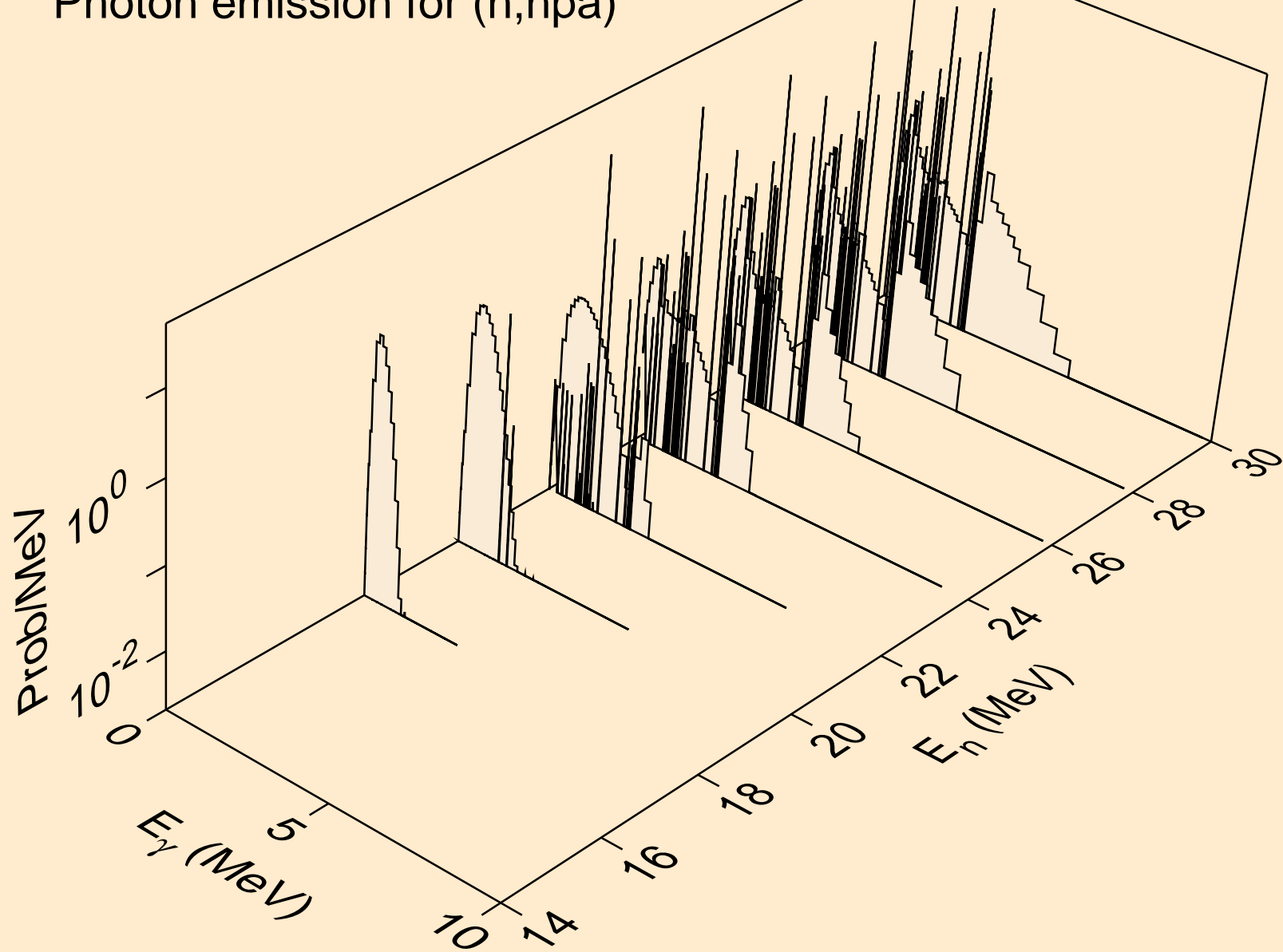

SC044M NEUTRON ACER TENDL-2023 LIBRARY; T=0.K
Photon emission for (n,n*1)

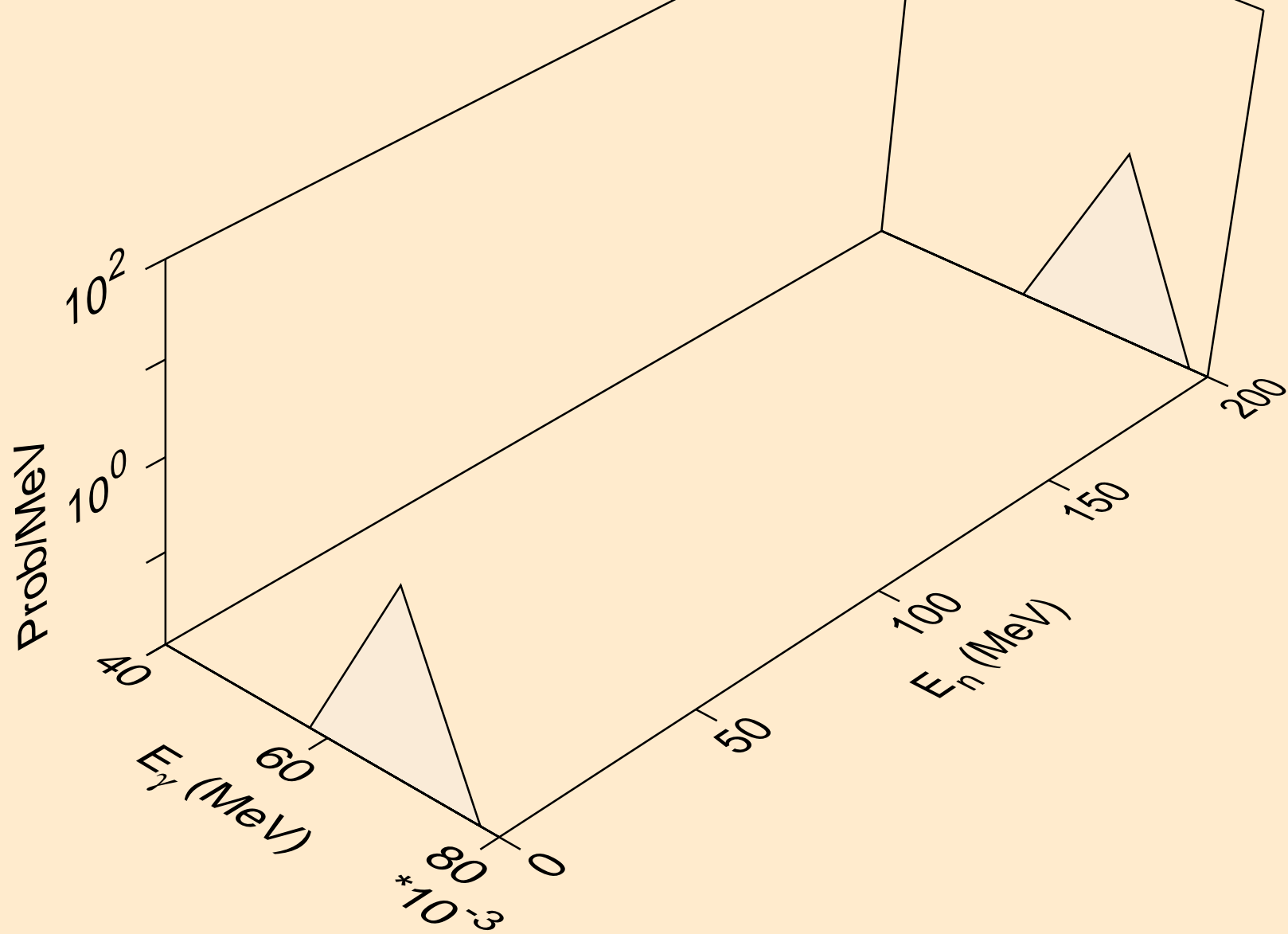

SC044M NEUTRON ACER TENDL-2023 LIBRARY; T=0.K
Photon emission for (n,n*2)

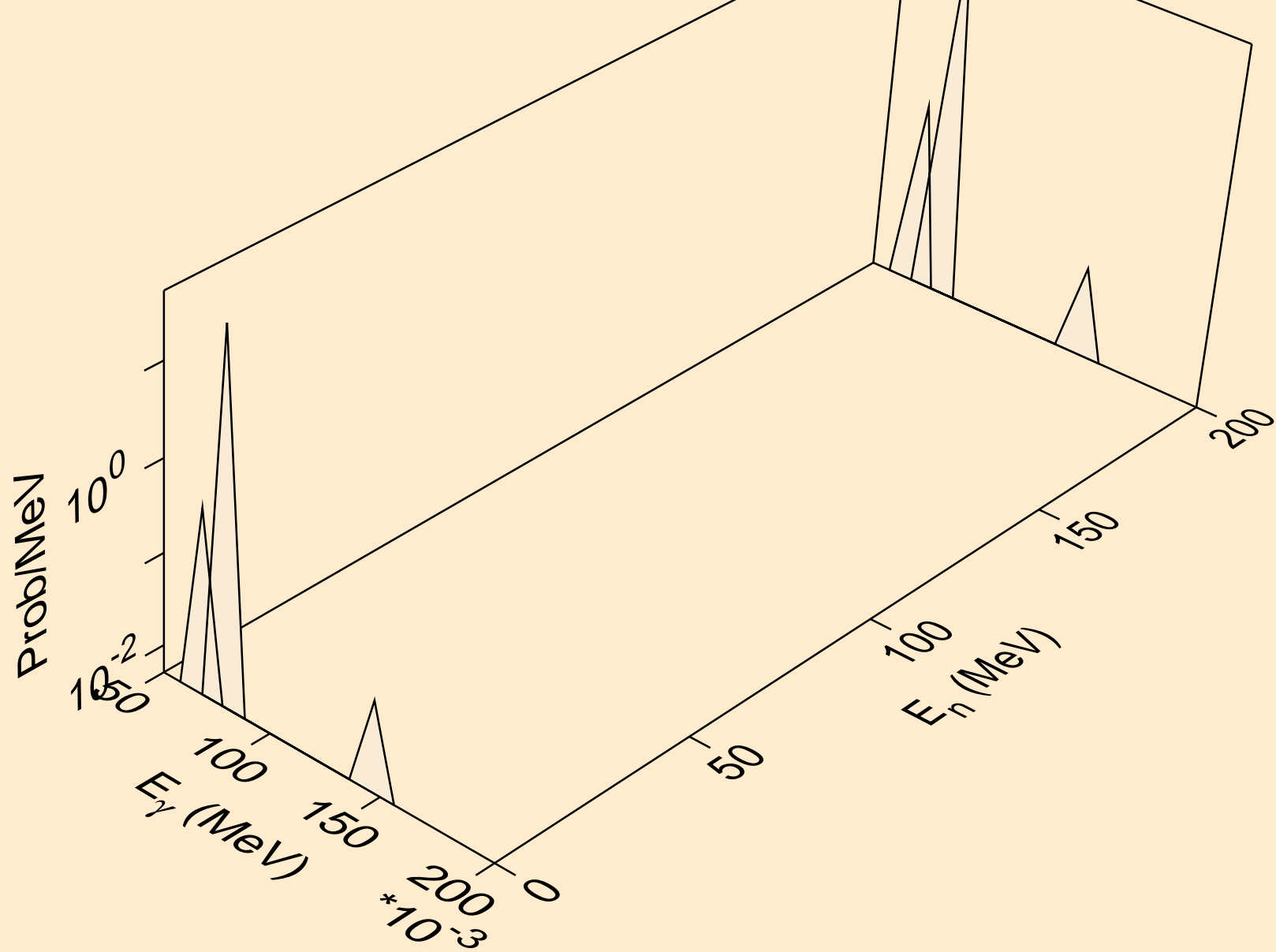

SC044M NEUTRON ACER TENDL-2023 LIBRARY; T=0.K
Photon emission for (n,n*3)

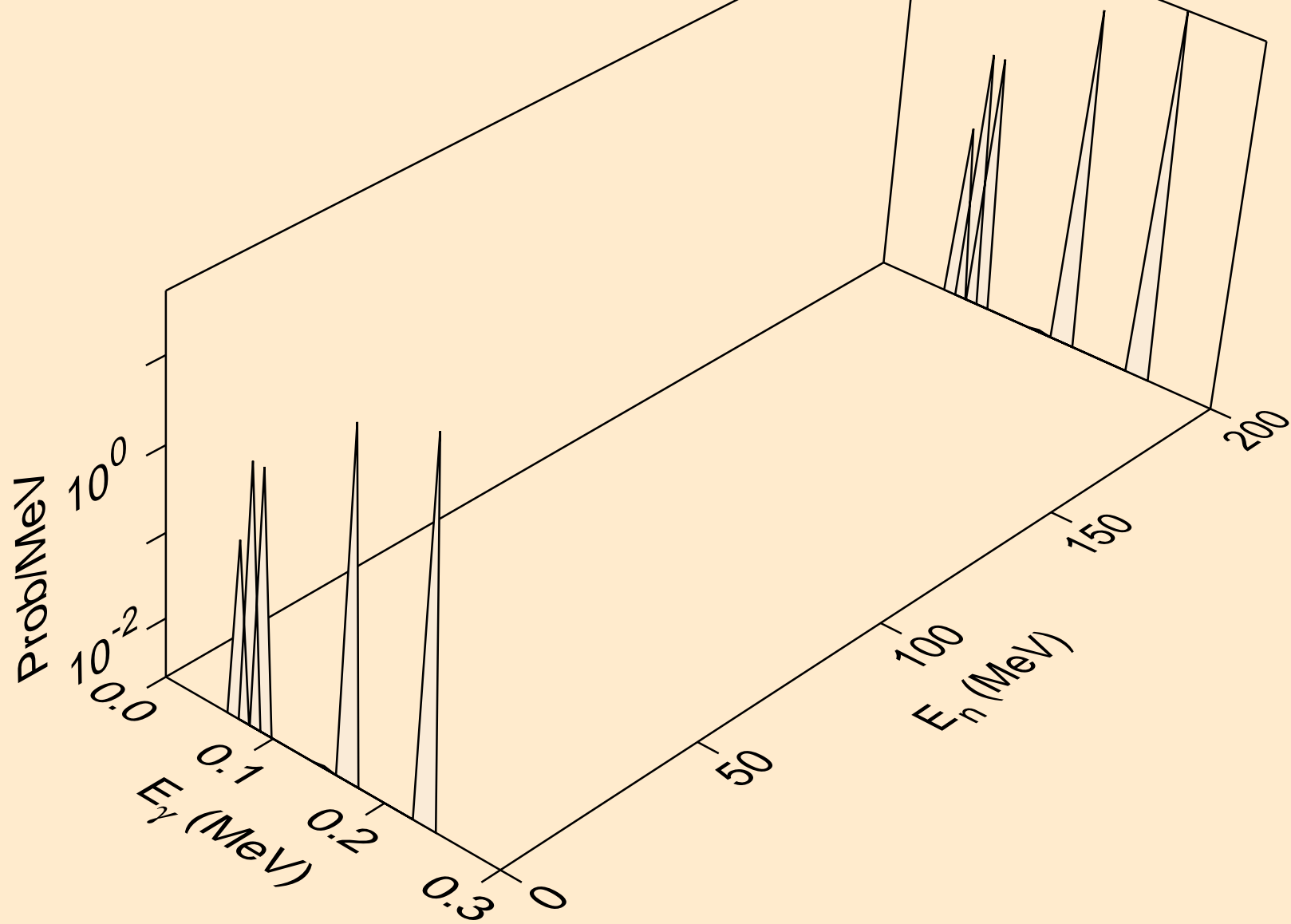

SC044M NEUTRON ACER TENDL-2023 LIBRARY; T=0.K
Photon emission for (n,n*5)

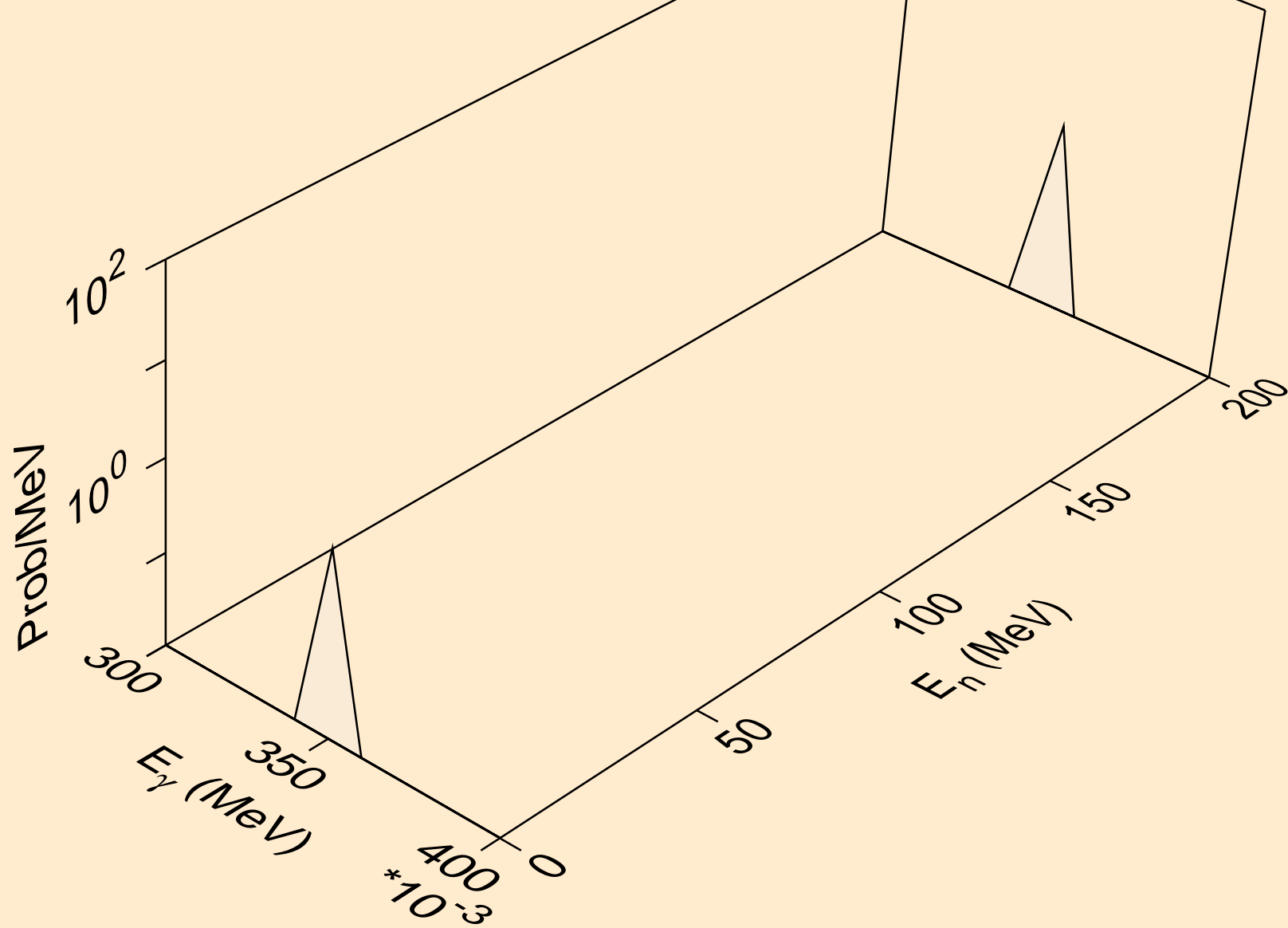

SC044M NEUTRON ACER TENDL-2023 LIBRARY; T=0.K
Photon emission for (n,n*6)

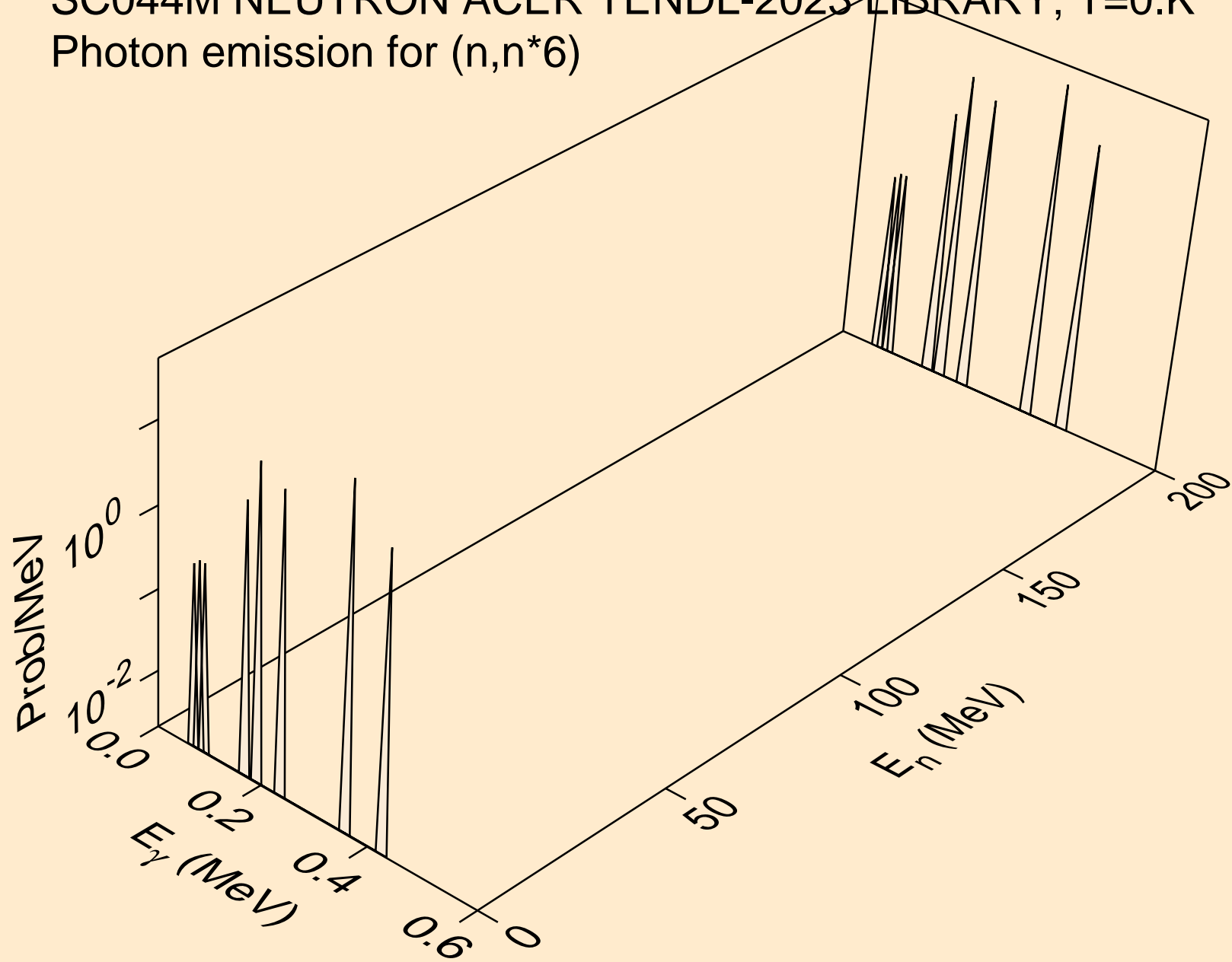

SC044M NEUTRON ACER TENDL-2023 LIBRARY; T=0.K
Photon emission for (n,n*7)

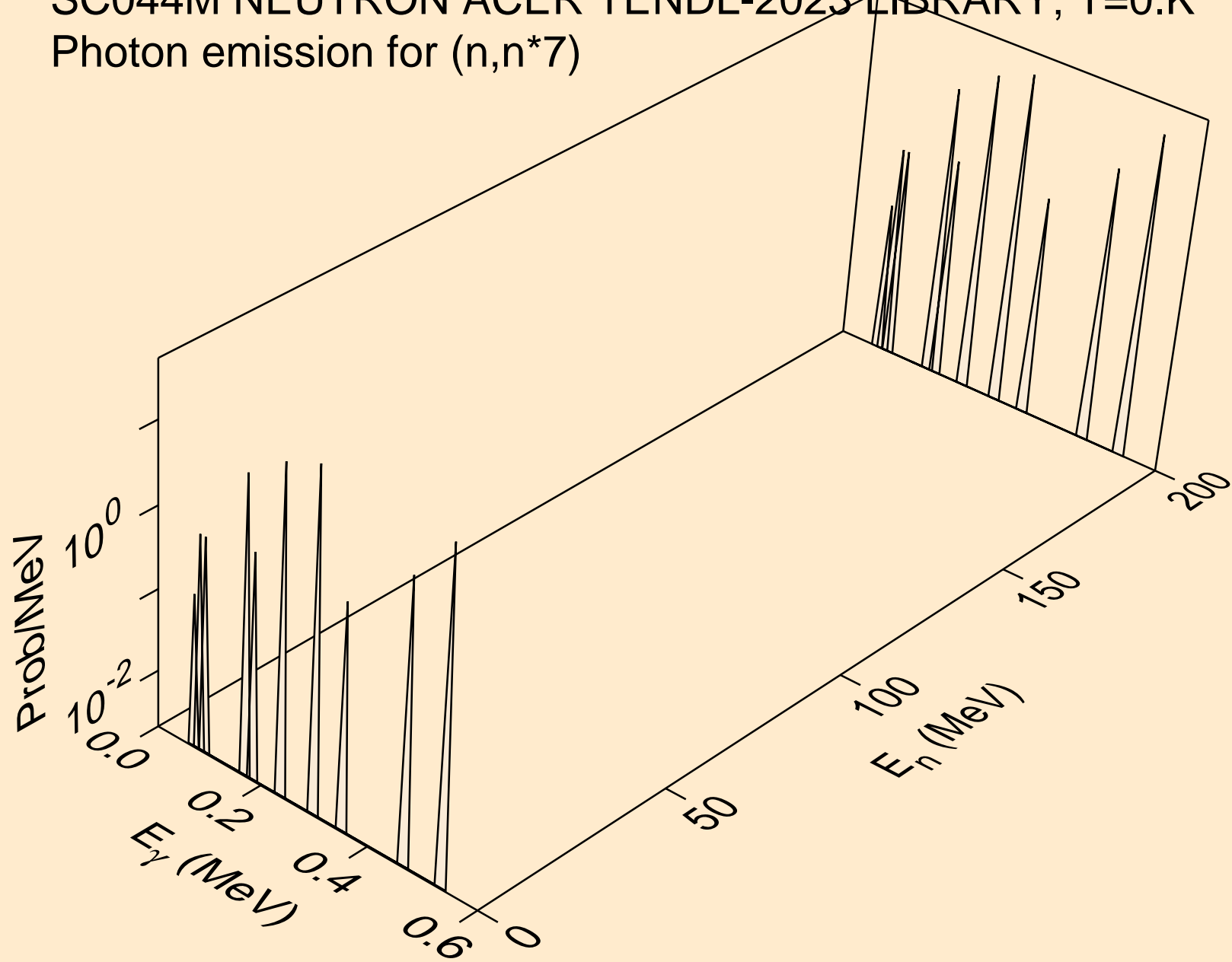

SC044M NEUTRON ACER TENDL-2023 LIBRARY; T=0.K
Photon emission for (n,n*8)

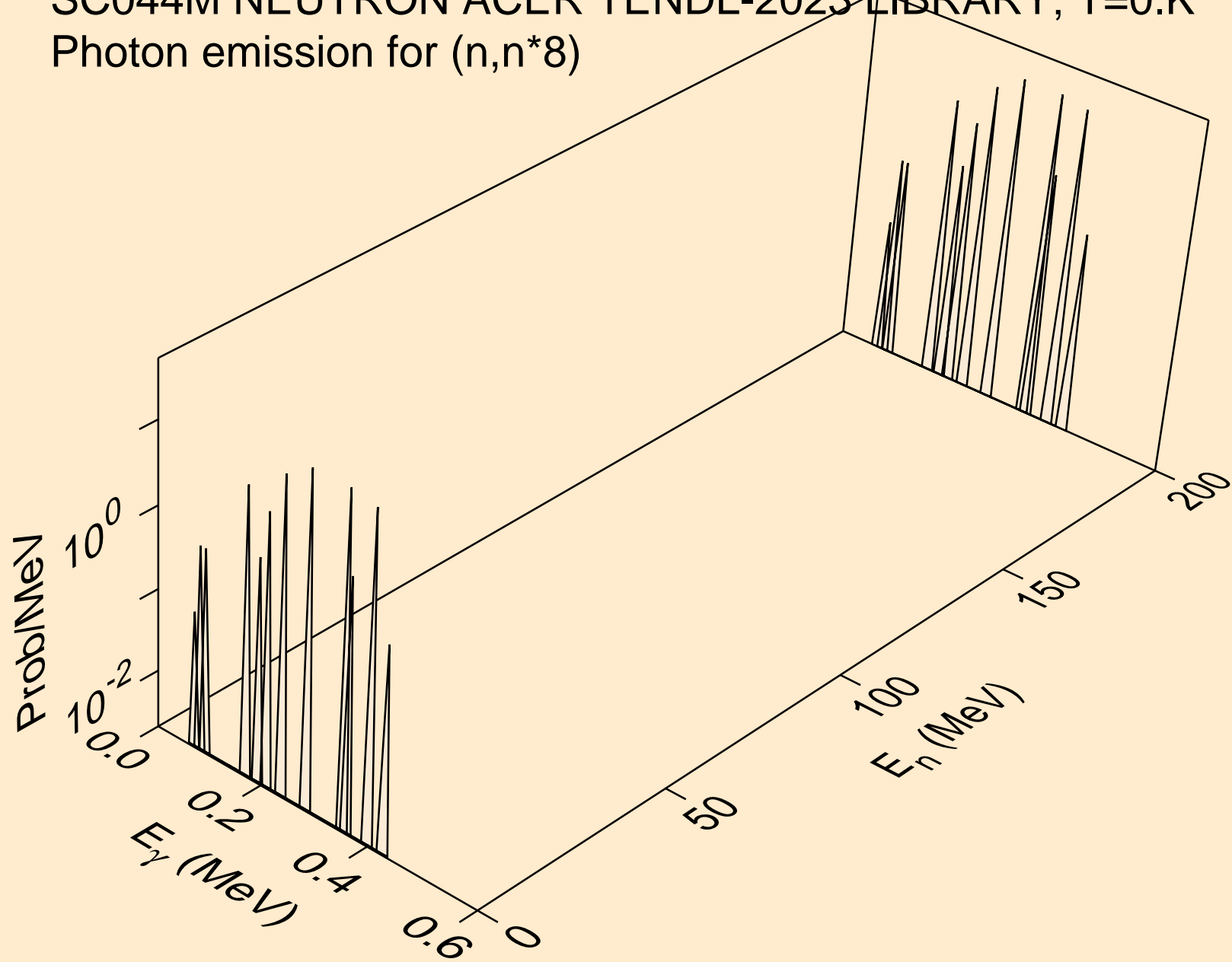

SC044M NEUTRON ACER TENDL-2023 LIBRARY; T=0.K
Photon emission for (n,n*9)

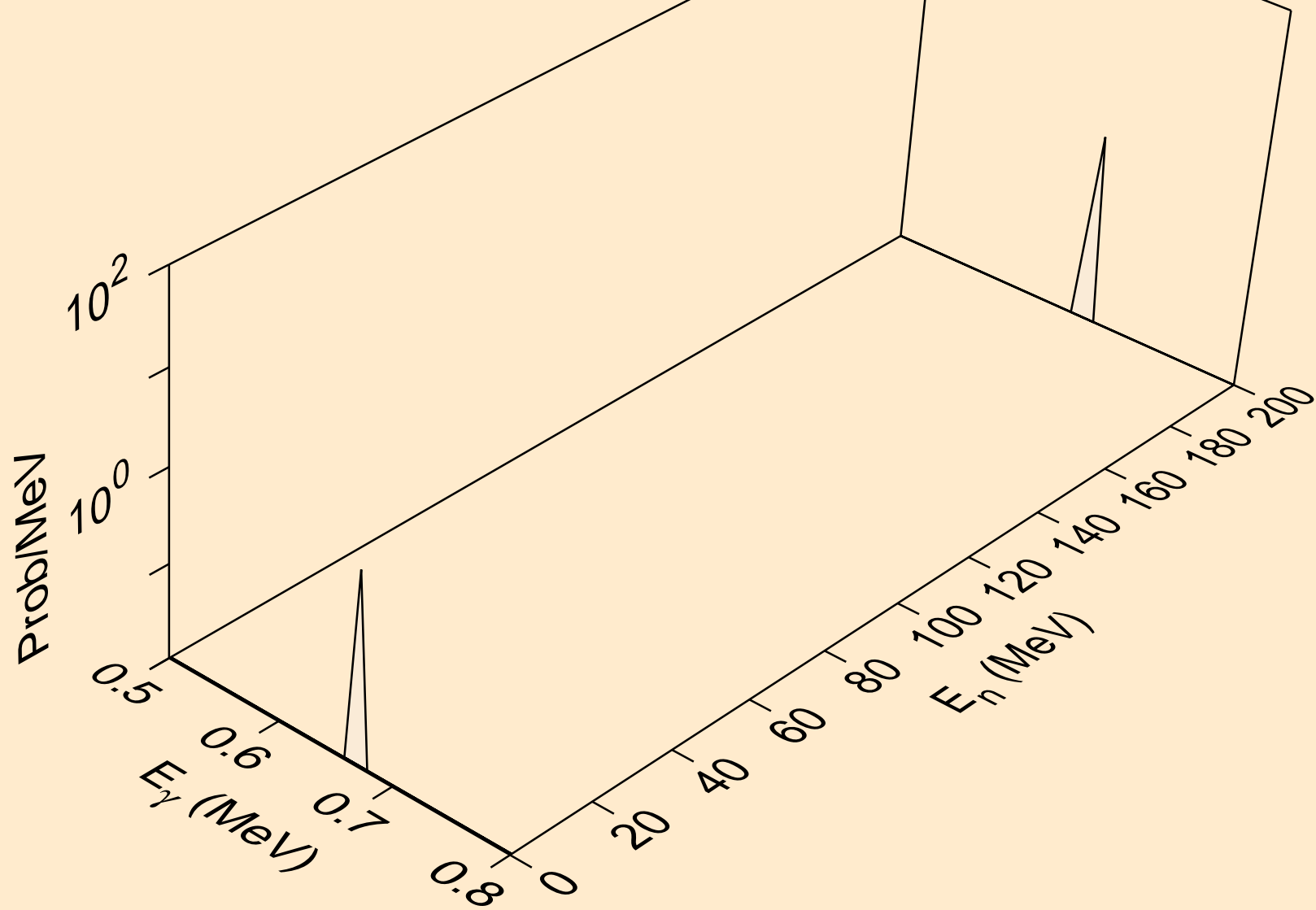

SC044M NEUTRON ACER TENDL-2023 LIBRARY; T=0.K
Photon emission for (n,n*10)

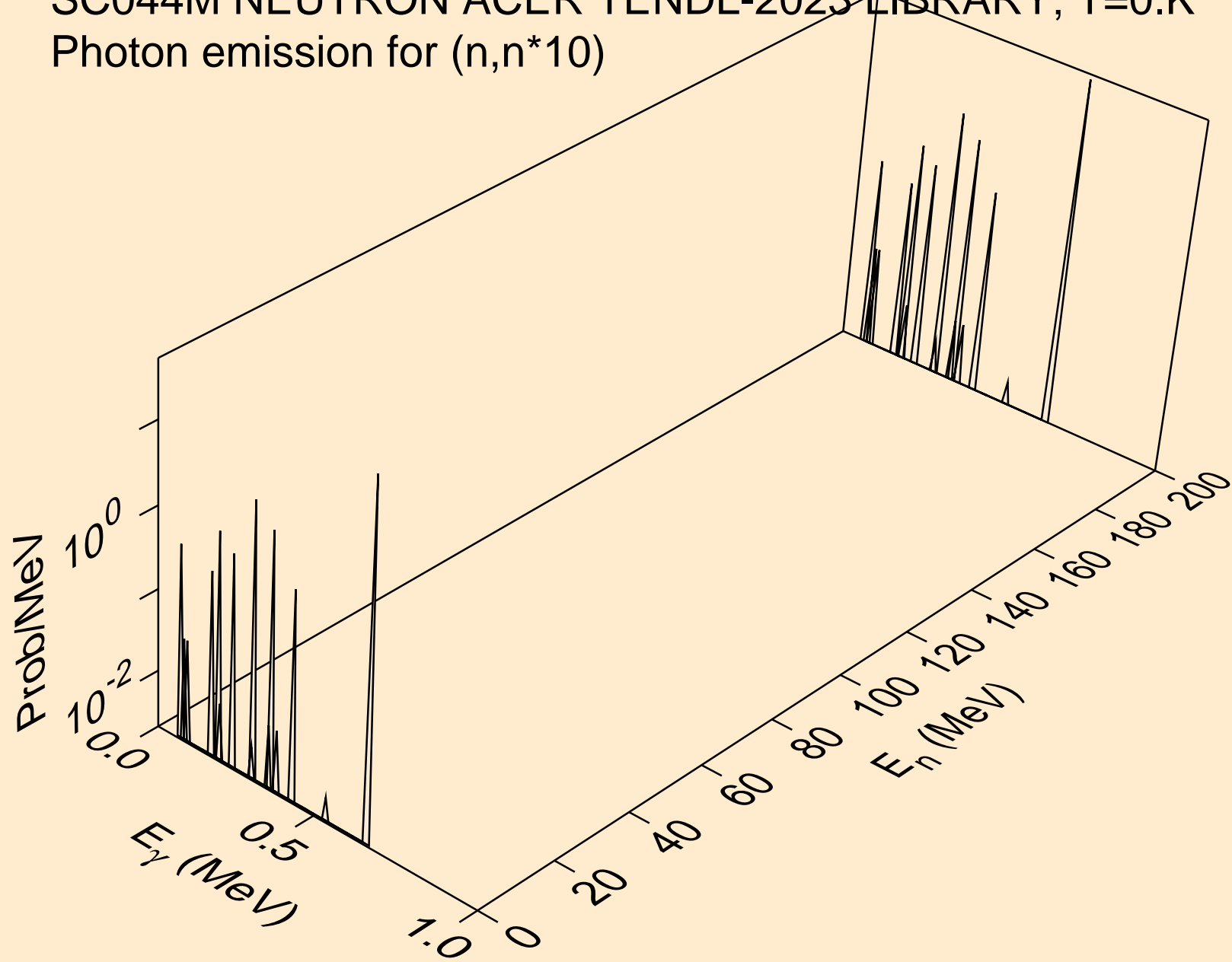

SC044M NEUTRON ACER TENDL-2023 LIBRARY; T=0.K
Photon emission for (n,n*11)

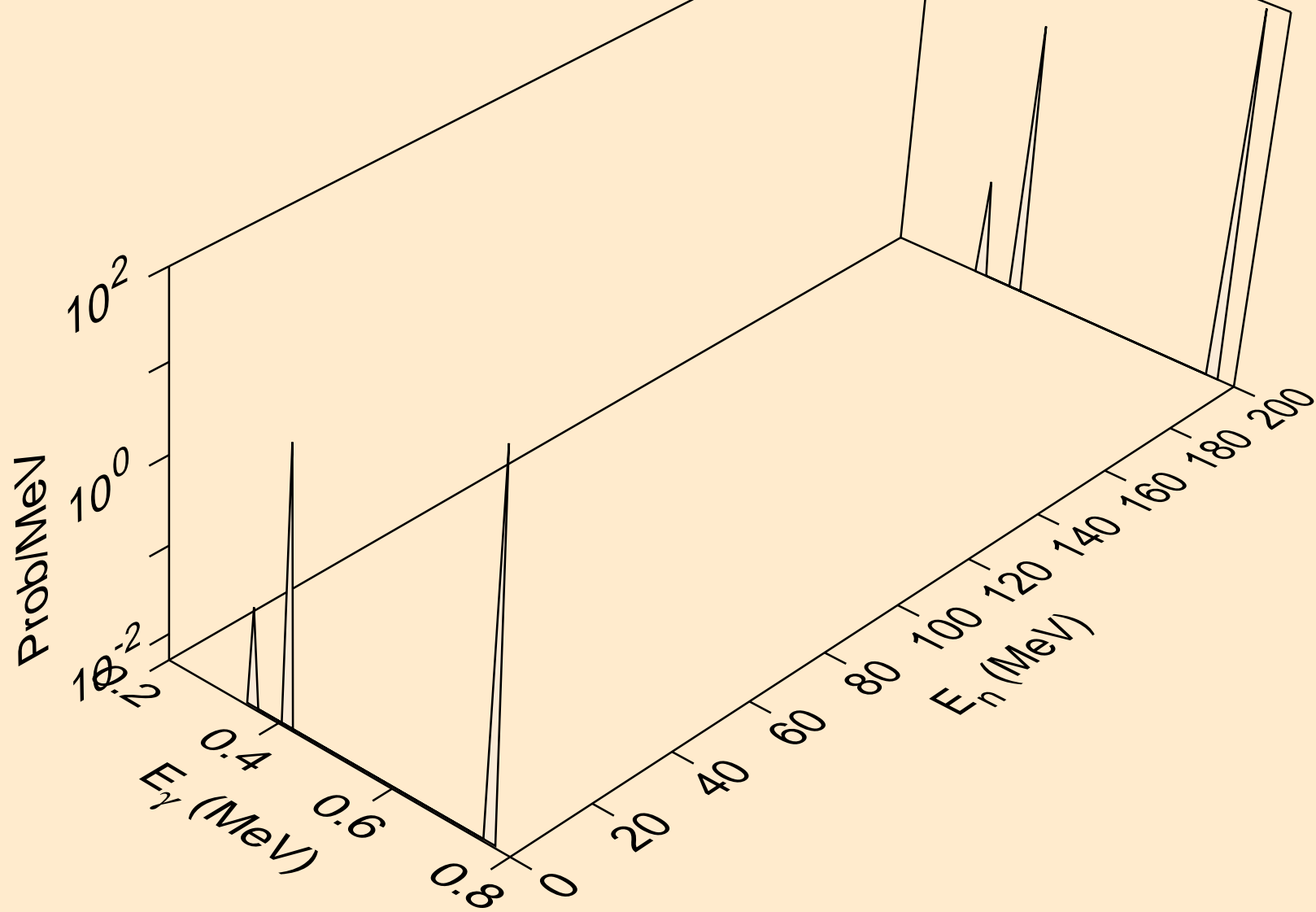

SC044M NEUTRON ACER TENDL-2023 LIBRARY; T=0.K
Photon emission for (n,n*12)

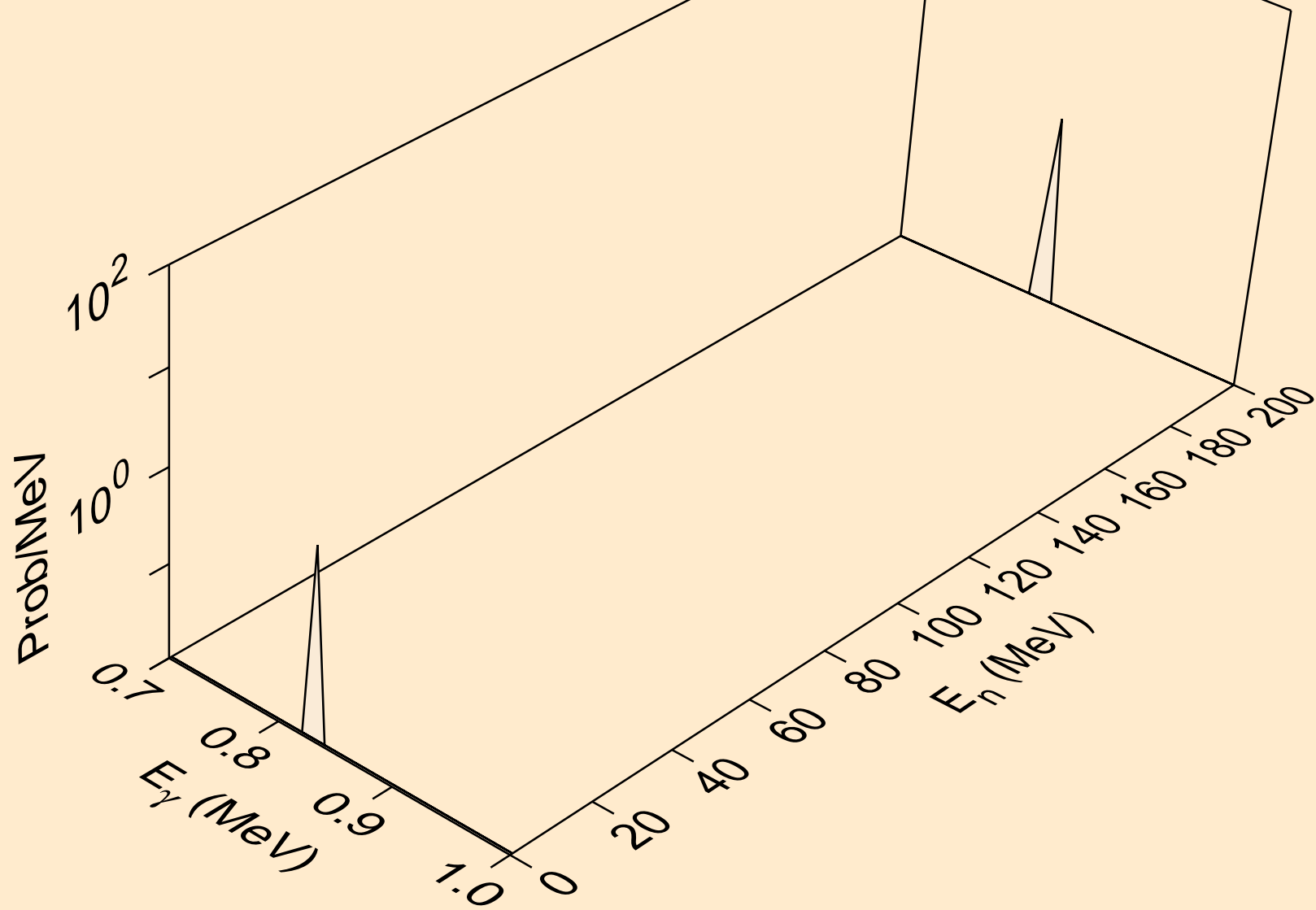

SC044M NEUTRON ACER TENDL-2023 LIBRARY; T=0.K
Photon emission for (n,n*13)

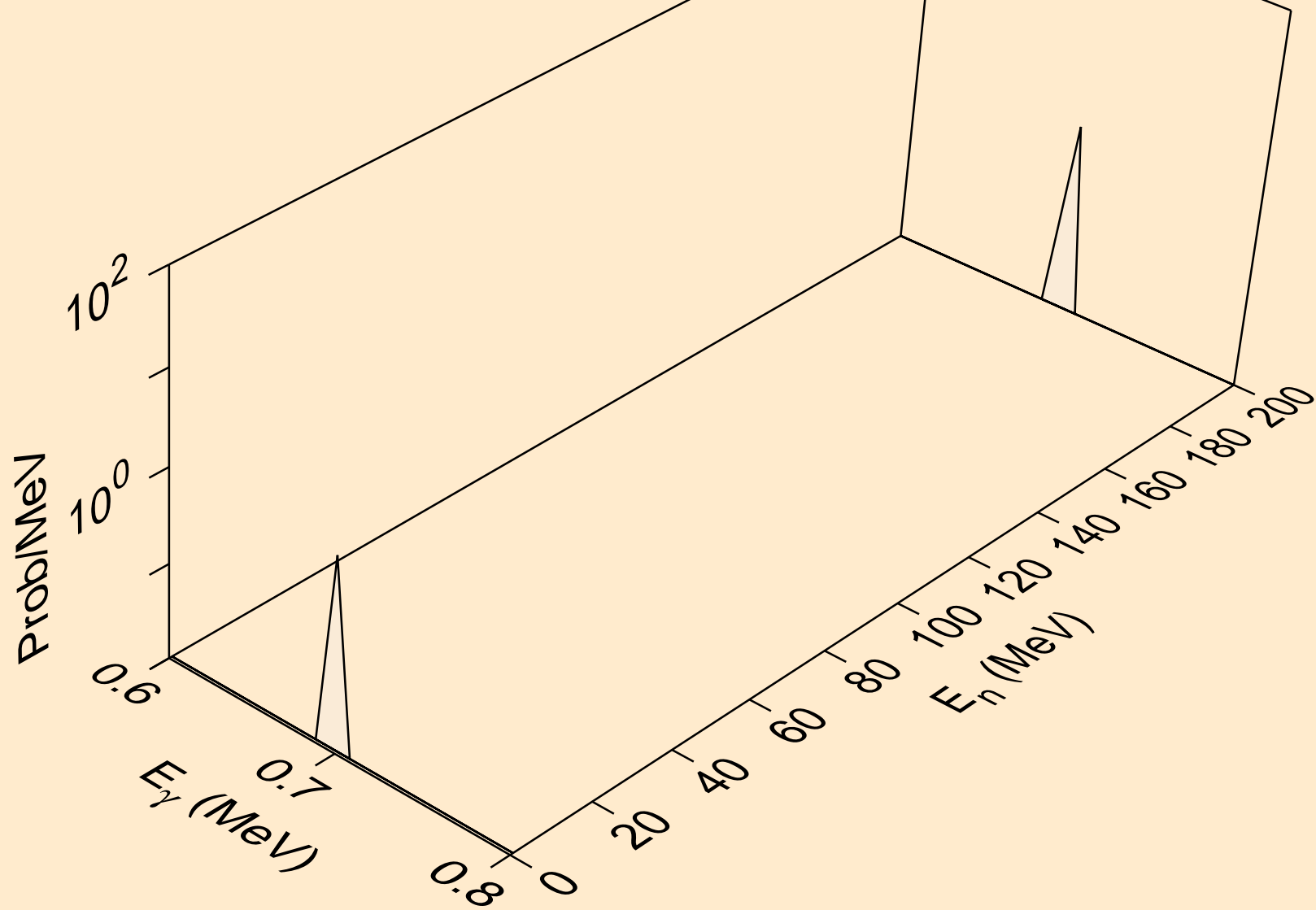

SC044M NEUTRON ACER TENDL-2023 LIBRARY; T=0.K
Photon emission for (n,n*14)

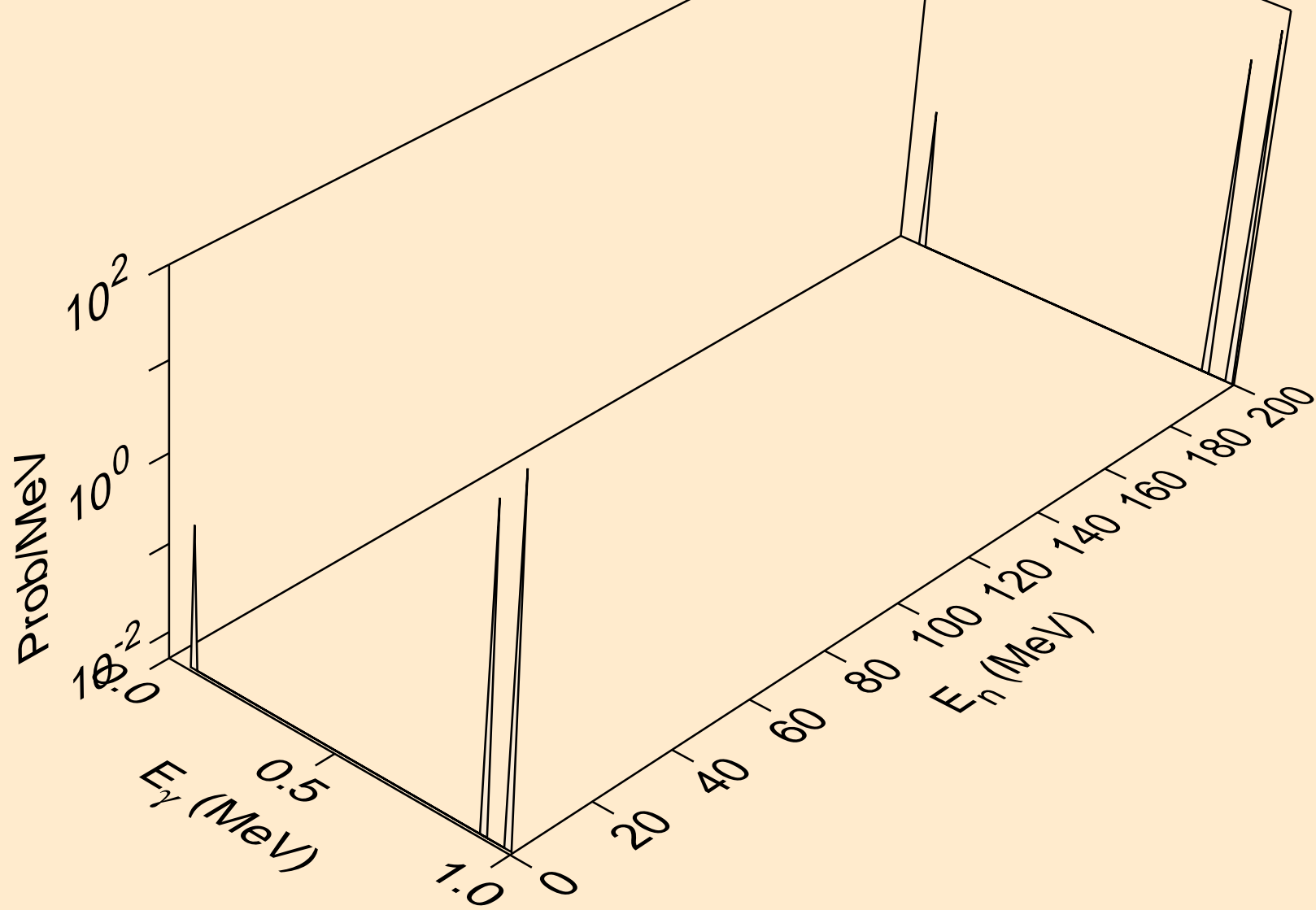

SC044M NEUTRON ACER TENDL-2023 LIBRARY; T=0.K
Photon emission for (n,n*15)

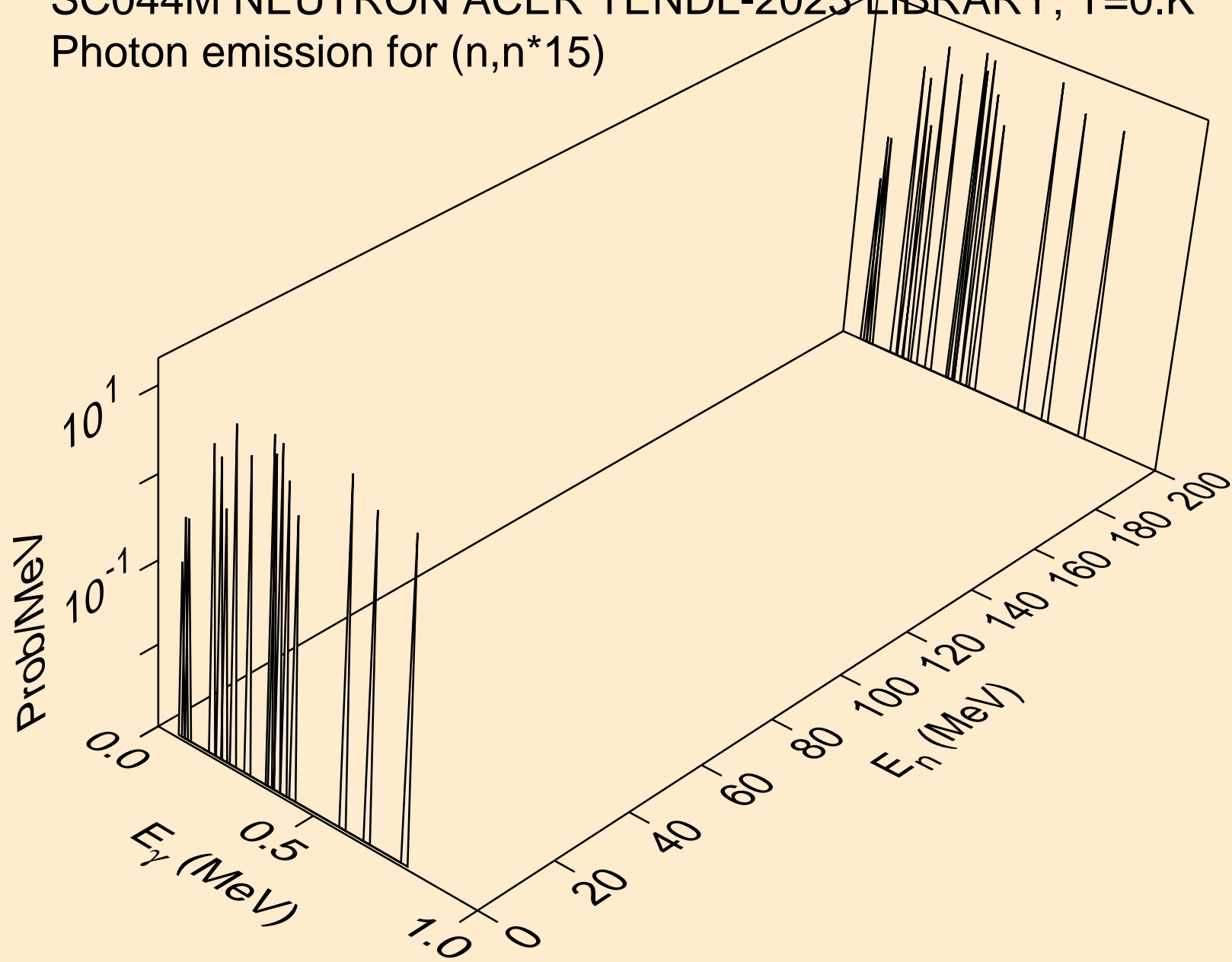

SC044M NEUTRON ACER TENDL-2023 LIBRARY; T=0.K
Photon emission for (n,n*16)

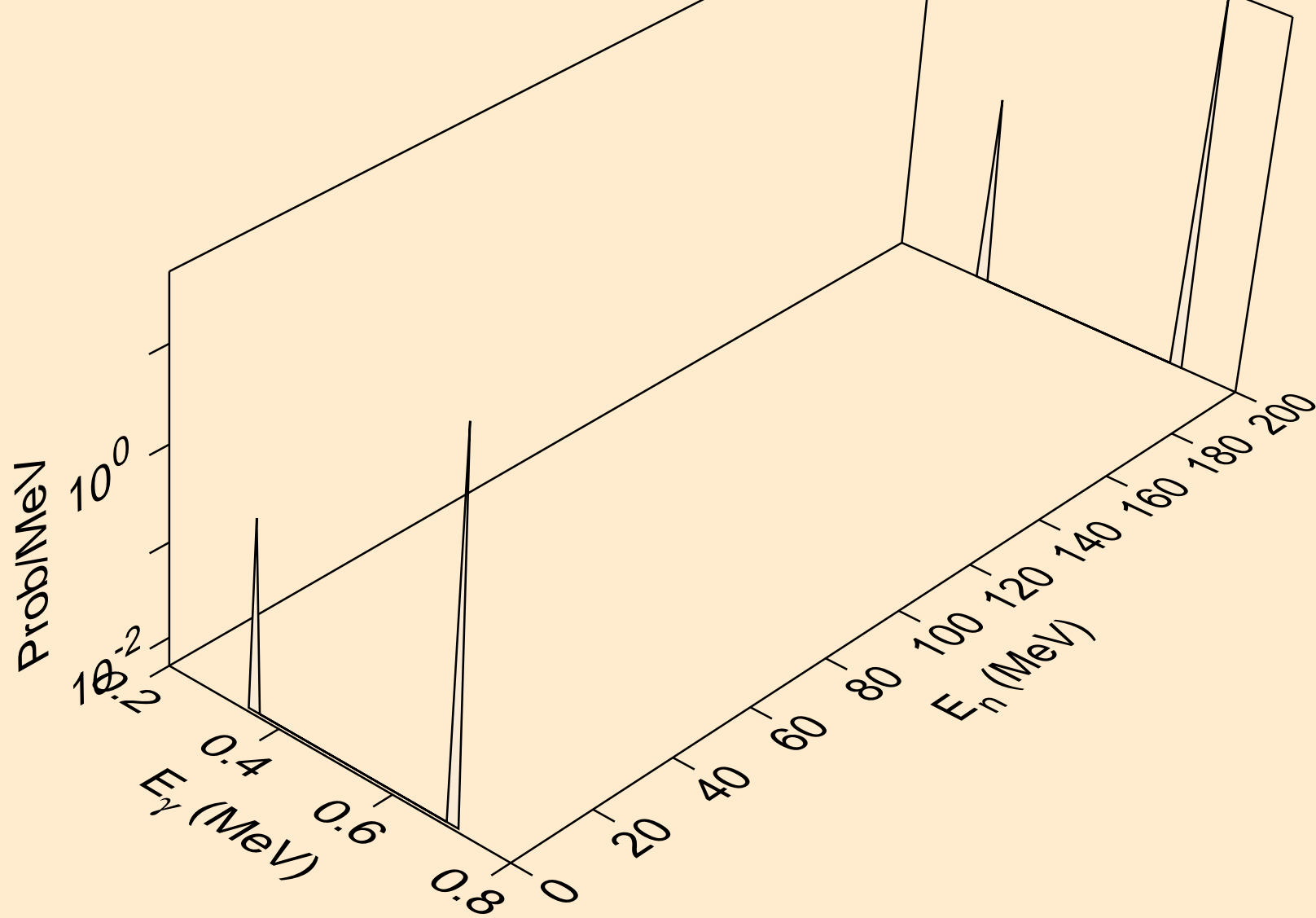

SC044M NEUTRON ACER TENDL-2023 LIBRARY; T=0.K
Photon emission for (n,n*17)

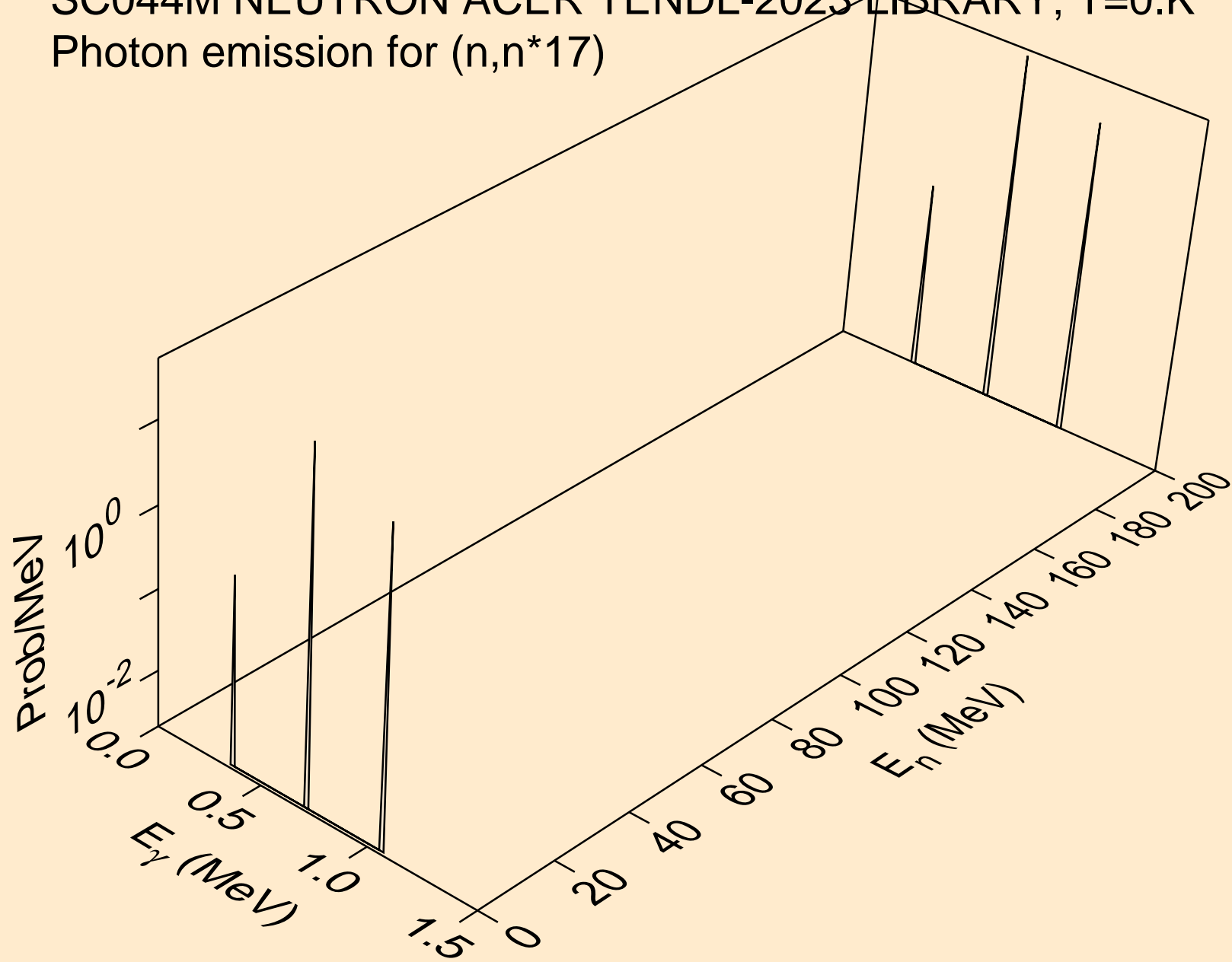

SC044M NEUTRON ACER TENDL-2023 LIBRARY; T=0.K
Photon emission for (n,n*c)

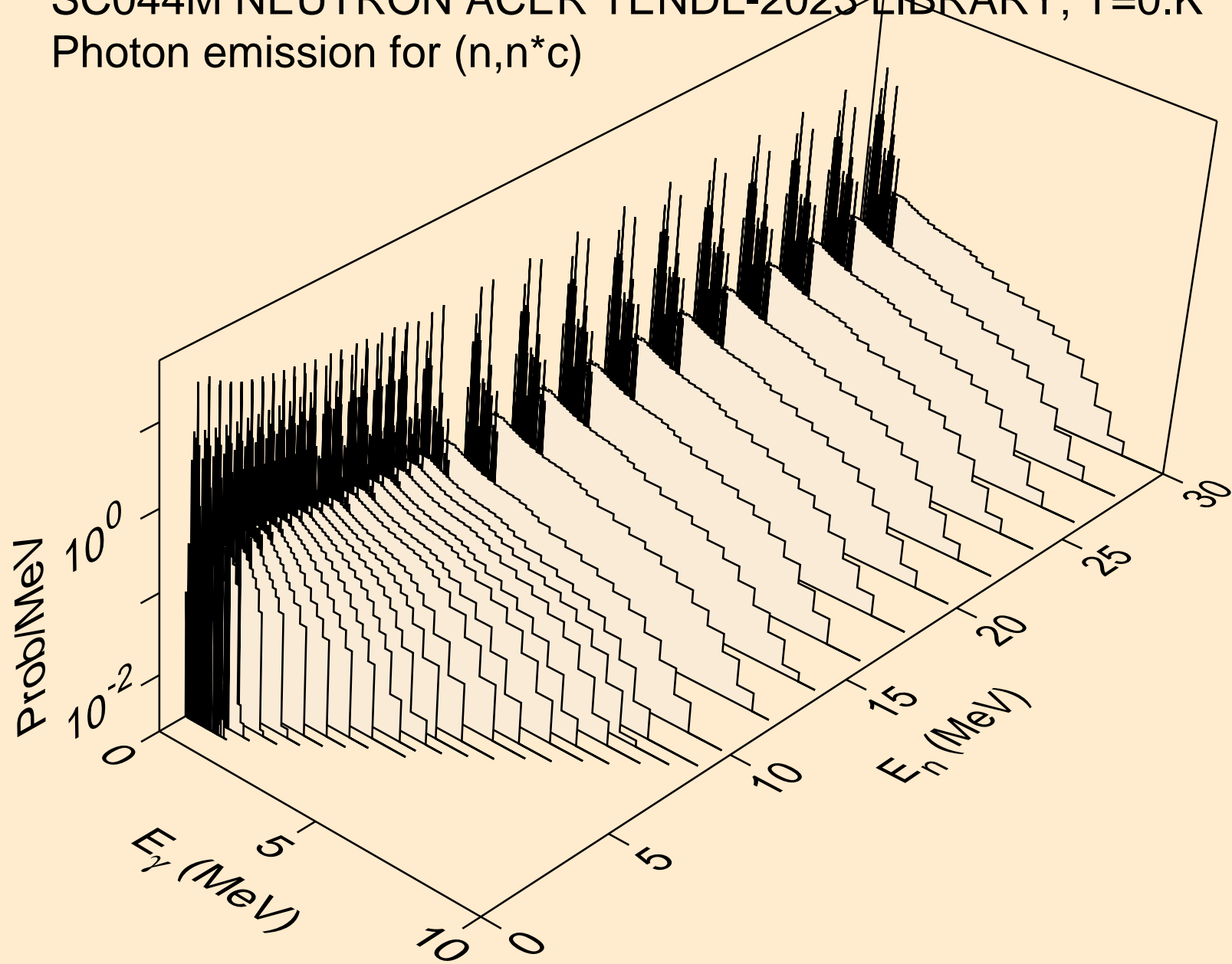

SC044M NEUTRON ACER TENDL-2023 LIBRARY; T=0.K
Photon emission for (n,gma)

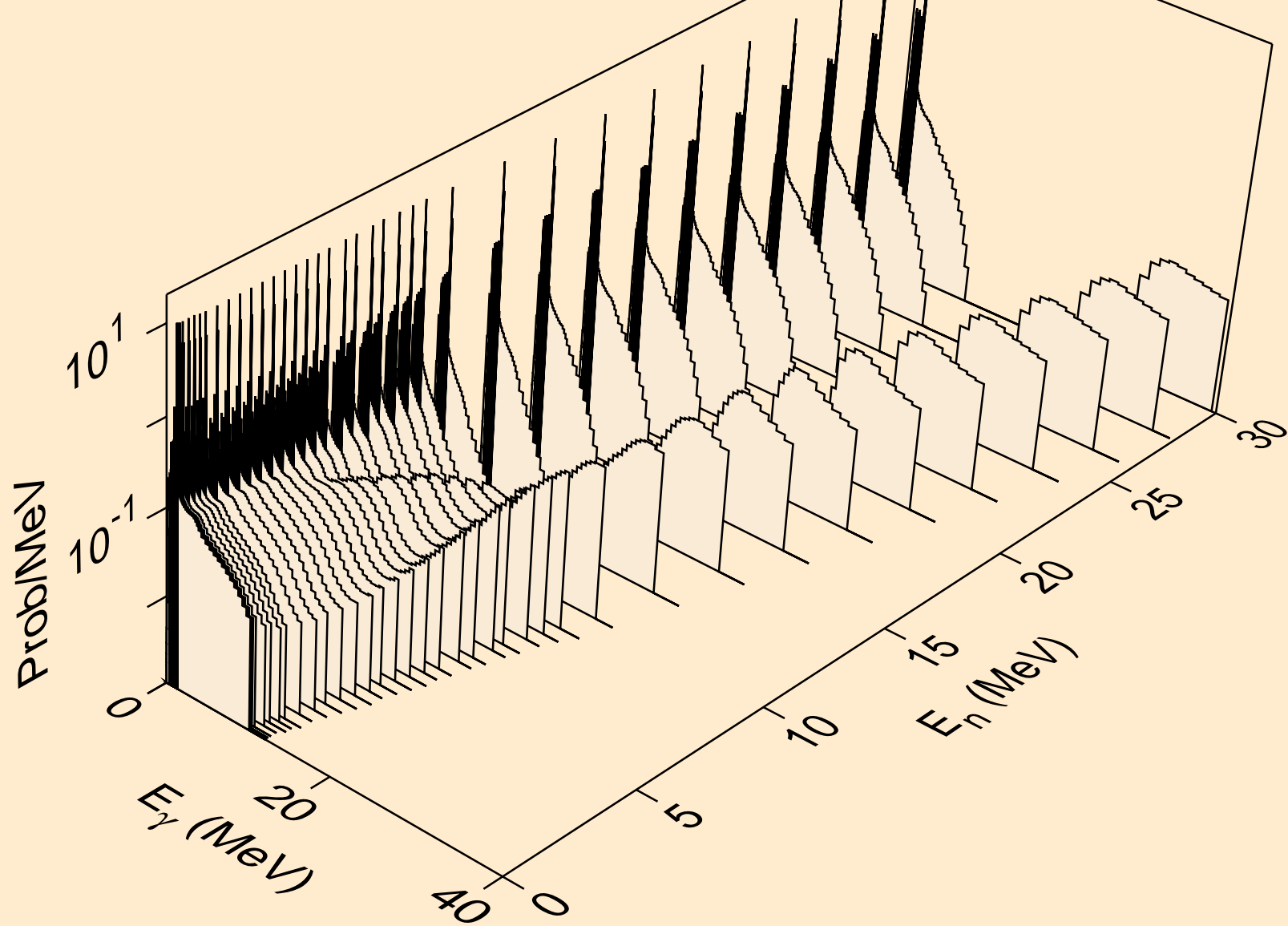

SC044M NEUTRON ACER TENDL-2023 LIBRARY; T=0.K
Photon emission for (n,p)

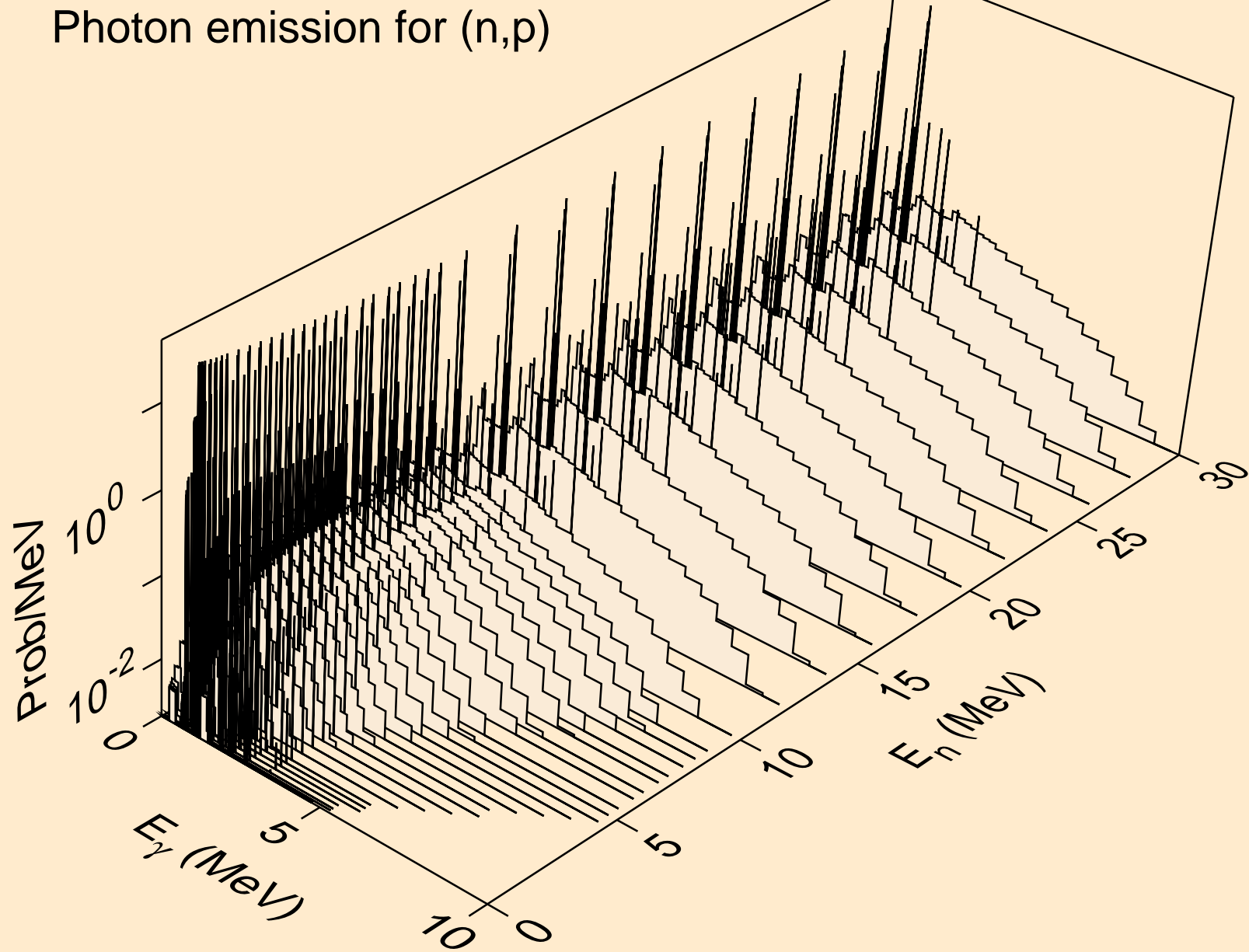

SC044M NEUTRON ACER TENDL-2023 LIBRARY; T=0.K
Photon emission for (n,d)

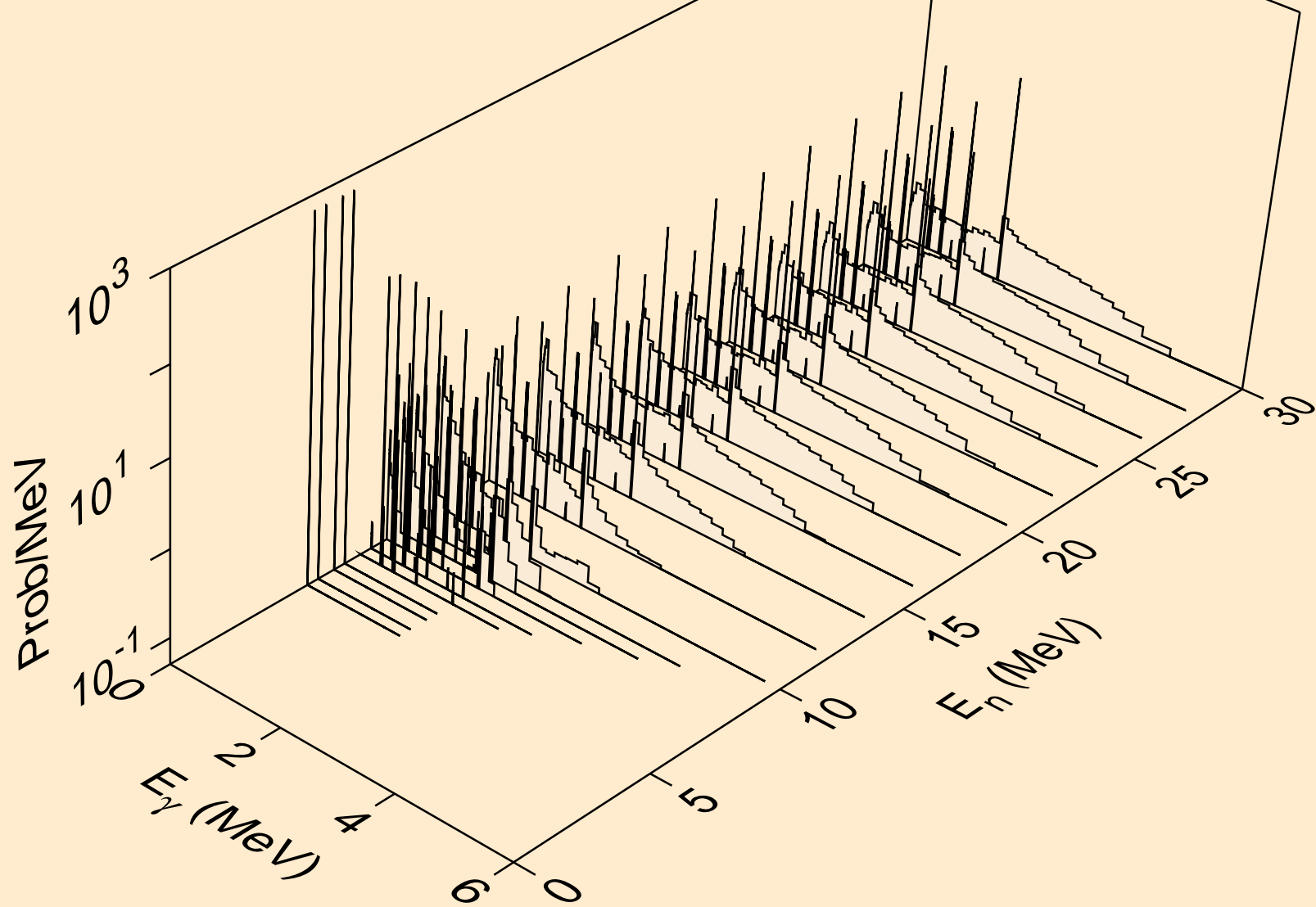

SC044M NEUTRON ACER TENDL-2023 LIBRARY; T=0.K
Photon emission for (n,t)

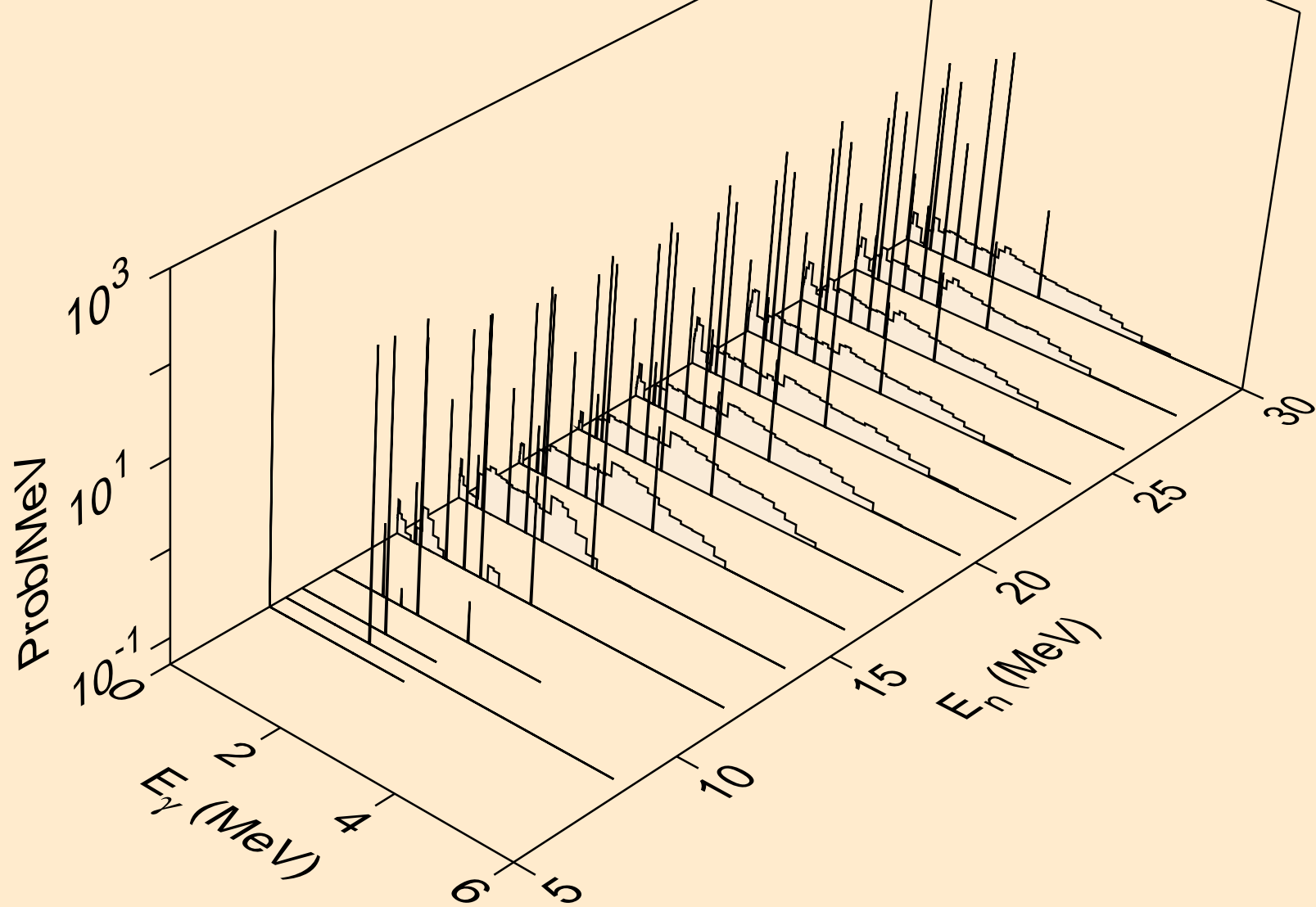

SC044M NEUTRON ACER TENDL-2023 LIBRARY; T=0.K
Photon emission for (n,he3)

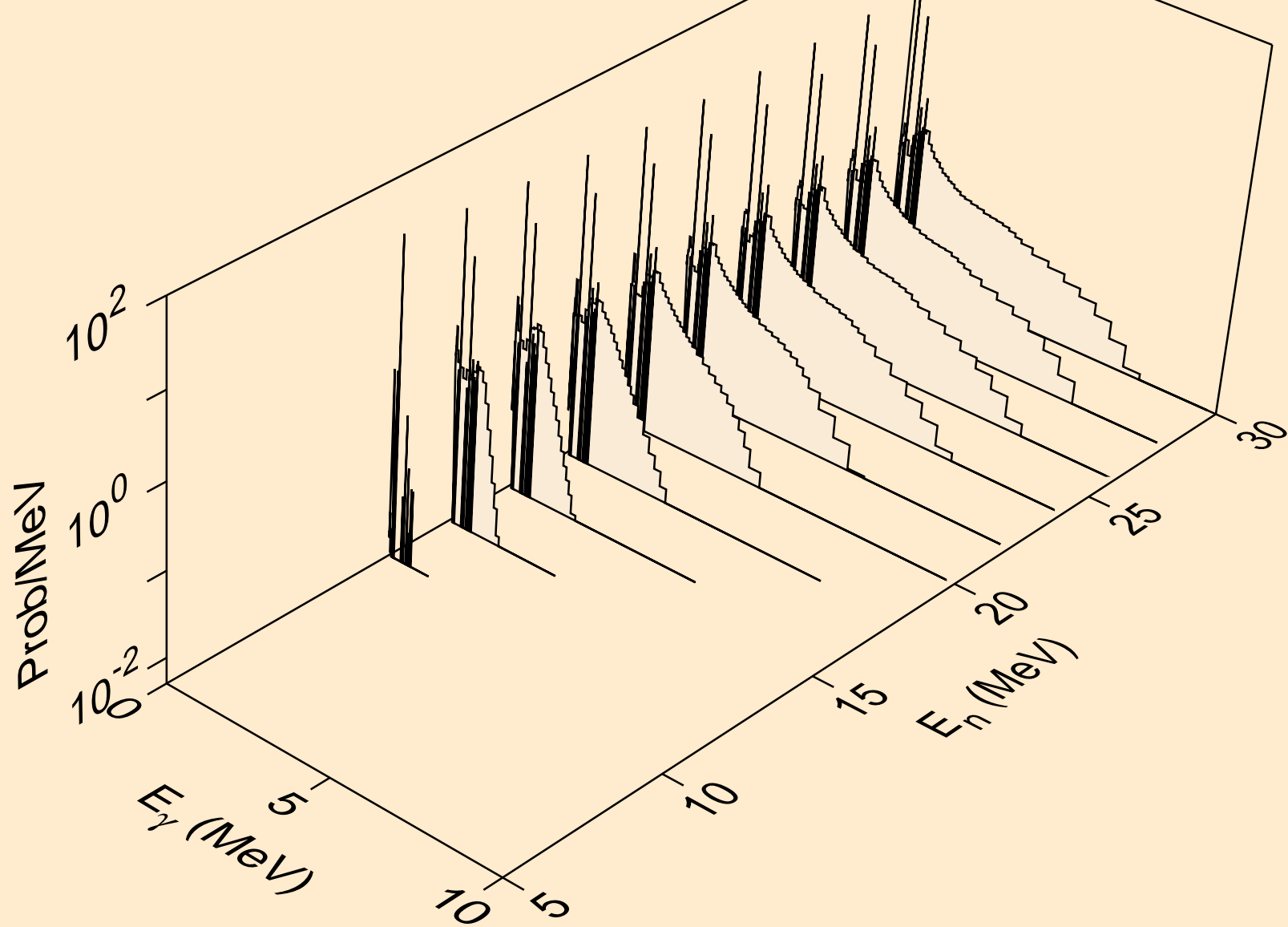

SC044M NEUTRON ACER TENDL-2023 LIBRARY; T=0.K
Photon emission for (n,a)

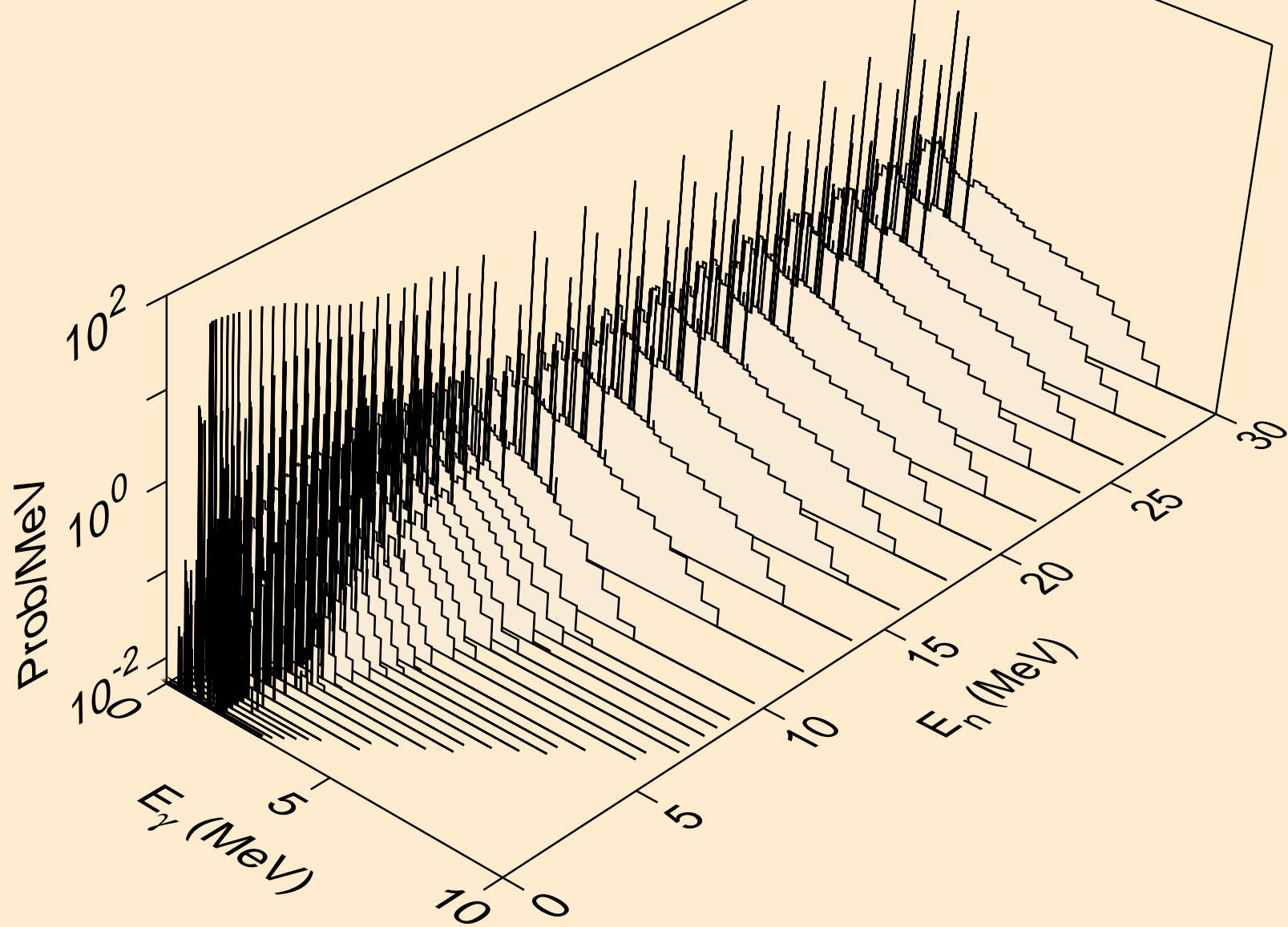

SC044M NEUTRON ACER TENDL-2023 LIBRARY; T=0.K
Photon emission for (n,2a)

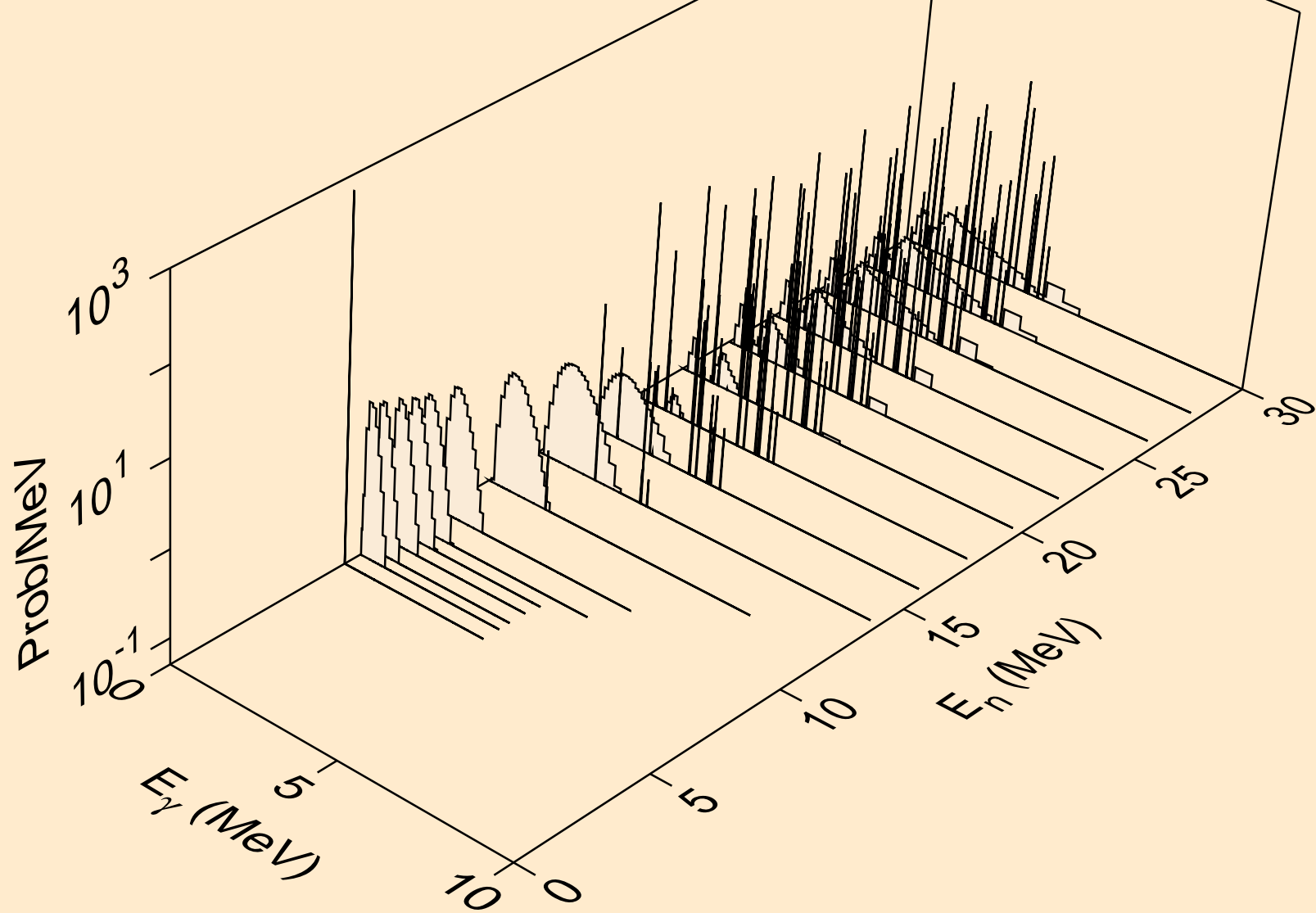

SC044M NEUTRON ACER TENDL-2023 LIBRARY; T=0.K
Photon emission for (n,3a)

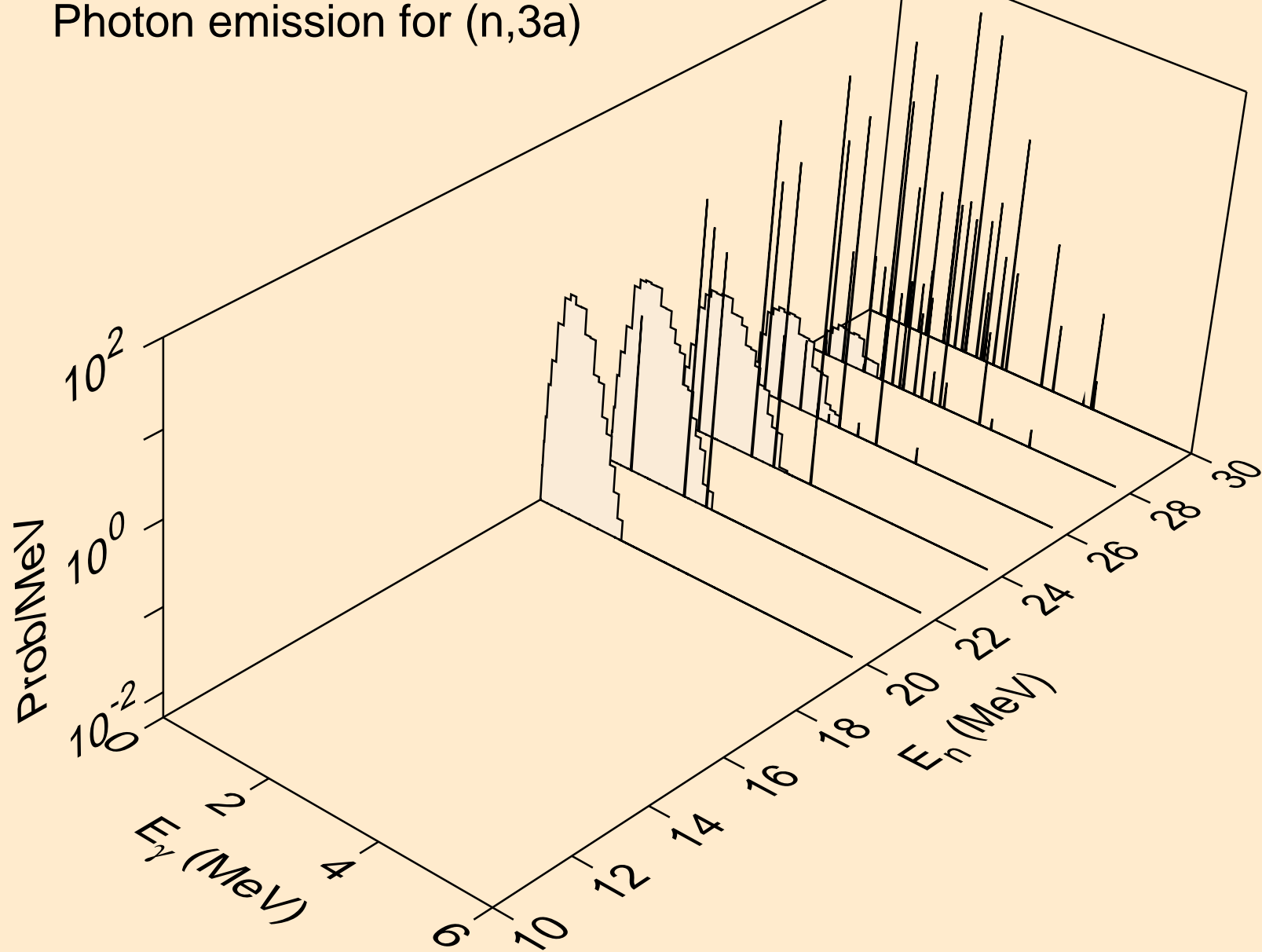

SC044M NEUTRON ACER TENDL-2023 LIBRARY; T=0.K
Photon emission for (n,2p)

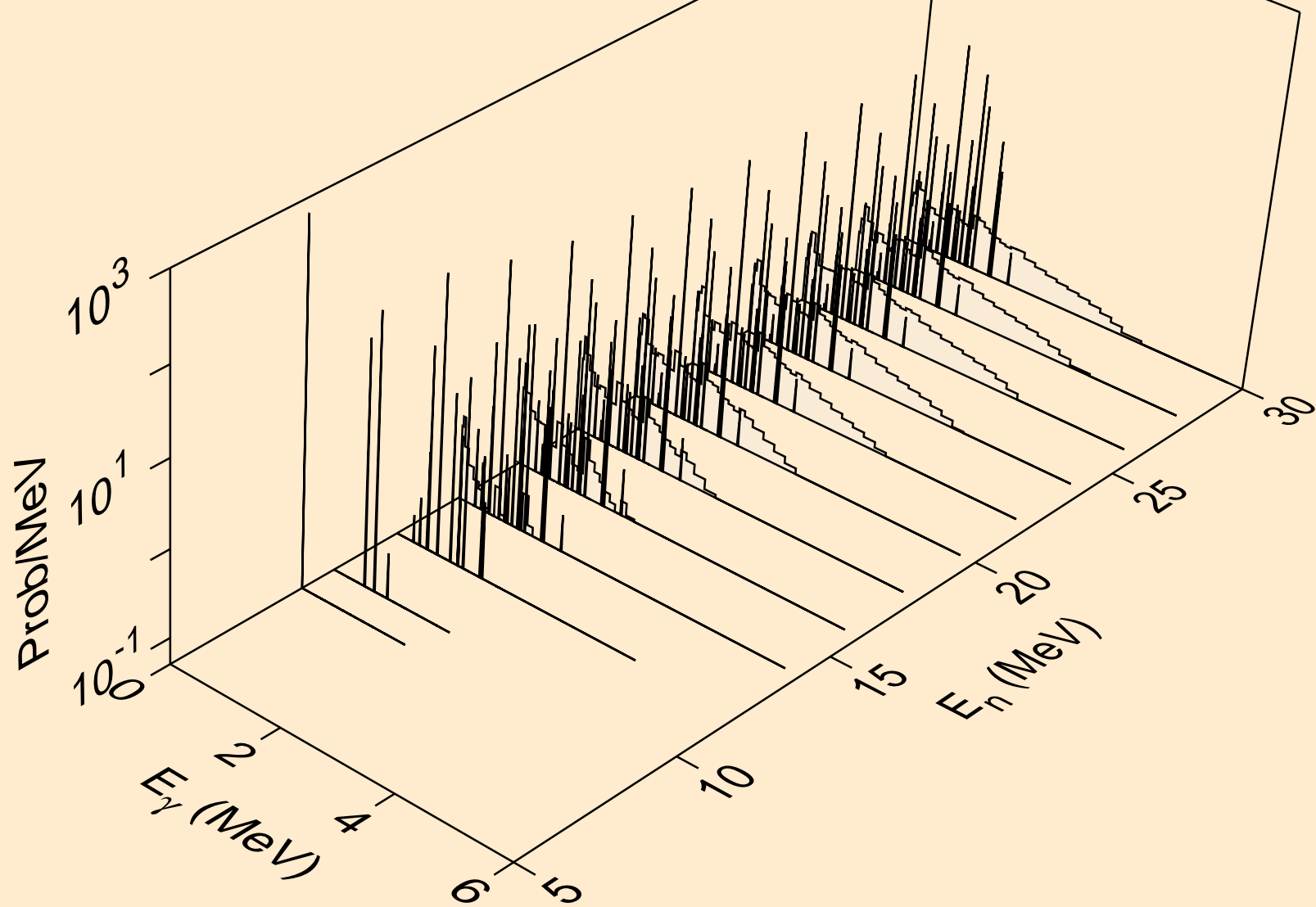

SC044M NEUTRON ACER TENDL-2023 LIBRARY; T=0.K
Photon emission for (n,p α)

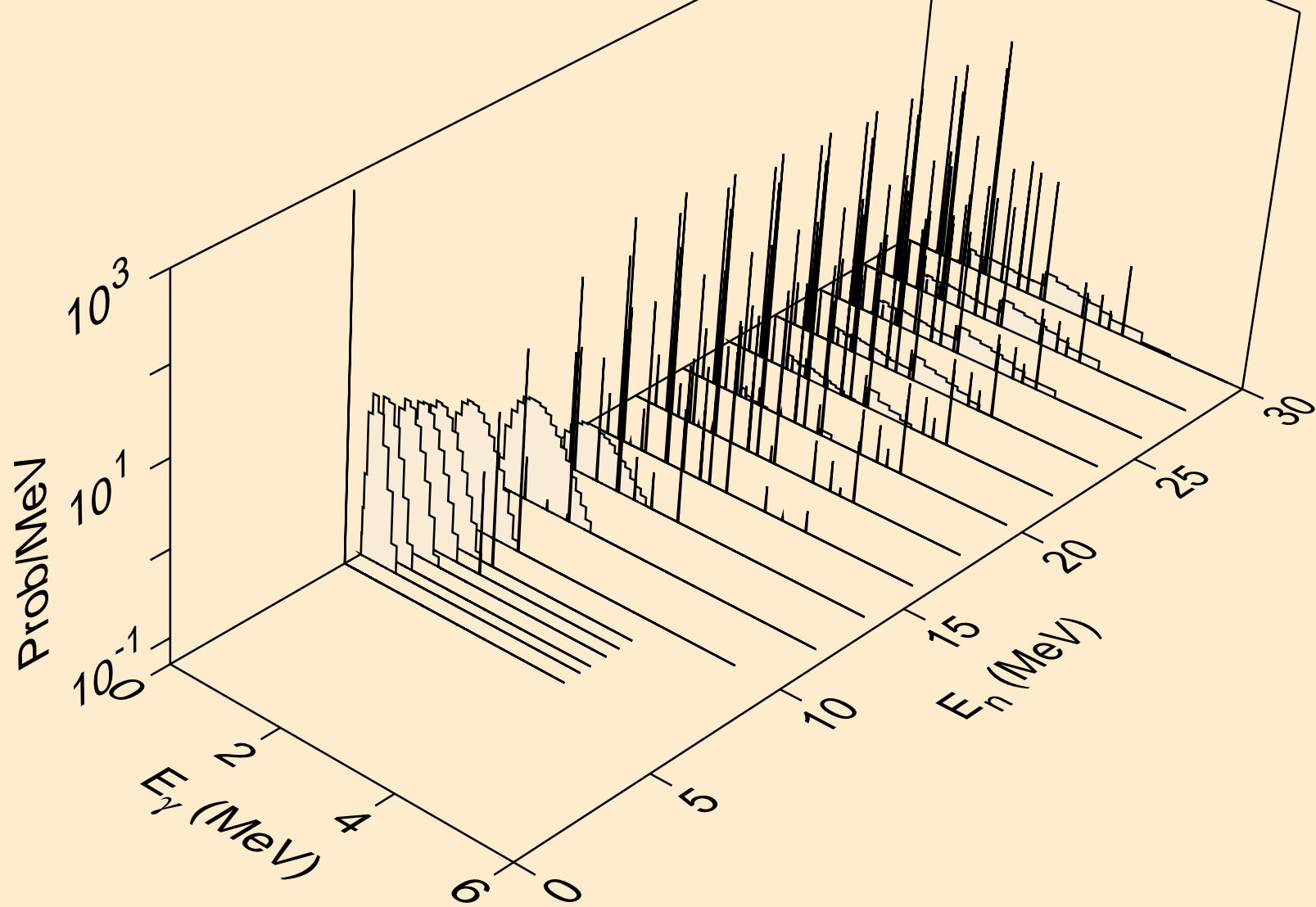

SC044M NEUTRON ACER TENDL-2023 LIBRARY; T=0.K
Photon emission for (n,d2a)

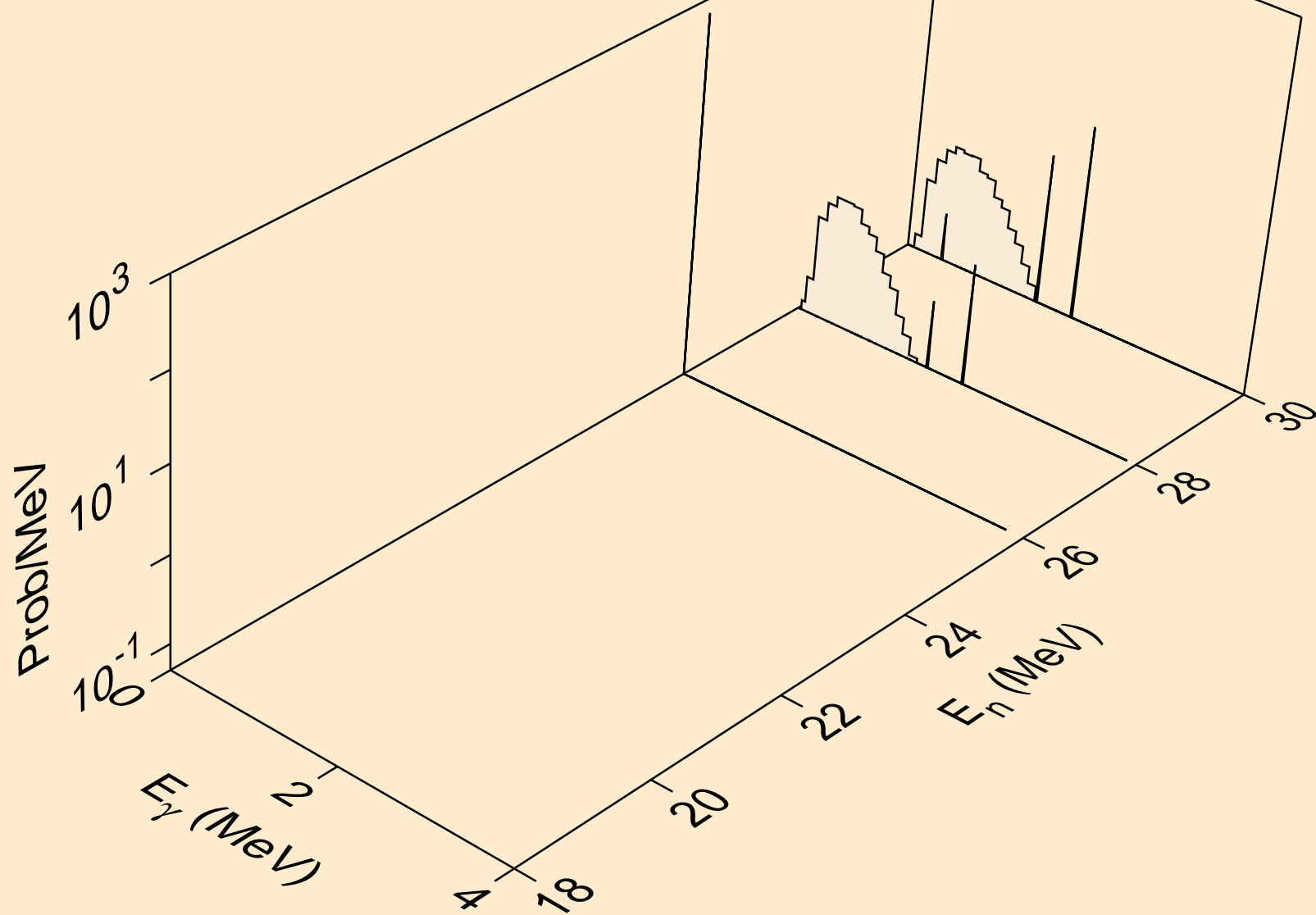

SC044M NEUTRON ACER TENDL-2023 LIBRARY; T=0.K
Photon emission for (n,pd)

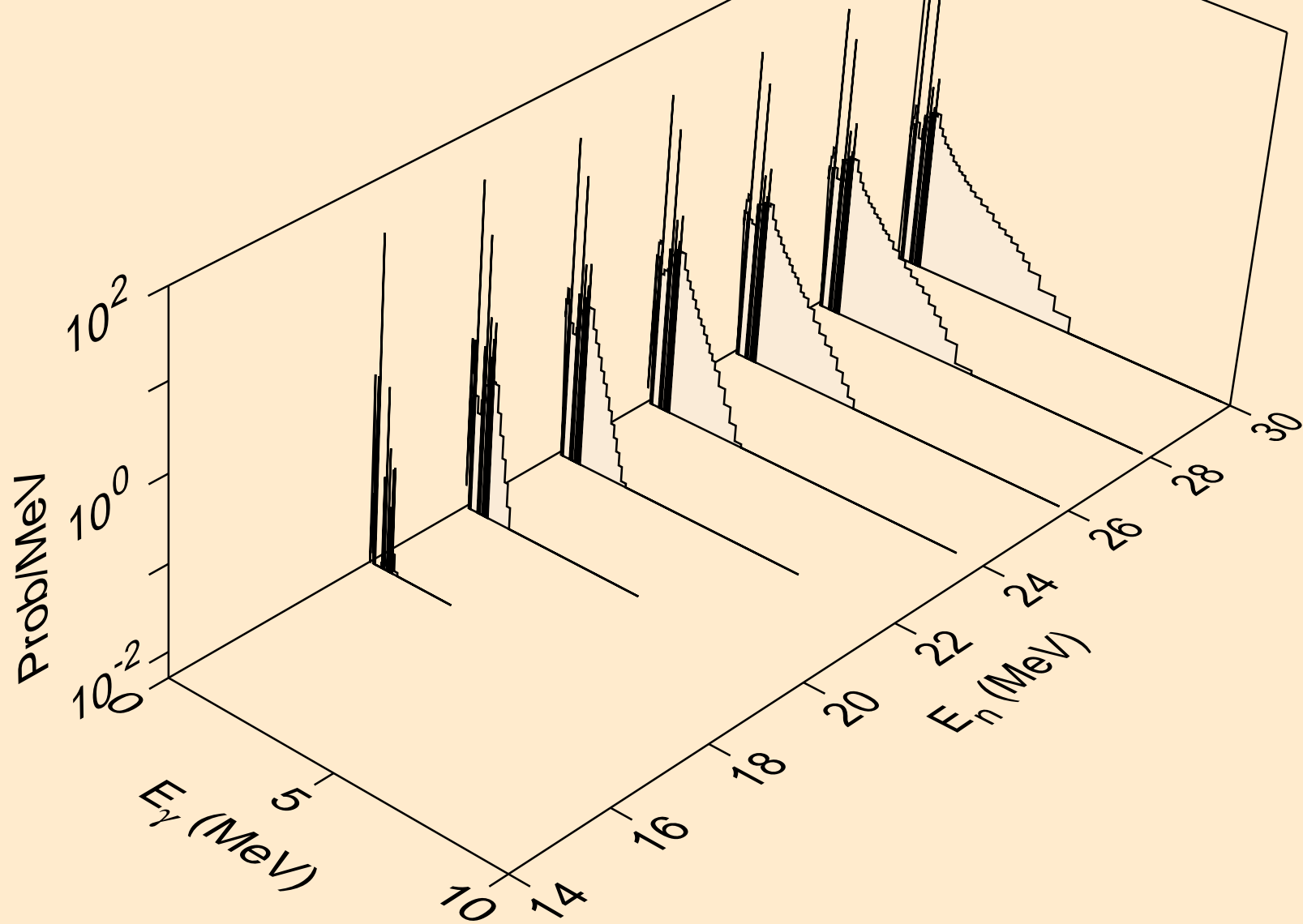

SC044M NEUTRON ACER TENDL-2023 LIBRARY; T=0.K
Photon emission for (n,pt)

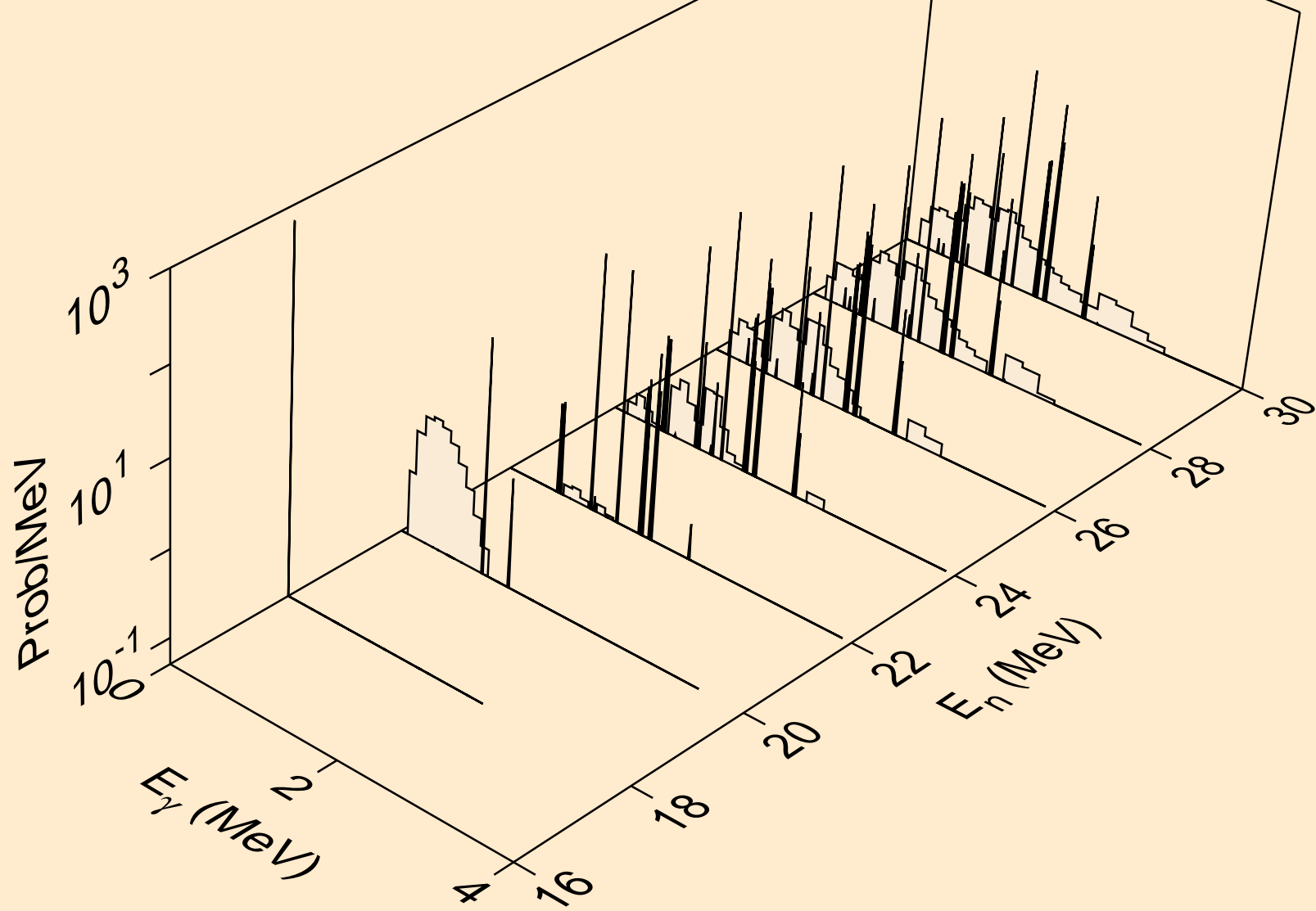

SC044M NEUTRON ACER TENDL-2023 LIBRARY; T=0.K
Photon emission for (n,da)

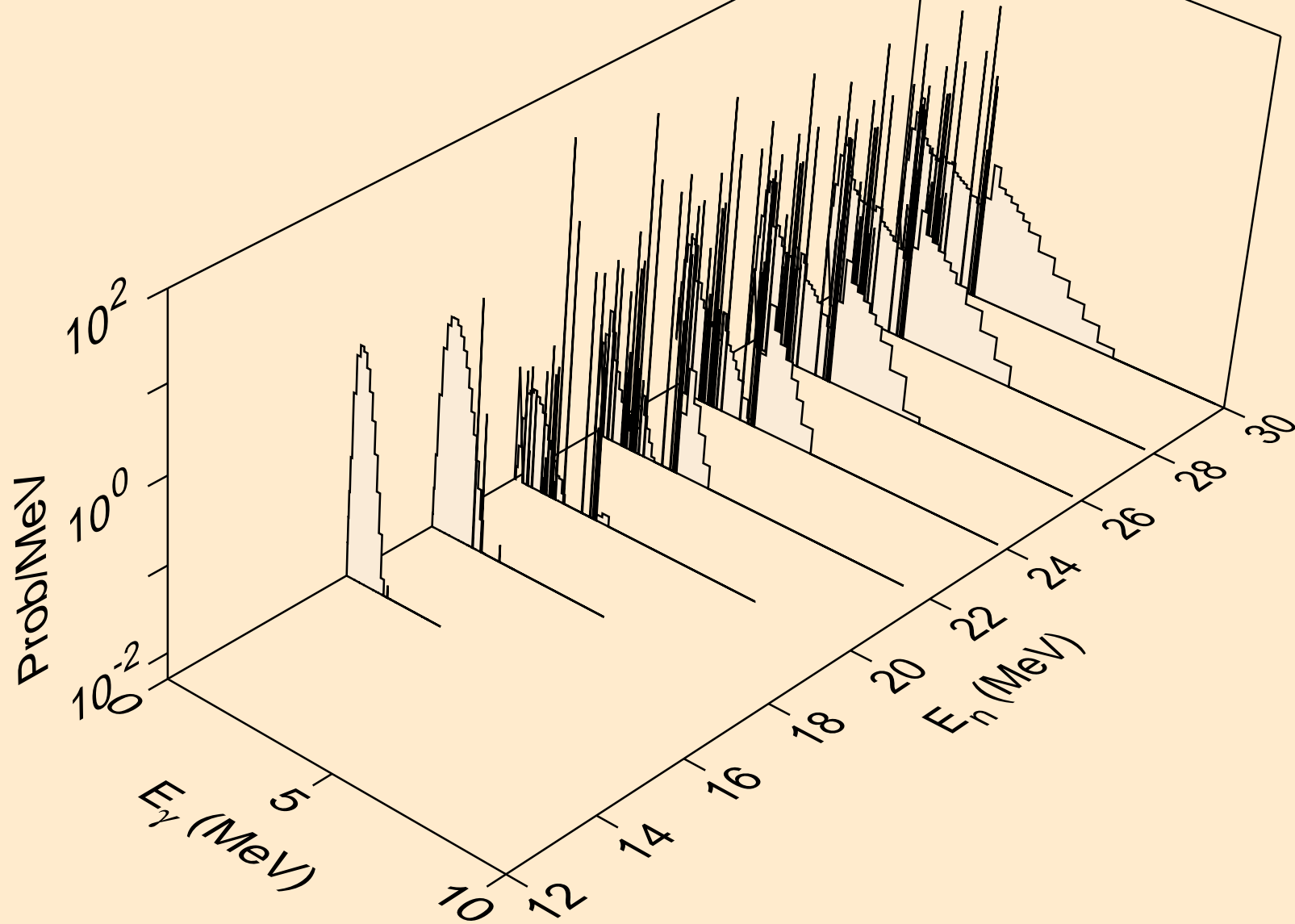

SC044M NEUTRON ACER TENDL-2023 LIBRARY; T=0.K
thermal capture photon spectrum

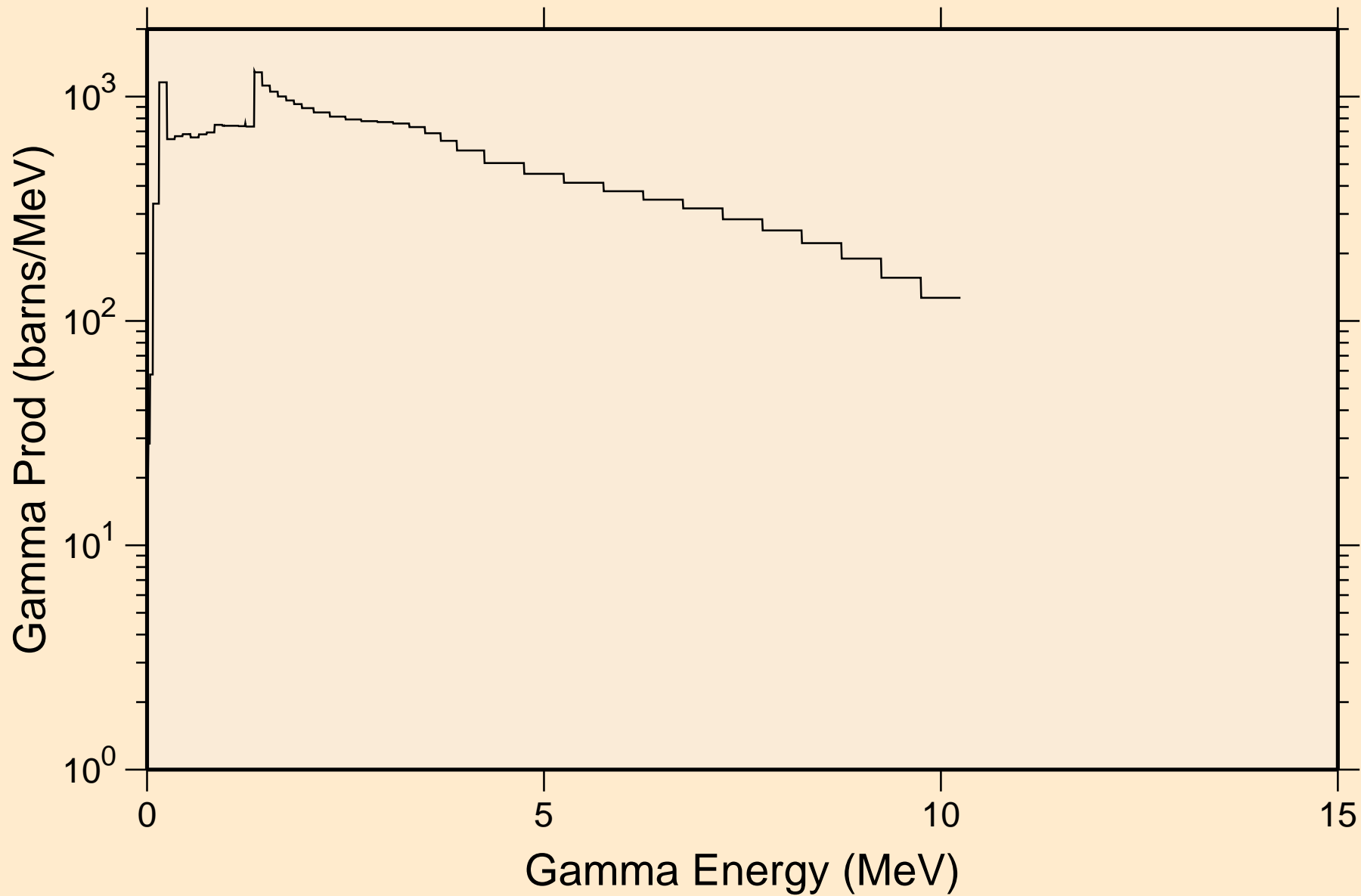

SC044M NEUTRON ACER TENDL-2023 LIBRARY; T=0.K
14 MeV photon spectrum

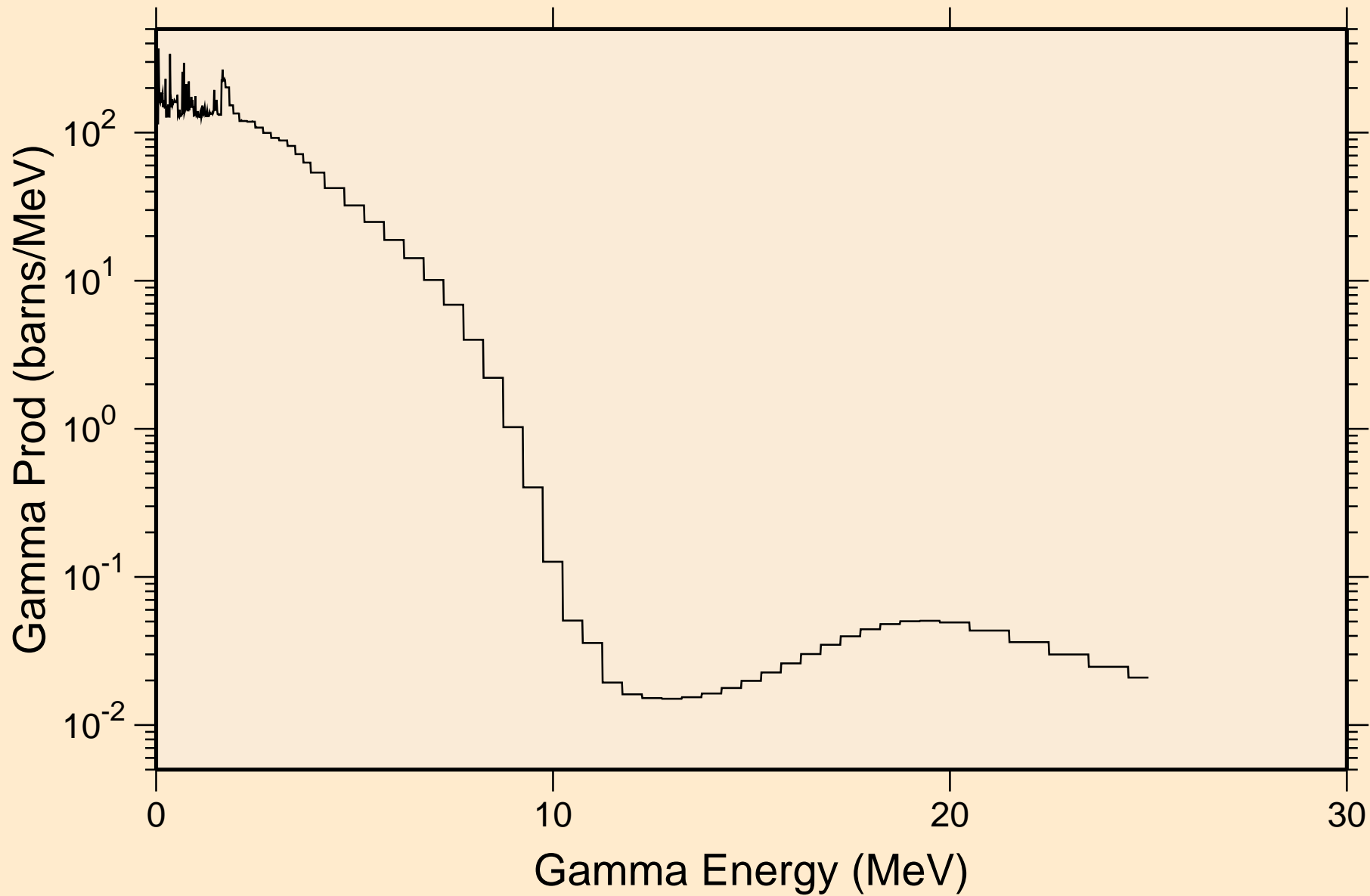

SC044M NEUTRON ACER TENDL-2023 LIBRARY; T=0.K

Particle heating contributions

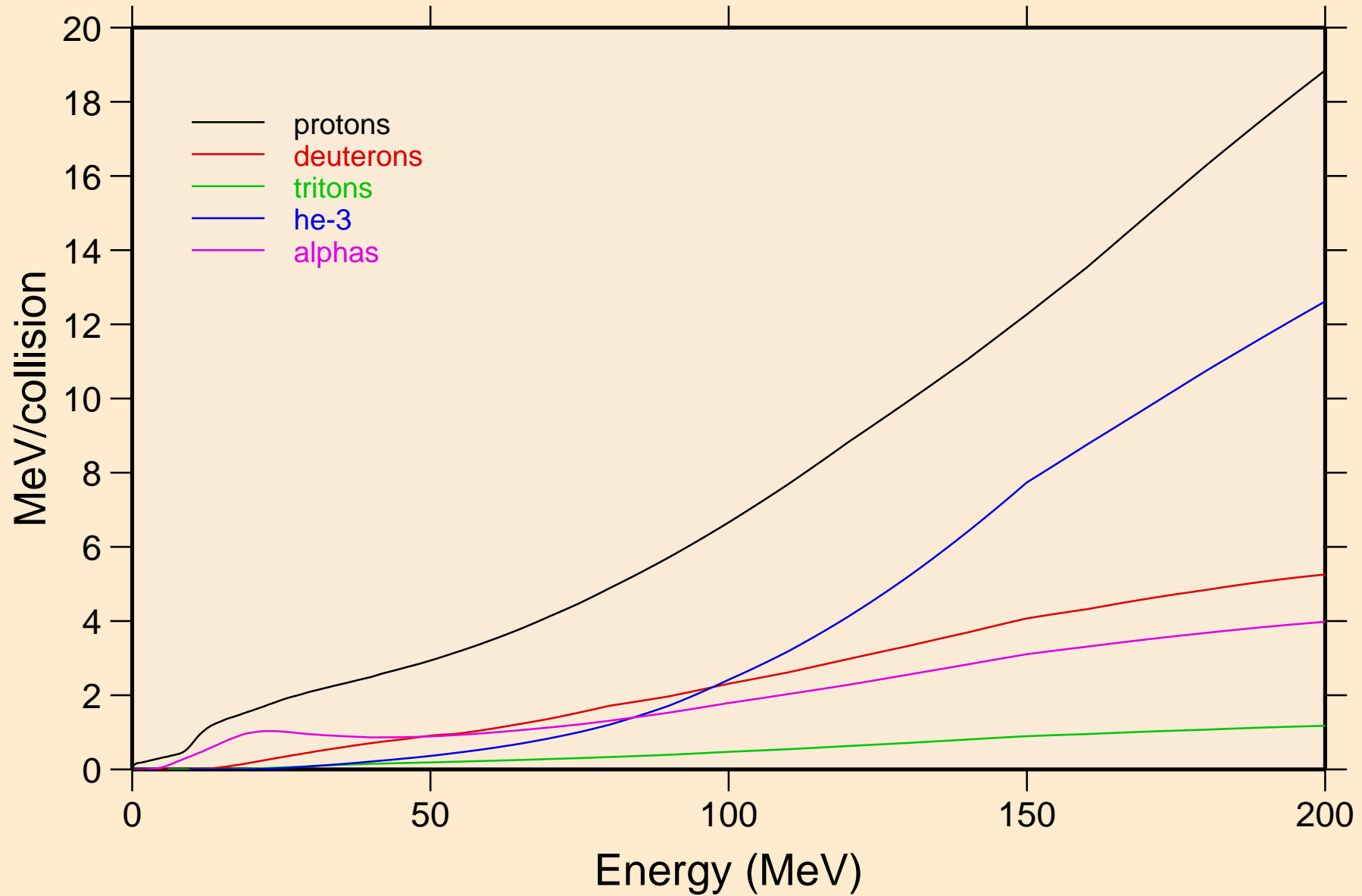

SC044M NEUTRON ACER TENDL-2023 LIBRARY; T=0.K
Recoil Heating

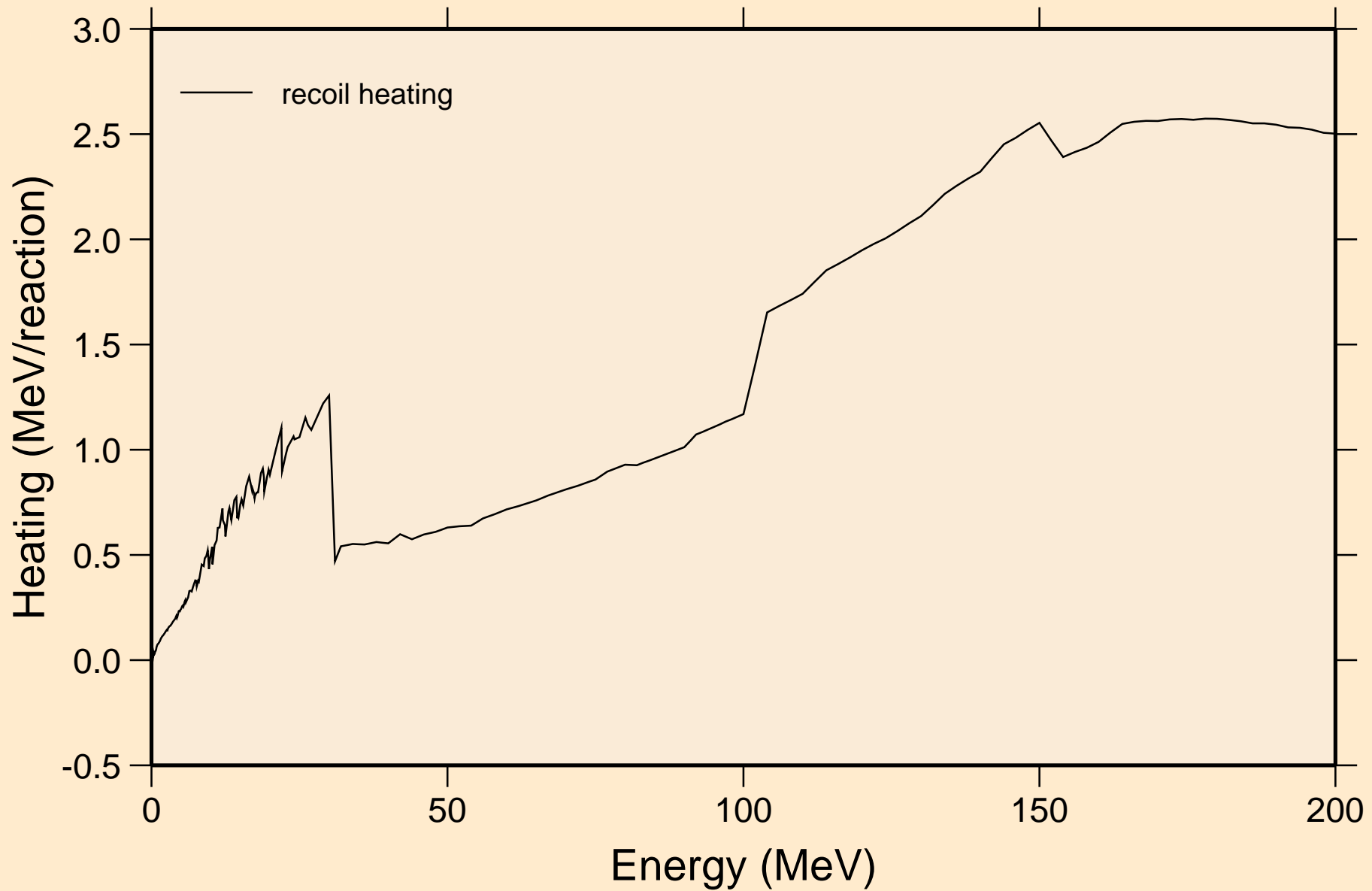

SC044M NEUTRON ACER TENDL-2023 LIBRARY; T=0.K

Particle production cross sections

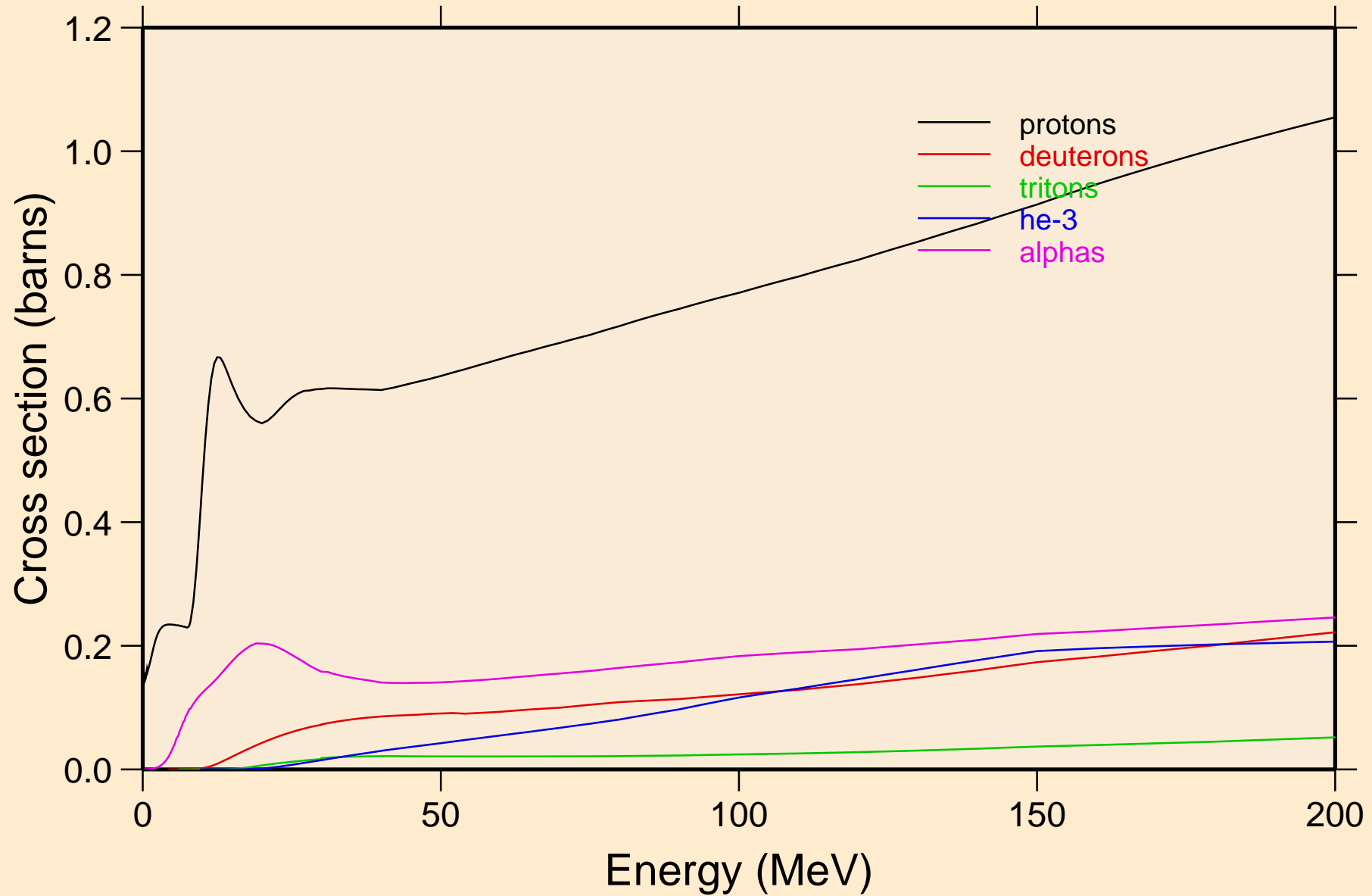

SC044M NEUTRON ACER TENDL-2023 LIBRARY; T=0.K
protons from (n,x)

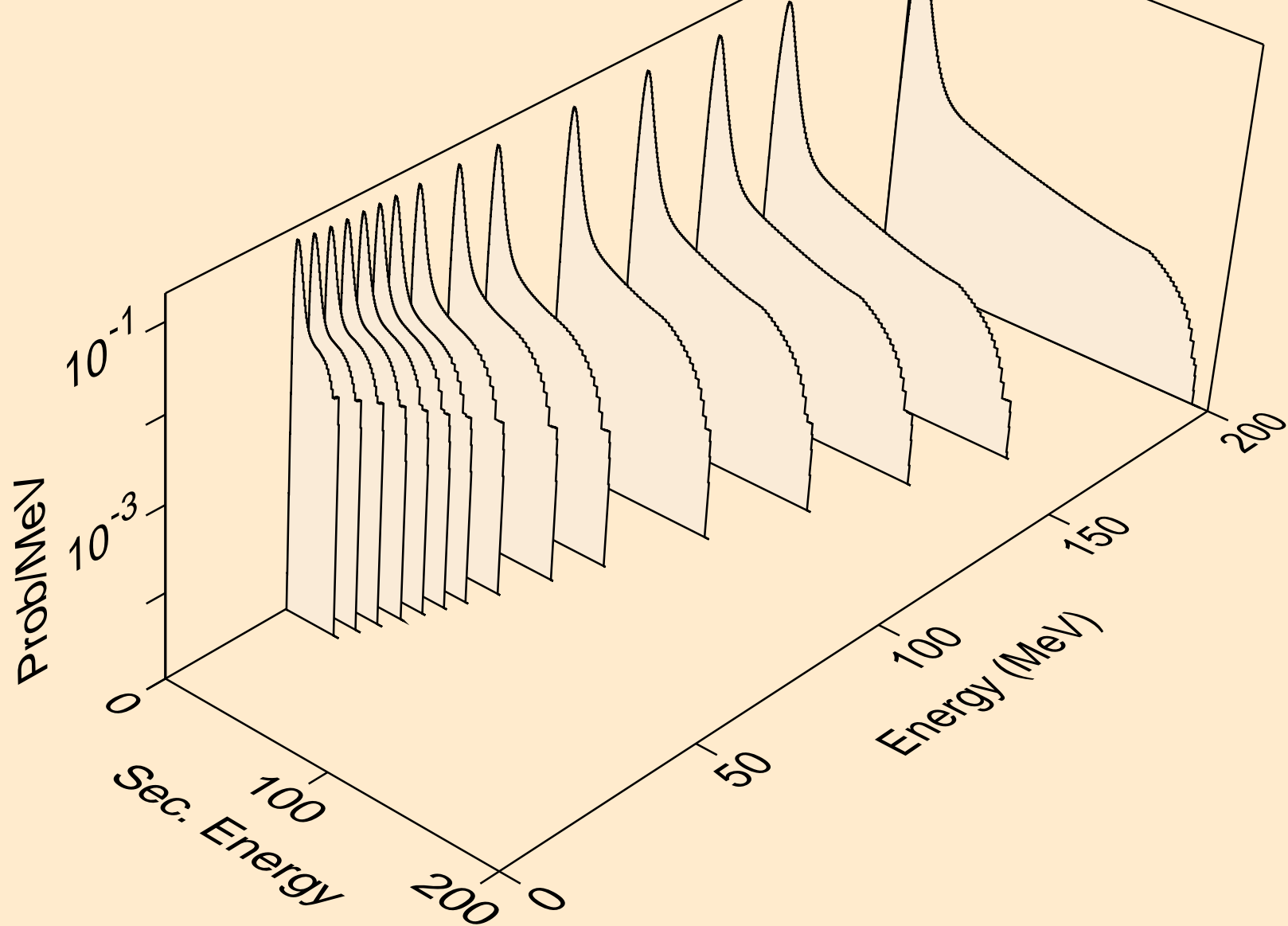

SC044M NEUTRON ACER TENDL-2023 LIBRARY; T=0.K
protons from (n,n*)p

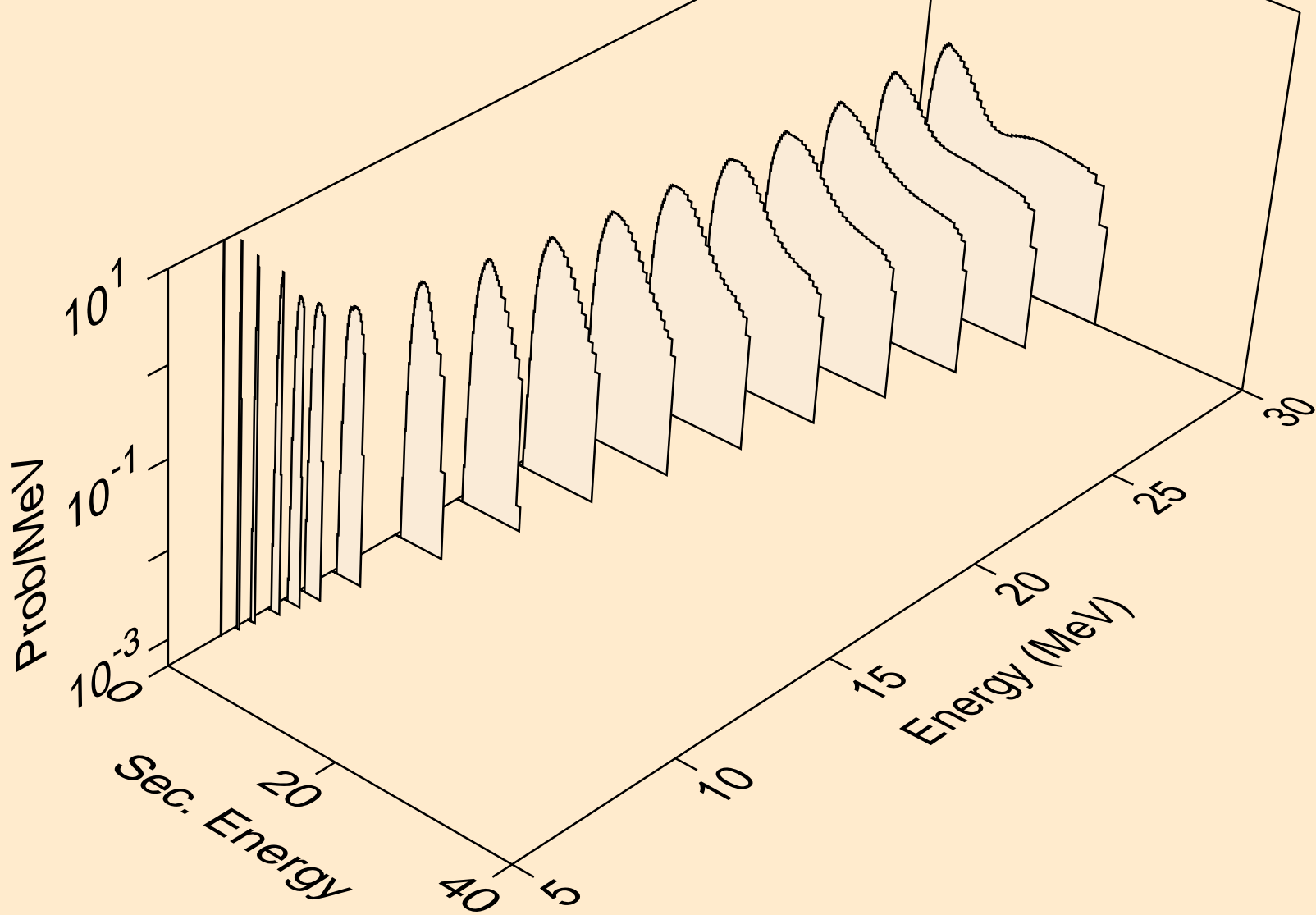

SC044M NEUTRON ACER TENDL-2023 LIBRARY; T=0.K
protons from (n,2np)

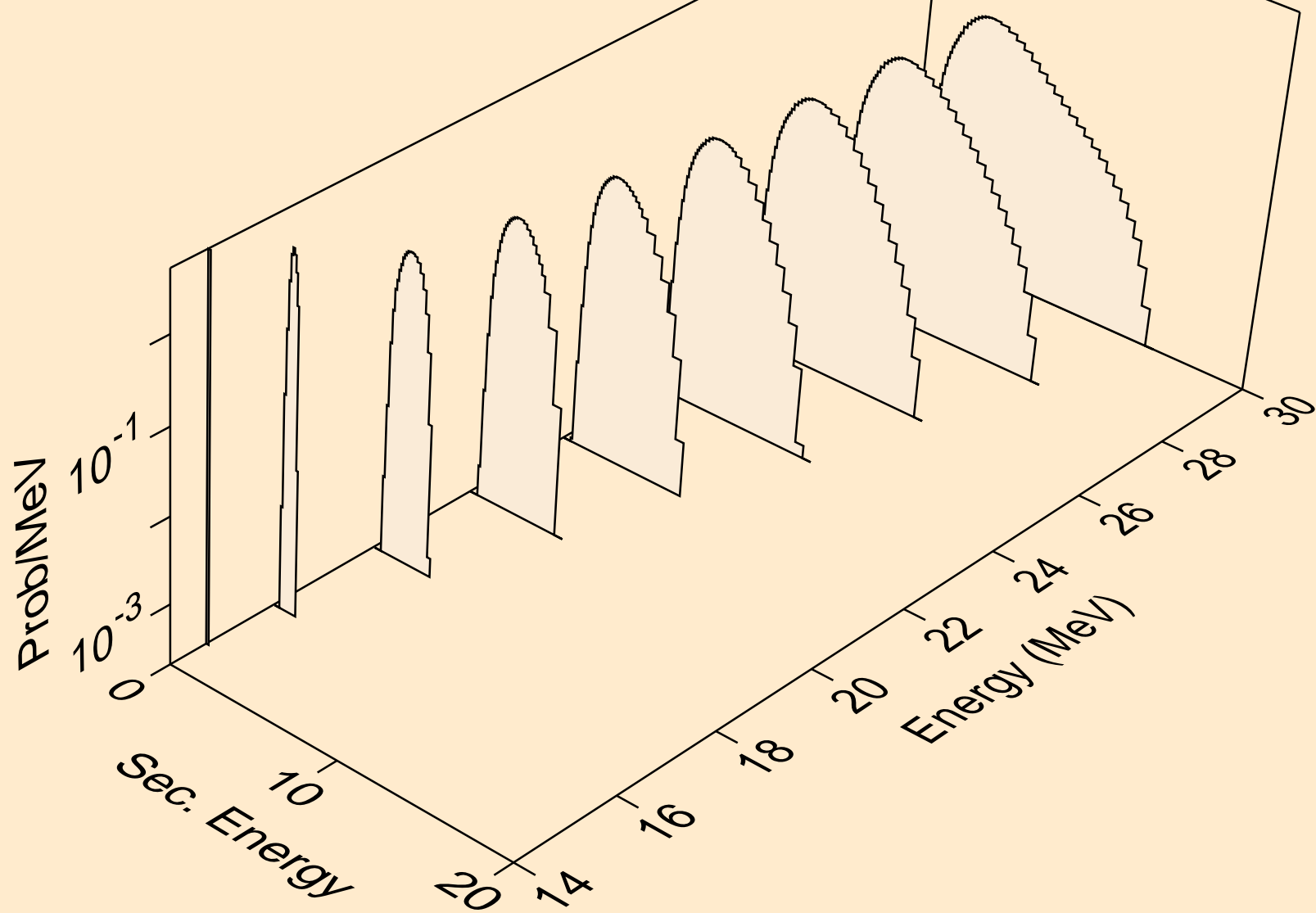

SC044M NEUTRON ACER TENDL-2023 LIBRARY; T=0.K
protons from (n,3np)

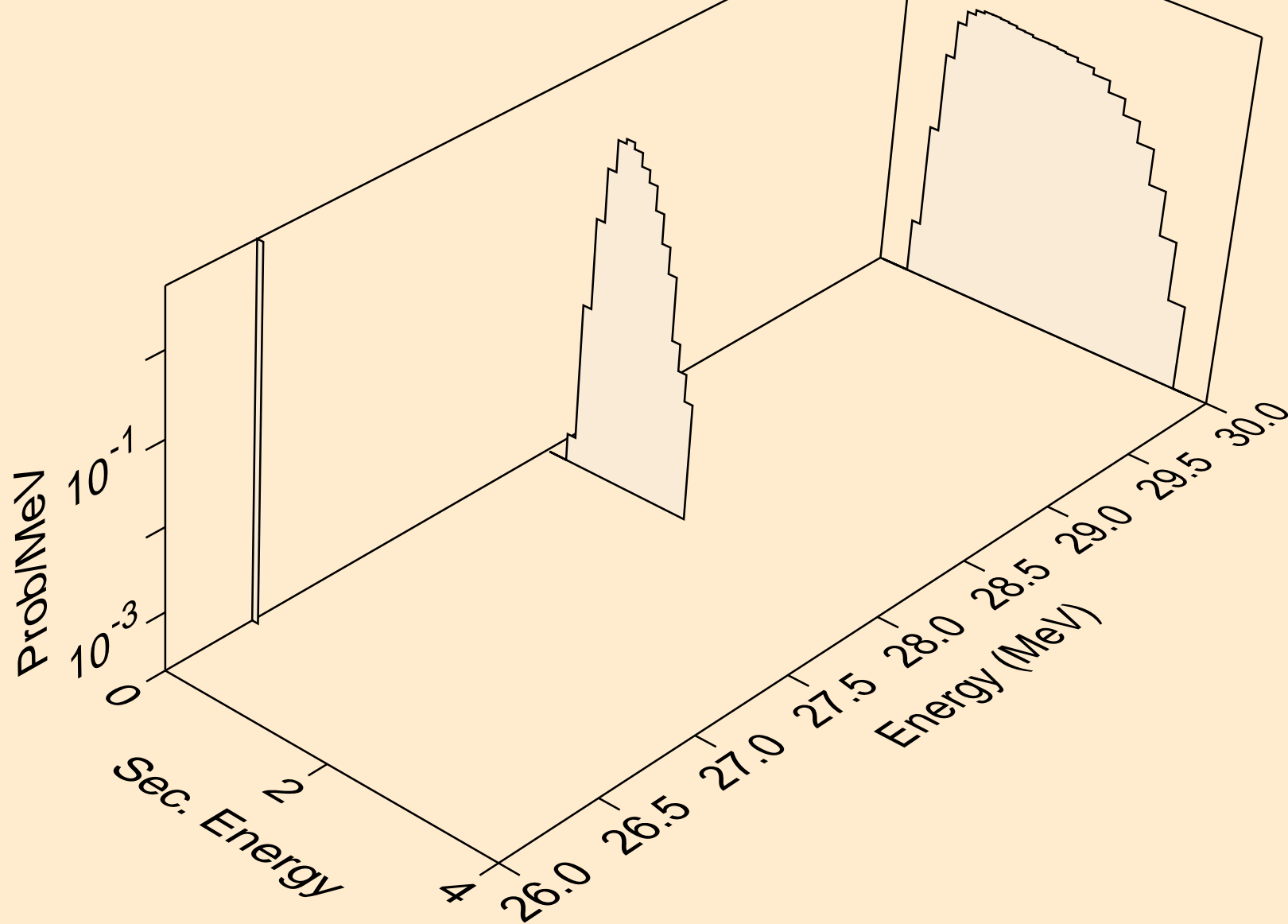

SC044M NEUTRON ACER TENDL-2023 LIBRARY; T=0.K
protons from (n,n2p)

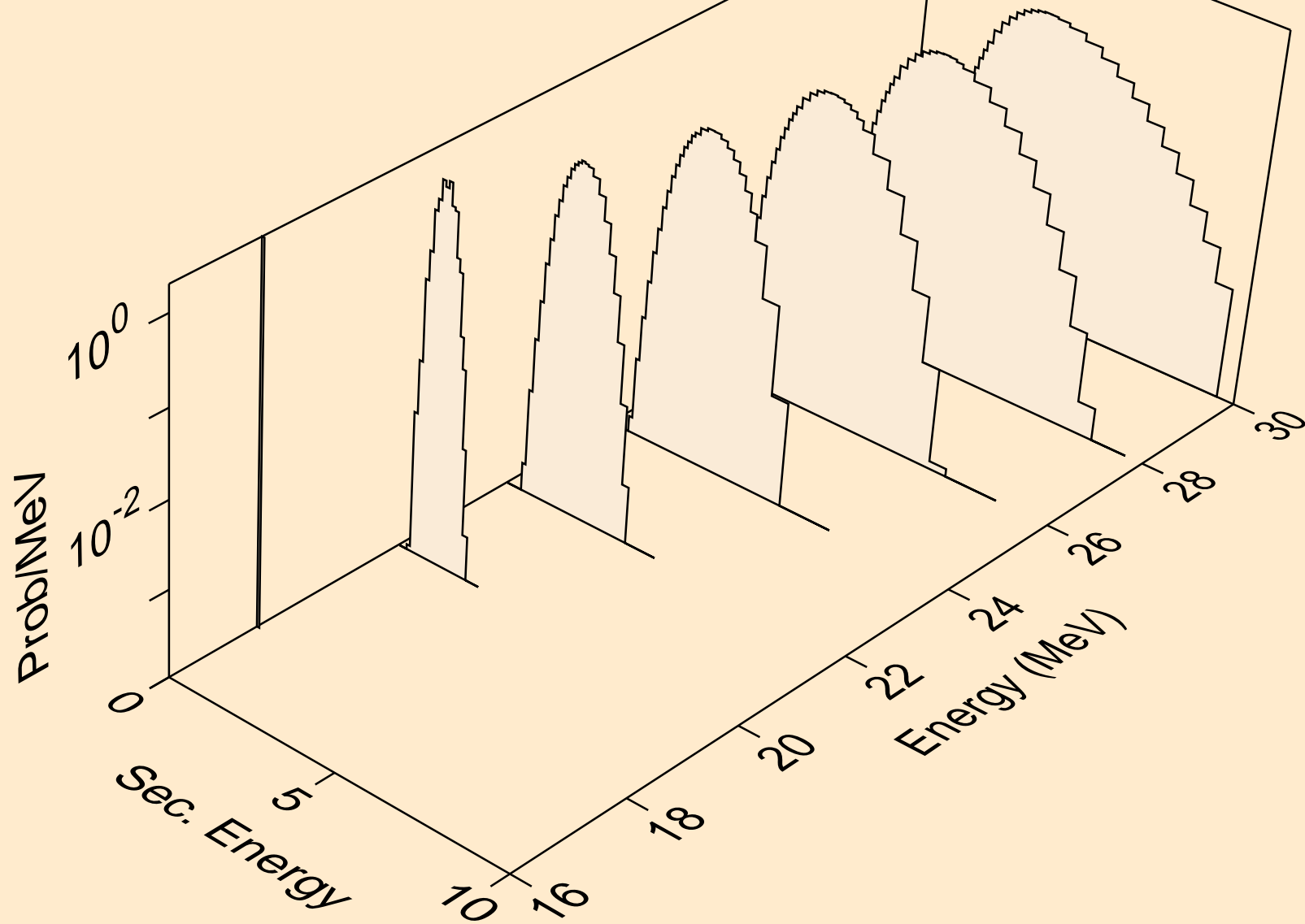

SC044M NEUTRON ACER TENDL-2023 LIBRARY; T=0.K
protons from (n,npa)

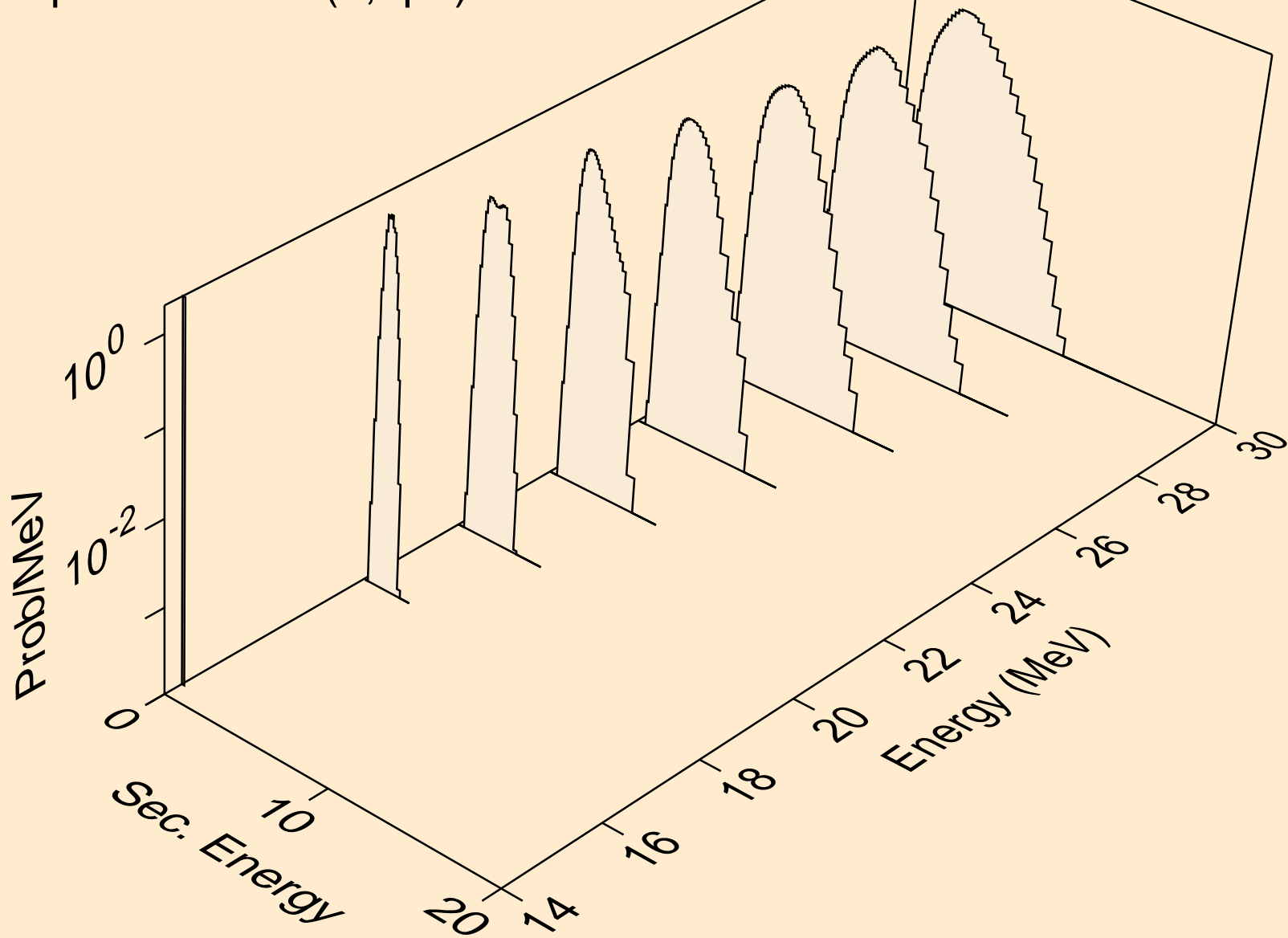

SC044M NEUTRON ACER TENDL-2023 LIBRARY; T=0.K
protons from (n,p)

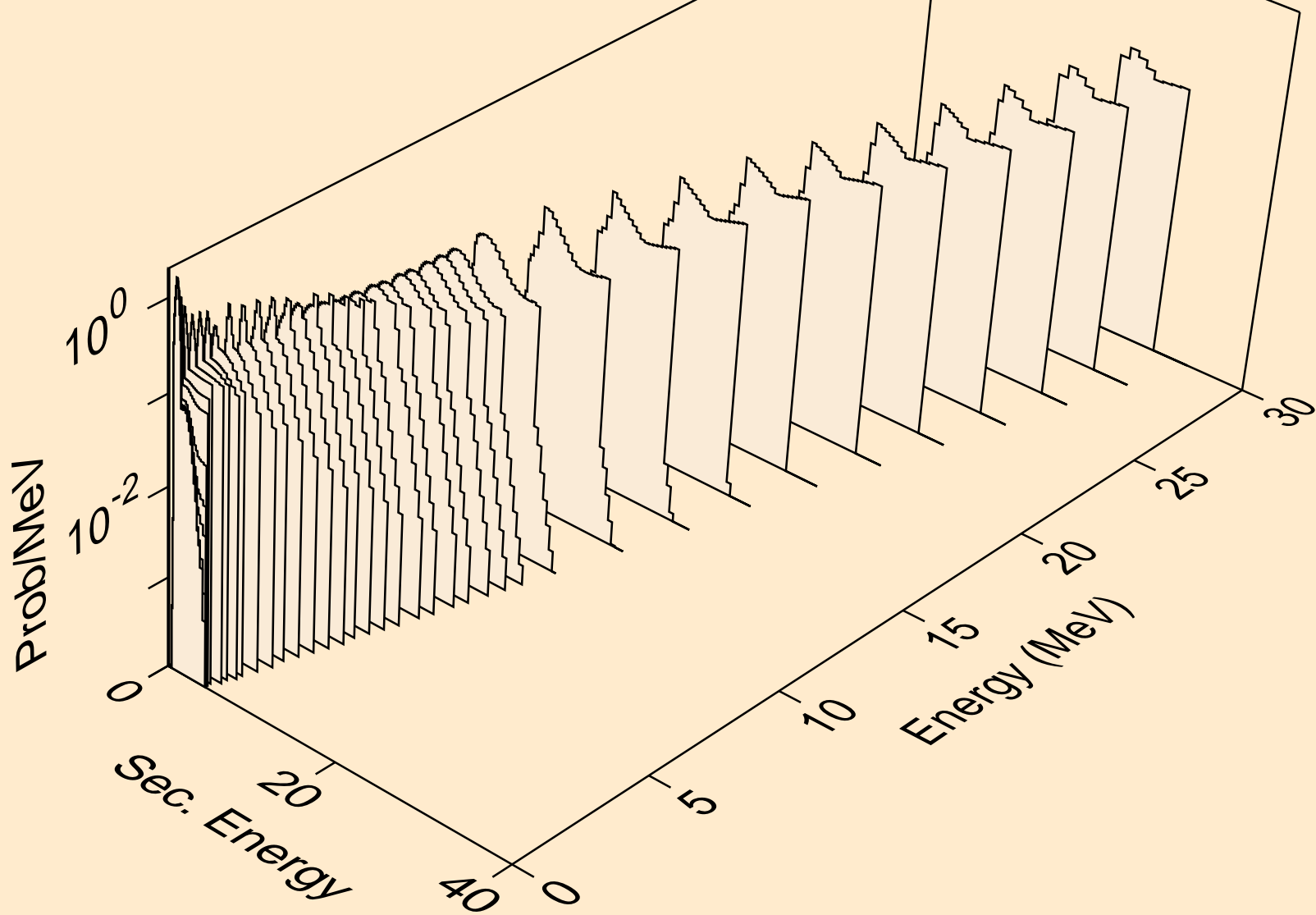

SC044M NEUTRON ACER TENDL-2023 LIBRARY; T=0.K
protons from (n,2p)

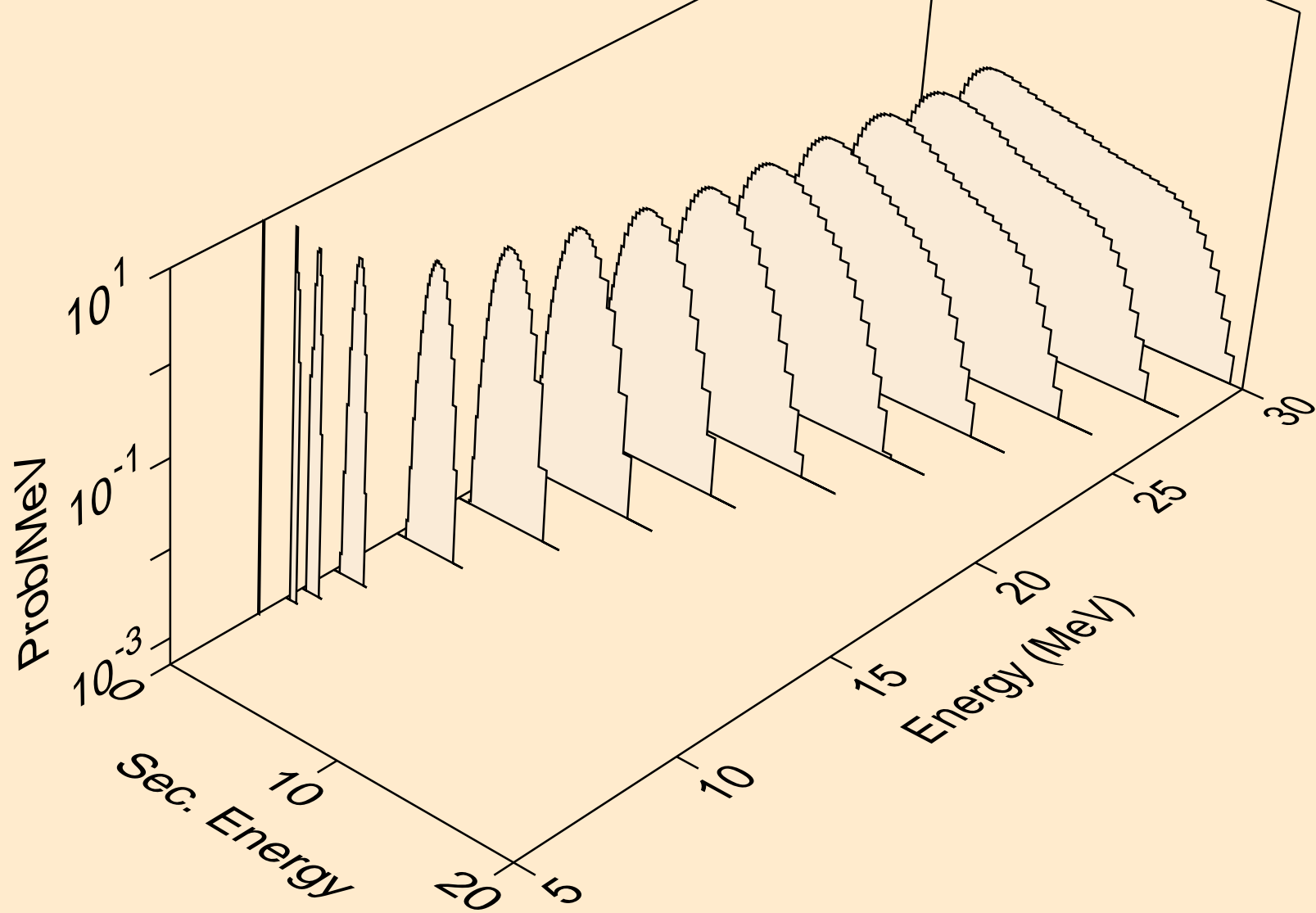

SC044M NEUTRON ACER TENDL-2023 LIBRARY; T=0.K
protons from (n,p)

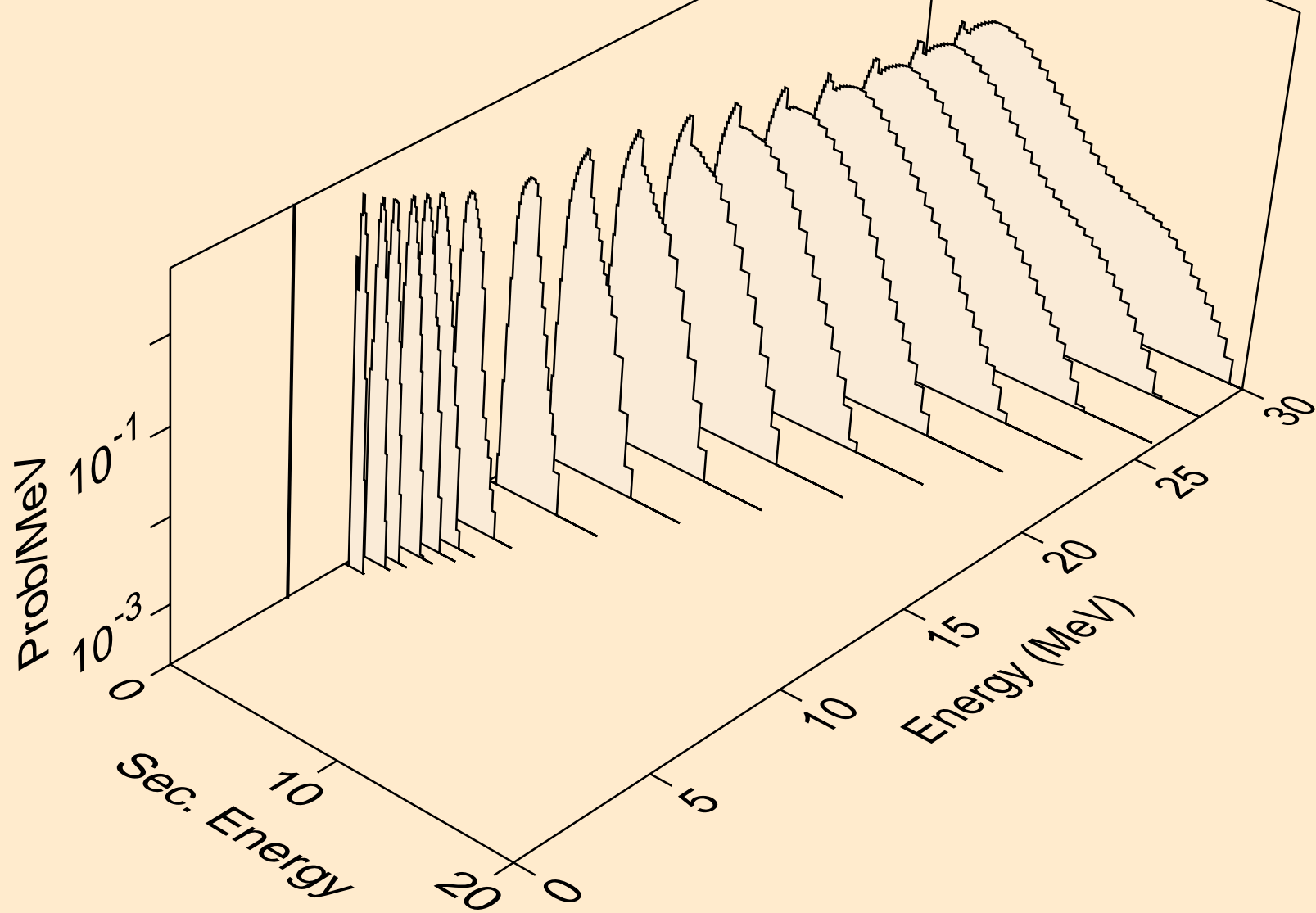

SC044M NEUTRON ACER TENDL-2023 LIBRARY; T=0.K
protons from (n,pd)

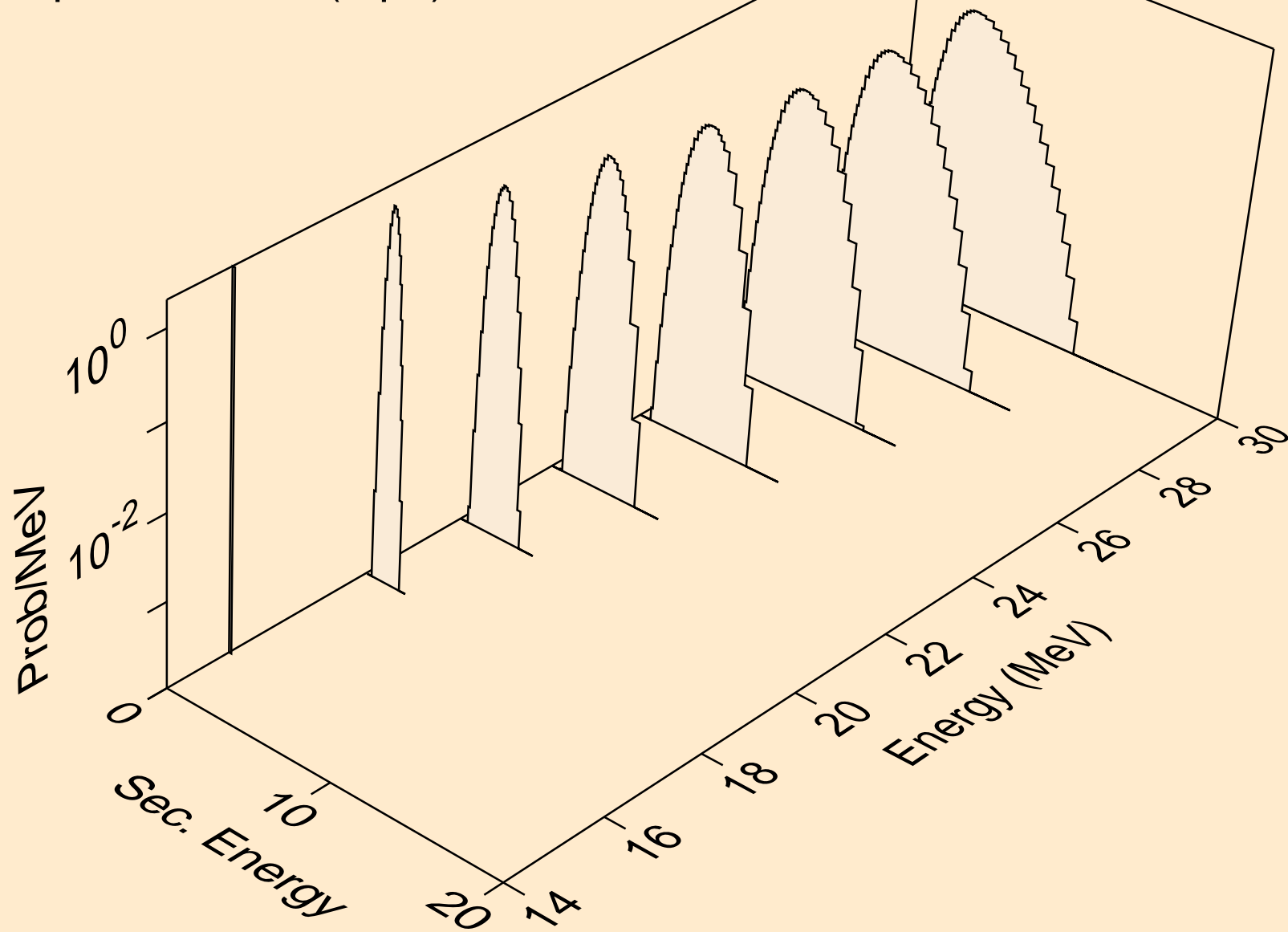

SC044M NEUTRON ACER TENDL-2023 LIBRARY; T=0.K
protons from (n,pt)

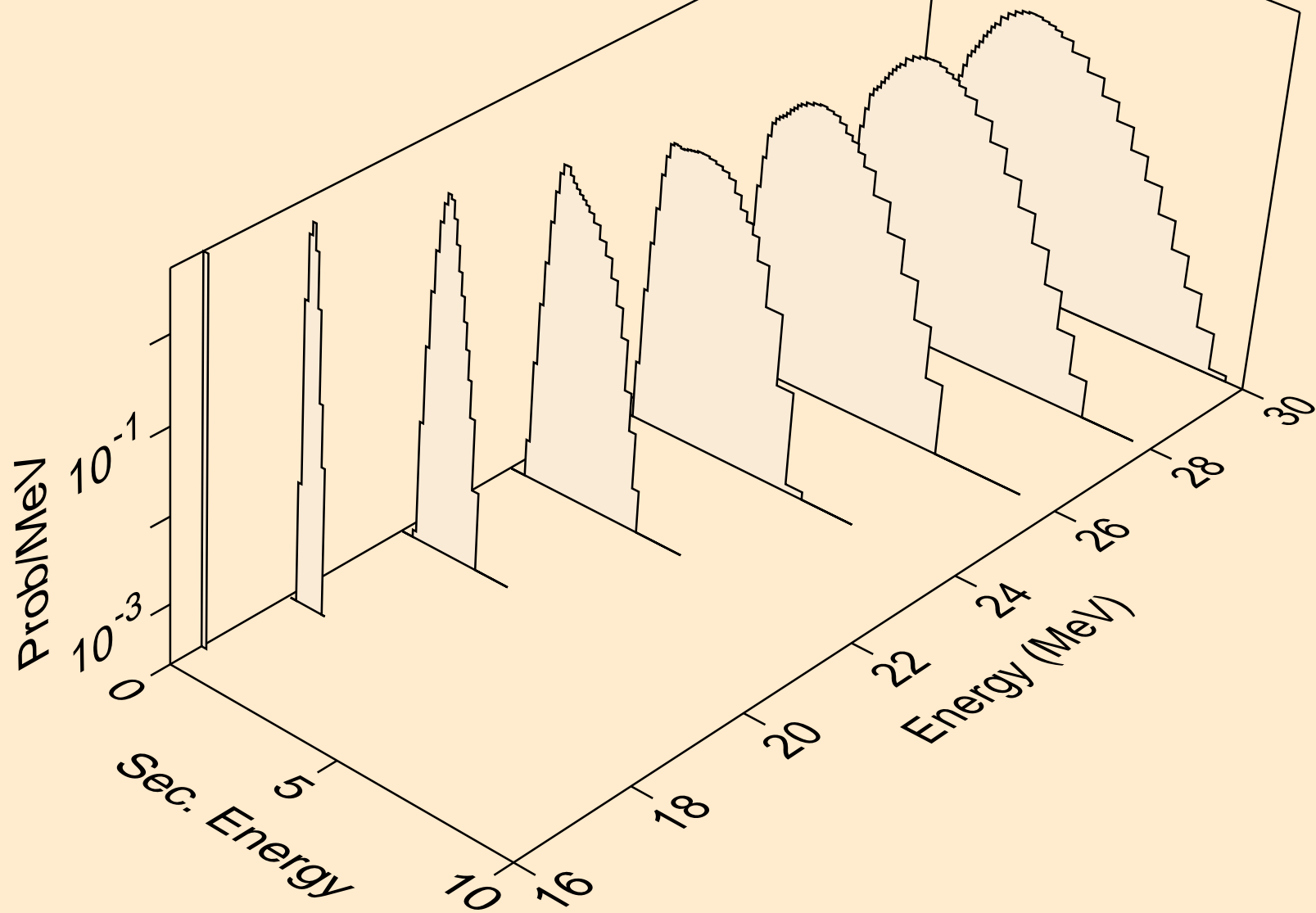

SC044M NEUTRON ACER TENDL-2023 LIBRARY; T=0.K
deuterons from (n,x)

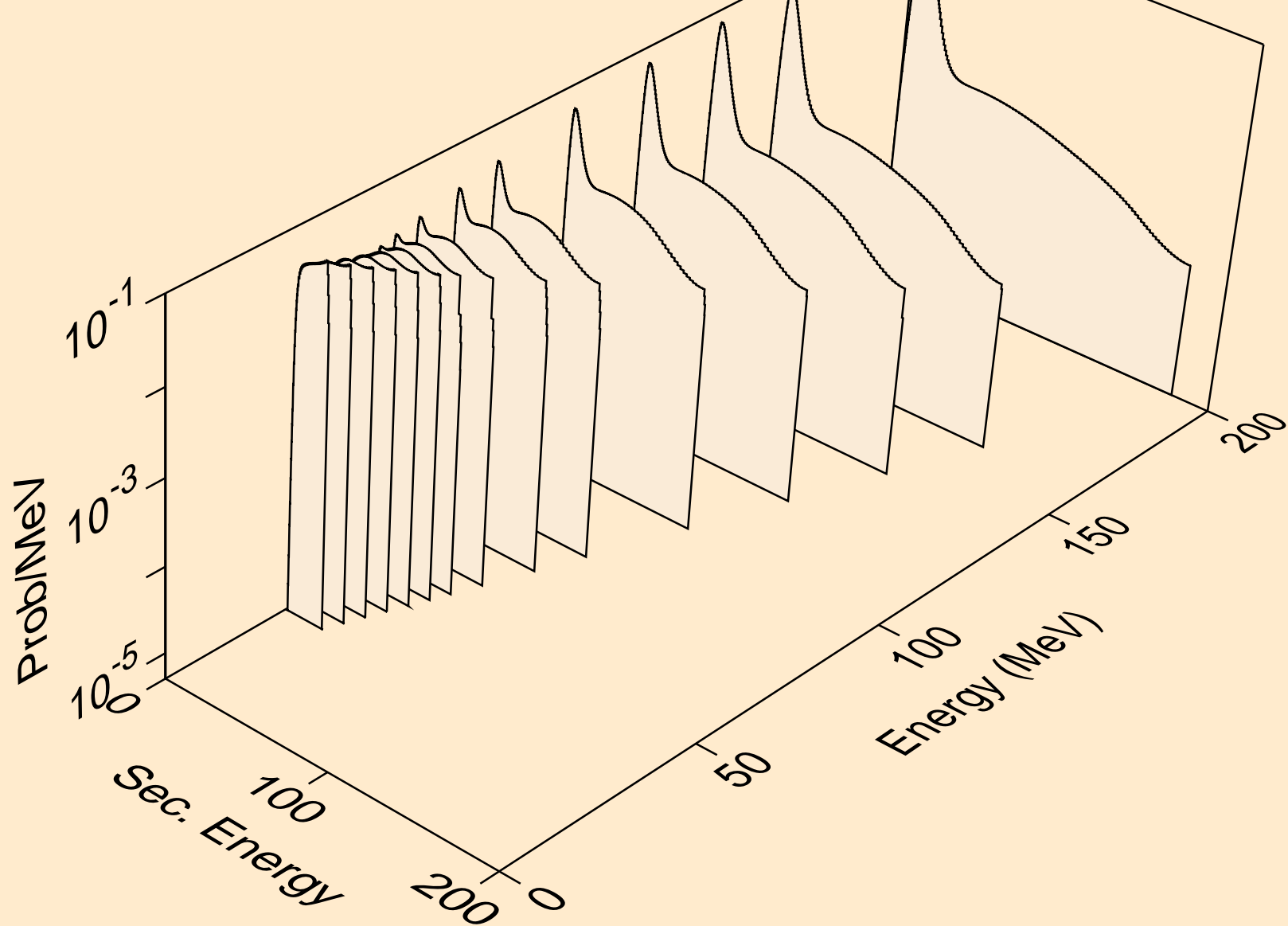

SC044M NEUTRON ACER TENDL-2023 LIBRARY; T=0.K
deuterons from (n,2nd)

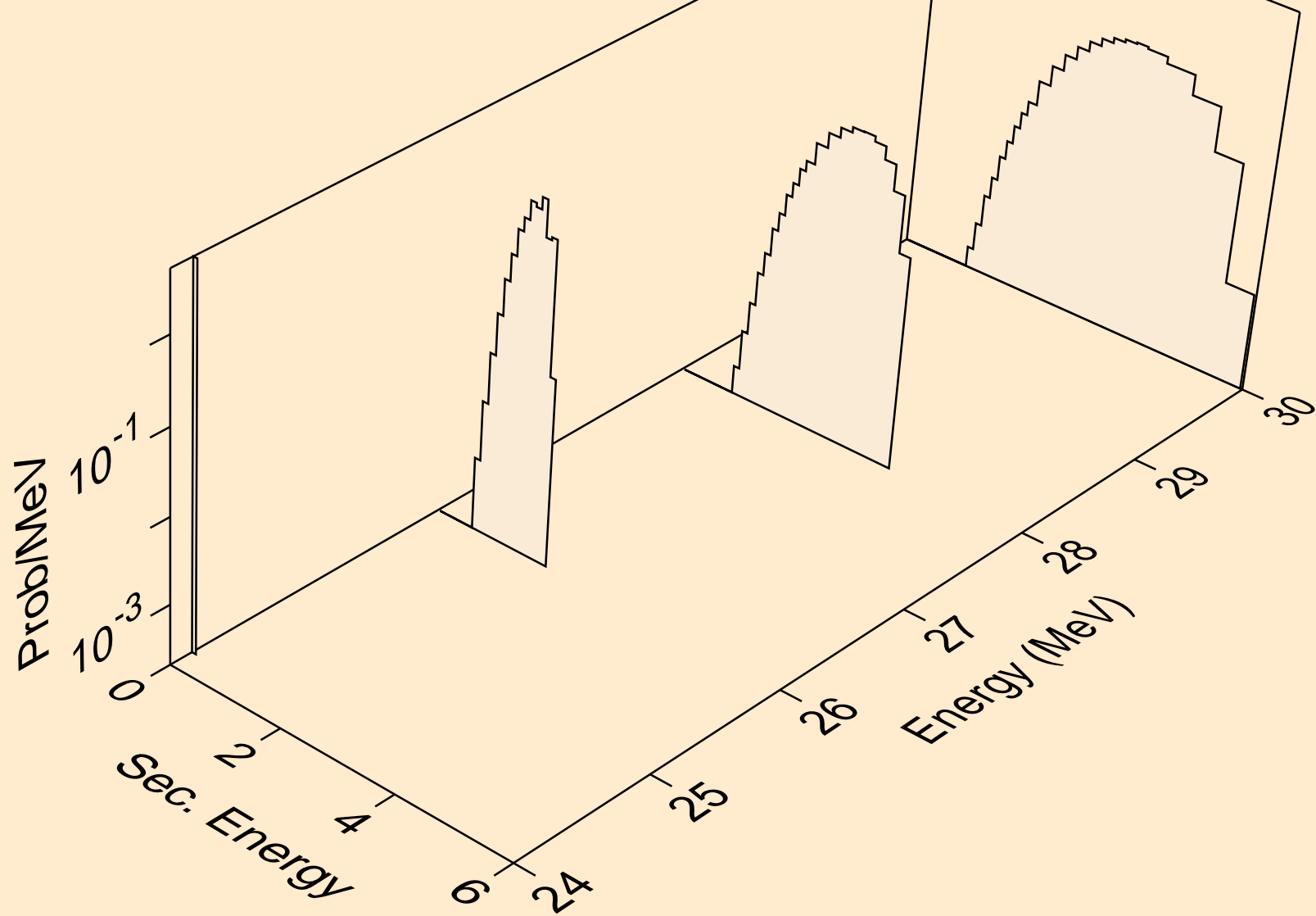

SC044M NEUTRON ACER TENDL-2023 LIBRARY; T=0.K
deuterons from (n,n*)d

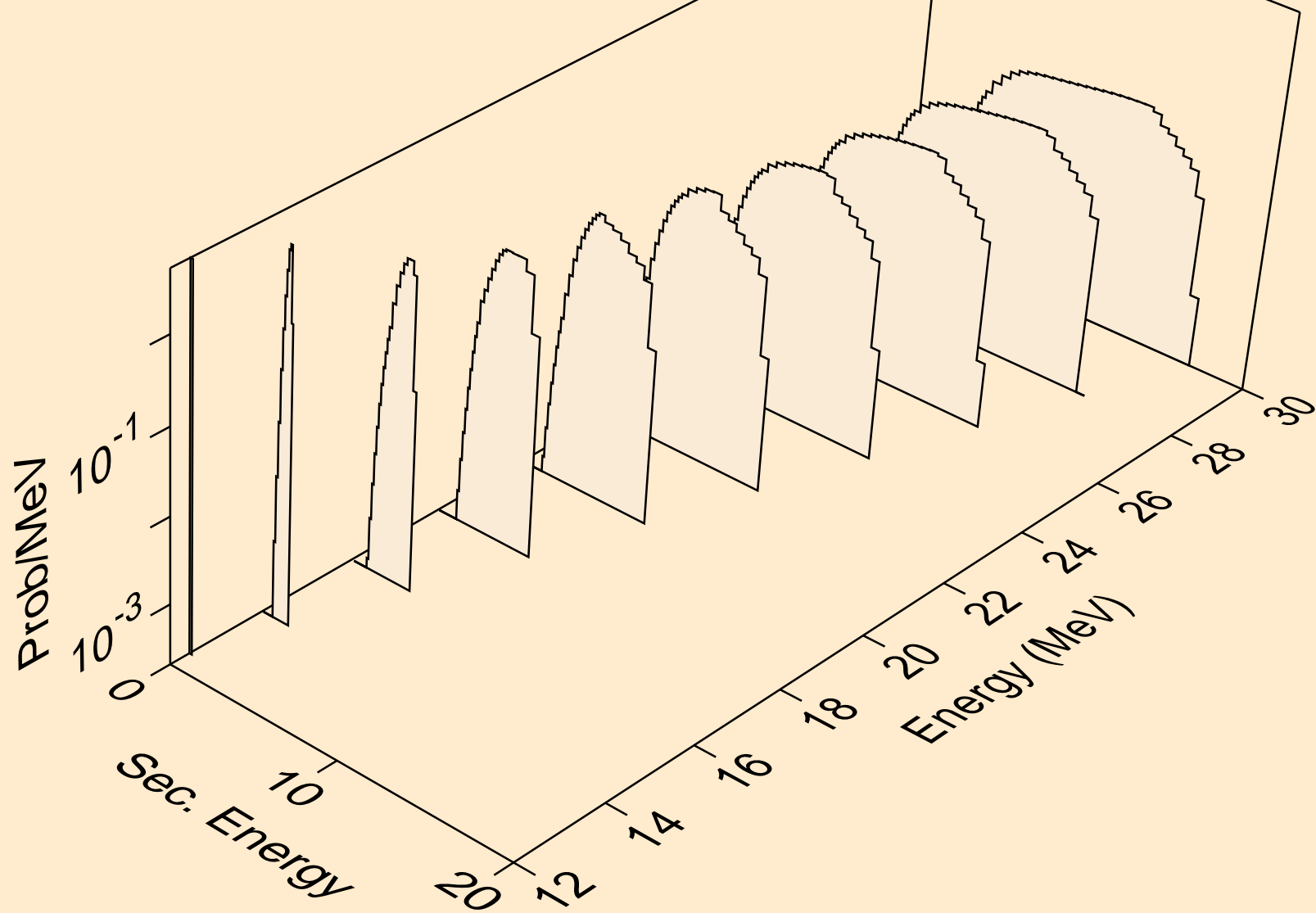

SC044M NEUTRON ACER TENDL-2023 LIBRARY; T=0.K
deuterons from (n,d)

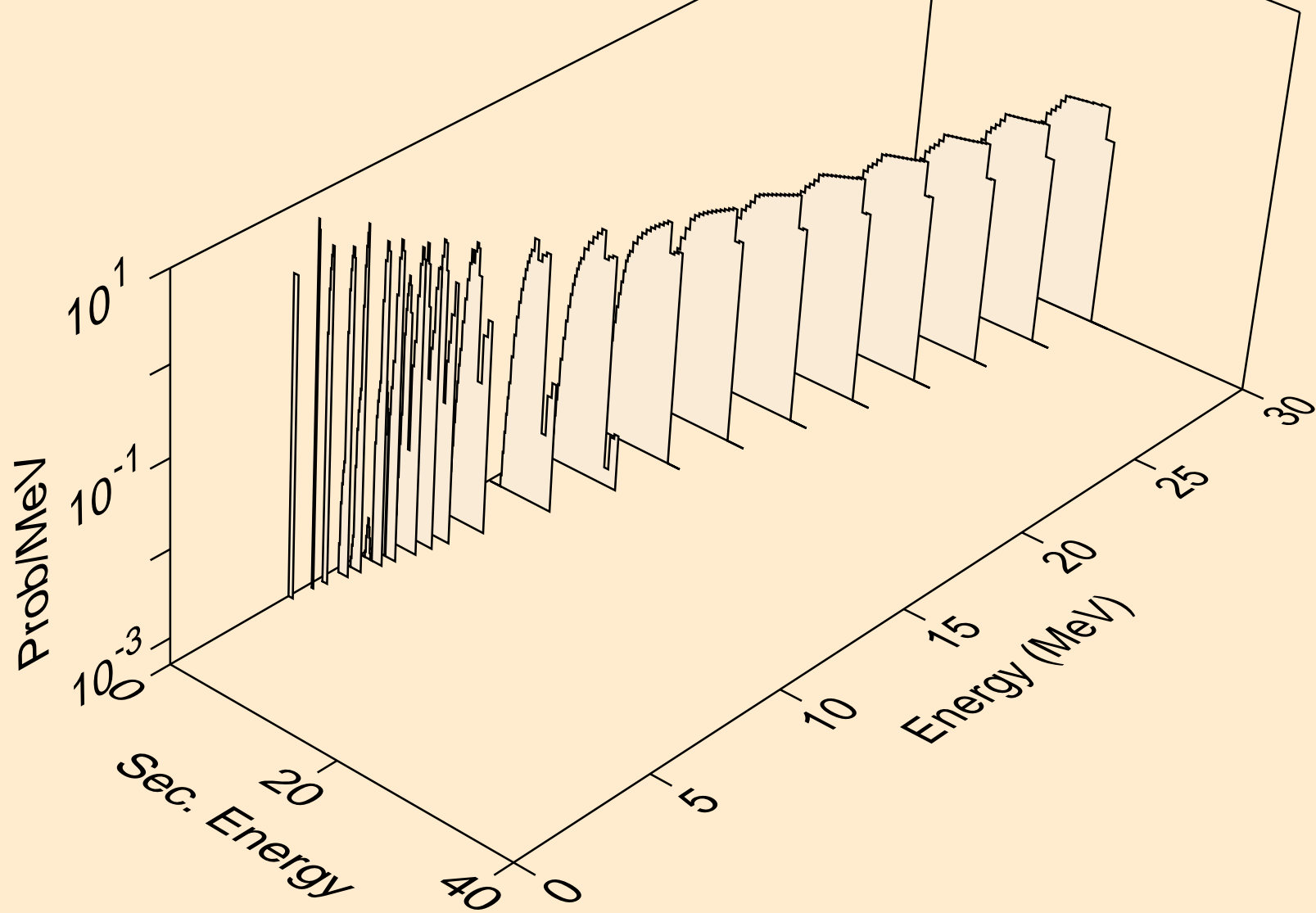

SC044M NEUTRON ACER TENDL-2023 LIBRARY; T=0.K
deuterons from (n,d2a)

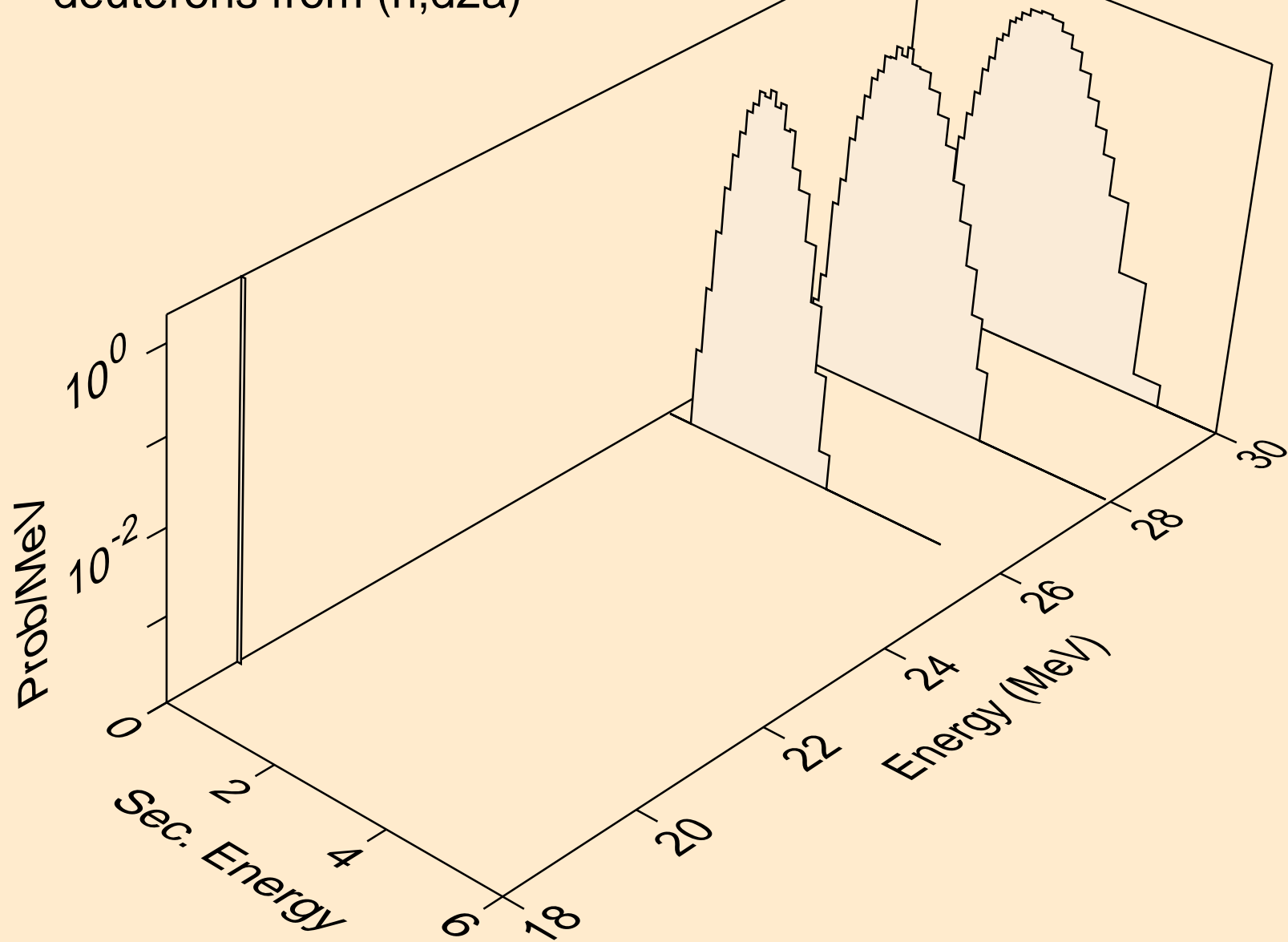

SC044M NEUTRON ACER TENDL-2023 LIBRARY; T=0.K
deuterons from (n,pd)

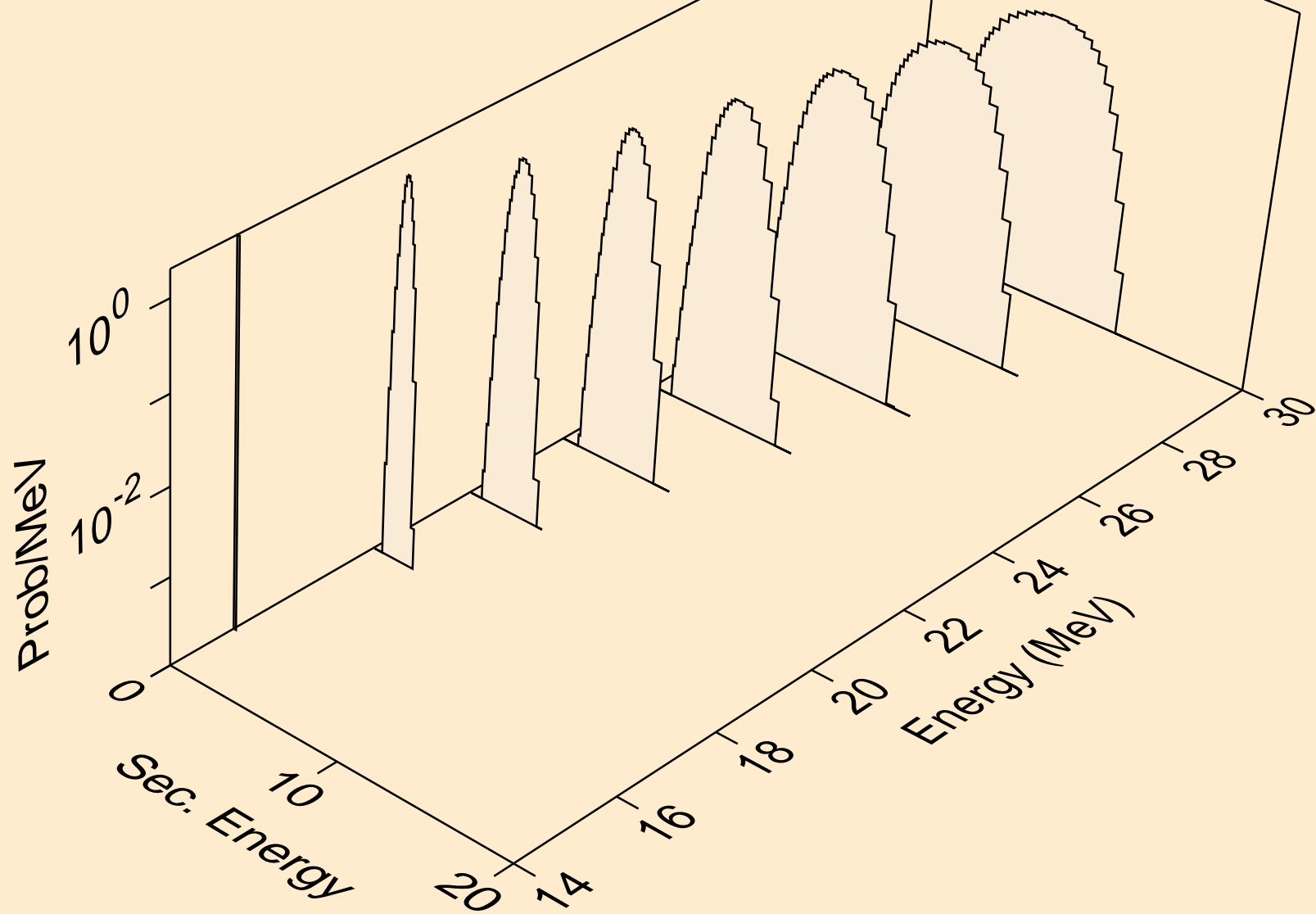

SC044M NEUTRON ACER TENDL-2023 LIBRARY; T=0.K
deuterons from (n,da)

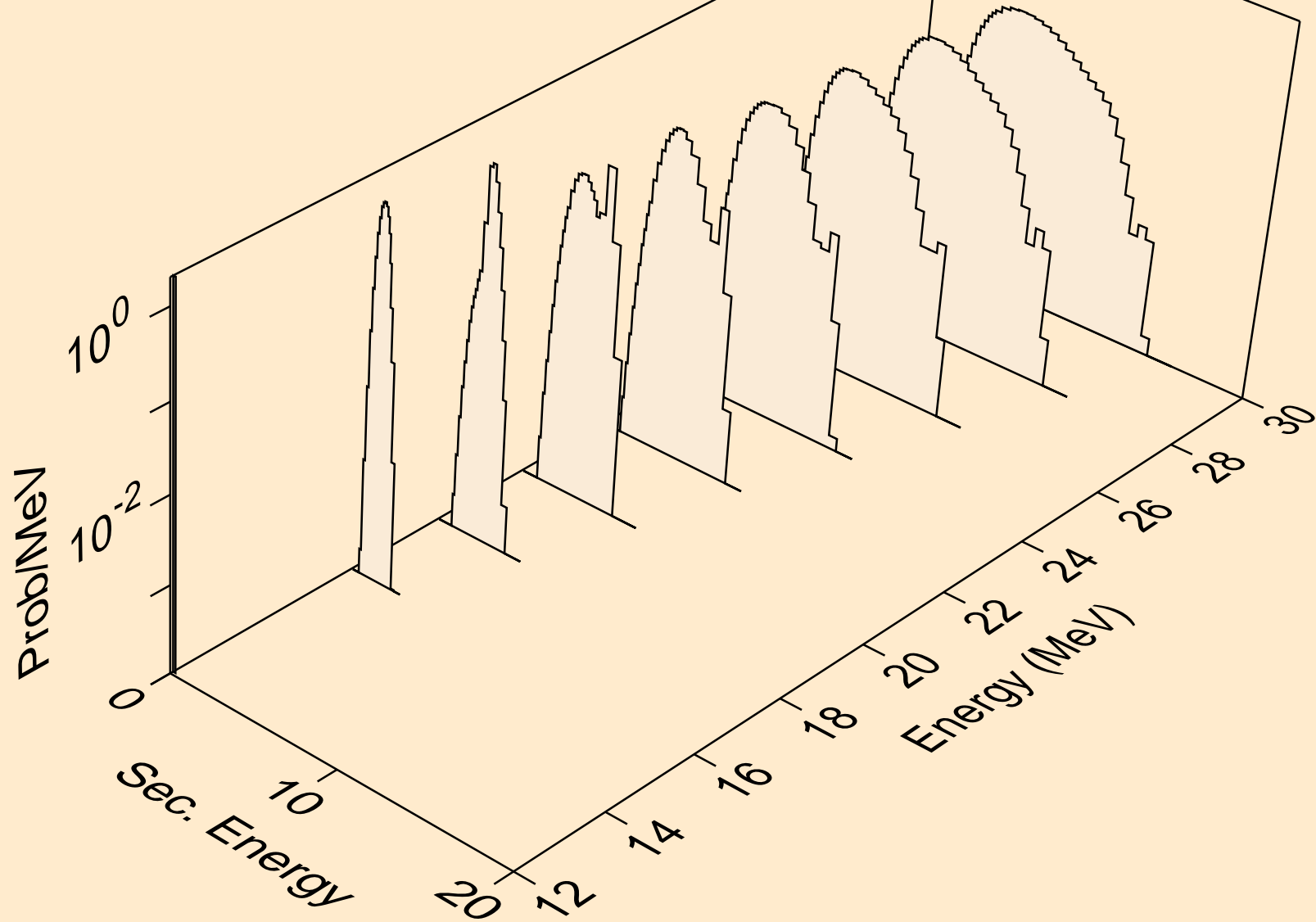

SC044M NEUTRON ACER TENDL-2023 LIBRARY; T=0.K
tritons from (n,x)

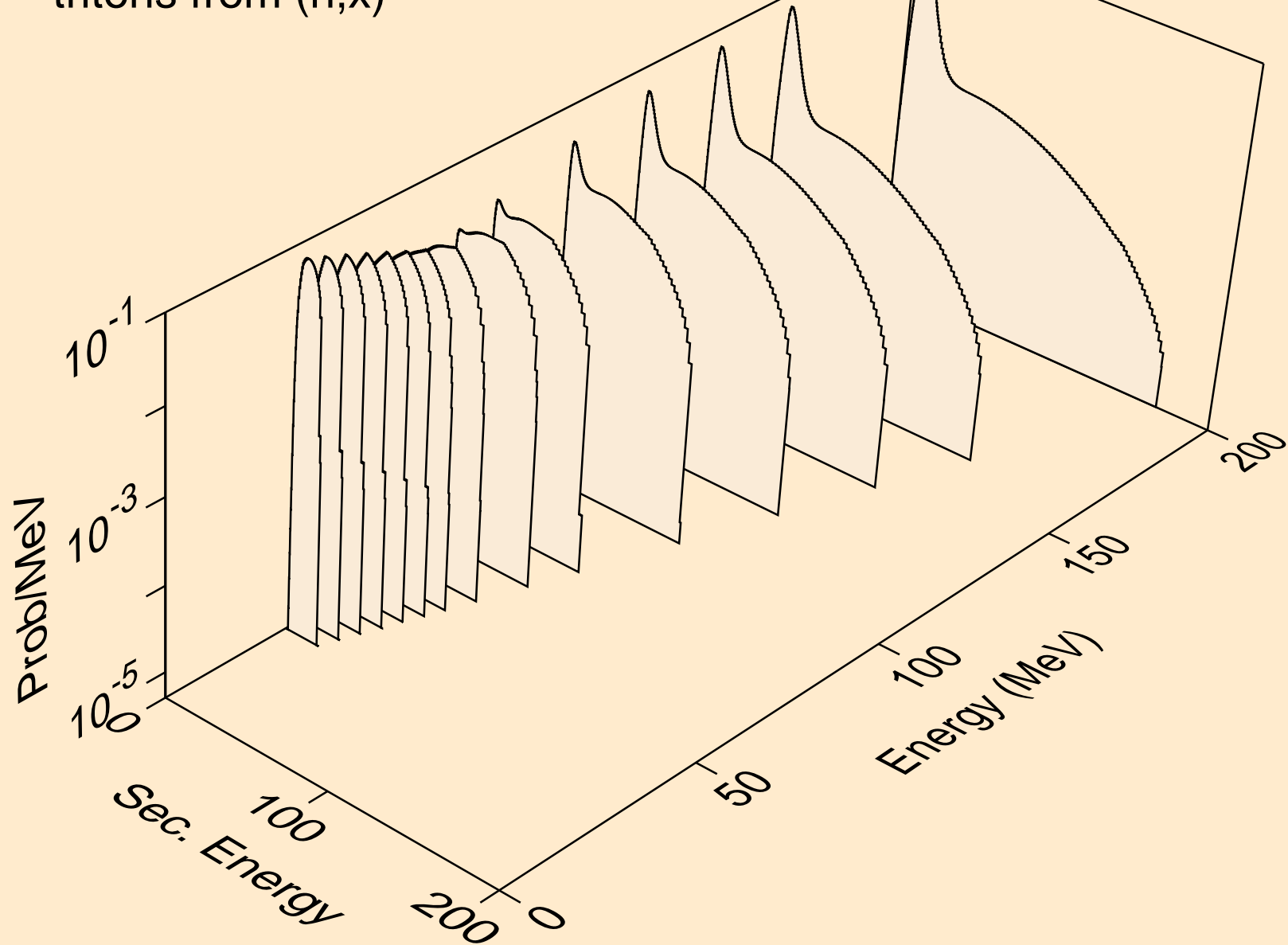

SC044M NEUTRON ACER TENDL-2023 LIBRARY; T=0.K
tritons from (n,n*)t

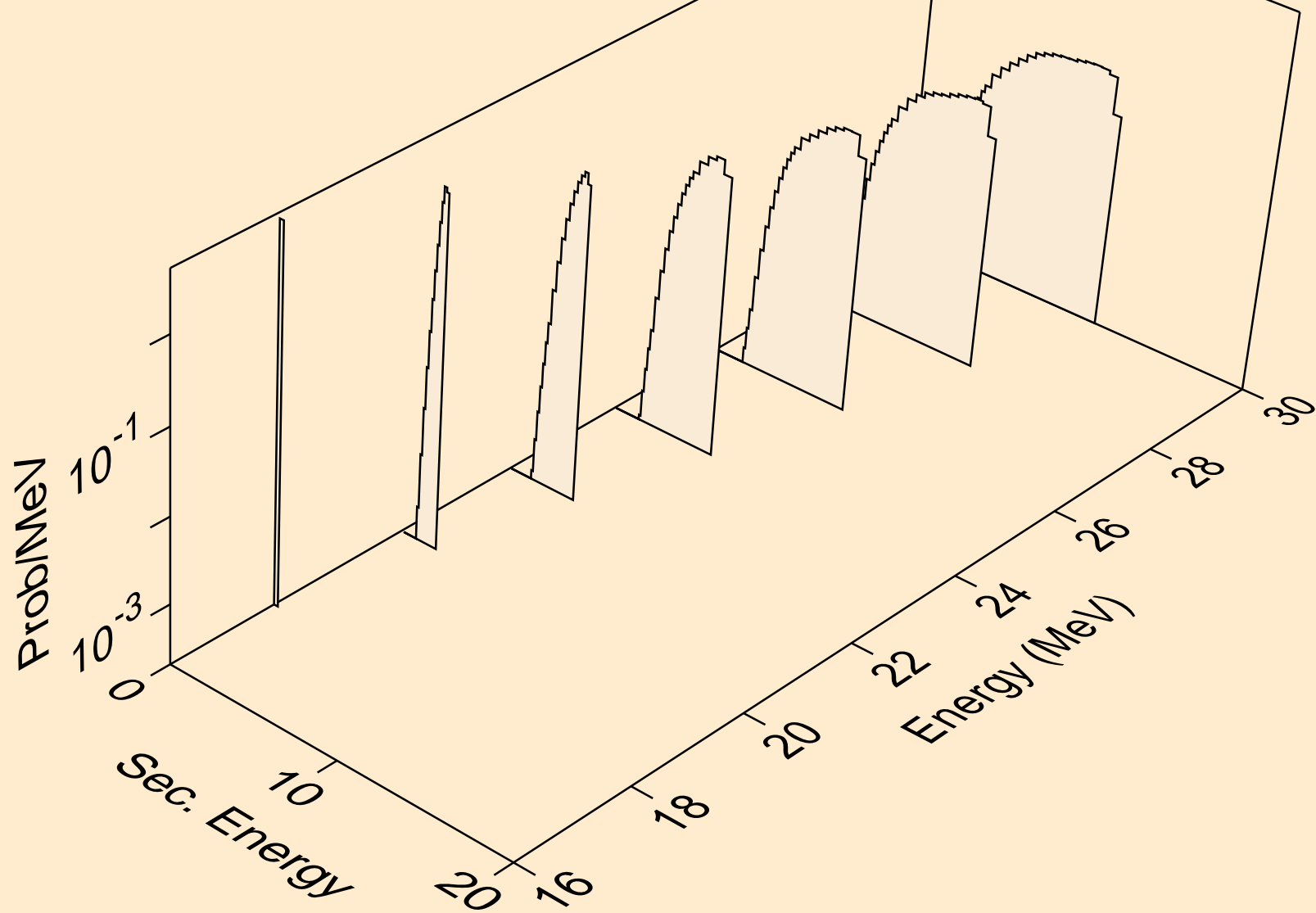

SC044M NEUTRON ACER TENDL-2023 LIBRARY; T=0.K
tritons from (n,t)

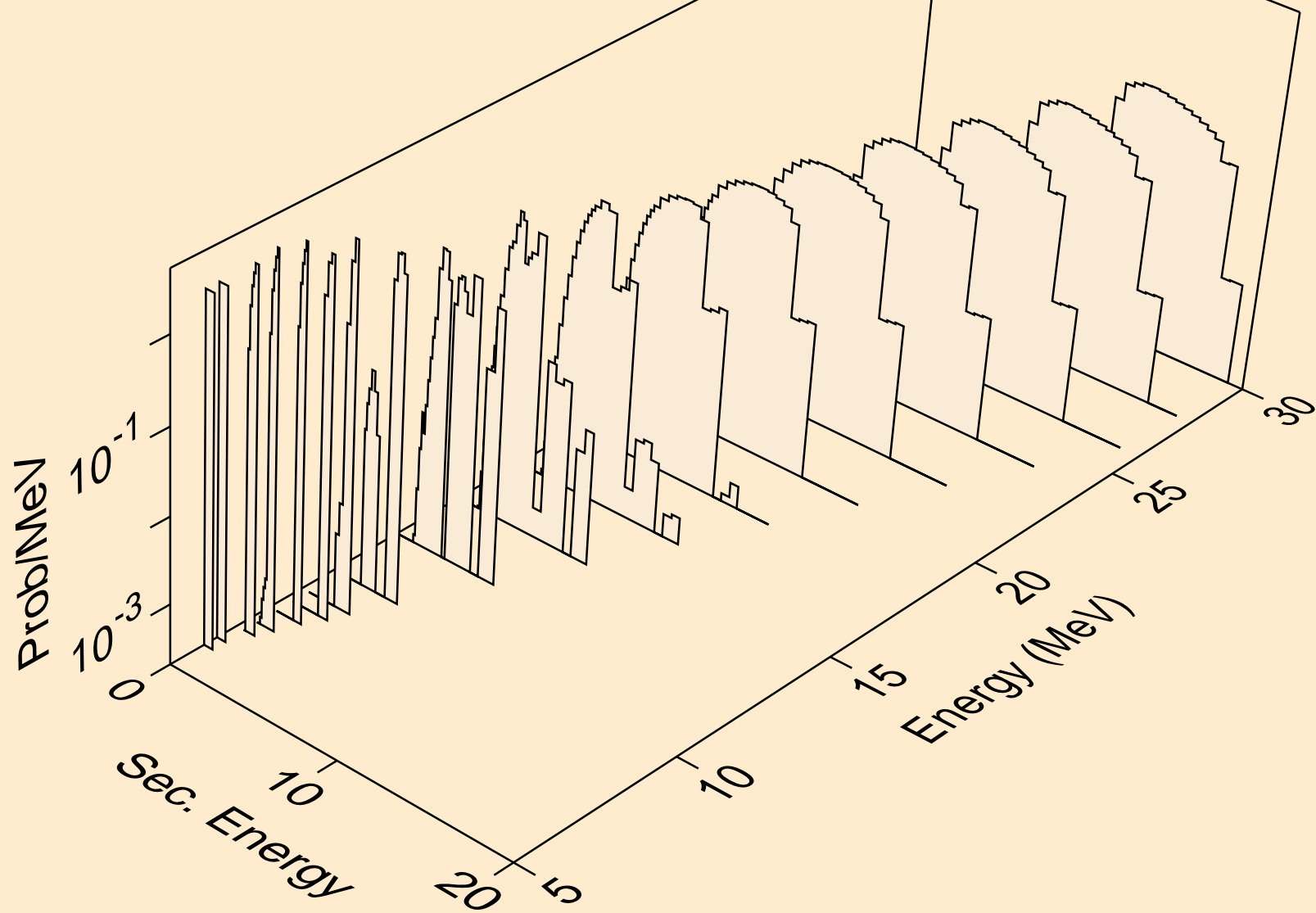

SC044M NEUTRON ACER TENDL-2023 LIBRARY; T=0.K
tritons from (n,pt)

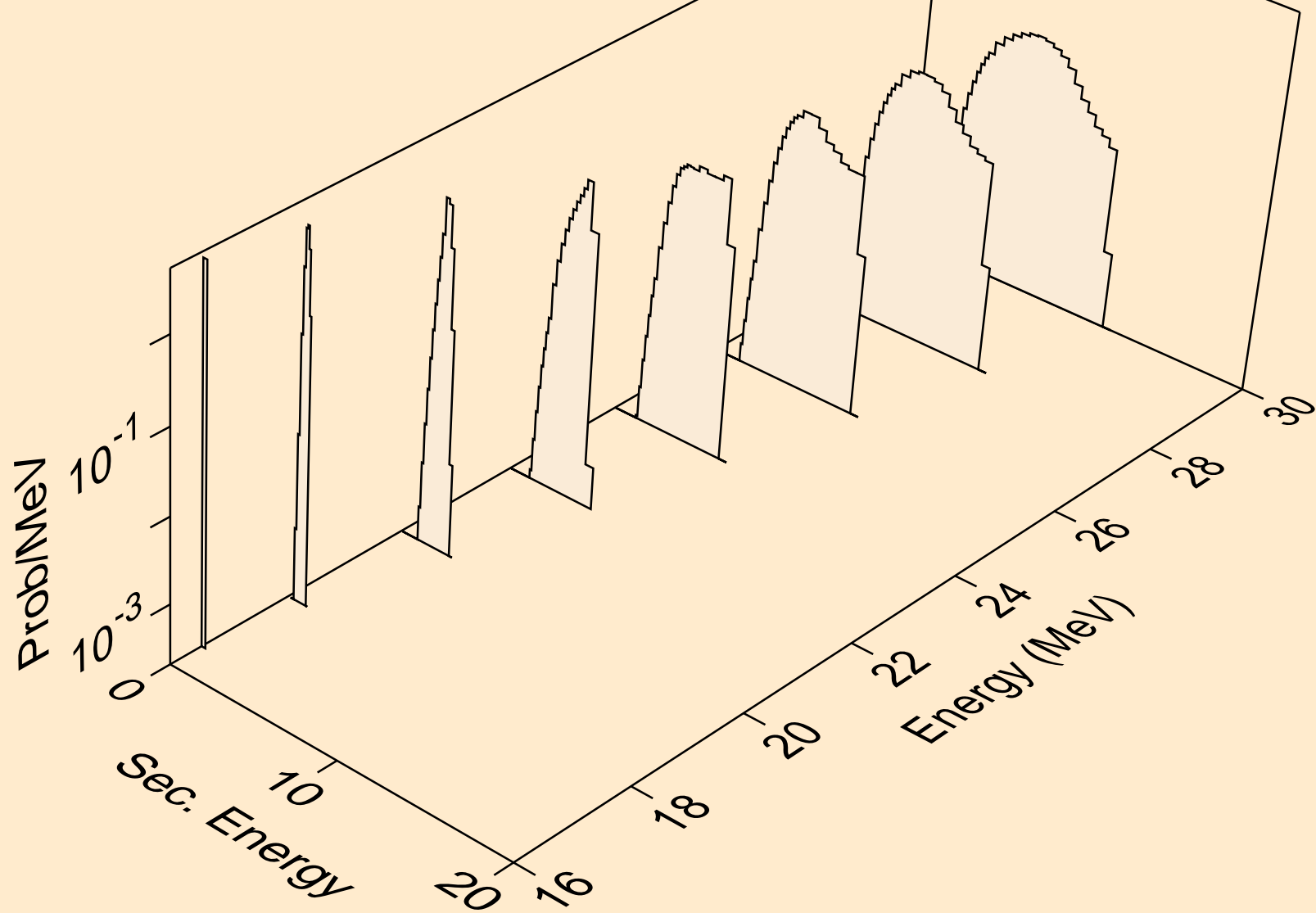

SC044M NEUTRON ACER TENDL-2023 LIBRARY; T=0.K
he3s from (n,x)

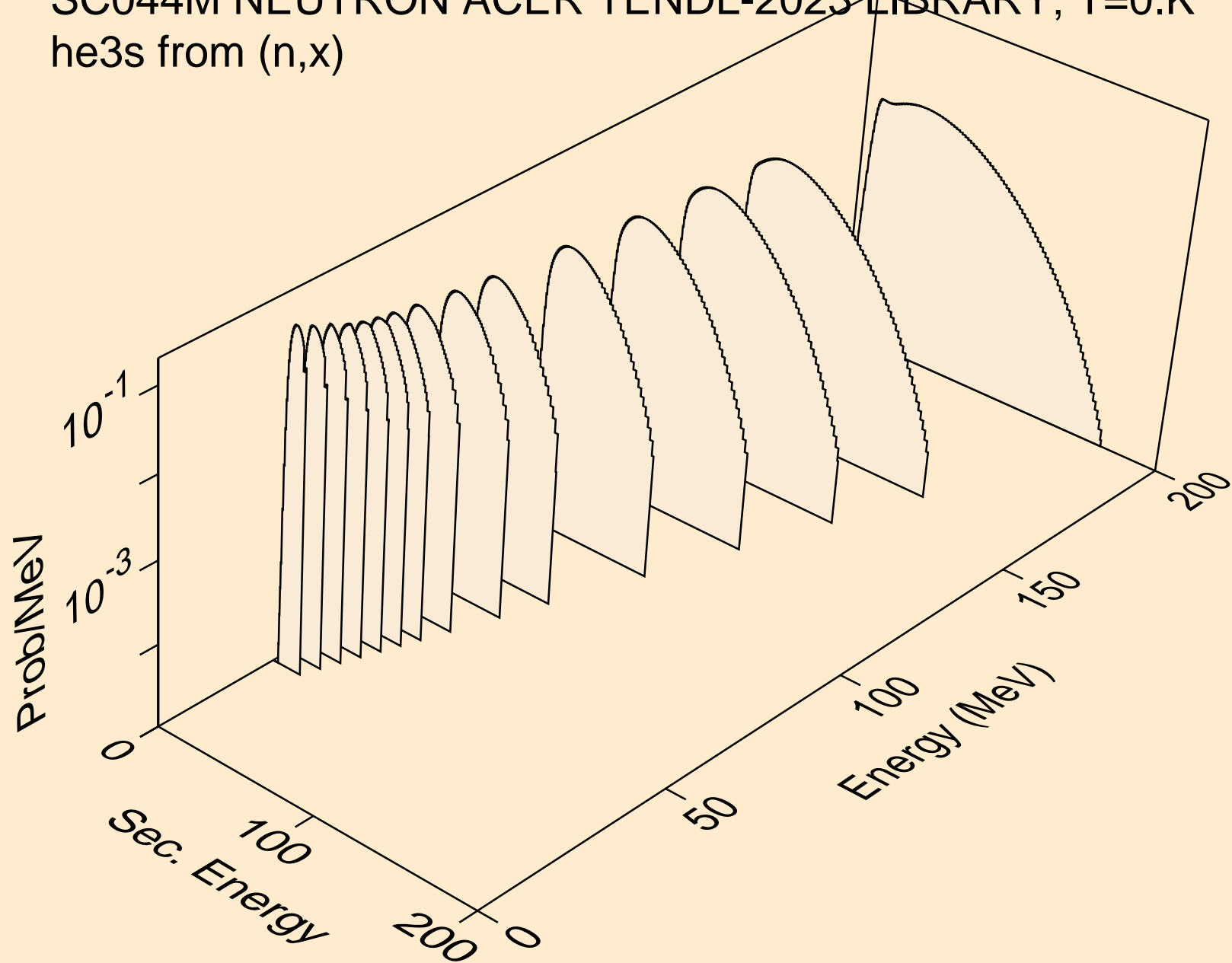

SC044M NEUTRON ACER TENDL-2023 LIBRARY; T=0.K
he3s from (n,n*)he3

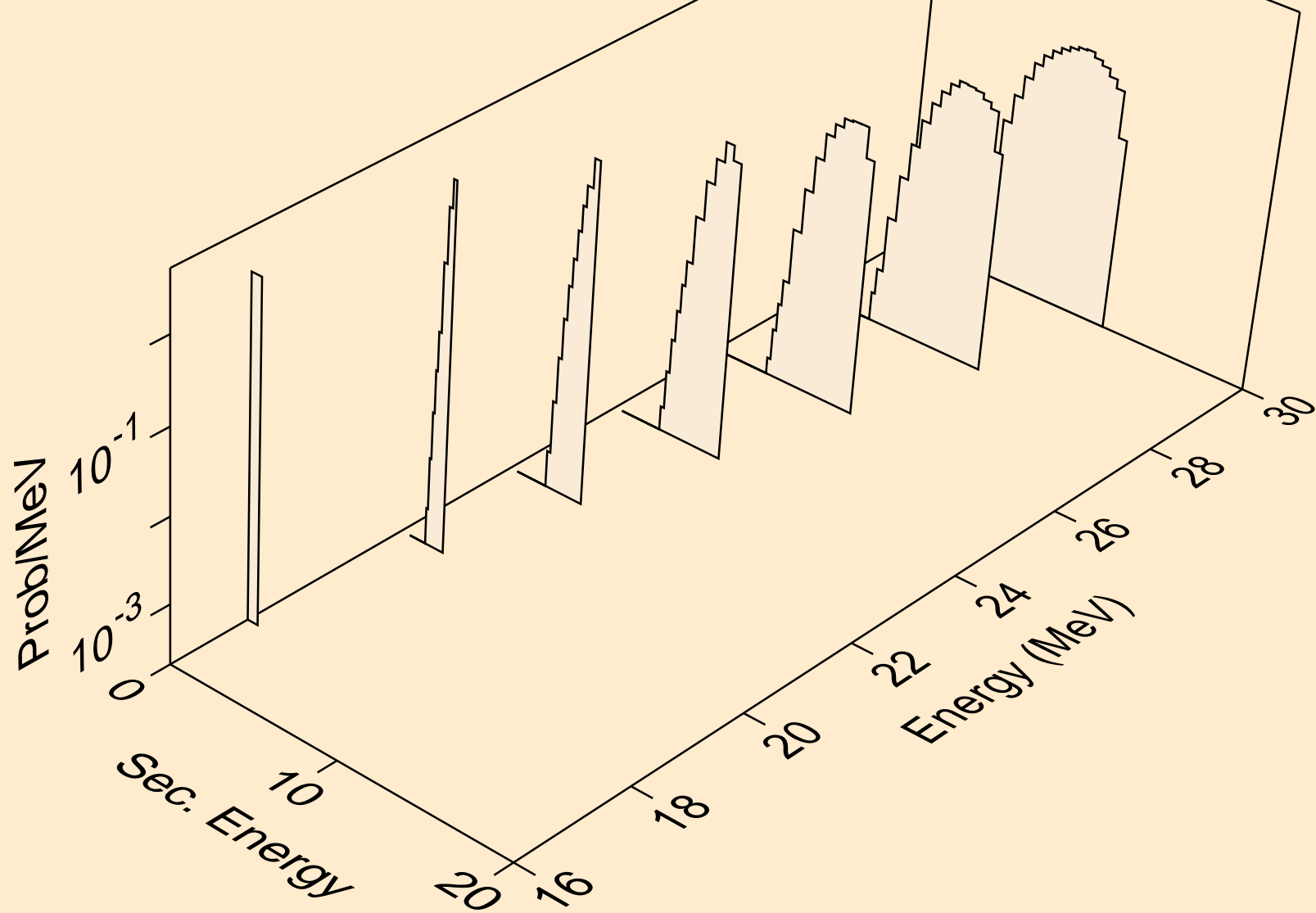

SC044M NEUTRON ACER TENDL-2023 LIBRARY; T=0.K
he3s from (n,he3)

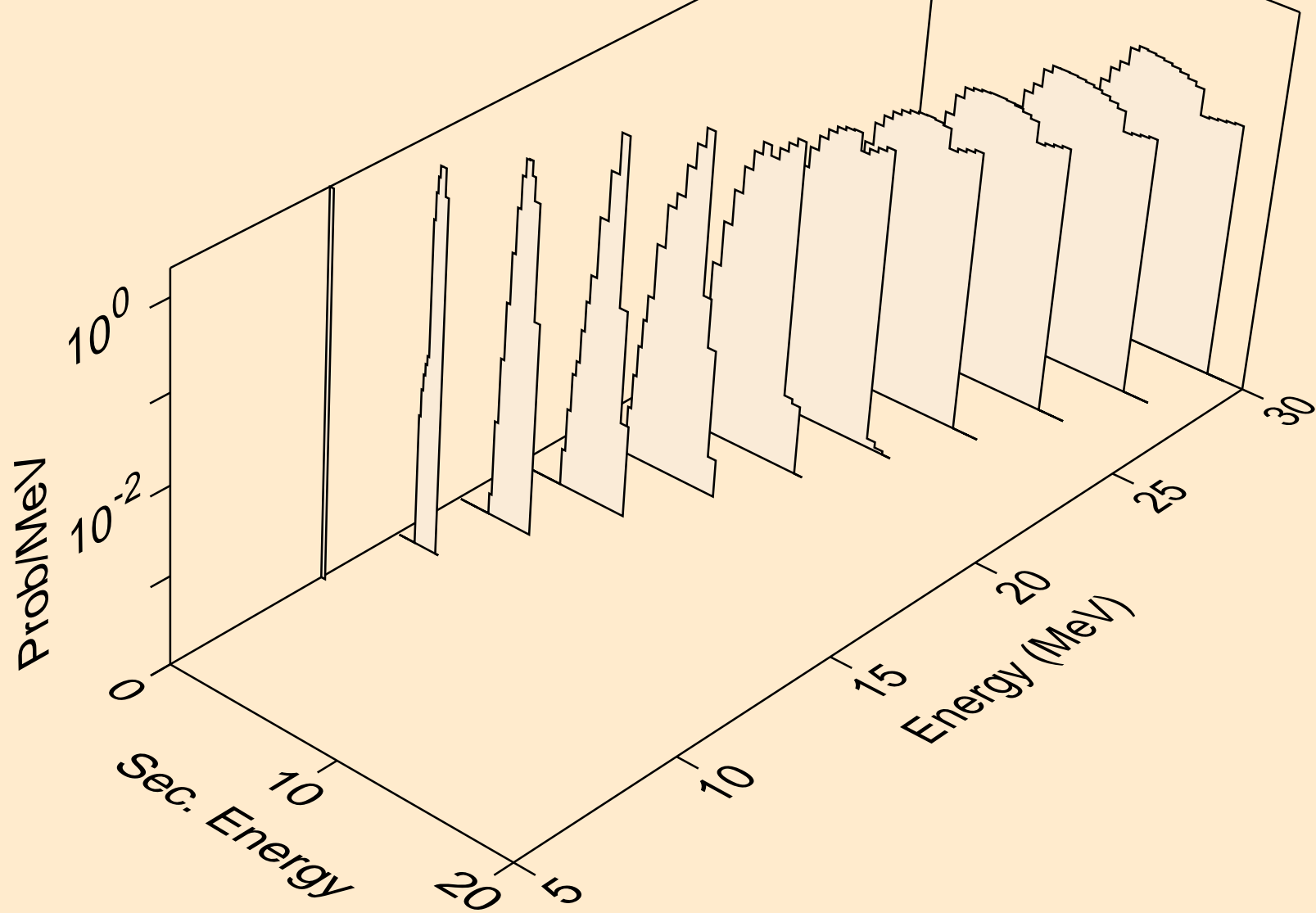

SC044M NEUTRON ACER TENDL-2023 LIBRARY; T=0.K
alphas from (n,x)

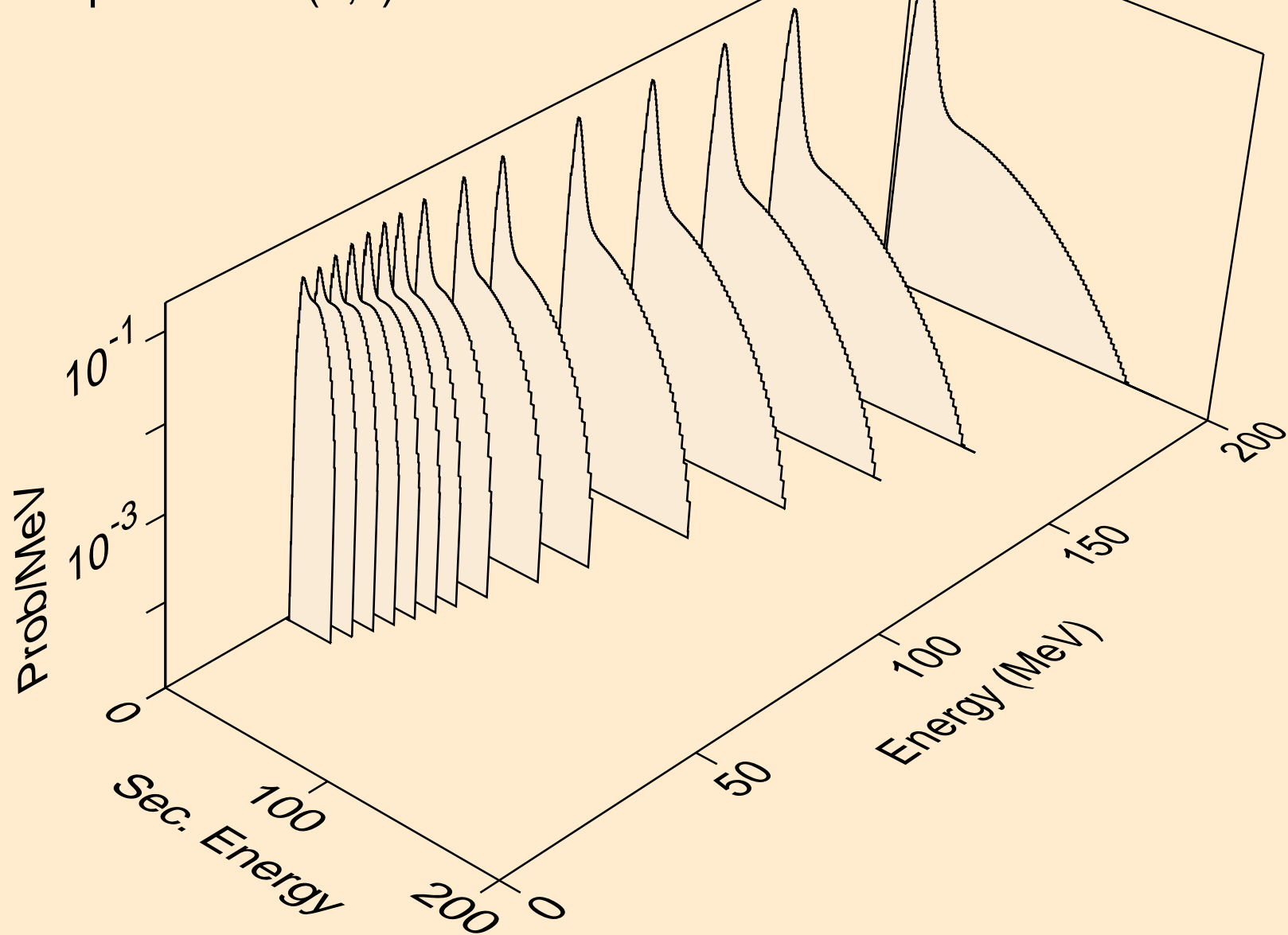

SC044M NEUTRON ACER TENDL-2023 LIBRARY; T=0.K
alphas from (n,n*)a

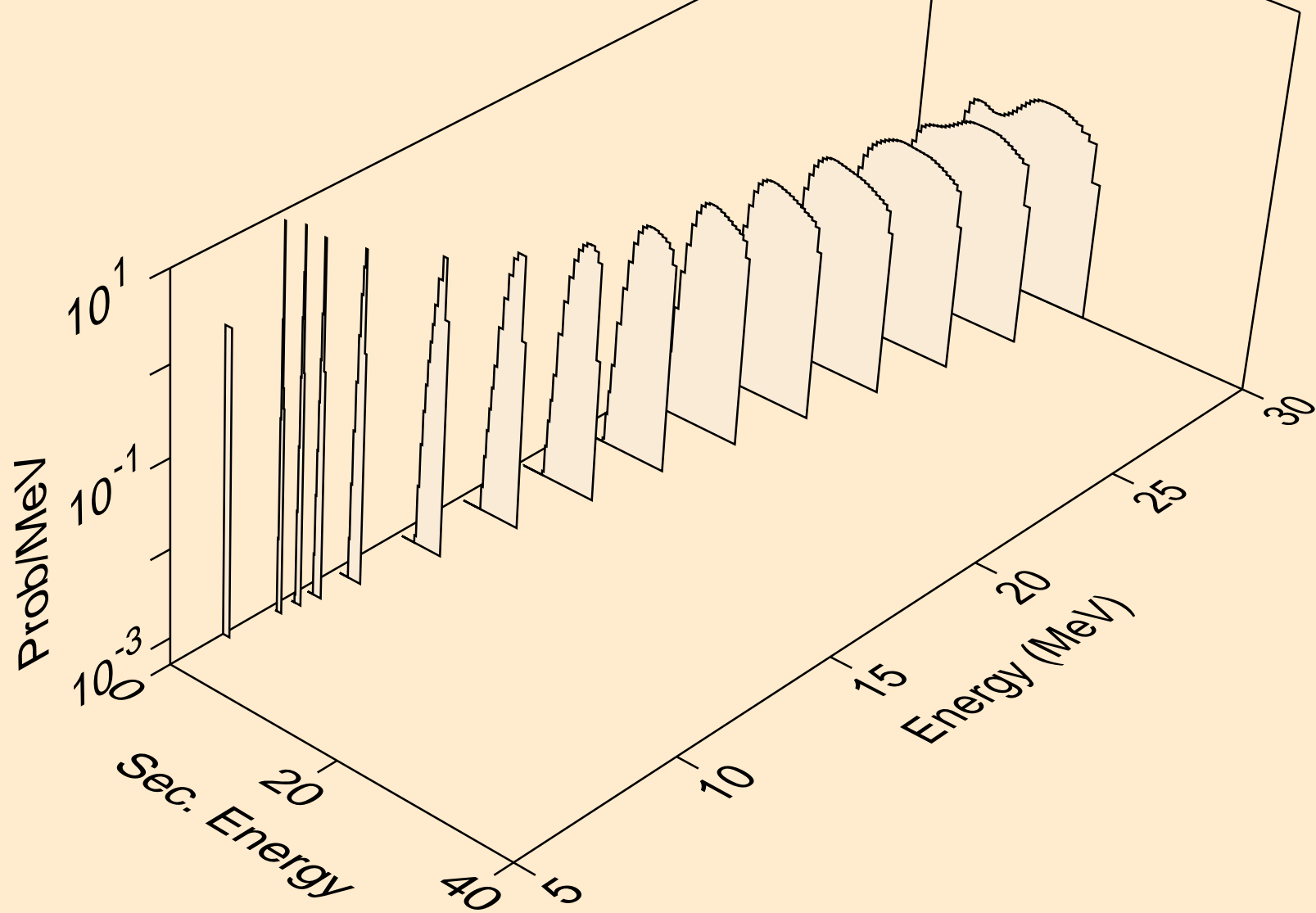

SC044M NEUTRON ACER TENDL-2023 LIBRARY; T=0.K
alphas from (n,2n)a

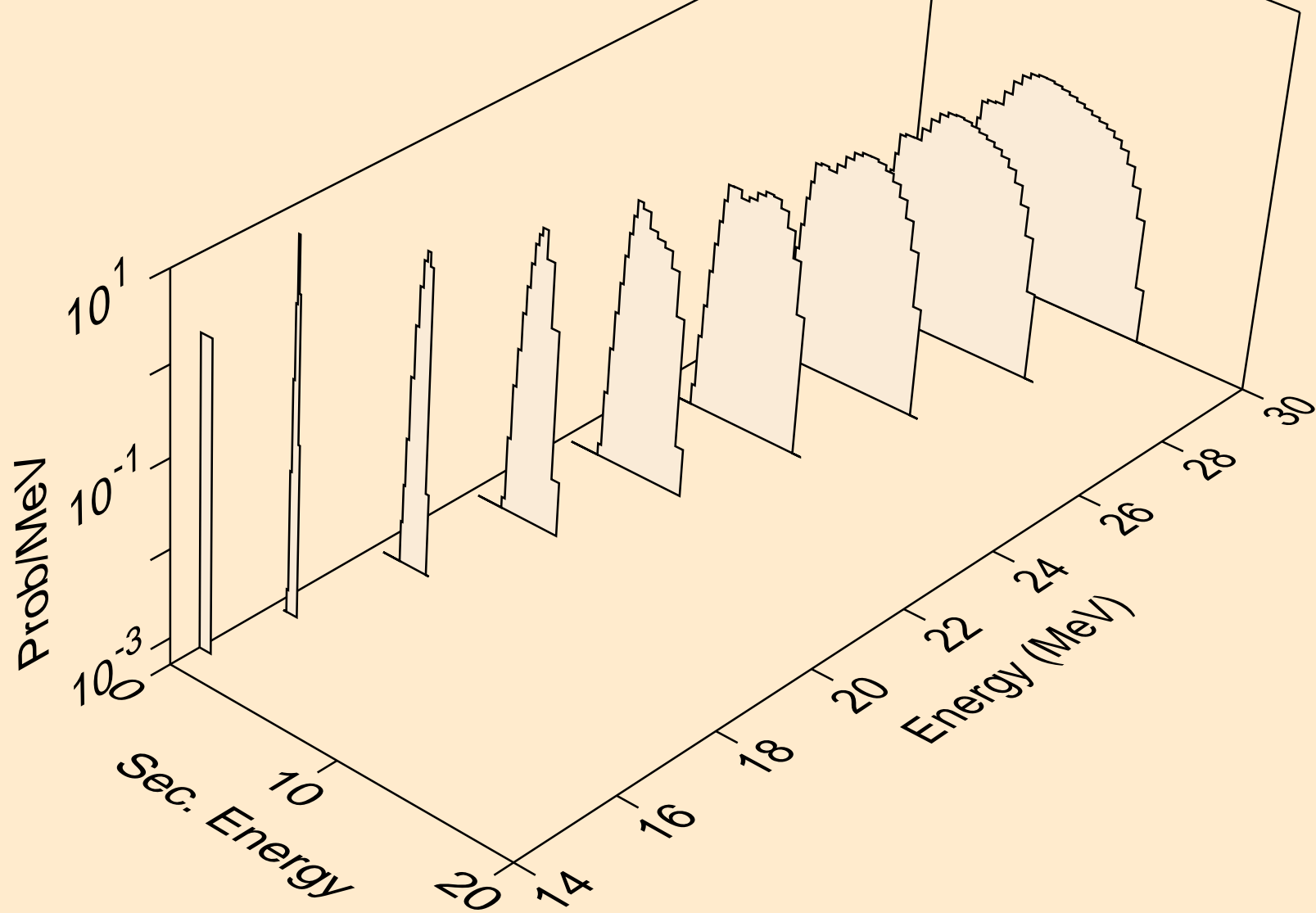

SC044M NEUTRON ACER TENDL-2023 LIBRARY; T=0.K
alphas from (n,n*)2a

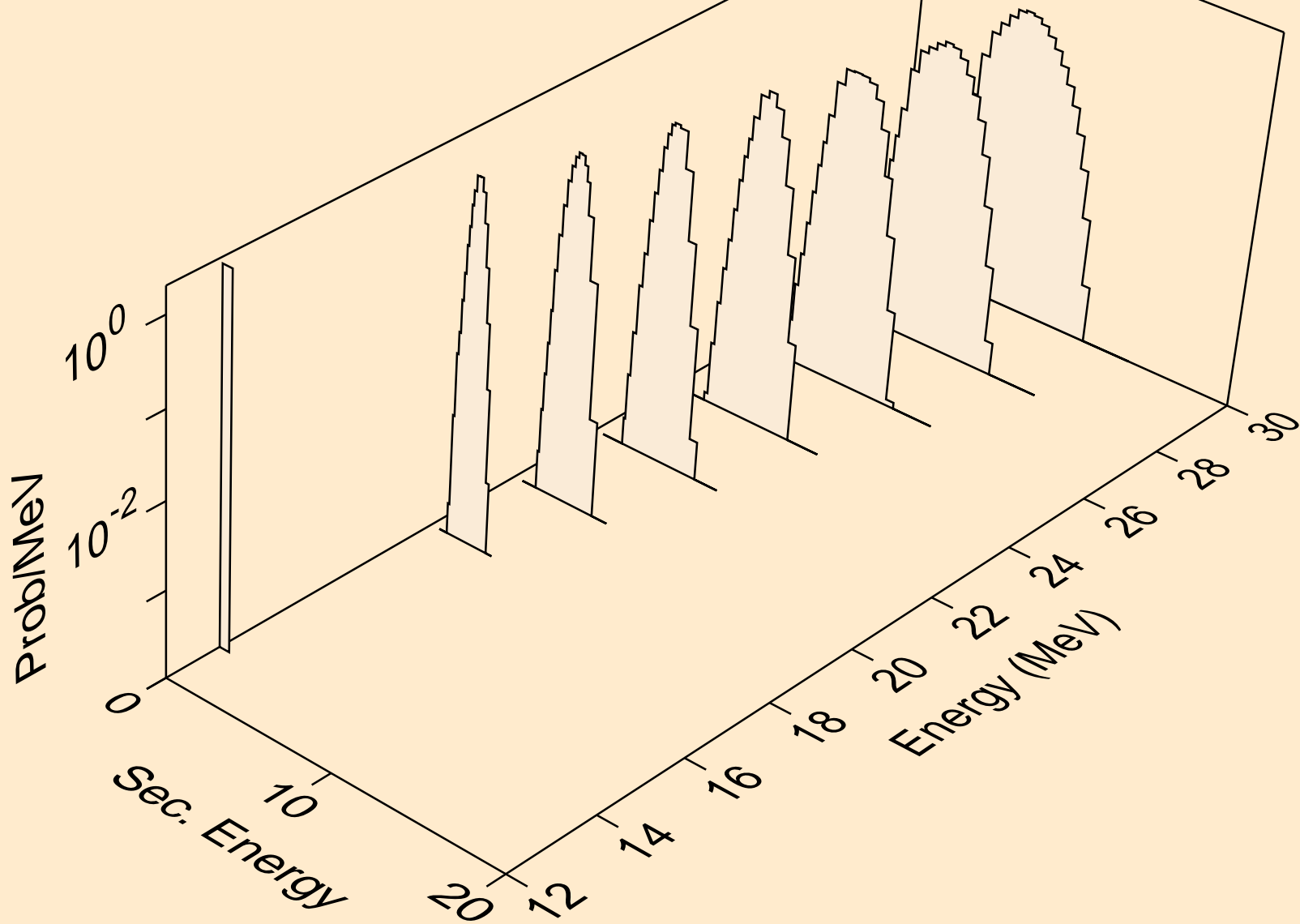

SC044M NEUTRON ACER TENDL-2023 LIBRARY; T=0.K
alphas from (n,2n)2a

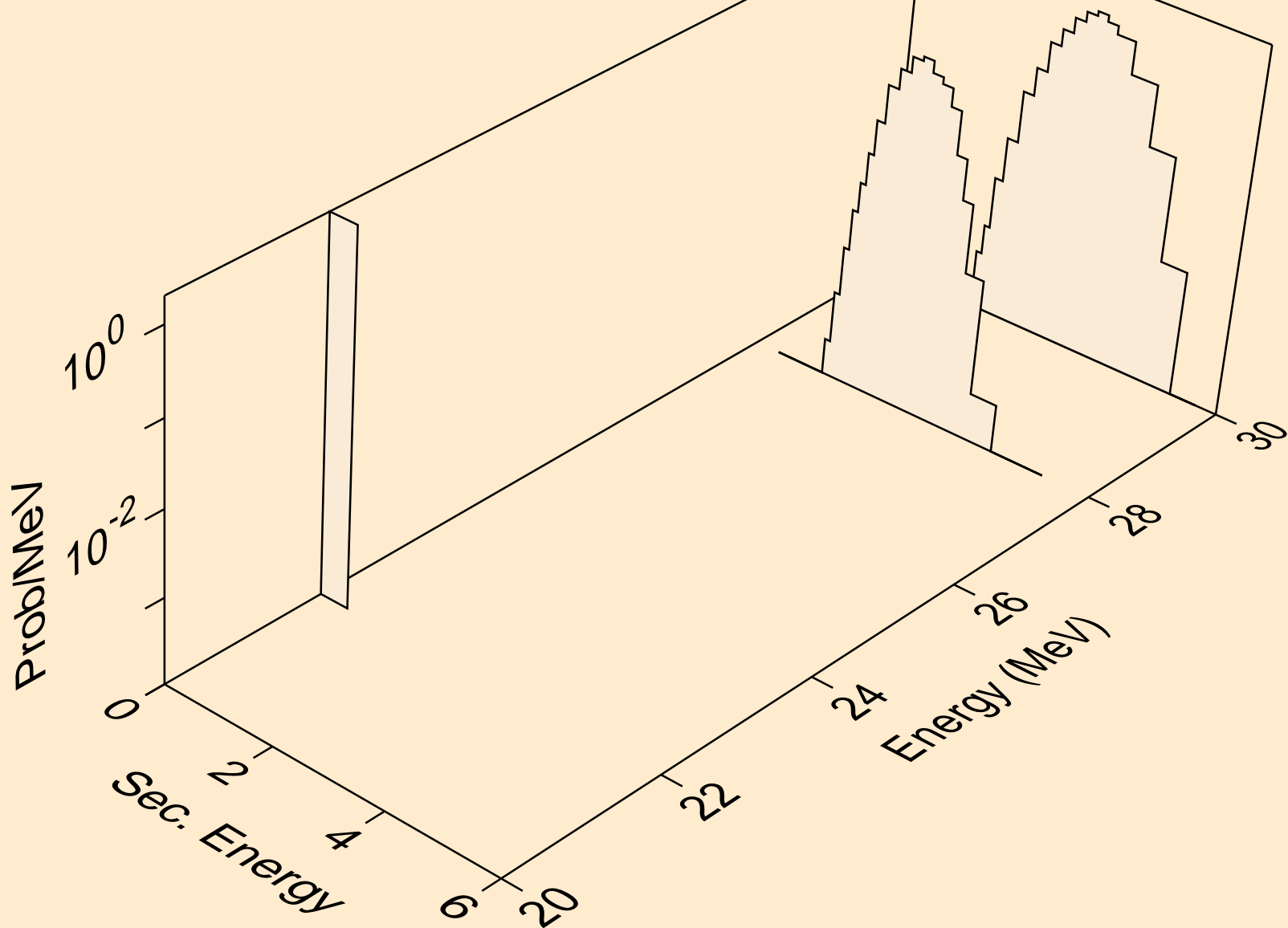

SC044M NEUTRON ACER TENDL-2023 LIBRARY; T=0.K
alphas from (n,npa)

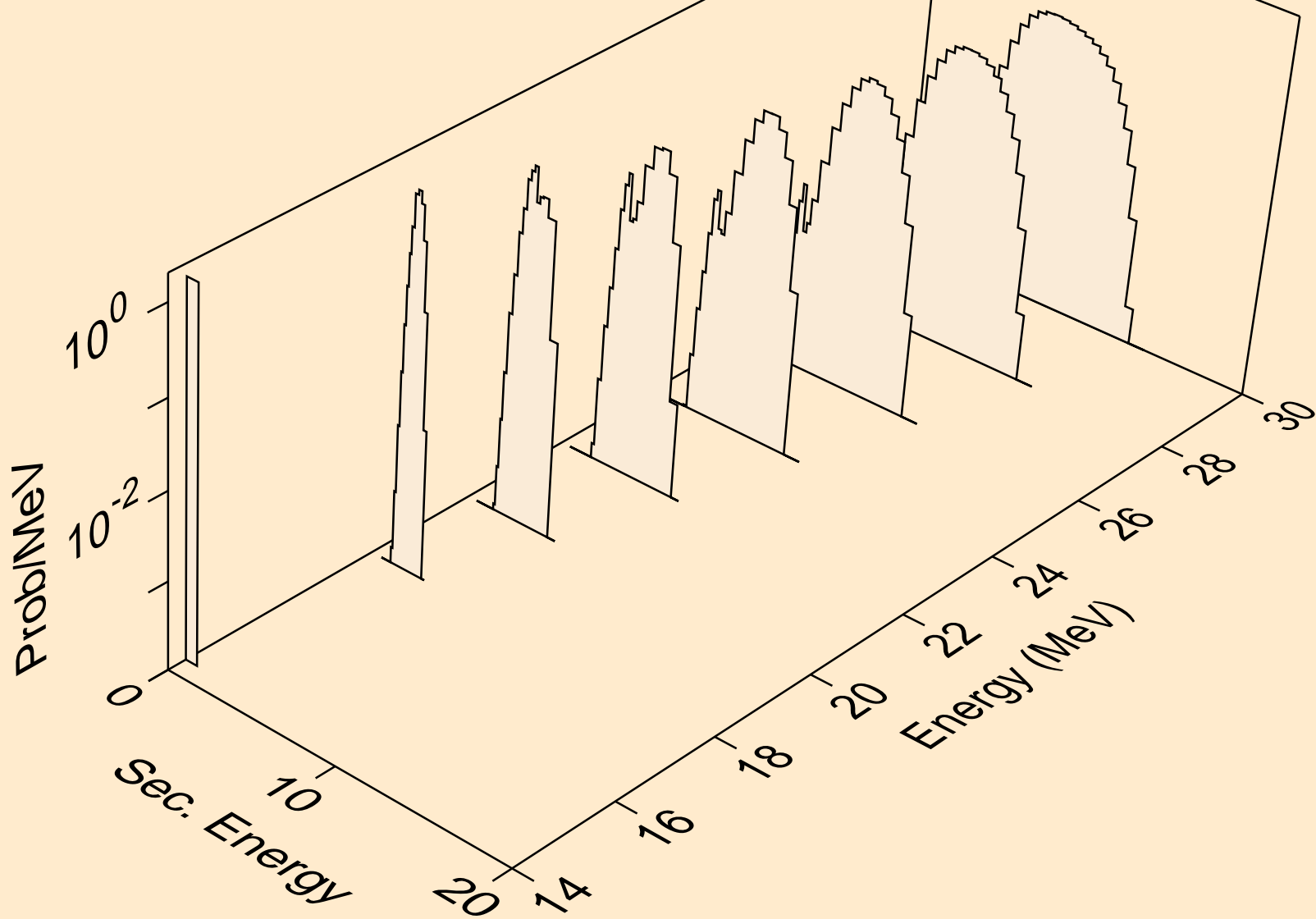

SC044M NEUTRON ACER TENDL-2023 LIBRARY; T=0.K
alphas from (n,a)

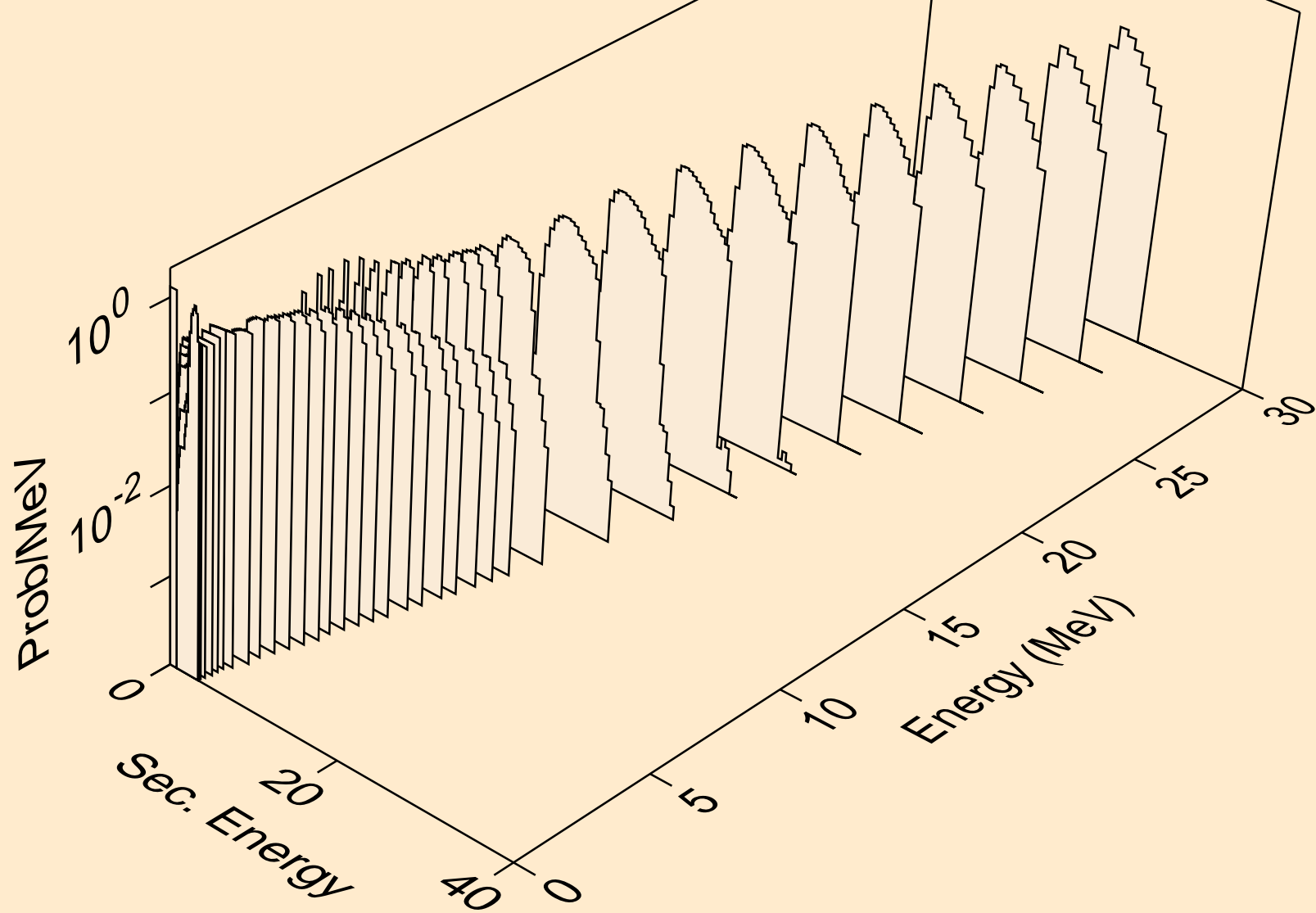

SC044M NEUTRON ACER TENDL-2023 LIBRARY; T=0.K
alphas from (n,2a)

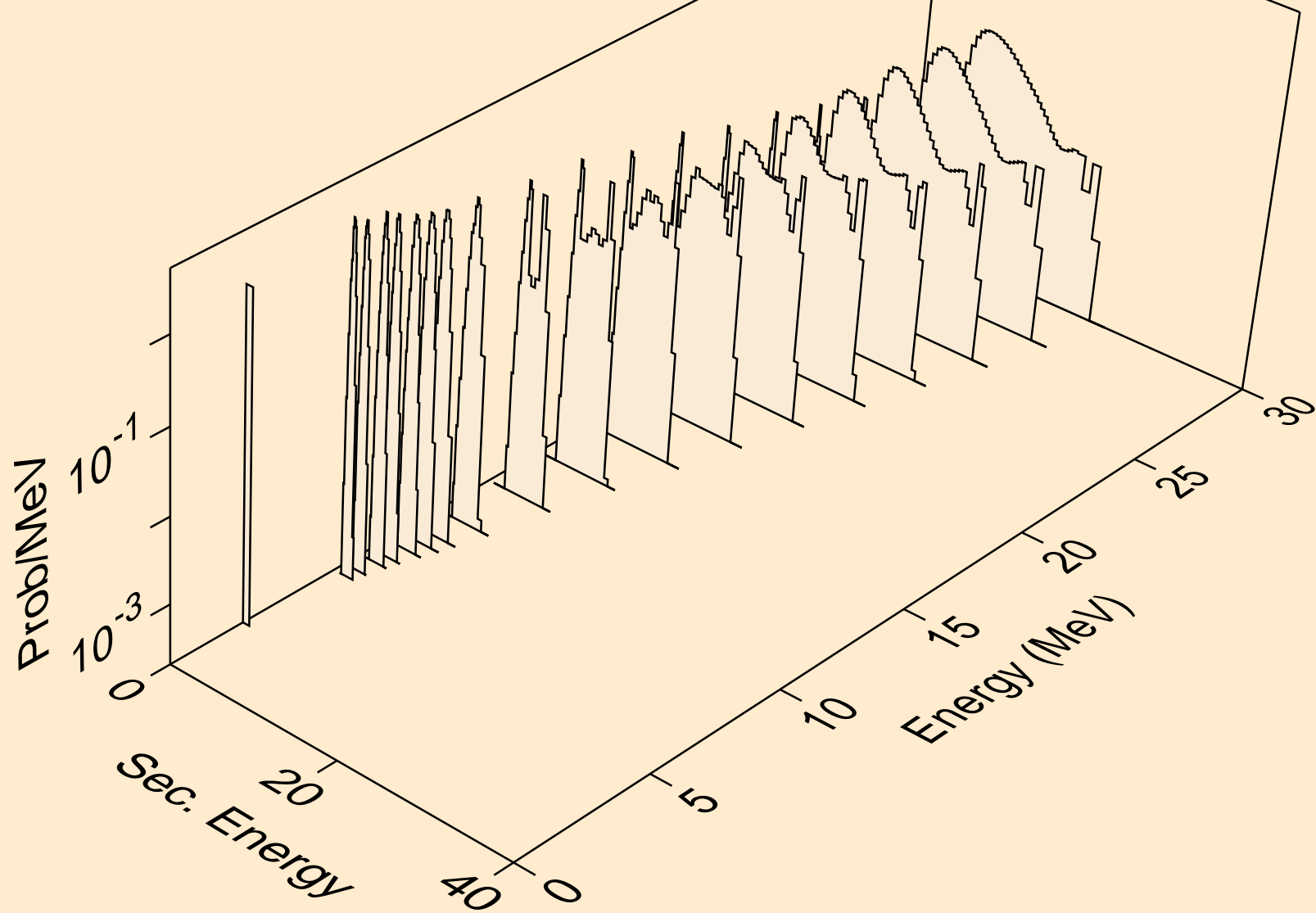

SC044M NEUTRON ACER TENDL-2023 LIBRARY; T=0.K
alphas from (n,3a)

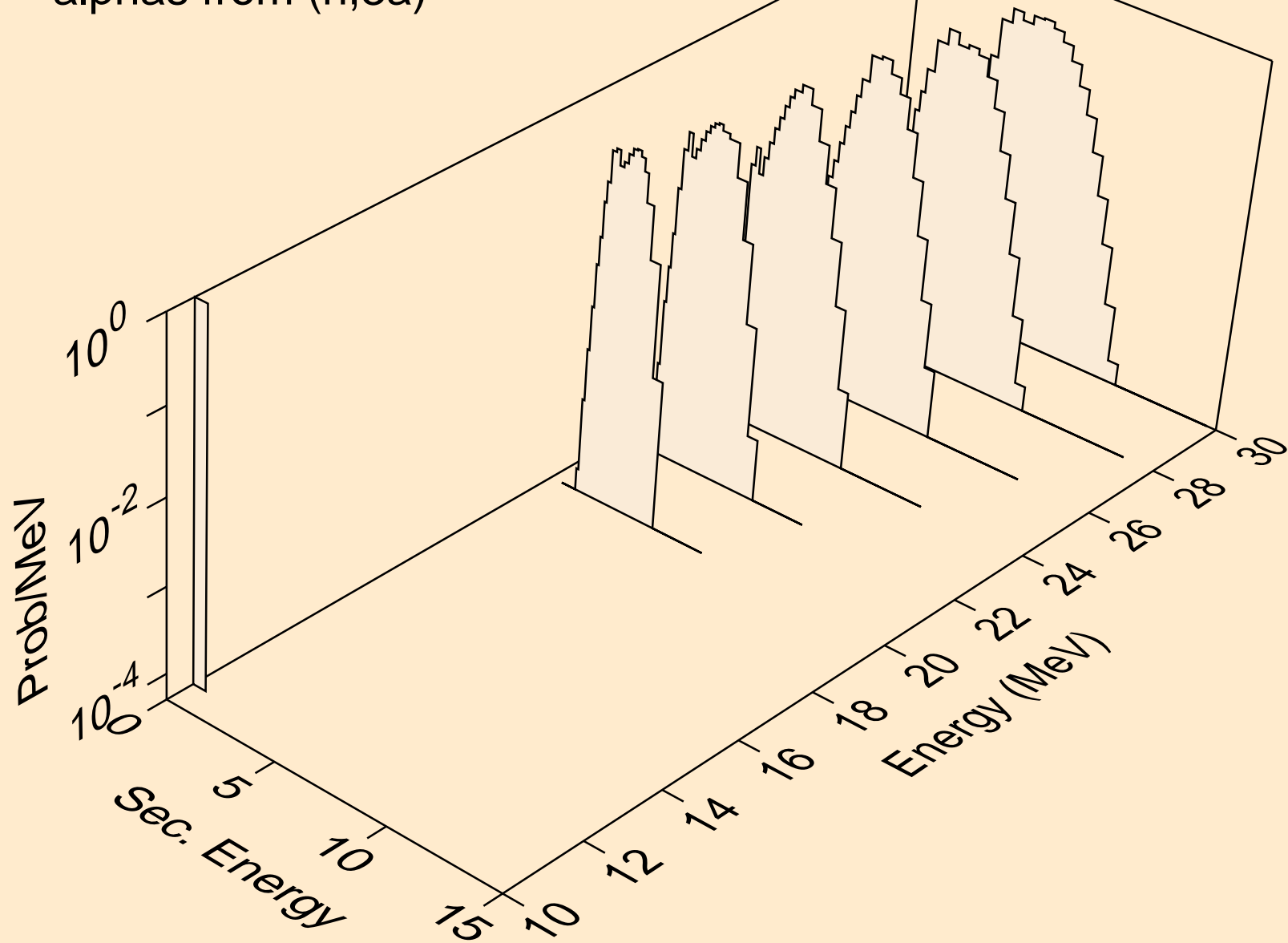

SC044M NEUTRON ACER TENDL-2023 LIBRARY; T=0.K
alphas from (n,pa)

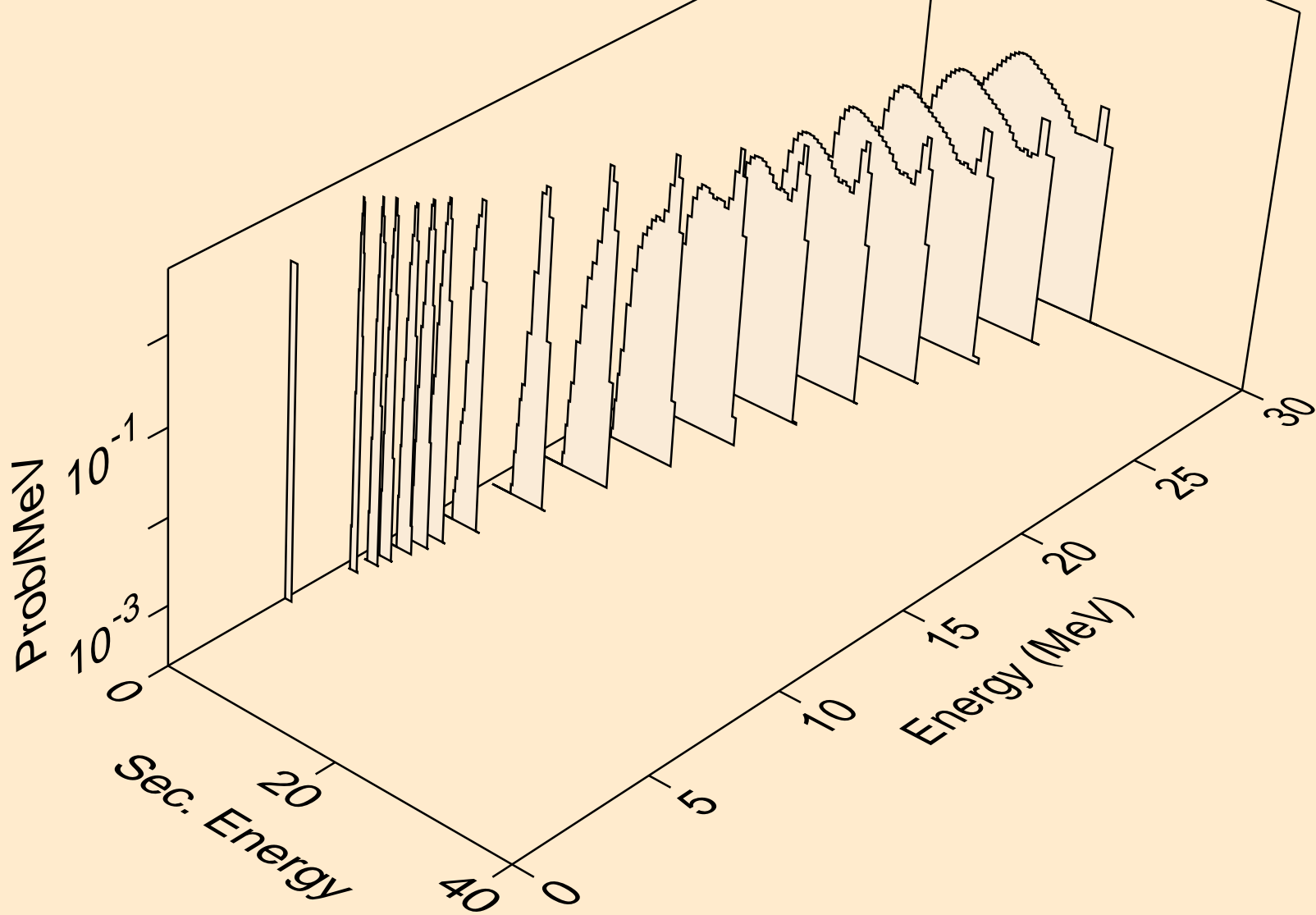

SC044M NEUTRON ACER TENDL-2023 LIBRARY; T=0.K
alphas from (n,d2a)

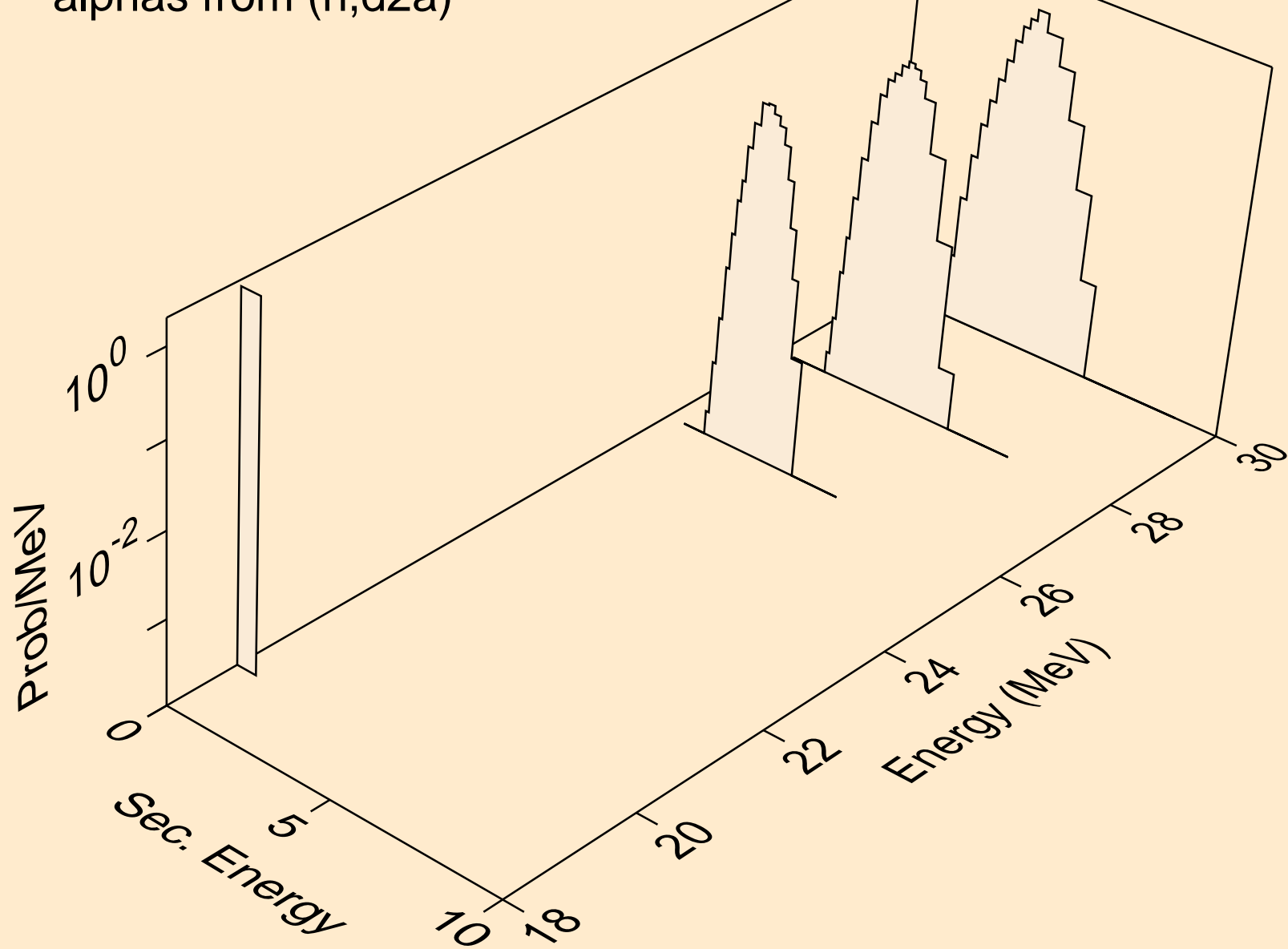

SC044M NEUTRON ACER TENDL-2023 LIBRARY; T=0.K
alphas from (n,da)

