

# SC051 NEUTRON ACER TENDL-2023 LIBRARY; T=0.K

## Principal cross sections

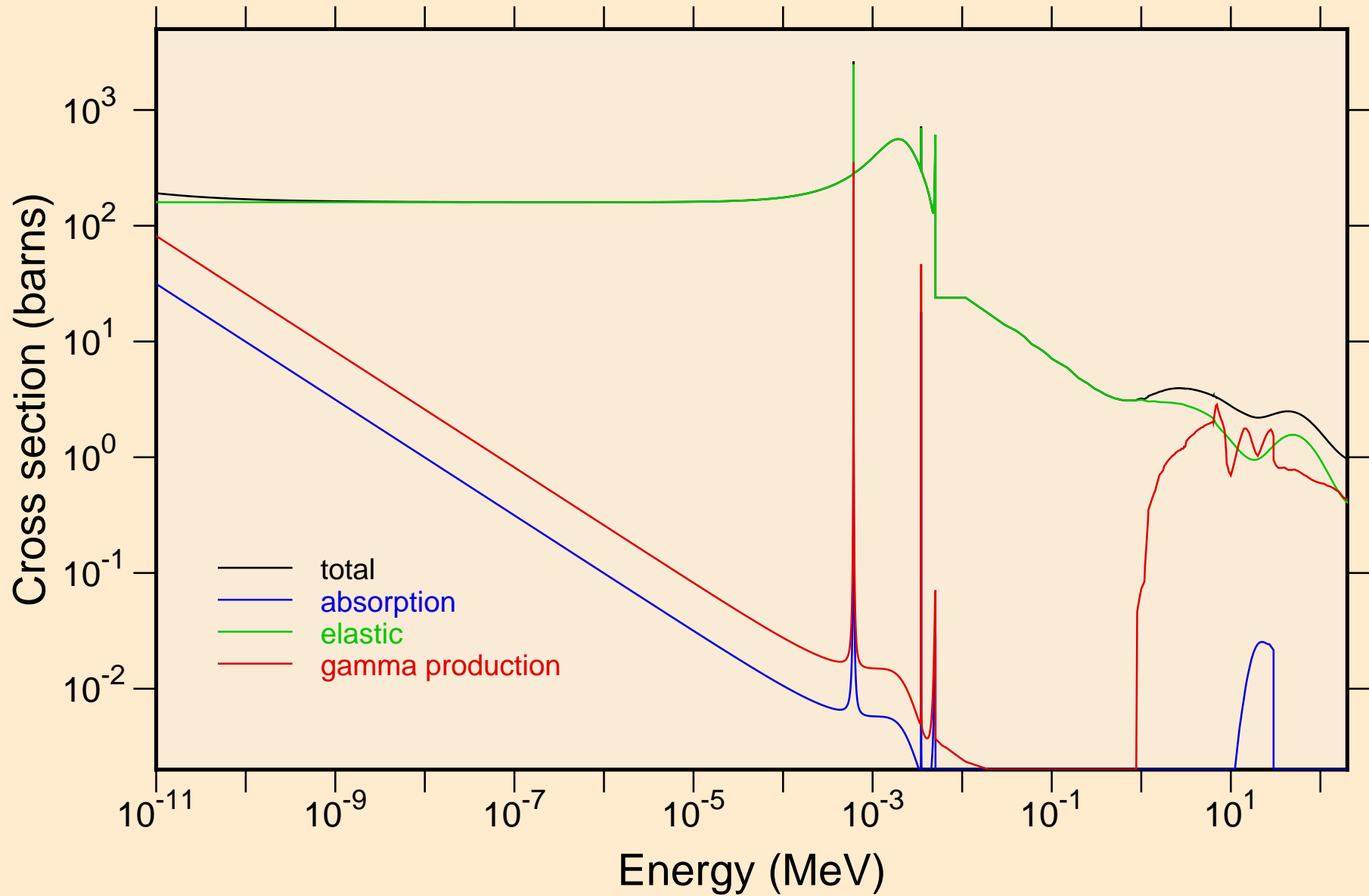

# SC051 NEUTRON ACER TENDL-2023 LIBRARY; T=0.K

## Heating

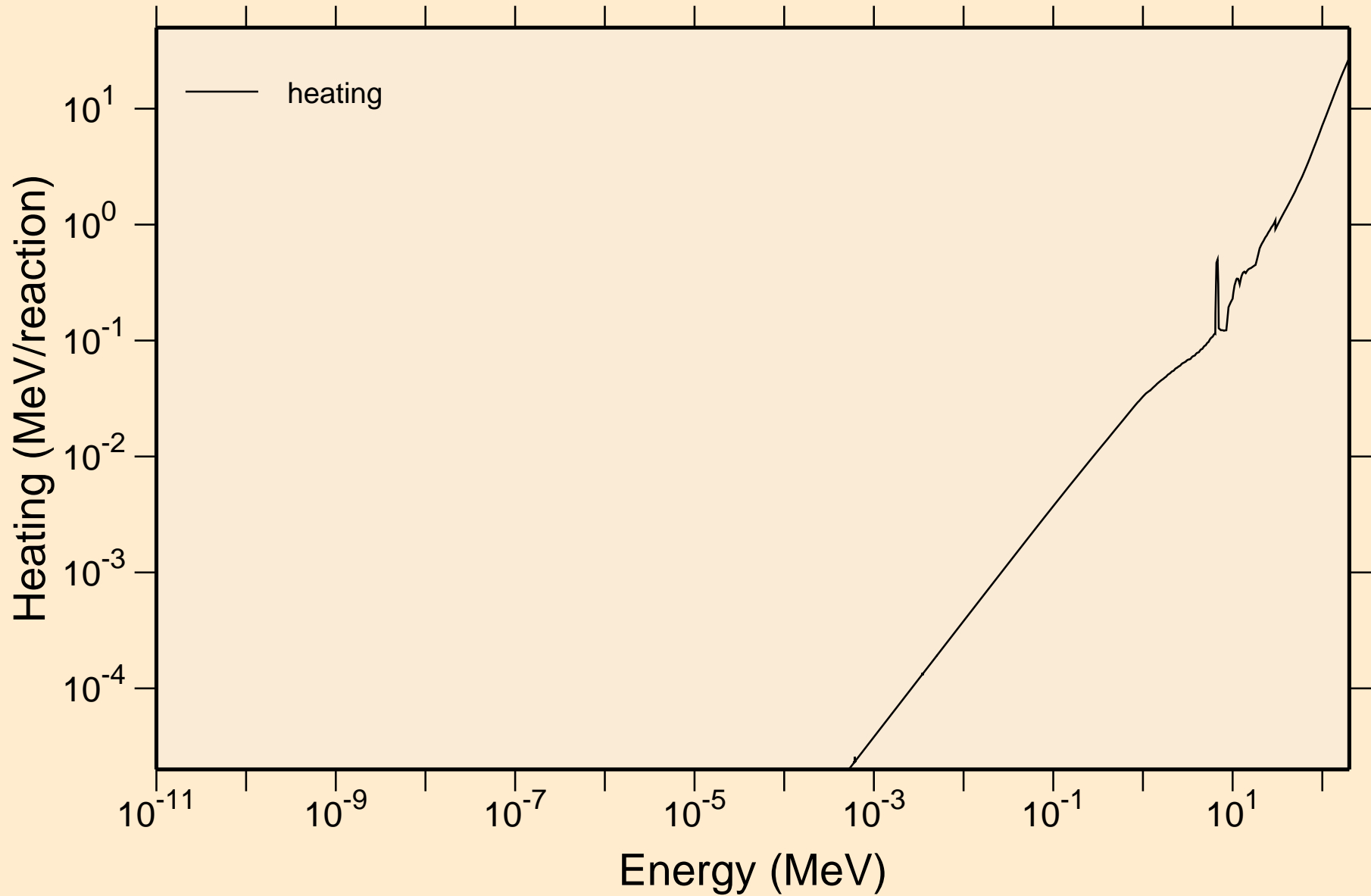

SC051 NEUTRON ACER TENDL-2023 LIBRARY; T=0.K  
Damage

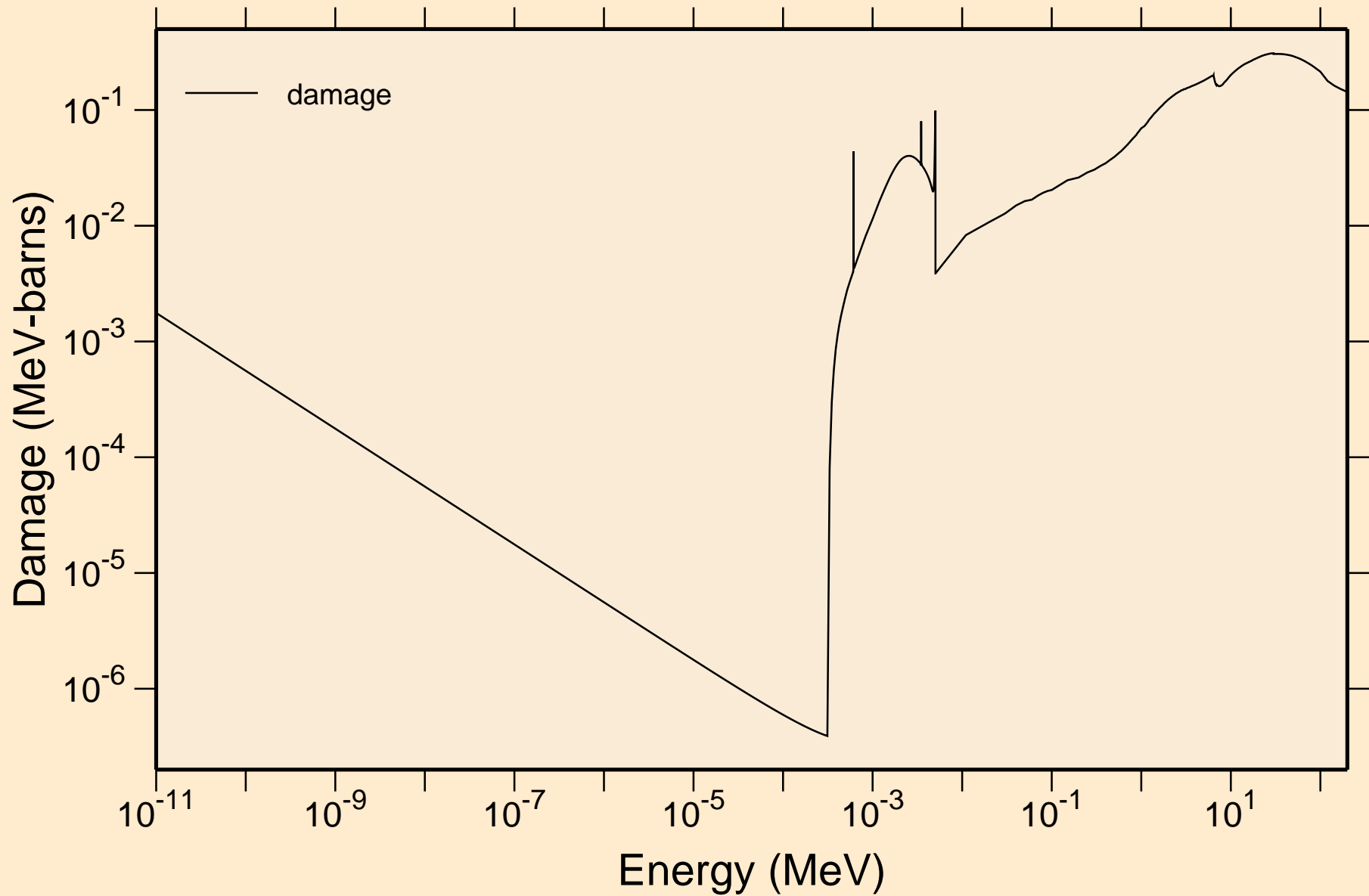

SC051 NEUTRON ACER TENDL-2023 LIBRARY; T=0.K  
Non-threshold reactions

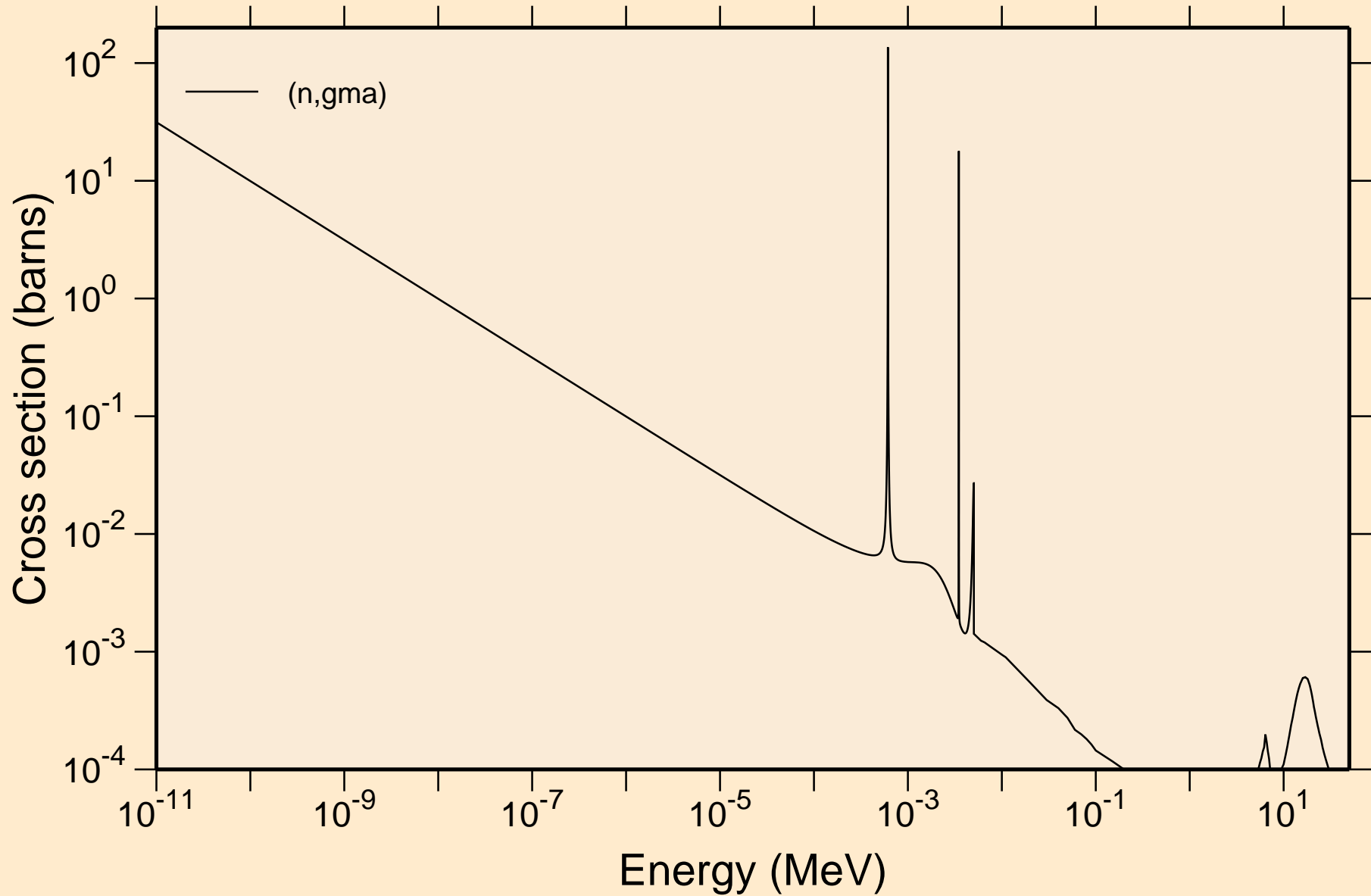

# SC051 NEUTRON ACER TENDL-2023 LIBRARY; T=0.K

## Principal cross sections

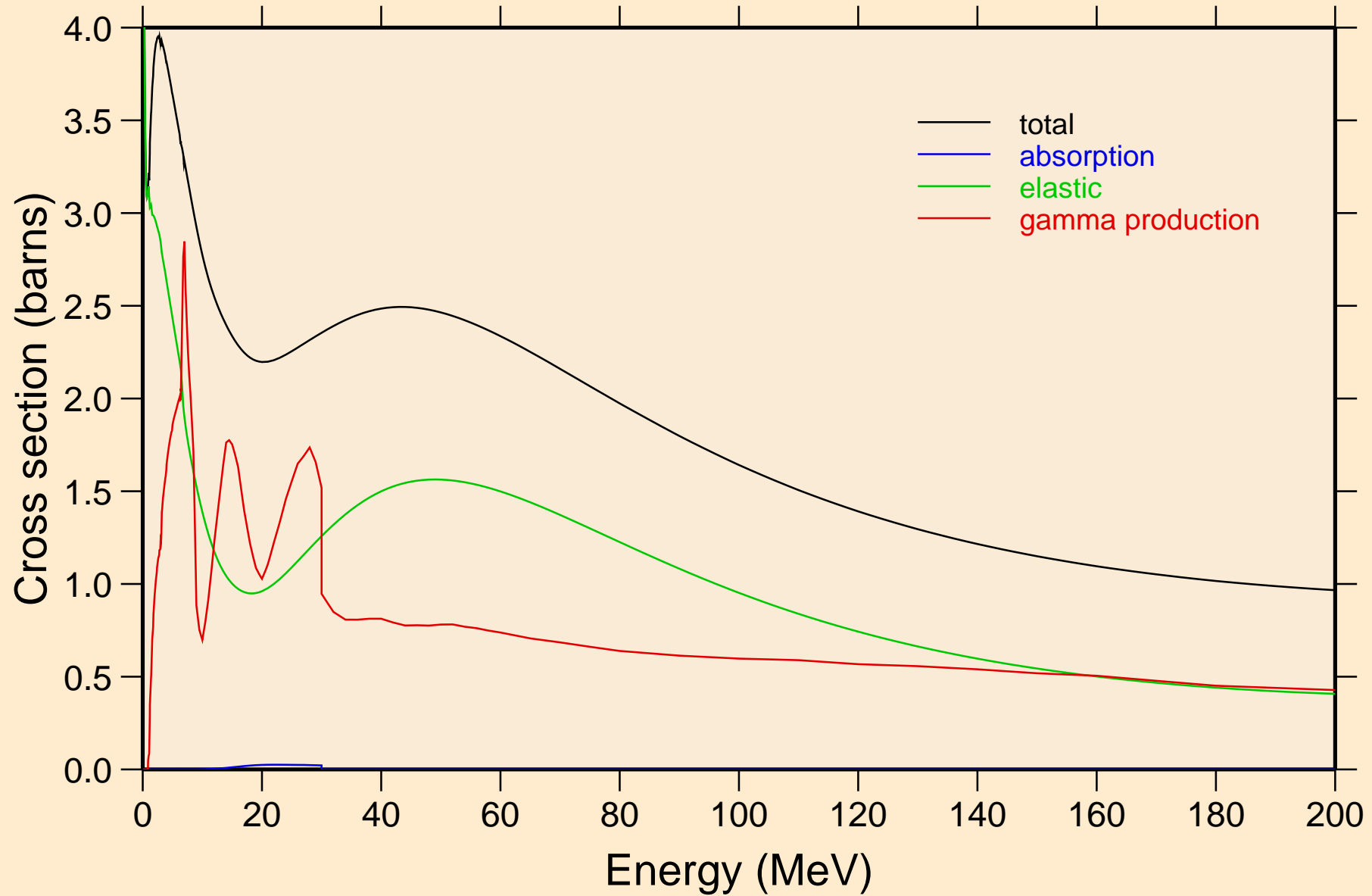

# SC051 NEUTRON ACER TENDL-2023 LIBRARY; T=0.K

## Heating

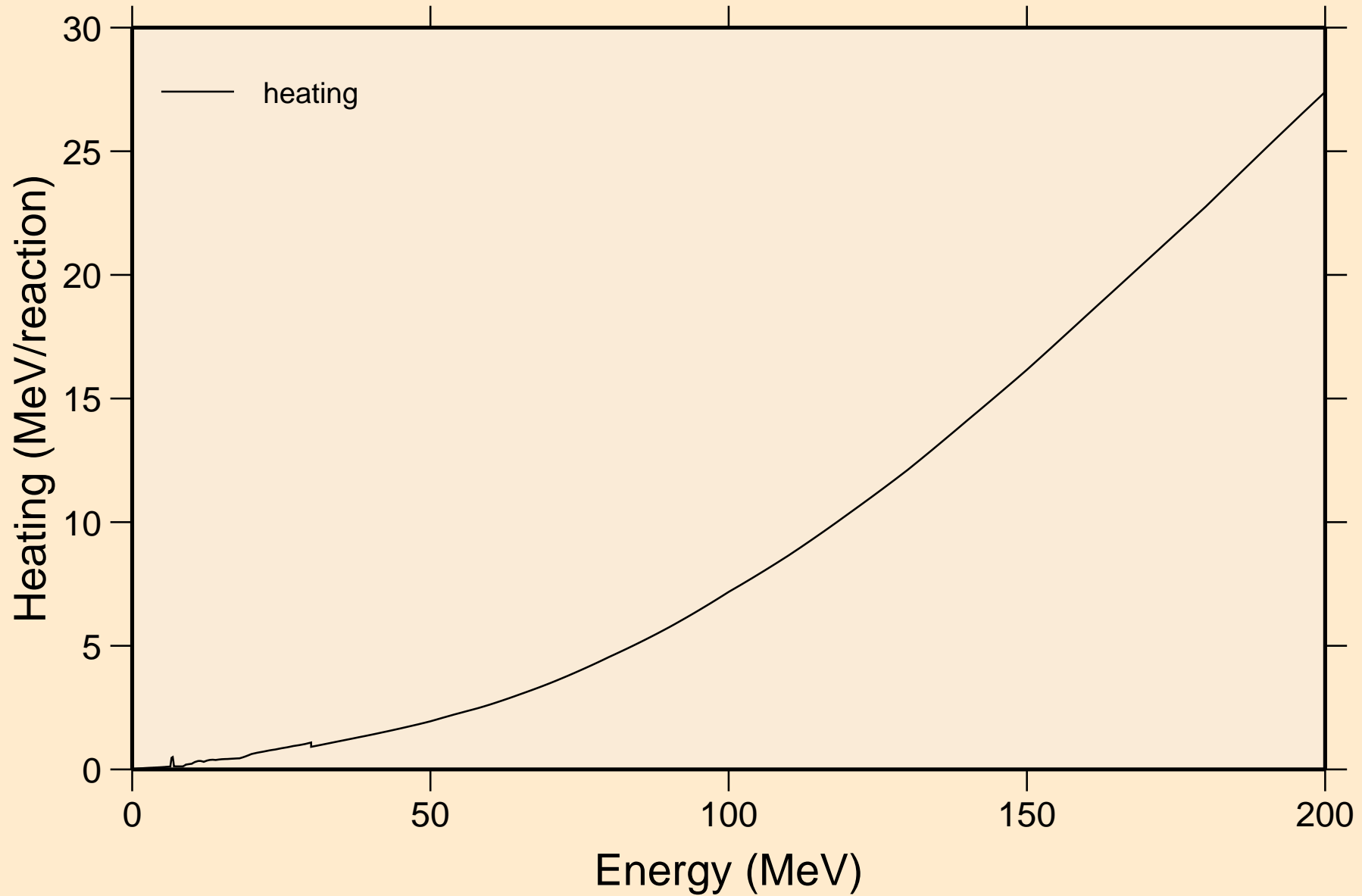

# SC051 NEUTRON ACER TENDL-2023 LIBRARY; T=0.K

## Damage

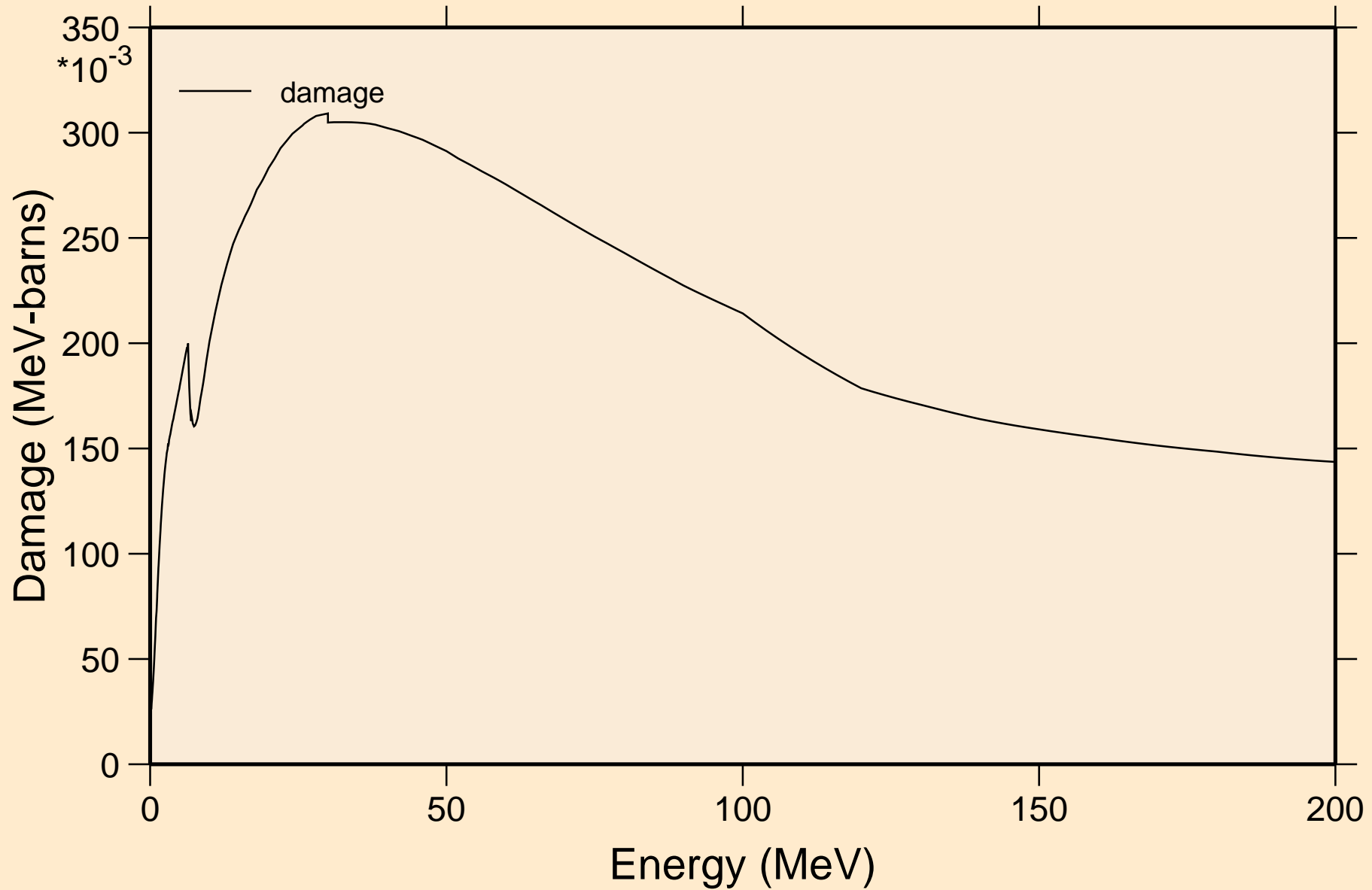

SC051 NEUTRON ACER TENDL-2023 LIBRARY; T=0.K  
Non-threshold reactions

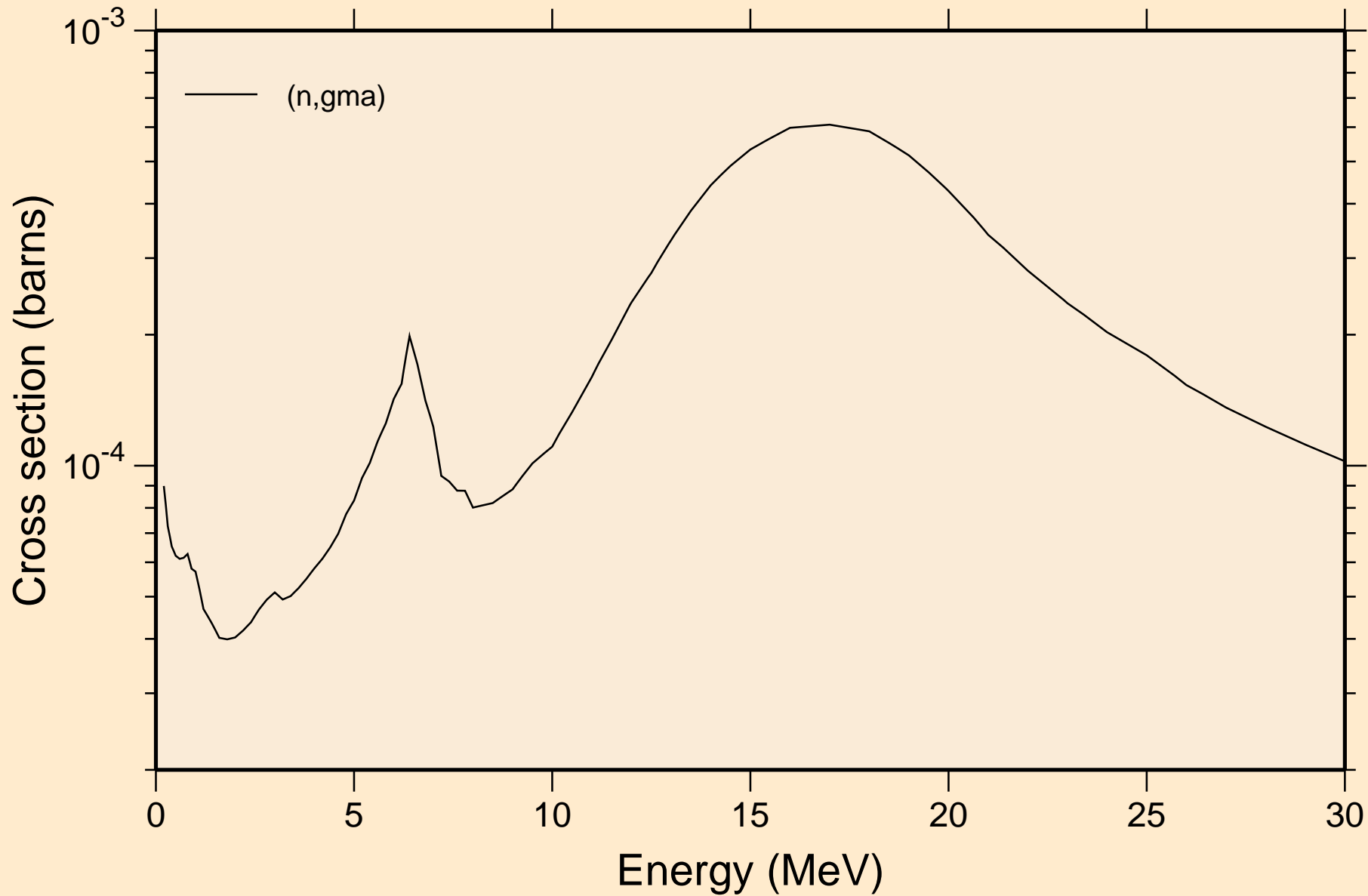



SC051 NEUTRON ACER TENDL-2023 LIBRARY; T=0.K  
Inelastic levels

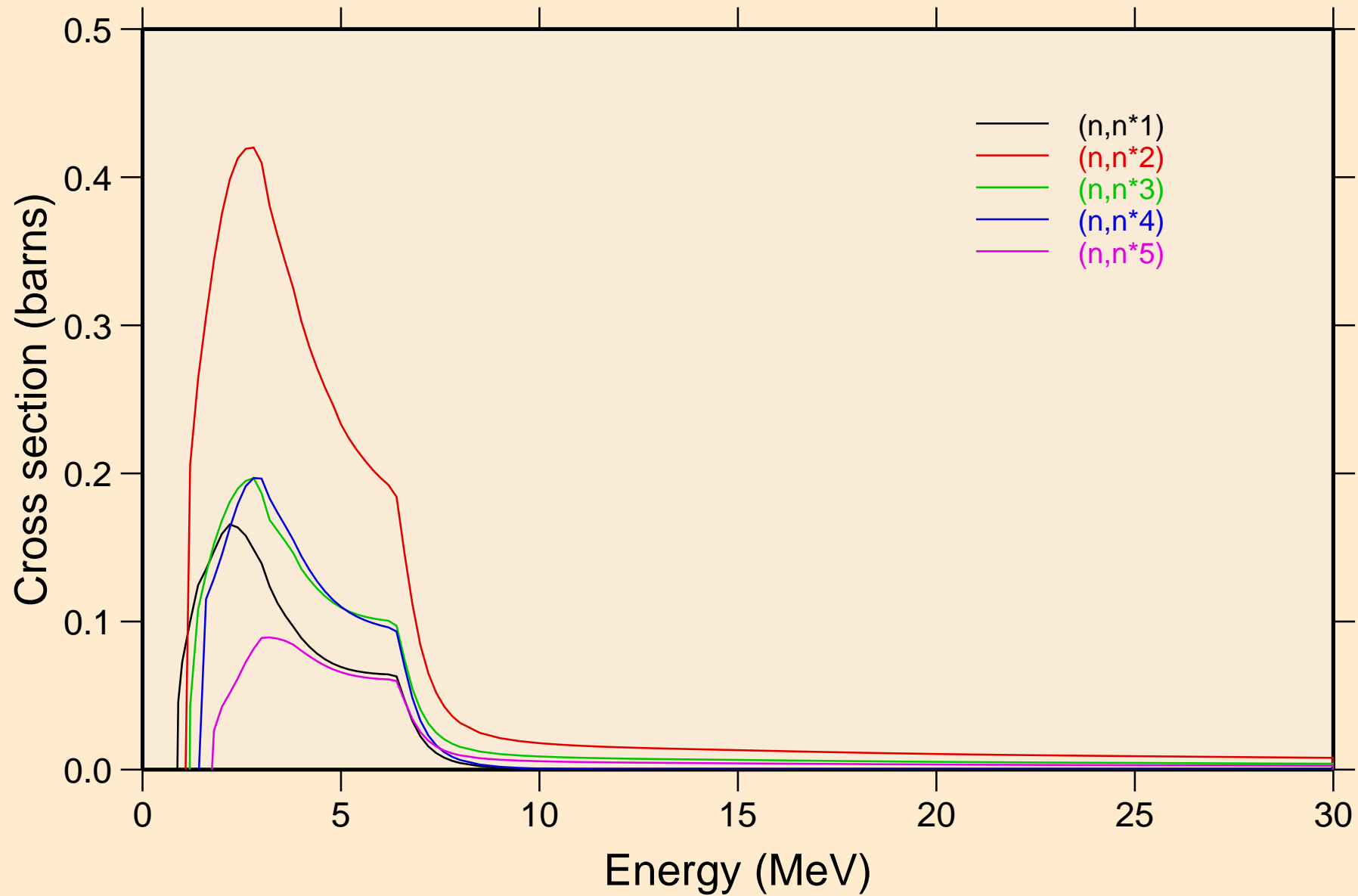

SC051 NEUTRON ACER TENDL-2023 LIBRARY; T=0.K  
Inelastic levels

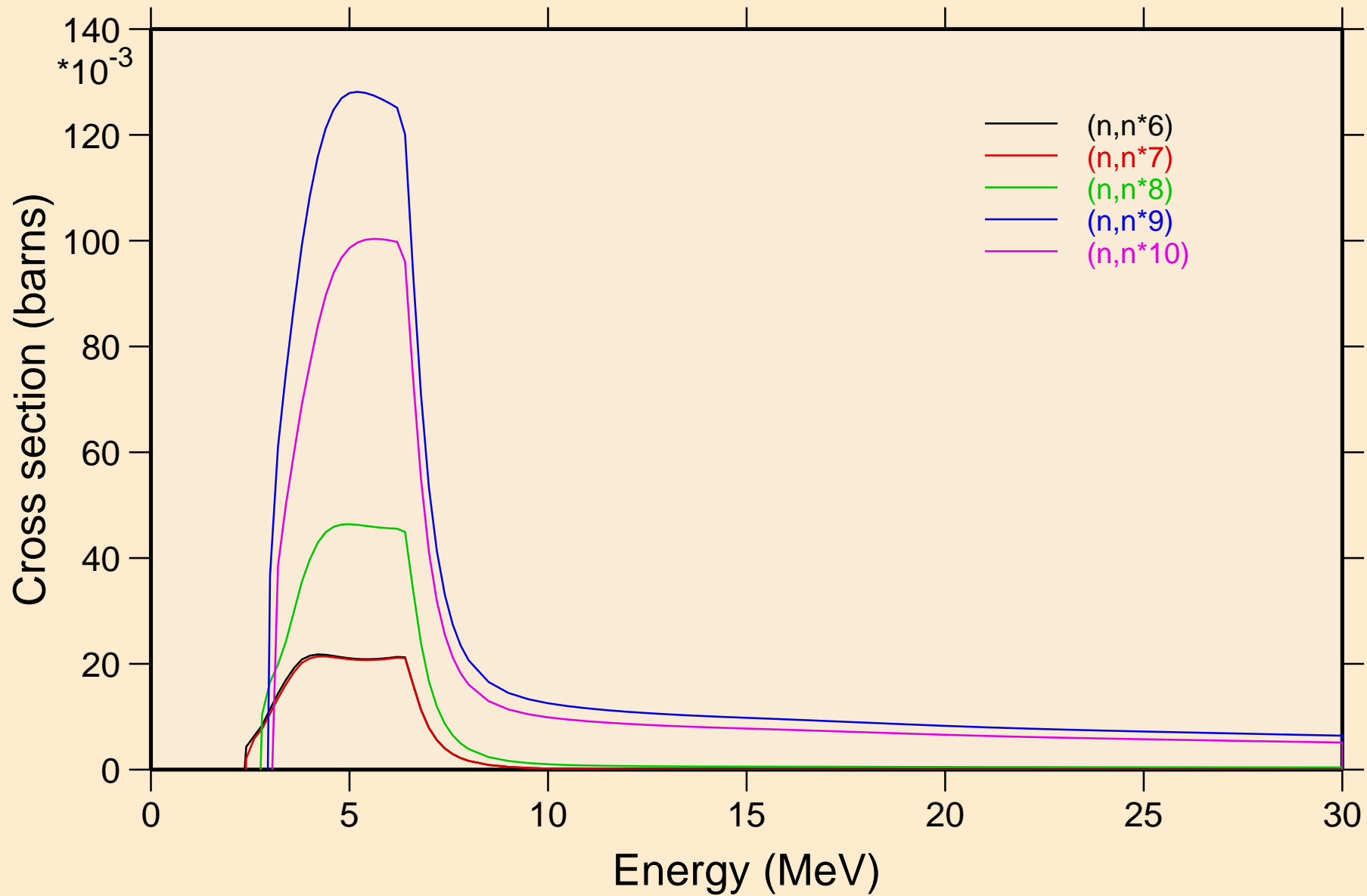

SC051 NEUTRON ACER TENDL-2023 LIBRARY; T=0.K  
Inelastic levels

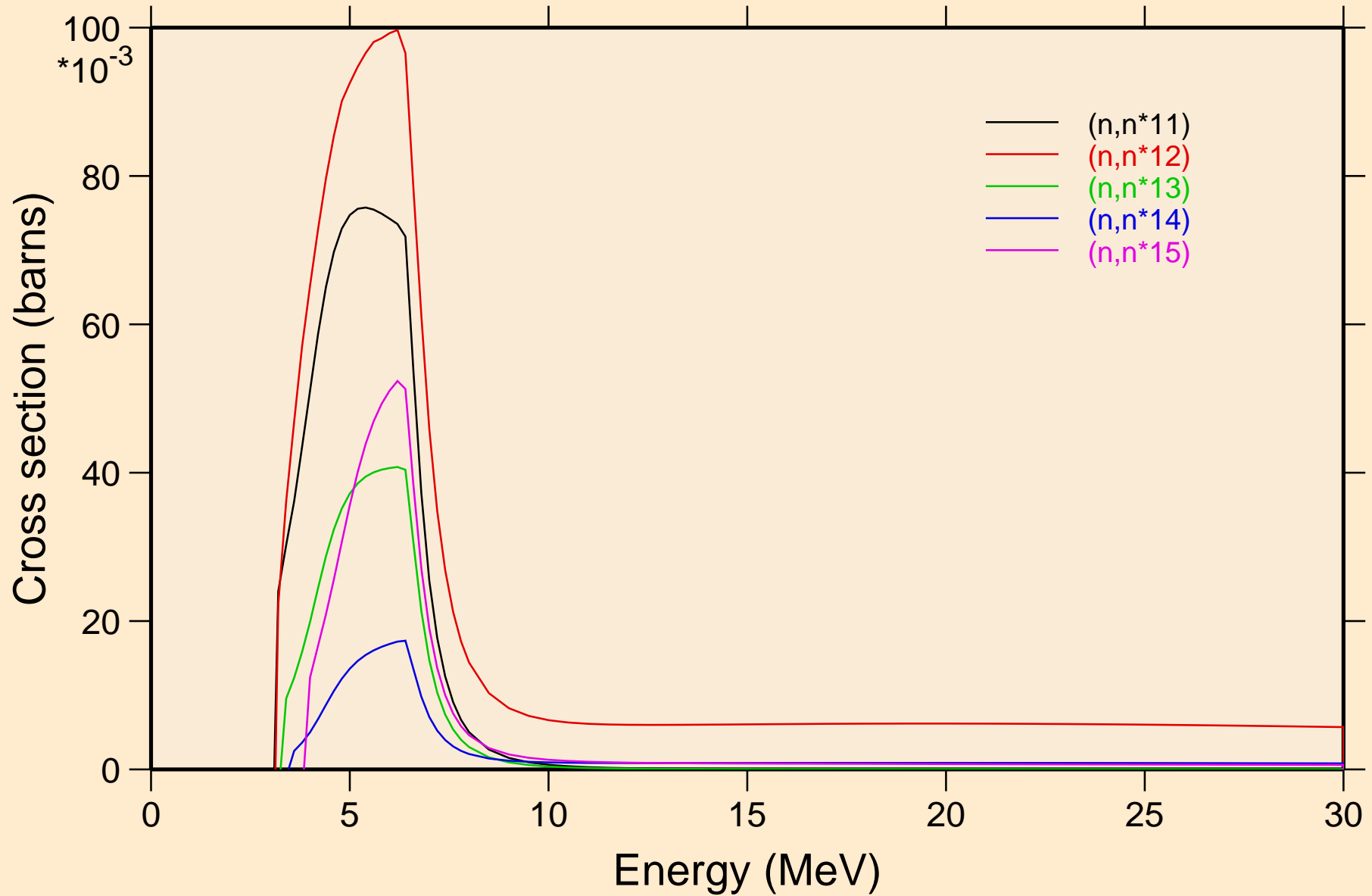

# SC051 NEUTRON ACER TENDL-2023 LIBRARY; T=0.K

## Inelastic levels

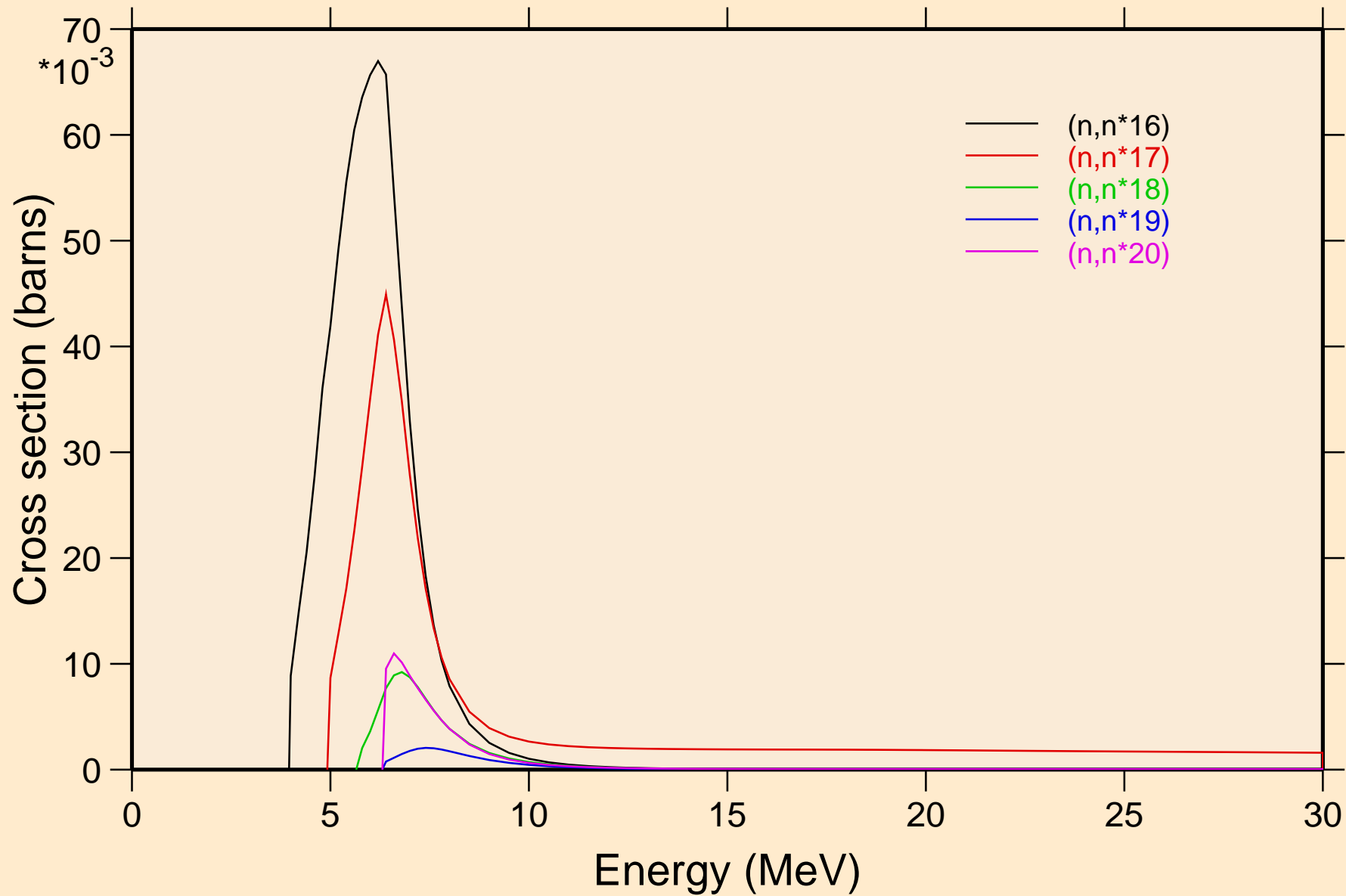

SC051 NEUTRON ACER TENDL-2023 LIBRARY; T=0.K  
Inelastic levels

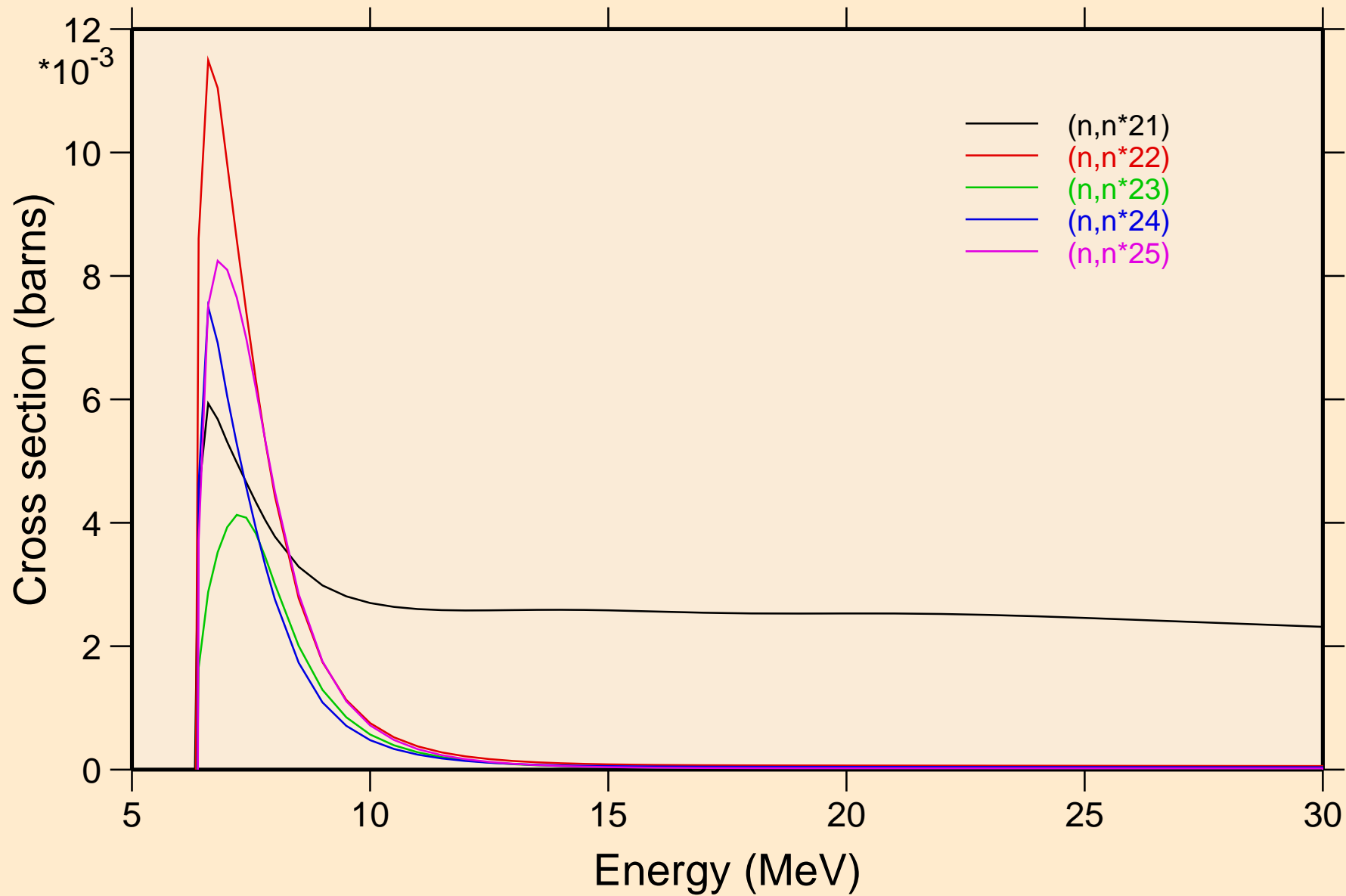

SC051 NEUTRON ACER TENDL-2023 LIBRARY; T=0.K  
Inelastic levels

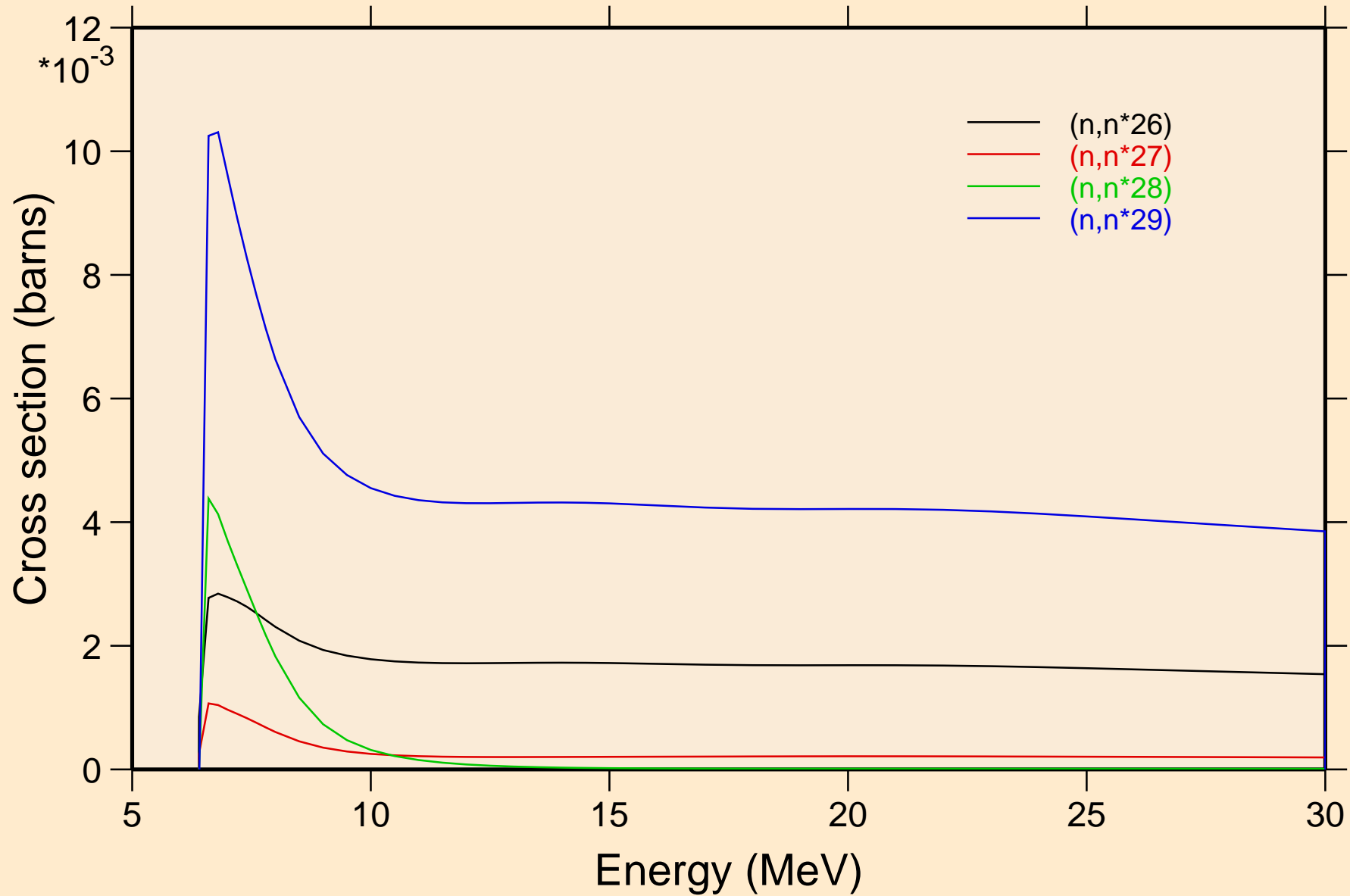

SC051 NEUTRON ACER TENDL-2023 LIBRARY; T=0.K  
Threshold reactions

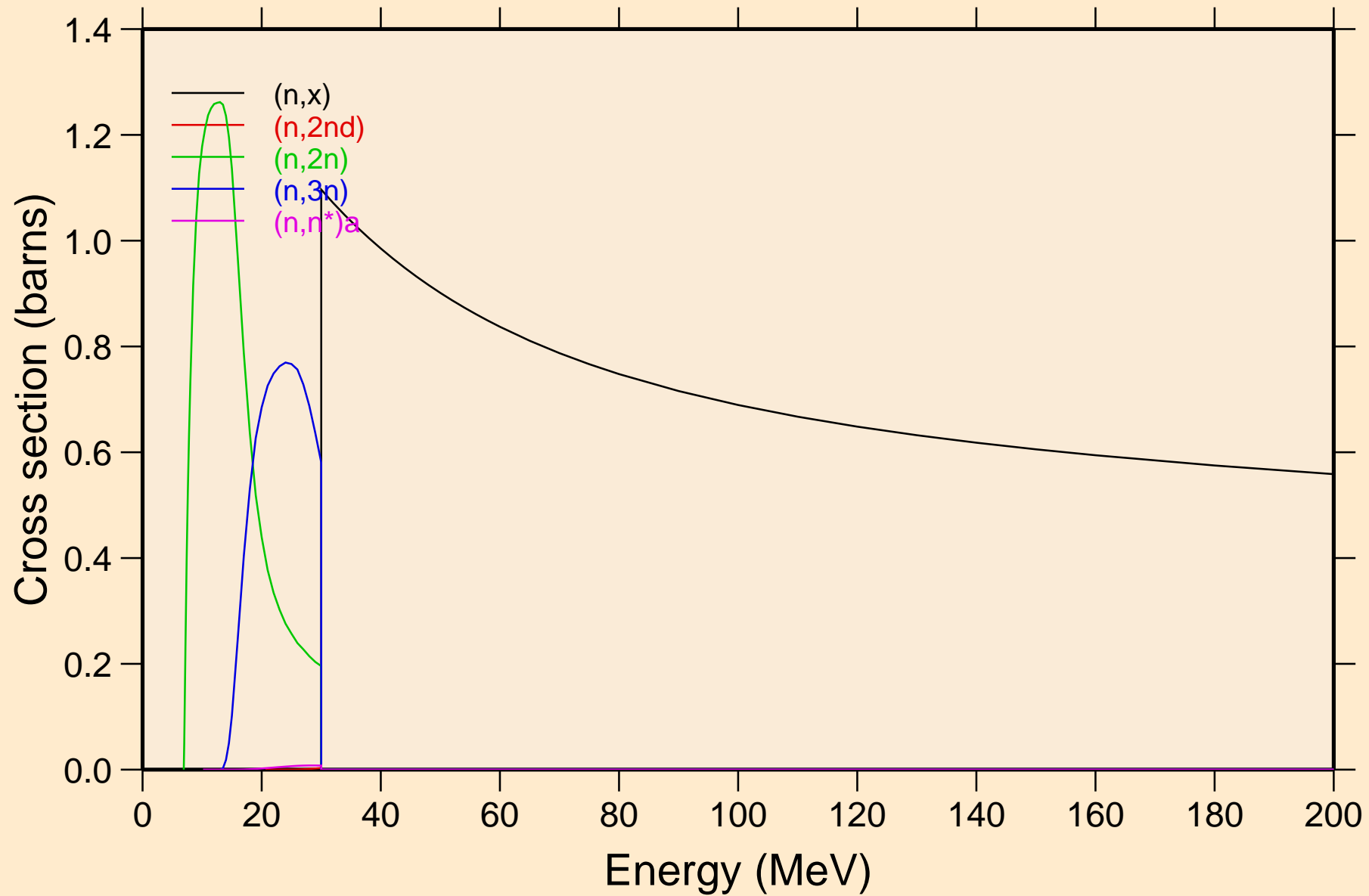

SC051 NEUTRON ACER TENDL-2023 LIBRARY; T=0.K  
Threshold reactions

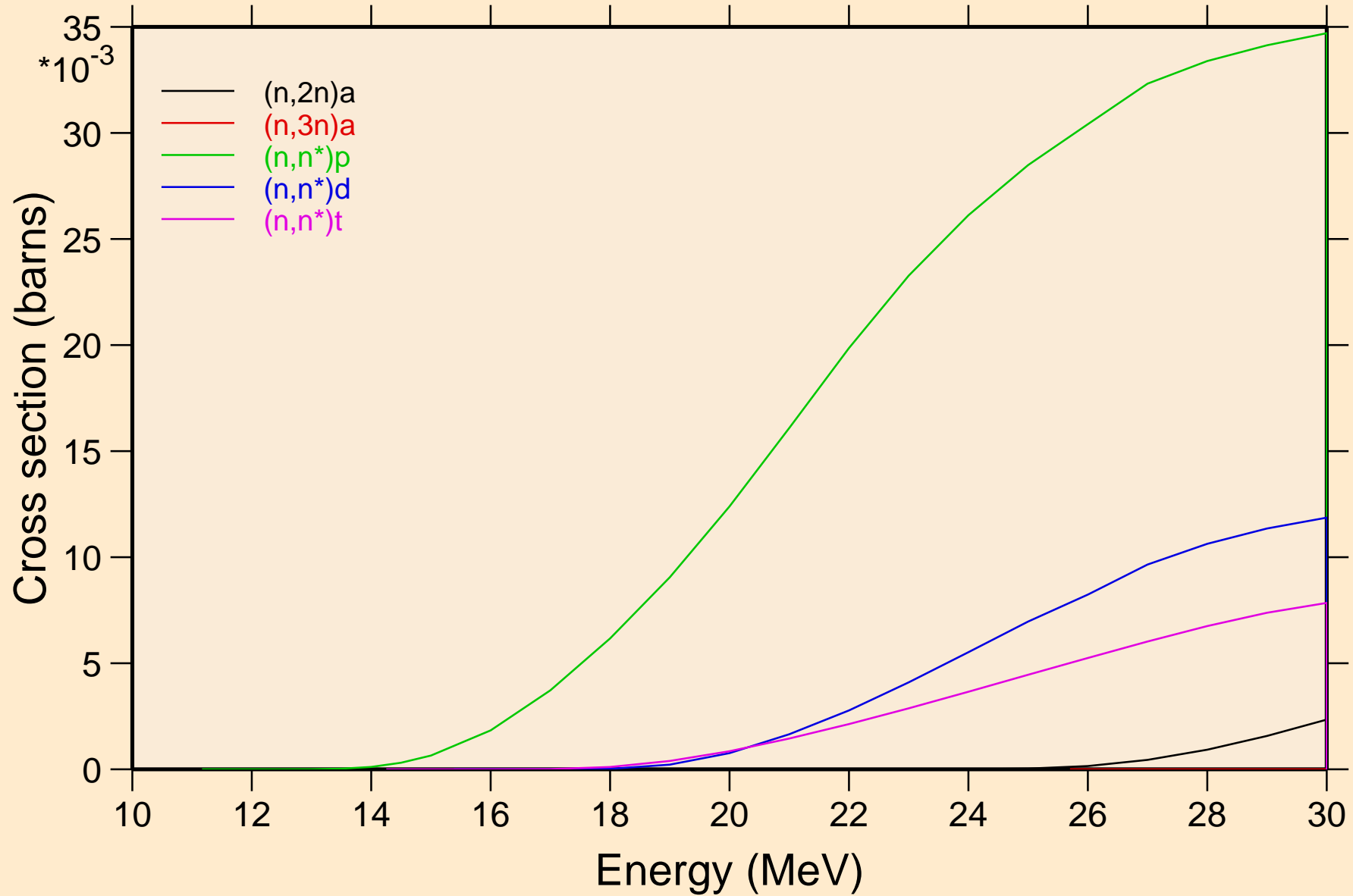



# SC051 NEUTRON ACER TENDL-2023 LIBRARY; T=0.K

## Threshold reactions

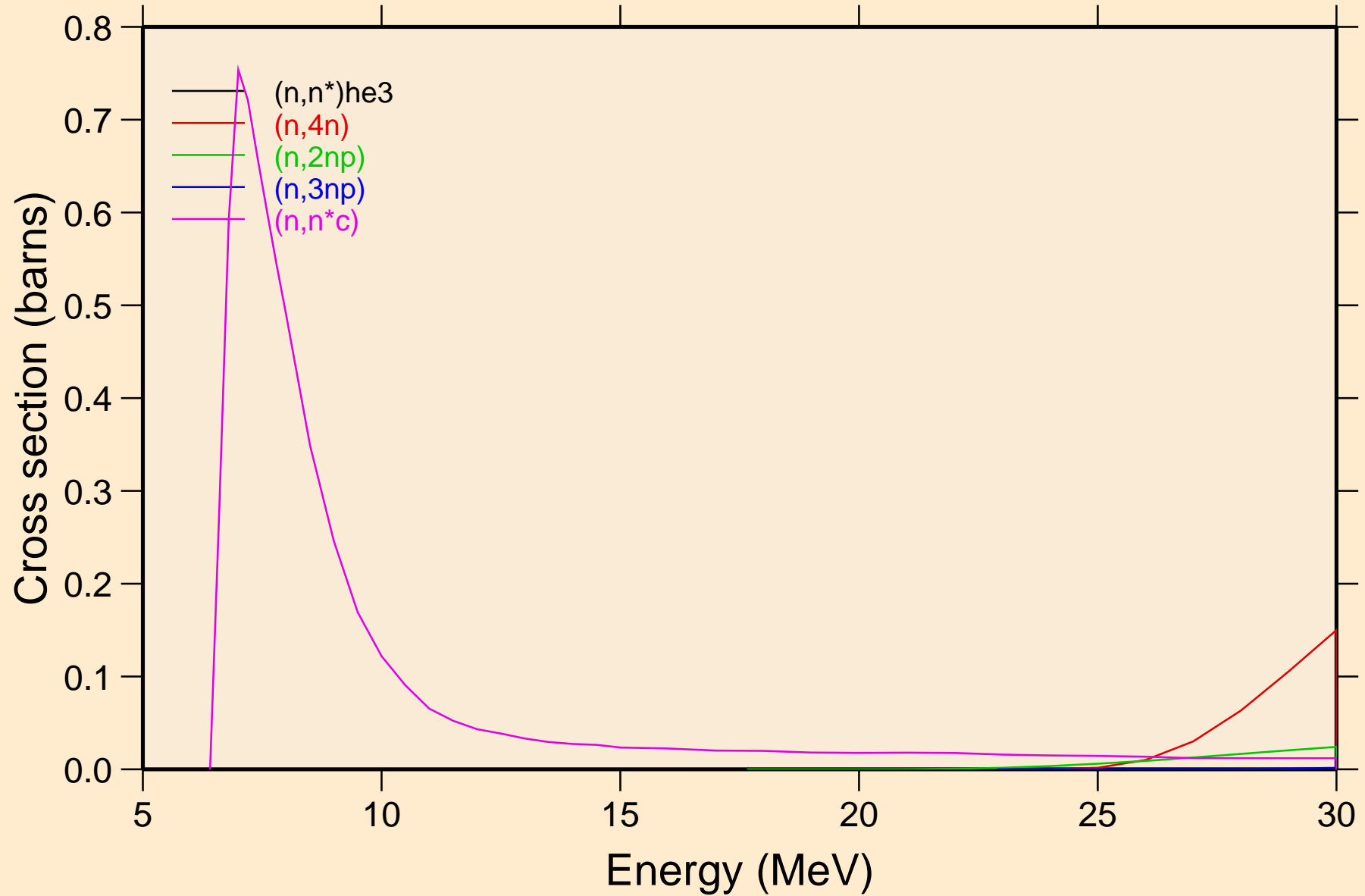

SC051 NEUTRON ACER TENDL-2023 LIBRARY; T=0.K  
Threshold reactions

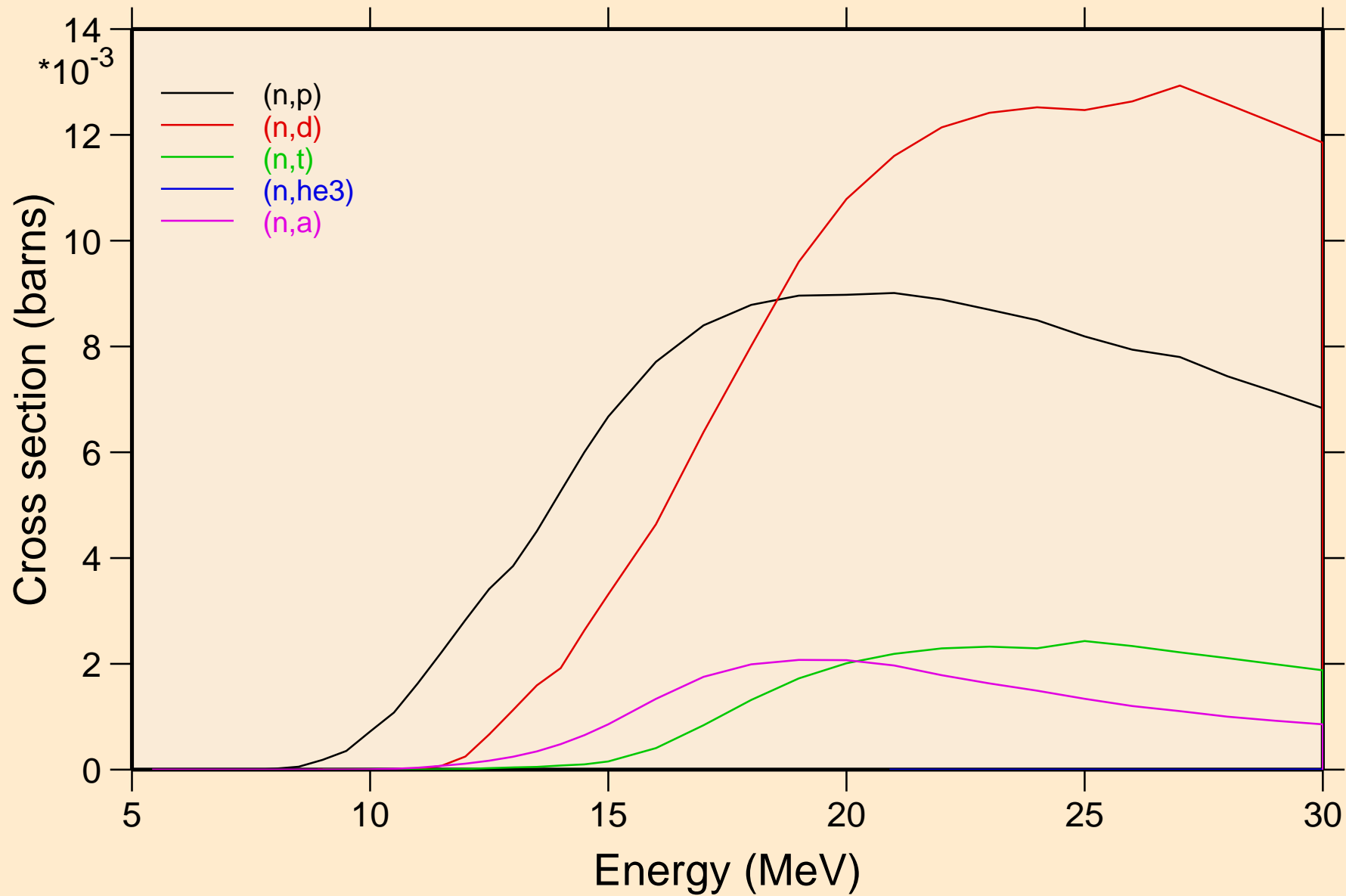

SC051 NEUTRON ACER TENDL-2023 LIBRARY; T=0.K  
Threshold reactions

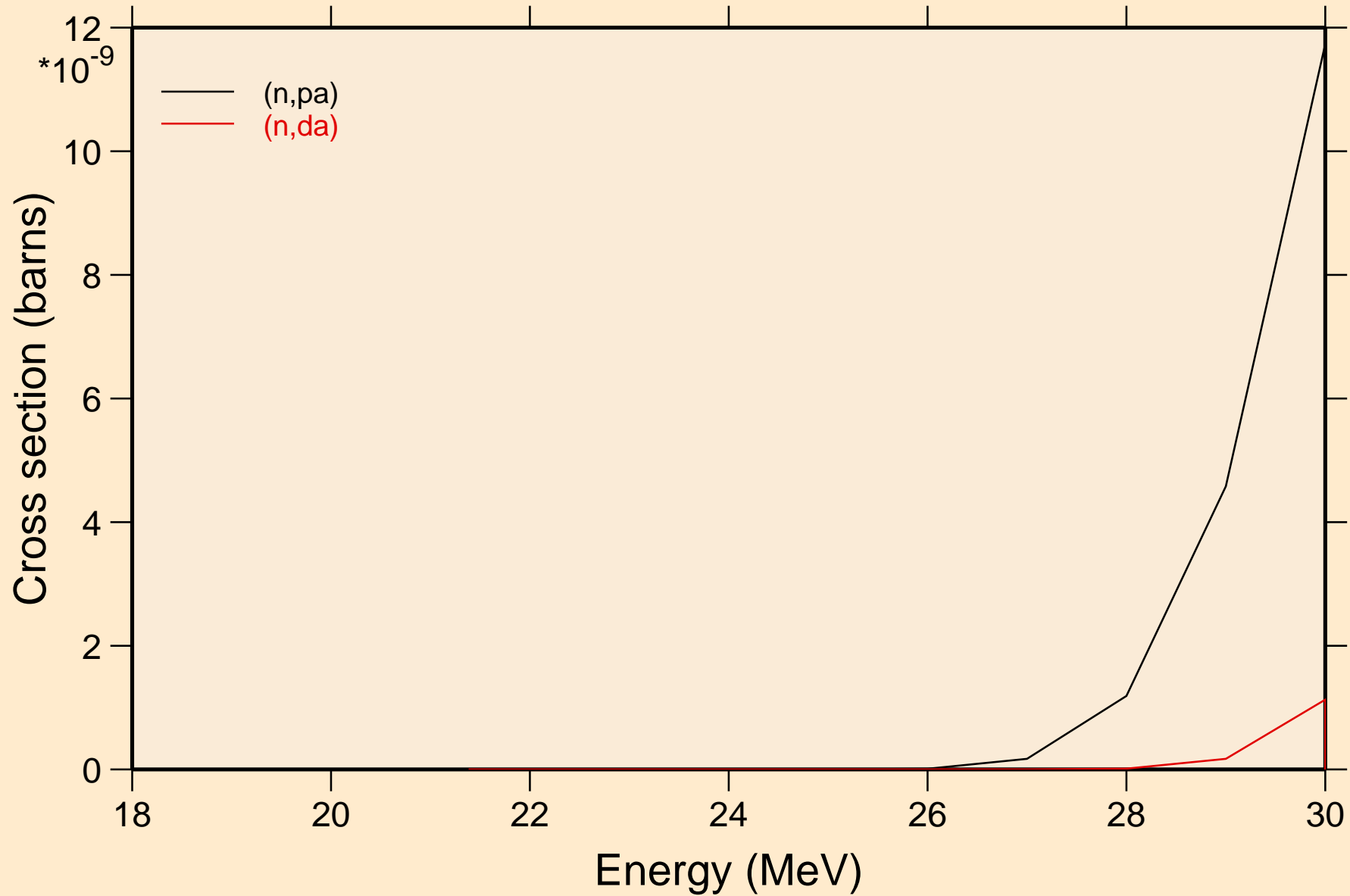

SC051 NEUTRON ACER TENDL-2023 LIBRARY; T=0.K  
Threshold reactions

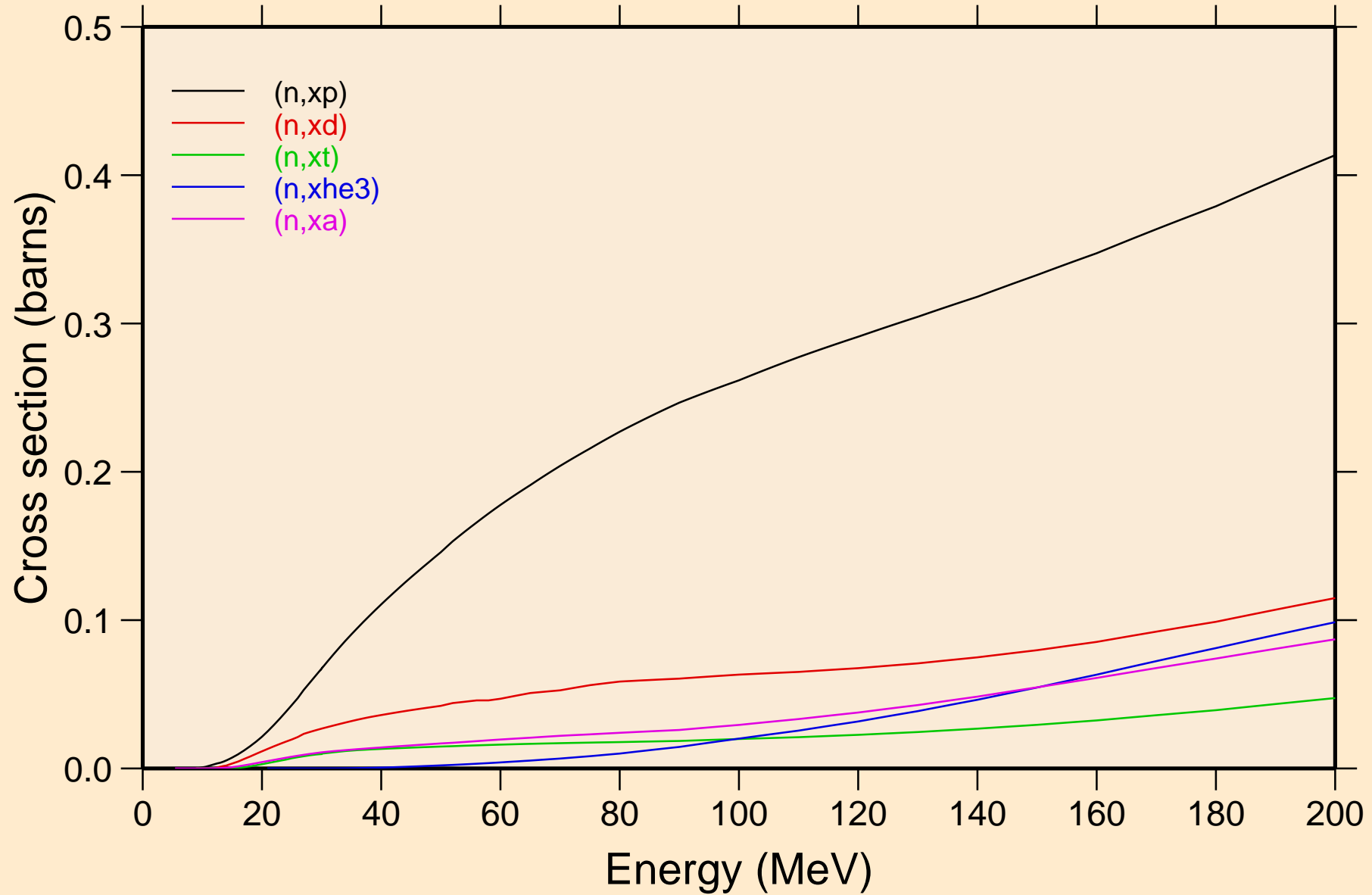

SC051 NEUTRON ACER TENDL-2023 LIBRARY; T=0.K  
angular distribution for elastic

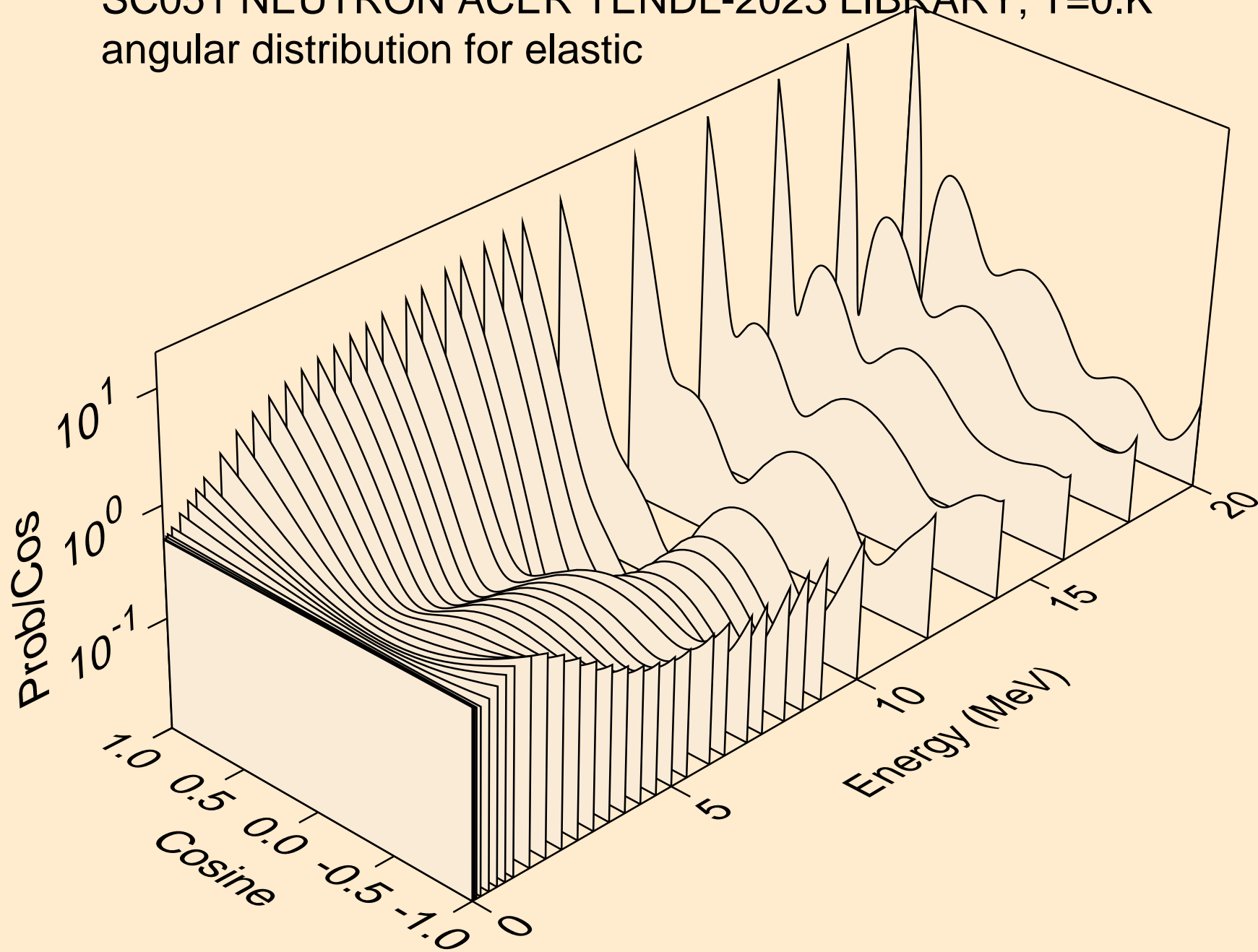

SC051 NEUTRON ACER TENDL-2023 LIBRARY; T=0.K  
angular distribution for elastic

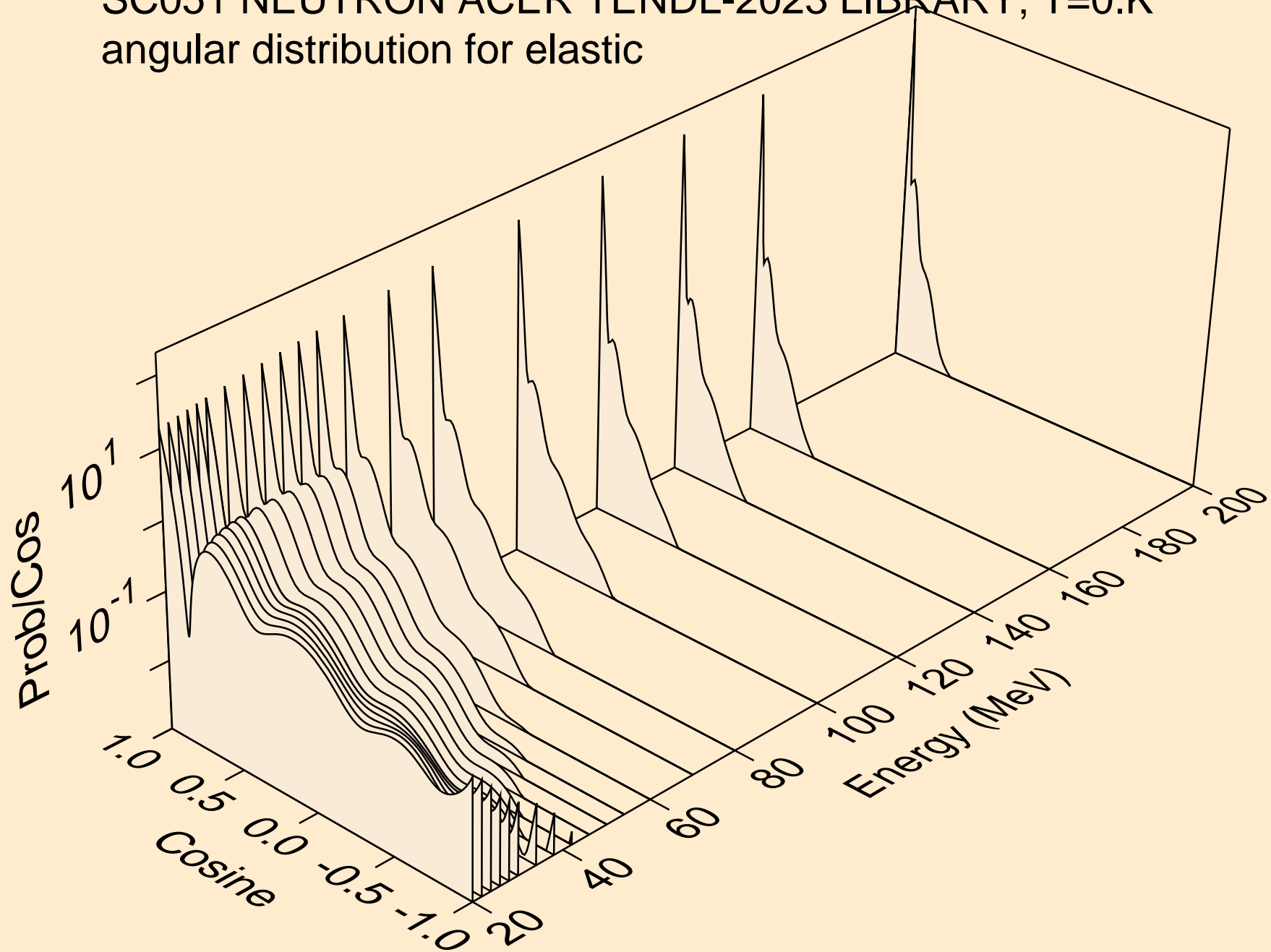

SC051 NEUTRON ACER TENDL-2023 LIBRARY; T=0.K  
angular distribution for (n,n\*1)

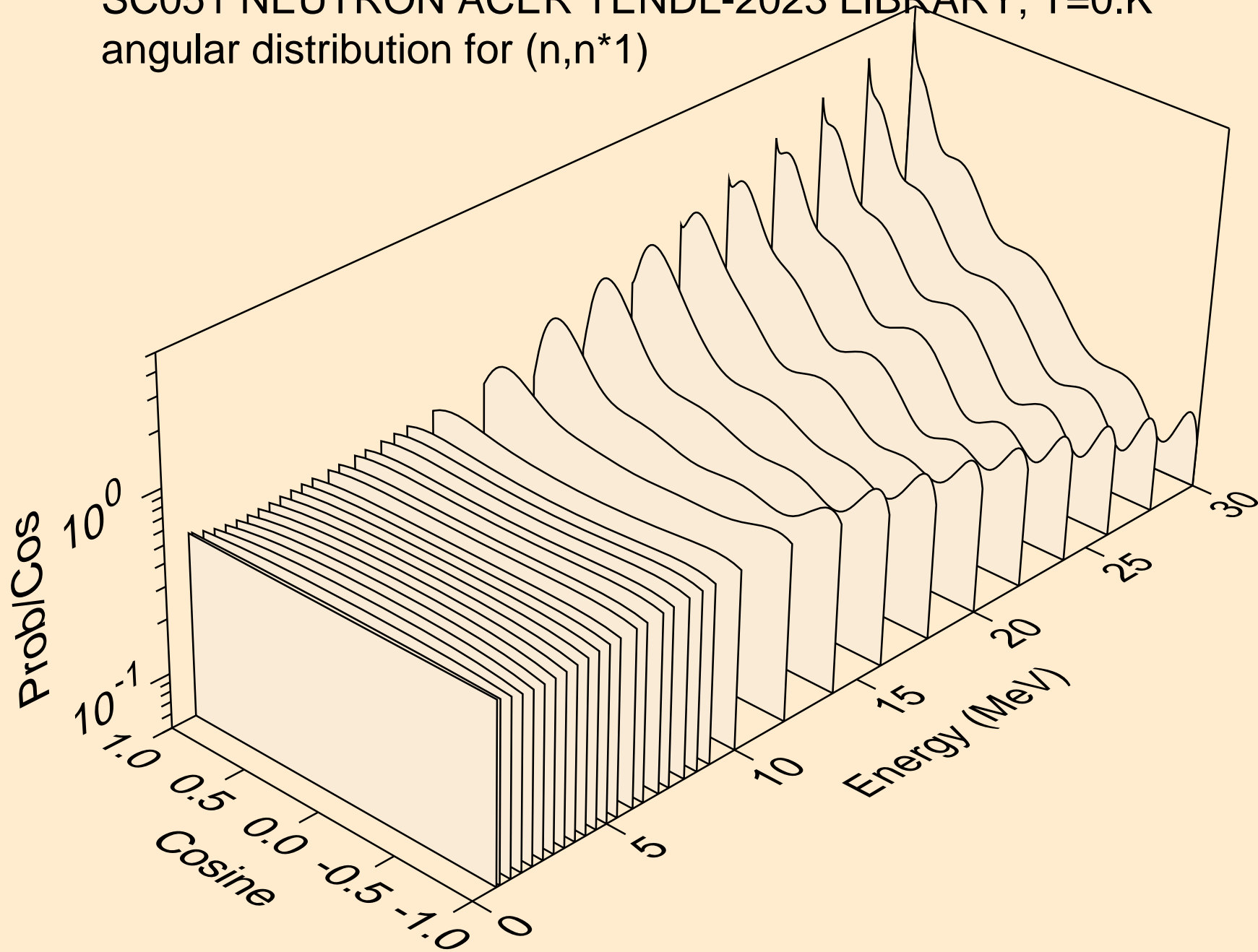

SC051 NEUTRON ACER TENDL-2023 LIBRARY; T=0.K  
angular distribution for (n,n\*2)

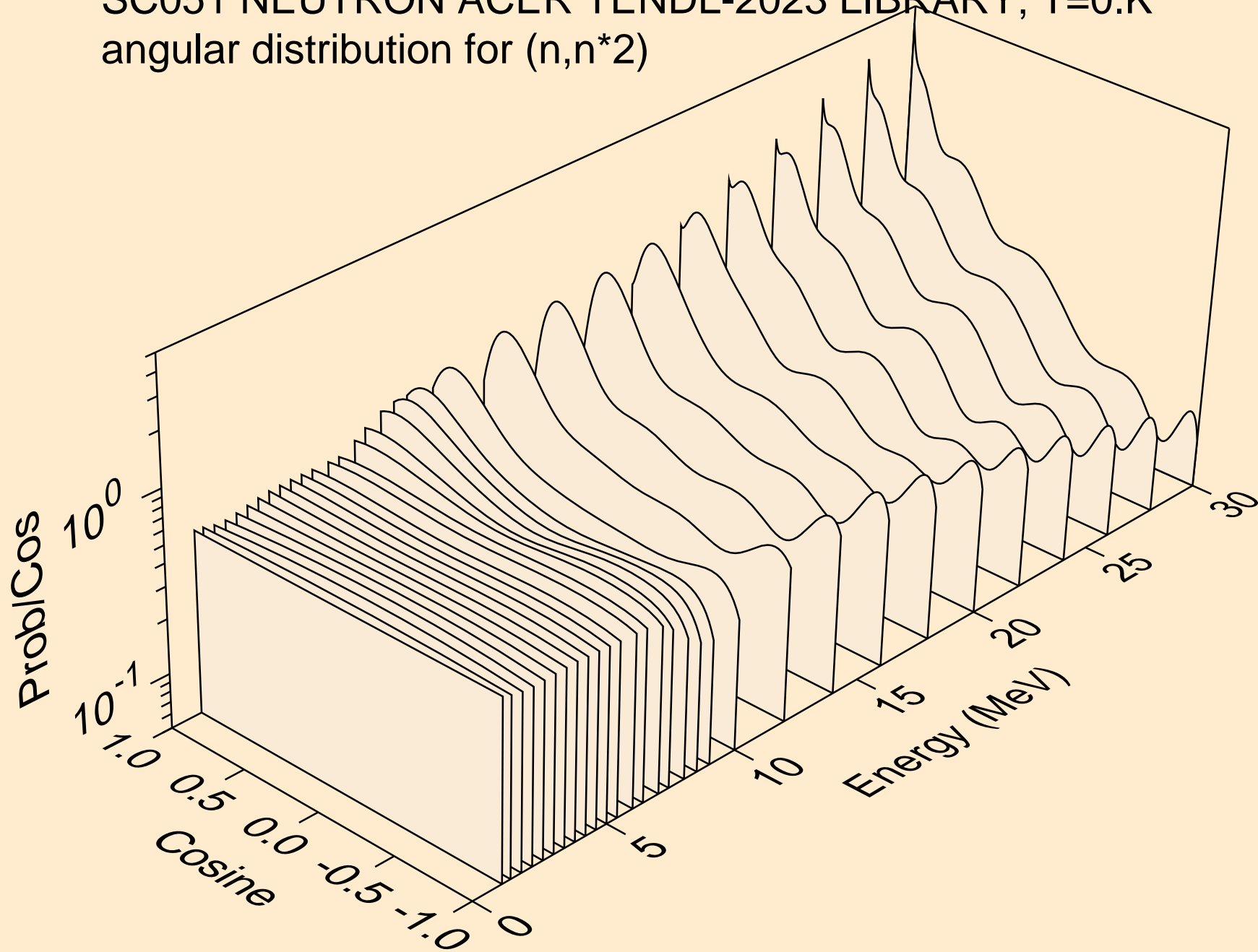



SC051 NEUTRON ACER TENDL-2023 LIBRARY; T=0.K  
angular distribution for (n,n\*3)

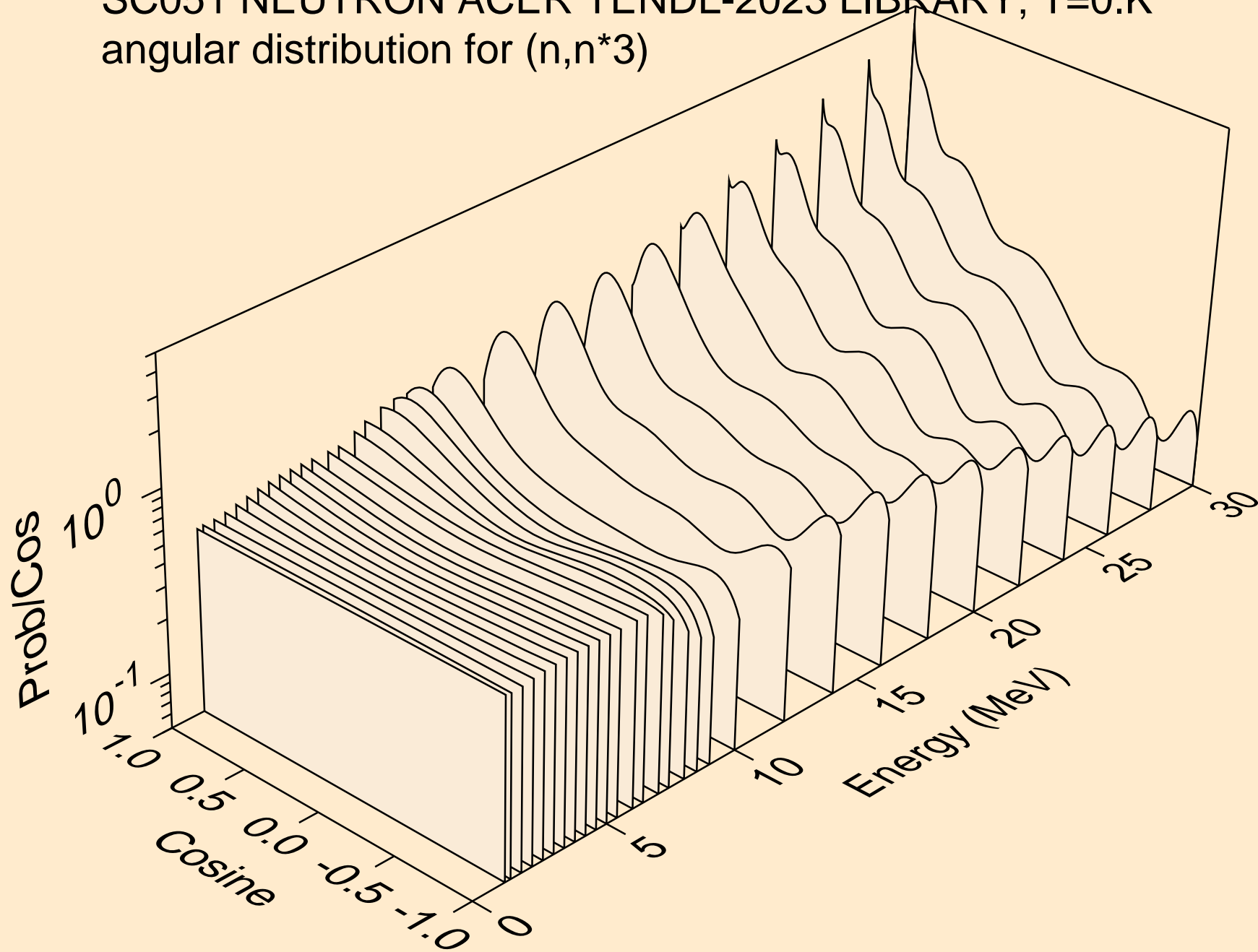

SC051 NEUTRON ACER TENDL-2023 LIBRARY; T=0.K  
angular distribution for (n,n\*4)

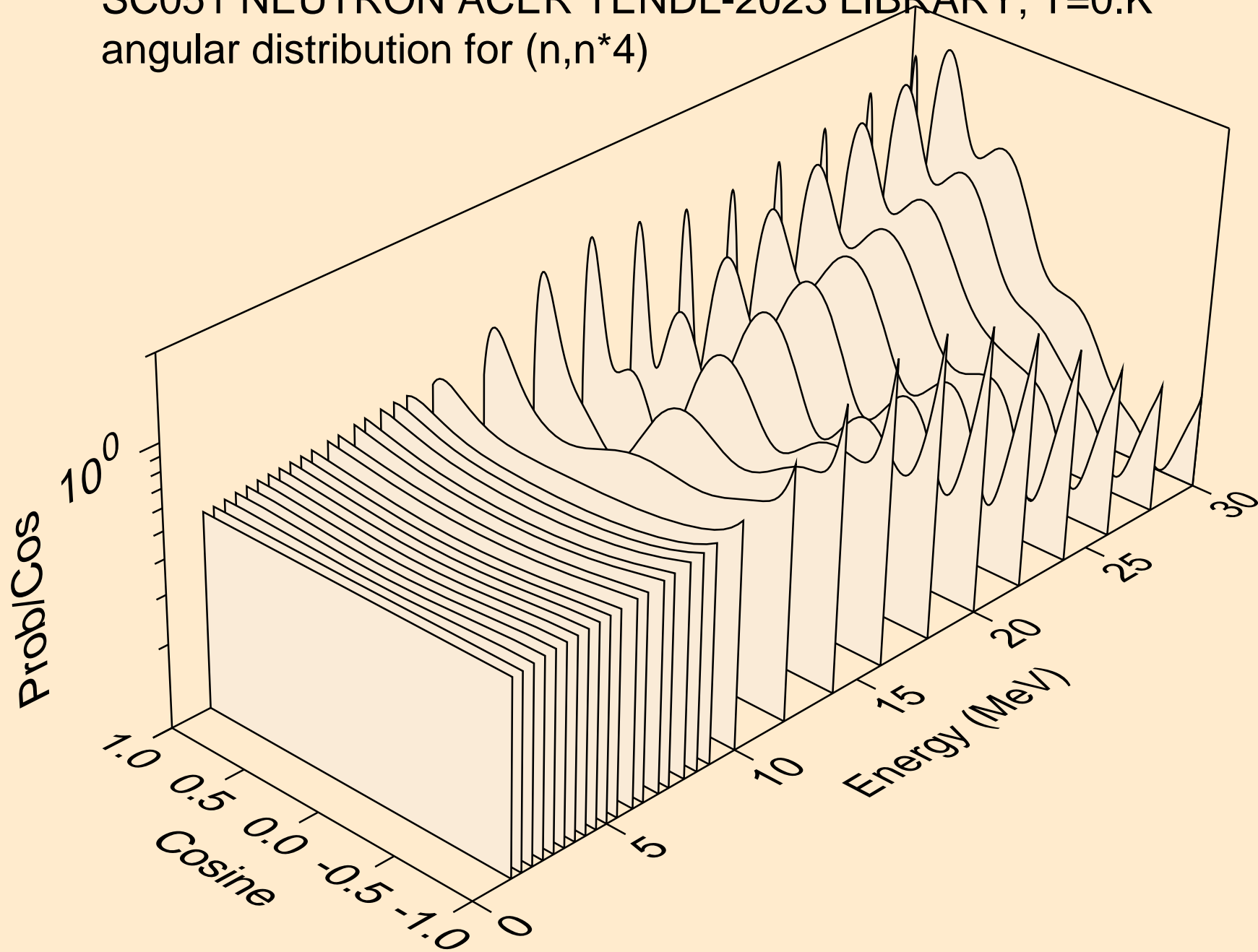

SC051 NEUTRON ACER TENDL-2023 LIBRARY; T=0.K  
angular distribution for (n,n\*5)

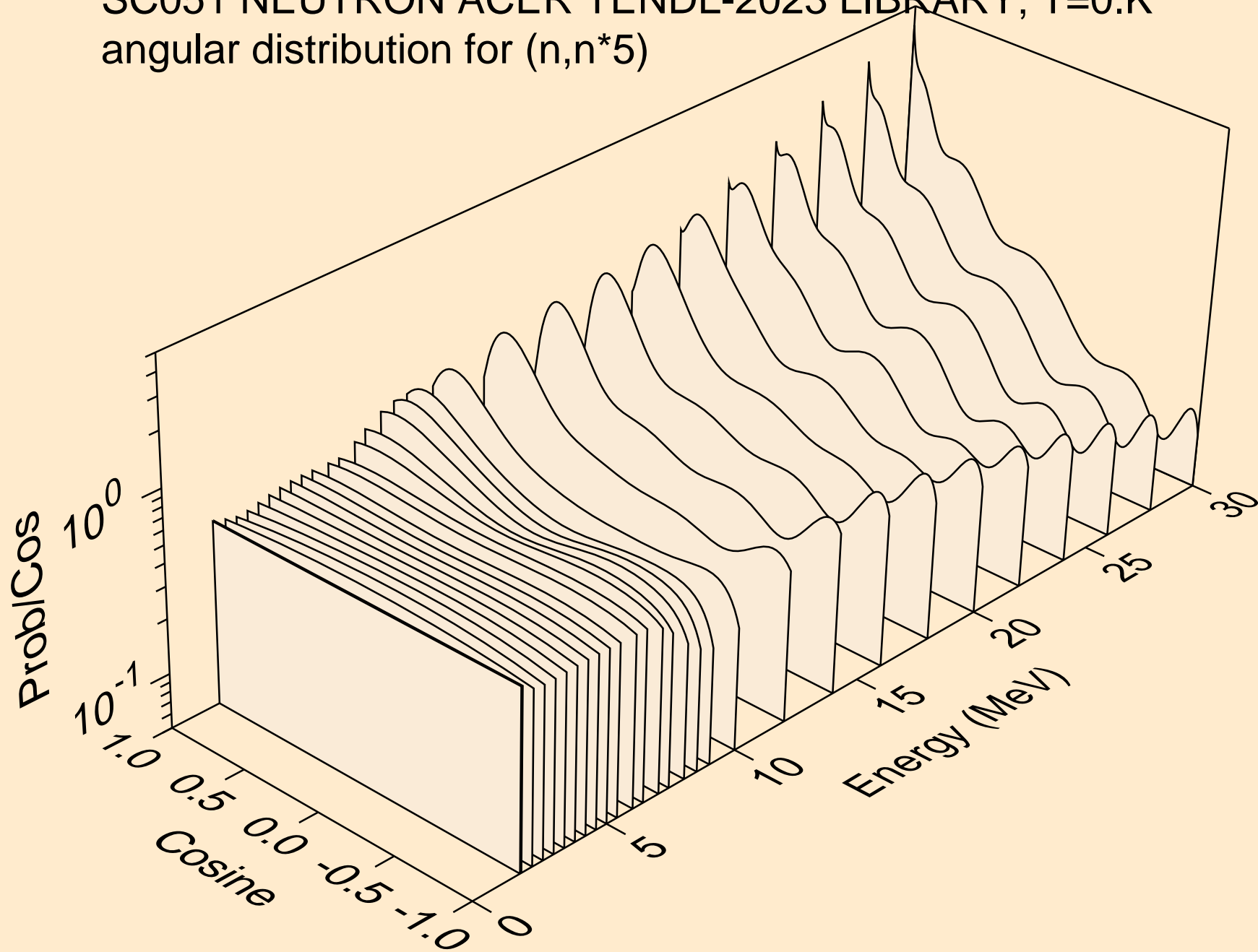

SC051 NEUTRON ACER TENDL-2023 LIBRARY; T=0.K  
angular distribution for (n,n\*6)

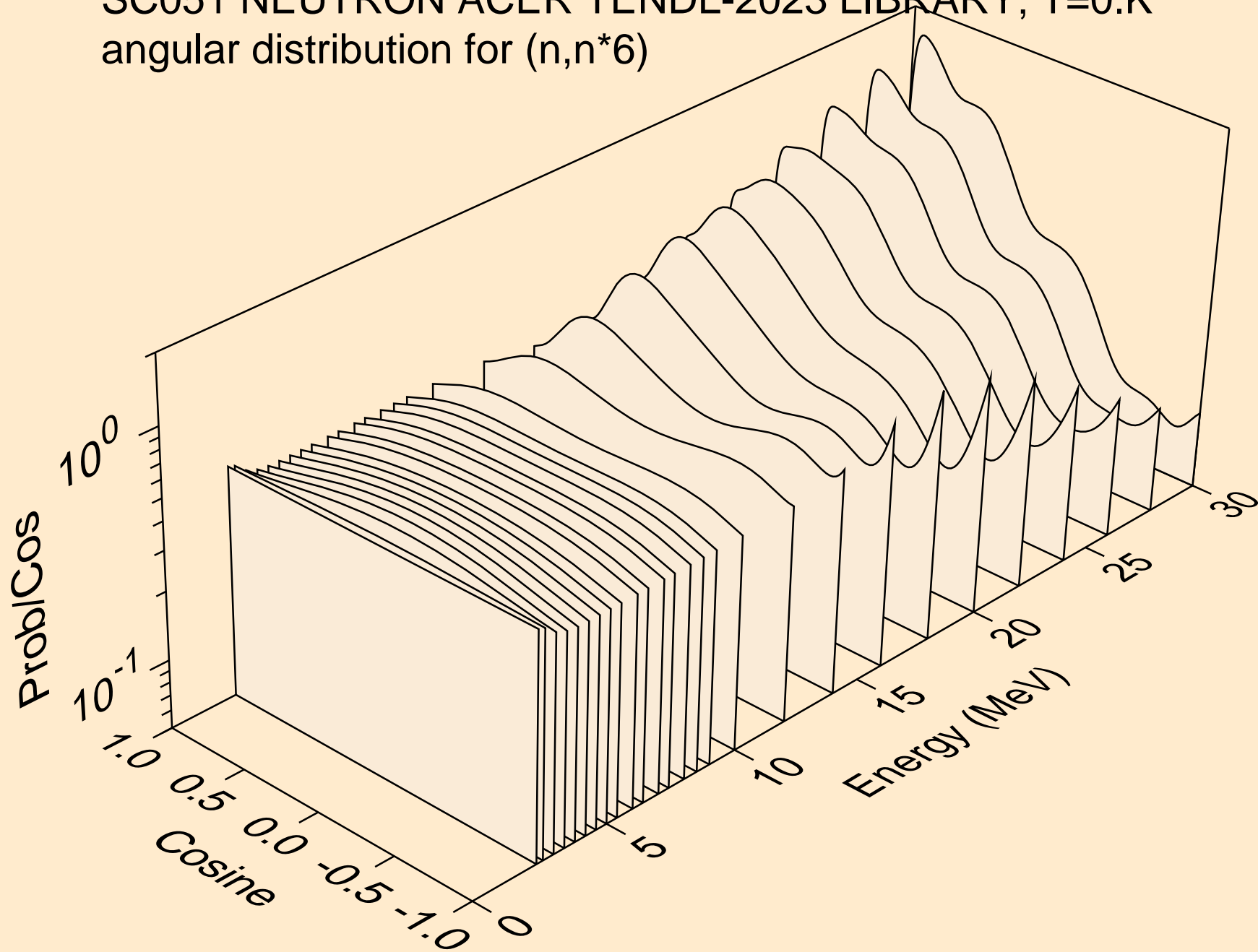

SC051 NEUTRON ACER TENDL-2023 LIBRARY; T=0.K  
angular distribution for (n,n\*7)

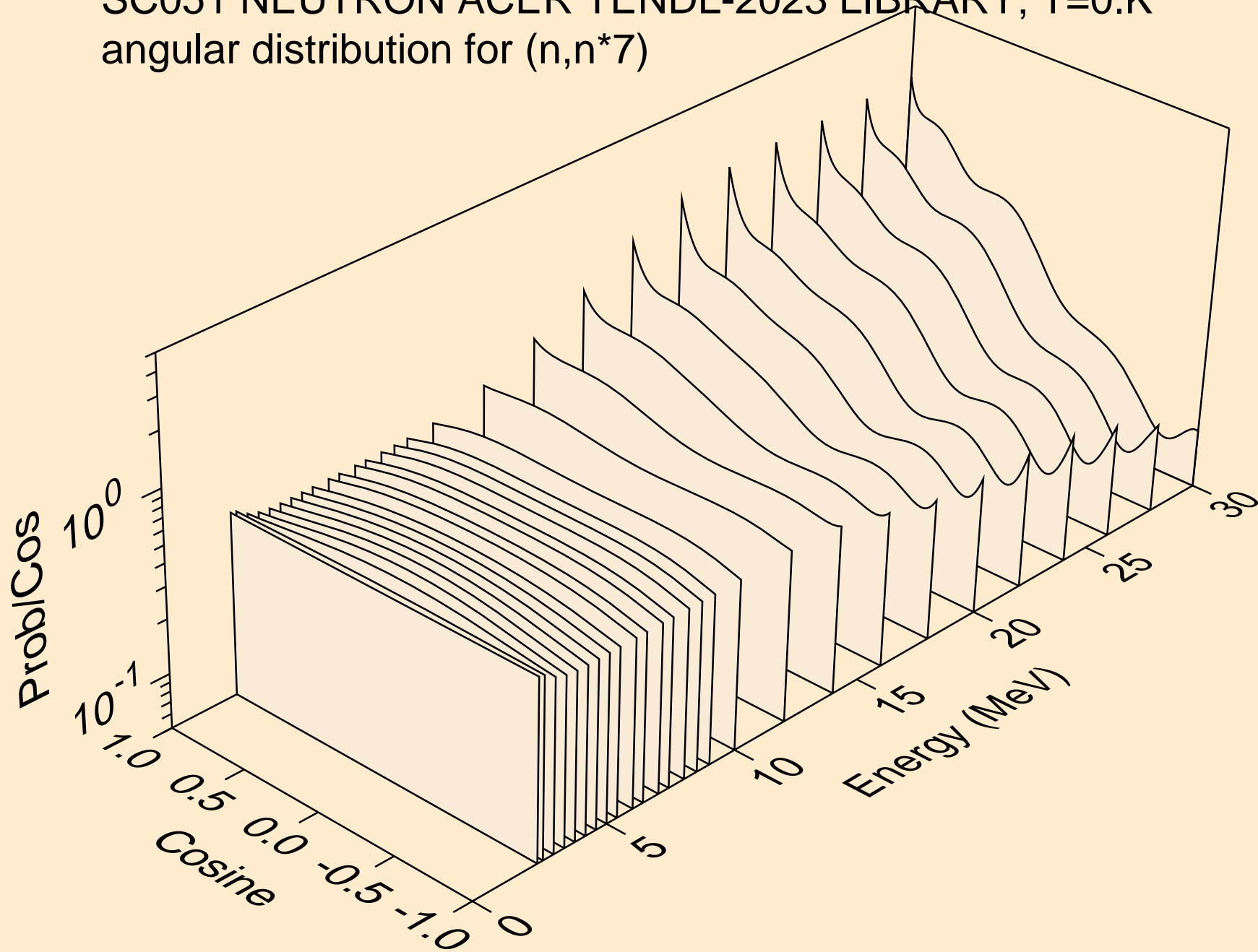

SC051 NEUTRON ACER TENDL-2023 LIBRARY; T=0.K  
angular distribution for (n,n\*8)

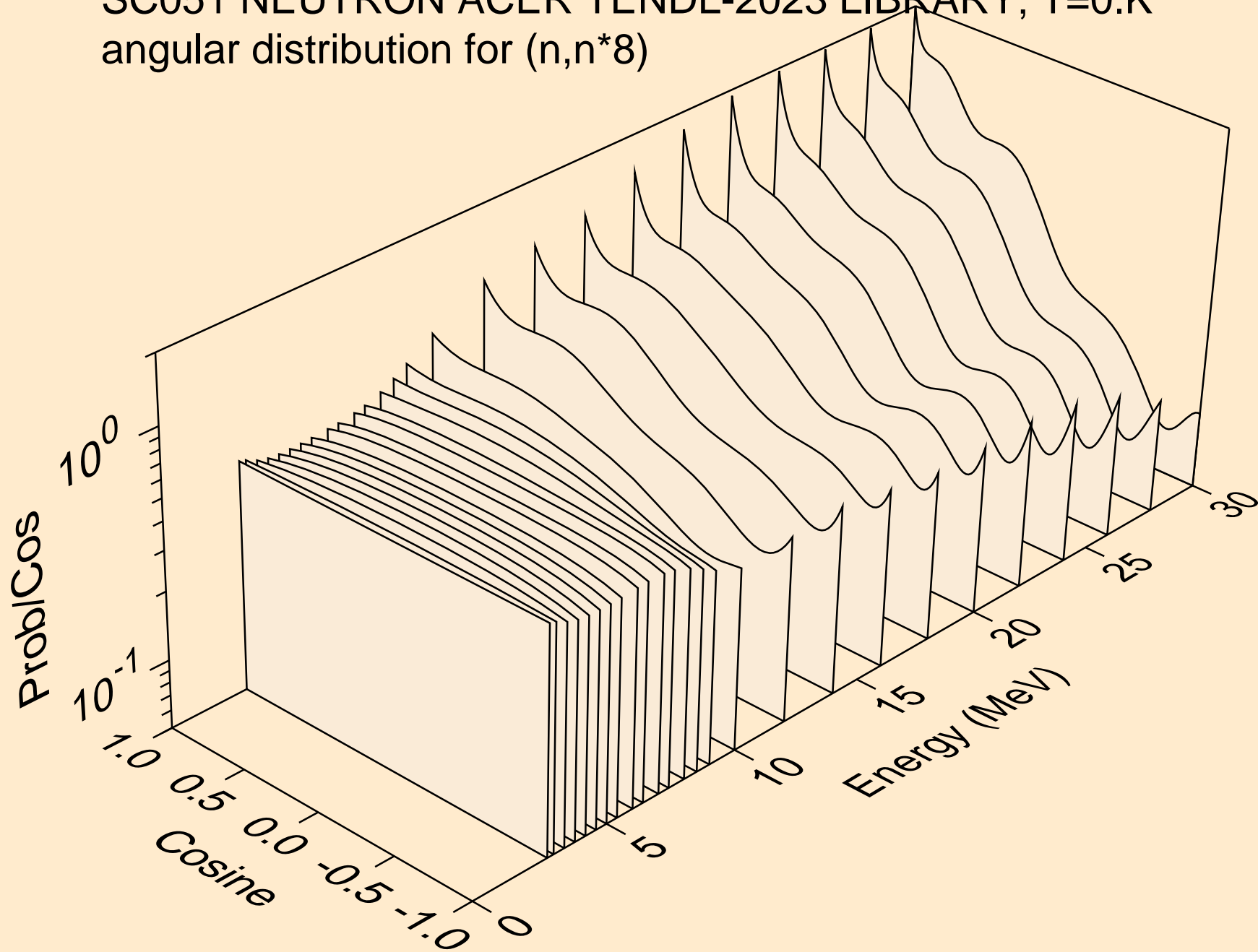

SC051 NEUTRON ACER TENDL-2023 LIBRARY; T=0.K  
angular distribution for (n,n\*9)

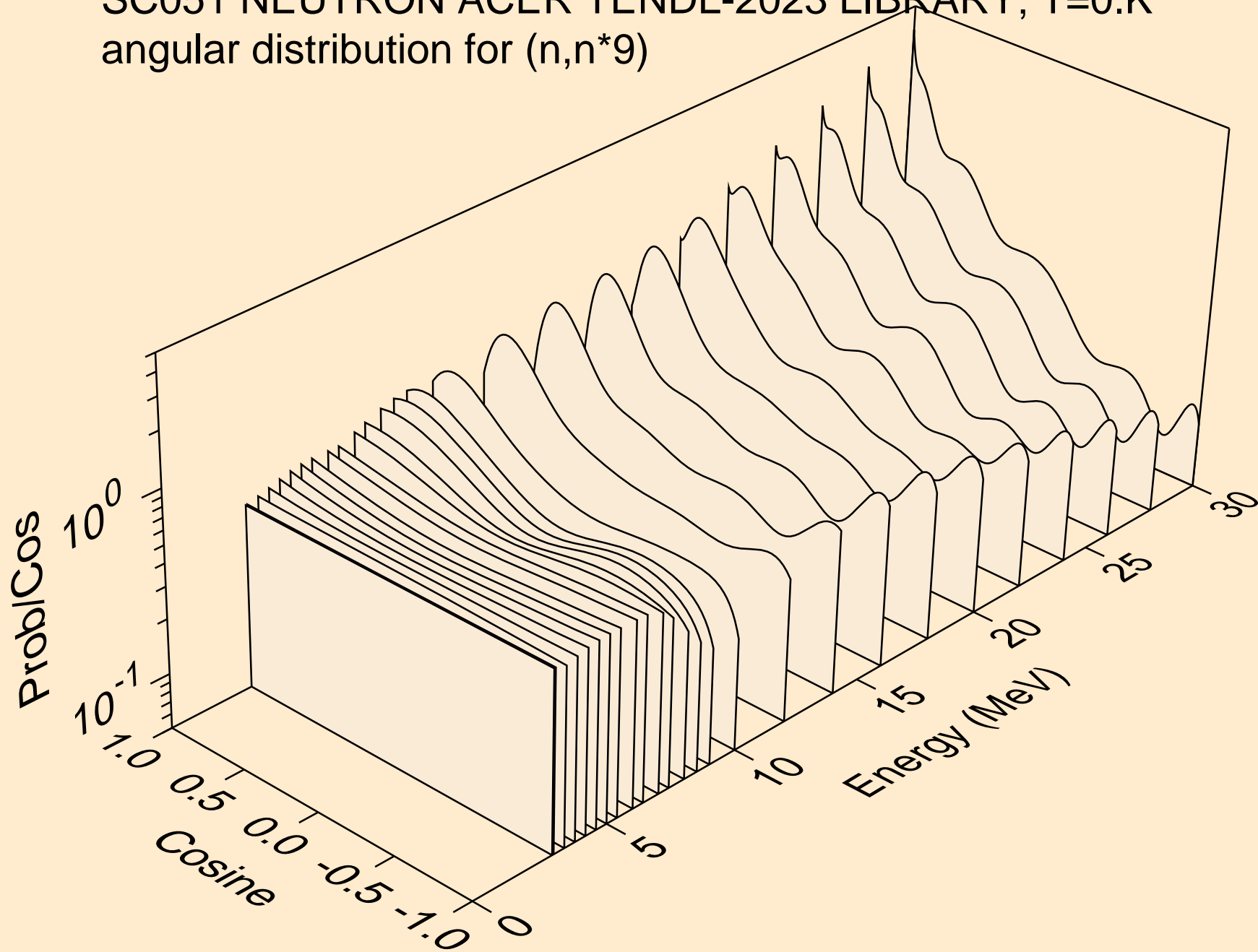

SC051 NEUTRON ACER TENDL-2023 LIBRARY; T=0.K  
angular distribution for (n,n\*10)

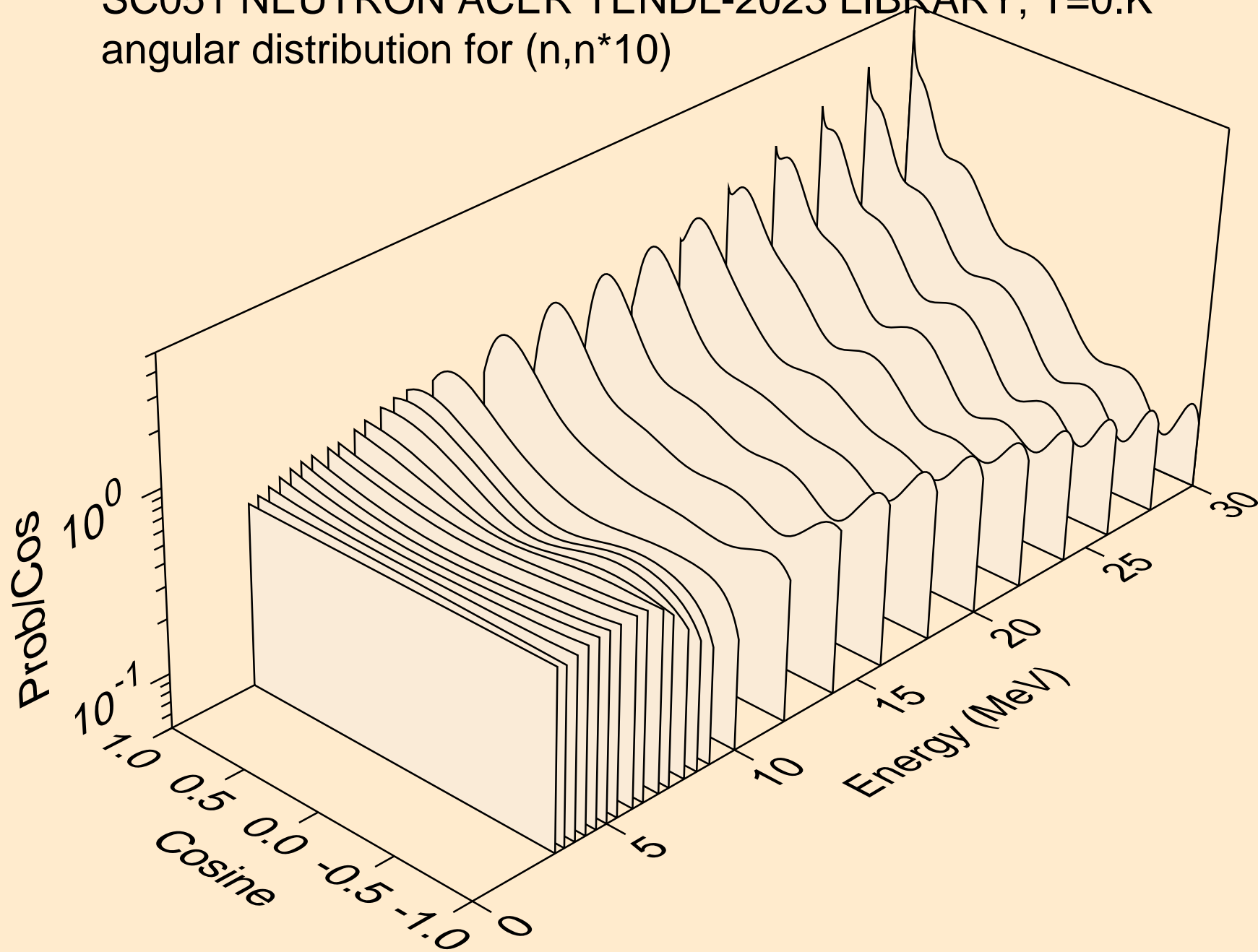



SC051 NEUTRON ACER TENDL-2023 LIBRARY; T=0.K  
angular distribution for (n,n\*11)

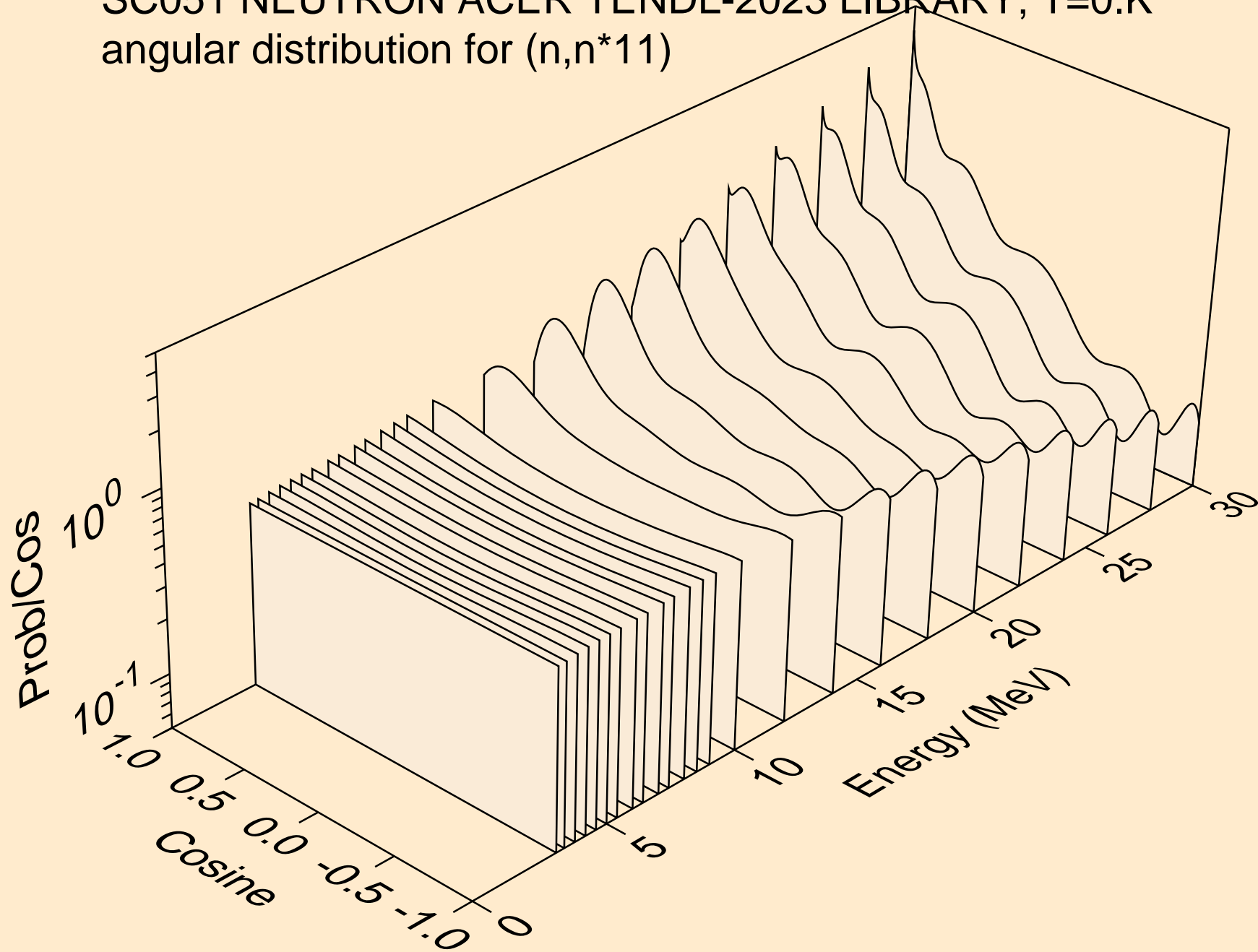

SC051 NEUTRON ACER TENDL-2023 LIBRARY; T=0.K  
angular distribution for (n,n\*12)

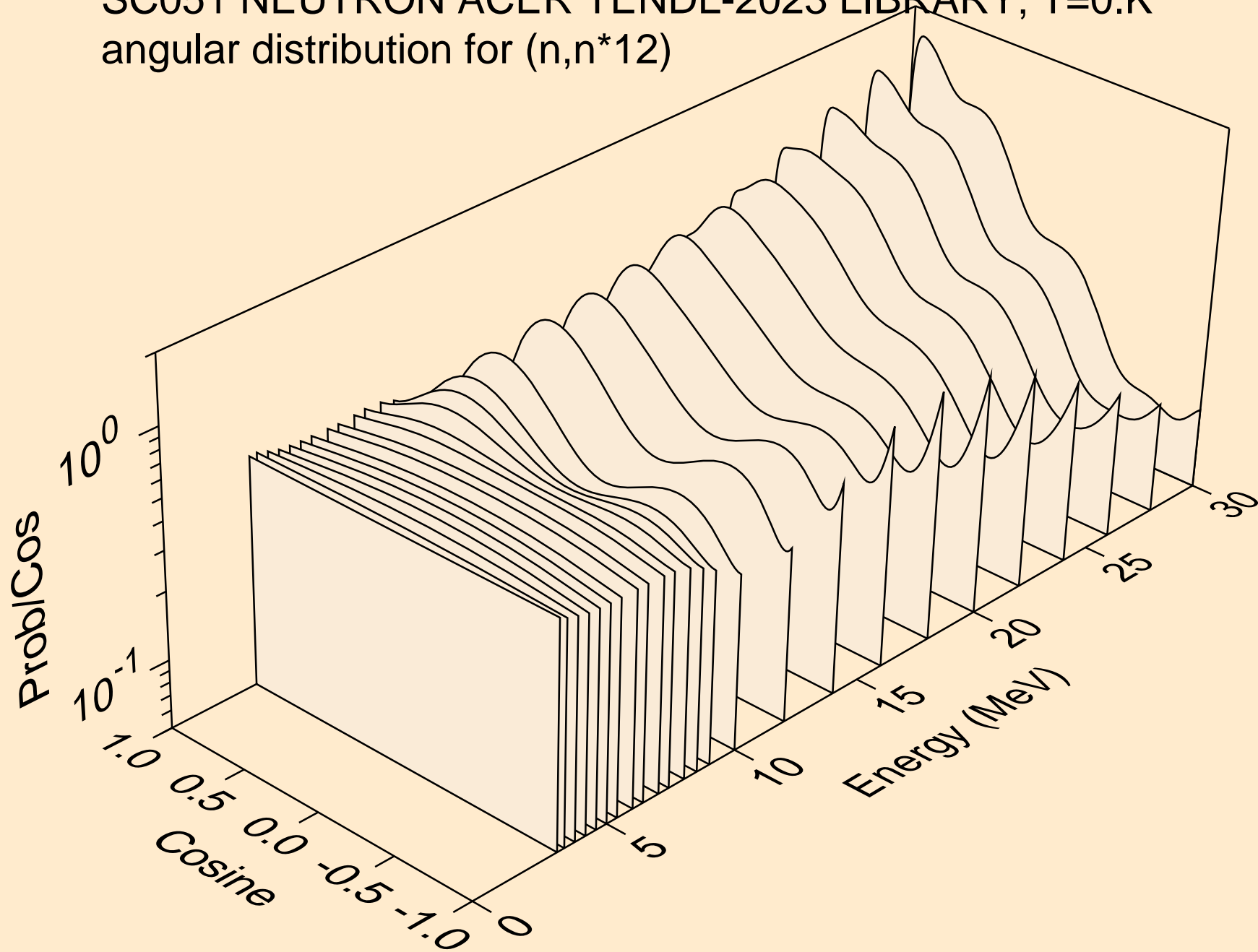

SC051 NEUTRON ACER TENDL-2023 LIBRARY; T=0.K  
angular distribution for (n,n\*13)

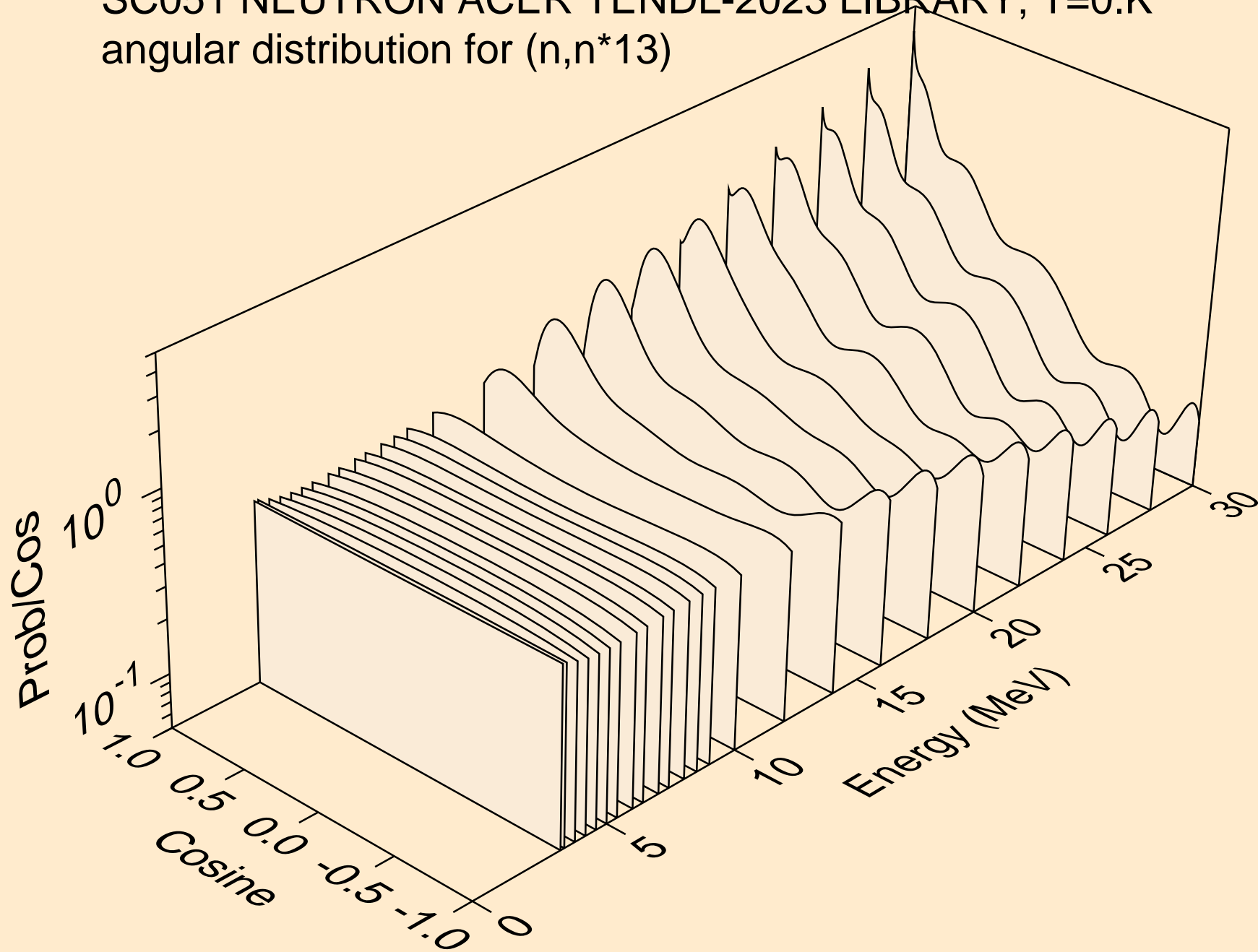

SC051 NEUTRON ACER TENDL-2023 LIBRARY; T=0.K  
angular distribution for (n,n\*14)

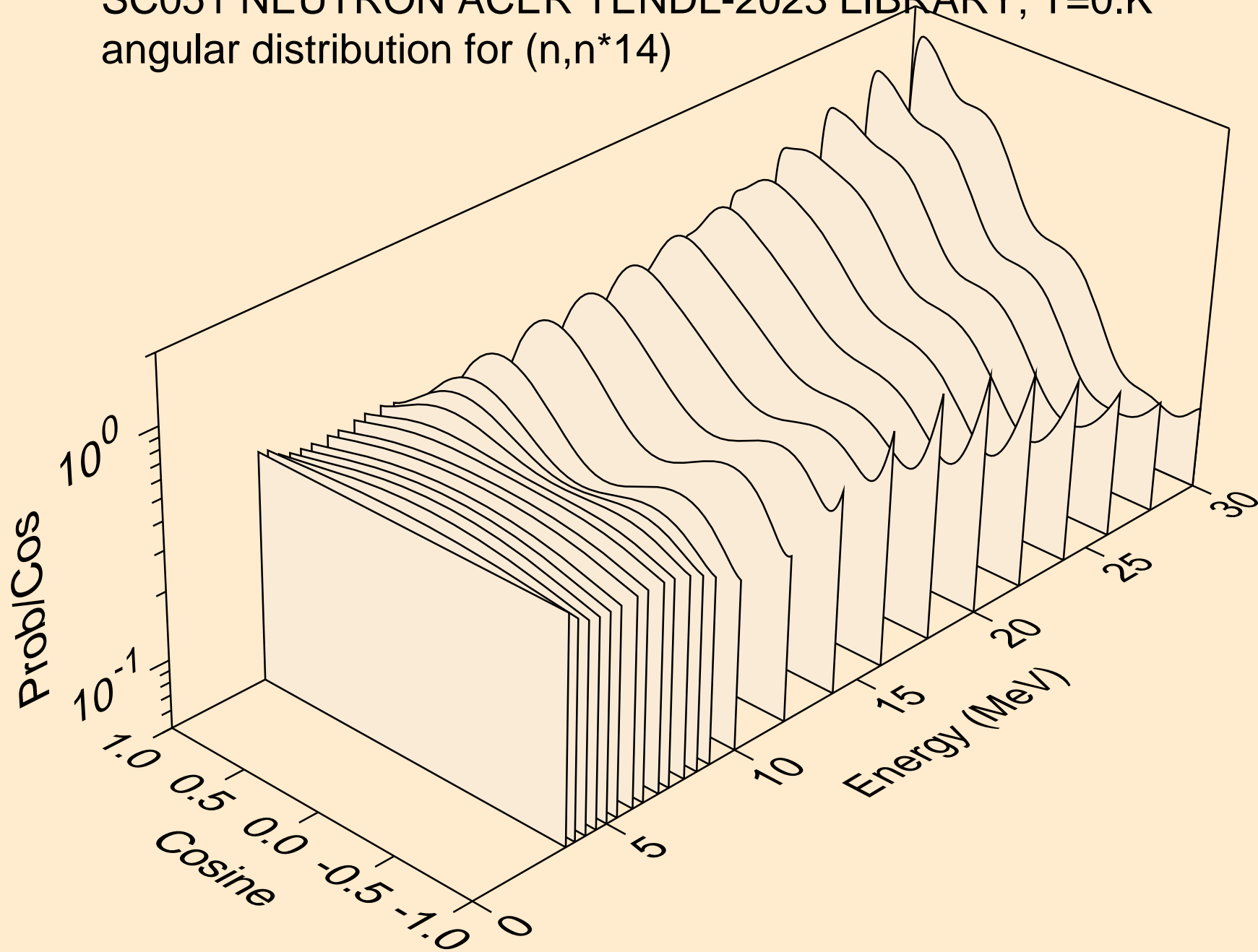

SC051 NEUTRON ACER TENDL-2023 LIBRARY; T=0.K  
angular distribution for (n,n\*15)

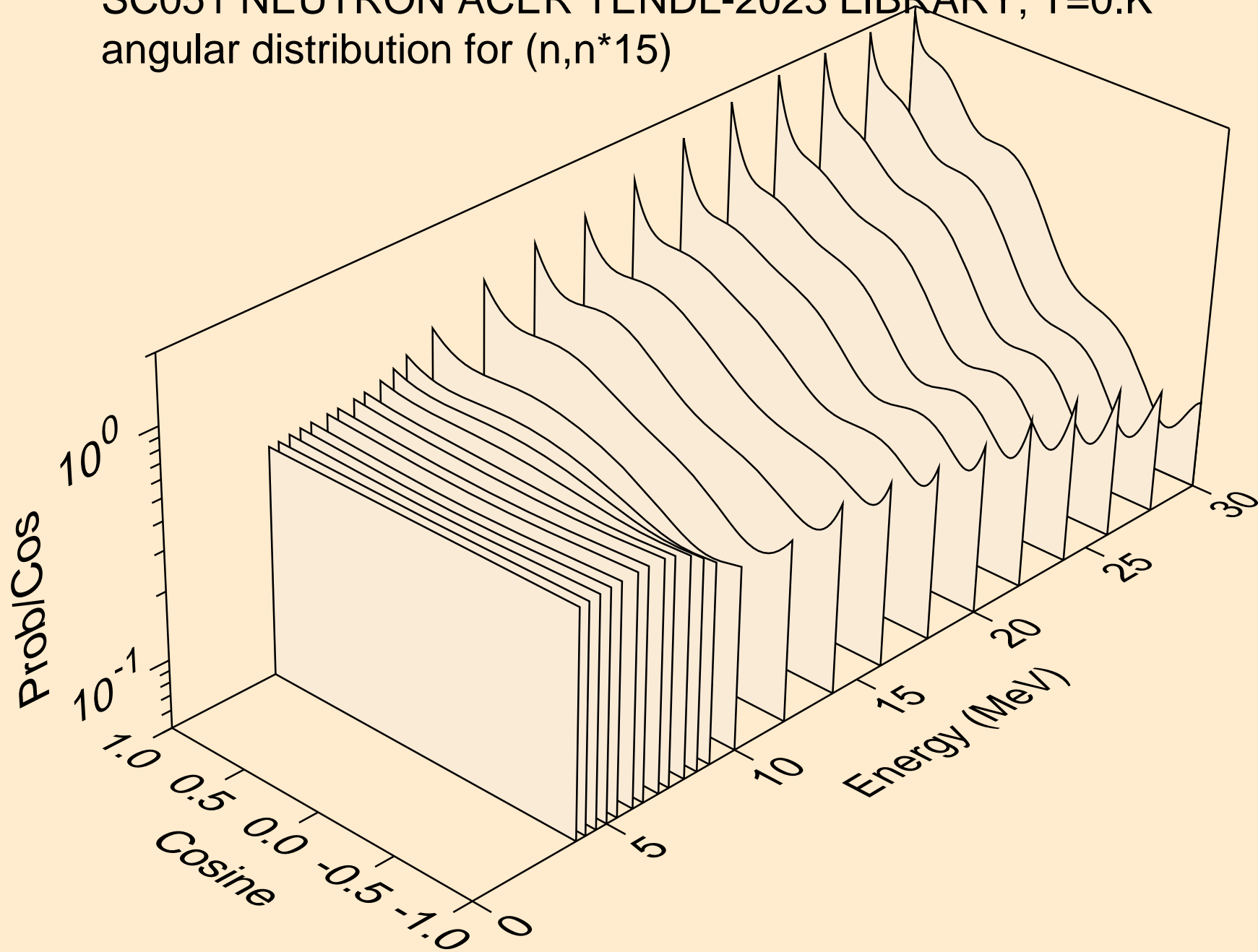

SC051 NEUTRON ACER TENDL-2023 LIBRARY; T=0.K  
angular distribution for (n,n\*16)

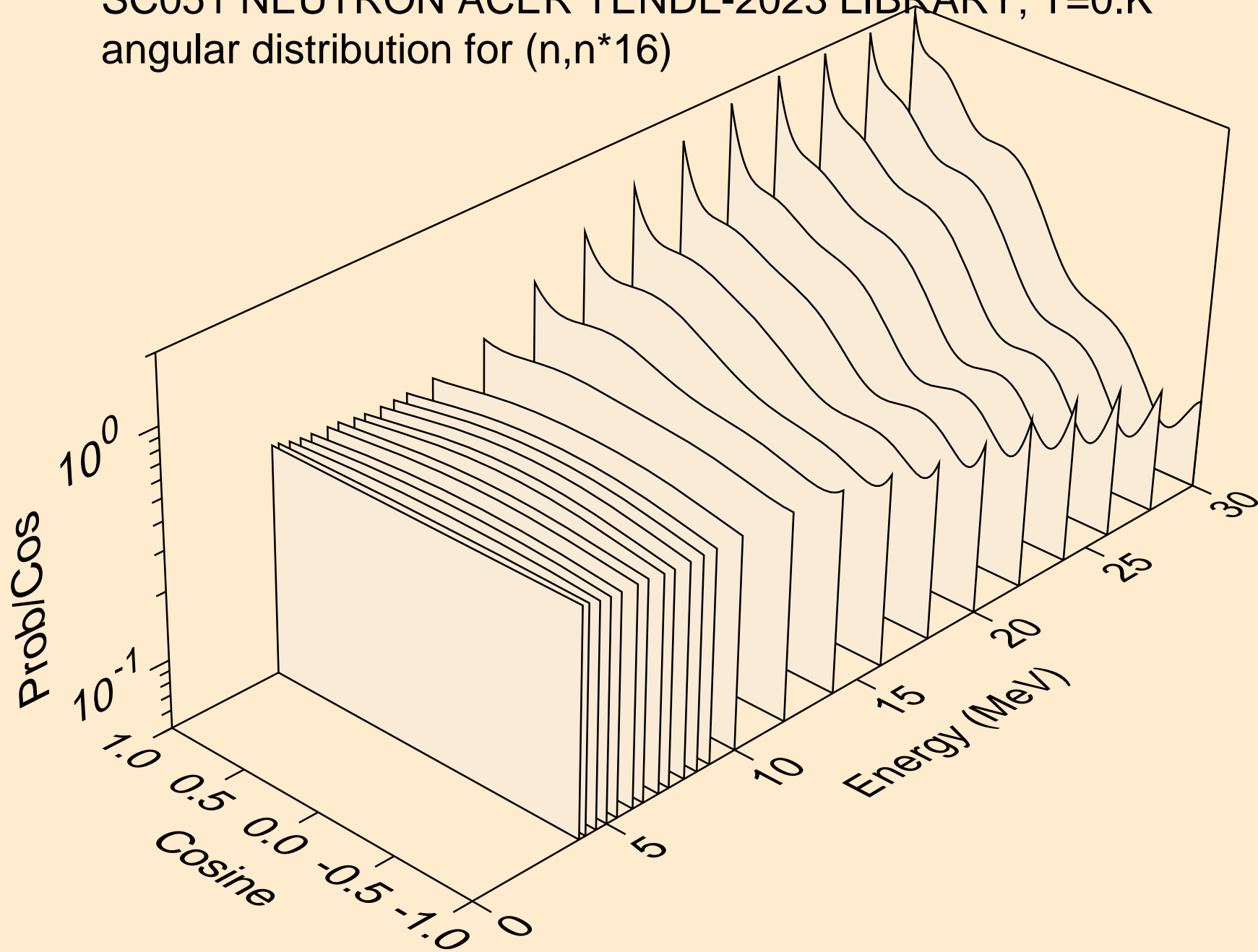

SC051 NEUTRON ACER TENDL-2023 LIBRARY; T=0.K  
angular distribution for (n,n\*17)

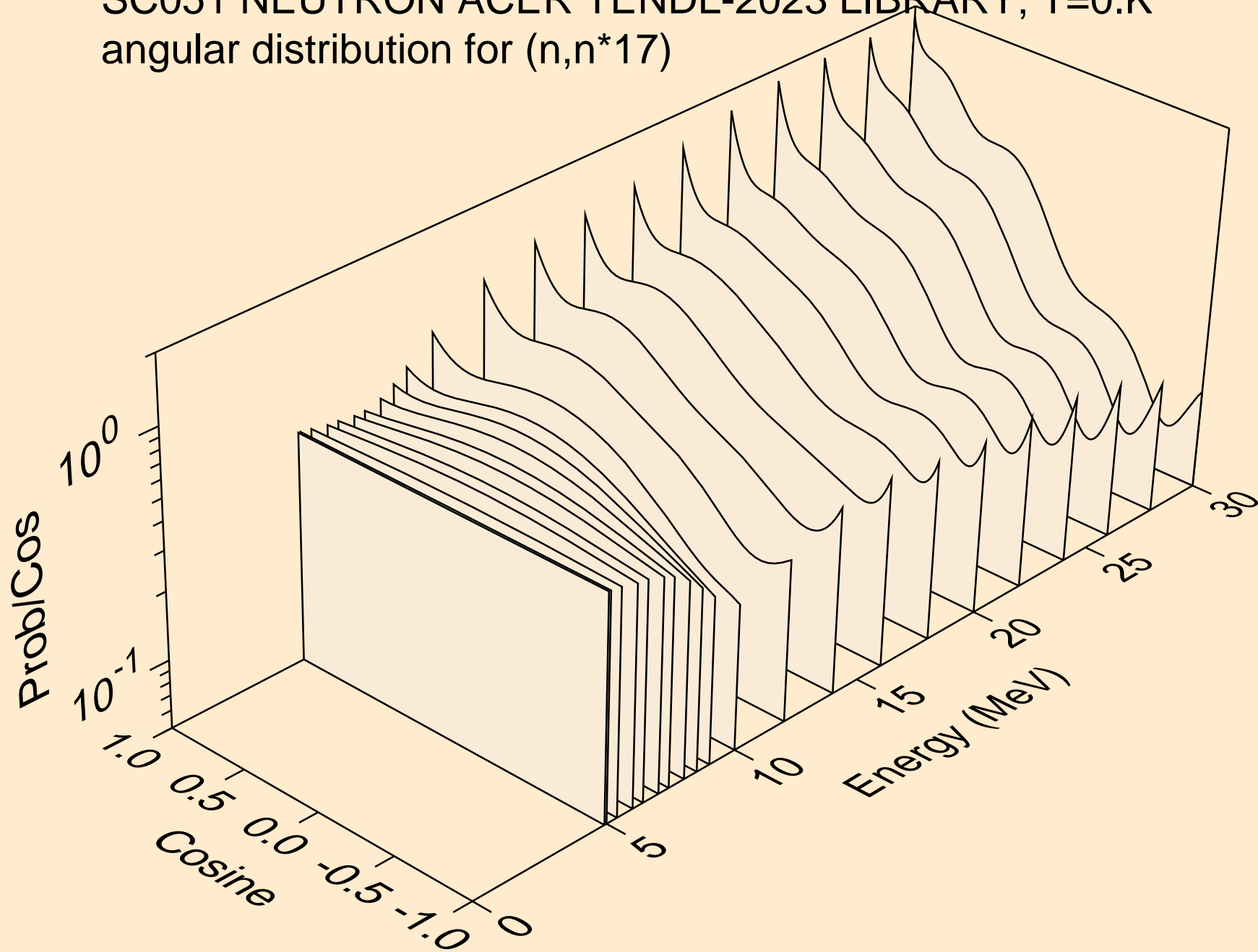

SC051 NEUTRON ACER TENDL-2023 LIBRARY; T=0.K  
angular distribution for (n,n\*18)

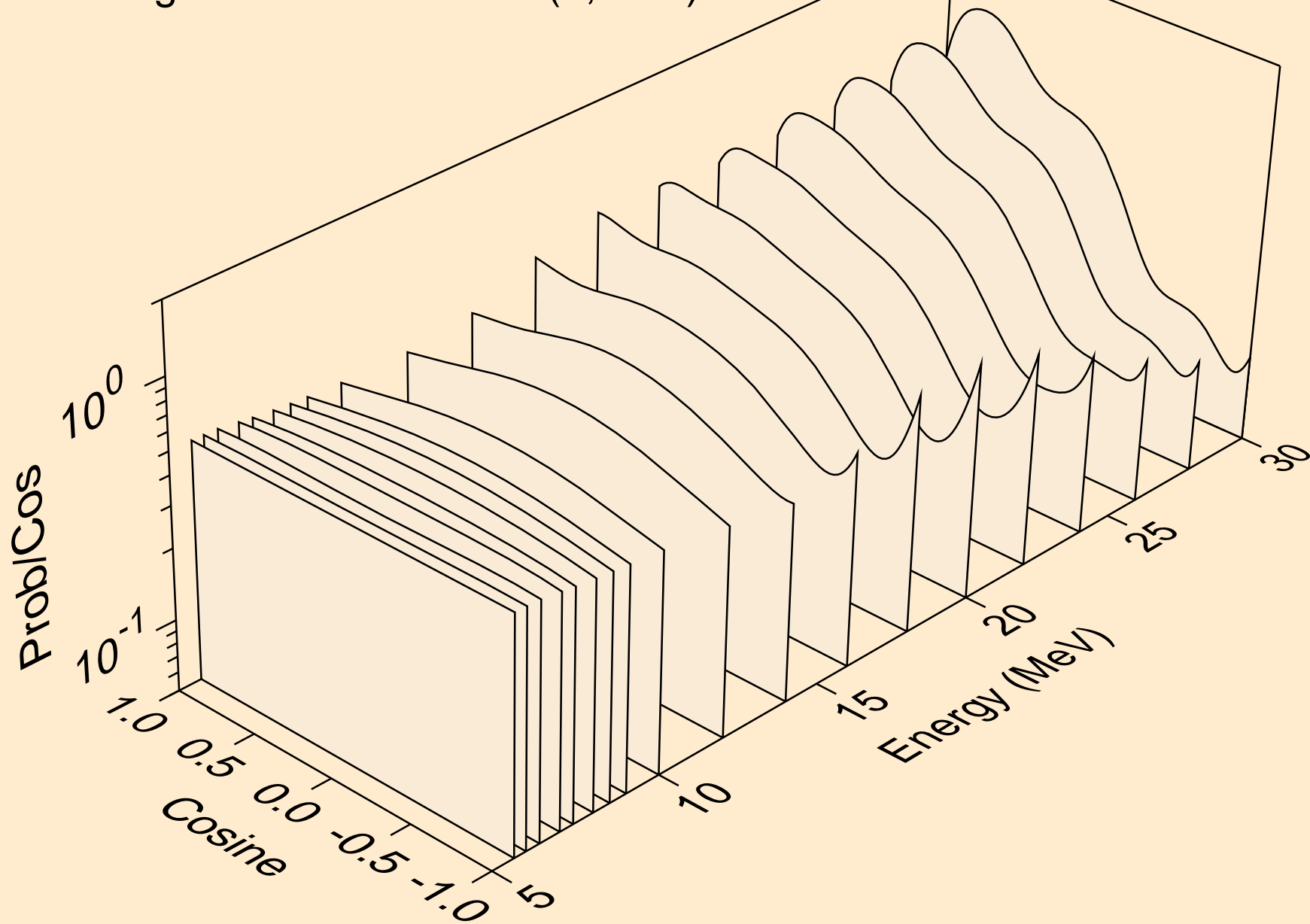



SC051 NEUTRON ACER TENDL-2023 LIBRARY; T=0.K  
angular distribution for (n,n\*19)

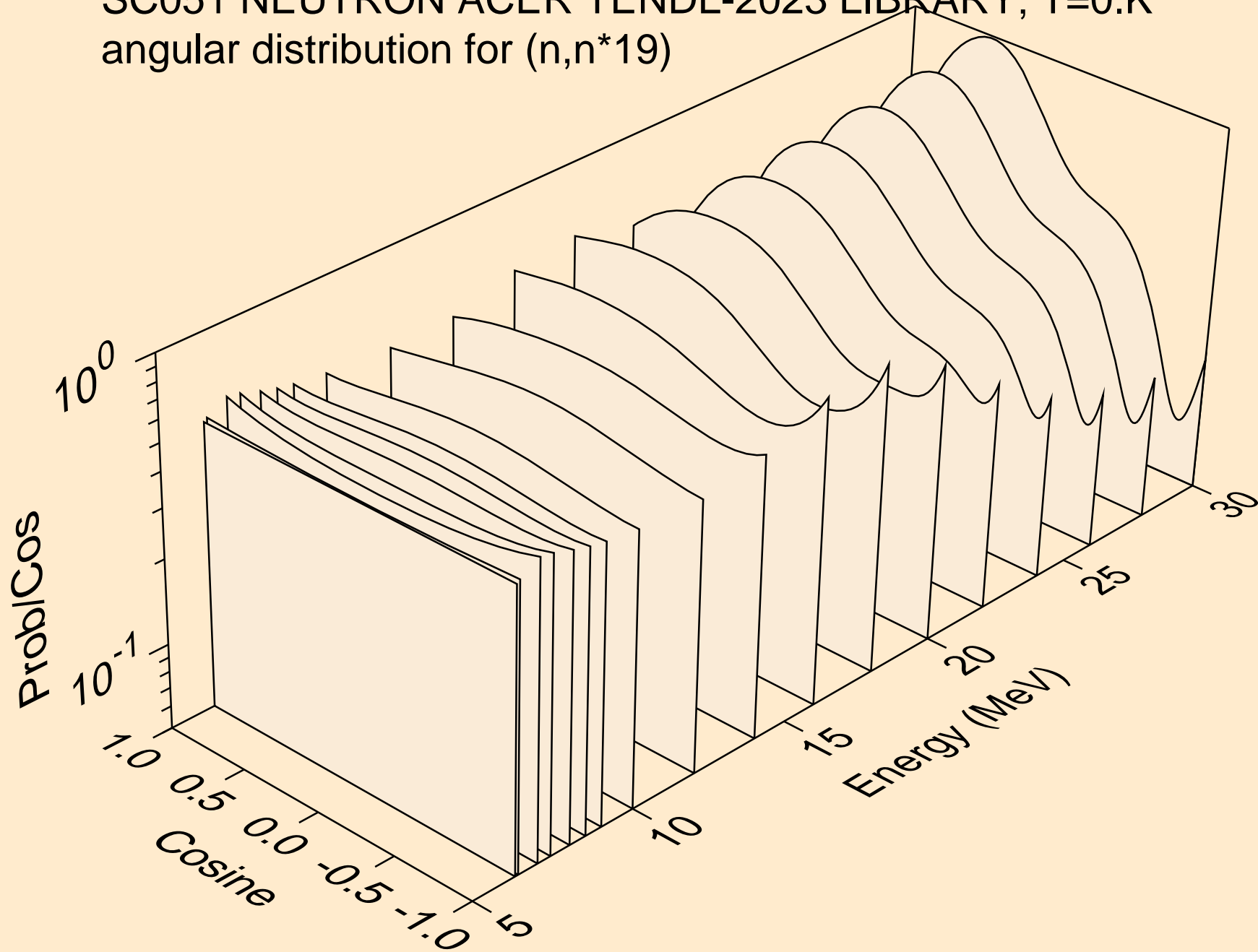

SC051 NEUTRON ACER TENDL-2023 LIBRARY; T=0.K  
angular distribution for (n,n\*20)

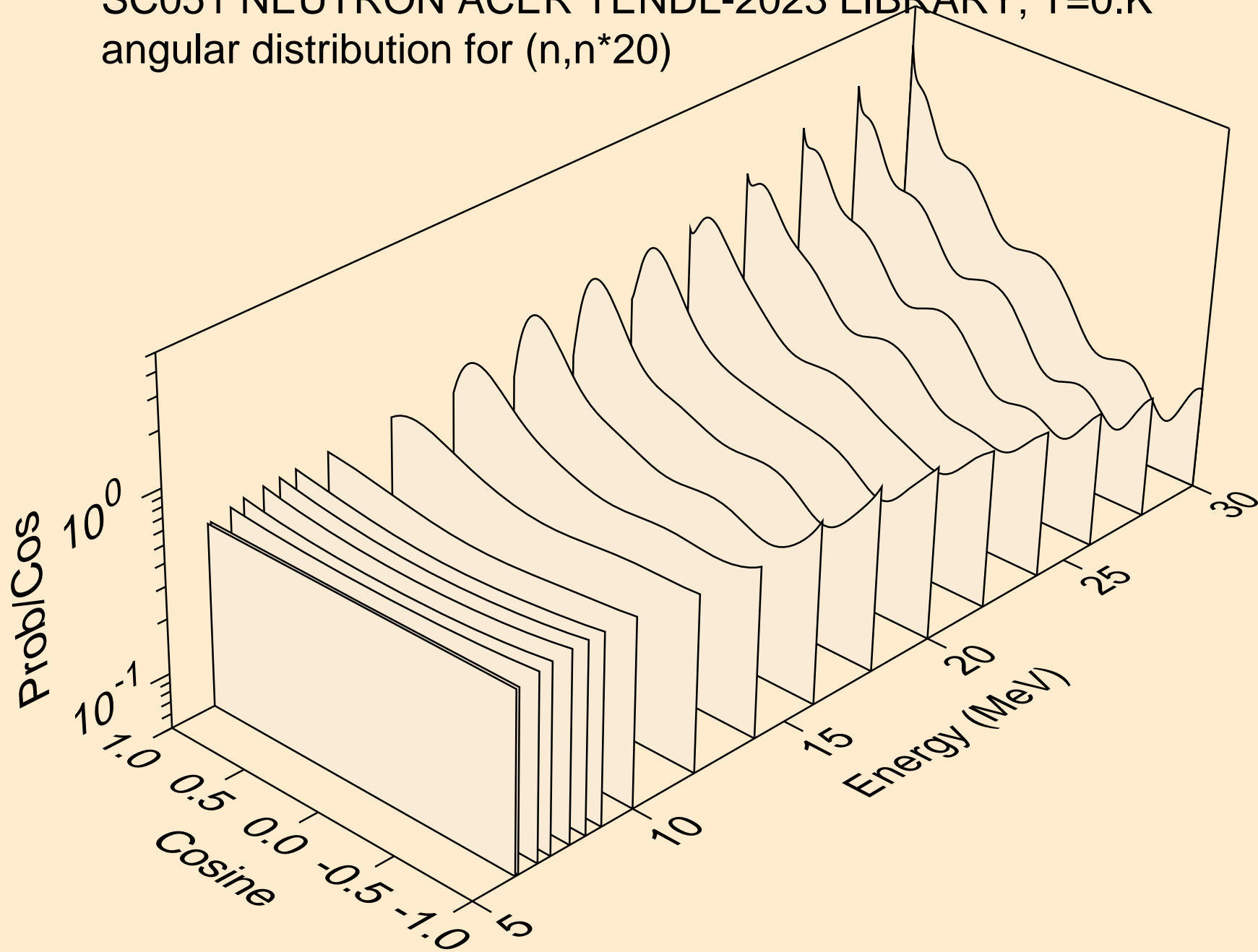

SC051 NEUTRON ACER TENDL-2023 LIBRARY; T=0.K  
angular distribution for (n,n\*21)

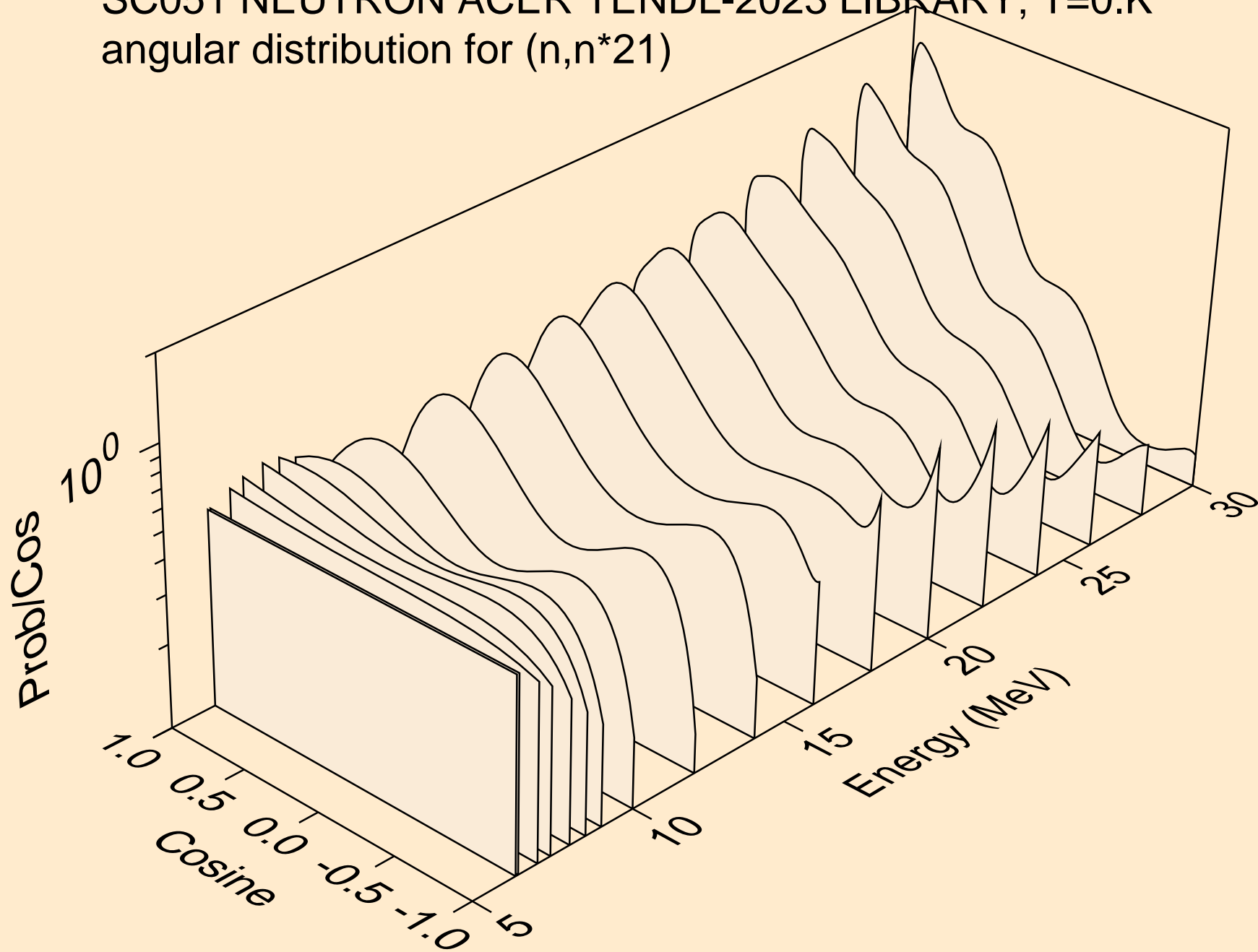

SC051 NEUTRON ACER TENDL-2023 LIBRARY; T=0.K  
angular distribution for (n,n\*22)

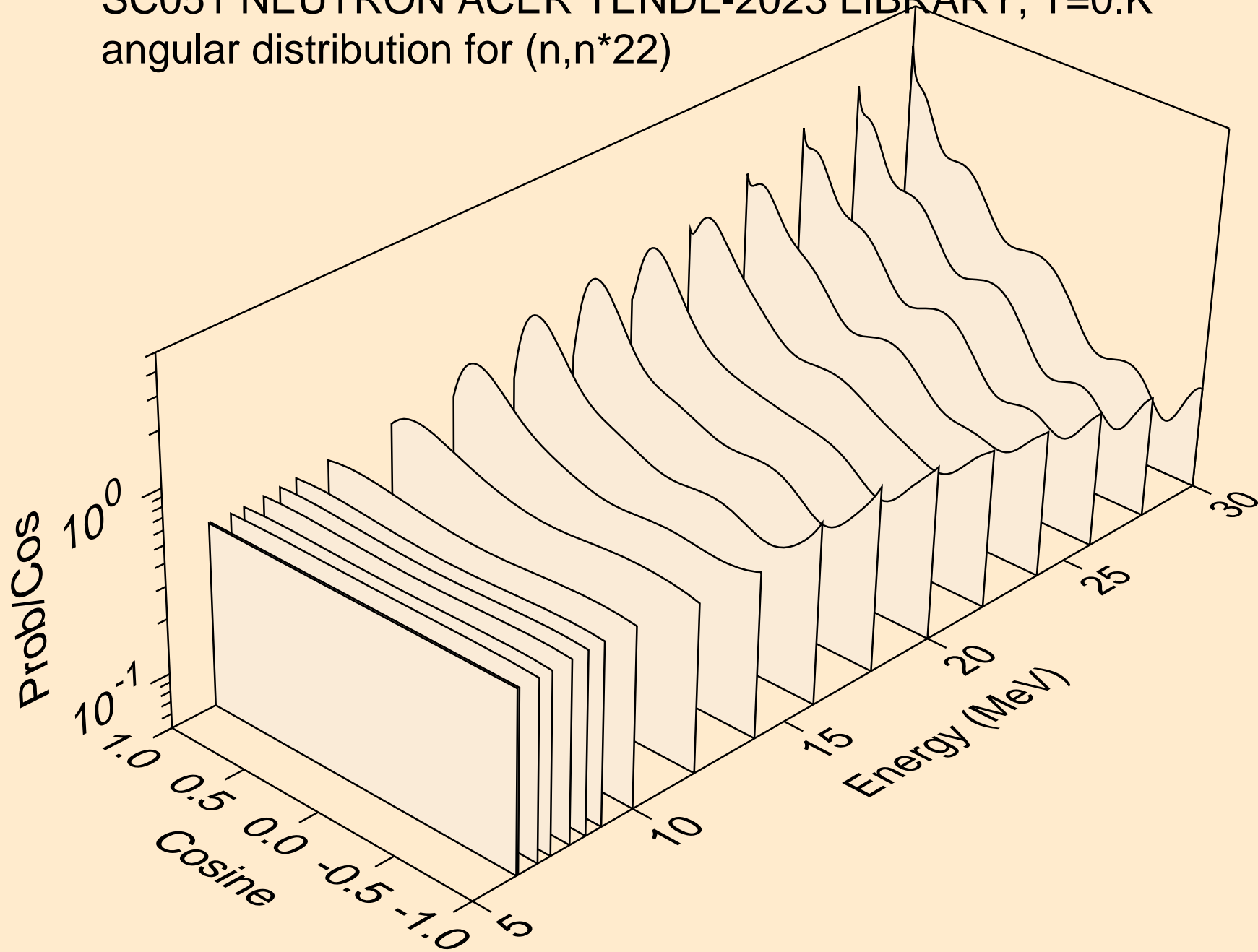

SC051 NEUTRON ACER TENDL-2023 LIBRARY; T=0.K  
angular distribution for (n,n\*23)

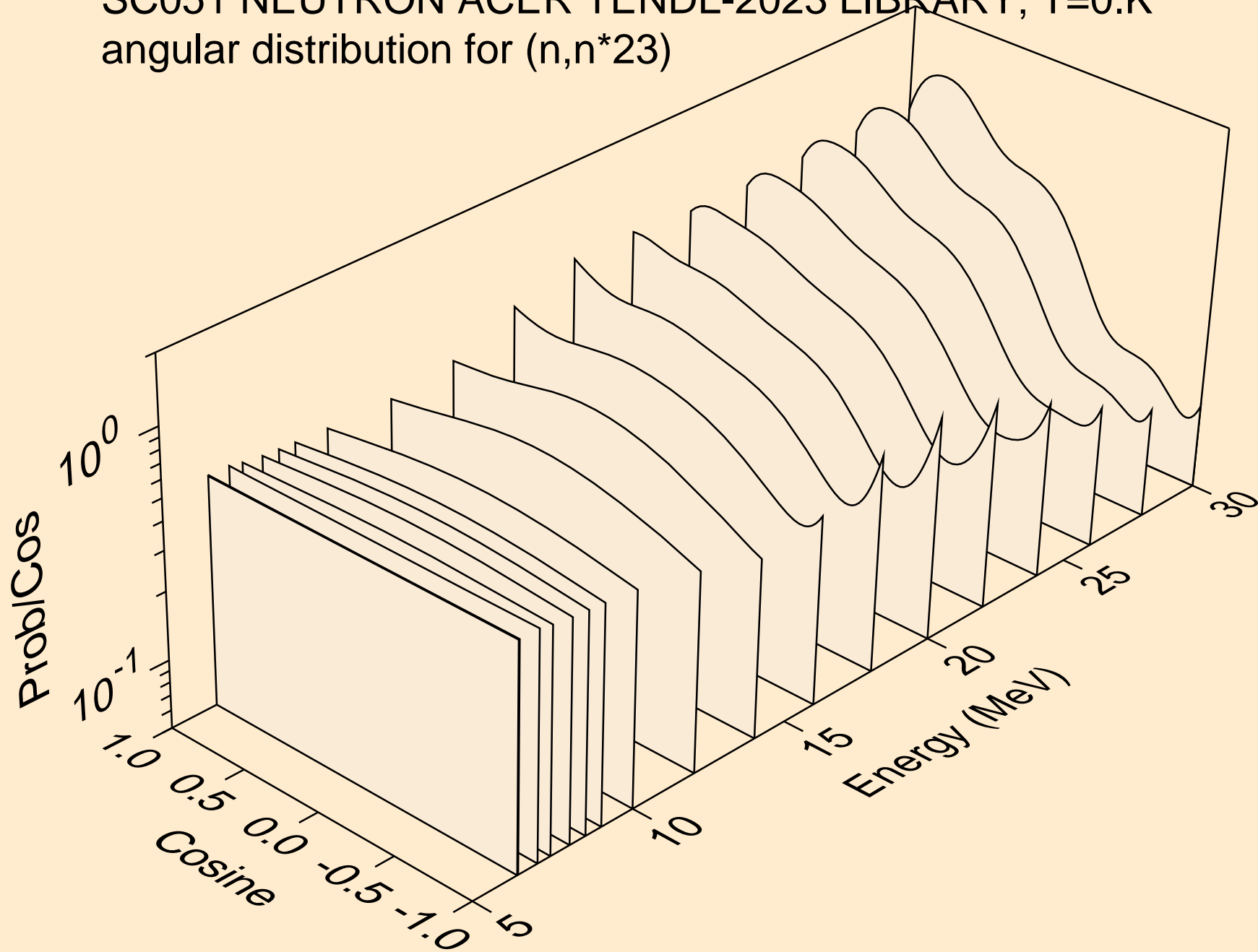

SC051 NEUTRON ACER TENDL-2023 LIBRARY; T=0.K  
angular distribution for (n,n\*24)

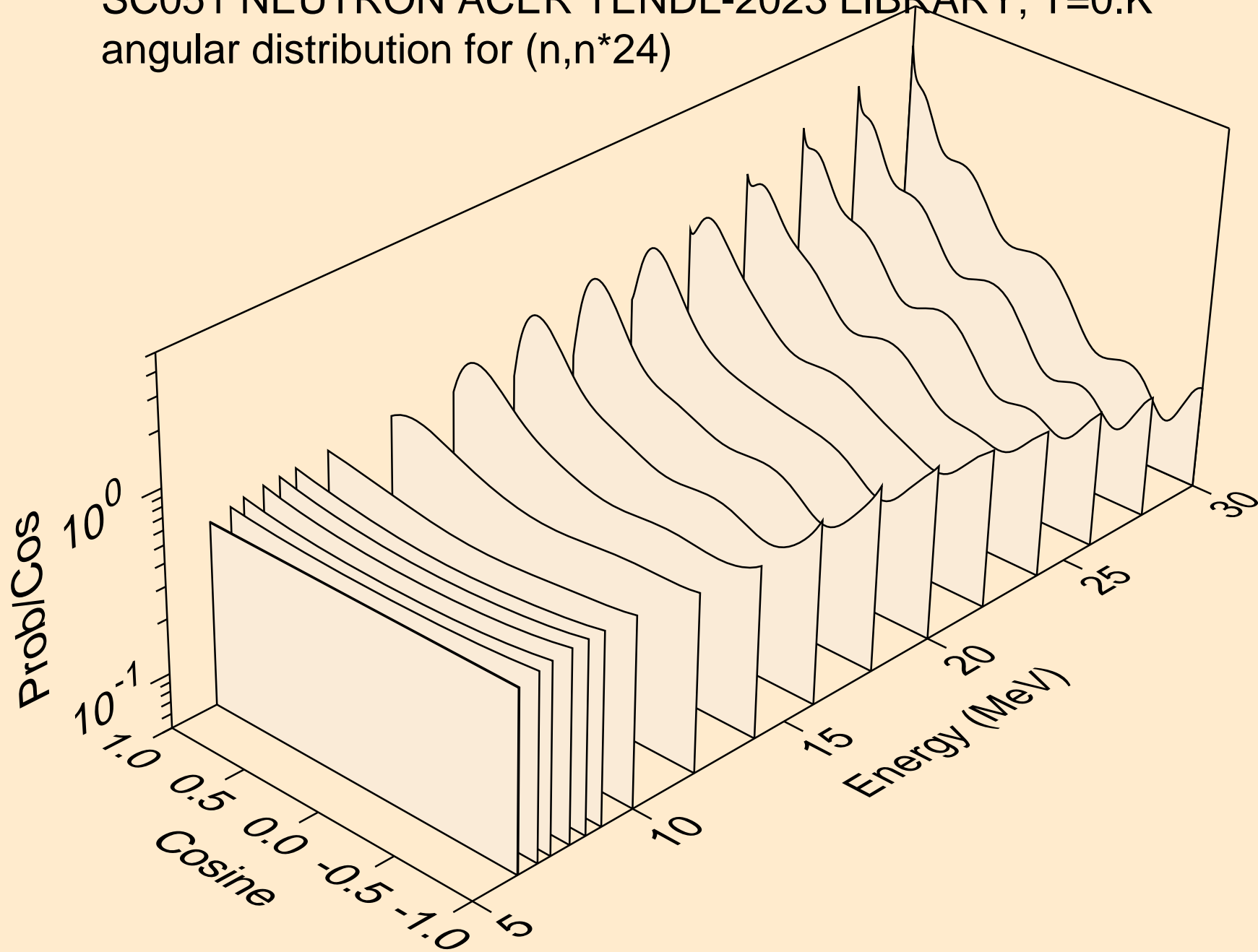

SC051 NEUTRON ACER TENDL-2023 LIBRARY; T=0.K  
angular distribution for (n,n\*25)

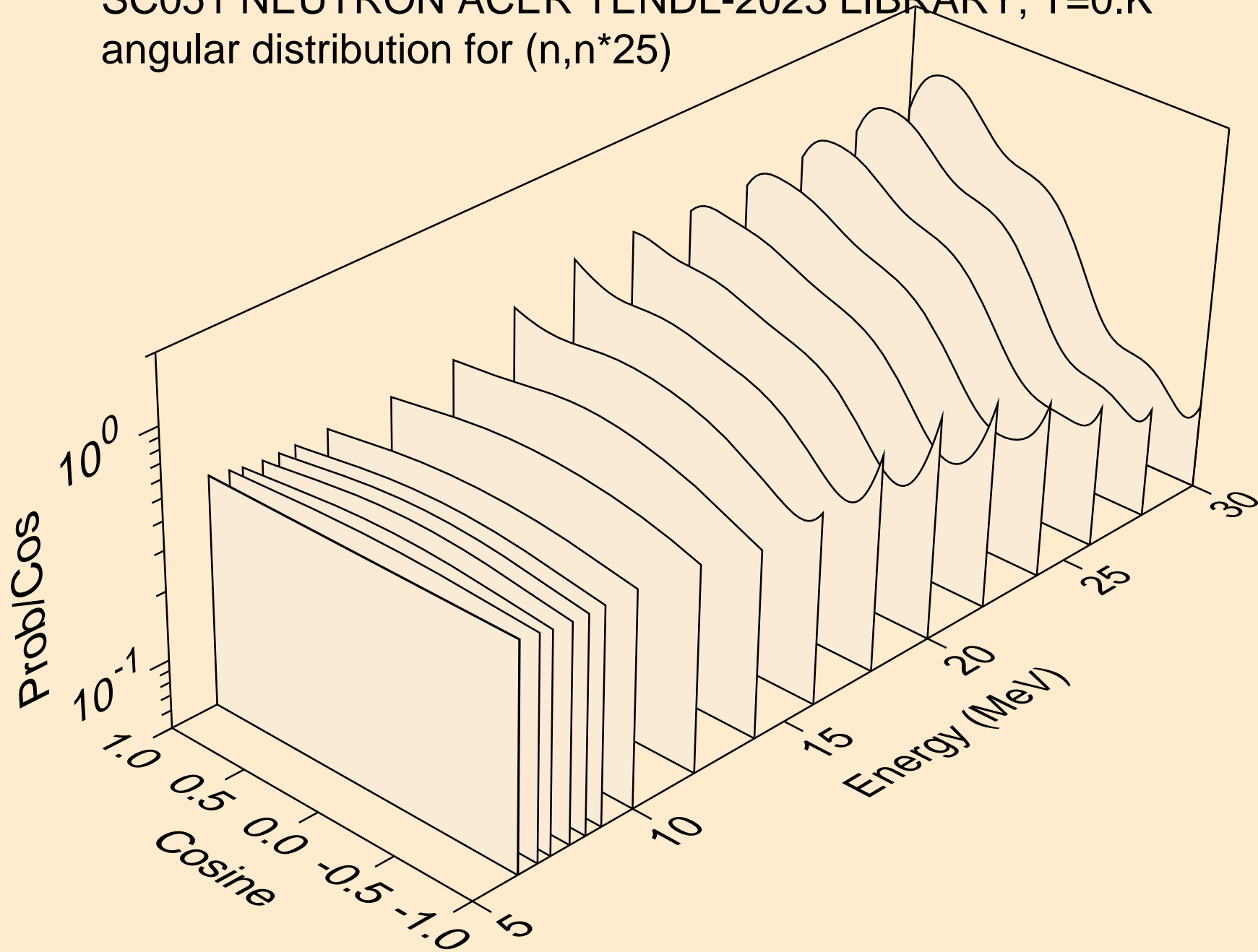

SC051 NEUTRON ACER TENDL-2023 LIBRARY; T=0.K  
angular distribution for (n,n\*26)

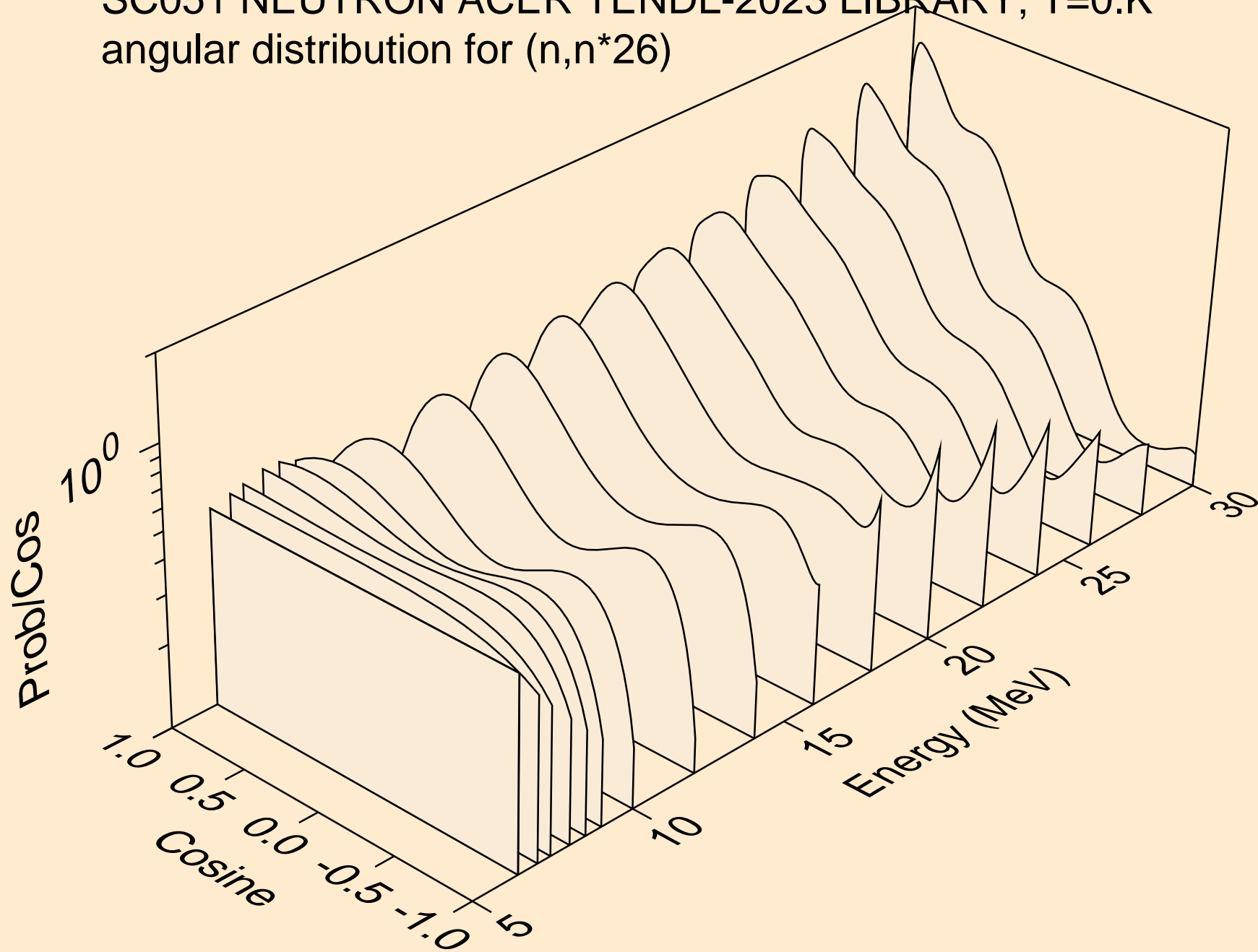



SC051 NEUTRON ACER TENDL-2023 LIBRARY; T=0.K  
angular distribution for (n,n\*27)

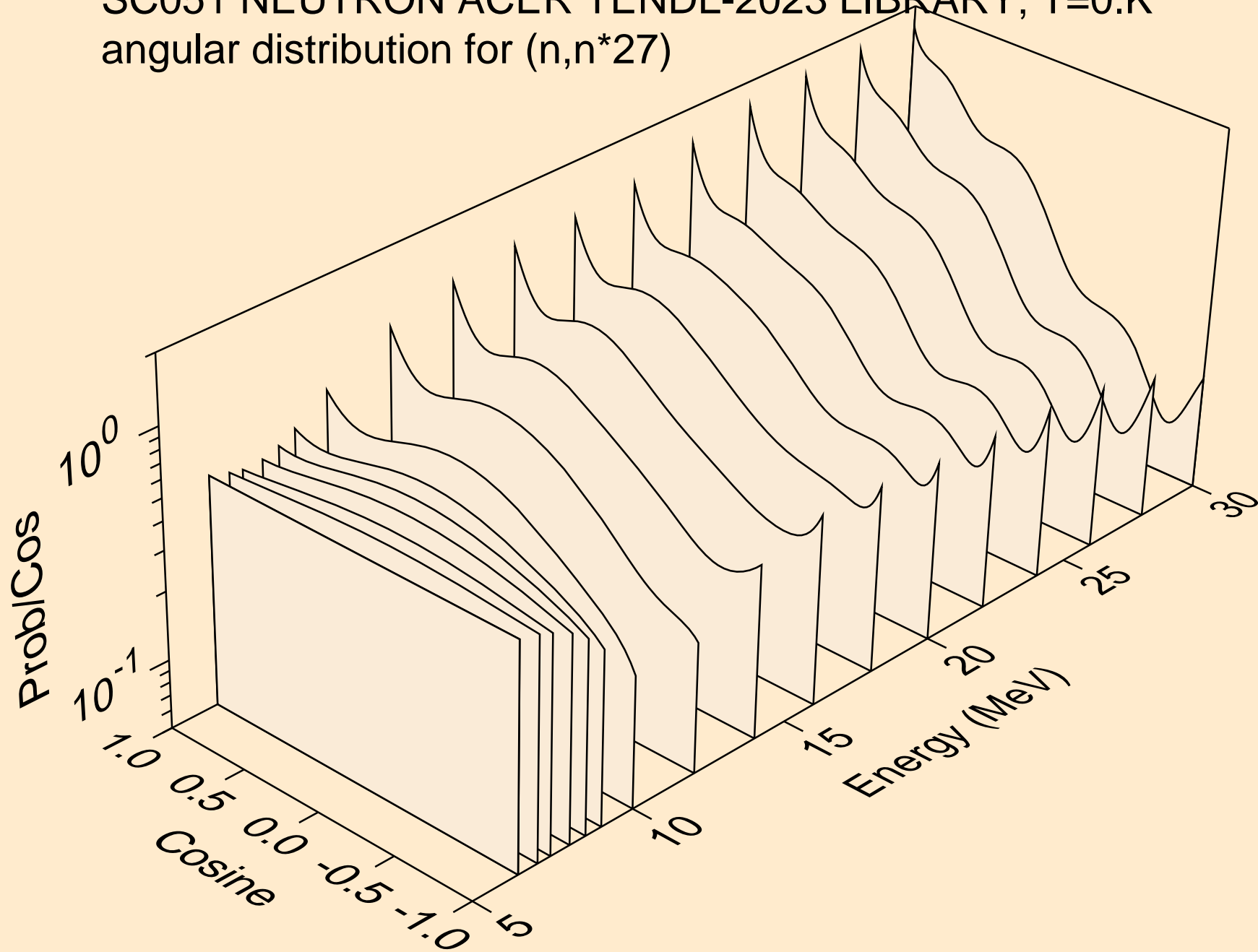

SC051 NEUTRON ACER TENDL-2023 LIBRARY; T=0.K  
angular distribution for (n,n\*28)

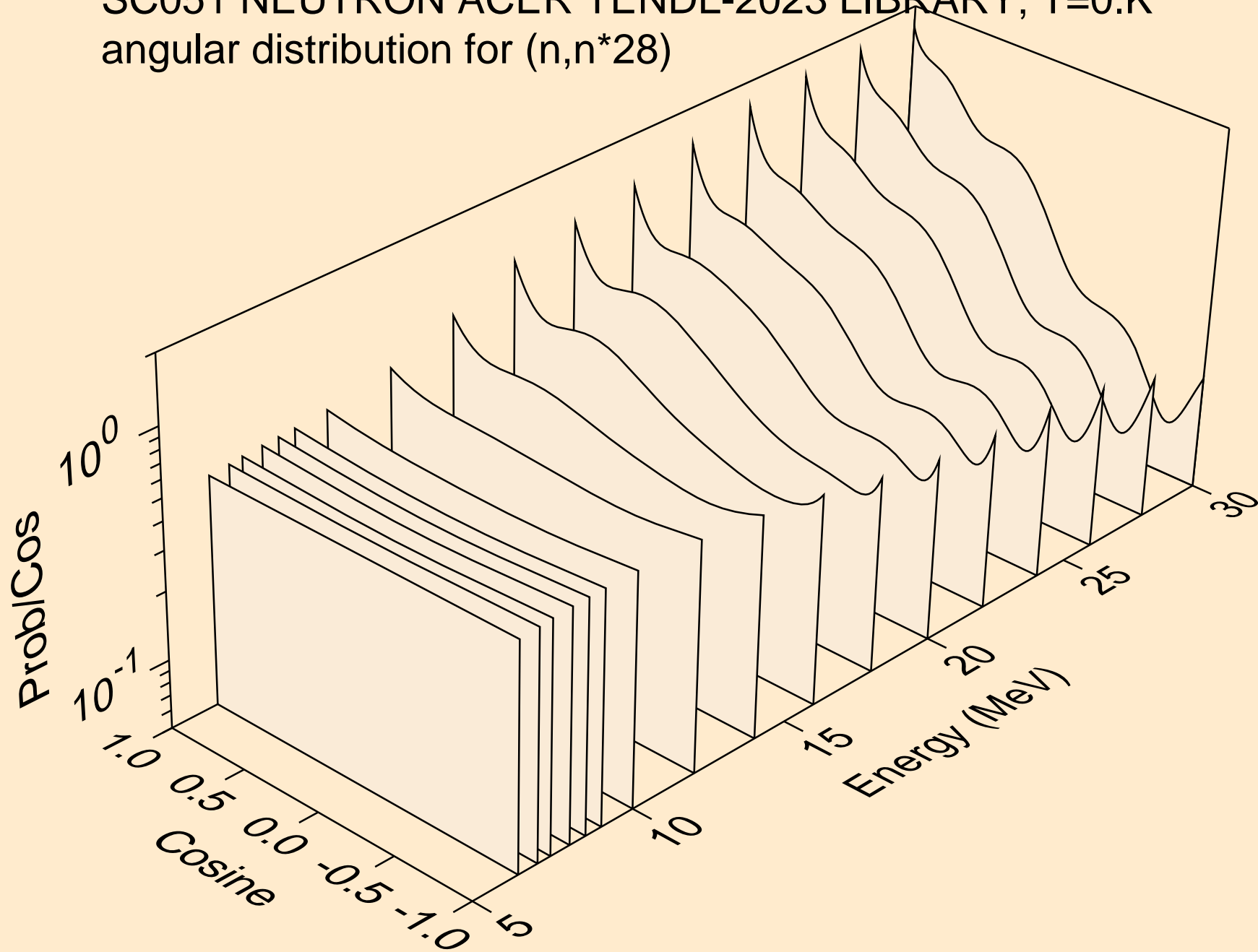

SC051 NEUTRON ACER TENDL-2023 LIBRARY; T=0.K  
angular distribution for (n,n\*29)

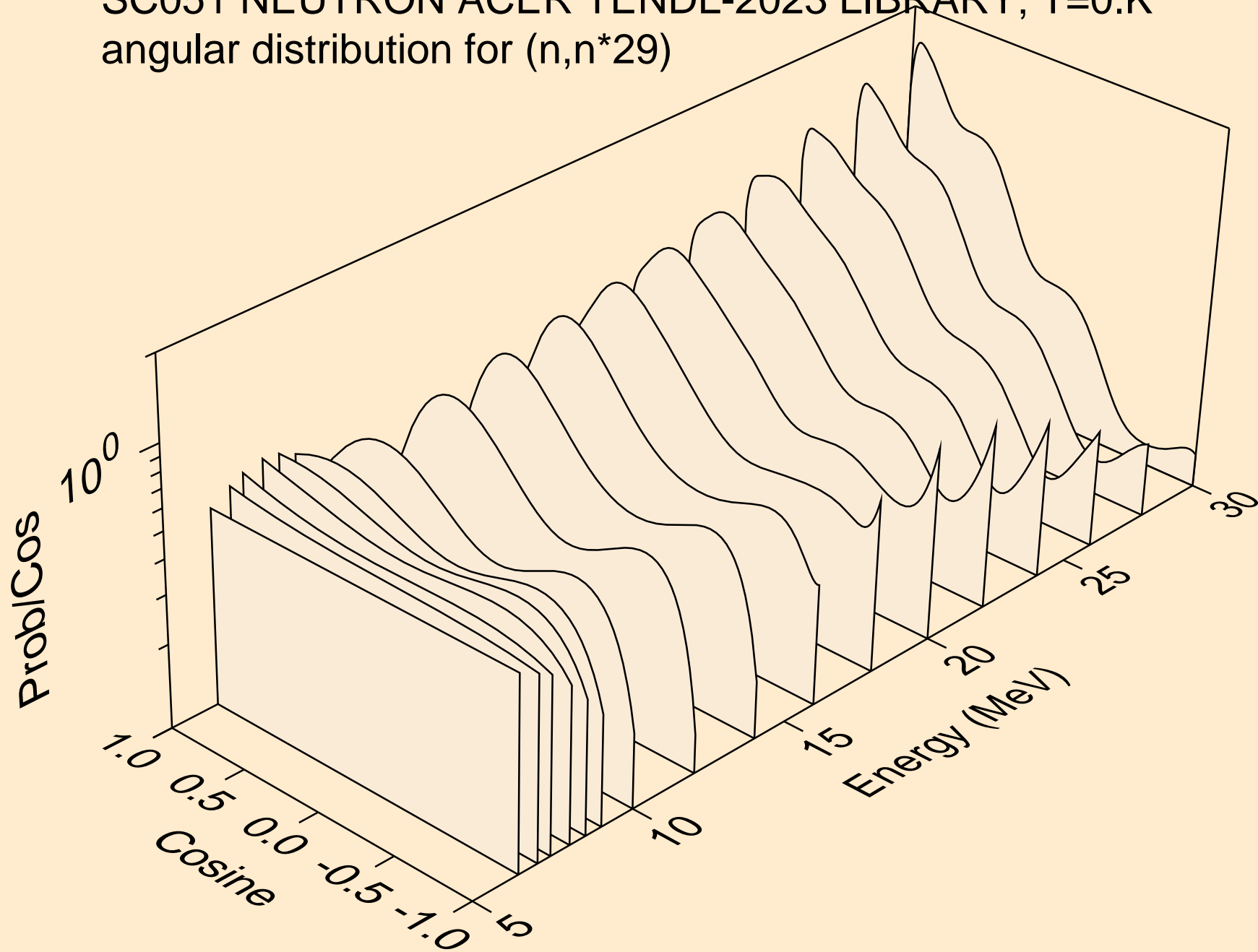

SC051 NEUTRON ACER TENDL-2023 LIBRARY; T=0.K  
Neutron emission for (n,x)

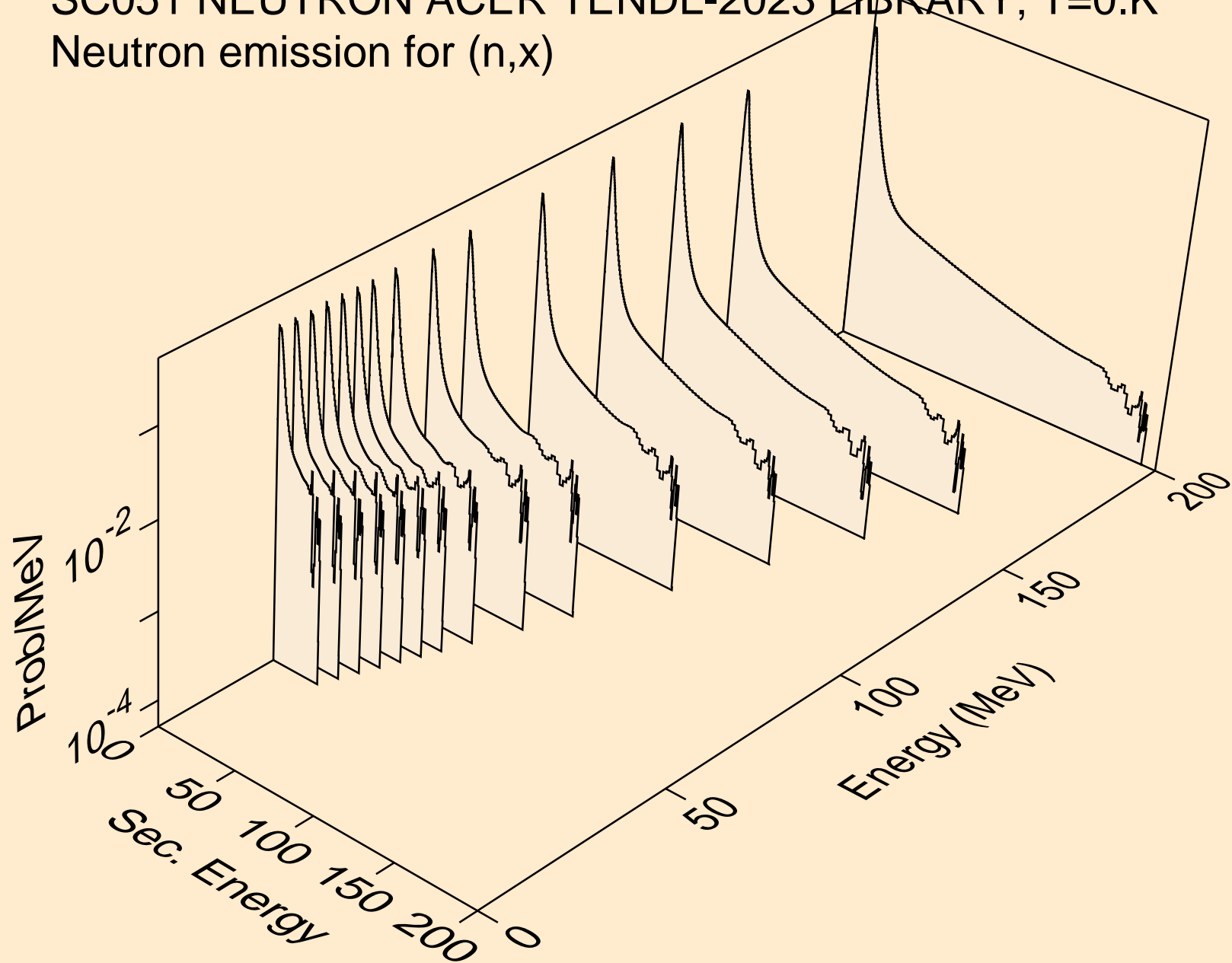

SC051 NEUTRON ACER TENDL-2023 LIBRARY; T=0.K  
Neutron emission for (n,2nd)

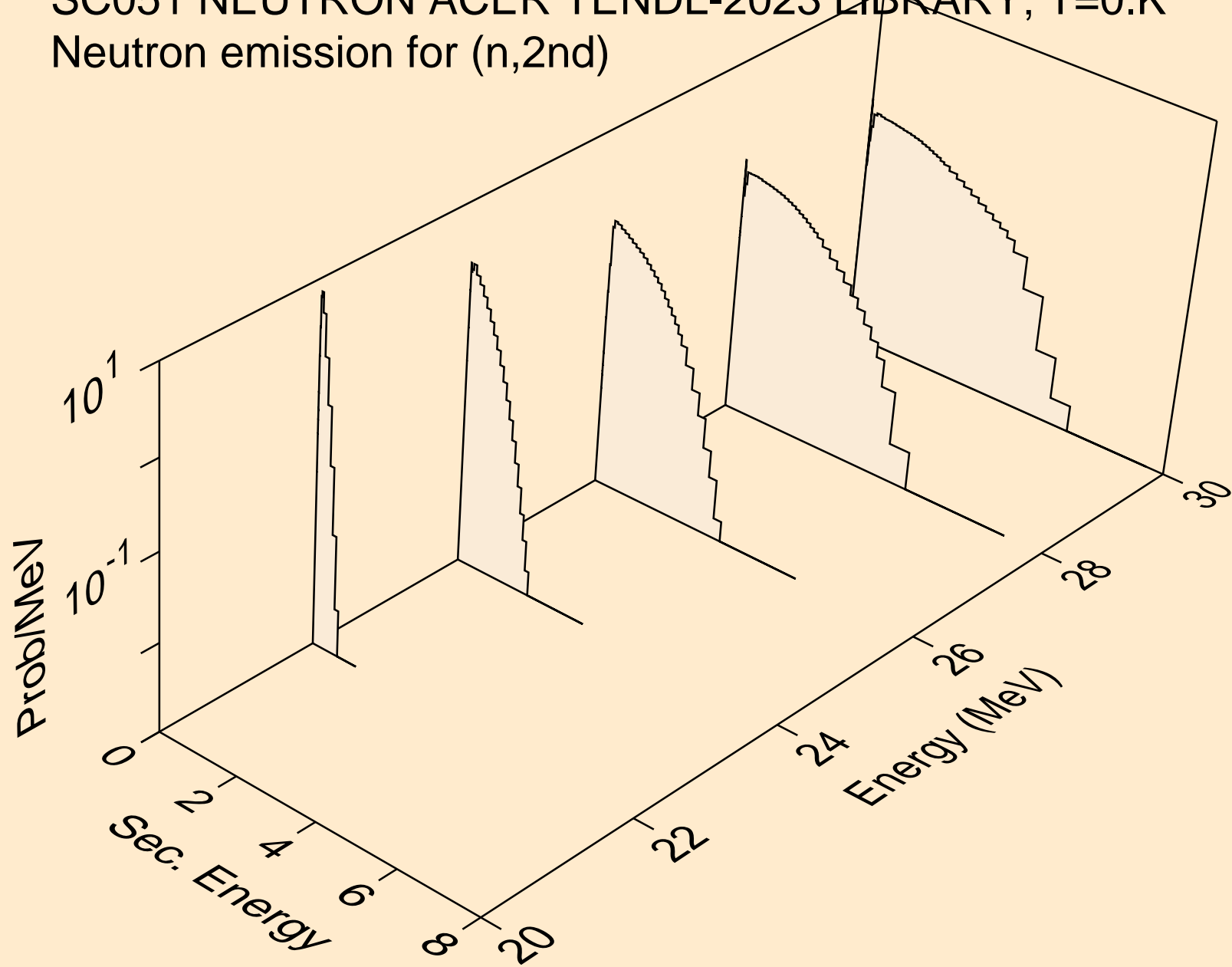

SC051 NEUTRON ACER TENDL-2023 LIBRARY; T=0.K  
Neutron emission for (n,2n)

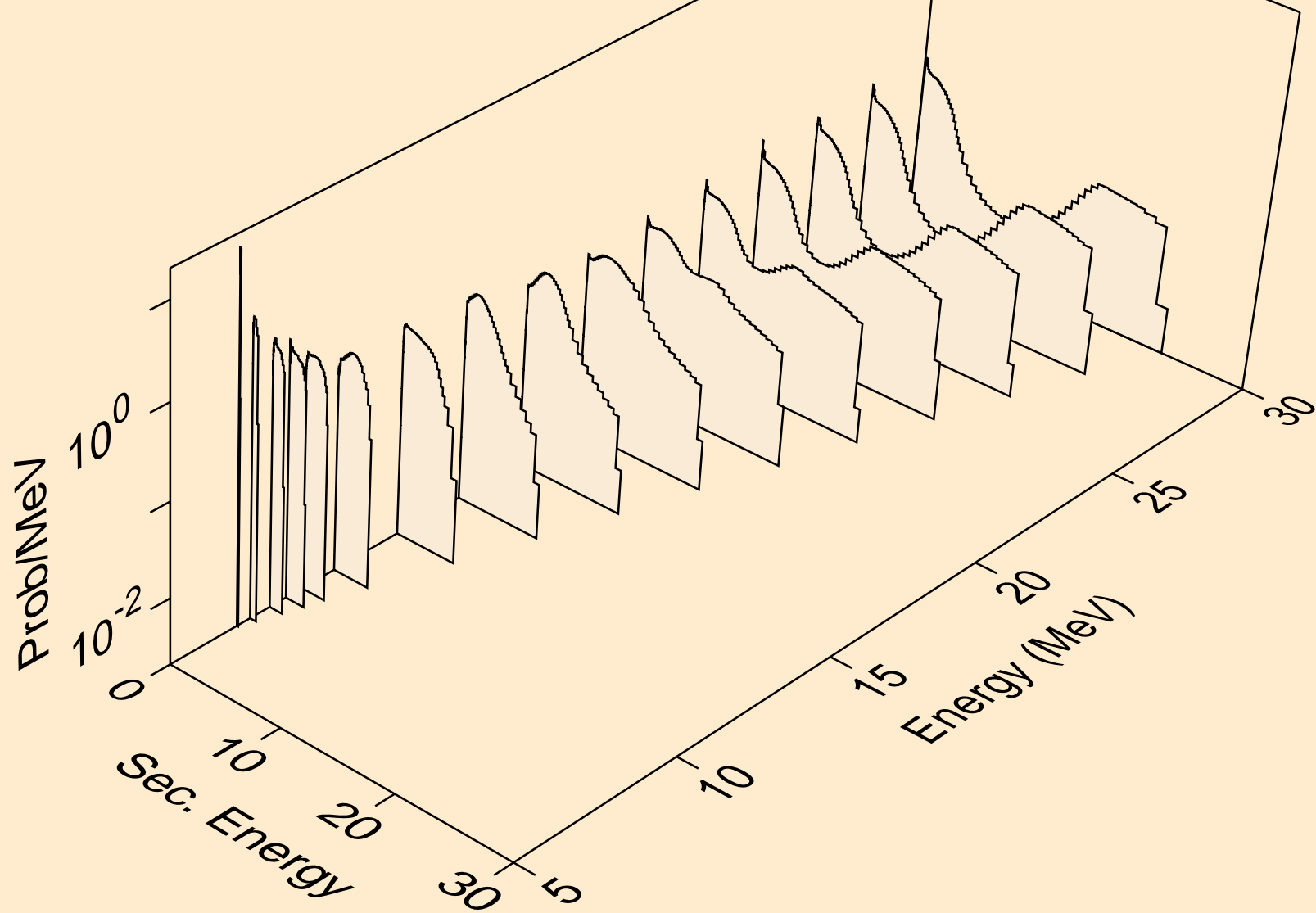

SC051 NEUTRON ACER TENDL-2023 LIBRARY; T=0.K  
Neutron emission for (n,3n)

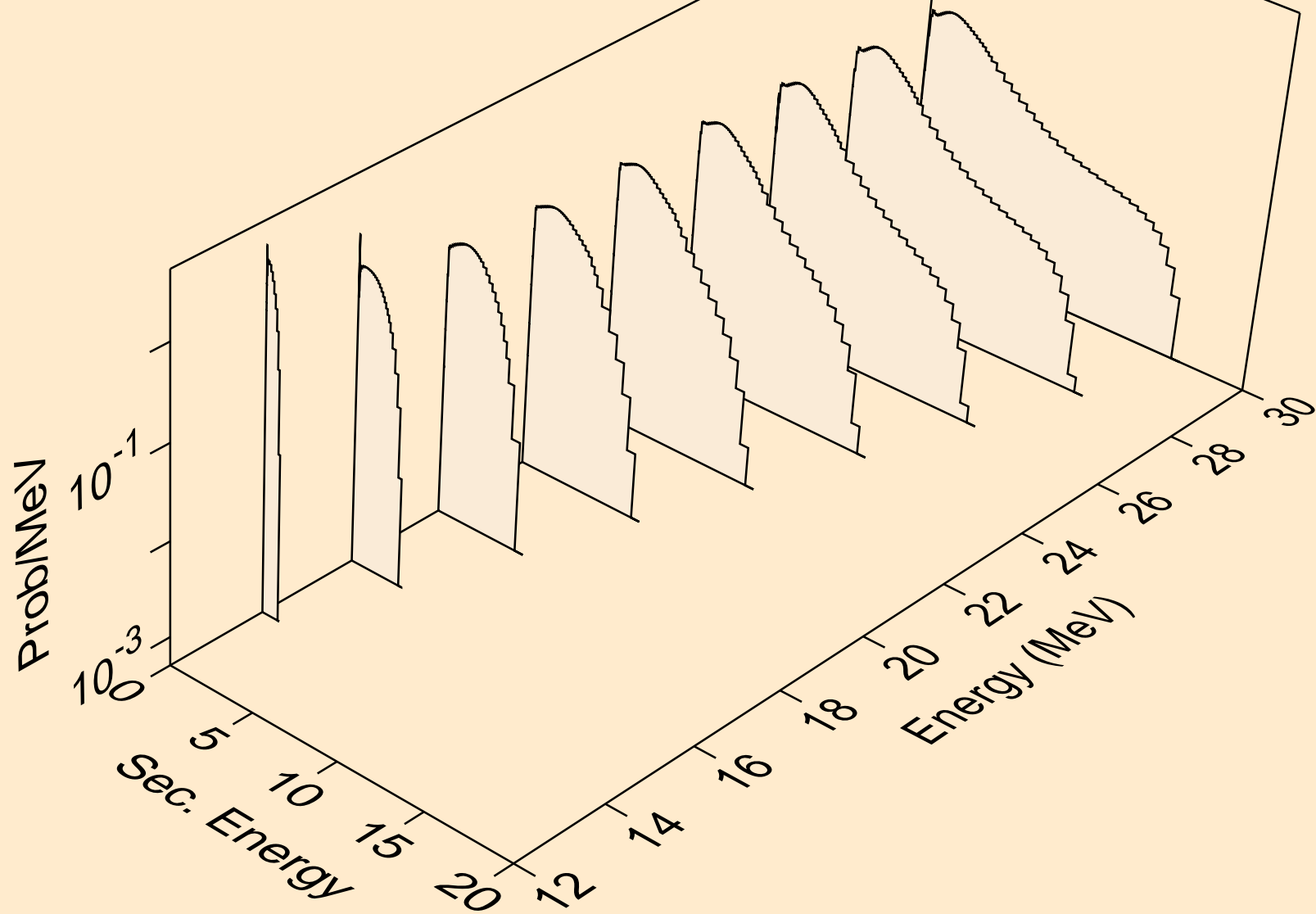

SC051 NEUTRON ACER TENDL-2023 LIBRARY; T=0.K  
Neutron emission for (n,n\*)a

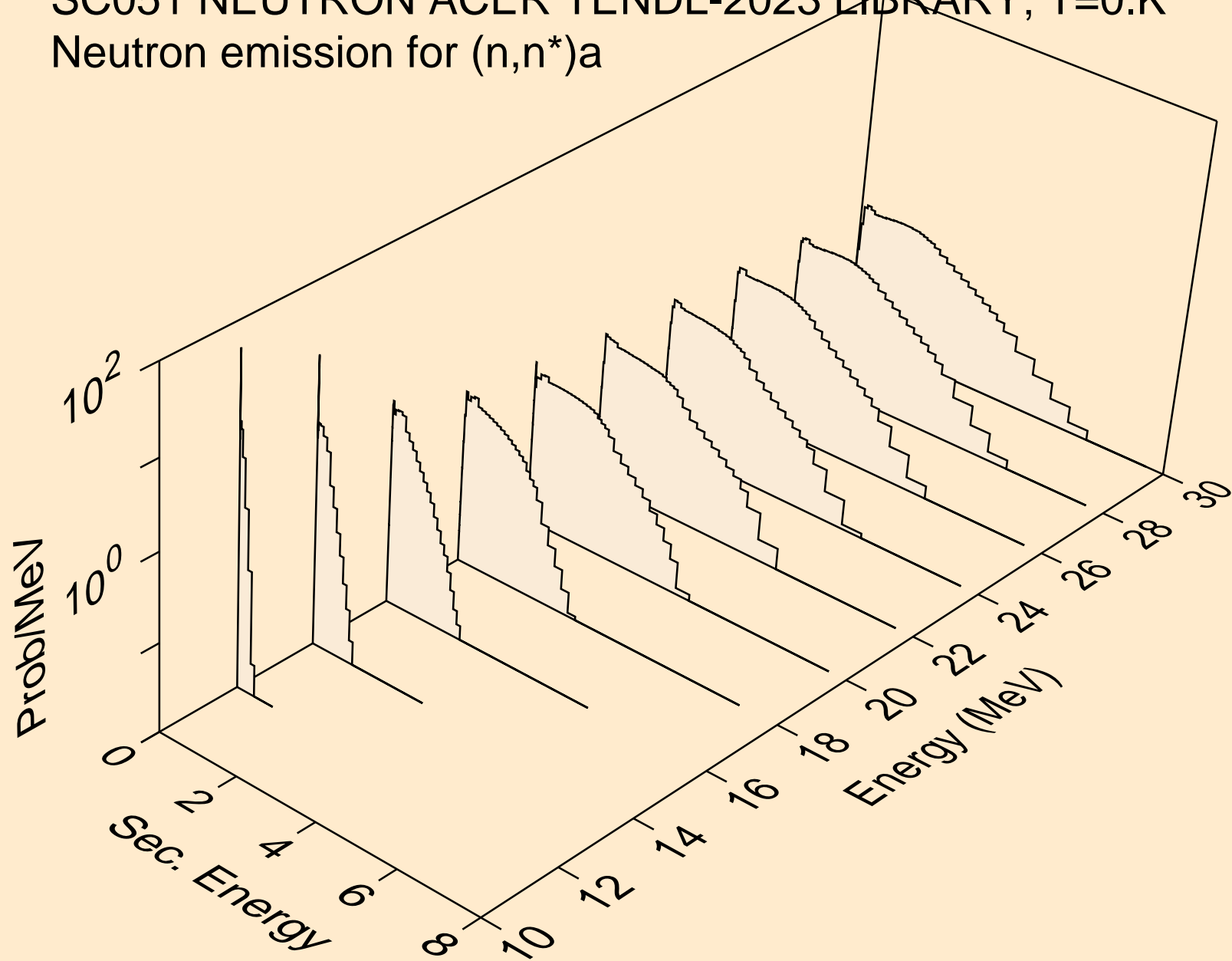



SC051 NEUTRON ACER TENDL-2023 LIBRARY; T=0.K  
Neutron emission for (n,2n)a

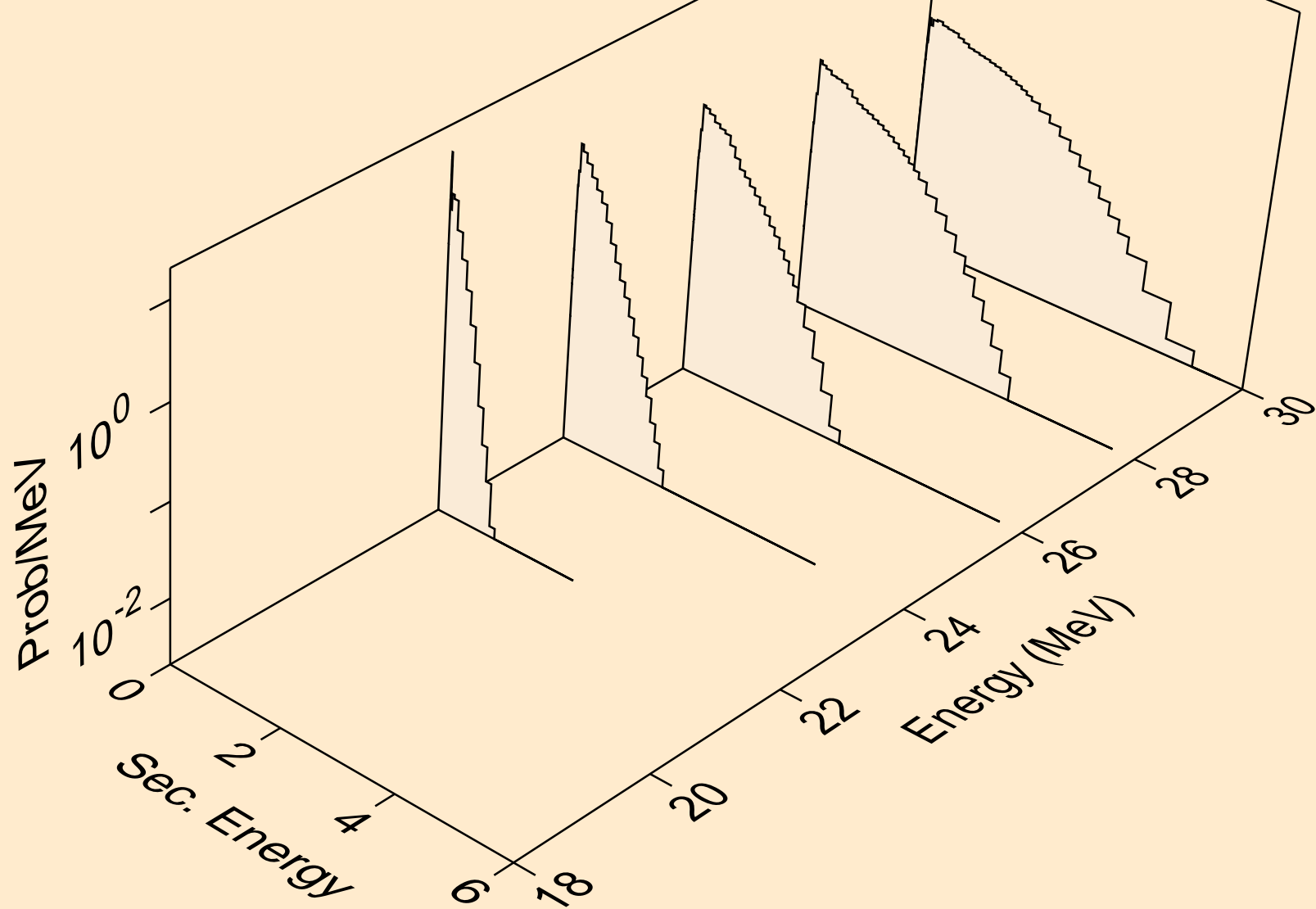

SC051 NEUTRON ACER TENDL-2023 LIBRARY; T=0.K  
Neutron emission for (n,3n)a

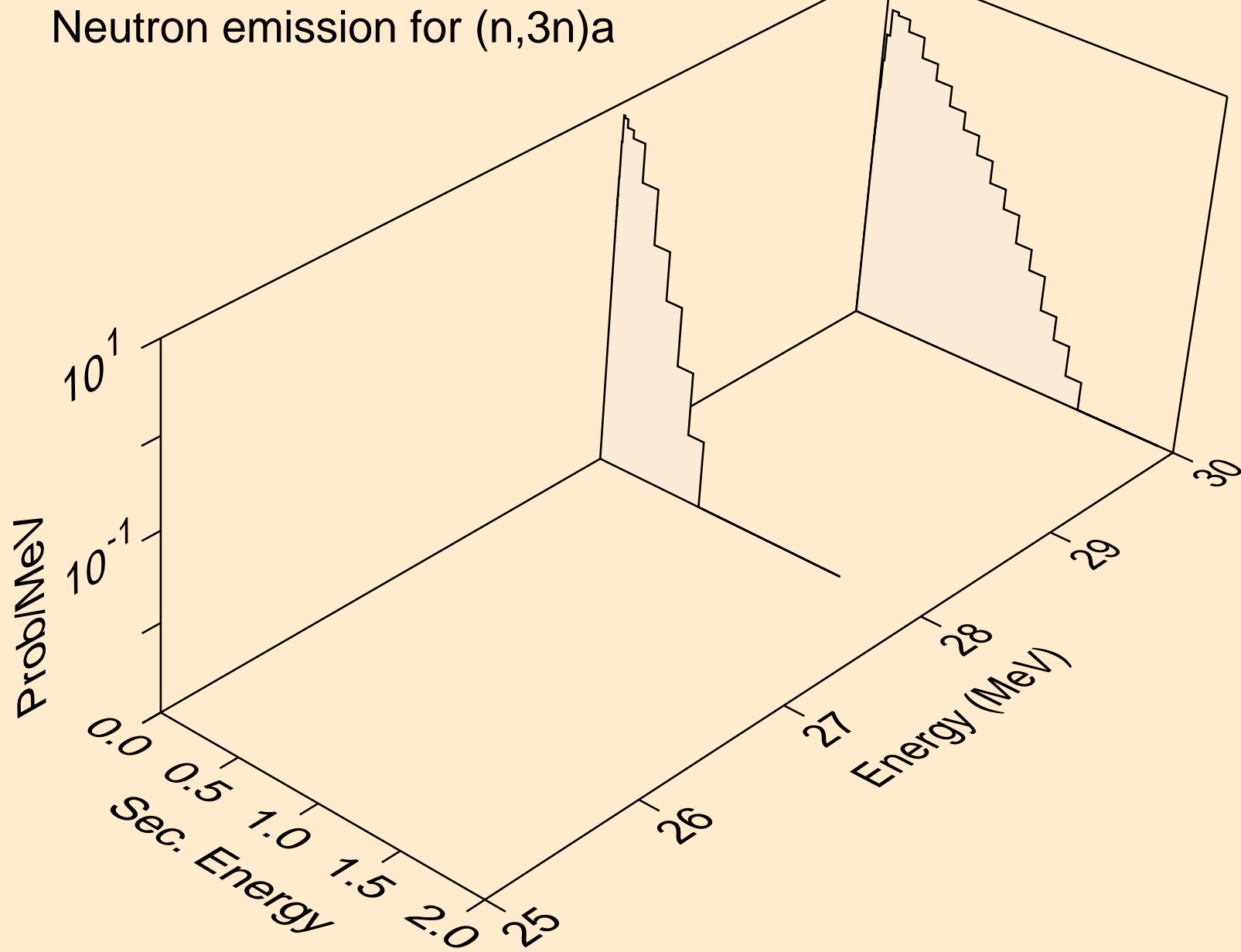

SC051 NEUTRON ACER TENDL-2023 LIBRARY; T=0.K  
Neutron emission for (n,n\*)p

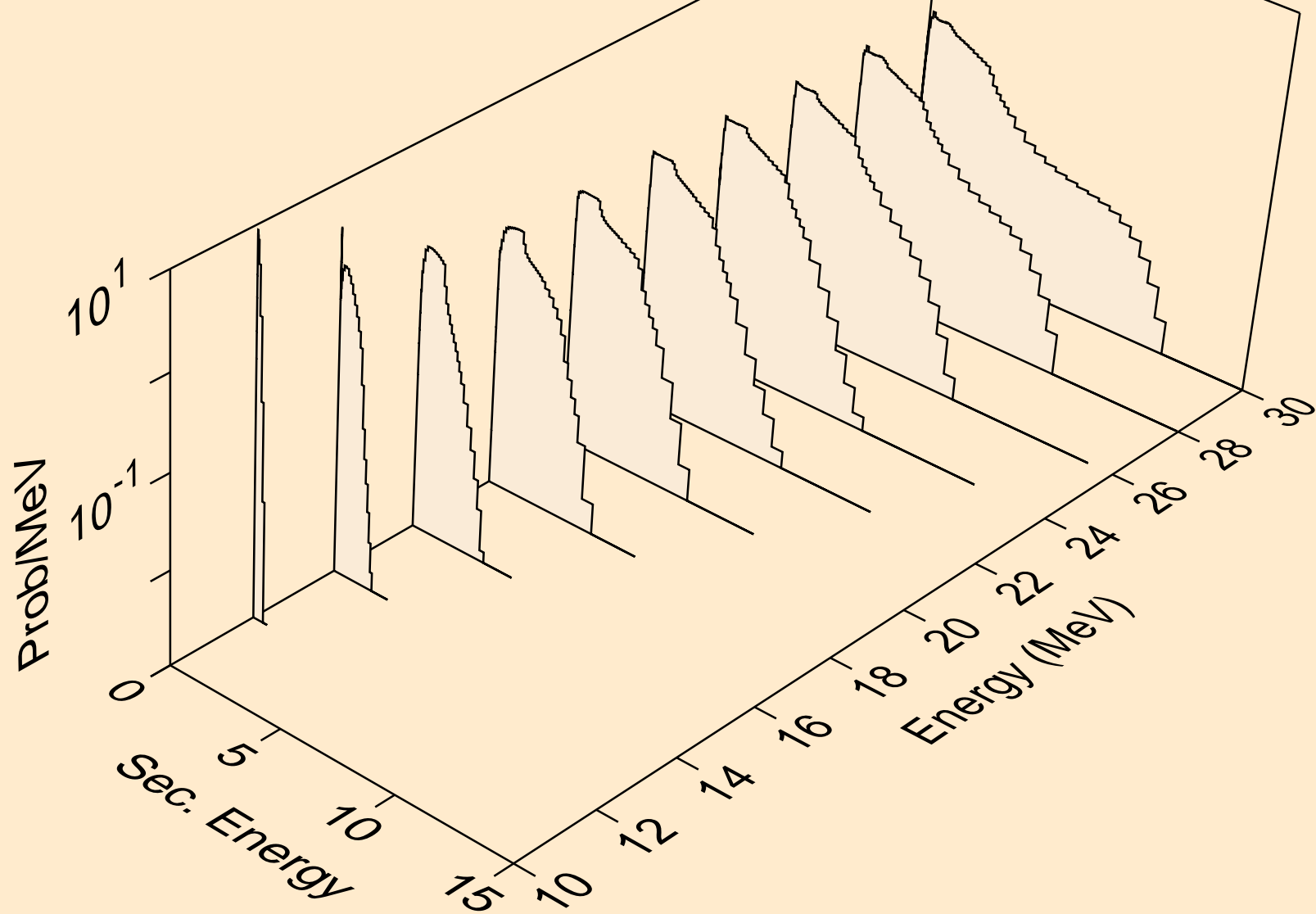

SC051 NEUTRON ACER TENDL-2023 LIBRARY; T=0.K  
Neutron emission for (n,n\*)d

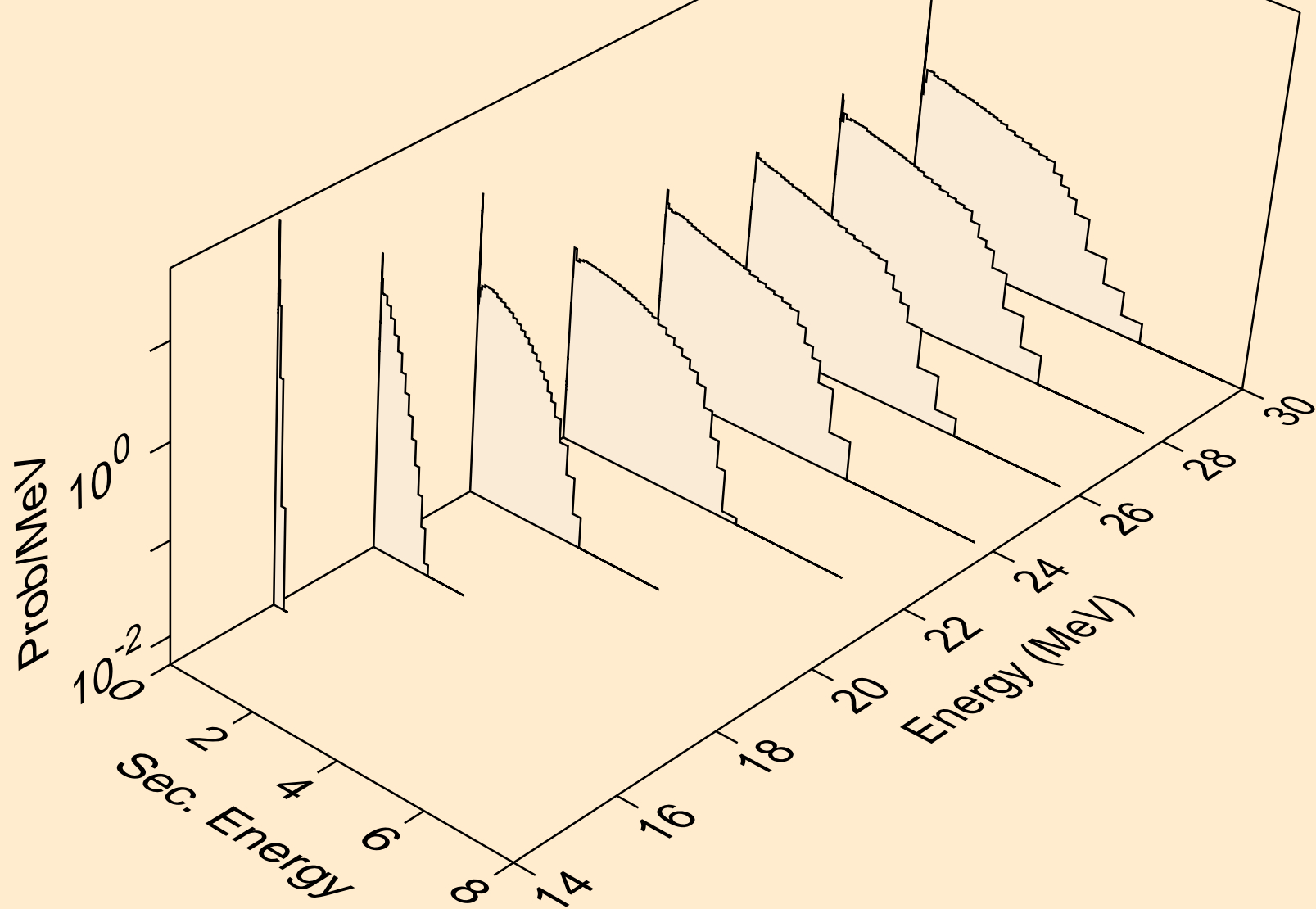

SC051 NEUTRON ACER TENDL-2023 LIBRARY; T=0.K  
Neutron emission for (n,n\*)t

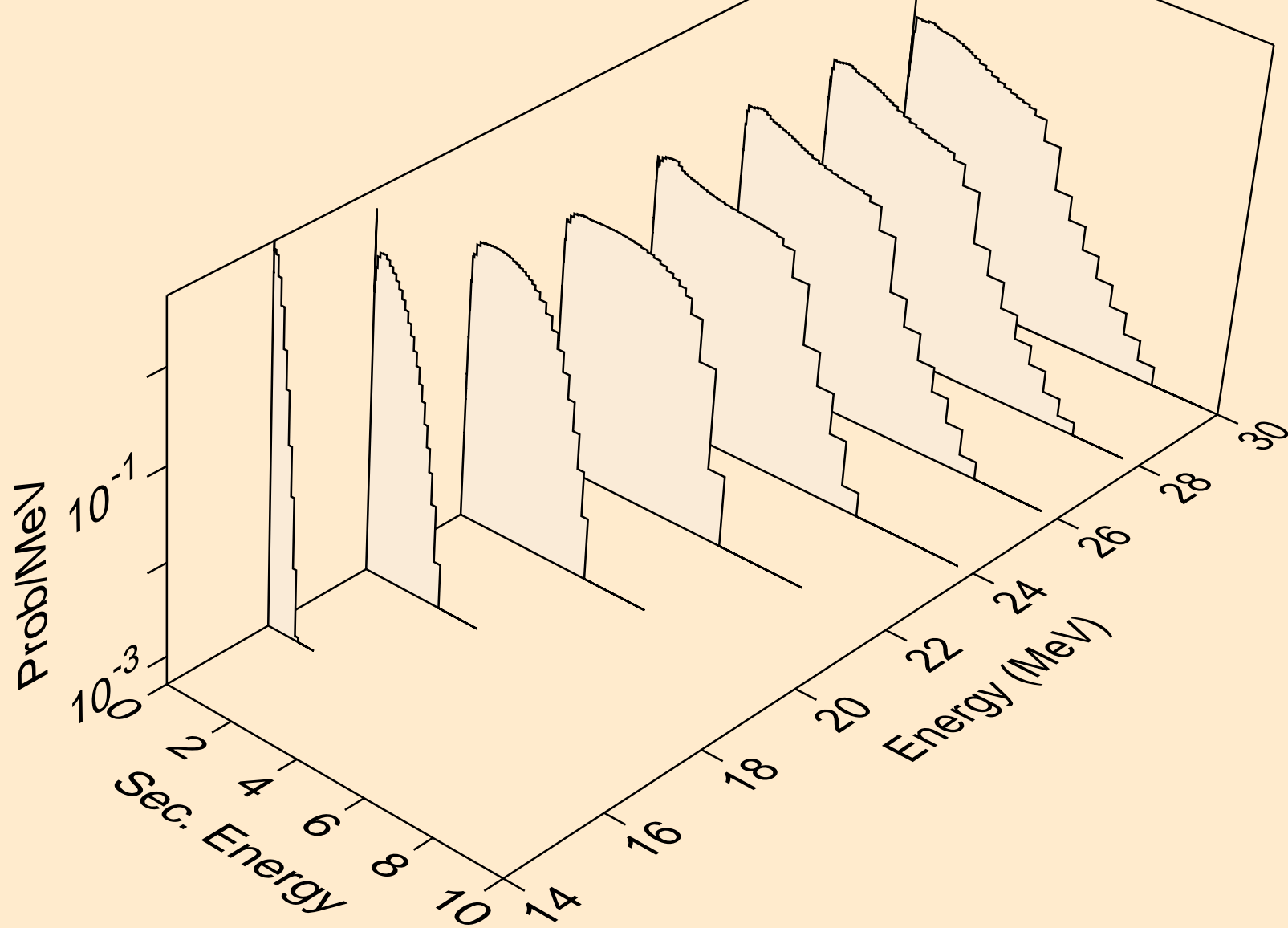

SC051 NEUTRON ACER TENDL-2023 LIBRARY; T=0.K  
Neutron emission for (n,n\*)he3

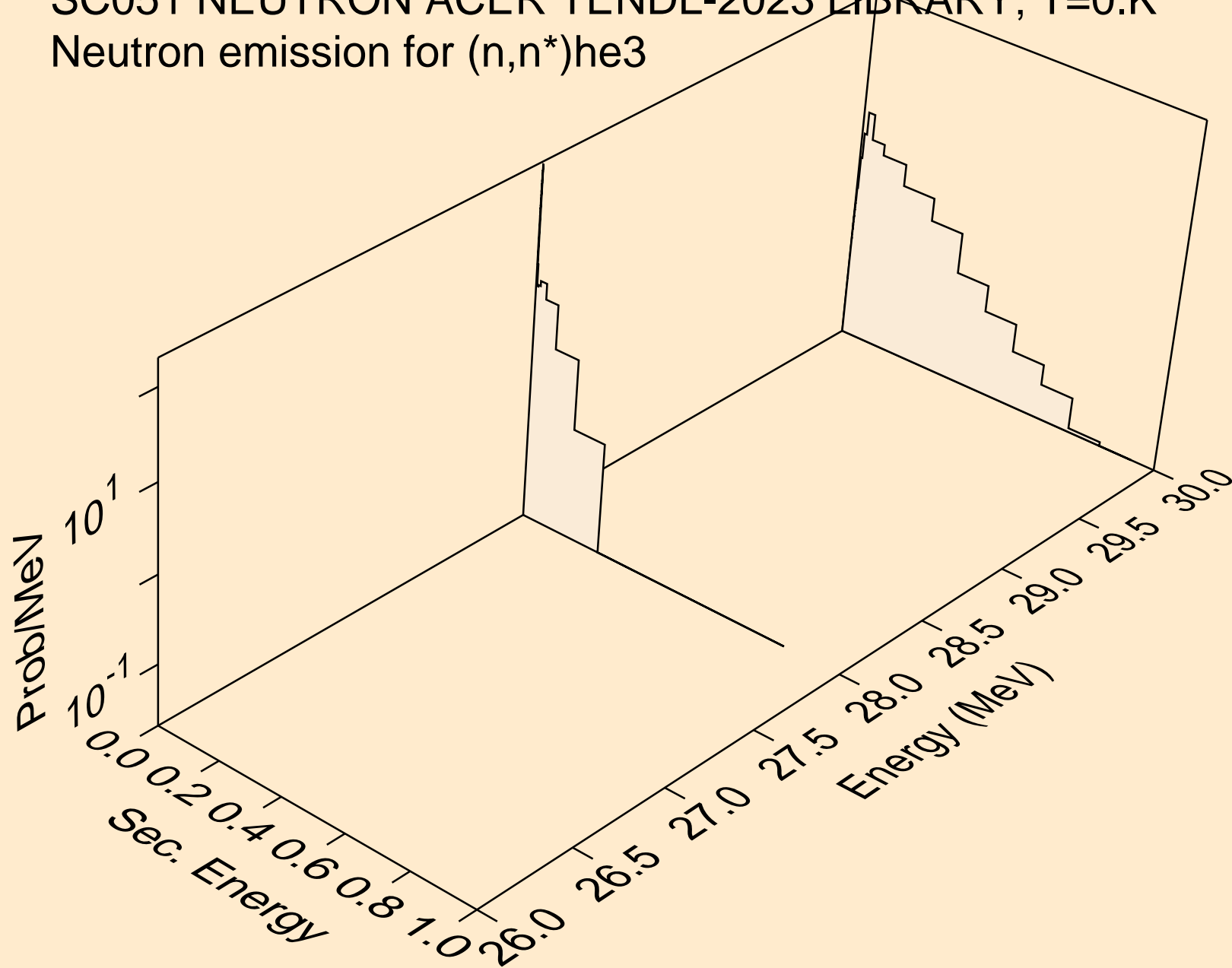

SC051 NEUTRON ACER TENDL-2023 LIBRARY; T=0.K  
Neutron emission for (n,4n)

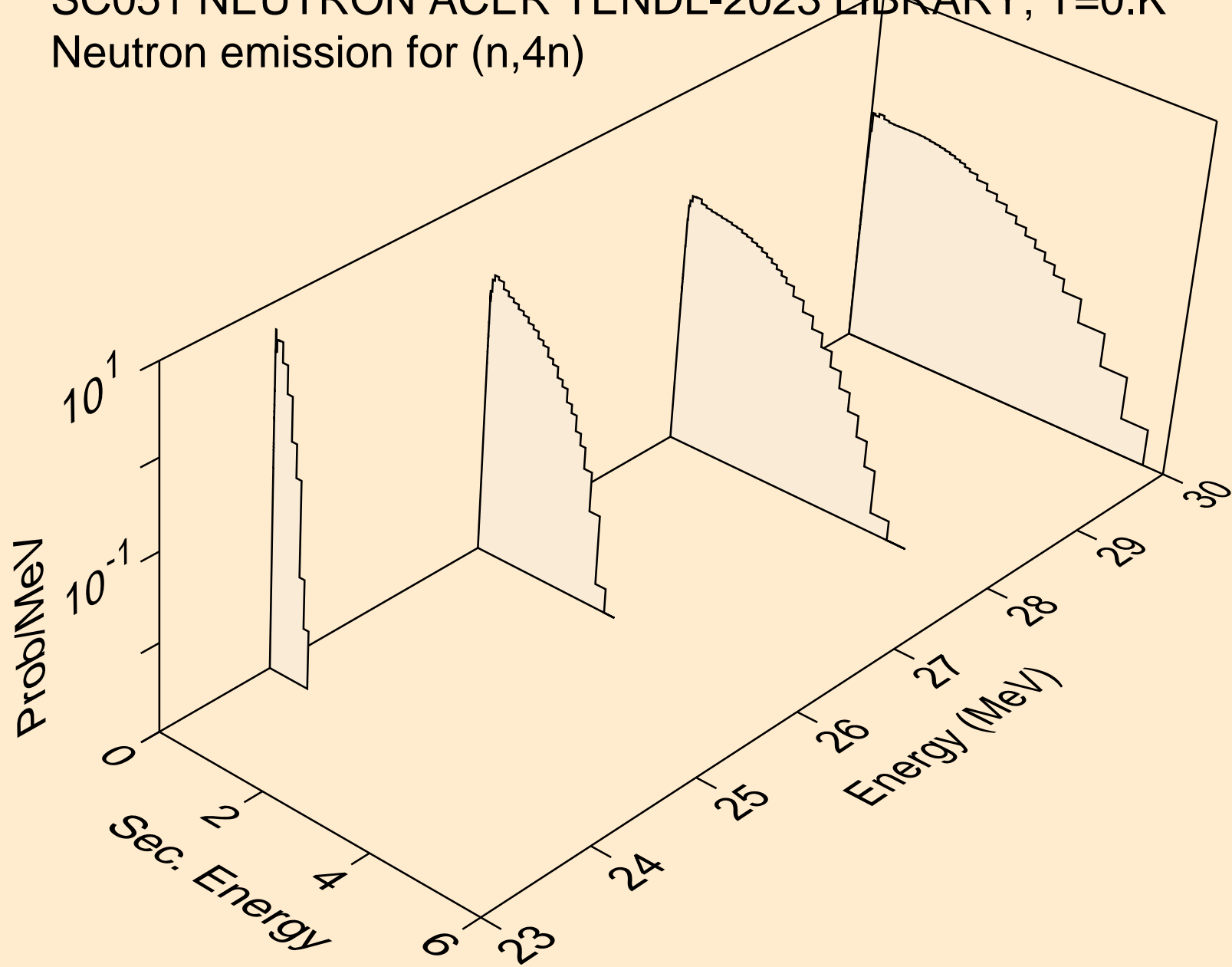

SC051 NEUTRON ACER TENDL-2023 LIBRARY; T=0.K  
Neutron emission for (n,2np)

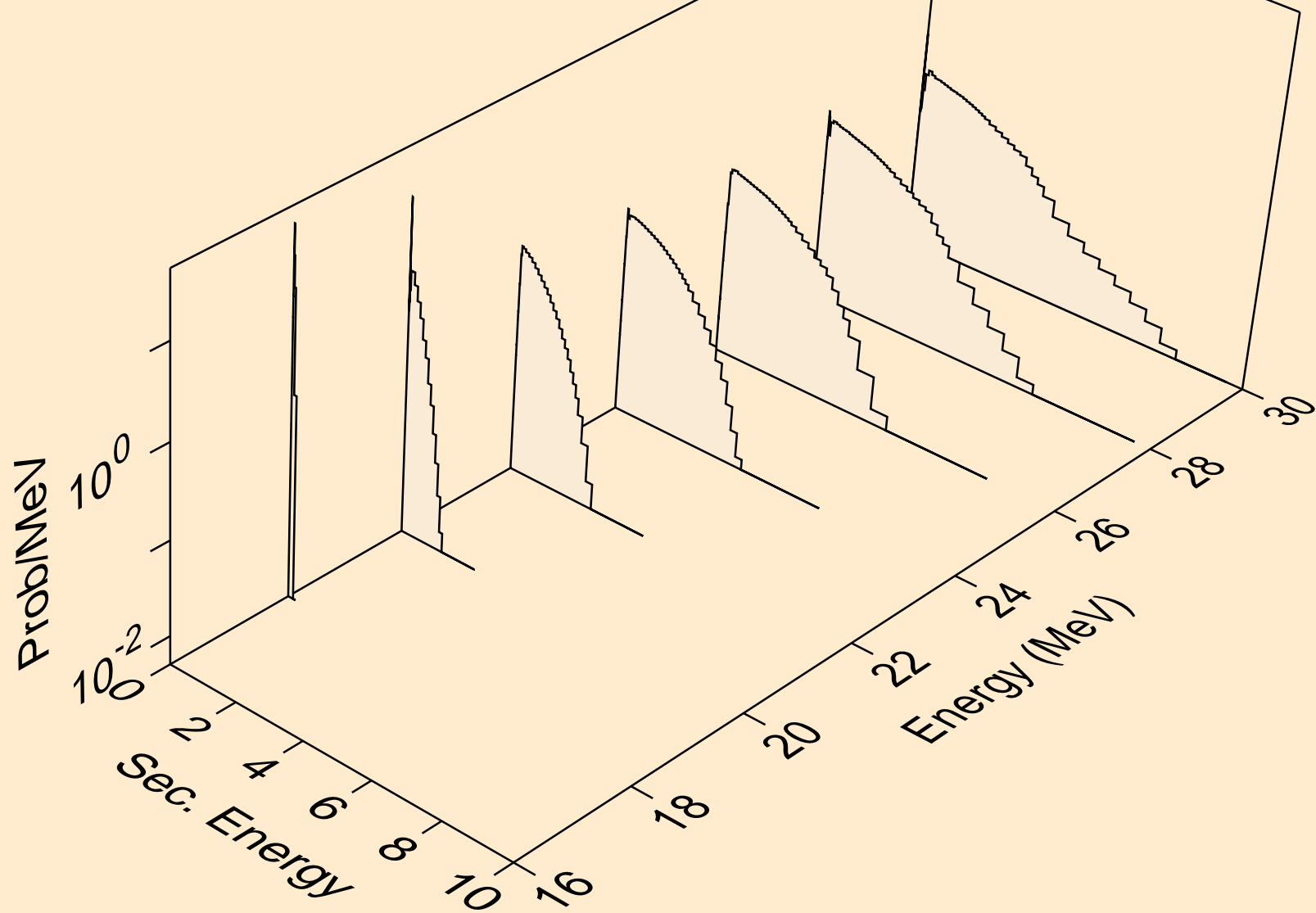



SC051 NEUTRON ACER TENDL-2023 LIBRARY; T=0.K  
Neutron emission for (n,3np)

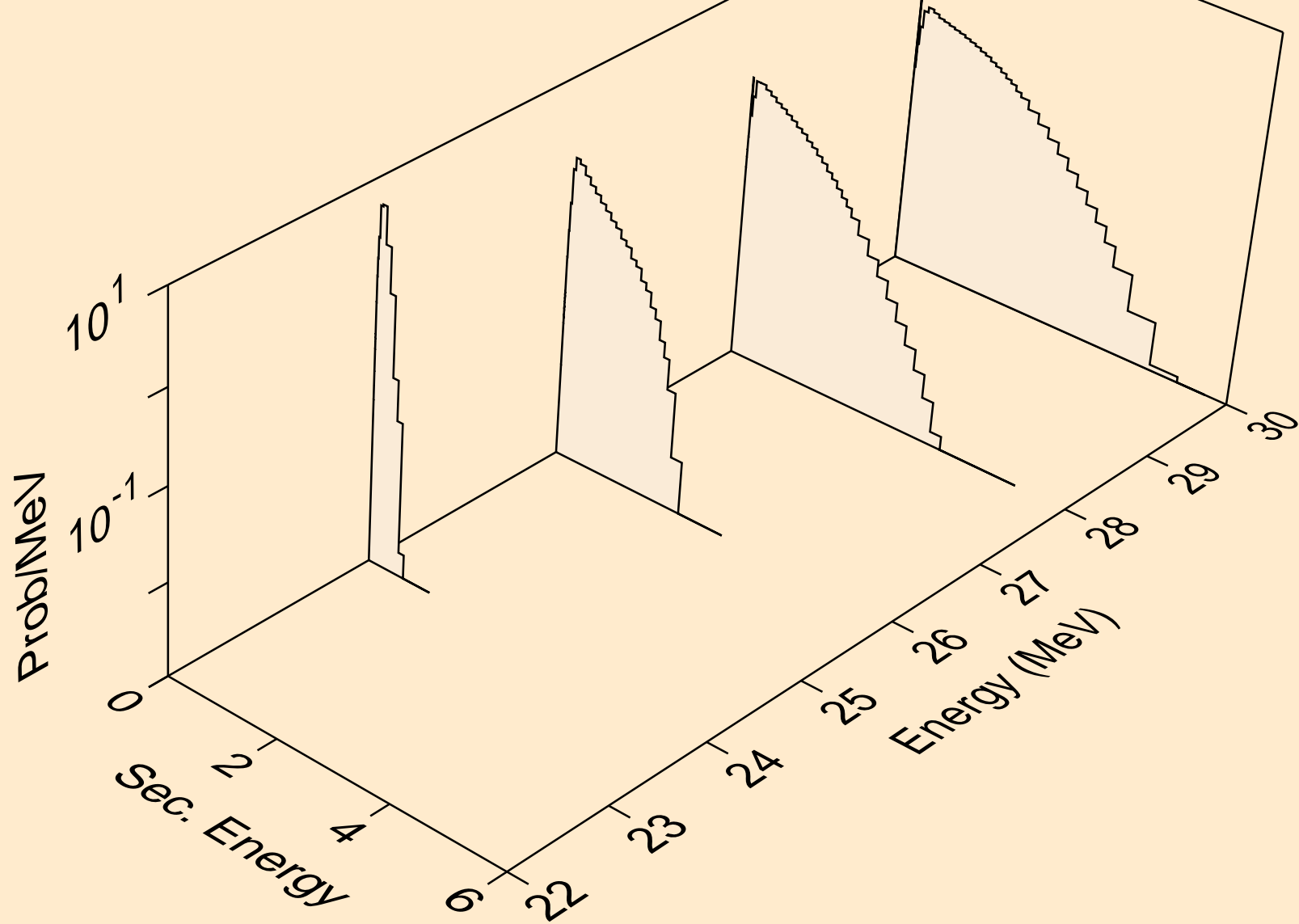

SC051 NEUTRON ACER TENDL-2023 LIBRARY; T=0.K  
Neutron emission for (n,n\*c)

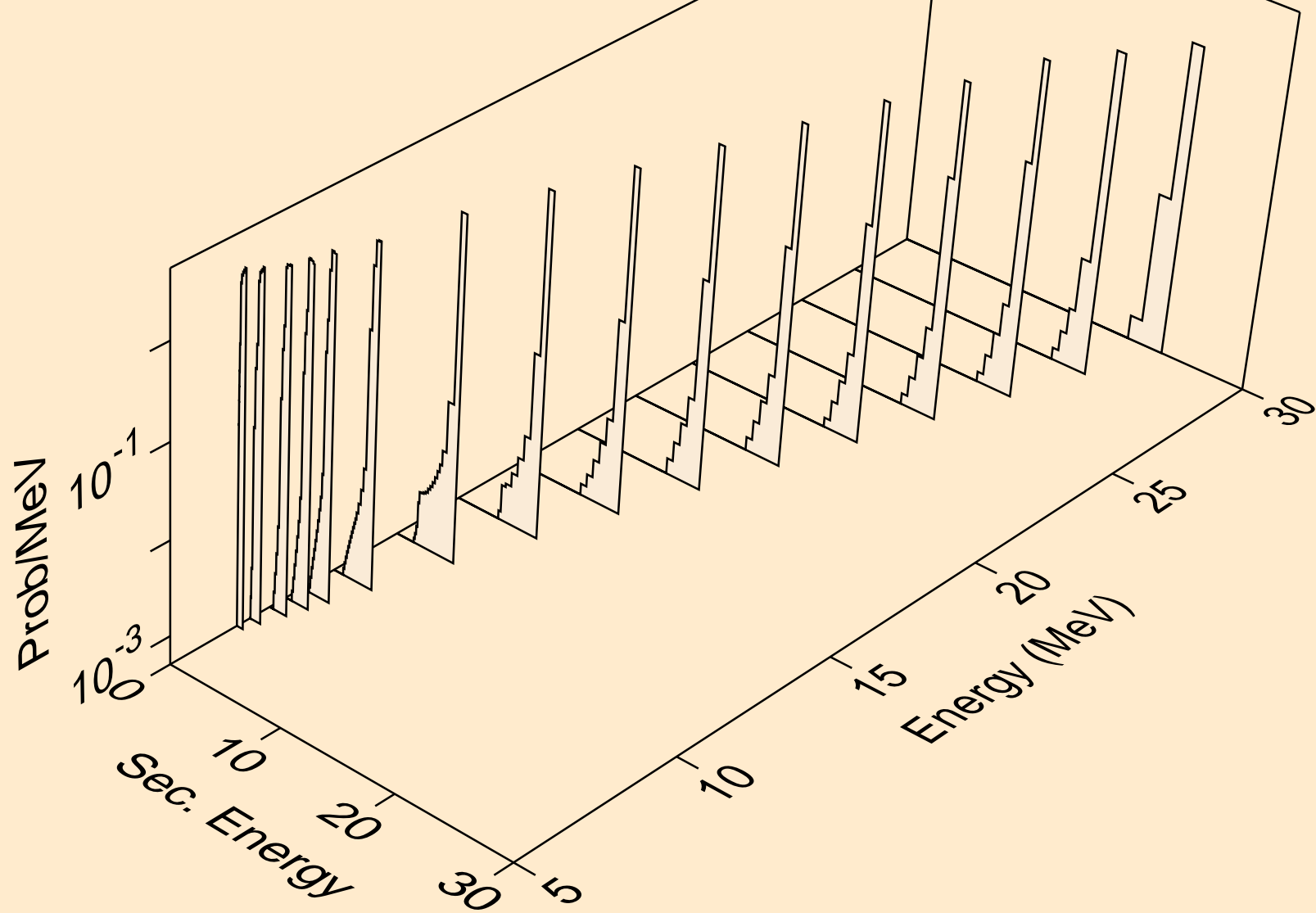

SC051 NEUTRON ACER TENDL-2023 LIBRARY; T=0.K  
Photon emission for (n,x)

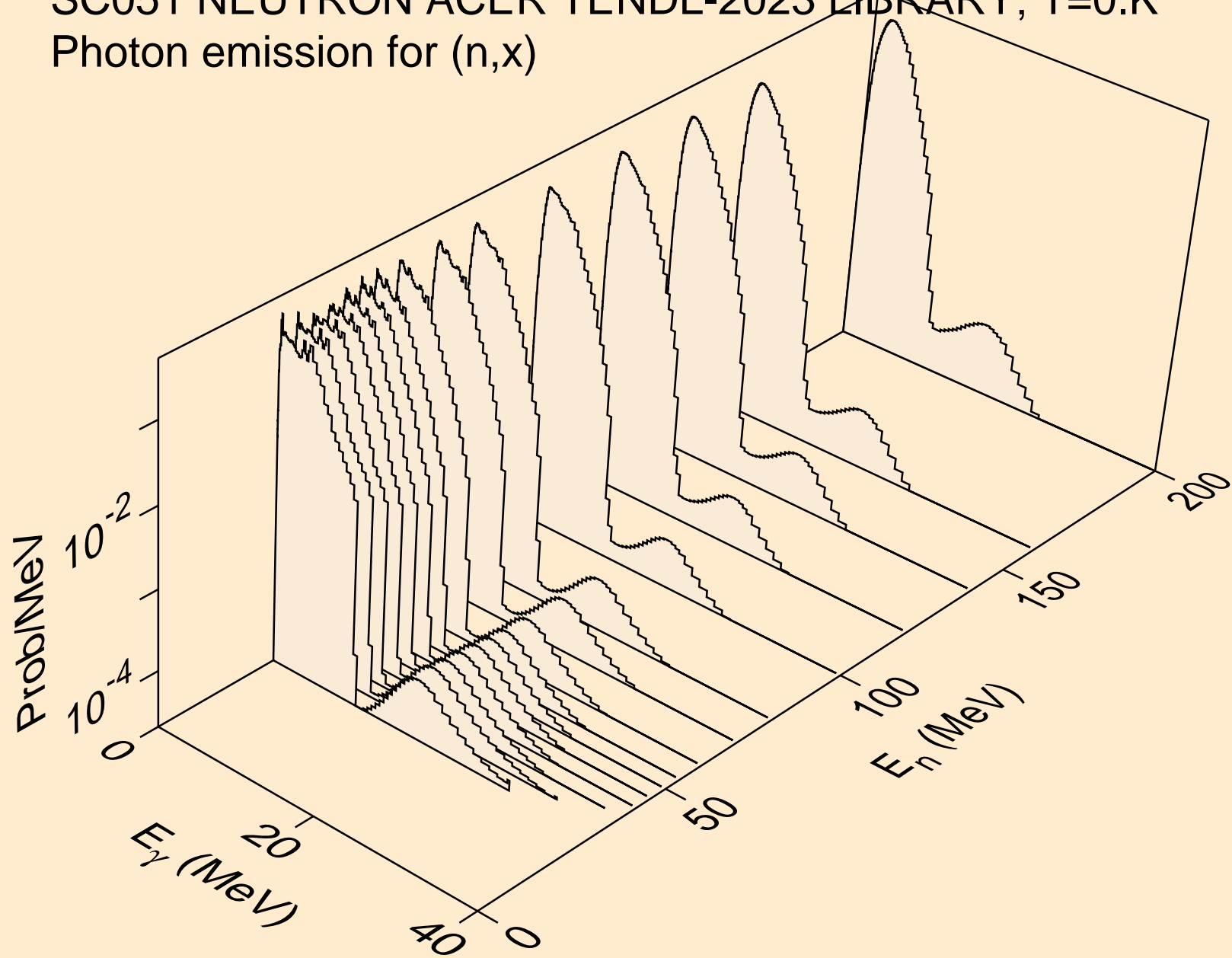

SC051 NEUTRON ACER TENDL-2023 LIBRARY; T=0.K  
Photon emission for (n,2nd)

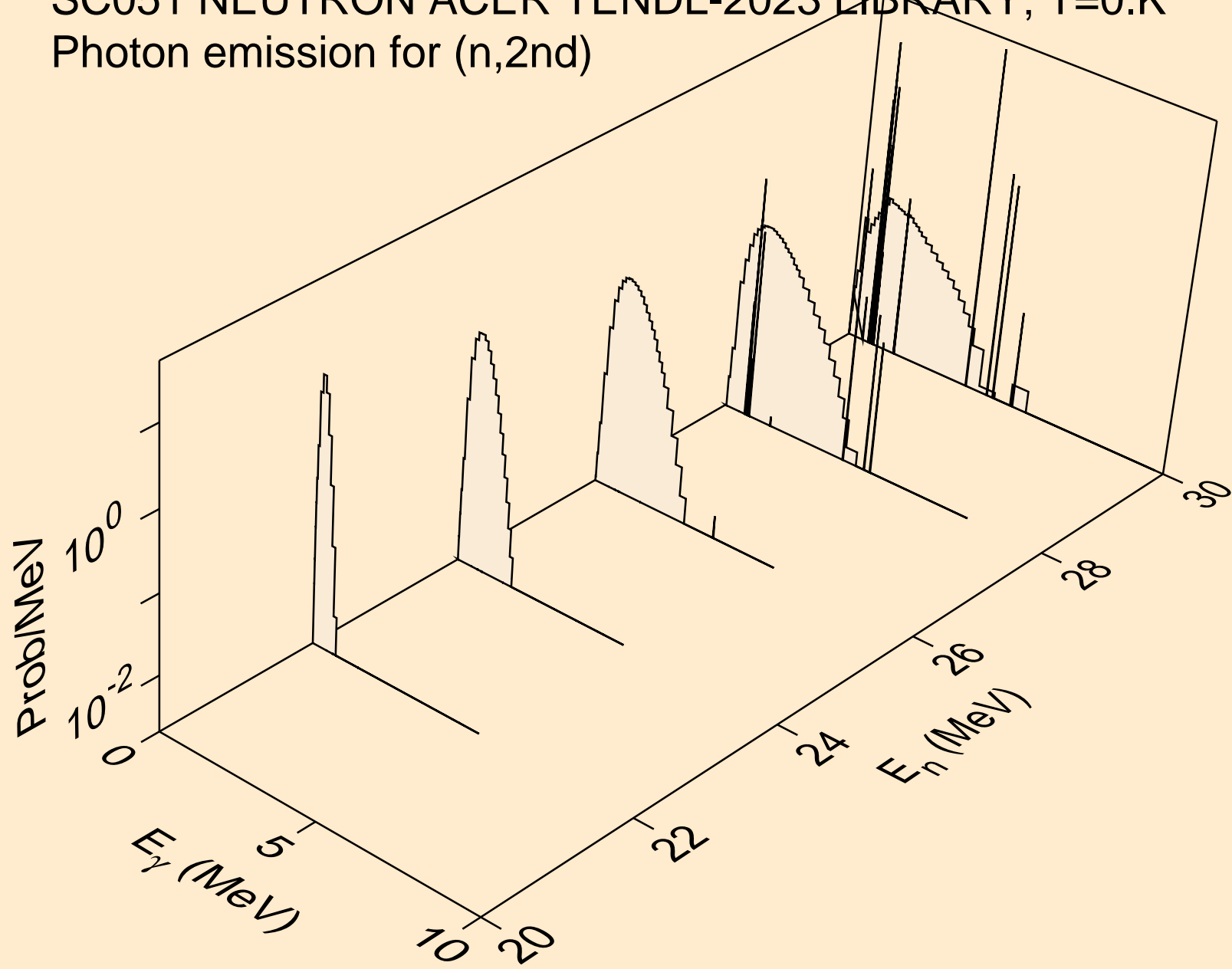

SC051 NEUTRON ACER TENDL-2023 LIBRARY; T=0.K  
Photon emission for (n,2n)

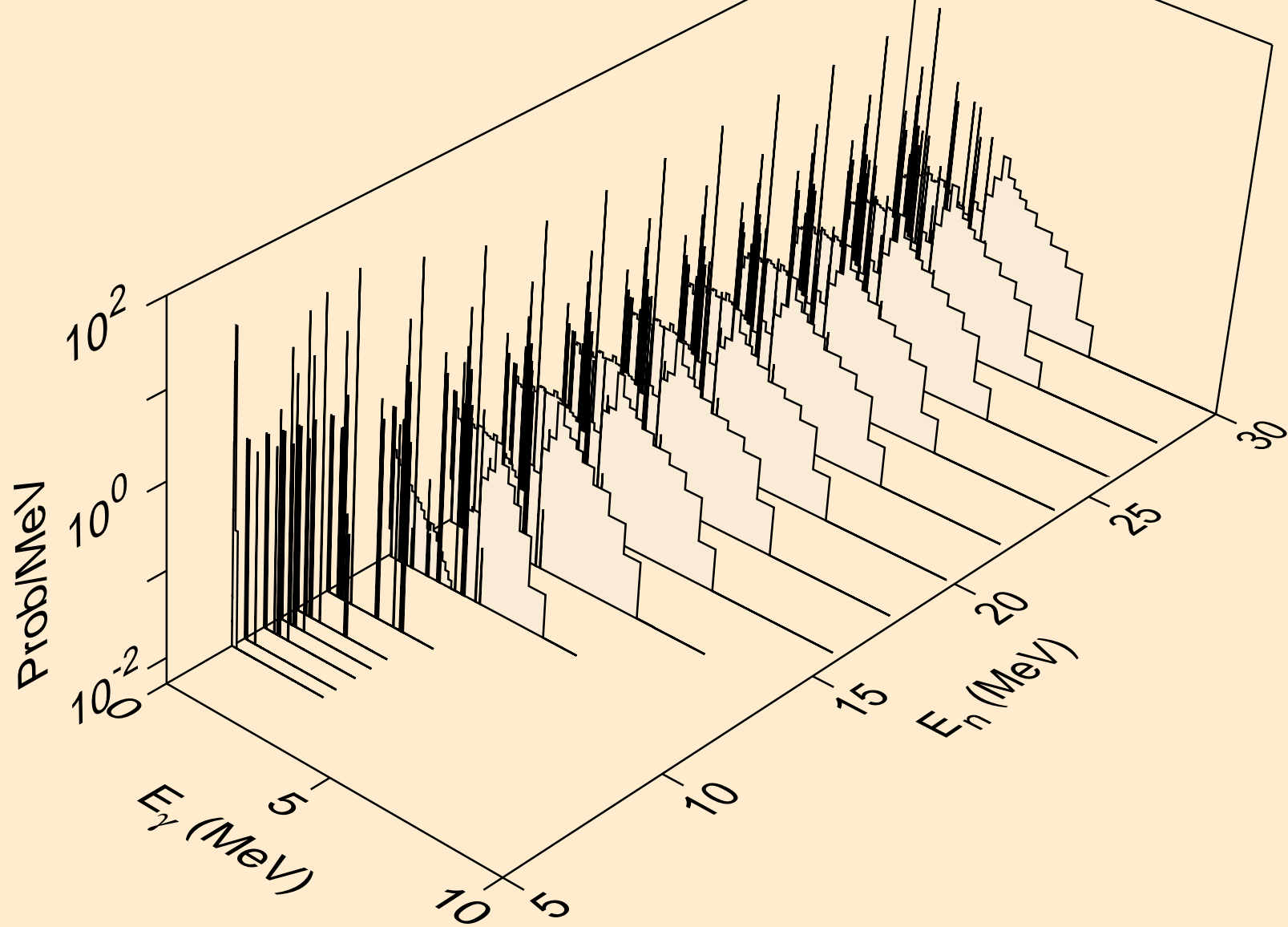

SC051 NEUTRON ACER TENDL-2023 LIBRARY; T=0.K  
Photon emission for (n,3n)

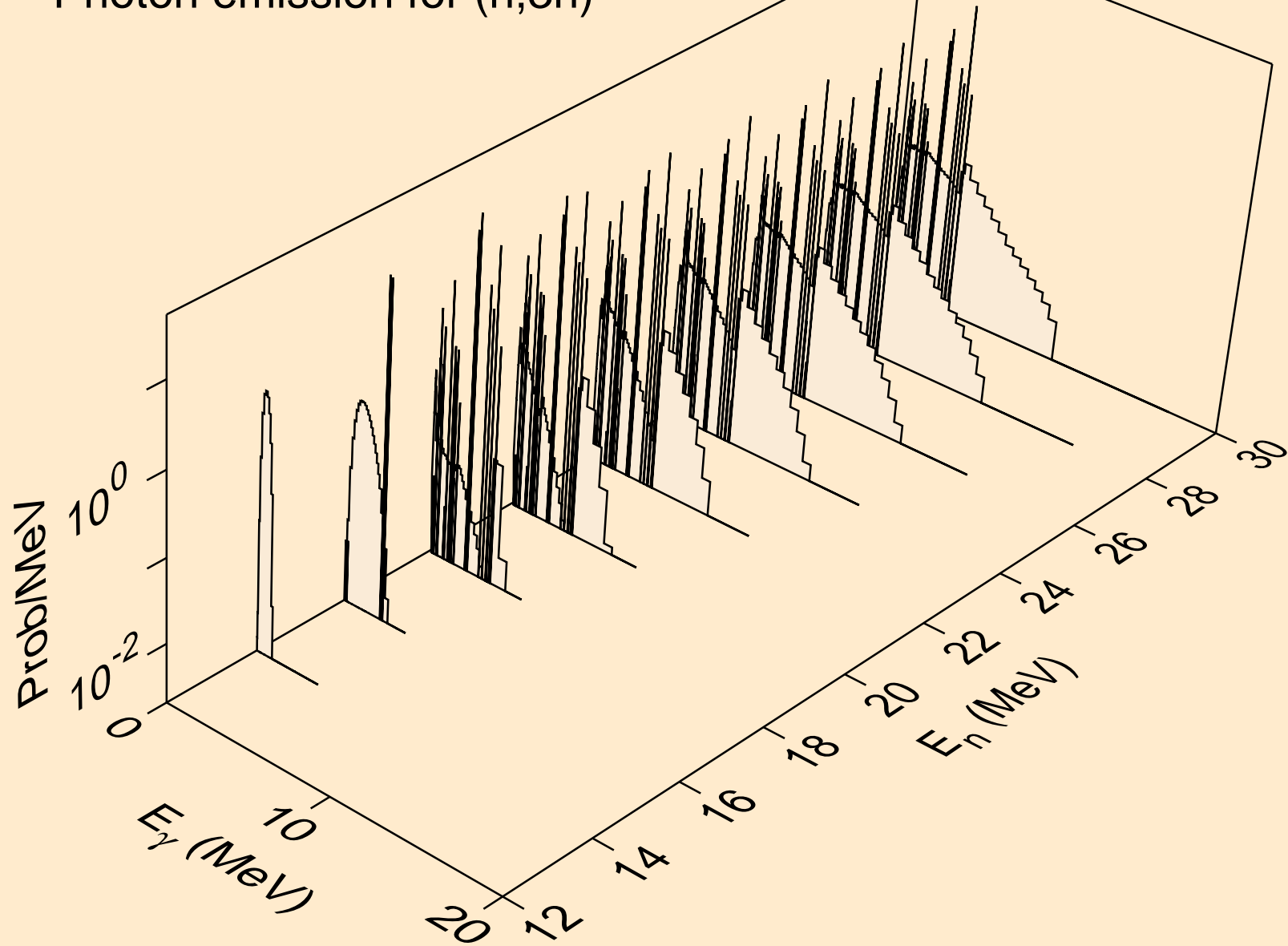

SC051 NEUTRON ACER TENDL-2023 LIBRARY; T=0.K  
Photon emission for (n,n\*)a

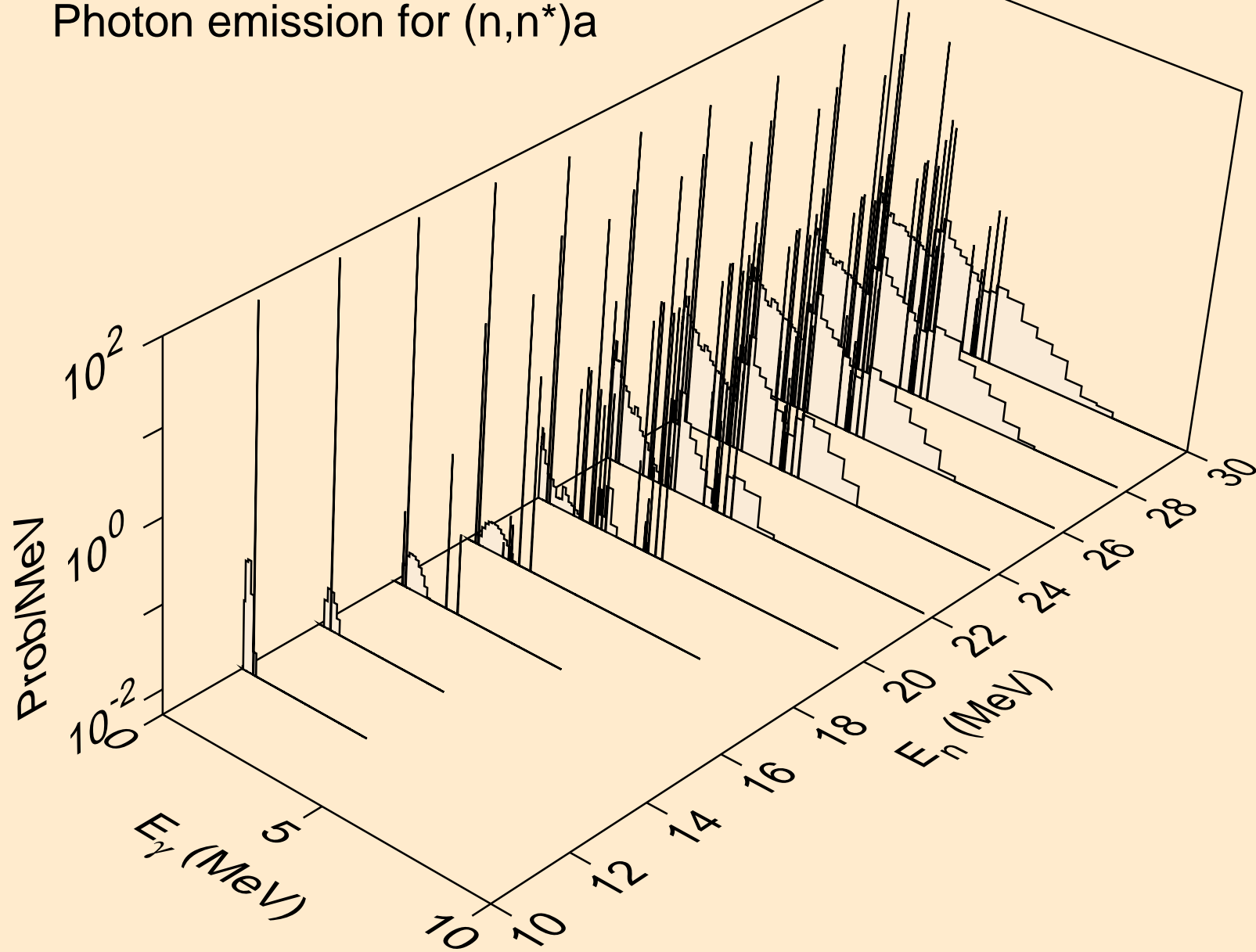

SC051 NEUTRON ACER TENDL-2023 LIBRARY; T=0.K  
Photon emission for (n,2n)a

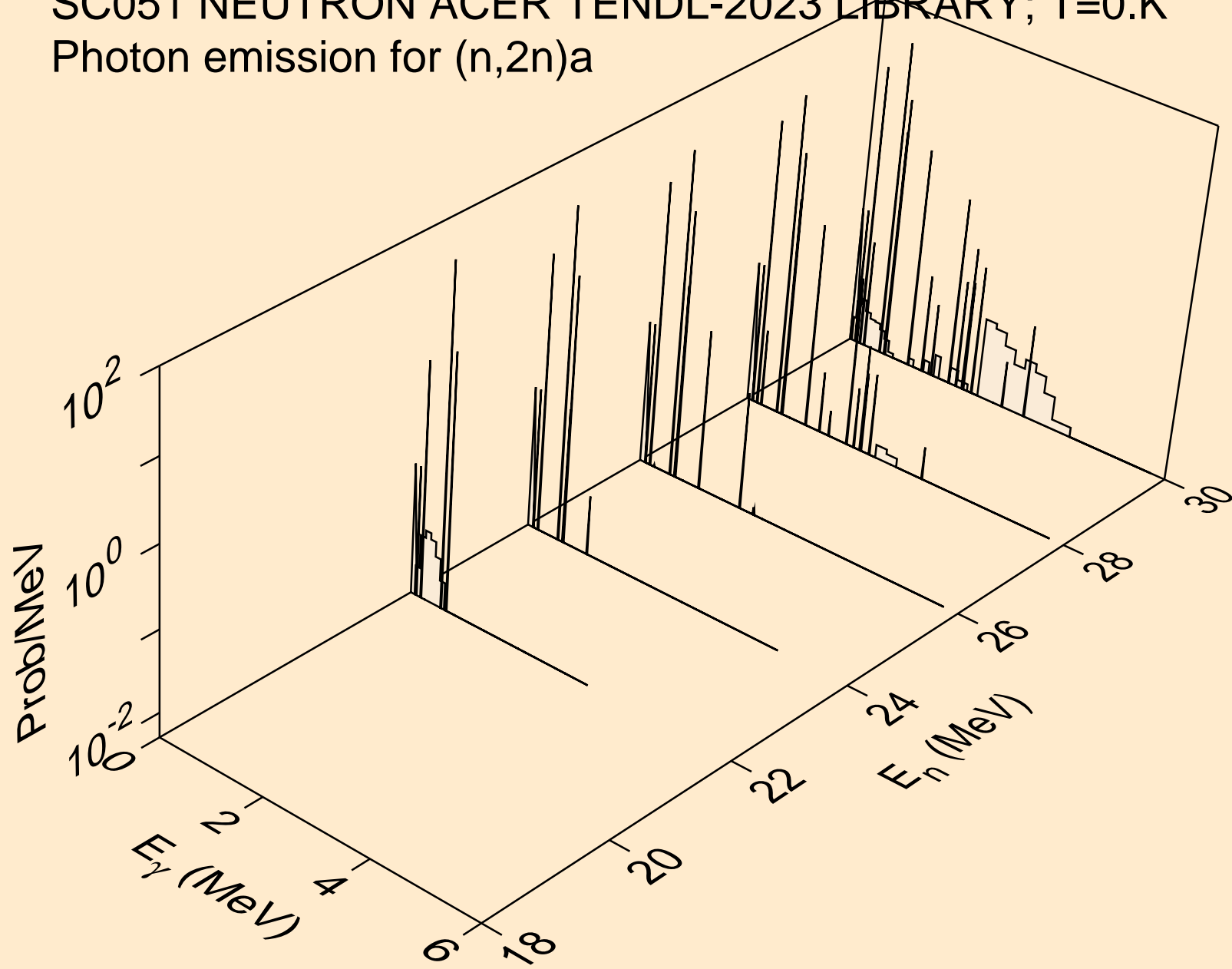



SC051 NEUTRON ACER TENDL-2023 LIBRARY; T=0.K  
Photon emission for (n,3n)a

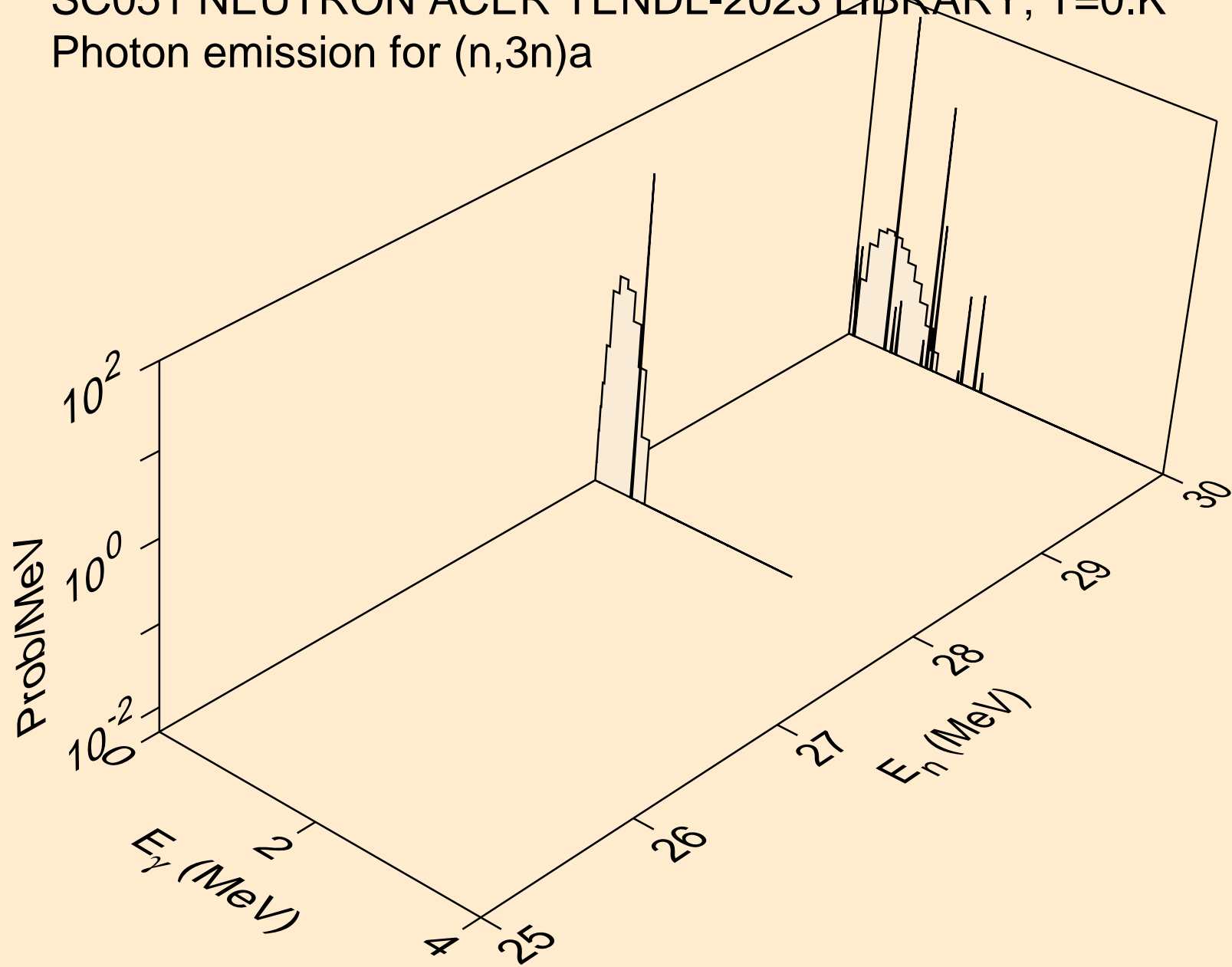

SC051 NEUTRON ACER TENDL-2023 LIBRARY; T=0.K  
Photon emission for (n,n\*)p

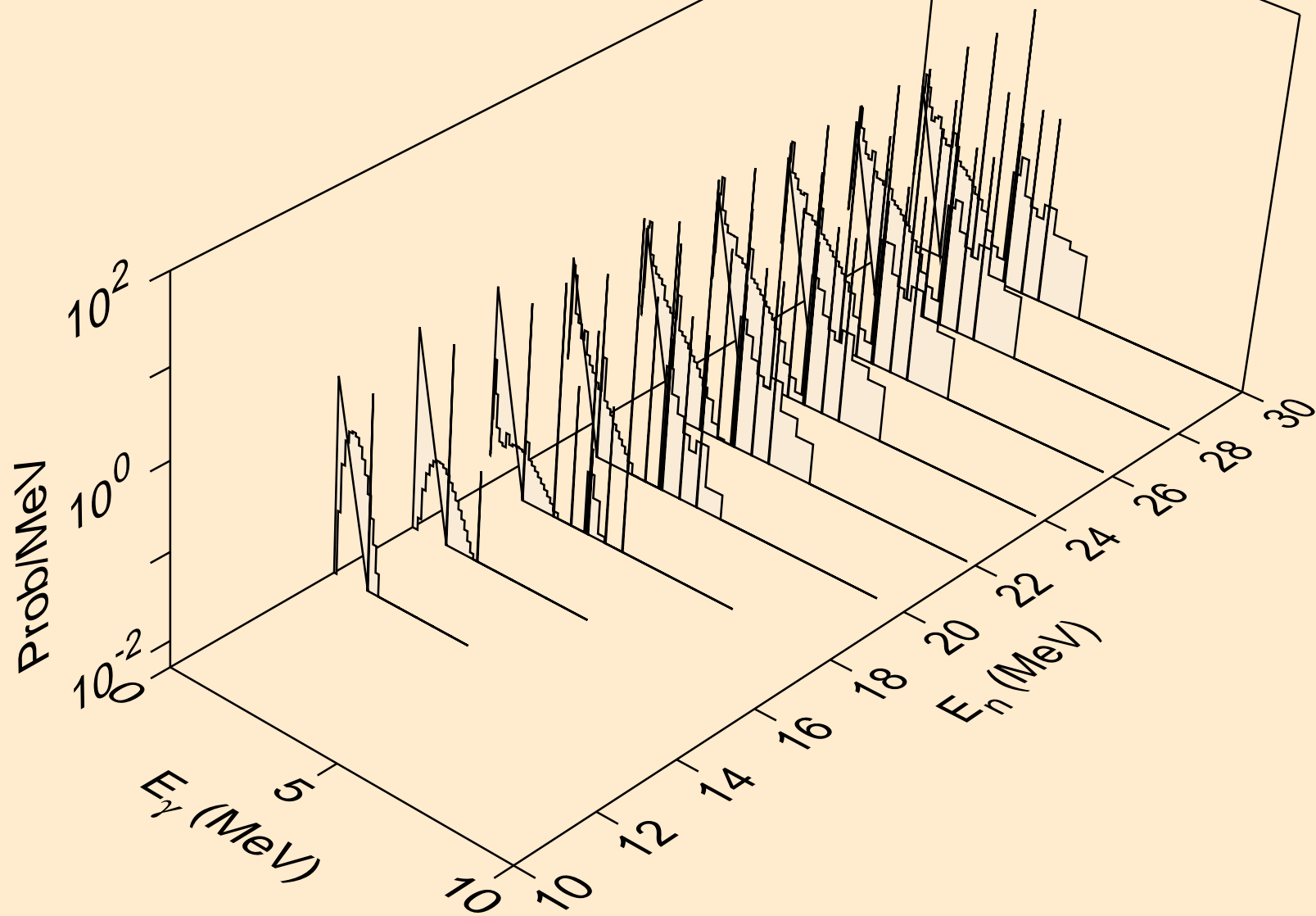

SC051 NEUTRON ACER TENDL-2023 LIBRARY; T=0.K  
Photon emission for (n,n\*)d

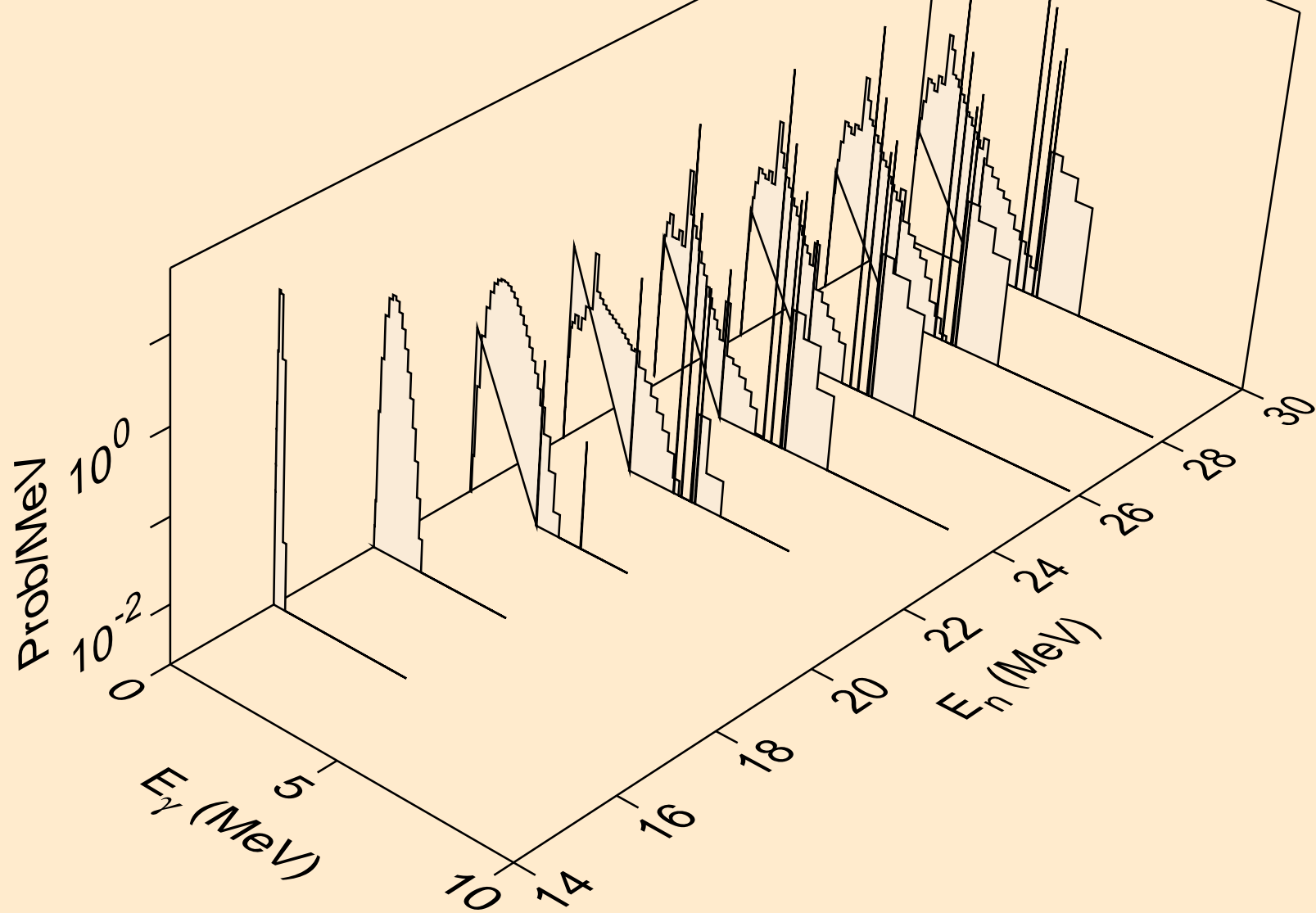

SC051 NEUTRON ACER TENDL-2023 LIBRARY; T=0.K  
Photon emission for (n,n\*)t

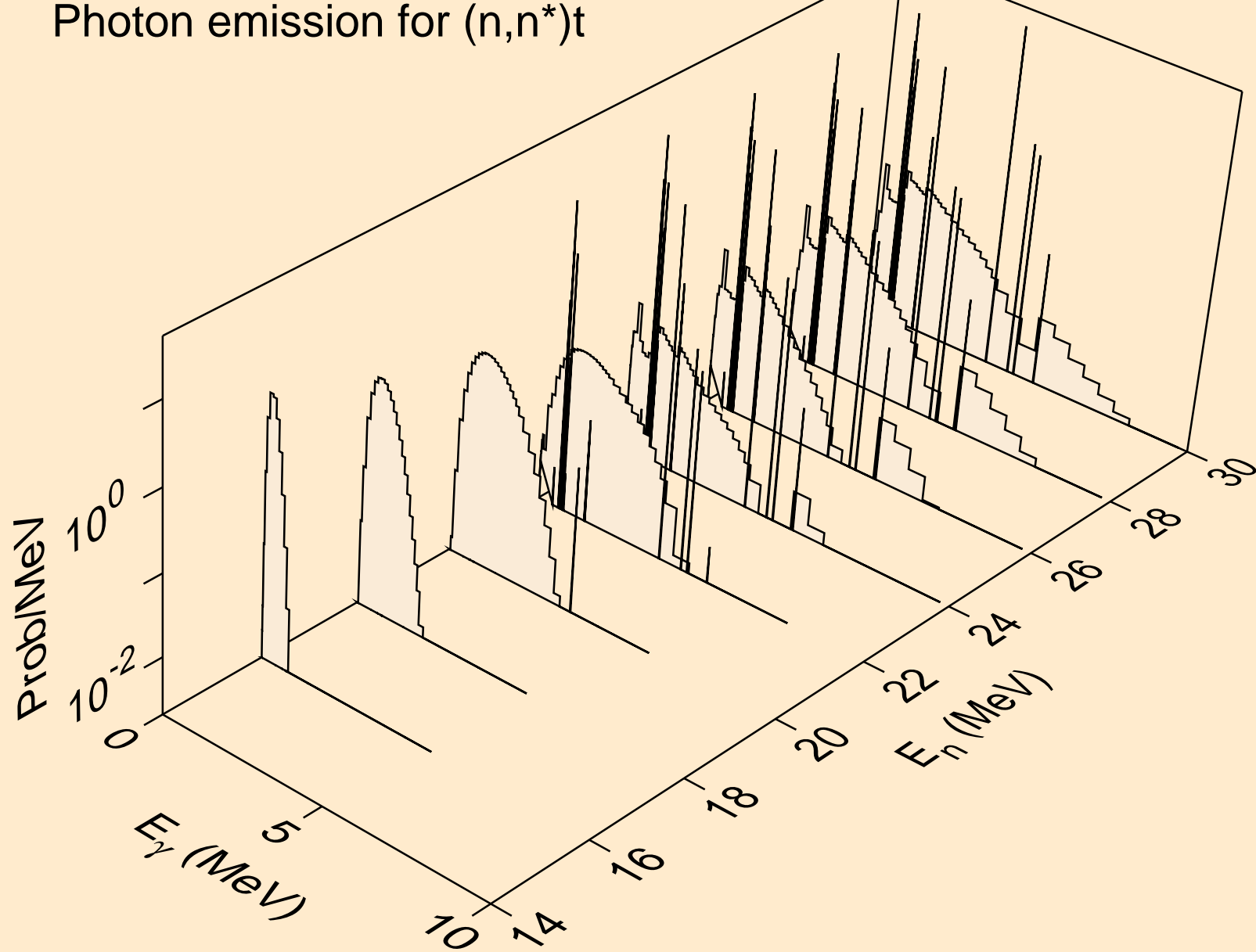

SC051 NEUTRON ACER TENDL-2023 LIBRARY; T=0.K  
Photon emission for (n,n\*)he3

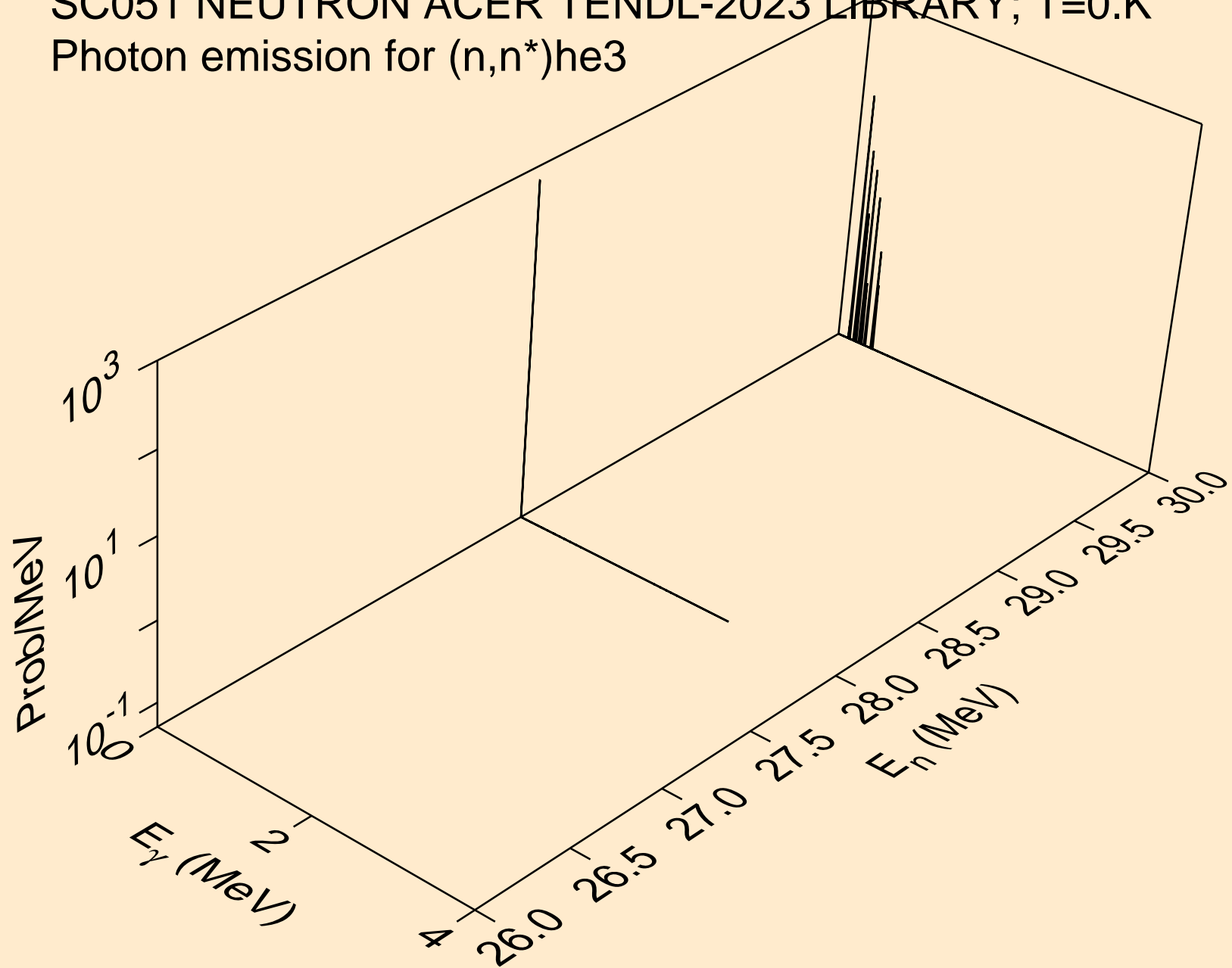

SC051 NEUTRON ACER TENDL-2023 LIBRARY; T=0.K  
Photon emission for (n,4n)

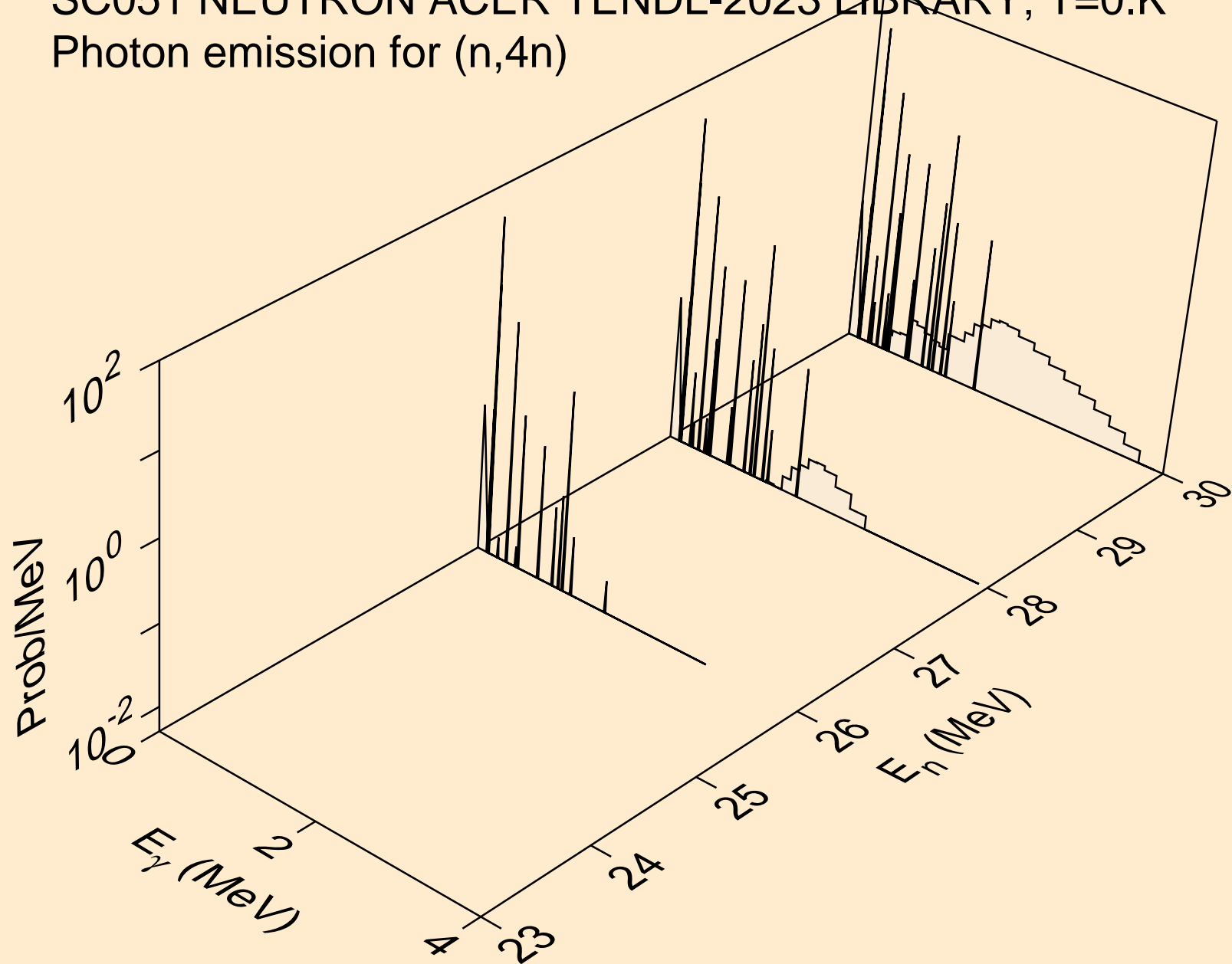

SC051 NEUTRON ACER TENDL-2023 LIBRARY; T=0.K  
Photon emission for (n,2np)

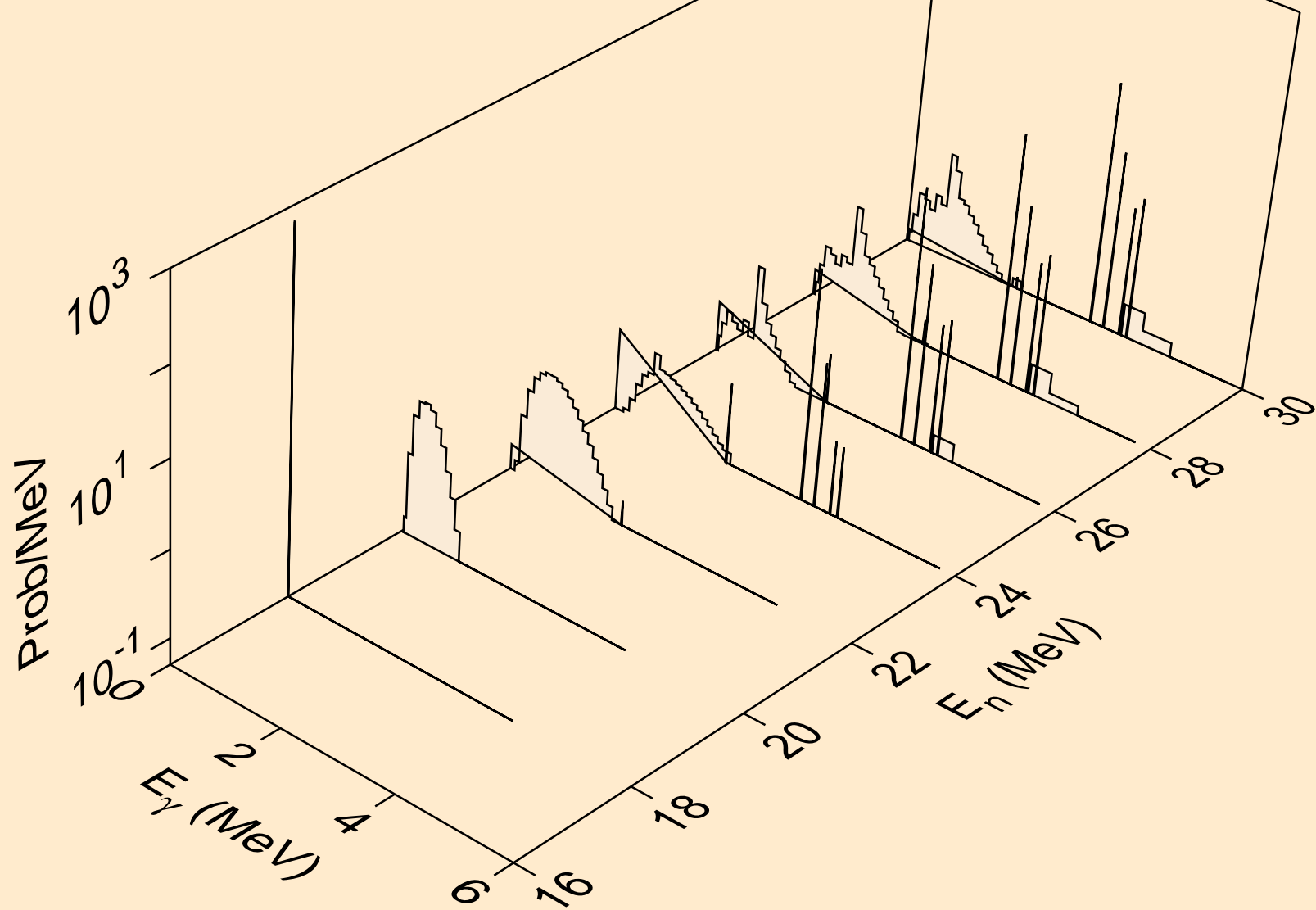

SC051 NEUTRON ACER TENDL-2023 LIBRARY; T=0.K  
Photon emission for (n,3np)

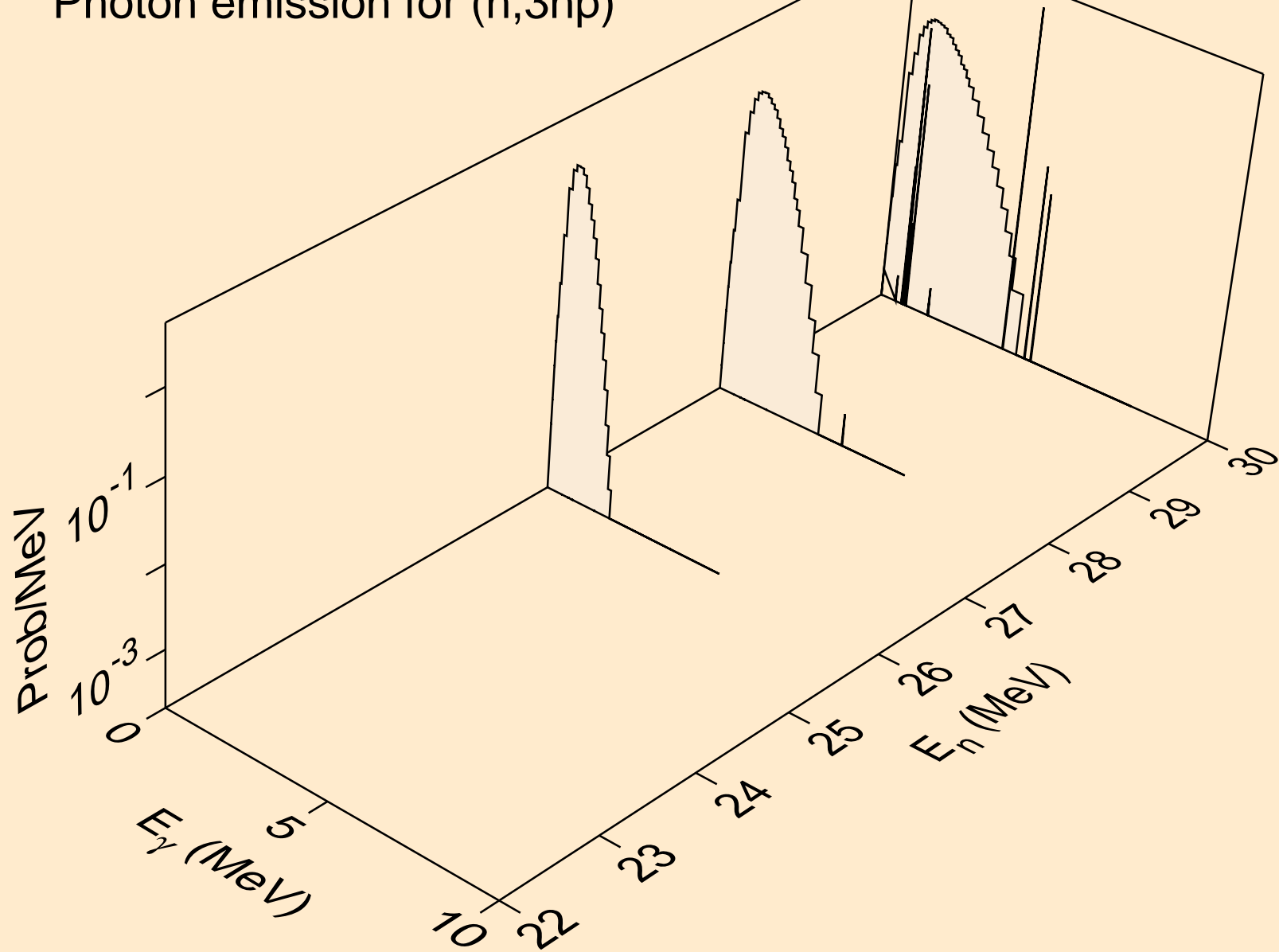



SC051 NEUTRON ACER TENDL-2023 LIBRARY; T=0.K  
Photon emission for (n,n\*c)

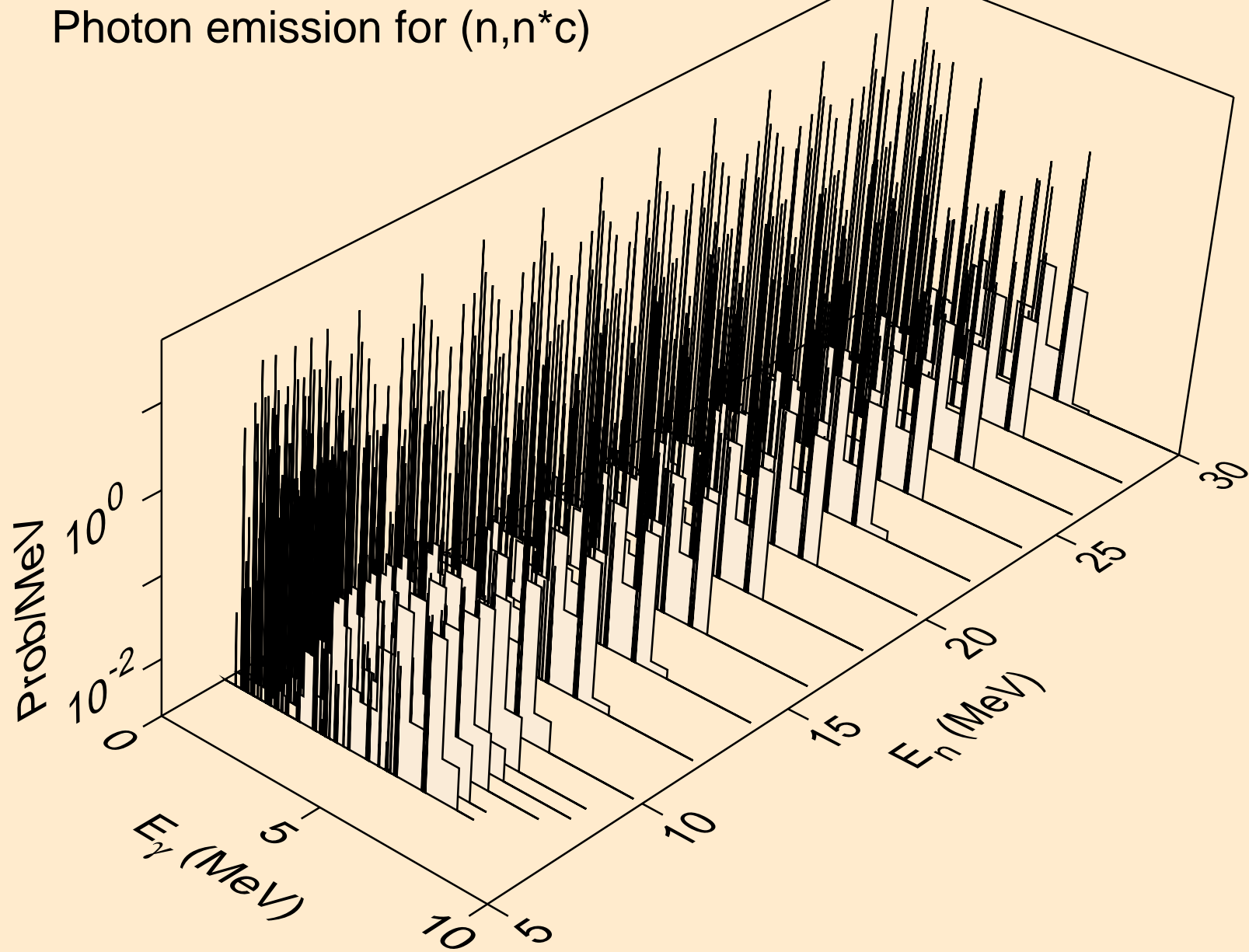

SC051 NEUTRON ACER TENDL-2023 LIBRARY; T=0.K  
Photon emission for (n,gma)

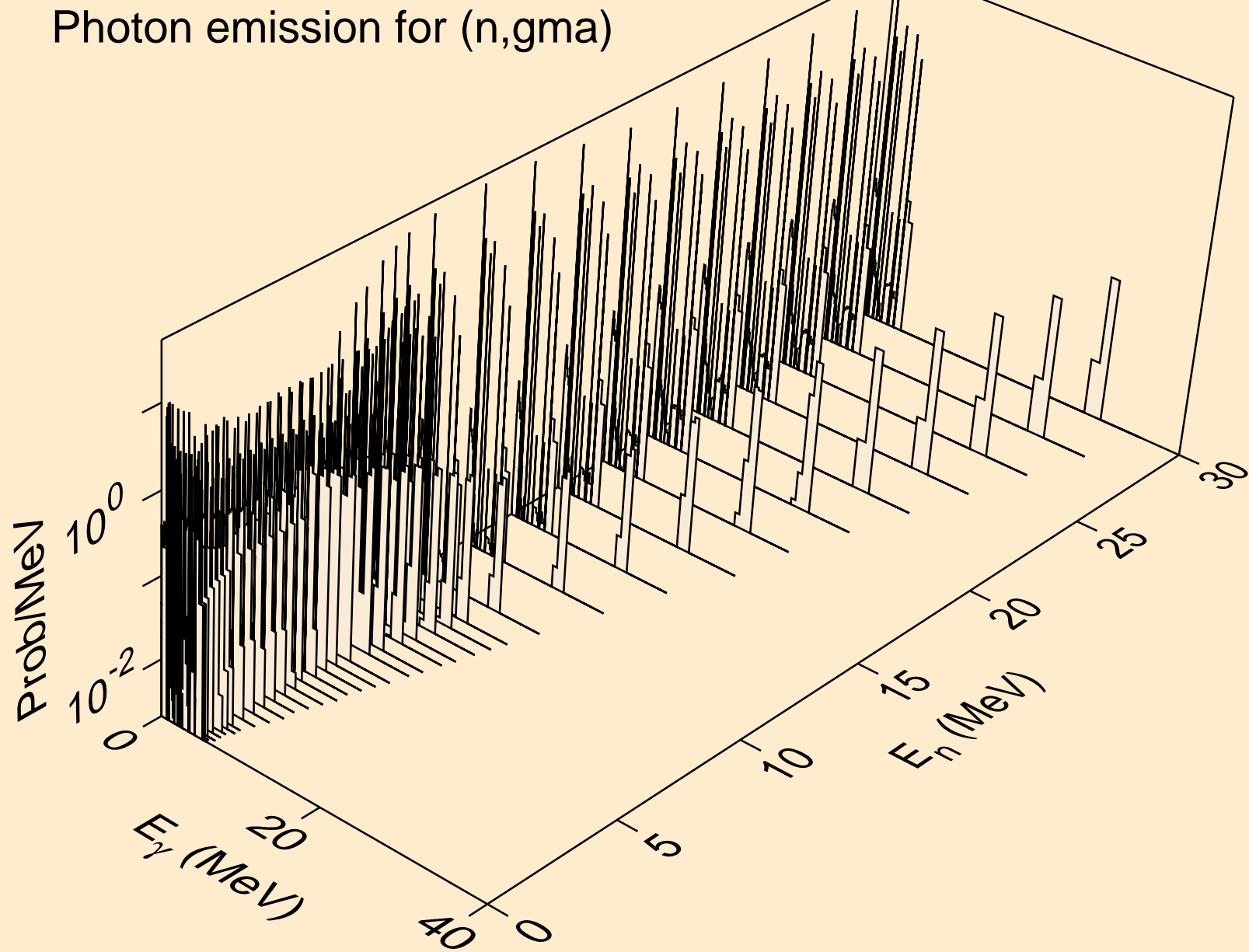

SC051 NEUTRON ACER TENDL-2023 LIBRARY; T=0.K  
Photon emission for (n,p)

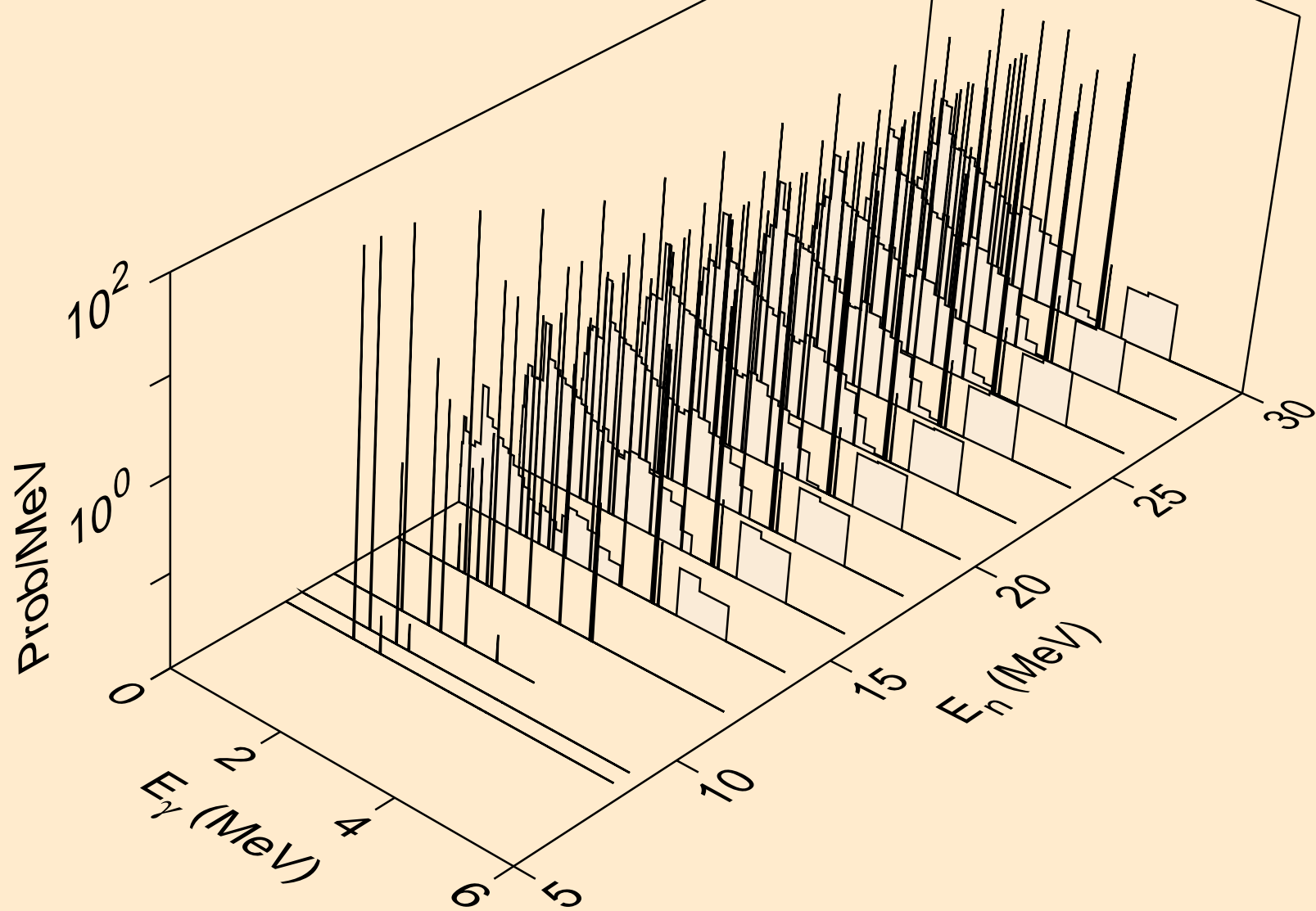

SC051 NEUTRON ACER TENDL-2023 LIBRARY; T=0.K  
Photon emission for (n,d)

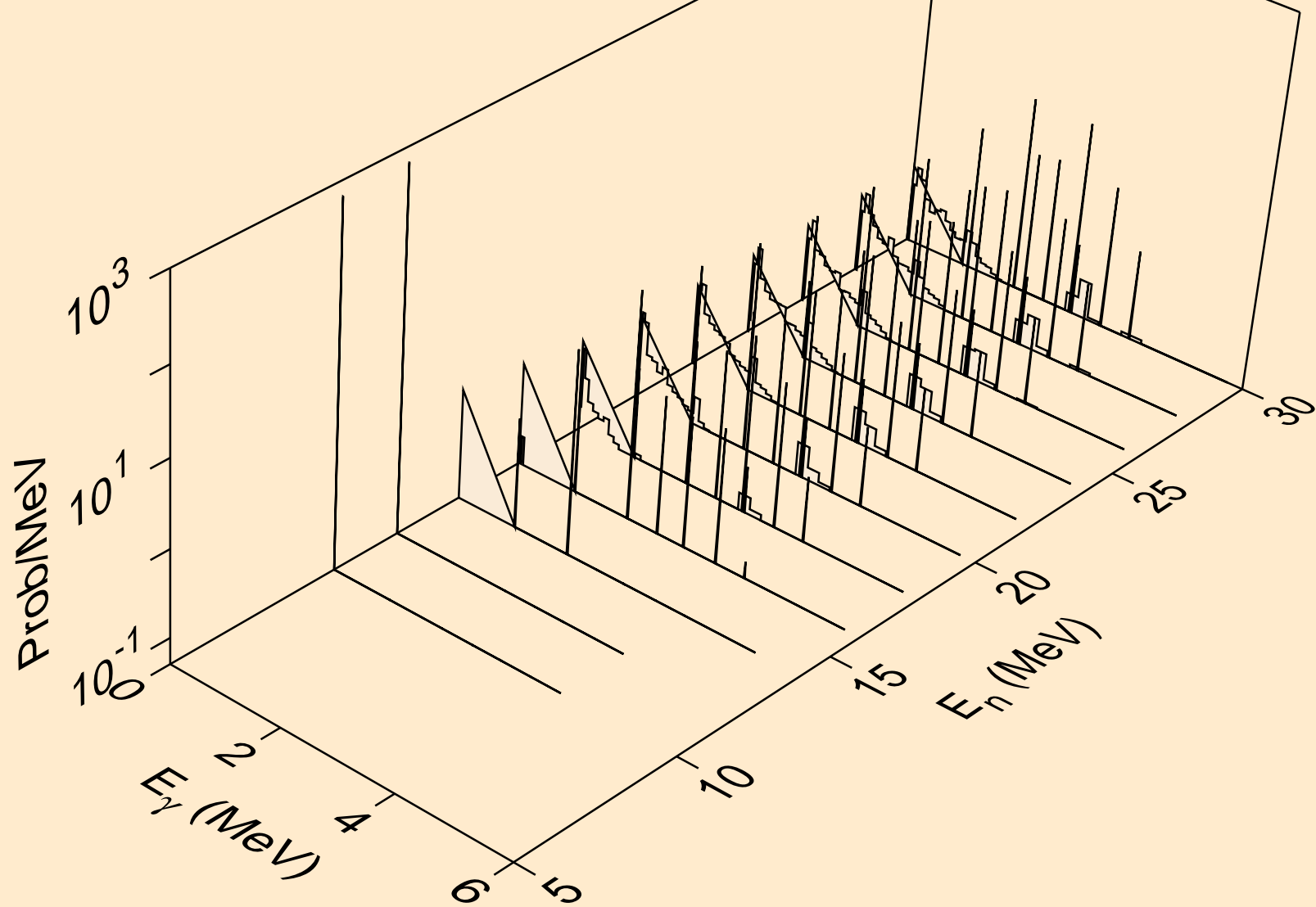

SC051 NEUTRON ACER TENDL-2023 LIBRARY; T=0.K  
Photon emission for (n,t)

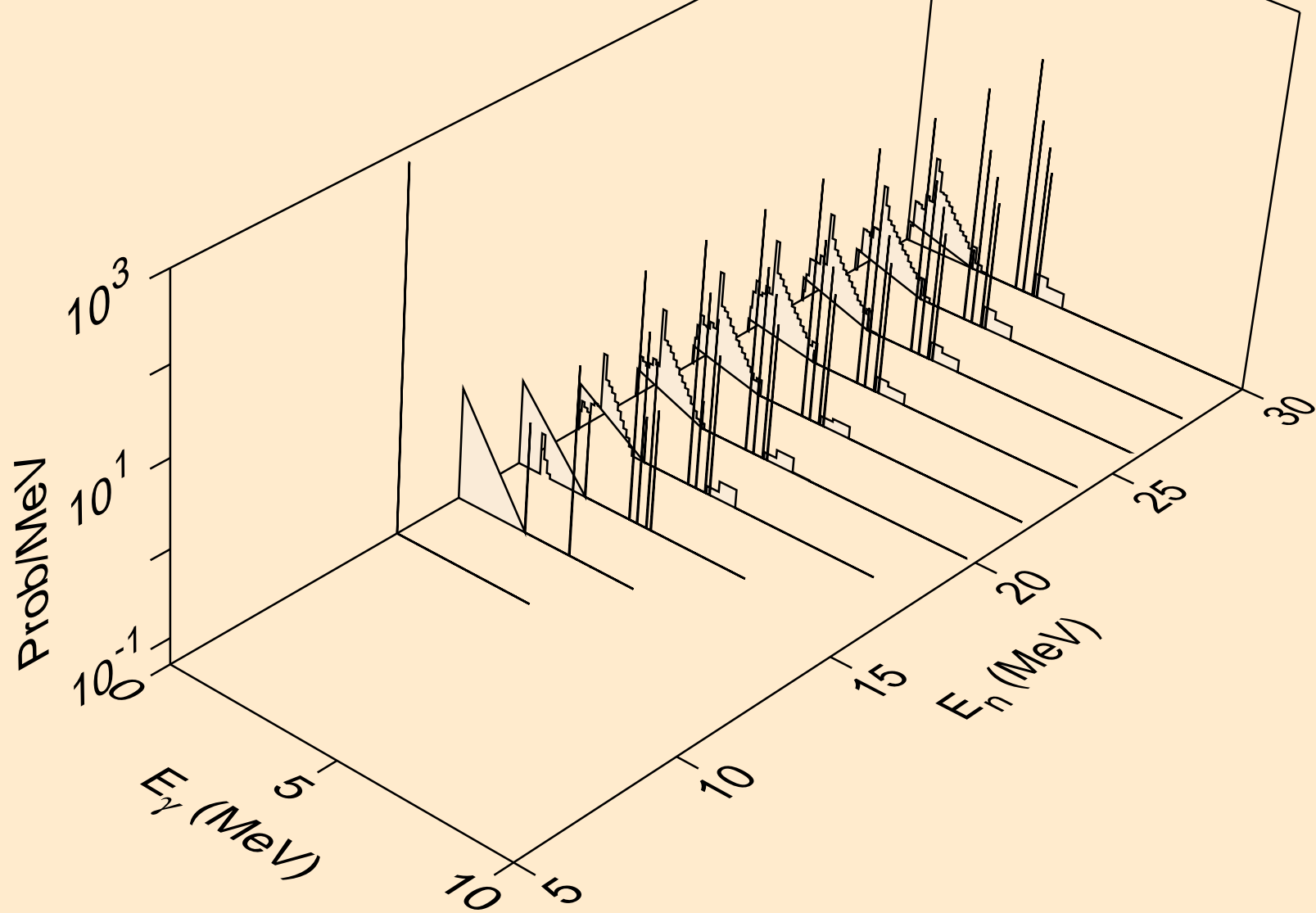

SC051 NEUTRON ACER TENDL-2023 LIBRARY; T=0.K  
Photon emission for (n,he3)

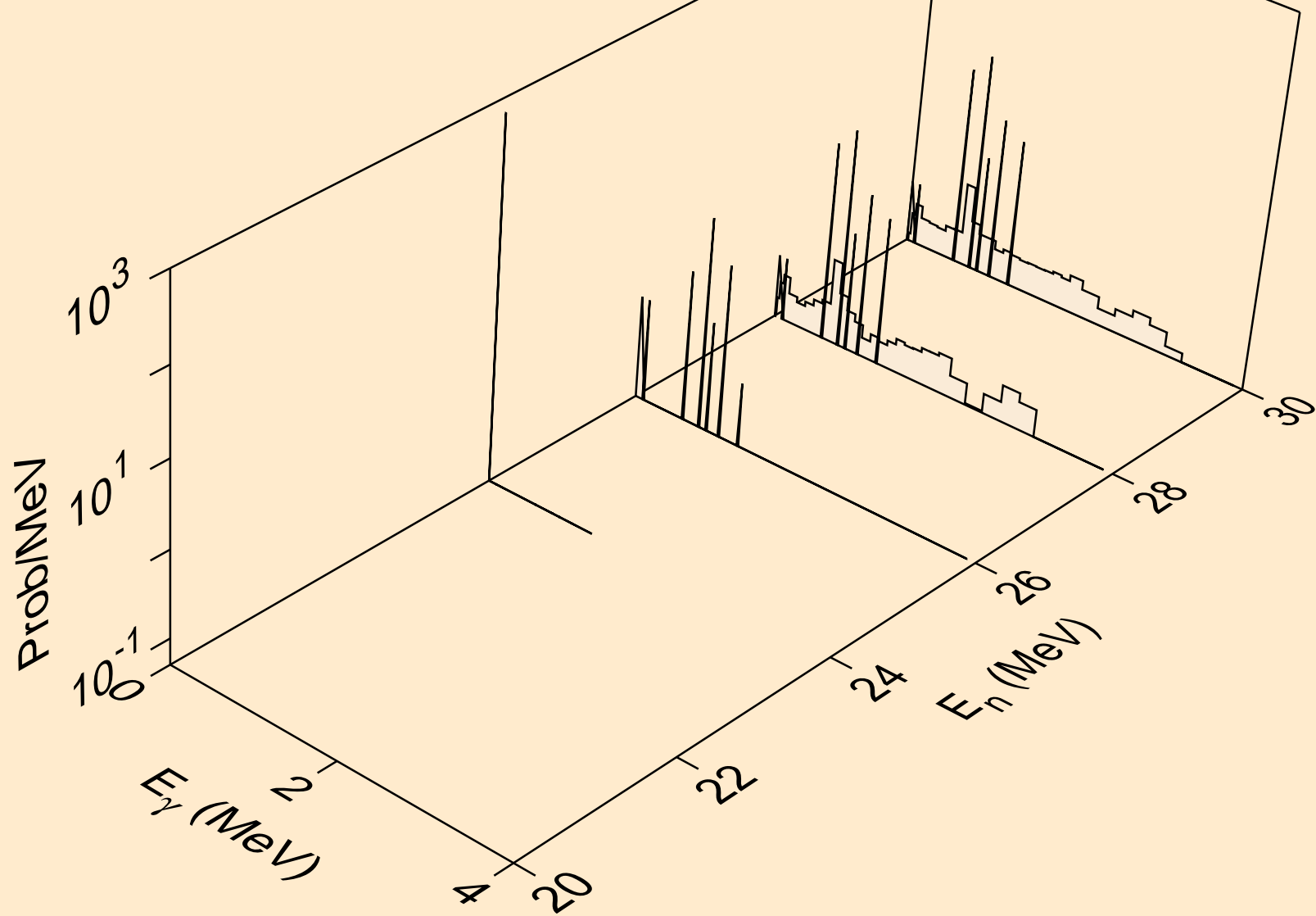

SC051 NEUTRON ACER TENDL-2023 LIBRARY; T=0.K  
Photon emission for (n,a)

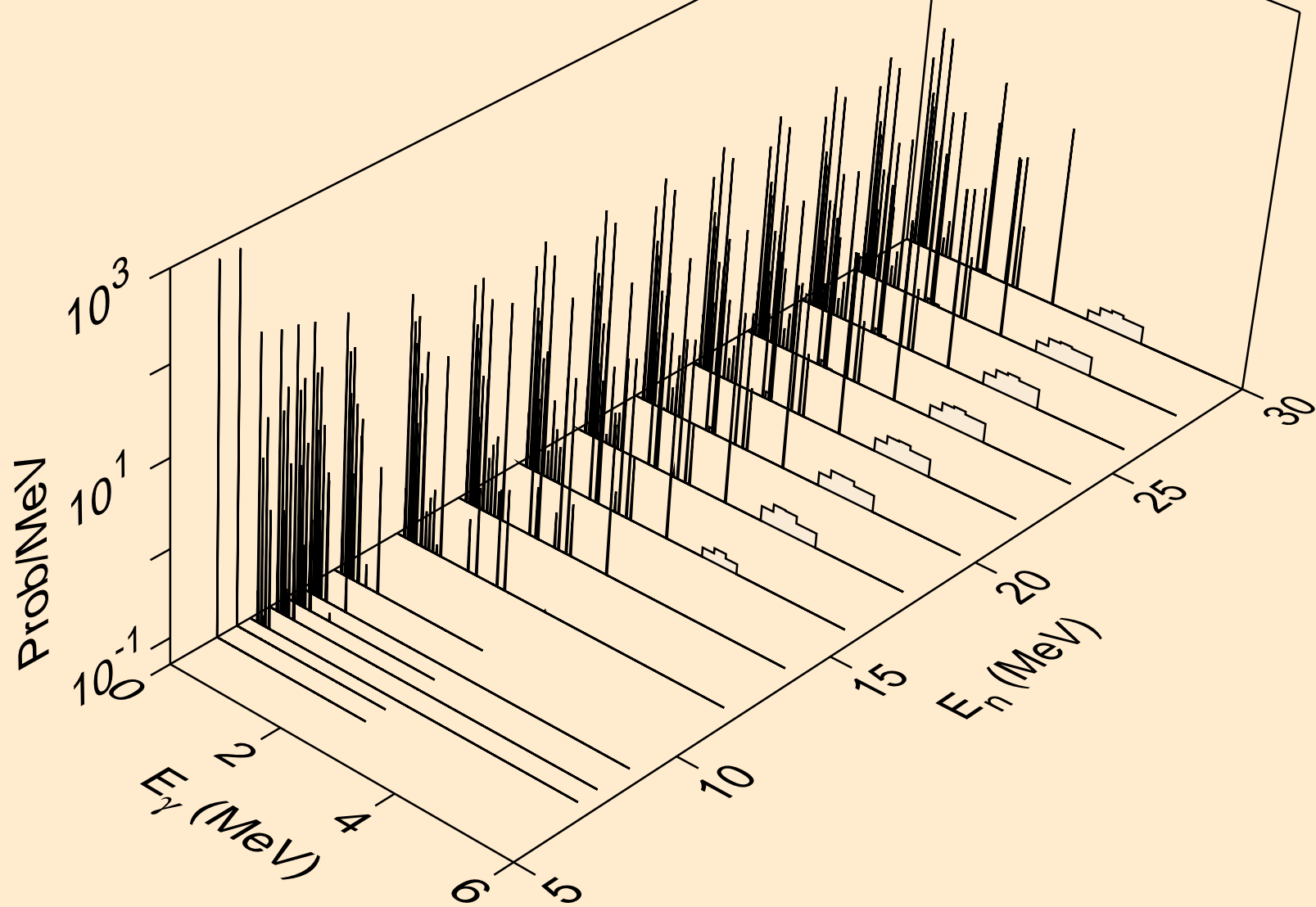

SC051 NEUTRON ACER TENDL-2023 LIBRARY; T=0.K  
Photon emission for (n,p $\alpha$ )

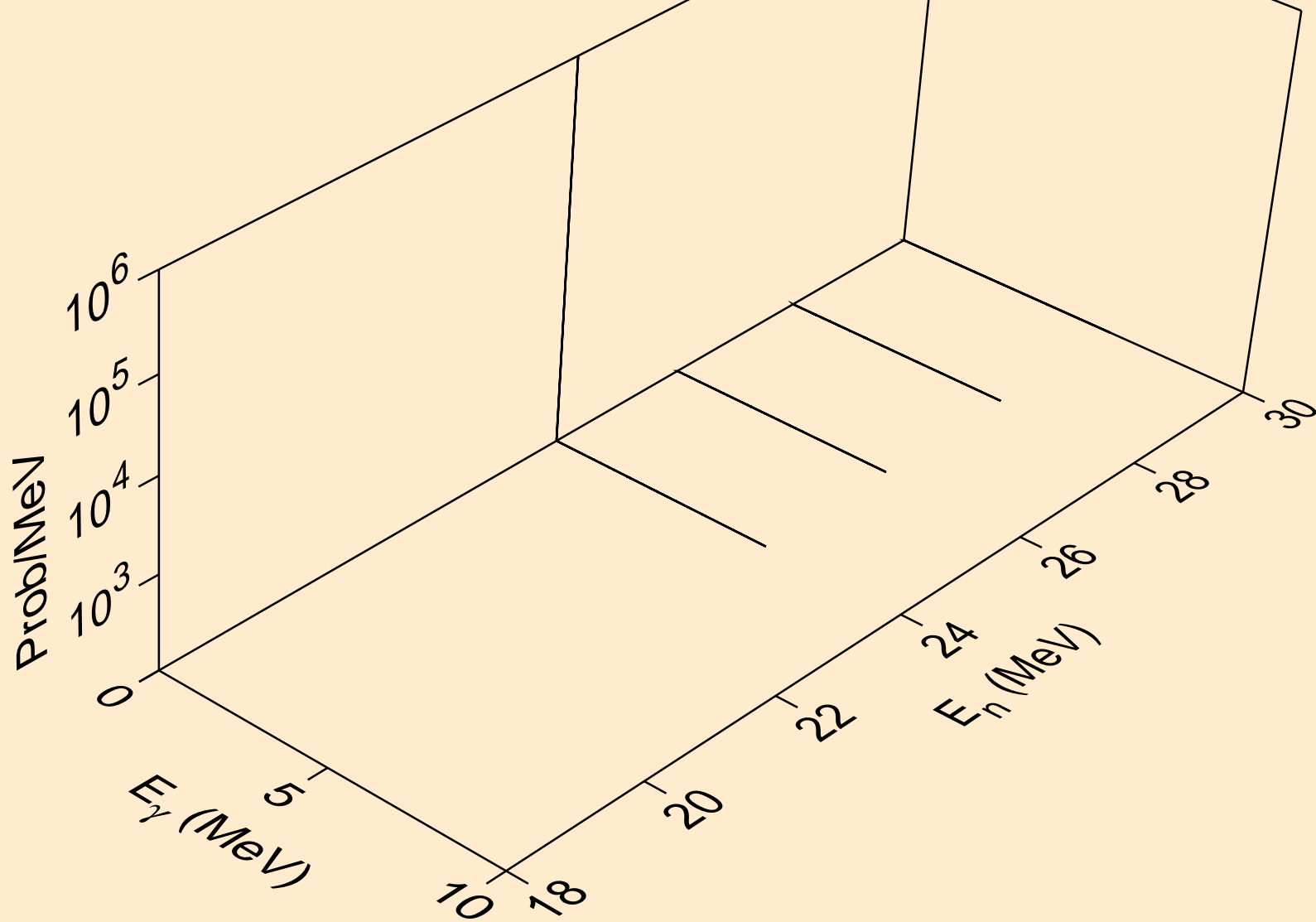



SC051 NEUTRON ACER TENDL-2023 LIBRARY; T=0.K  
Photon emission for (n,da)

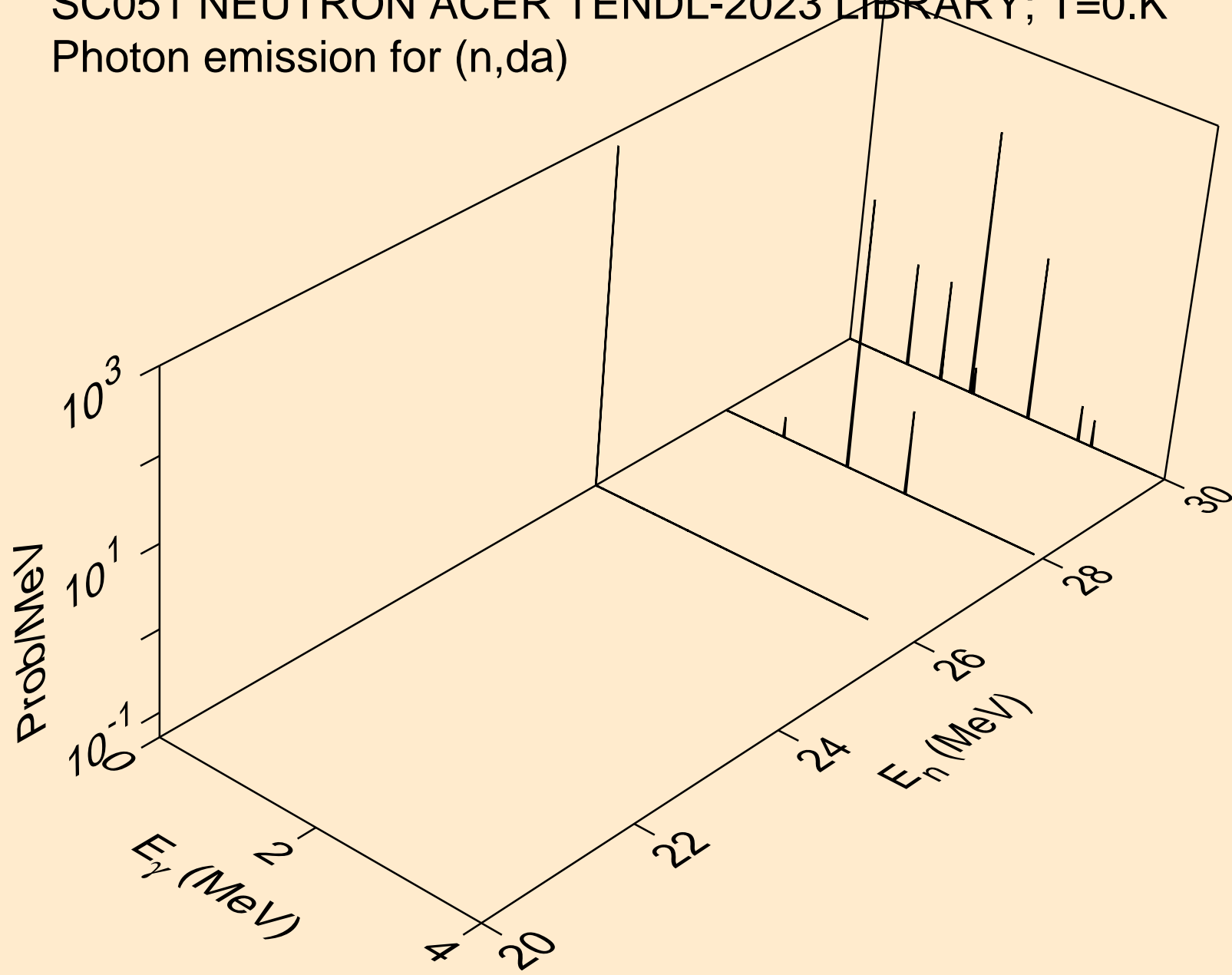

SC051 NEUTRON ACER TENDL-2023 LIBRARY; T=0.K  
thermal capture photon spectrum

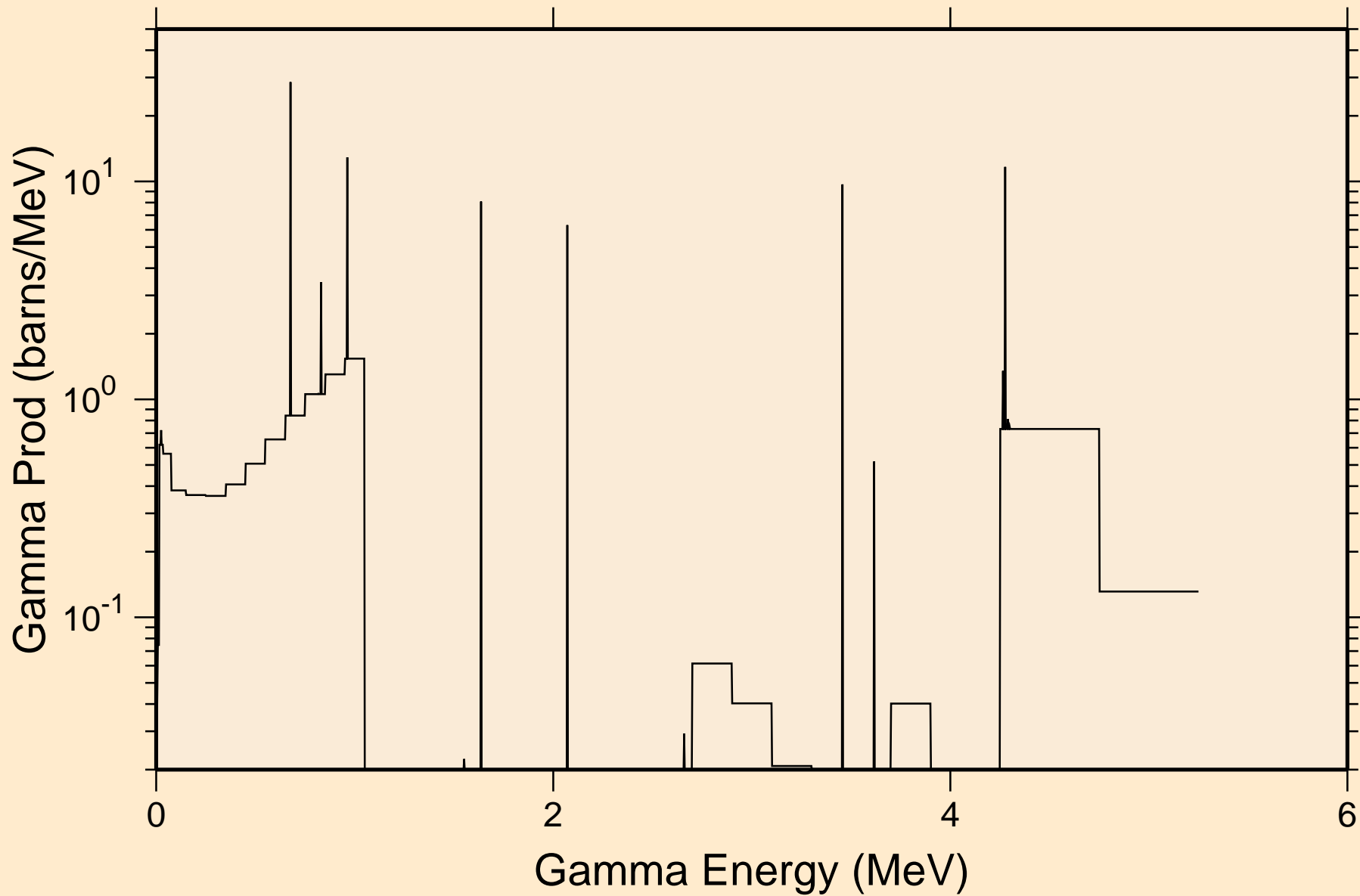

SC051 NEUTRON ACER TENDL-2023 LIBRARY; T=0.K  
14 MeV photon spectrum

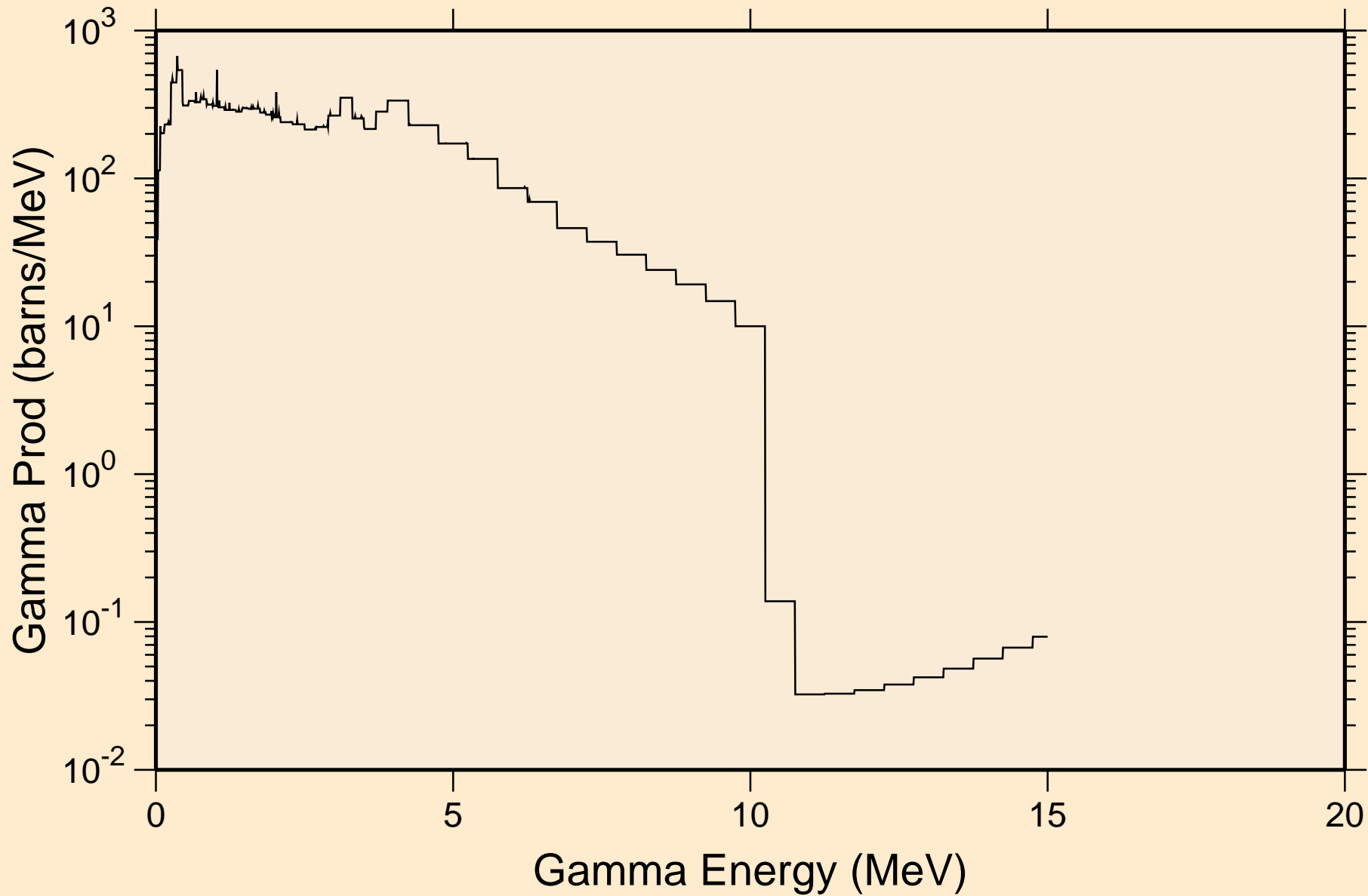

# SC051 NEUTRON ACER TENDL-2023 LIBRARY; T=0.K

## Particle heating contributions

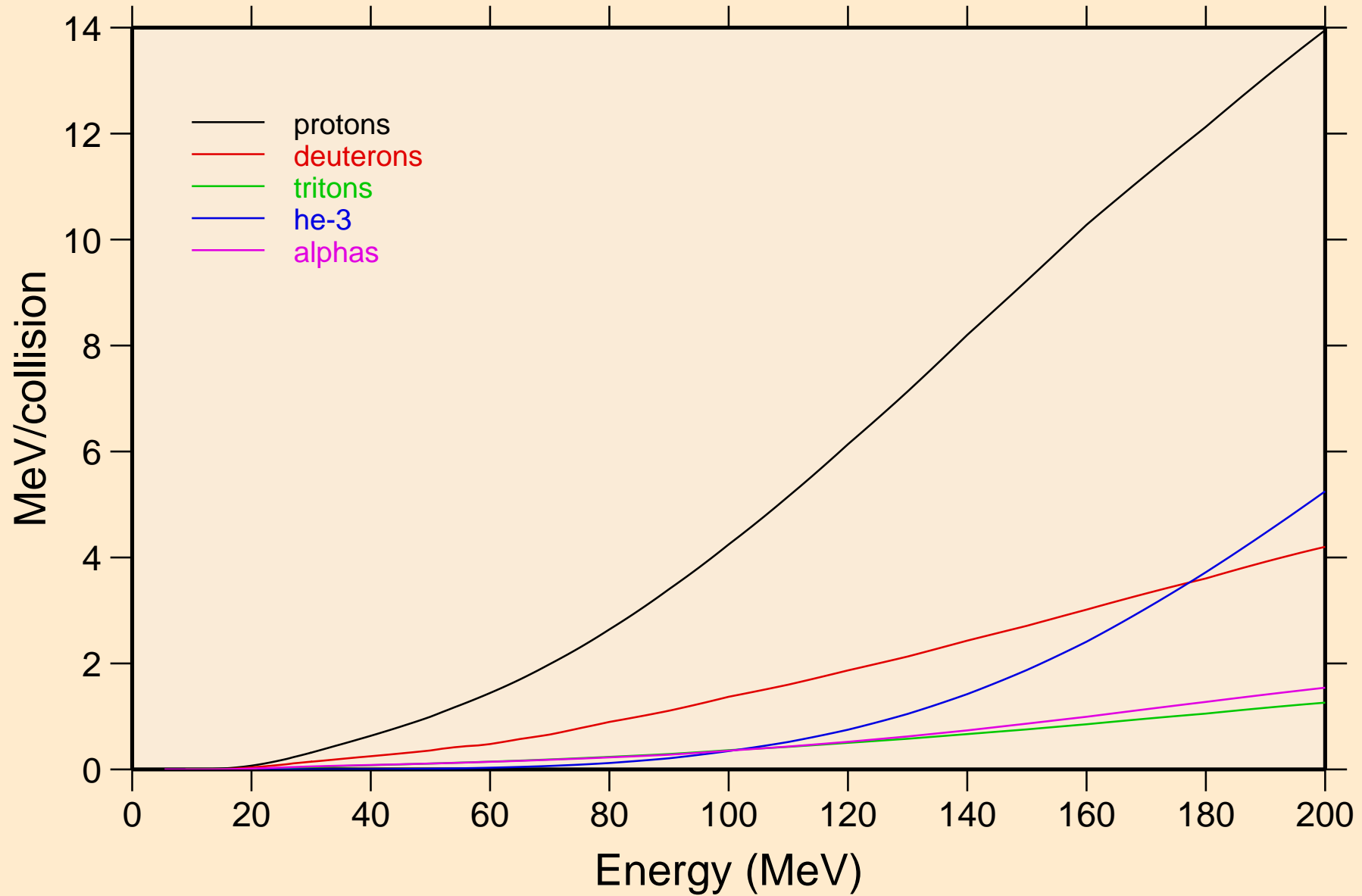

SC051 NEUTRON ACER TENDL-2023 LIBRARY; T=0.K  
Recoil Heating

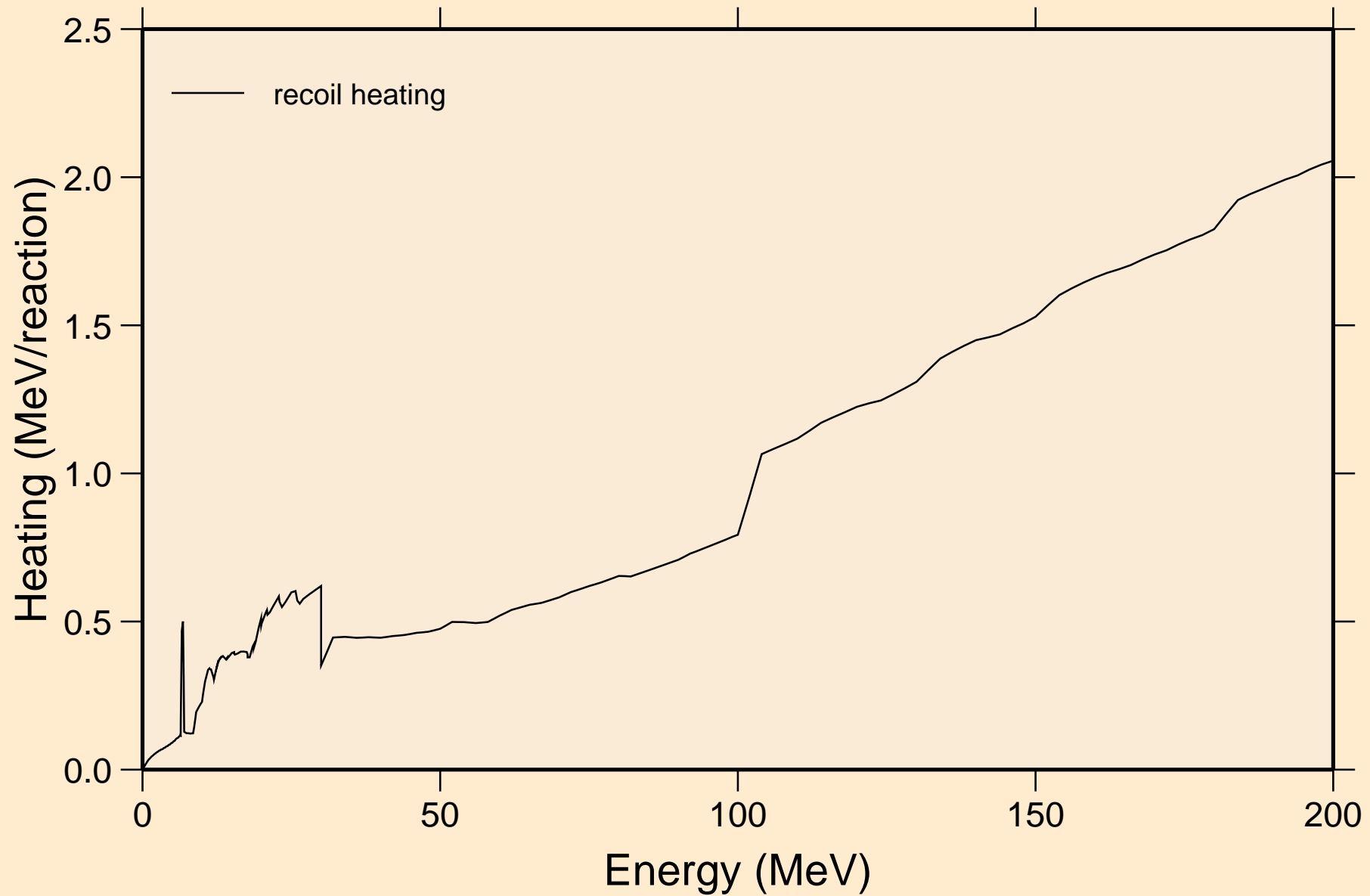

SC051 NEUTRON ACER TENDL-2023 LIBRARY; T=0.K  
Particle production cross sections

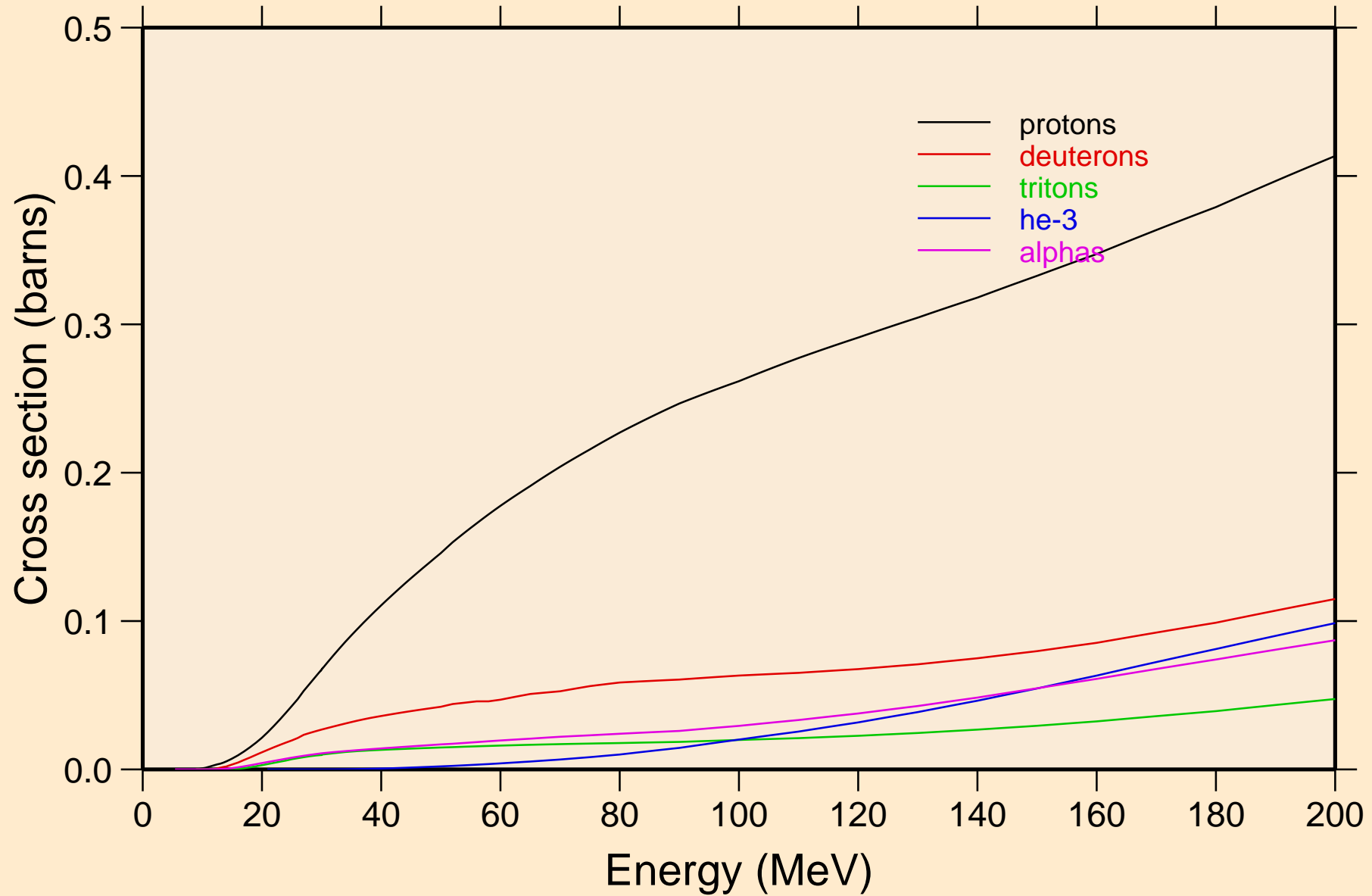

SC051 NEUTRON ACER TENDL-2023 LIBRARY; T=0.K  
protons from (n,x)

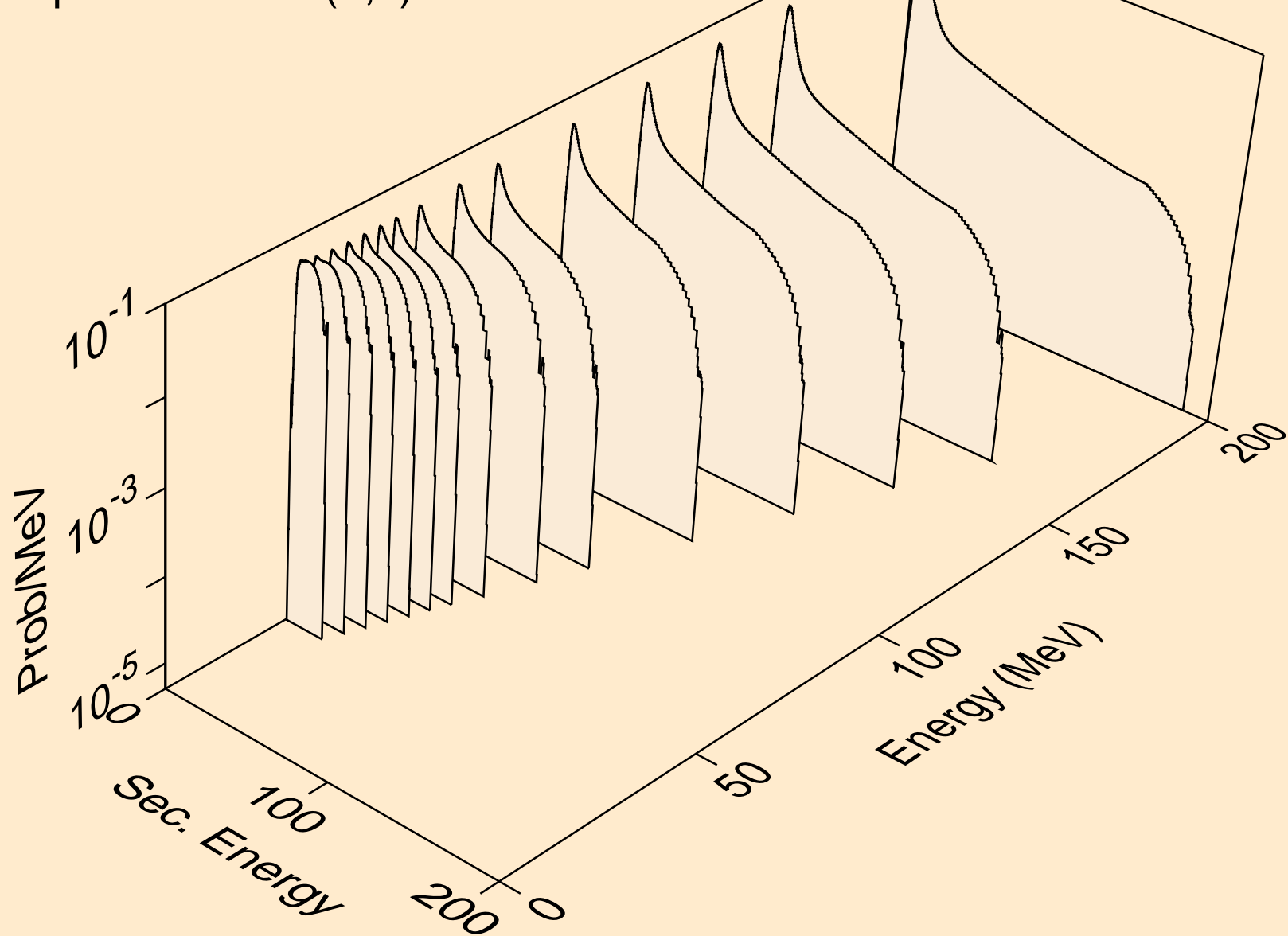

SC051 NEUTRON ACER TENDL-2023 LIBRARY; T=0.K  
protons from (n,n\*)p

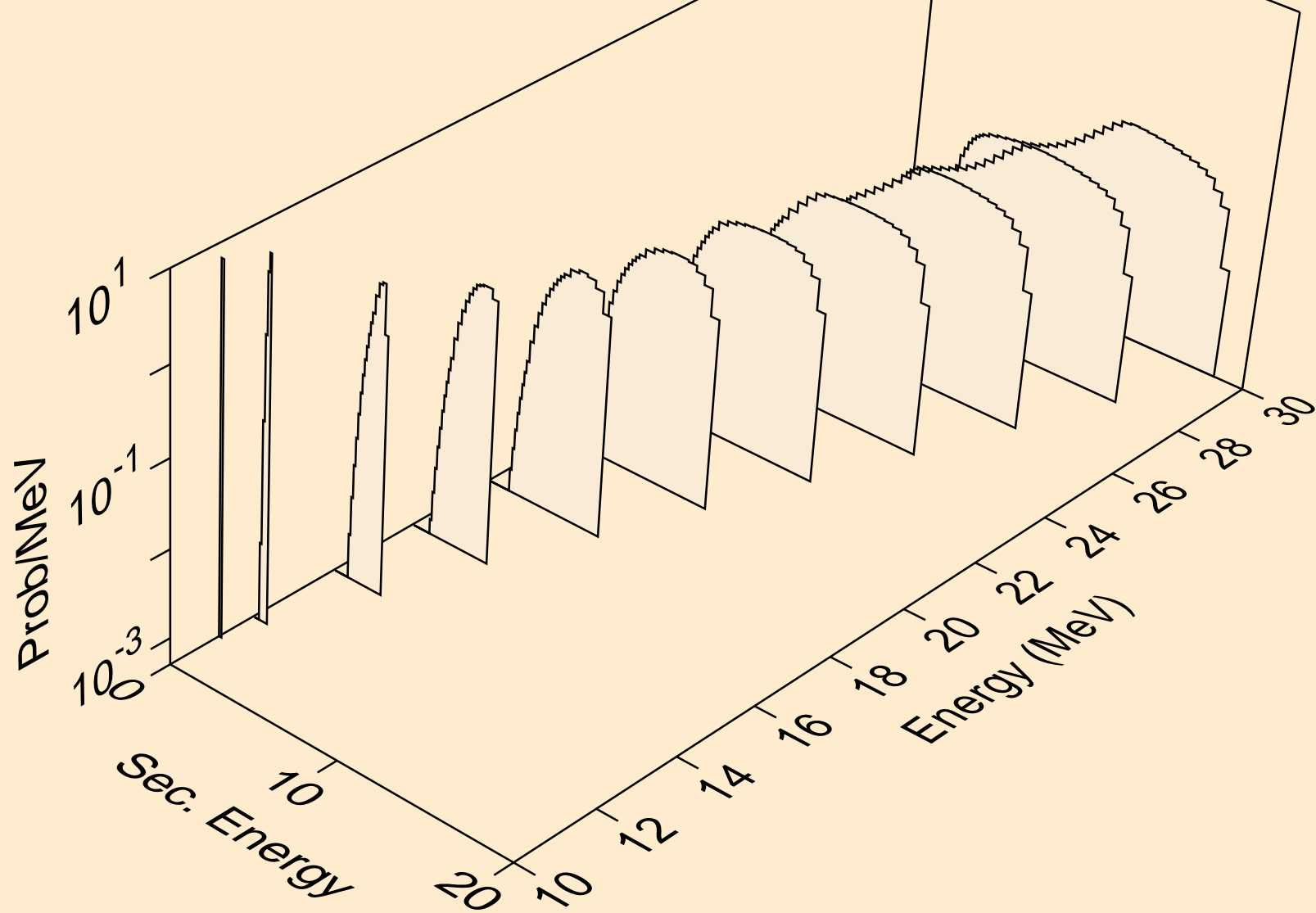



SC051 NEUTRON ACER TENDL-2023 LIBRARY; T=0.K  
protons from (n,2np)

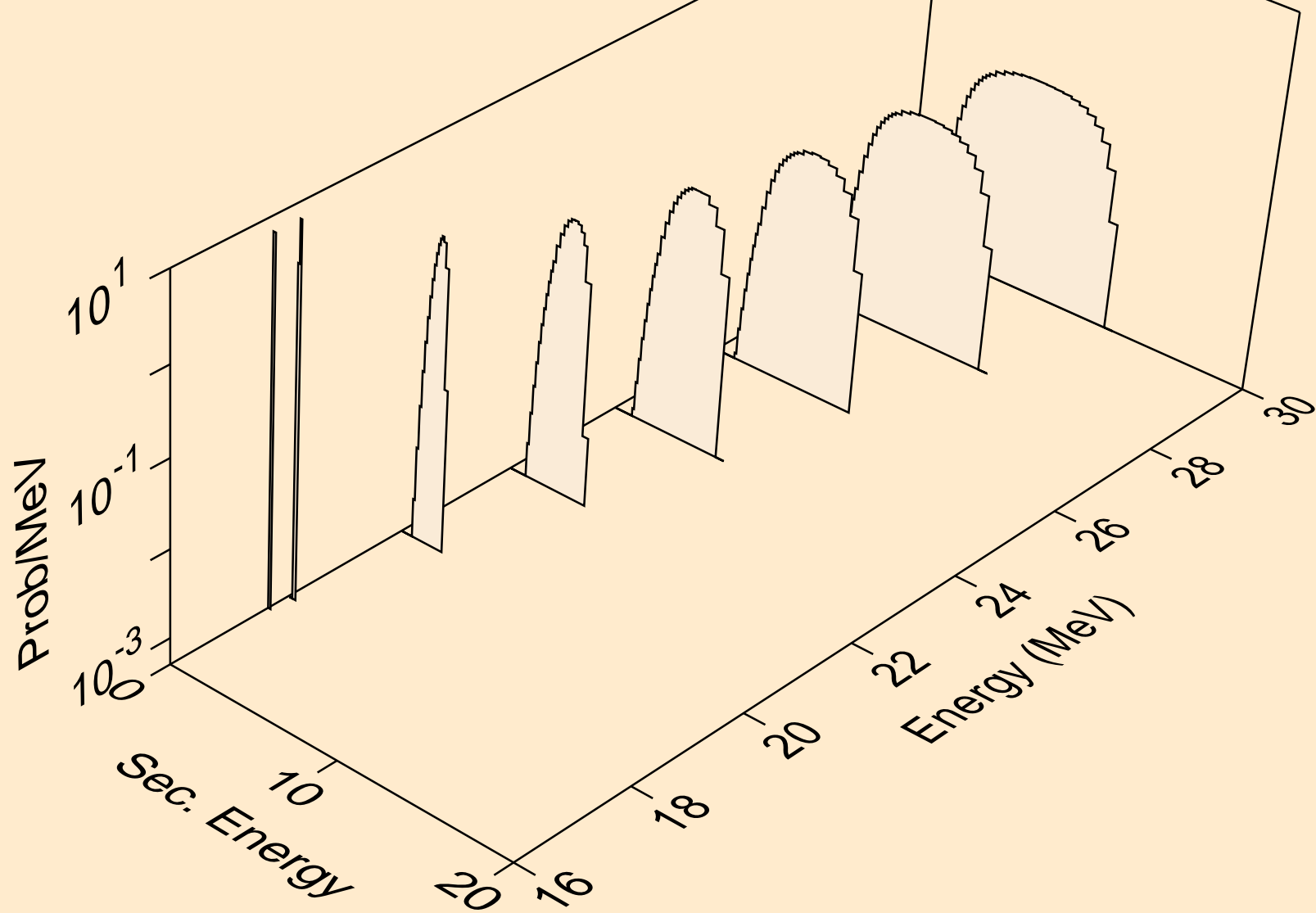

SC051 NEUTRON ACER TENDL-2023 LIBRARY; T=0.K  
protons from (n,3np)

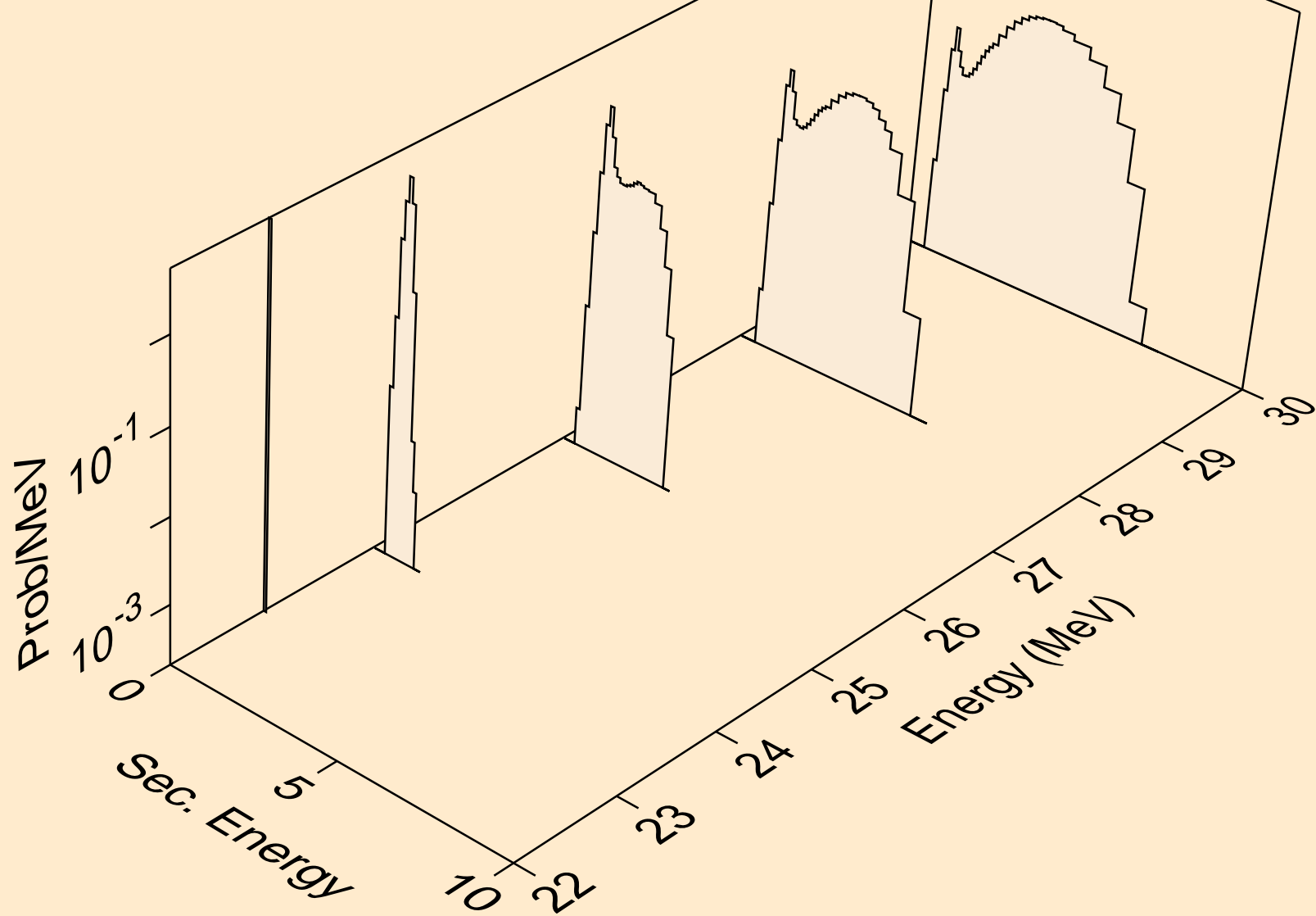

SC051 NEUTRON ACER TENDL-2023 LIBRARY; T=0.K  
protons from (n,p)

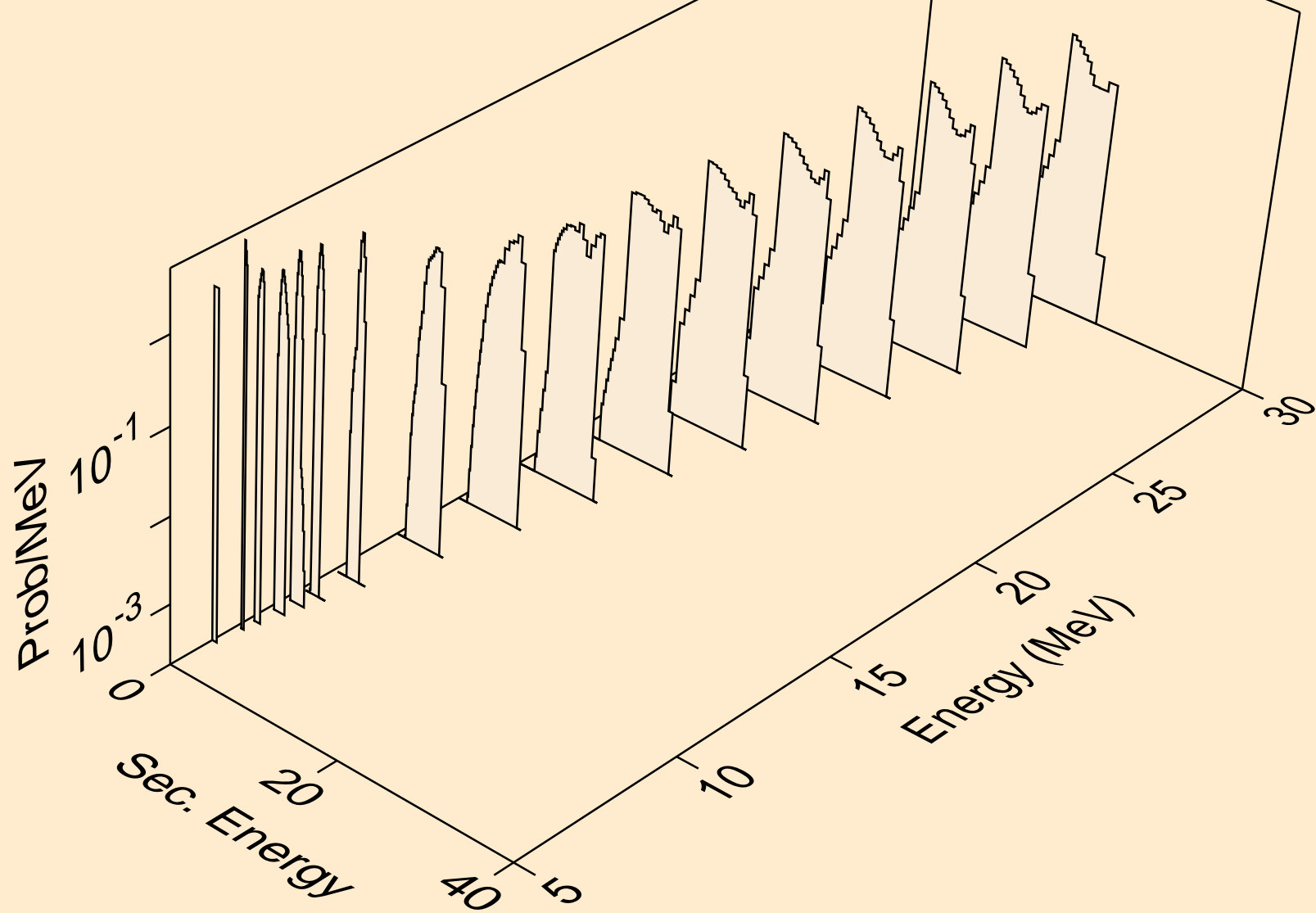

SC051 NEUTRON ACER TENDL-2023 LIBRARY; T=0.K  
protons from (n,pa)

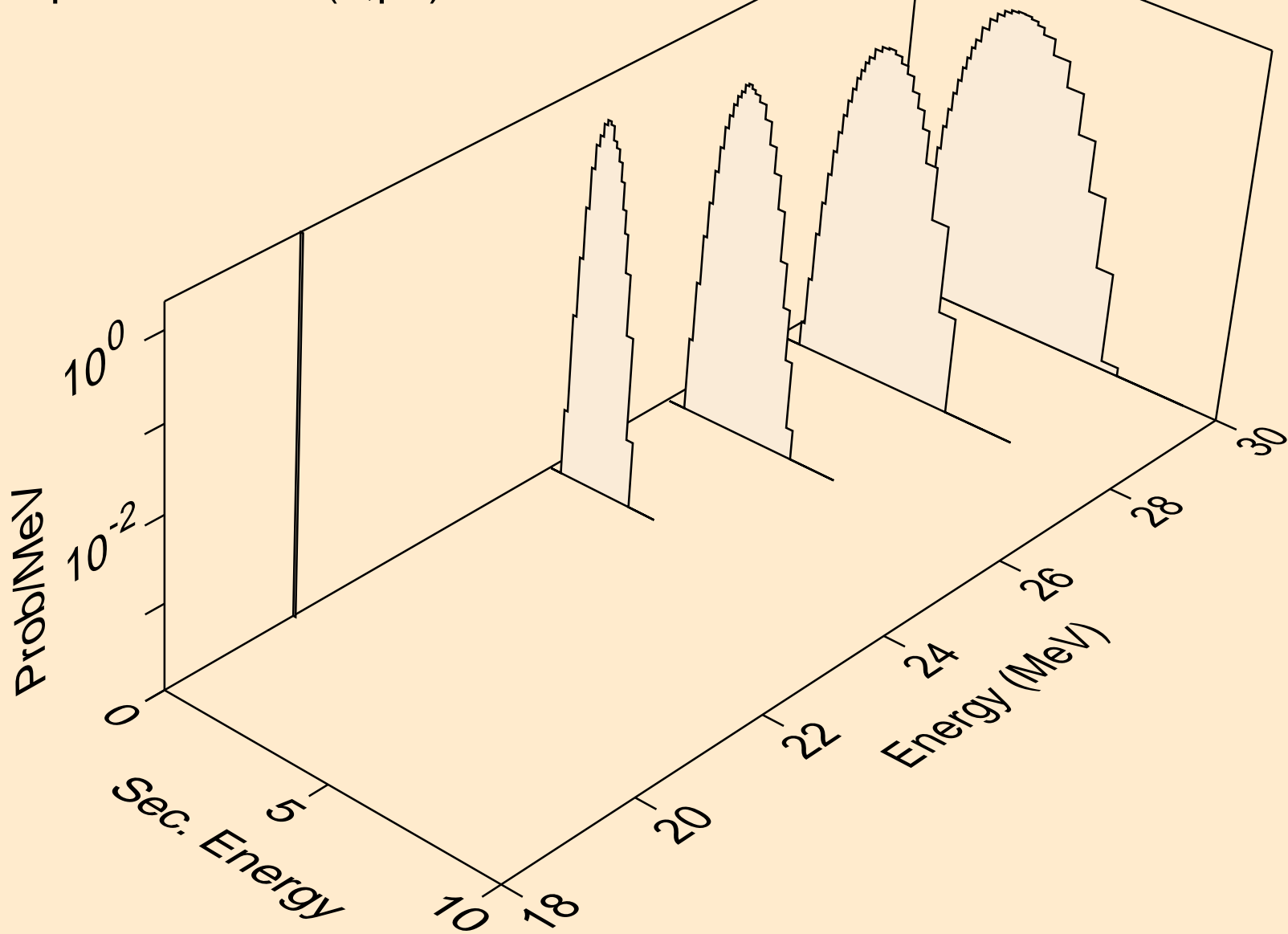

SC051 NEUTRON ACER TENDL-2023 LIBRARY; T=0.K  
deuterons from (n,x)

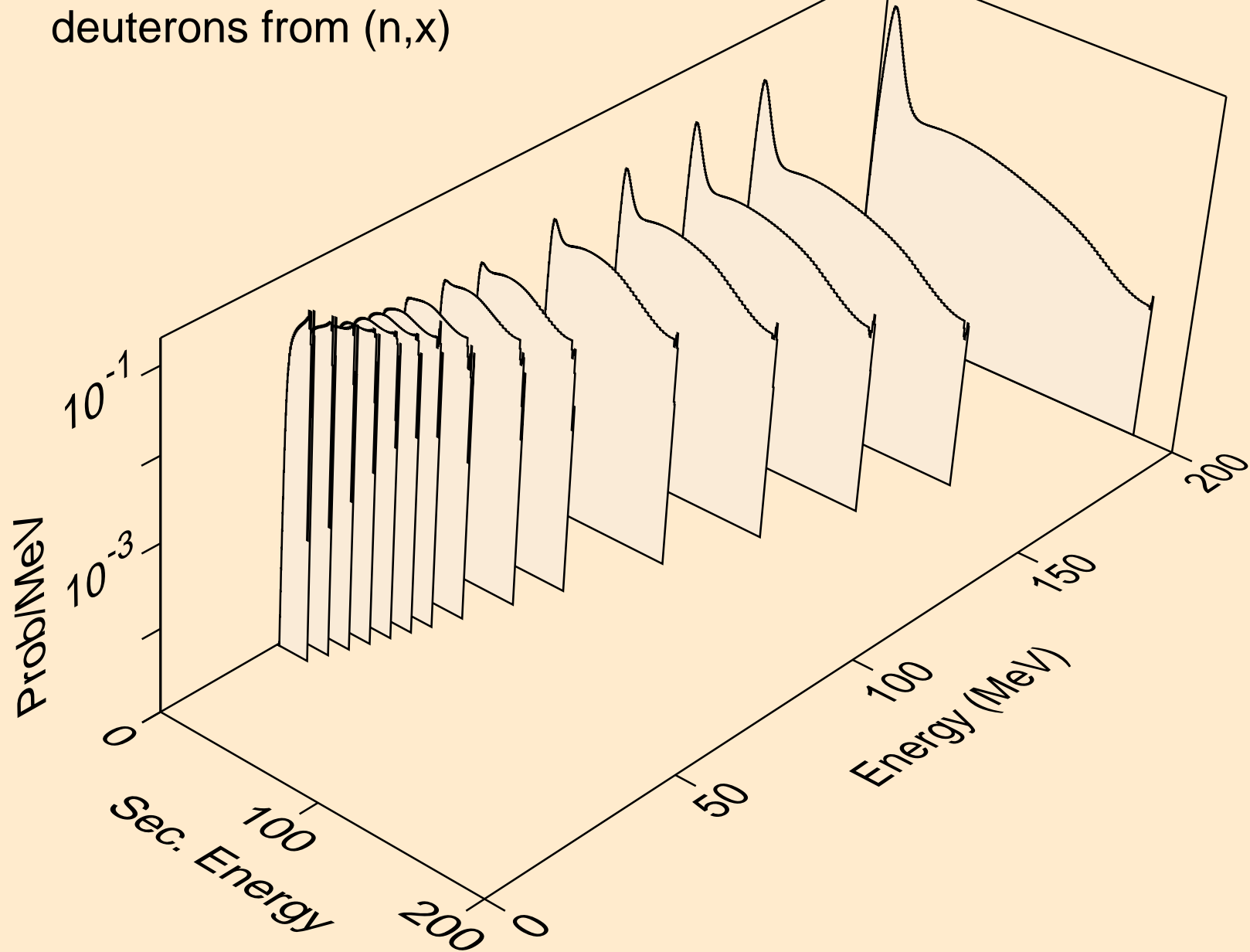

SC051 NEUTRON ACER TENDL-2023 LIBRARY; T=0.K  
deuterons from (n,2nd)

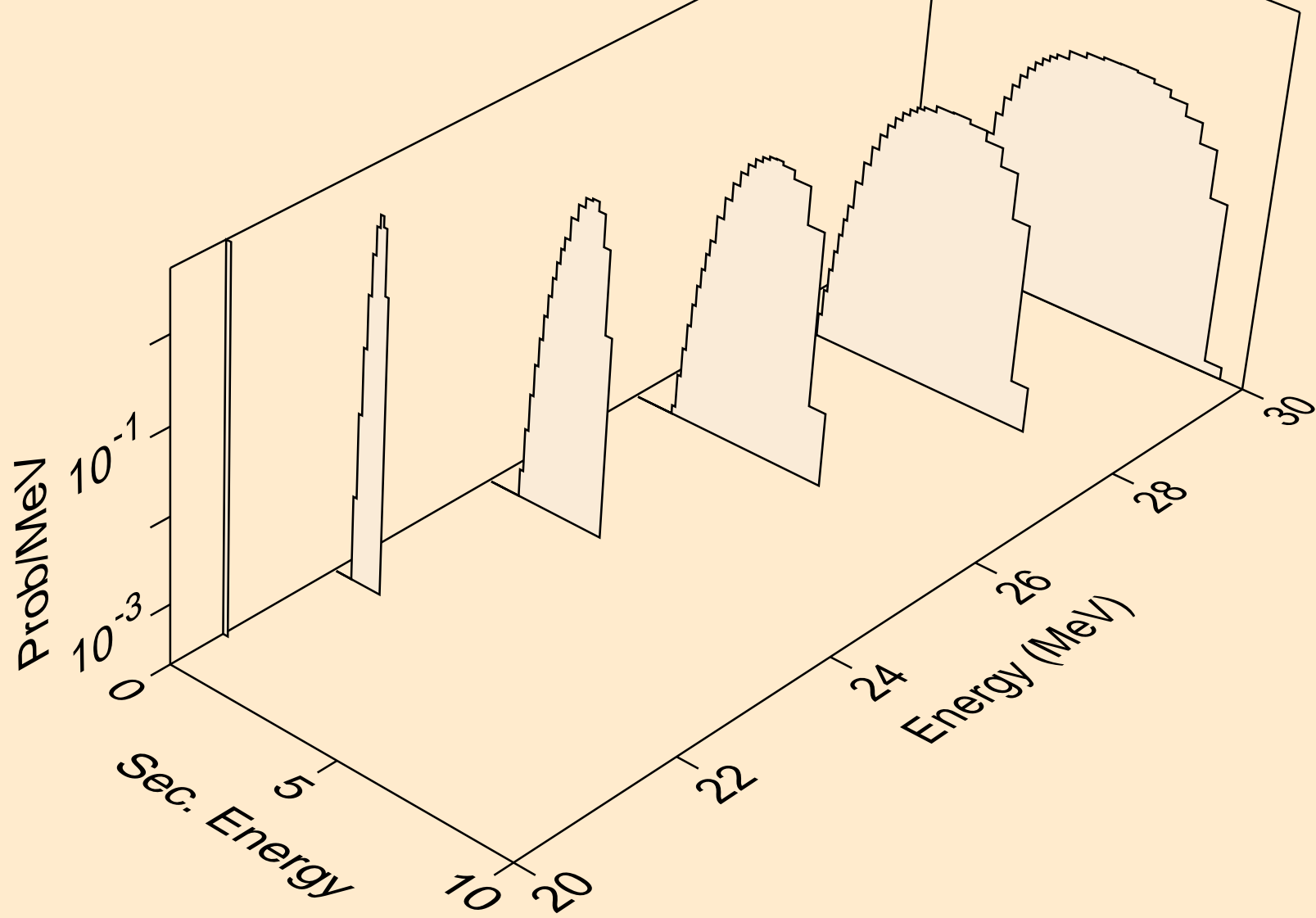

SC051 NEUTRON ACER TENDL-2023 LIBRARY; T=0.K  
deuterons from (n,n\*)d

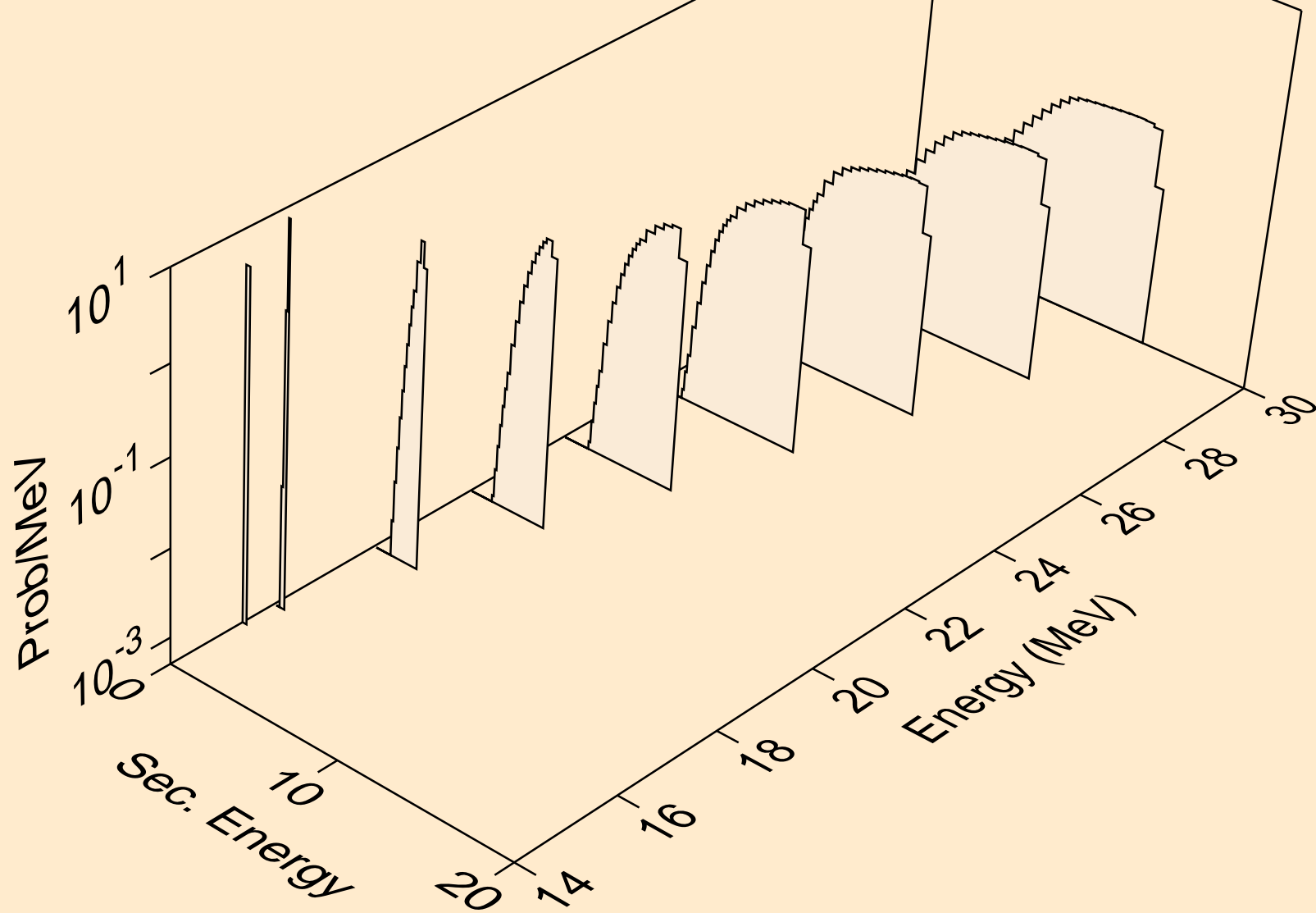

SC051 NEUTRON ACER TENDL-2023 LIBRARY; T=0.K  
deuterons from (n,d)

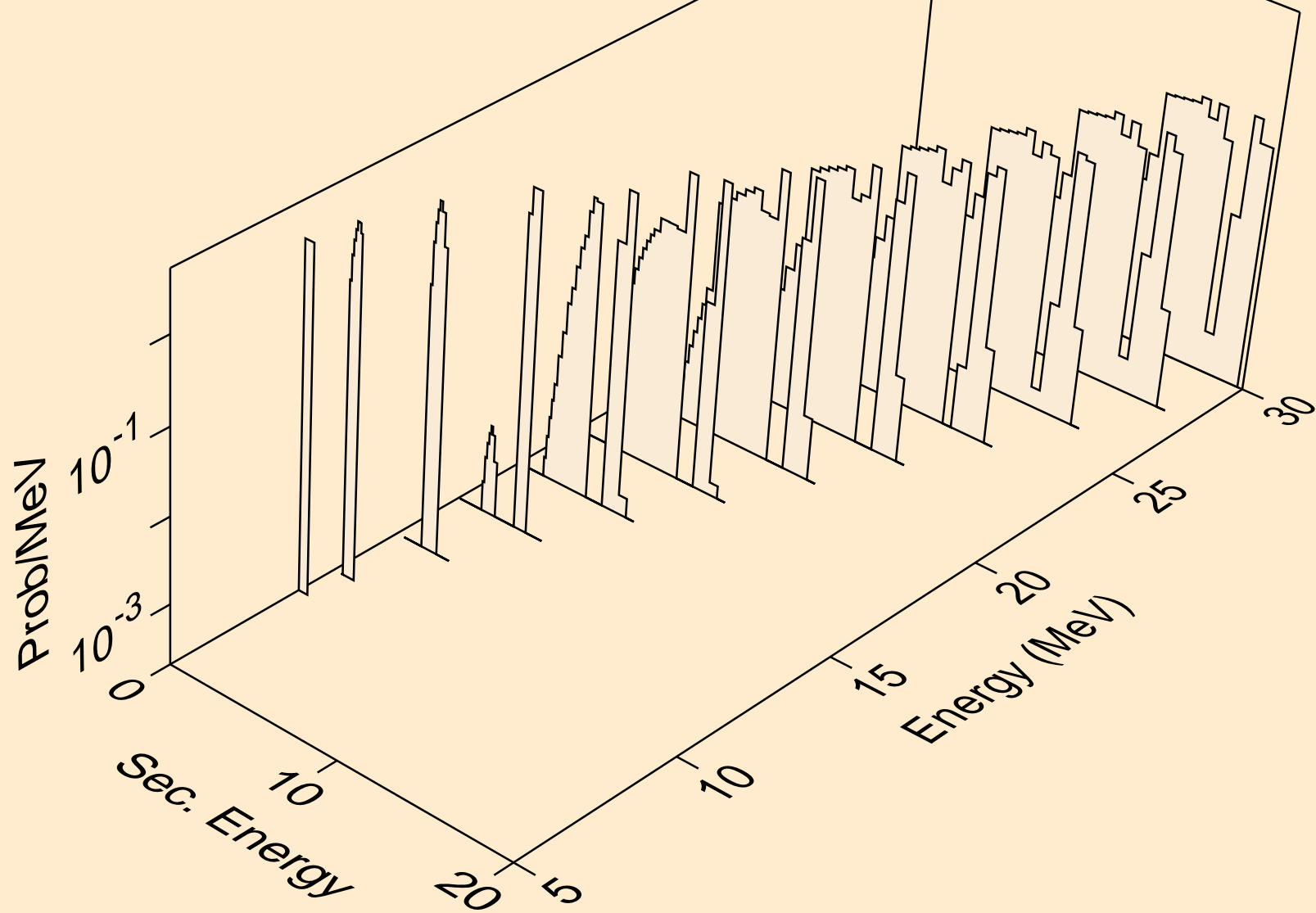



SC051 NEUTRON ACER TENDL-2023 LIBRARY; T=0.K  
deuterons from (n,da)

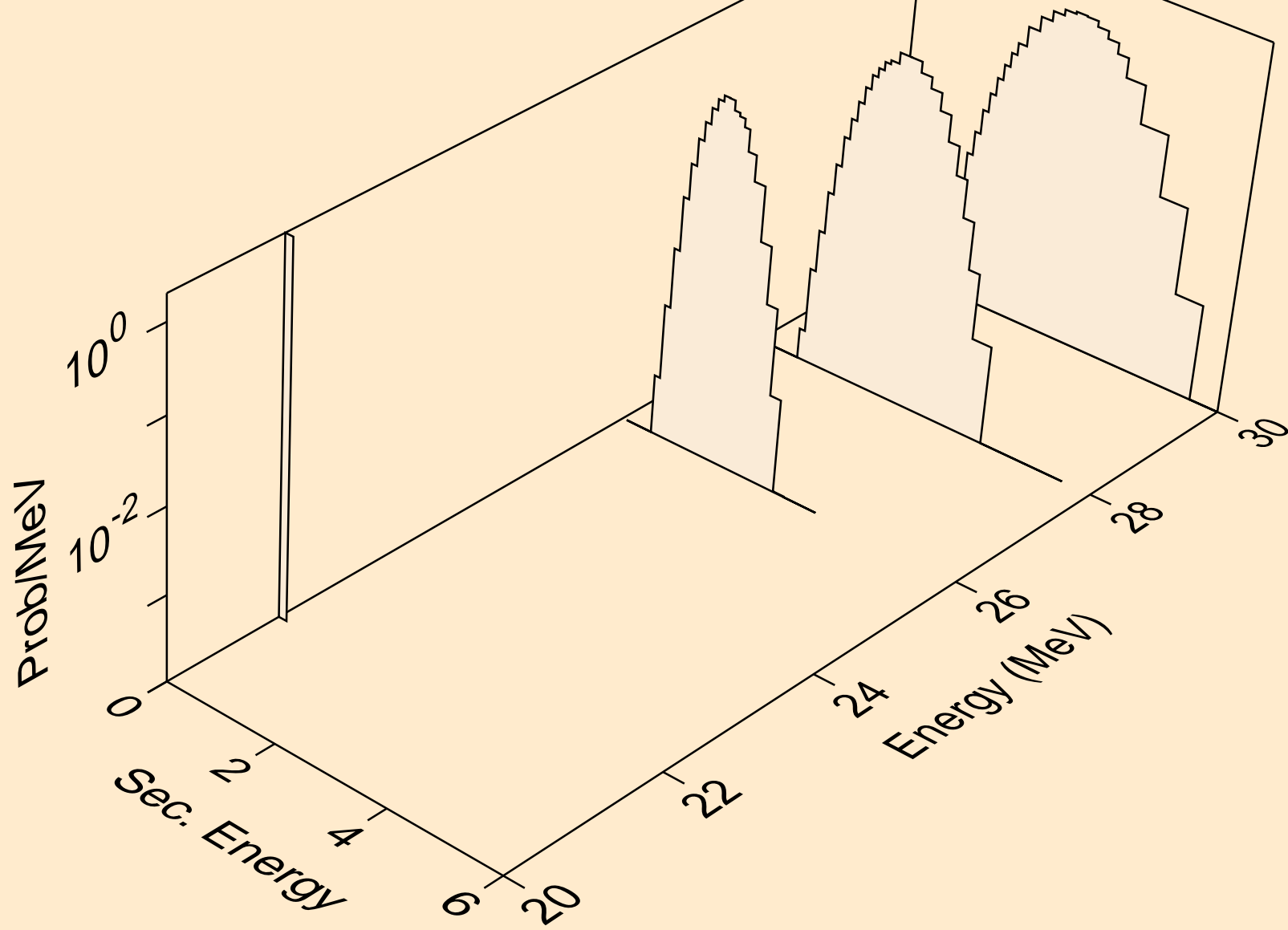

SC051 NEUTRON ACER TENDL-2023 LIBRARY; T=0.K  
tritons from (n,x)

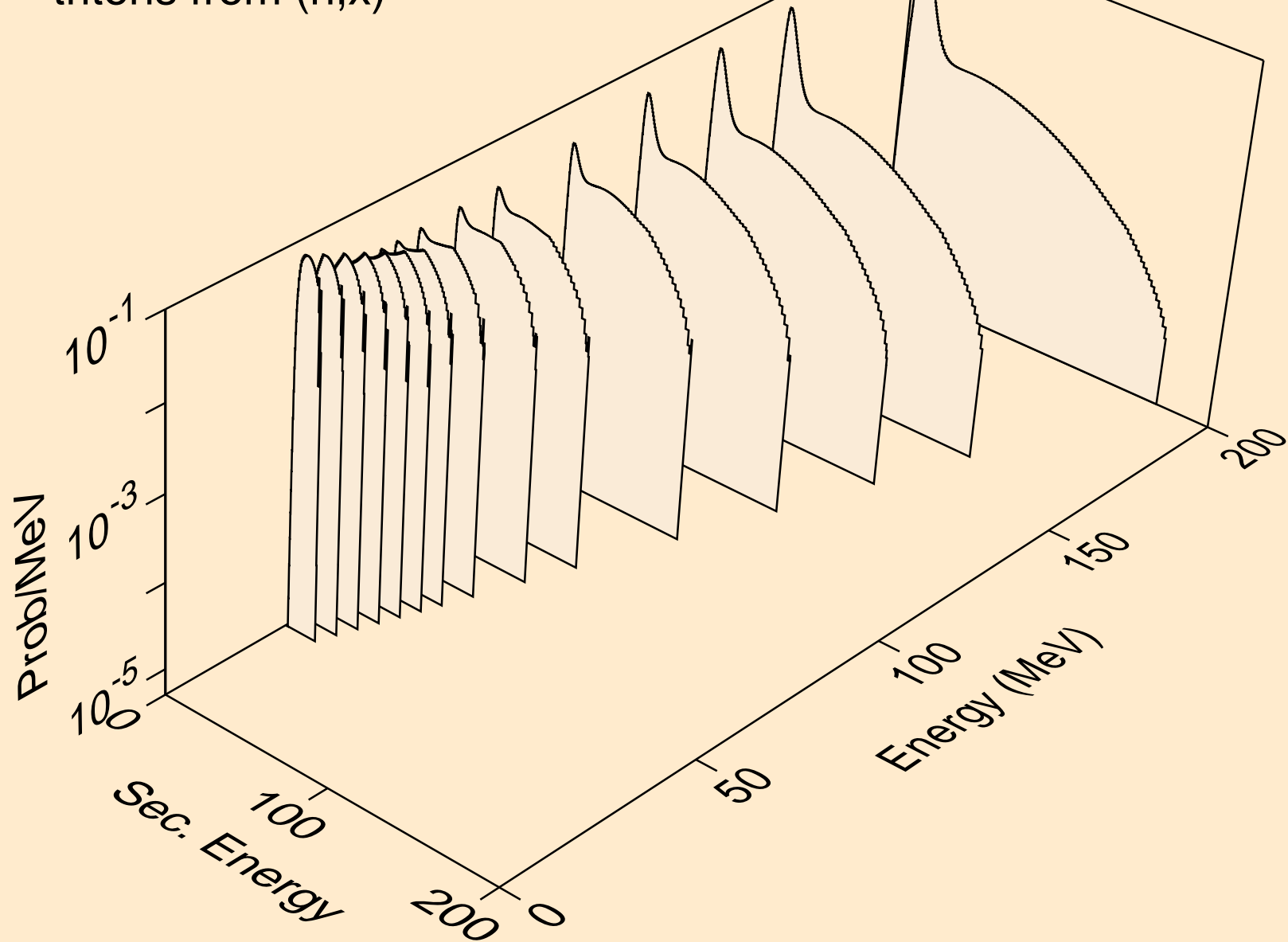

SC051 NEUTRON ACER TENDL-2023 LIBRARY; T=0.K  
tritons from (n,n\*)t

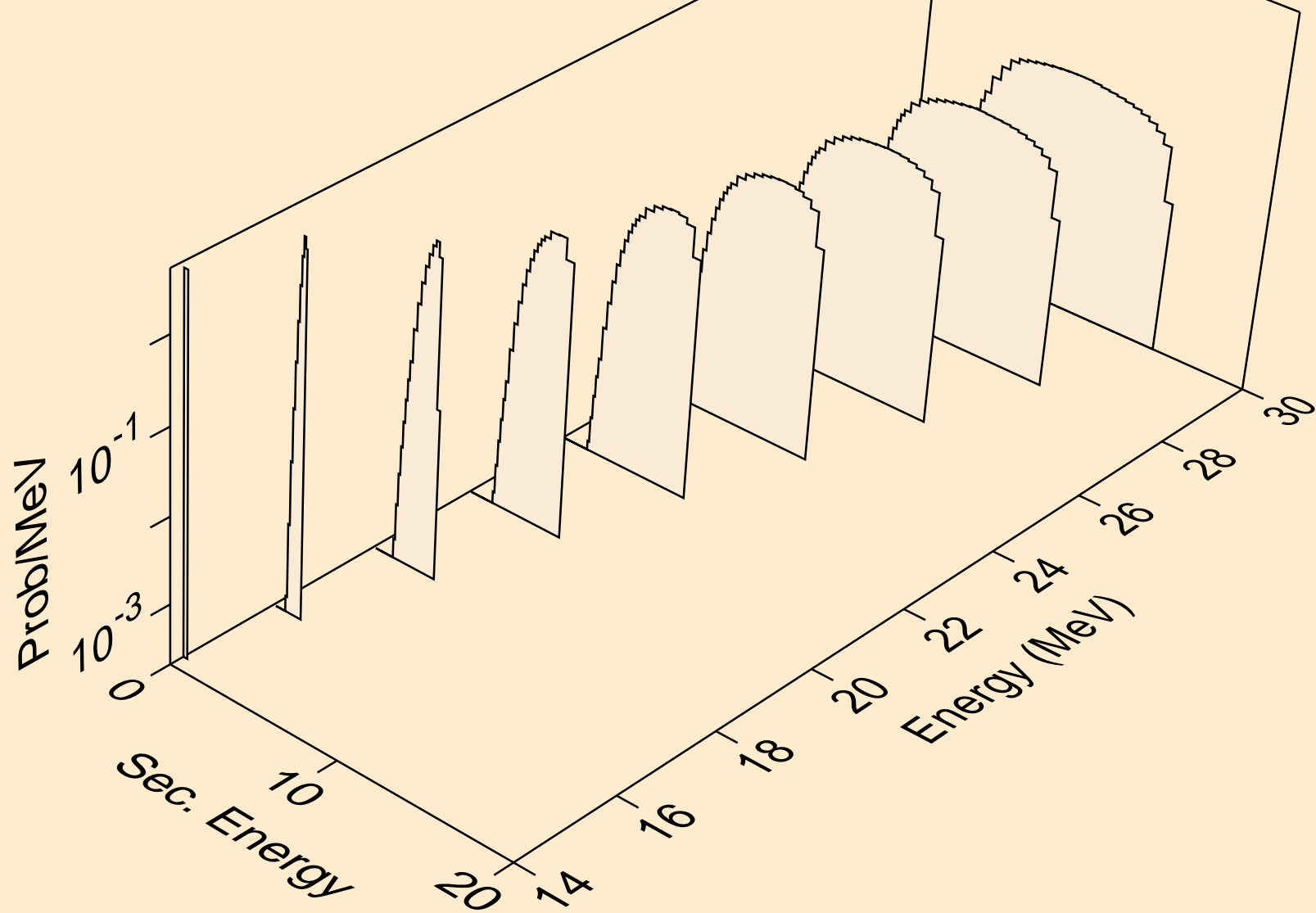

SC051 NEUTRON ACER TENDL-2023 LIBRARY; T=0.K  
tritons from (n,t)

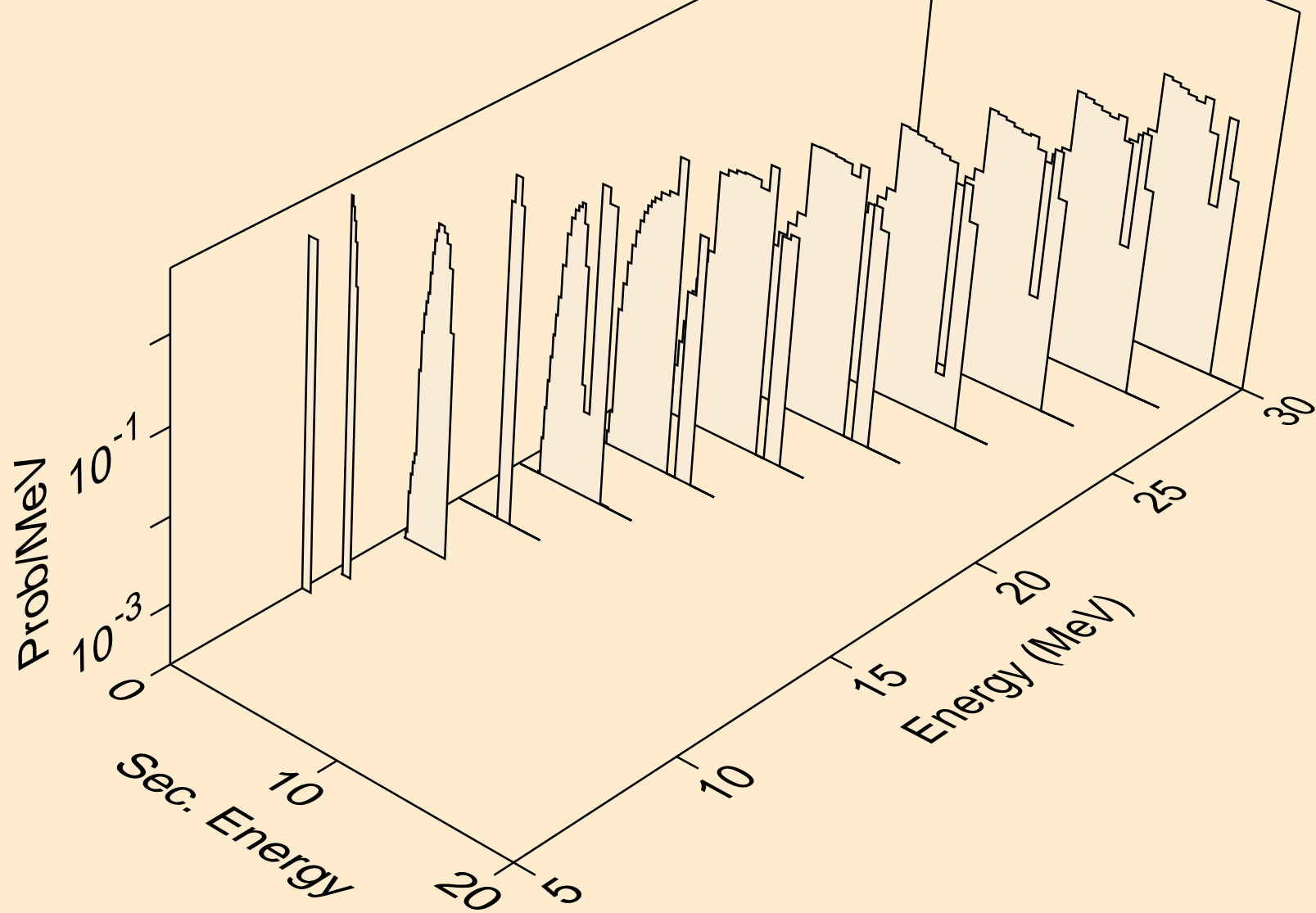

SC051 NEUTRON ACER TENDL-2023 LIBRARY; T=0.K  
he3s from (n,x)

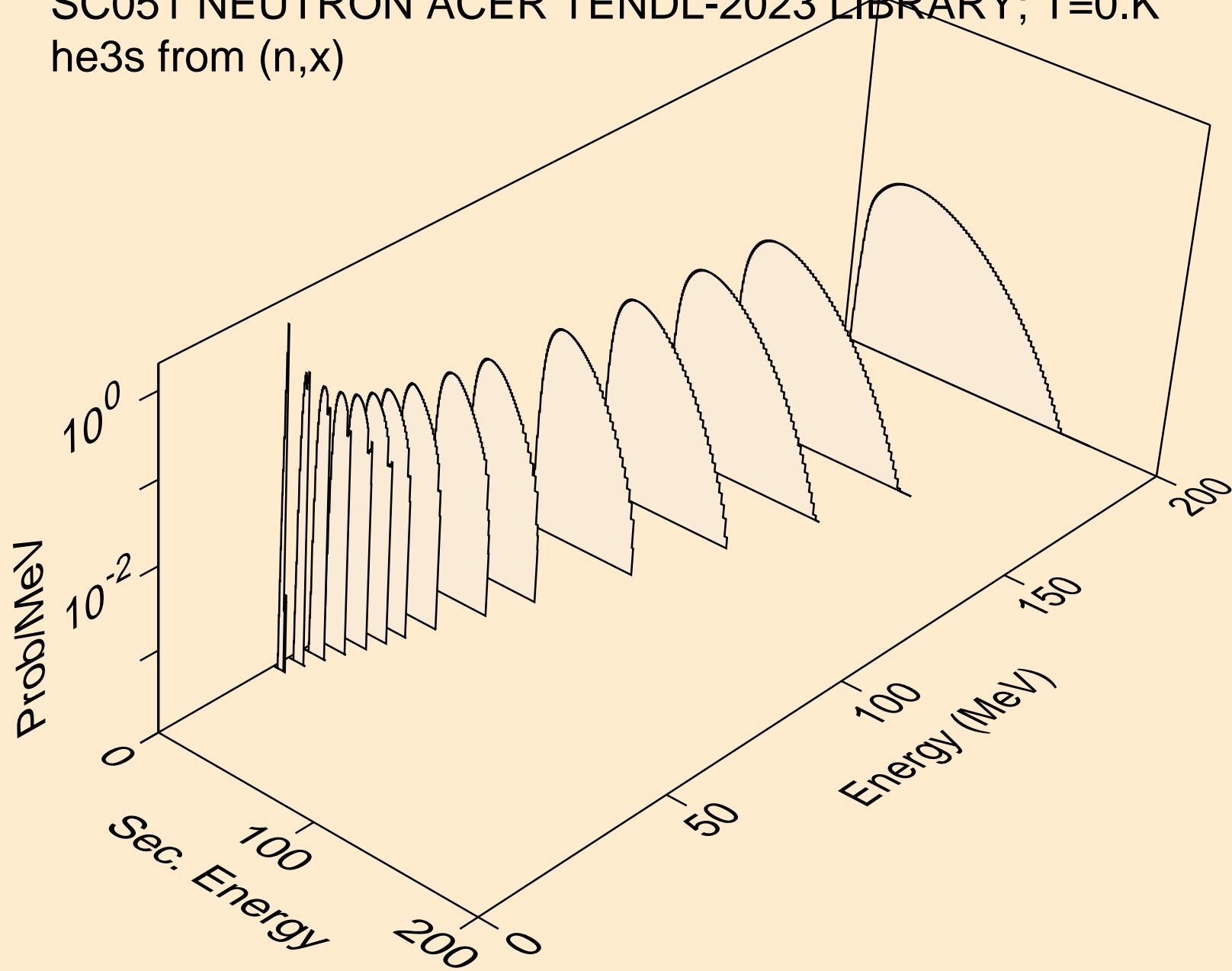

SC051 NEUTRON ACER TENDL-2023 LIBRARY; T=0.K  
he3s from (n,n\*)he3

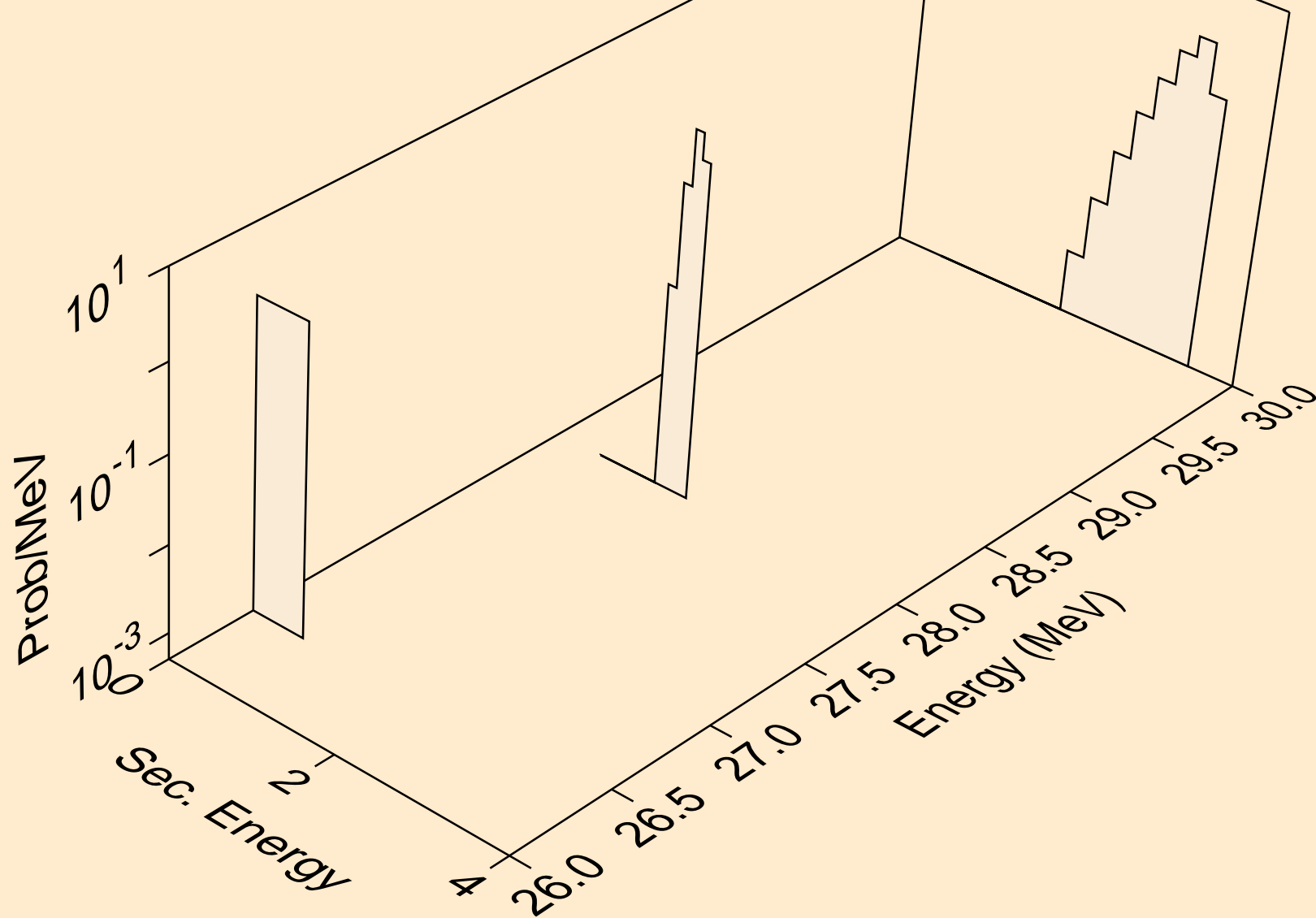

SC051 NEUTRON ACER TENDL-2023 LIBRARY; T=0.K  
he3s from (n,he3)

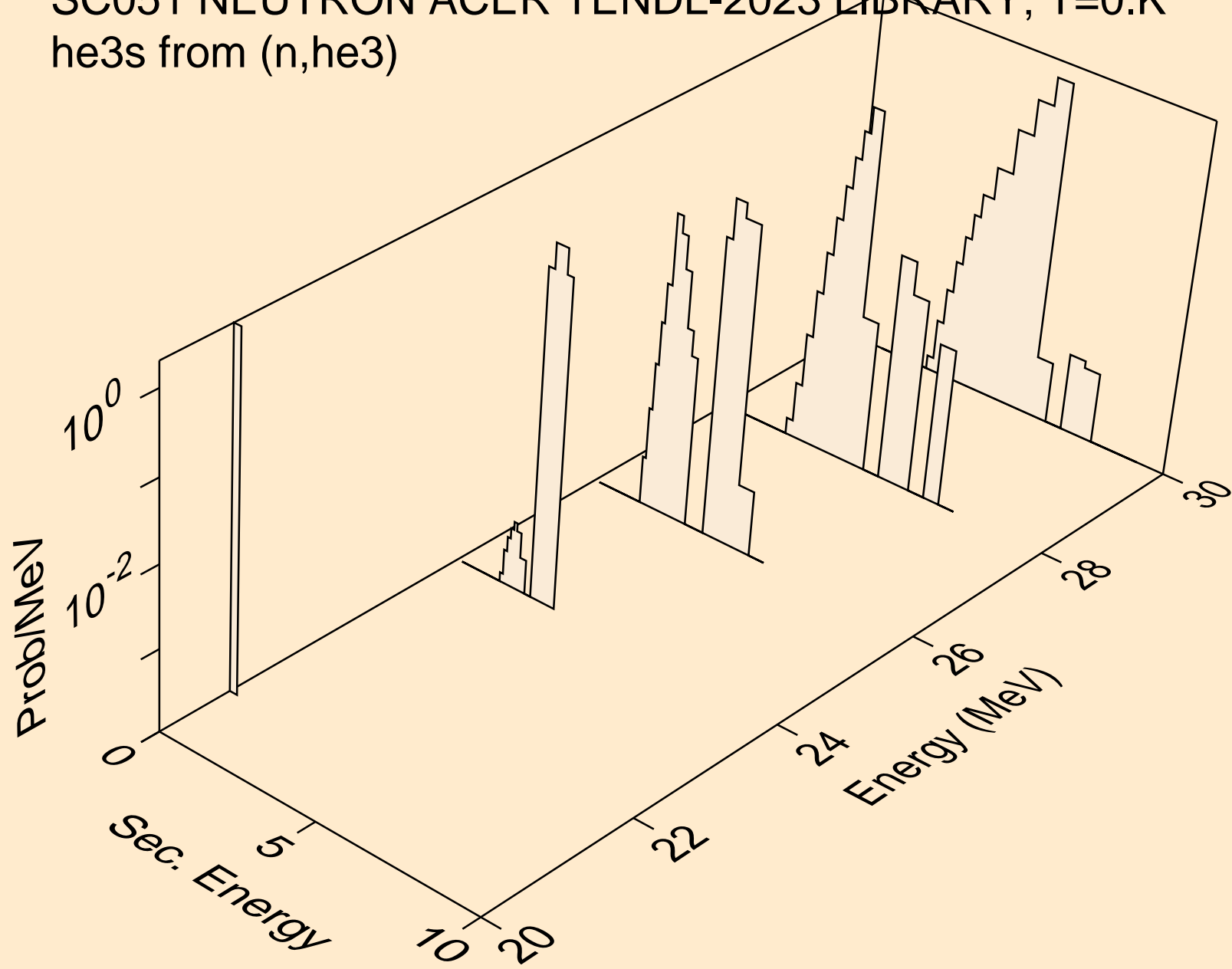

SC051 NEUTRON ACER TENDL-2023 LIBRARY; T=0.K  
alphas from (n,x)

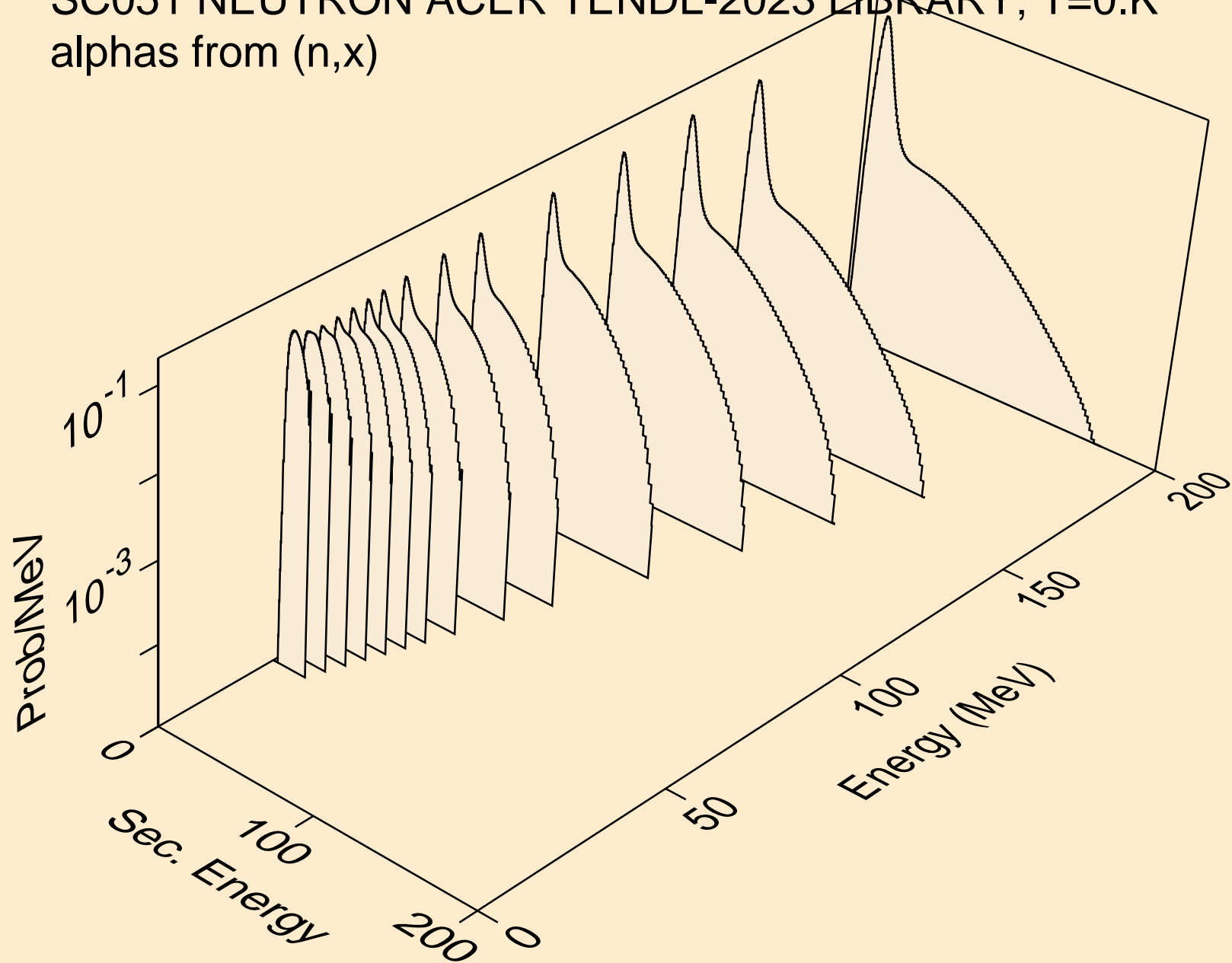



SC051 NEUTRON ACER TENDL-2023 LIBRARY; T=0.K  
alphas from (n,n\*)a

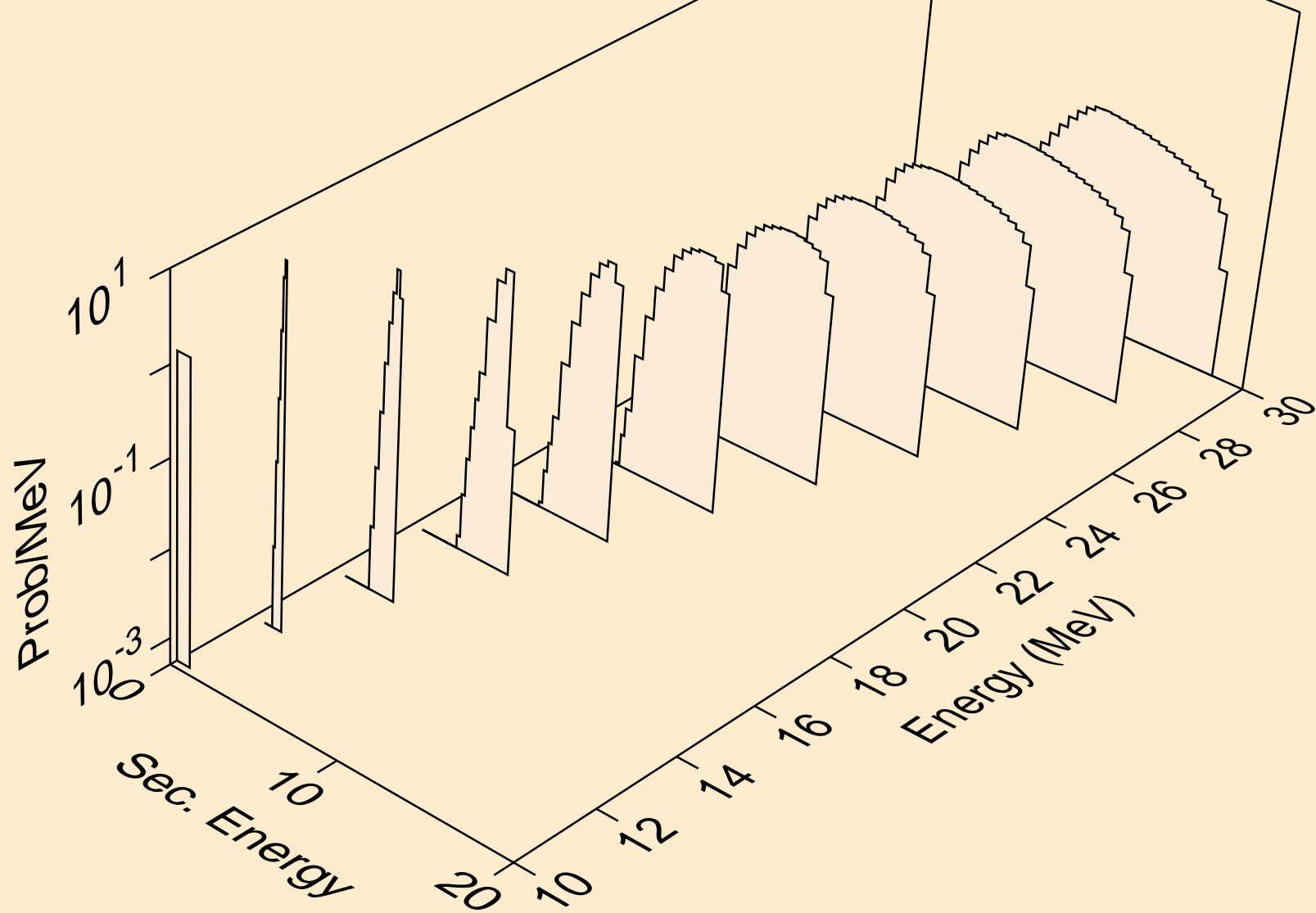

SC051 NEUTRON ACER TENDL-2023 LIBRARY; T=0.K  
alphas from (n,2n)a

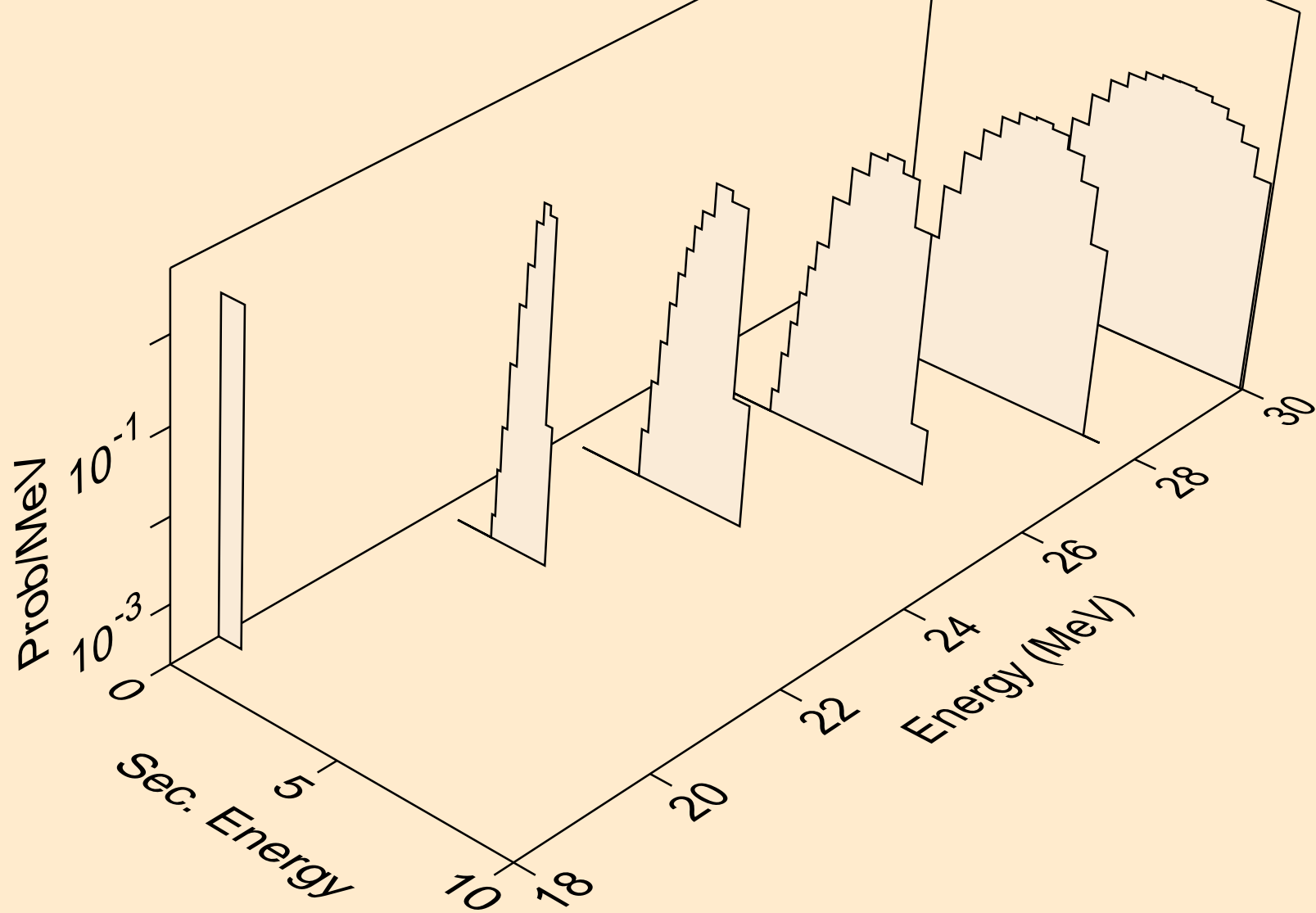

SC051 NEUTRON ACER TENDL-2023 LIBRARY; T=0.K  
alphas from (n,3n)a

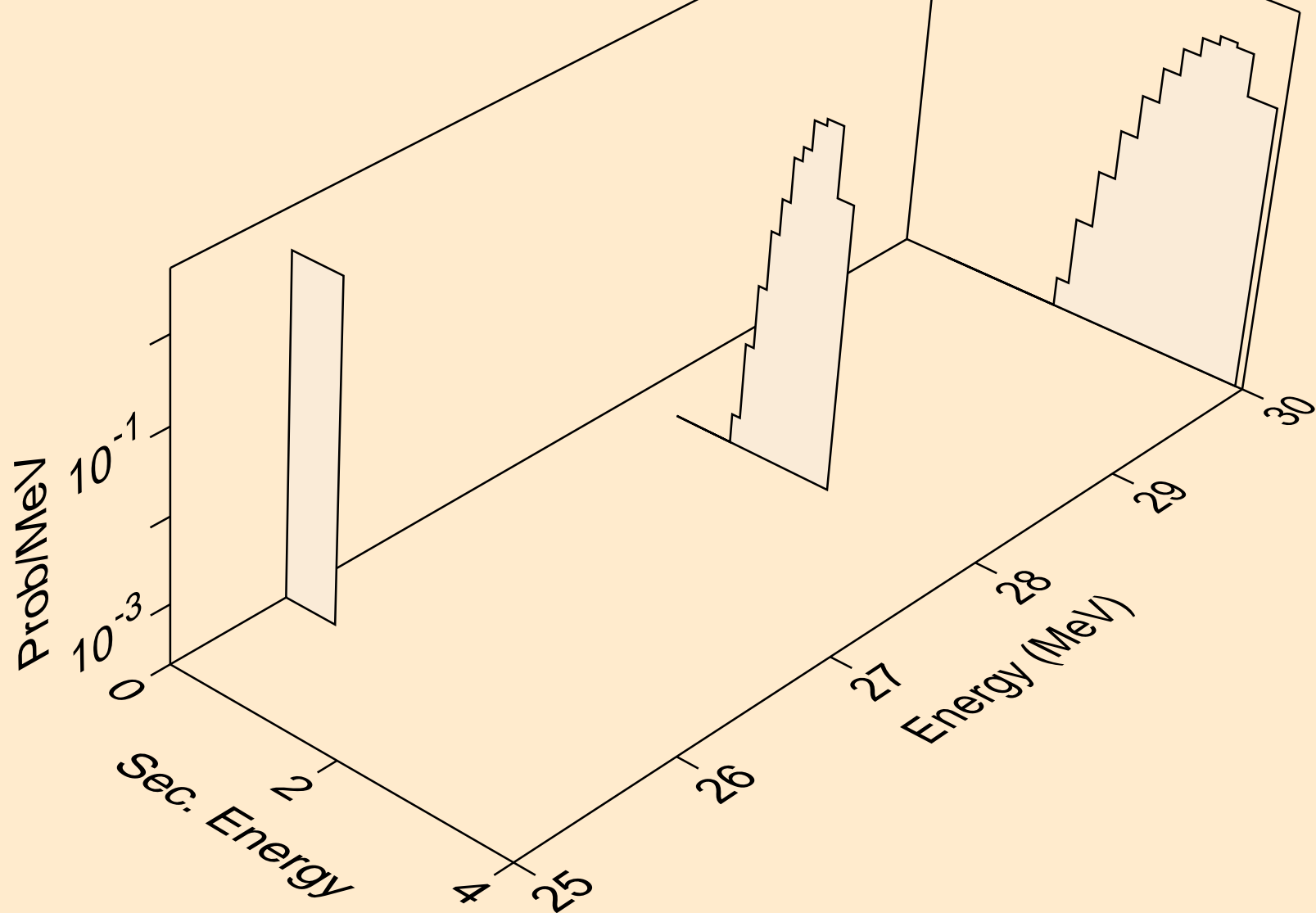

SC051 NEUTRON ACER TENDL-2023 LIBRARY; T=0.K  
alphas from (n,a)

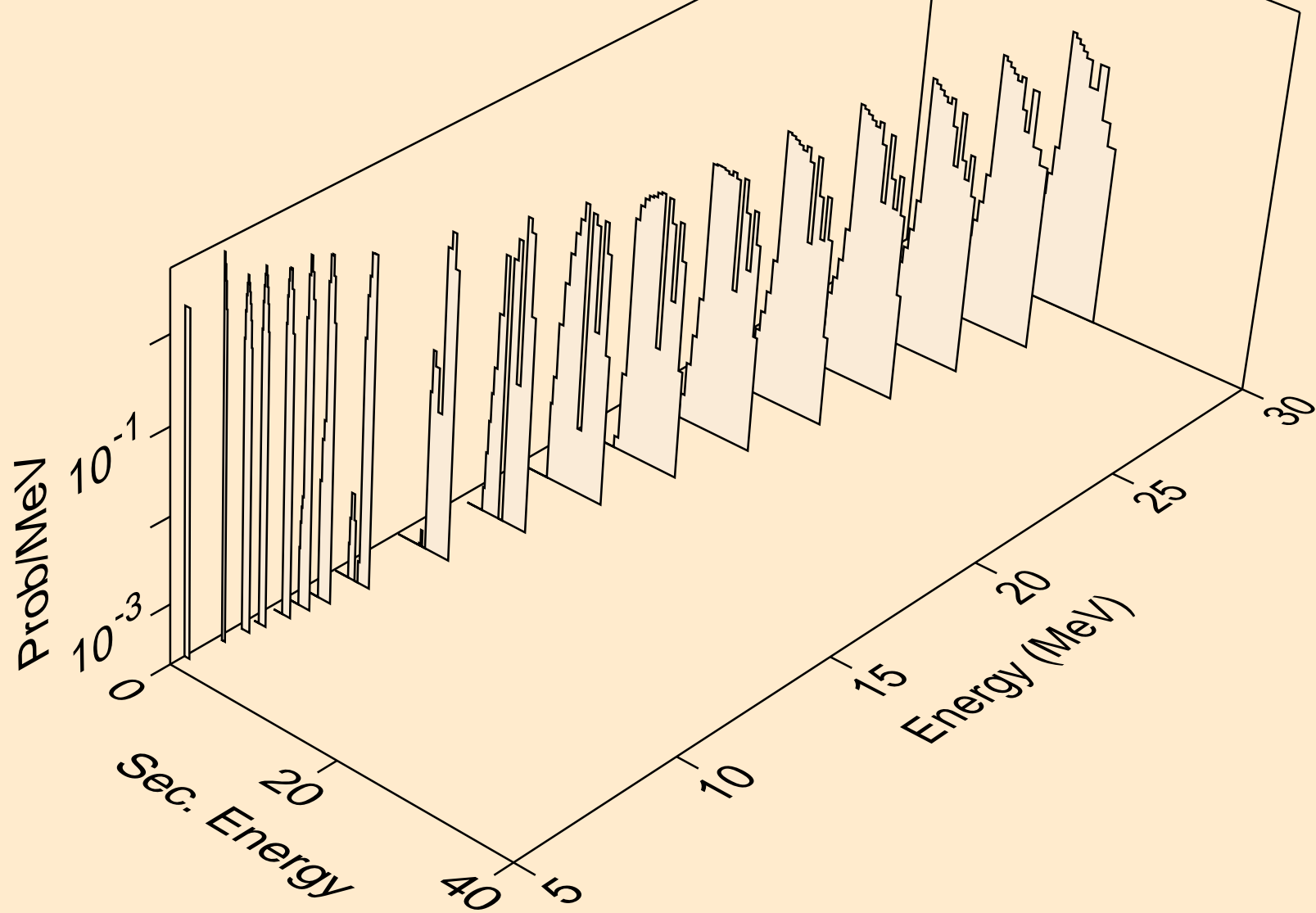

SC051 NEUTRON ACER TENDL-2023 LIBRARY; T=0.K  
alphas from (n,pa)

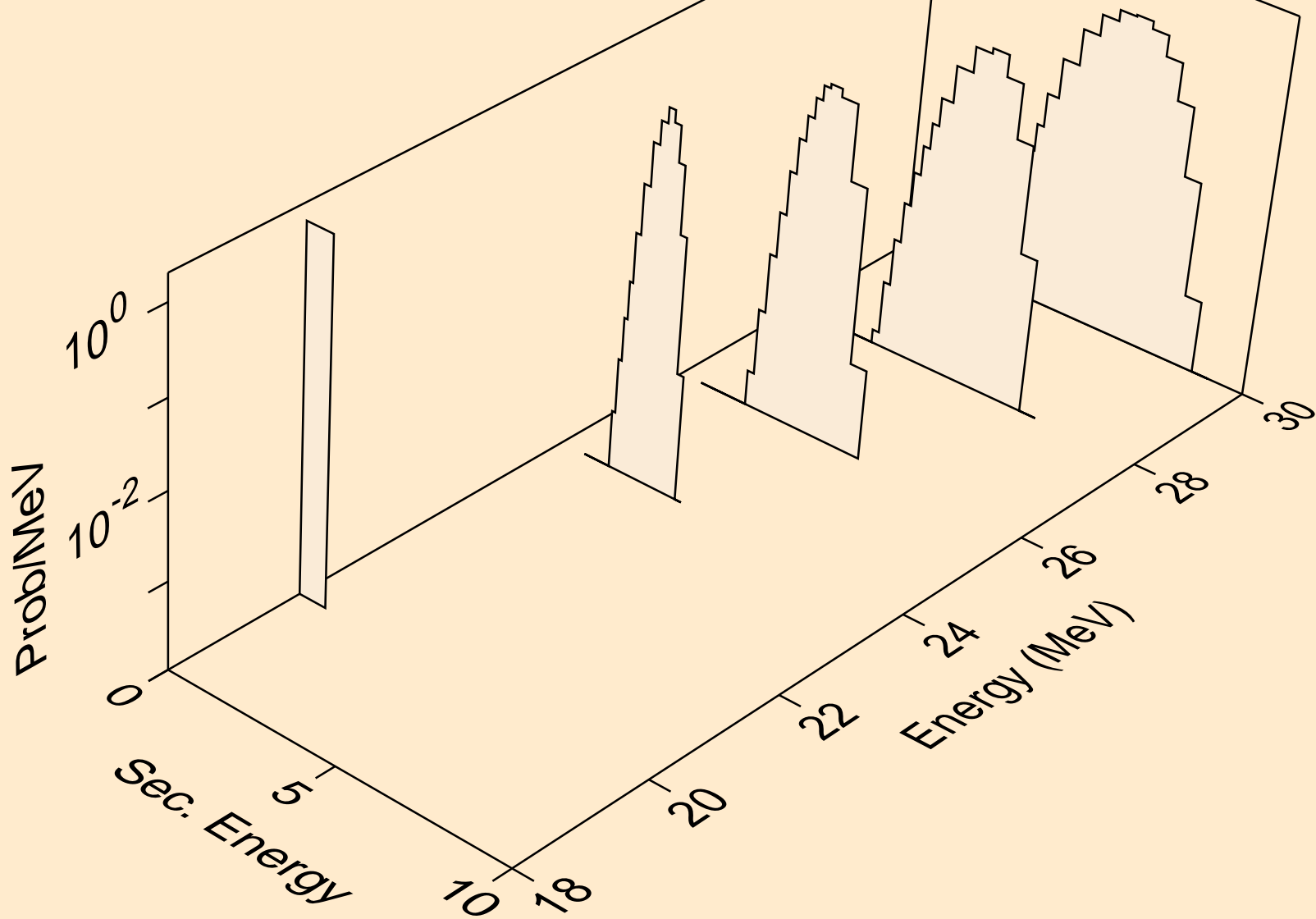

SC051 NEUTRON ACER TENDL-2023 LIBRARY; T=0.K  
alphas from (n,da)

