

# SE074 NEUTRON ACER TENDL-2023 LIBRARY; T=0.K

## Principal cross sections

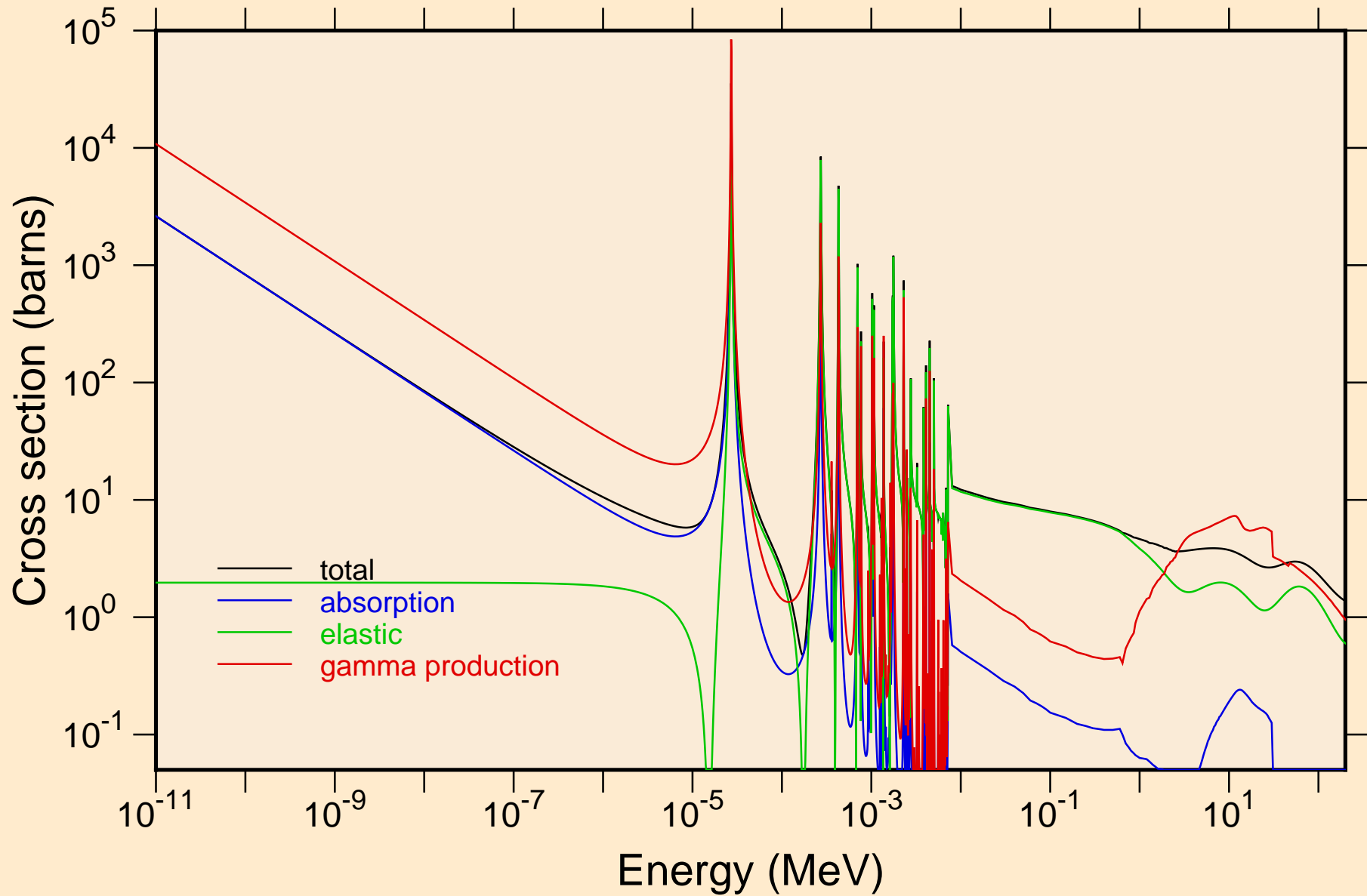

SE074 NEUTRON ACER TENDL-2023 LIBRARY; T=0.K  
resonance total cross section

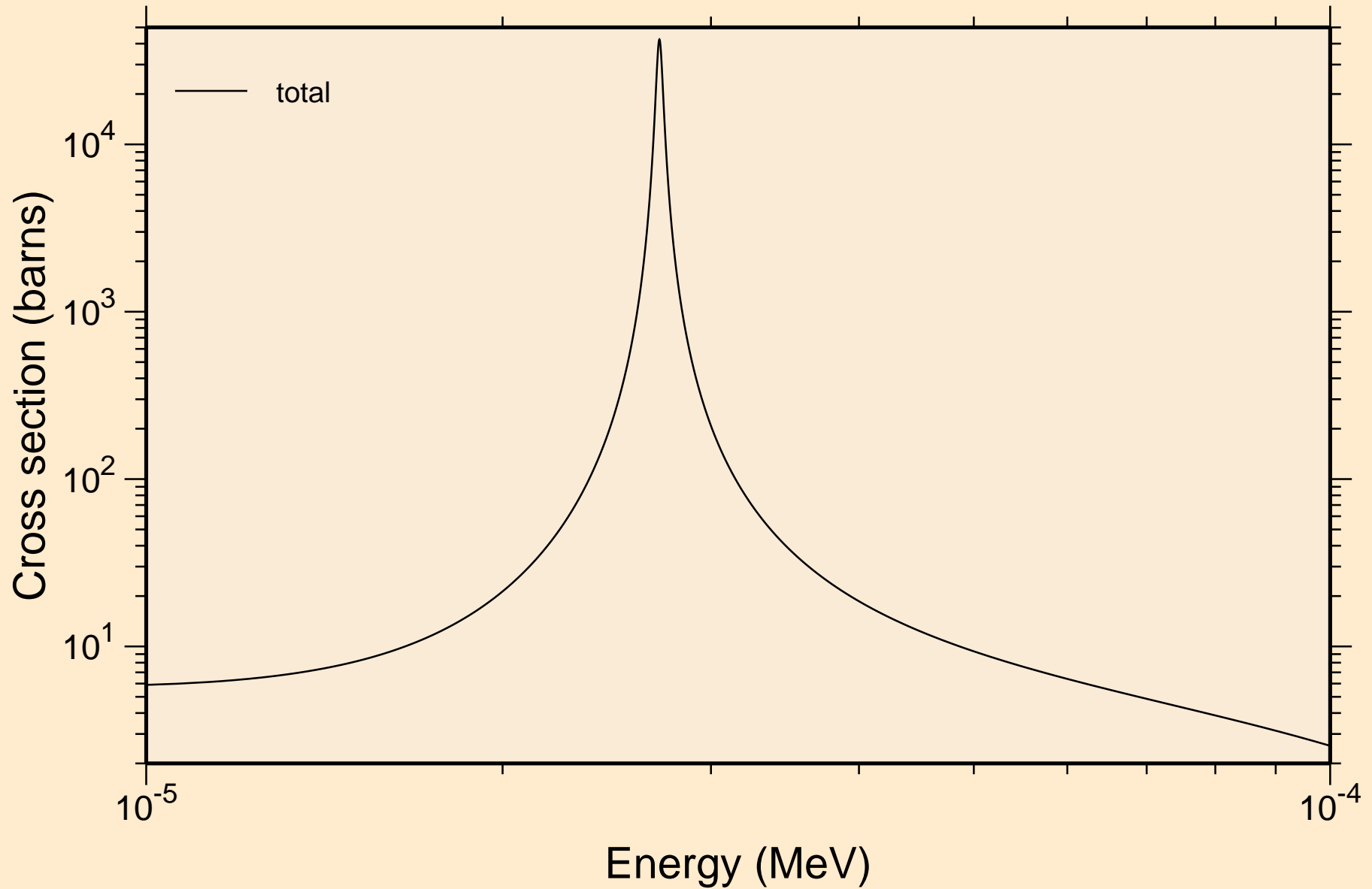

SE074 NEUTRON ACER TENDL-2023 LIBRARY; T=0.K  
resonance total cross section

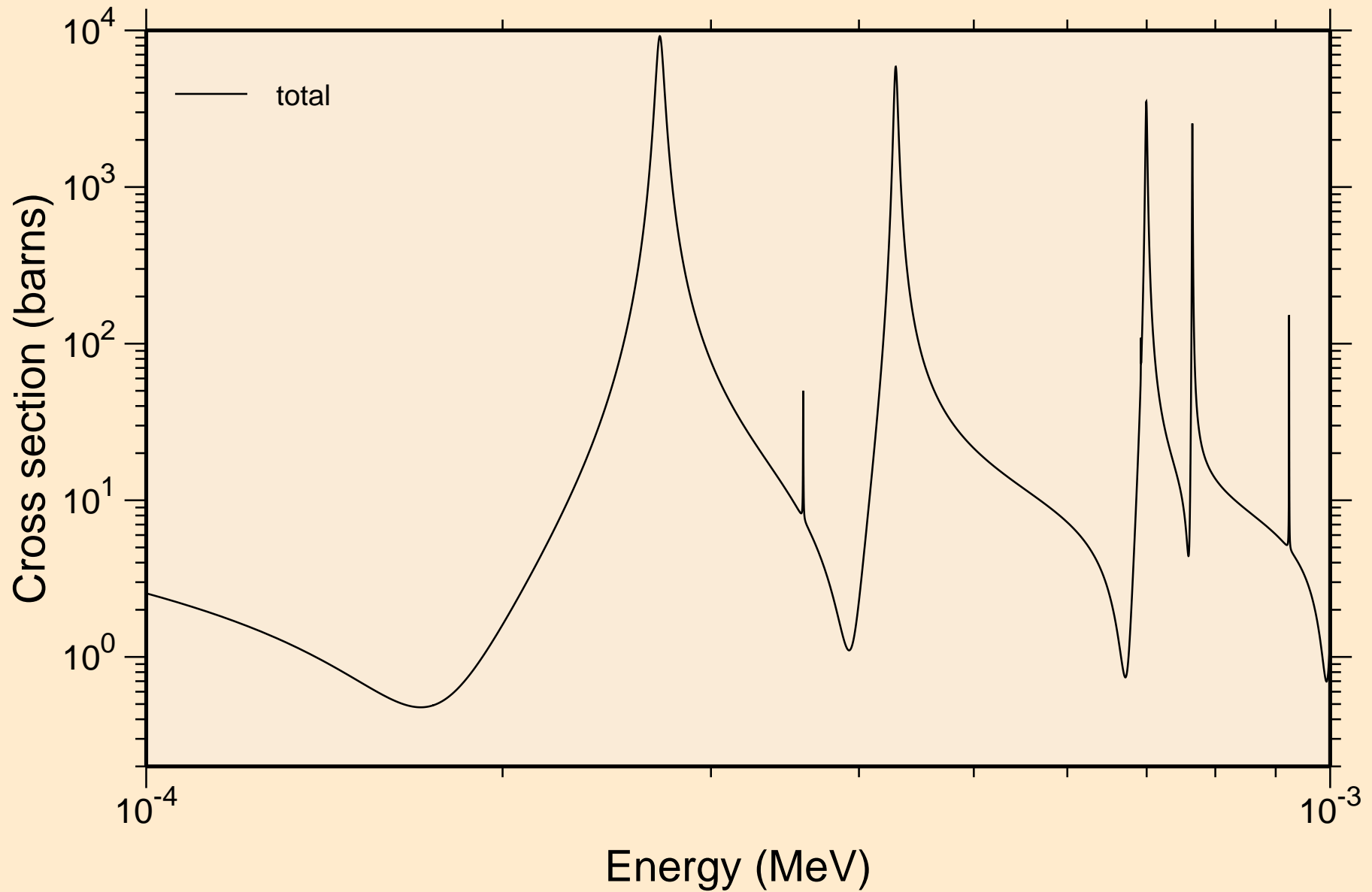

SE074 NEUTRON ACER TENDL-2023 LIBRARY; T=0.K  
resonance total cross section

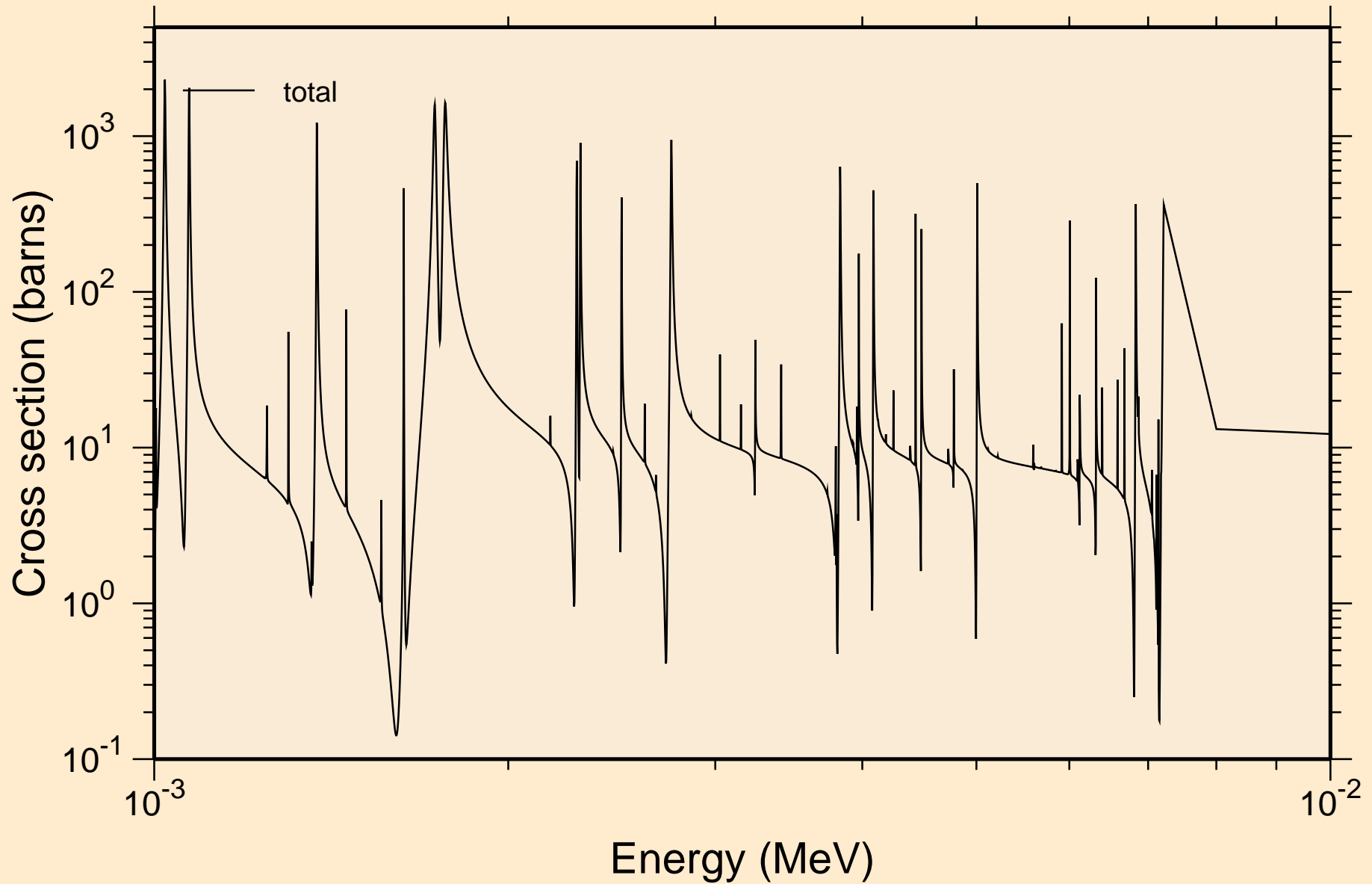

S<sub>E</sub>074 NEUTRON ACER TENDL-2023 LIBRARY; T=0.K  
resonance total cross section

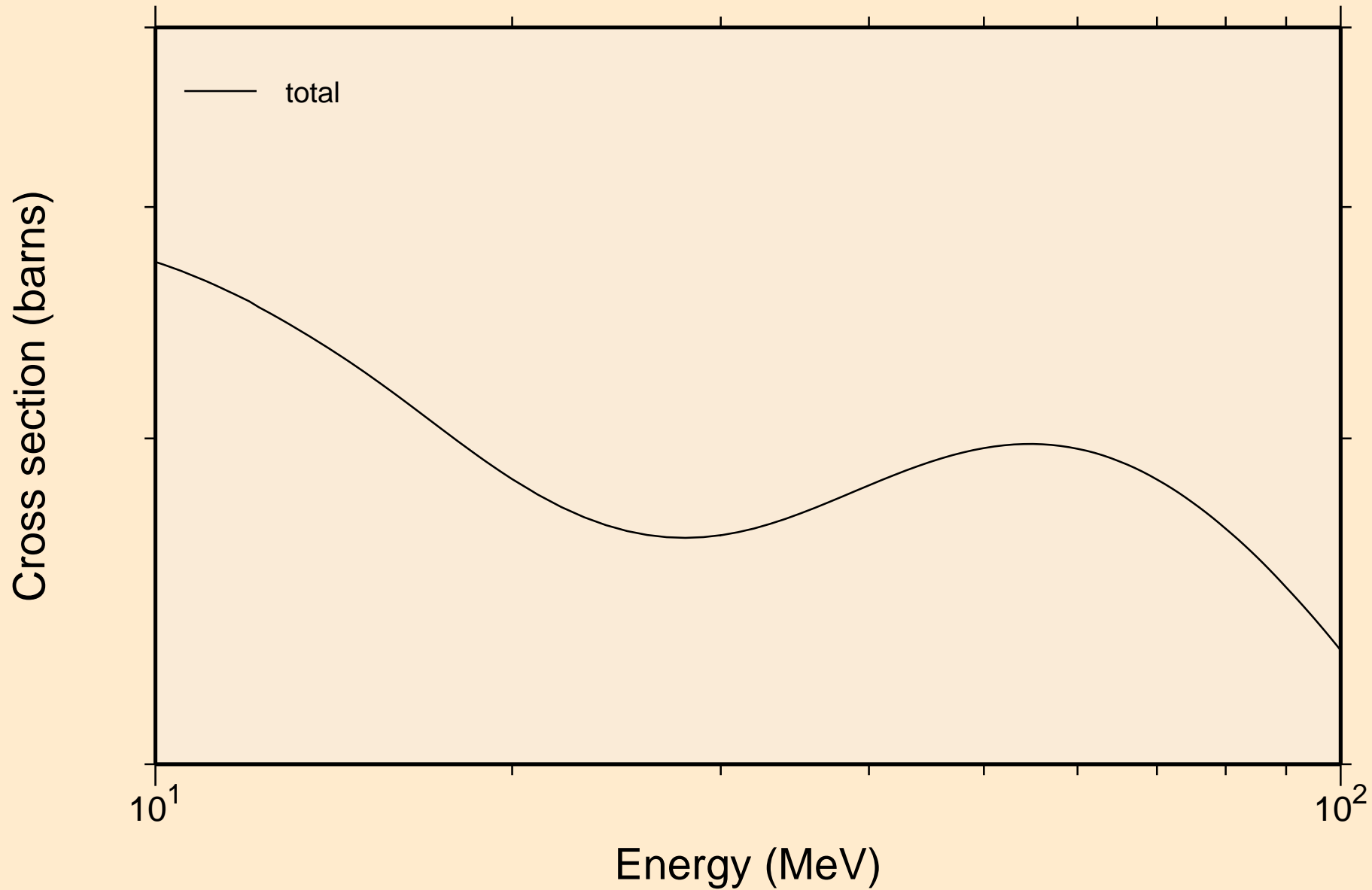

SE074 NEUTRON ACER TENDL-2023 LIBRARY; T=0.K  
resonance absorption cross sections

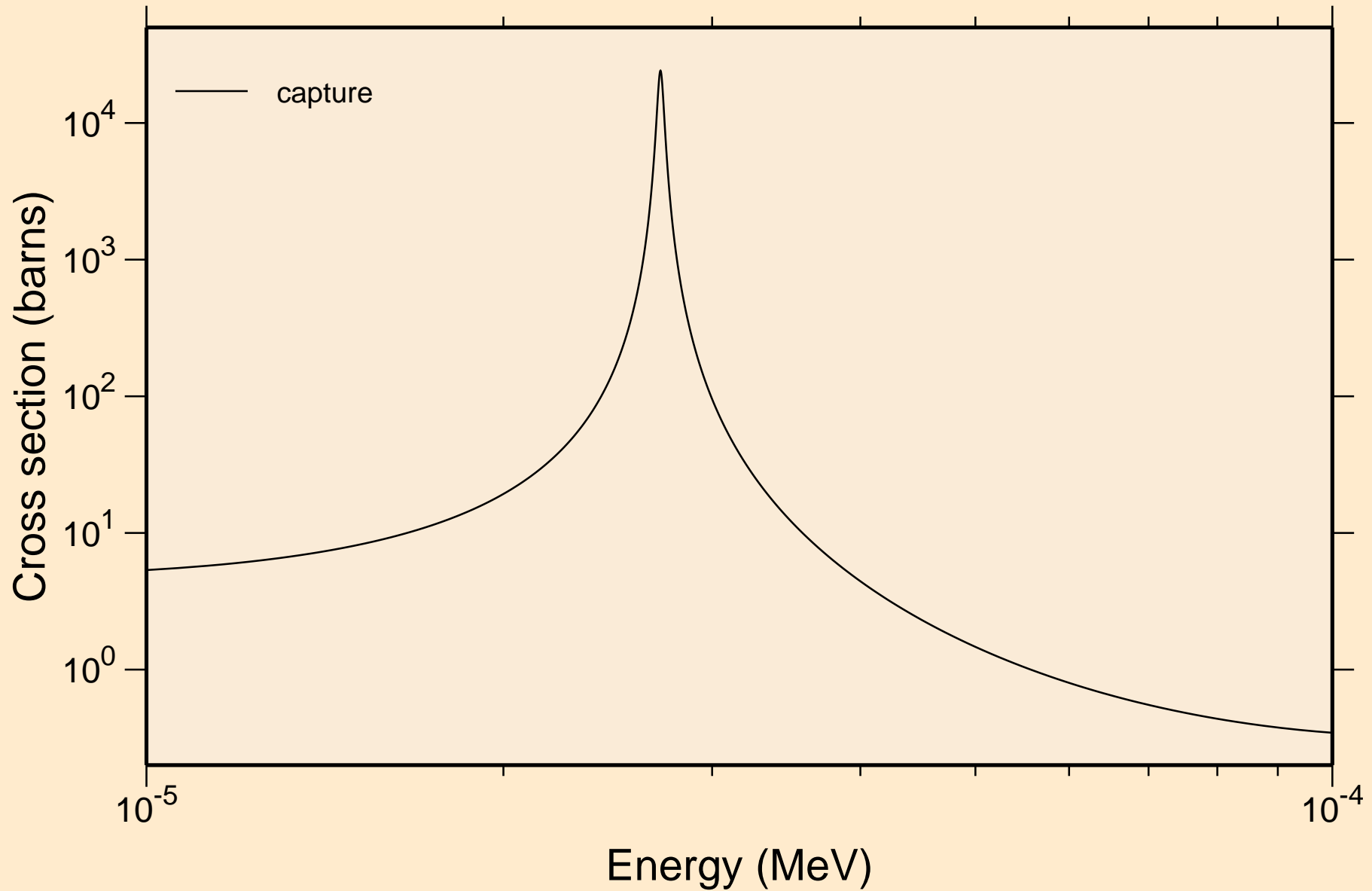

SE074 NEUTRON ACER TENDL-2023 LIBRARY; T=0.K  
resonance absorption cross sections

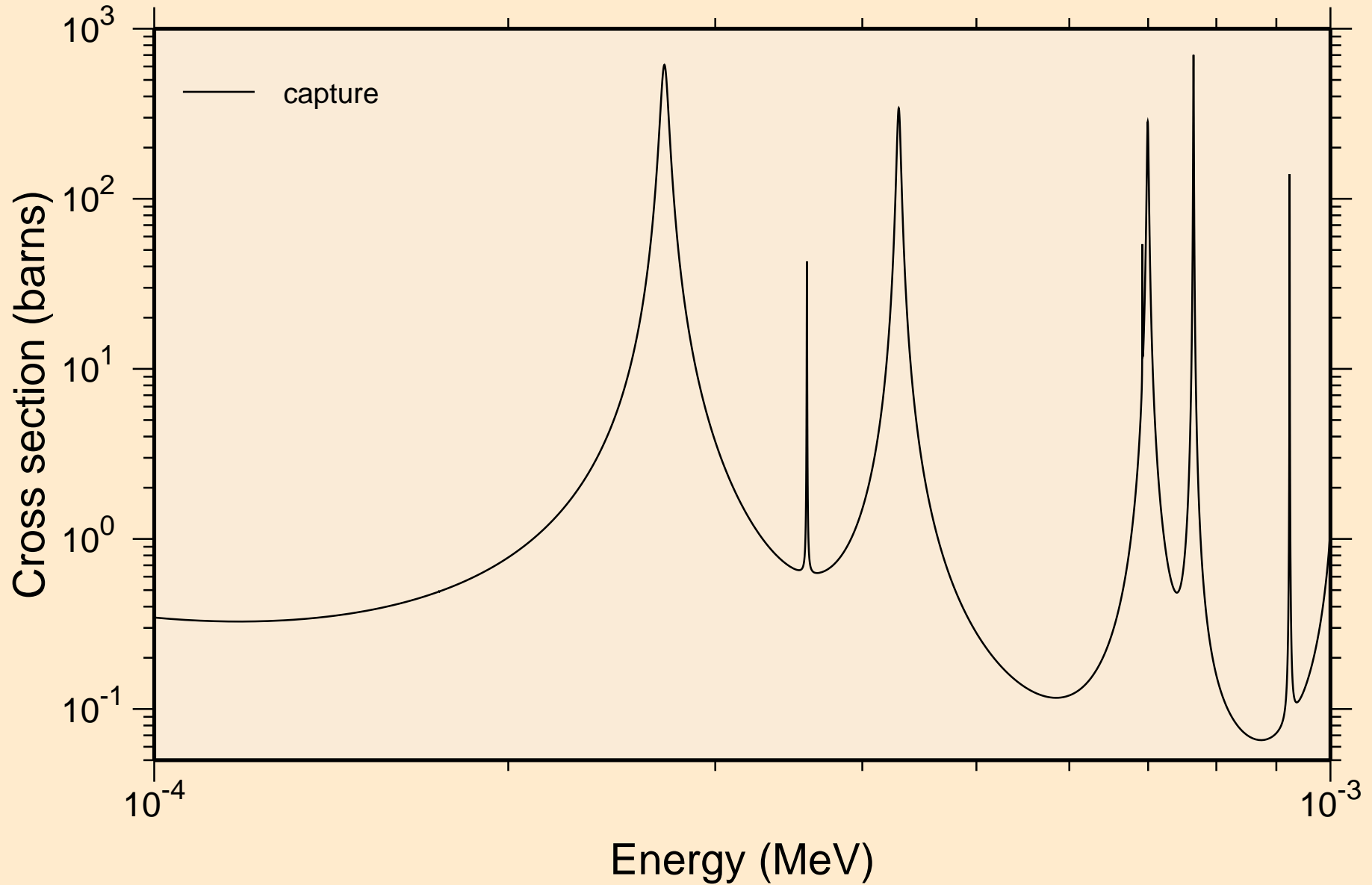

SE074 NEUTRON ACER TENDL-2023 LIBRARY; T=0.K  
resonance absorption cross sections

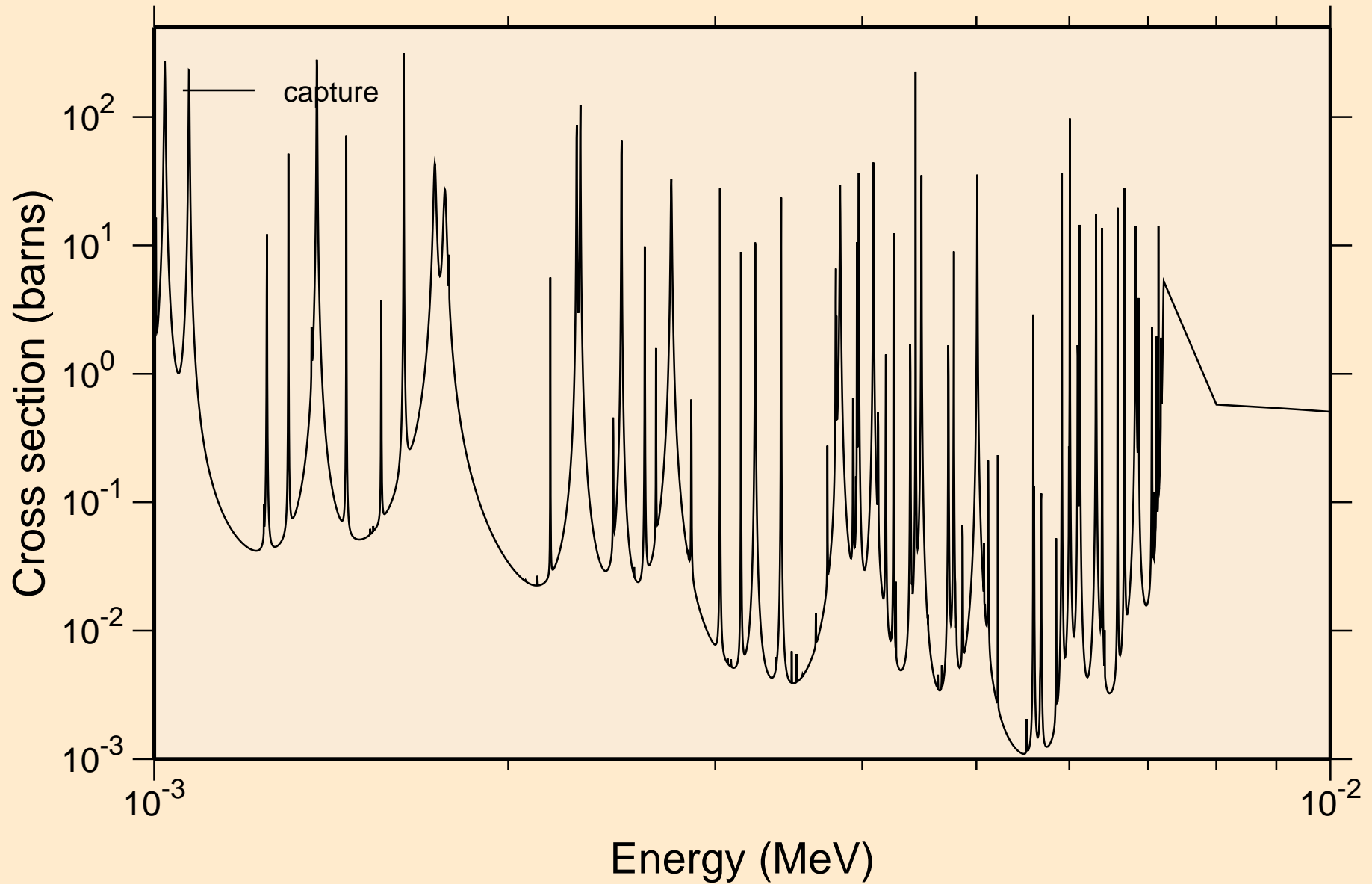



SE074 NEUTRON ACER TENDL-2023 LIBRARY; T=0.K  
resonance absorption cross sections

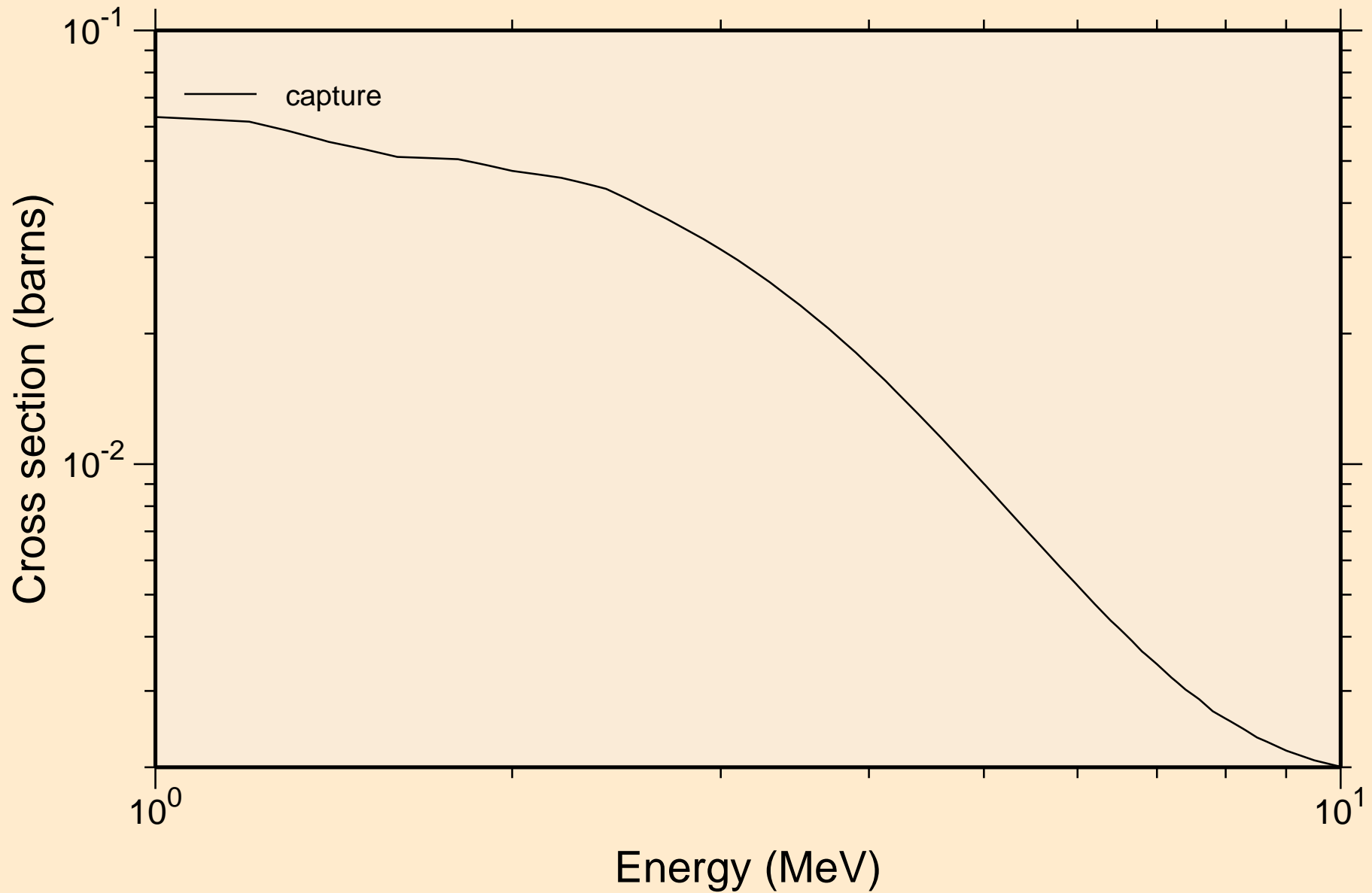

SE074 NEUTRON ACER TENDL-2023 LIBRARY; T=0.K  
Heating

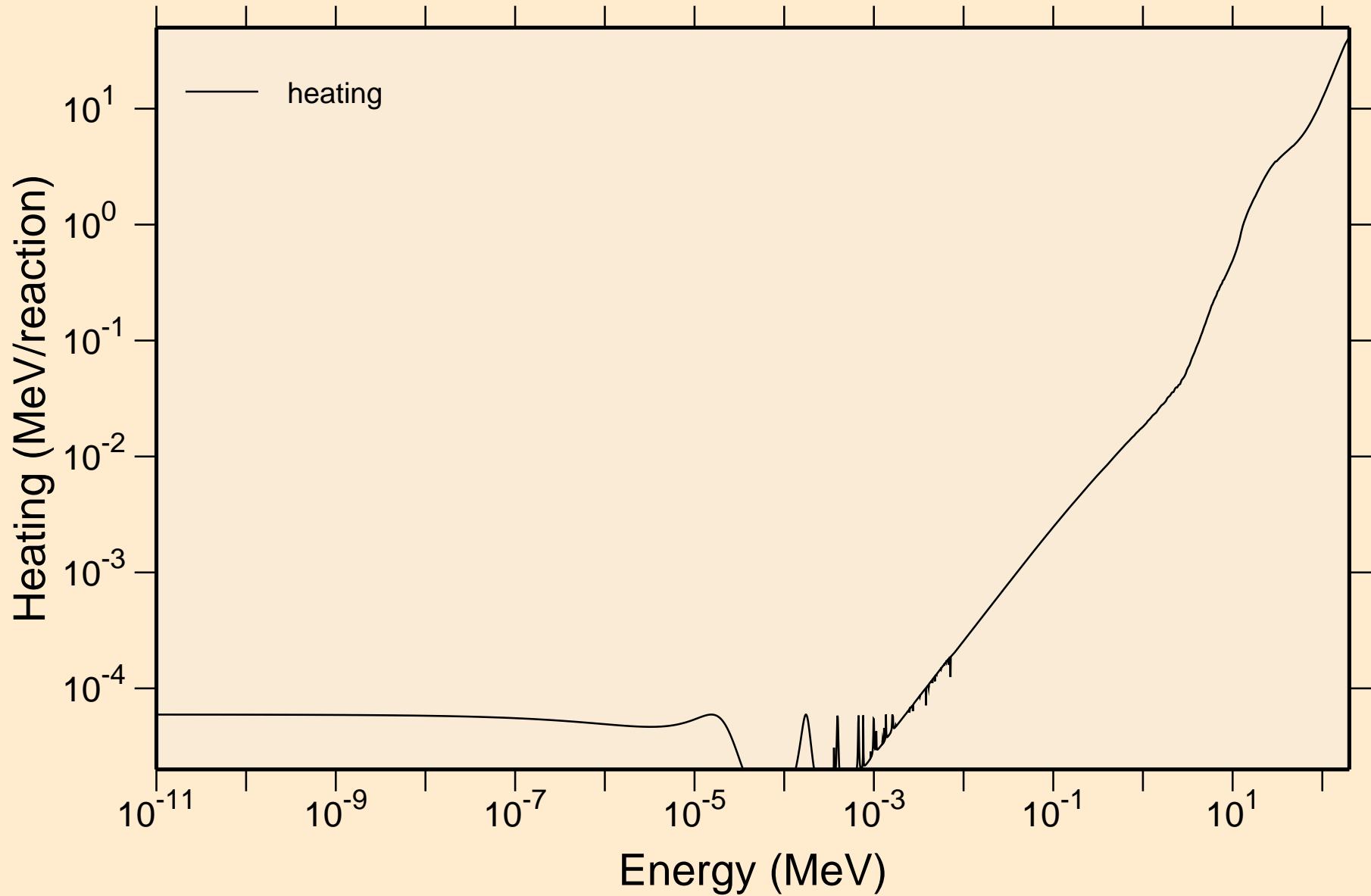

SE074 NEUTRON ACER TENDL-2023 LIBRARY; T=0.K  
Damage

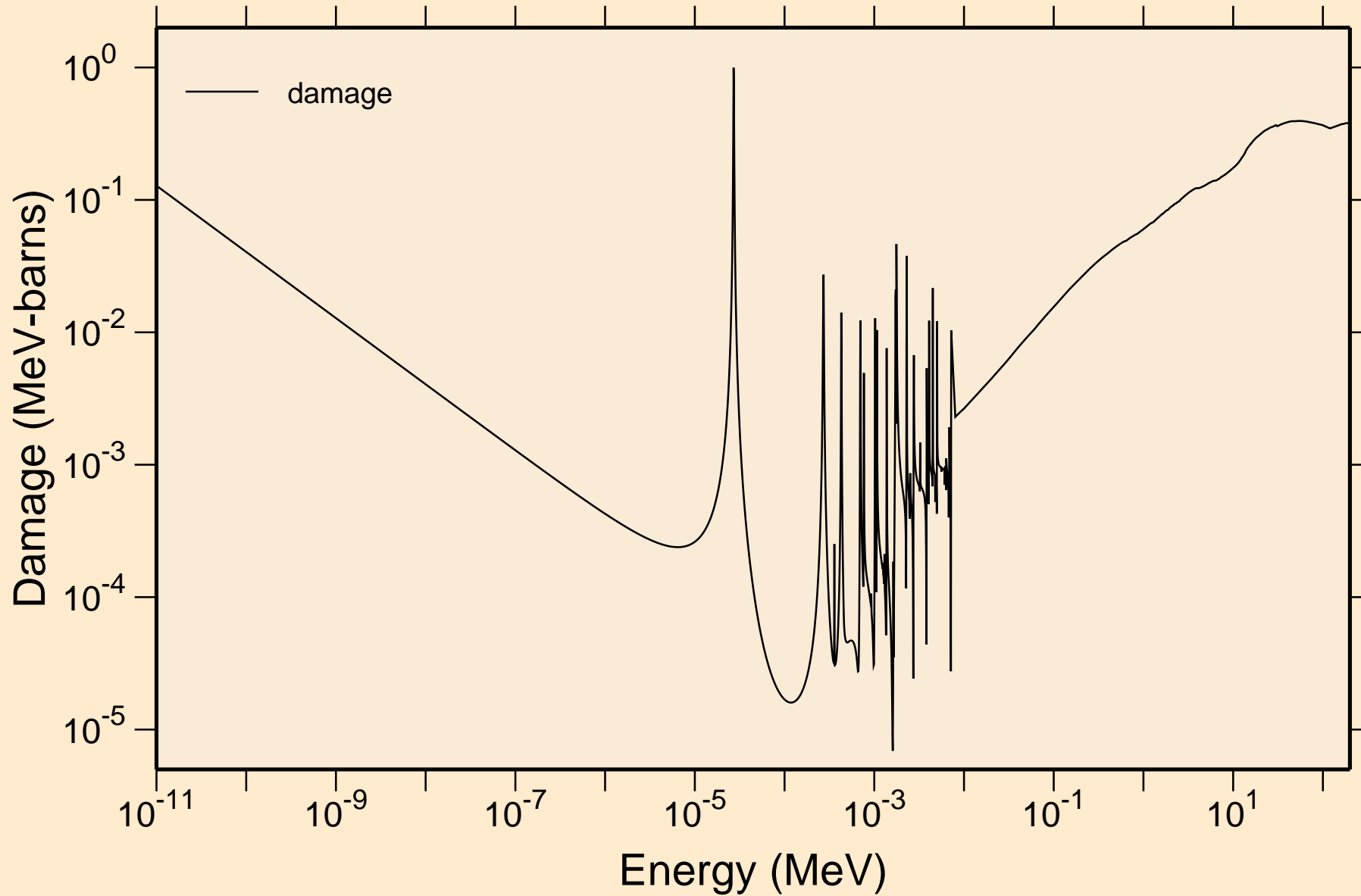

SE074 NEUTRON ACER TENDL-2023 LIBRARY; T=0.K  
Non-threshold reactions

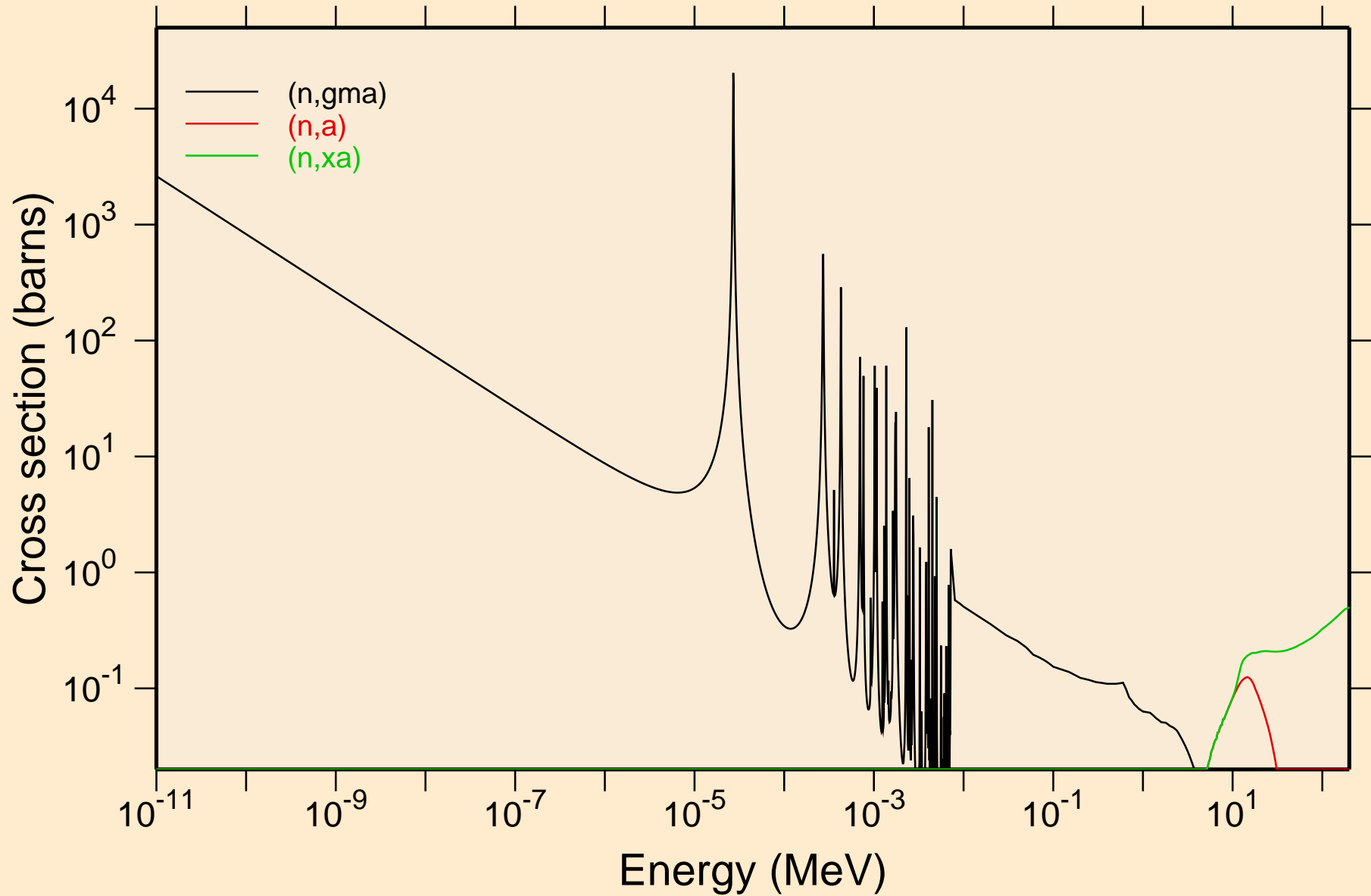

# SE074 NEUTRON ACER TENDL-2023 LIBRARY; T=0.K

## Principal cross sections

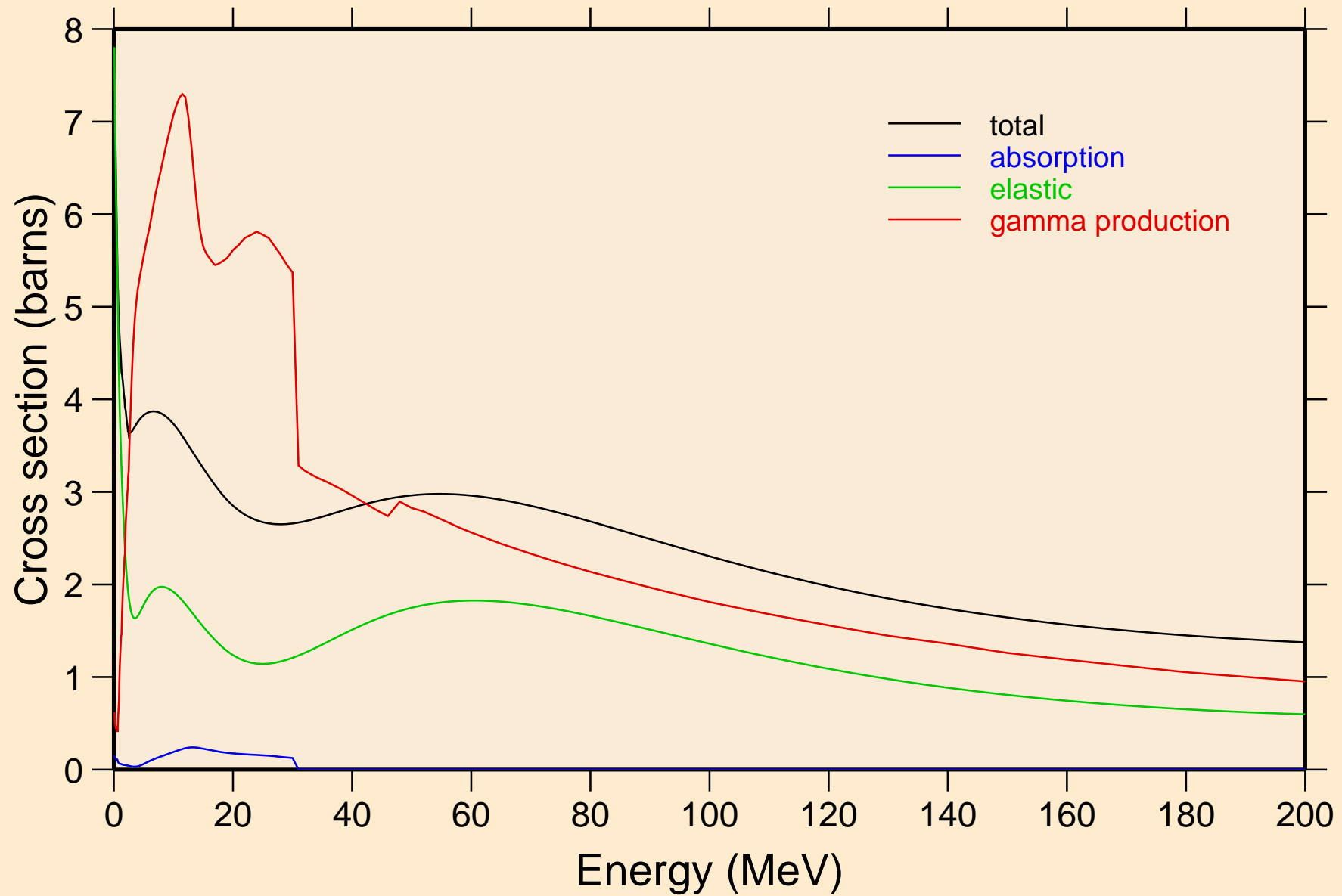

# SE074 NEUTRON ACER TENDL-2023 LIBRARY; T=0.K

## Heating

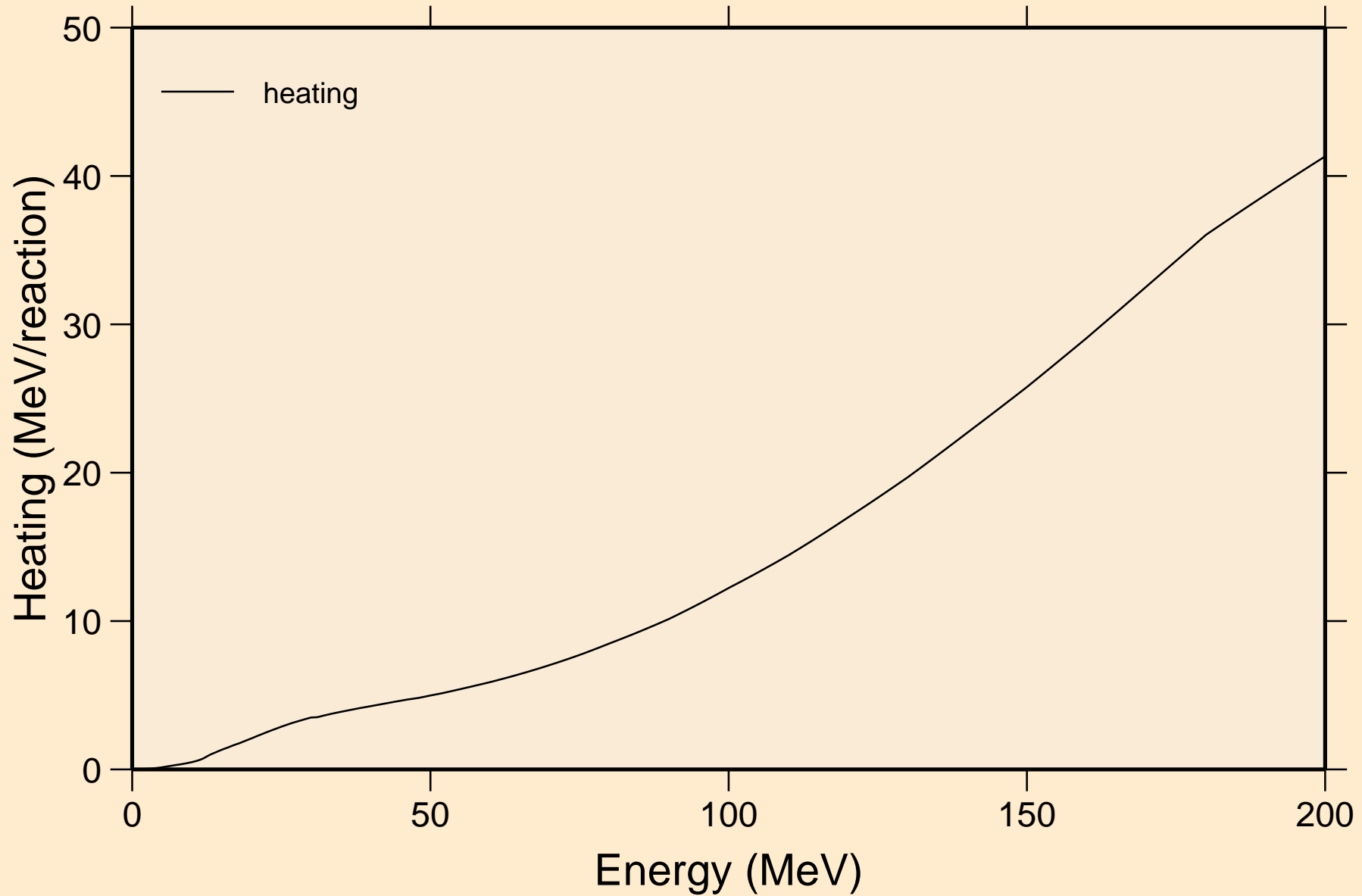

# SE074 NEUTRON ACER TENDL-2023 LIBRARY; T=0.K

## Damage

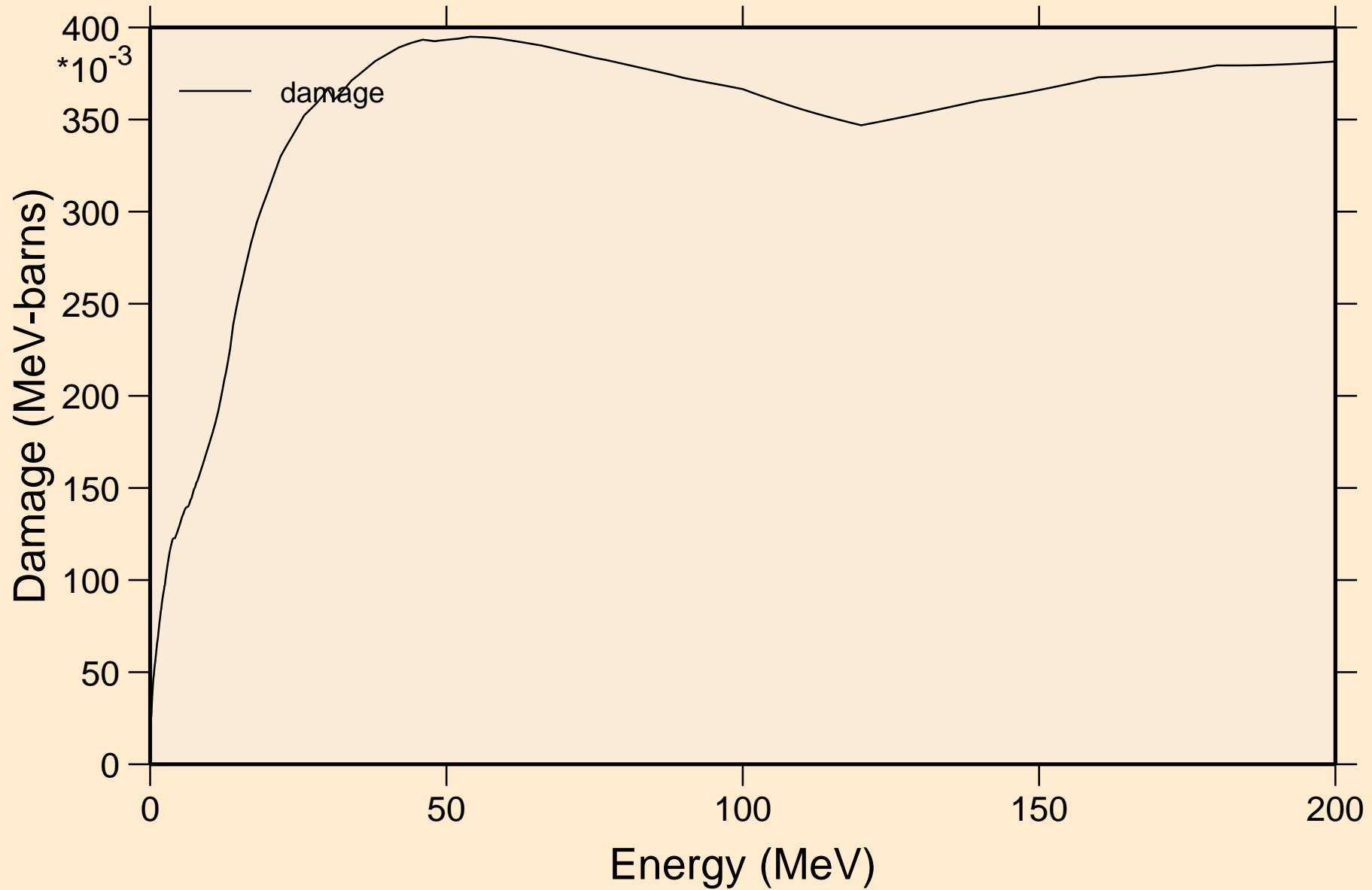

SE074 NEUTRON ACER TENDL-2023 LIBRARY; T=0.K  
Non-threshold reactions

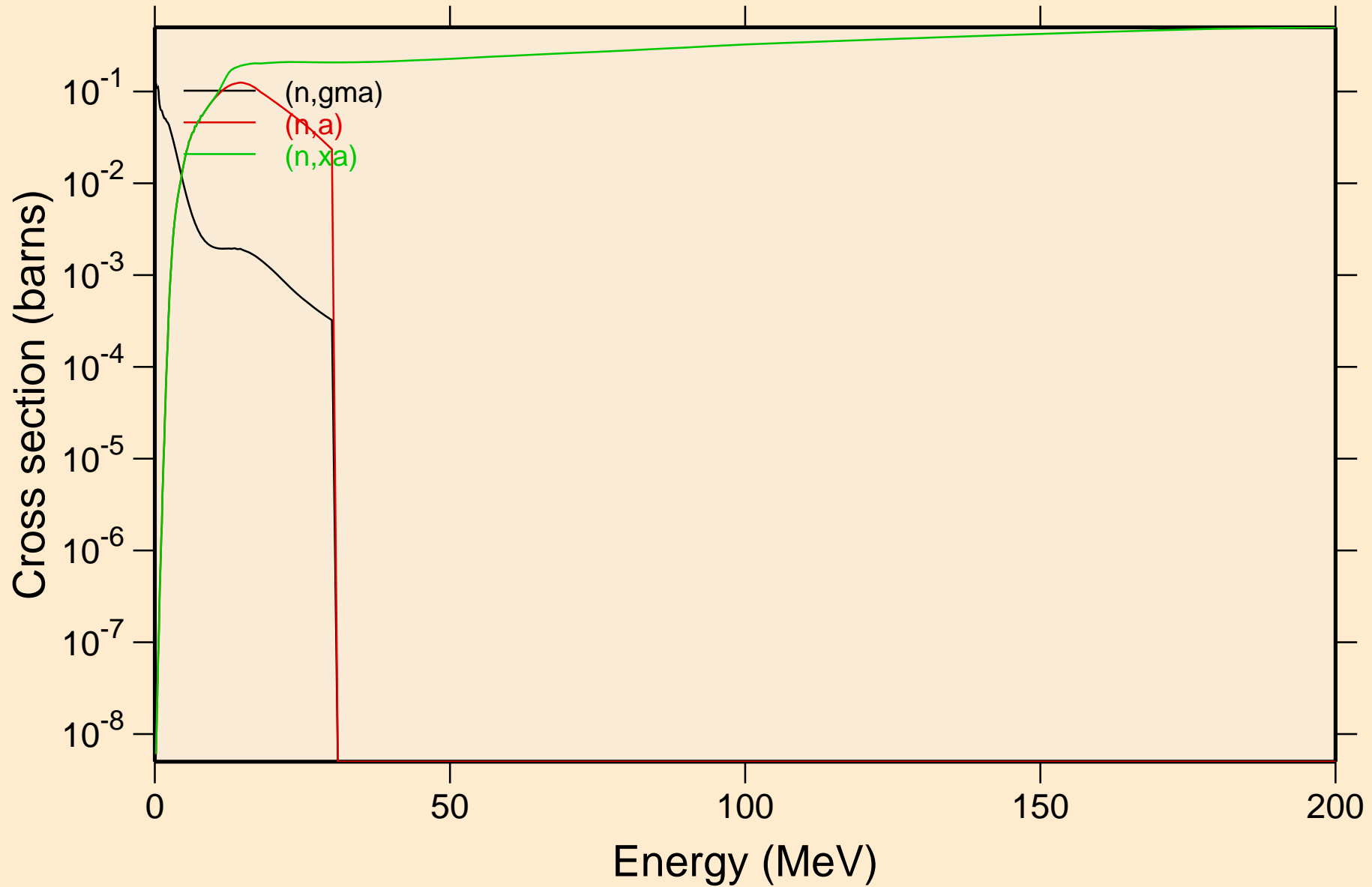



SE074 NEUTRON ACER TENDL-2023 LIBRARY; T=0.K  
Inelastic levels

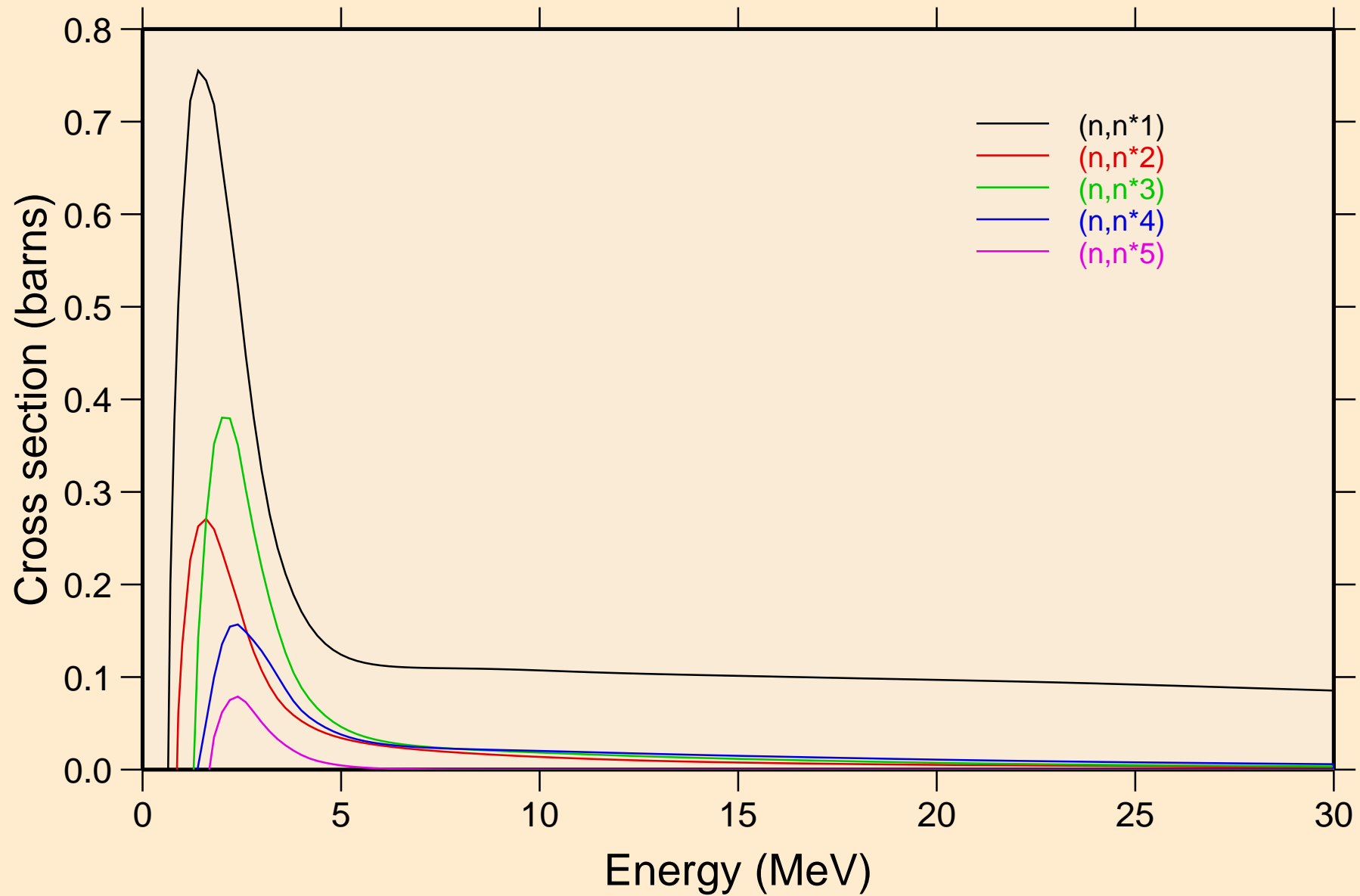

# SE074 NEUTRON ACER TENDL-2023 LIBRARY; T=0.K

## Inelastic levels

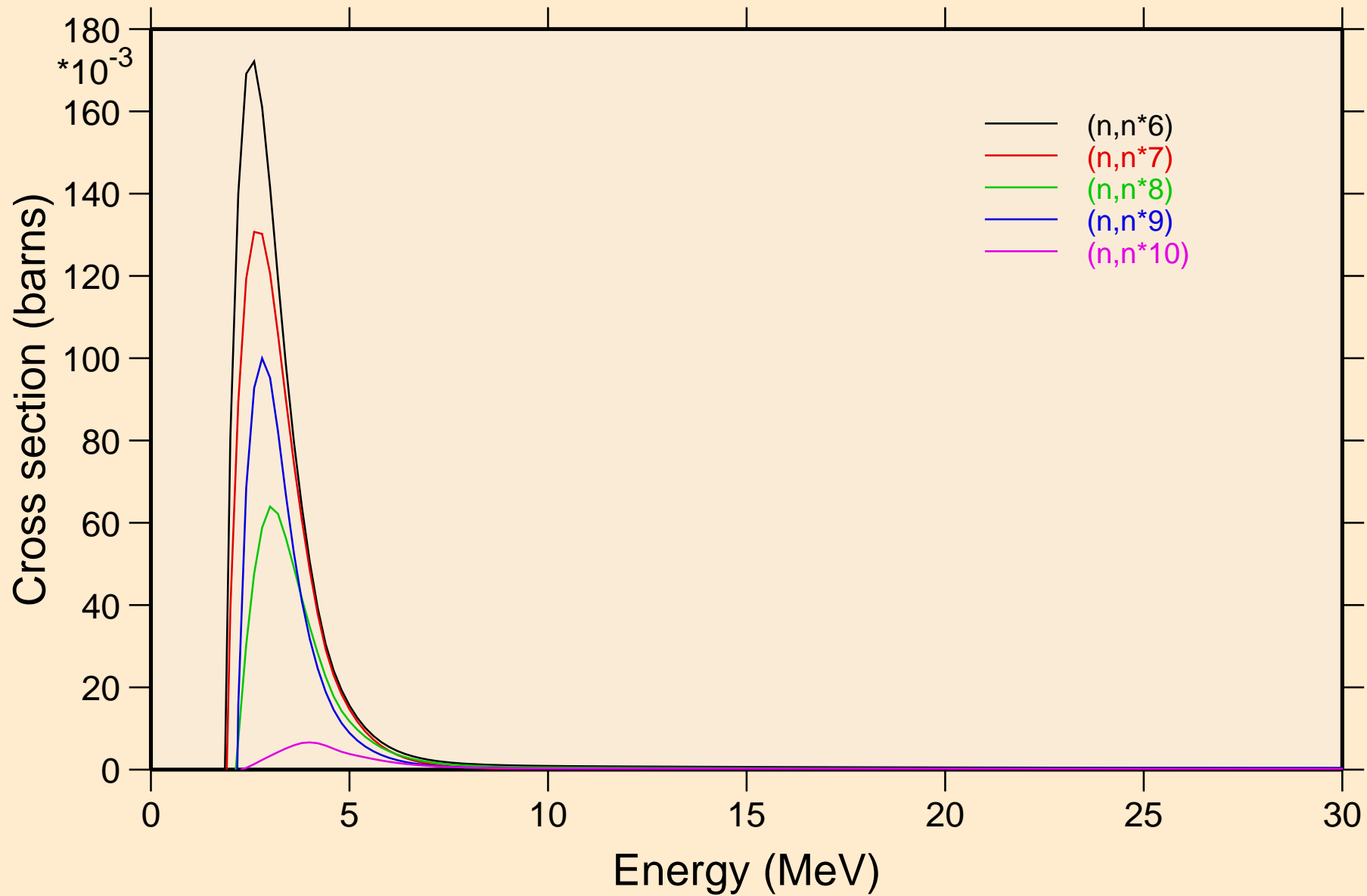

SE074 NEUTRON ACER TENDL-2023 LIBRARY; T=0.K  
Inelastic levels

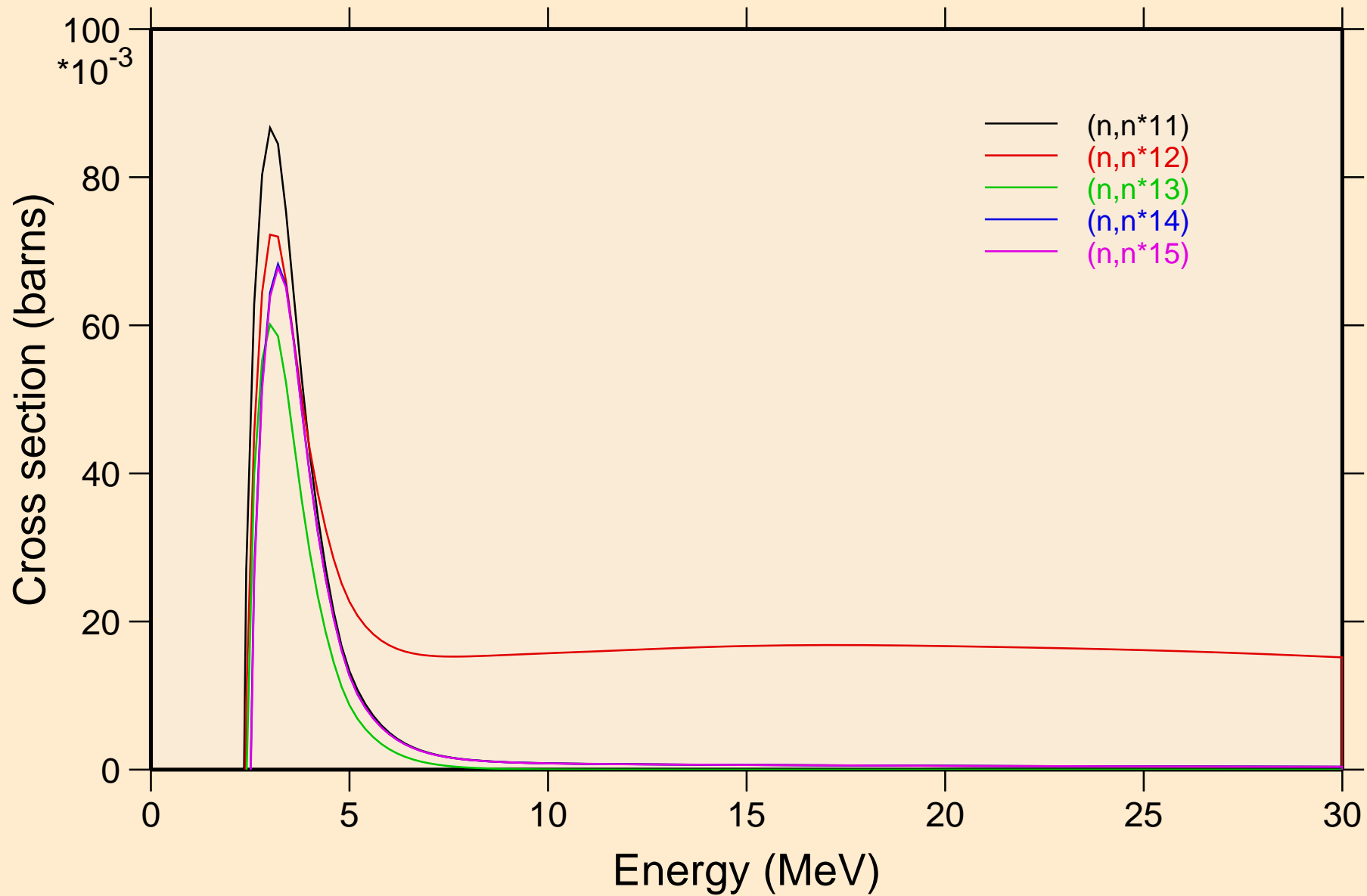

SE074 NEUTRON ACER TENDL-2023 LIBRARY; T=0.K  
Threshold reactions

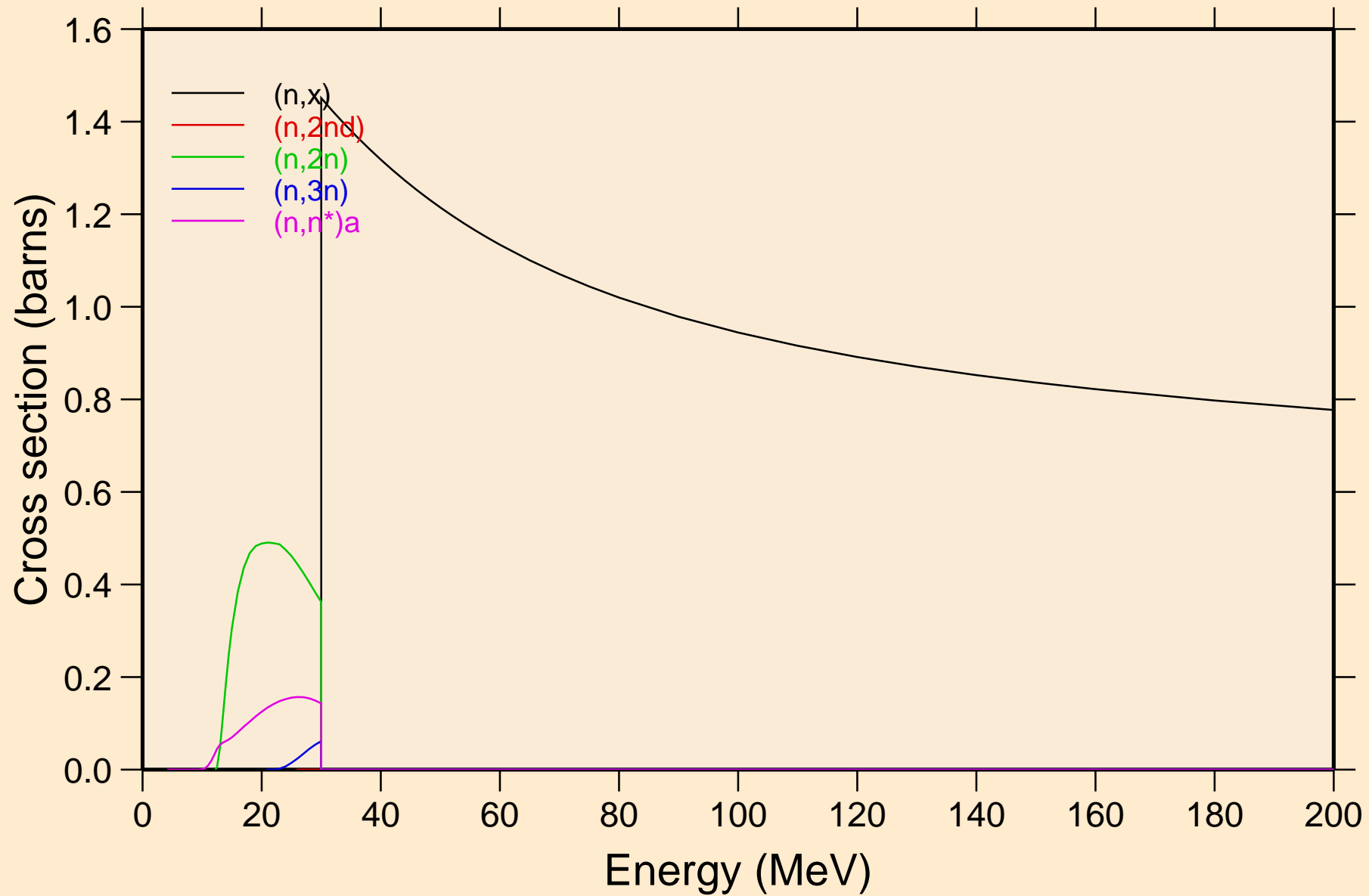

# SE074 NEUTRON ACER TENDL-2023 LIBRARY; T=0.K

## Threshold reactions

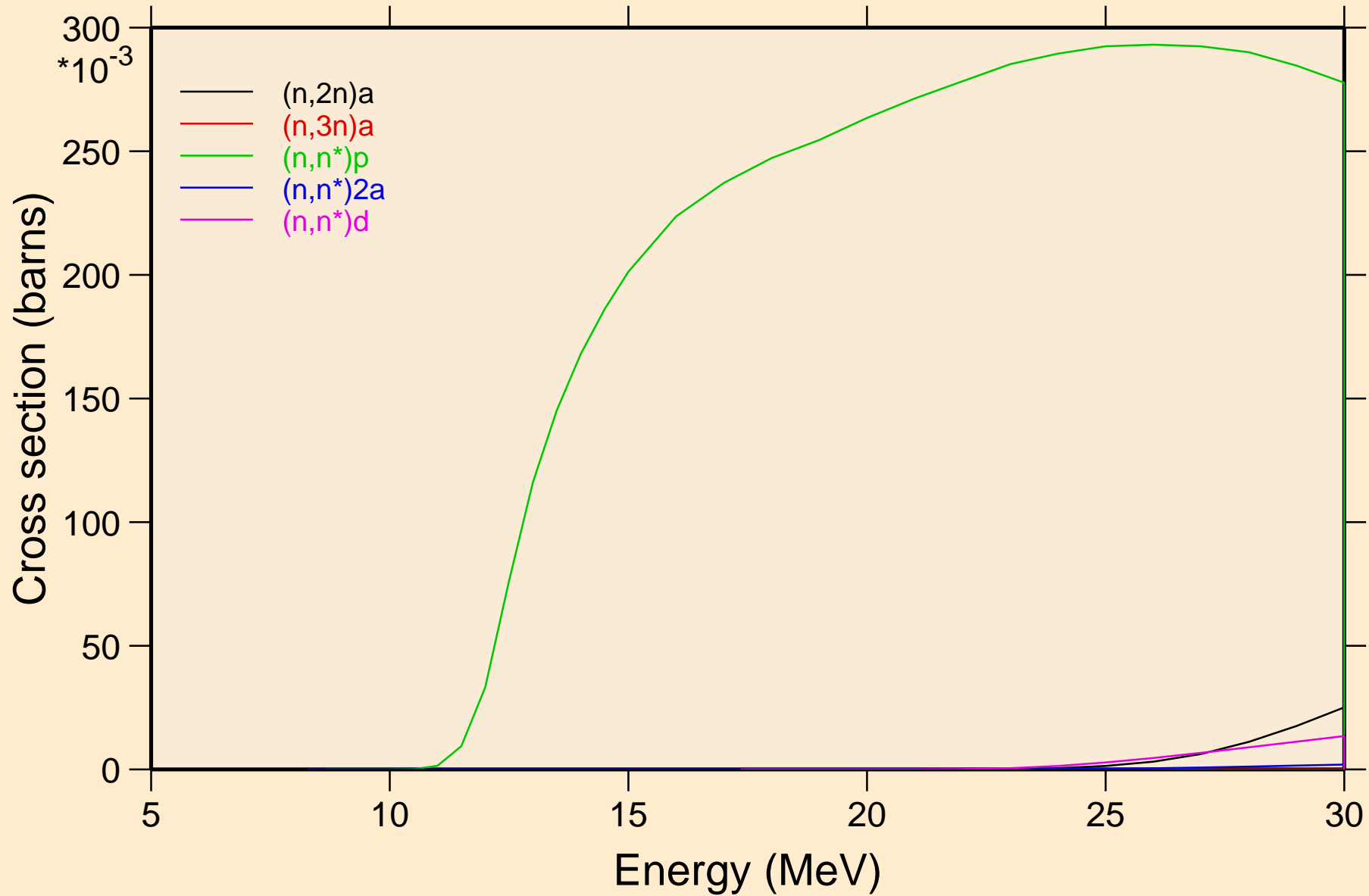

# SE074 NEUTRON ACER TENDL-2023 LIBRARY; T=0.K

## Threshold reactions

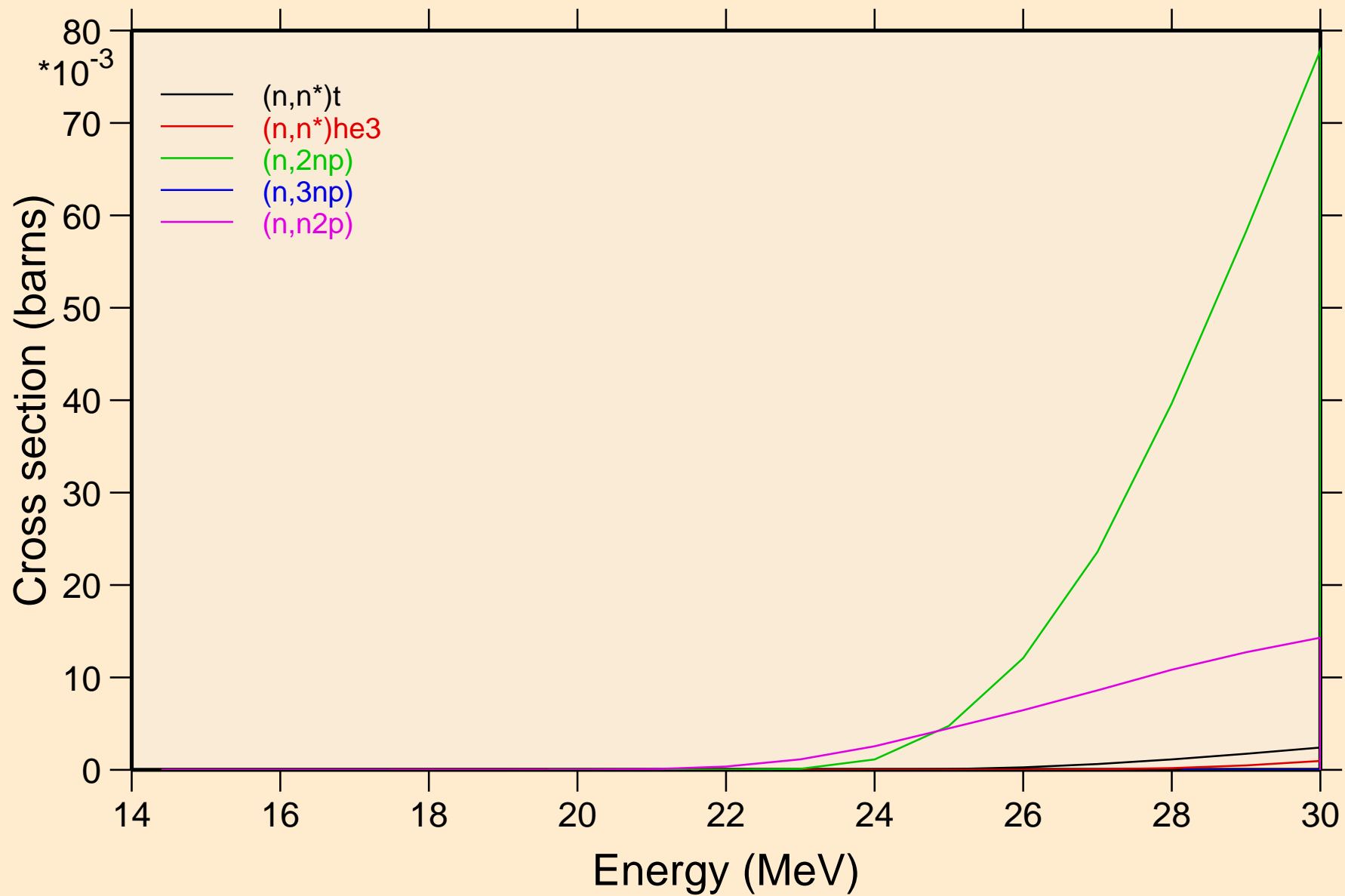

SE074 NEUTRON ACER TENDL-2023 LIBRARY; T=0.K  
Threshold reactions

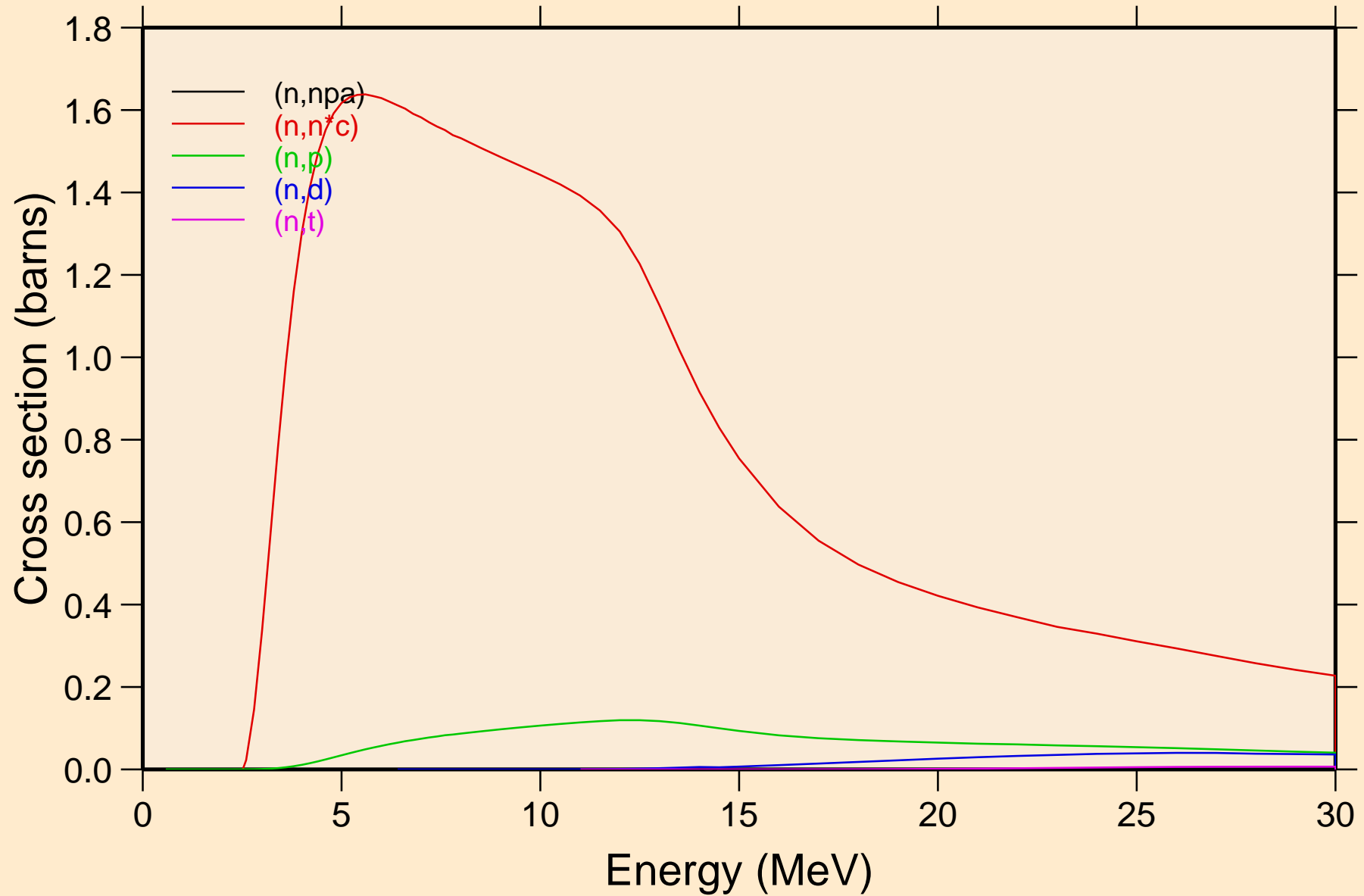

SE074 NEUTRON ACER TENDL-2023 LIBRARY; T=0.K  
Threshold reactions

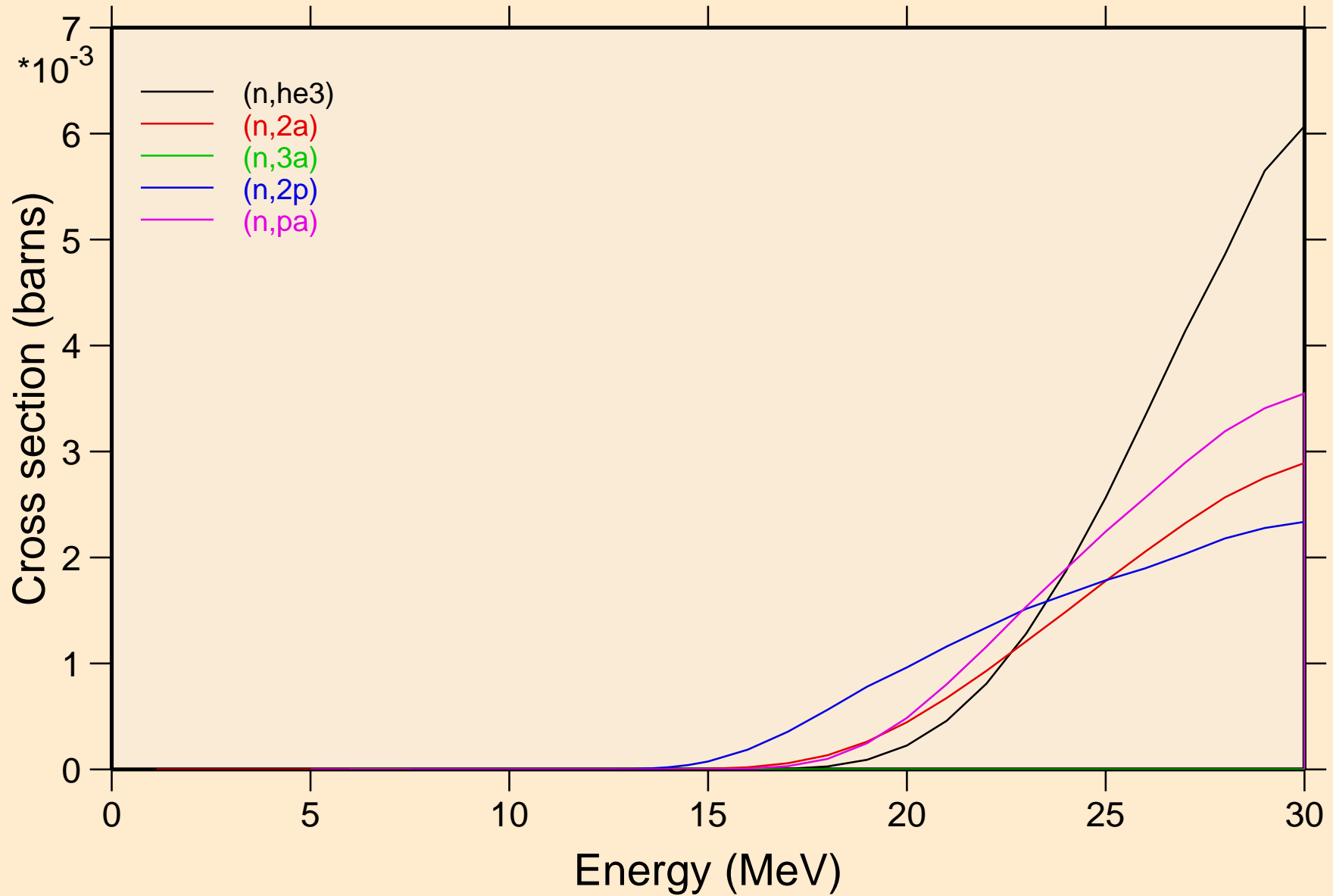



# SE074 NEUTRON ACER TENDL-2023 LIBRARY; T=0.K

## Threshold reactions

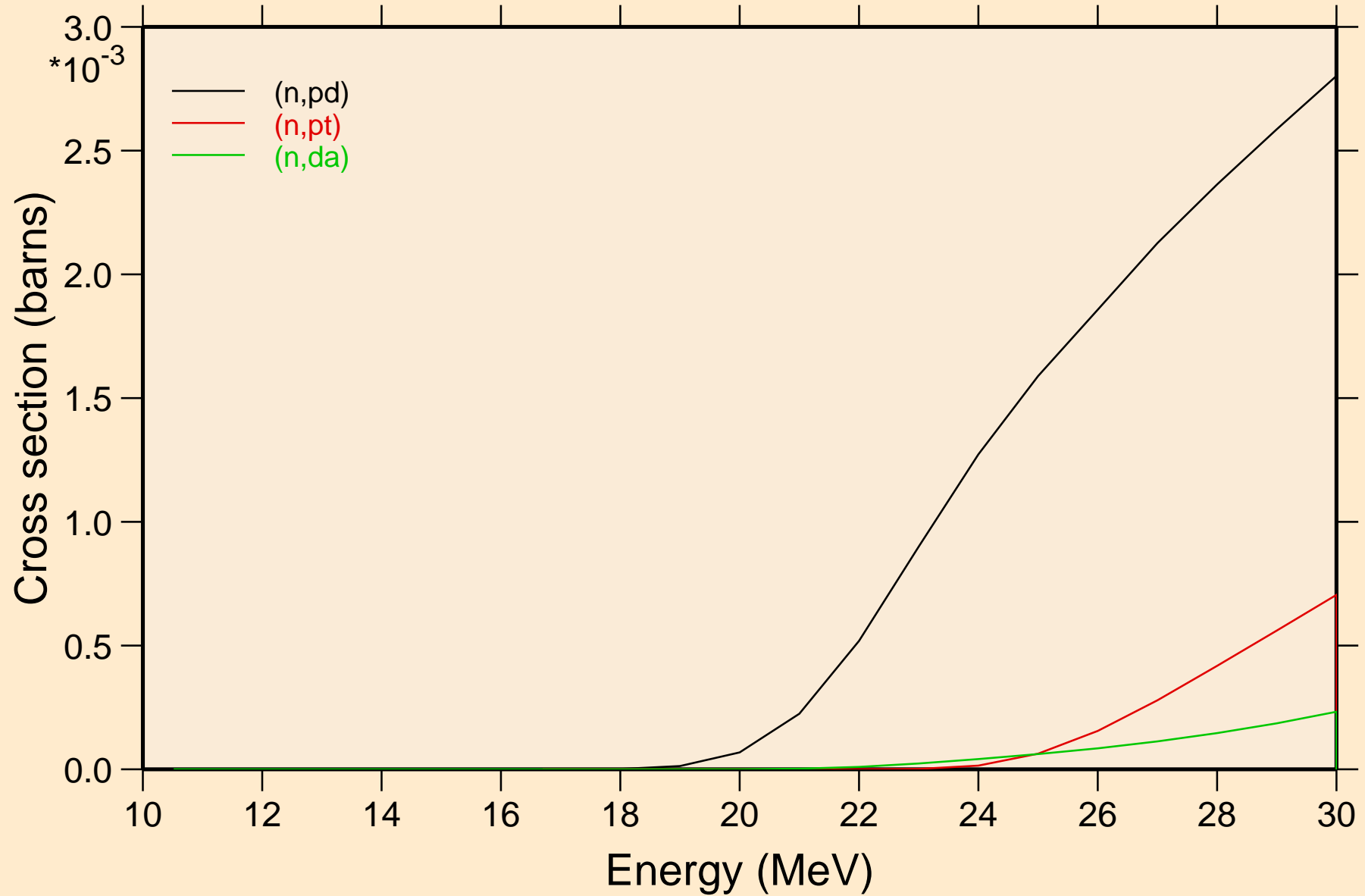

# SE074 NEUTRON ACER TENDL-2023 LIBRARY; T=0.K

## Threshold reactions

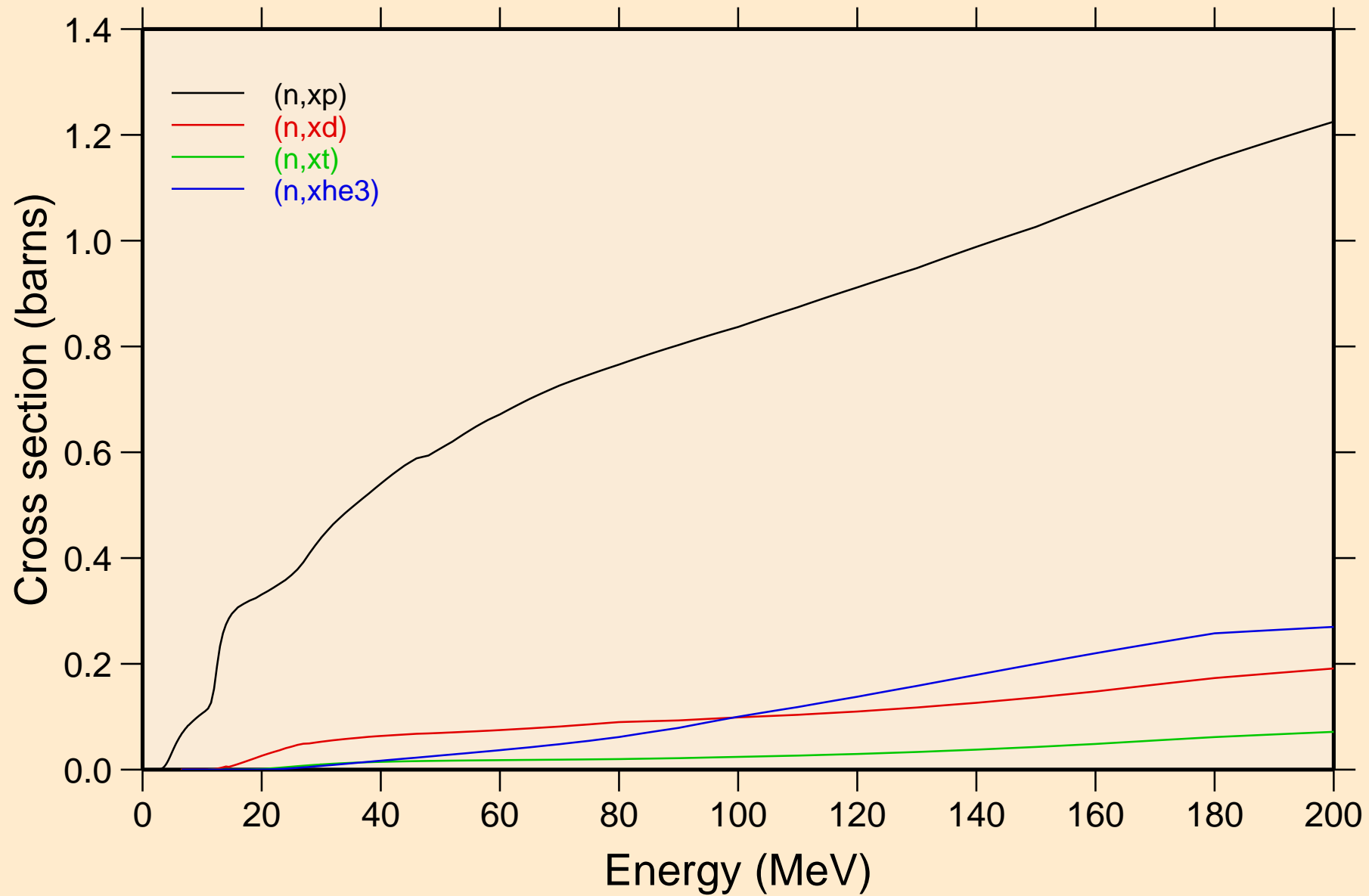

SE074 NEUTRON ACER TENDL-2023 LIBRARY; T=0.K  
angular distribution for elastic

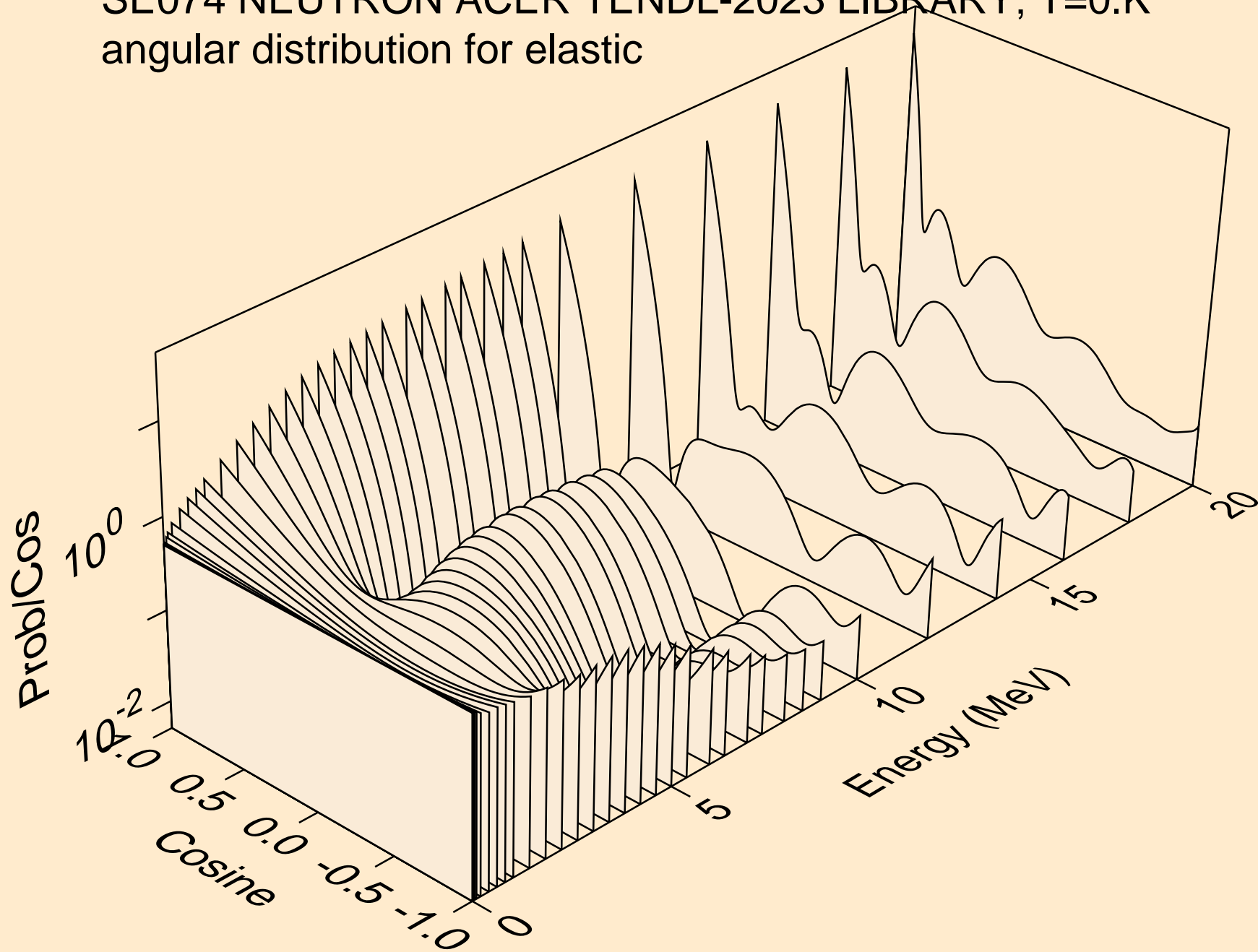

SE074 NEUTRON ACER TENDL-2023 LIBRARY; T=0.K  
angular distribution for elastic

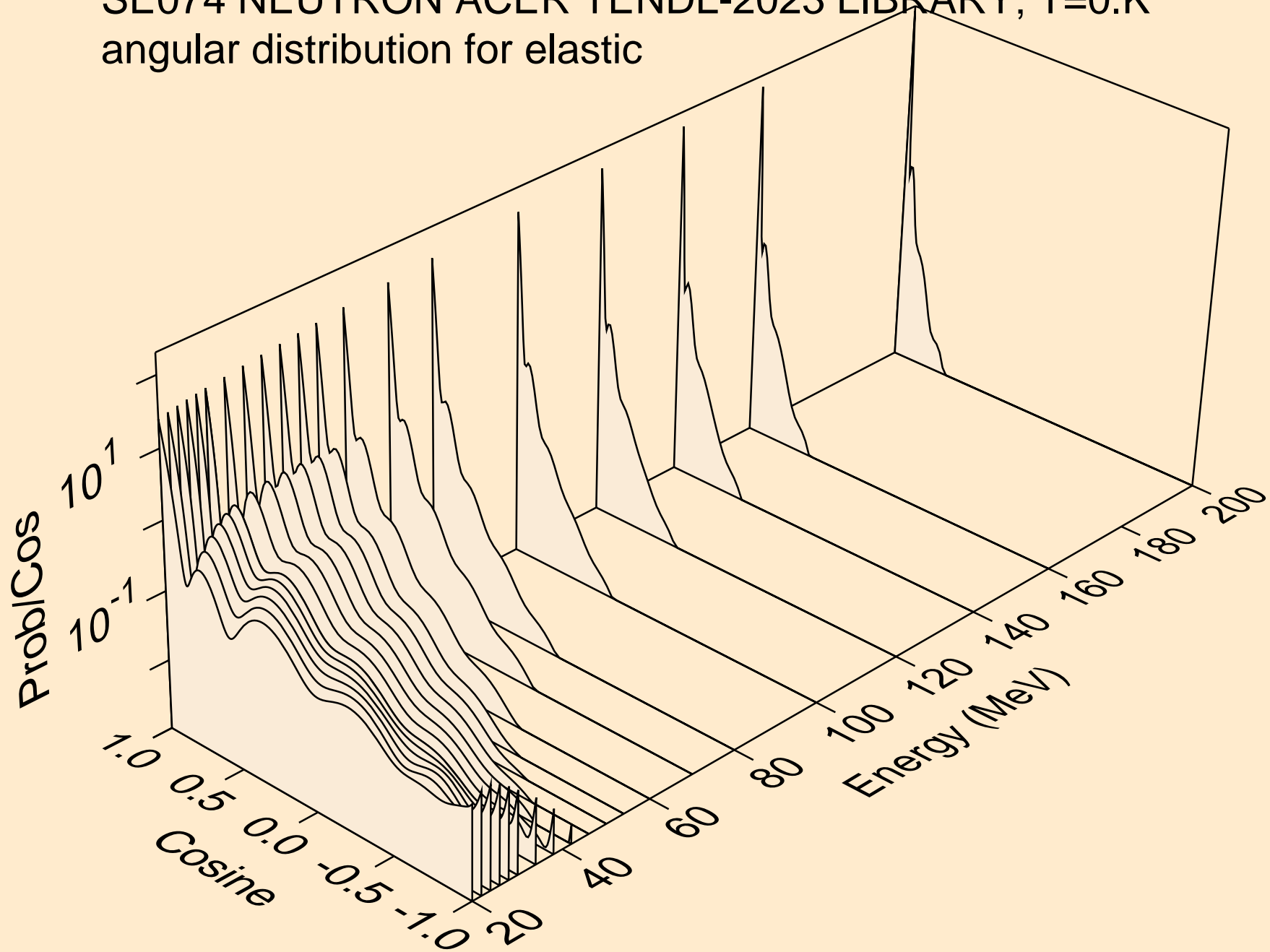

SE074 NEUTRON ACER TENDL-2023 LIBRARY; T=0.K  
angular distribution for (n,n\*1)

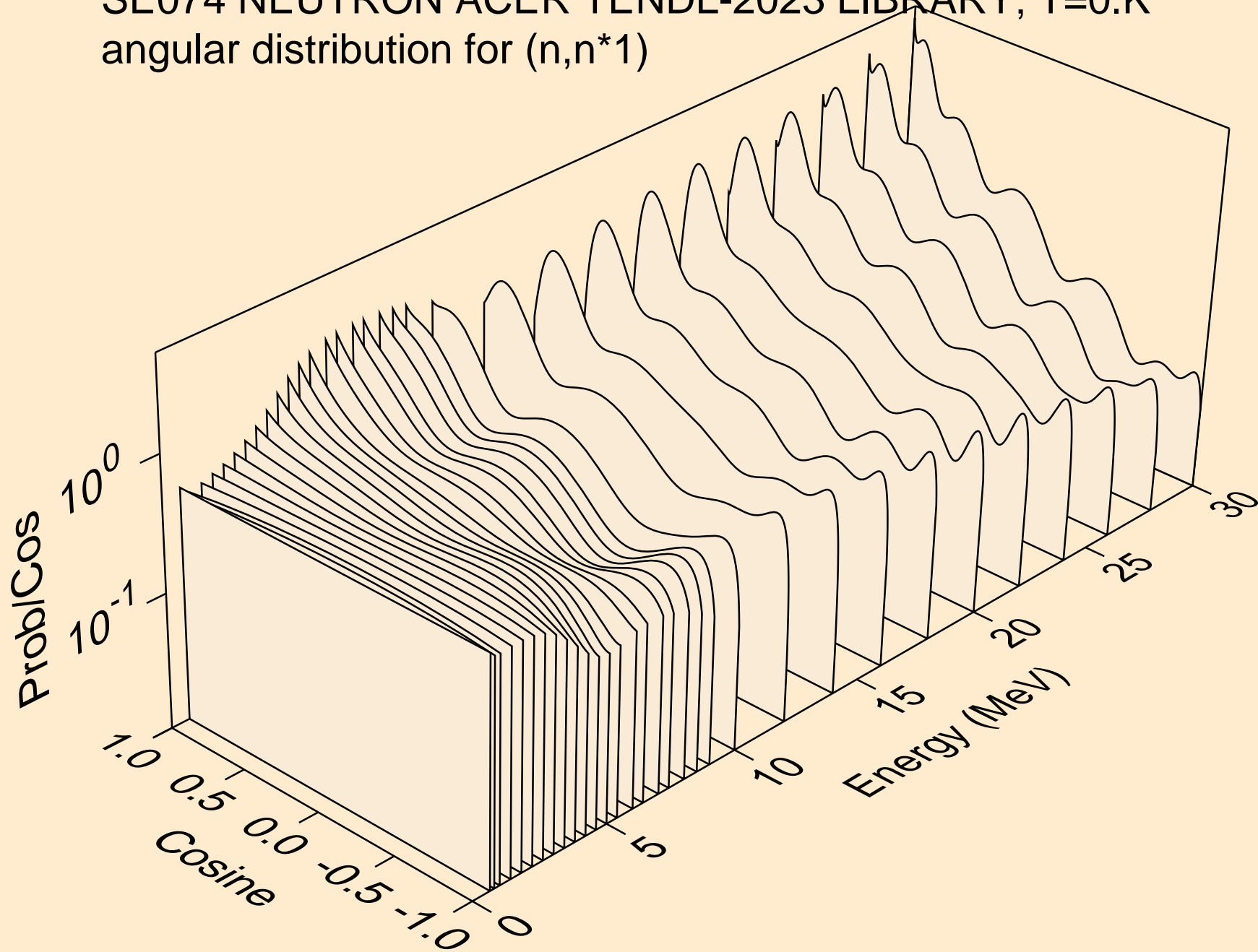

SE074 NEUTRON ACER TENDL-2023 LIBRARY; T=0.K  
angular distribution for (n,n\*2)

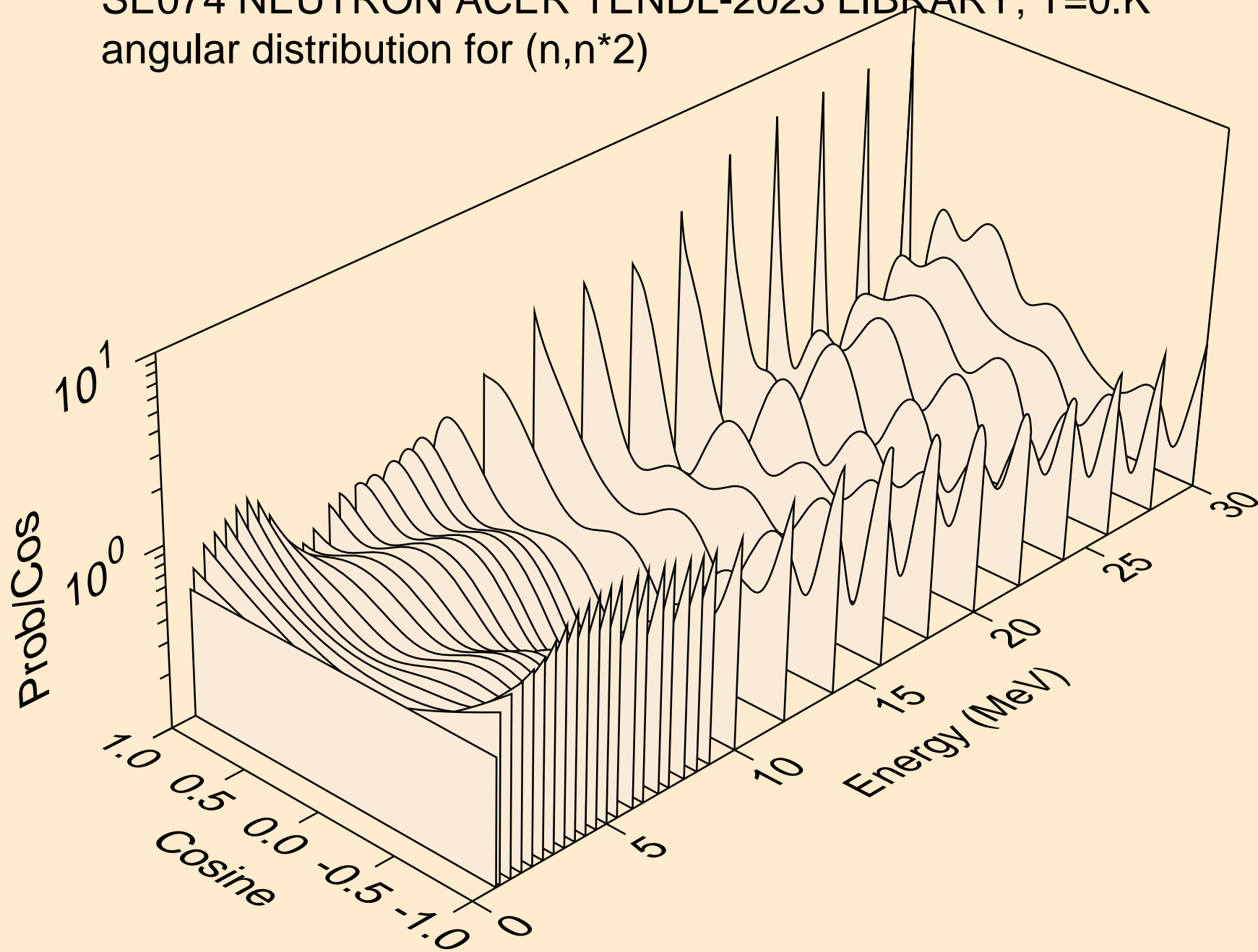

SE074 NEUTRON ACER TENDL-2023 LIBRARY; T=0.K  
angular distribution for (n,n\*3)

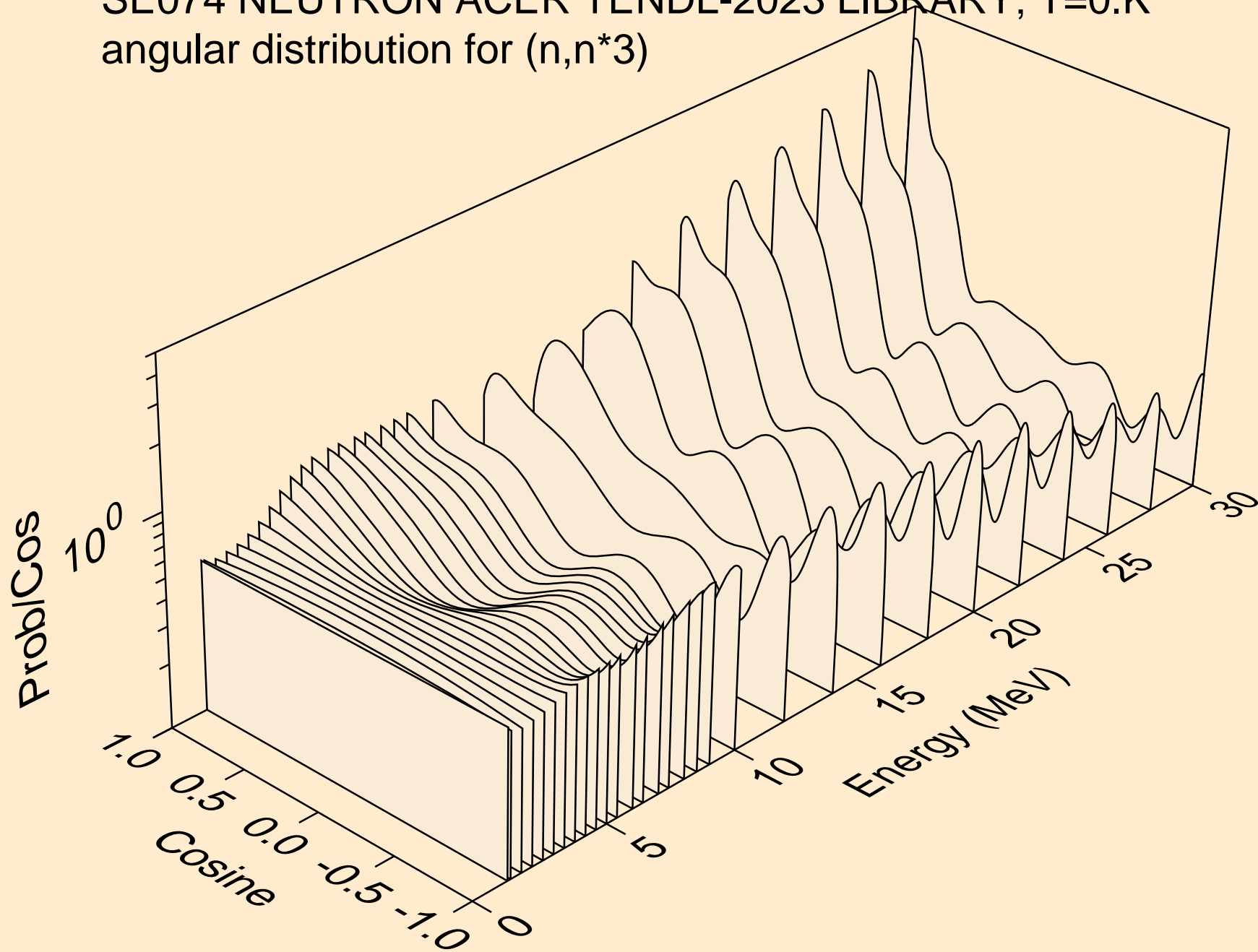

SE074 NEUTRON ACER TENDL-2023 LIBRARY; T=0.K  
angular distribution for (n,n\*4)

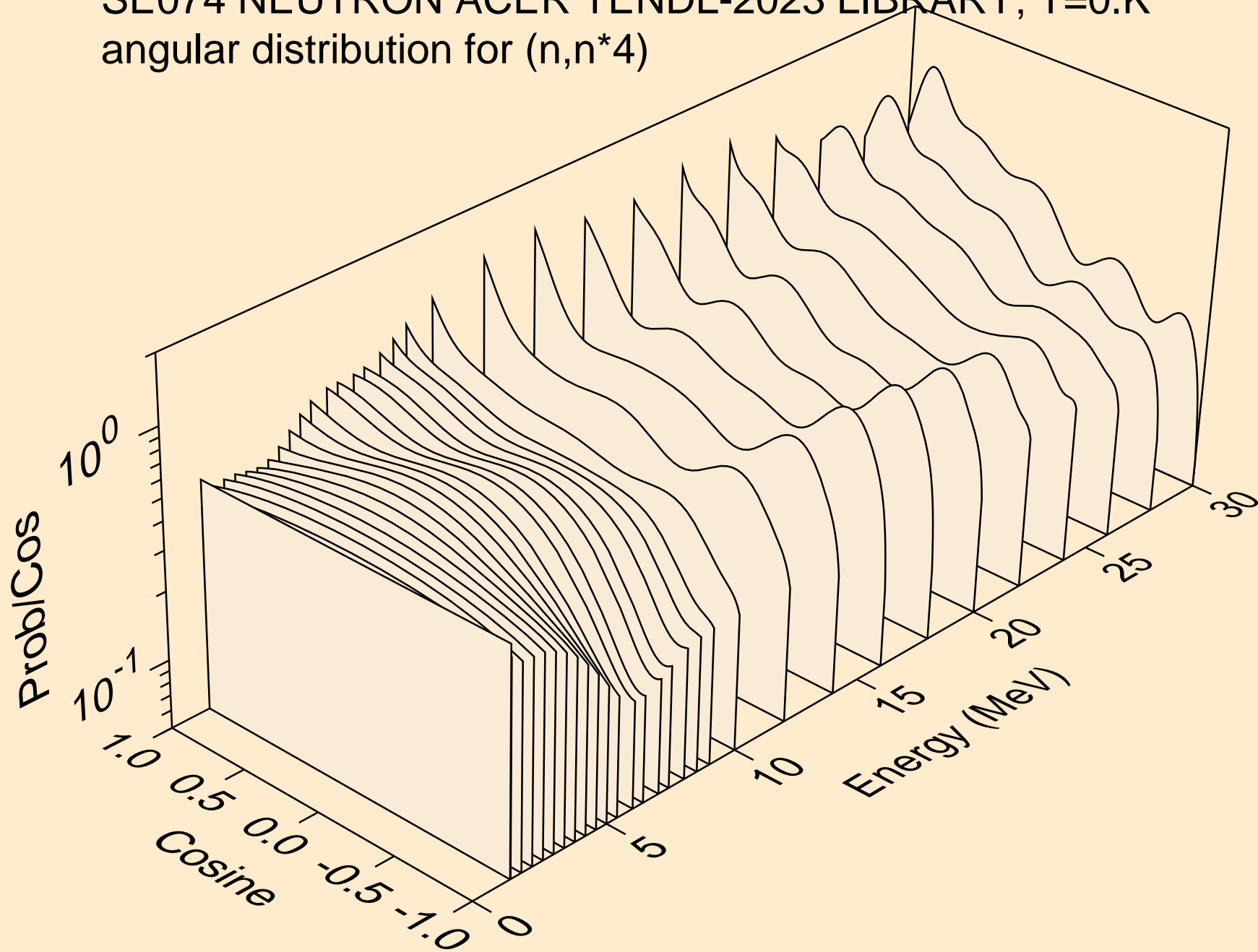



SE074 NEUTRON ACER TENDL-2023 LIBRARY; T=0.K  
angular distribution for (n,n\*5)

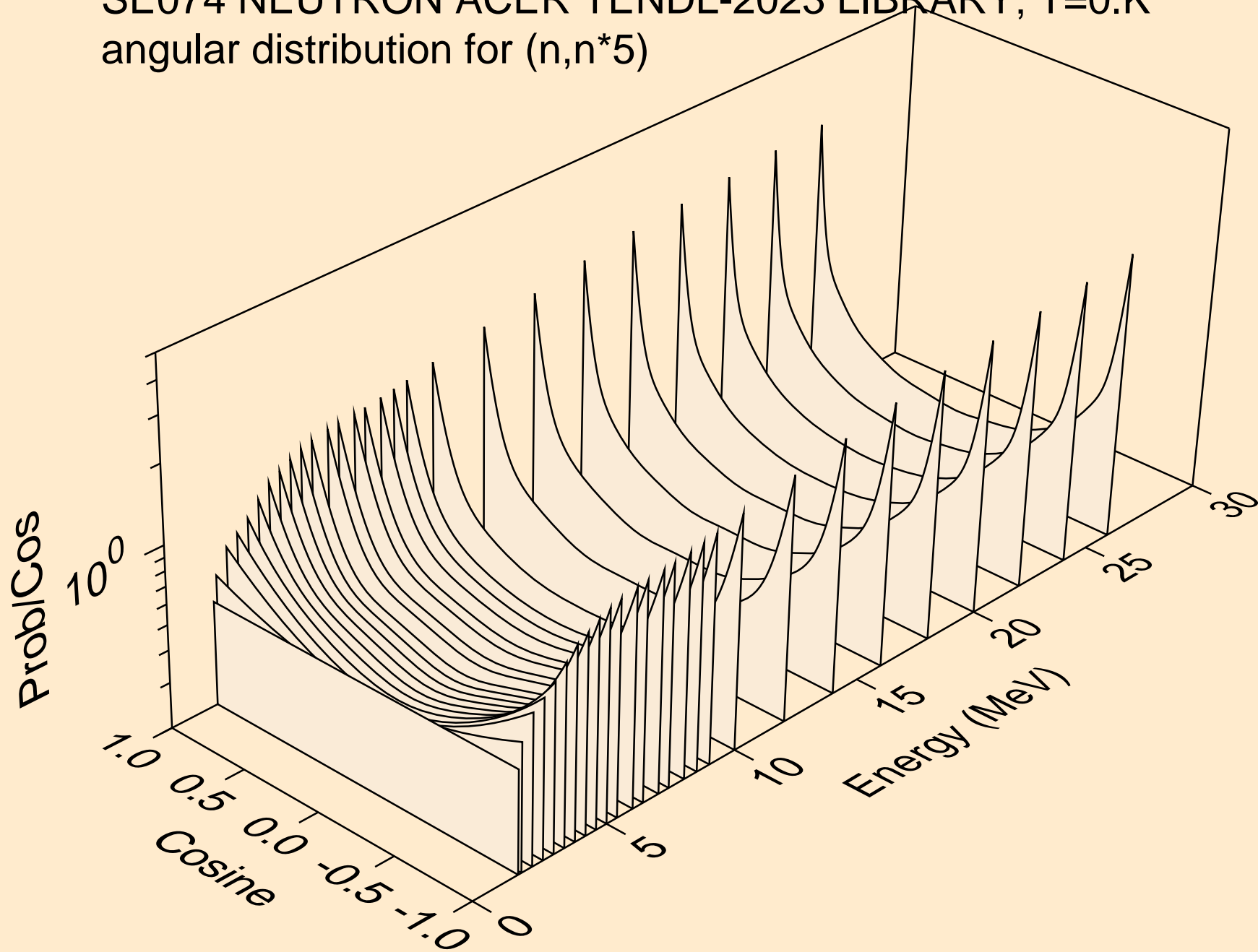

SE074 NEUTRON ACER TENDL-2023 LIBRARY; T=0.K  
angular distribution for (n,n\*6)

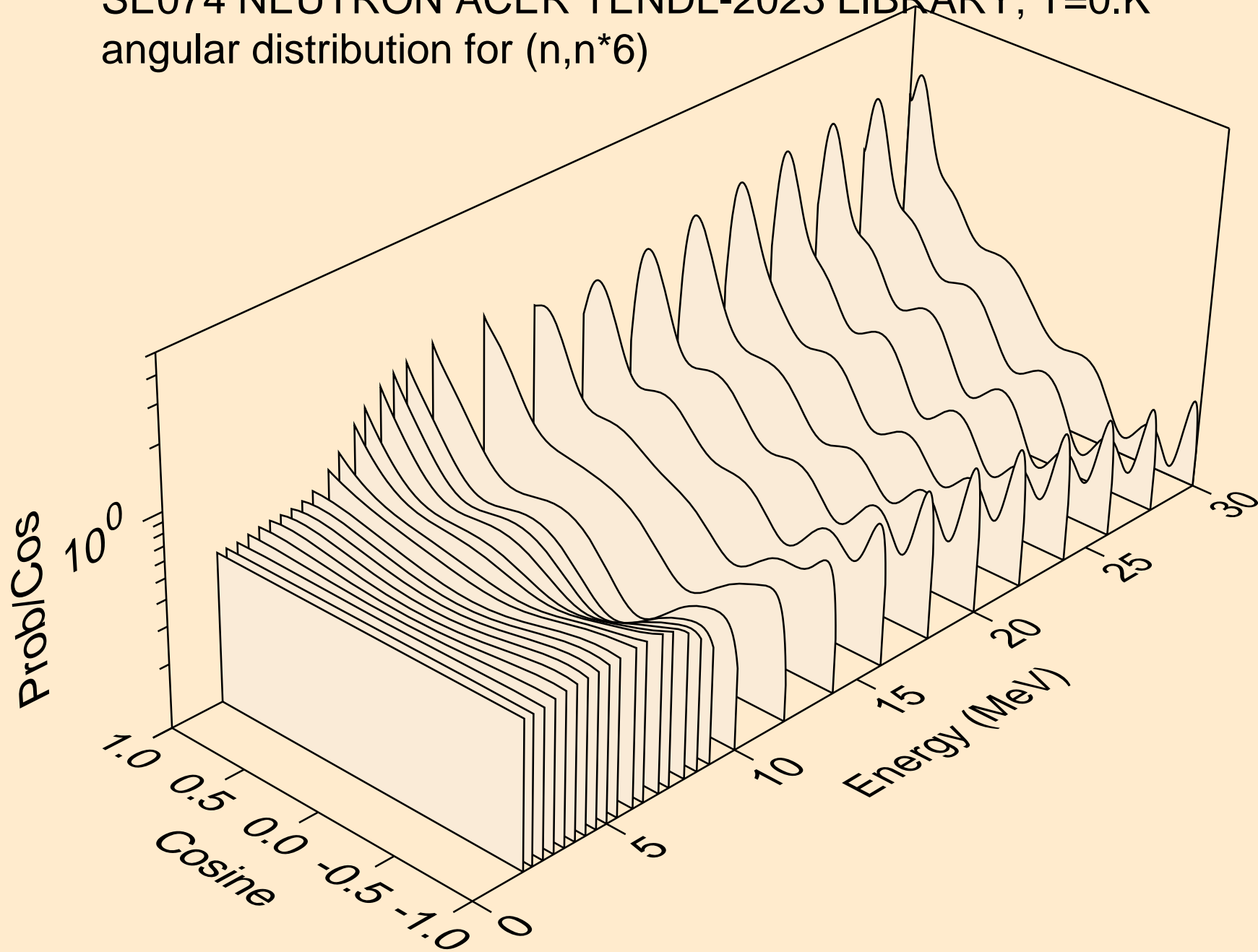

SE074 NEUTRON ACER TENDL-2023 LIBRARY; T=0.K  
angular distribution for (n,n\*7)

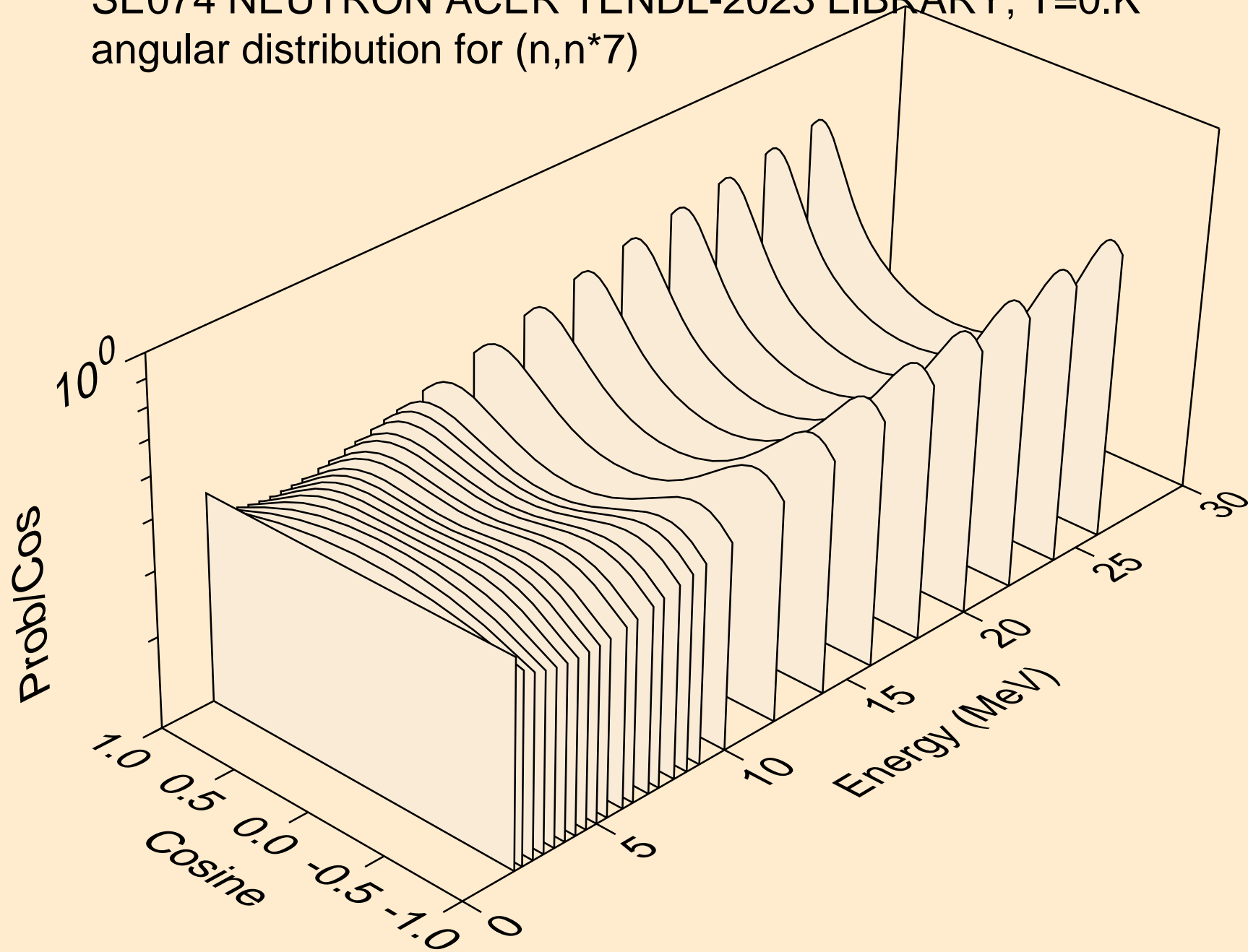

SE074 NEUTRON ACER TENDL-2023 LIBRARY; T=0.K  
angular distribution for (n,n\*8)

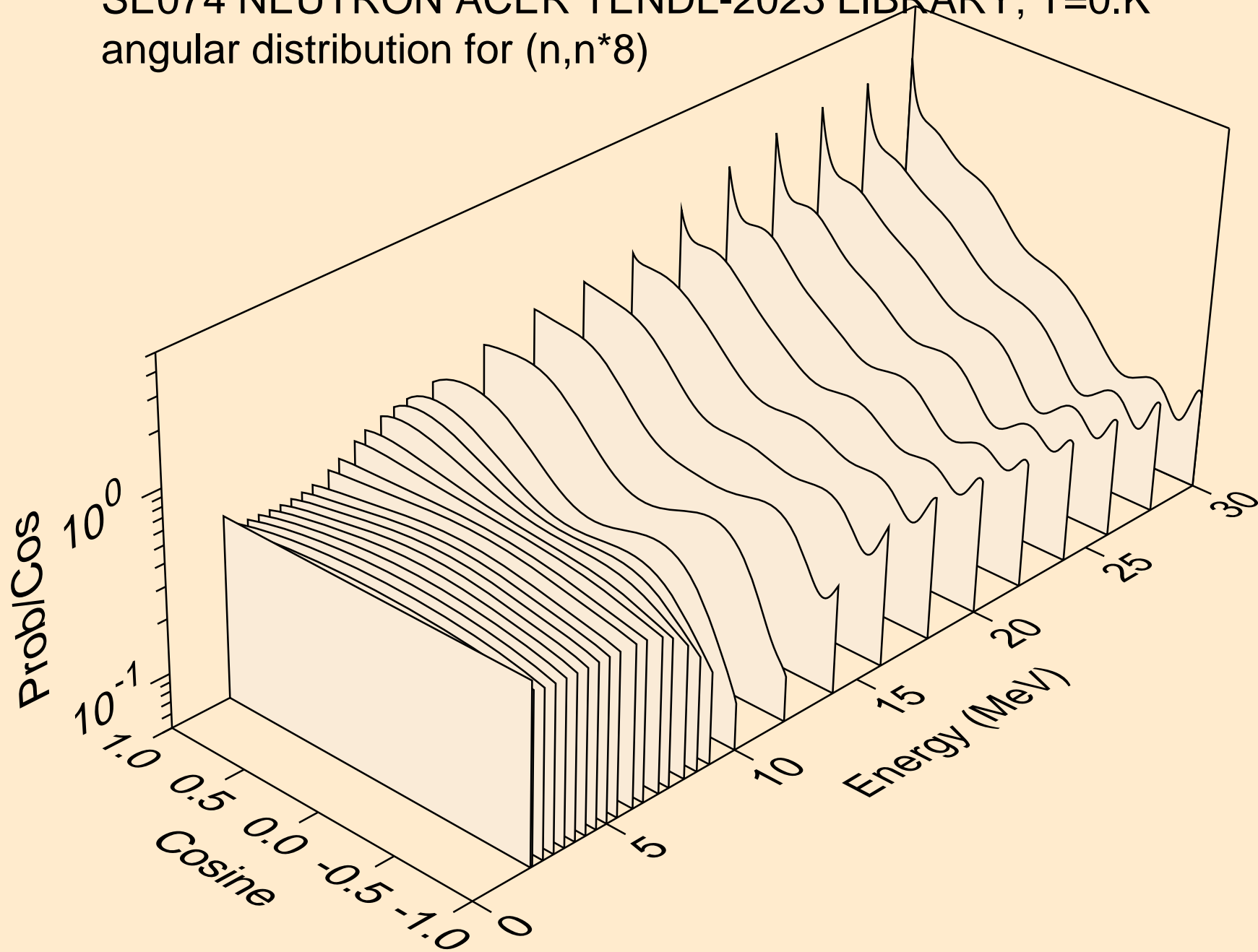

SE074 NEUTRON ACER TENDL-2023 LIBRARY; T=0.K  
angular distribution for (n,n\*9)

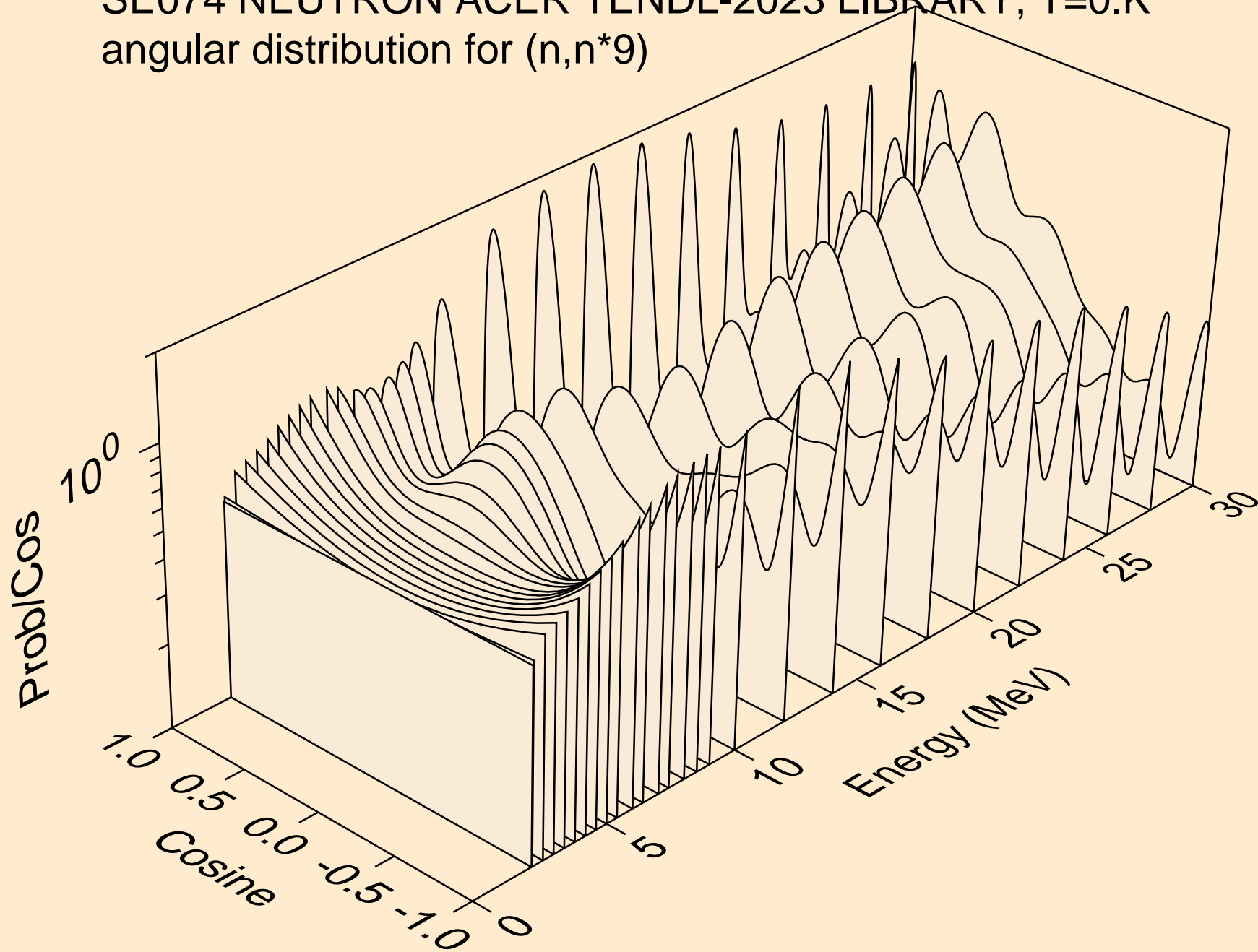

SE074 NEUTRON ACER TENDL-2023 LIBRARY; T=0.K  
angular distribution for (n,n\*10)

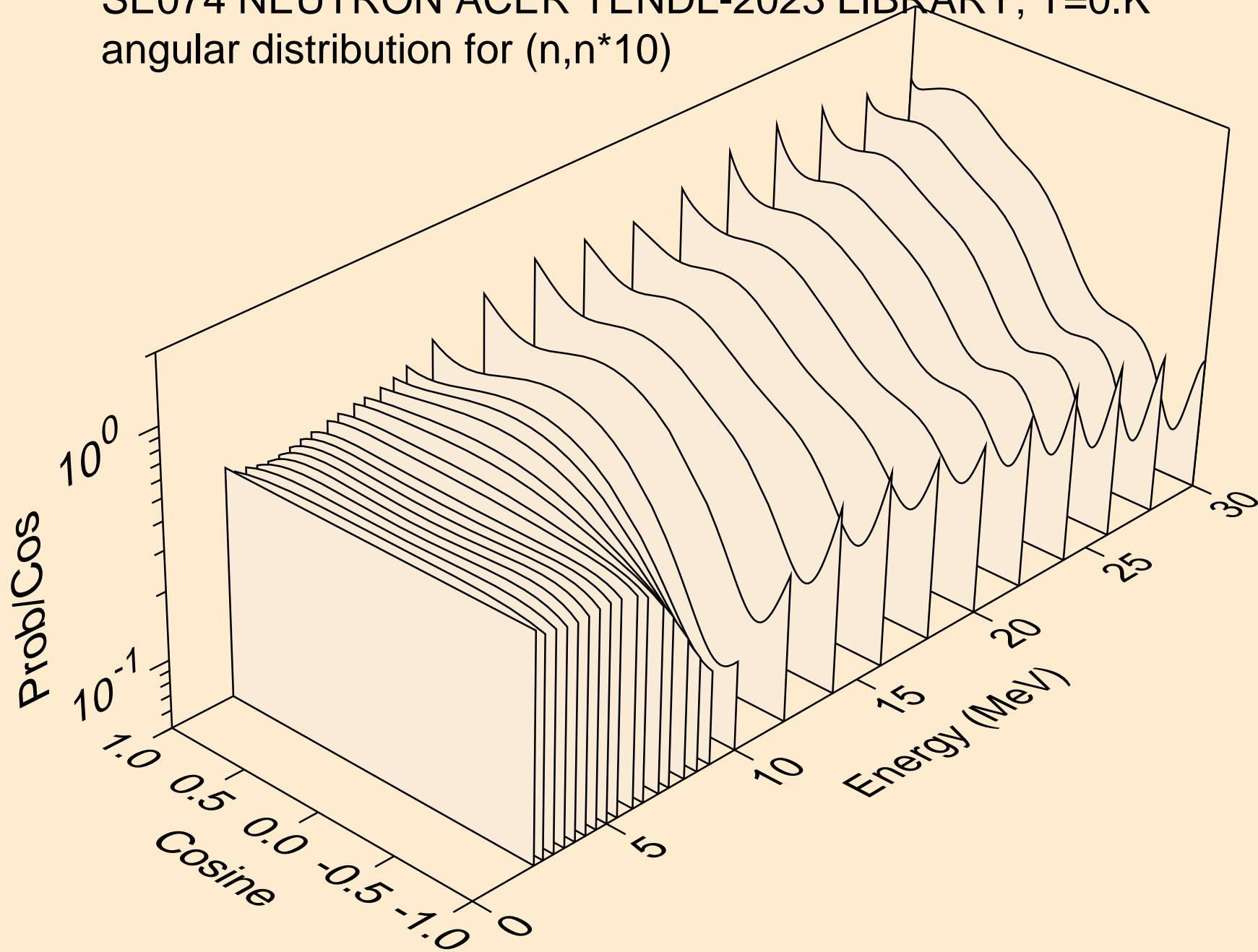

SE074 NEUTRON ACER TENDL-2023 LIBRARY; T=0.K  
angular distribution for (n,n\*11)

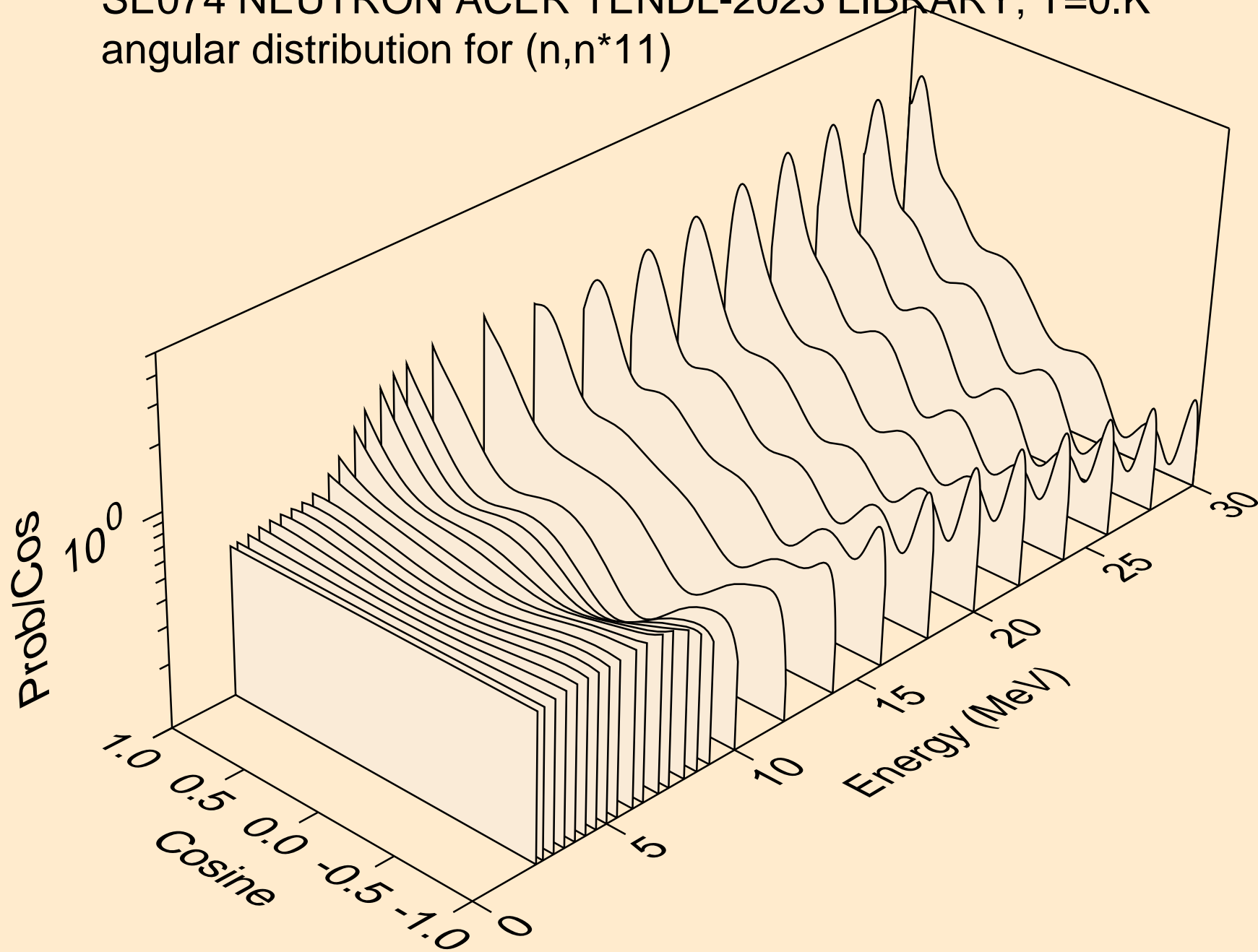

SE074 NEUTRON ACER TENDL-2023 LIBRARY; T=0.K  
angular distribution for (n,n\*12)

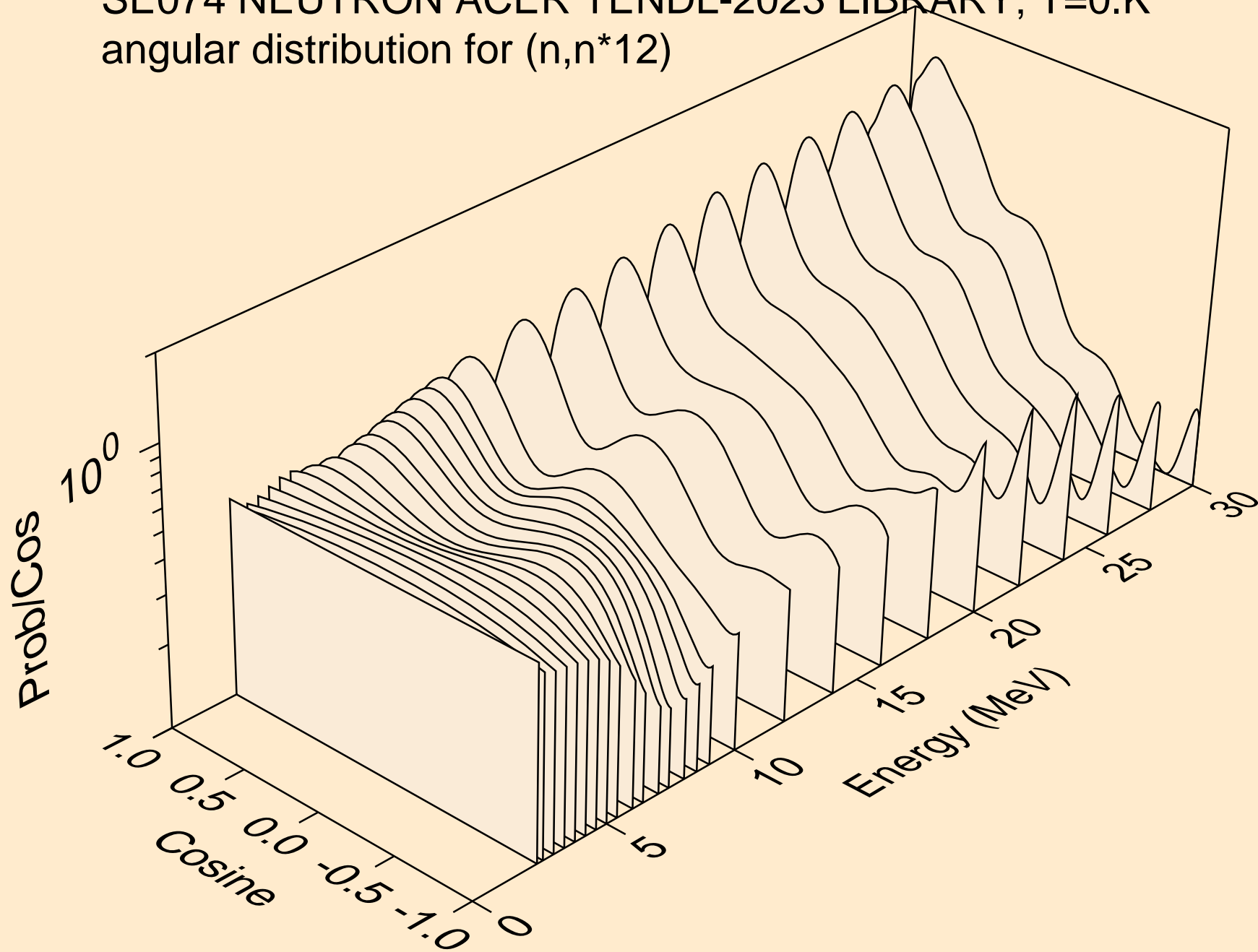



SE074 NEUTRON ACER TENDL-2023 LIBRARY; T=0.K  
angular distribution for (n,n\*13)

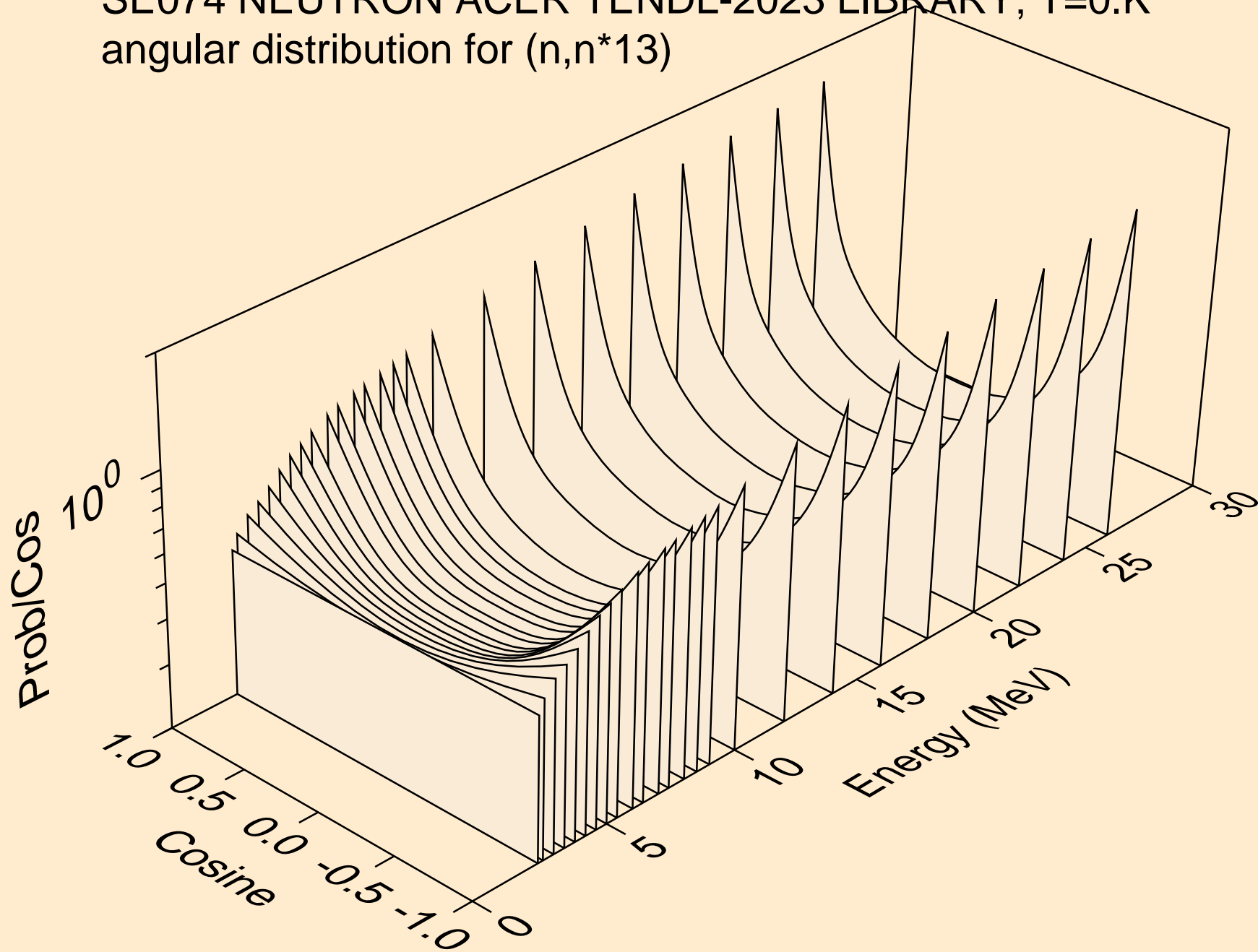

SE074 NEUTRON ACER TENDL-2023 LIBRARY; T=0.K  
angular distribution for (n,n\*14)

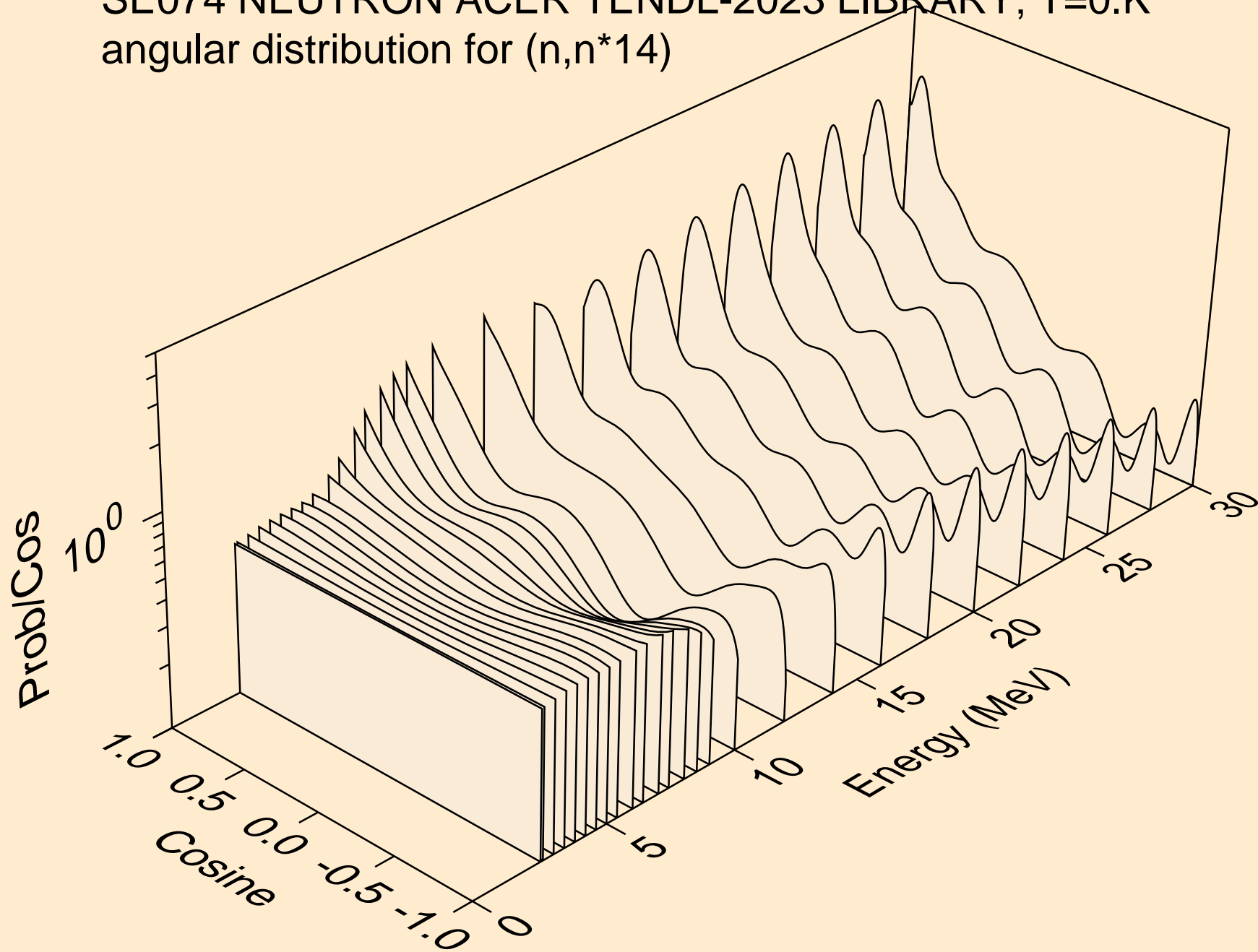

SE074 NEUTRON ACER TENDL-2023 LIBRARY; T=0.K  
angular distribution for (n,n\*15)

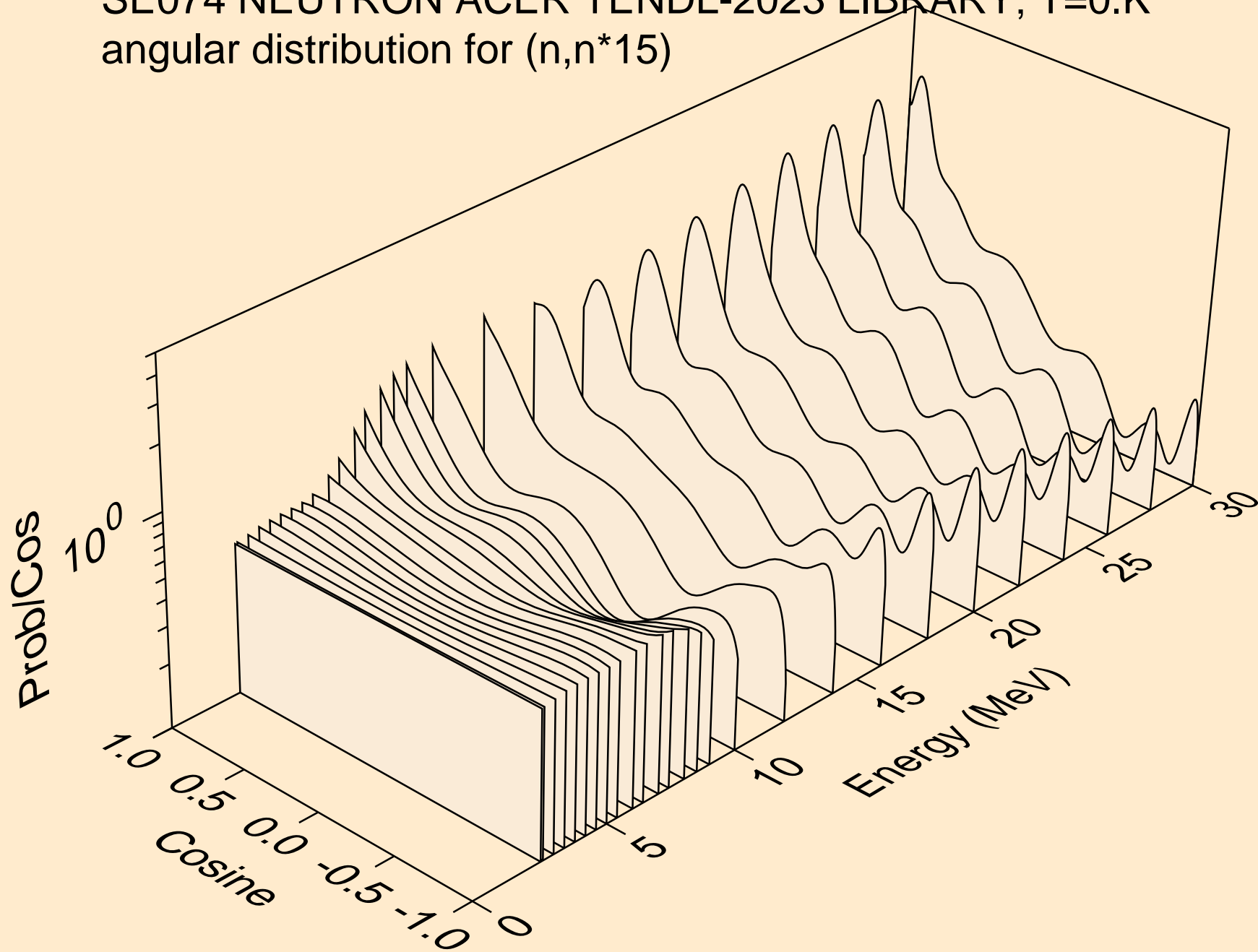

SE074 NEUTRON ACER TENDL-2023 LIBRARY; T=0.K  
Neutron emission for (n,x)

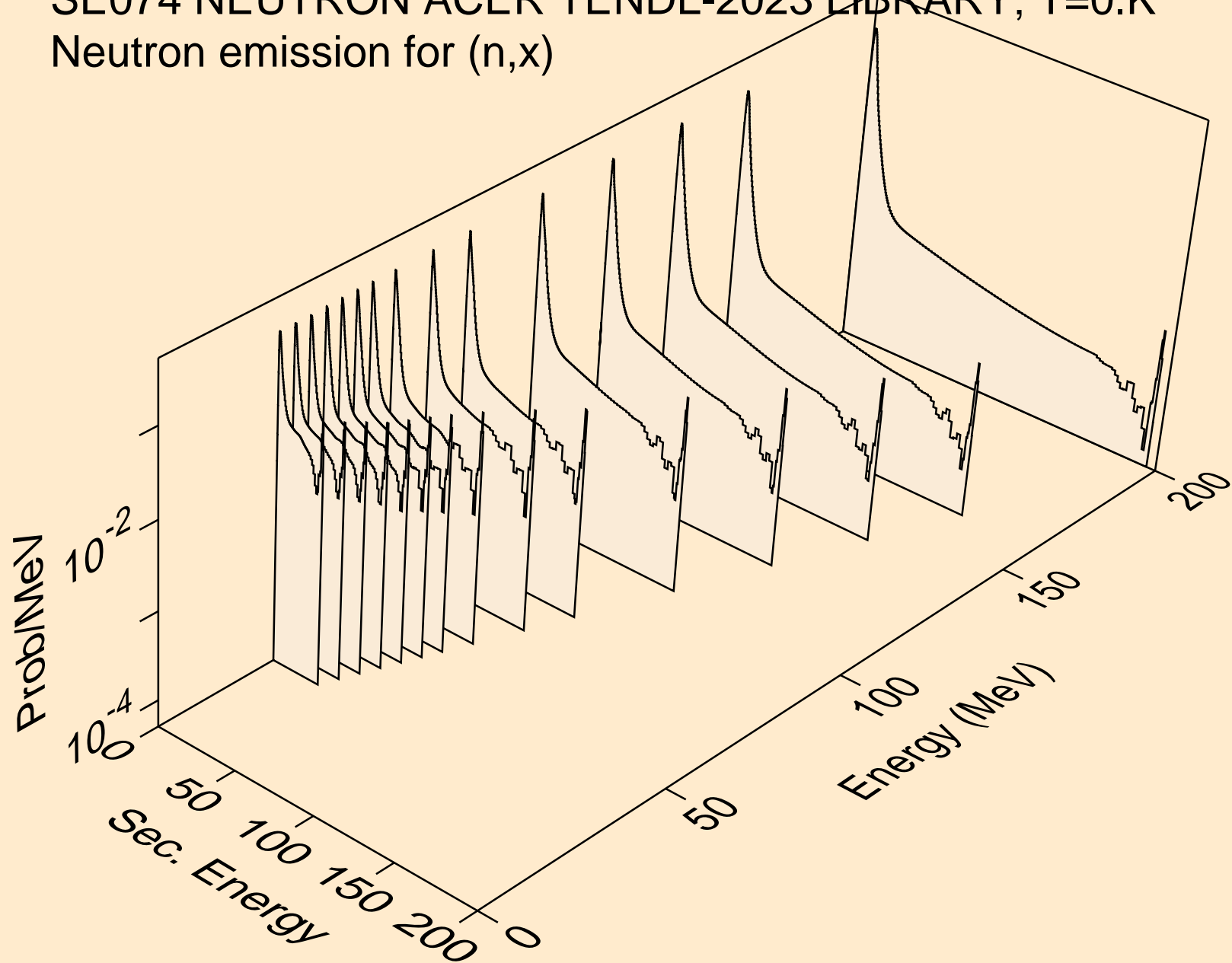

SE074 NEUTRON ACER TENDL-2023 LIBRARY; T=0.K  
Neutron emission for (n,2nd)

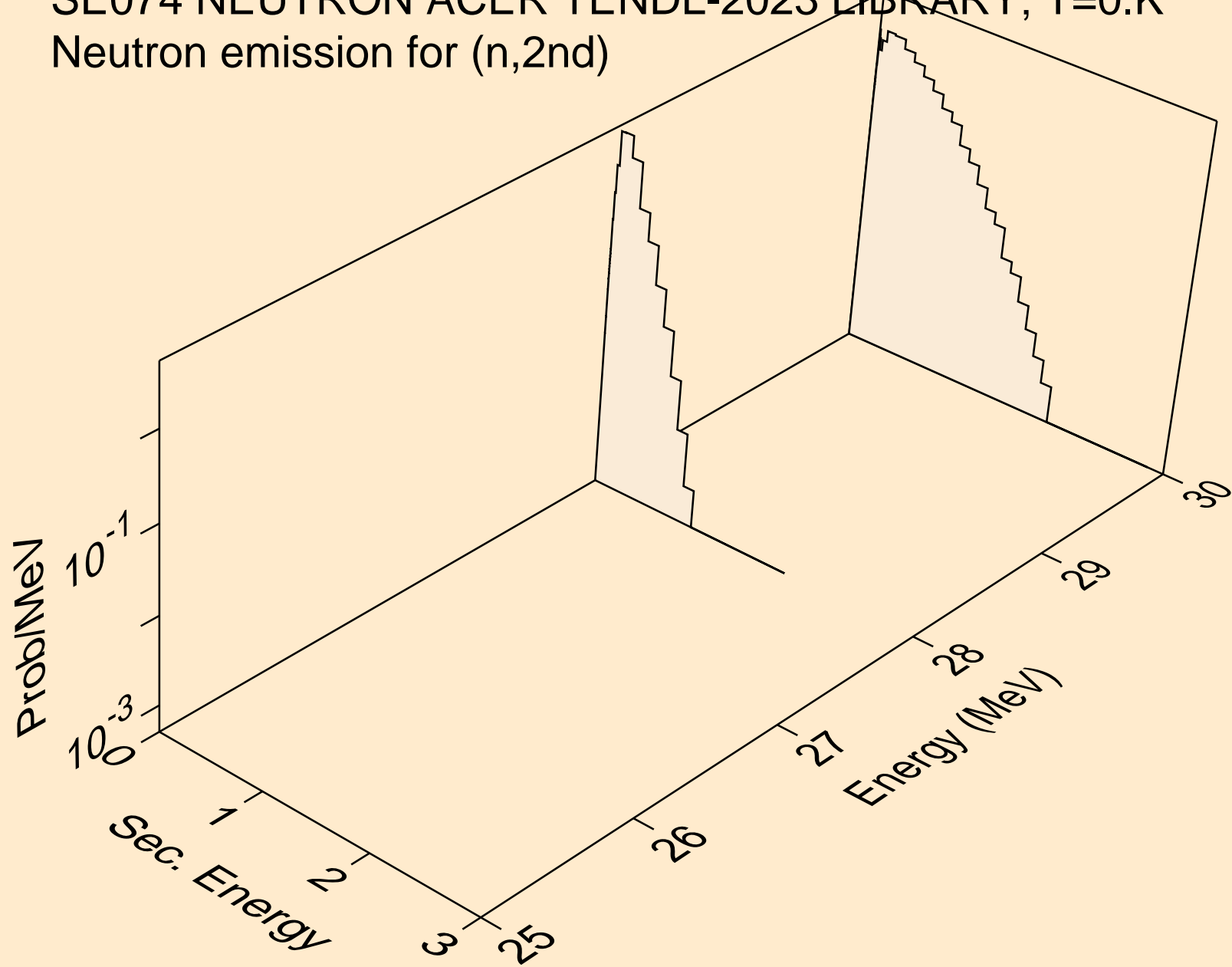

SE074 NEUTRON ACER TENDL-2023 LIBRARY; T=0.K  
Neutron emission for (n,2n)

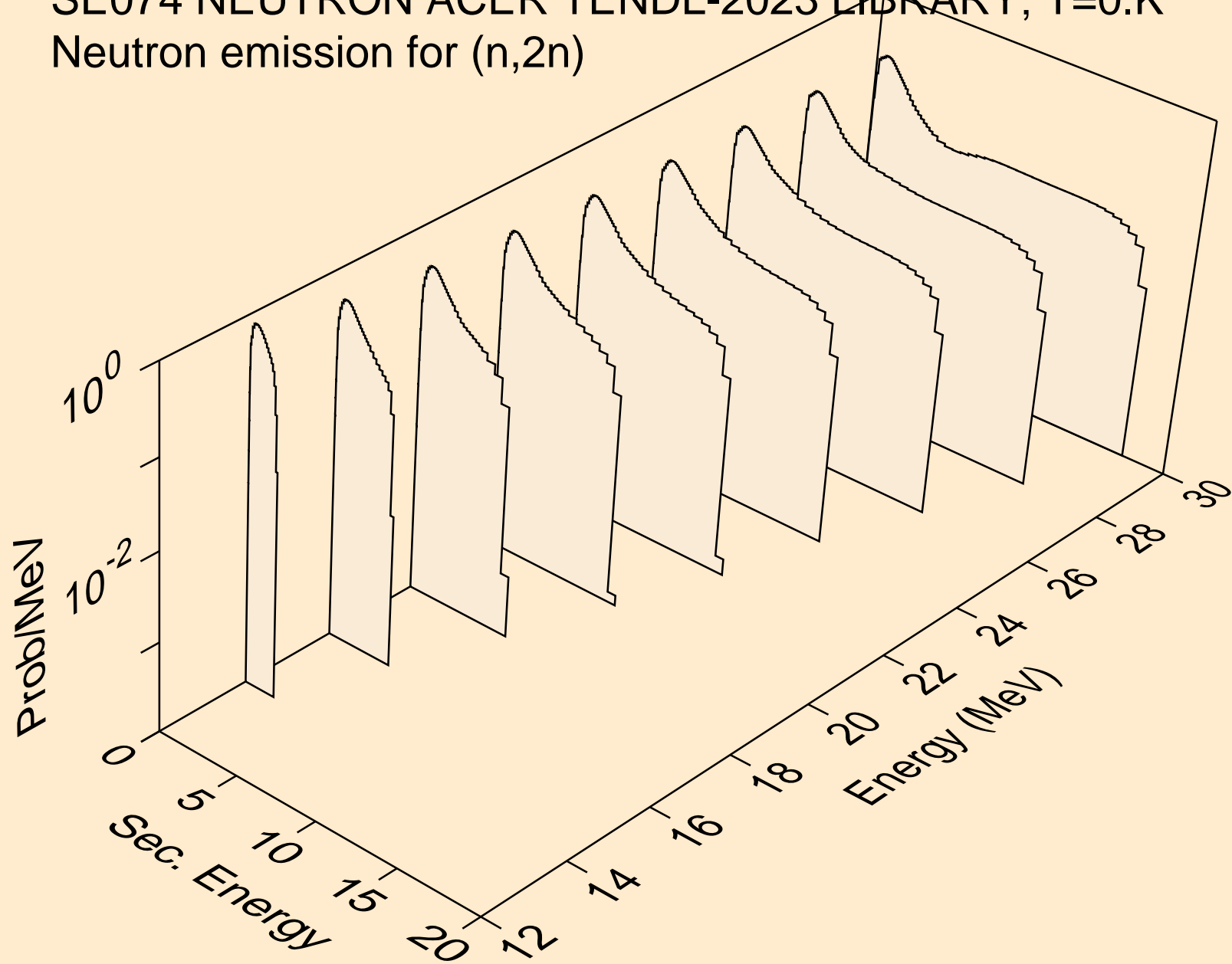

SE074 NEUTRON ACER TENDL-2023 LIBRARY; T=0.K  
Neutron emission for (n,3n)

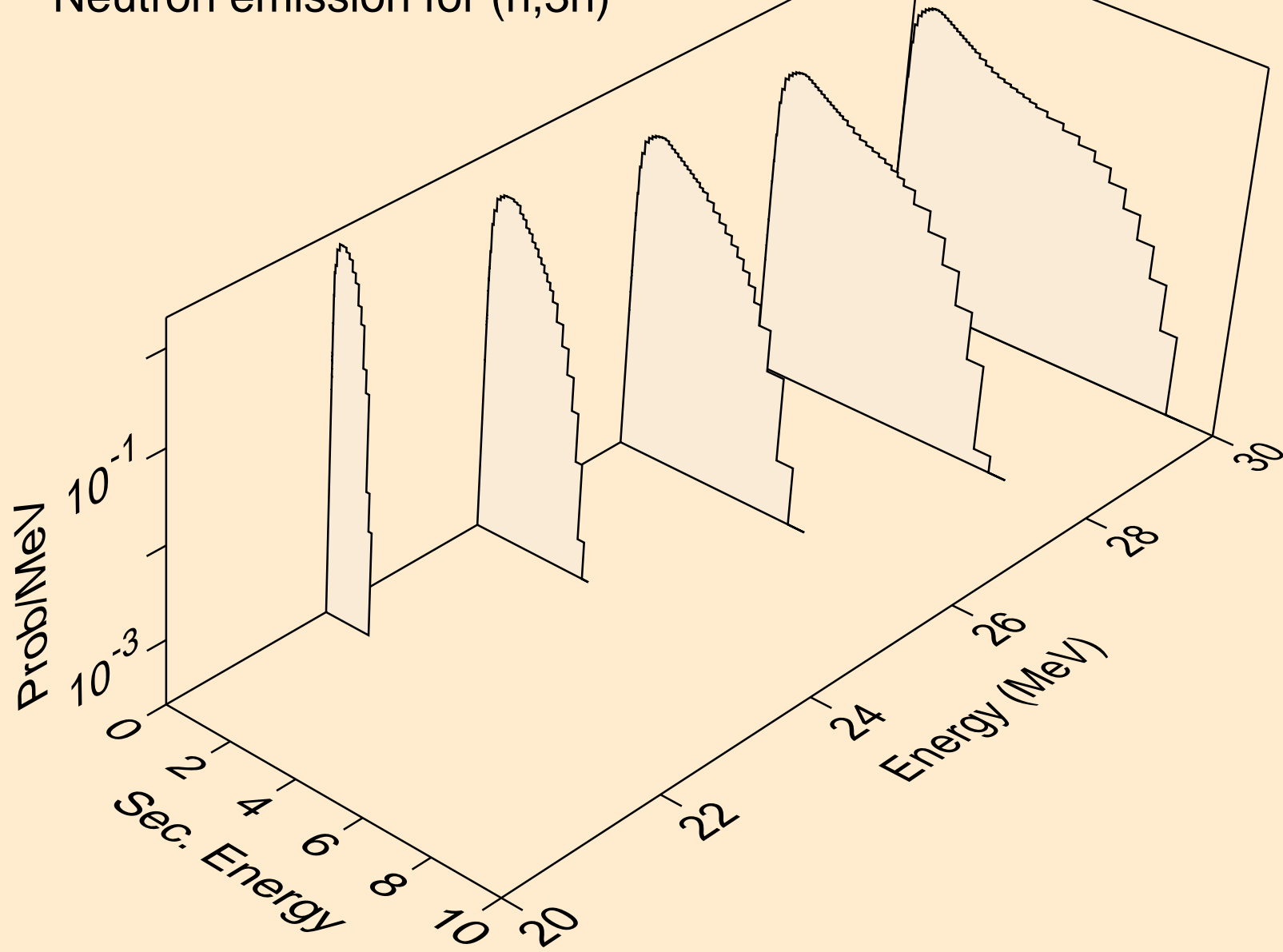

SE074 NEUTRON ACER TENDL-2023 LIBRARY; T=0.K  
Neutron emission for (n,n\*)a

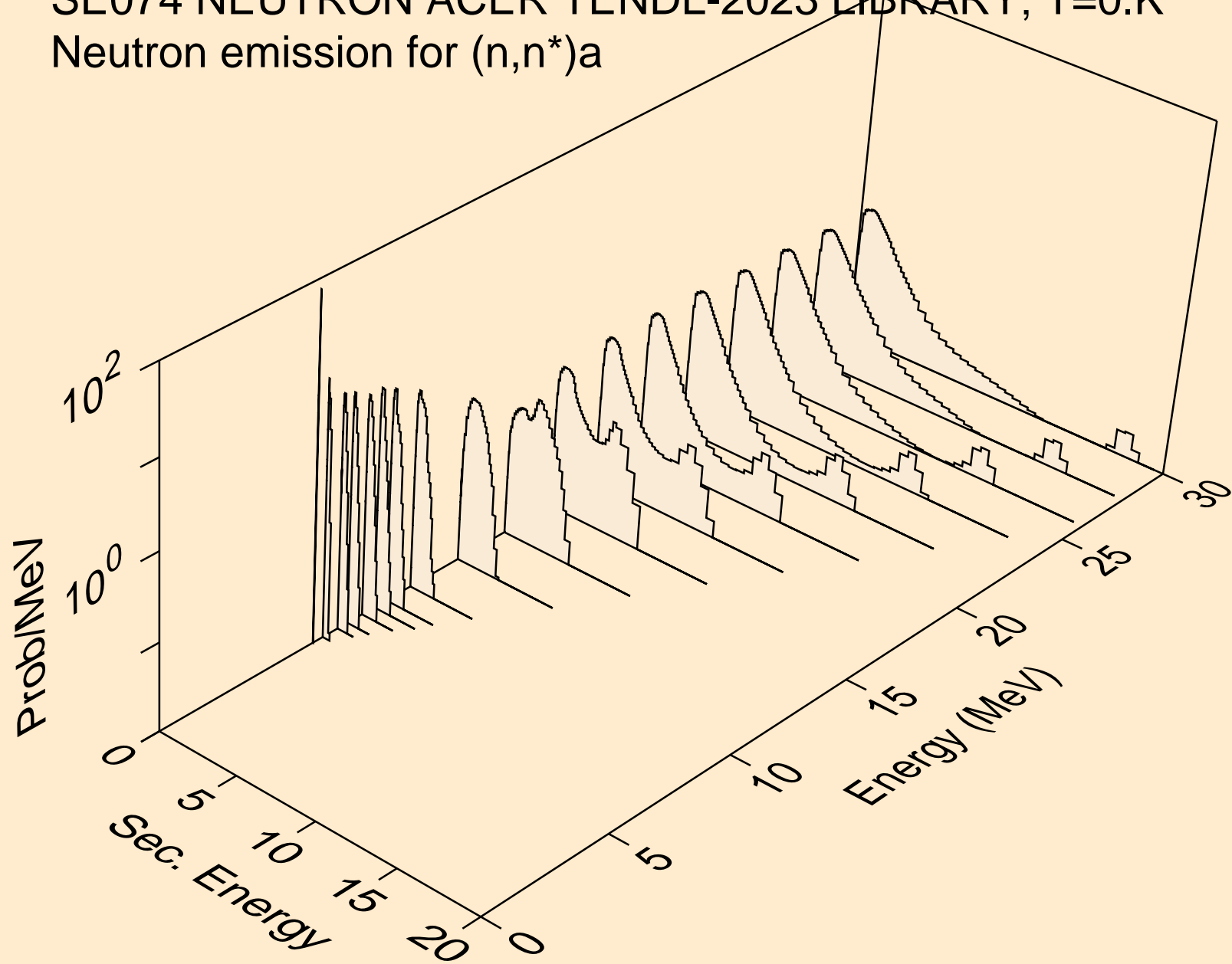



SE074 NEUTRON ACER TENDL-2023 LIBRARY; T=0.K  
Neutron emission for (n,2n)a

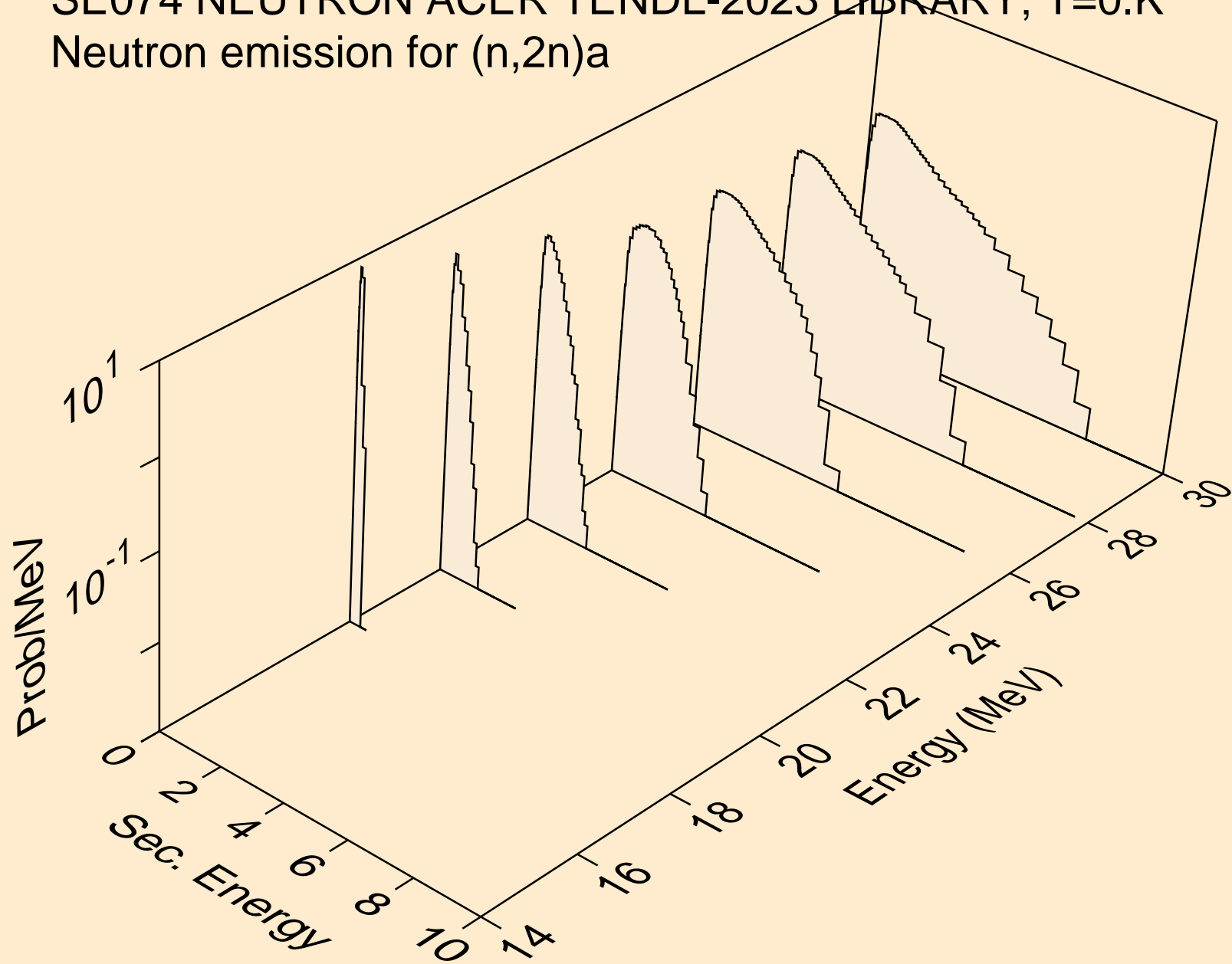

SE074 NEUTRON ACER TENDL-2023 LIBRARY; T=0.K  
Neutron emission for (n,3n)a

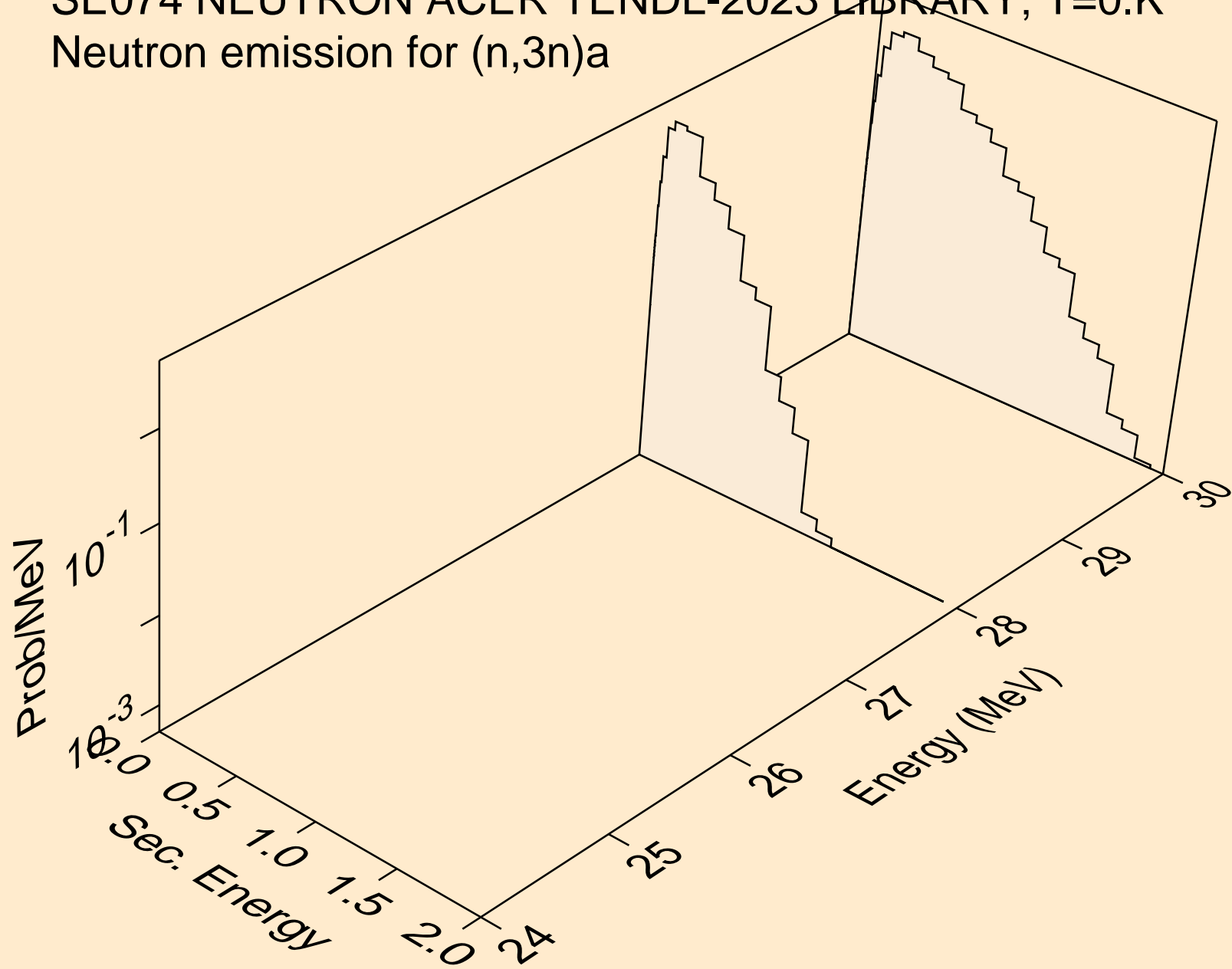

SE074 NEUTRON ACER TENDL-2023 LIBRARY; T=0.K  
Neutron emission for (n,n\*)p

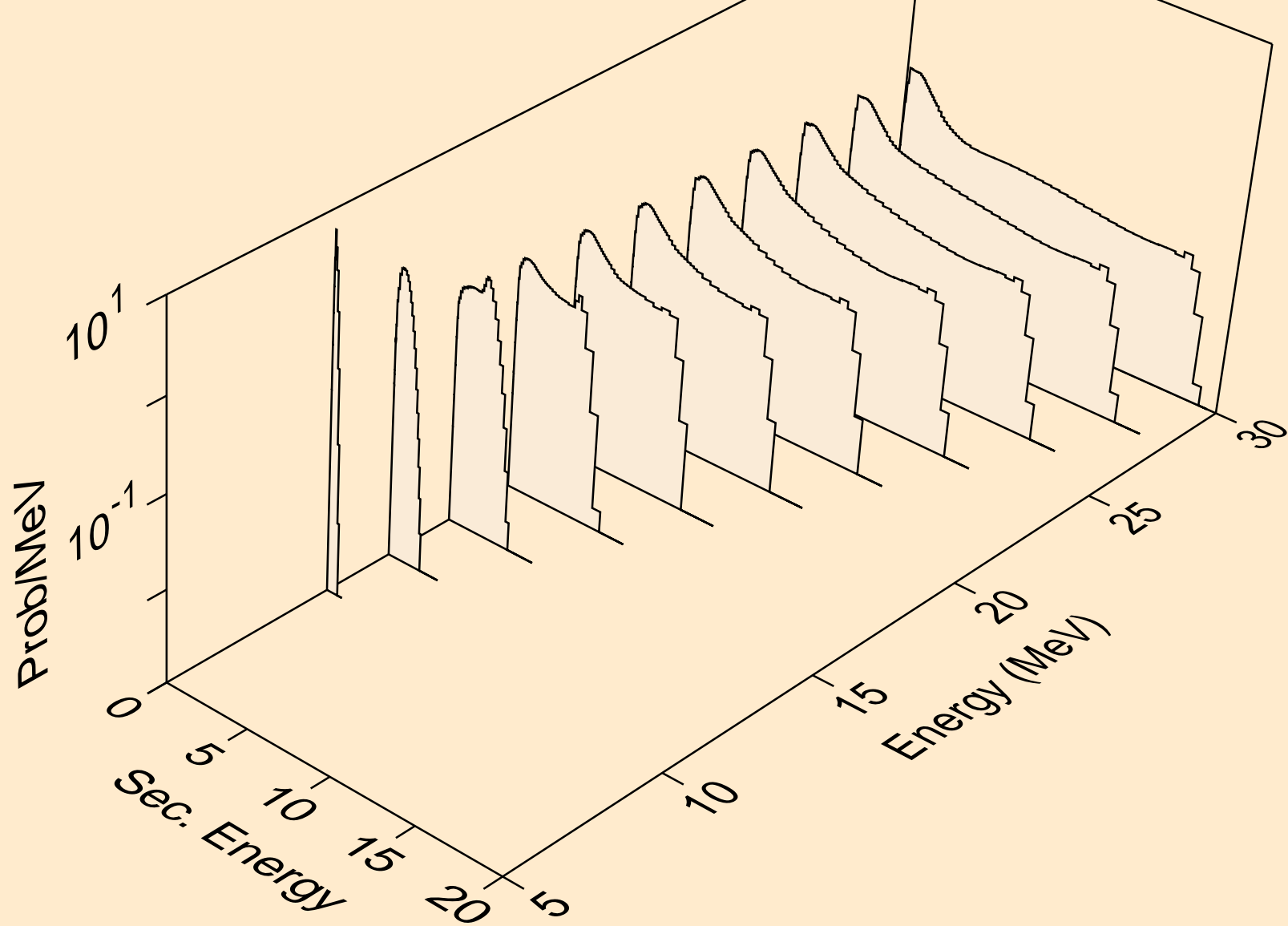

SE074 NEUTRON ACER TENDL-2023 LIBRARY; T=0.K  
Neutron emission for (n,n\*)2a

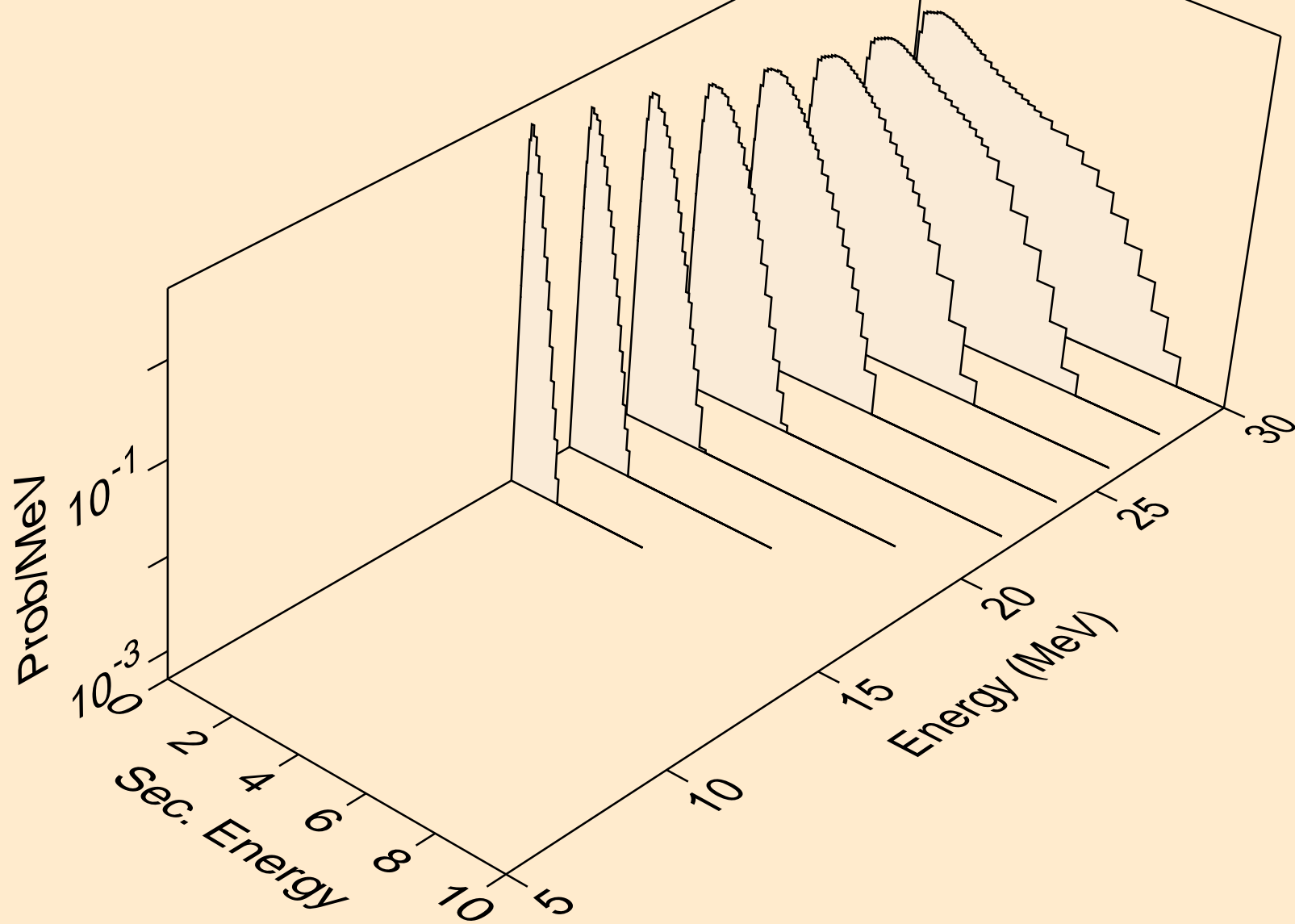

SE074 NEUTRON ACER TENDL-2023 LIBRARY; T=0.K  
Neutron emission for (n,n\*)d

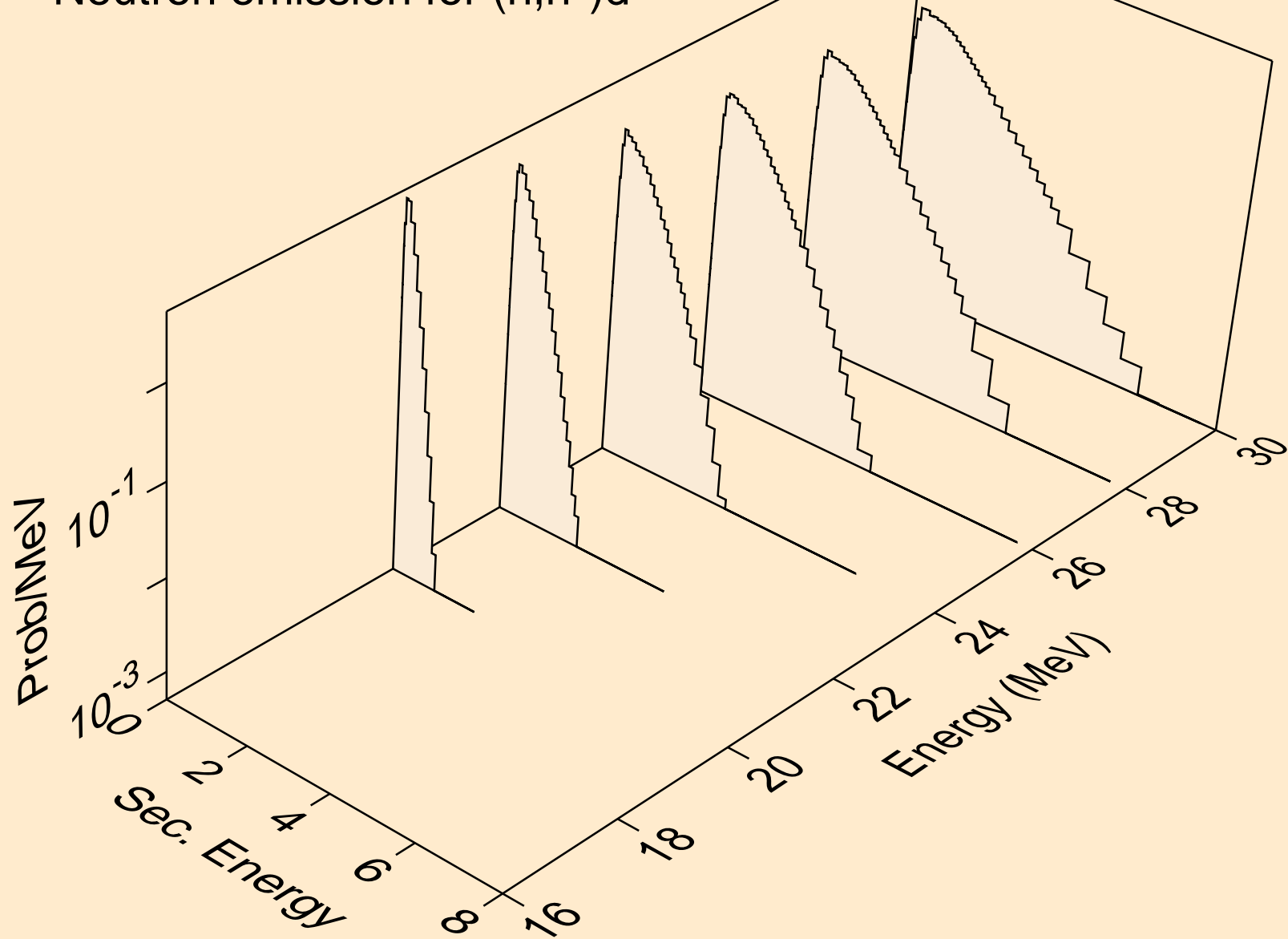

SE074 NEUTRON ACER TENDL-2023 LIBRARY; T=0.K  
Neutron emission for (n,n\*)t

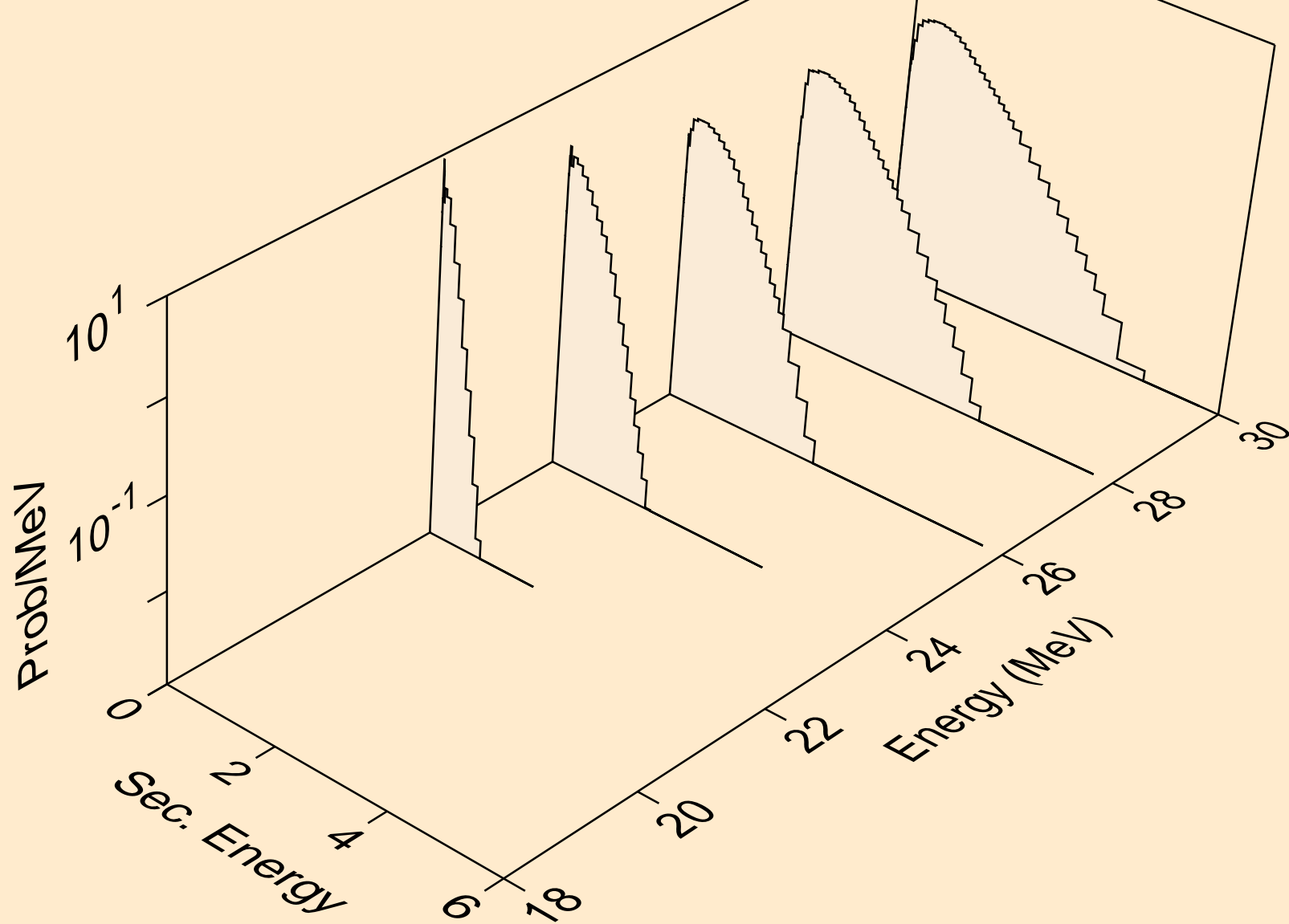

SE074 NEUTRON ACER TENDL-2023 LIBRARY; T=0.K  
Neutron emission for (n,n\*)he3

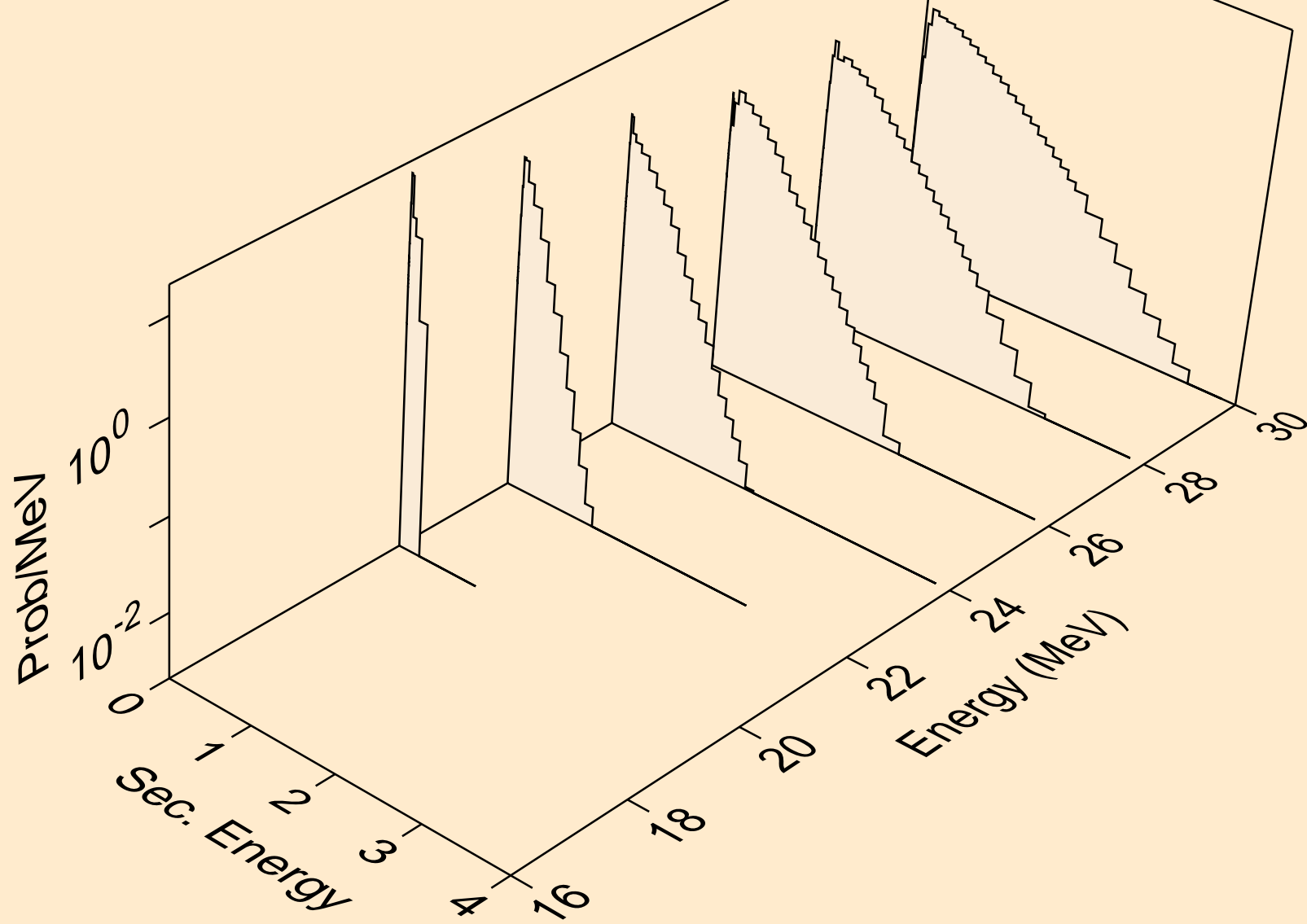

SE074 NEUTRON ACER TENDL-2023 LIBRARY; T=0.K  
Neutron emission for (n,2np)

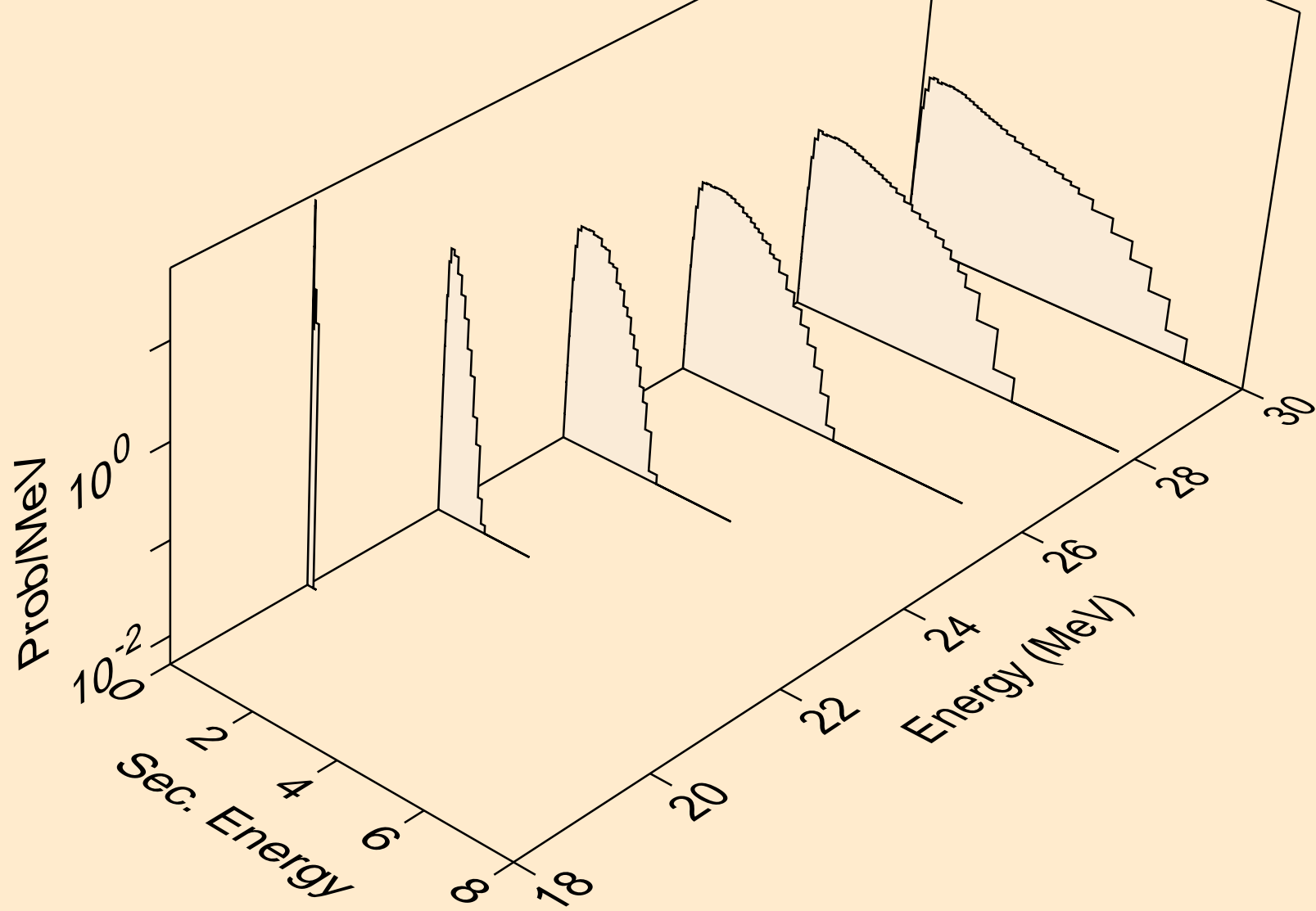



SE074 NEUTRON ACER TENDL-2023 LIBRARY; T=0.K  
Neutron emission for (n,3np)

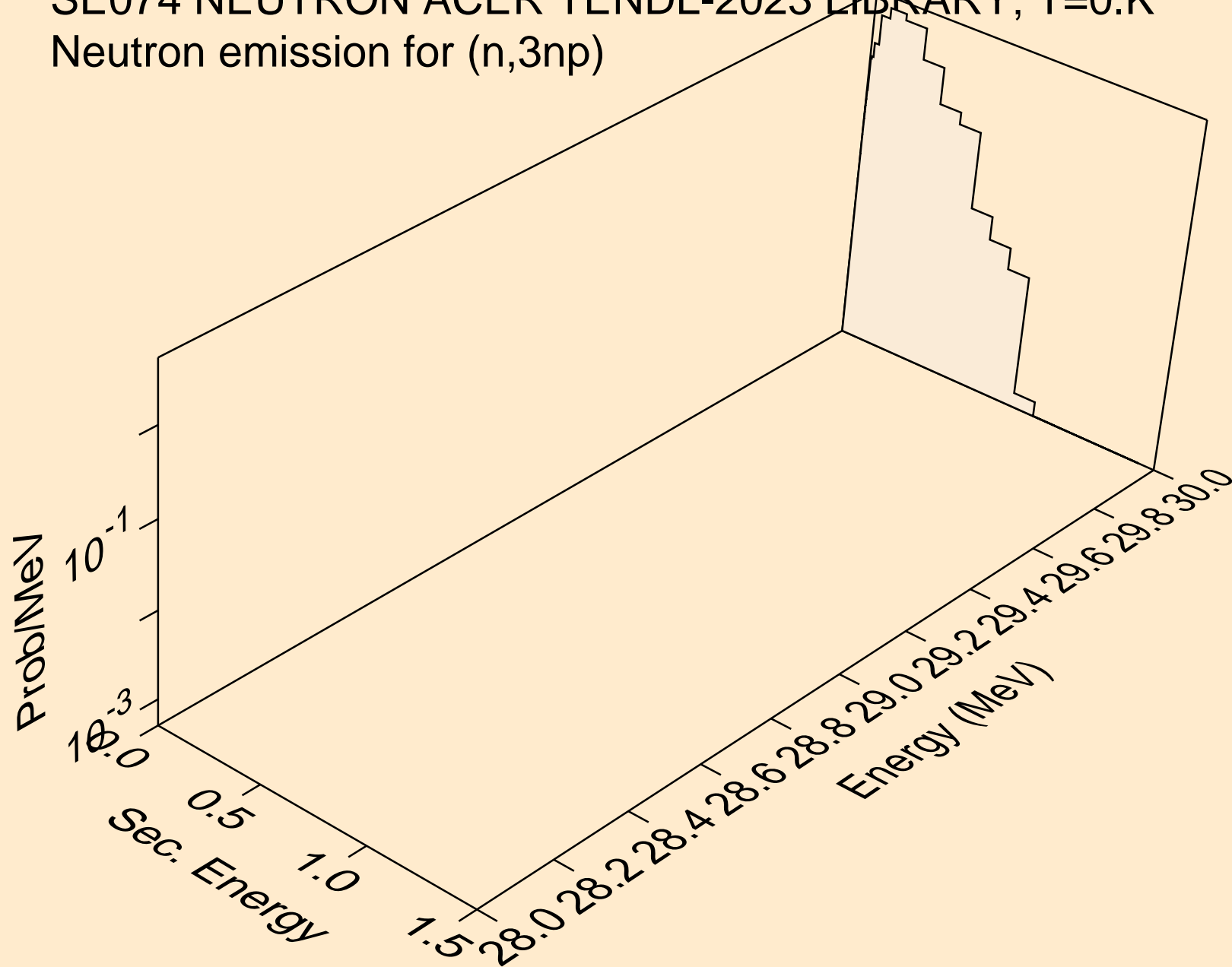

SE074 NEUTRON ACER TENDL-2023 LIBRARY; T=0.K  
Neutron emission for (n,n2p)

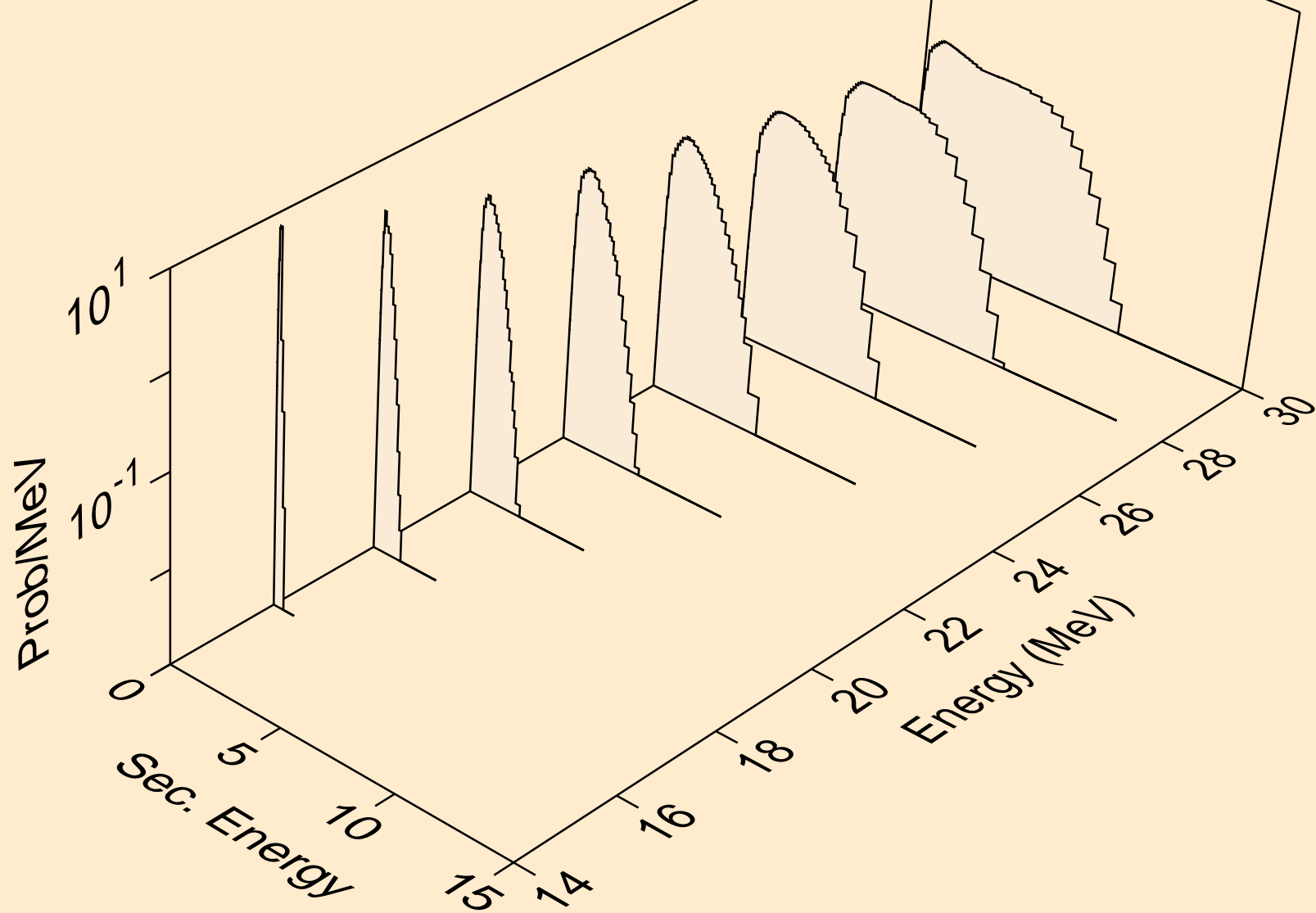

SE074 NEUTRON ACER TENDL-2023 LIBRARY; T=0.K  
Neutron emission for (n,npa)

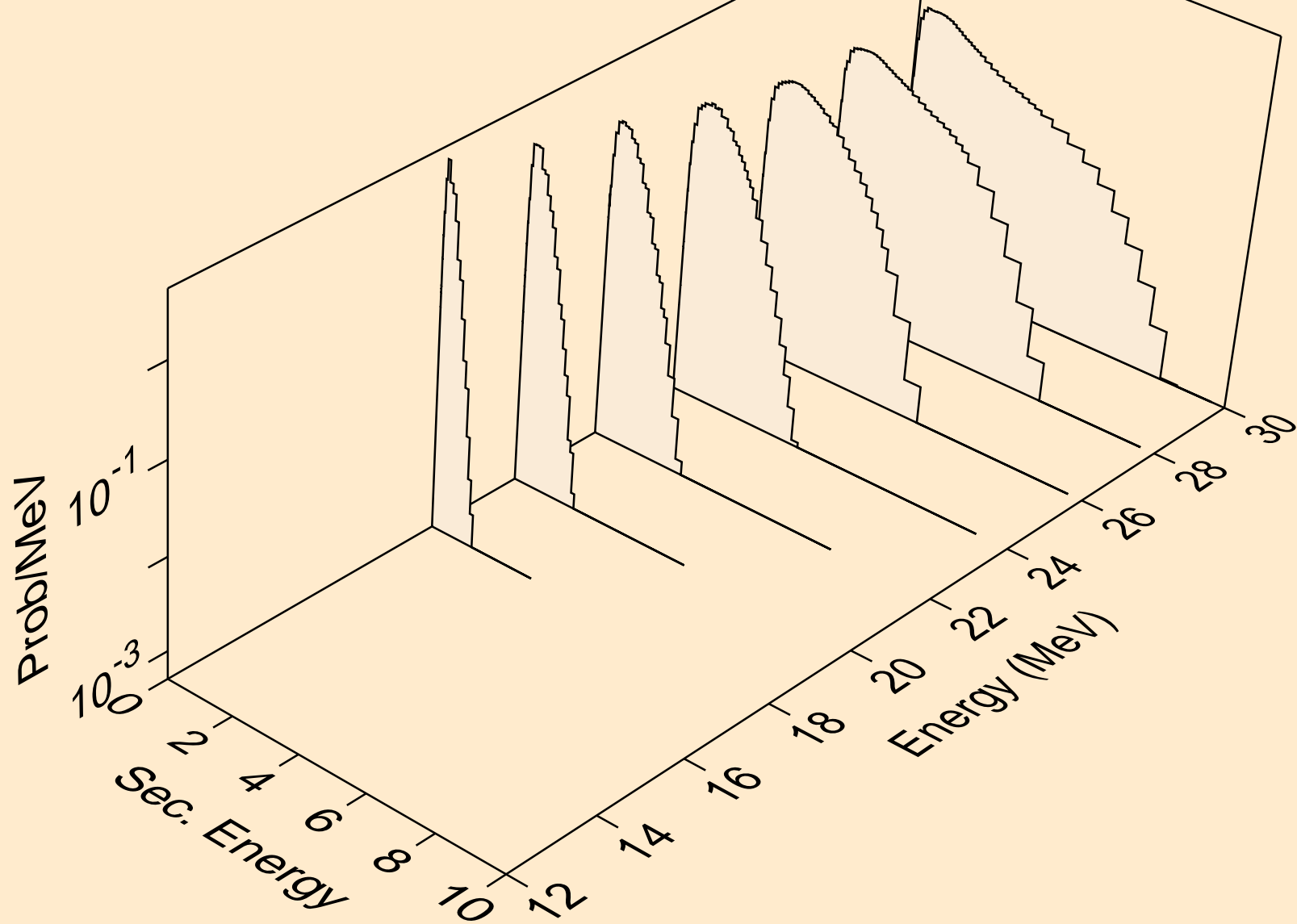

SE074 NEUTRON ACER TENDL-2023 LIBRARY; T=0.K  
Neutron emission for (n,n\*c)

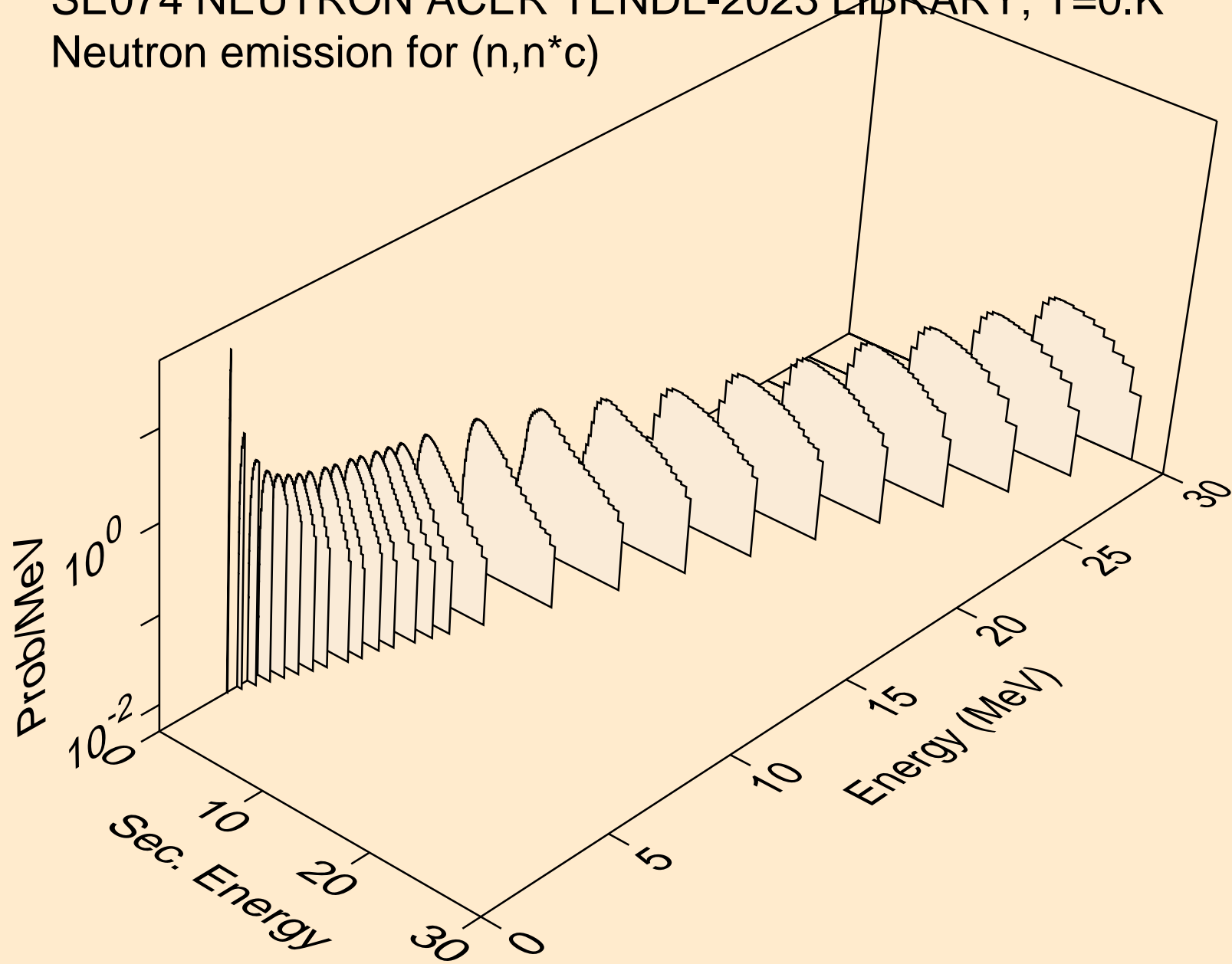

SE074 NEUTRON ACER TENDL-2023 LIBRARY; T=0.K  
Photon emission for (n,x)

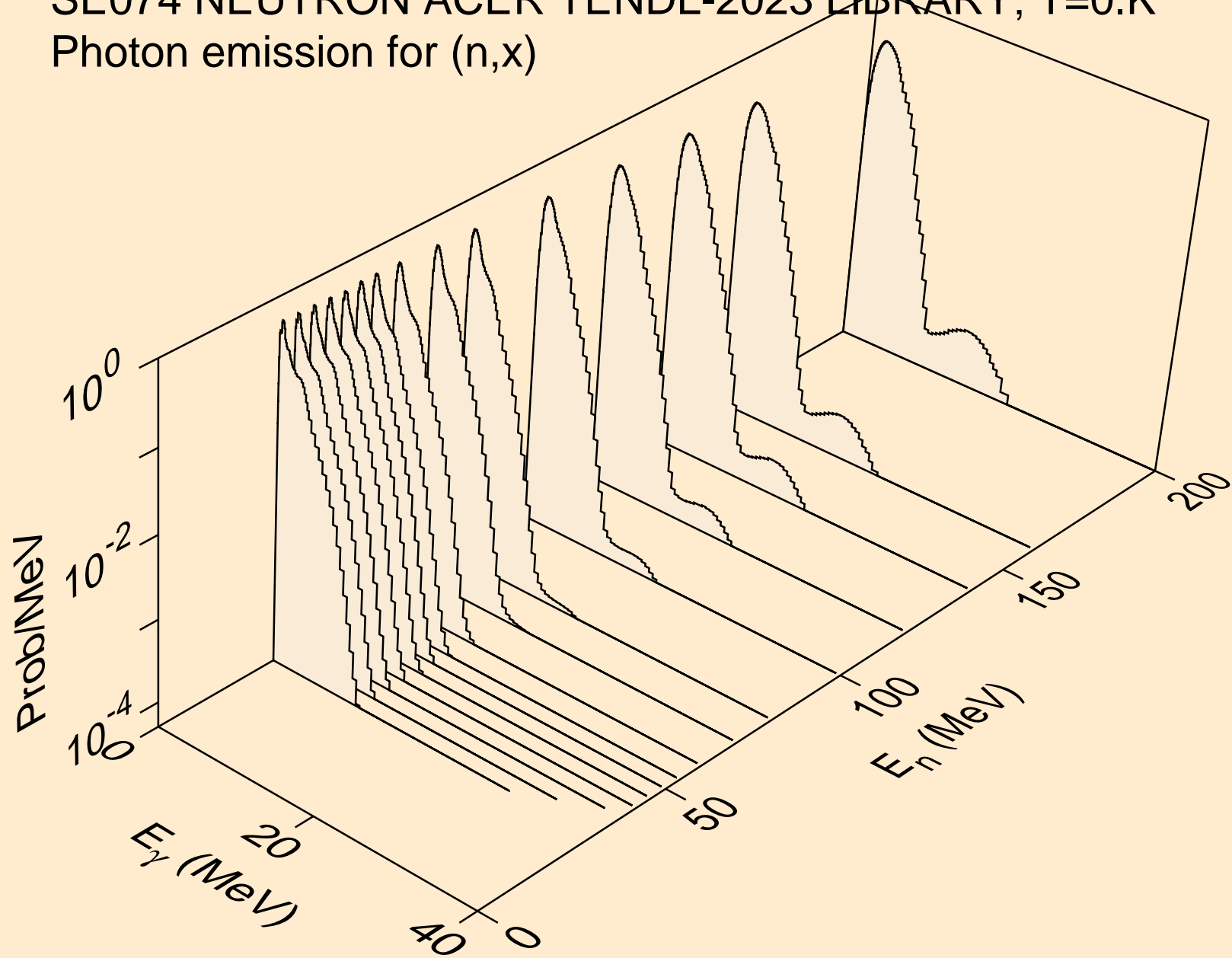

SE074 NEUTRON ACER TENDL-2023 LIBRARY; T=0.K  
Photon emission for (n,2nd)

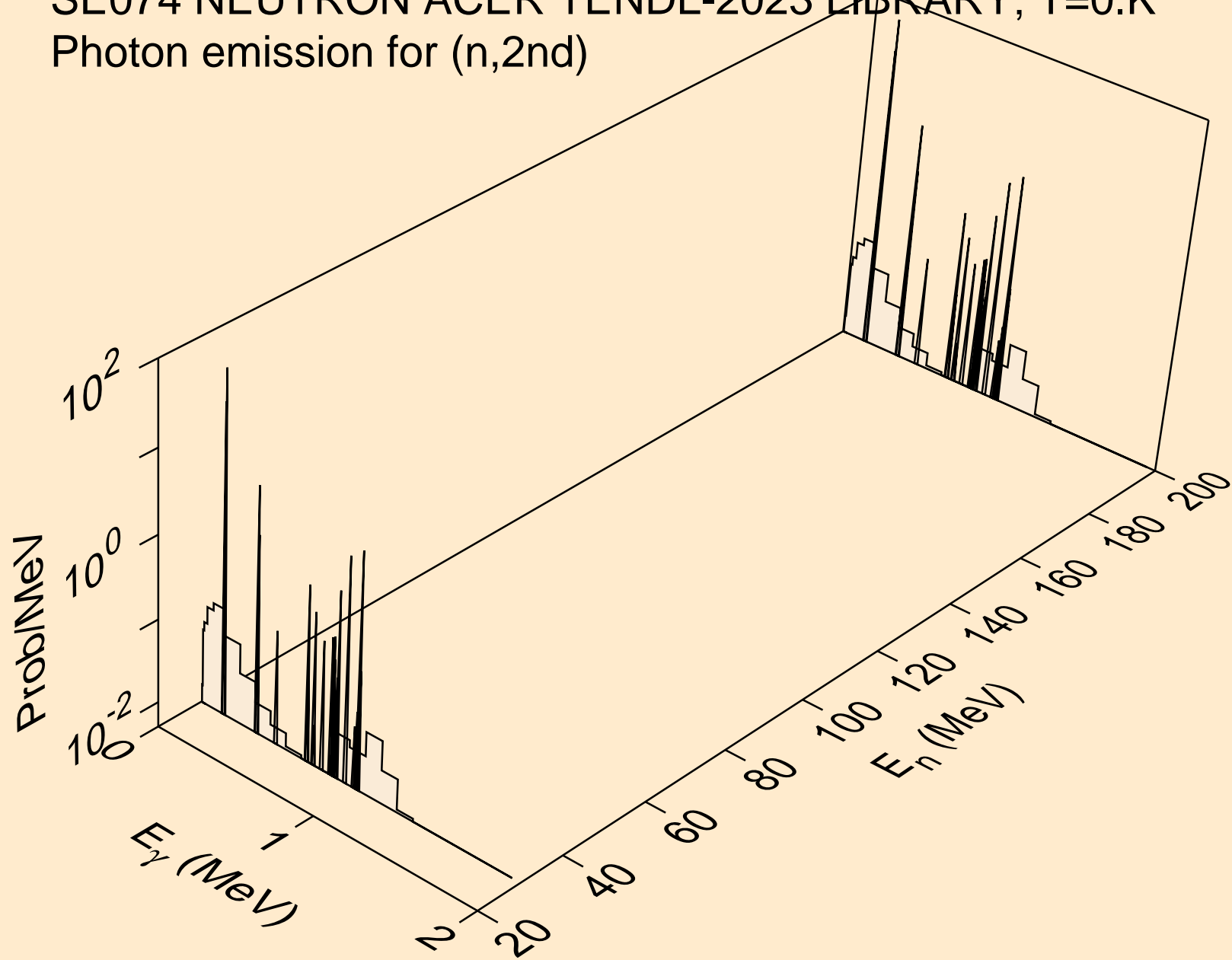

SE074 NEUTRON ACER TENDL-2023 LIBRARY; T=0.K  
Photon emission for (n,2n)

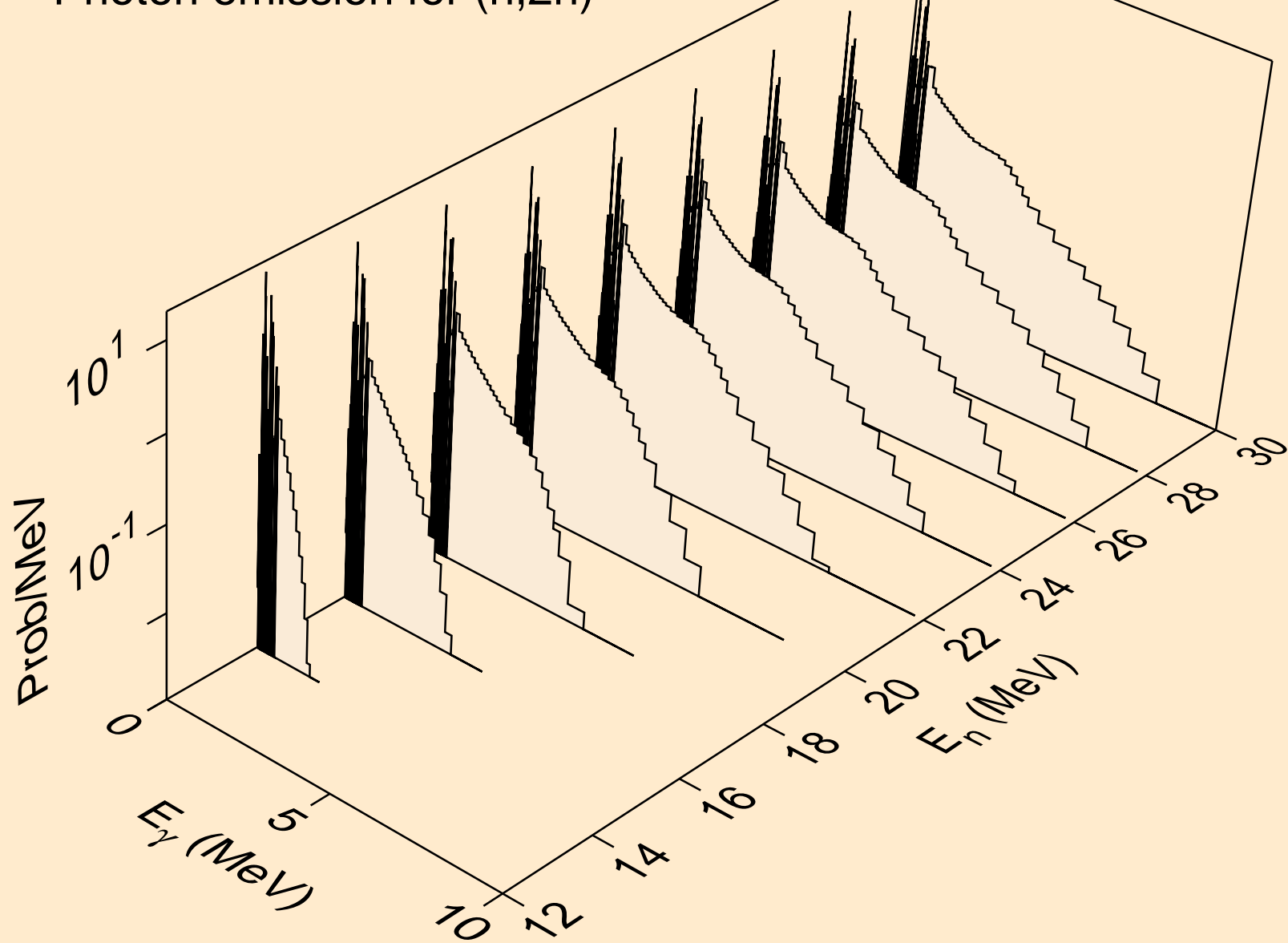

SE074 NEUTRON ACER TENDL-2023 LIBRARY; T=0.K  
Photon emission for (n,3n)

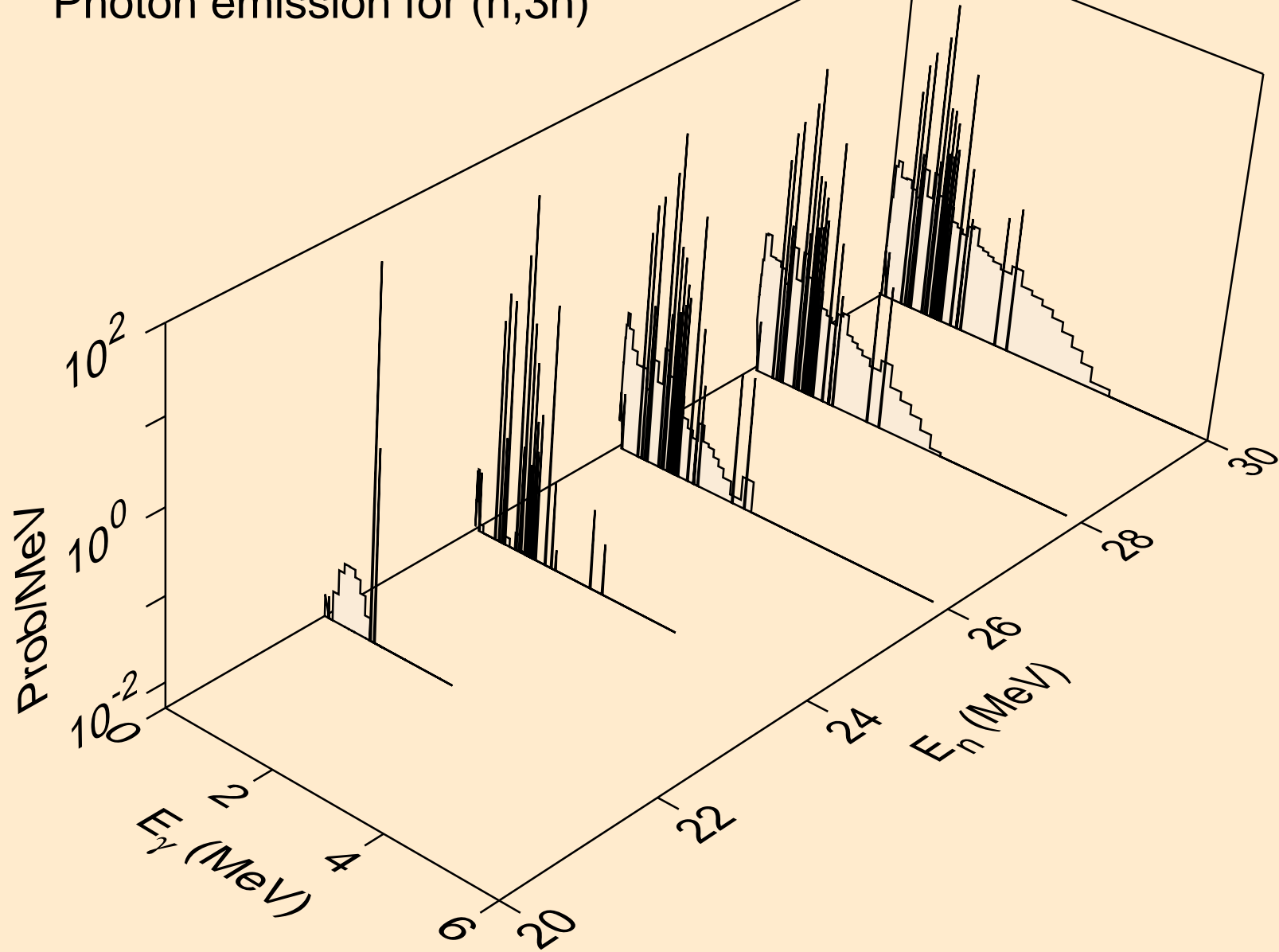



SE074 NEUTRON ACER TENDL-2023 LIBRARY; T=0.K  
Photon emission for (n,n\*)a

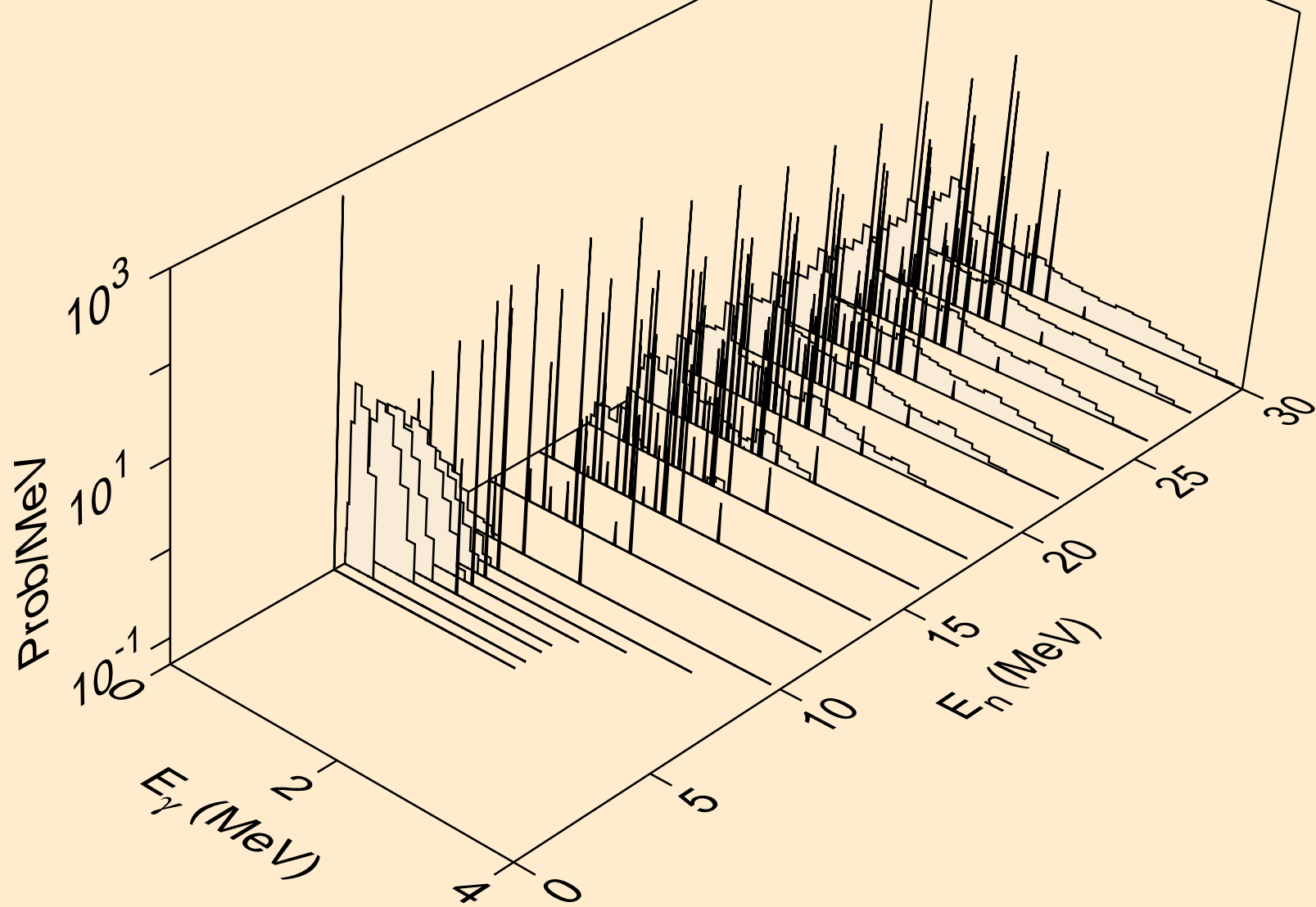

SE074 NEUTRON ACER TENDL-2023 LIBRARY; T=0.K  
Photon emission for (n,2n)a

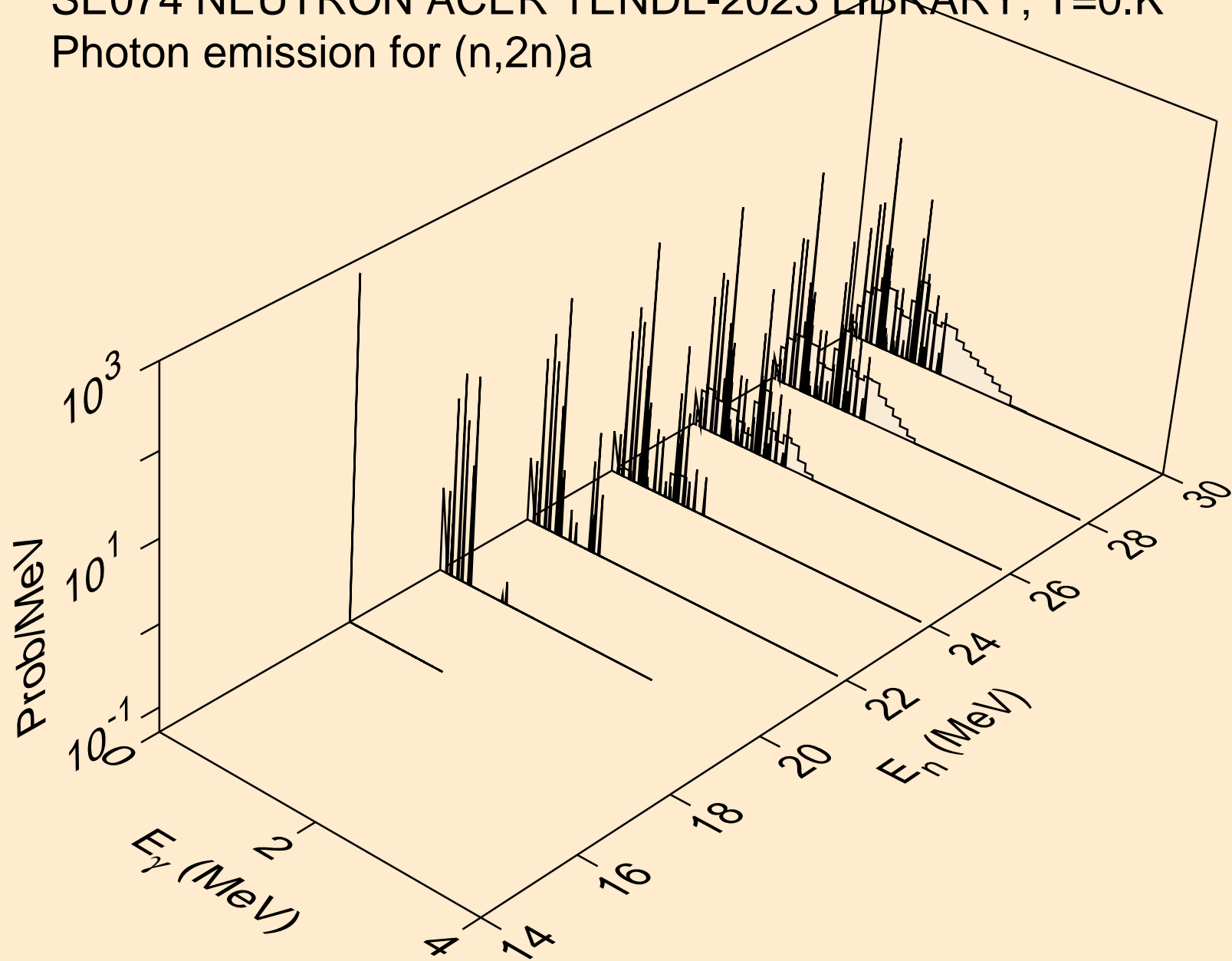

SE074 NEUTRON ACER TENDL-2023 LIBRARY; T=0.K  
Photon emission for (n,3n)a

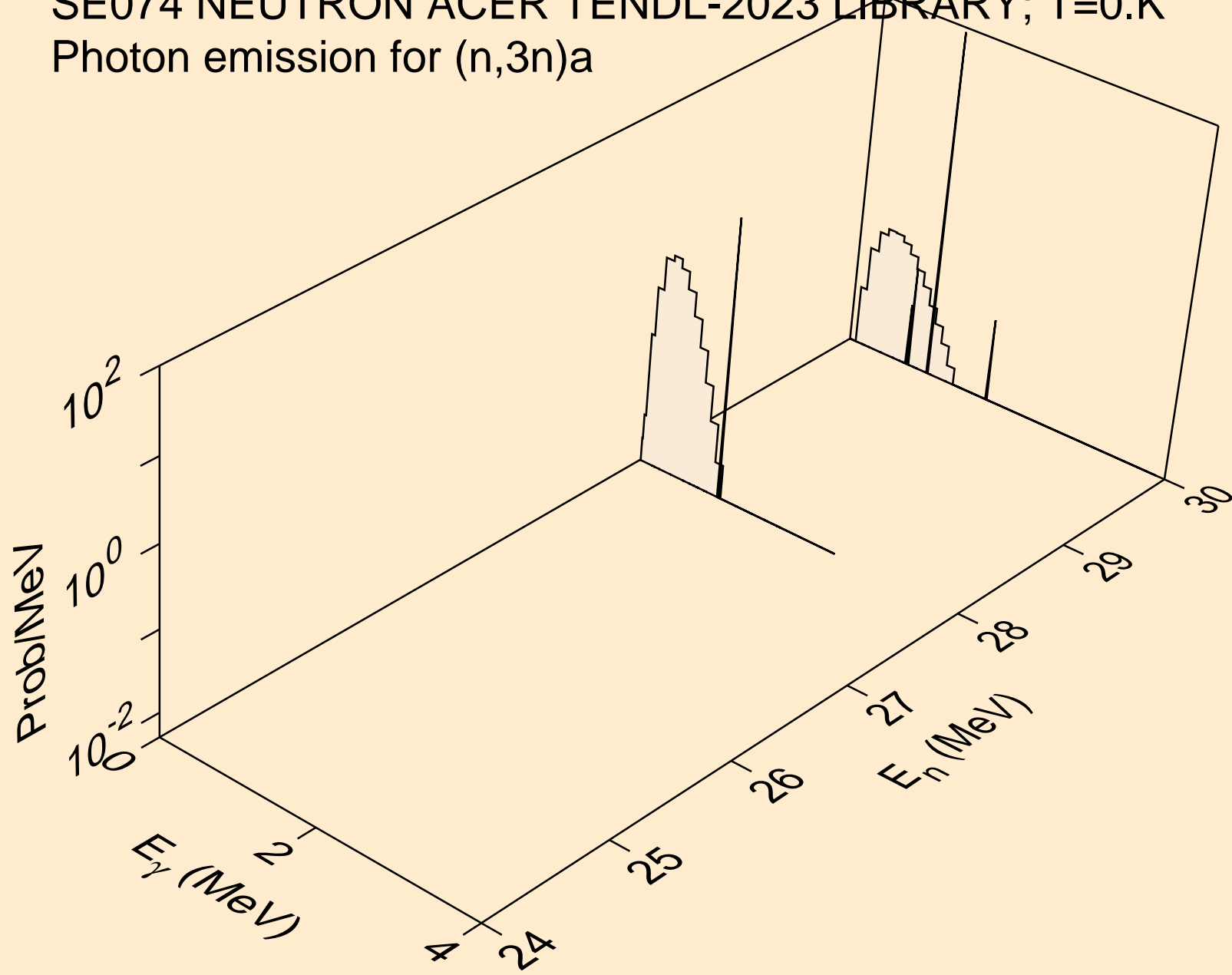

SE074 NEUTRON ACER TENDL-2023 LIBRARY; T=0.K  
Photon emission for (n,n\*)p

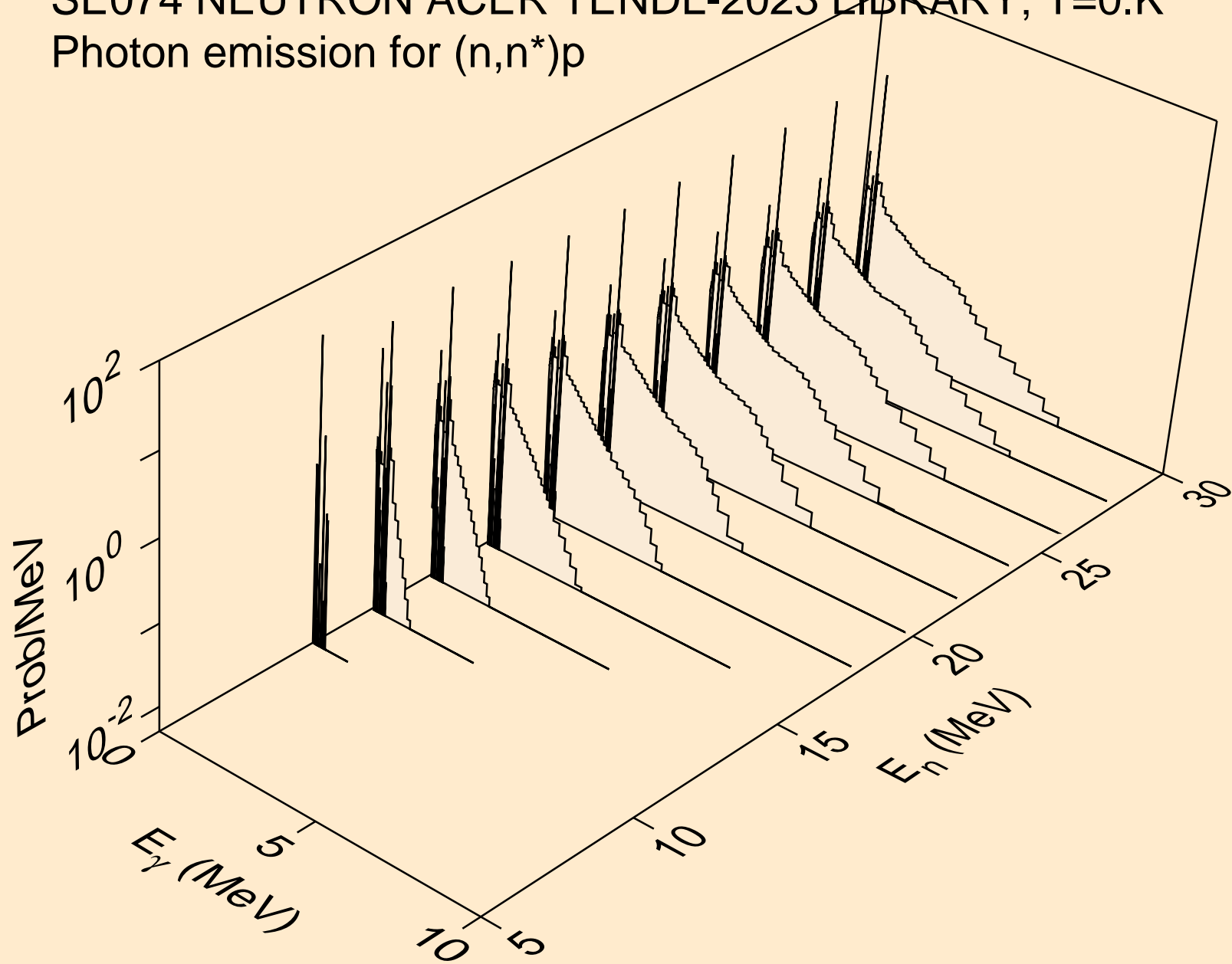

SE074 NEUTRON ACER TENDL-2023 LIBRARY; T=0.K  
Photon emission for (n,n\*)2a

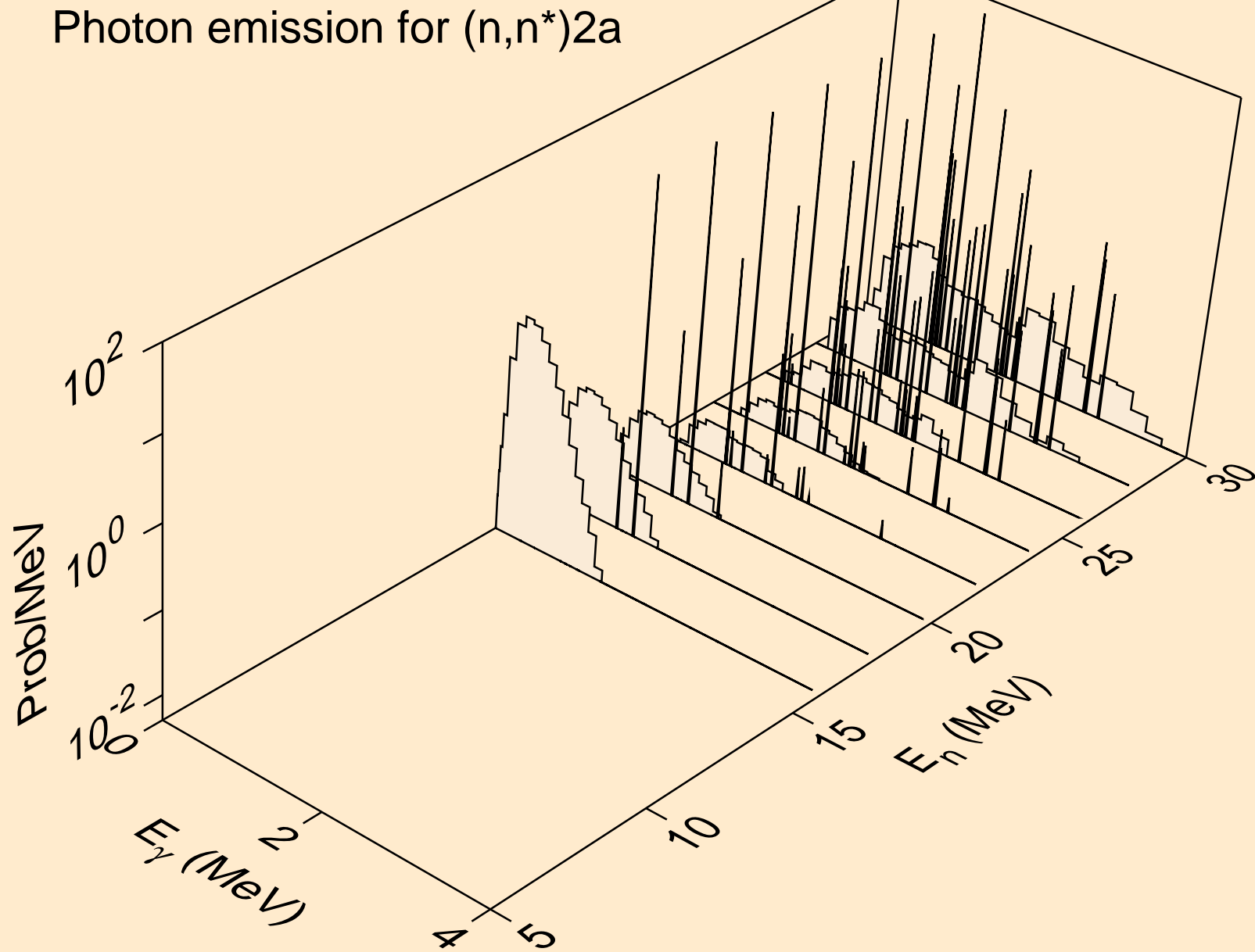

SE074 NEUTRON ACER TENDL-2023 LIBRARY; T=0.K  
Photon emission for (n,n\*)d

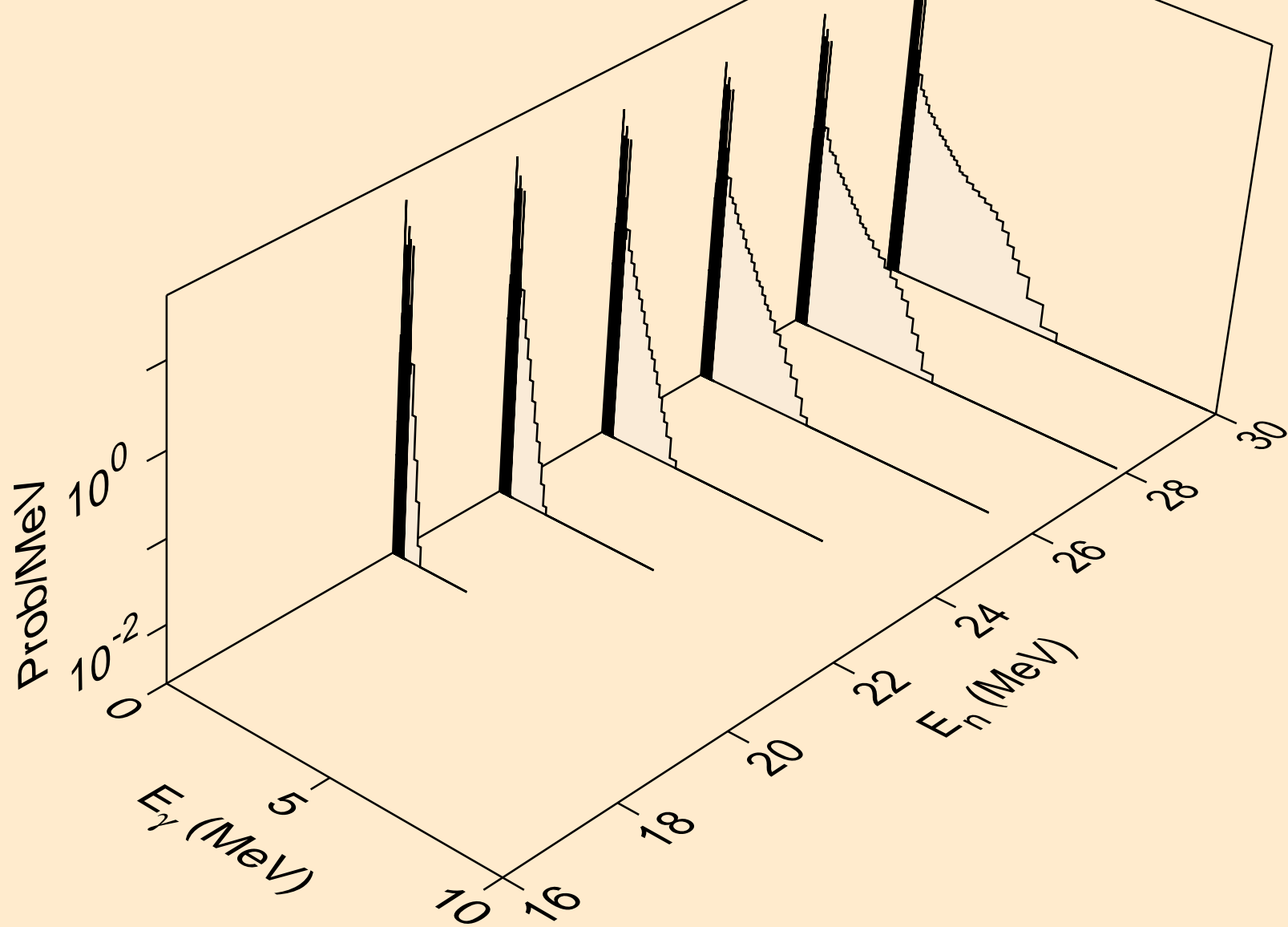

SE074 NEUTRON ACER TENDL-2023 LIBRARY; T=0.K  
Photon emission for (n,n\*)t

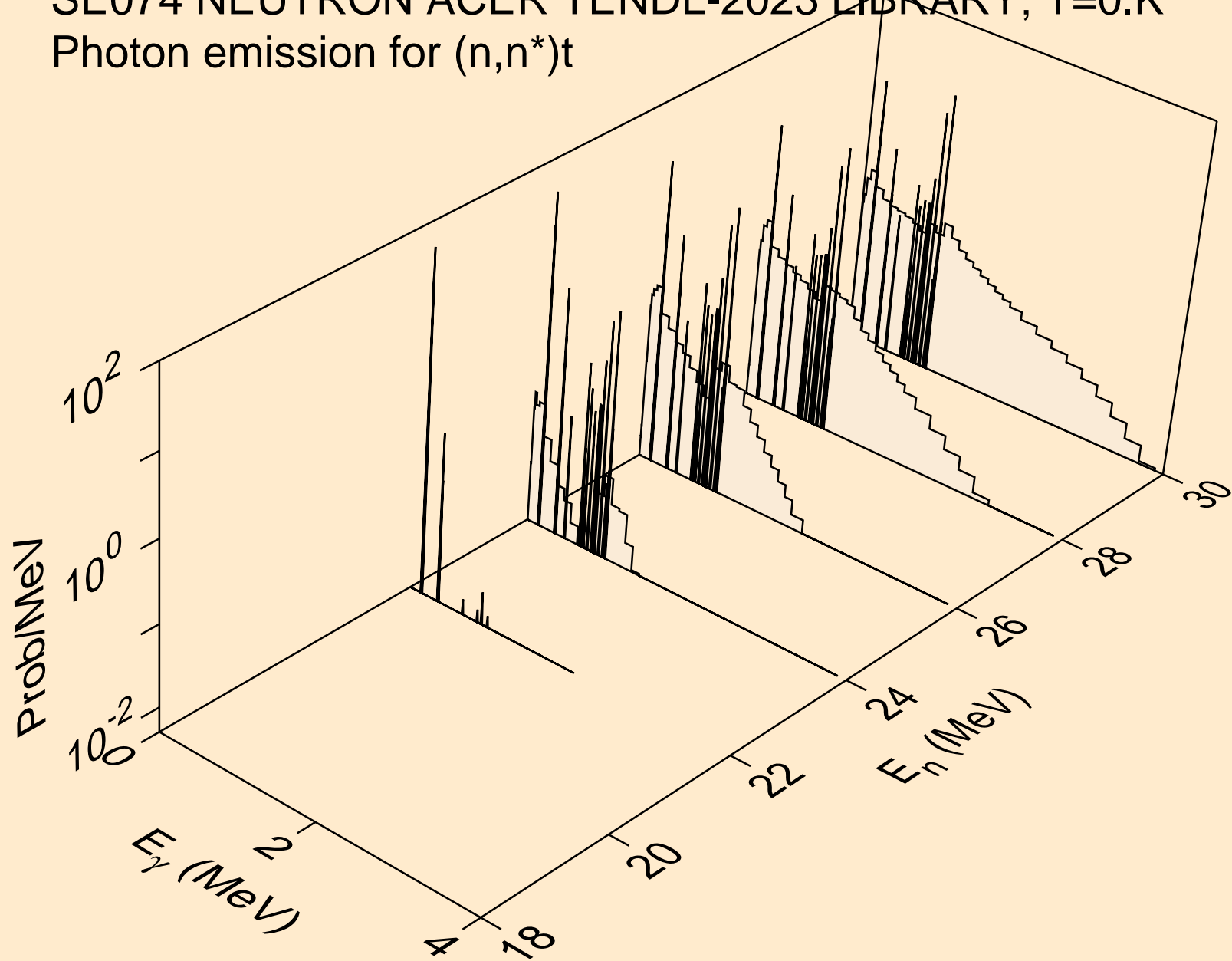

SE074 NEUTRON ACER TENDL-2023 LIBRARY; T=0.K  
Photon emission for (n,n\*)he3

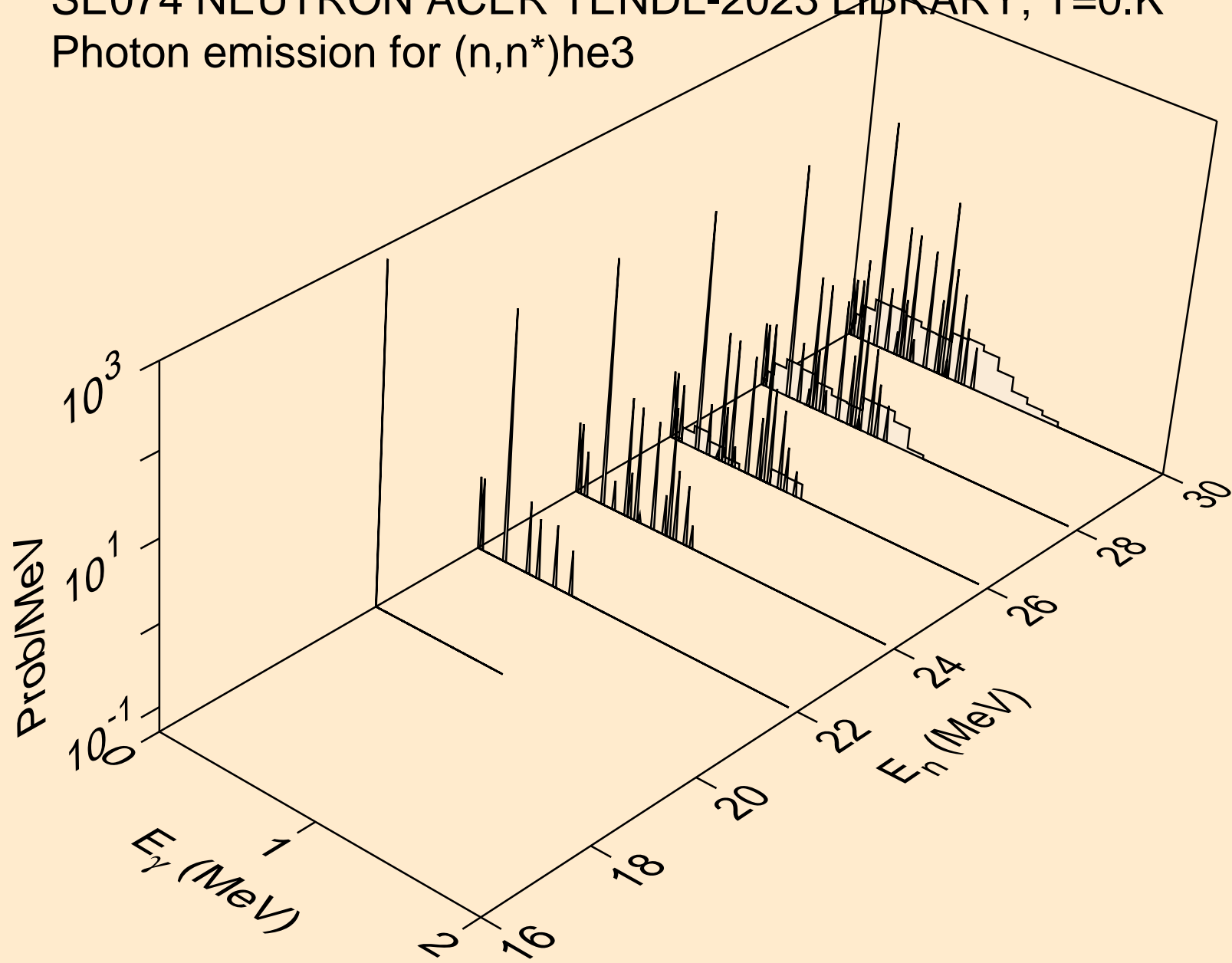



SE074 NEUTRON ACER TENDL-2023 LIBRARY; T=0.K  
Photon emission for (n,2np)

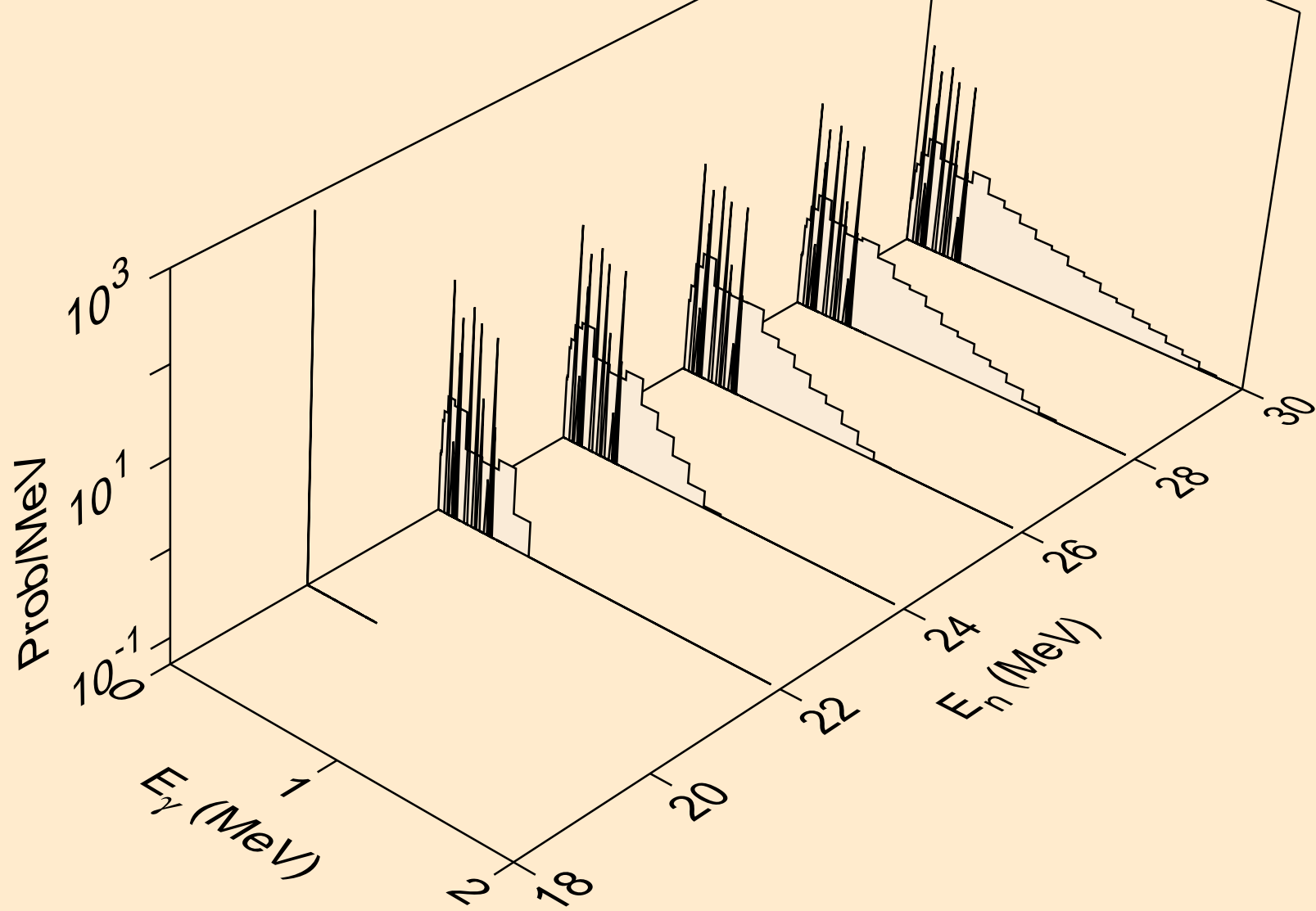

SE074 NEUTRON ACER TENDL-2023 LIBRARY; T=0.K  
Photon emission for (n,3np)

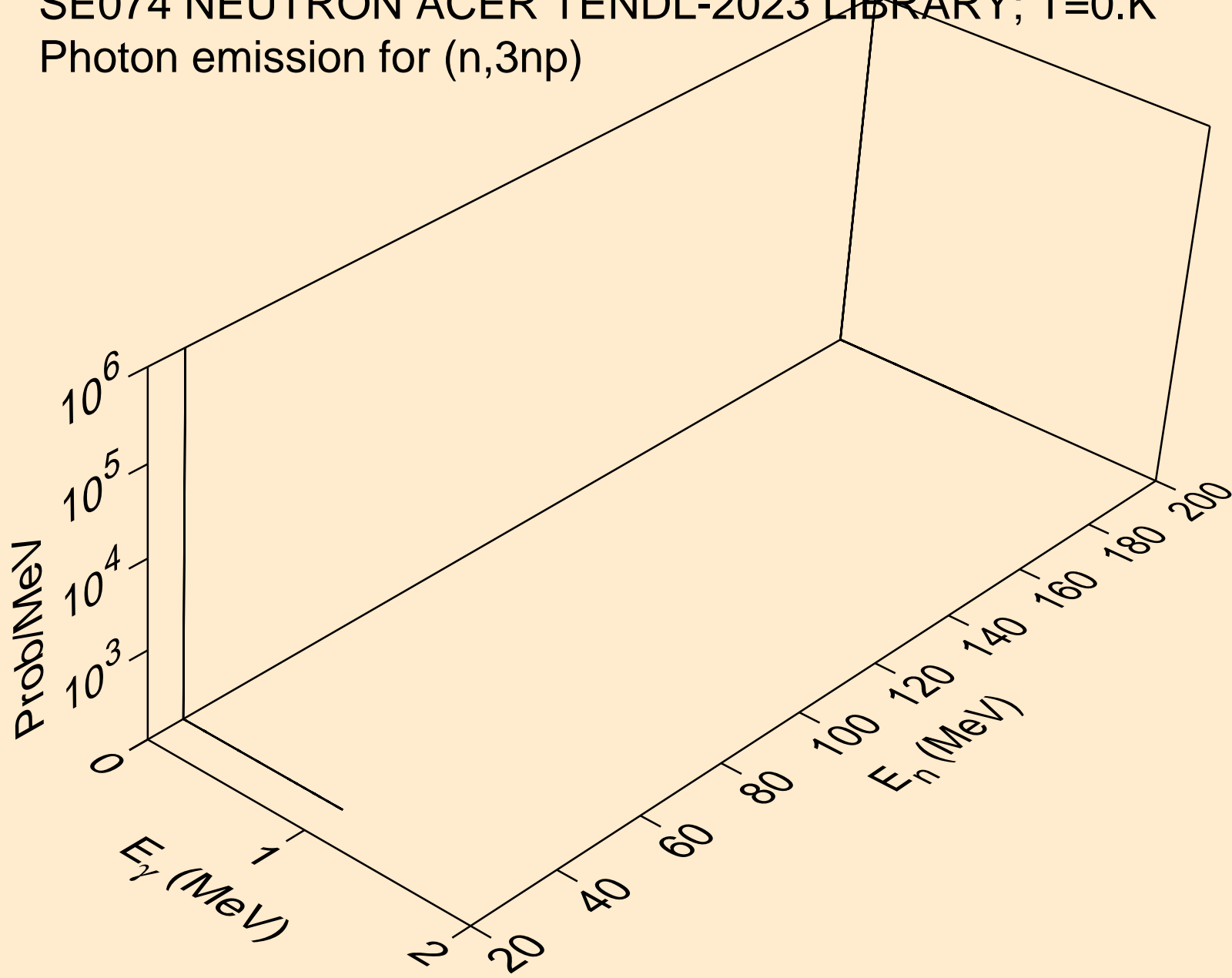

SE074 NEUTRON ACER TENDL-2023 LIBRARY; T=0.K  
Photon emission for (n,n2p)

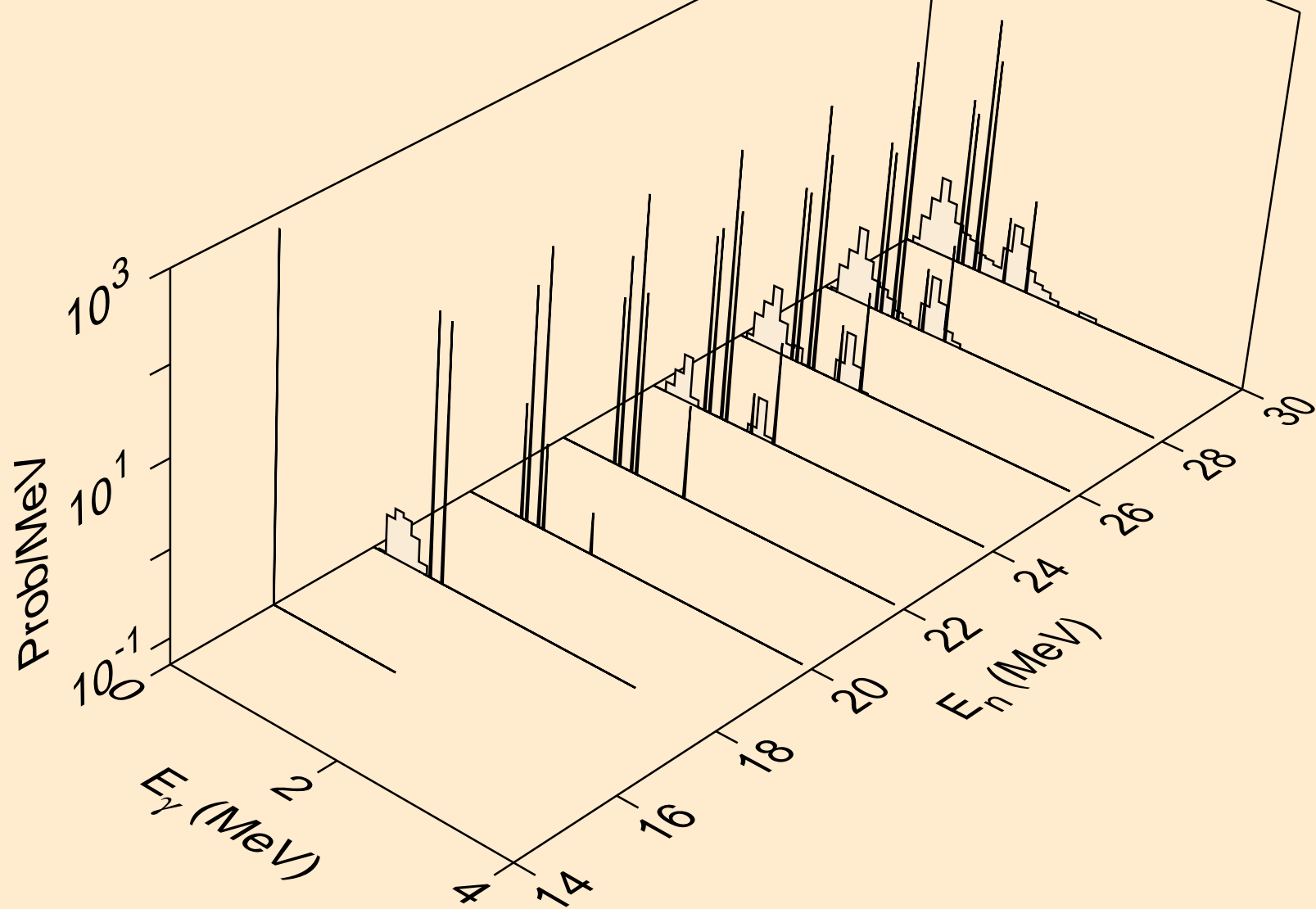

SE074 NEUTRON ACER TENDL-2023 LIBRARY; T=0.K  
Photon emission for (n,npa)

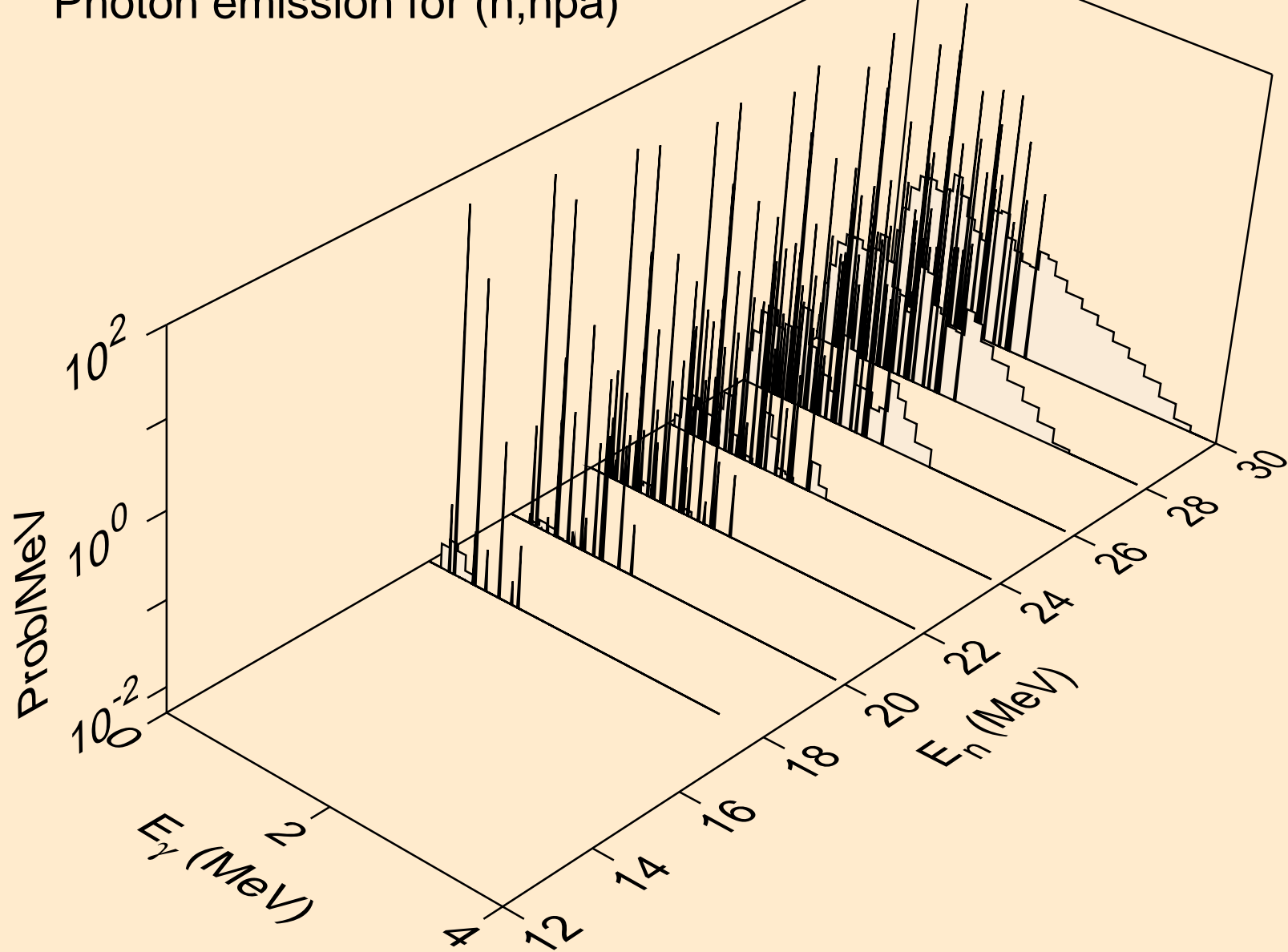

SE074 NEUTRON ACER TENDL-2023 LIBRARY; T=0.K  
Photon emission for (n,n\*c)

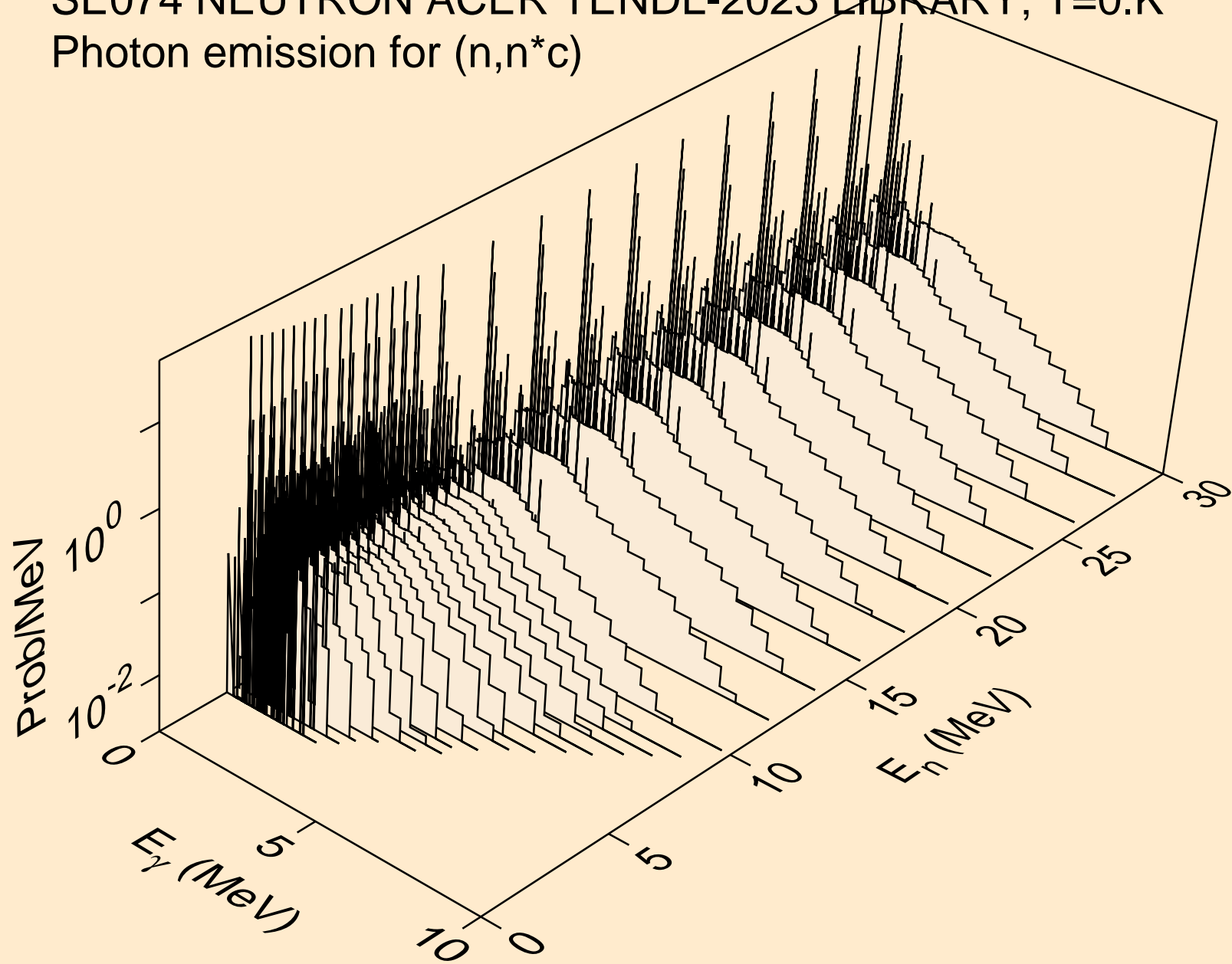

SE074 NEUTRON ACER TENDL-2023 LIBRARY; T=0.K  
Photon emission for (n,gma)

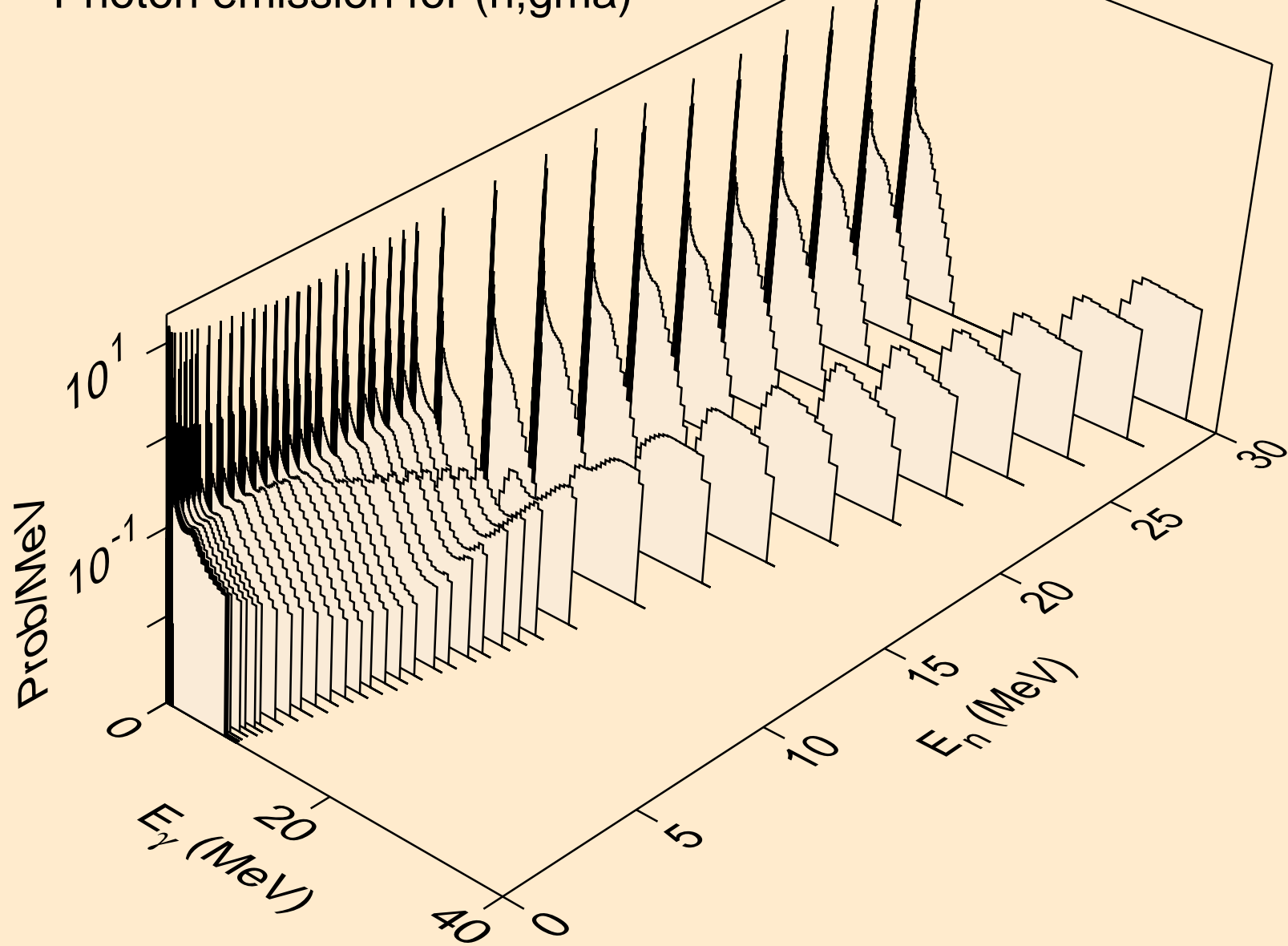

SE074 NEUTRON ACER TENDL-2023 LIBRARY; T=0.K  
Photon emission for (n,p)

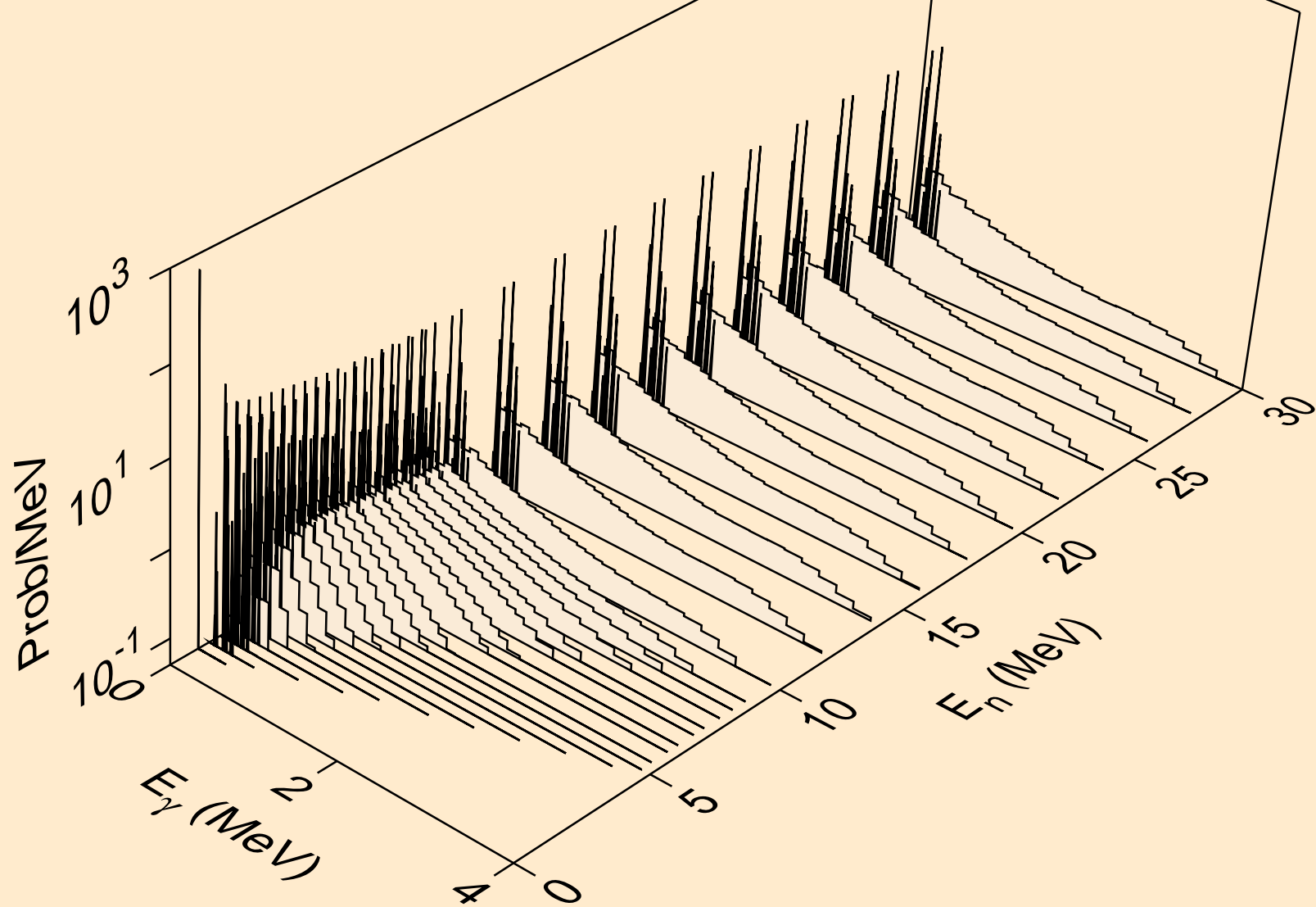

SE074 NEUTRON ACER TENDL-2023 LIBRARY; T=0.K  
Photon emission for (n,d)

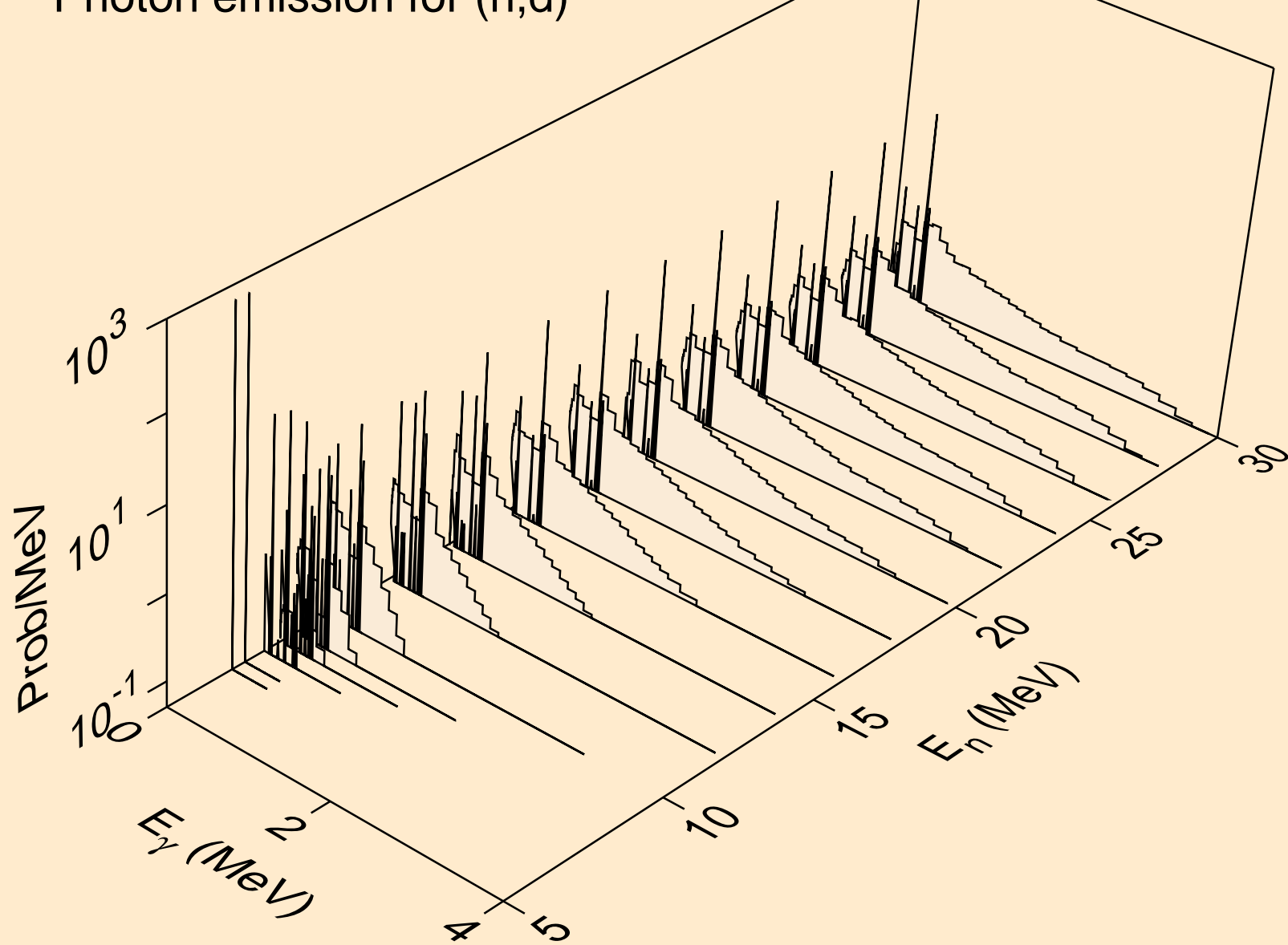



SE074 NEUTRON ACER TENDL-2023 LIBRARY; T=0.K  
Photon emission for (n,t)

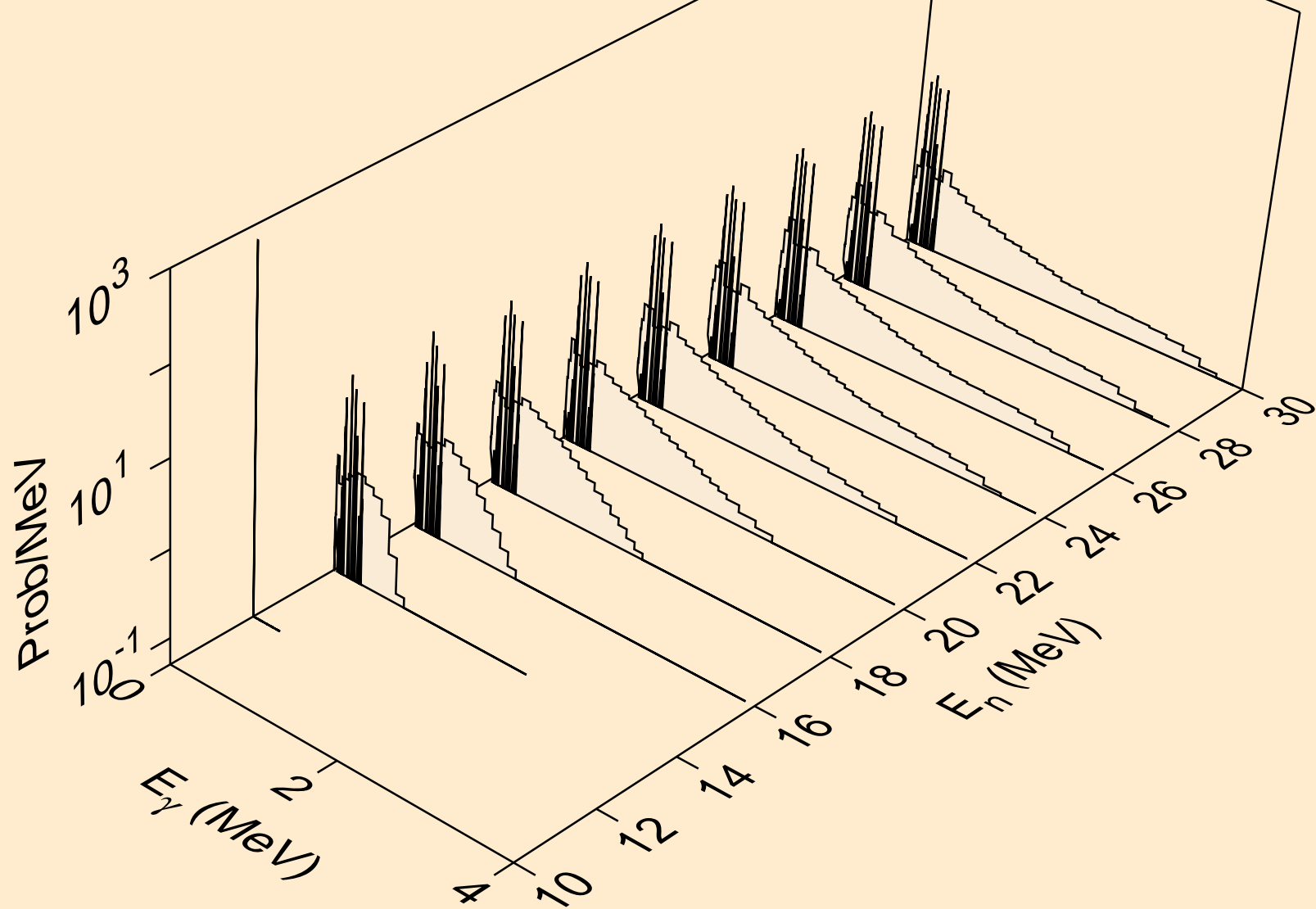

SE074 NEUTRON ACER TENDL-2023 LIBRARY; T=0.K  
Photon emission for (n,he3)

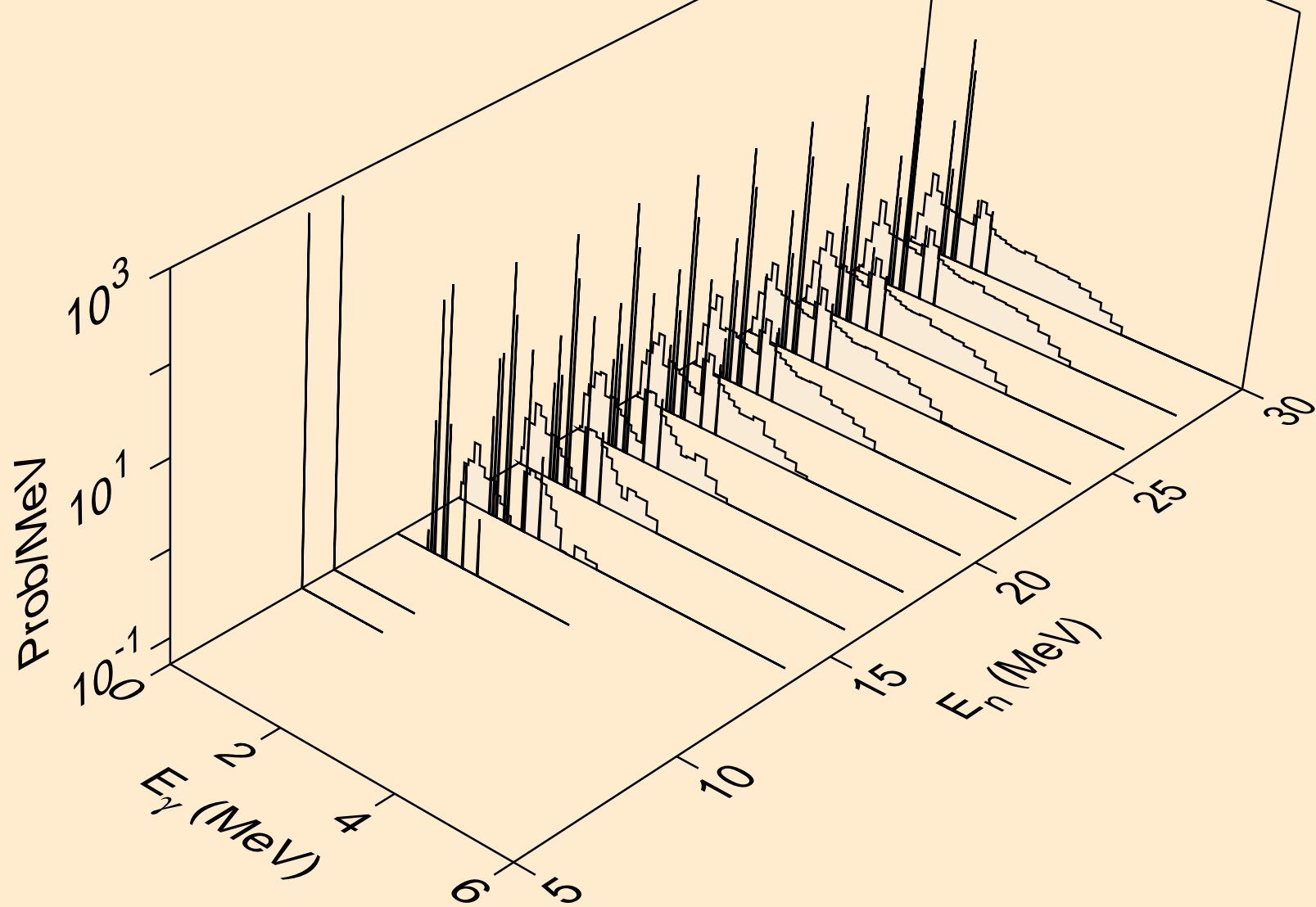

SE074 NEUTRON ACER TENDL-2023 LIBRARY; T=0.K  
Photon emission for (n,a)

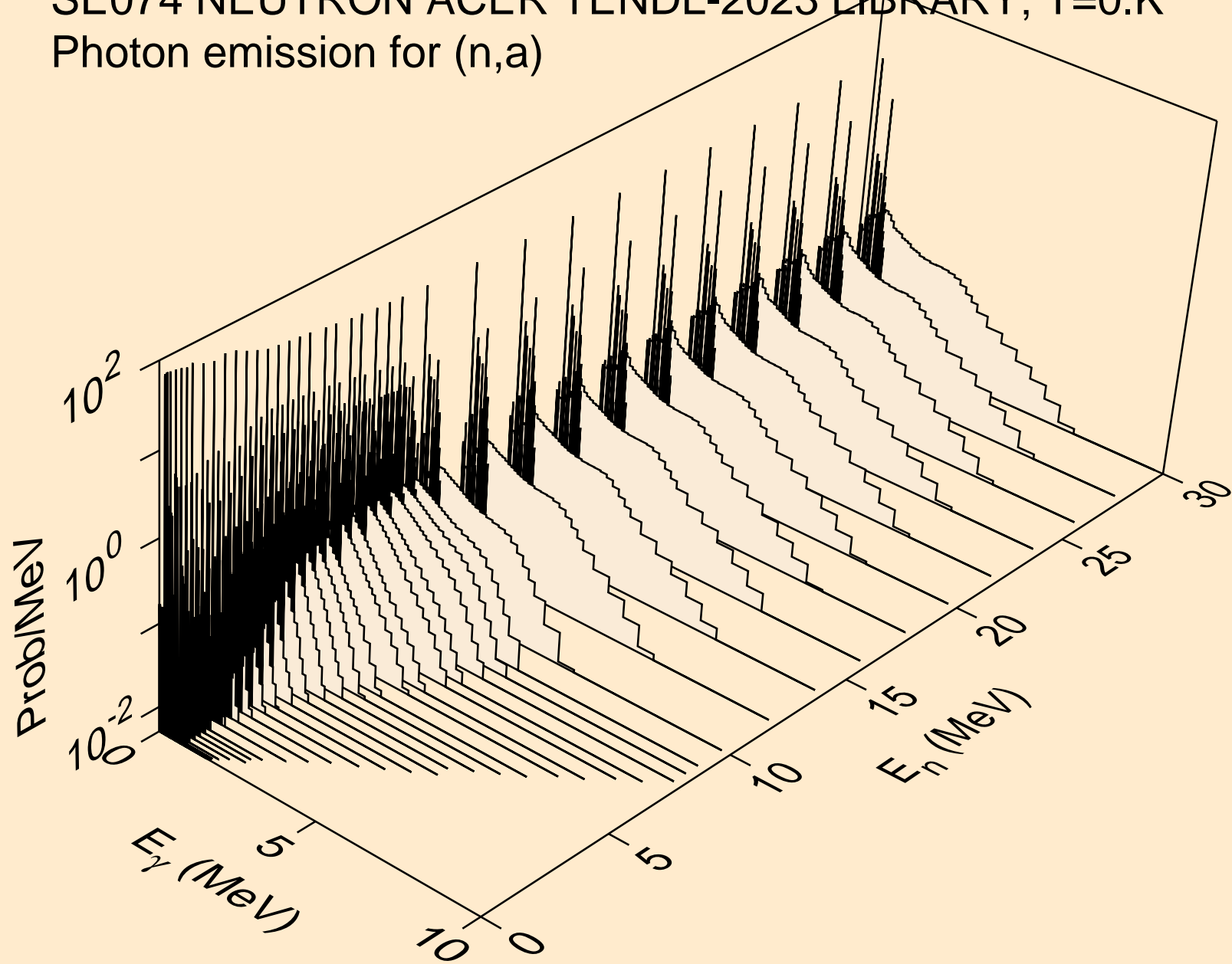

SE074 NEUTRON ACER TENDL-2023 LIBRARY; T=0.K  
Photon emission for (n,2a)

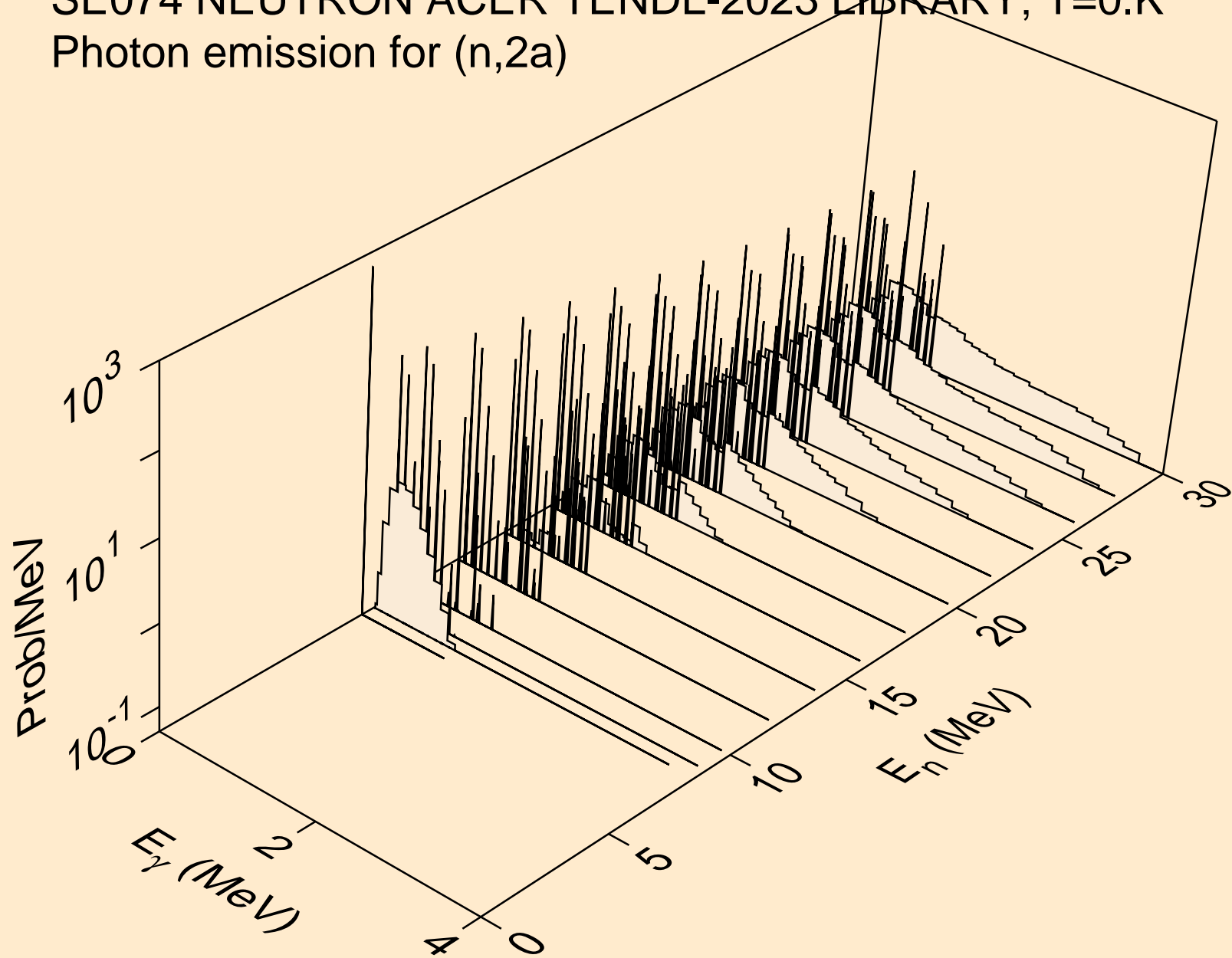

SE074 NEUTRON ACER TENDL-2023 LIBRARY; T=0.K  
Photon emission for (n,3a)

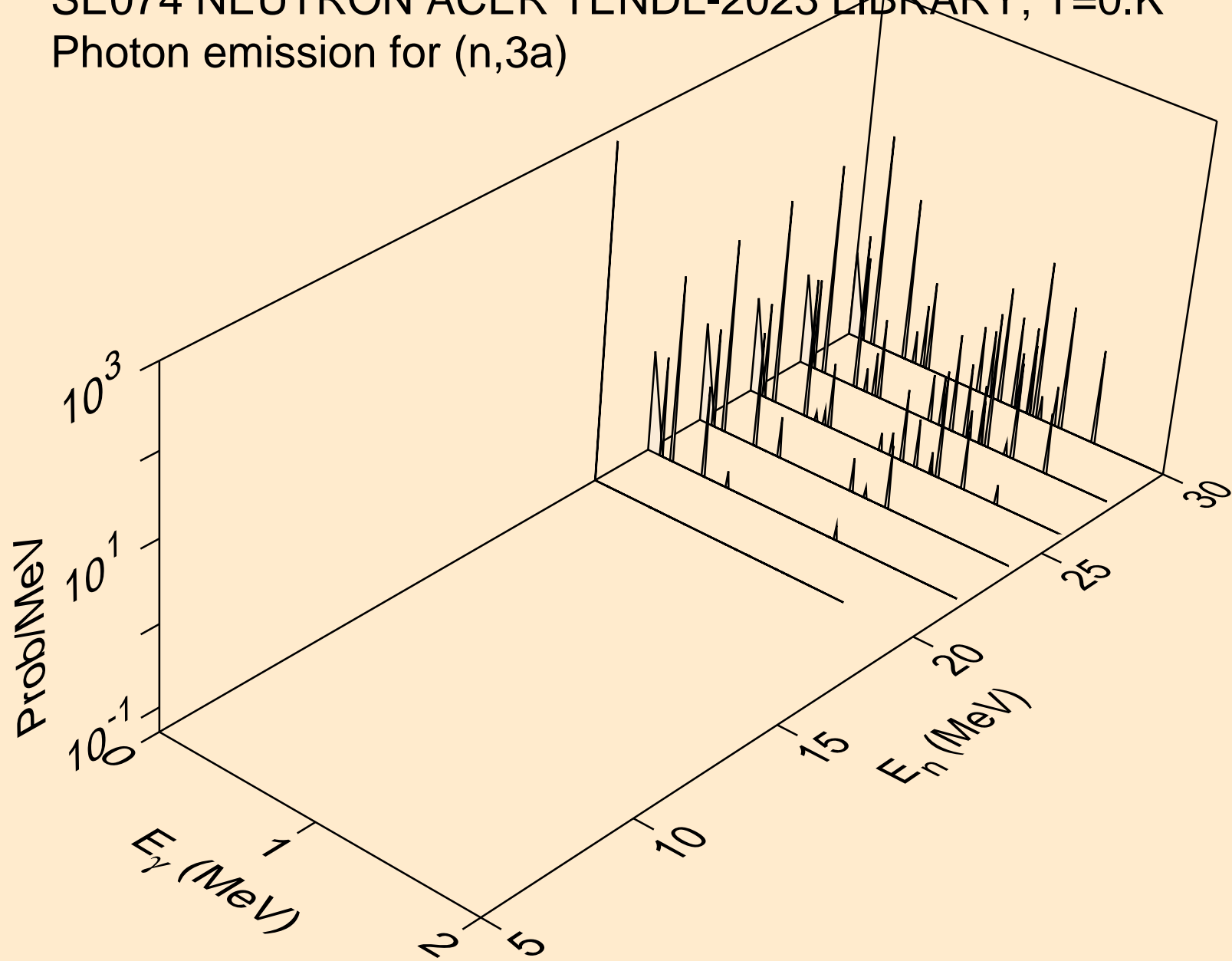

SE074 NEUTRON ACER TENDL-2023 LIBRARY; T=0.K  
Photon emission for (n,2p)

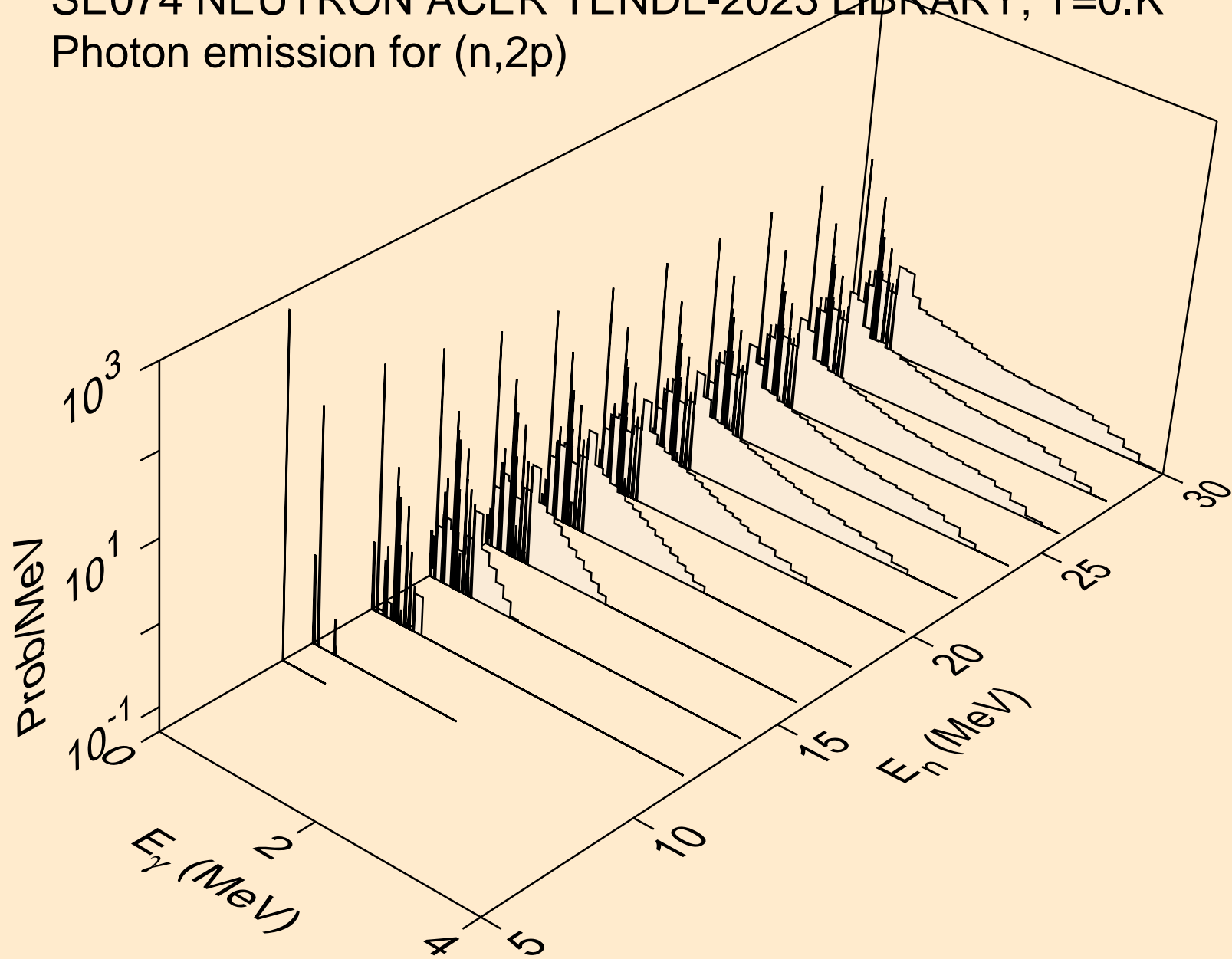

SE074 NEUTRON ACER TENDL-2023 LIBRARY; T=0.K  
Photon emission for (n,p $\alpha$ )

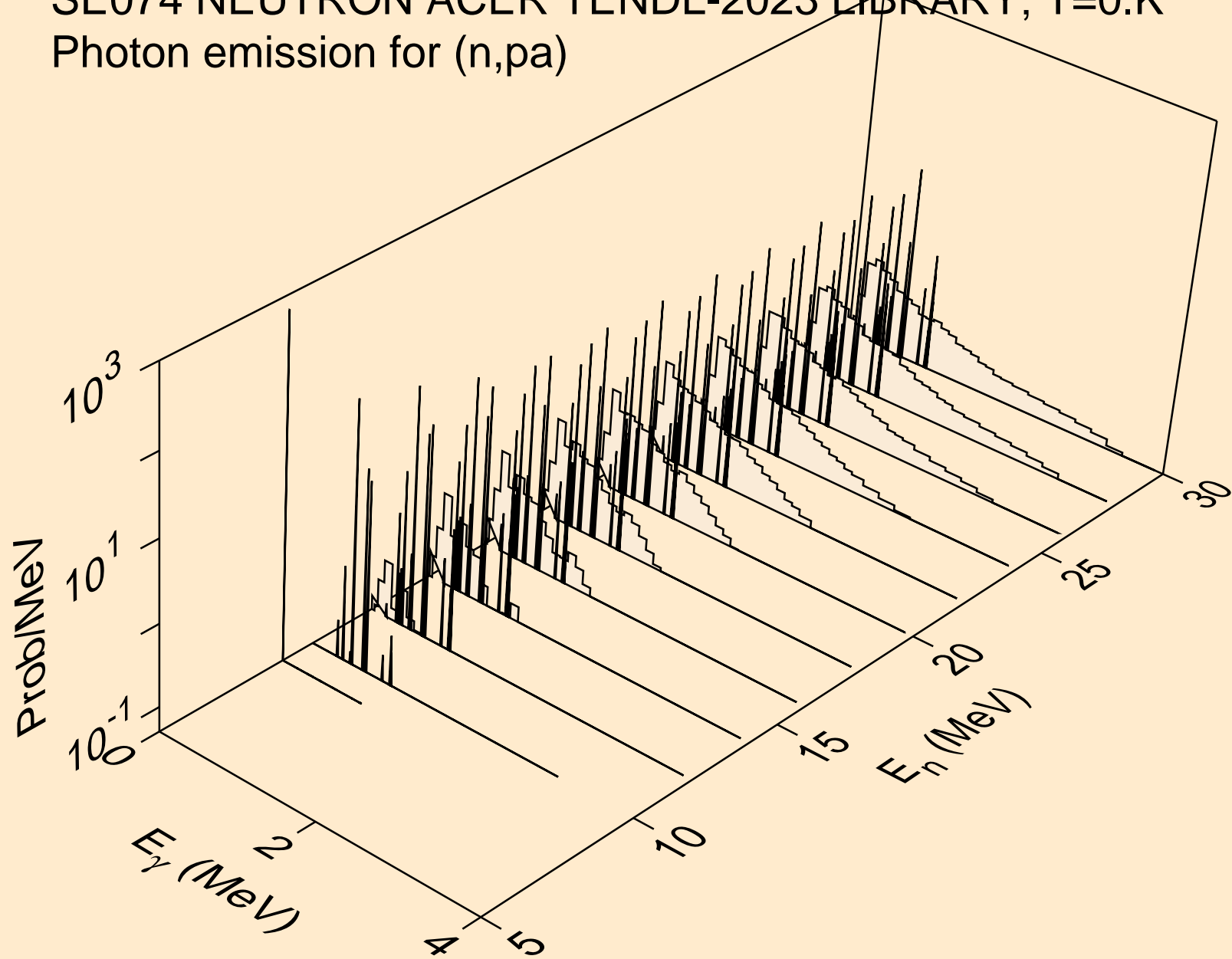

SE074 NEUTRON ACER TENDL-2023 LIBRARY; T=0.K  
Photon emission for (n,pd)

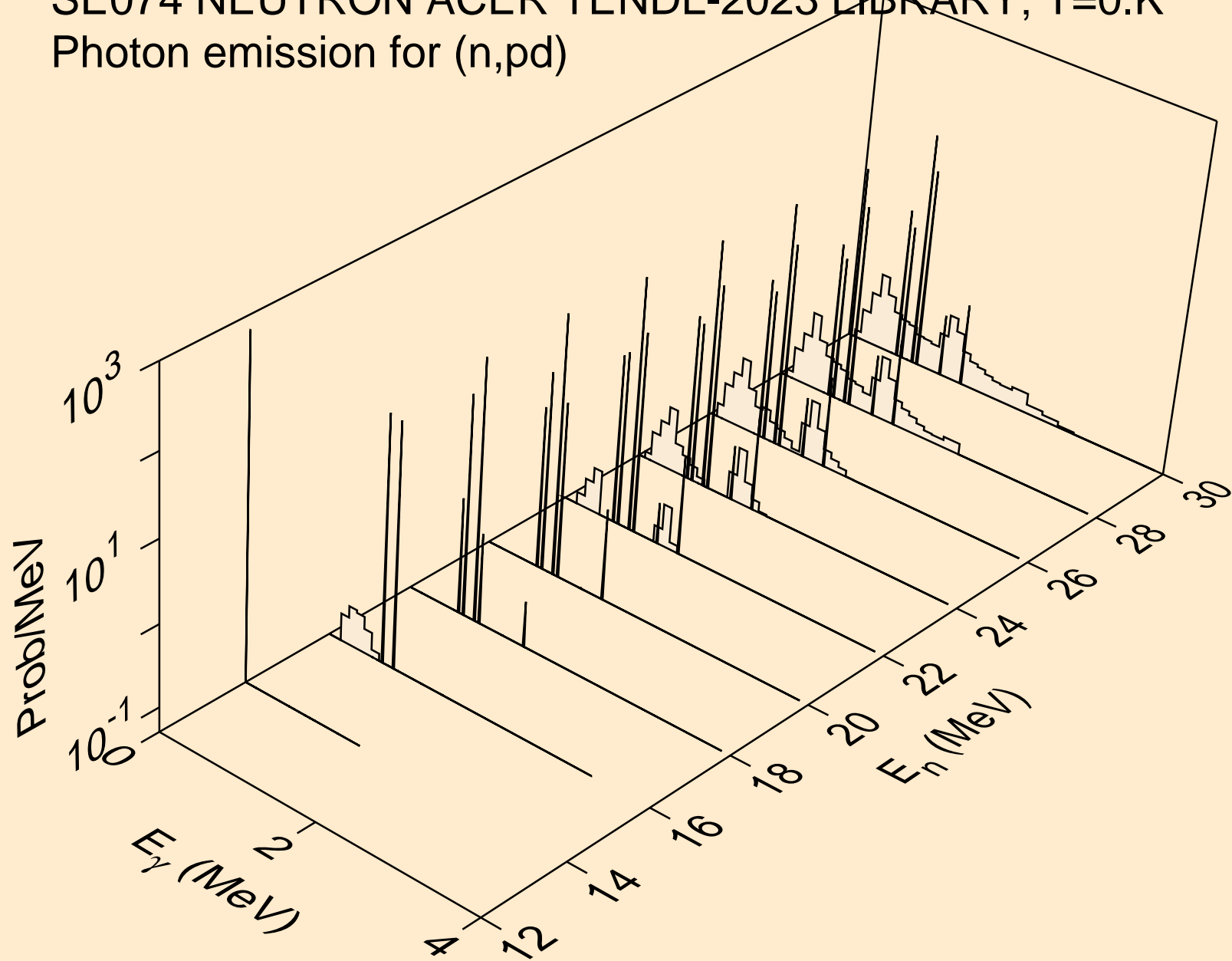



SE074 NEUTRON ACER TENDL-2023 LIBRARY; T=0.K  
Photon emission for (n,pt)

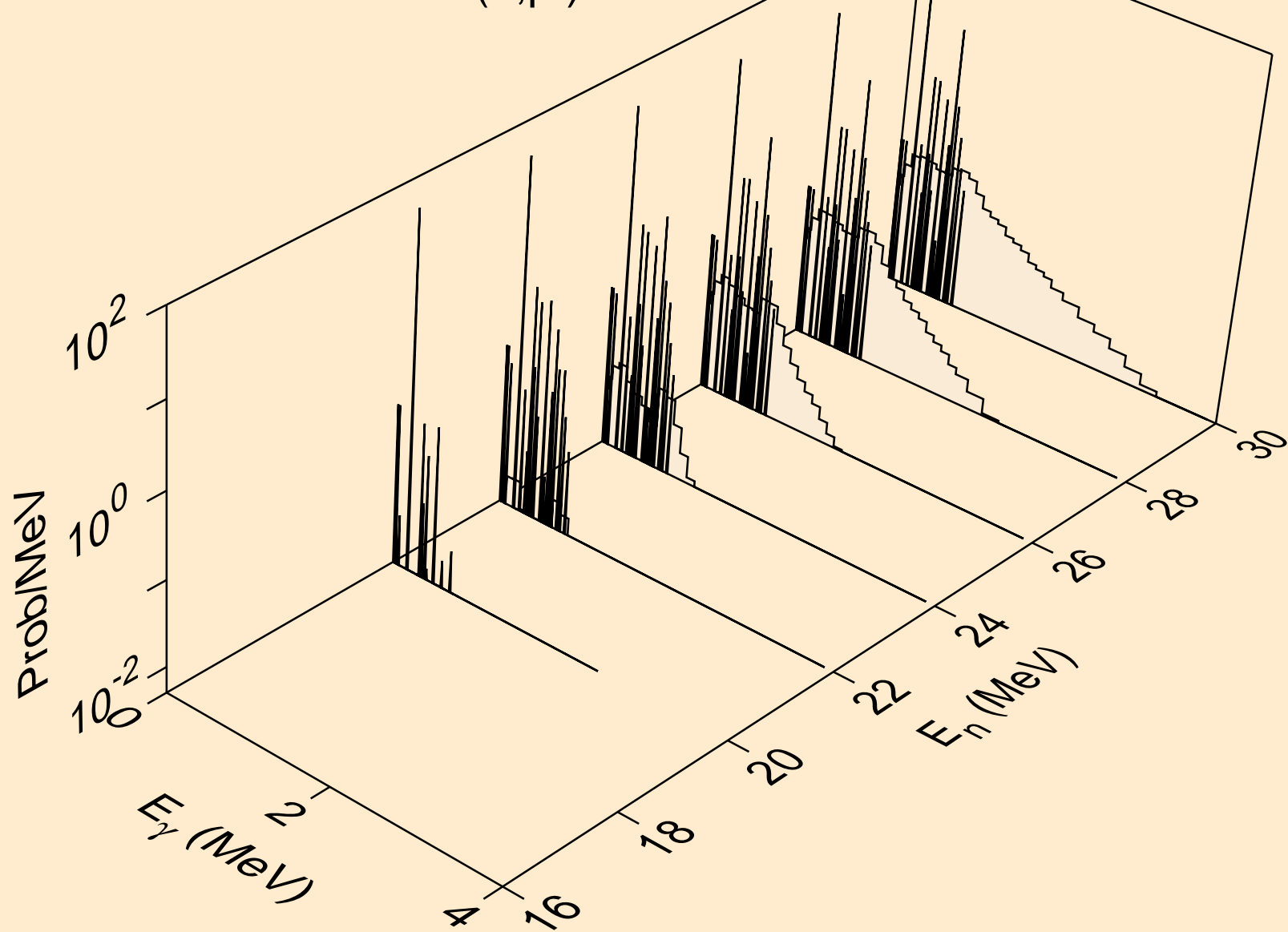

SE074 NEUTRON ACER TENDL-2023 LIBRARY; T=0.K  
Photon emission for (n,da)

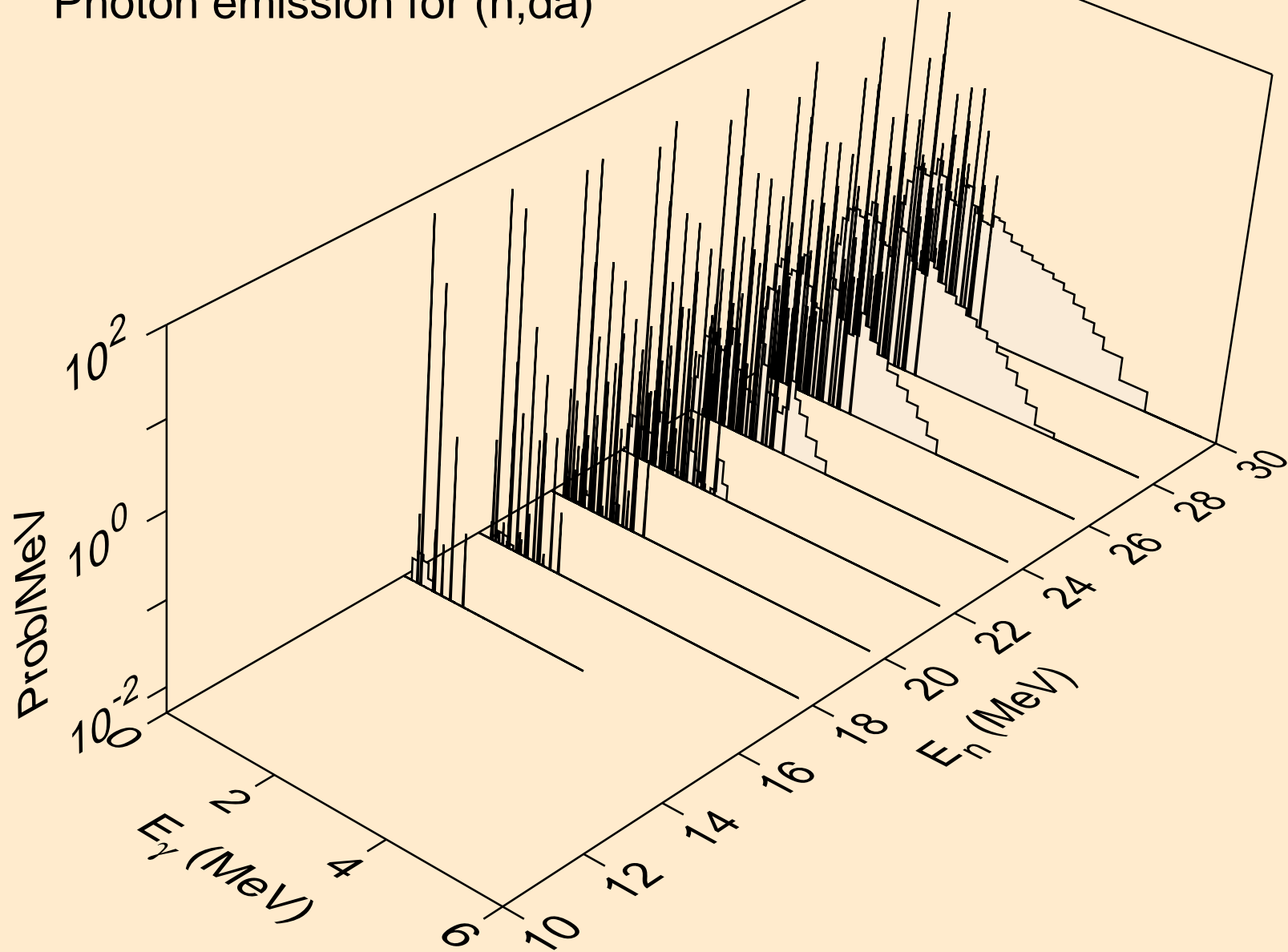

SE074 NEUTRON ACER TENDL-2023 LIBRARY; T=0.K  
thermal capture photon spectrum

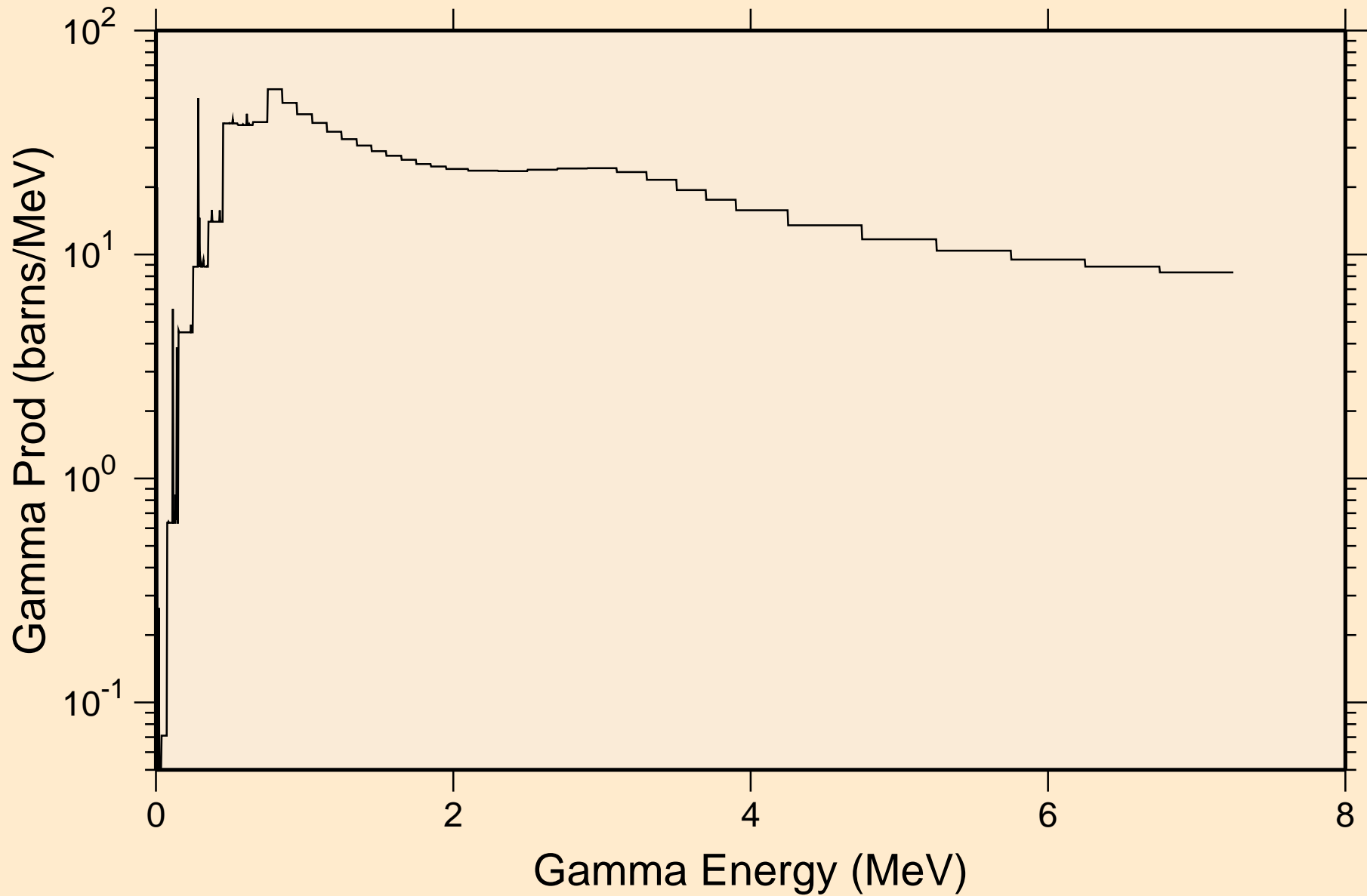

SE074 NEUTRON ACER TENDL-2023 LIBRARY; T=0.K  
14 MeV photon spectrum

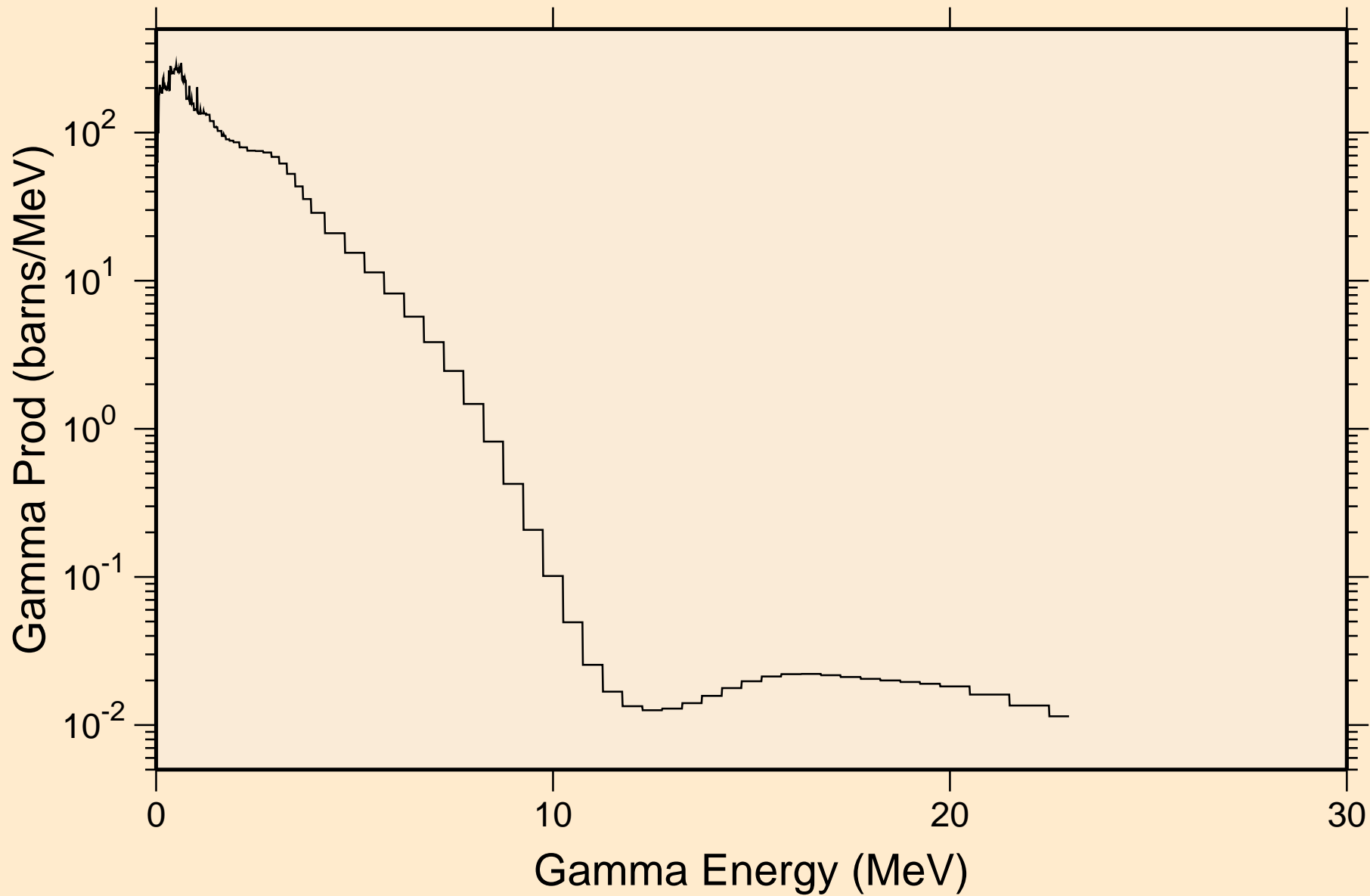

# SE074 NEUTRON ACER TENDL-2023 LIBRARY; T=0.K

## Particle heating contributions

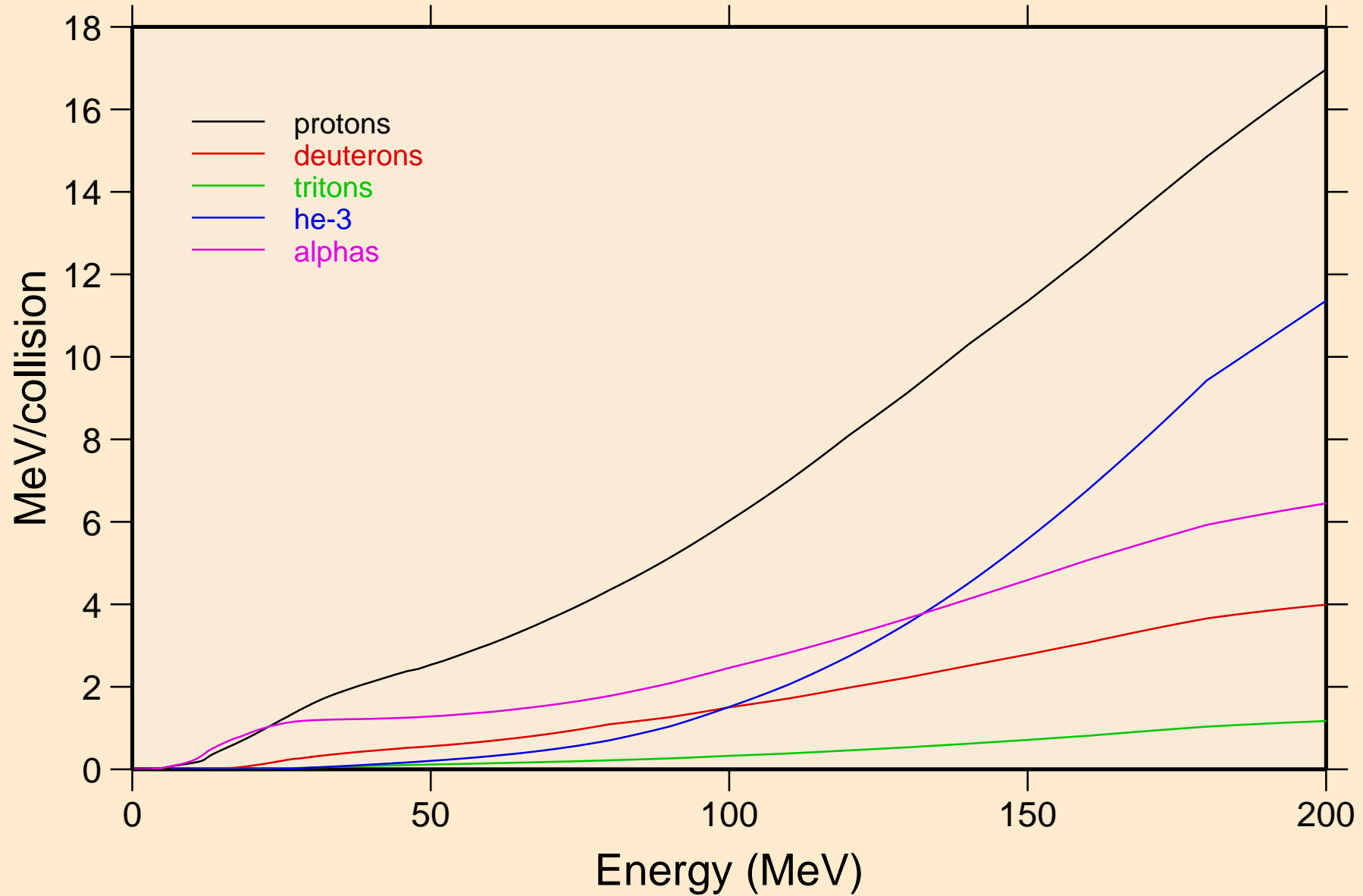

SE074 NEUTRON ACER TENDL-2023 LIBRARY; T=0.K  
Recoil Heating

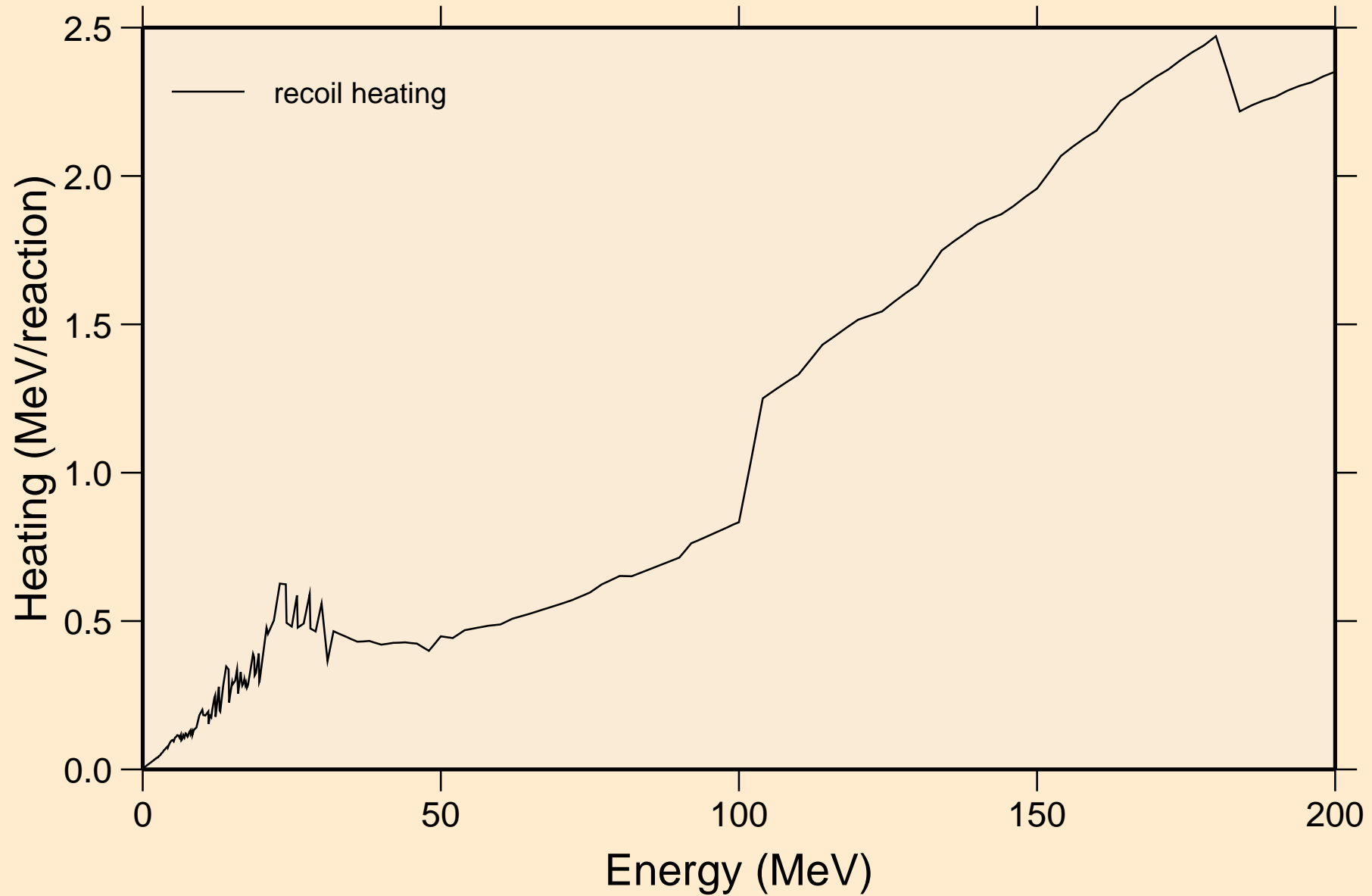

SE074 NEUTRON ACER TENDL-2023 LIBRARY; T=0.K  
Particle production cross sections

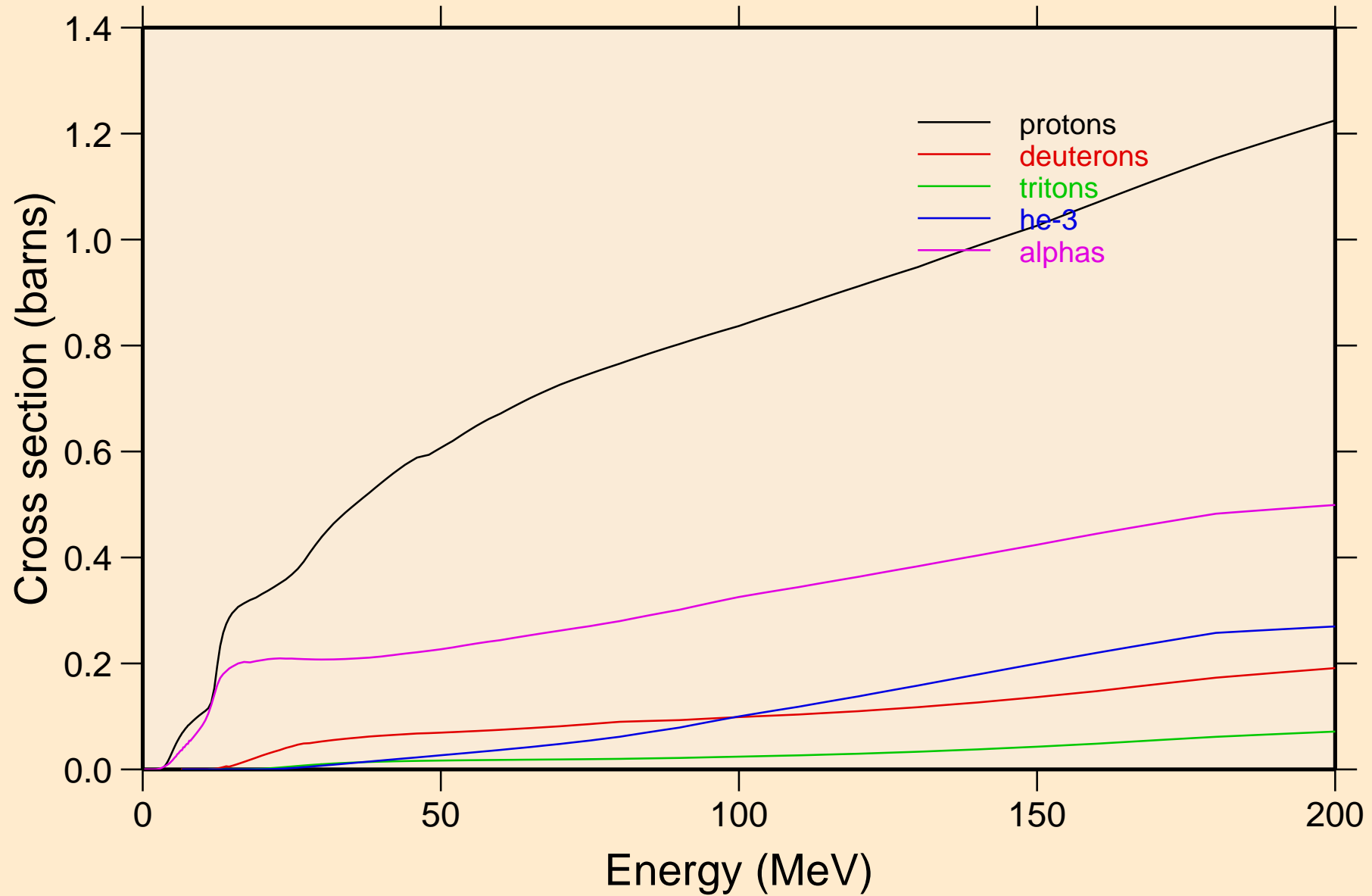

SE074 NEUTRON ACER TENDL-2023 LIBRARY; T=0.K  
protons from (n,x)

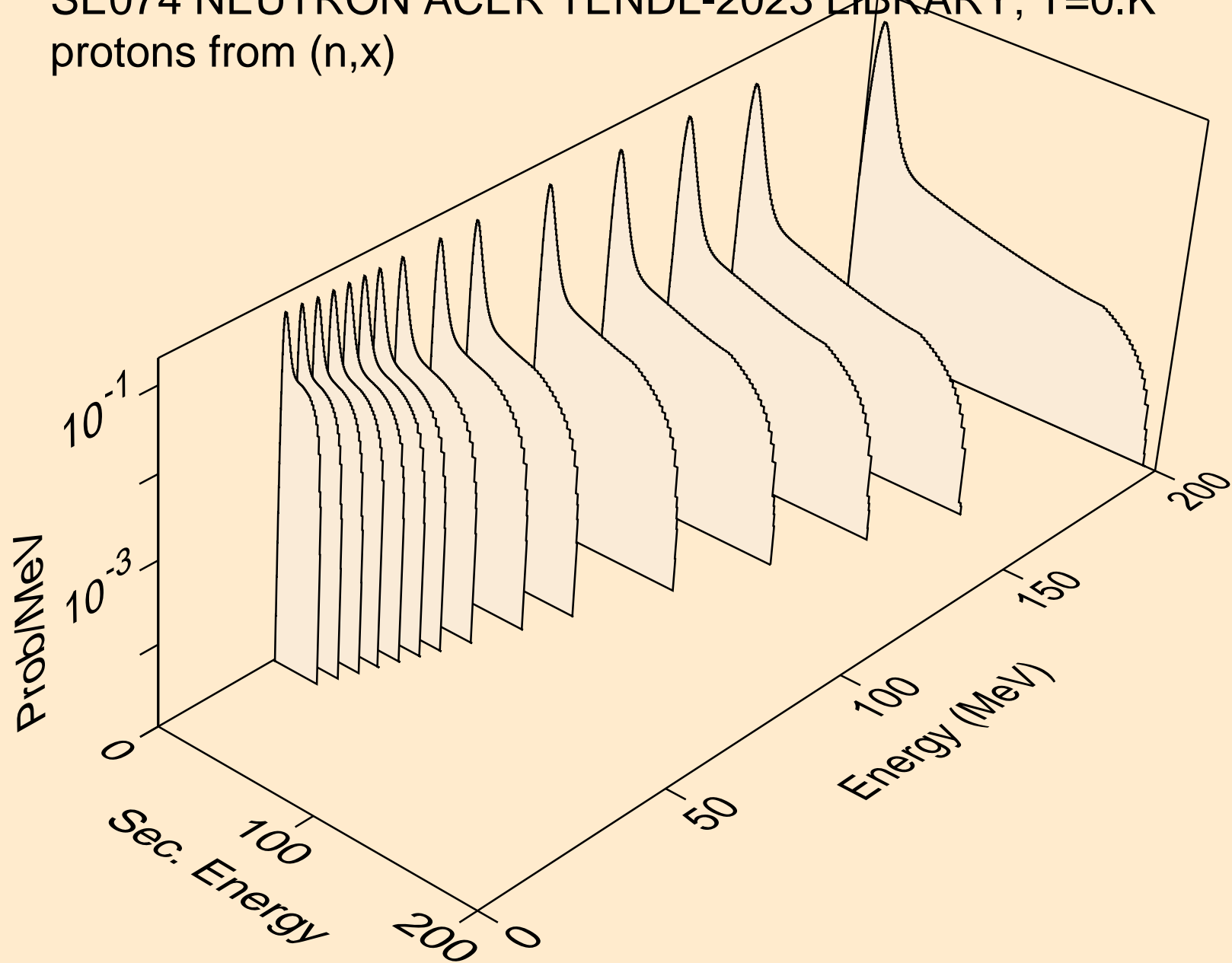



SE074 NEUTRON ACER TENDL-2023 LIBRARY; T=0.K  
protons from (n,n\*)p

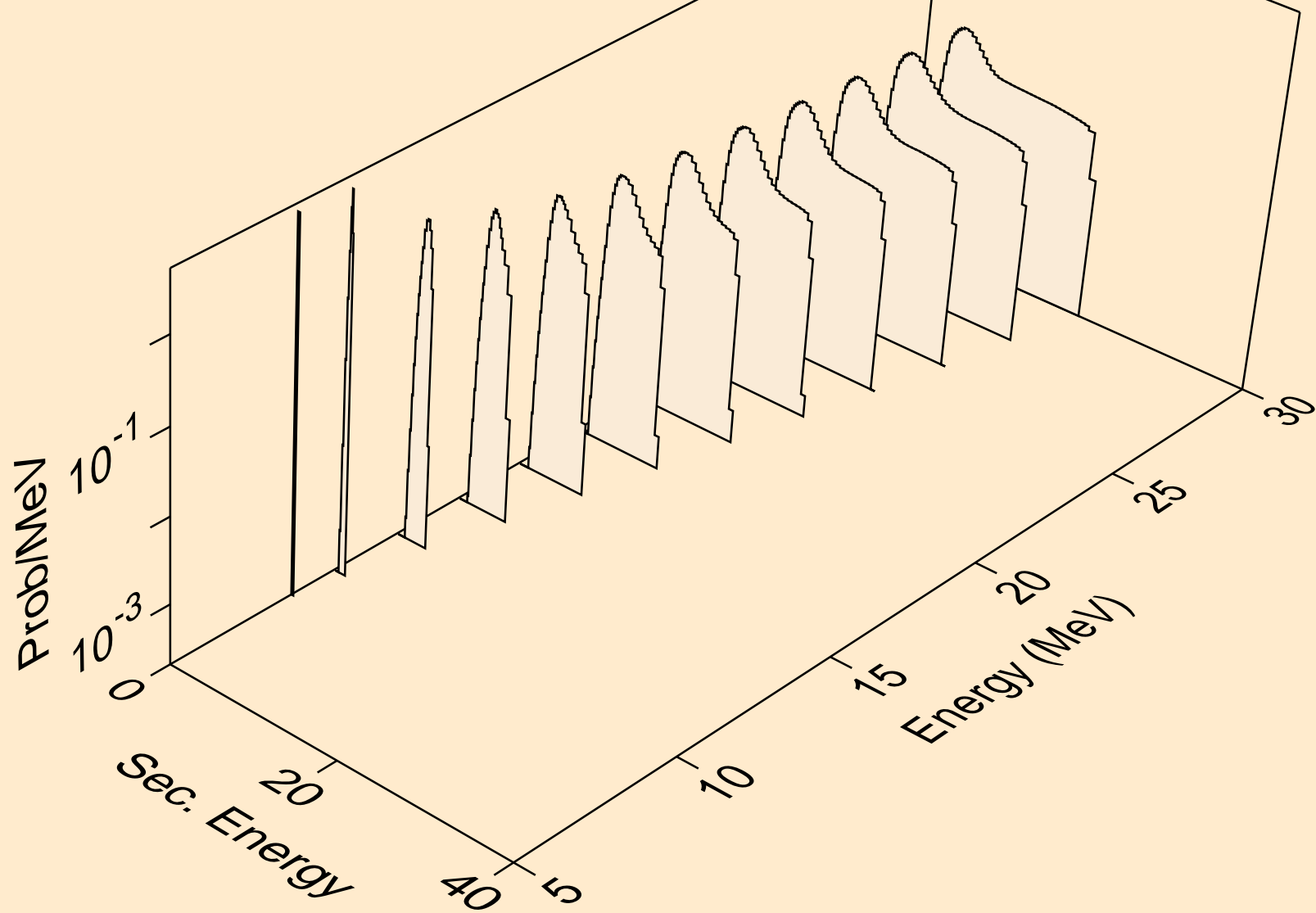

SE074 NEUTRON ACER TENDL-2023 LIBRARY; T=0.K  
protons from (n,2np)

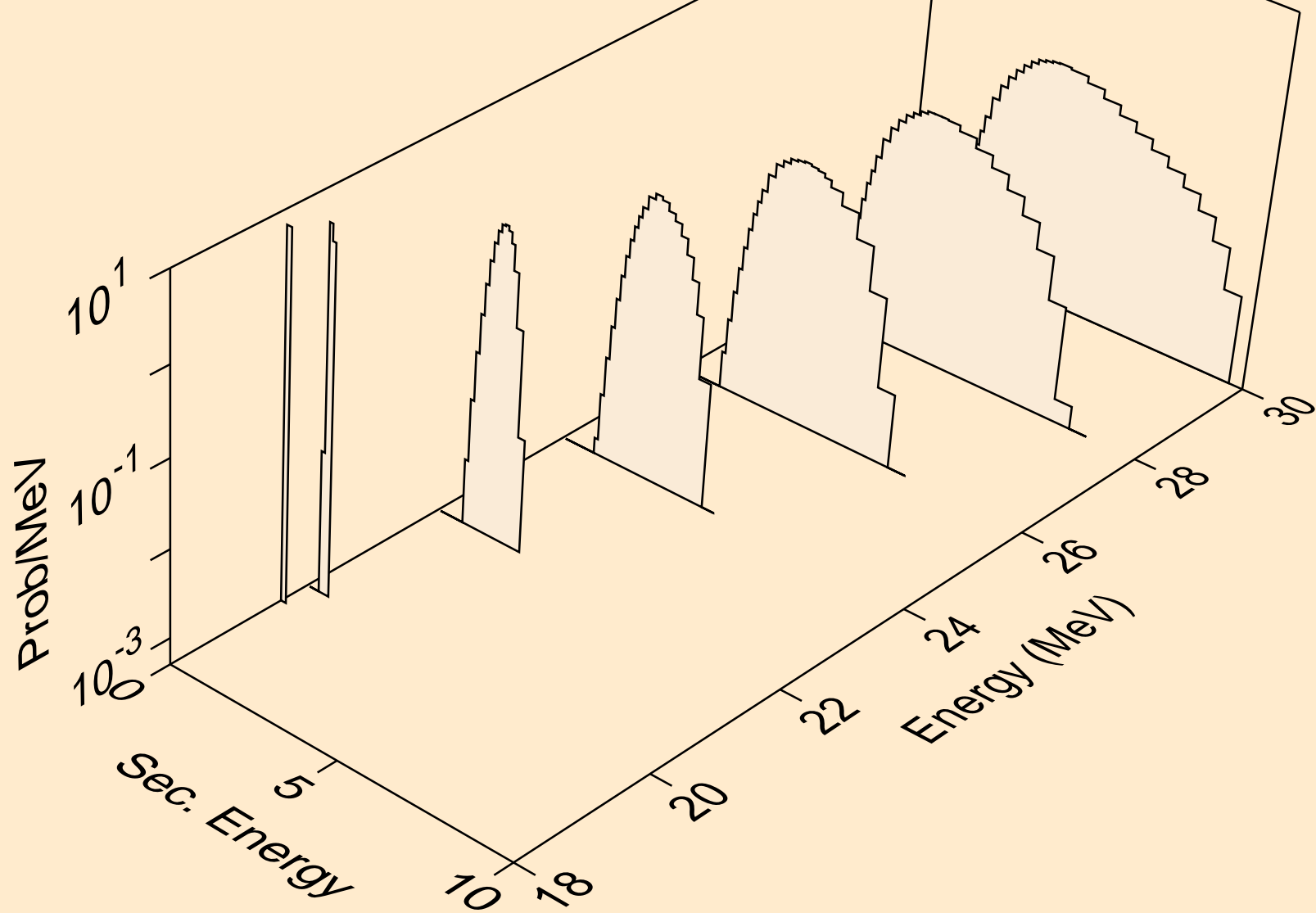

SE074 NEUTRON ACER TENDL-2023 LIBRARY; T=0.K  
protons from (n,3np)

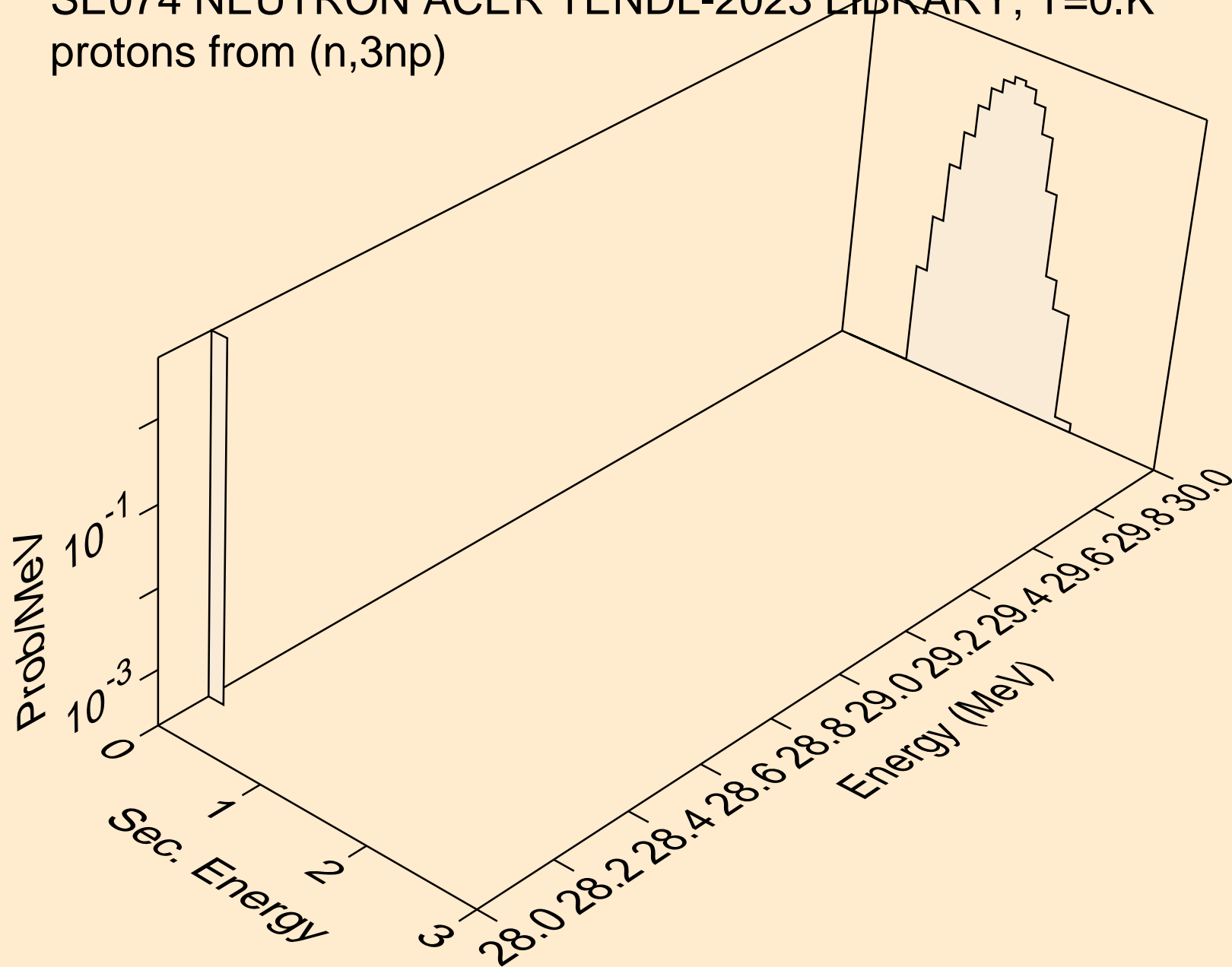

SE074 NEUTRON ACER TENDL-2023 LIBRARY; T=0.K  
protons from (n,n2p)

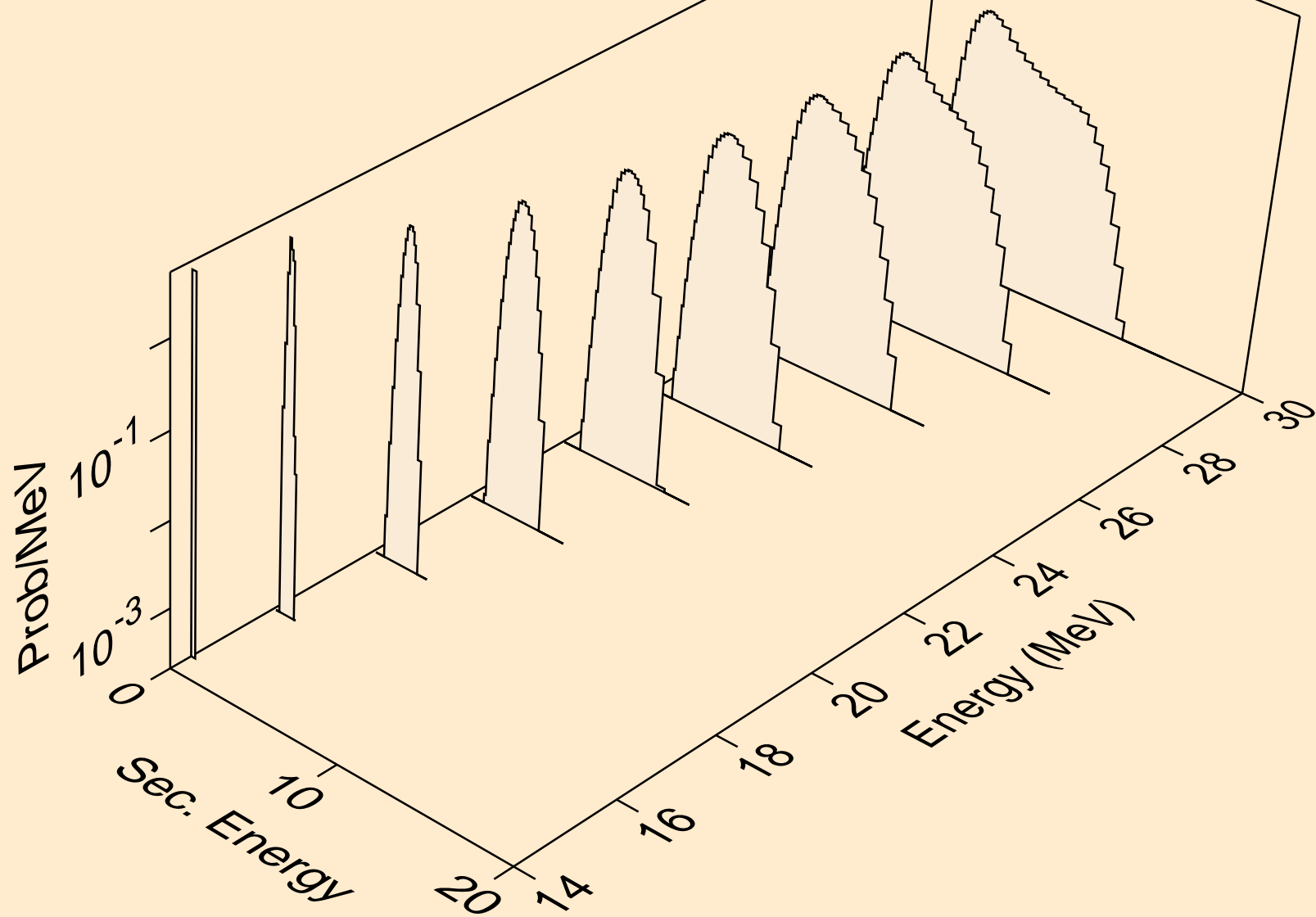

SE074 NEUTRON ACER TENDL-2023 LIBRARY; T=0.K  
protons from (n,npa)

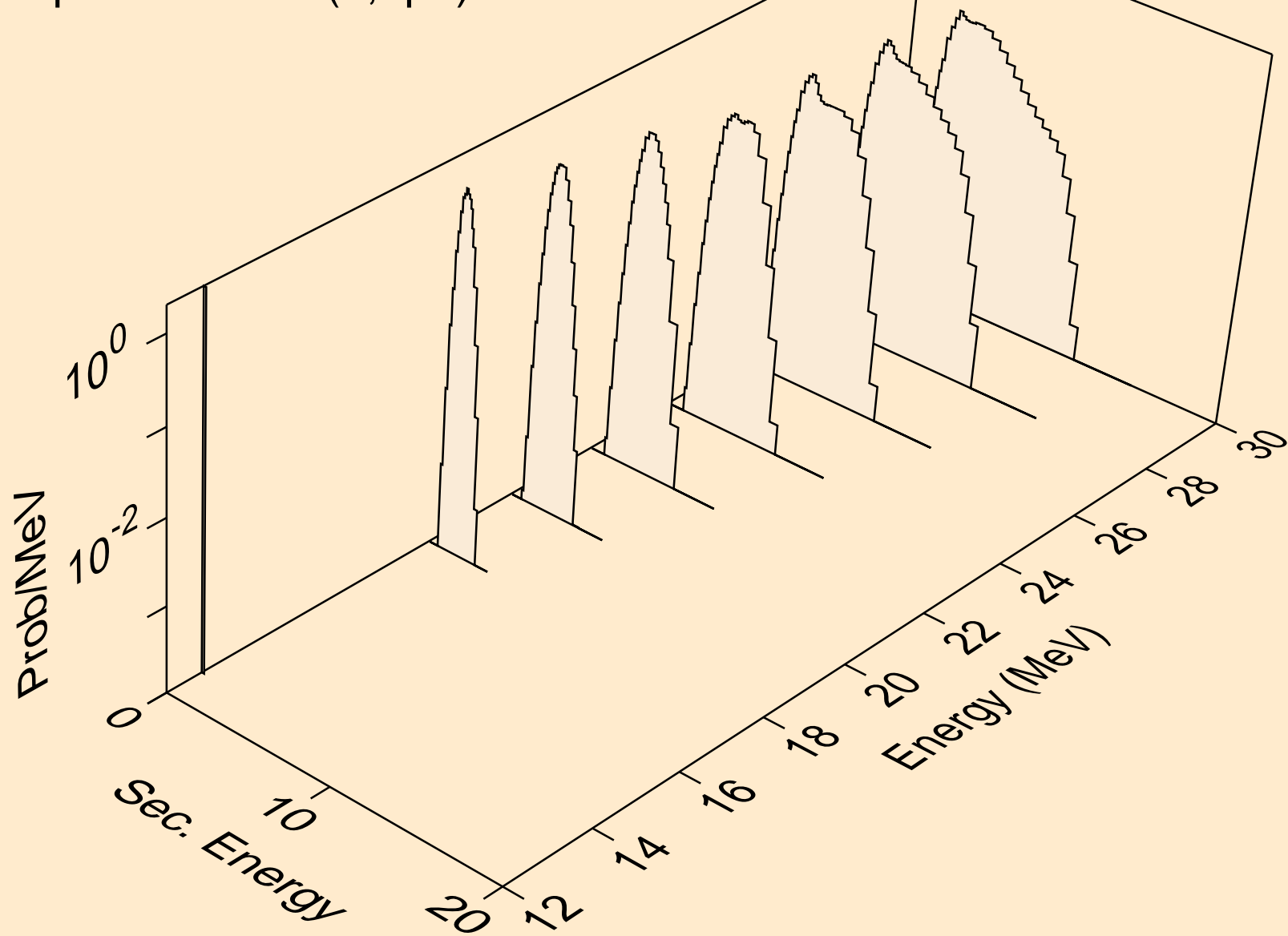

SE074 NEUTRON ACER TENDL-2023 LIBRARY; T=0.K  
protons from (n,p)

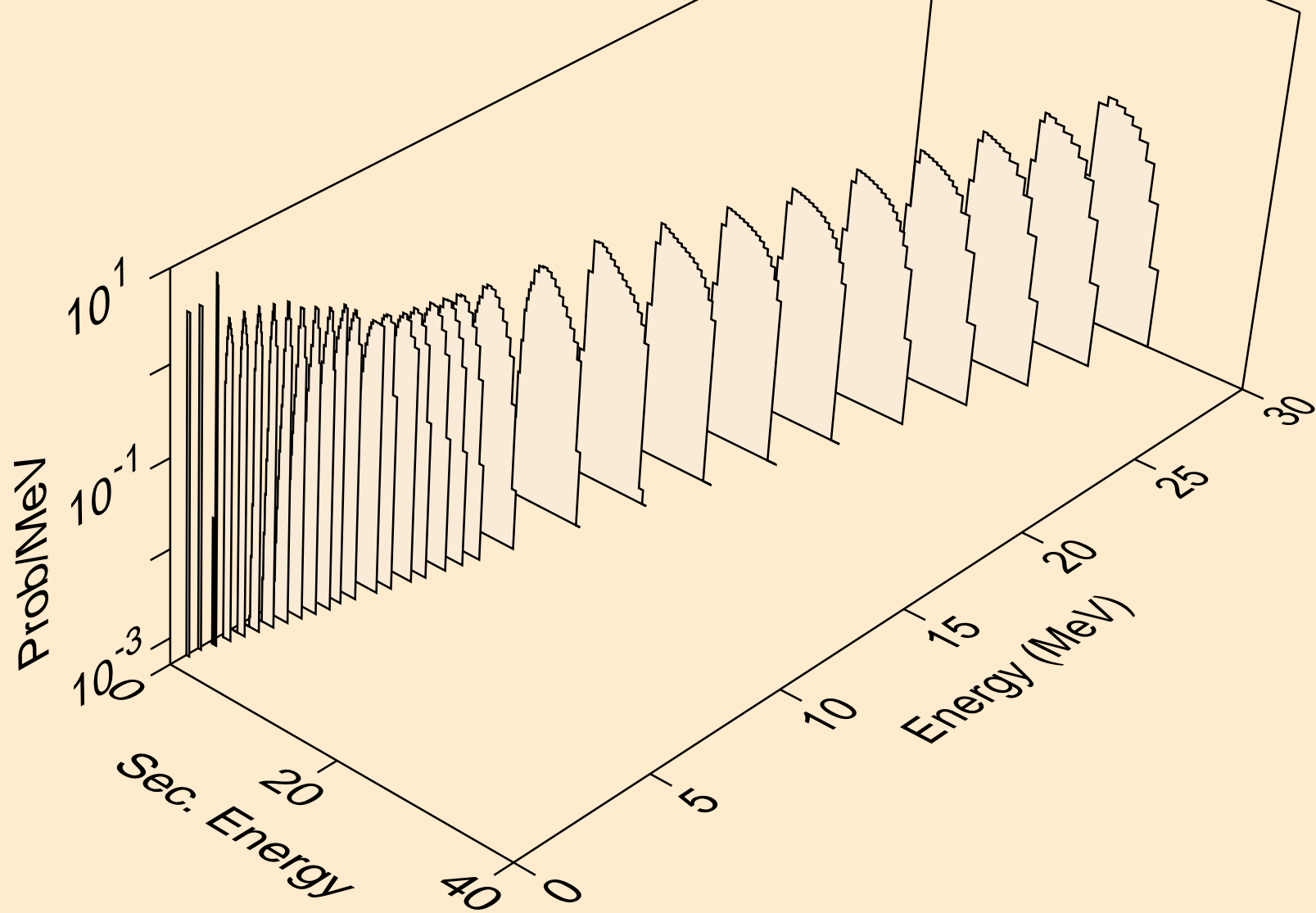

SE074 NEUTRON ACER TENDL-2023 LIBRARY; T=0.K  
protons from (n,2p)

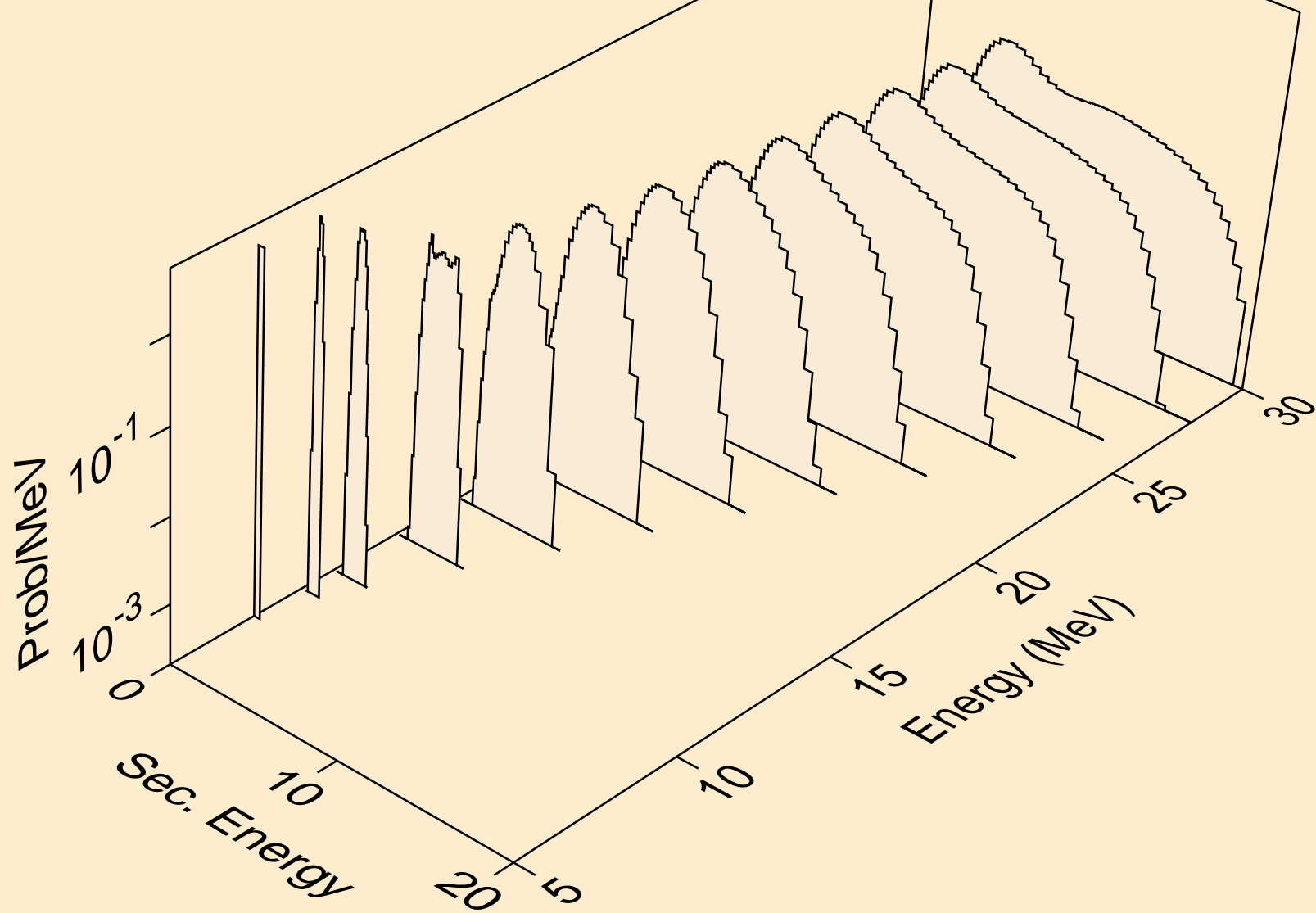

SE074 NEUTRON ACER TENDL-2023 LIBRARY; T=0.K  
protons from (n,p)

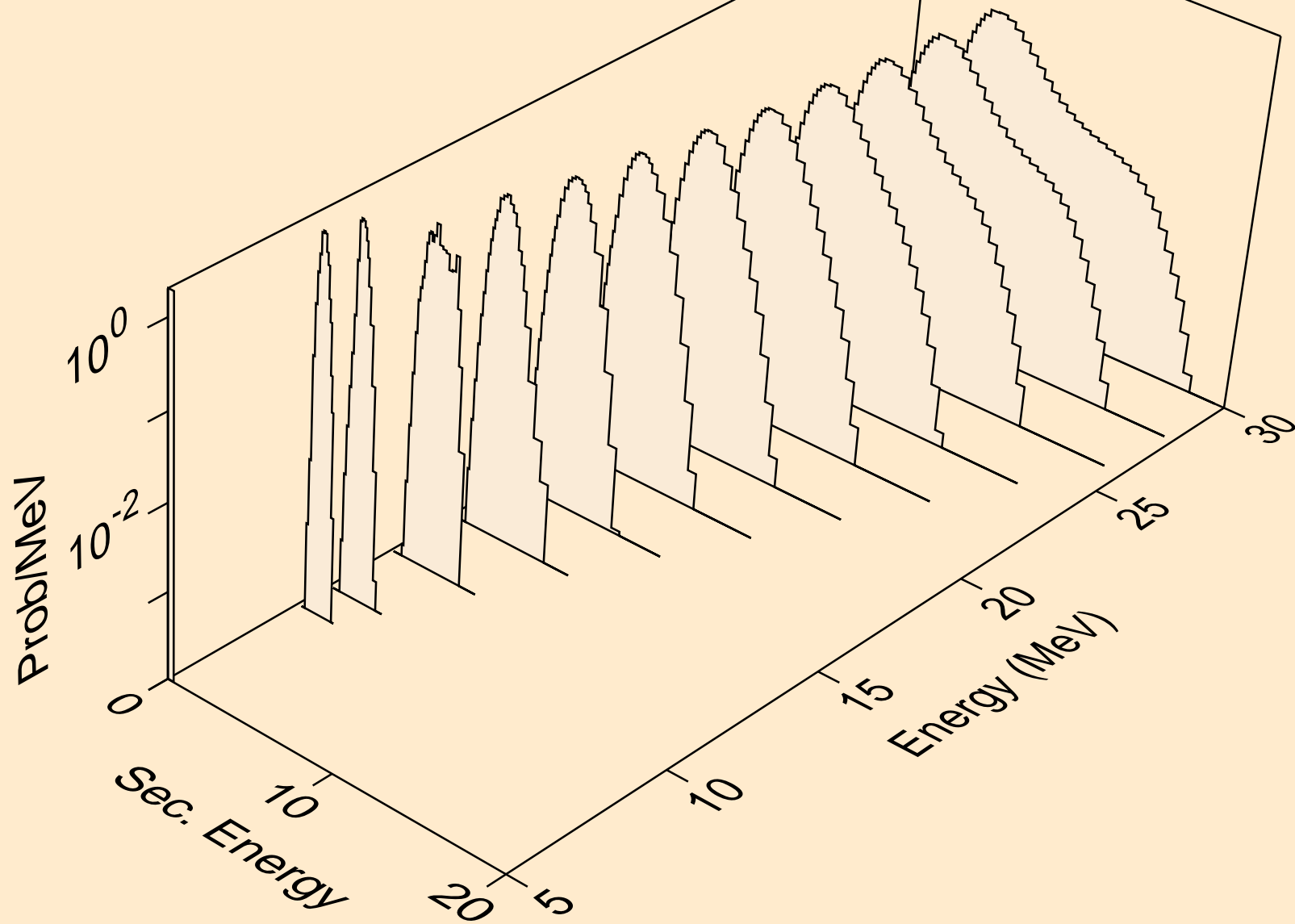



SE074 NEUTRON ACER TENDL-2023 LIBRARY; T=0.K  
protons from (n,pd)

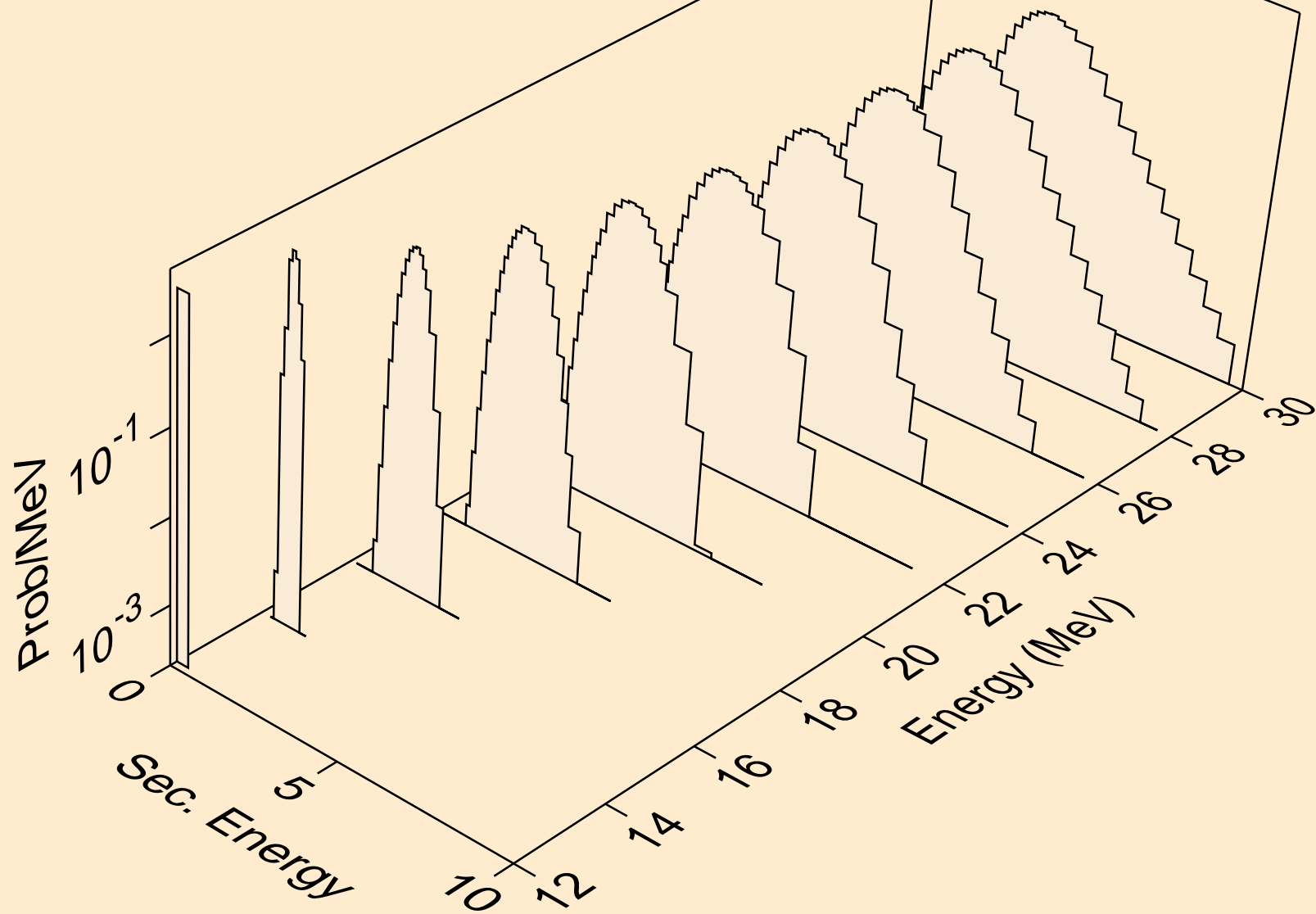

SE074 NEUTRON ACER TENDL-2023 LIBRARY; T=0.K  
protons from (n,pt)

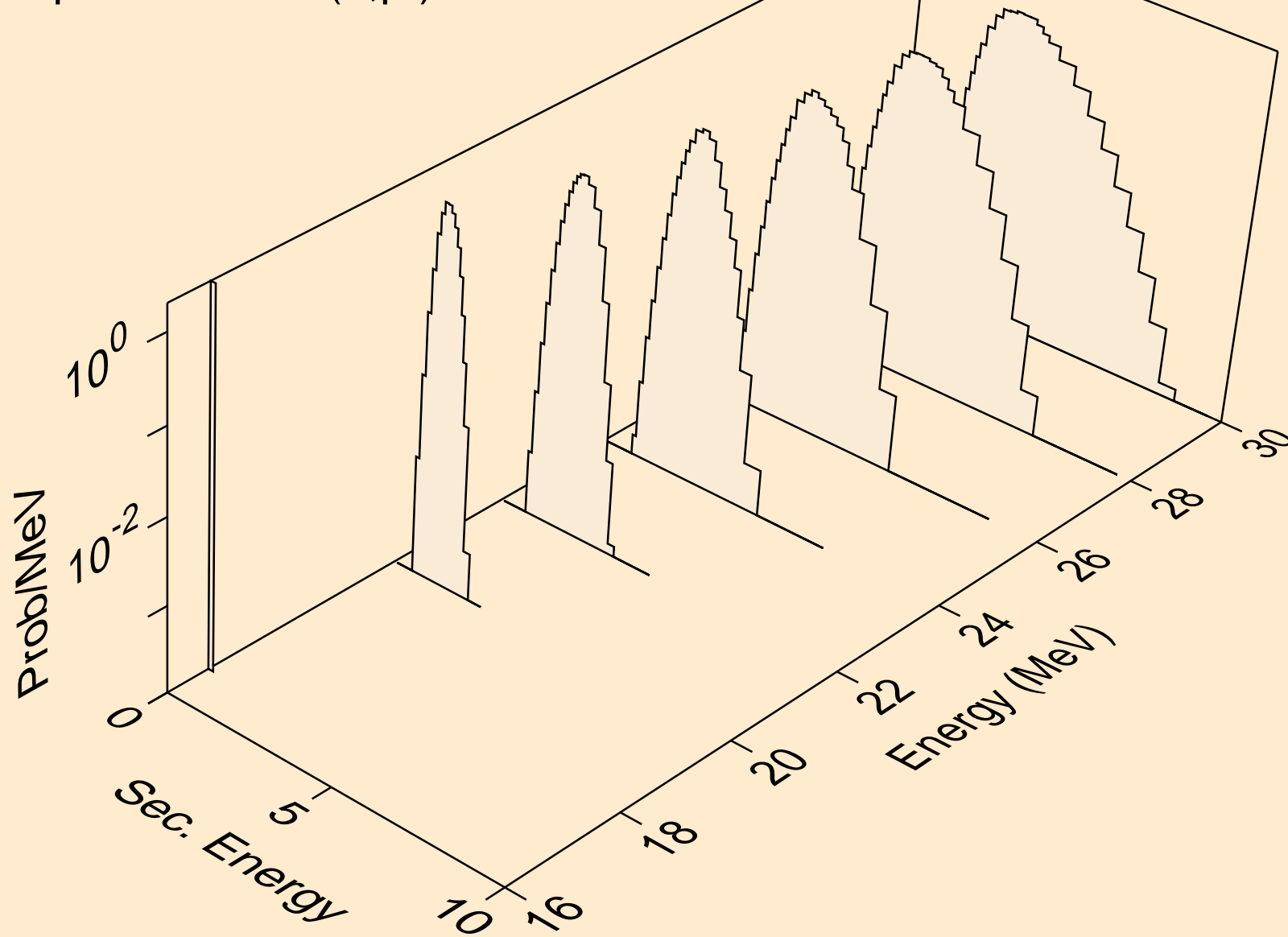

SE074 NEUTRON ACER TENDL-2023 LIBRARY; T=0.K  
deuterons from (n,x)

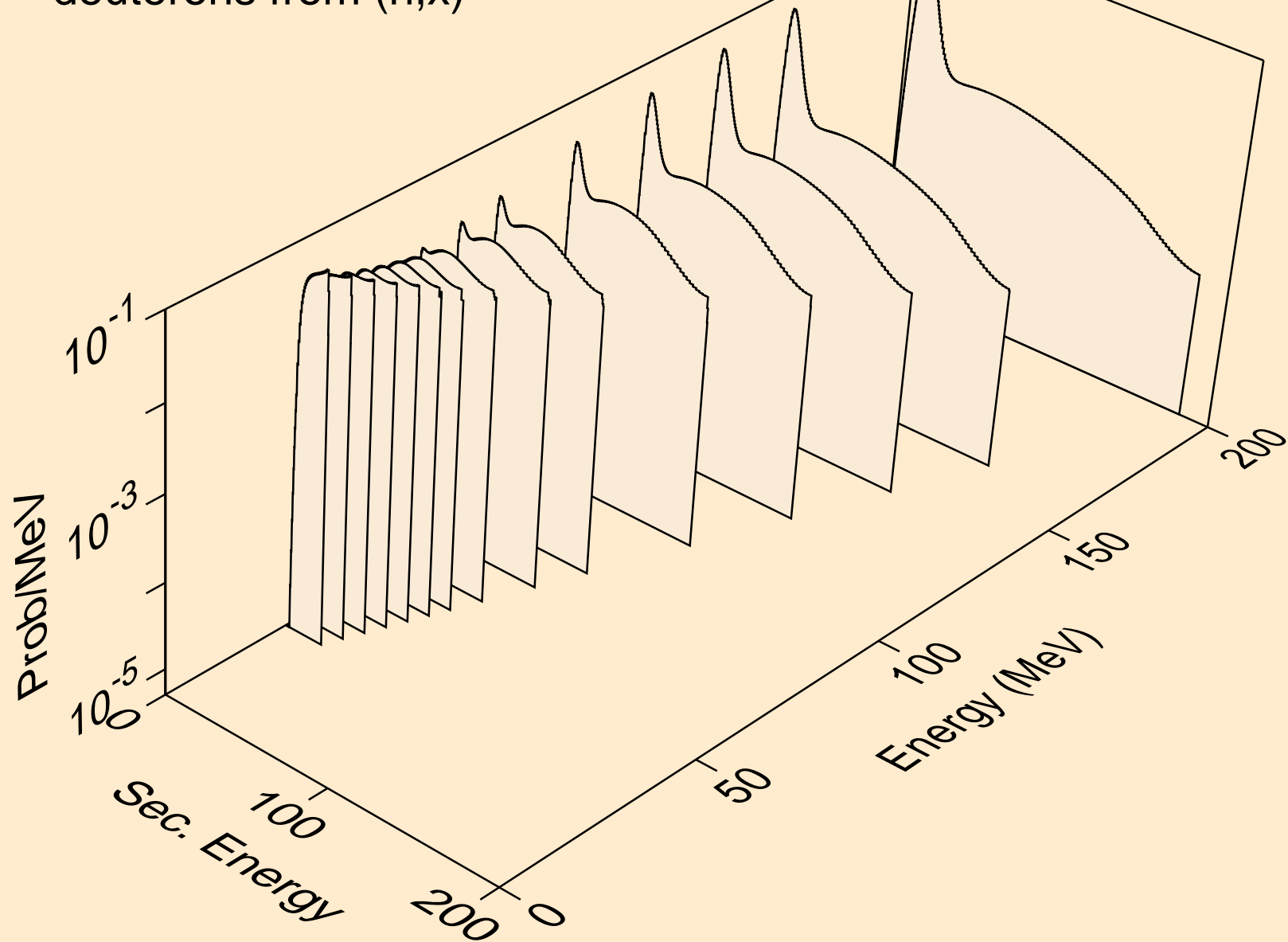

SE074 NEUTRON ACER TENDL-2023 LIBRARY; T=0.K  
deuterons from (n,2nd)

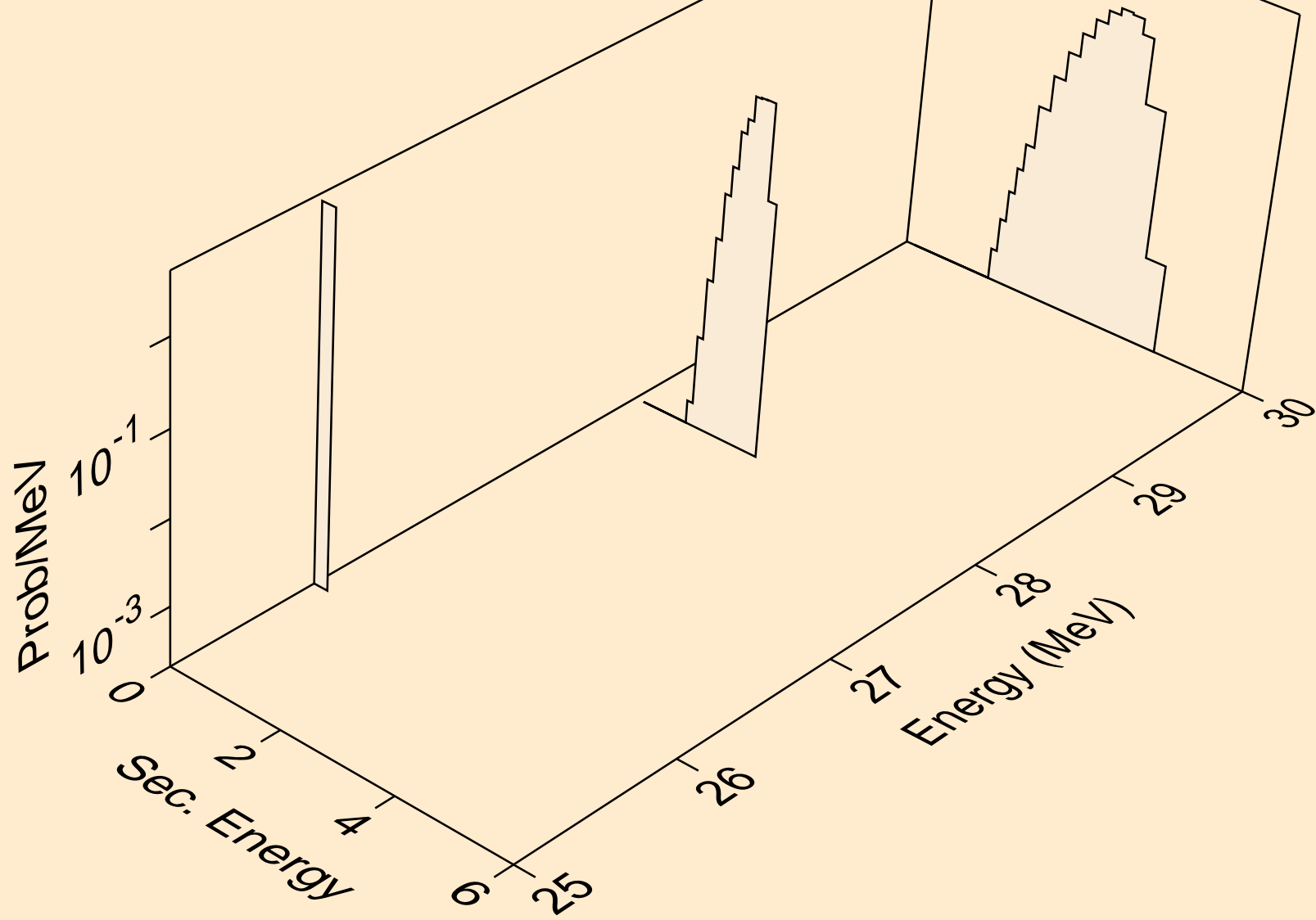

SE074 NEUTRON ACER TENDL-2023 LIBRARY; T=0.K  
deuterons from (n,n\*)d

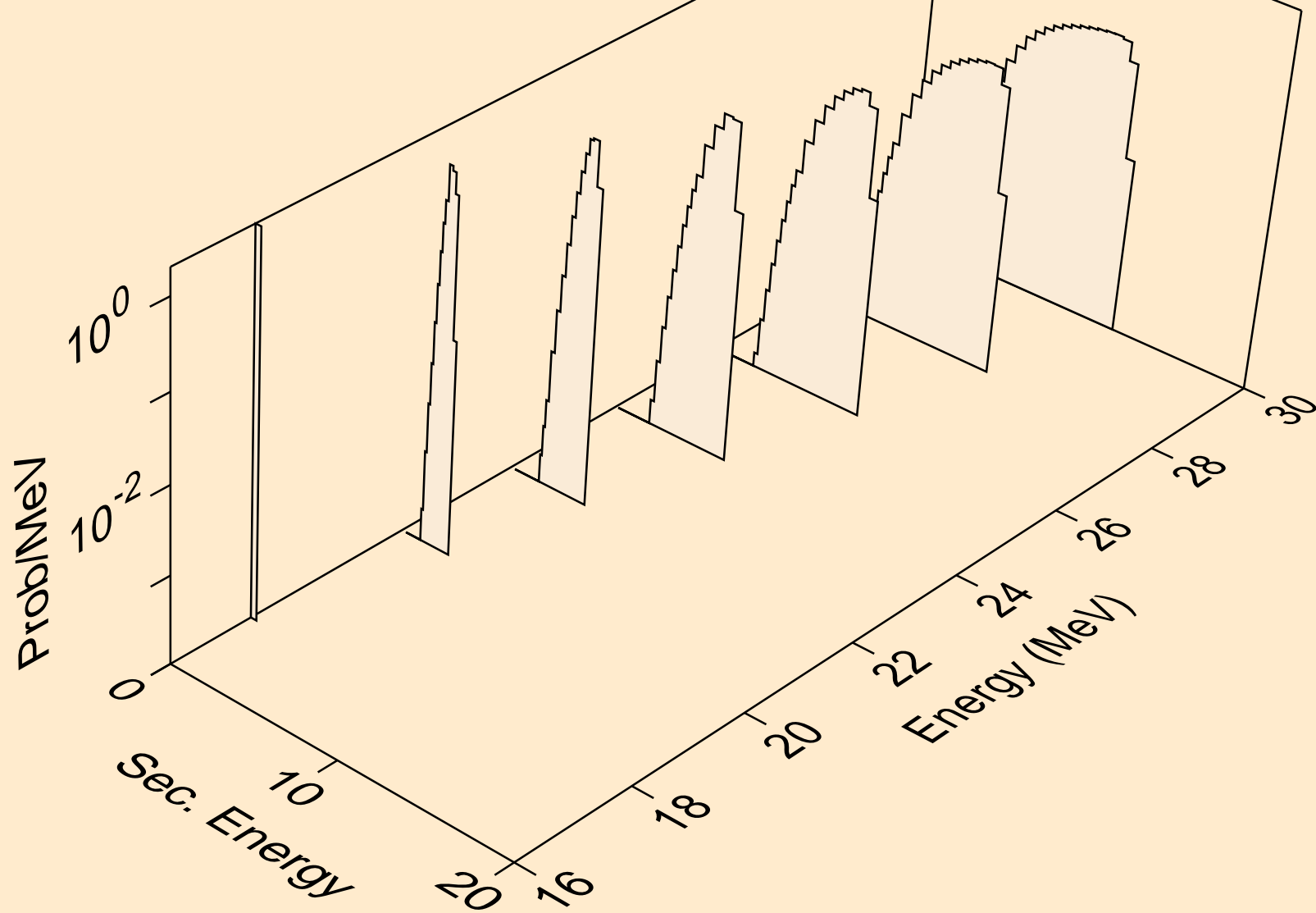

SE074 NEUTRON ACER TENDL-2023 LIBRARY; T=0.K  
deuterons from (n,d)

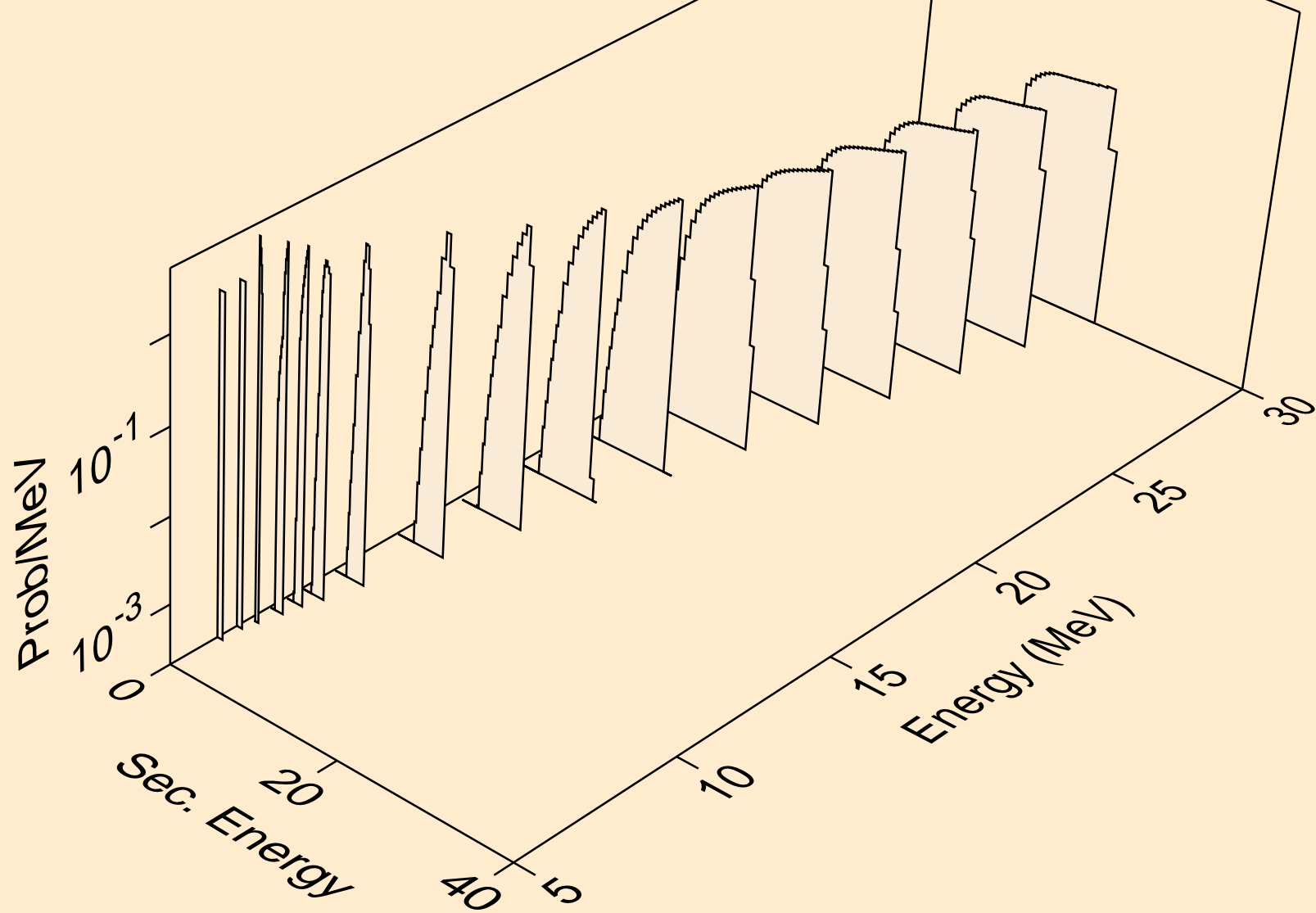

SE074 NEUTRON ACER TENDL-2023 LIBRARY; T=0.K  
deuterons from (n,pd)

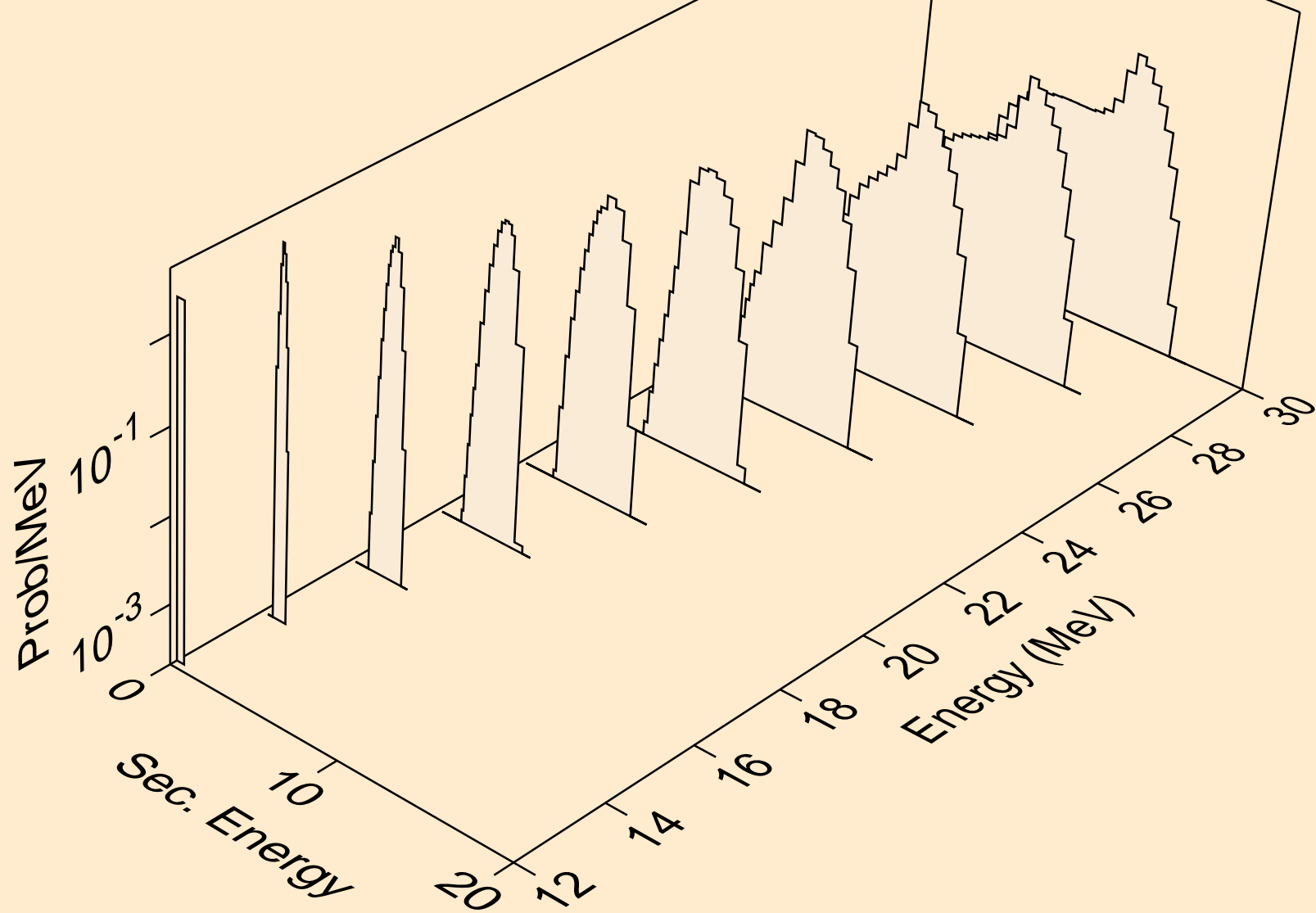

SE074 NEUTRON ACER TENDL-2023 LIBRARY; T=0.K  
deuterons from (n,da)

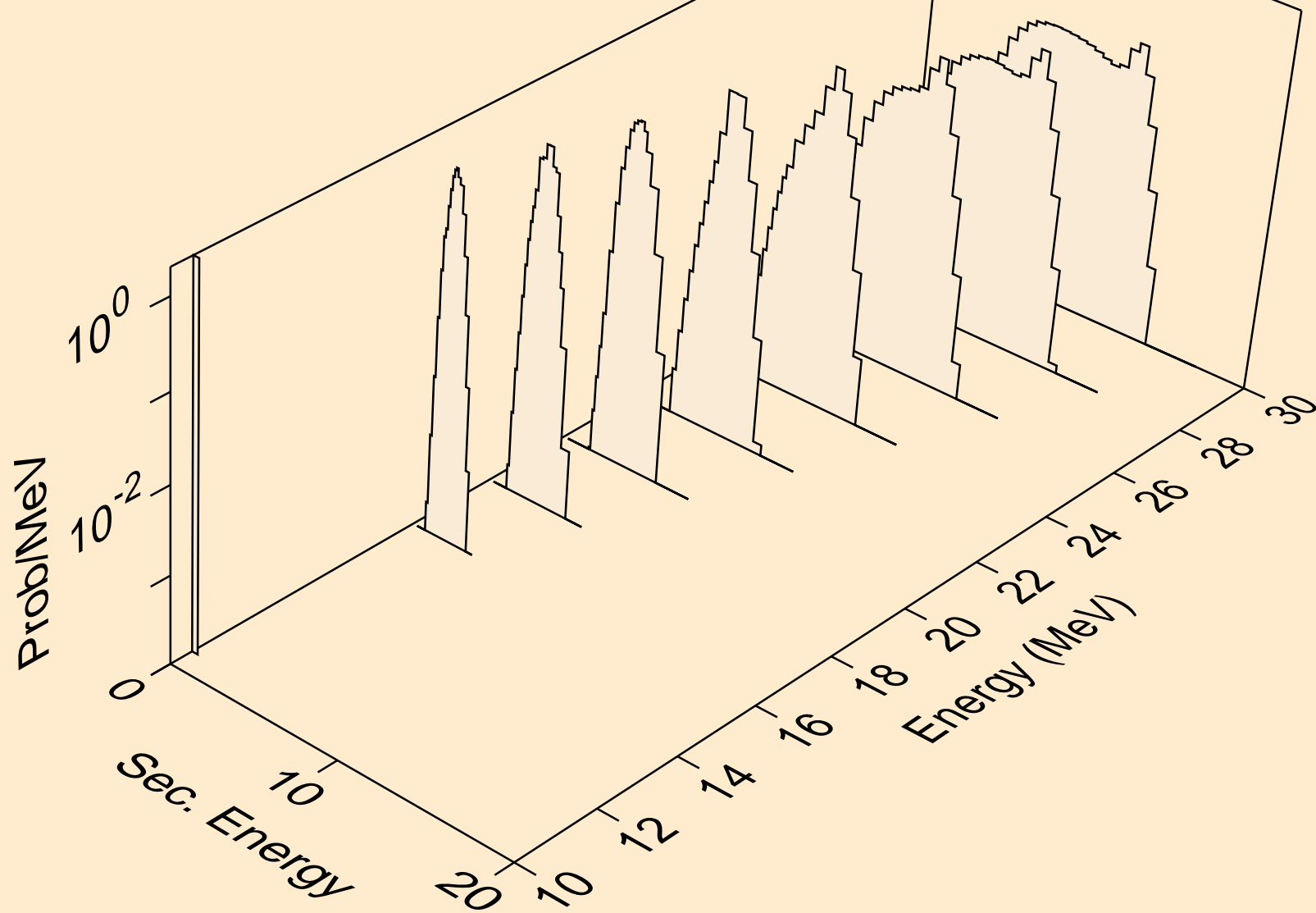



SE074 NEUTRON ACER TENDL-2023 LIBRARY; T=0.K  
tritons from (n,x)

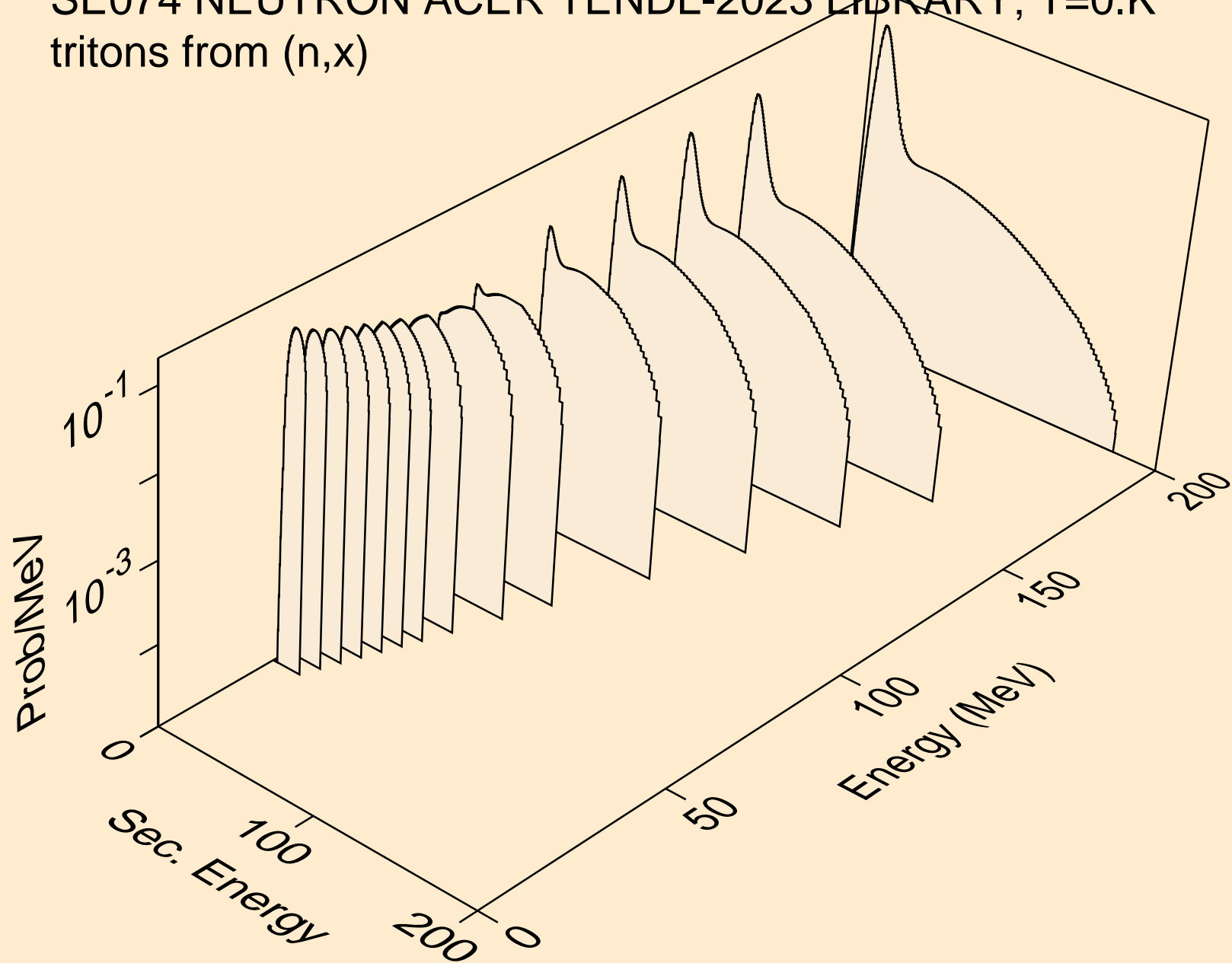

SE074 NEUTRON ACER TENDL-2023 LIBRARY; T=0.K  
tritons from (n,n\*)t

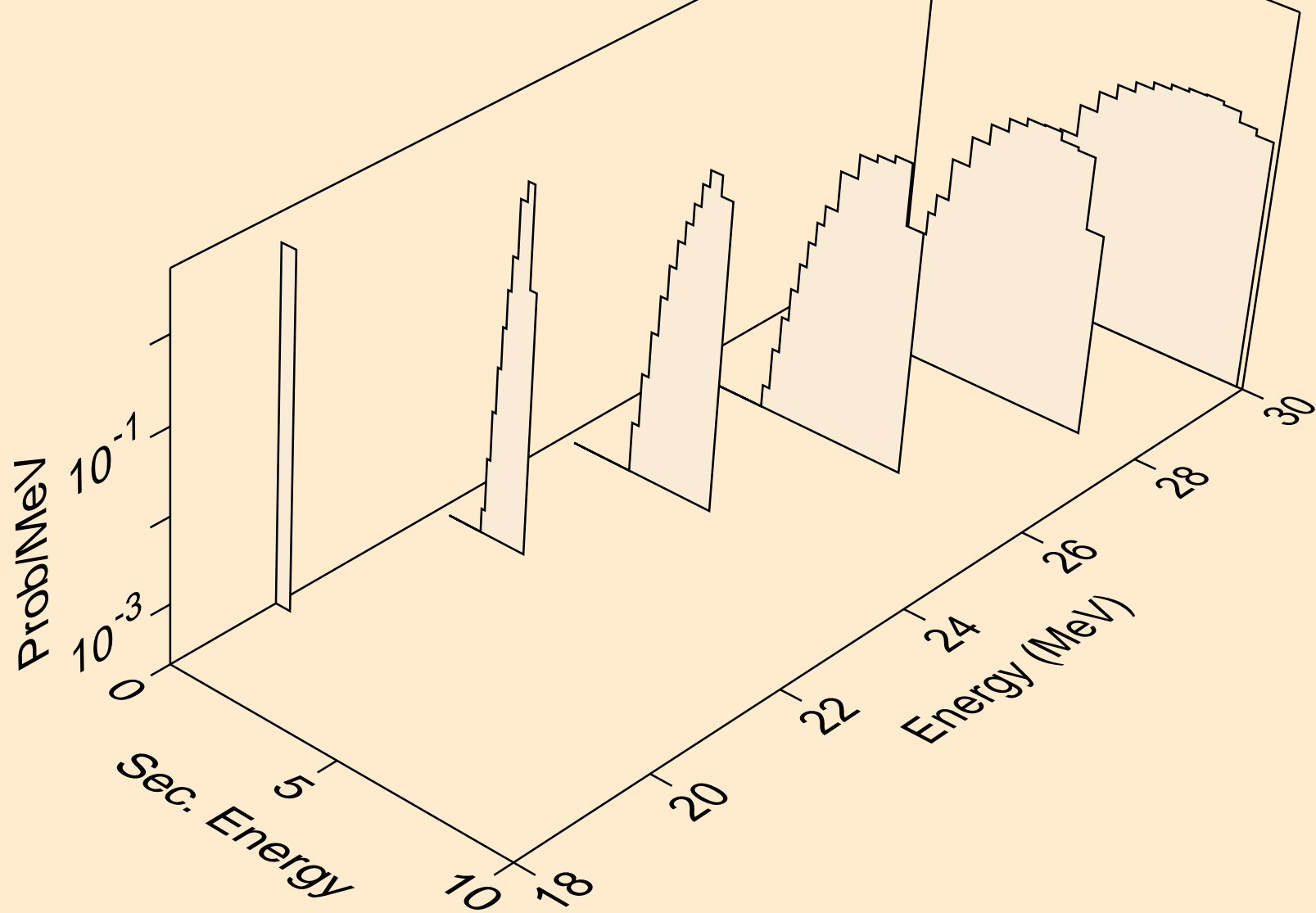

SE074 NEUTRON ACER TENDL-2023 LIBRARY; T=0.K  
tritons from (n,t)

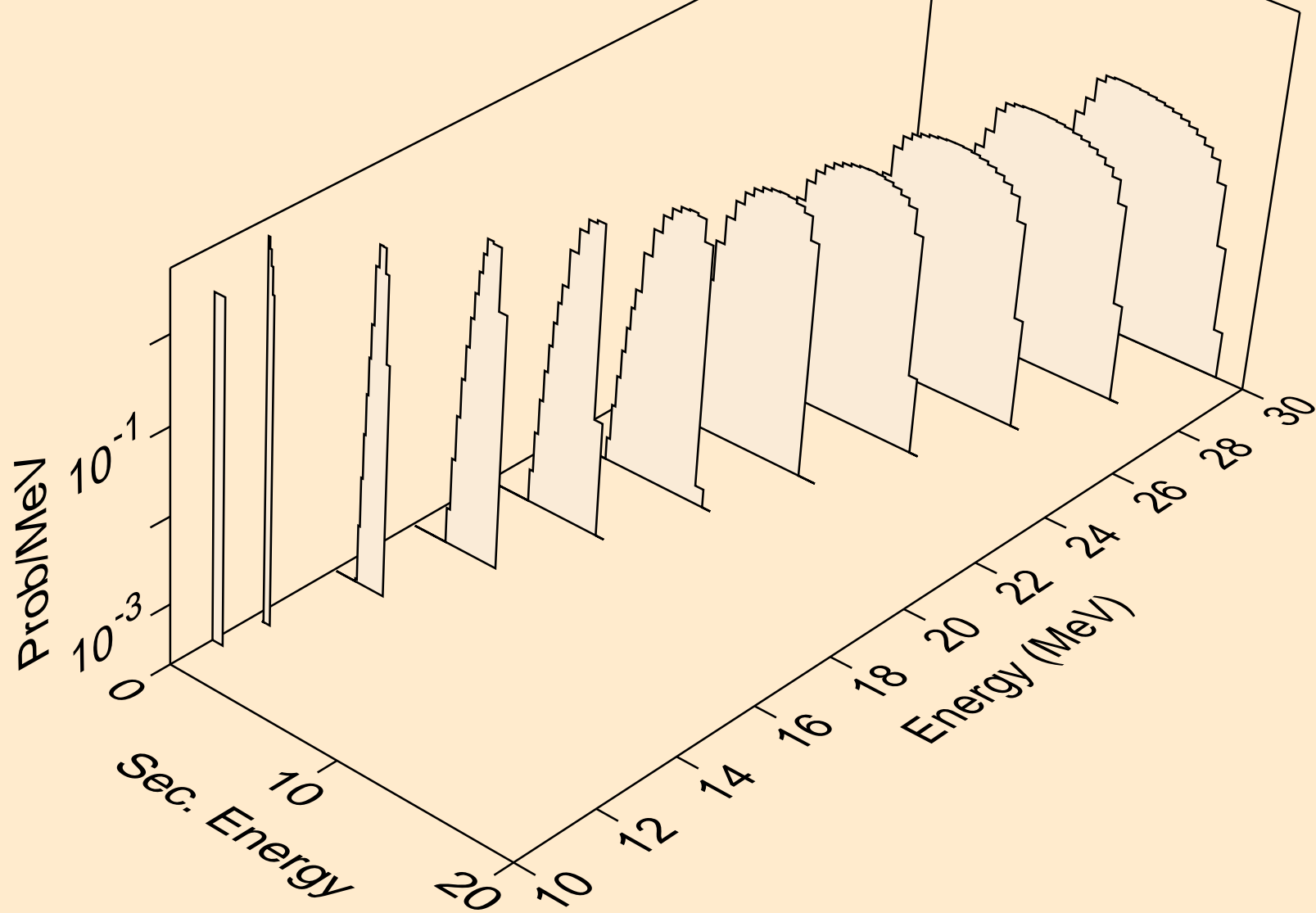

SE074 NEUTRON ACER TENDL-2023 LIBRARY; T=0.K  
tritons from (n,pt)

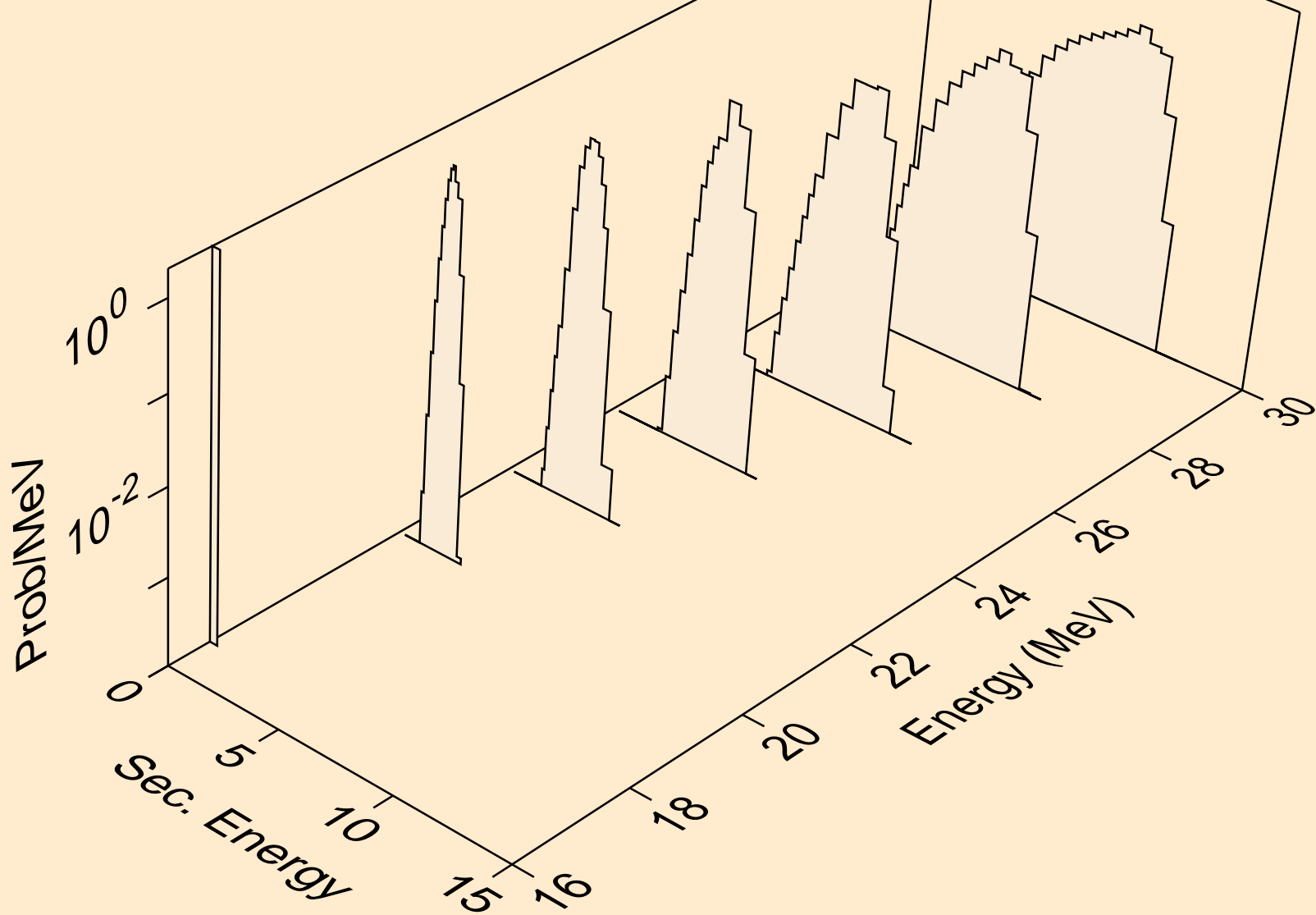

SE074 NEUTRON ACER TENDL-2023 LIBRARY; T=0.K  
he3s from (n,x)

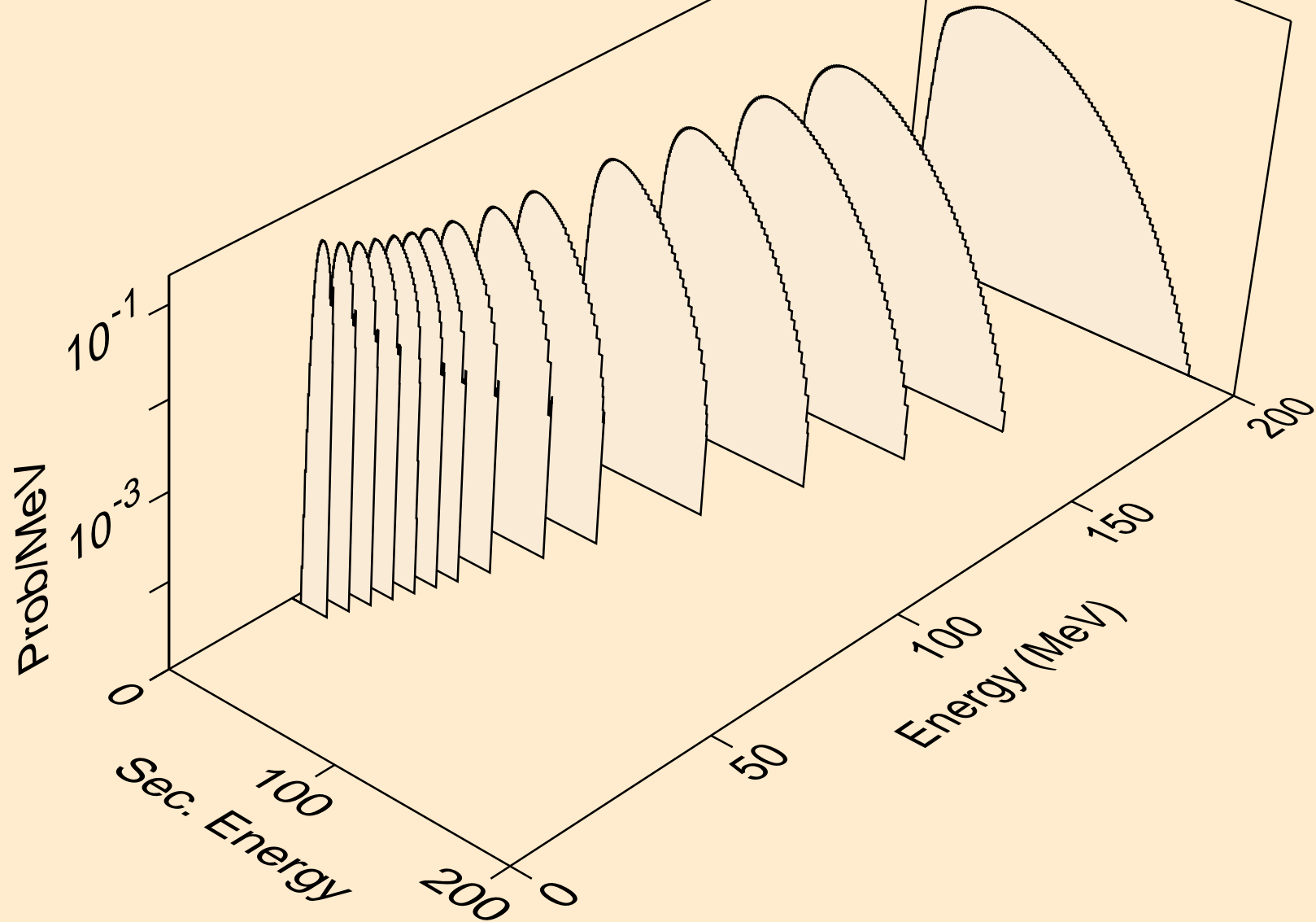

SE074 NEUTRON ACER TENDL-2023 LIBRARY; T=0.K  
he3s from (n,n\*)he3

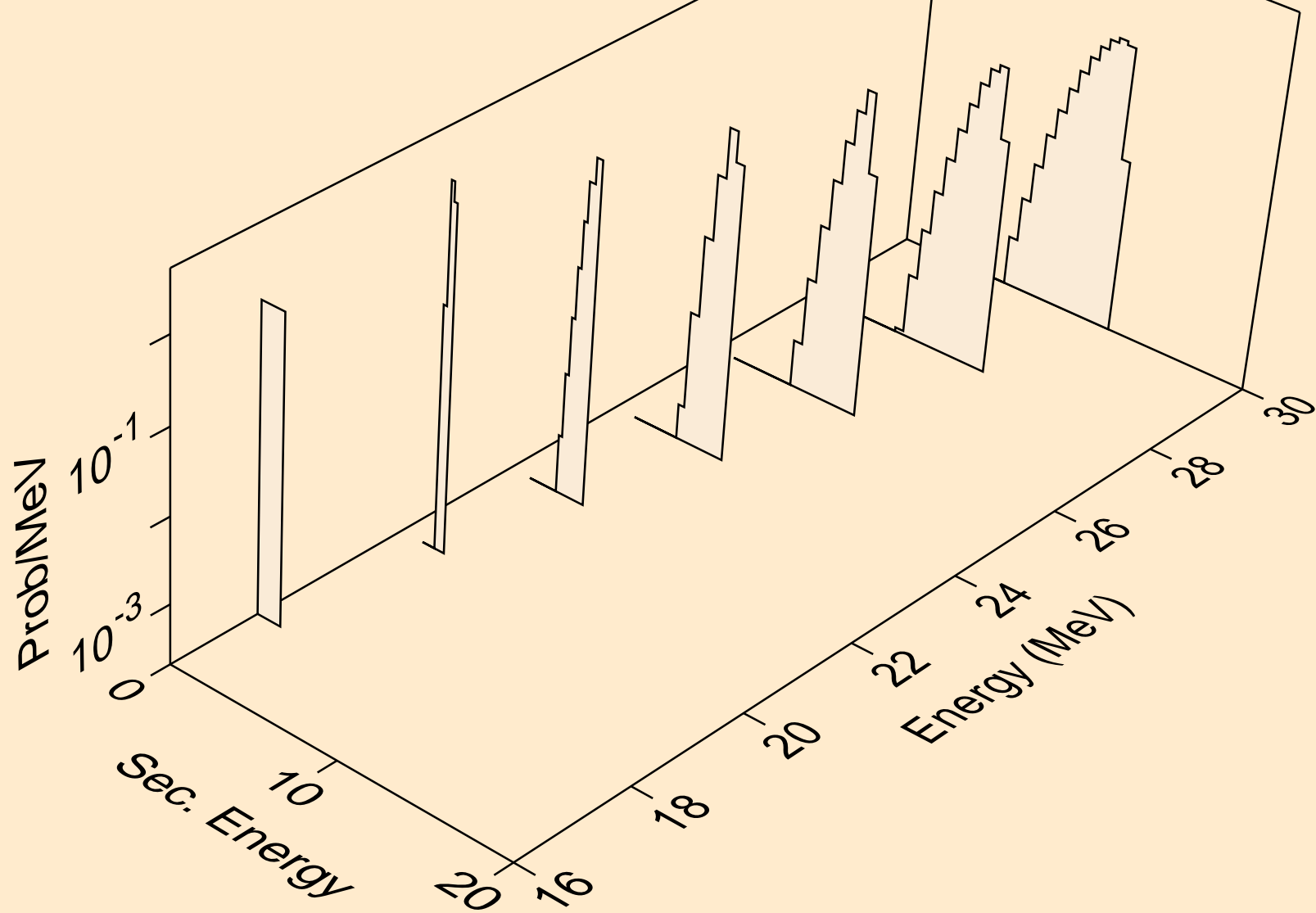

SE074 NEUTRON ACER TENDL-2023 LIBRARY; T=0.K  
he3s from (n,he3)

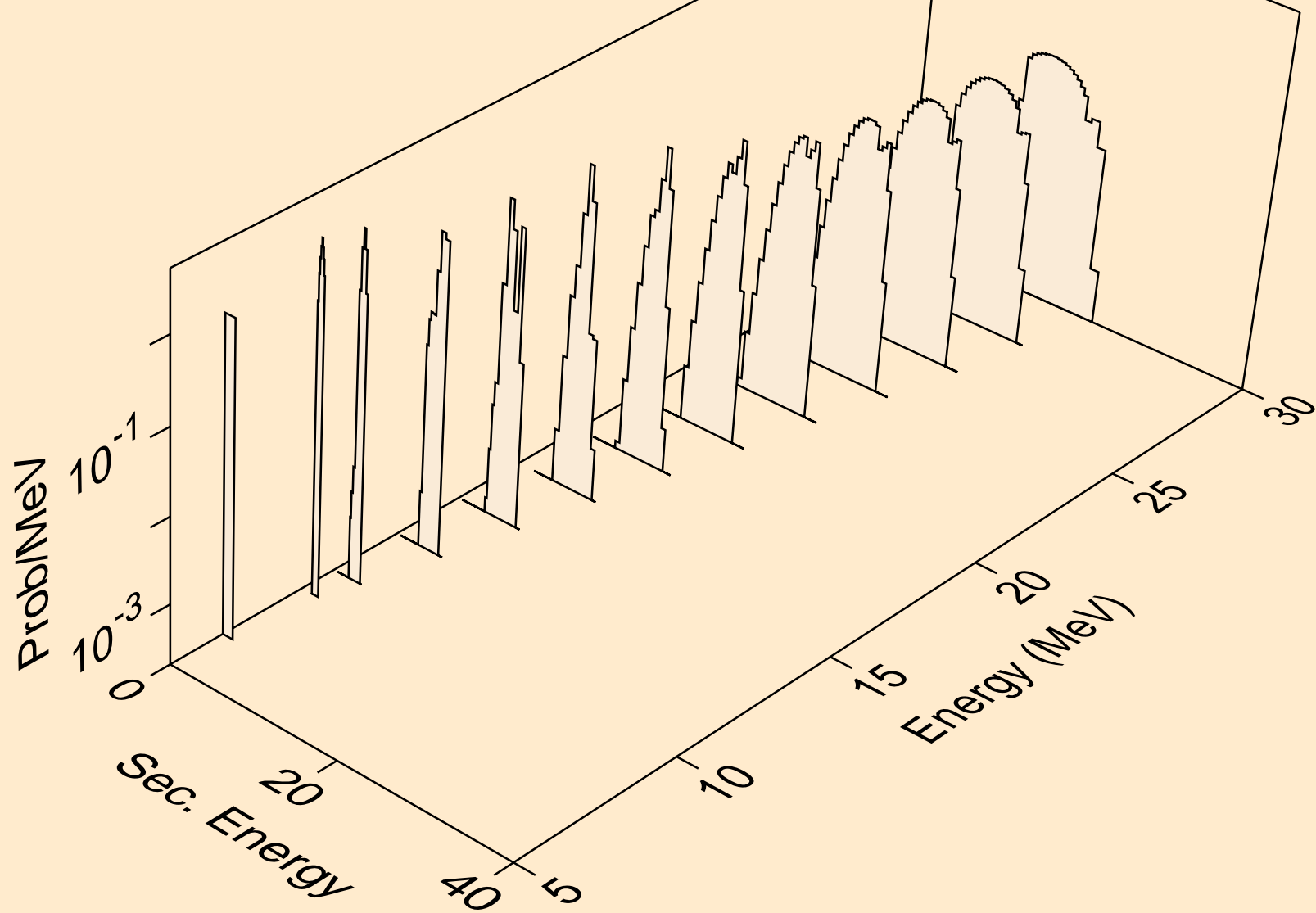

SE074 NEUTRON ACER TENDL-2023 LIBRARY; T=0.K  
alphas from (n,x)

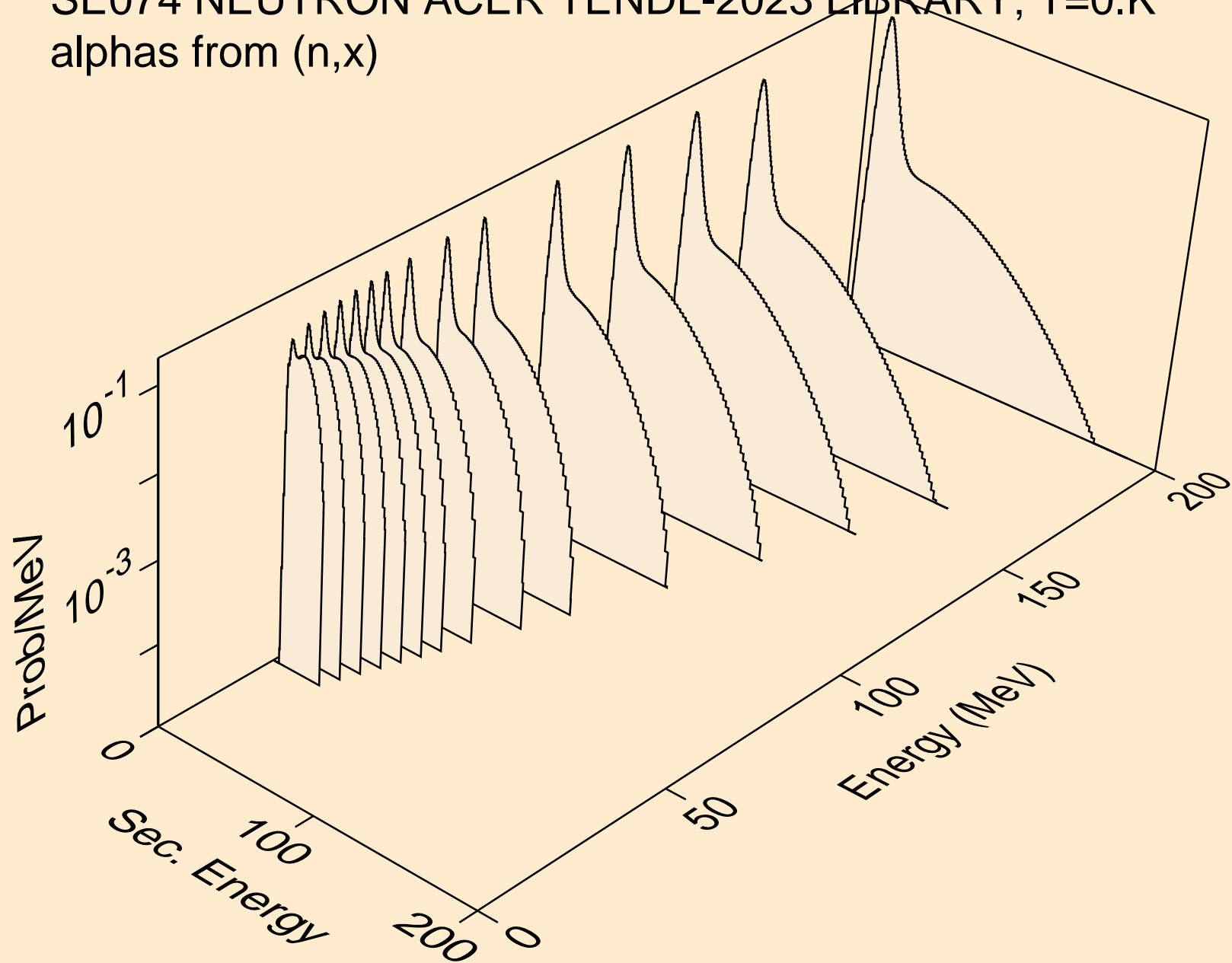



SE074 NEUTRON ACER TENDL-2023 LIBRARY; T=0.K  
alphas from (n,n\*)a

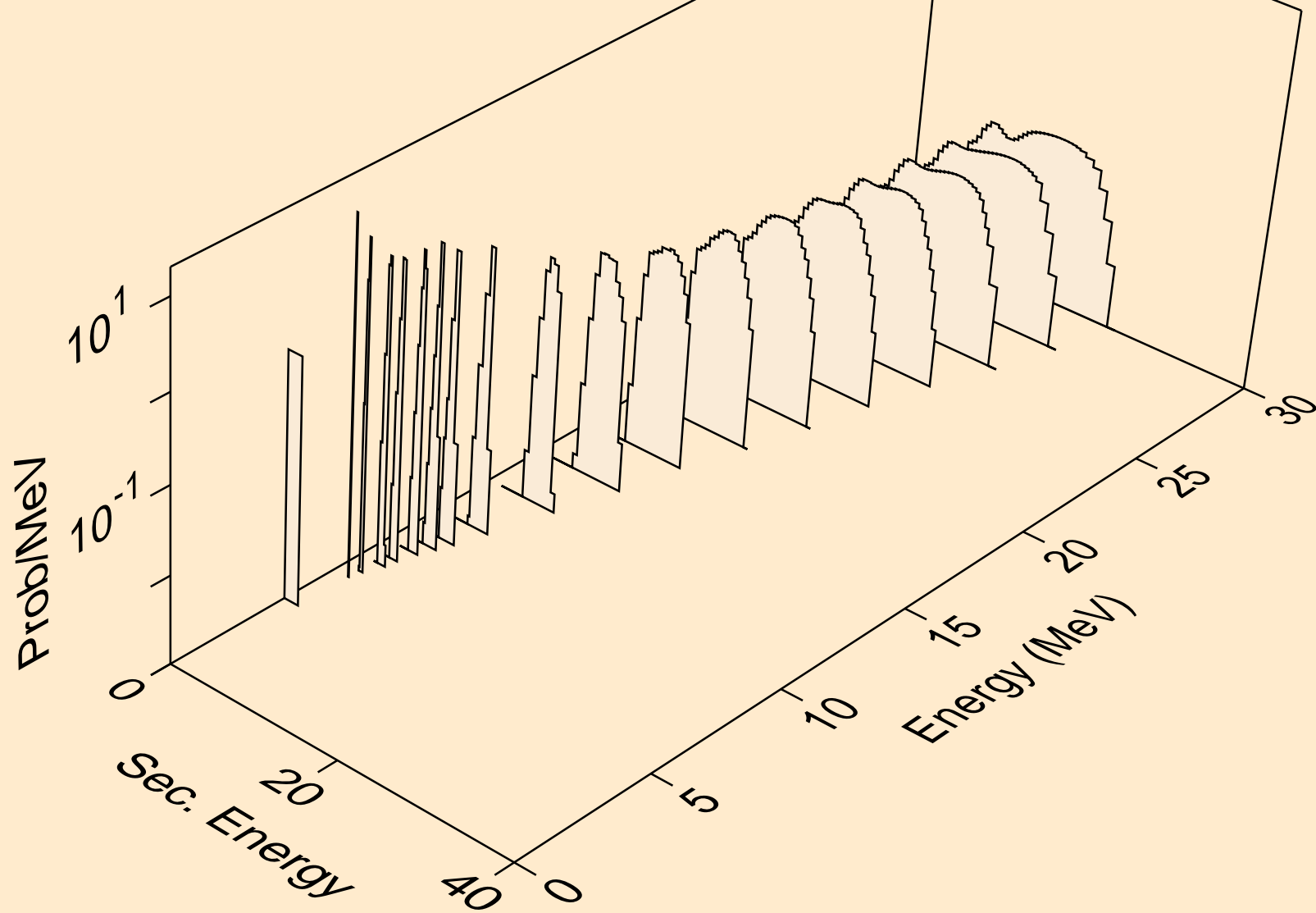

SE074 NEUTRON ACER TENDL-2023 LIBRARY; T=0.K  
alphas from (n,2n)a

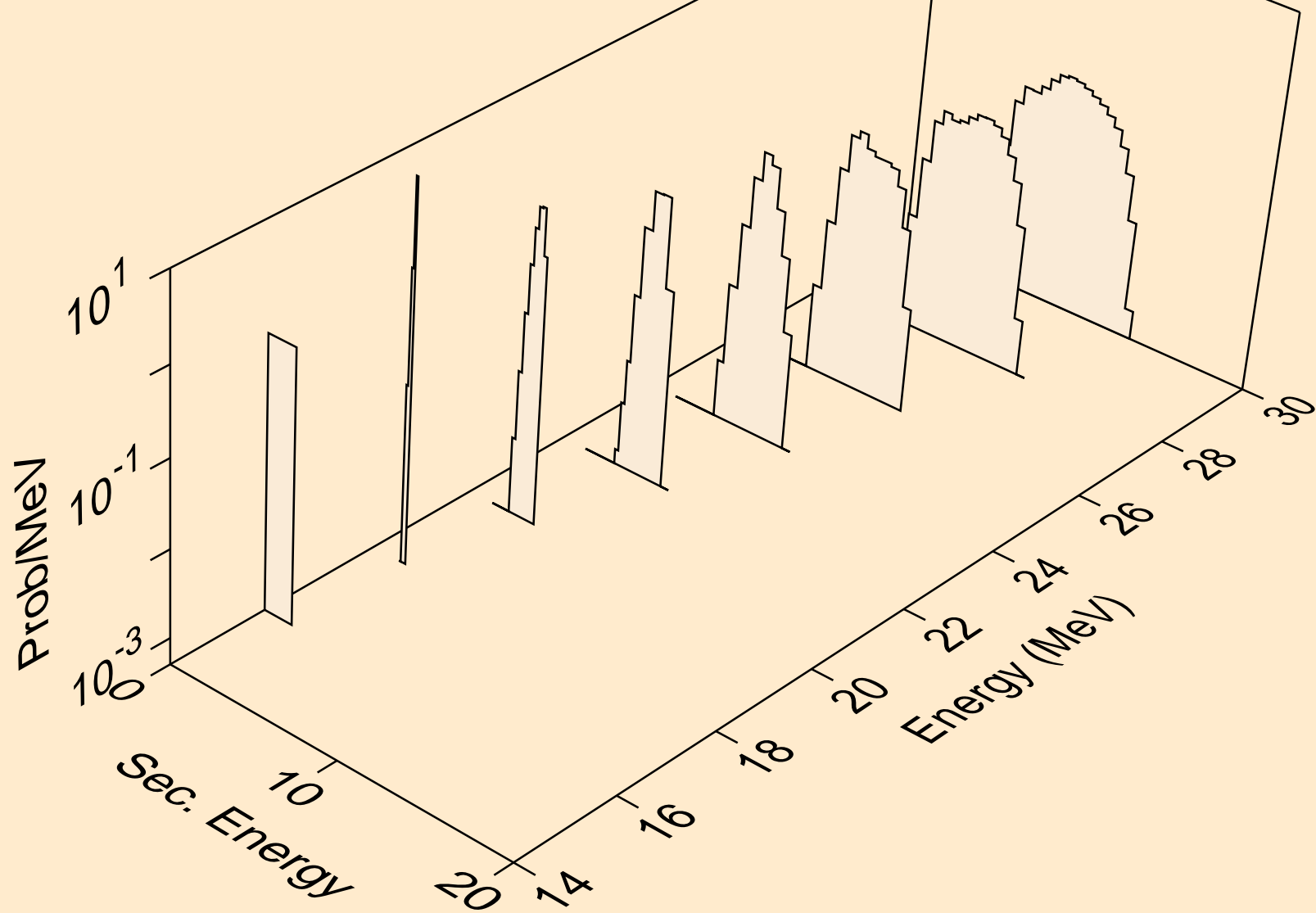

SE074 NEUTRON ACER TENDL-2023 LIBRARY; T=0.K  
alphas from (n,3n)a

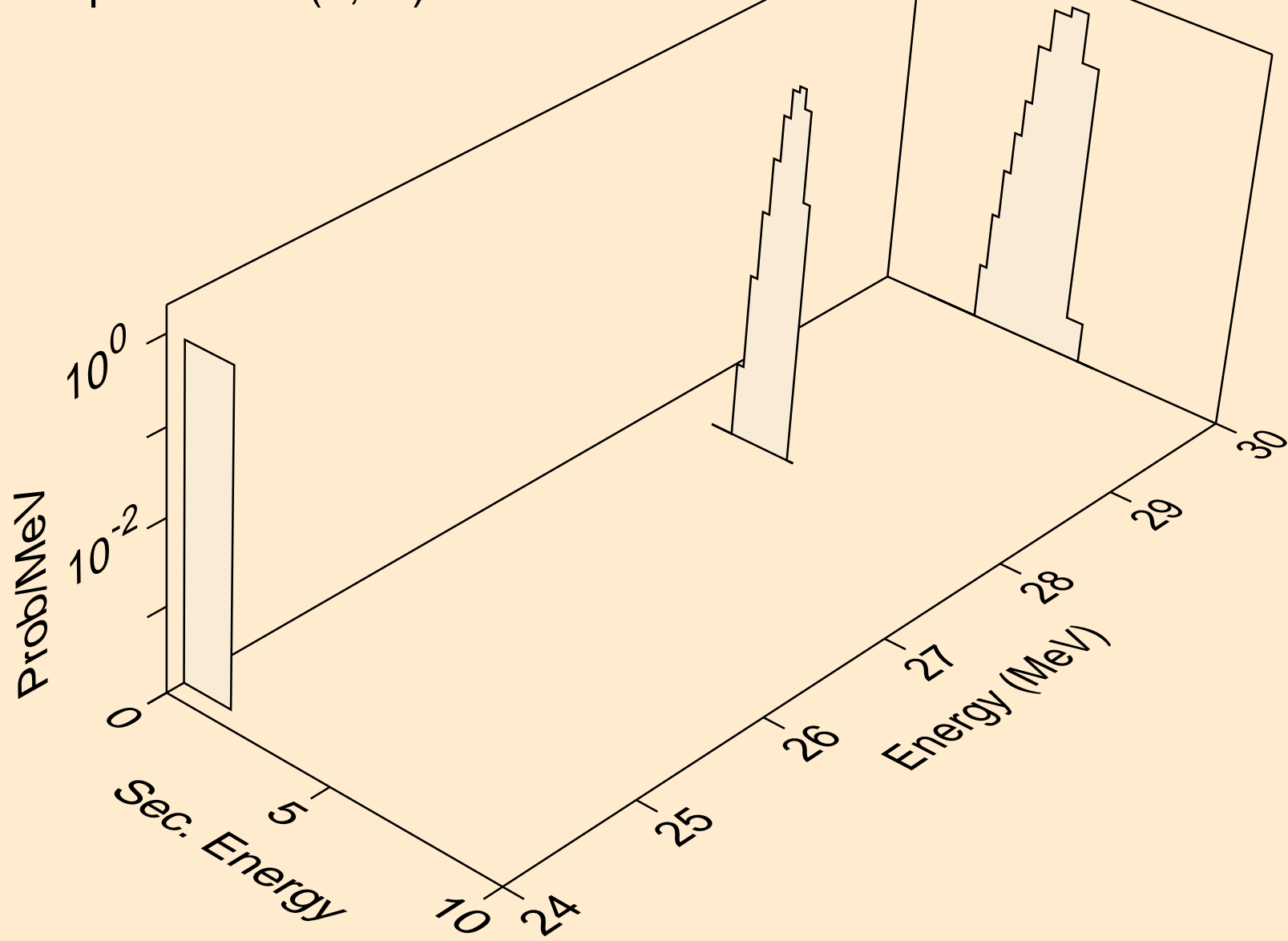

SE074 NEUTRON ACER TENDL-2023 LIBRARY; T=0.K  
alphas from (n,n\*)2a

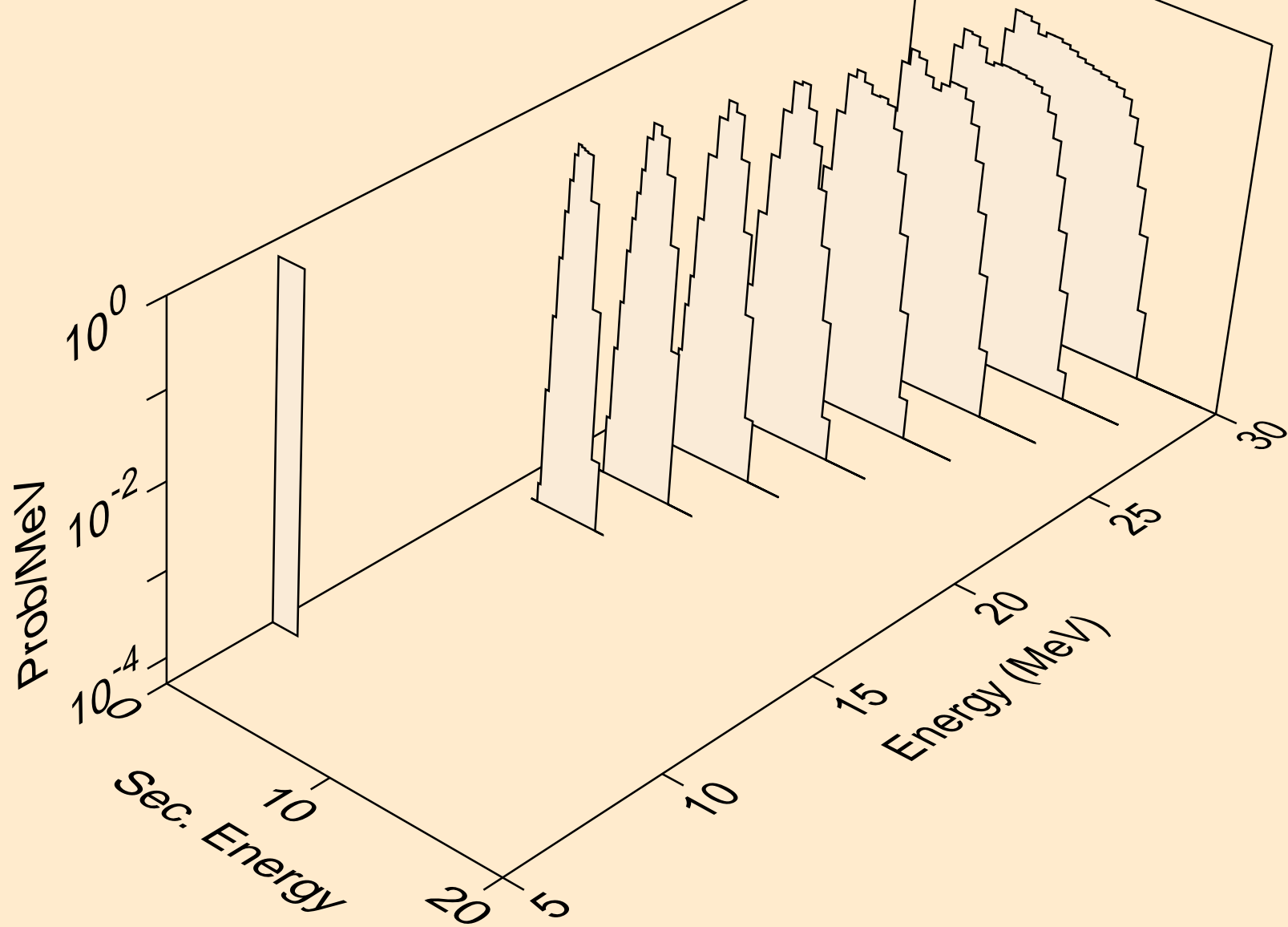

SE074 NEUTRON ACER TENDL-2023 LIBRARY; T=0.K  
alphas from (n,npa)

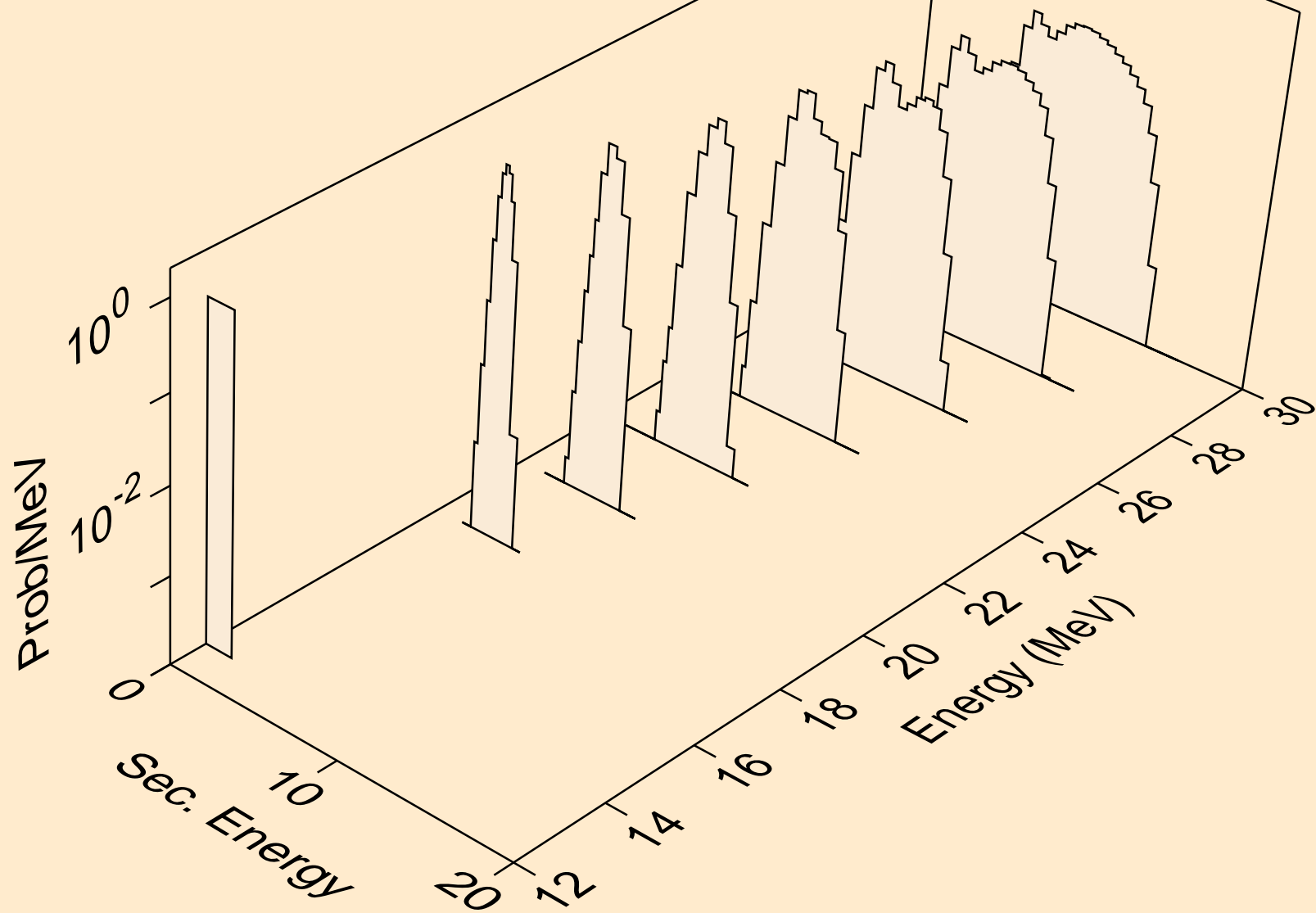

SE074 NEUTRON ACER TENDL-2023 LIBRARY; T=0.K  
alphas from (n,a)

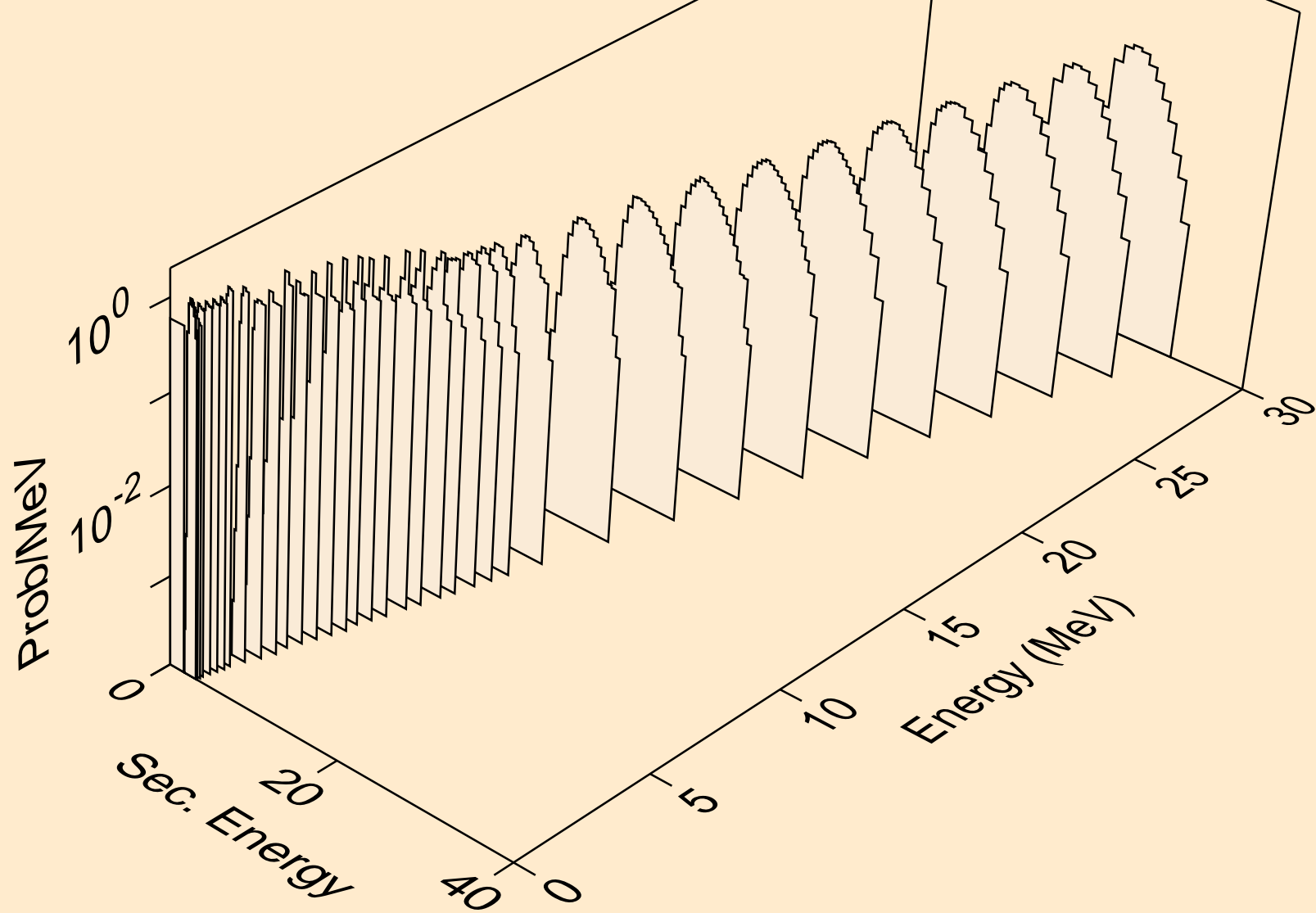

SE074 NEUTRON ACER TENDL-2023 LIBRARY; T=0.K  
alphas from (n,2a)

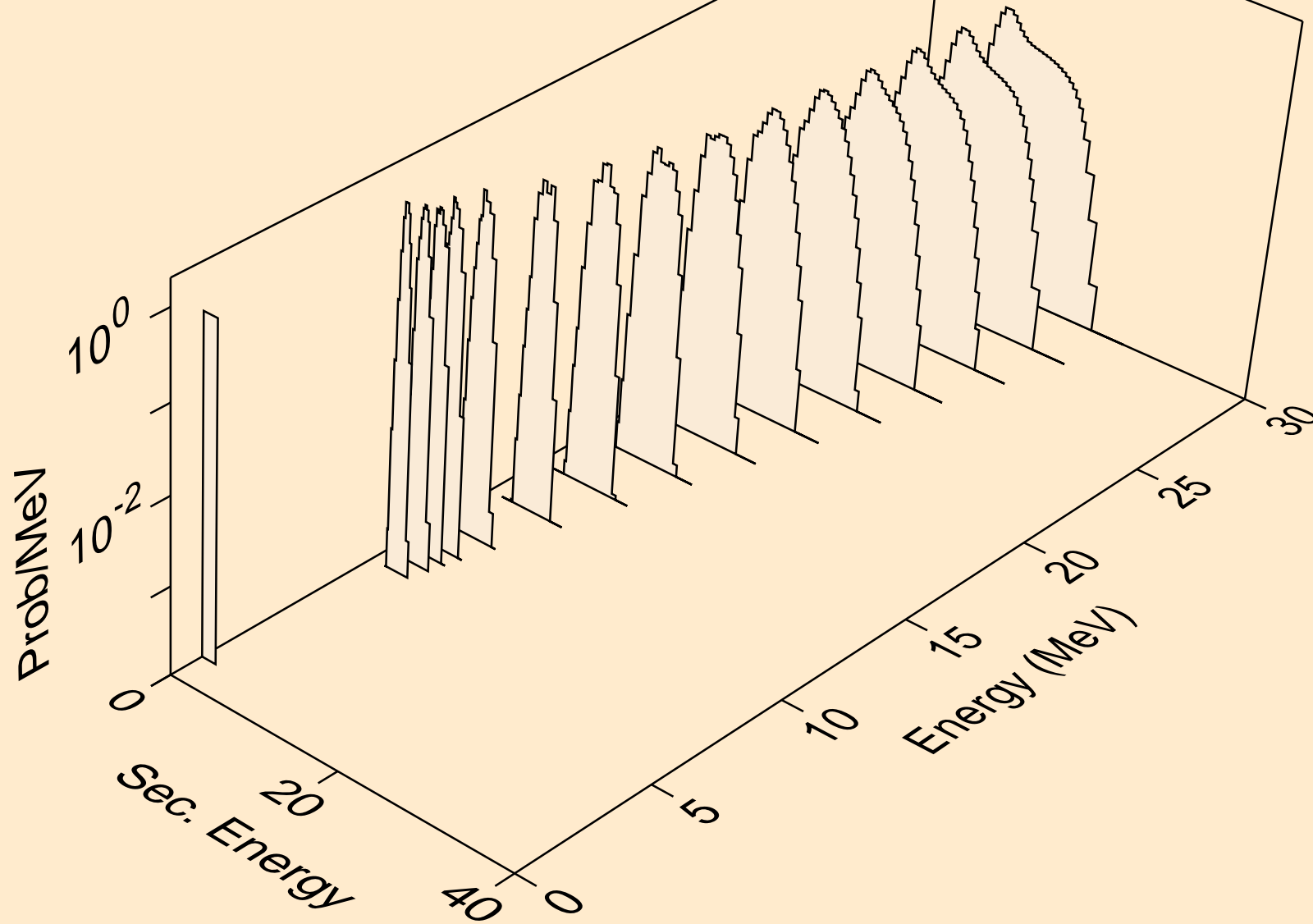

SE074 NEUTRON ACER TENDL-2023 LIBRARY; T=0.K  
alphas from (n,3a)

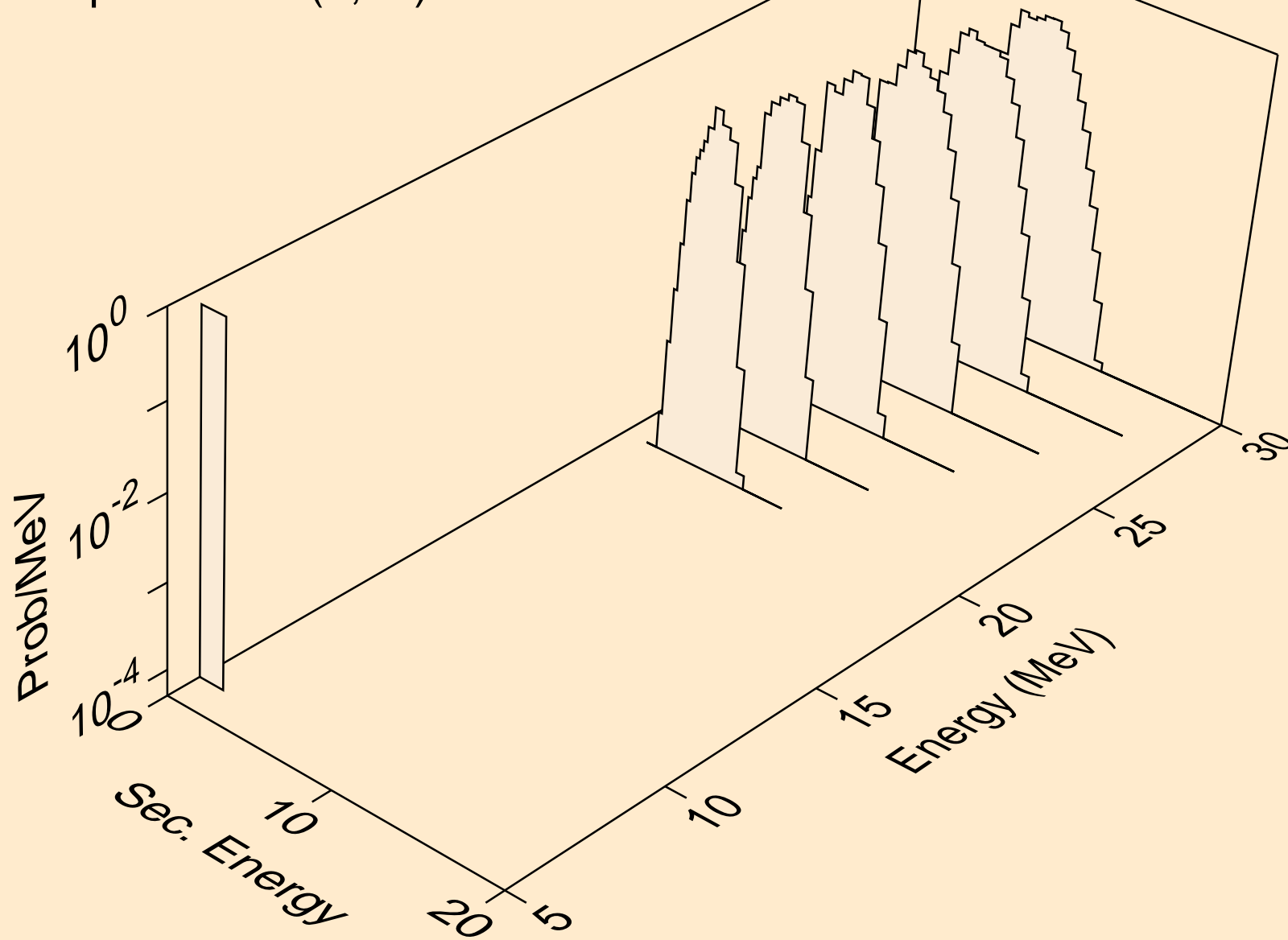



SE074 NEUTRON ACER TENDL-2023 LIBRARY; T=0.K  
alphas from (n,pa)

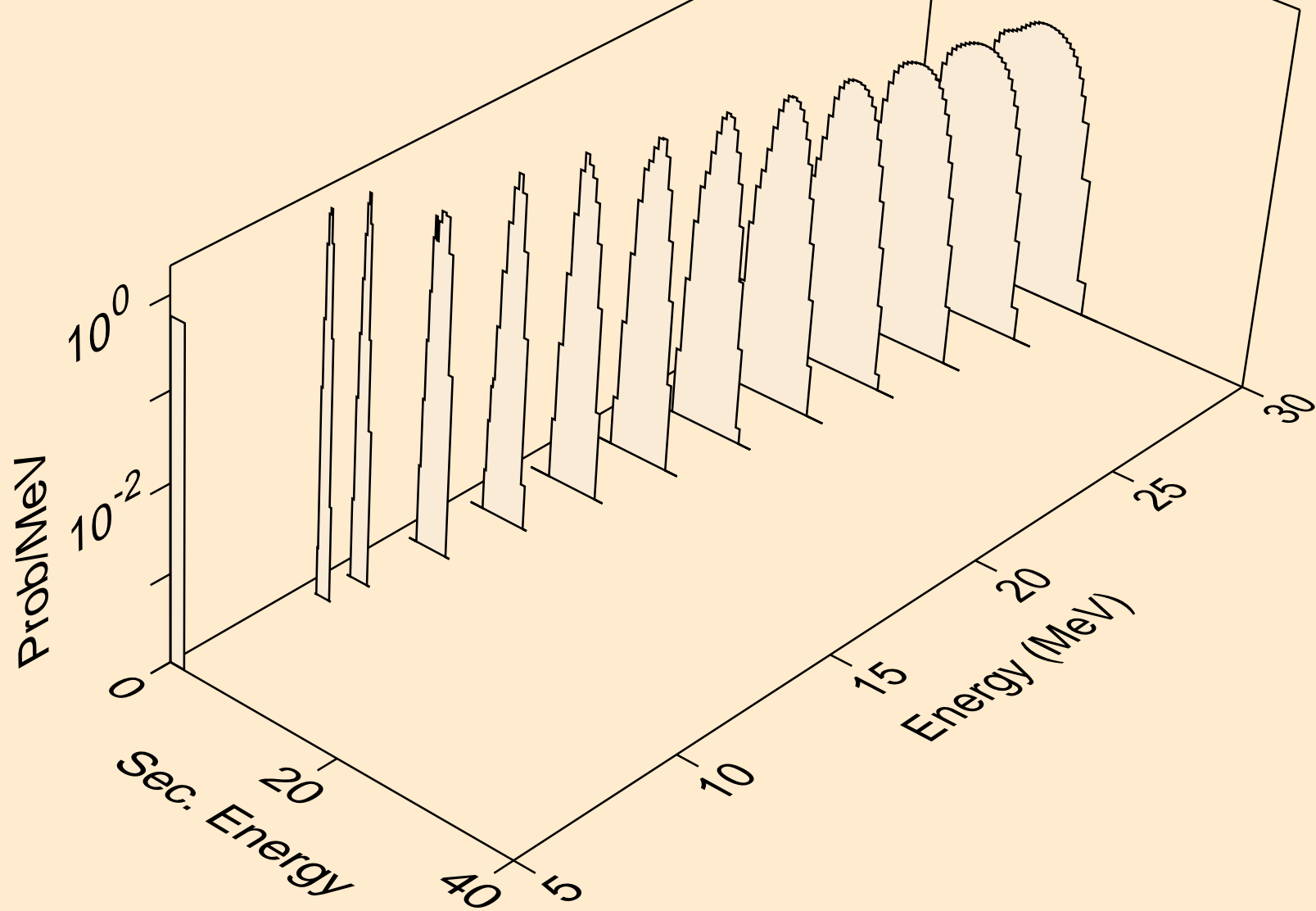

SE074 NEUTRON ACER TENDL-2023 LIBRARY; T=0.K  
alphas from (n,da)

