

SI027 NEUTRON ACER TENDL-2023 LIBRARY; T=0.K

Principal cross sections

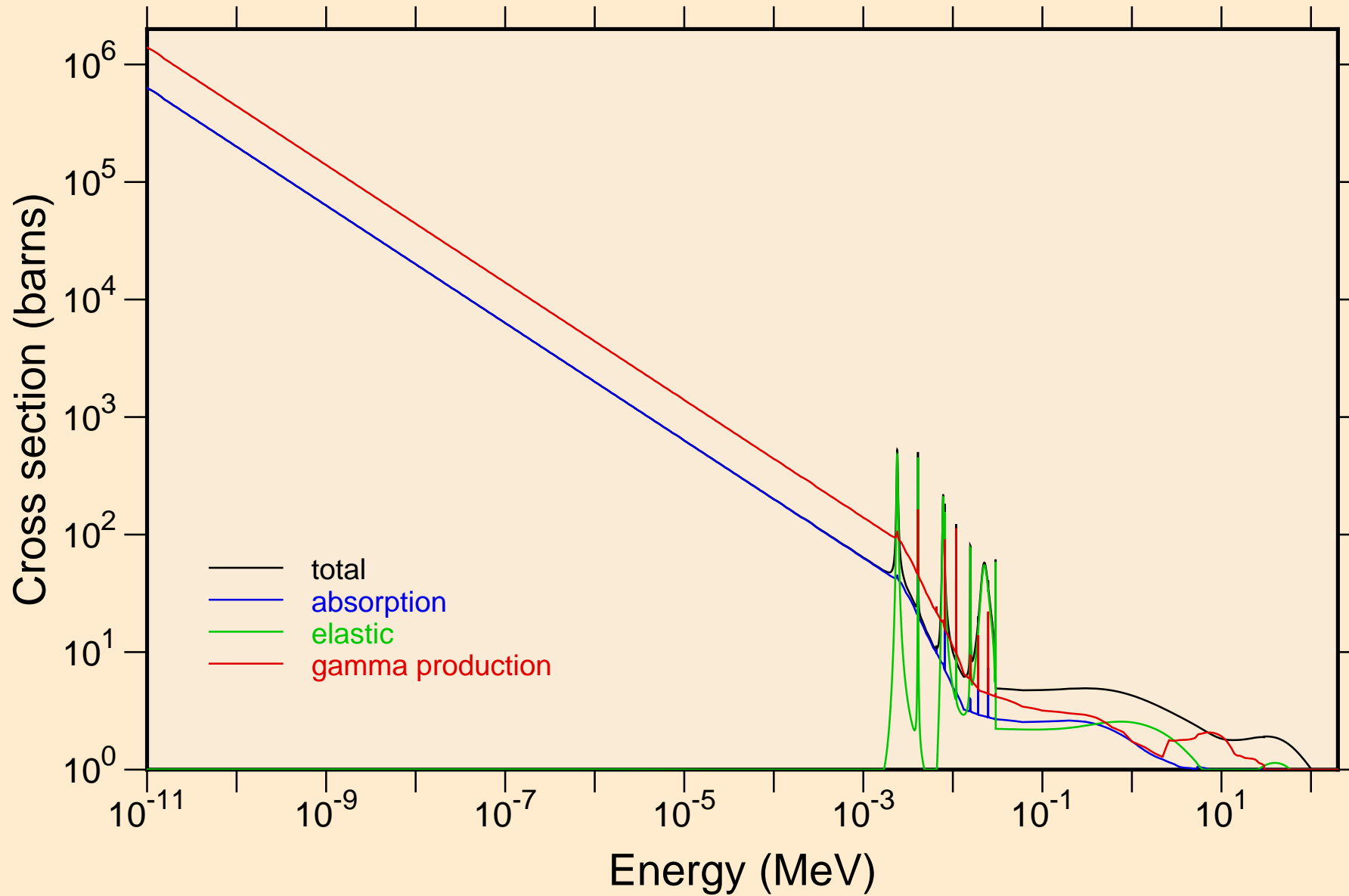

SI027 NEUTRON ACER TENDL-2023 LIBRARY; T=0.K
resonance total cross section

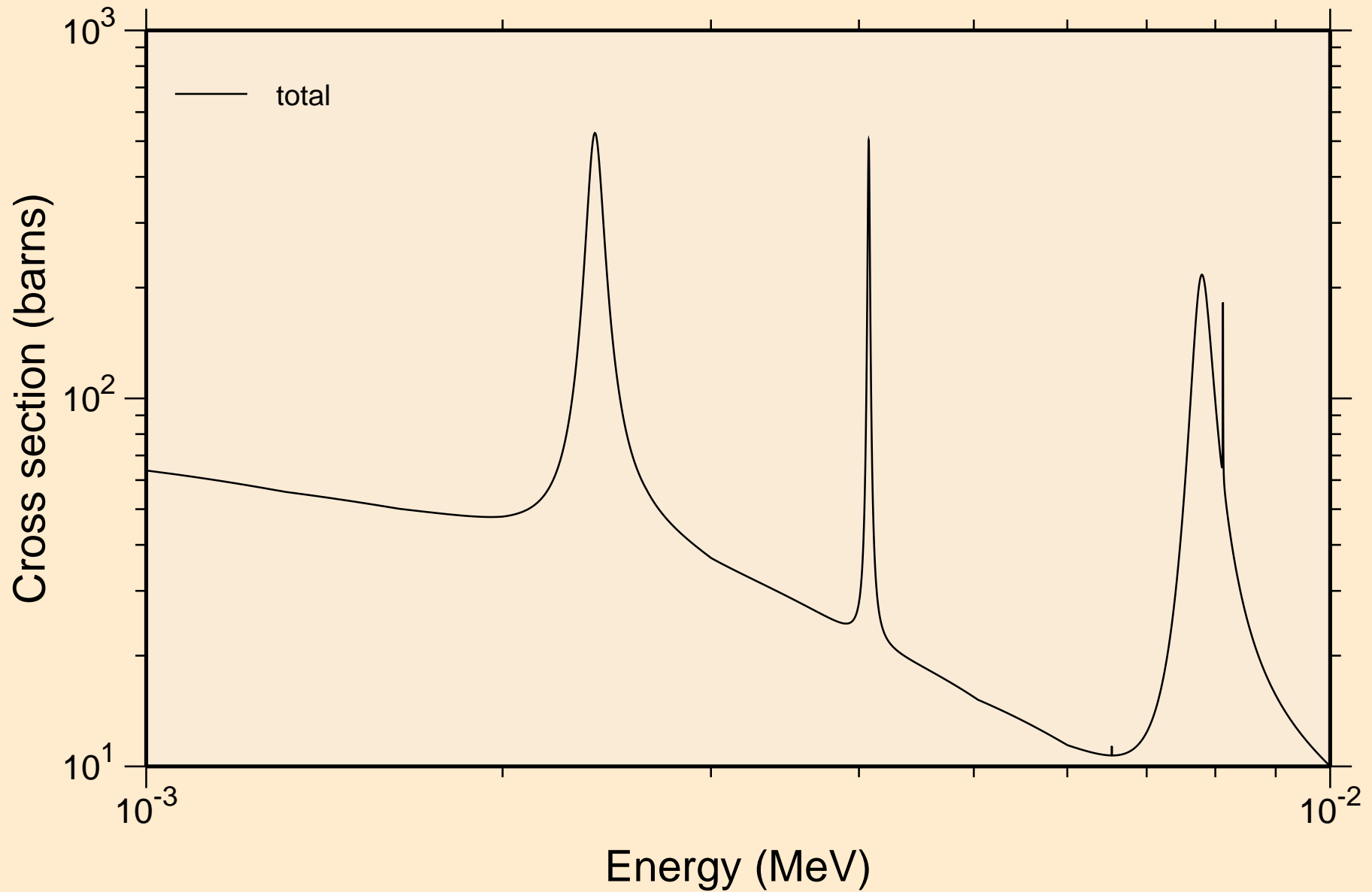

SI027 NEUTRON ACER TENDL-2023 LIBRARY; T=0.K
resonance total cross section

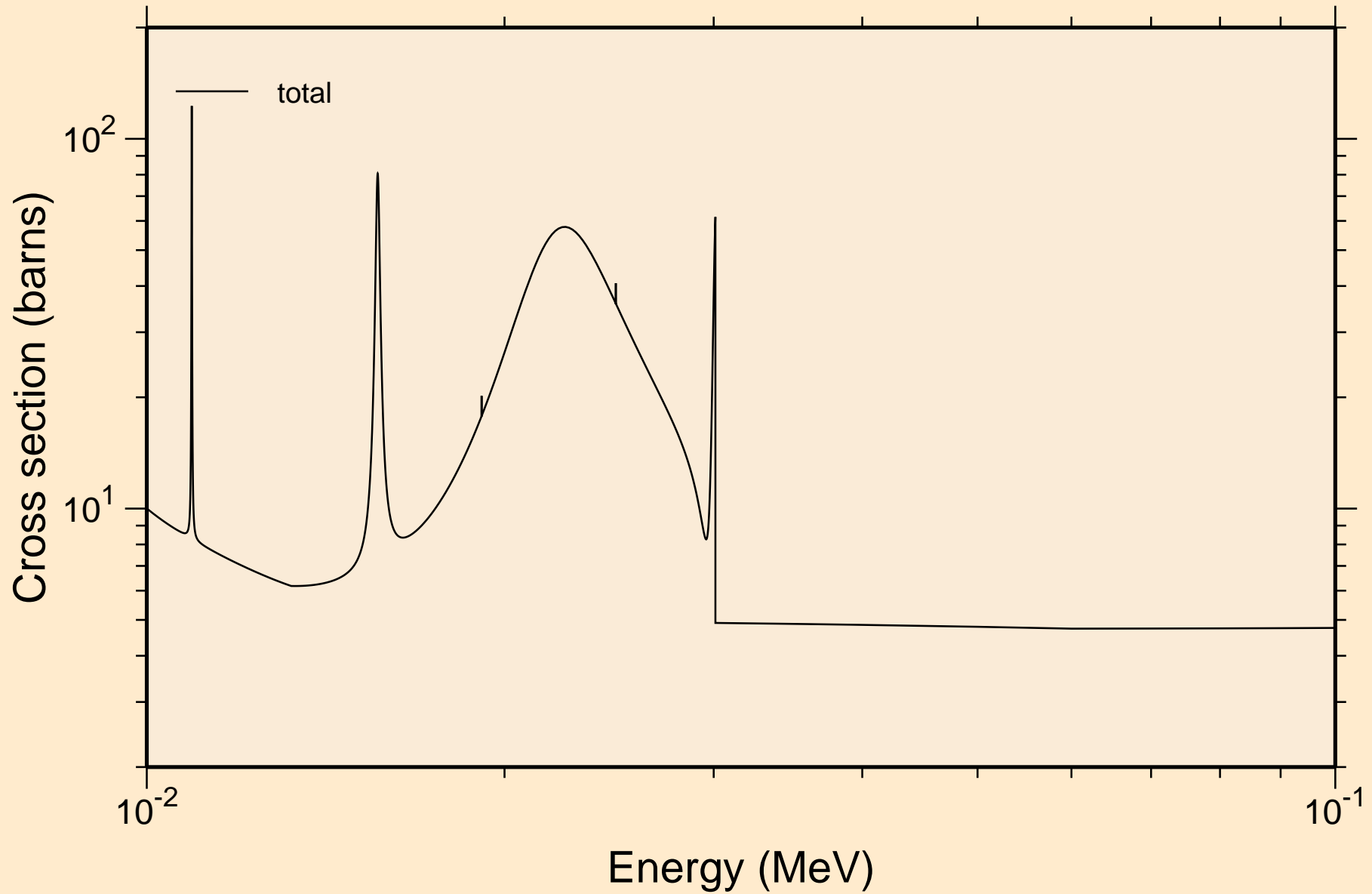

SI027 NEUTRON ACER TENDL-2023 LIBRARY; T=0.K
resonance total cross section

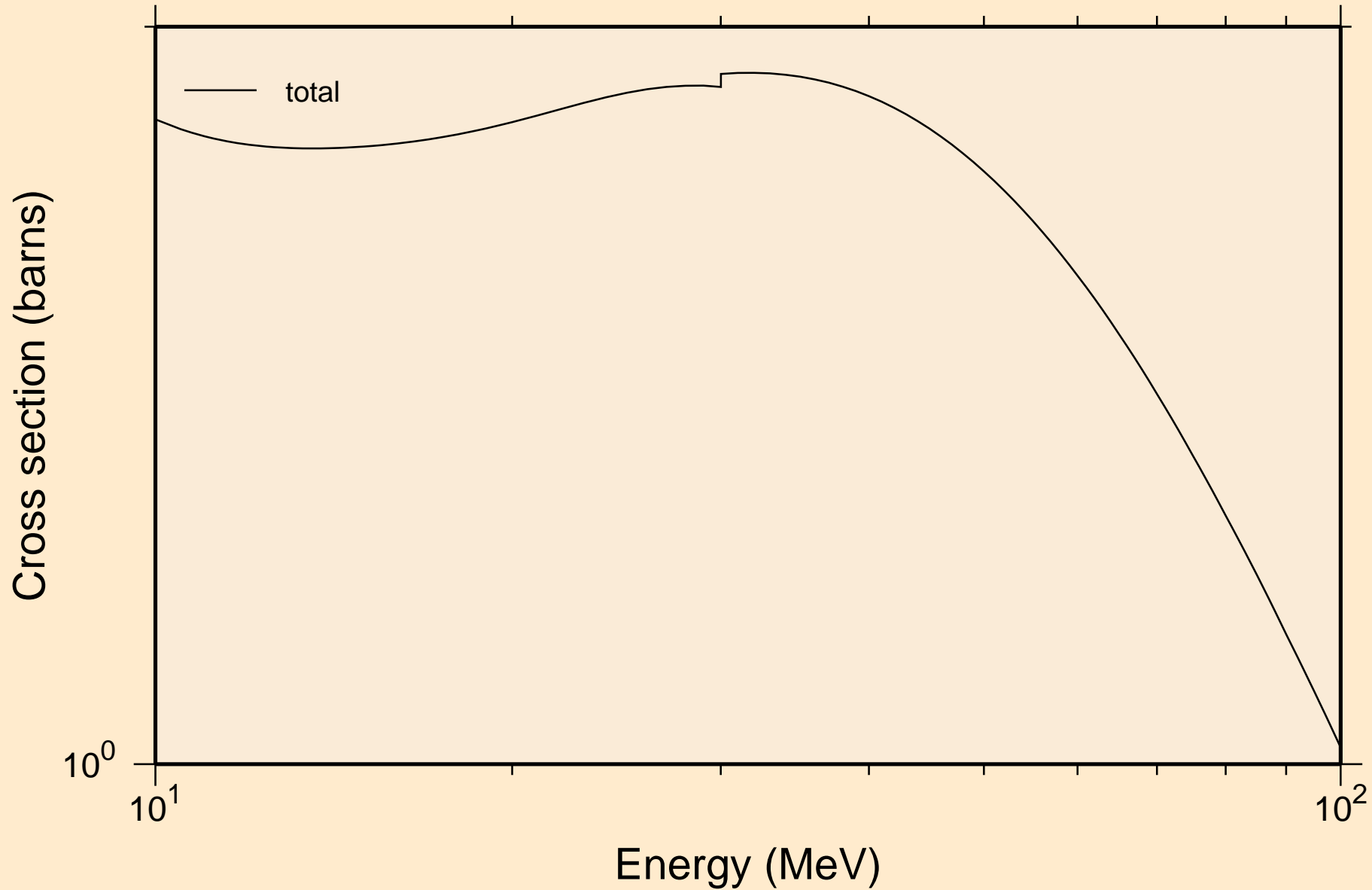

SI027 NEUTRON ACER TENDL-2023 LIBRARY; T=0.K
resonance absorption cross sections

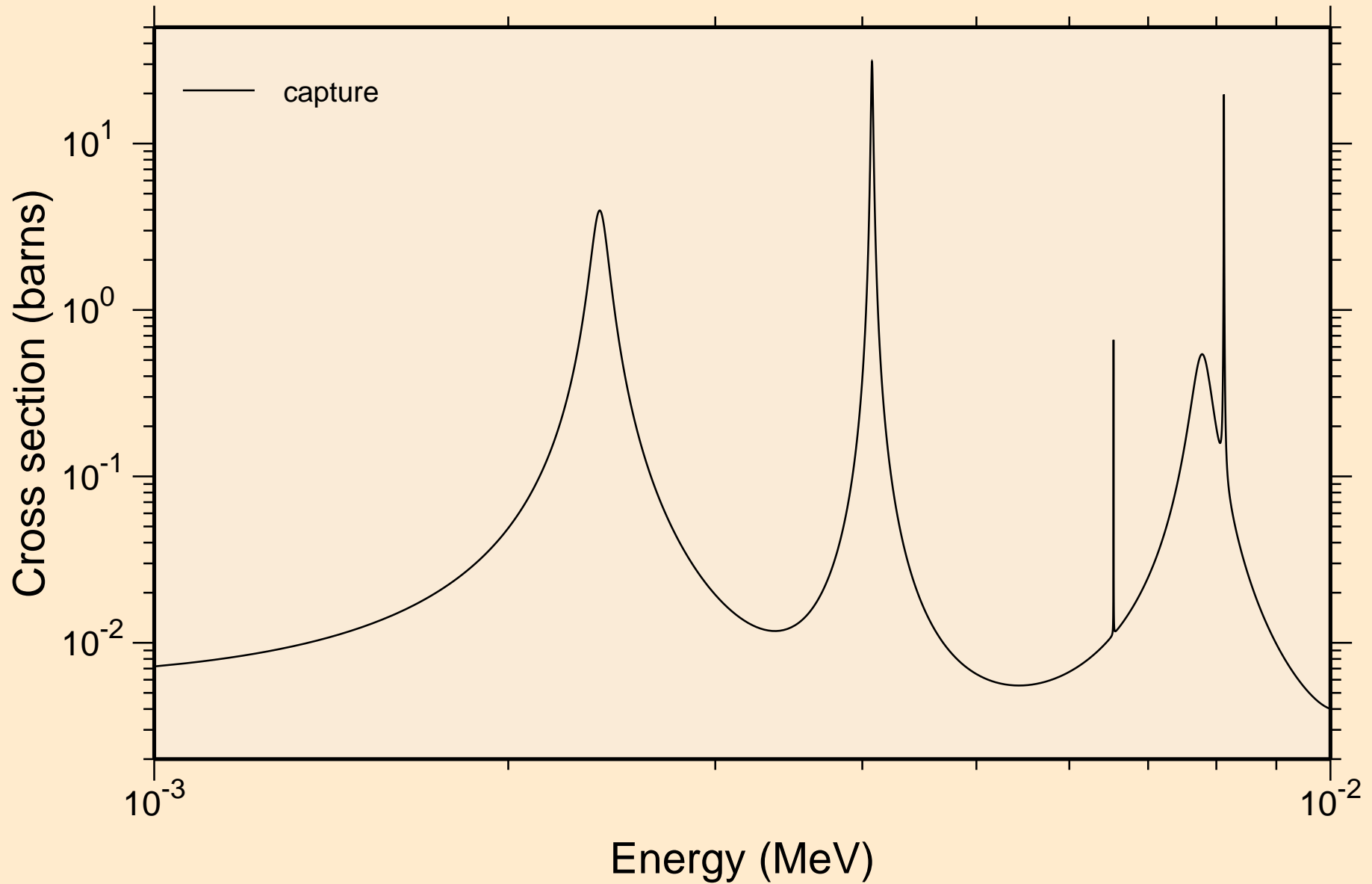

SI027 NEUTRON ACER TENDL-2023 LIBRARY; T=0.K
resonance absorption cross sections

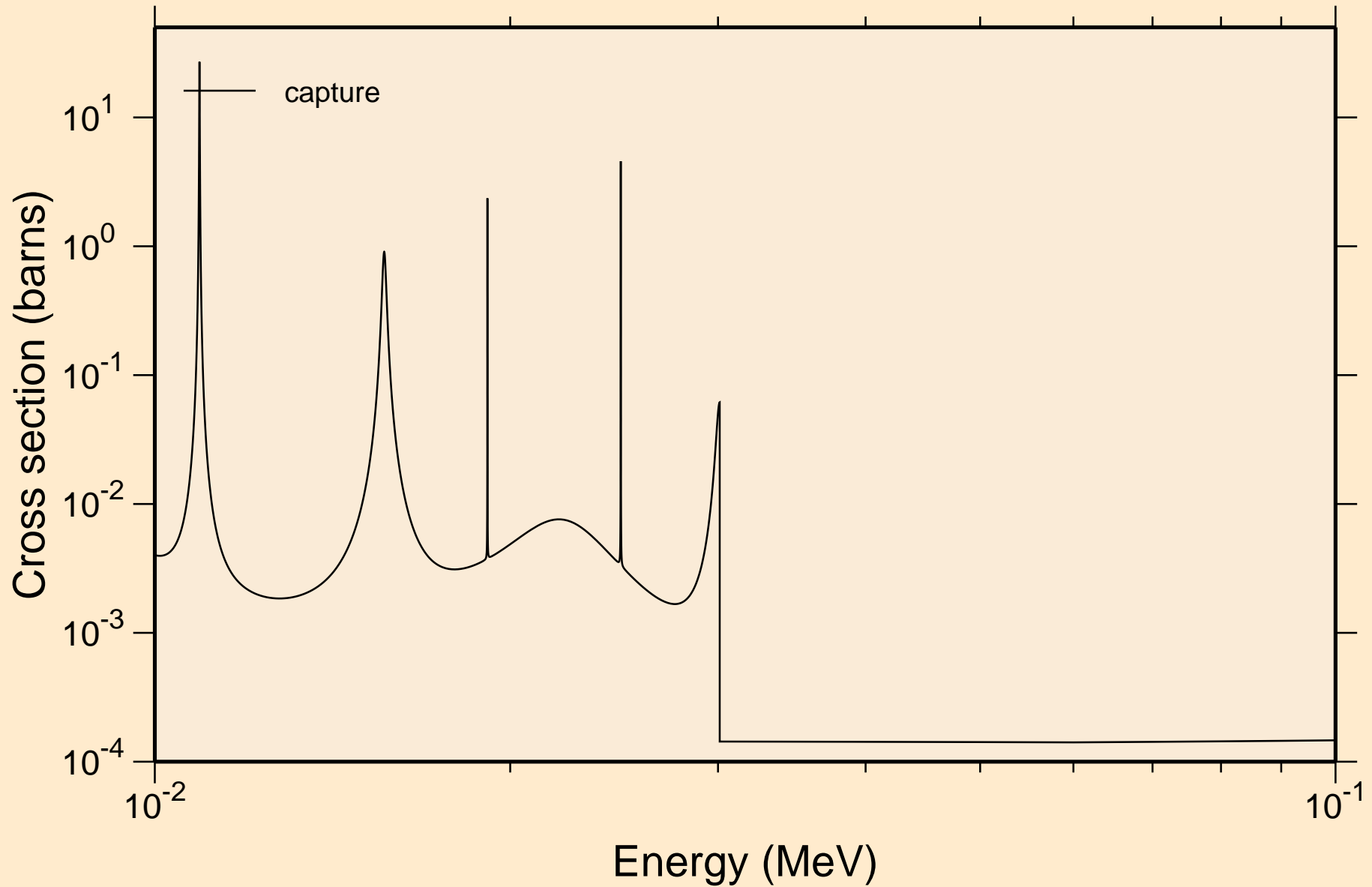

SI027 NEUTRON ACER TENDL-2023 LIBRARY; T=0.K
resonance absorption cross sections

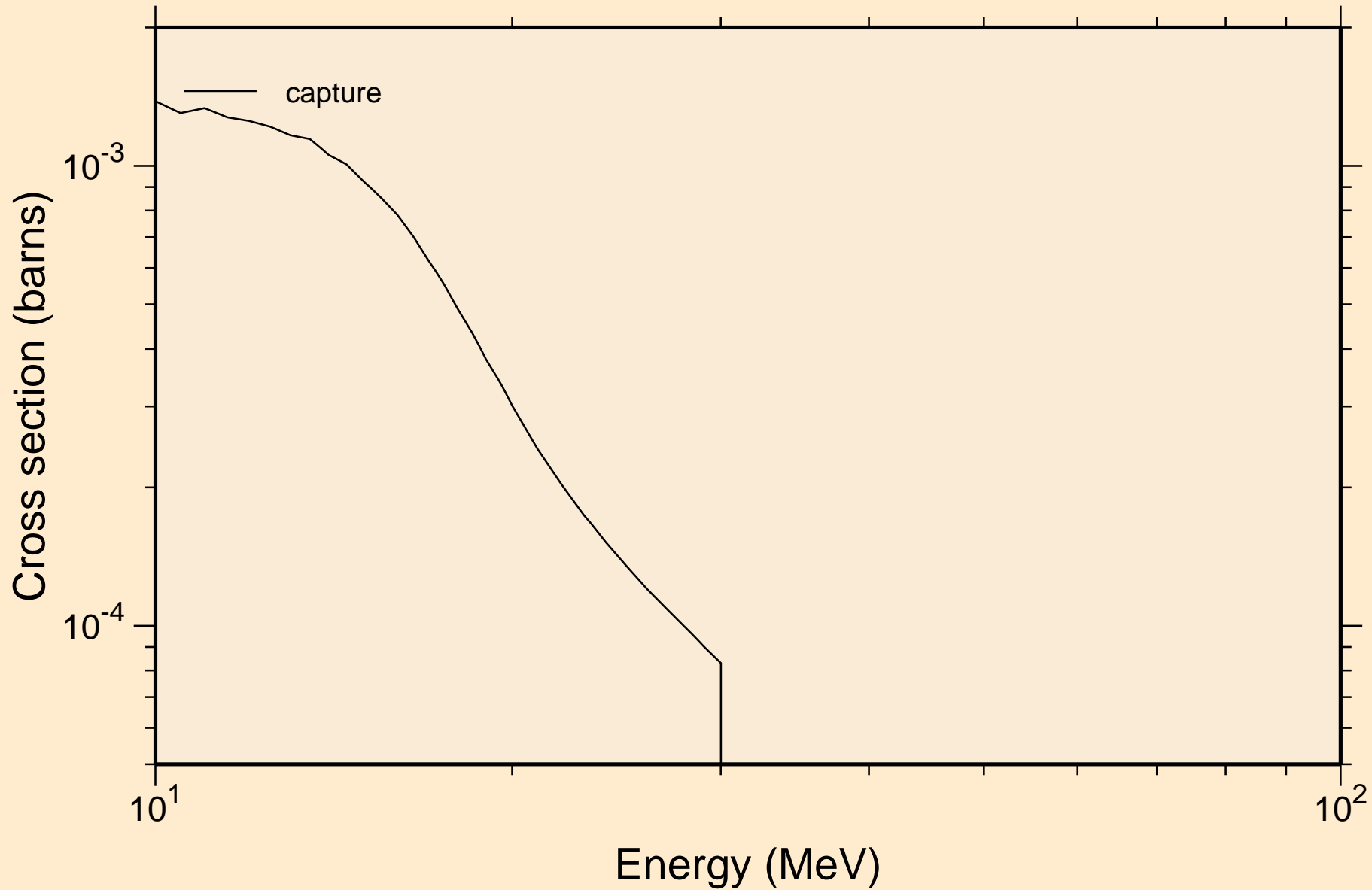

SI027 NEUTRON ACER TENDL-2023 LIBRARY; T=0.K

Heating

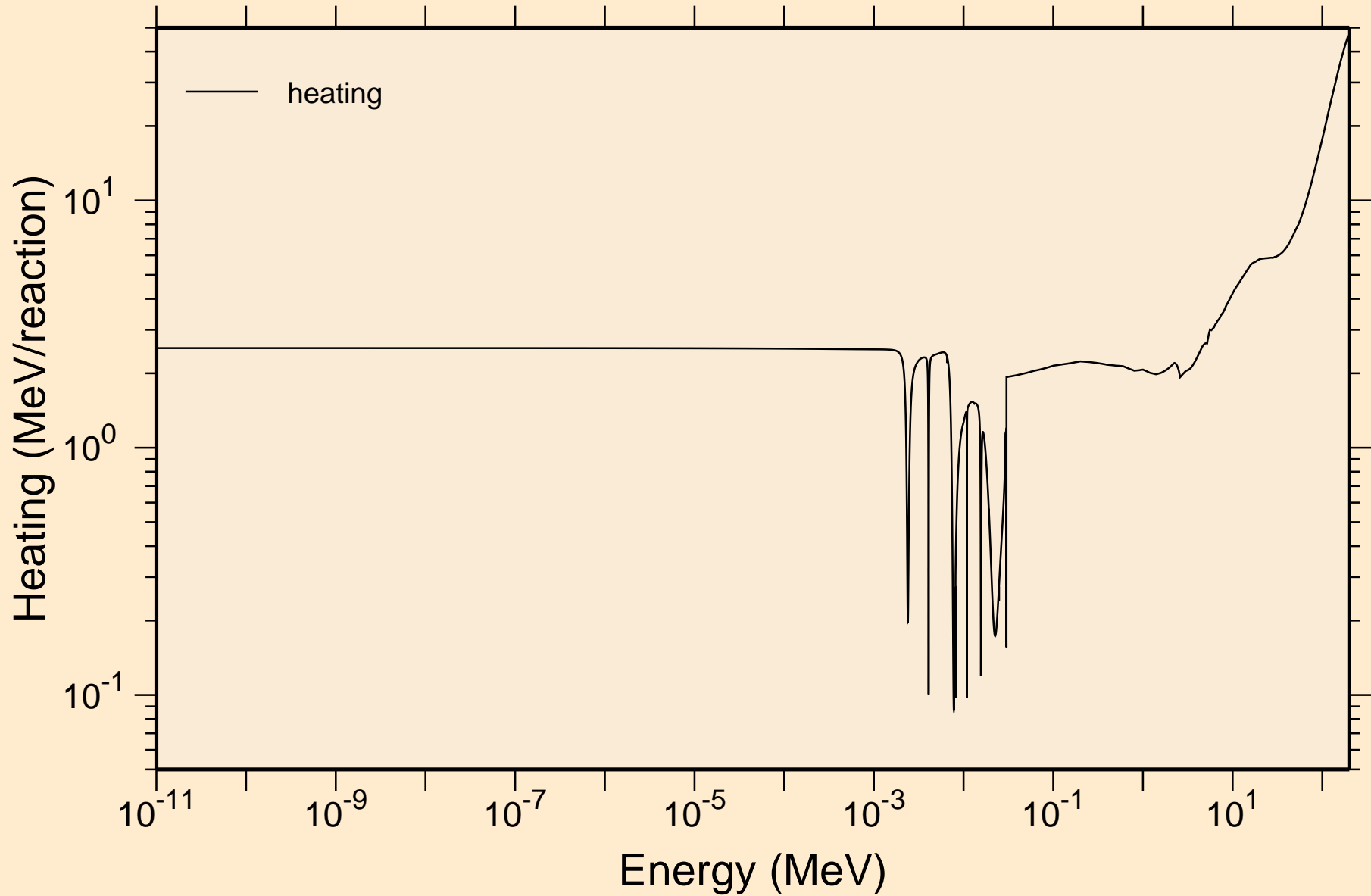

SI027 NEUTRON ACER TENDL-2023 LIBRARY; T=0.K

Damage

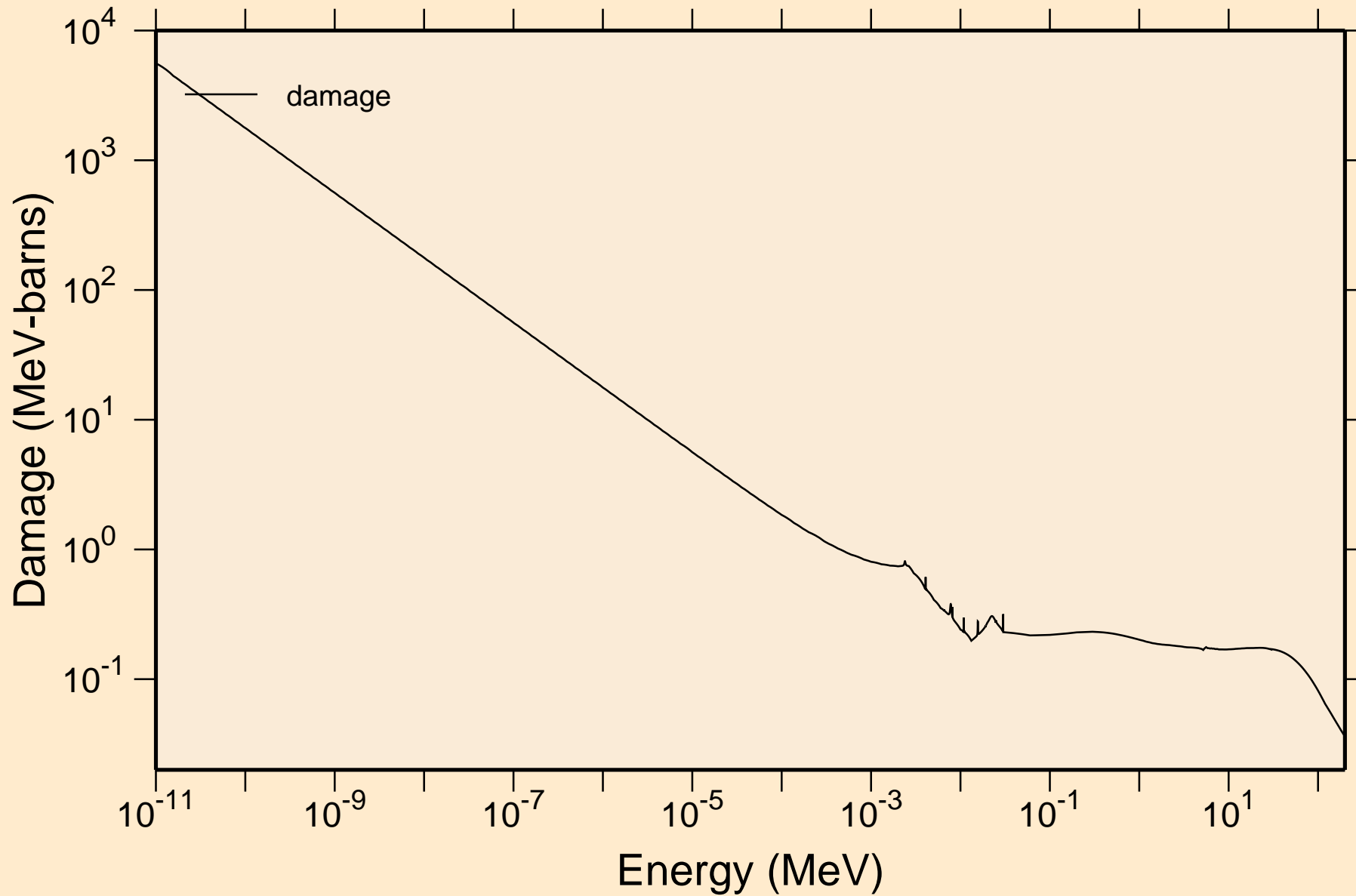

SI027 NEUTRON ACER TENDL-2023 LIBRARY; T=0.K

Principal cross sections

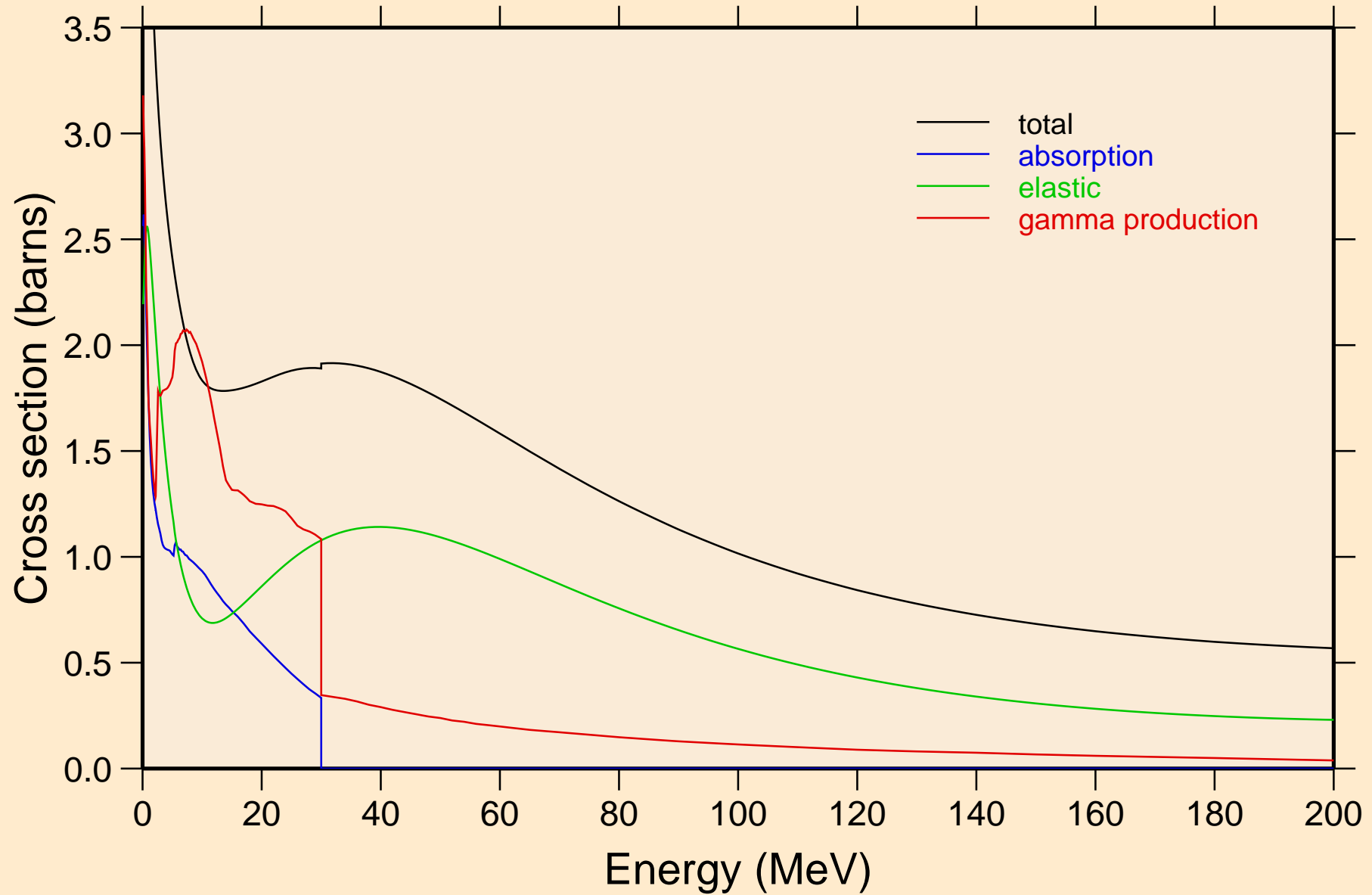

SI027 NEUTRON ACER TENDL-2023 LIBRARY; T=0.K

Heating

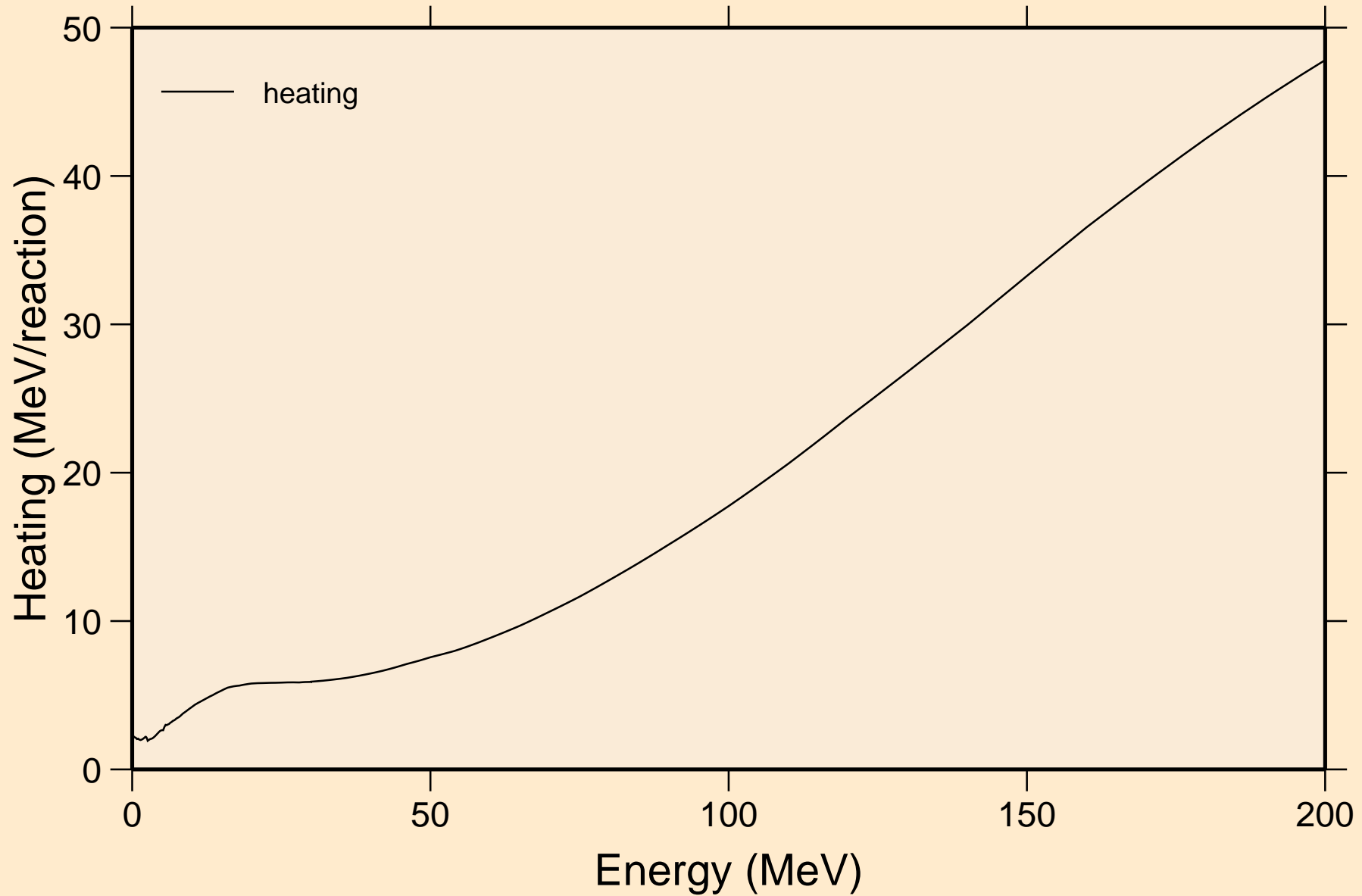

SI027 NEUTRON ACER TENDL-2023 LIBRARY; T=0.K
Damage

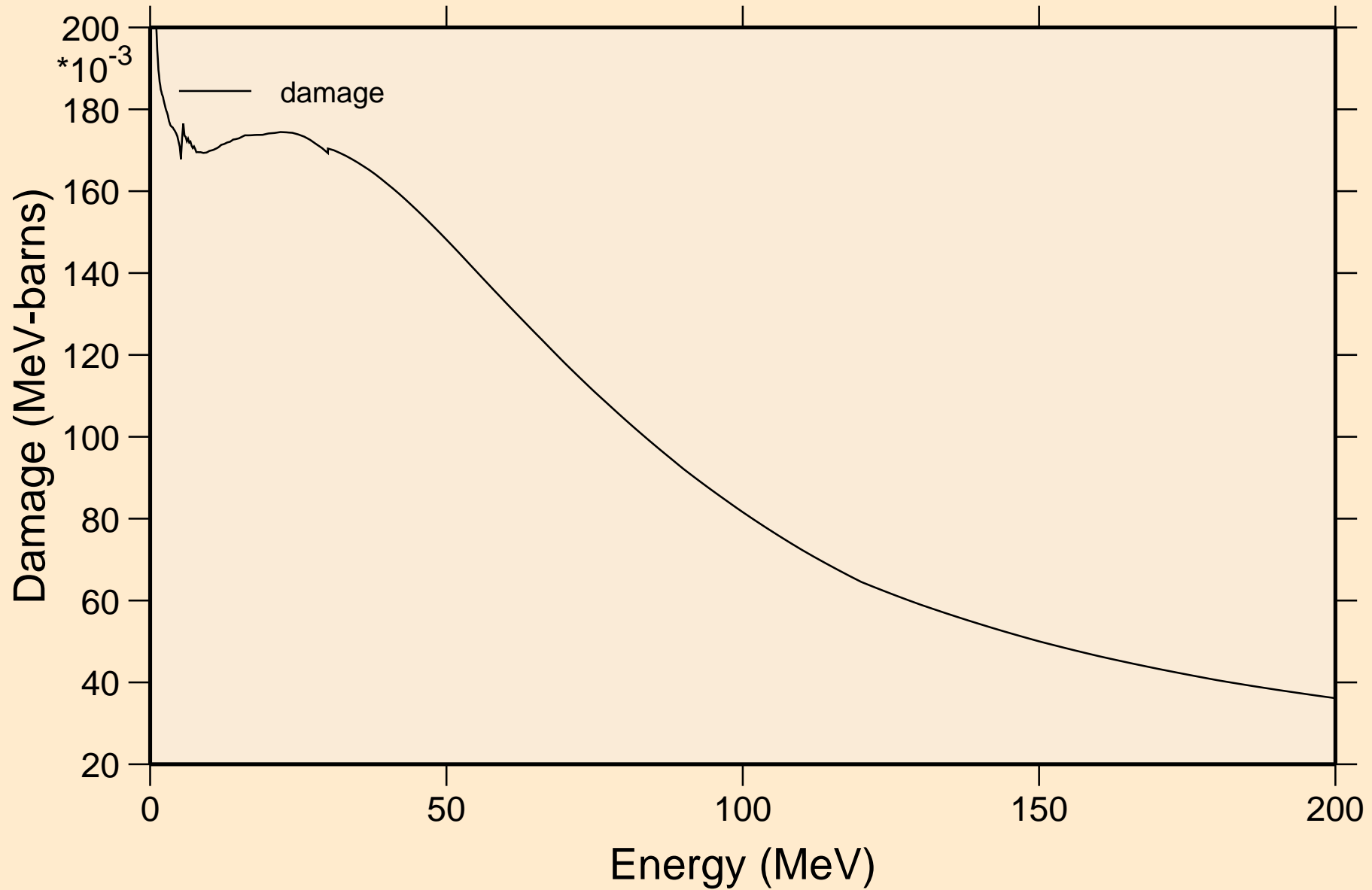

SI027 NEUTRON ACER TENDL-2023 LIBRARY; T=0.K

Non-threshold reactions

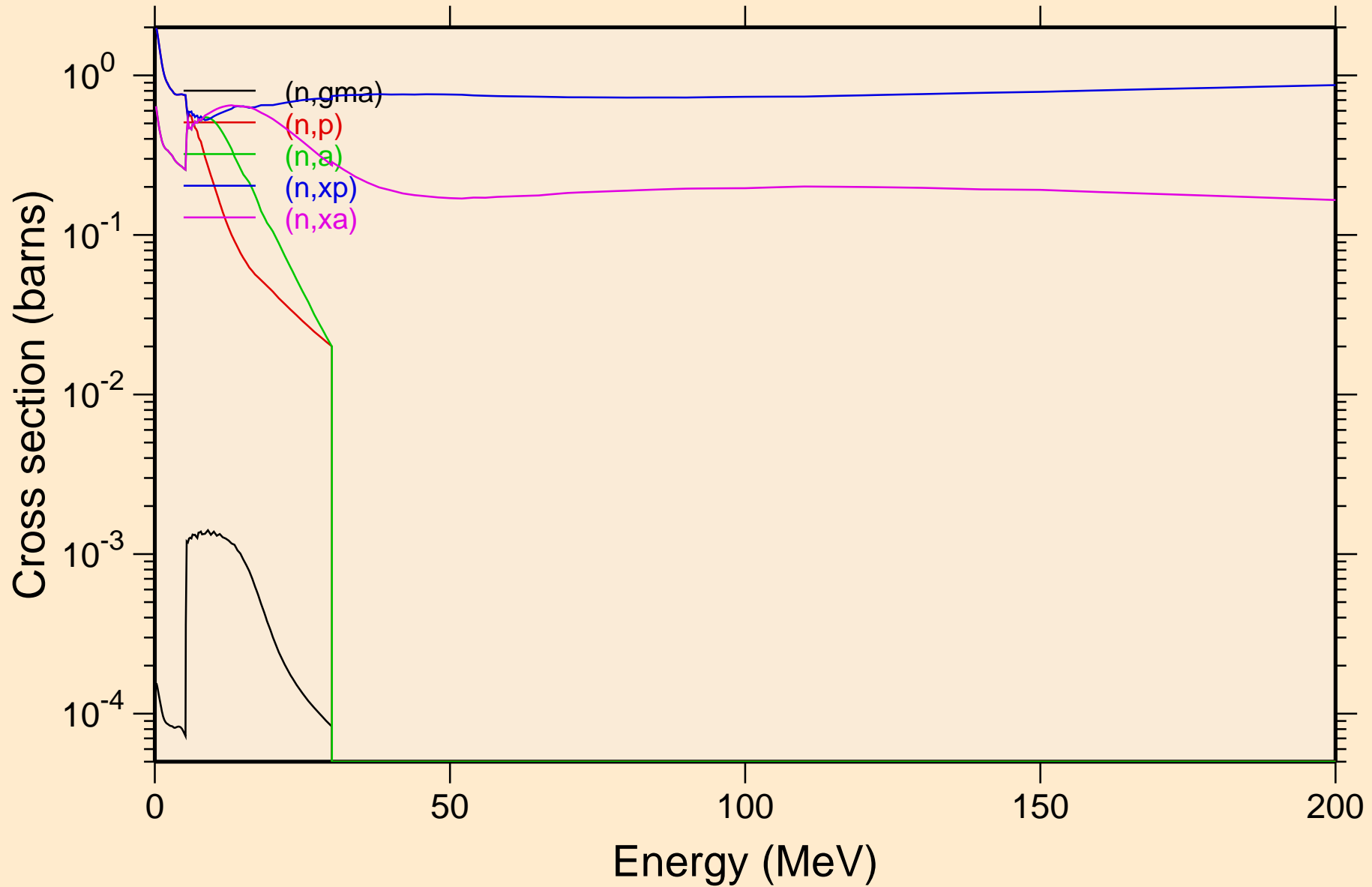

SI027 NEUTRON ACER TENDL-2023 LIBRARY; T=0.K
Inelastic levels

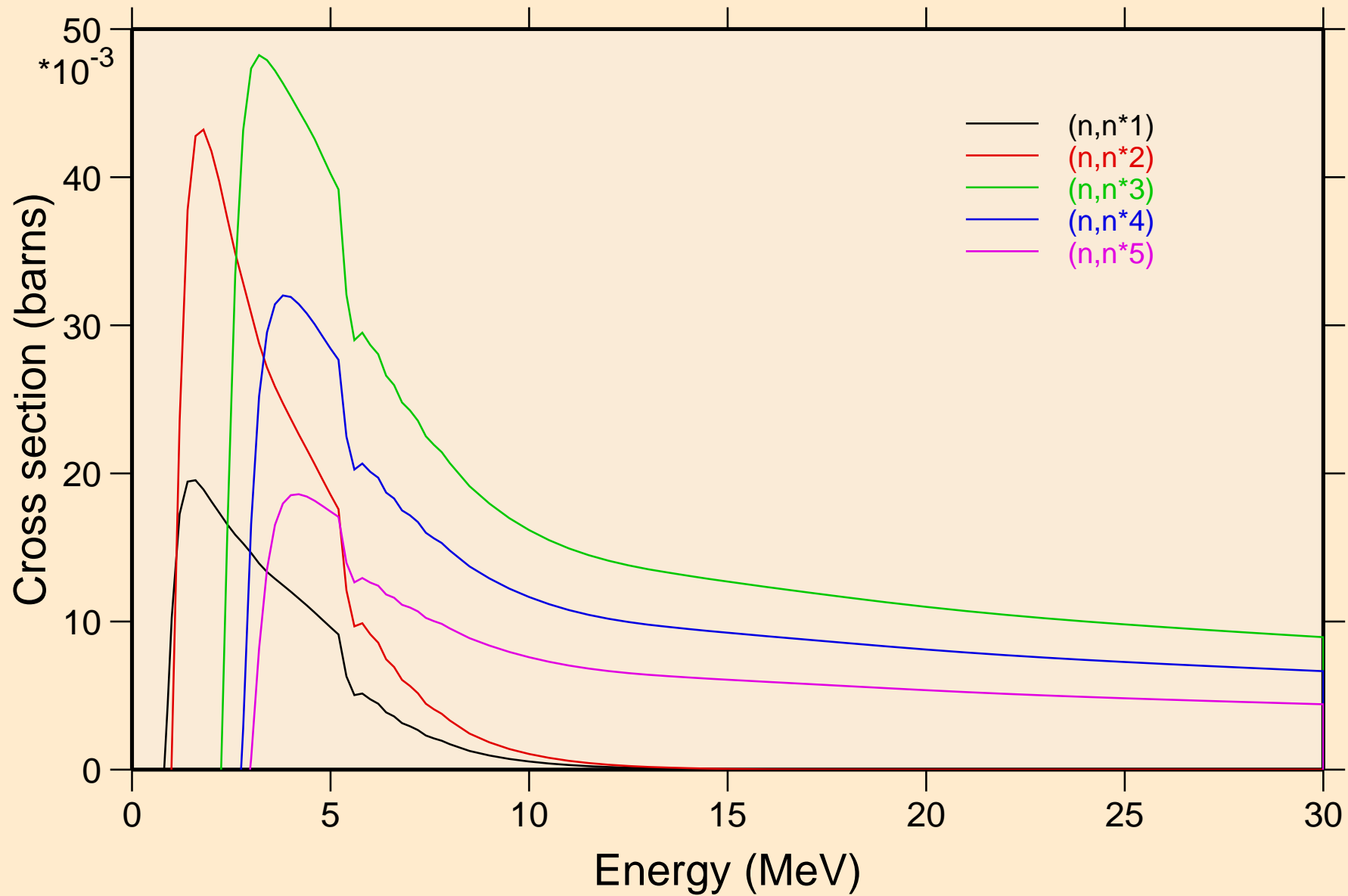

SI027 NEUTRON ACER TENDL-2023 LIBRARY; T=0.K
Inelastic levels

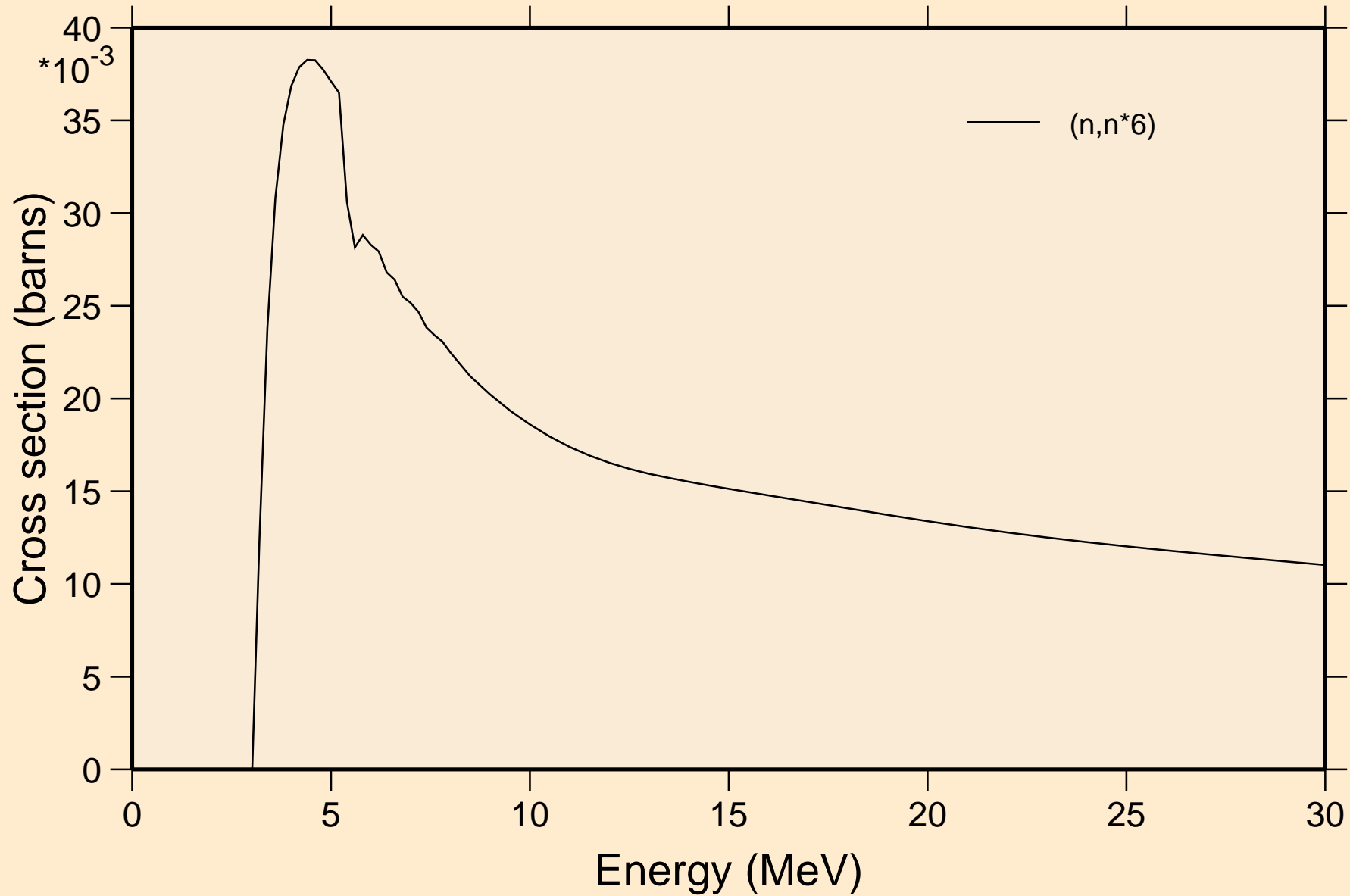

SI027 NEUTRON ACER TENDL-2023 LIBRARY; T=0.K

Threshold reactions

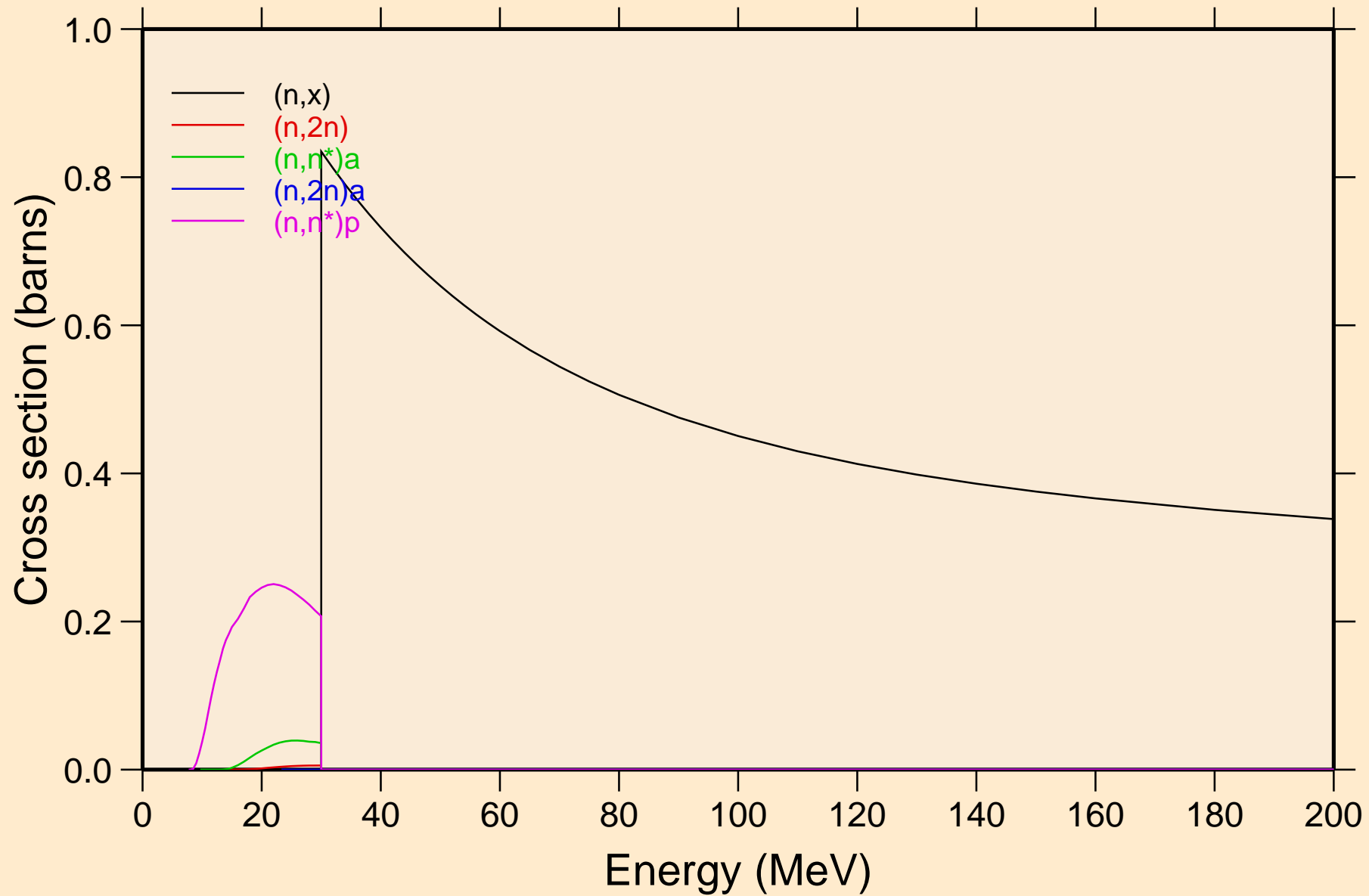

SI027 NEUTRON ACER TENDL-2023 LIBRARY; T=0.K

Threshold reactions

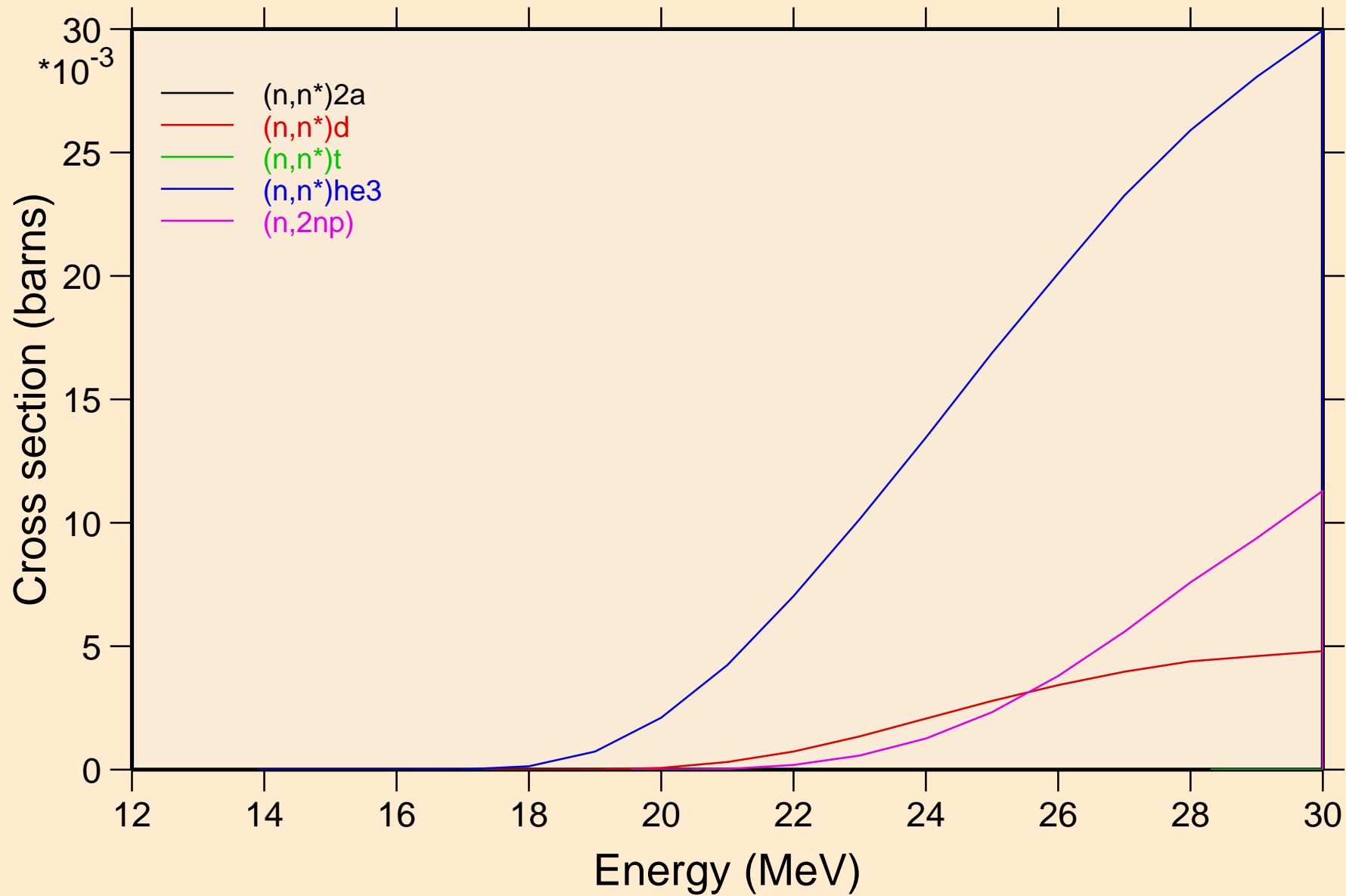

SI027 NEUTRON ACER TENDL-2023 LIBRARY; T=0.K

Threshold reactions

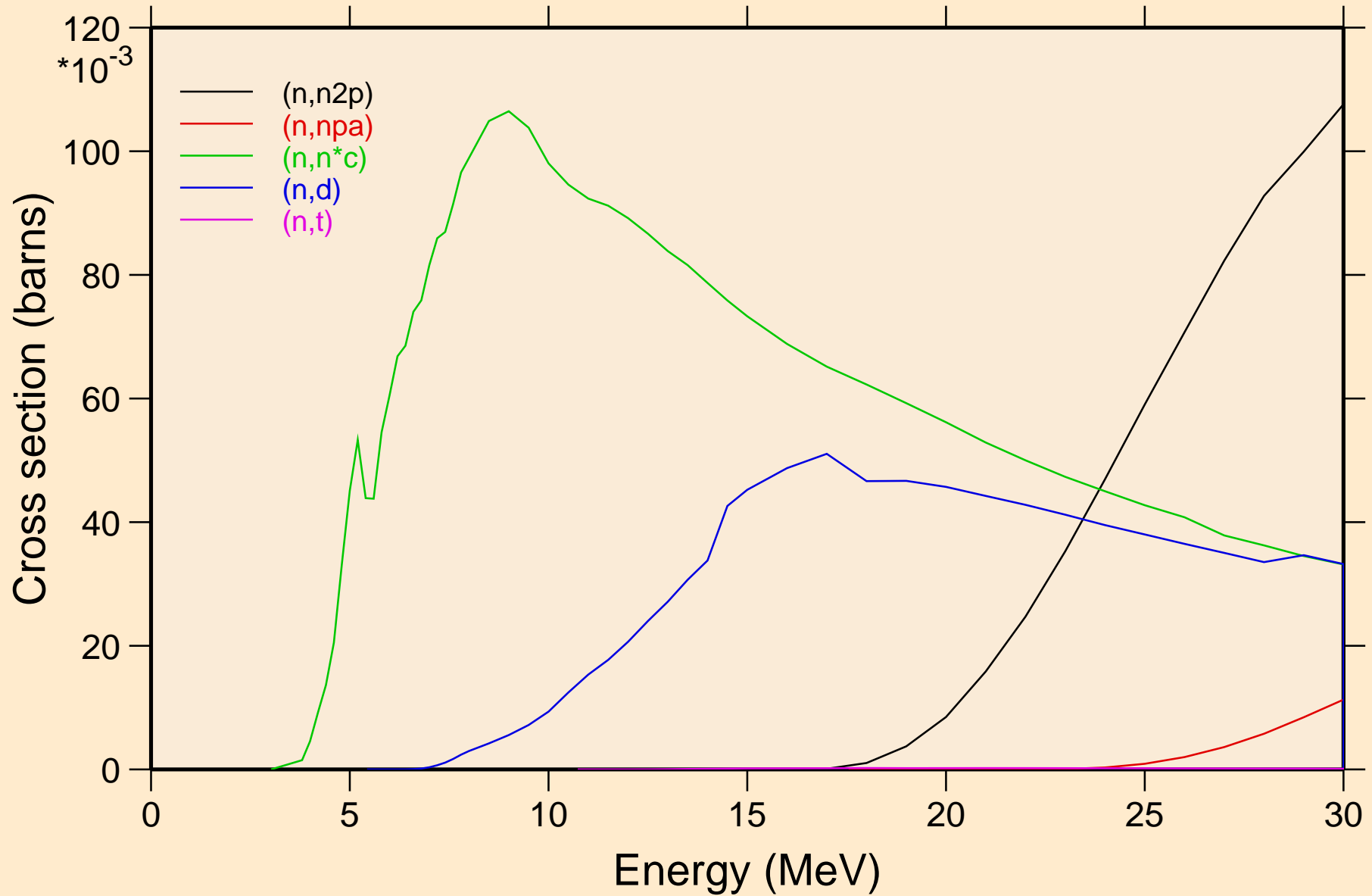

SI027 NEUTRON ACER TENDL-2023 LIBRARY; T=0.K

Threshold reactions

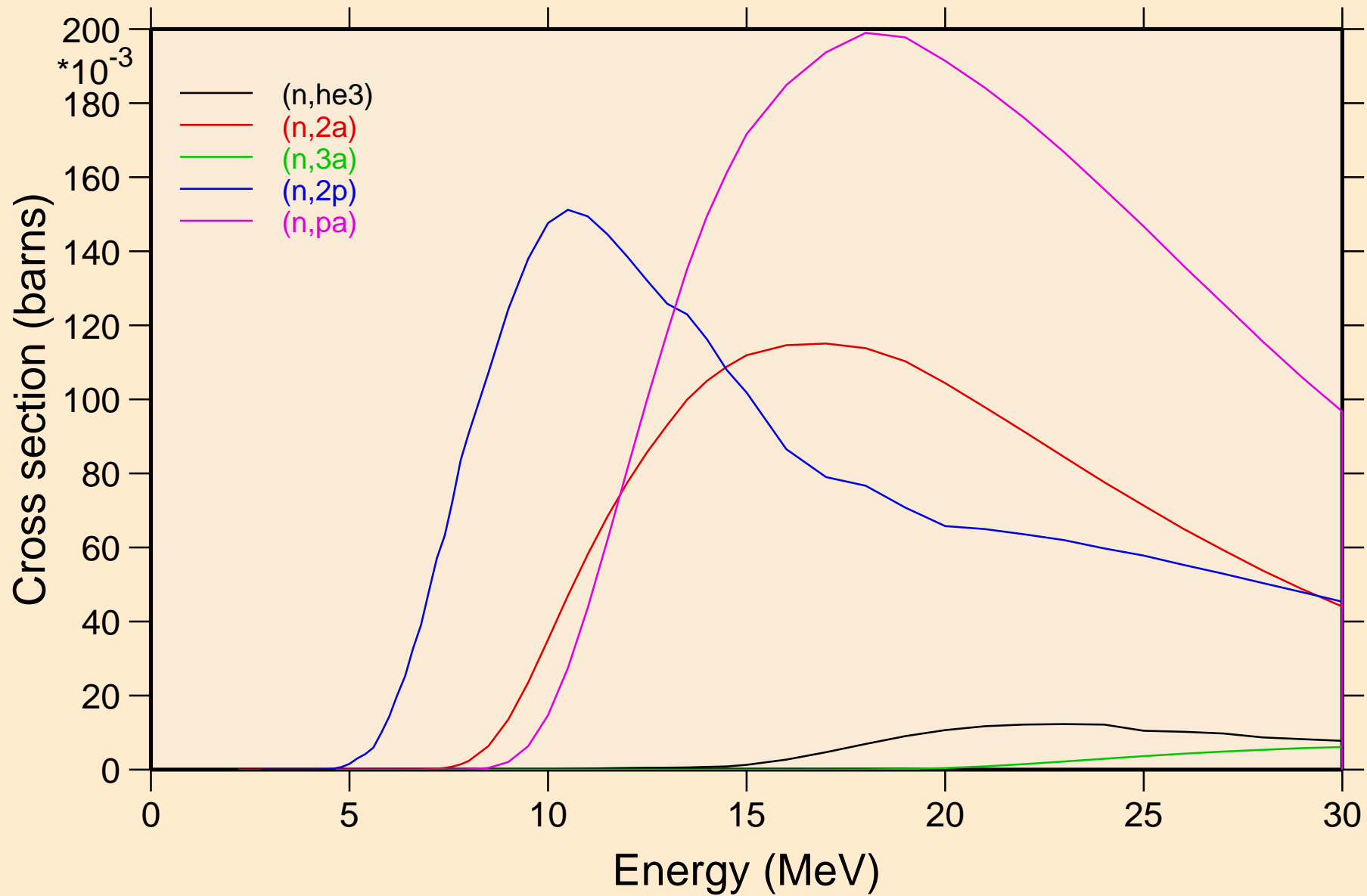

SI027 NEUTRON ACER TENDL-2023 LIBRARY; T=0.K
Threshold reactions

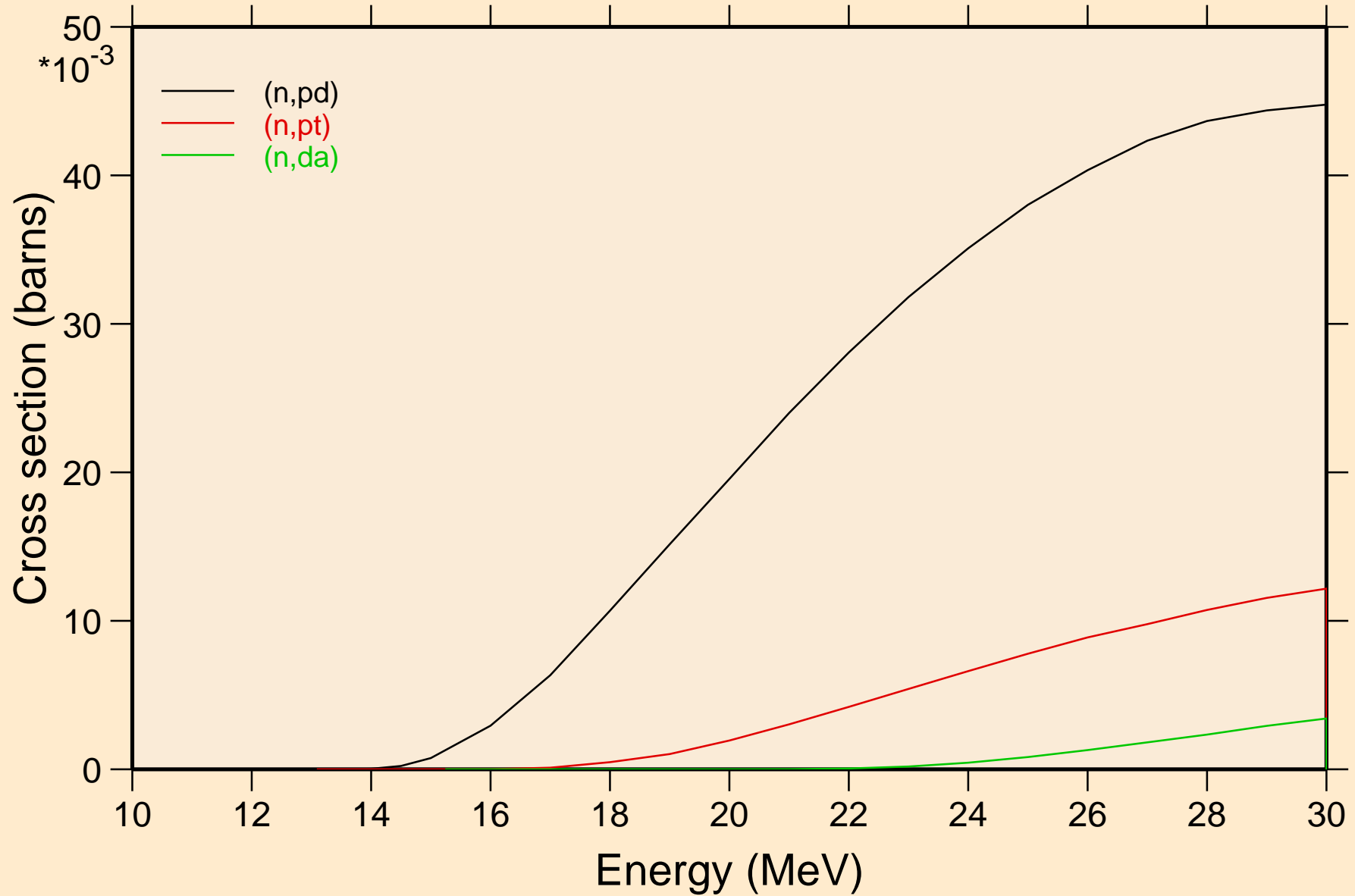

SI027 NEUTRON ACER TENDL-2023 LIBRARY; T=0.K

Threshold reactions

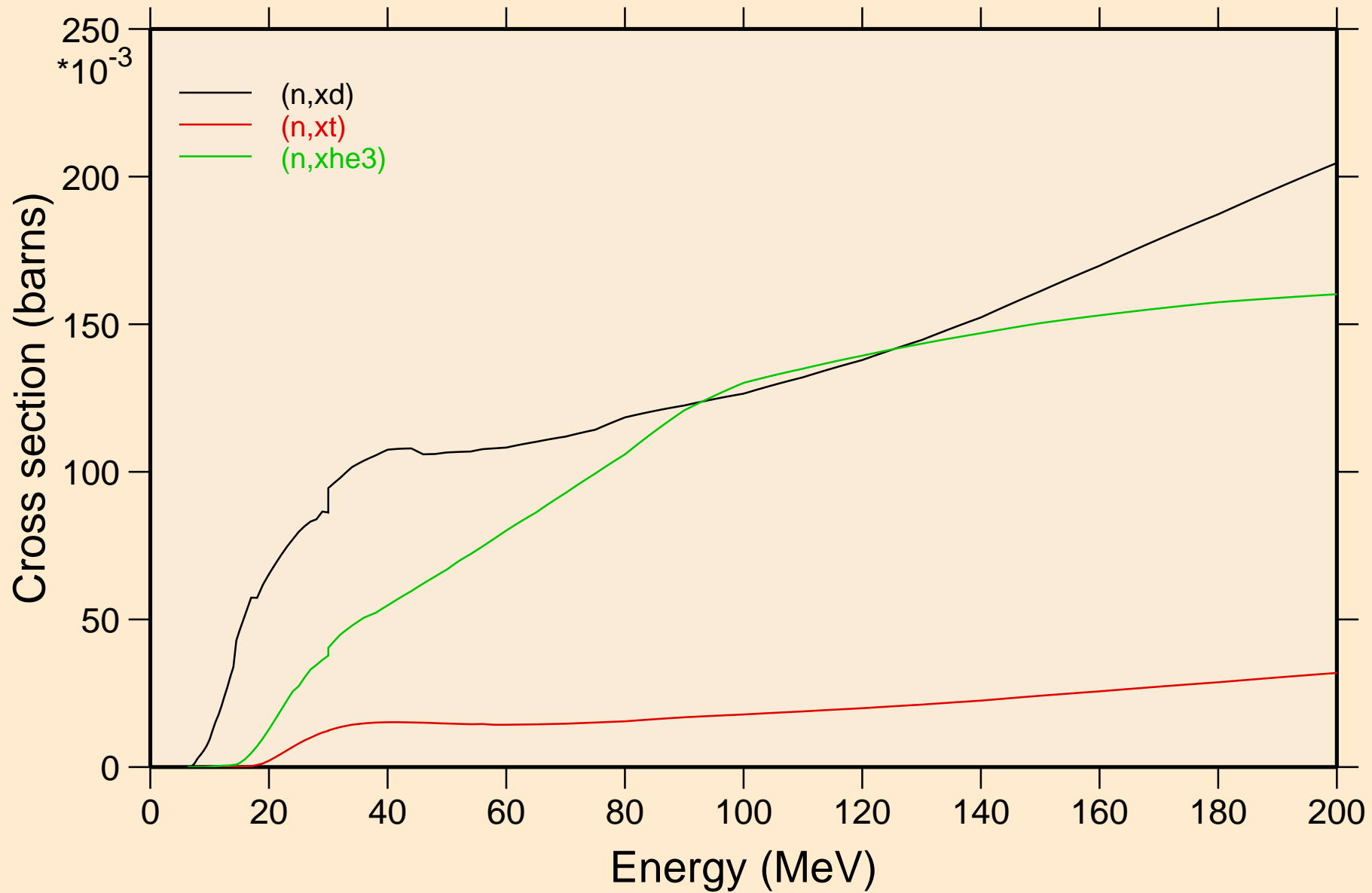

SI027 NEUTRON ACER TENDL-2023 LIBRARY; T=0.K
angular distribution for elastic

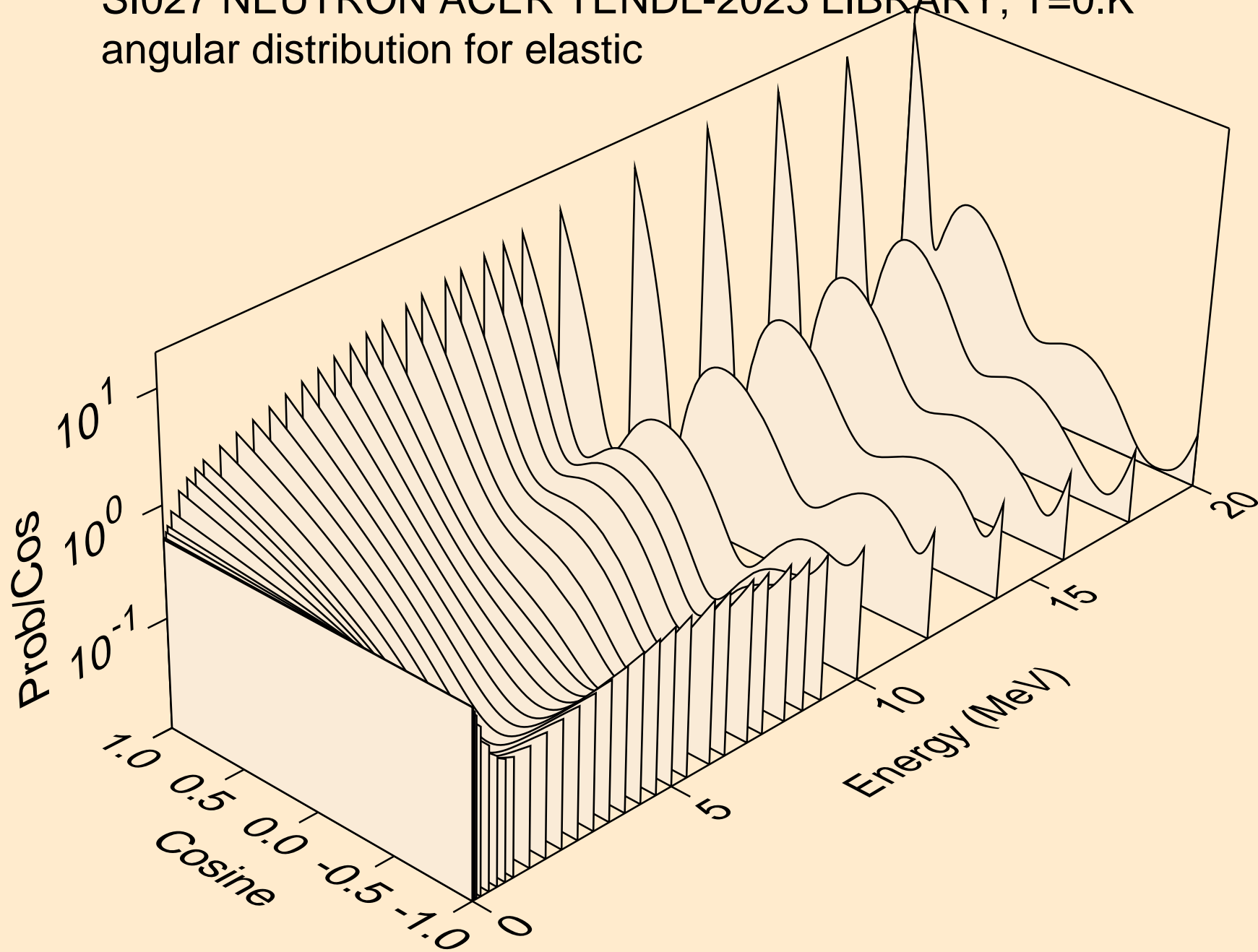

SI027 NEUTRON ACER TENDL-2023 LIBRARY; T=0.K
angular distribution for elastic

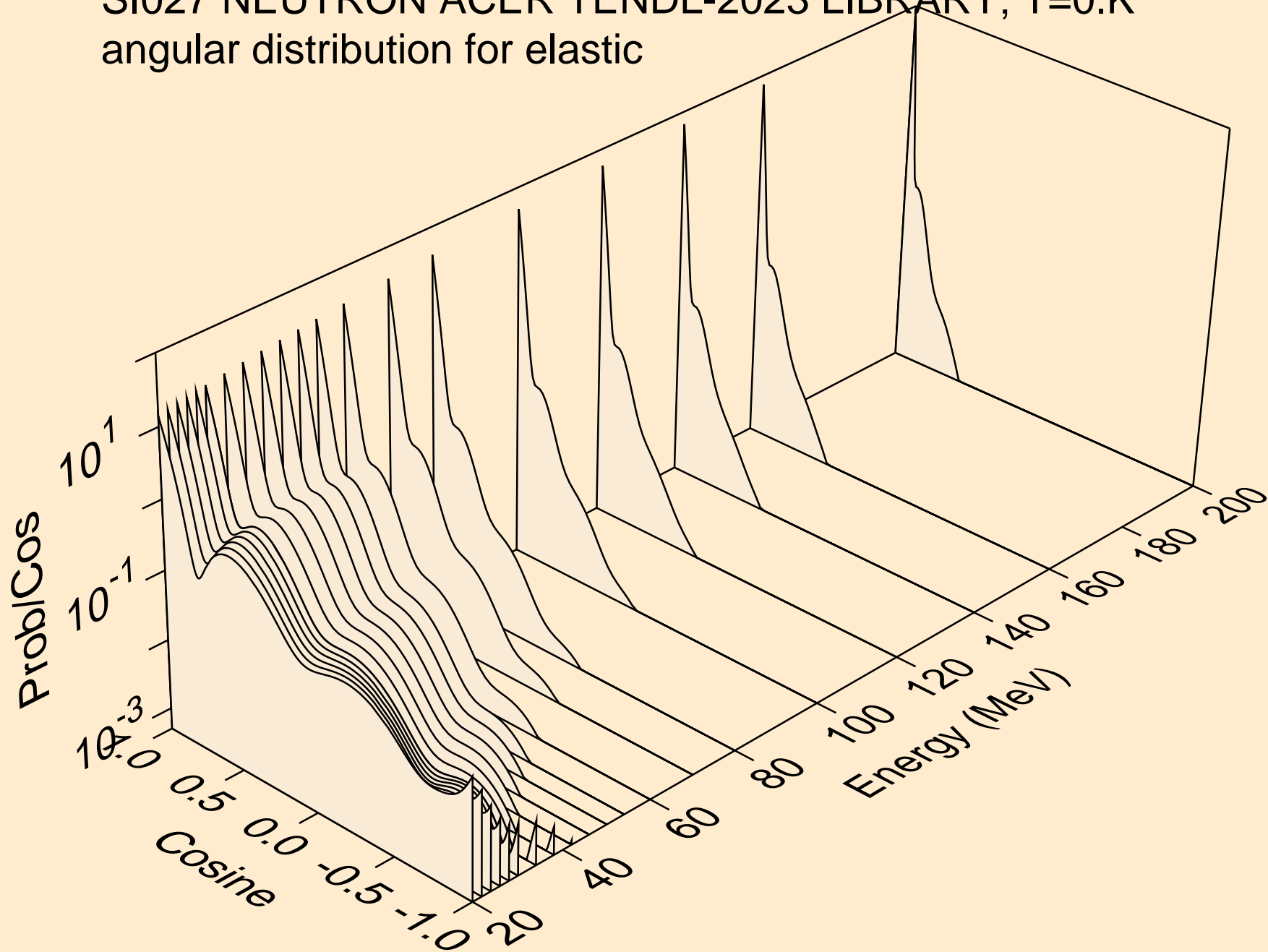

SI027 NEUTRON ACER TENDL-2023 LIBRARY; T=0.K
angular distribution for (n,n*1)

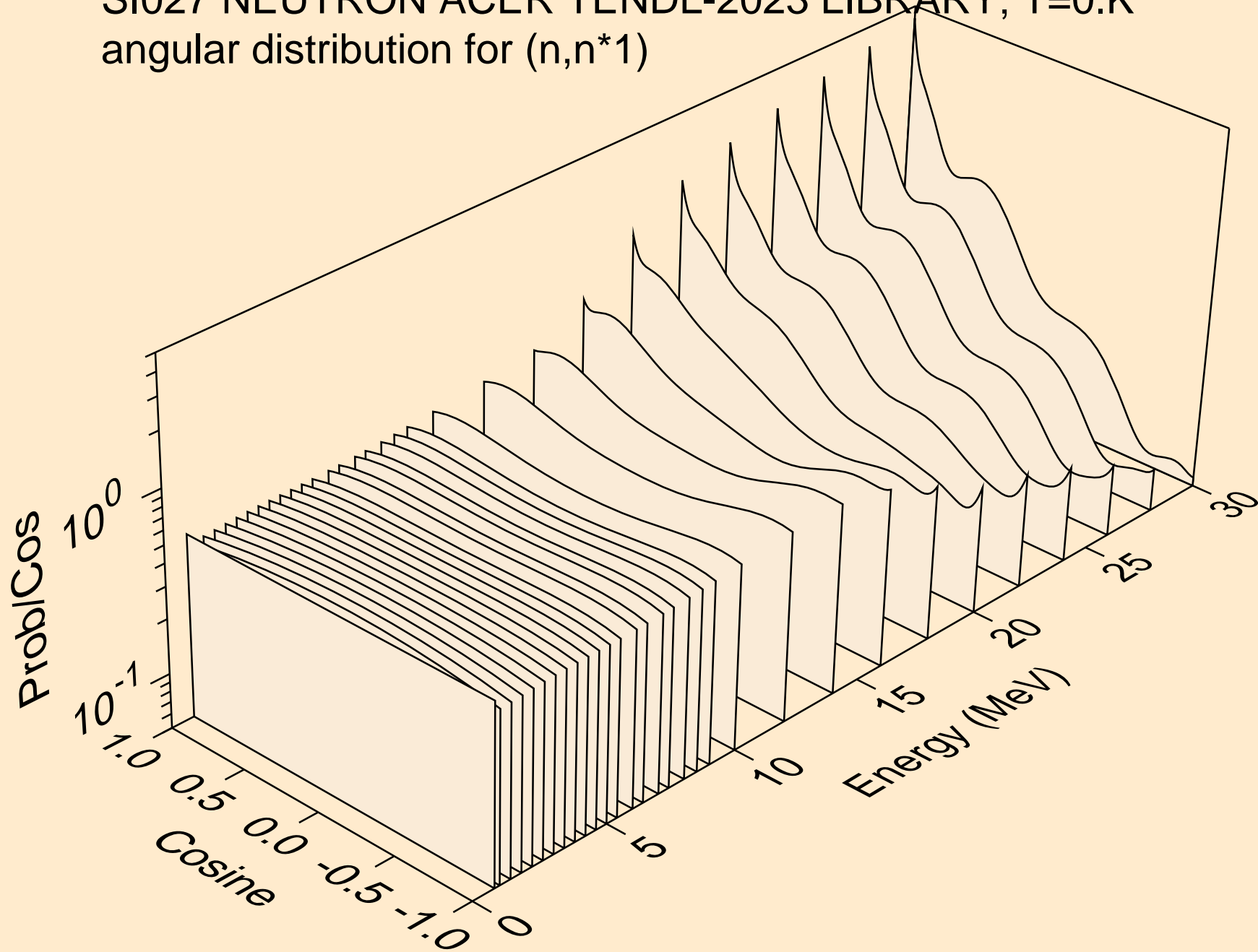

SI027 NEUTRON ACER TENDL-2023 LIBRARY; T=0.K
angular distribution for (n,n*2)

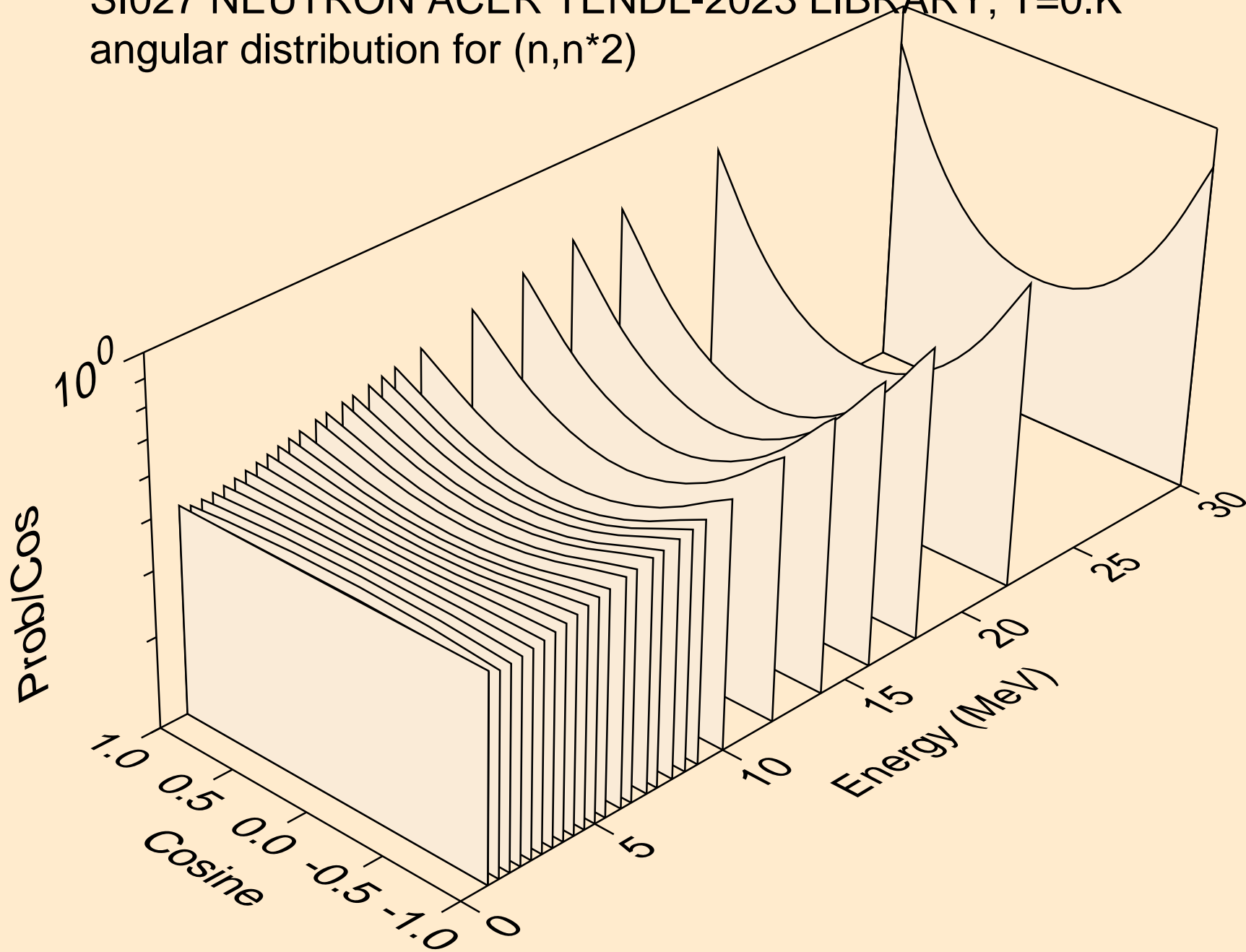

SI027 NEUTRON ACER TENDL-2023 LIBRARY; T=0.K
angular distribution for (n,n*3)

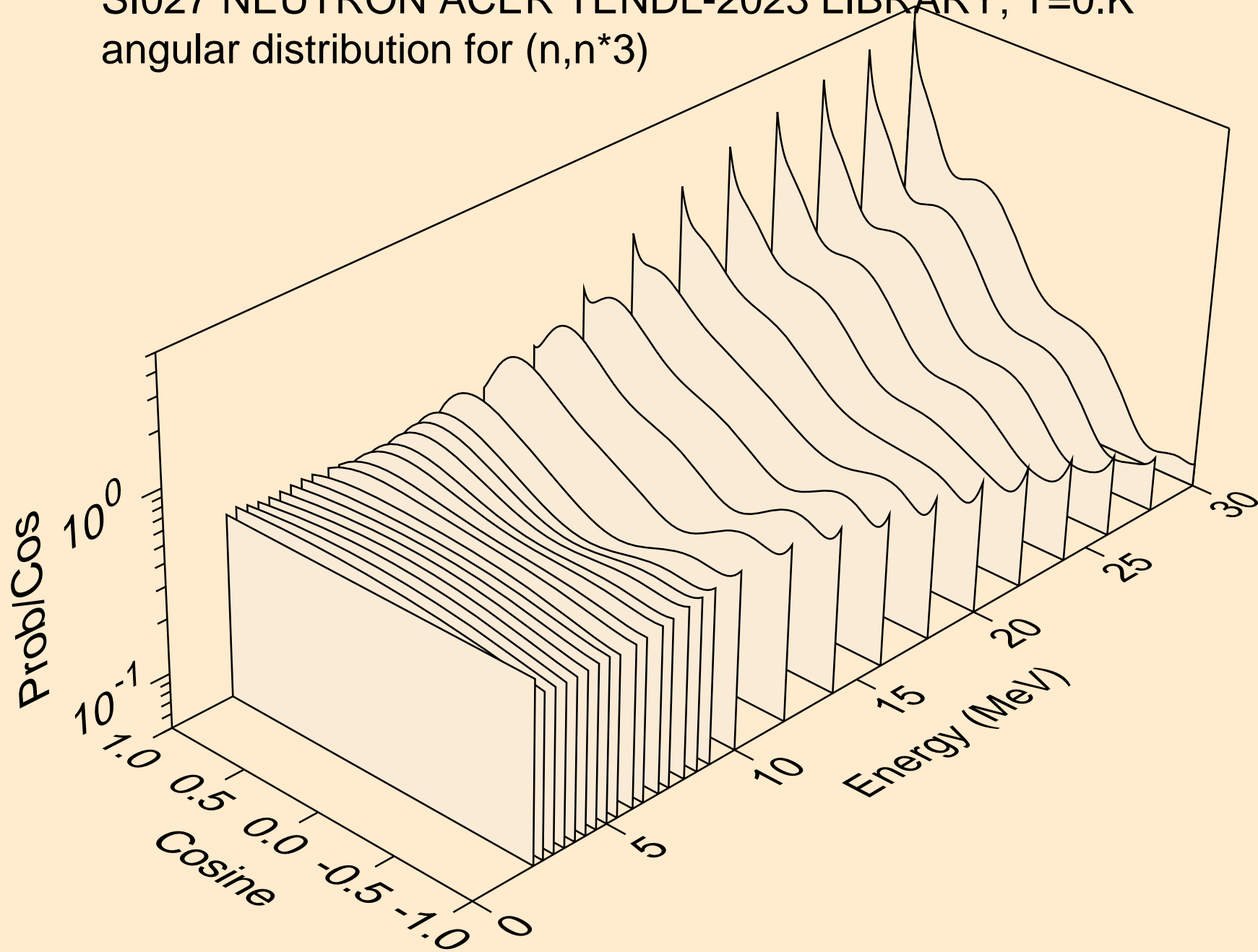

SI027 NEUTRON ACER TENDL-2023 LIBRARY; T=0.K
angular distribution for (n,n*4)

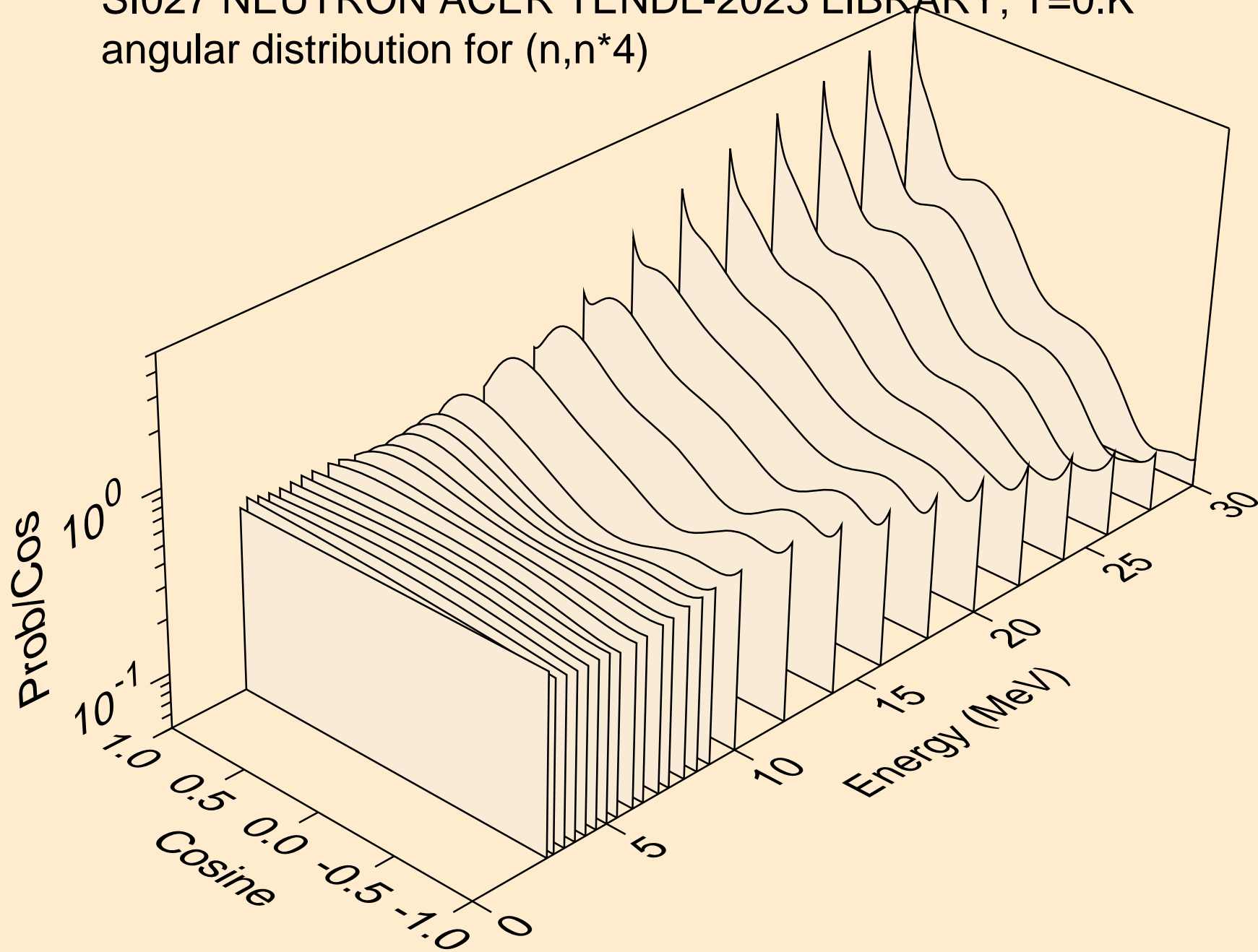

SI027 NEUTRON ACER TENDL-2023 LIBRARY; T=0.K
angular distribution for (n,n*5)

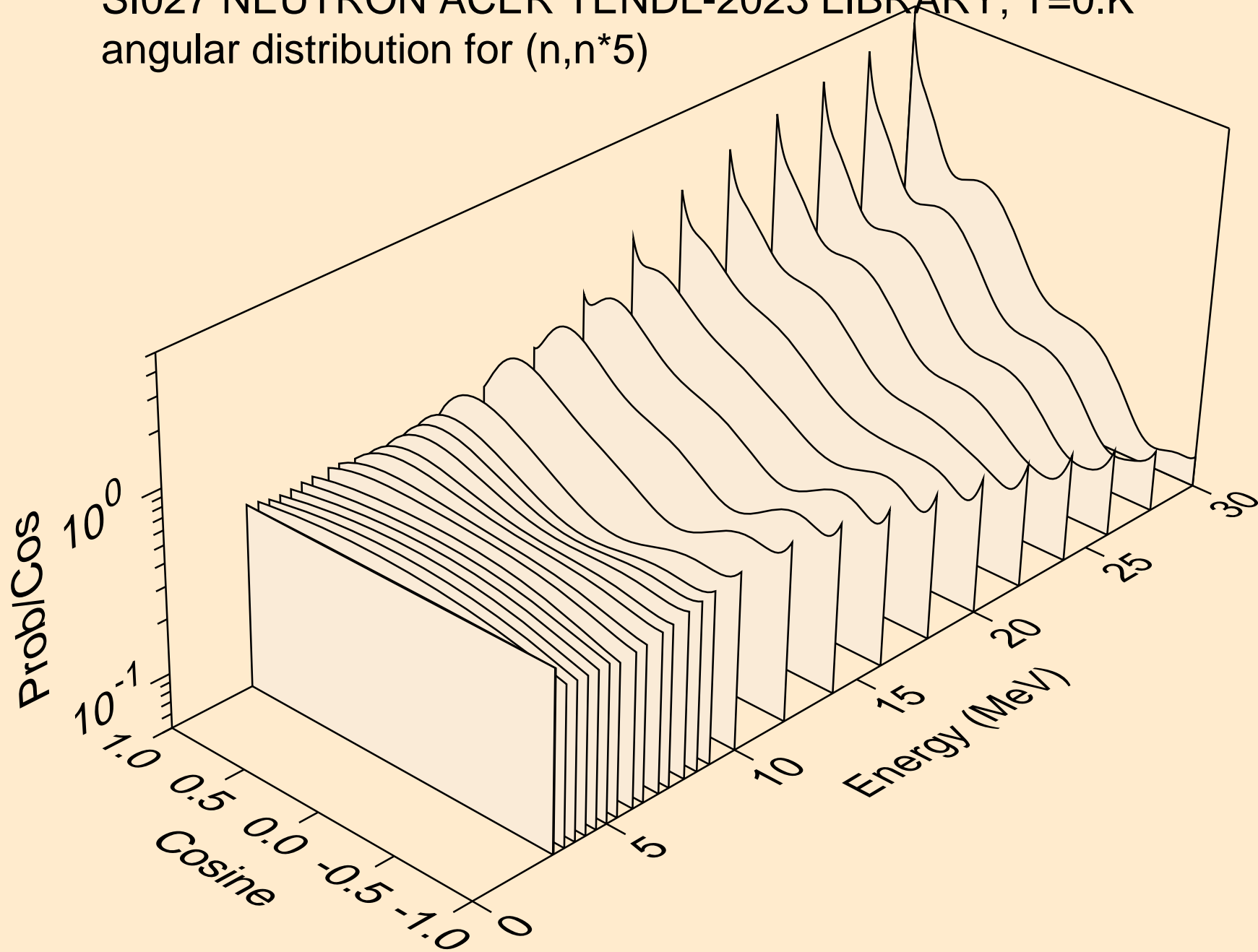

SI027 NEUTRON ACER TENDL-2023 LIBRARY; T=0.K
angular distribution for (n,n*6)

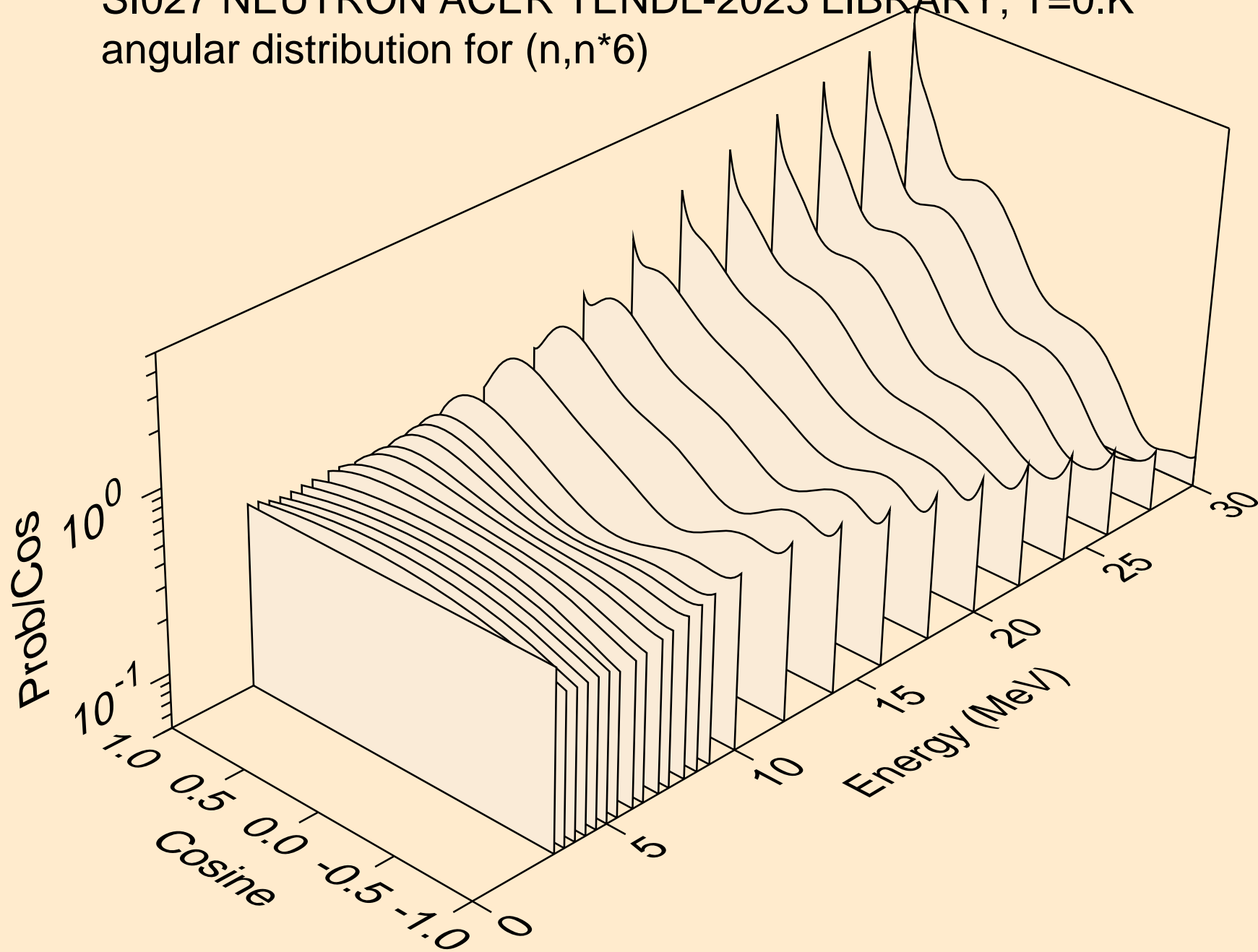

SI027 NEUTRON ACER TENDL-2023 LIBRARY; T=0.K
Neutron emission for (n,x)

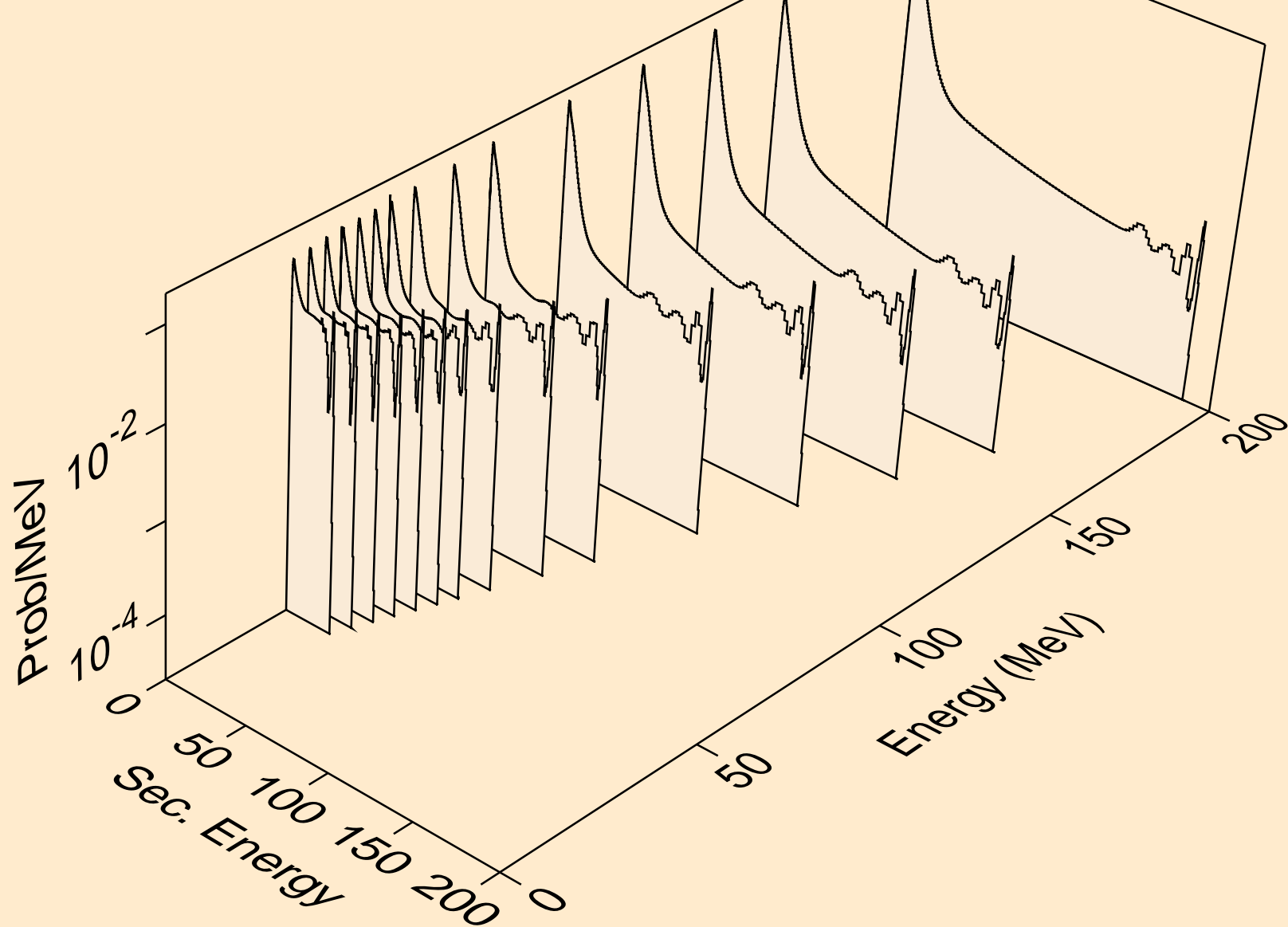

SI027 NEUTRON ACER TENDL-2023 LIBRARY; T=0.K
Neutron emission for (n,2n)

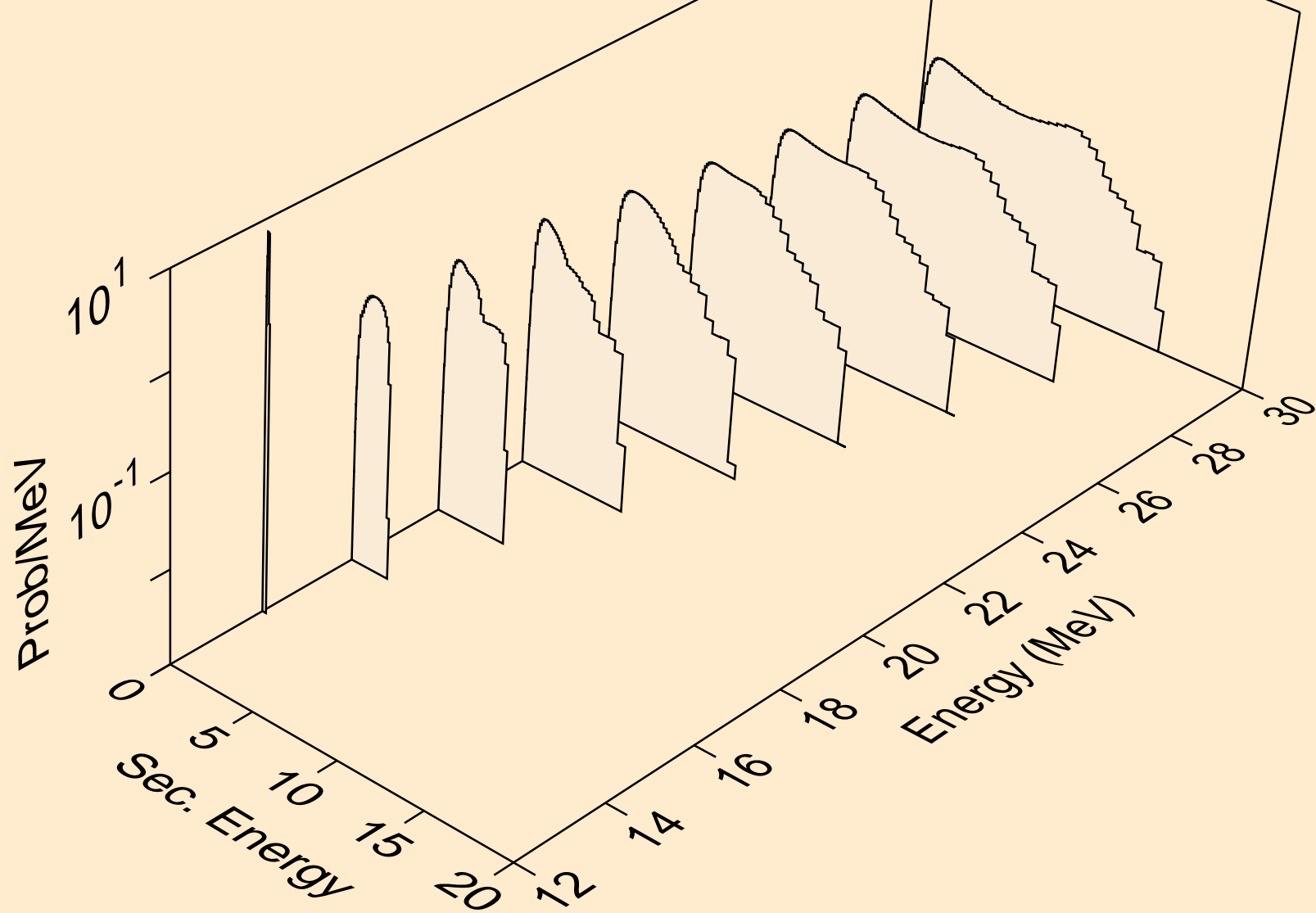

SI027 NEUTRON ACER TENDL-2023 LIBRARY; T=0.K
Neutron emission for (n,n*)a

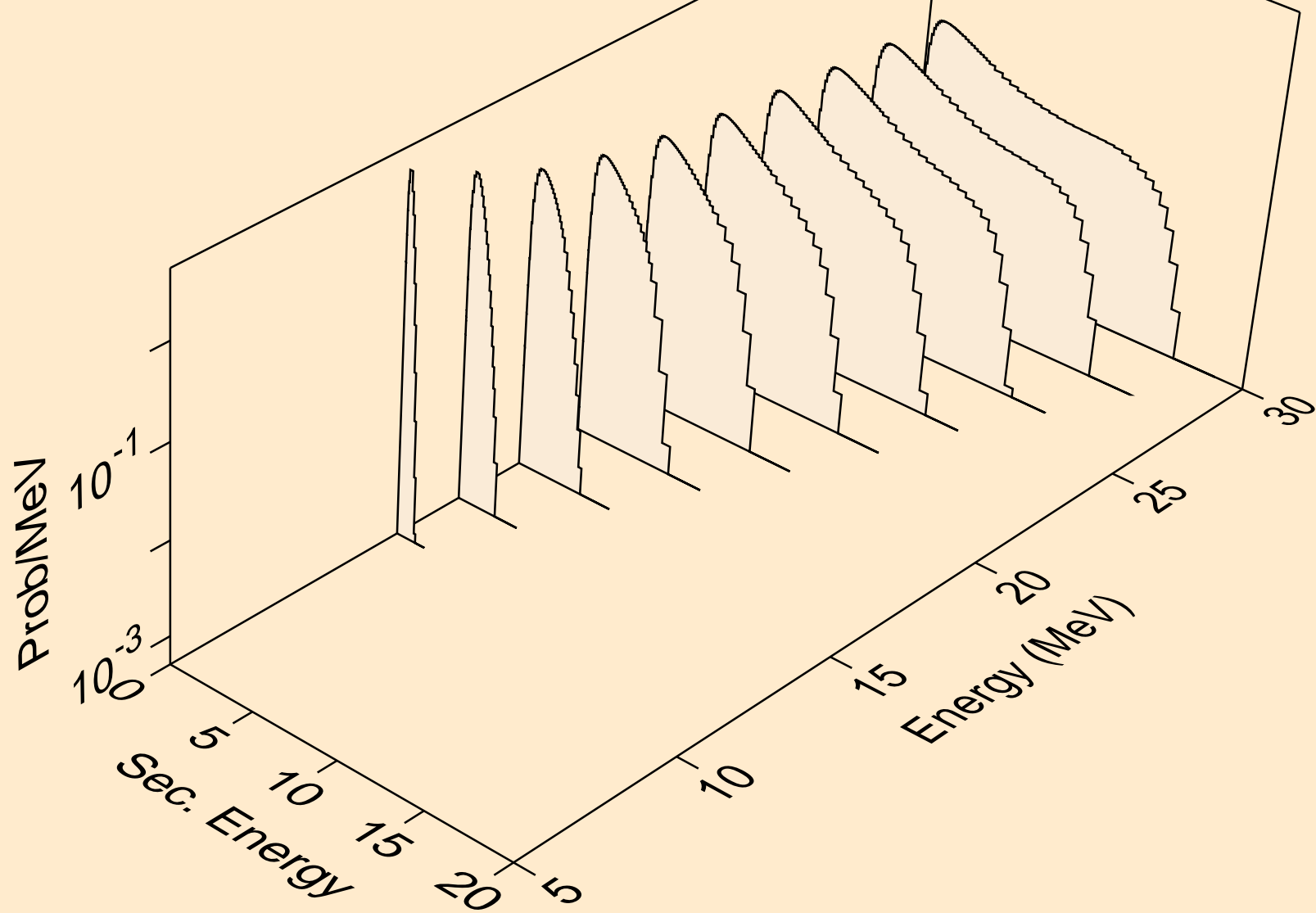

SI027 NEUTRON ACER TENDL-2023 LIBRARY; T=0.K
Neutron emission for (n,2n)a

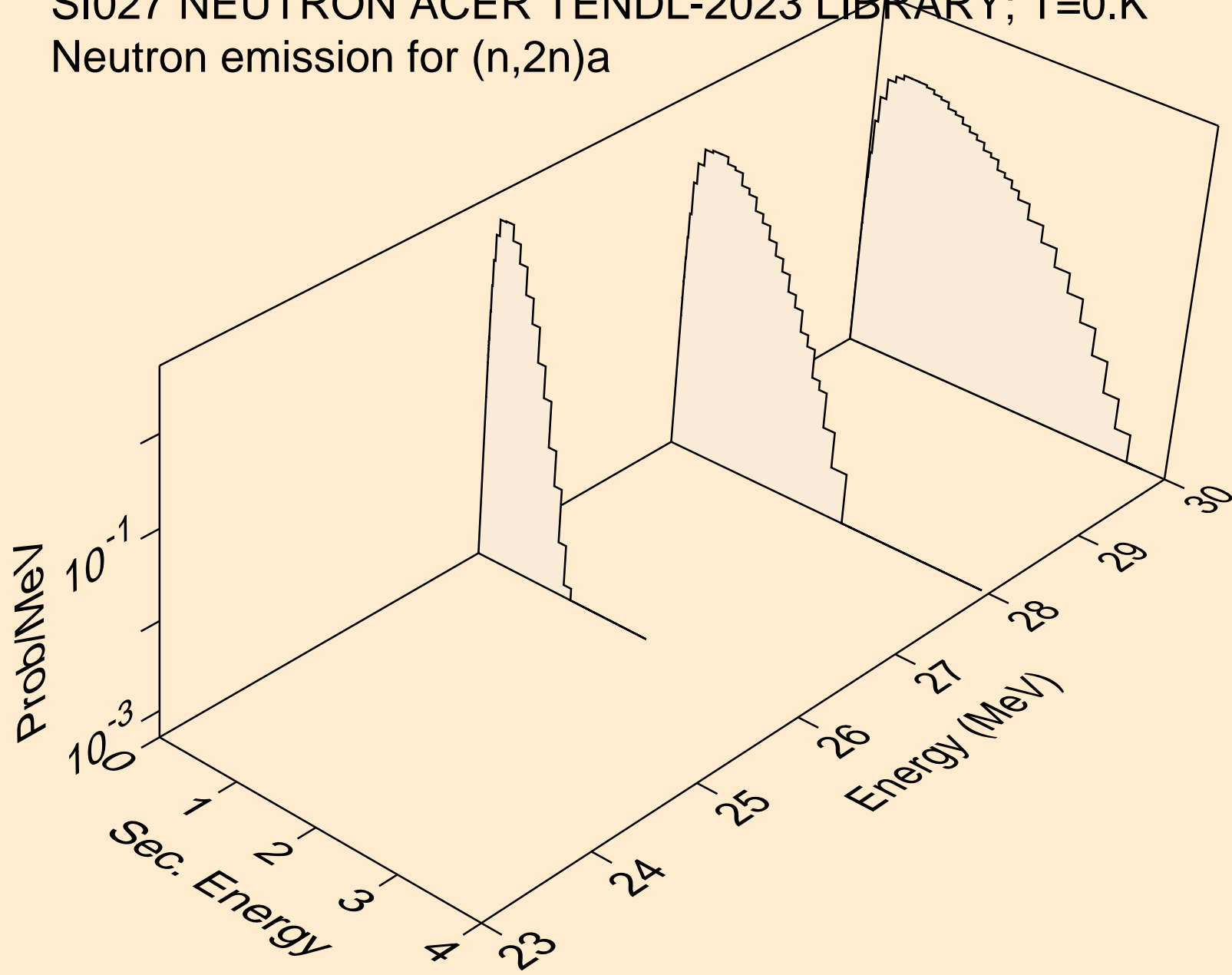

SI027 NEUTRON ACER TENDL-2023 LIBRARY; T=0.K
Neutron emission for (n,n*)p

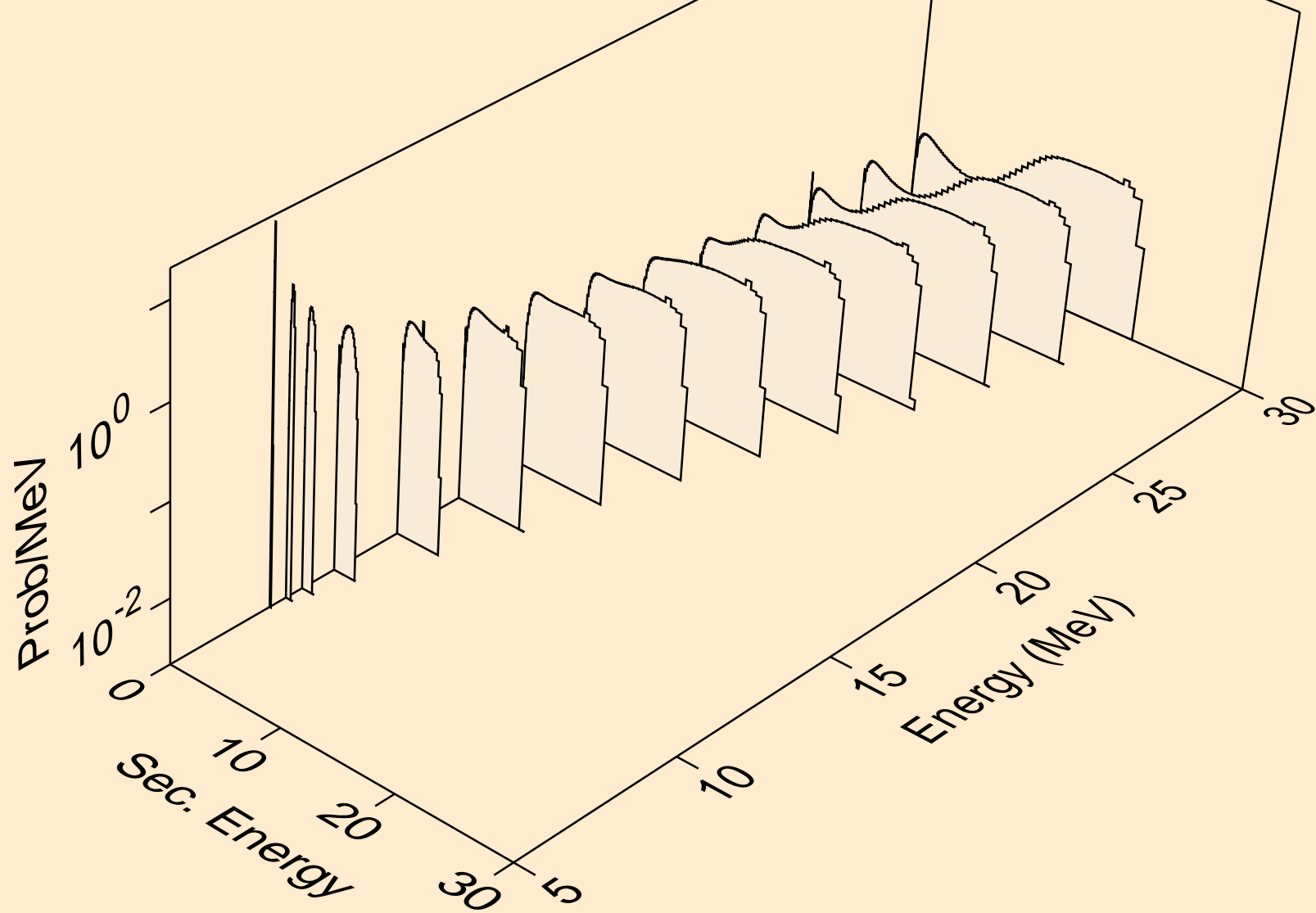

SI027 NEUTRON ACER TENDL-2023 LIBRARY; T=0.K
Neutron emission for (n,n*)2a

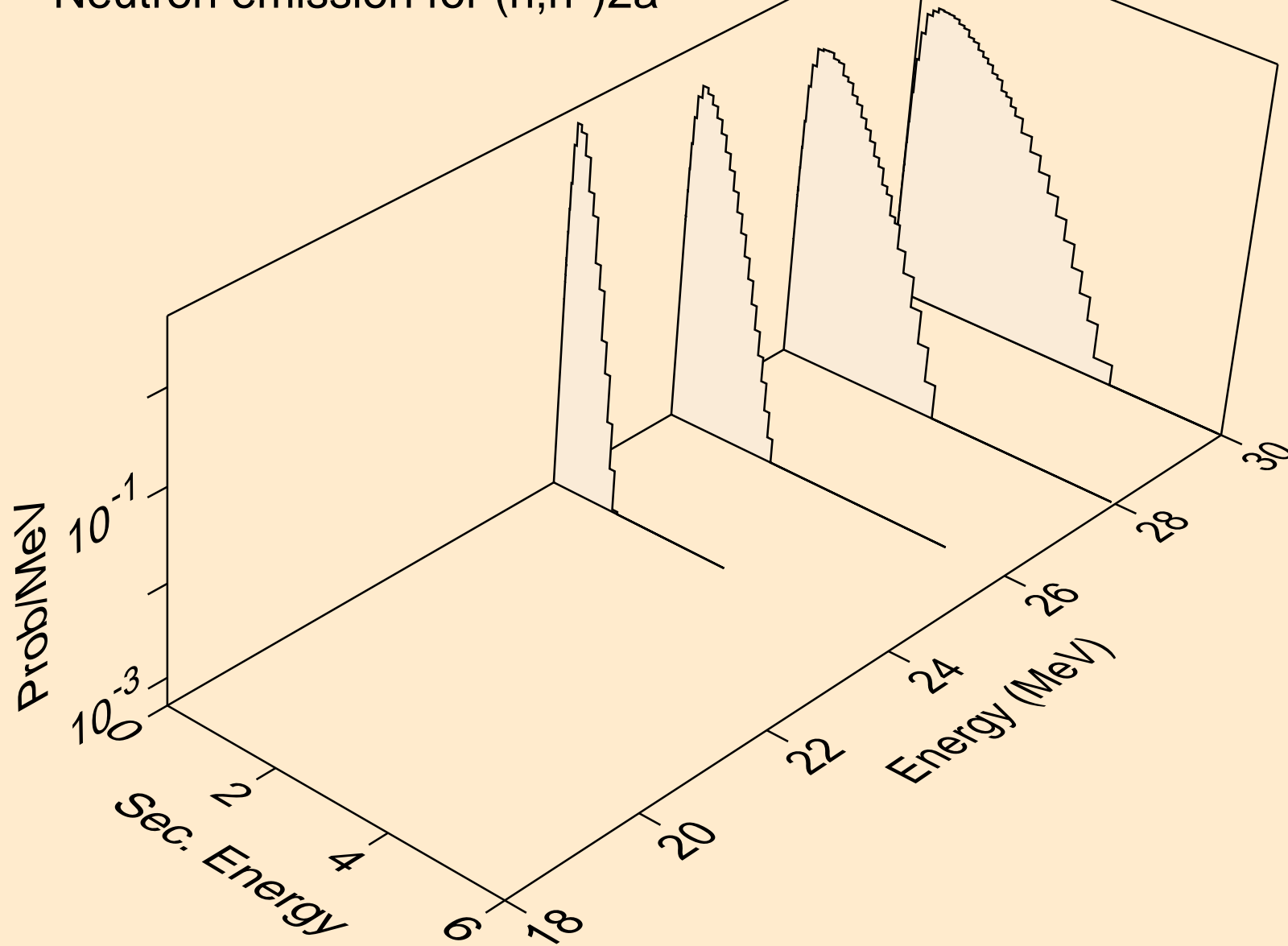

SI027 NEUTRON ACER TENDL-2023 LIBRARY; T=0.K
Neutron emission for (n,n*)d

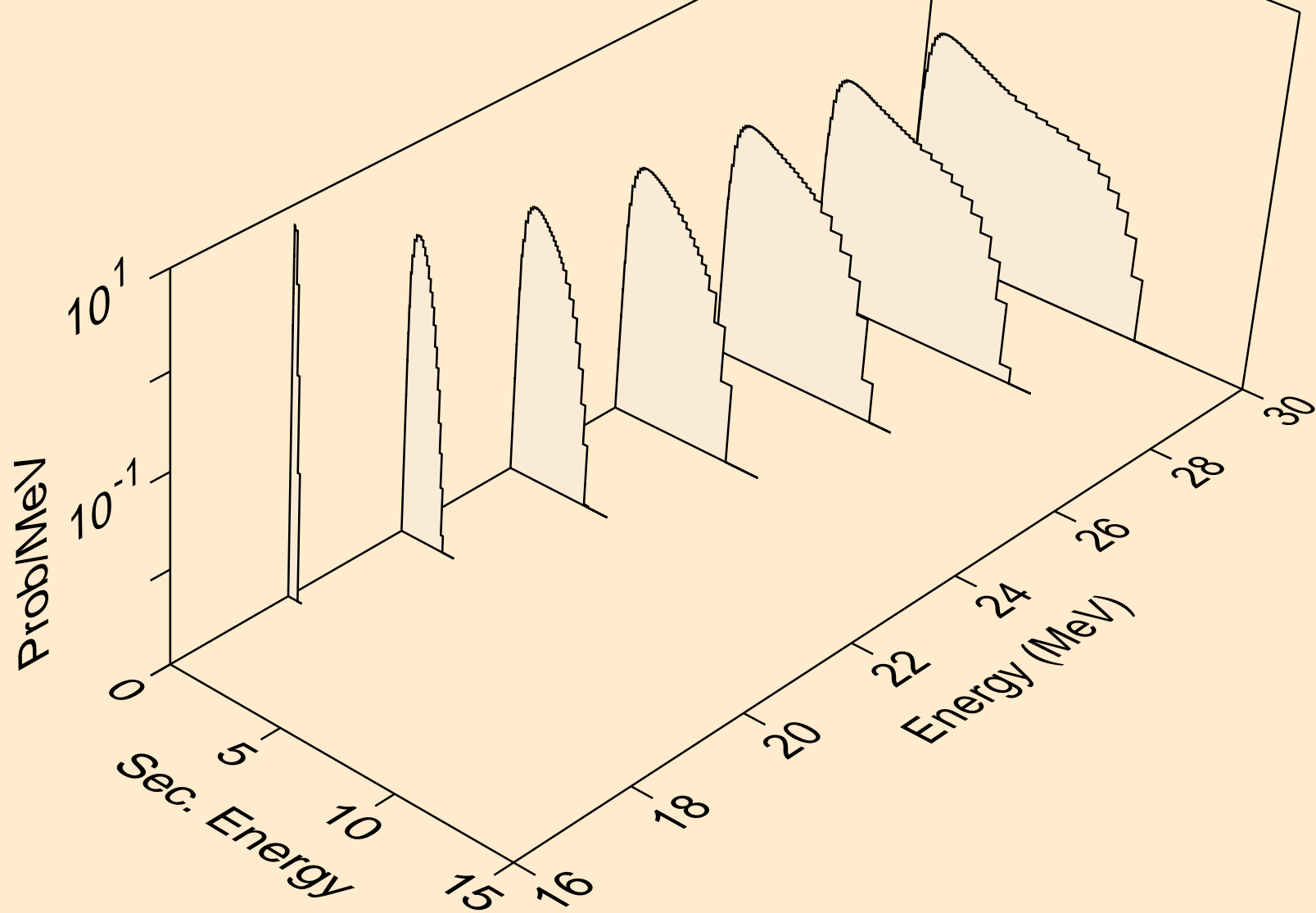

SI027 NEUTRON ACER TENDL-2023 LIBRARY; T=0.K
Neutron emission for (n,n*)t

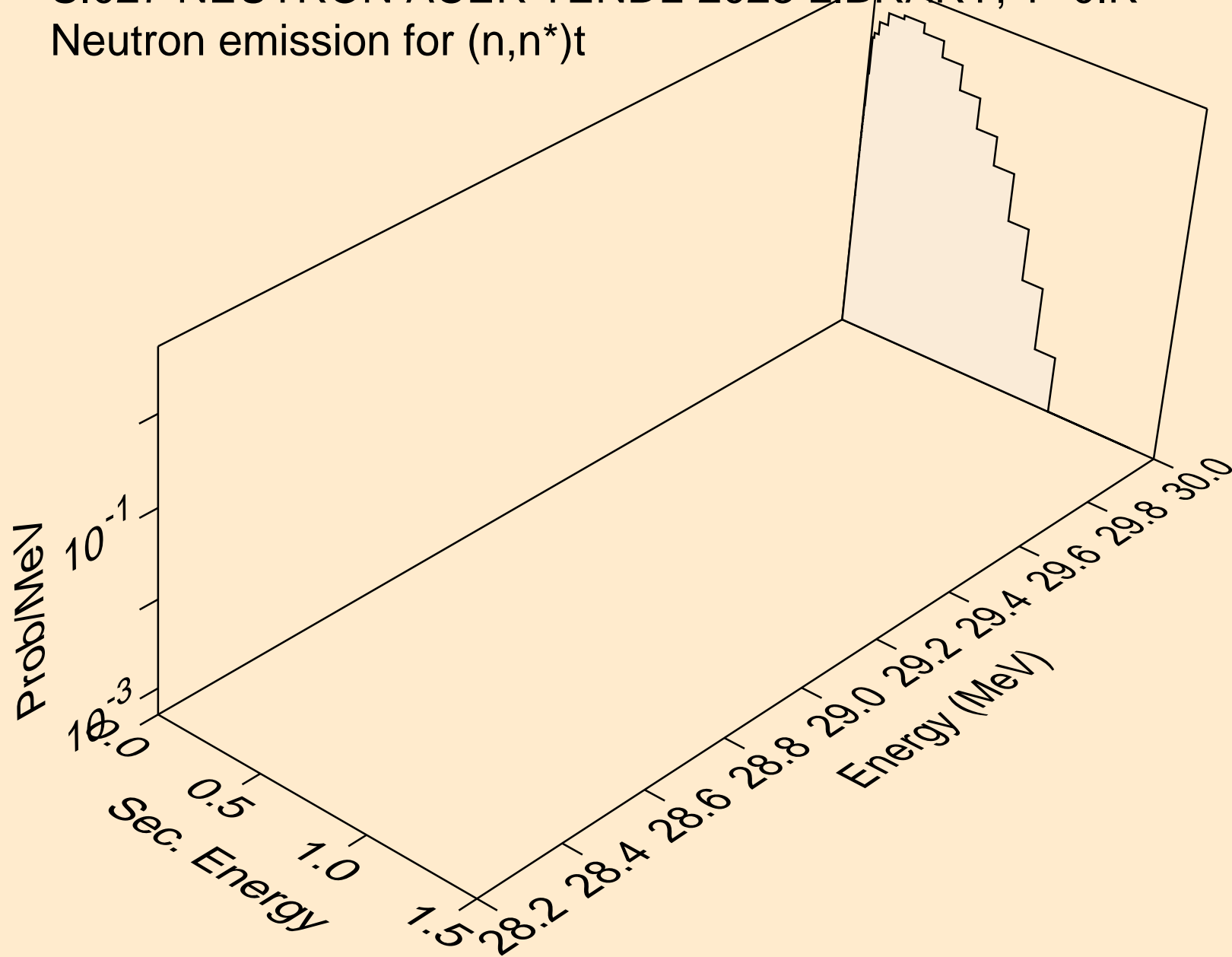

SI027 NEUTRON ACER TENDL-2023 LIBRARY; T=0.K
Neutron emission for (n,n*)he3

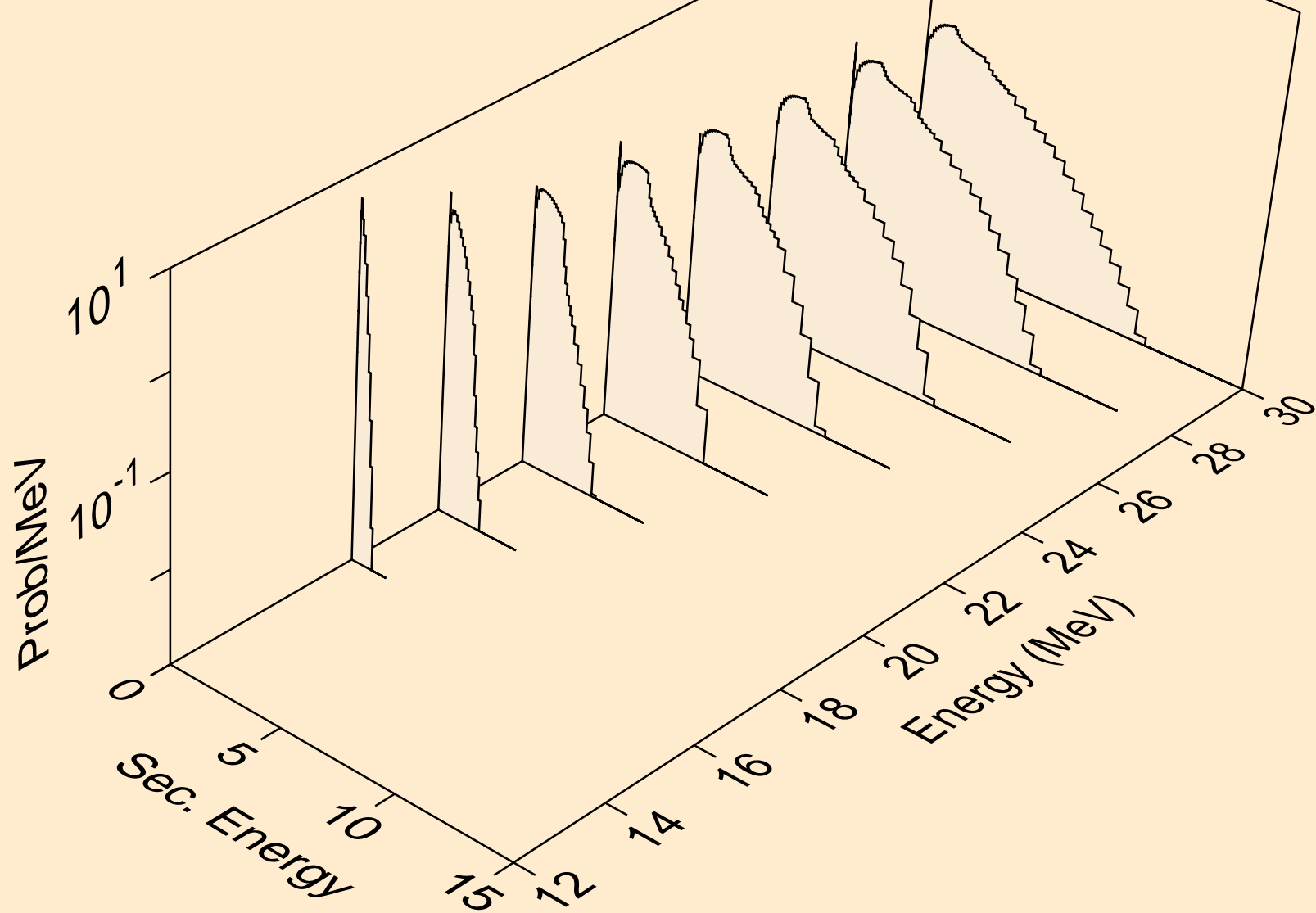

SI027 NEUTRON ACER TENDL-2023 LIBRARY; T=0.K
Neutron emission for (n,2np)

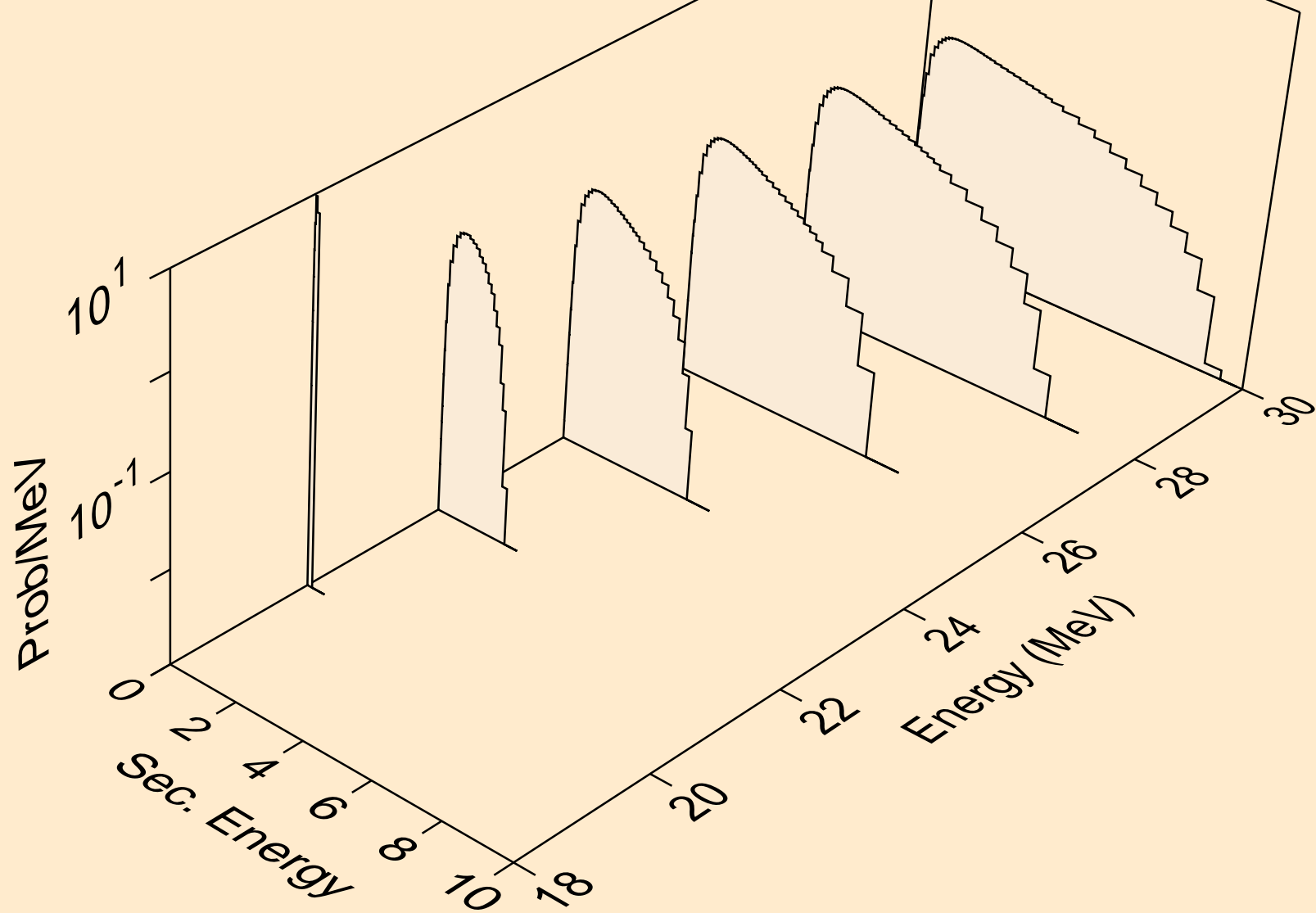

SI027 NEUTRON ACER TENDL-2023 LIBRARY; T=0.K
Neutron emission for (n,n2p)

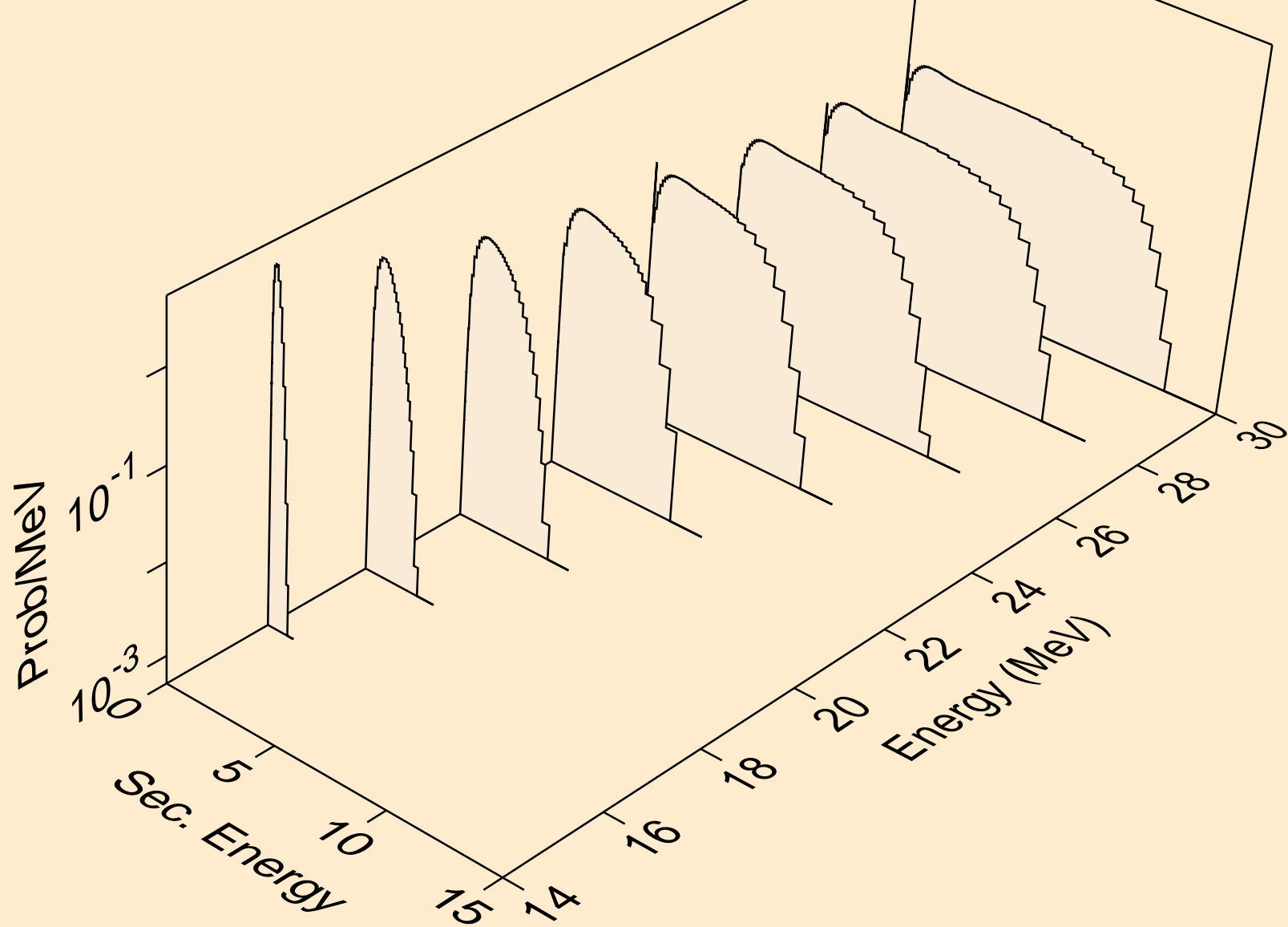

SI027 NEUTRON ACER TENDL-2023 LIBRARY; T=0.K
Neutron emission for (n,npa)

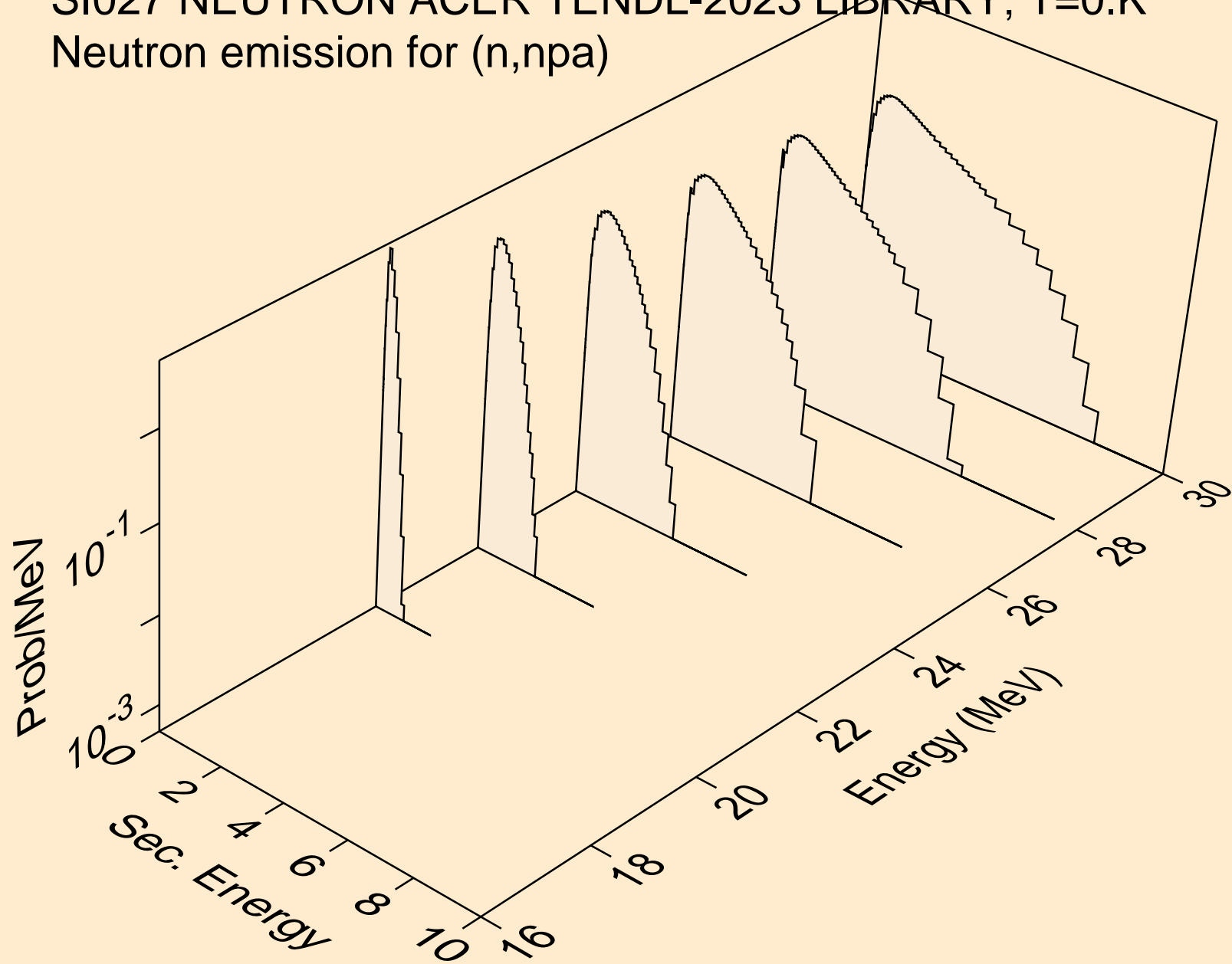

SI027 NEUTRON ACER TENDL-2023 LIBRARY; T=0.K
Neutron emission for (n,n*c)

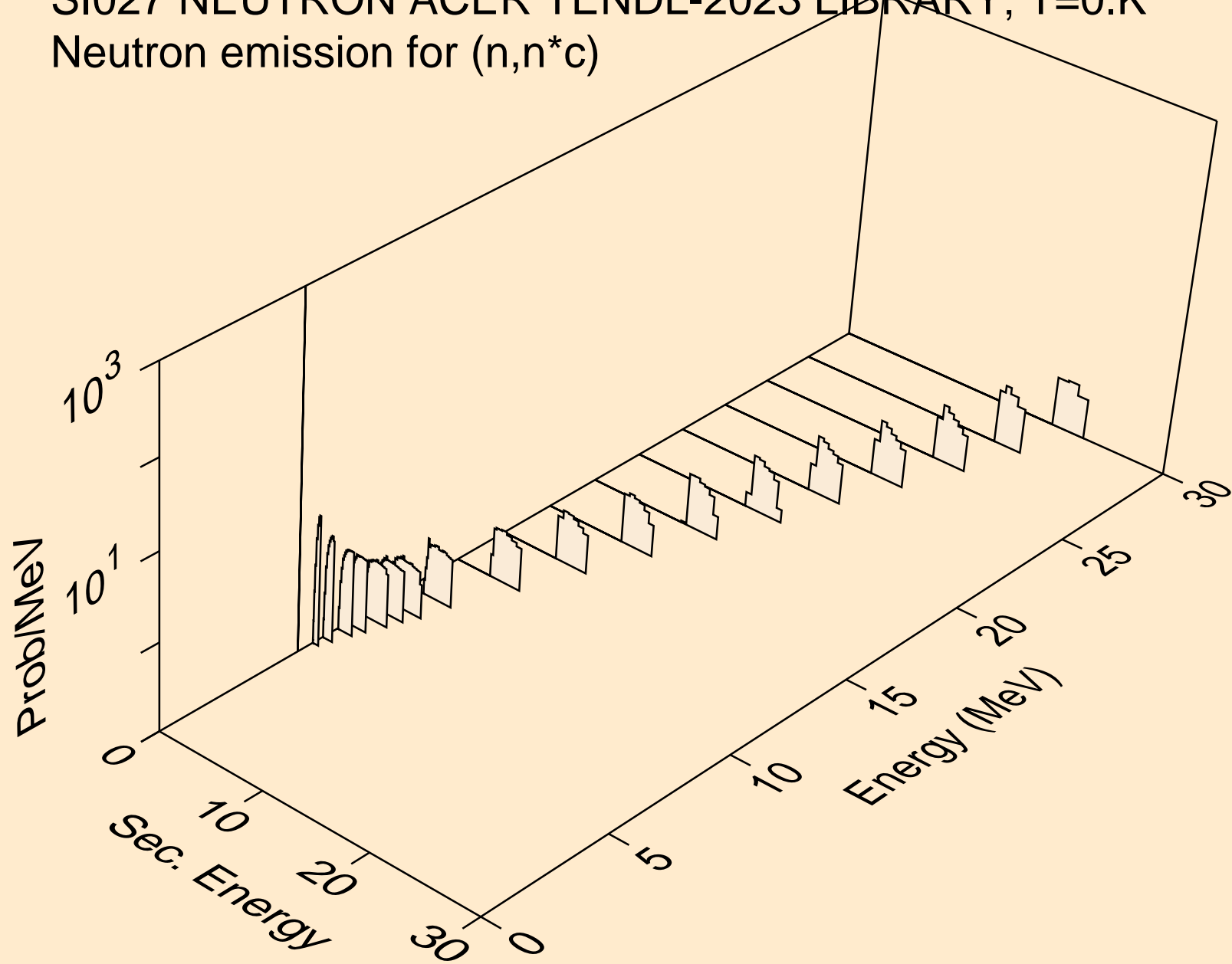

SI027 NEUTRON ACER TENDL-2023 LIBRARY; T=0.K
Photon emission for (n,x)

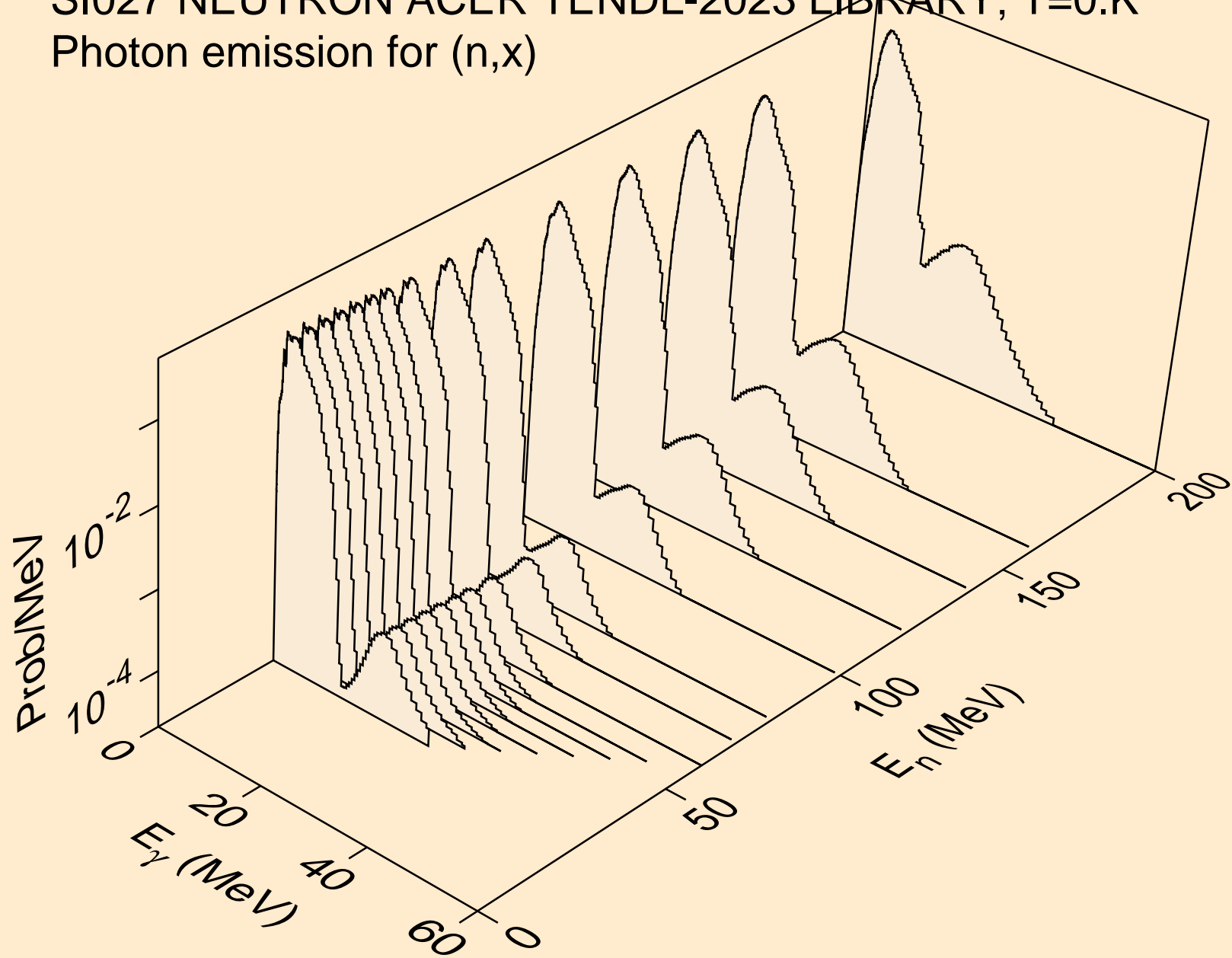

SI027 NEUTRON ACER TENDL-2023 LIBRARY; T=0.K
Photon emission for (n,2n)

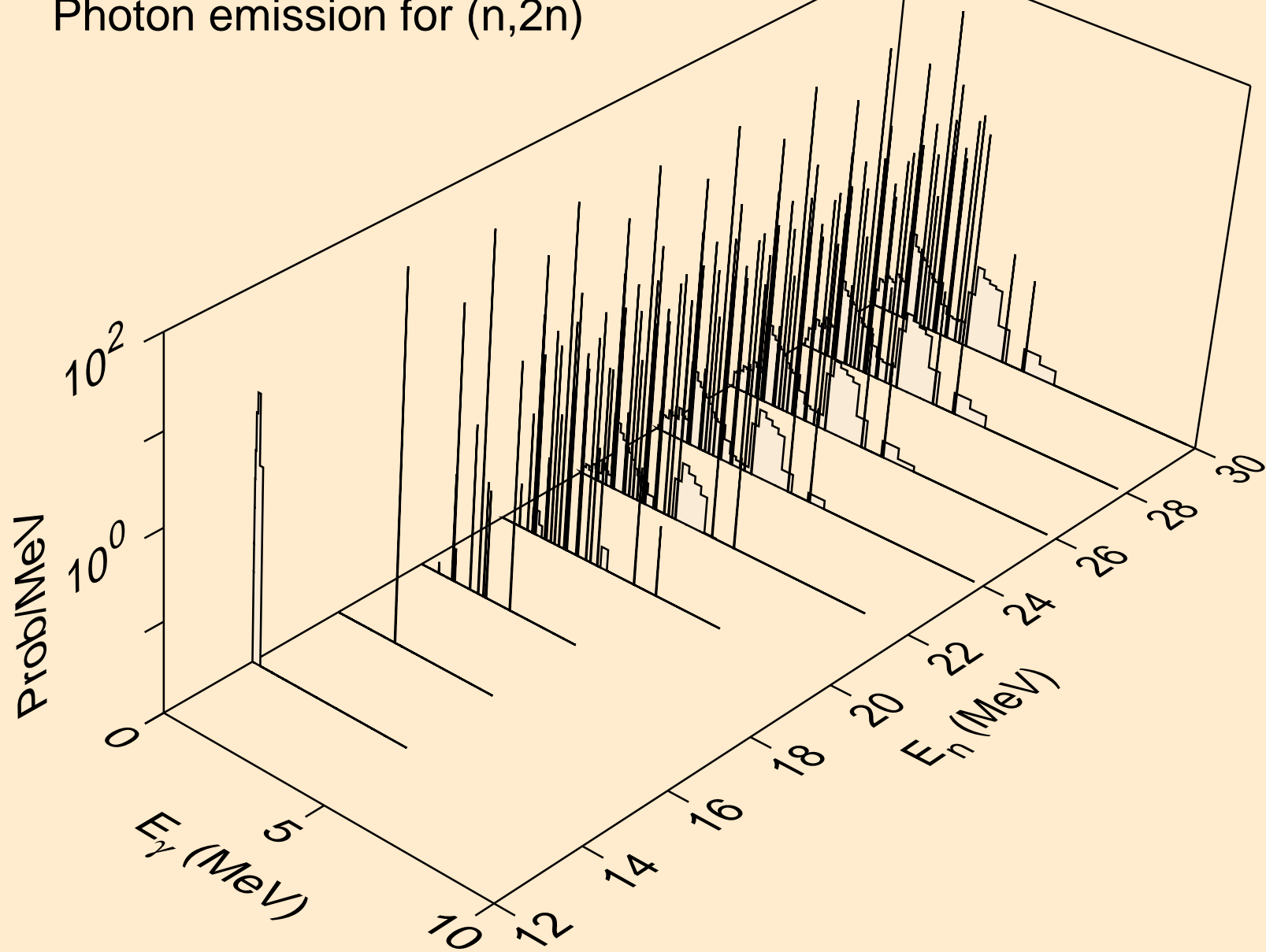

SI027 NEUTRON ACER TENDL-2023 LIBRARY; T=0.K
Photon emission for (n,n*)a

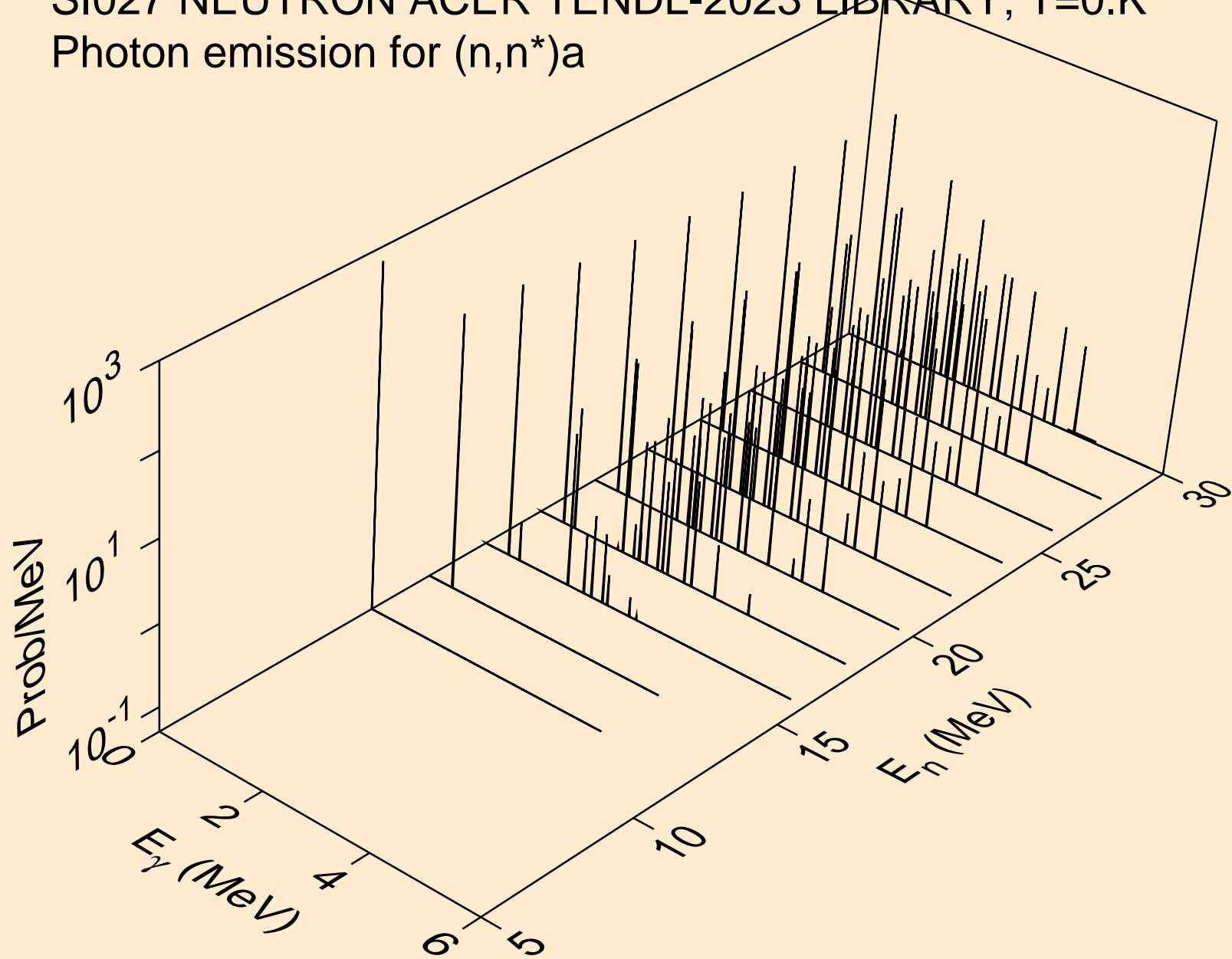

SI027 NEUTRON ACER TENDL-2023 LIBRARY; T=0.K
Photon emission for (n,2n)a

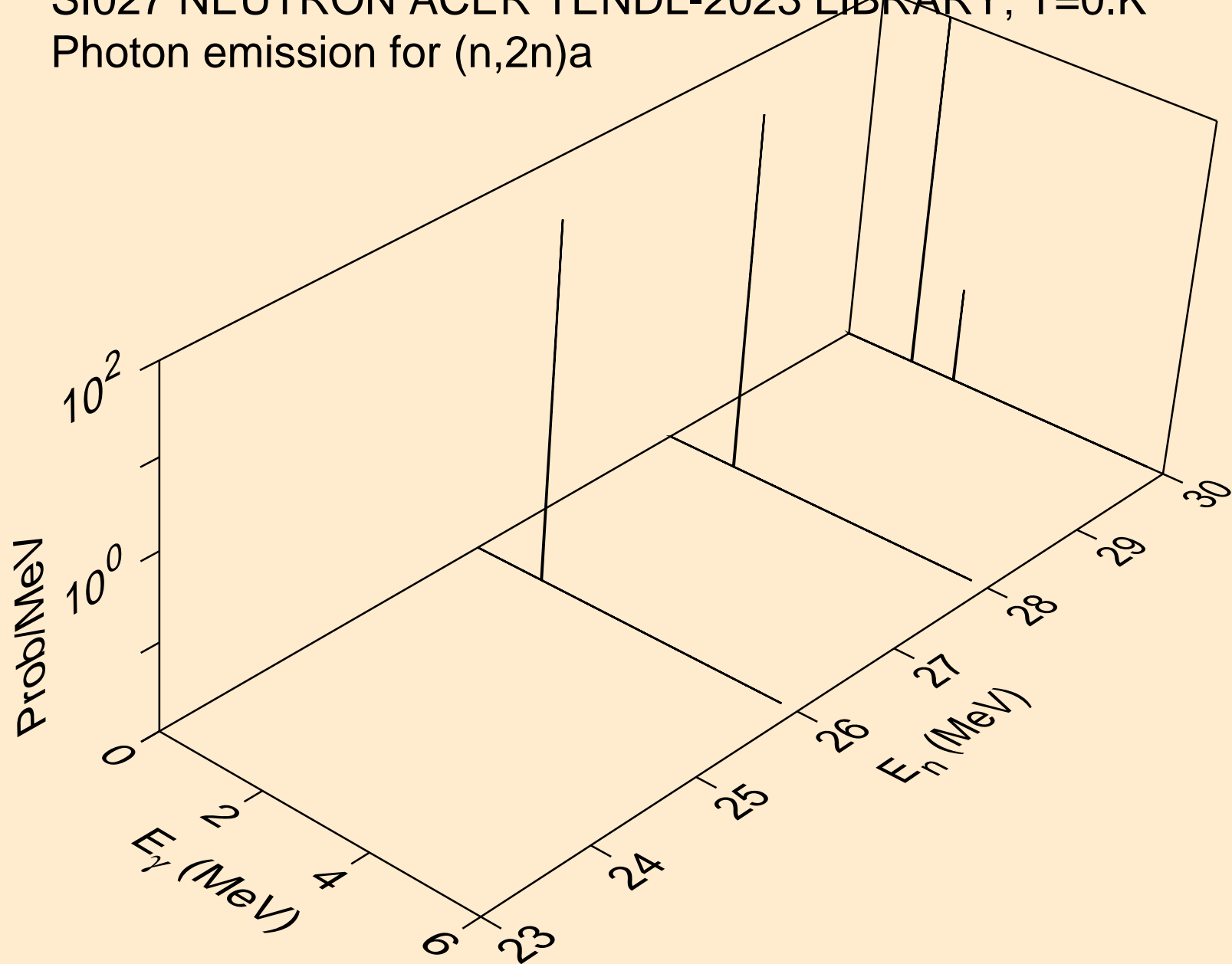

SI027 NEUTRON ACER TENDL-2023 LIBRARY; T=0.K
Photon emission for (n,n*)p

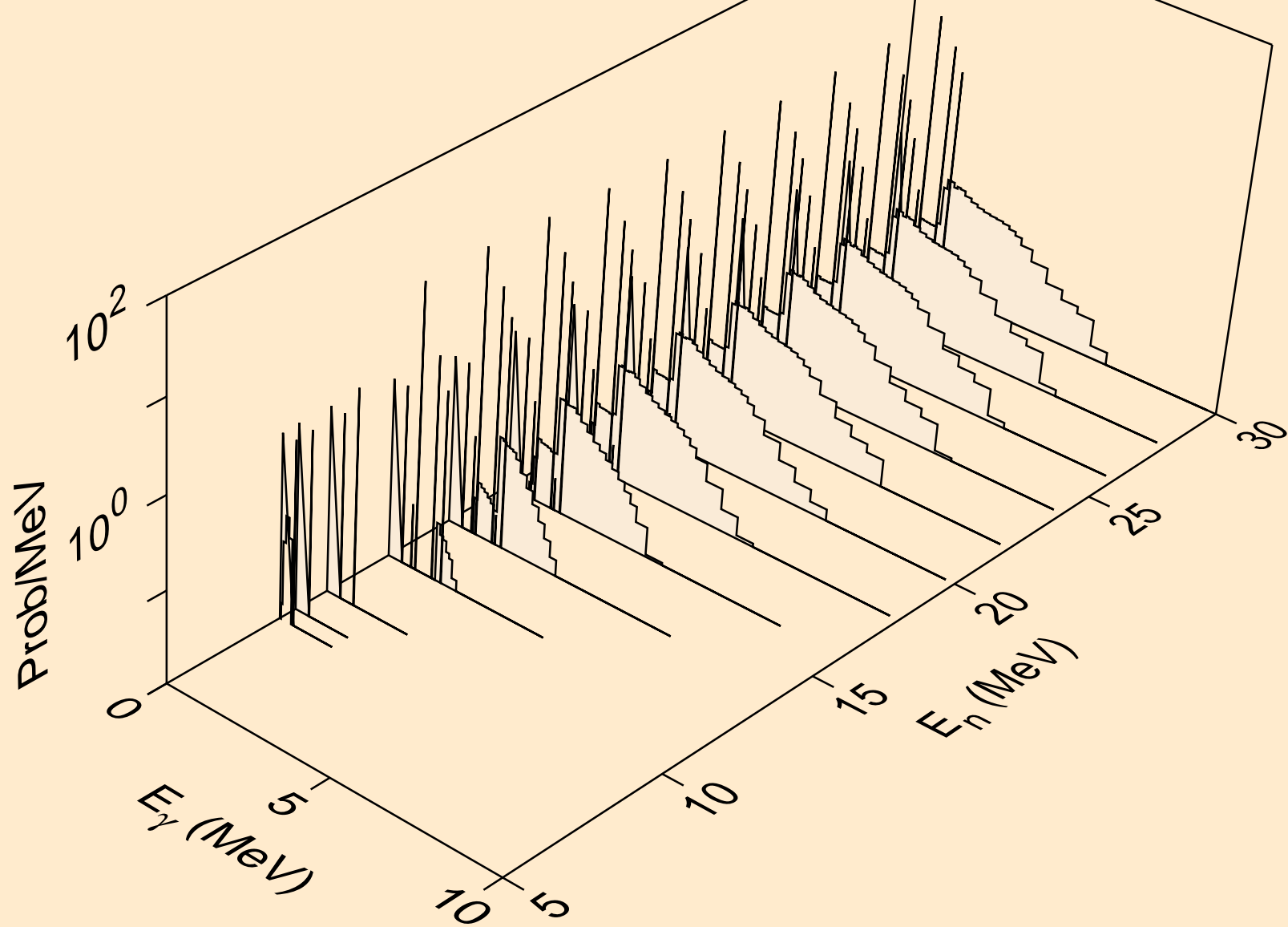

SI027 NEUTRON ACER TENDL-2023 LIBRARY; T=0.K
Photon emission for (n,n*)2a

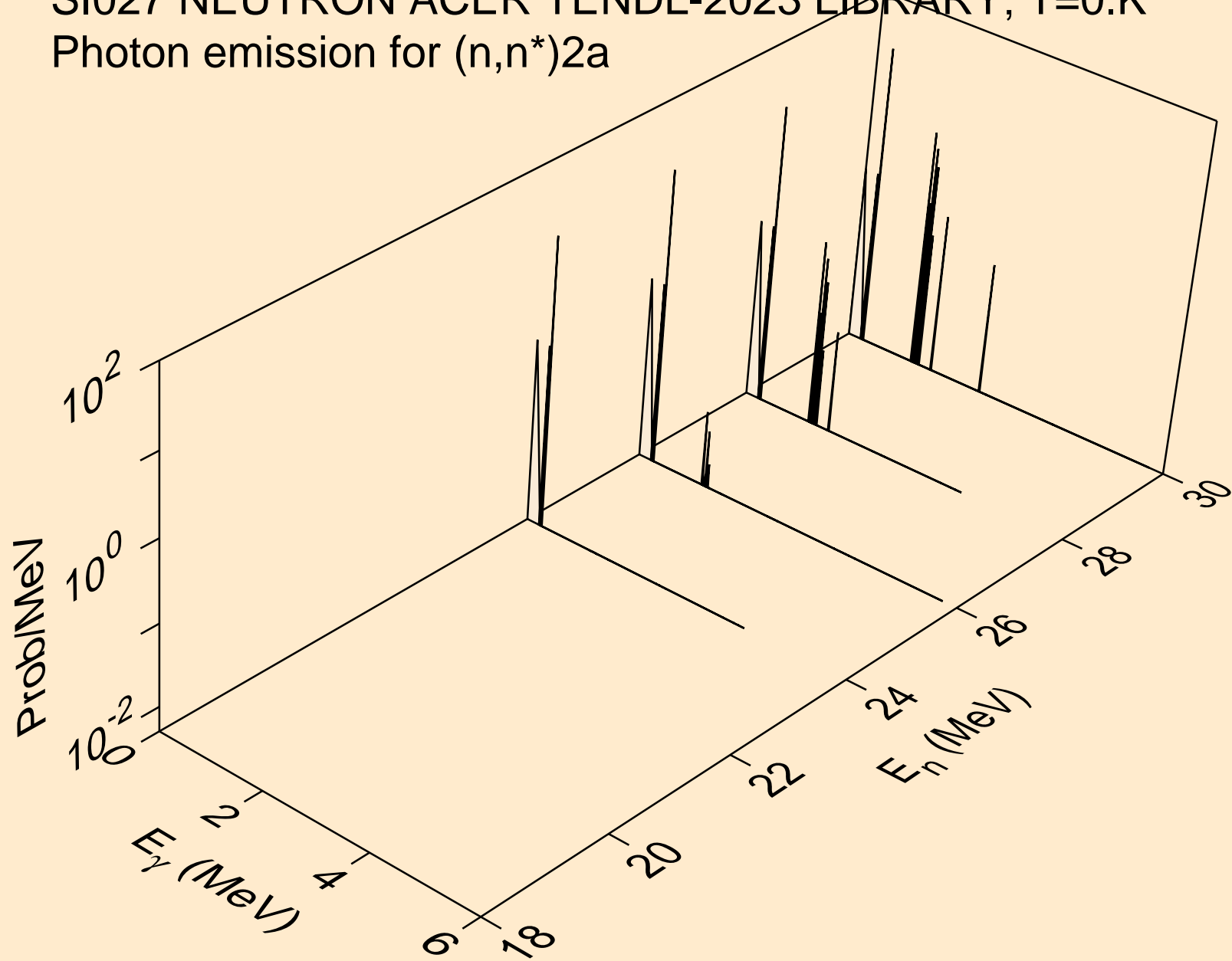

SI027 NEUTRON ACER TENDL-2023 LIBRARY; T=0.K
Photon emission for (n,n*)d

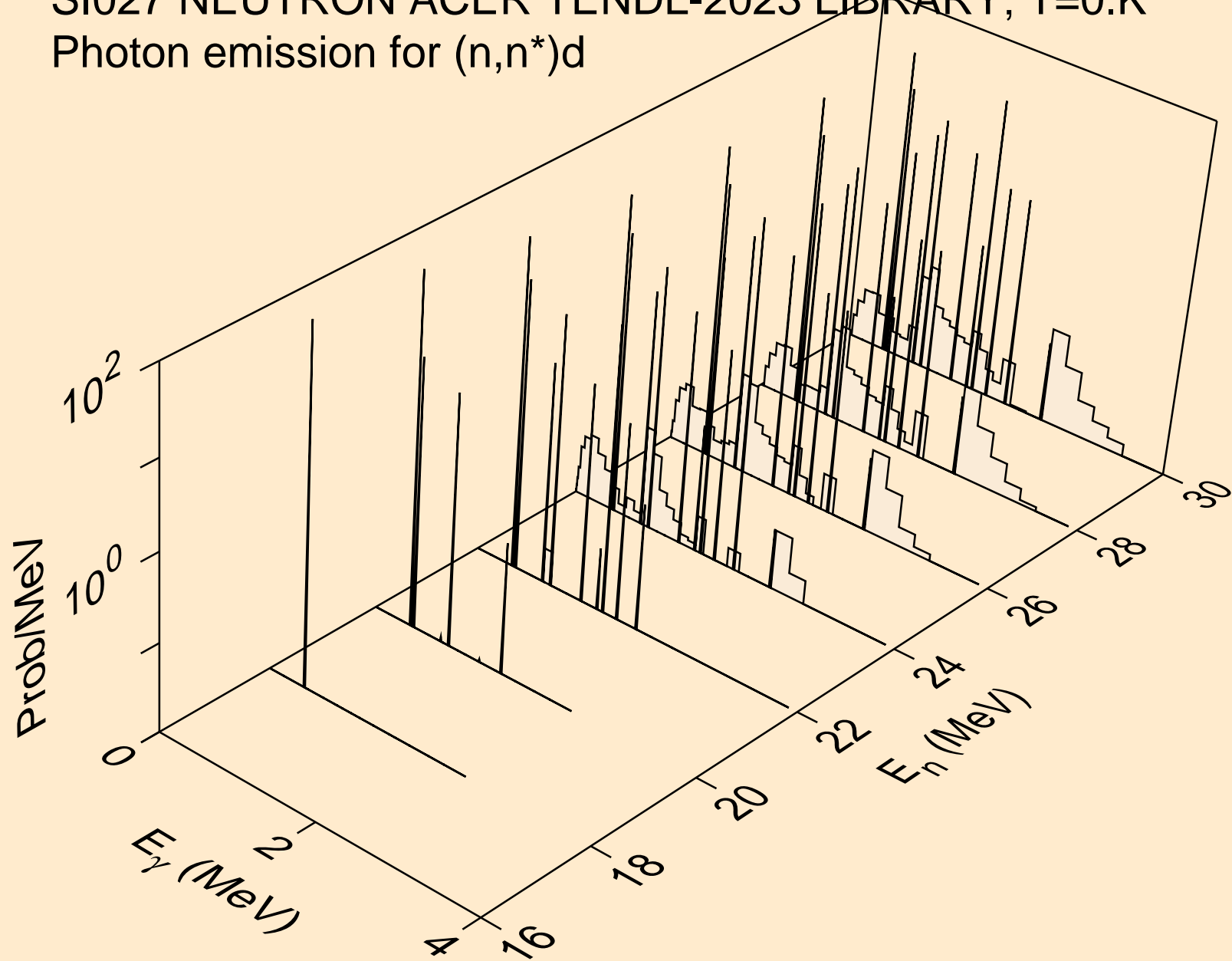

SI027 NEUTRON ACER TENDL-2023 LIBRARY; T=0.K
Photon emission for (n,n*)t

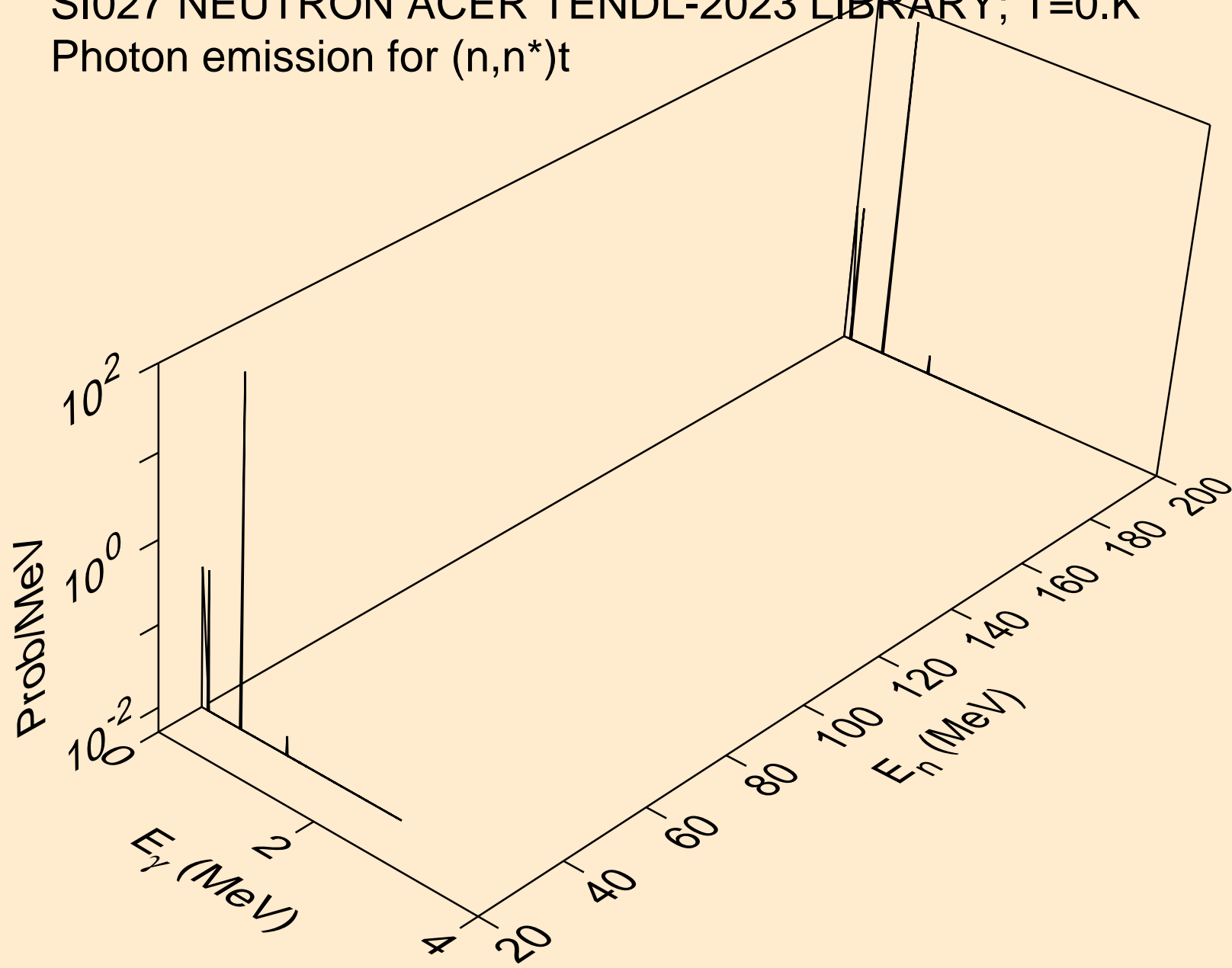

SI027 NEUTRON ACER TENDL-2023 LIBRARY; T=0.K
Photon emission for (n,n*)he3

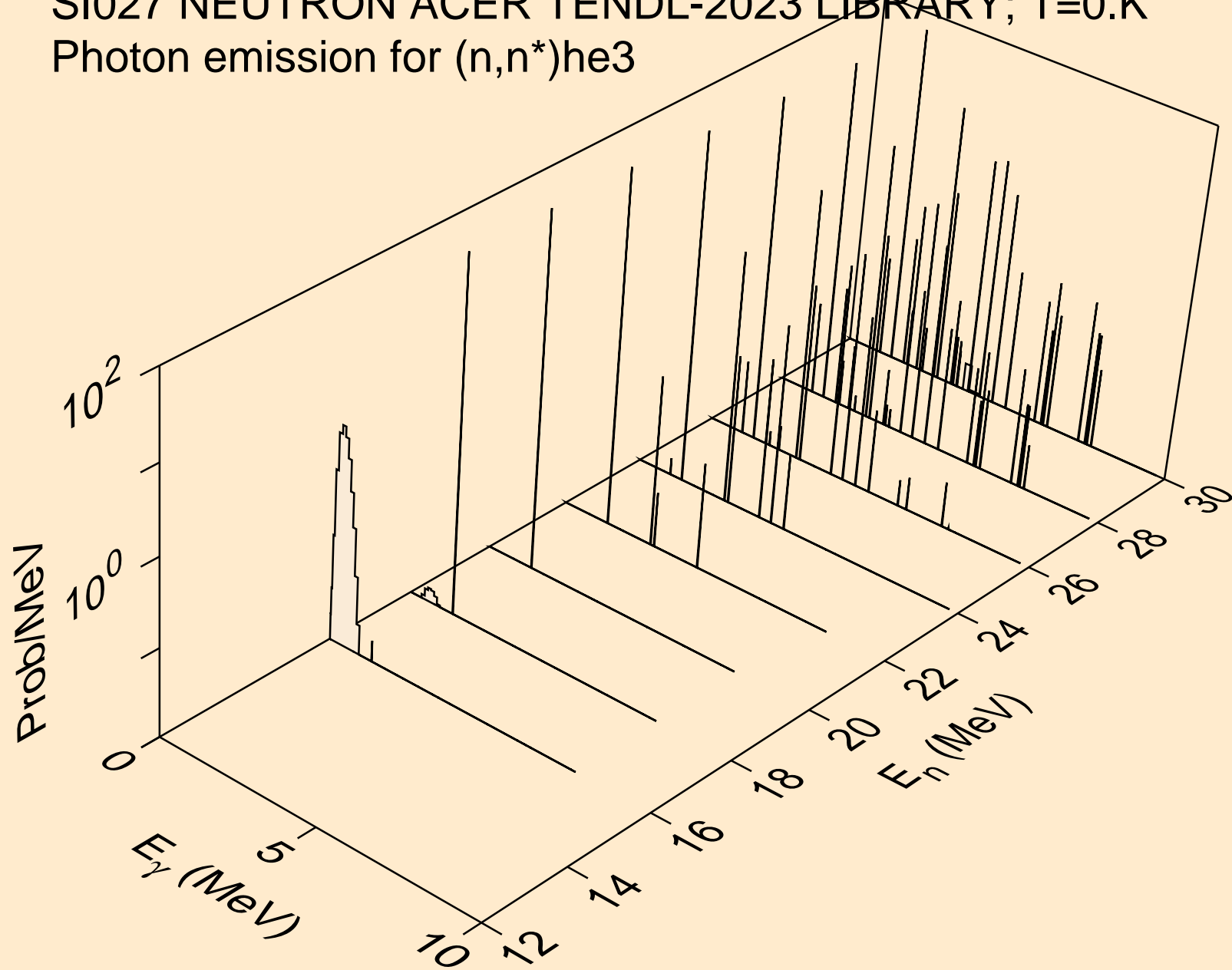

SI027 NEUTRON ACER TENDL-2023 LIBRARY; T=0.K
Photon emission for (n,2np)

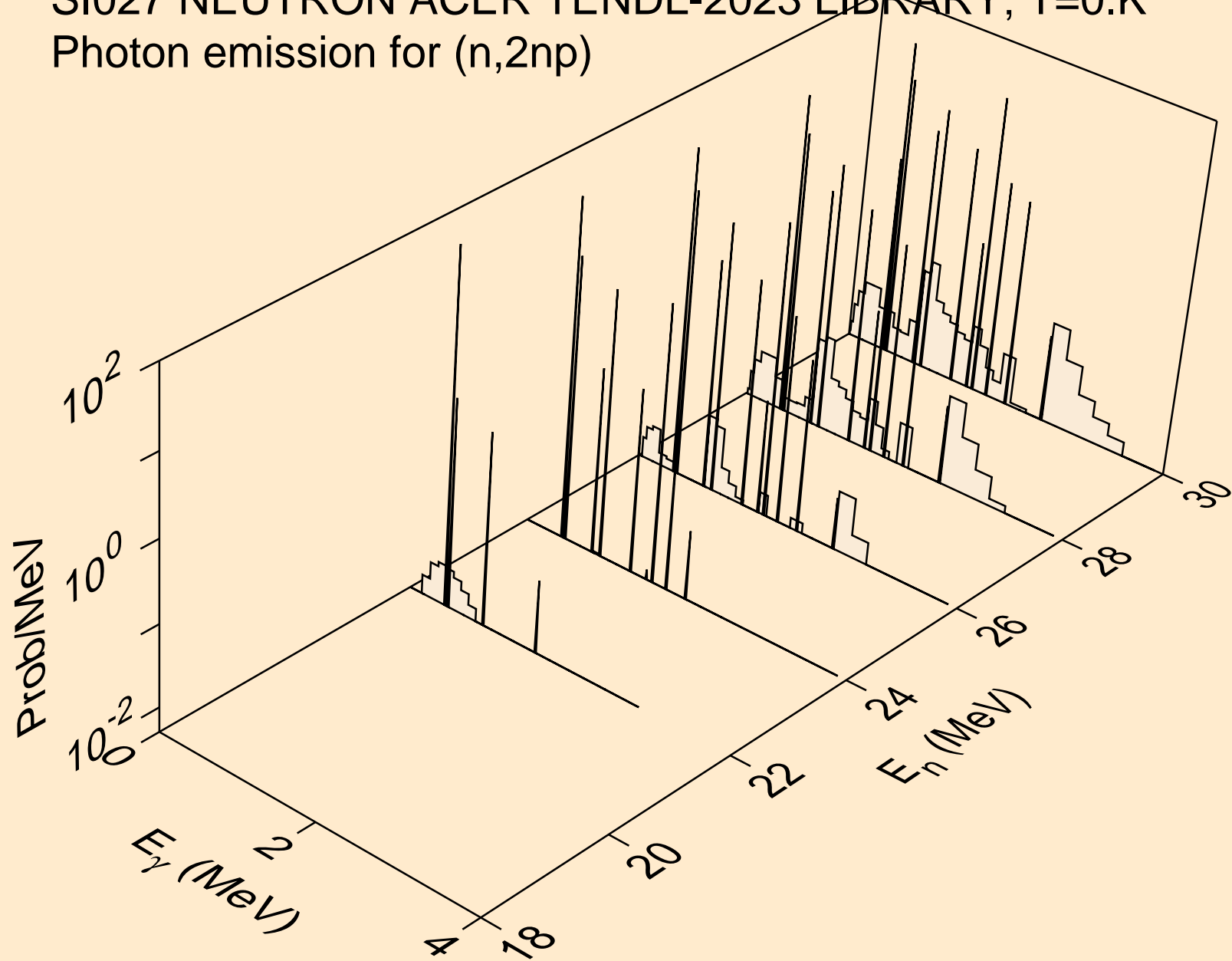

SI027 NEUTRON ACER TENDL-2023 LIBRARY; T=0.K
Photon emission for (n,n2p)

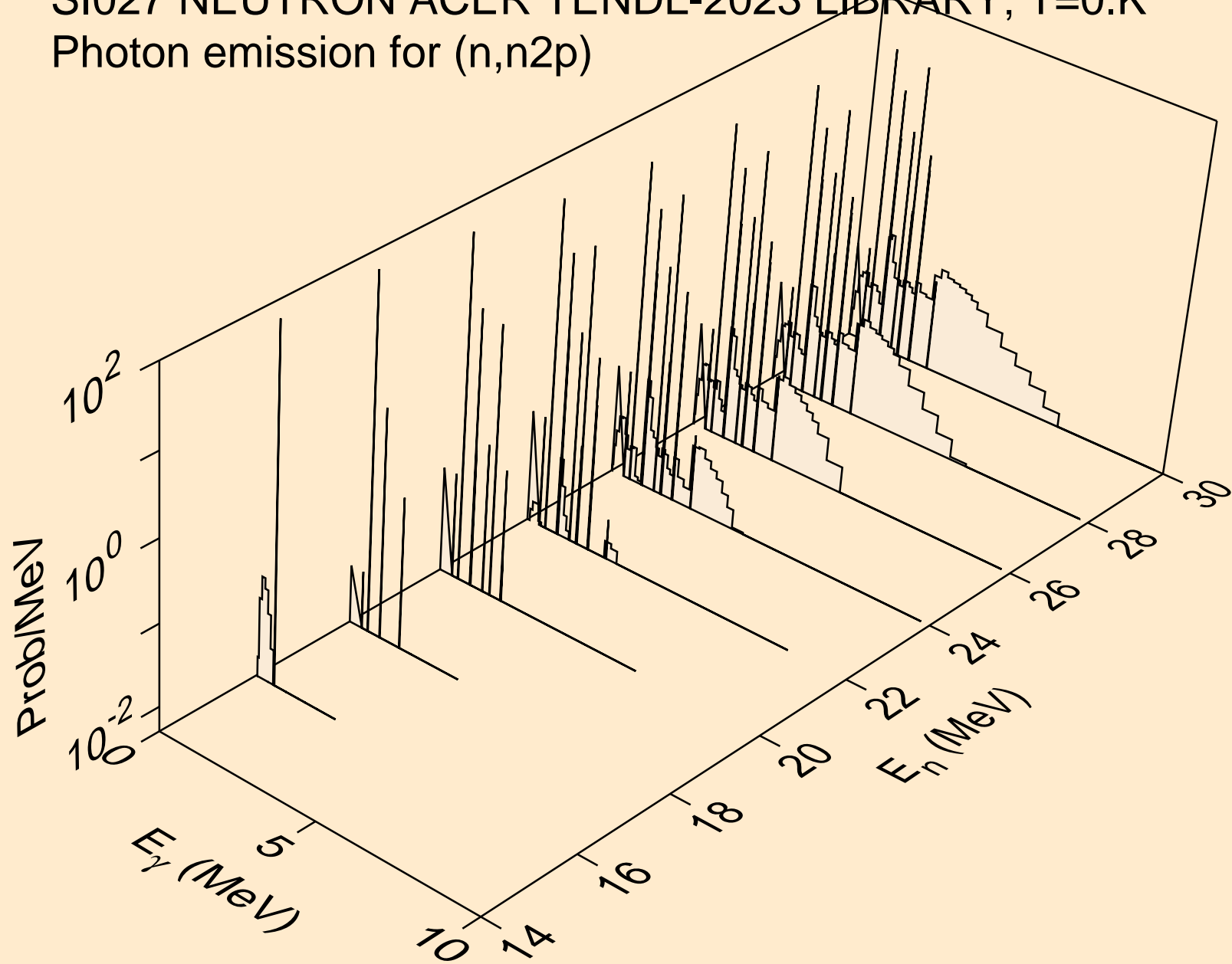

SI027 NEUTRON ACER TENDL-2023 LIBRARY; T=0.K
Photon emission for (n,npa)

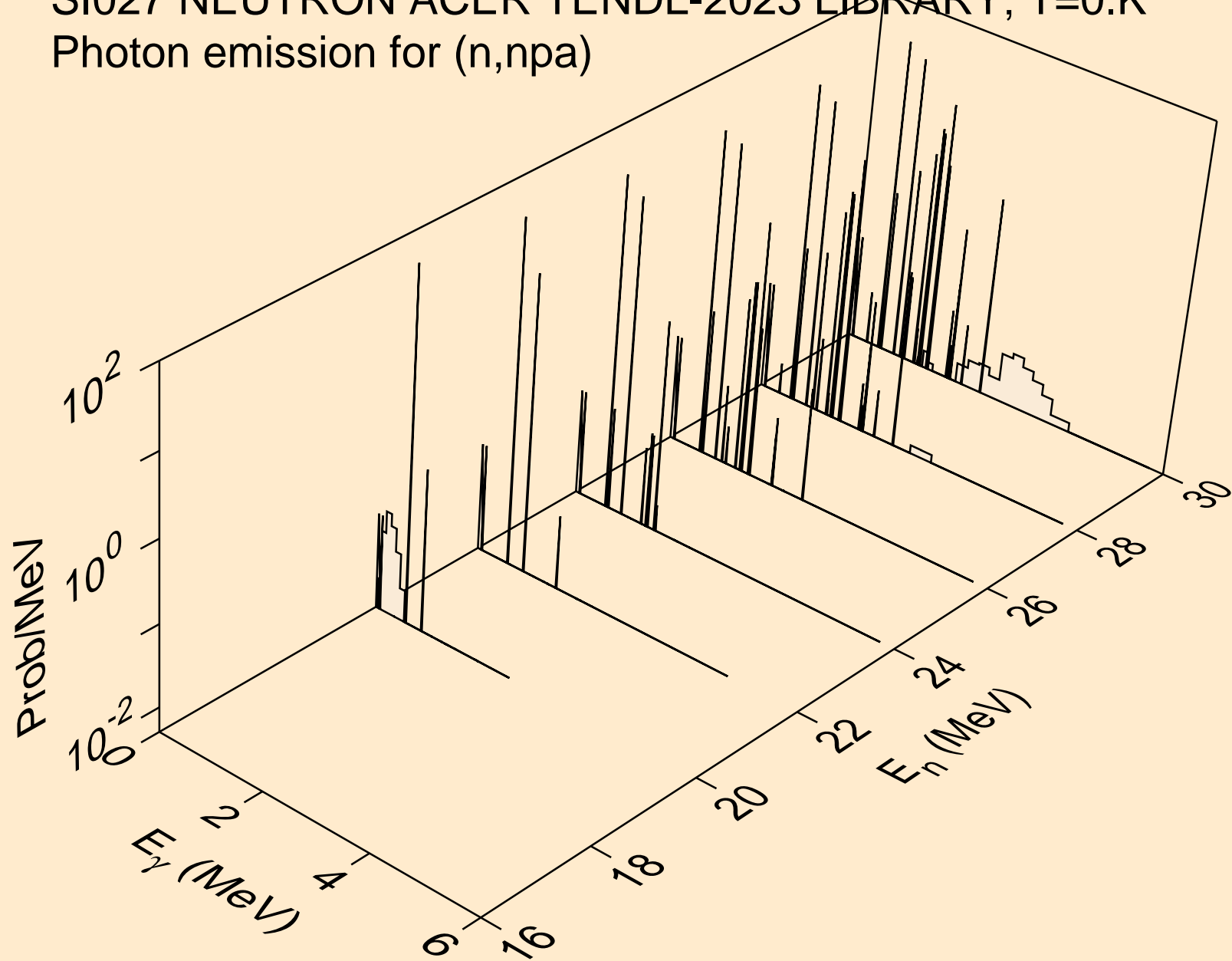

SI027 NEUTRON ACER TENDL-2023 LIBRARY; T=0.K
Photon emission for (n,n*c)

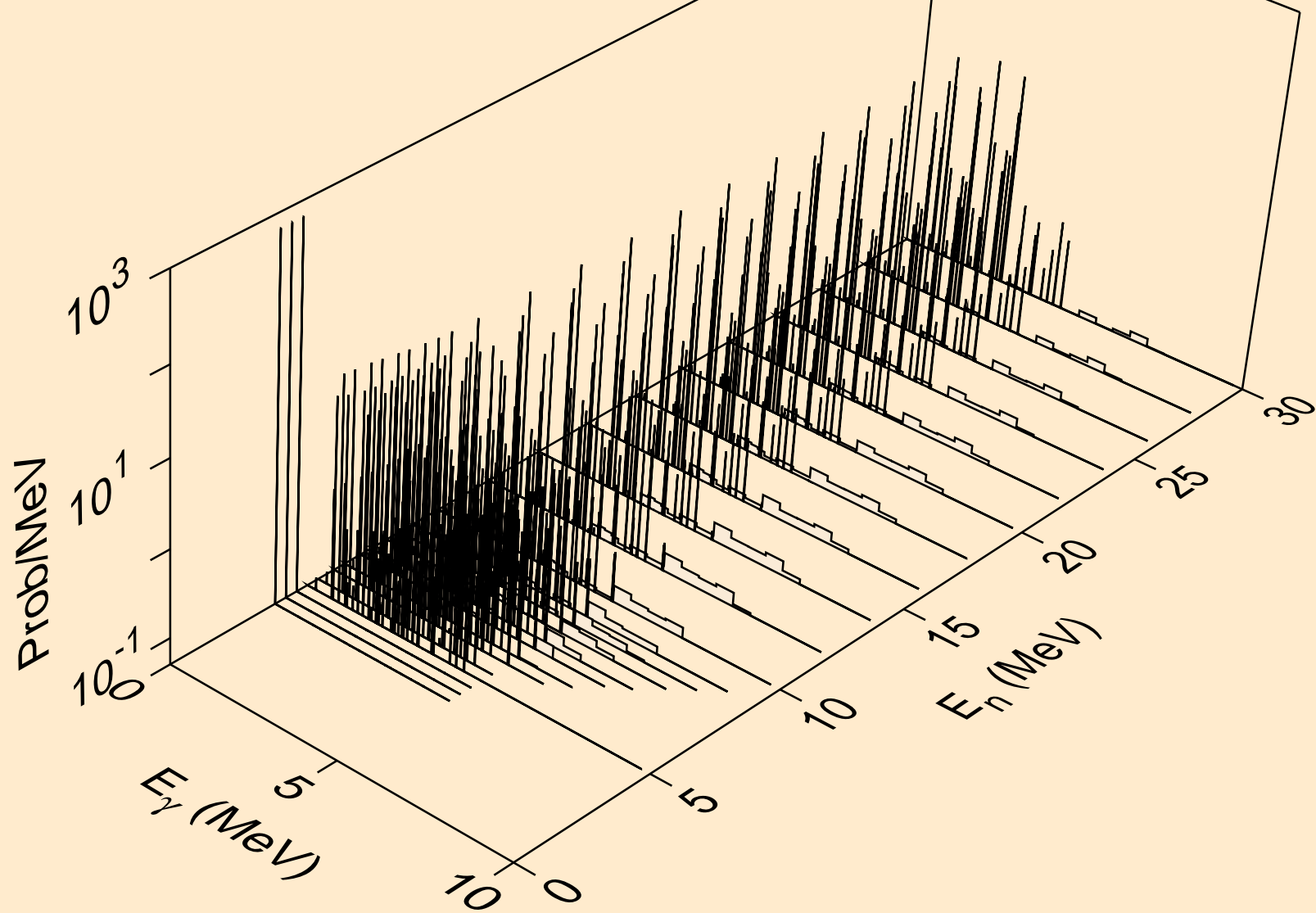

SI027 NEUTRON ACER TENDL-2023 LIBRARY; T=0.K
Photon emission for (n,gma)

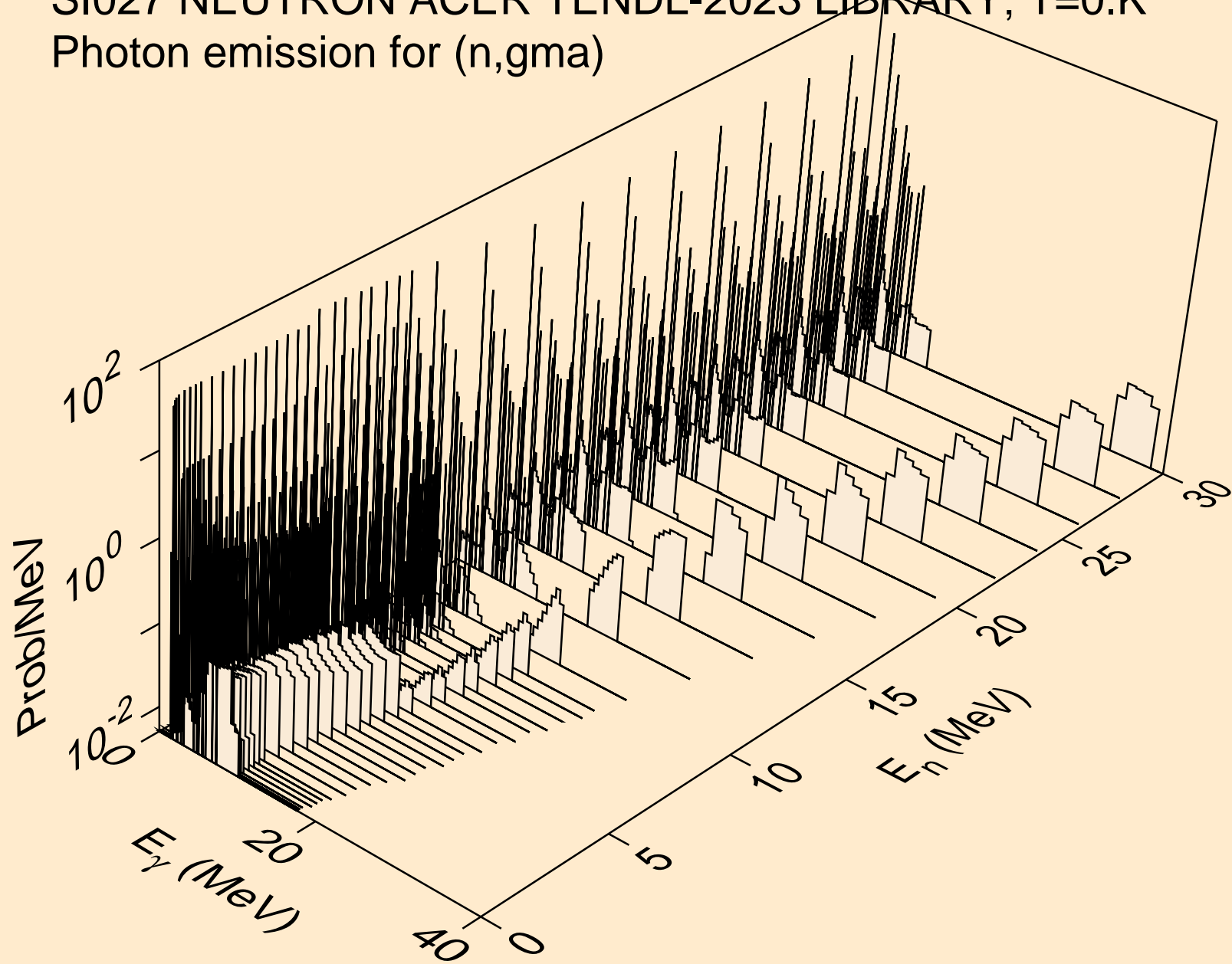

SI027 NEUTRON ACER TENDL-2023 LIBRARY; T=0.K
Photon emission for (n,p)

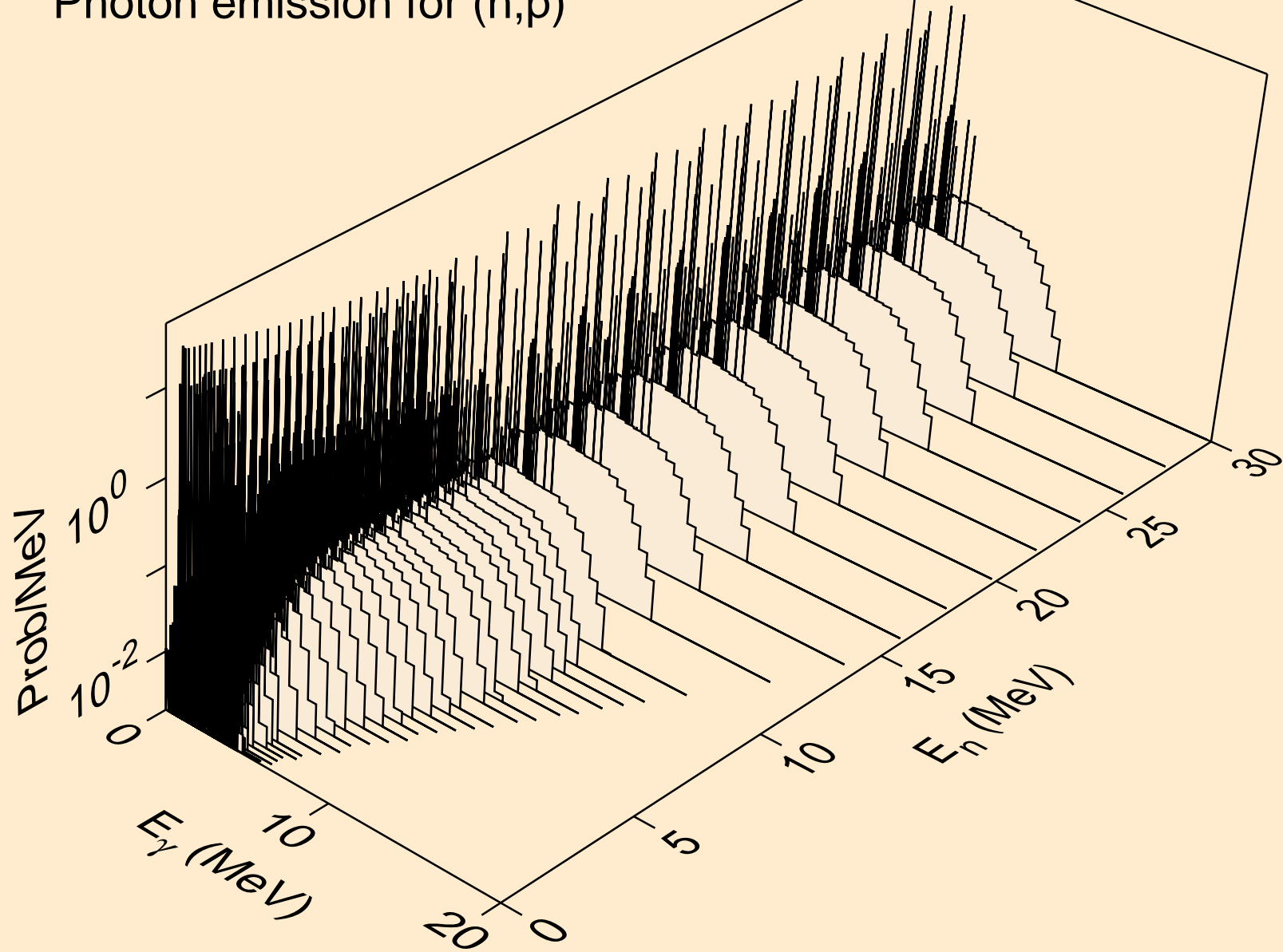

SI027 NEUTRON ACER TENDL-2023 LIBRARY; T=0.K
Photon emission for (n,d)

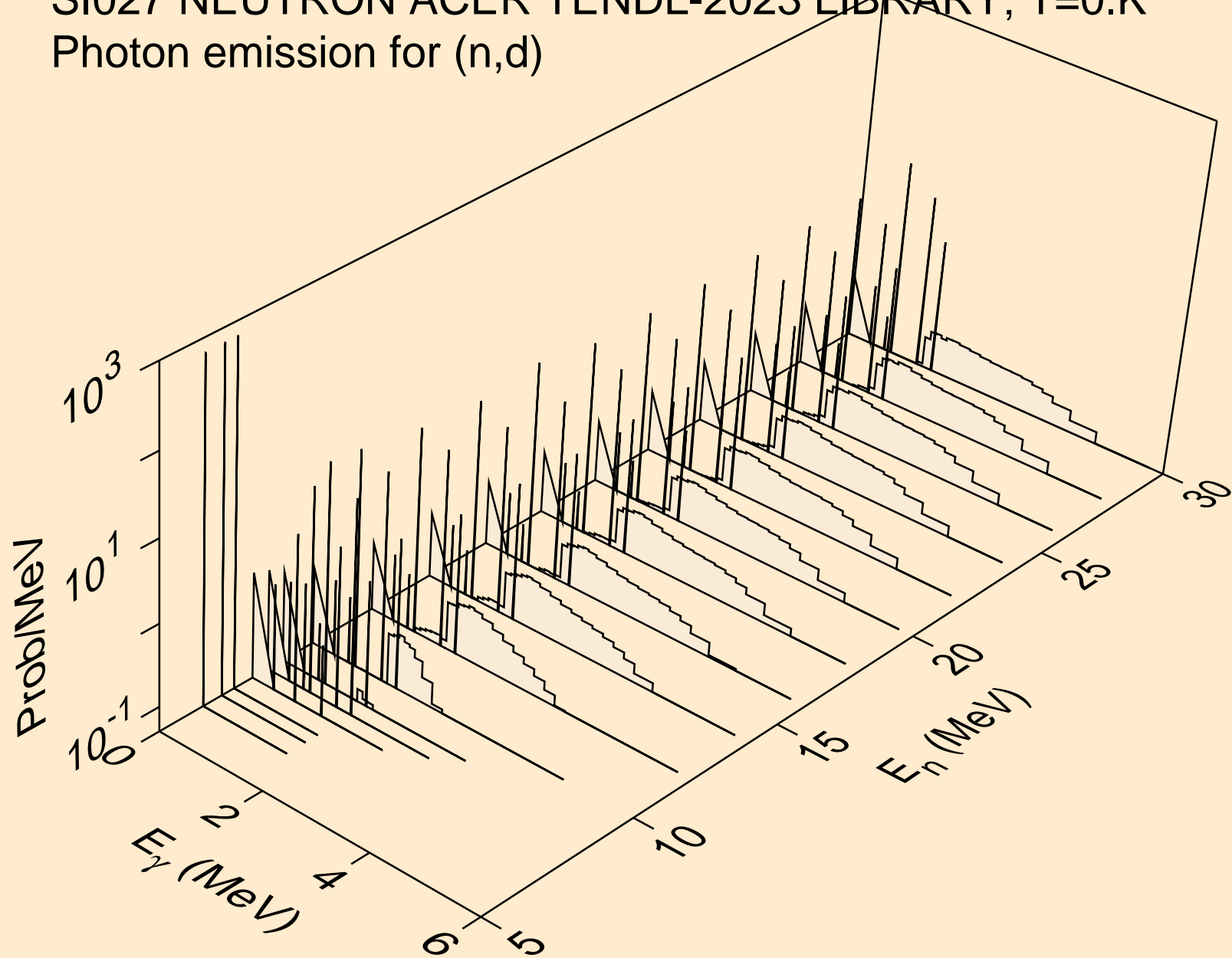

SI027 NEUTRON ACER TENDL-2023 LIBRARY; T=0.K
Photon emission for (n,t)

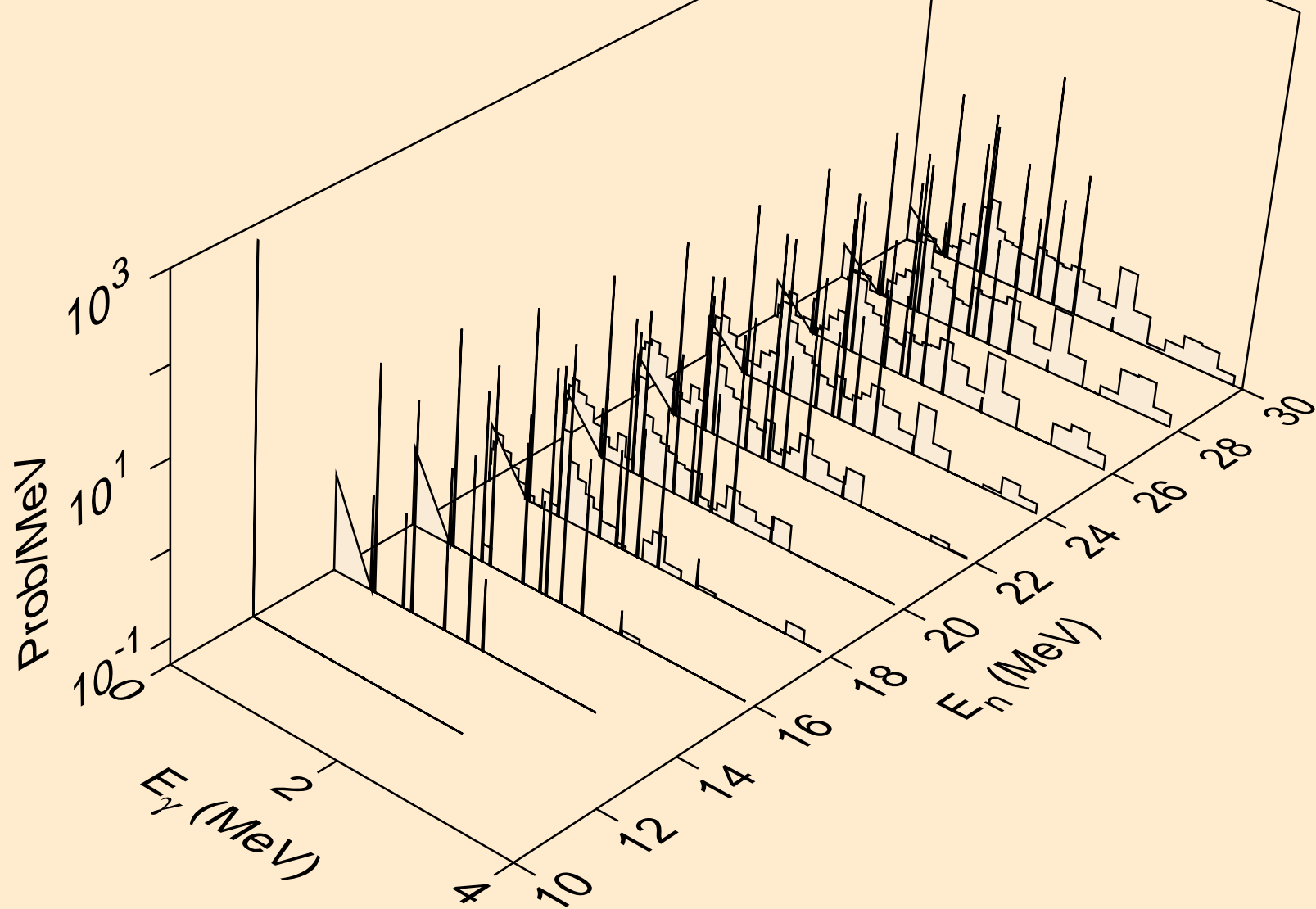

SI027 NEUTRON ACER TENDL-2023 LIBRARY; T=0.K
Photon emission for (n,he3)

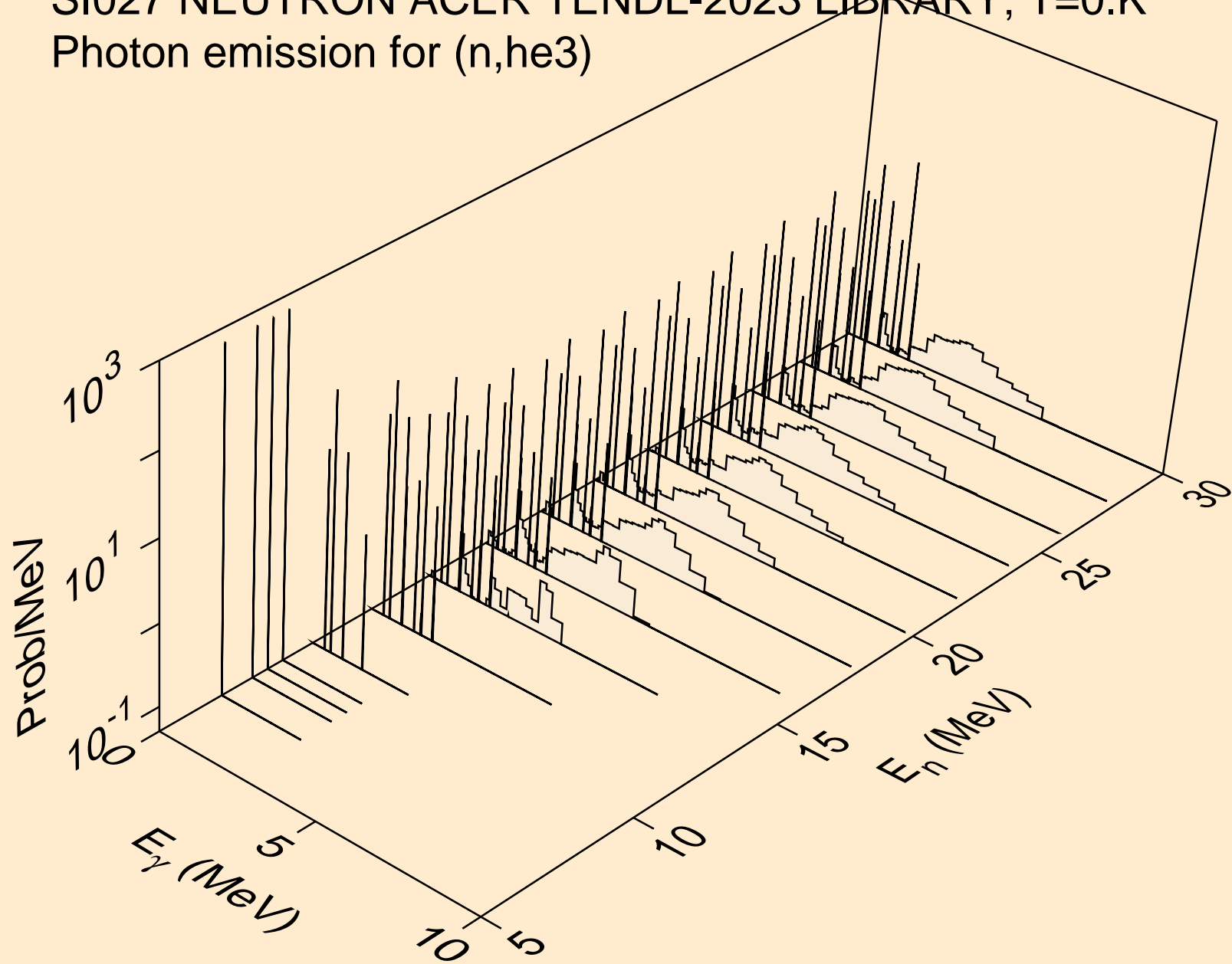

SI027 NEUTRON ACER TENDL-2023 LIBRARY; T=0.K
Photon emission for (n,a)

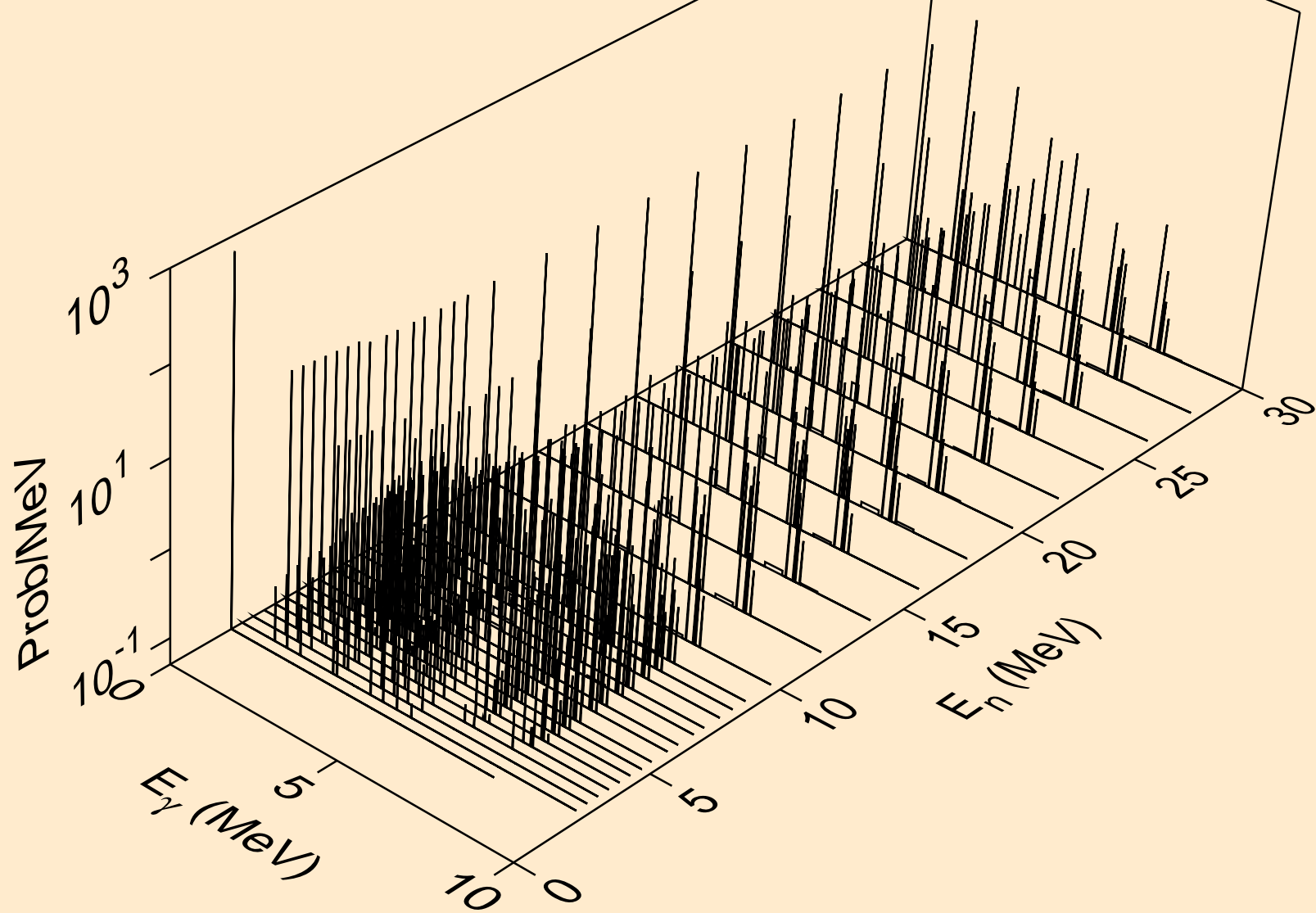

SI027 NEUTRON ACER TENDL-2023 LIBRARY; T=0.K
Photon emission for (n,2a)

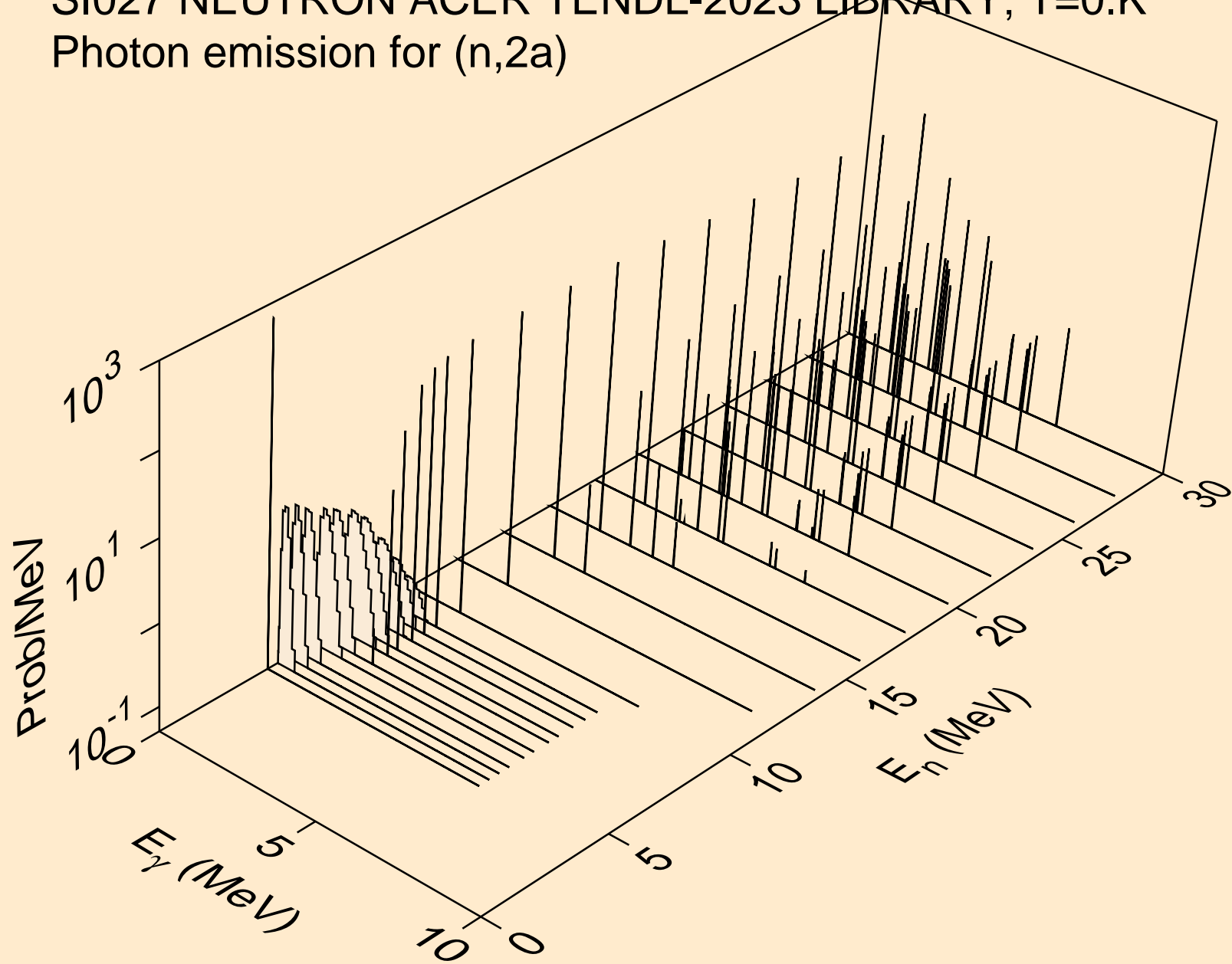

SI027 NEUTRON ACER TENDL-2023 LIBRARY; T=0.K
Photon emission for (n,3a)

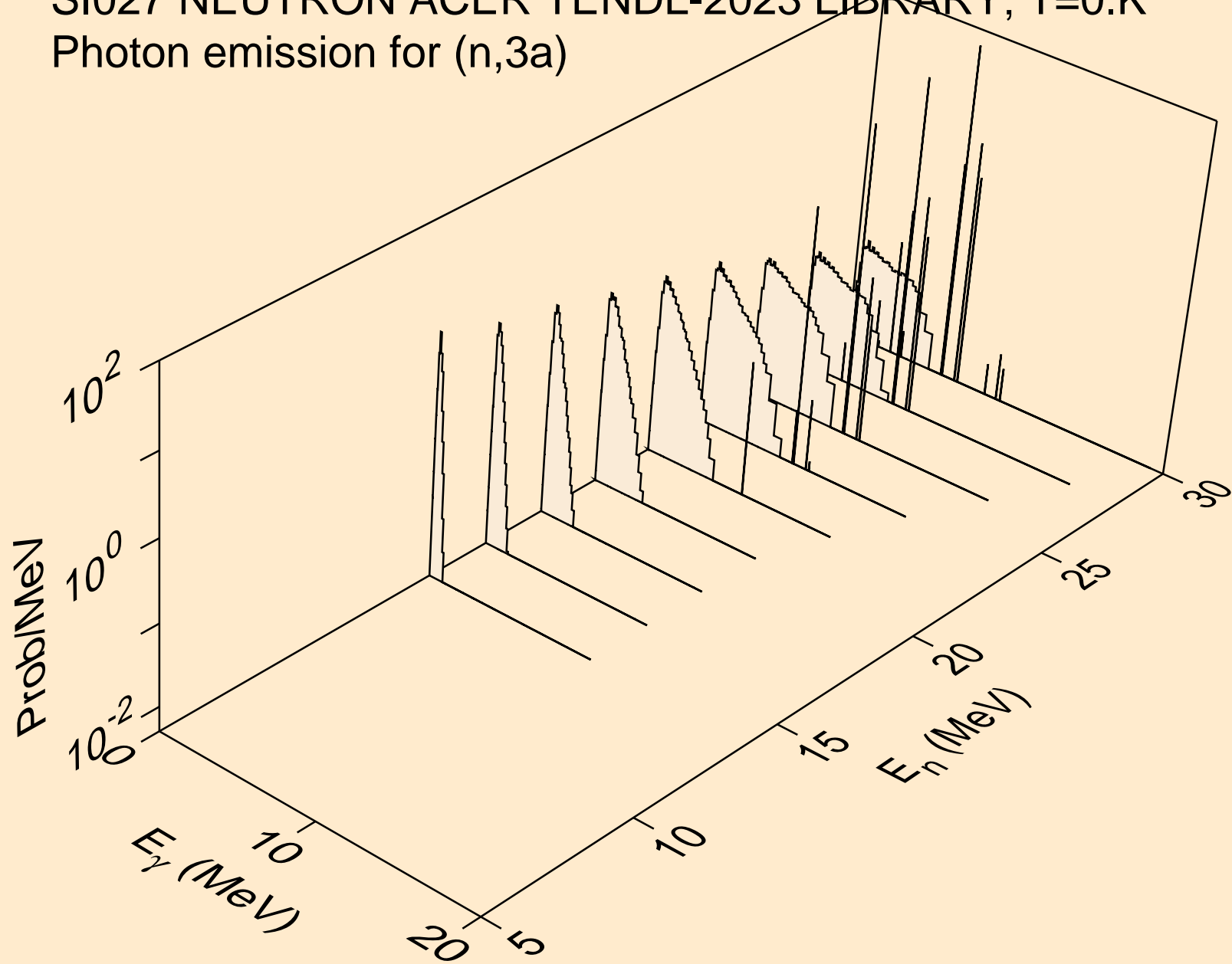

SI027 NEUTRON ACER TENDL-2023 LIBRARY; T=0.K
Photon emission for (n,2p)

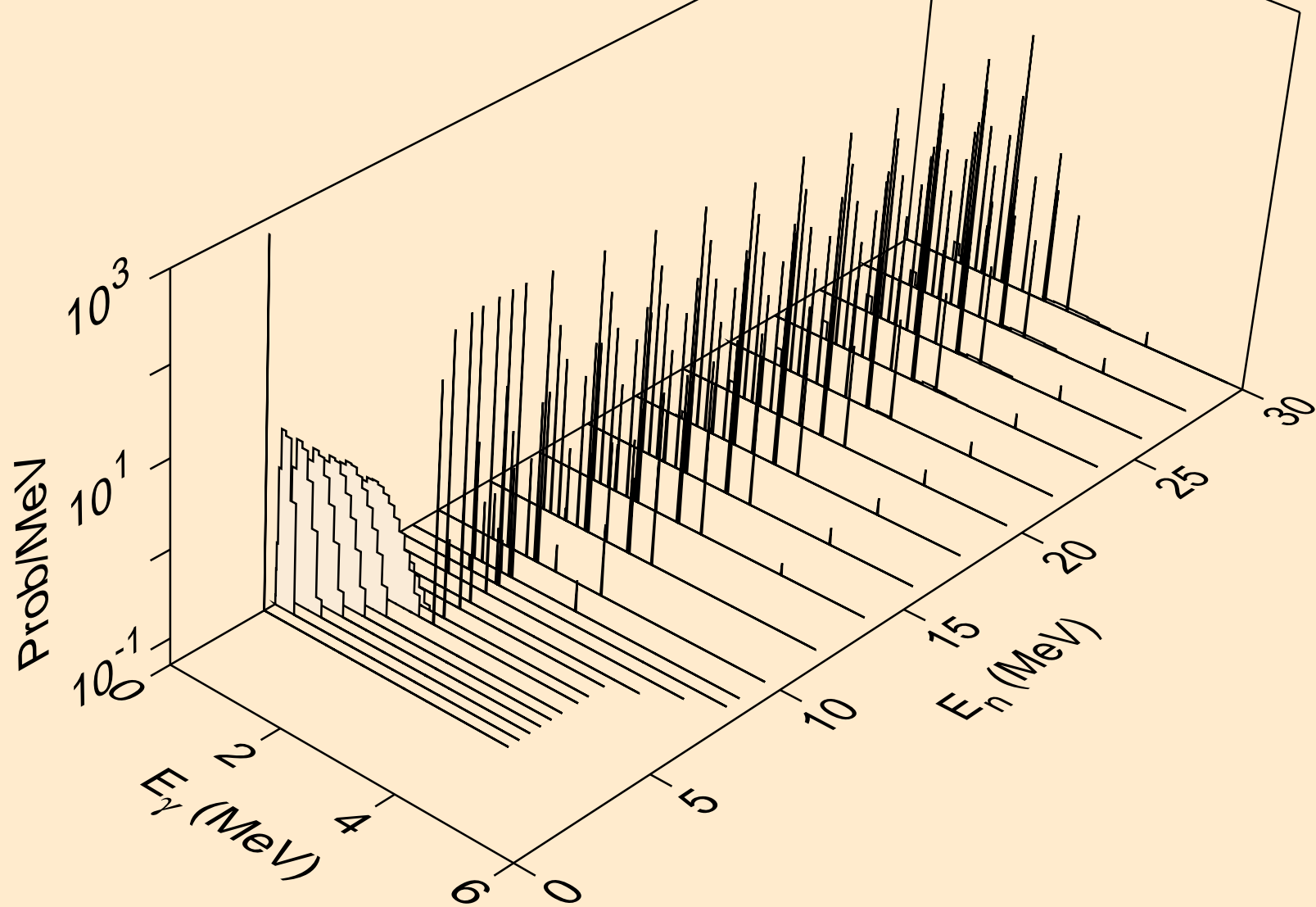

SI027 NEUTRON ACER TENDL-2023 LIBRARY; T=0.K
Photon emission for (n,p α)

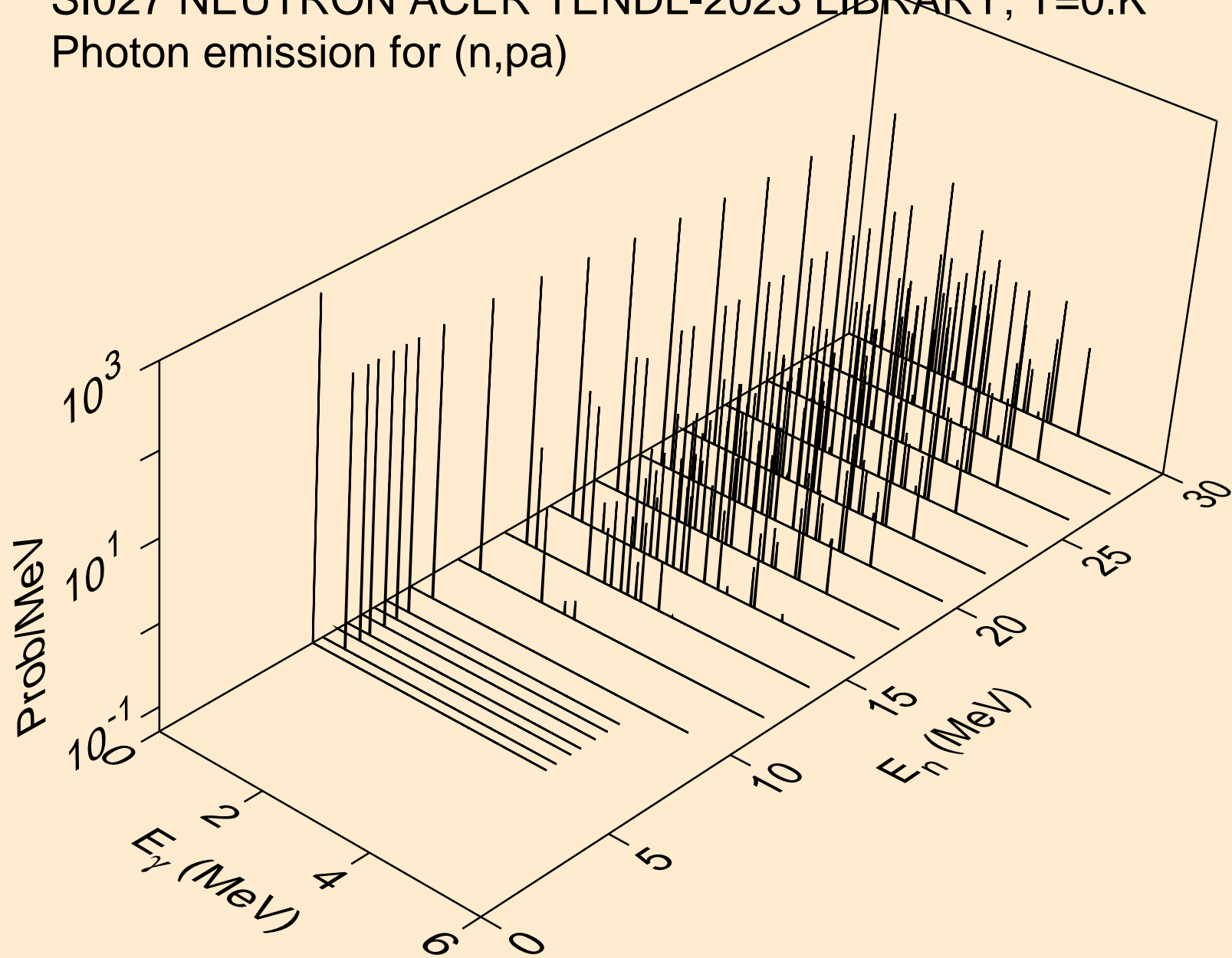

SI027 NEUTRON ACER TENDL-2023 LIBRARY; T=0.K
Photon emission for (n,pd)

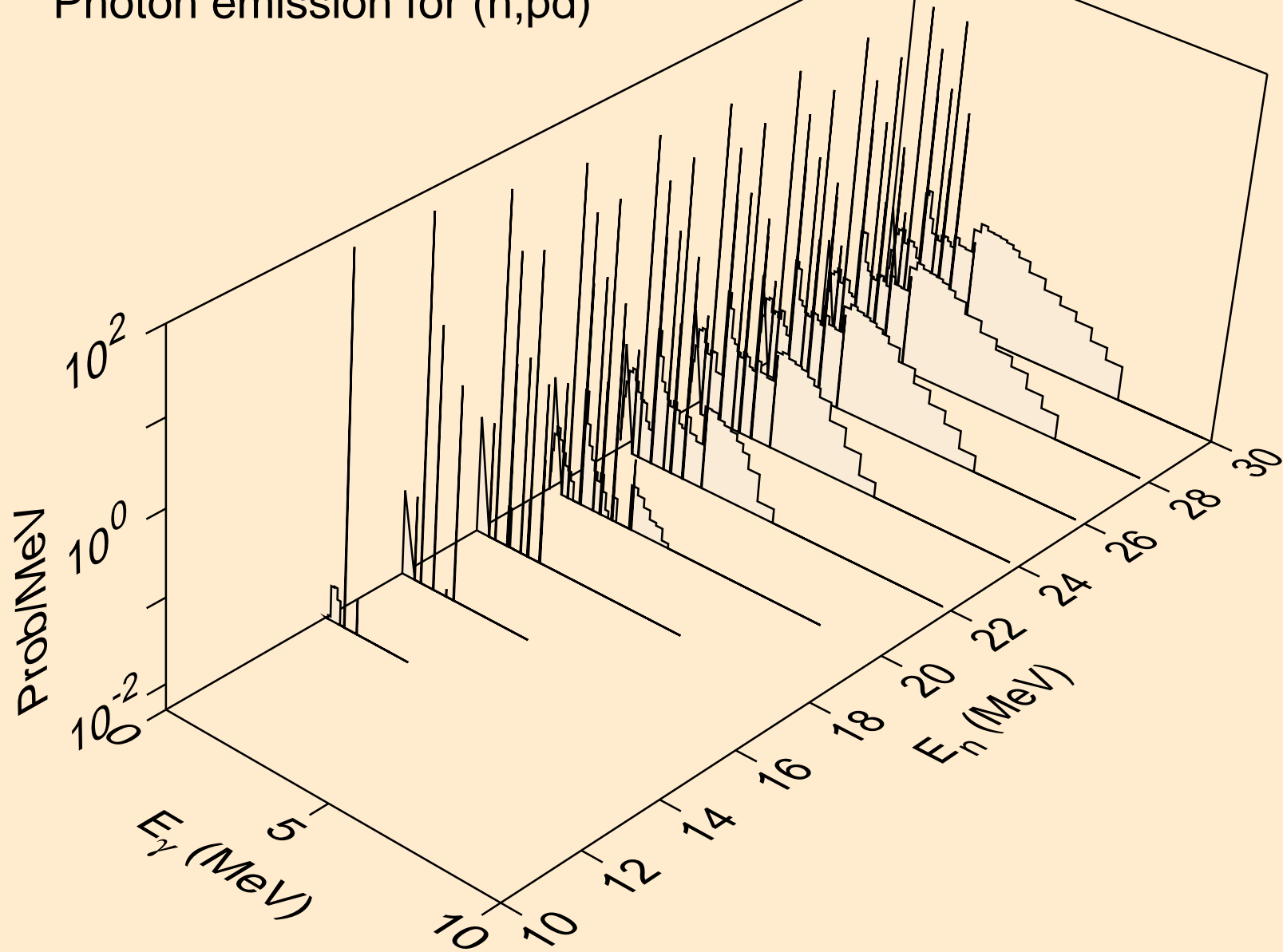

SI027 NEUTRON ACER TENDL-2023 LIBRARY; T=0.K
Photon emission for (n,pt)

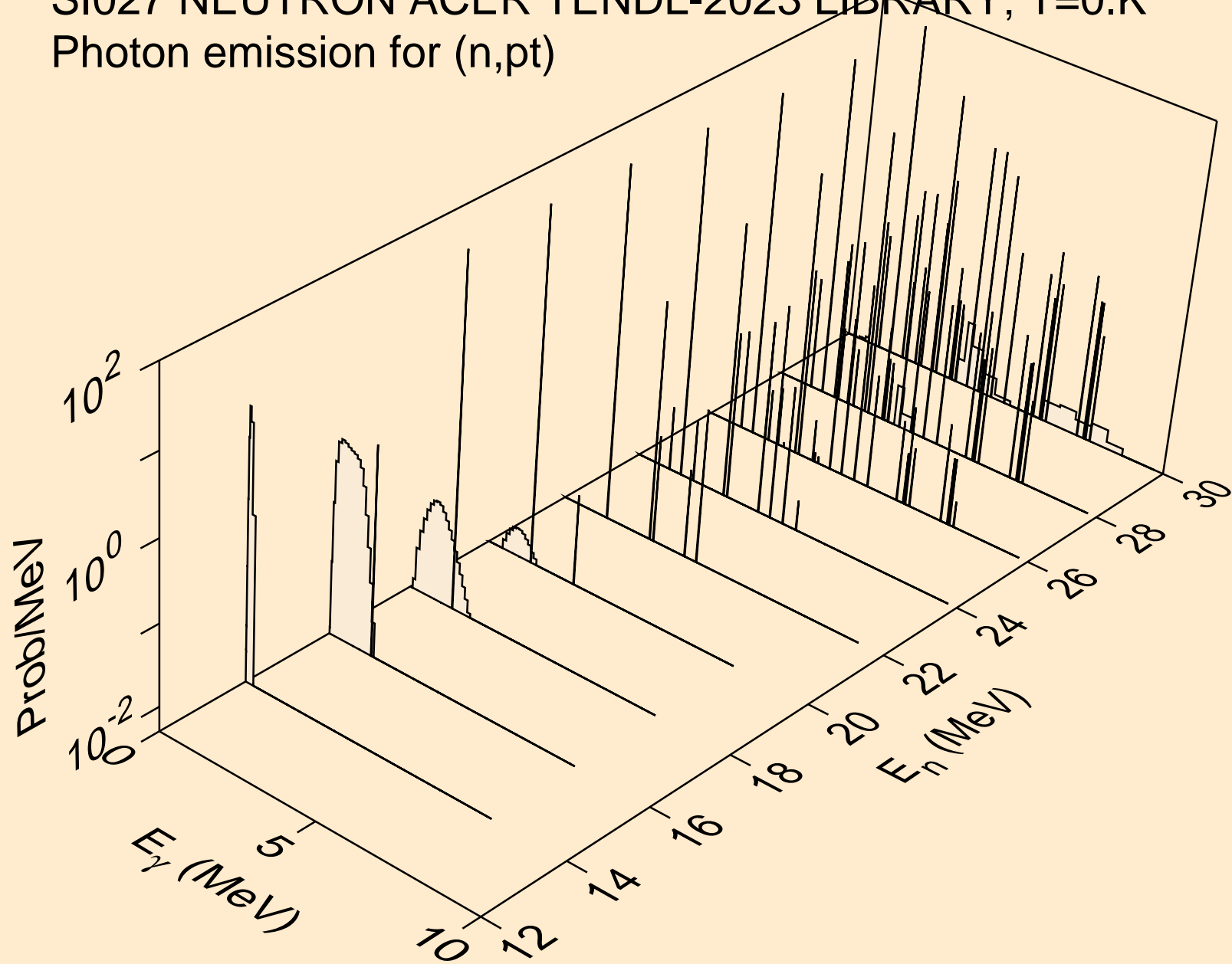

SI027 NEUTRON ACER TENDL-2023 LIBRARY; T=0.K
Photon emission for (n,da)

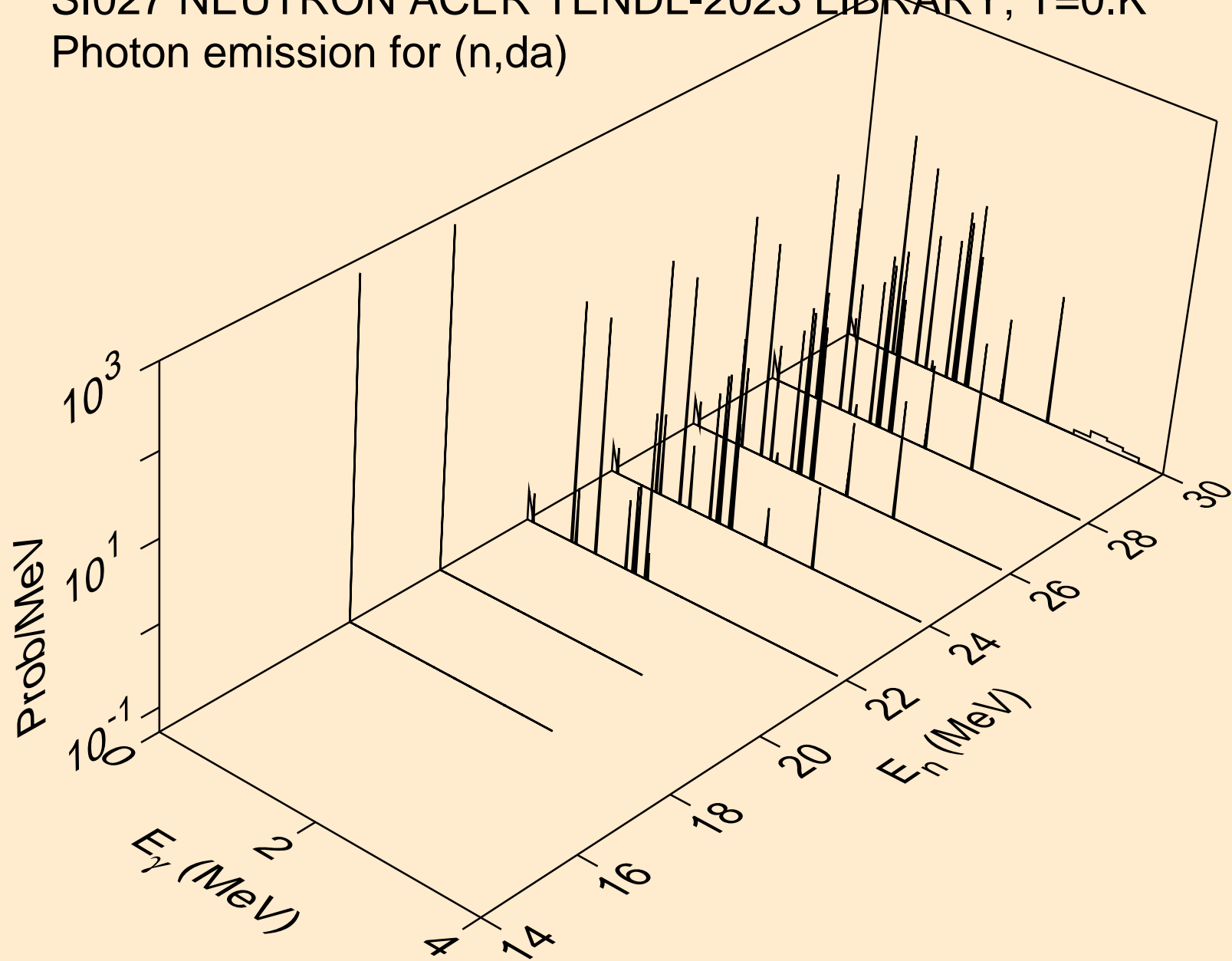

SI027 NEUTRON ACER TENDL-2023 LIBRARY; T=0.K
thermal capture photon spectrum

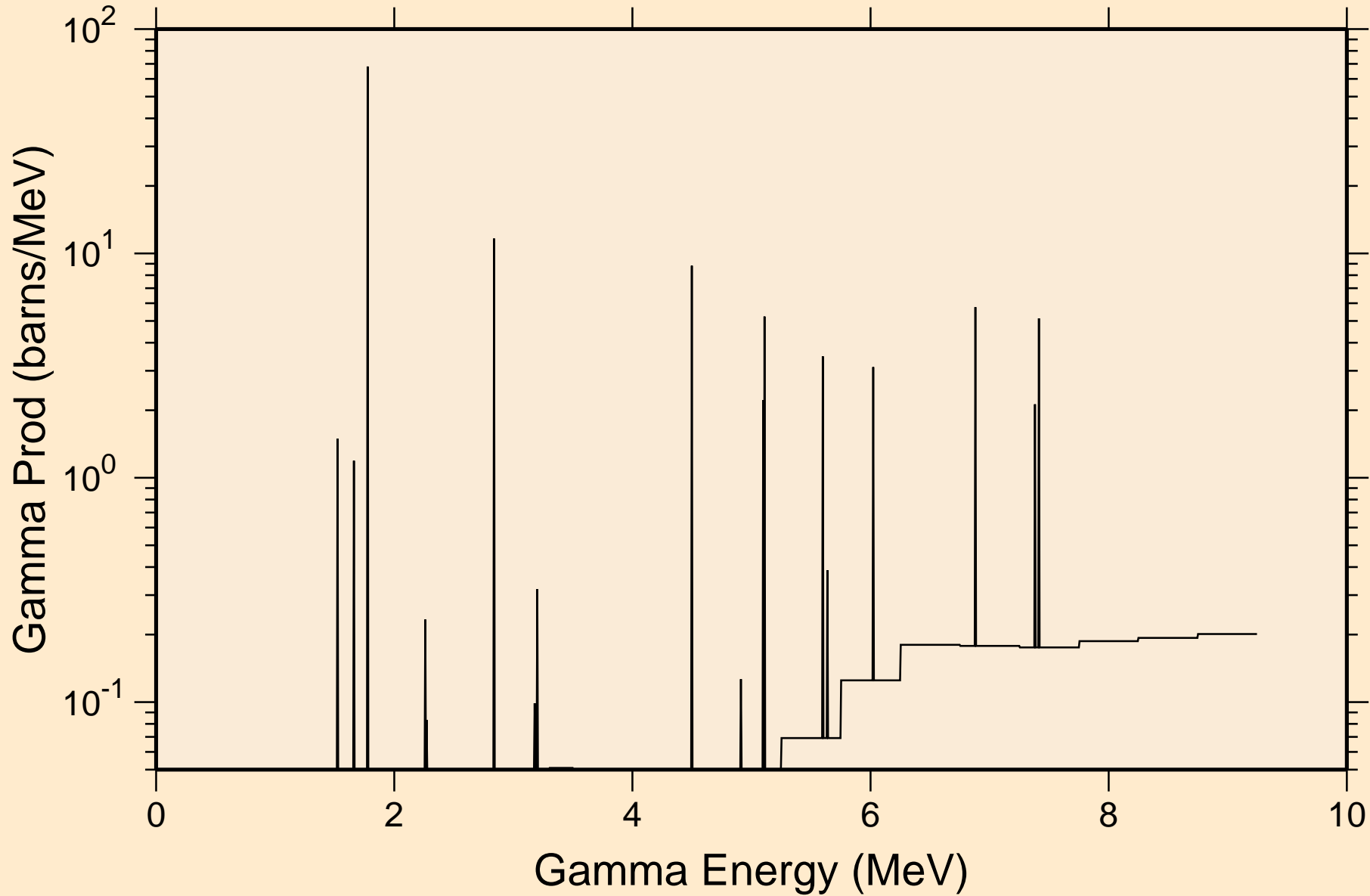

SI027 NEUTRON ACER TENDL-2023 LIBRARY; T=0.K
14 MeV photon spectrum

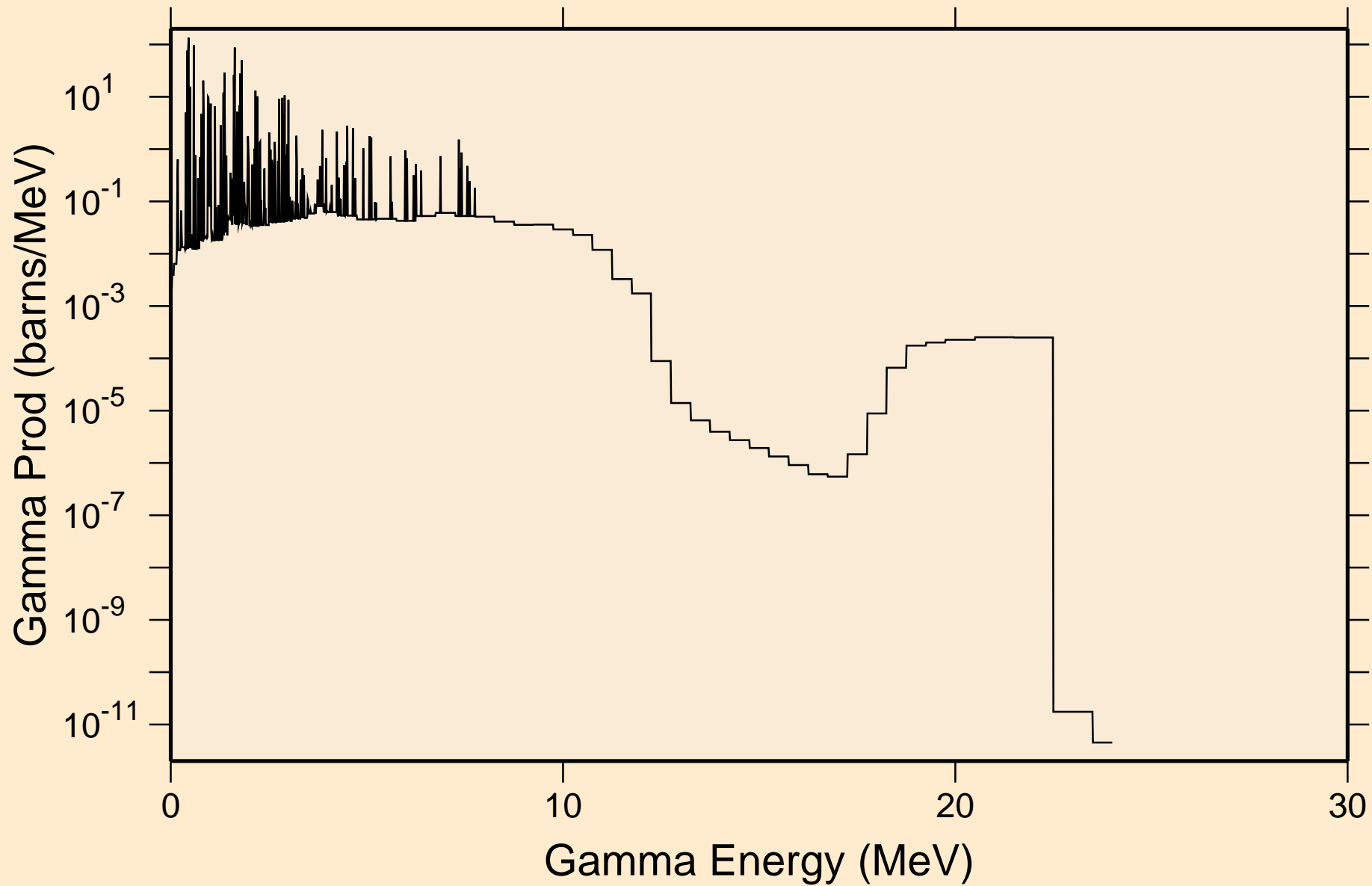

SI027 NEUTRON ACER TENDL-2023 LIBRARY; T=0.K

Particle heating contributions

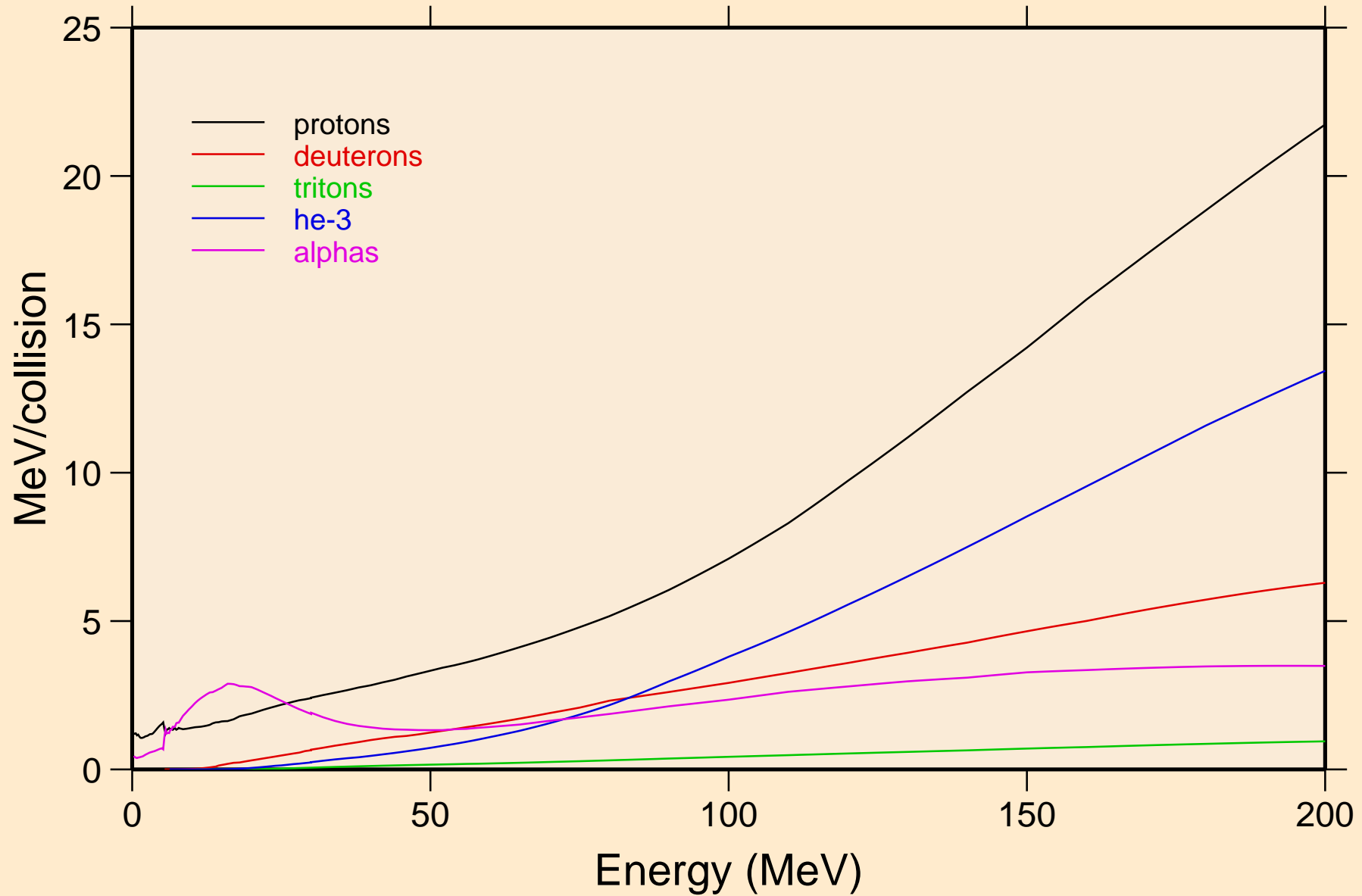

SI027 NEUTRON ACER TENDL-2023 LIBRARY; T=0.K

Recoil Heating

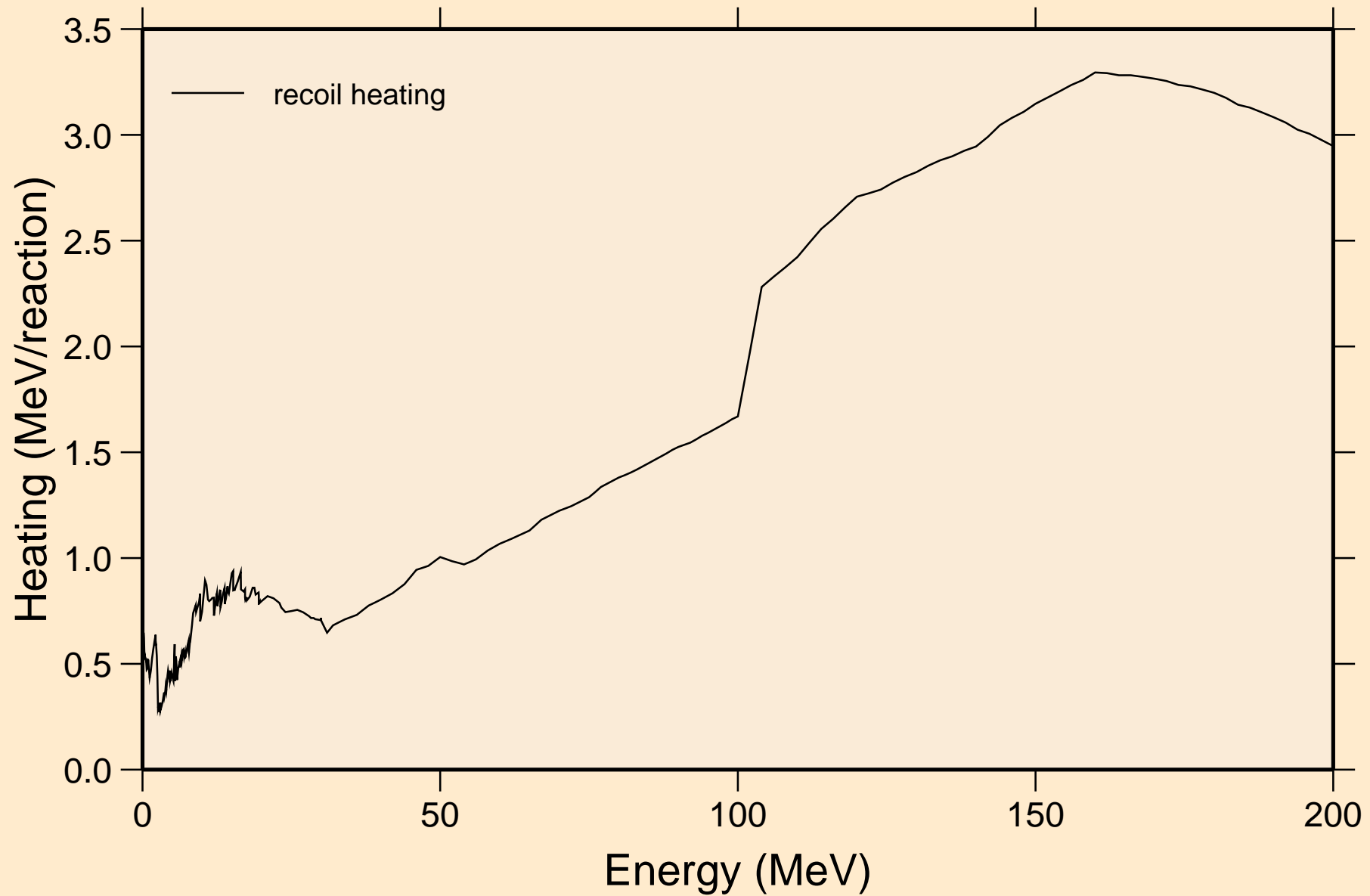

SI027 NEUTRON ACER TENDL-2023 LIBRARY; T=0.K
Particle production cross sections

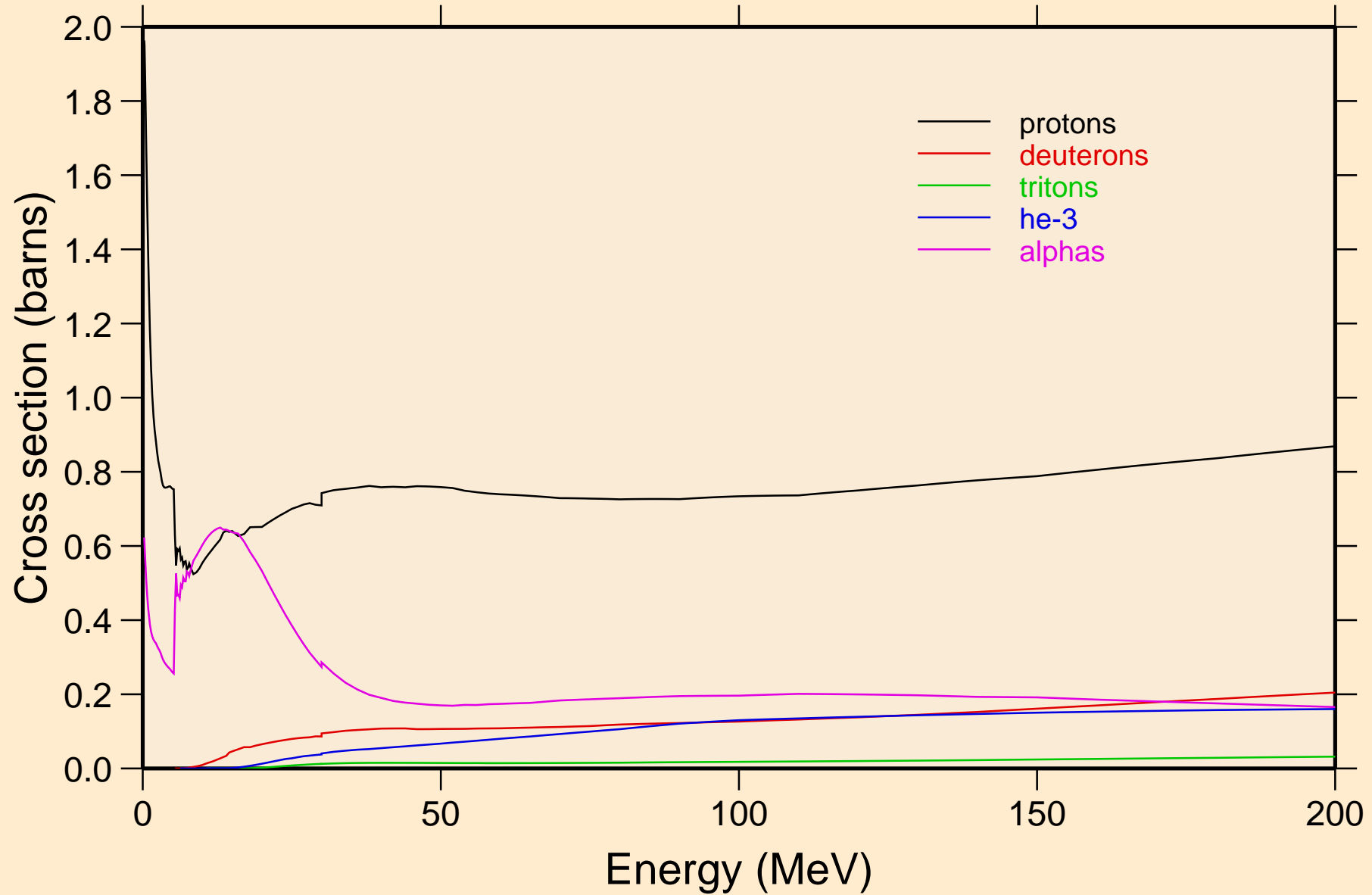

SI027 NEUTRON ACER TENDL-2023 LIBRARY; T=0.K
protons from (n,x)

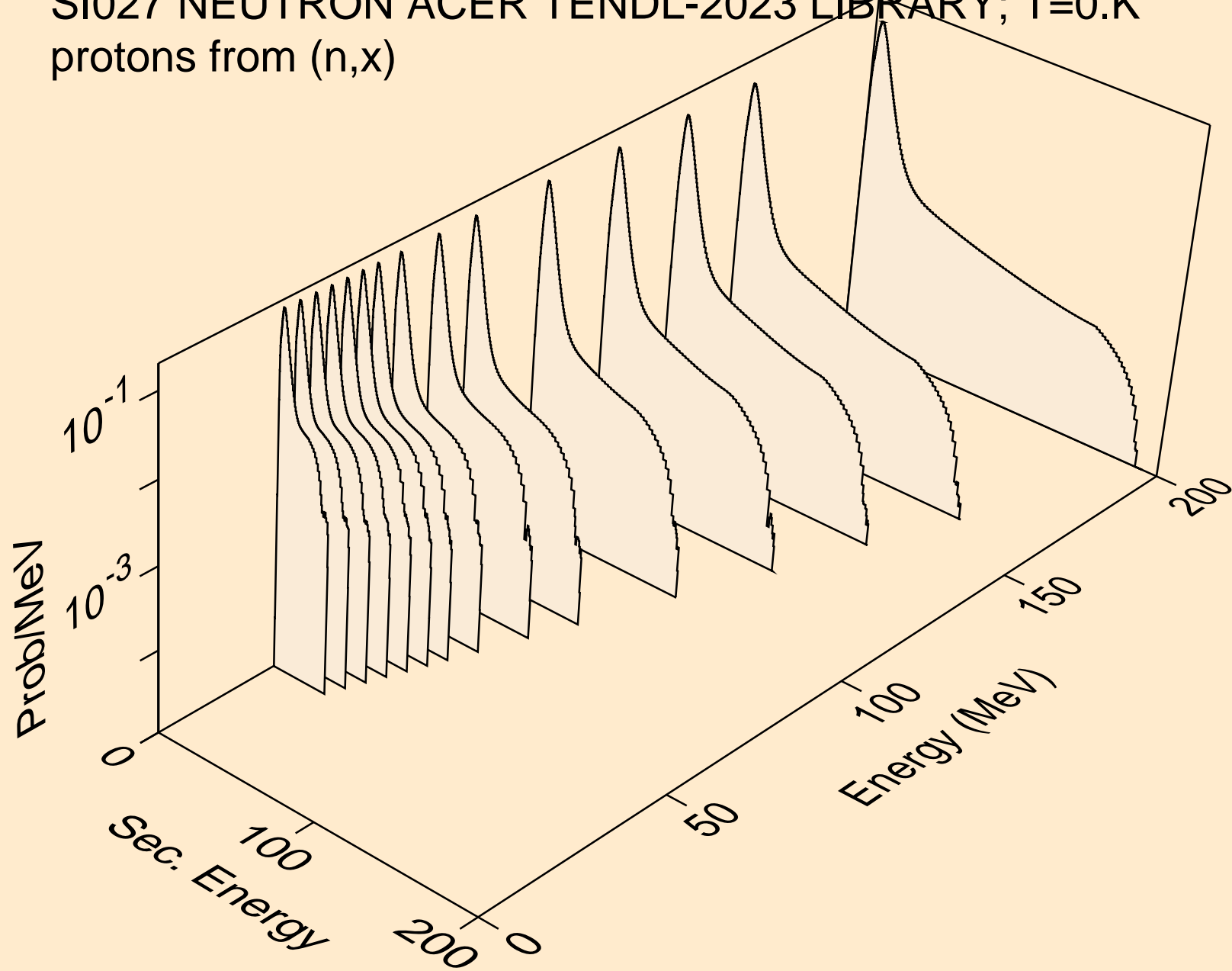

SI027 NEUTRON ACER TENDL-2023 LIBRARY; T=0.K
protons from (n,n*)p

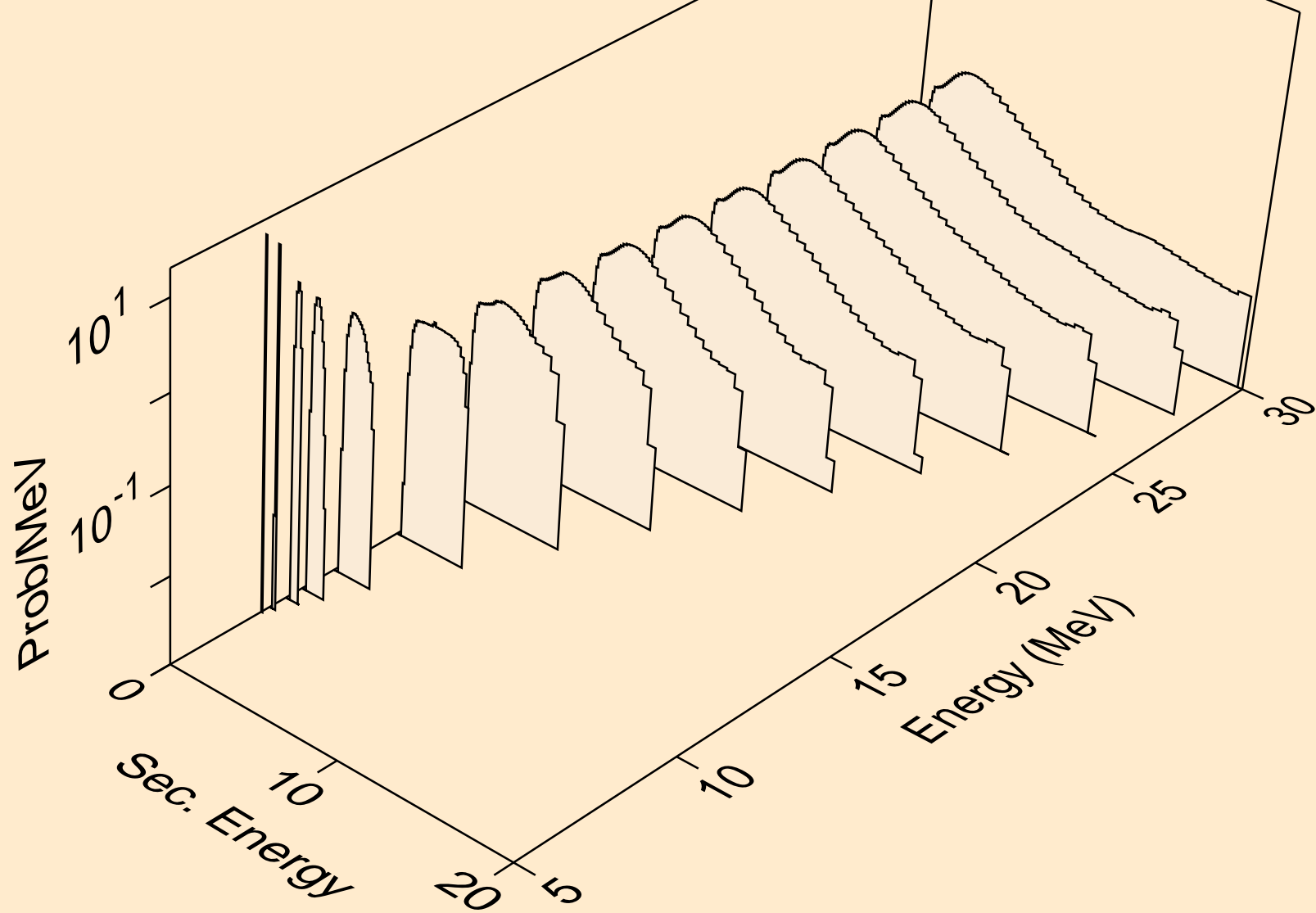

SI027 NEUTRON ACER TENDL-2023 LIBRARY; T=0.K
protons from (n,2np)

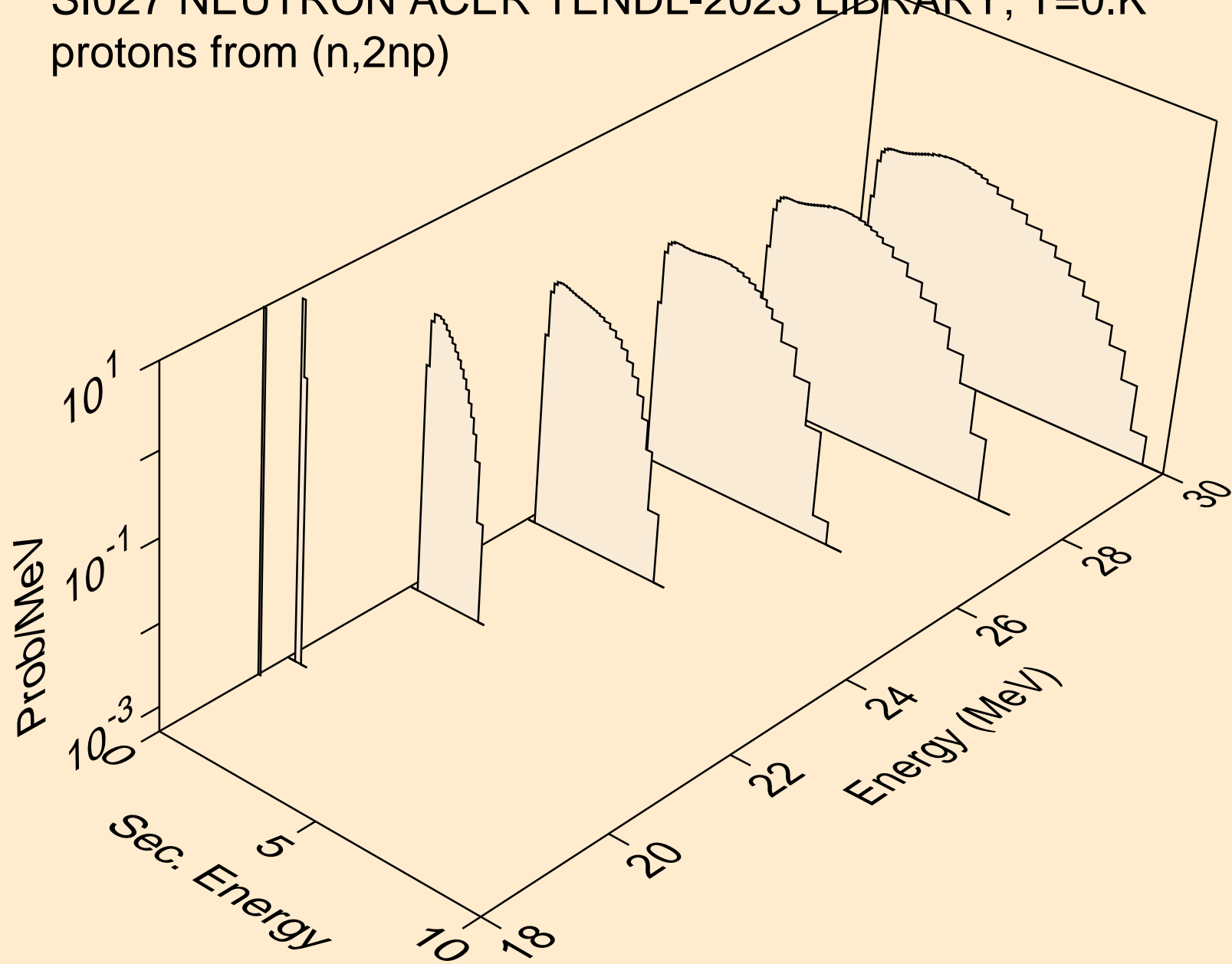

SI027 NEUTRON ACER TENDL-2023 LIBRARY; T=0.K
protons from (n,n2p)

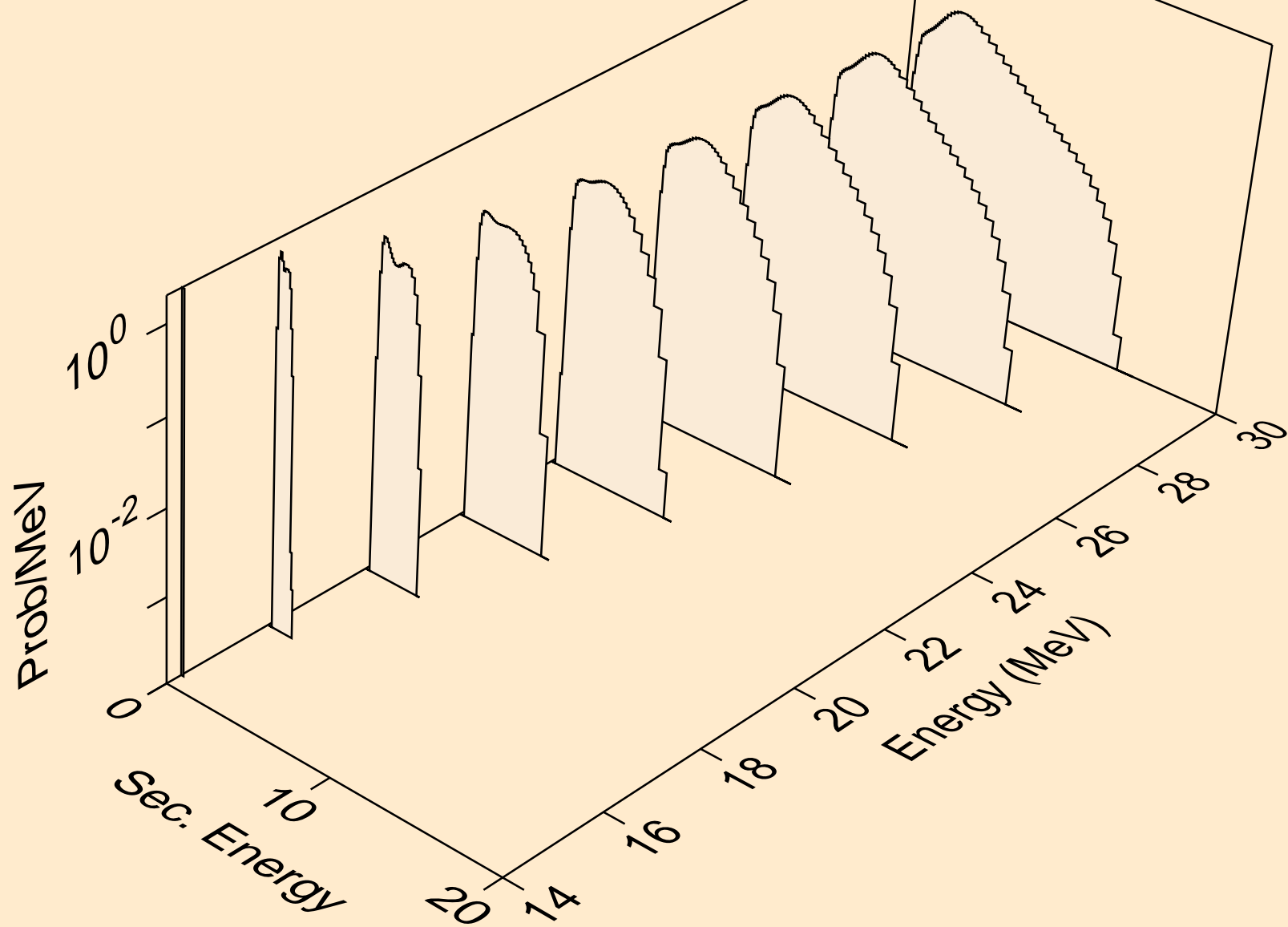

SI027 NEUTRON ACER TENDL-2023 LIBRARY; T=0.K
protons from (n,npa)

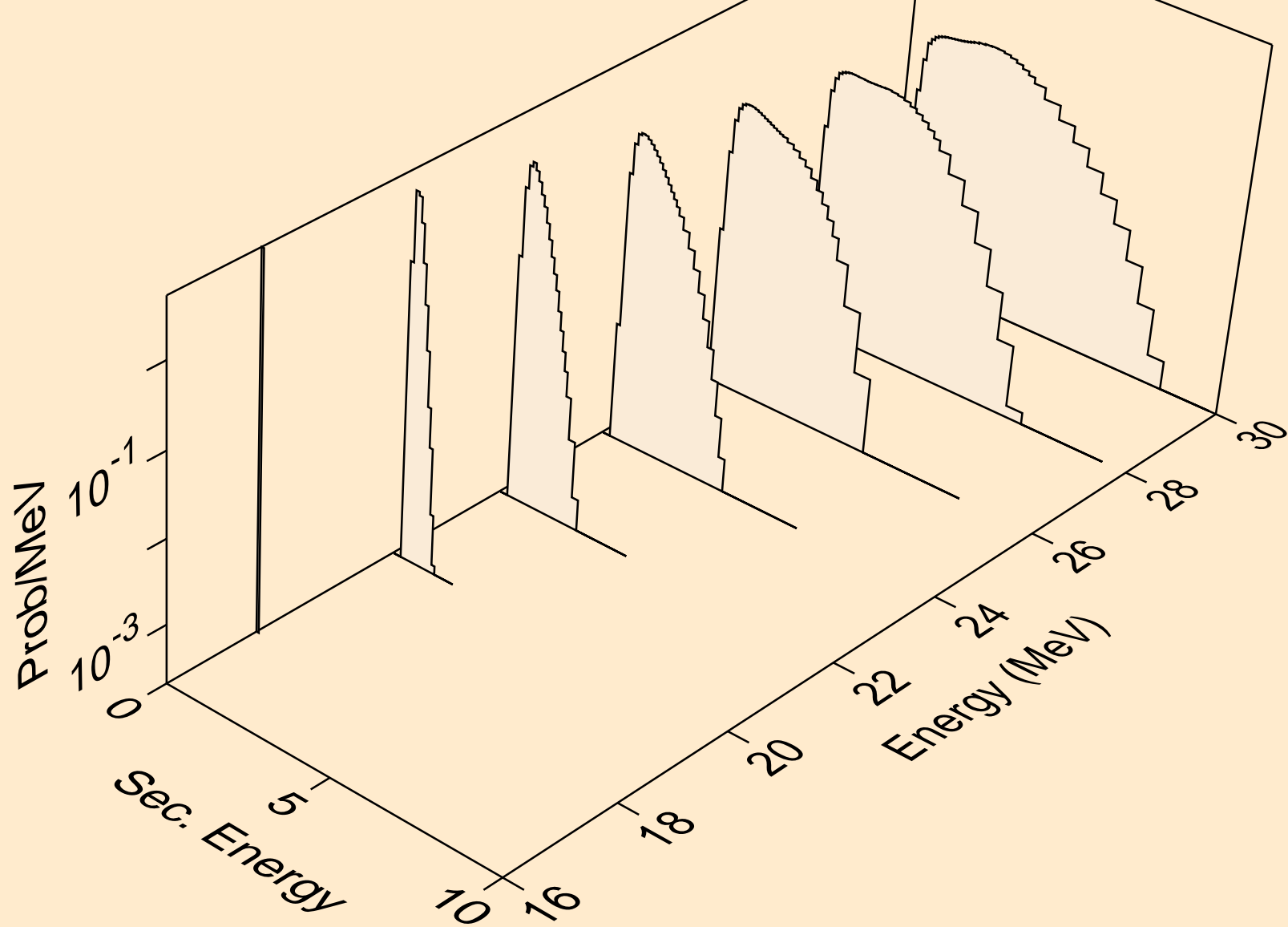

SI027 NEUTRON ACER TENDL-2023 LIBRARY; T=0.K
protons from (n,p)

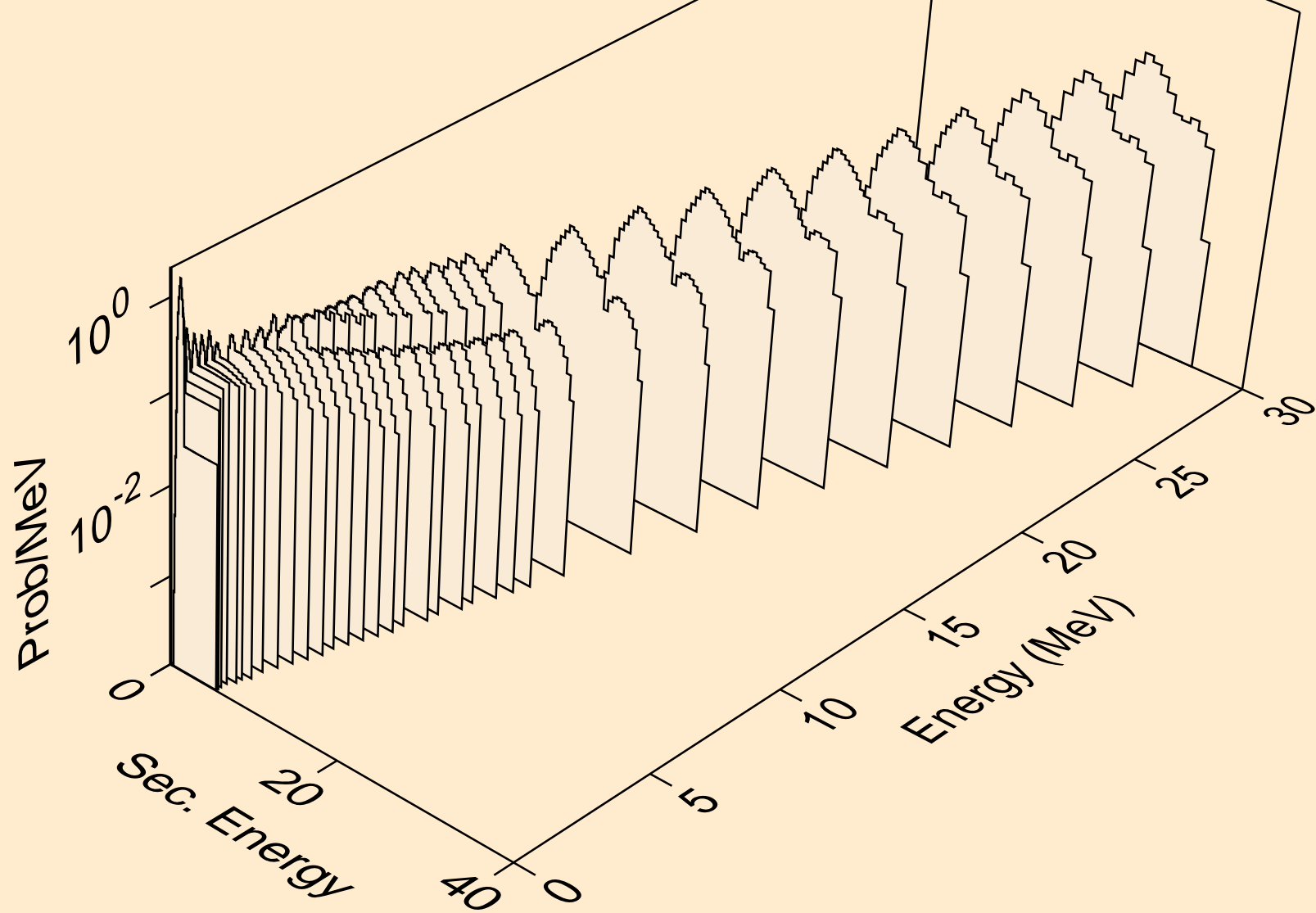

SI027 NEUTRON ACER TENDL-2023 LIBRARY; T=0.K
protons from (n,2p)

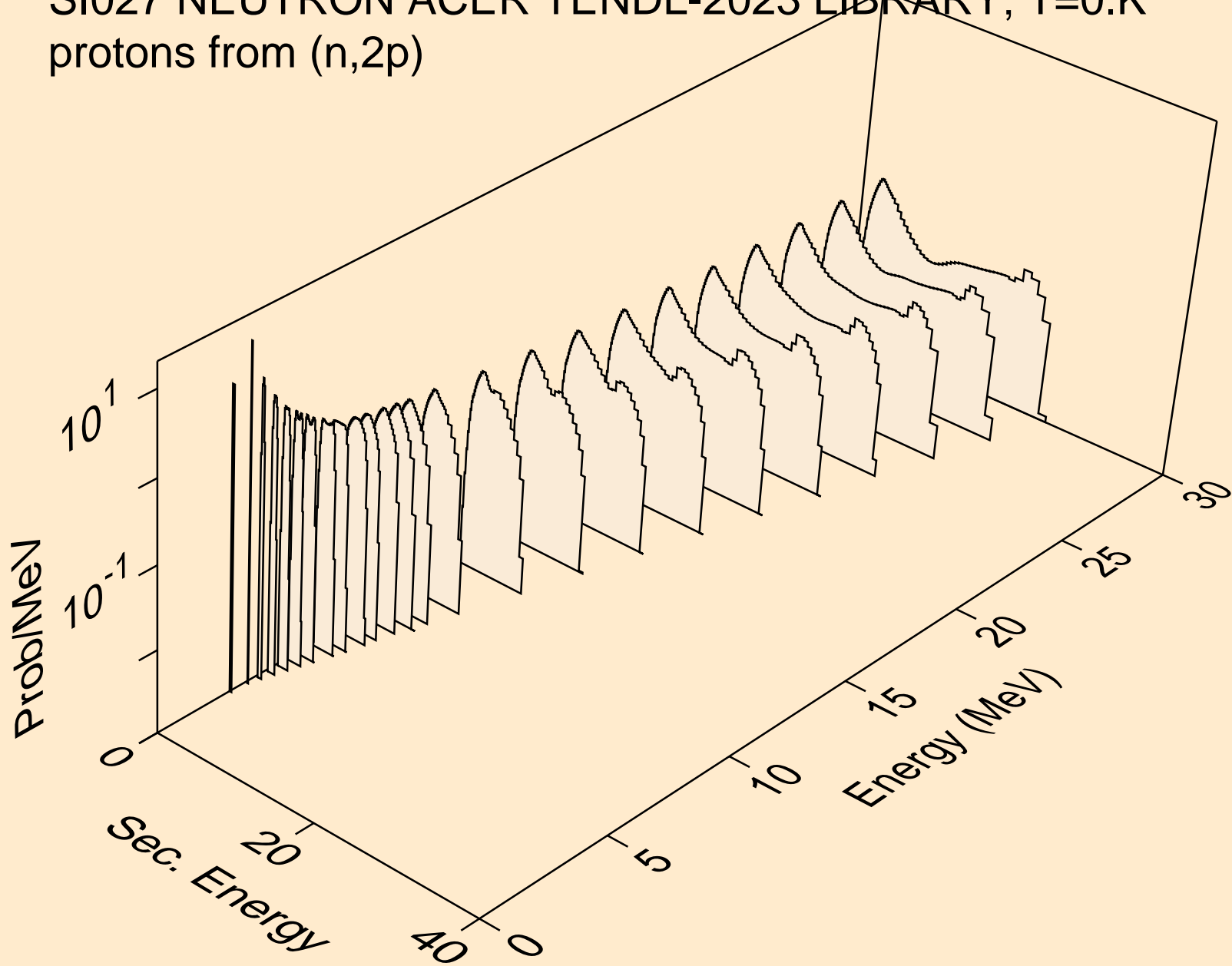

SI027 NEUTRON ACER TENDL-2023 LIBRARY; T=0.K
protons from (n,p)

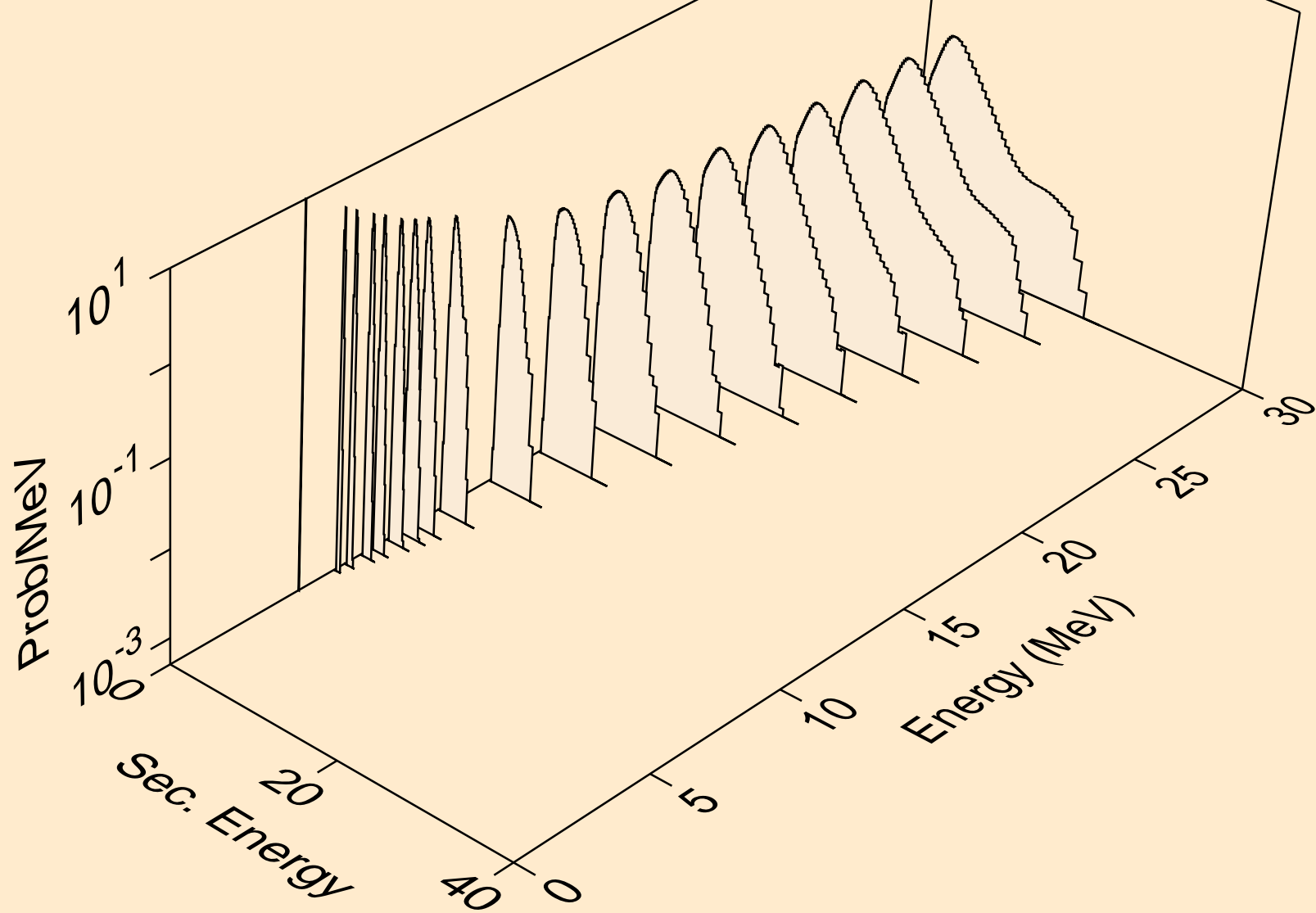

SI027 NEUTRON ACER TENDL-2023 LIBRARY; T=0.K
protons from (n,pd)

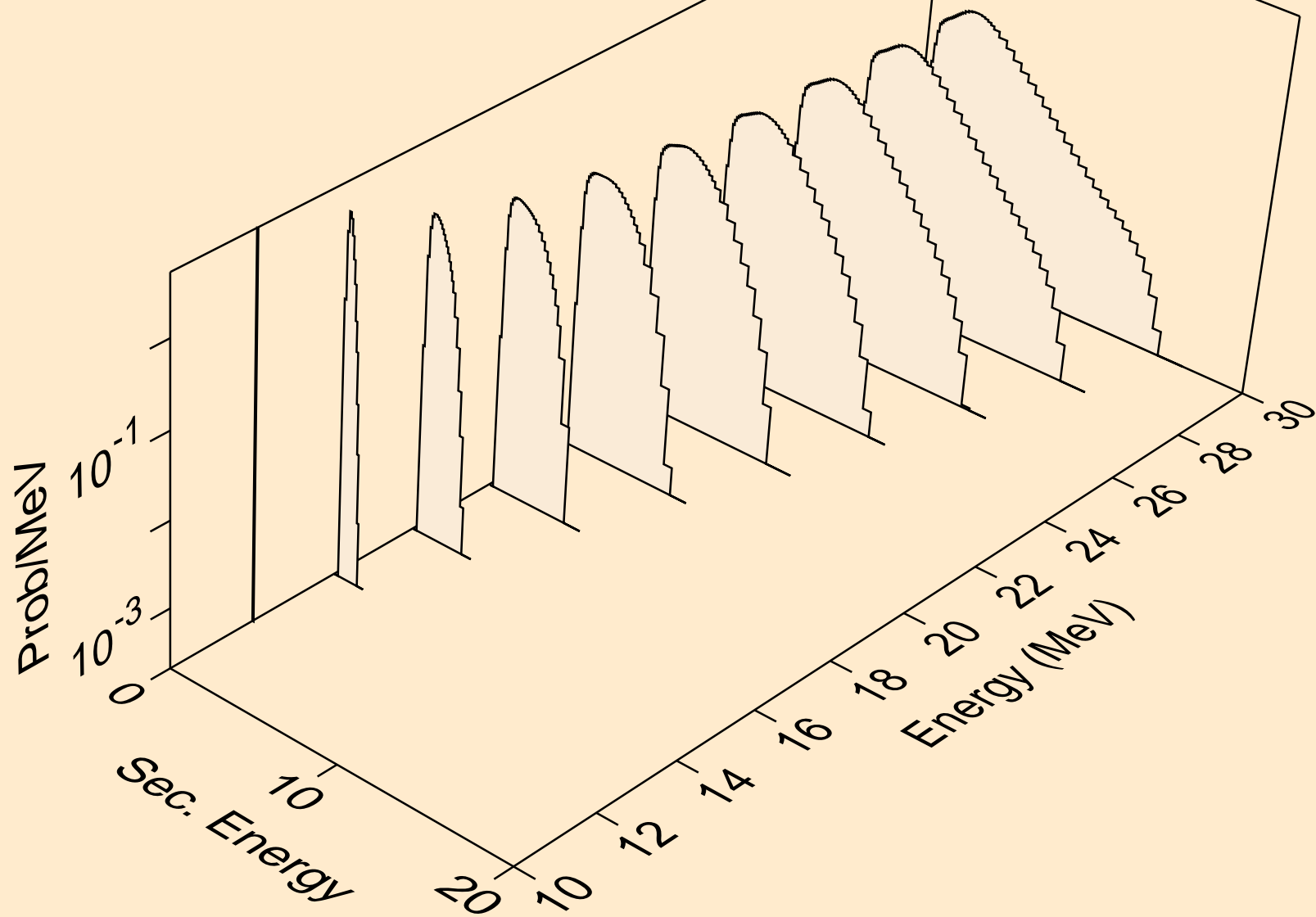

SI027 NEUTRON ACER TENDL-2023 LIBRARY; T=0.K
protons from (n,pt)

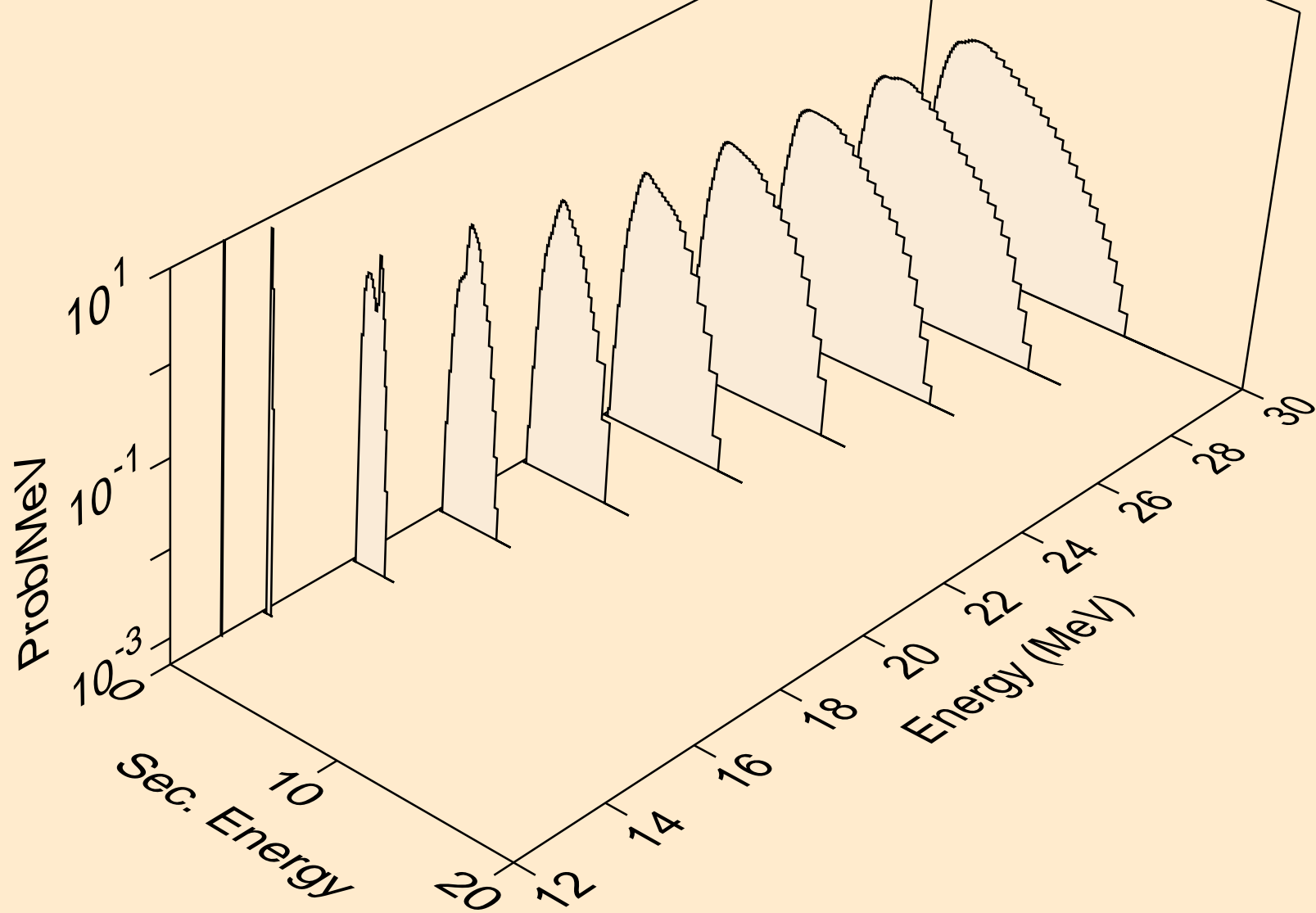

SI027 NEUTRON ACER TENDL-2023 LIBRARY; T=0.K
deuterons from (n,x)

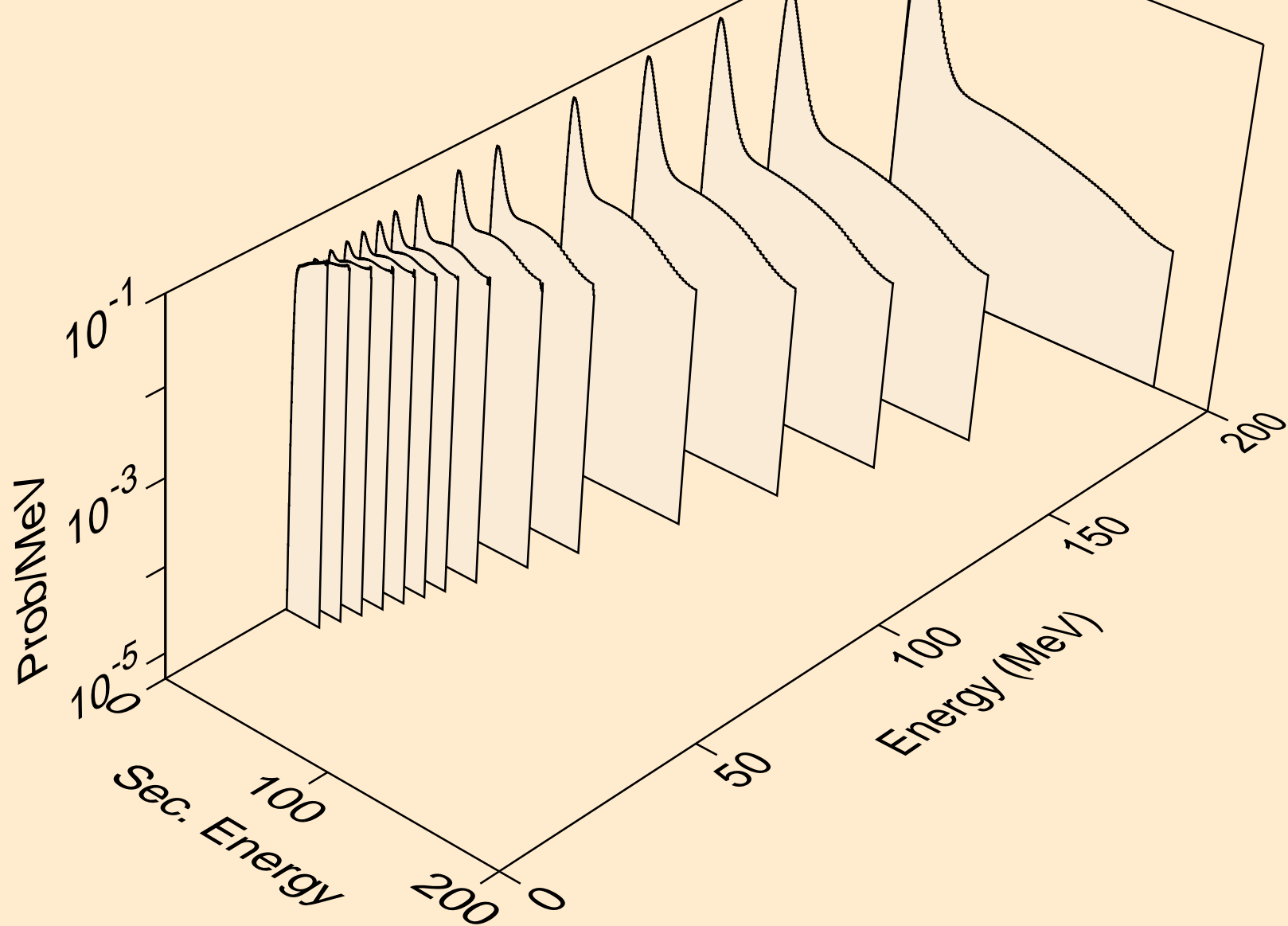

SI027 NEUTRON ACER TENDL-2023 LIBRARY; T=0.K
deuterons from (n,n*)d

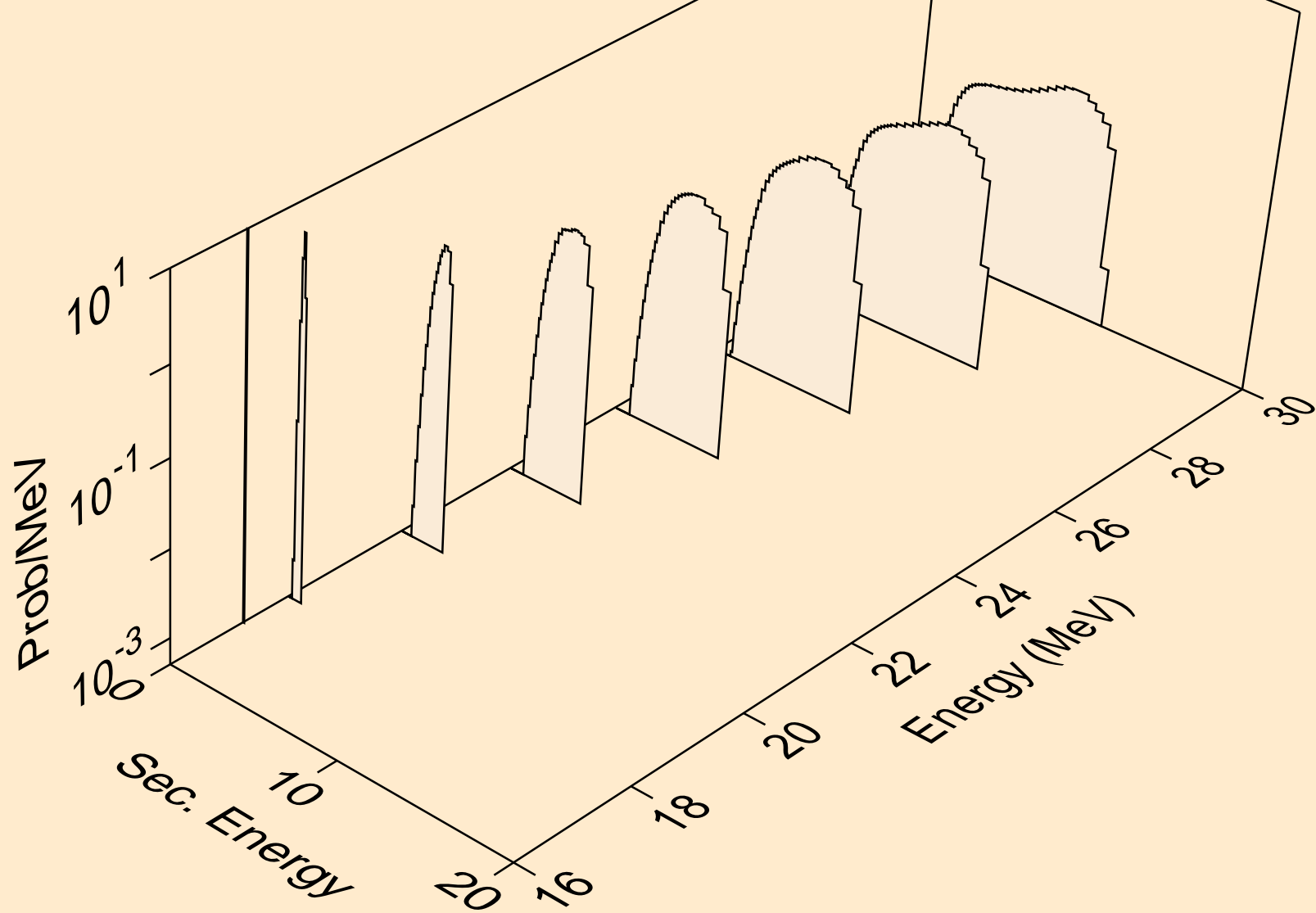

SI027 NEUTRON ACER TENDL-2023 LIBRARY; T=0.K
deuterons from (n,d)

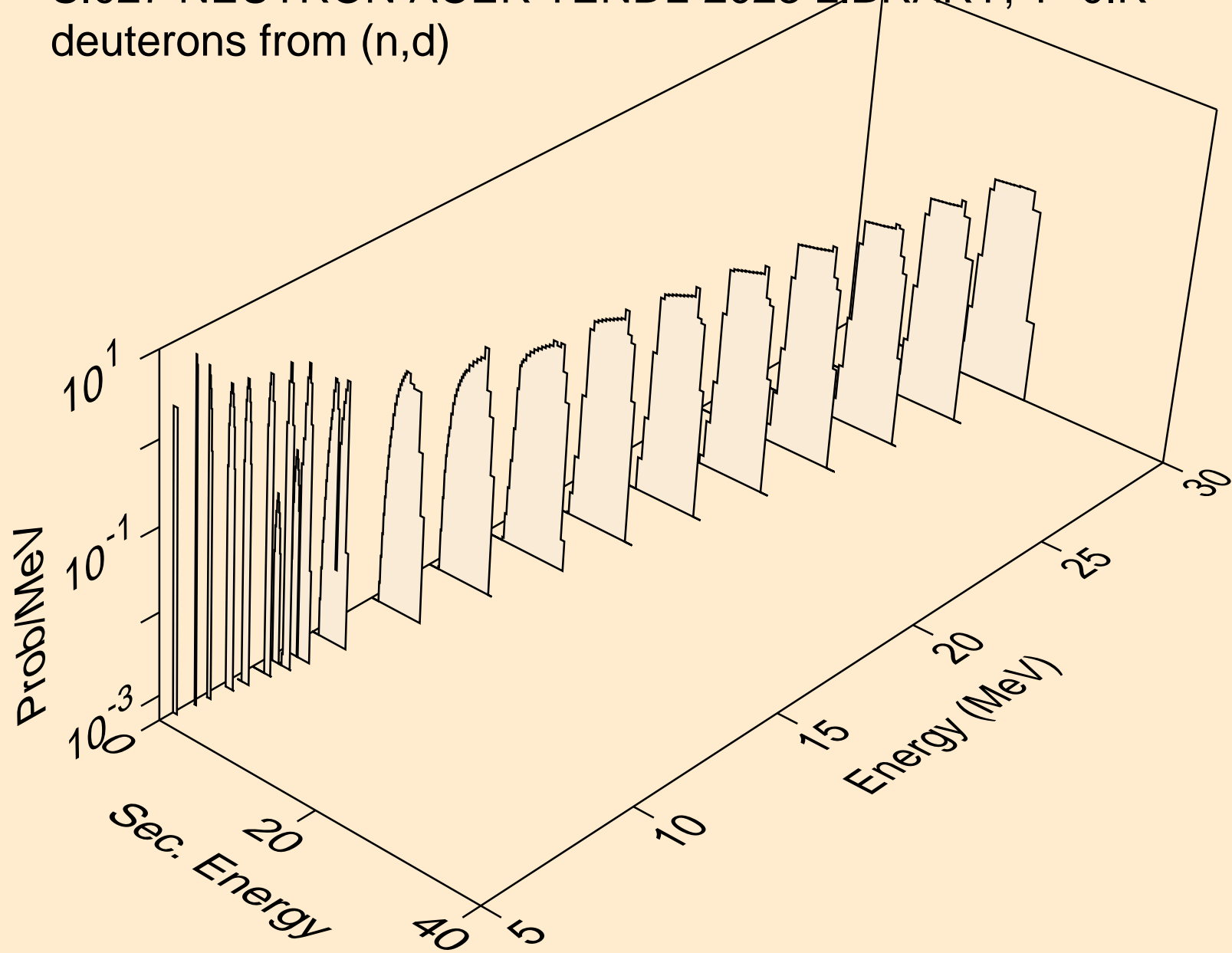

SI027 NEUTRON ACER TENDL-2023 LIBRARY; T=0.K
deuterons from (n,pd)

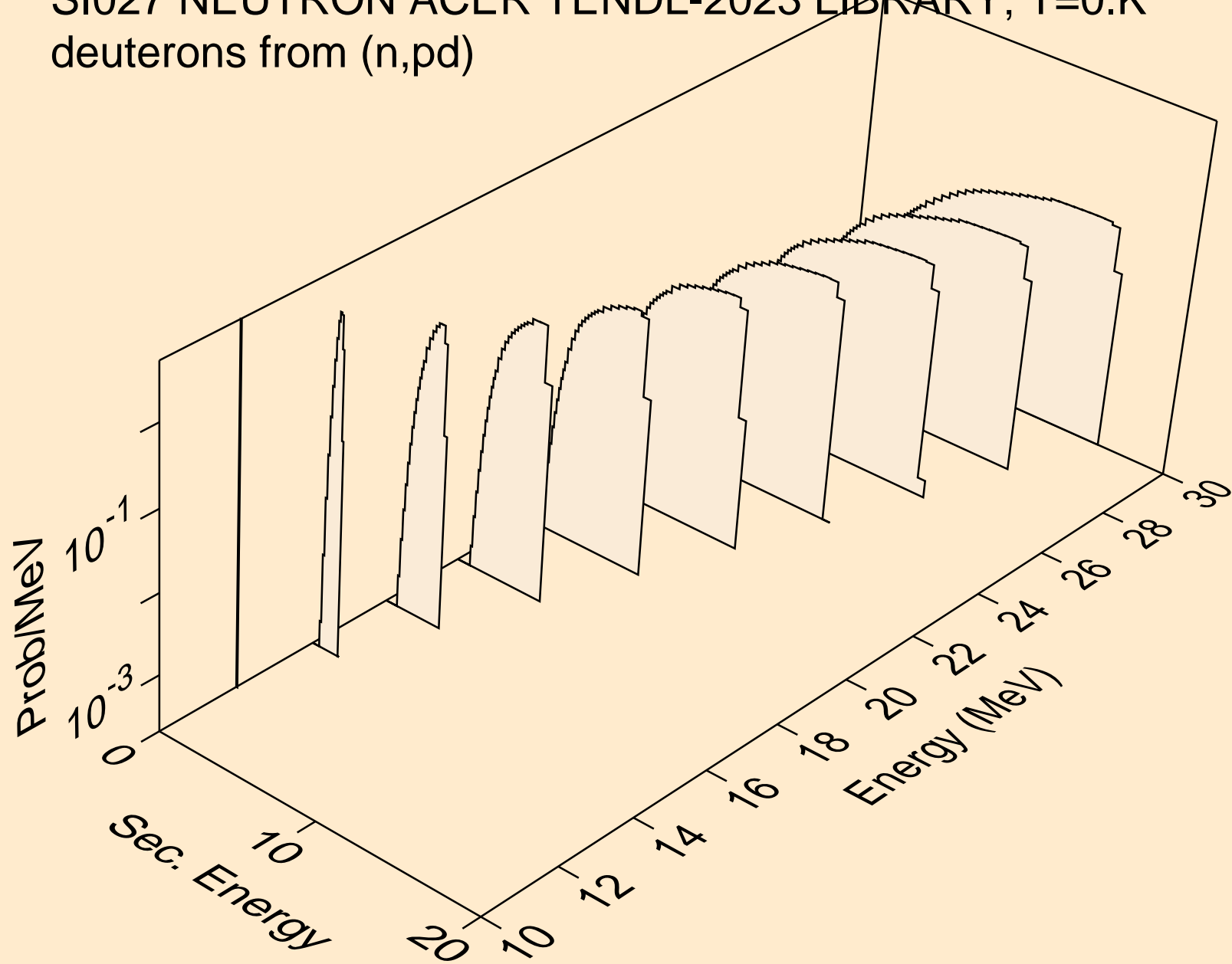

SI027 NEUTRON ACER TENDL-2023 LIBRARY; T=0.K
deuterons from (n,da)

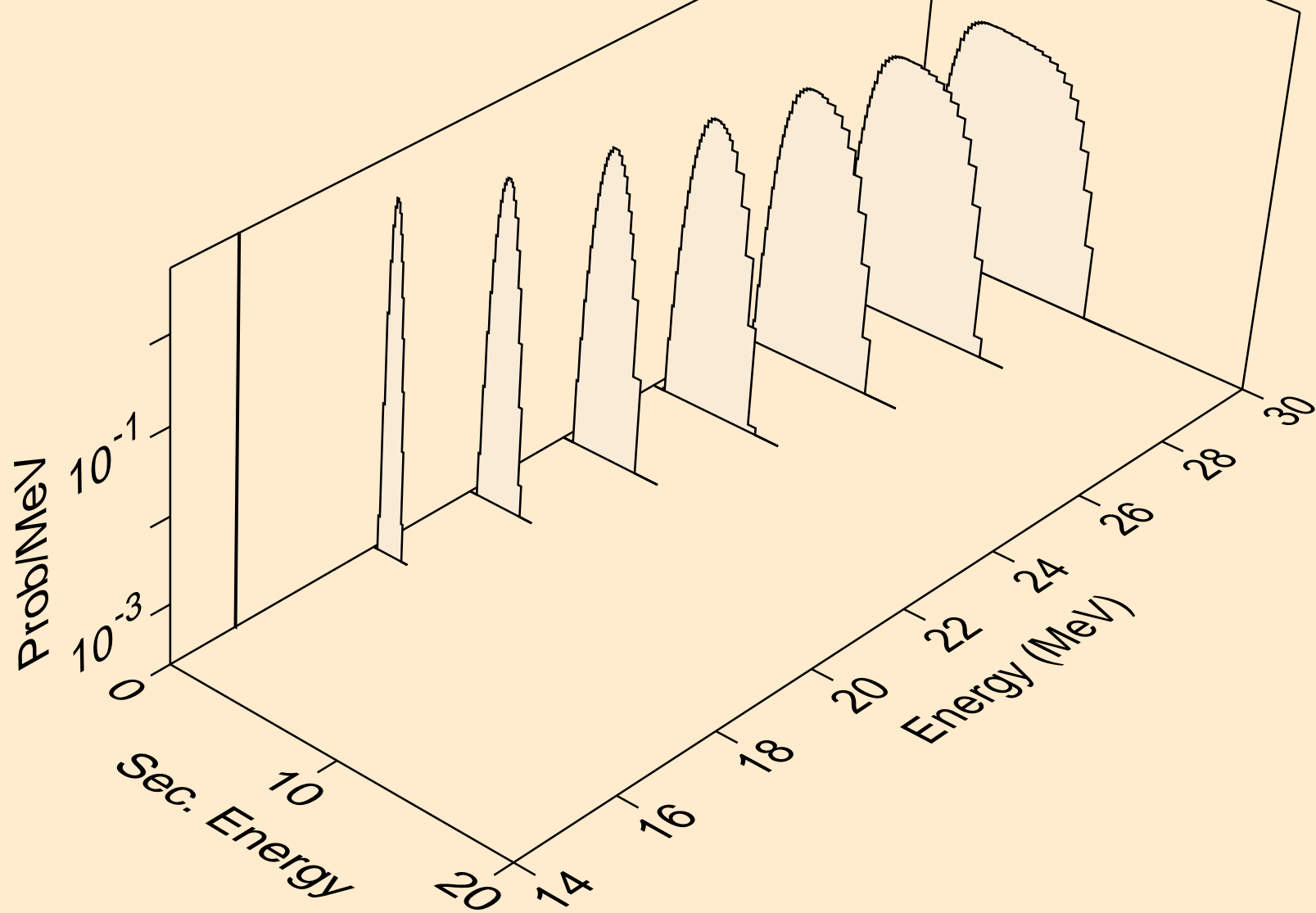

SI027 NEUTRON ACER TENDL-2023 LIBRARY; T=0.K
tritons from (n,x)

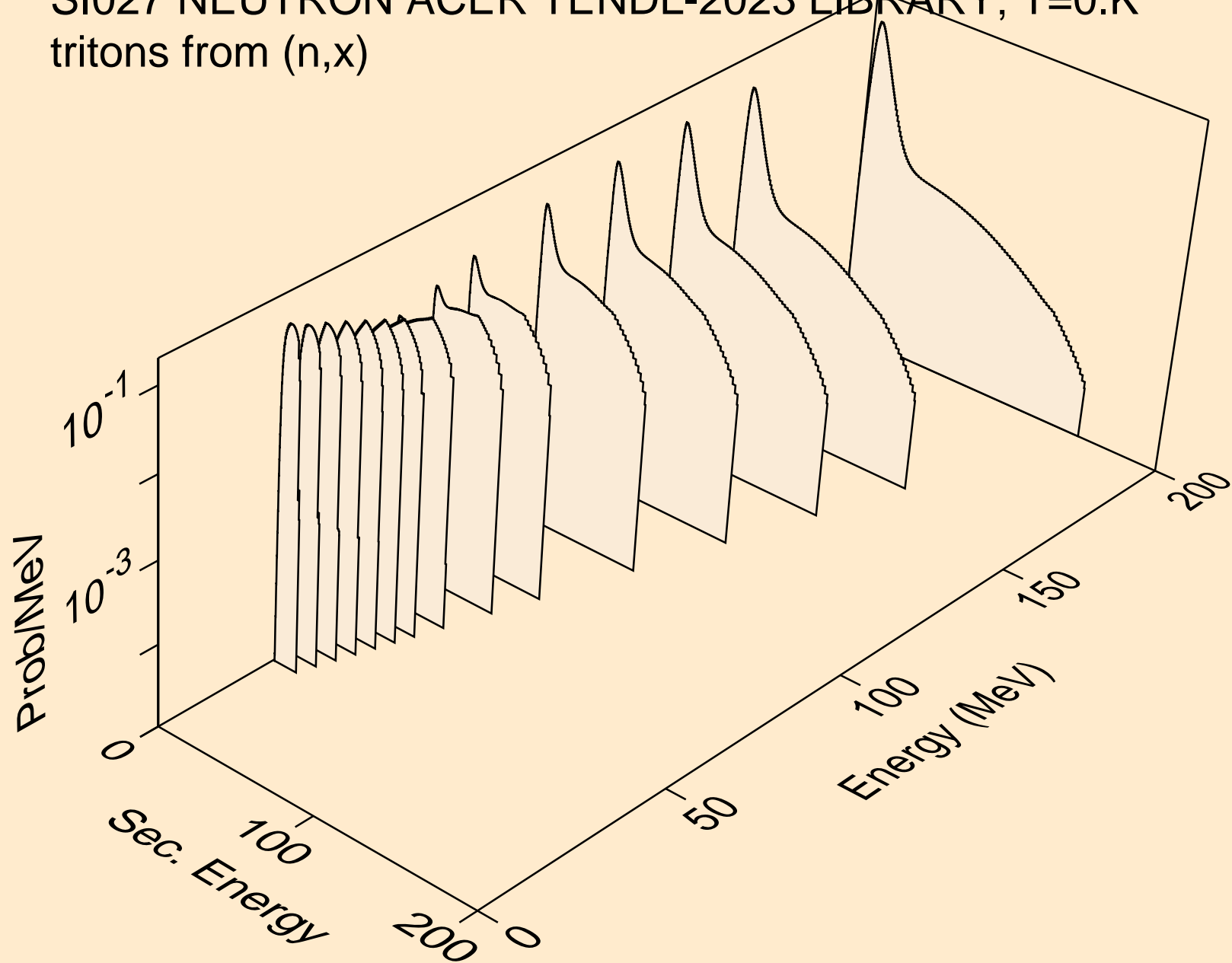

SI027 NEUTRON ACER TENDL-2023 LIBRARY; T=0.K
tritons from (n,n*)t

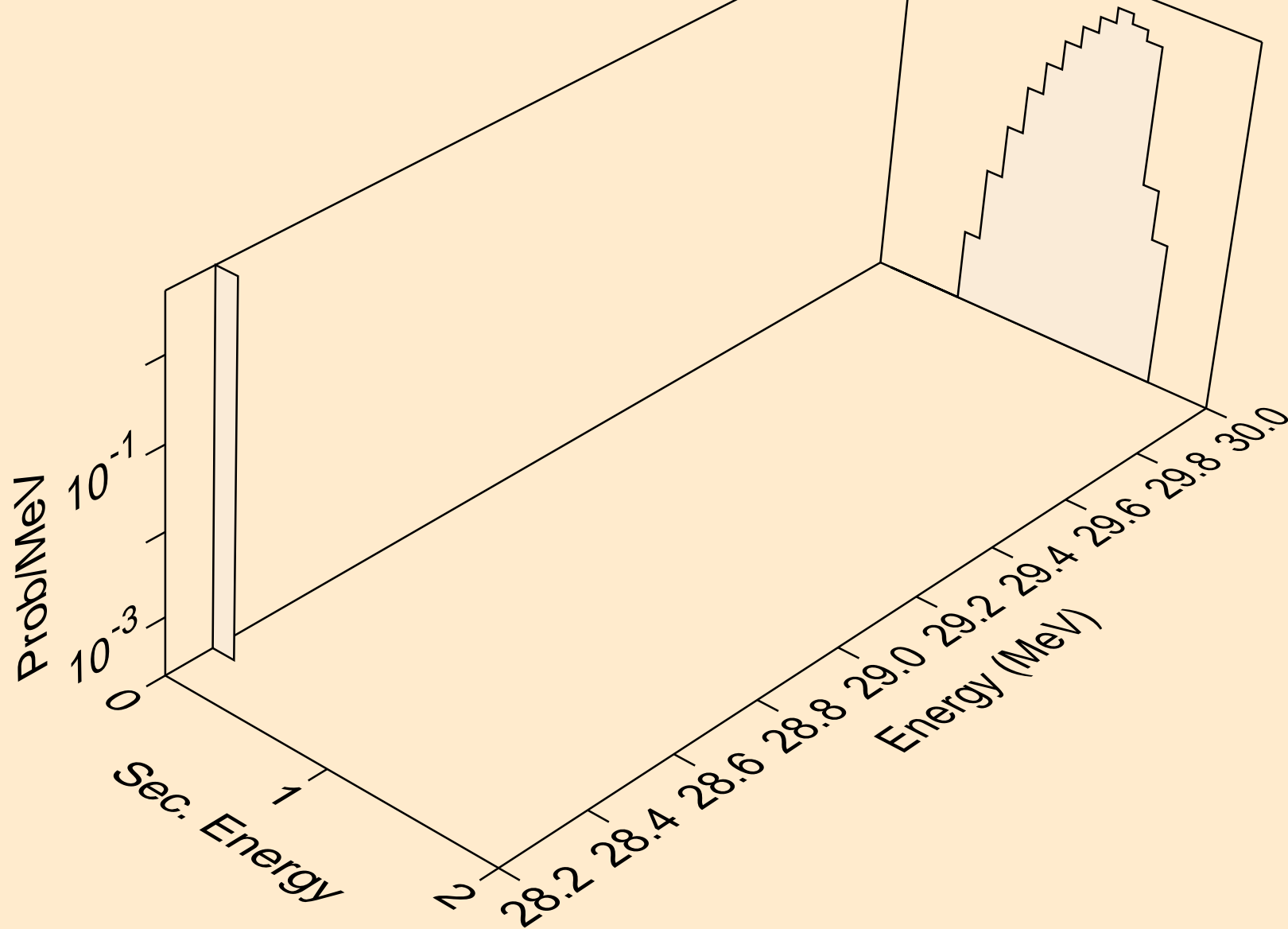

SI027 NEUTRON ACER TENDL-2023 LIBRARY; T=0.K
tritons from (n,t)

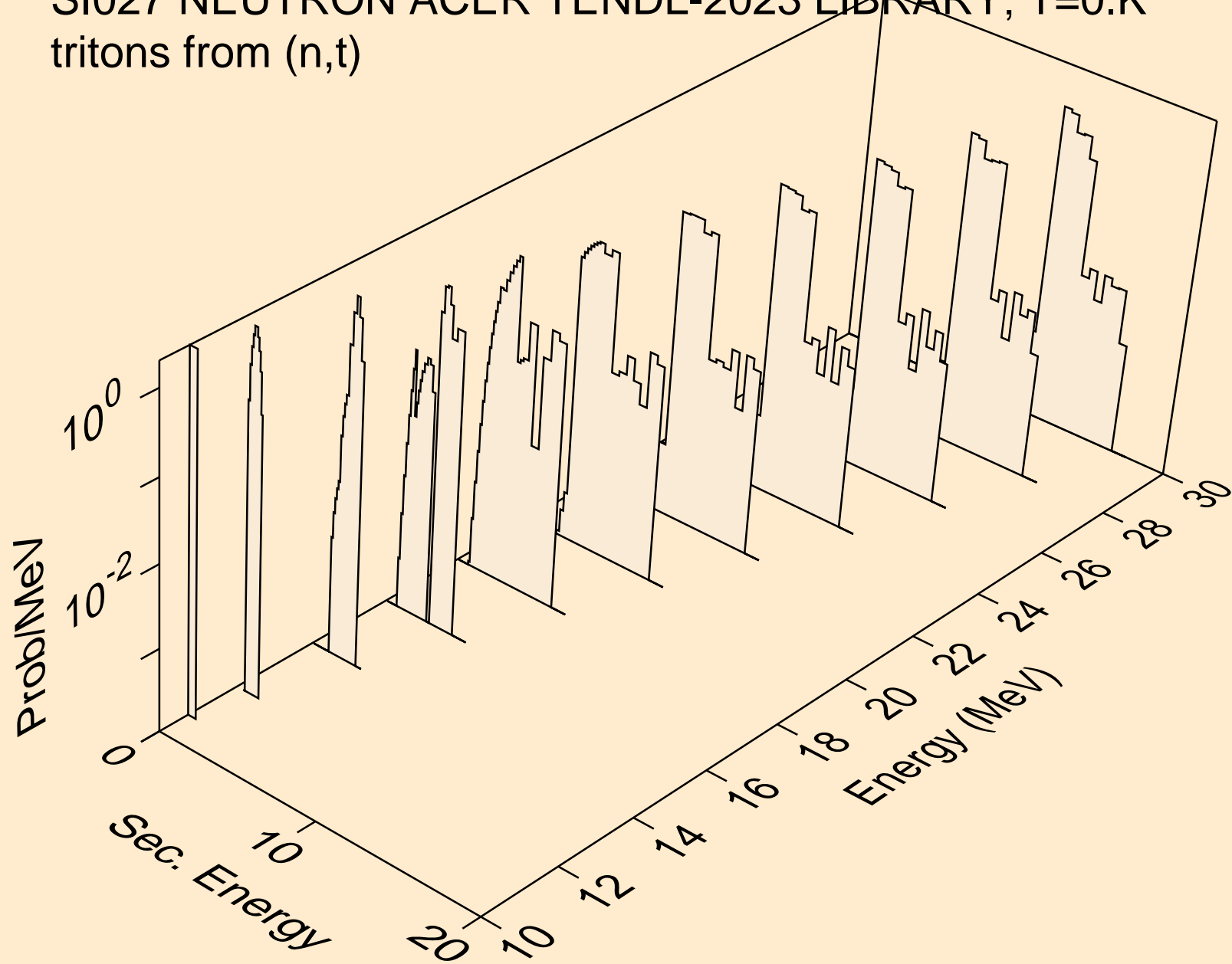

SI027 NEUTRON ACER TENDL-2023 LIBRARY; T=0.K
tritons from (n,pt)

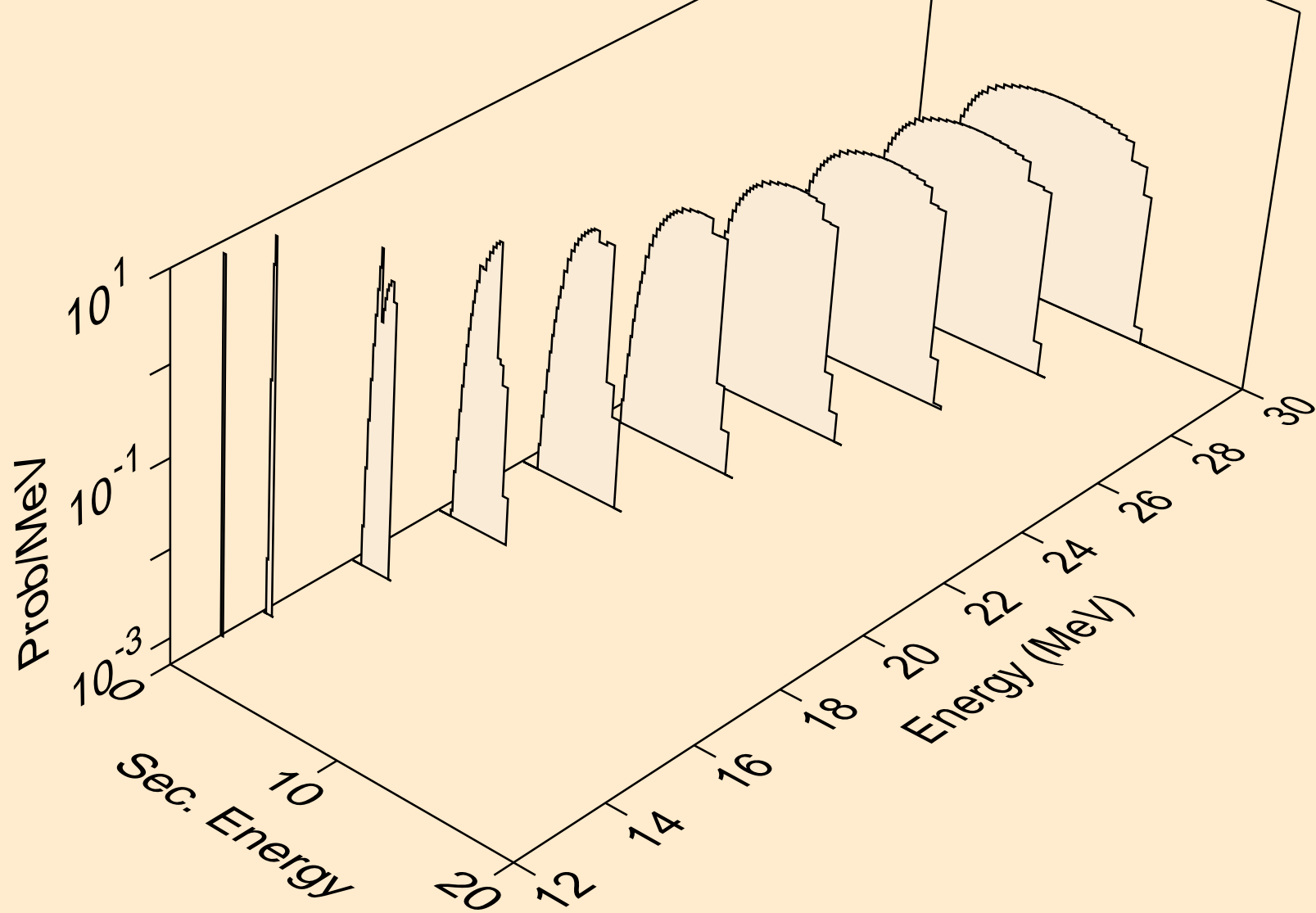

SI027 NEUTRON ACER TENDL-2023 LIBRARY; T=0.K
he3s from (n,x)

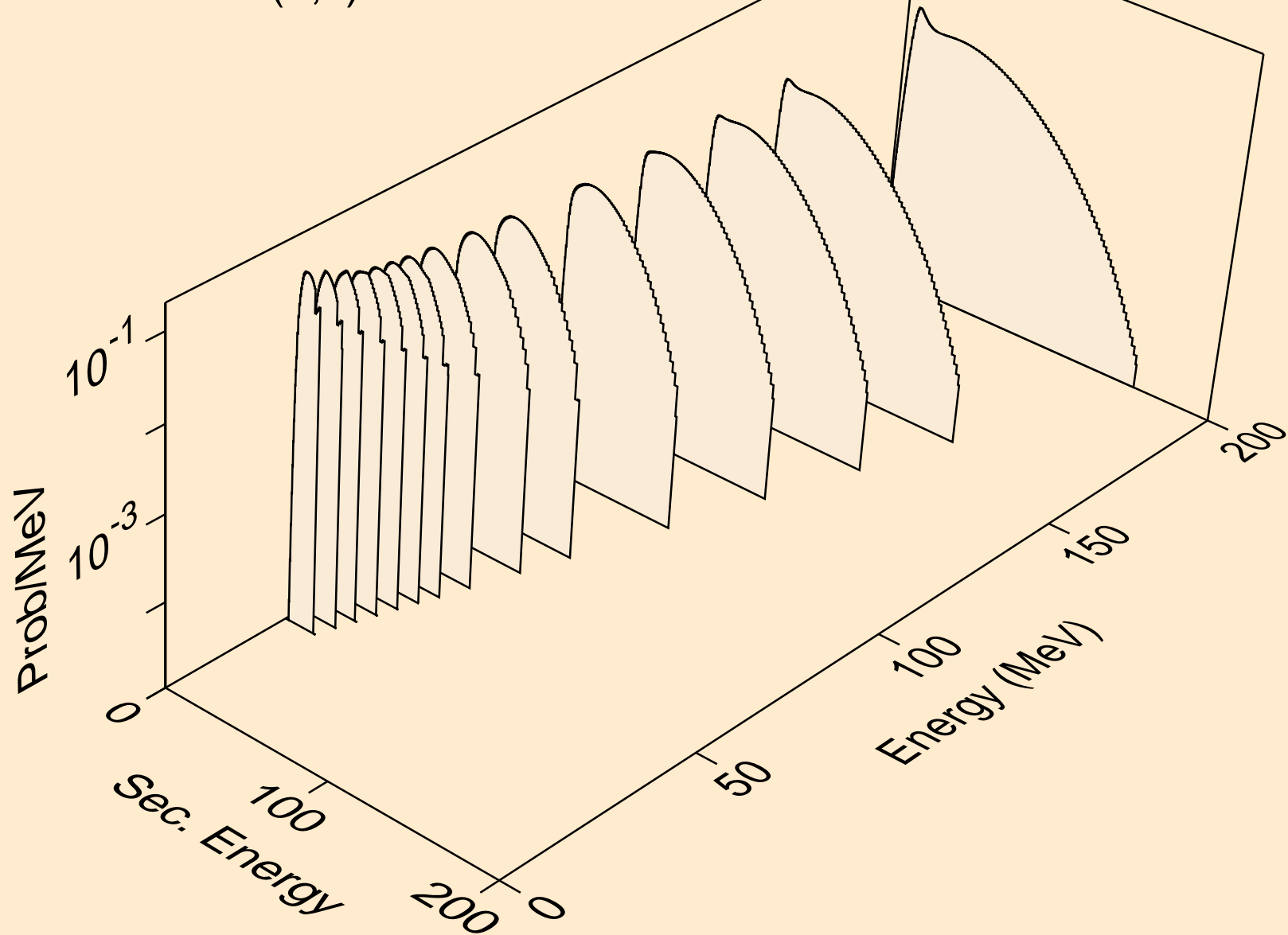

SI027 NEUTRON ACER TENDL-2023 LIBRARY; T=0.K
he3s from (n,n*)he3

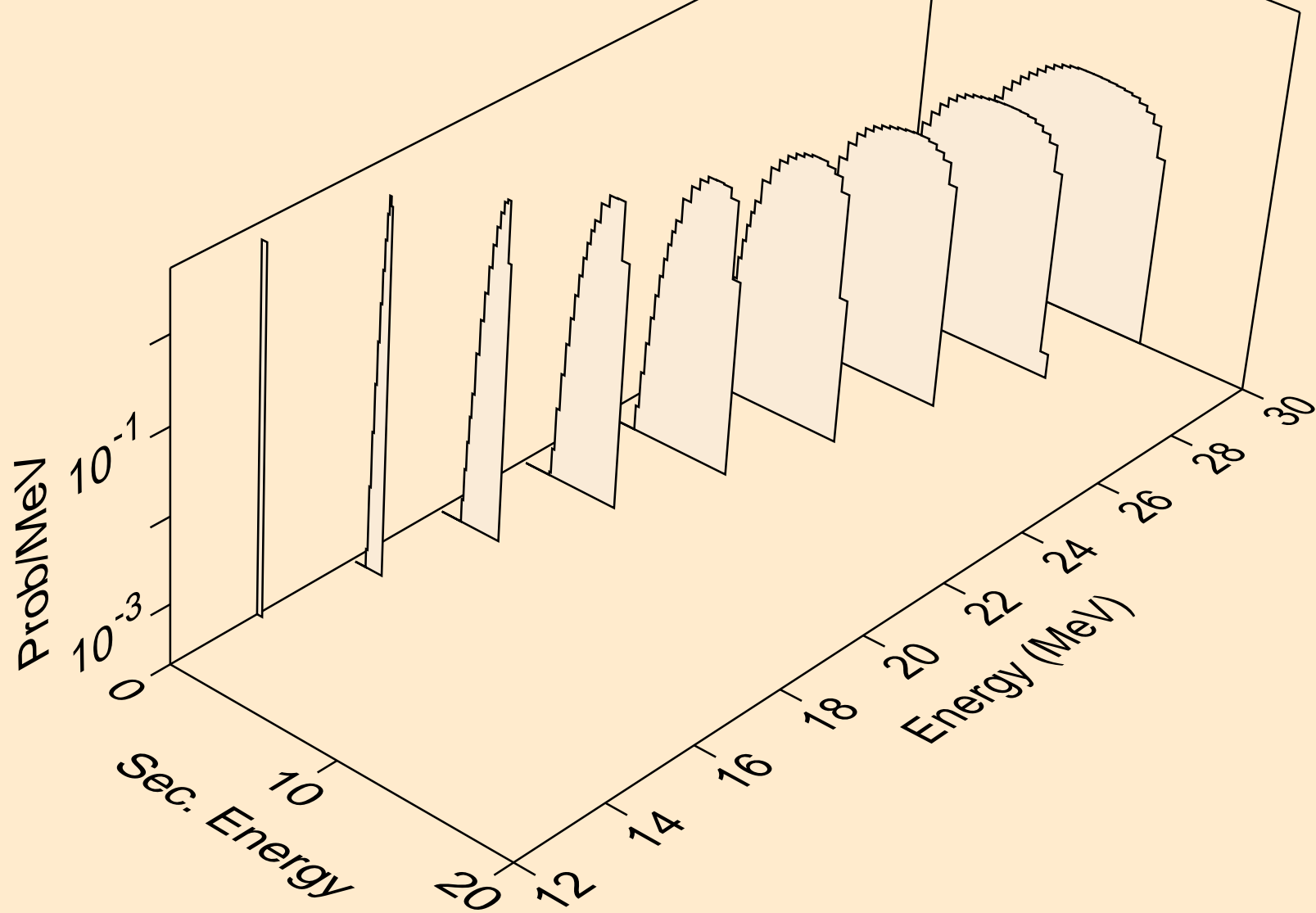

SI027 NEUTRON ACER TENDL-2023 LIBRARY; T=0.K
he3s from (n,he3)

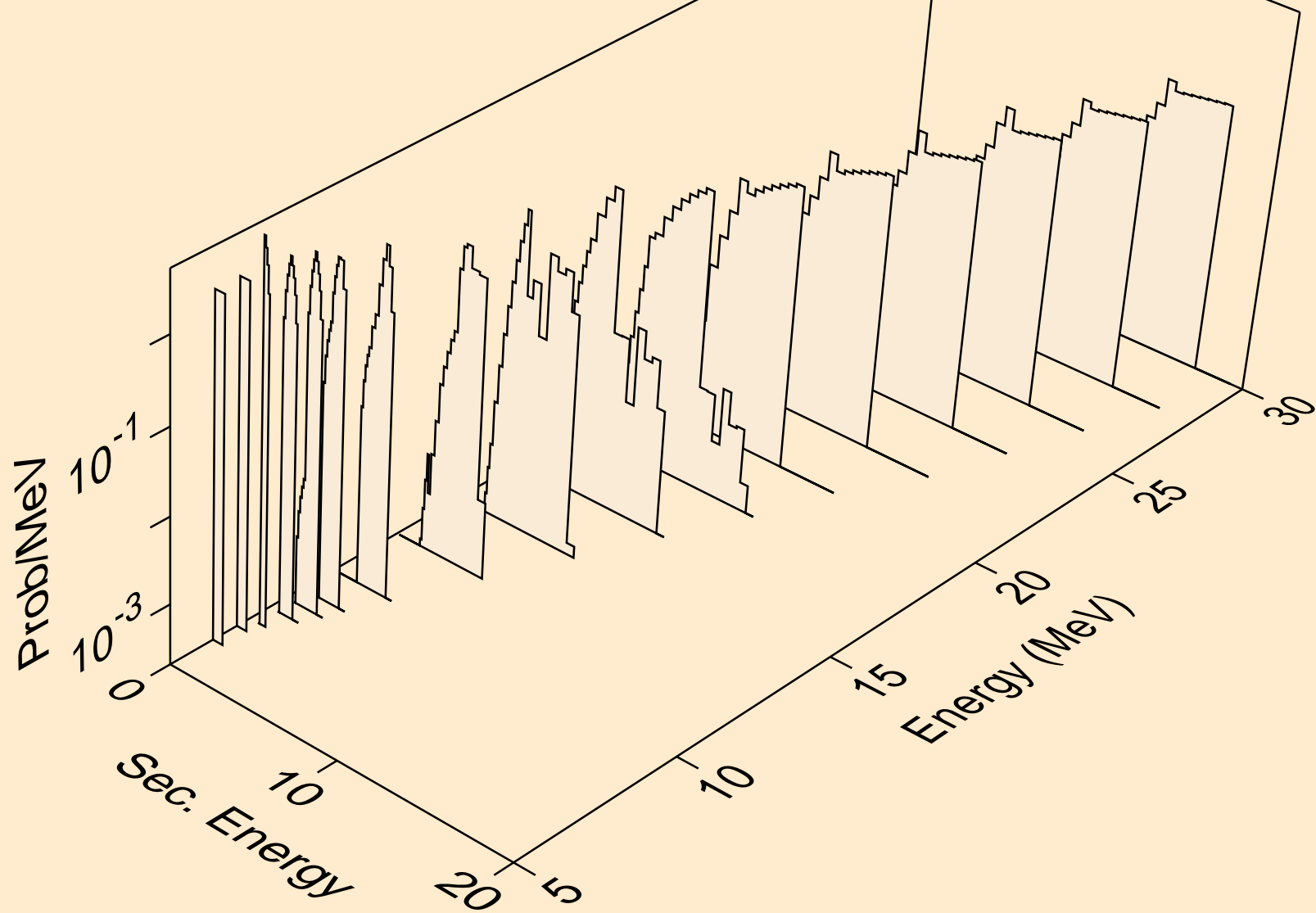

SI027 NEUTRON ACER TENDL-2023 LIBRARY; T=0.K
alphas from (n,x)

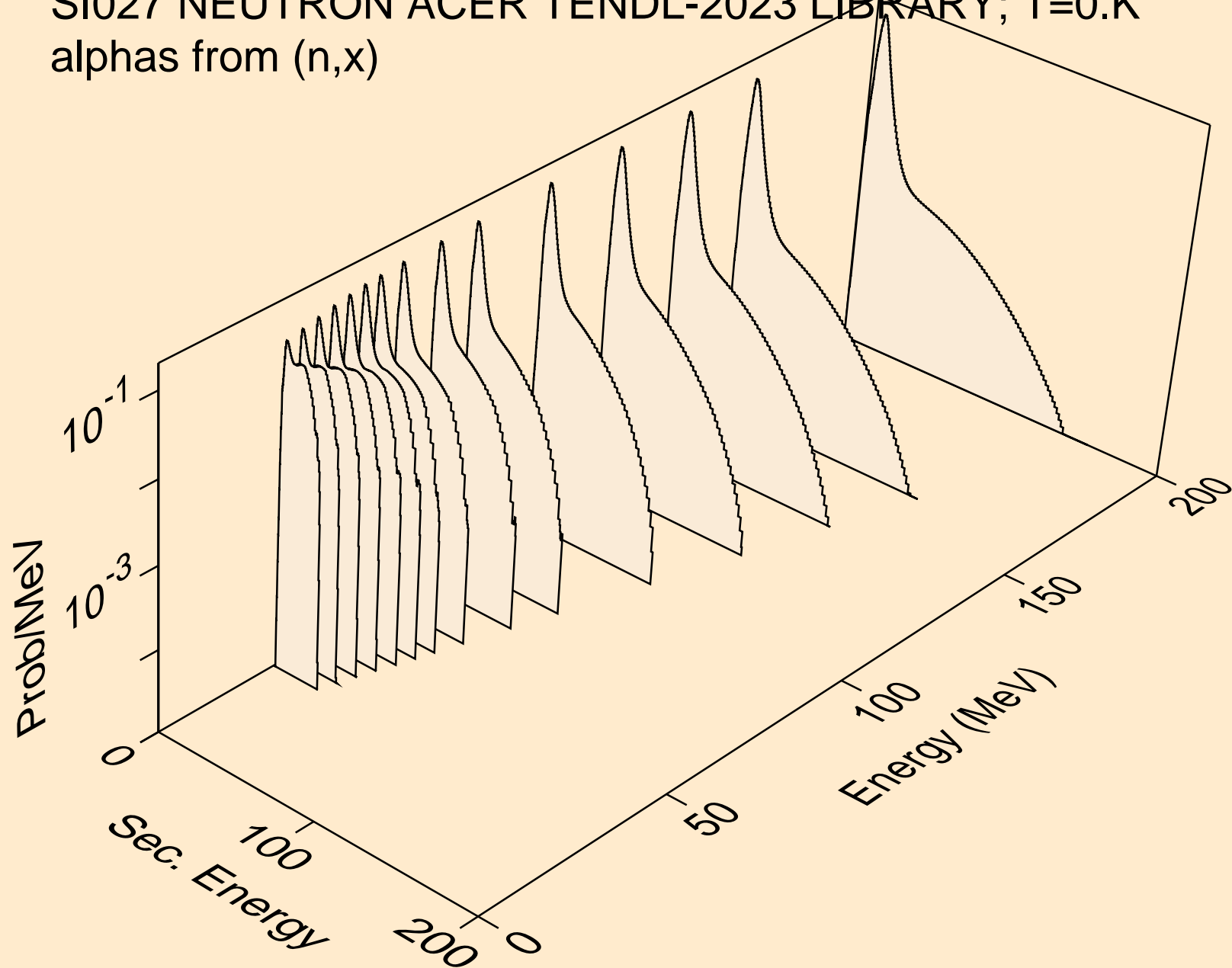

SI027 NEUTRON ACER TENDL-2023 LIBRARY; T=0.K
alphas from (n,n*)a

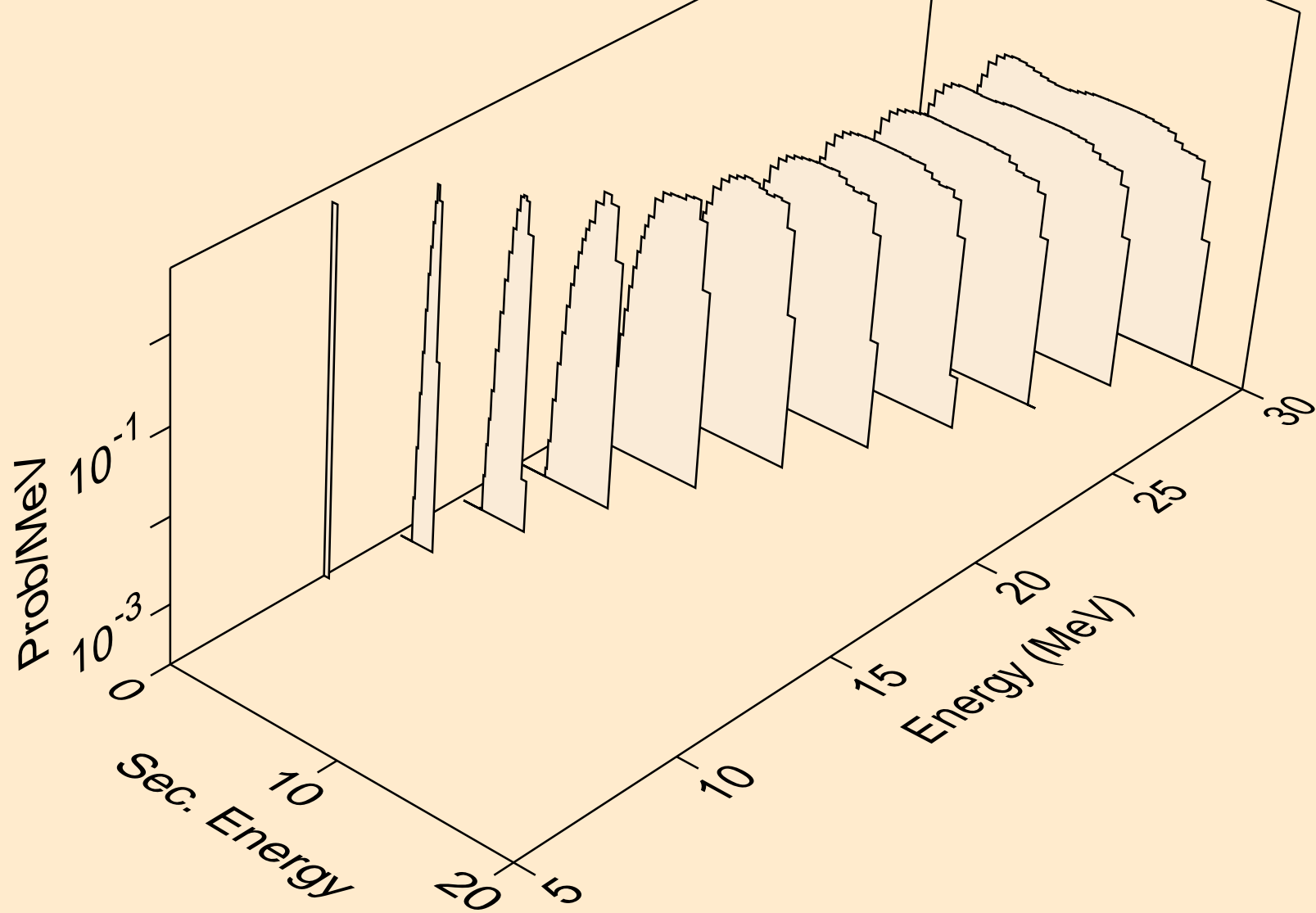

SI027 NEUTRON ACER TENDL-2023 LIBRARY; T=0.K
alphas from (n,2n)a

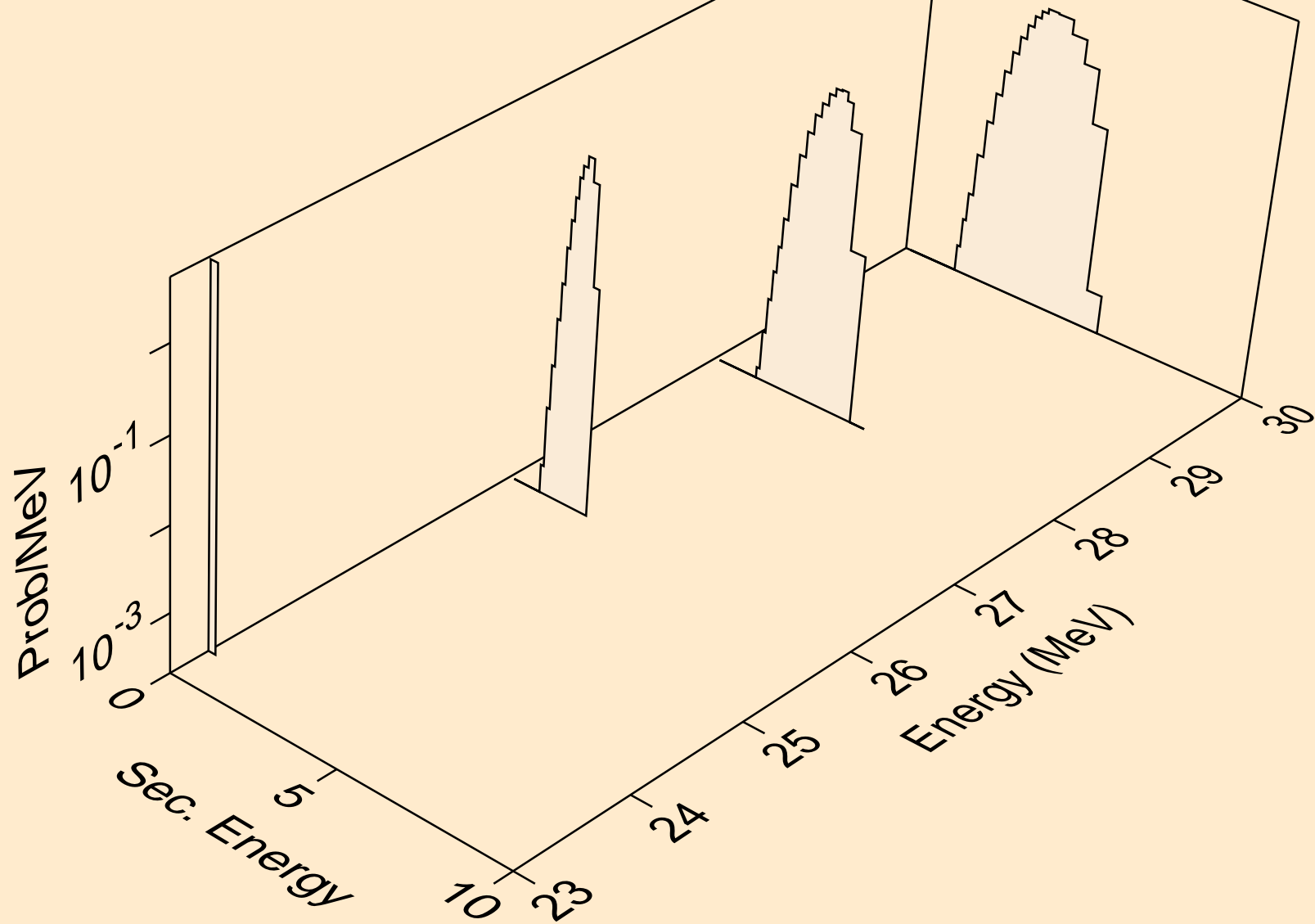

SI027 NEUTRON ACER TENDL-2023 LIBRARY; T=0.K
alphas from (n,n*)2a

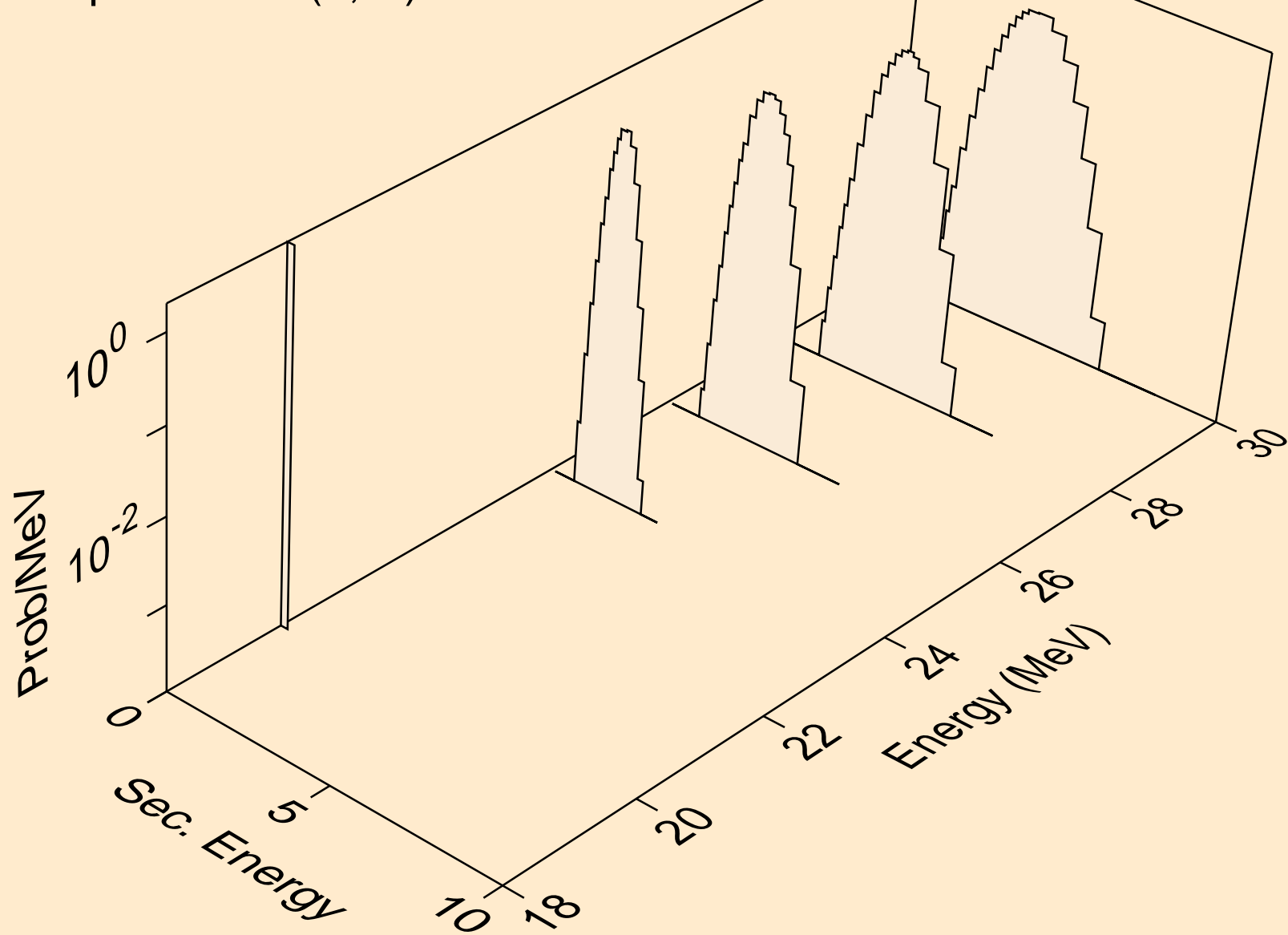

SI027 NEUTRON ACER TENDL-2023 LIBRARY; T=0.K
alphas from (n,npa)

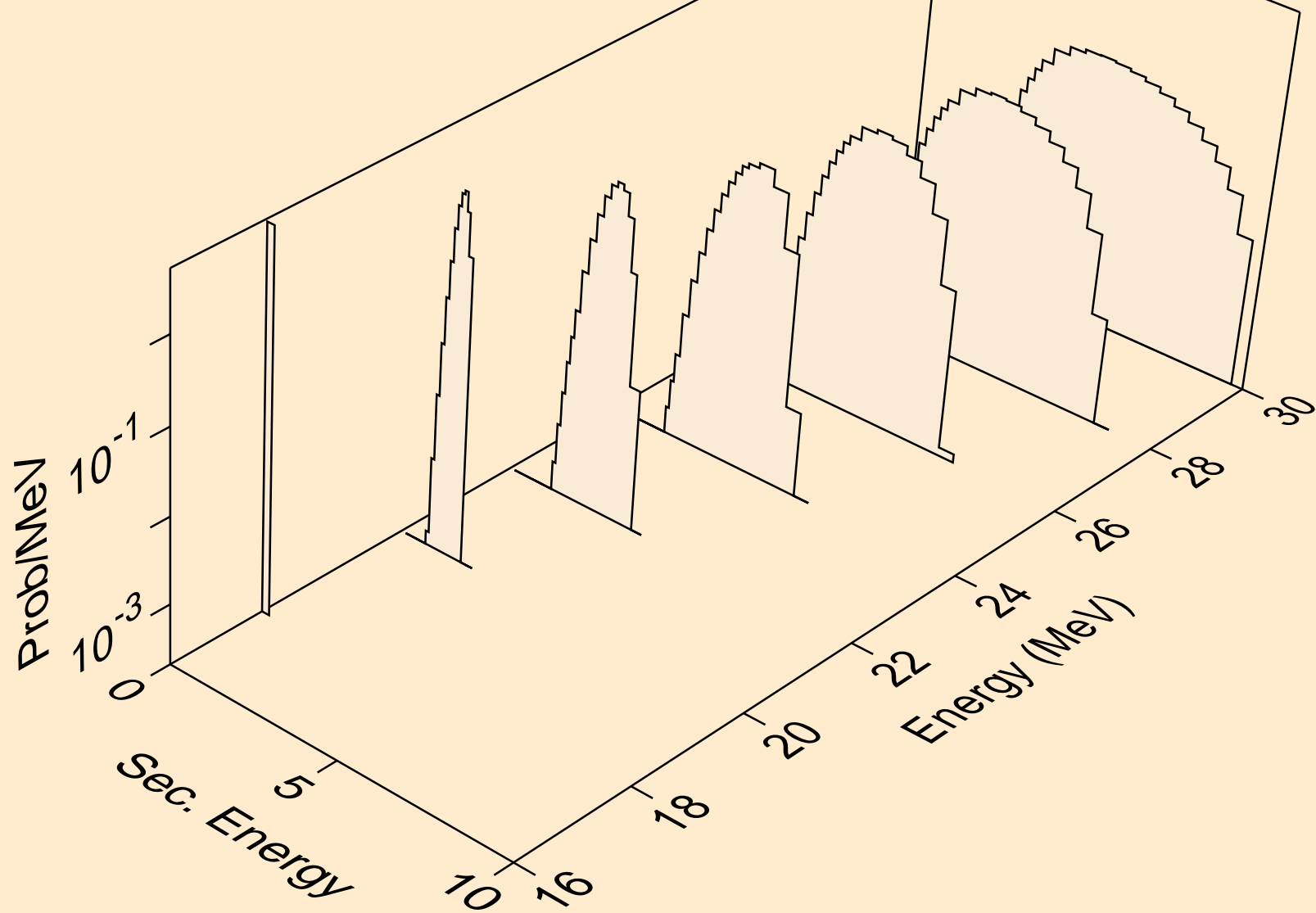

SI027 NEUTRON ACER TENDL-2023 LIBRARY; T=0.K
alphas from (n,a)

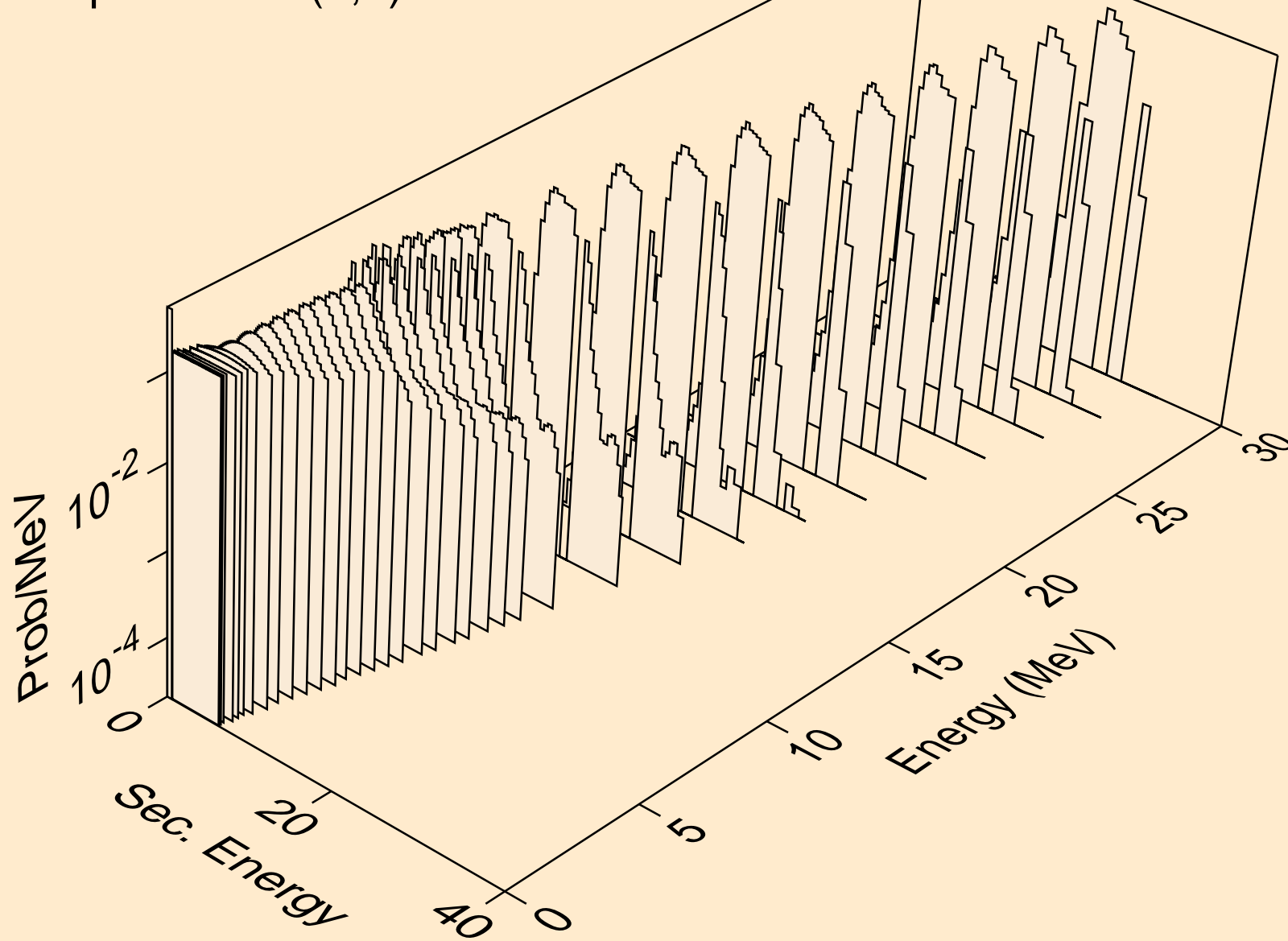

SI027 NEUTRON ACER TENDL-2023 LIBRARY; T=0.K
alphas from (n,2a)

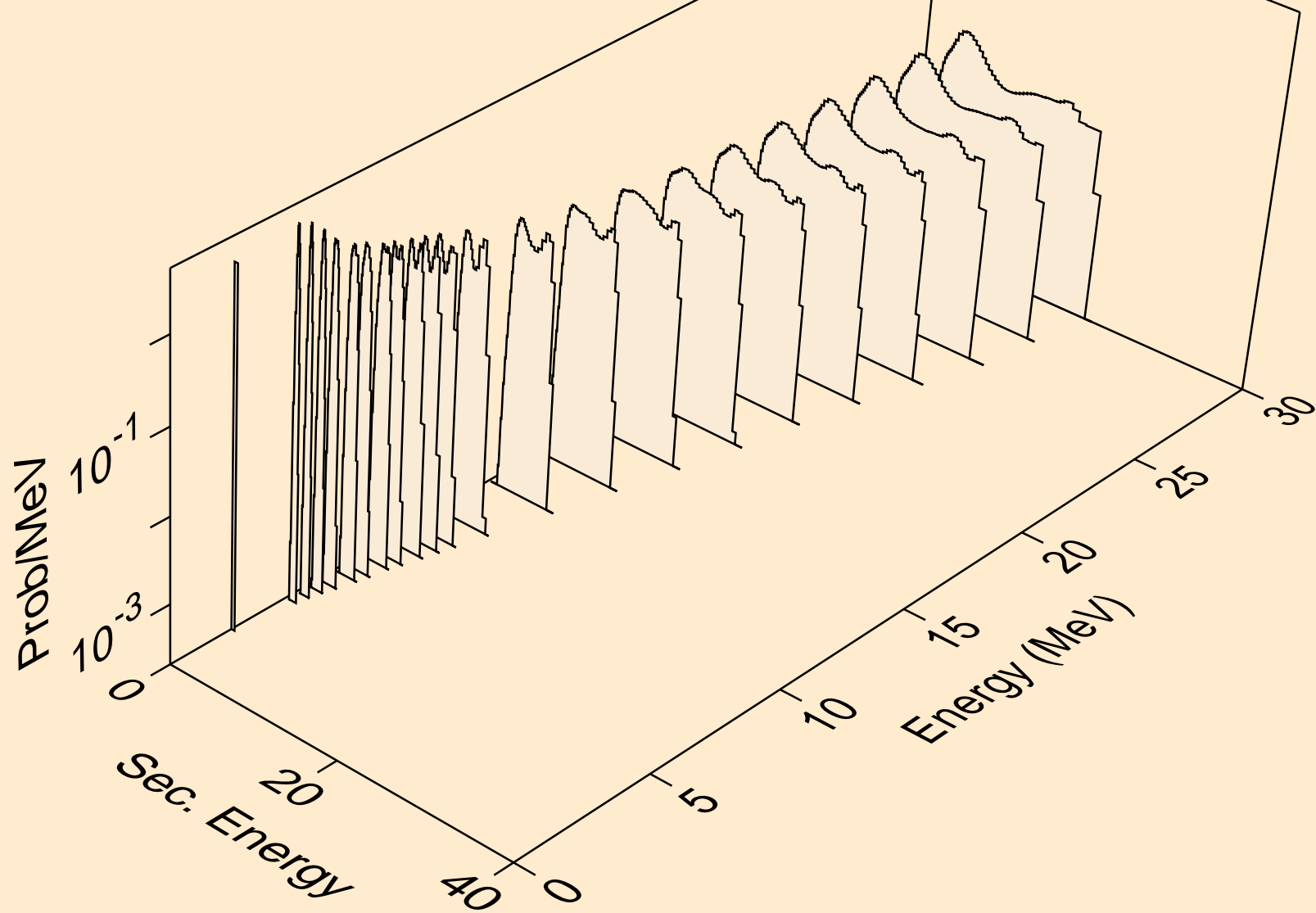

SI027 NEUTRON ACER TENDL-2023 LIBRARY; T=0.K
alphas from (n,3a)

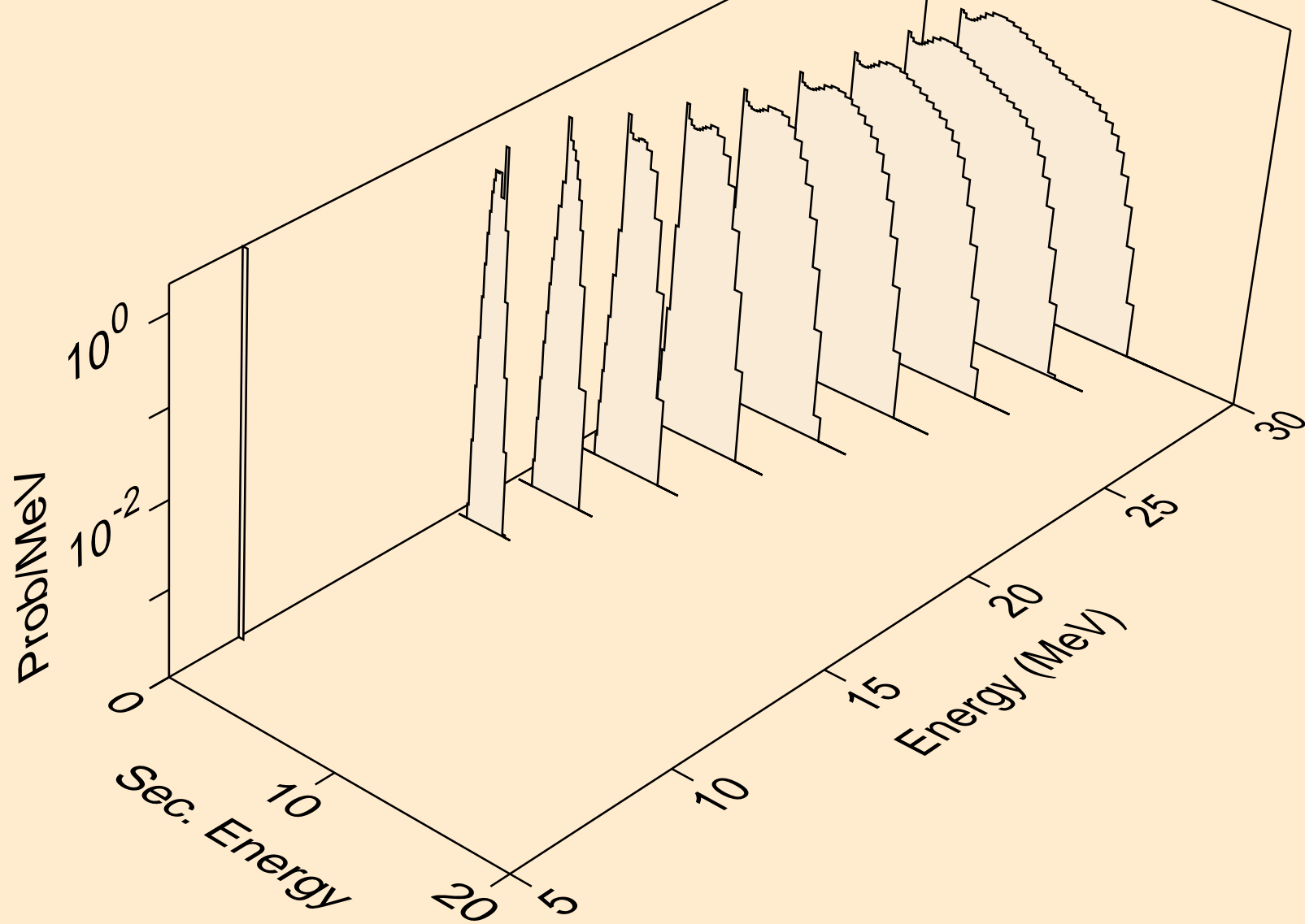

SI027 NEUTRON ACER TENDL-2023 LIBRARY; T=0.K
alphas from (n,pa)

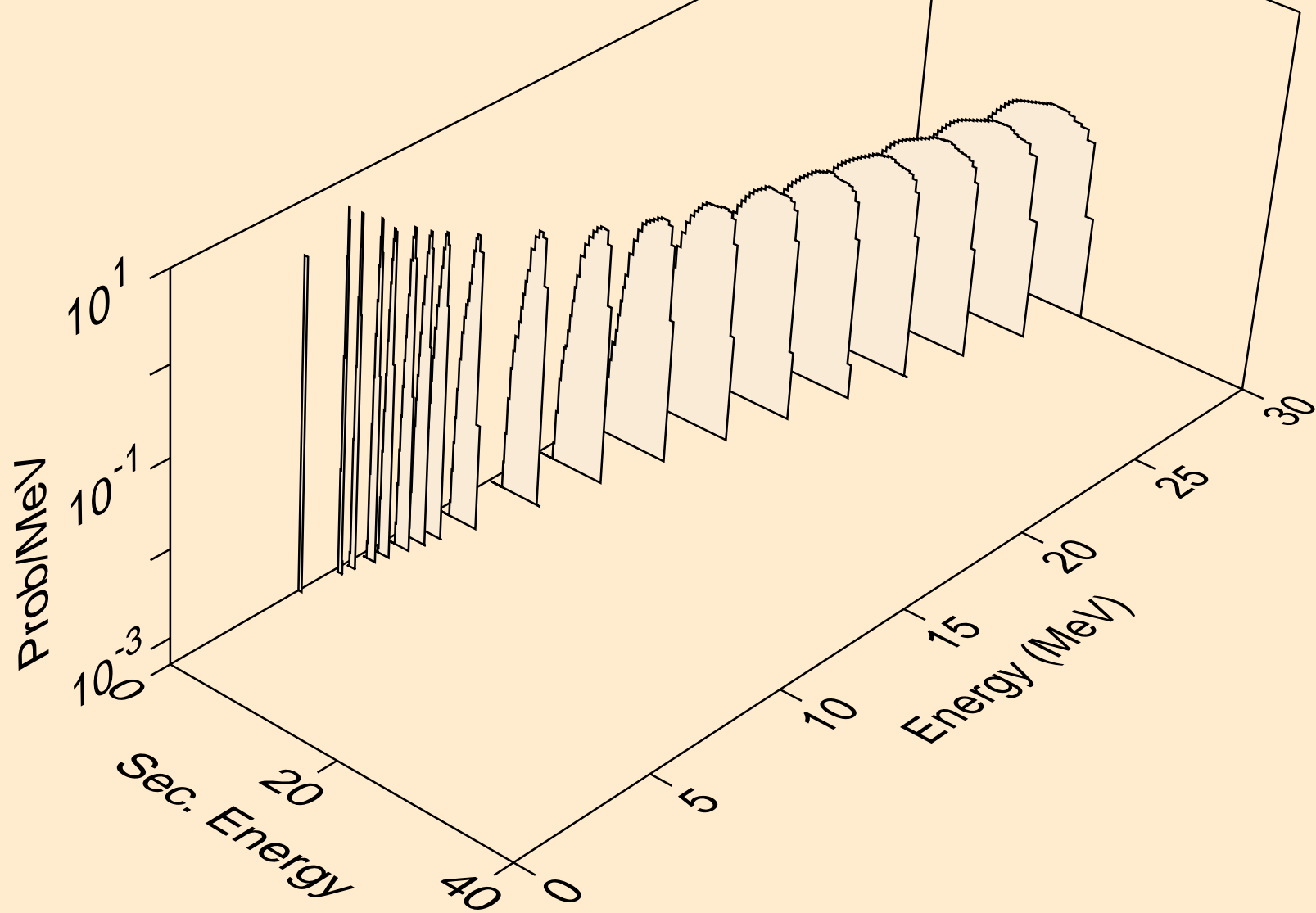

SI027 NEUTRON ACER TENDL-2023 LIBRARY; T=0.K
alphas from (n,da)

