

# SI030 NEUTRON ACER TENDL-2023 LIBRARY; T=0.K

## Principal cross sections

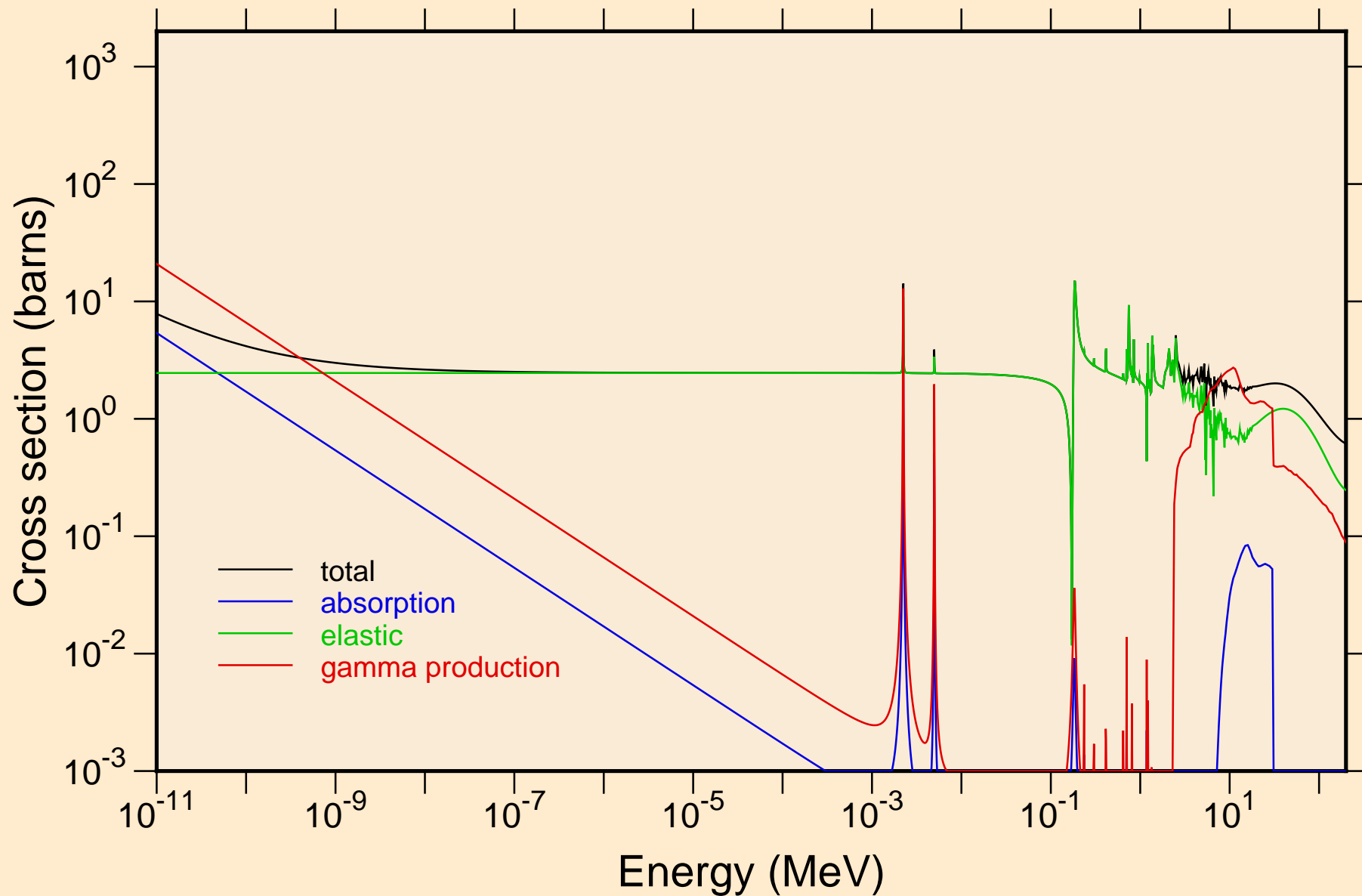

SI030 NEUTRON ACER TENDL-2023 LIBRARY; T=0.K  
resonance total cross section

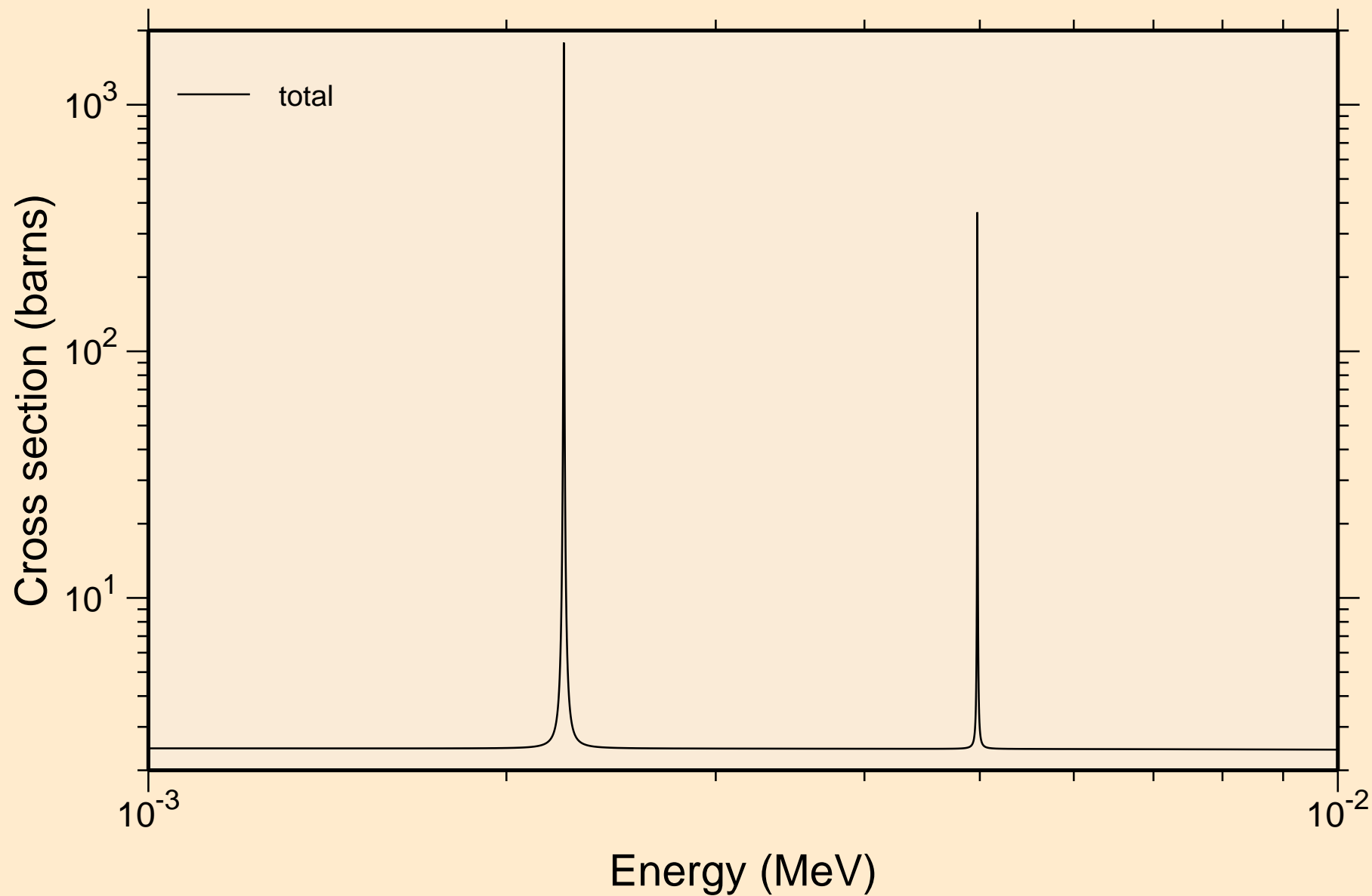

SI030 NEUTRON ACER TENDL-2023 LIBRARY; T=0.K  
resonance total cross section

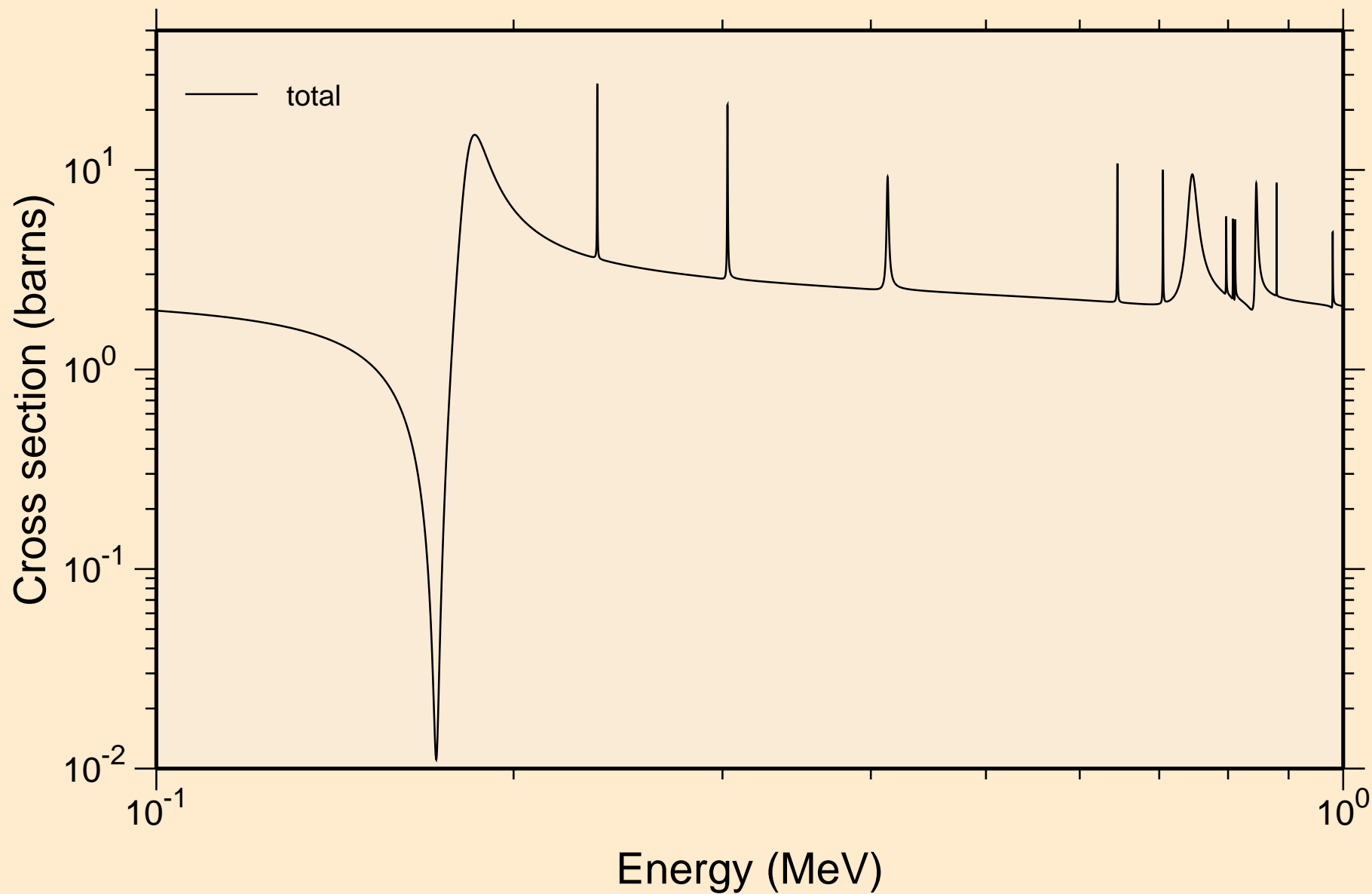

SI030 NEUTRON ACER TENDL-2023 LIBRARY; T=0.K  
resonance total cross section

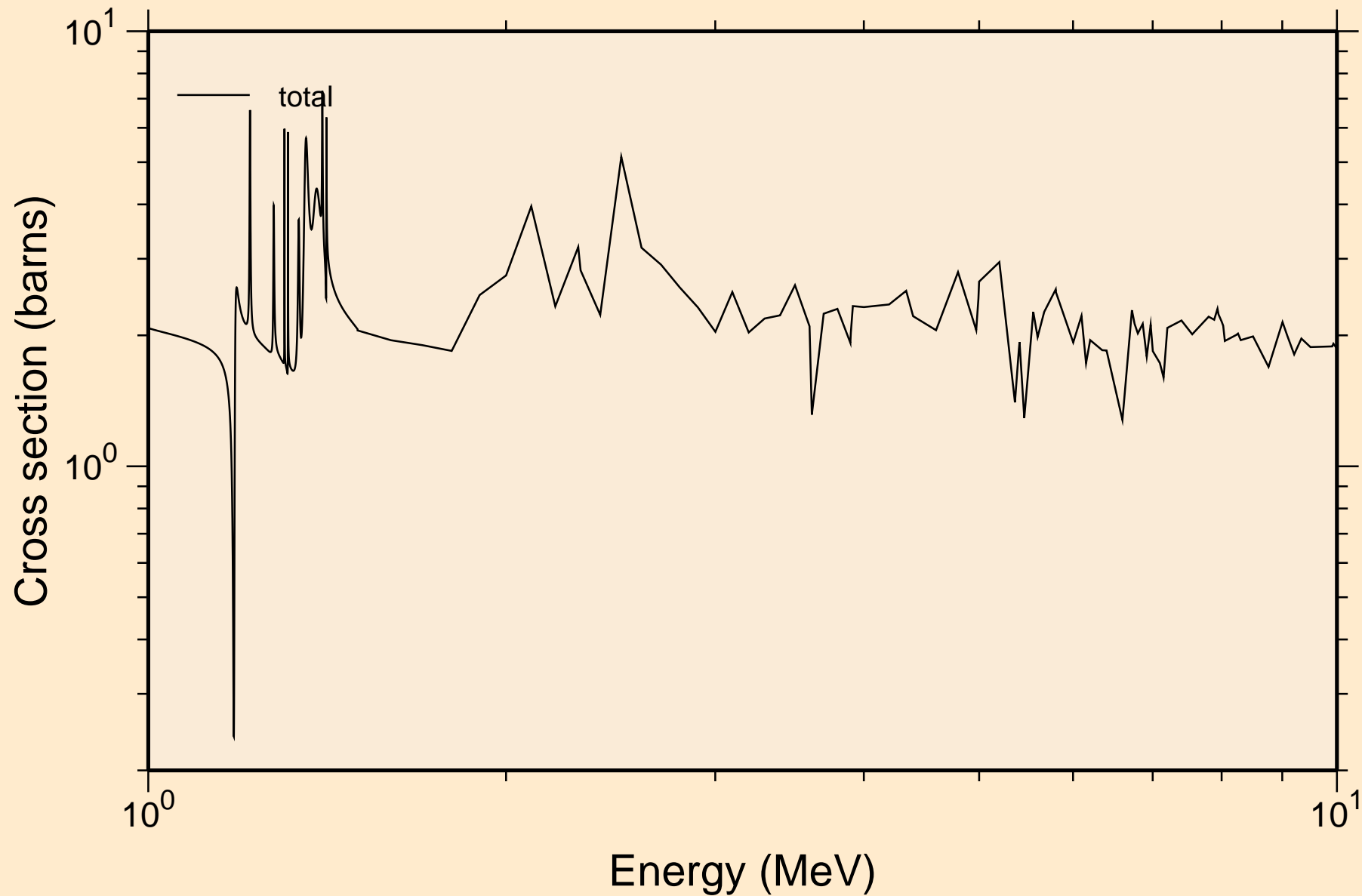

SI030 NEUTRON ACER TENDL-2023 LIBRARY; T=0.K  
resonance absorption cross sections

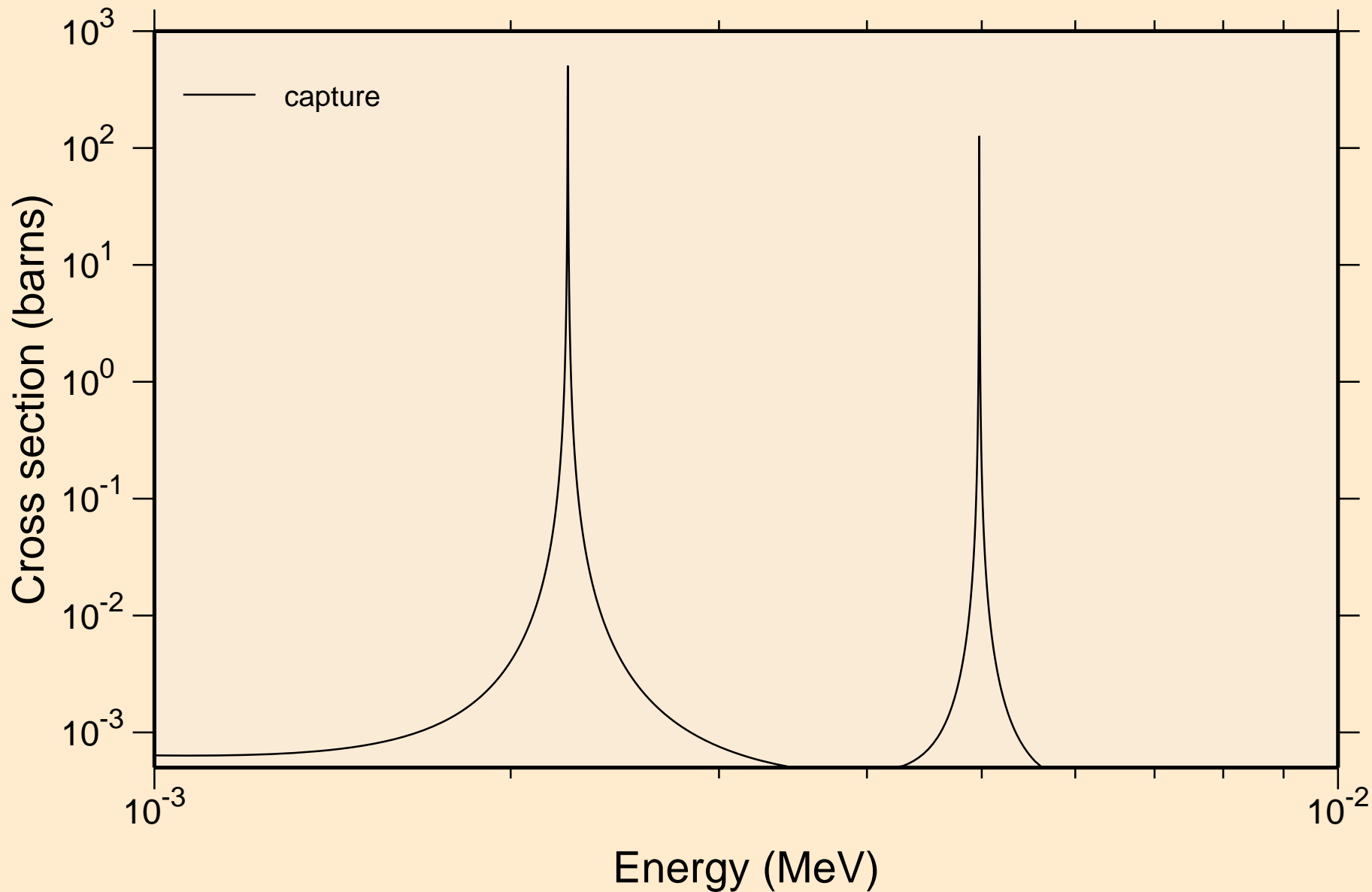

SI030 NEUTRON ACER TENDL-2023 LIBRARY; T=0.K  
resonance absorption cross sections

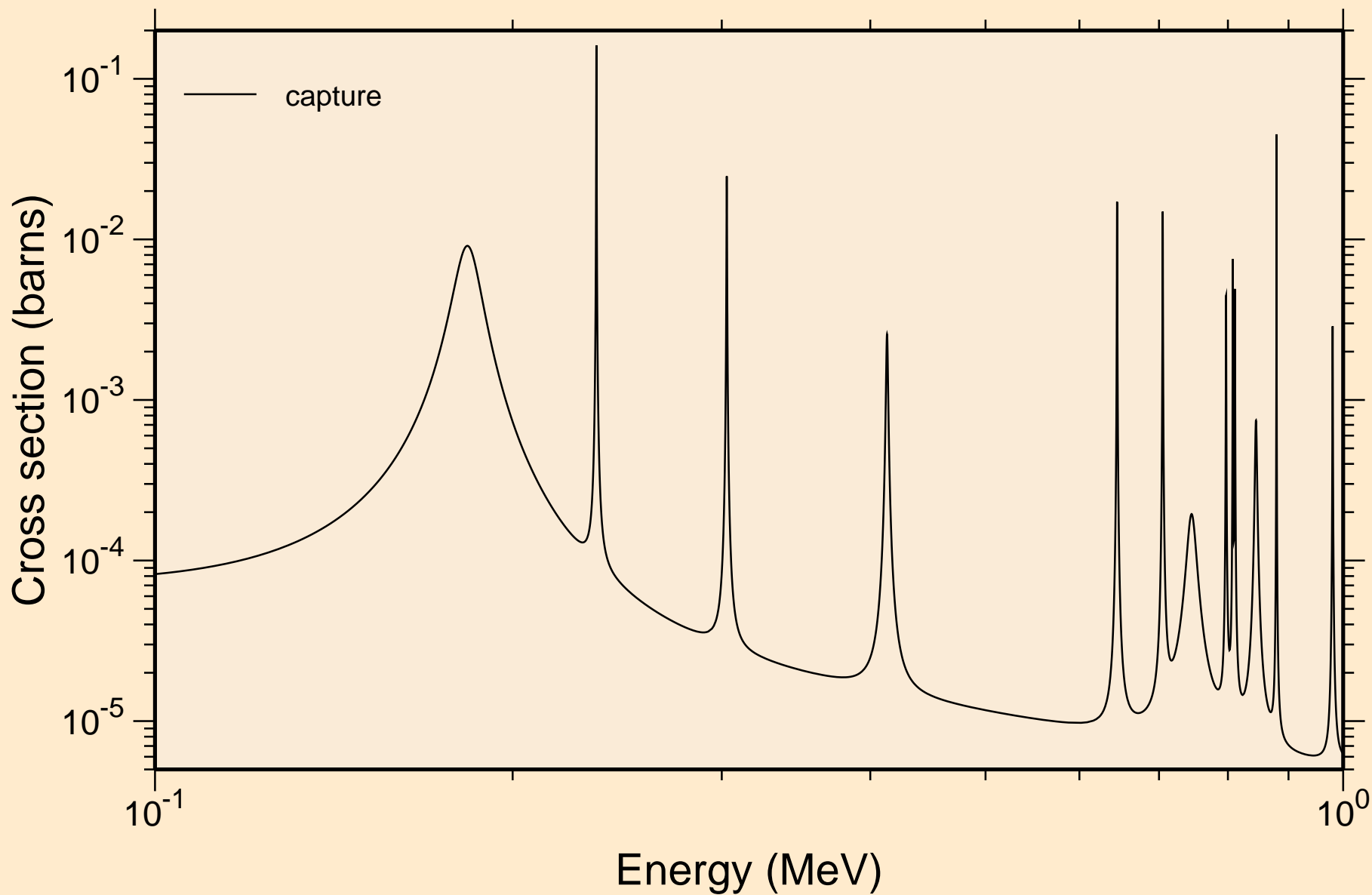

SI030 NEUTRON ACER TENDL-2023 LIBRARY; T=0.K  
resonance absorption cross sections

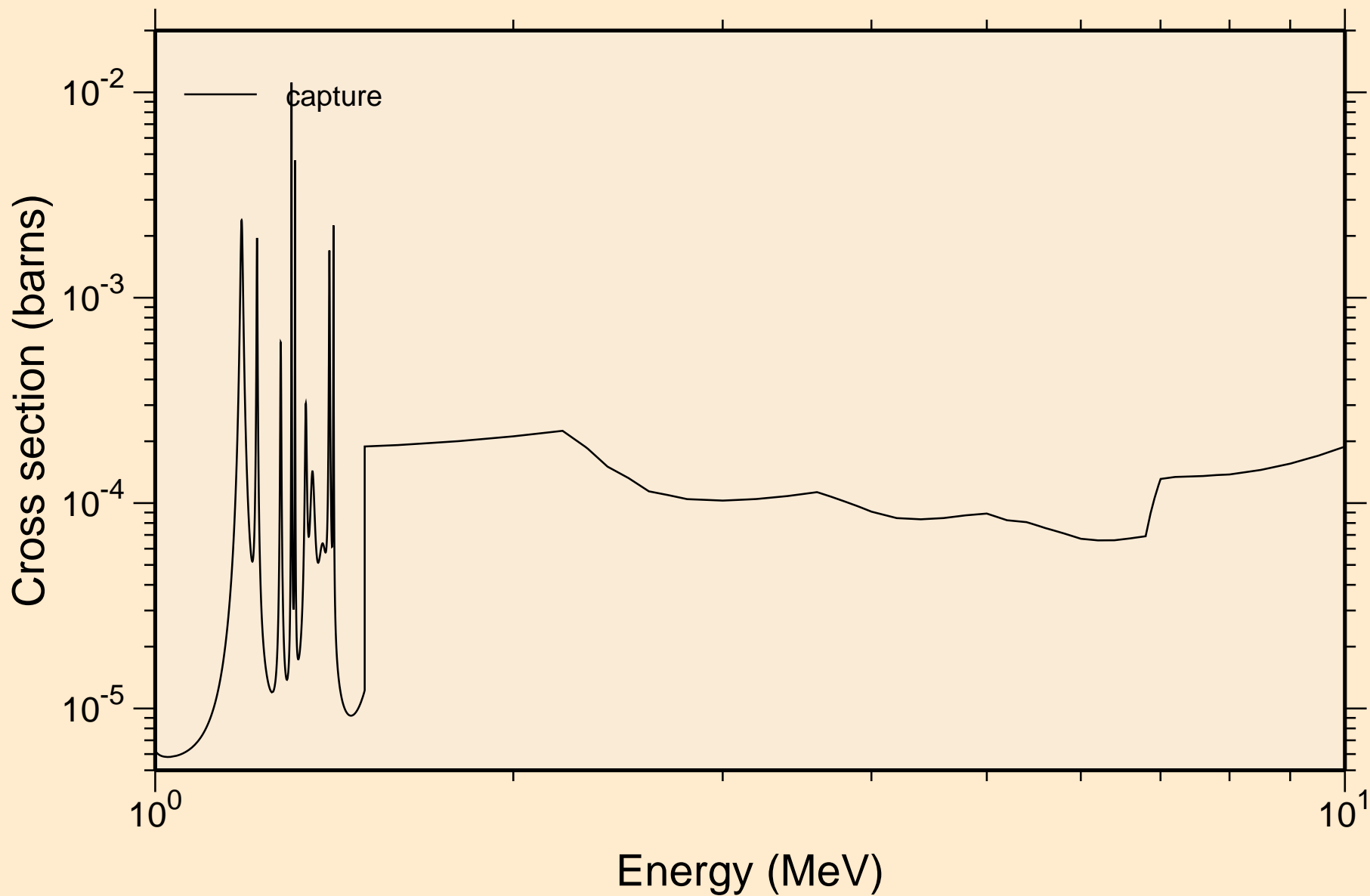

SI030 NEUTRON ACER TENDL-2023 LIBRARY; T=0.K  
Heating

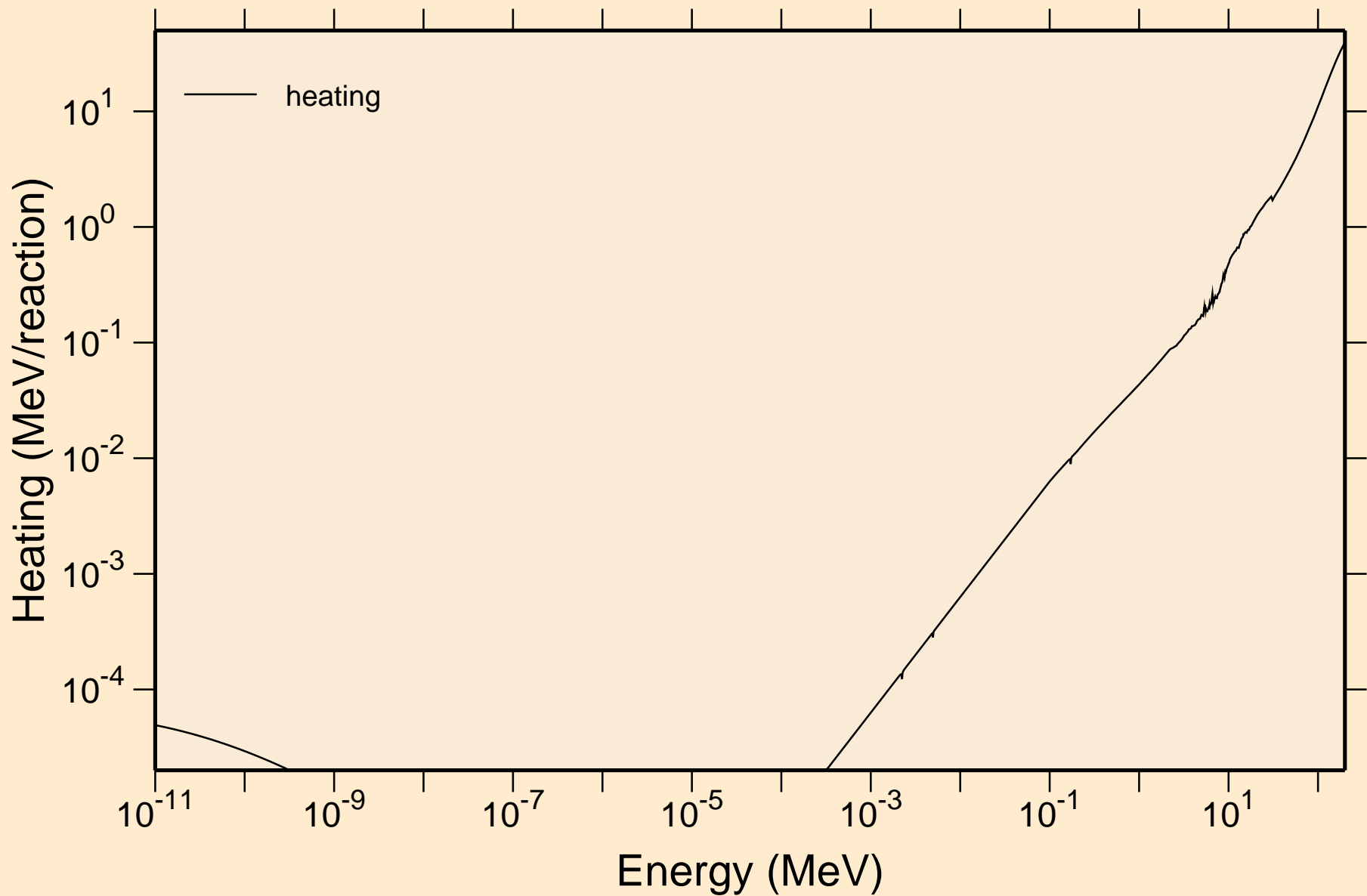



# SI030 NEUTRON ACER TENDL-2023 LIBRARY; T=0.K

## Damage

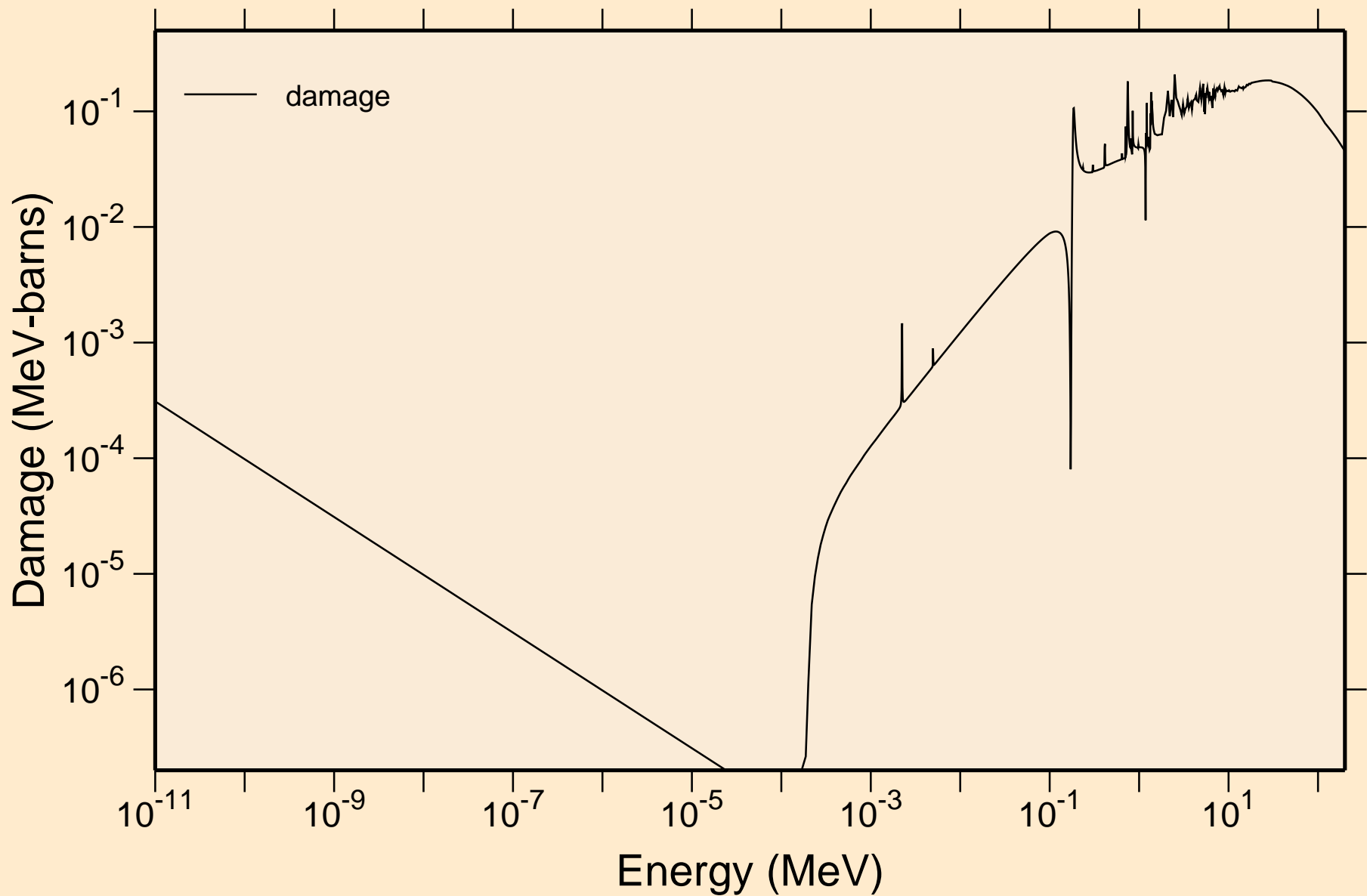

SI030 NEUTRON ACER TENDL-2023 LIBRARY; T=0.K  
Non-threshold reactions

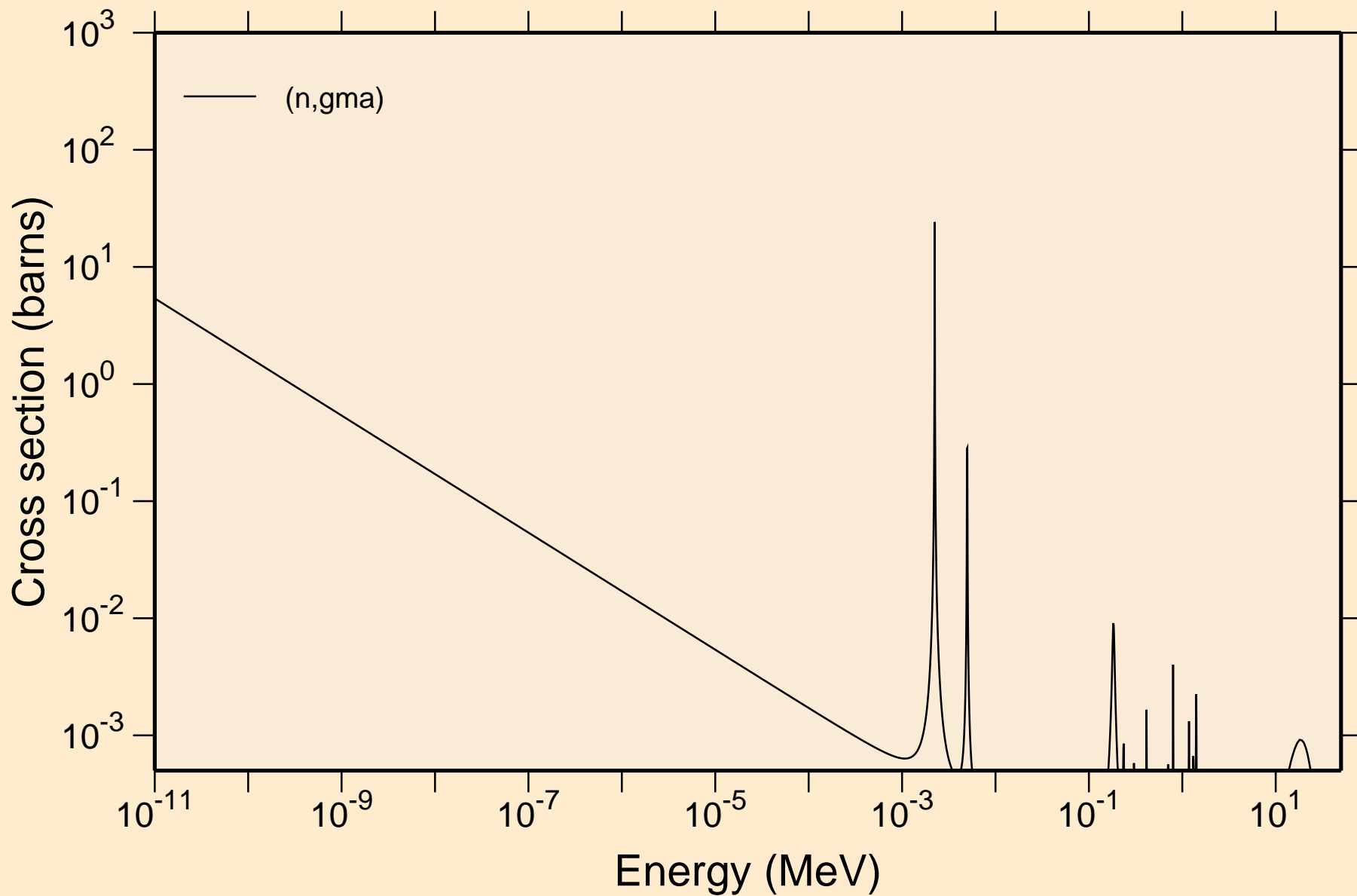

# SI030 NEUTRON ACER TENDL-2023 LIBRARY; T=0.K

## Principal cross sections

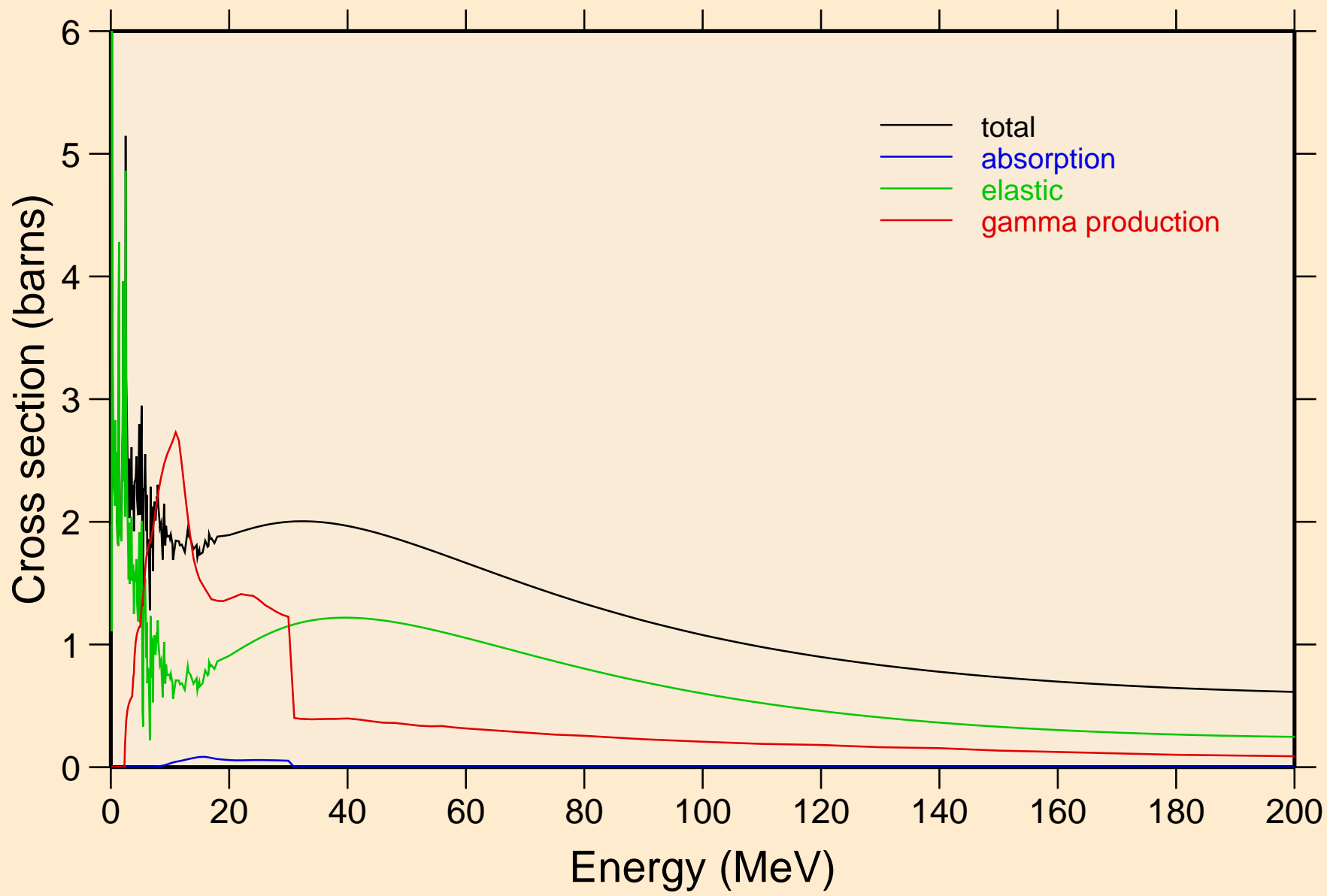

# SI030 NEUTRON ACER TENDL-2023 LIBRARY; T=0.K

## Heating

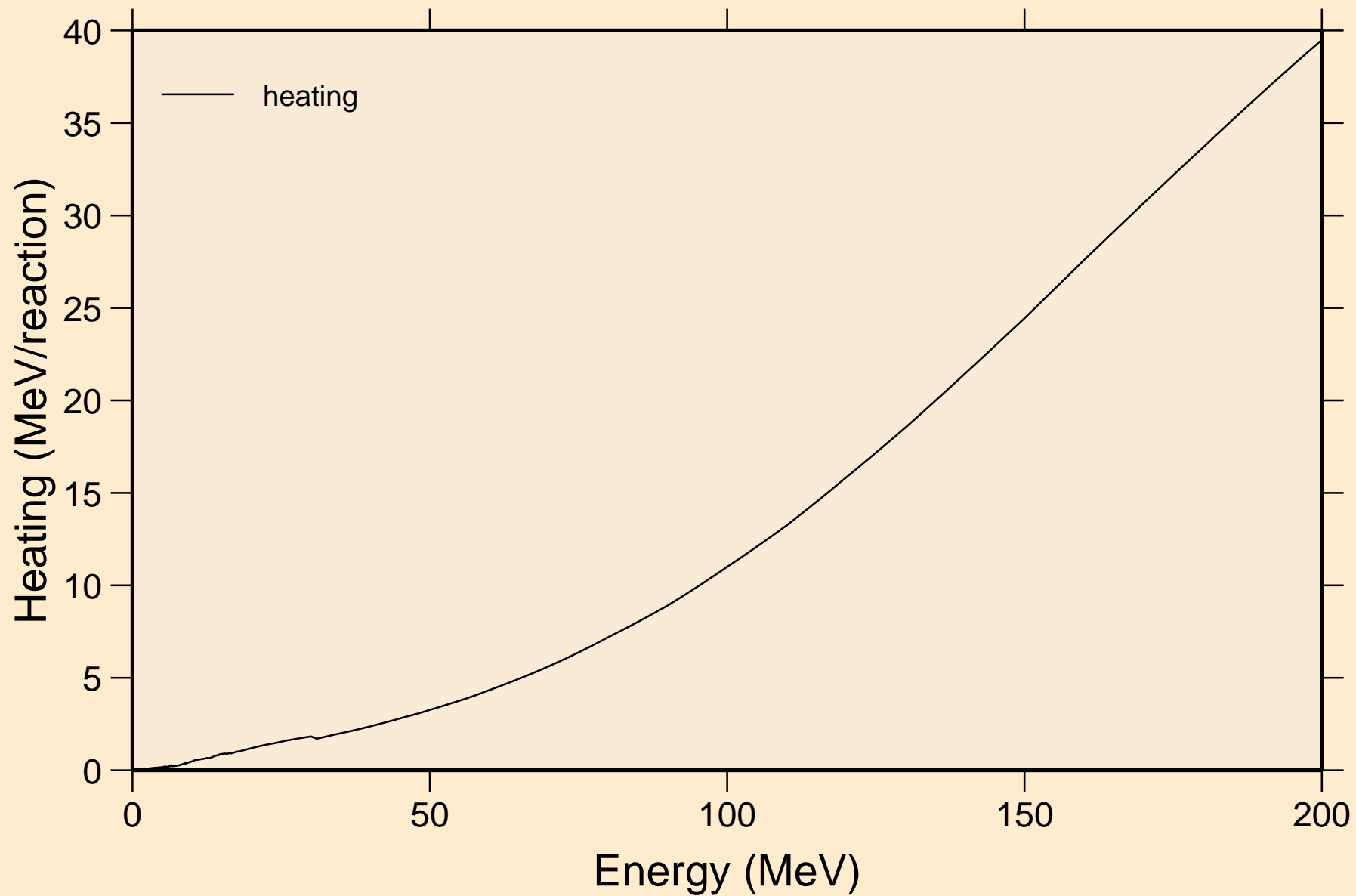

SI030 NEUTRON ACER TENDL-2023 LIBRARY; T=0.K  
Damage

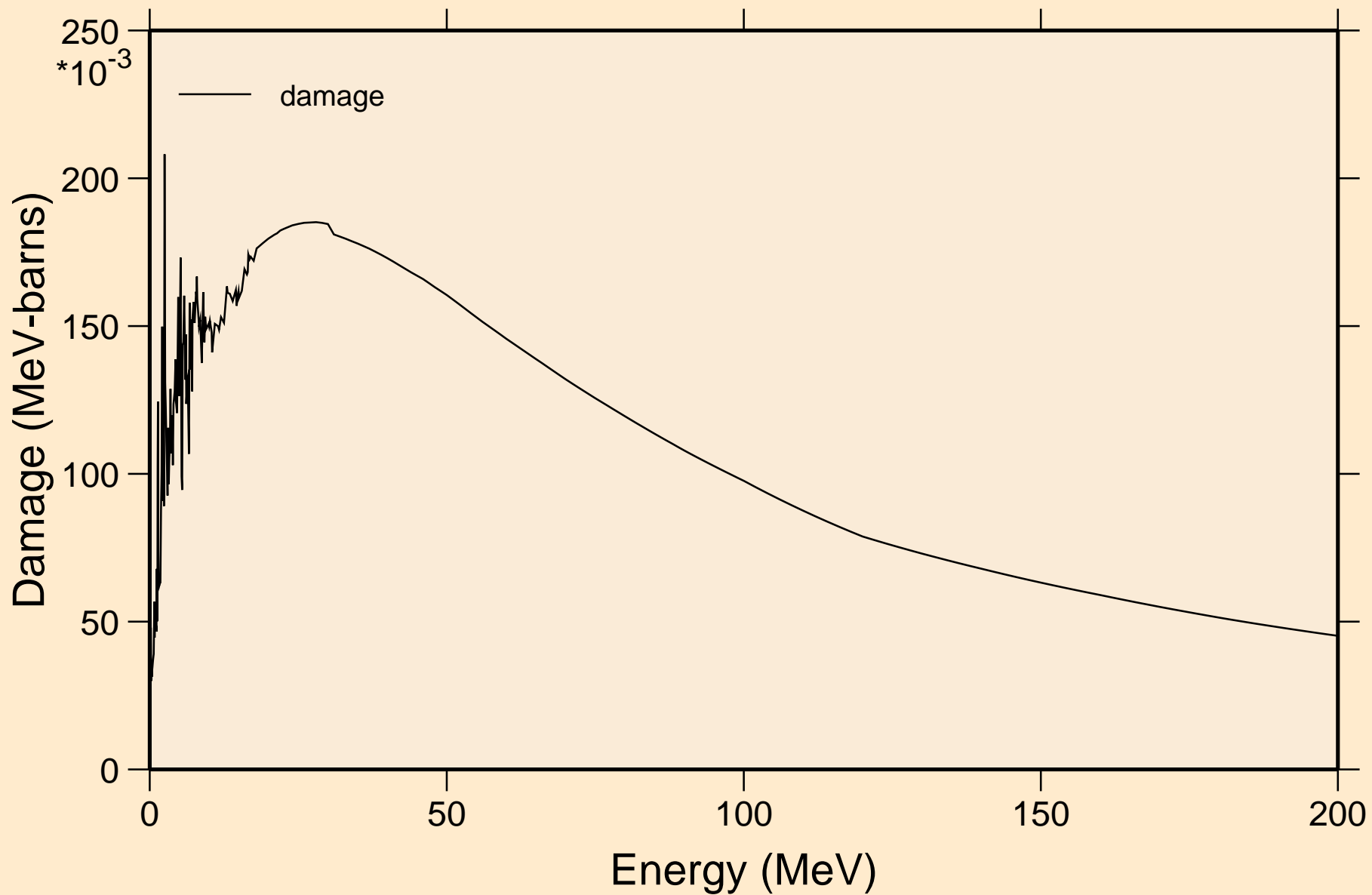

SI030 NEUTRON ACER TENDL-2023 LIBRARY; T=0.K  
Non-threshold reactions

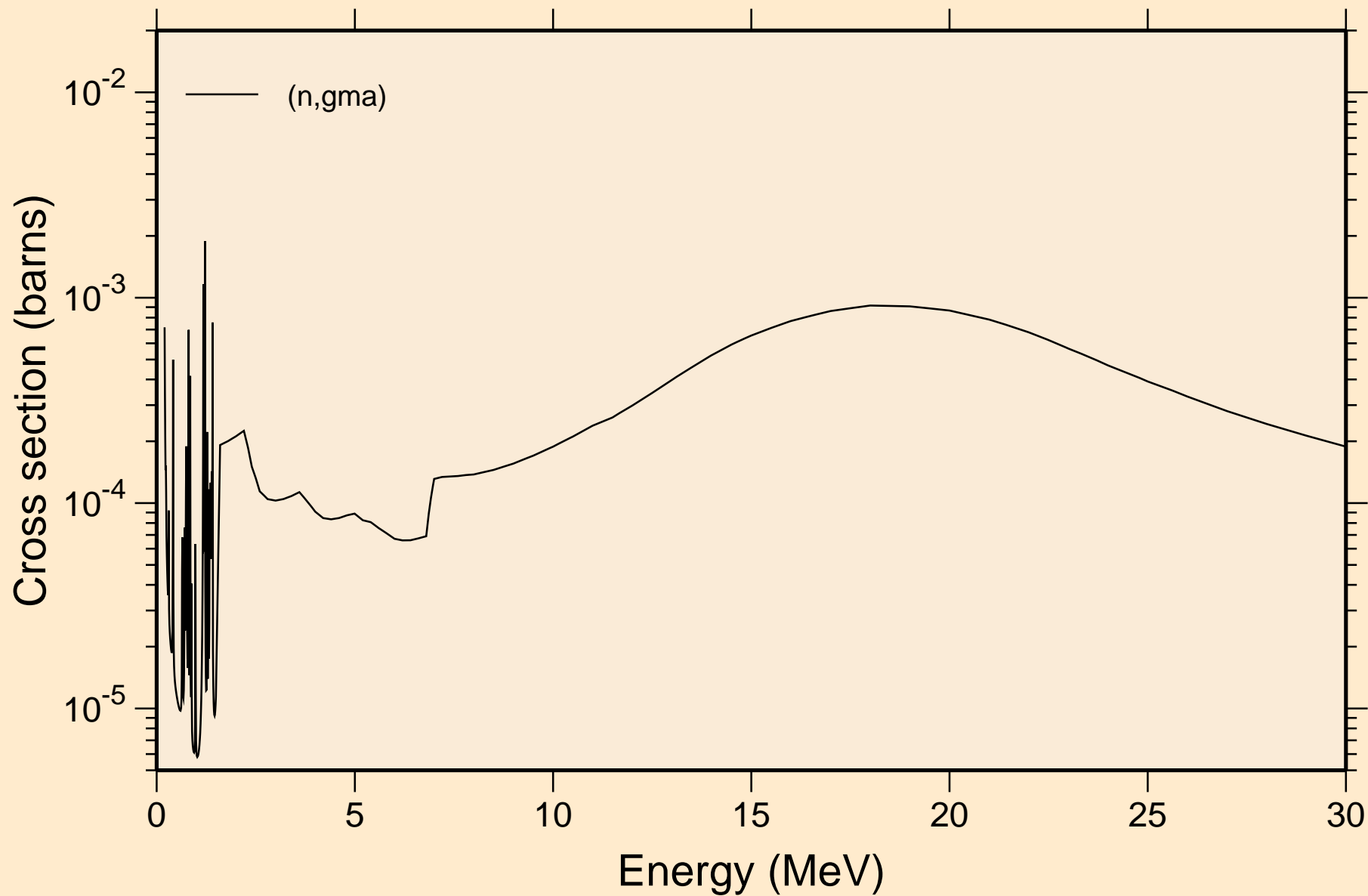

SI030 NEUTRON ACER TENDL-2023 LIBRARY; T=0.K  
Inelastic levels

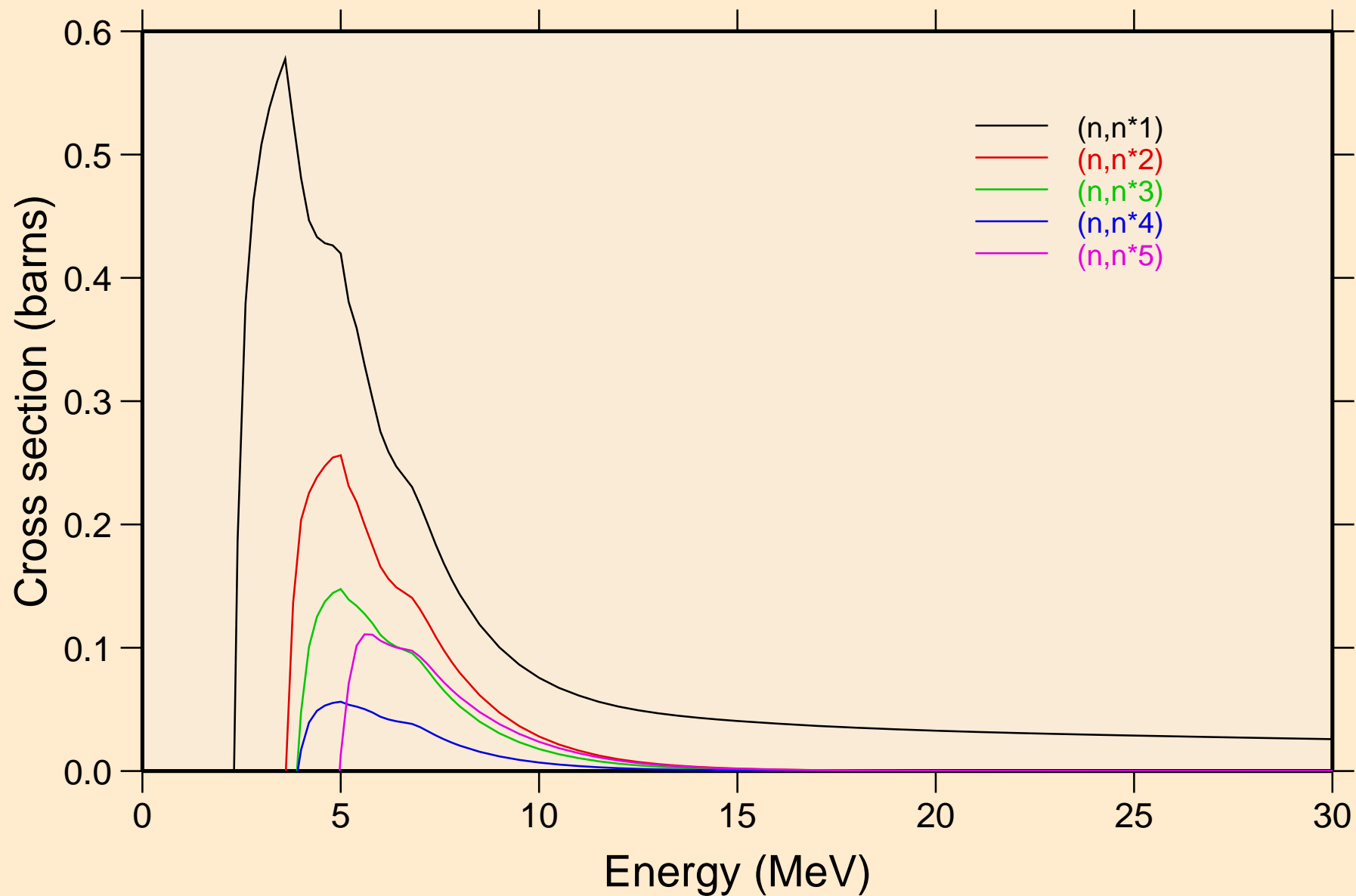

SI030 NEUTRON ACER TENDL-2023 LIBRARY; T=0.K  
Inelastic levels

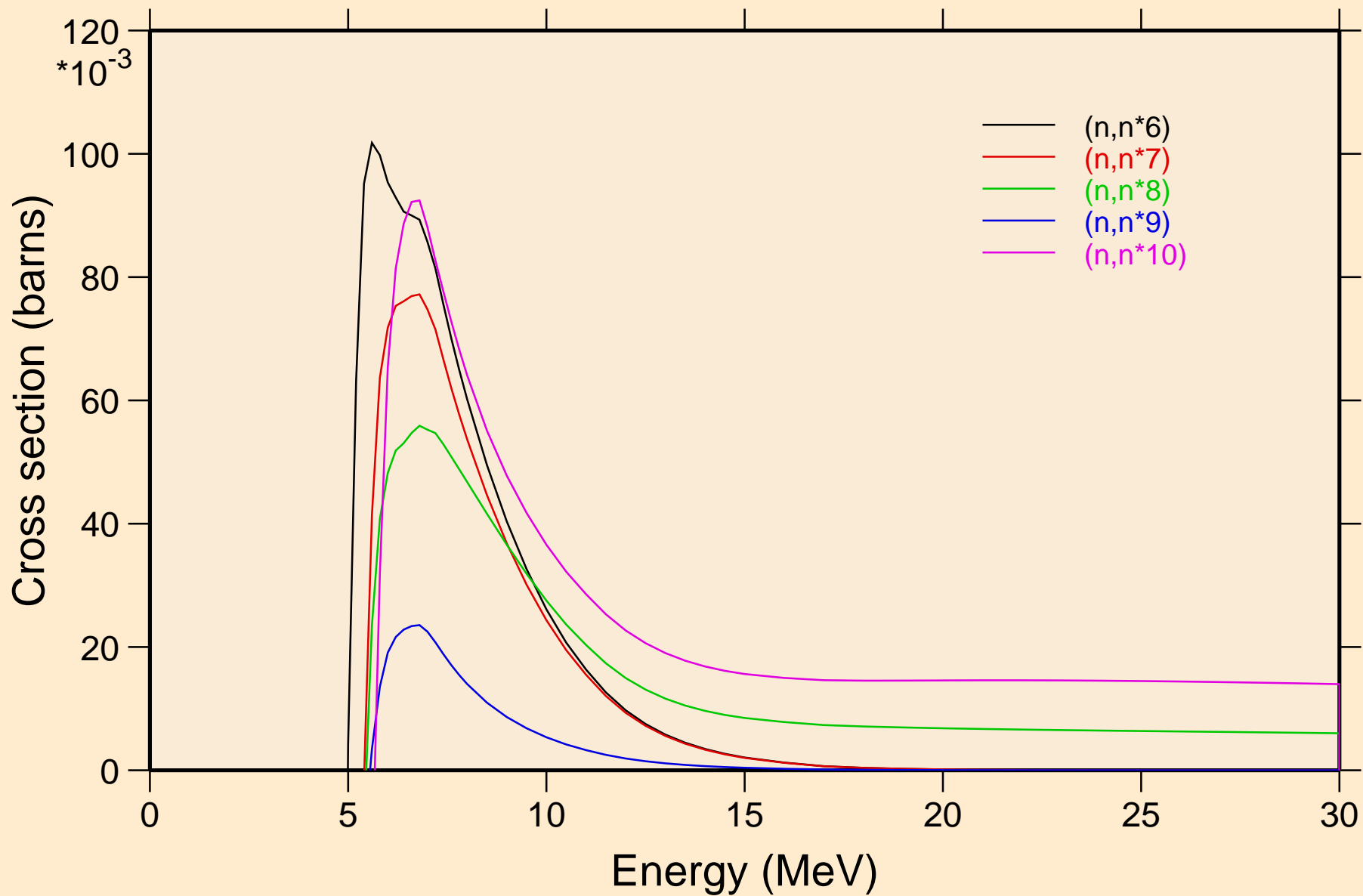



# SI030 NEUTRON ACER TENDL-2023 LIBRARY; T=0.K

## Inelastic levels

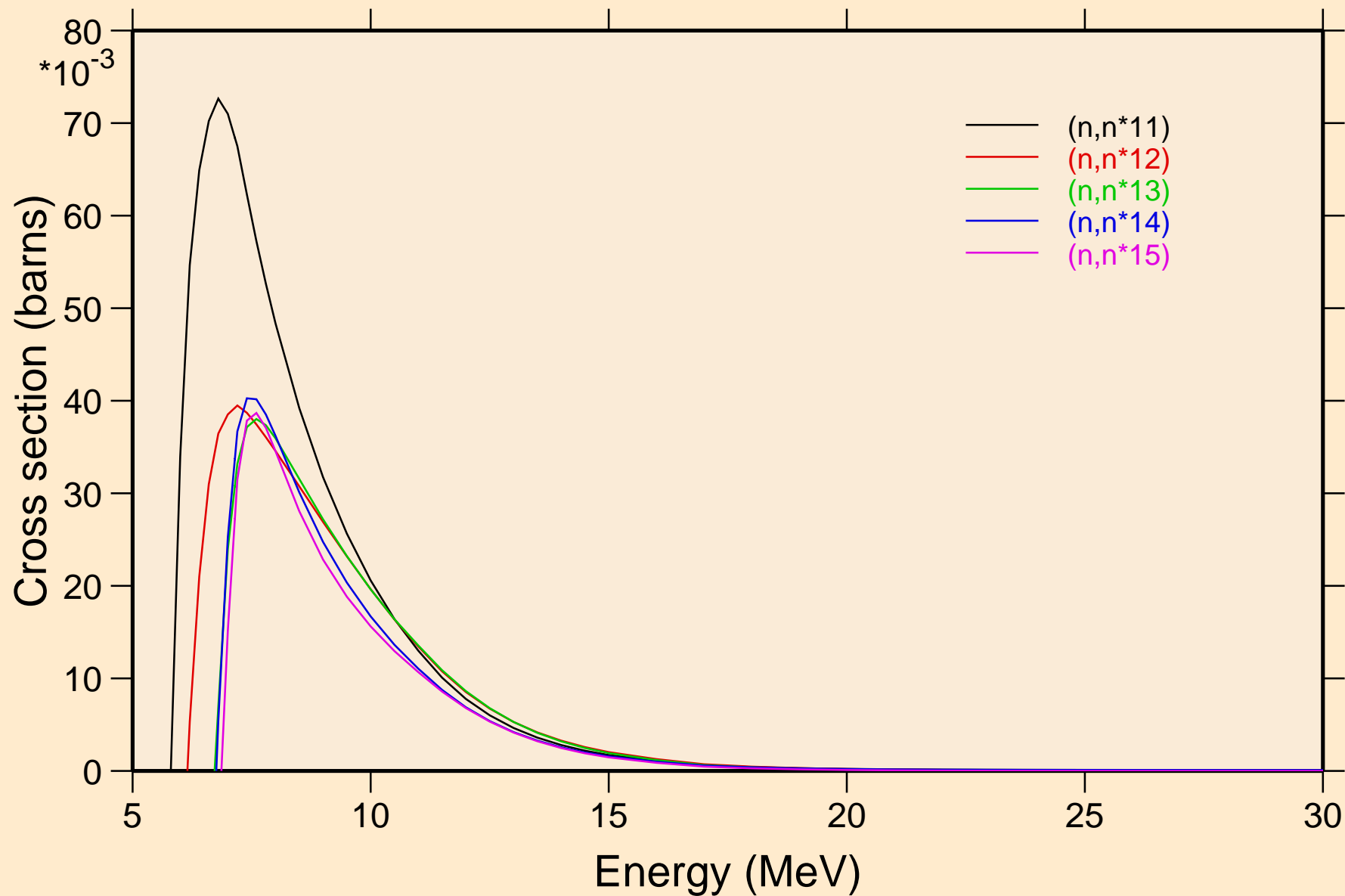

# SI030 NEUTRON ACER TENDL-2023 LIBRARY; T=0.K

## Inelastic levels

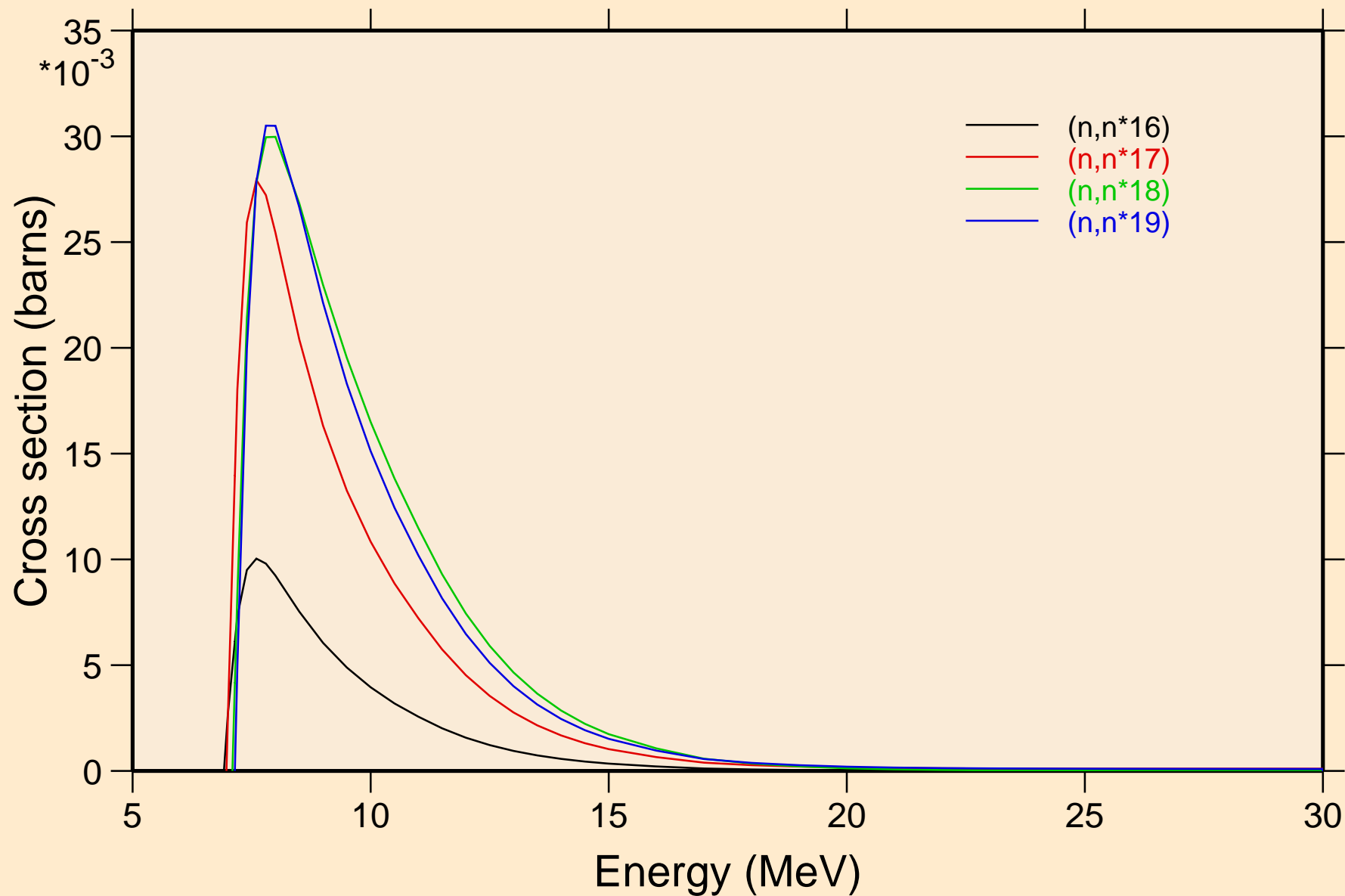

# SI030 NEUTRON ACER TENDL-2023 LIBRARY; T=0.K

## Threshold reactions

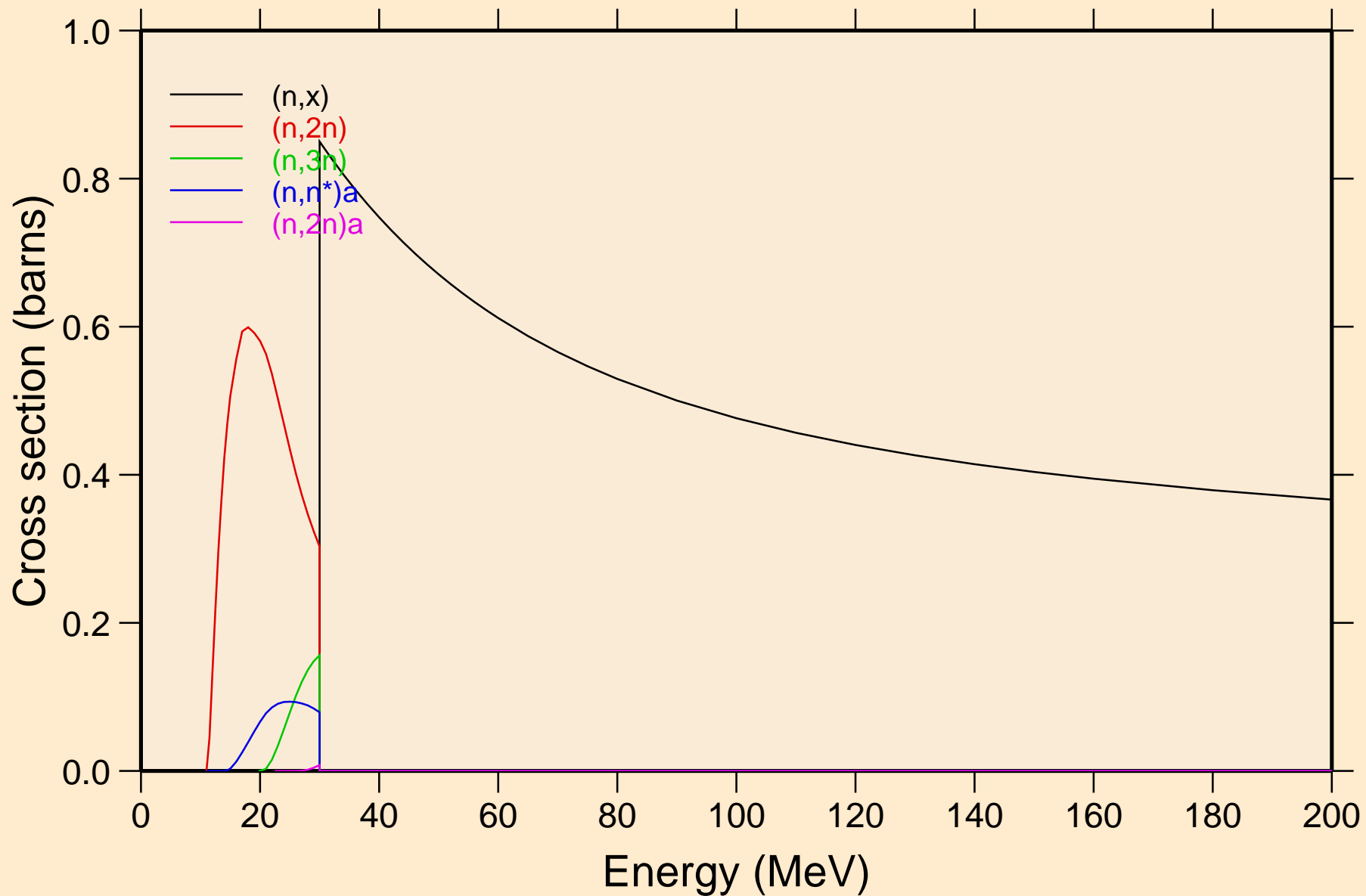

SI030 NEUTRON ACER TENDL-2023 LIBRARY; T=0.K  
Threshold reactions

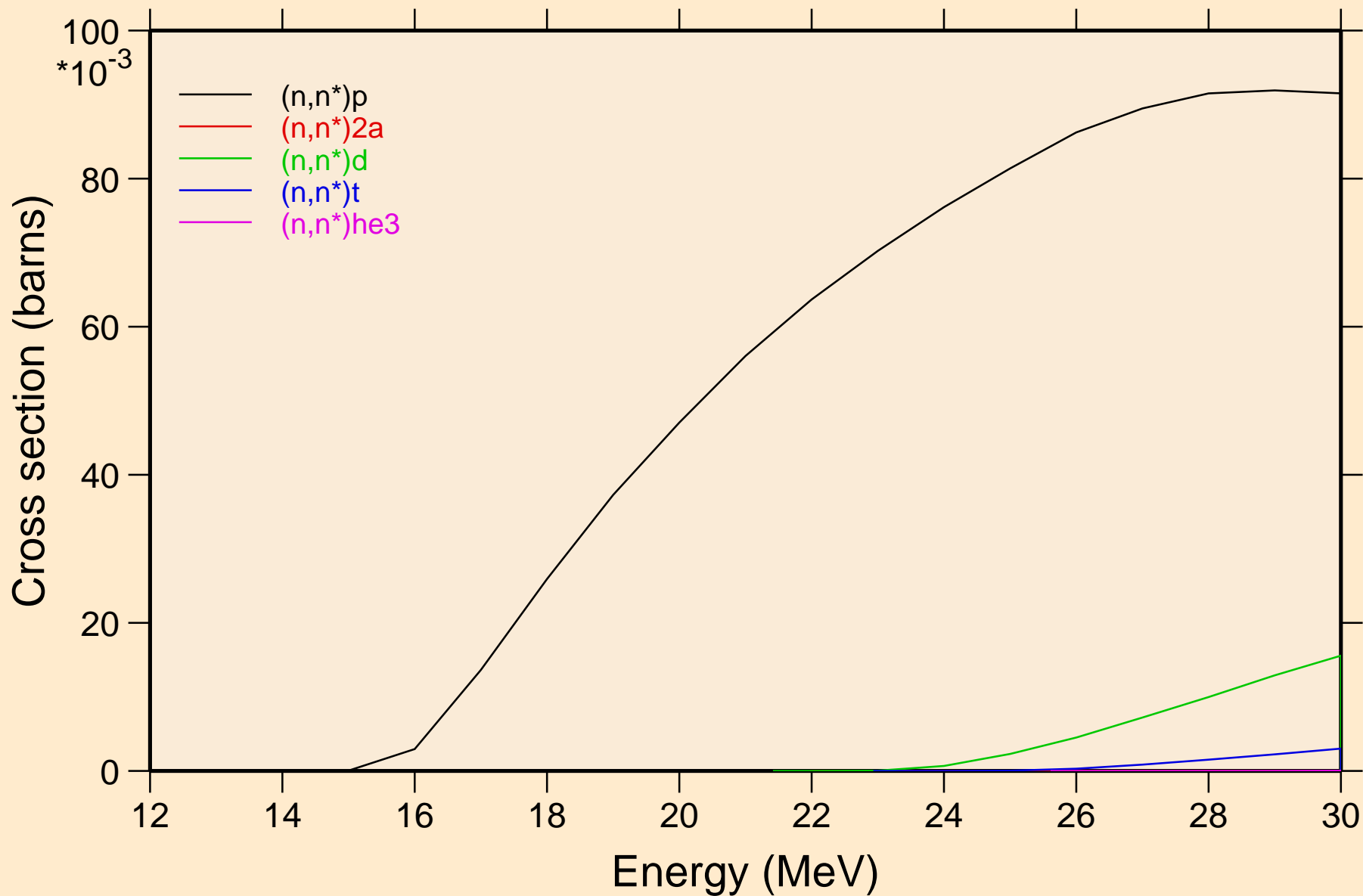

# SI030 NEUTRON ACER TENDL-2023 LIBRARY; T=0.K

## Threshold reactions

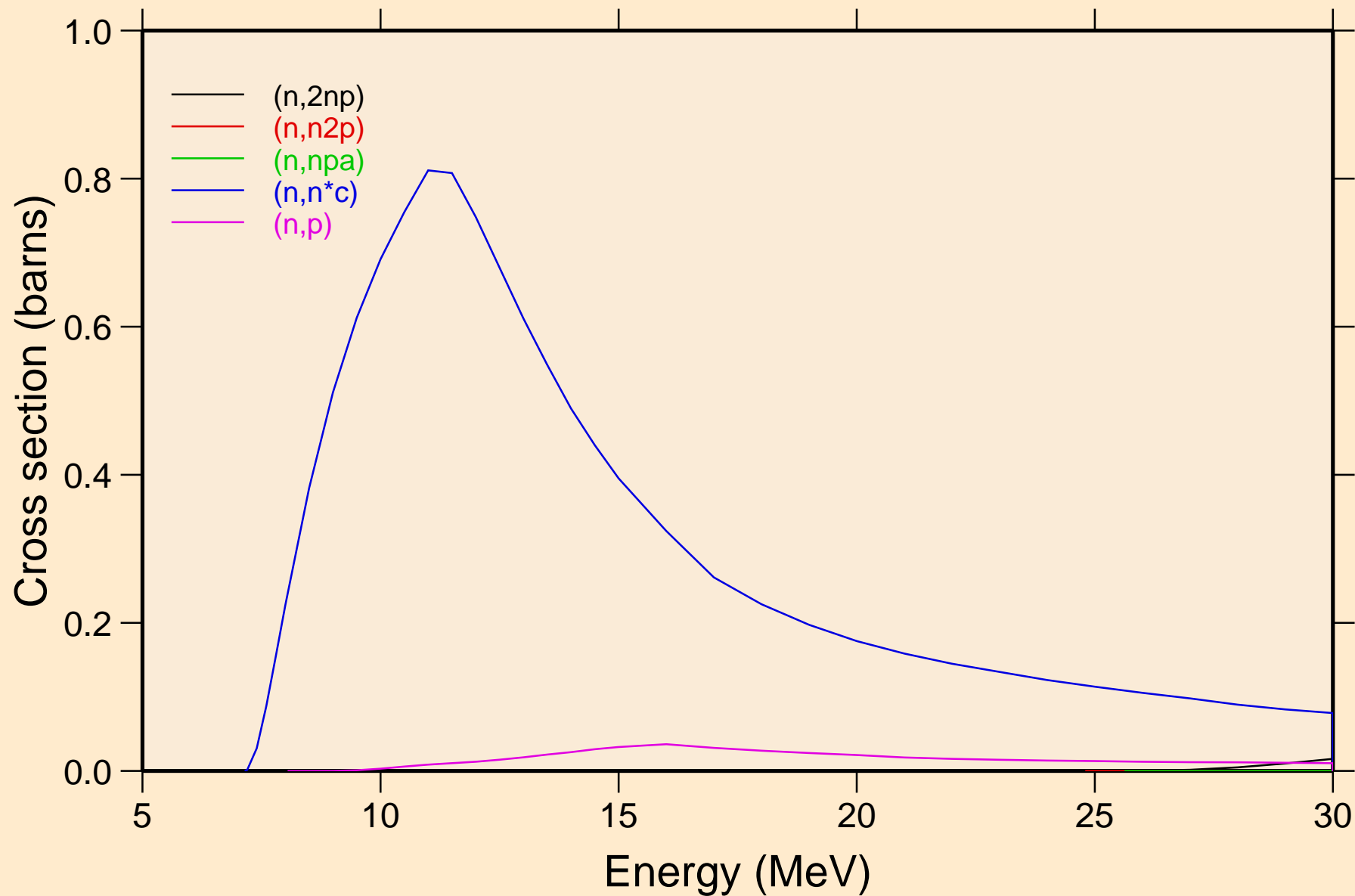

# SI030 NEUTRON ACER TENDL-2023 LIBRARY; T=0.K

## Threshold reactions

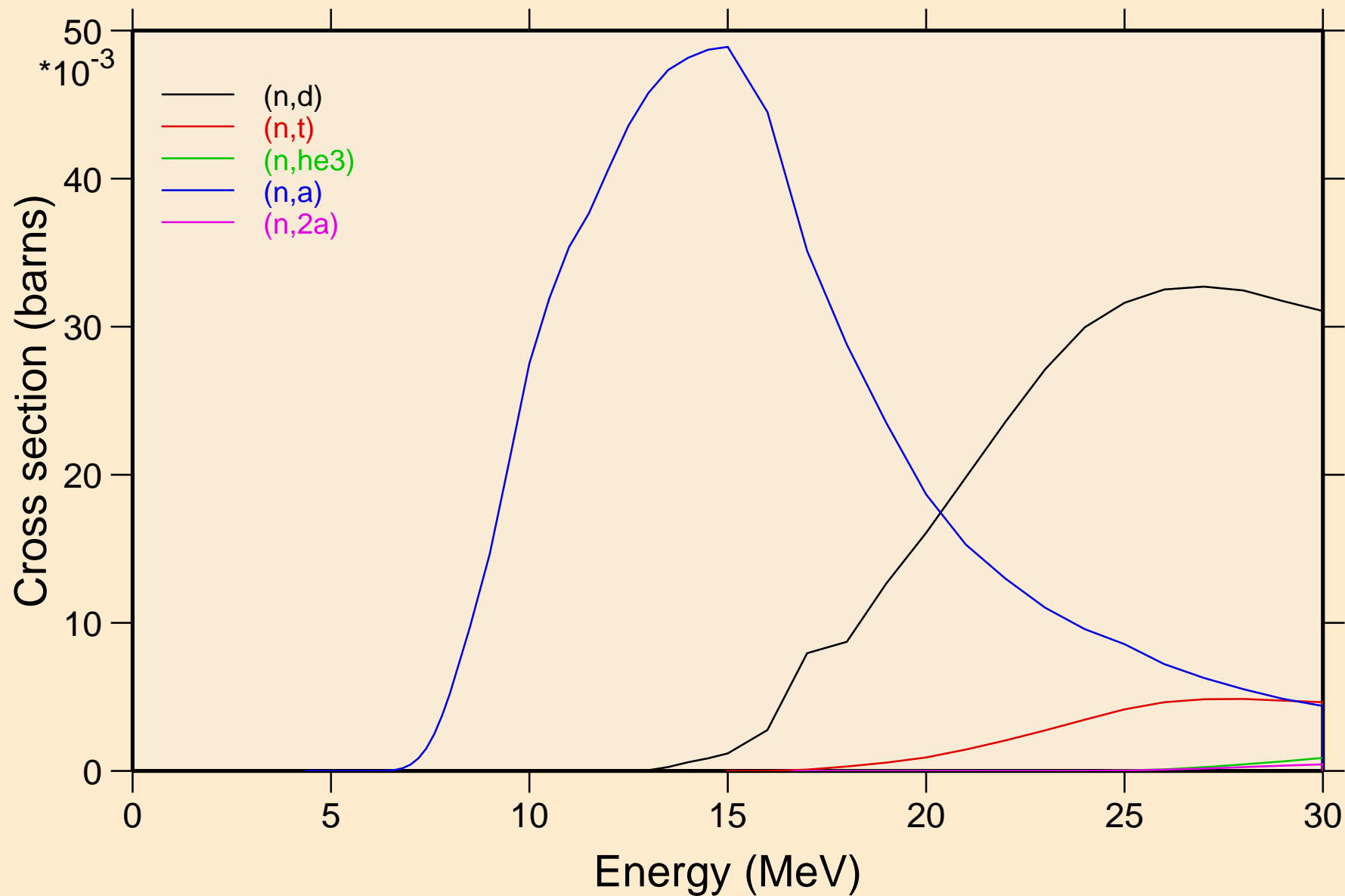

# SI030 NEUTRON ACER TENDL-2023 LIBRARY; T=0.K

## Threshold reactions

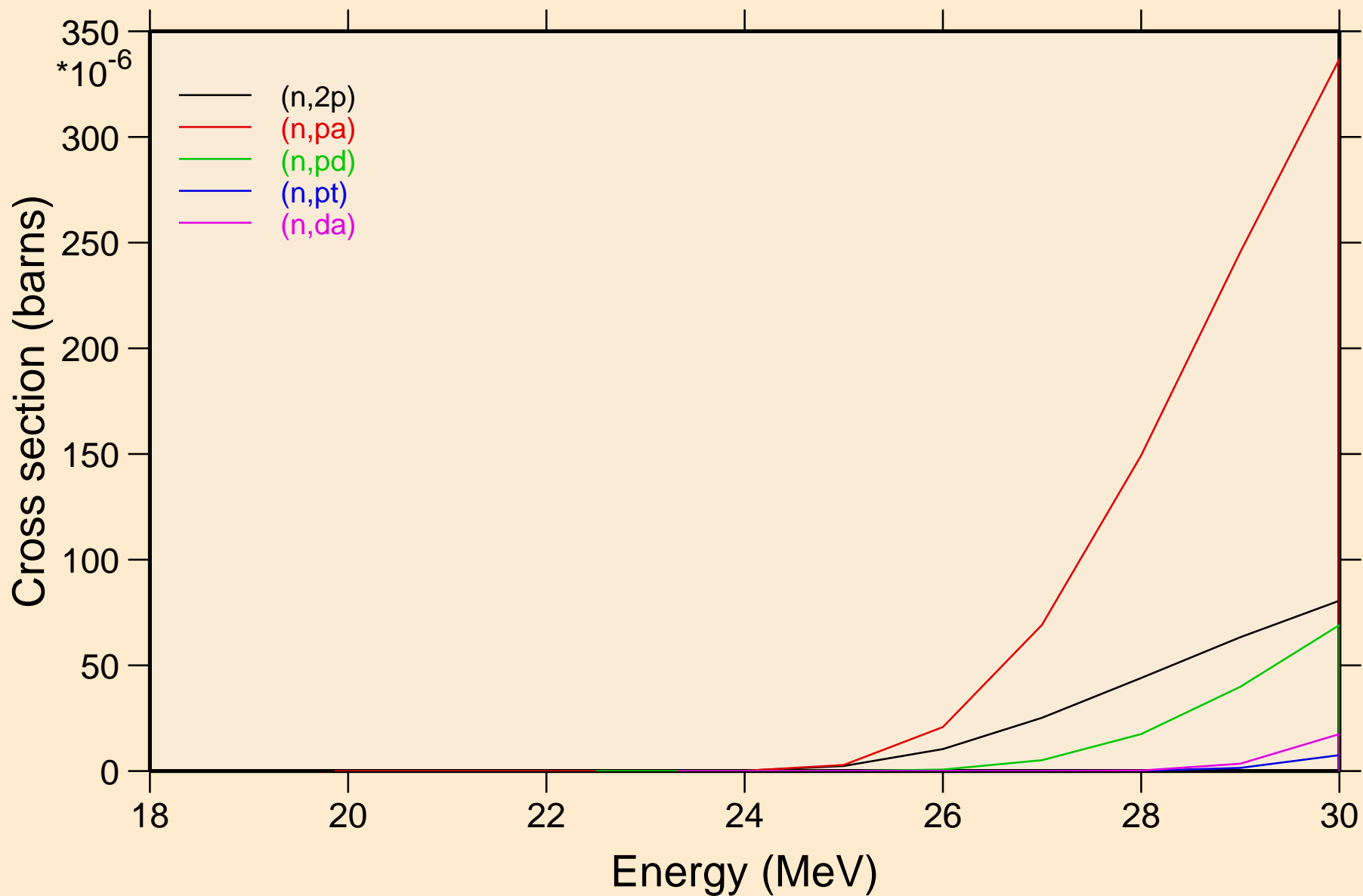

# SI030 NEUTRON ACER TENDL-2023 LIBRARY; T=0.K

## Threshold reactions

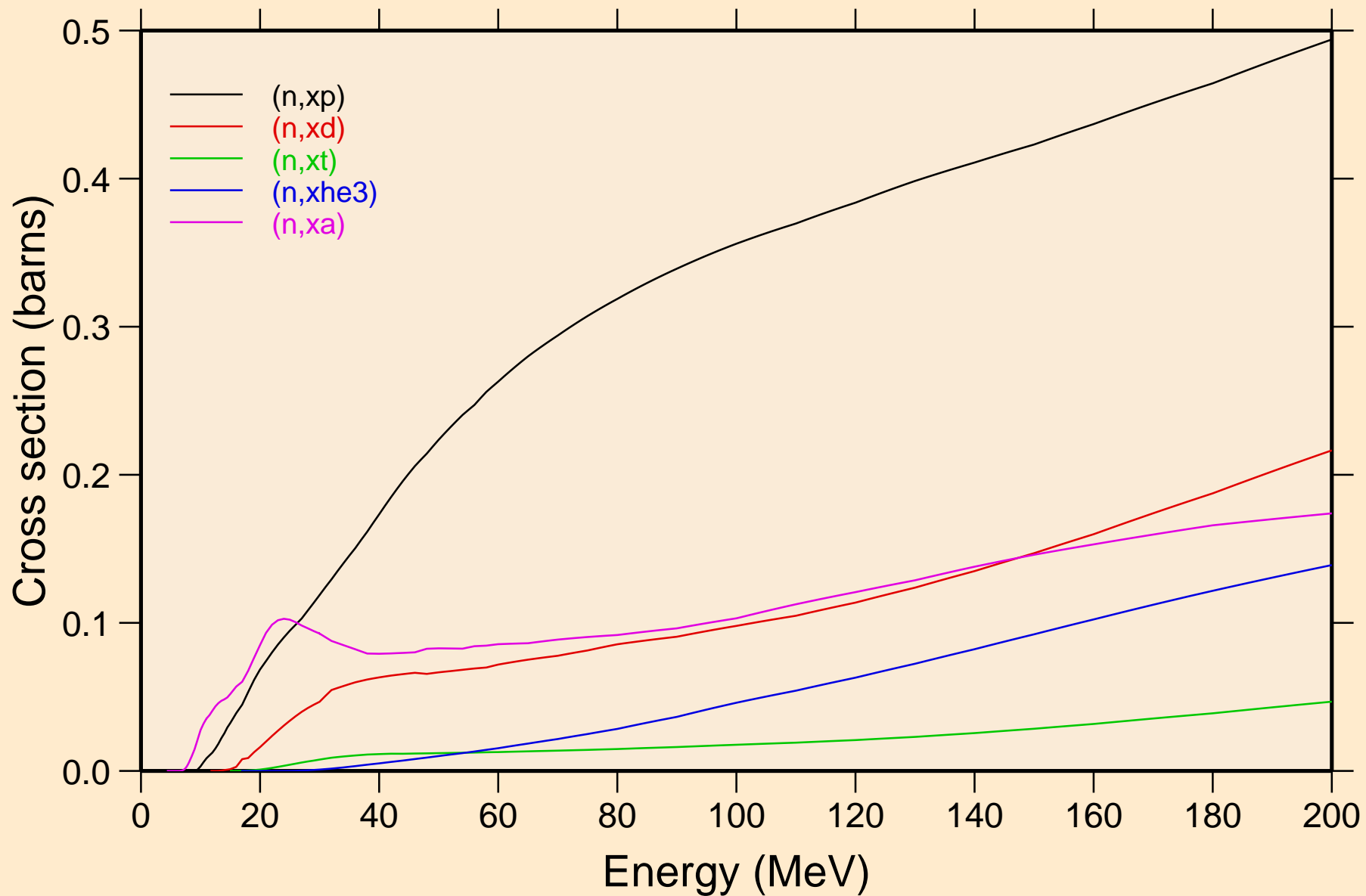



SI030 NEUTRON ACER TENDL-2023 LIBRARY; T=0.K  
angular distribution for elastic

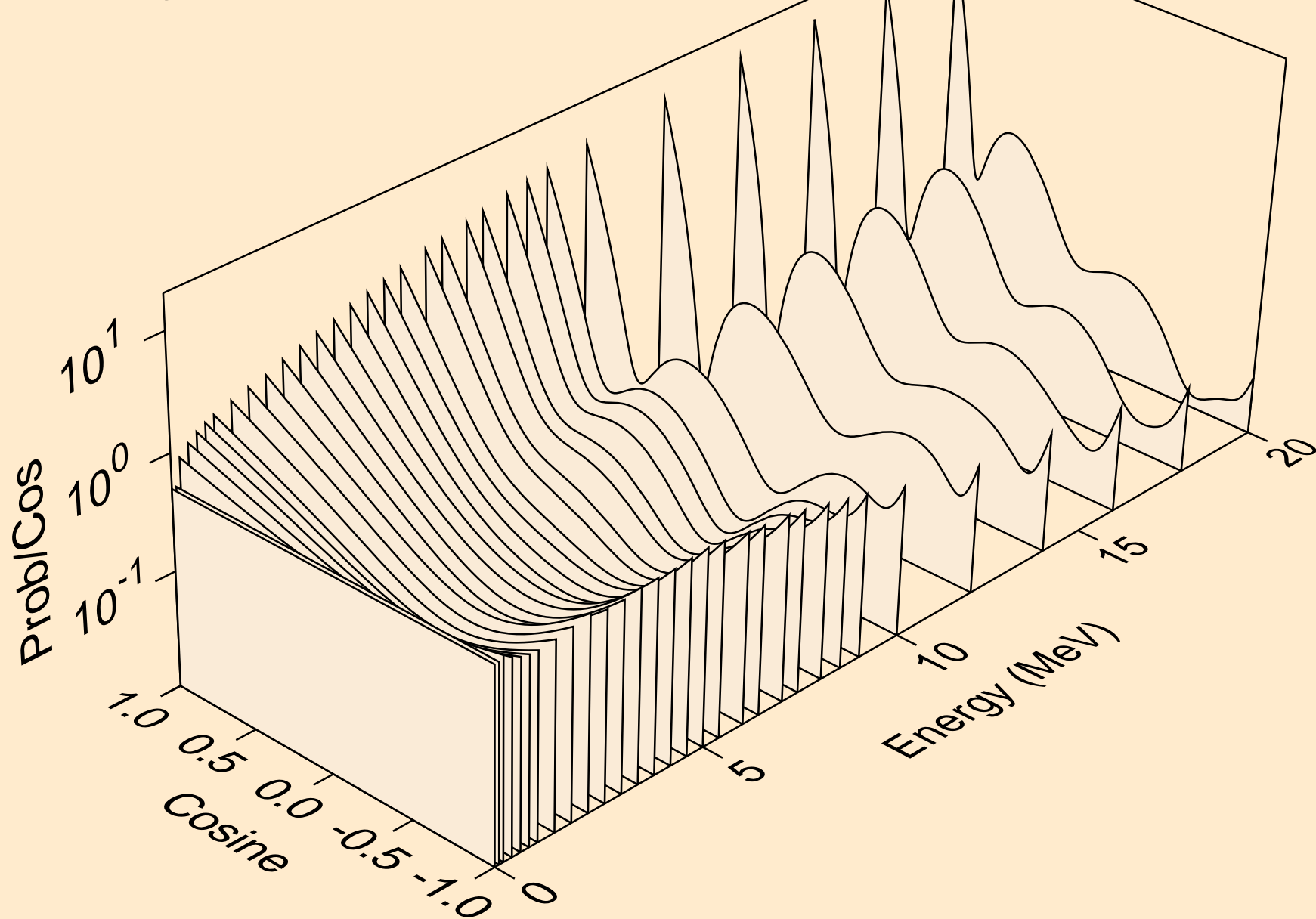

SI030 NEUTRON ACER TENDL-2023 LIBRARY; T=0.K  
angular distribution for elastic

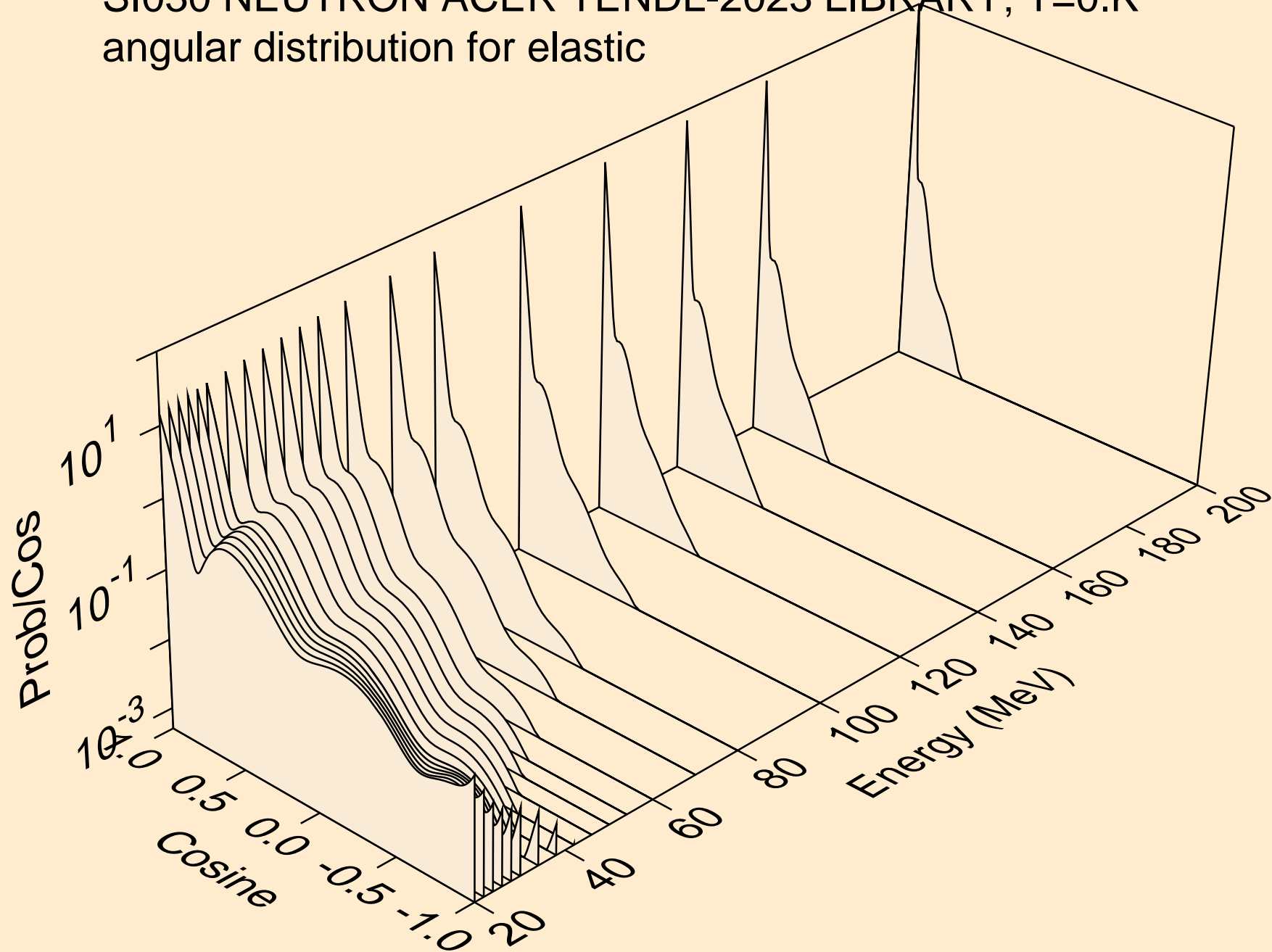

SI030 NEUTRON ACER TENDL-2023 LIBRARY; T=0.K  
angular distribution for (n,n\*1)

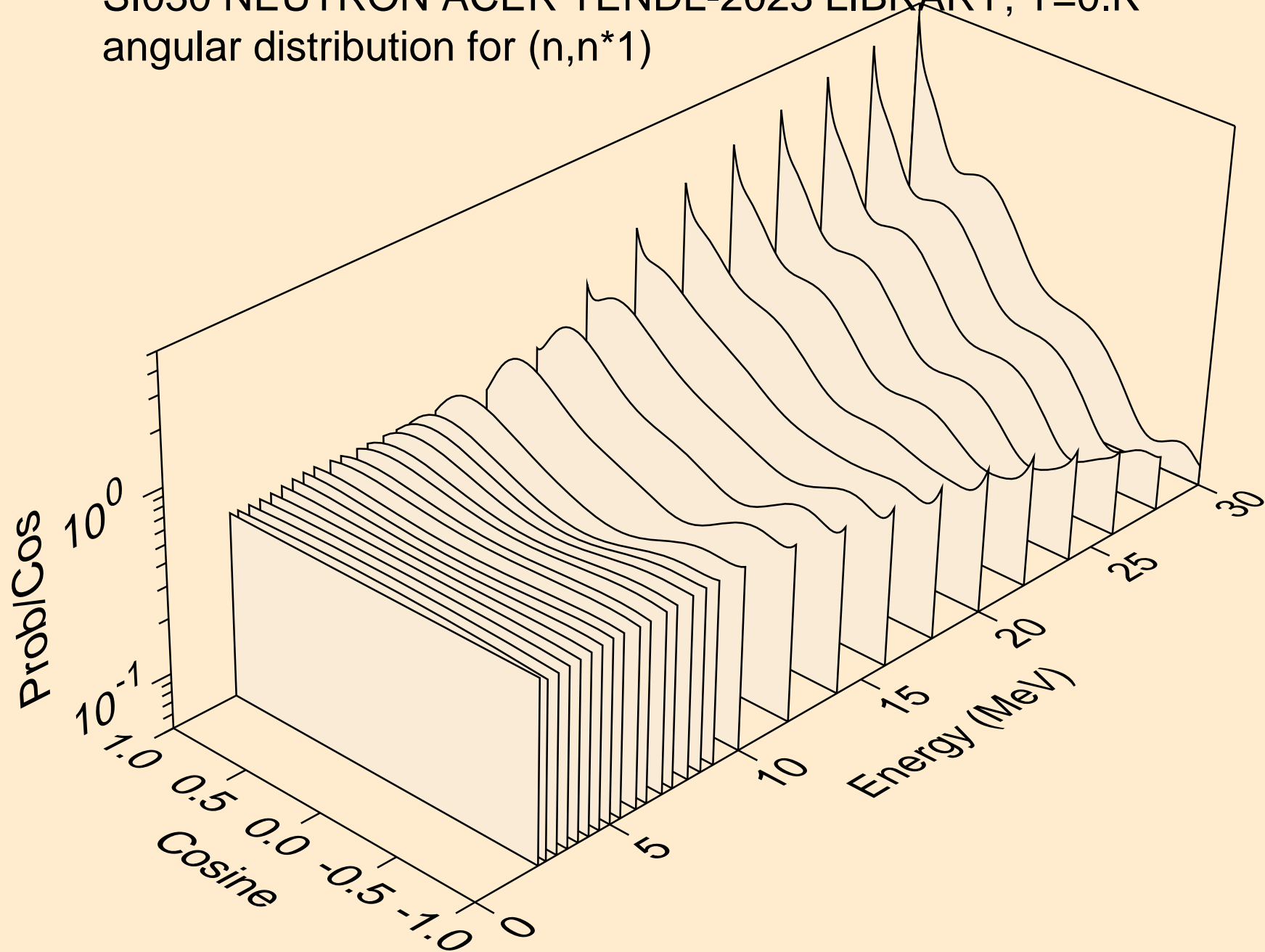

SI030 NEUTRON ACER TENDL-2023 LIBRARY; T=0.K  
angular distribution for (n,n\*2)

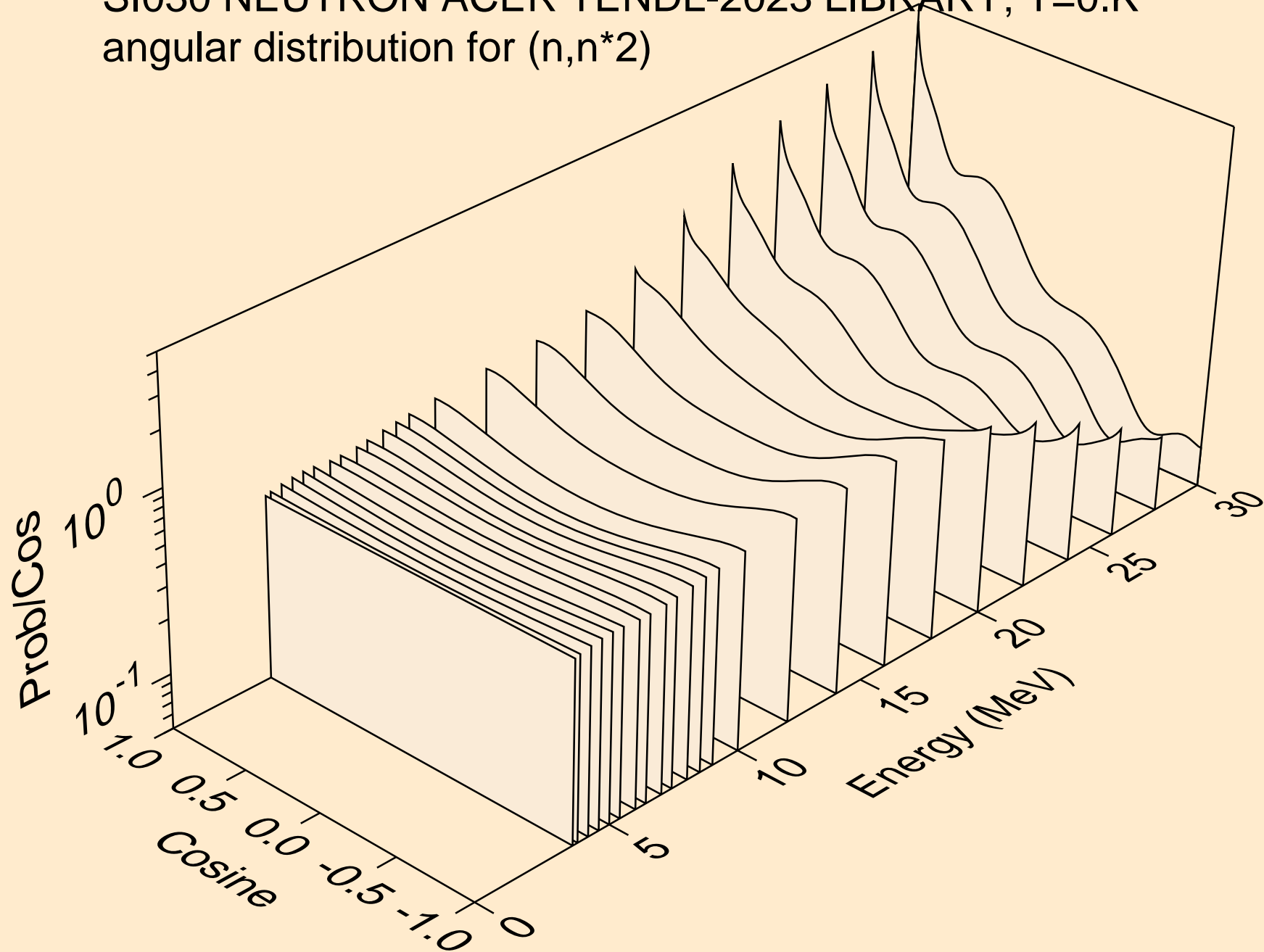

SI030 NEUTRON ACER TENDL-2023 LIBRARY; T=0.K  
angular distribution for (n,n\*3)

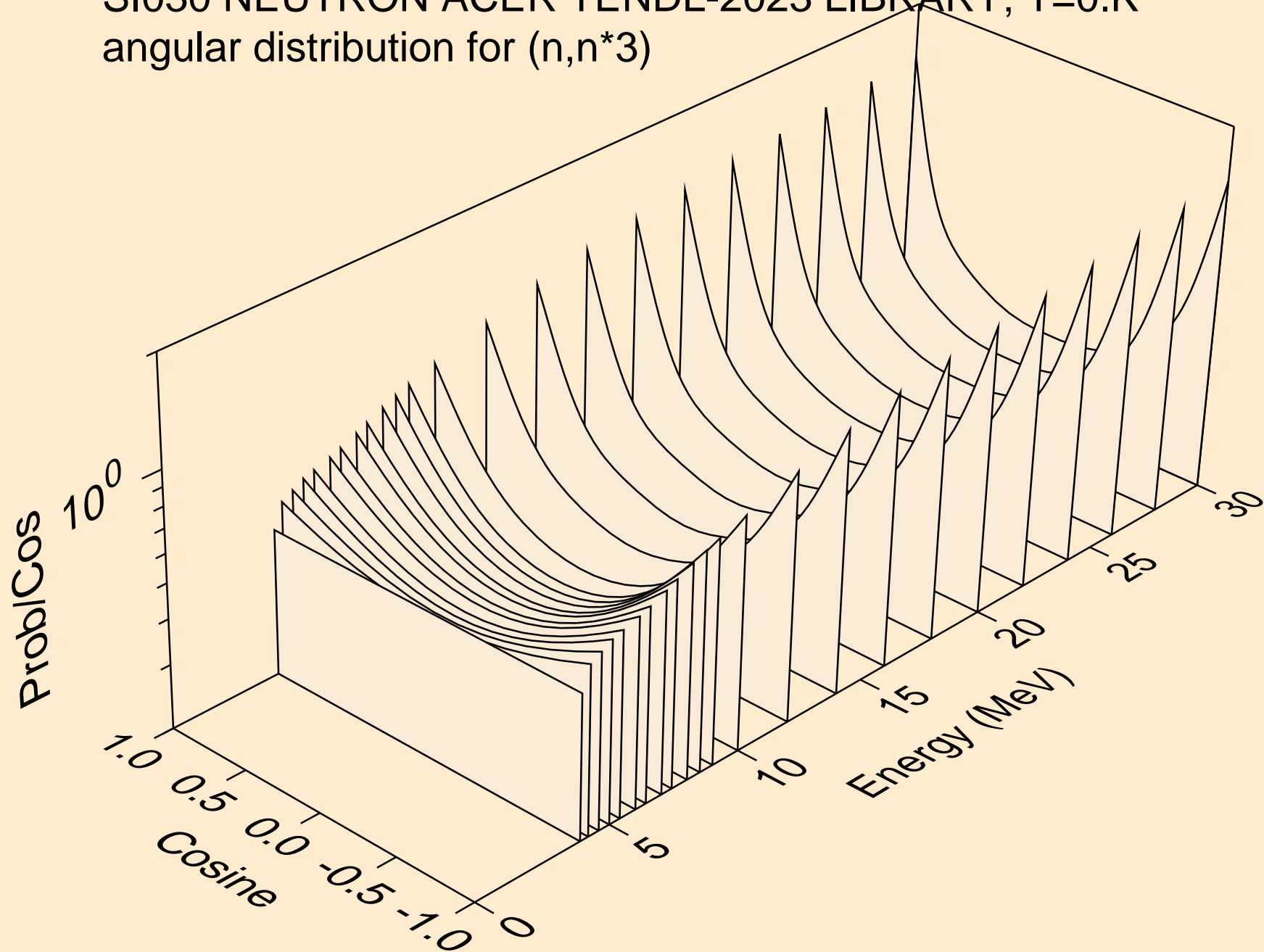

SI030 NEUTRON ACER TENDL-2023 LIBRARY; T=0.K  
angular distribution for (n,n\*4)

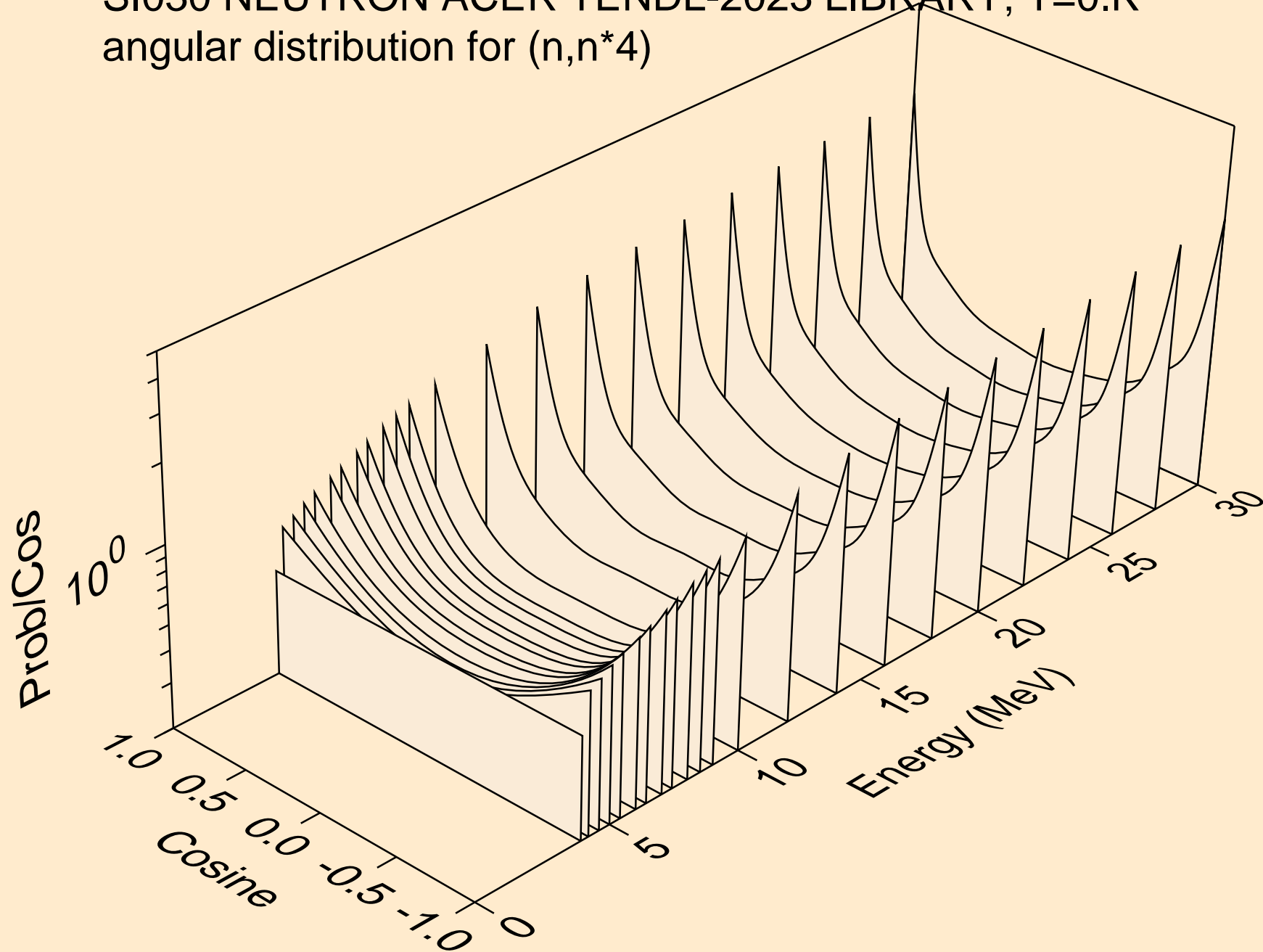

SI030 NEUTRON ACER TENDL-2023 LIBRARY; T=0.K  
angular distribution for (n,n\*5)

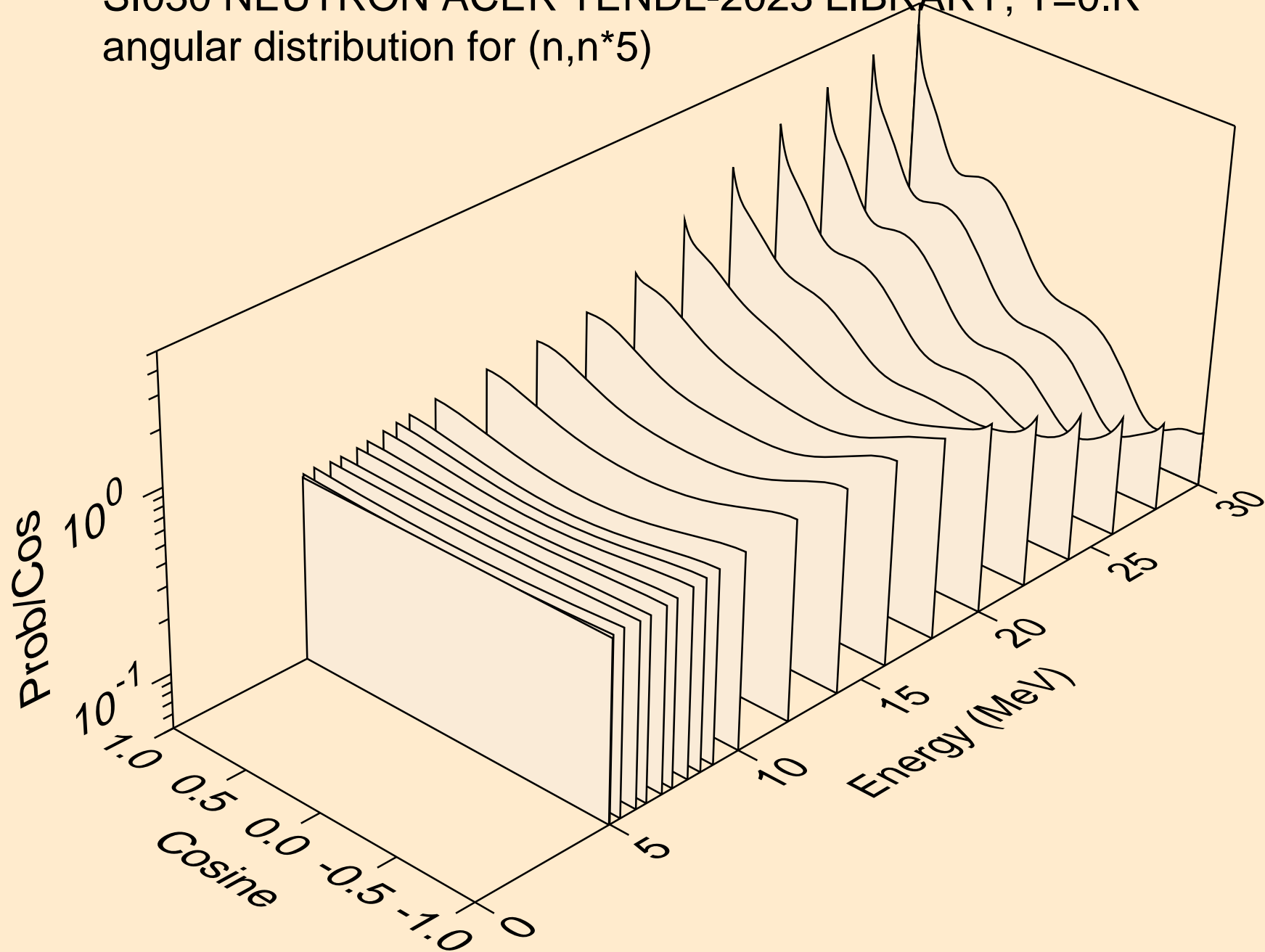

SI030 NEUTRON ACER TENDL-2023 LIBRARY; T=0.K  
angular distribution for (n,n\*6)

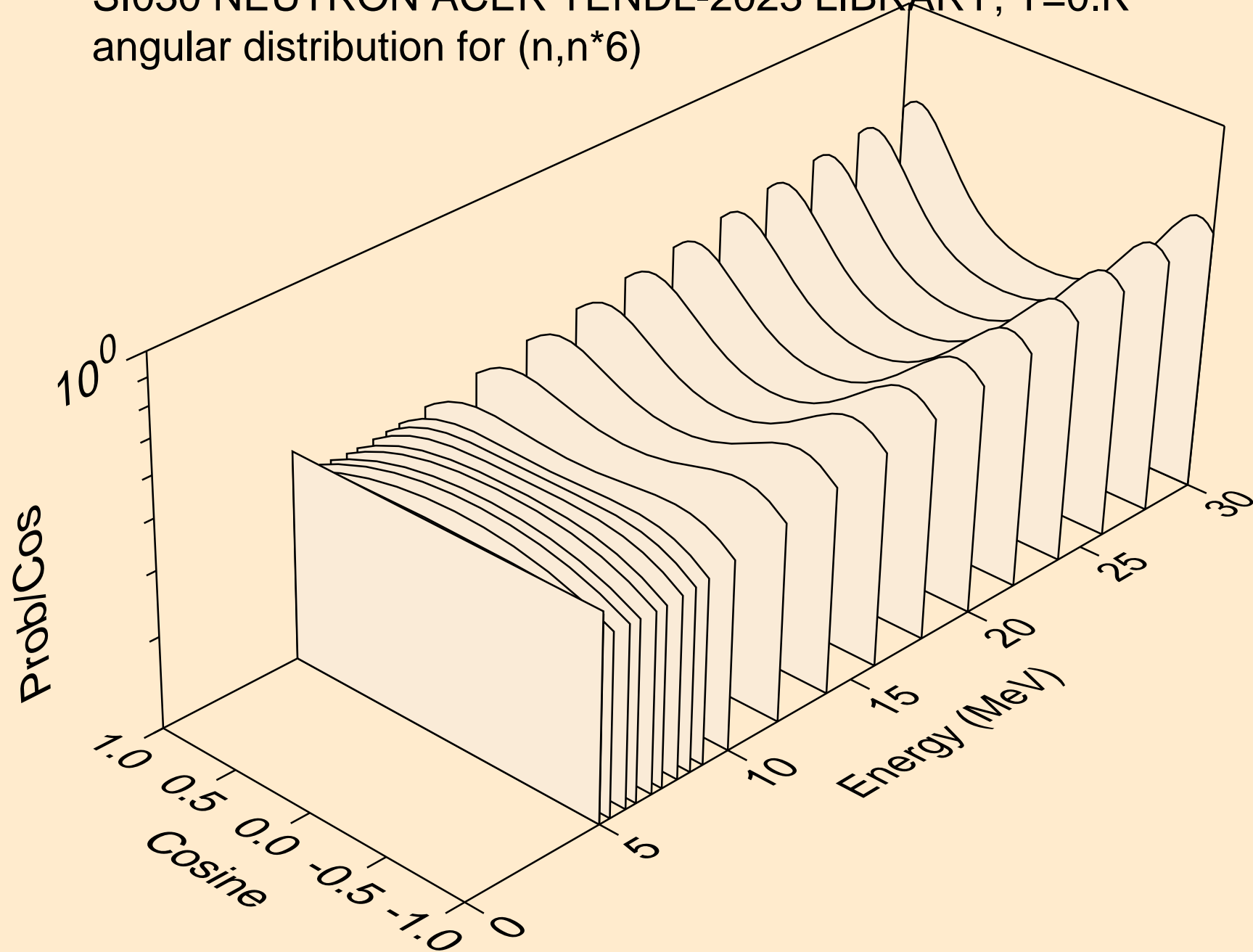



SI030 NEUTRON ACER TENDL-2023 LIBRARY; T=0.K  
angular distribution for (n,n\*7)

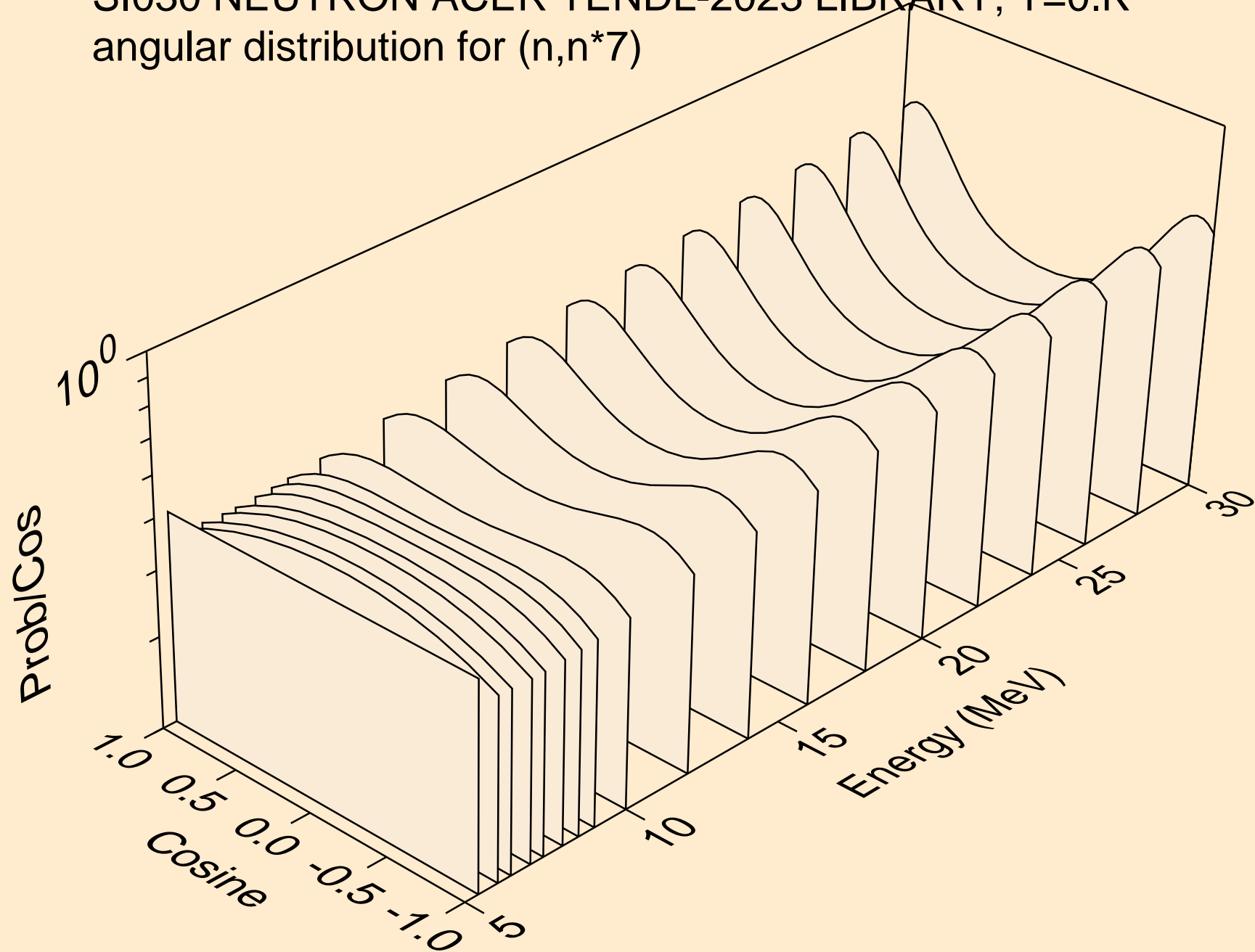

SI030 NEUTRON ACER TENDL-2023 LIBRARY; T=0.K  
angular distribution for (n,n\*8)

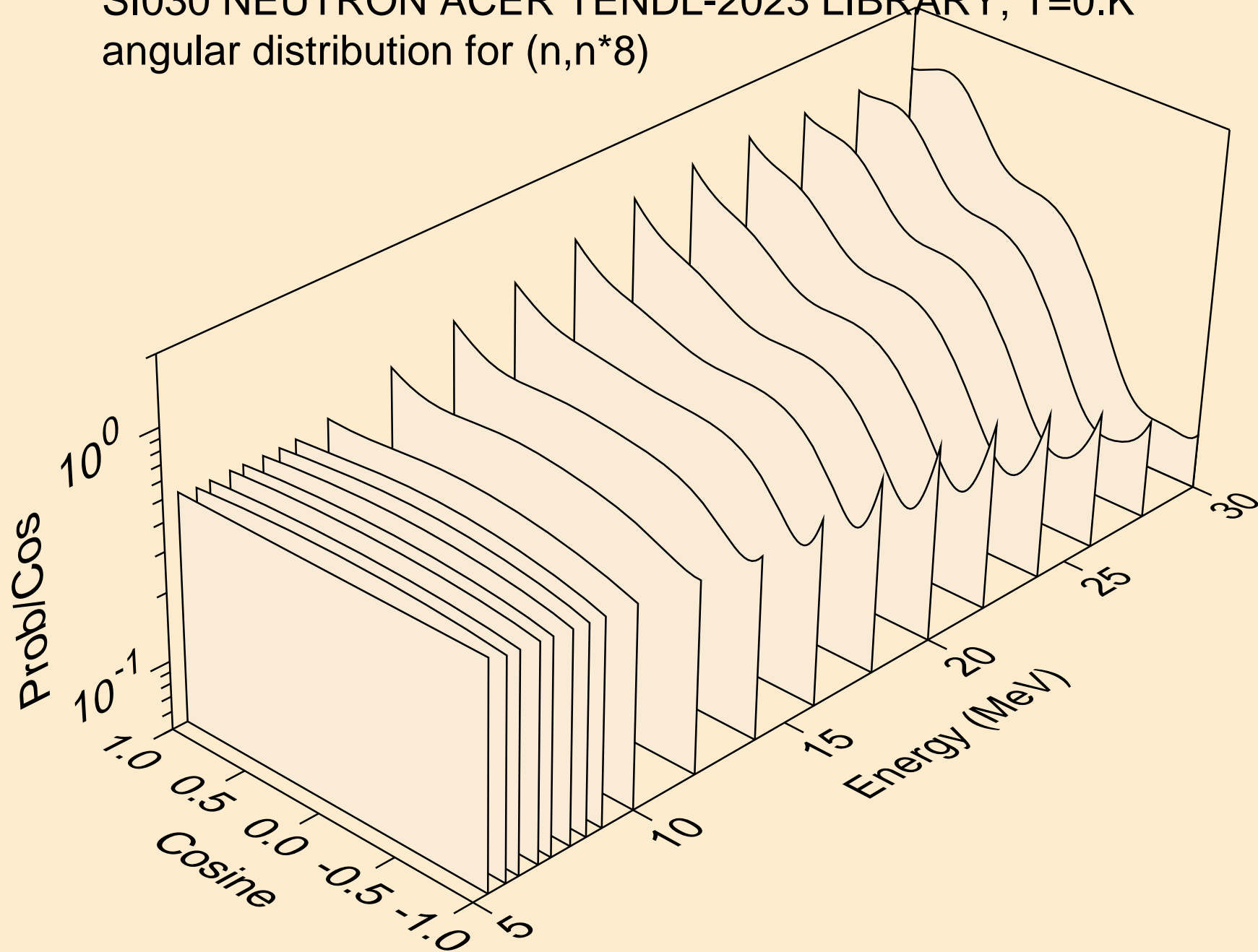

SI030 NEUTRON ACER TENDL-2023 LIBRARY; T=0.K  
angular distribution for (n,n\*9)

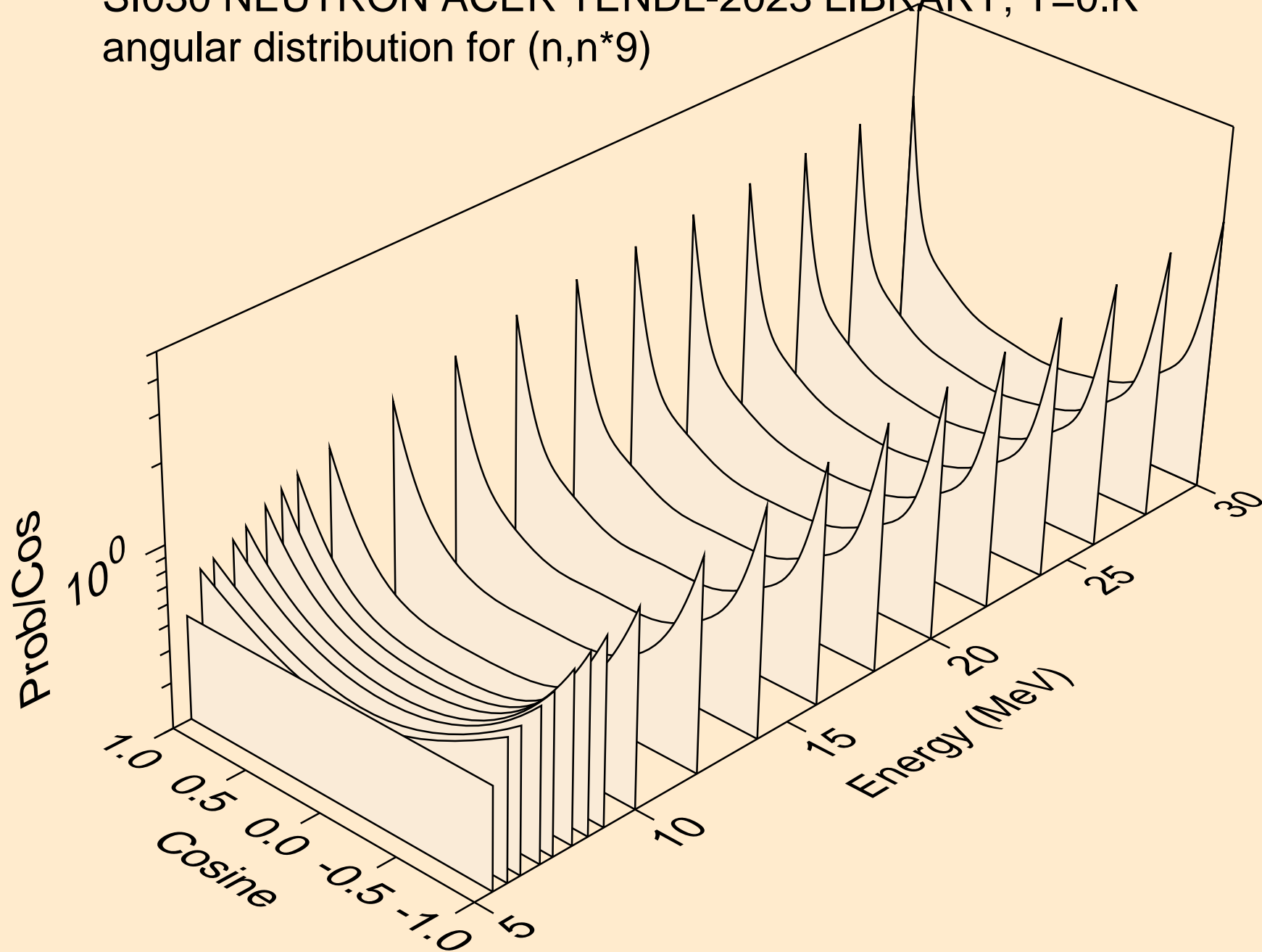

SI030 NEUTRON ACER TENDL-2023 LIBRARY; T=0.K  
angular distribution for (n,n\*10)

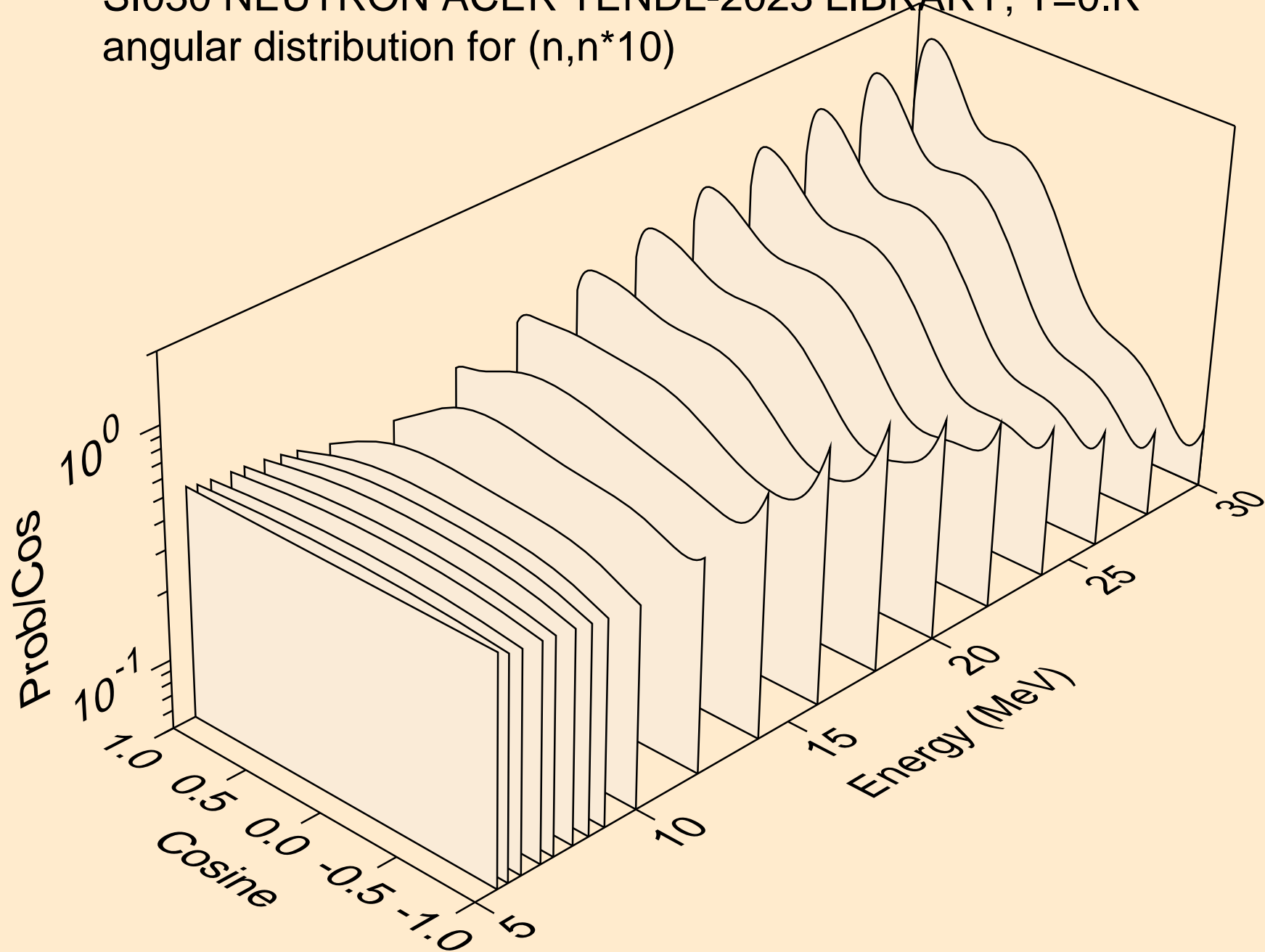

SI030 NEUTRON ACER TENDL-2023 LIBRARY; T=0.K  
angular distribution for (n,n\*11)

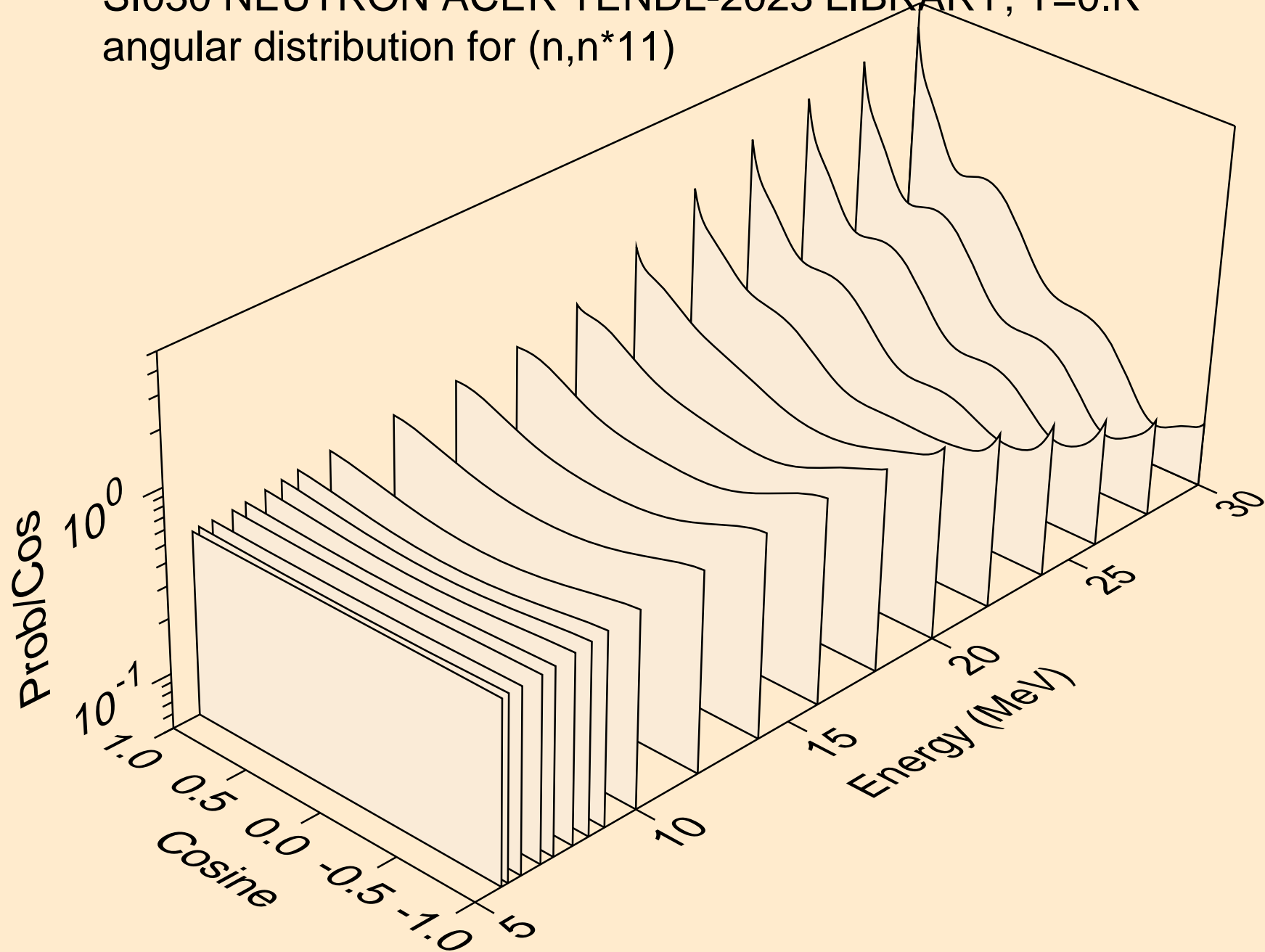

SI030 NEUTRON ACER TENDL-2023 LIBRARY; T=0.K  
angular distribution for (n,n\*12)

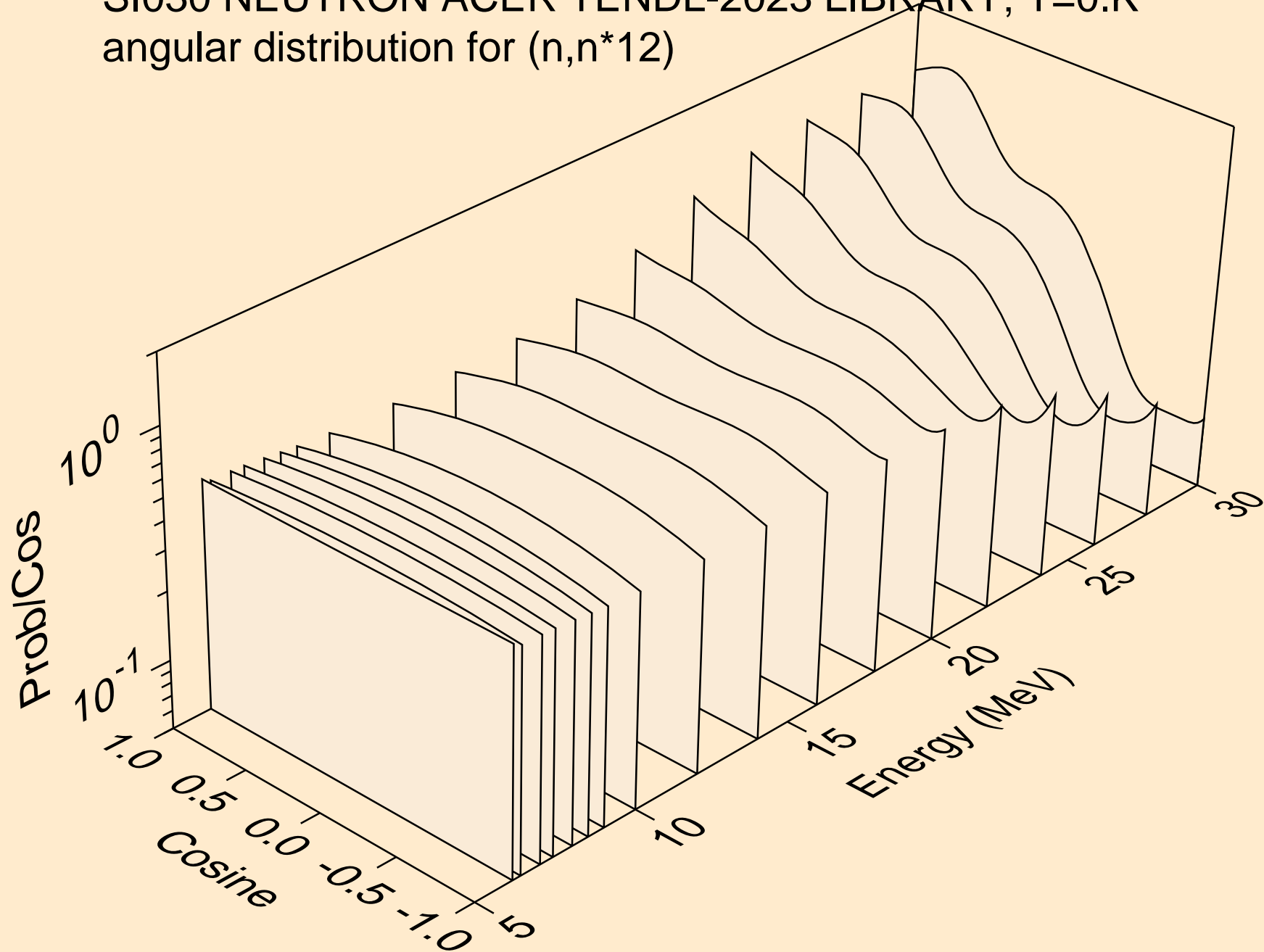

SI030 NEUTRON ACER TENDL-2023 LIBRARY; T=0.K  
angular distribution for (n,n\*13)

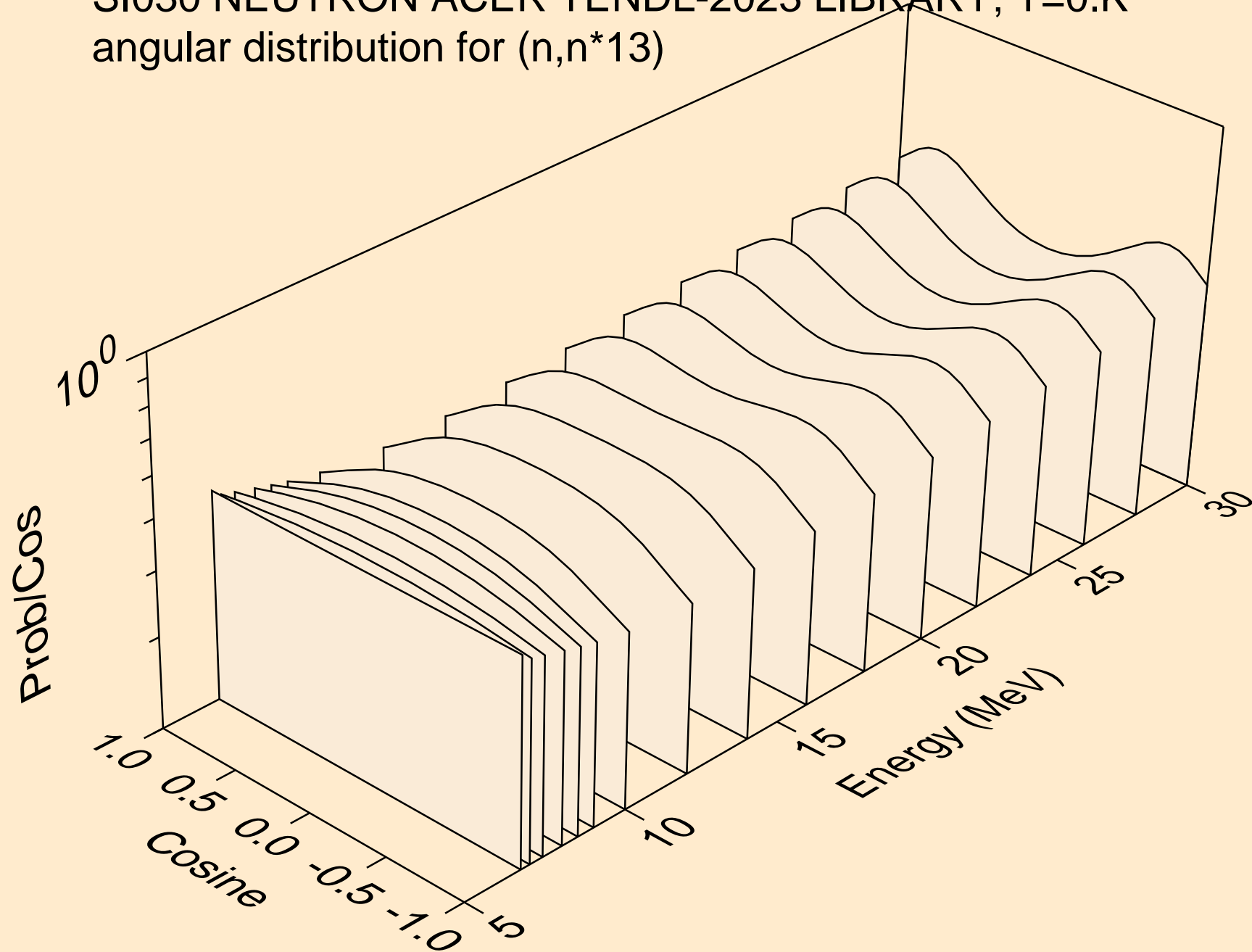

SI030 NEUTRON ACER TENDL-2023 LIBRARY; T=0.K  
angular distribution for (n,n\*14)

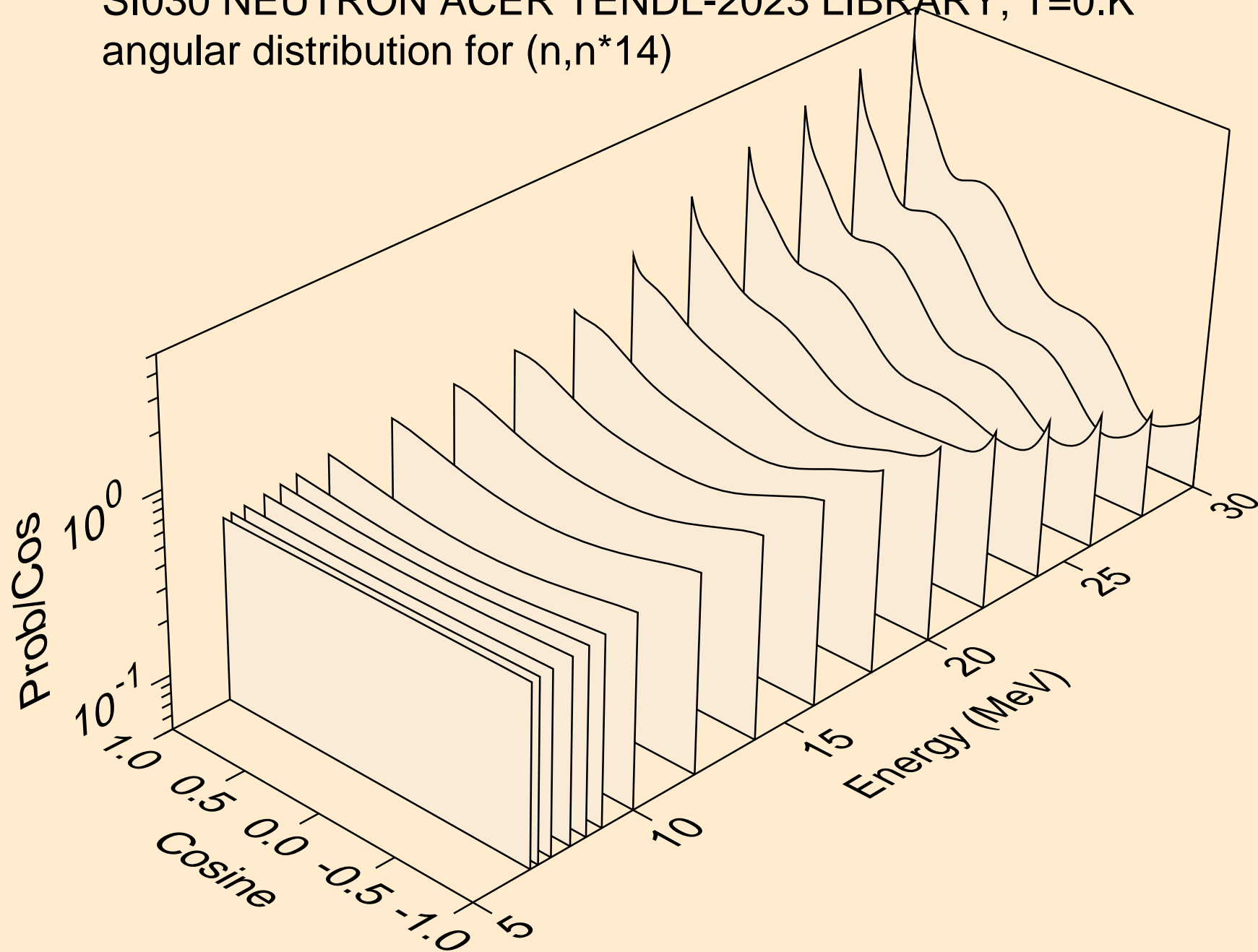



SI030 NEUTRON ACER TENDL-2023 LIBRARY; T=0.K  
angular distribution for (n,n\*15)

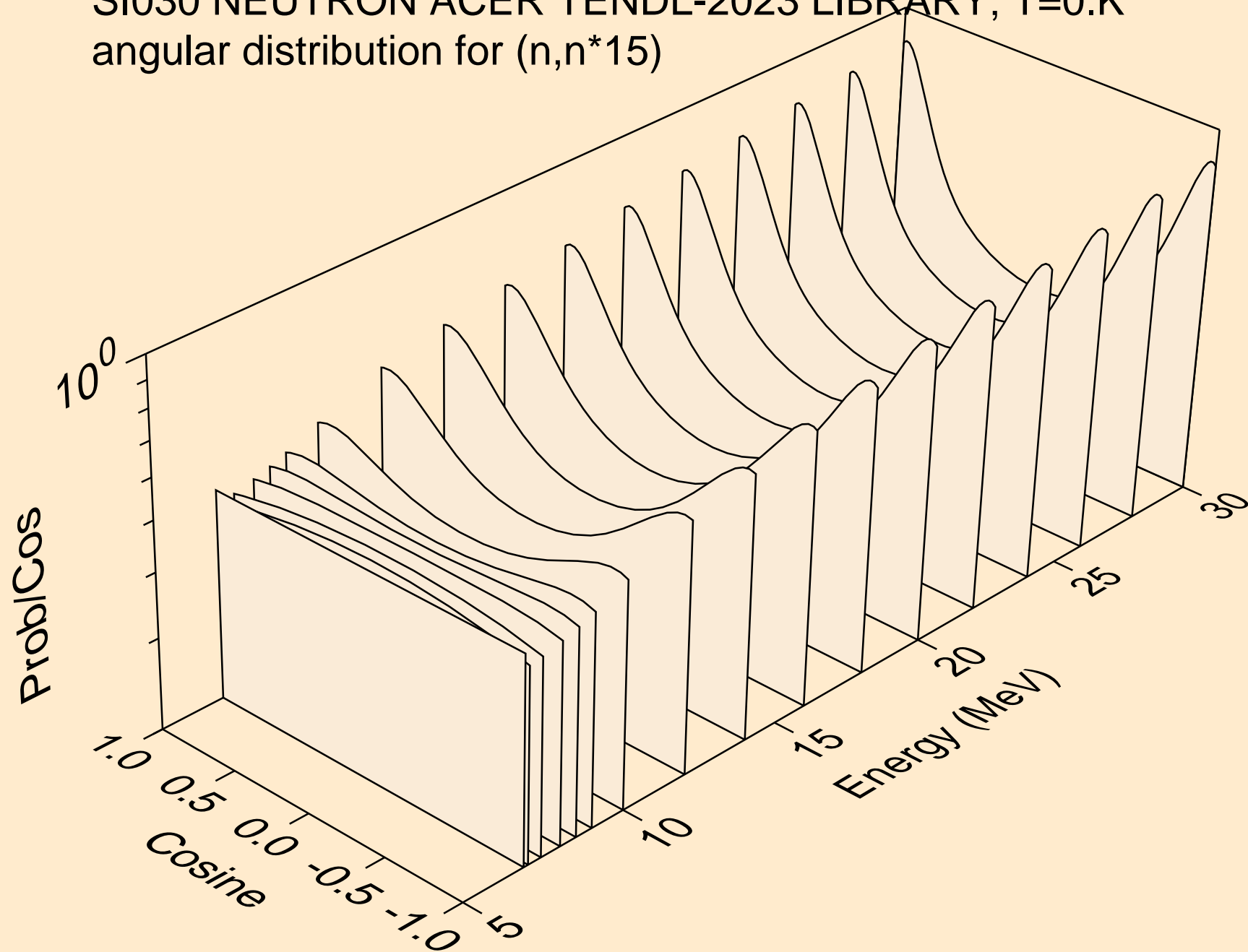

SI030 NEUTRON ACER TENDL-2023 LIBRARY; T=0.K  
angular distribution for (n,n\*16)

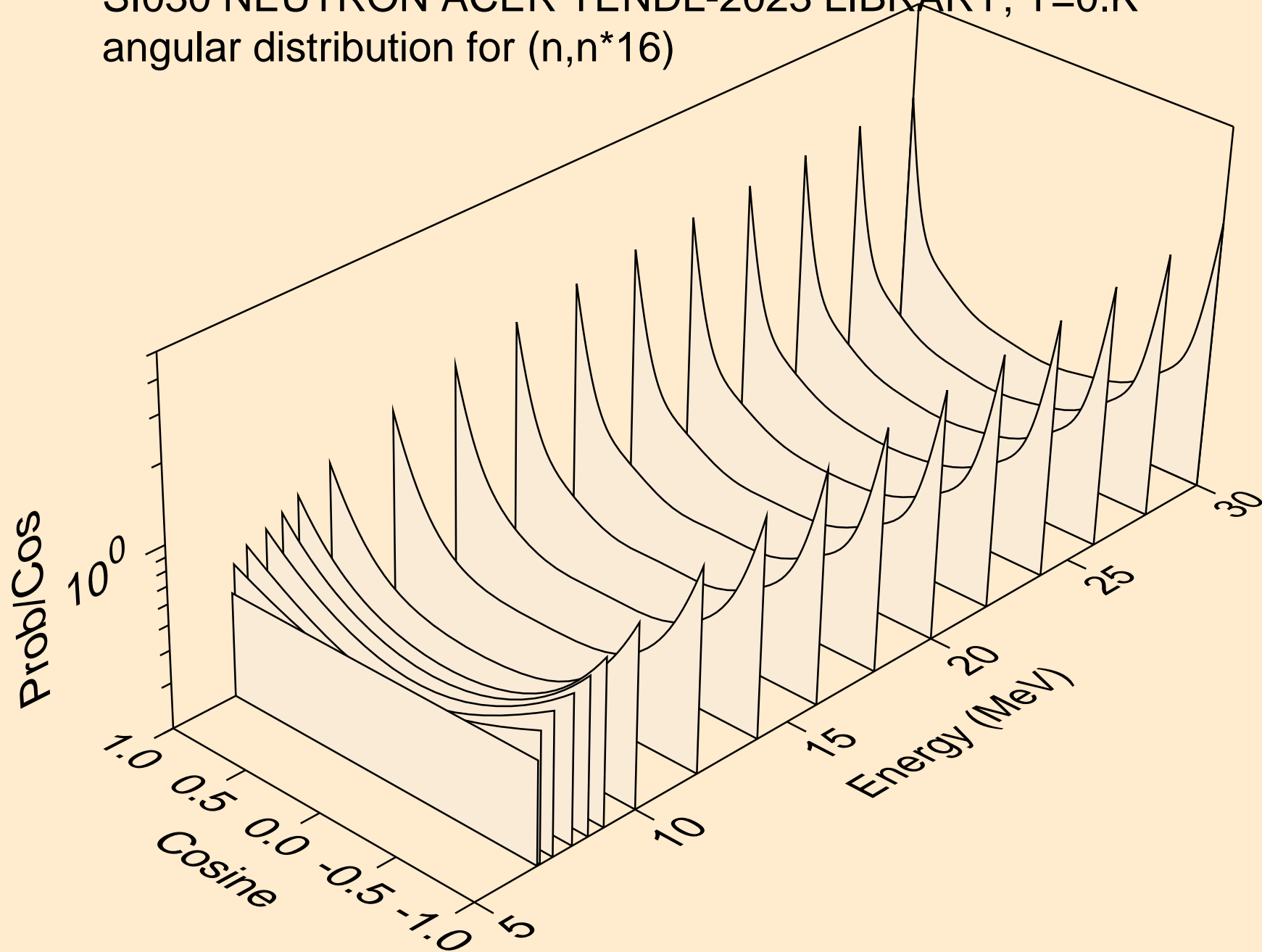

SI030 NEUTRON ACER TENDL-2023 LIBRARY; T=0.K  
angular distribution for (n,n\*17)

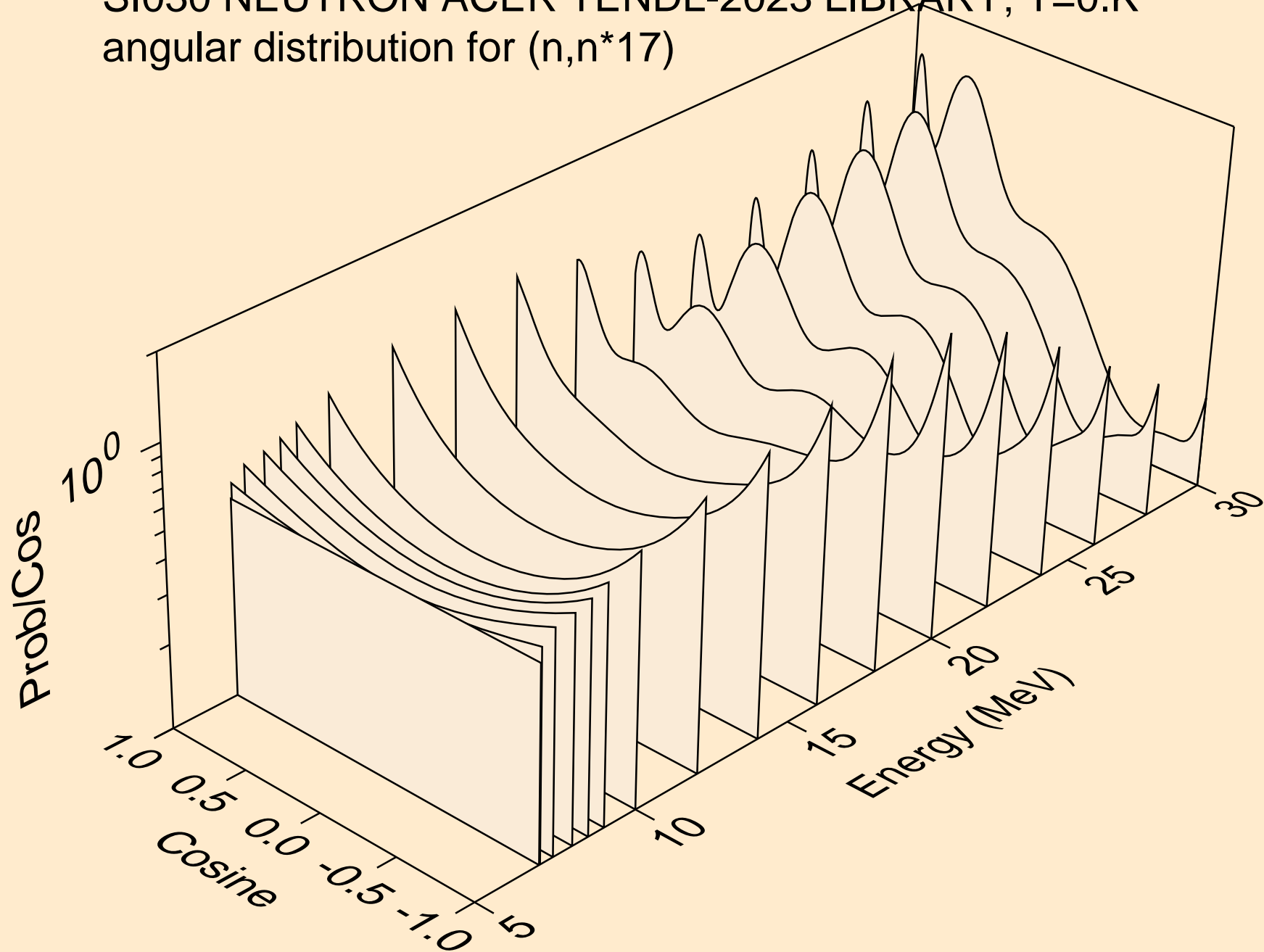

SI030 NEUTRON ACER TENDL-2023 LIBRARY; T=0.K  
angular distribution for (n,n\*18)

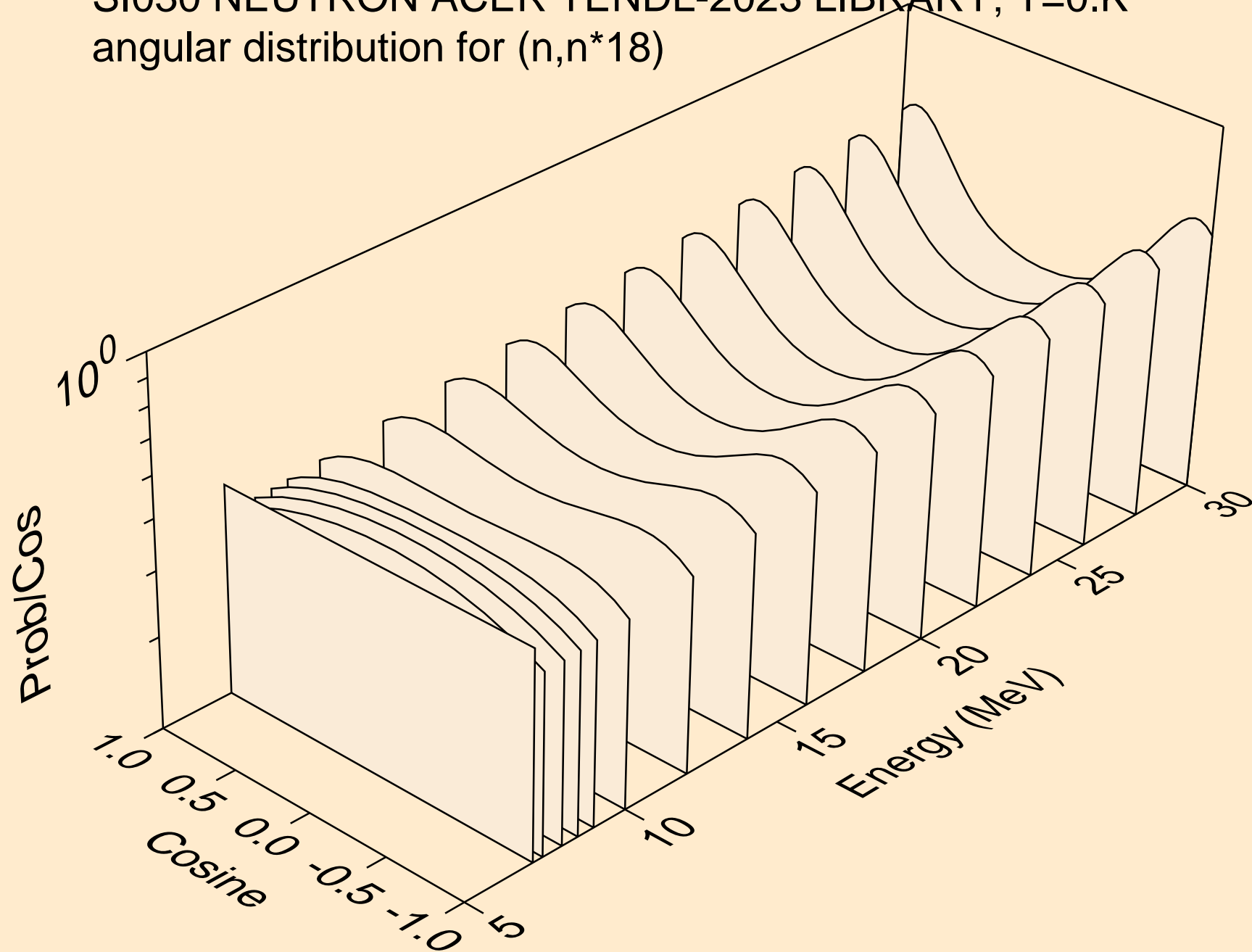

SI030 NEUTRON ACER TENDL-2023 LIBRARY; T=0.K  
angular distribution for (n,n\*19)

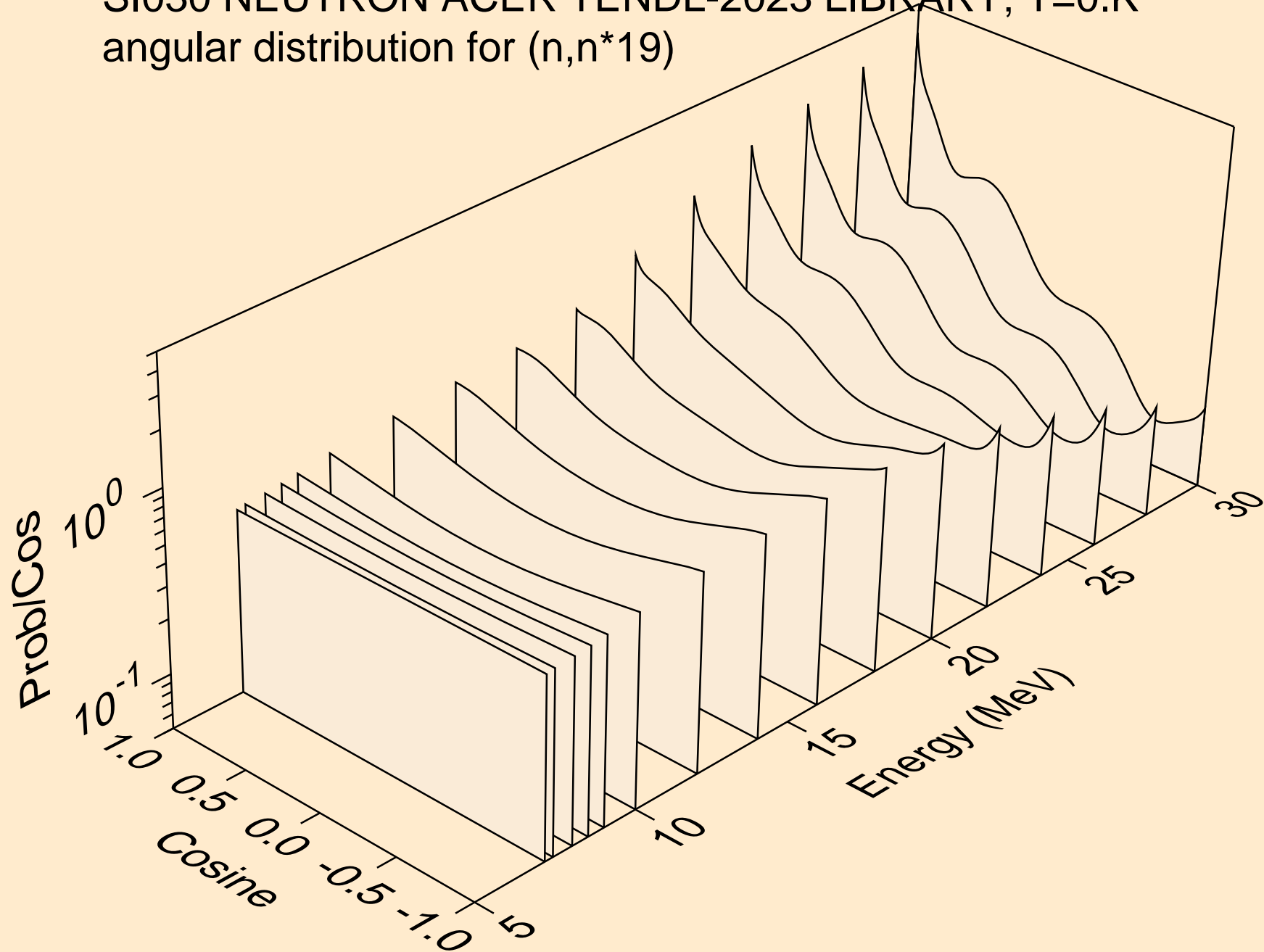

SI030 NEUTRON ACER TENDL-2023 LIBRARY; T=0.K  
Neutron emission for (n,x)

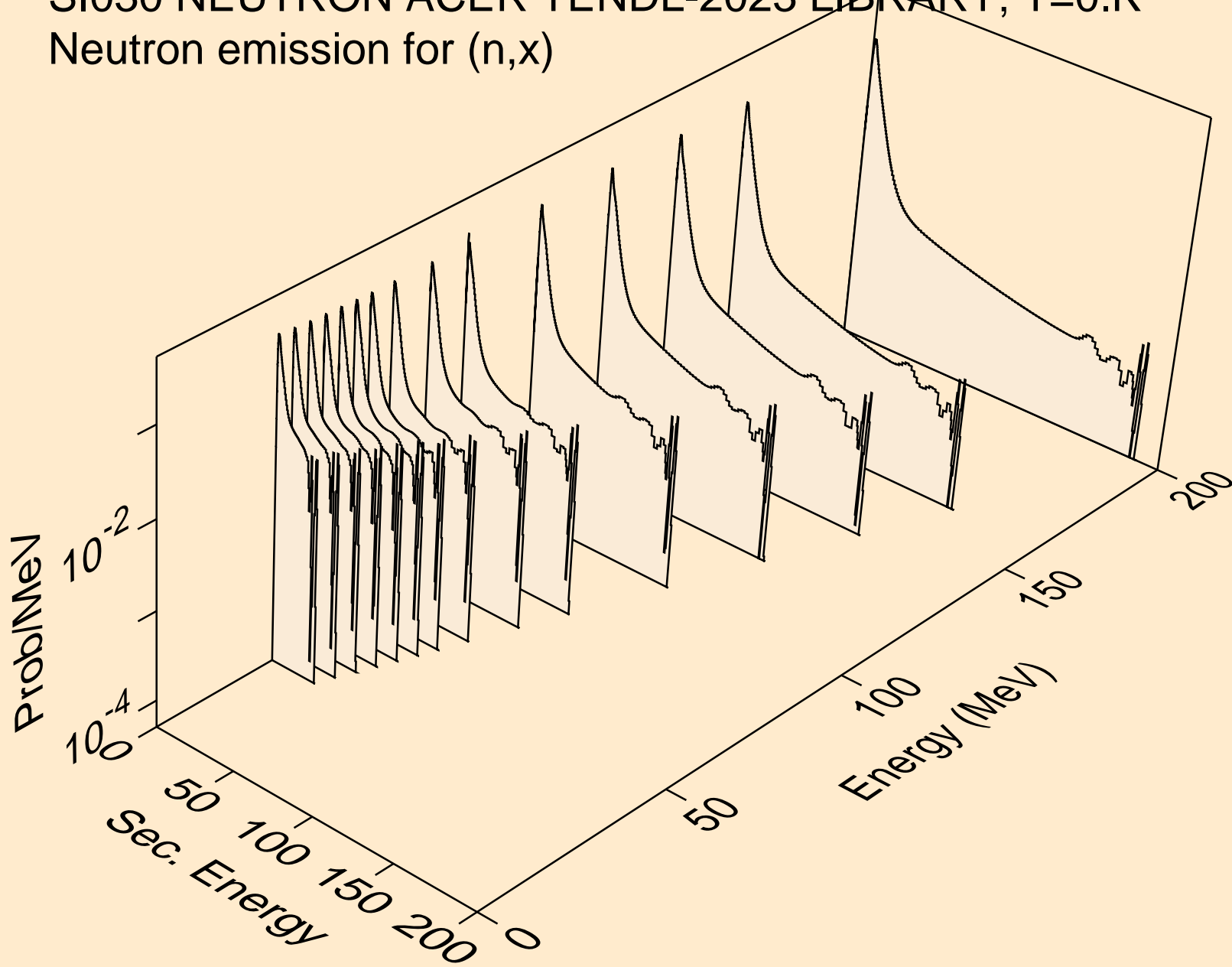

SI030 NEUTRON ACER TENDL-2023 LIBRARY; T=0.K  
Neutron emission for (n,2n)

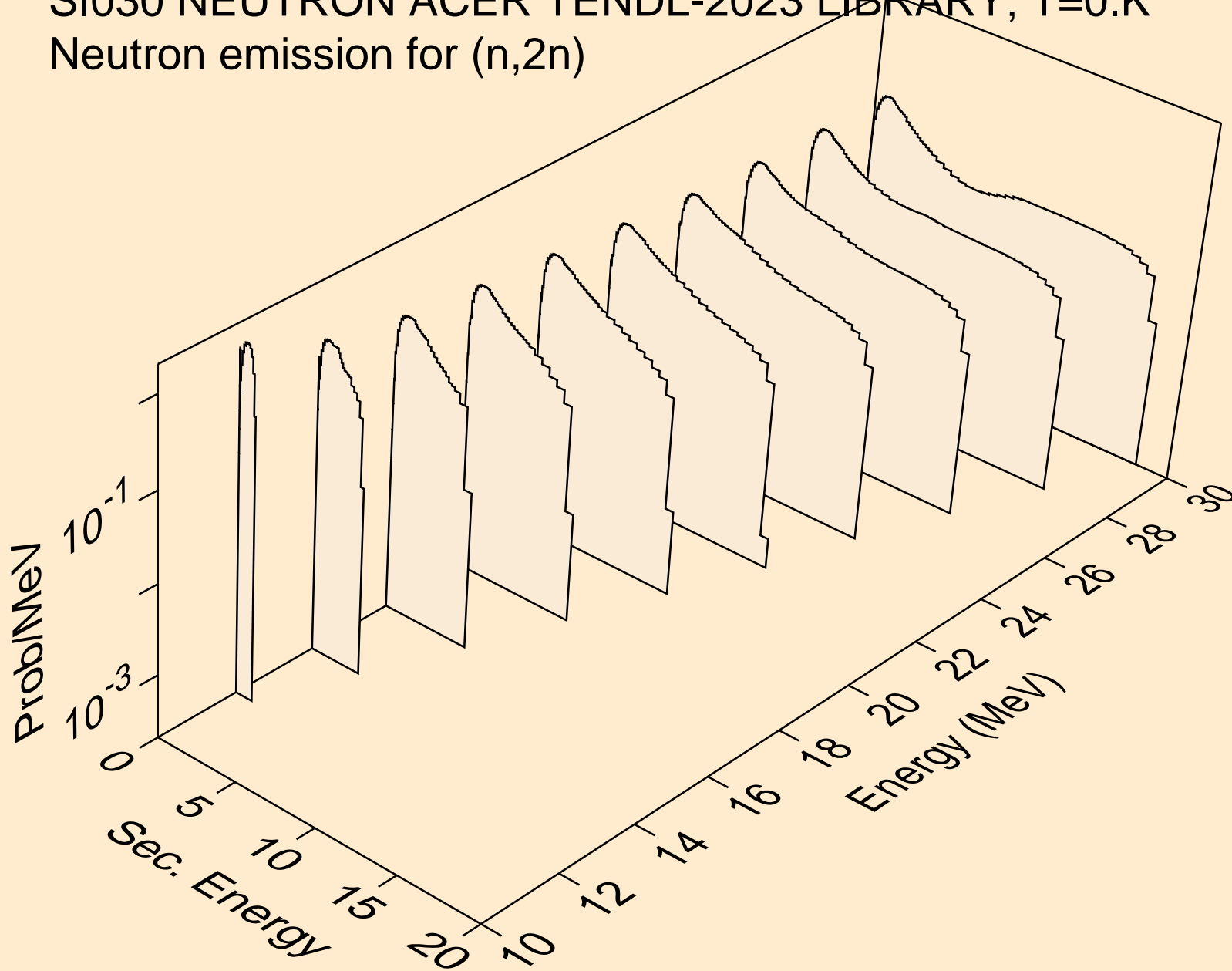

SI030 NEUTRON ACER TENDL-2023 LIBRARY; T=0.K  
Neutron emission for (n,3n)

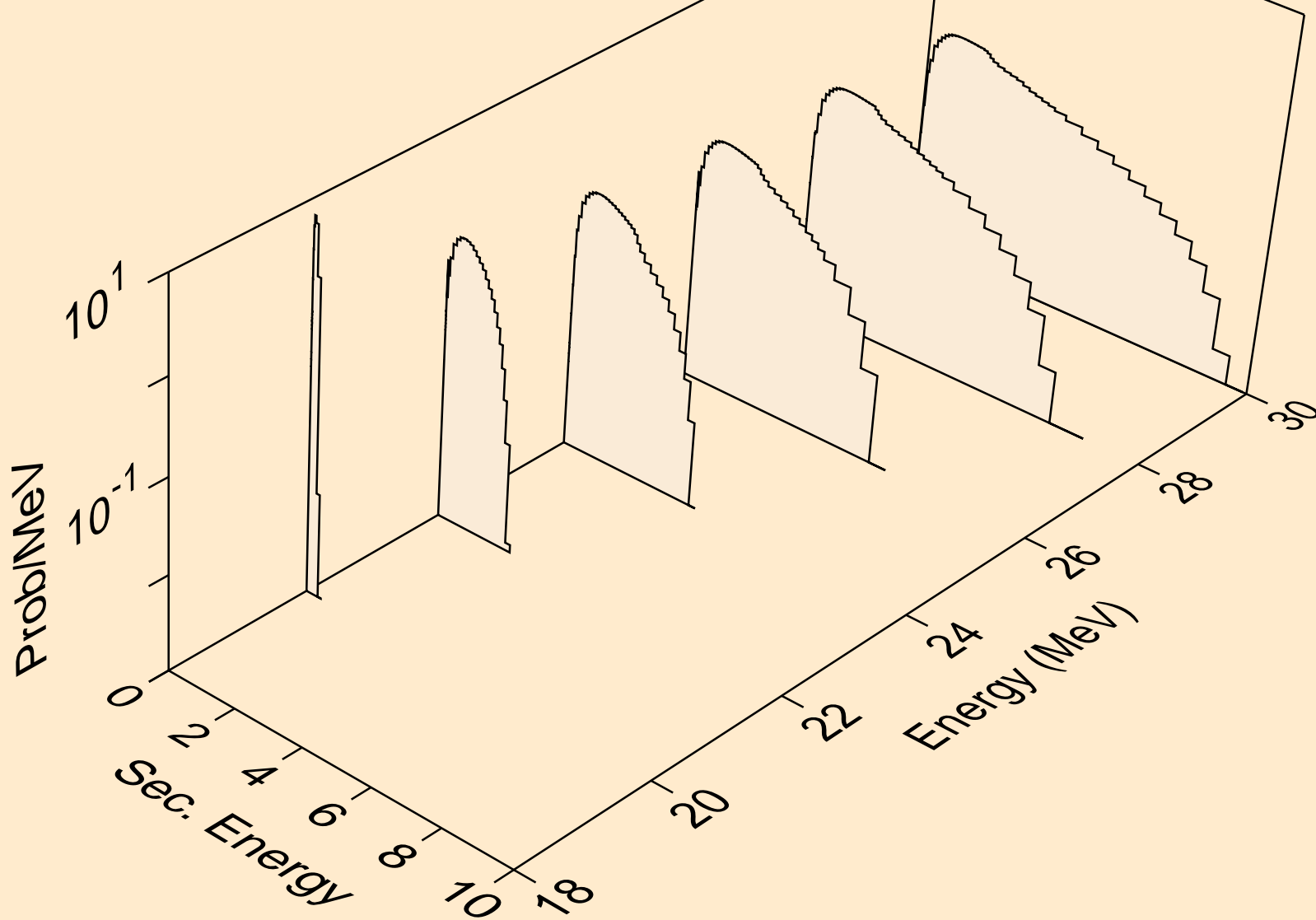



SI030 NEUTRON ACER TENDL-2023 LIBRARY; T=0.K  
Neutron emission for (n,n\*)a

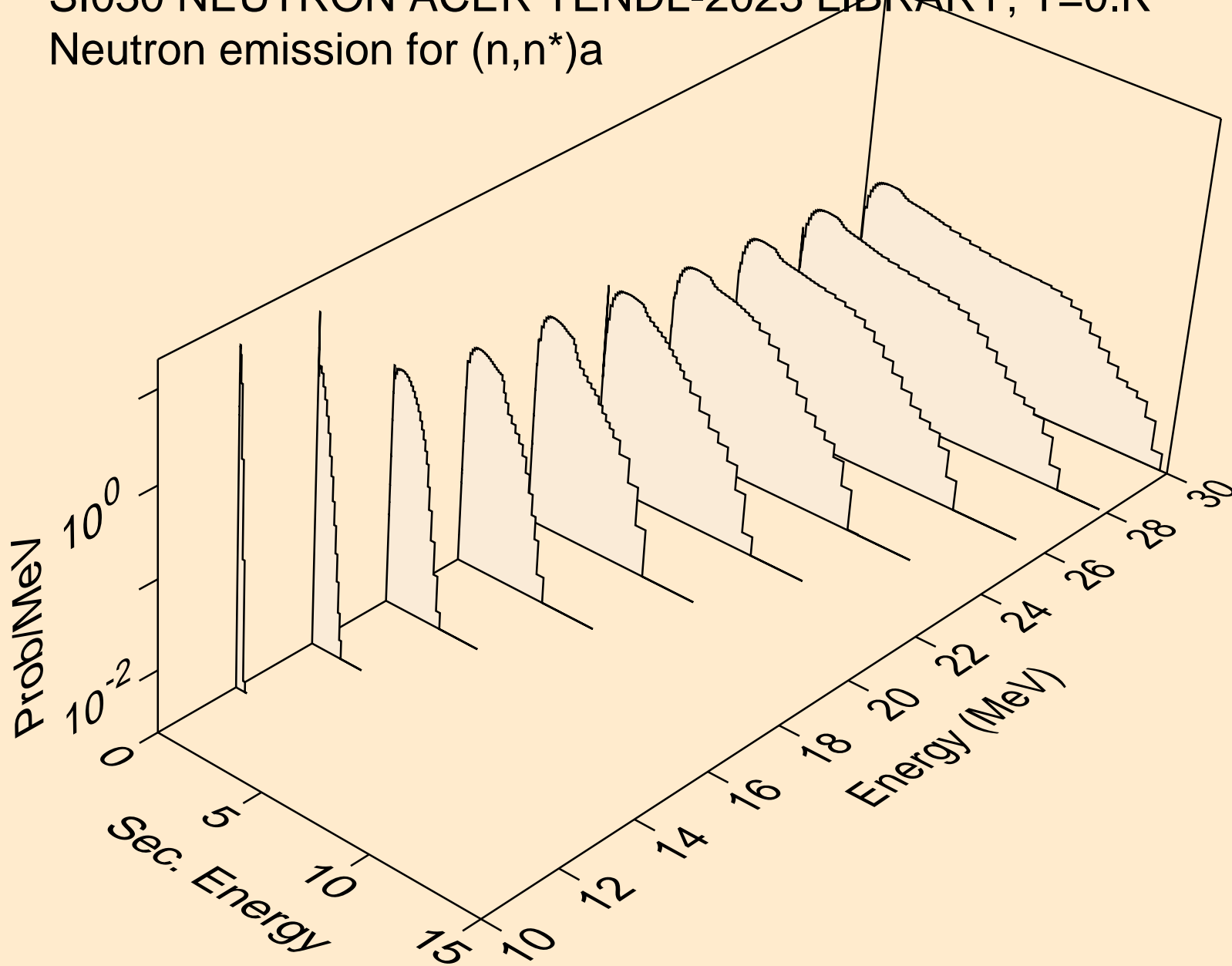

SI030 NEUTRON ACER TENDL-2023 LIBRARY; T=0.K  
Neutron emission for (n,2n)a

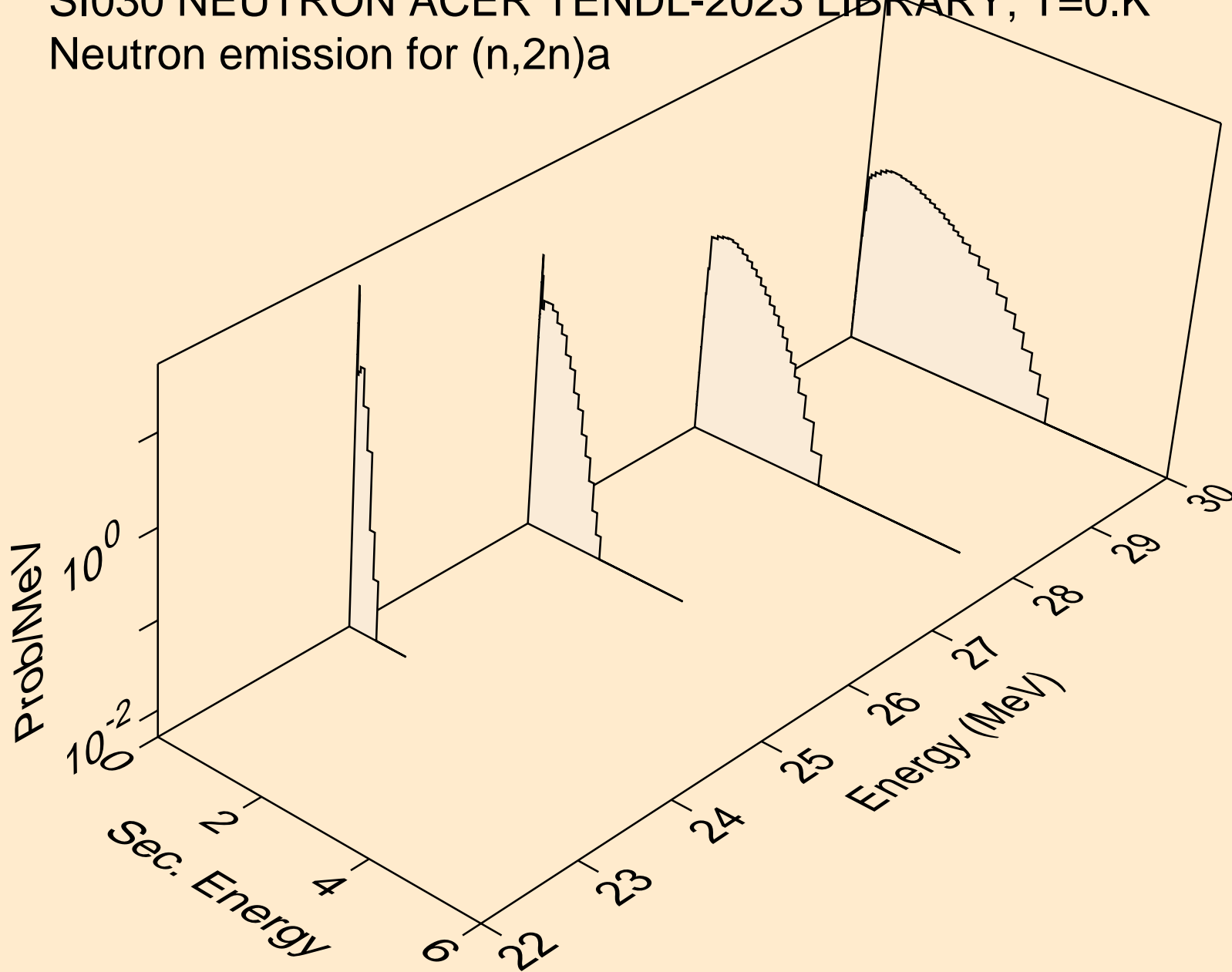

SI030 NEUTRON ACER TENDL-2023 LIBRARY; T=0.K  
Neutron emission for (n,n\*)p

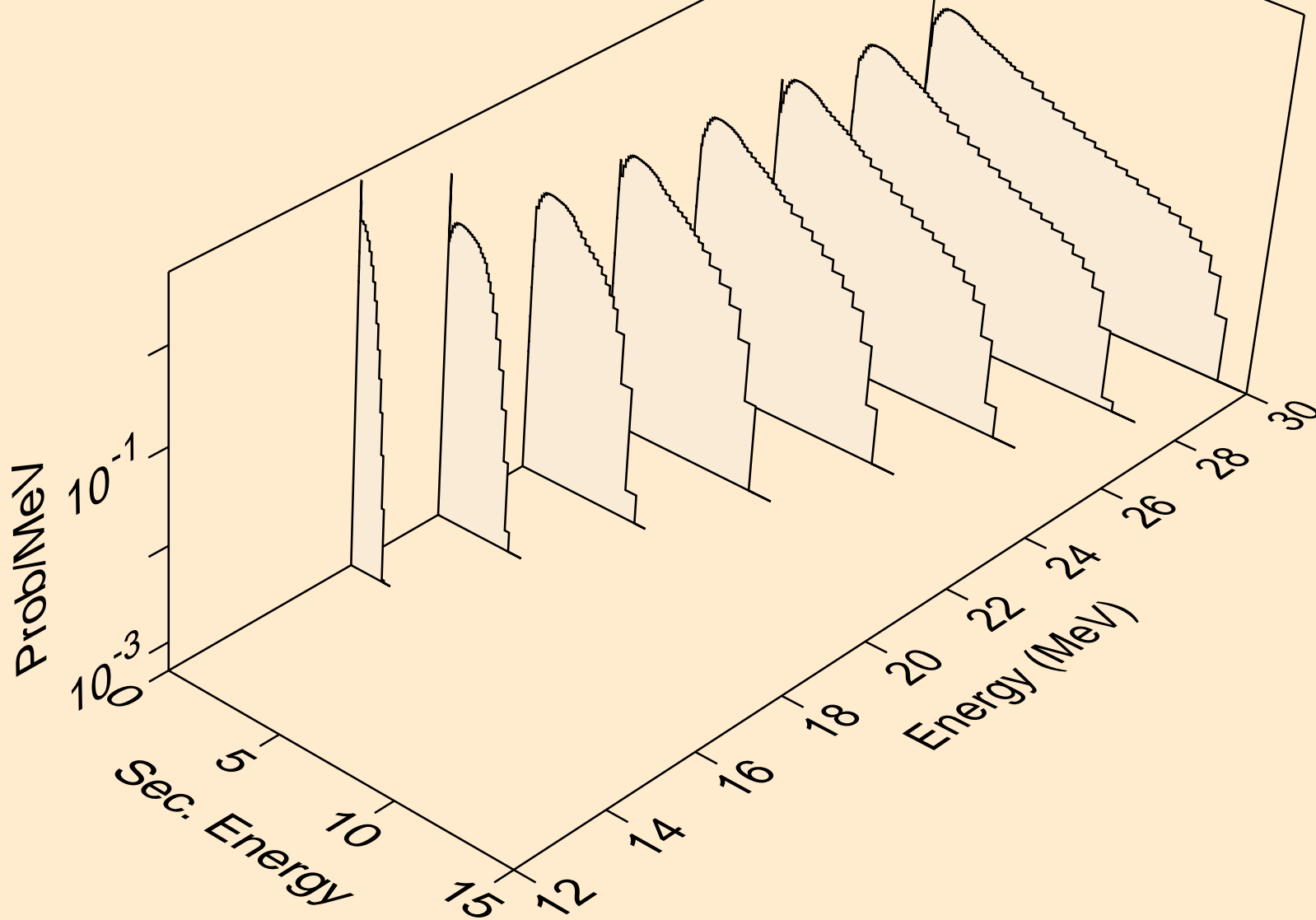

SI030 NEUTRON ACER TENDL-2023 LIBRARY; T=0.K  
Neutron emission for (n,n\*)2a

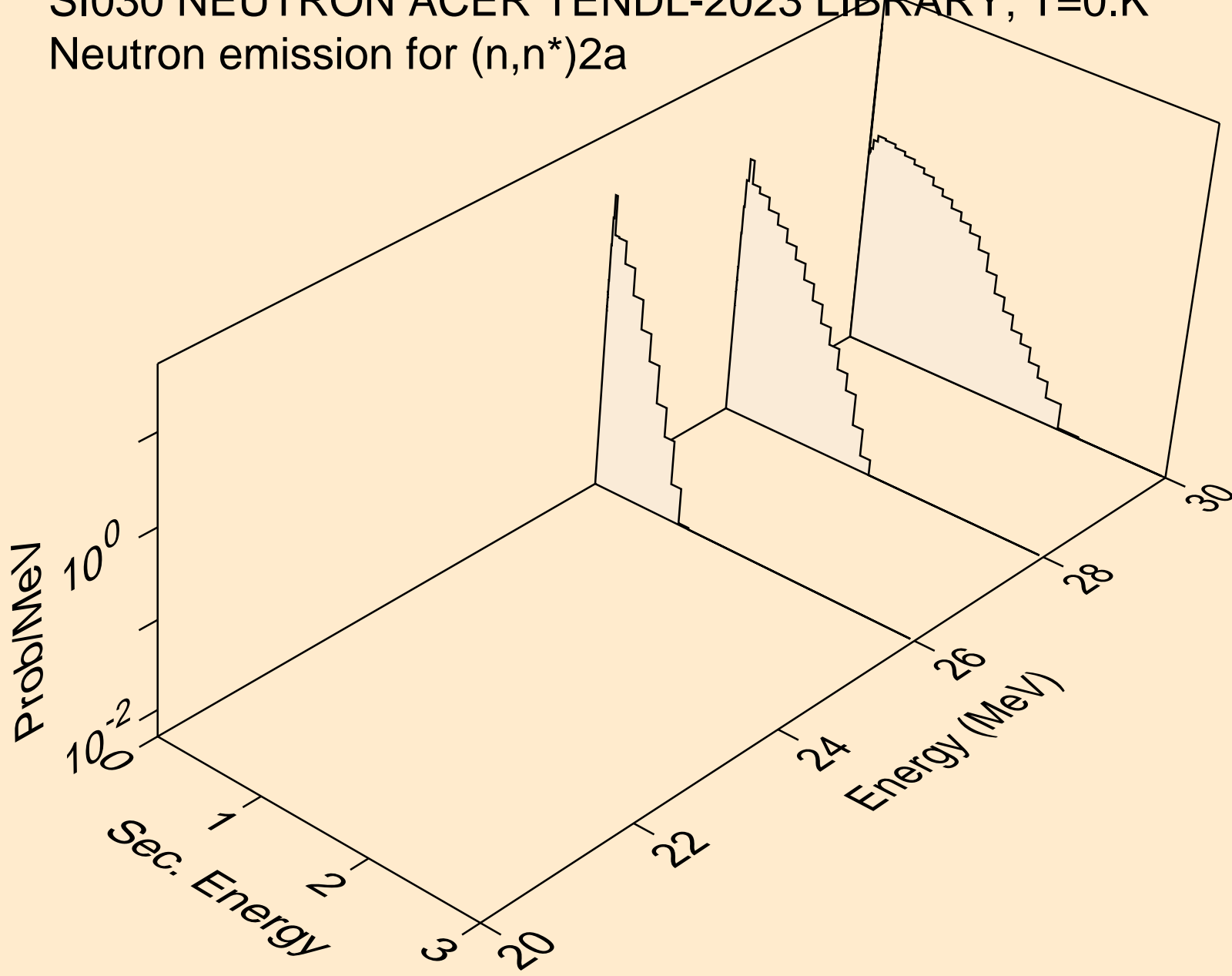

SI030 NEUTRON ACER TENDL-2023 LIBRARY; T=0.K  
Neutron emission for (n,n\*)d

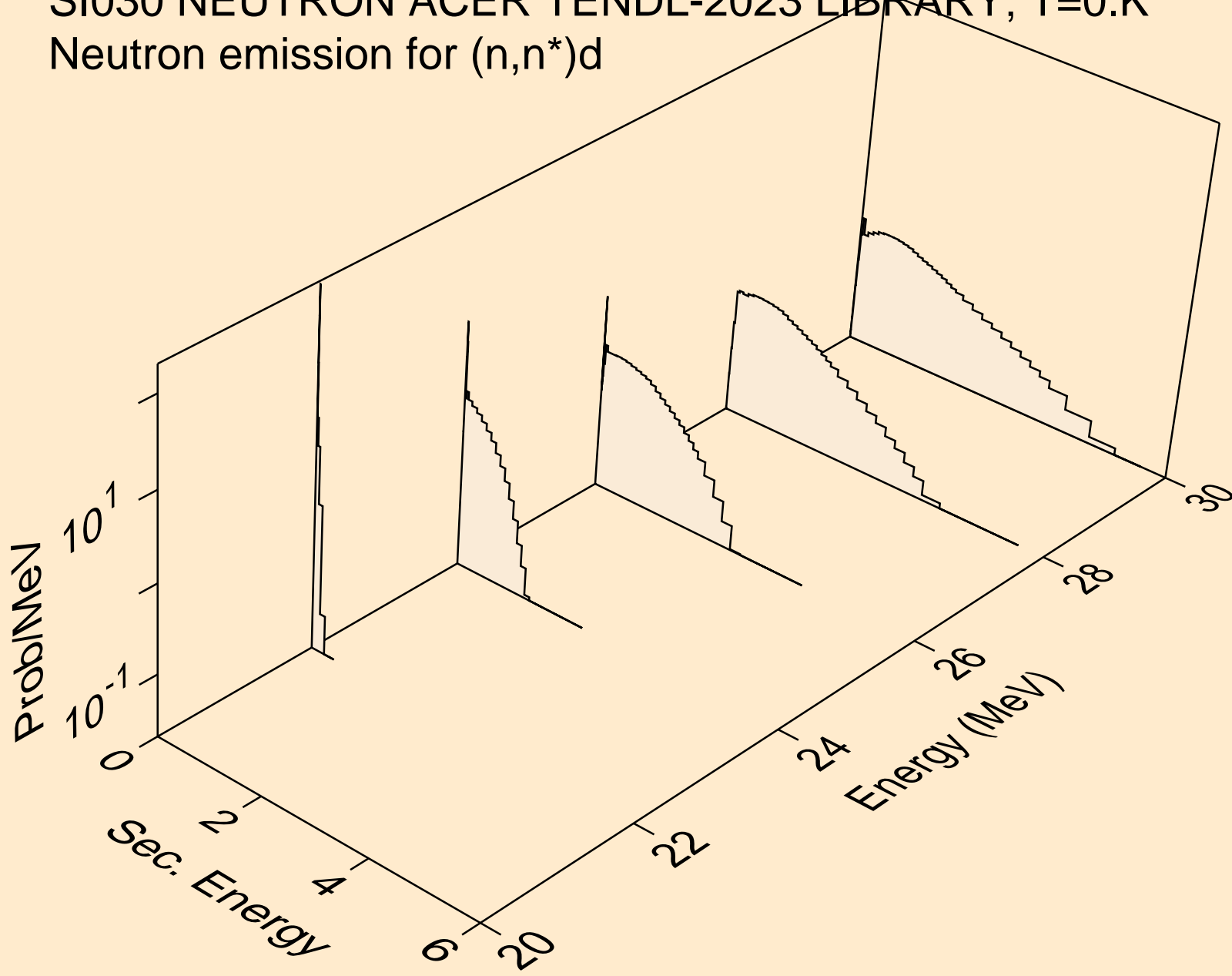

SI030 NEUTRON ACER TENDL-2023 LIBRARY; T=0.K  
Neutron emission for (n,n\*)t

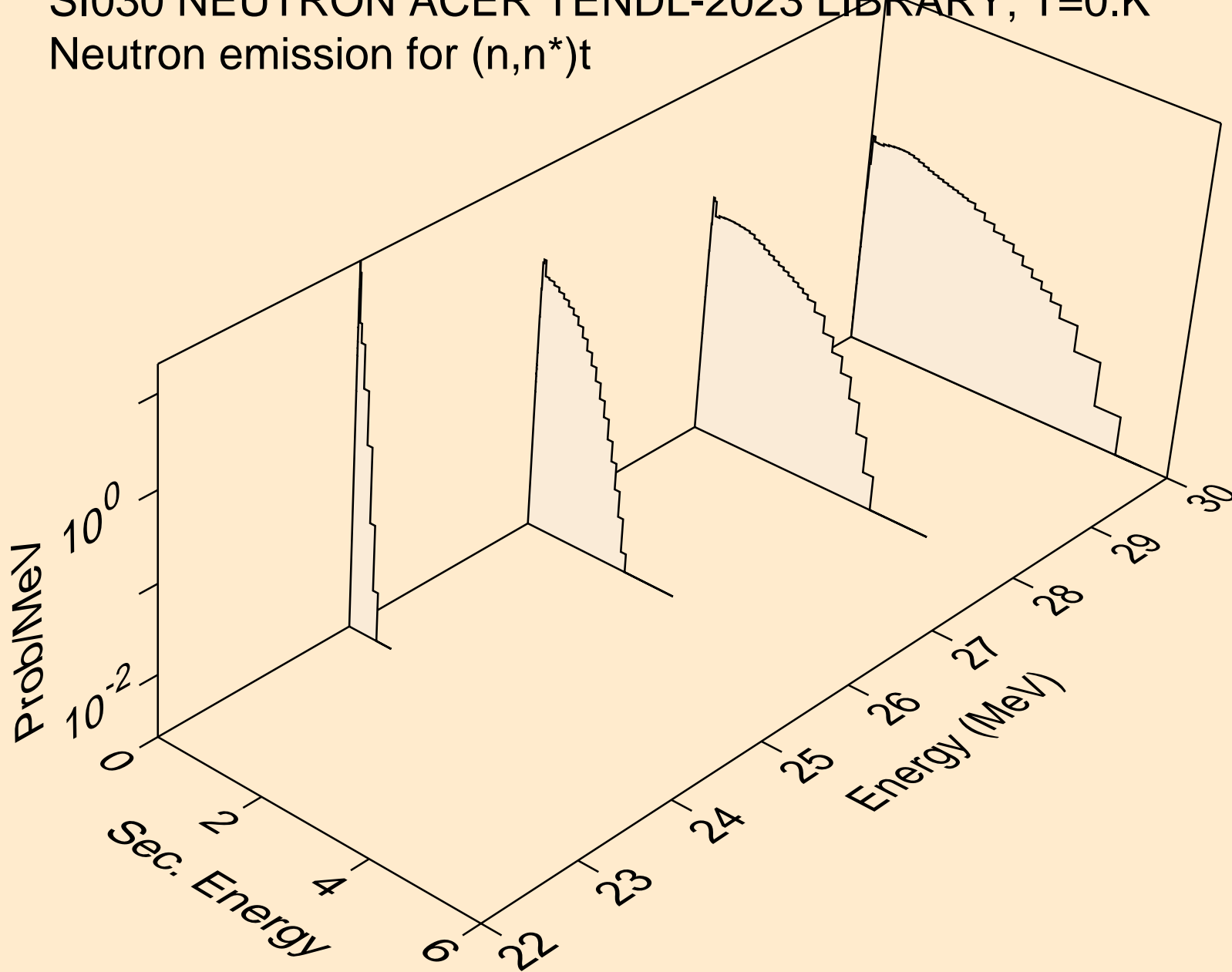

SI030 NEUTRON ACER TENDL-2023 LIBRARY; T=0.K  
Neutron emission for (n,n\*)he3

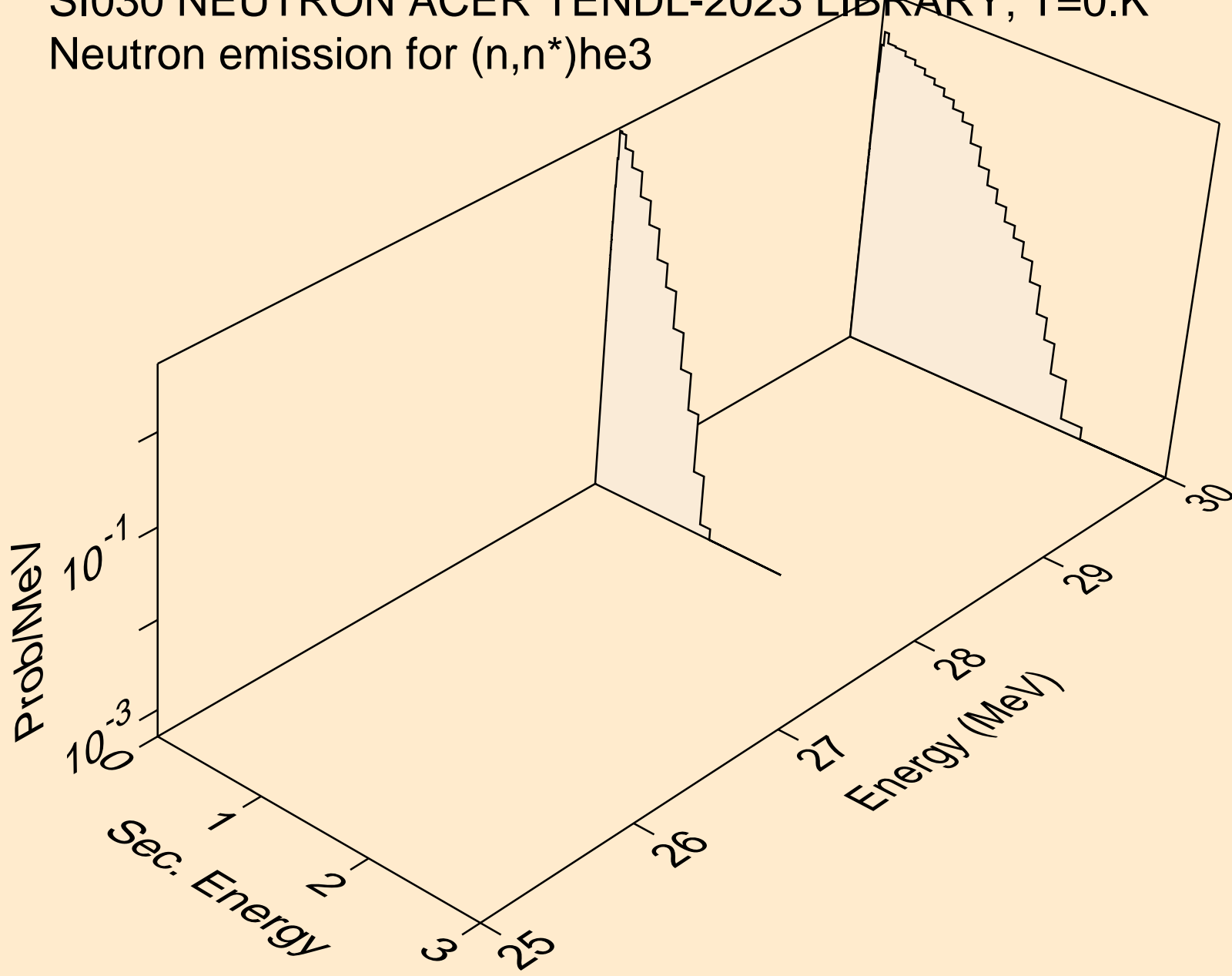

SI030 NEUTRON ACER TENDL-2023 LIBRARY; T=0.K  
Neutron emission for (n,2np)

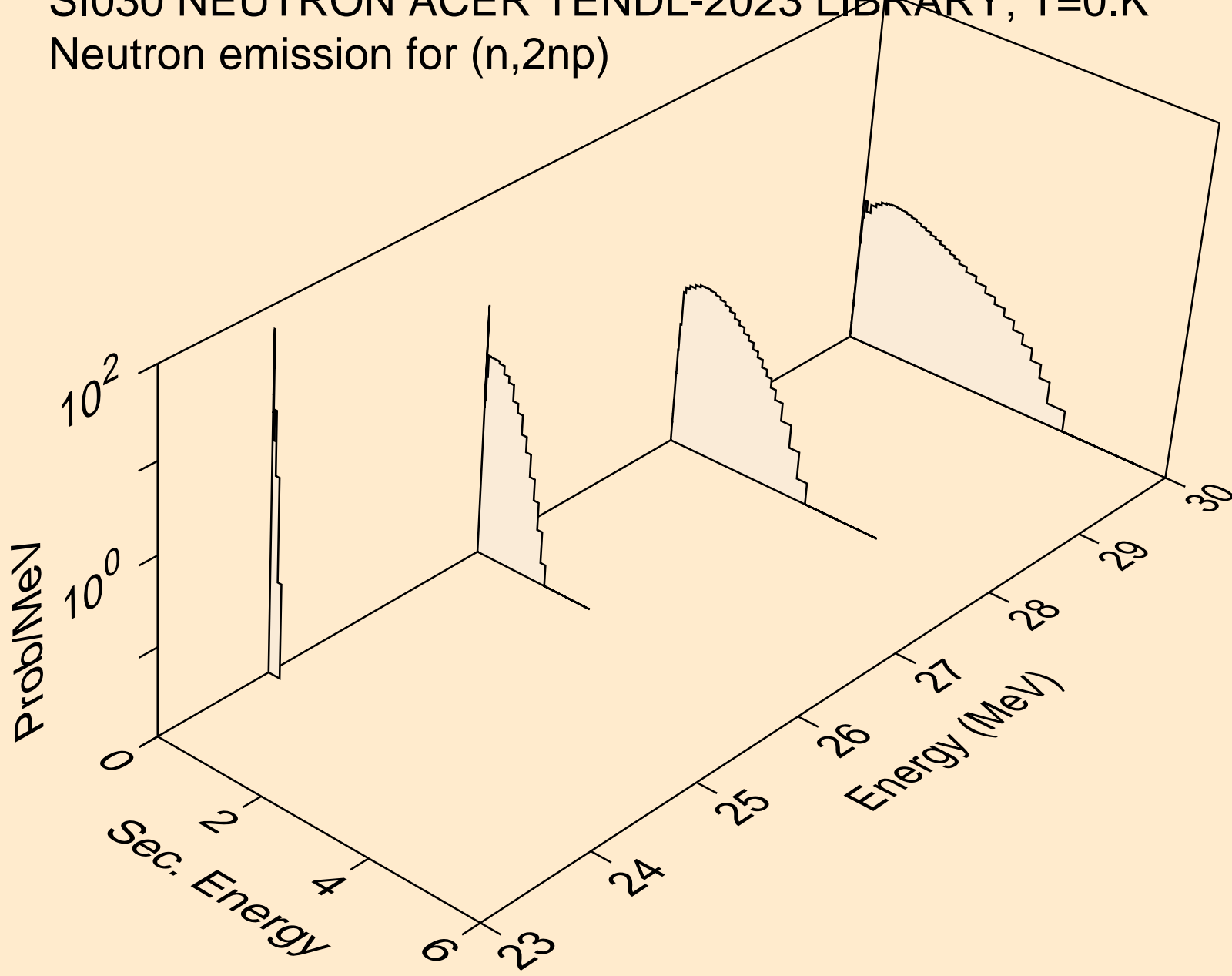



SI030 NEUTRON ACER TENDL-2023 LIBRARY; T=0.K  
Neutron emission for (n,n2p)

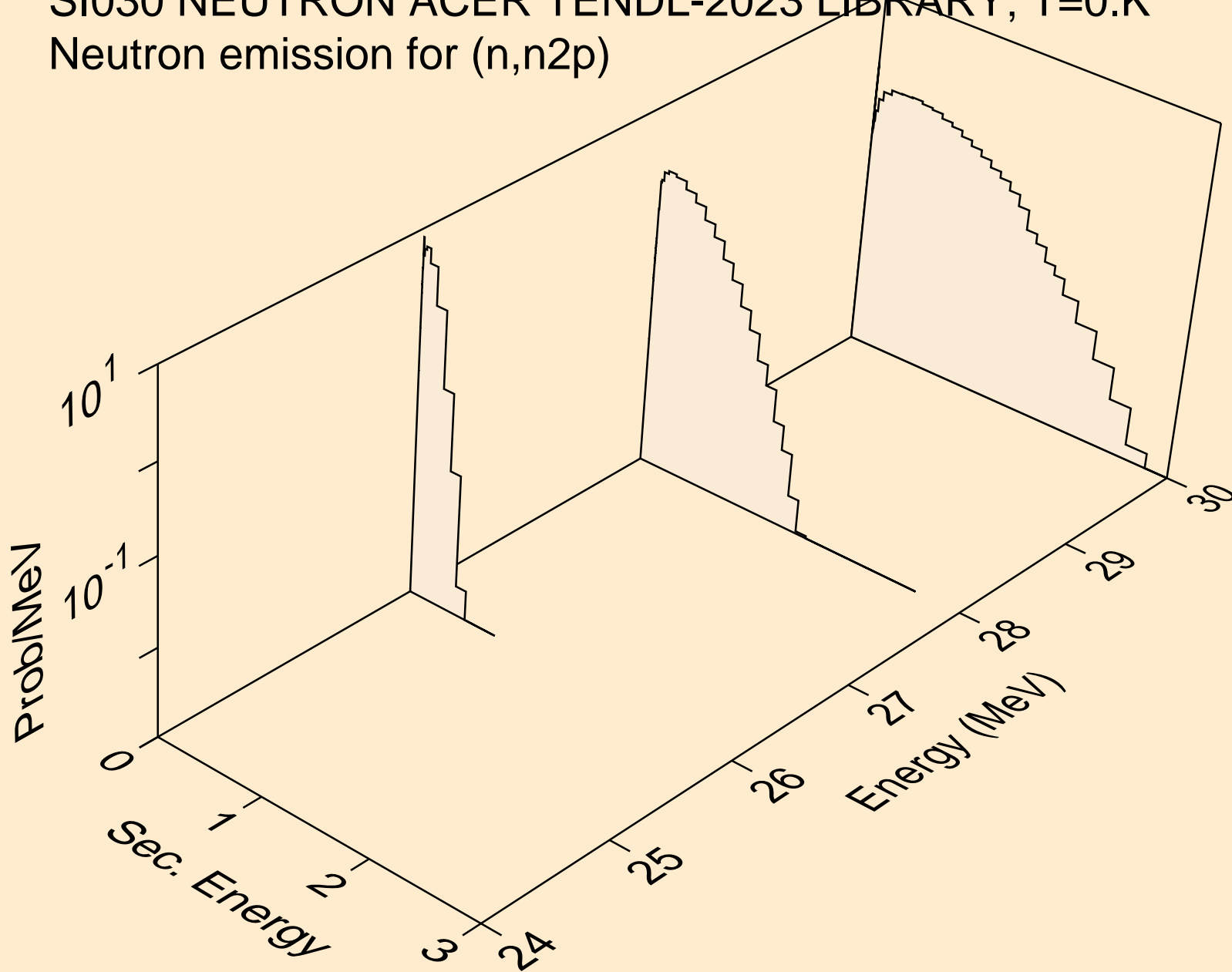

SI030 NEUTRON ACER TENDL-2023 LIBRARY; T=0.K  
Neutron emission for (n,npa)

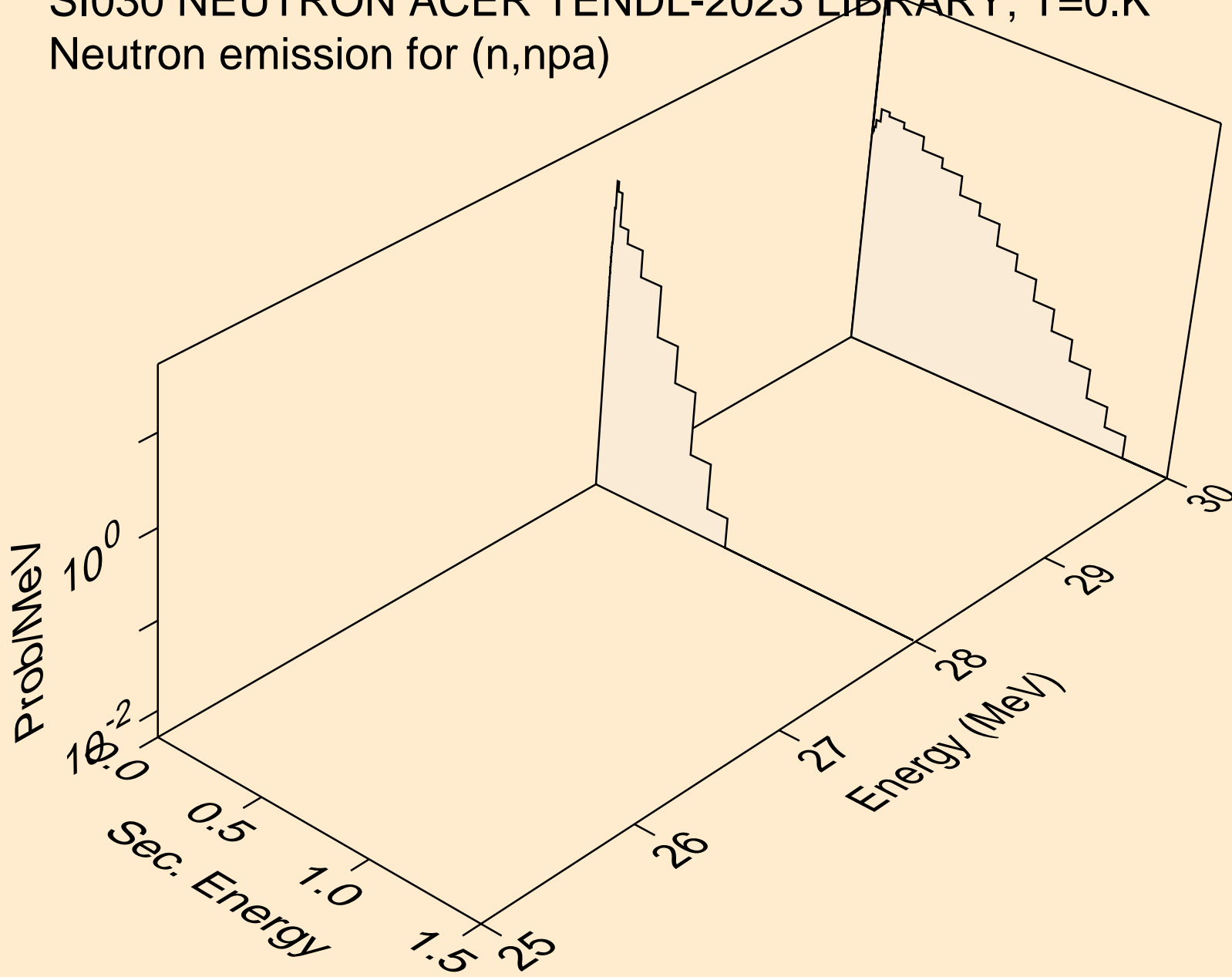

SI030 NEUTRON ACER TENDL-2023 LIBRARY; T=0.K  
Neutron emission for (n,n\*c)

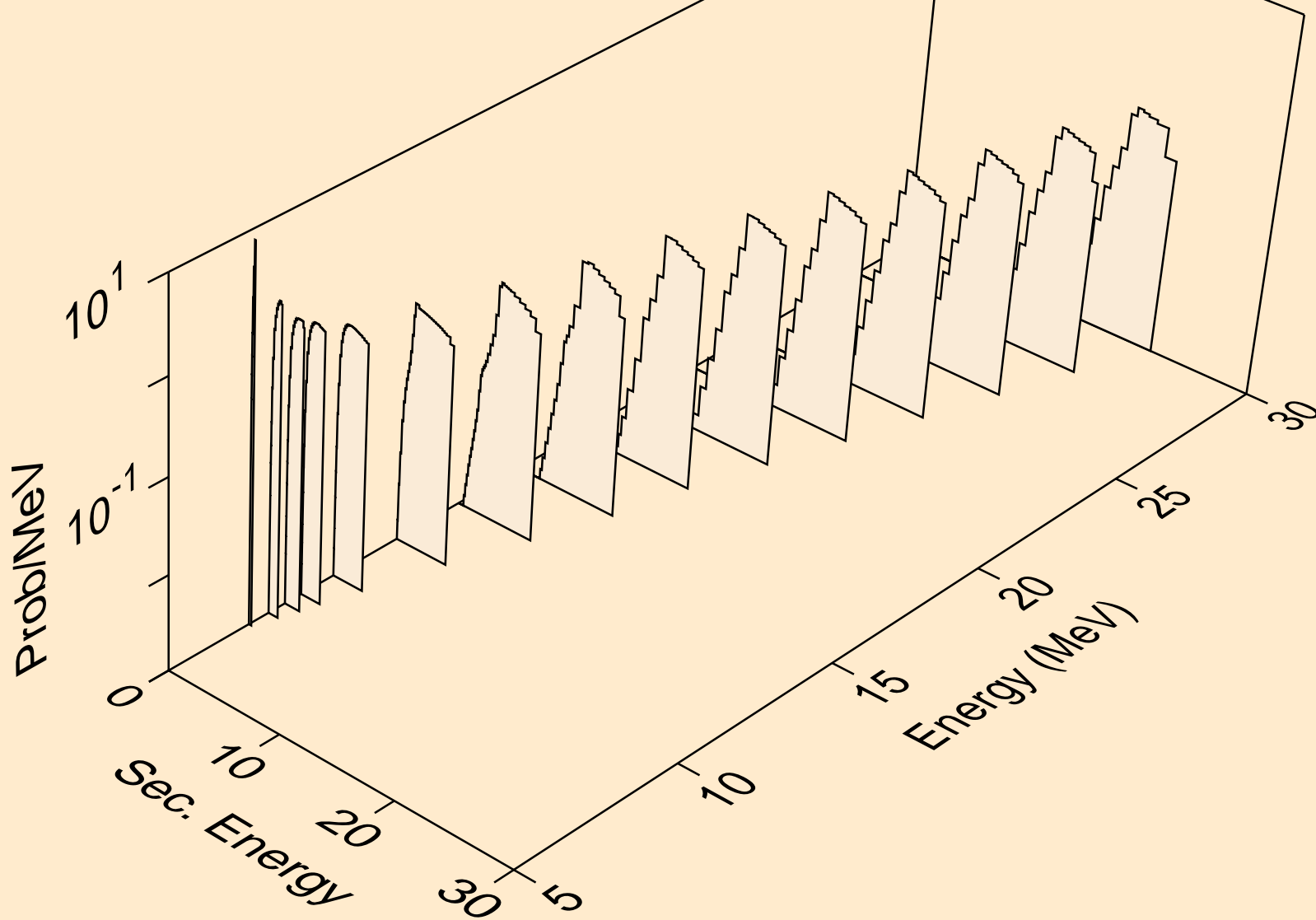

SI030 NEUTRON ACER TENDL-2023 LIBRARY; T=0.K  
Photon emission for (n,x)

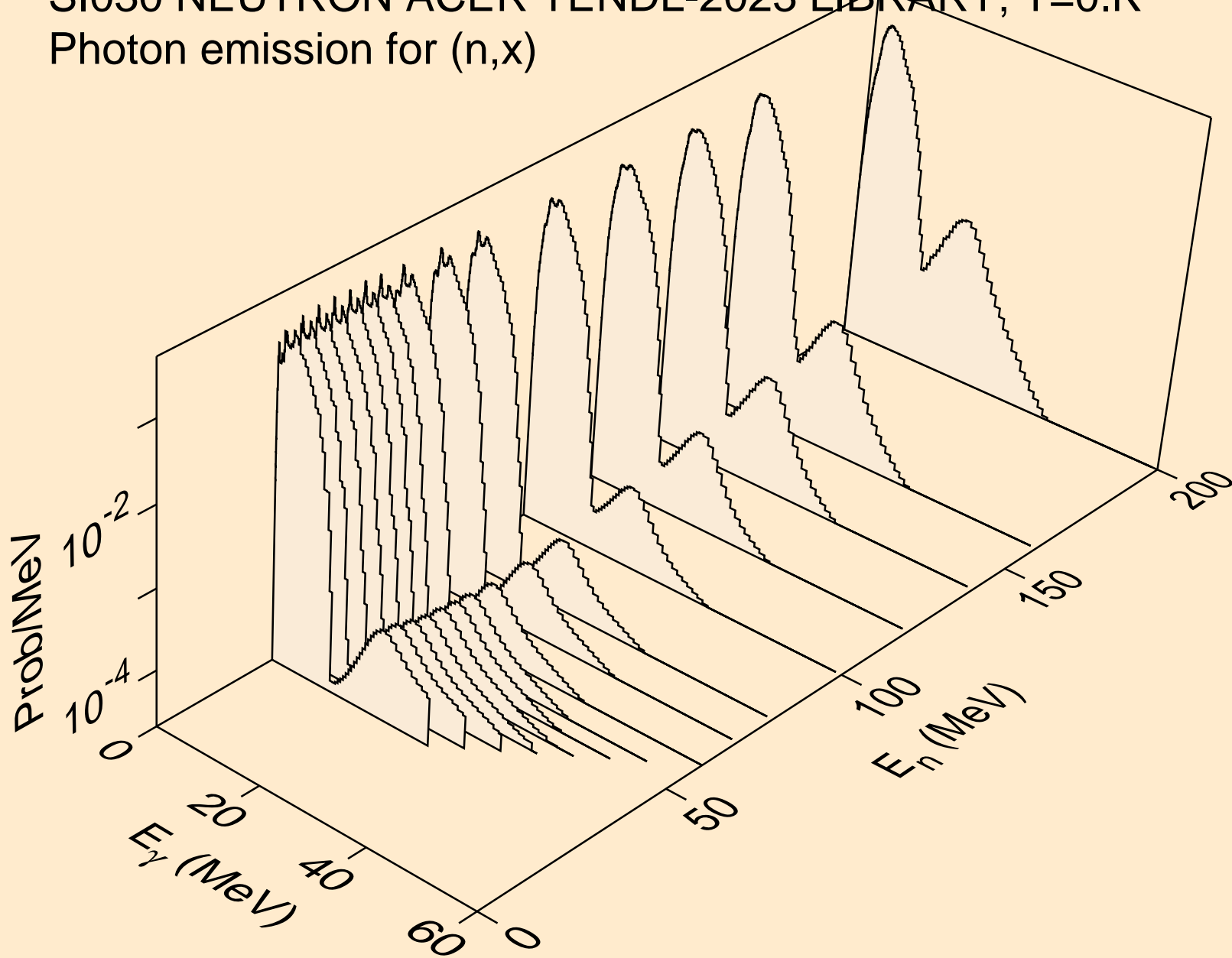

SI030 NEUTRON ACER TENDL-2023 LIBRARY; T=0.K  
Photon emission for (n,2n)

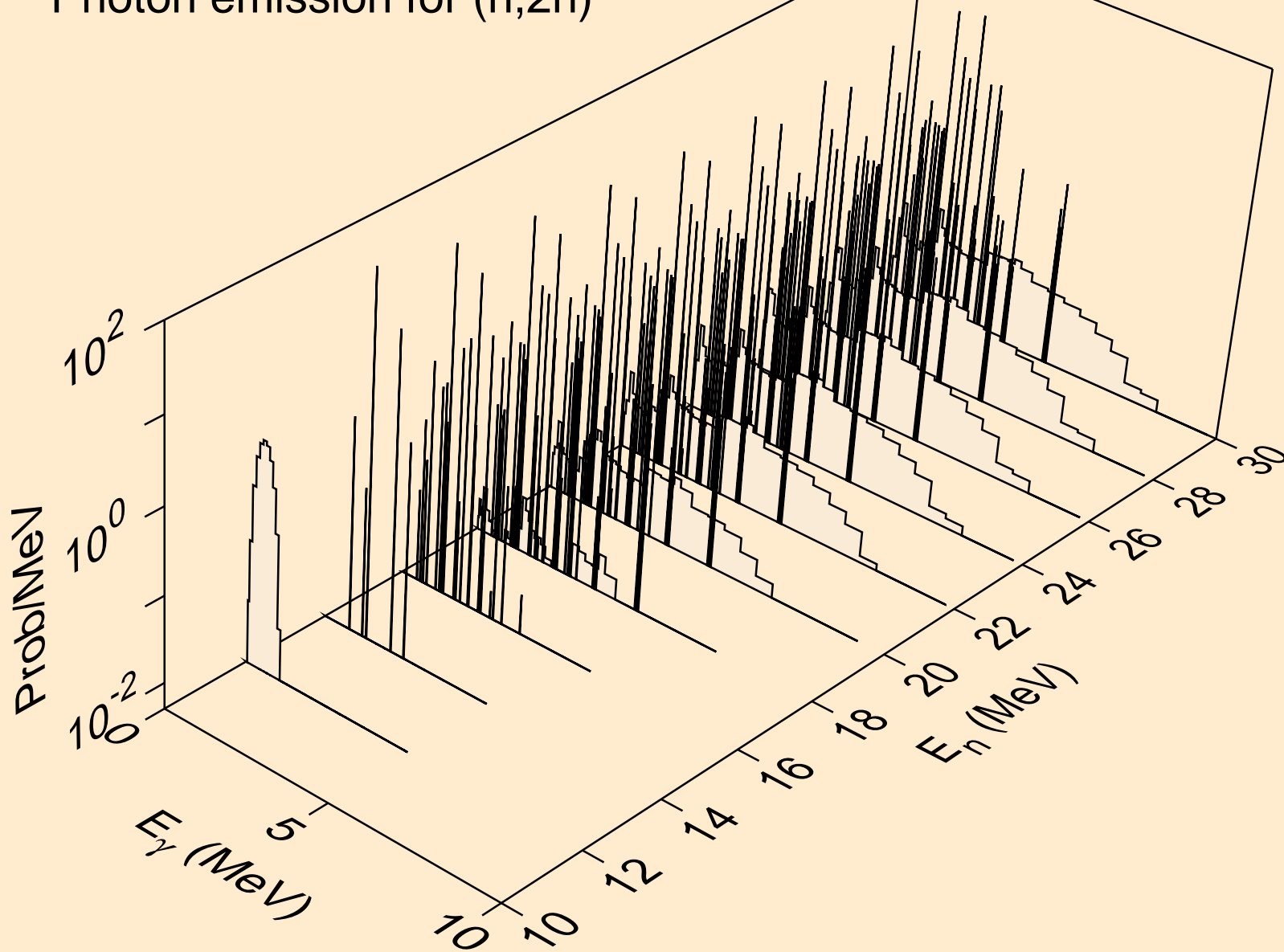

SI030 NEUTRON ACER TENDL-2023 LIBRARY; T=0.K  
Photon emission for (n,3n)

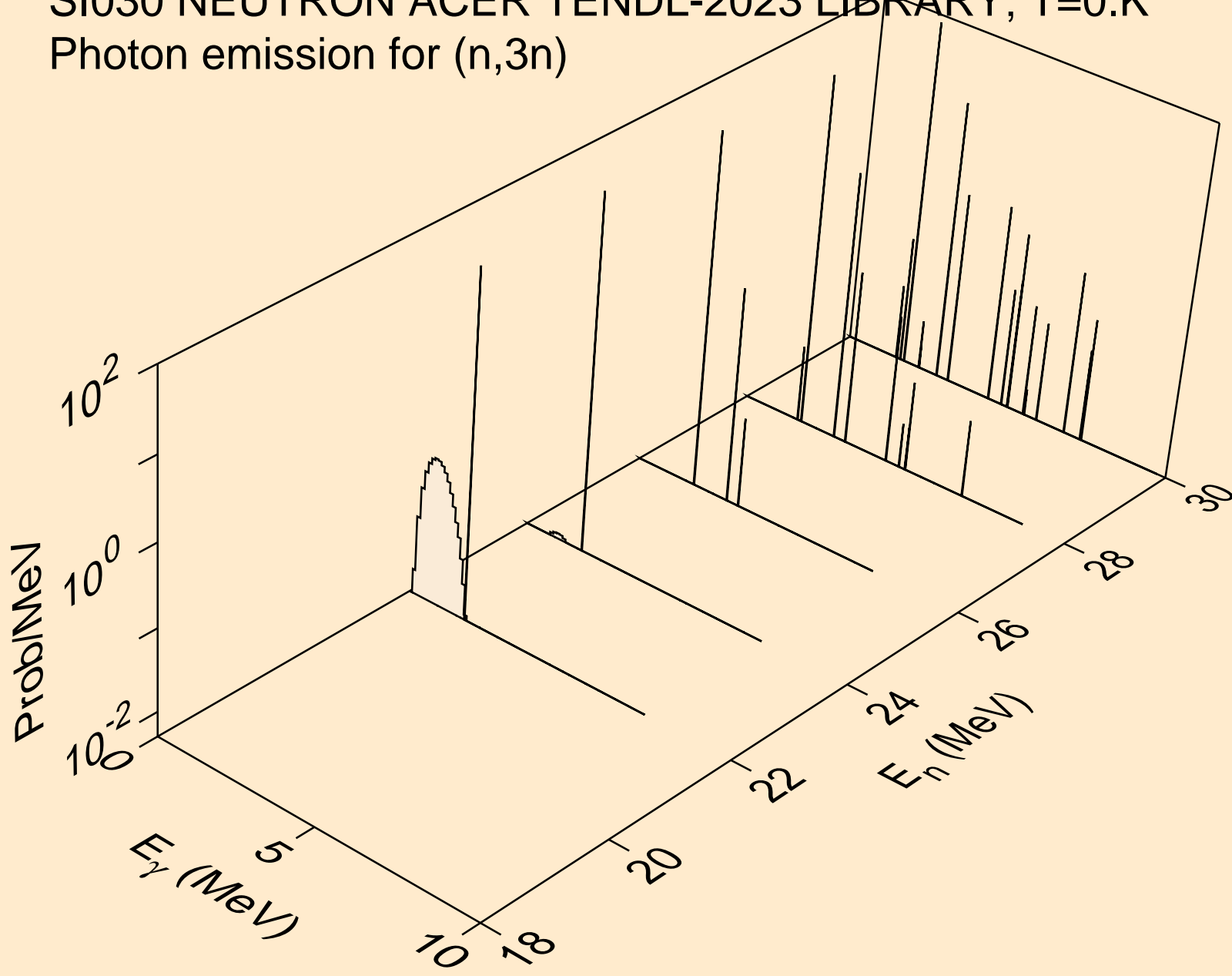

SI030 NEUTRON ACER TENDL-2023 LIBRARY; T=0.K  
Photon emission for (n,n\*)a

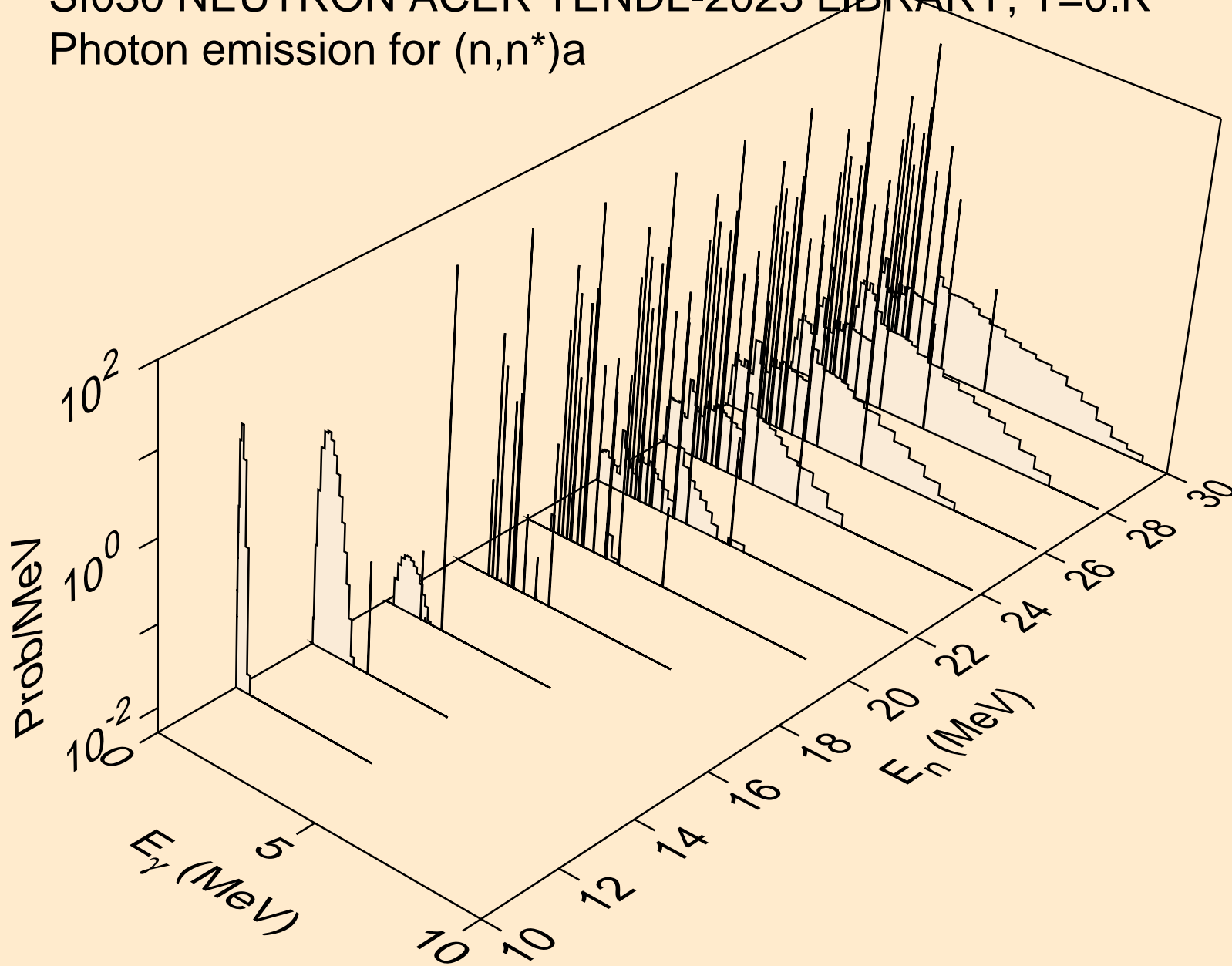

SI030 NEUTRON ACER TENDL-2023 LIBRARY; T=0.K  
Photon emission for (n,2n)a

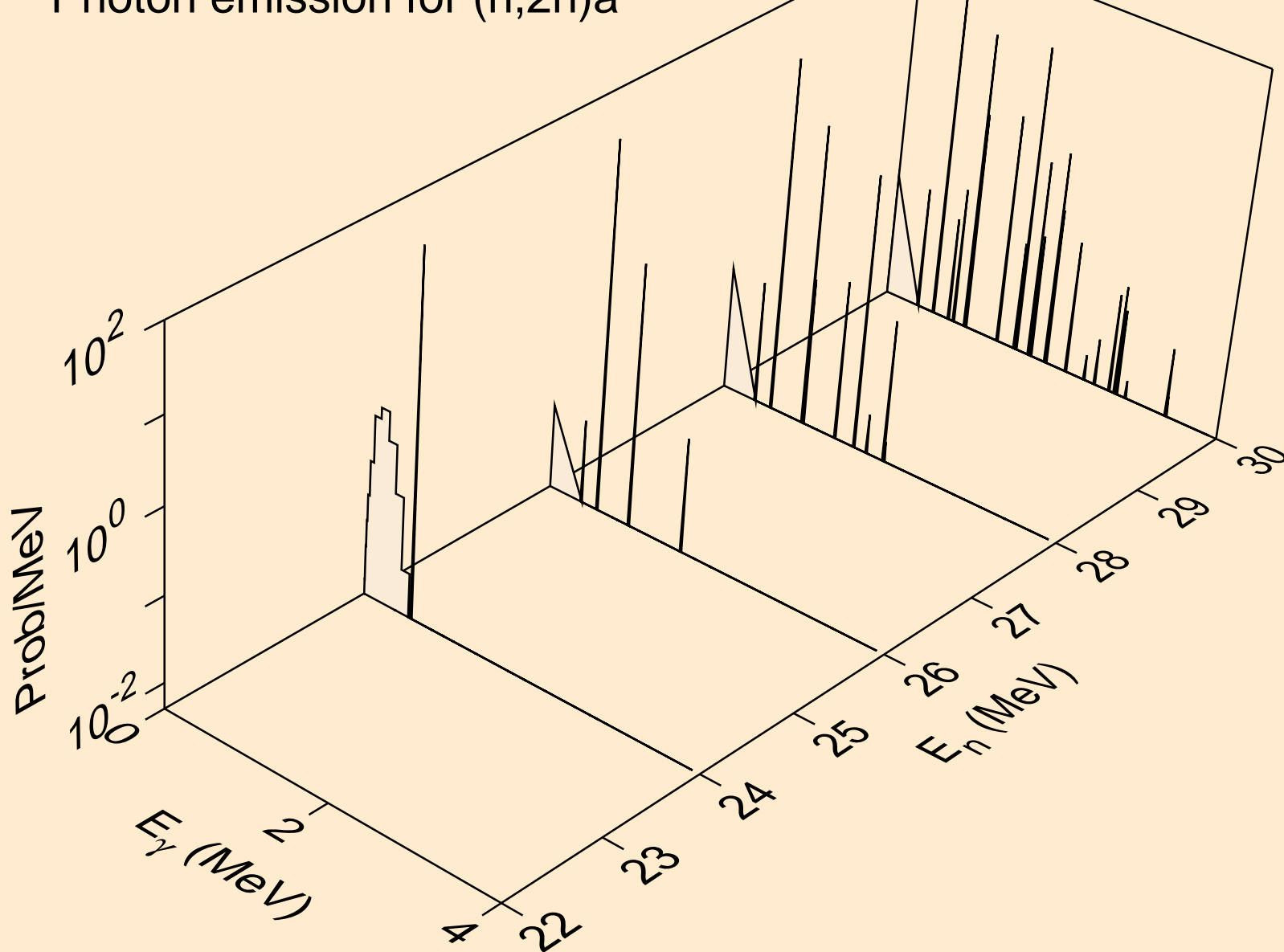



SI030 NEUTRON ACER TENDL-2023 LIBRARY; T=0.K  
Photon emission for (n,n\*)p

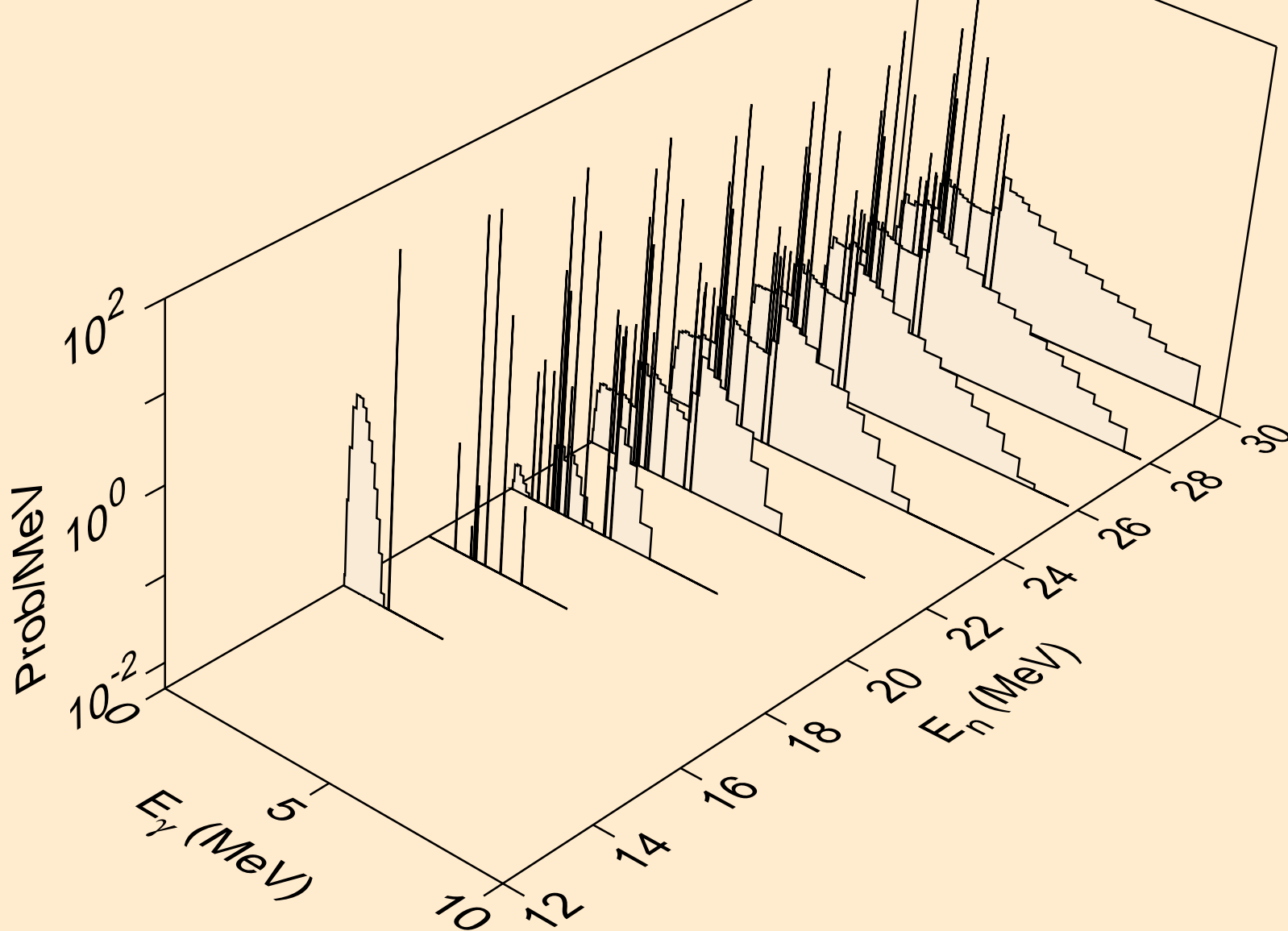

SI030 NEUTRON ACER TENDL-2023 LIBRARY; T=0.K  
Photon emission for (n,n\*)2a

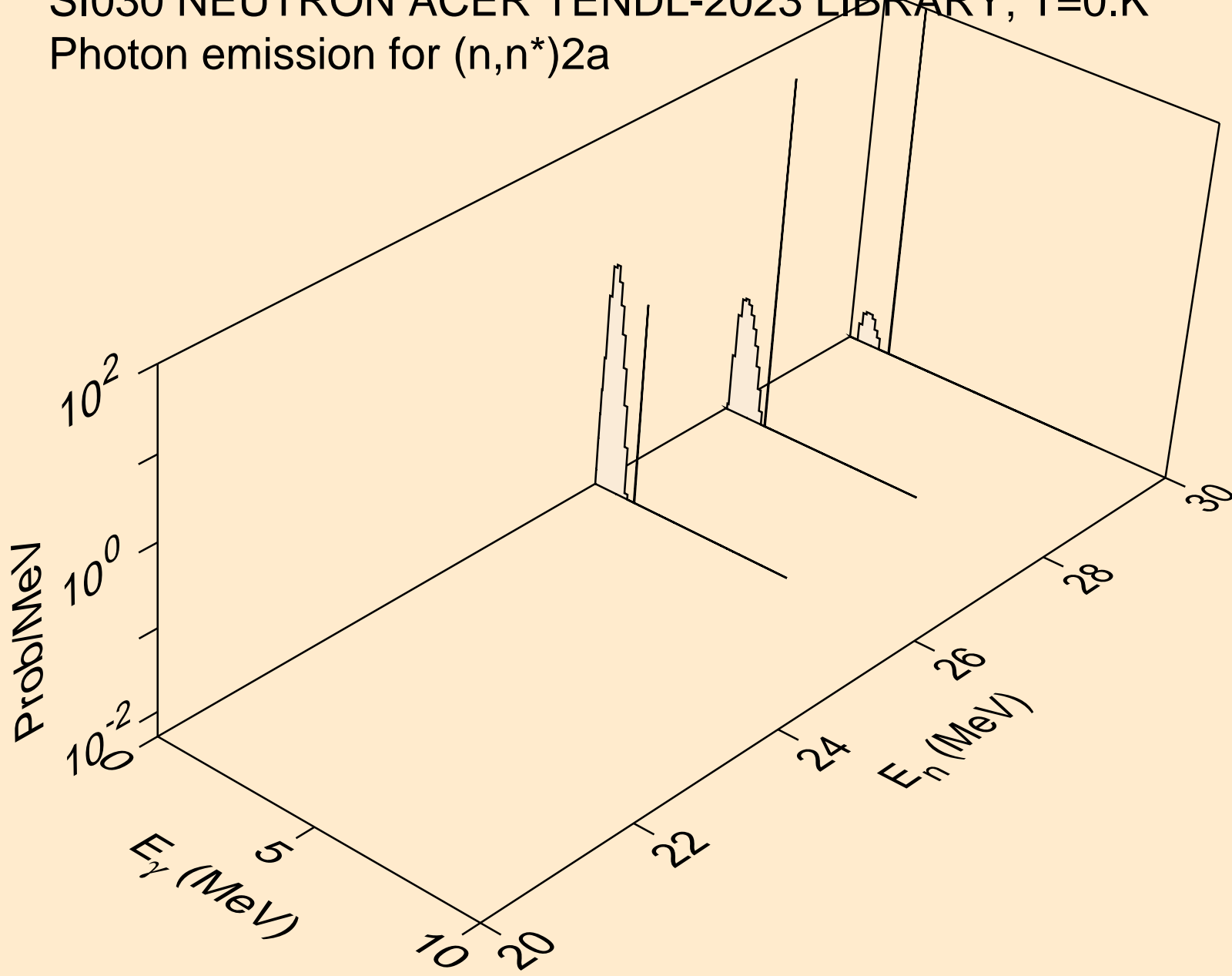

SI030 NEUTRON ACER TENDL-2023 LIBRARY; T=0.K  
Photon emission for (n,n\*)d

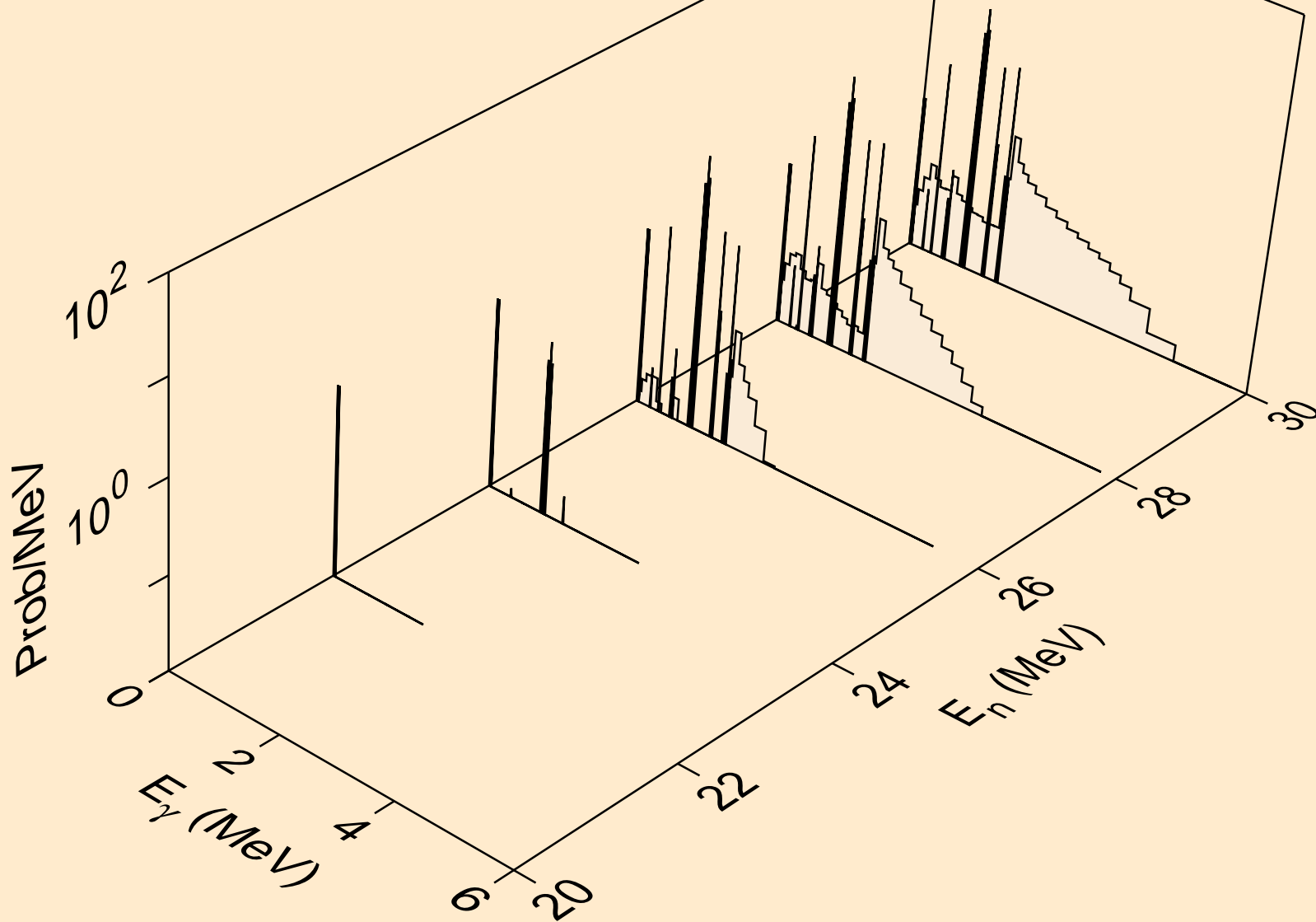

SI030 NEUTRON ACER TENDL-2023 LIBRARY; T=0.K  
Photon emission for (n,n\*)t

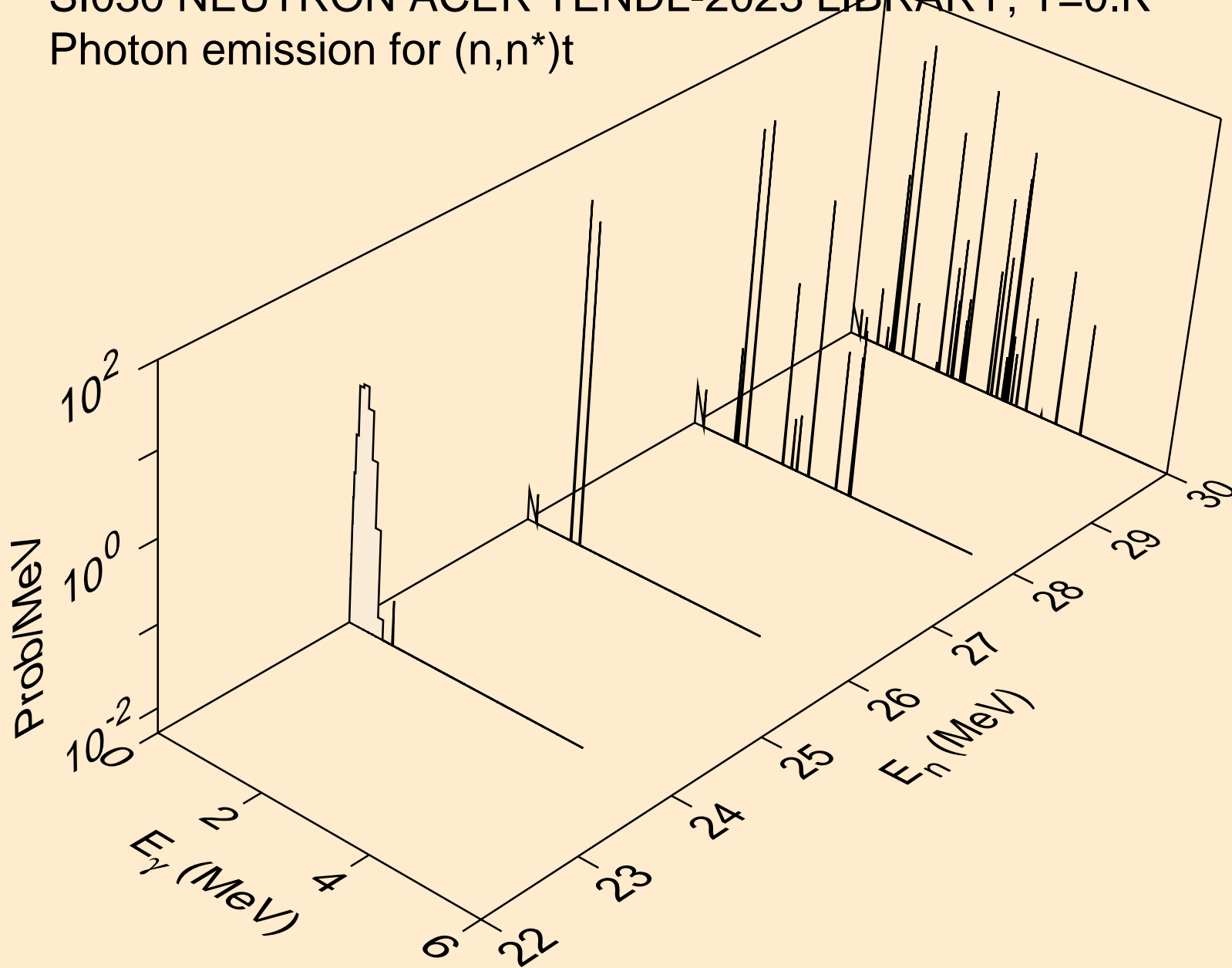

SI030 NEUTRON ACER TENDL-2023 LIBRARY; T=0.K  
Photon emission for (n,n\*)he3

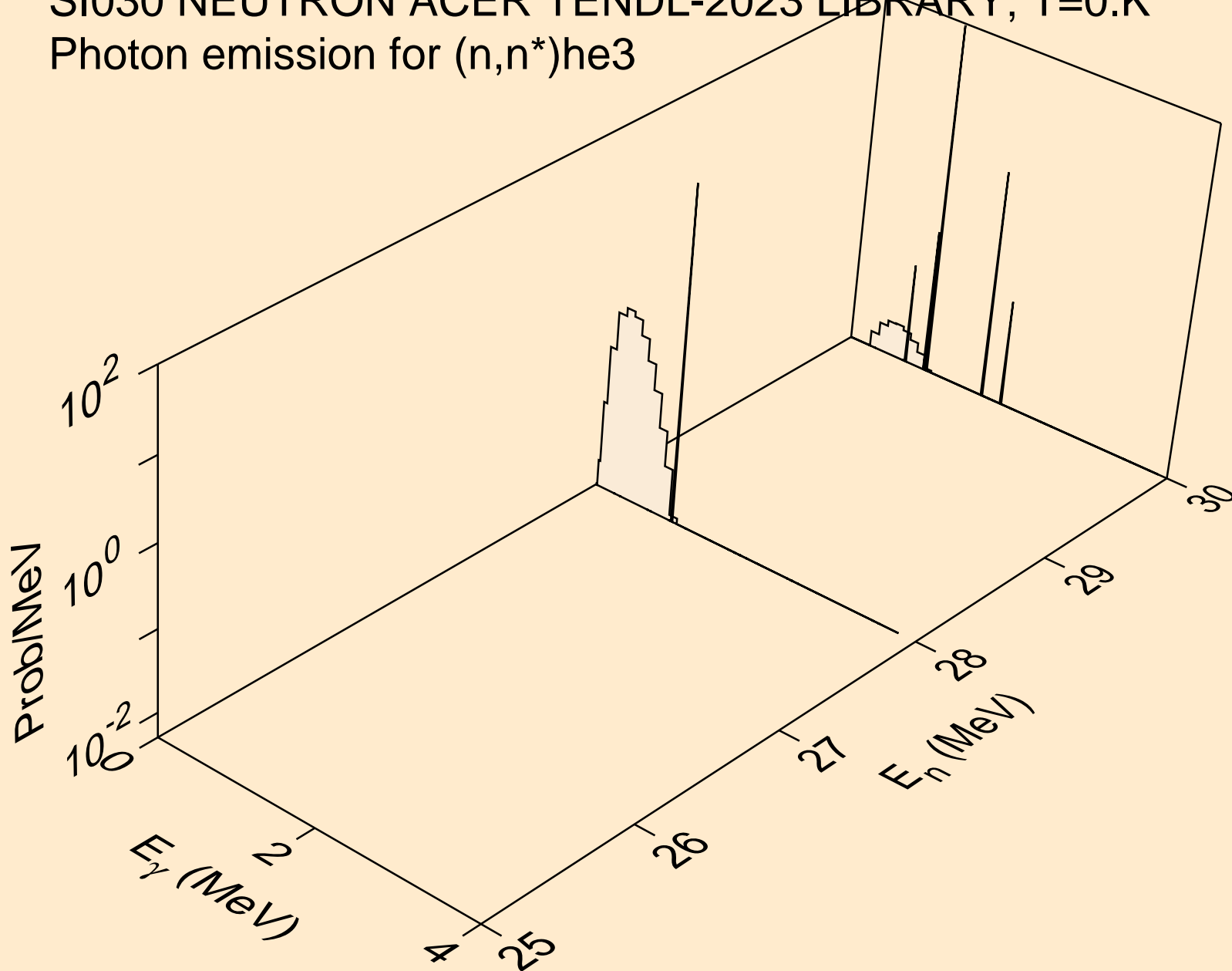

SI030 NEUTRON ACER TENDL-2023 LIBRARY; T=0.K  
Photon emission for (n,2np)

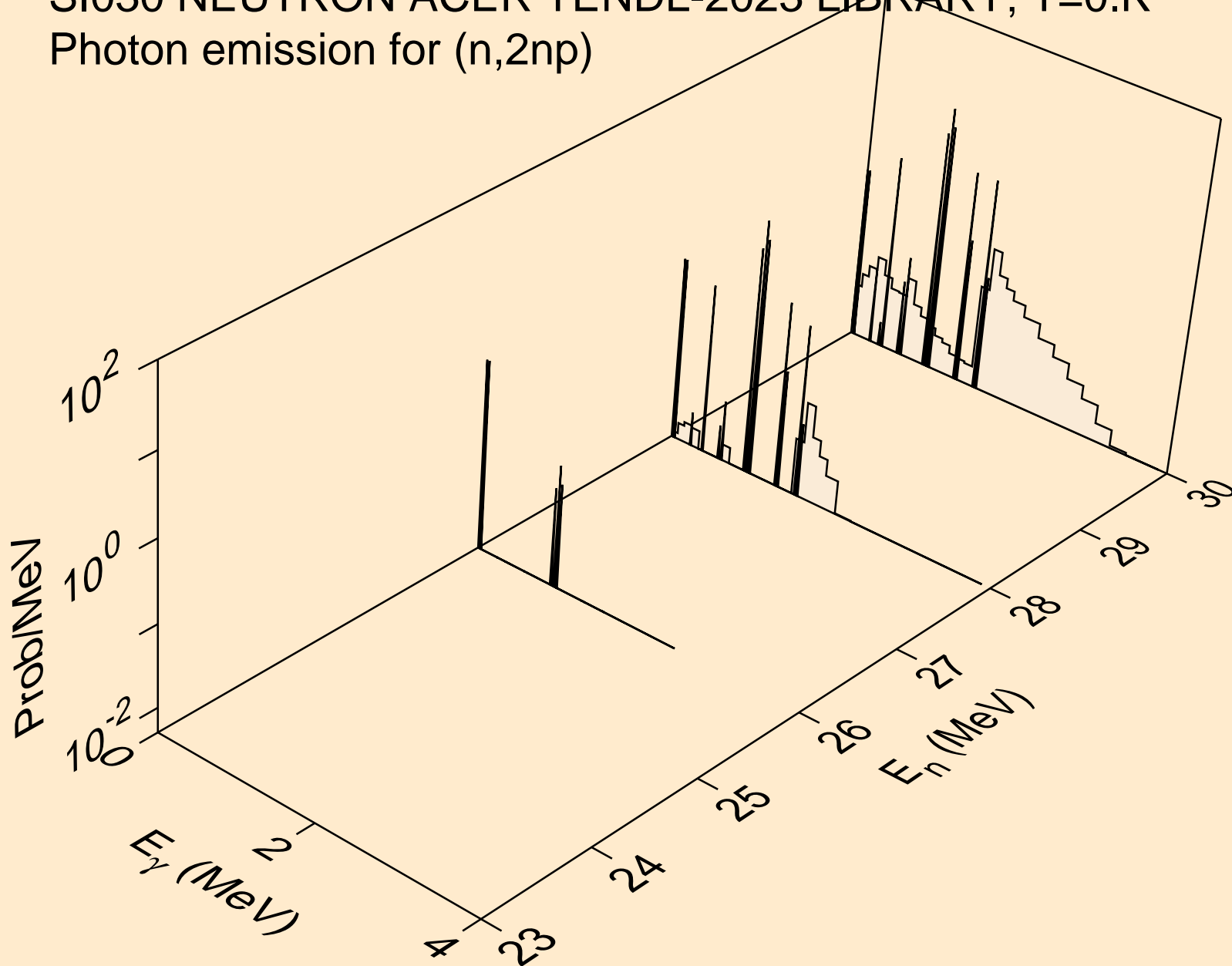

SI030 NEUTRON ACER TENDL-2023 LIBRARY; T=0.K  
Photon emission for (n,n2p)

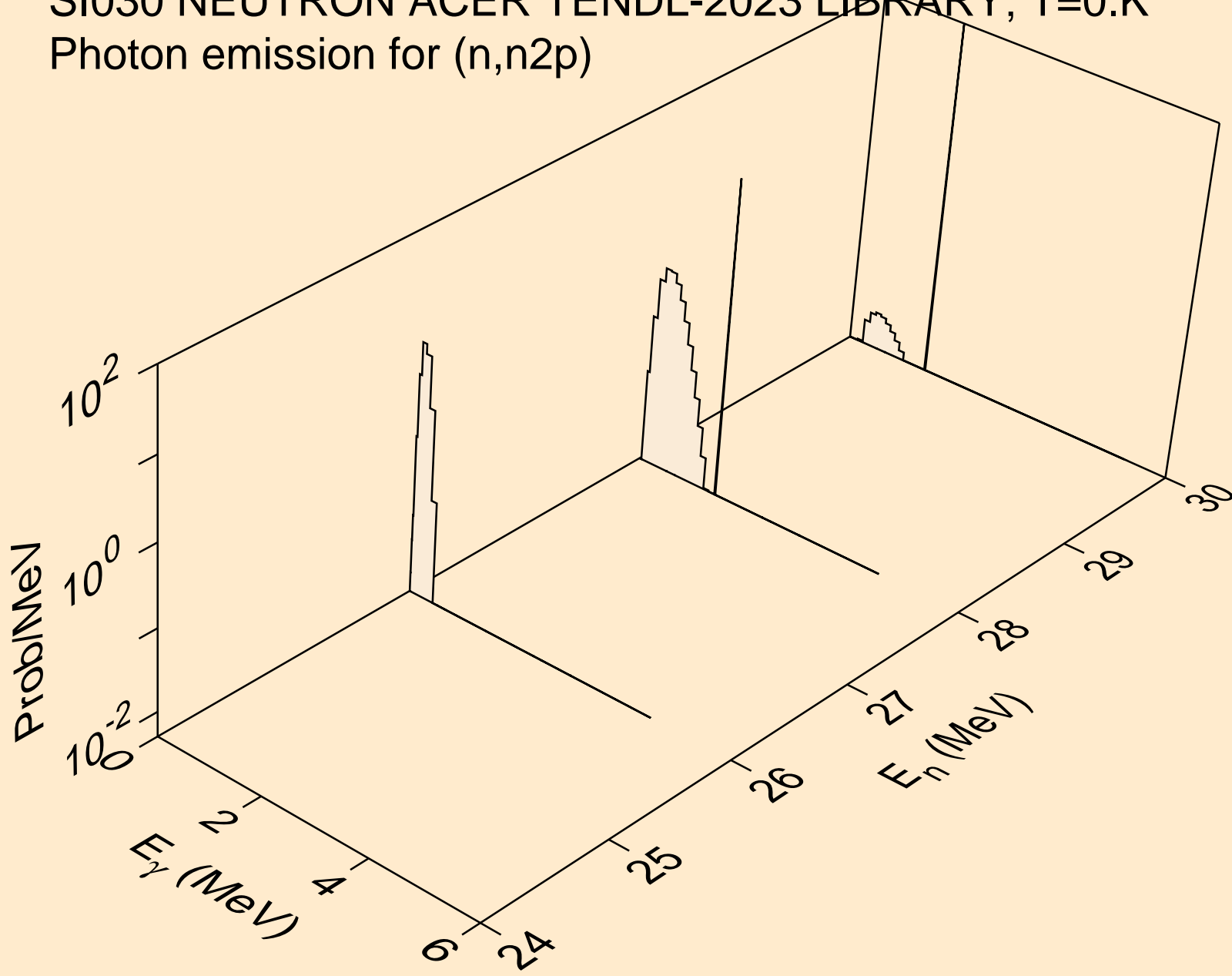

SI030 NEUTRON ACER TENDL-2023 LIBRARY; T=0.K  
Photon emission for (n,npa)

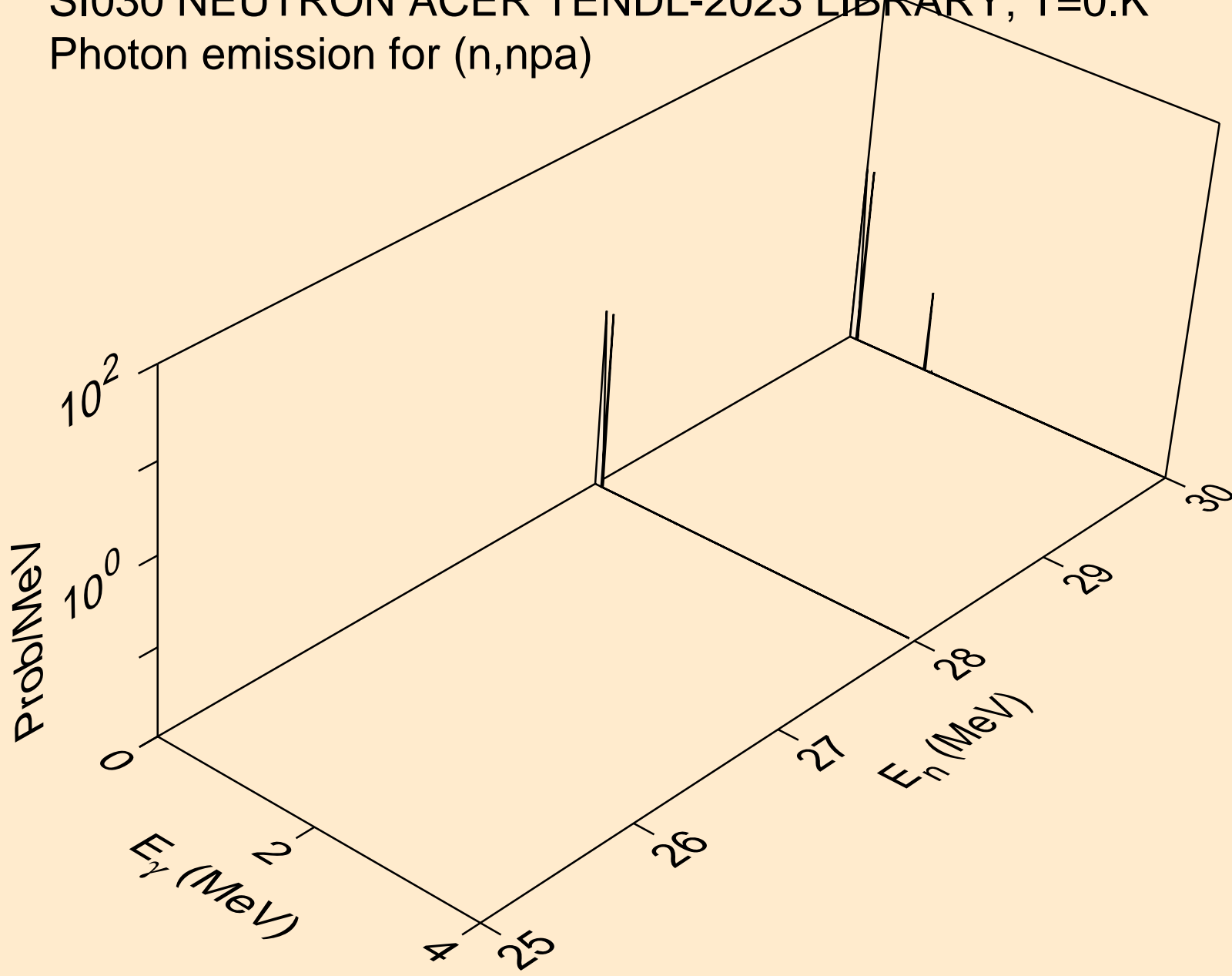



SI030 NEUTRON ACER TENDL-2023 LIBRARY; T=0.K  
Photon emission for (n,n\*c)

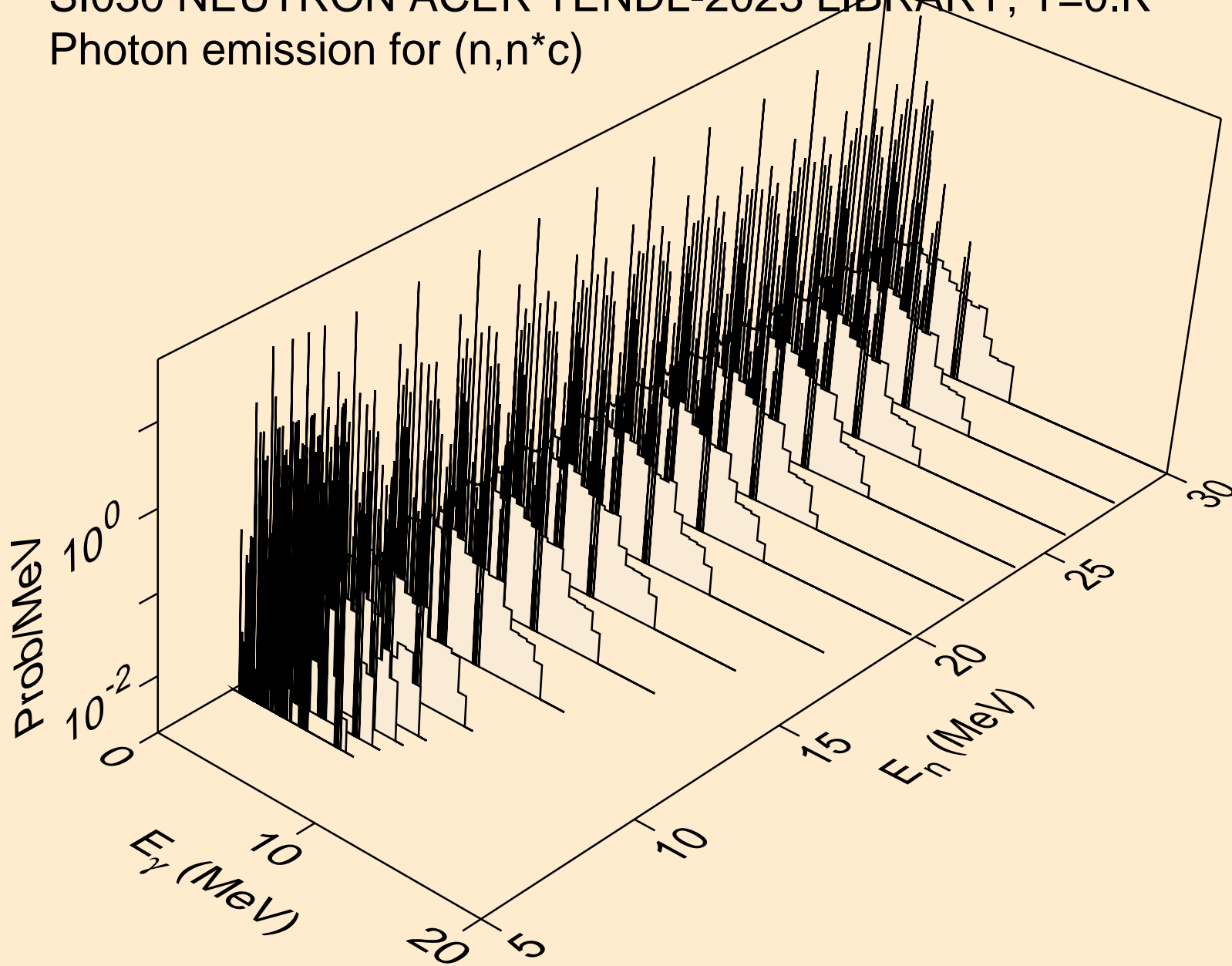

SI030 NEUTRON ACER TENDL-2023 LIBRARY; T=0.K  
Photon emission for (n,gma)

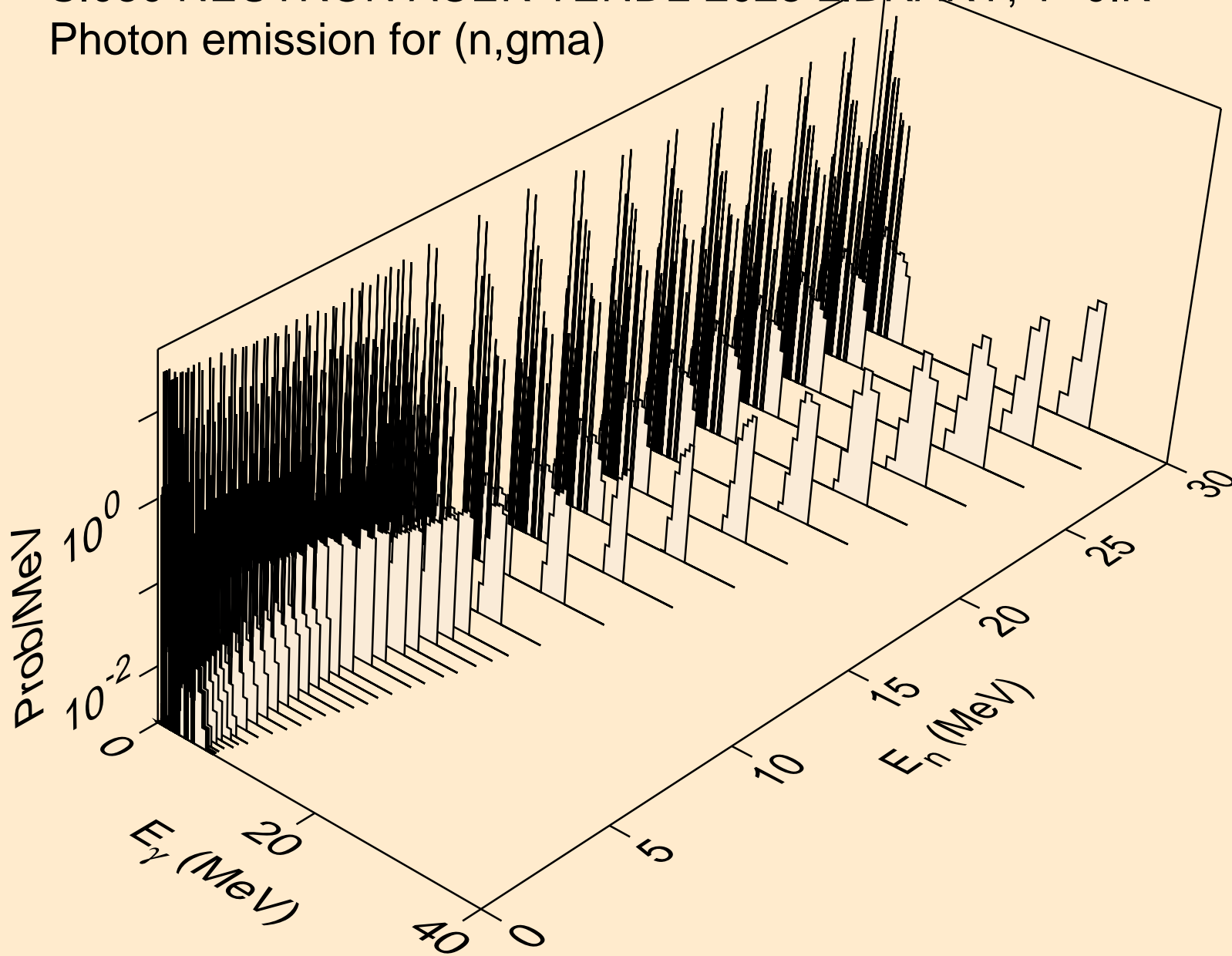

SI030 NEUTRON ACER TENDL-2023 LIBRARY; T=0.K  
Photon emission for (n,p)

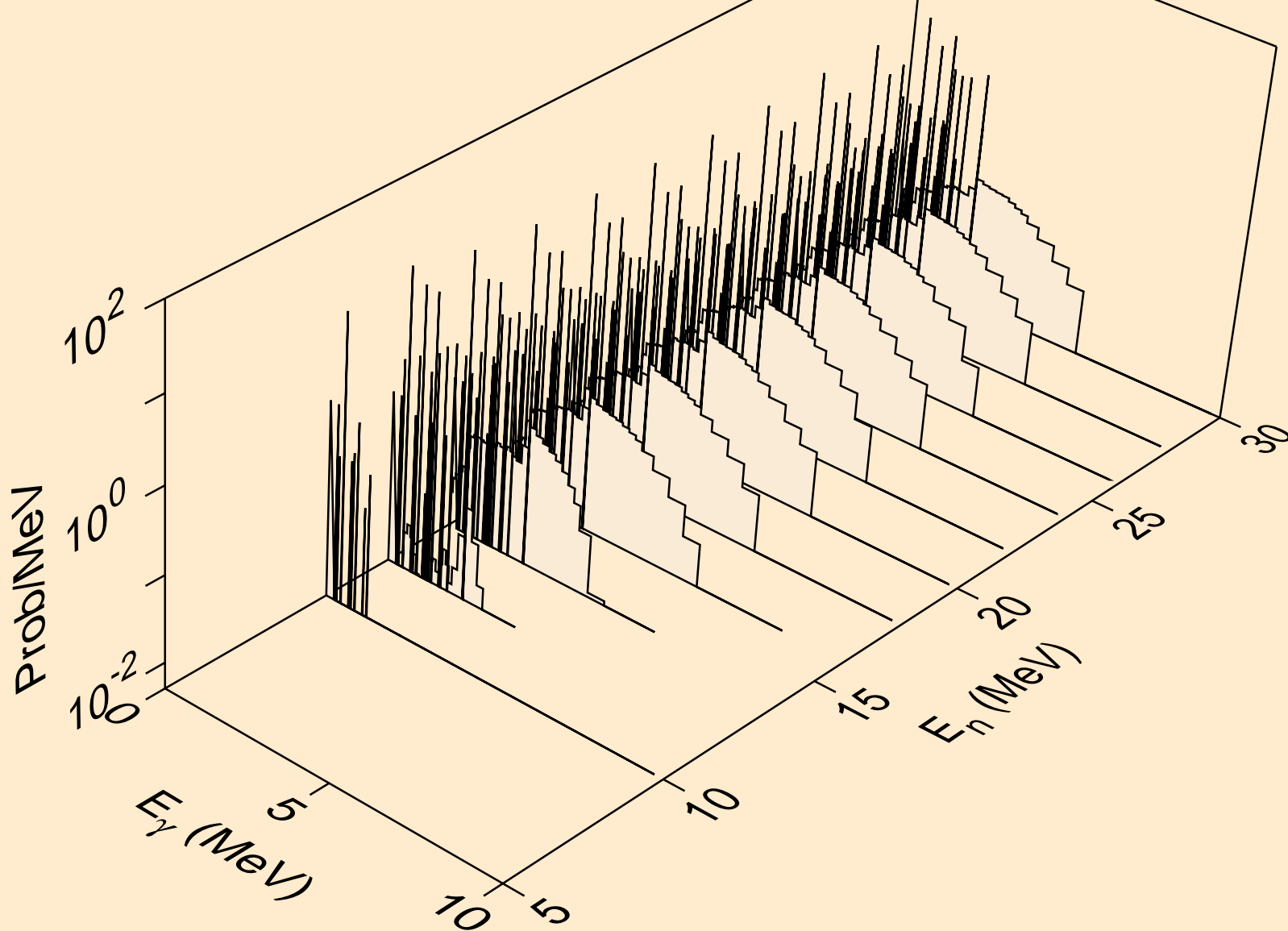

SI030 NEUTRON ACER TENDL-2023 LIBRARY; T=0.K  
Photon emission for (n,d)

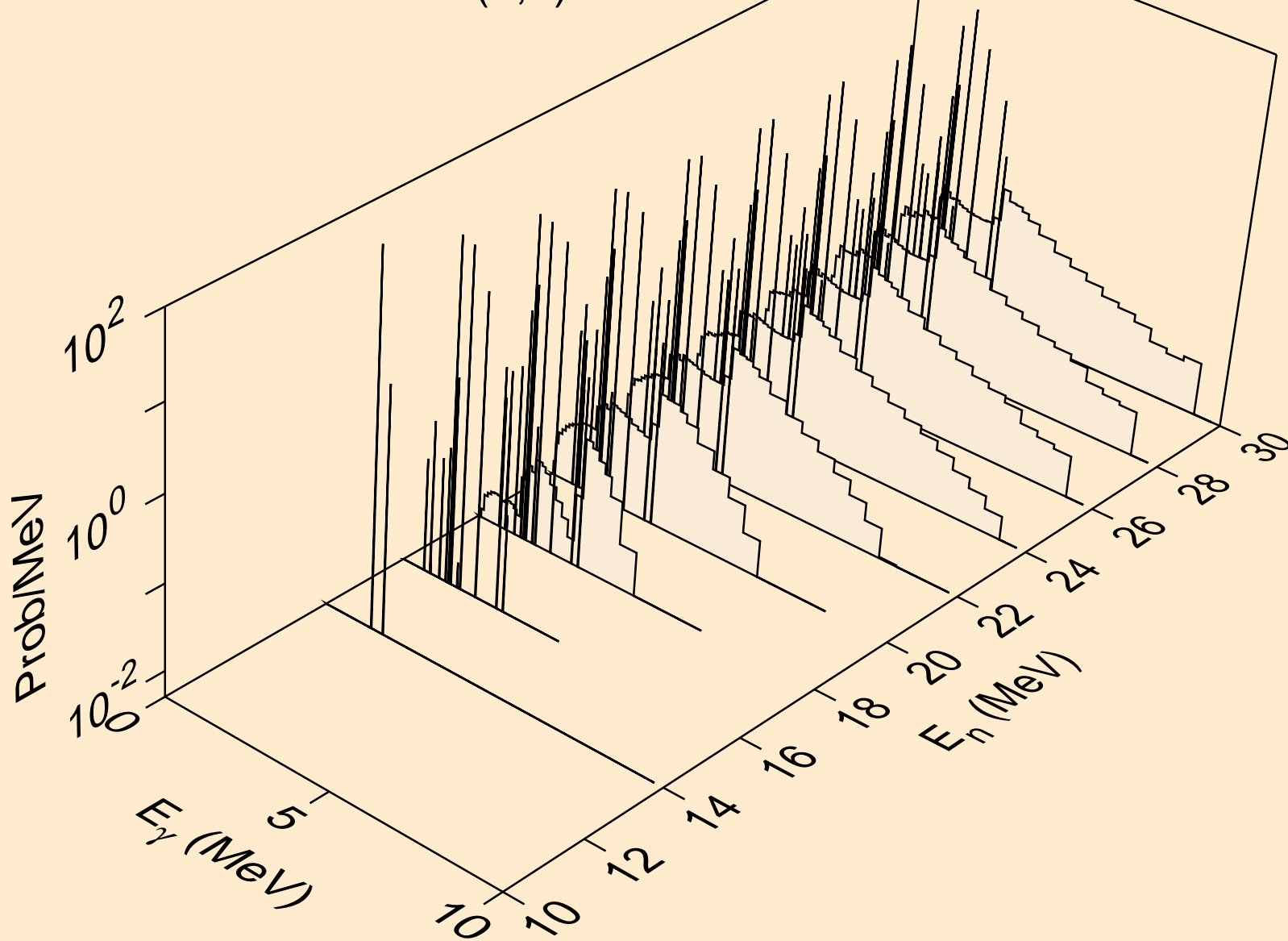

SI030 NEUTRON ACER TENDL-2023 LIBRARY; T=0.K  
Photon emission for (n,t)

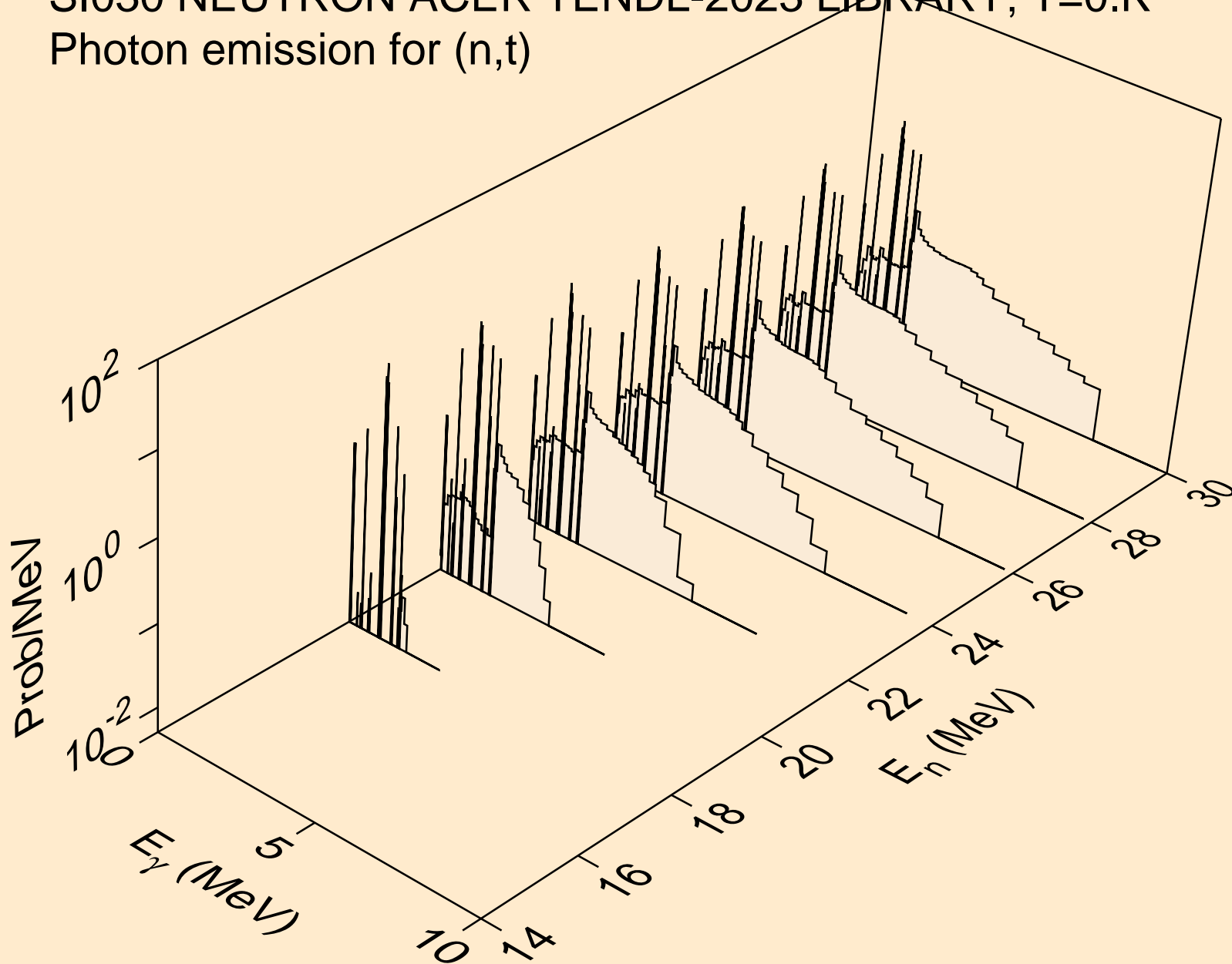

SI030 NEUTRON ACER TENDL-2023 LIBRARY; T=0.K  
Photon emission for (n,he3)

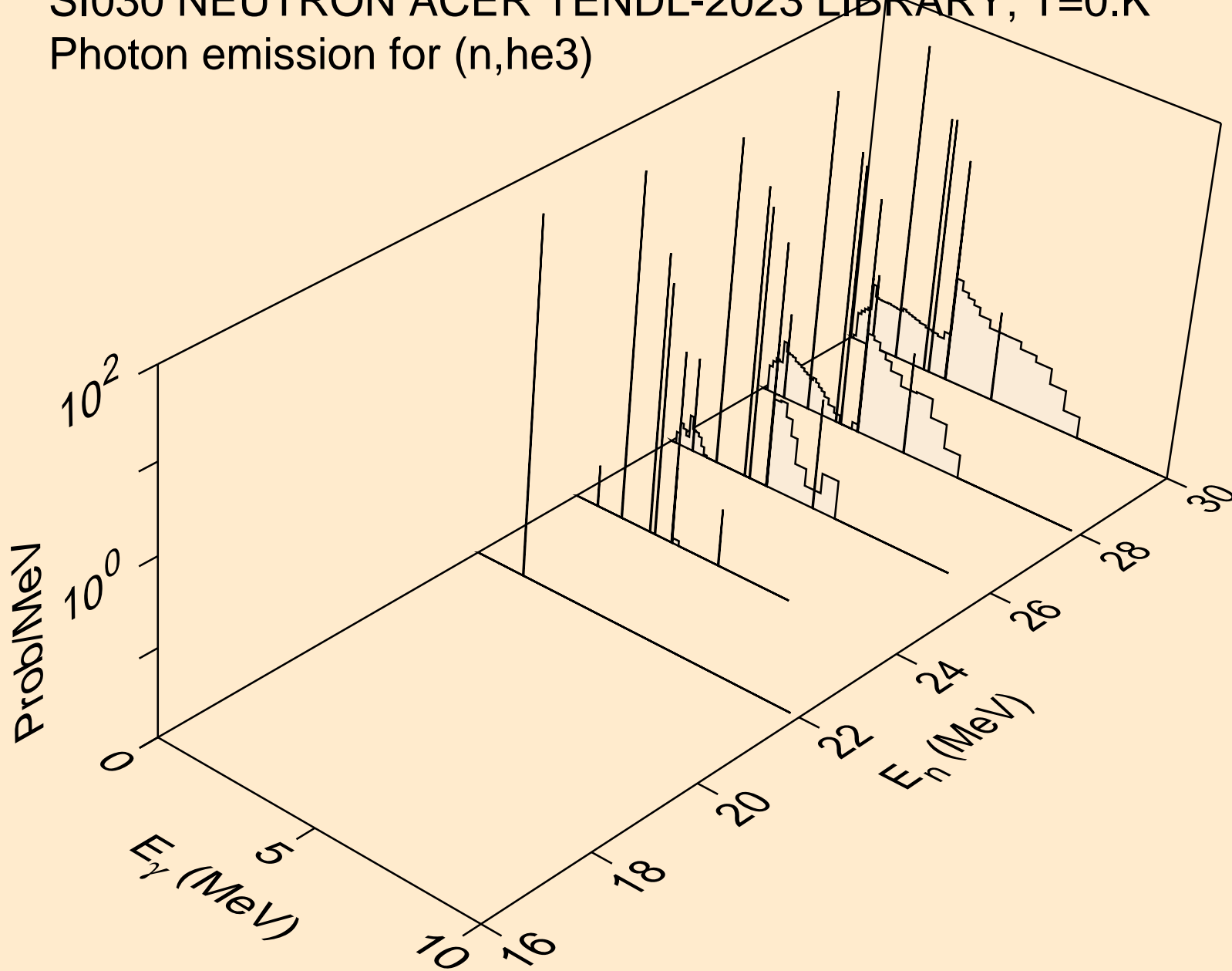

SI030 NEUTRON ACER TENDL-2023 LIBRARY; T=0.K  
Photon emission for (n,a)

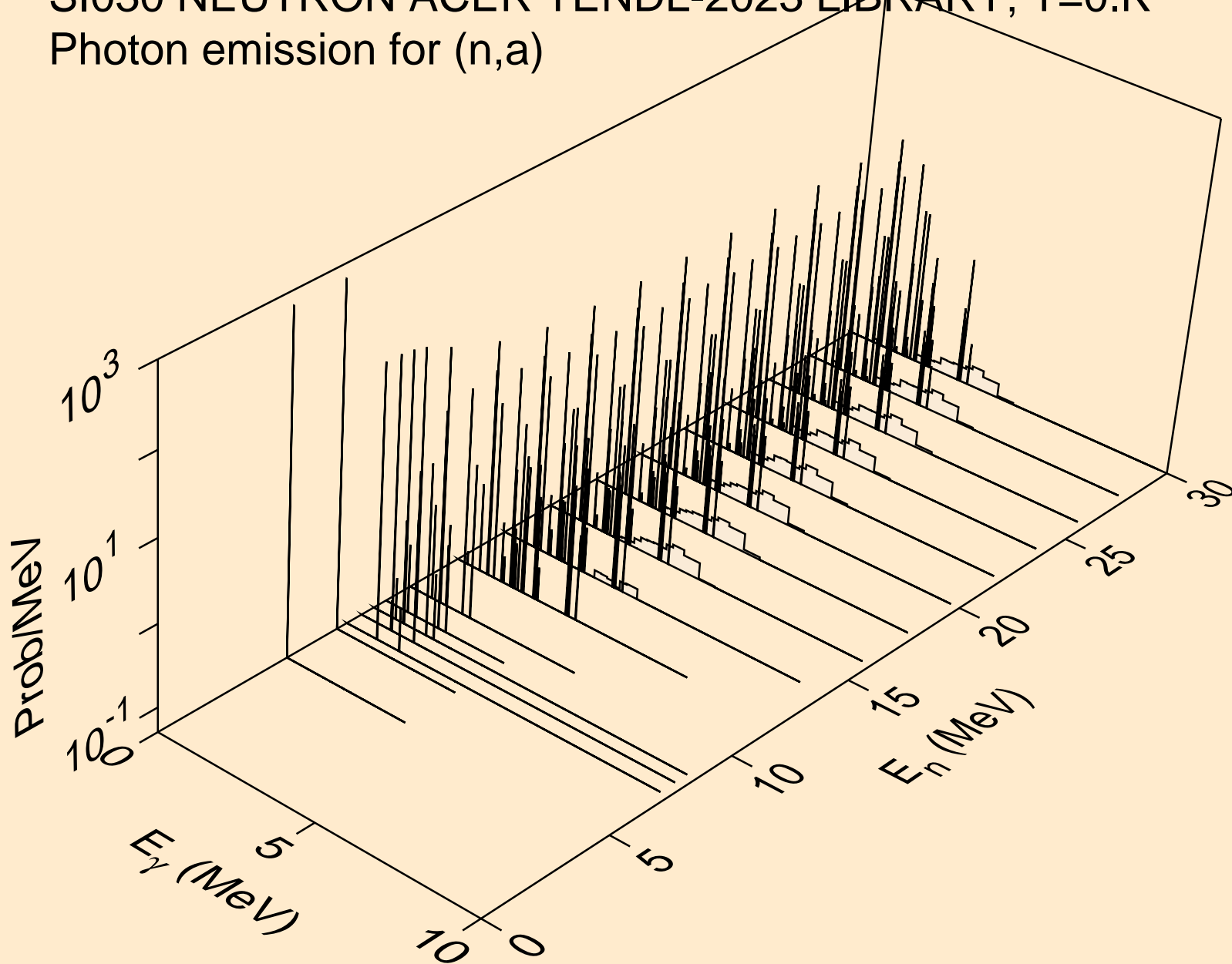

SI030 NEUTRON ACER TENDL-2023 LIBRARY; T=0.K  
Photon emission for (n,2a)

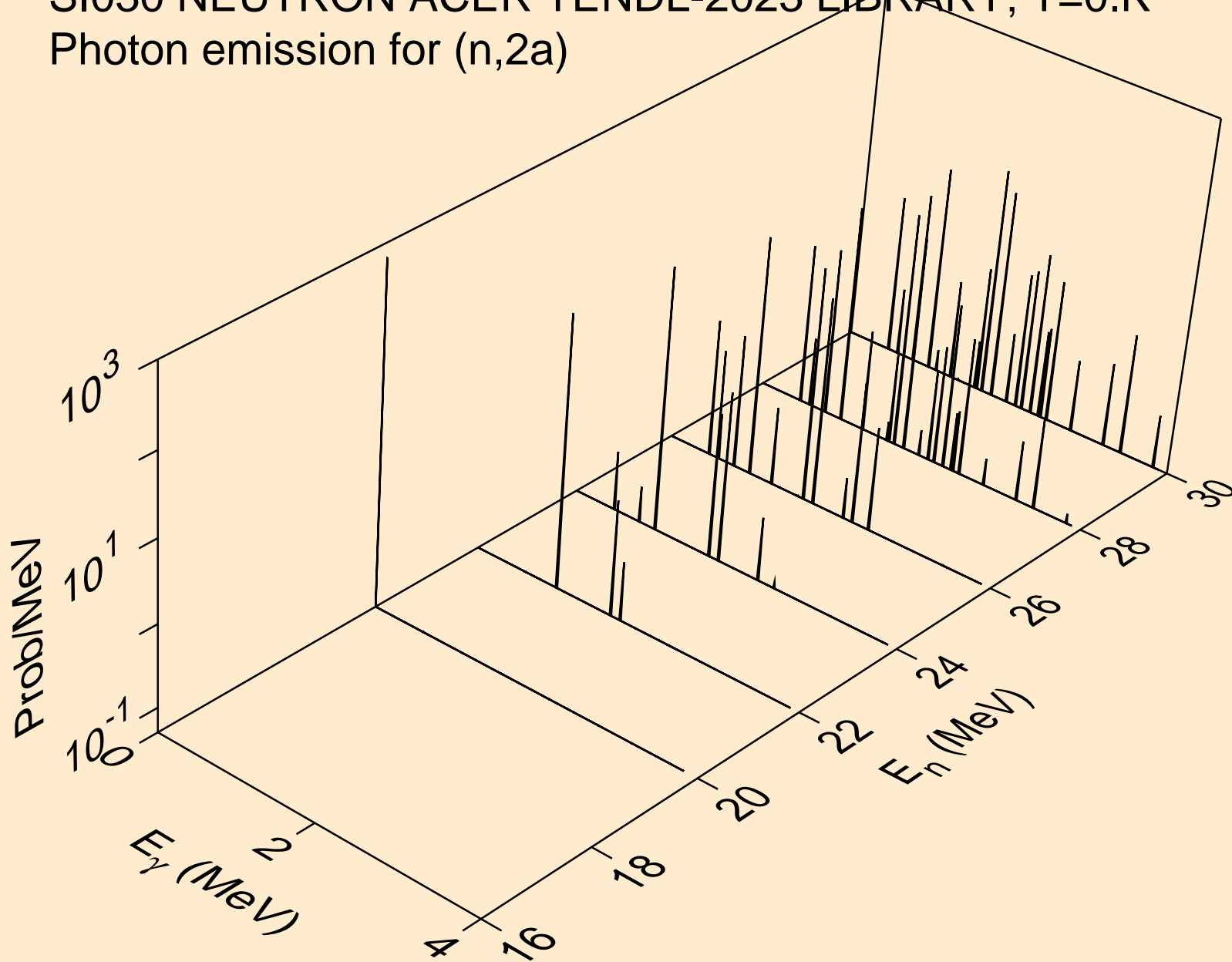



SI030 NEUTRON ACER TENDL-2023 LIBRARY; T=0.K  
Photon emission for (n,2p)

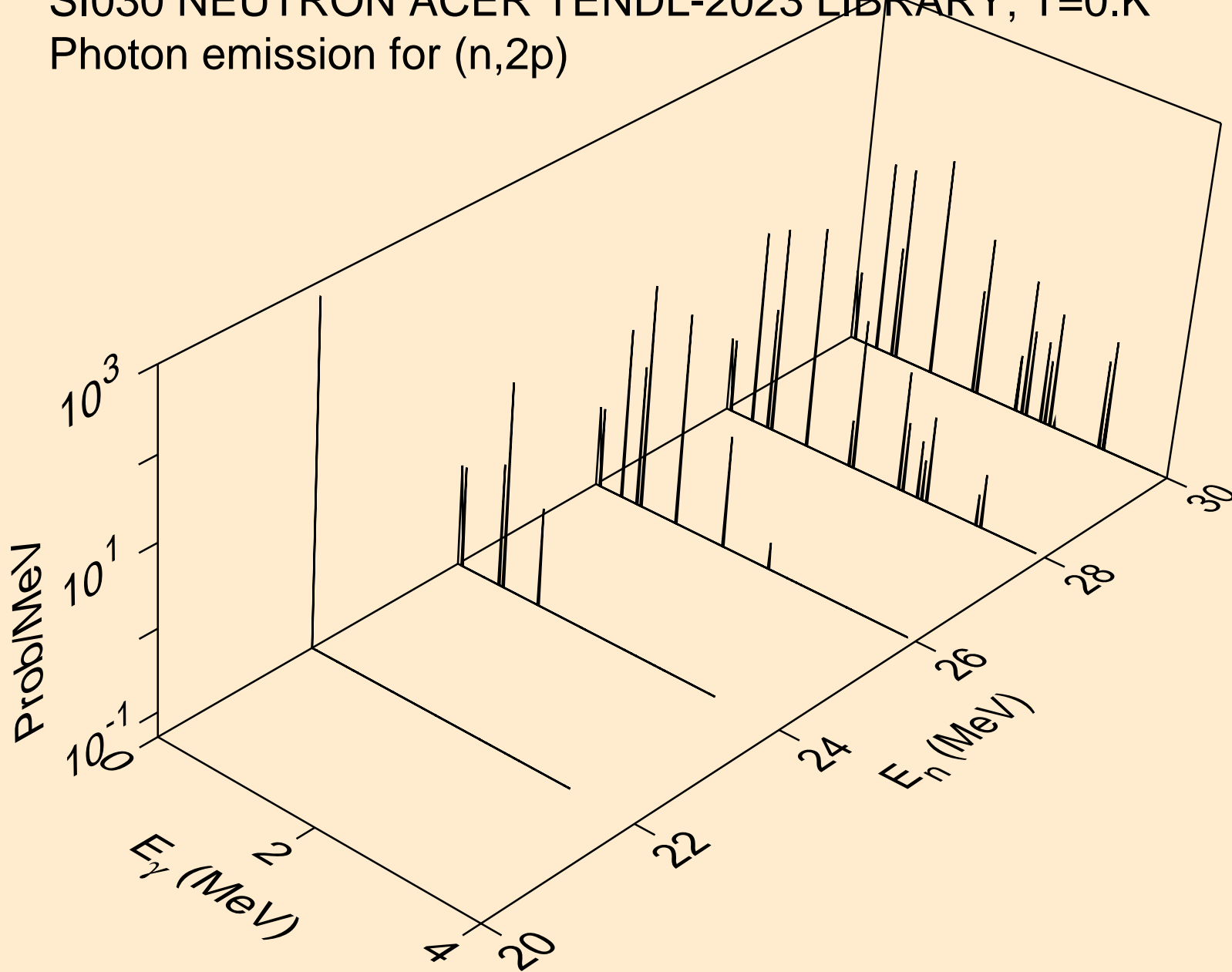

SI030 NEUTRON ACER TENDL-2023 LIBRARY; T=0.K  
Photon emission for (n,p $\alpha$ )

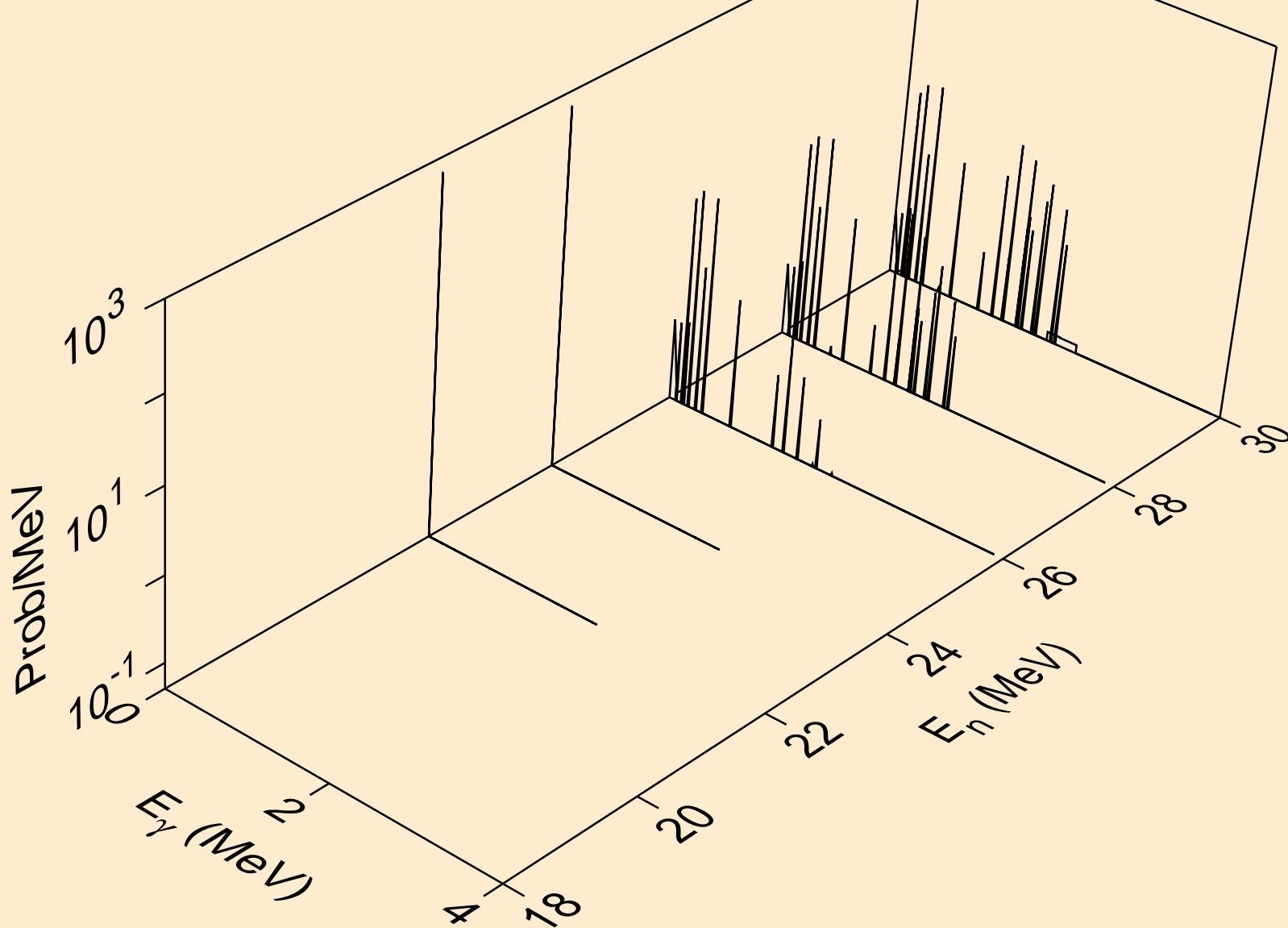

SI030 NEUTRON ACER TENDL-2023 LIBRARY; T=0.K  
Photon emission for (n,pd)

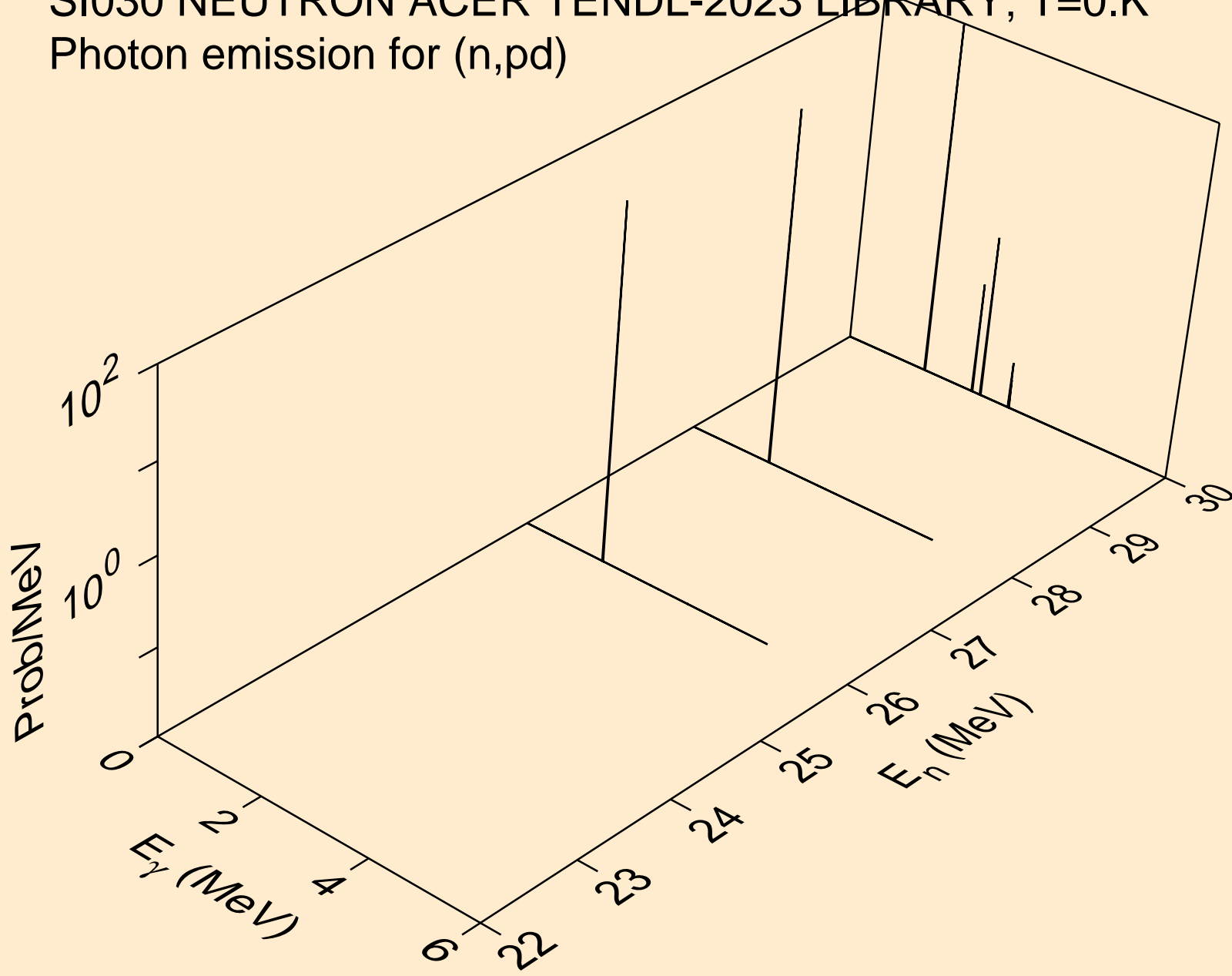

SI030 NEUTRON ACER TENDL-2023 LIBRARY; T=0.K  
Photon emission for (n,pt)

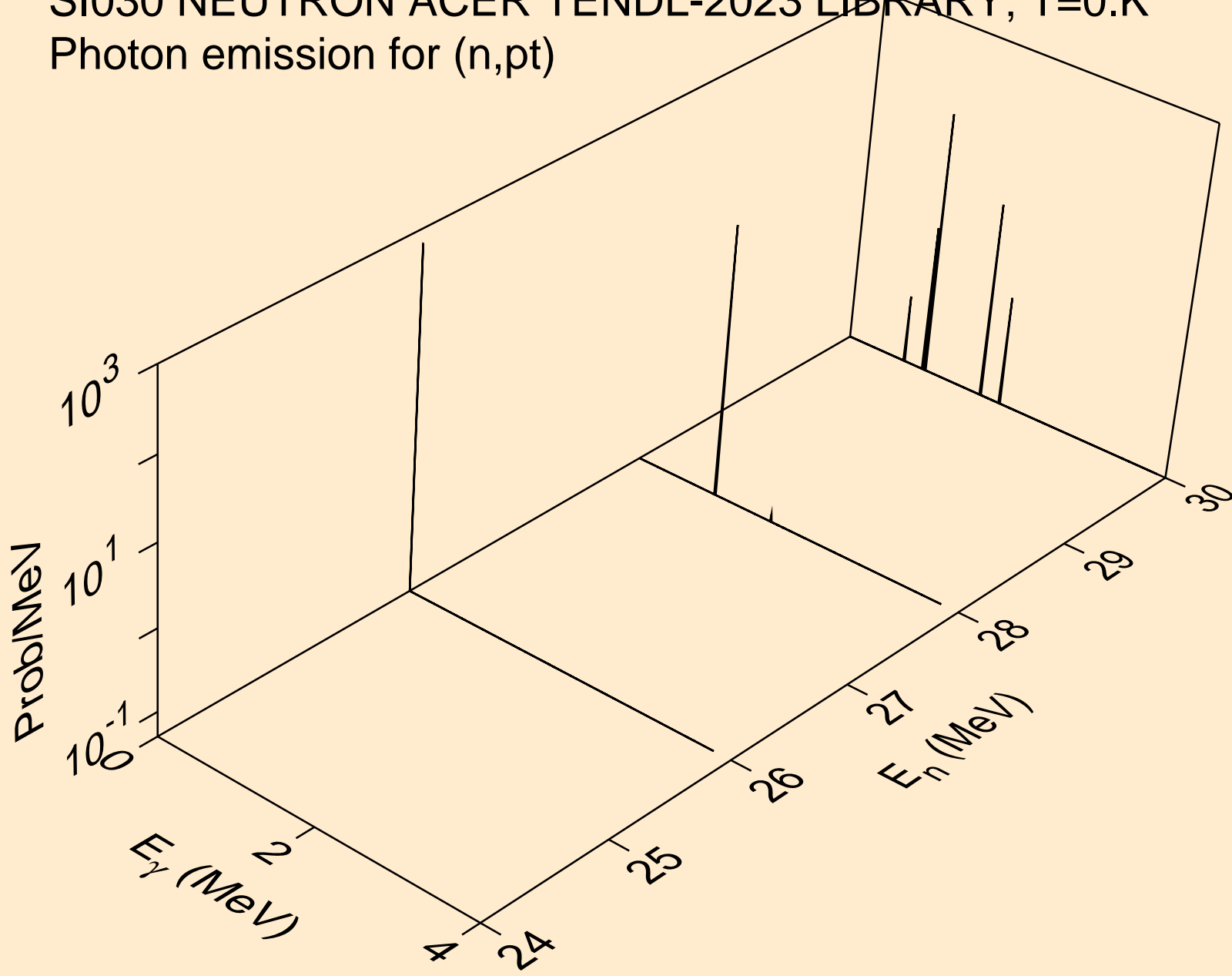

SI030 NEUTRON ACER TENDL-2023 LIBRARY; T=0.K  
Photon emission for (n,da)

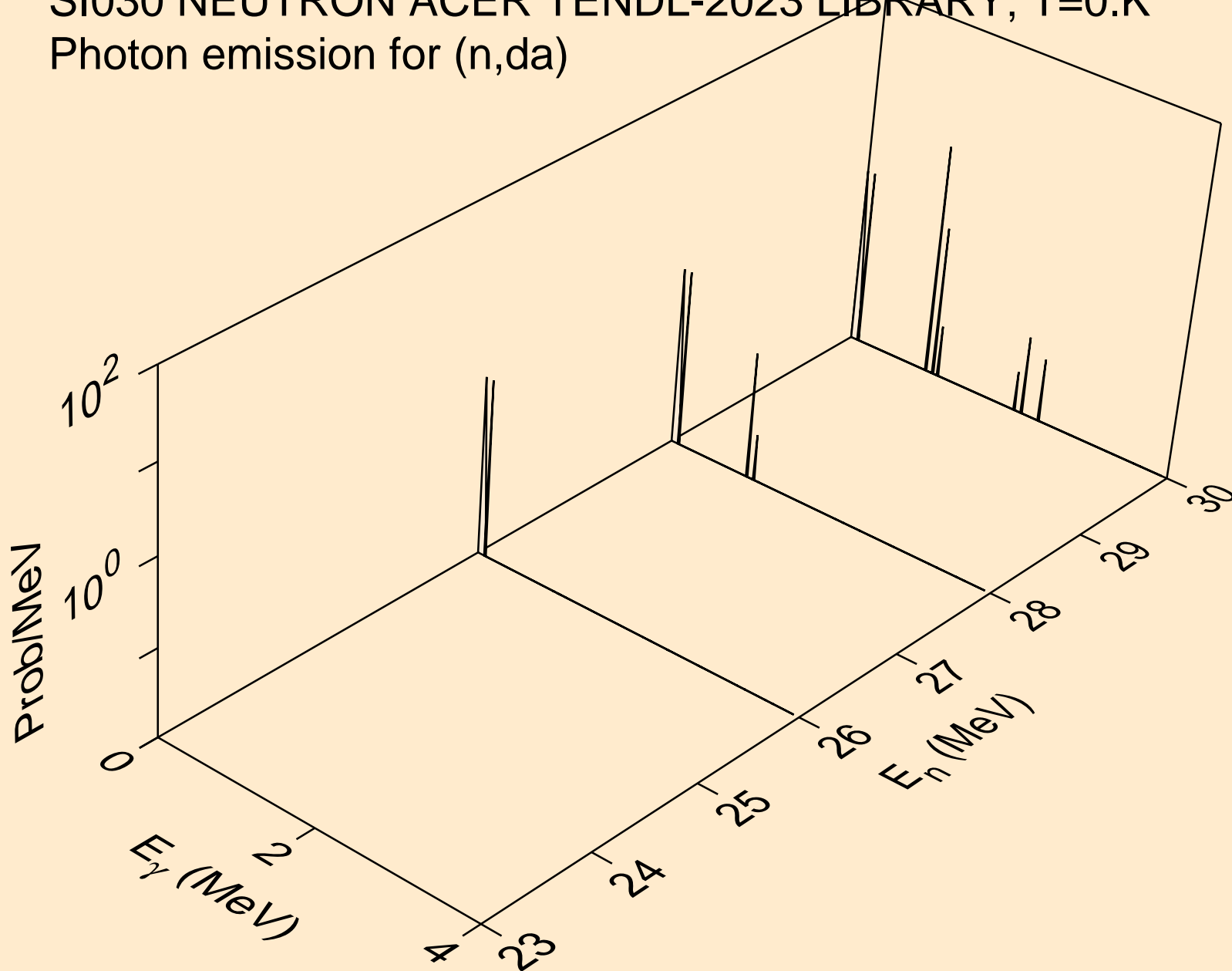

SI030 NEUTRON ACER TENDL-2023 LIBRARY; T=0.K  
thermal capture photon spectrum

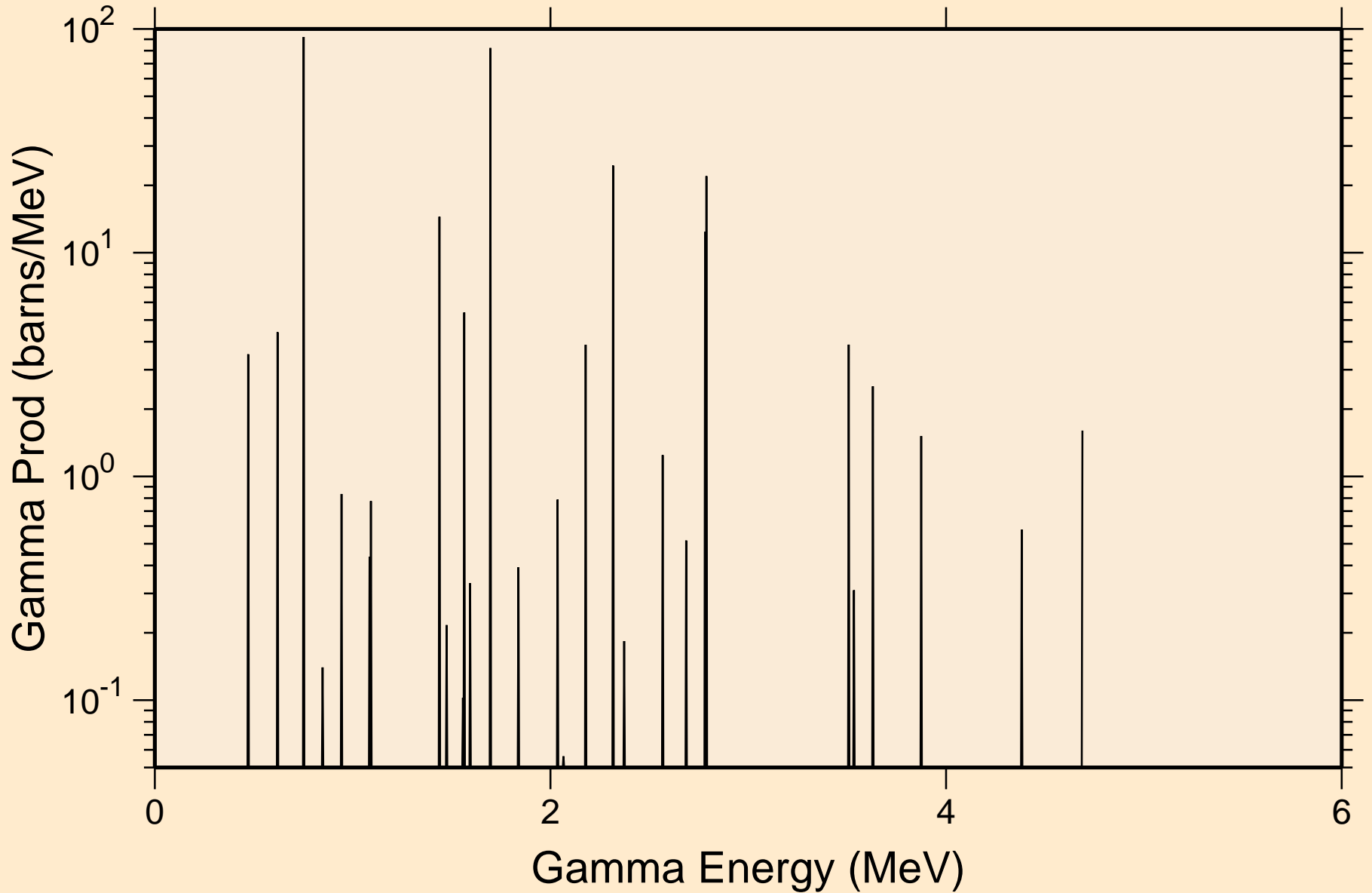

SI030 NEUTRON ACER TENDL-2023 LIBRARY; T=0.K  
14 MeV photon spectrum

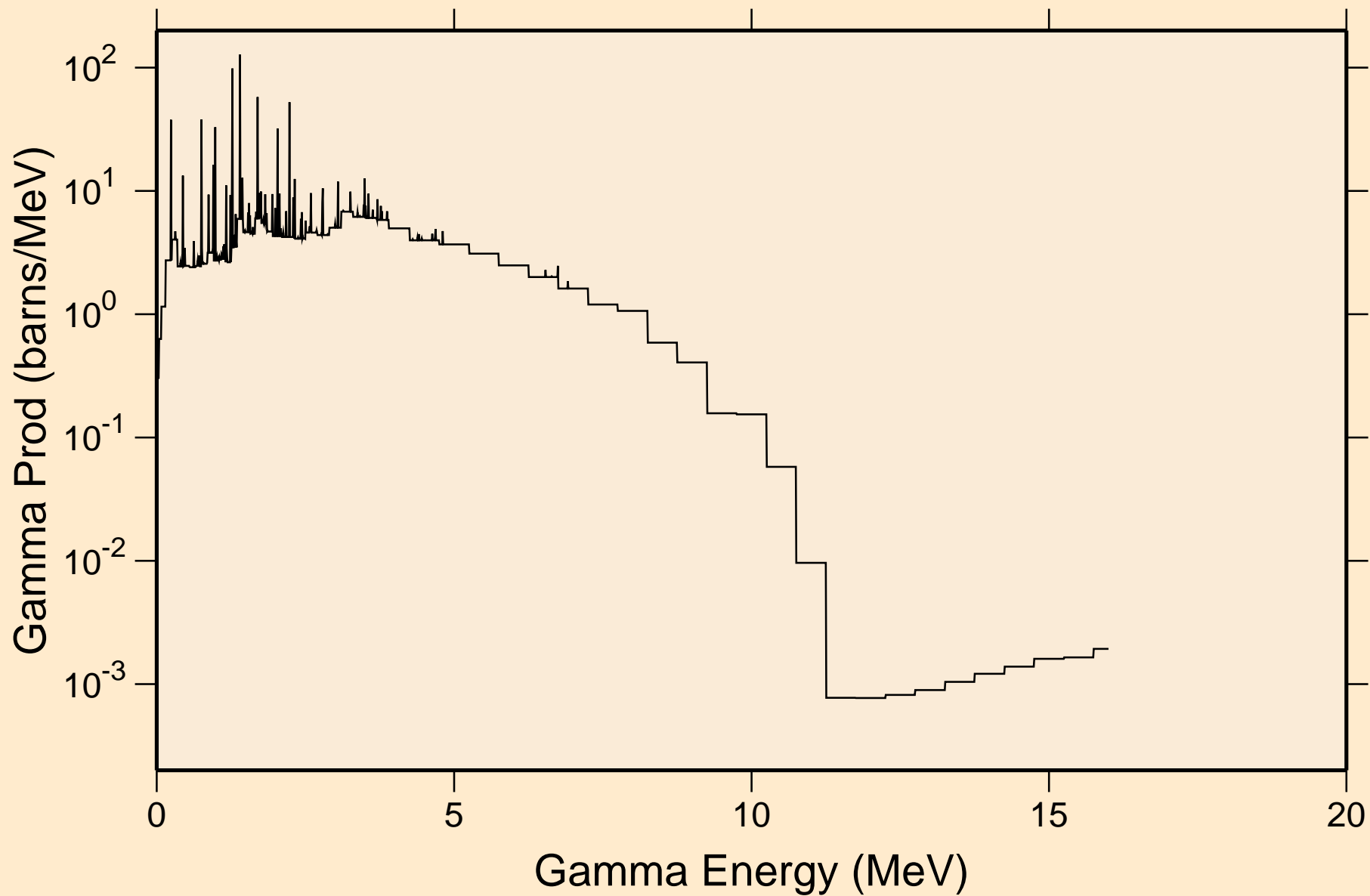

# SI030 NEUTRON ACER TENDL-2023 LIBRARY; T=0.K

## Particle heating contributions

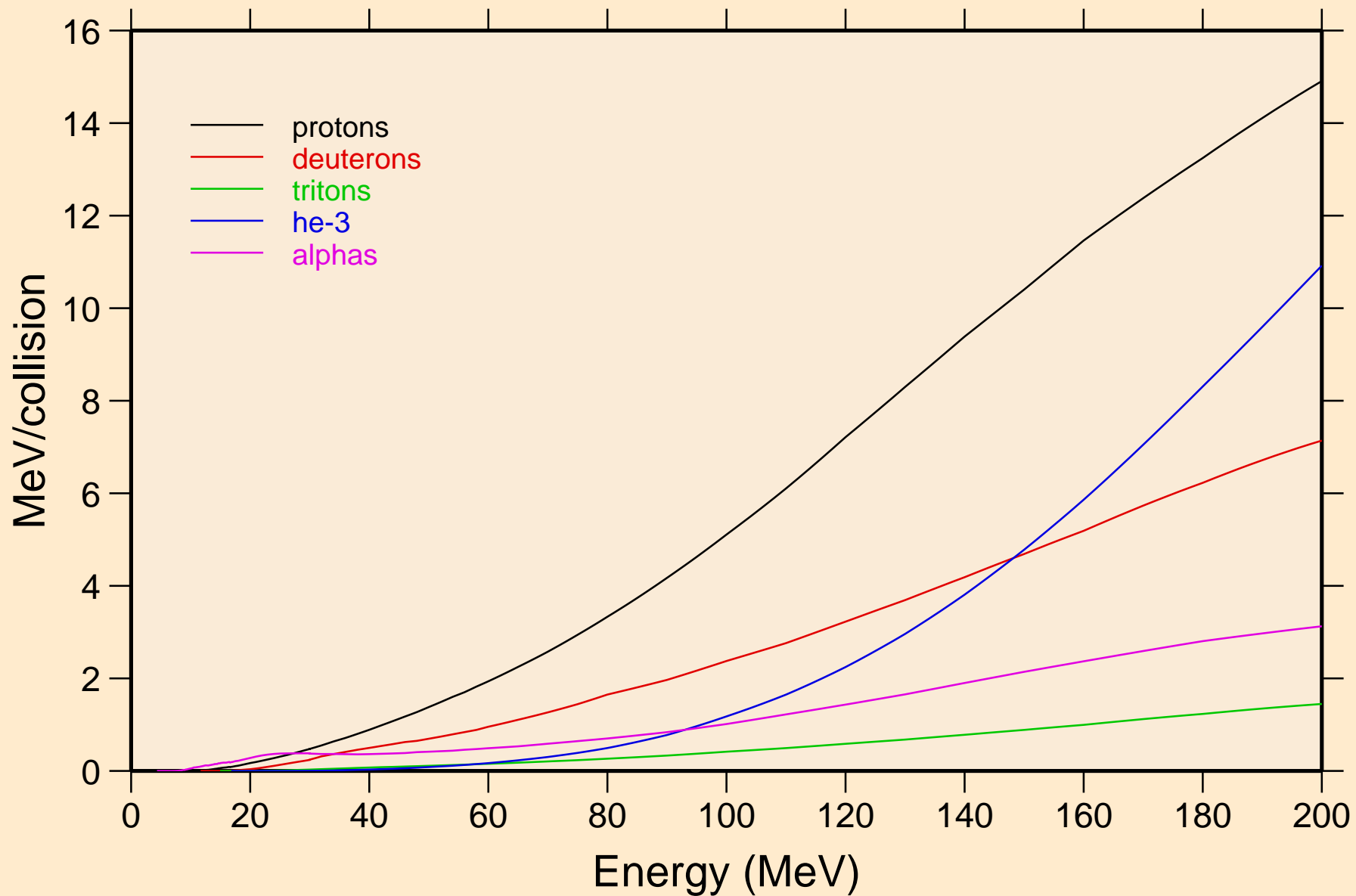



SI030 NEUTRON ACER TENDL-2023 LIBRARY; T=0.K  
Recoil Heating

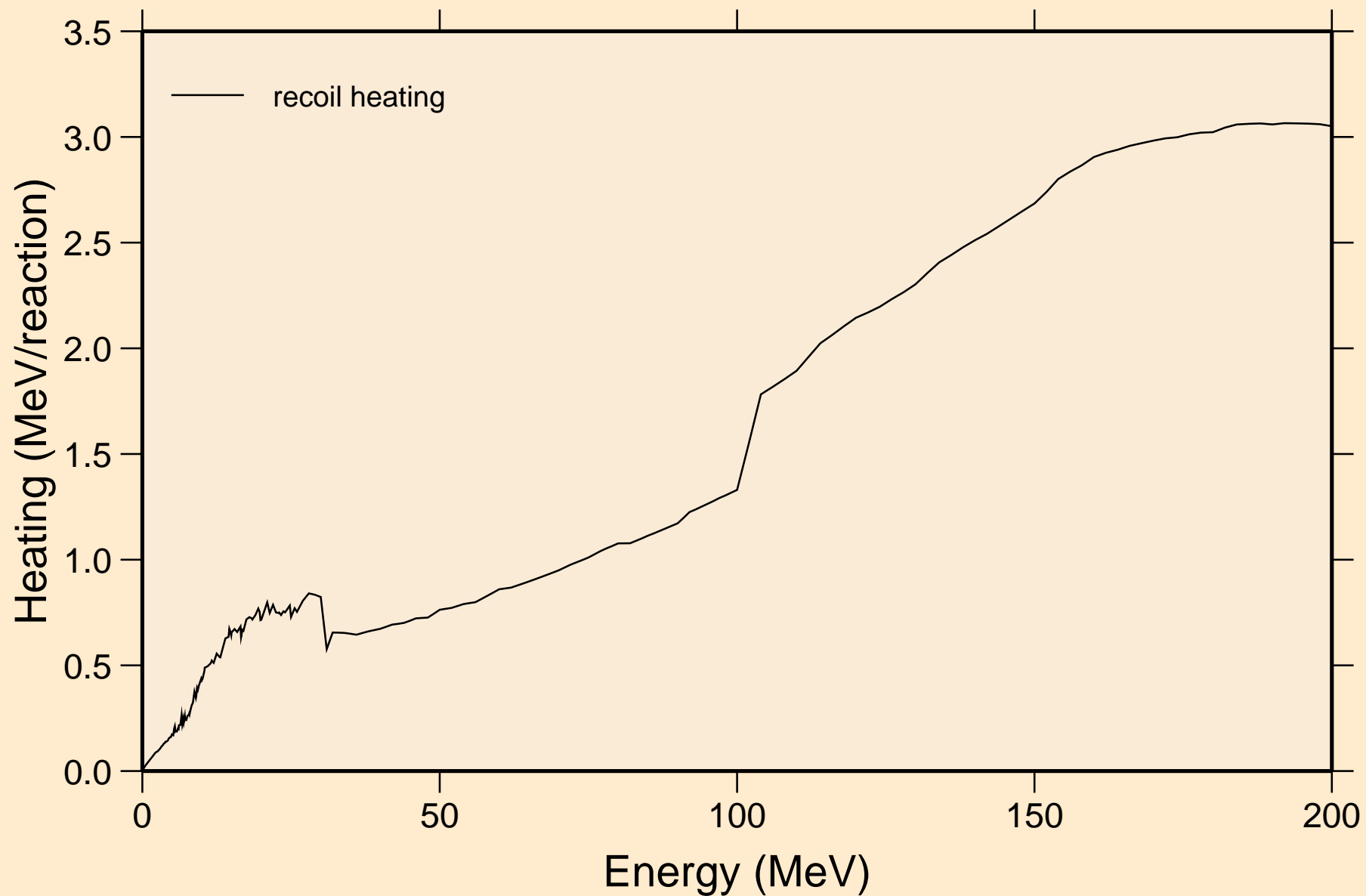

# SI030 NEUTRON ACER TENDL-2023 LIBRARY; T=0.K

## Particle production cross sections

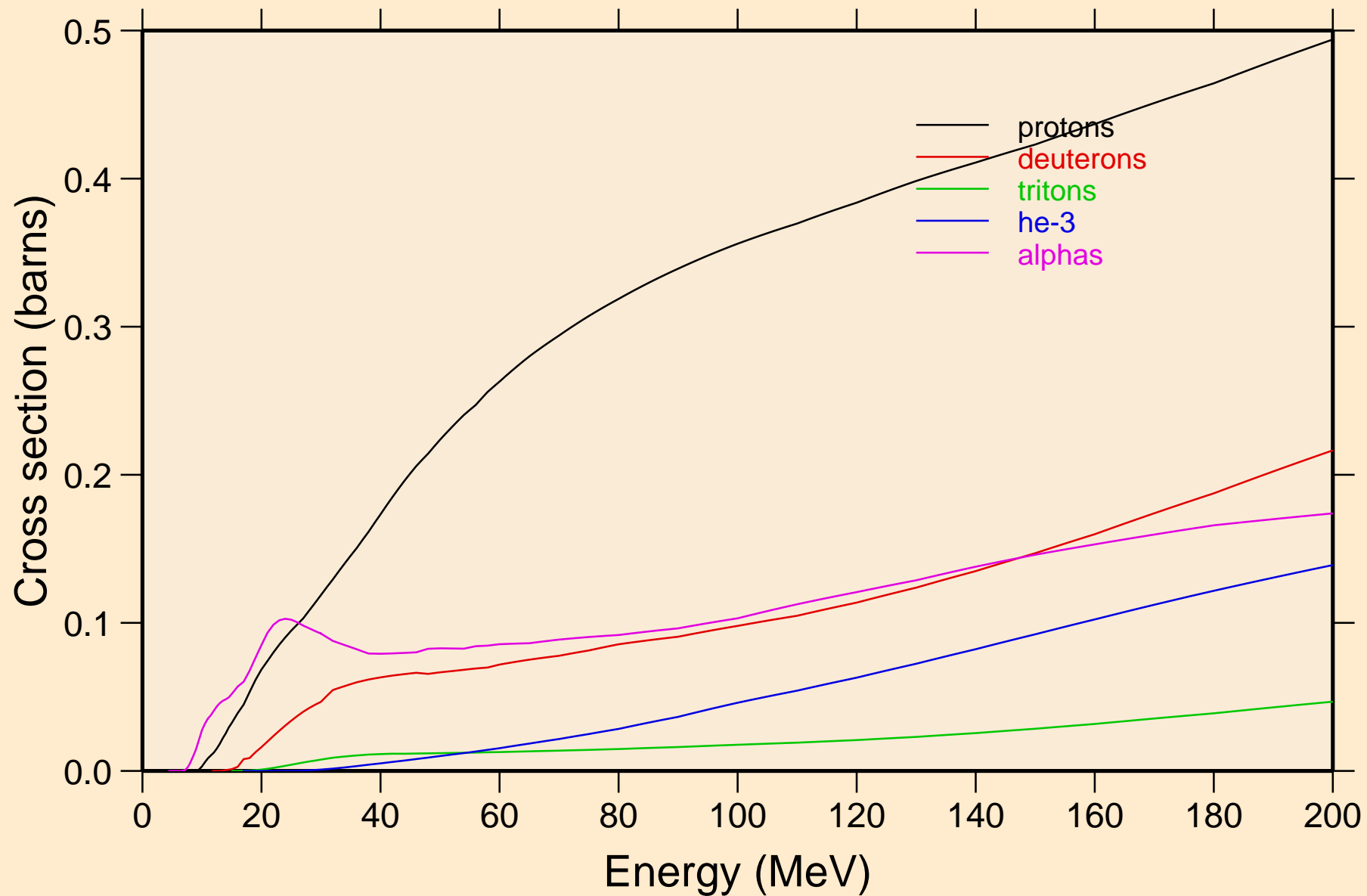

SI030 NEUTRON ACER TENDL-2023 LIBRARY; T=0.K  
protons from (n,x)

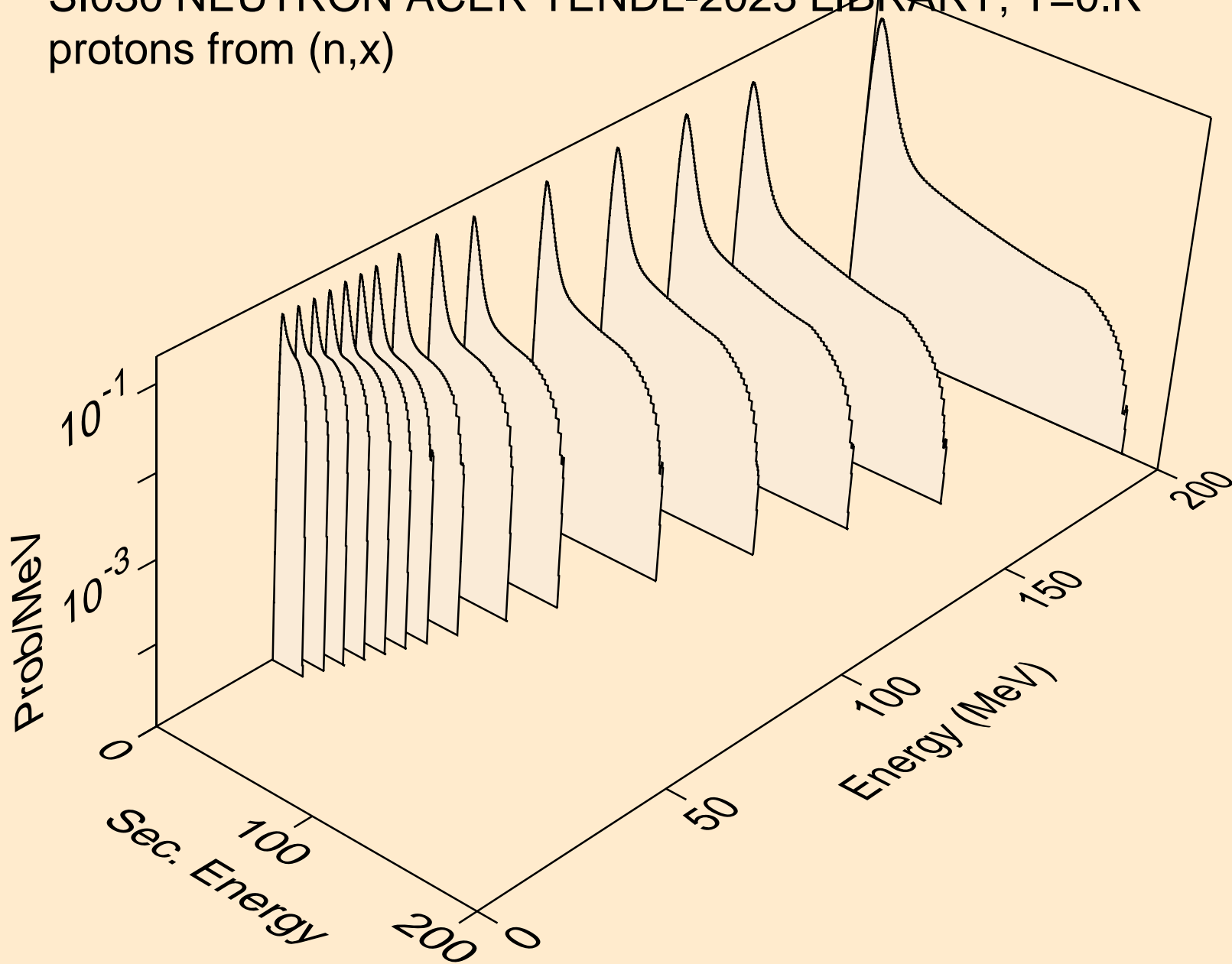

SI030 NEUTRON ACER TENDL-2023 LIBRARY; T=0.K  
protons from (n,n\*)p

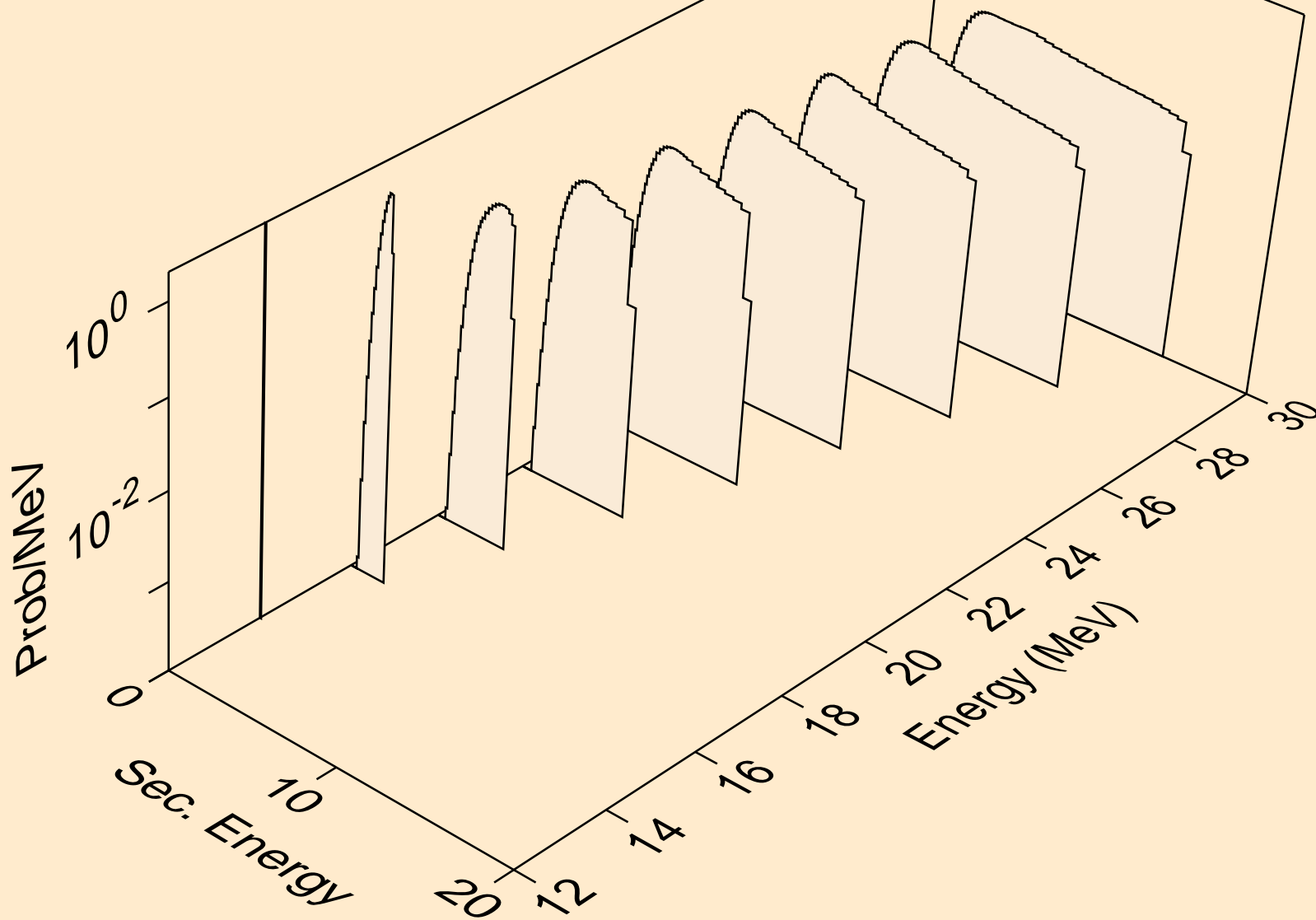

SI030 NEUTRON ACER TENDL-2023 LIBRARY; T=0.K  
protons from (n,2np)

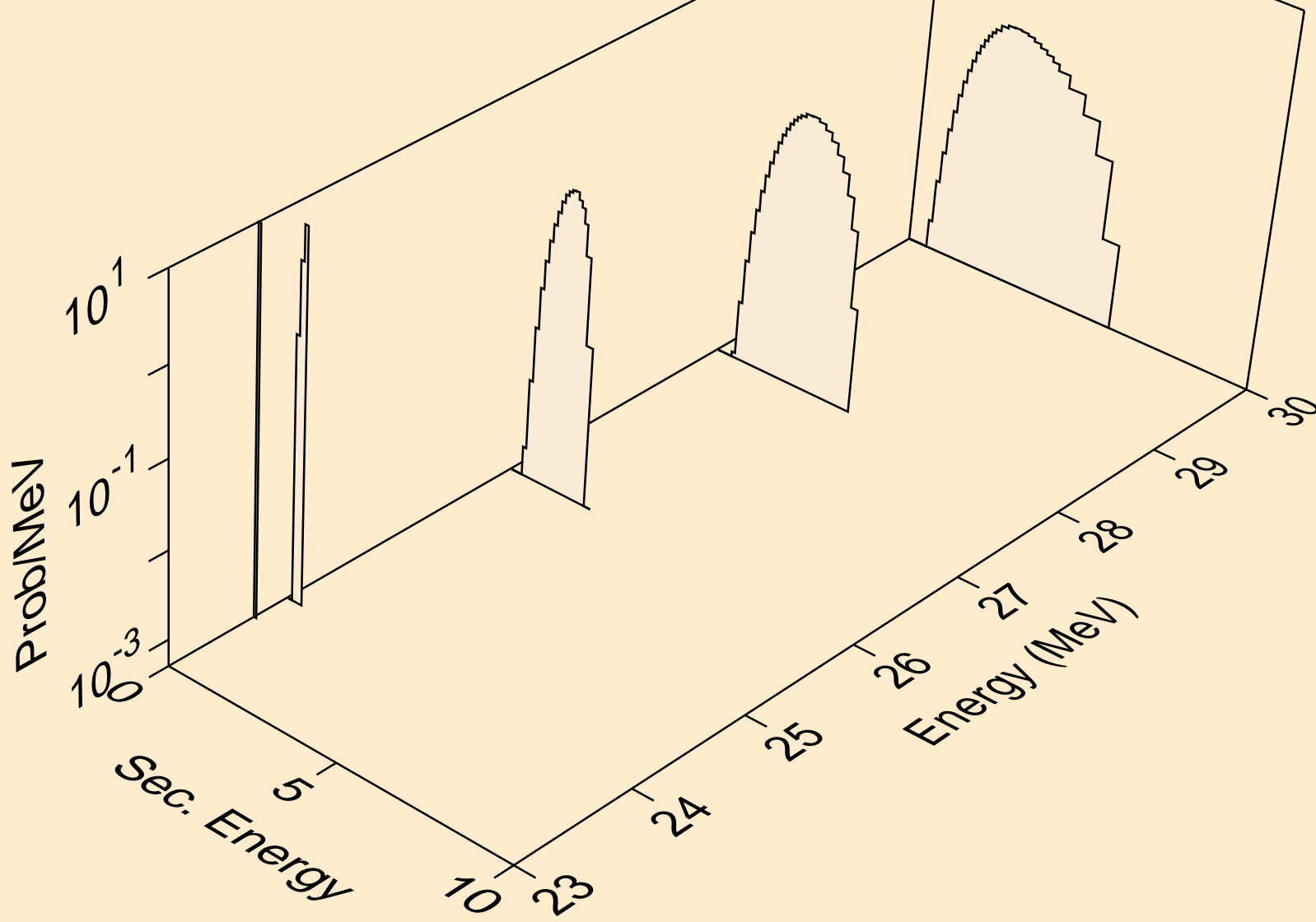

SI030 NEUTRON ACER TENDL-2023 LIBRARY; T=0.K  
protons from (n,n2p)

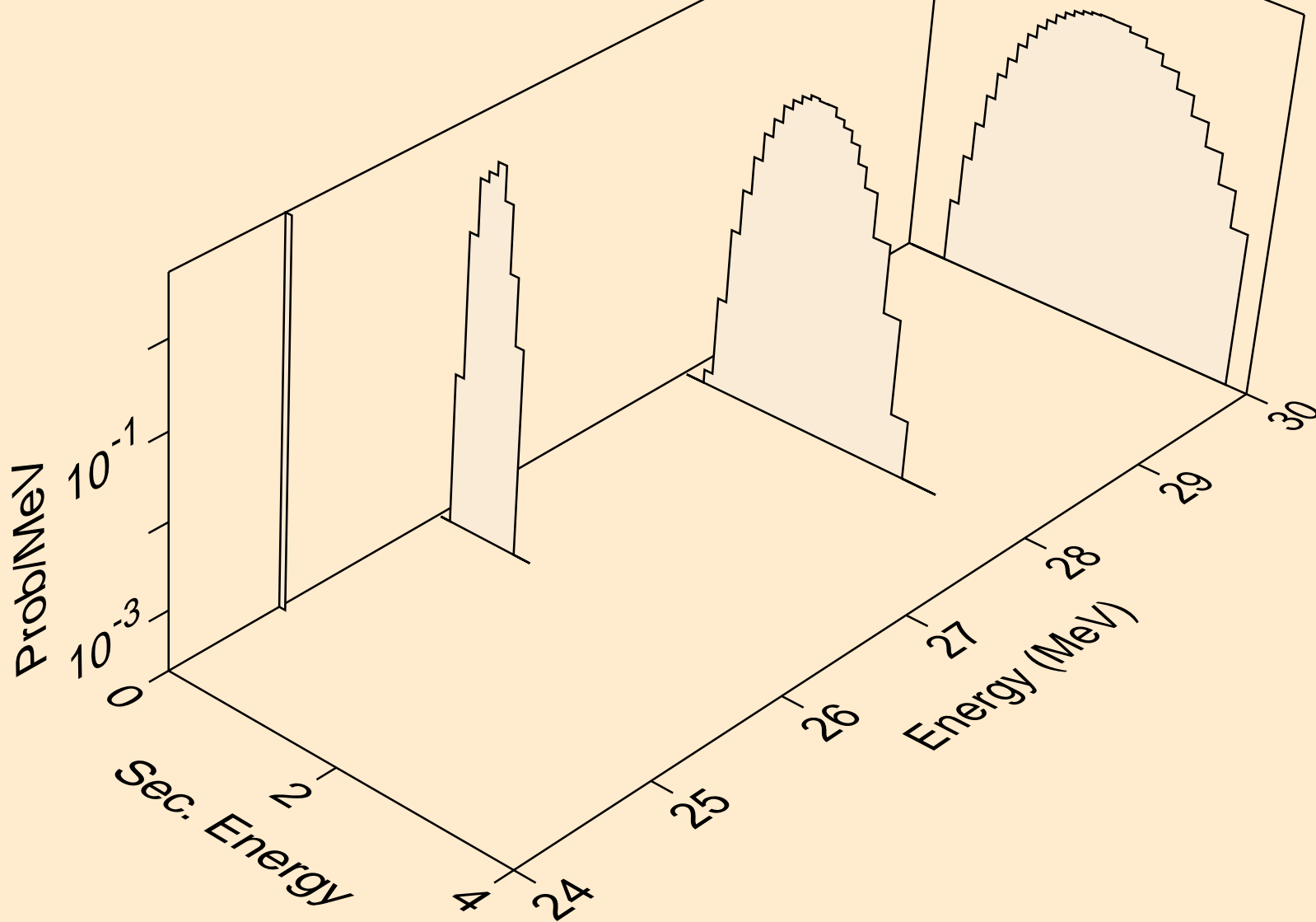

SI030 NEUTRON ACER TENDL-2023 LIBRARY; T=0.K  
protons from (n,npa)

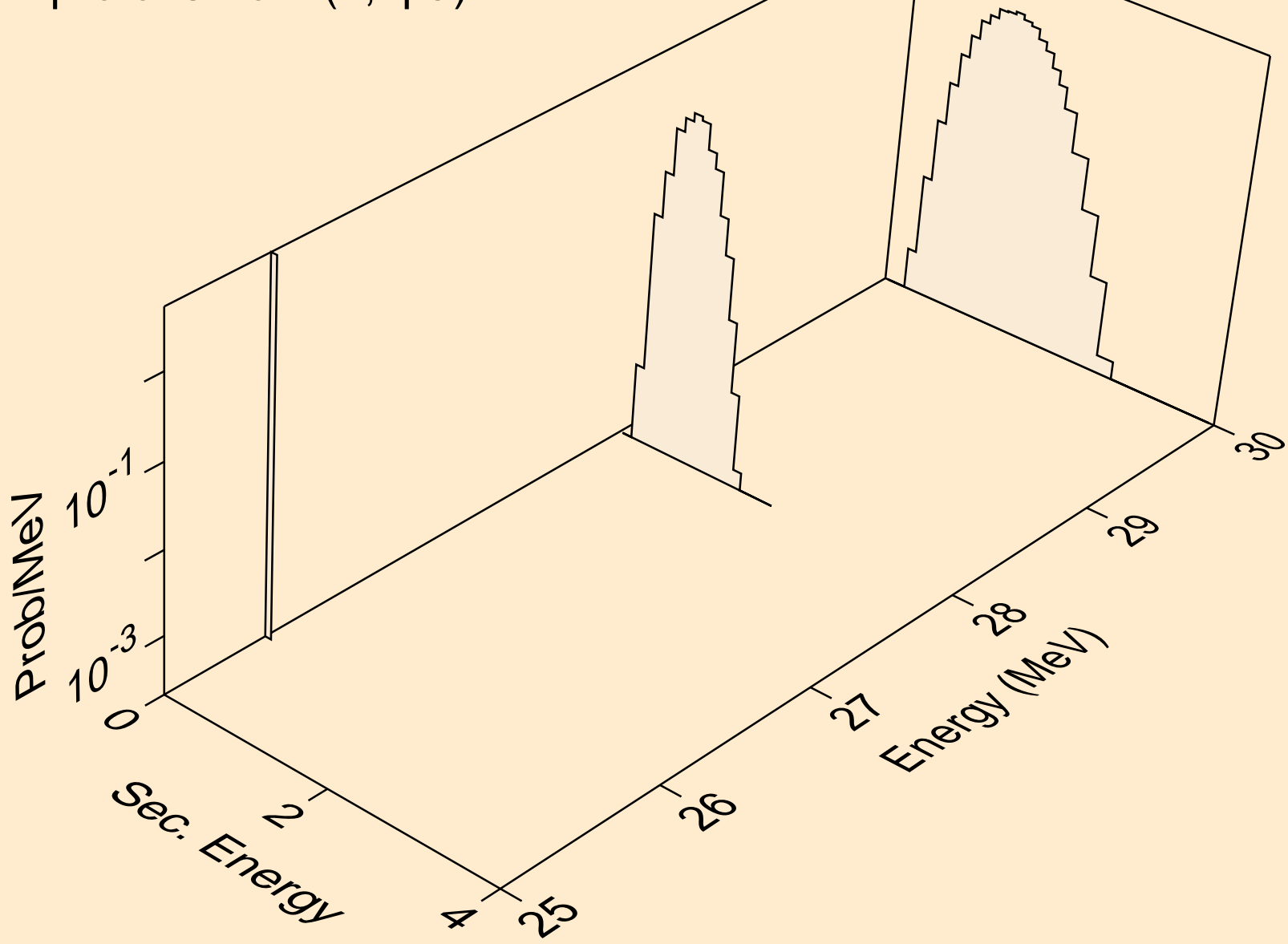

SI030 NEUTRON ACER TENDL-2023 LIBRARY; T=0.K  
protons from (n,p)

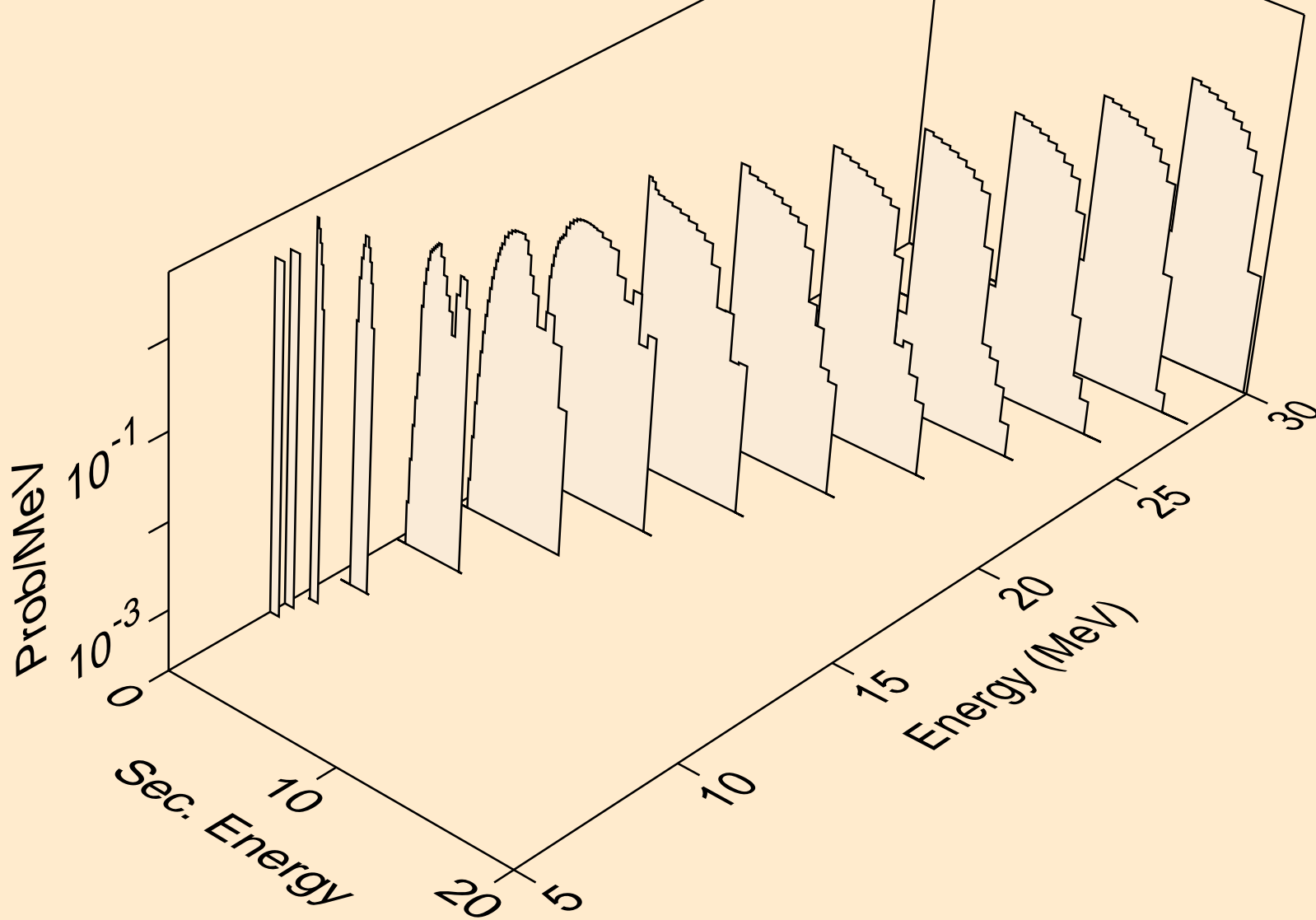



SI030 NEUTRON ACER TENDL-2023 LIBRARY; T=0.K  
protons from (n,2p)

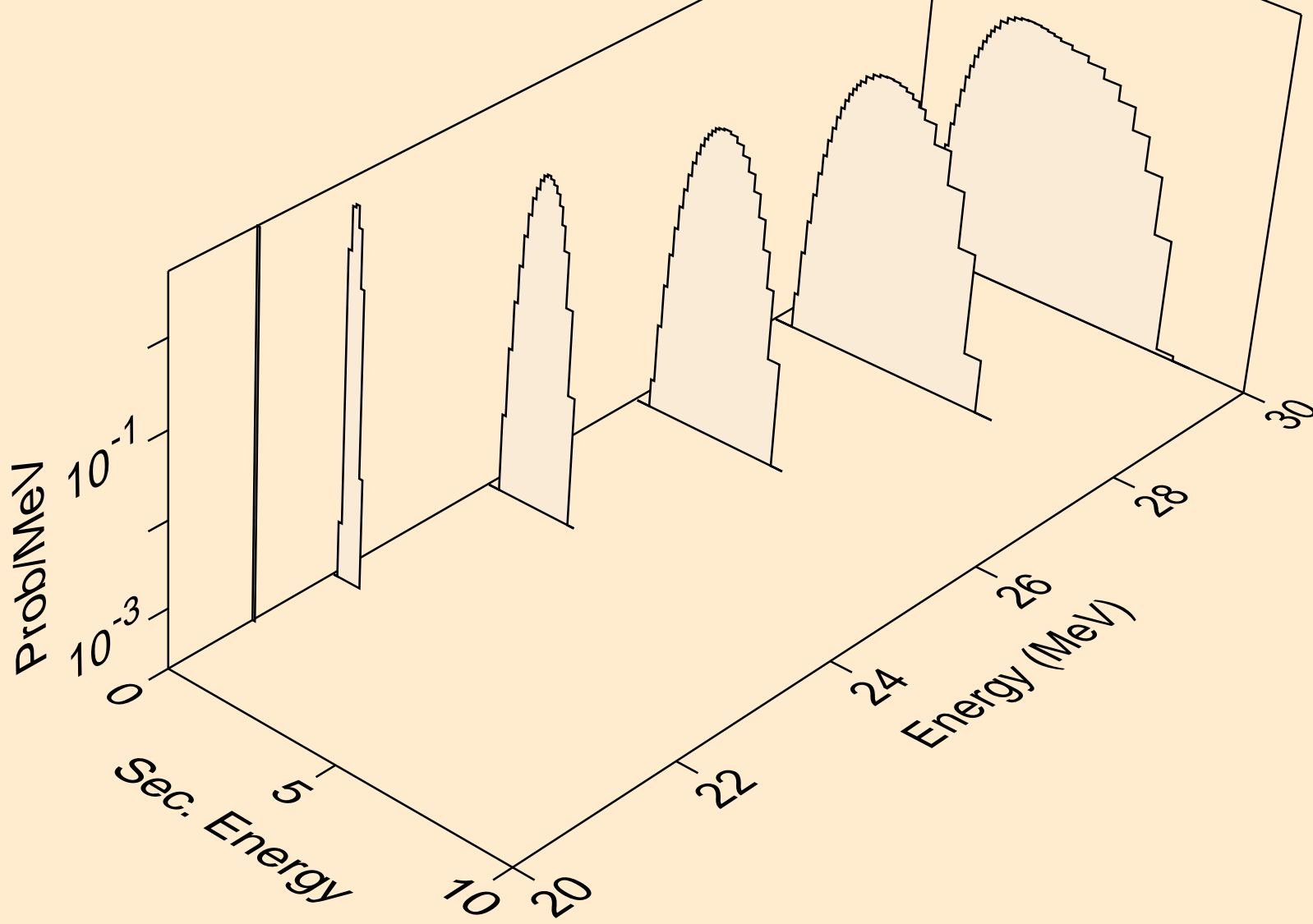

SI030 NEUTRON ACER TENDL-2023 LIBRARY; T=0.K  
protons from (n,pa)

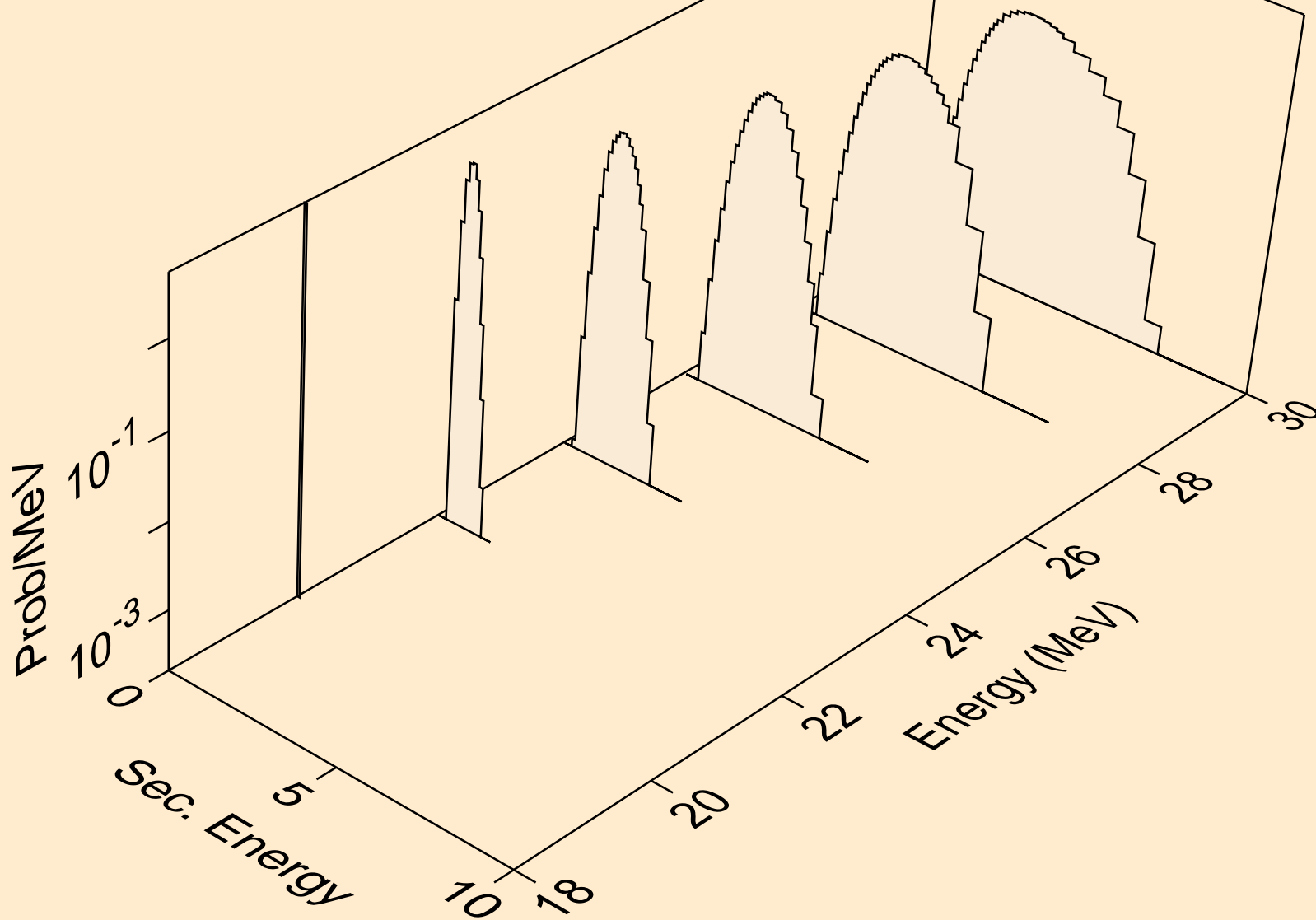

SI030 NEUTRON ACER TENDL-2023 LIBRARY; T=0.K  
protons from (n,pd)

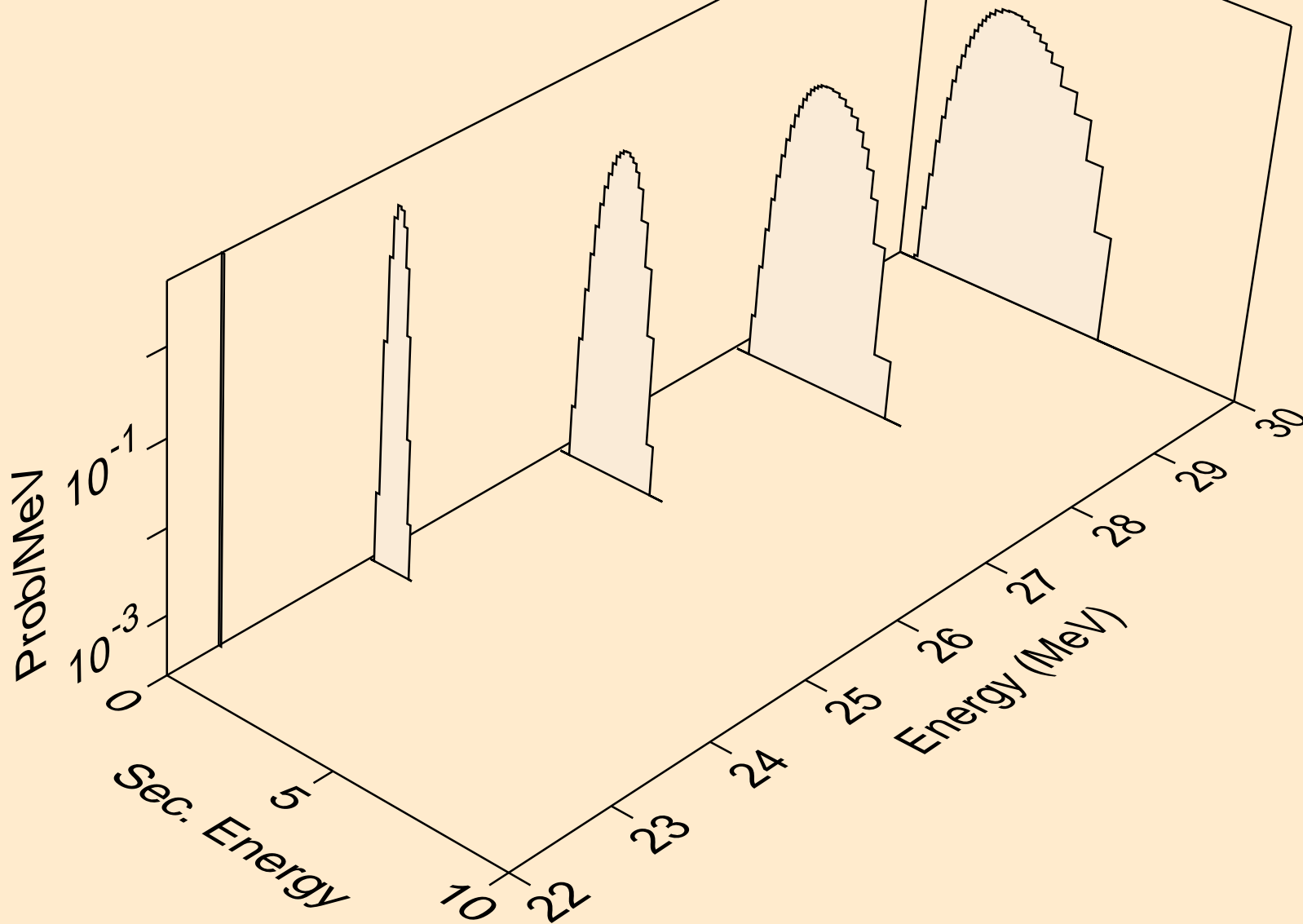

SI030 NEUTRON ACER TENDL-2023 LIBRARY; T=0.K  
protons from (n,pt)

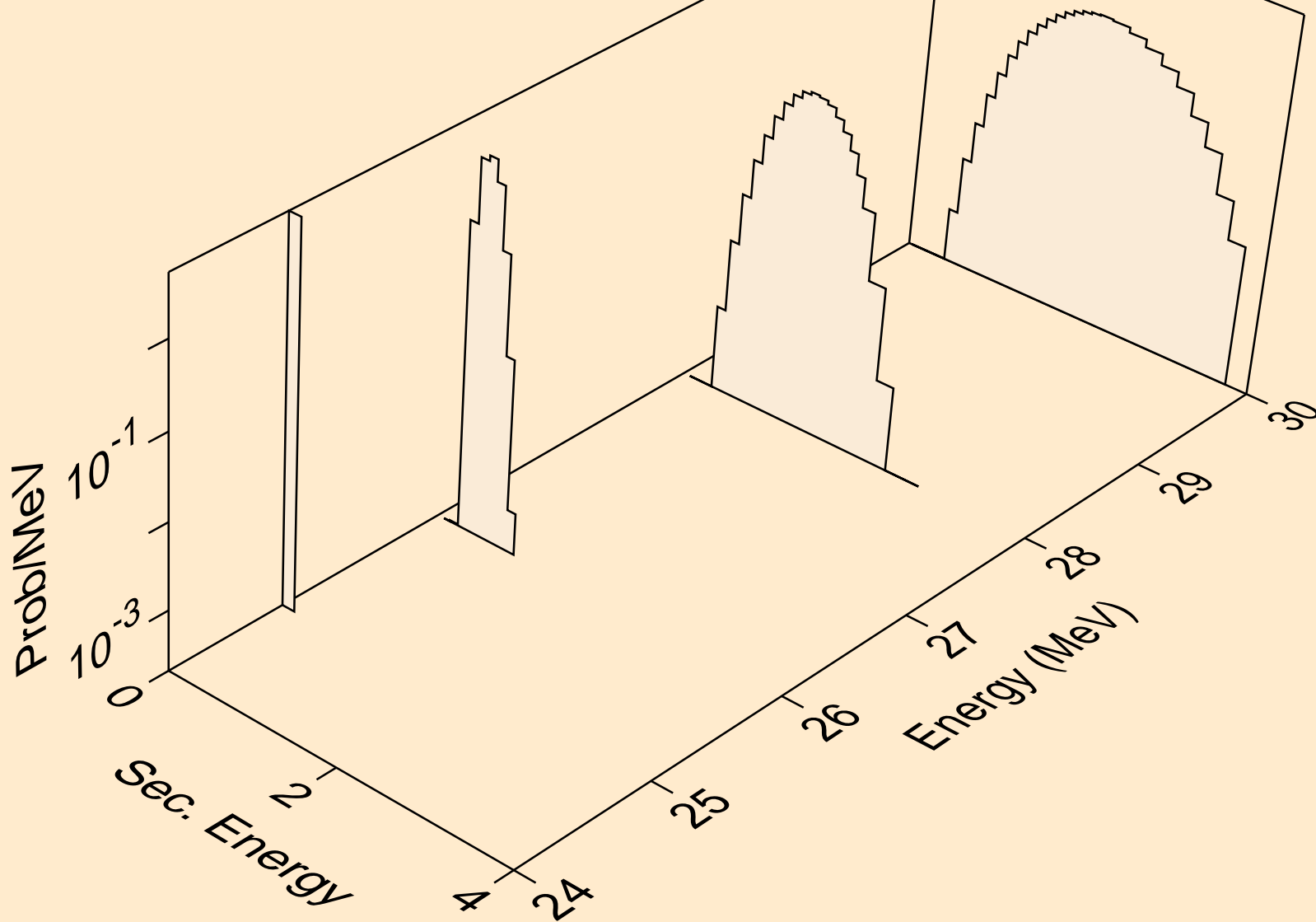

SI030 NEUTRON ACER TENDL-2023 LIBRARY; T=0.K  
deuterons from (n,x)

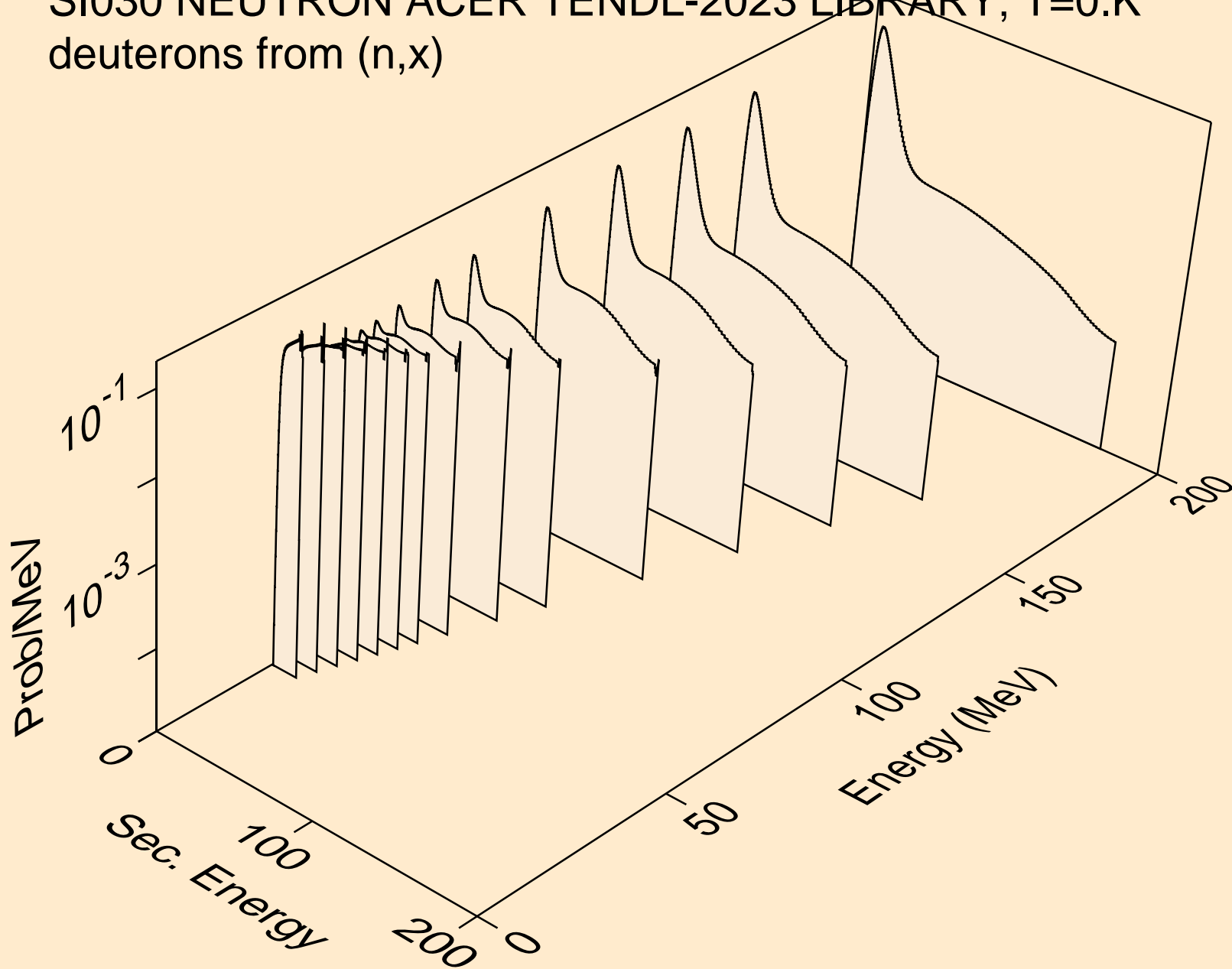

SI030 NEUTRON ACER TENDL-2023 LIBRARY; T=0.K  
deuterons from (n,n\*)d

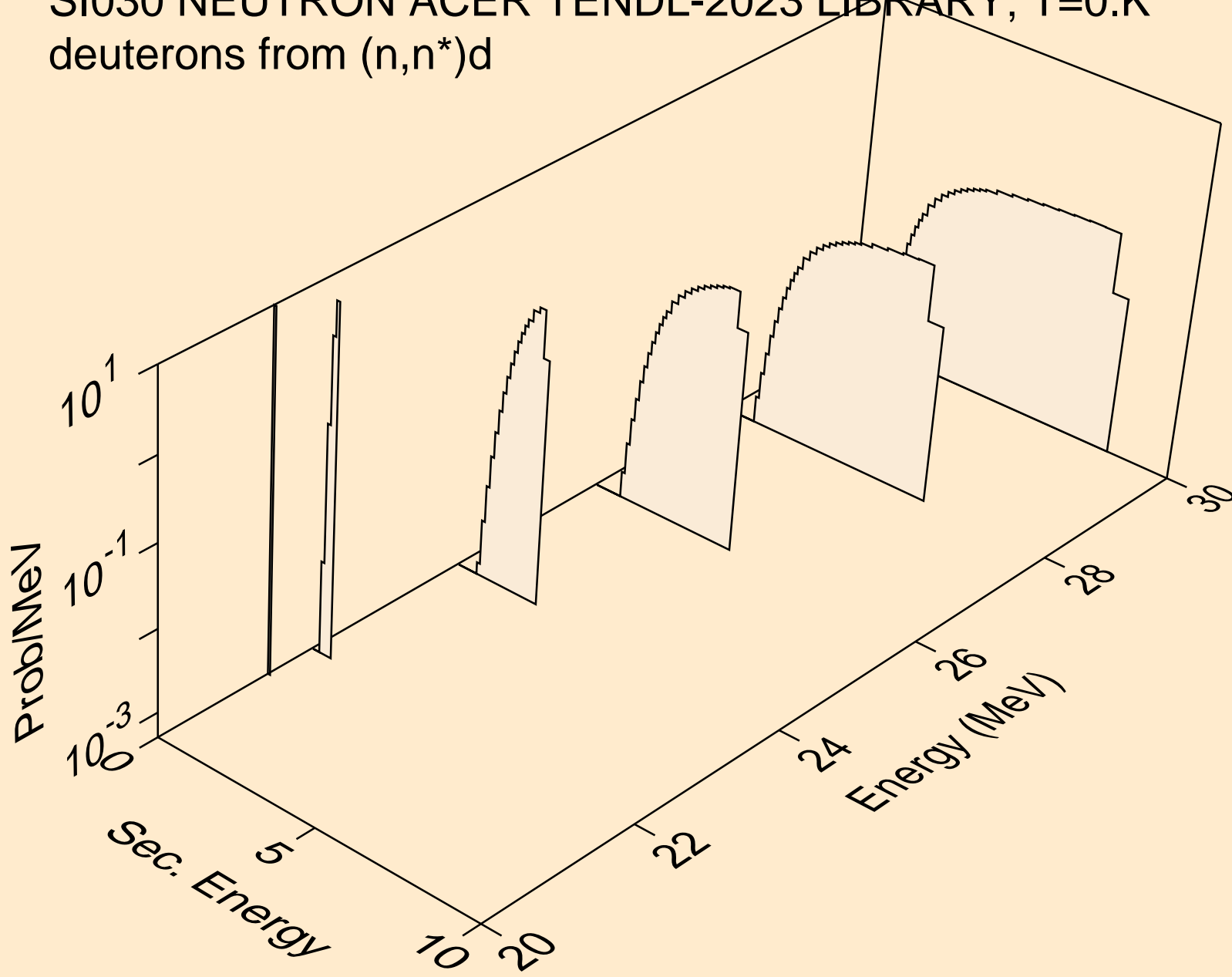

SI030 NEUTRON ACER TENDL-2023 LIBRARY; T=0.K  
deuterons from (n,d)

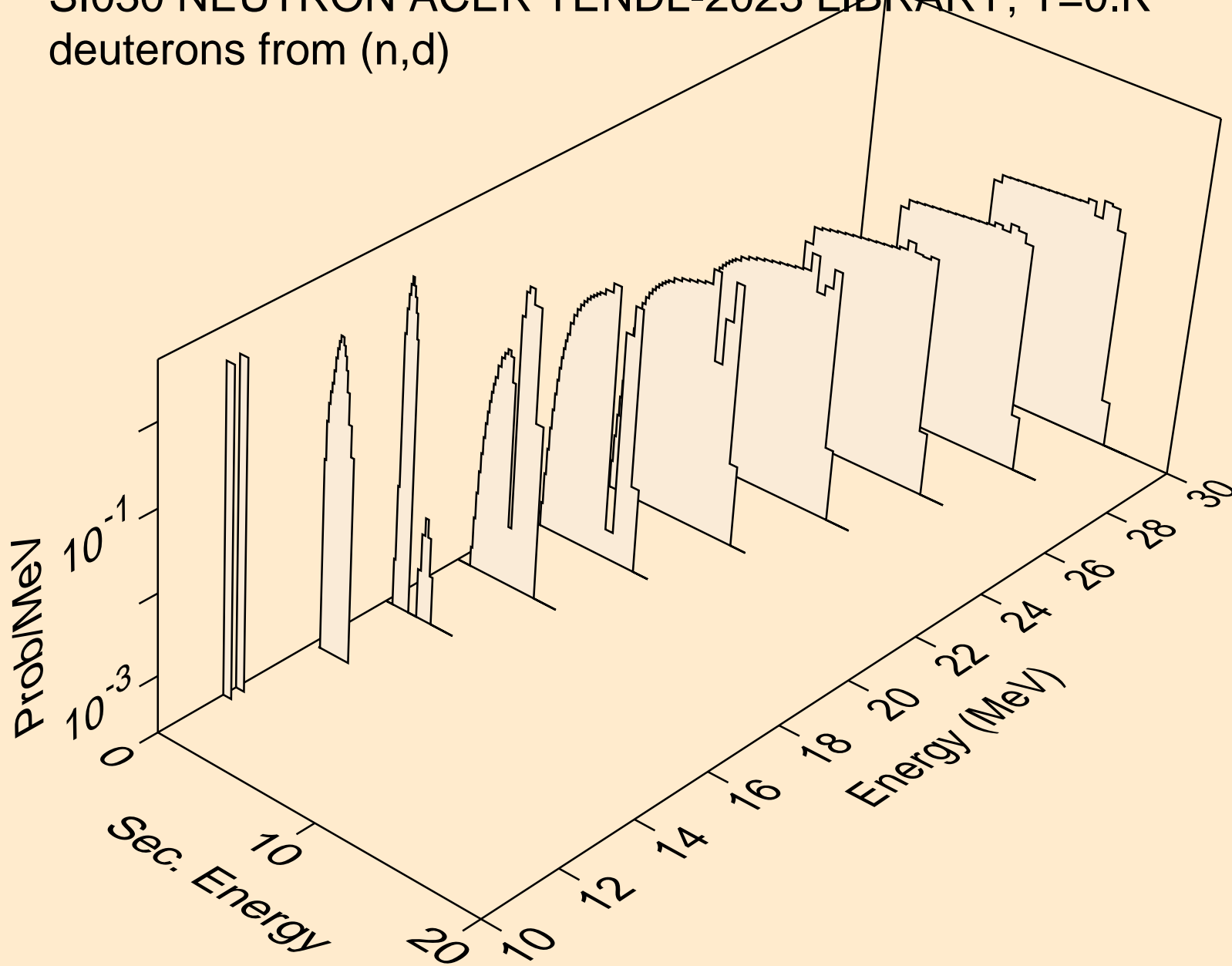

SI030 NEUTRON ACER TENDL-2023 LIBRARY; T=0.K  
deuterons from (n,pd)

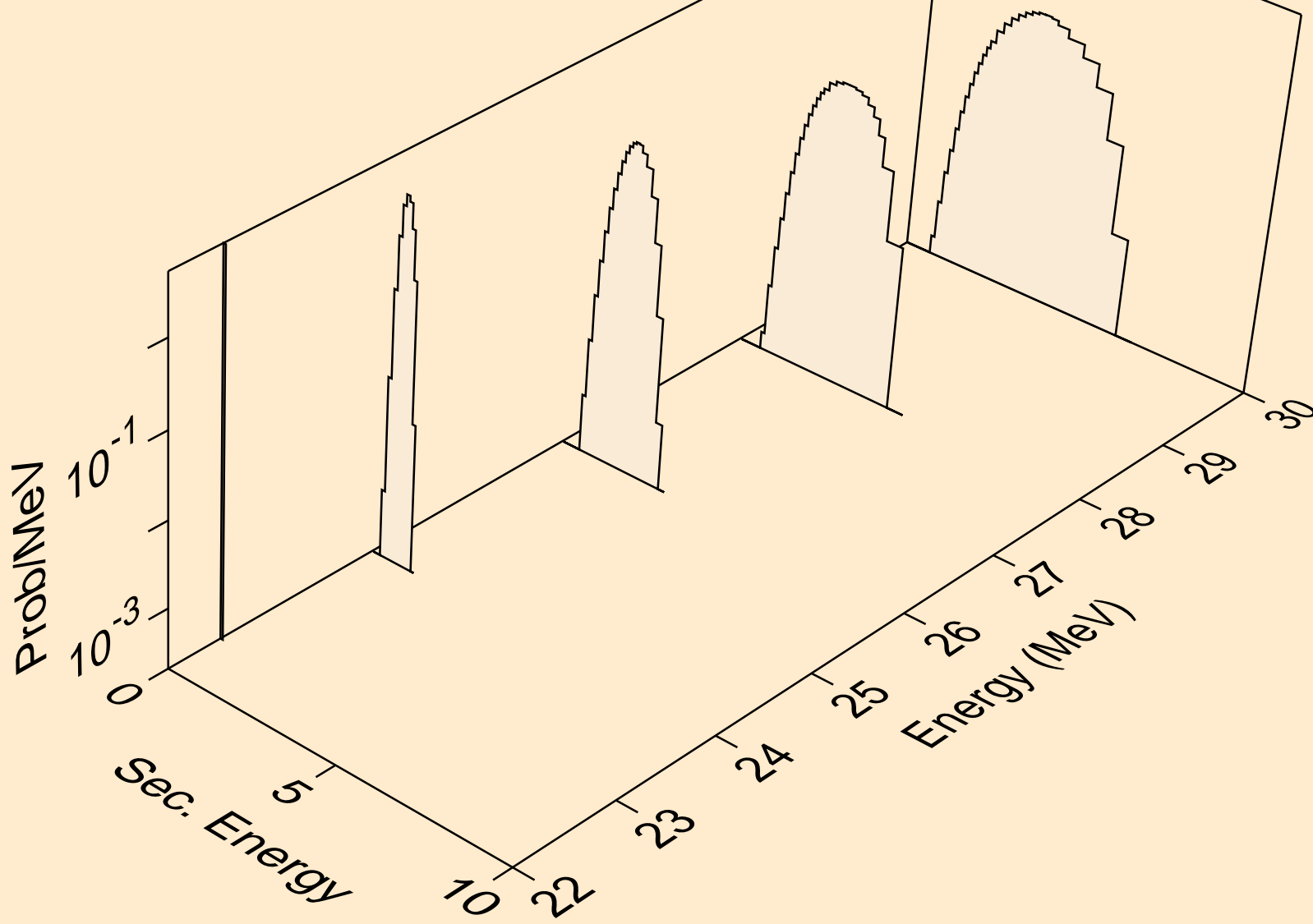



SI030 NEUTRON ACER TENDL-2023 LIBRARY; T=0.K  
deuterons from (n,da)

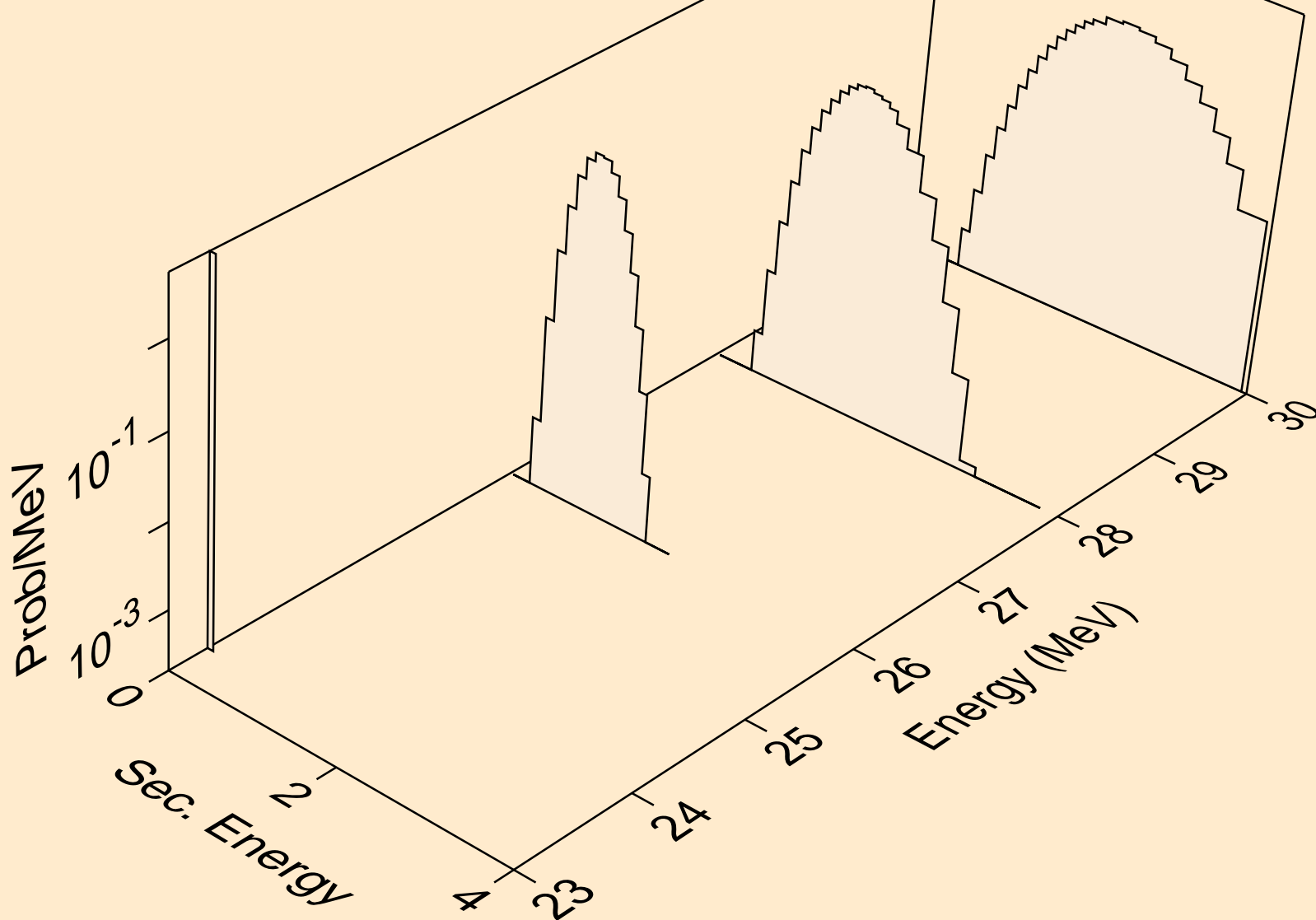

SI030 NEUTRON ACER TENDL-2023 LIBRARY; T=0.K  
tritons from (n,x)

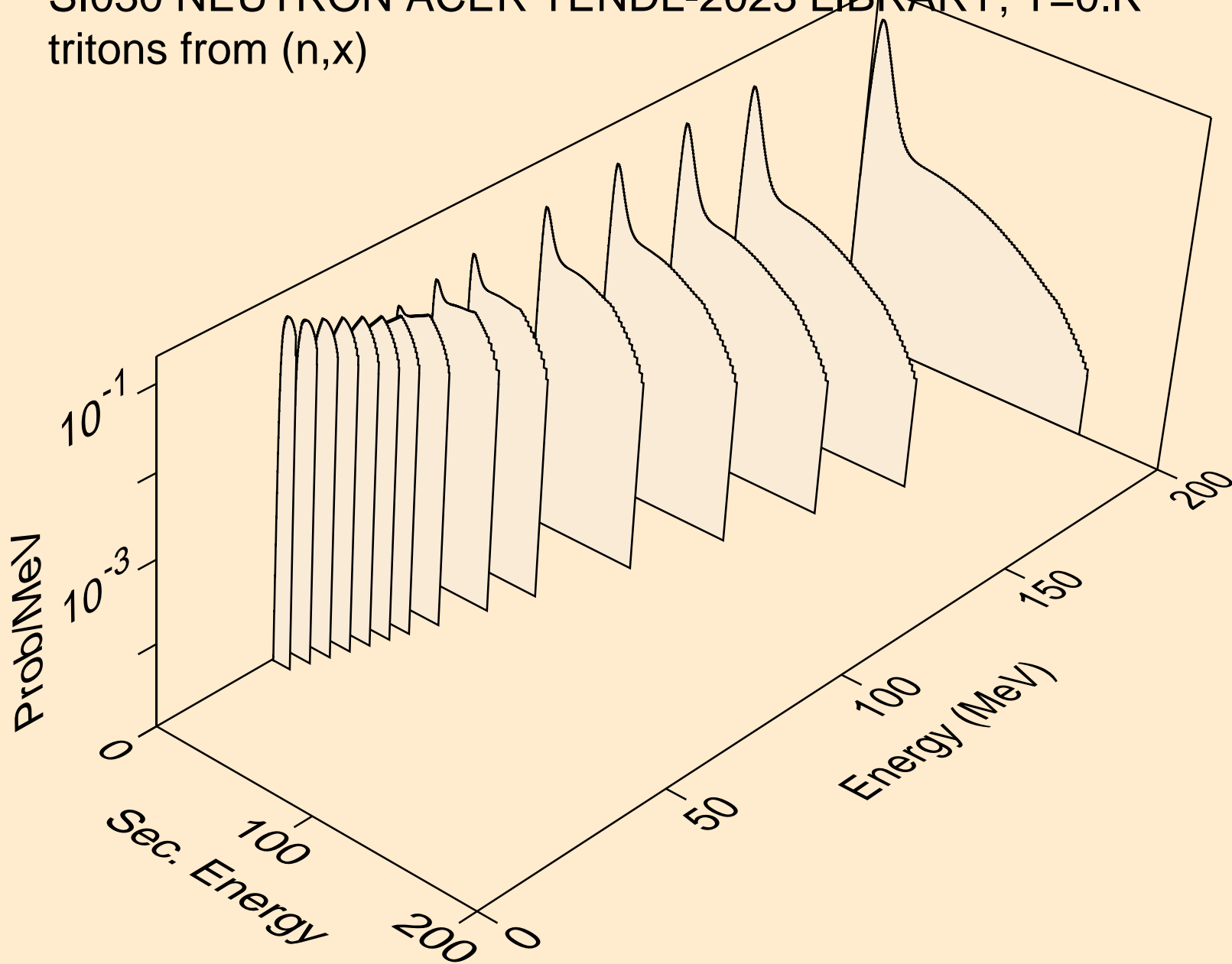

SI030 NEUTRON ACER TENDL-2023 LIBRARY; T=0.K  
tritons from (n,n\*)t

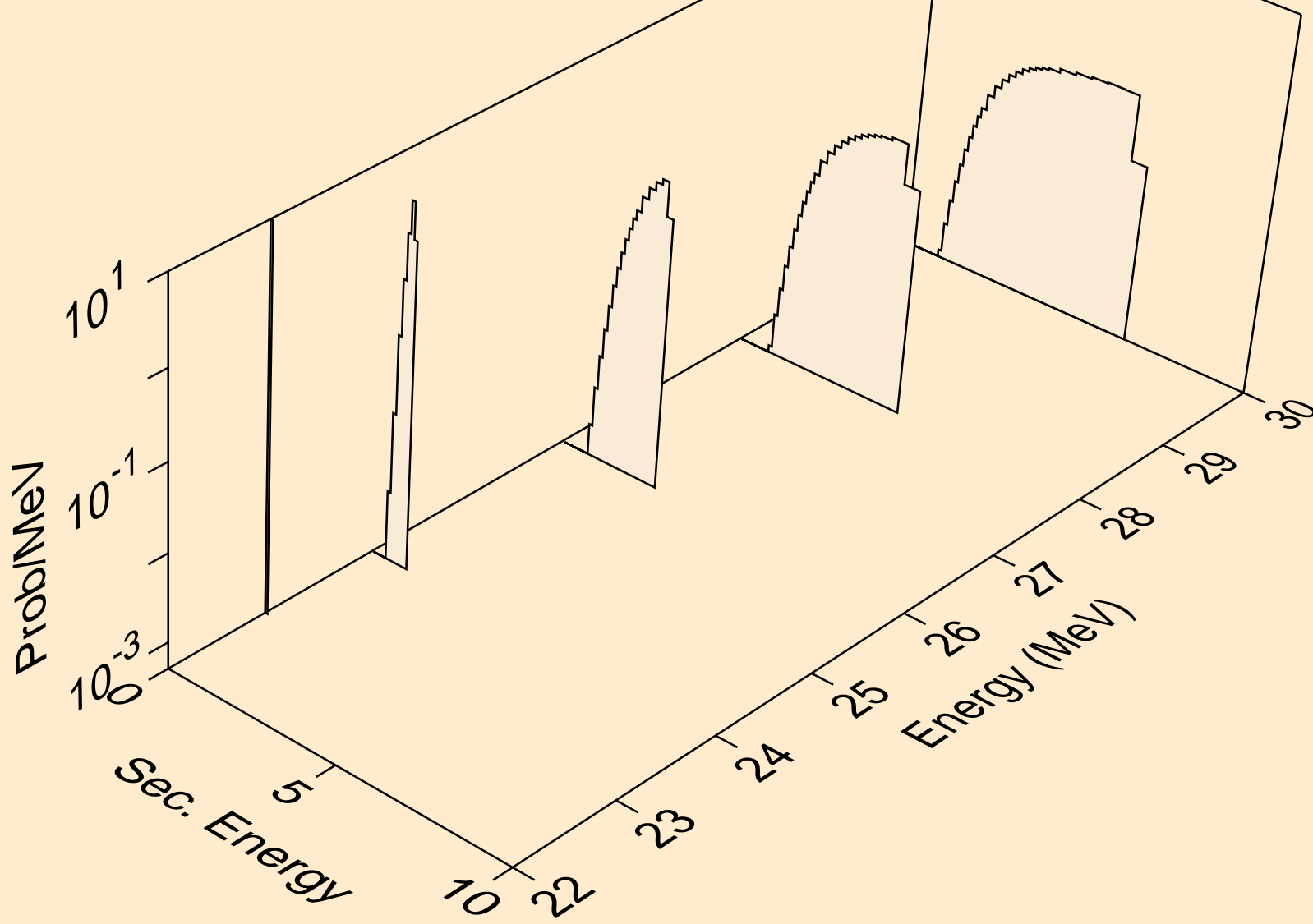

SI030 NEUTRON ACER TENDL-2023 LIBRARY; T=0.K  
tritons from (n,t)

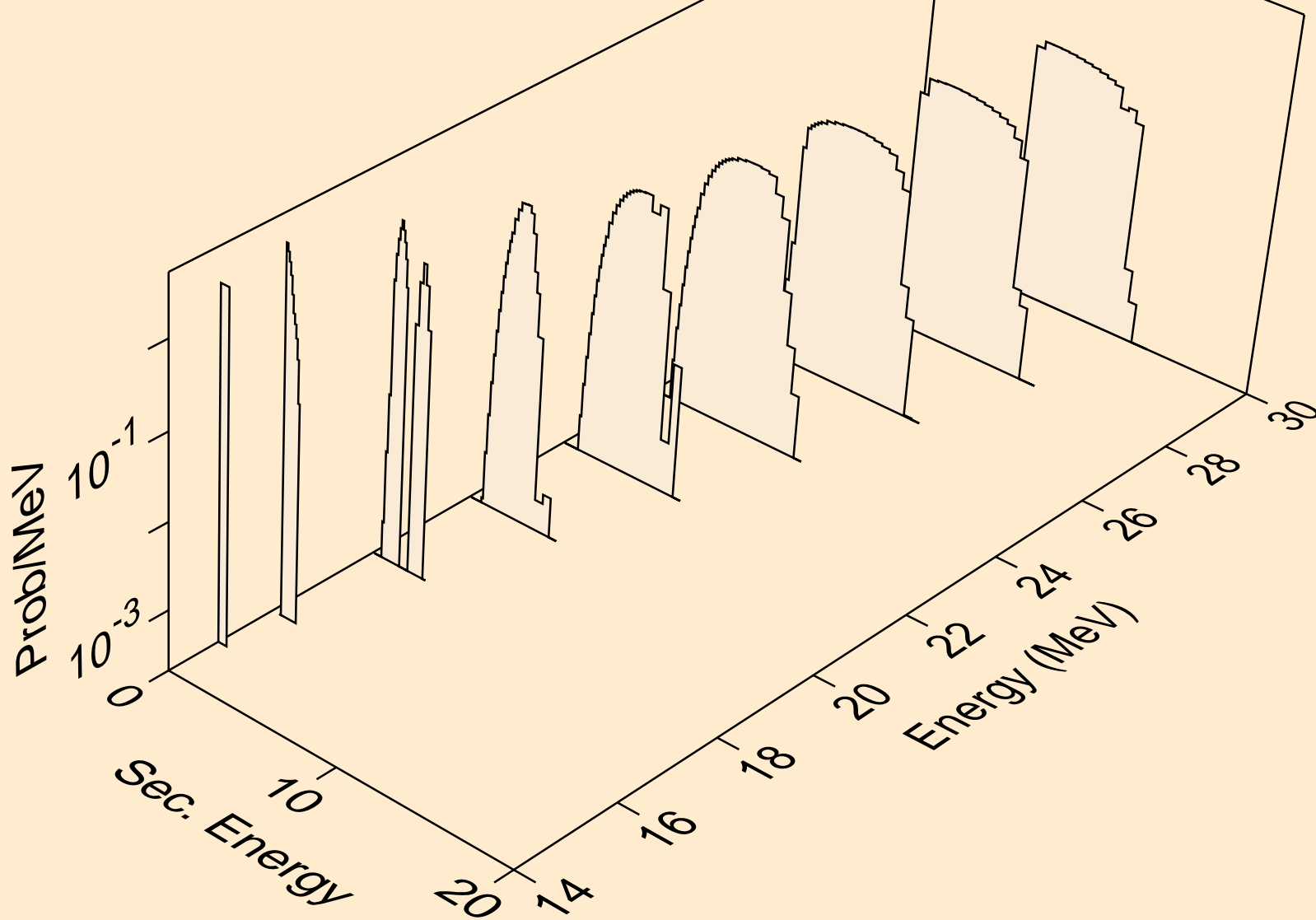

SI030 NEUTRON ACER TENDL-2023 LIBRARY; T=0.K  
tritons from (n,pt)

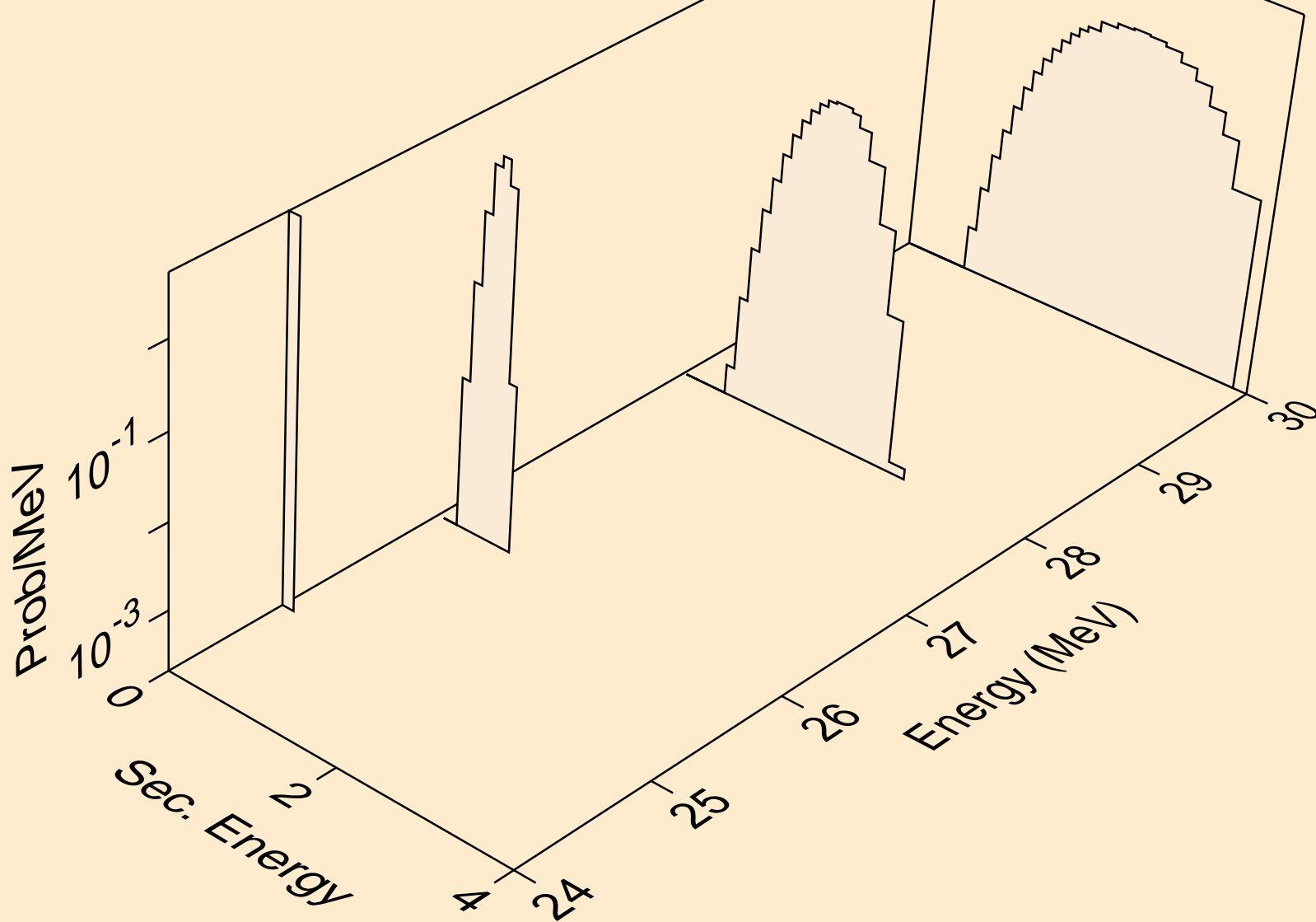

SI030 NEUTRON ACER TENDL-2023 LIBRARY; T=0.K  
he3s from (n,x)

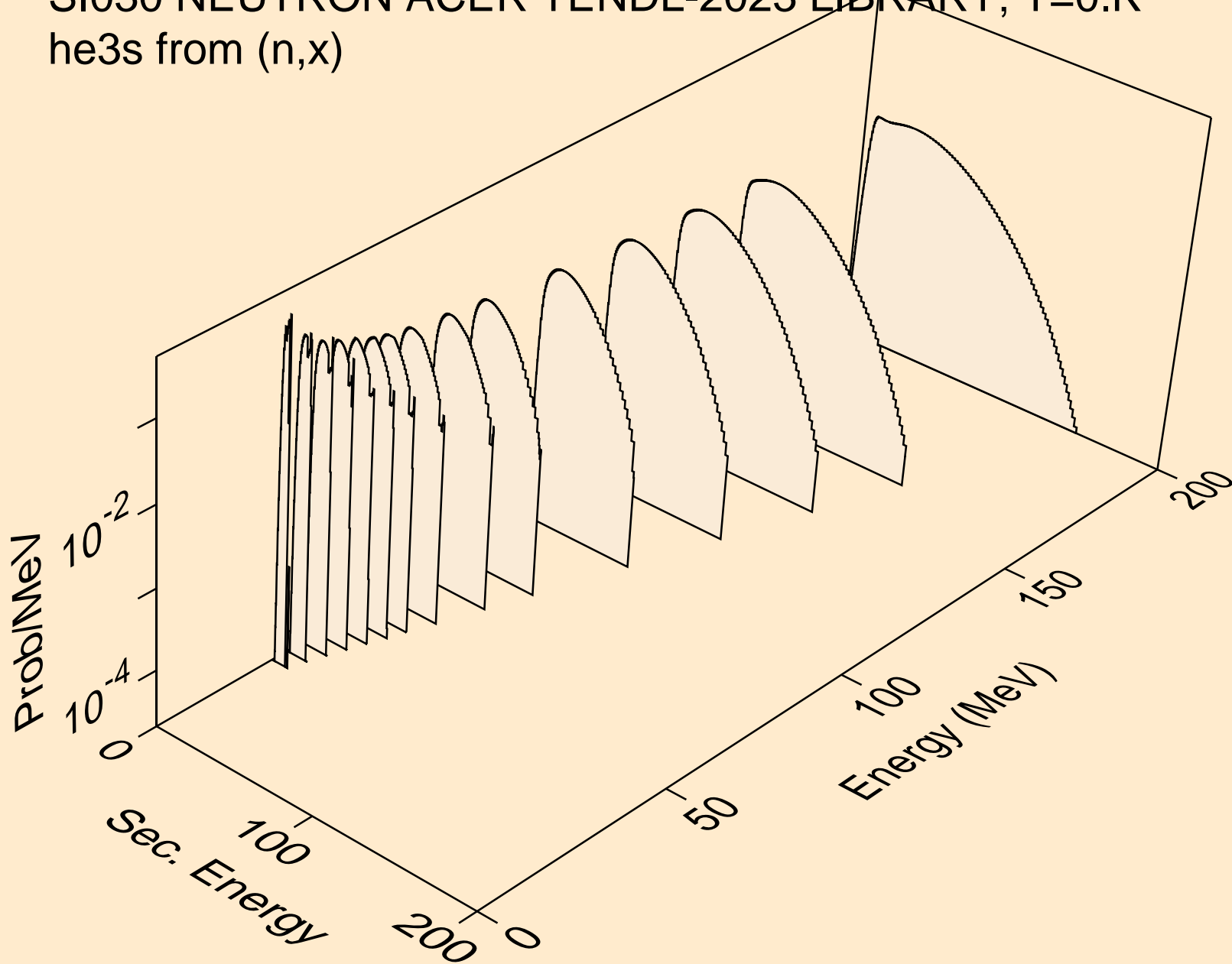

SI030 NEUTRON ACER TENDL-2023 LIBRARY; T=0.K  
he3s from (n,n\*)he3

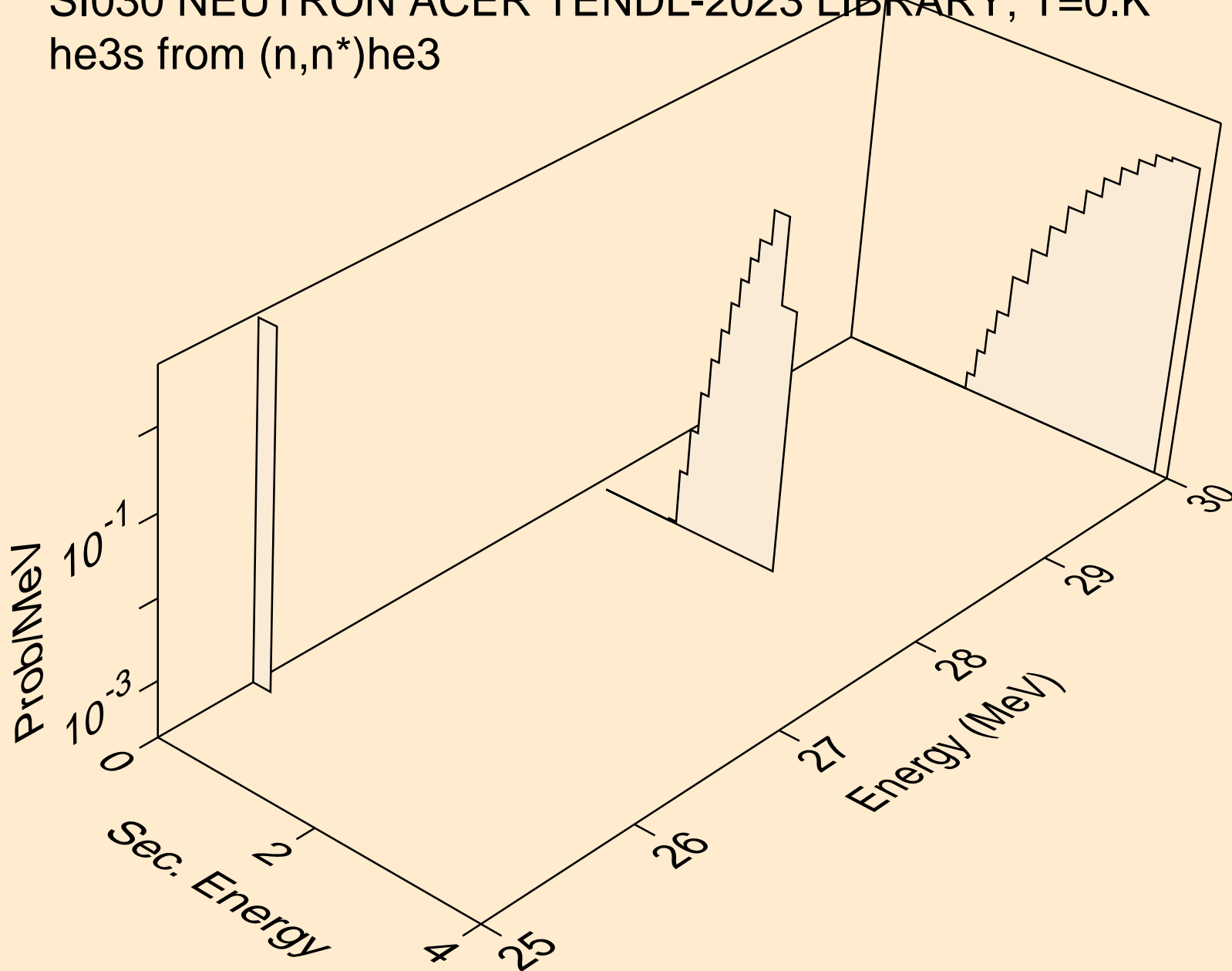

SI030 NEUTRON ACER TENDL-2023 LIBRARY; T=0.K  
he3s from (n,he3)

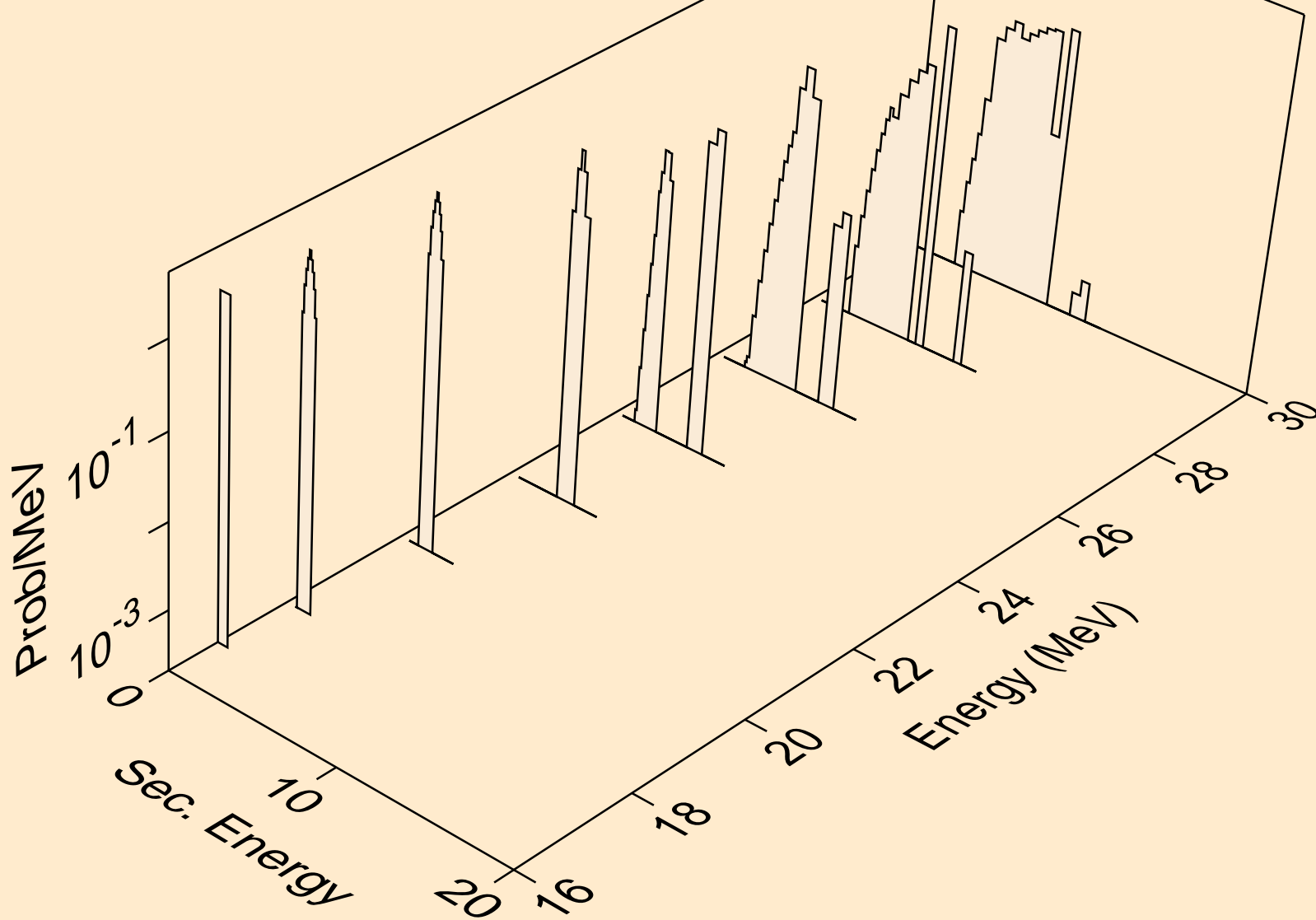



SI030 NEUTRON ACER TENDL-2023 LIBRARY; T=0.K  
alphas from (n,x)

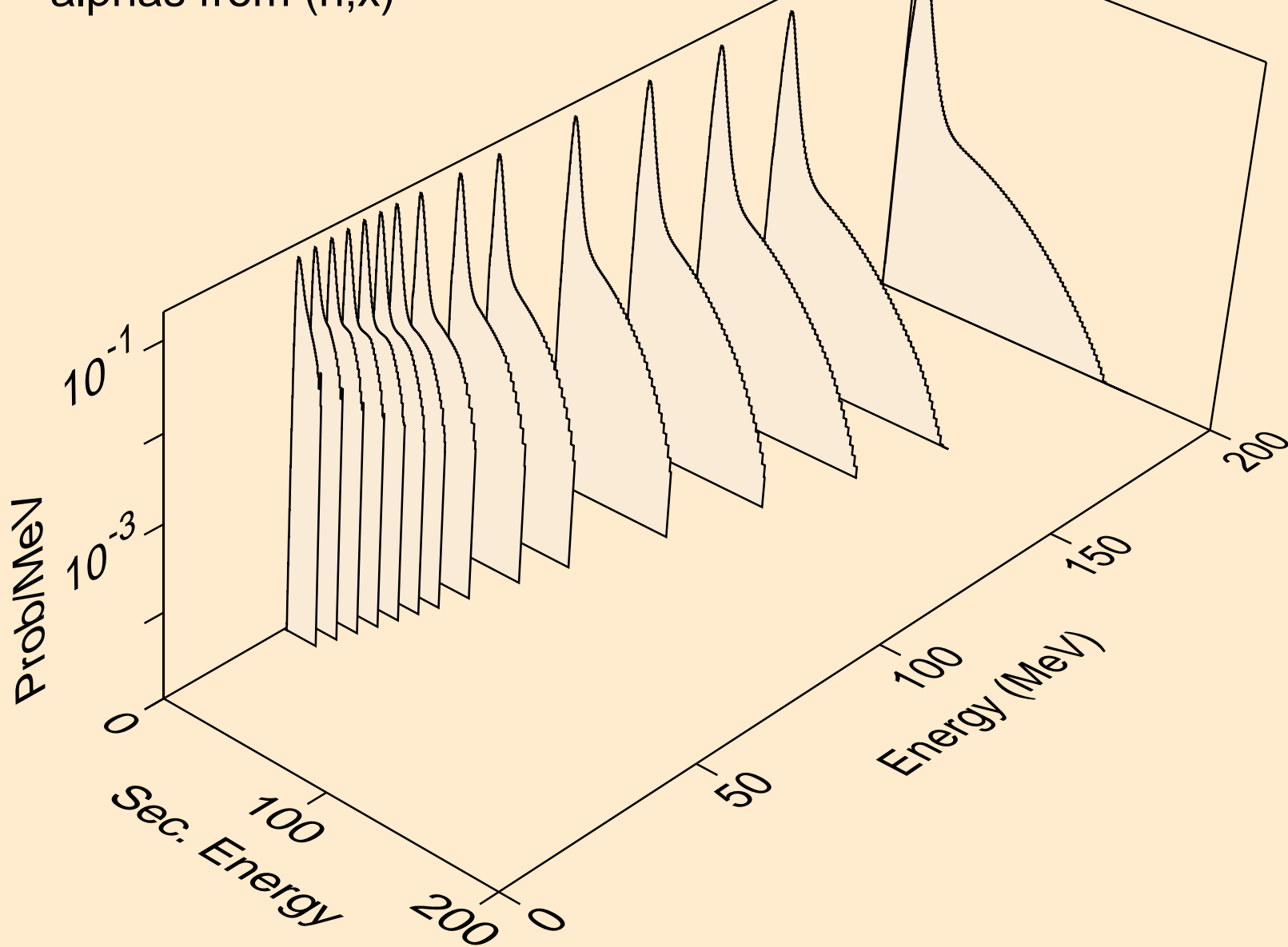

SI030 NEUTRON ACER TENDL-2023 LIBRARY; T=0.K  
alphas from (n,n\*)a

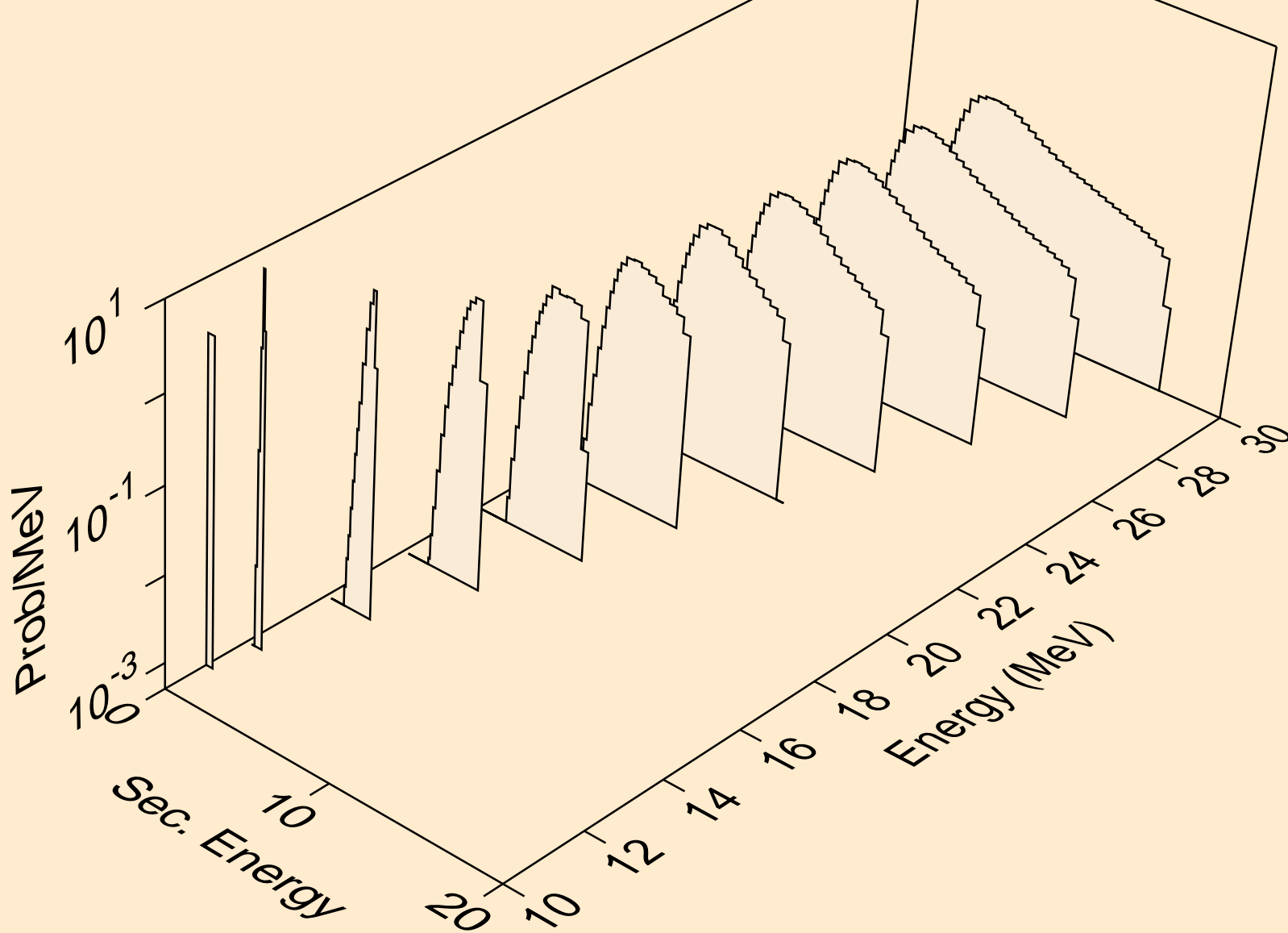

SI030 NEUTRON ACER TENDL-2023 LIBRARY; T=0.K  
alphas from (n,2n)a

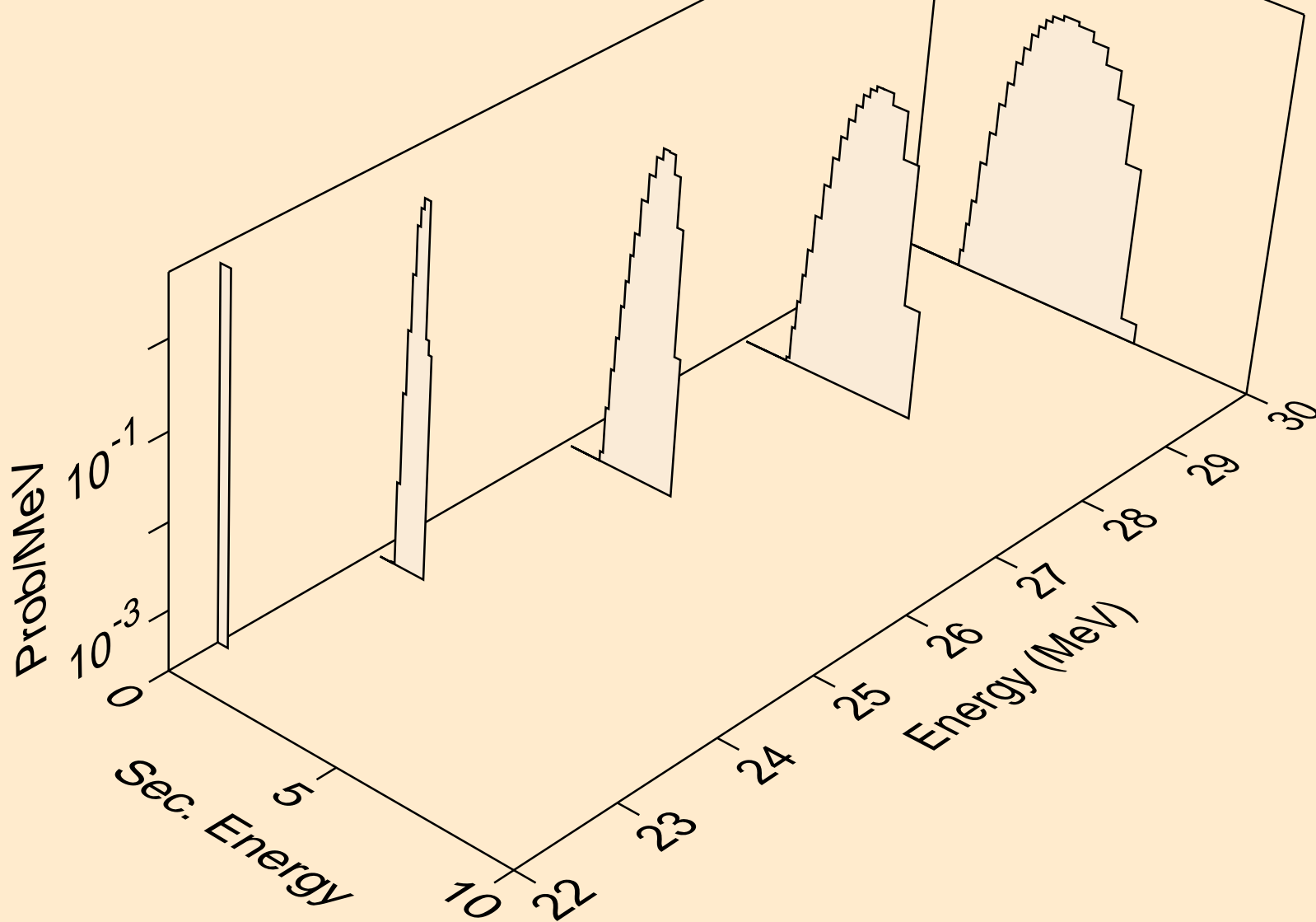

SI030 NEUTRON ACER TENDL-2023 LIBRARY; T=0.K  
alphas from (n,n\*)2a

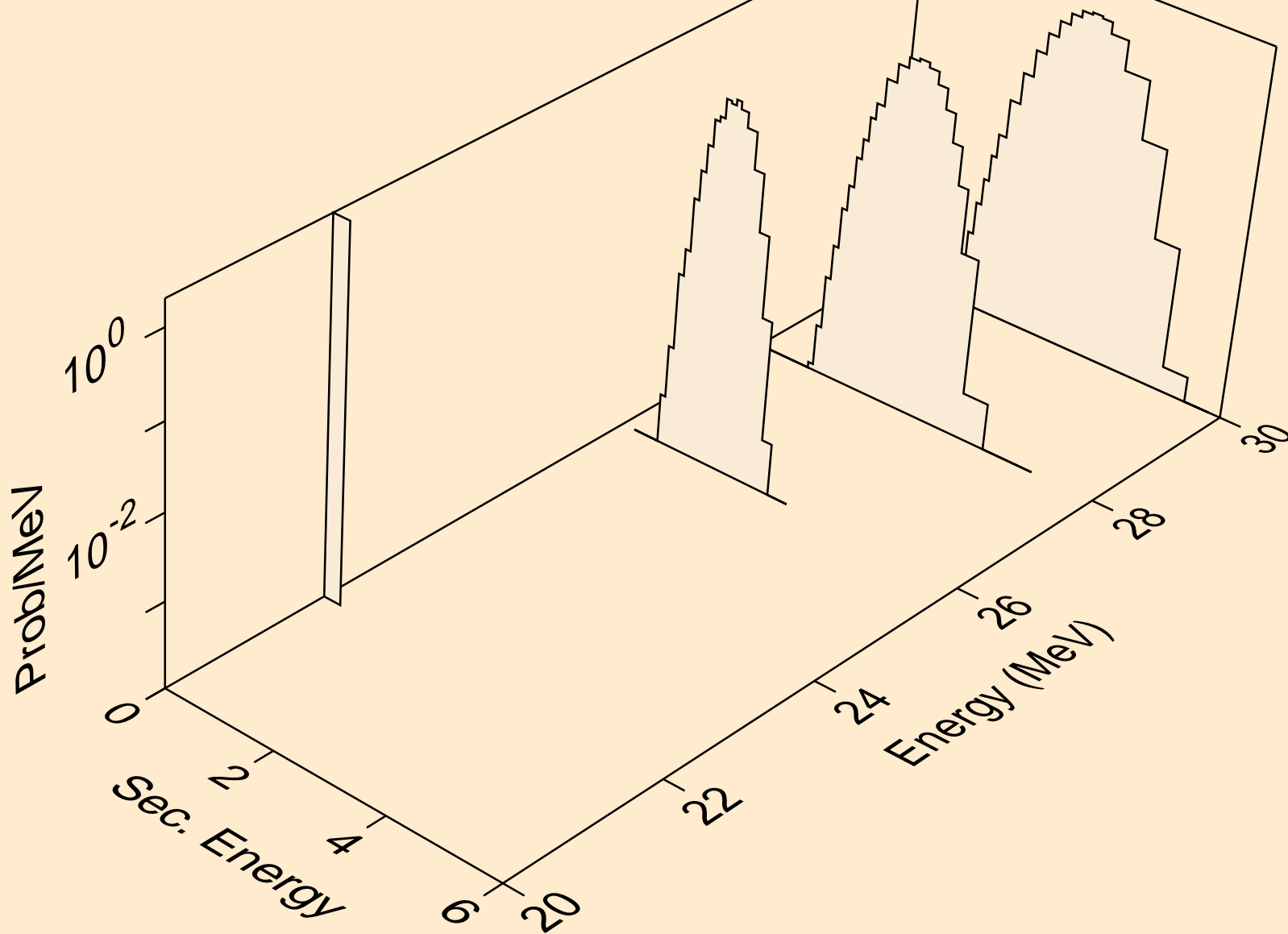

SI030 NEUTRON ACER TENDL-2023 LIBRARY; T=0.K  
alphas from (n,npa)

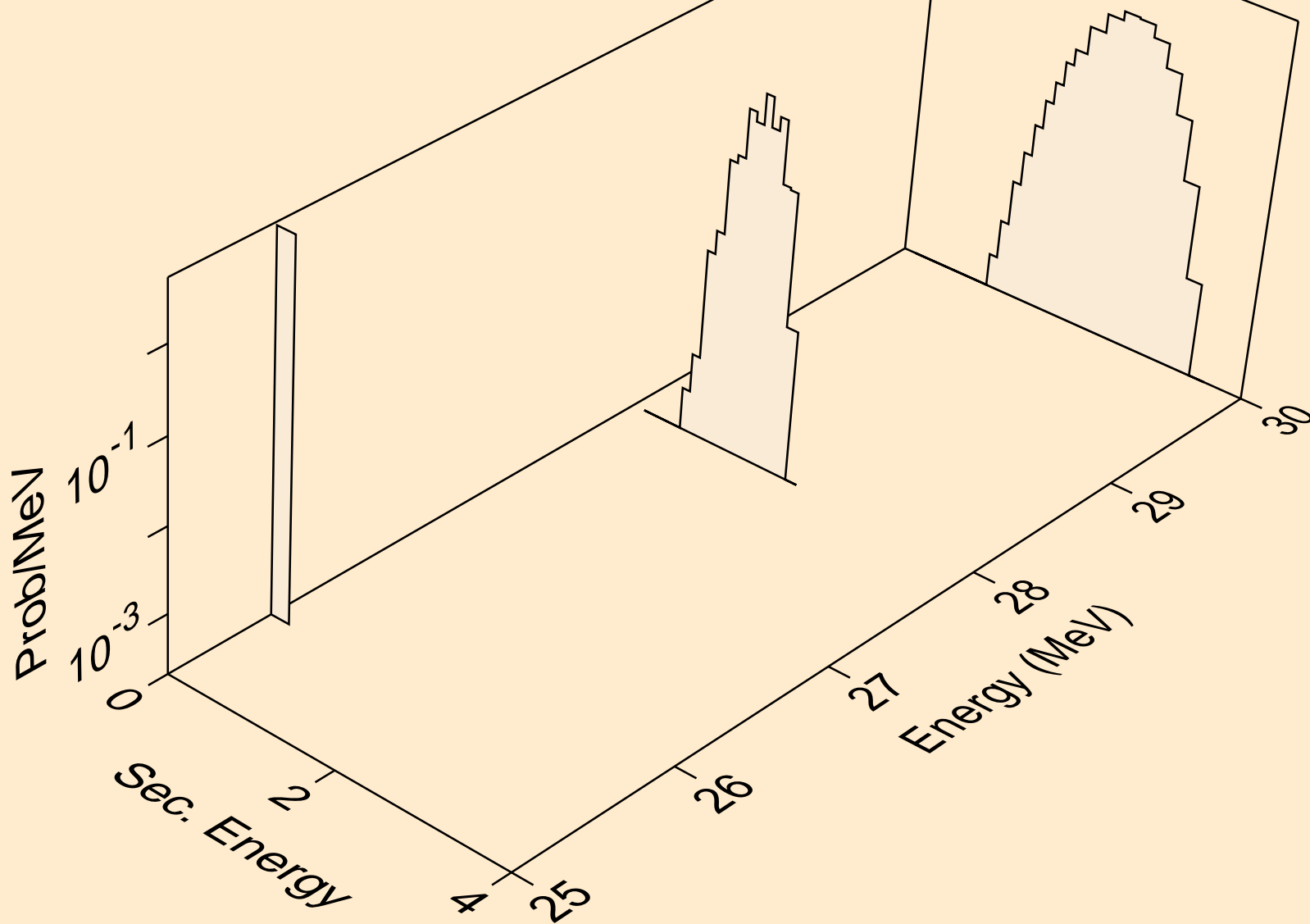

SI030 NEUTRON ACER TENDL-2023 LIBRARY; T=0.K  
alphas from (n,a)

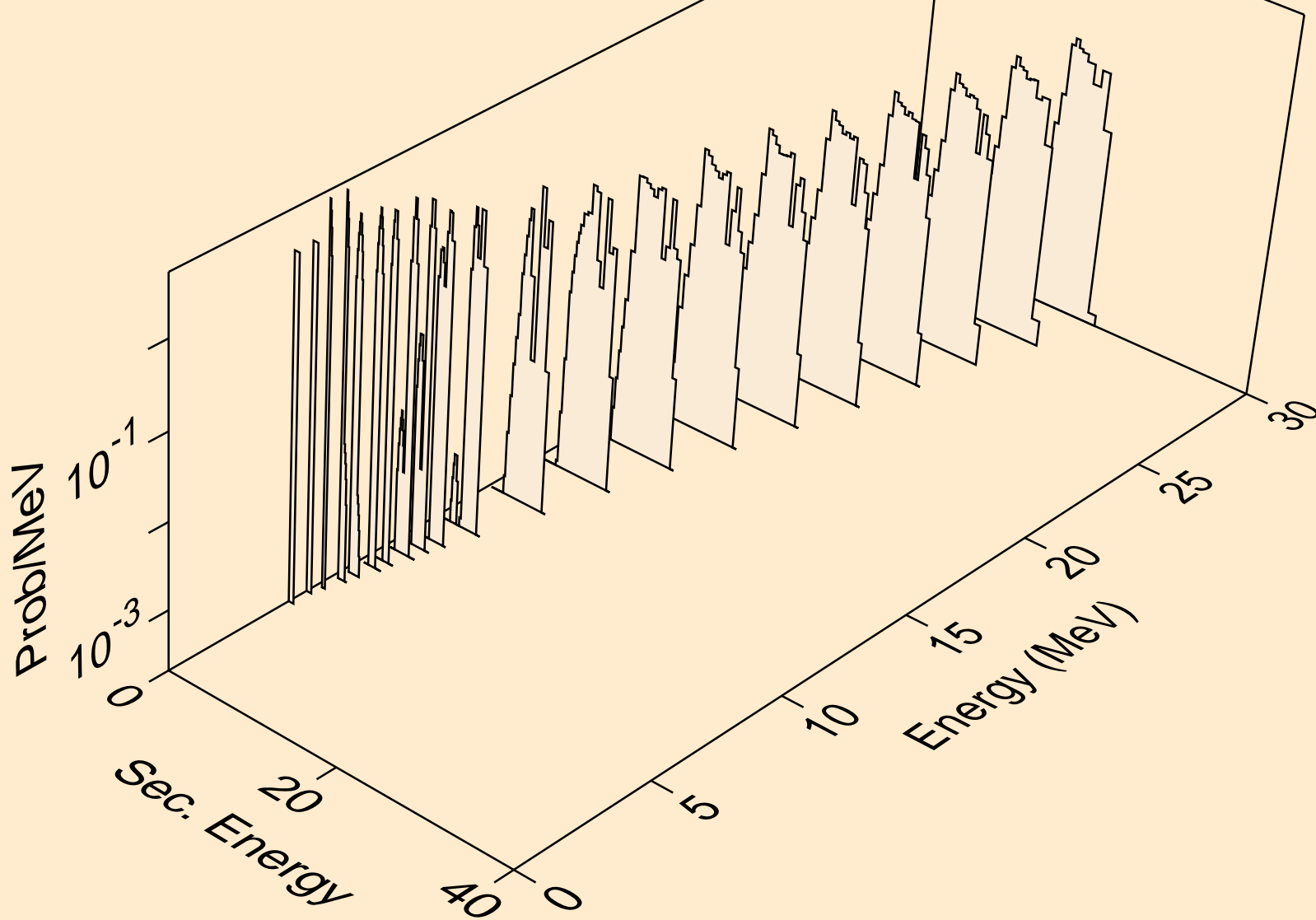

SI030 NEUTRON ACER TENDL-2023 LIBRARY; T=0.K  
alphas from (n,2a)

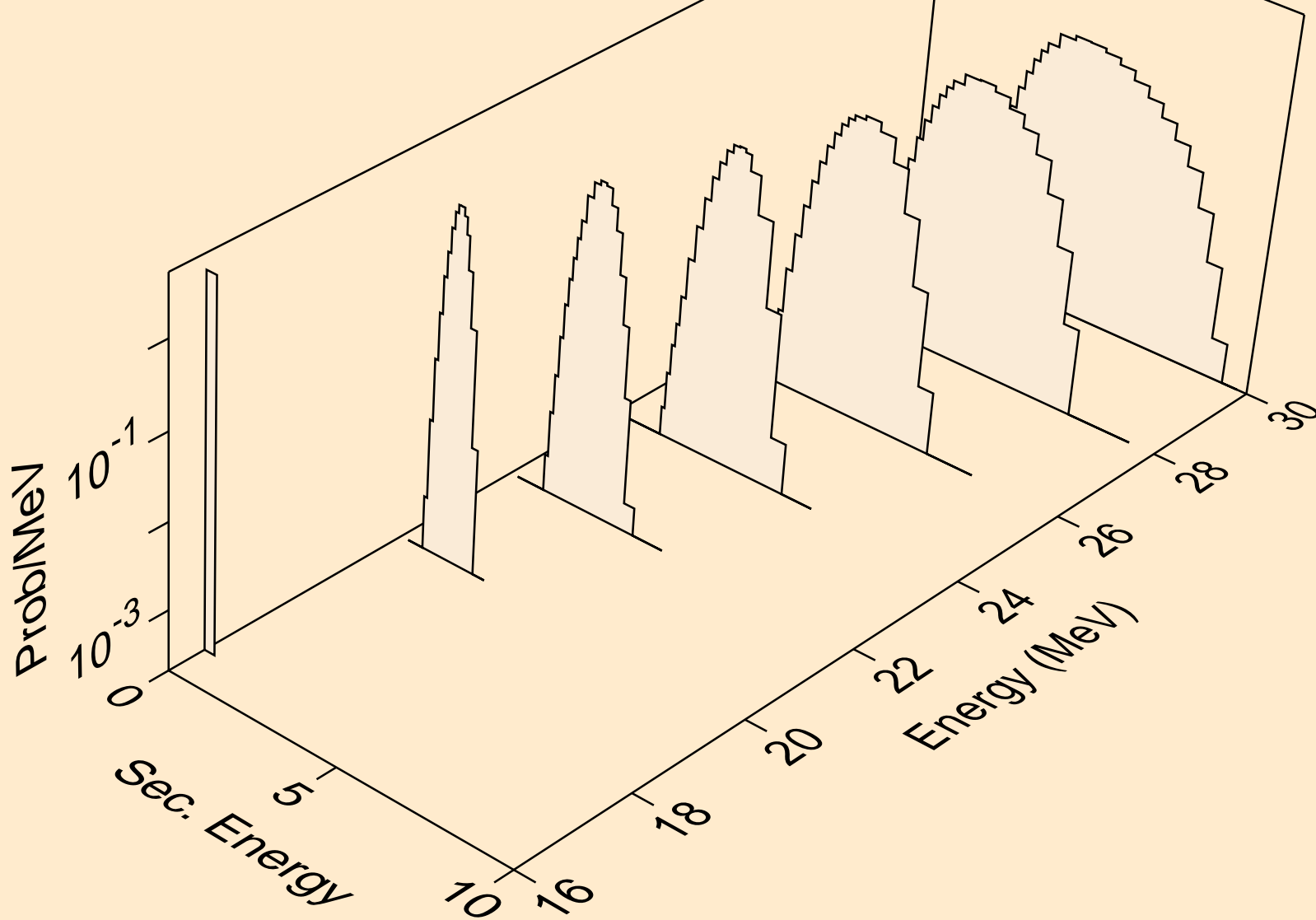

SI030 NEUTRON ACER TENDL-2023 LIBRARY; T=0.K  
alphas from (n,pa)

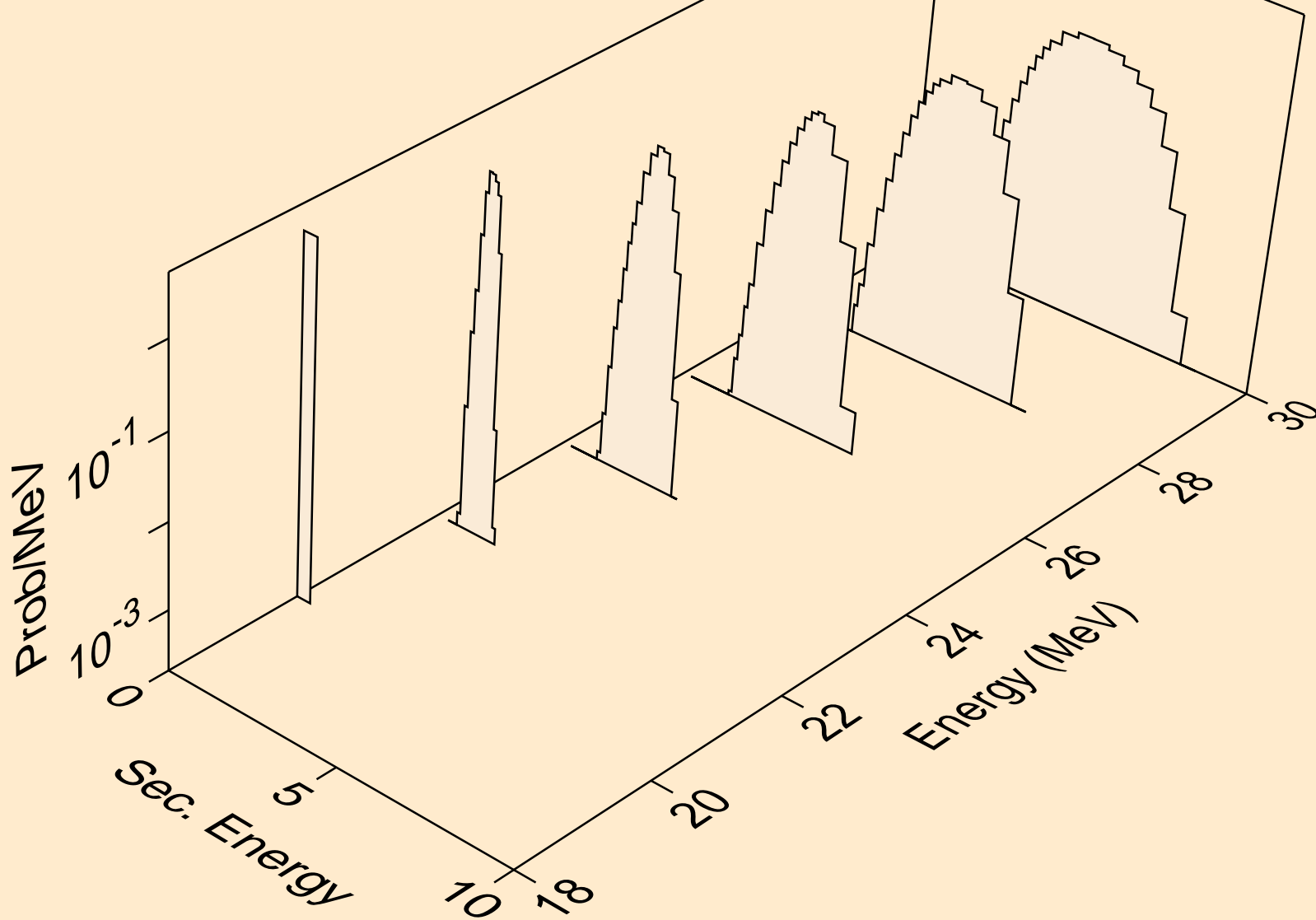



SI030 NEUTRON ACER TENDL-2023 LIBRARY; T=0.K  
alphas from (n,da)

