

SM130 NEUTRON ACER TENDL-2023 LIBRARY; T=0.K

Principal cross sections

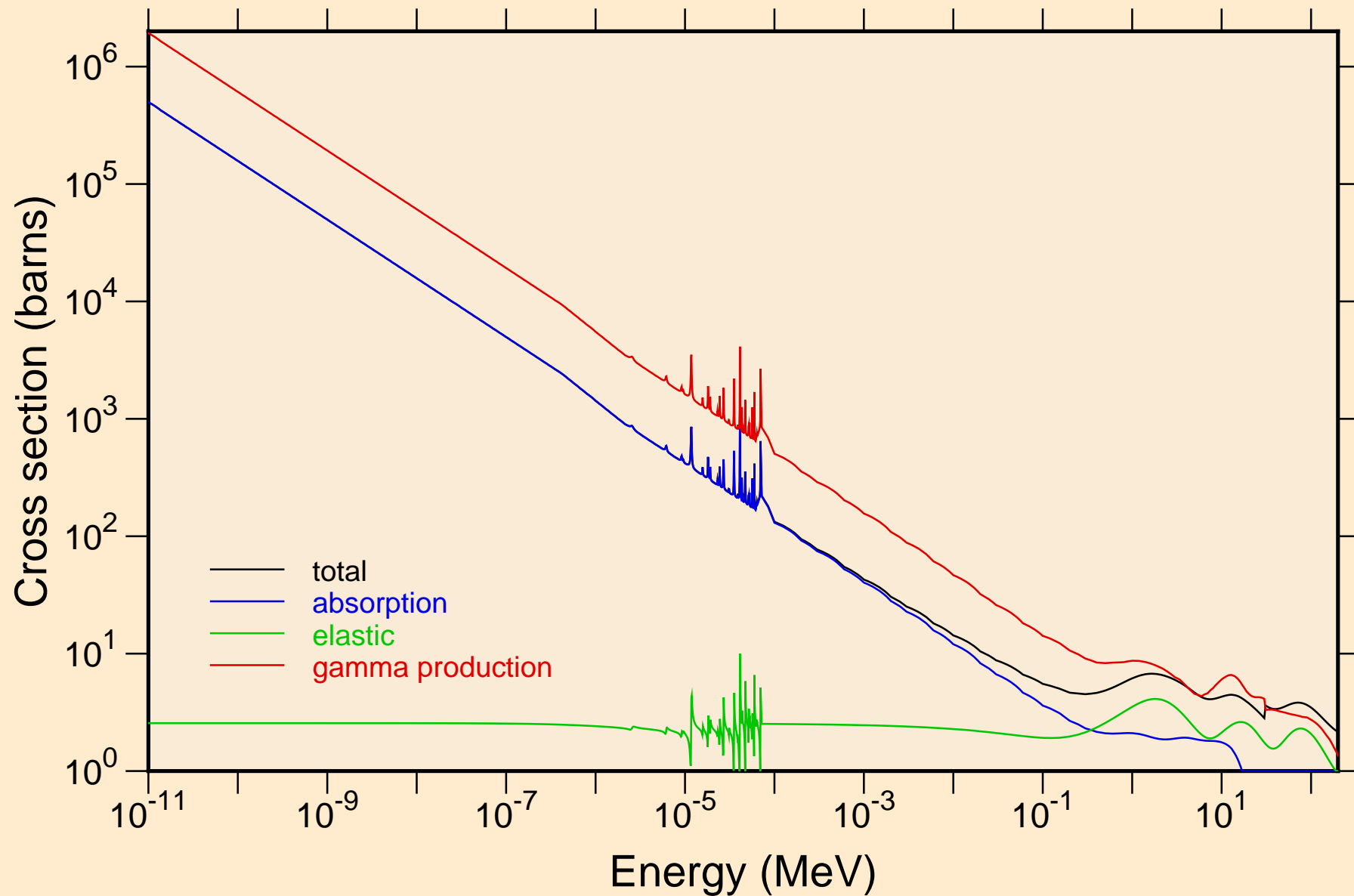

SM130 NEUTRON ACER TENDL-2023 LIBRARY; T=0.K
resonance total cross section

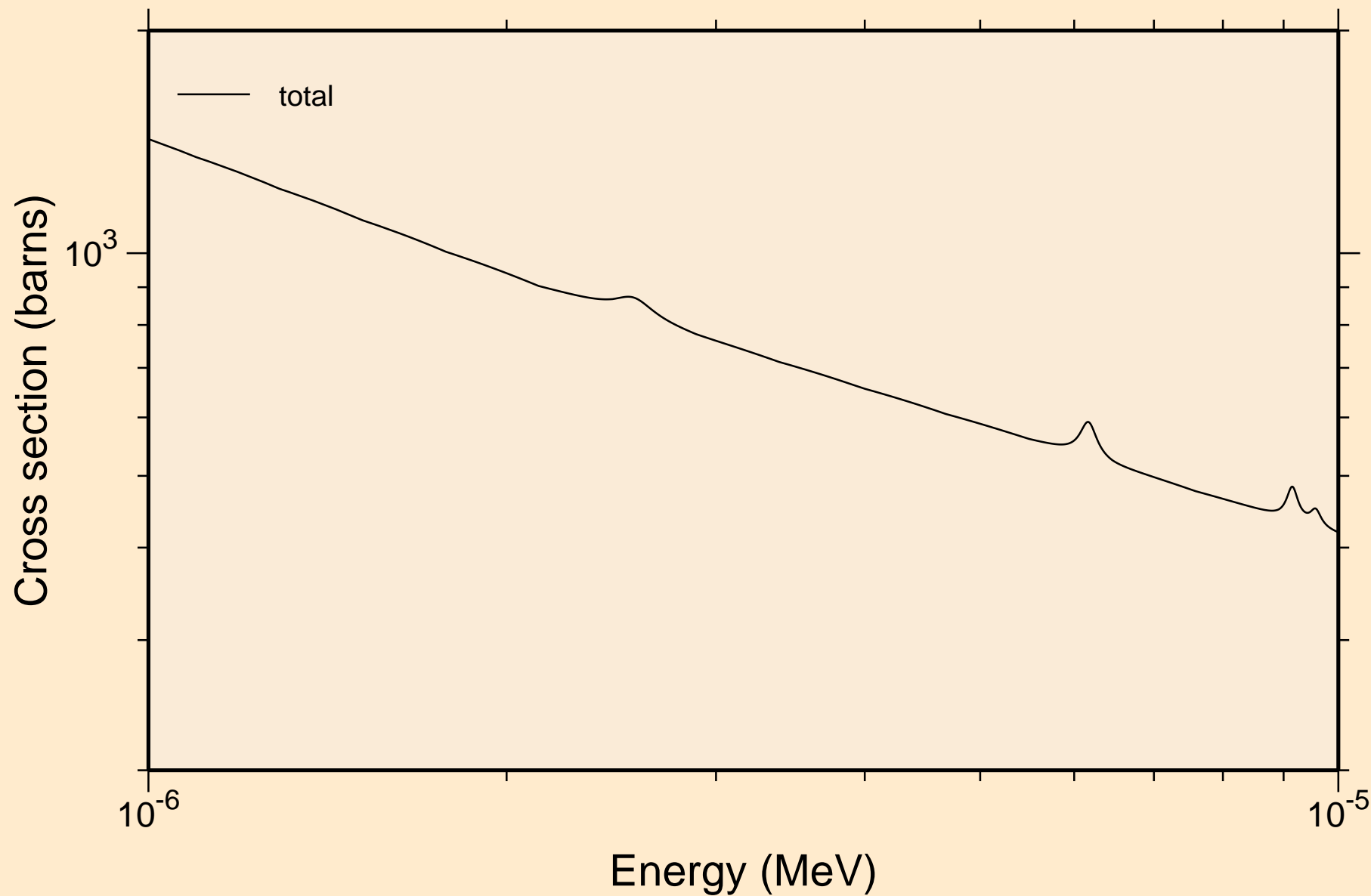

SM130 NEUTRON ACER TENDL-2023 LIBRARY; T=0.K
resonance total cross section

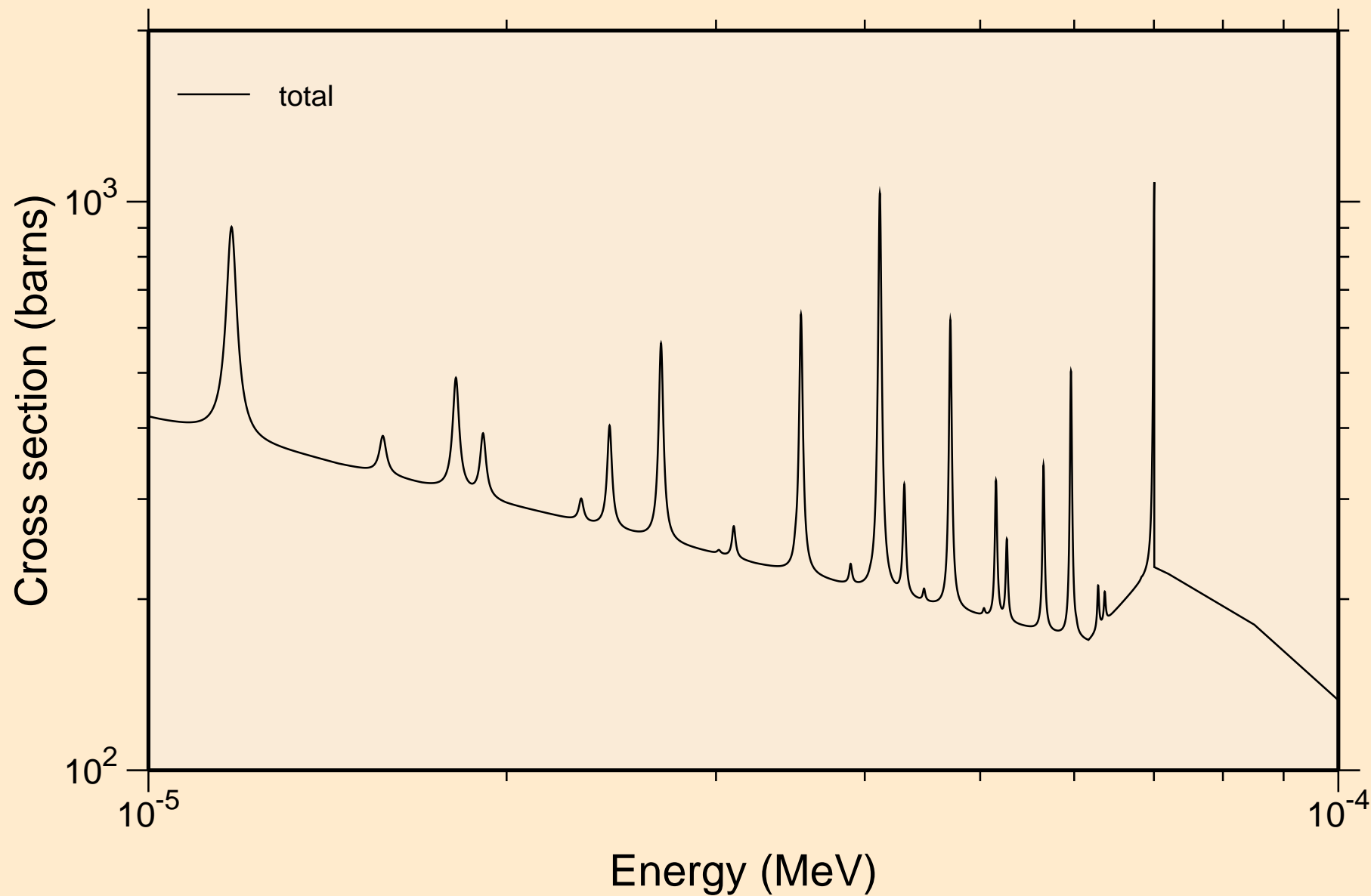

SM130 NEUTRON ACER TENDL-2023 LIBRARY; T=0.K
resonance total cross section

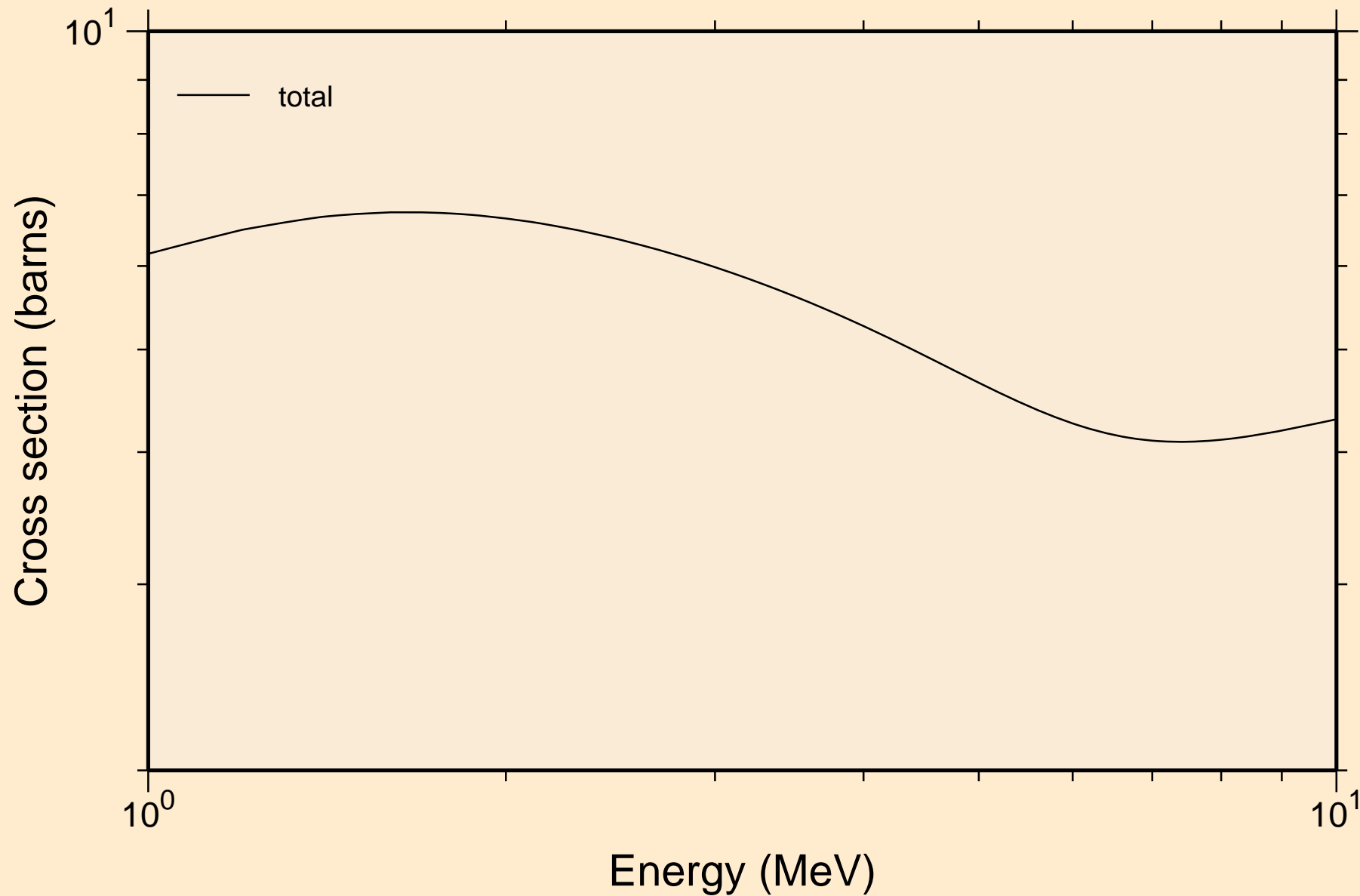

SM130 NEUTRON ACER TENDL-2023 LIBRARY; T=0.K
resonance absorption cross sections

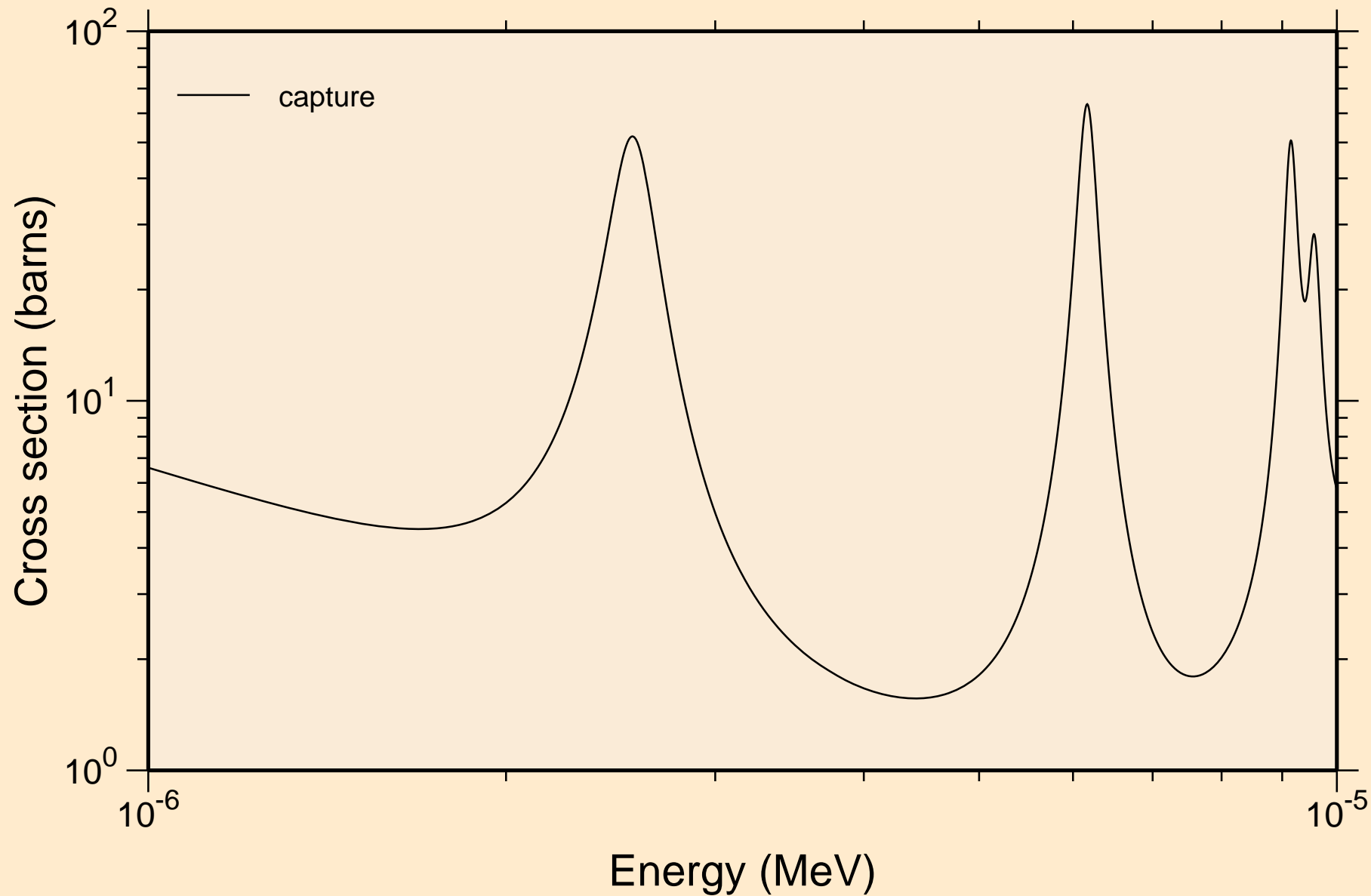

SM130 NEUTRON ACER TENDL-2023 LIBRARY; T=0.K
resonance absorption cross sections

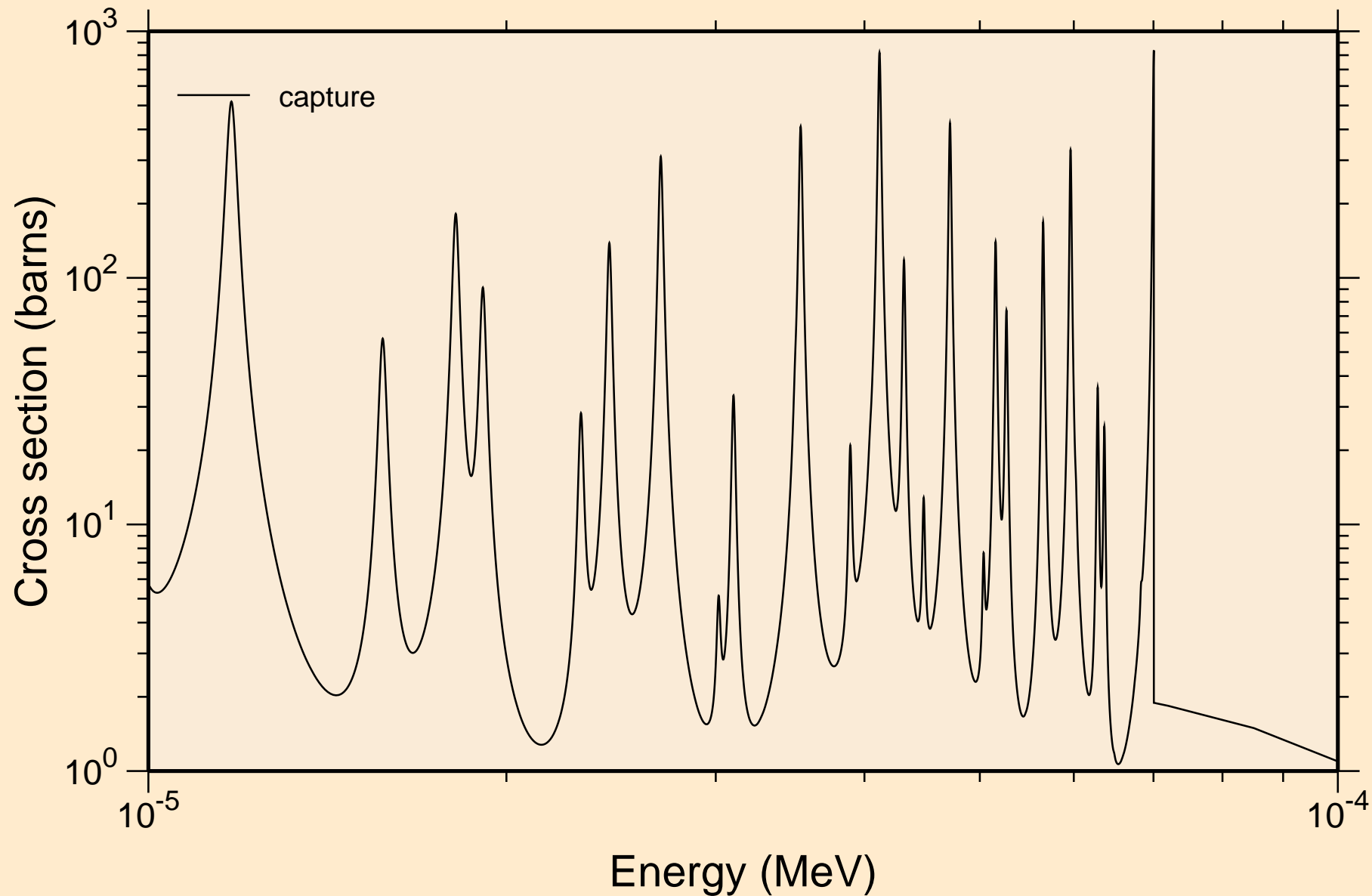

SM130 NEUTRON ACER TENDL-2023 LIBRARY; T=0.K
resonance absorption cross sections

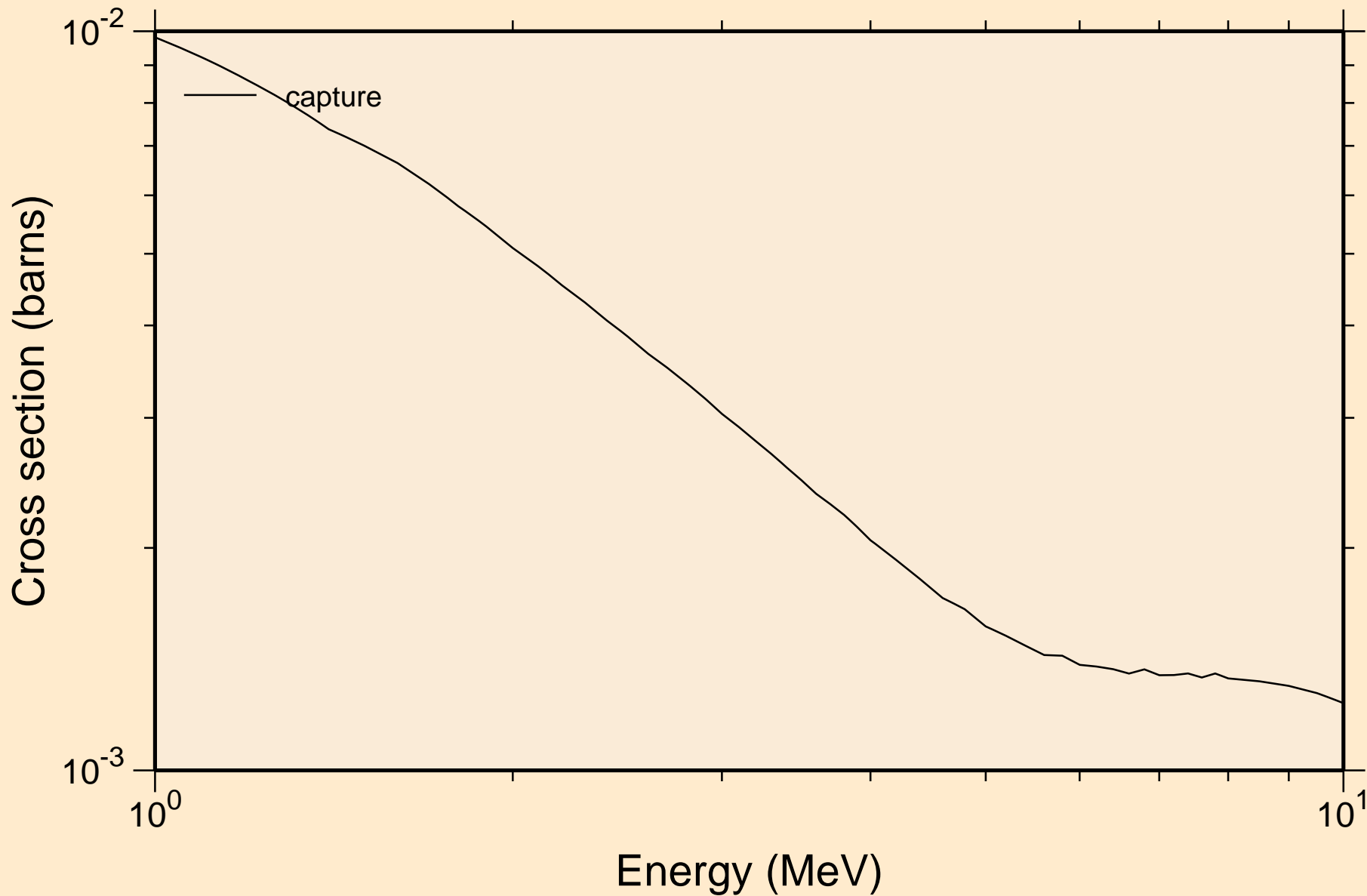

SM130 NEUTRON ACER TENDL-2023 LIBRARY; T=0.K

Heating

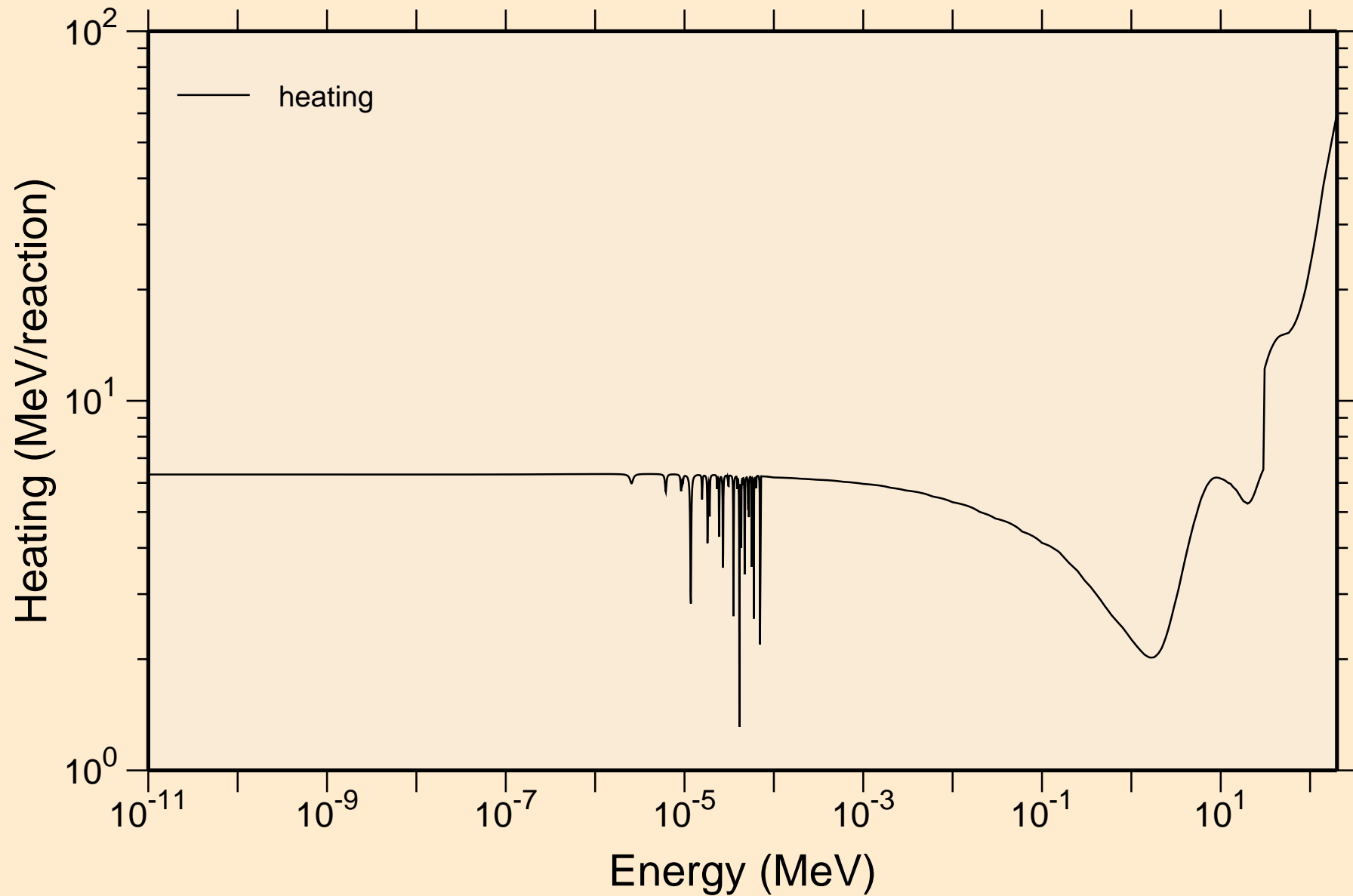

SM130 NEUTRON ACER TENDL-2023 LIBRARY; T=0.K

Damage

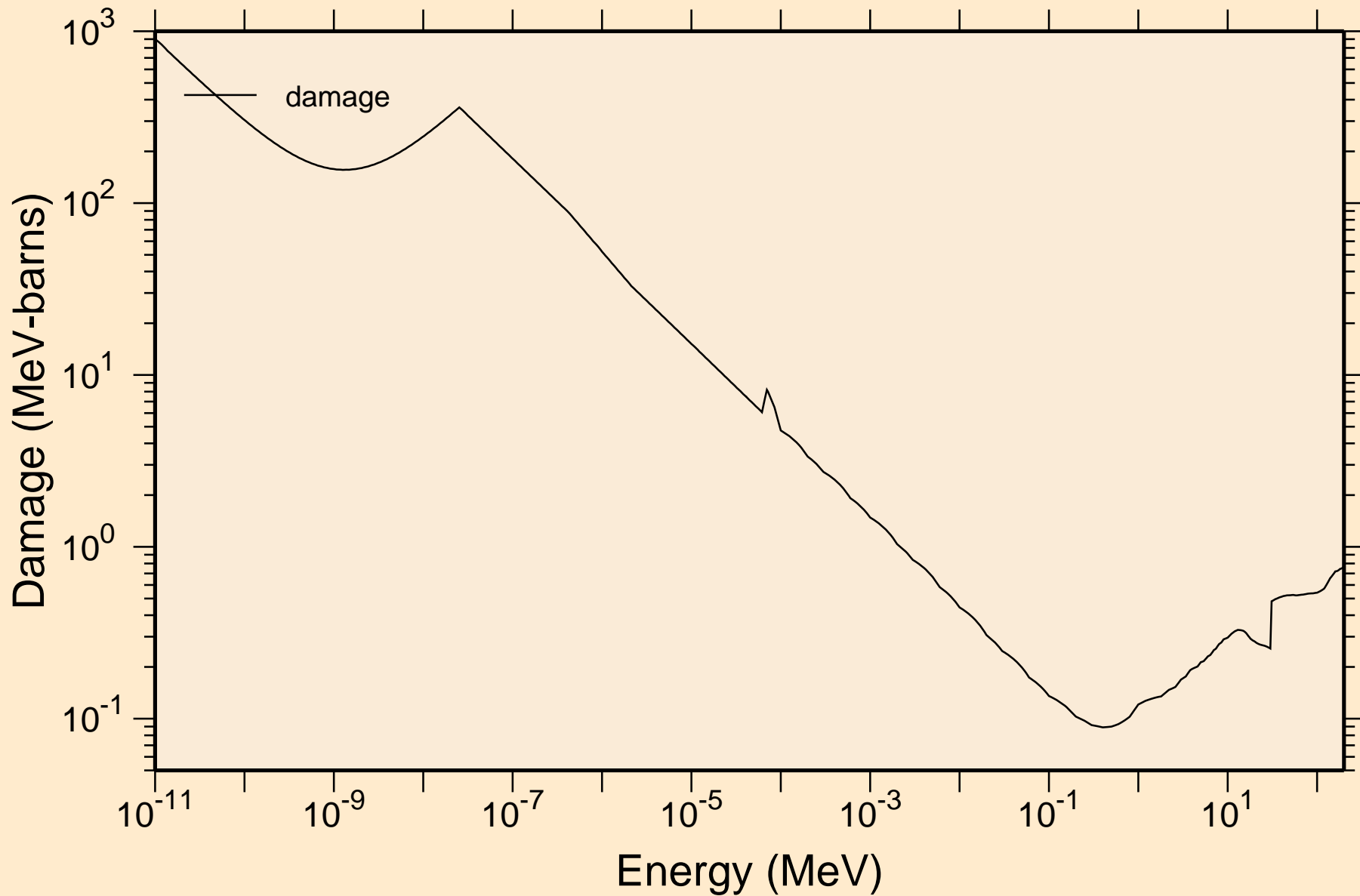

SM130 NEUTRON ACER TENDL-2023 LIBRARY; T=0.K
Non-threshold reactions

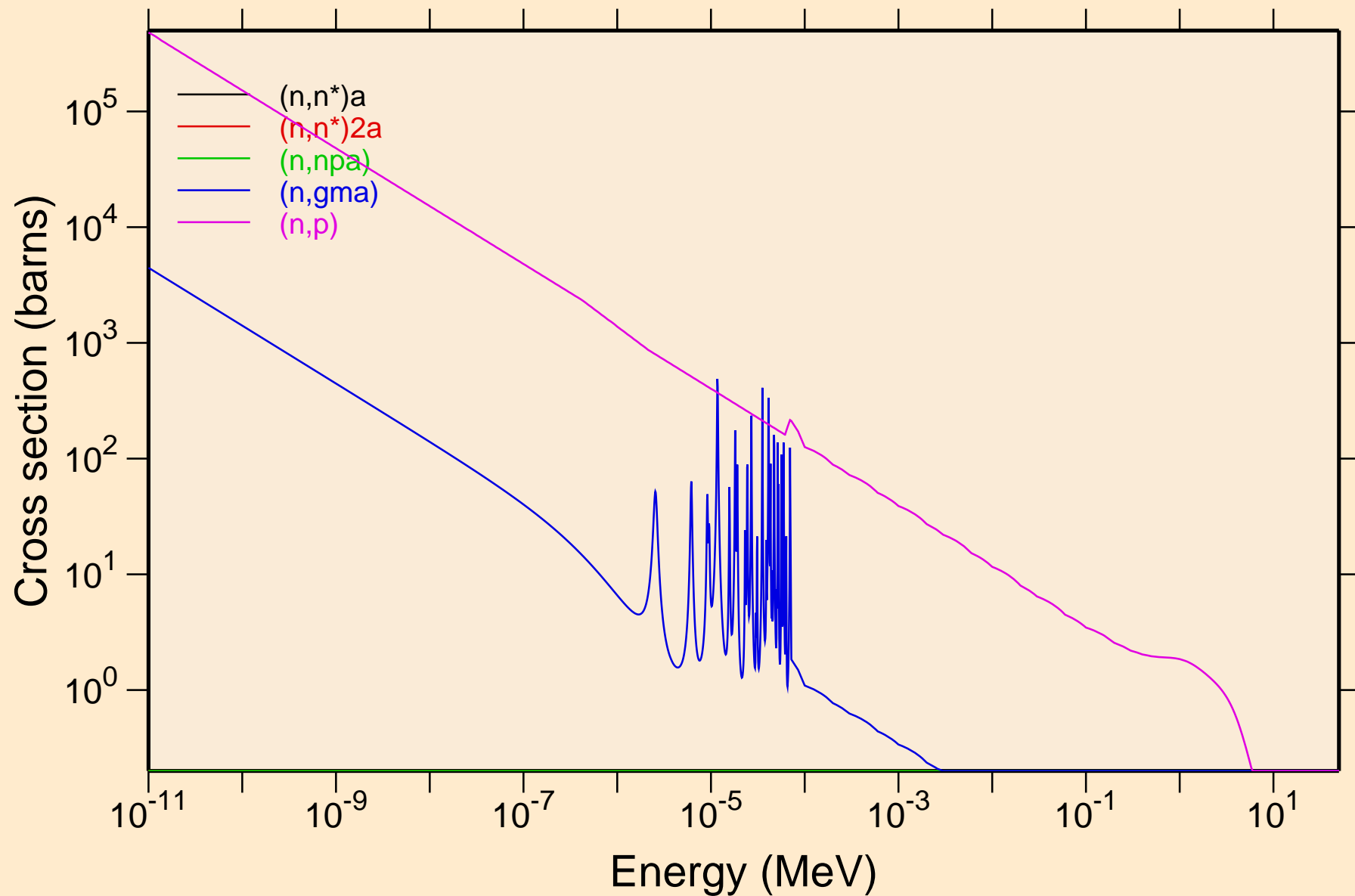

SM130 NEUTRON ACER TENDL-2023 LIBRARY; T=0.K
Non-threshold reactions

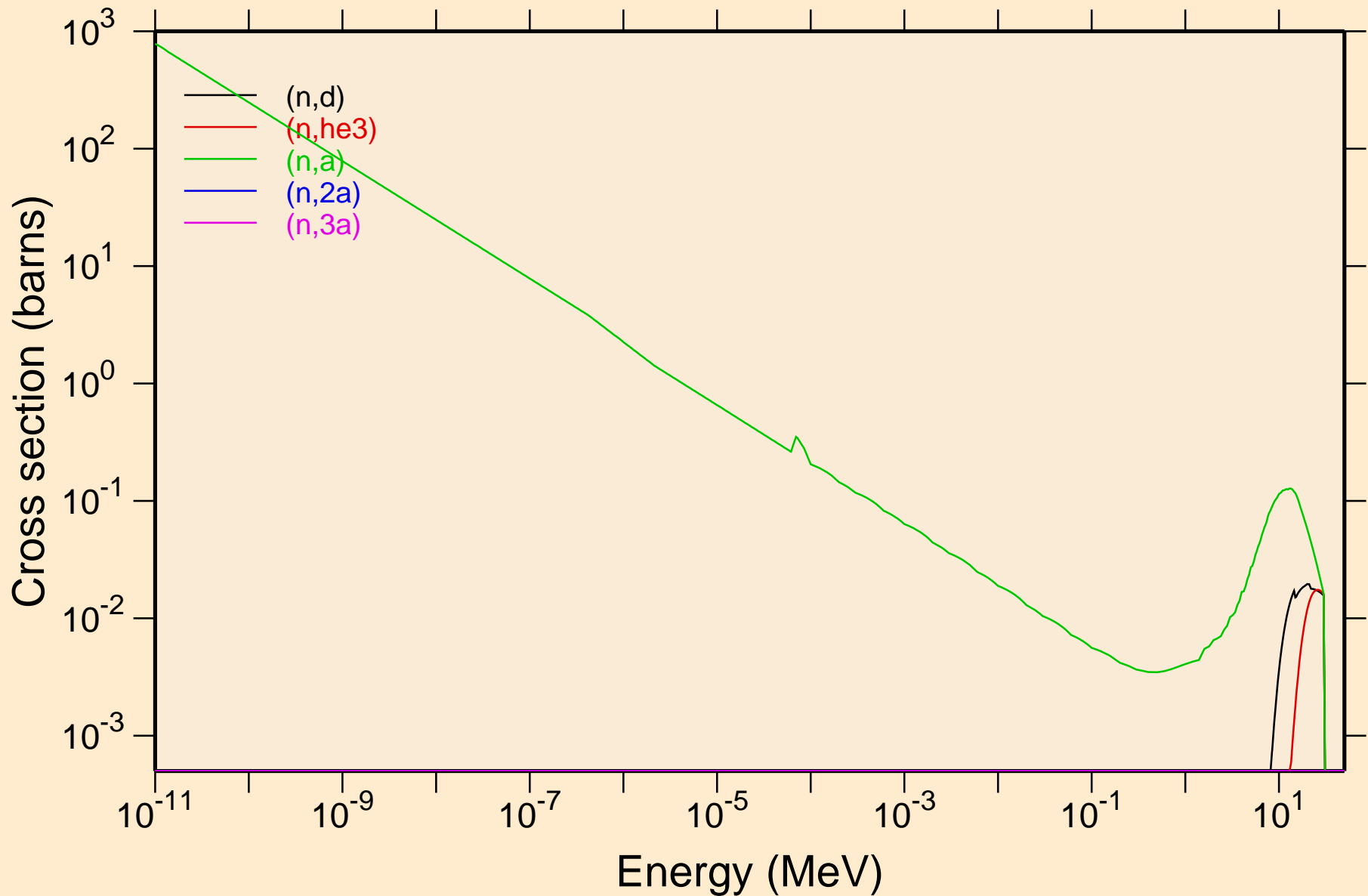

SM130 NEUTRON ACER TENDL-2023 LIBRARY; T=0.K

Non-threshold reactions

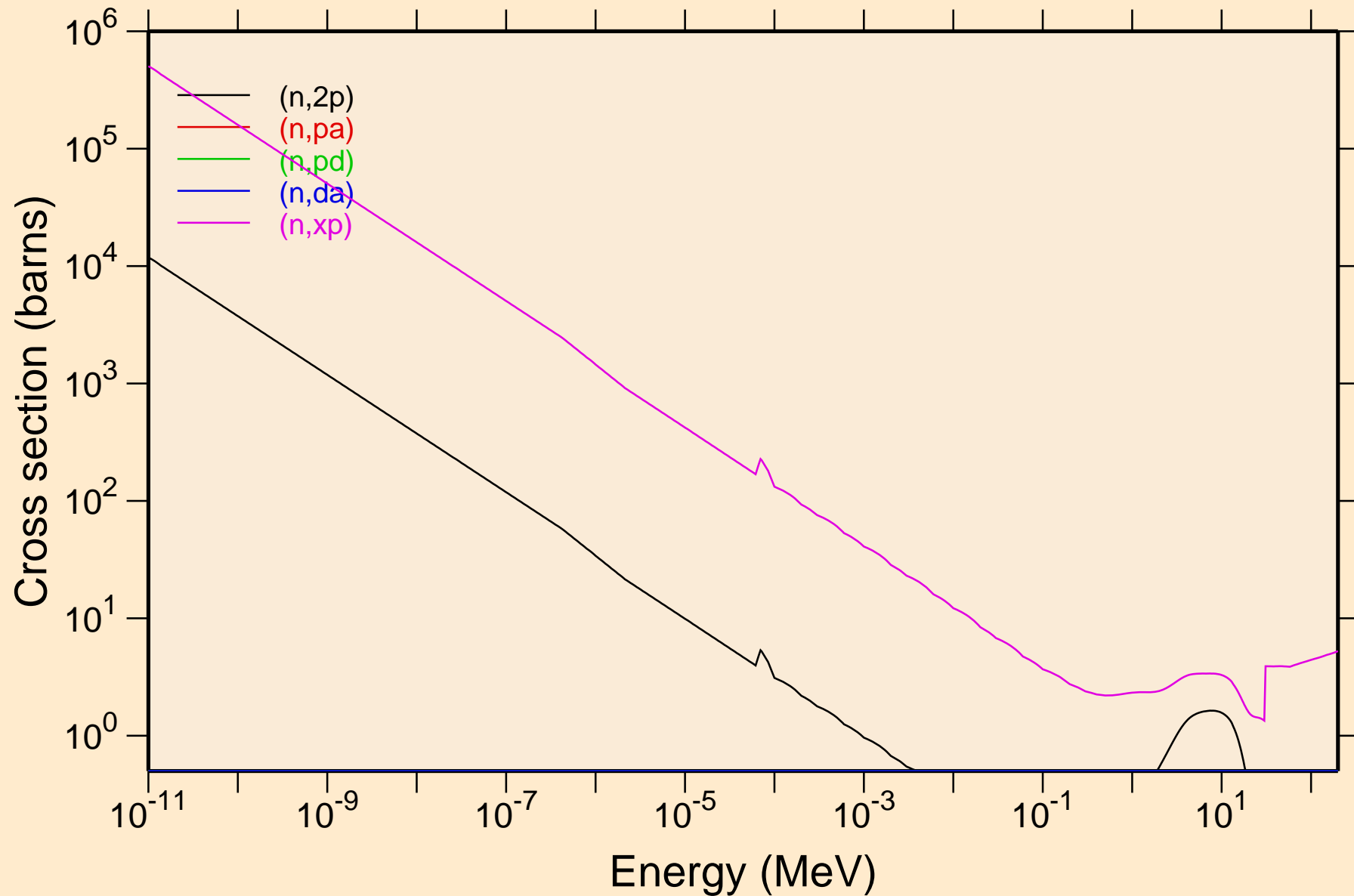

SM130 NEUTRON ACER TENDL-2023 LIBRARY; T=0.K

Non-threshold reactions

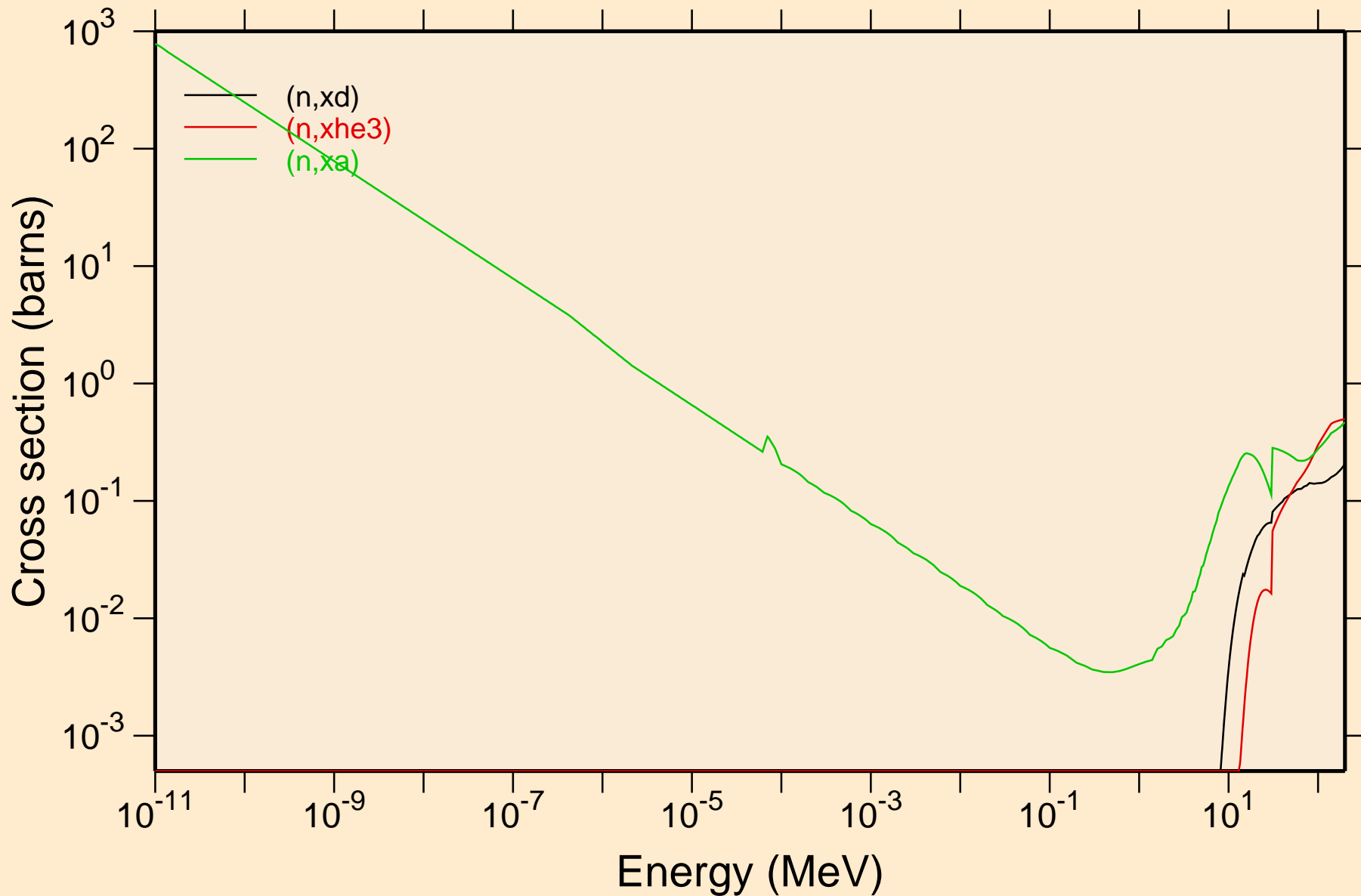

SM130 NEUTRON ACER TENDL-2023 LIBRARY; T=0.K

Principal cross sections

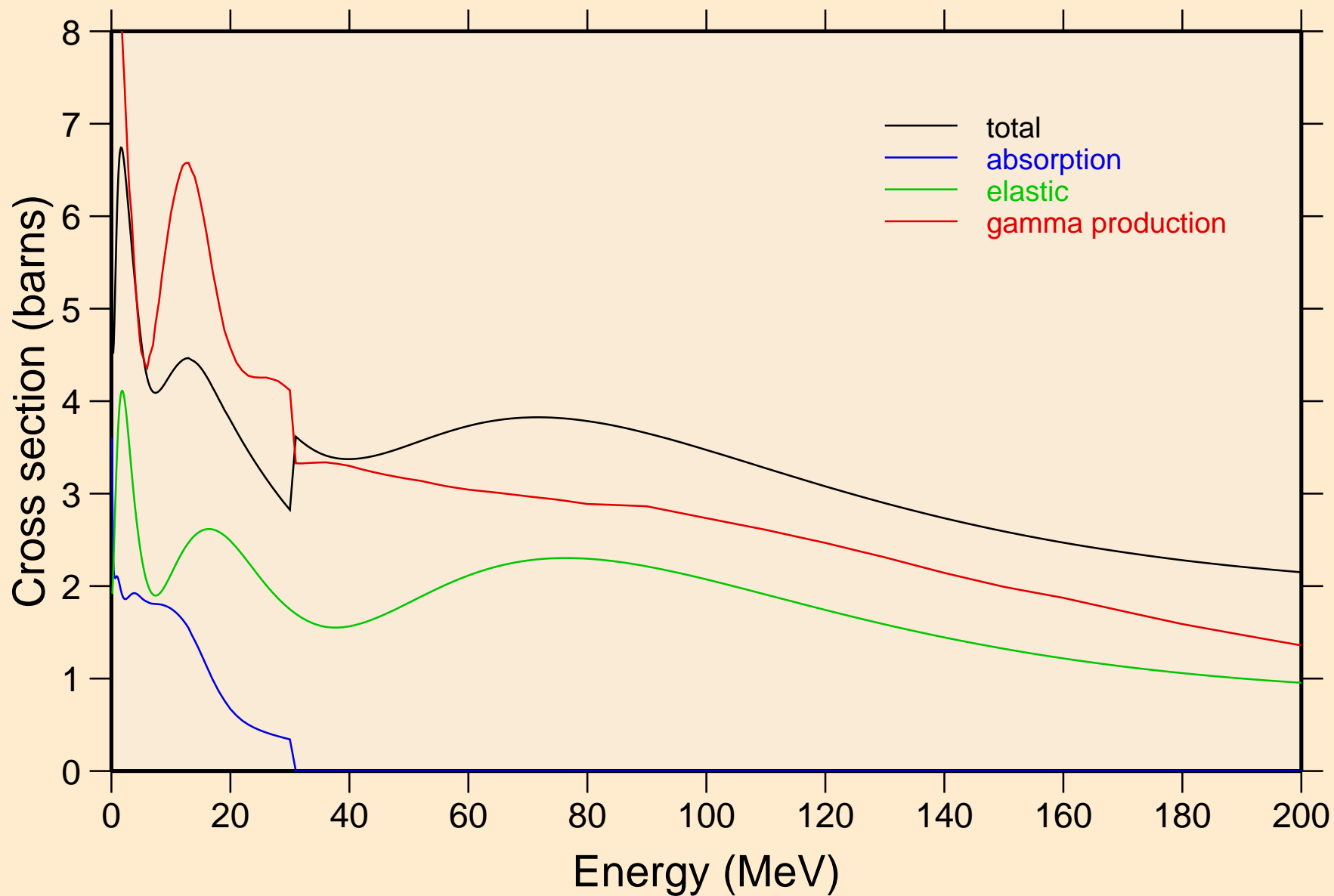

SM130 NEUTRON ACER TENDL-2023 LIBRARY; T=0.K

Heating

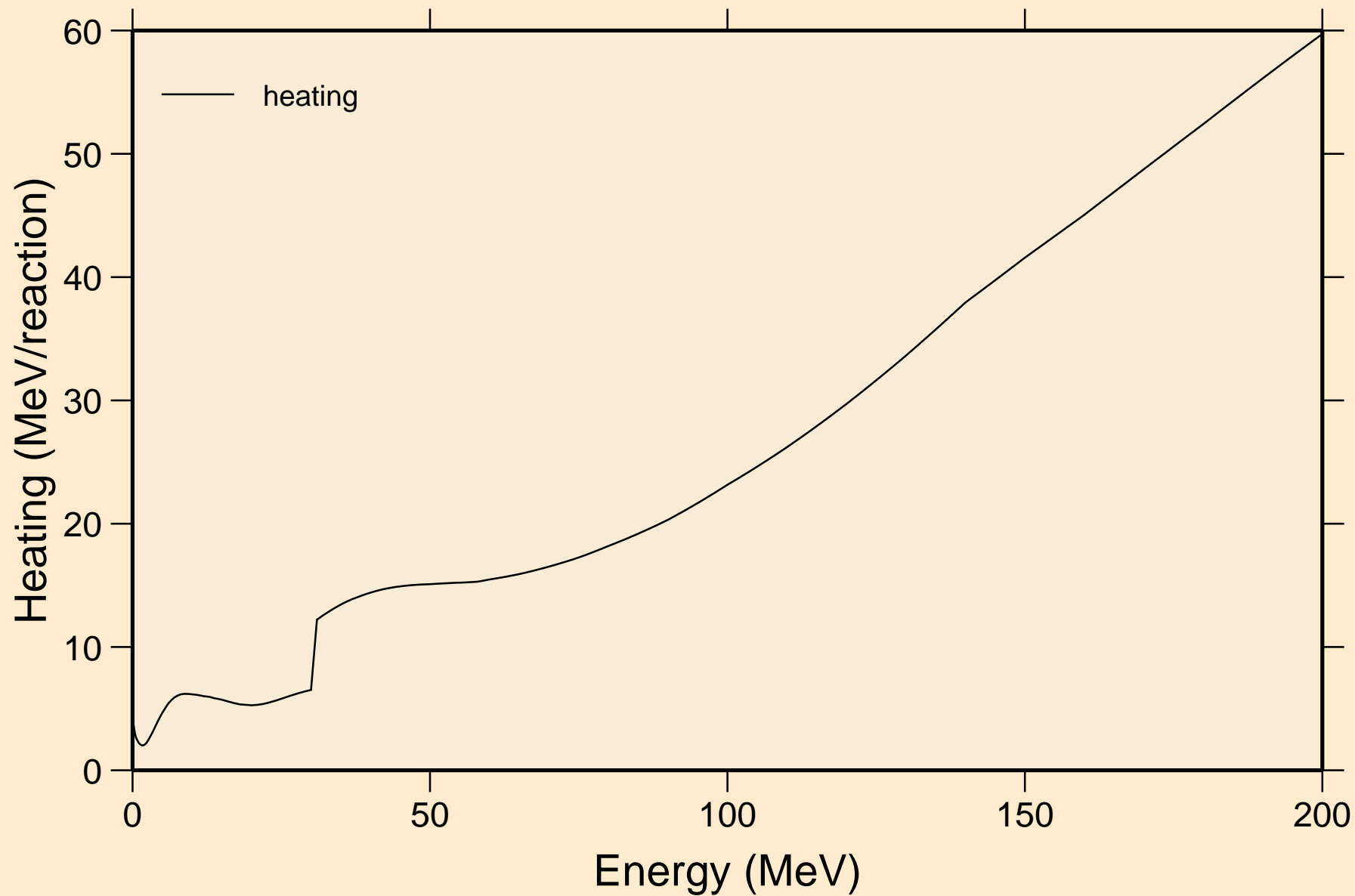

SM130 NEUTRON ACER TENDL-2023 LIBRARY; T=0.K

Damage

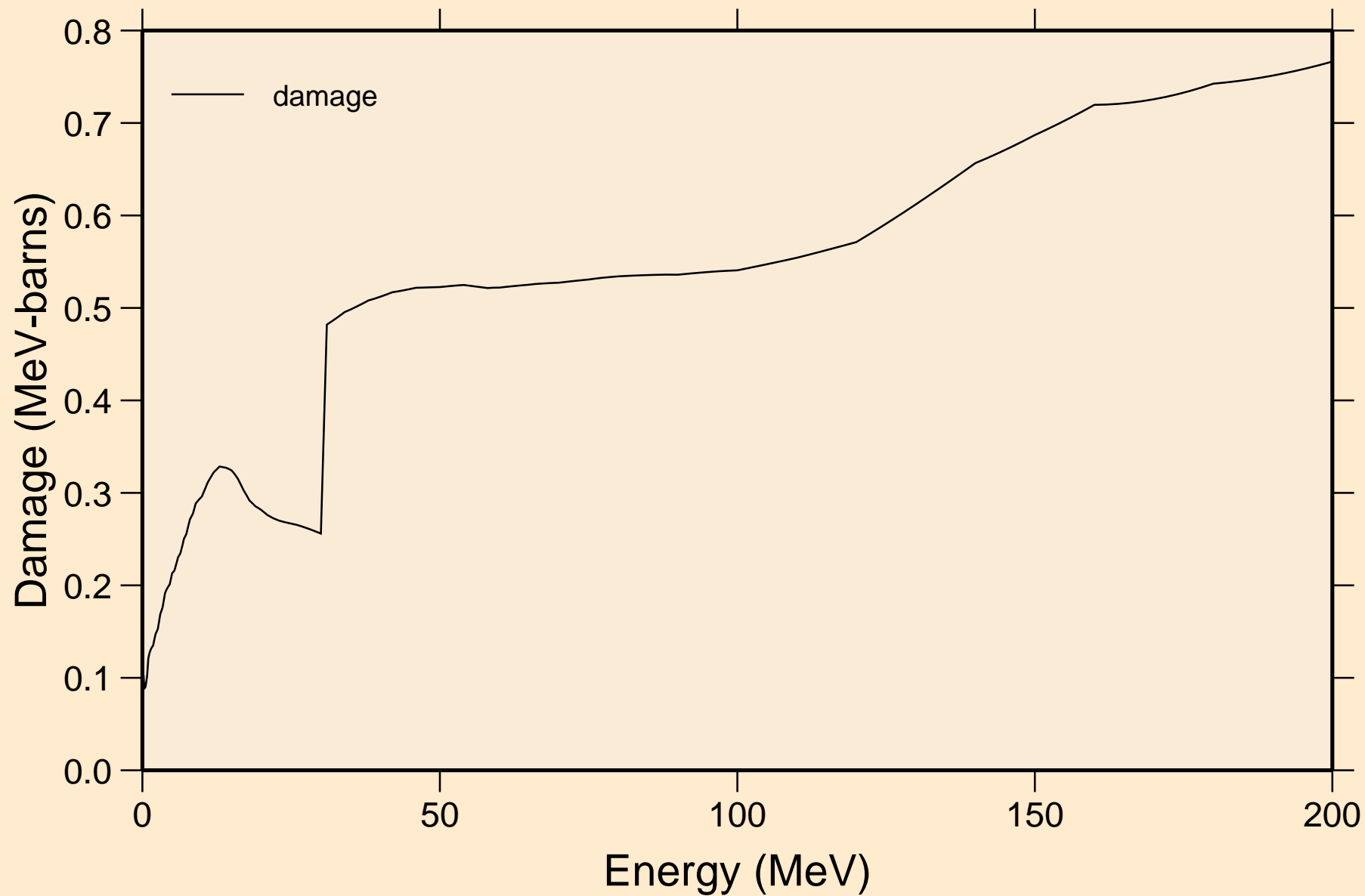

SM130 NEUTRON ACER TENDL-2023 LIBRARY; T=0.K

Non-threshold reactions

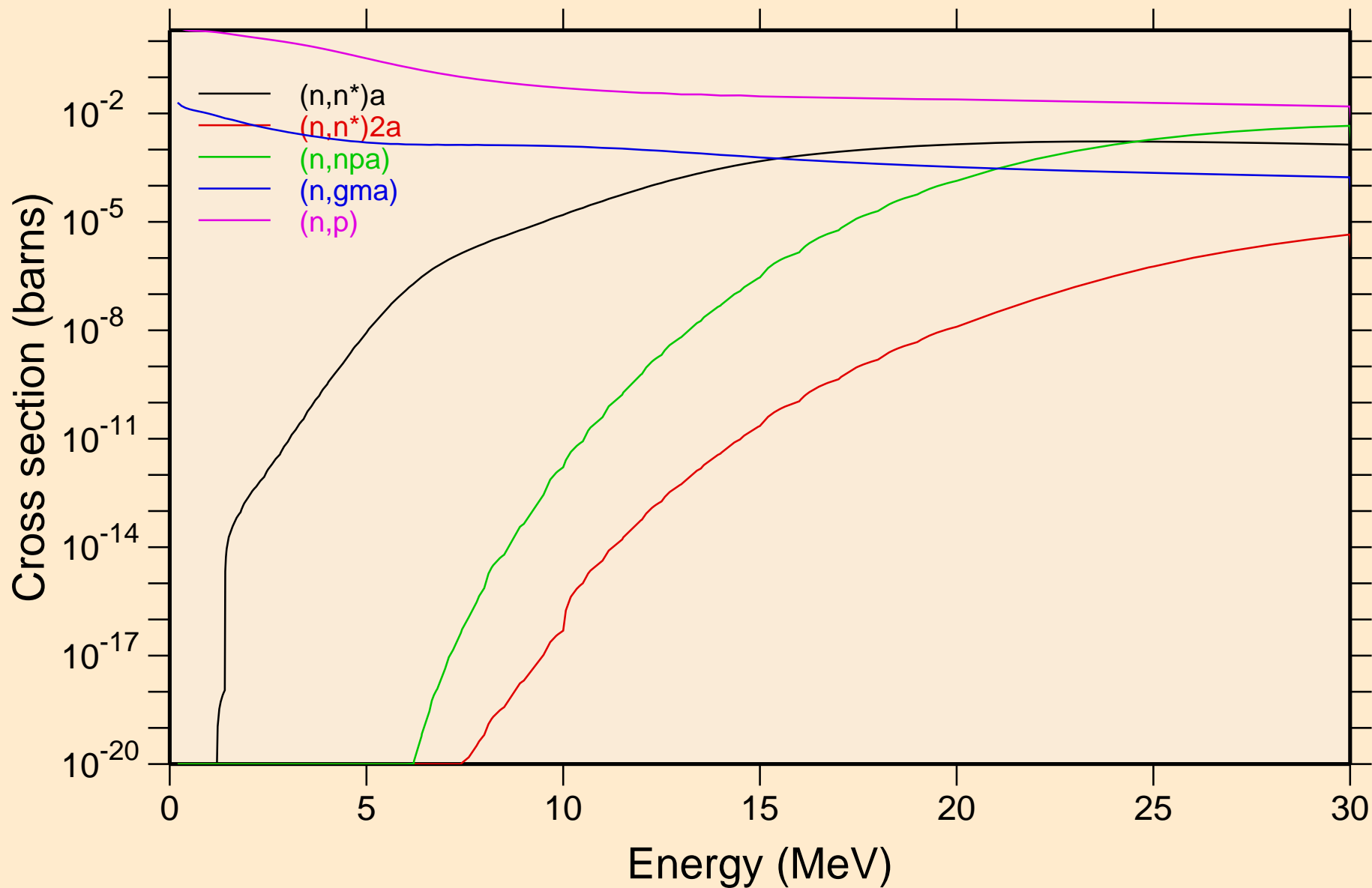

SM130 NEUTRON ACER TENDL-2023 LIBRARY; T=0.K
Non-threshold reactions

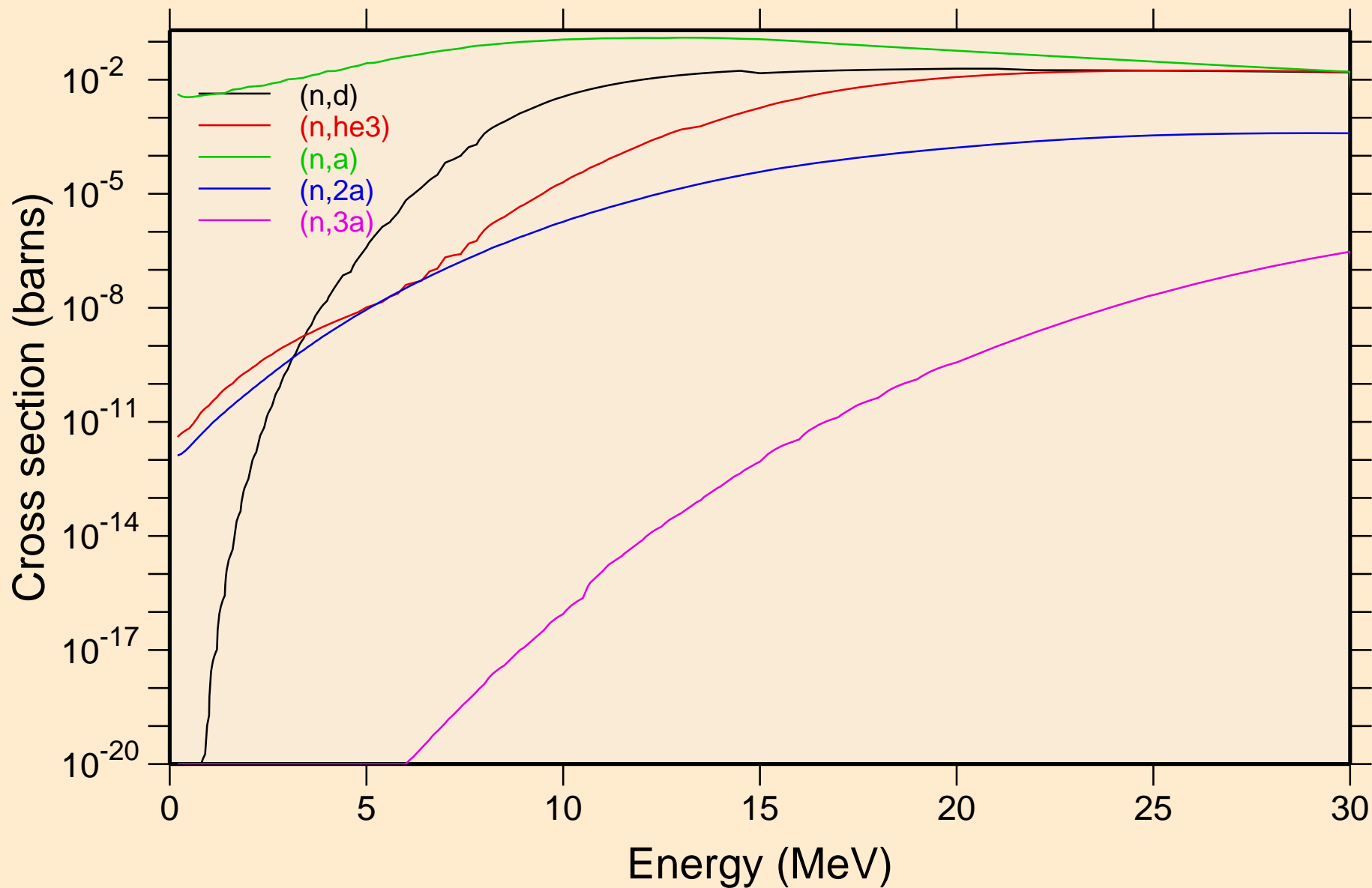

SM130 NEUTRON ACER TENDL-2023 LIBRARY; T=0.K

Non-threshold reactions

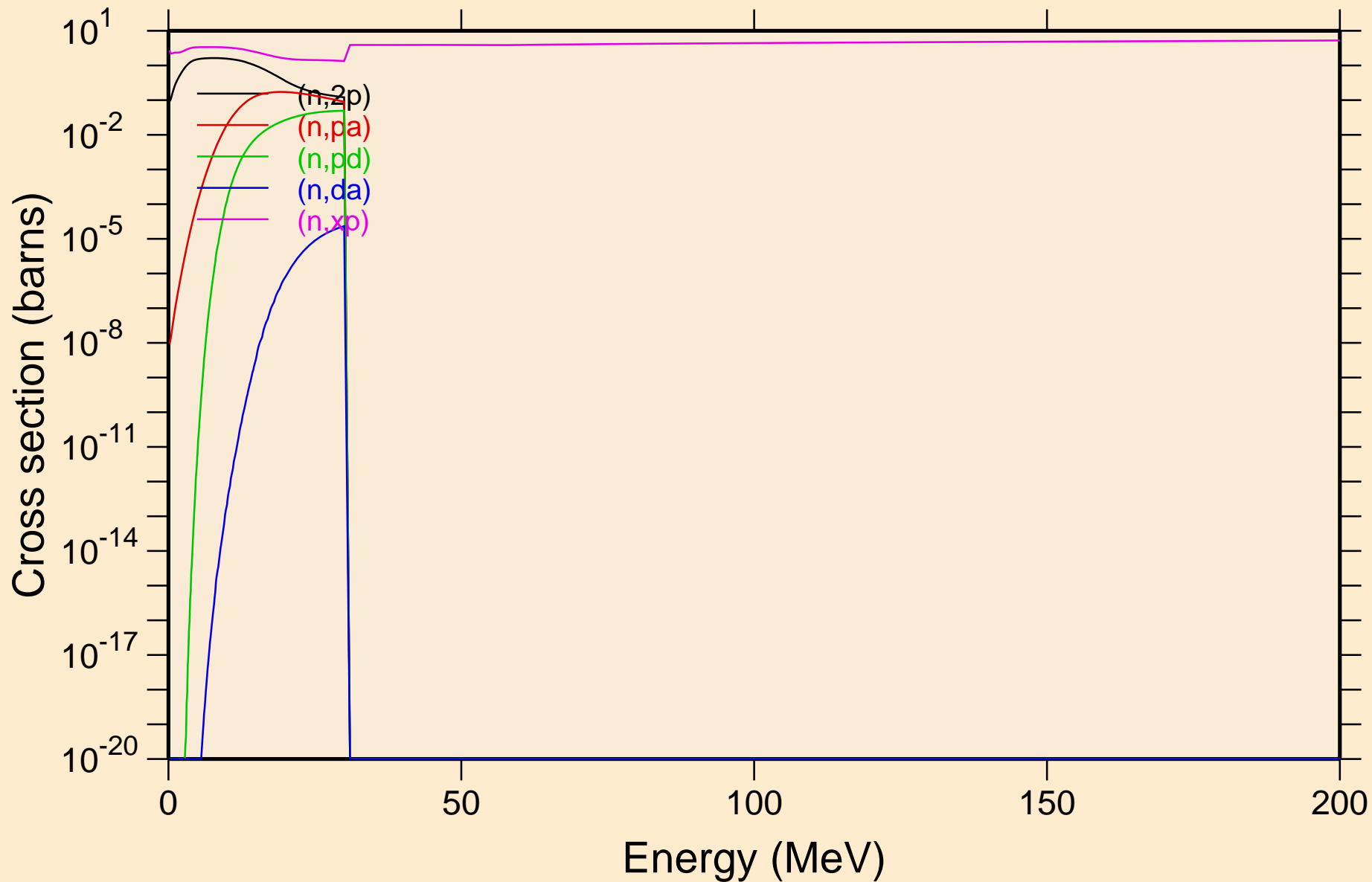

SM130 NEUTRON ACER TENDL-2023 LIBRARY; T=0.K
Non-threshold reactions

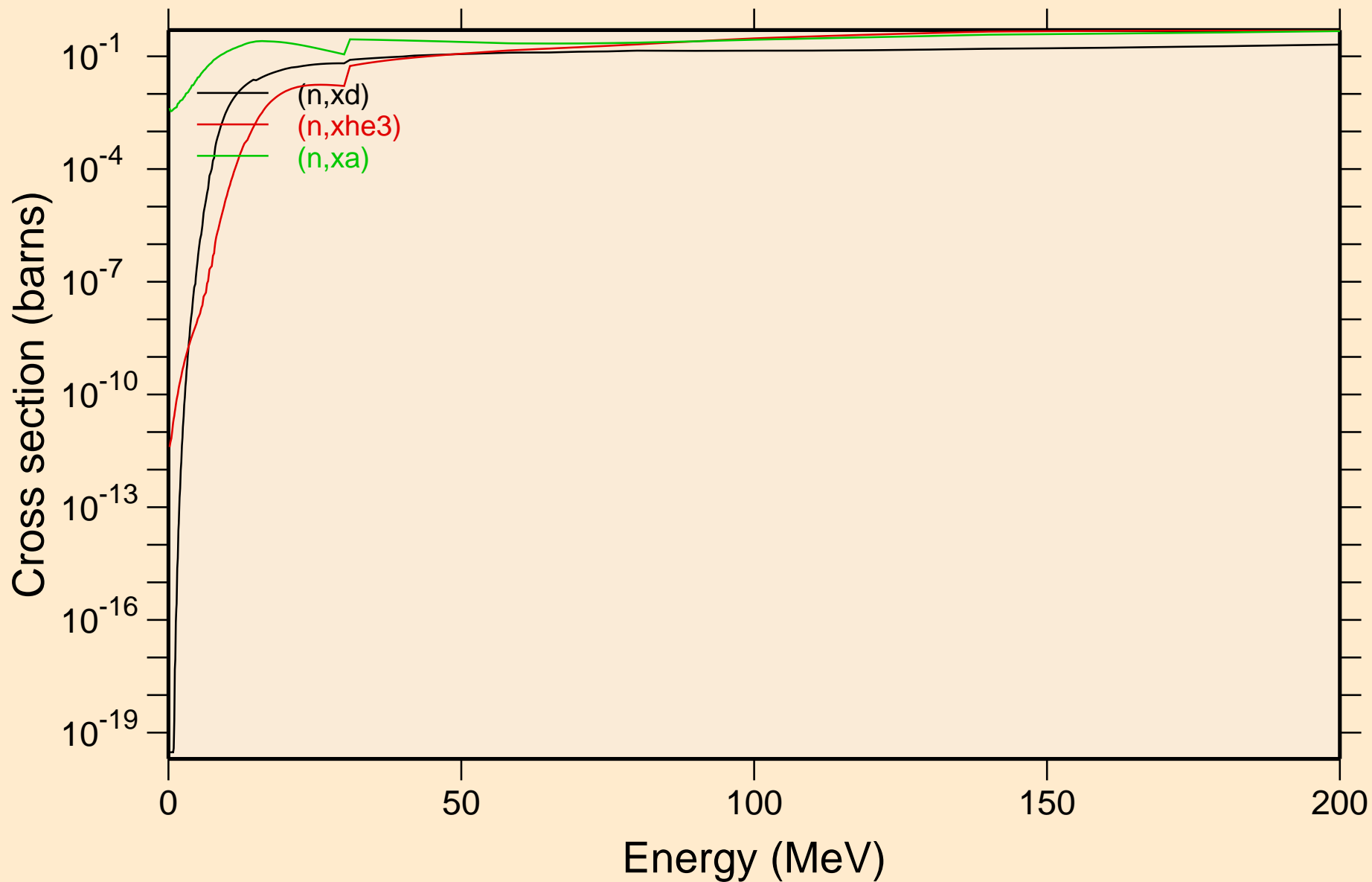

SM130 NEUTRON ACER TENDL-2023 LIBRARY; T=0.K
Inelastic levels

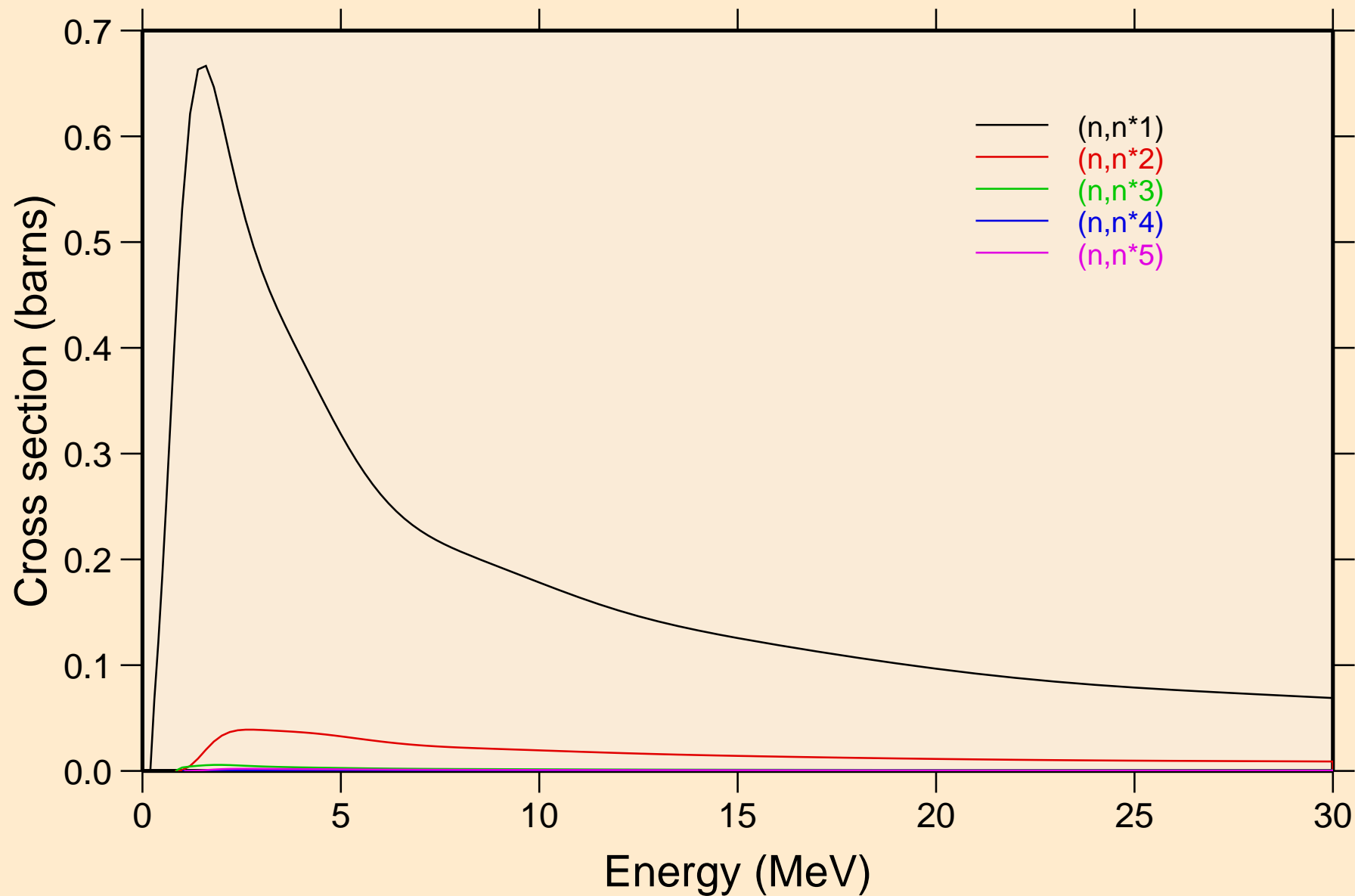

SM130 NEUTRON ACER TENDL-2023 LIBRARY; T=0.K
Inelastic levels

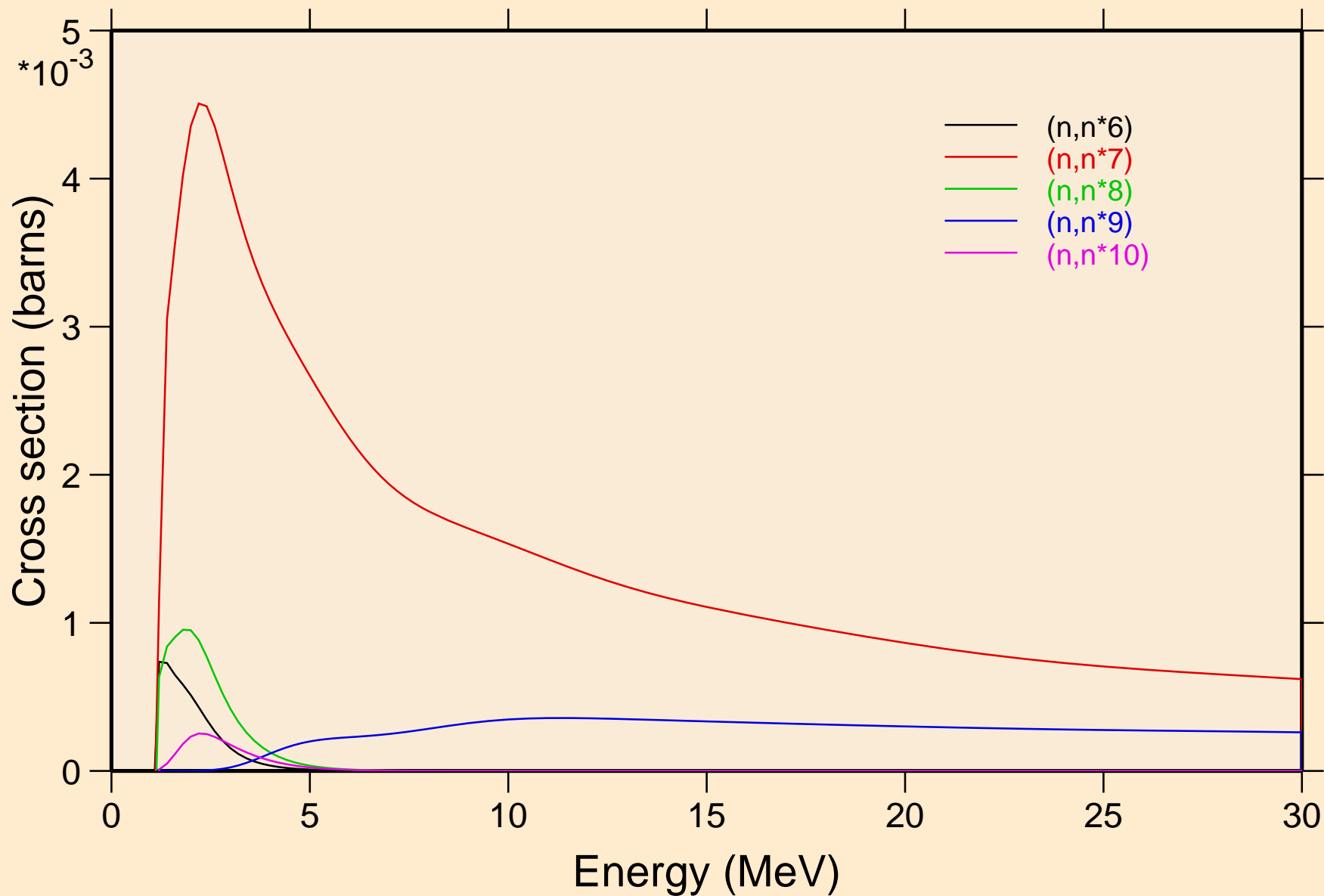

SM130 NEUTRON ACER TENDL-2023 LIBRARY; T=0.K
Inelastic levels

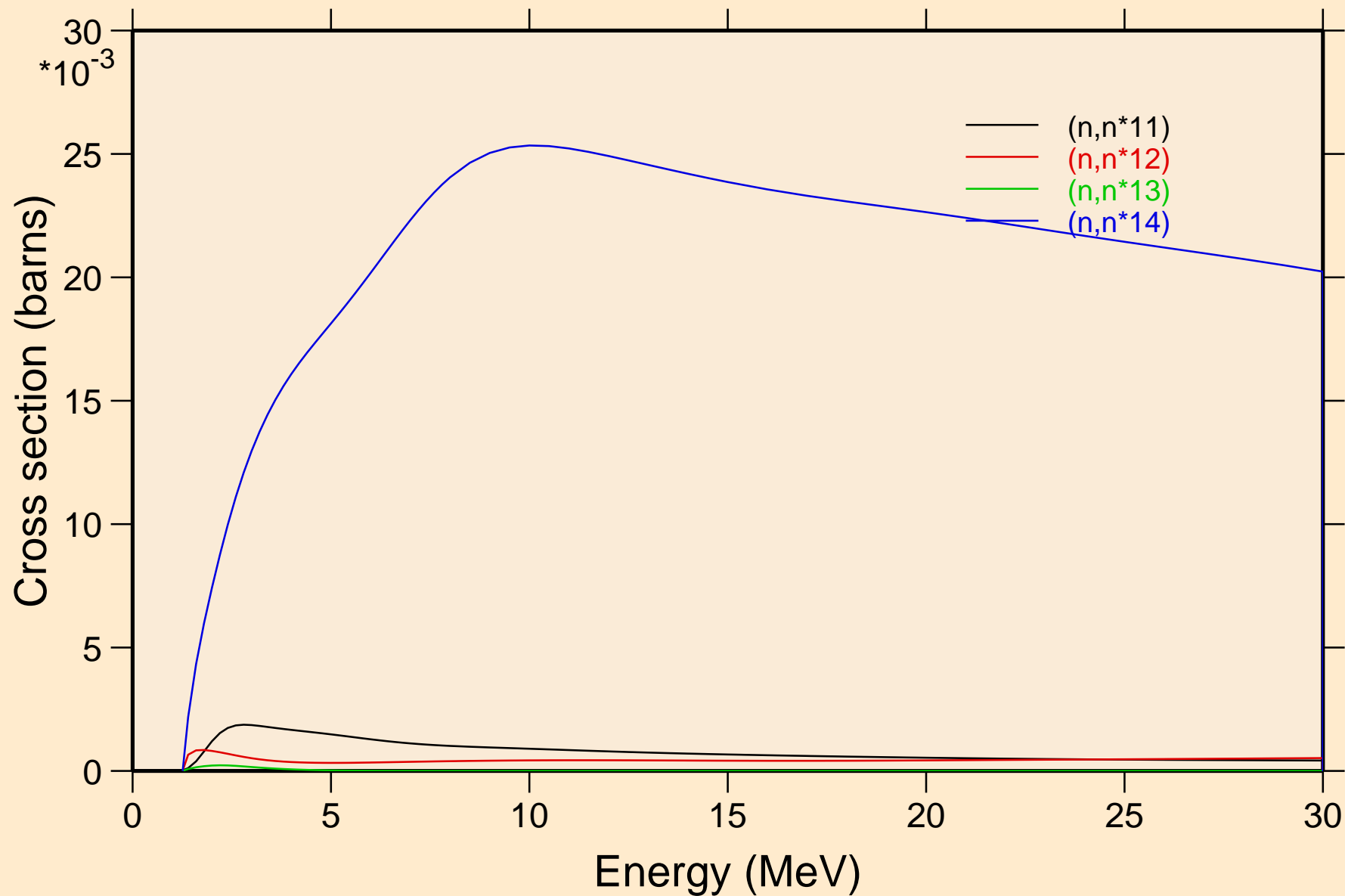

SM130 NEUTRON ACER TENDL-2023 LIBRARY; T=0.K

Threshold reactions

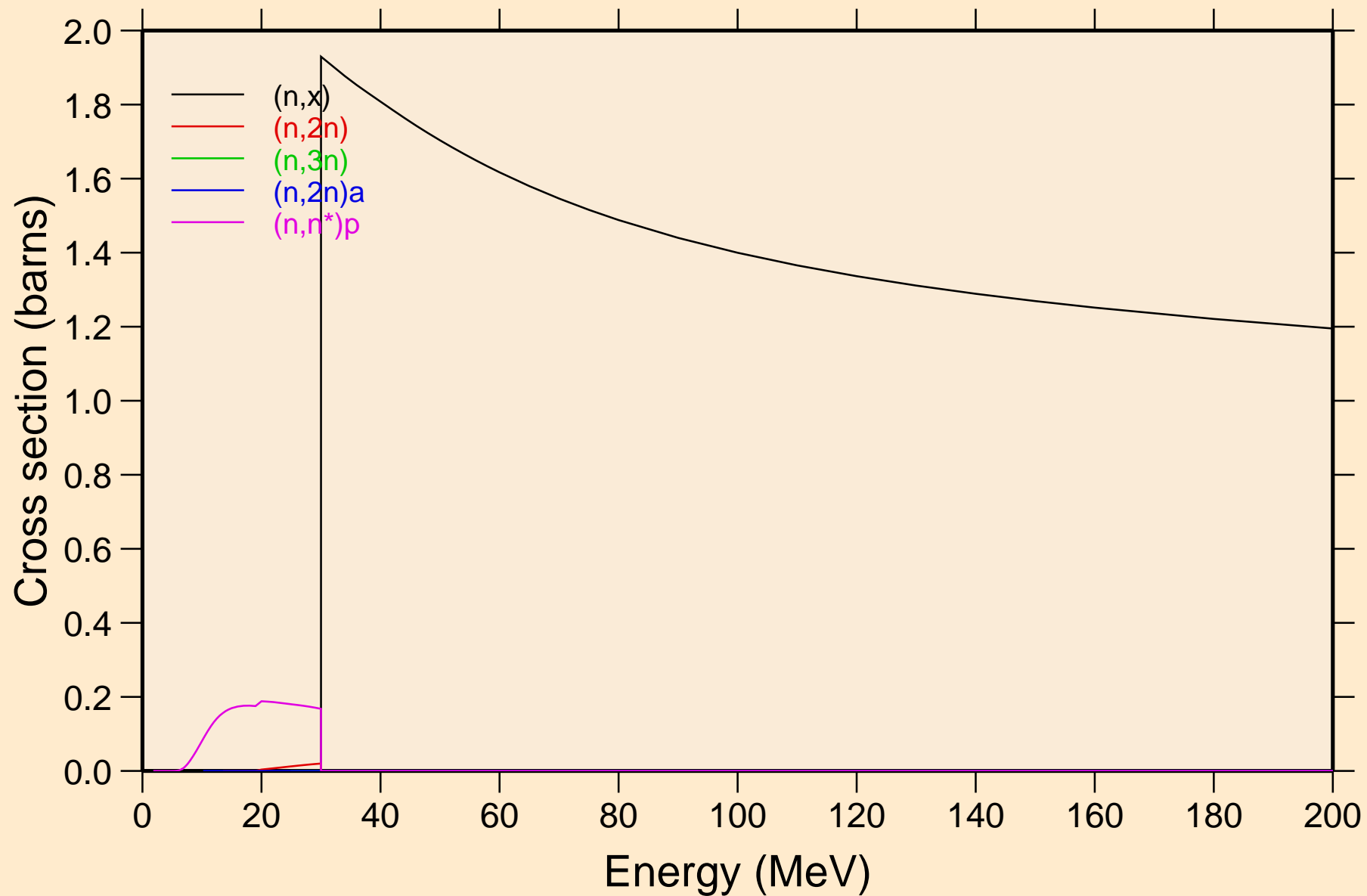

SM130 NEUTRON ACER TENDL-2023 LIBRARY; T=0.K
Threshold reactions

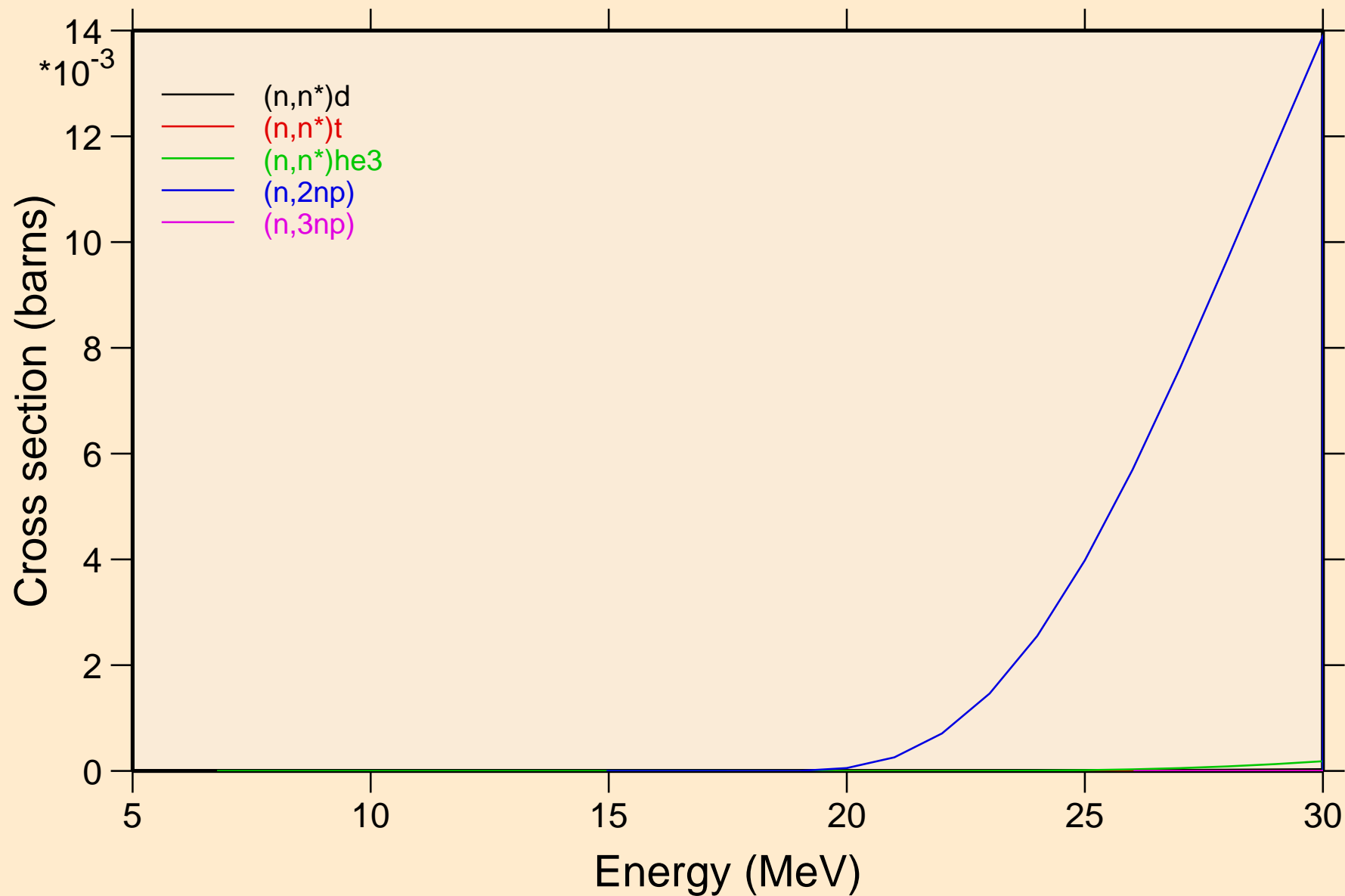

SM130 NEUTRON ACER TENDL-2023 LIBRARY; T=0.K

Threshold reactions

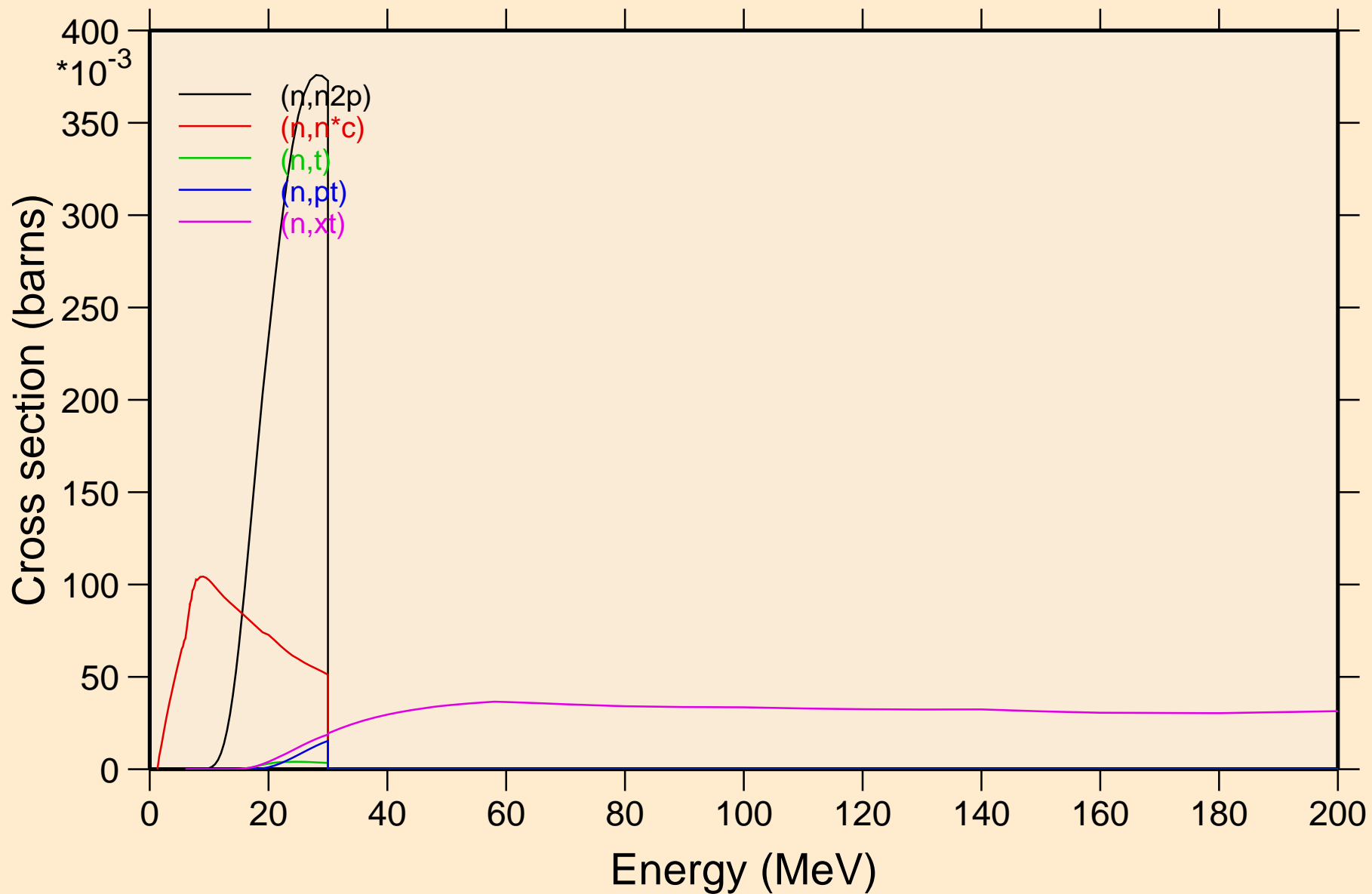

SM130 NEUTRON ACER TENDL-2023 LIBRARY; T=0.K
angular distribution for elastic

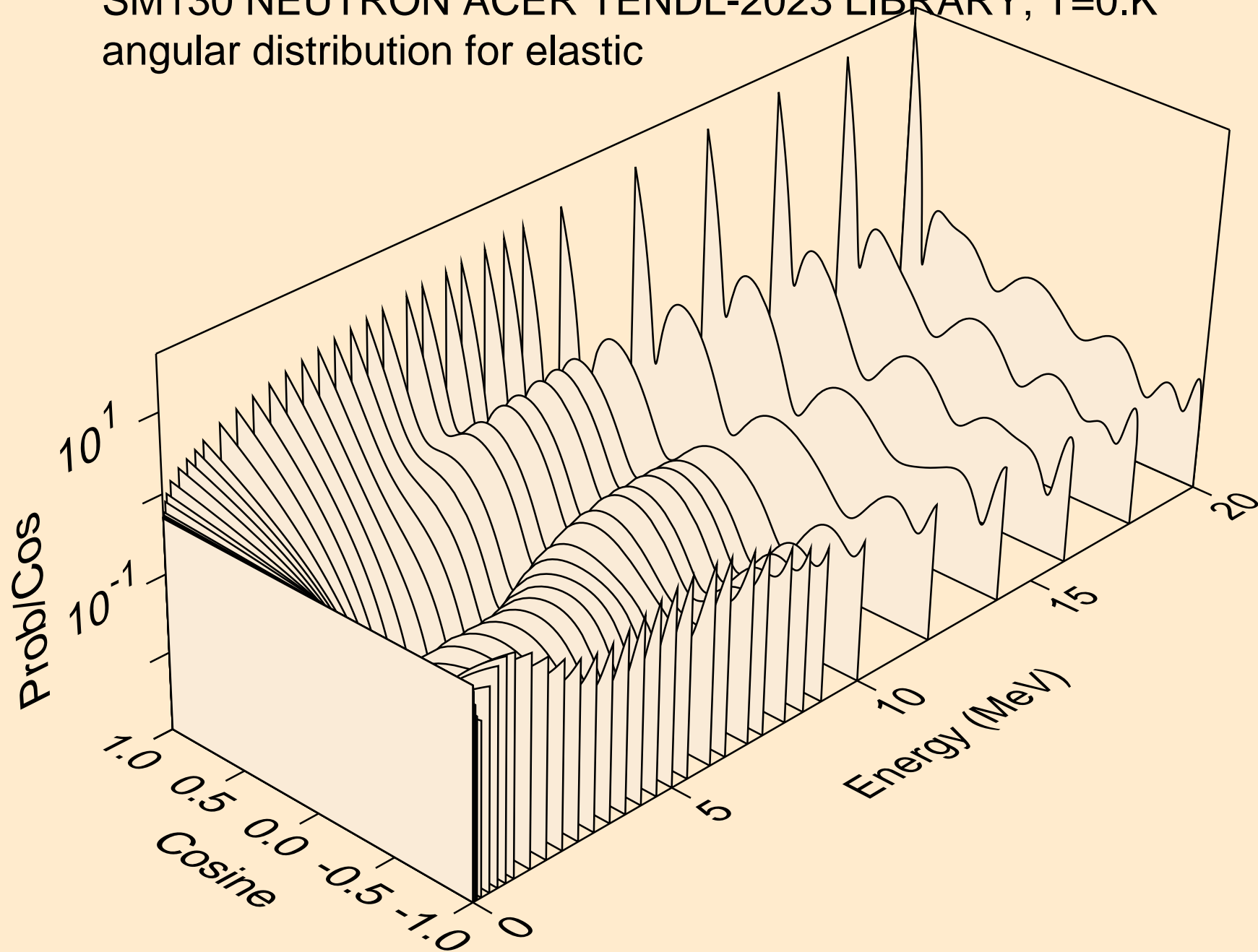

SM130 NEUTRON ACER TENDL-2023 LIBRARY; T=0.K
angular distribution for elastic

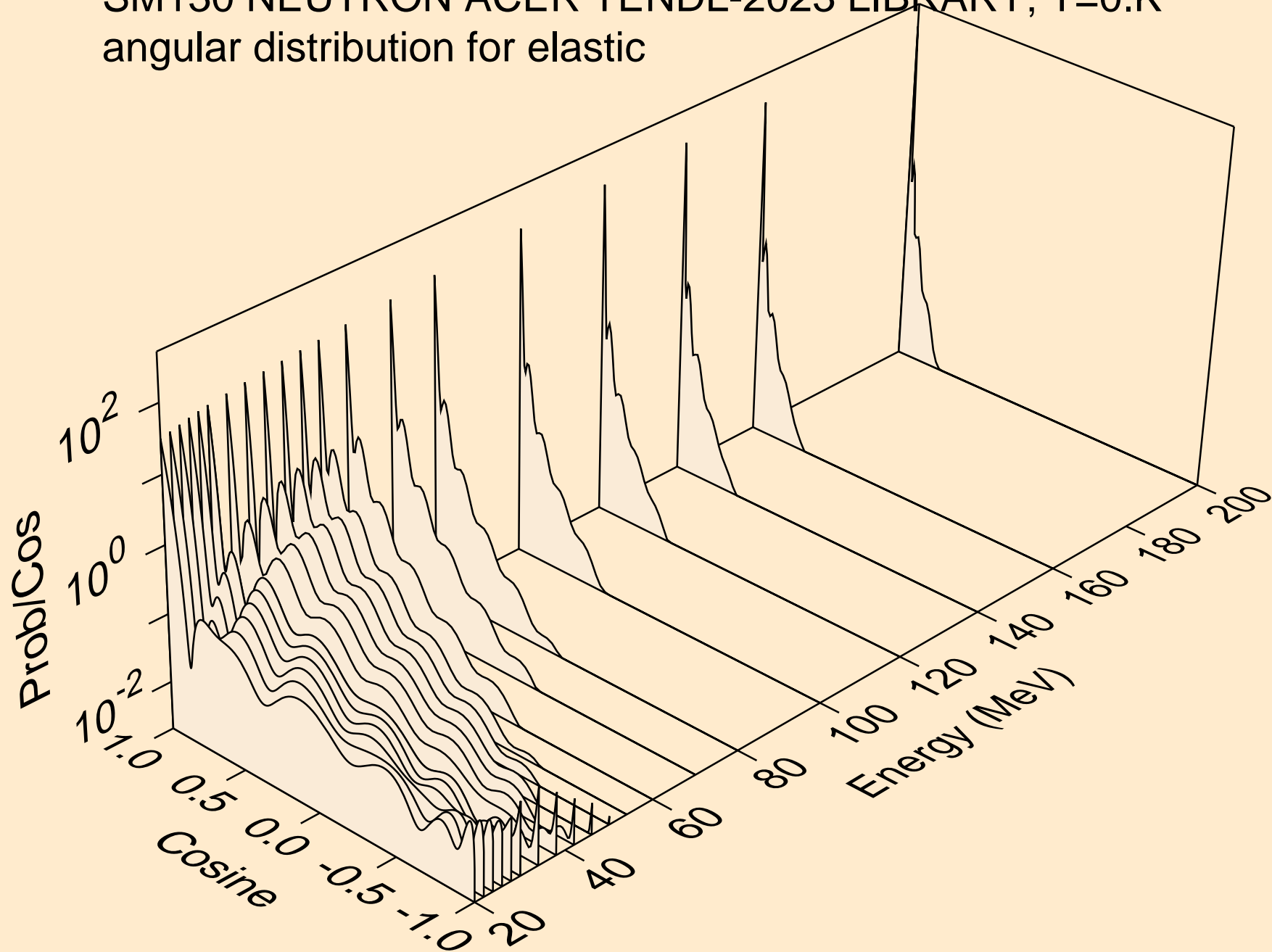

SM130 NEUTRON ACER TENDL-2023 LIBRARY; T=0.K
angular distribution for (n,n*1)

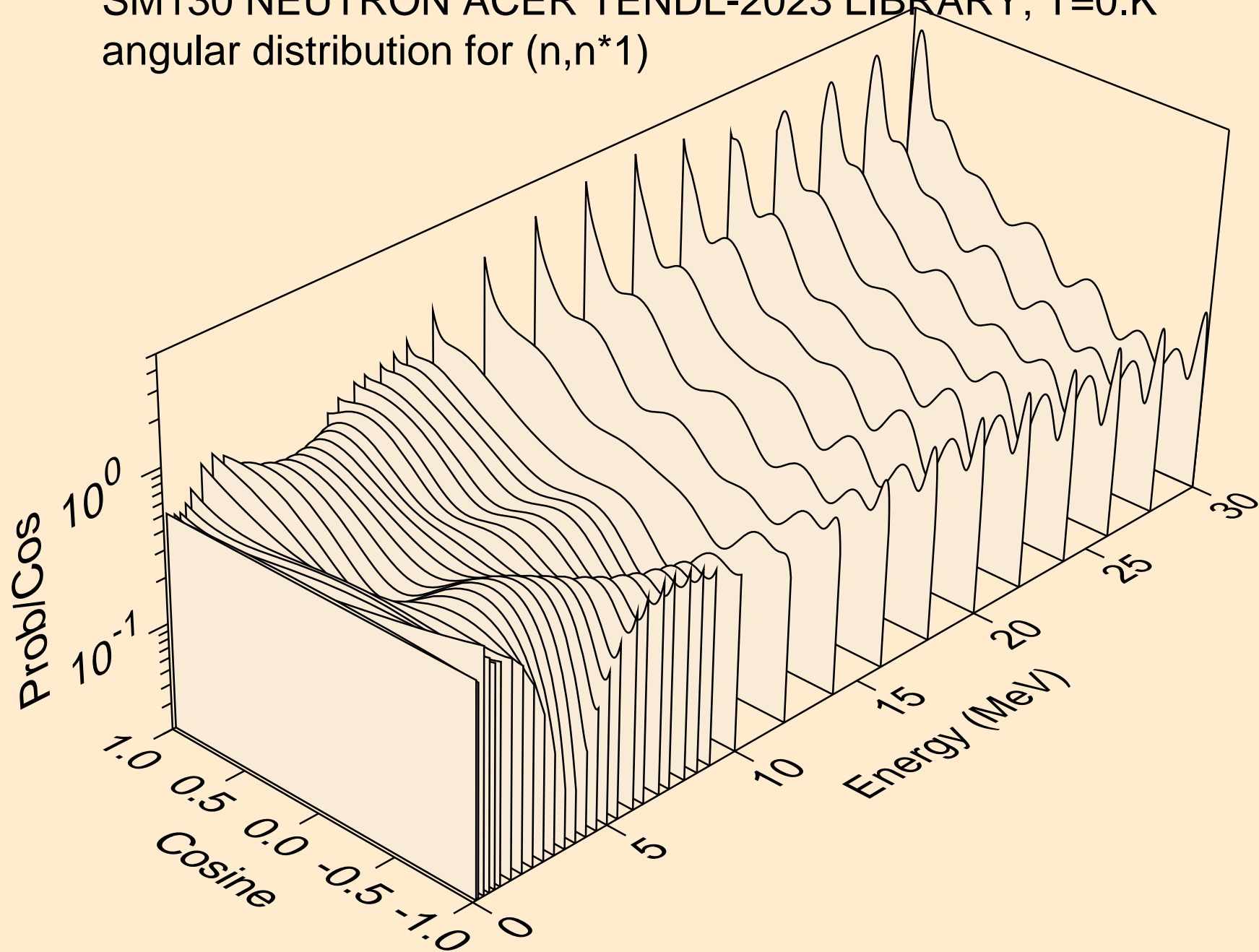

SM130 NEUTRON ACER TENDL-2023 LIBRARY; T=0.K
angular distribution for (n,n*2)

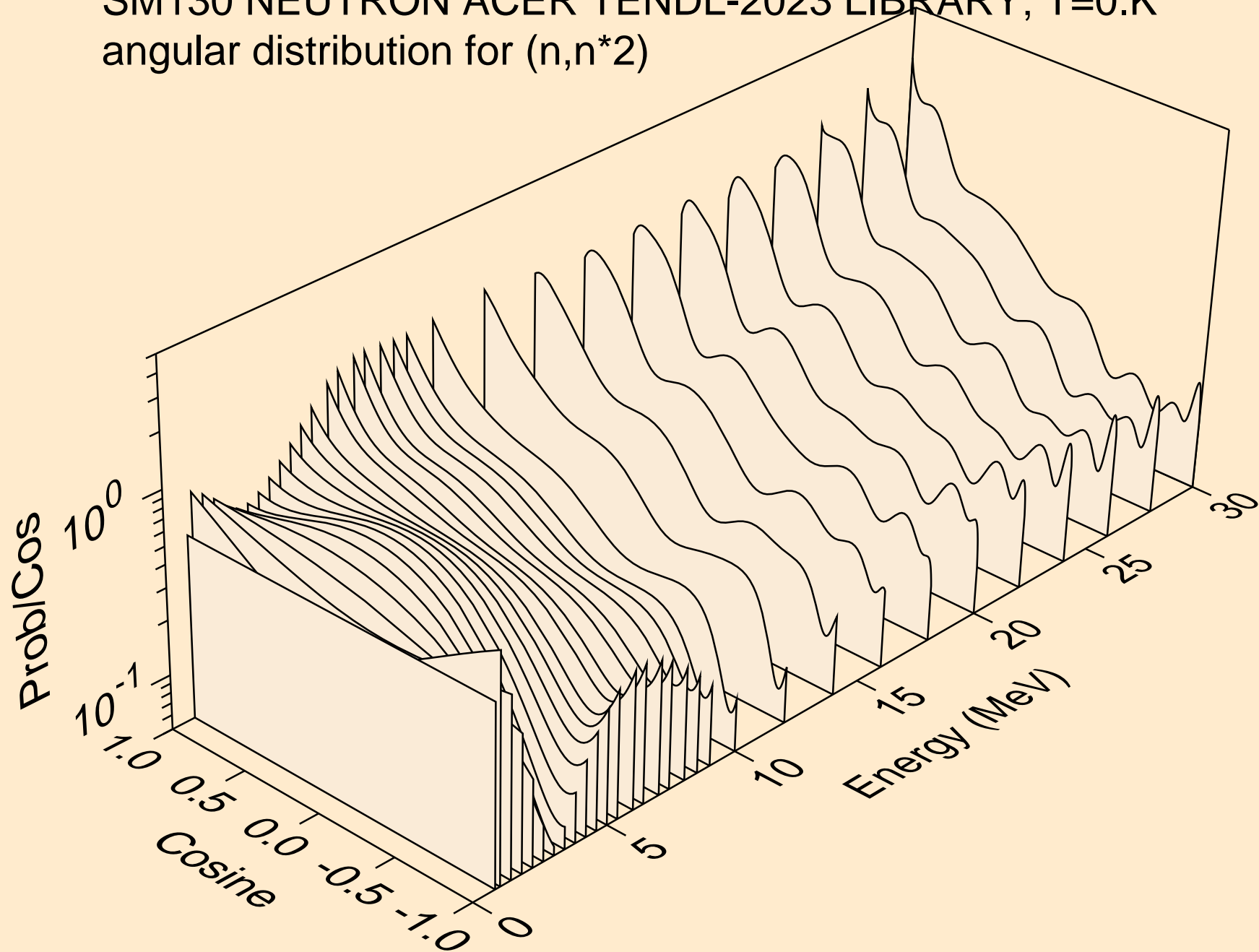

SM130 NEUTRON ACER TENDL-2023 LIBRARY; T=0.K
angular distribution for (n,n*3)

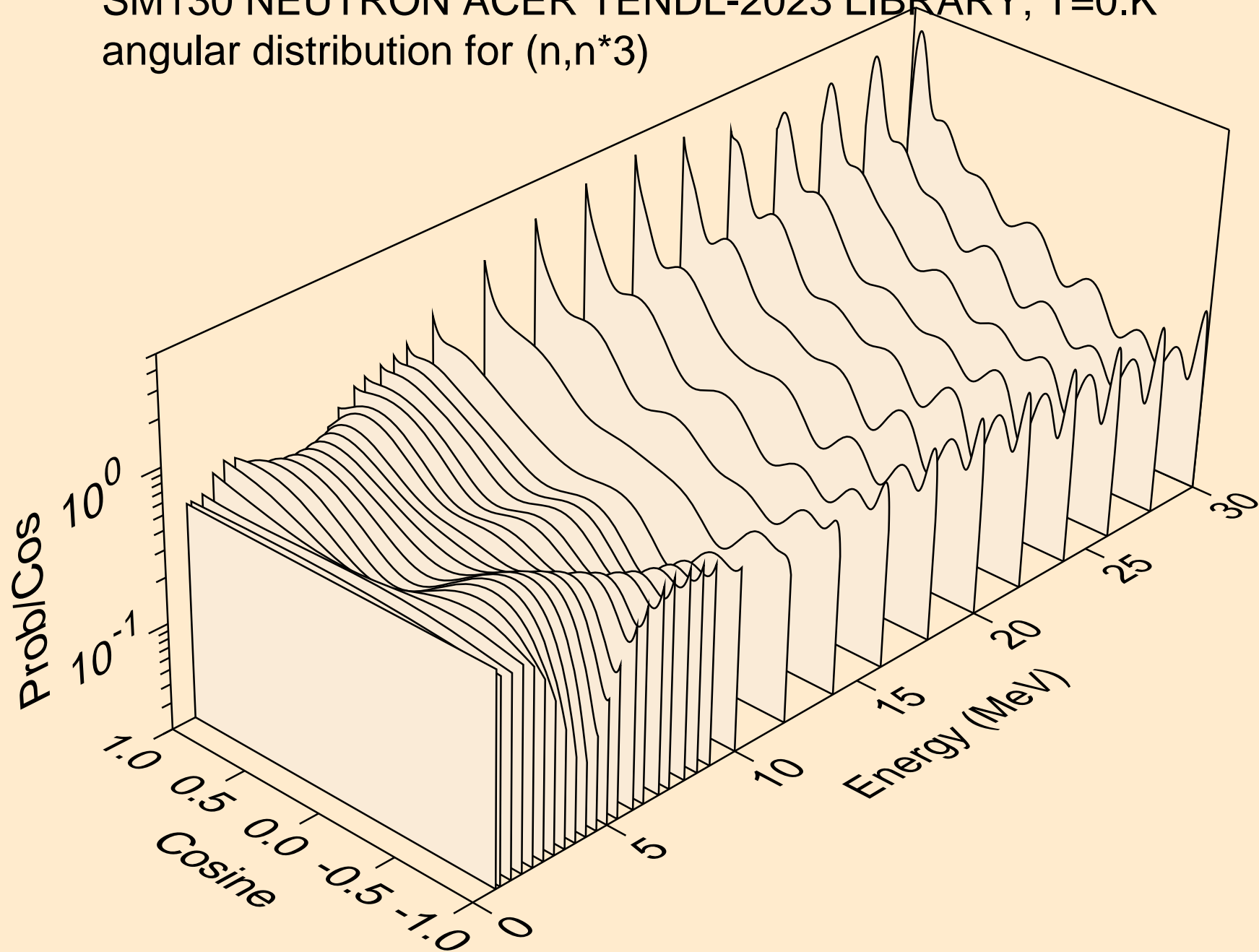

SM130 NEUTRON ACER TENDL-2023 LIBRARY; T=0.K
angular distribution for (n,n*4)

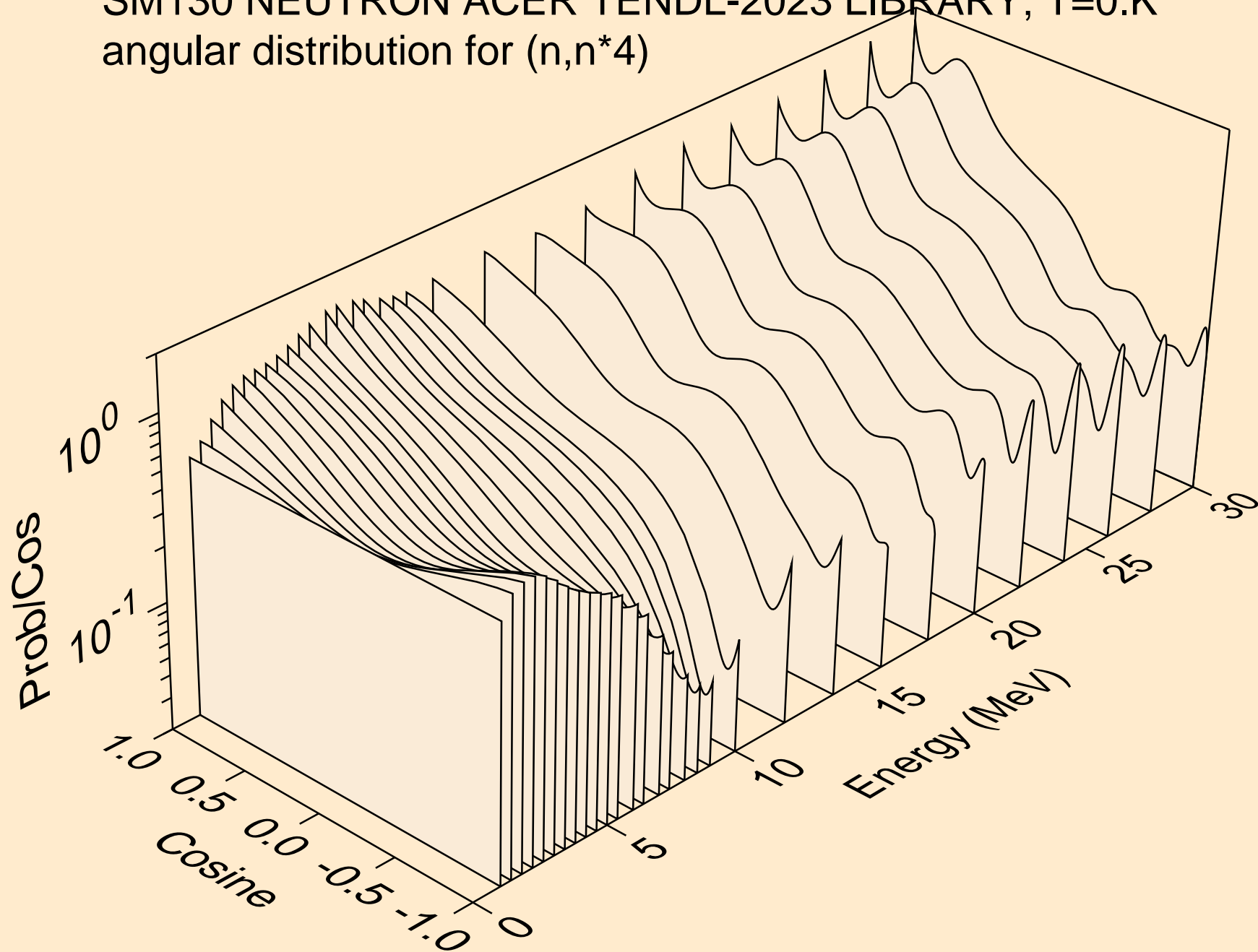

SM130 NEUTRON ACER TENDL-2023 LIBRARY; T=0.K
angular distribution for (n,n*5)

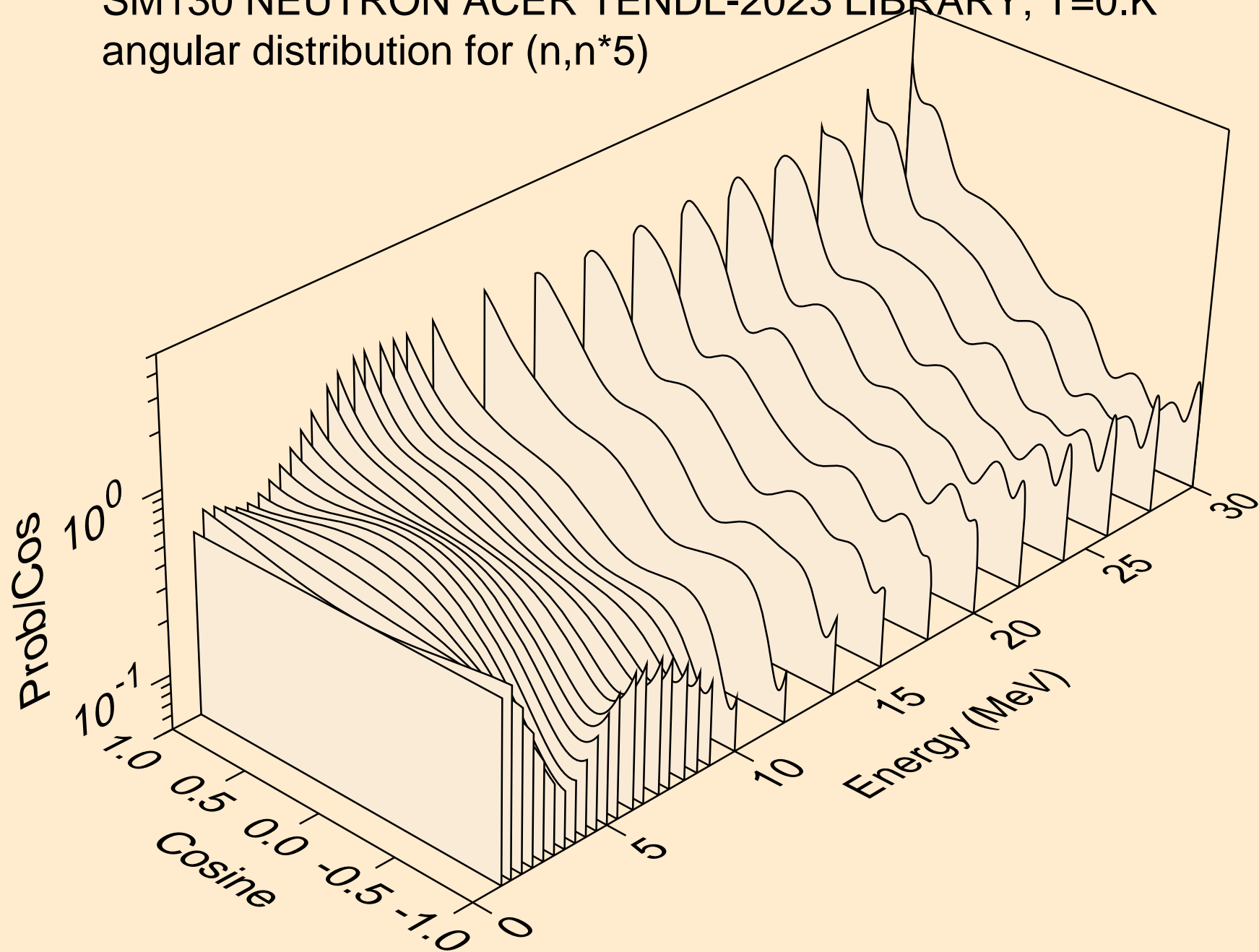

SM130 NEUTRON ACER TENDL-2023 LIBRARY; T=0.K
angular distribution for (n,n*6)

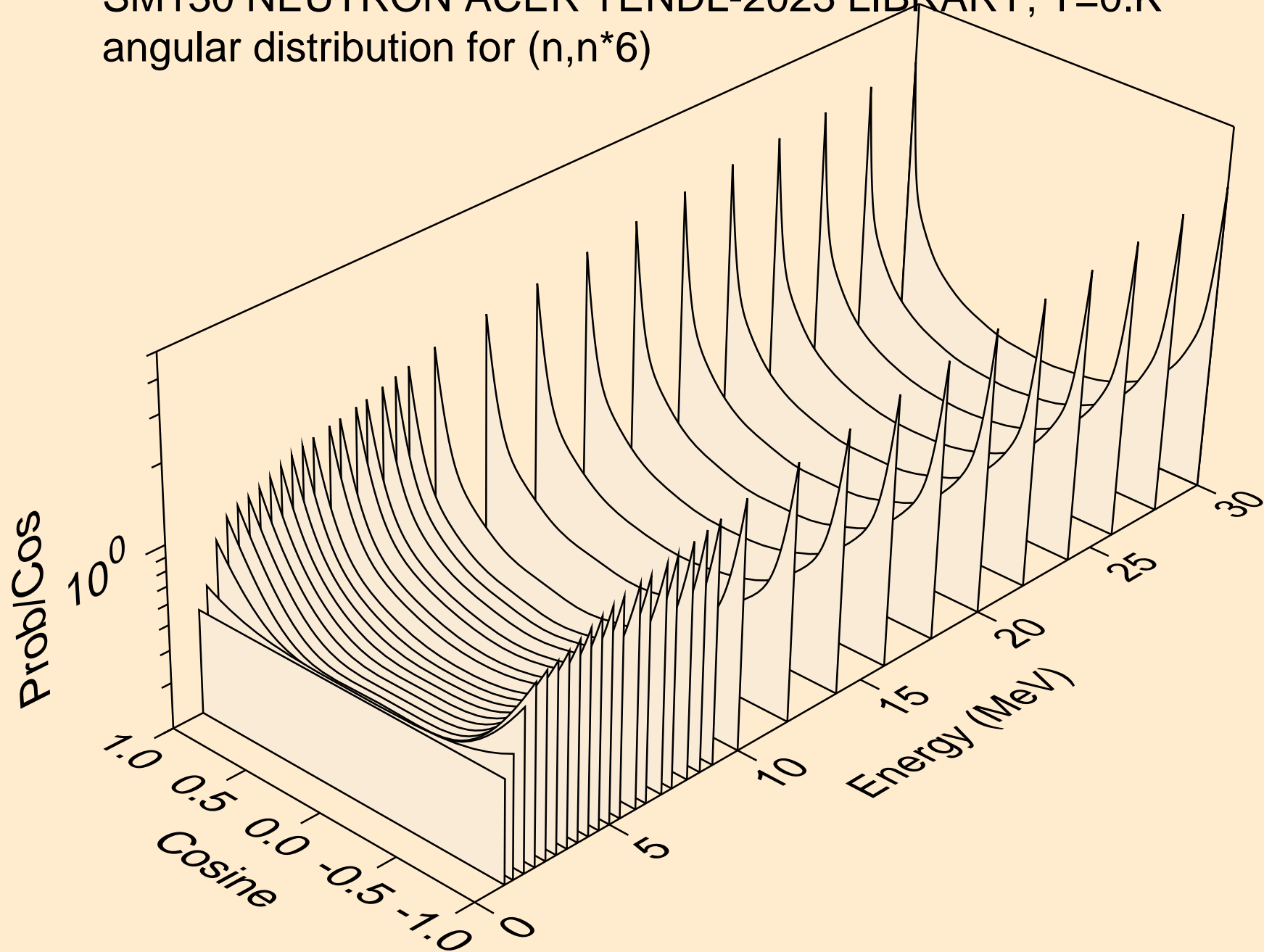

SM130 NEUTRON ACER TENDL-2023 LIBRARY; T=0.K
angular distribution for (n,n*7)

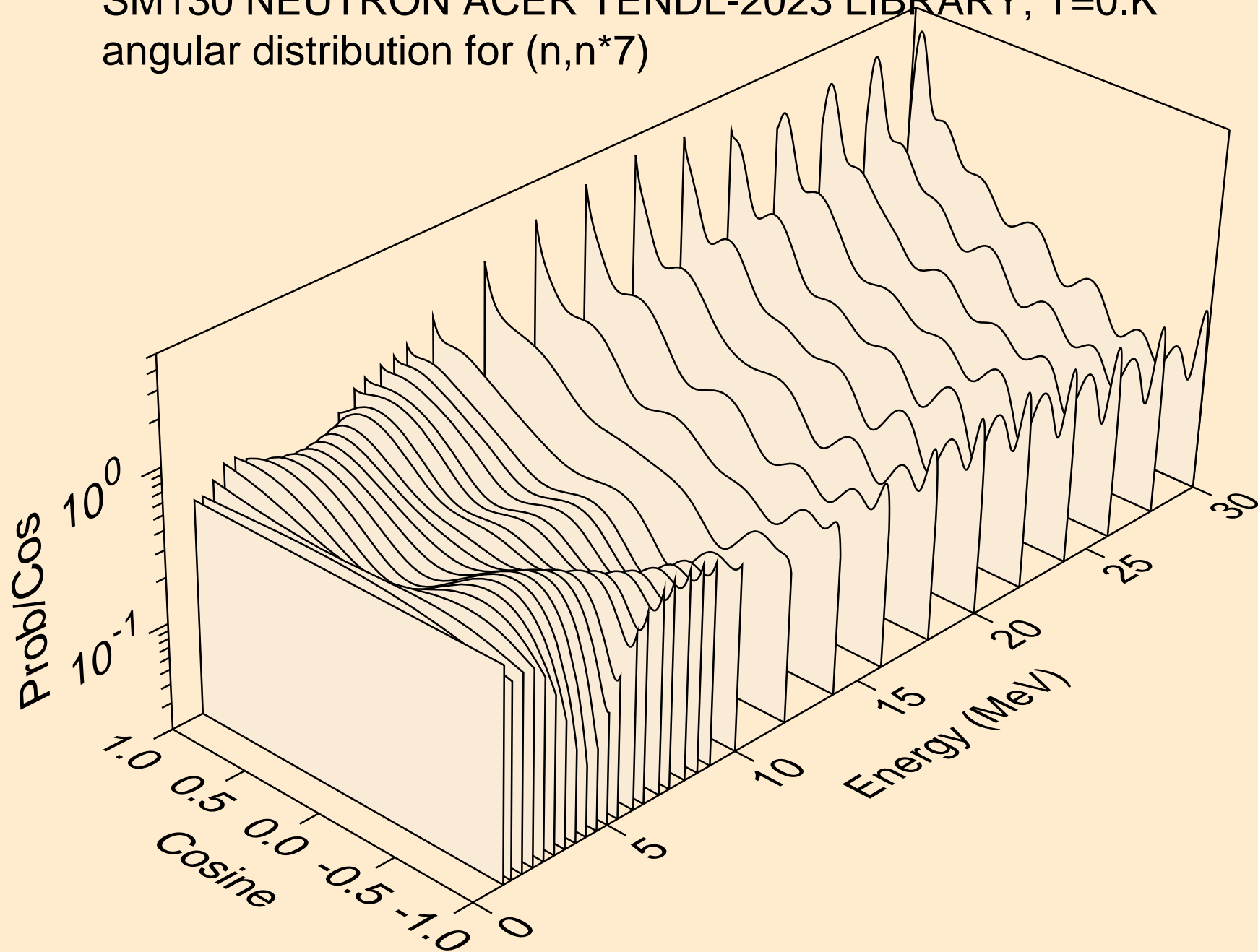

SM130 NEUTRON ACER TENDL-2023 LIBRARY; T=0.K
angular distribution for (n,n*8)

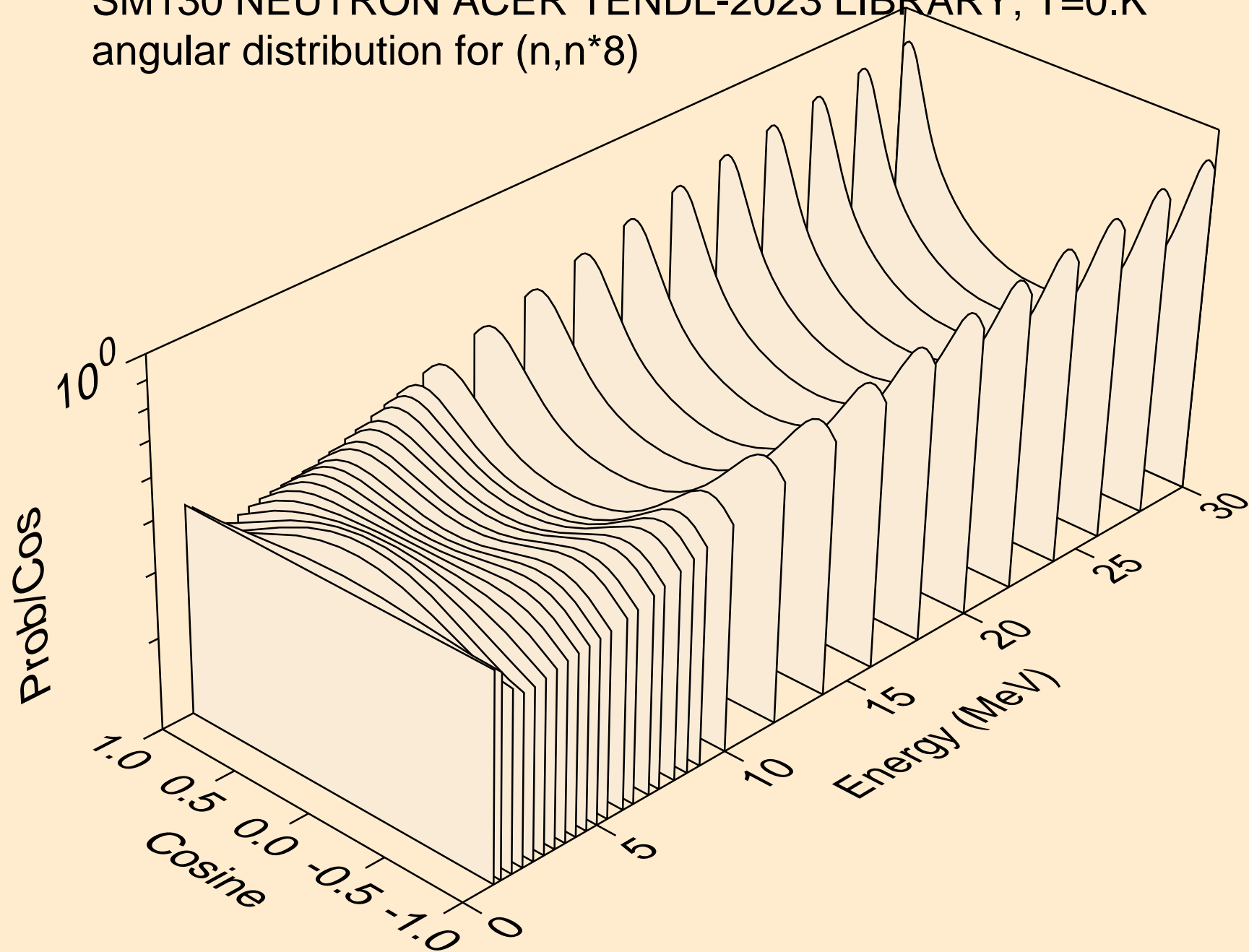

SM130 NEUTRON ACER TENDL-2023 LIBRARY; T=0.K
angular distribution for (n,n*9)

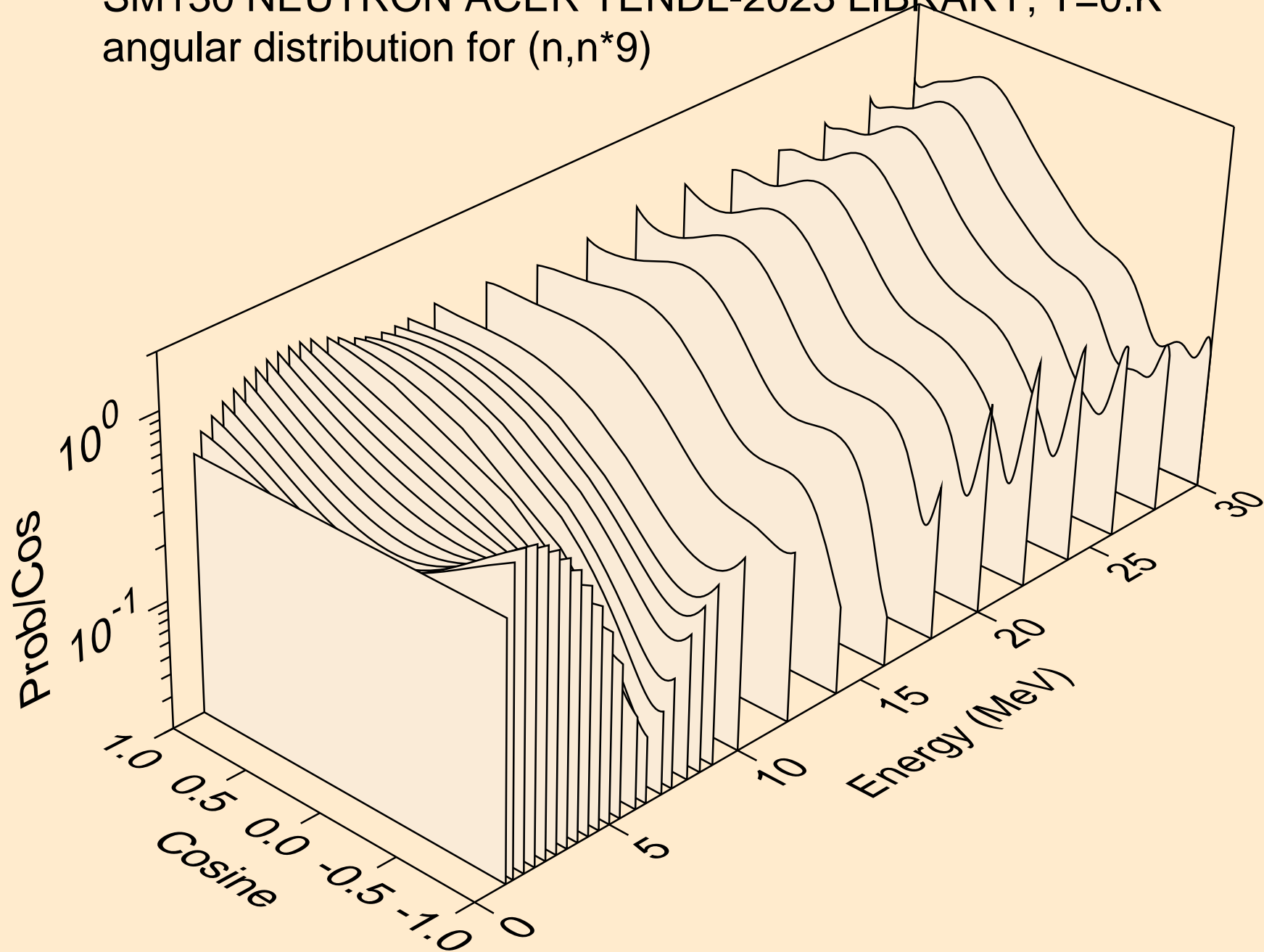

SM130 NEUTRON ACER TENDL-2023 LIBRARY; T=0.K
angular distribution for (n,n*10)

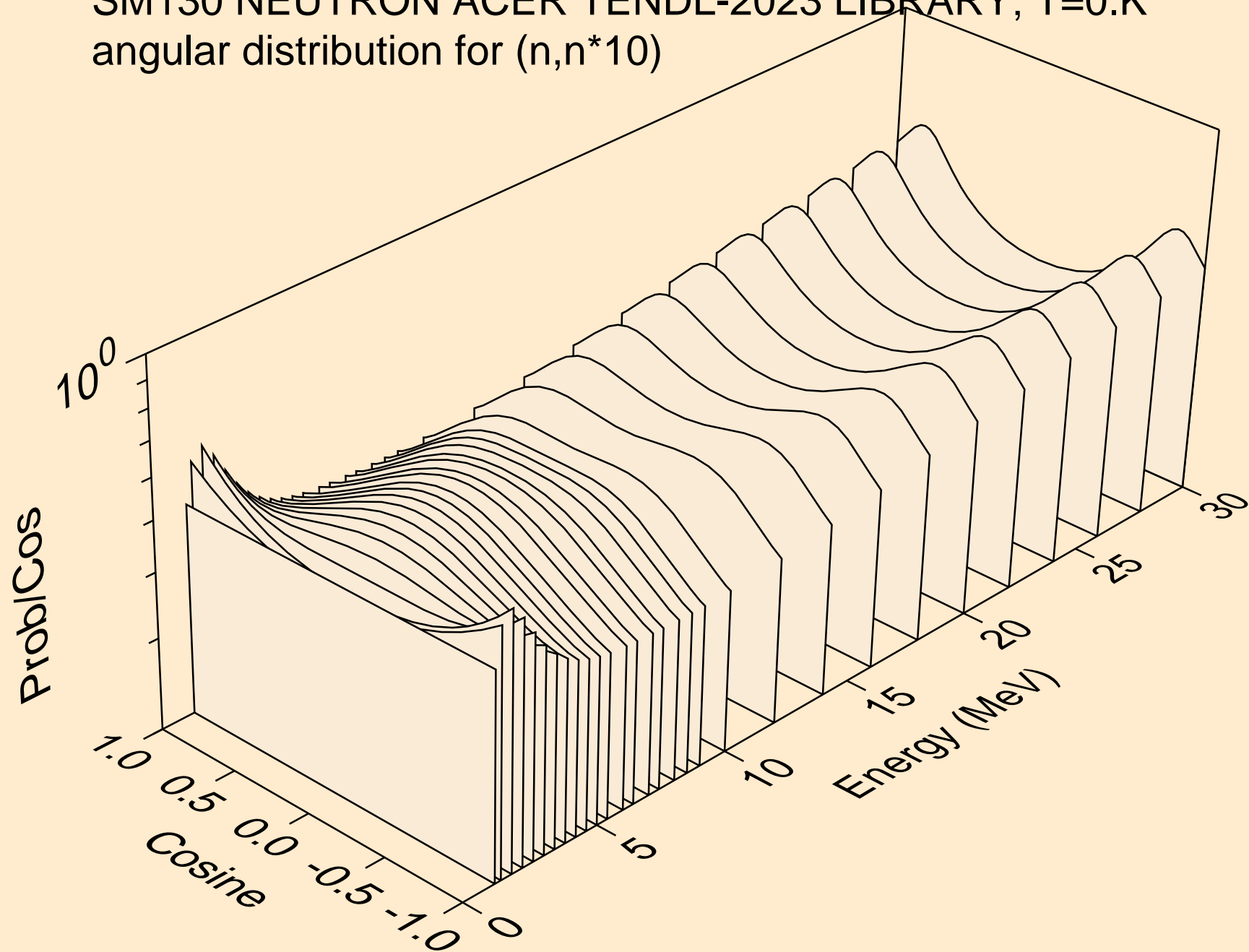

SM130 NEUTRON ACER TENDL-2023 LIBRARY; T=0.K
angular distribution for (n,n*11)

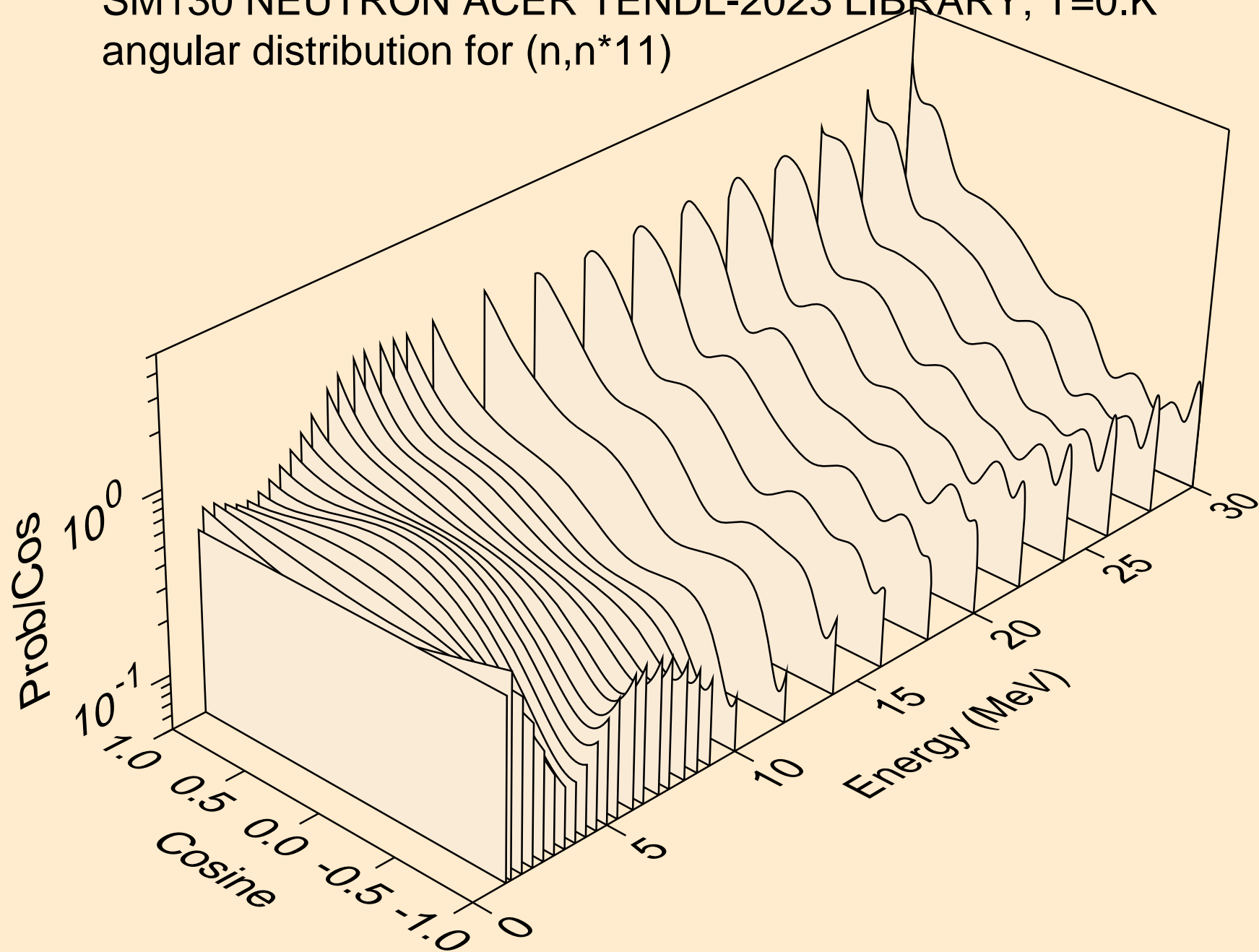

SM130 NEUTRON ACER TENDL-2023 LIBRARY; T=0.K
angular distribution for (n,n*12)

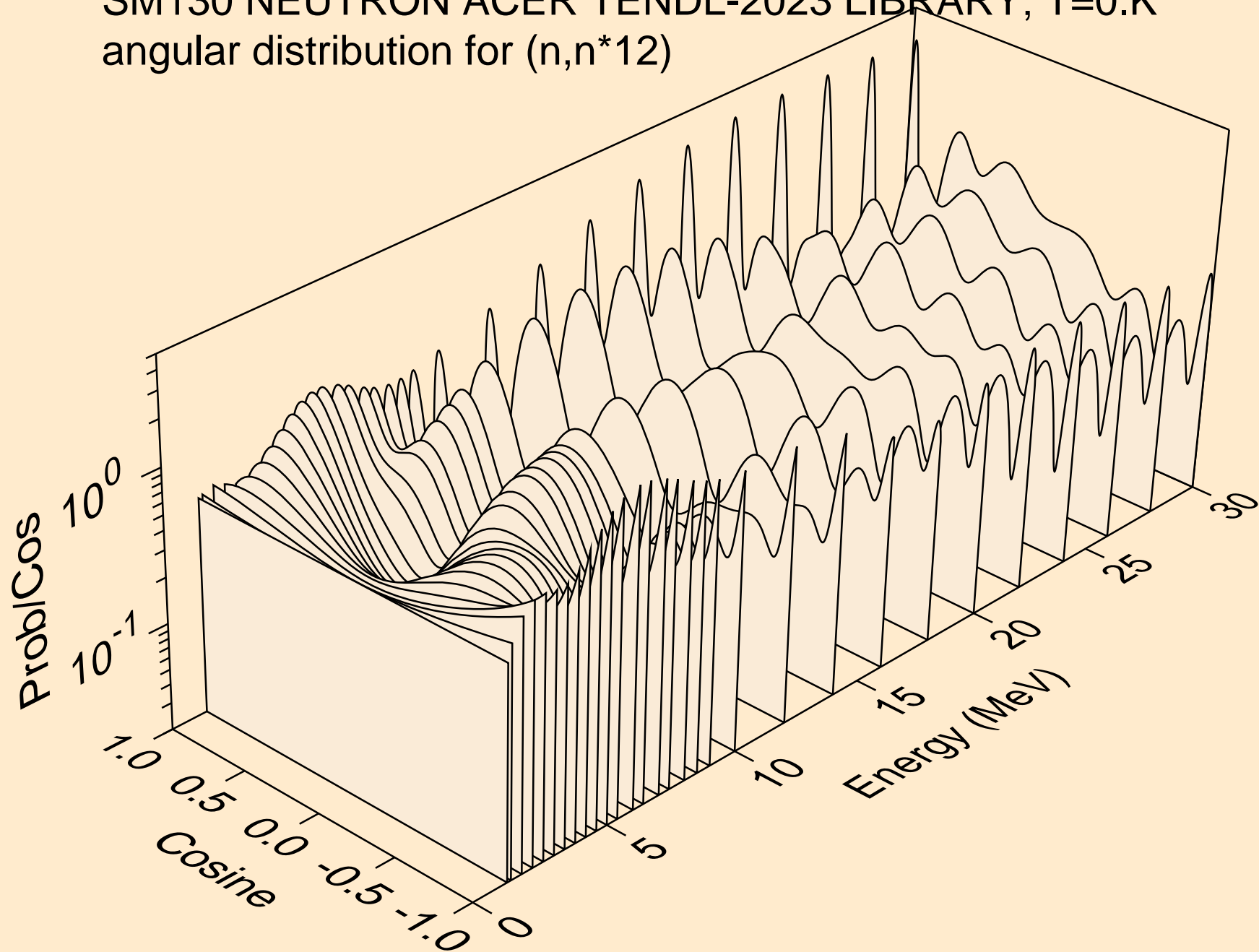

SM130 NEUTRON ACER TENDL-2023 LIBRARY; T=0.K
angular distribution for (n,n*13)

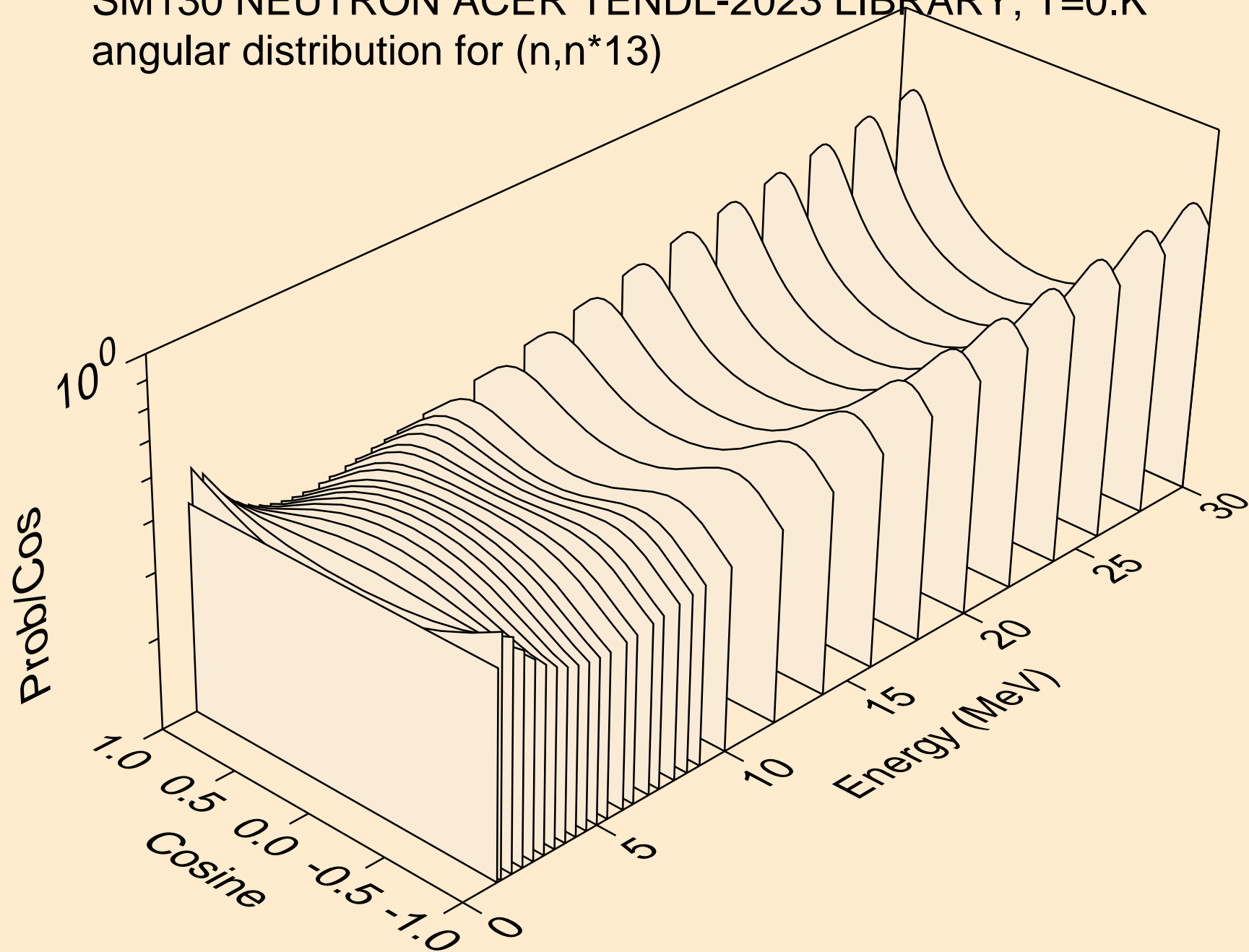

SM130 NEUTRON ACER TENDL-2023 LIBRARY; T=0.K
angular distribution for (n,n*14)

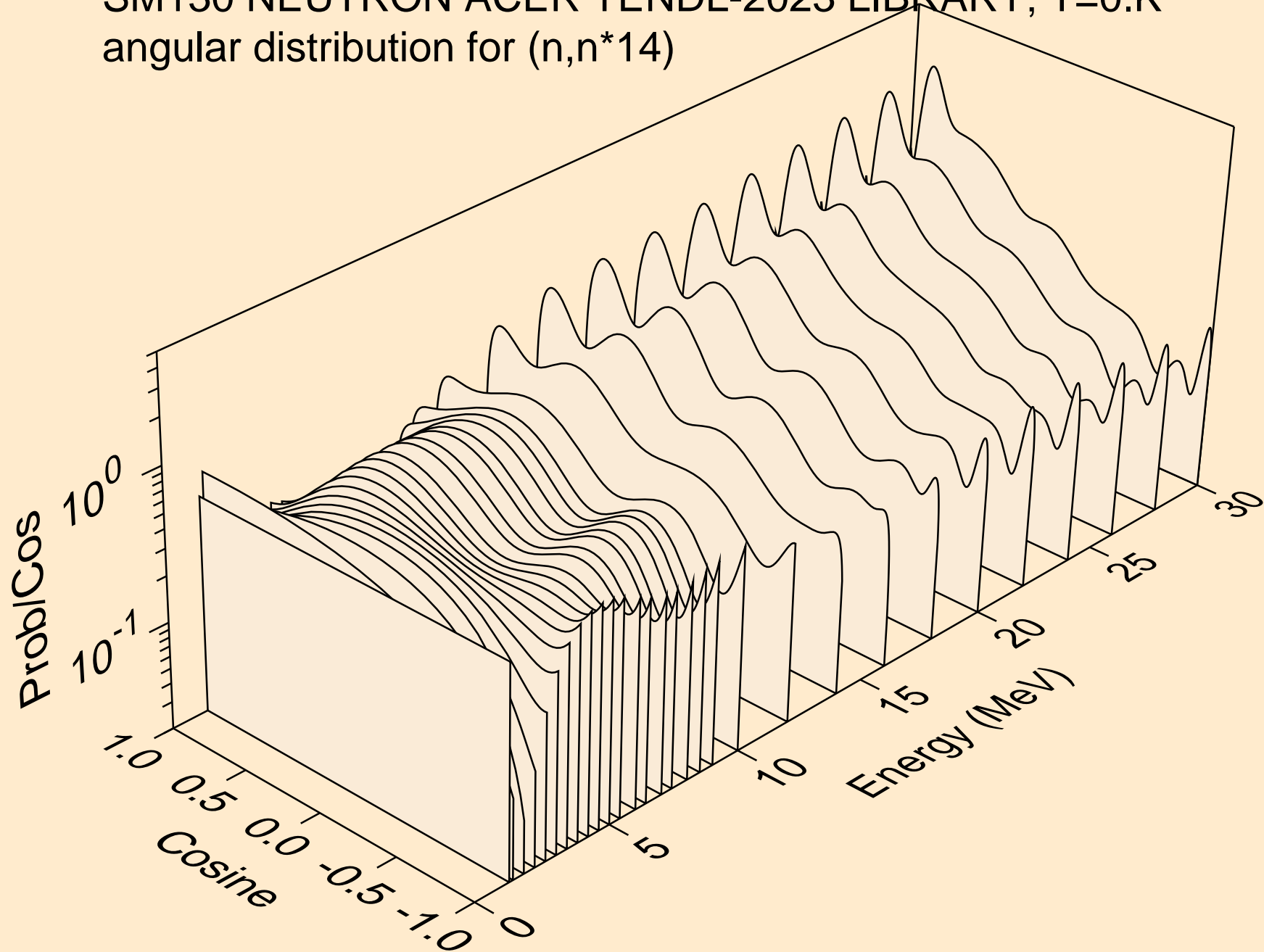

SM130 NEUTRON ACER TENDL-2023 LIBRARY; T=0.K
Neutron emission for (n,x)

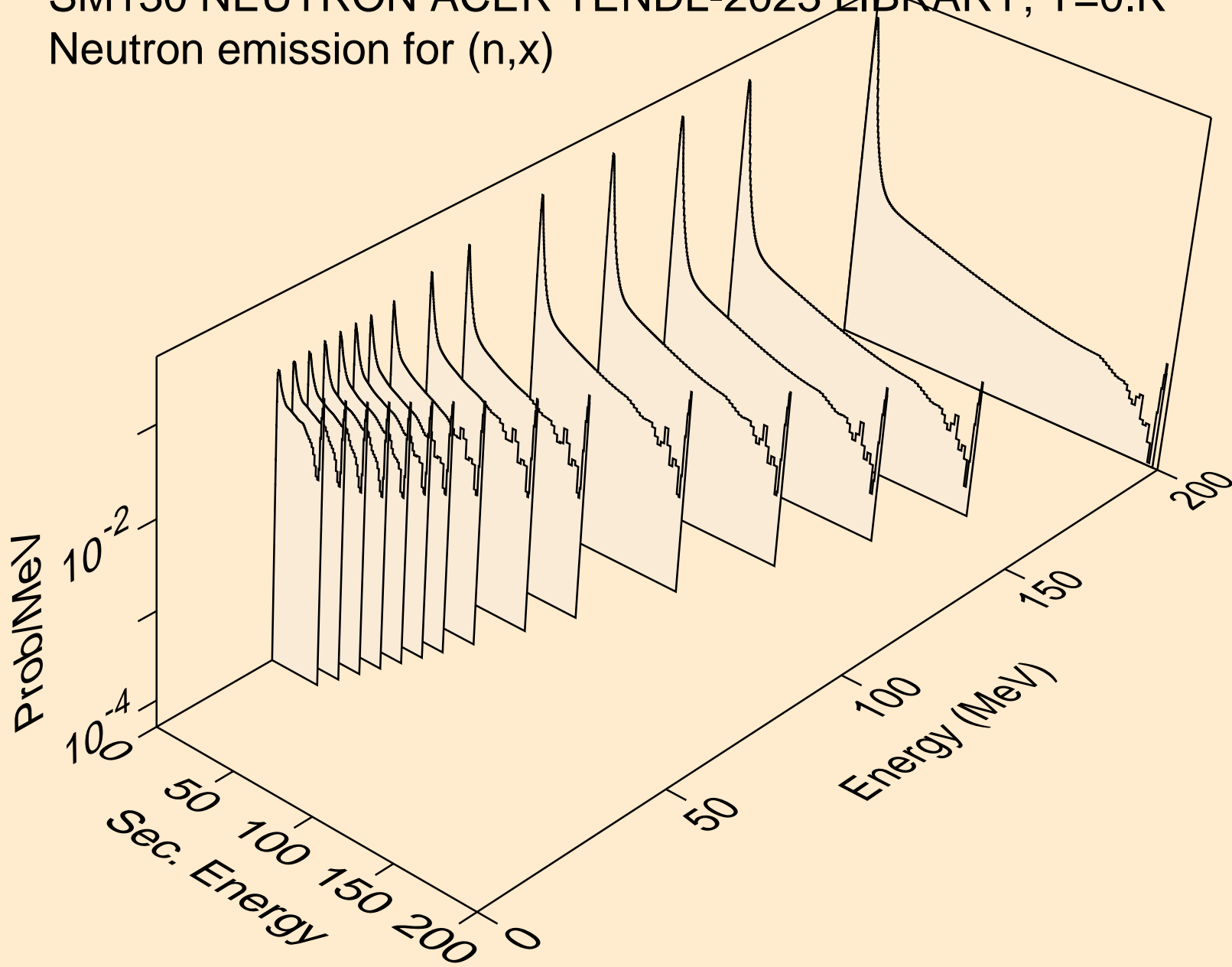

SM130 NEUTRON ACER TENDL-2023 LIBRARY; T=0.K
Neutron emission for (n,2n)

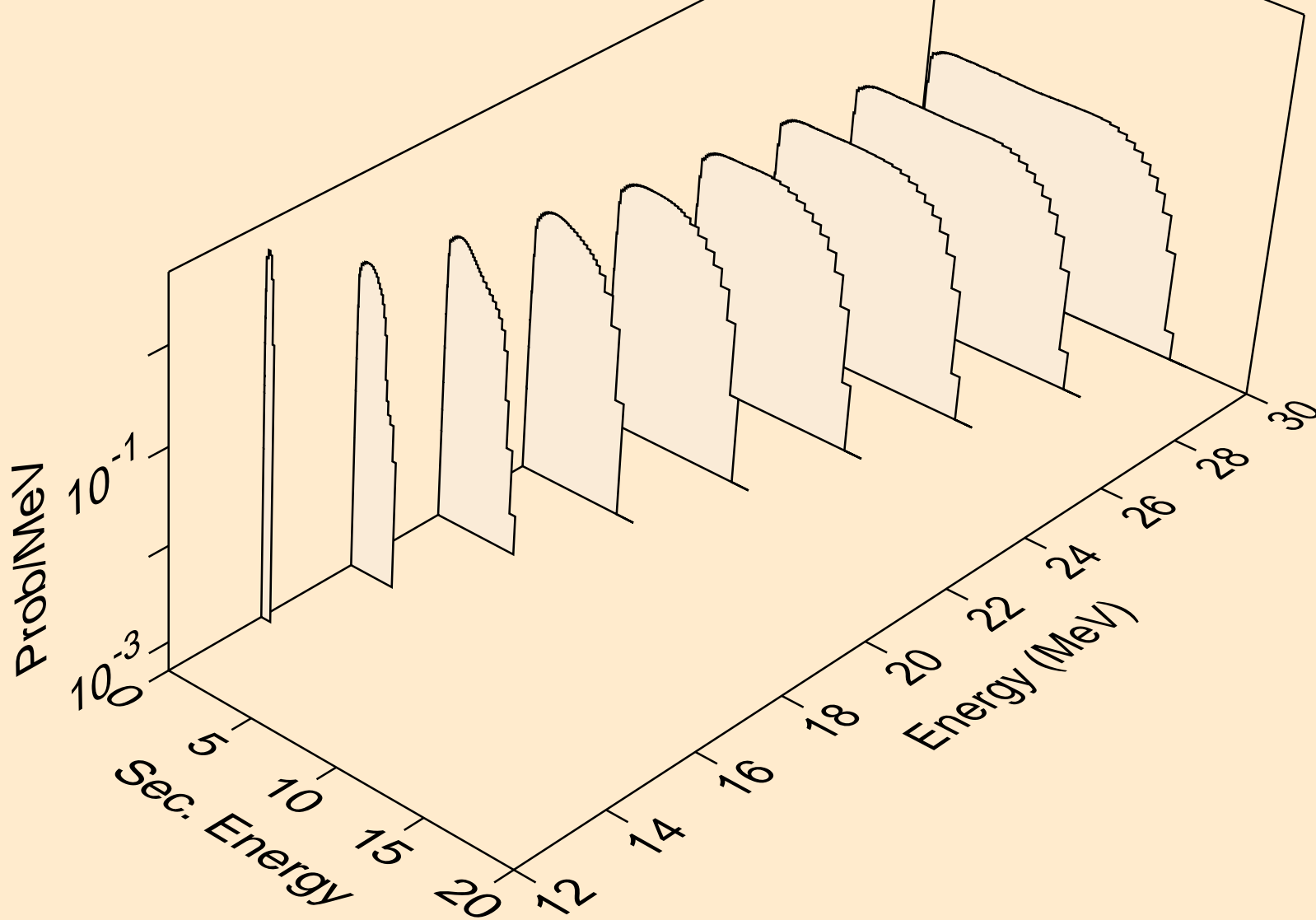

SM130 NEUTRON ACER TENDL-2023 LIBRARY; T=0.K
Neutron emission for (n,3n)

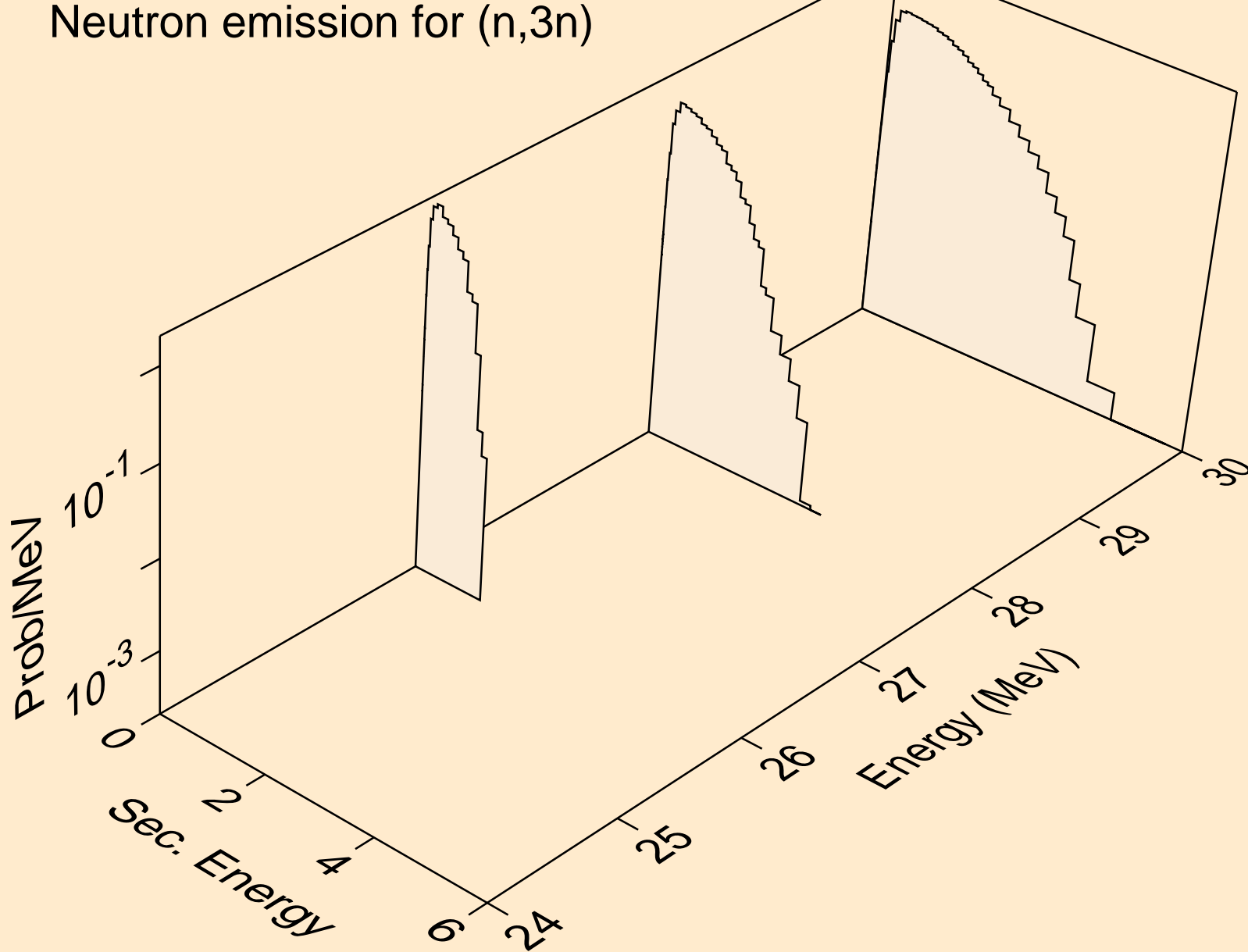

SM130 NEUTRON ACER TENDL-2023 LIBRARY; T=0.K
Neutron emission for (n,n*)a

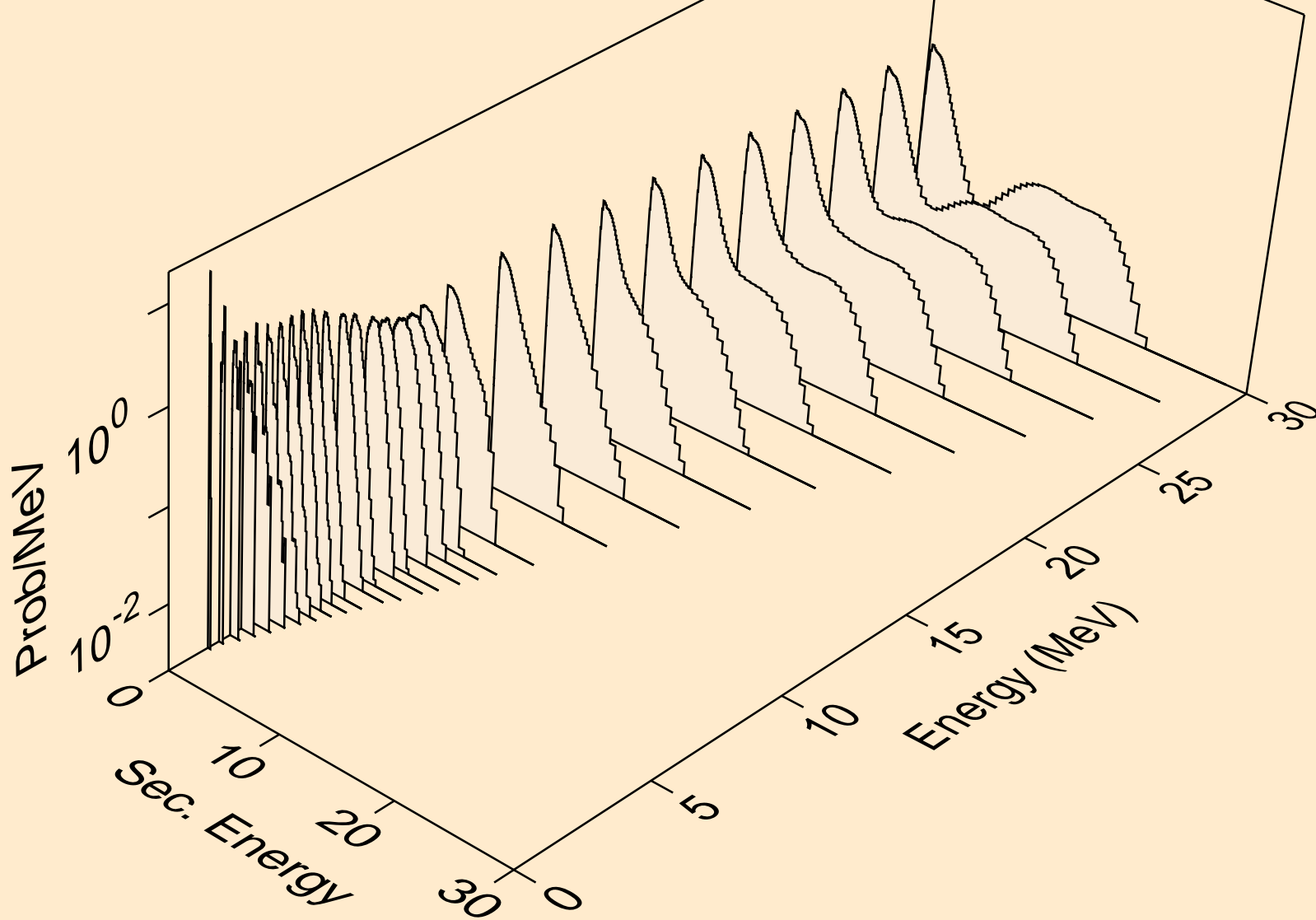

SM130 NEUTRON ACER TENDL-2023 LIBRARY; T=0.K
Neutron emission for (n,2n)a

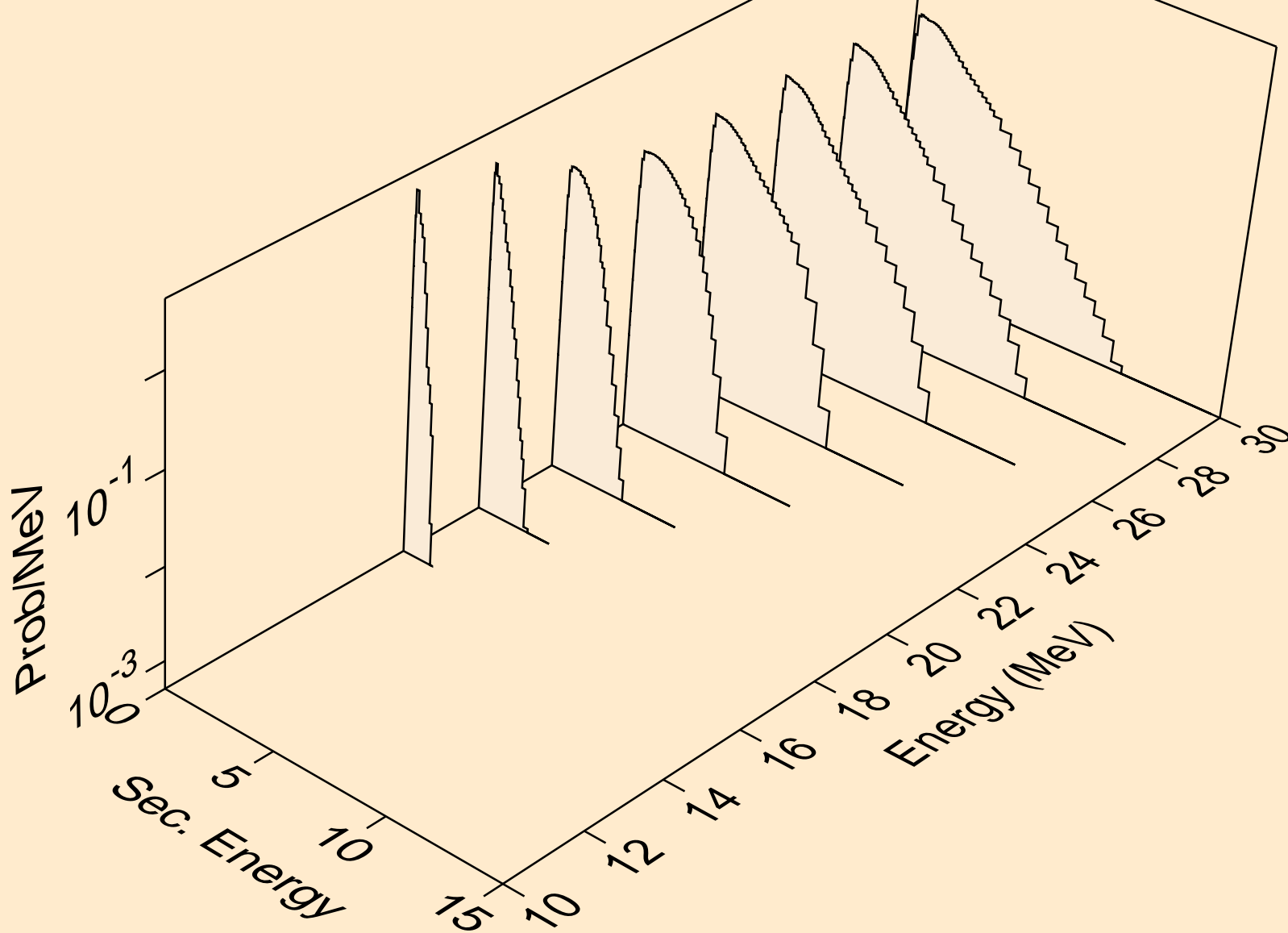

SM130 NEUTRON ACER TENDL-2023 LIBRARY; T=0.K
Neutron emission for (n,n*)p

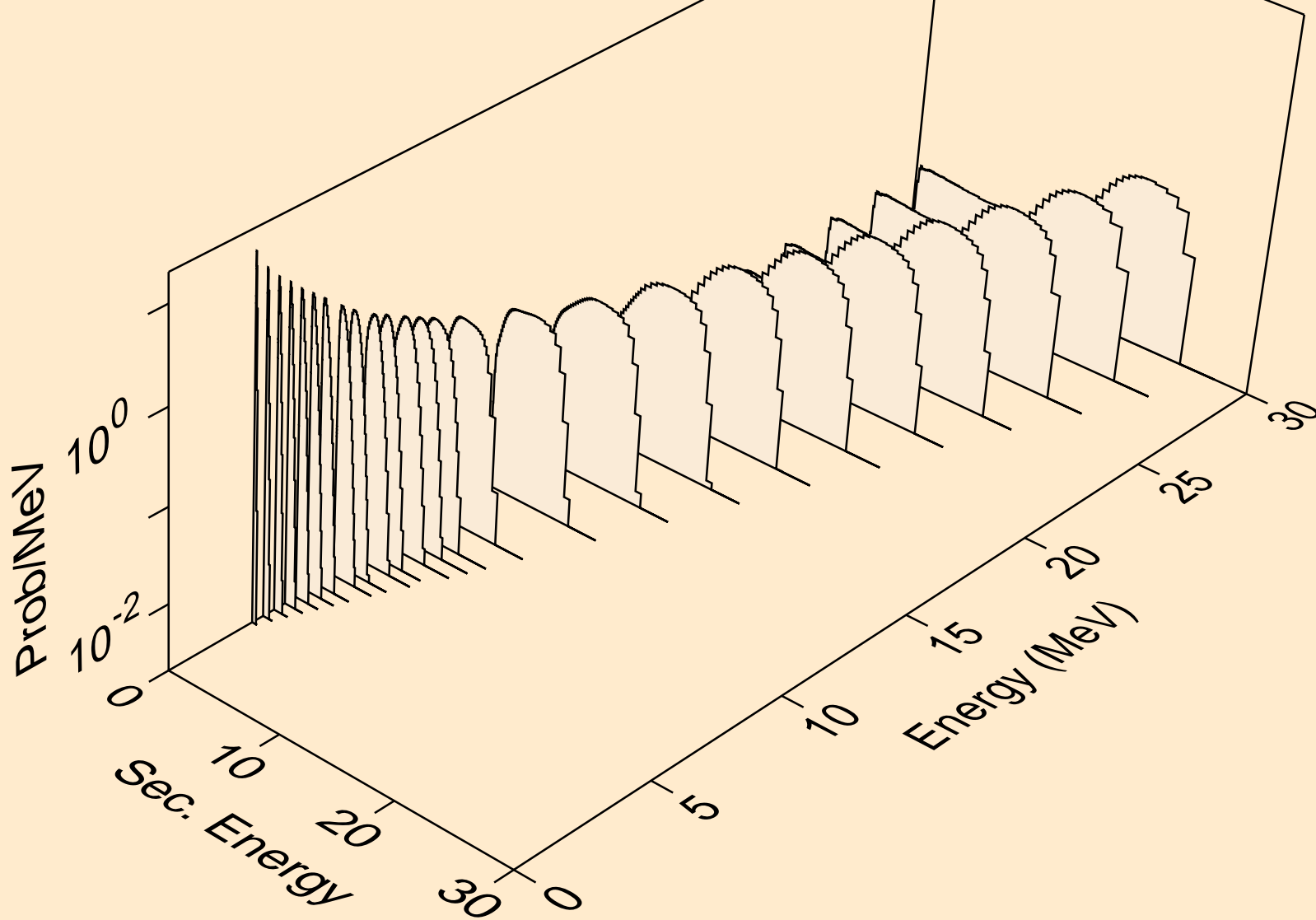

SM130 NEUTRON ACER TENDL-2023 LIBRARY; T=0.K
Neutron emission for (n,n*)2a

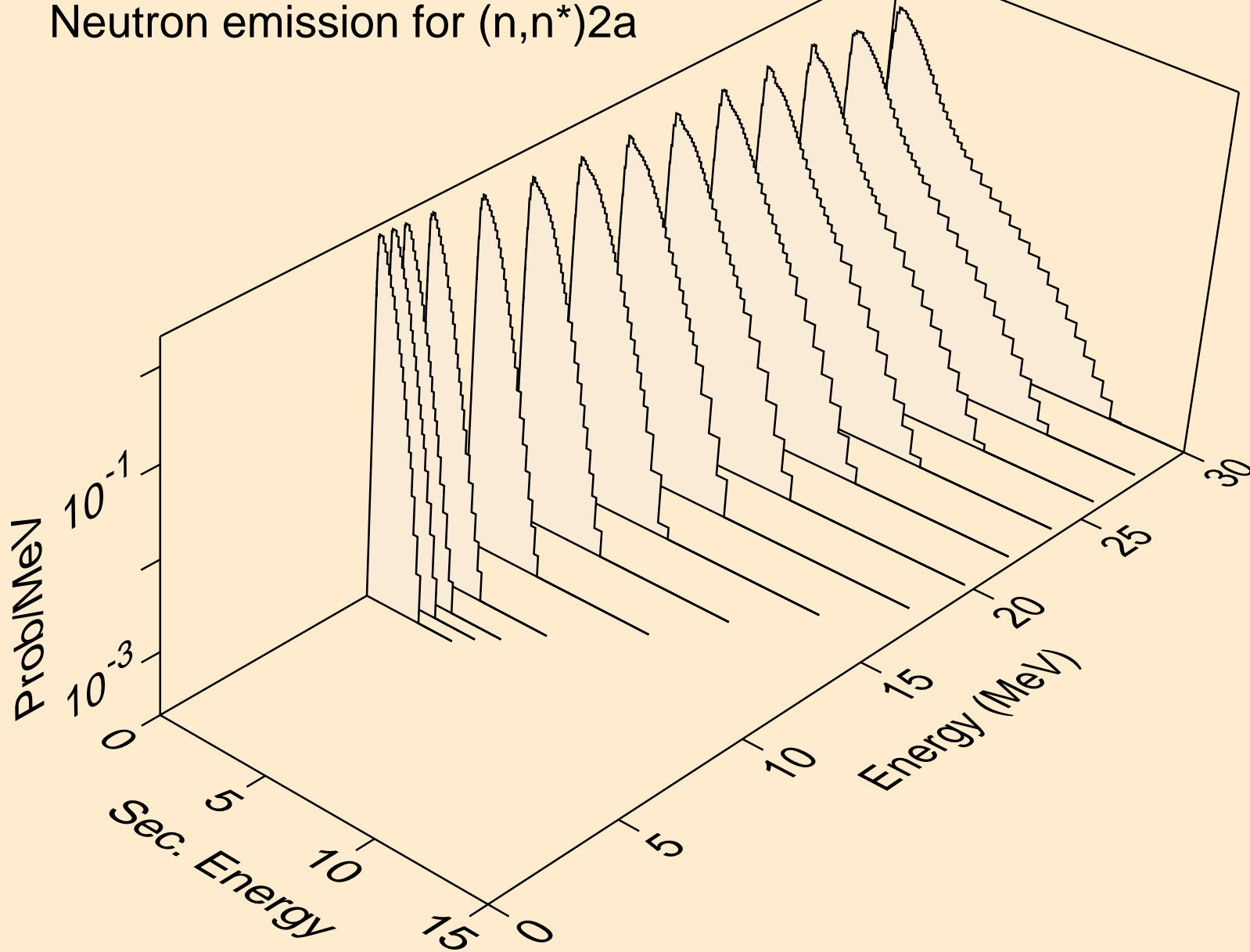

SM130 NEUTRON ACER TENDL-2023 LIBRARY; T=0.K
Neutron emission for (n,n*)d

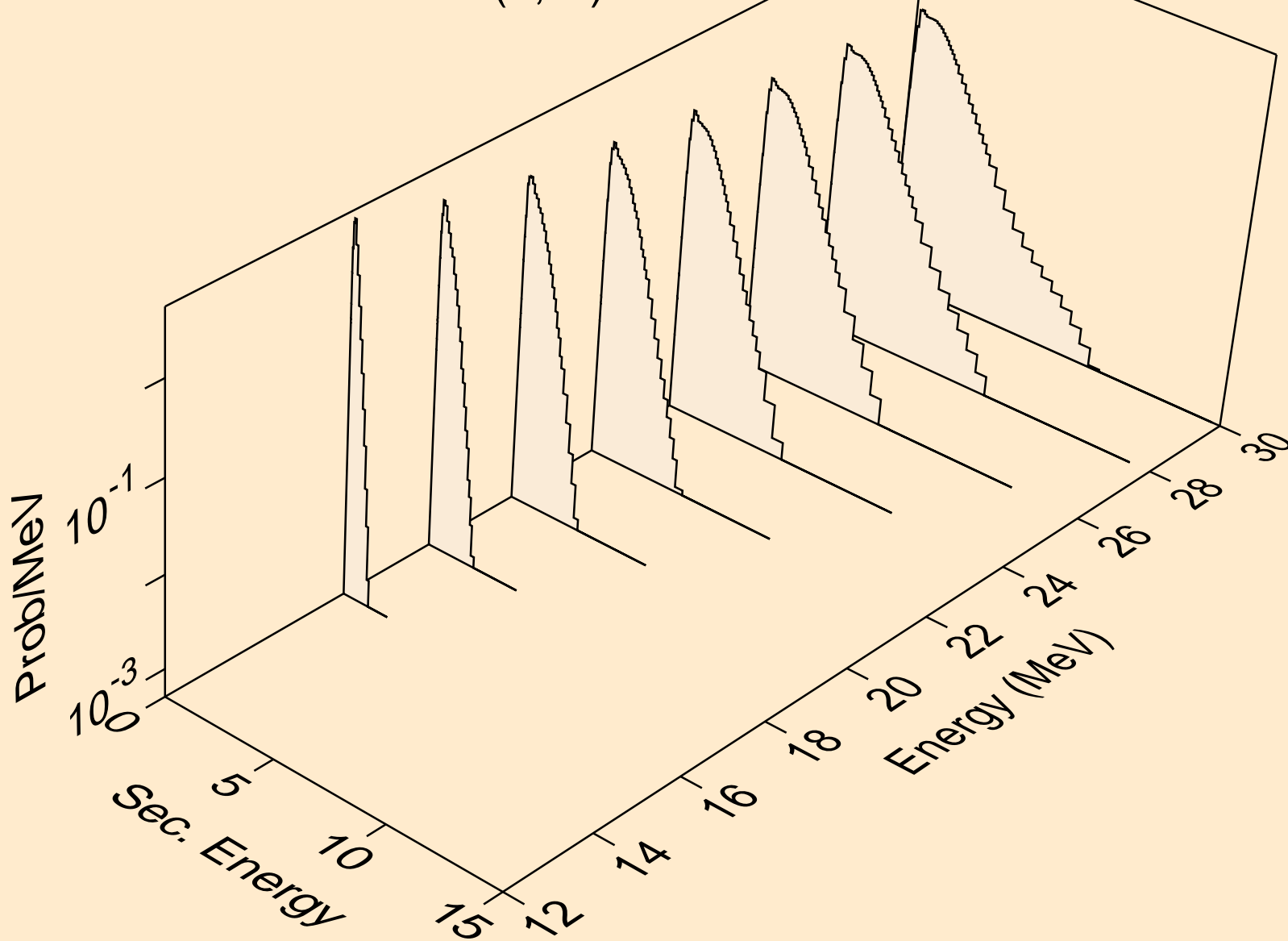

SM130 NEUTRON ACER TENDL-2023 LIBRARY; T=0.K
Neutron emission for (n,n*)t

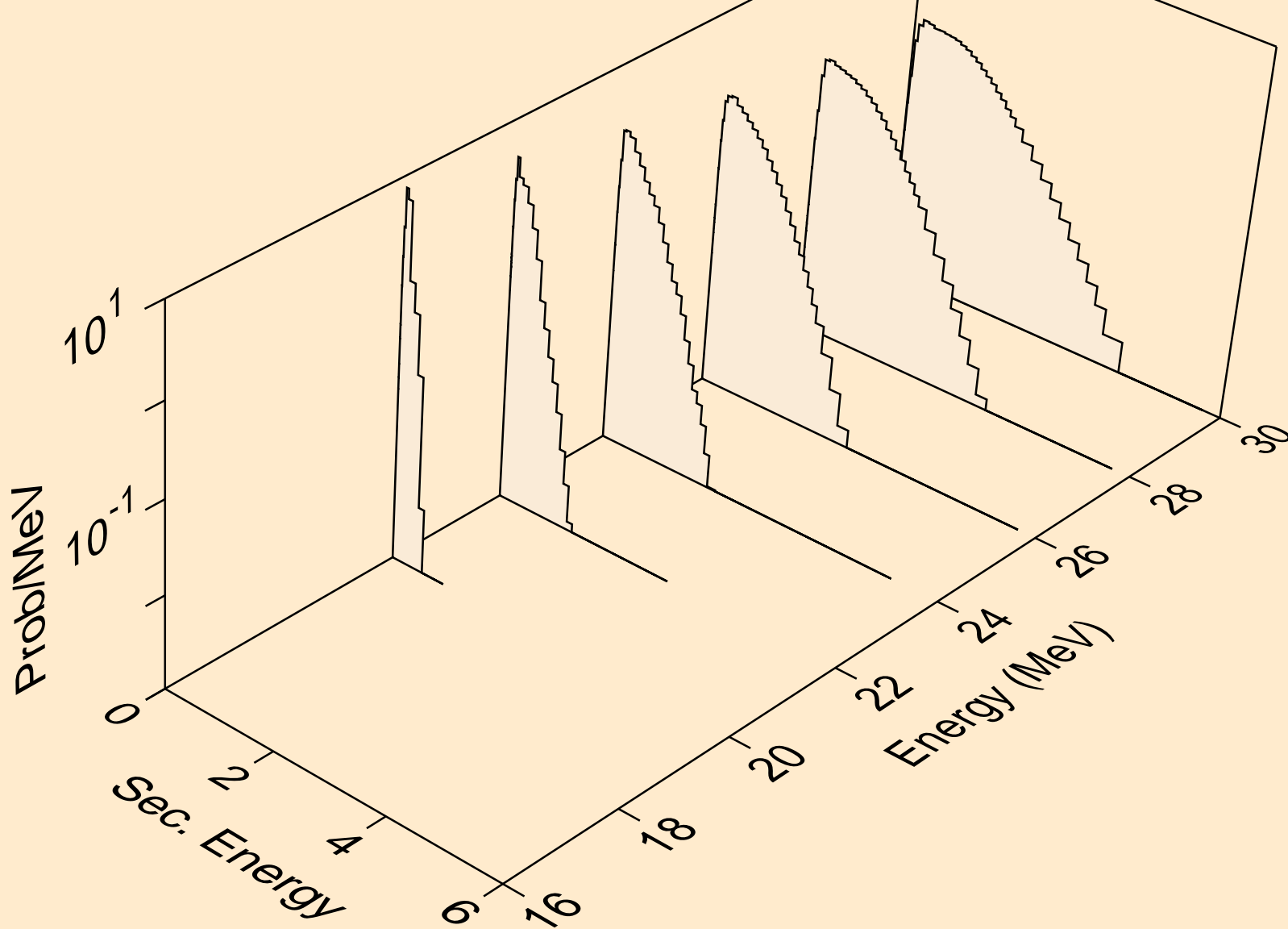

SM130 NEUTRON ACER TENDL-2023 LIBRARY; T=0.K
Neutron emission for (n,n*)he3

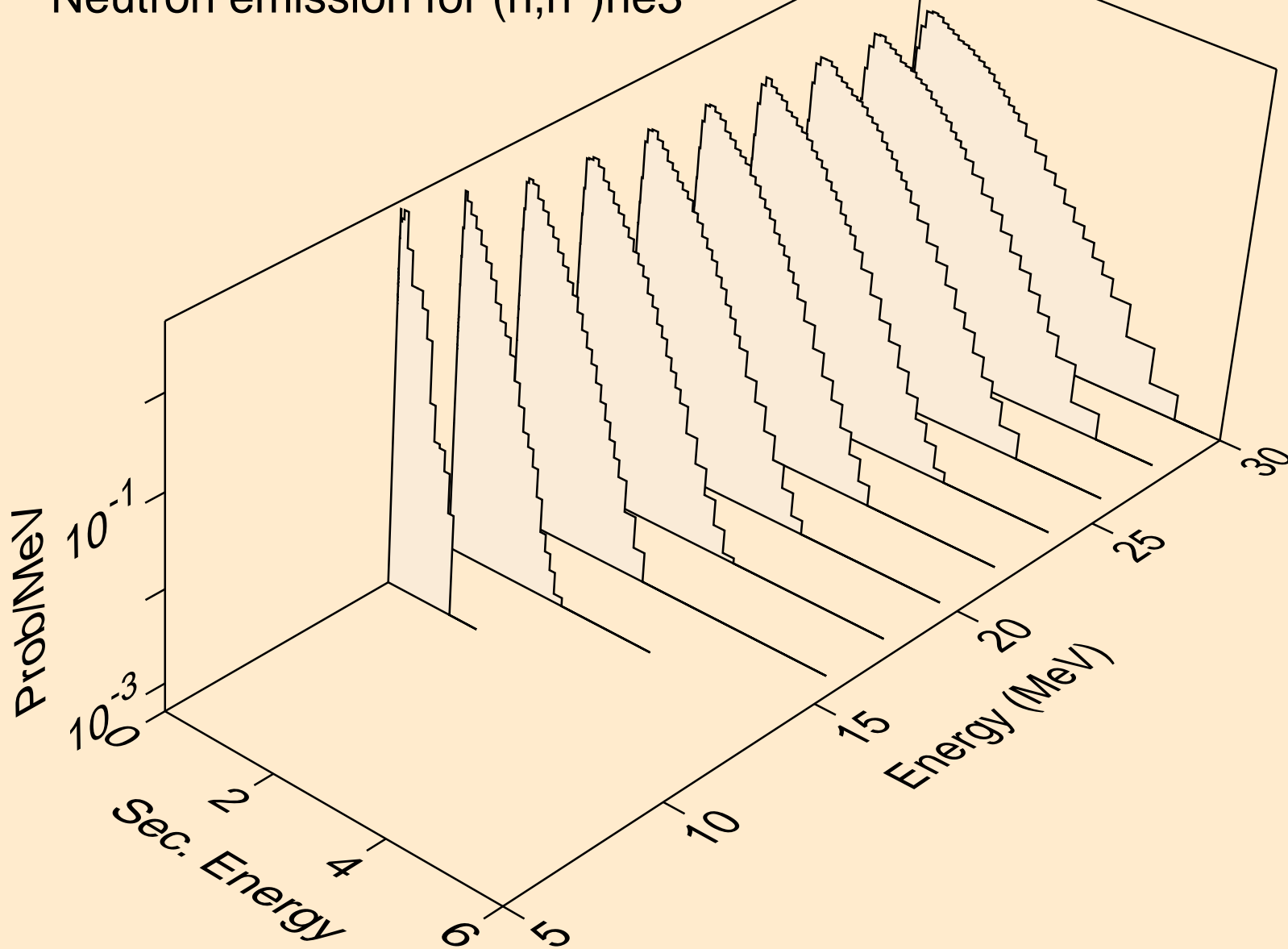

SM130 NEUTRON ACER TENDL-2023 LIBRARY; T=0.K
Neutron emission for (n,2np)

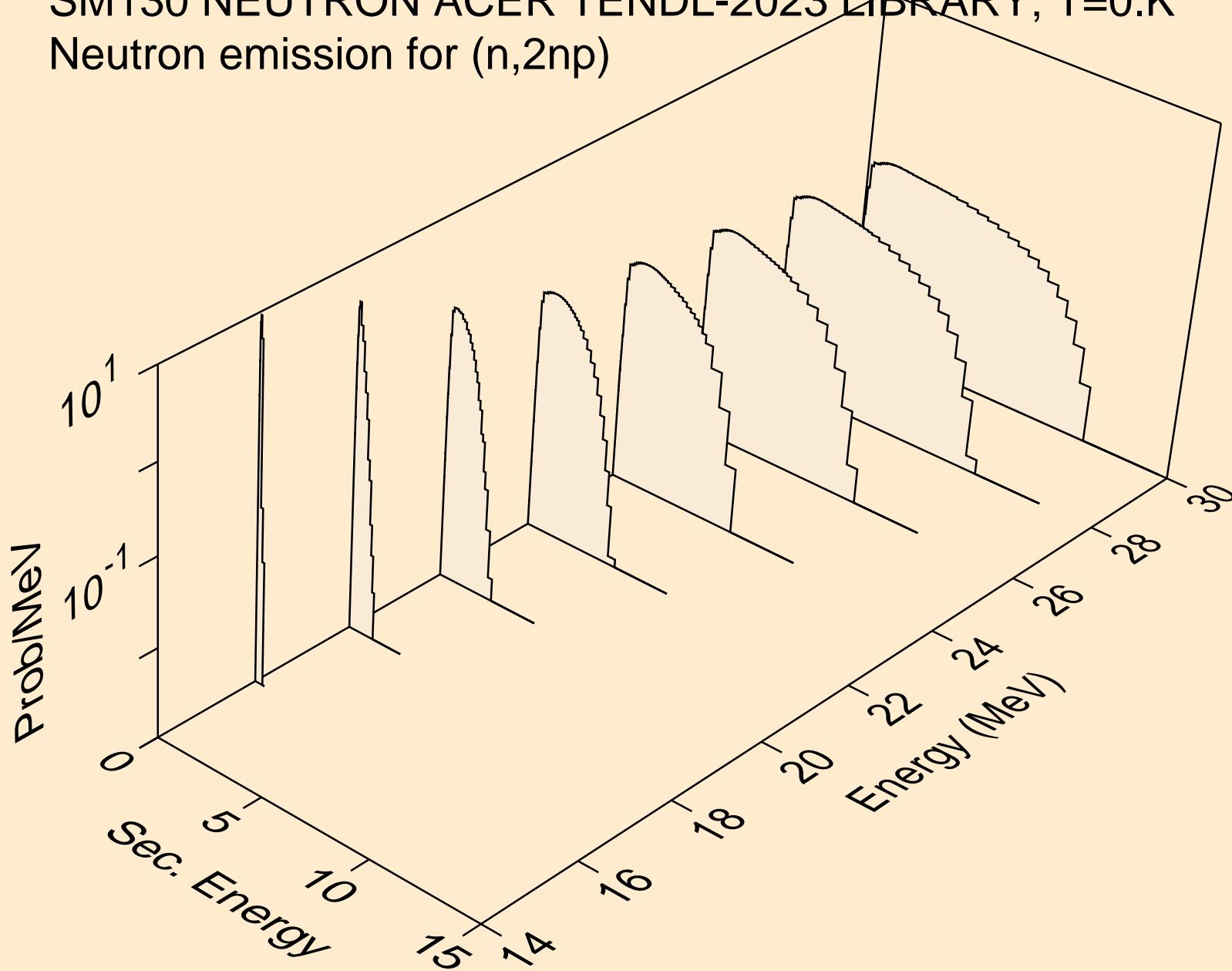

SM130 NEUTRON ACER TENDL-2023 LIBRARY; T=0.K
Neutron emission for (n,3np)

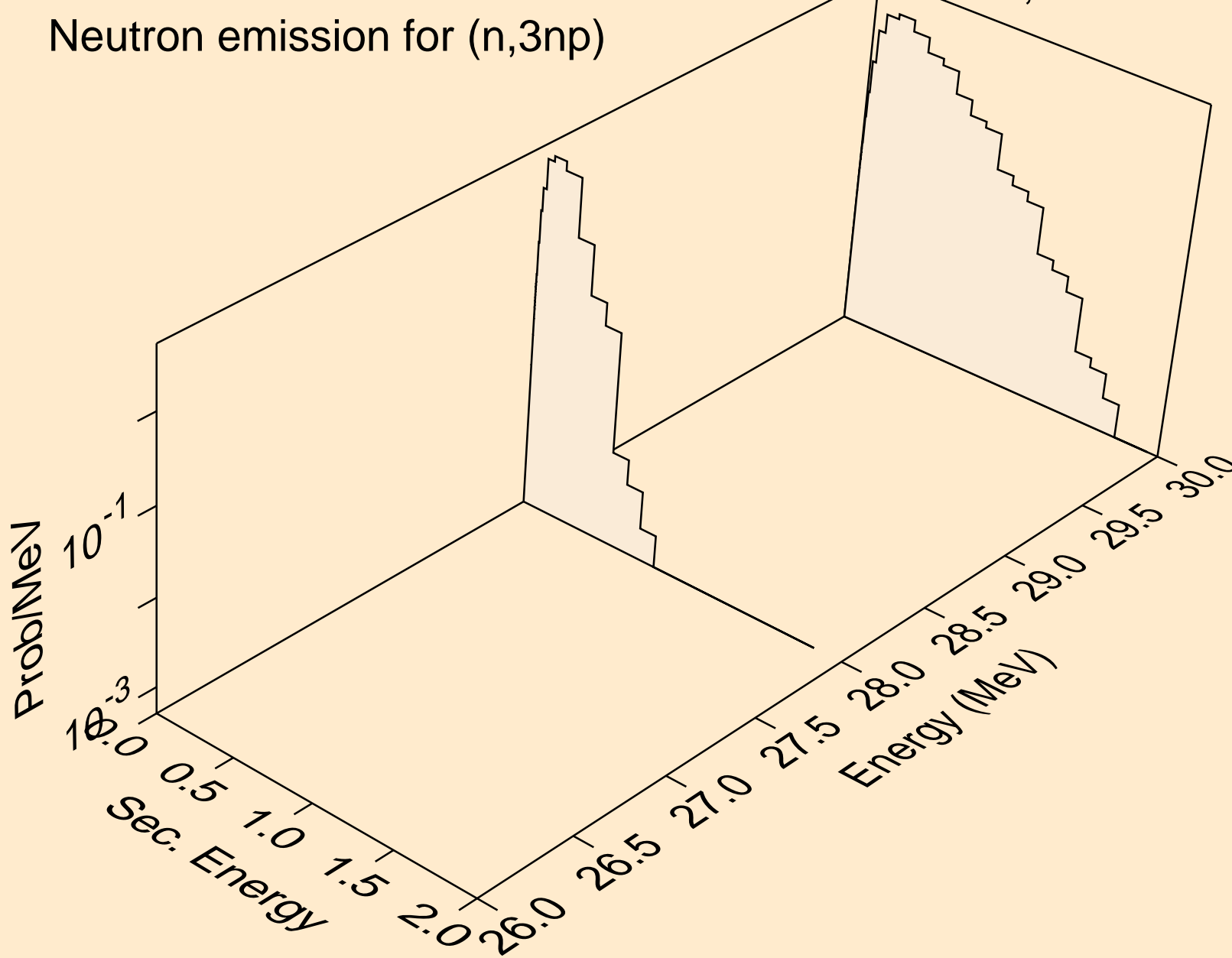

SM130 NEUTRON ACER TENDL-2023 LIBRARY; T=0.K
Neutron emission for (n,n2p)

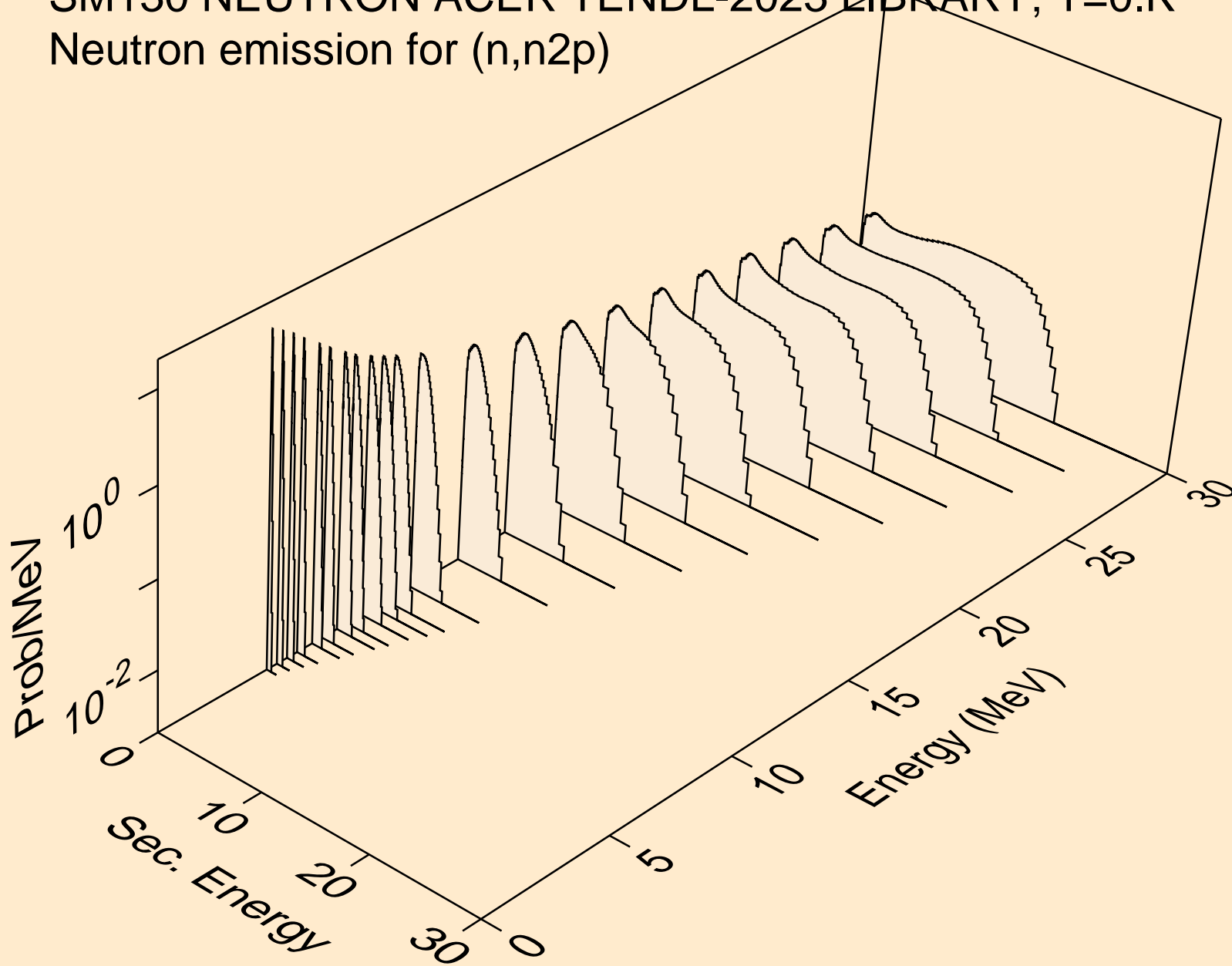

SM130 NEUTRON ACER TENDL-2023 LIBRARY; T=0.K
Neutron emission for (n,npa)

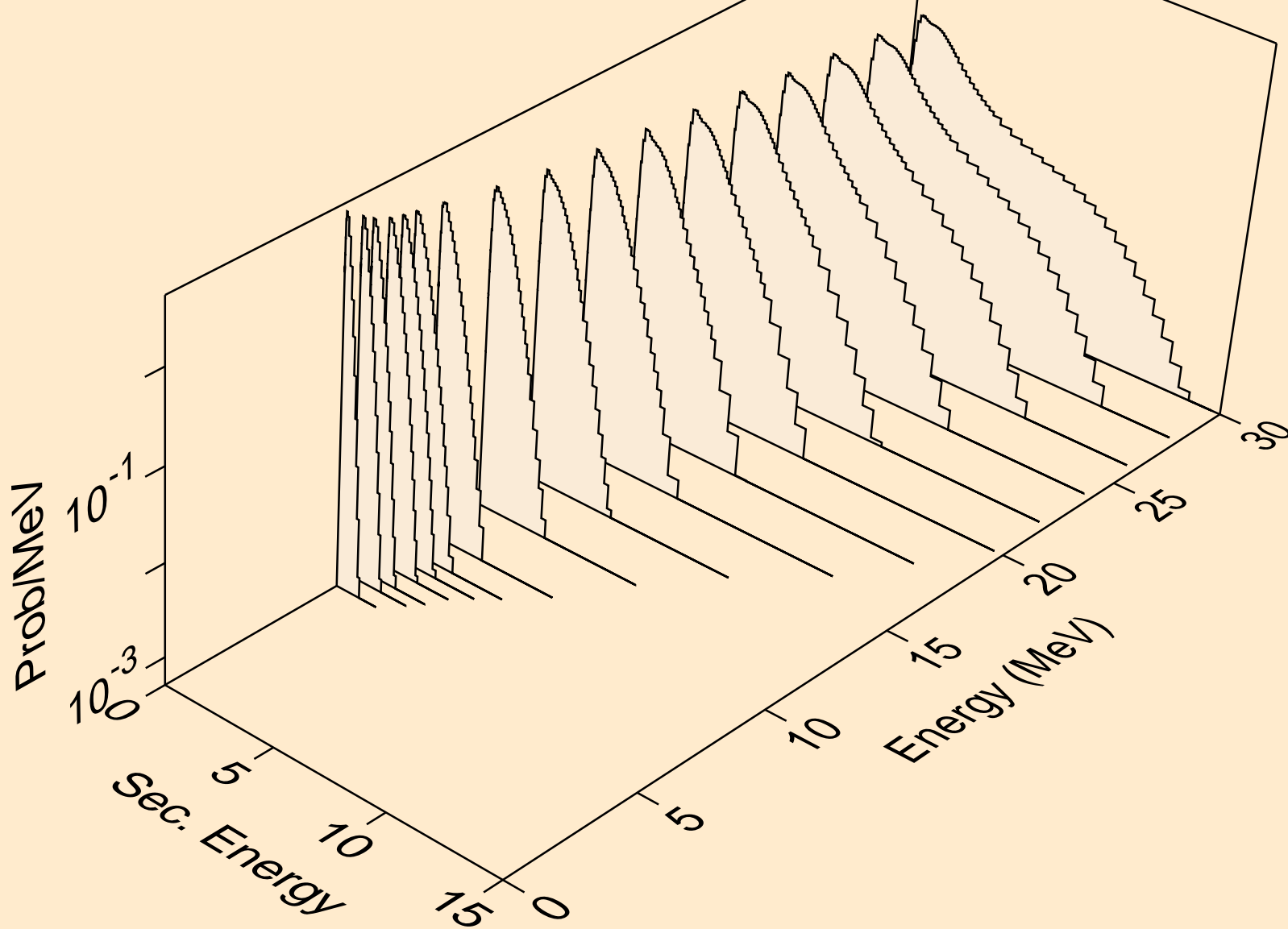

SM130 NEUTRON ACER TENDL-2023 LIBRARY; T=0.K
Neutron emission for (n,n*c)

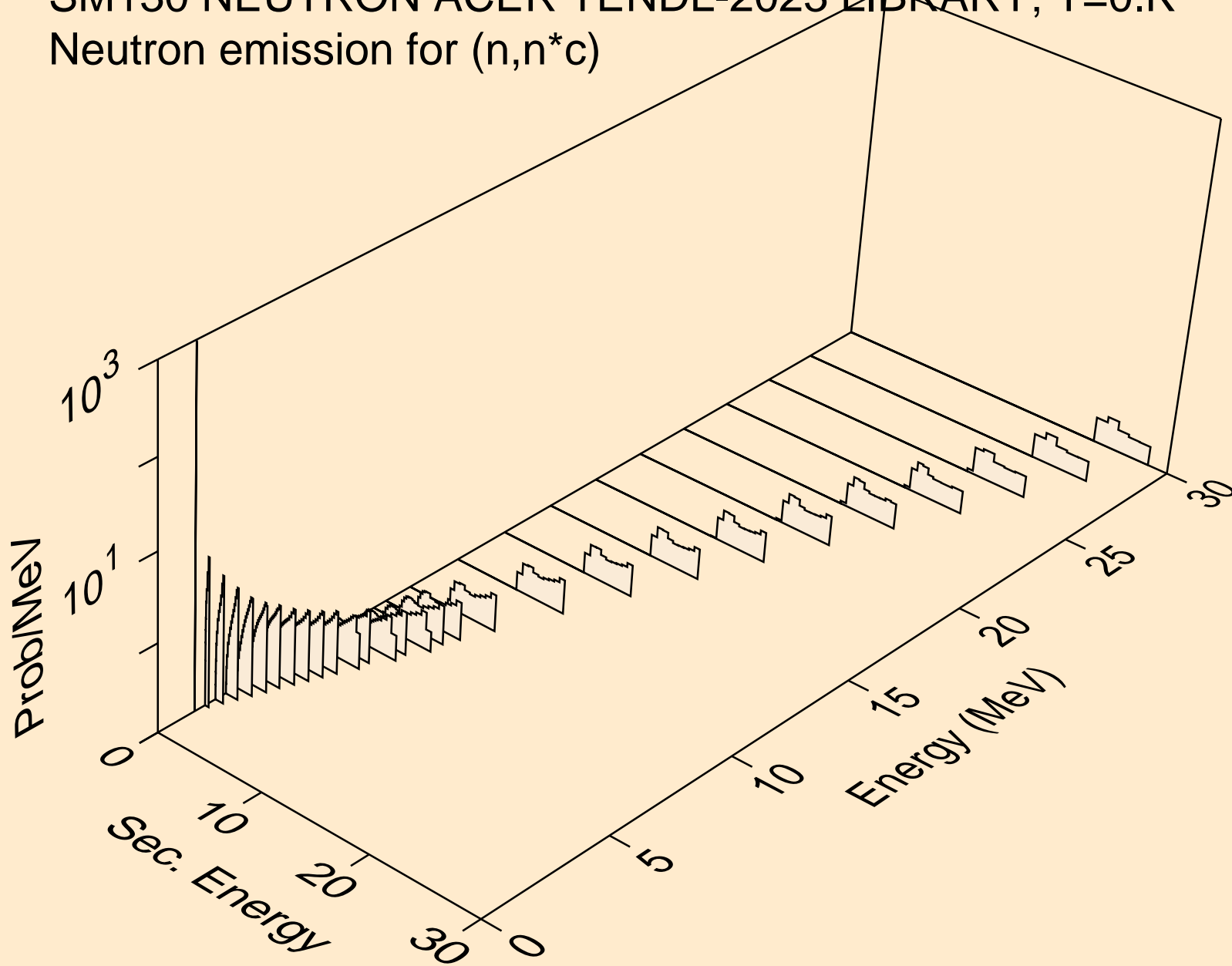

SM130 NEUTRON ACER TENDL-2023 LIBRARY; T=0.K
Photon emission for (n,x)

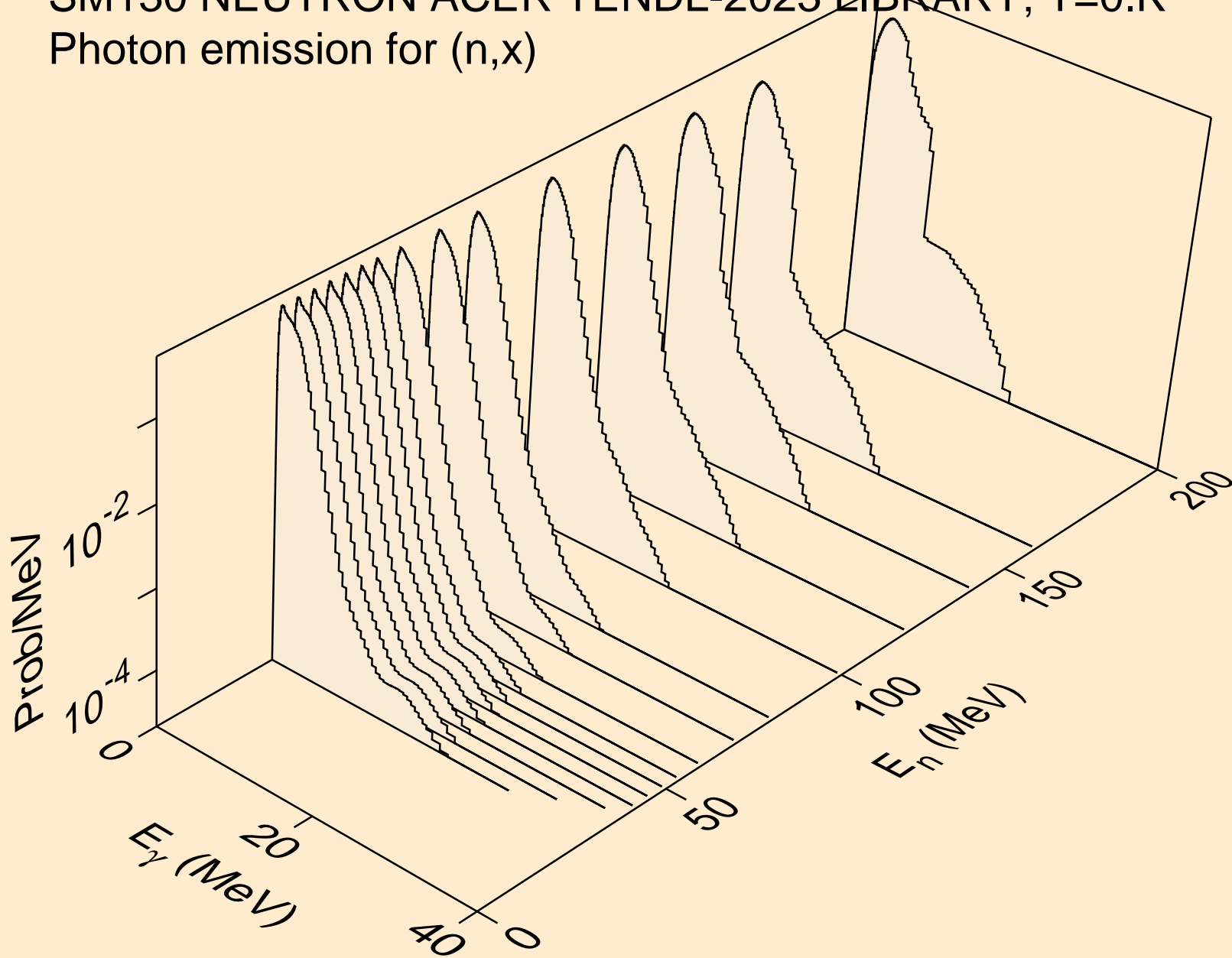

SM130 NEUTRON ACER TENDL-2023 LIBRARY; T=0.K
Photon emission for (n,2n)

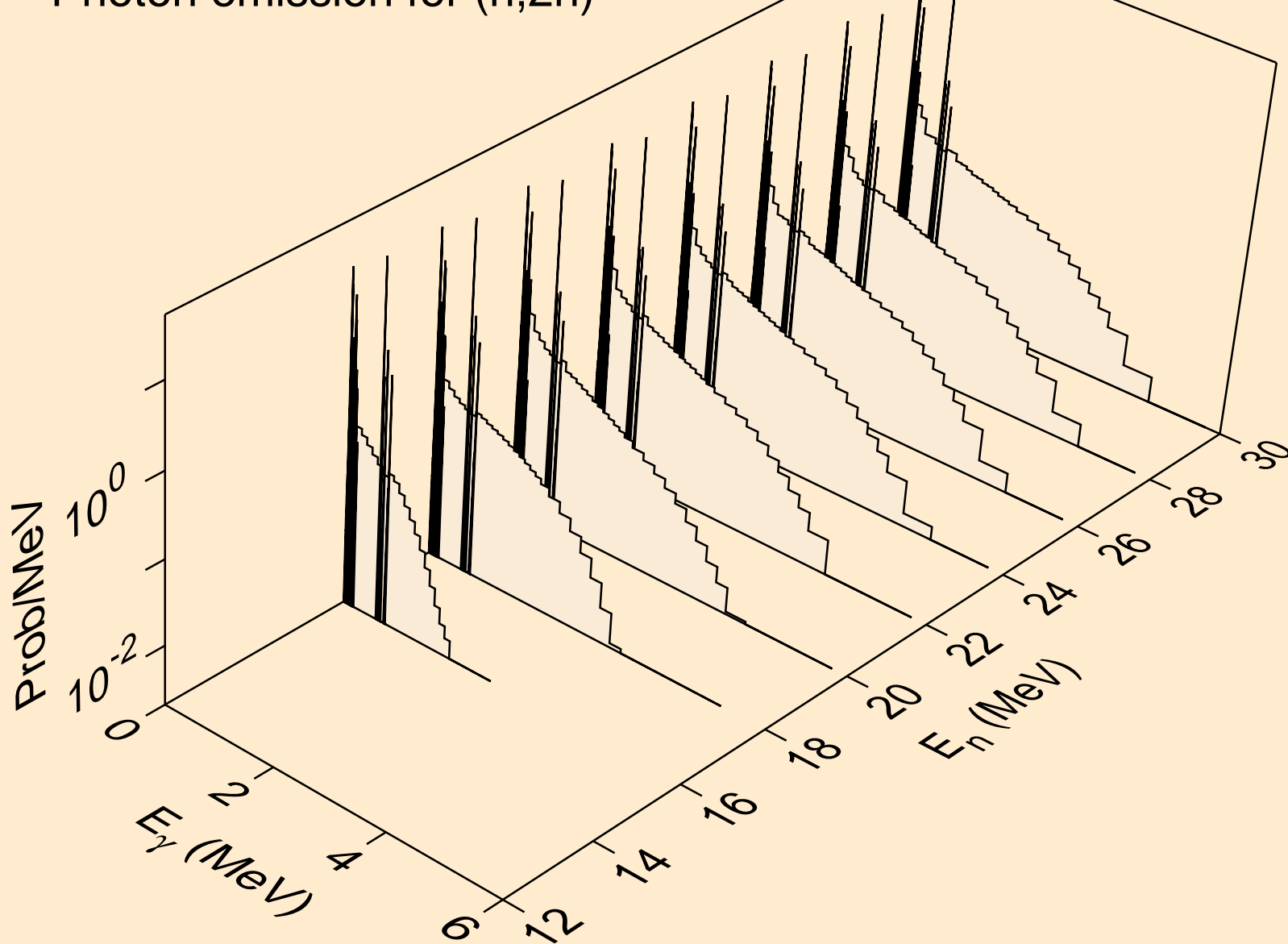

SM130 NEUTRON ACER TENDL-2023 LIBRARY; T=0.K
Photon emission for (n,3n)

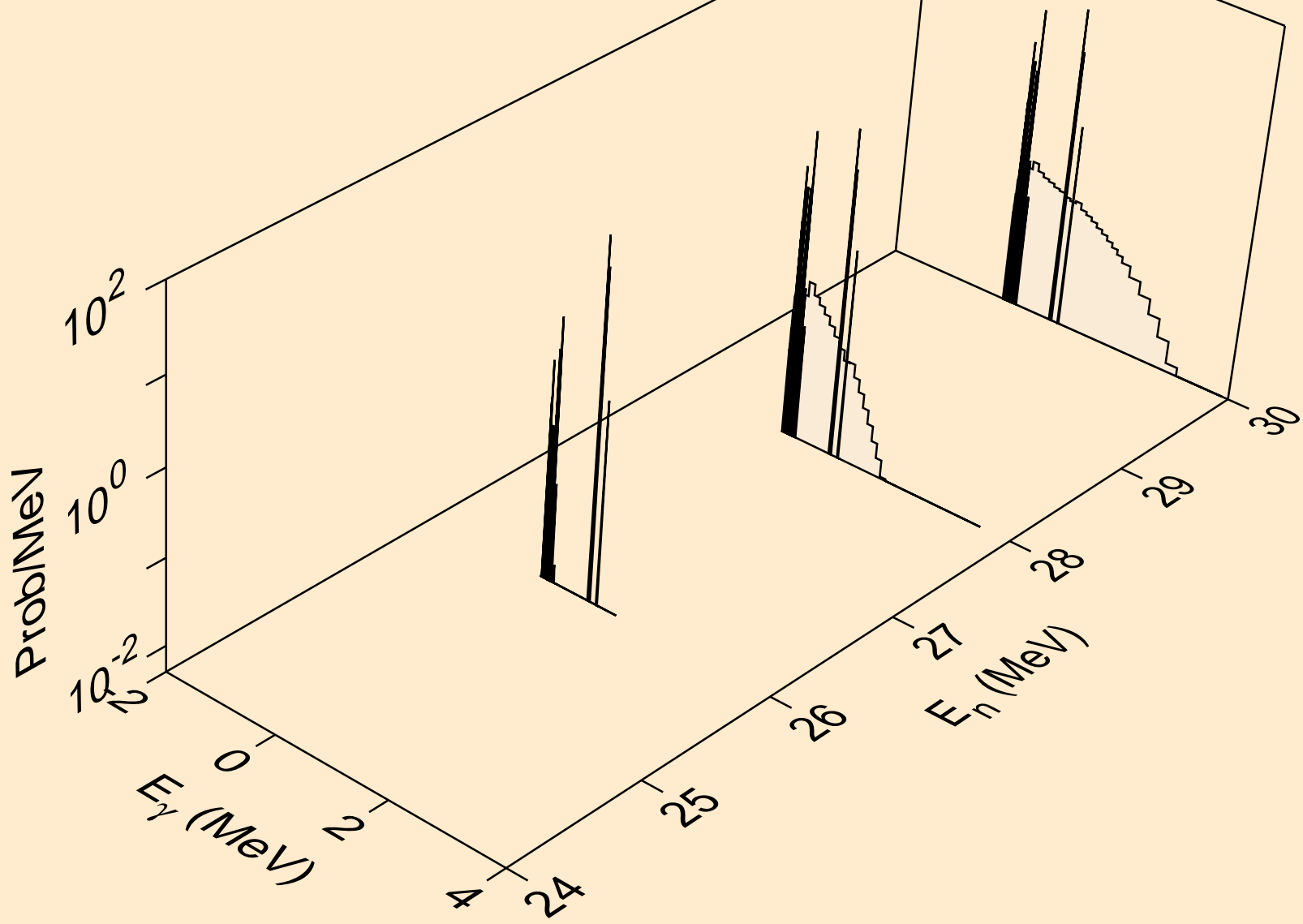

SM130 NEUTRON ACER TENDL-2023 LIBRARY; T=0.K
Photon emission for (n,n*)a

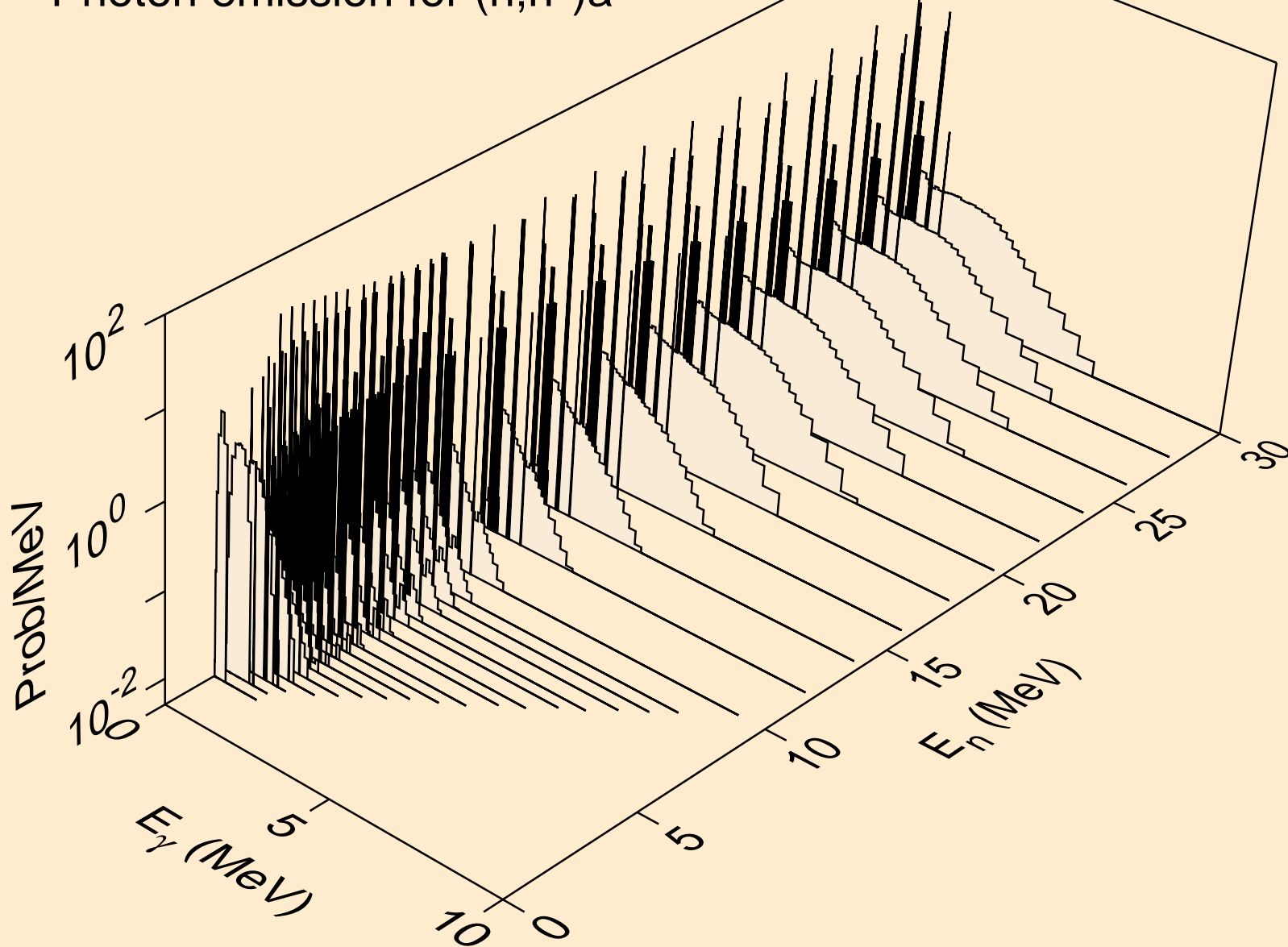

SM130 NEUTRON ACER TENDL-2023 LIBRARY; T=0.K
Photon emission for (n,2n)a

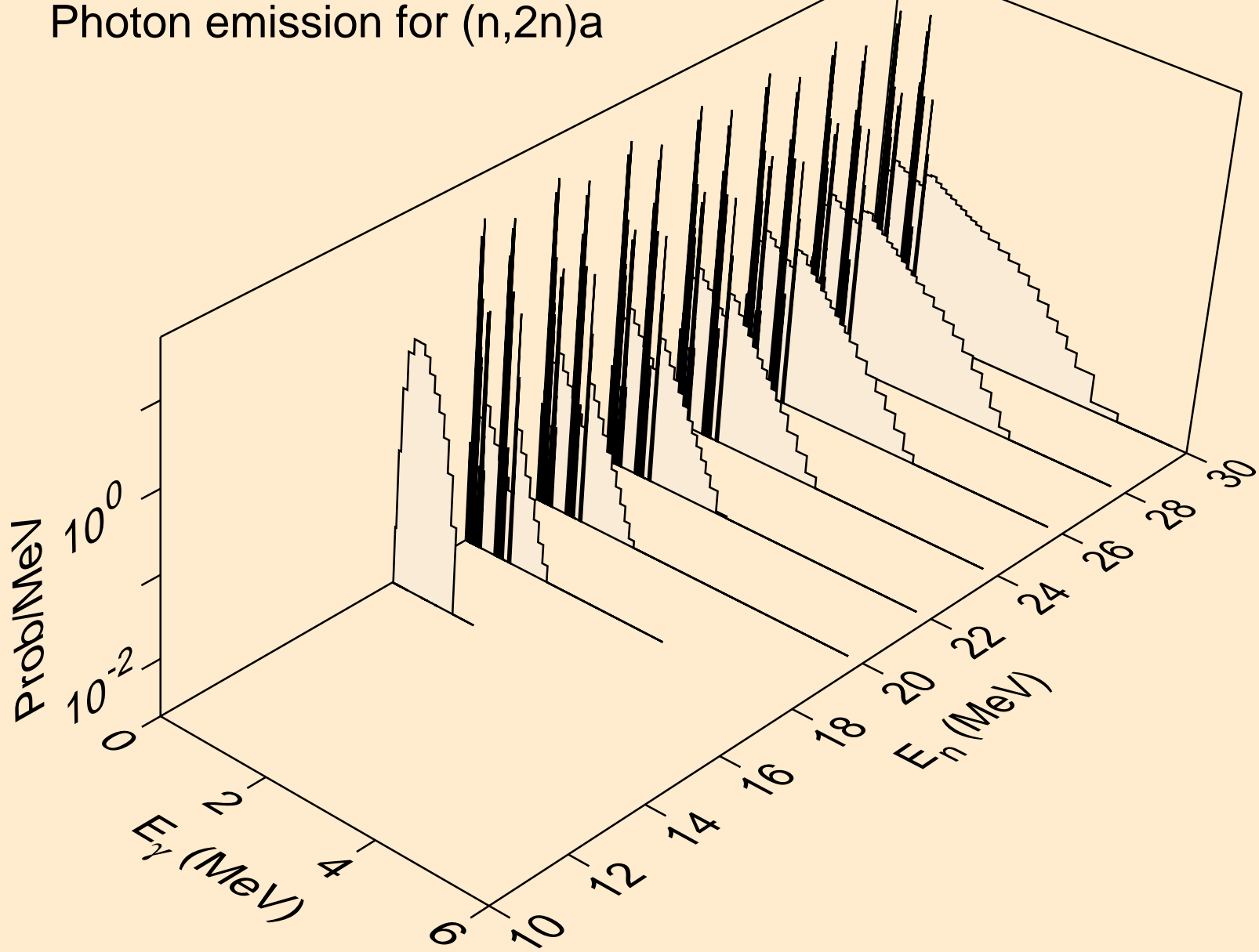

SM130 NEUTRON ACER TENDL-2023 LIBRARY; T=0.K
Photon emission for (n,n*)p

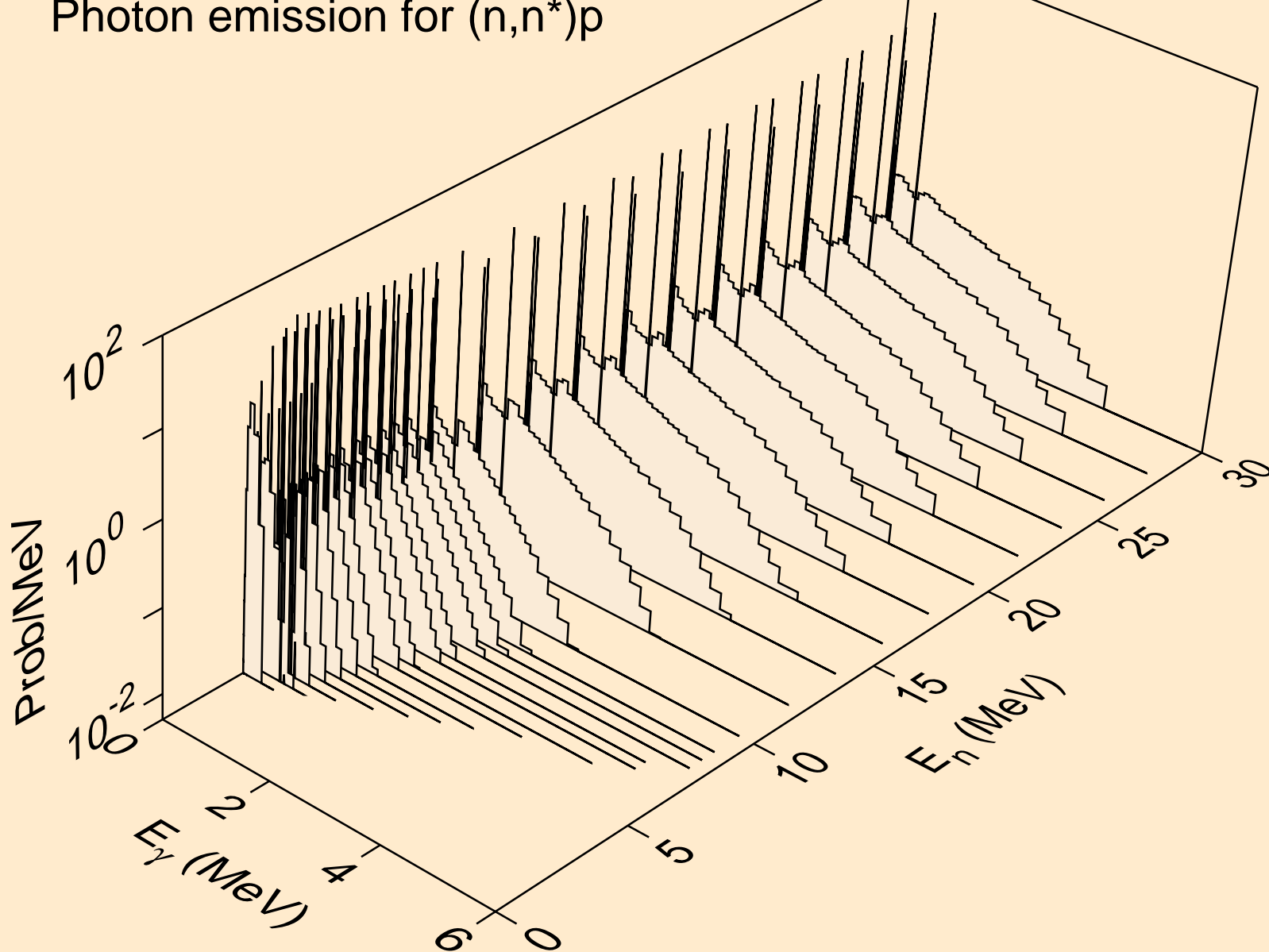

SM130 NEUTRON ACER TENDL-2023 LIBRARY; T=0.K
Photon emission for (n,n*)2a

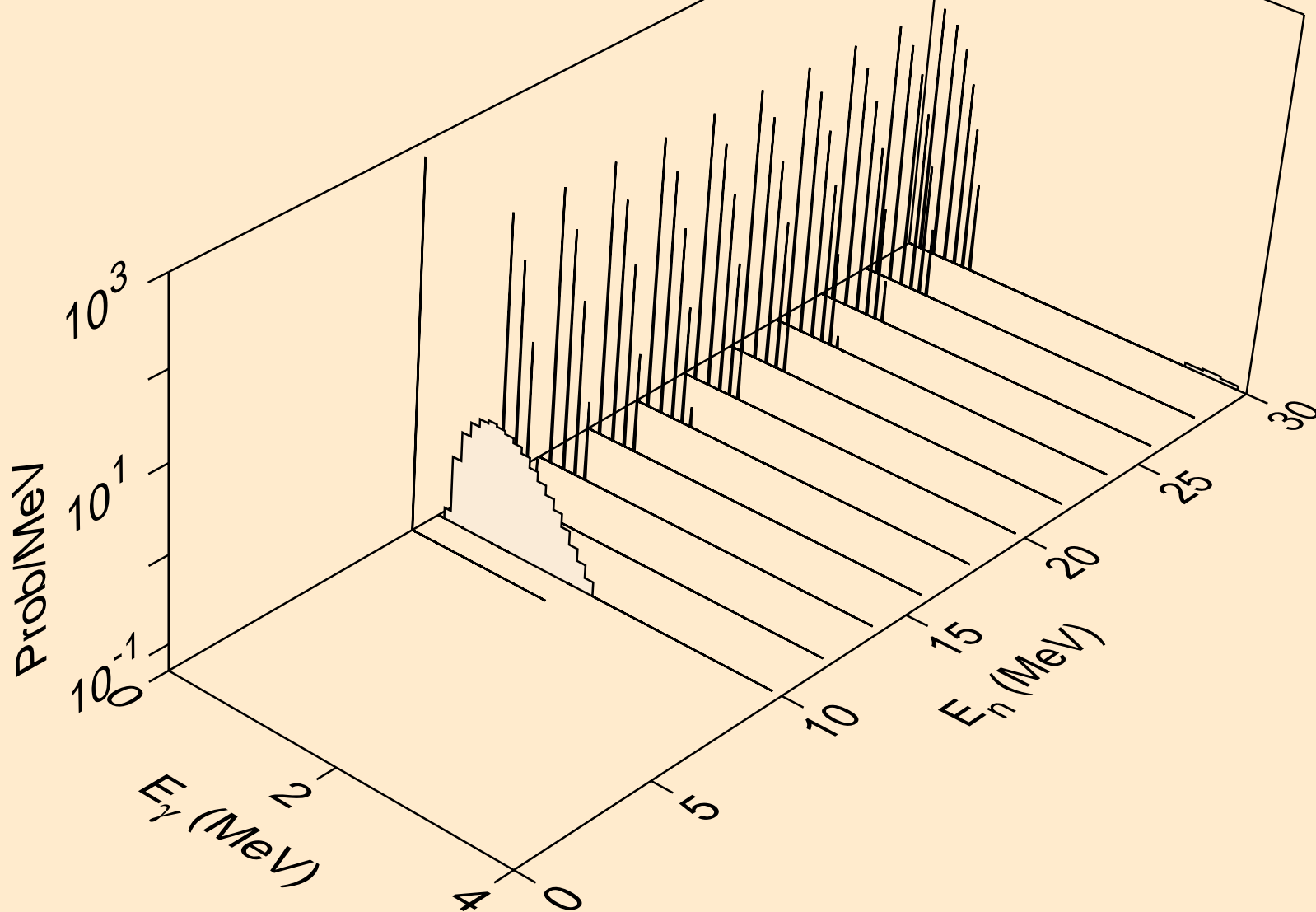

SM130 NEUTRON ACER TENDL-2023 LIBRARY; T=0.K
Photon emission for (n,n*)d

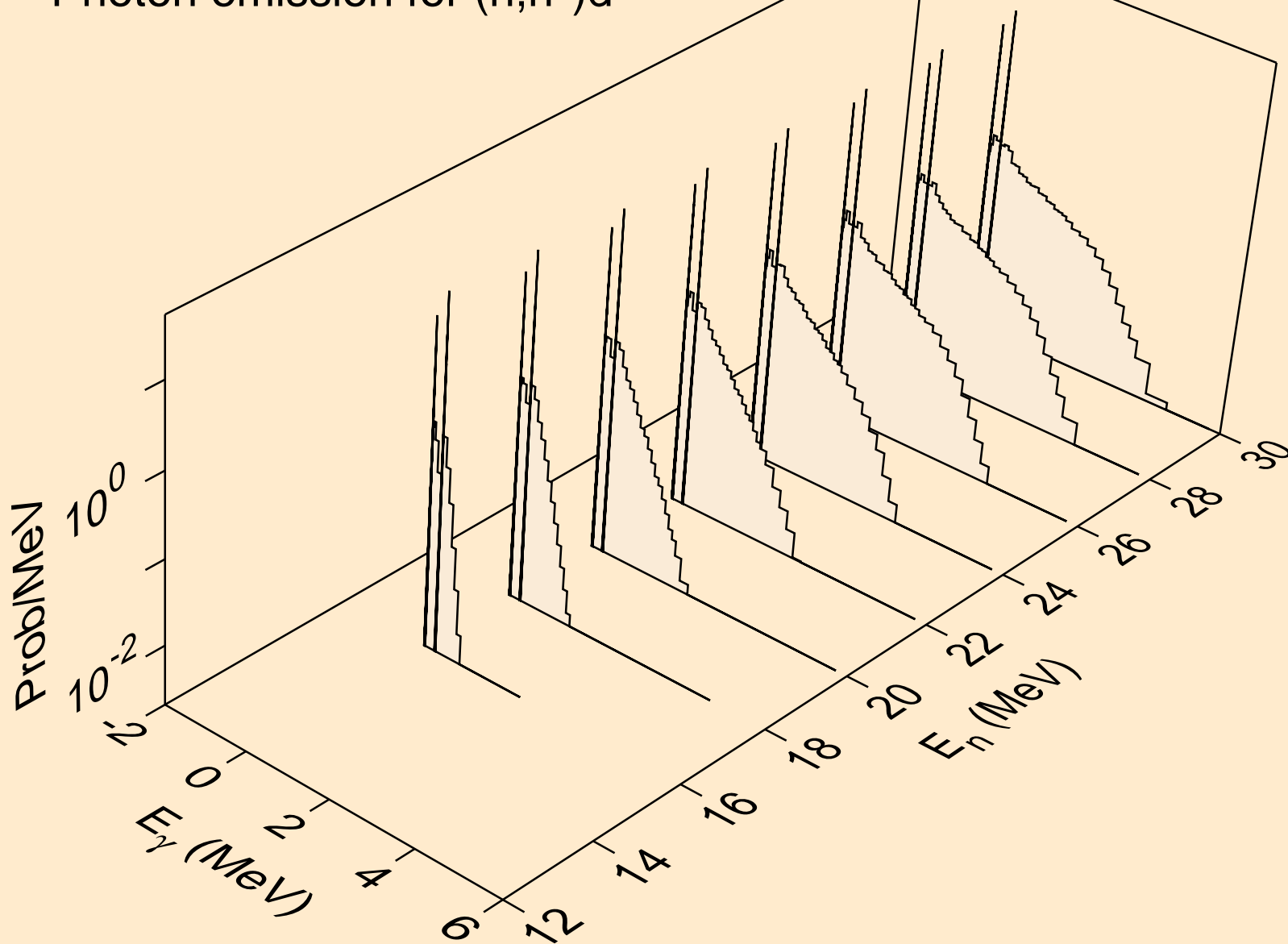

SM130 NEUTRON ACER TENDL-2023 LIBRARY; T=0.K
Photon emission for (n,n*)t

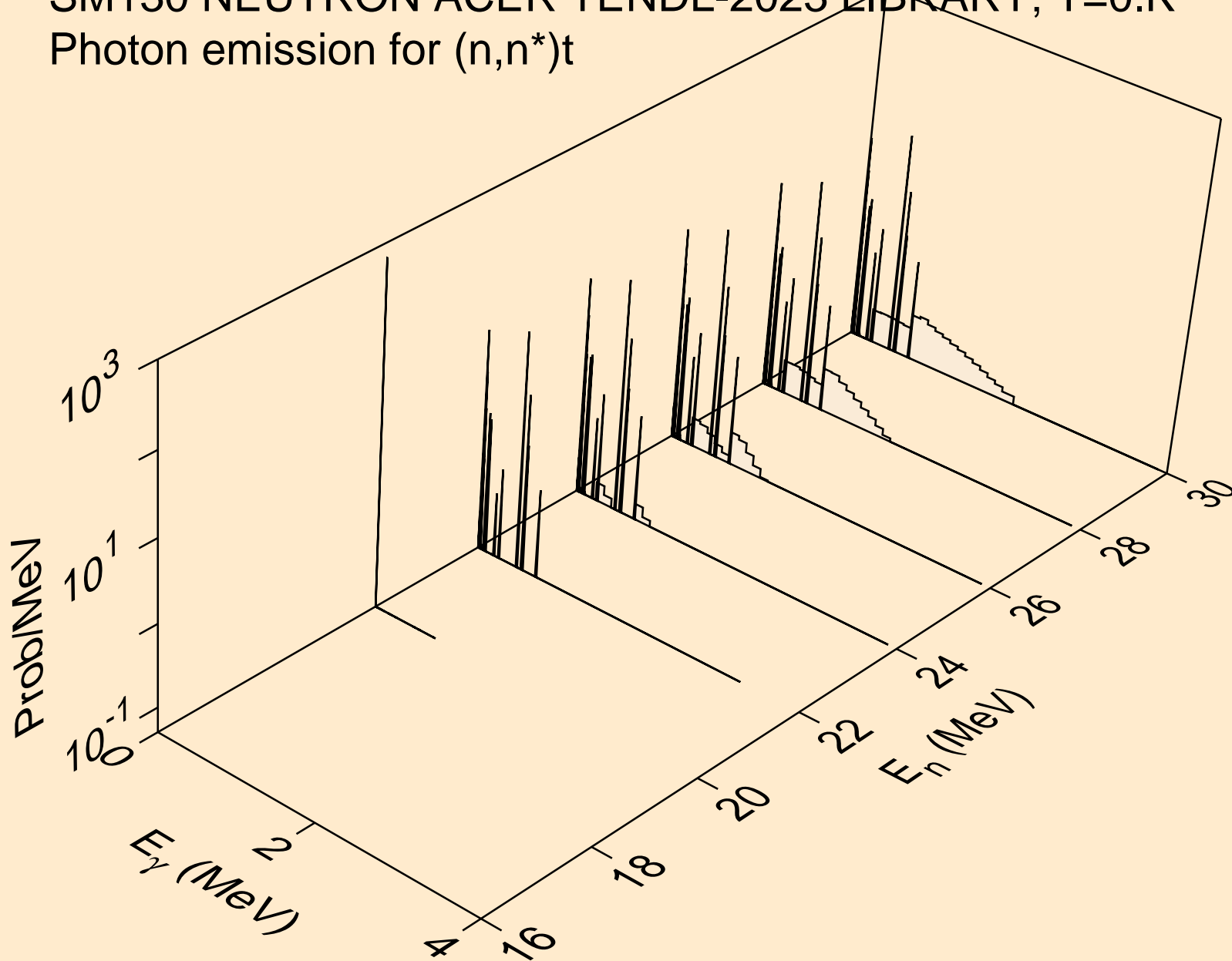

SM130 NEUTRON ACER TENDL-2023 LIBRARY; T=0.K
Photon emission for (n,n*)he3

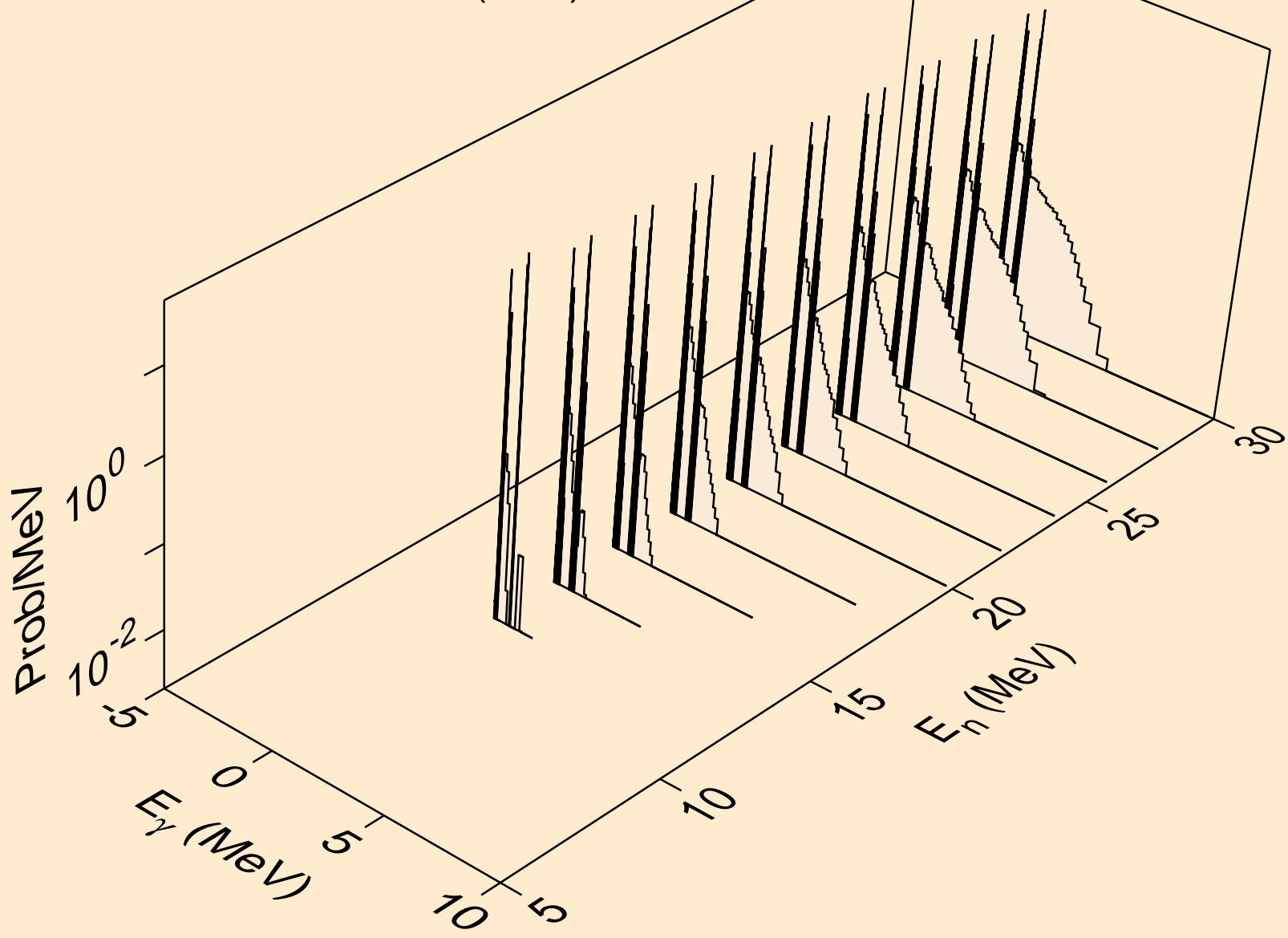

SM130 NEUTRON ACER TENDL-2023 LIBRARY; T=0.K
Photon emission for (n,2np)

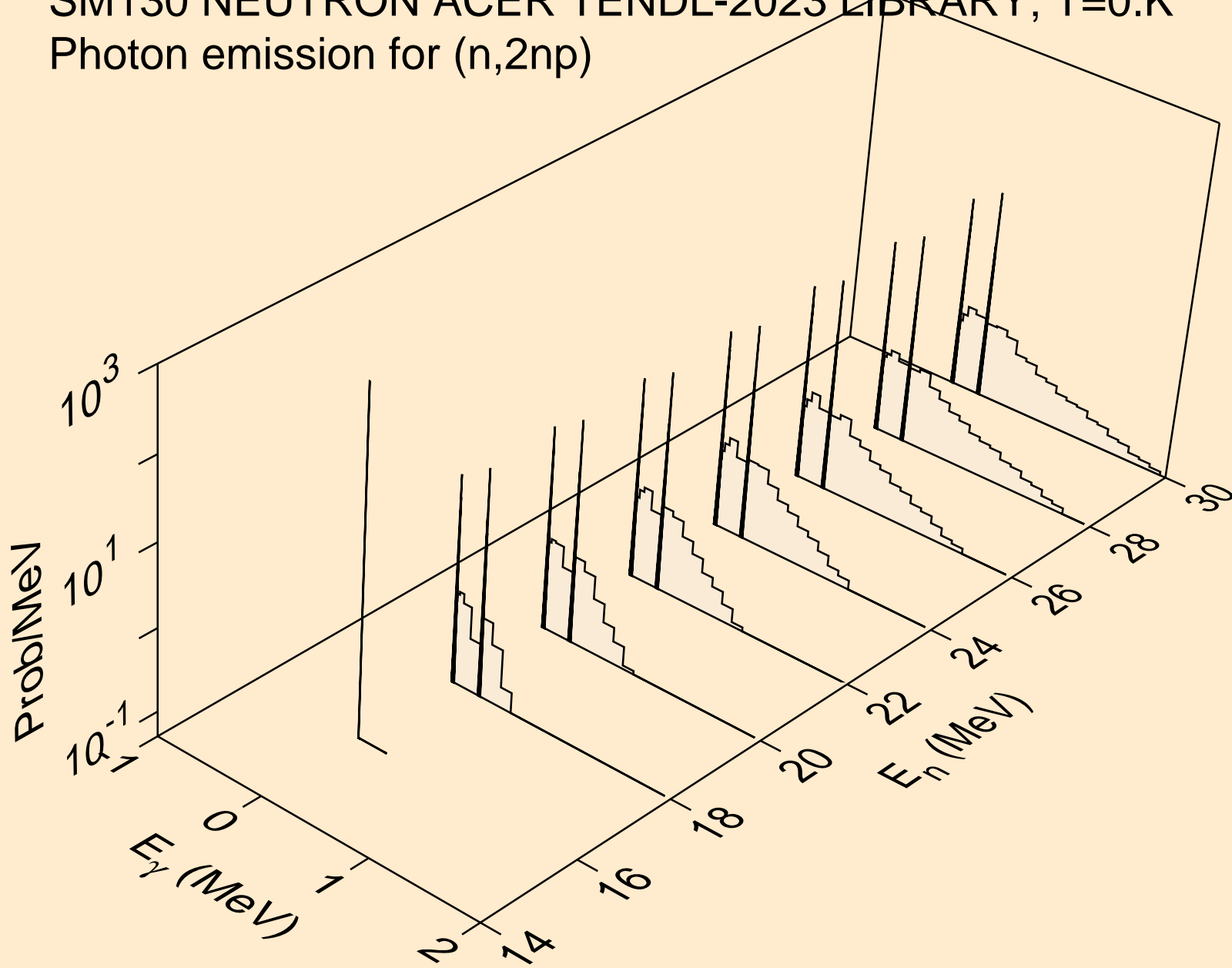

SM130 NEUTRON ACER TENDL-2023 LIBRARY; T=0.K
Photon emission for (n,3np)

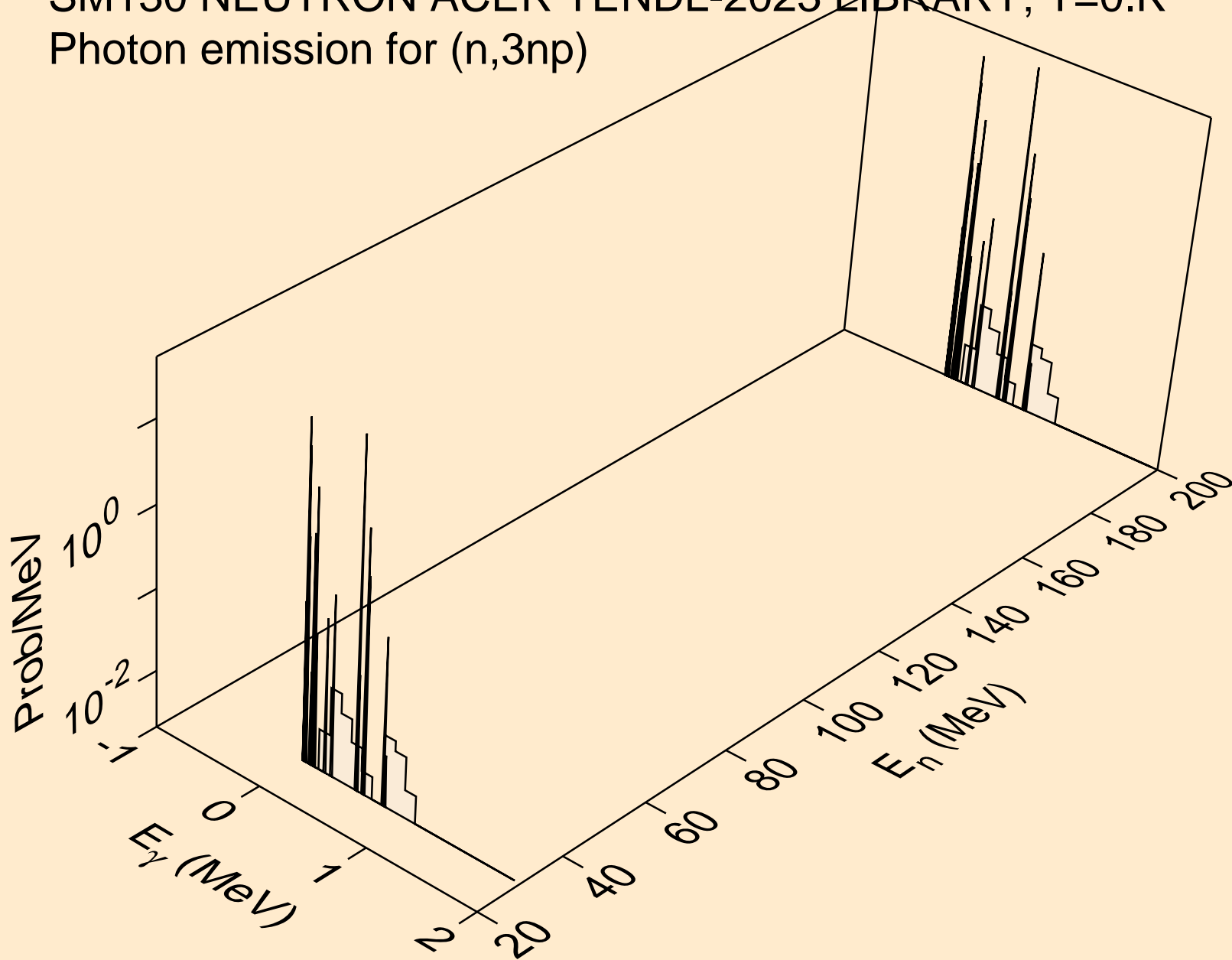

SM130 NEUTRON ACER TENDL-2023 LIBRARY; T=0.K
Photon emission for (n,n2p)

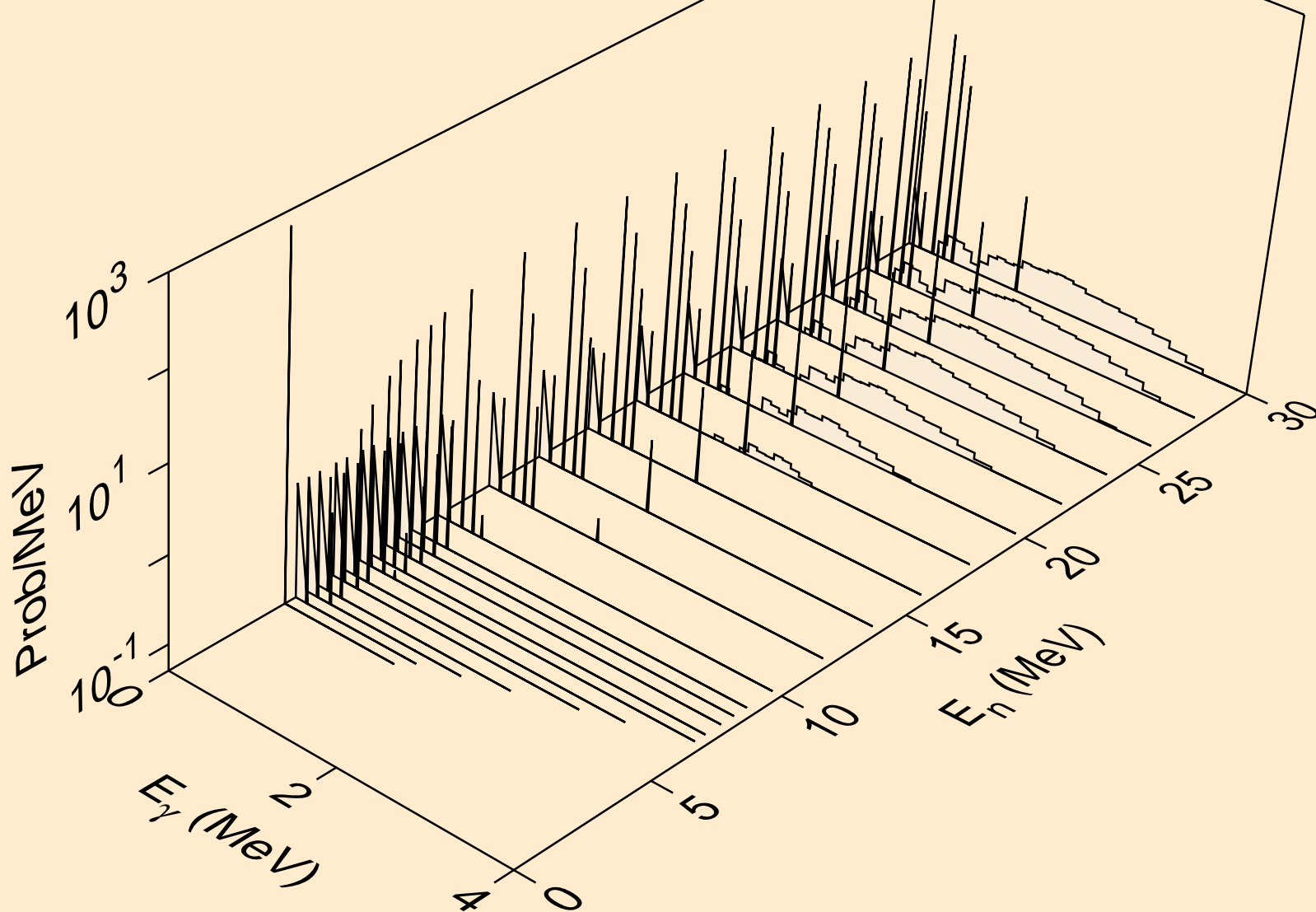

SM130 NEUTRON ACER TENDL-2023 LIBRARY; T=0.K
Photon emission for (n,npa)

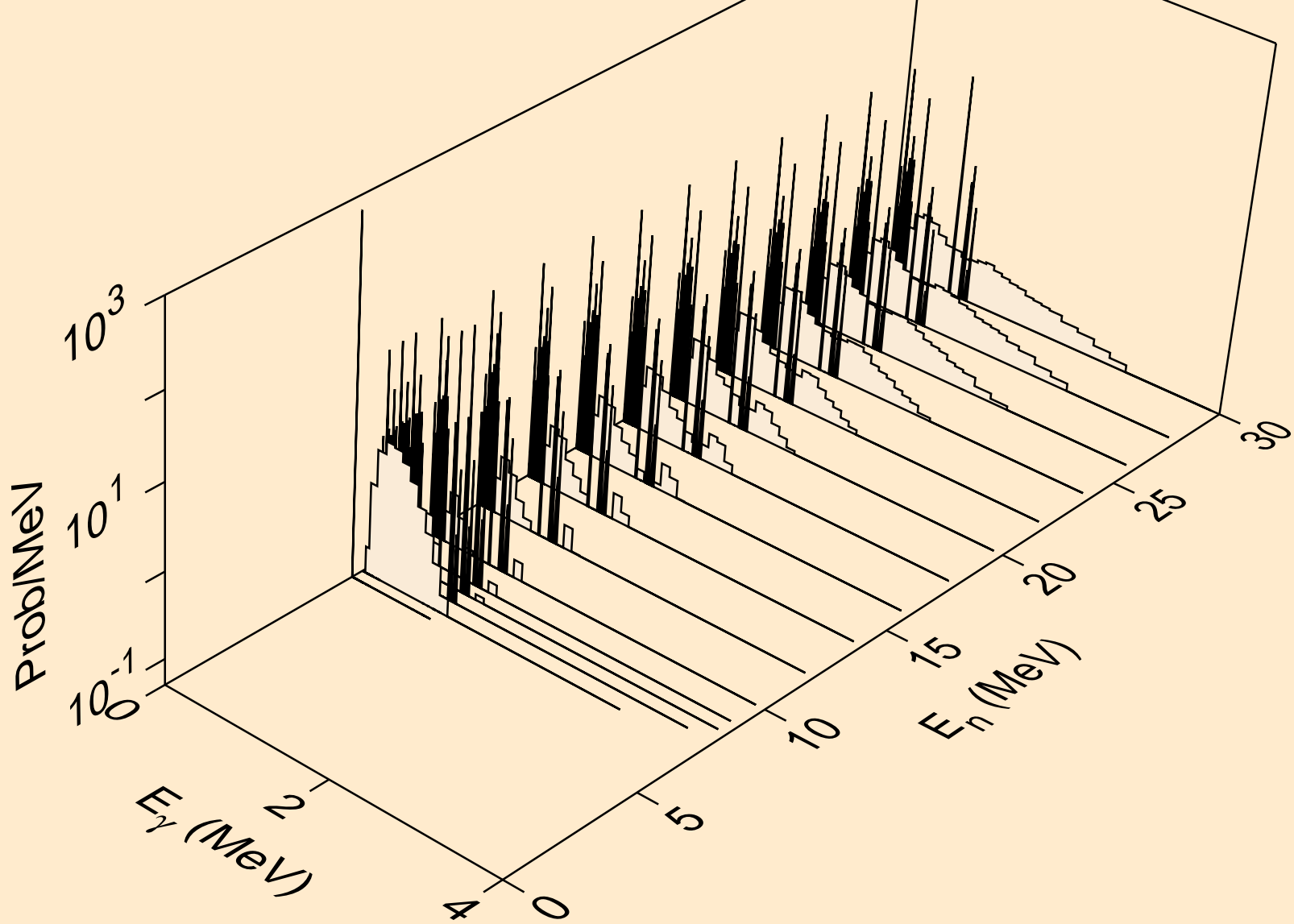

SM130 NEUTRON ACER TENDL-2023 LIBRARY; T=0.K
Photon emission for (n,n*c)

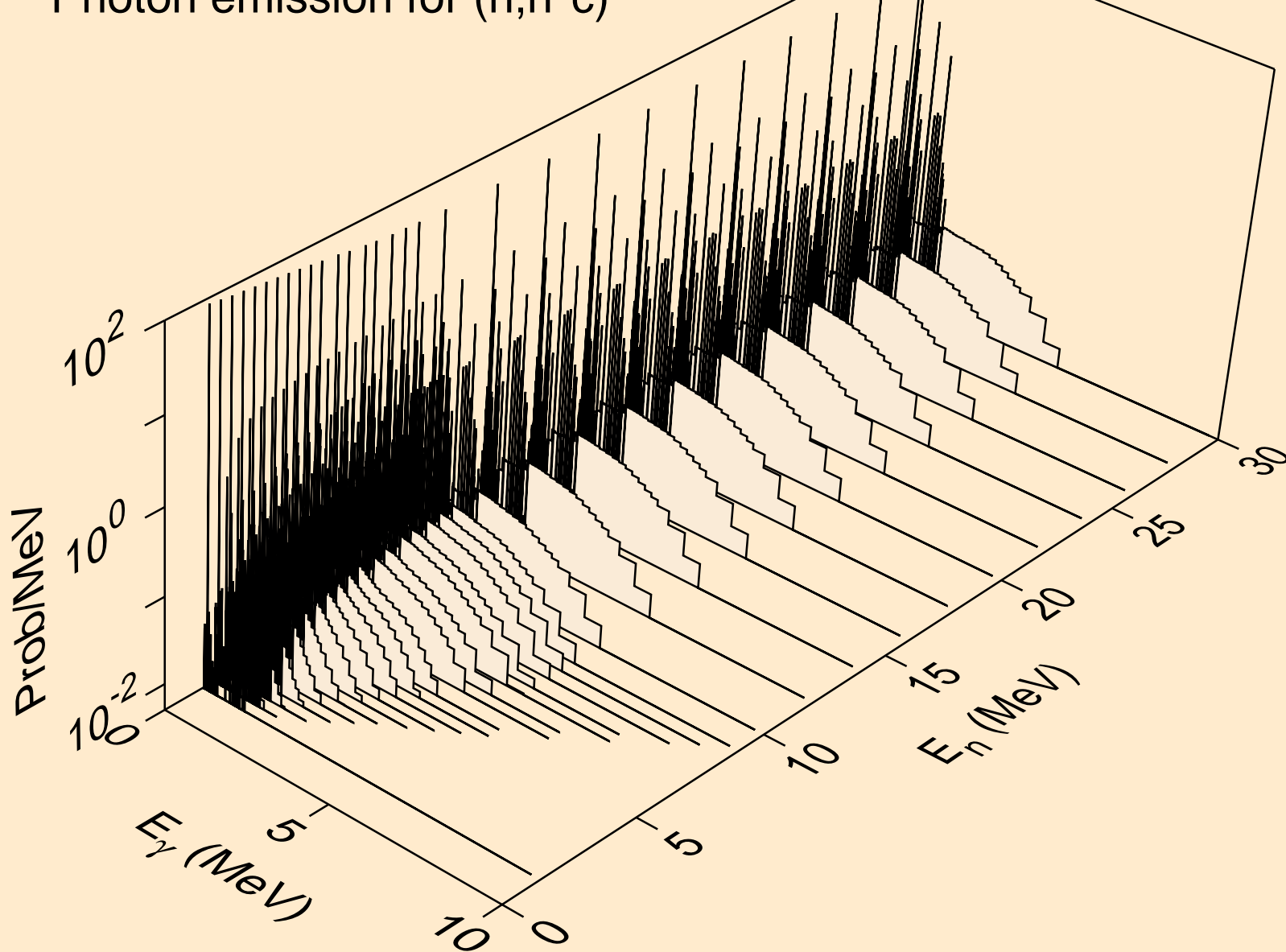

SM130 NEUTRON ACER TENDL-2023 LIBRARY; T=0.K
Photon emission for (n,gma)

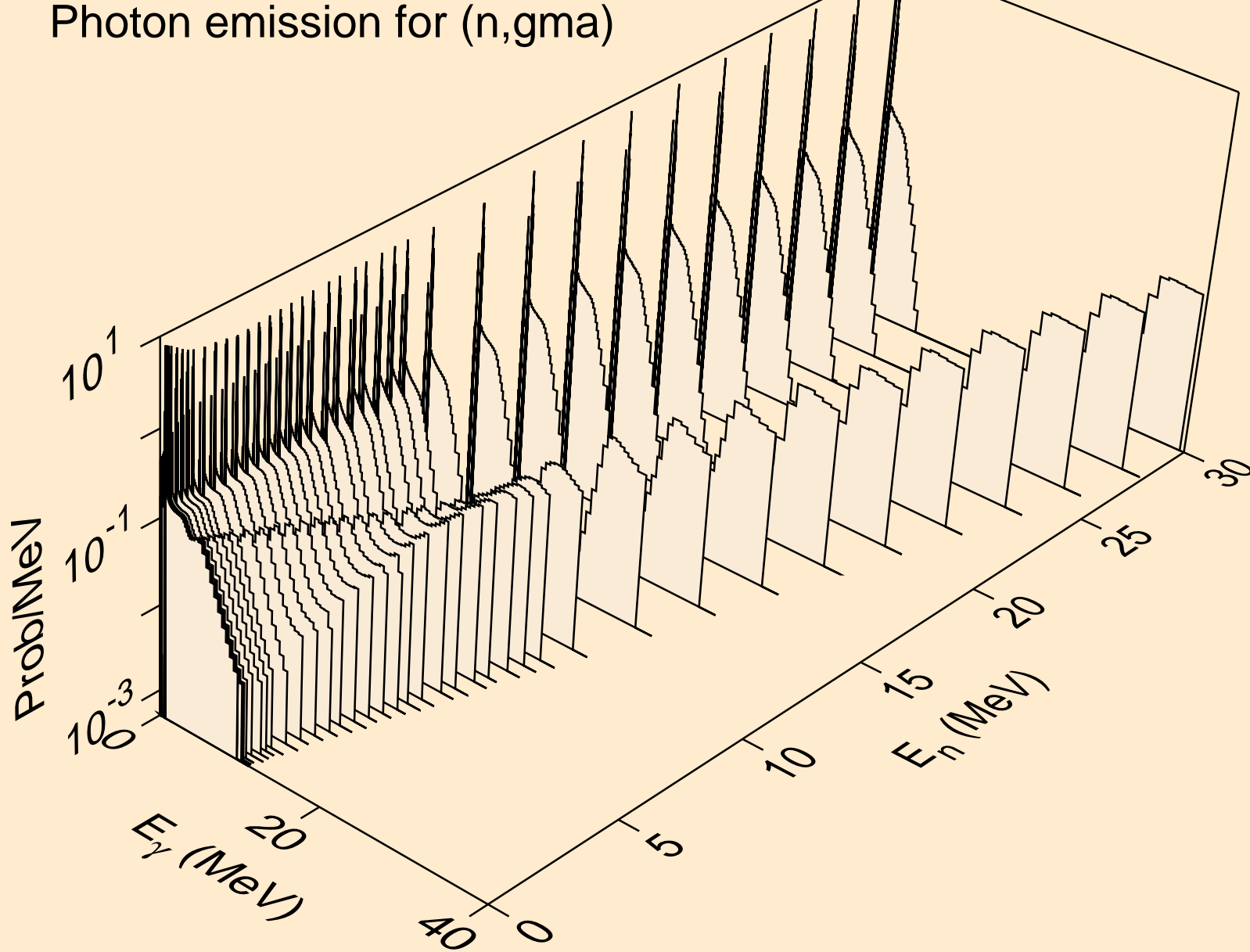

SM130 NEUTRON ACER TENDL-2023 LIBRARY; T=0.K
Photon emission for (n,p)

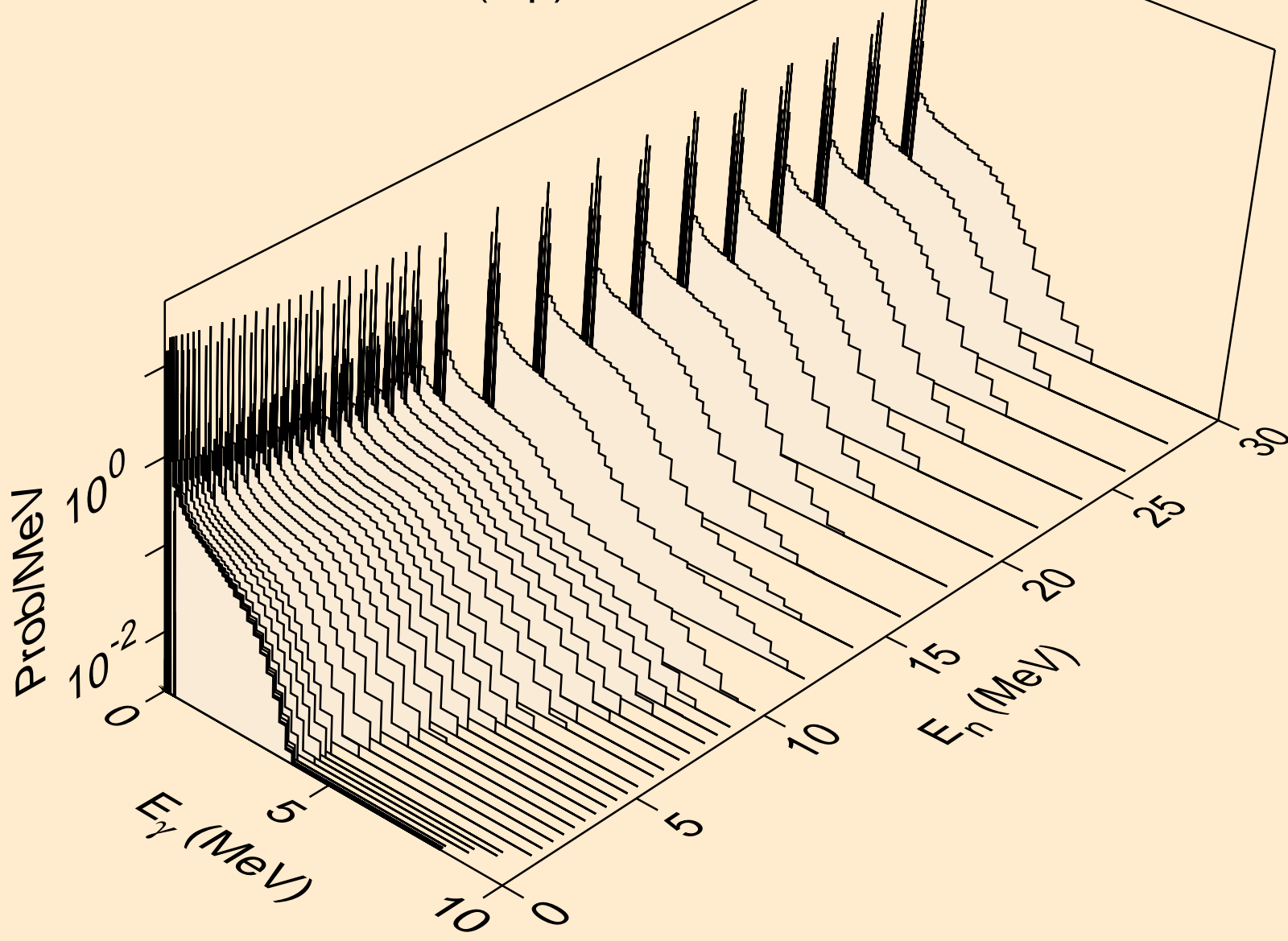

SM130 NEUTRON ACER TENDL-2023 LIBRARY; T=0.K
Photon emission for (n,d)

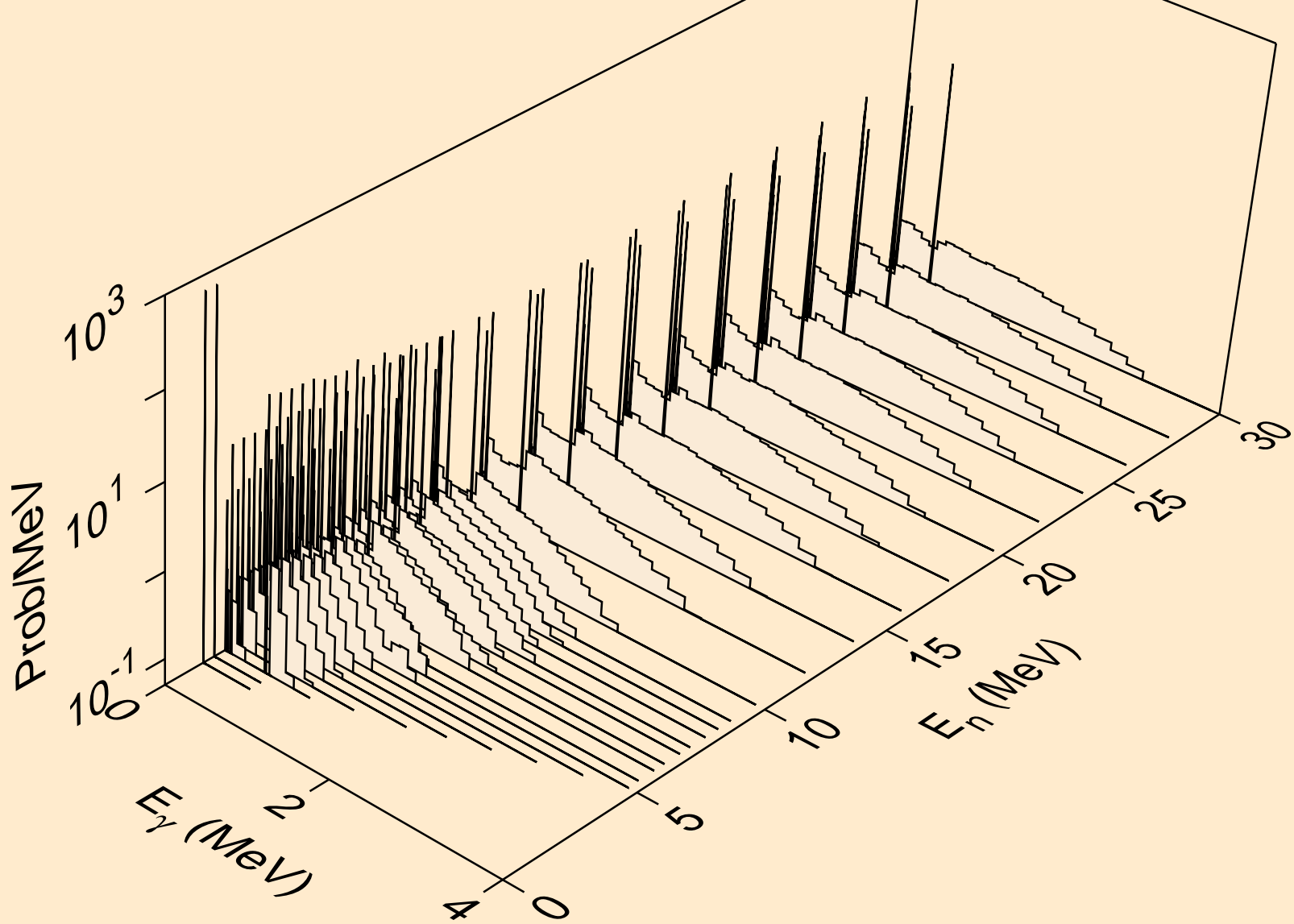

SM130 NEUTRON ACER TENDL-2023 LIBRARY; T=0.K
Photon emission for (n,t)

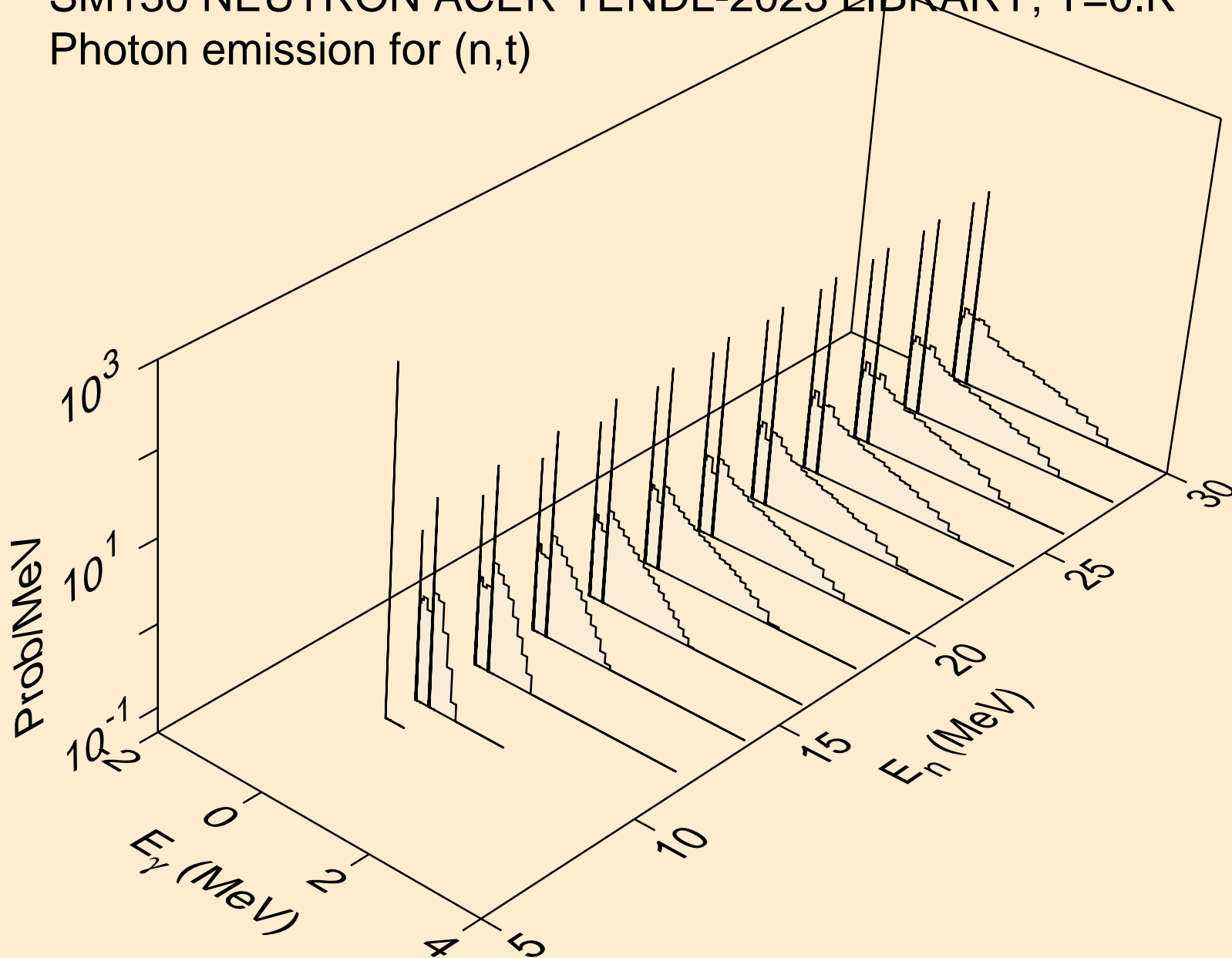

SM130 NEUTRON ACER TENDL-2023 LIBRARY; T=0.K
Photon emission for (n,he3)

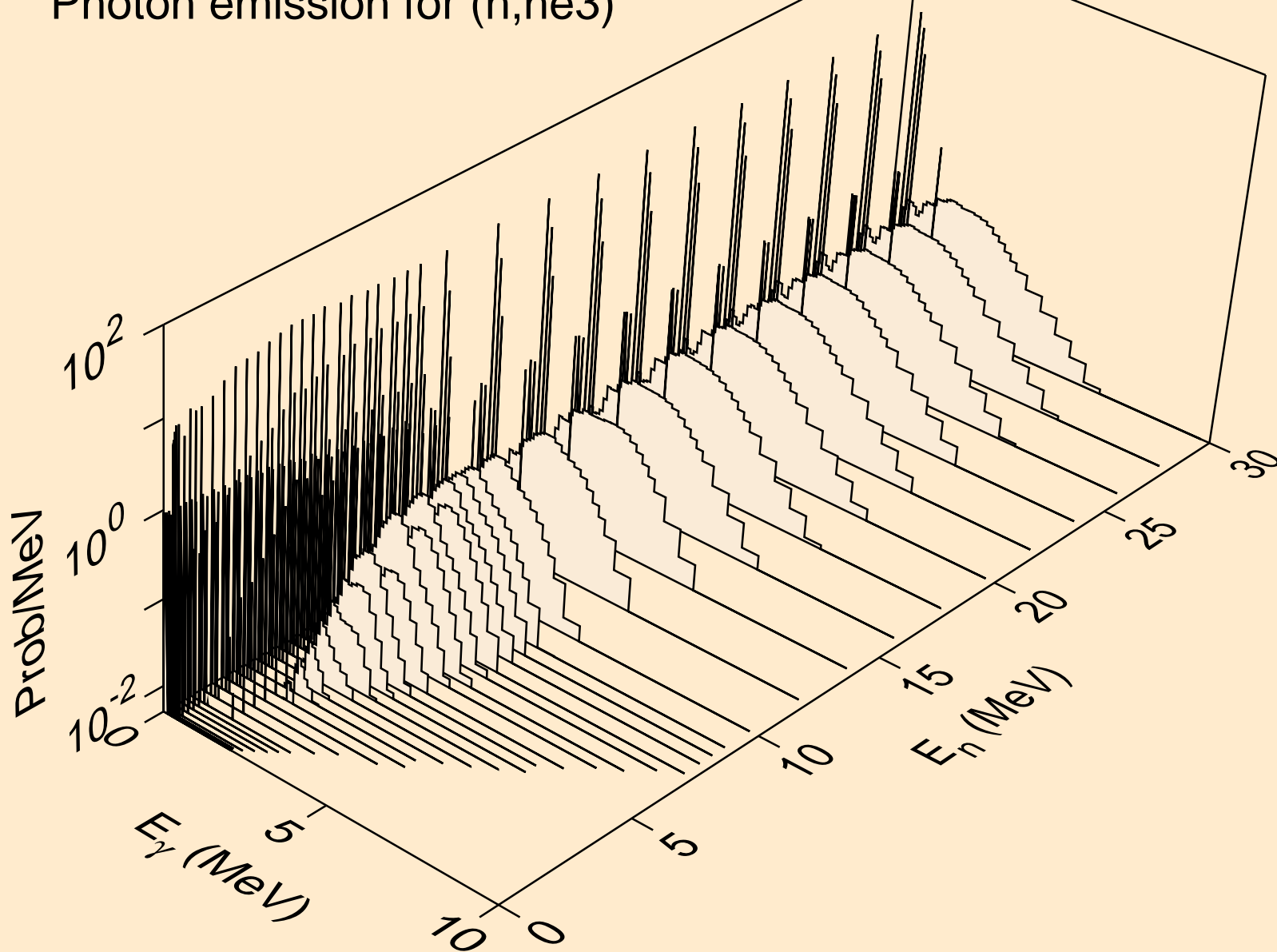

SM130 NEUTRON ACER TENDL-2023 LIBRARY; T=0.K
Photon emission for (n,a)

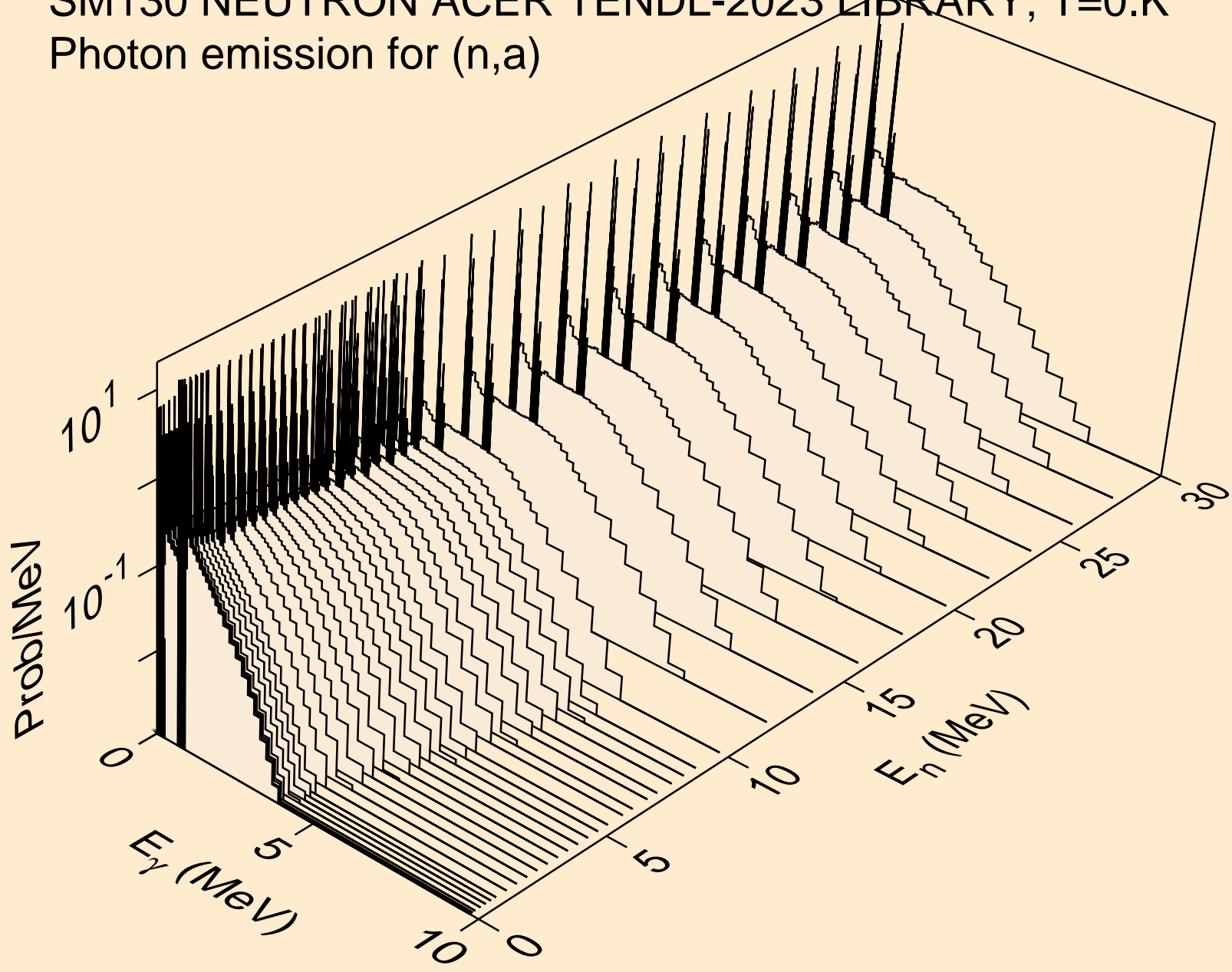

SM130 NEUTRON ACER TENDL-2023 LIBRARY; T=0.K
Photon emission for (n,2a)

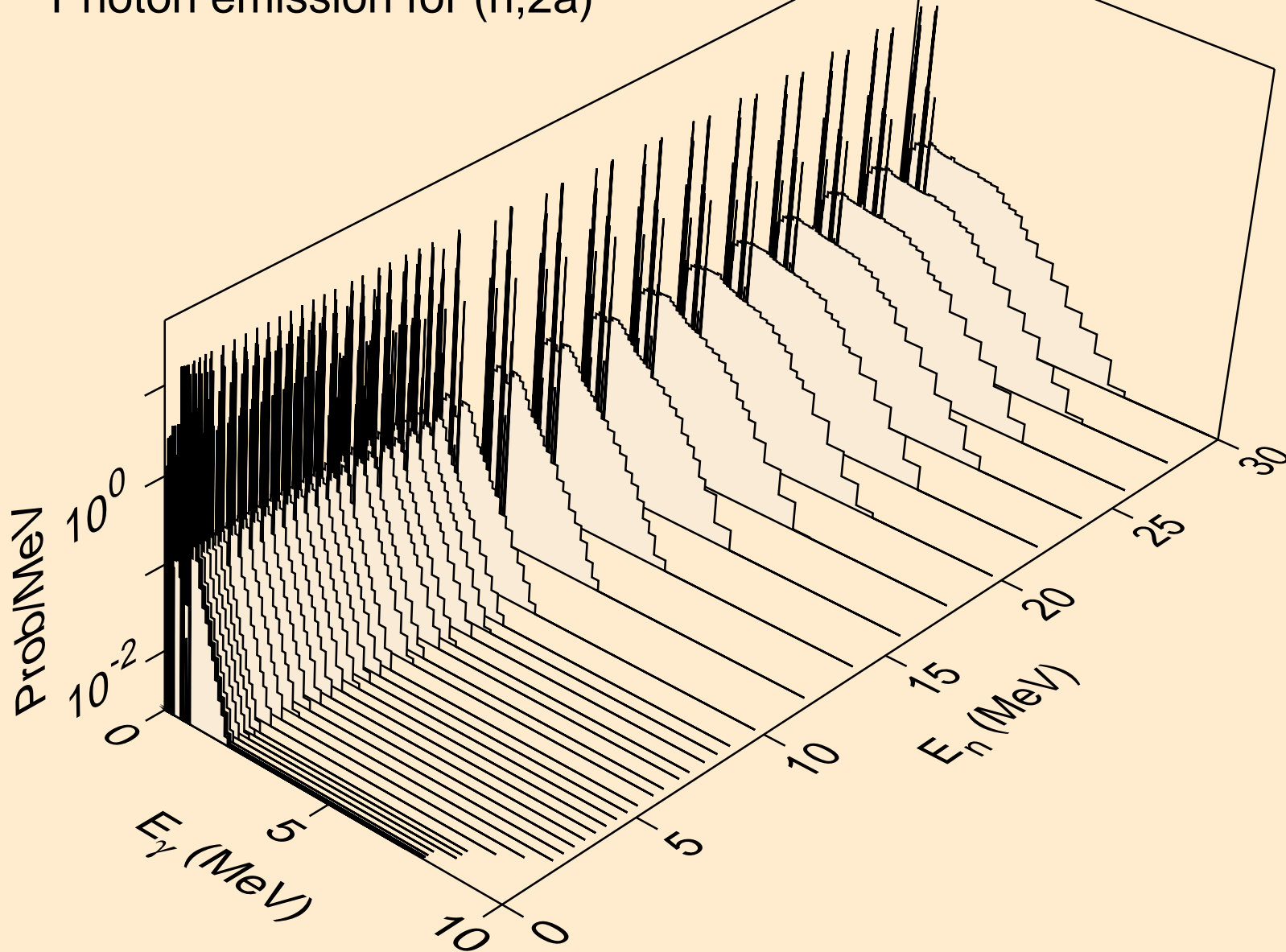

SM130 NEUTRON ACER TENDL-2023 LIBRARY; T=0.K
Photon emission for (n,3a)

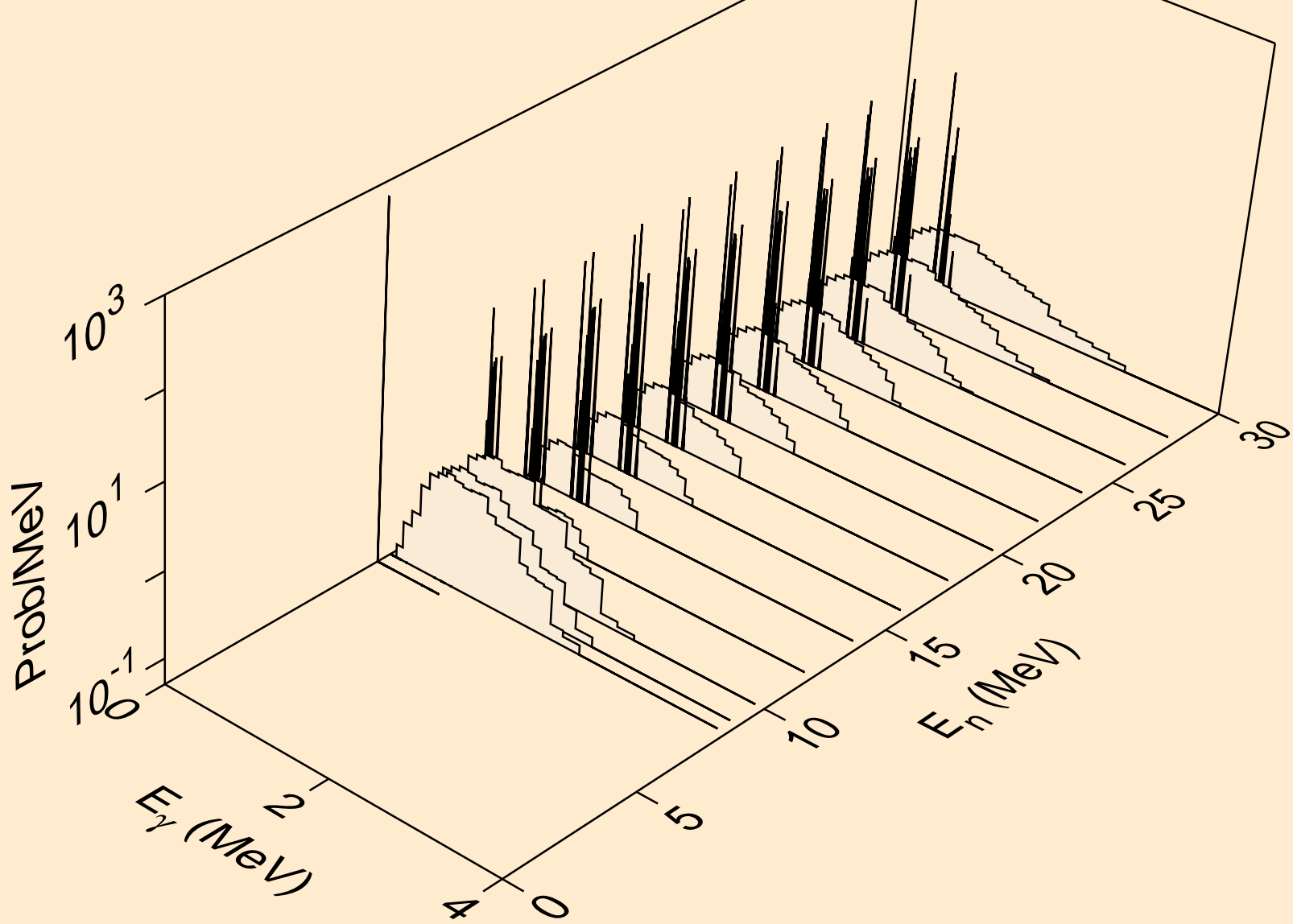

SM130 NEUTRON ACER TENDL-2023 LIBRARY; T=0.K
Photon emission for (n,2p)

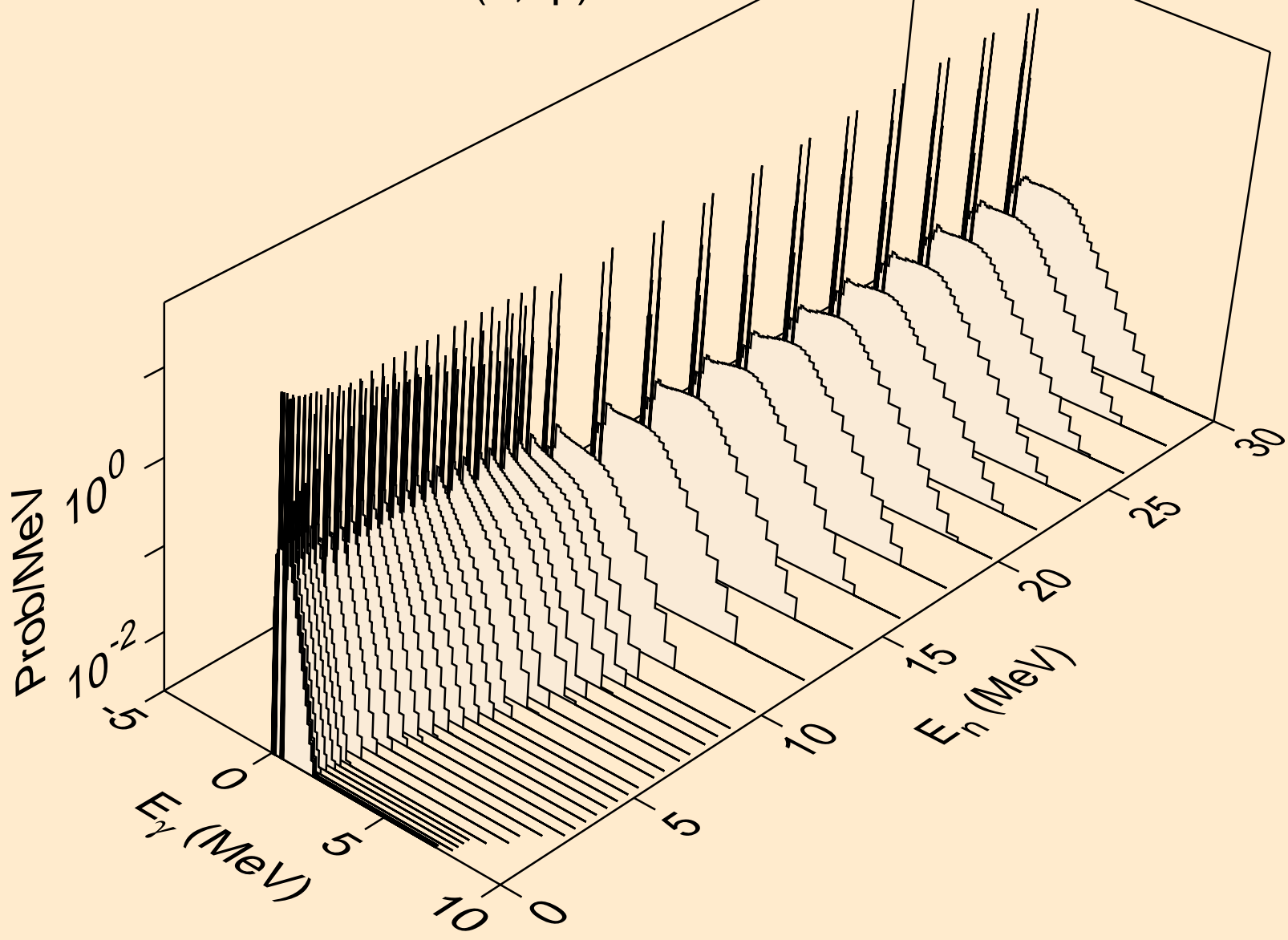

SM130 NEUTRON ACER TENDL-2023 LIBRARY; T=0.K
Photon emission for (n,pa)

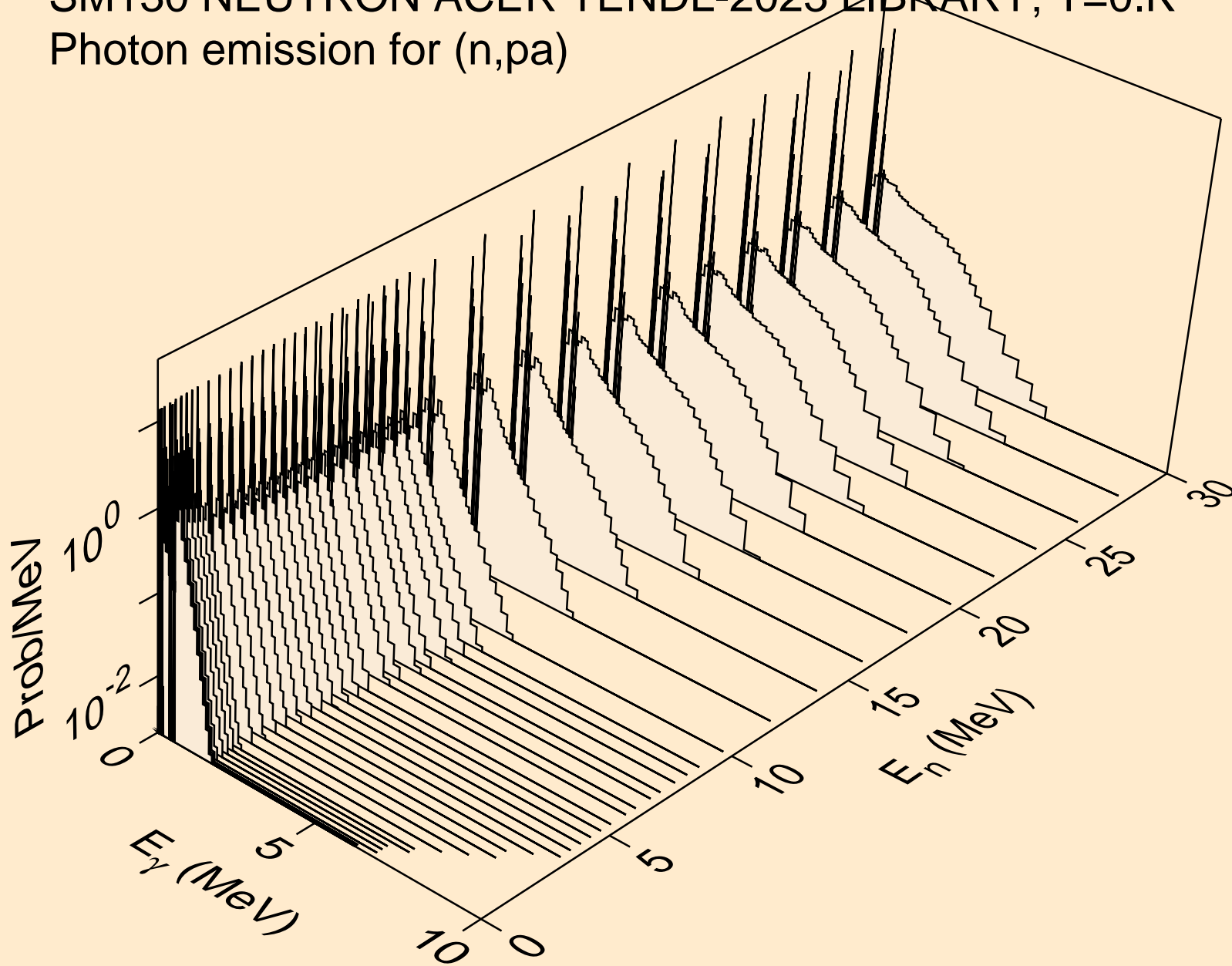

SM130 NEUTRON ACER TENDL-2023 LIBRARY; T=0.K
Photon emission for (n,pd)

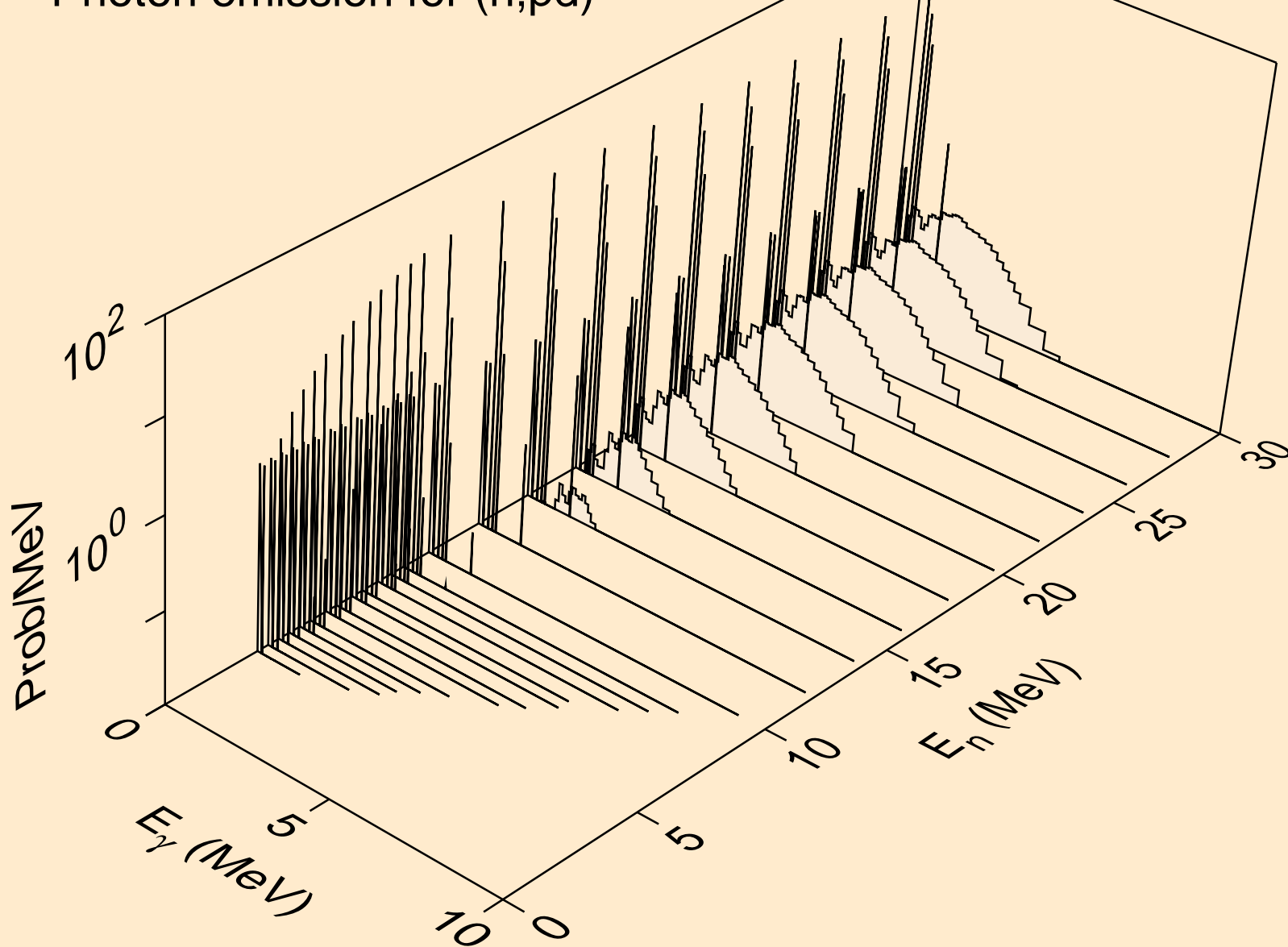

SM130 NEUTRON ACER TENDL-2023 LIBRARY; T=0.K
Photon emission for (n,pt)

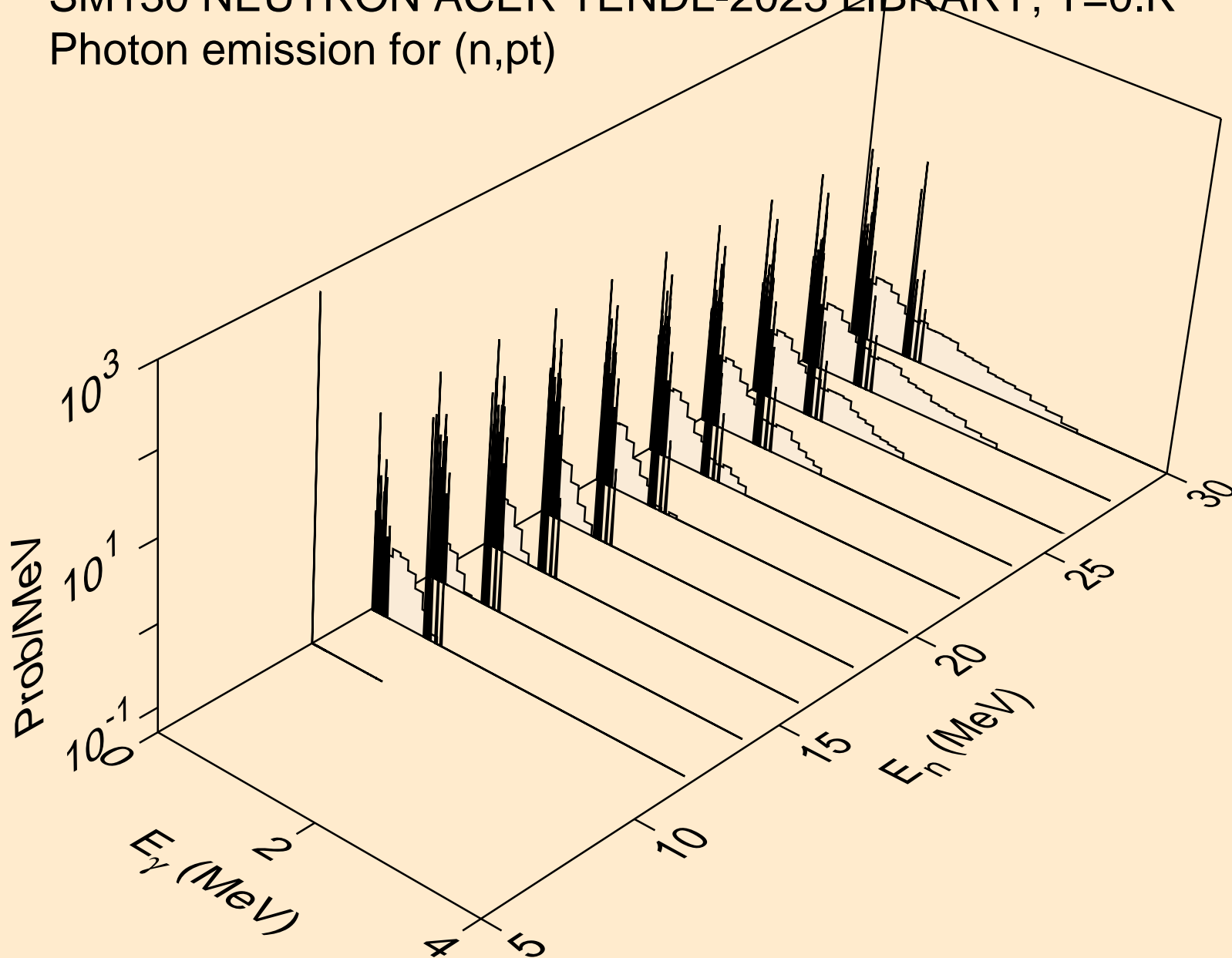

SM130 NEUTRON ACER TENDL-2023 LIBRARY; T=0.K
Photon emission for (n,da)

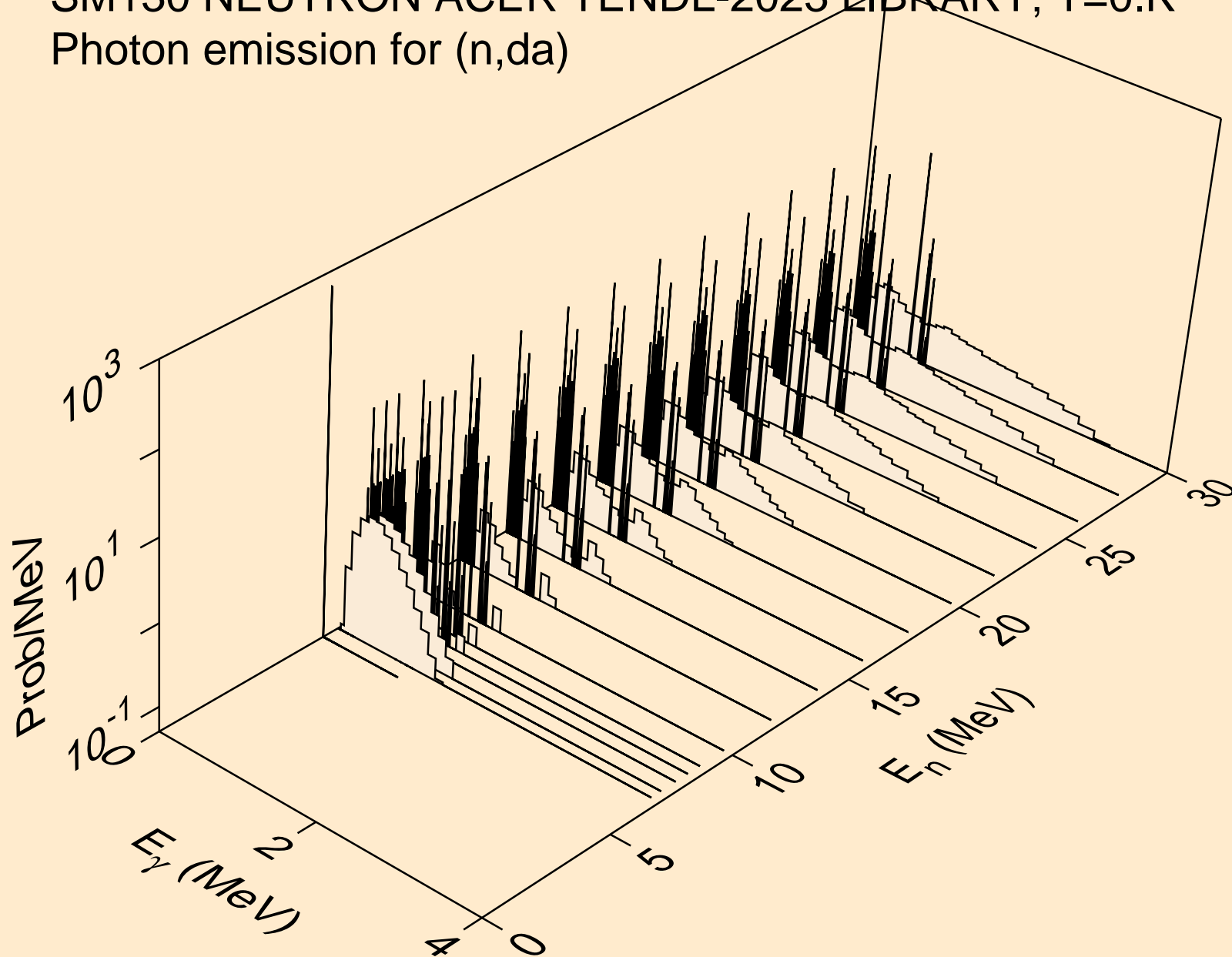

SM130 NEUTRON ACER TENDL-2023 LIBRARY; T=0.K
thermal capture photon spectrum

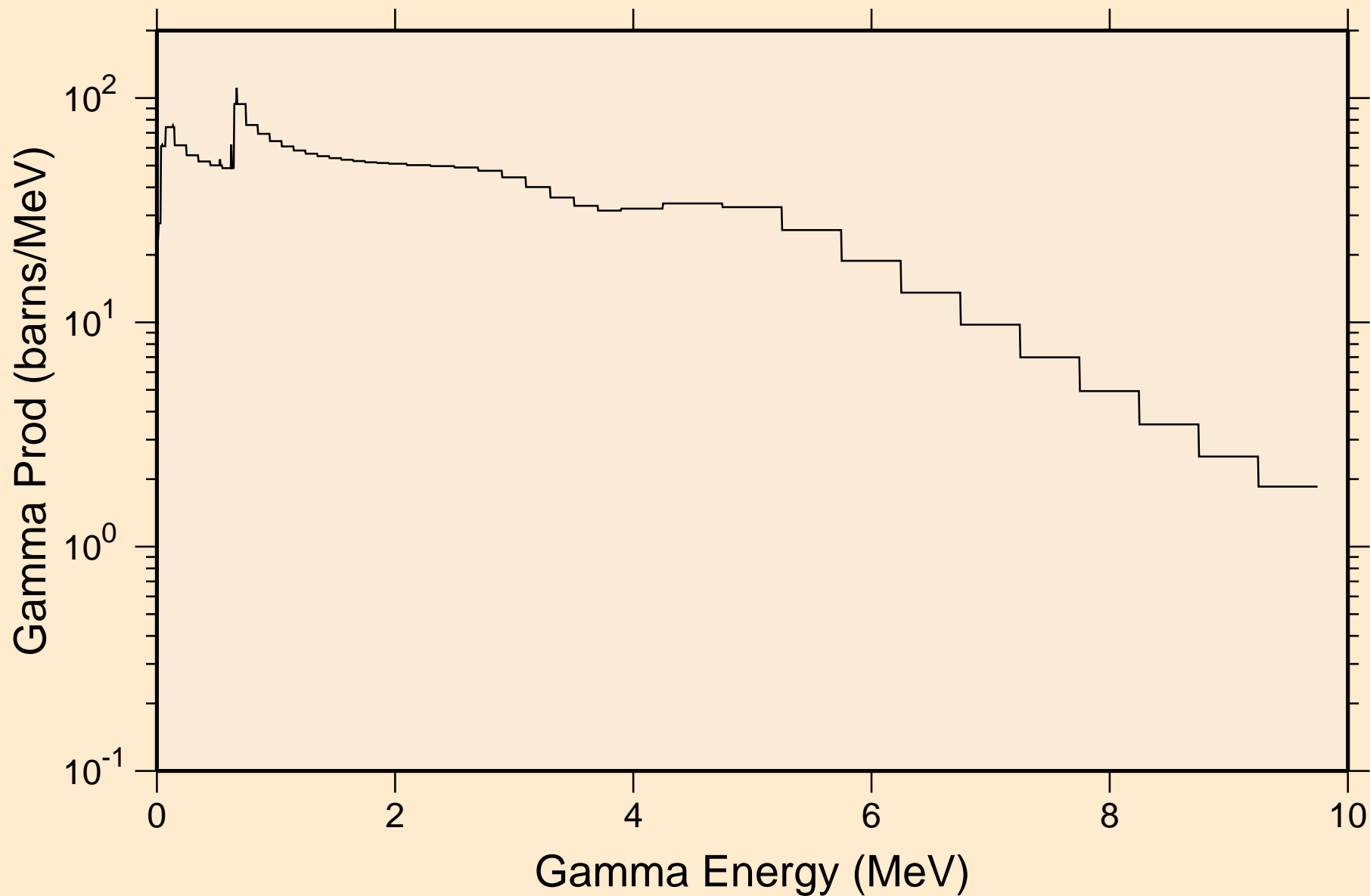

SM130 NEUTRON ACER TENDL-2023 LIBRARY; T=0.K
14 MeV photon spectrum

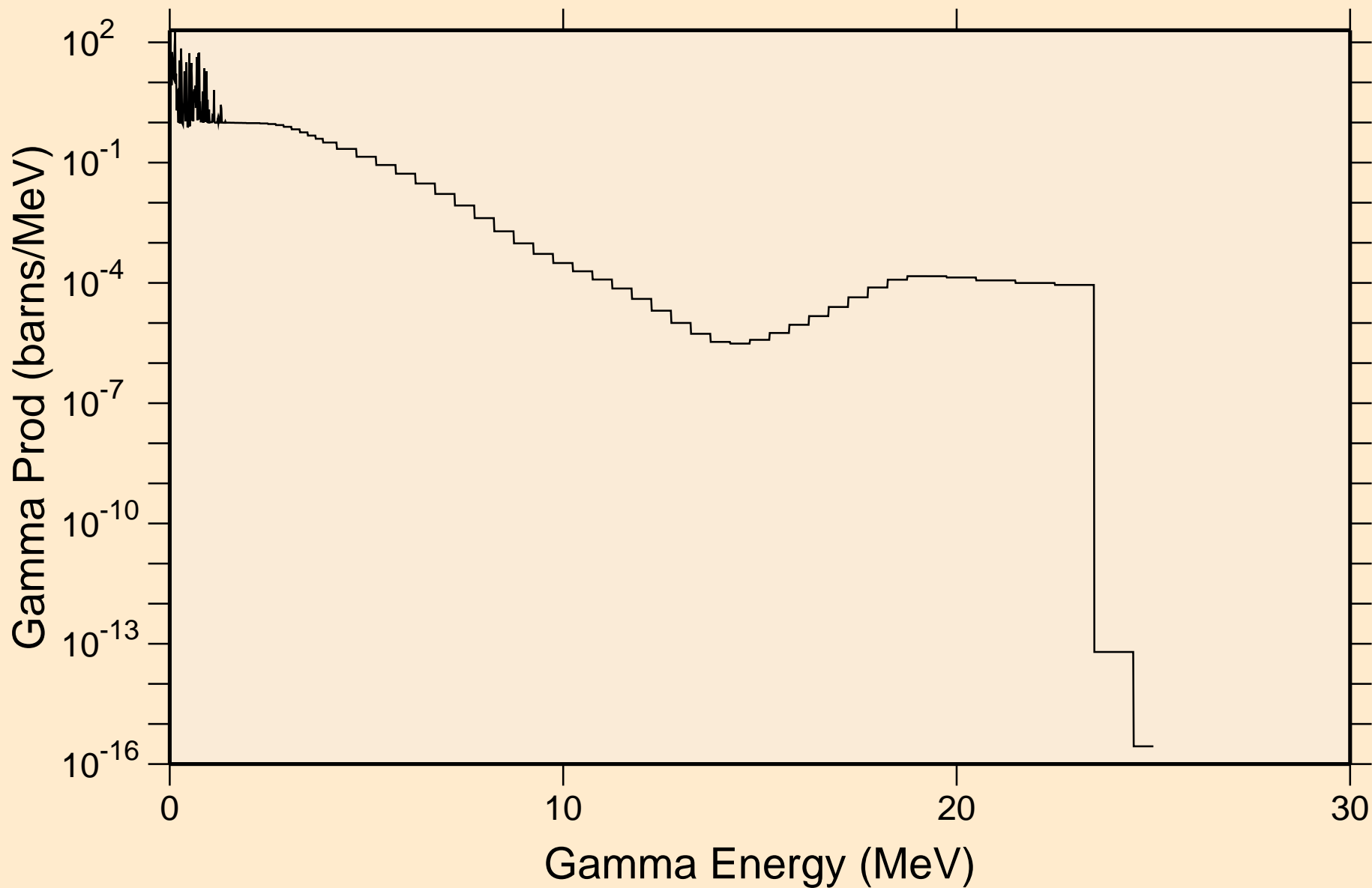

SM130 NEUTRON ACER TENDL-2023 LIBRARY; T=0.K

Particle heating contributions

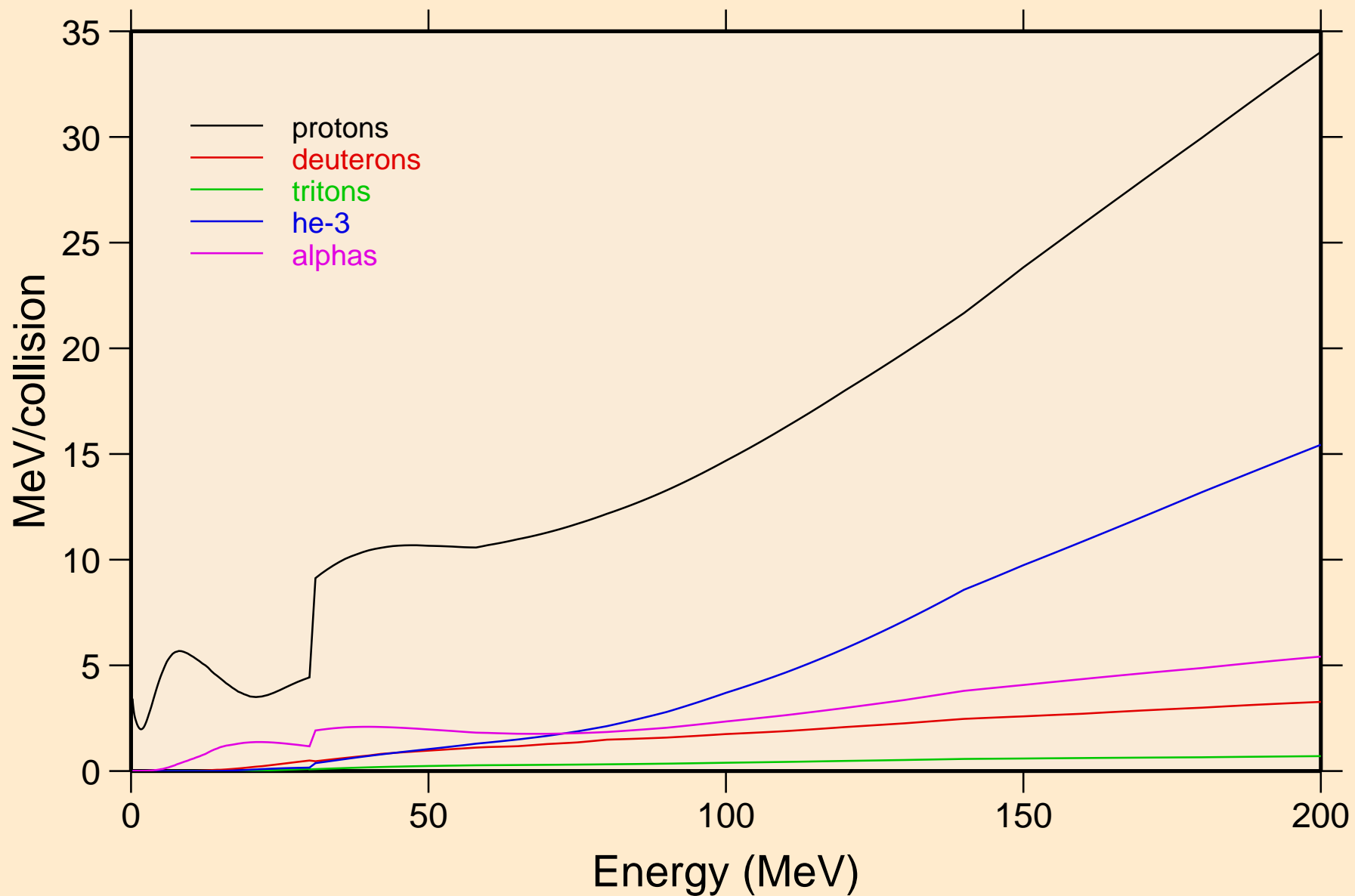

SM130 NEUTRON ACER TENDL-2023 LIBRARY; T=0.K

Recoil Heating

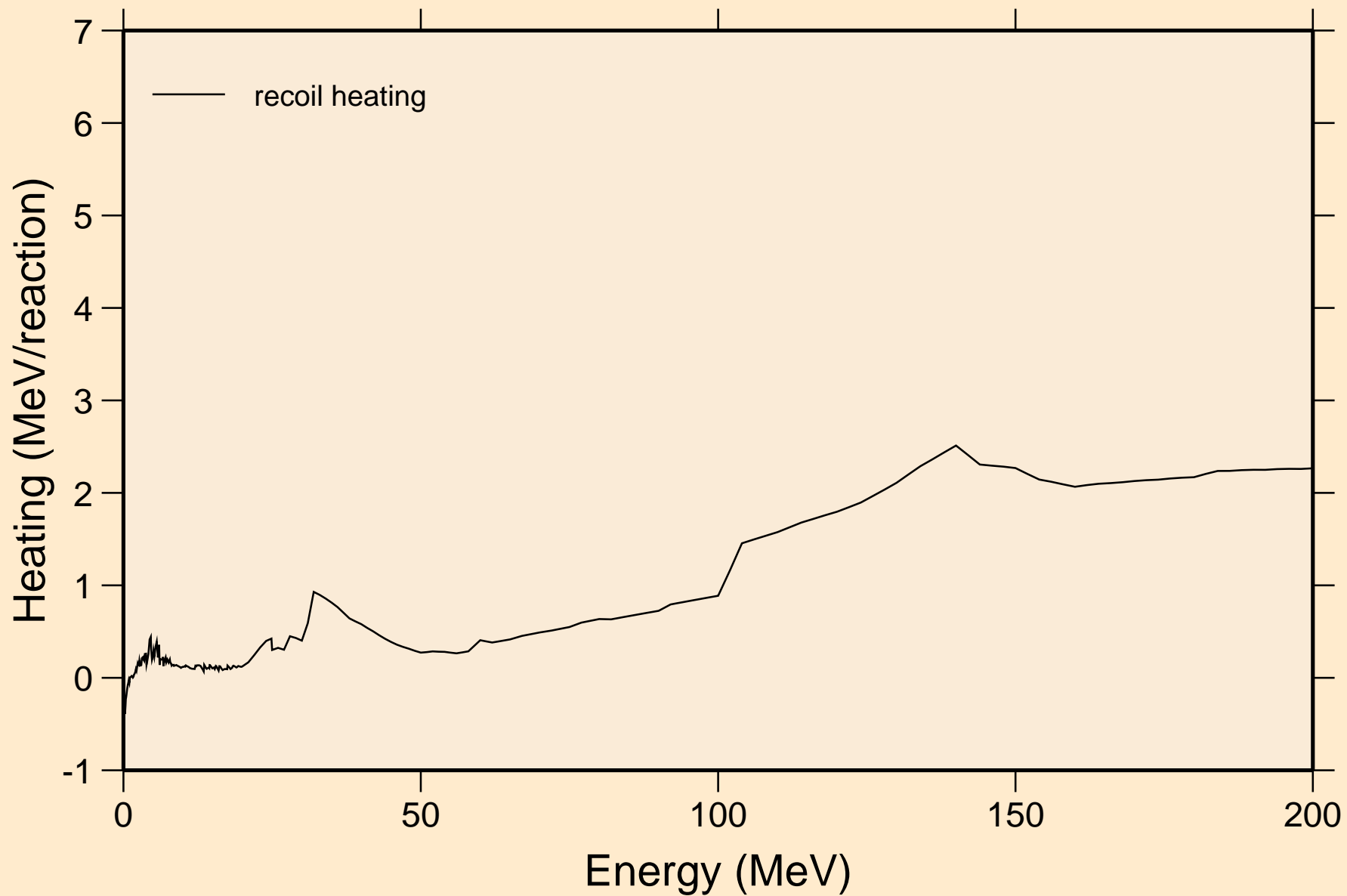

SM130 NEUTRON ACER TENDL-2023 LIBRARY; T=0.K

Particle production cross sections

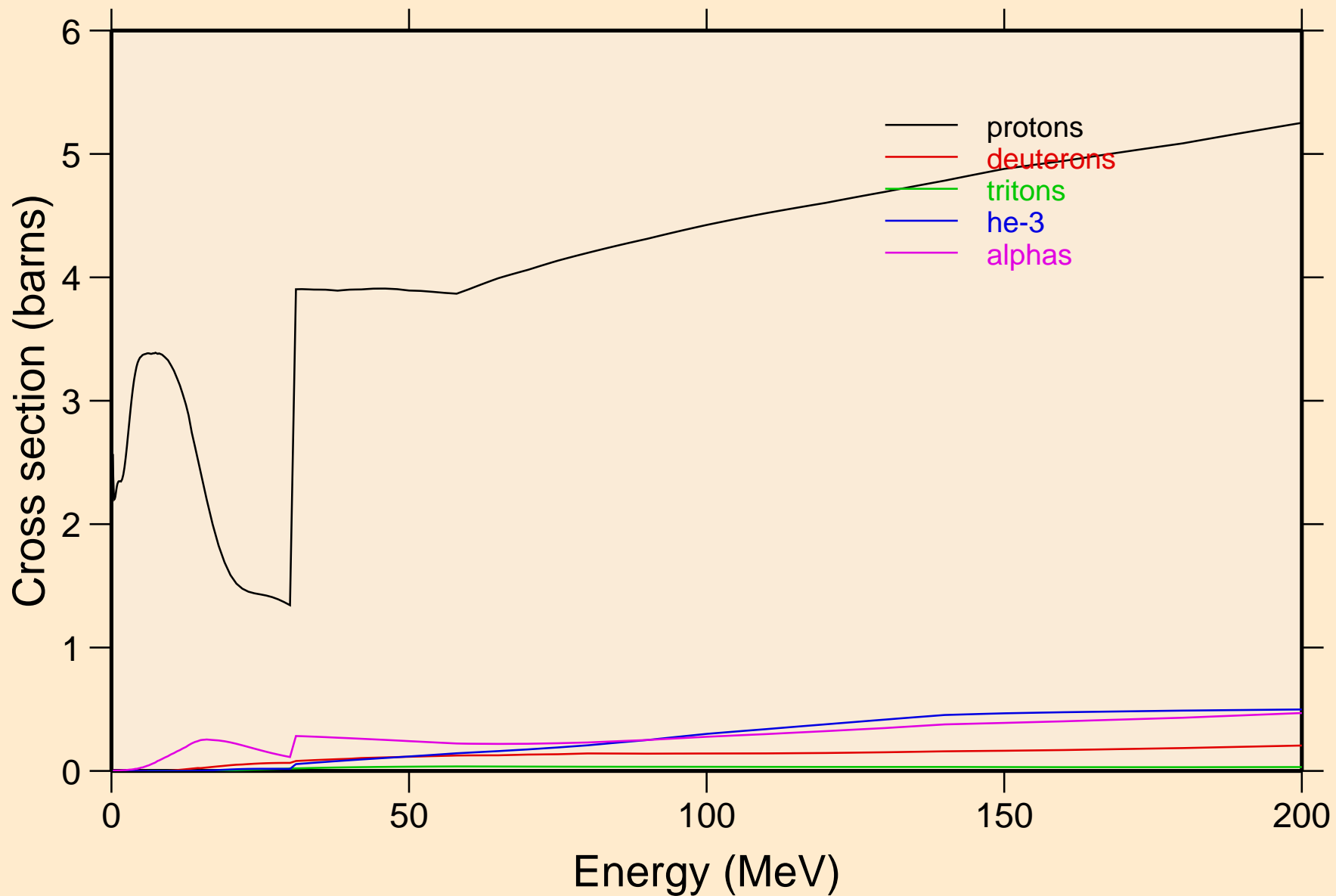

SM130 NEUTRON ACER TENDL-2023 LIBRARY; T=0.K
protons from (n,x)

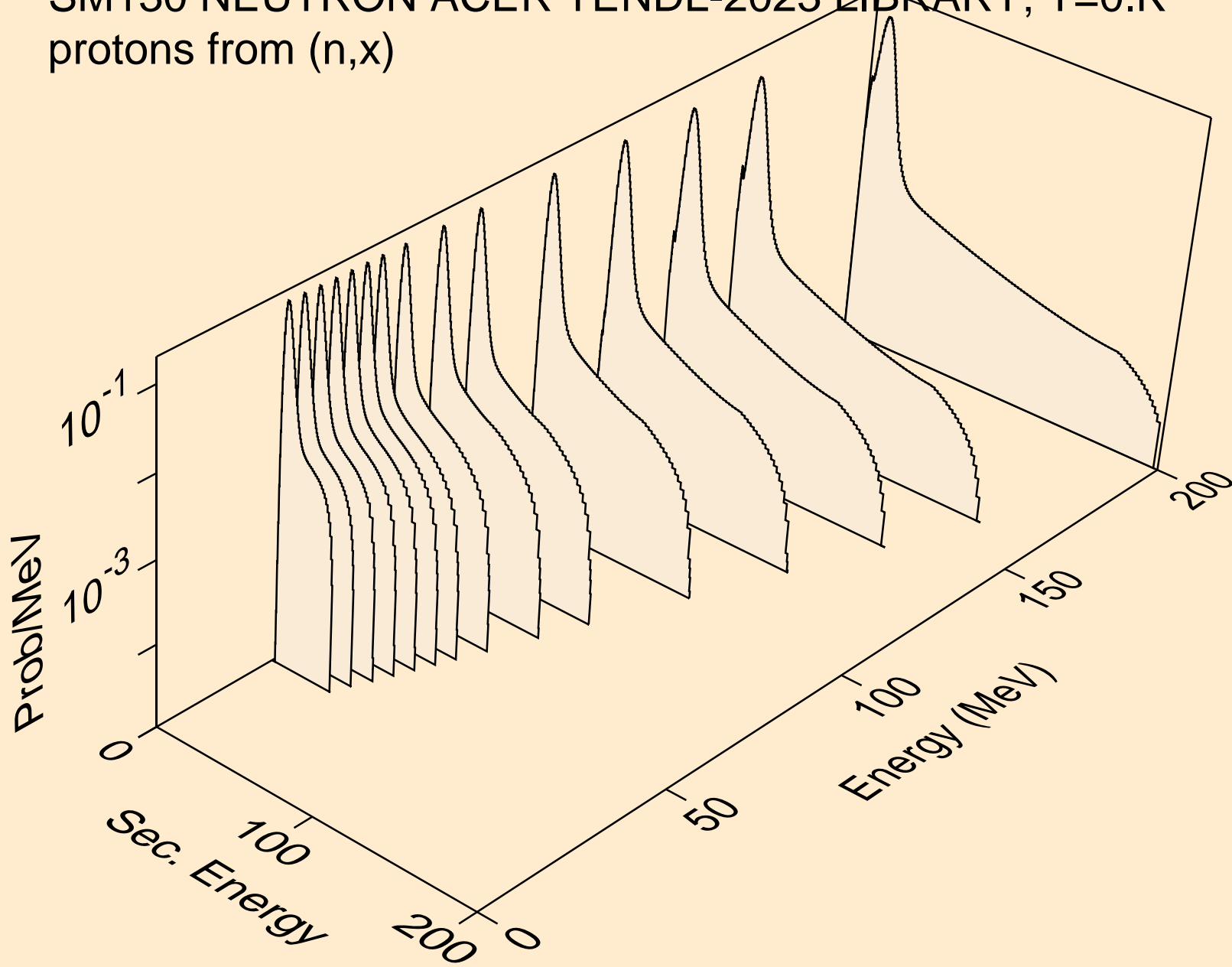

SM130 NEUTRON ACER TENDL-2023 LIBRARY; T=0.K
protons from (n,n*)p

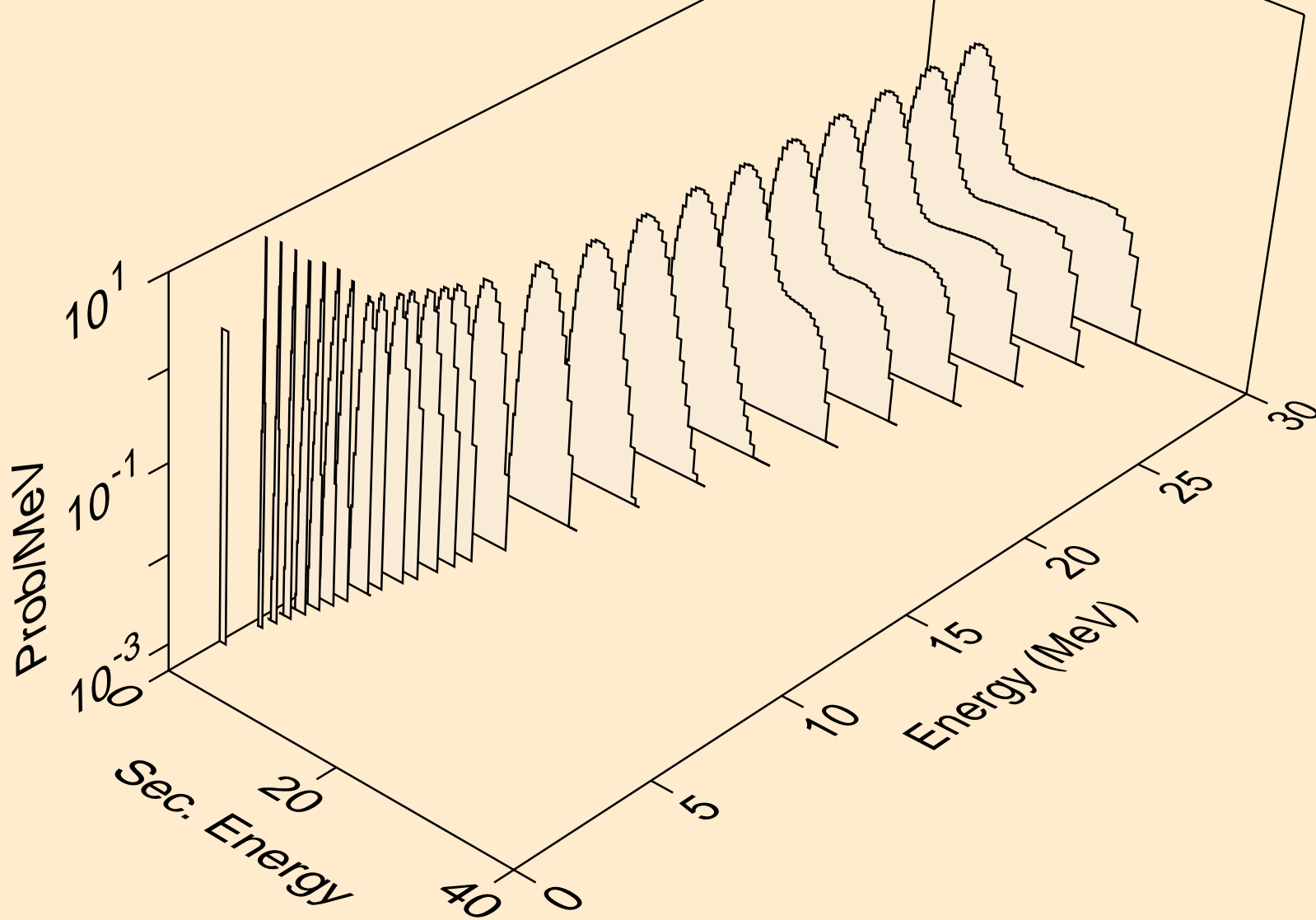

SM130 NEUTRON ACER TENDL-2023 LIBRARY; T=0.K
protons from (n,2np)

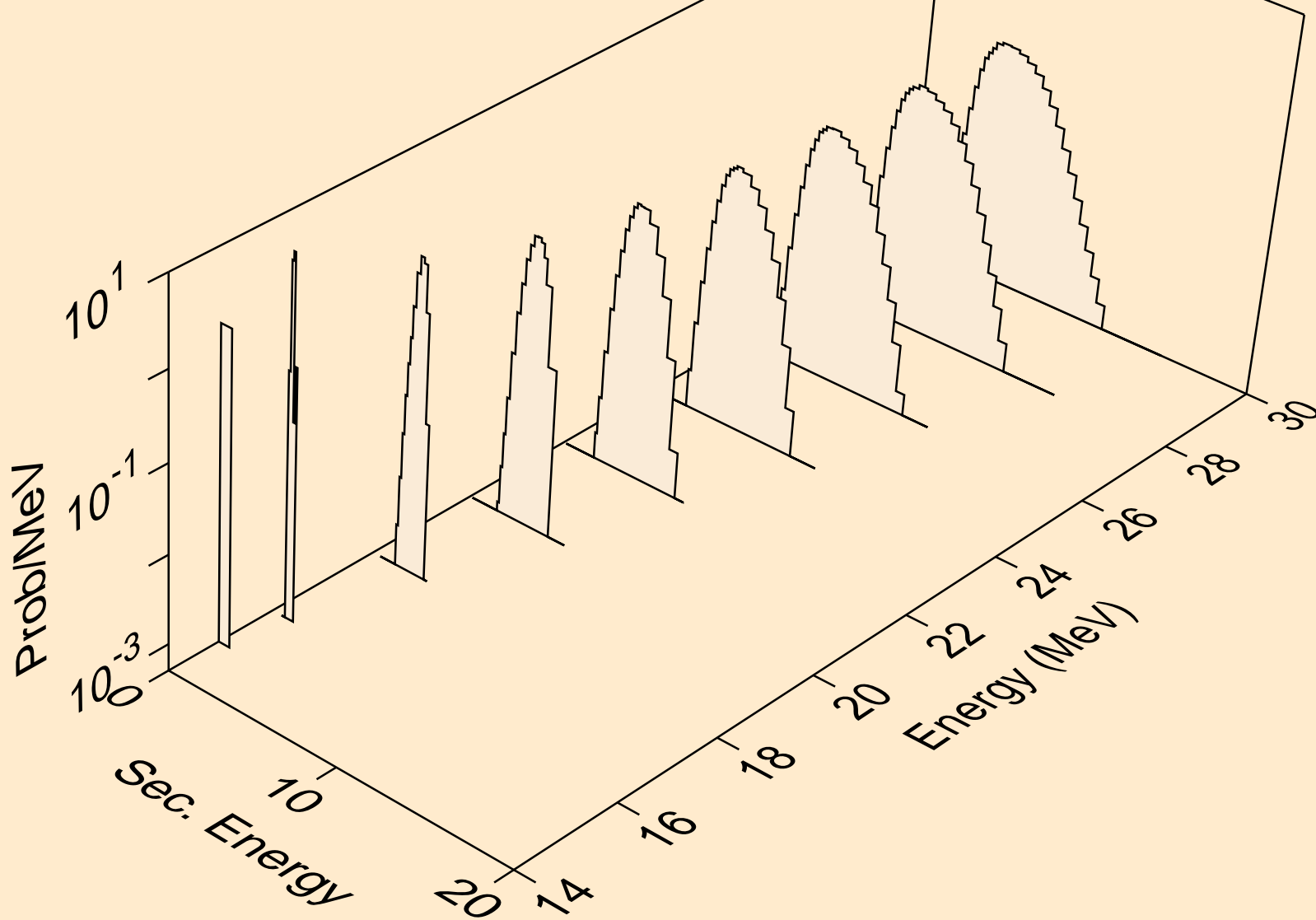

SM130 NEUTRON ACER TENDL-2023 LIBRARY; T=0.K
protons from (n,3np)

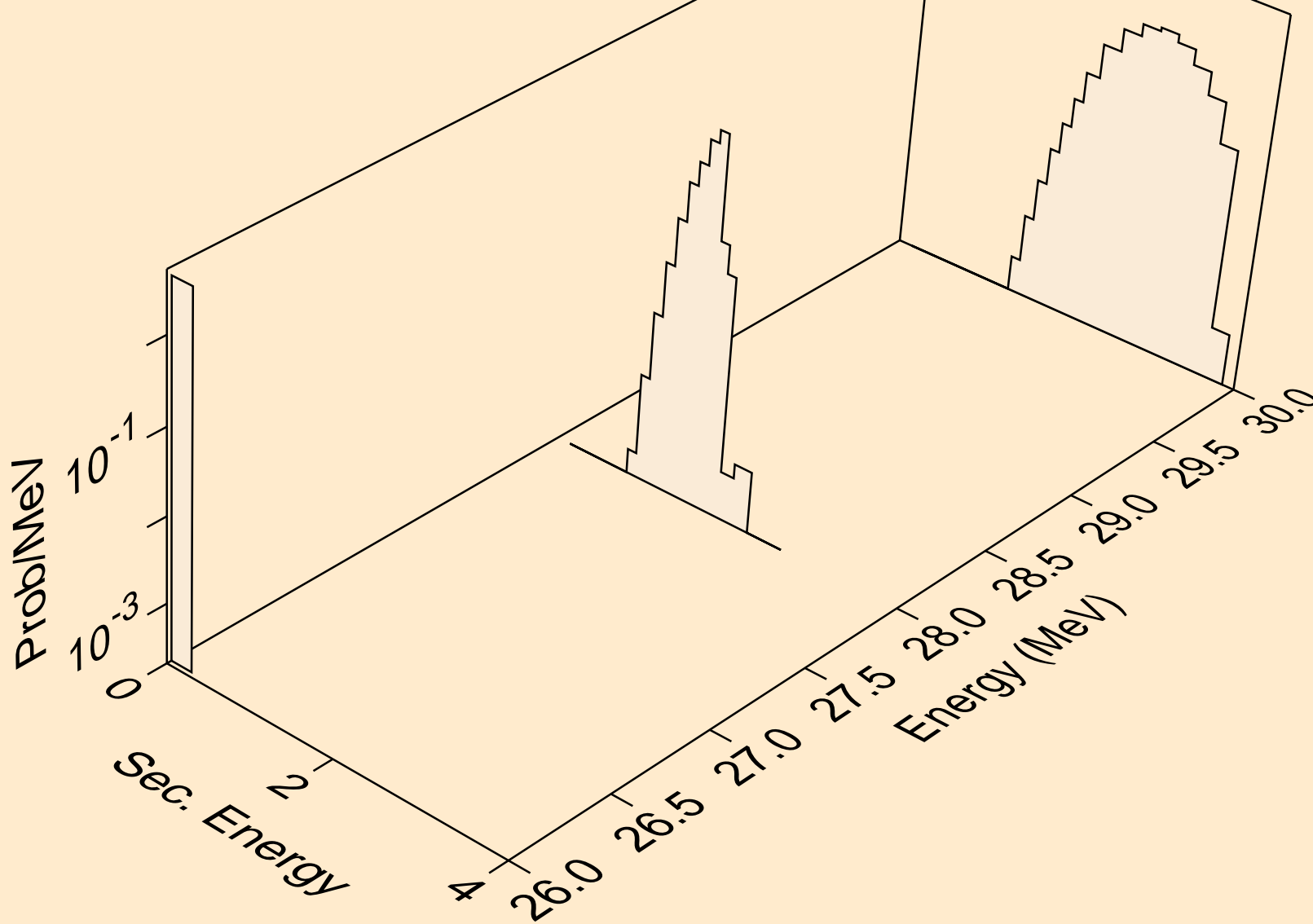

SM130 NEUTRON ACER TENDL-2023 LIBRARY; T=0.K
protons from (n,n2p)

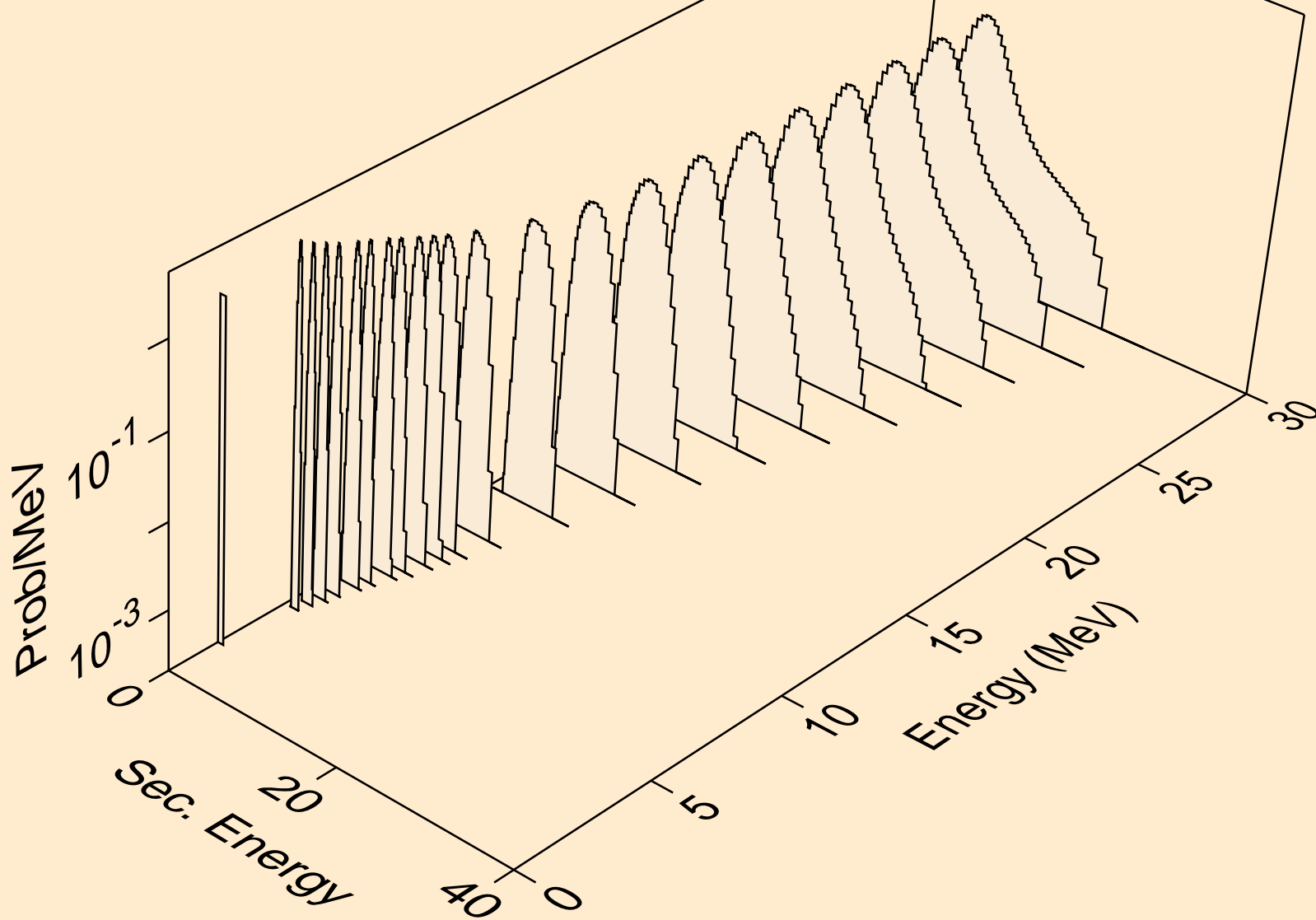

SM130 NEUTRON ACER TENDL-2023 LIBRARY; T=0.K
protons from (n,npa)

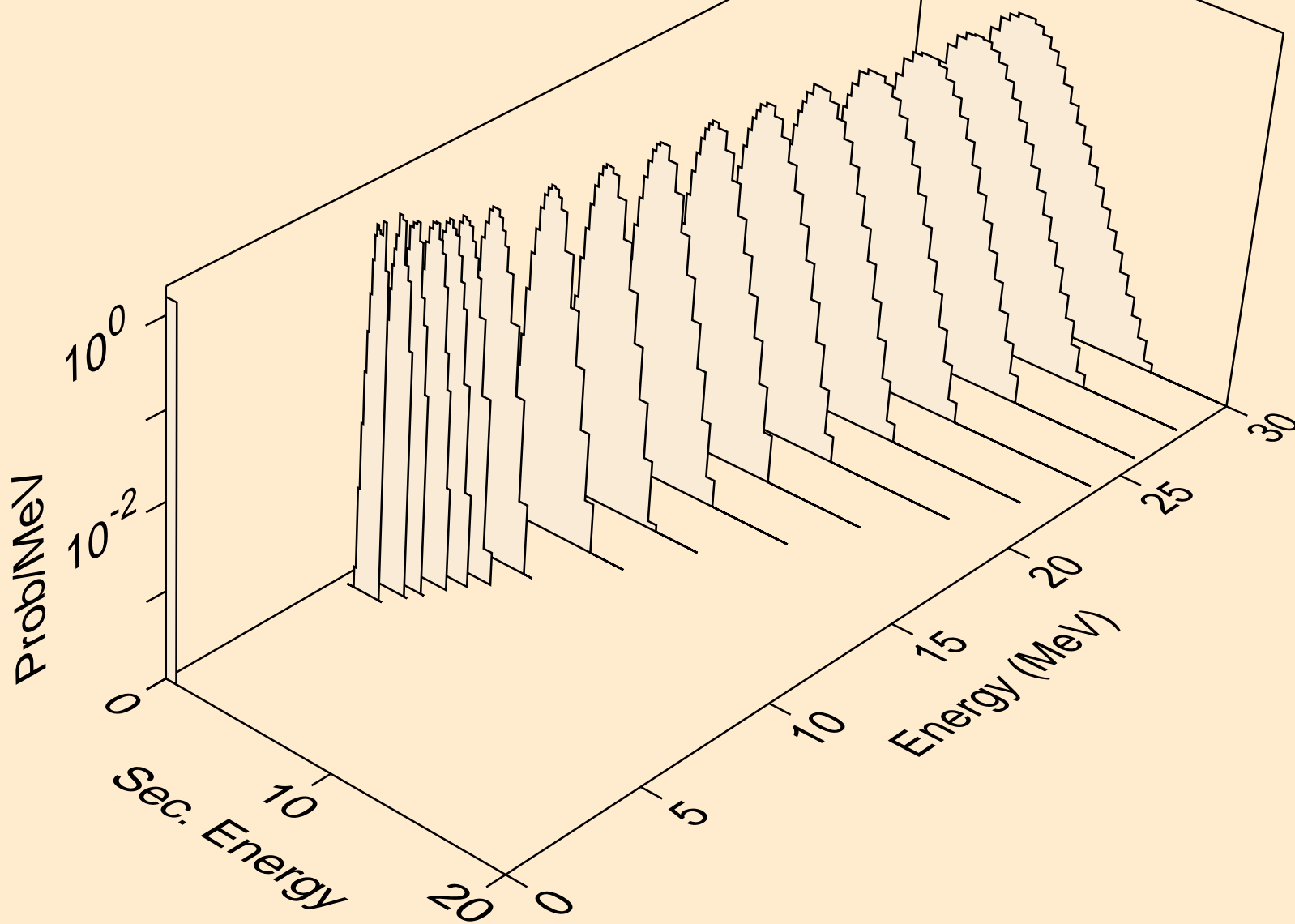

SM130 NEUTRON ACER TENDL-2023 LIBRARY; T=0.K
protons from (n,p)

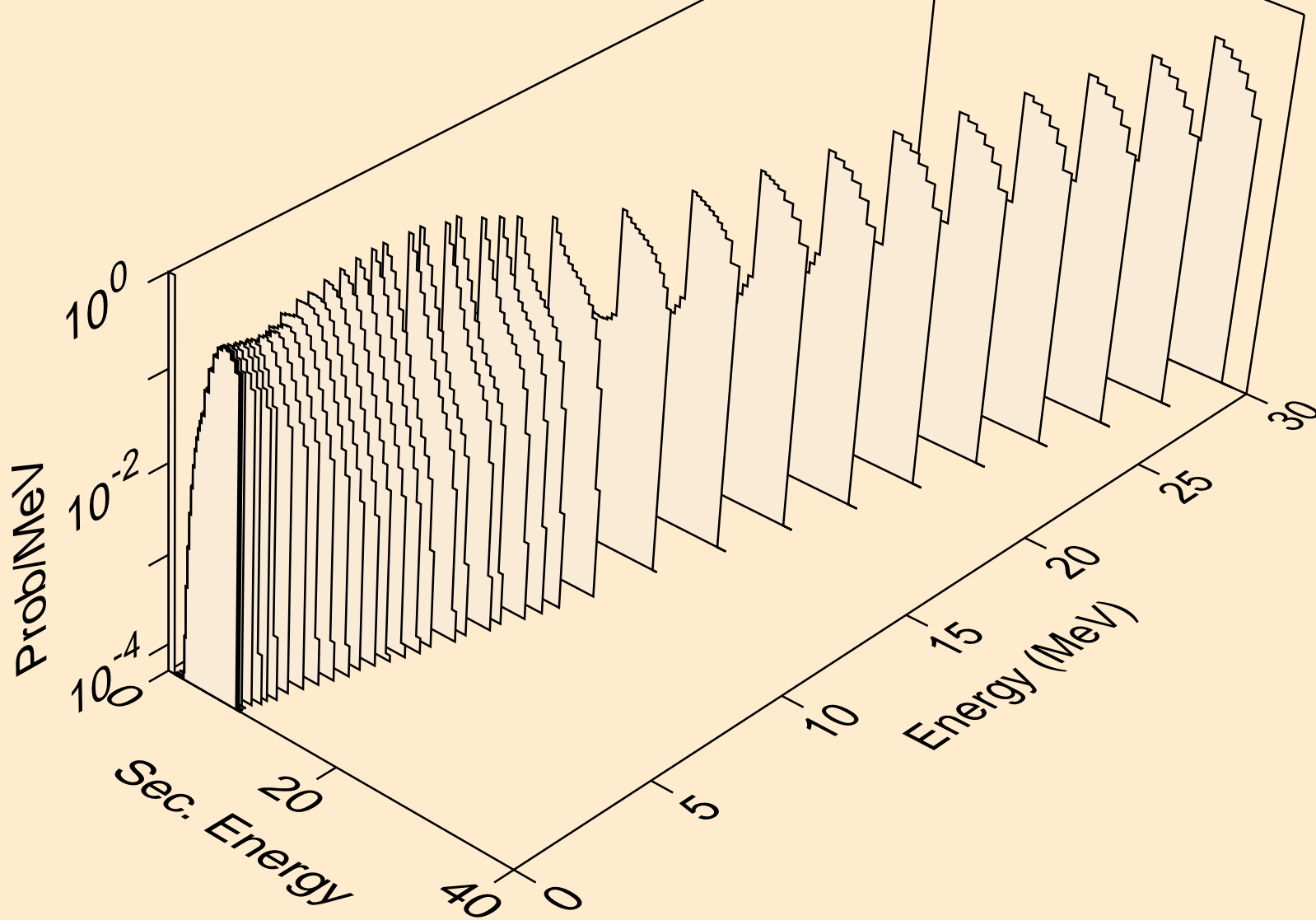

SM130 NEUTRON ACER TENDL-2023 LIBRARY; T=0.K
protons from (n,2p)

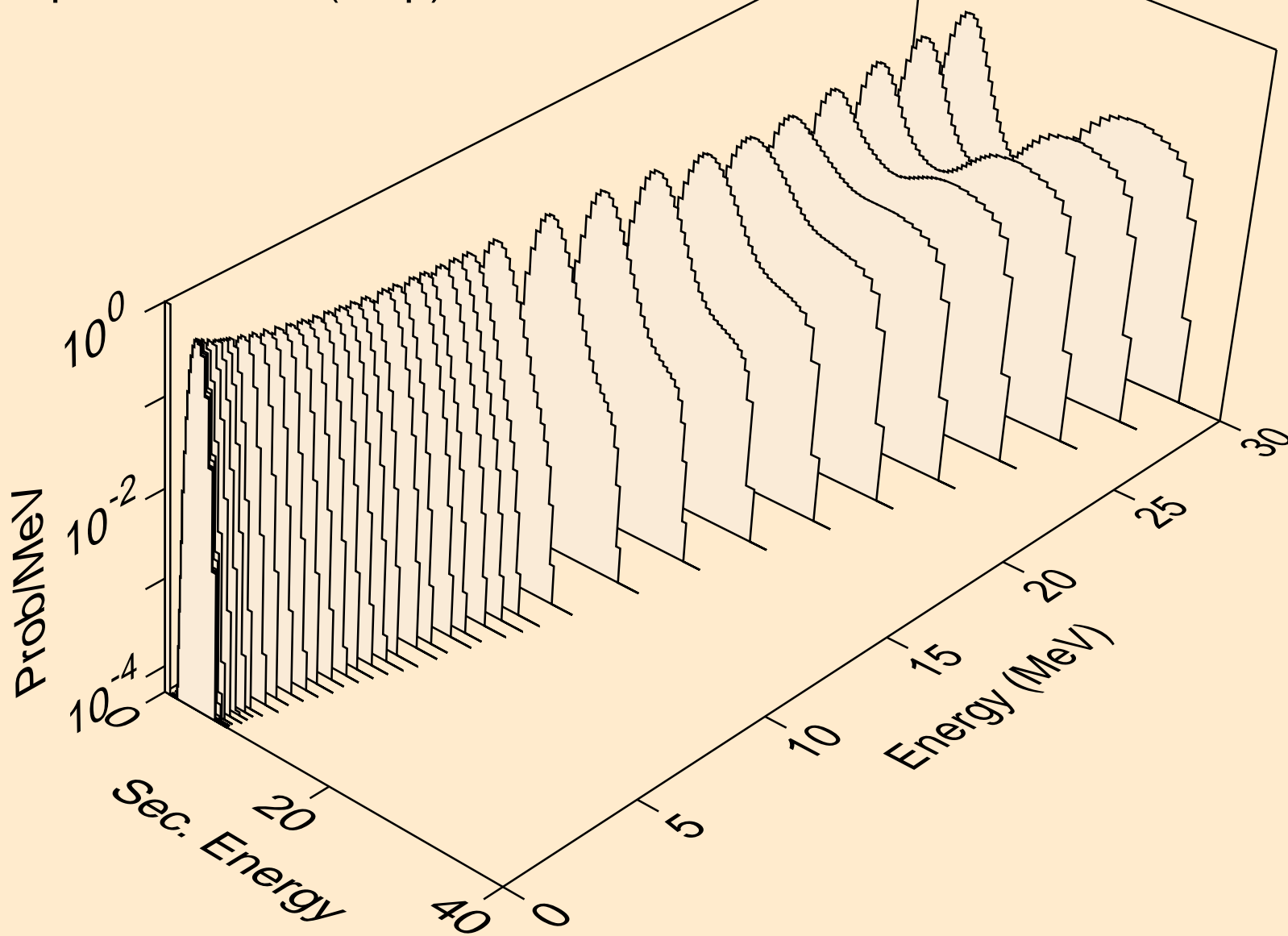

SM130 NEUTRON ACER TENDL-2023 LIBRARY; T=0.K
protons from (n,p)

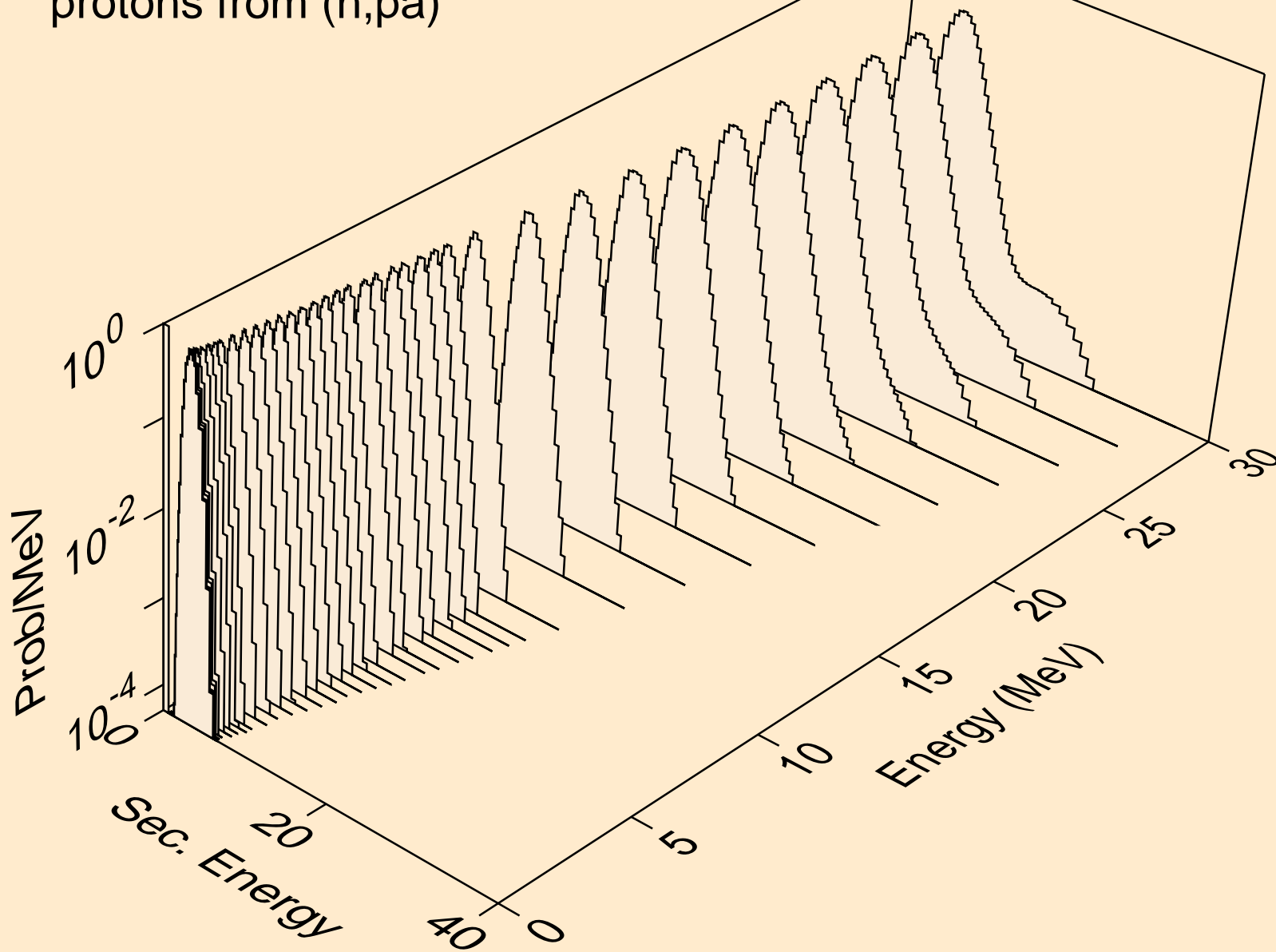

SM130 NEUTRON ACER TENDL-2023 LIBRARY; T=0.K
protons from (n,pd)

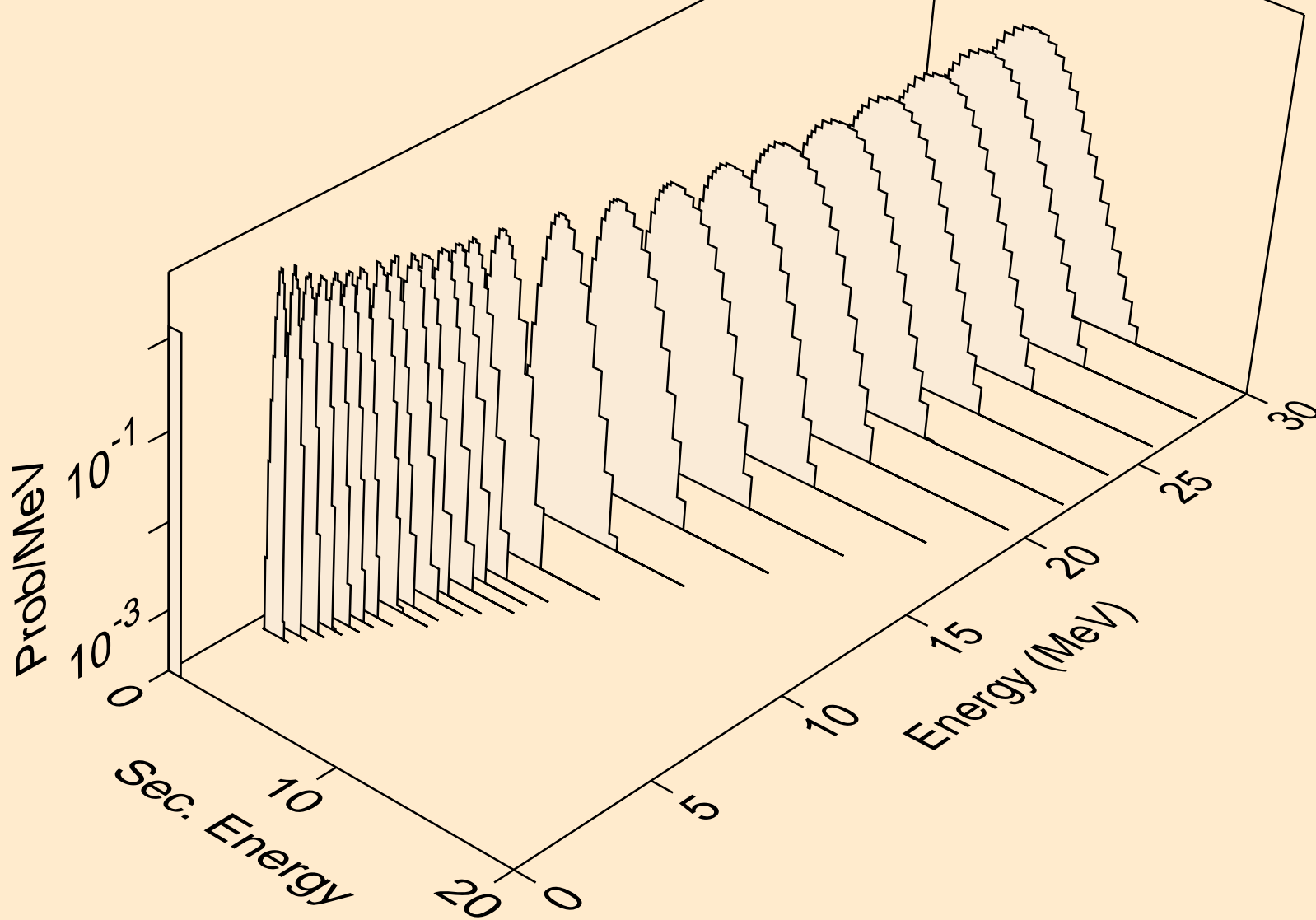

SM130 NEUTRON ACER TENDL-2023 LIBRARY; T=0.K
protons from (n,pt)

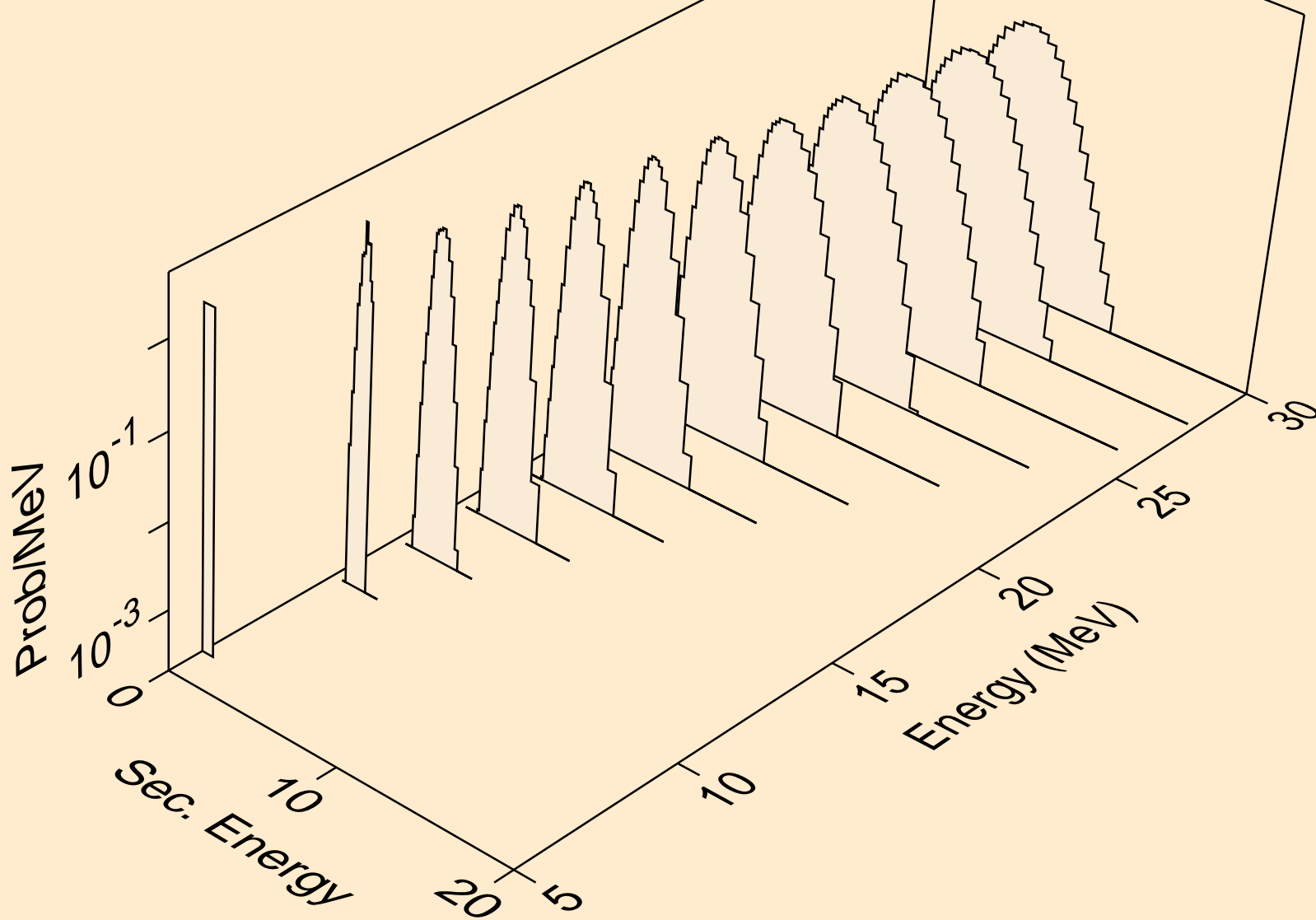

SM130 NEUTRON ACER TENDL-2023 LIBRARY; T=0.K
deuterons from (n,x)

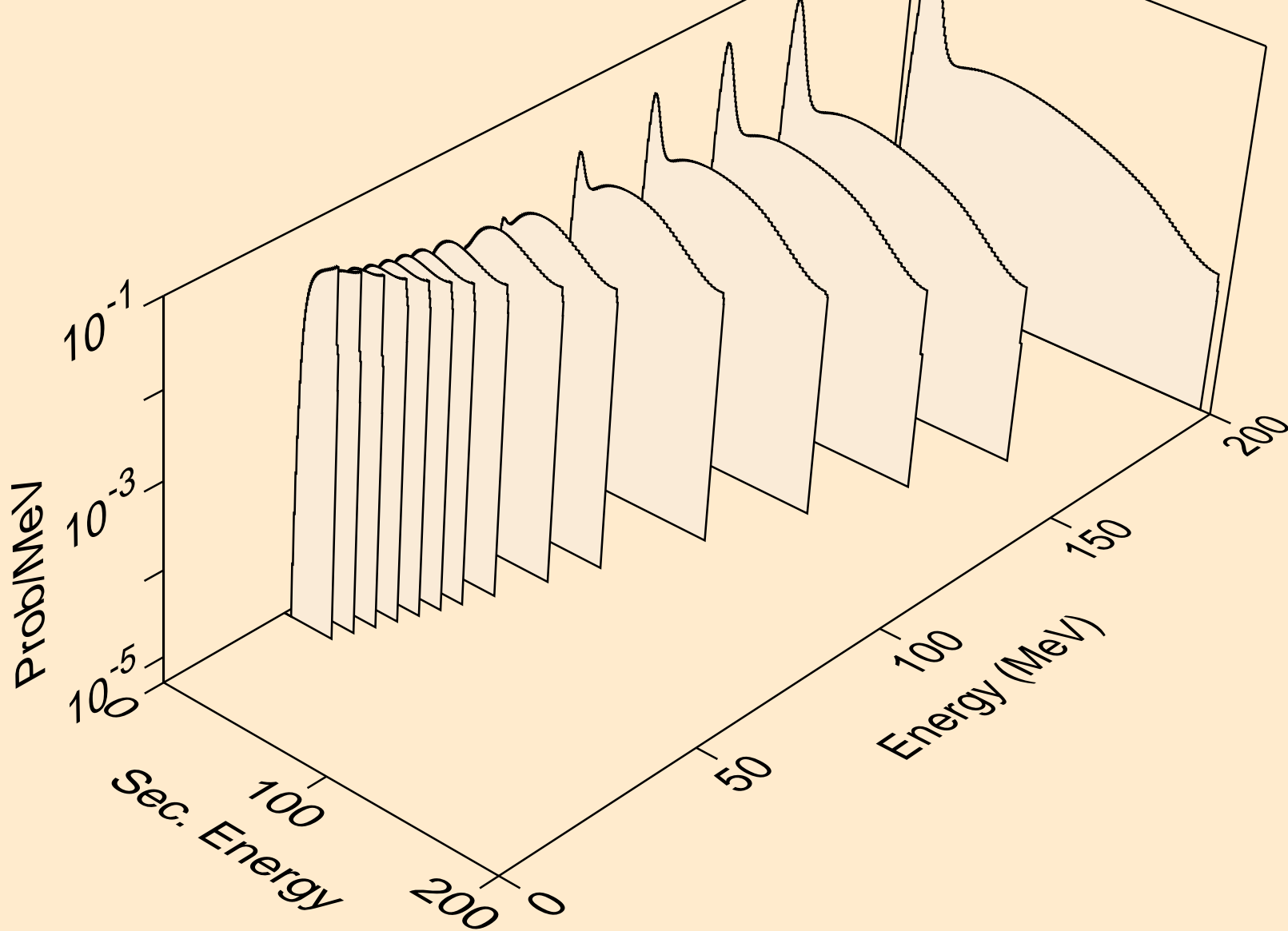

SM130 NEUTRON ACER TENDL-2023 LIBRARY; T=0.K
deuterons from (n,n*)d

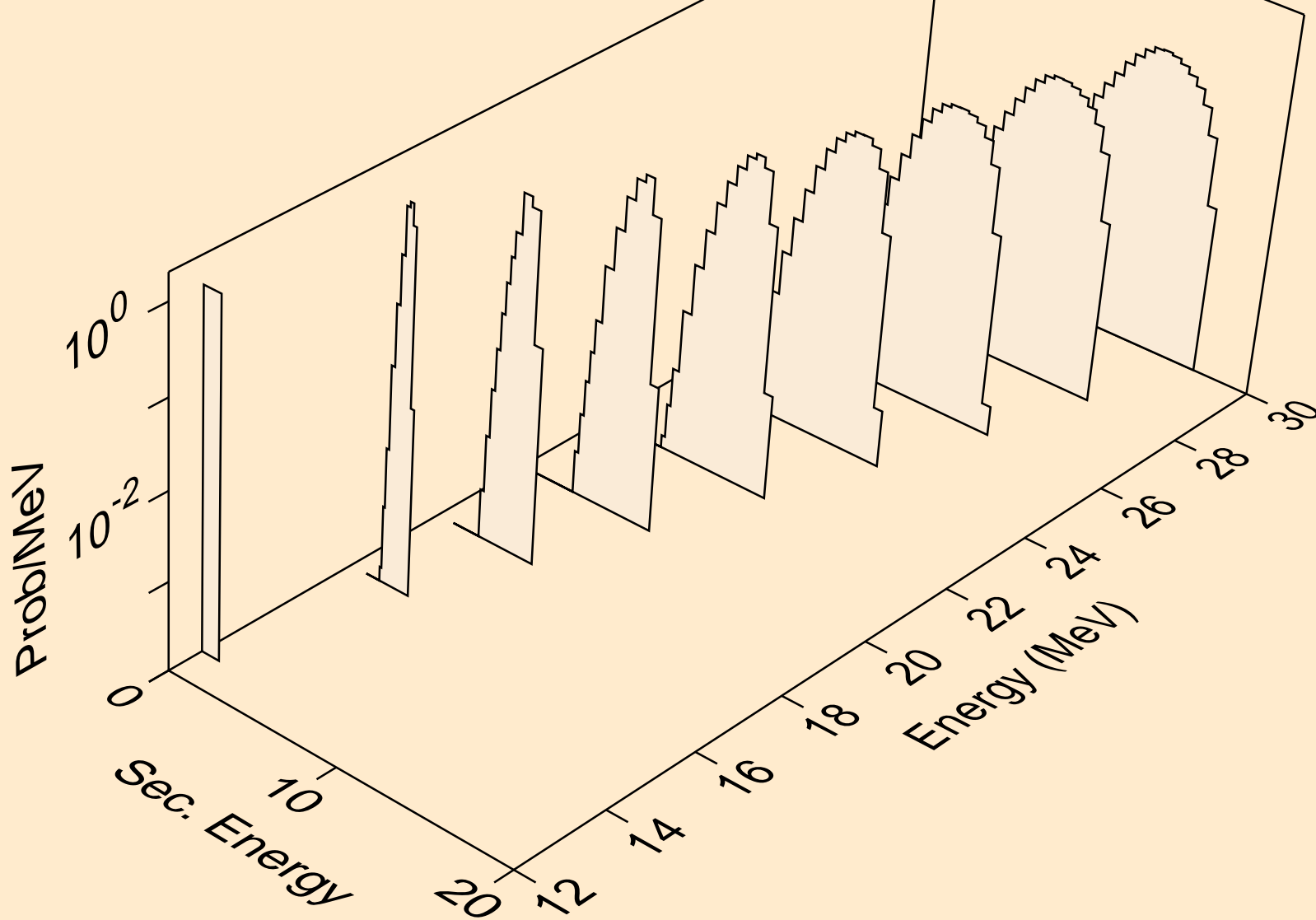

SM130 NEUTRON ACER TENDL-2023 LIBRARY; T=0.K
deuterons from (n,d)

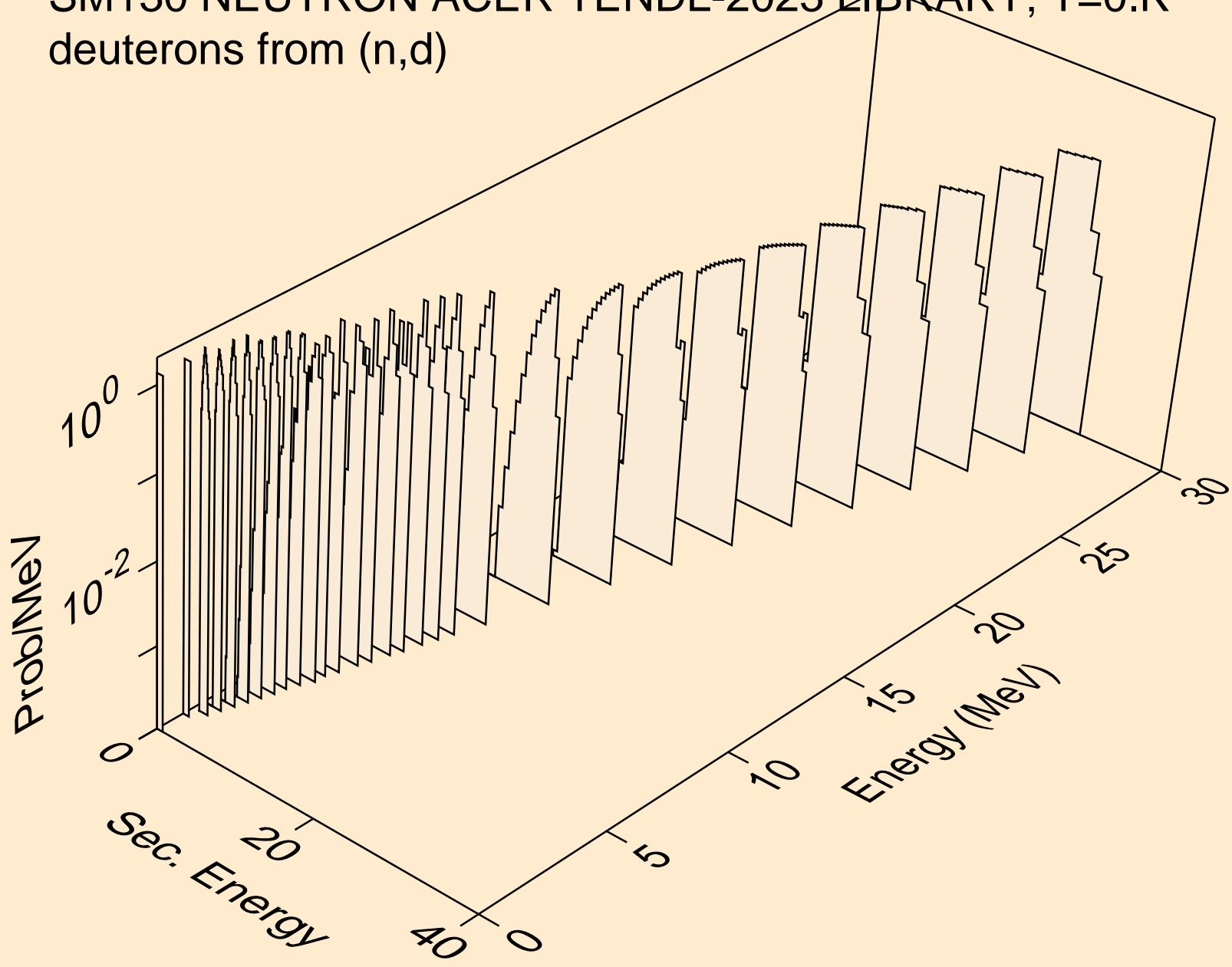

SM130 NEUTRON ACER TENDL-2023 LIBRARY; T=0.K
deuterons from (n,pd)

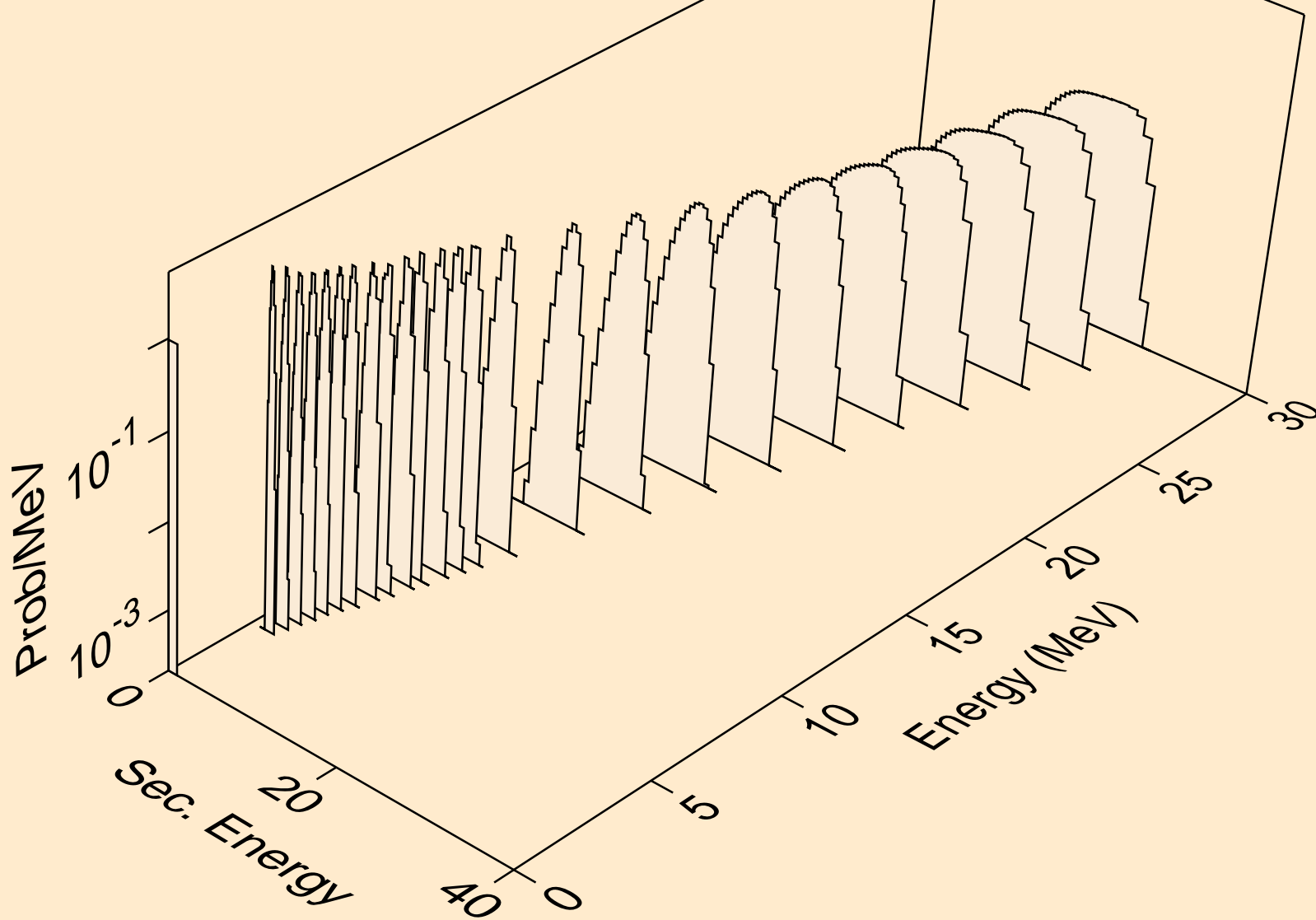

SM130 NEUTRON ACER TENDL-2023 LIBRARY; T=0.K
deuterons from (n,da)

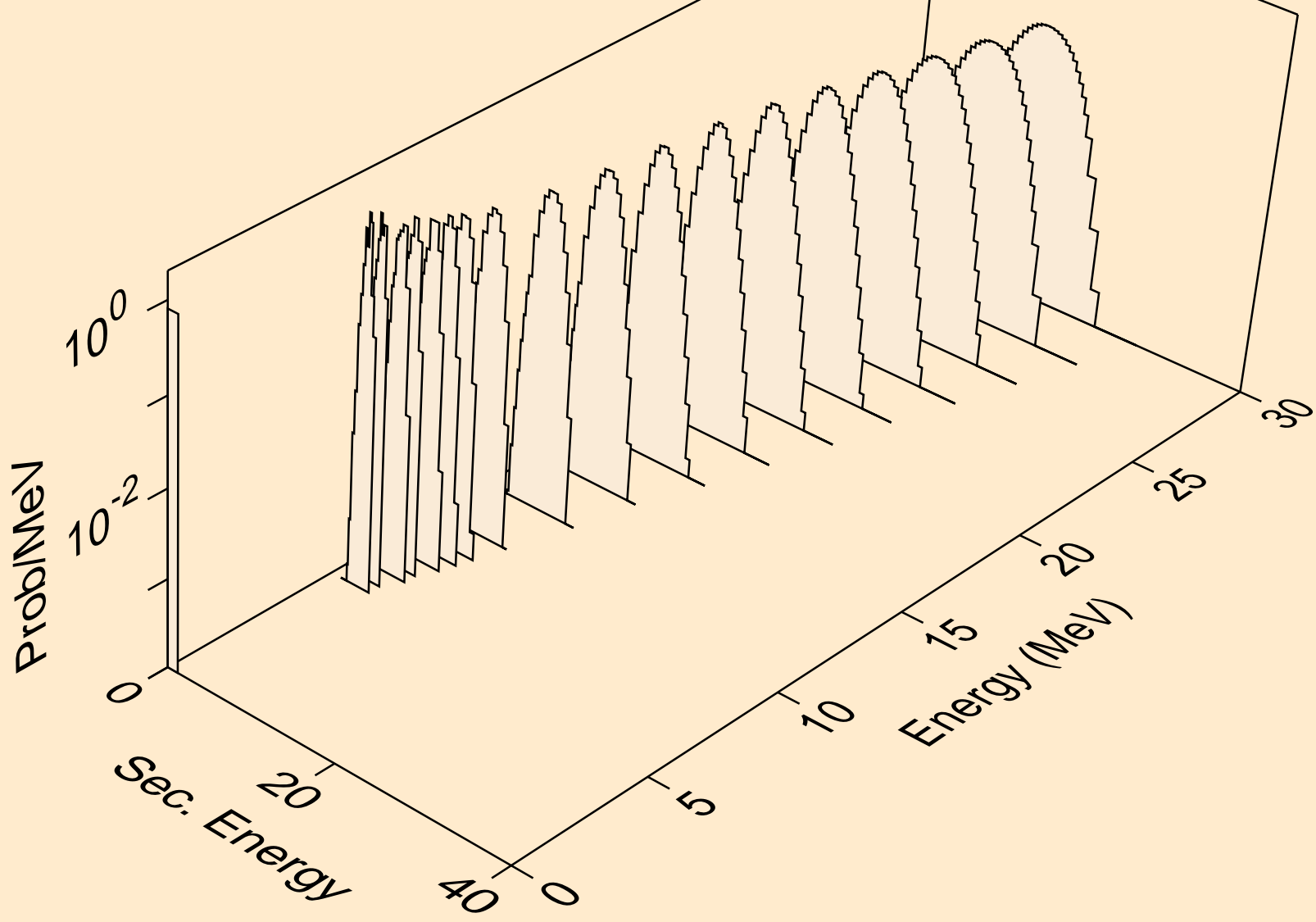

SM130 NEUTRON ACER TENDL-2023 LIBRARY; T=0.K
tritons from (n,x)

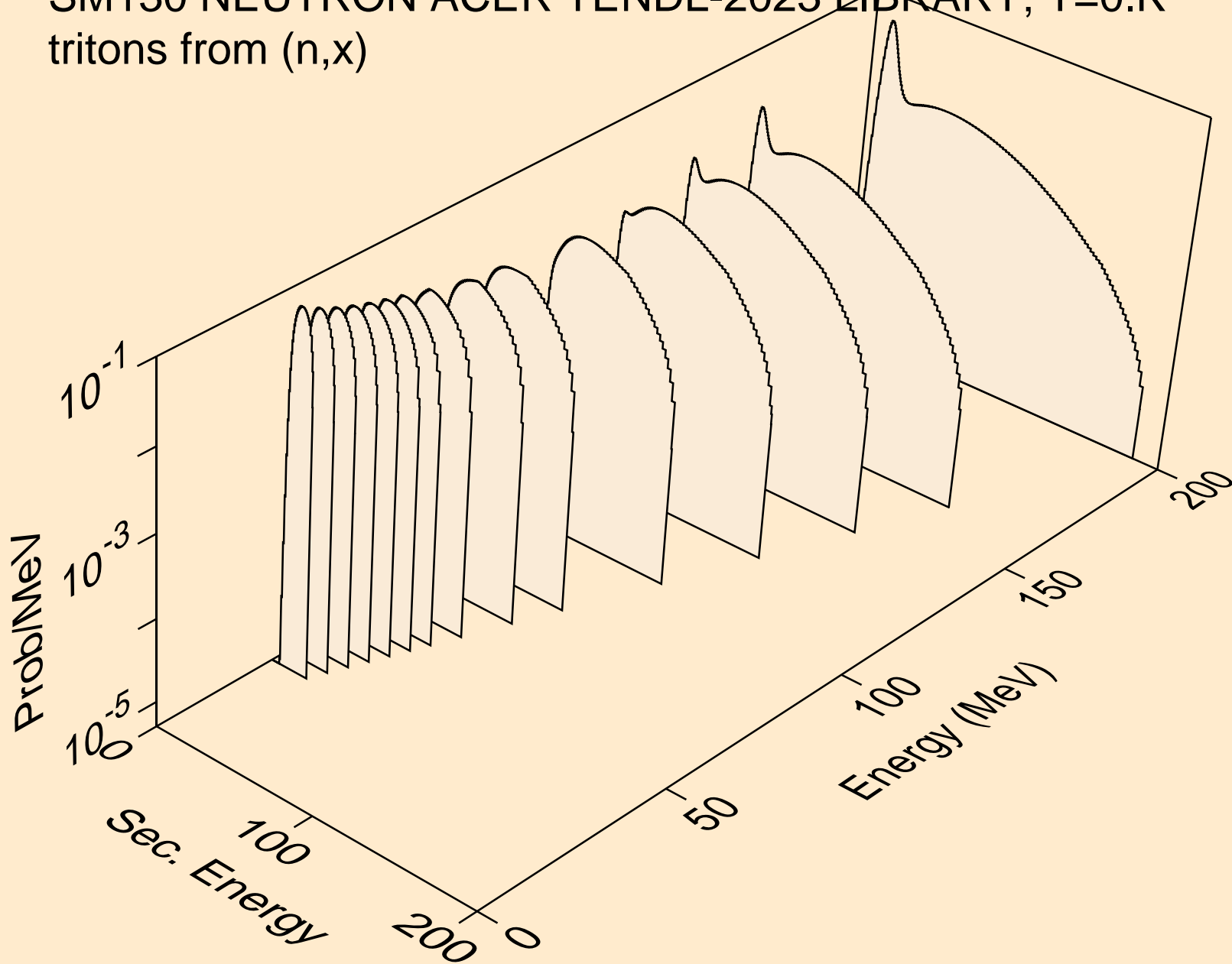

SM130 NEUTRON ACER TENDL-2023 LIBRARY; T=0.K
tritons from (n,n*)t

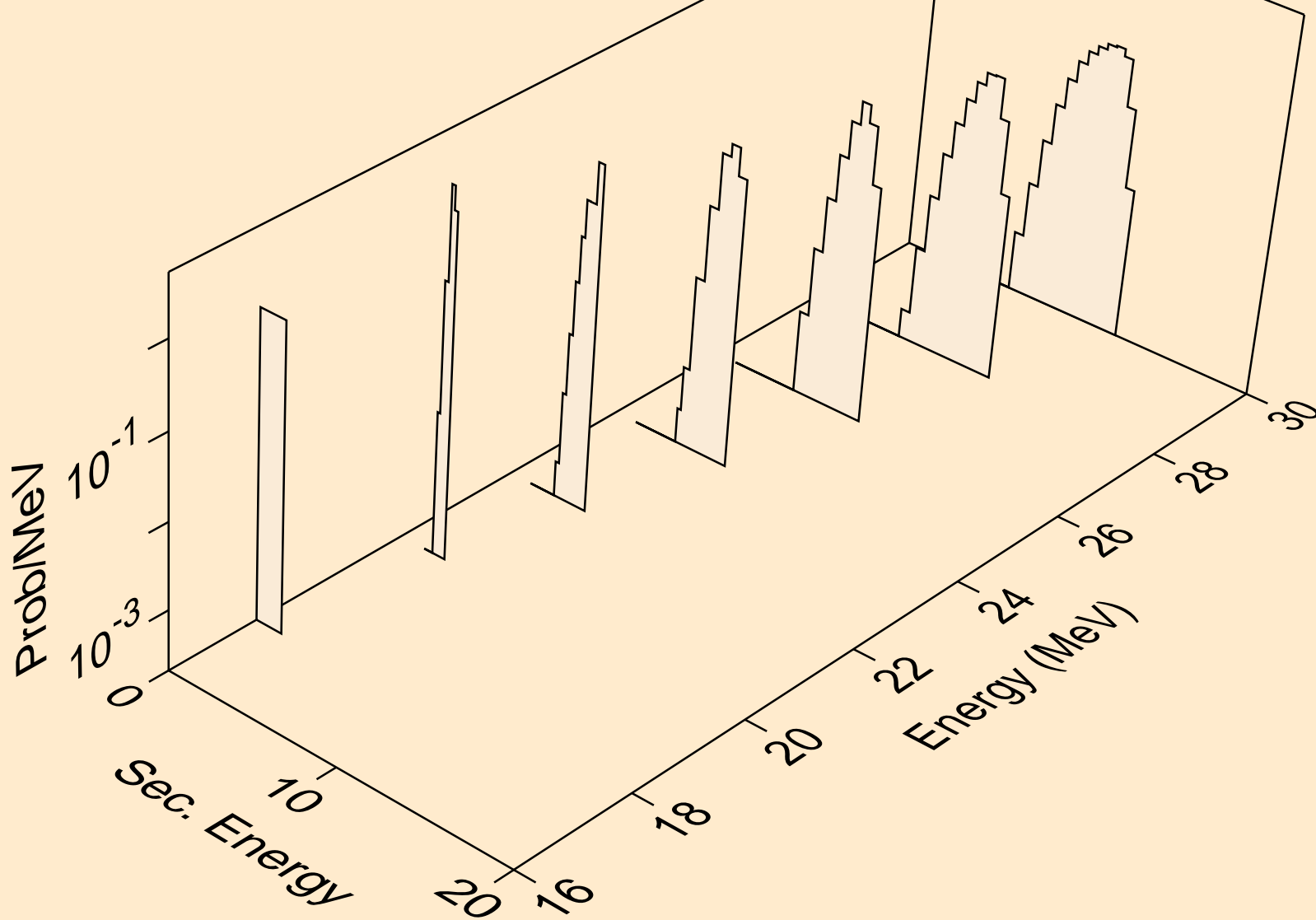

SM130 NEUTRON ACER TENDL-2023 LIBRARY; T=0.K
tritons from (n,t)

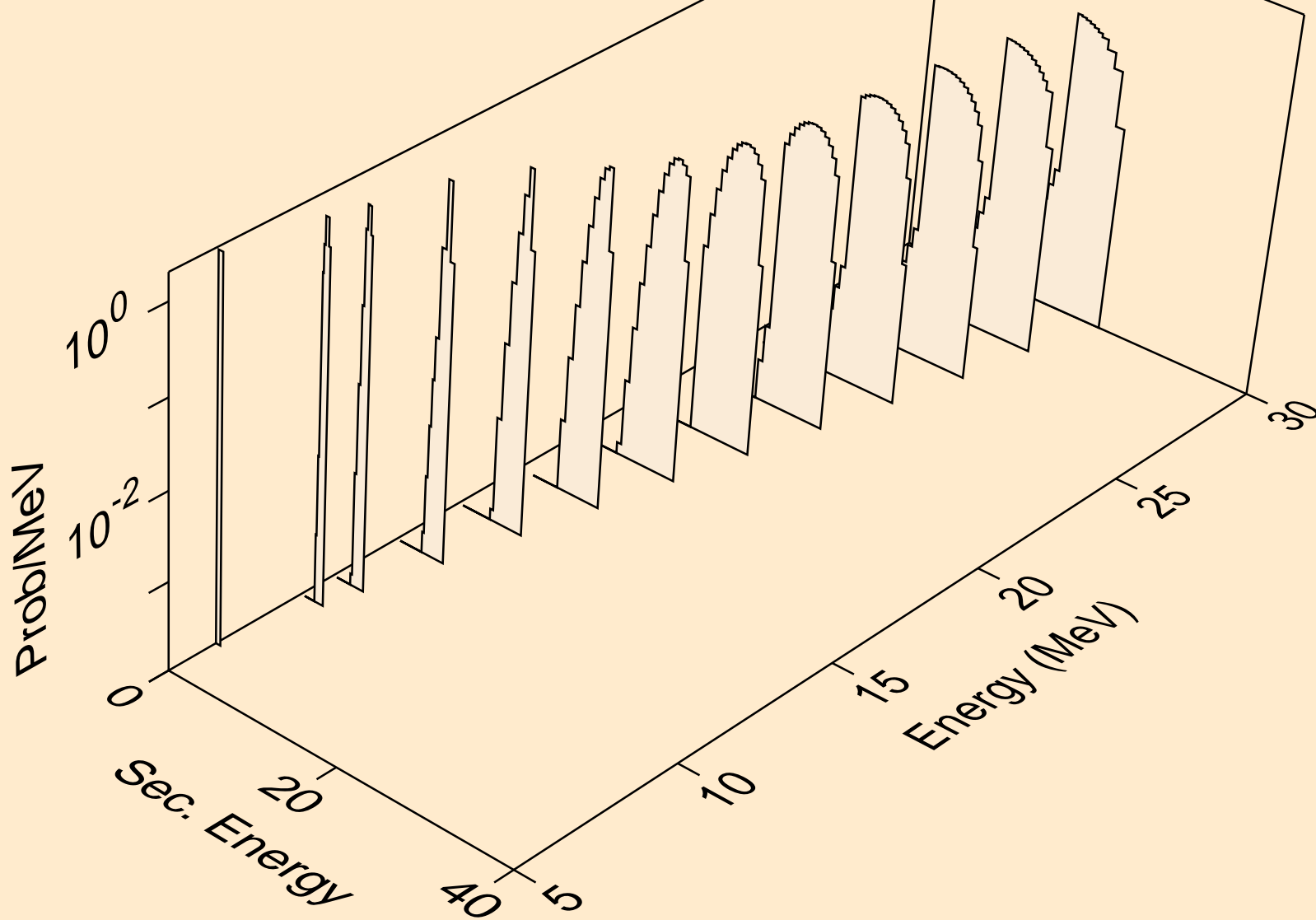

SM130 NEUTRON ACER TENDL-2023 LIBRARY; T=0.K
tritons from (n,pt)

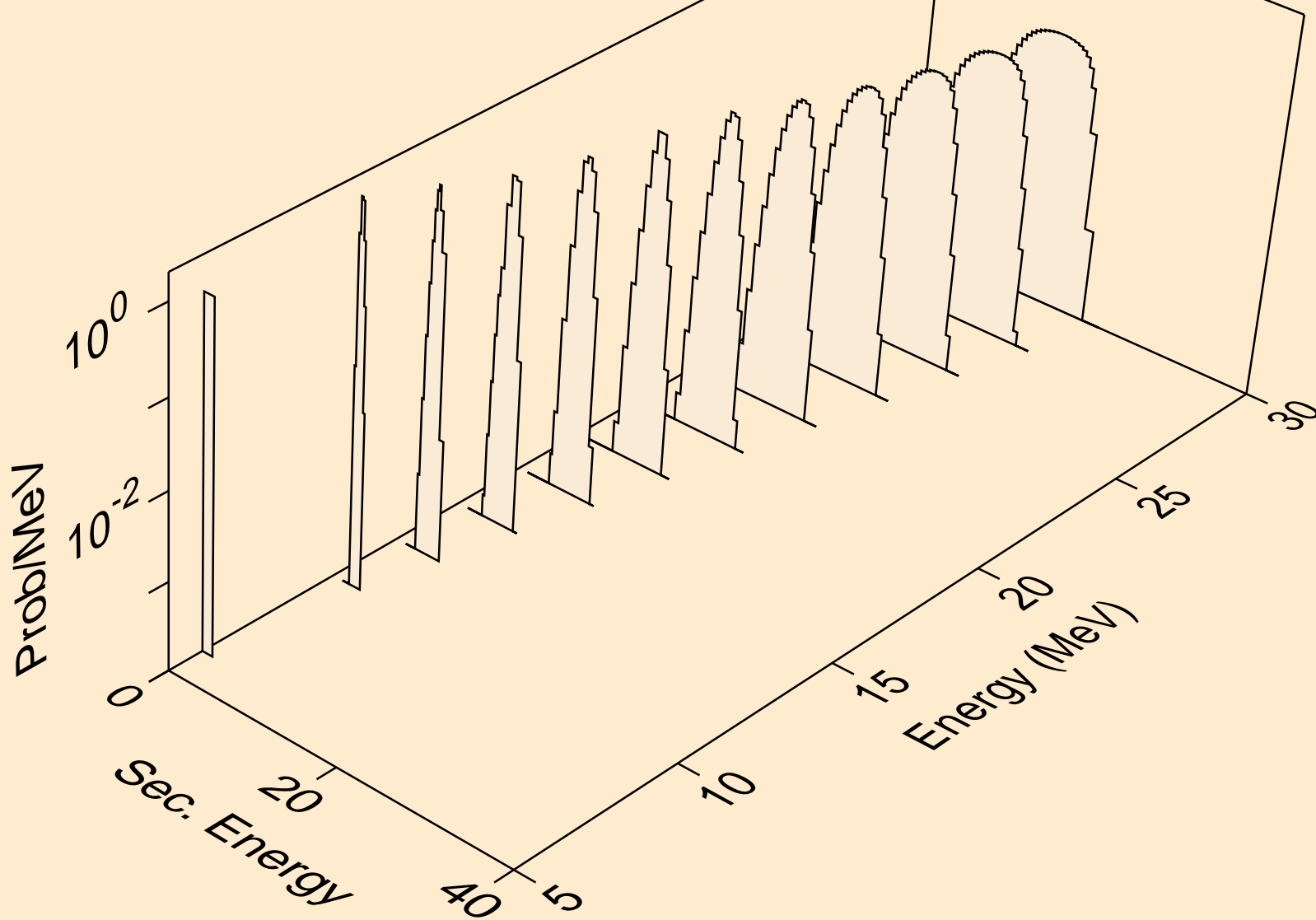

SM130 NEUTRON ACER TENDL-2023 LIBRARY; T=0.K
he3s from (n,x)

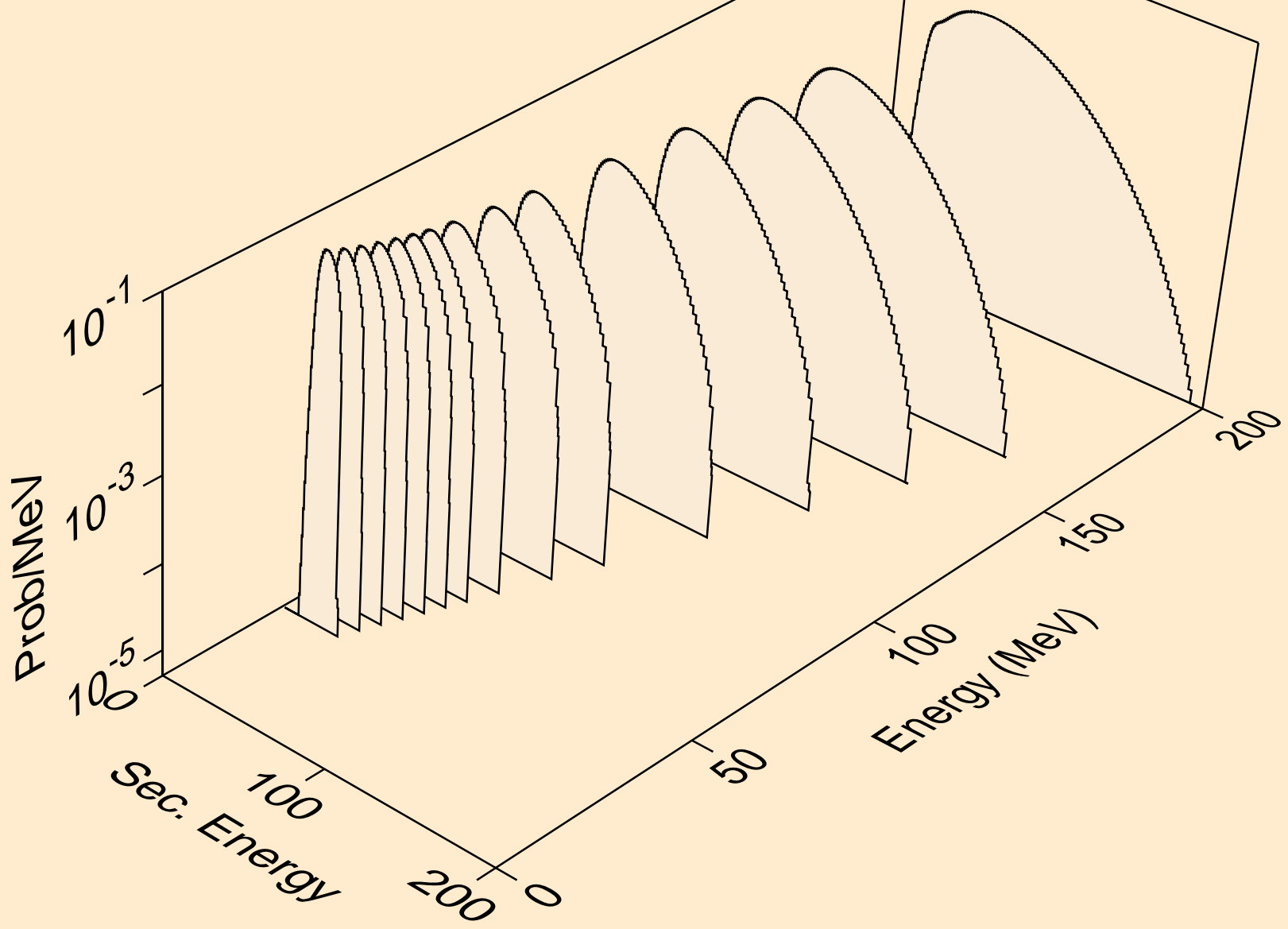

SM130 NEUTRON ACER TENDL-2023 LIBRARY; T=0.K
he3s from (n,n*)he3

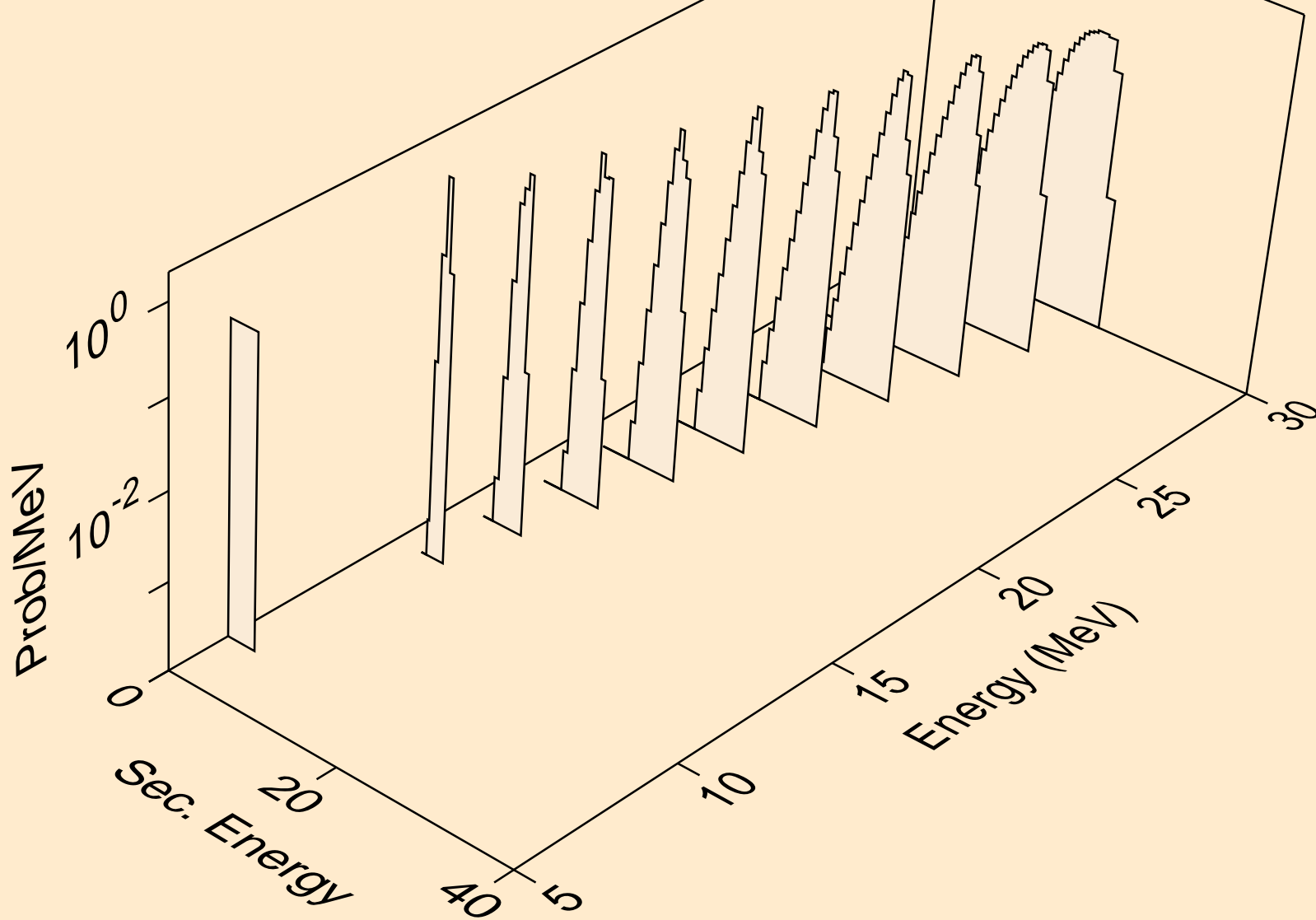

SM130 NEUTRON ACER TENDL-2023 LIBRARY; T=0.K
he3s from (n,he3)

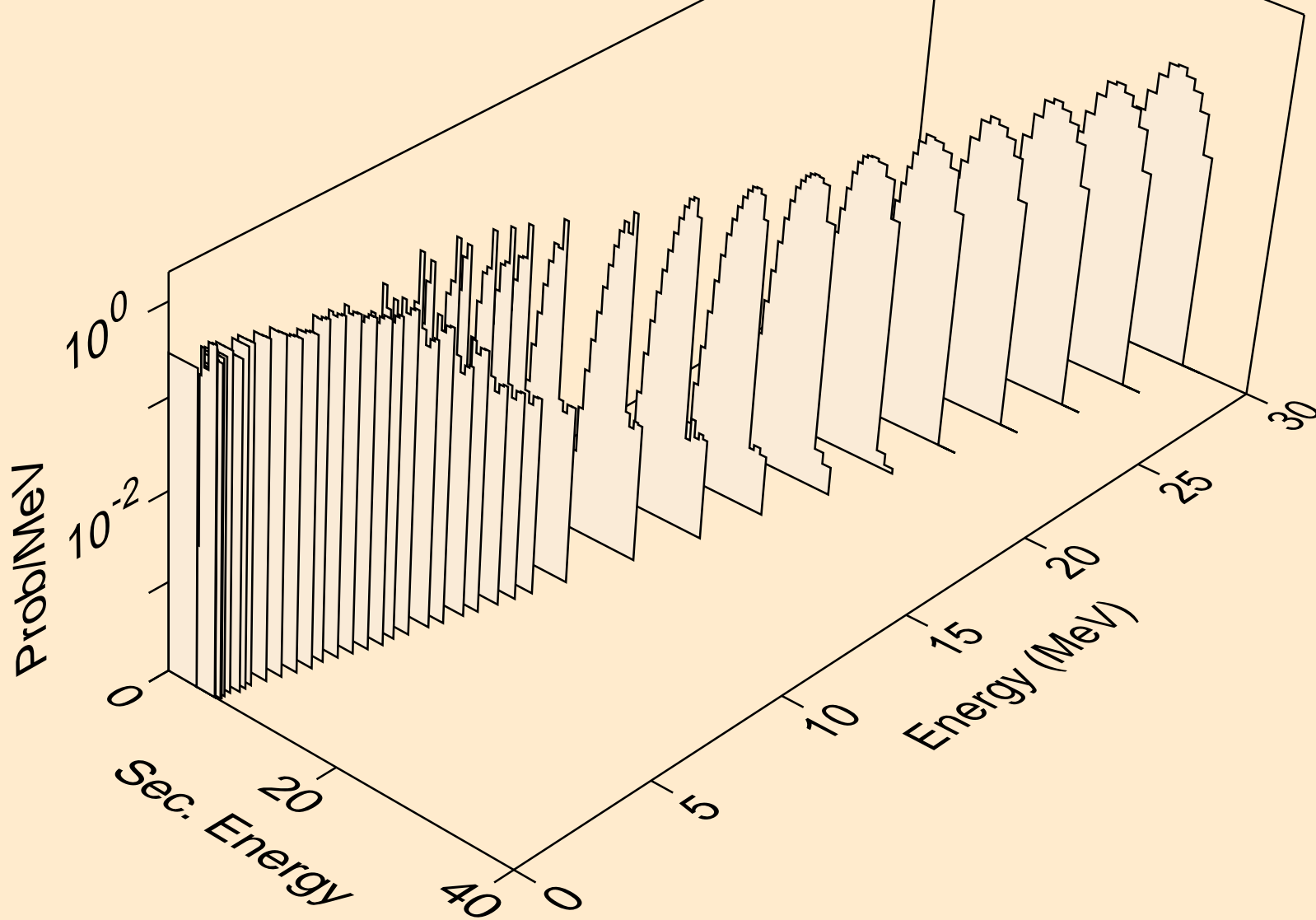

SM130 NEUTRON ACER TENDL-2023 LIBRARY; T=0.K
alphas from (n,x)

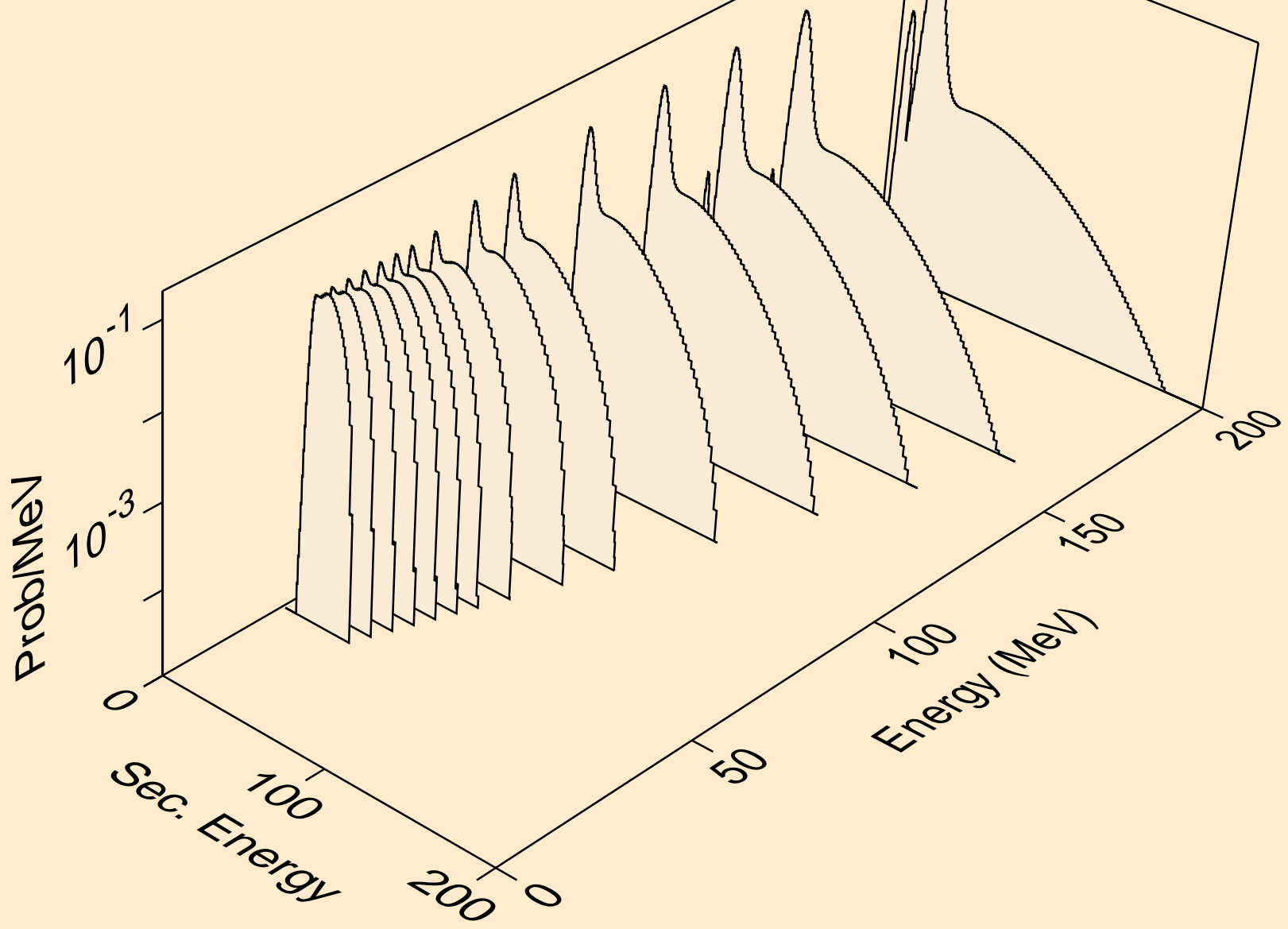

SM130 NEUTRON ACER TENDL-2023 LIBRARY; T=0.K
alphas from (n,n*)a

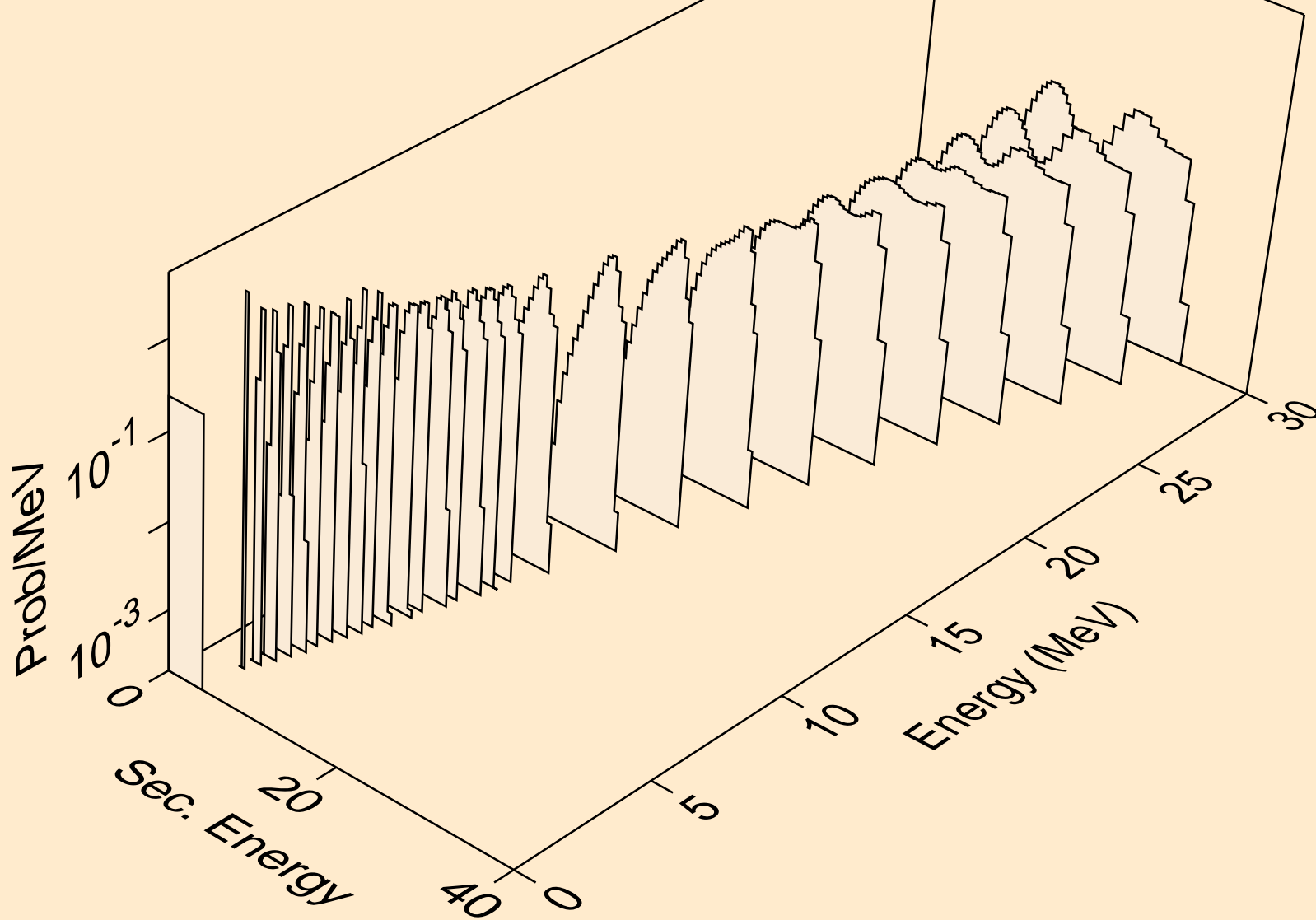

SM130 NEUTRON ACER TENDL-2023 LIBRARY; T=0.K
alphas from (n,2n)a

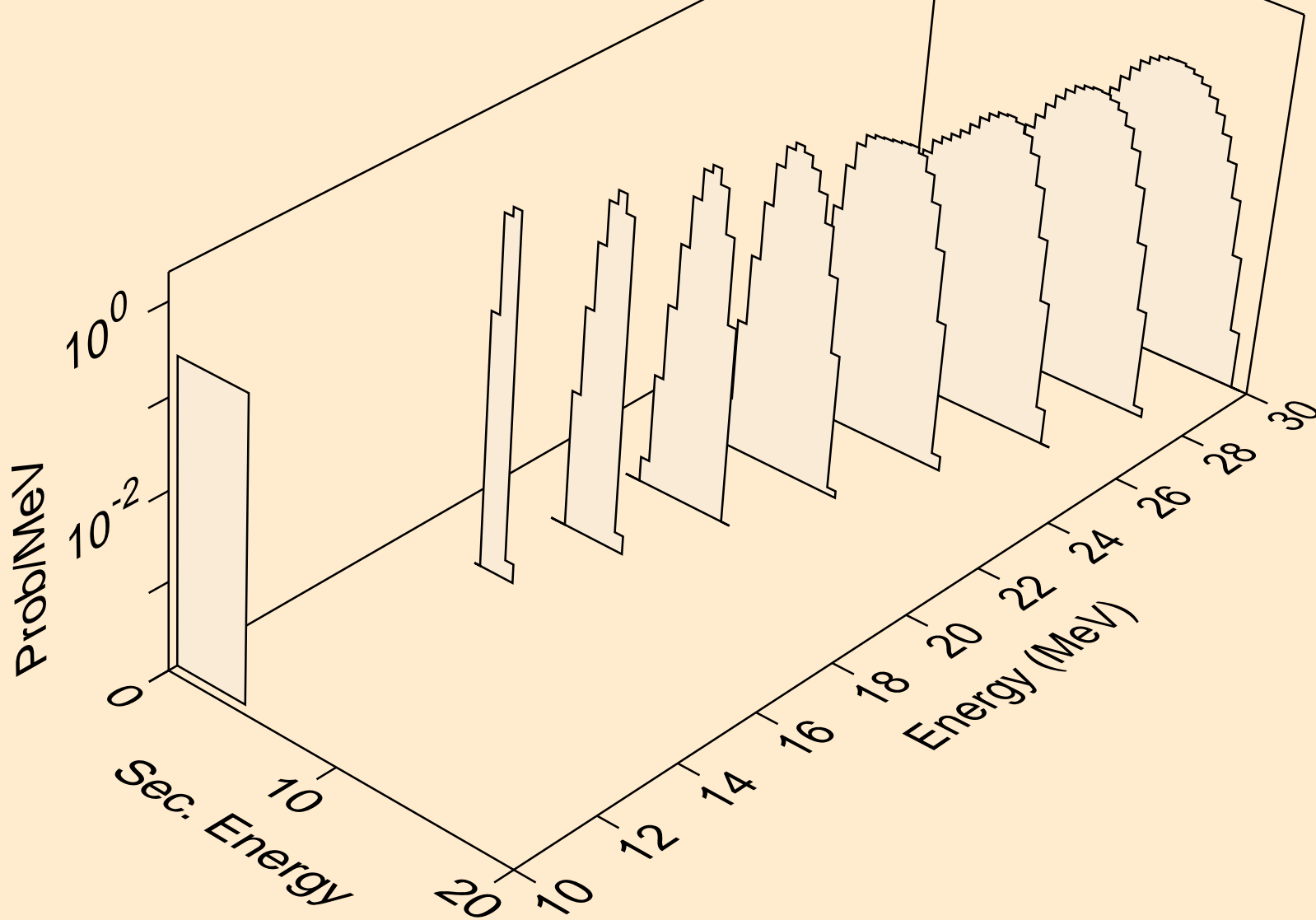

SM130 NEUTRON ACER TENDL-2023 LIBRARY; T=0.K
alphas from (n,n*)2a

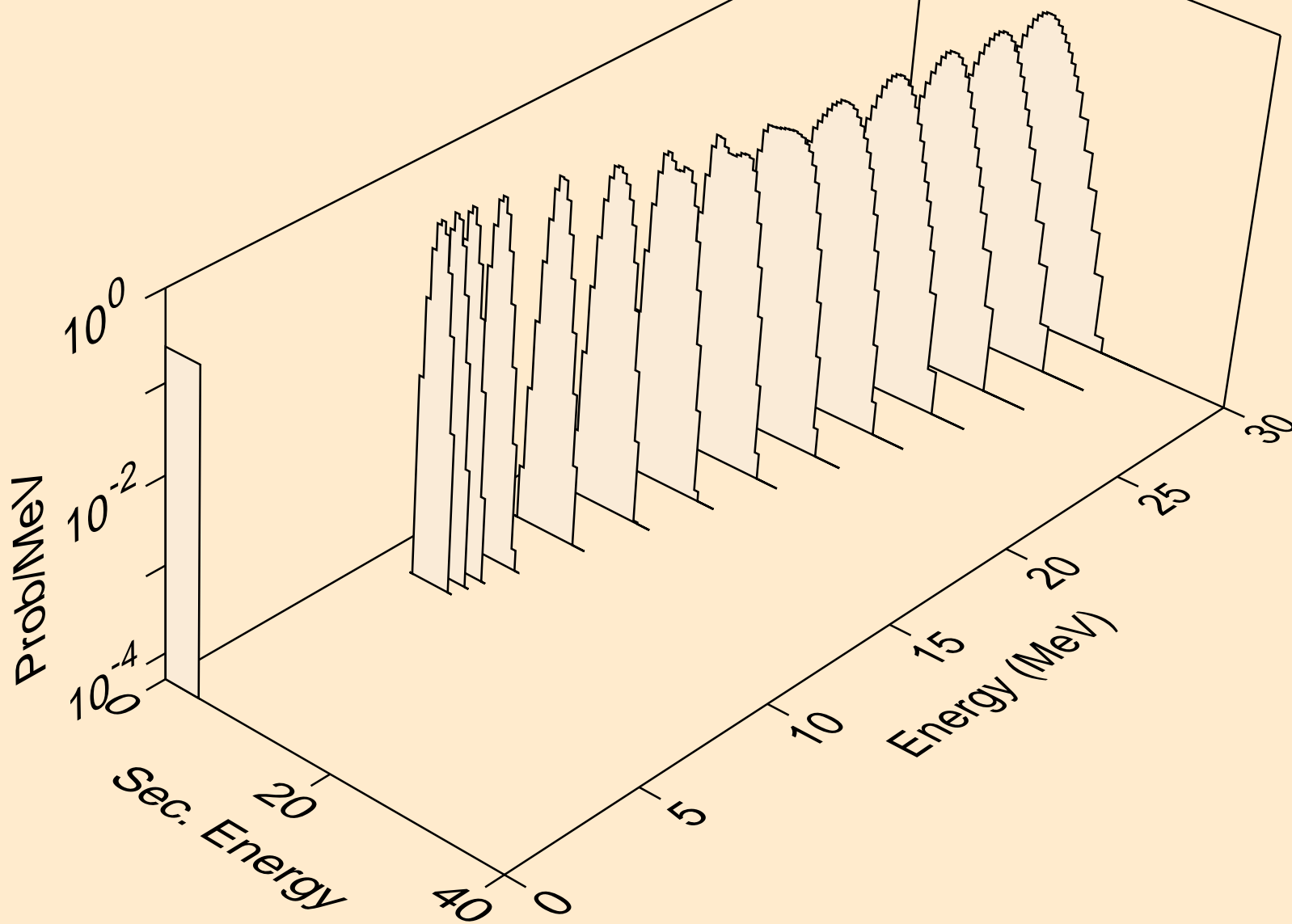

SM130 NEUTRON ACER TENDL-2023 LIBRARY; T=0.K
alphas from (n,npa)

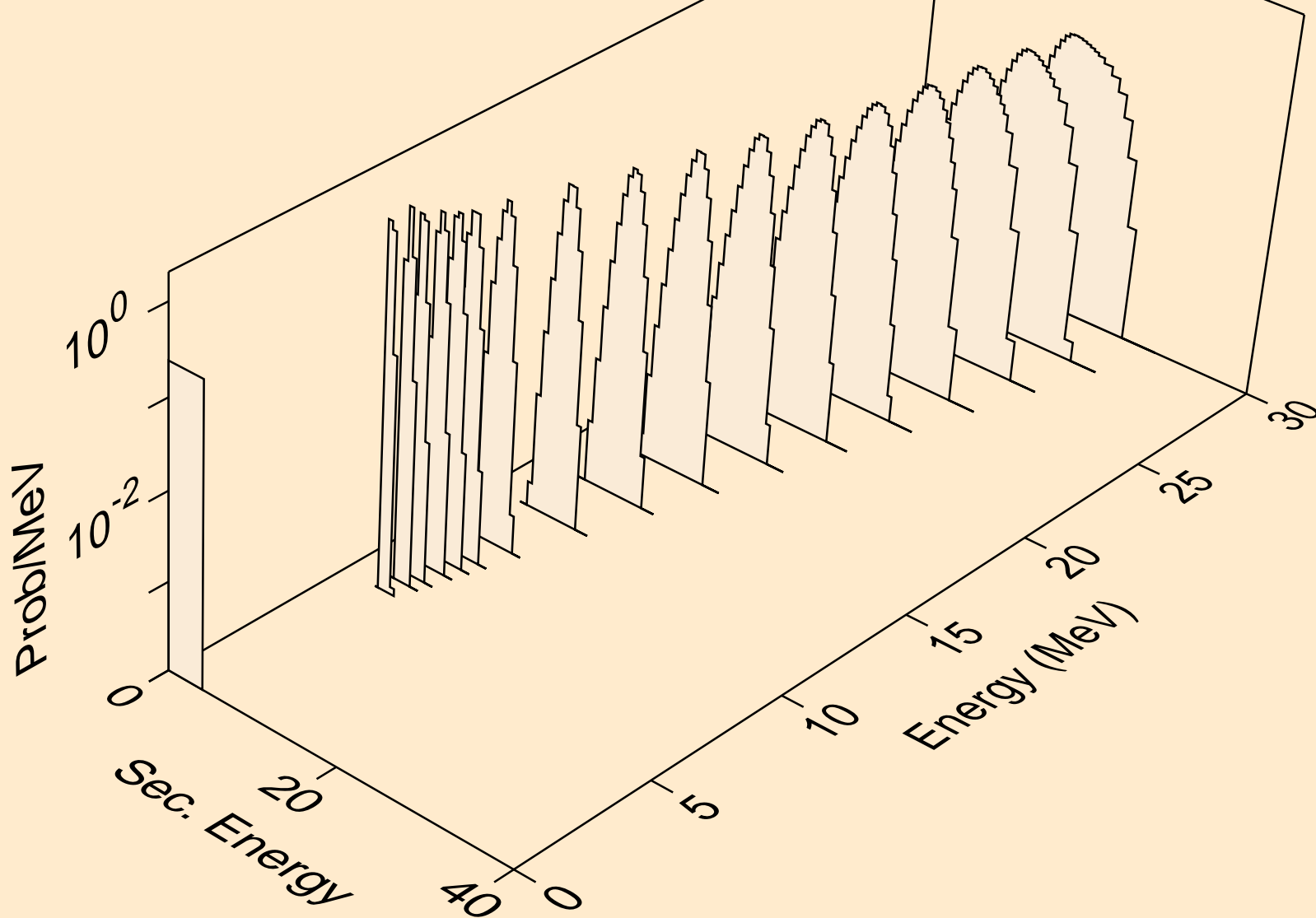

SM130 NEUTRON ACER TENDL-2023 LIBRARY; T=0.K
alphas from (n,a)

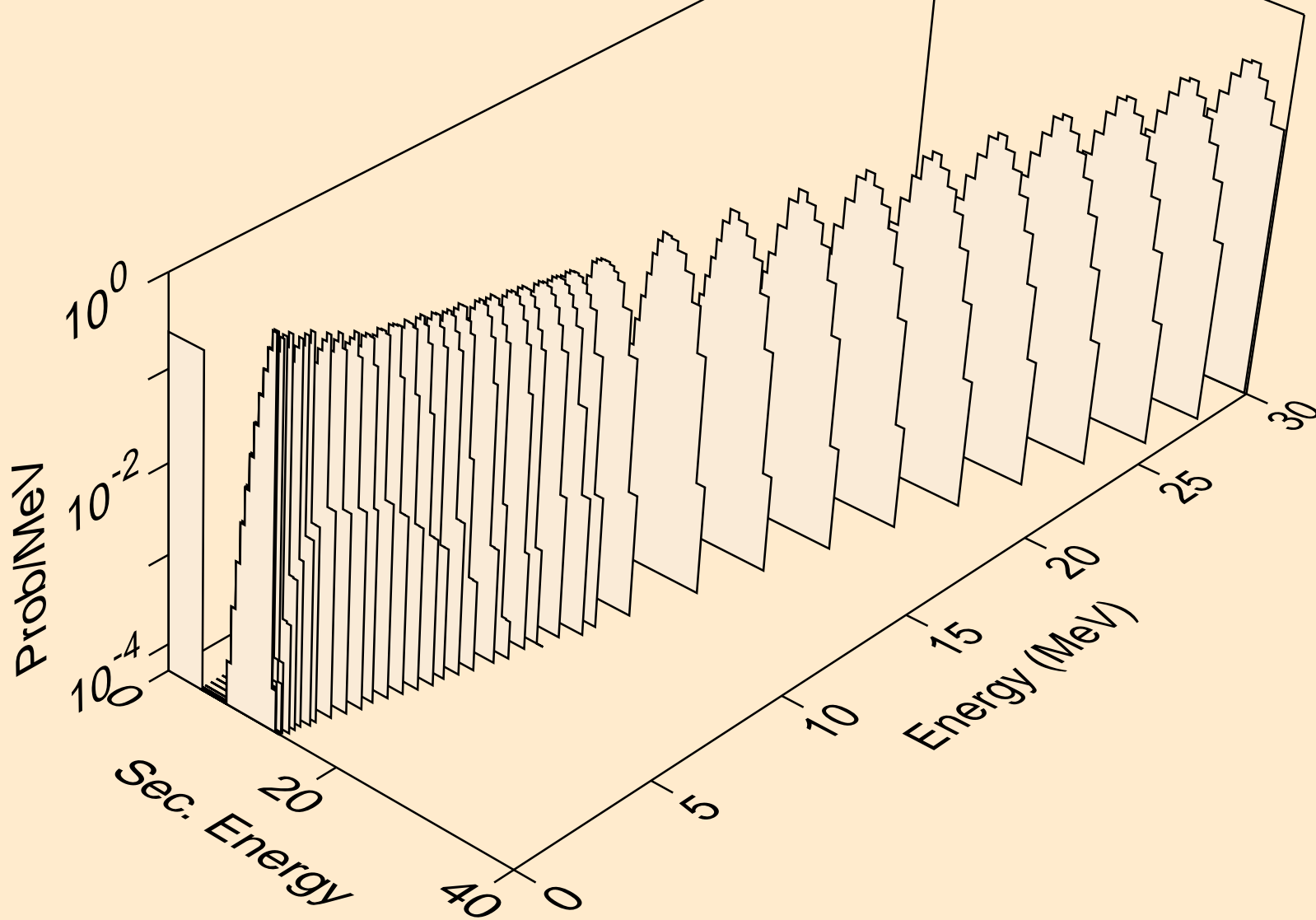

SM130 NEUTRON ACER TENDL-2023 LIBRARY; T=0.K
alphas from (n,2a)

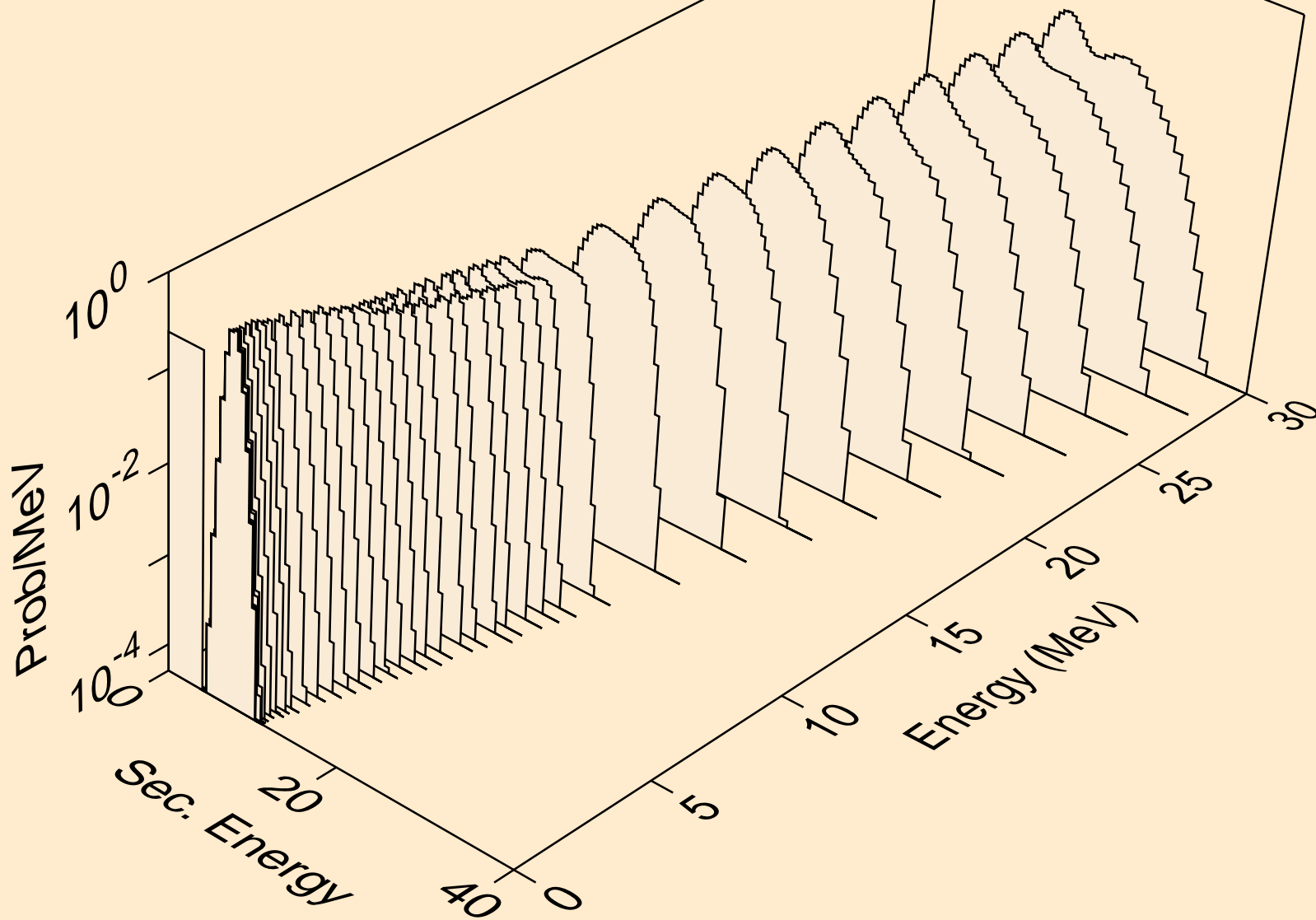

SM130 NEUTRON ACER TENDL-2023 LIBRARY; T=0.K
alphas from (n,3a)

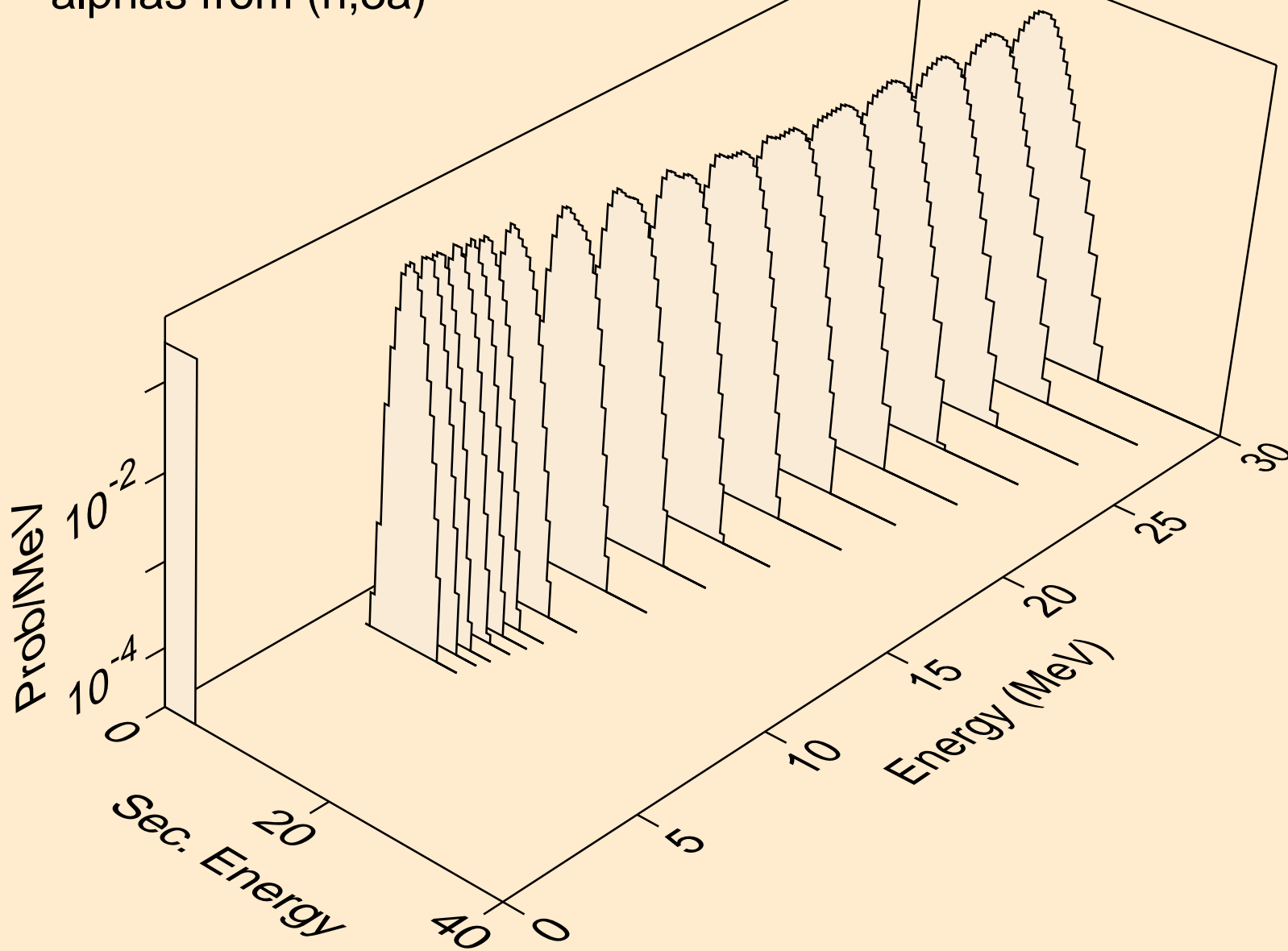

SM130 NEUTRON ACER TENDL-2023 LIBRARY; T=0.K
alphas from (n,pa)

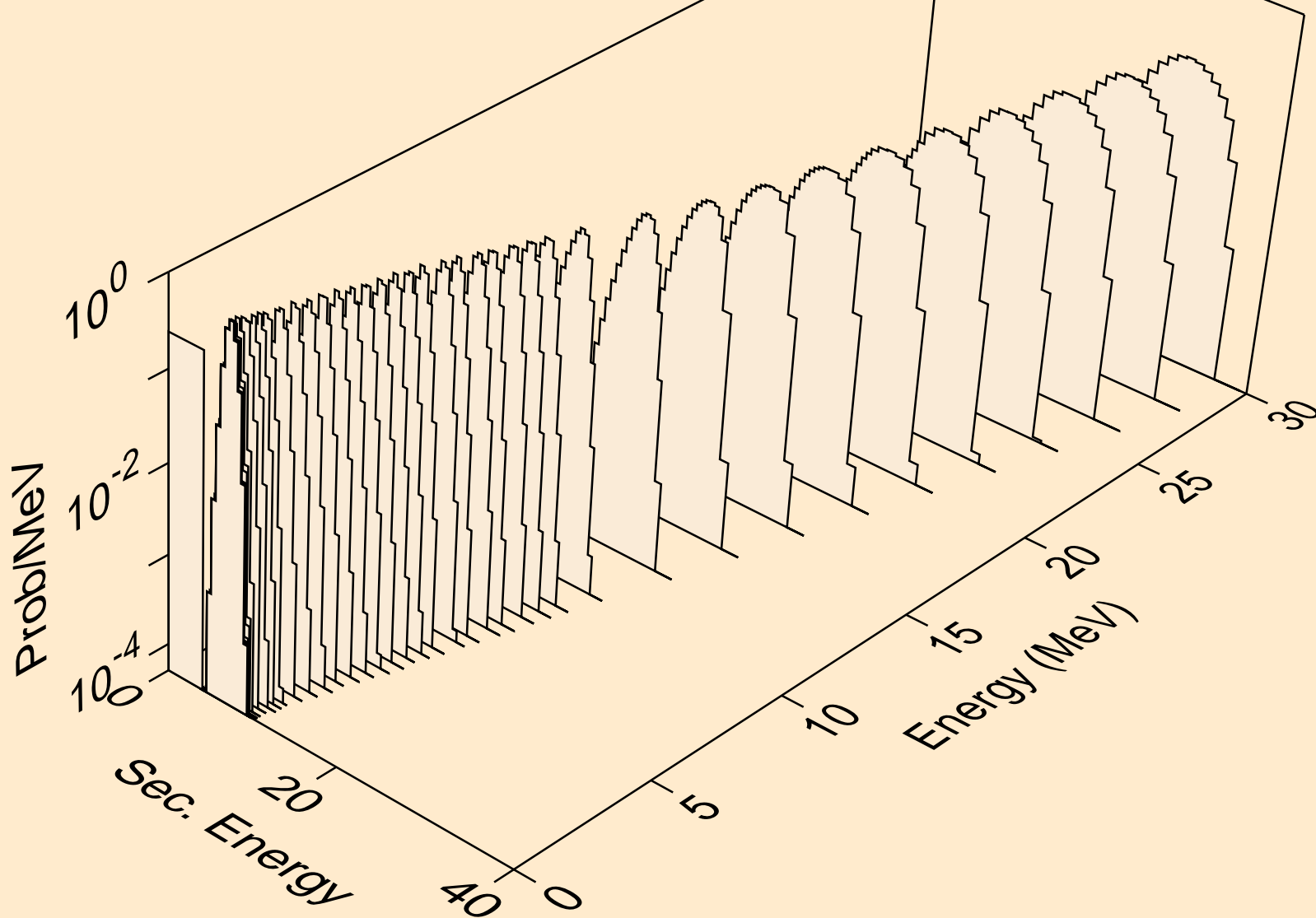

SM130 NEUTRON ACER TENDL-2023 LIBRARY; T=0.K
alphas from (n,da)

