

# SM146 NEUTRON ACER TENDL-2023 LIBRARY; T=0.K

## Principal cross sections

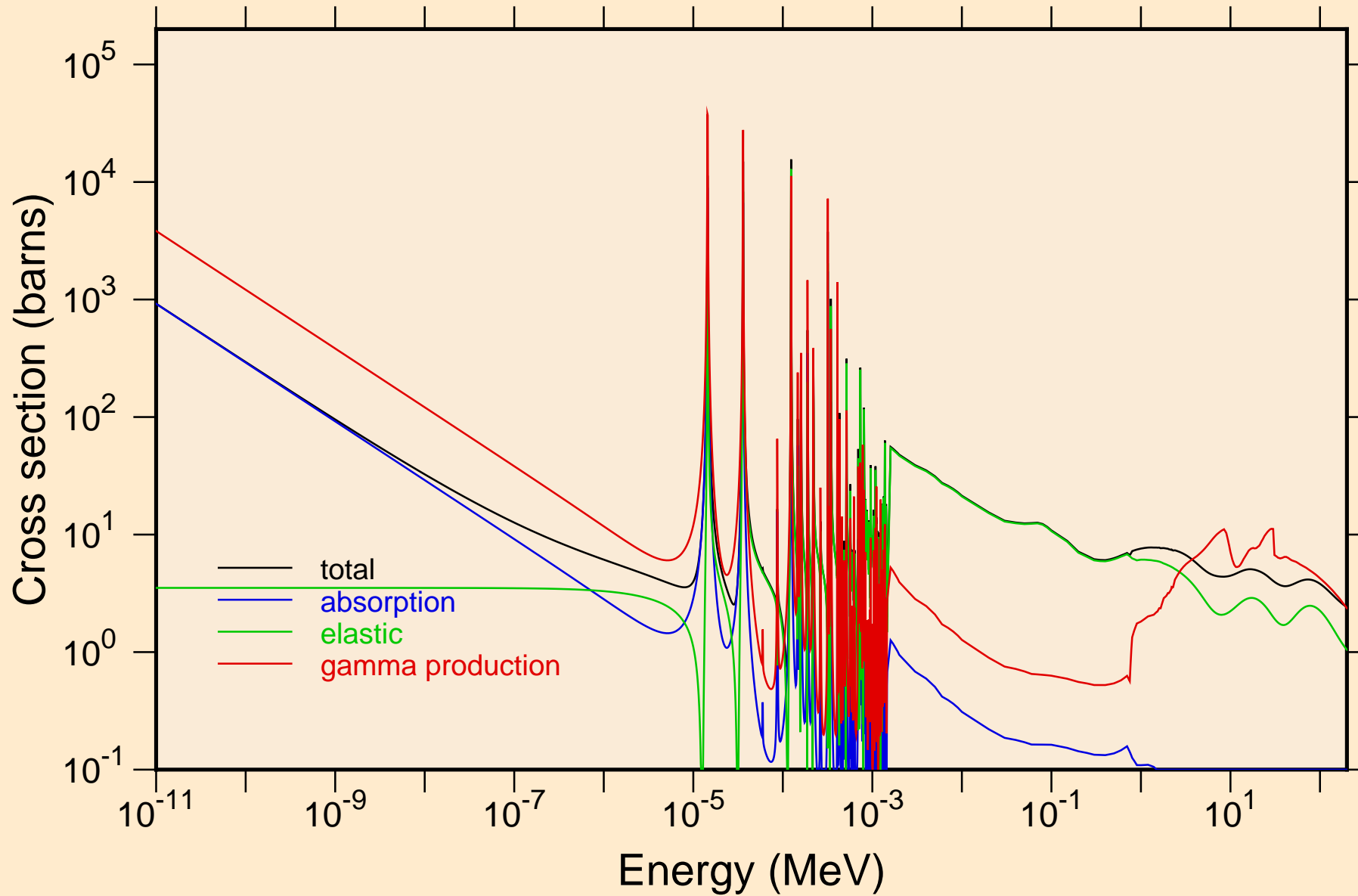

SM146 NEUTRON ACER TENDL-2023 LIBRARY; T=0.K  
resonance total cross section

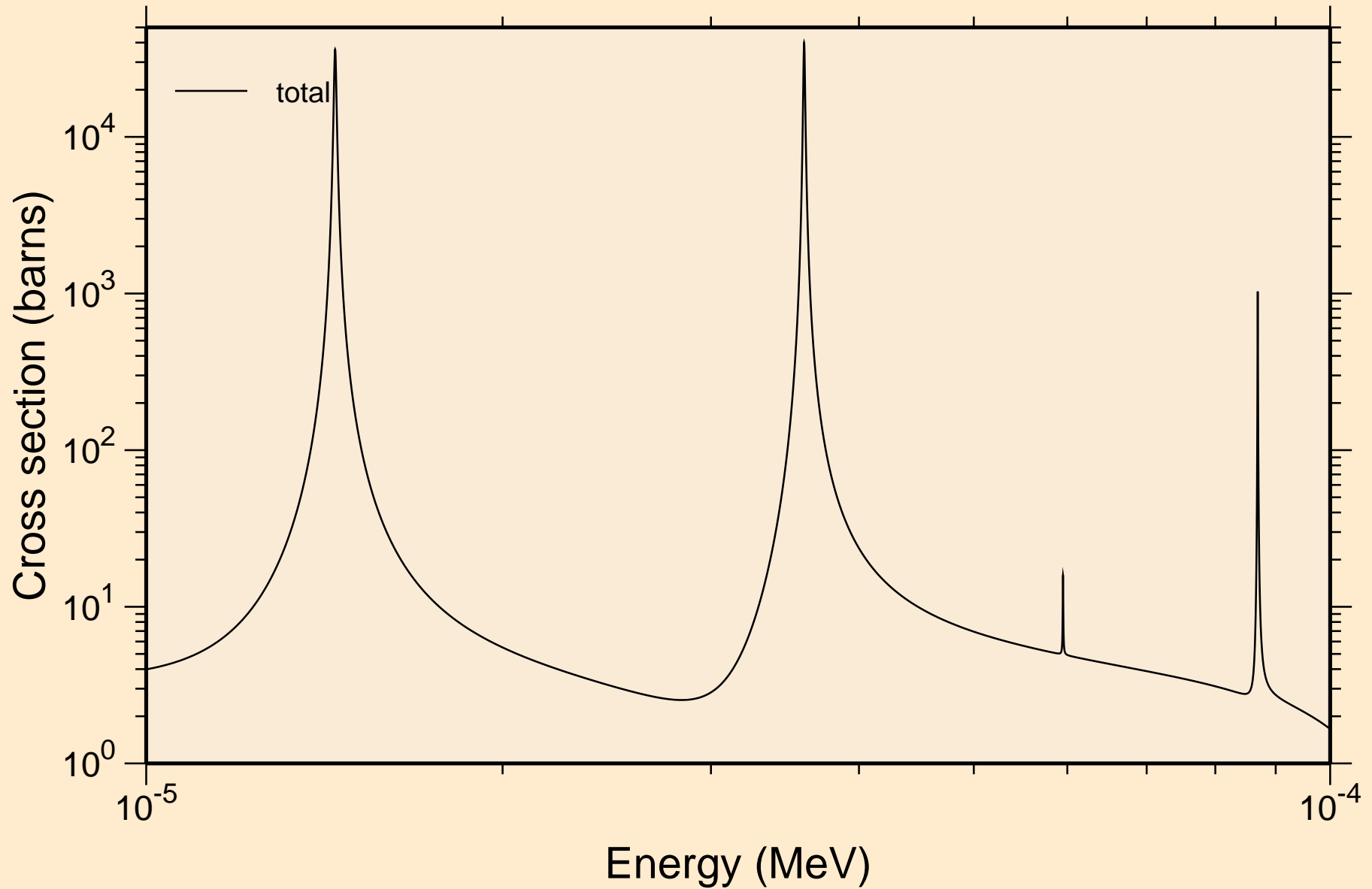

SM146 NEUTRON ACER TENDL-2023 LIBRARY; T=0.K  
resonance total cross section

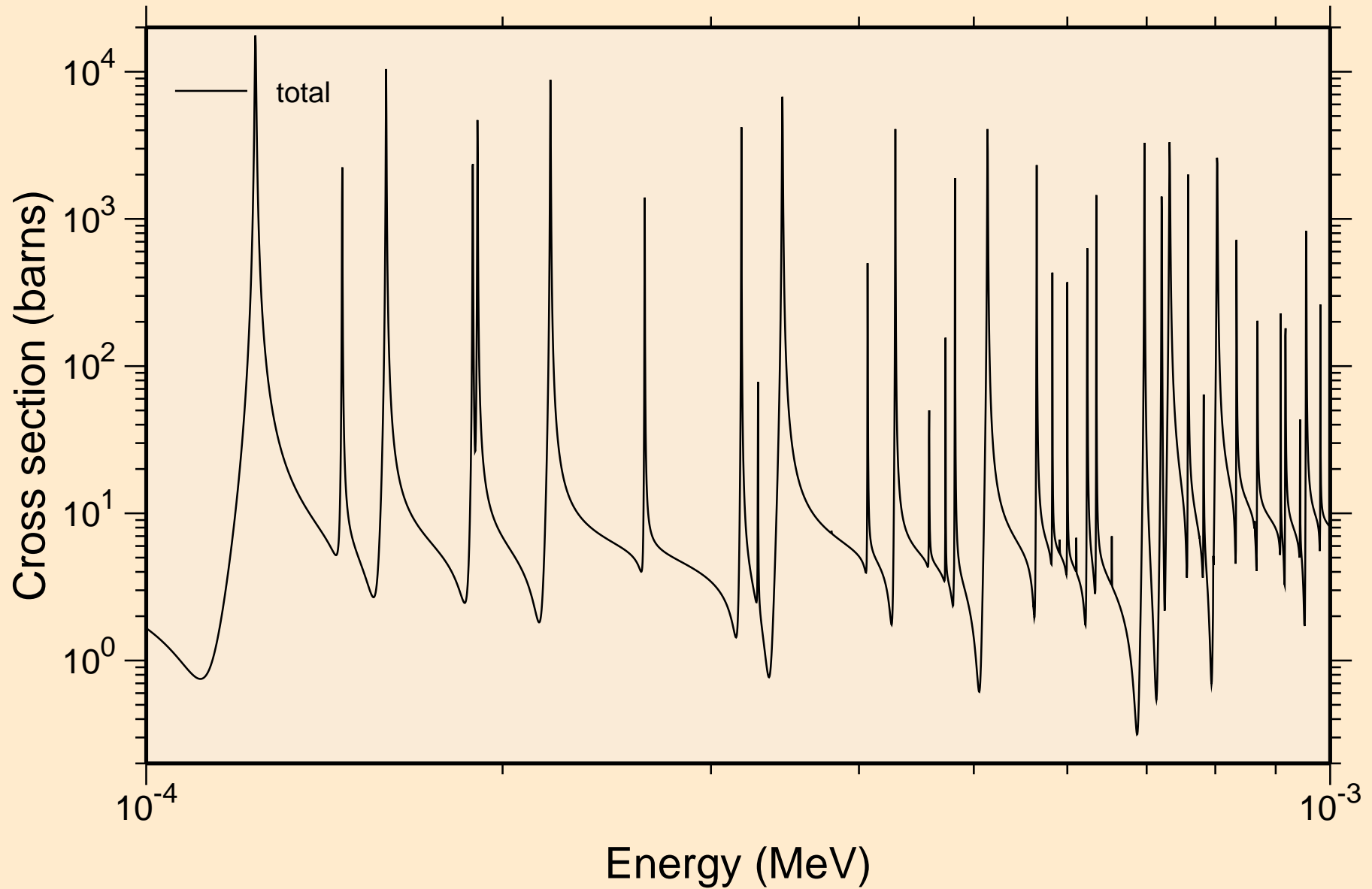

SM146 NEUTRON ACER TENDL-2023 LIBRARY; T=0.K  
resonance total cross section

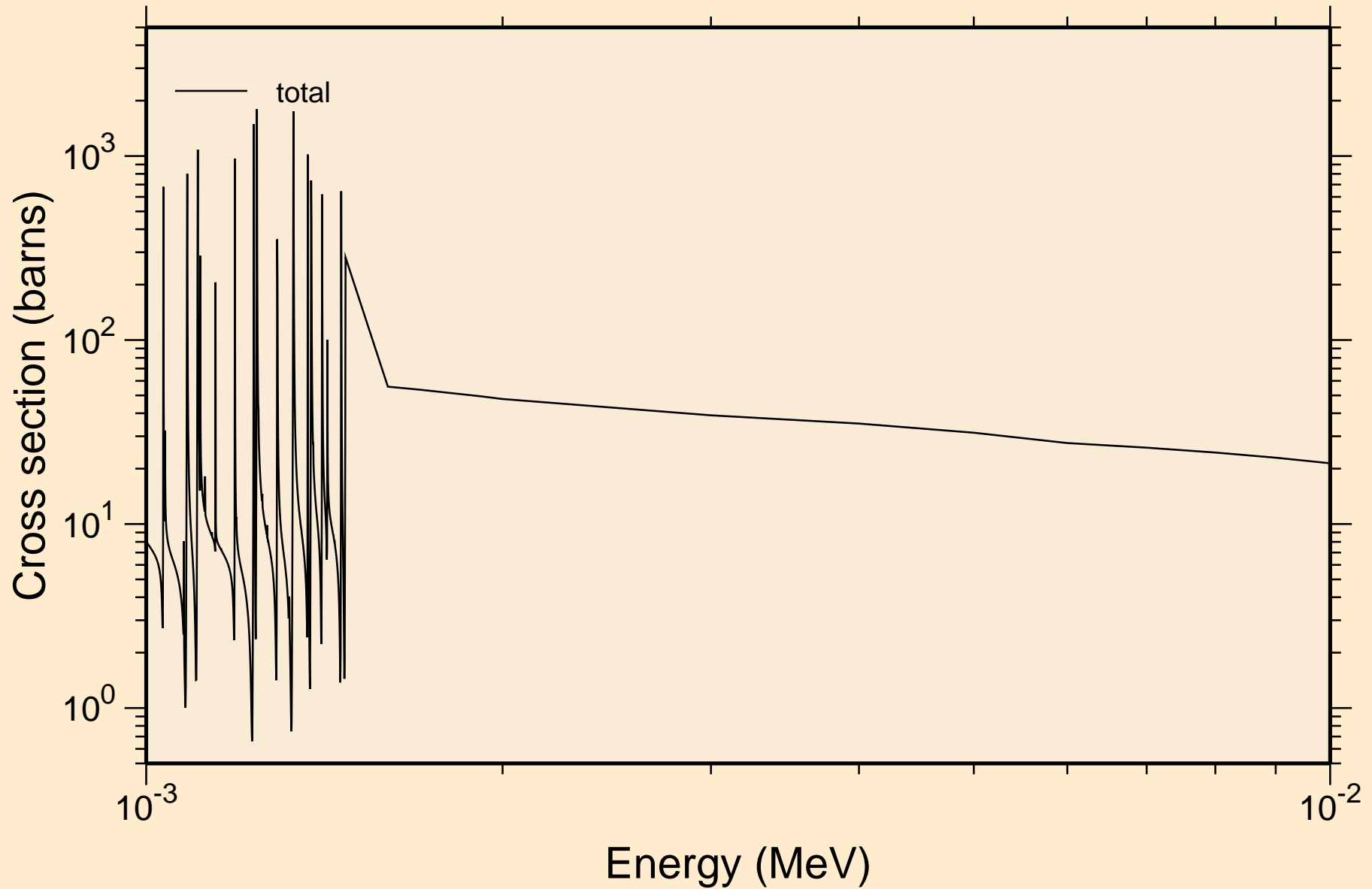

SM146 NEUTRON ACER TENDL-2023 LIBRARY; T=0.K  
resonance total cross section

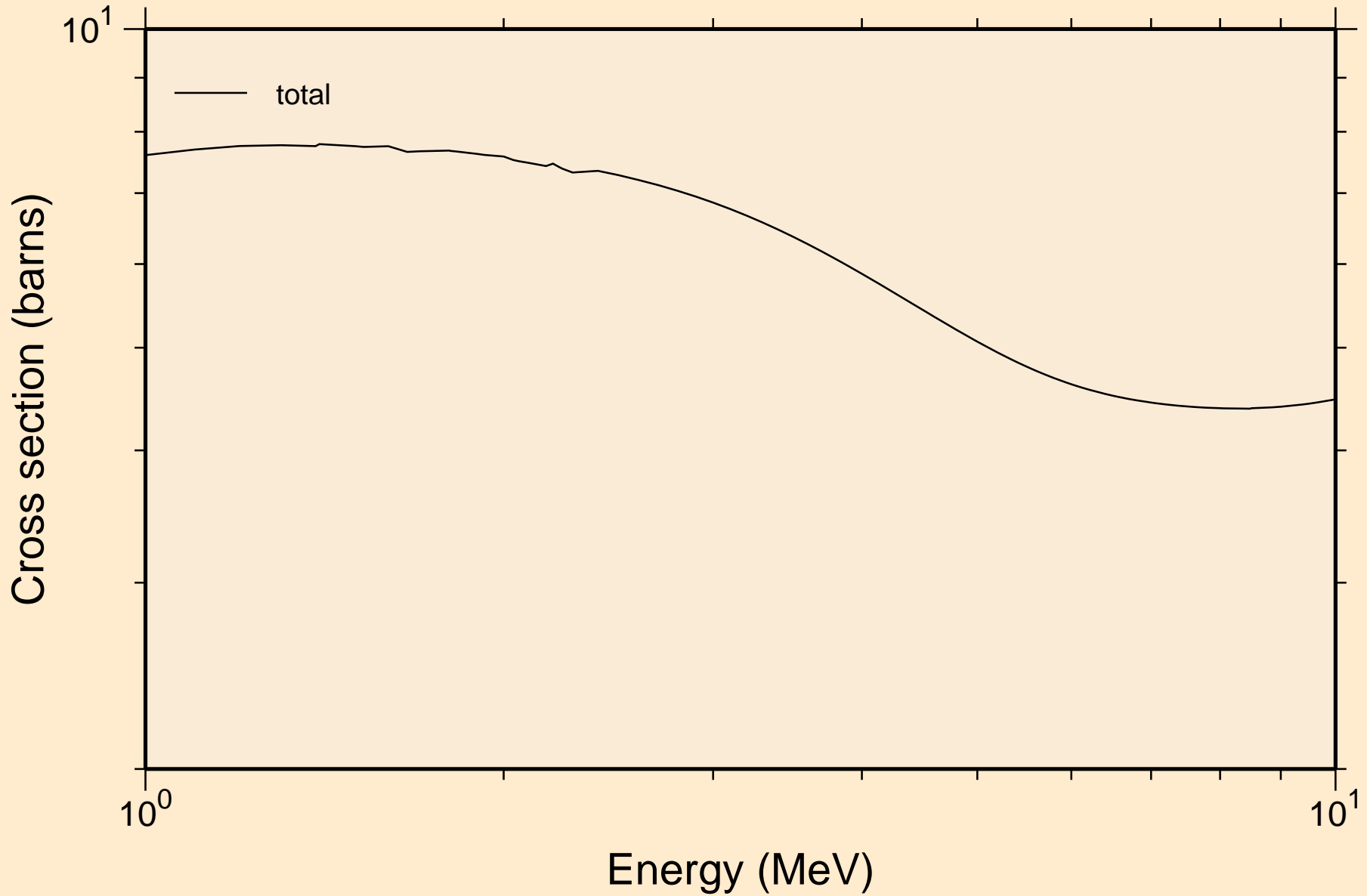

SM146 NEUTRON ACER TENDL-2023 LIBRARY; T=0.K  
resonance absorption cross sections

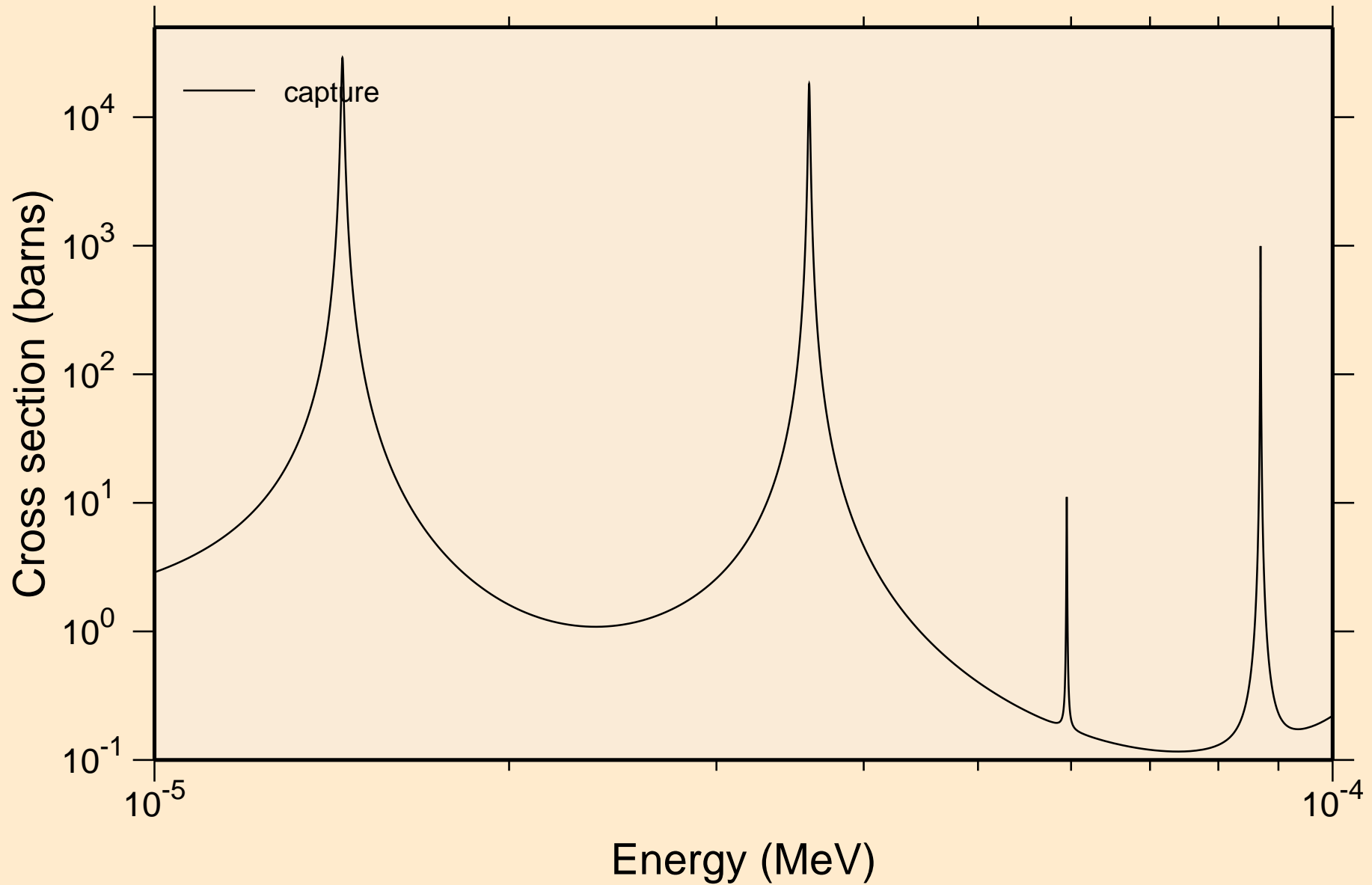

SM146 NEUTRON ACER TENDL-2023 LIBRARY; T=0.K  
resonance absorption cross sections

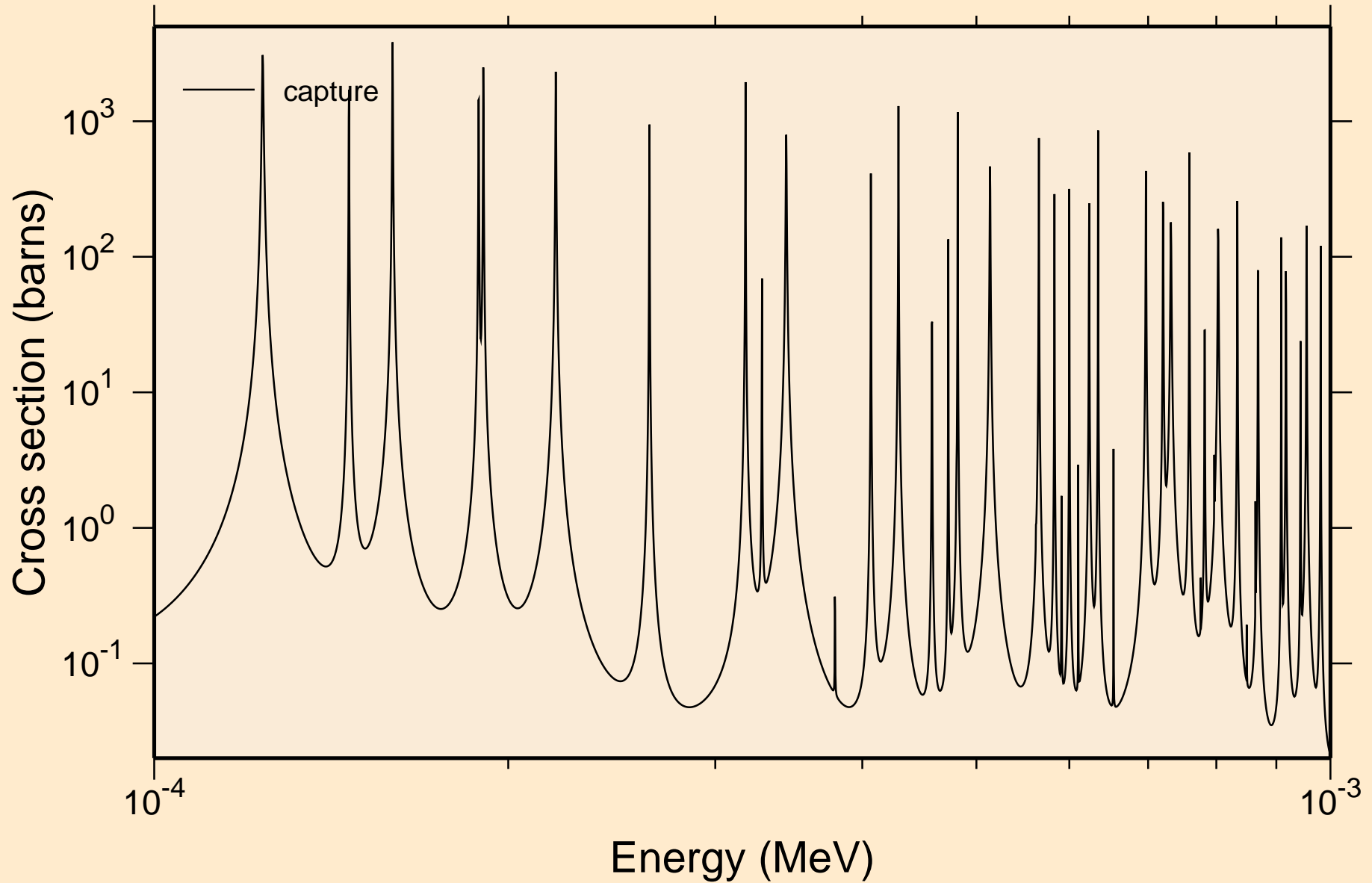

SM146 NEUTRON ACER TENDL-2023 LIBRARY; T=0.K  
resonance absorption cross sections

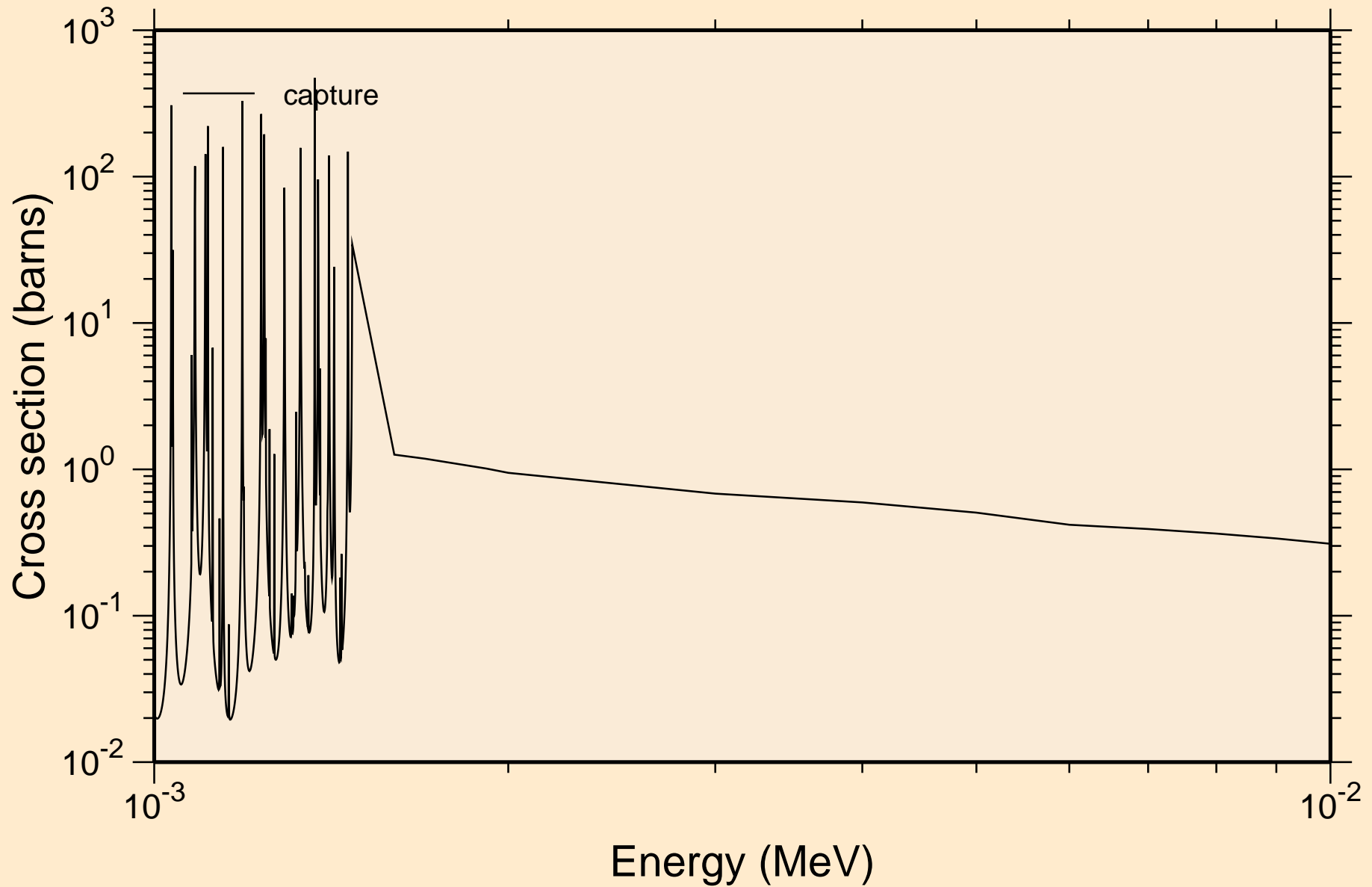



SM146 NEUTRON ACER TENDL-2023 LIBRARY; T=0.K  
resonance absorption cross sections

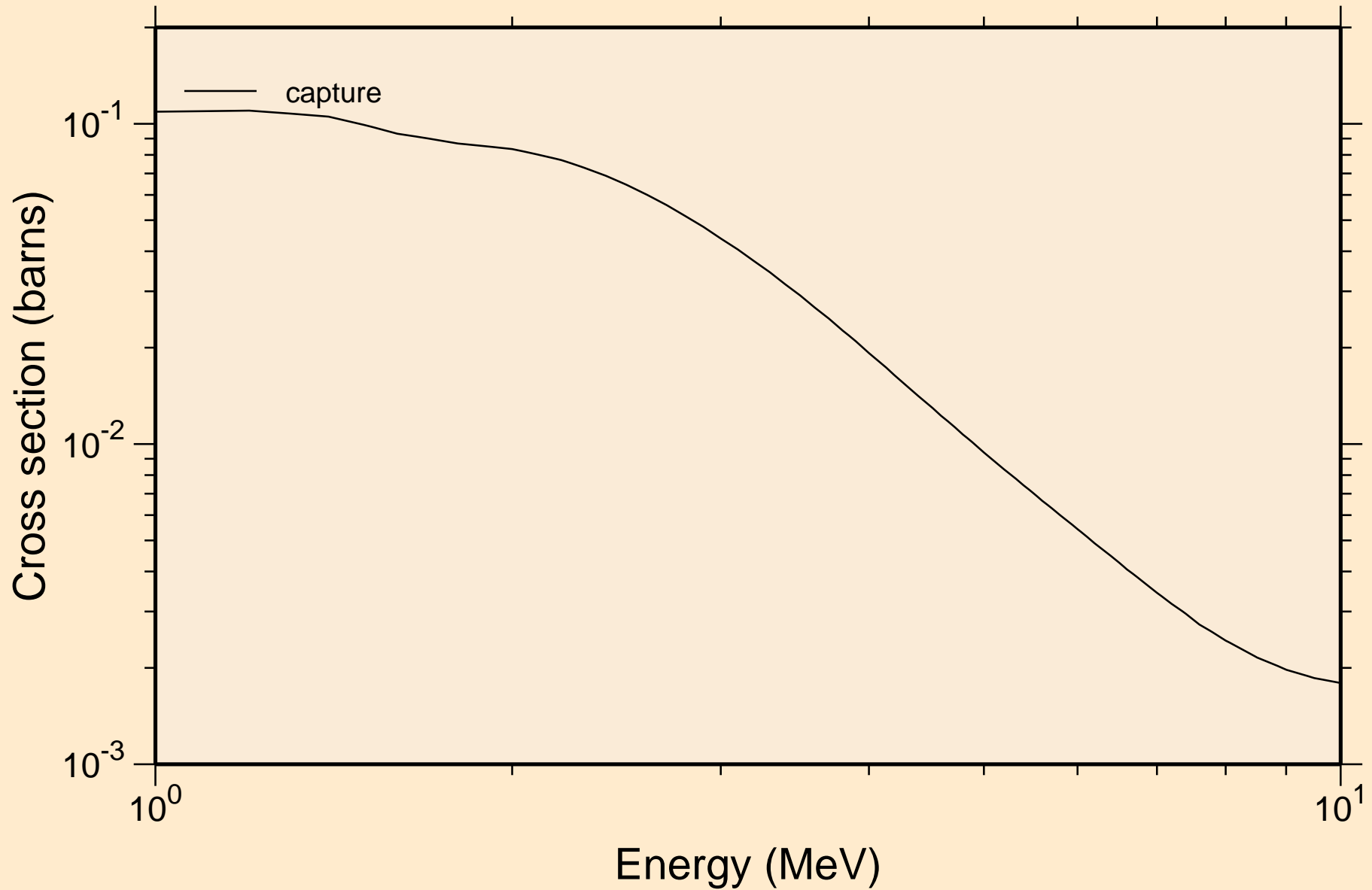

# SM146 NEUTRON ACER TENDL-2023 LIBRARY; T=0.K

## Heating

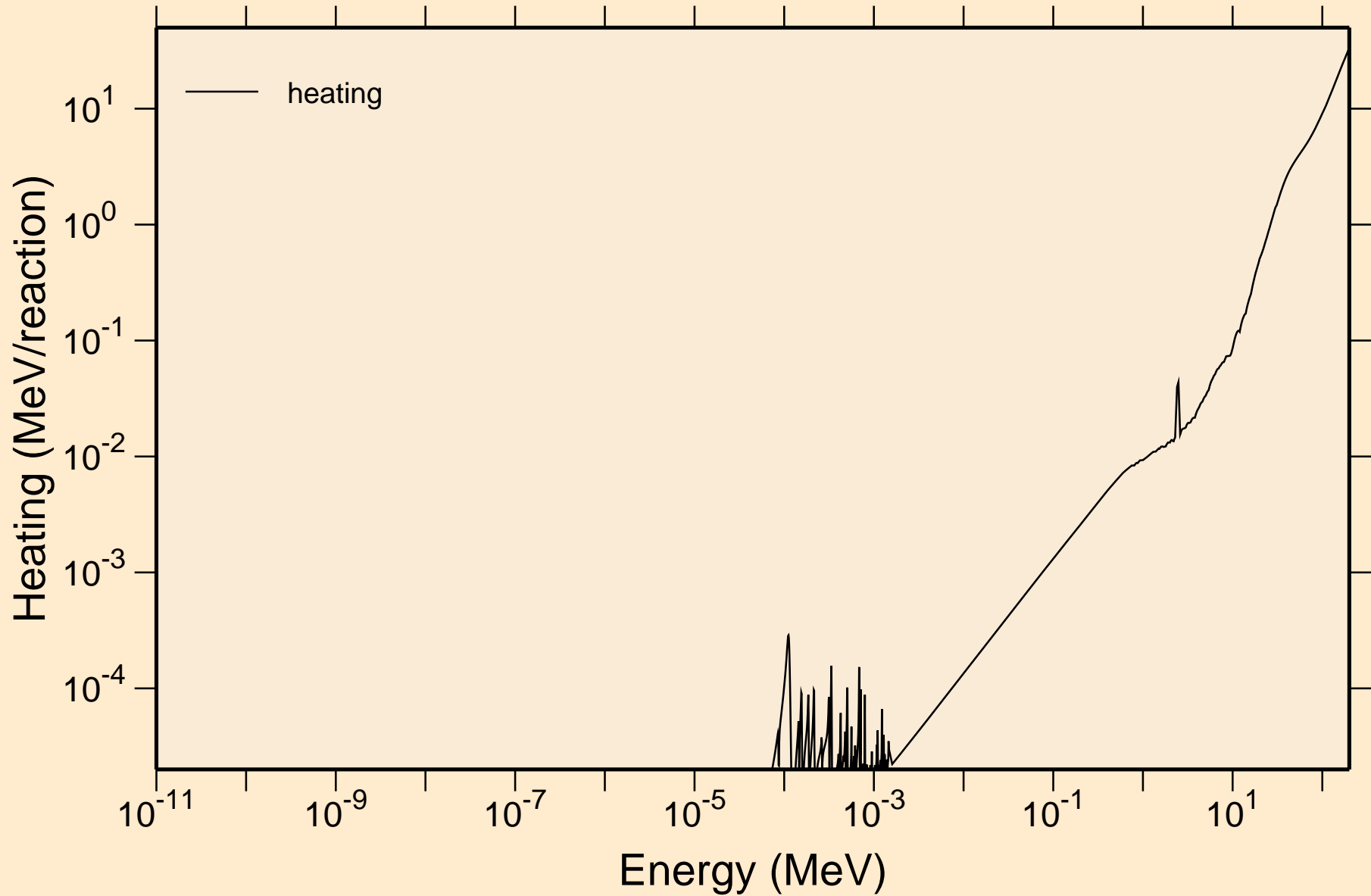

# SM146 NEUTRON ACER TENDL-2023 LIBRARY; T=0.K

## Damage

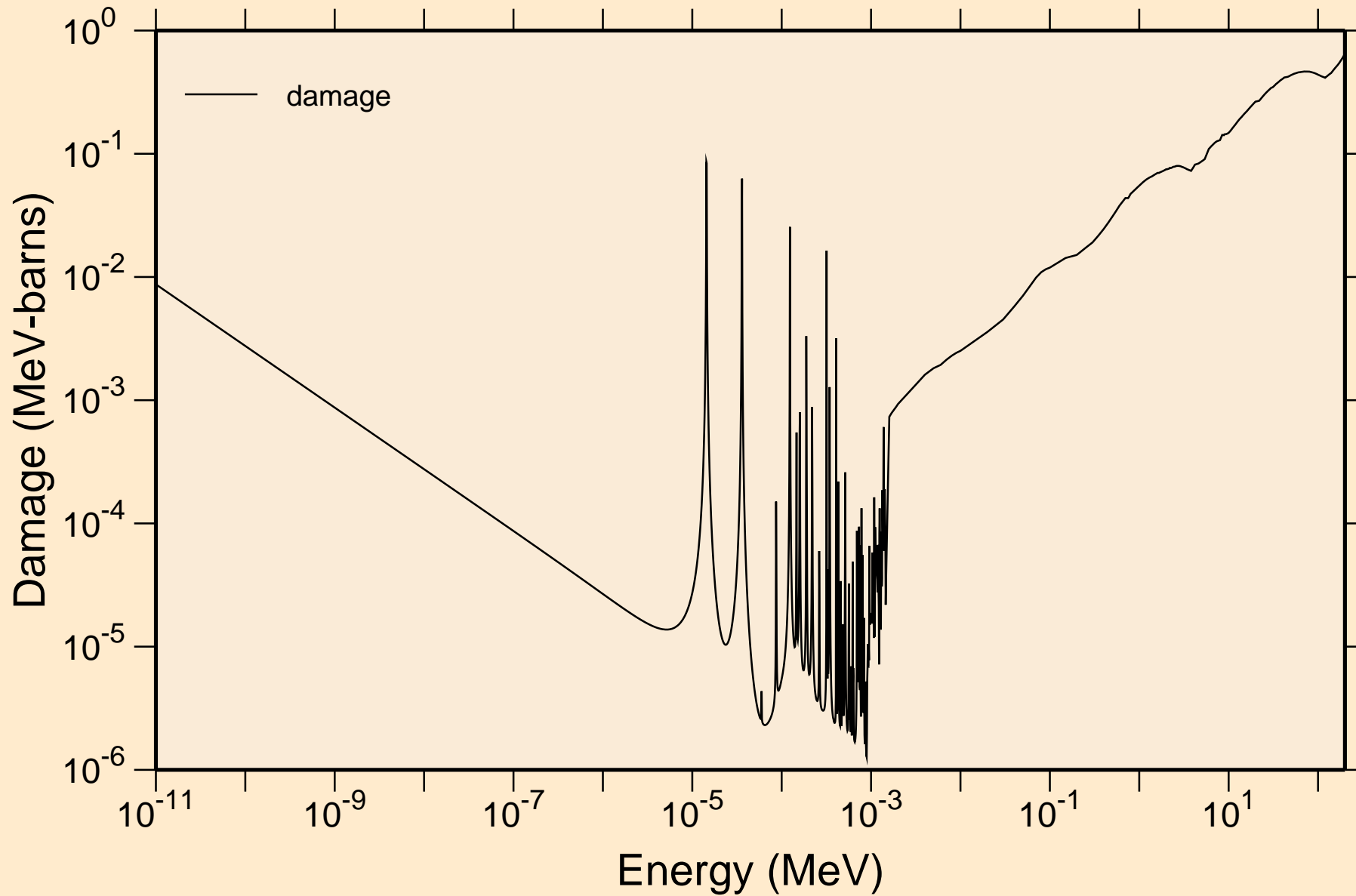

# SM146 NEUTRON ACER TENDL-2023 LIBRARY; T=0.K

## Non-threshold reactions

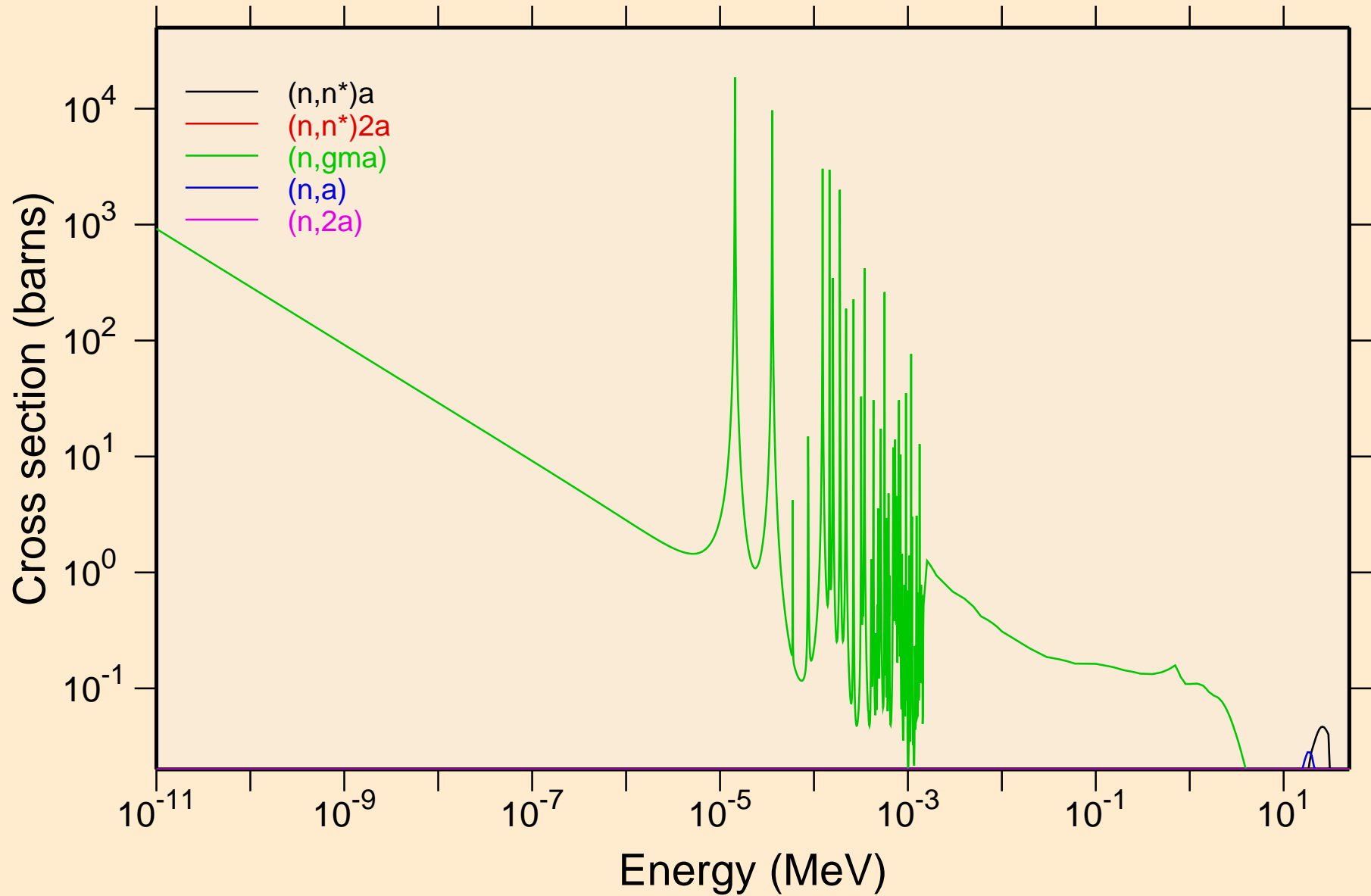

SM146 NEUTRON ACER TENDL-2023 LIBRARY; T=0.K  
Non-threshold reactions

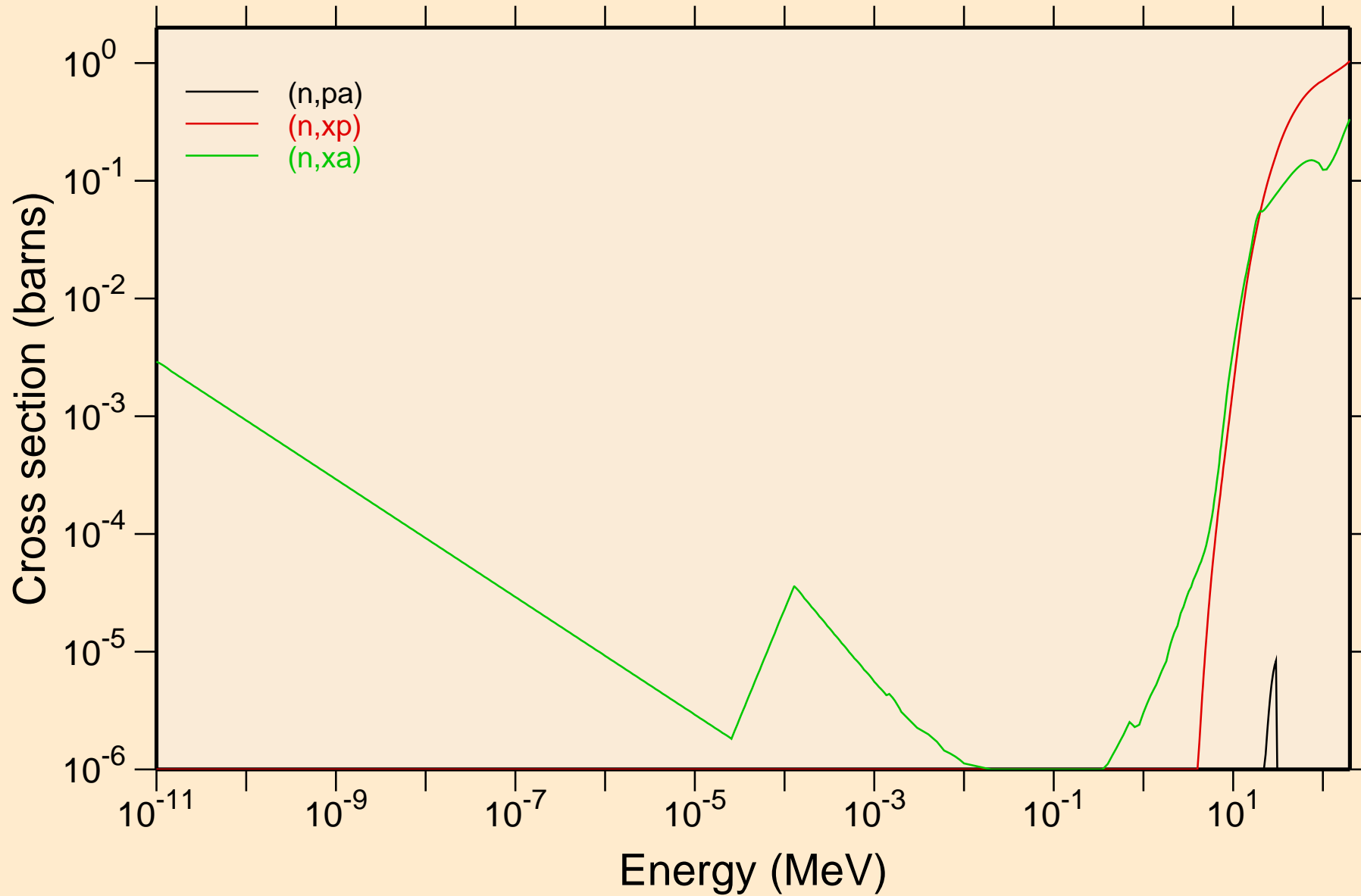

# SM146 NEUTRON ACER TENDL-2023 LIBRARY; T=0.K

## Principal cross sections

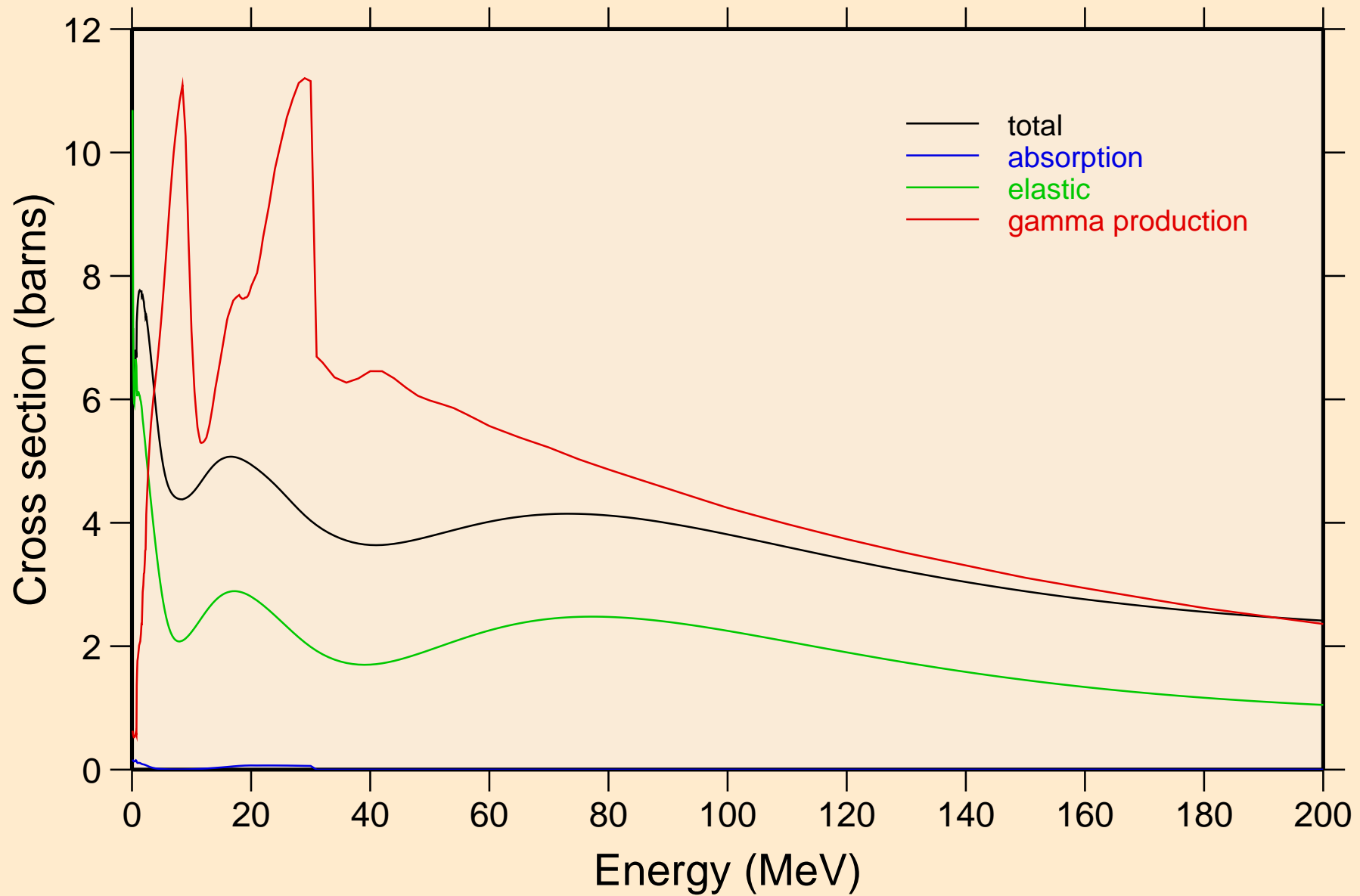

# SM146 NEUTRON ACER TENDL-2023 LIBRARY; T=0.K

## Heating

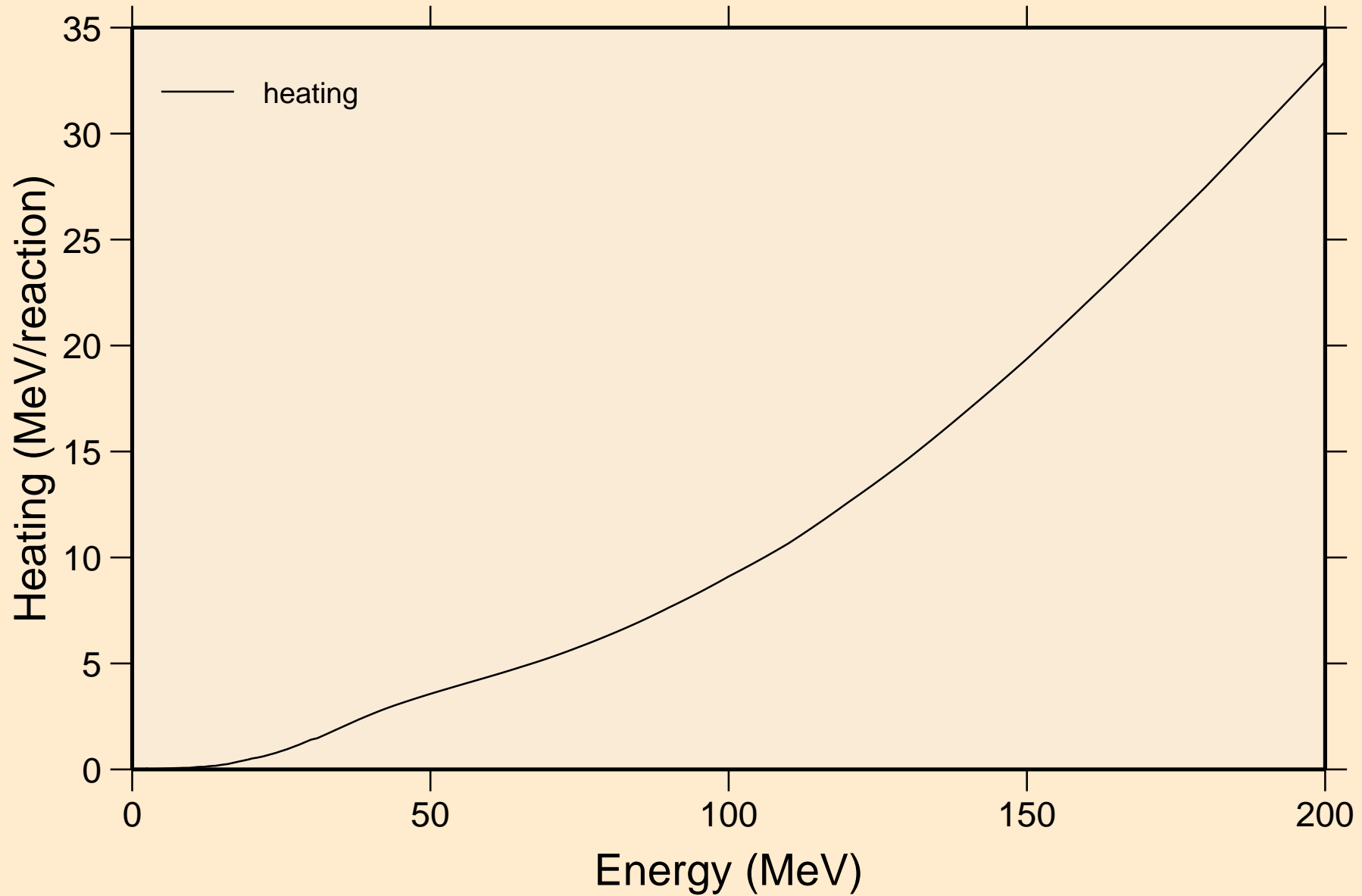

# SM146 NEUTRON ACER TENDL-2023 LIBRARY; T=0.K

## Damage

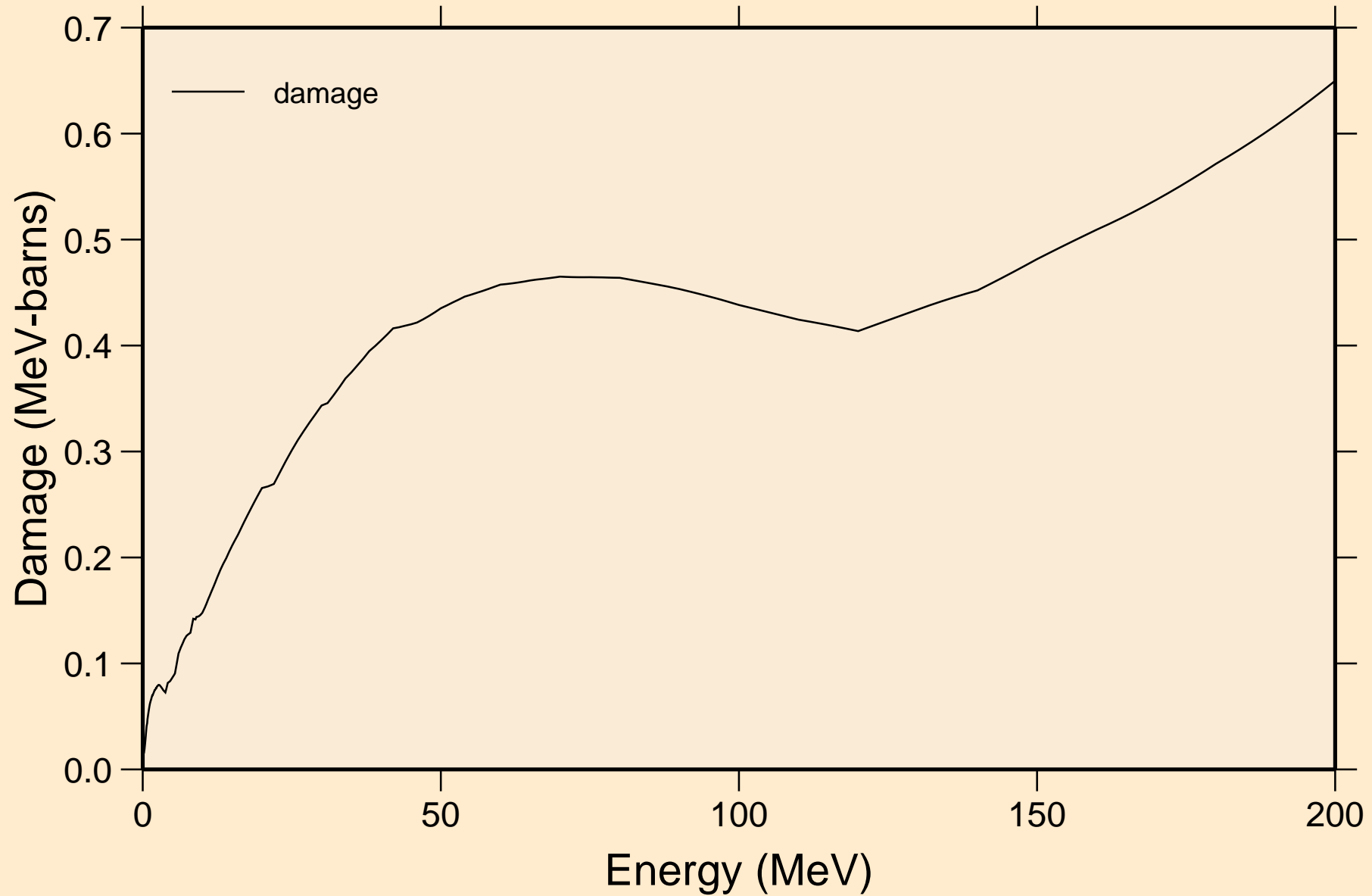



SM146 NEUTRON ACER TENDL-2023 LIBRARY; T=0.K  
Non-threshold reactions

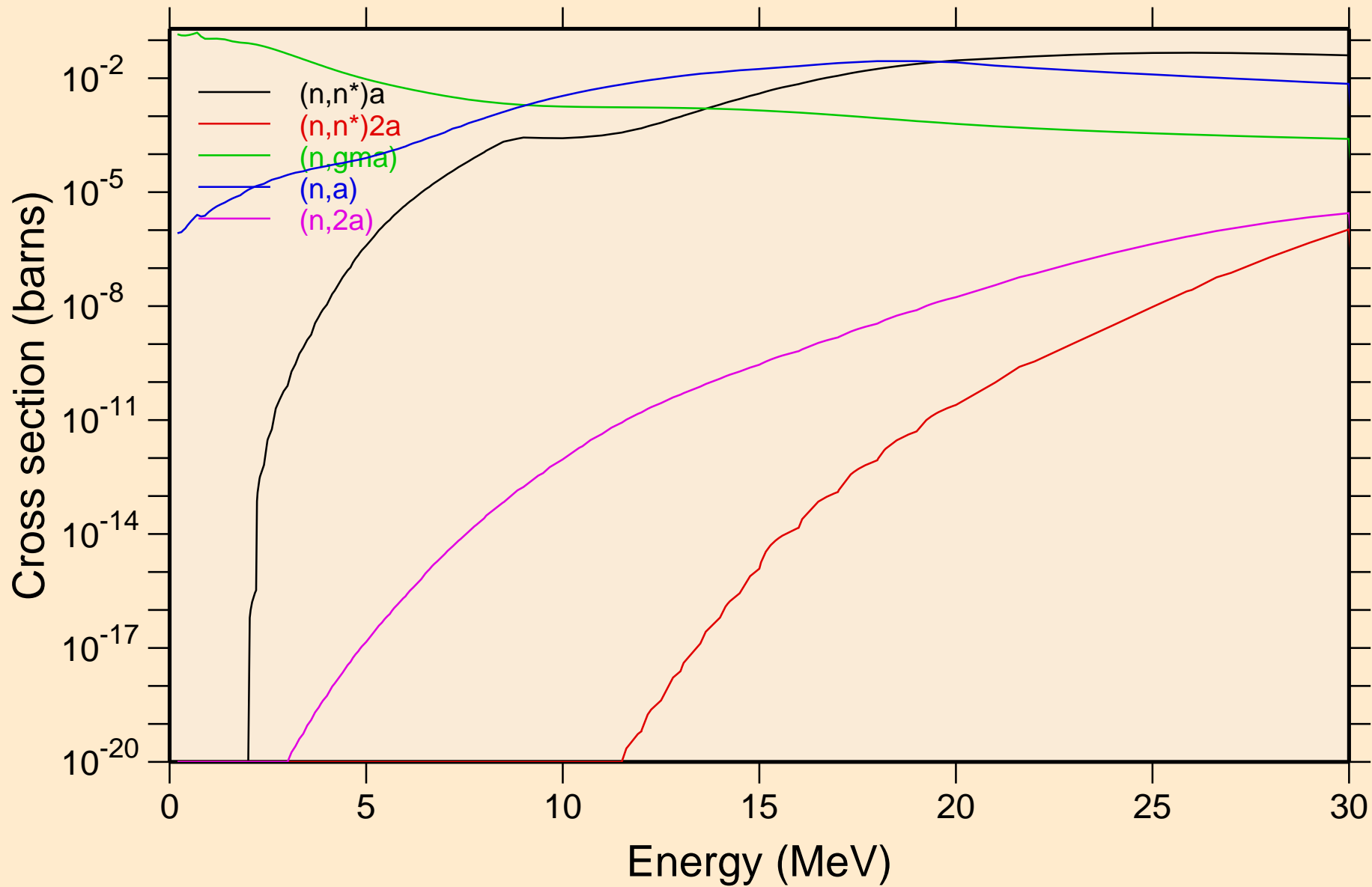

# SM146 NEUTRON ACER TENDL-2023 LIBRARY; T=0.K

## Non-threshold reactions

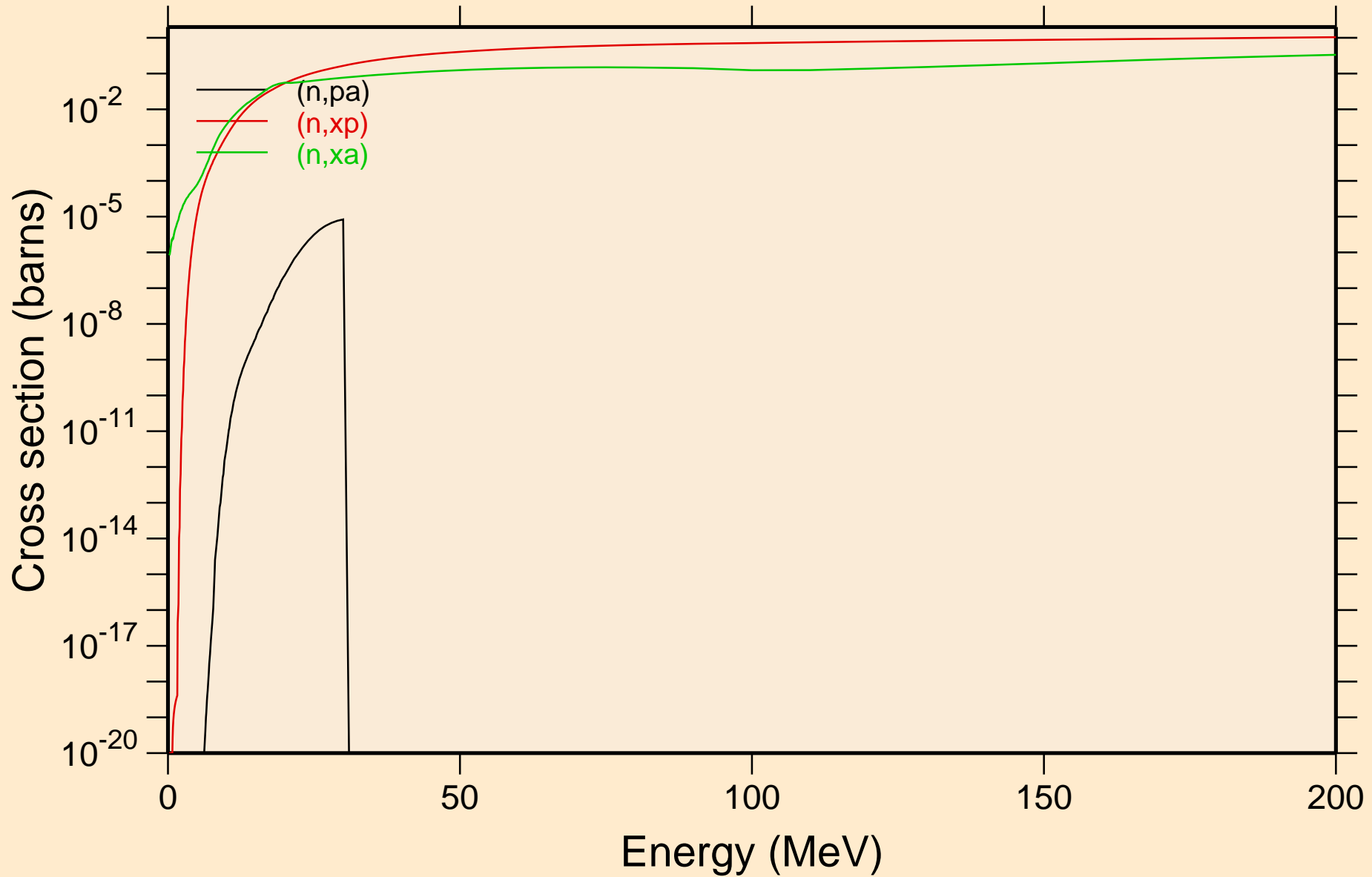

SM146 NEUTRON ACER TENDL-2023 LIBRARY; T=0.K  
Inelastic levels

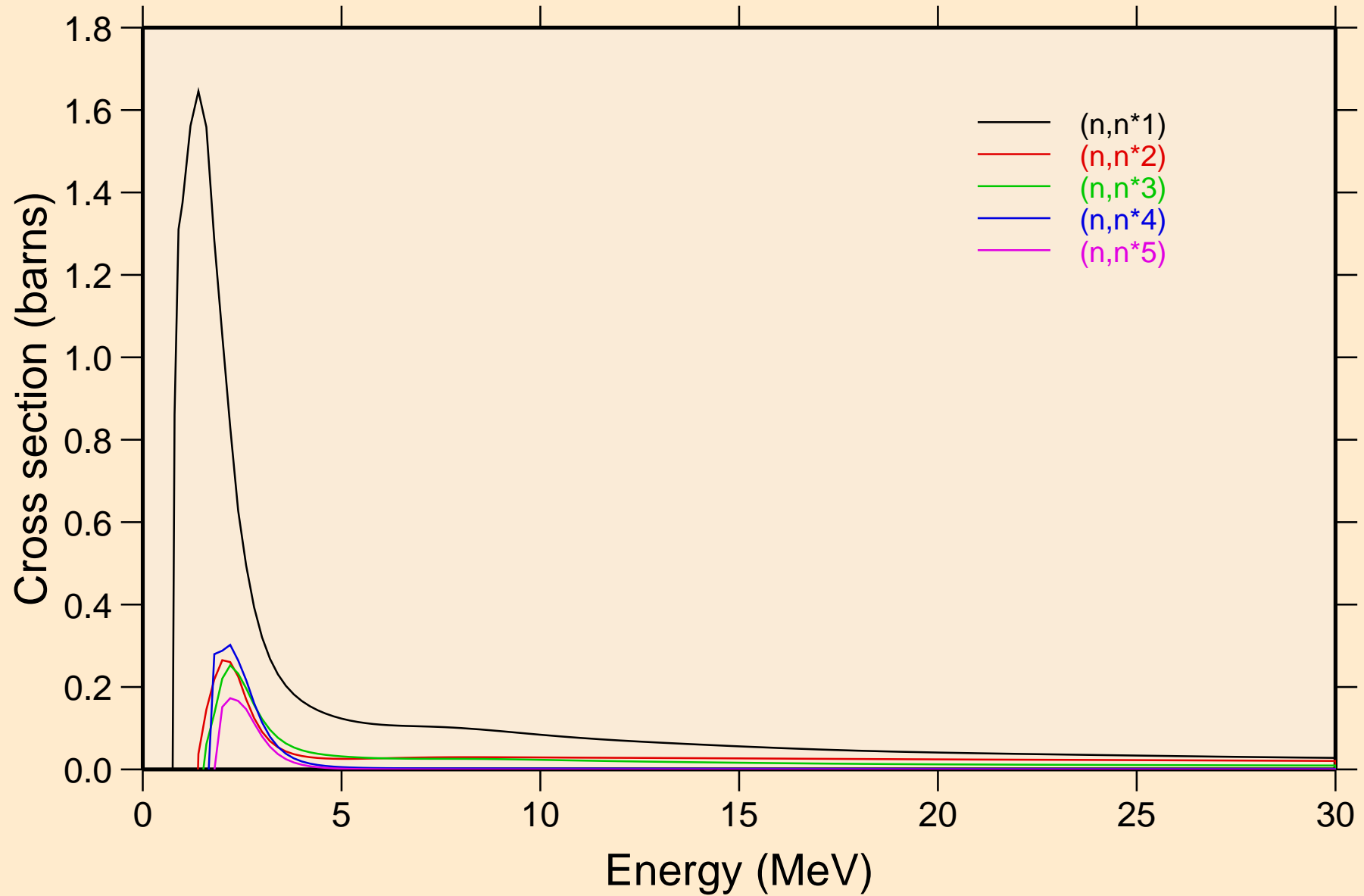

SM146 NEUTRON ACER TENDL-2023 LIBRARY; T=0.K  
Inelastic levels

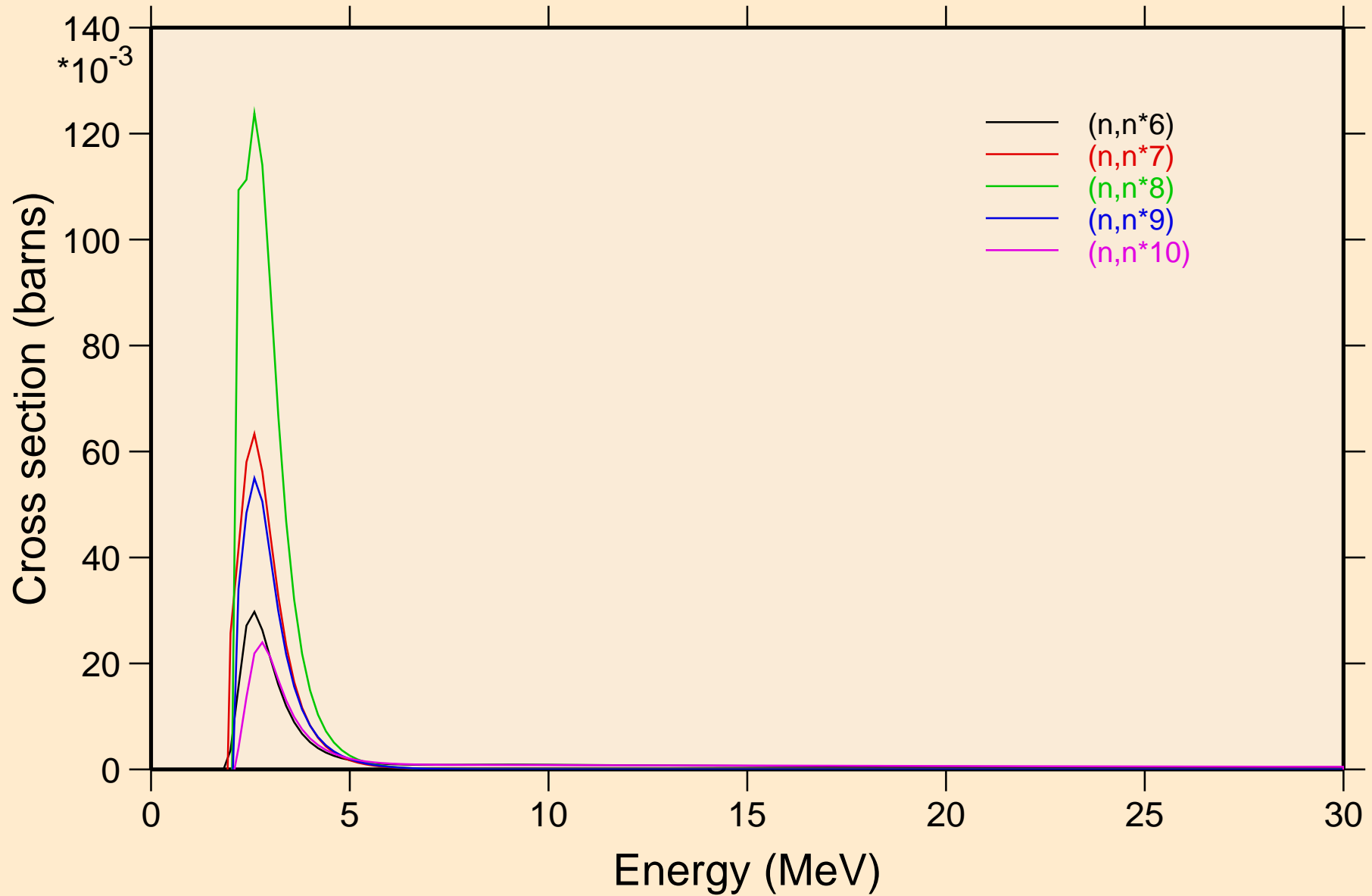

SM146 NEUTRON ACER TENDL-2023 LIBRARY; T=0.K  
Inelastic levels

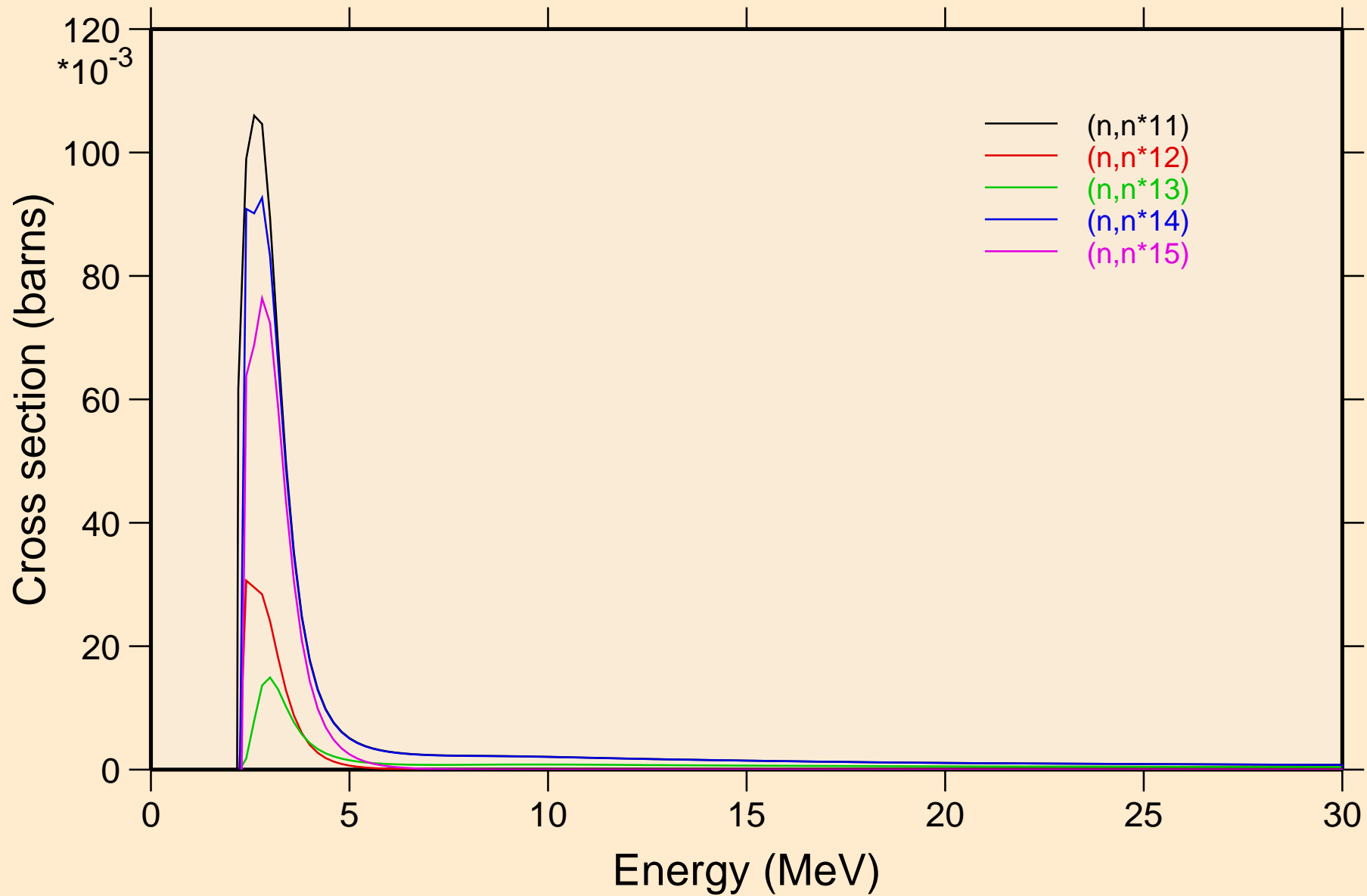

SM146 NEUTRON ACER TENDL-2023 LIBRARY; T=0.K  
Threshold reactions

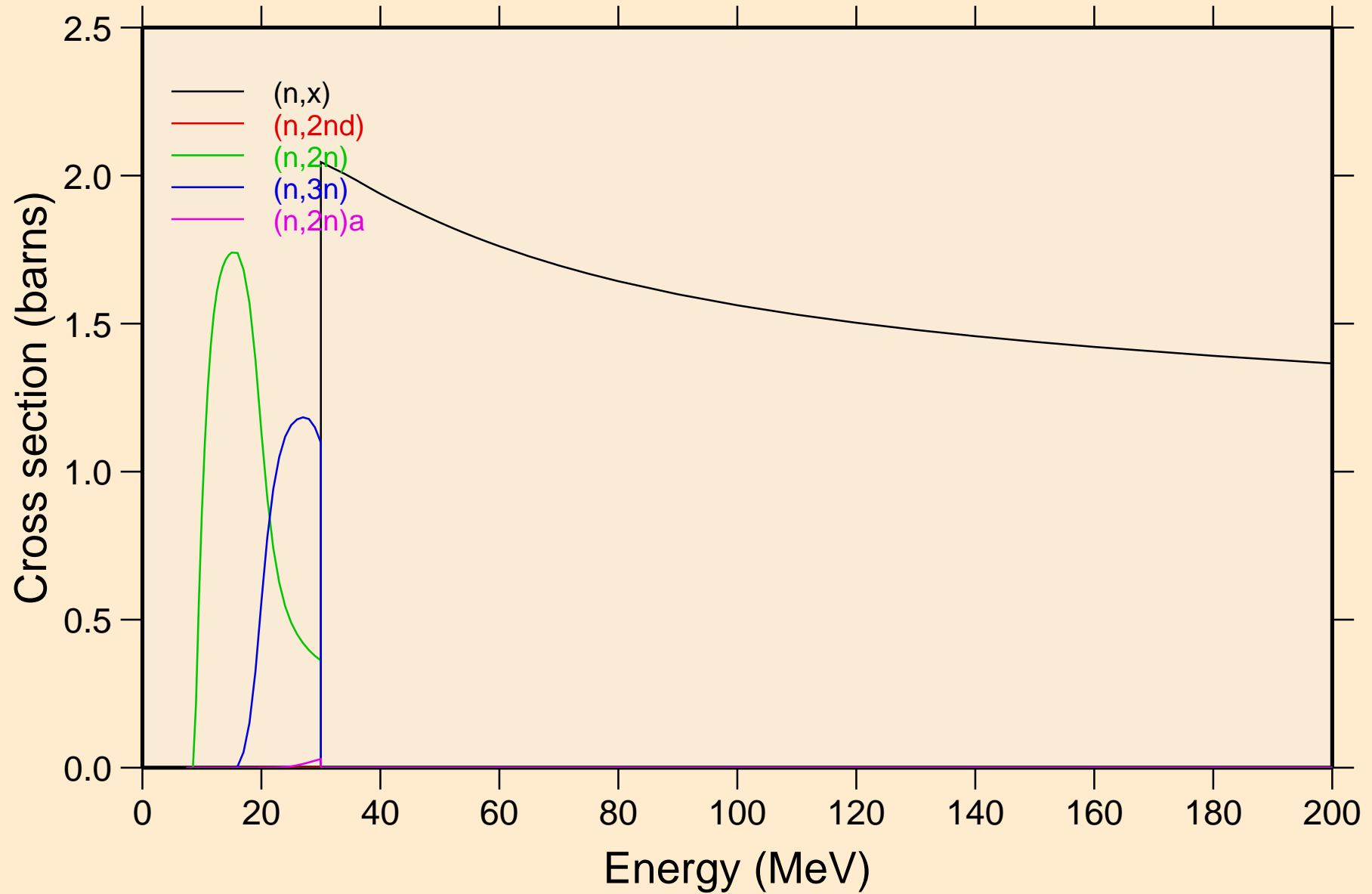

SM146 NEUTRON ACER TENDL-2023 LIBRARY; T=0.K  
Threshold reactions

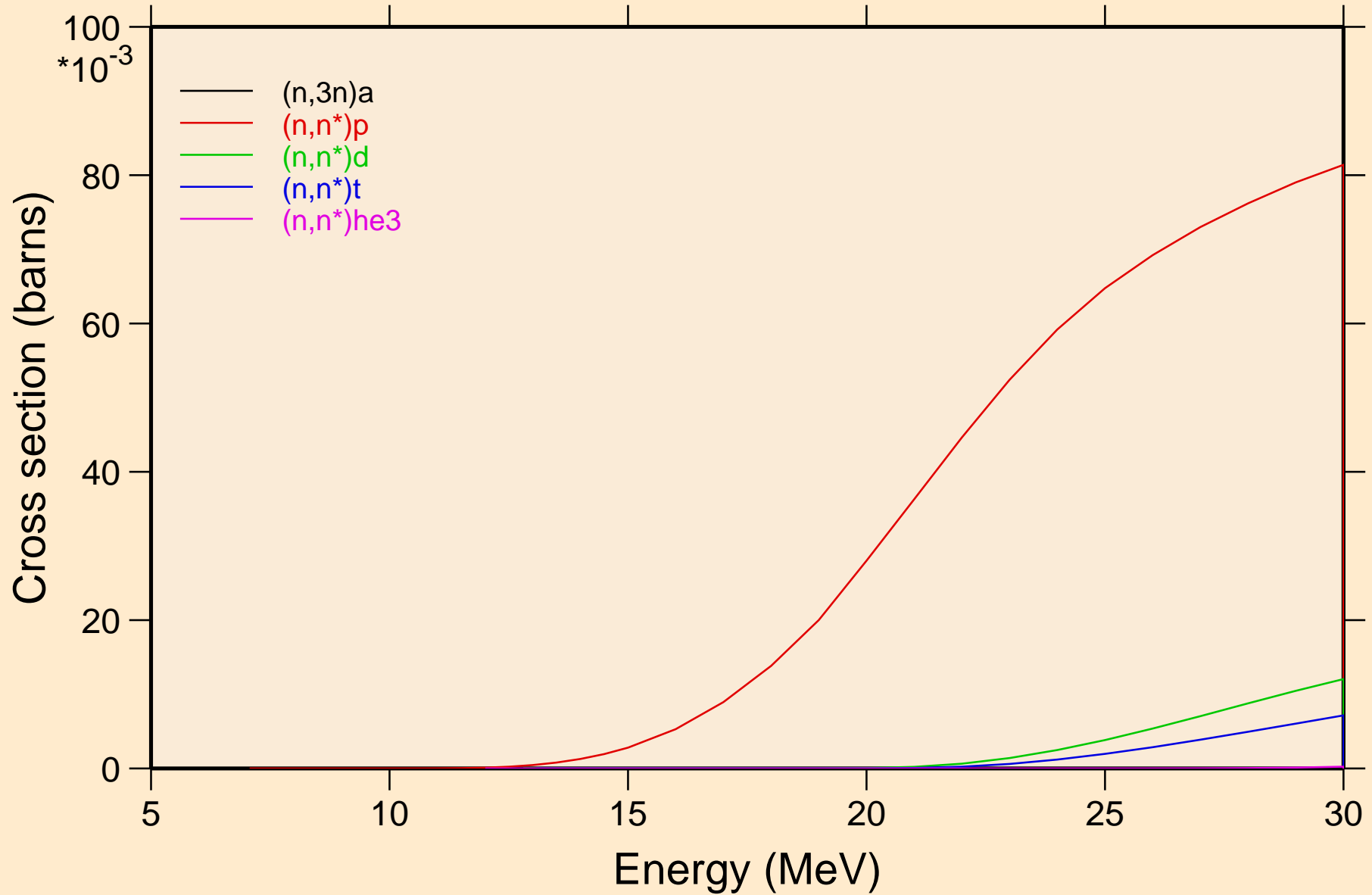

# SM146 NEUTRON ACER TENDL-2023 LIBRARY; T=0.K

## Threshold reactions

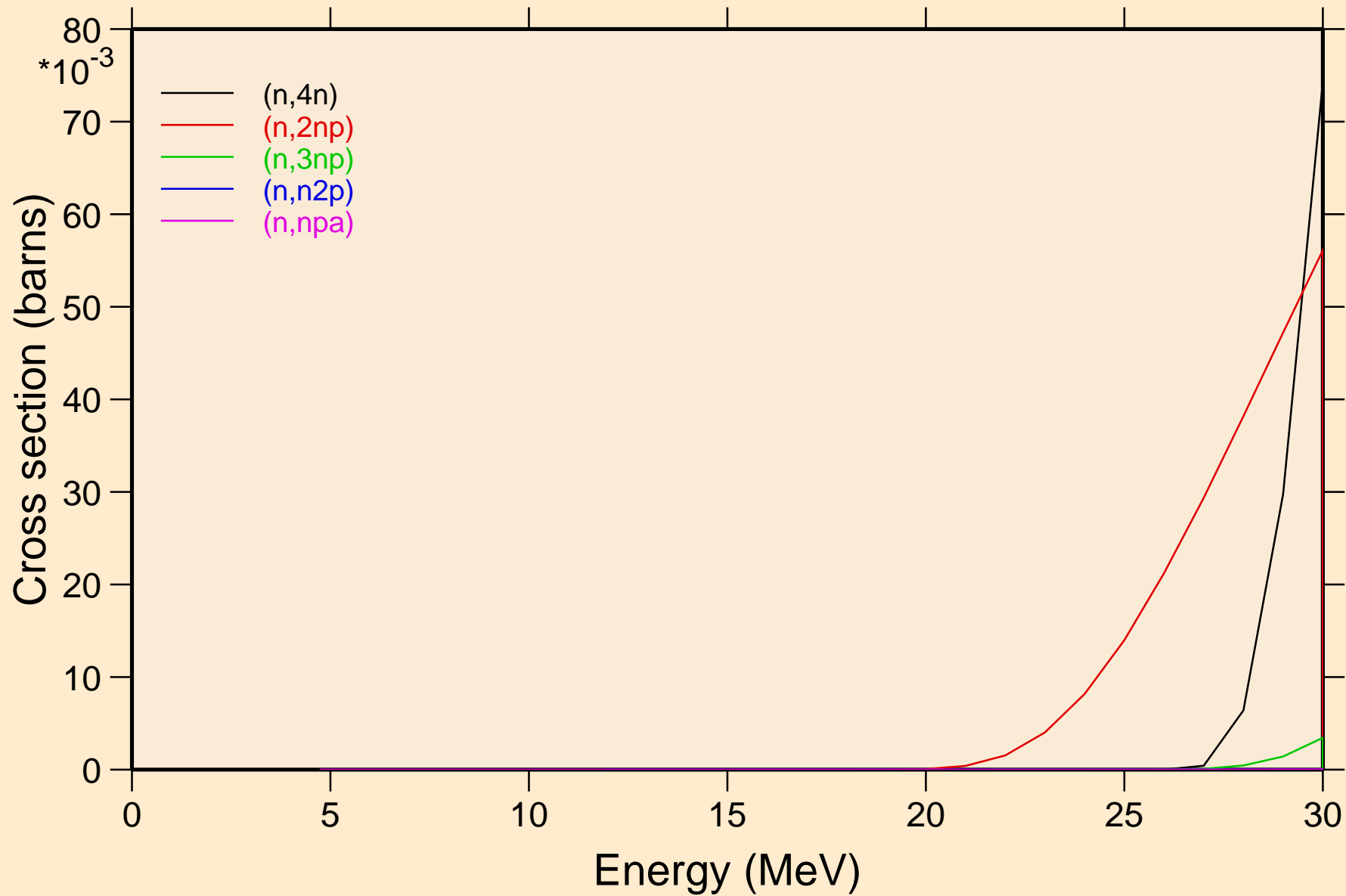



# SM146 NEUTRON ACER TENDL-2023 LIBRARY; T=0.K

## Threshold reactions

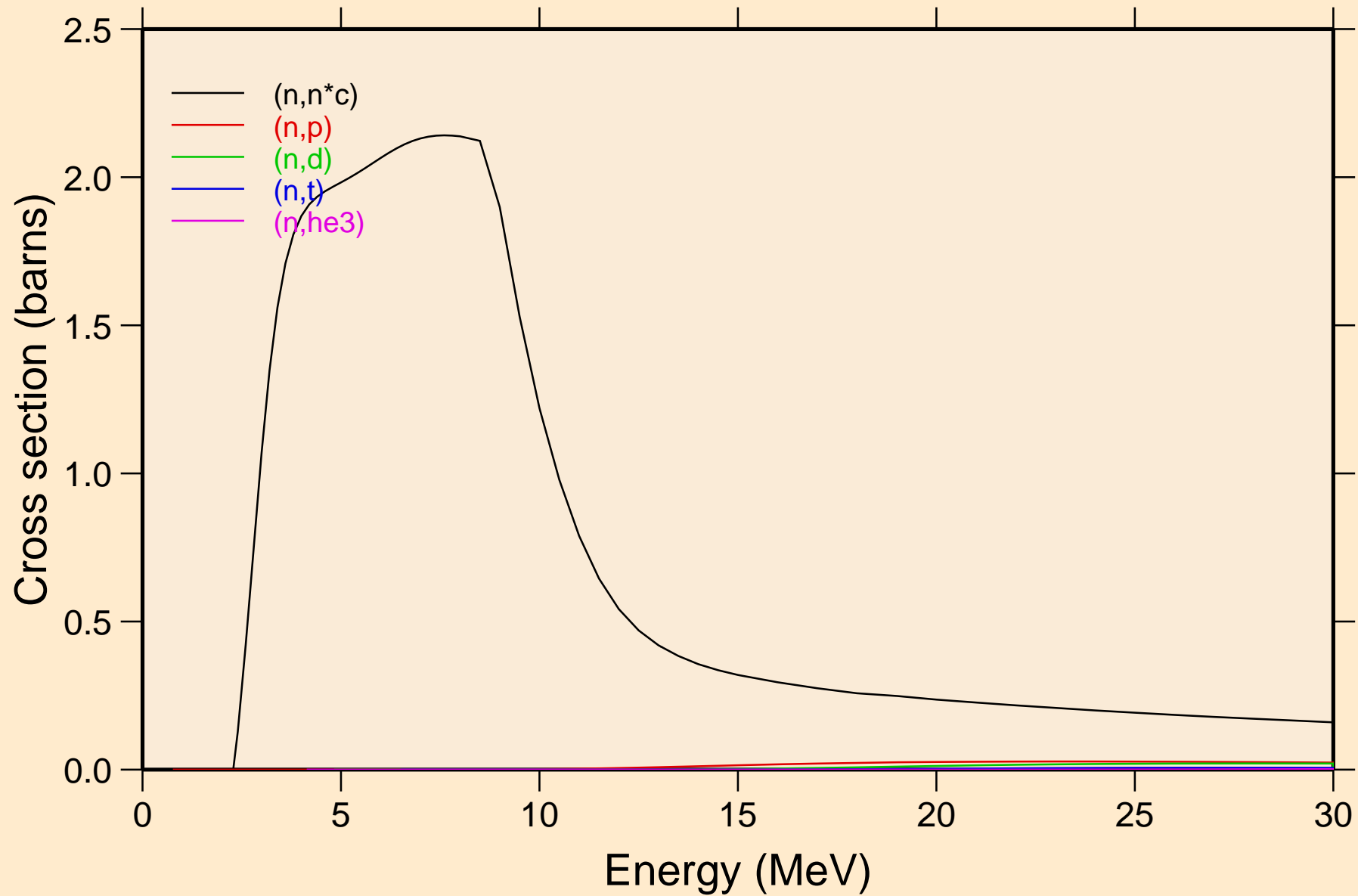

SM146 NEUTRON ACER TENDL-2023 LIBRARY; T=0.K  
Threshold reactions

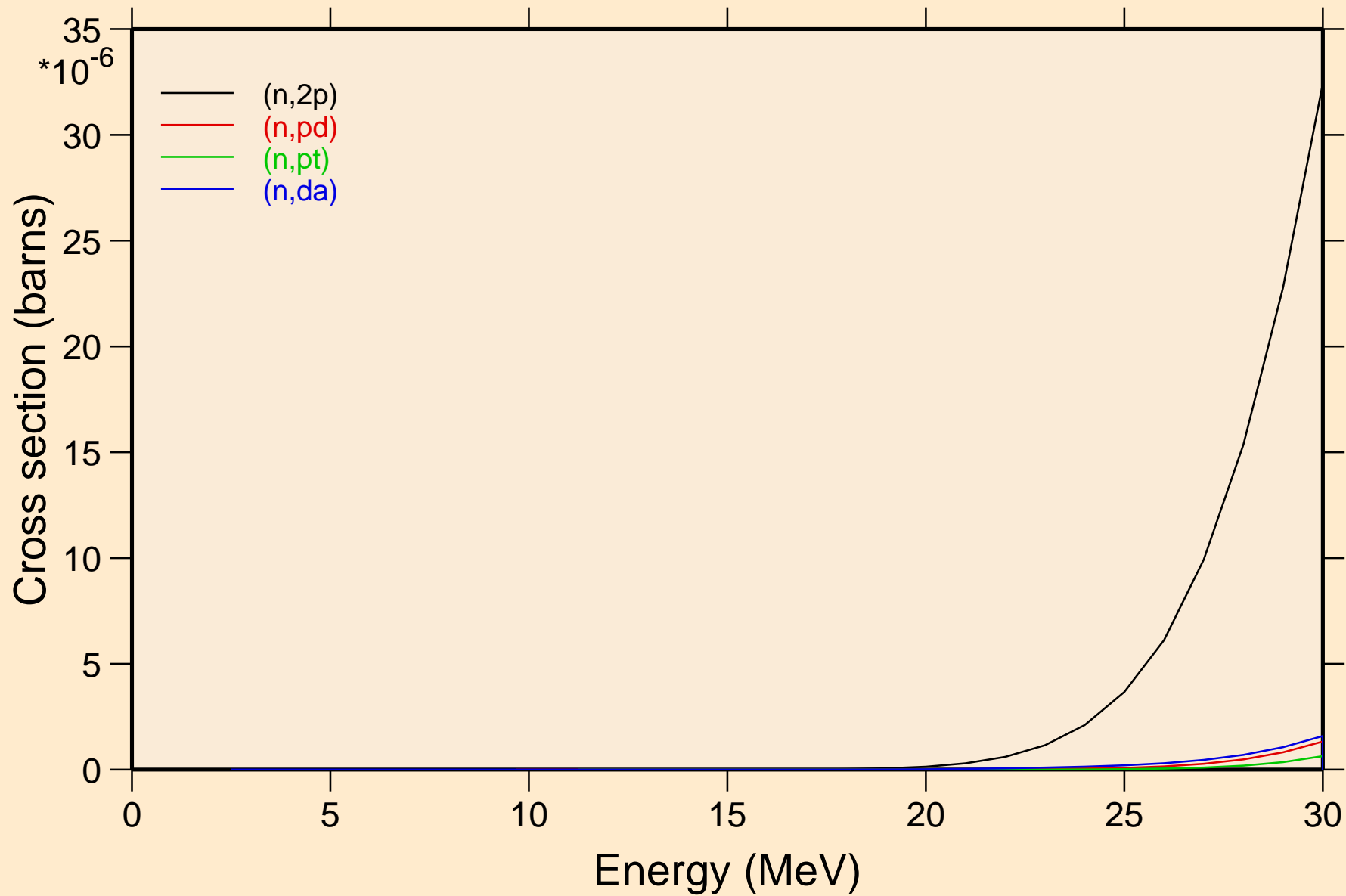

# SM146 NEUTRON ACER TENDL-2023 LIBRARY; T=0.K

## Threshold reactions

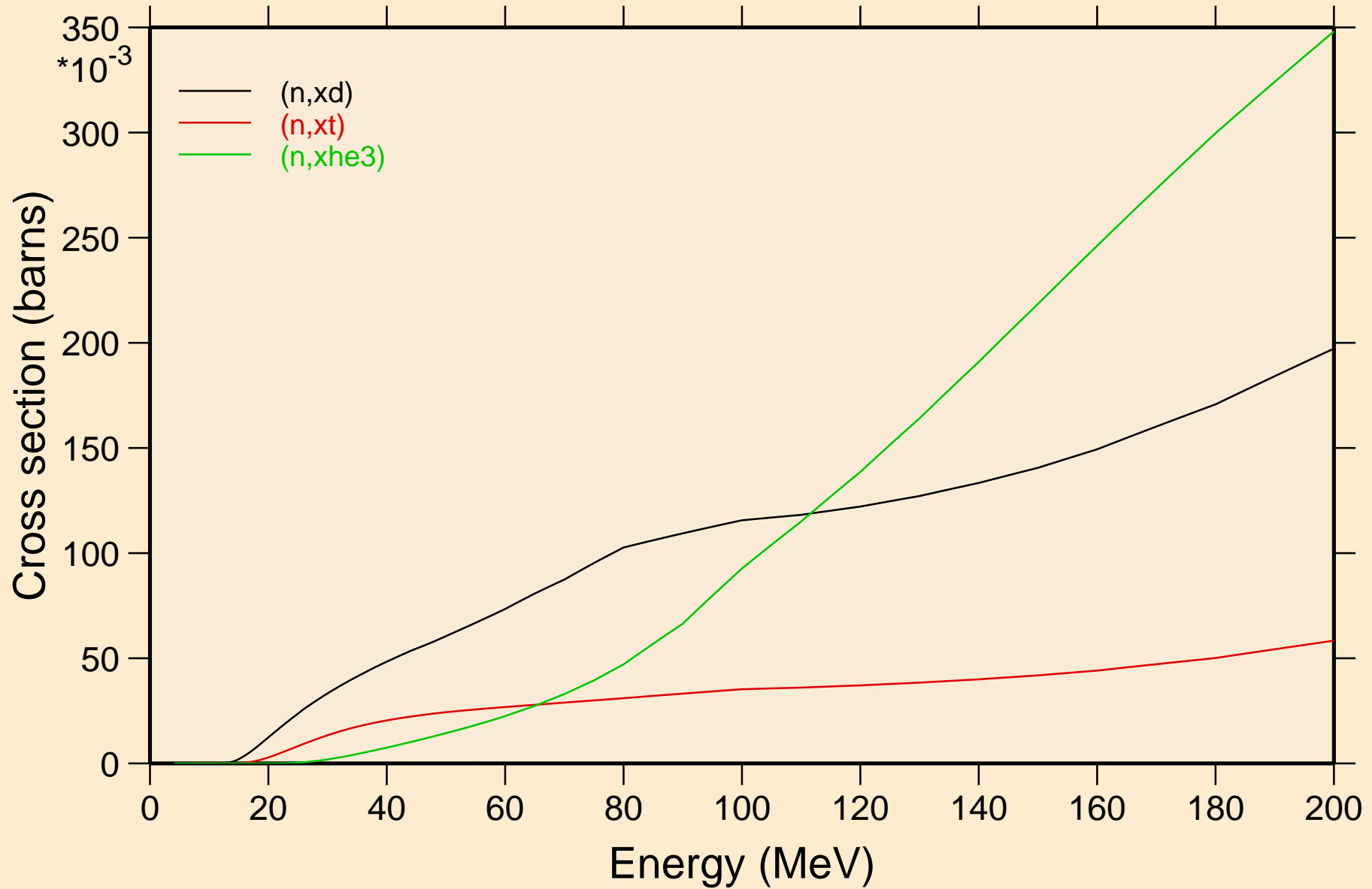

SM146 NEUTRON ACER TENDL-2023 LIBRARY; T=0.K  
angular distribution for elastic

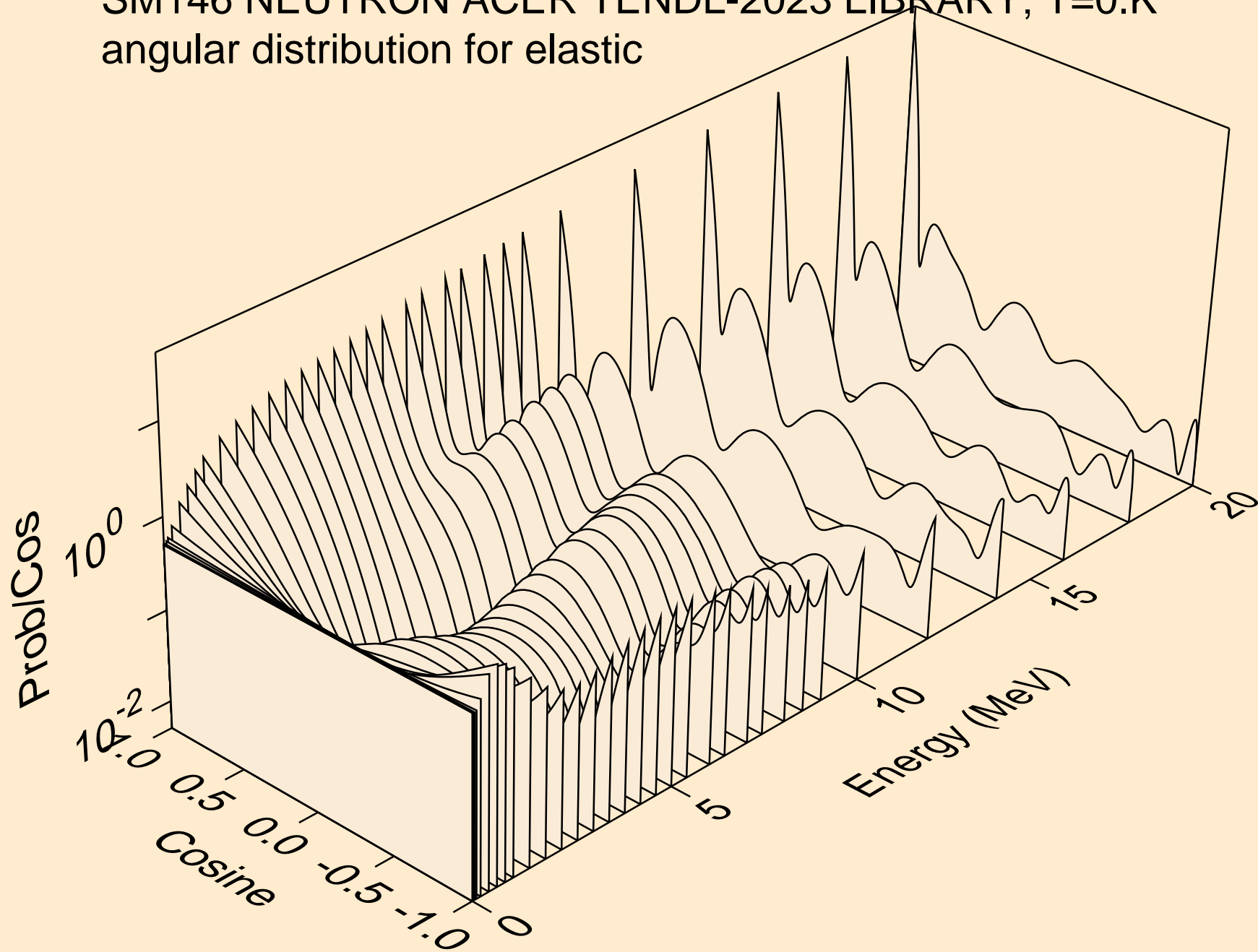

SM146 NEUTRON ACER TENDL-2023 LIBRARY; T=0.K  
angular distribution for elastic

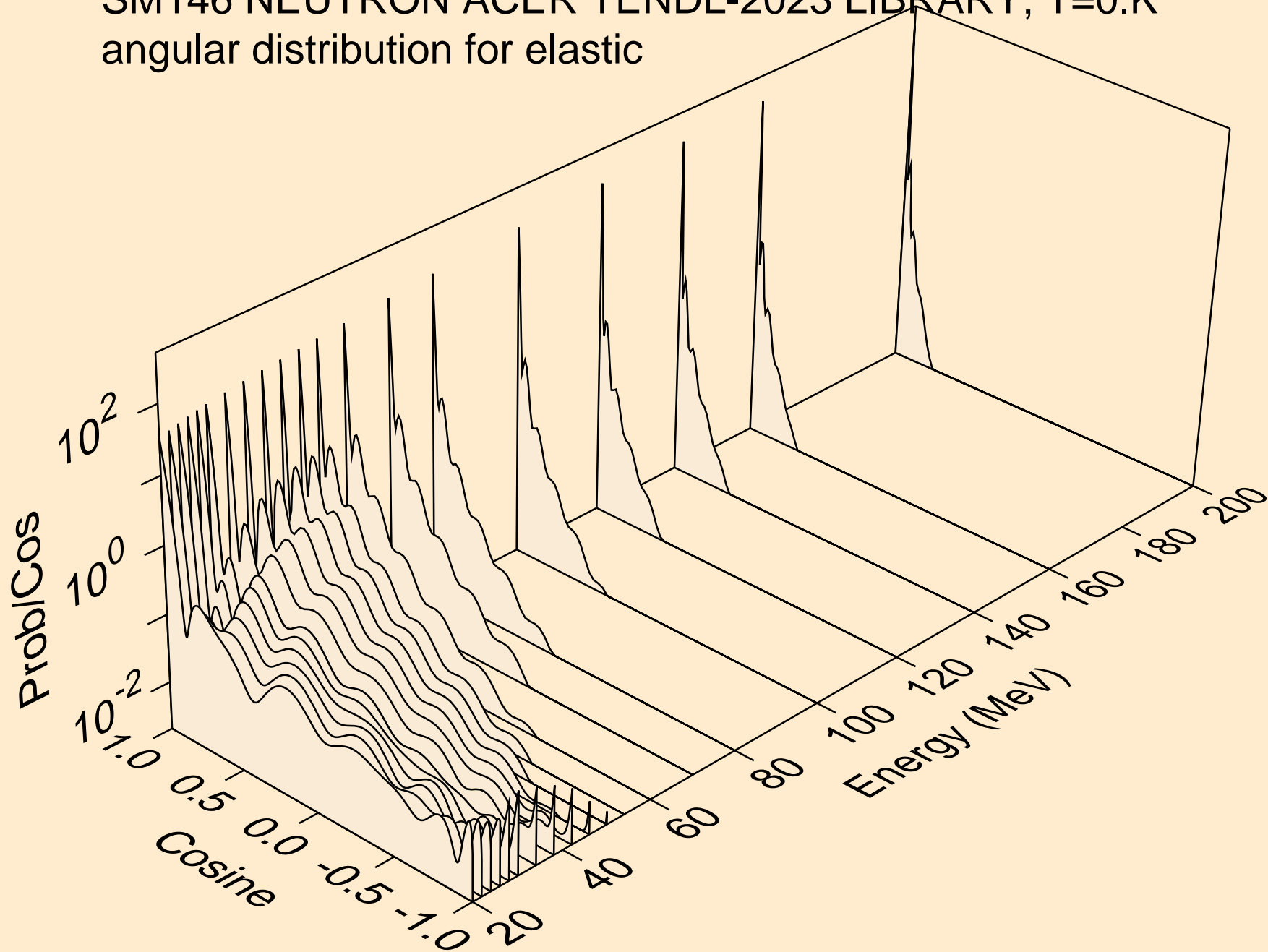

SM146 NEUTRON ACER TENDL-2023 LIBRARY; T=0.K  
angular distribution for (n,n\*1)

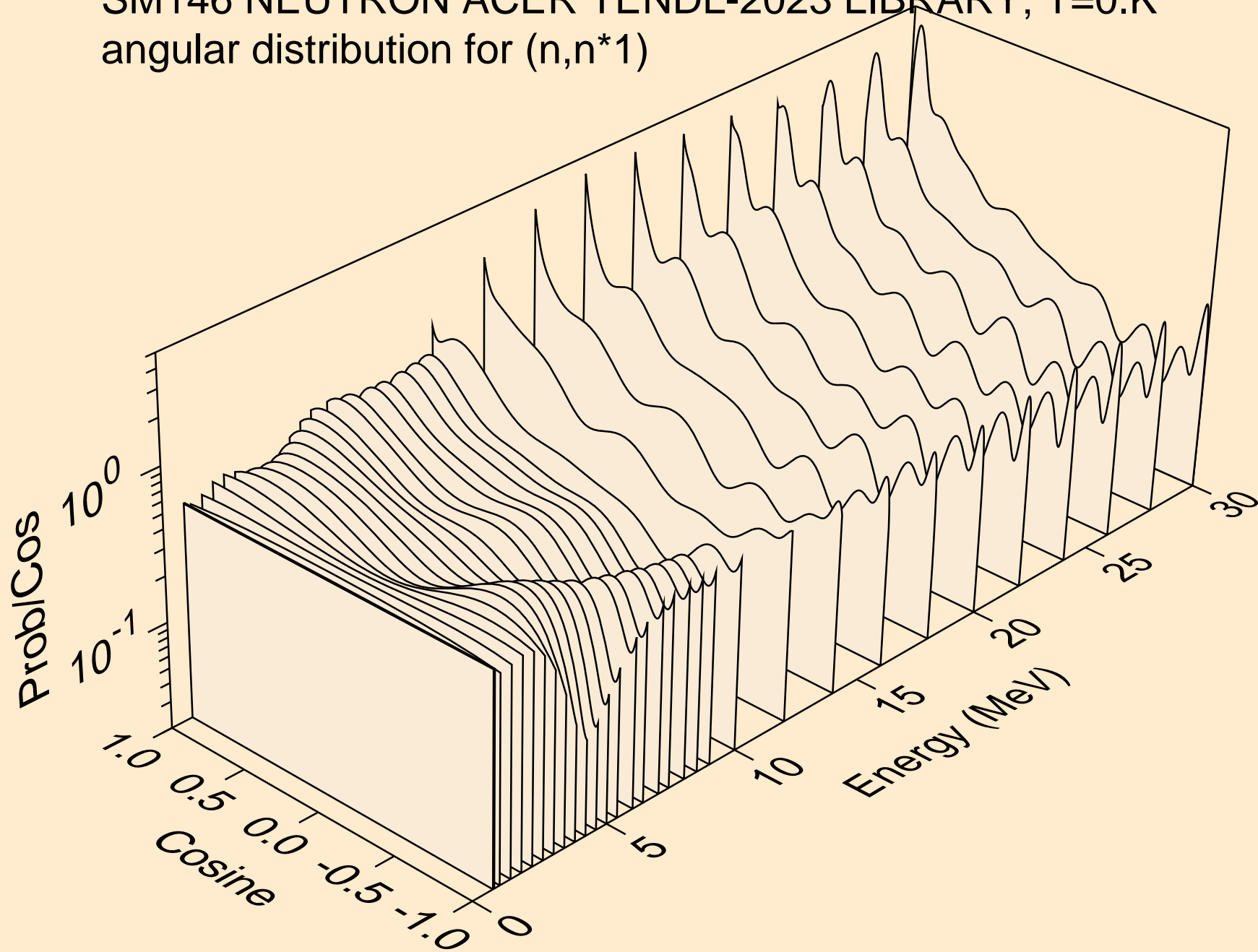

SM146 NEUTRON ACER TENDL-2023 LIBRARY; T=0.K  
angular distribution for (n,n\*2)

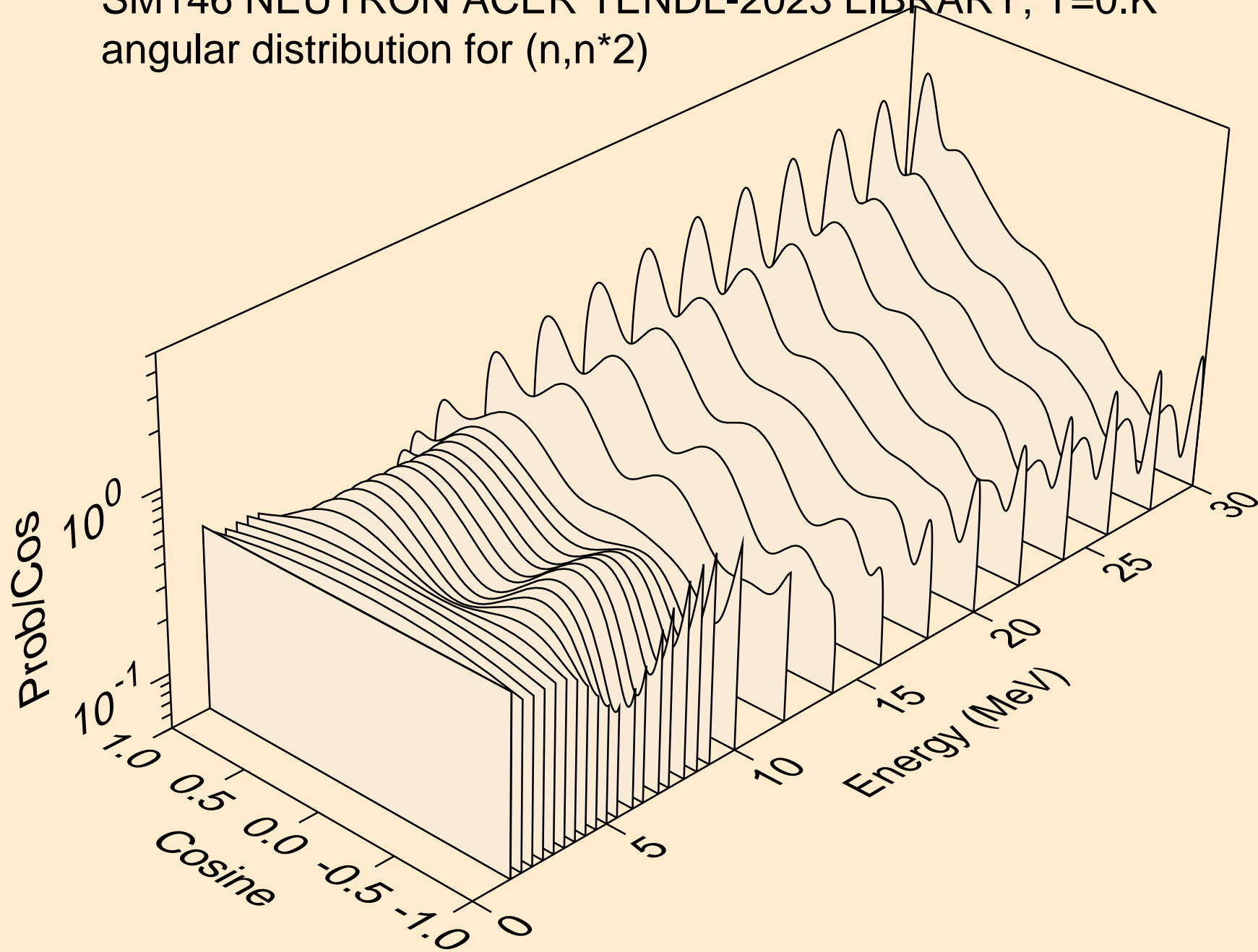

SM146 NEUTRON ACER TENDL-2023 LIBRARY; T=0.K  
angular distribution for (n,n\*3)

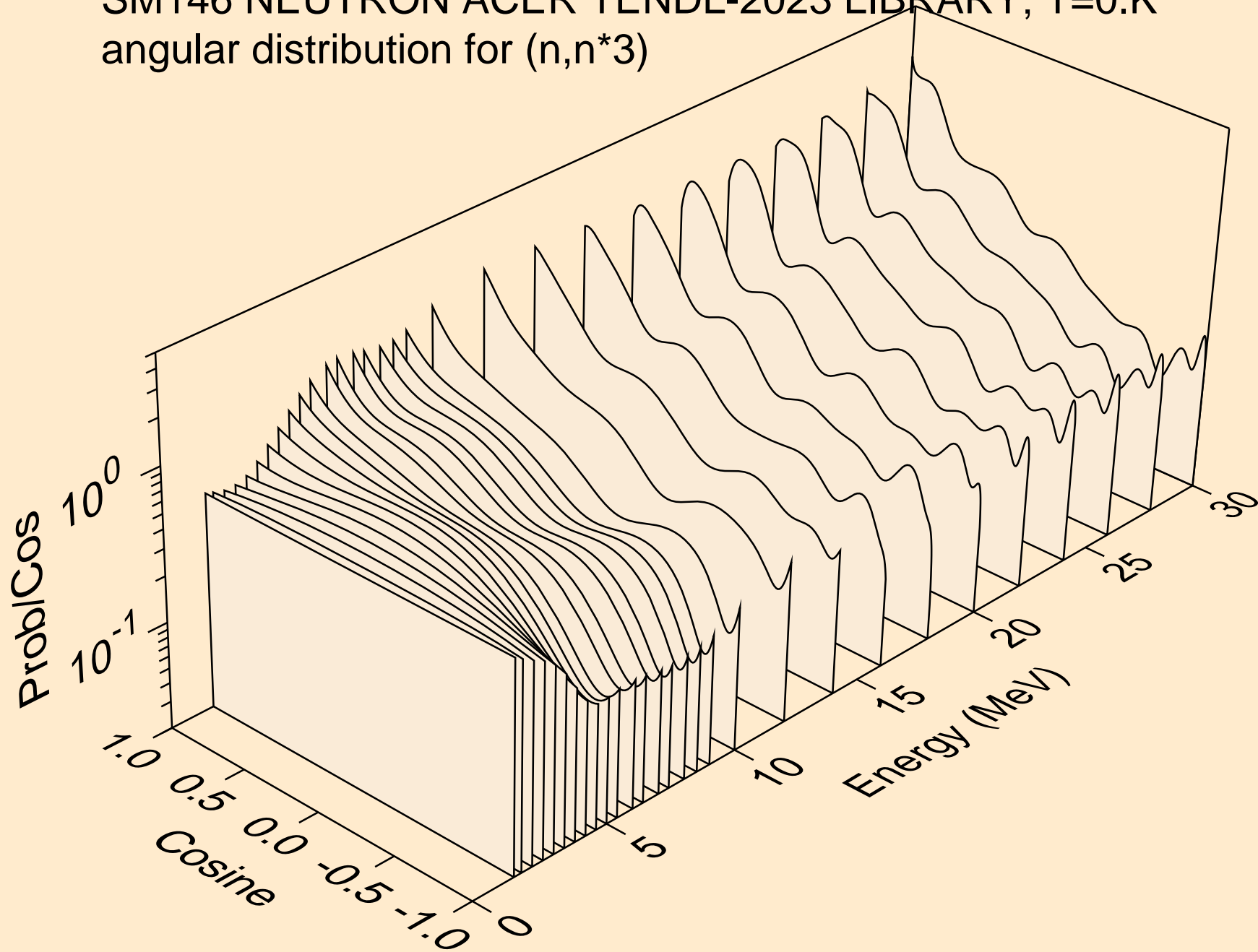



SM146 NEUTRON ACER TENDL-2023 LIBRARY; T=0.K  
angular distribution for (n,n\*4)

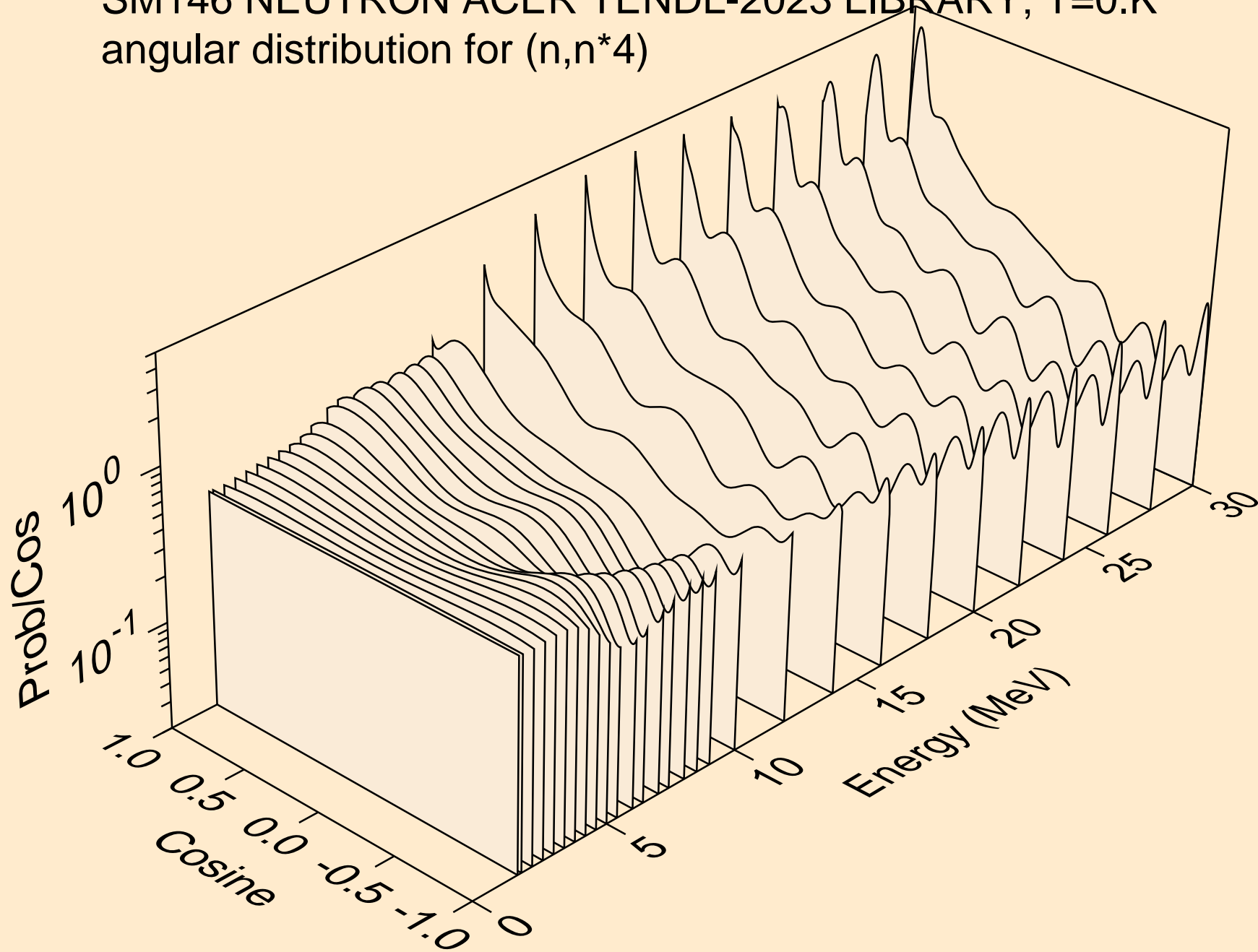

SM146 NEUTRON ACER TENDL-2023 LIBRARY; T=0.K  
angular distribution for (n,n\*5)

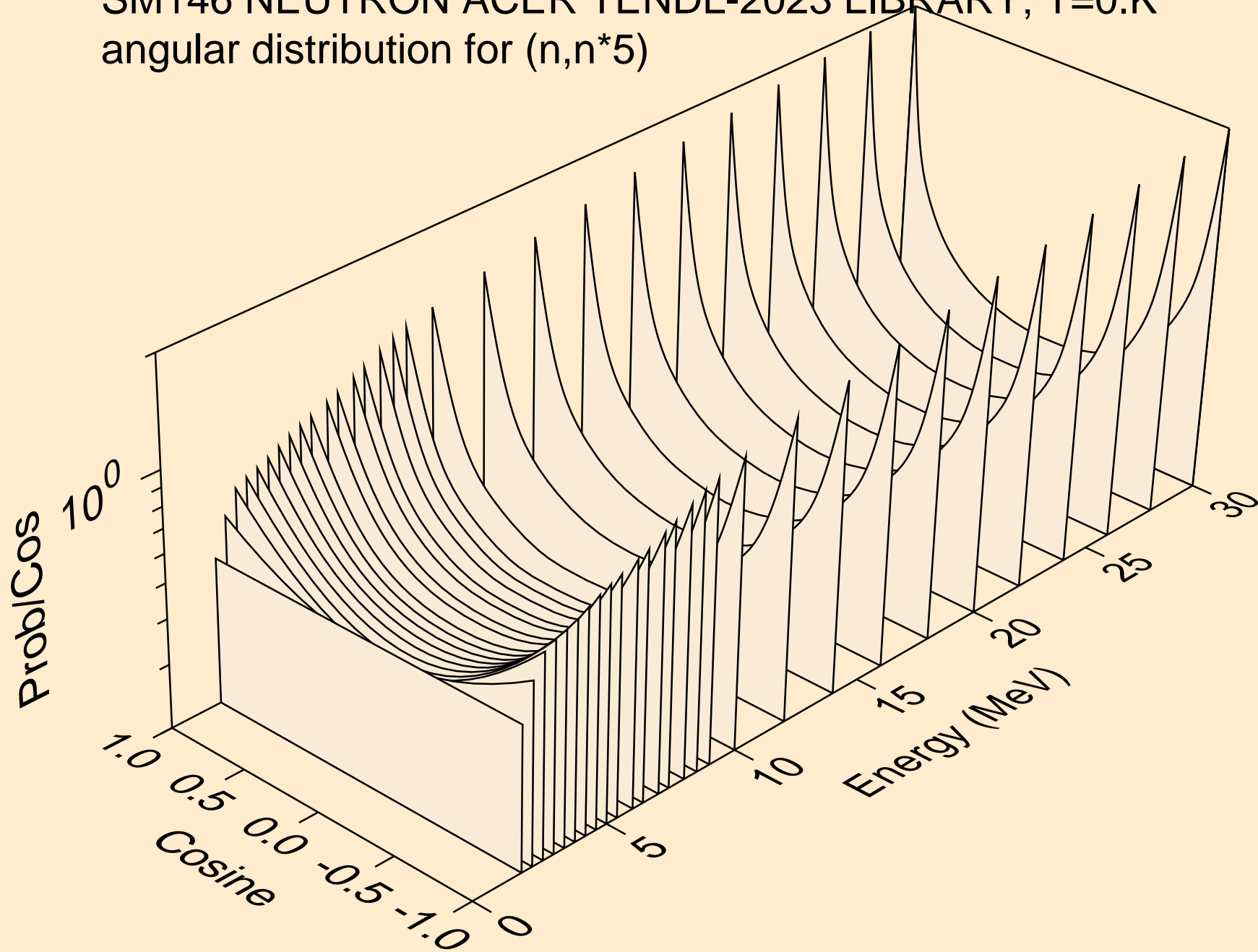

SM146 NEUTRON ACER TENDL-2023 LIBRARY; T=0.K  
angular distribution for (n,n\*6)

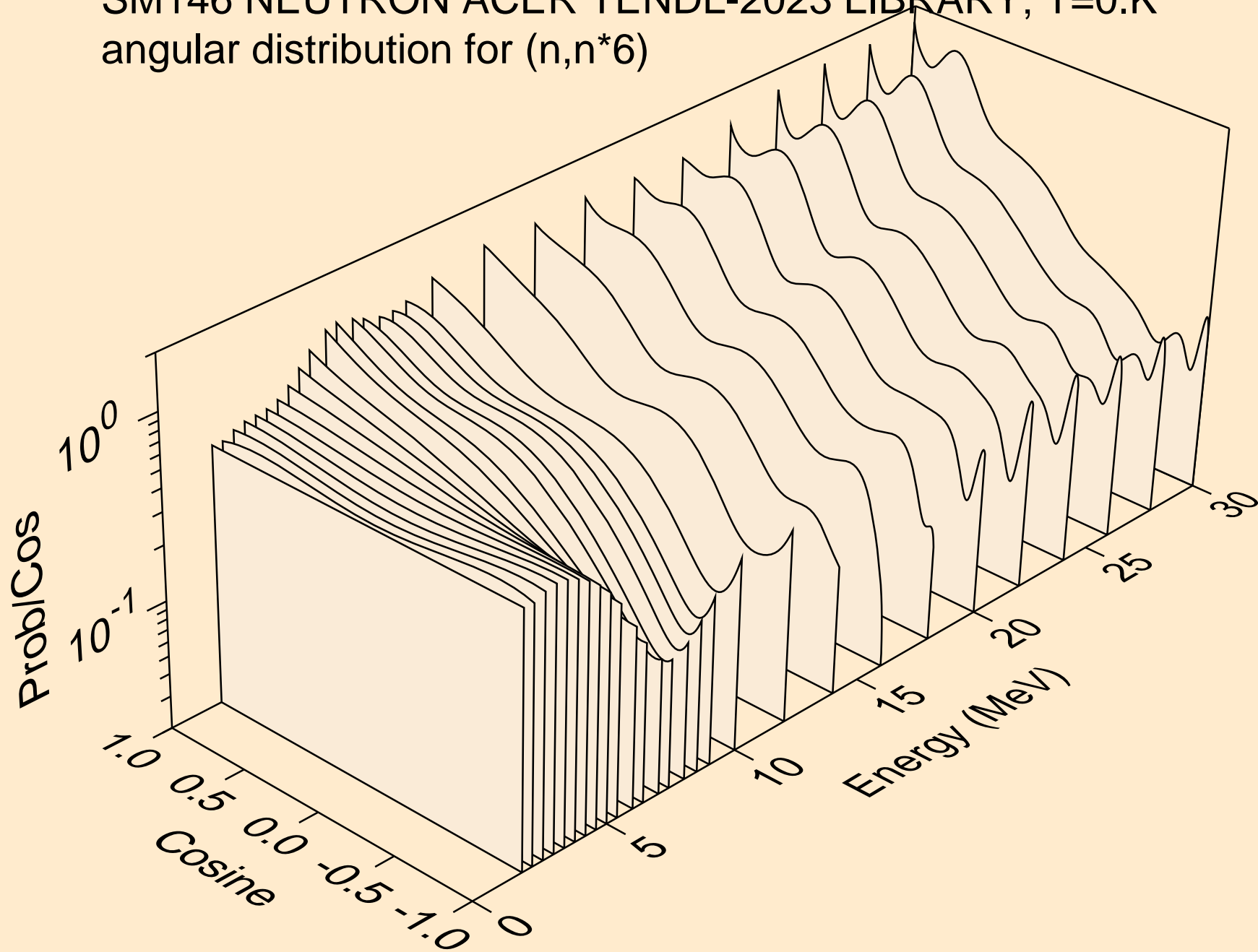

SM146 NEUTRON ACER TENDL-2023 LIBRARY; T=0.K  
angular distribution for (n,n\*7)

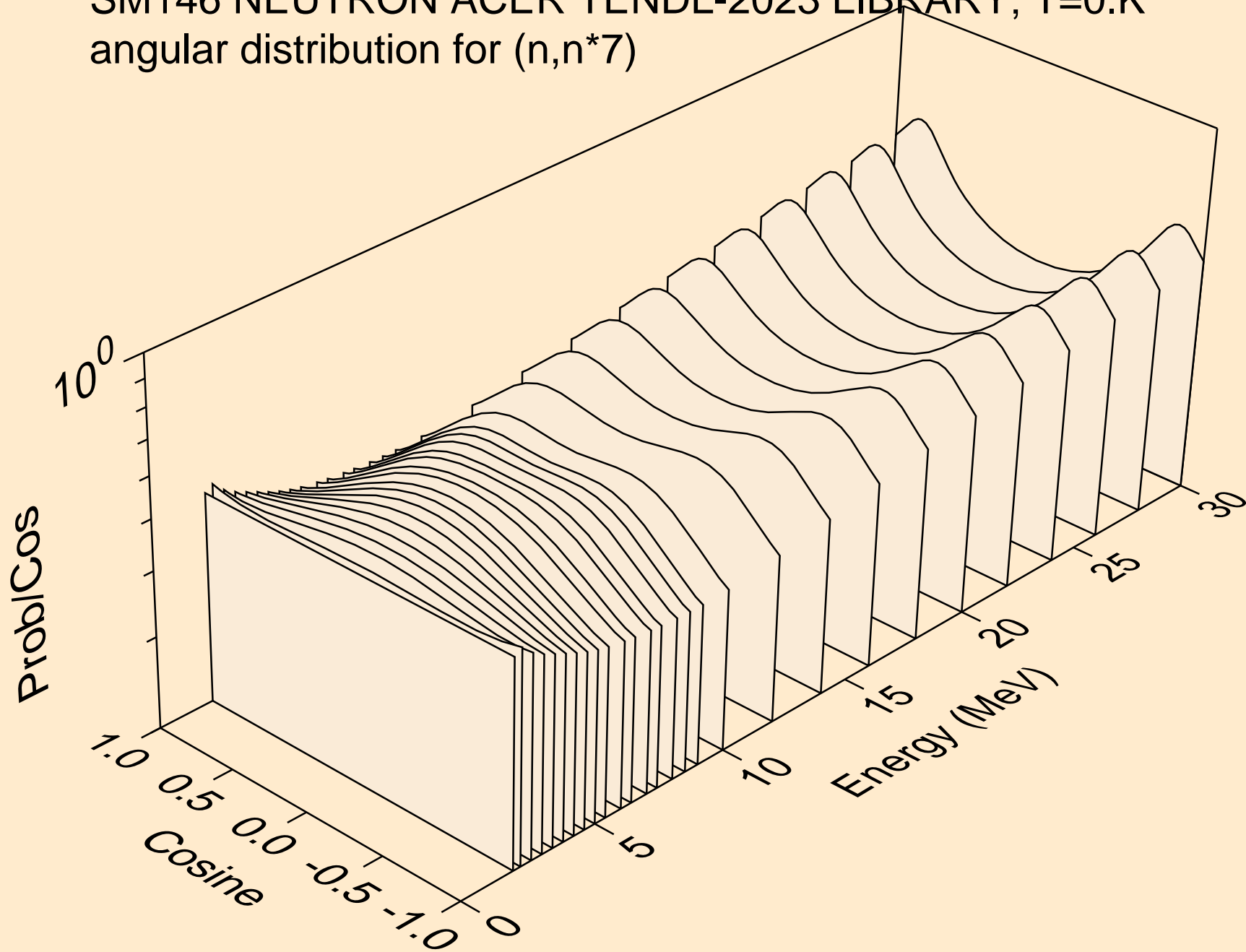

SM146 NEUTRON ACER TENDL-2023 LIBRARY; T=0.K  
angular distribution for (n,n\*8)

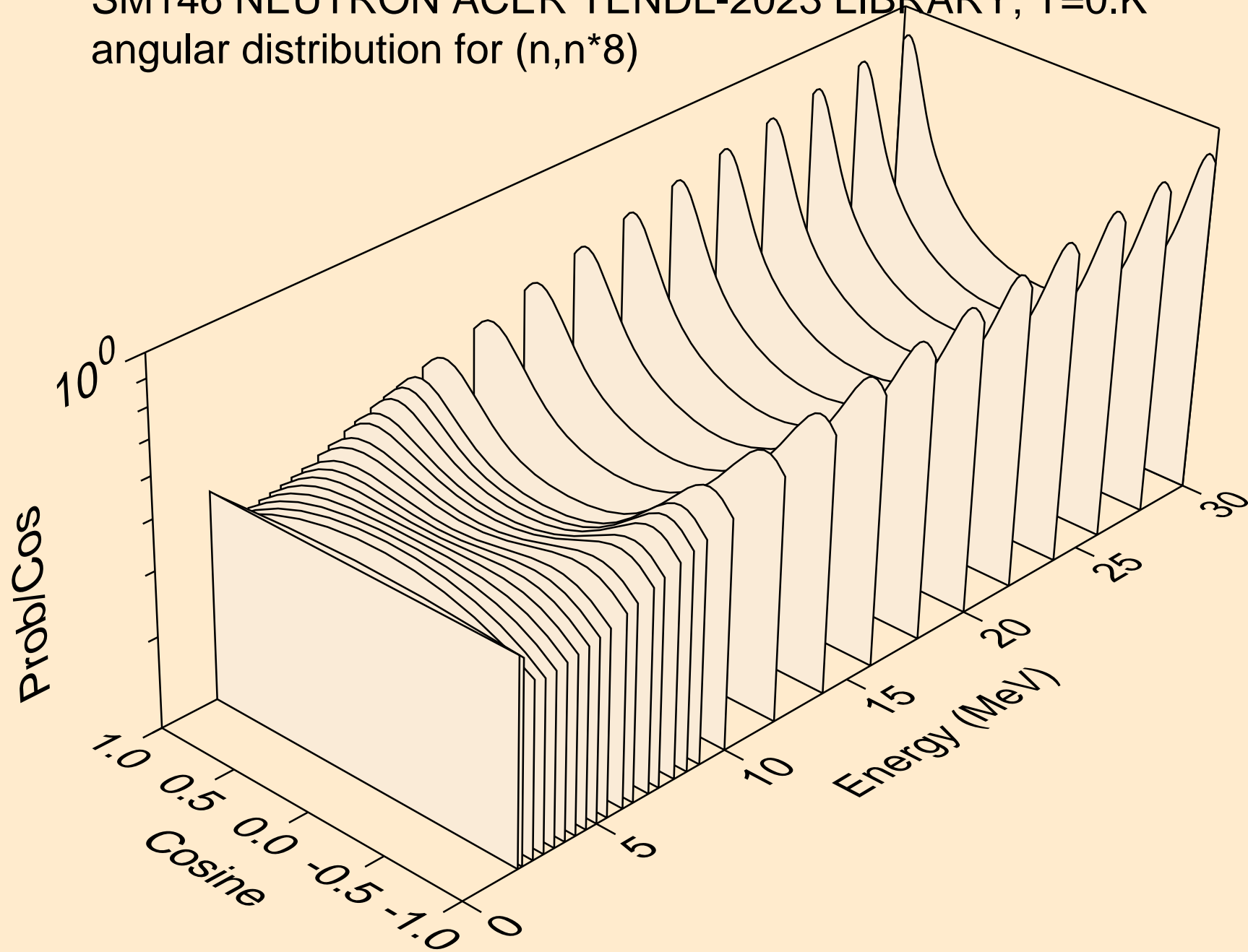

SM146 NEUTRON ACER TENDL-2023 LIBRARY; T=0.K  
angular distribution for (n,n\*9)

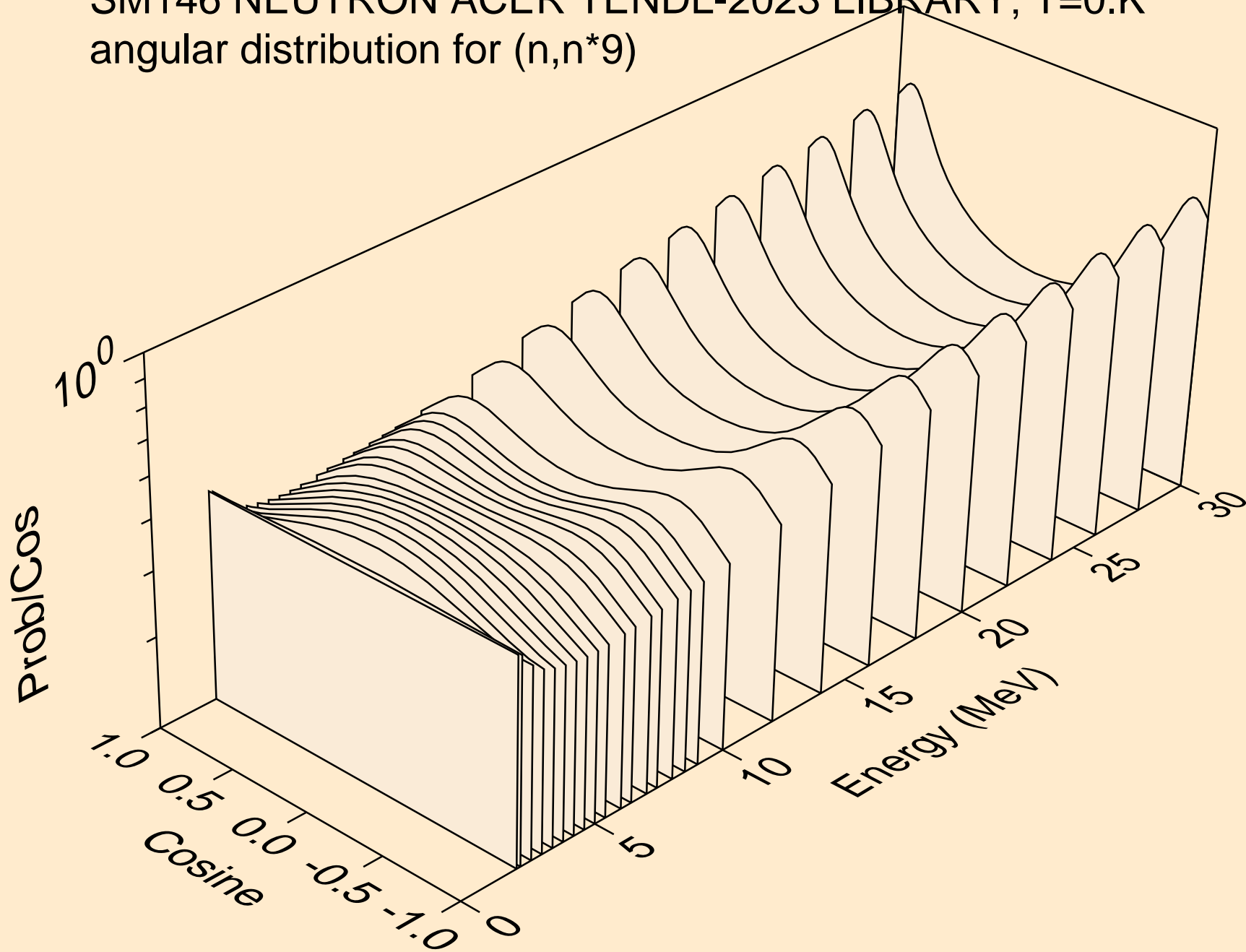

SM146 NEUTRON ACER TENDL-2023 LIBRARY; T=0.K  
angular distribution for (n,n\*10)

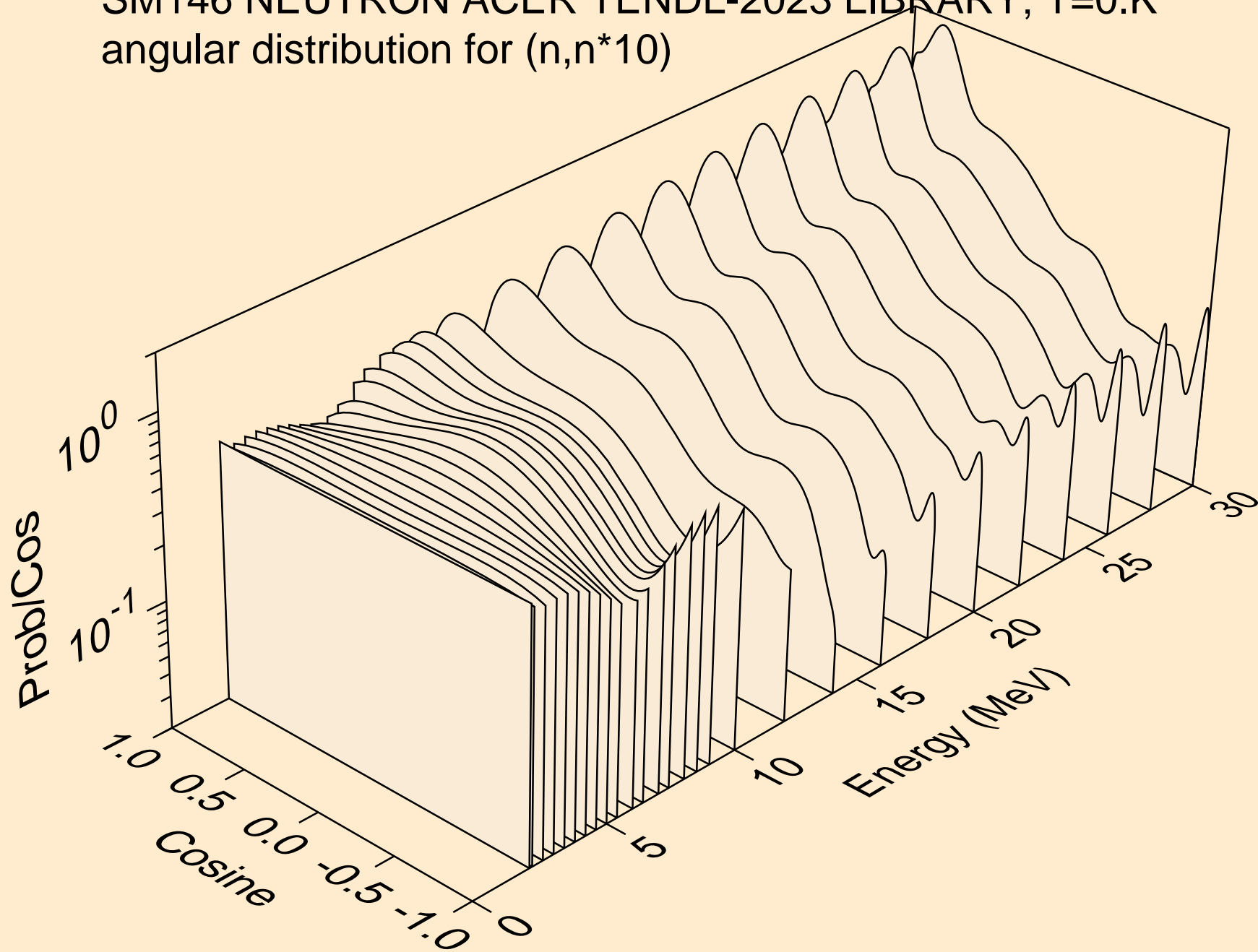

SM146 NEUTRON ACER TENDL-2023 LIBRARY; T=0.K  
angular distribution for (n,n\*11)

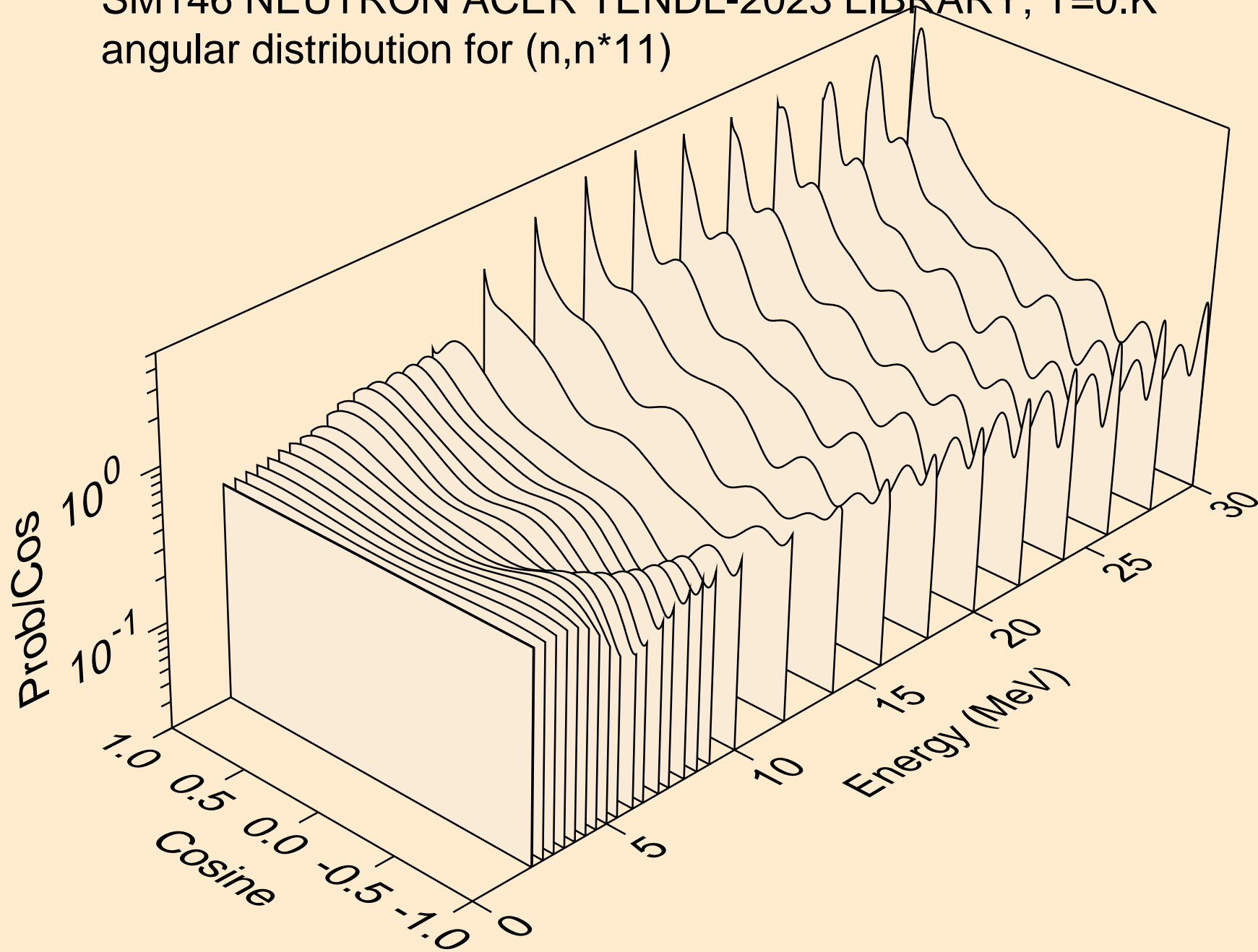



SM146 NEUTRON ACER TENDL-2023 LIBRARY; T=0.K  
angular distribution for (n,n\*12)

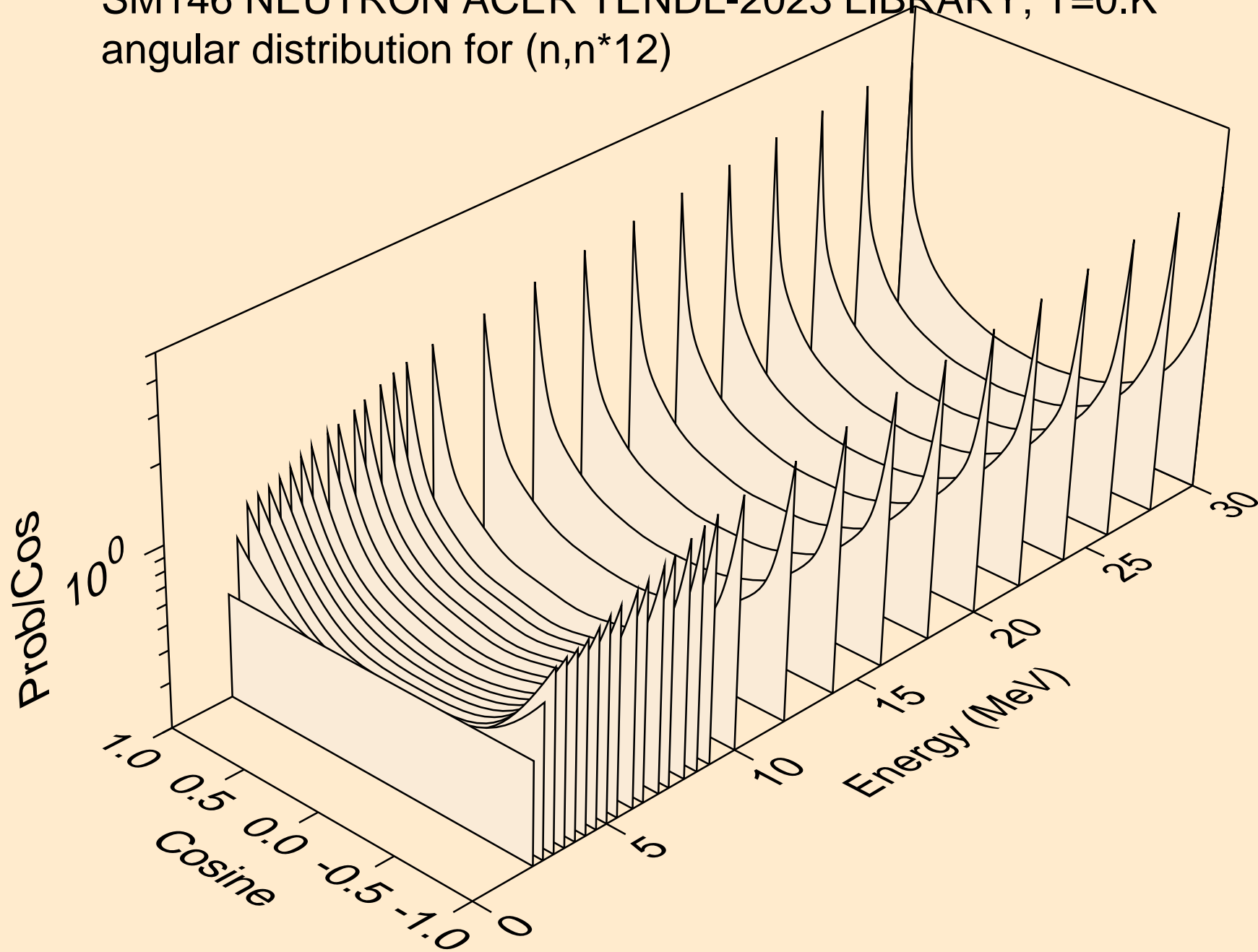

SM146 NEUTRON ACER TENDL-2023 LIBRARY; T=0.K  
angular distribution for (n,n\*13)

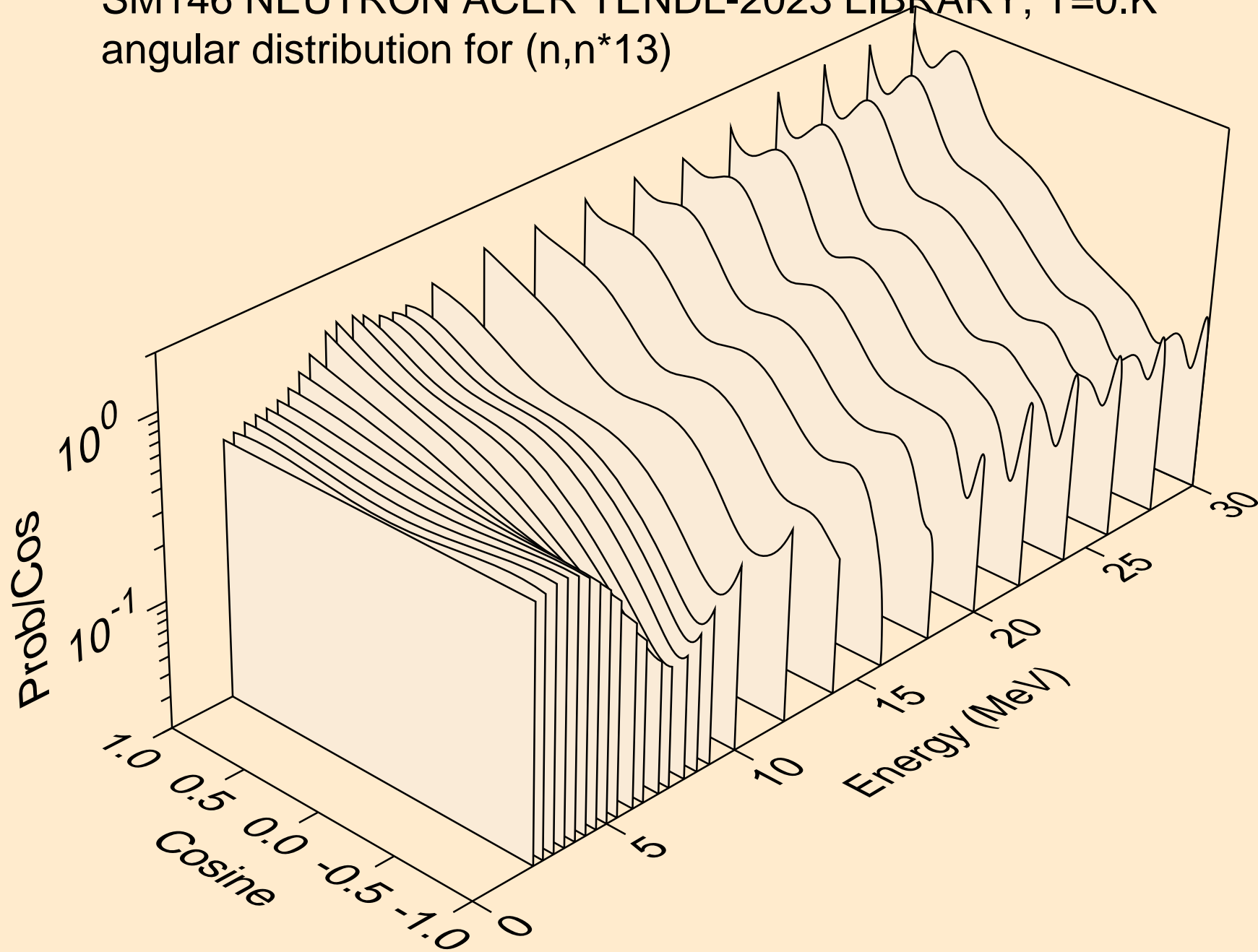

SM146 NEUTRON ACER TENDL-2023 LIBRARY; T=0.K  
angular distribution for (n,n\*14)

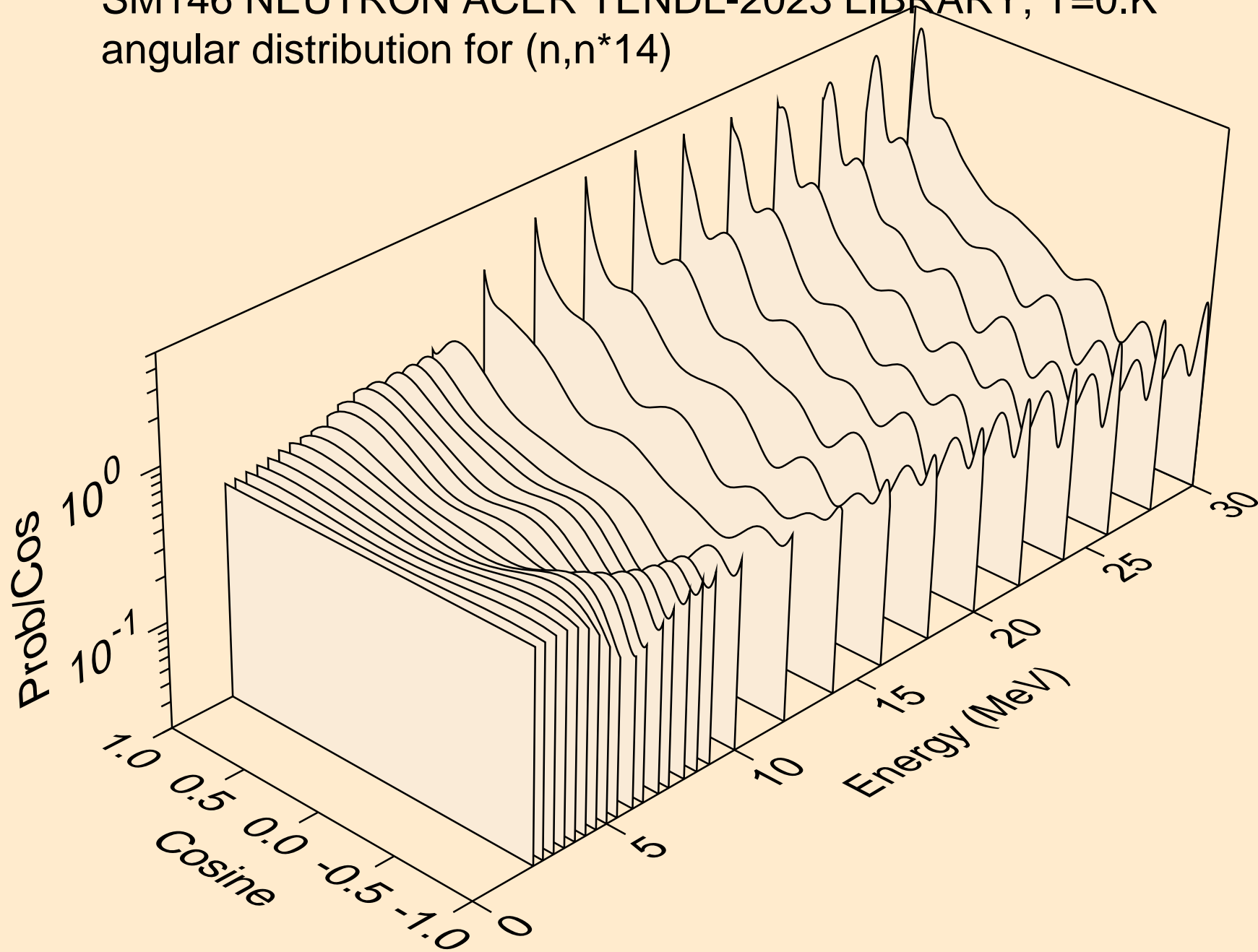

SM146 NEUTRON ACER TENDL-2023 LIBRARY; T=0.K  
angular distribution for (n,n\*15)

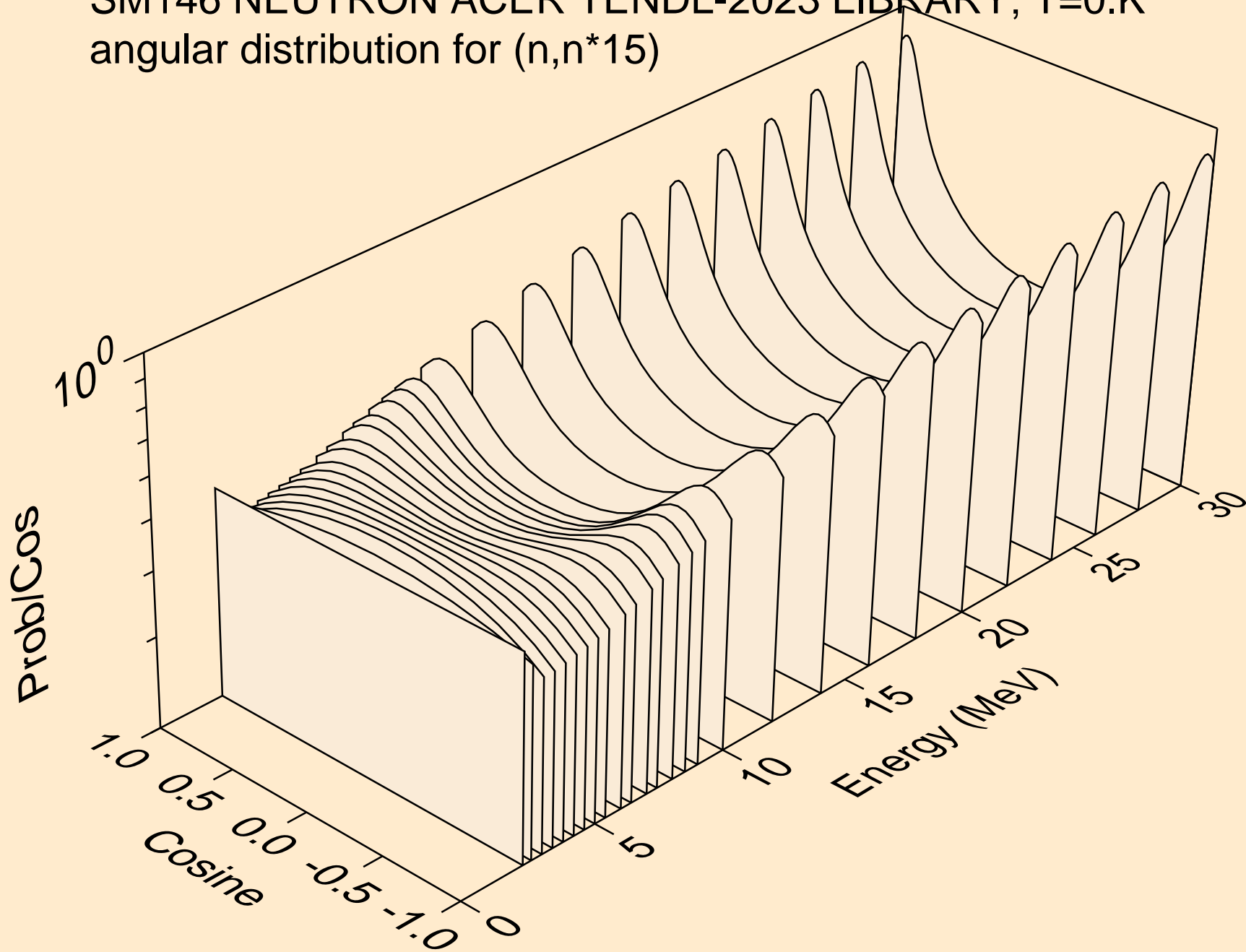

SM146 NEUTRON ACER TENDL-2023 LIBRARY; T=0.K  
Neutron emission for (n,x)

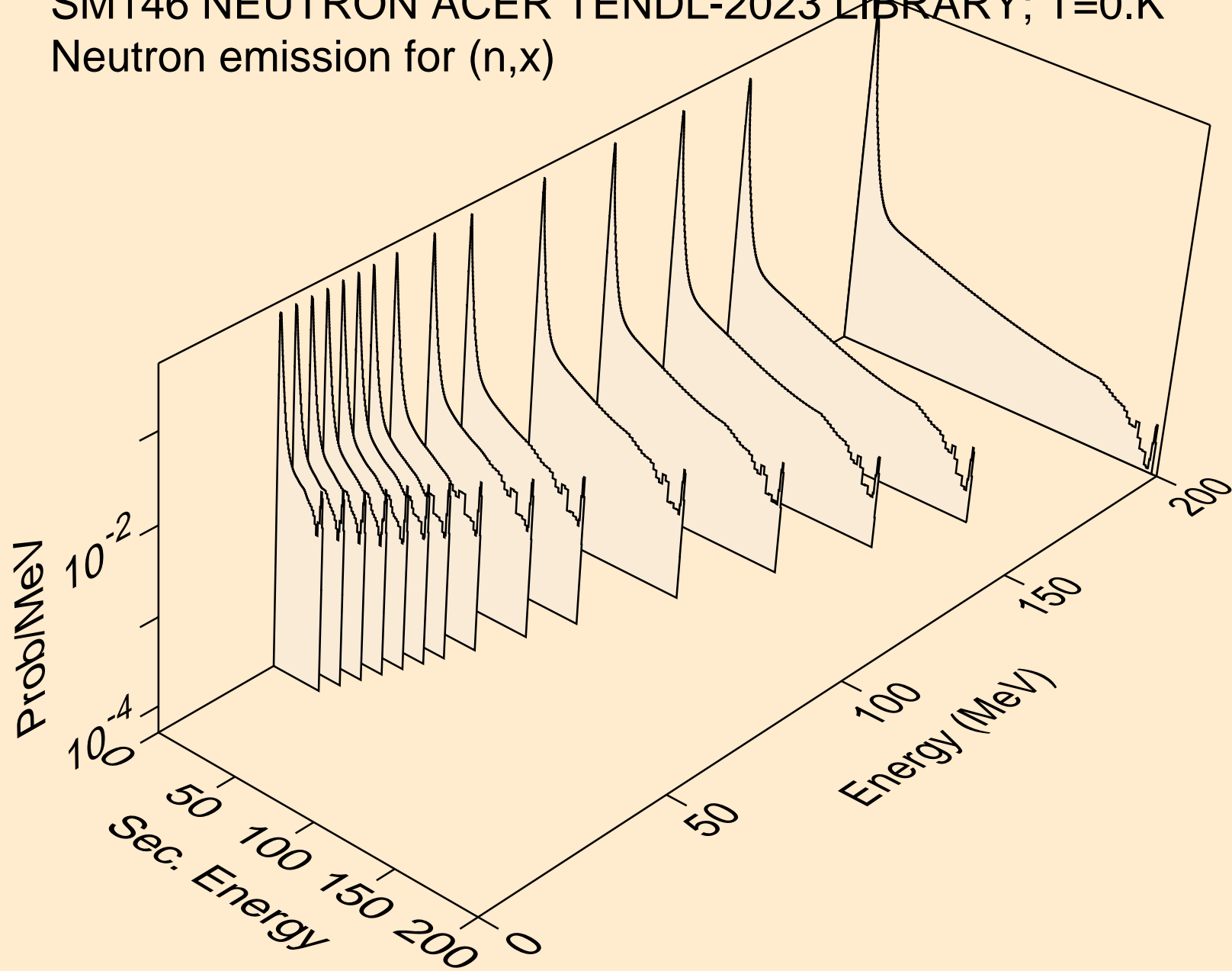

SM146 NEUTRON ACER TENDL-2023 LIBRARY; T=0.K  
Neutron emission for (n,2nd)

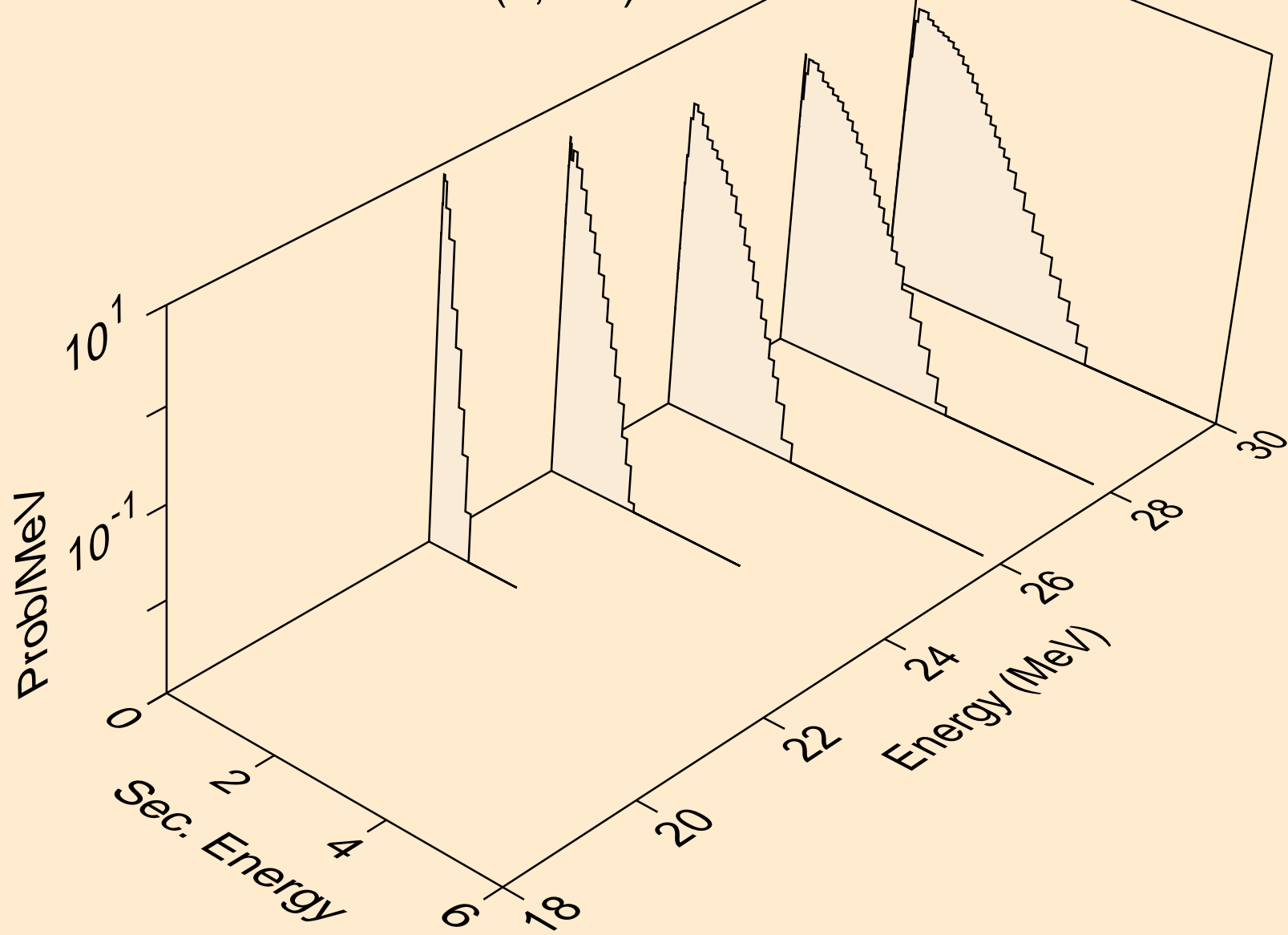

SM146 NEUTRON ACER TENDL-2023 LIBRARY; T=0.K  
Neutron emission for (n,2n)

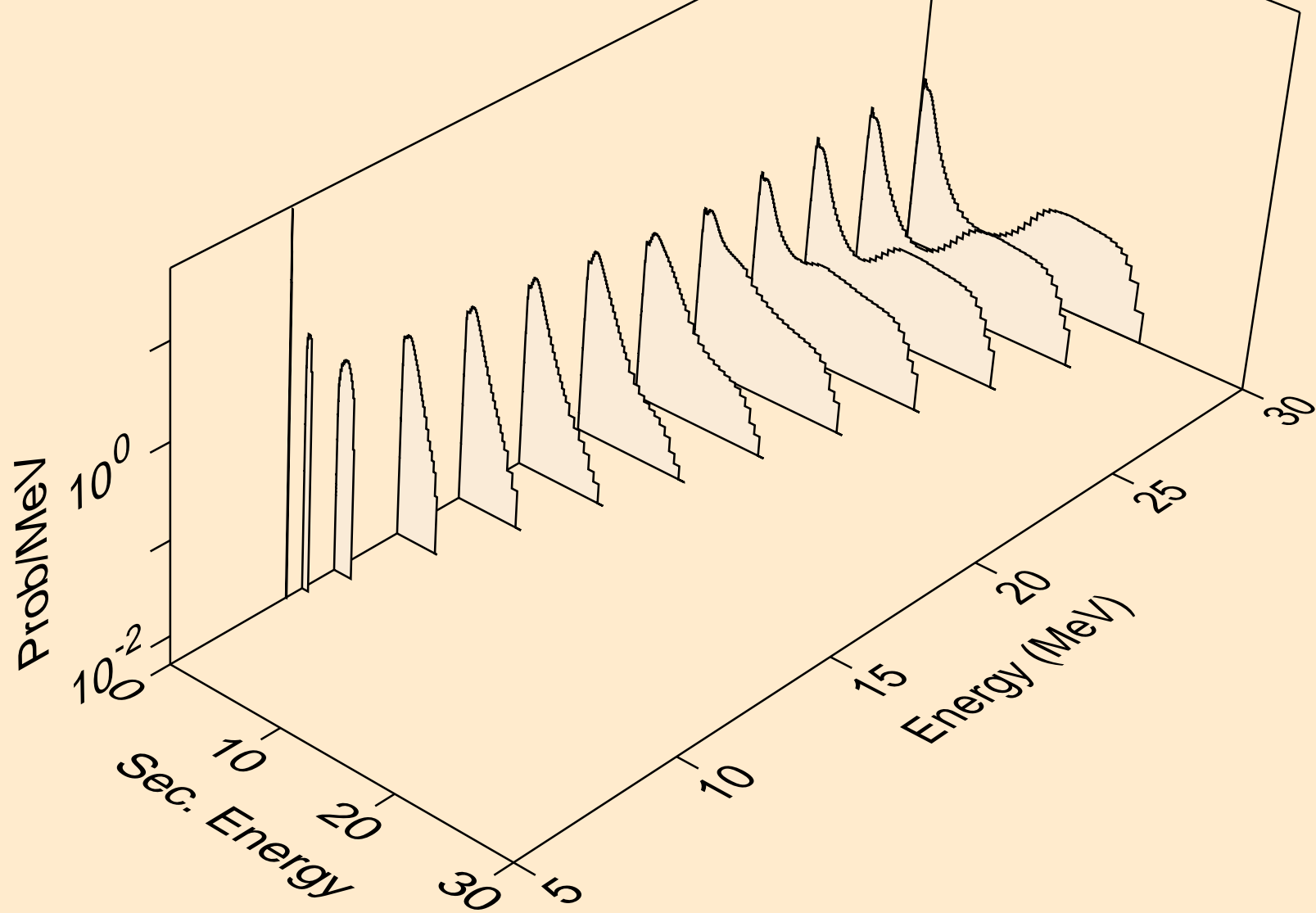

SM146 NEUTRON ACER TENDL-2023 LIBRARY; T=0.K  
Neutron emission for (n,3n)

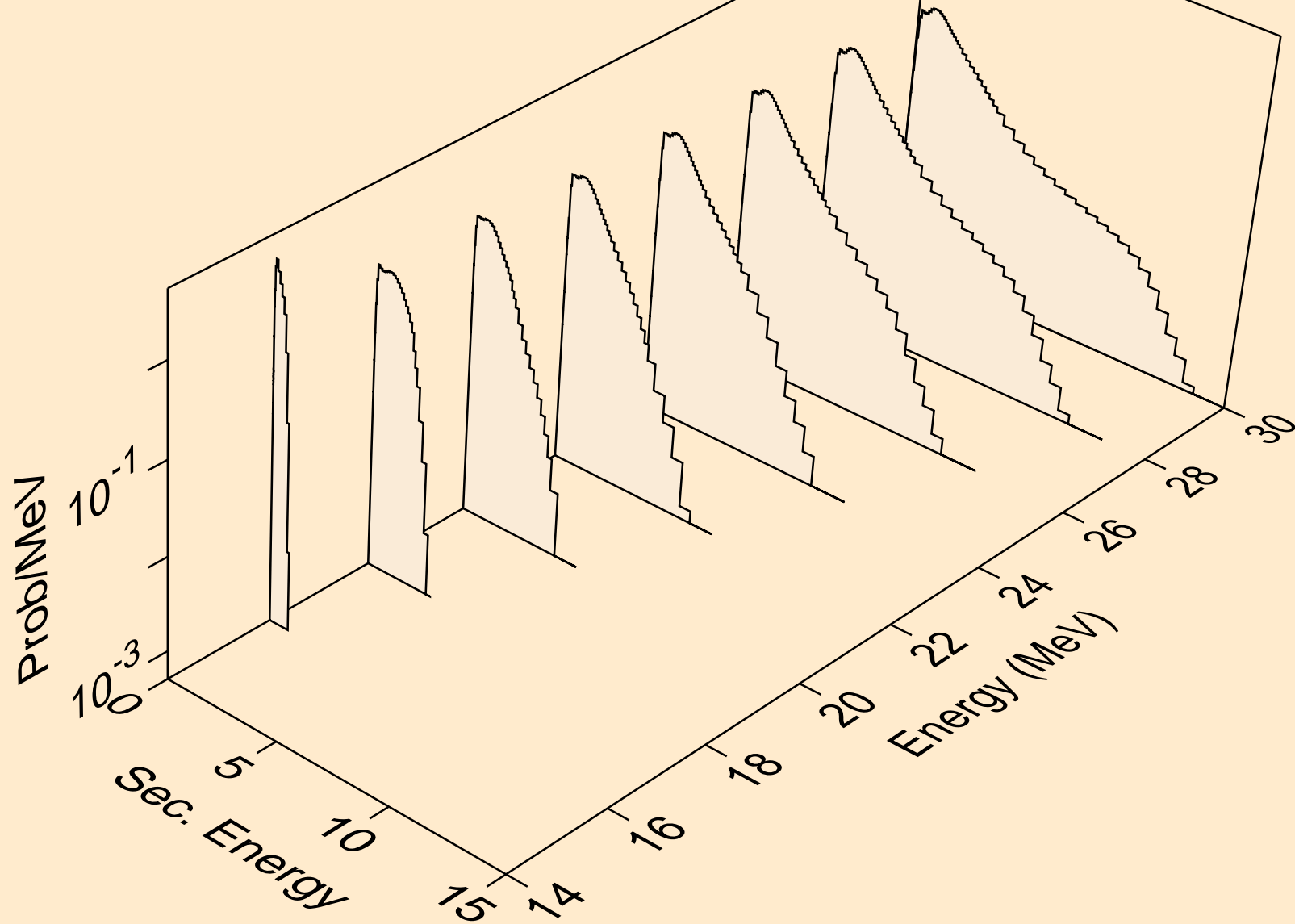



SM146 NEUTRON ACER TENDL-2023 LIBRARY; T=0.K  
Neutron emission for (n,n\*)a

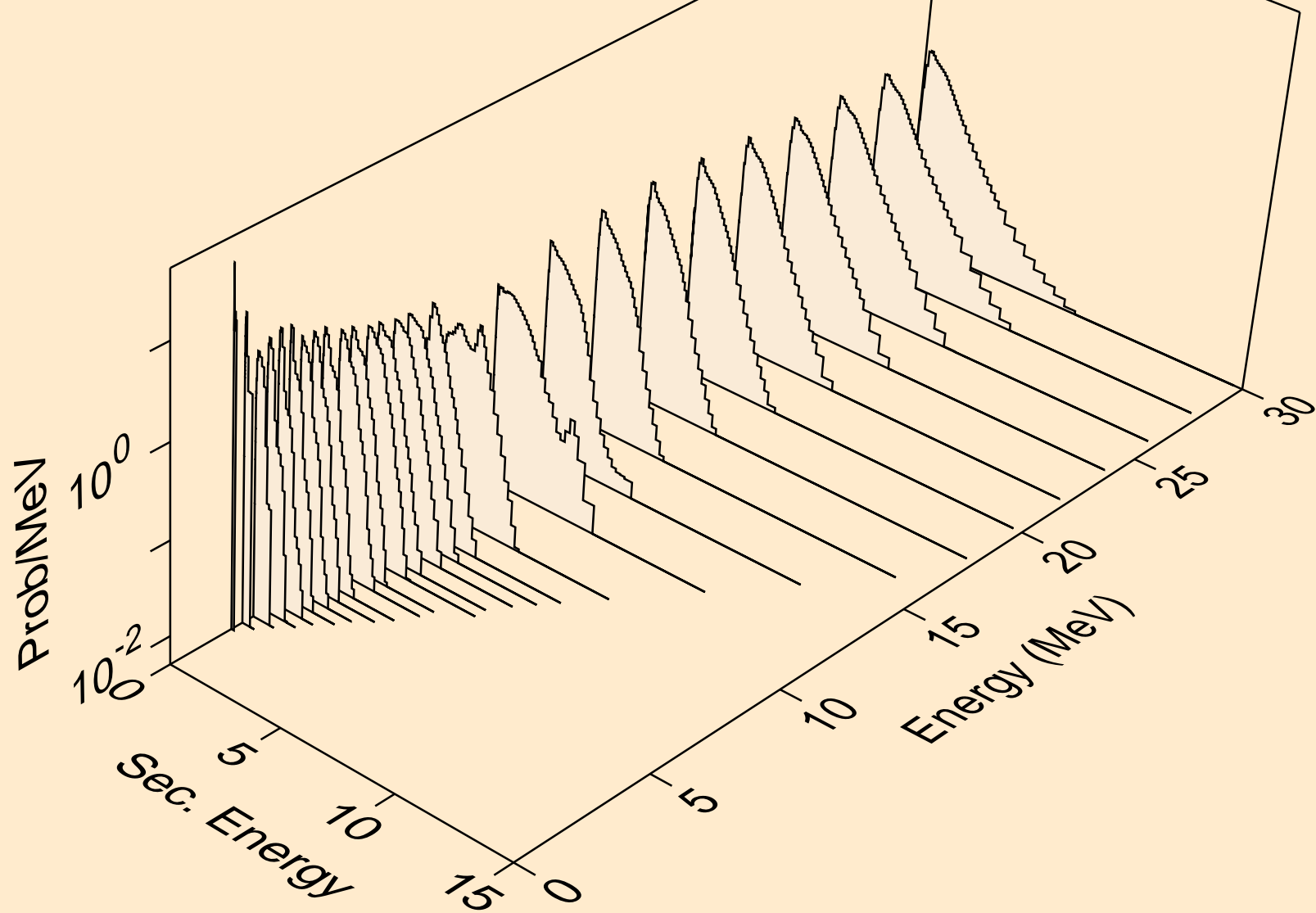

SM146 NEUTRON ACER TENDL-2023 LIBRARY; T=0.K  
Neutron emission for (n,2n)a

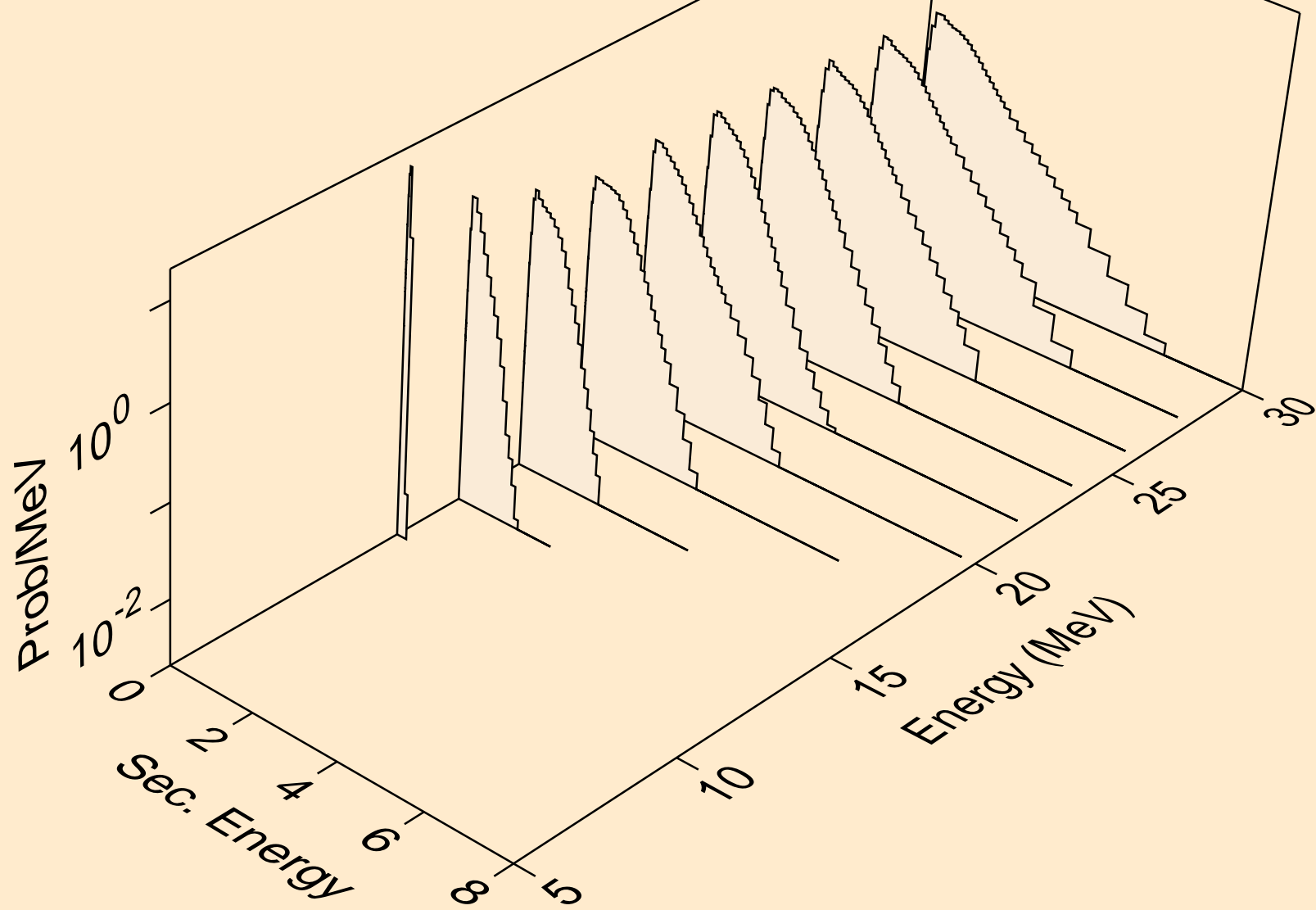

SM146 NEUTRON ACER TENDL-2023 LIBRARY; T=0.K  
Neutron emission for (n,3n)a

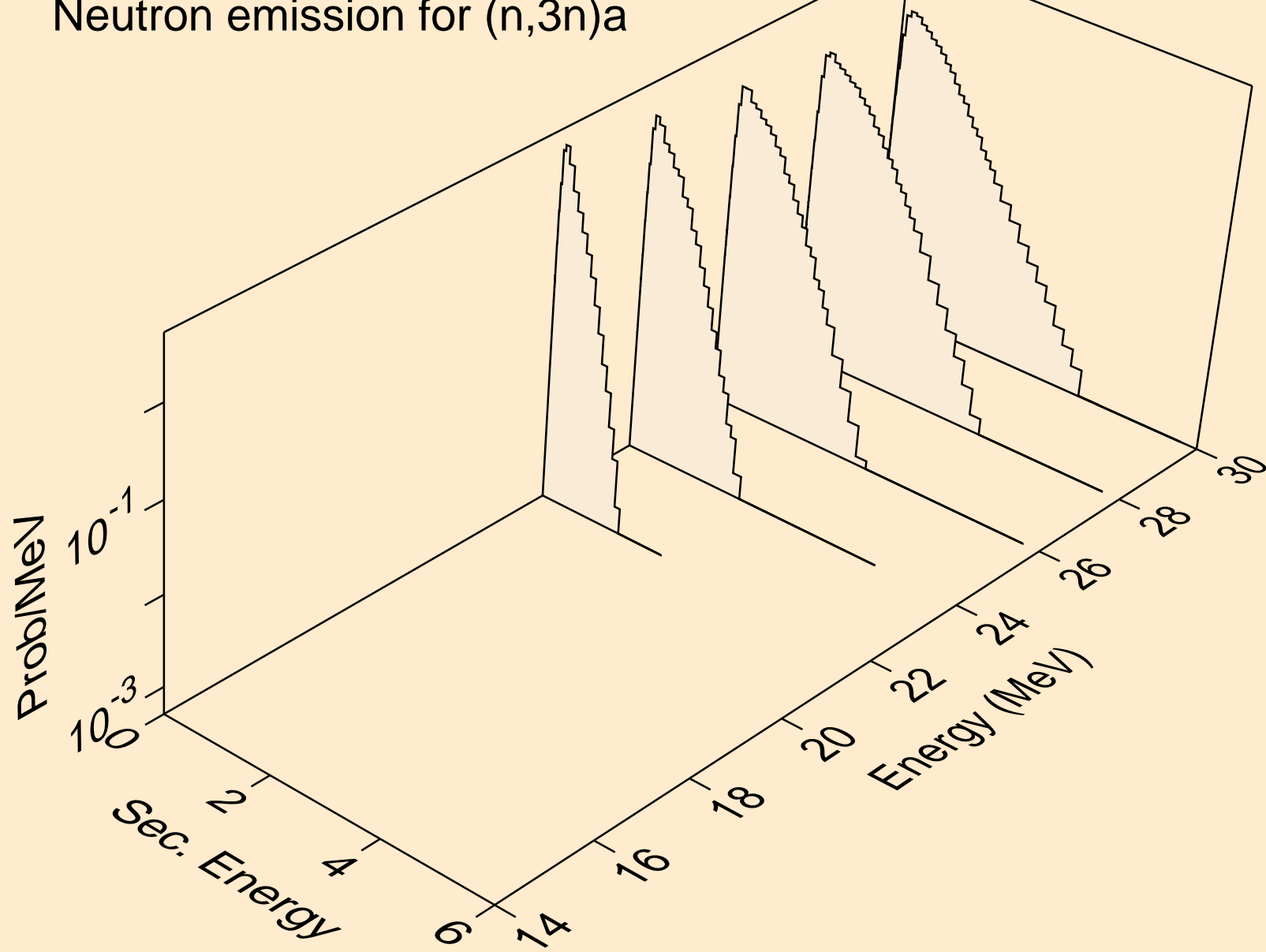

SM146 NEUTRON ACER TENDL-2023 LIBRARY; T=0.K  
Neutron emission for (n,n\*)p

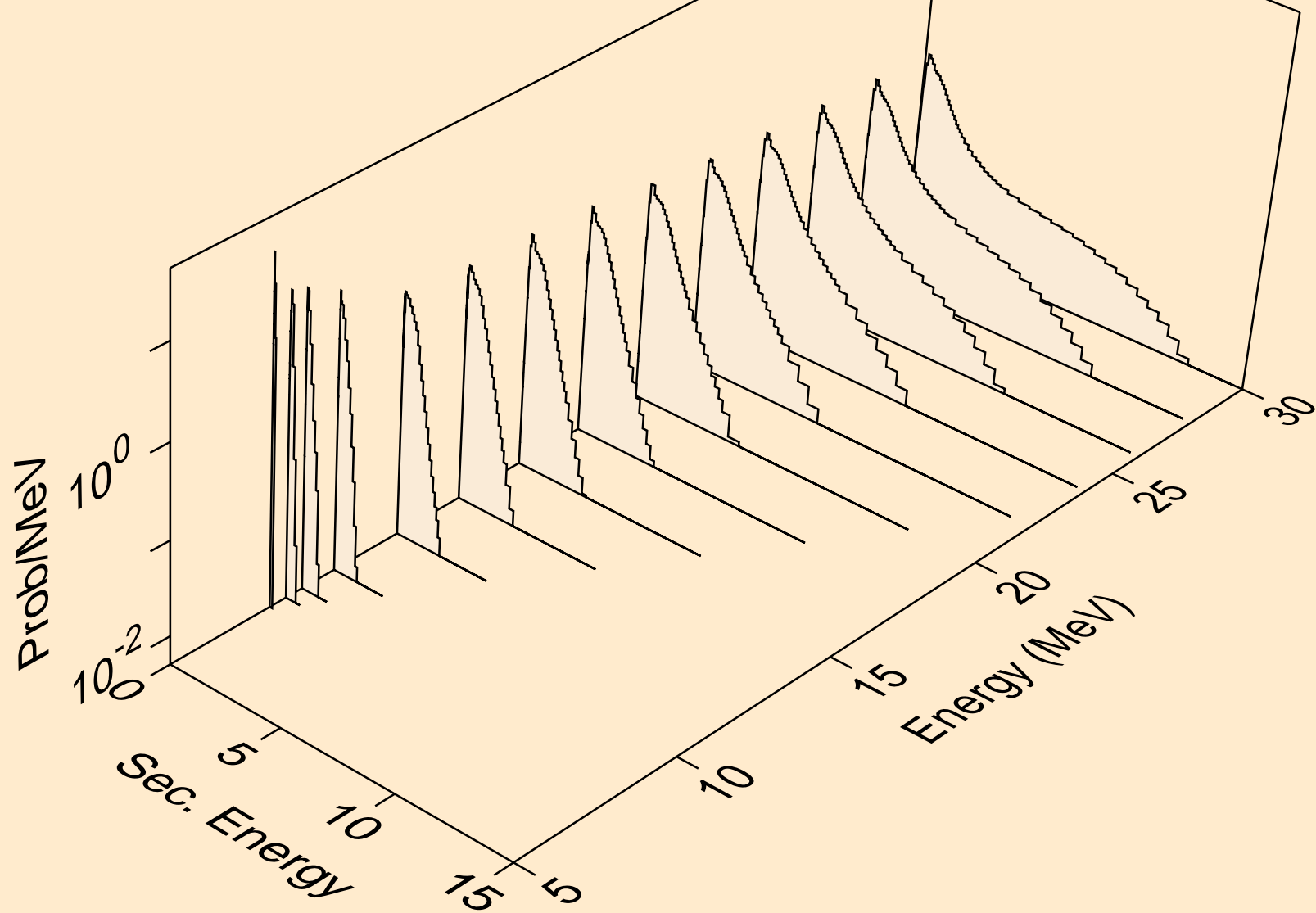

SM146 NEUTRON ACER TENDL-2023 LIBRARY; T=0.K  
Neutron emission for (n,n\*)2a

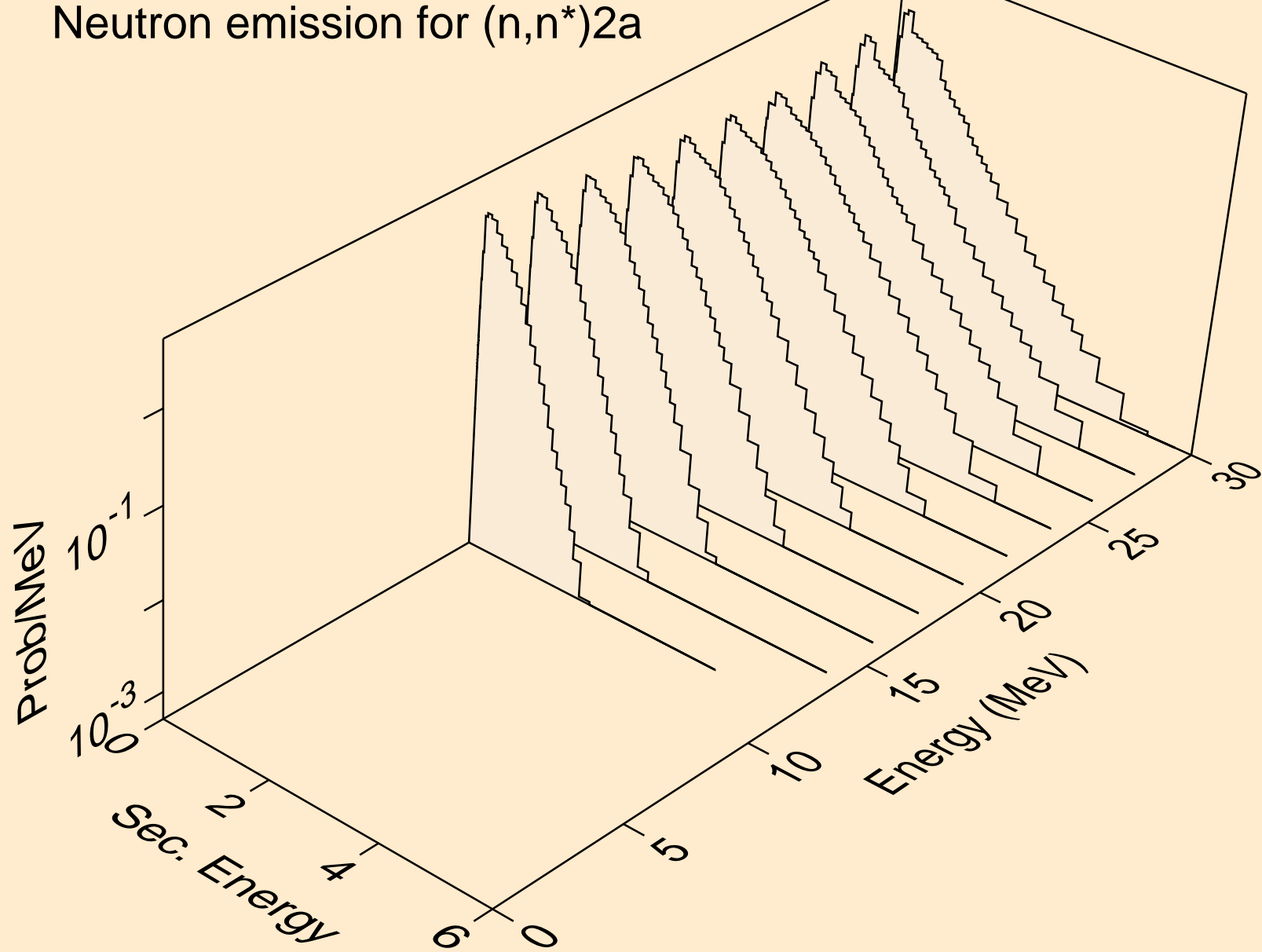

SM146 NEUTRON ACER TENDL-2023 LIBRARY; T=0.K  
Neutron emission for (n,n\*)d

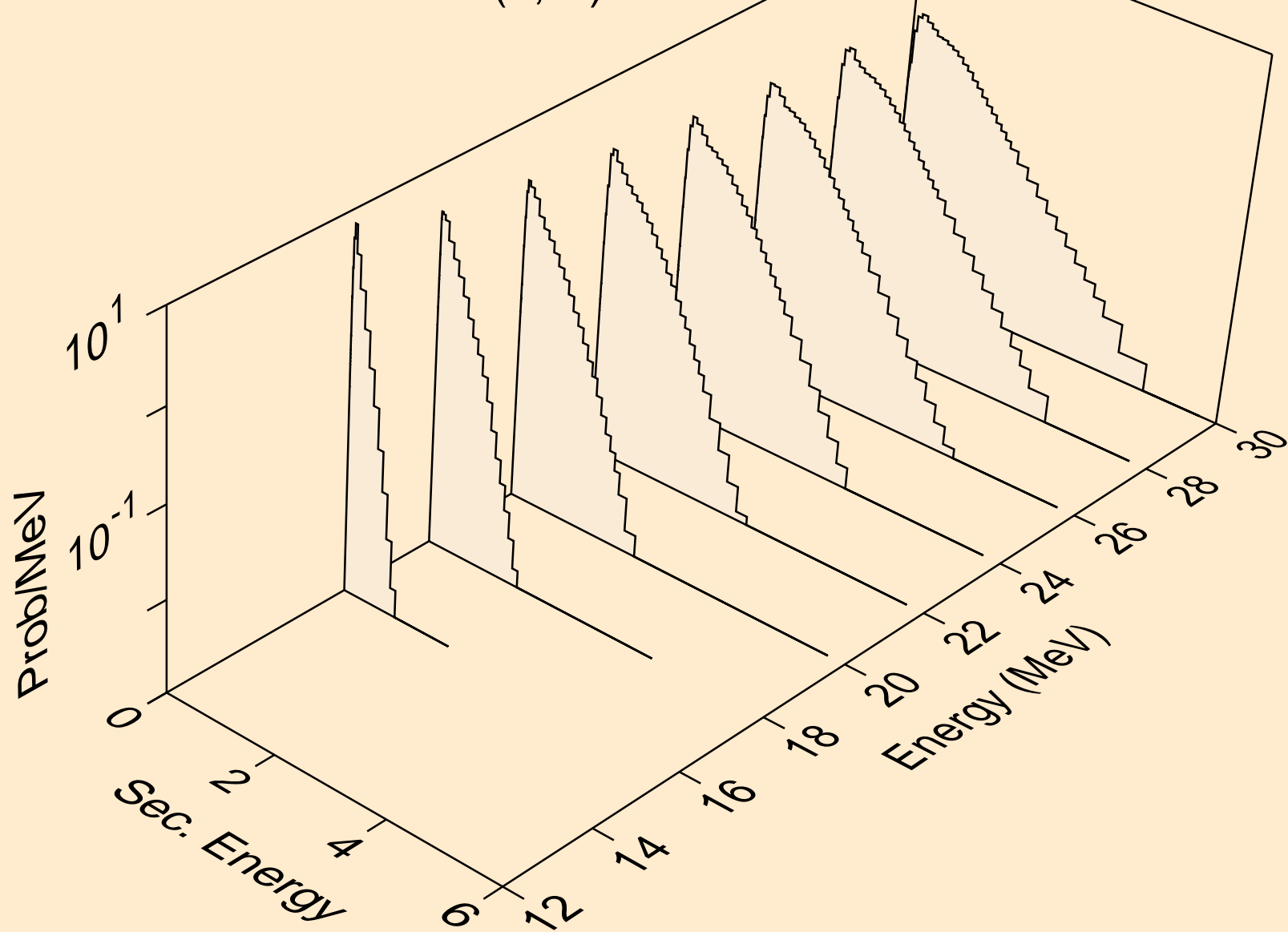

SM146 NEUTRON ACER TENDL-2023 LIBRARY; T=0.K  
Neutron emission for (n,n\*)t

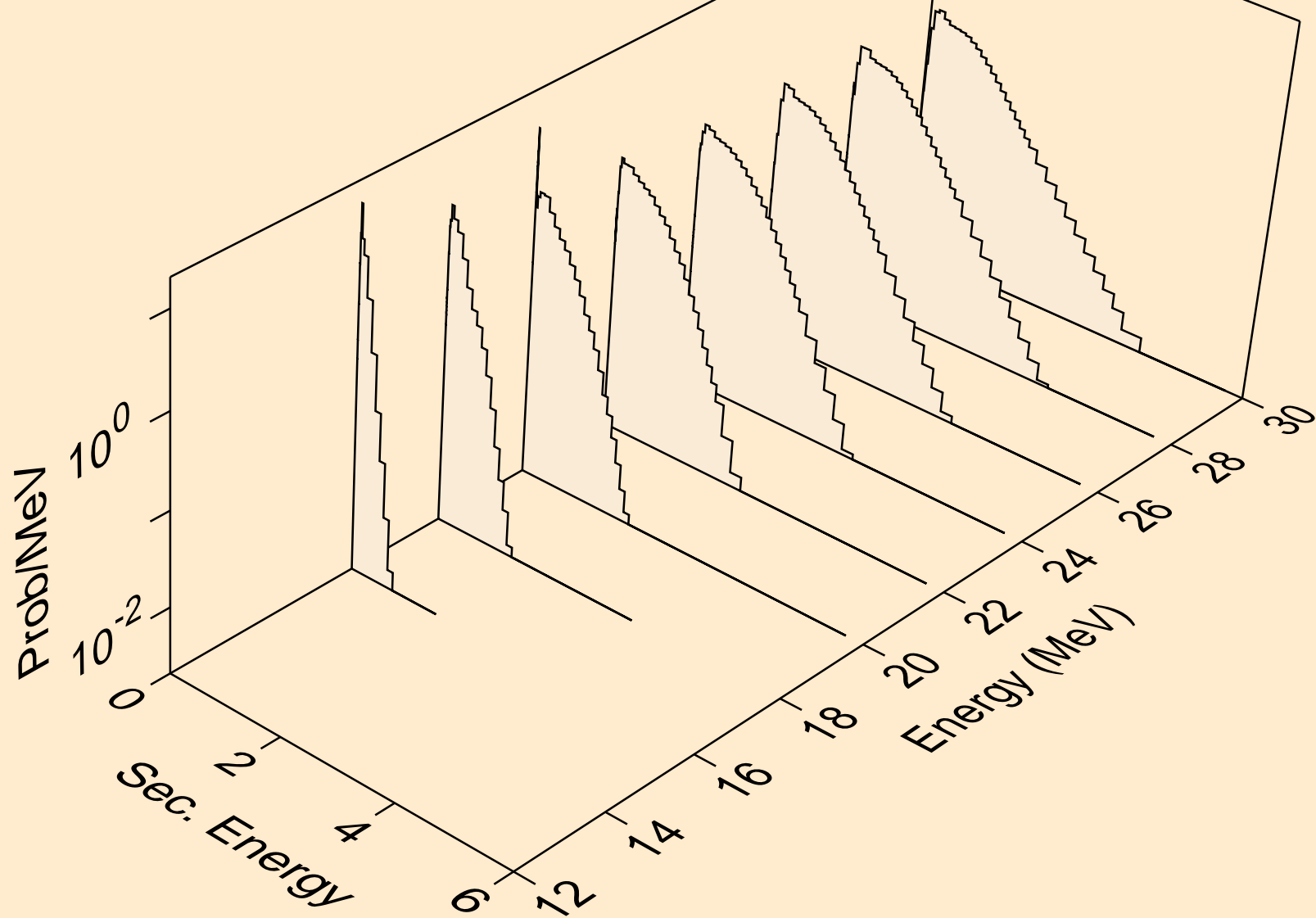

SM146 NEUTRON ACER TENDL-2023 LIBRARY; T=0.K  
Neutron emission for (n,n\*)he3

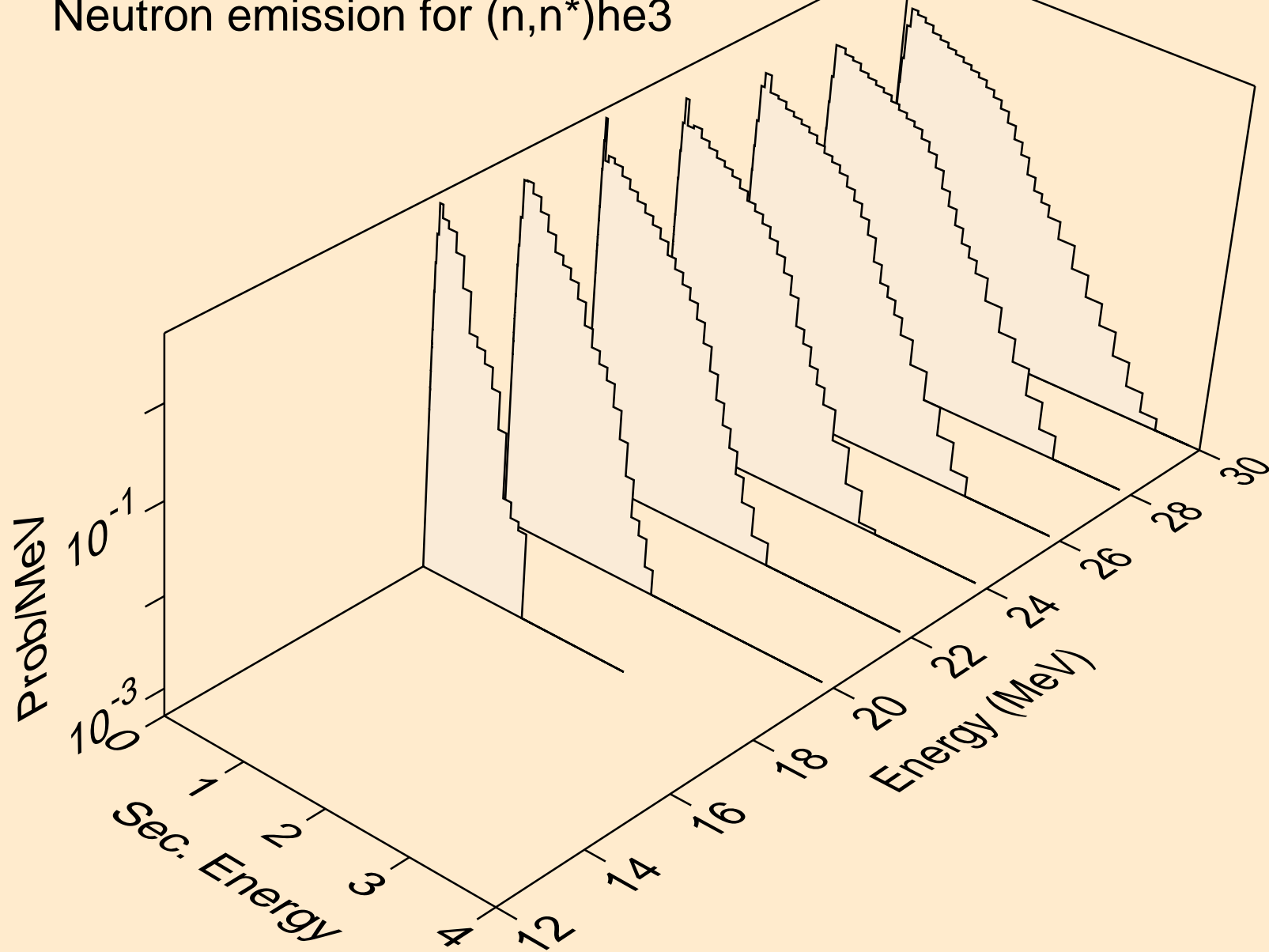



SM146 NEUTRON ACER TENDL-2023 LIBRARY; T=0.K  
Neutron emission for (n,4n)

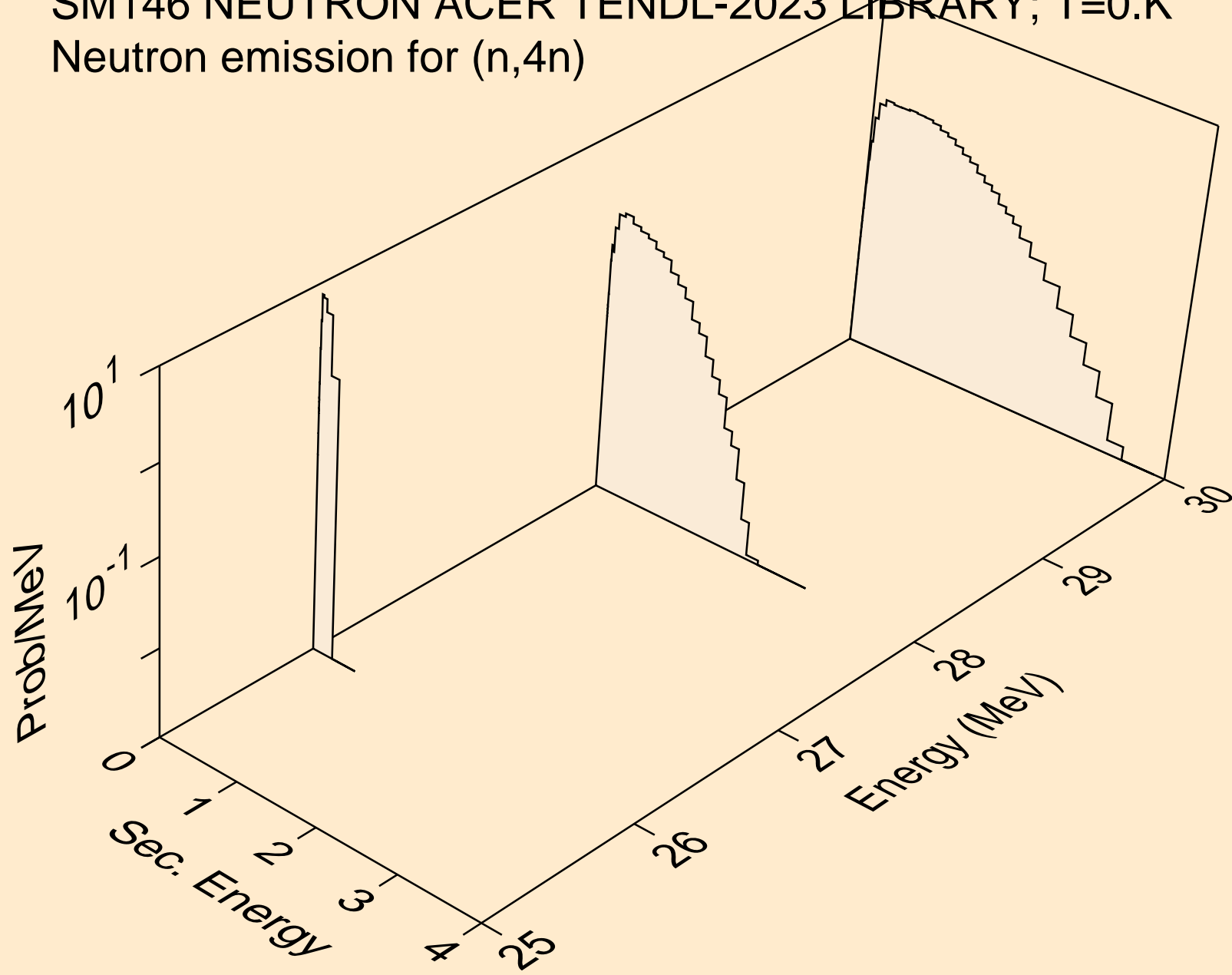

SM146 NEUTRON ACER TENDL-2023 LIBRARY; T=0.K  
Neutron emission for (n,2np)

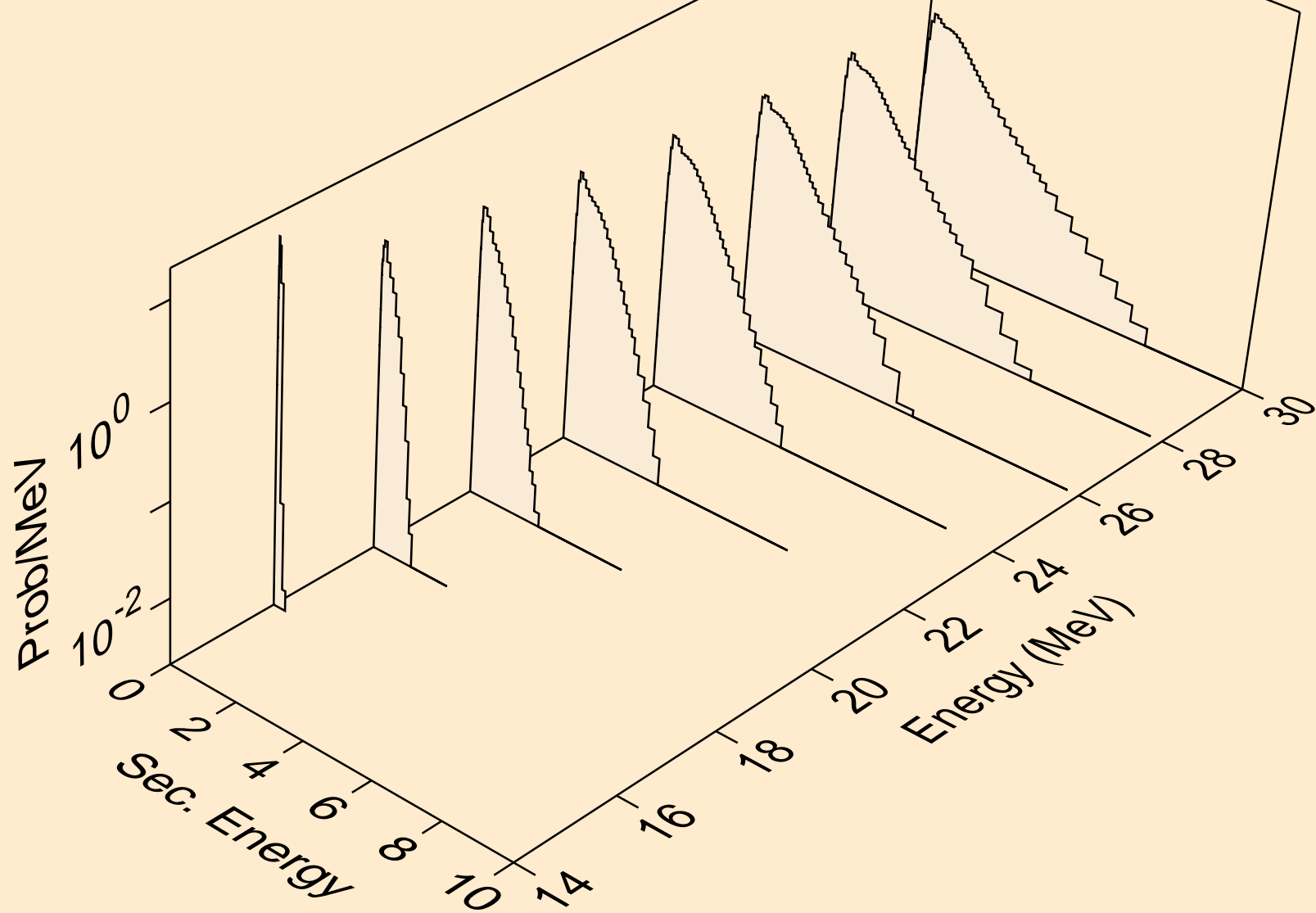

SM146 NEUTRON ACER TENDL-2023 LIBRARY; T=0.K  
Neutron emission for (n,3np)

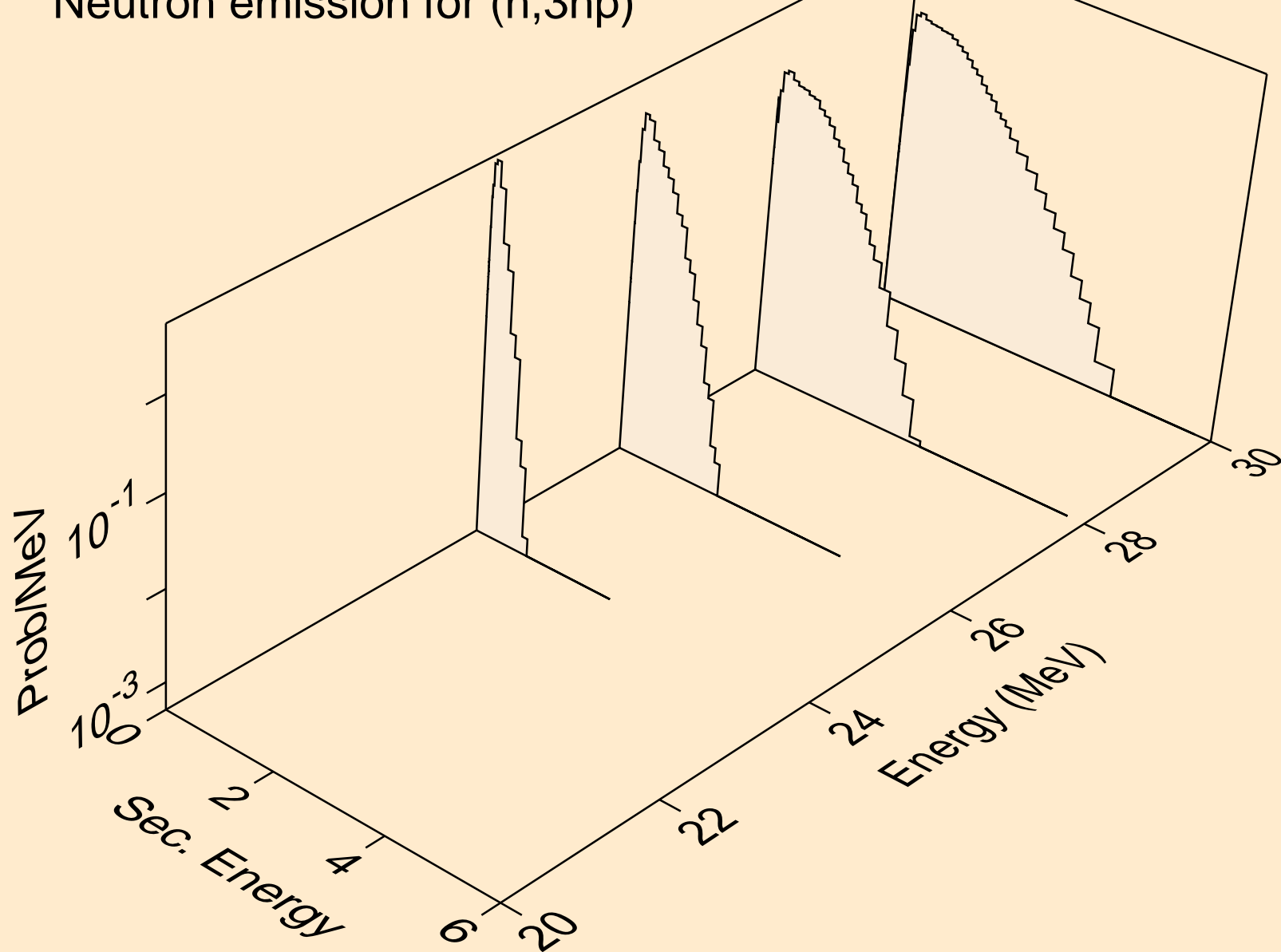

SM146 NEUTRON ACER TENDL-2023 LIBRARY; T=0.K  
Neutron emission for (n,n2p)

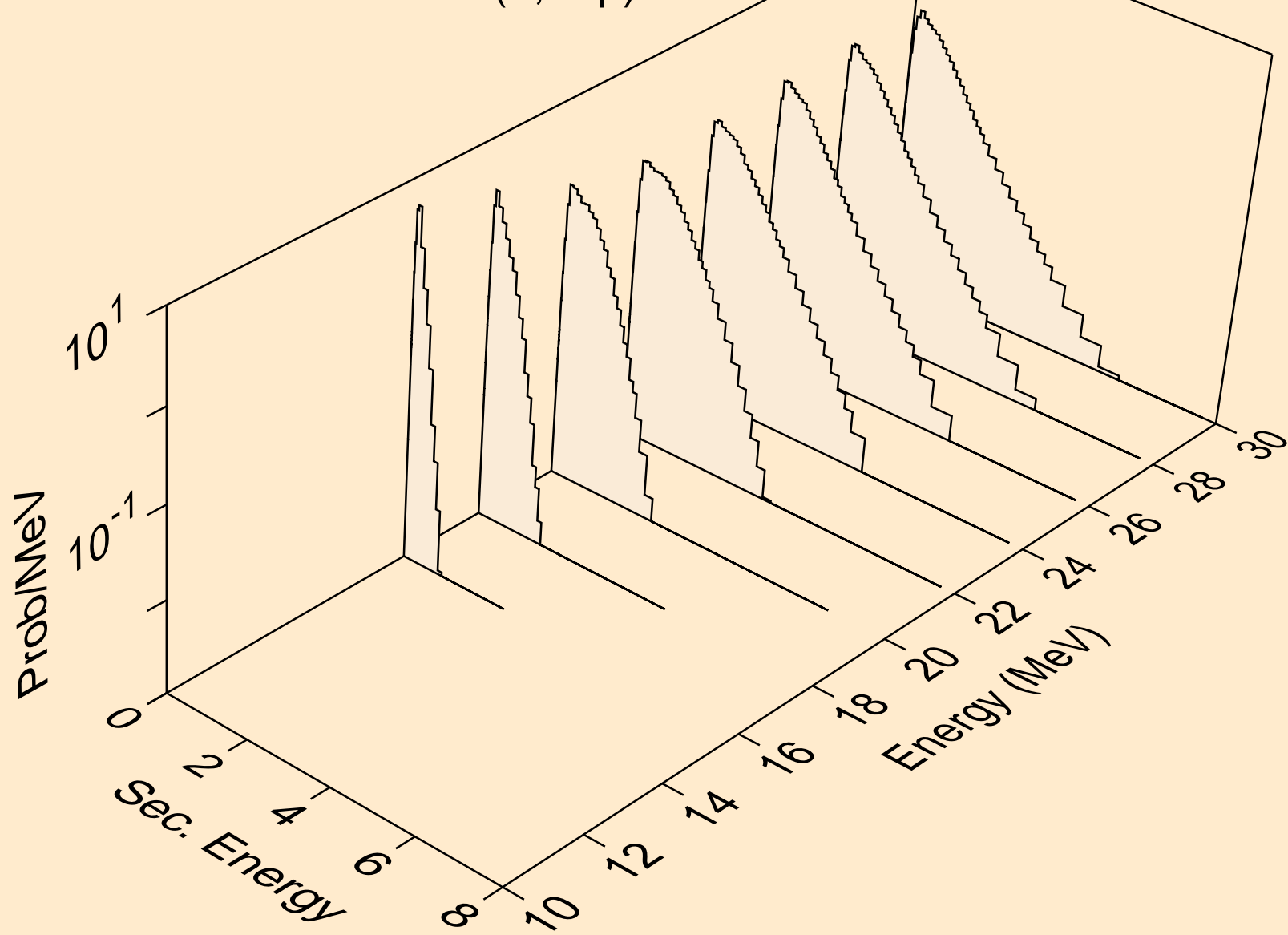

SM146 NEUTRON ACER TENDL-2023 LIBRARY; T=0.K  
Neutron emission for (n,npa)

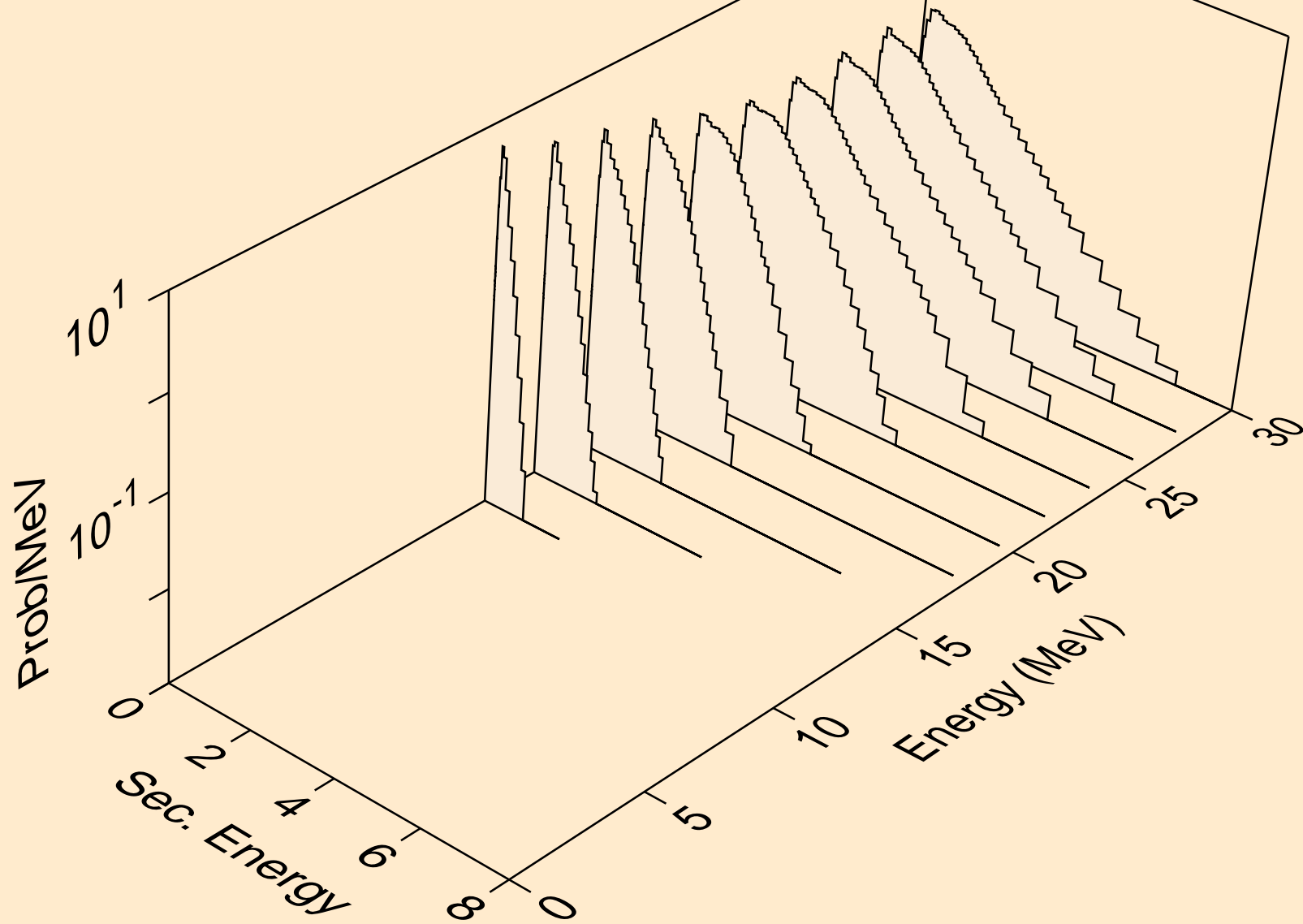

SM146 NEUTRON ACER TENDL-2023 LIBRARY; T=0.K  
Neutron emission for (n,n\*c)

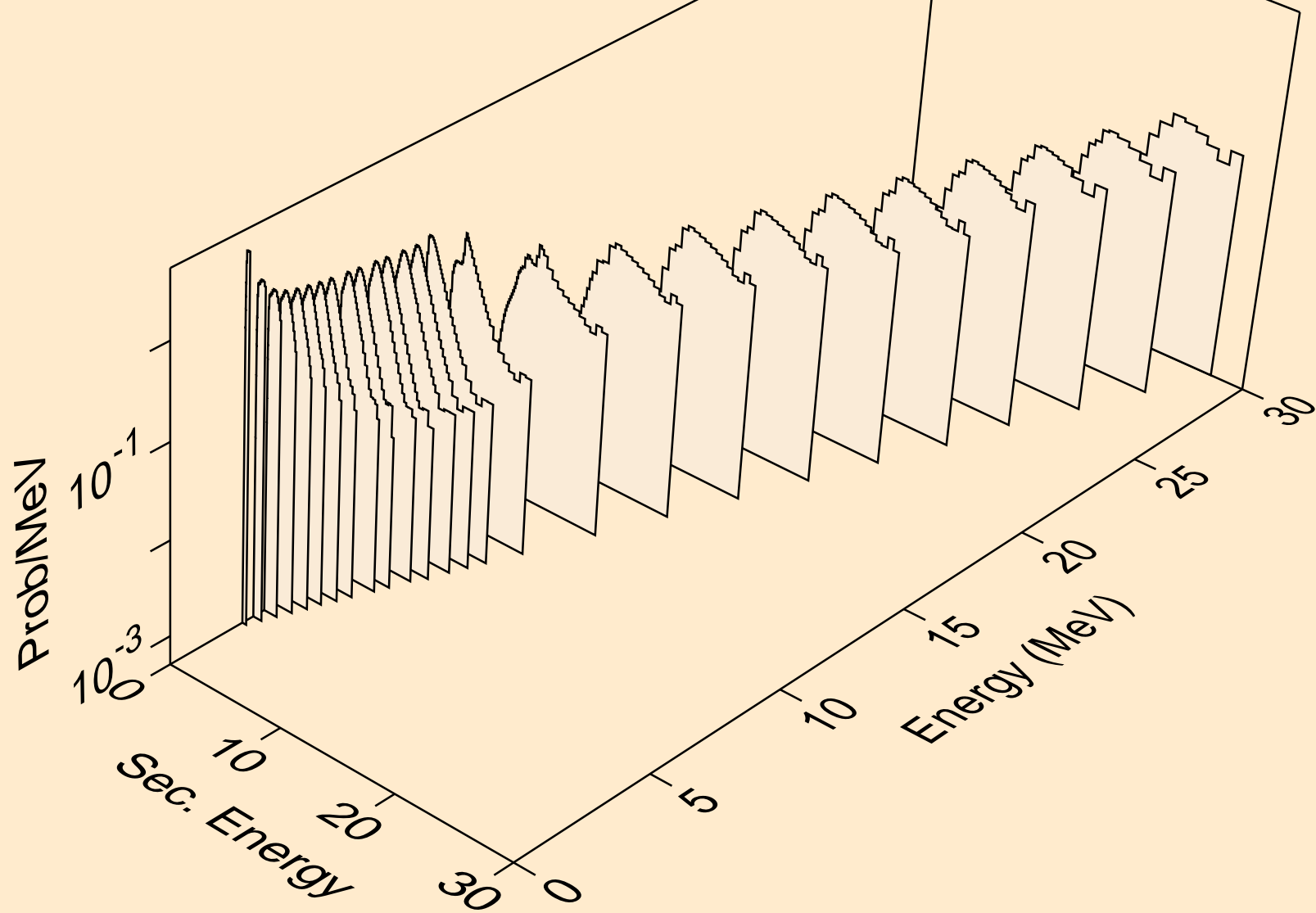

SM146 NEUTRON ACER TENDL-2023 LIBRARY; T=0.K  
Photon emission for (n,x)

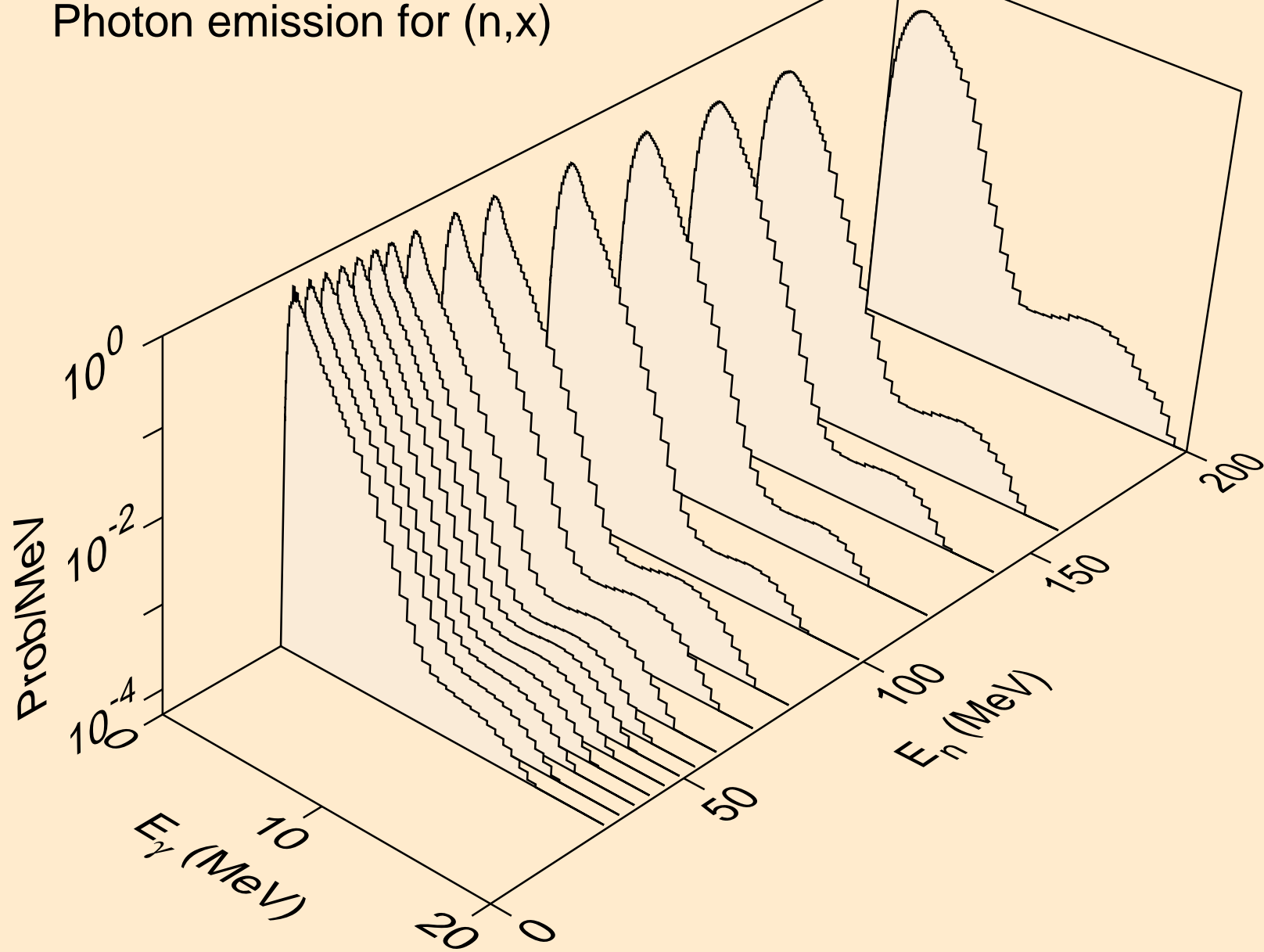

SM146 NEUTRON ACER TENDL-2023 LIBRARY; T=0.K  
Photon emission for (n,2nd)

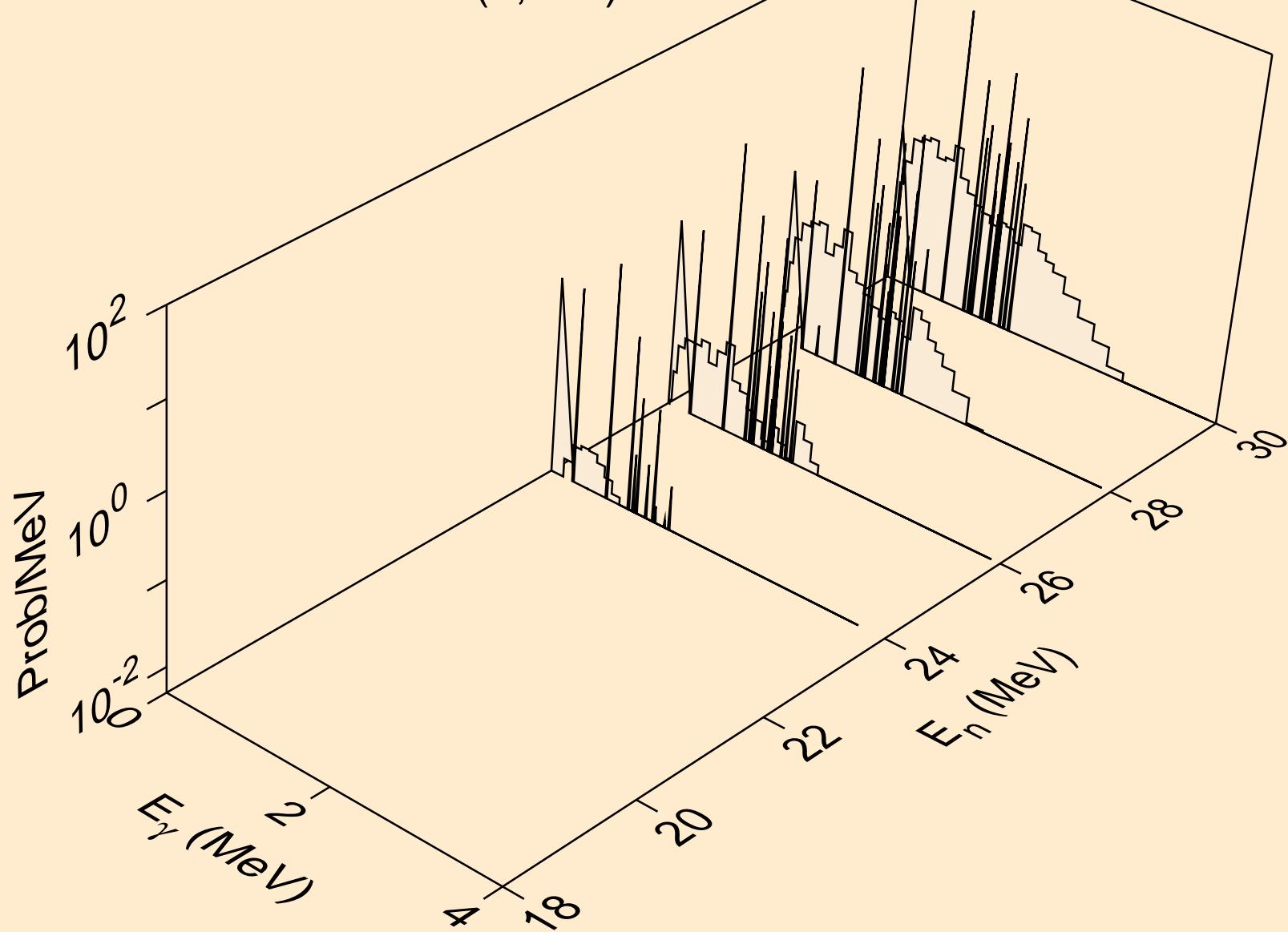



SM146 NEUTRON ACER TENDL-2023 LIBRARY; T=0.K  
Photon emission for (n,2n)

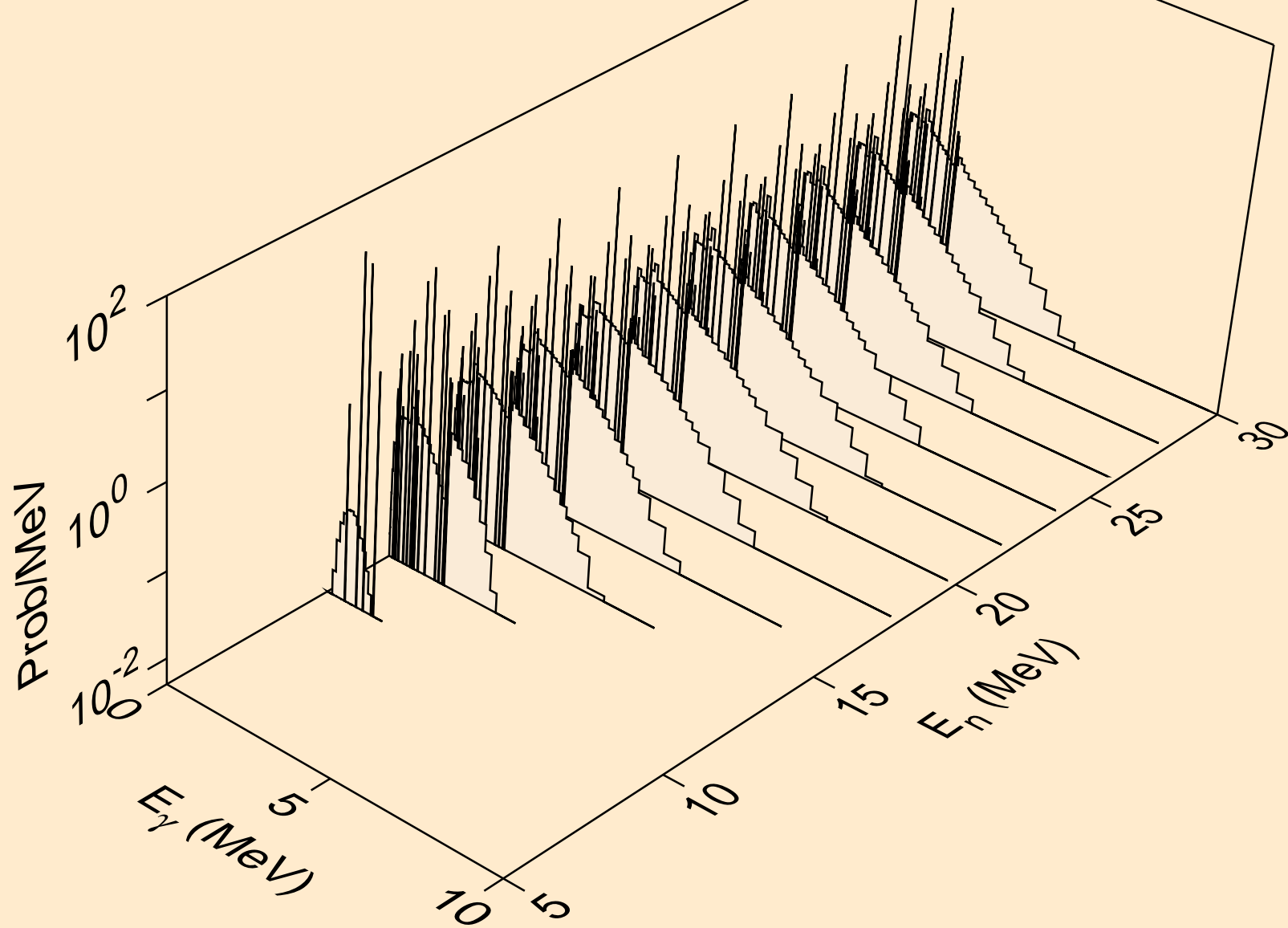

SM146 NEUTRON ACER TENDL-2023 LIBRARY; T=0.K  
Photon emission for (n,3n)

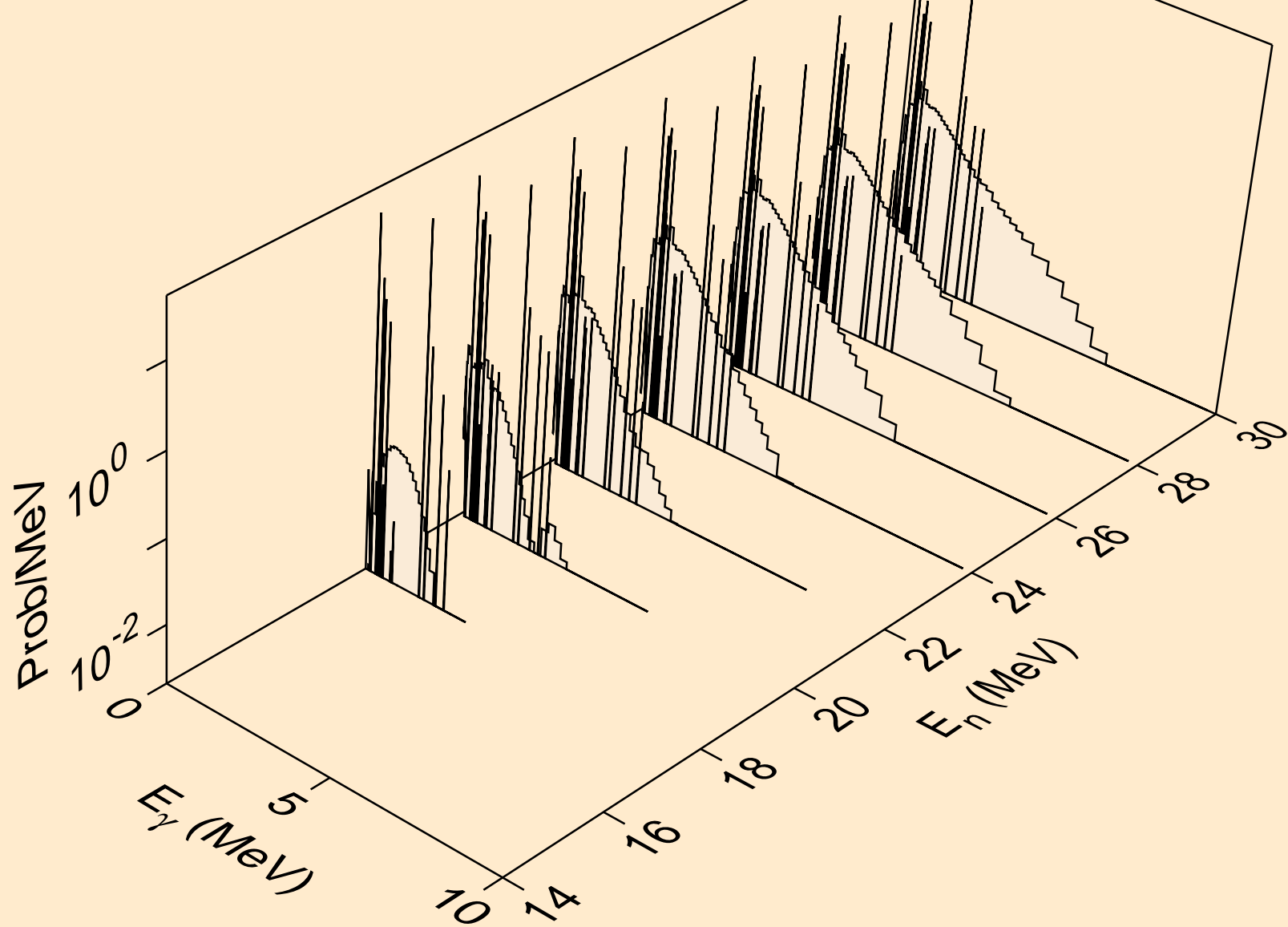

SM146 NEUTRON ACER TENDL-2023 LIBRARY; T=0.K  
Photon emission for (n,n\*)a

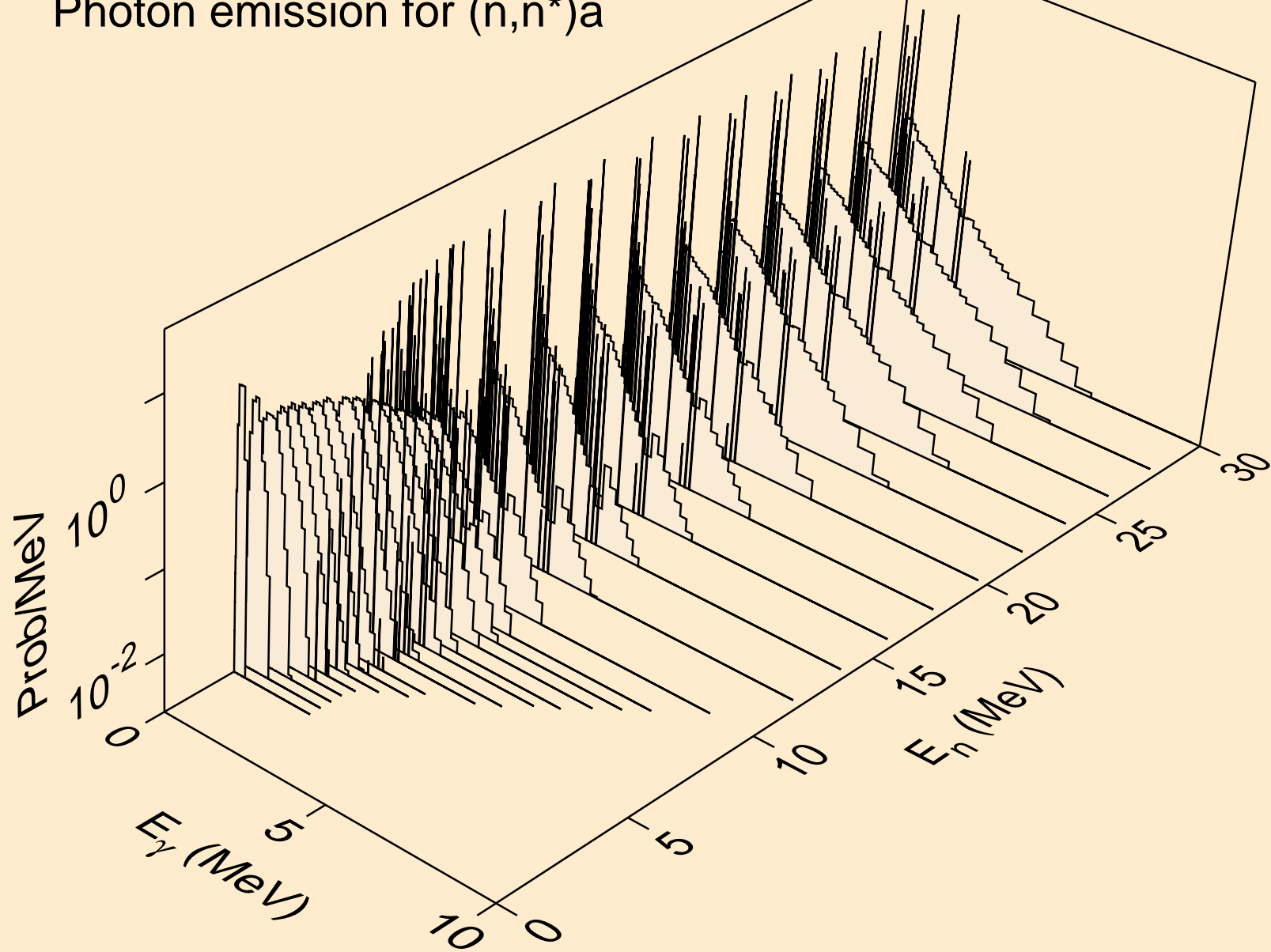

SM146 NEUTRON ACER TENDL-2023 LIBRARY; T=0.K  
Photon emission for (n,2n)a

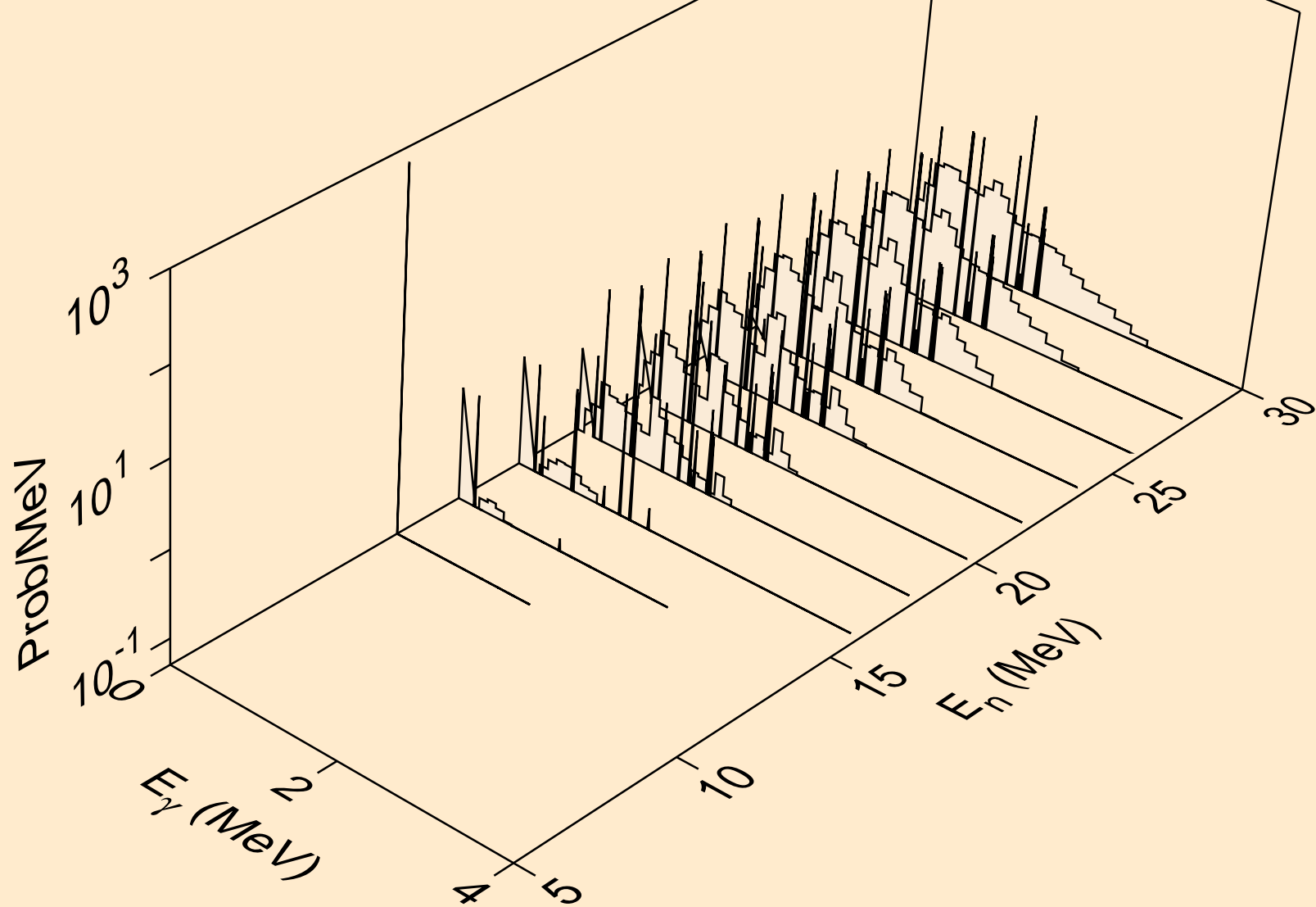

SM146 NEUTRON ACER TENDL-2023 LIBRARY; T=0.K  
Photon emission for (n,3n)a

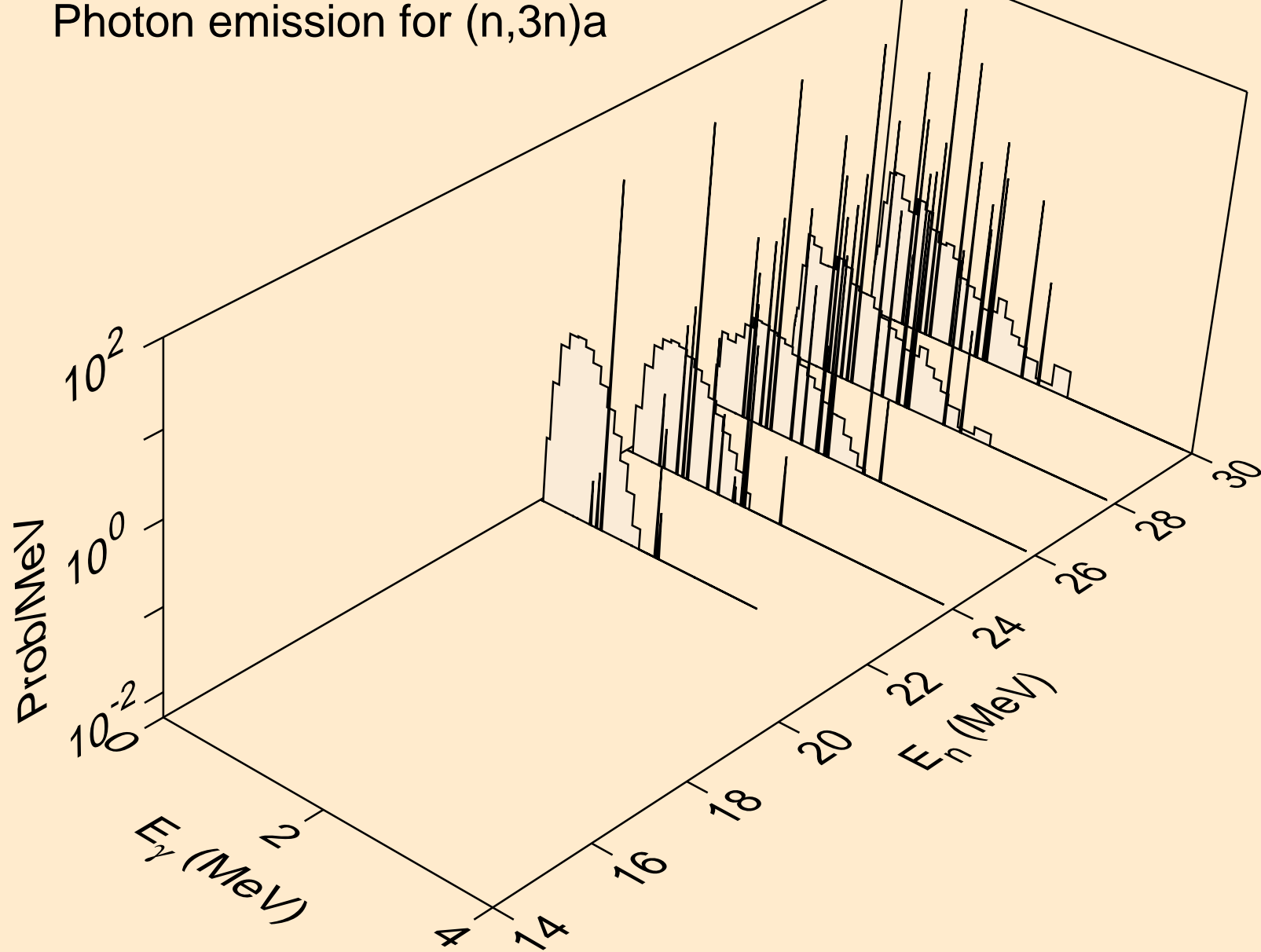

SM146 NEUTRON ACER TENDL-2023 LIBRARY; T=0.K  
Photon emission for (n,n\*)p

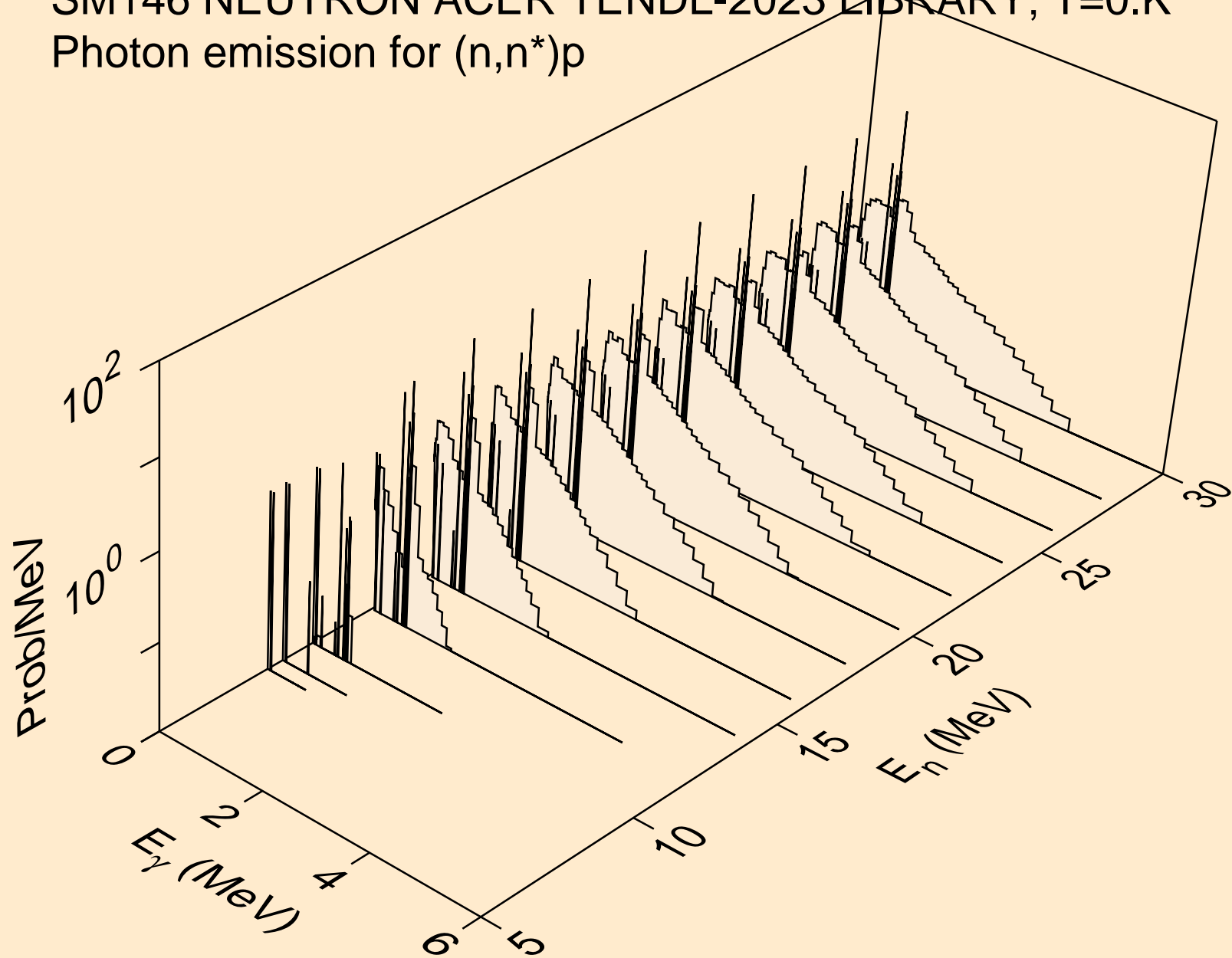

SM146 NEUTRON ACER TENDL-2023 LIBRARY; T=0.K  
Photon emission for (n,n\*)2a

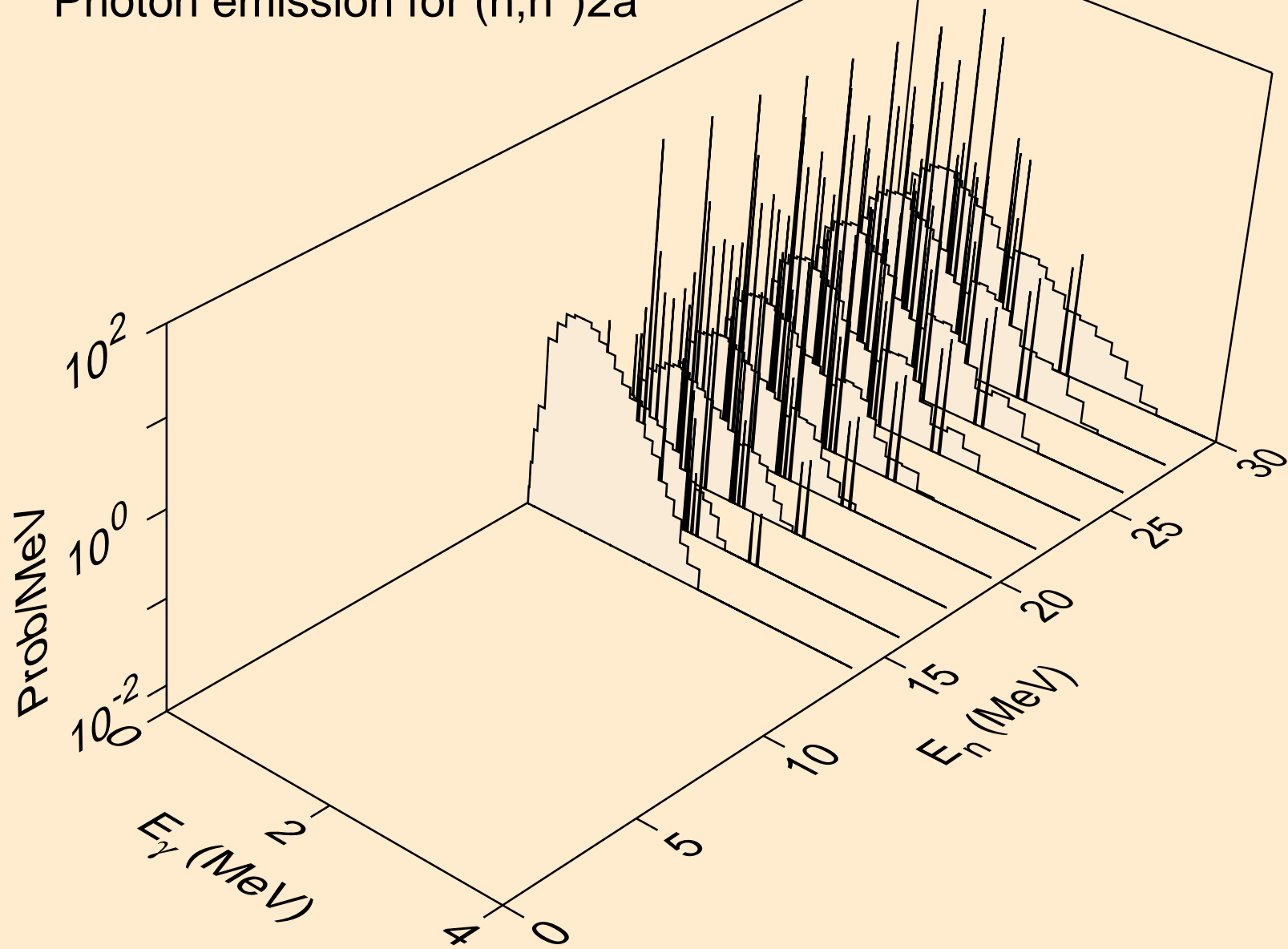

SM146 NEUTRON ACER TENDL-2023 LIBRARY; T=0.K  
Photon emission for (n,n\*)d

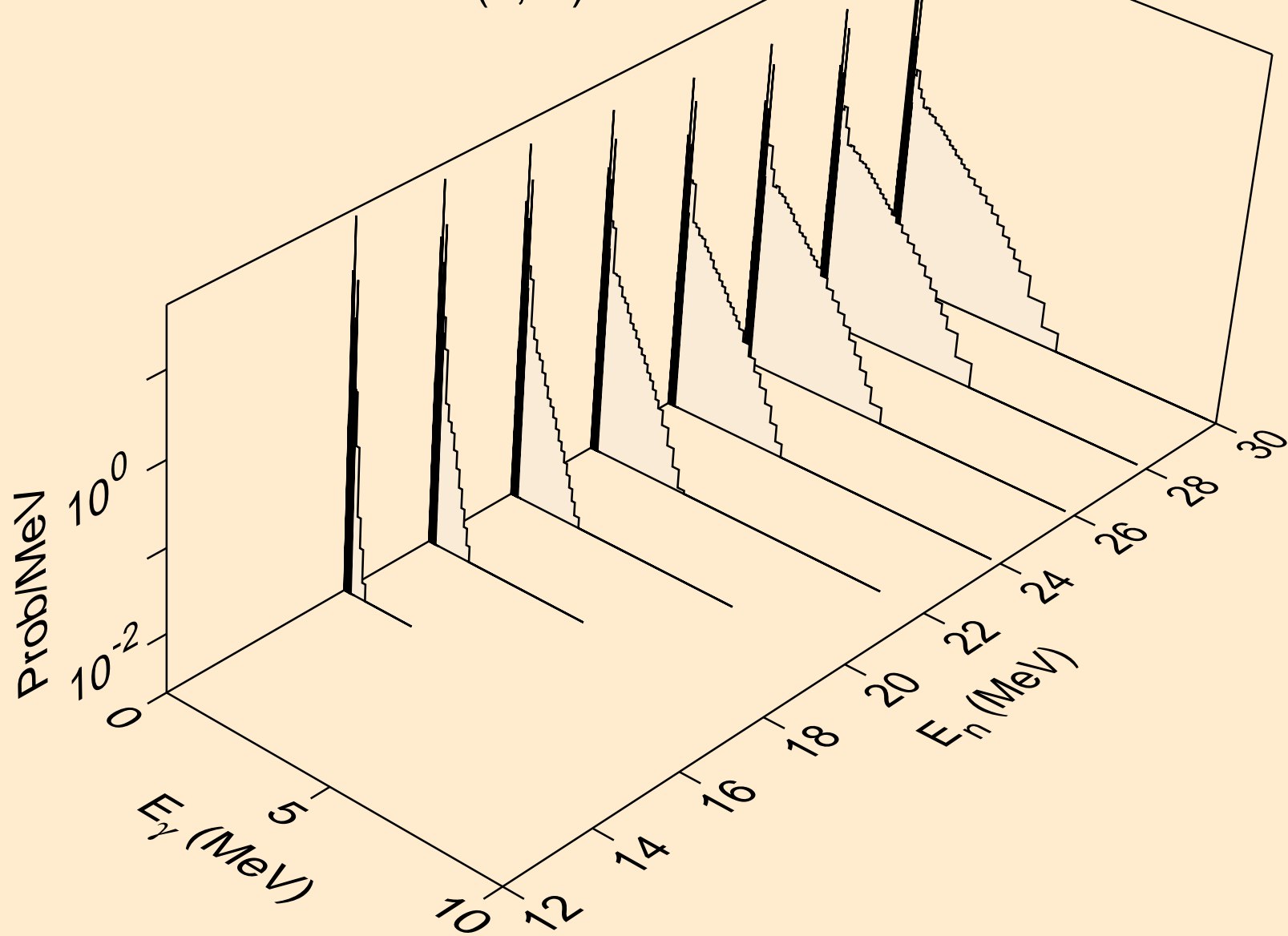



SM146 NEUTRON ACER TENDL-2023 LIBRARY; T=0.K  
Photon emission for (n,n\*)t

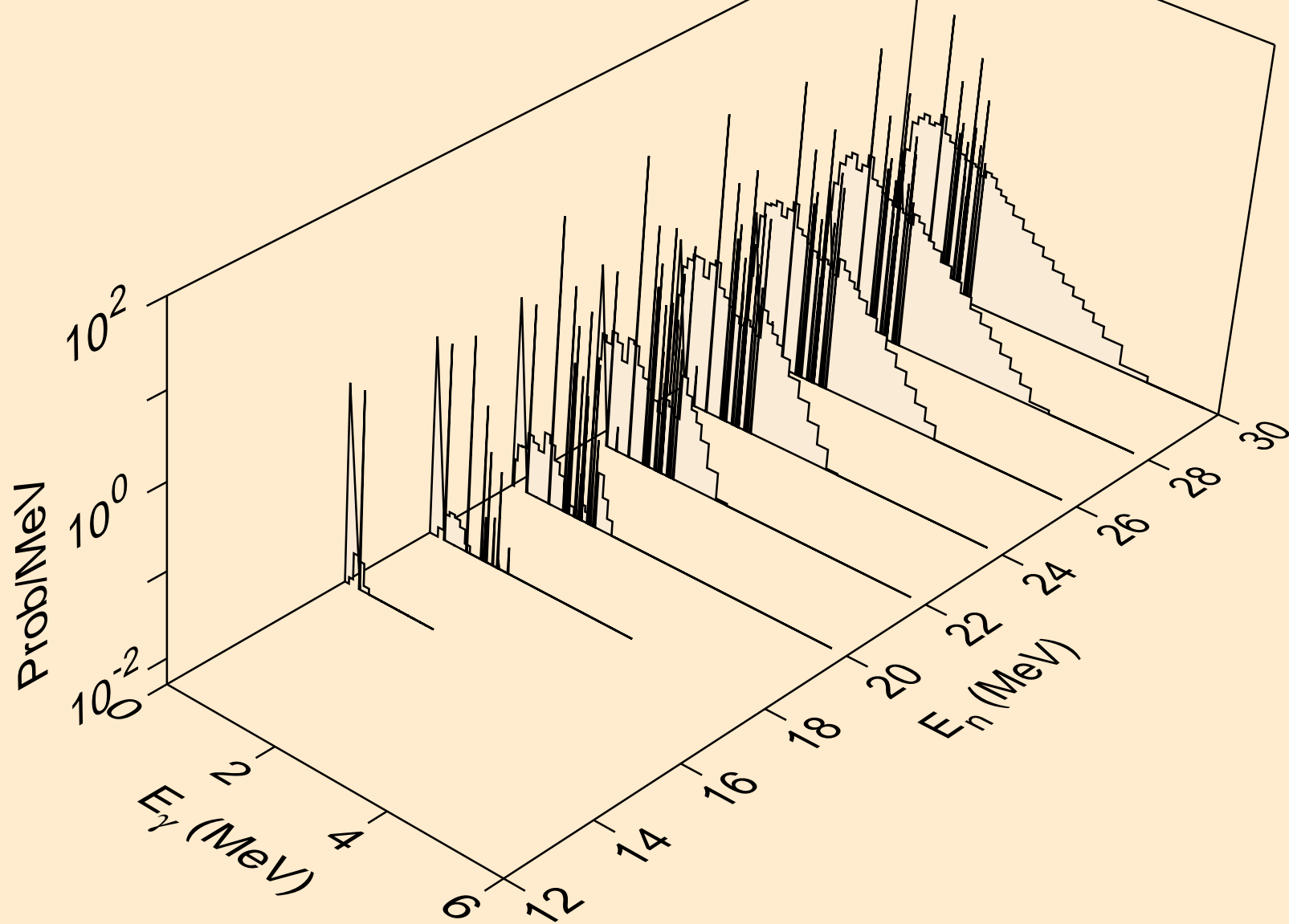

SM146 NEUTRON ACER TENDL-2023 LIBRARY; T=0.K  
Photon emission for (n,n\*)he3

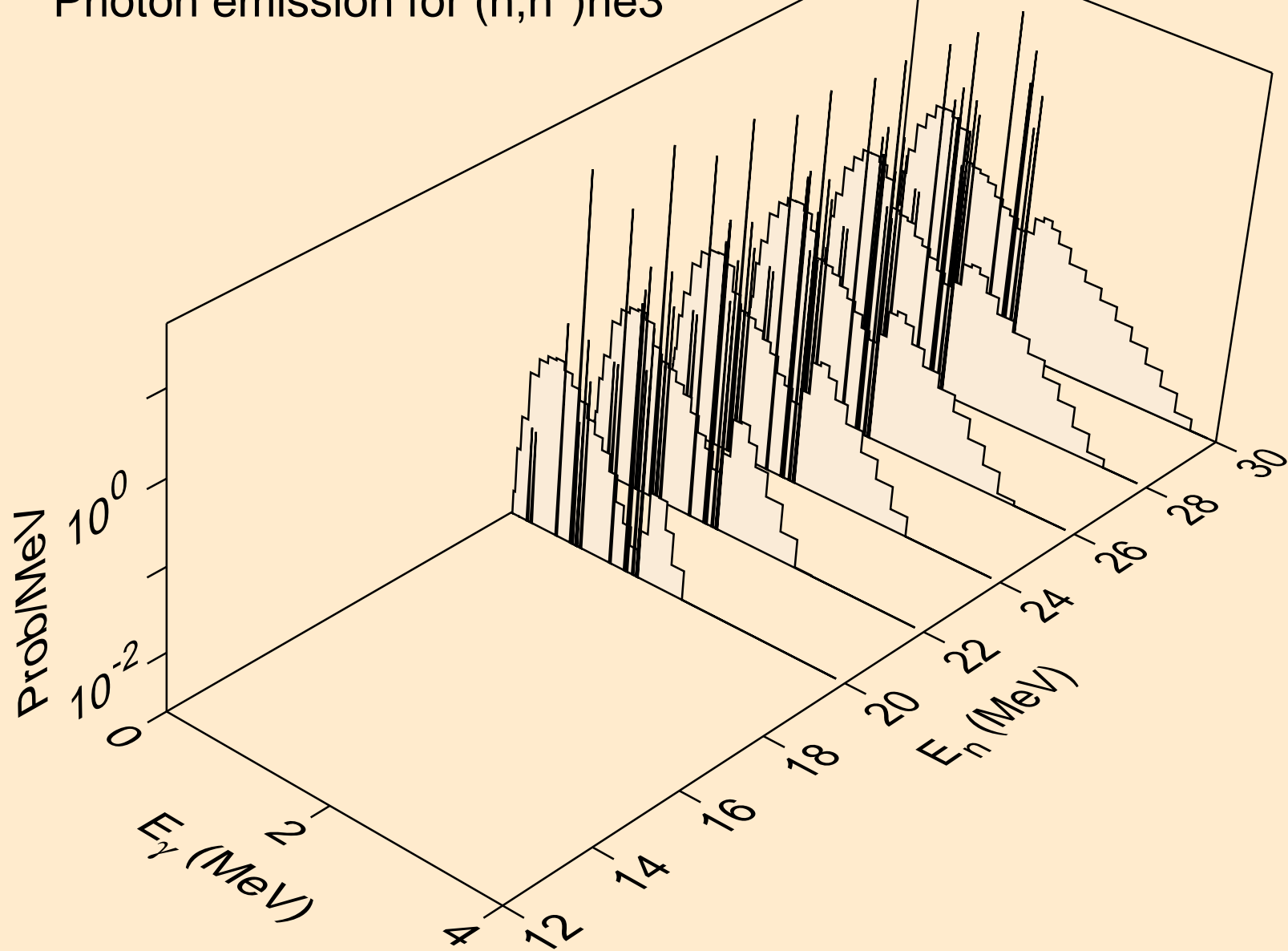

SM146 NEUTRON ACER TENDL-2023 LIBRARY; T=0.K  
Photon emission for (n,4n)

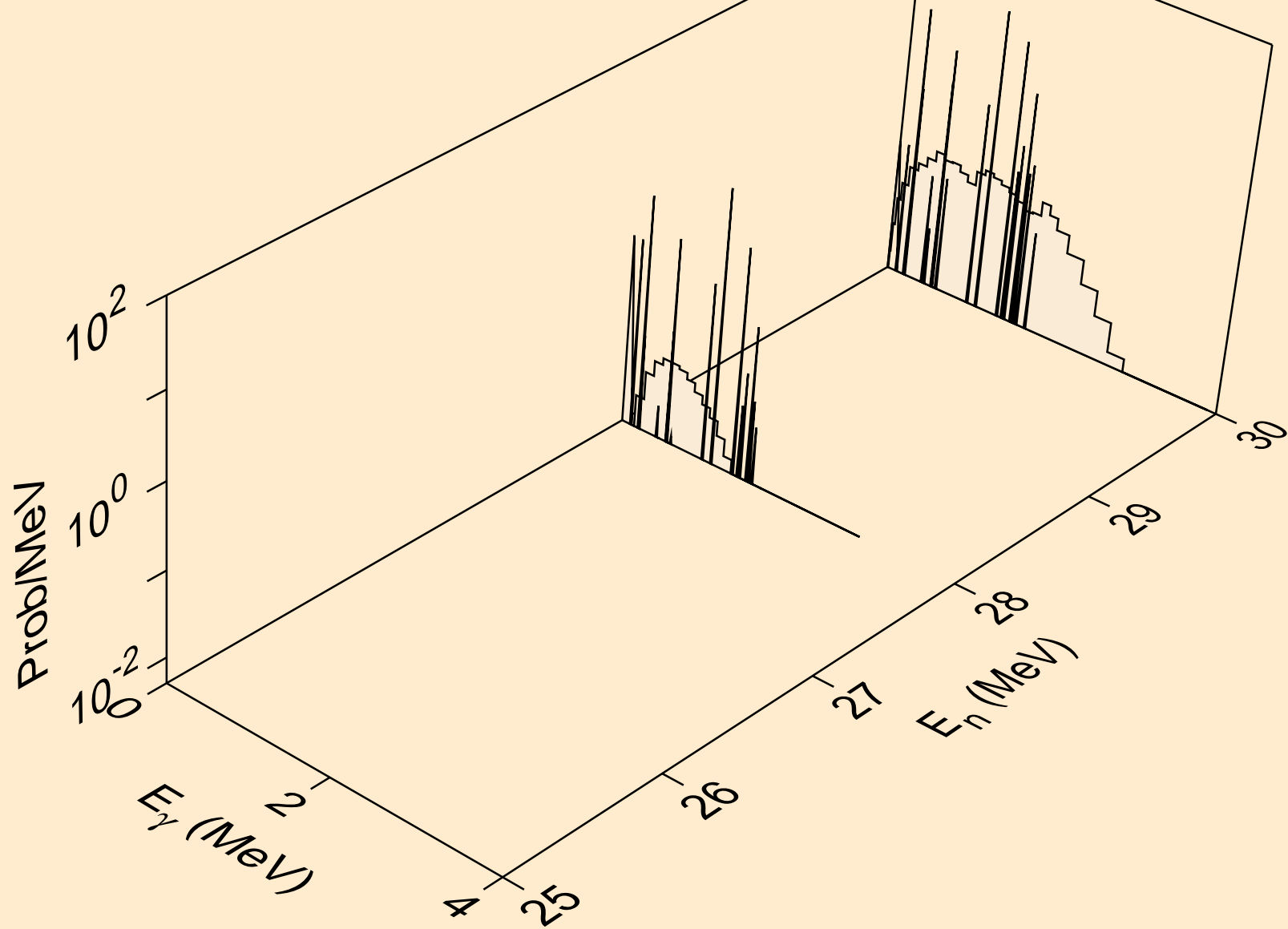

SM146 NEUTRON ACER TENDL-2023 LIBRARY; T=0.K  
Photon emission for (n,2np)

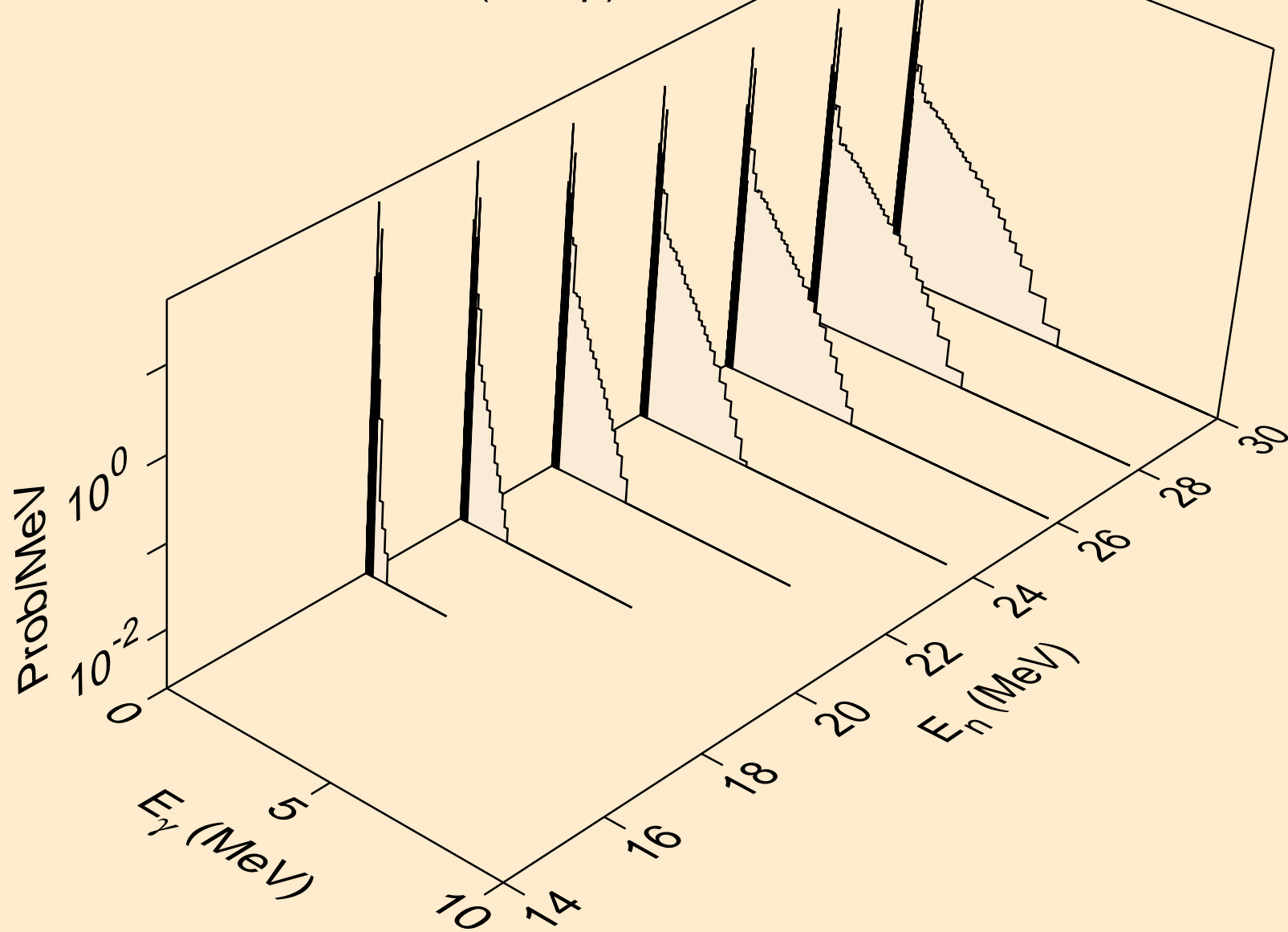

SM146 NEUTRON ACER TENDL-2023 LIBRARY; T=0.K  
Photon emission for (n,3np)

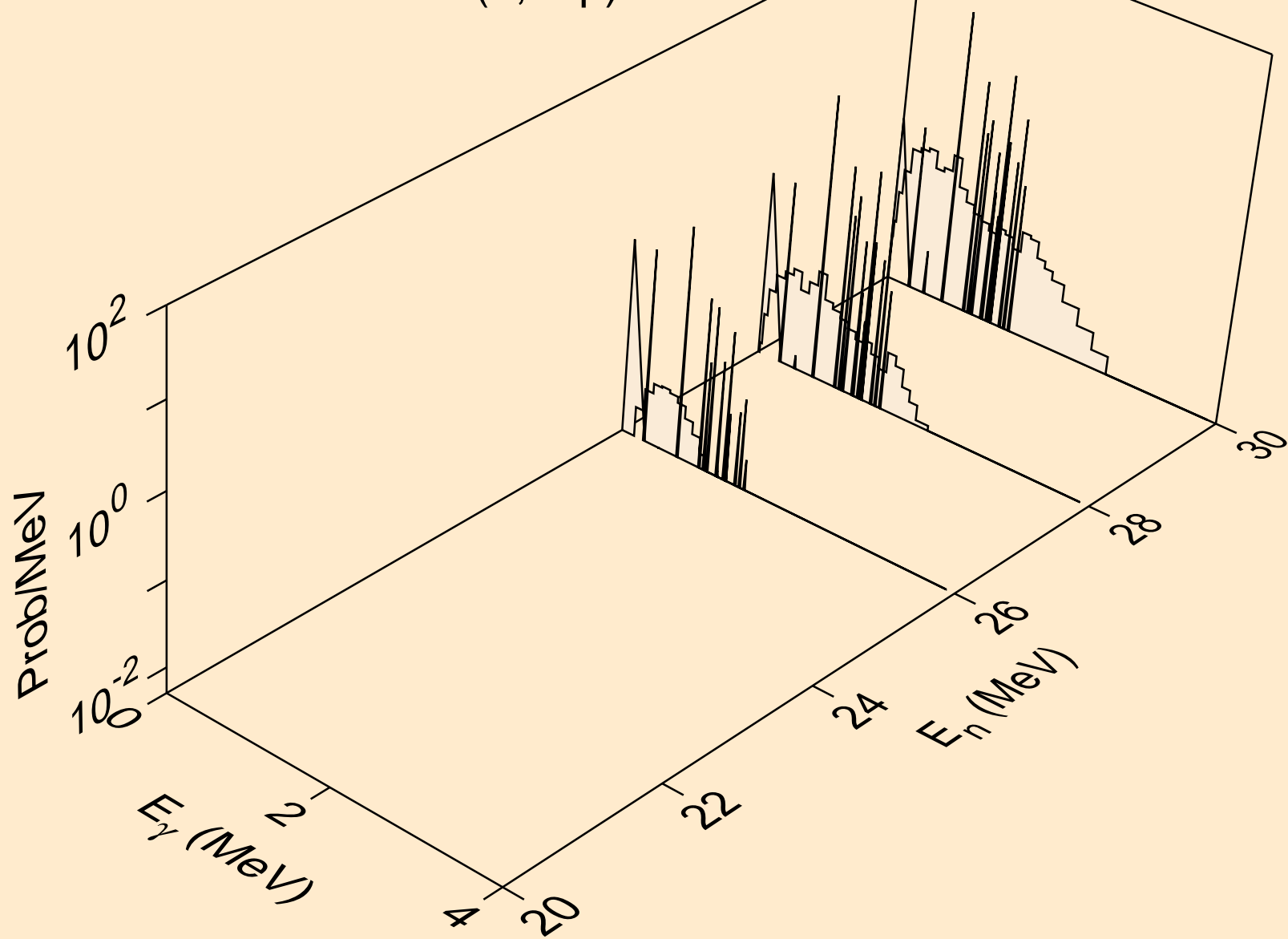

SM146 NEUTRON ACER TENDL-2023 LIBRARY; T=0.K  
Photon emission for (n,n2p)

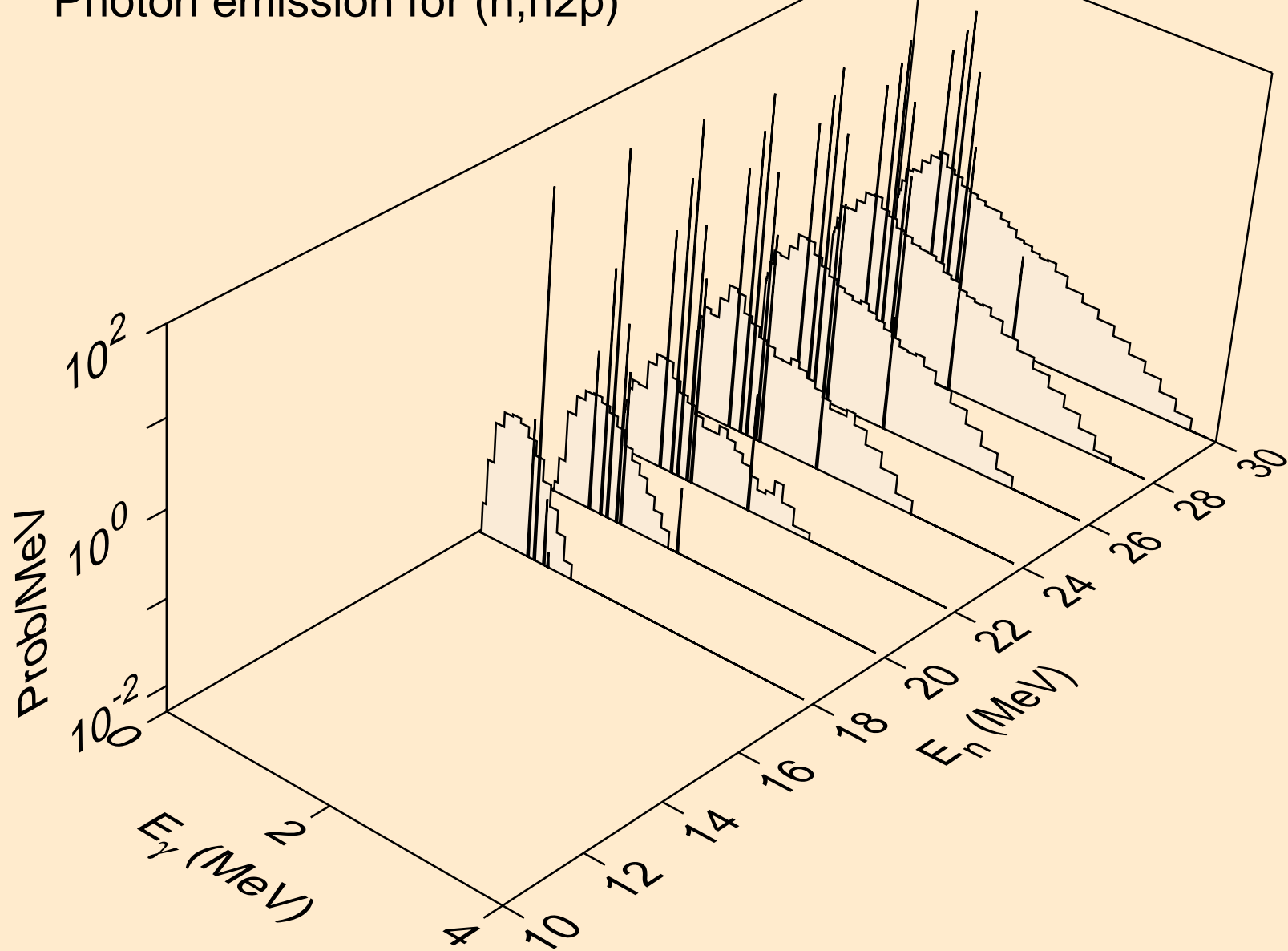

SM146 NEUTRON ACER TENDL-2023 LIBRARY; T=0.K  
Photon emission for (n,npa)

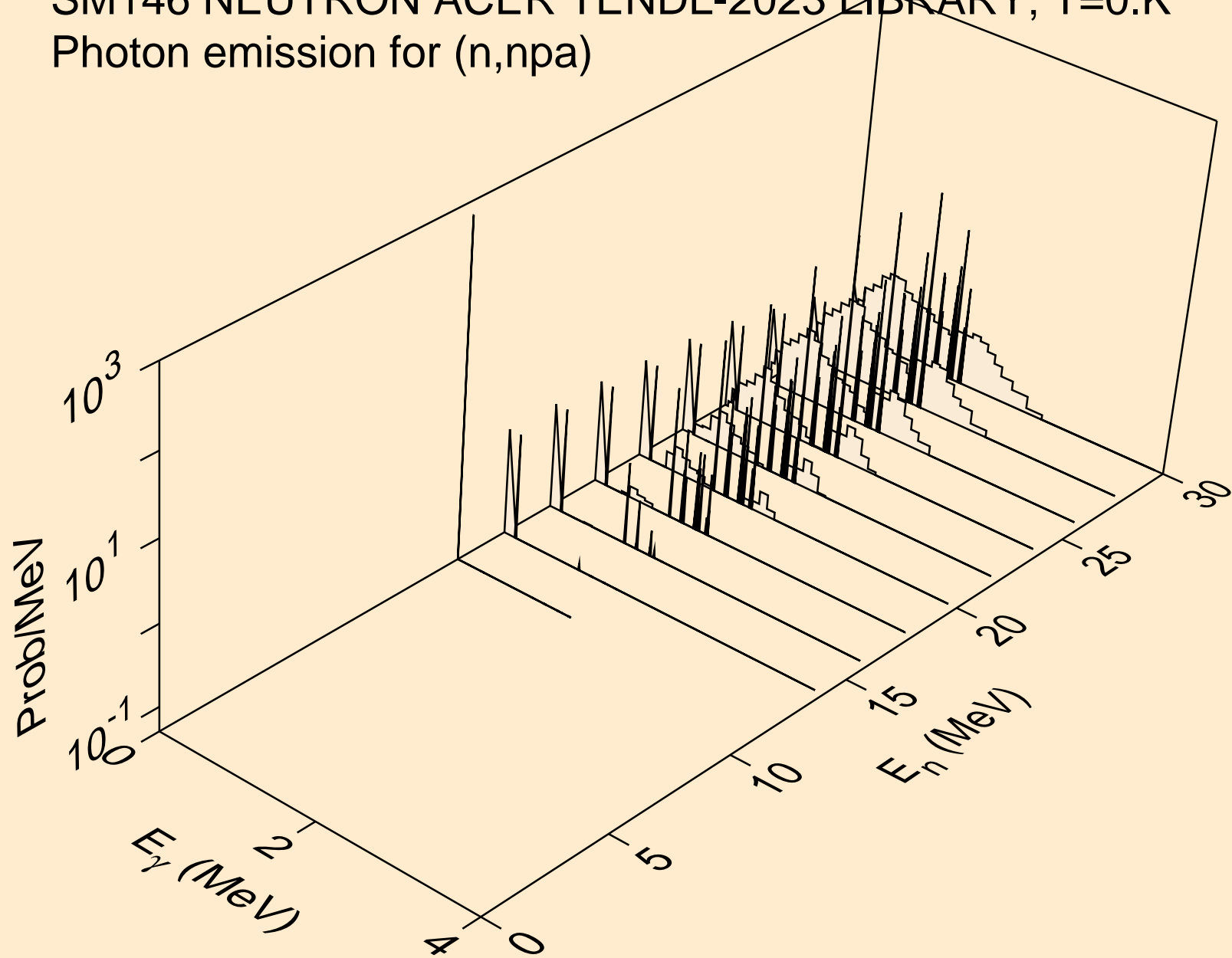

SM146 NEUTRON ACER TENDL-2023 LIBRARY; T=0.K  
Photon emission for (n,n\*c)

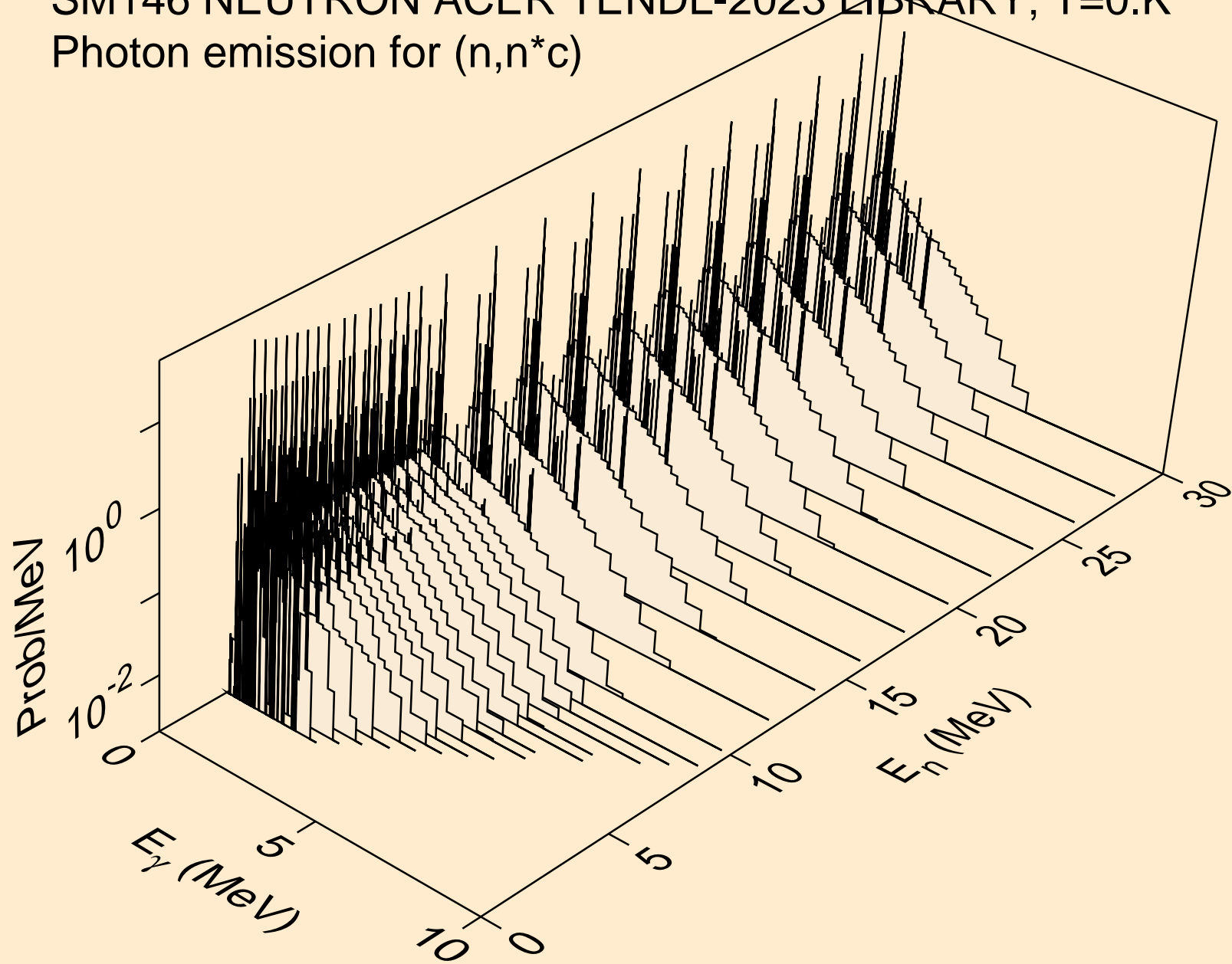



SM146 NEUTRON ACER TENDL-2023 LIBRARY; T=0.K  
Photon emission for (n,gma)

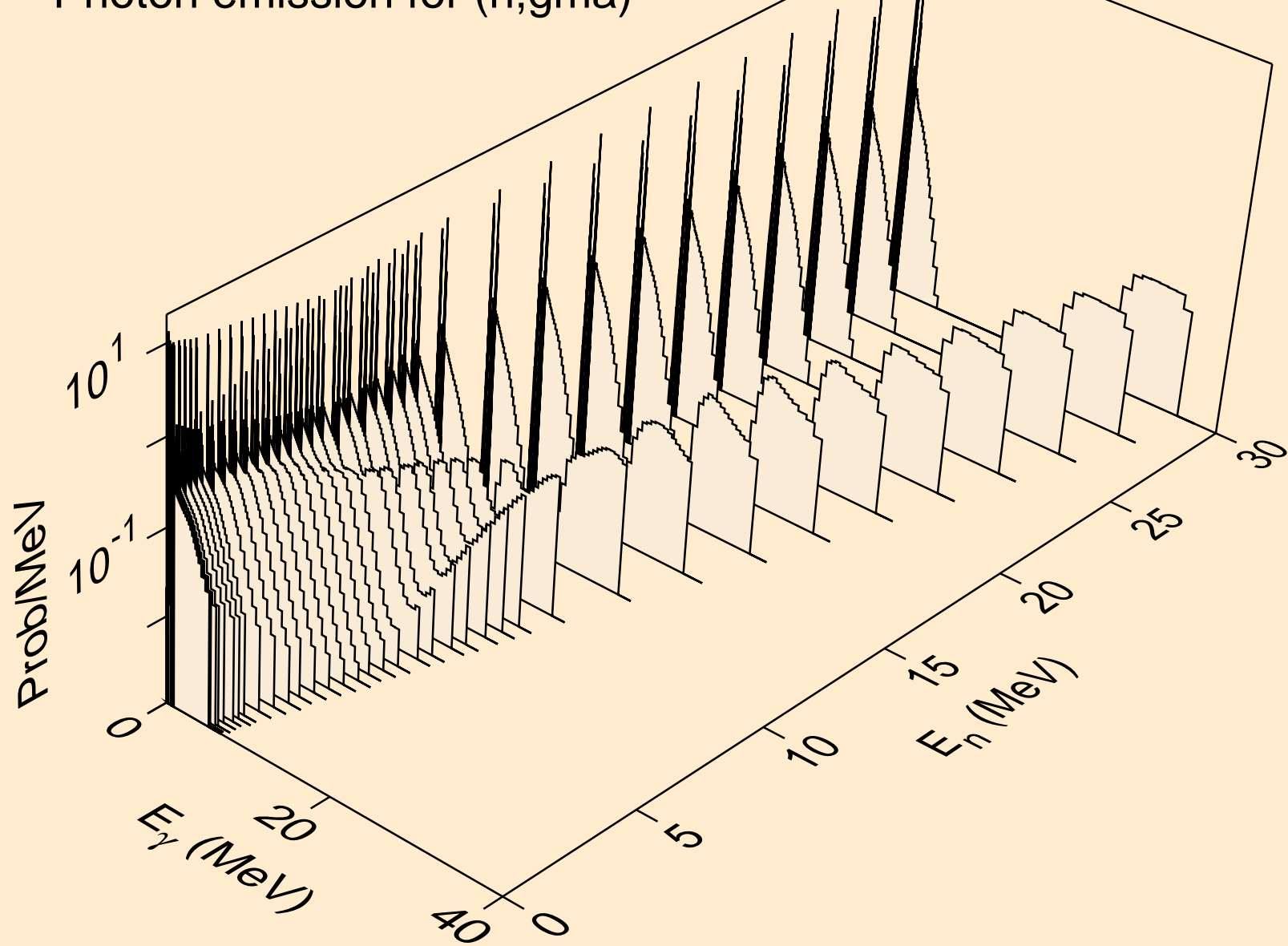

SM146 NEUTRON ACER TENDL-2023 LIBRARY; T=0.K  
Photon emission for (n,p)

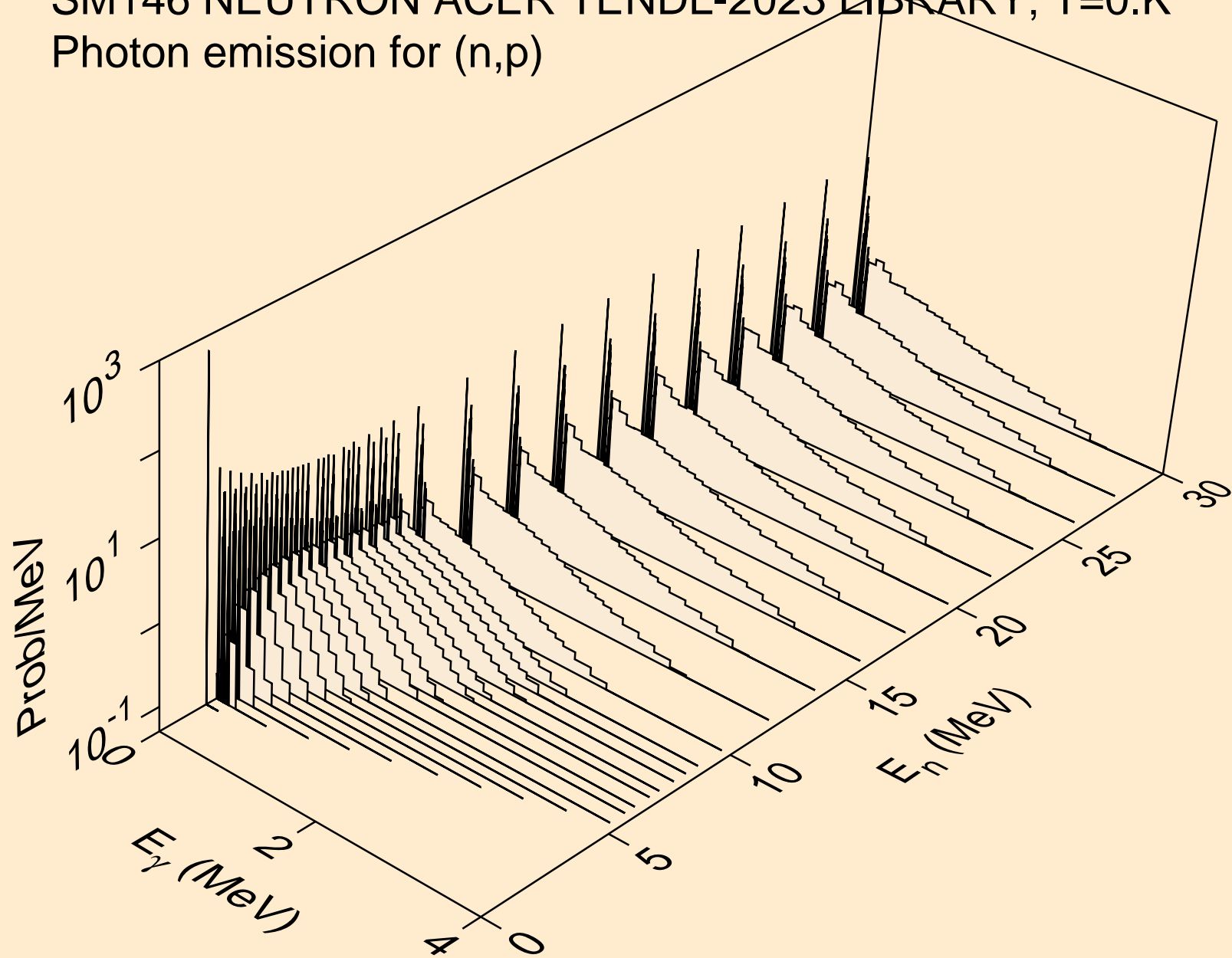

SM146 NEUTRON ACER TENDL-2023 LIBRARY; T=0.K  
Photon emission for (n,d)

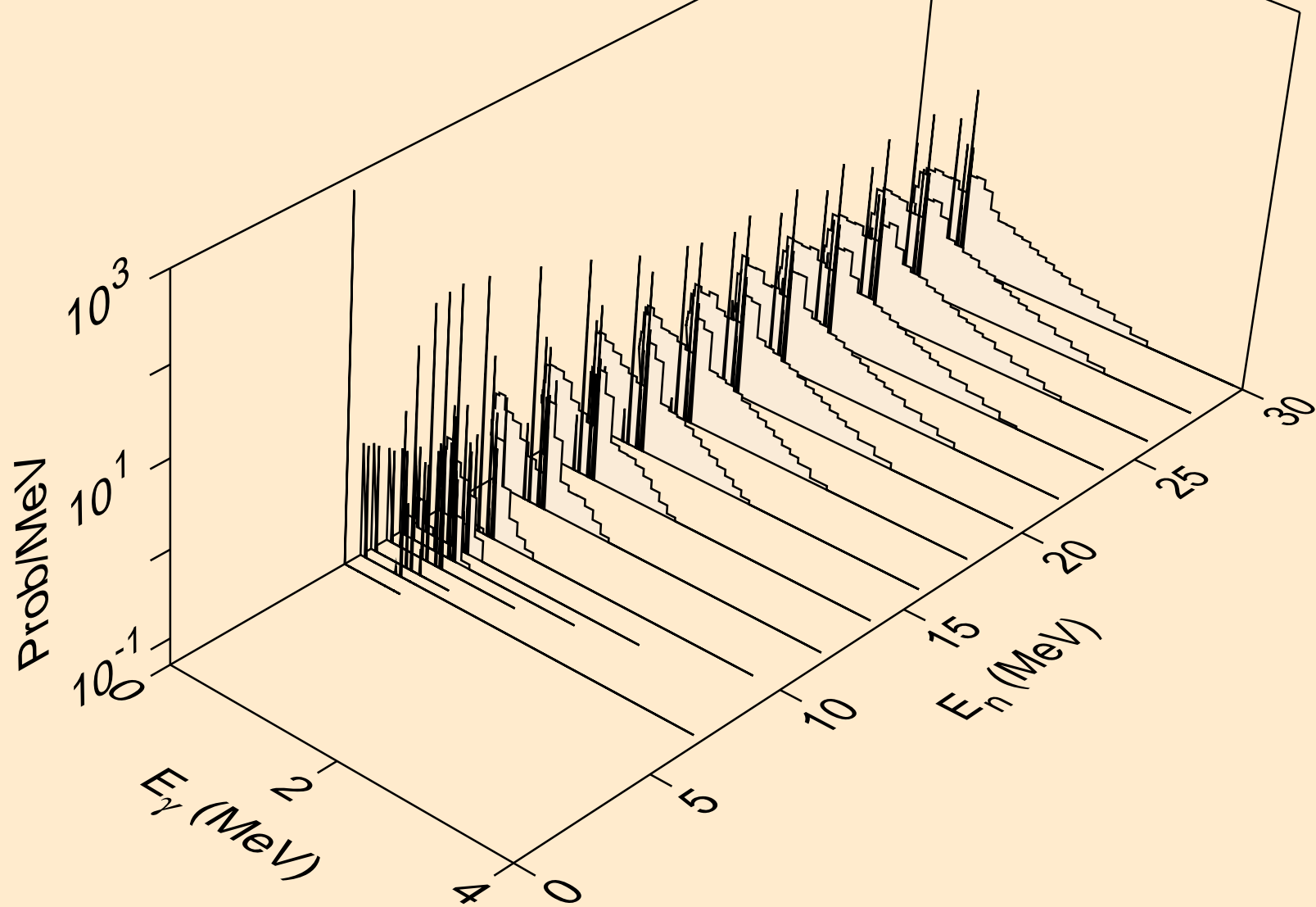

SM146 NEUTRON ACER TENDL-2023 LIBRARY; T=0.K  
Photon emission for (n,t)

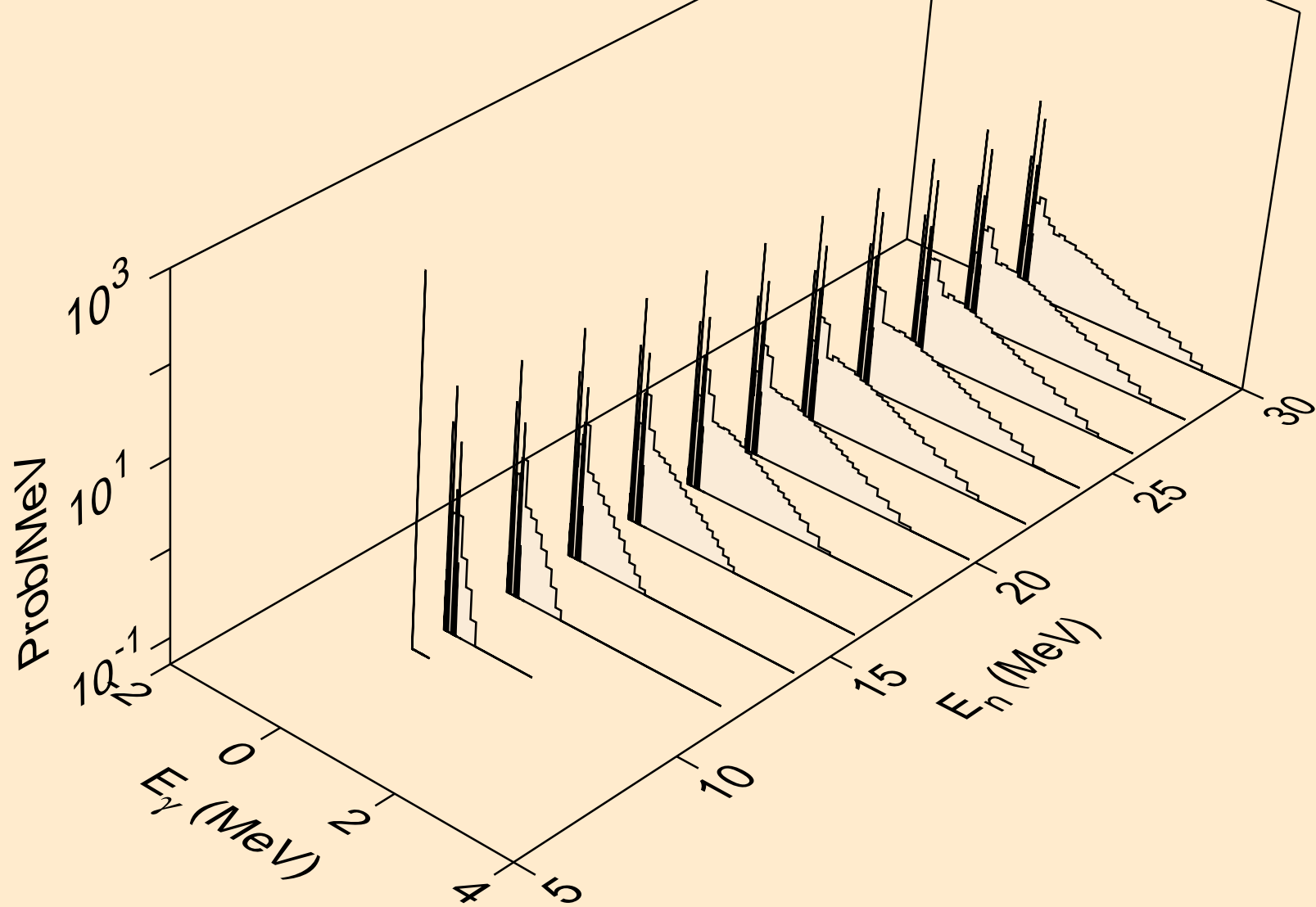

SM146 NEUTRON ACER TENDL-2023 LIBRARY; T=0.K  
Photon emission for (n,he3)

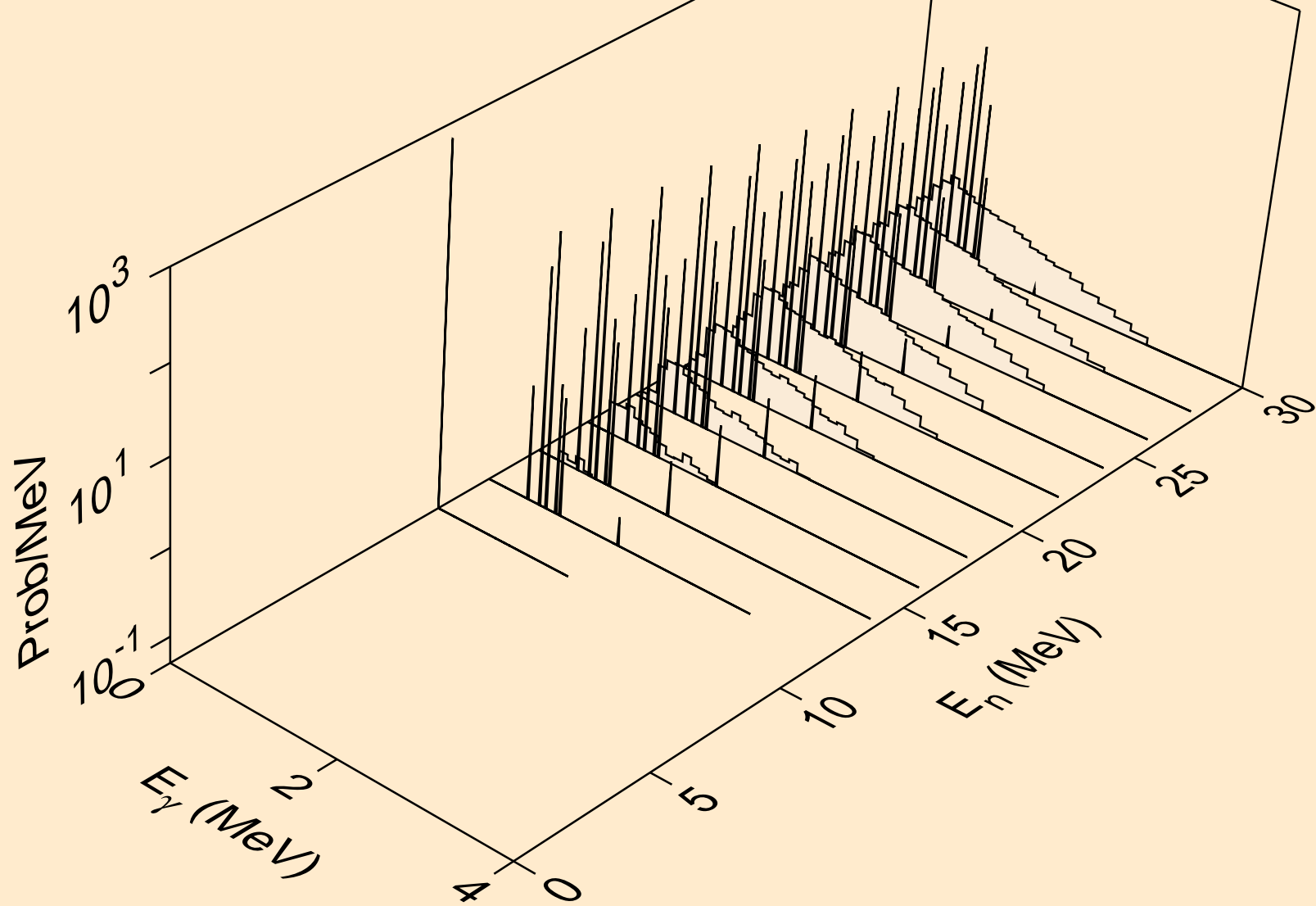

SM146 NEUTRON ACER TENDL-2023 LIBRARY; T=0.K  
Photon emission for (n,a)

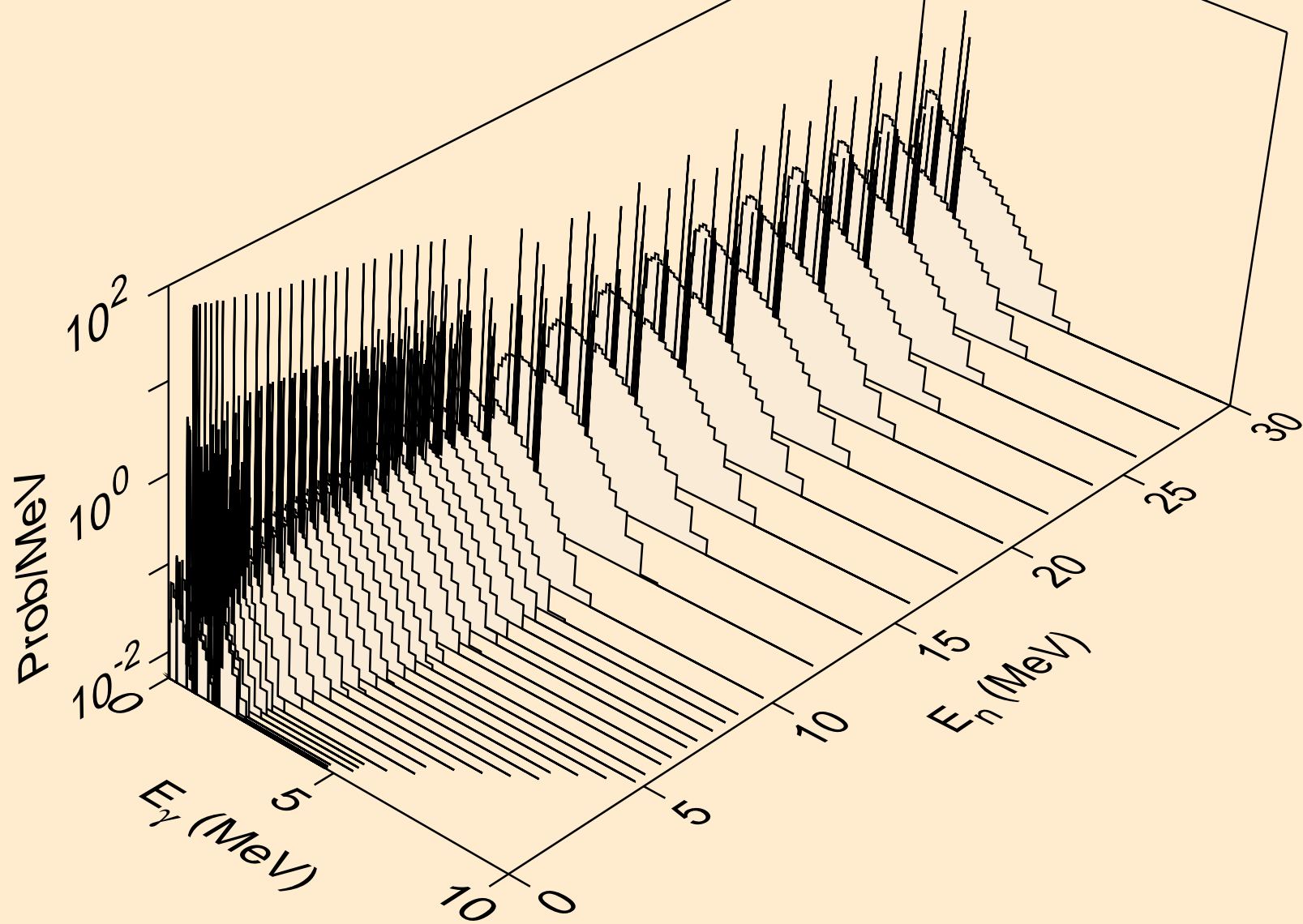

SM146 NEUTRON ACER TENDL-2023 LIBRARY; T=0.K  
Photon emission for (n,2a)

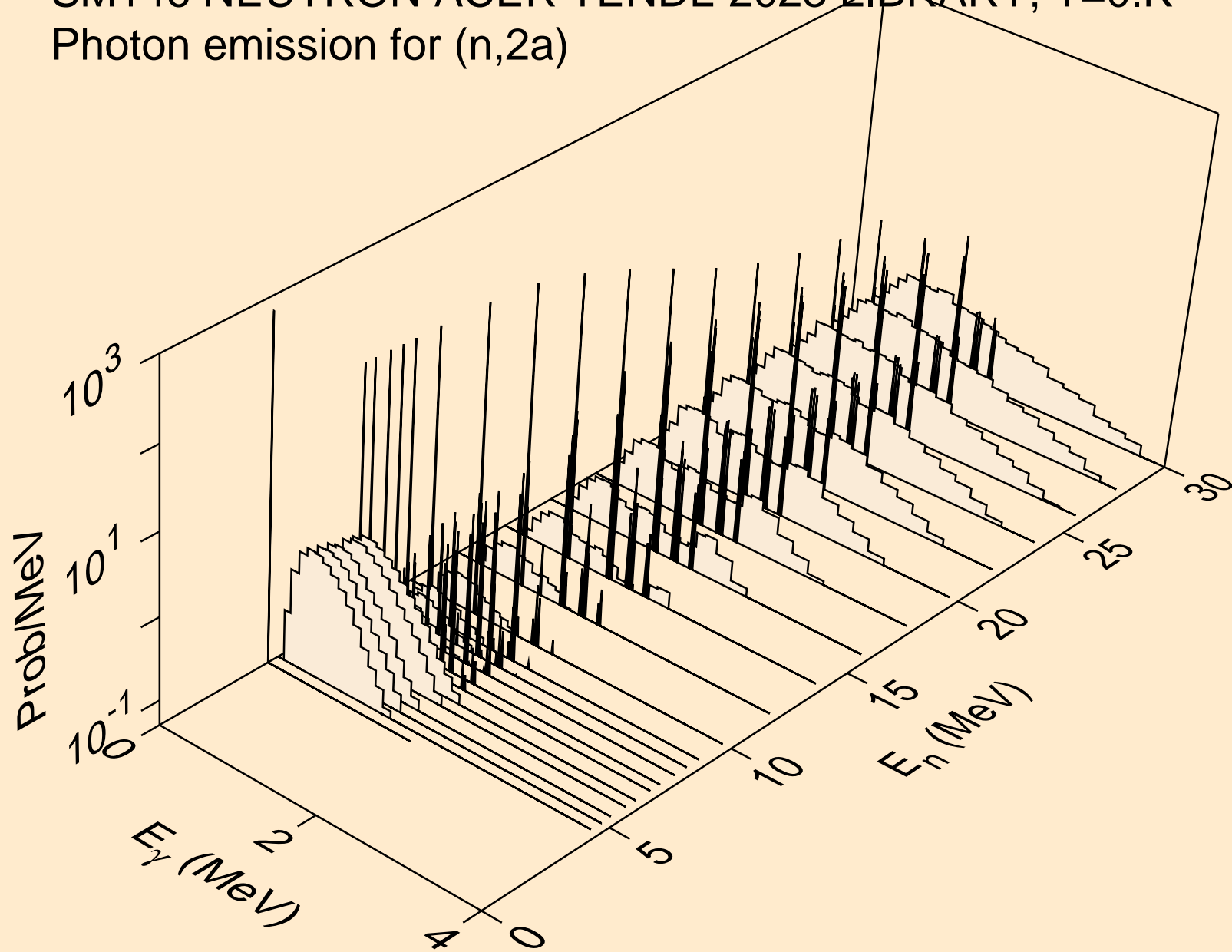

SM146 NEUTRON ACER TENDL-2023 LIBRARY; T=0.K  
Photon emission for (n,2p)

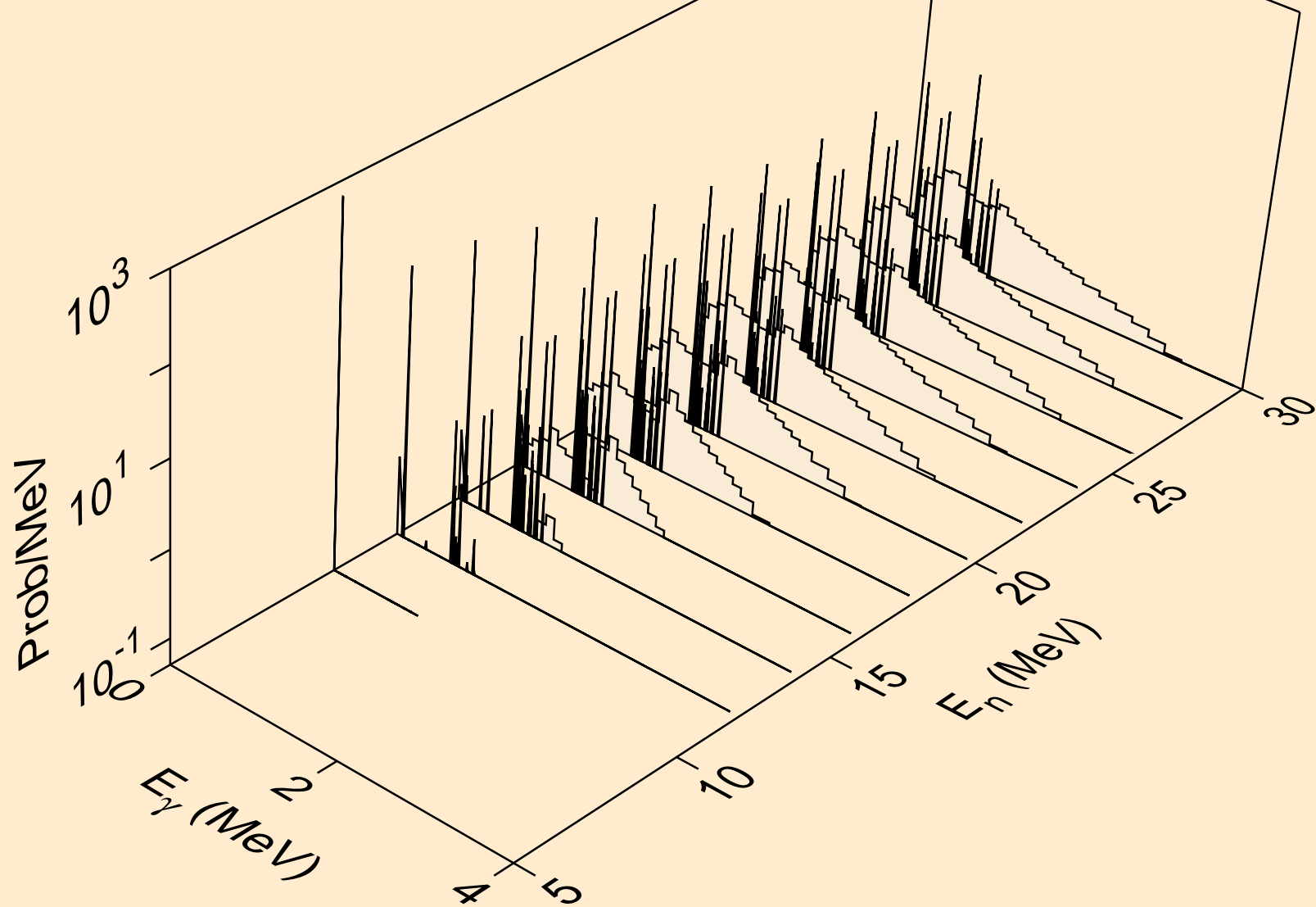



SM146 NEUTRON ACER TENDL-2023 LIBRARY; T=0.K  
Photon emission for (n,p $\alpha$ )

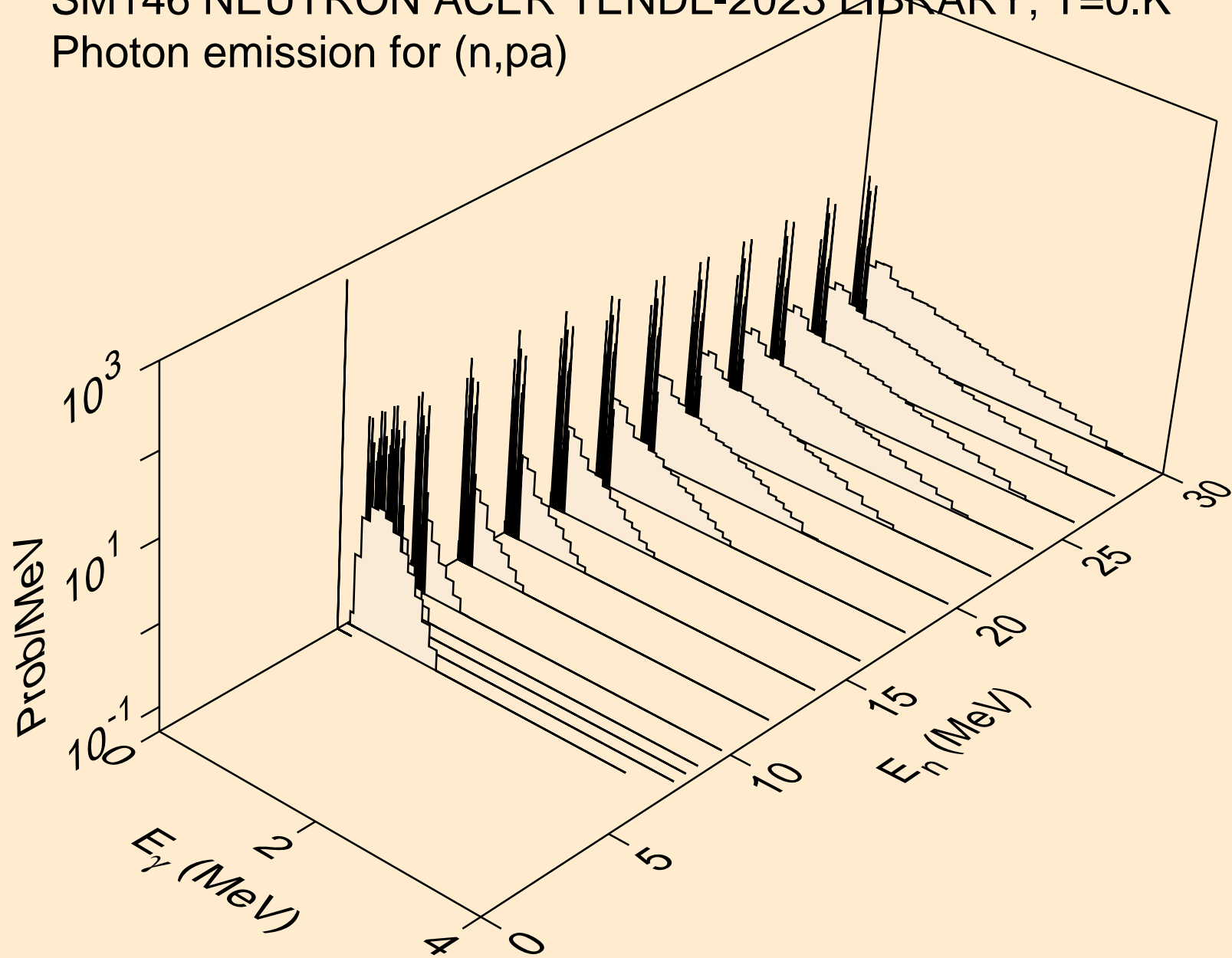

SM146 NEUTRON ACER TENDL-2023 LIBRARY; T=0.K  
Photon emission for (n,pd)

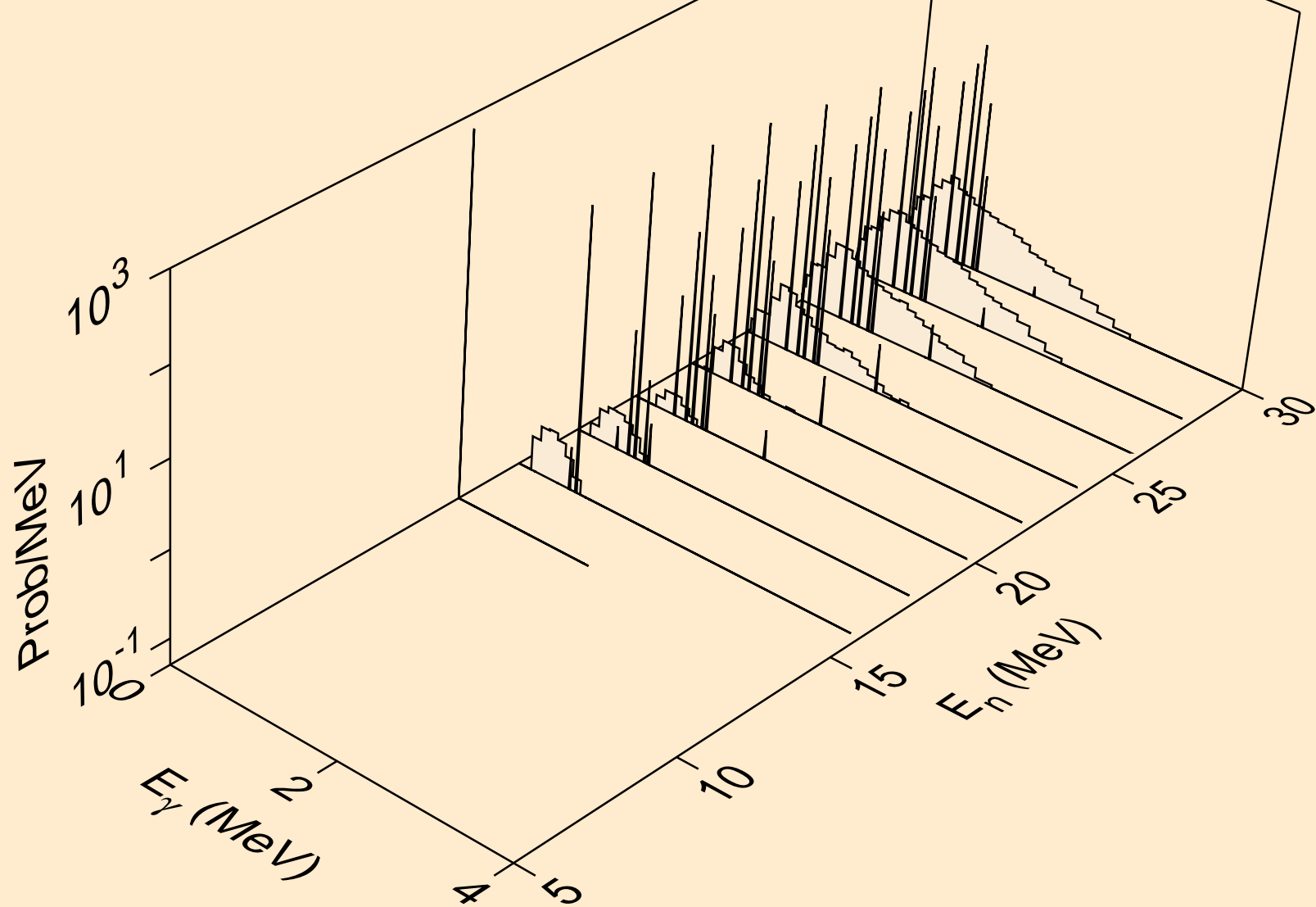

SM146 NEUTRON ACER TENDL-2023 LIBRARY; T=0.K  
Photon emission for (n,pt)

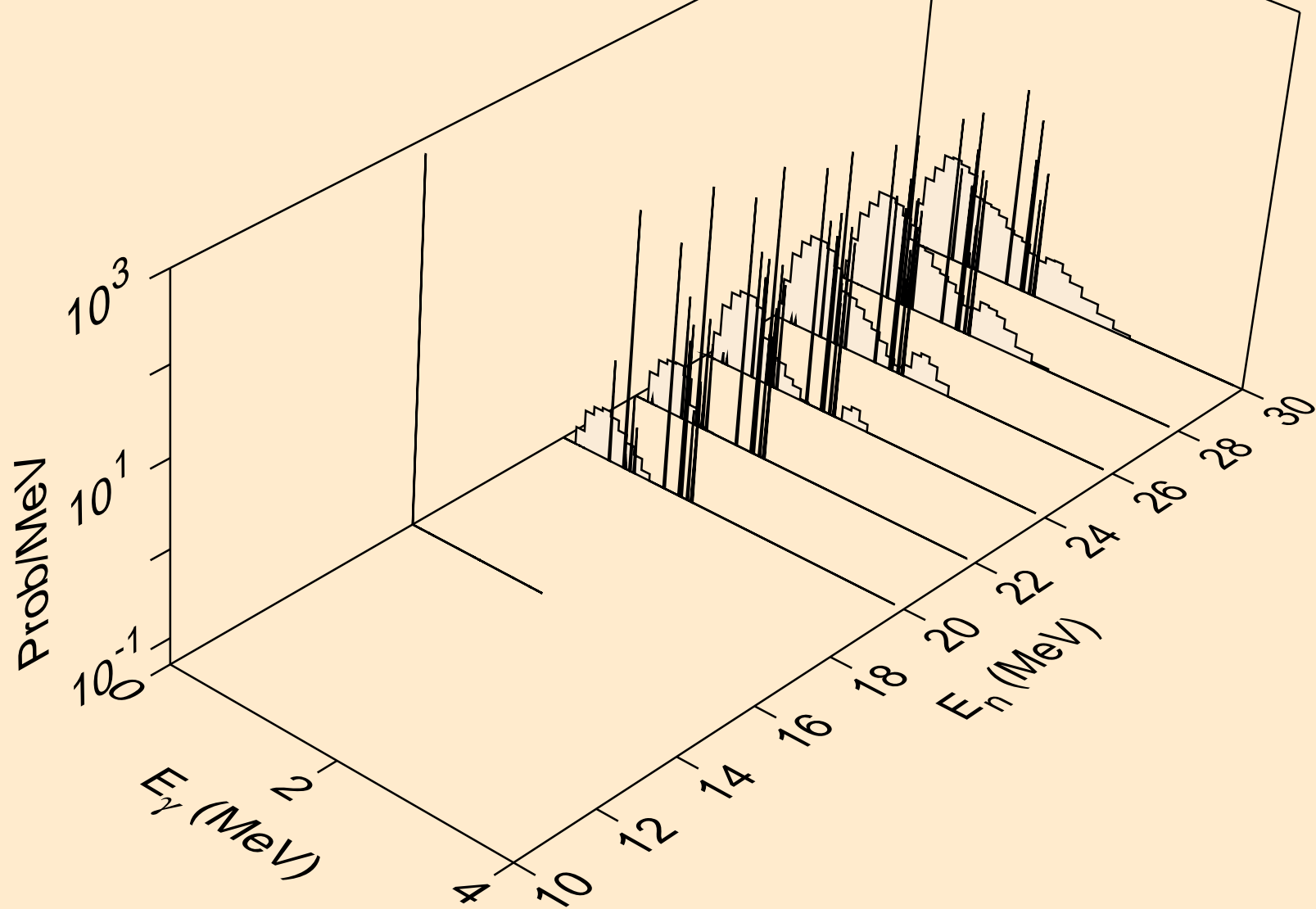

SM146 NEUTRON ACER TENDL-2023 LIBRARY; T=0.K  
Photon emission for (n,da)

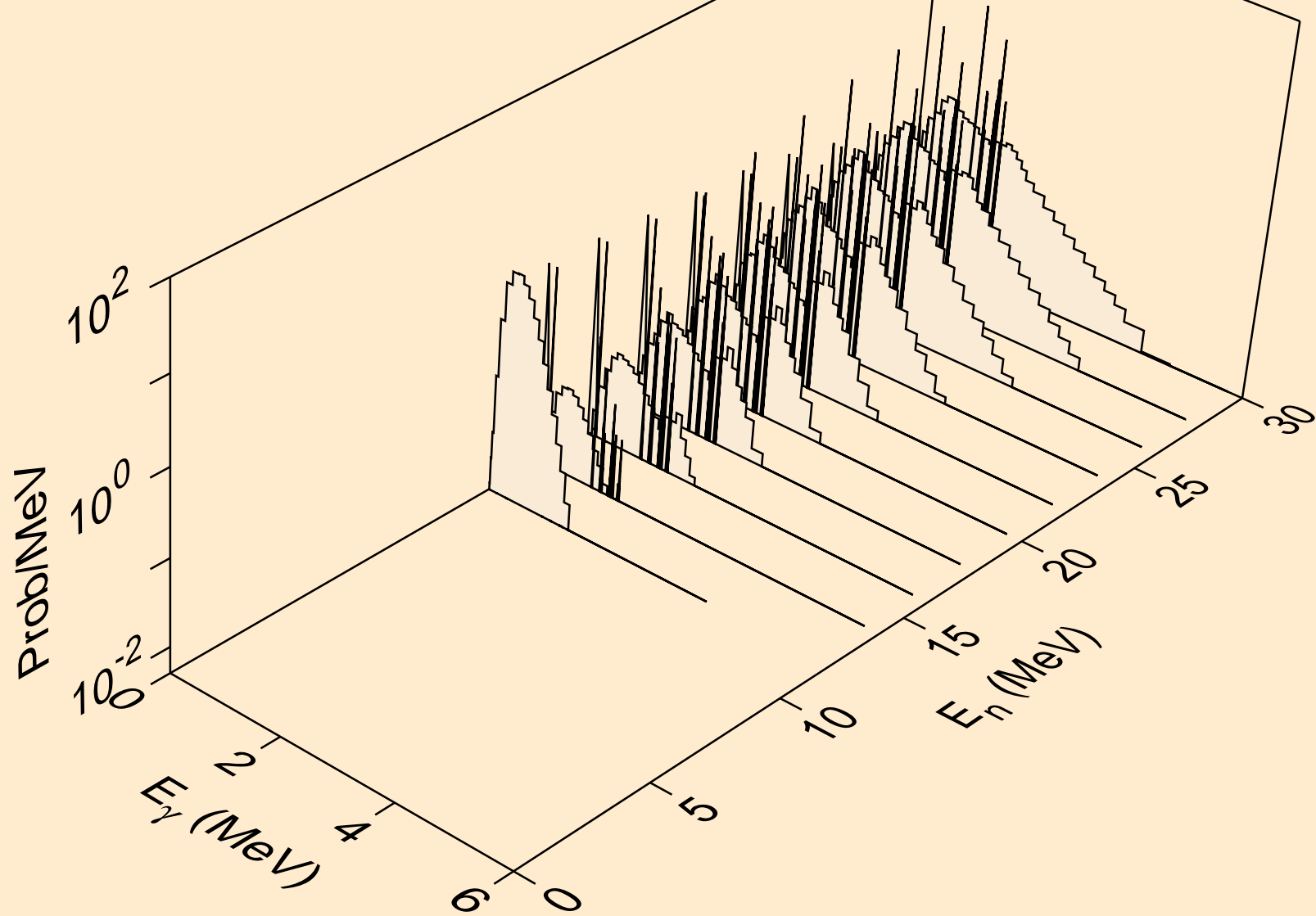

SM146 NEUTRON ACER TENDL-2023 LIBRARY; T=0.K  
thermal capture photon spectrum

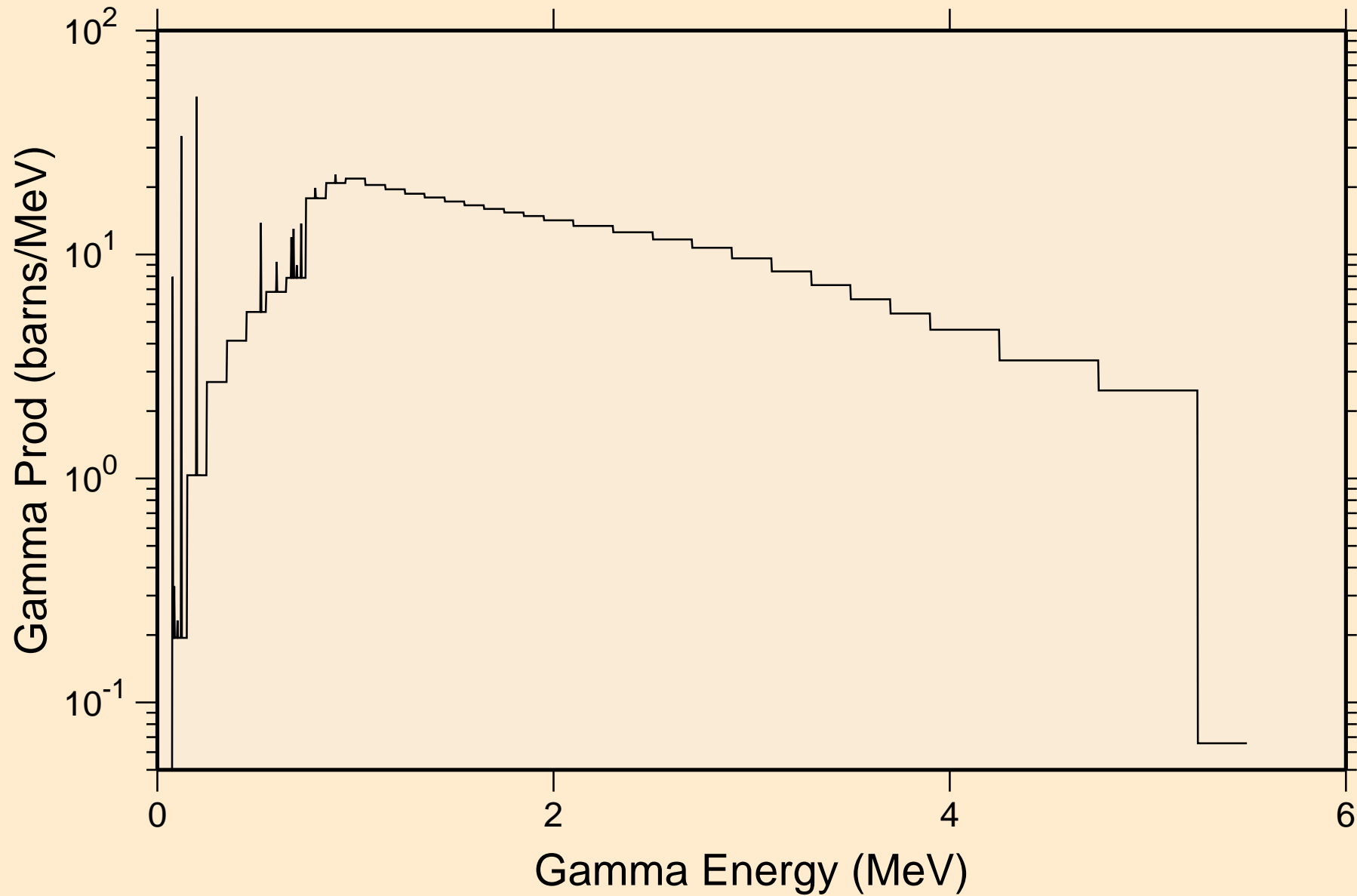

SM146 NEUTRON ACER TENDL-2023 LIBRARY; T=0.K  
14 MeV photon spectrum

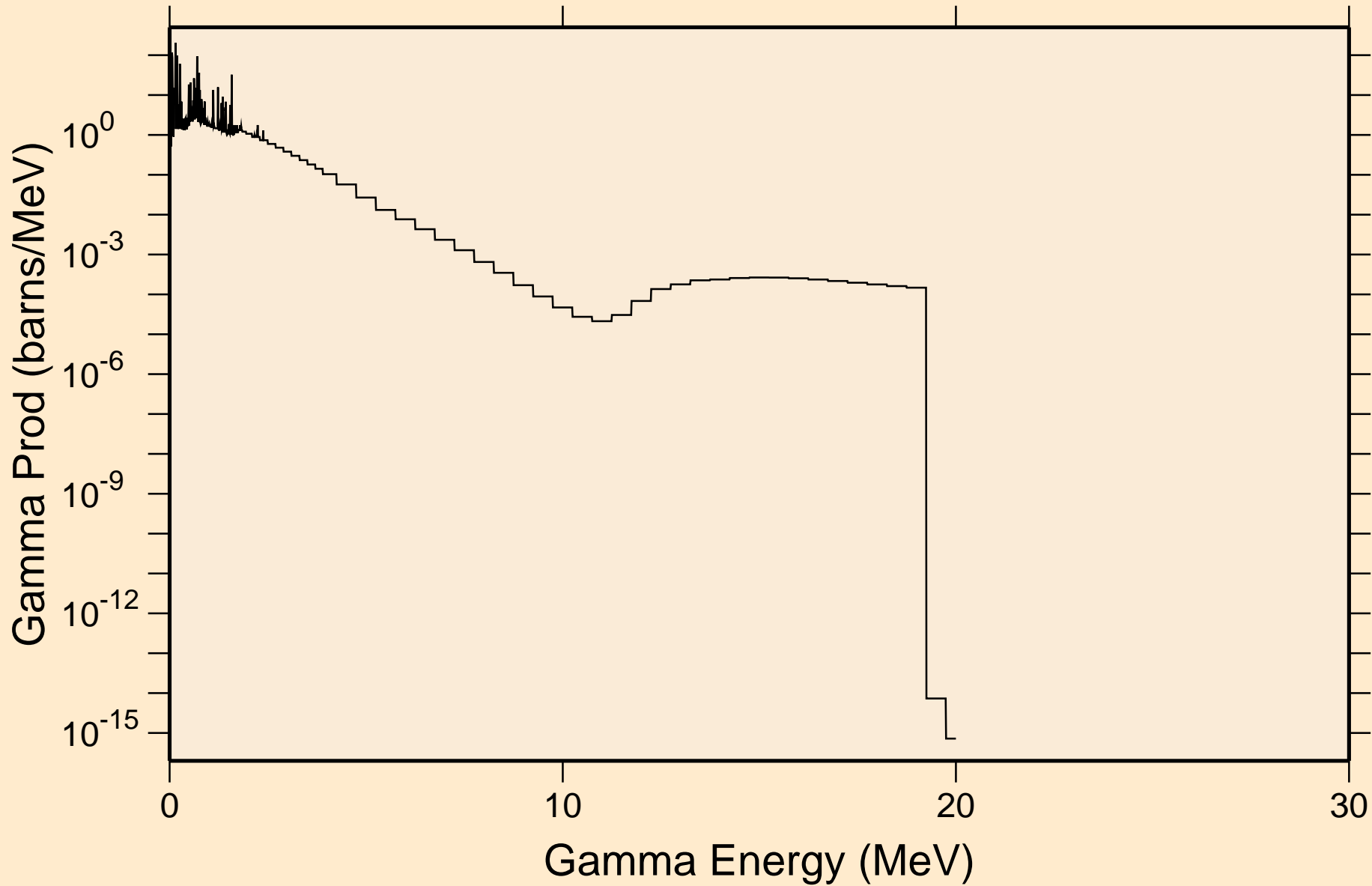

# SM146 NEUTRON ACER TENDL-2023 LIBRARY; T=0.K

## Particle heating contributions

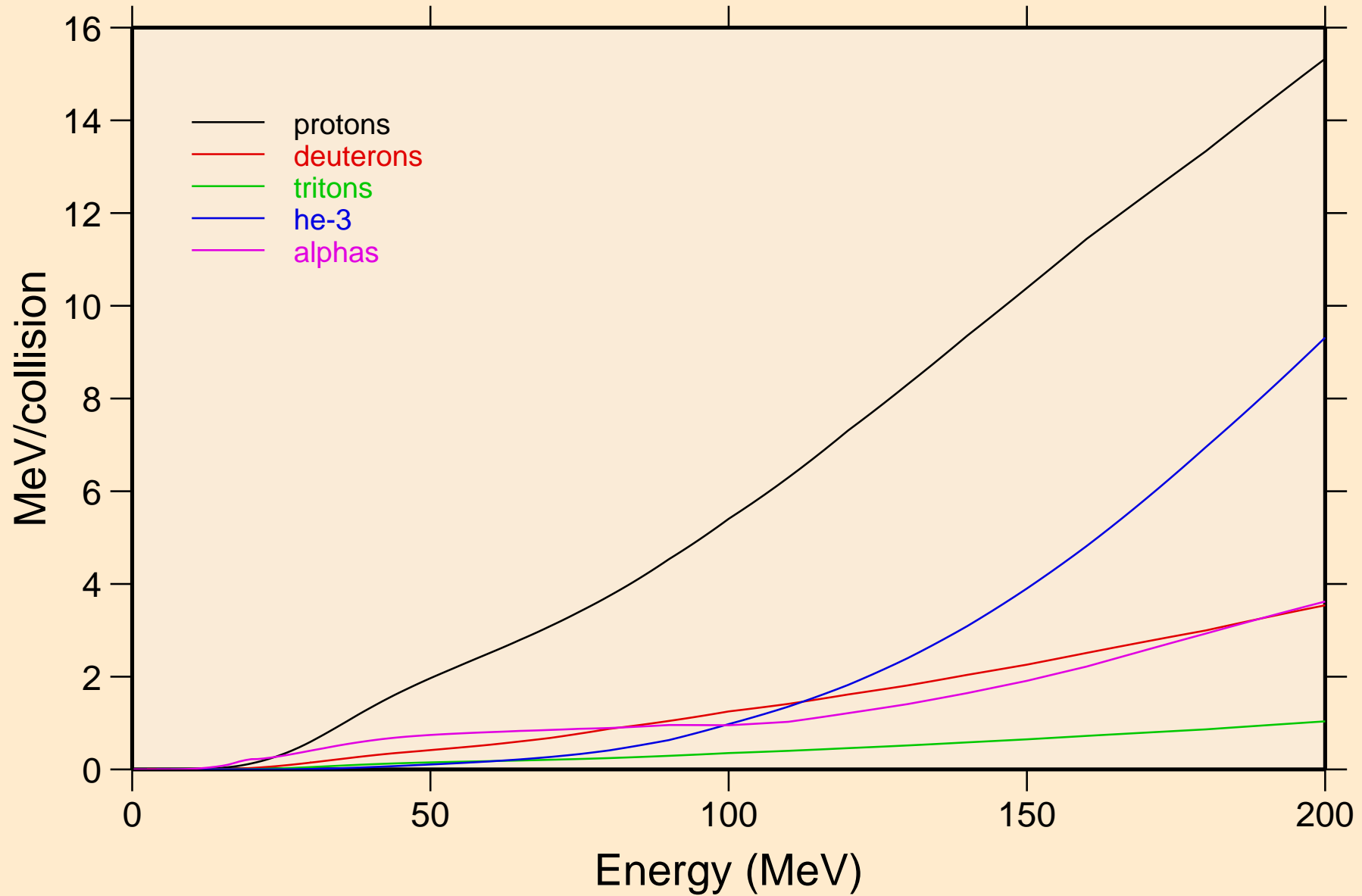

# SM146 NEUTRON ACER TENDL-2023 LIBRARY; T=0.K

## Recoil Heating

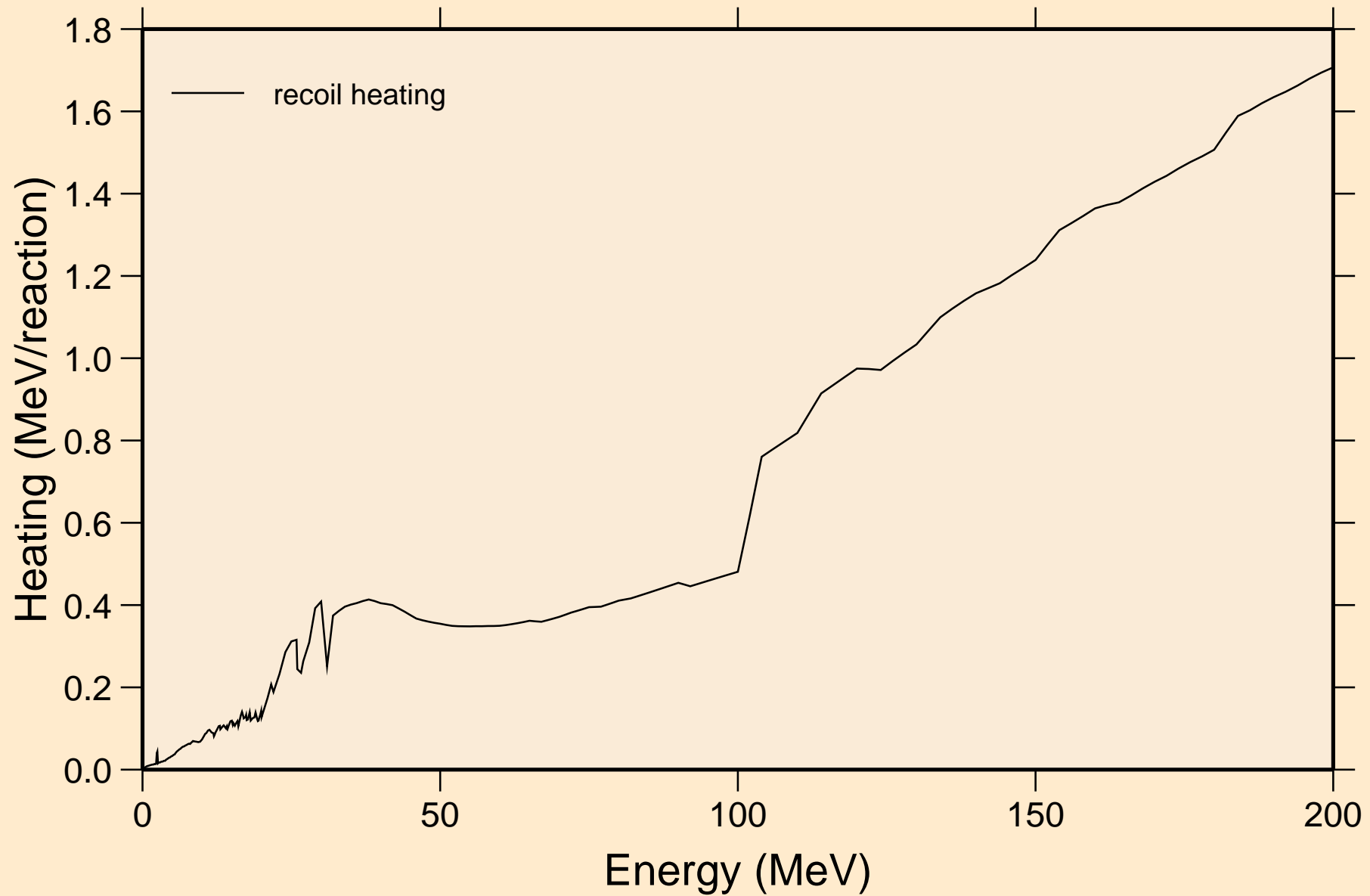



SM146 NEUTRON ACER TENDL-2023 LIBRARY; T=0.K  
Particle production cross sections

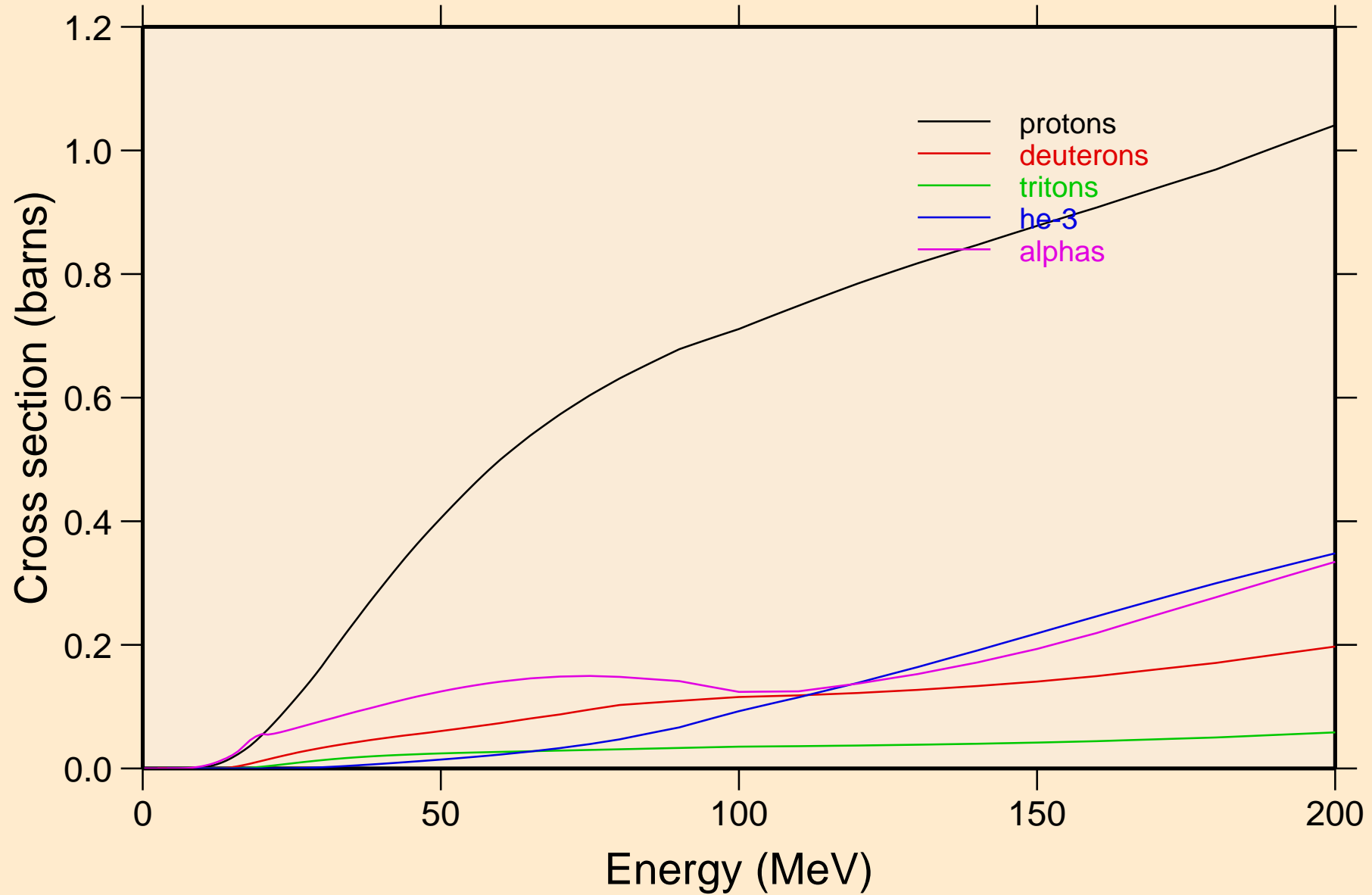

SM146 NEUTRON ACER TENDL-2023 LIBRARY; T=0.K  
protons from (n,x)

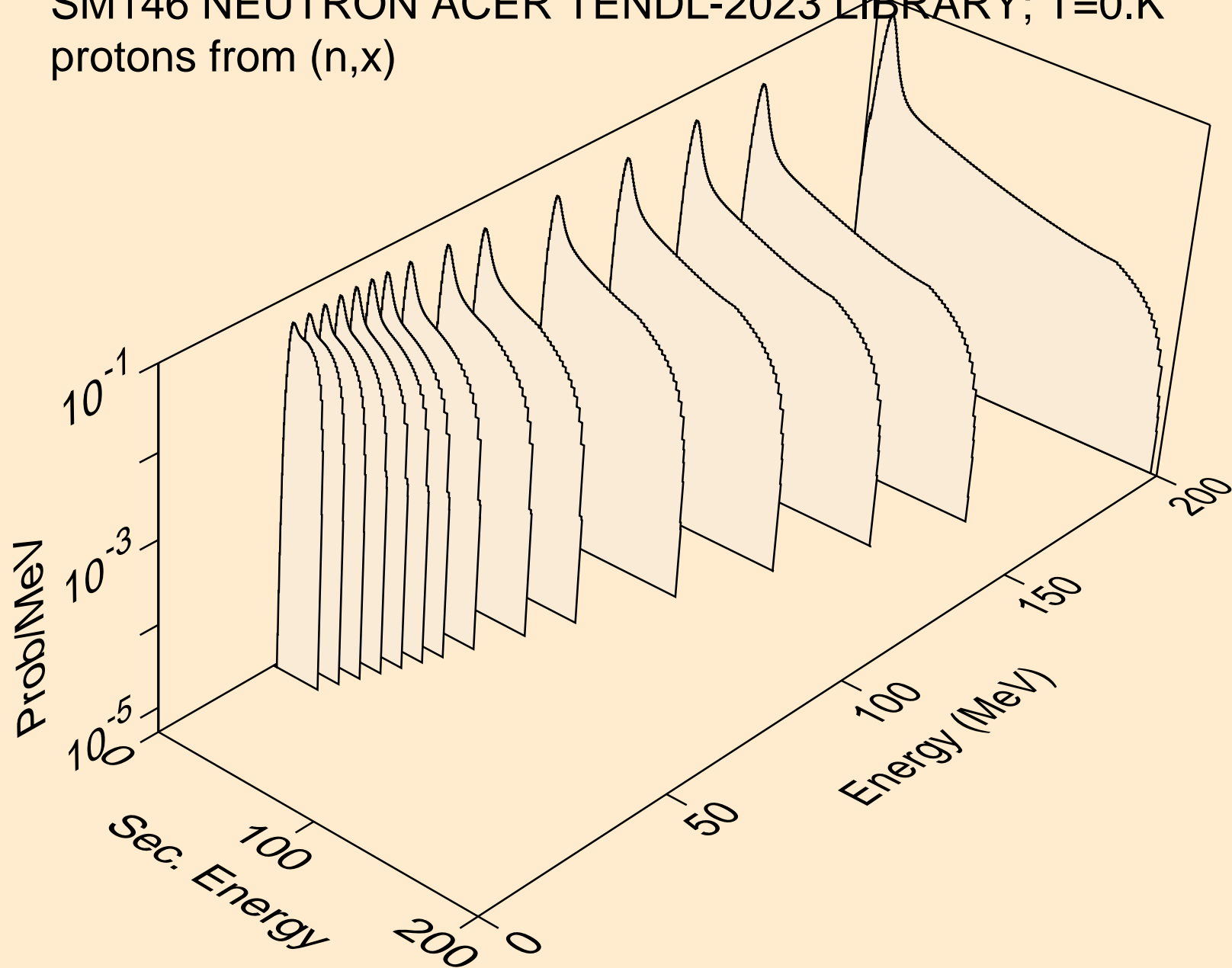

SM146 NEUTRON ACER TENDL-2023 LIBRARY; T=0.K  
protons from (n,n\*)p

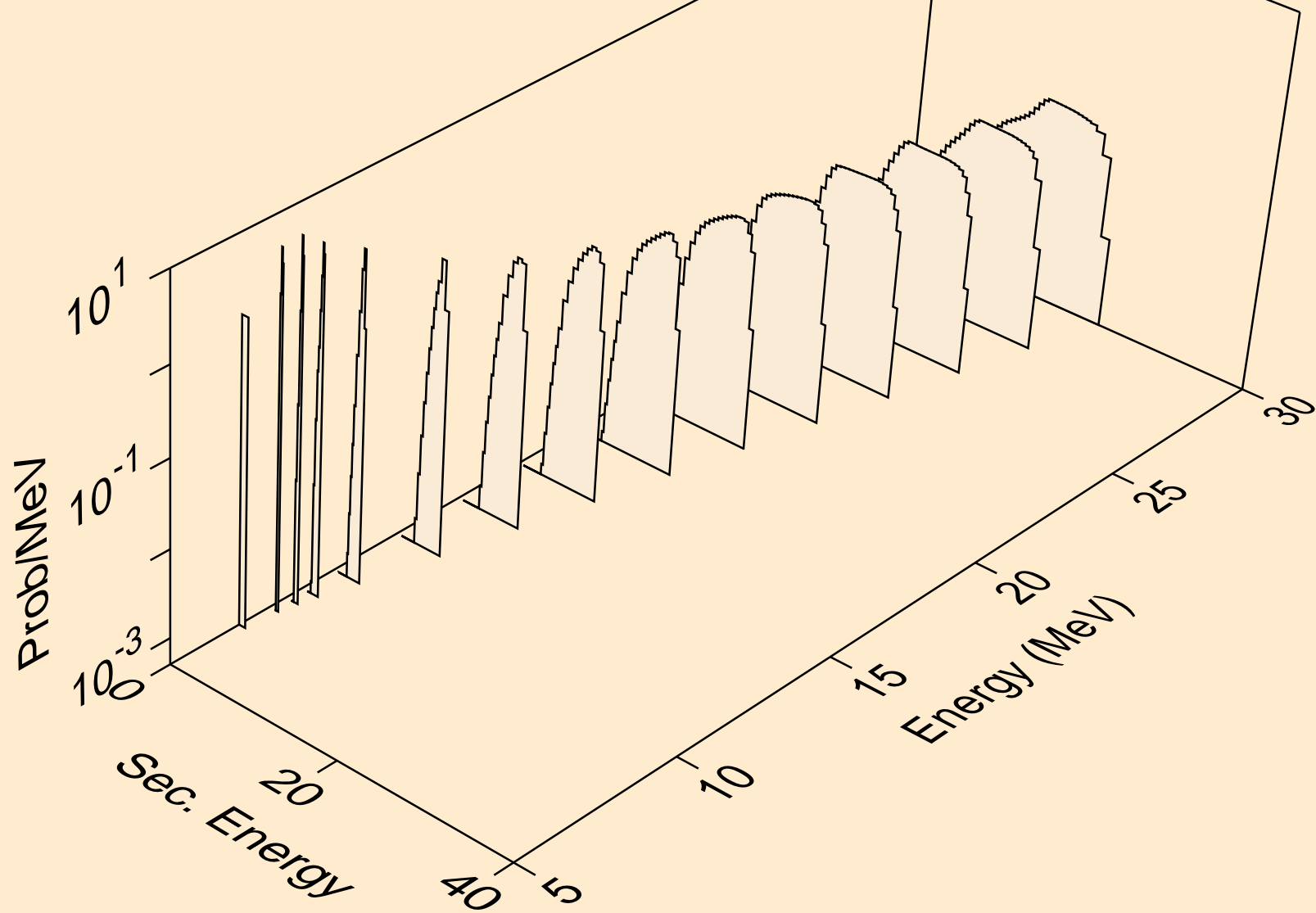

SM146 NEUTRON ACER TENDL-2023 LIBRARY; T=0.K  
protons from (n,2np)

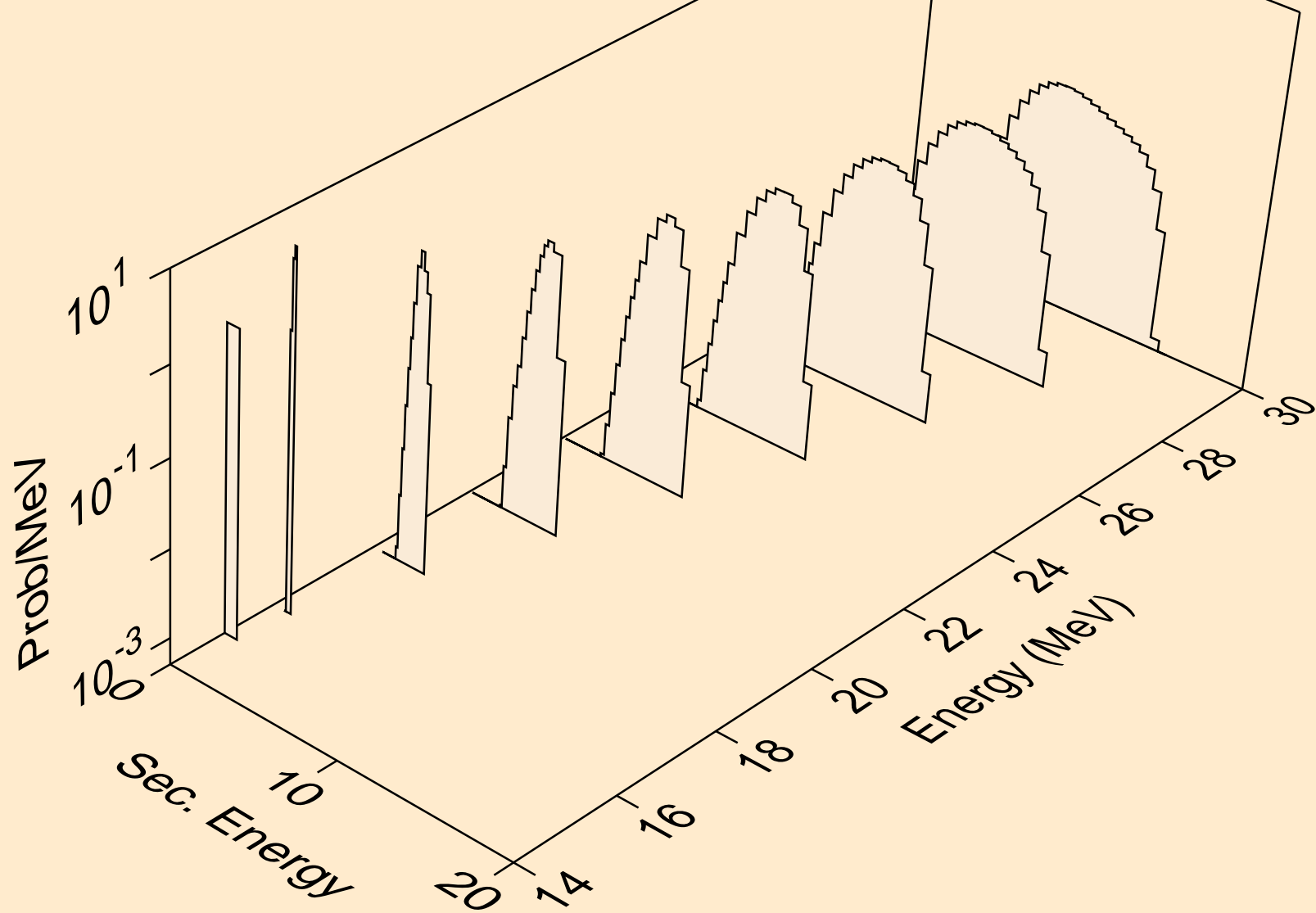

SM146 NEUTRON ACER TENDL-2023 LIBRARY; T=0.K  
protons from (n,3np)

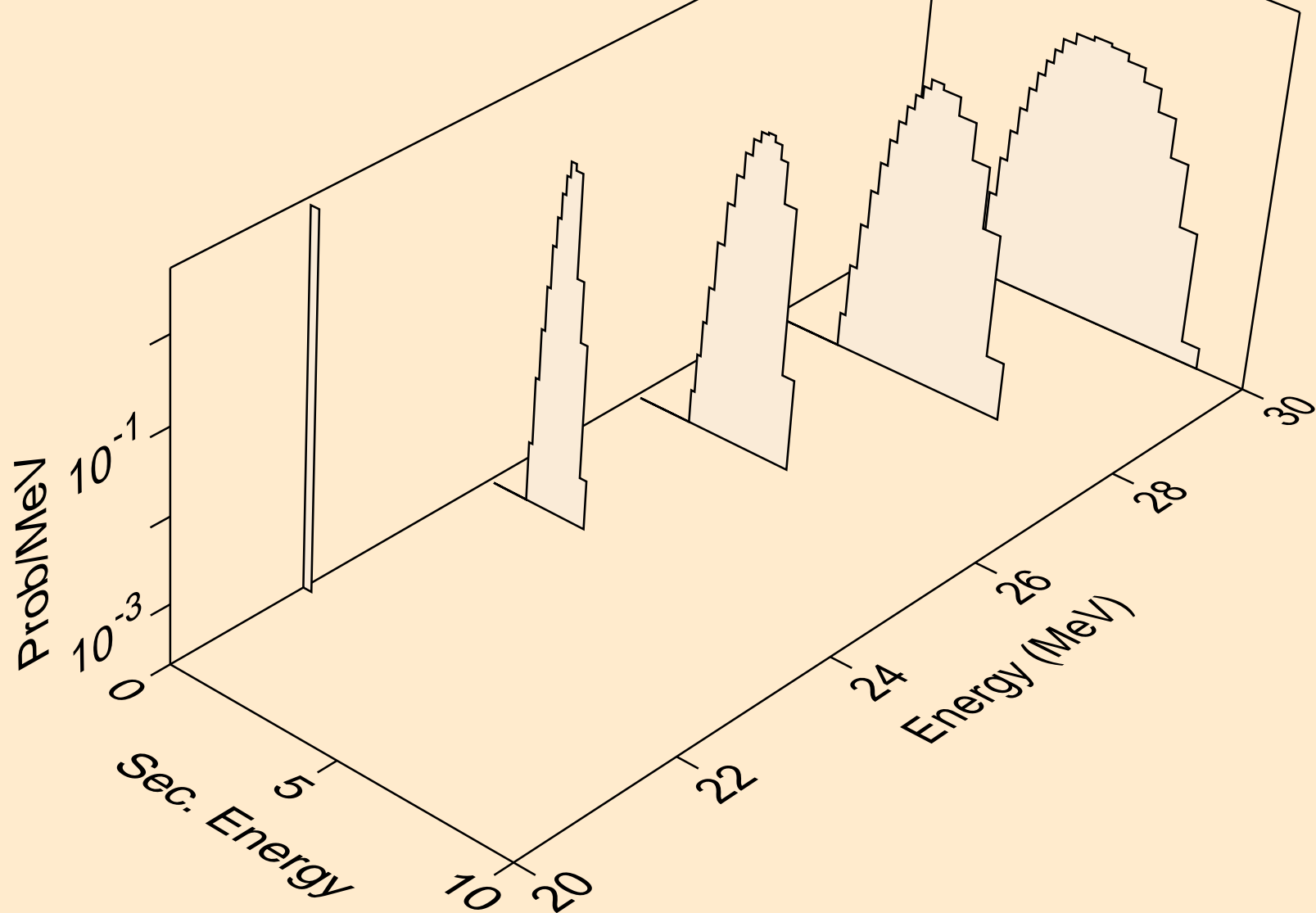

SM146 NEUTRON ACER TENDL-2023 LIBRARY; T=0.K  
protons from (n,n2p)

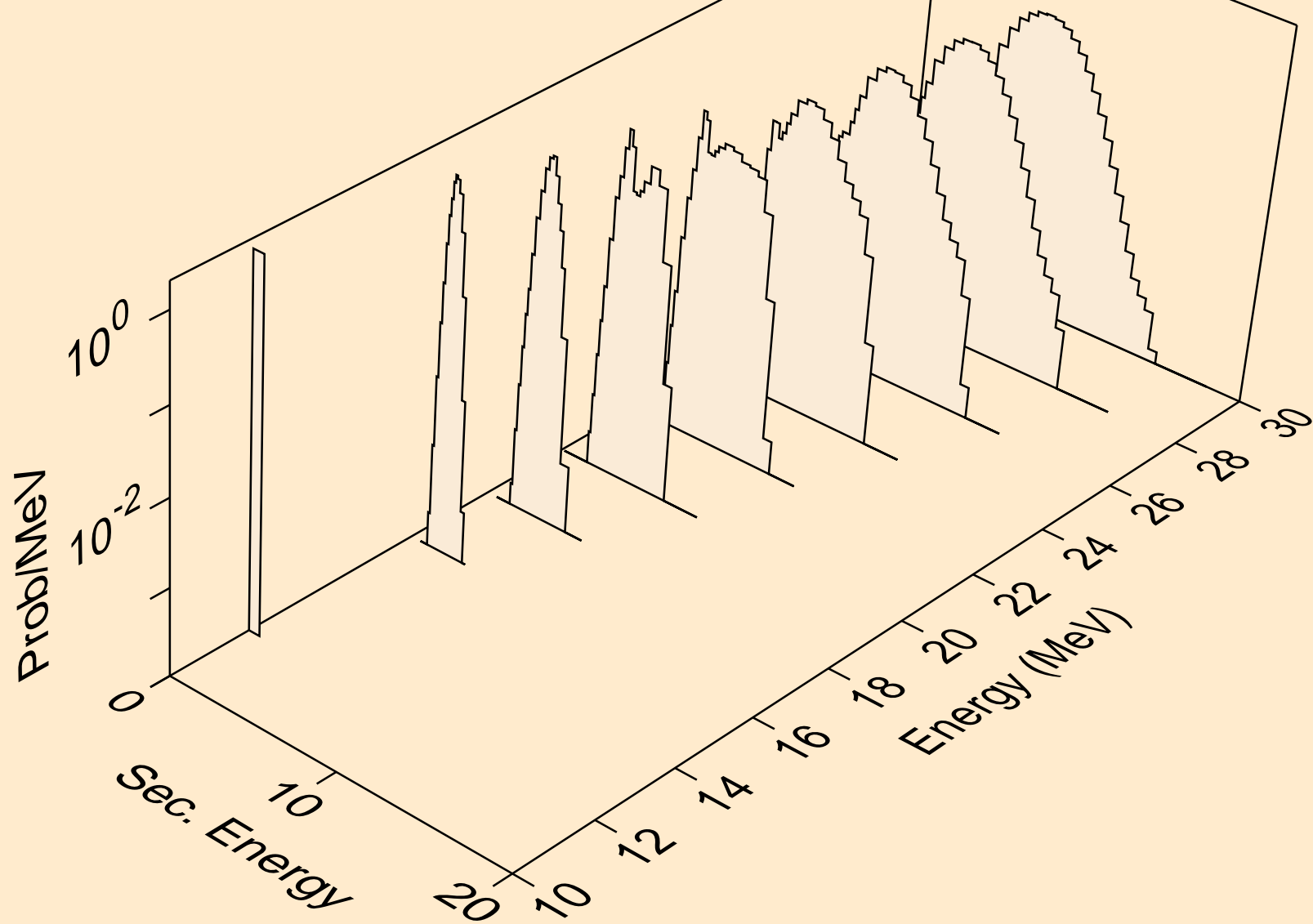

SM146 NEUTRON ACER TENDL-2023 LIBRARY; T=0.K  
protons from (n,npa)

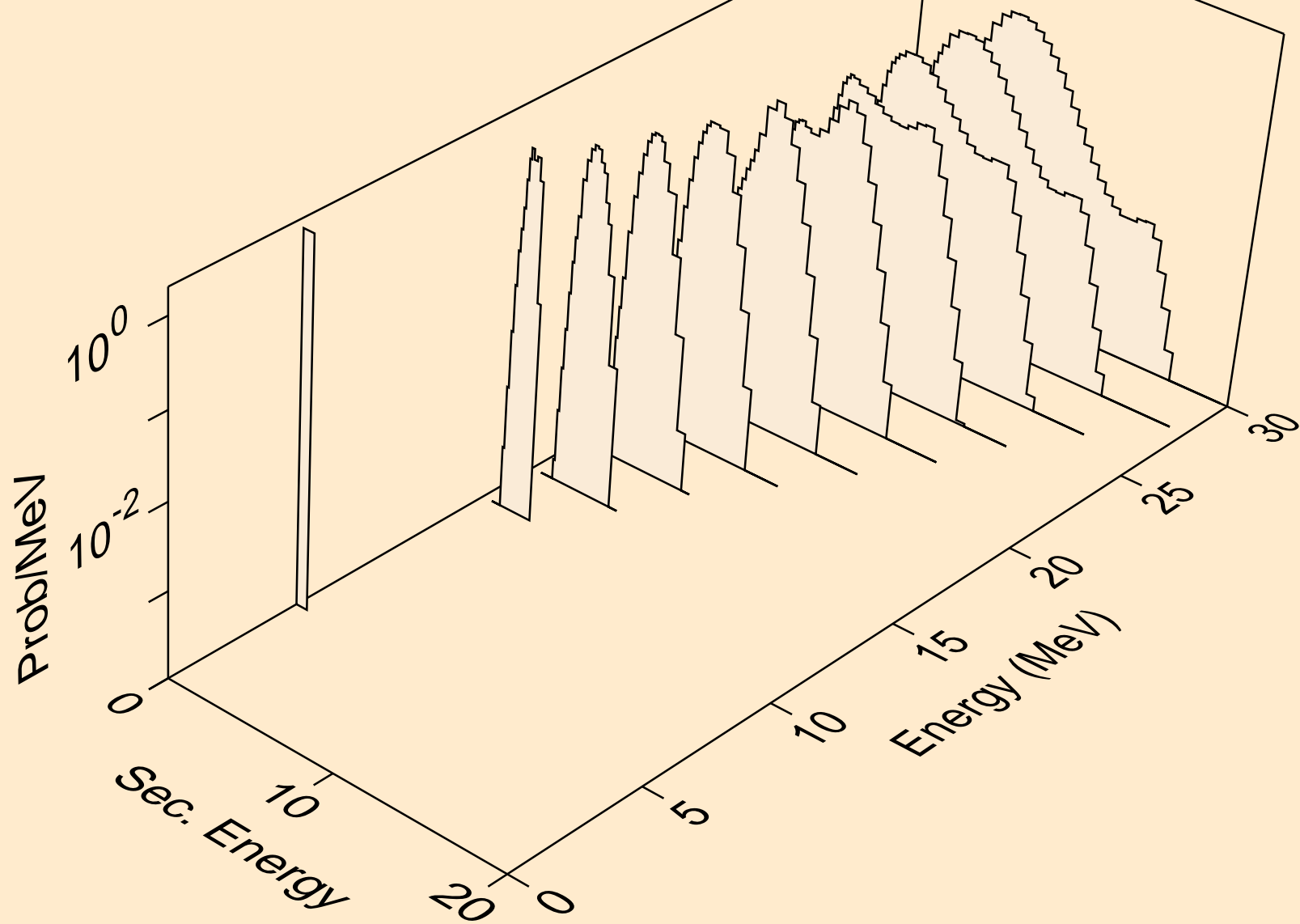

SM146 NEUTRON ACER TENDL-2023 LIBRARY; T=0.K  
protons from (n,p)

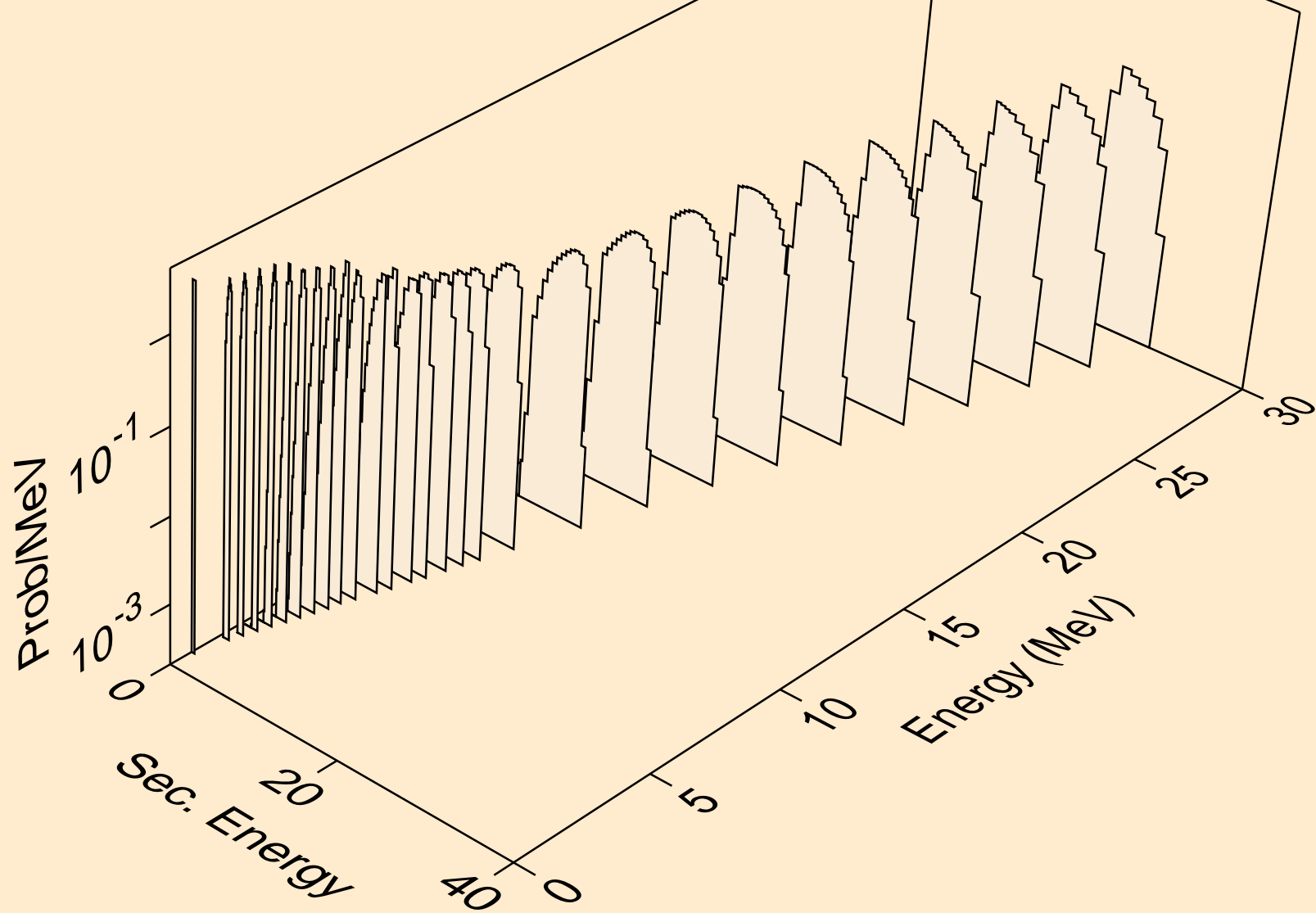



SM146 NEUTRON ACER TENDL-2023 LIBRARY; T=0.K  
protons from (n,2p)

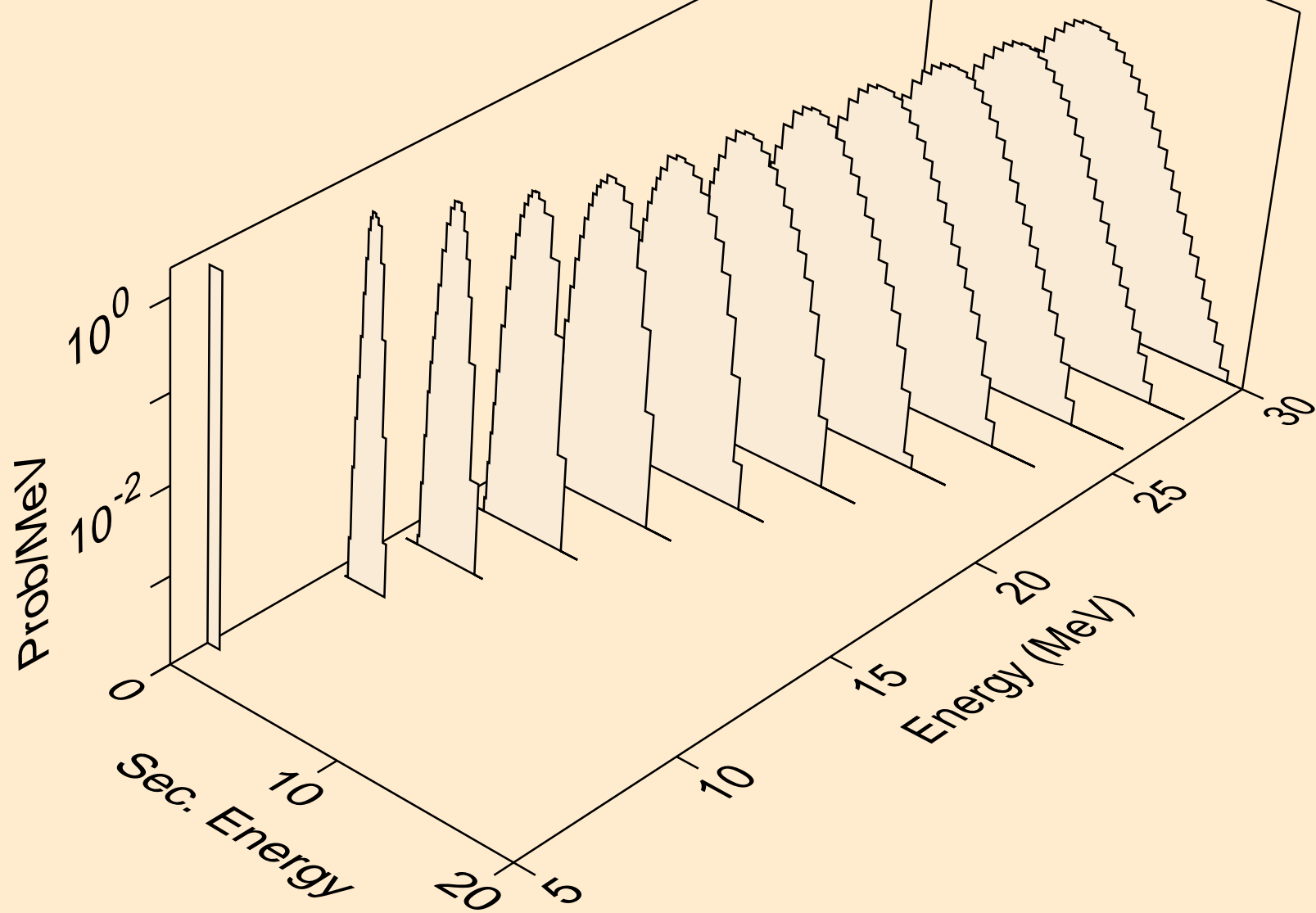

SM146 NEUTRON ACER TENDL-2023 LIBRARY; T=0.K  
protons from (n,pa)

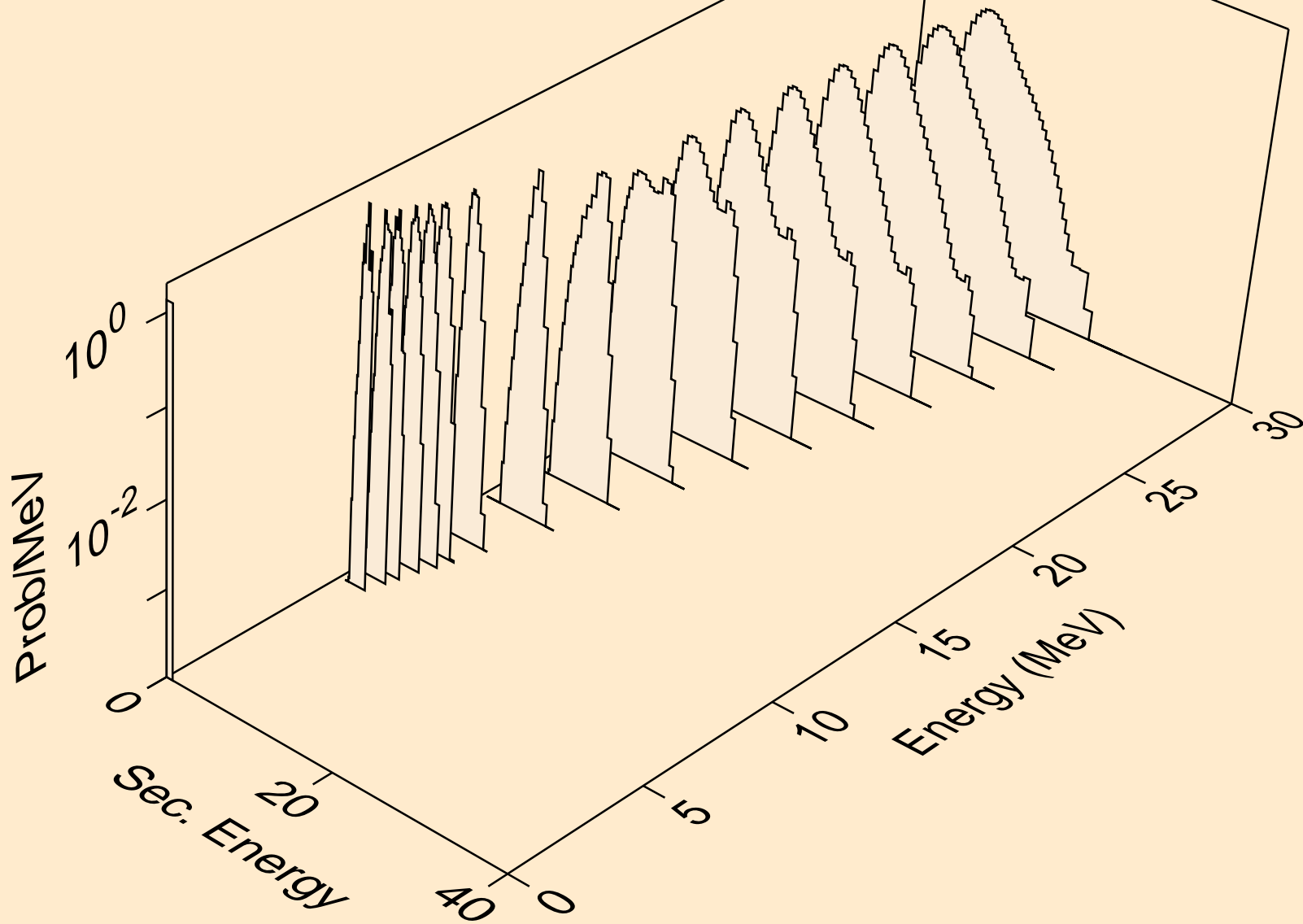

SM146 NEUTRON ACER TENDL-2023 LIBRARY; T=0.K  
protons from (n,pd)

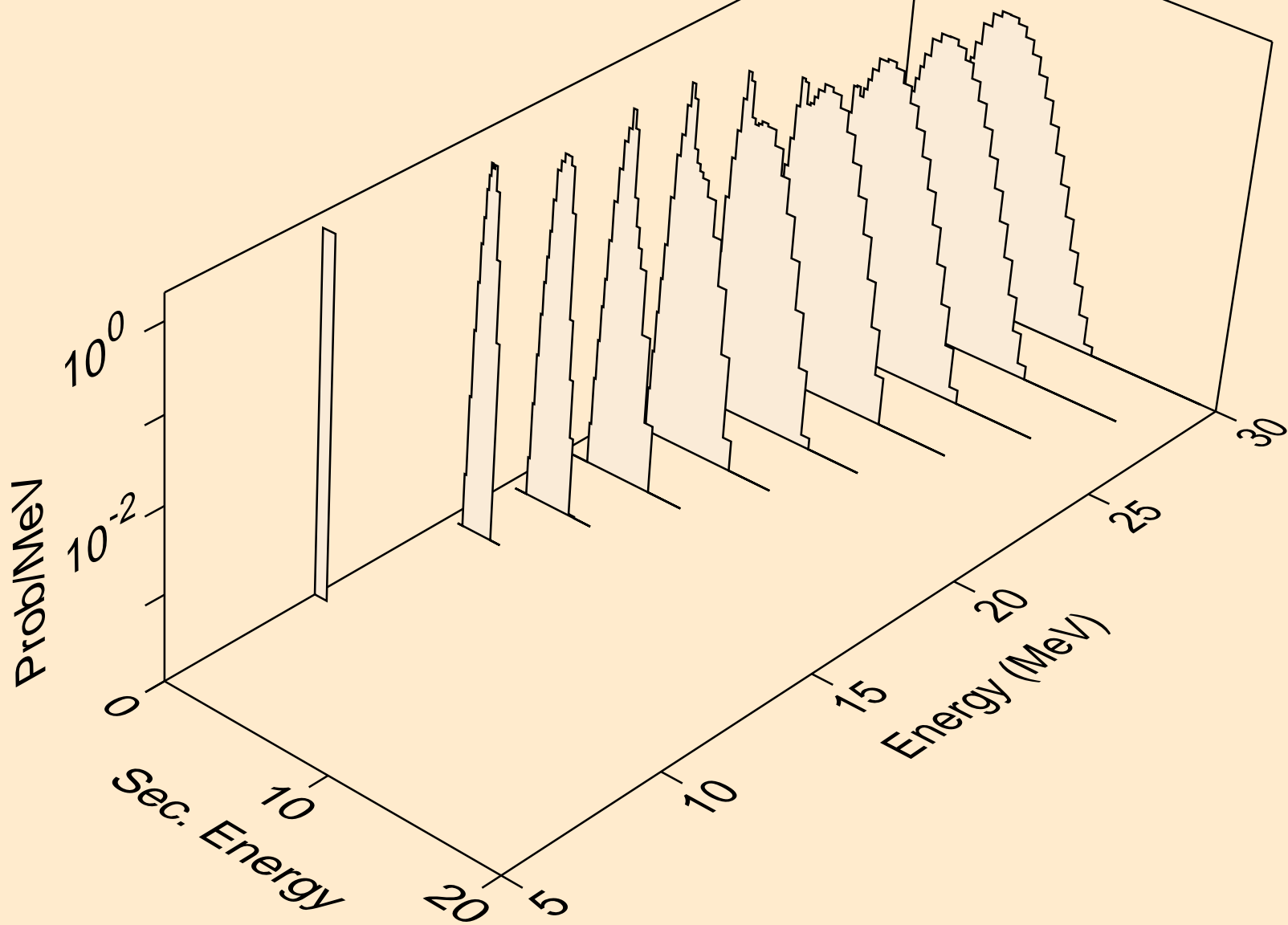

SM146 NEUTRON ACER TENDL-2023 LIBRARY; T=0.K  
protons from (n,pt)

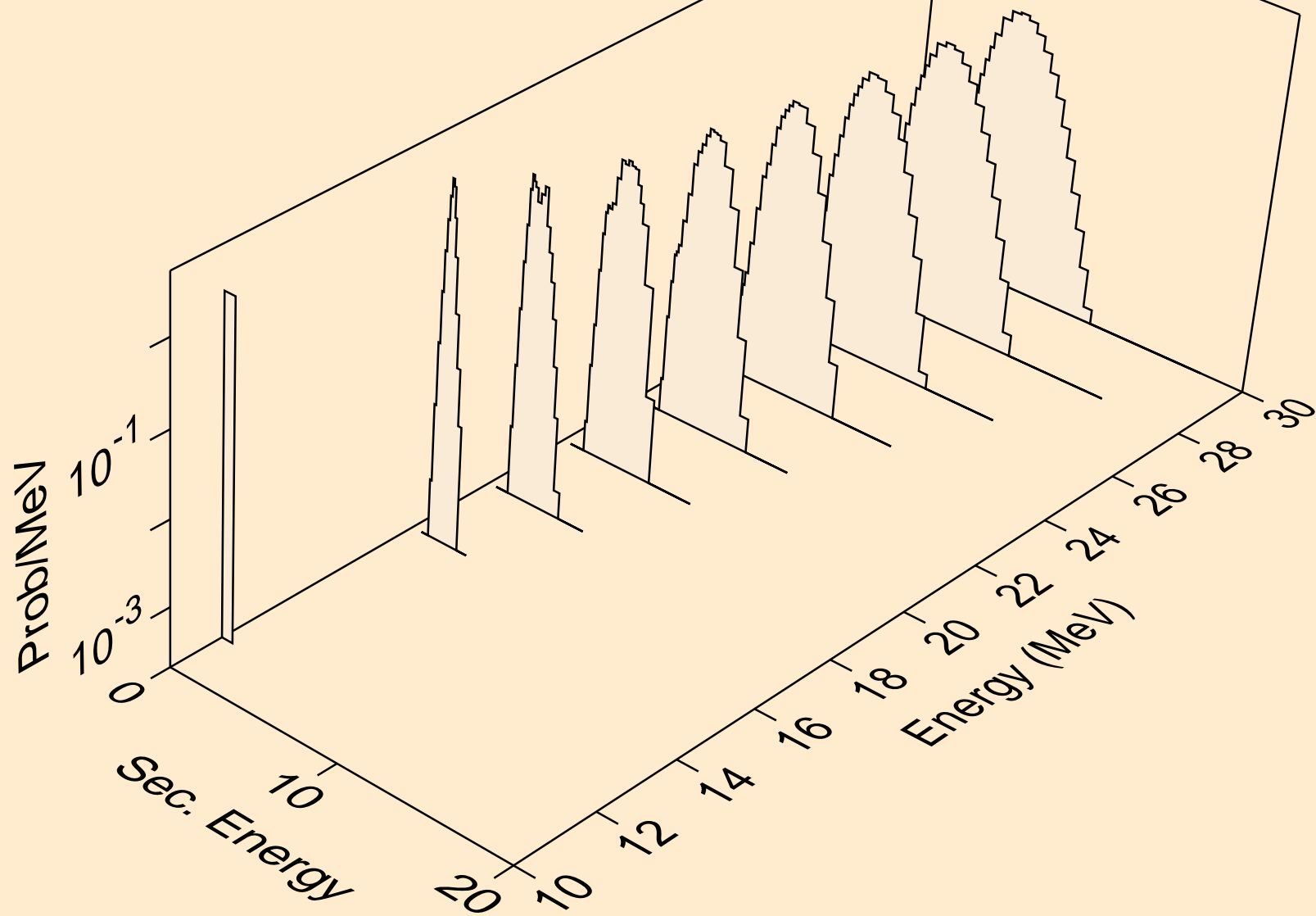

SM146 NEUTRON ACER TENDL-2023 LIBRARY; T=0.K  
deuterons from (n,x)

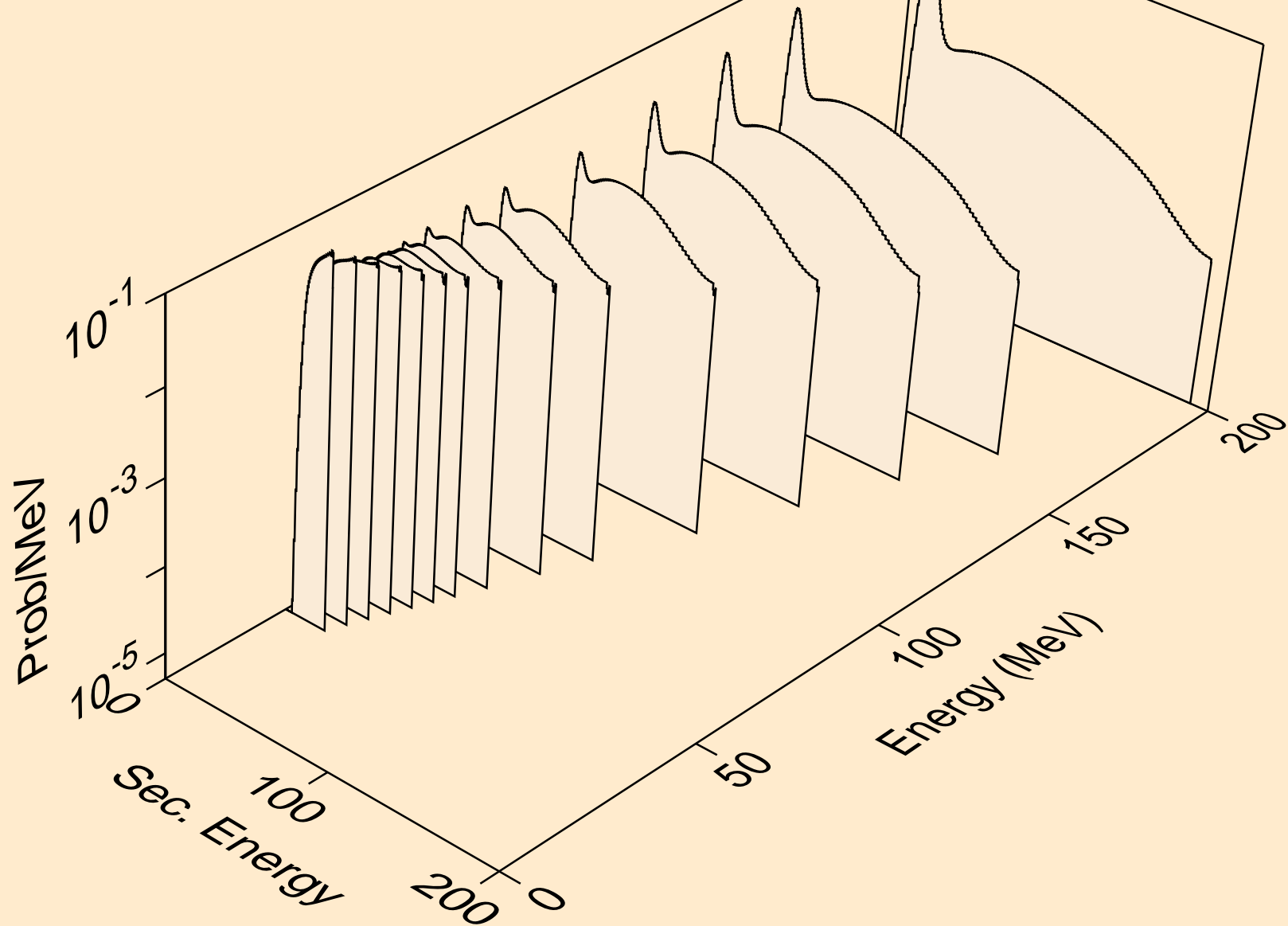

SM146 NEUTRON ACER TENDL-2023 LIBRARY; T=0.K  
deuterons from (n,2nd)

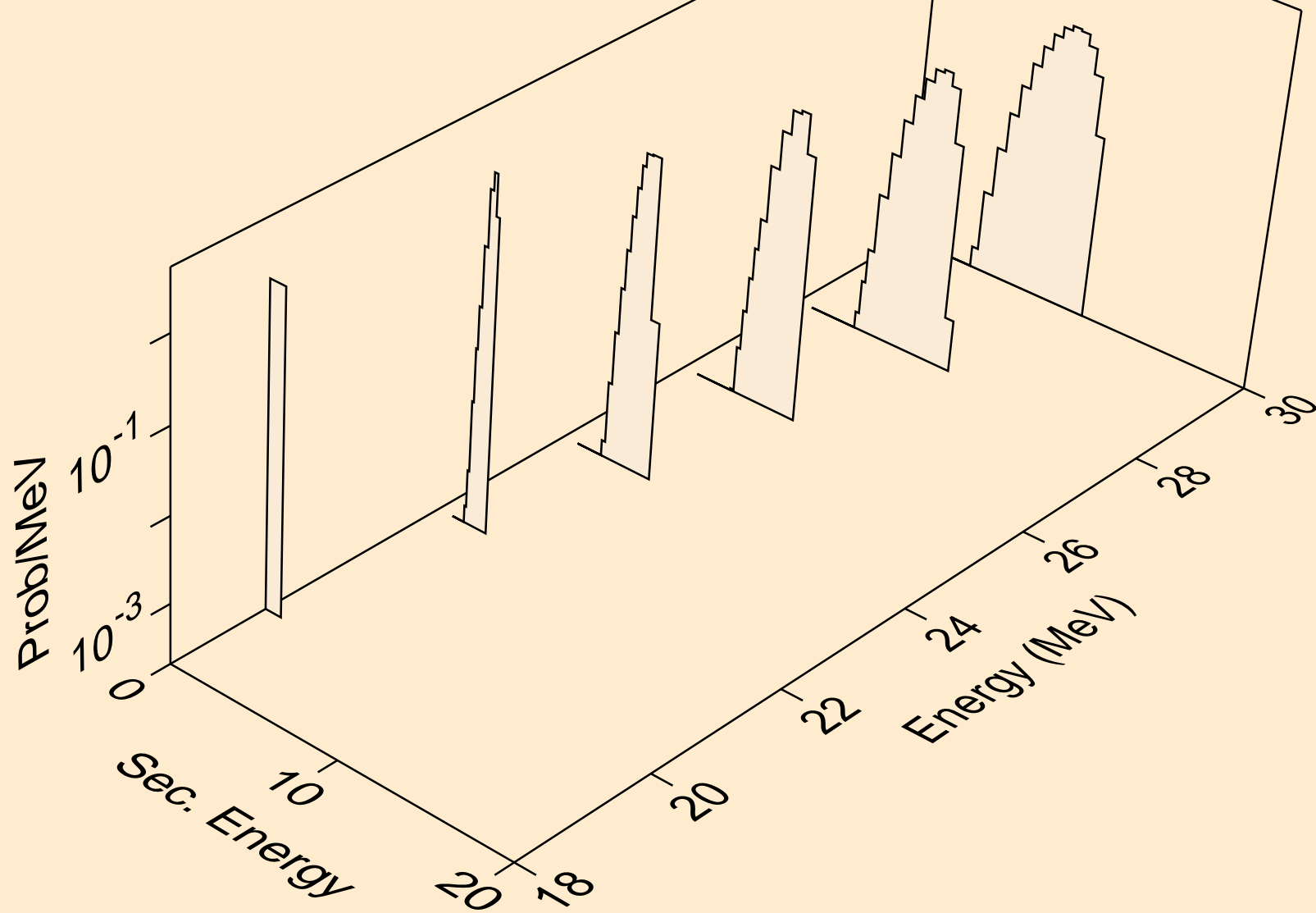

SM146 NEUTRON ACER TENDL-2023 LIBRARY; T=0.K  
deuterons from (n,n\*)d

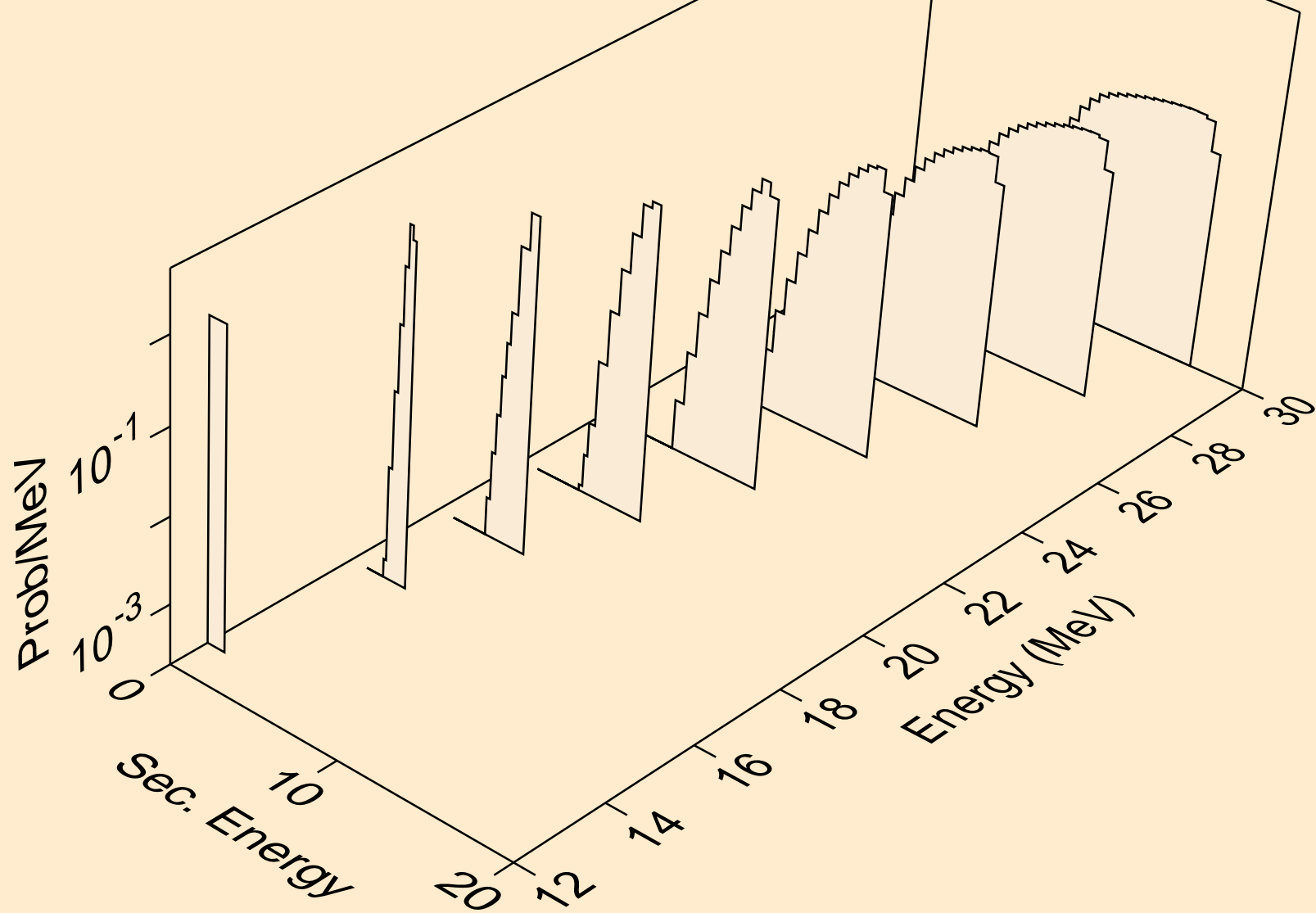

SM146 NEUTRON ACER TENDL-2023 LIBRARY; T=0.K  
deuterons from (n,d)

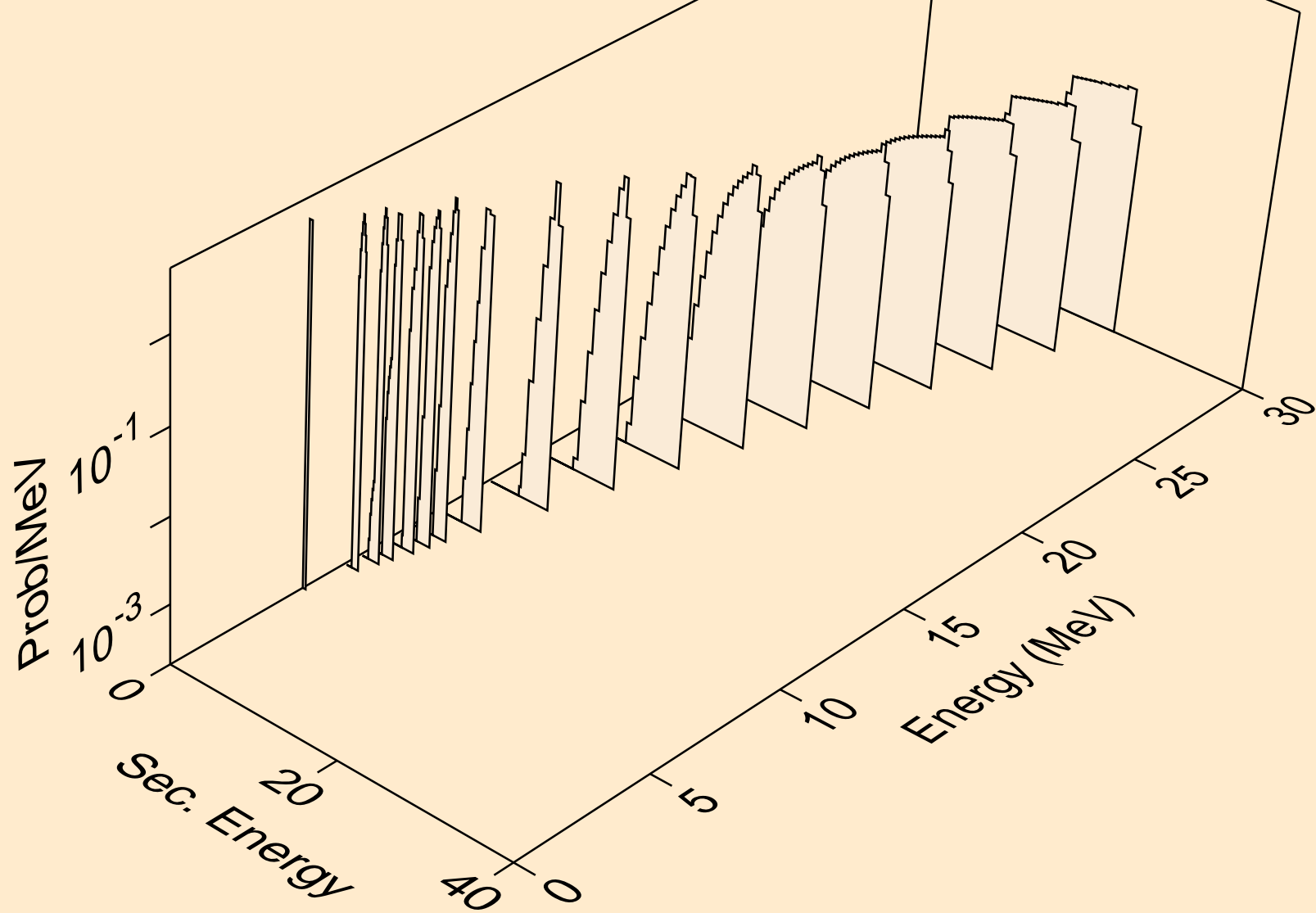



SM146 NEUTRON ACER TENDL-2023 LIBRARY; T=0.K  
deuterons from (n,pd)

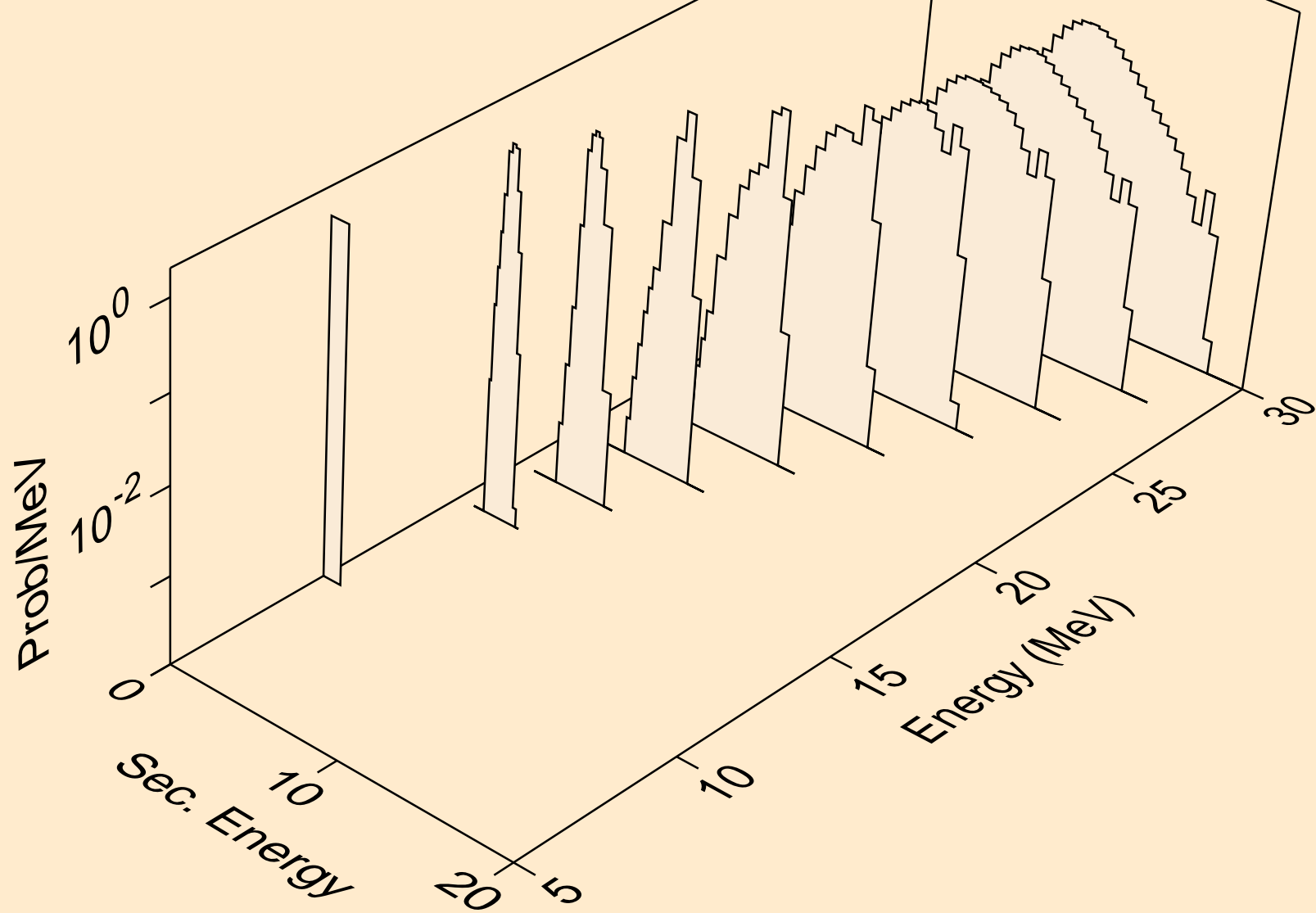

SM146 NEUTRON ACER TENDL-2023 LIBRARY; T=0.K  
deuterons from (n,da)

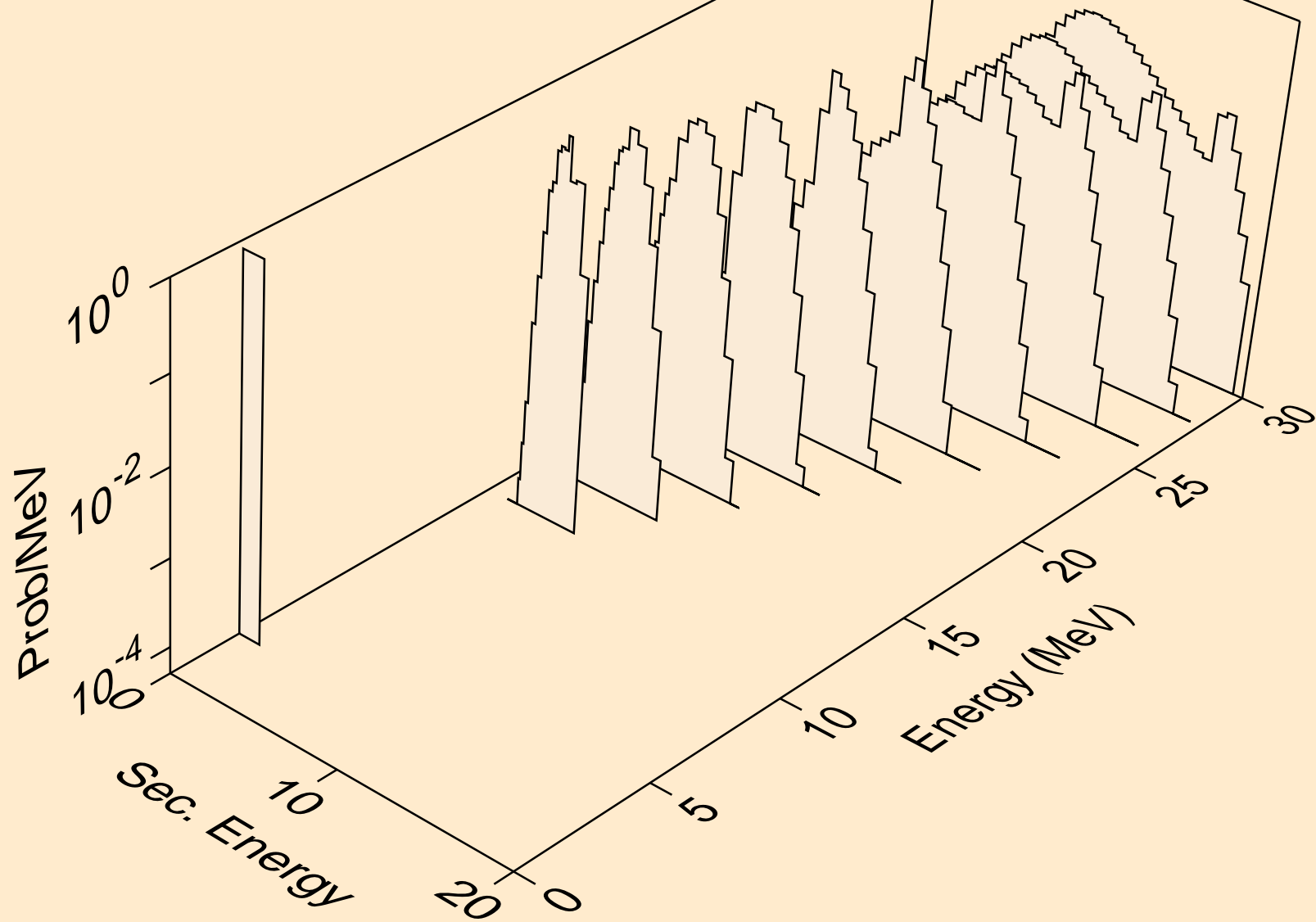

SM146 NEUTRON ACER TENDL-2023 LIBRARY; T=0.K  
tritons from (n,x)

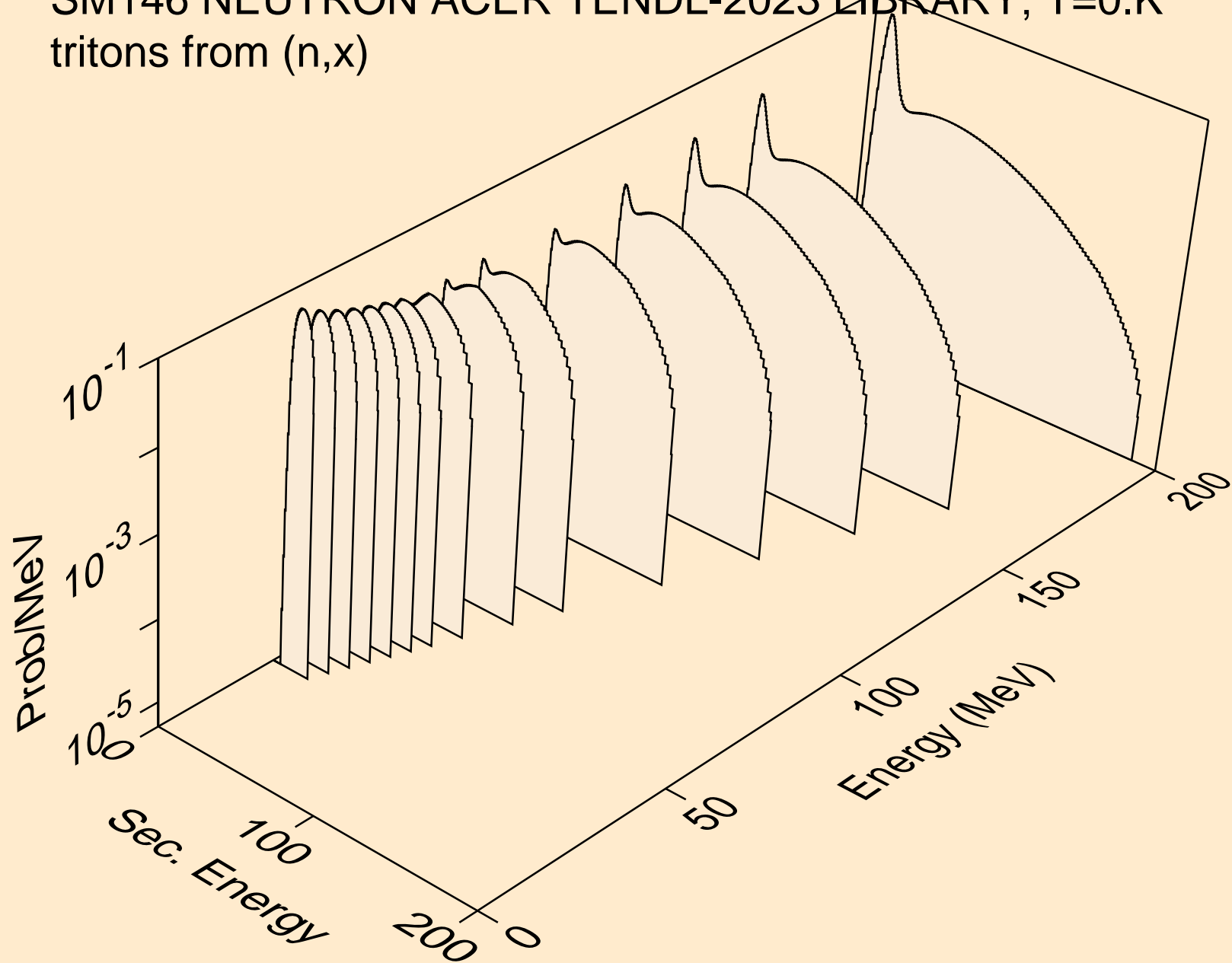

SM146 NEUTRON ACER TENDL-2023 LIBRARY; T=0.K  
tritons from (n,n\*)t

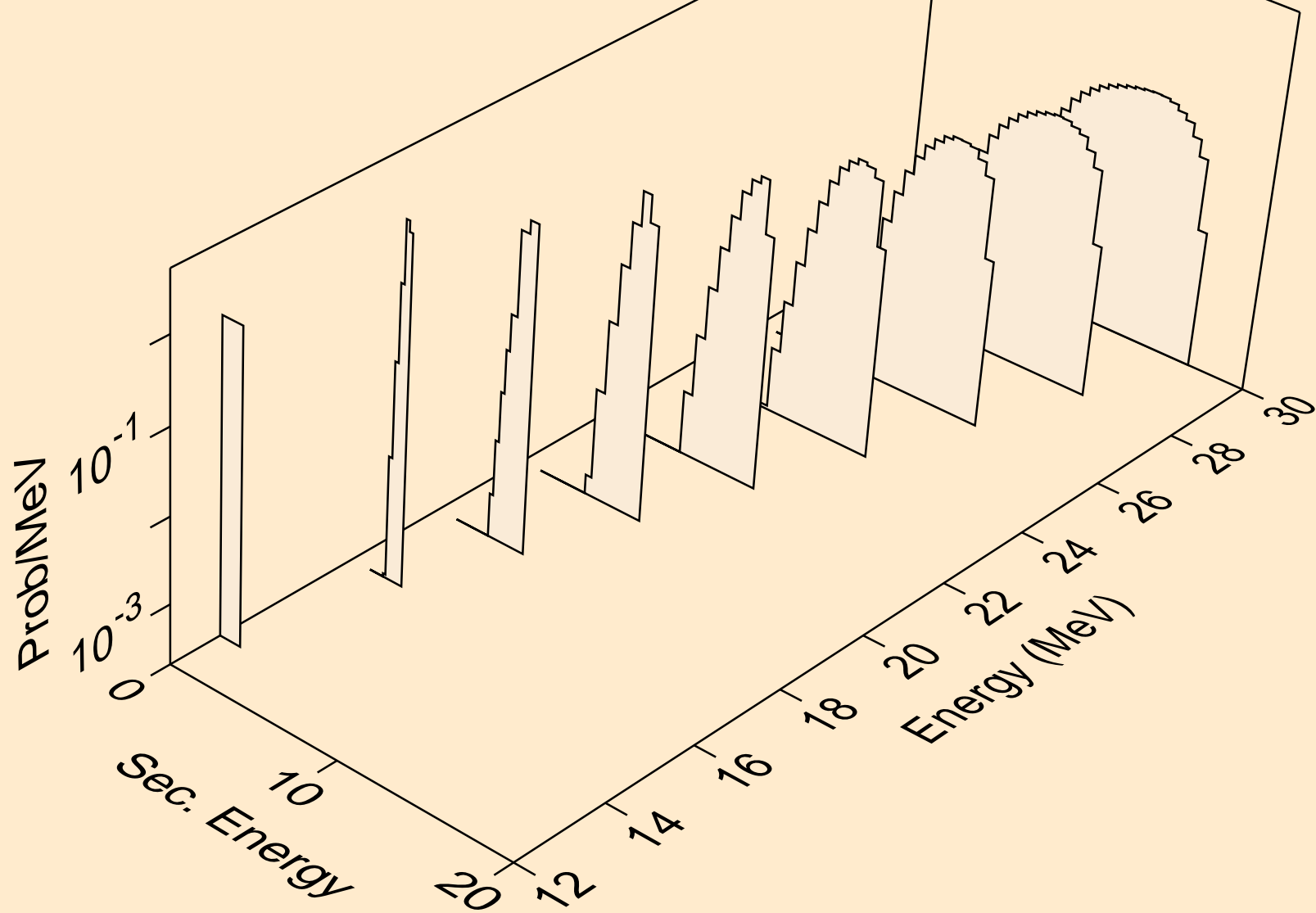

SM146 NEUTRON ACER TENDL-2023 LIBRARY; T=0.K  
tritons from (n,t)

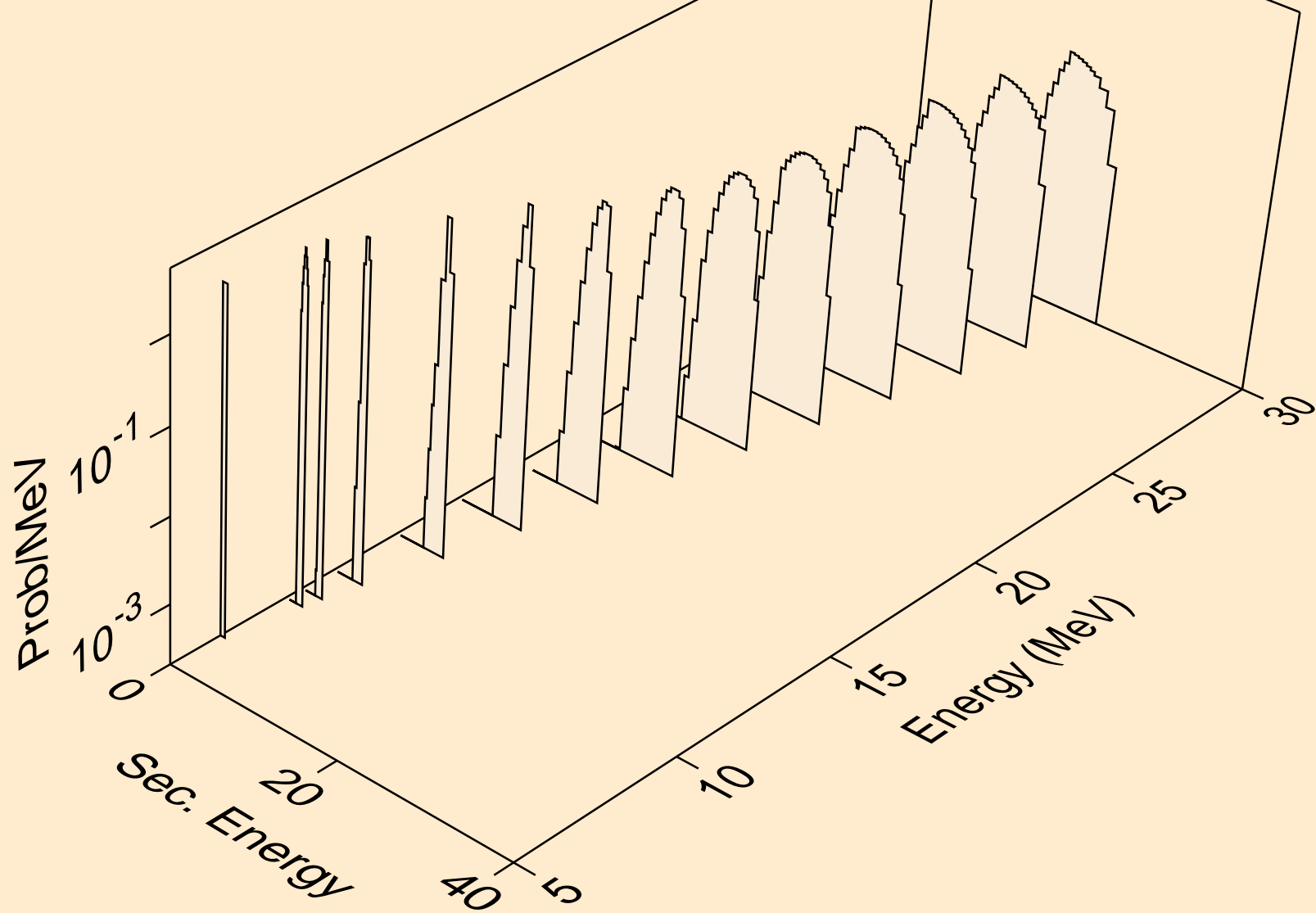

SM146 NEUTRON ACER TENDL-2023 LIBRARY; T=0.K  
tritons from (n,pt)

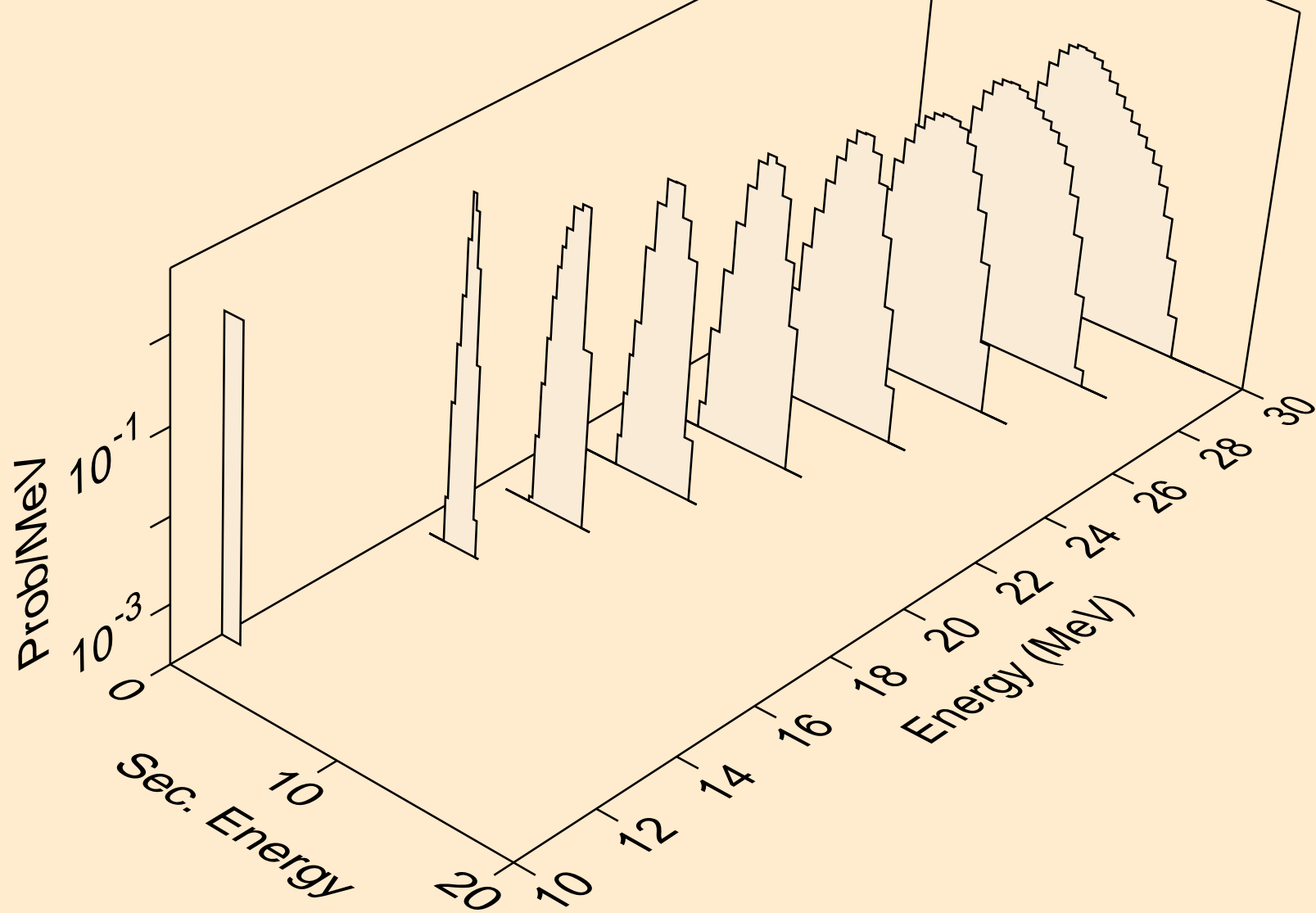

SM146 NEUTRON ACER TENDL-2023 LIBRARY; T=0.K  
he3s from (n,x)

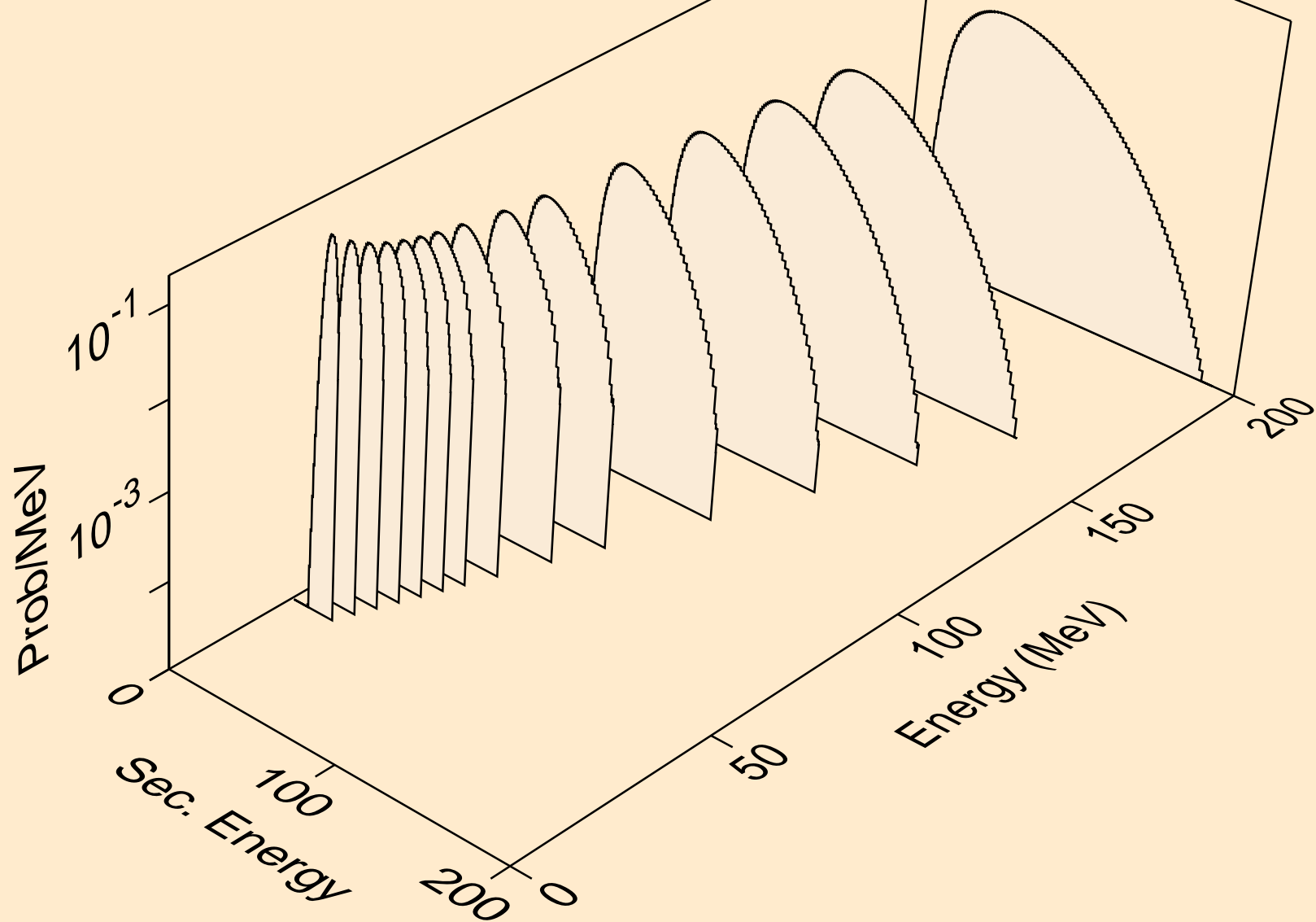

SM146 NEUTRON ACER TENDL-2023 LIBRARY; T=0.K  
he3s from (n,n\*)he3

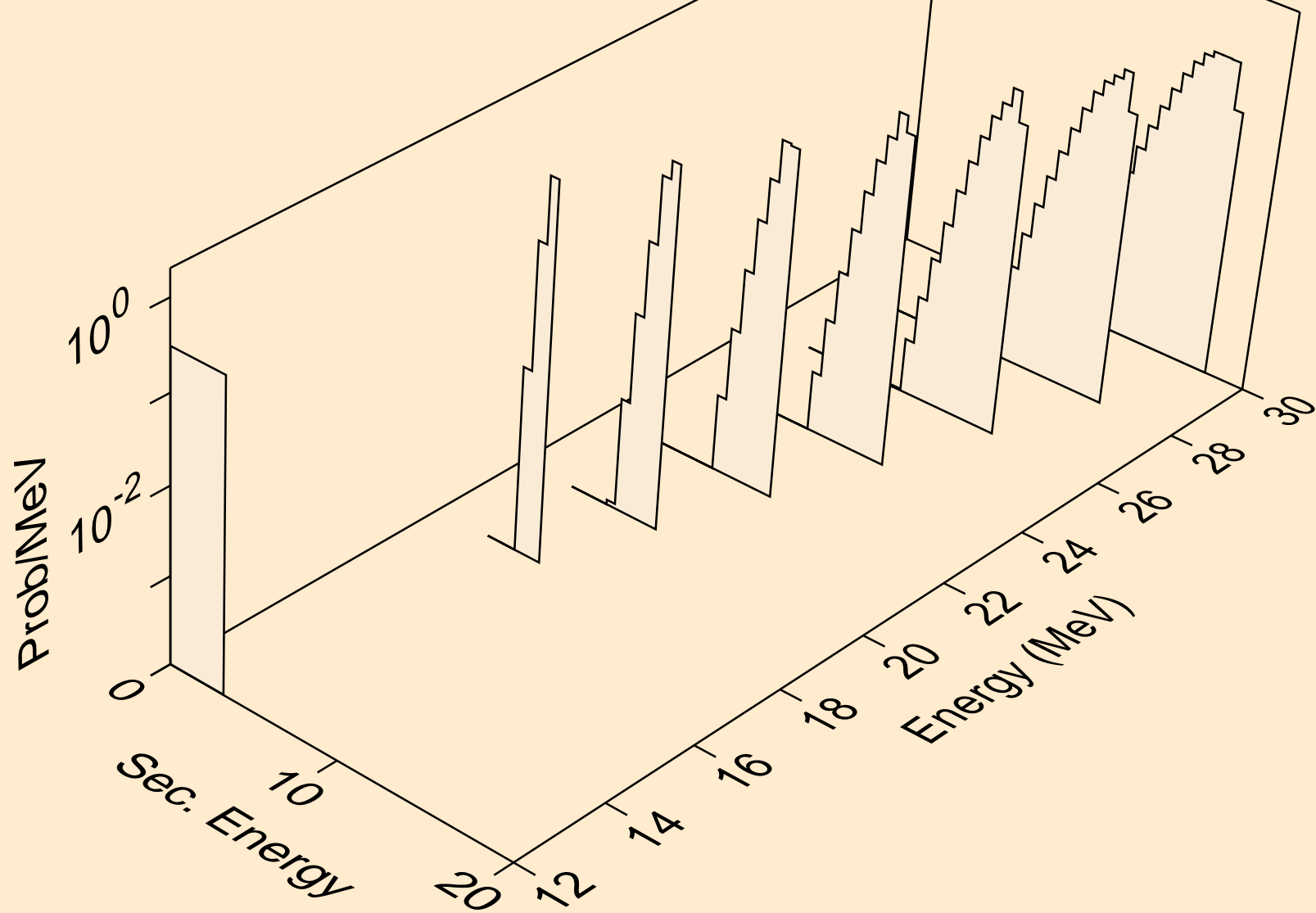



SM146 NEUTRON ACER TENDL-2023 LIBRARY; T=0.K  
he3s from (n,he3)

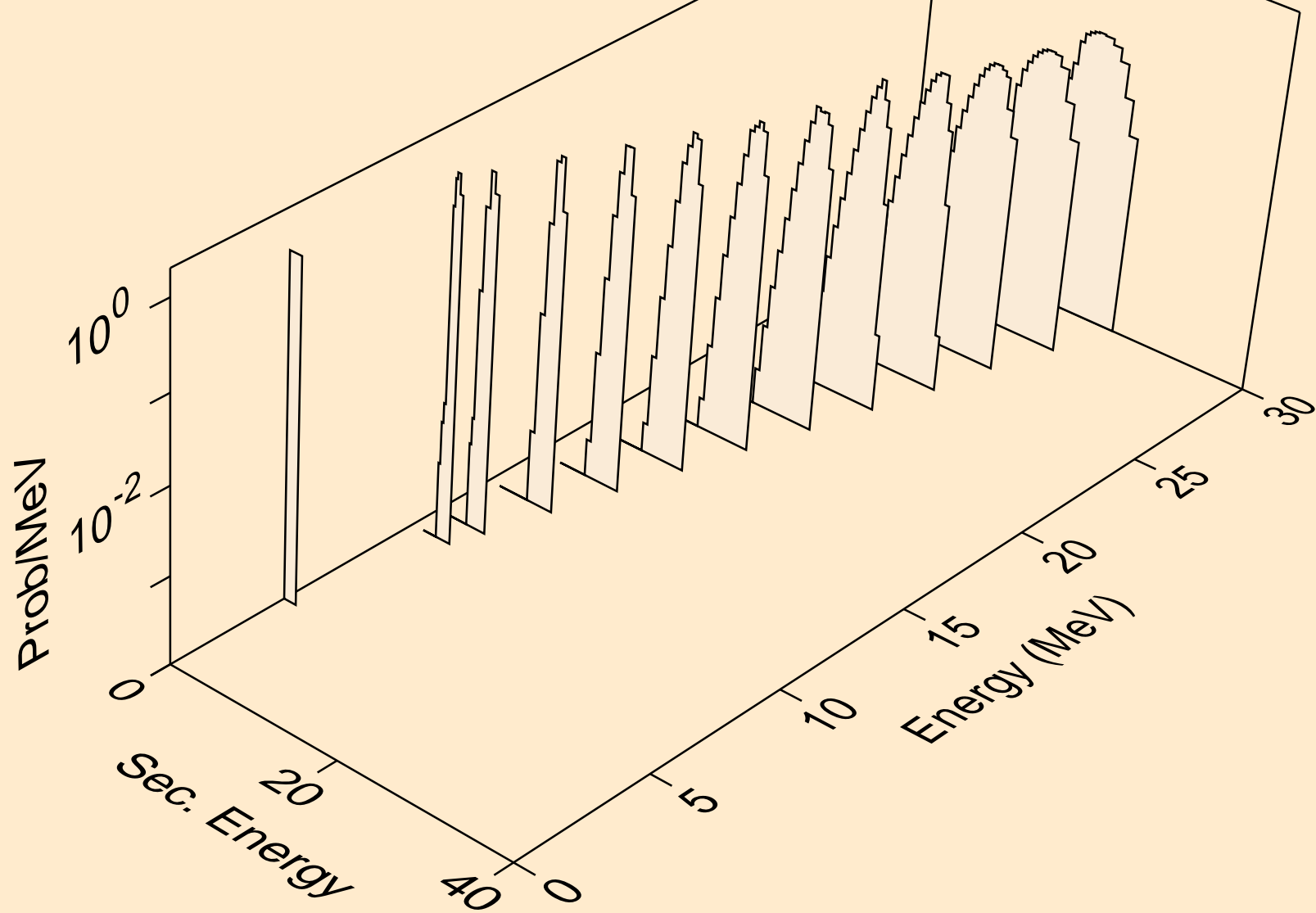

SM146 NEUTRON ACER TENDL-2023 LIBRARY; T=0.K  
alphas from (n,x)

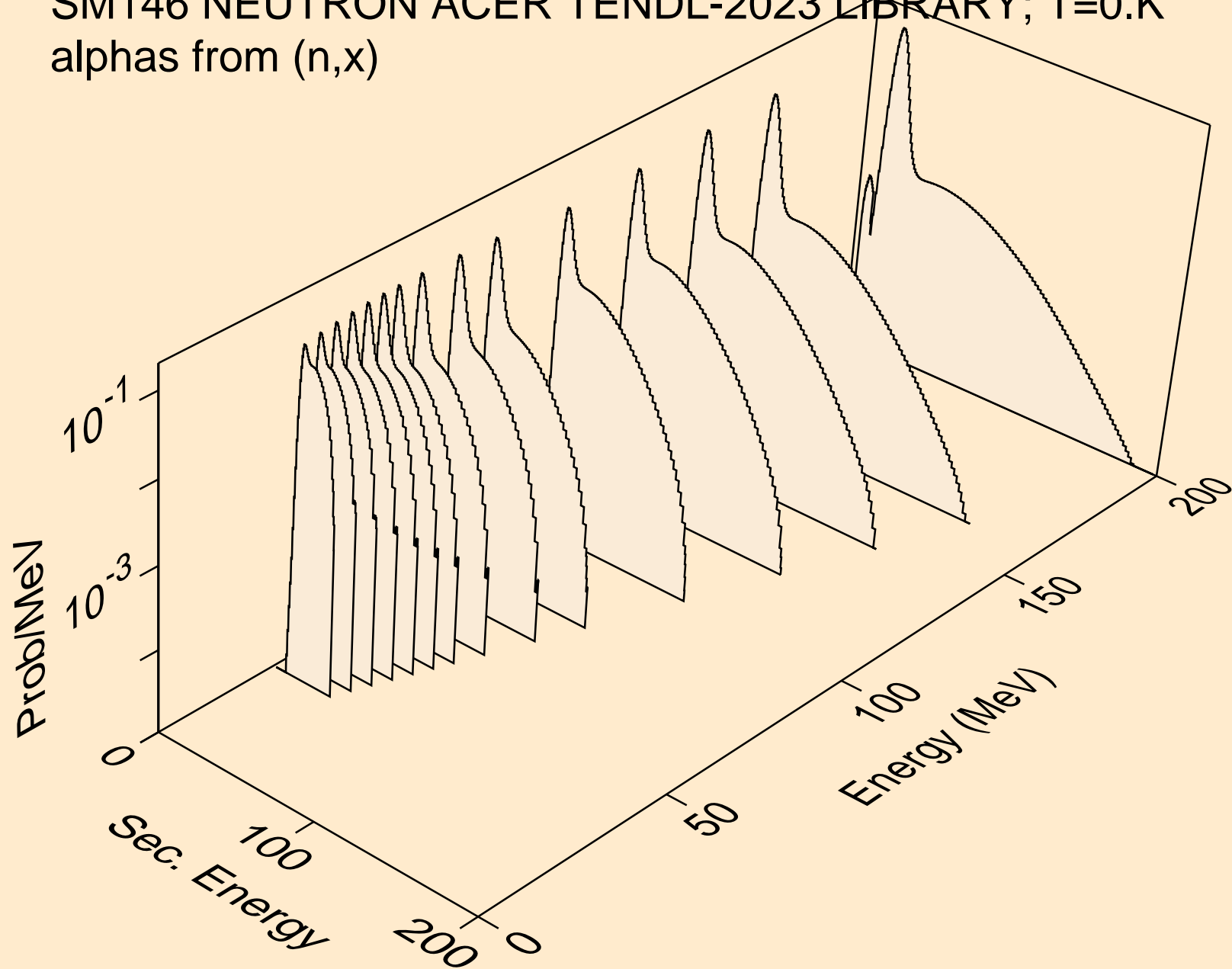

SM146 NEUTRON ACER TENDL-2023 LIBRARY; T=0.K  
alphas from (n,n\*)a

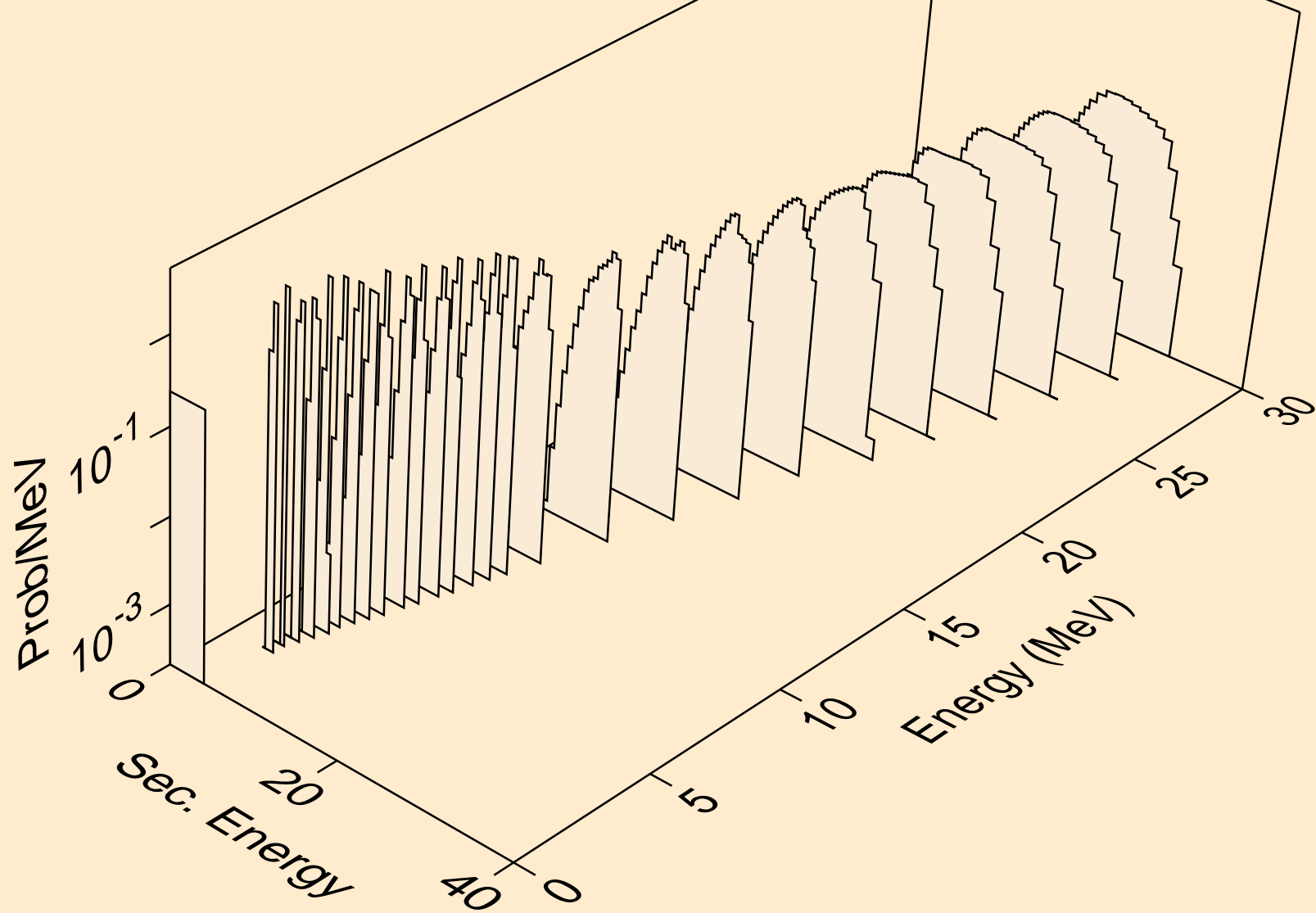

SM146 NEUTRON ACER TENDL-2023 LIBRARY; T=0.K  
alphas from (n,2n)a

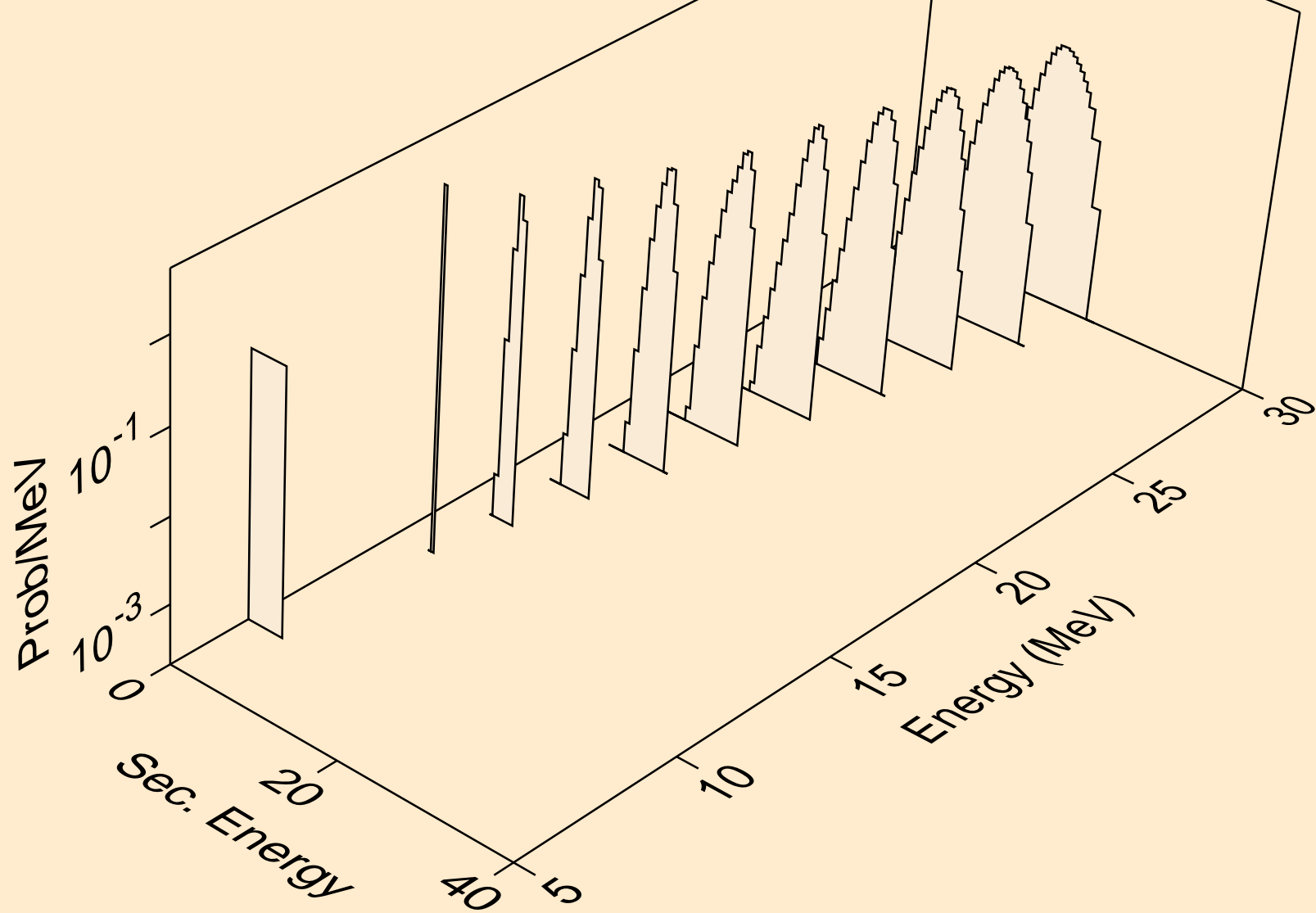

SM146 NEUTRON ACER TENDL-2023 LIBRARY; T=0.K  
alphas from (n,3n)a

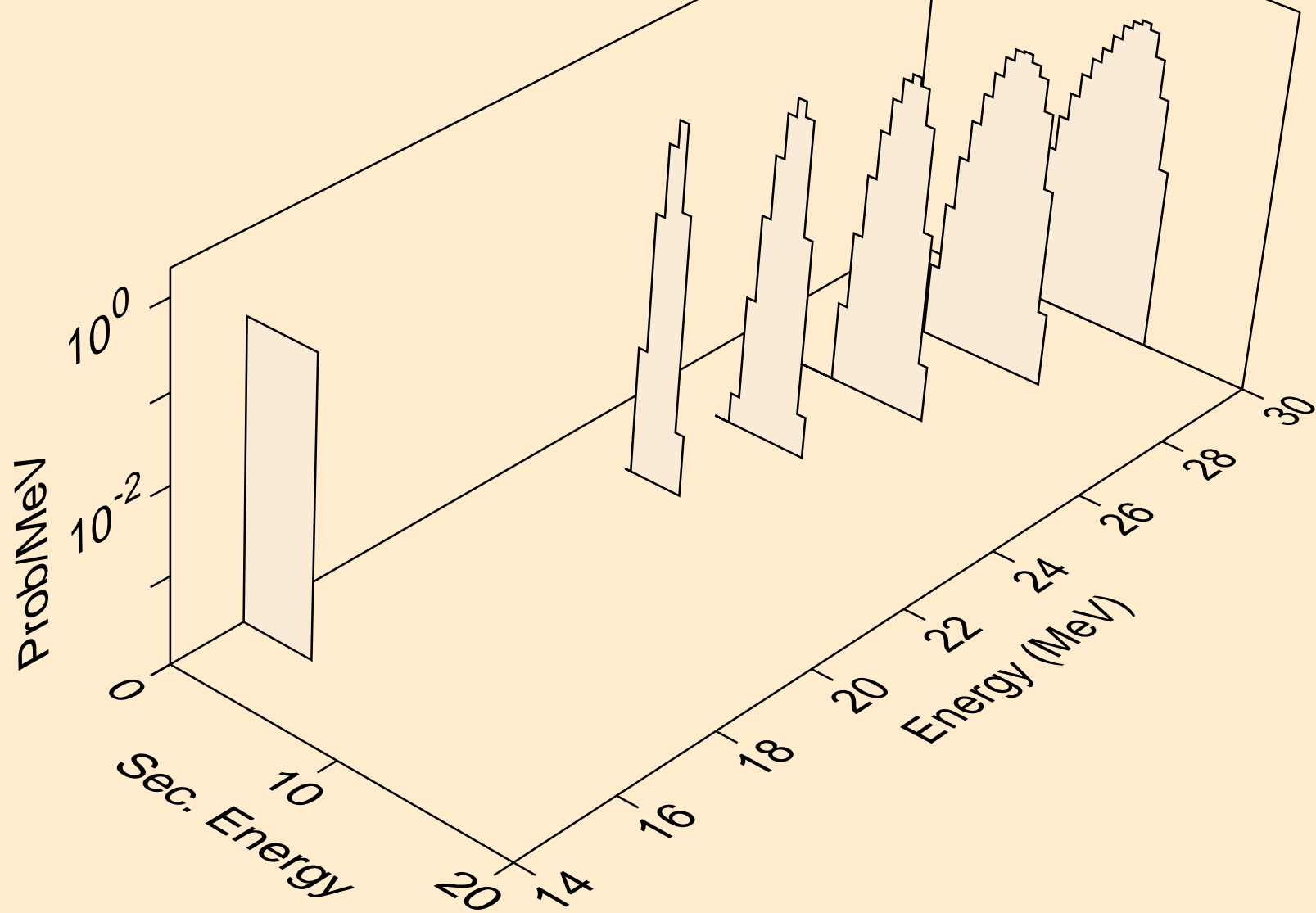

SM146 NEUTRON ACER TENDL-2023 LIBRARY; T=0.K  
alphas from (n,n\*)2a

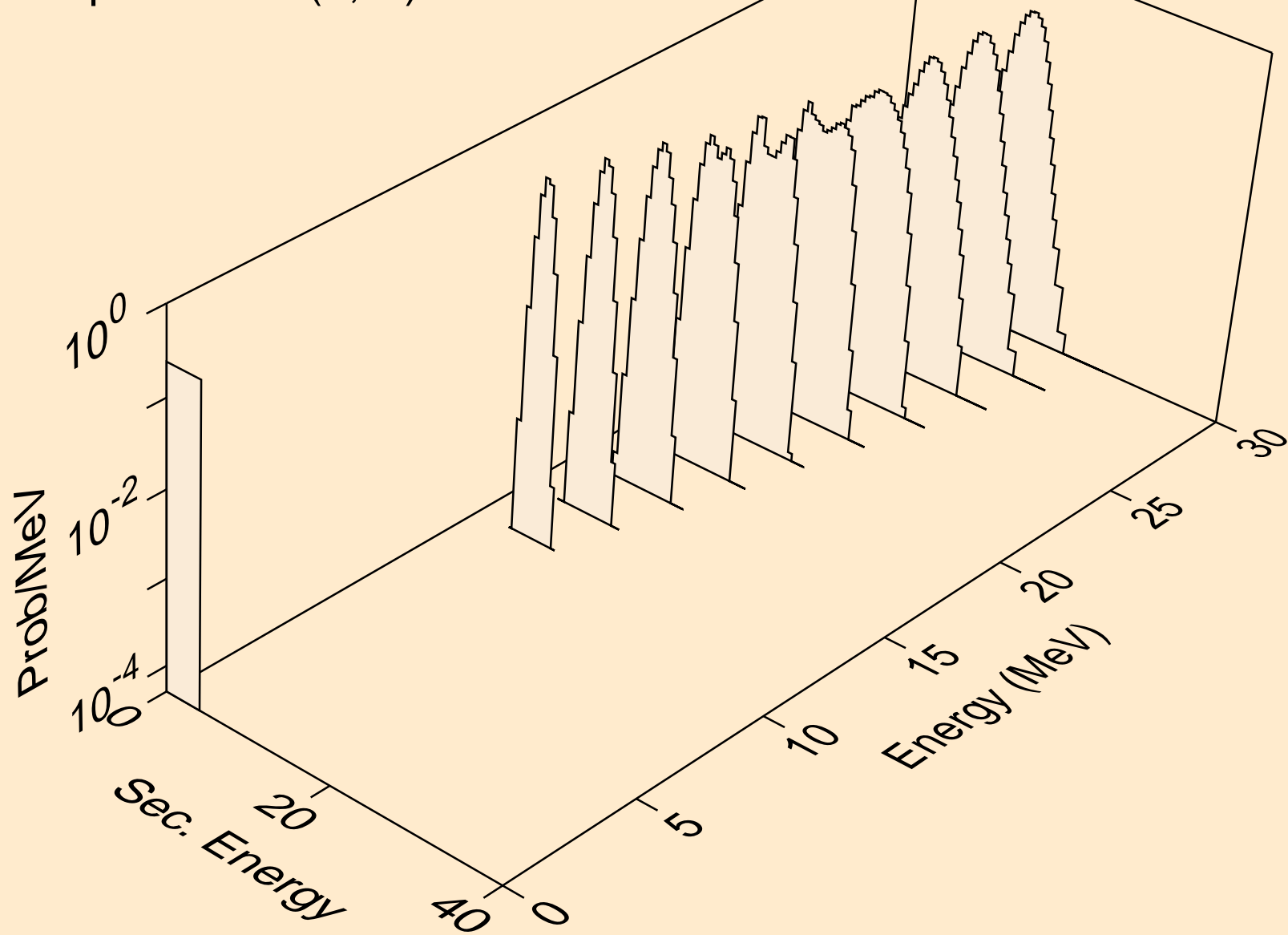

SM146 NEUTRON ACER TENDL-2023 LIBRARY; T=0.K  
alphas from (n,npa)

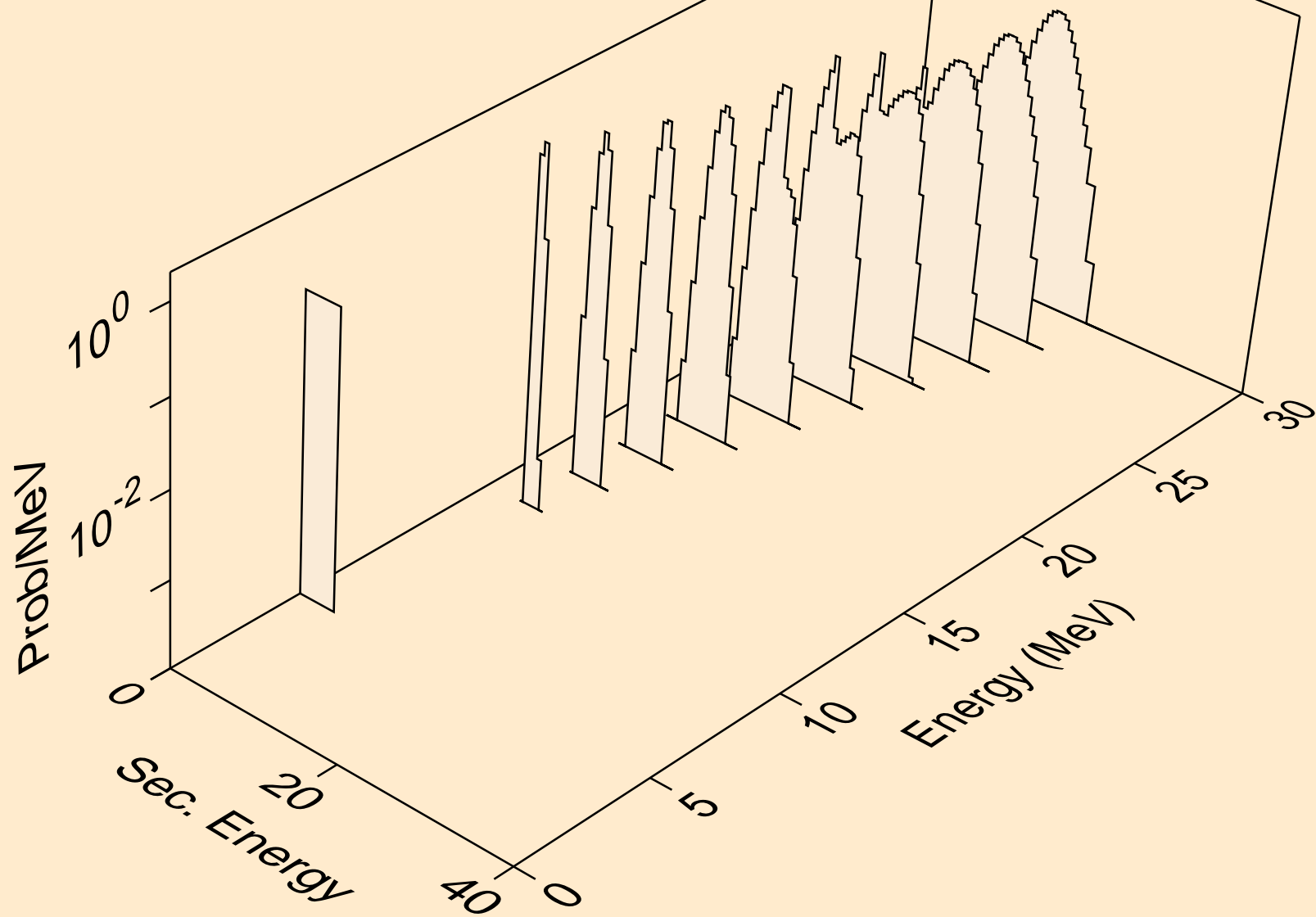

SM146 NEUTRON ACER TENDL-2023 LIBRARY; T=0.K  
alphas from (n,a)

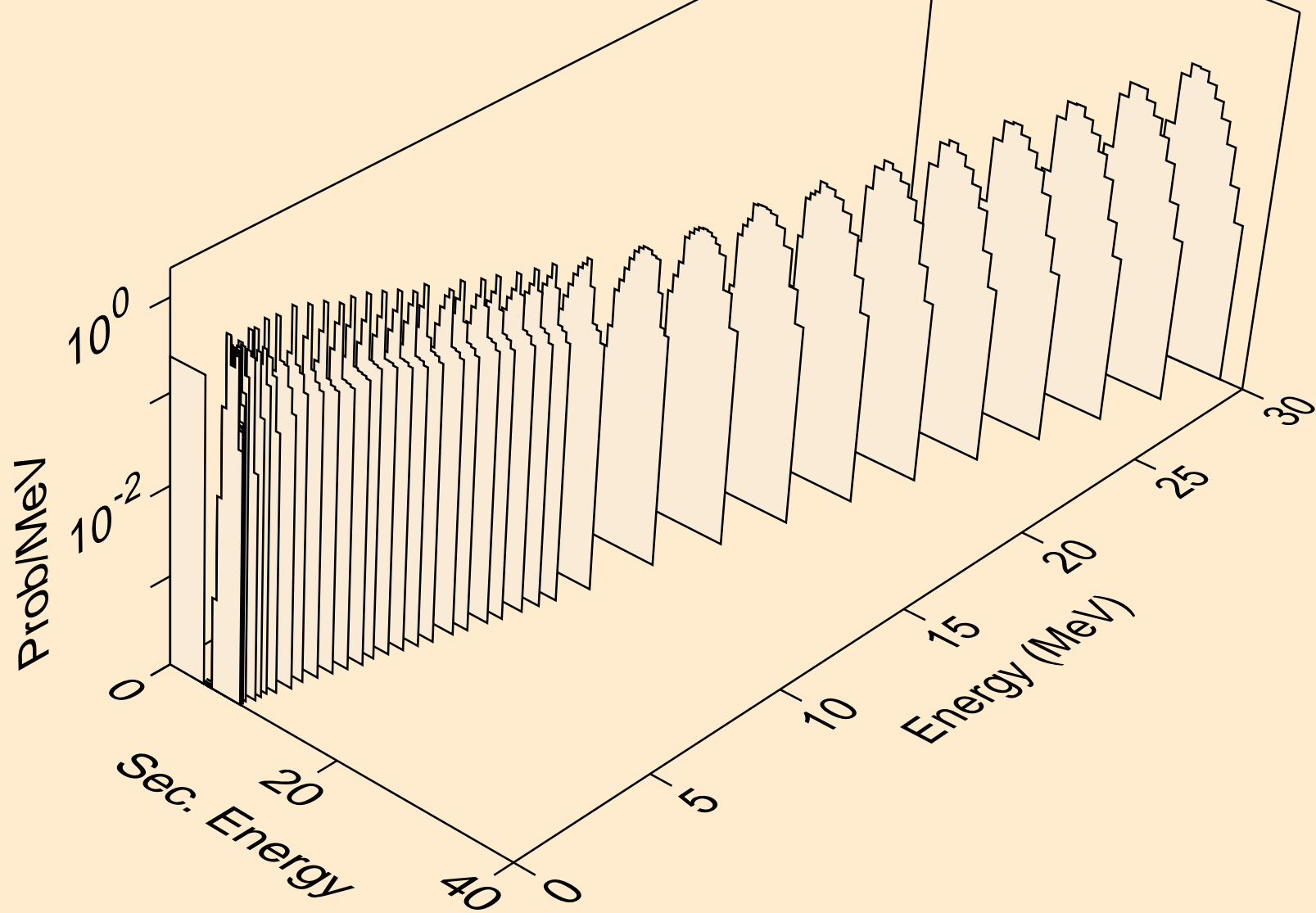



SM146 NEUTRON ACER TENDL-2023 LIBRARY; T=0.K  
alphas from (n,2a)

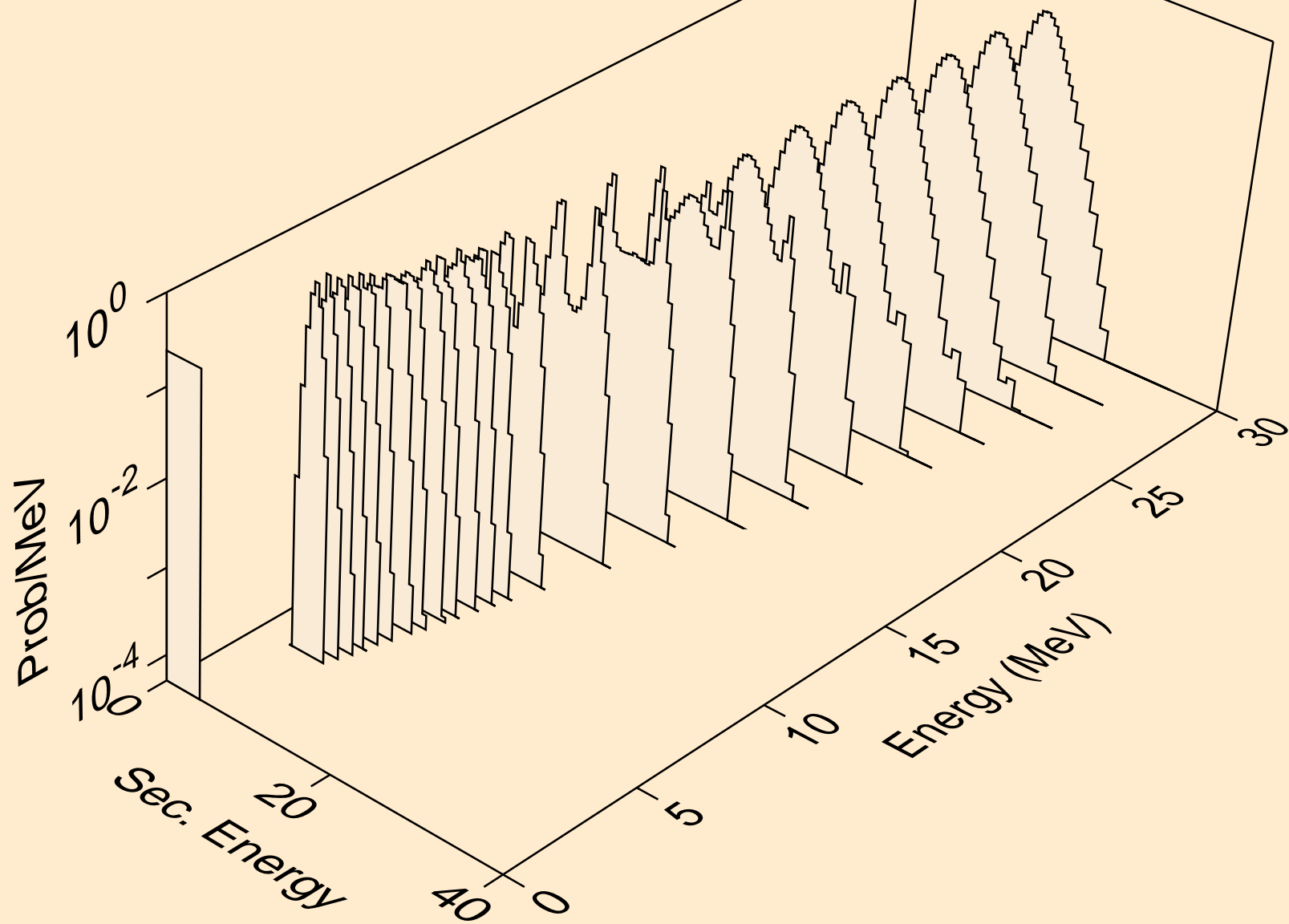

SM146 NEUTRON ACER TENDL-2023 LIBRARY; T=0.K  
alphas from (n,pa)

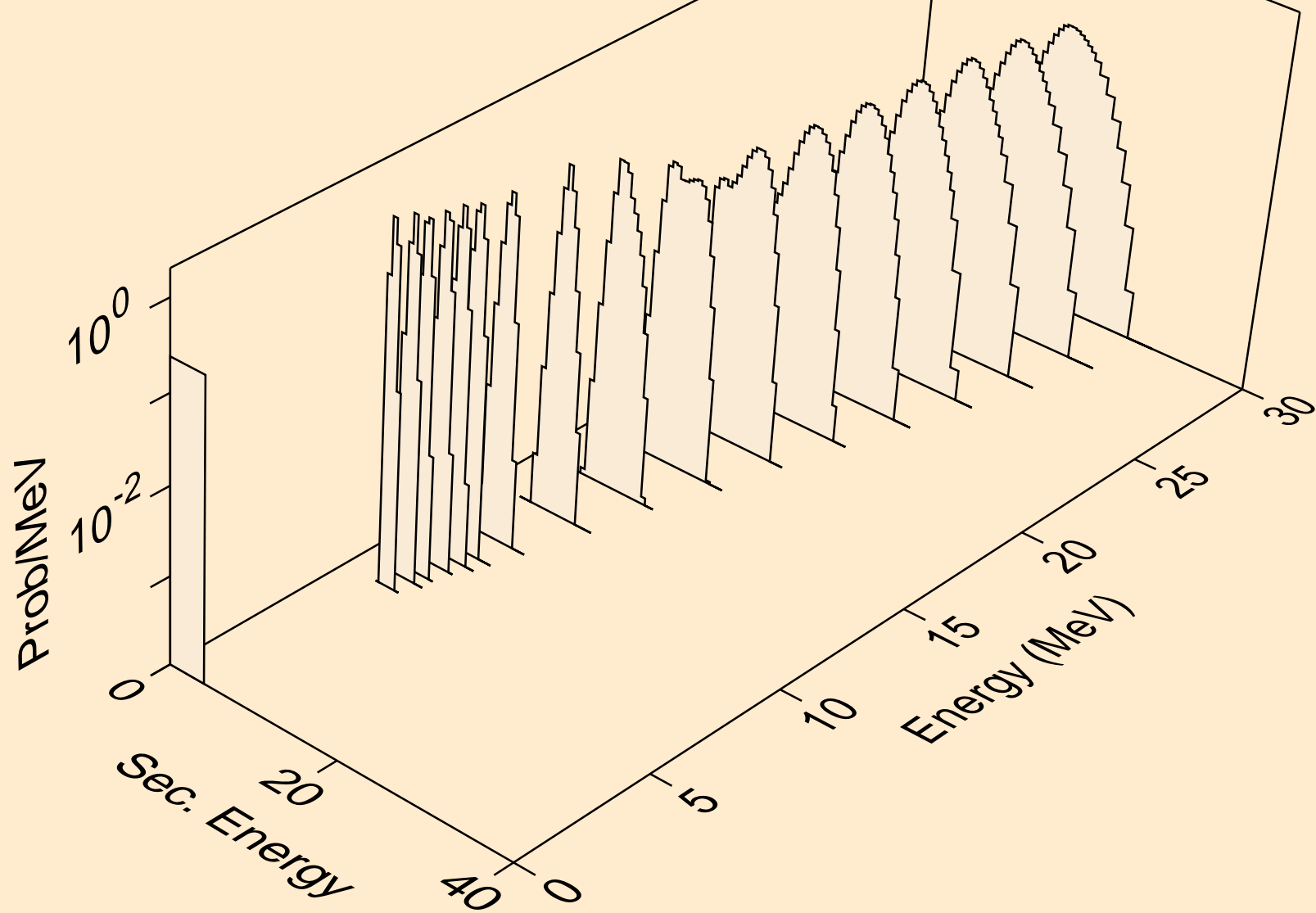

SM146 NEUTRON ACER TENDL-2023 LIBRARY; T=0.K  
alphas from (n,da)

