

SN128M NEUTRON ACER TENDL-2023 LIBRARY; T=0.K

Principal cross sections

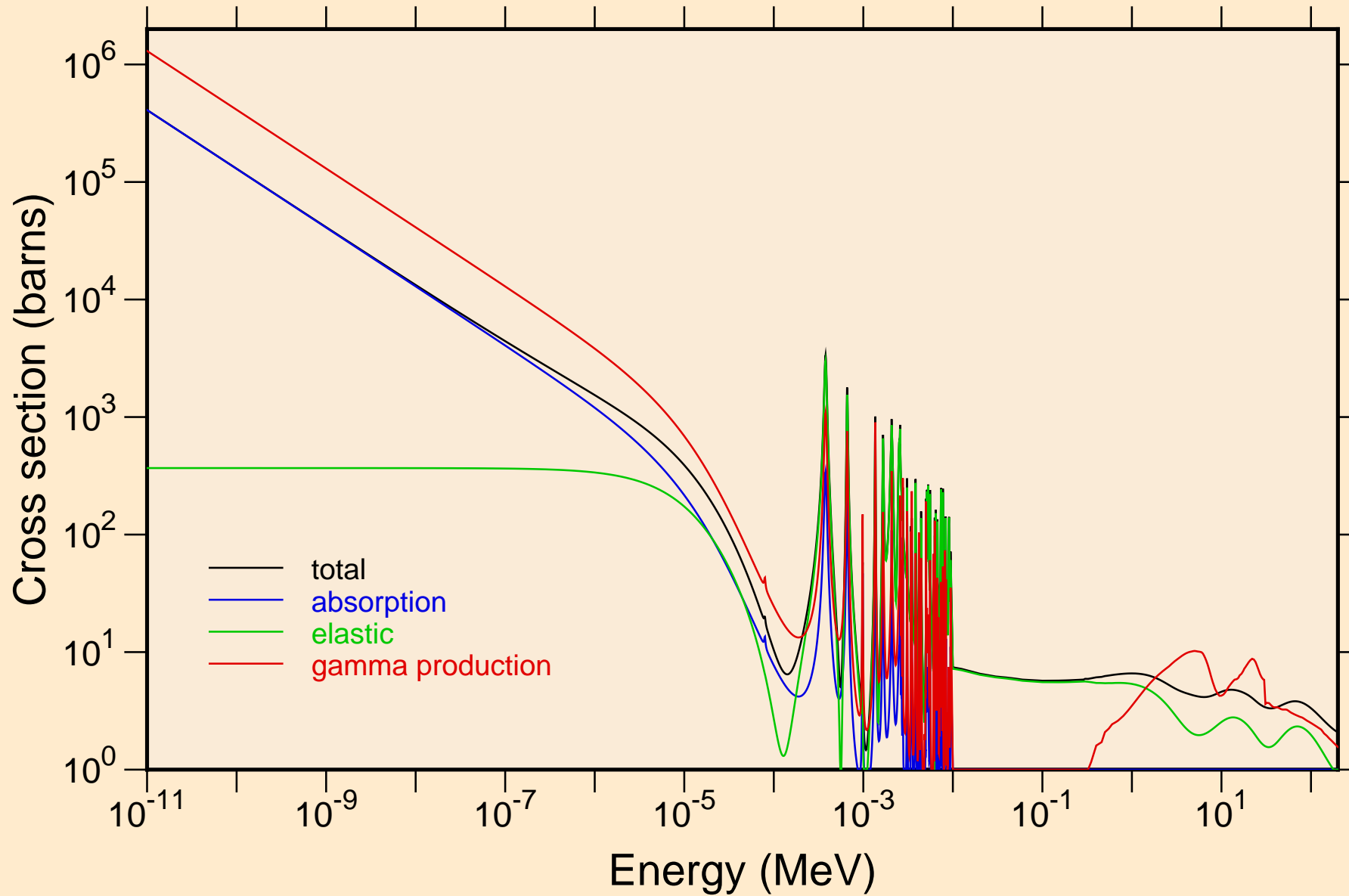

SN128M NEUTRON ACER TENDL-2023 LIBRARY; T=0.K
resonance total cross section

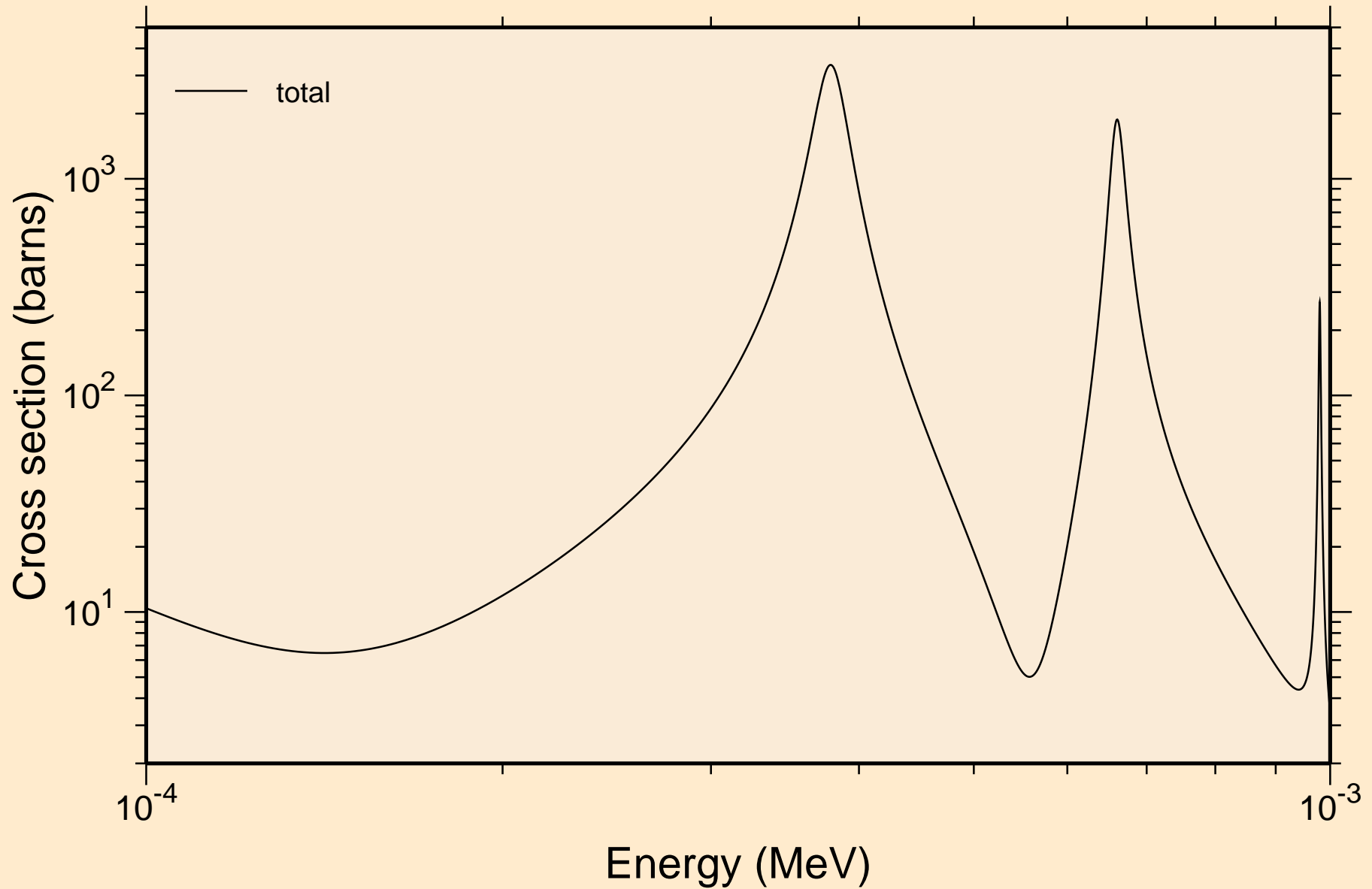

SN128M NEUTRON ACER TENDL-2023 LIBRARY; T=0.K
resonance total cross section

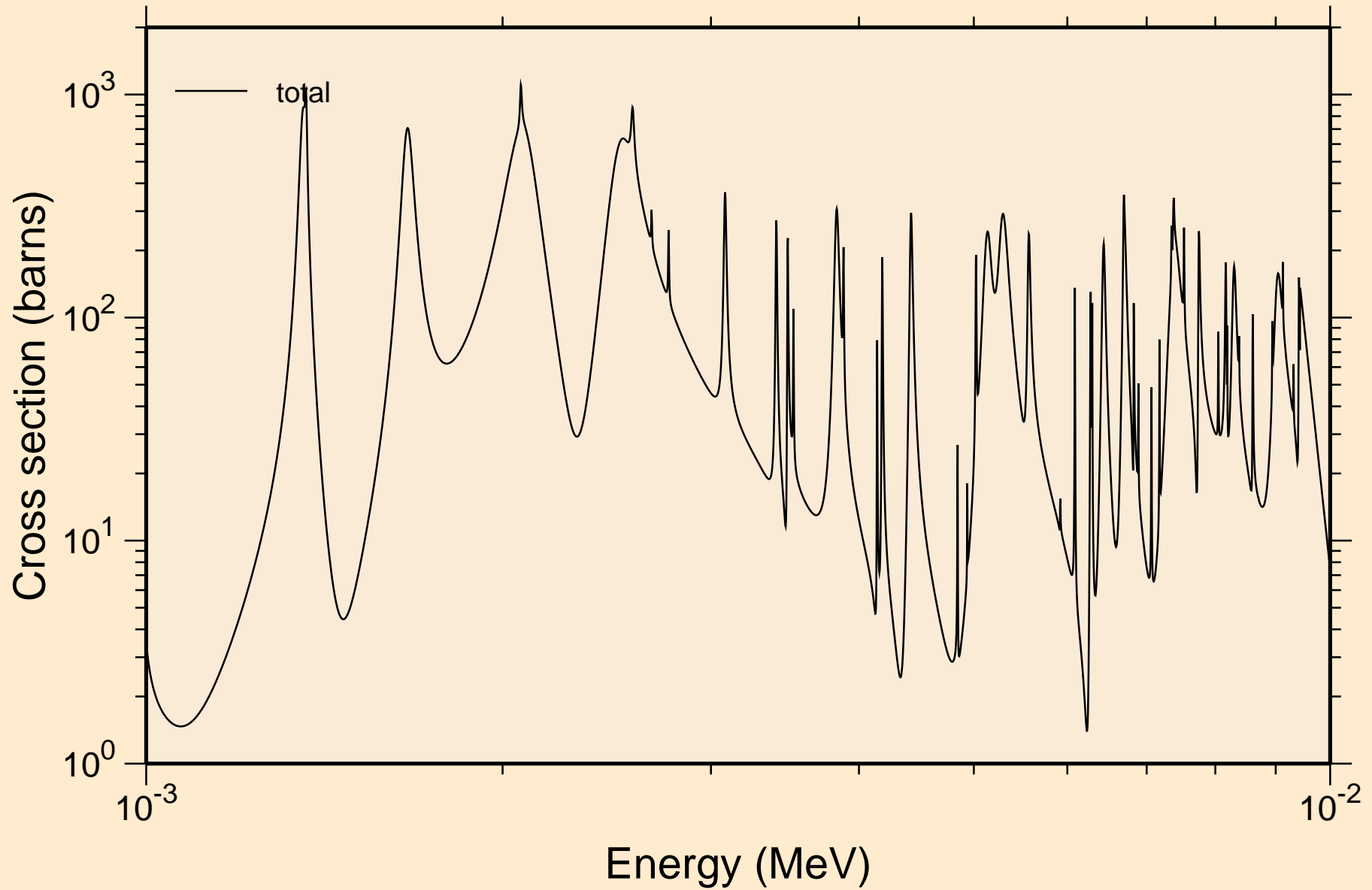

S¹²⁸M NEUTRON ACER TENDL-2023 LIBRARY; T=0.K
resonance total cross section

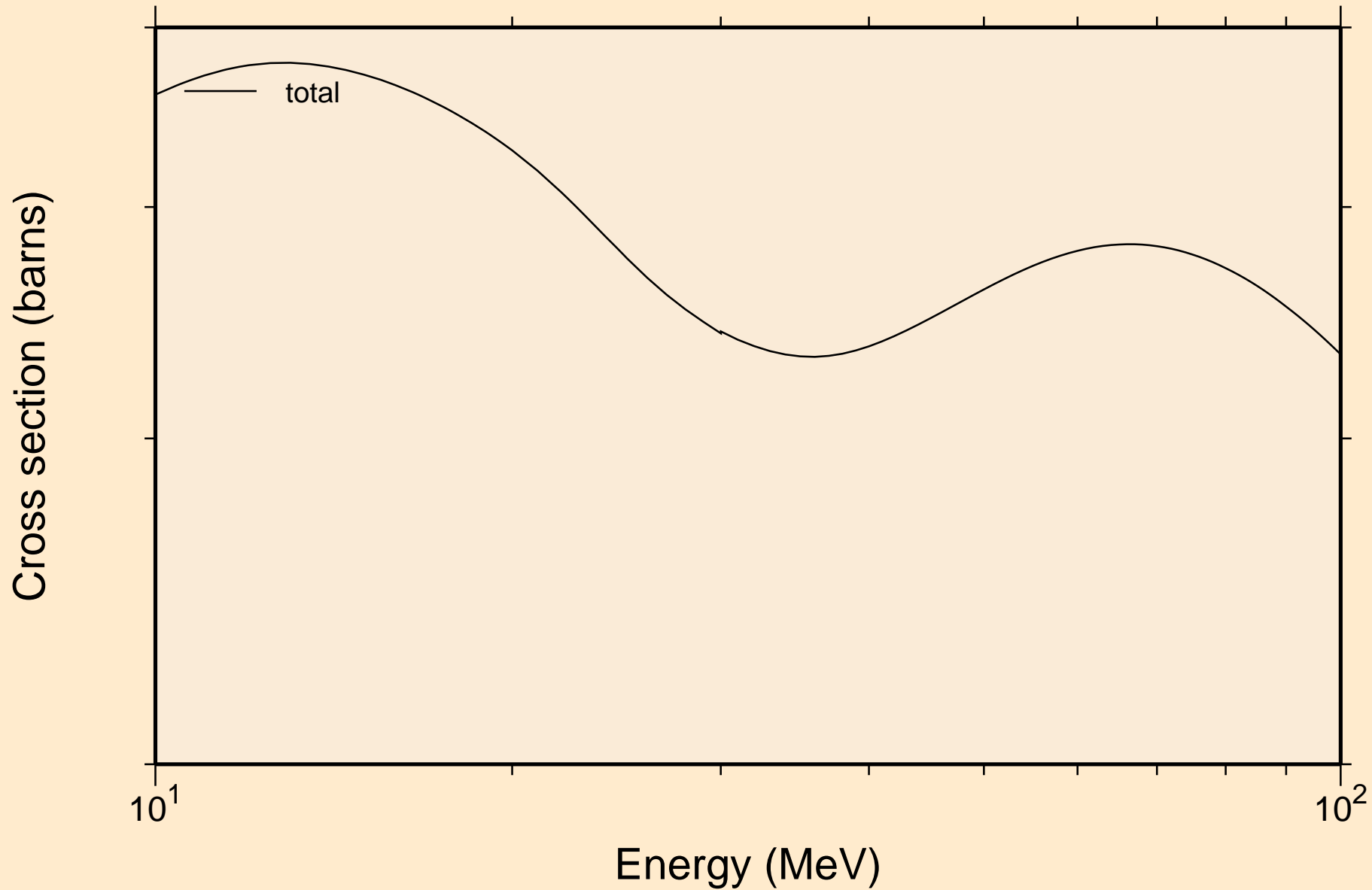

SN128M NEUTRON ACER TENDL-2023 LIBRARY; T=0.K
resonance absorption cross sections

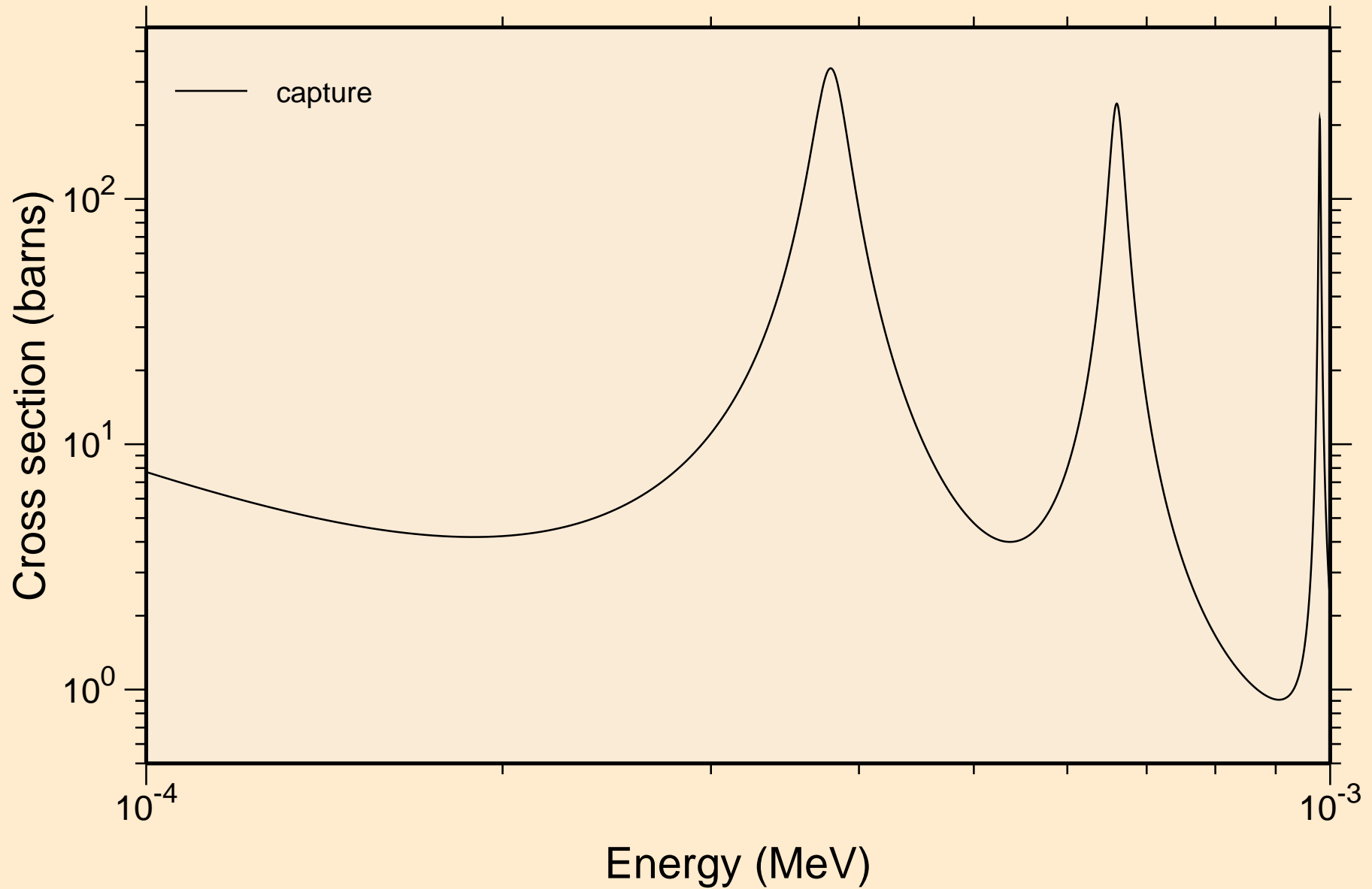

SN128M NEUTRON ACER TENDL-2023 LIBRARY; T=0.K
resonance absorption cross sections

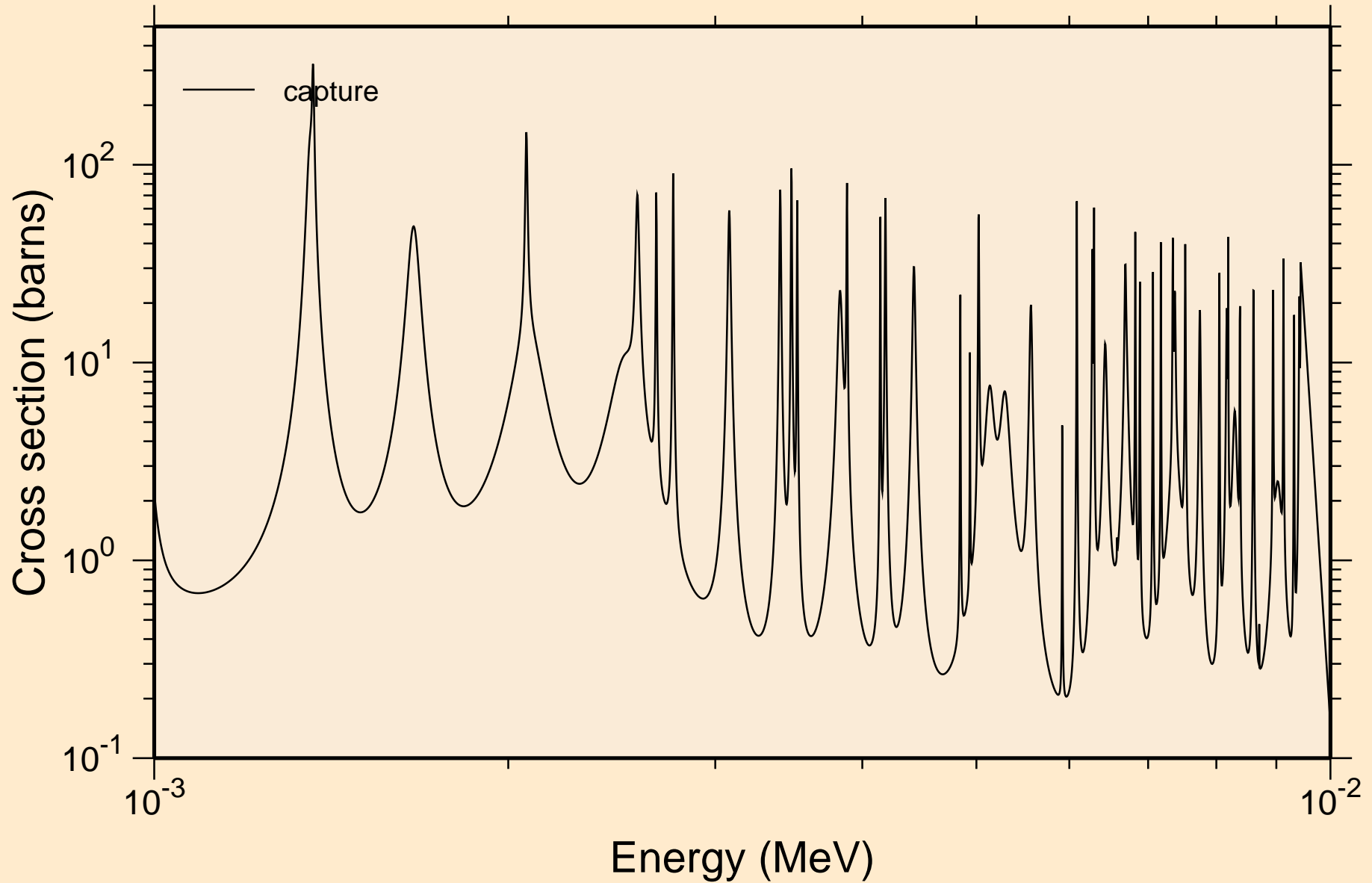

SN128M NEUTRON ACER TENDL-2023 LIBRARY; T=0.K
resonance absorption cross sections

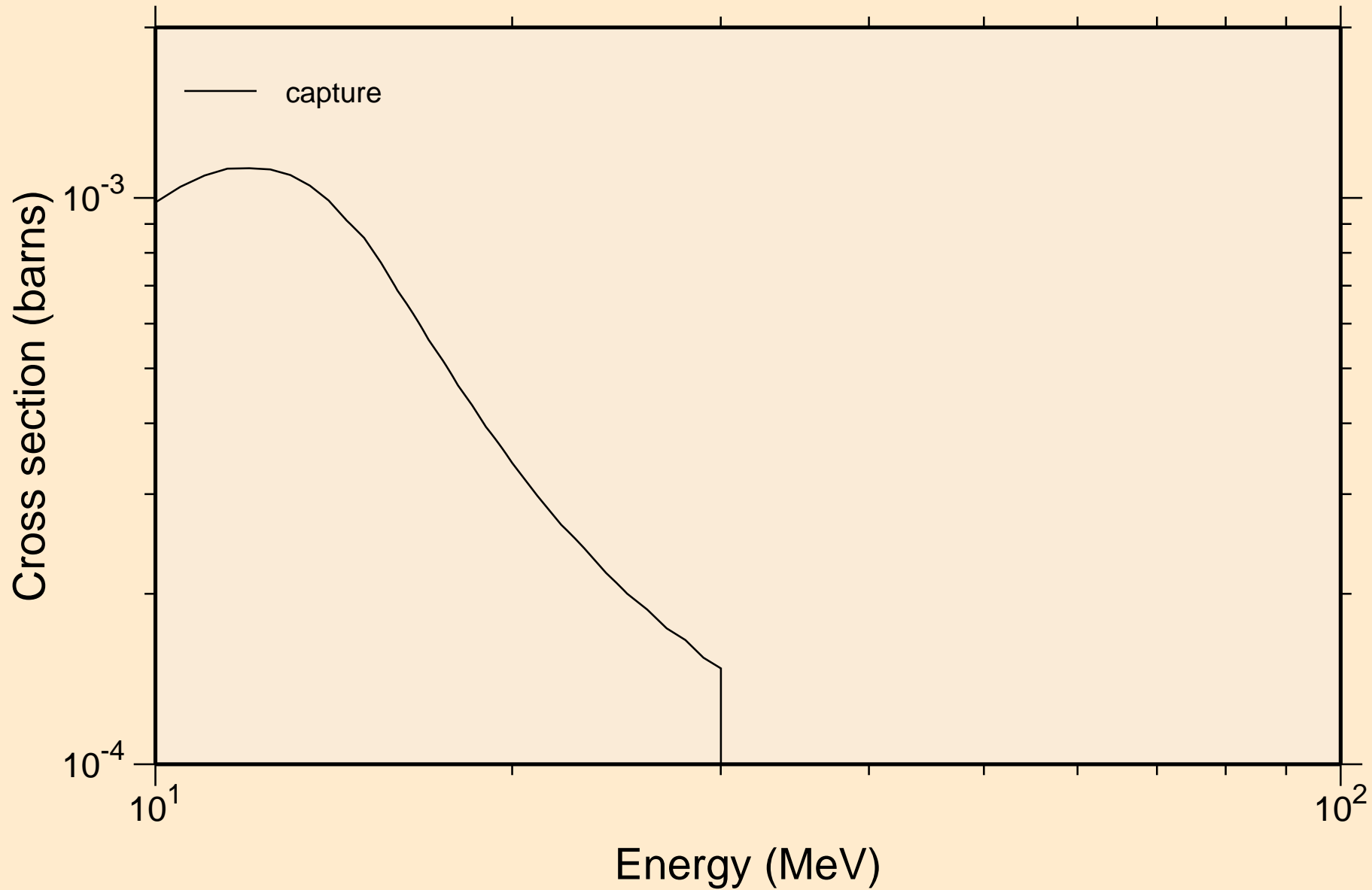

SN128M NEUTRON ACER TENDL-2023 LIBRARY; T=0.K

Heating

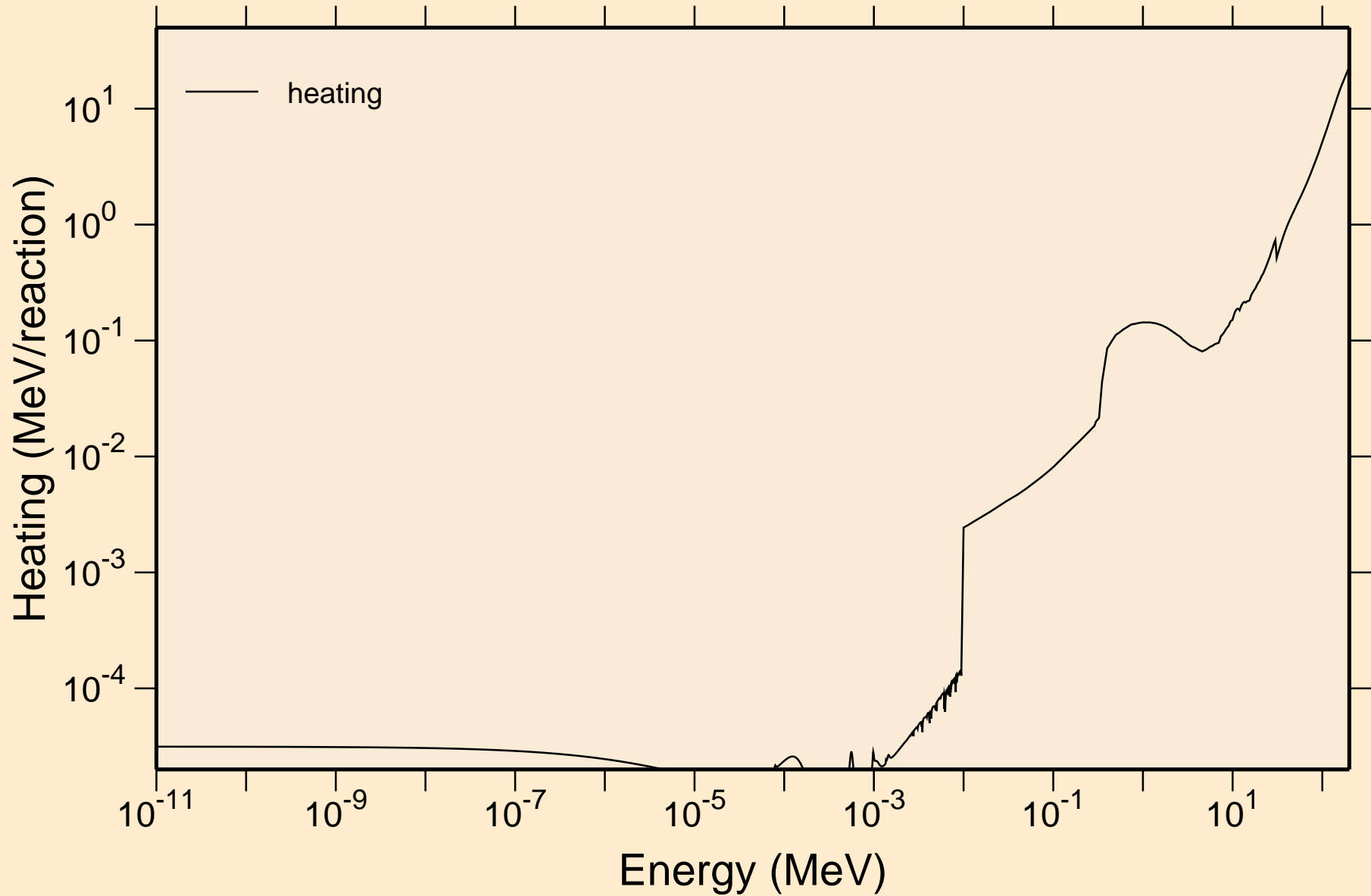

SN128M NEUTRON ACER TENDL-2023 LIBRARY; T=0.K

Damage

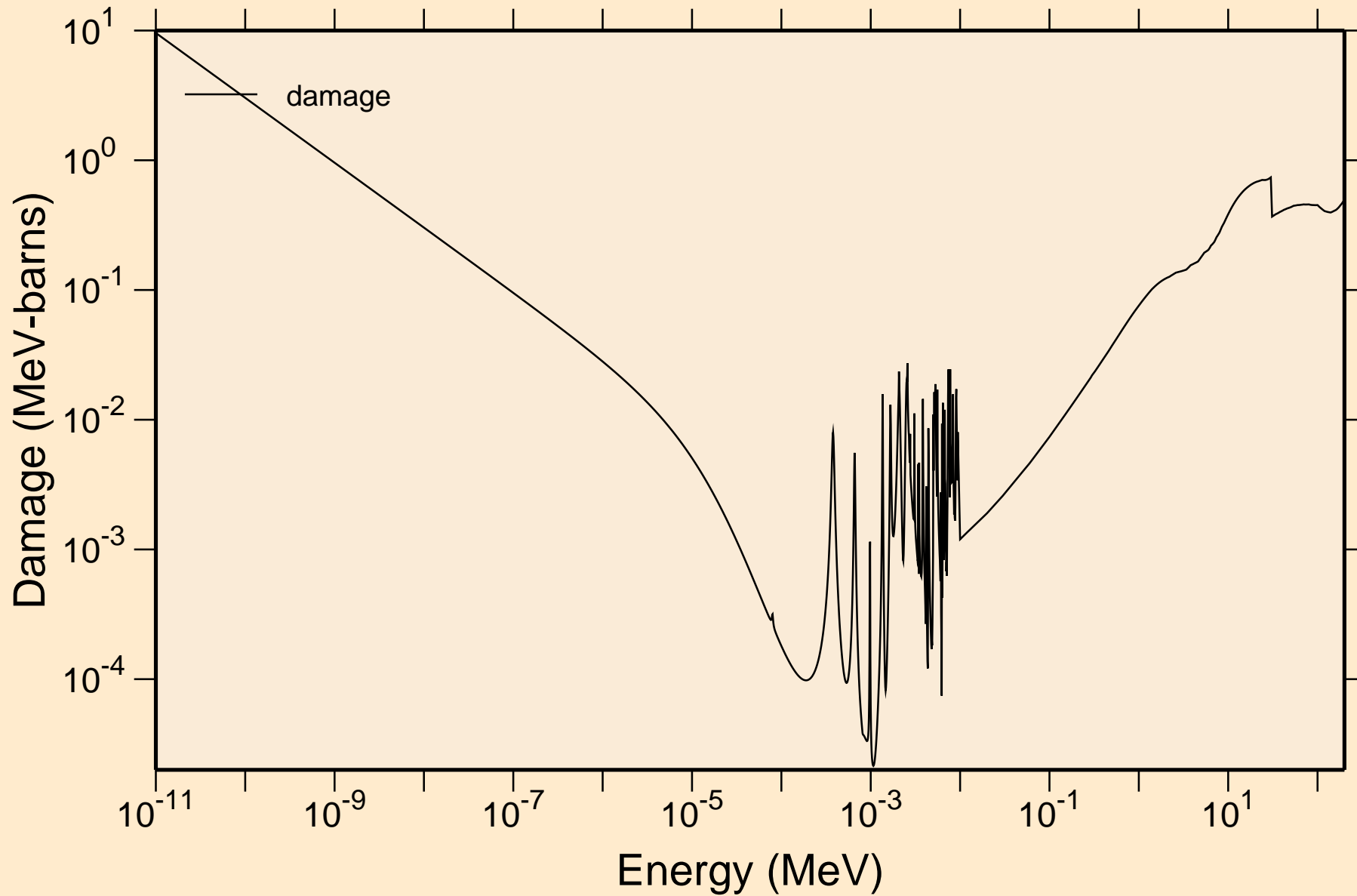

SN128M NEUTRON ACER TENDL-2023 LIBRARY; T=0.K
Non-threshold reactions

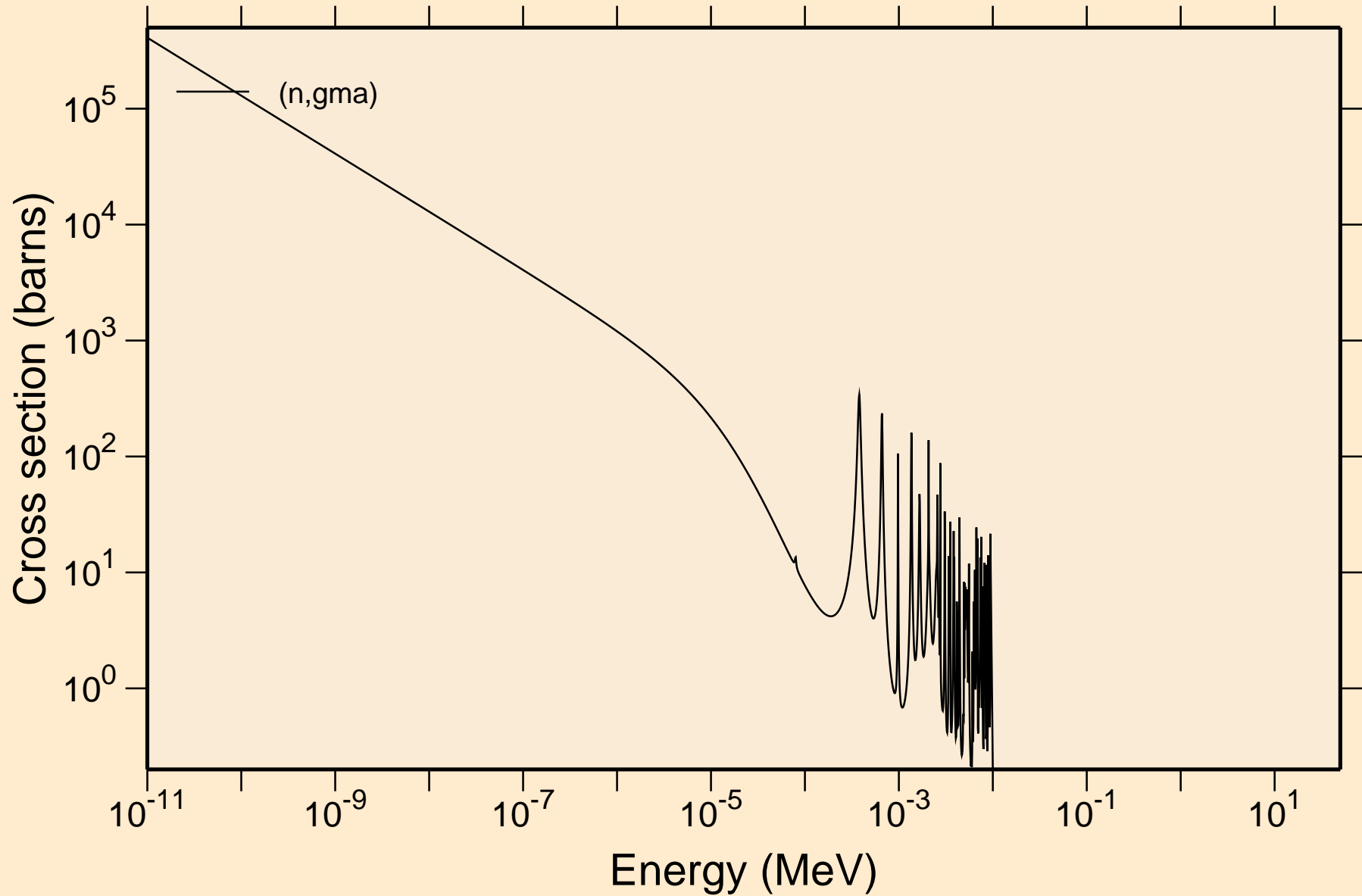

SN128M NEUTRON ACER TENDL-2023 LIBRARY; T=0.K

Principal cross sections

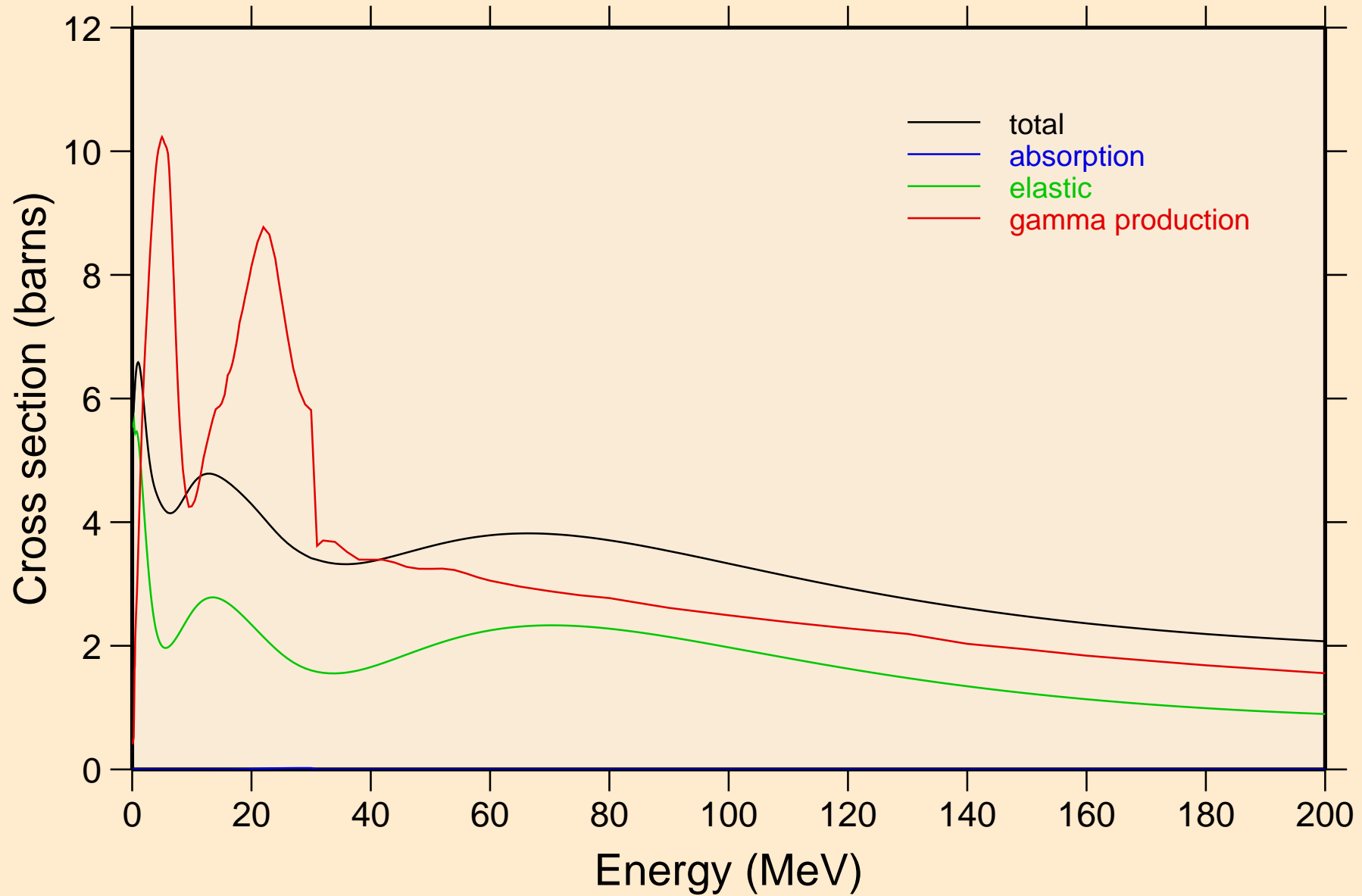

SN128M NEUTRON ACER TENDL-2023 LIBRARY; T=0.K

Heating

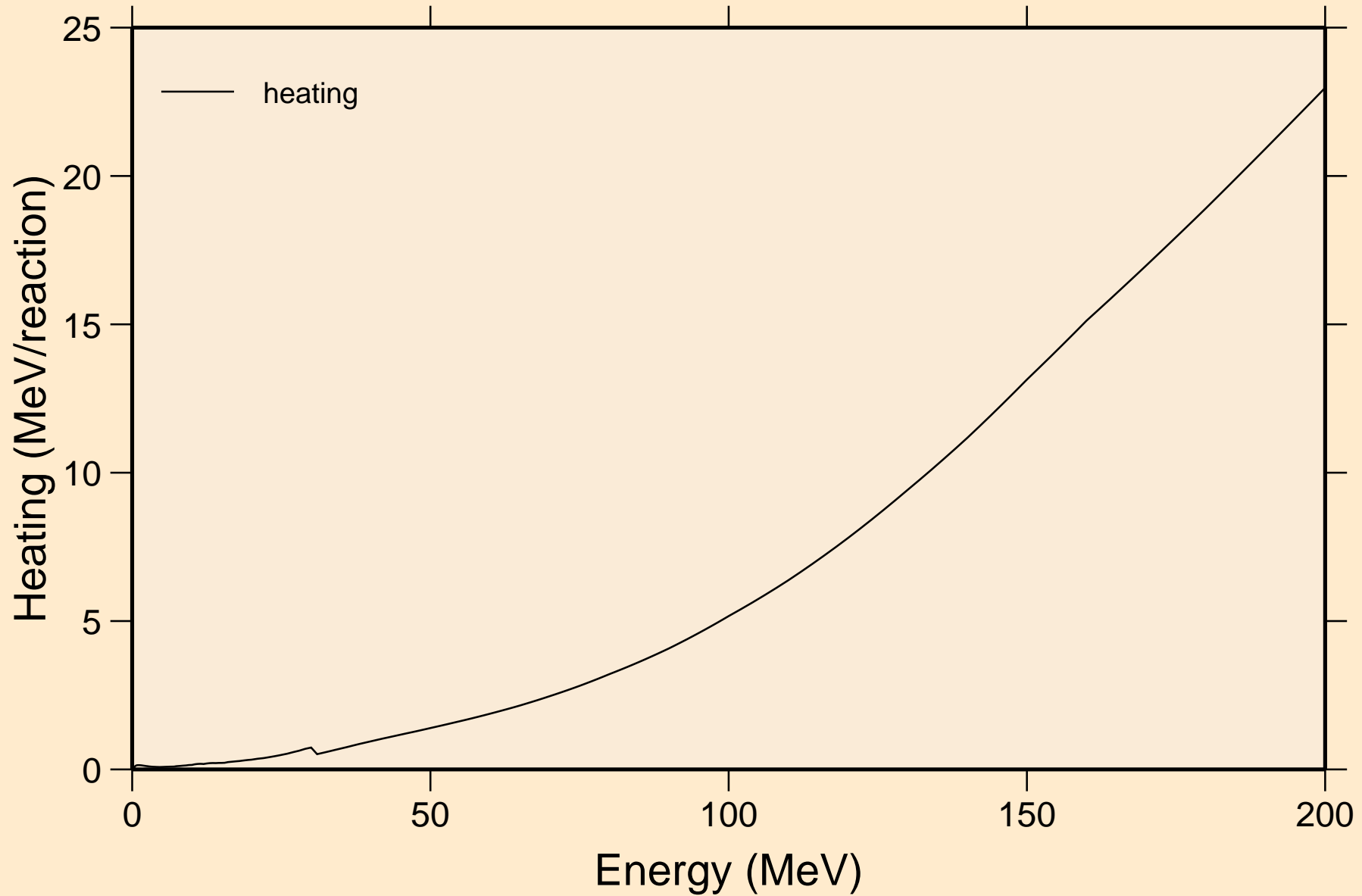

SN128M NEUTRON ACER TENDL-2023 LIBRARY; T=0.K

Damage

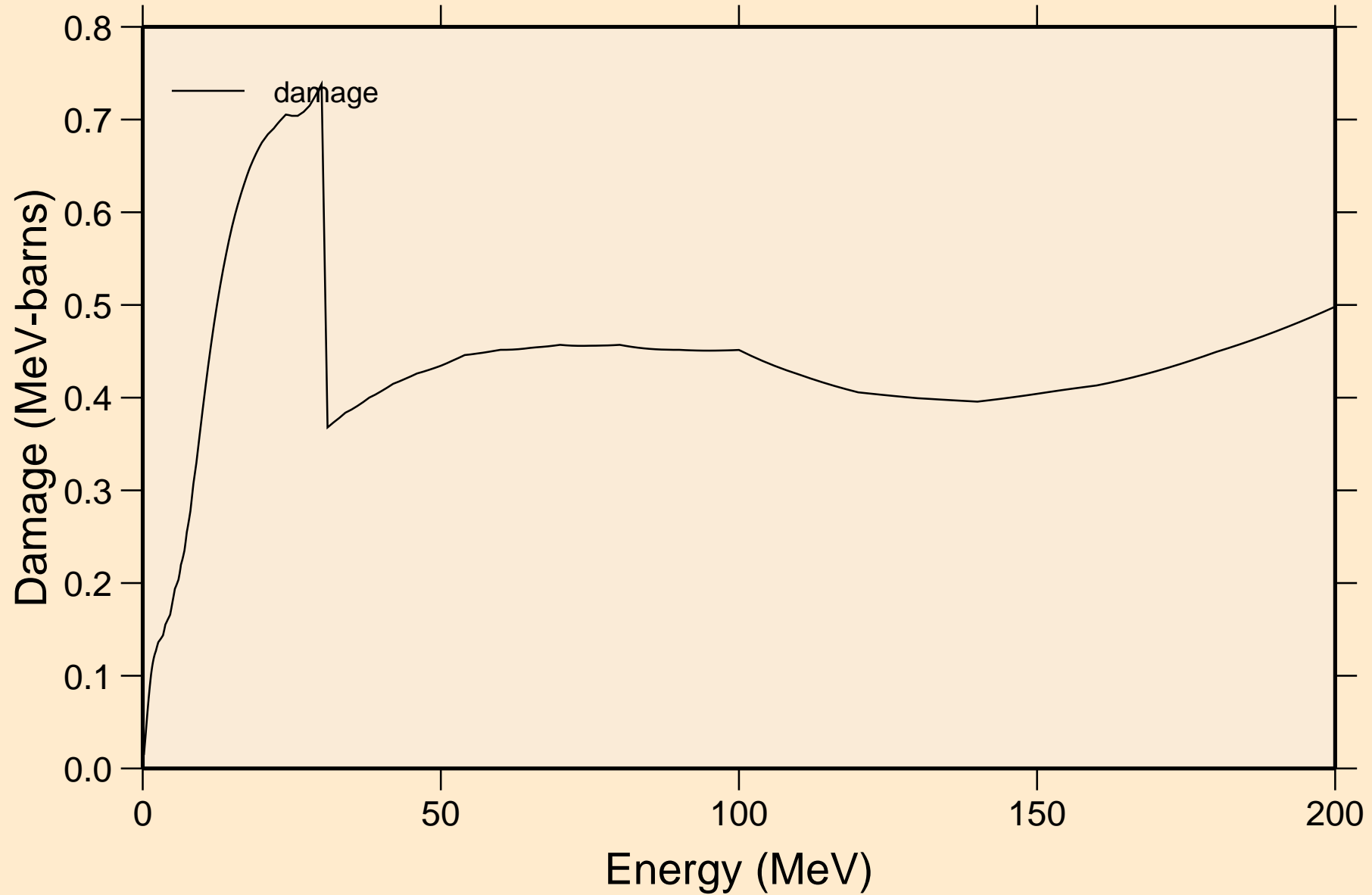

SN128M NEUTRON ACER TENDL-2023 LIBRARY; T=0.K
Non-threshold reactions

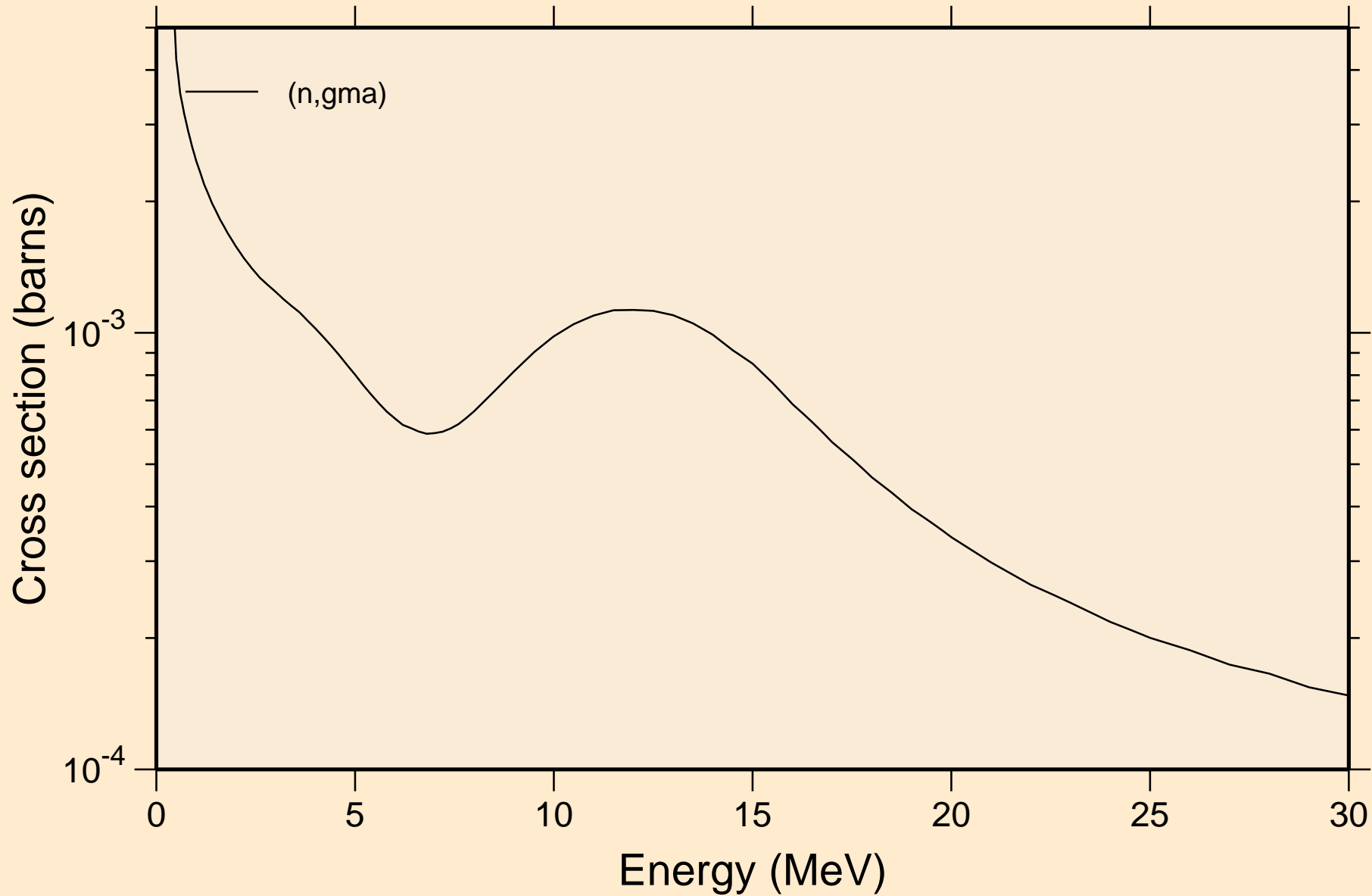

SN128M NEUTRON ACER TENDL-2023 LIBRARY; T=0.K

Inelastic levels

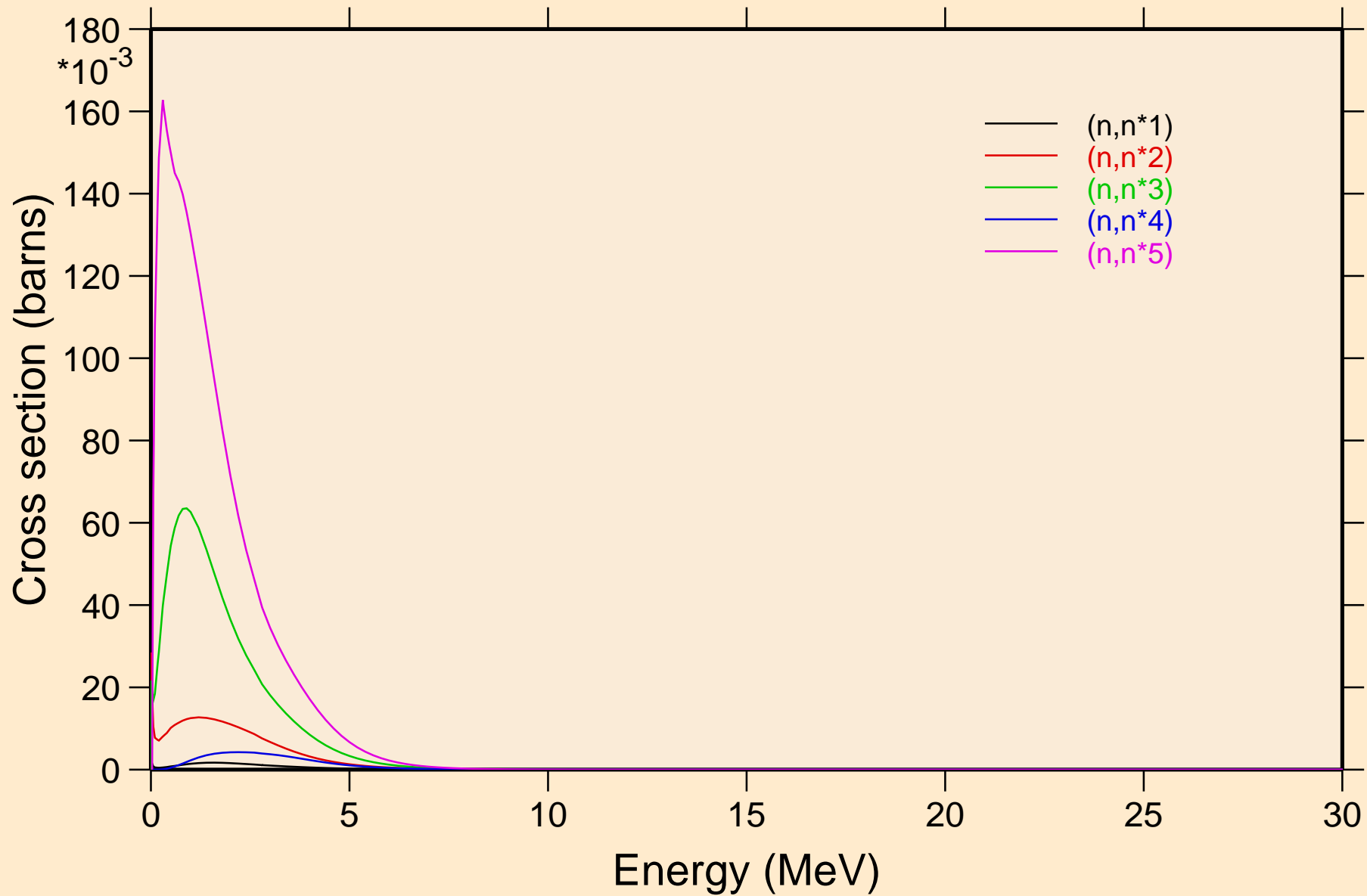

SN128M NEUTRON ACER TENDL-2023 LIBRARY; T=0.K

Inelastic levels

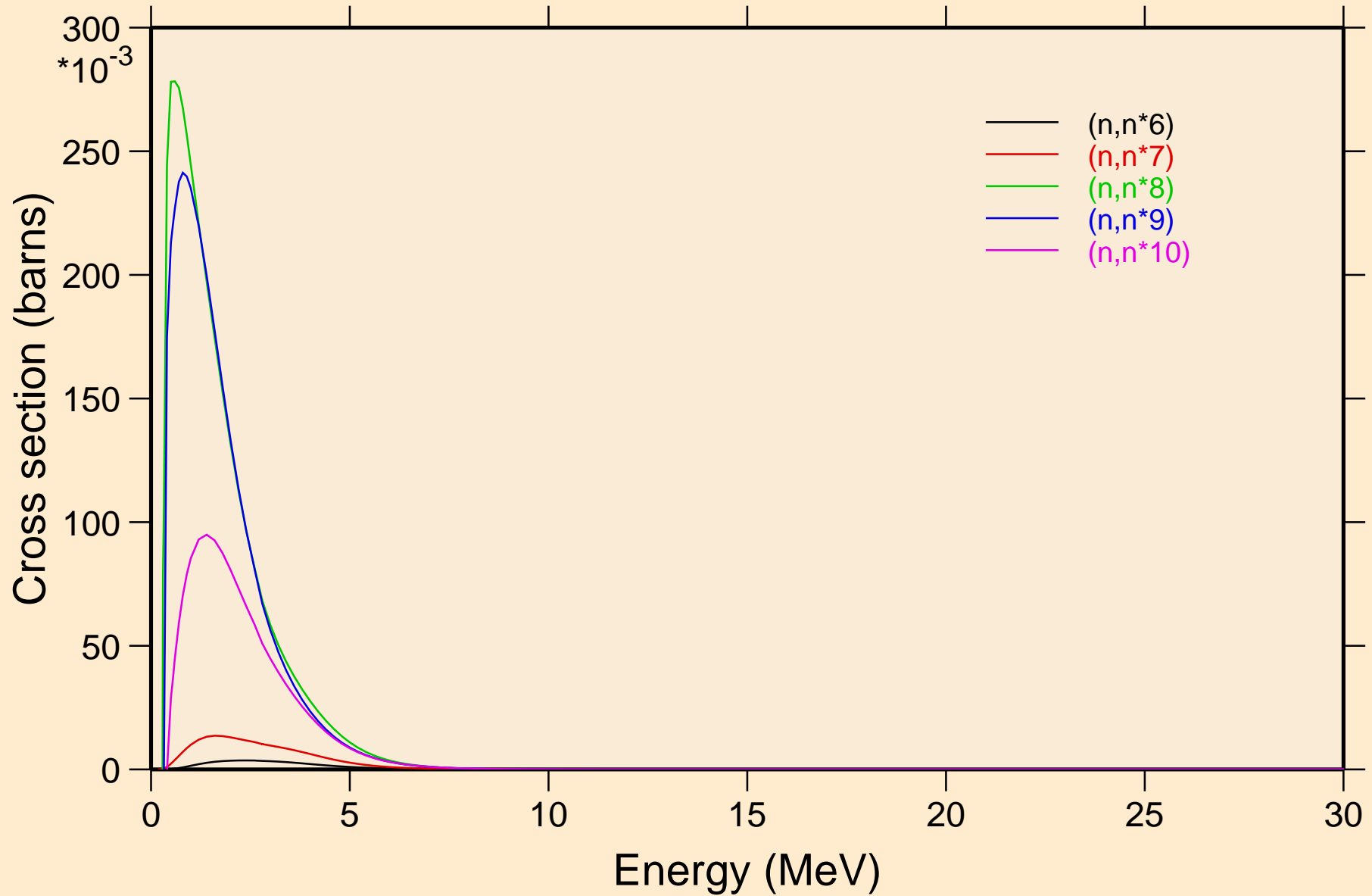

SN128M NEUTRON ACER TENDL-2023 LIBRARY; T=0.K

Inelastic levels

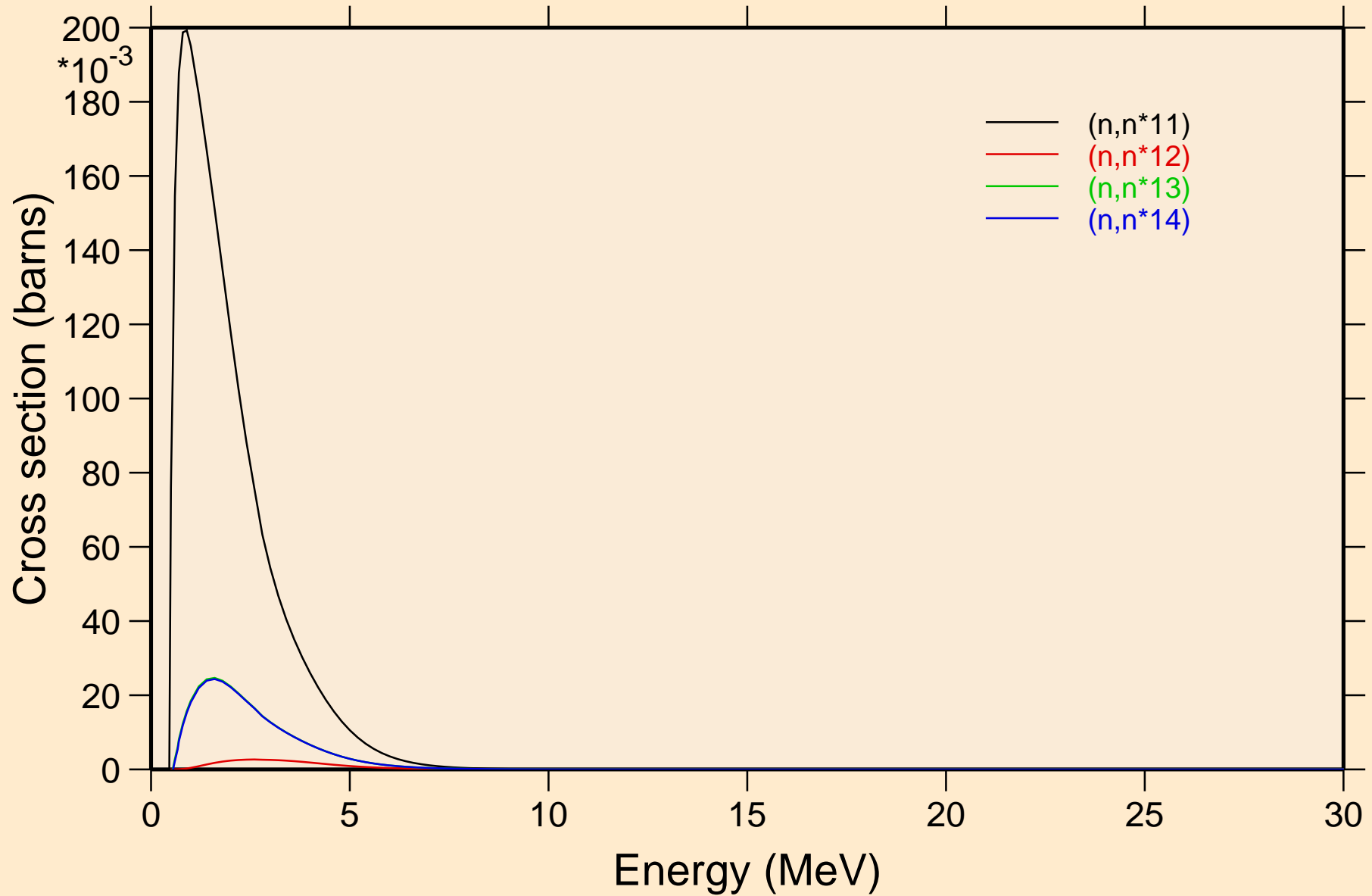

SN128M NEUTRON ACER TENDL-2023 LIBRARY; T=0.K

Threshold reactions

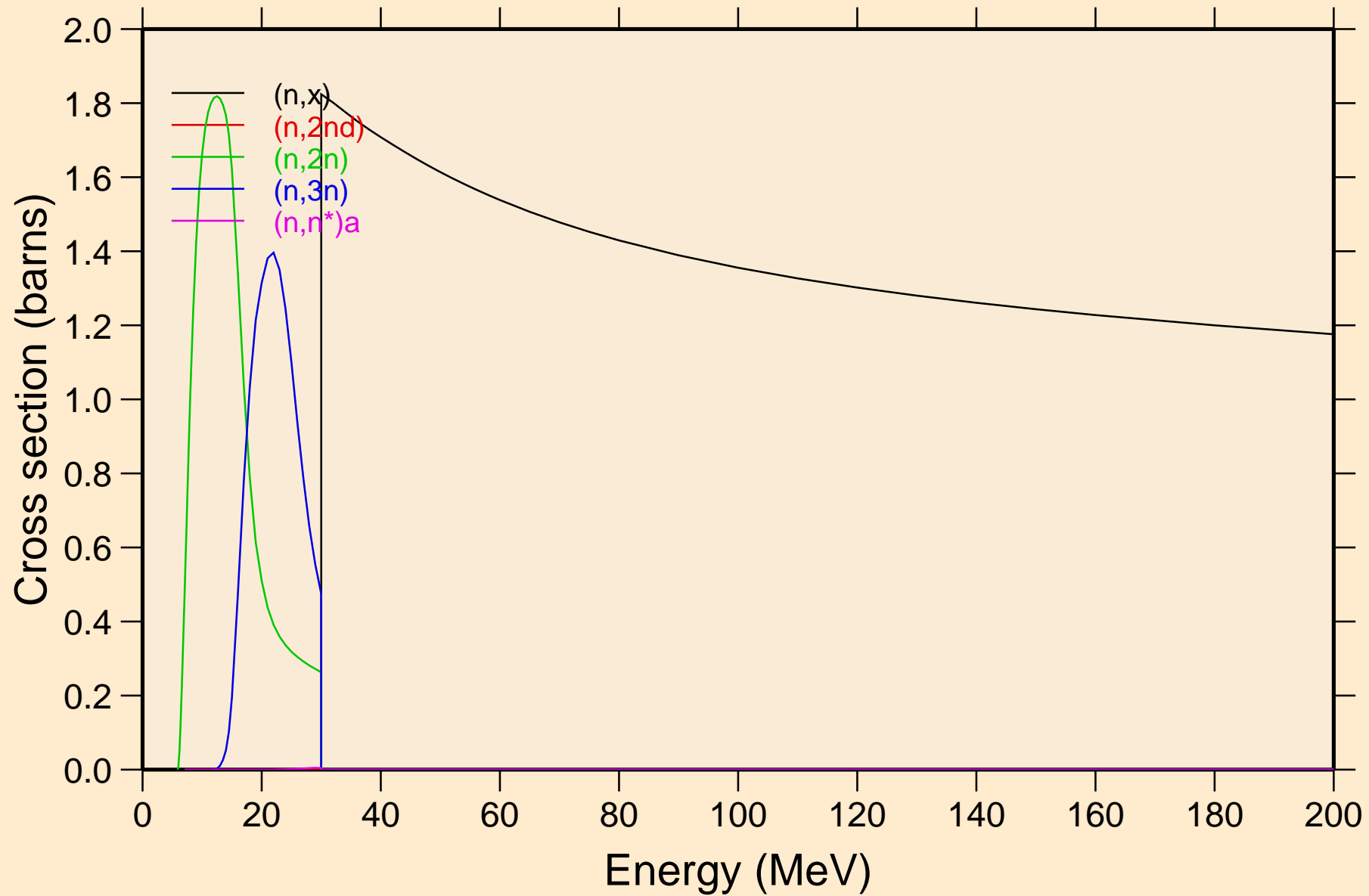

SN128M NEUTRON ACER TENDL-2023 LIBRARY; T=0.K

Threshold reactions

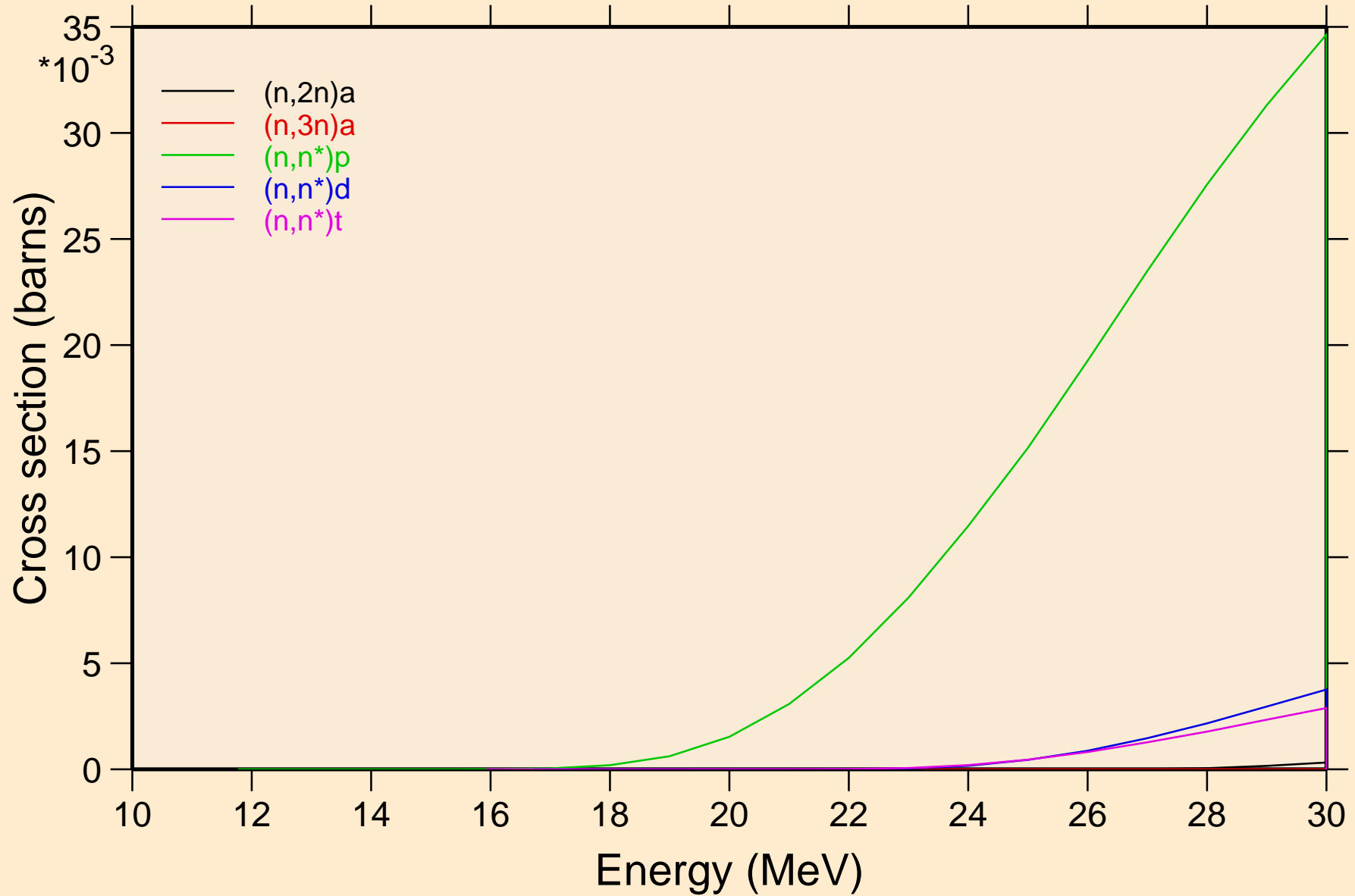

SN128M NEUTRON ACER TENDL-2023 LIBRARY; T=0.K

Threshold reactions

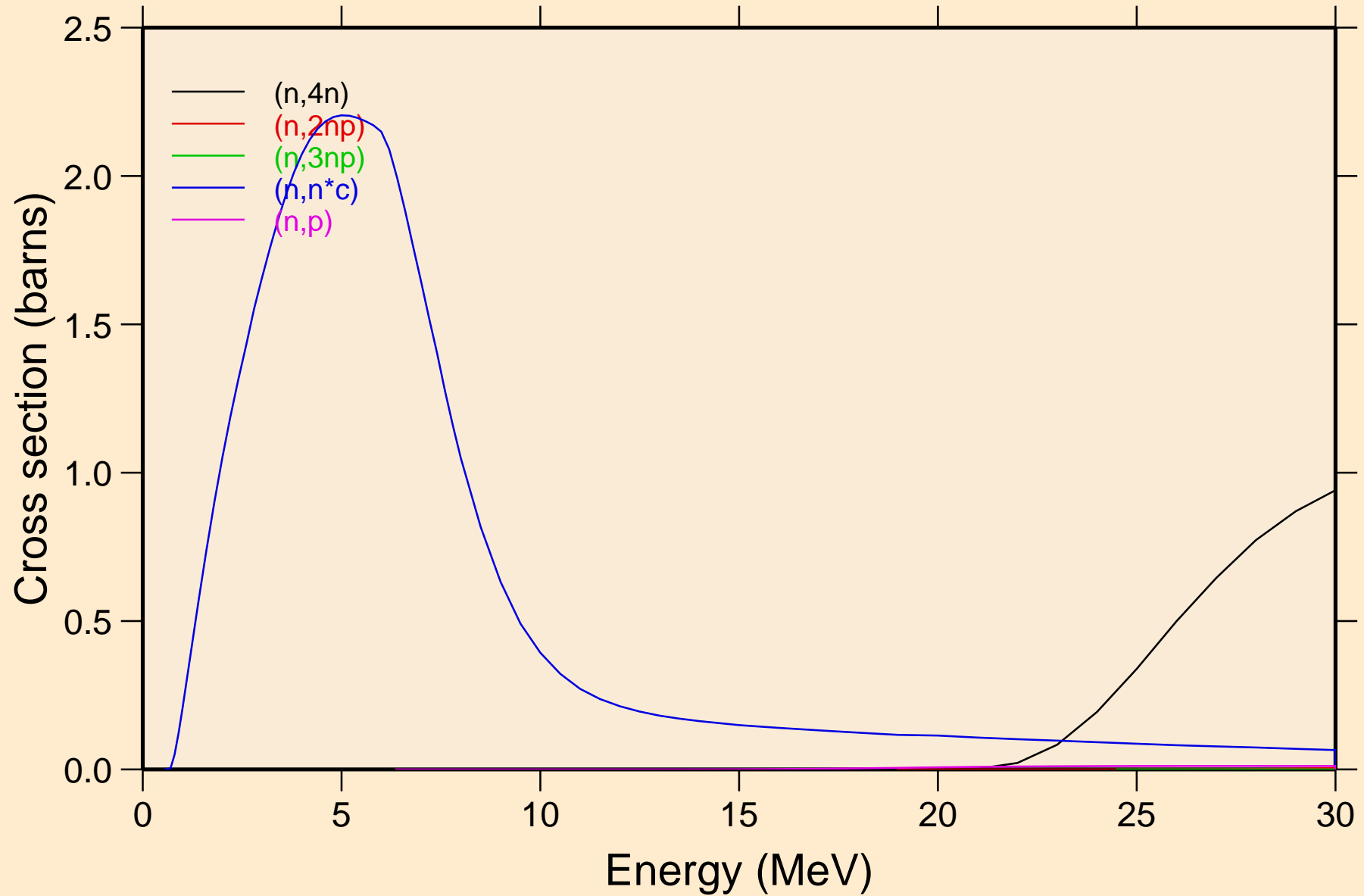

SN128M NEUTRON ACER TENDL-2023 LIBRARY; T=0.K

Threshold reactions

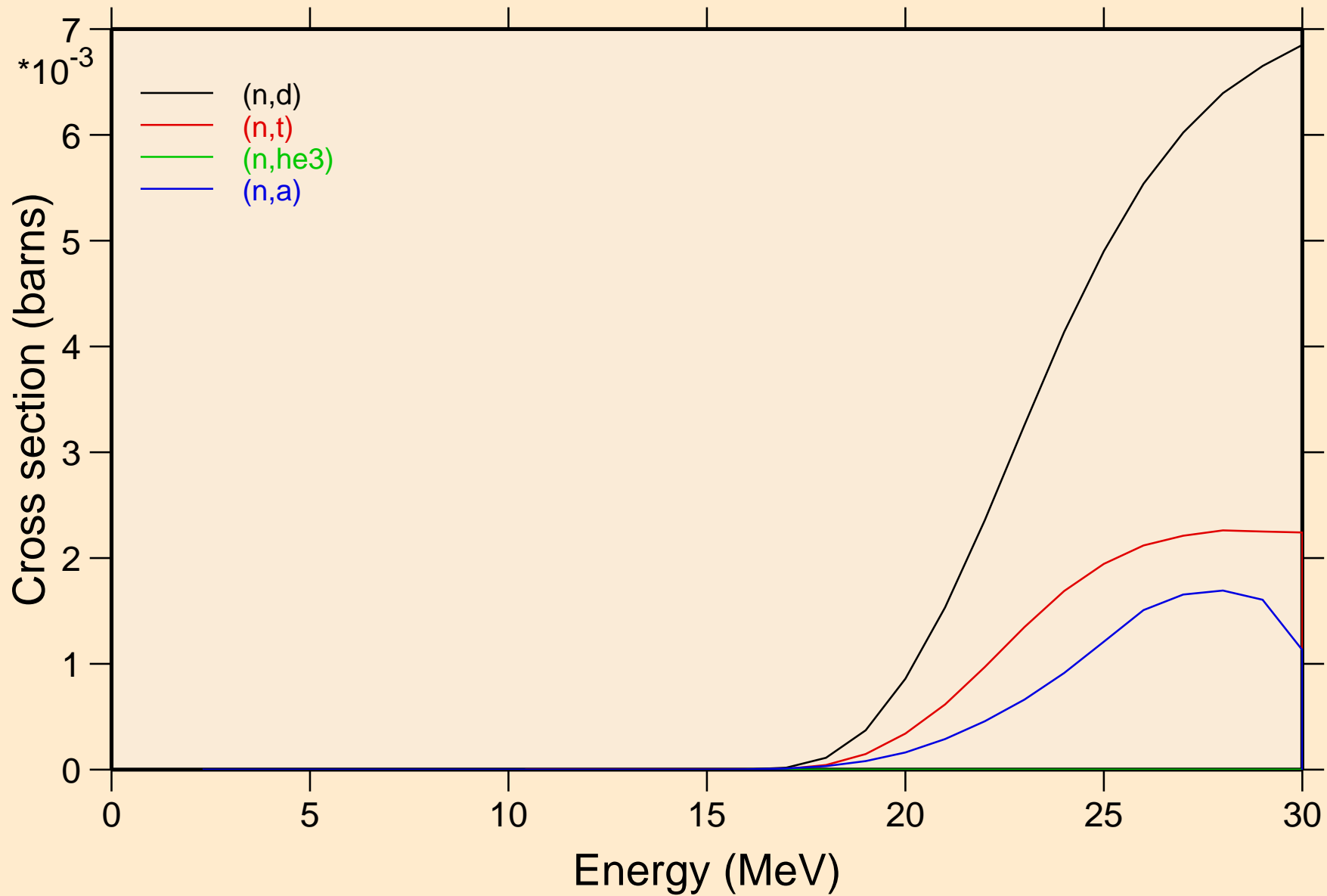

SN128M NEUTRON ACER TENDL-2023 LIBRARY; T=0.K

Threshold reactions

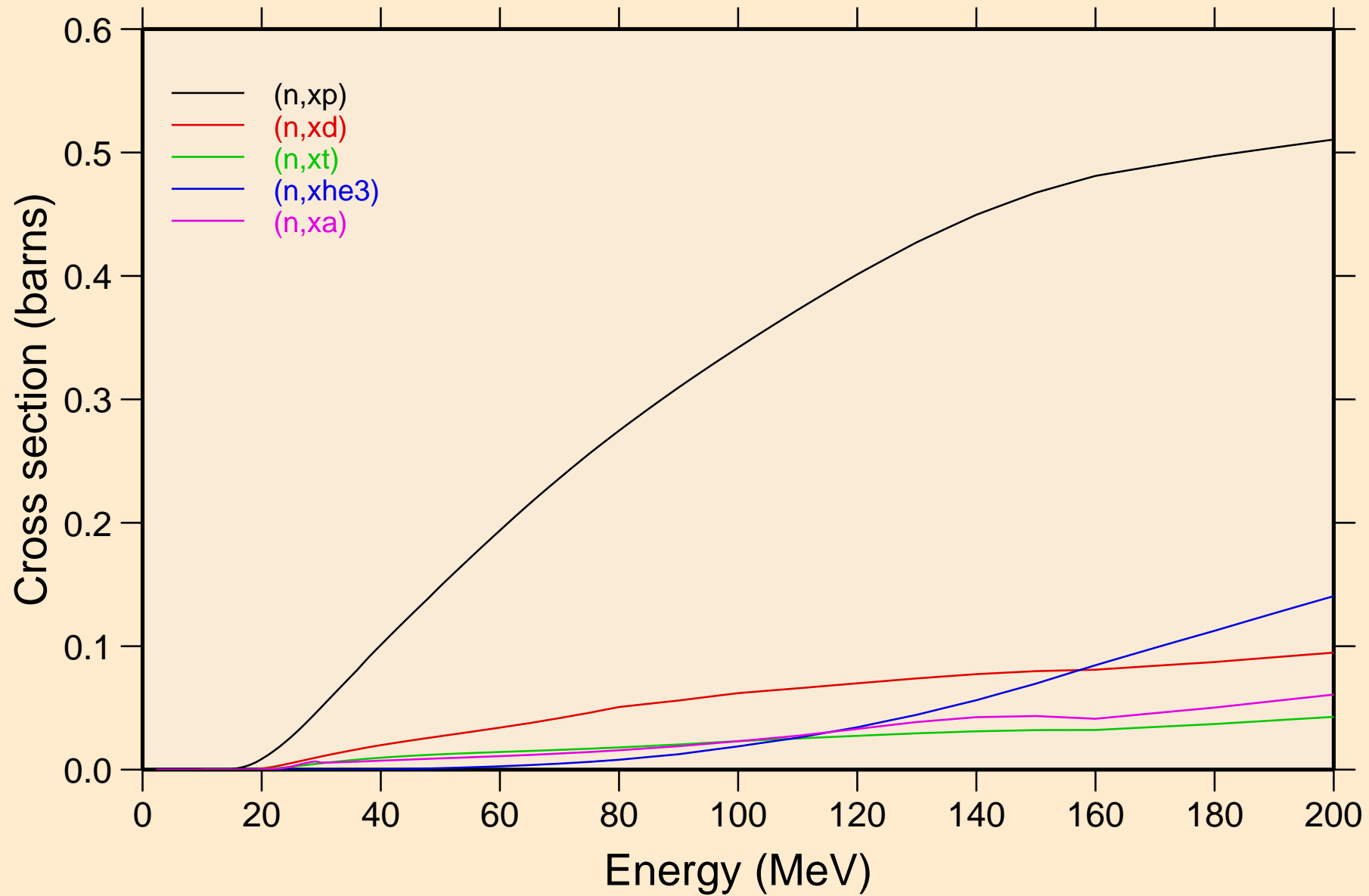

SN128M NEUTRON ACER TENDL-2023 LIBRARY; T=0.K
angular distribution for elastic

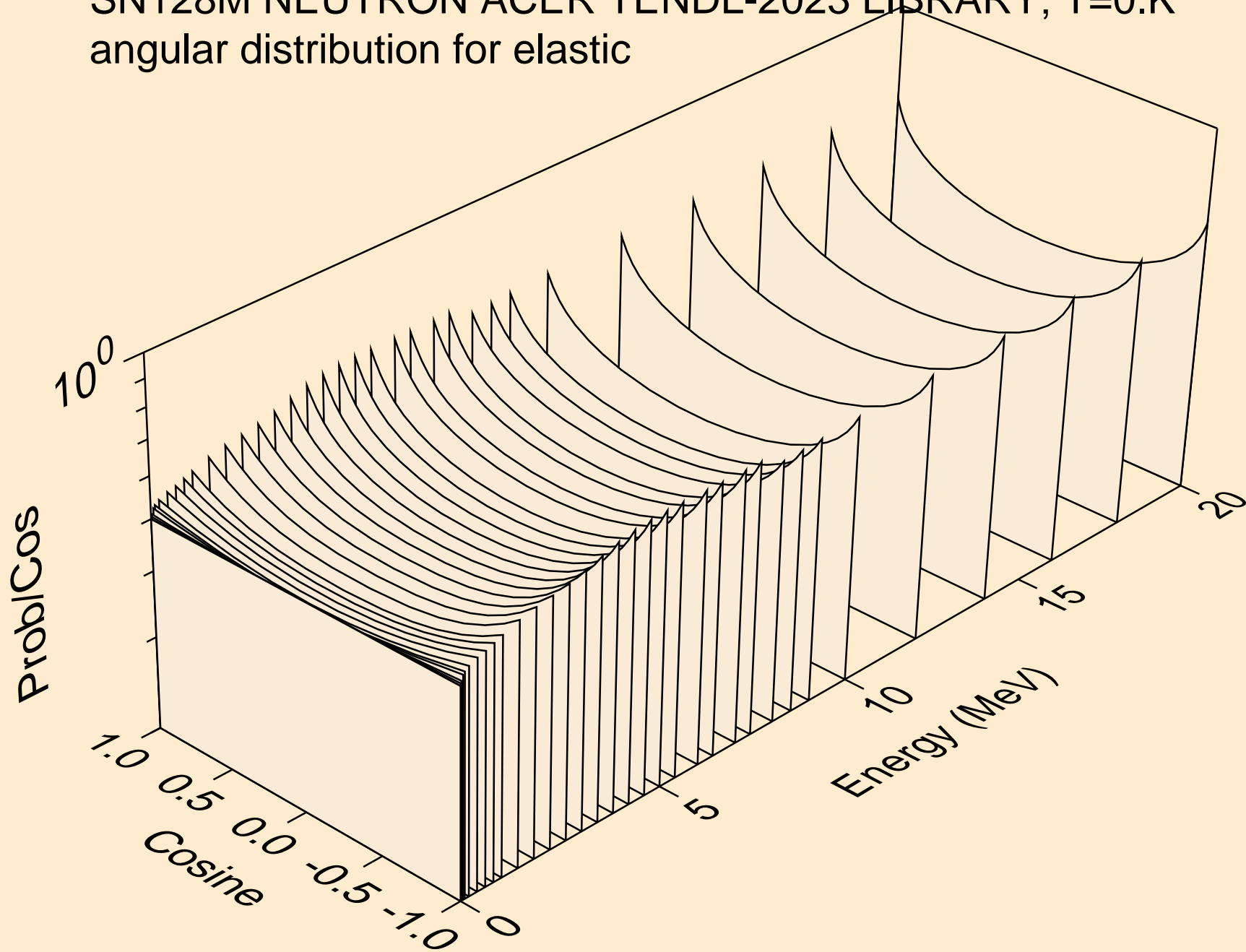

SN128M NEUTRON ACER TENDL-2023 LIBRARY; T=0.K
angular distribution for elastic

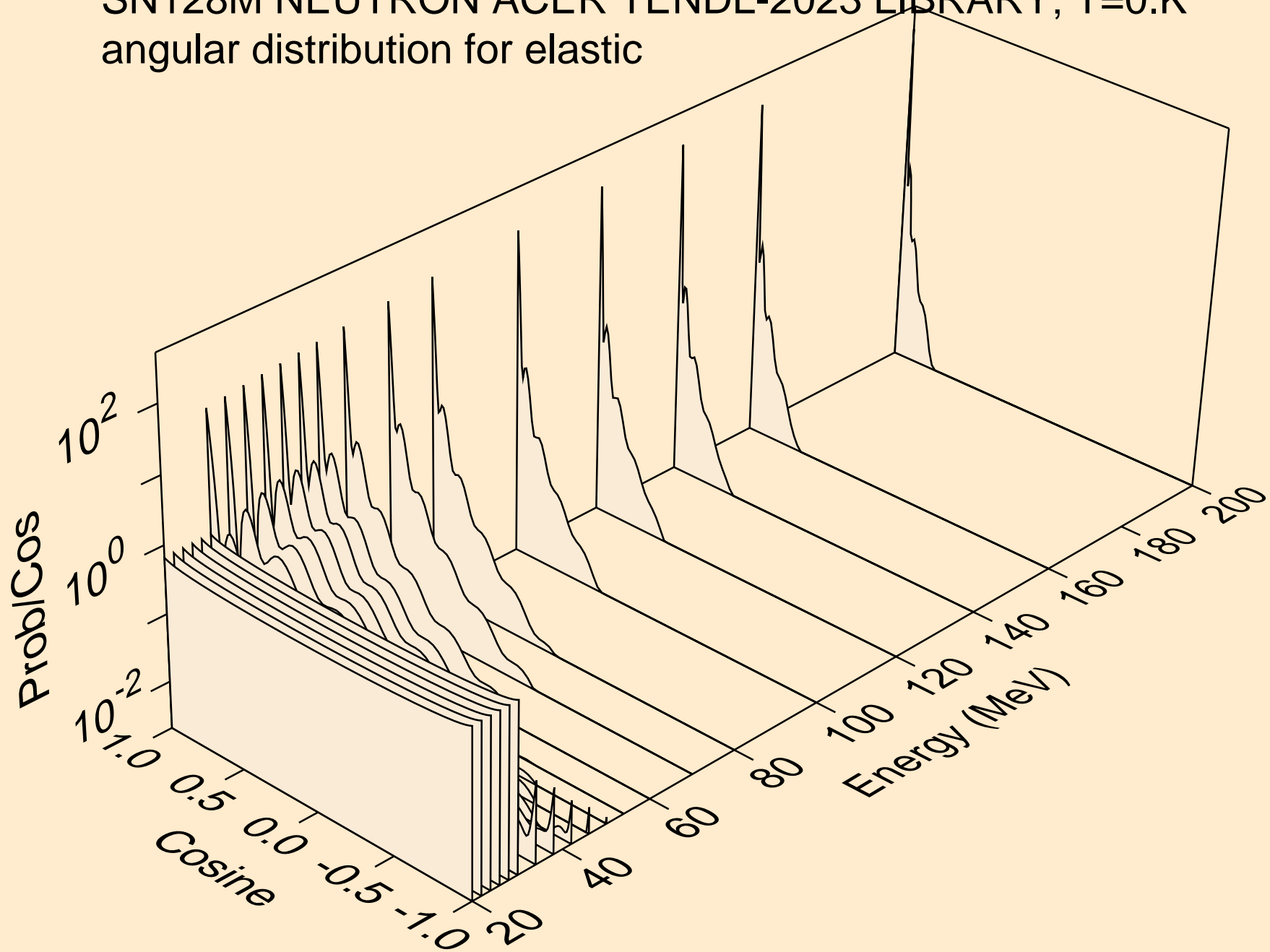

SN128M NEUTRON ACER TENDL-2023 LIBRARY; T=0.K
angular distribution for (n,n*1)

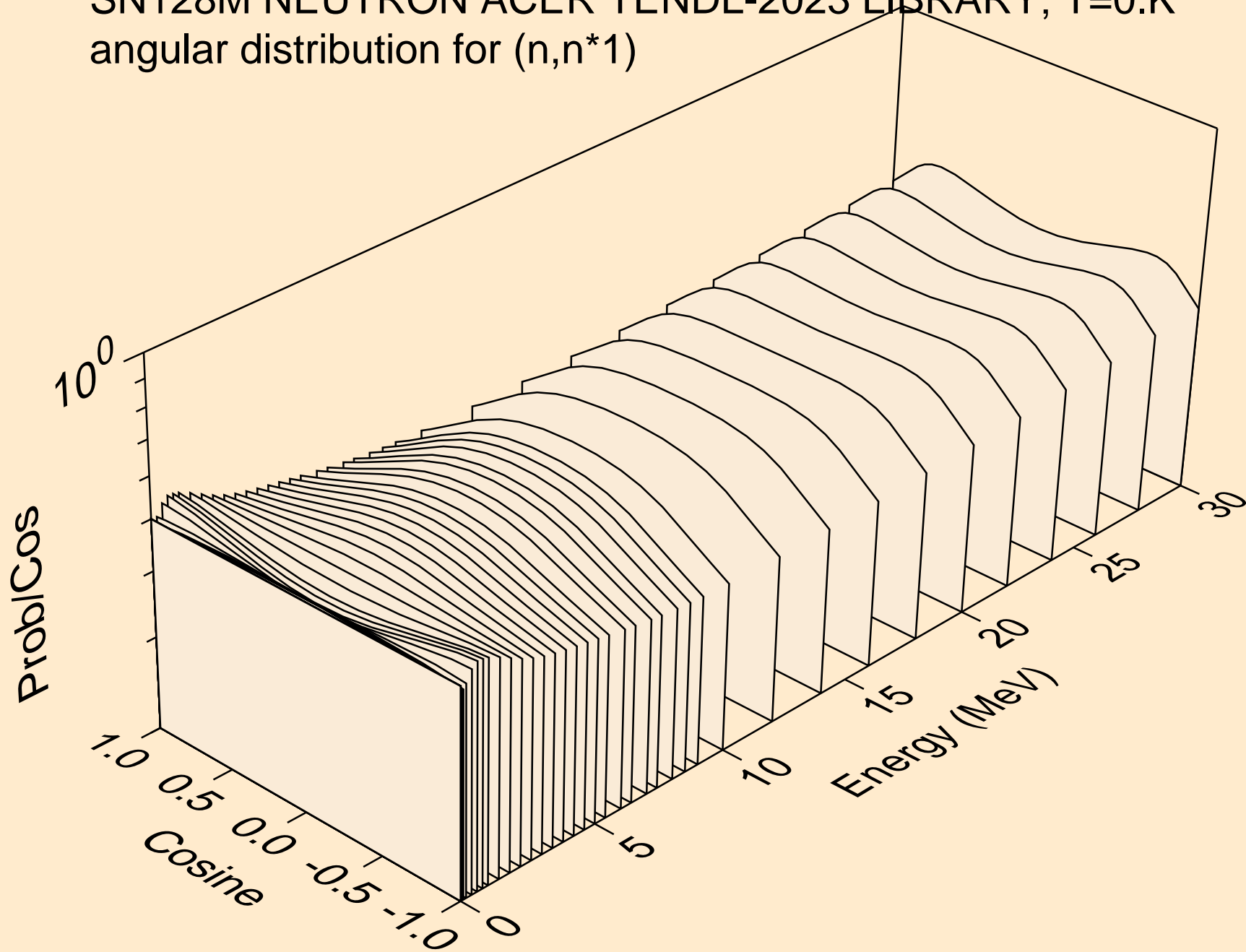

SN128M NEUTRON ACER TENDL-2023 LIBRARY; T=0.K
angular distribution for (n,n*2)

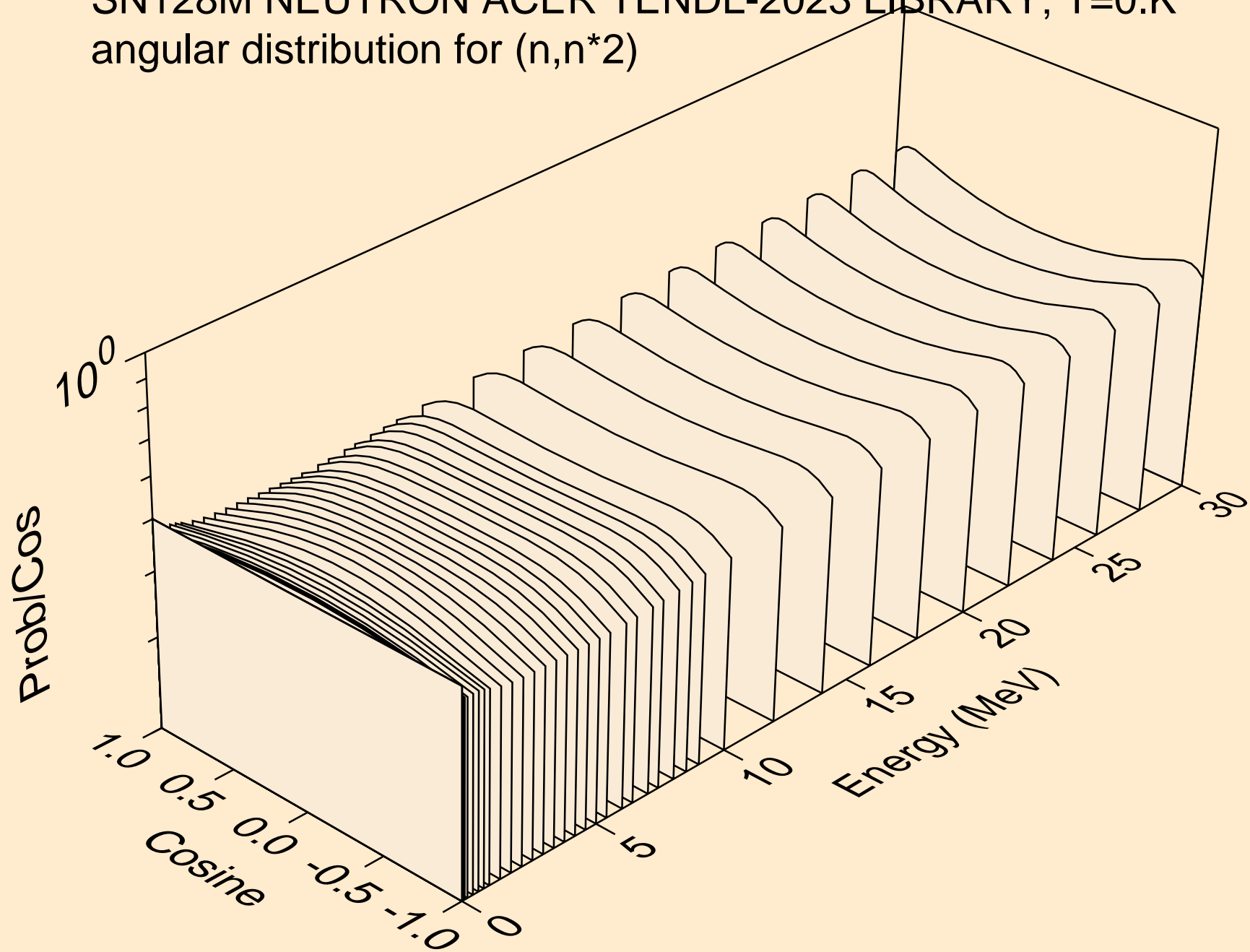

SN128M NEUTRON ACER TENDL-2023 LIBRARY; T=0.K
angular distribution for (n,n*3)

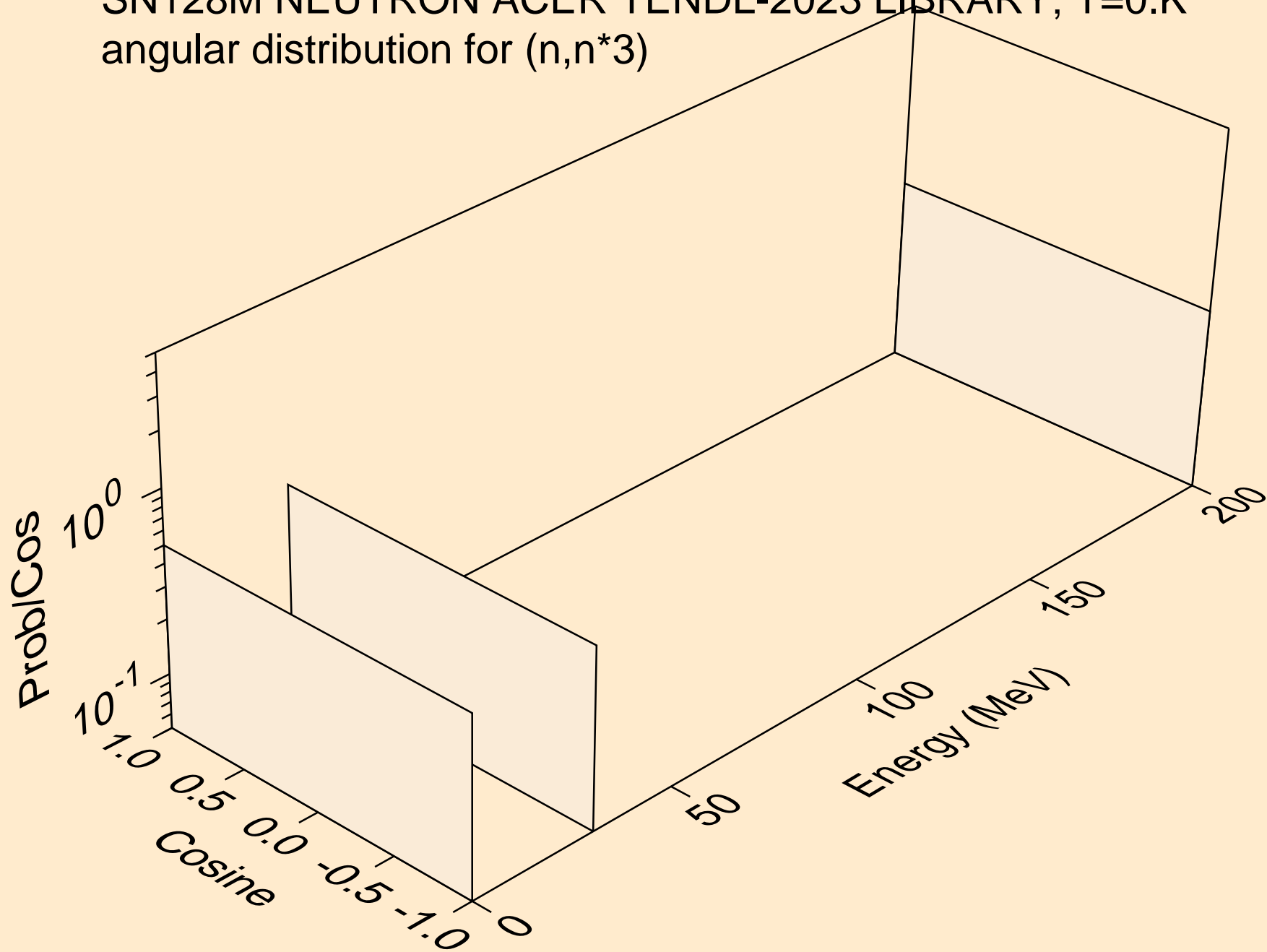

SN128M NEUTRON ACER TENDL-2023 LIBRARY; T=0.K
angular distribution for (n,n*4)

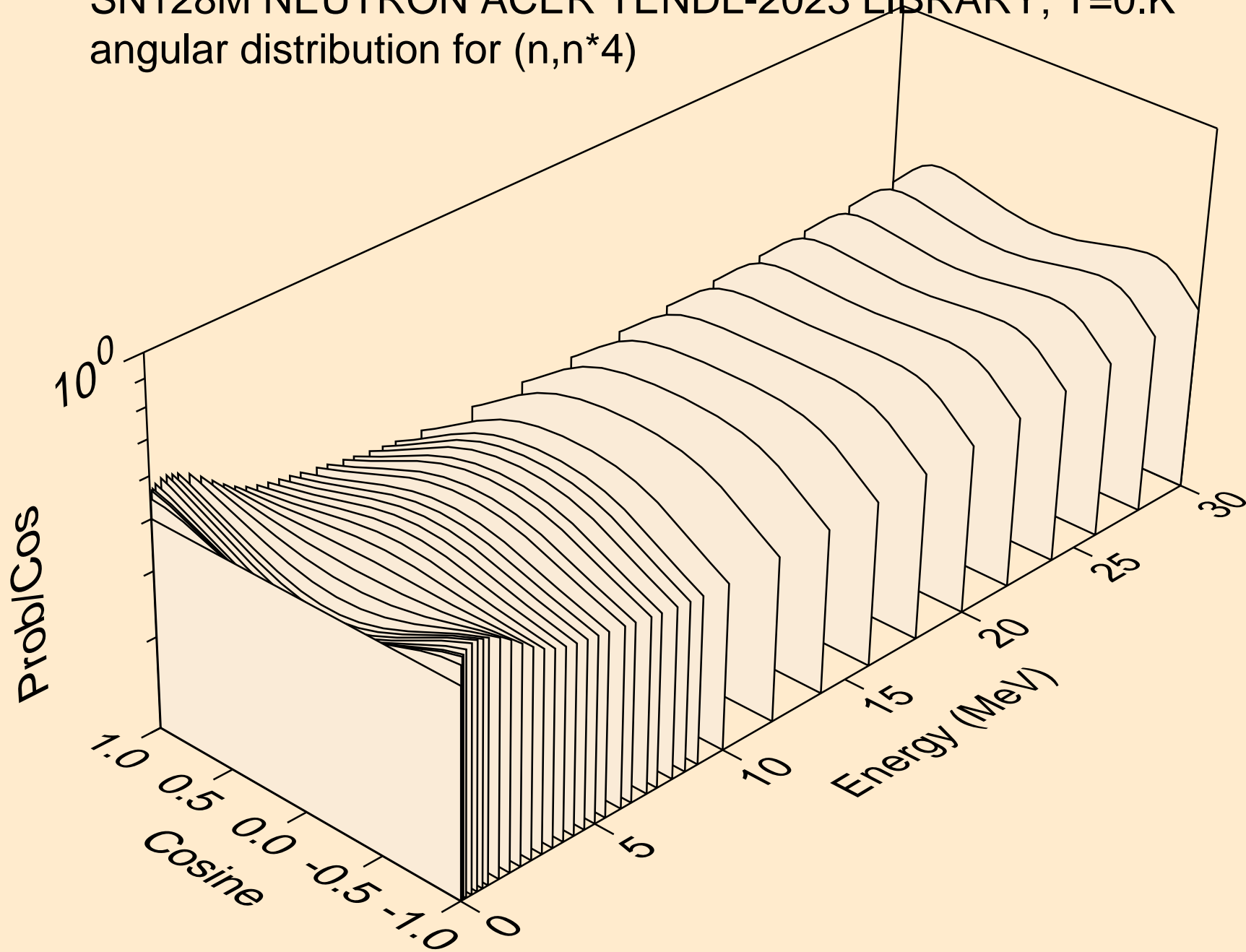

SN128M NEUTRON ACER TENDL-2023 LIBRARY; T=0.K
angular distribution for (n,n*5)

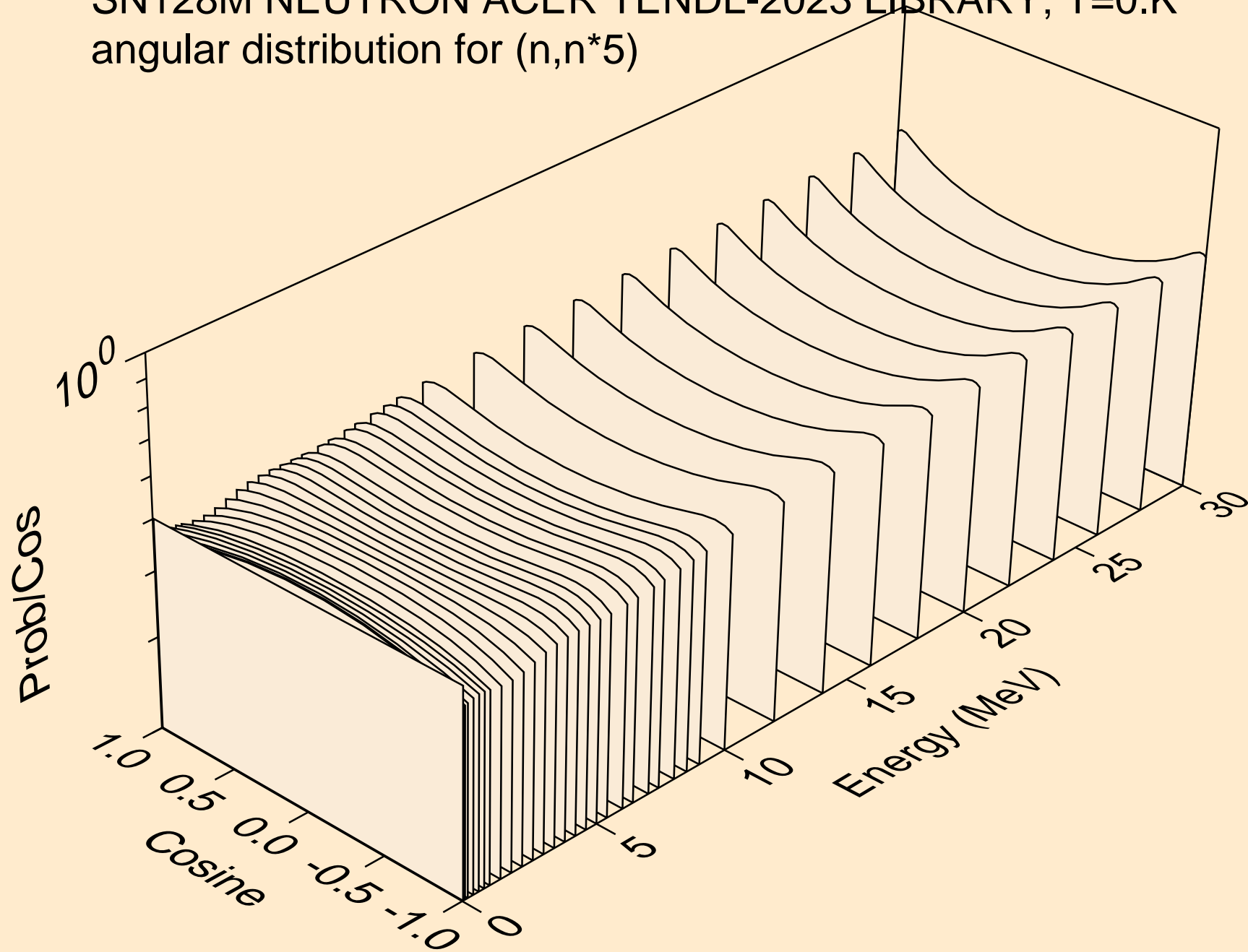

SN128M NEUTRON ACER TENDL-2023 LIBRARY; T=0.K
angular distribution for (n,n*6)

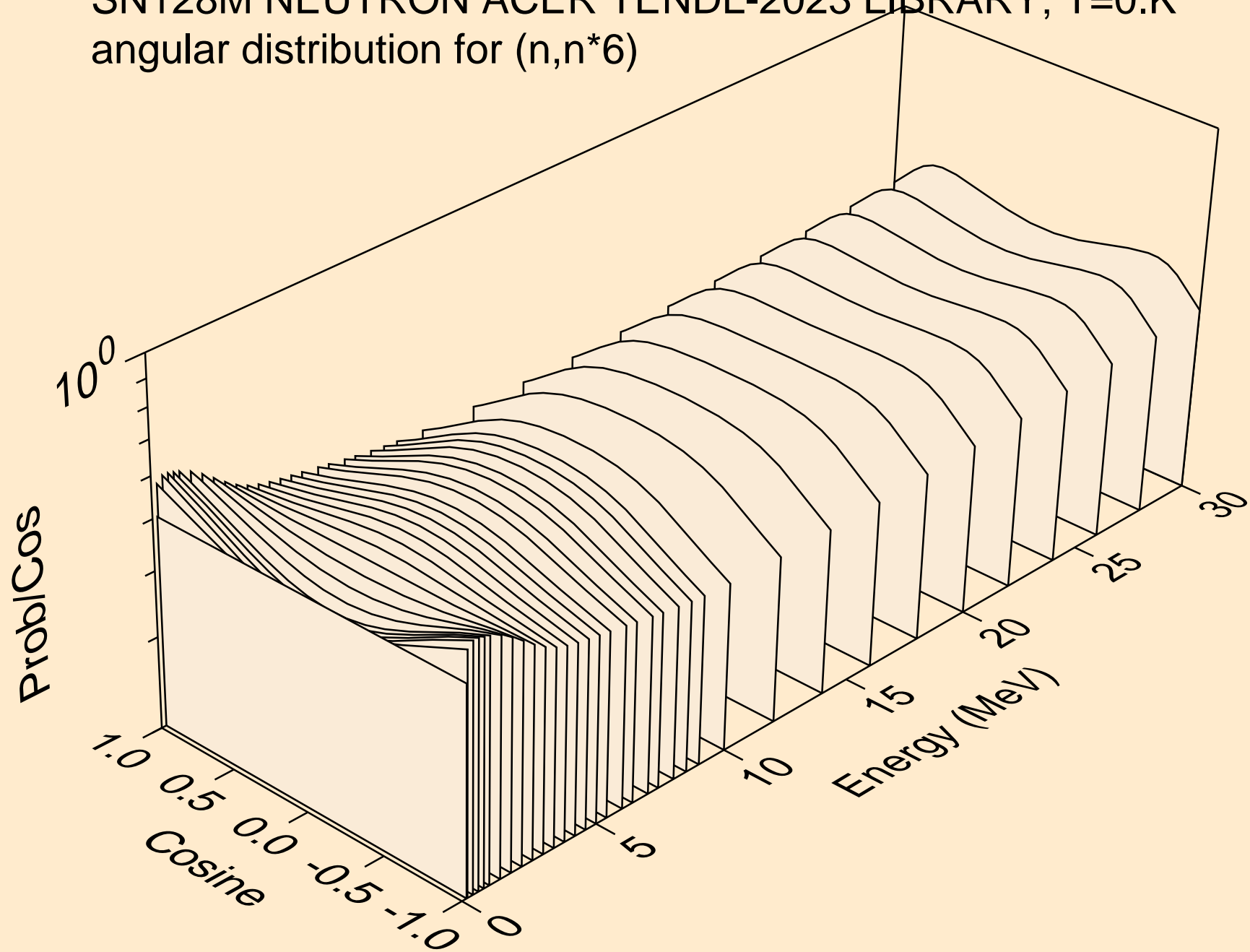

SN128M NEUTRON ACER TENDL-2023 LIBRARY; T=0.K
angular distribution for (n,n*7)

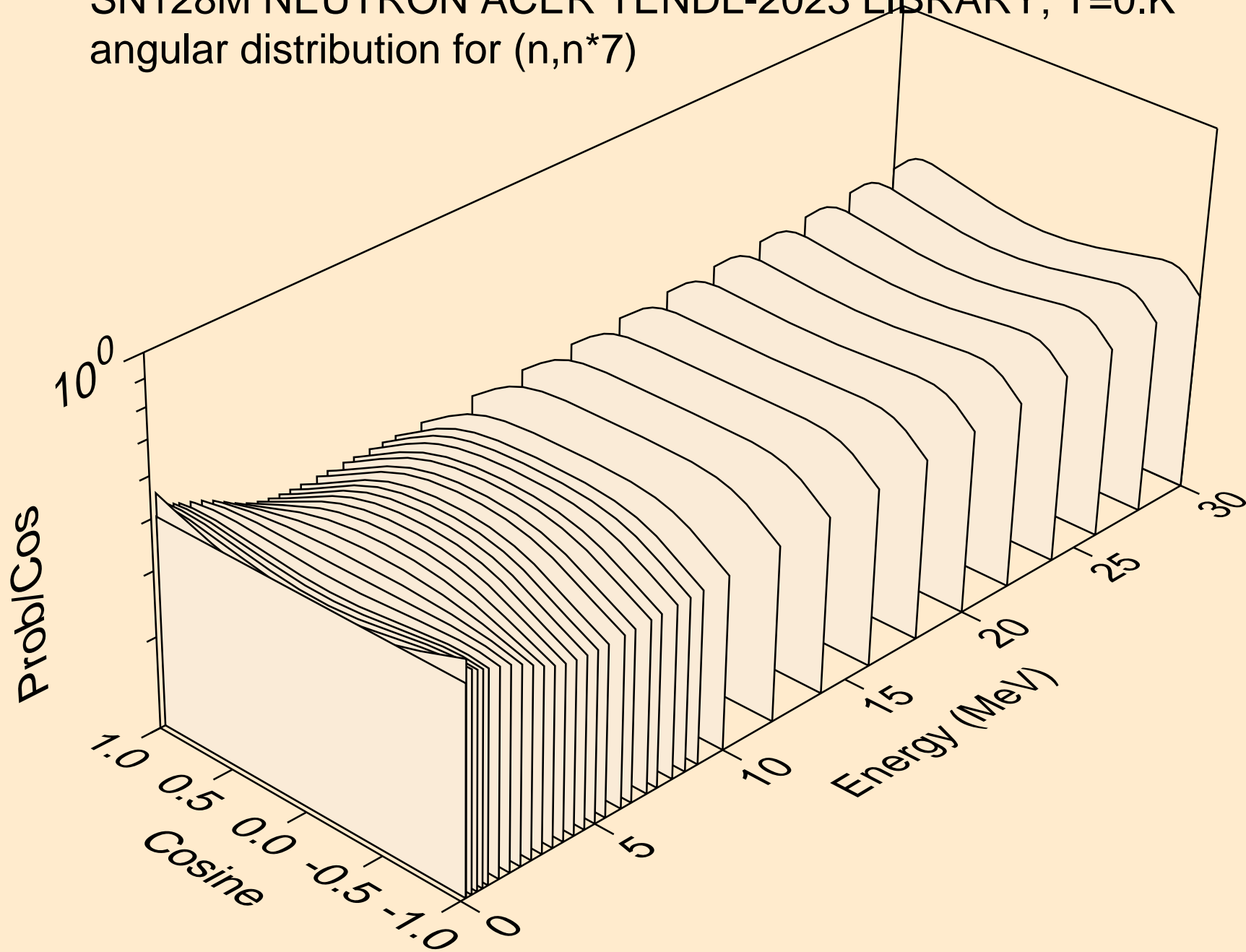

SN128M NEUTRON ACER TENDL-2023 LIBRARY; T=0.K
angular distribution for (n,n*8)

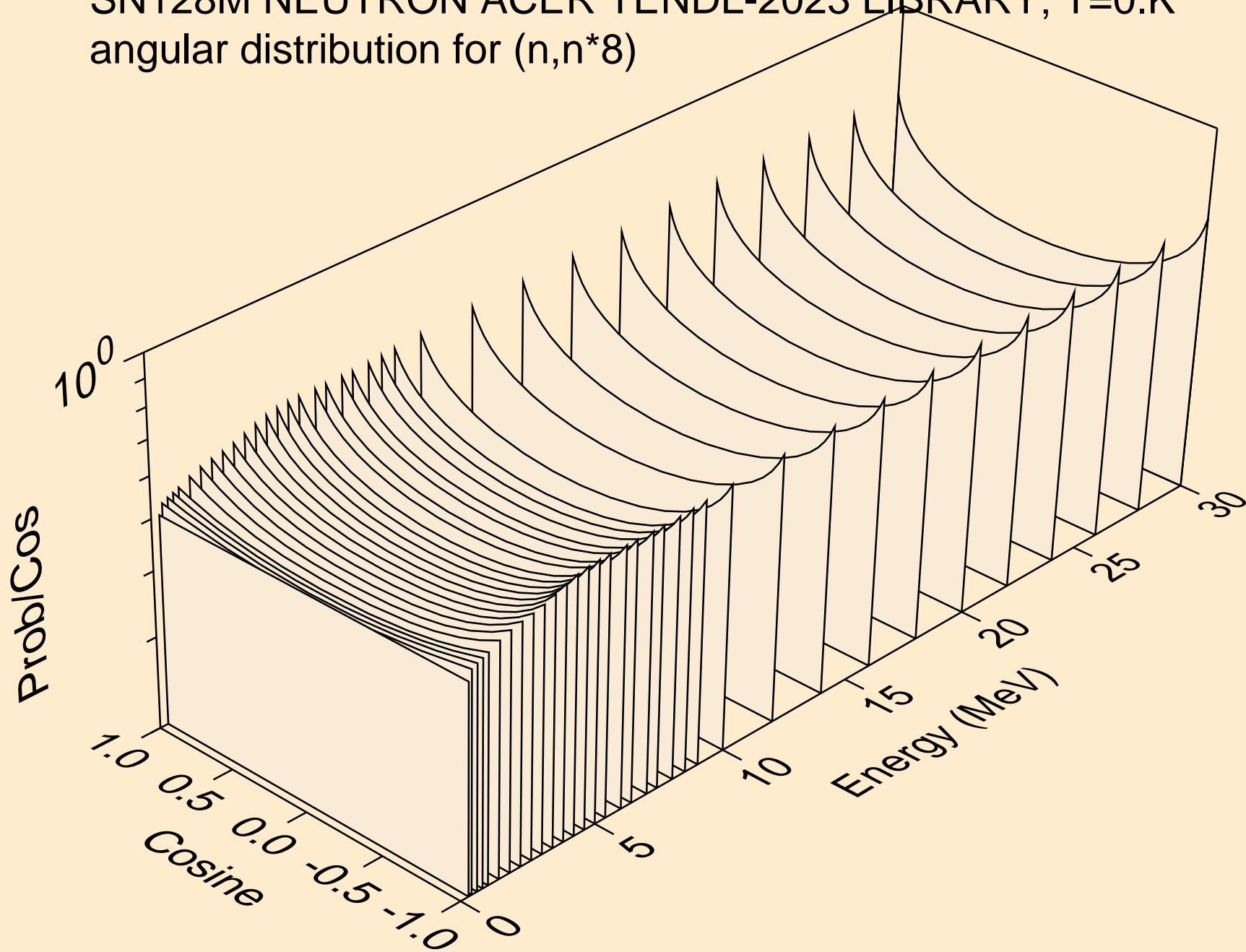

SN128M NEUTRON ACER TENDL-2023 LIBRARY; T=0.K
angular distribution for (n,n*9)

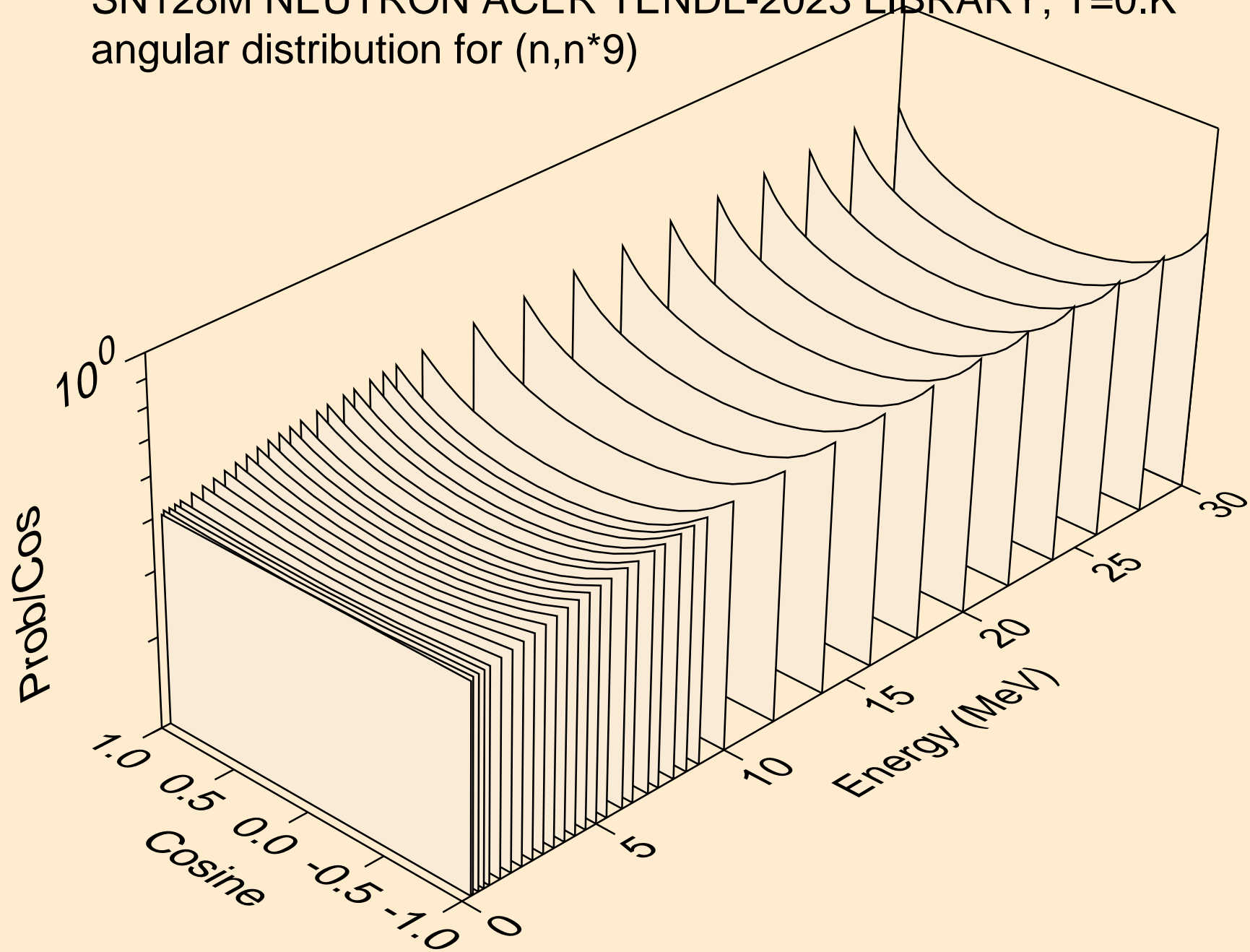

SN128M NEUTRON ACER TENDL-2023 LIBRARY; T=0.K
angular distribution for (n,n*10)

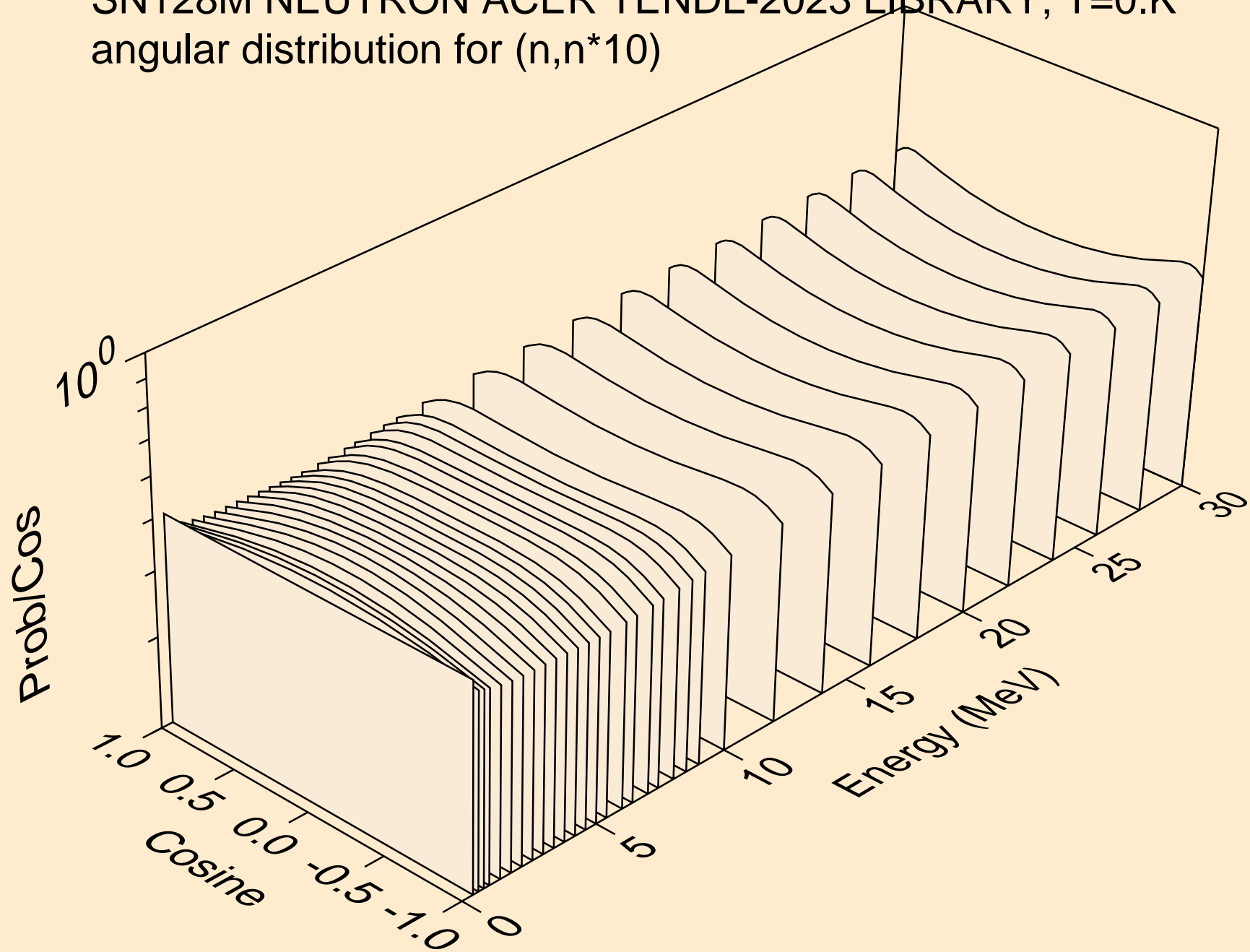

SN128M NEUTRON ACER TENDL-2023 LIBRARY; T=0.K
angular distribution for (n,n*11)

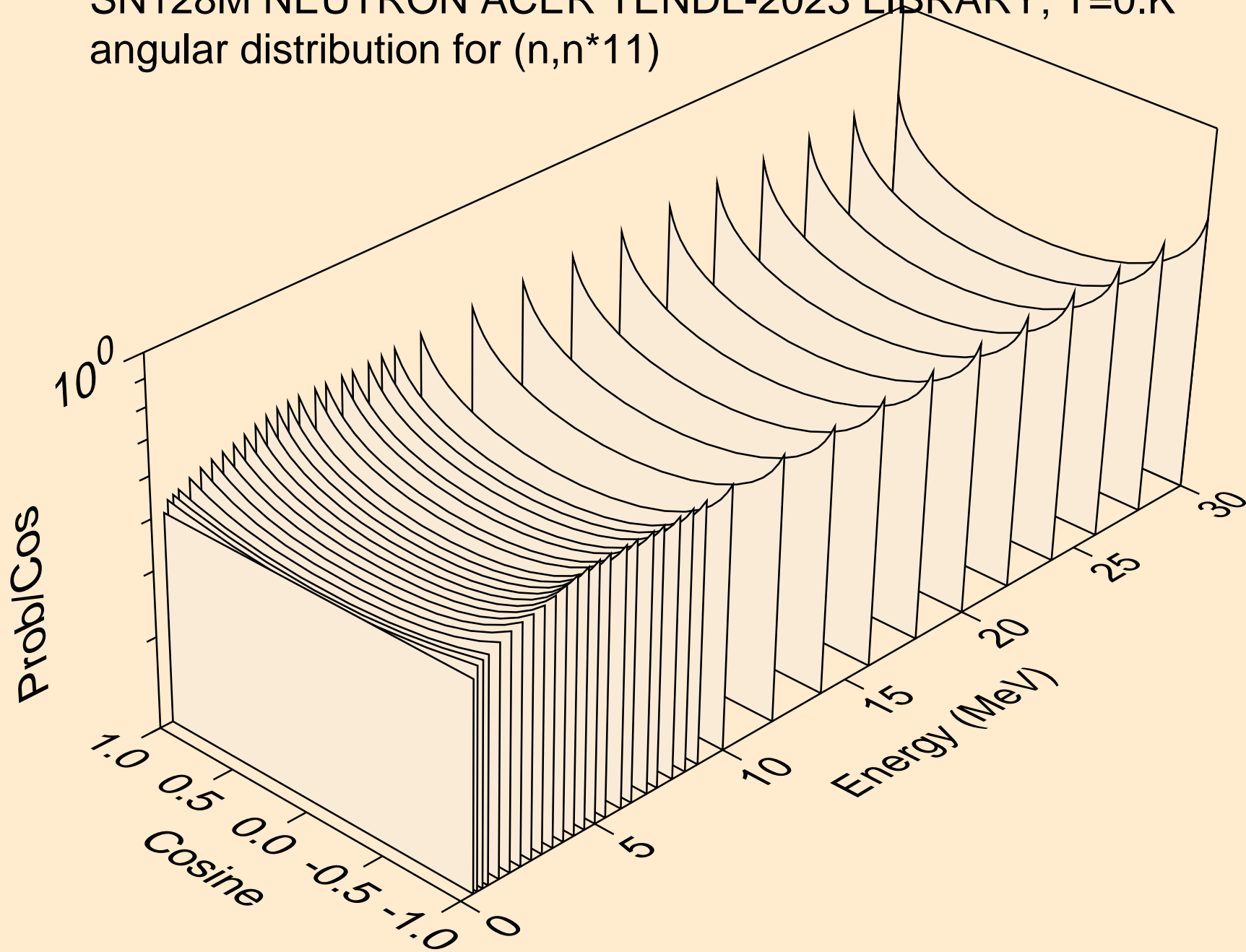

SN128M NEUTRON ACER TENDL-2023 LIBRARY; T=0.K
angular distribution for (n,n*12)

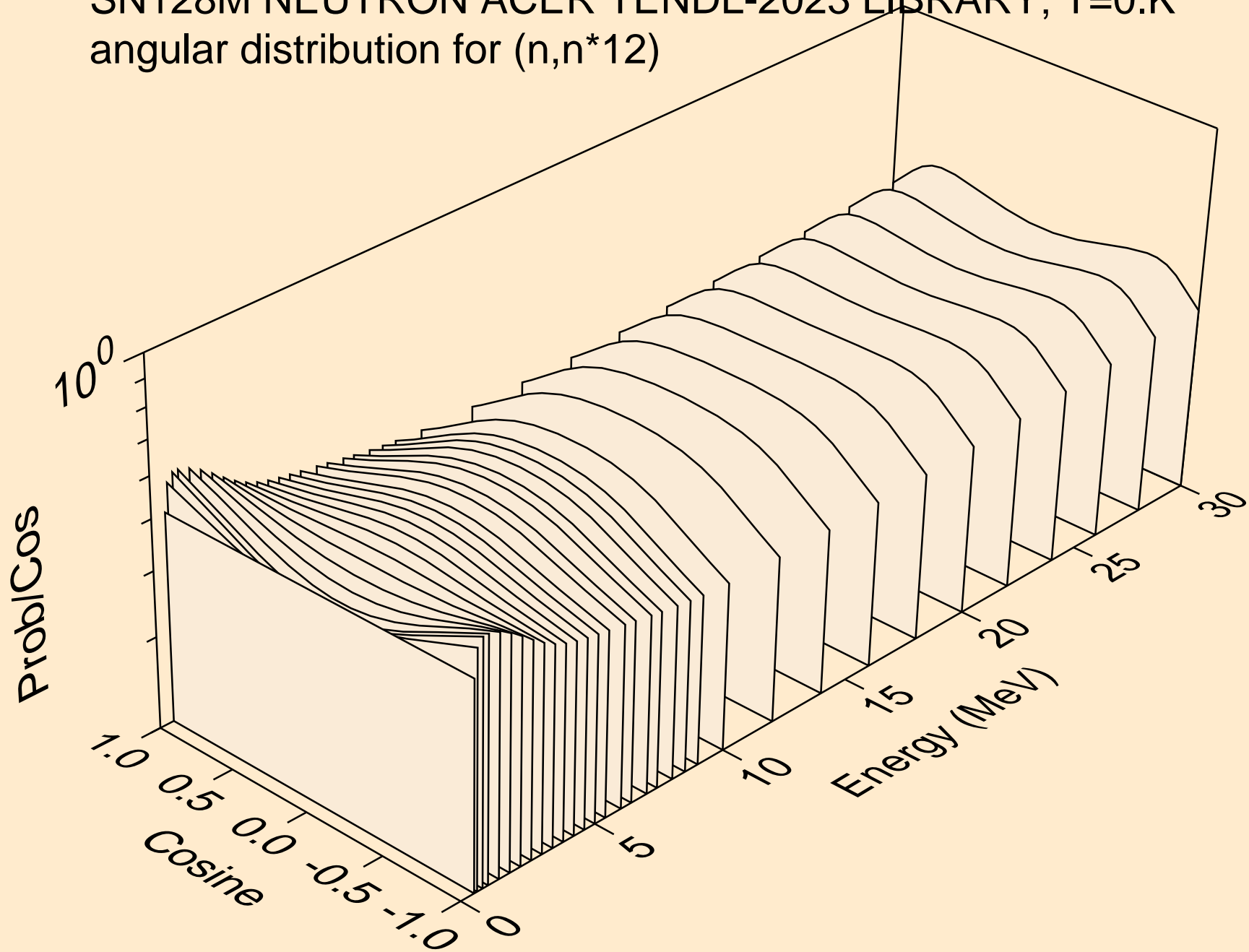

SN128M NEUTRON ACER TENDL-2023 LIBRARY; T=0.K
angular distribution for (n,n*13)

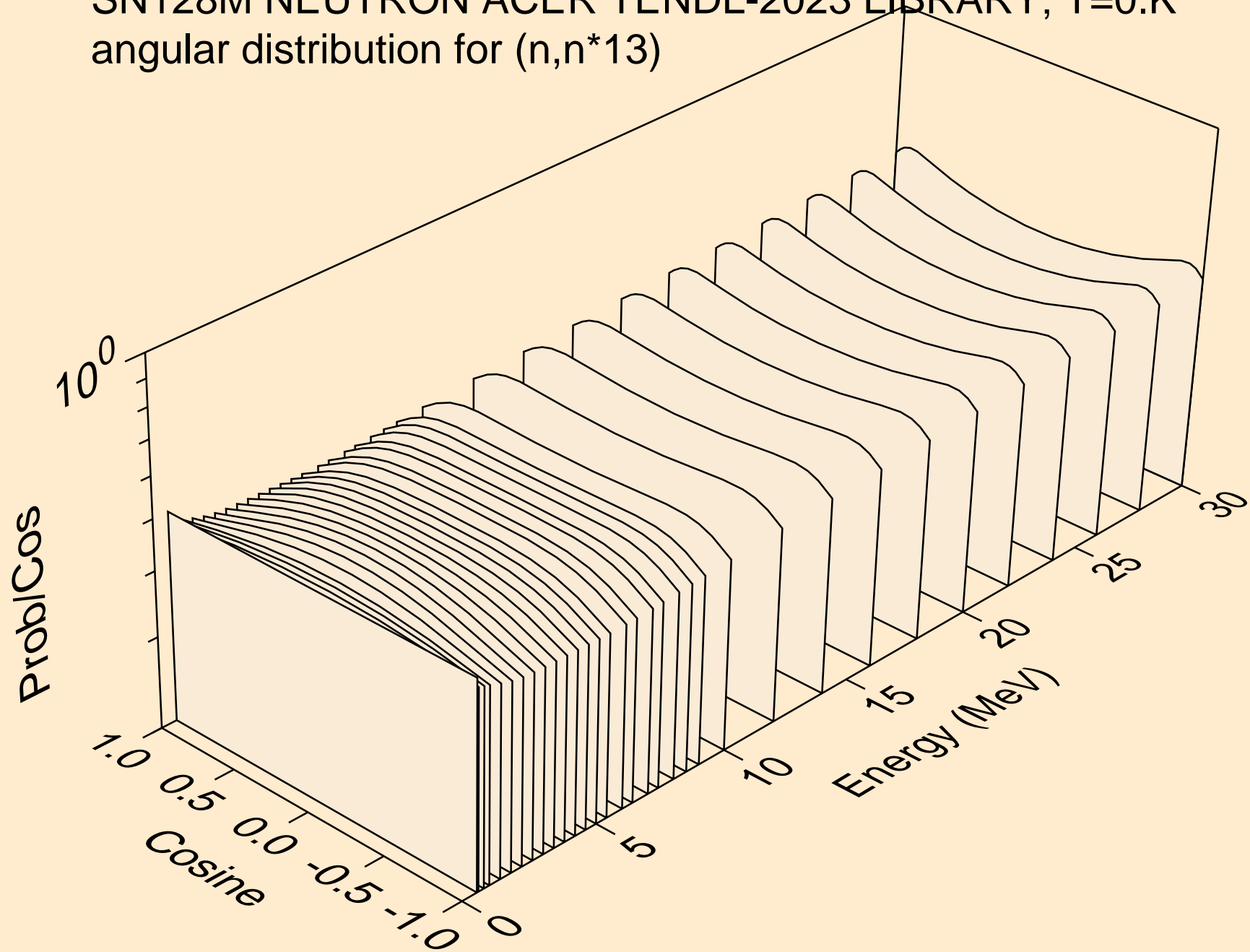

SN128M NEUTRON ACER TENDL-2023 LIBRARY; T=0.K
angular distribution for (n,n*14)

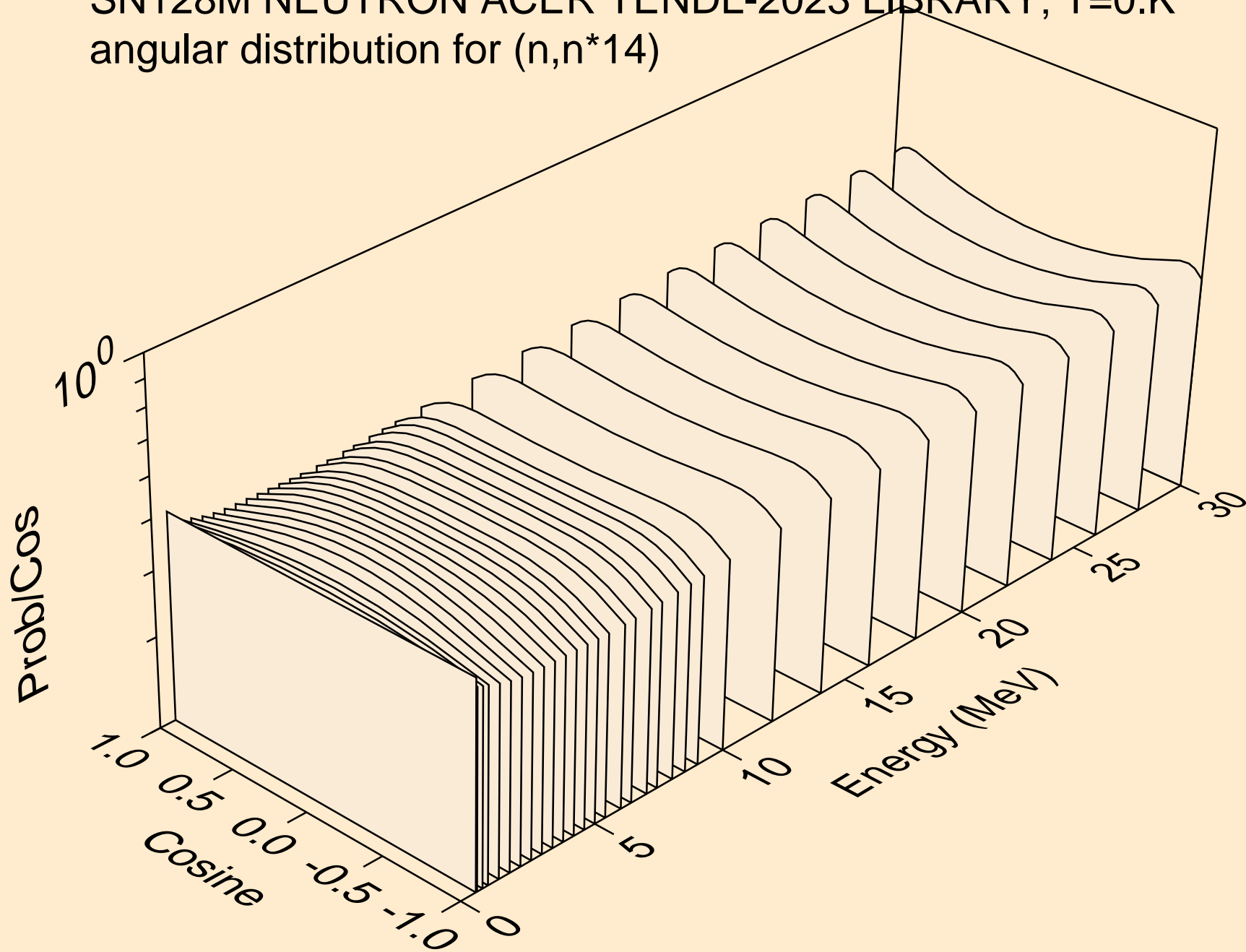

SN128M NEUTRON ACER TENDL-2023 LIBRARY; T=0.K
Neutron emission for (n,x)

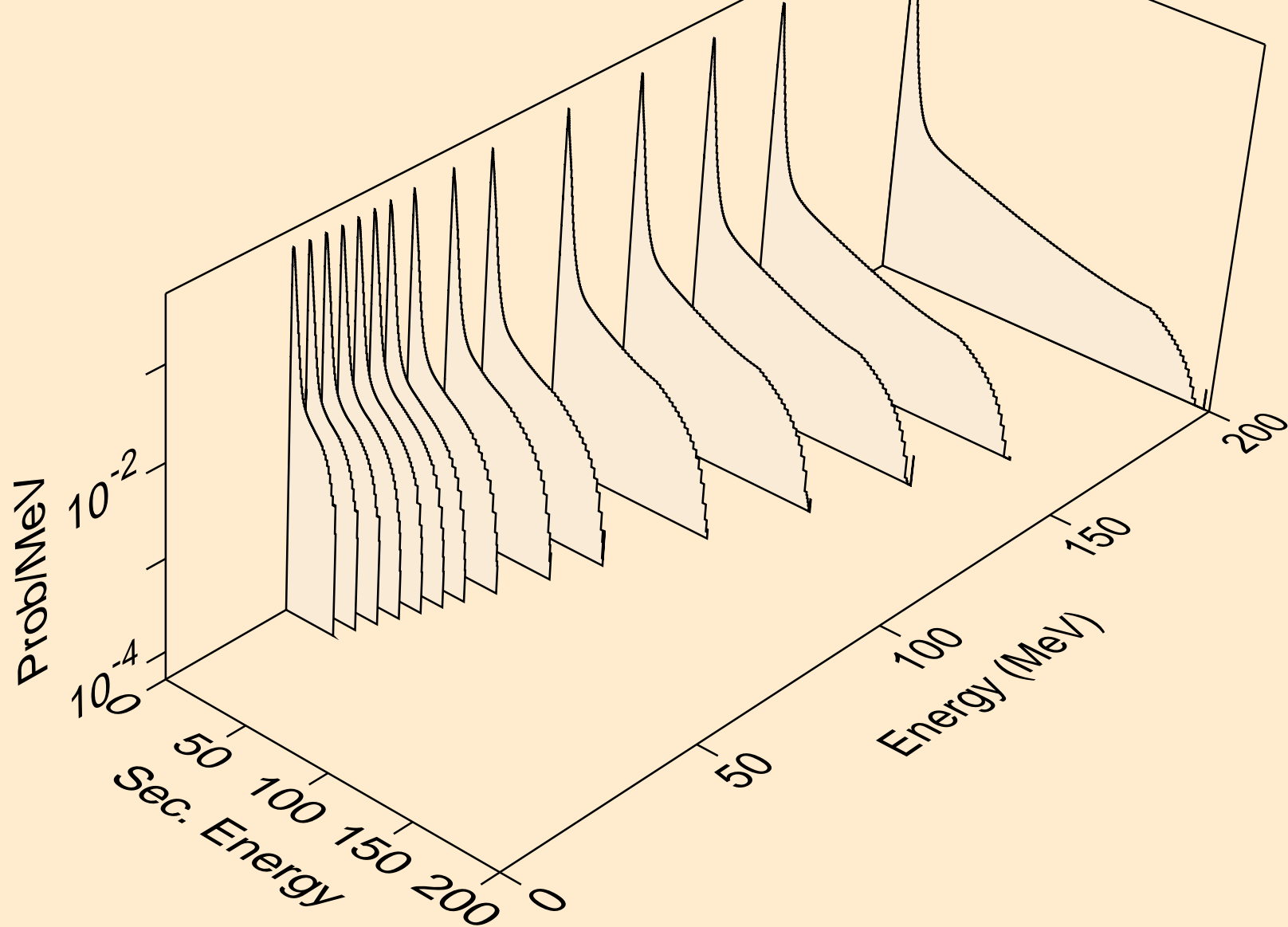

SN128M NEUTRON ACER TENDL-2023 LIBRARY; T=0.K
Neutron emission for (n,2nd)

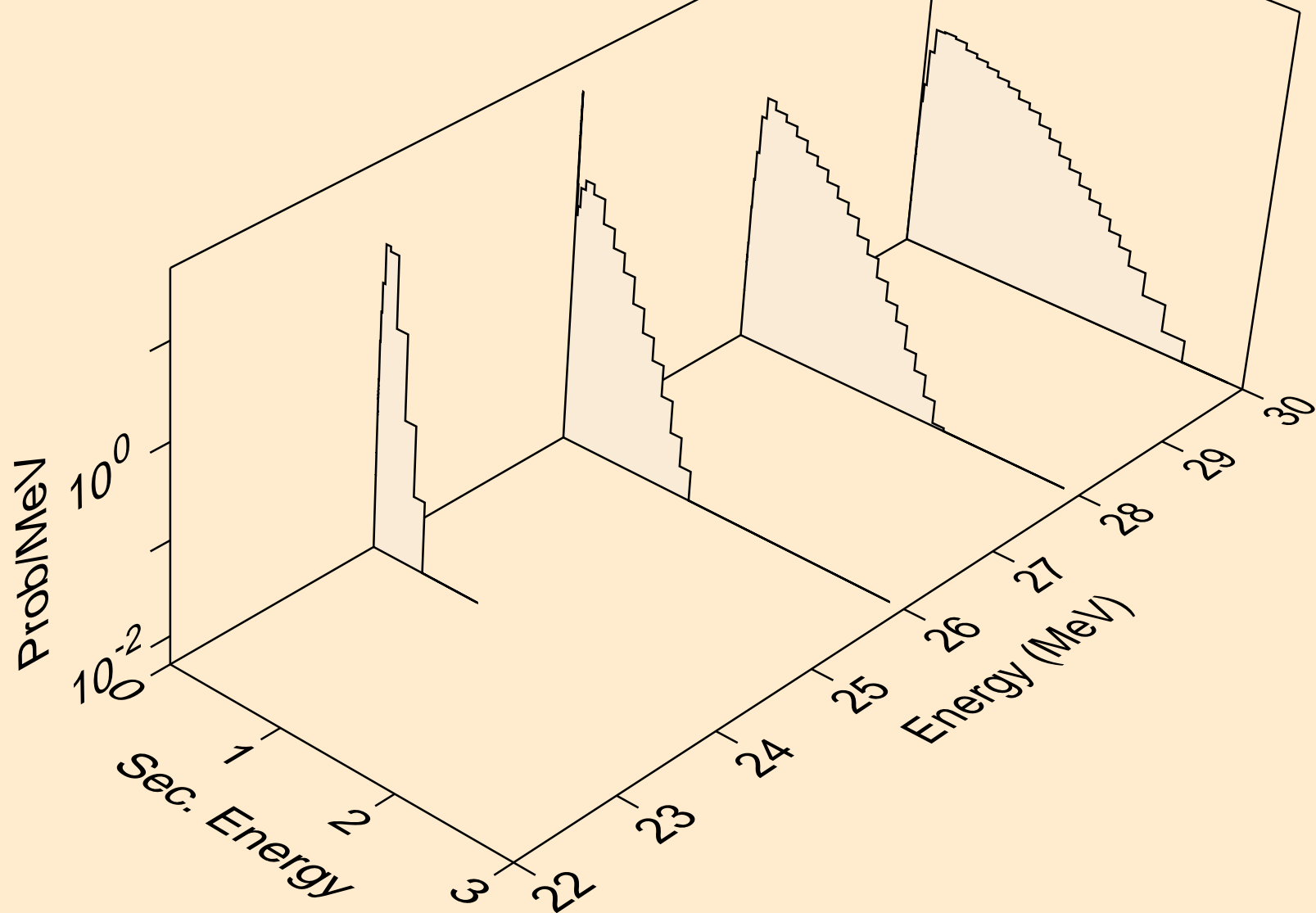

SN128M NEUTRON ACER TENDL-2023 LIBRARY; T=0.K
Neutron emission for (n,2n)

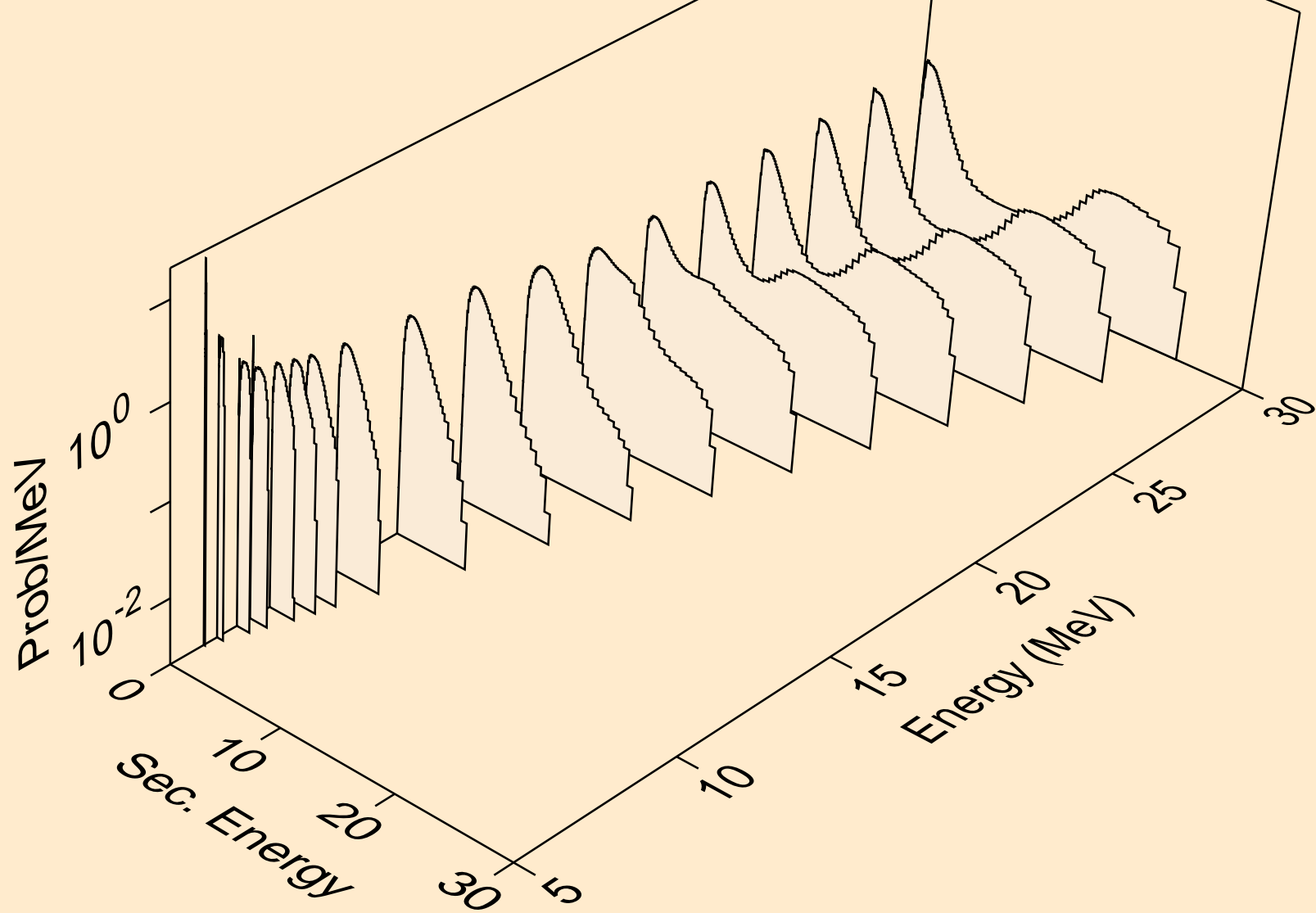

SN128M NEUTRON ACER TENDL-2023 LIBRARY; T=0.K
Neutron emission for (n,3n)

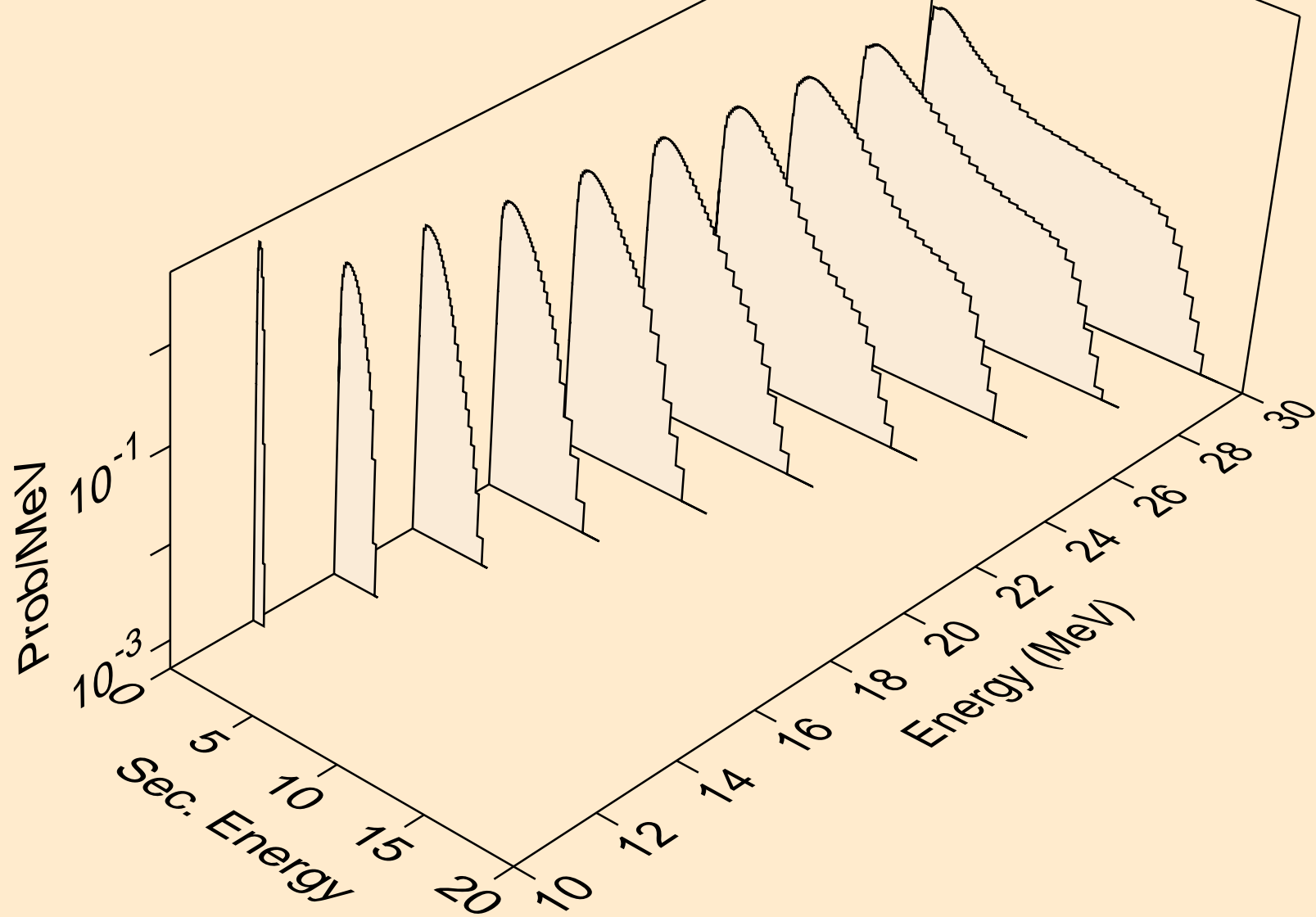

SN128M NEUTRON ACER TENDL-2023 LIBRARY; T=0.K
Neutron emission for (n,n*)a

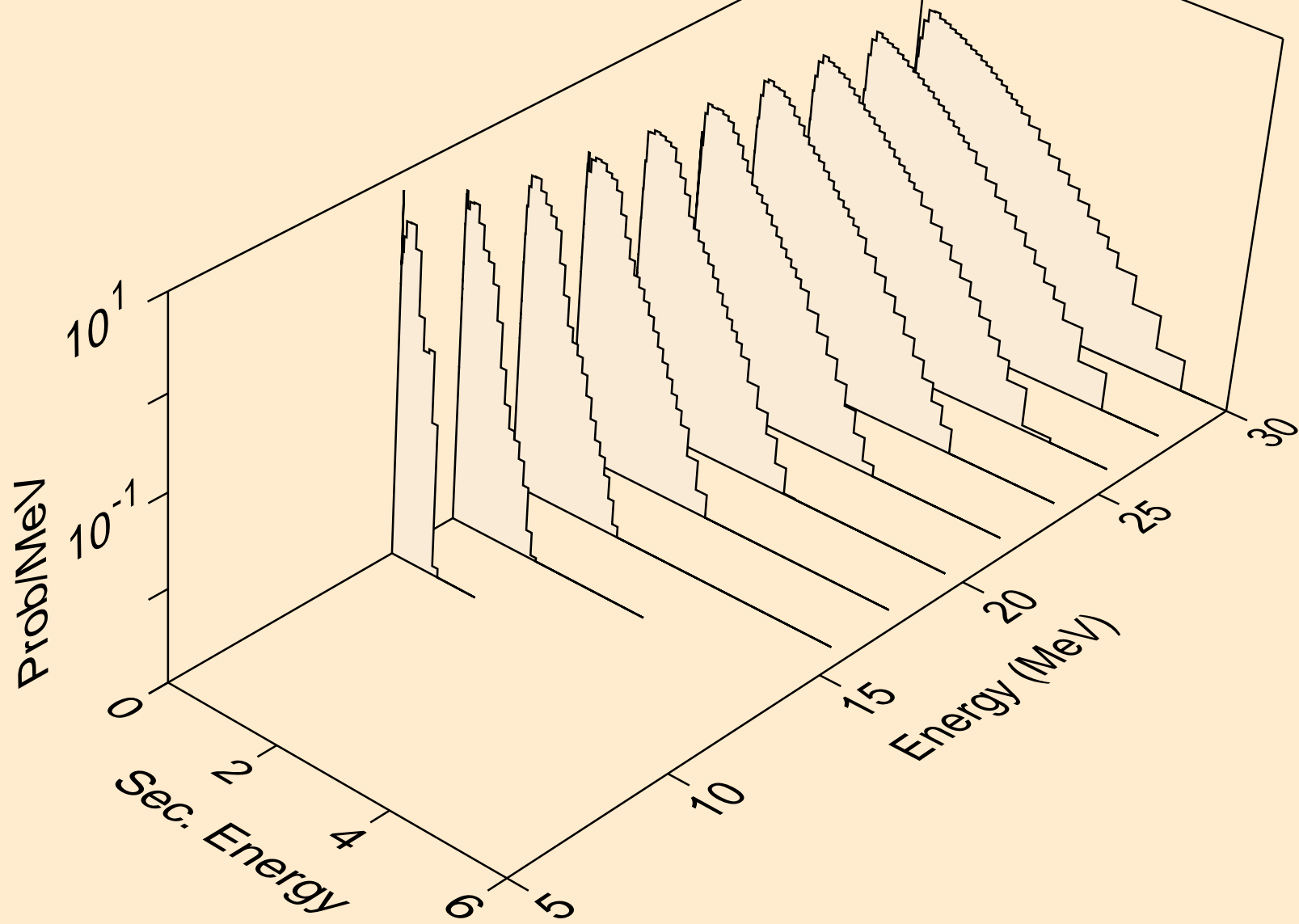

SN128M NEUTRON ACER TENDL-2023 LIBRARY; T=0.K
Neutron emission for (n,2n)a

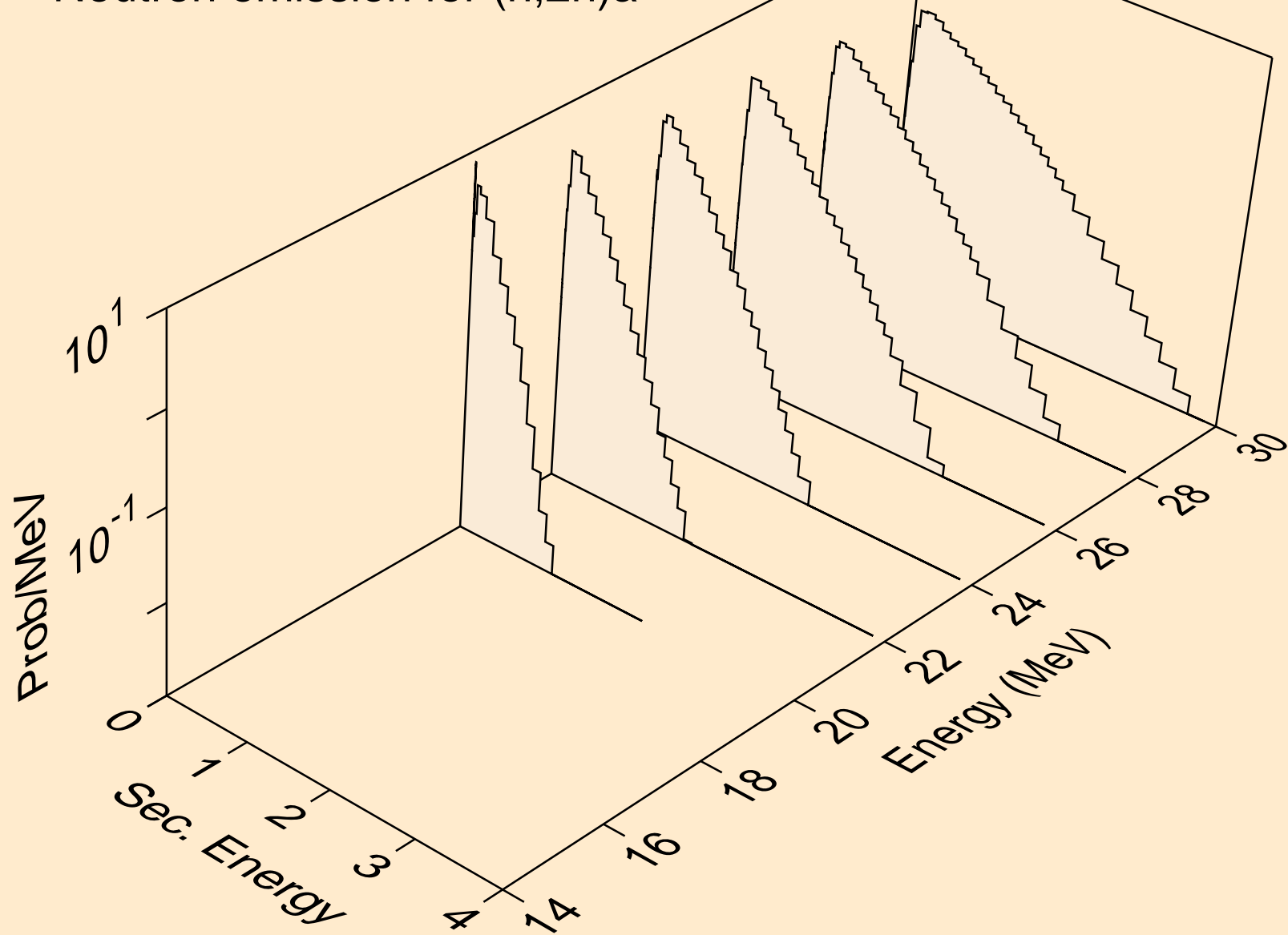

SN128M NEUTRON ACER TENDL-2023 LIBRARY; T=0.K
Neutron emission for (n,3n)a

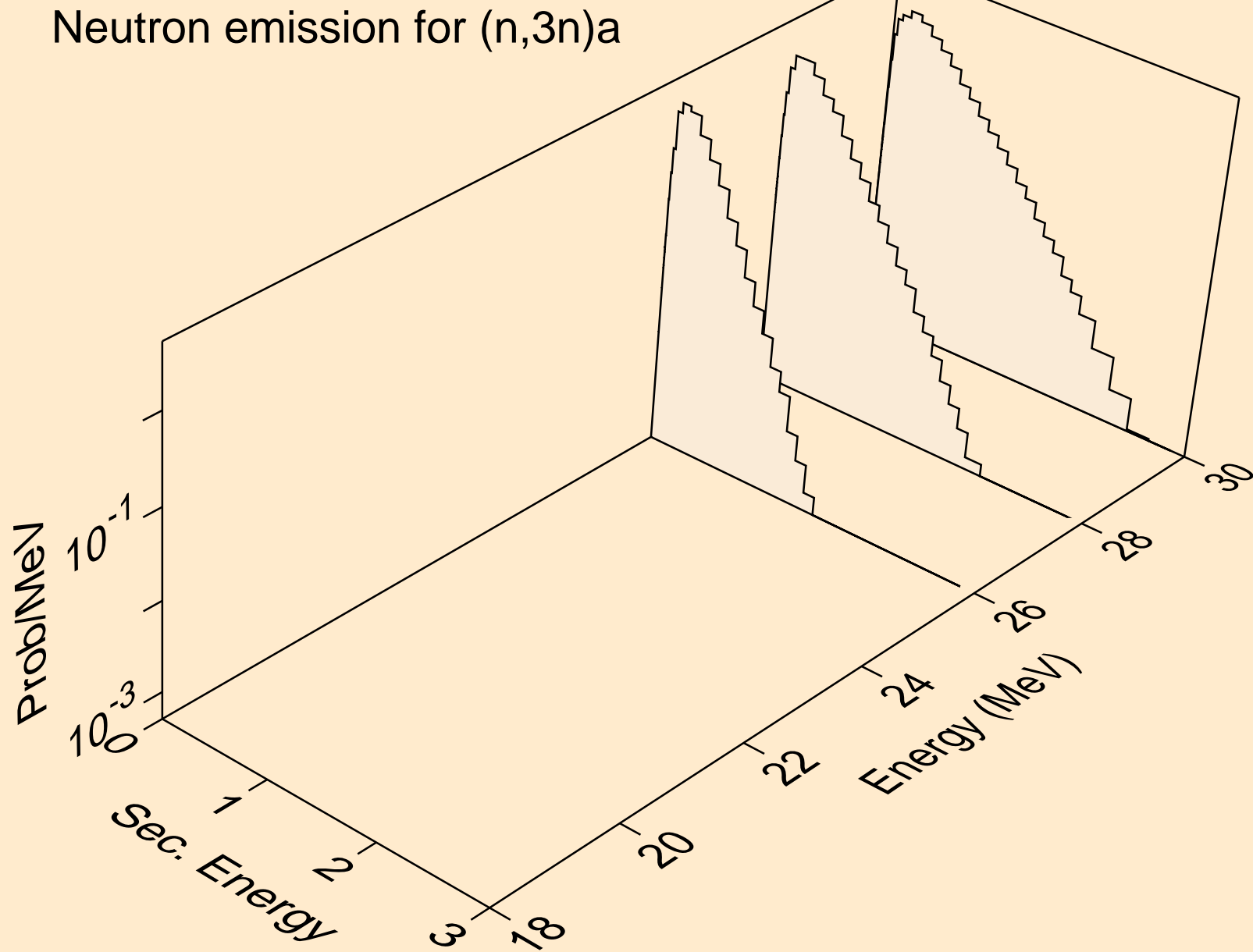

SN128M NEUTRON ACER TENDL-2023 LIBRARY; T=0.K
Neutron emission for (n,n*)p

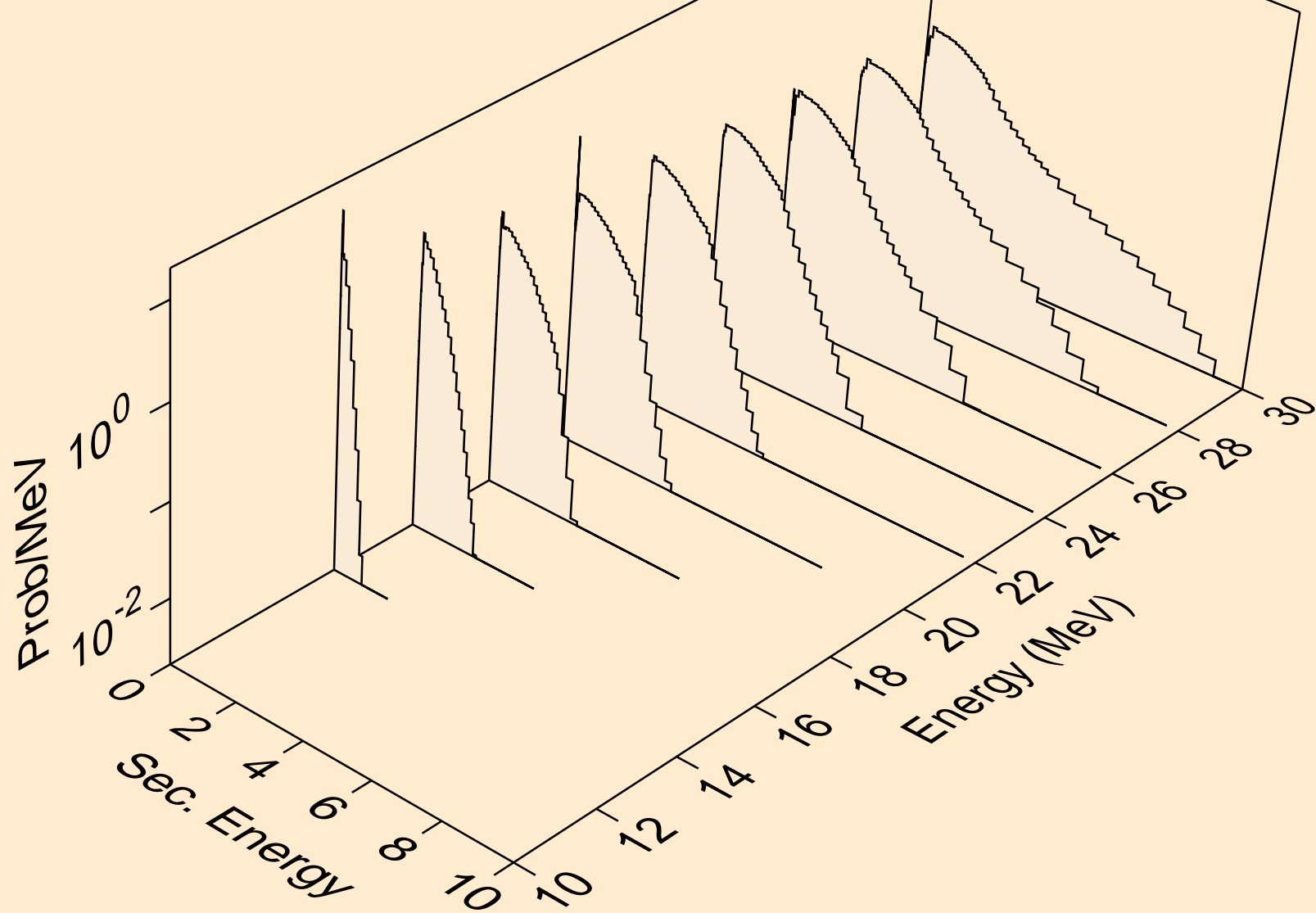

SN128M NEUTRON ACER TENDL-2023 LIBRARY; T=0.K
Neutron emission for (n,n*)d

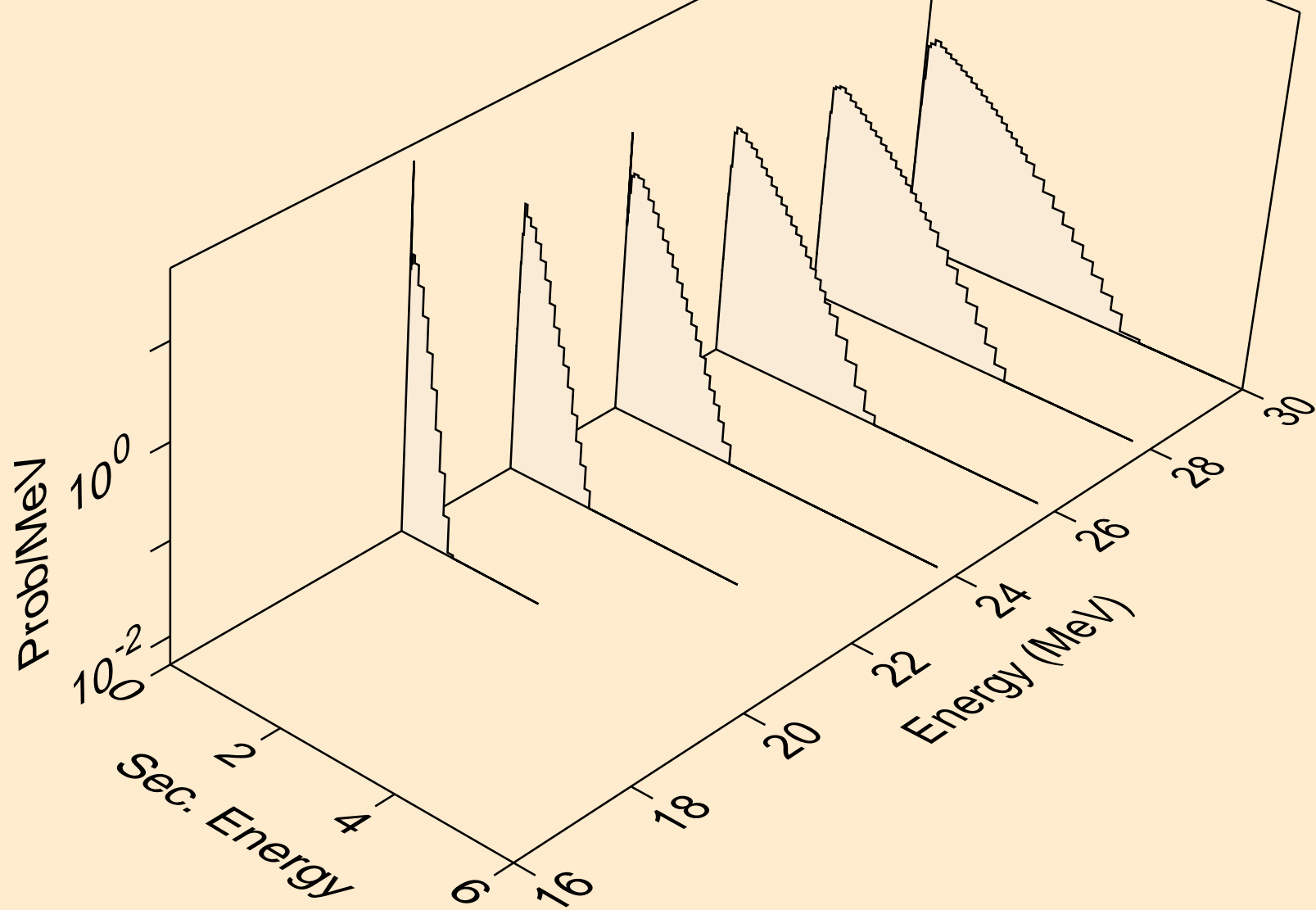

SN128M NEUTRON ACER TENDL-2023 LIBRARY; T=0.K
Neutron emission for (n,n*)t

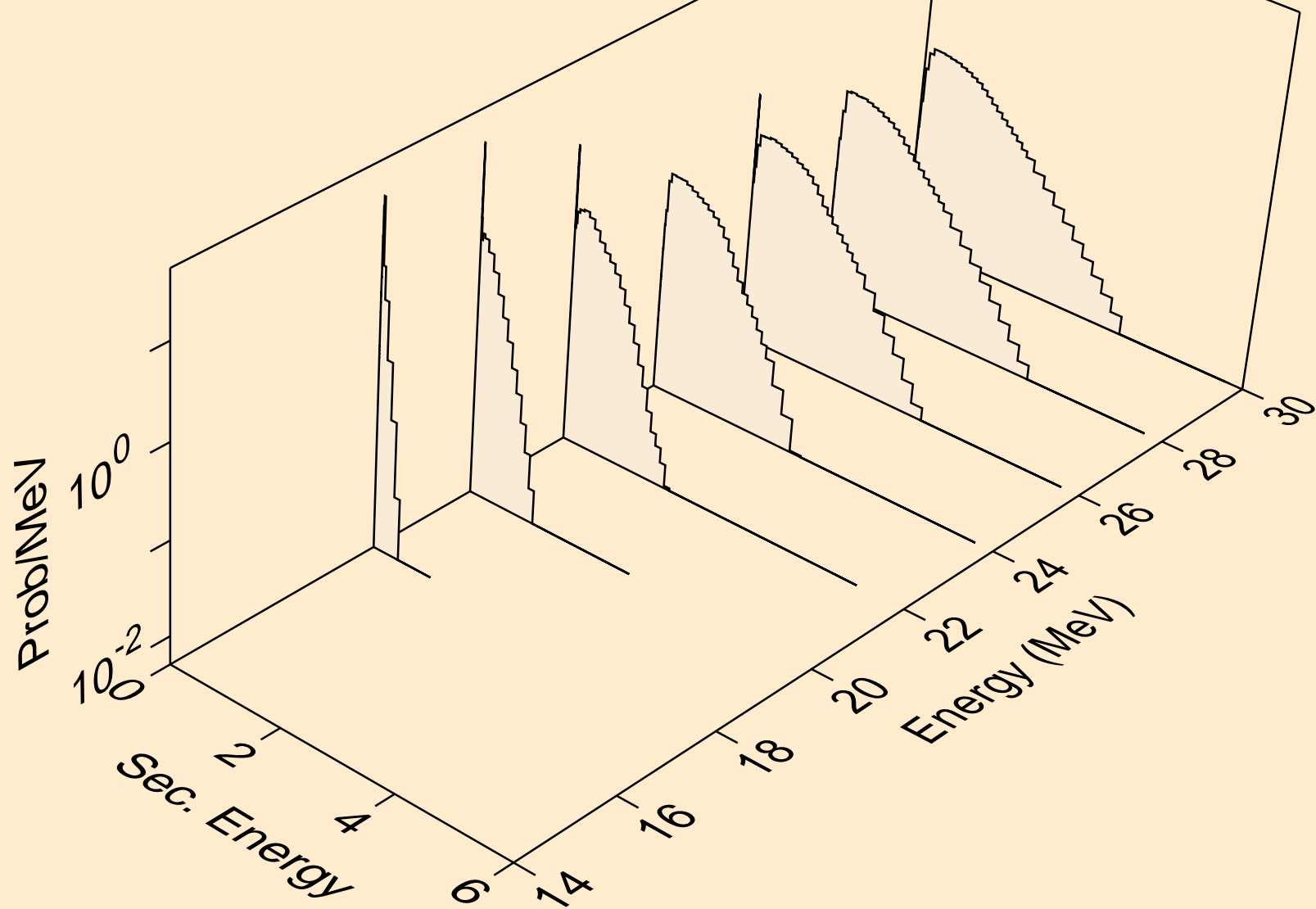

SN128M NEUTRON ACER TENDL-2023 LIBRARY; T=0.K
Neutron emission for (n,4n)

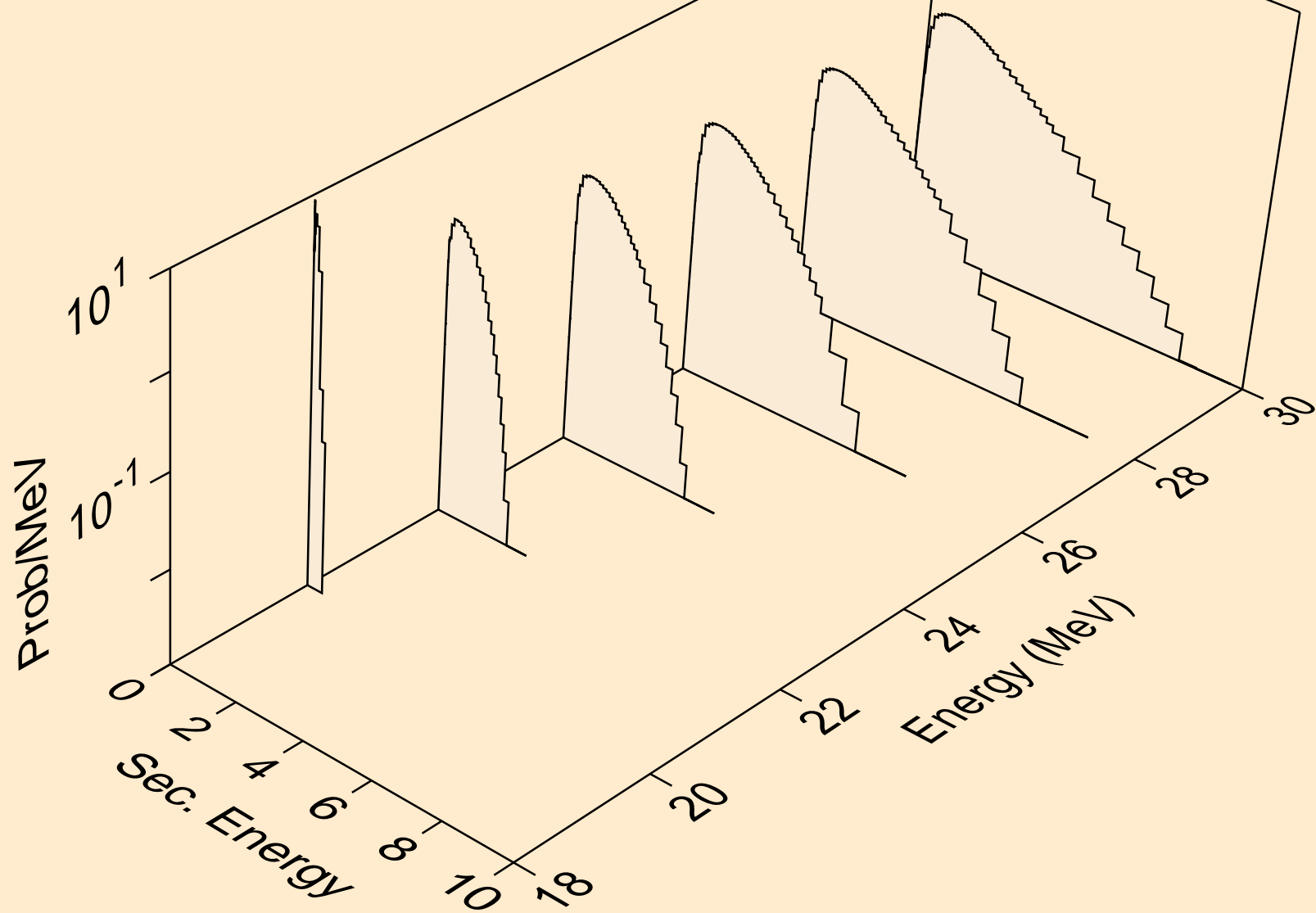

SN128M NEUTRON ACER TENDL-2023 LIBRARY; T=0.K
Neutron emission for (n,2np)

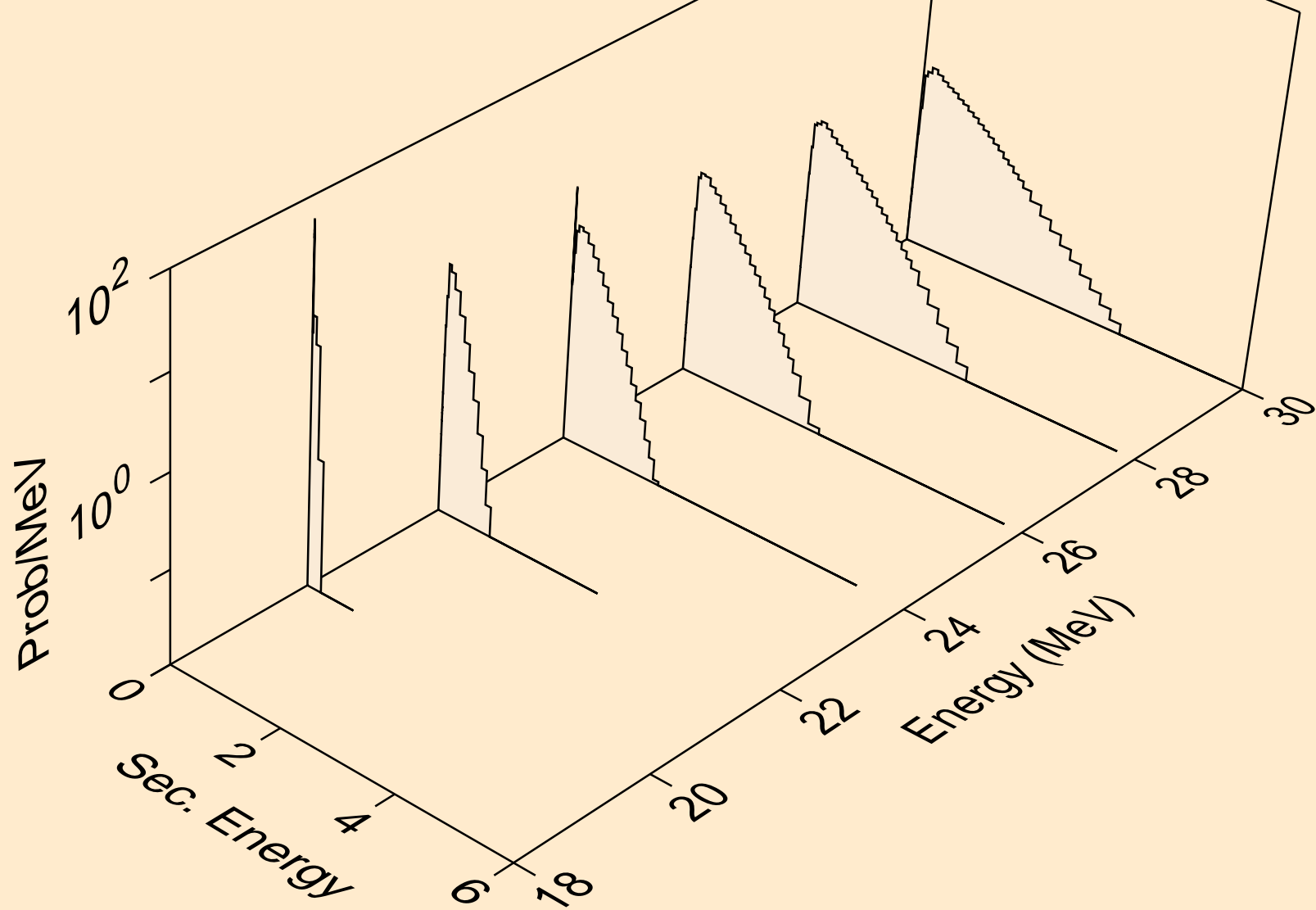

SN128M NEUTRON ACER TENDL-2023 LIBRARY; T=0.K
Neutron emission for (n,3np)

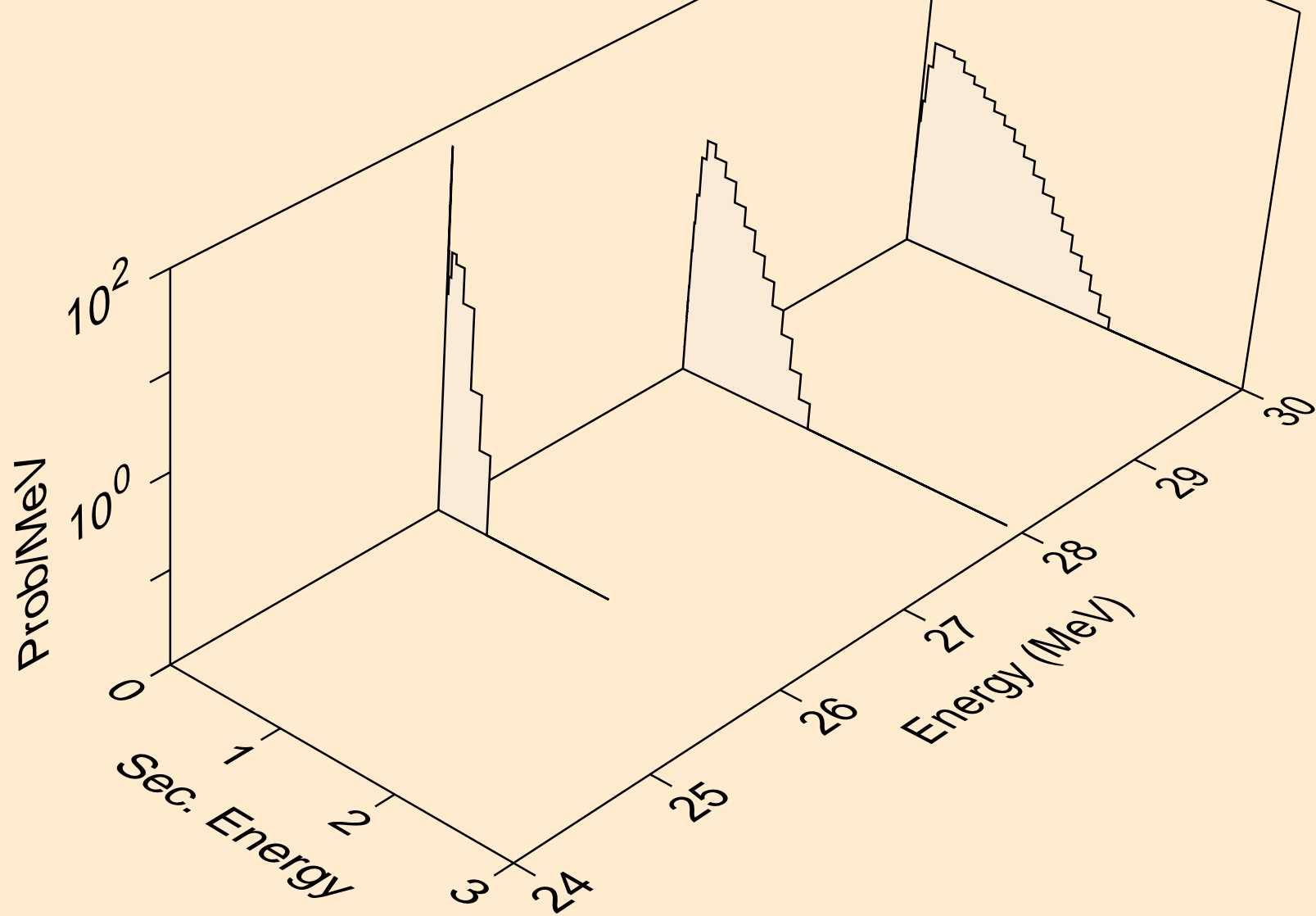

SN128M NEUTRON ACER TENDL-2023 LIBRARY; T=0.K
Neutron emission for (n,n*c)

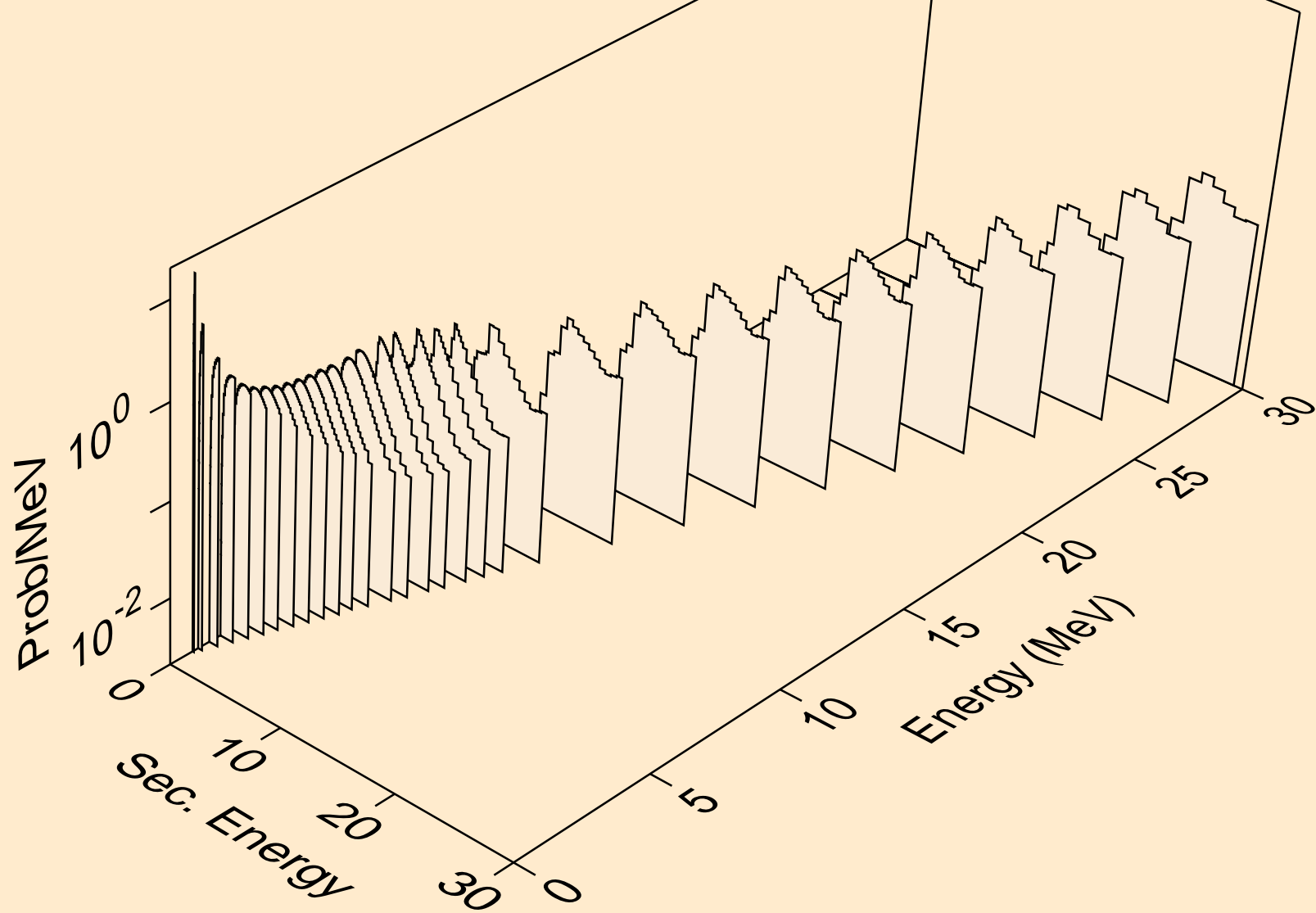

SN128M NEUTRON ACER TENDL-2023 LIBRARY; T=0.K
Photon emission for (n,x)

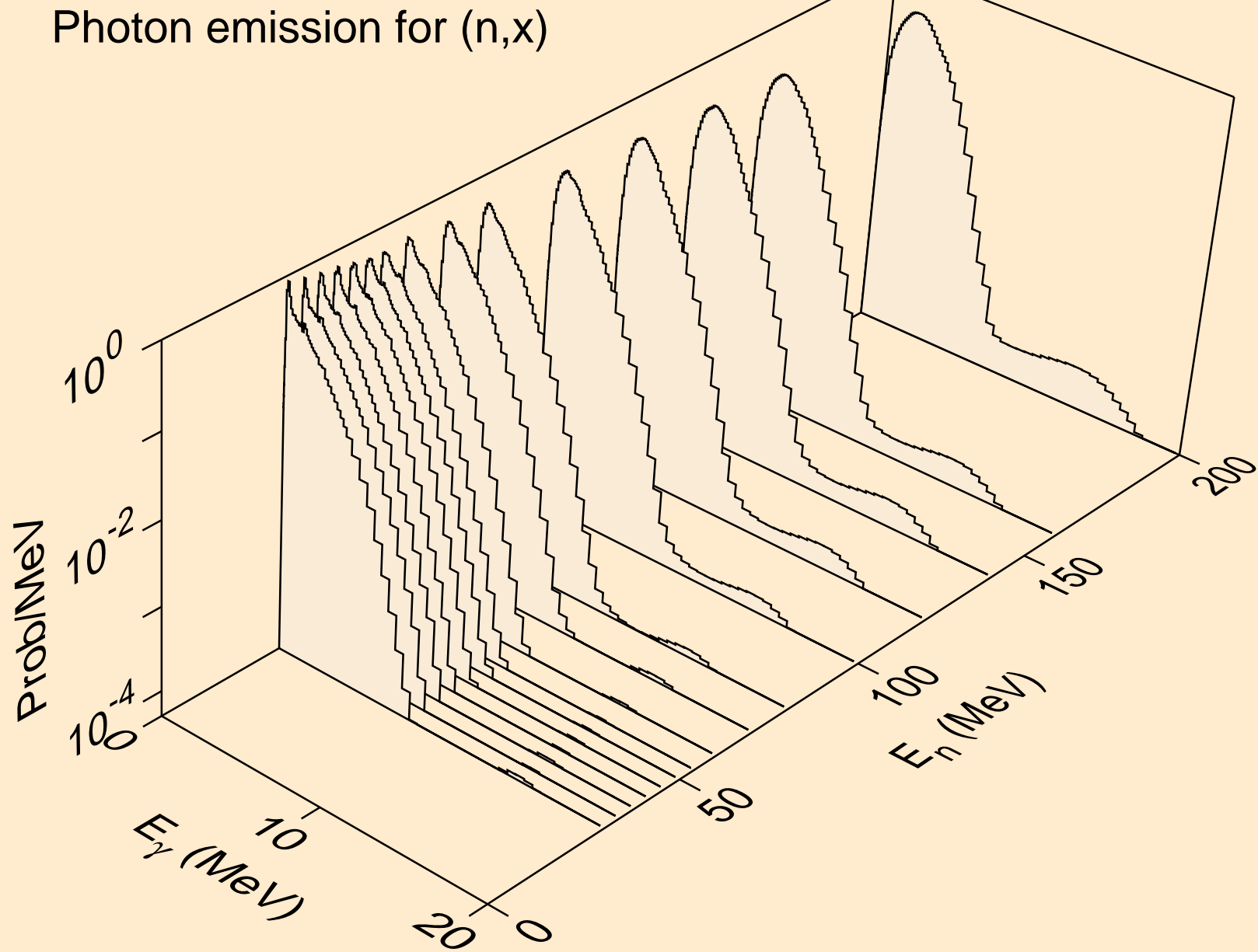

SN128M NEUTRON ACER TENDL-2023 LIBRARY; T=0.K
Photon emission for (n,2nd)

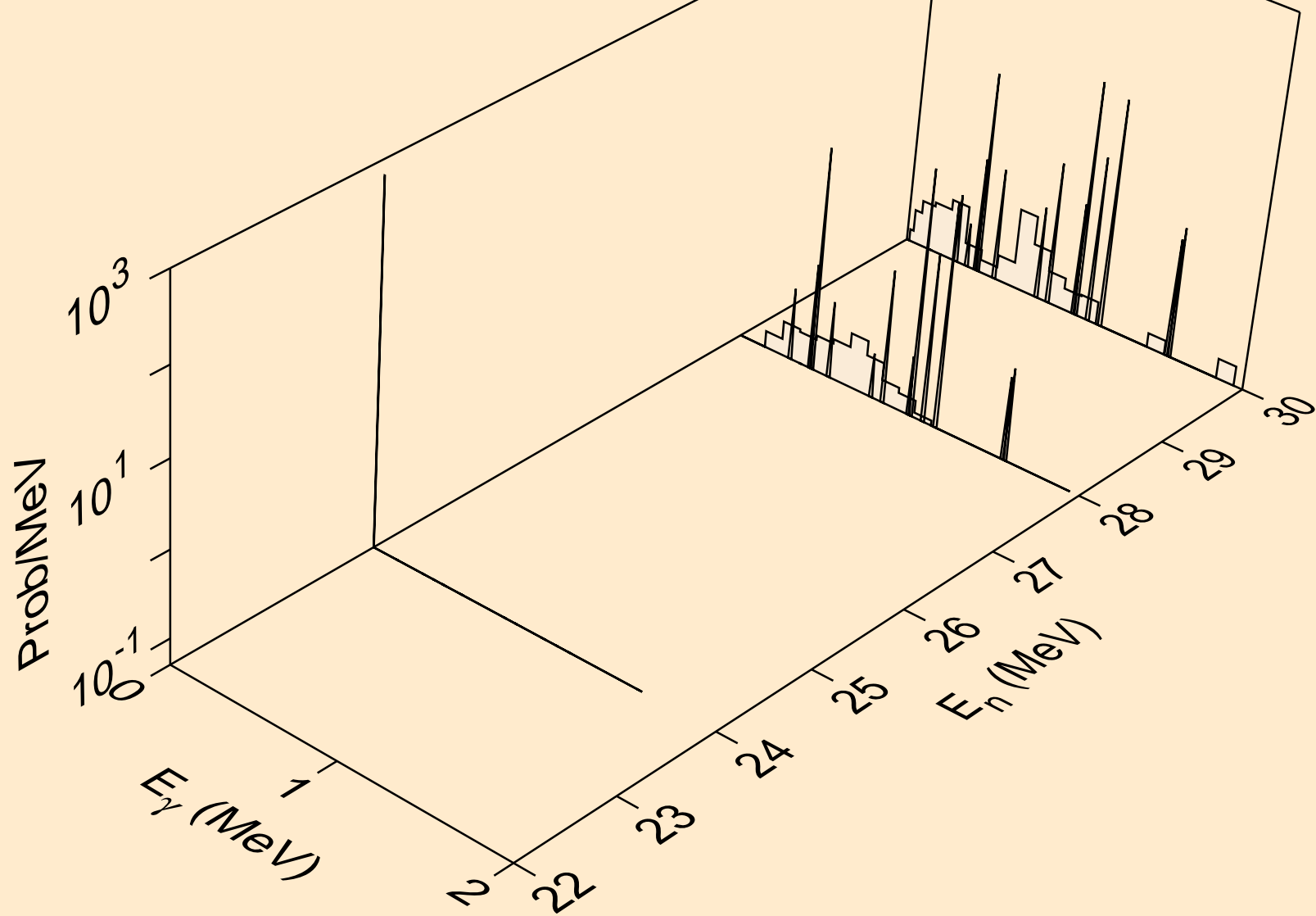

SN128M NEUTRON ACER TENDL-2023 LIBRARY; T=0.K
Photon emission for (n,2n)

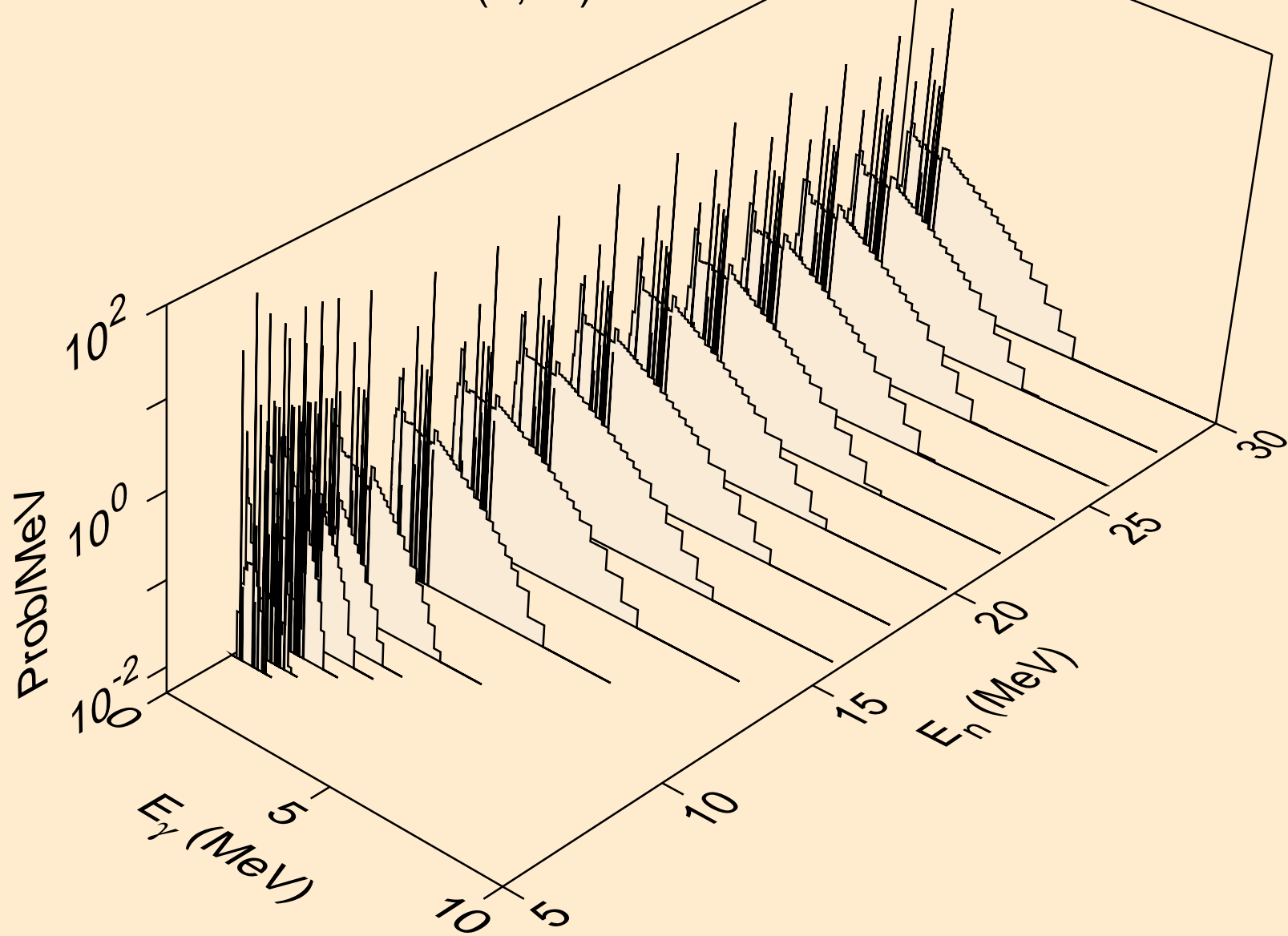

SN128M NEUTRON ACER TENDL-2023 LIBRARY; T=0.K
Photon emission for (n,3n)

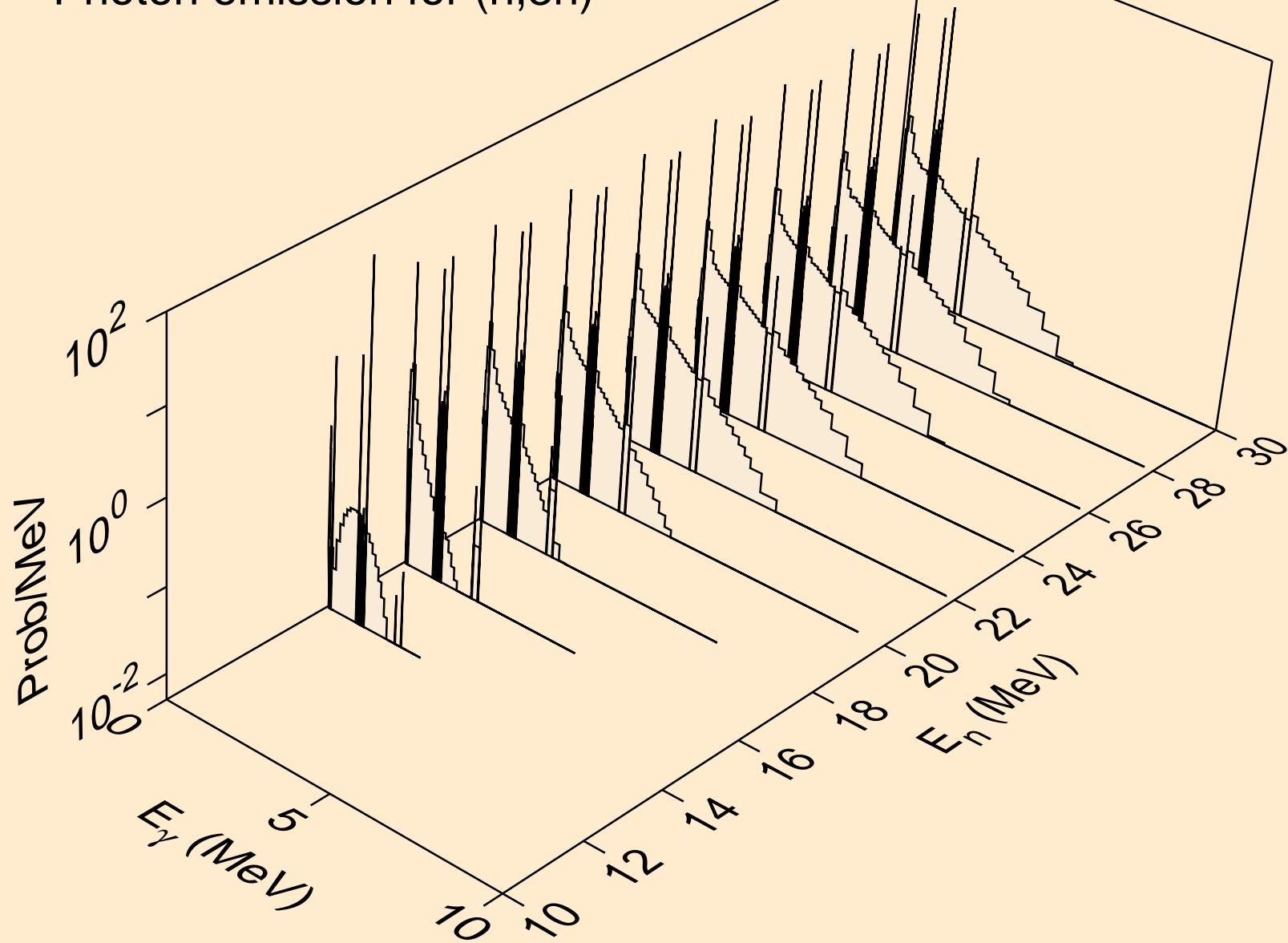

SN128M NEUTRON ACER TENDL-2023 LIBRARY; T=0.K
Photon emission for (n,n*)a

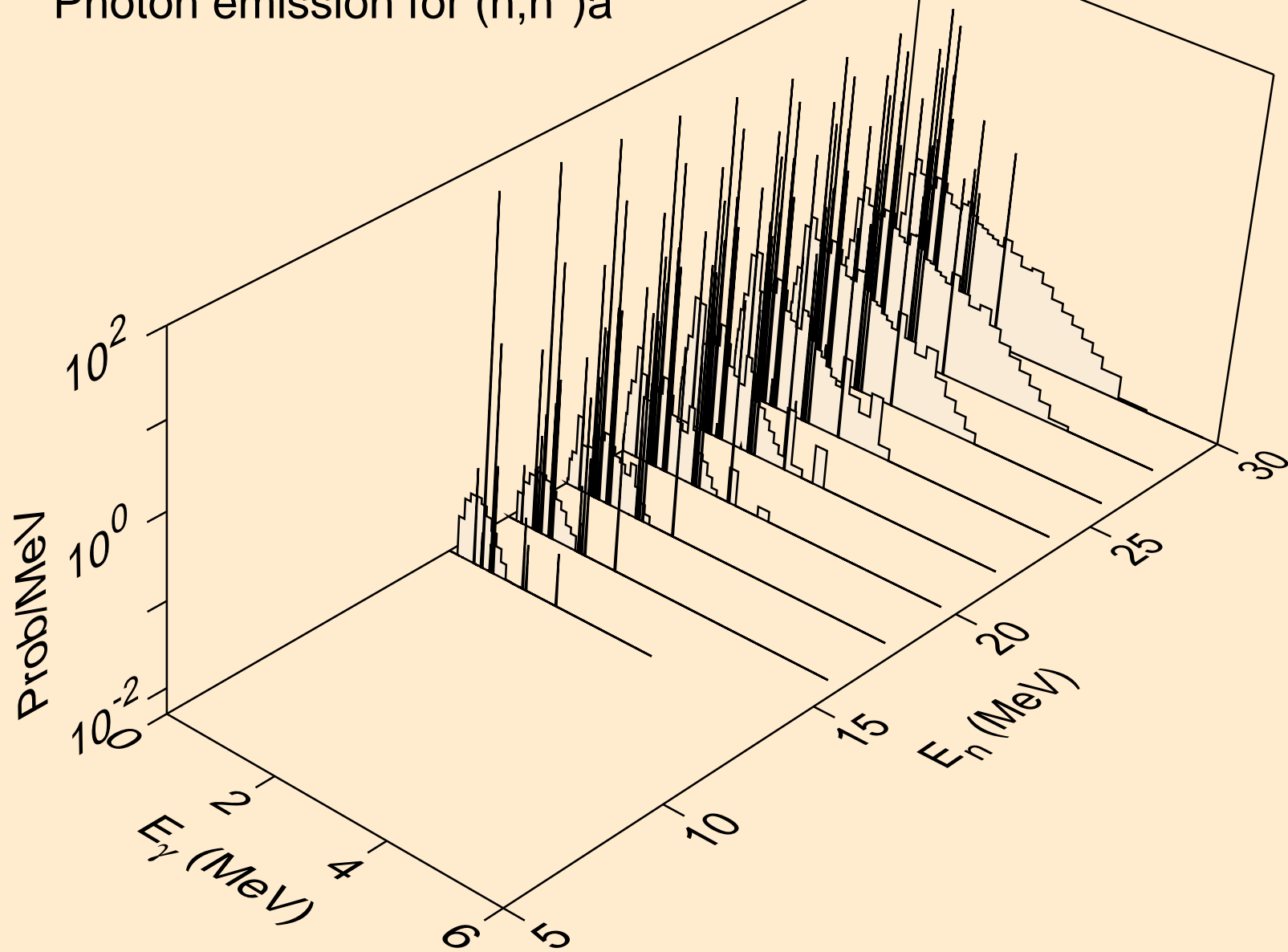

SN128M NEUTRON ACER TENDL-2023 LIBRARY; T=0.K
Photon emission for (n,2n)a

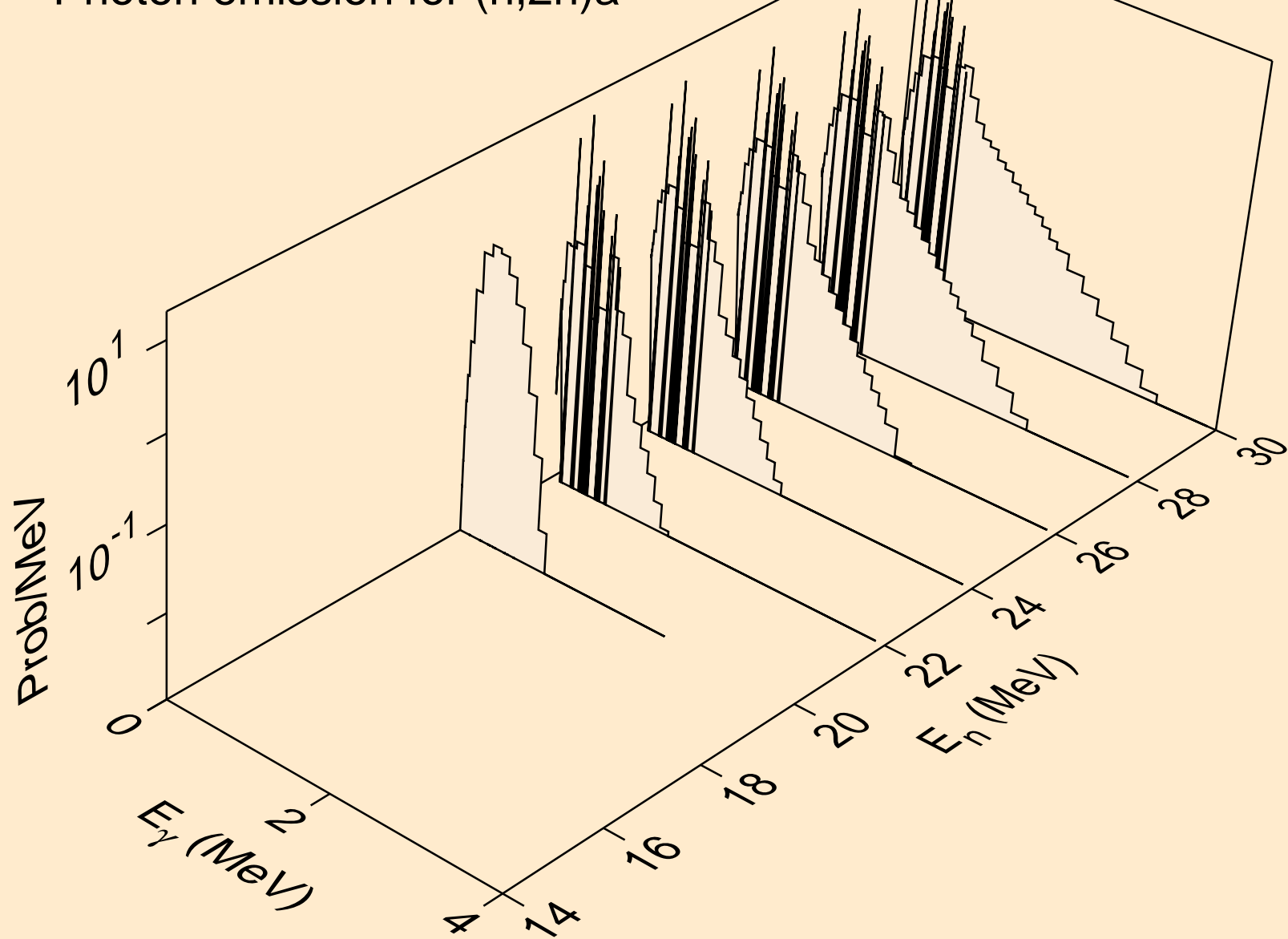

SN128M NEUTRON ACER TENDL-2023 LIBRARY; T=0.K
Photon emission for (n,3n)a

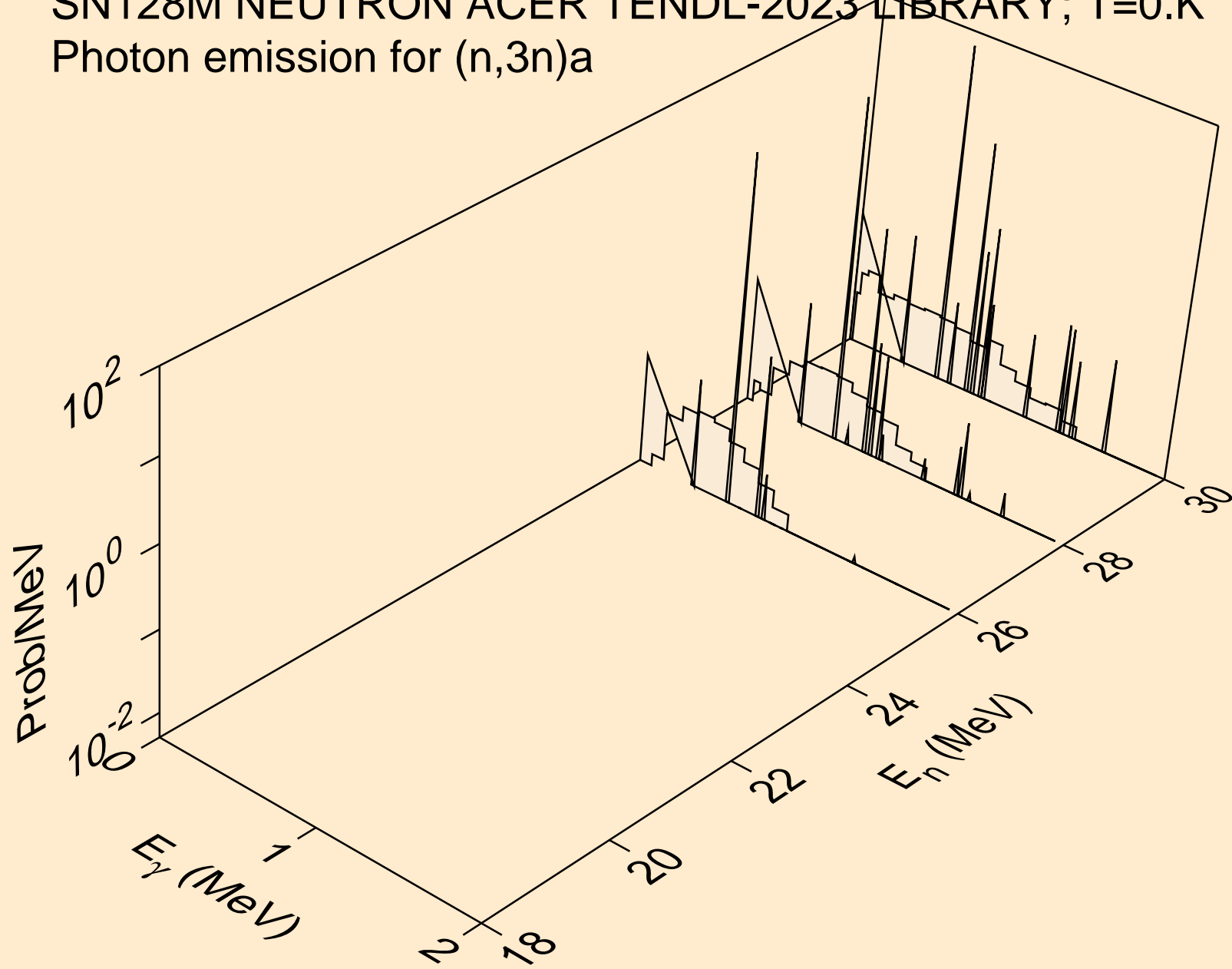

SN128M NEUTRON ACER TENDL-2023 LIBRARY; T=0.K
Photon emission for (n,n*)p

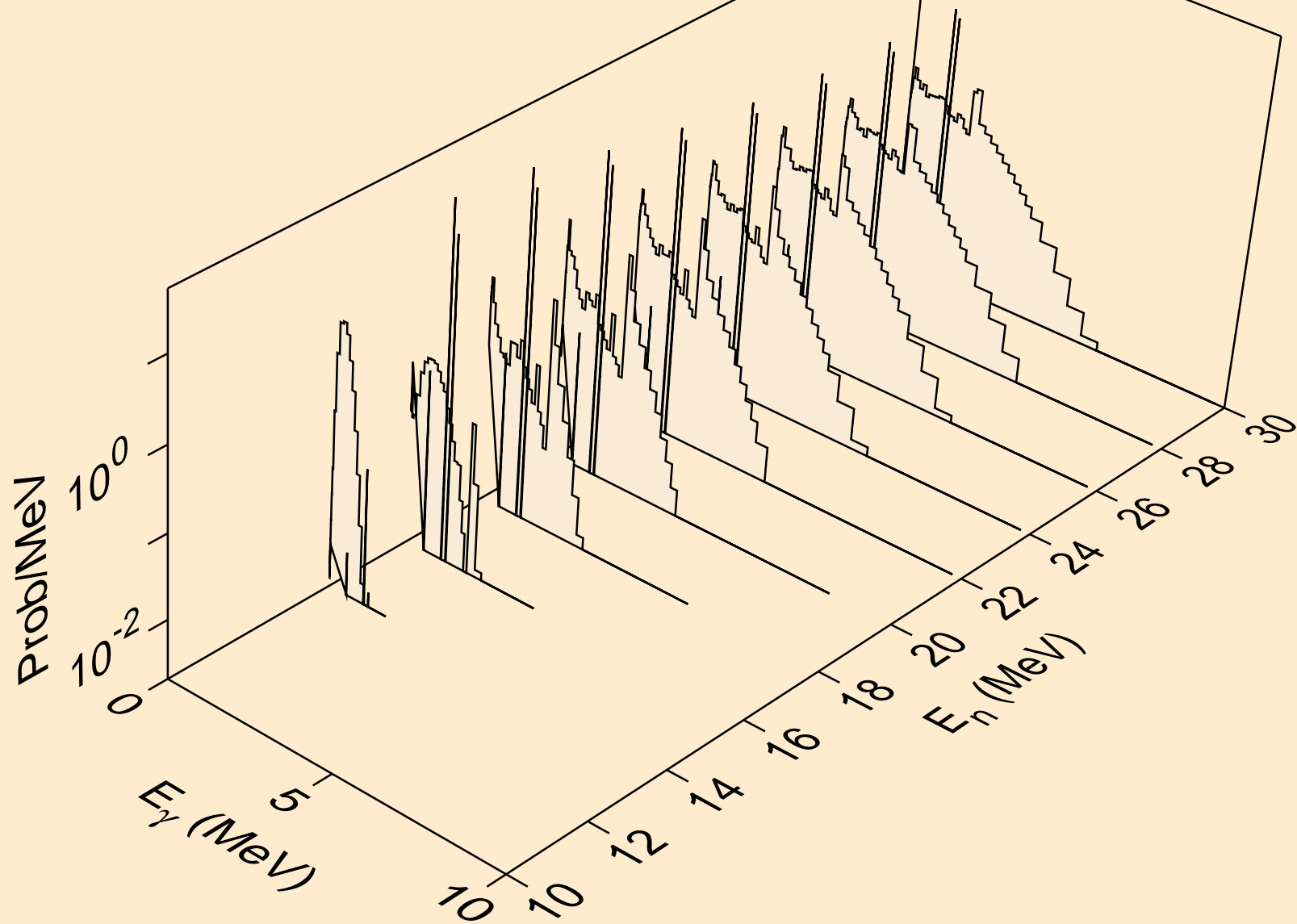

SN128M NEUTRON ACER TENDL-2023 LIBRARY; T=0.K
Photon emission for (n,n*)d

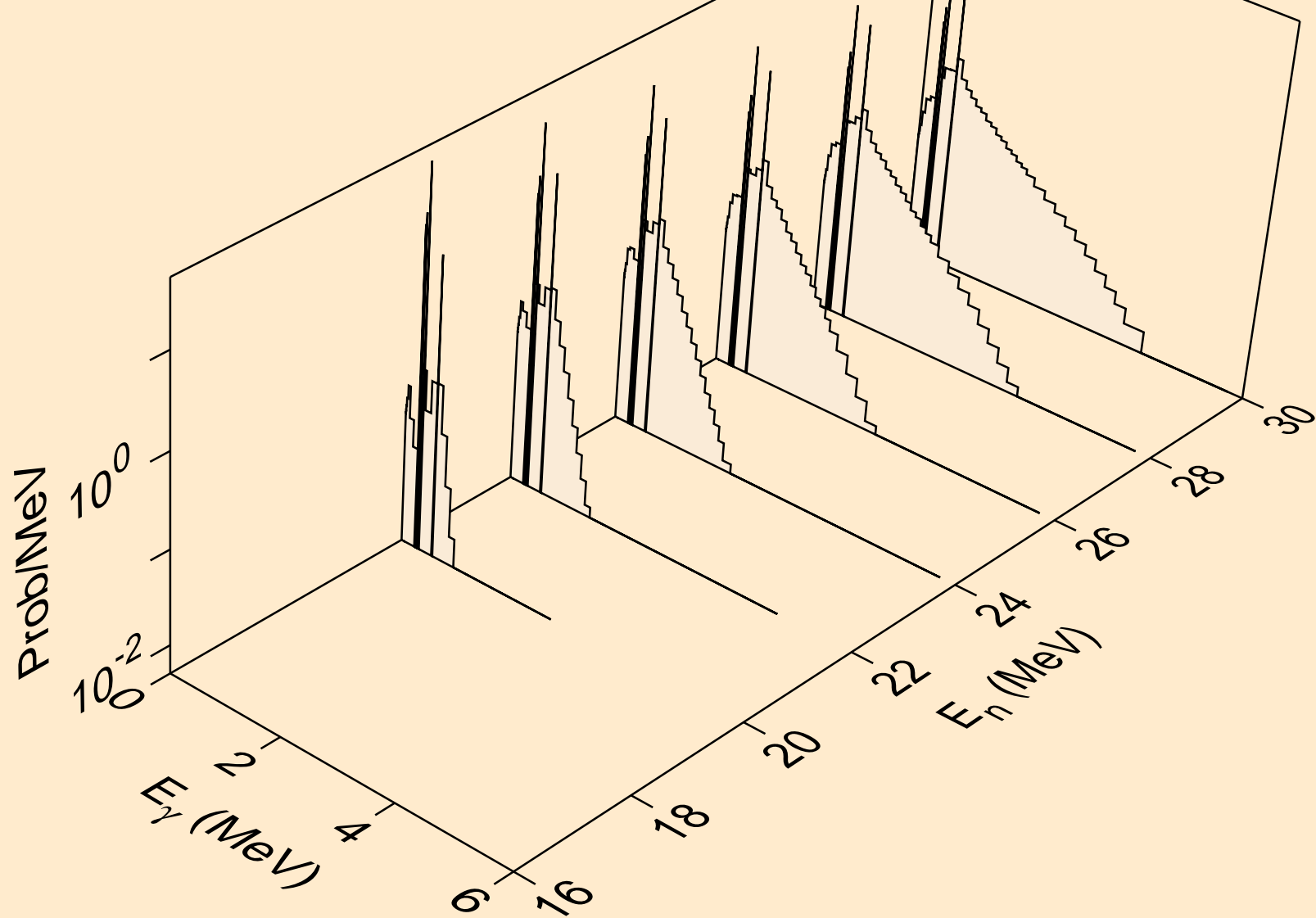

SN128M NEUTRON ACER TENDL-2023 LIBRARY; T=0.K
Photon emission for (n,n*)t

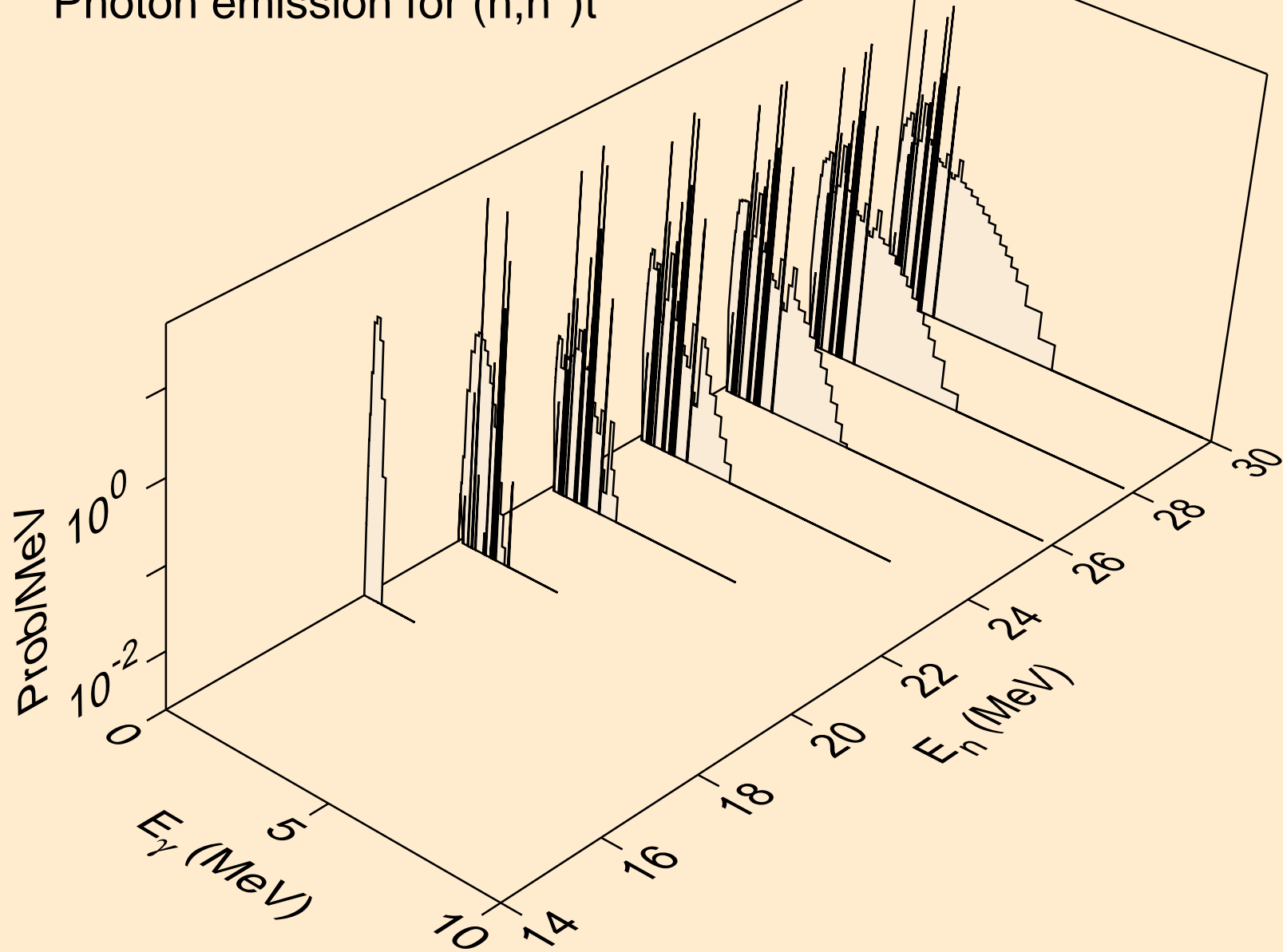

SN128M NEUTRON ACER TENDL-2023 LIBRARY; T=0.K
Photon emission for (n,4n)

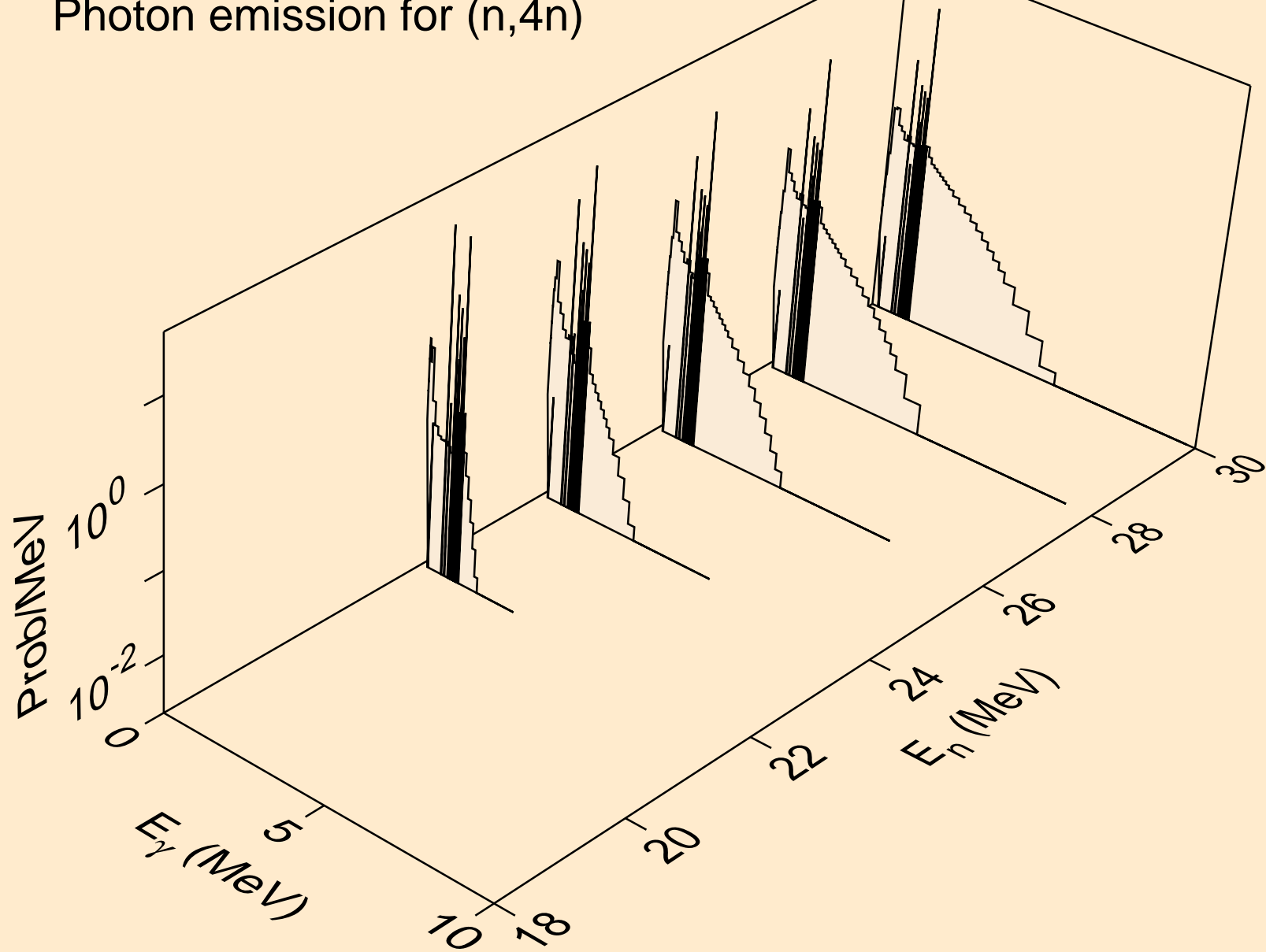

SN128M NEUTRON ACER TENDL-2023 LIBRARY; T=0.K
Photon emission for (n,2np)

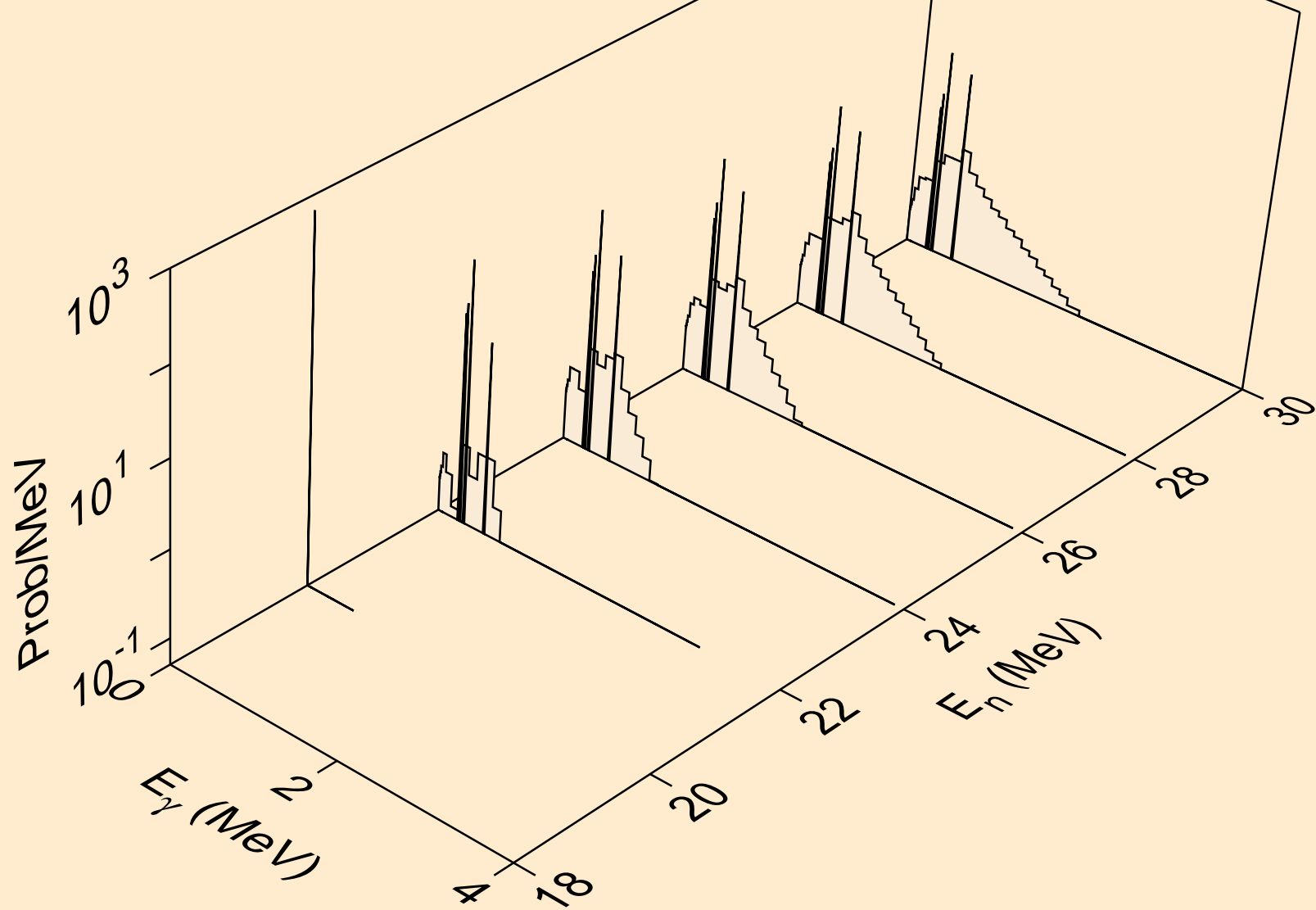

SN128M NEUTRON ACER TENDL-2023 LIBRARY; T=0.K
Photon emission for (n,3np)

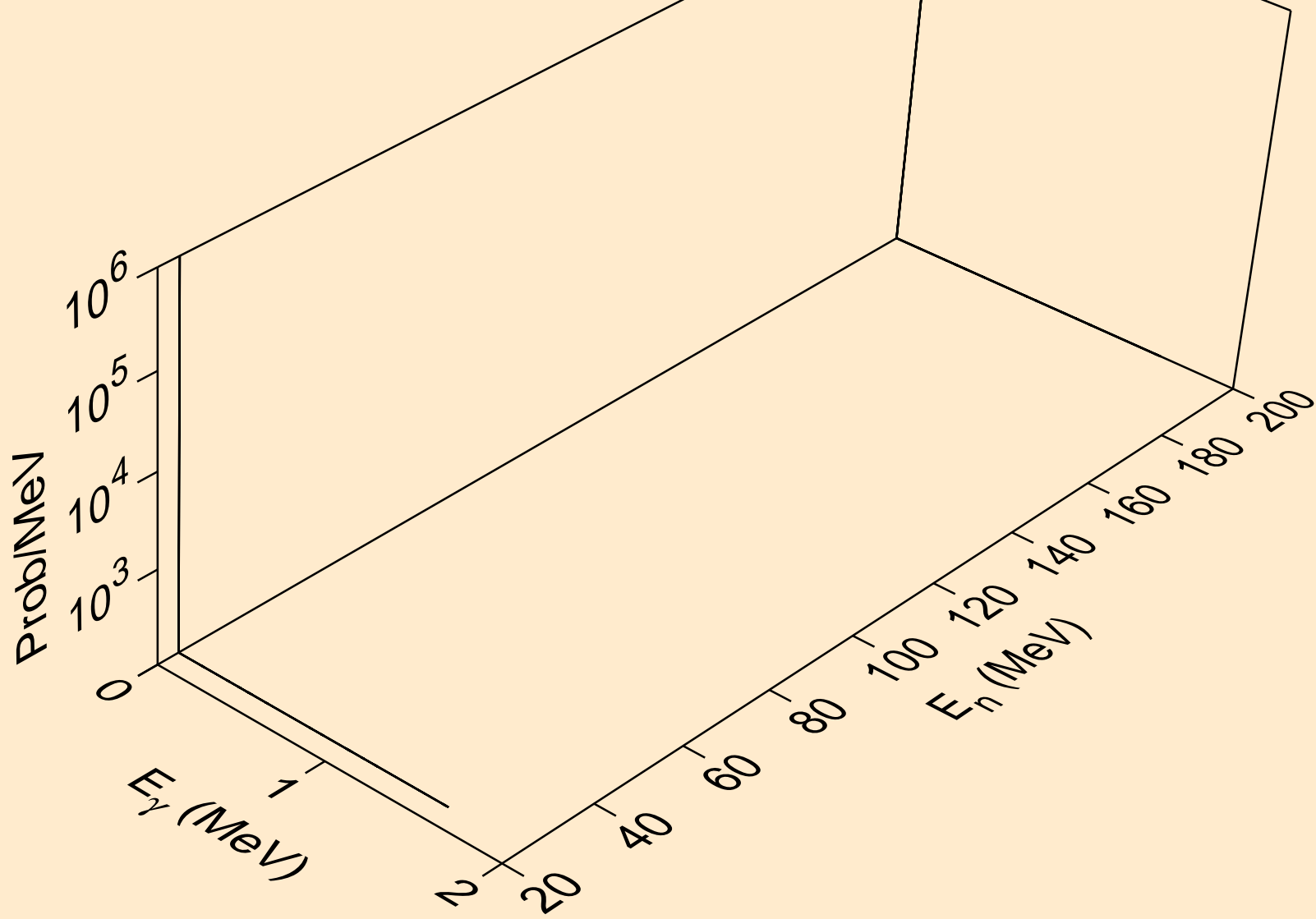

SN128M NEUTRON ACER TENDL-2023 LIBRARY; T=0.K
Photon emission for (n,n*1)

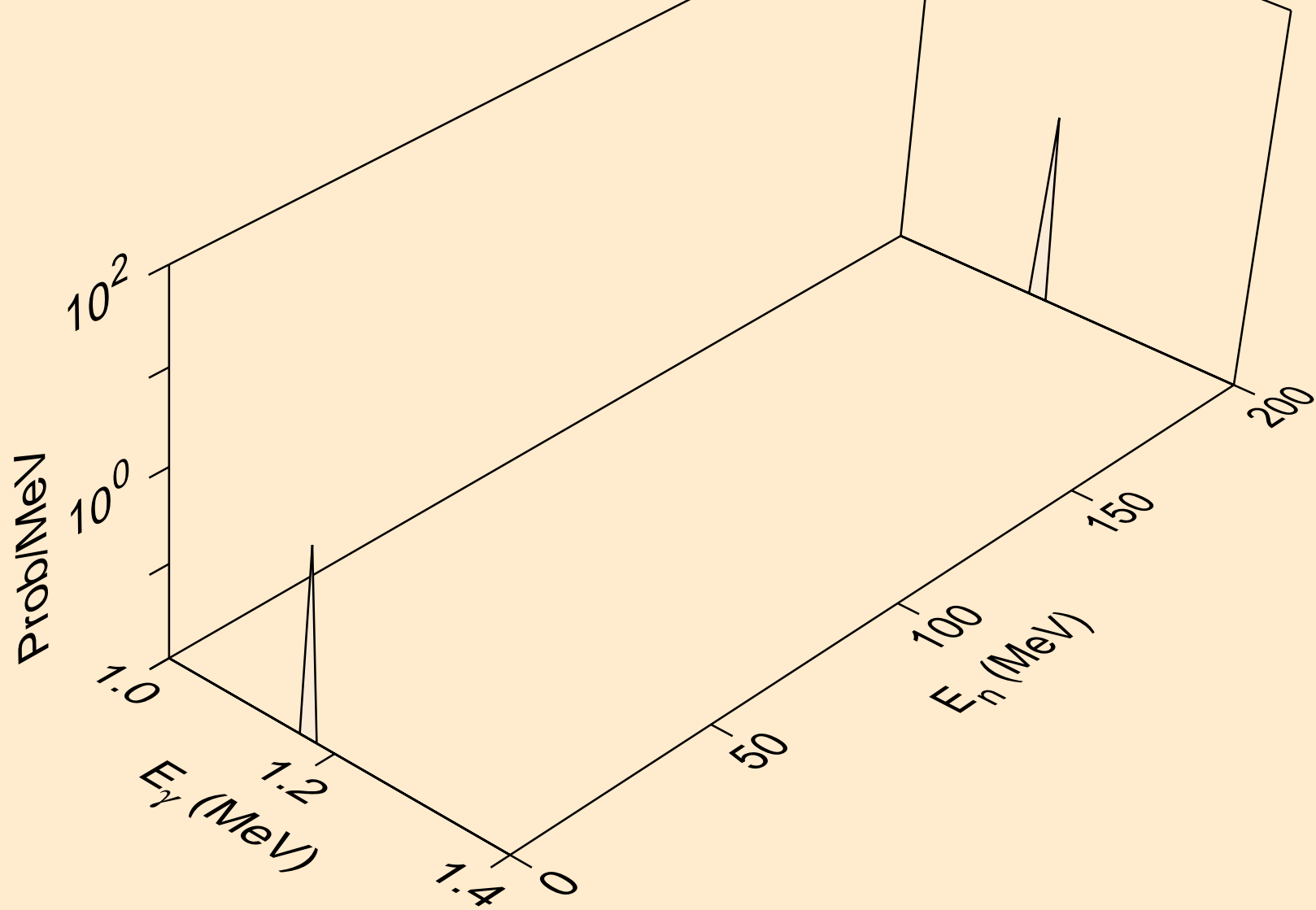

SN128M NEUTRON ACER TENDL-2023 LIBRARY; T=0.K
Photon emission for (n,n*2)

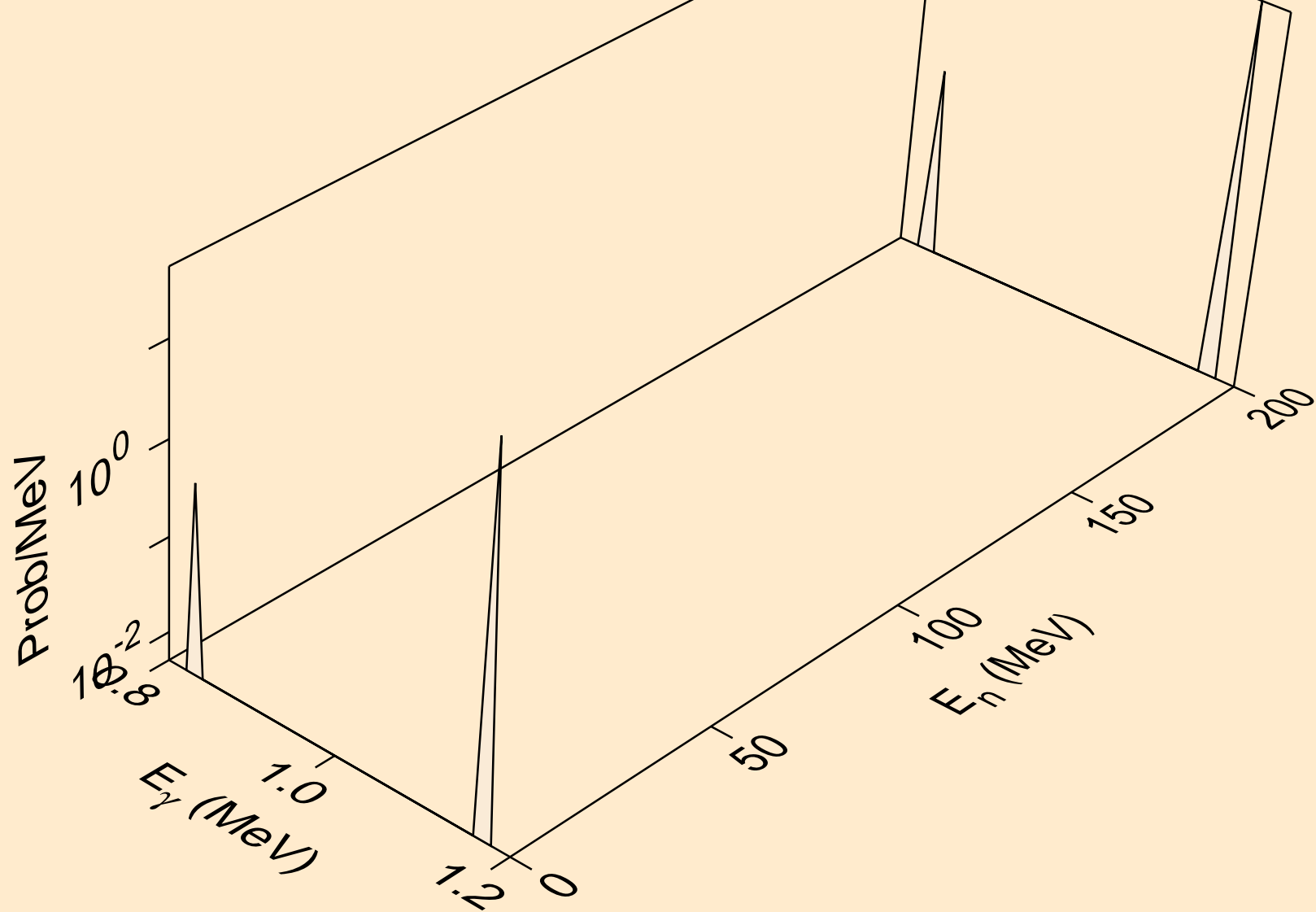

SN128M NEUTRON ACER TENDL-2023 LIBRARY; T=0.K
Photon emission for (n,n*4)

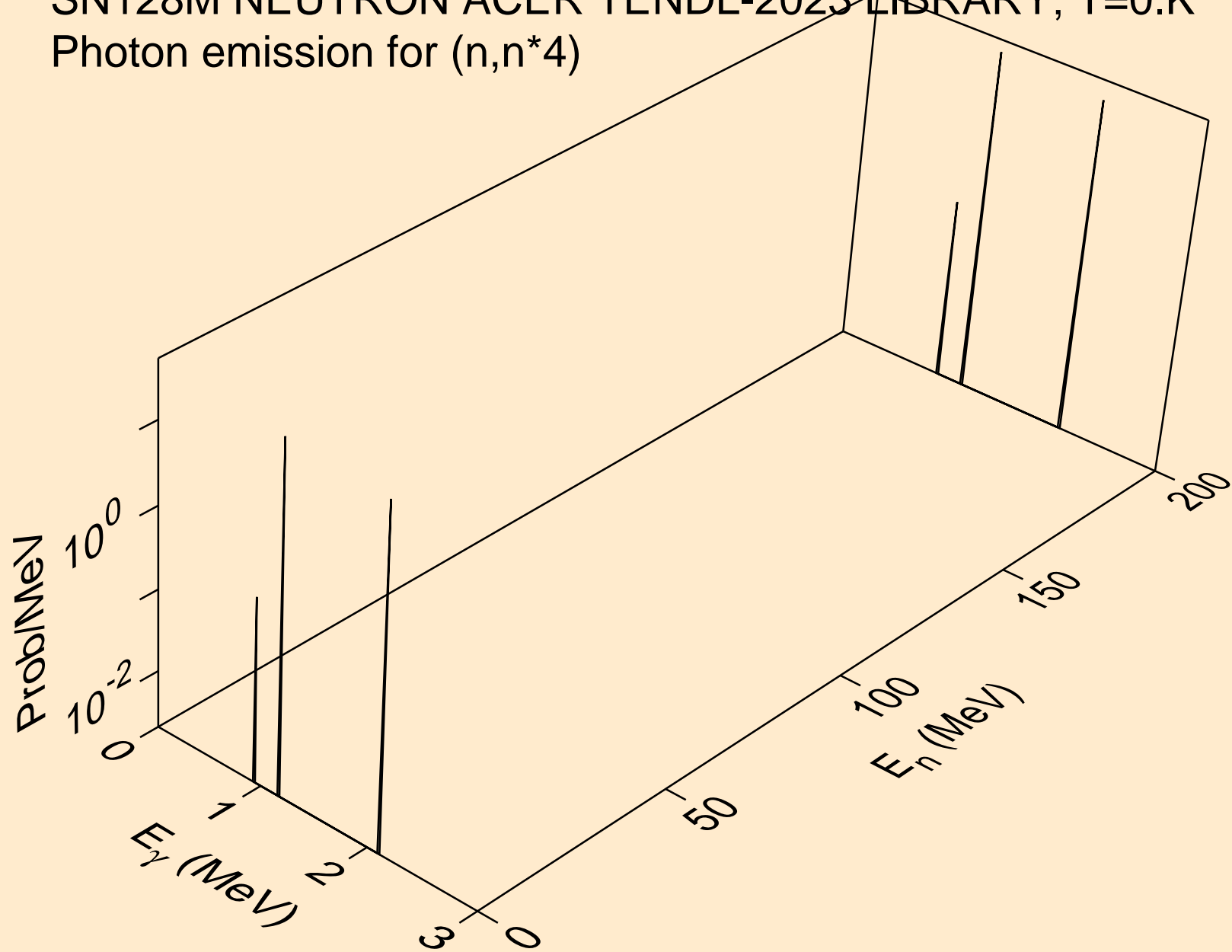

SN128M NEUTRON ACER TENDL-2023 LIBRARY; T=0.K
Photon emission for (n,n*5)

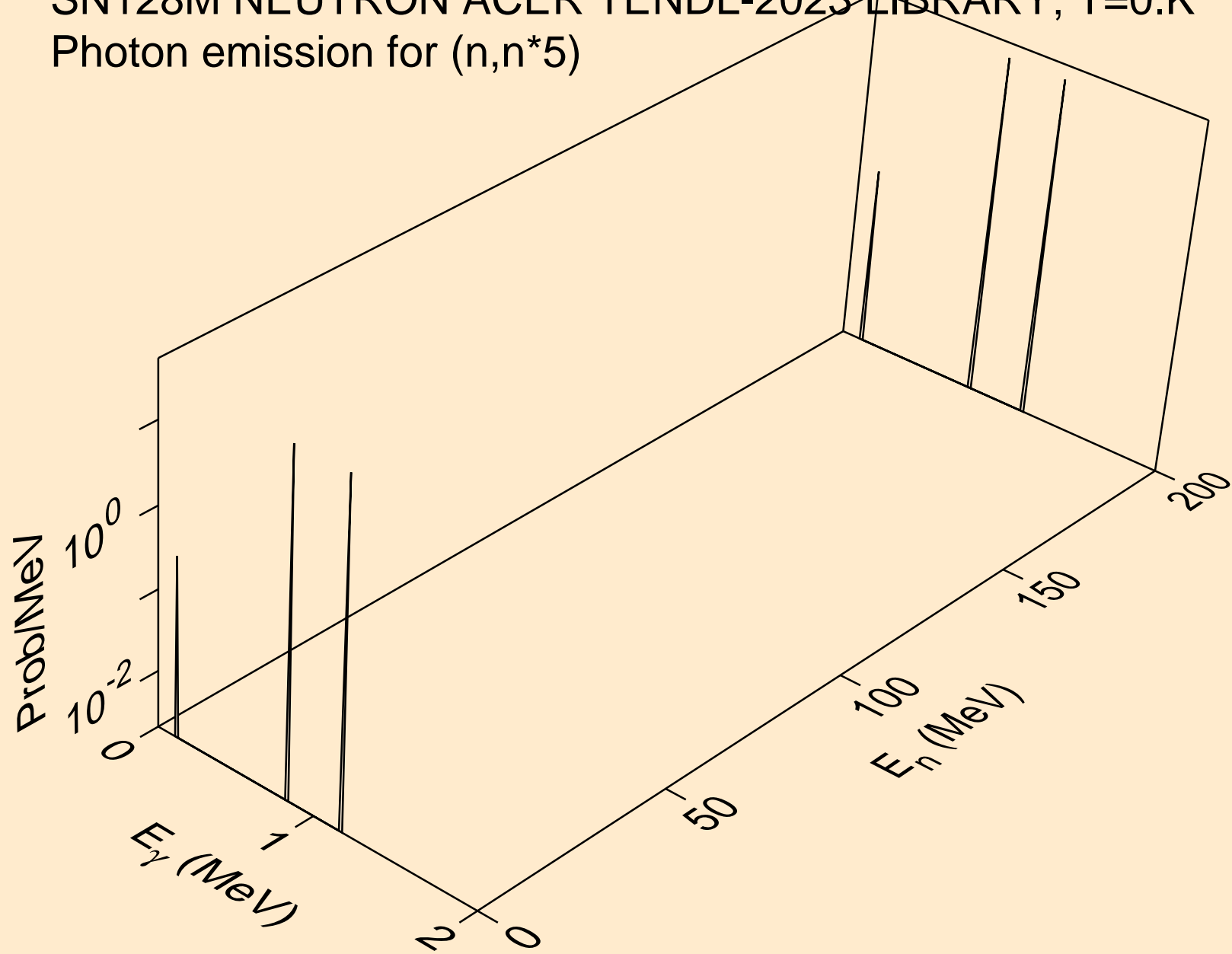

SN128M NEUTRON ACER TENDL-2023 LIBRARY; T=0.K
Photon emission for (n,n*6)

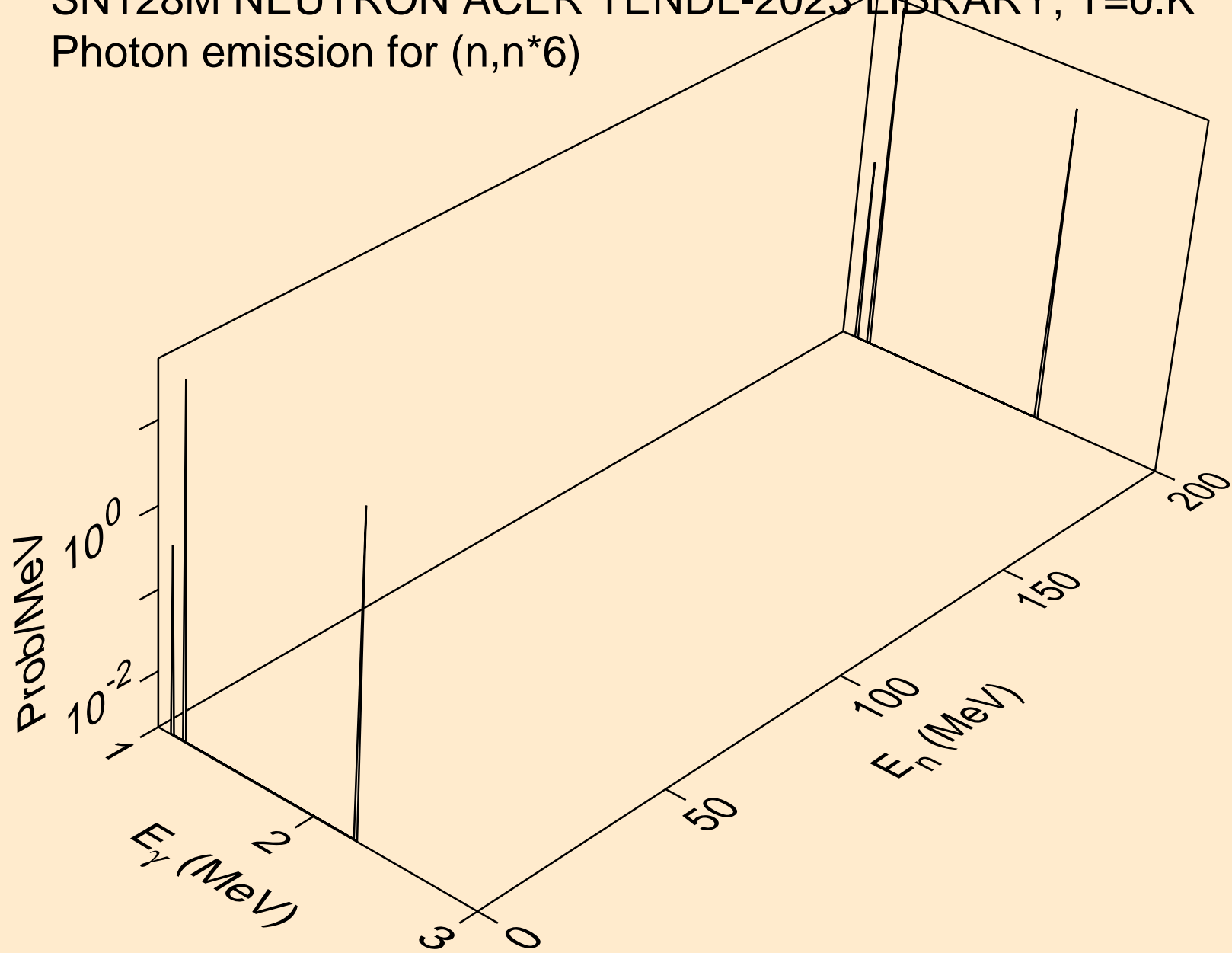

SN128M NEUTRON ACER TENDL-2023 LIBRARY; T=0.K
Photon emission for (n,n*7)

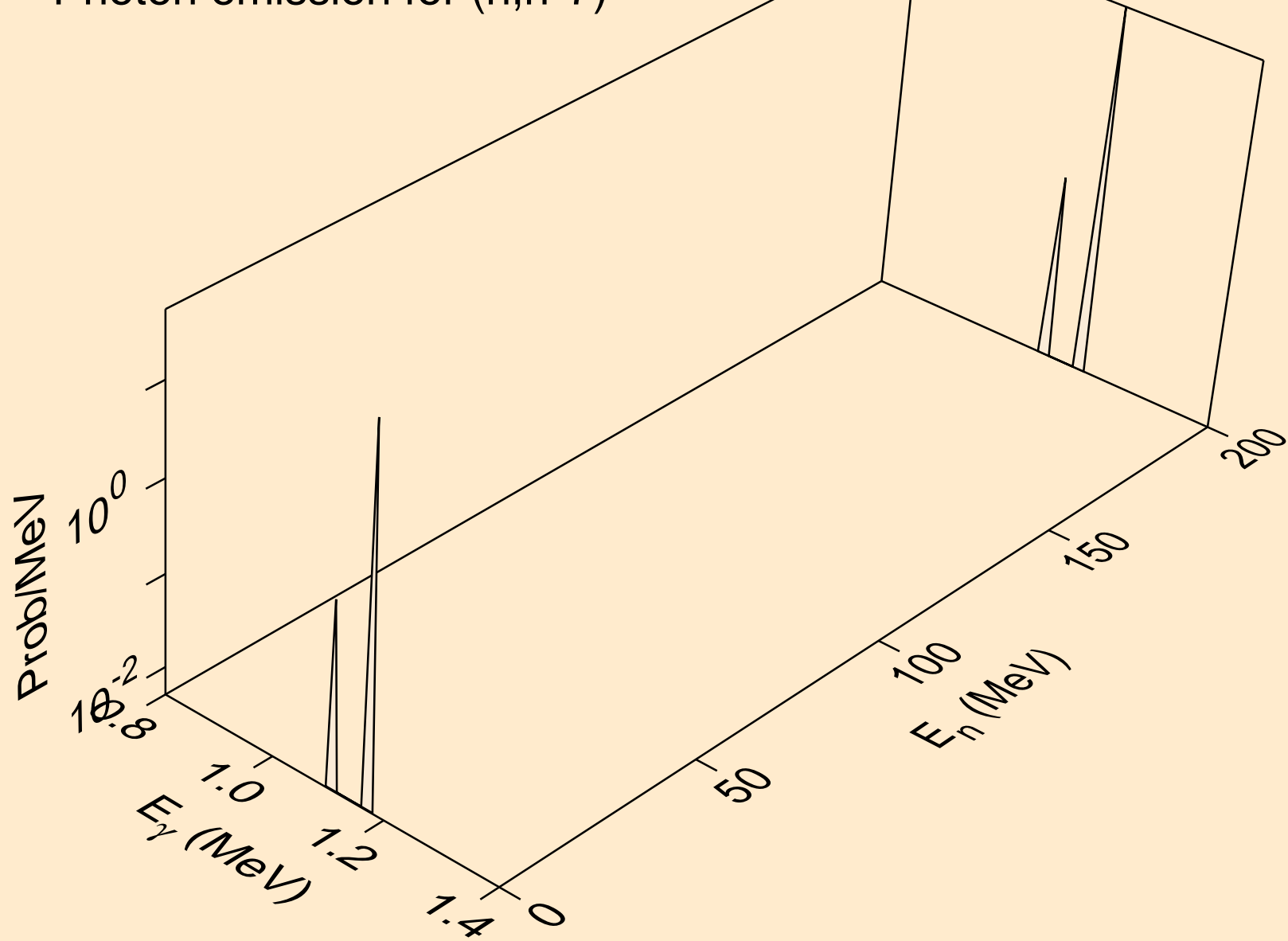

SN128M NEUTRON ACER TENDL-2023 LIBRARY; T=0.K
Photon emission for (n,n*8)

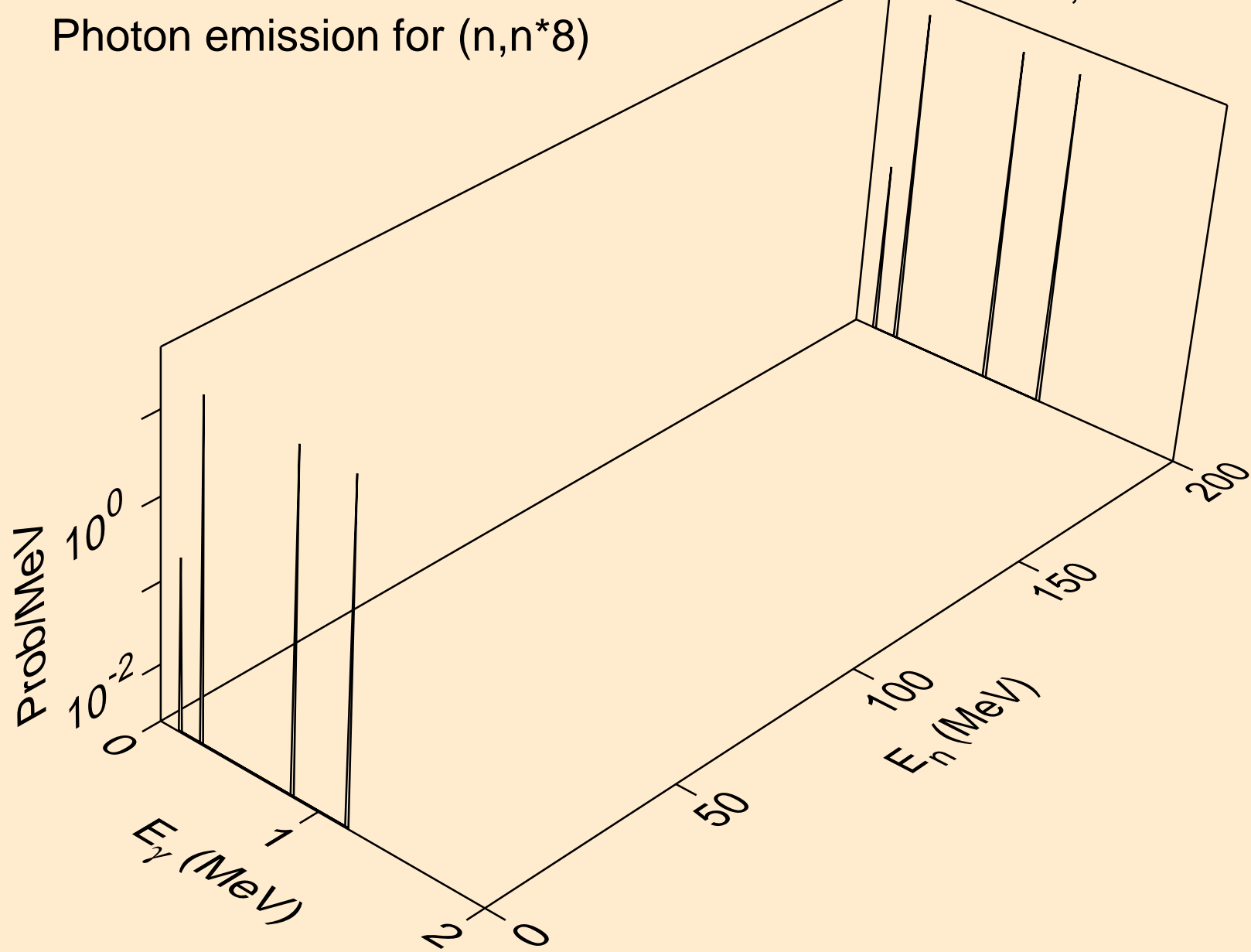

SN128M NEUTRON ACER TENDL-2023 LIBRARY; T=0.K
Photon emission for (n,n*9)

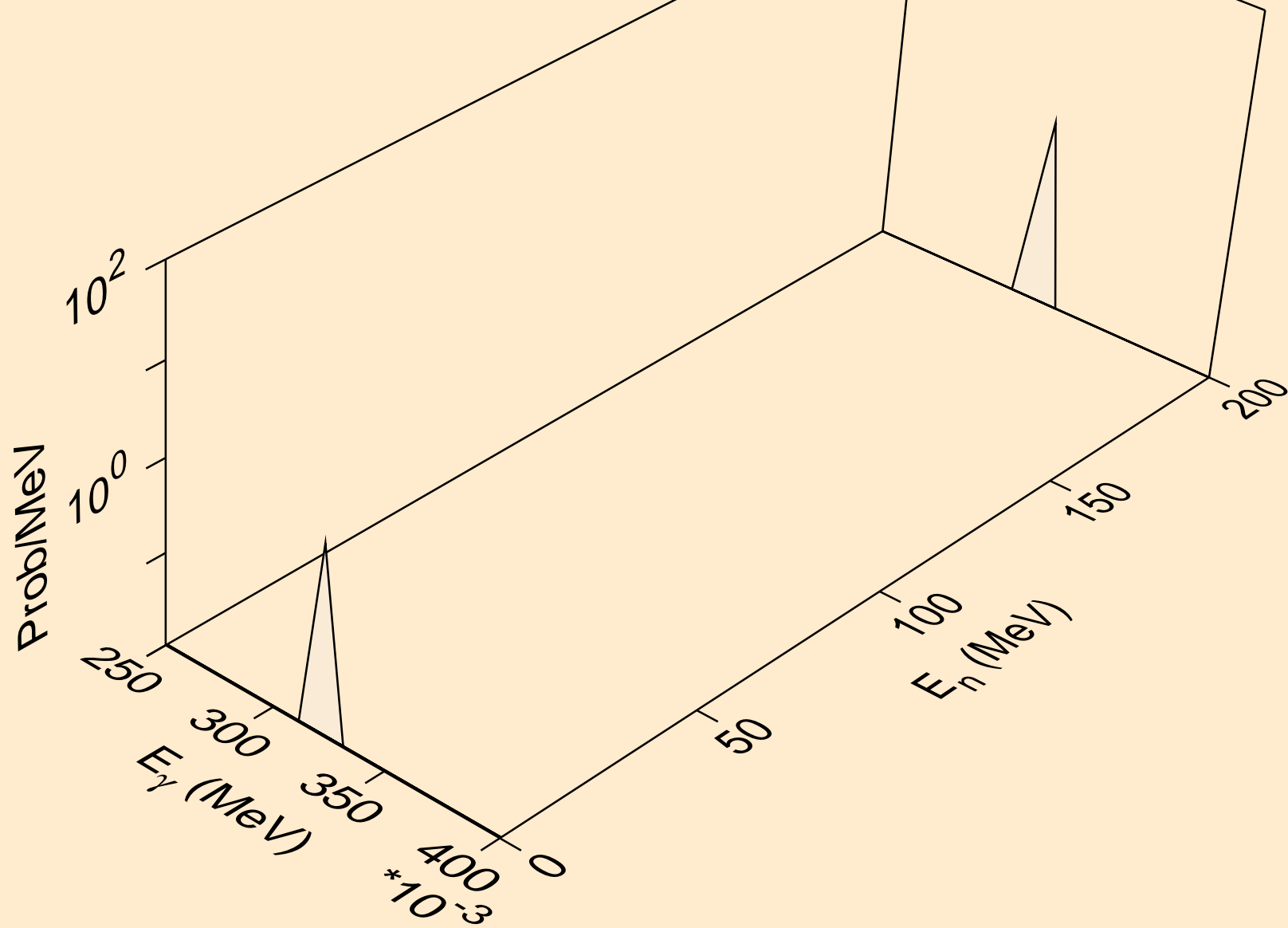

SN128M NEUTRON ACER TENDL-2023 LIBRARY; T=0.K
Photon emission for (n,n*10)

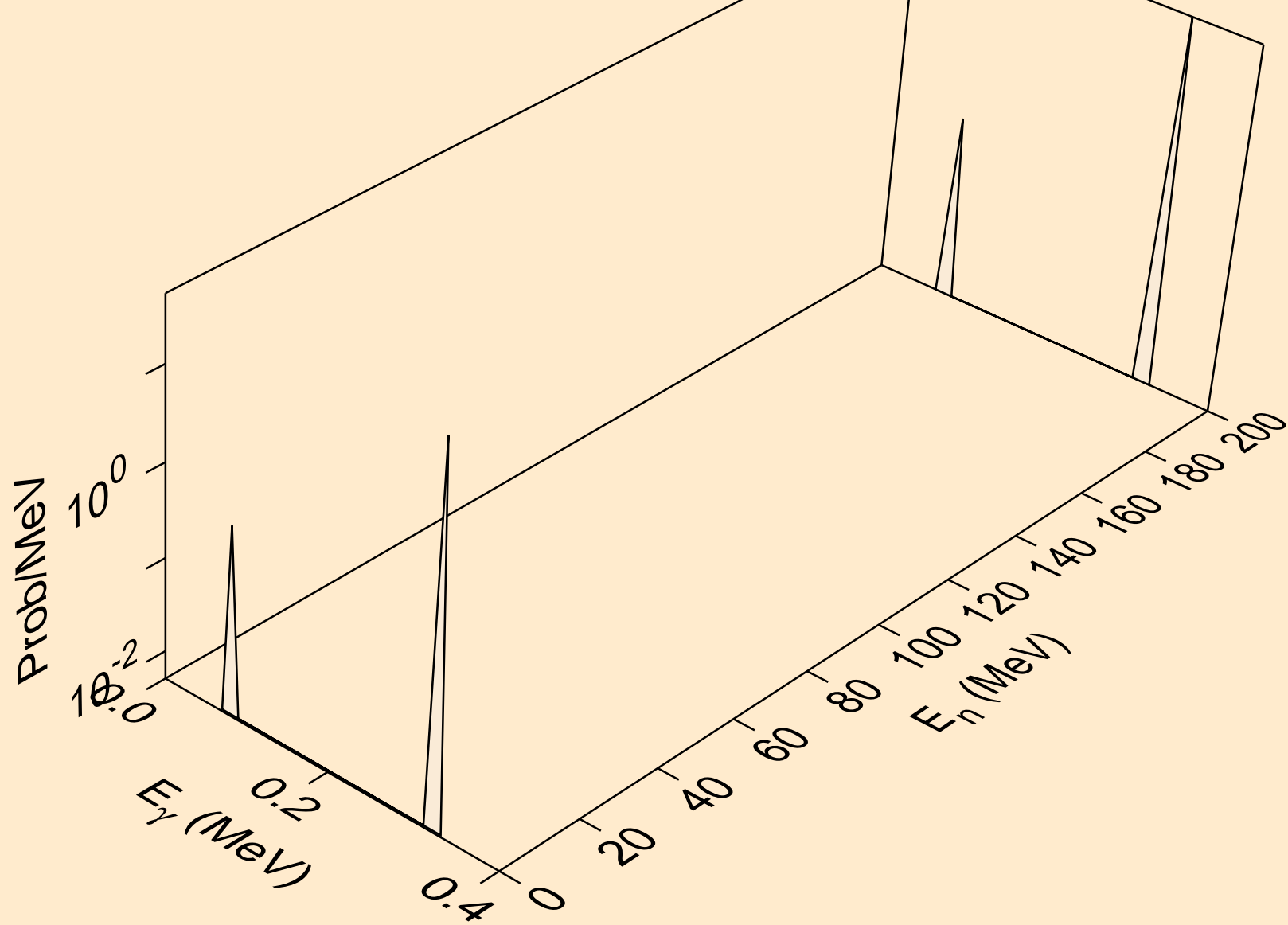

SN128M NEUTRON ACER TENDL-2023 LIBRARY; T=0.K
Photon emission for (n,n*11)

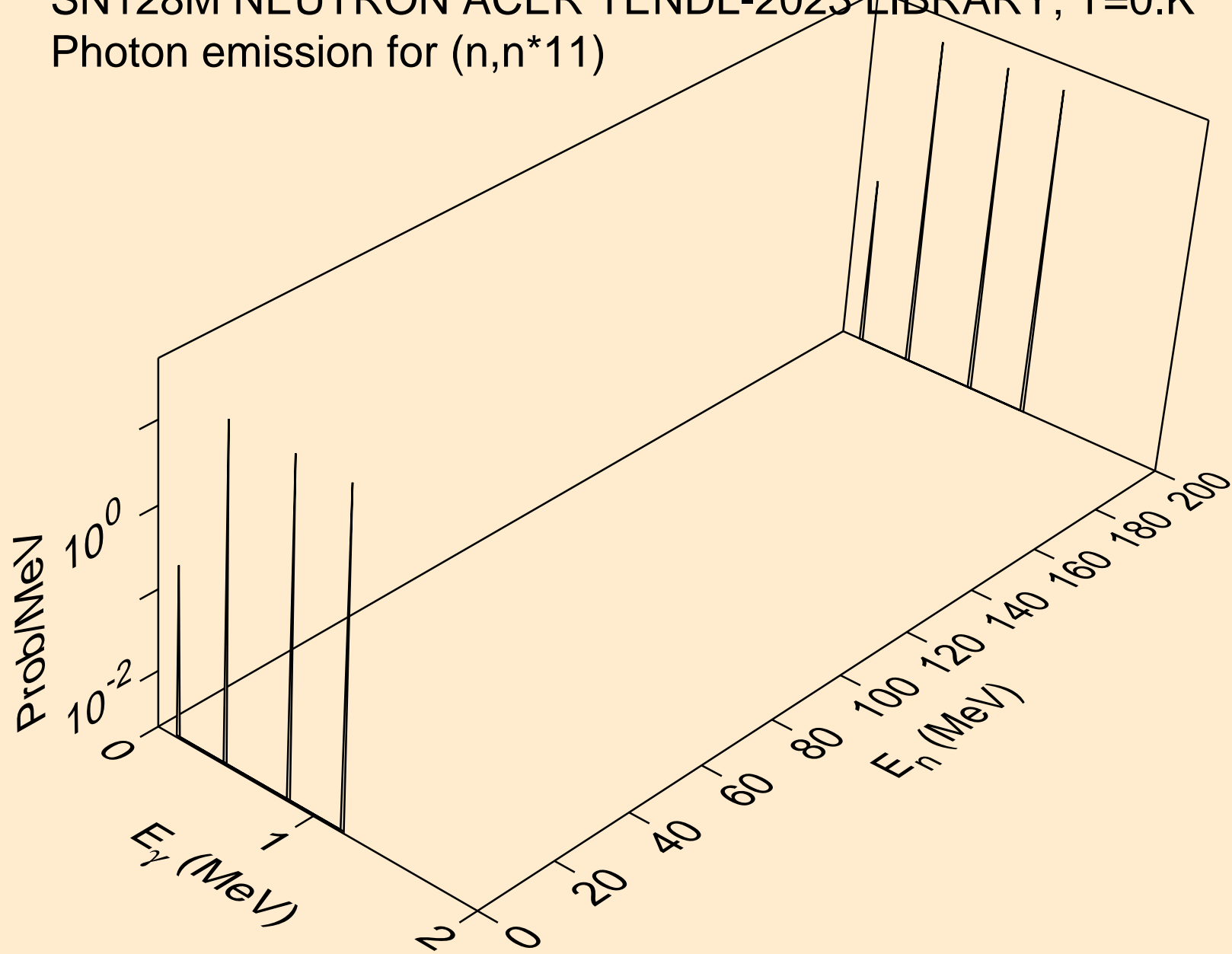

SN128M NEUTRON ACER TENDL-2023 LIBRARY; T=0.K
Photon emission for (n,n*12)

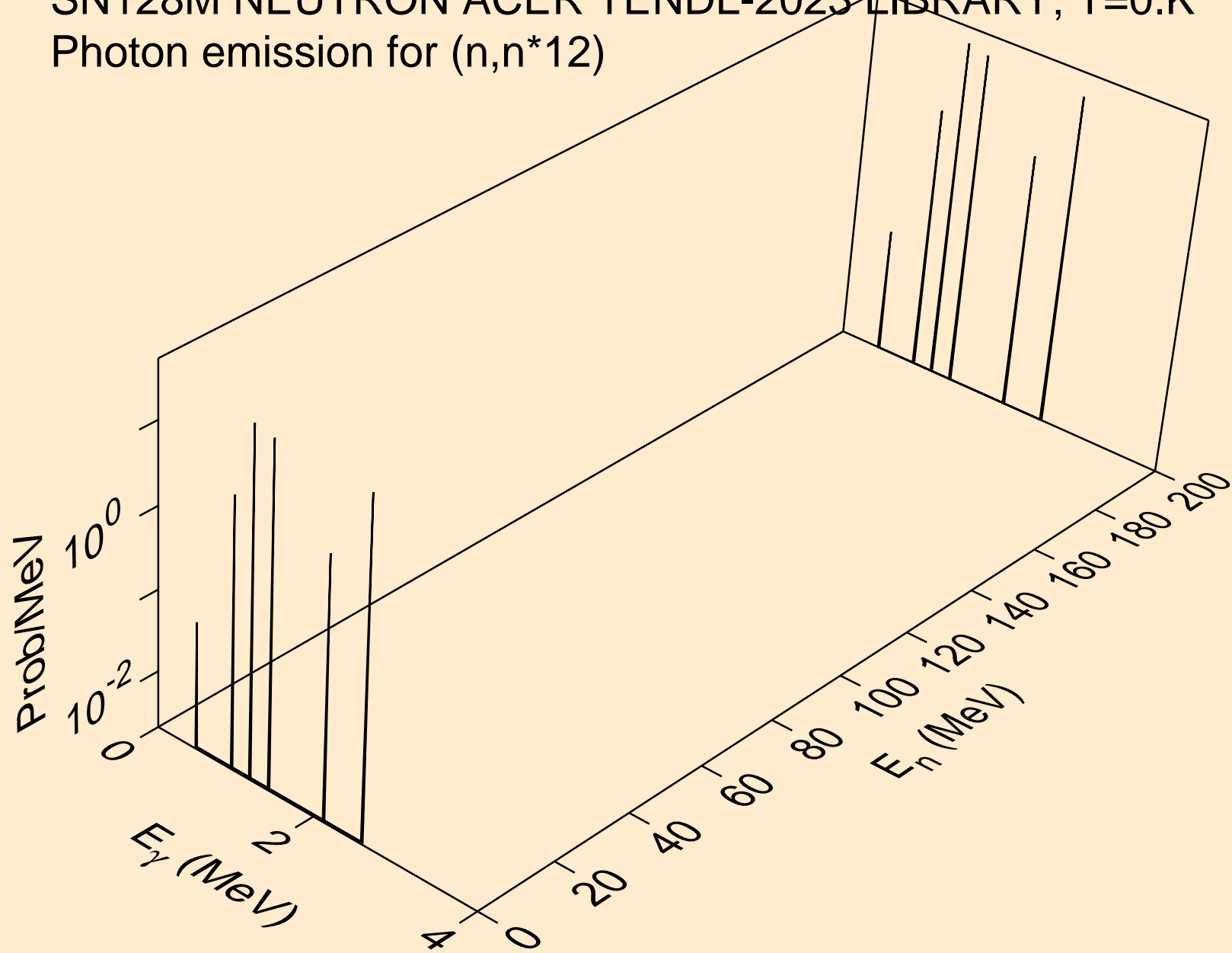

SN128M NEUTRON ACER TENDL-2023 LIBRARY; T=0.K
Photon emission for (n,n*13)

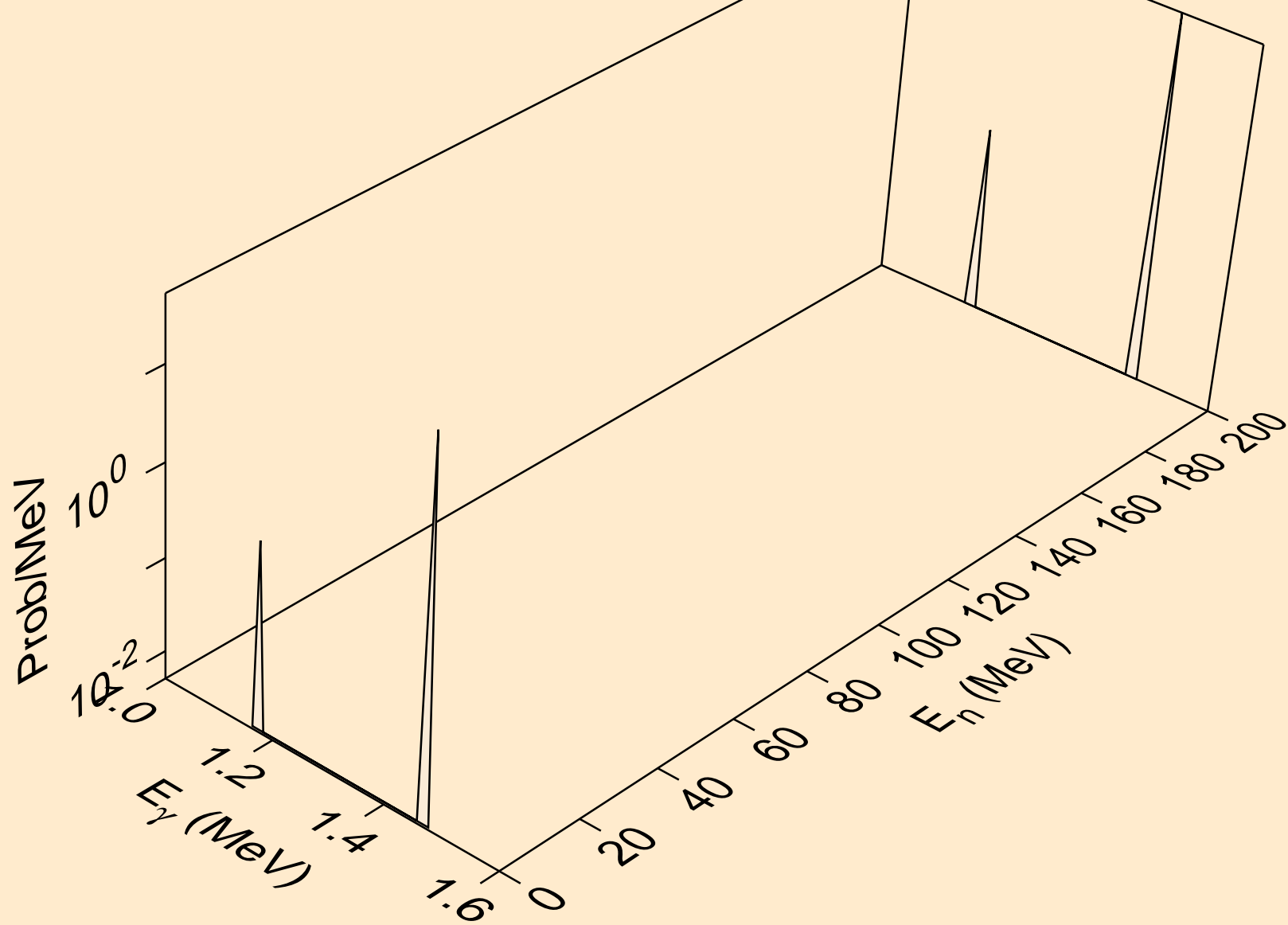

SN128M NEUTRON ACER TENDL-2023 LIBRARY; T=0.K
Photon emission for (n,n*14)

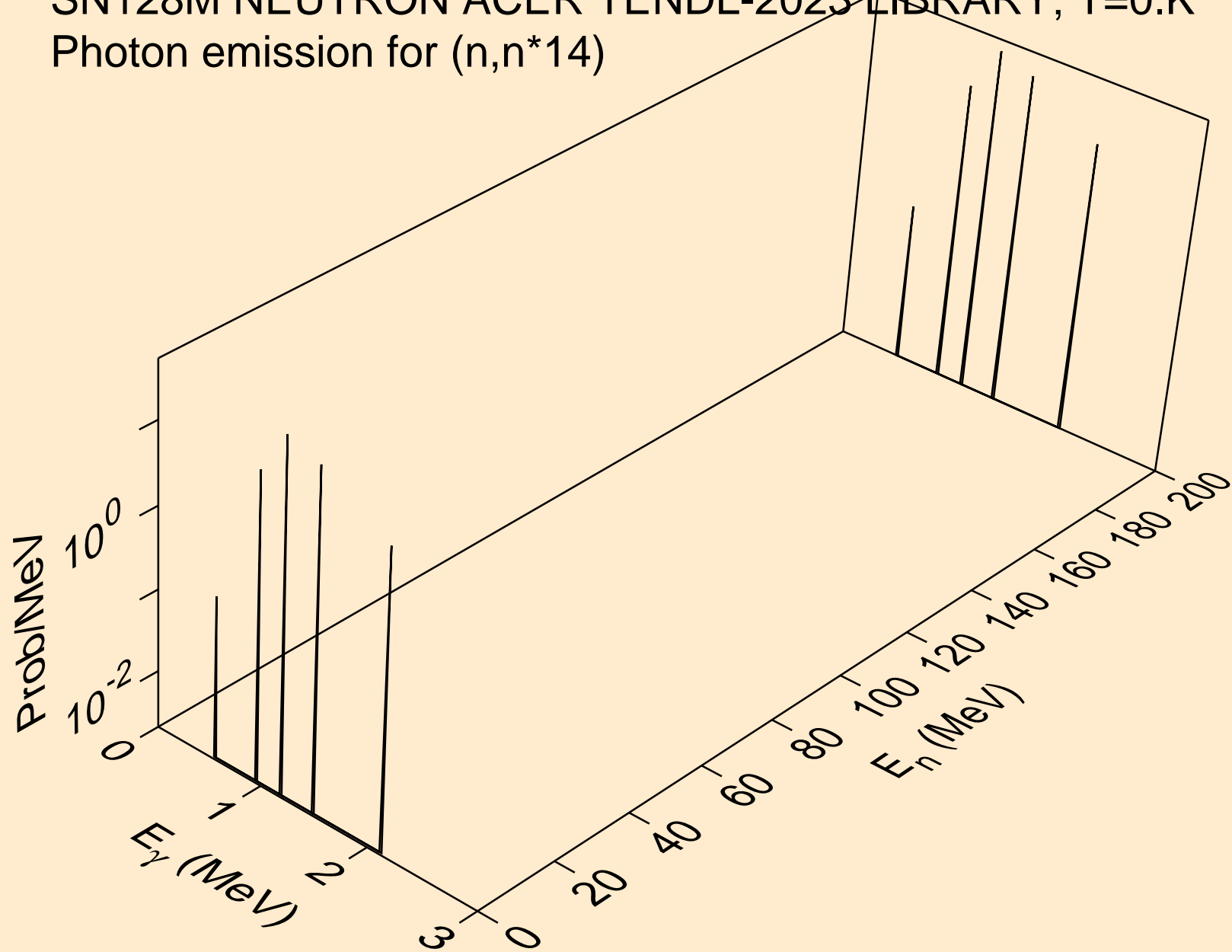

SN128M NEUTRON ACER TENDL-2023 LIBRARY; T=0.K
Photon emission for (n,n*c)

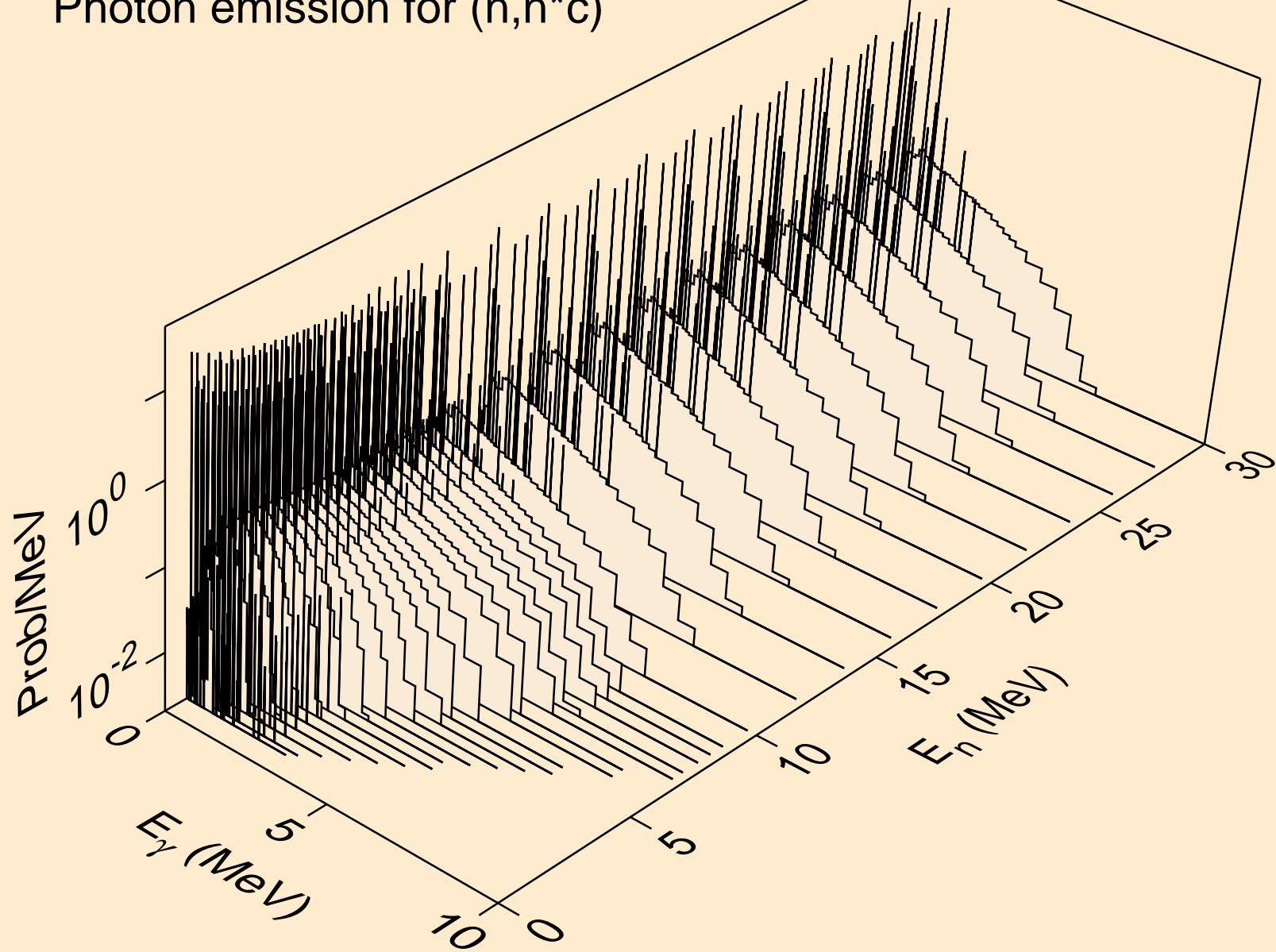

SN128M NEUTRON ACER TENDL-2023 LIBRARY; T=0.K
Photon emission for (n,gma)

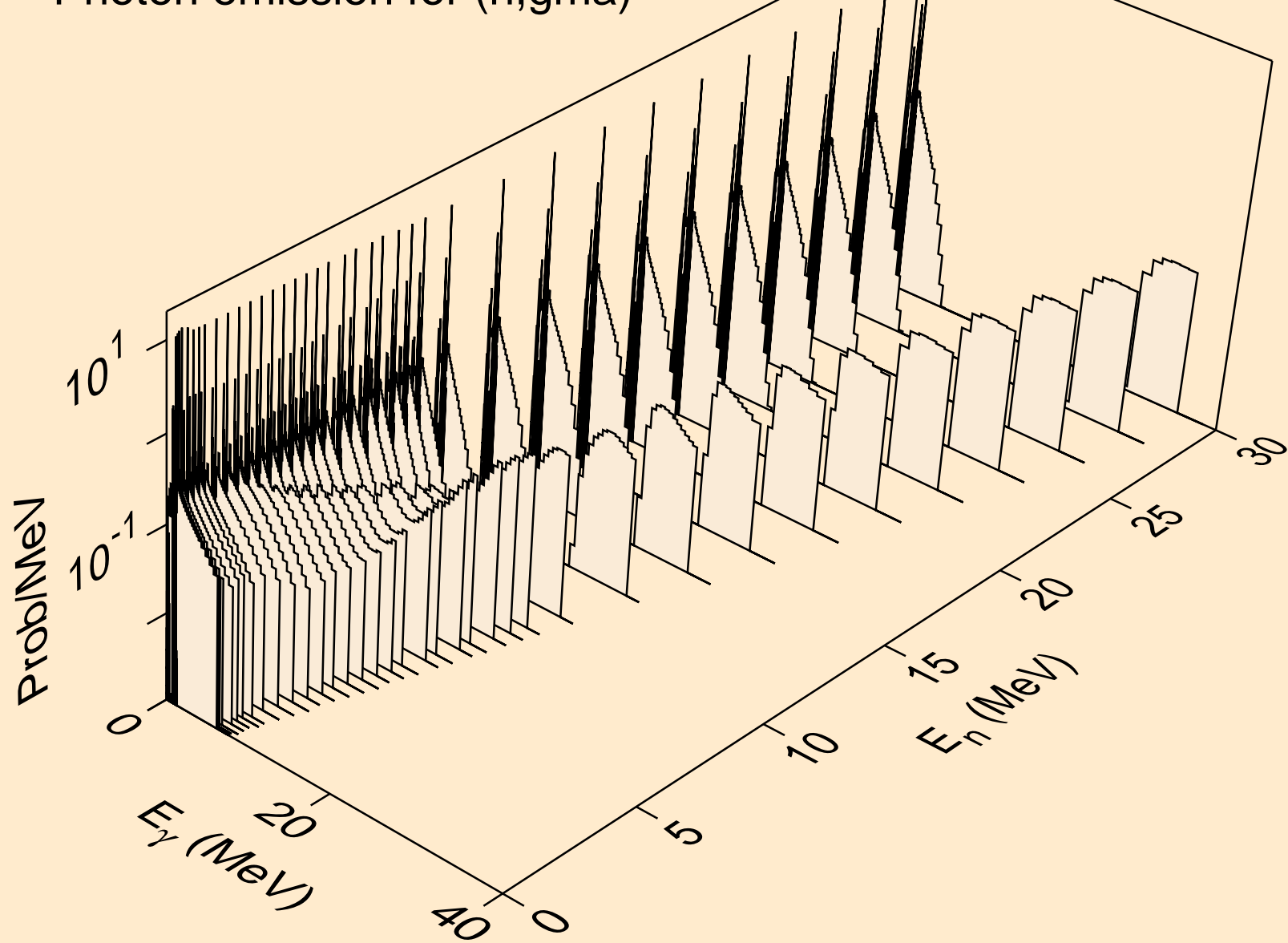

SN128M NEUTRON ACER TENDL-2023 LIBRARY; T=0.K
Photon emission for (n,p)

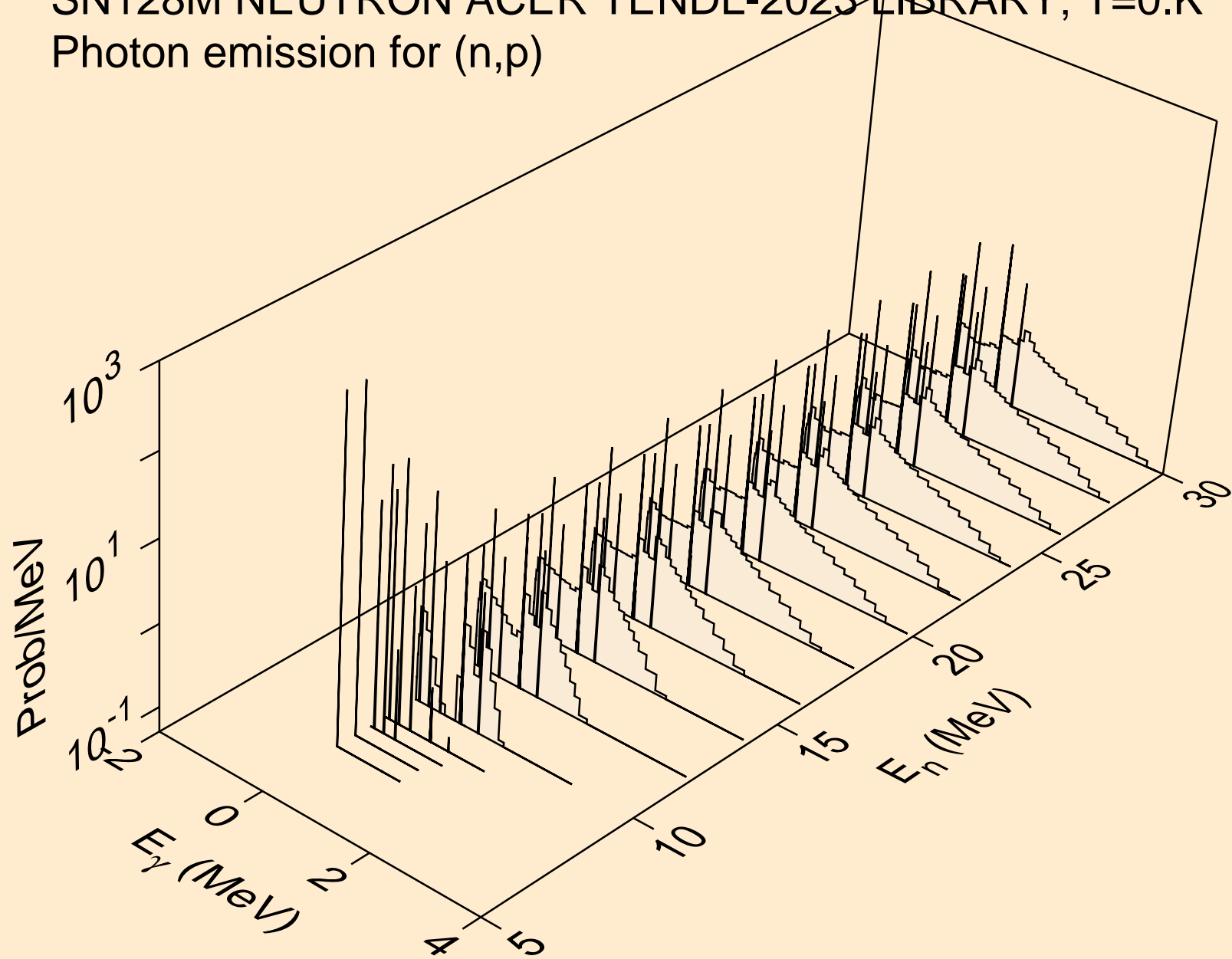

SN128M NEUTRON ACER TENDL-2023 LIBRARY; T=0.K
Photon emission for (n,d)

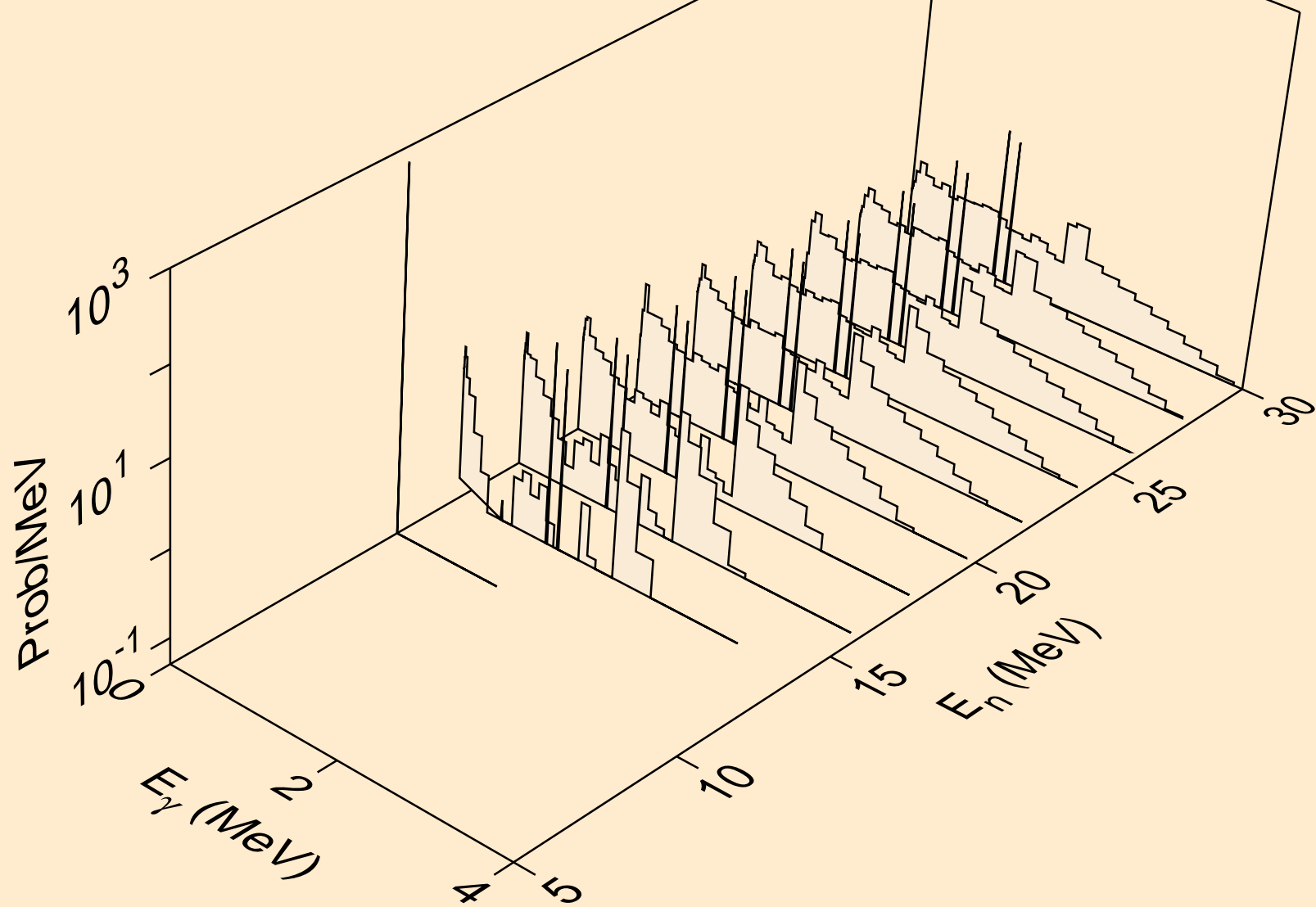

SN128M NEUTRON ACER TENDL-2023 LIBRARY; T=0.K
Photon emission for (n,t)

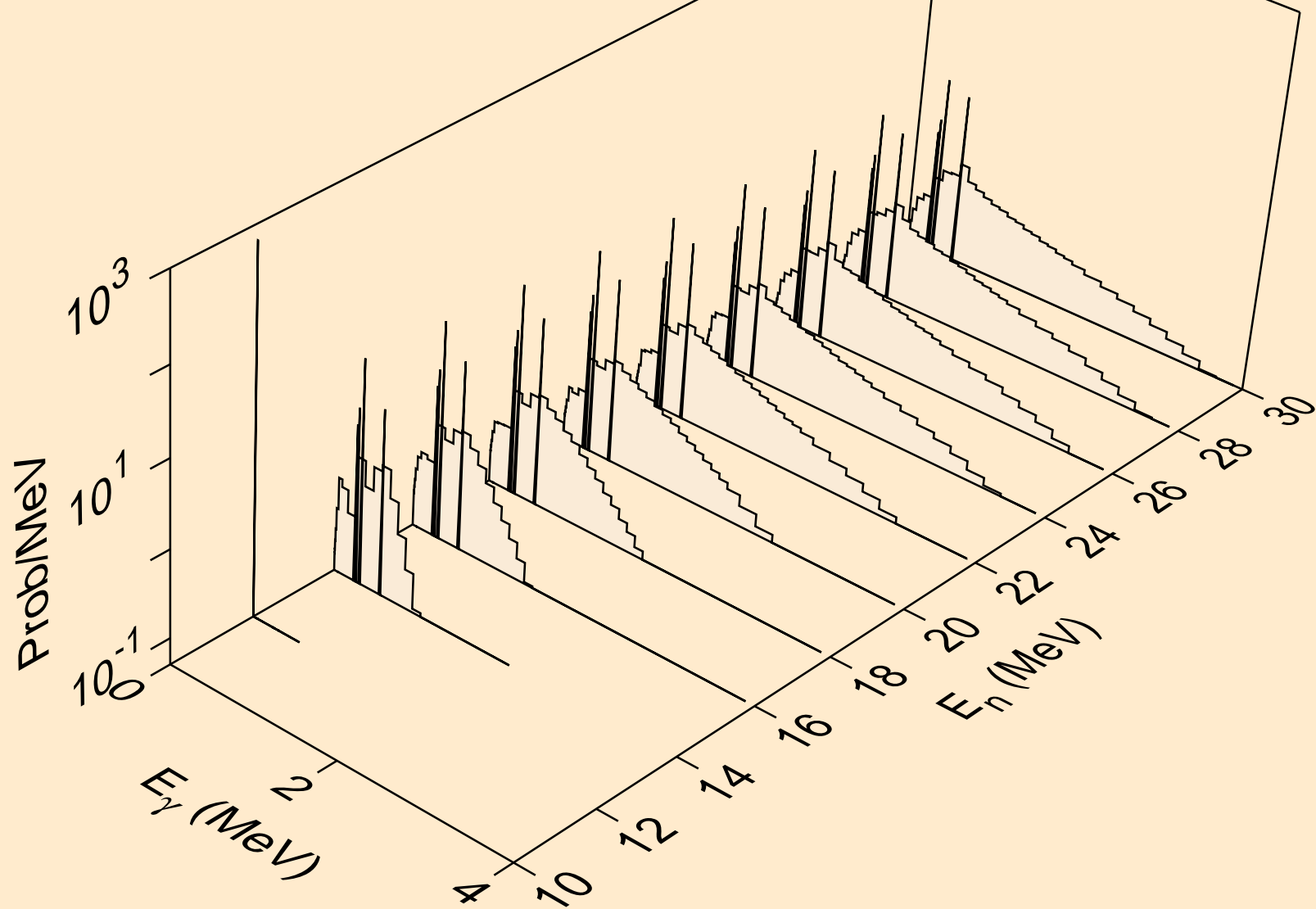

SN128M NEUTRON ACER TENDL-2023 LIBRARY; T=0.K
Photon emission for (n,he3)

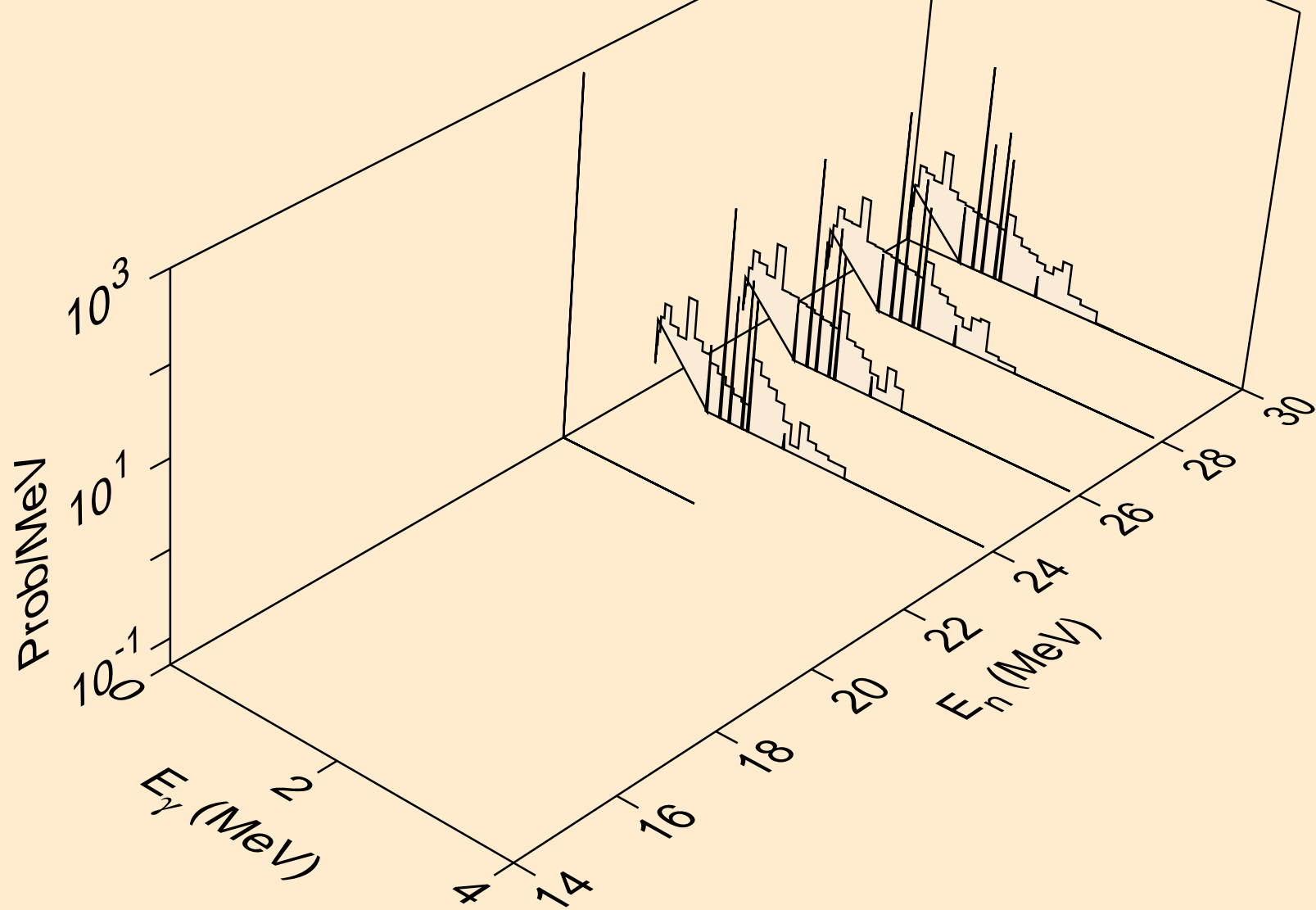

SN128M NEUTRON ACER TENDL-2023 LIBRARY; T=0.K
Photon emission for (n,a)

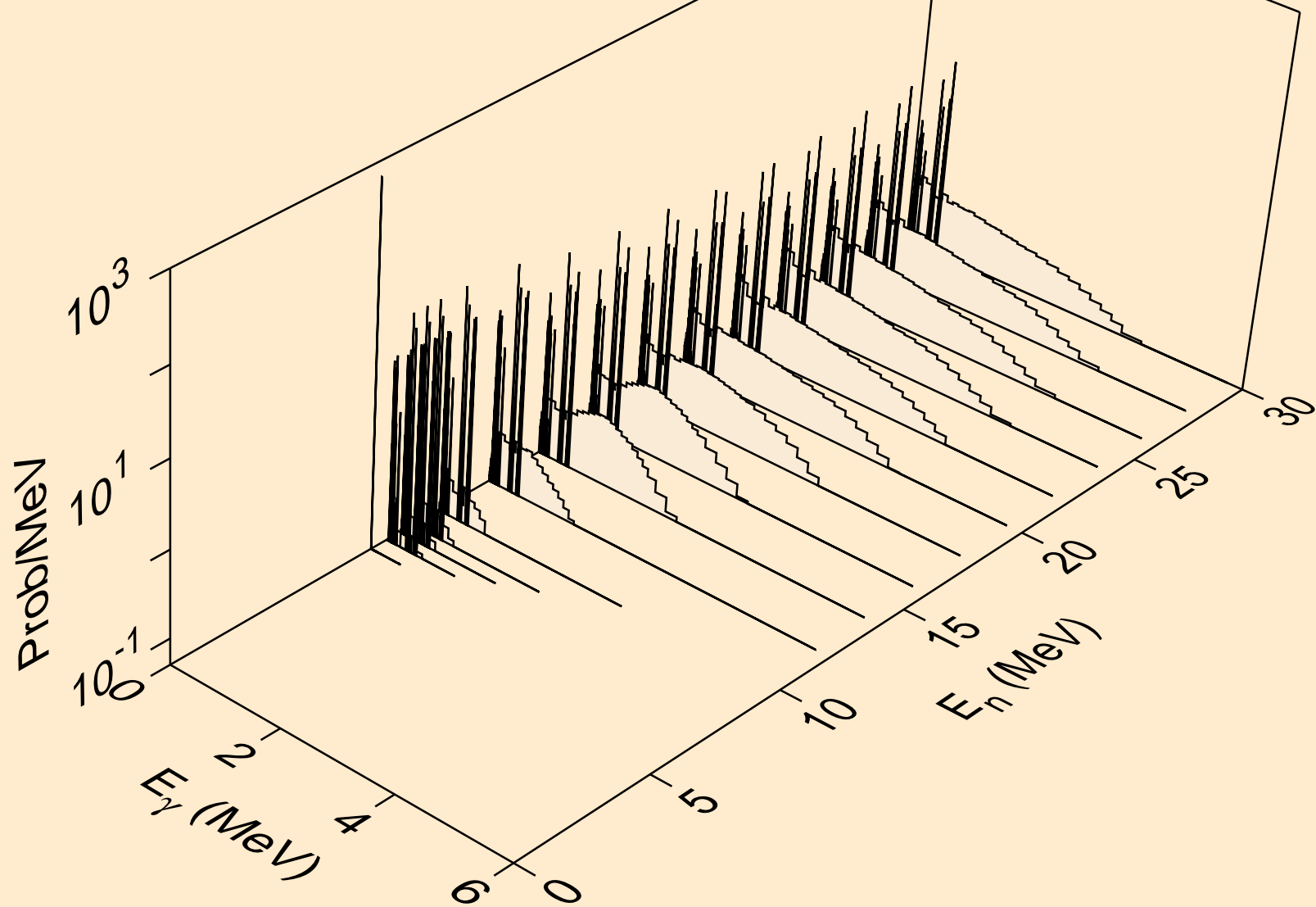

SN128M NEUTRON ACER TENDL-2023 LIBRARY; T=0.K
thermal capture photon spectrum

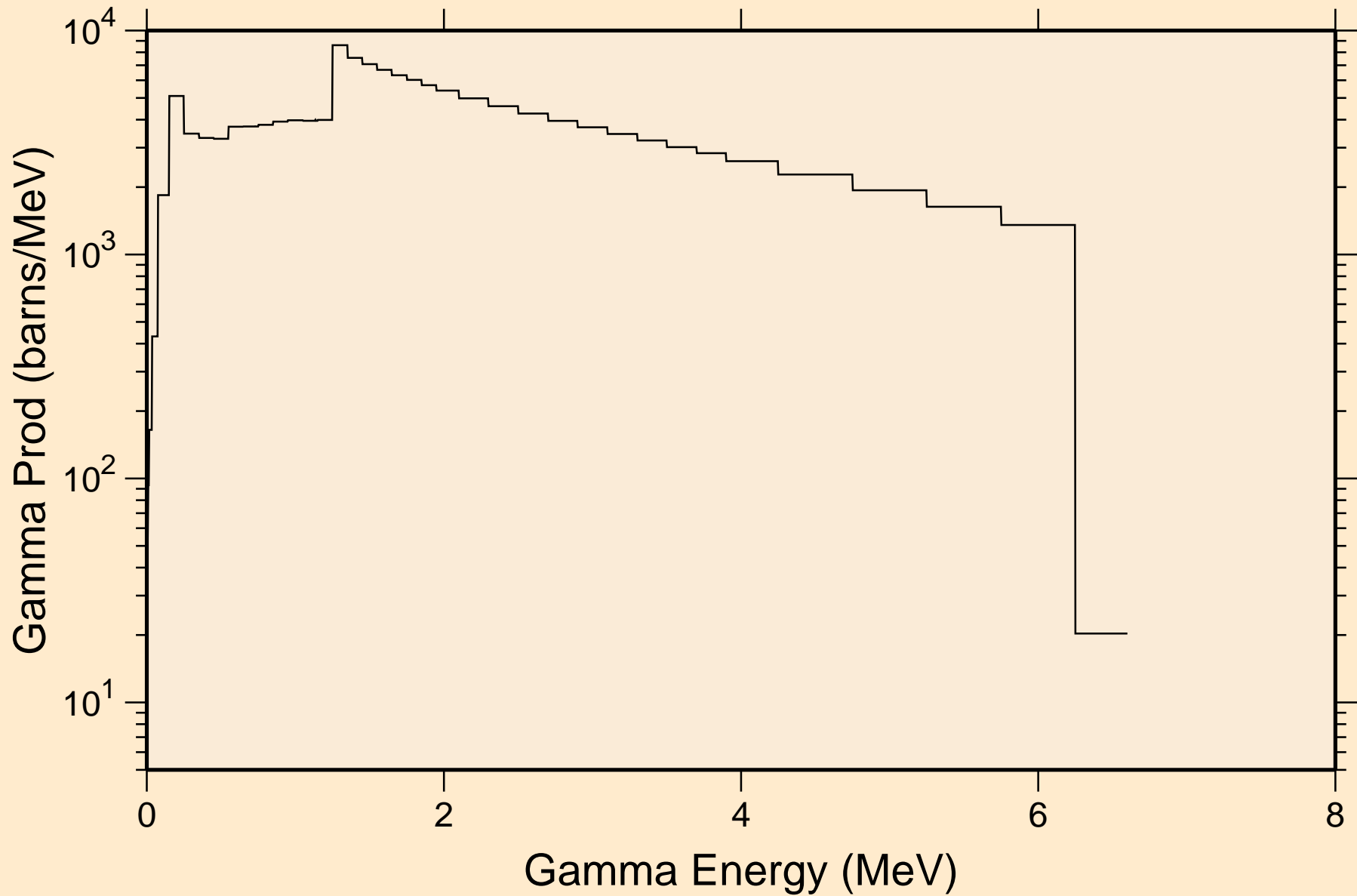

SN128M NEUTRON ACER TENDL-2023 LIBRARY; T=0.K
14 MeV photon spectrum

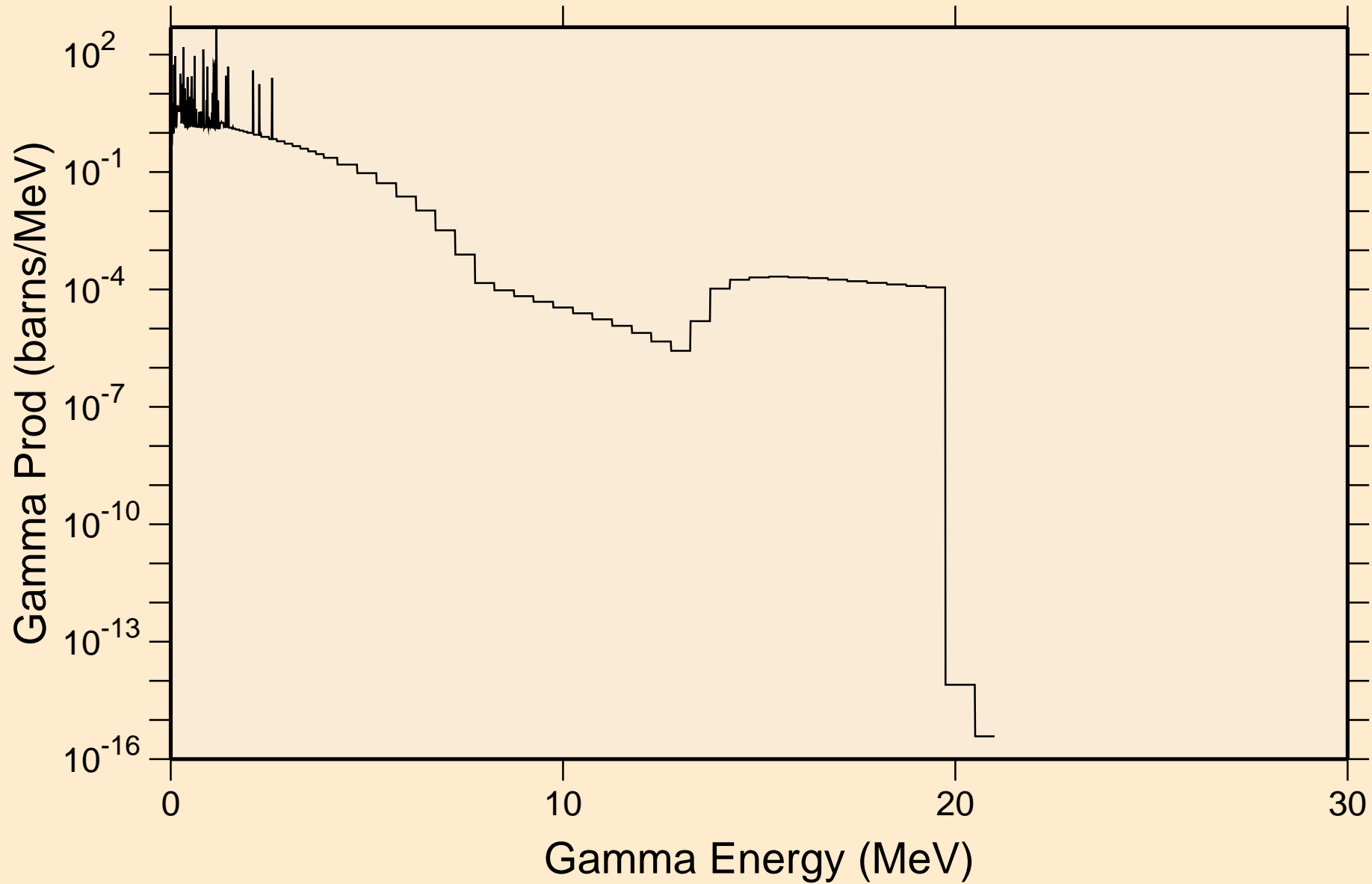

SN128M NEUTRON ACER TENDL-2023 LIBRARY; T=0.K

Particle heating contributions

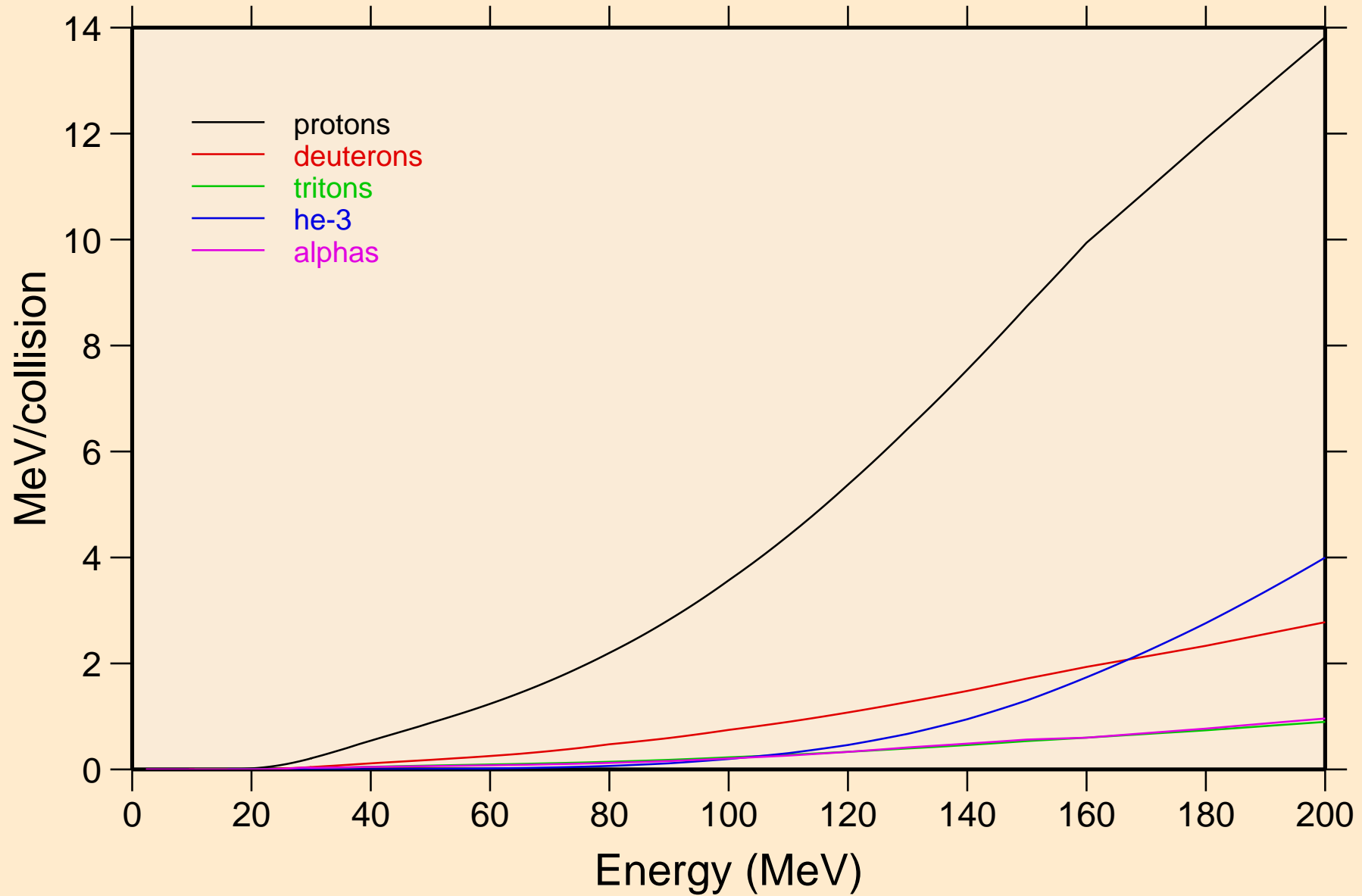

SN128M NEUTRON ACER TENDL-2023 LIBRARY; T=0.K

Recoil Heating

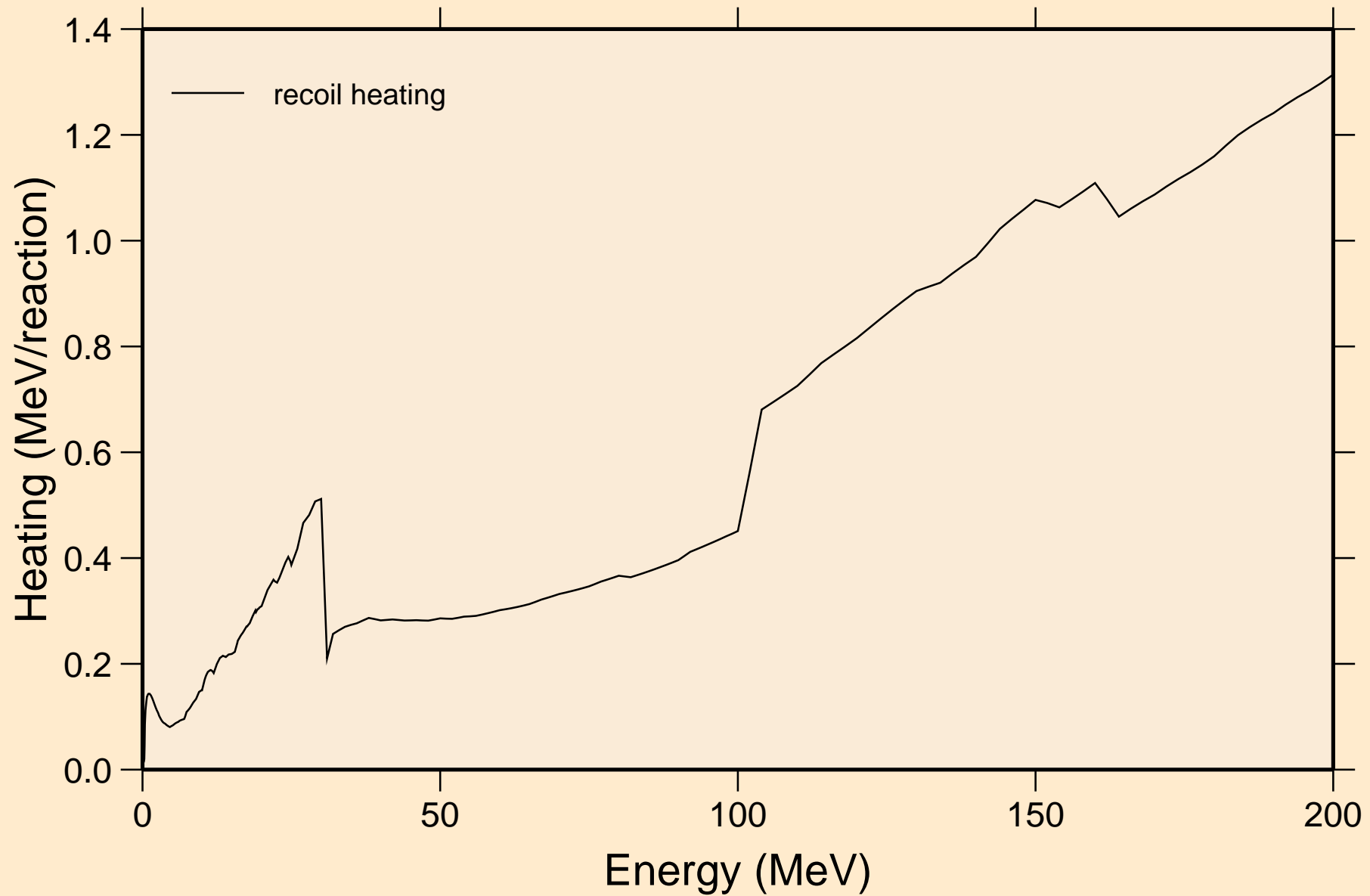

SN128M NEUTRON ACER TENDL-2023 LIBRARY; T=0.K

Particle production cross sections

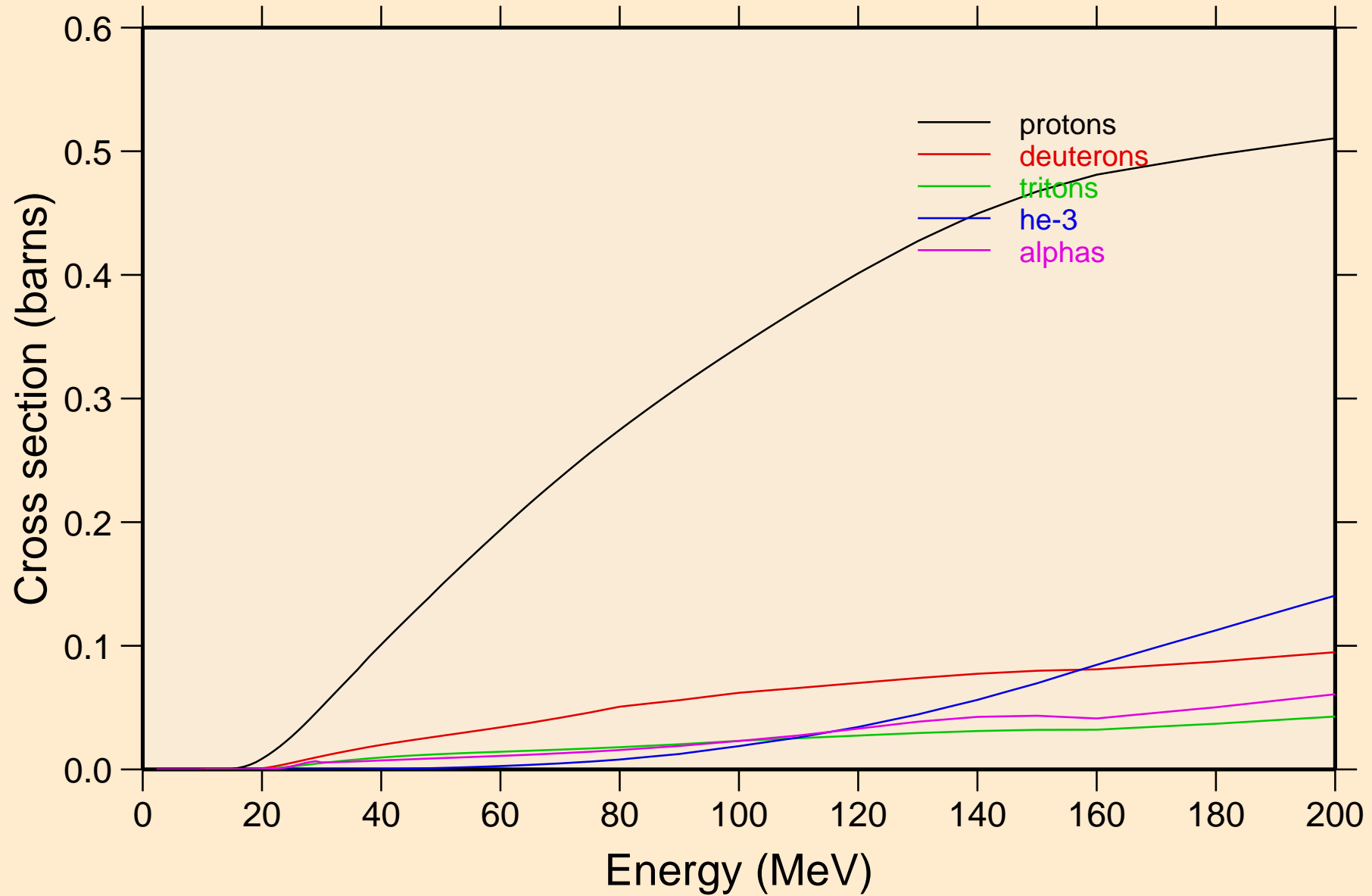

SN128M NEUTRON ACER TENDL-2023 LIBRARY; T=0.K
protons from (n,x)

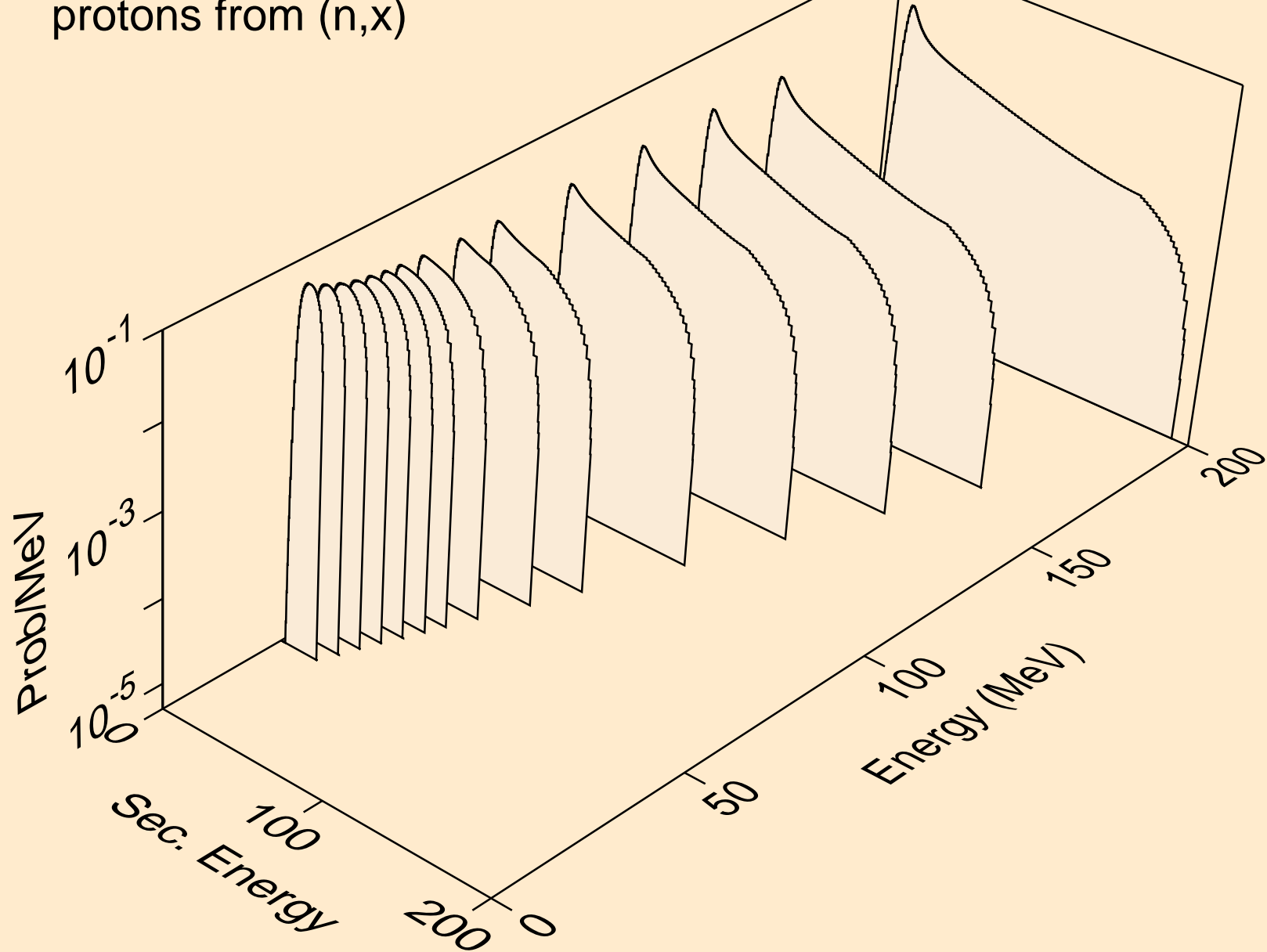

SN128M NEUTRON ACER TENDL-2023 LIBRARY; T=0.K
protons from (n,n*)p

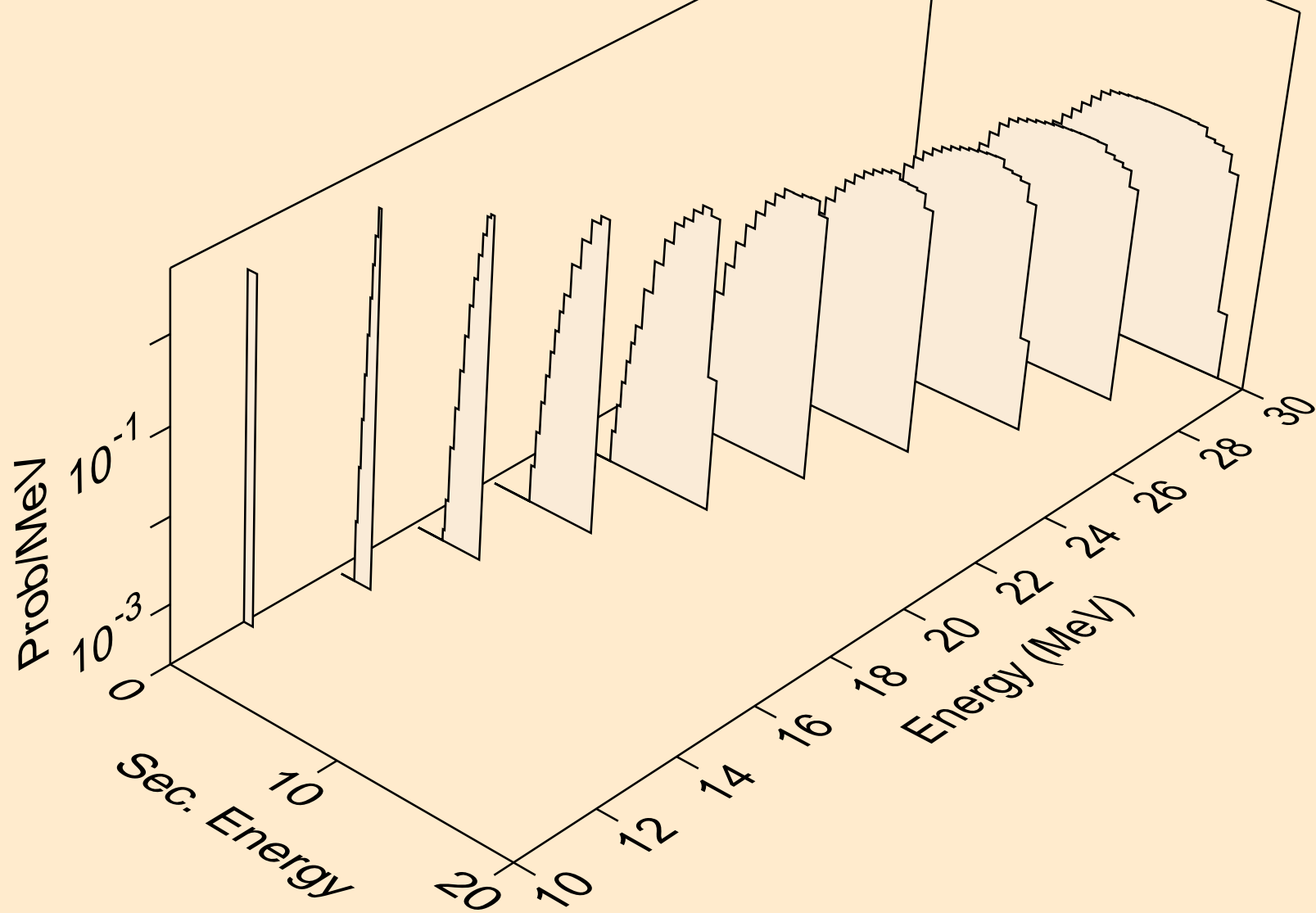

SN128M NEUTRON ACER TENDL-2023 LIBRARY; T=0.K
protons from (n,2np)

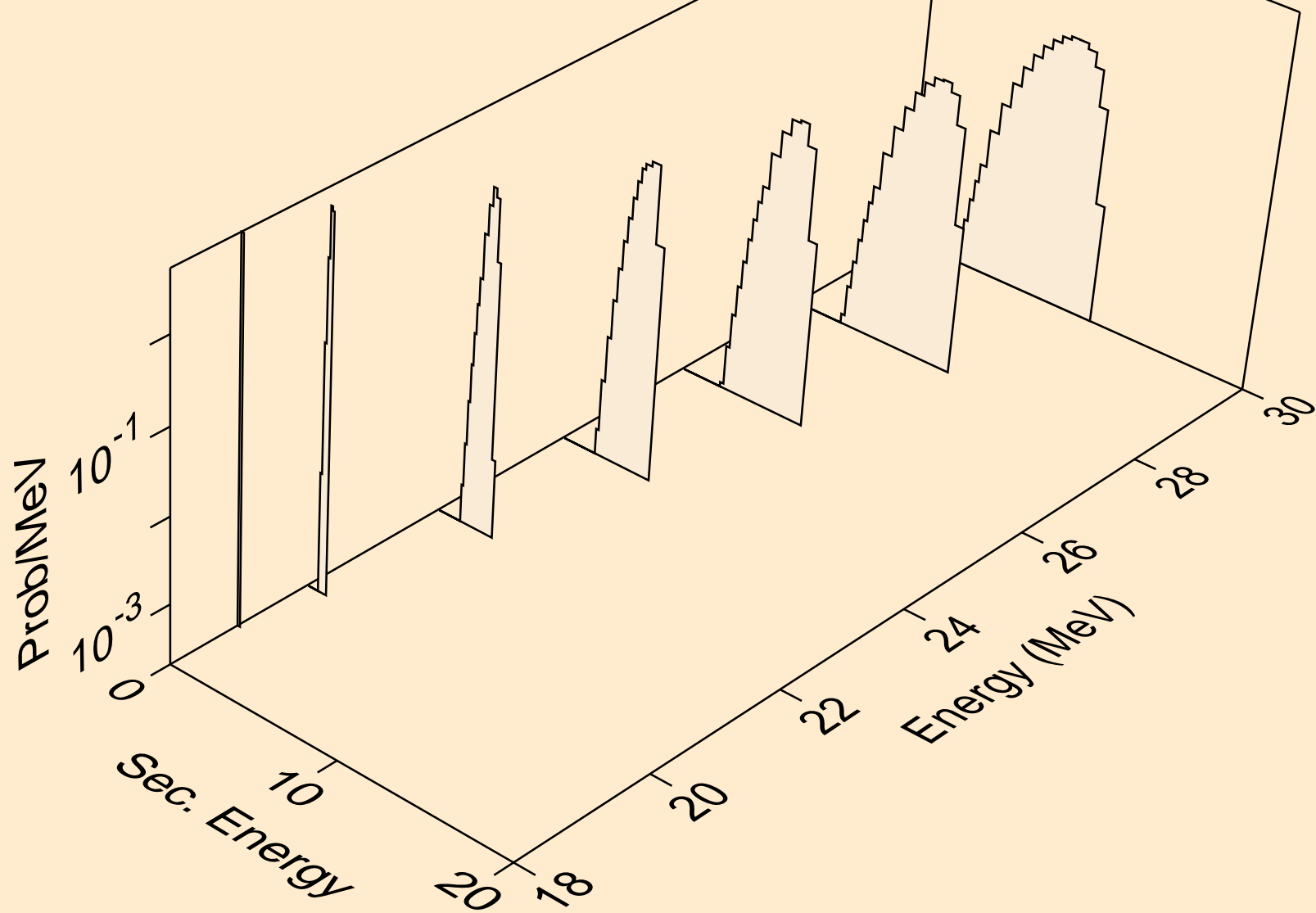

SN128M NEUTRON ACER TENDL-2023 LIBRARY; T=0.K
protons from (n,3np)

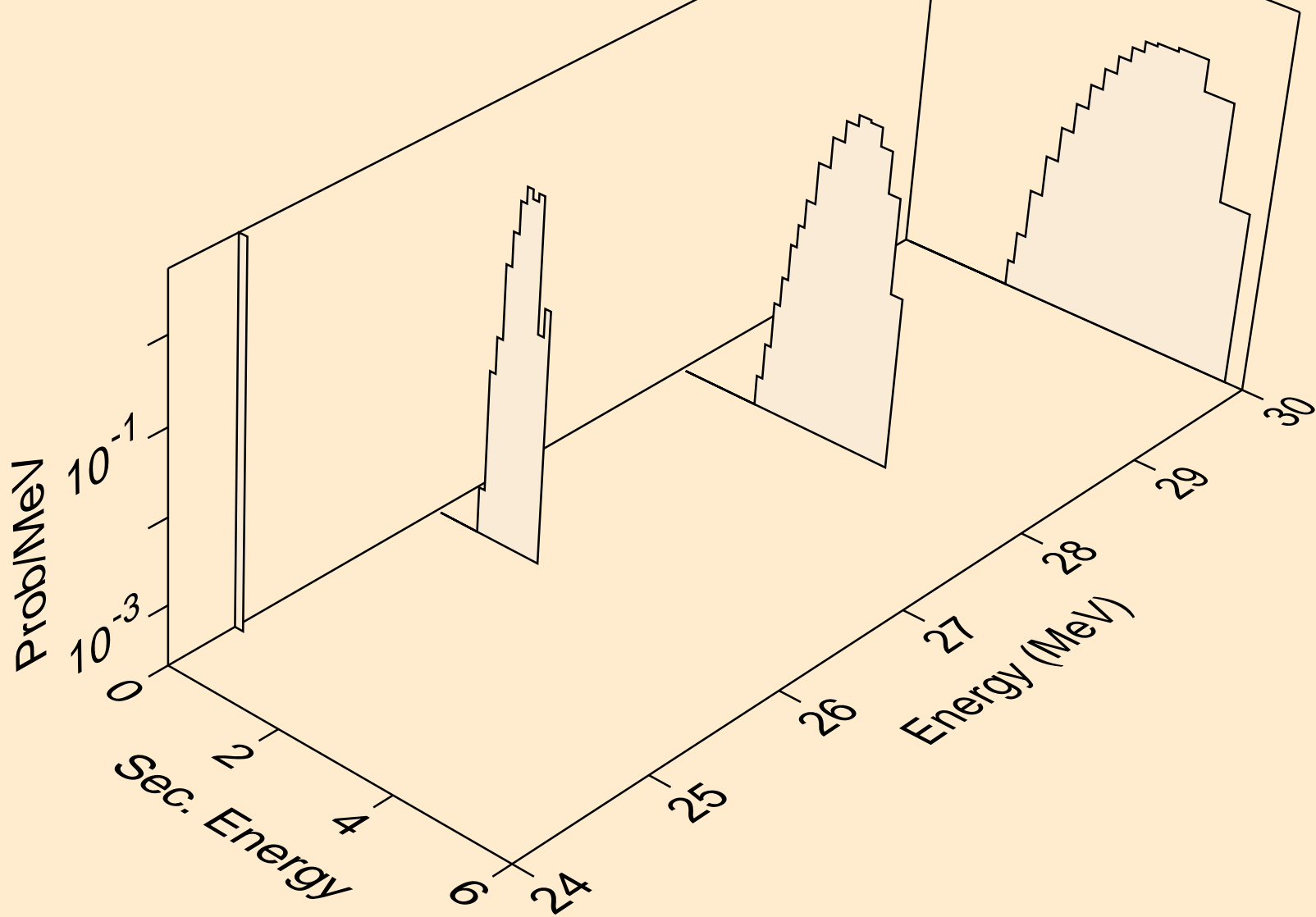

SN128M NEUTRON ACER TENDL-2023 LIBRARY; T=0.K
protons from (n,p)

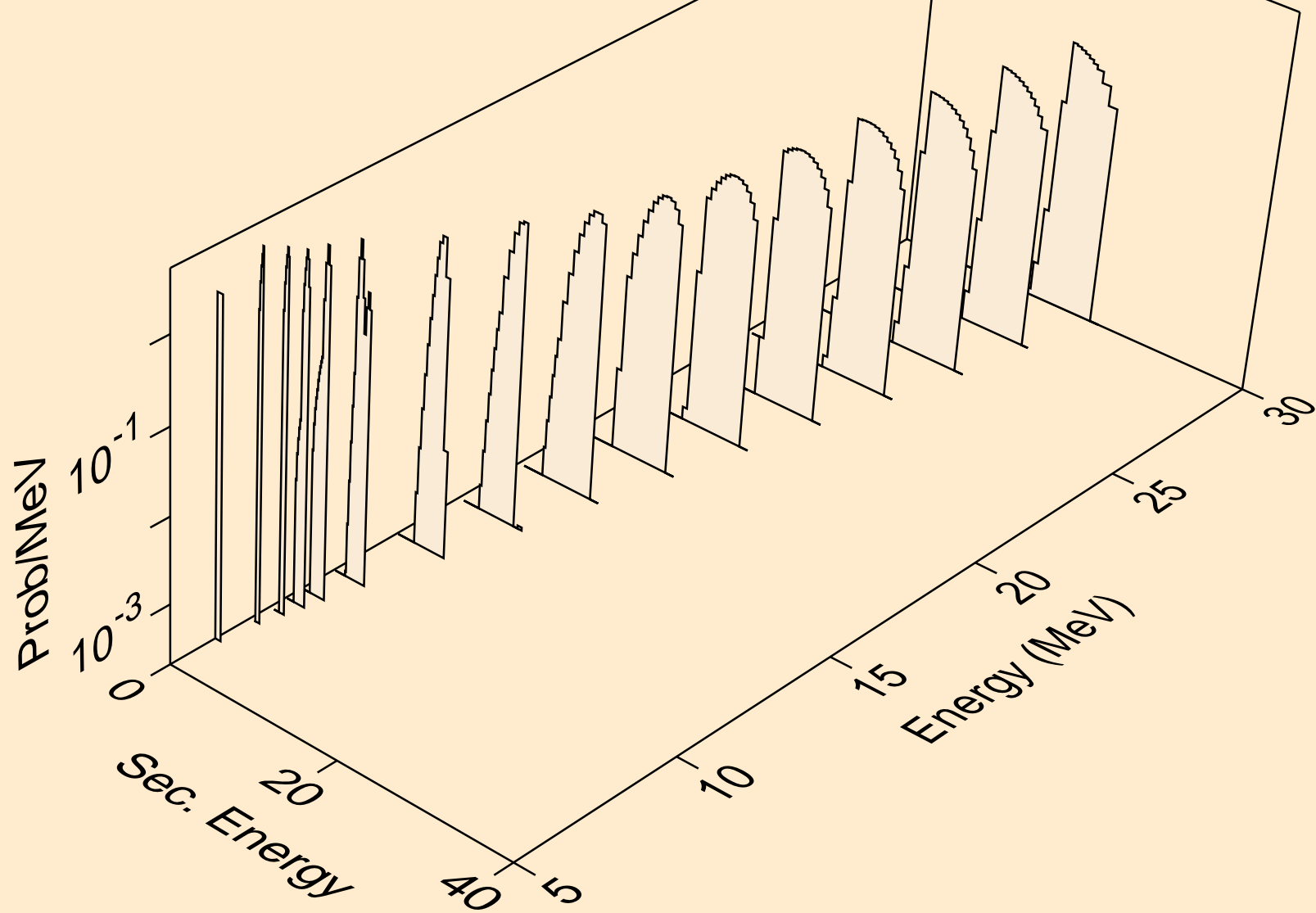

SN128M NEUTRON ACER TENDL-2023 LIBRARY; T=0.K
deuterons from (n,x)

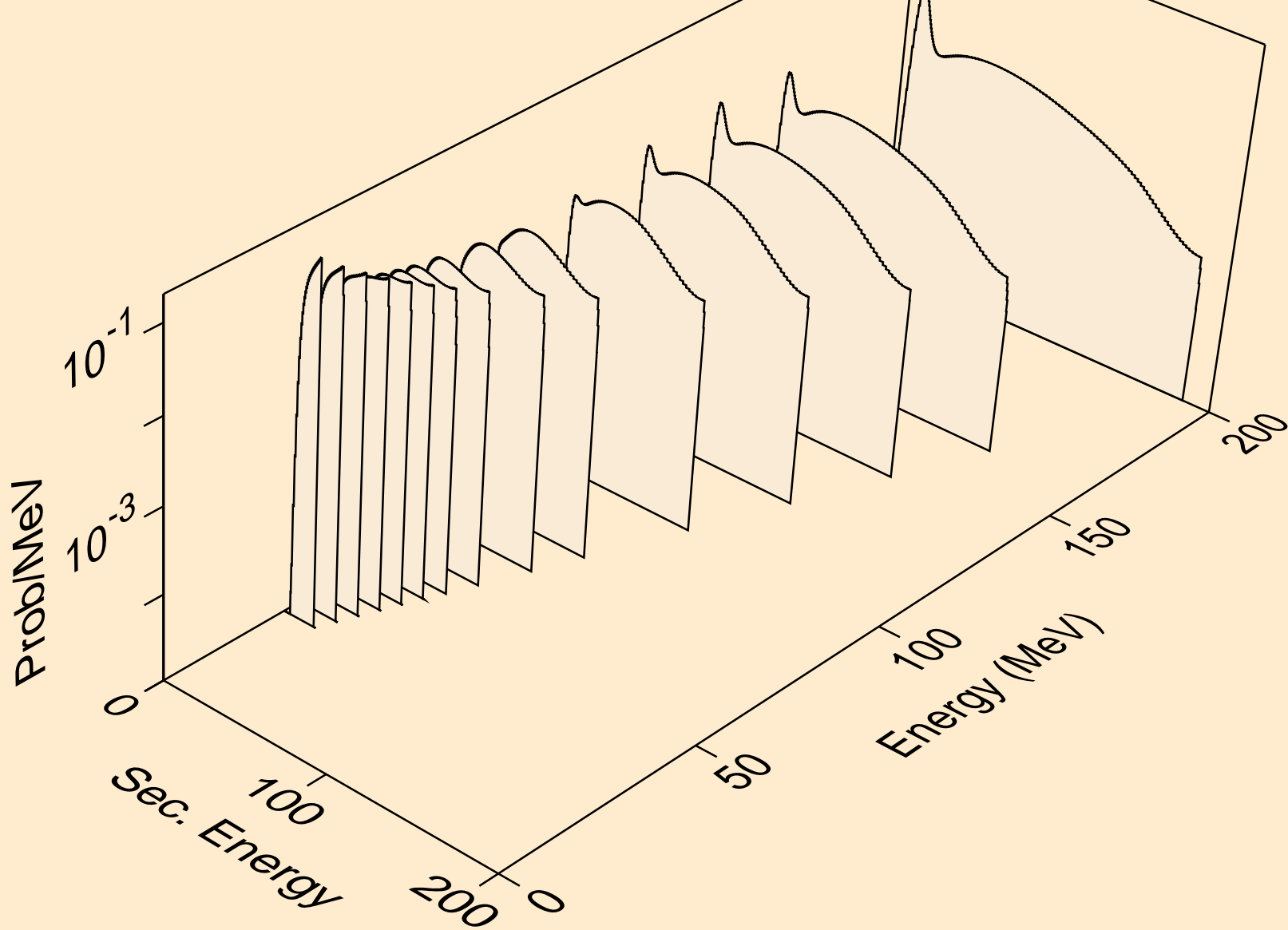

SN128M NEUTRON ACER TENDL-2023 LIBRARY; T=0.K
deuterons from (n,2nd)

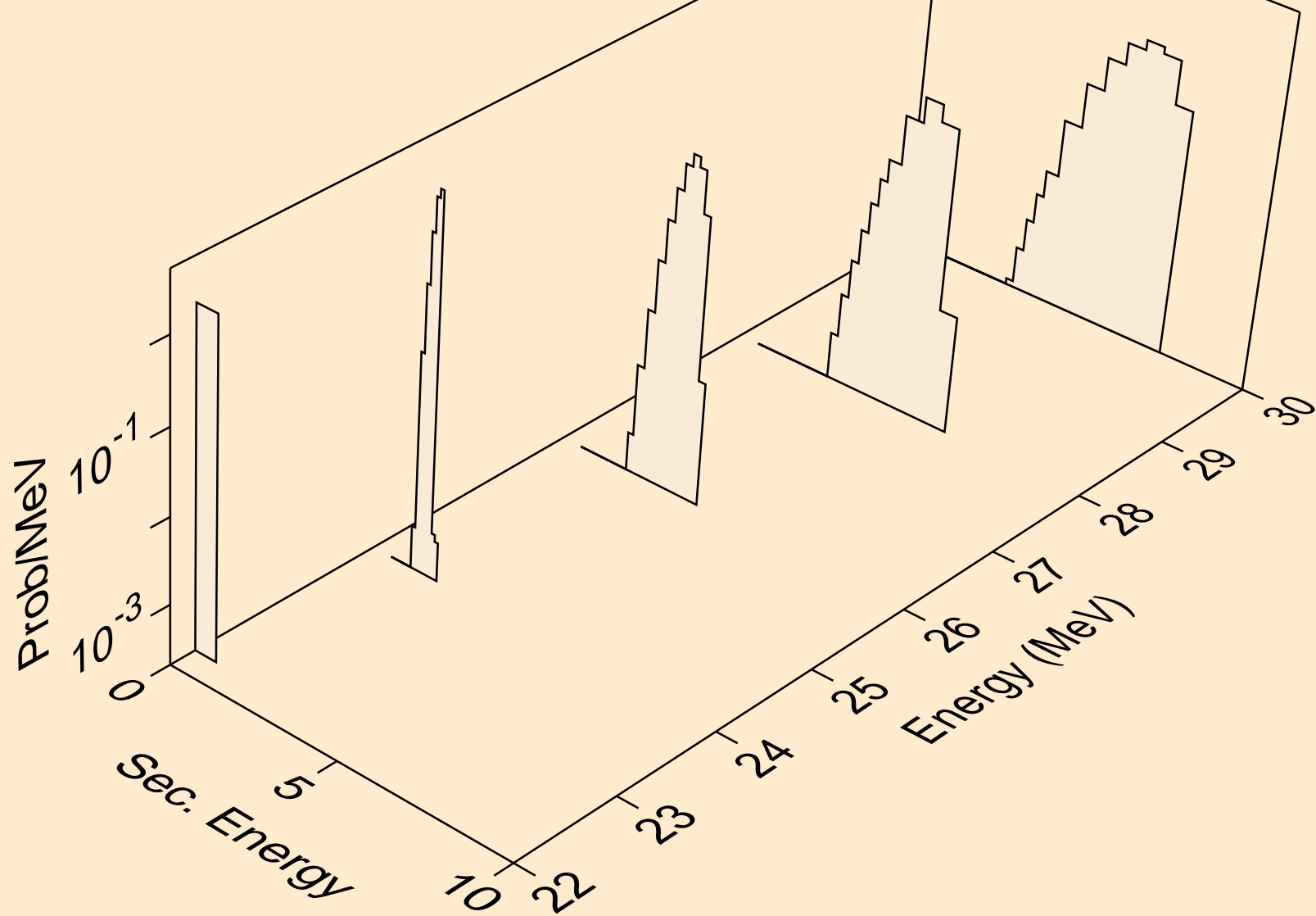

SN128M NEUTRON ACER TENDL-2023 LIBRARY; T=0.K
deuterons from (n,n*)d

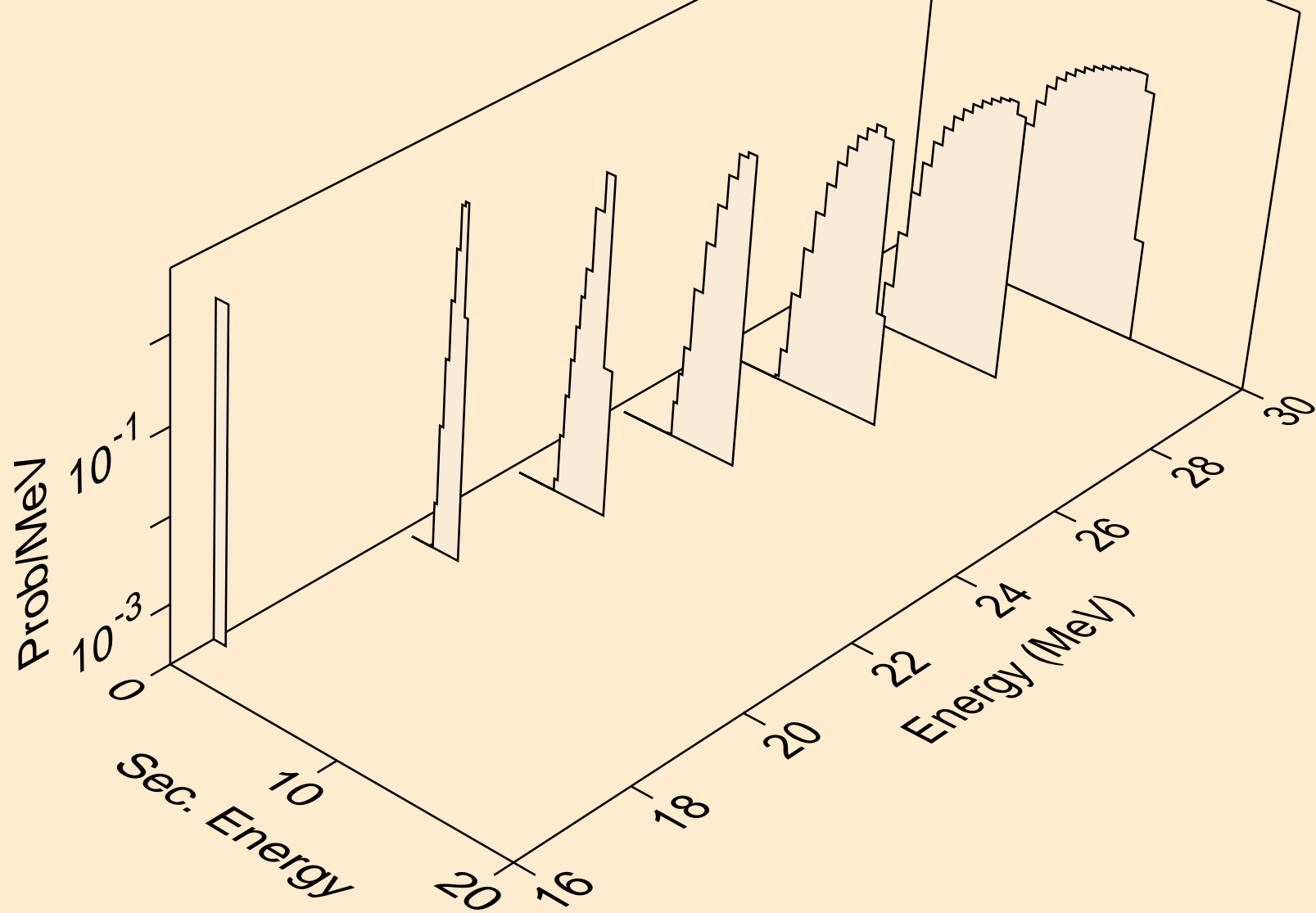

SN128M NEUTRON ACER TENDL-2023 LIBRARY; T=0.K
deuterons from (n,d)

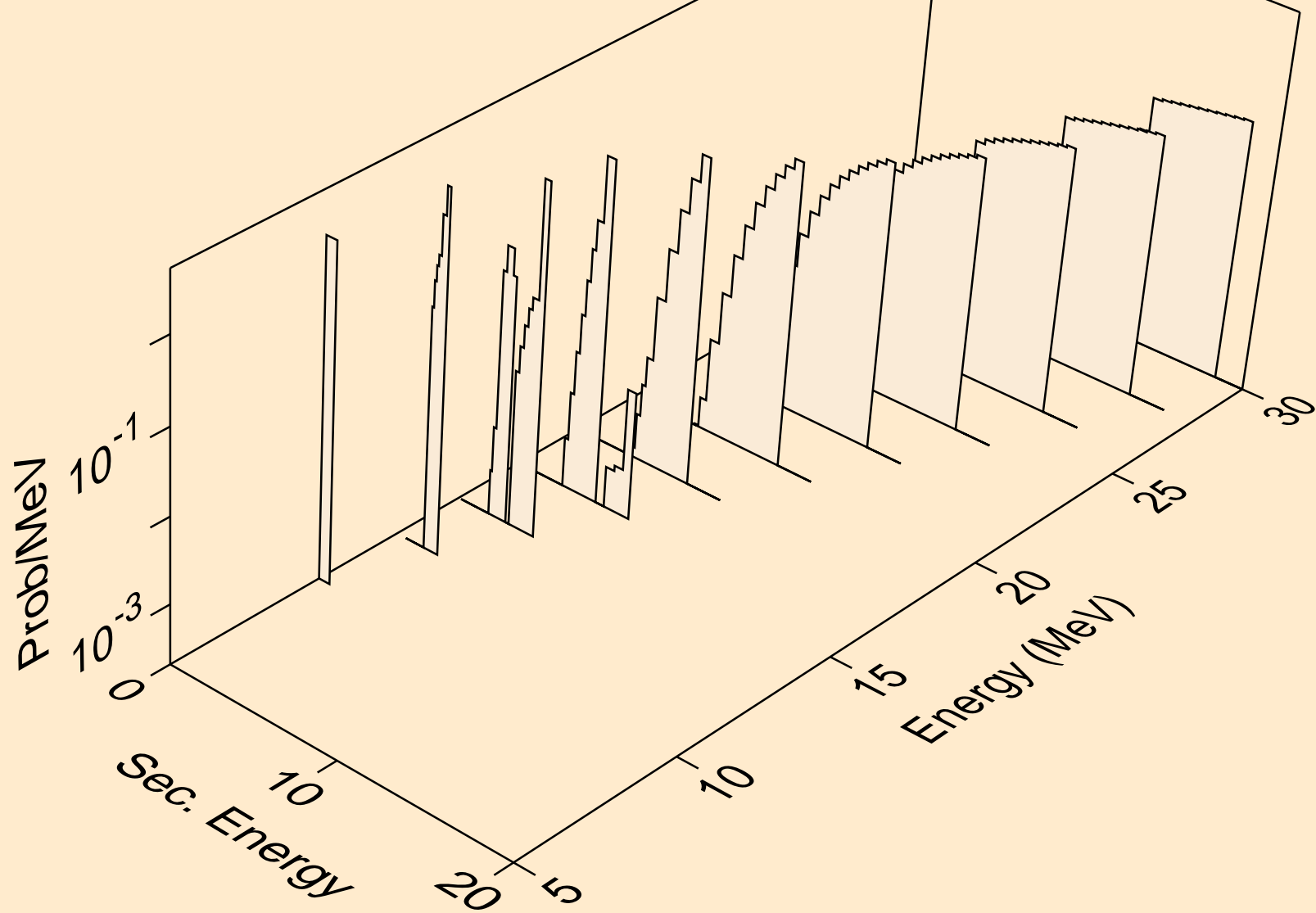

SN128M NEUTRON ACER TENDL-2023 LIBRARY; T=0.K
tritons from (n,x)

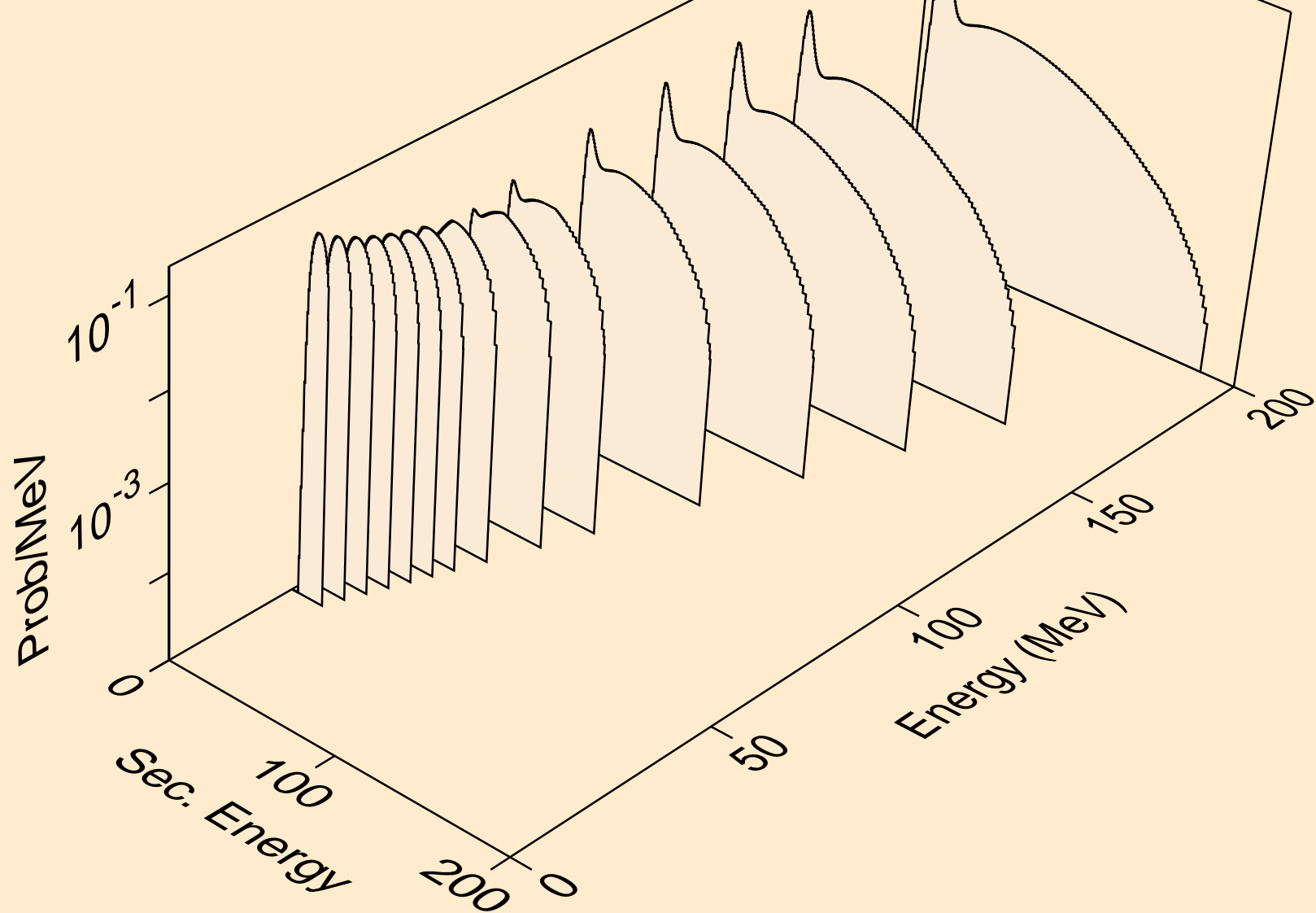

SN128M NEUTRON ACER TENDL-2023 LIBRARY; T=0.K
tritons from (n,n*)t

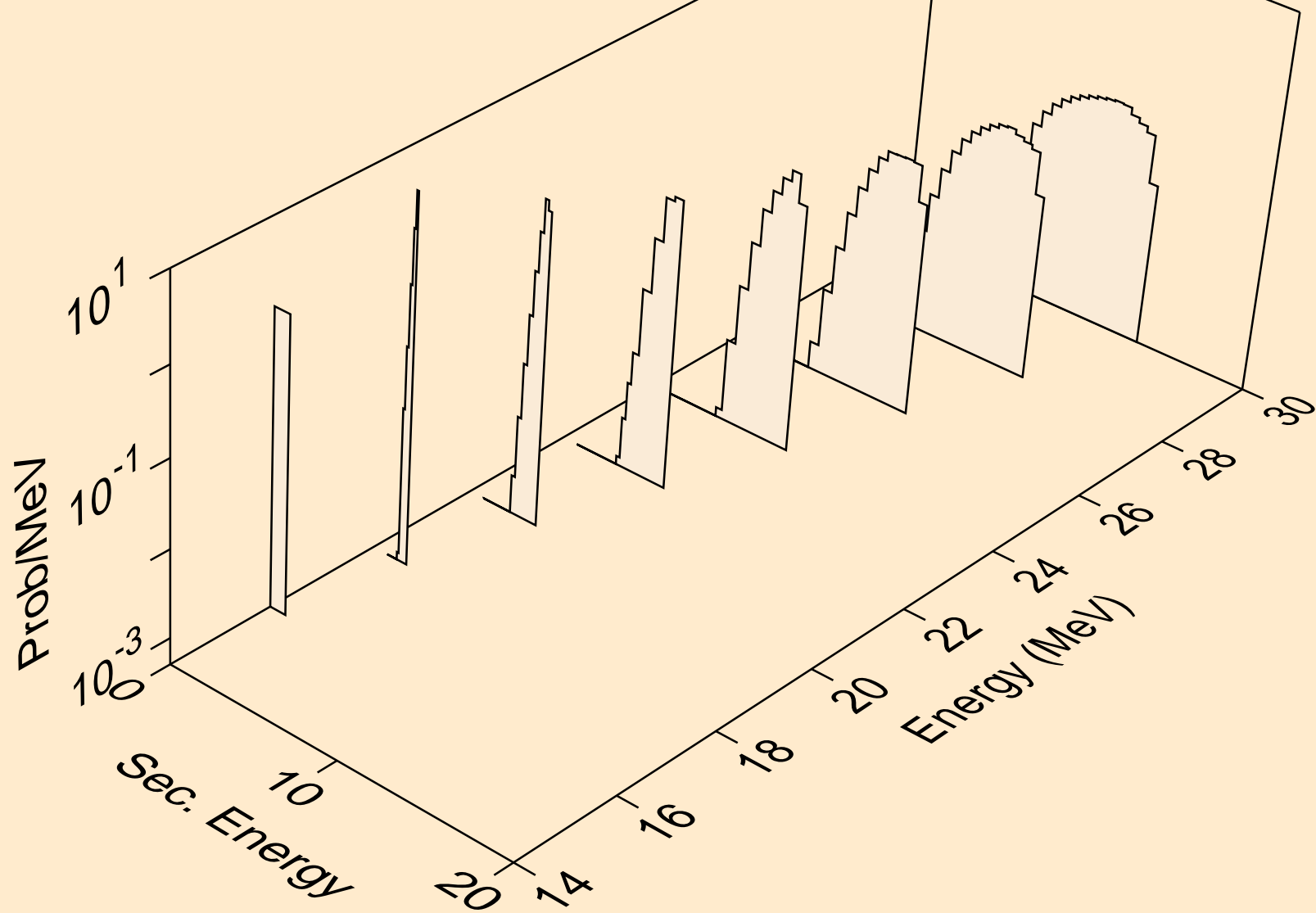

SN128M NEUTRON ACER TENDL-2023 LIBRARY; T=0.K
tritons from (n,t)

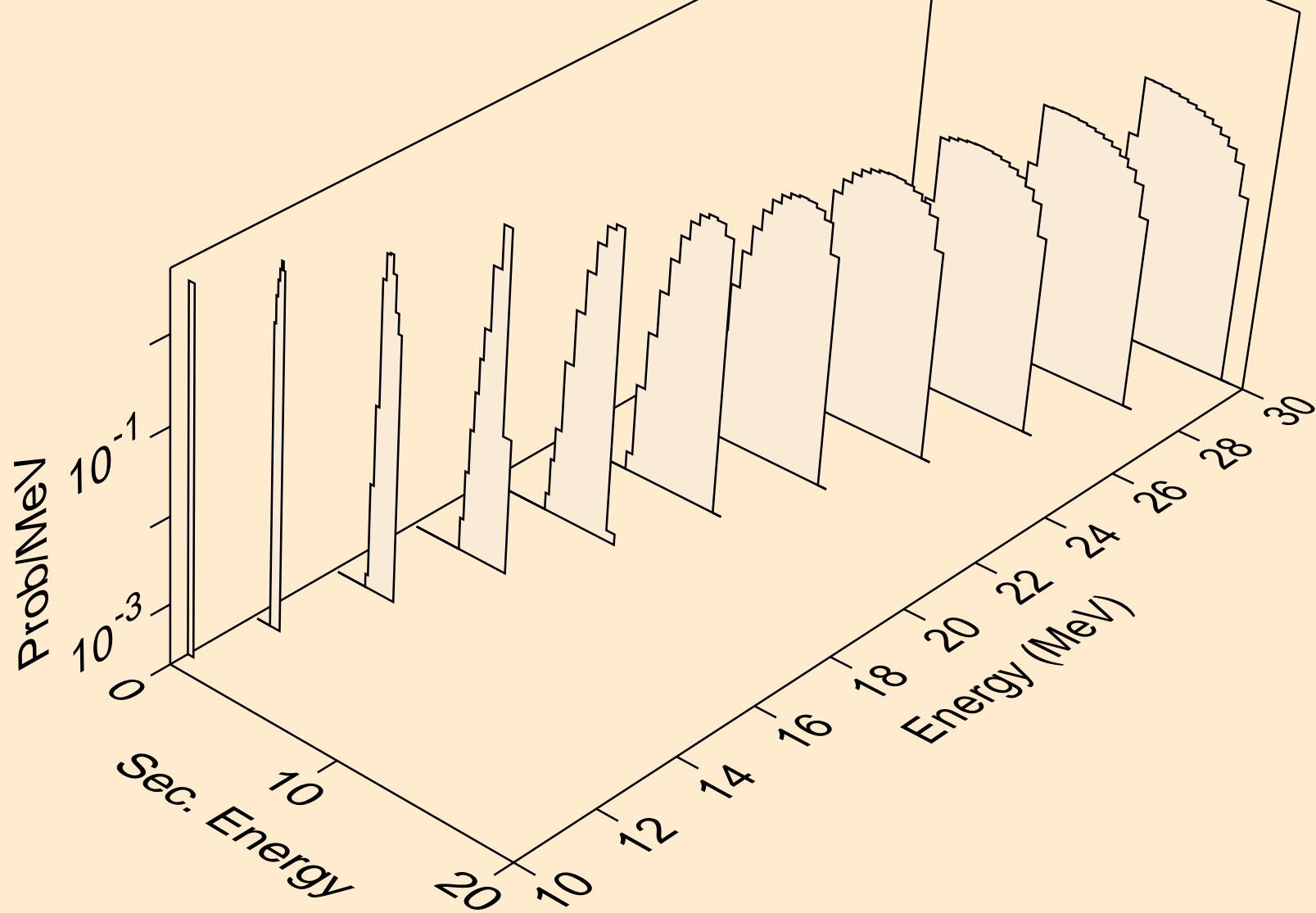

SN128M NEUTRON ACER TENDL-2023 LIBRARY; T=0.K
he3s from (n,x)

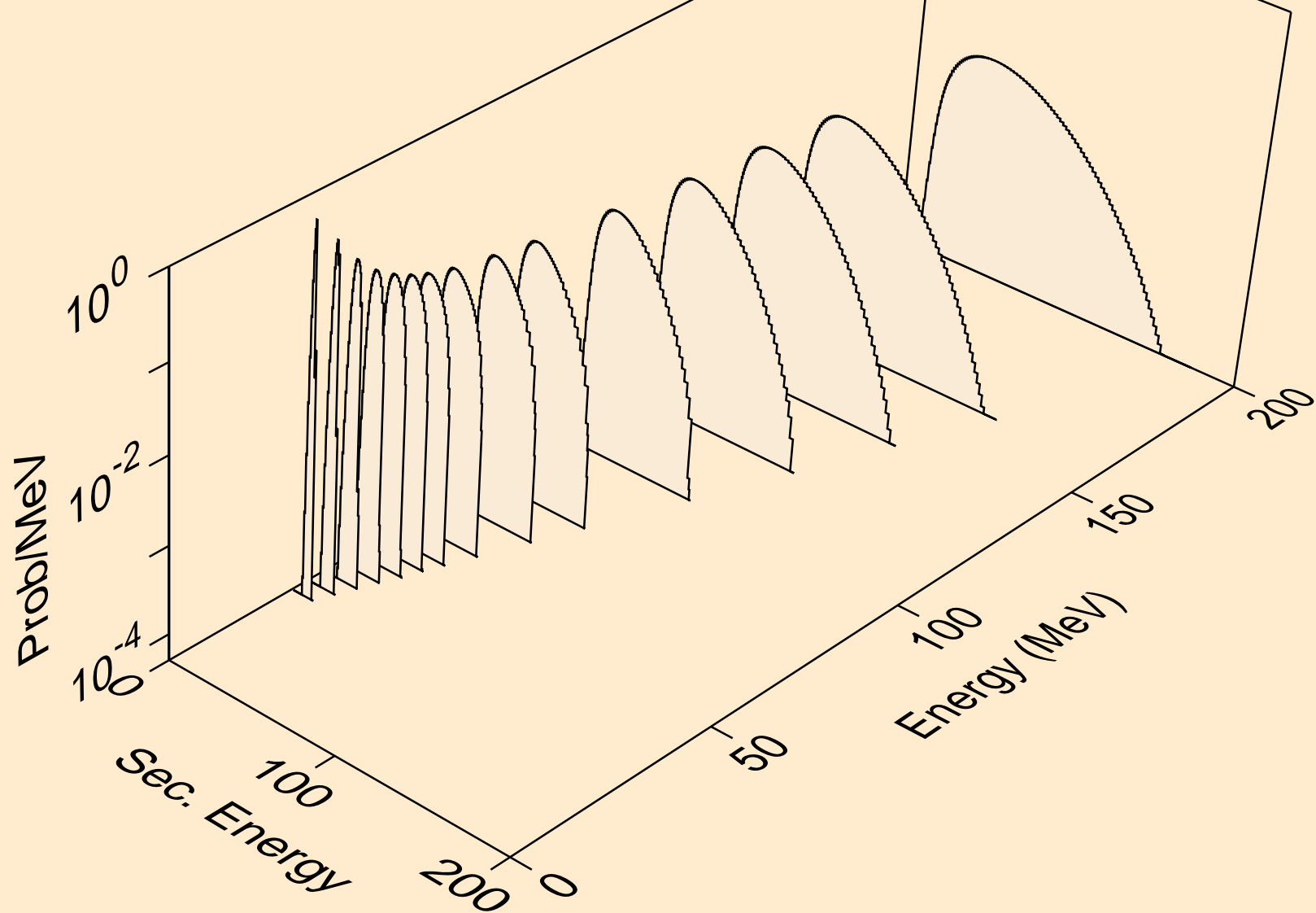

SN128M NEUTRON ACER TENDL-2023 LIBRARY; T=0.K
he3s from (n,he3)

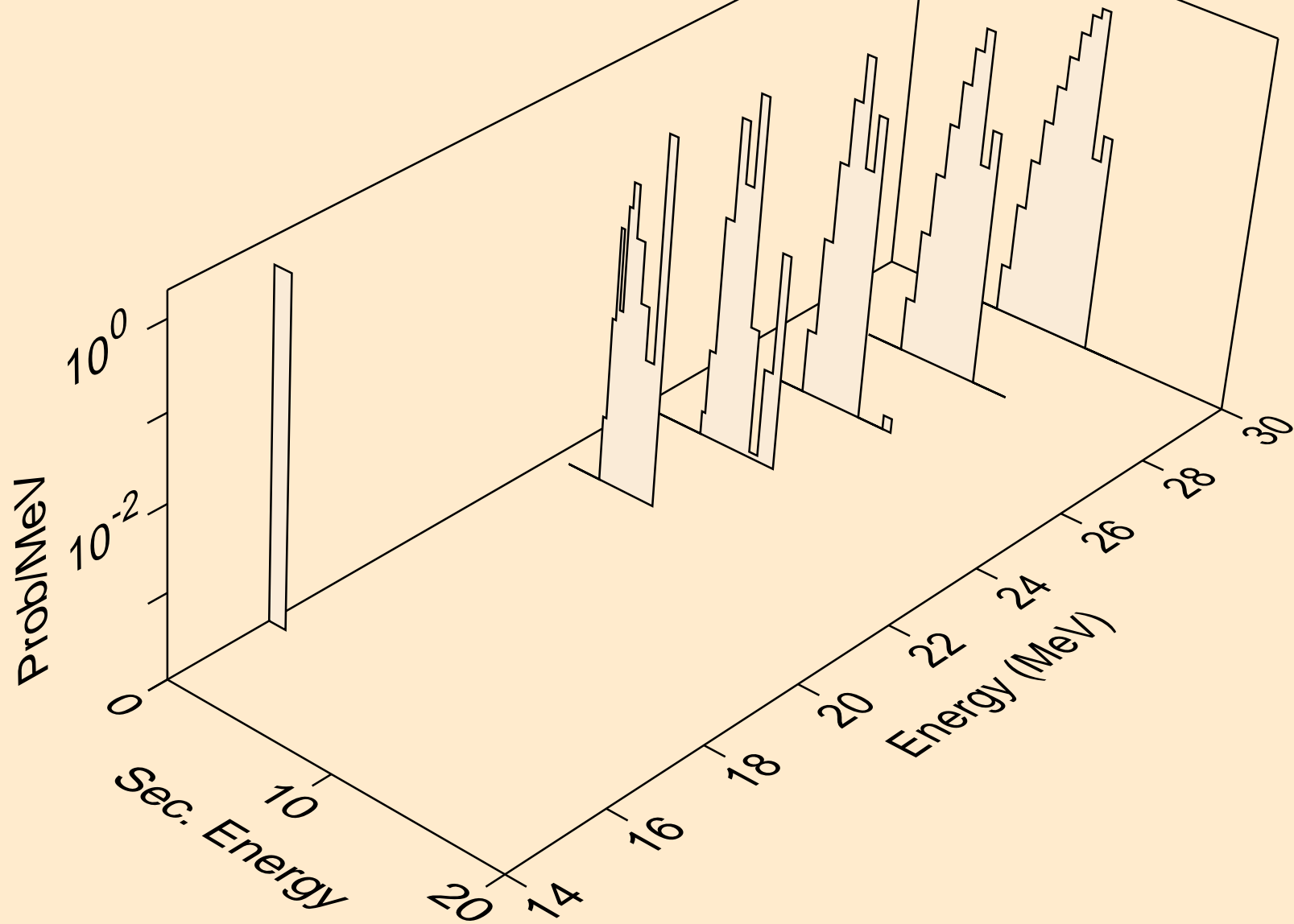

SN128M NEUTRON ACER TENDL-2023 LIBRARY; T=0.K
alphas from (n,x)

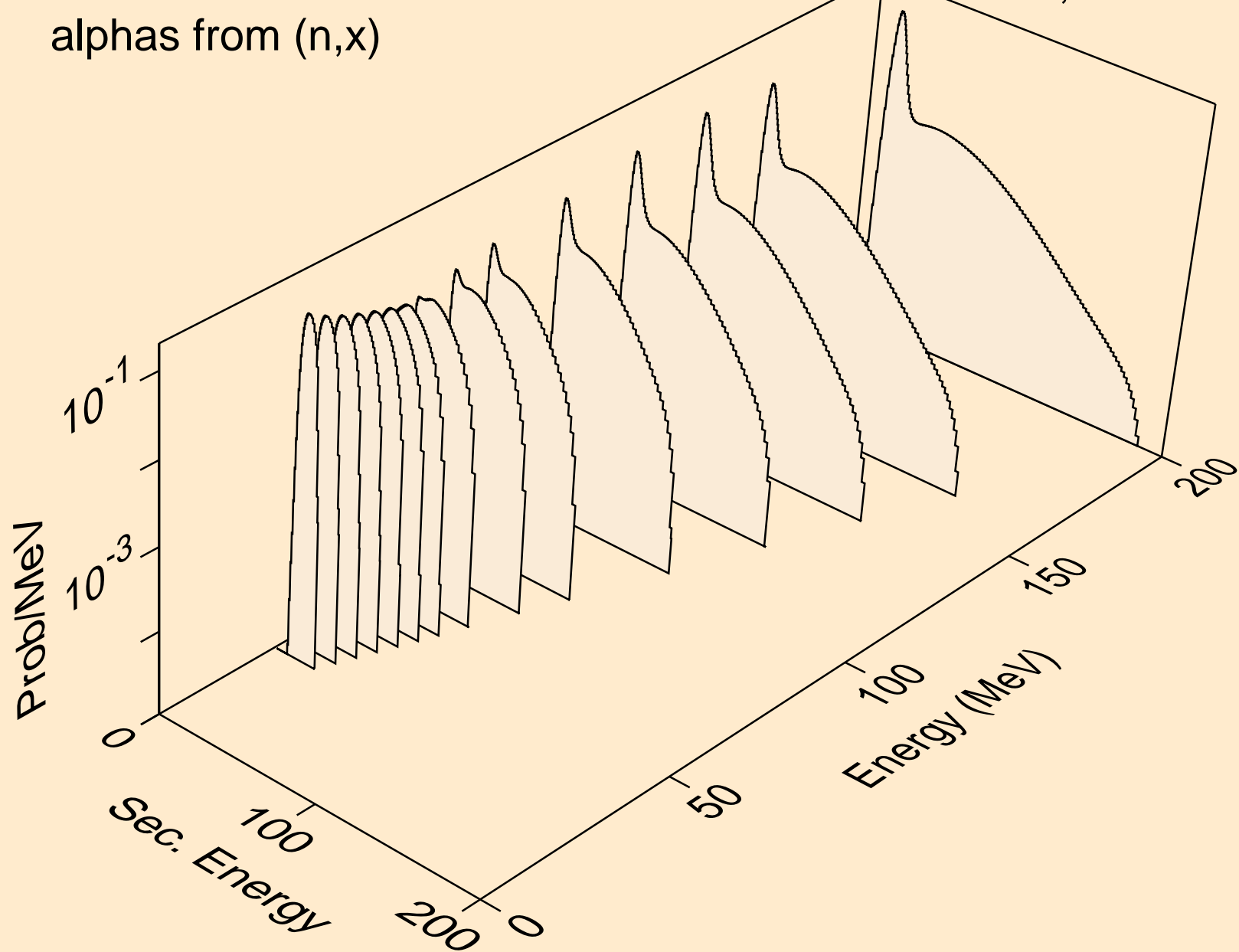

SN128M NEUTRON ACER TENDL-2023 LIBRARY; T=0.K
alphas from (n,n*)a

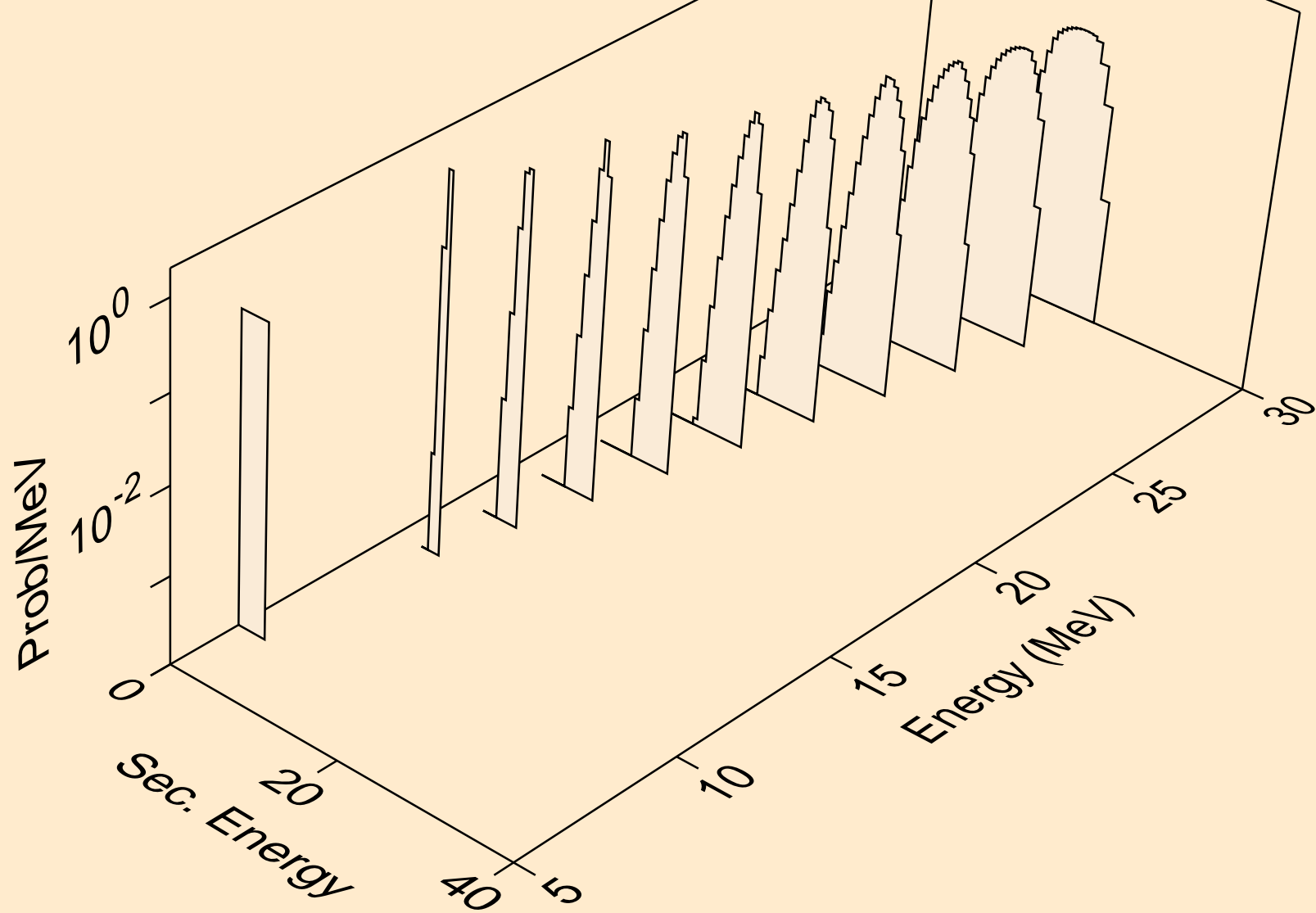

SN128M NEUTRON ACER TENDL-2023 LIBRARY; T=0.K
alphas from (n,2n)a

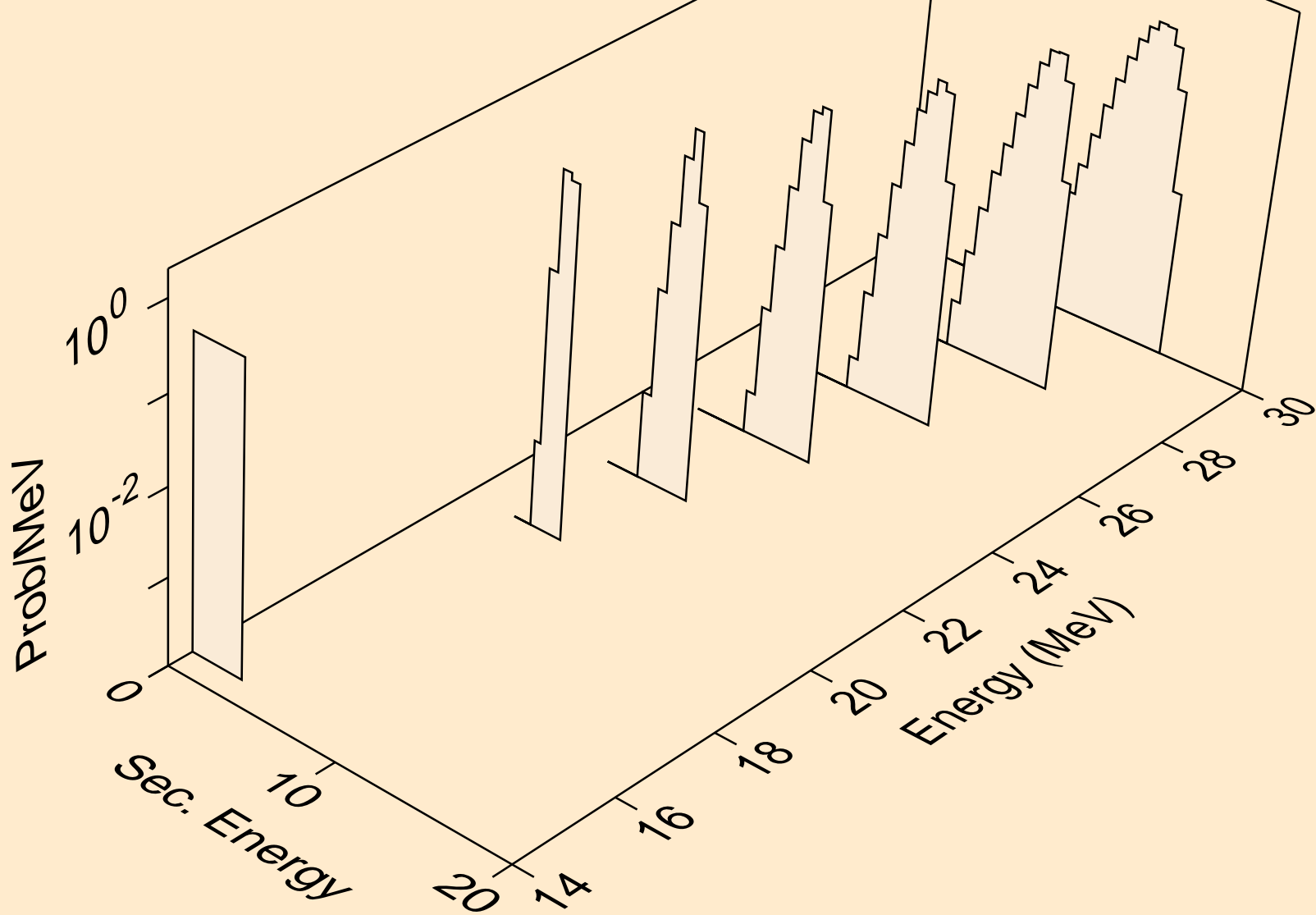

SN128M NEUTRON ACER TENDL-2023 LIBRARY; T=0.K
alphas from (n,3n)a

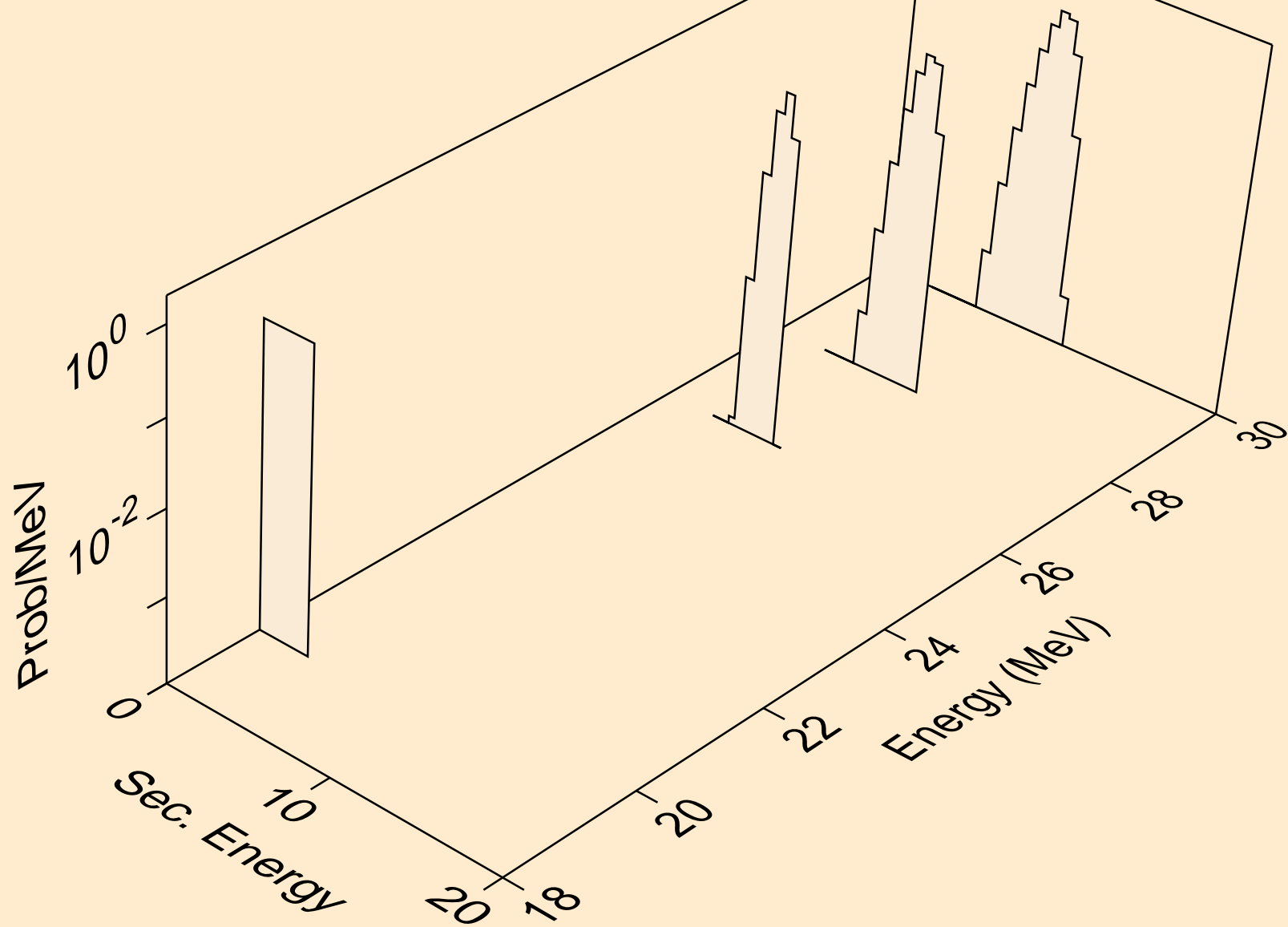

SN128M NEUTRON ACER TENDL-2023 LIBRARY; T=0.K
alphas from (n,a)

