

# TA160 NEUTRON ACER TENDL-2023 LIBRARY; T=0.K

## Principal cross sections

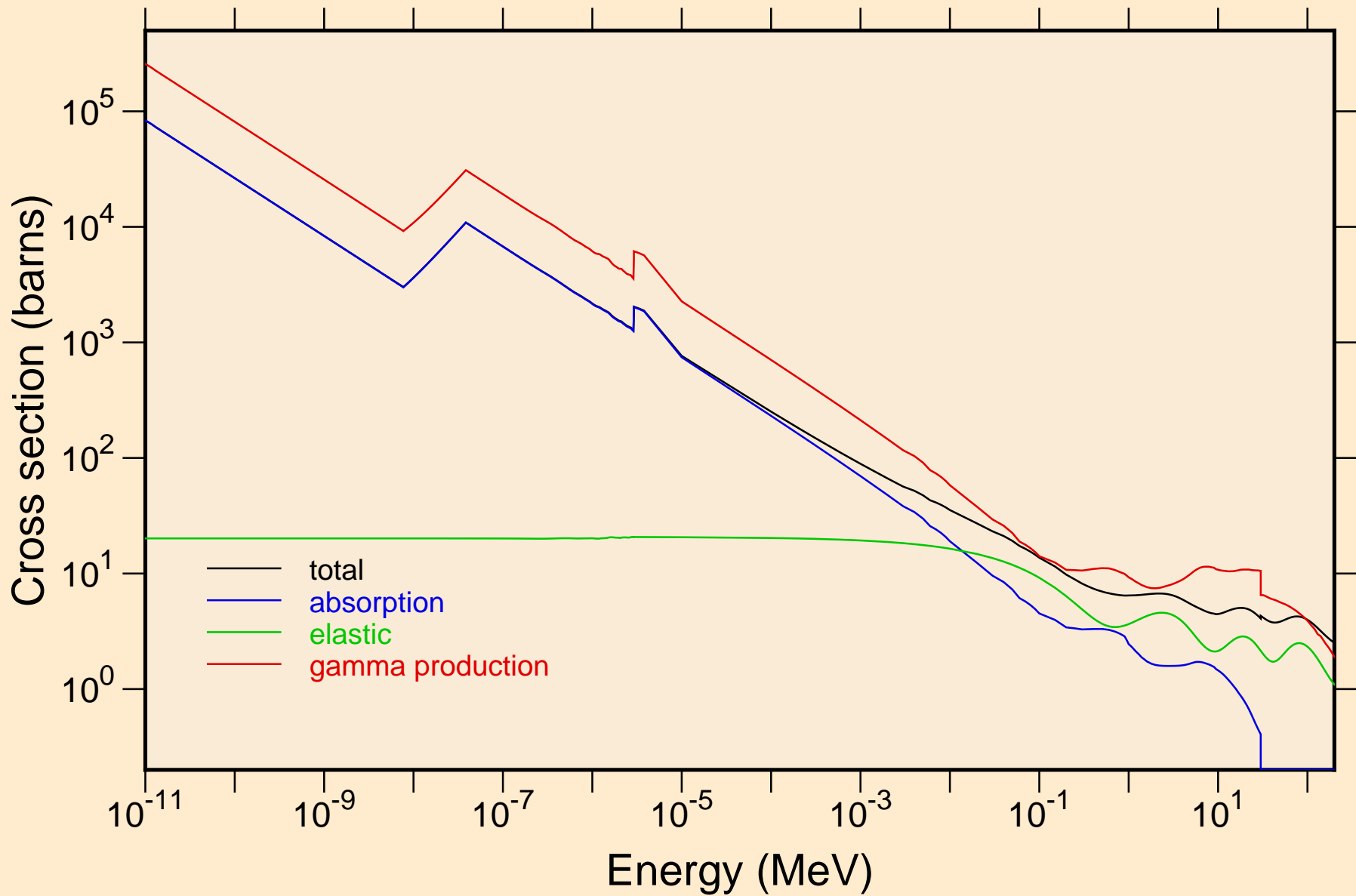

# TA160 NEUTRON ACER TENDL-2023 LIBRARY; T=0.K

## Heating

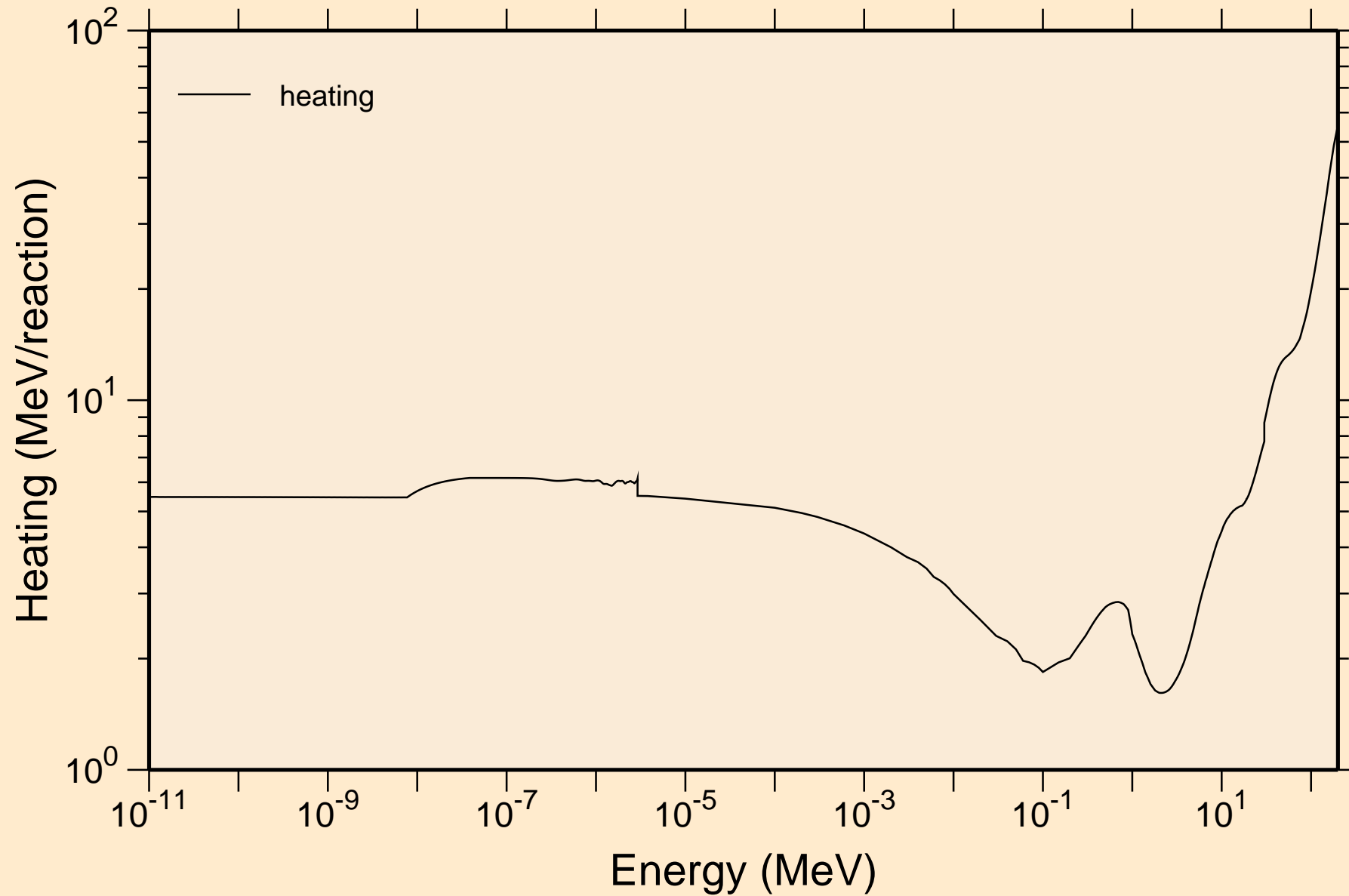

TA160 NEUTRON ACER TENDL-2023 LIBRARY; T=0.K  
Damage

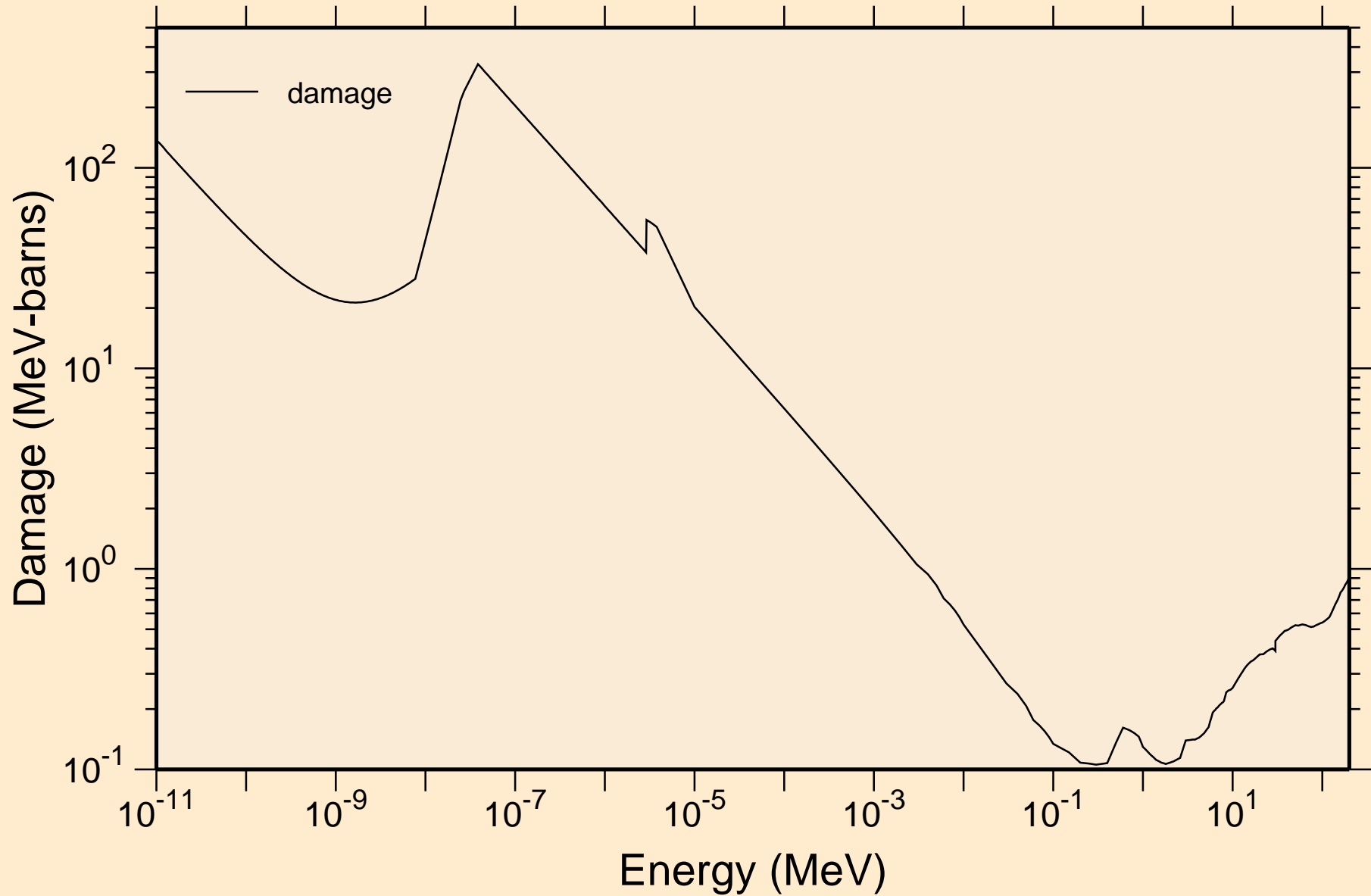

TA160 NEUTRON ACER TENDL-2023 LIBRARY; T=0.K  
Non-threshold reactions

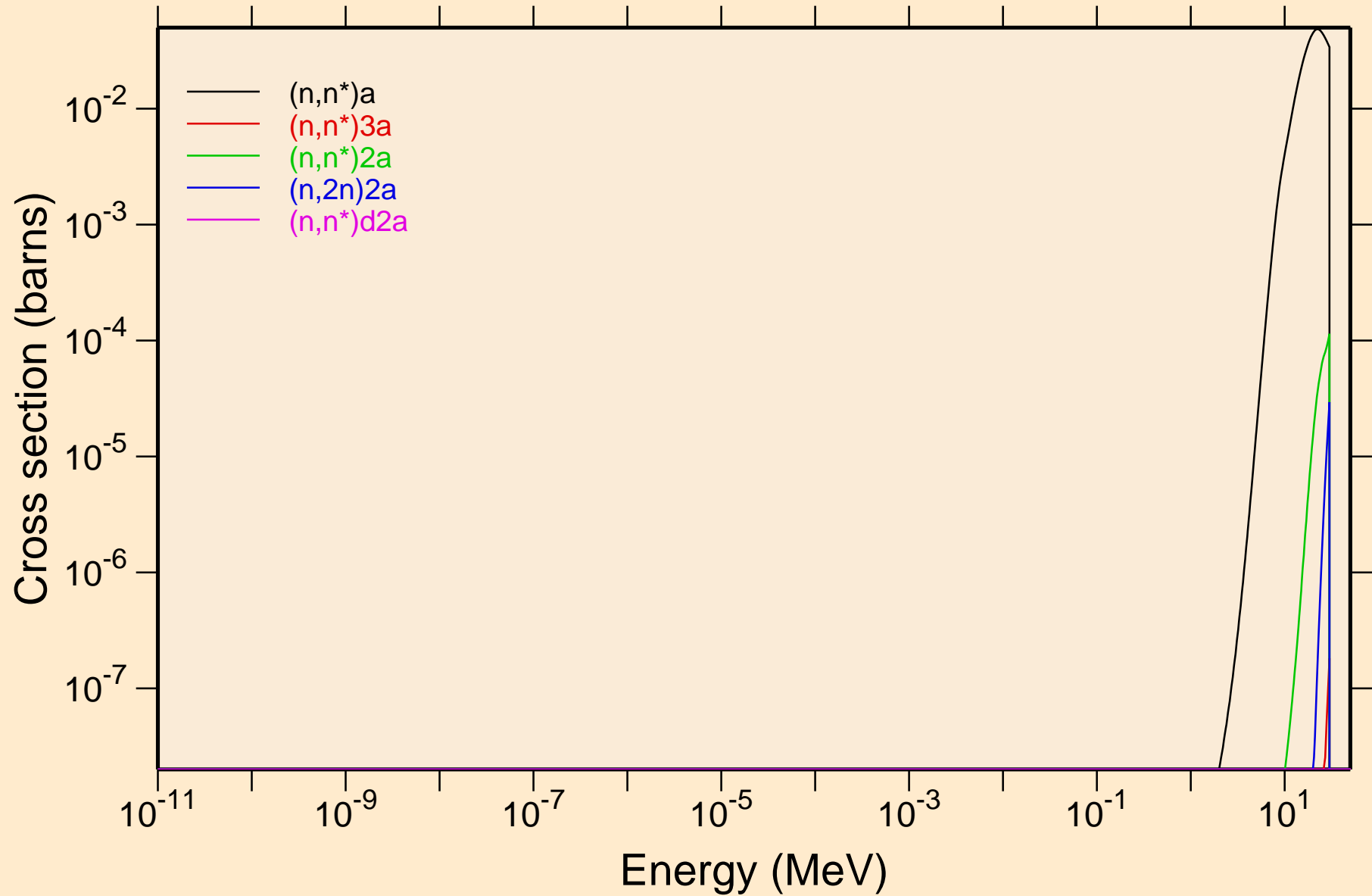

TA160 NEUTRON ACER TENDL-2023 LIBRARY; T=0.K  
Non-threshold reactions

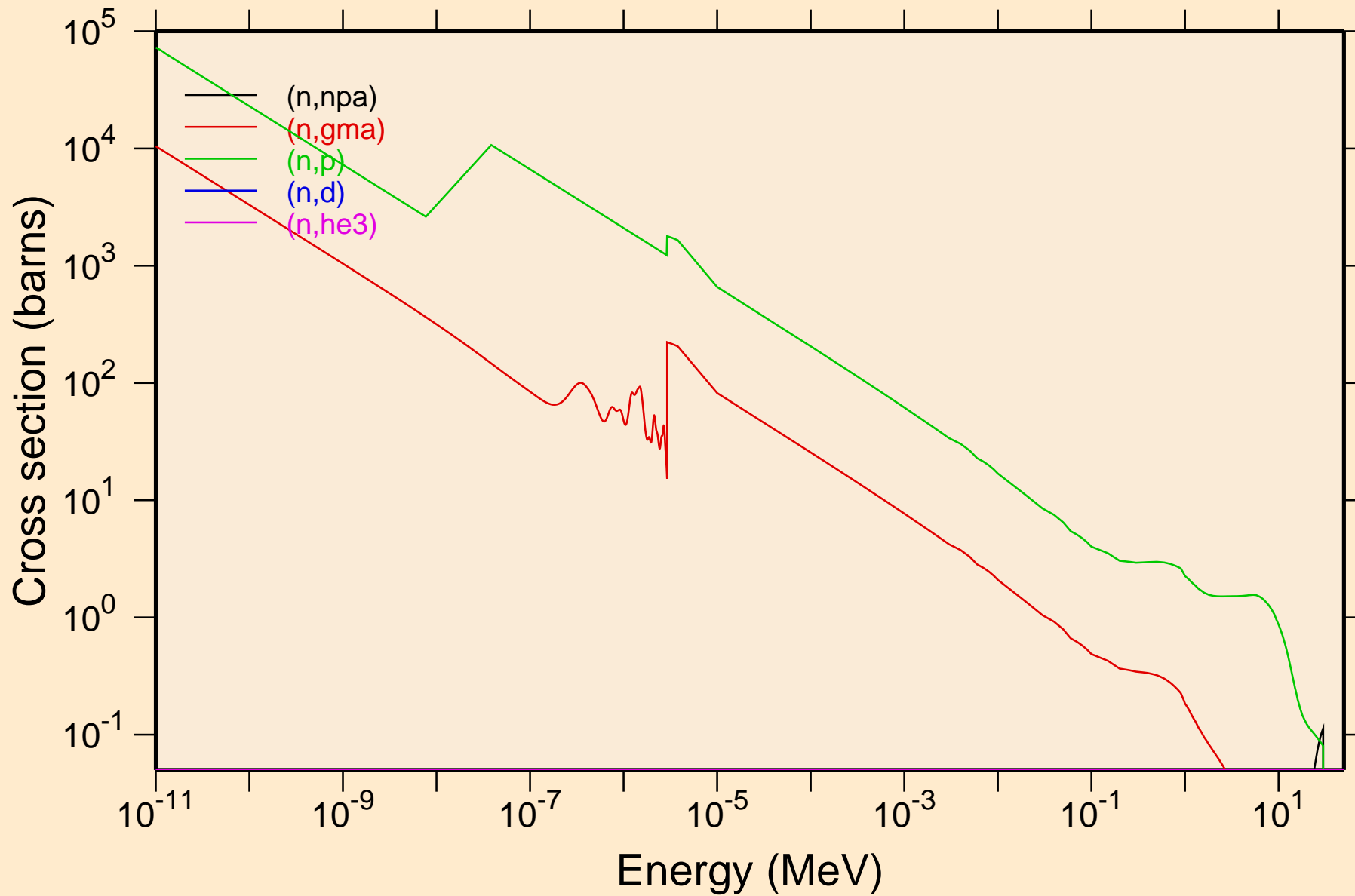

TA160 NEUTRON ACER TENDL-2023 LIBRARY; T=0.K  
Non-threshold reactions

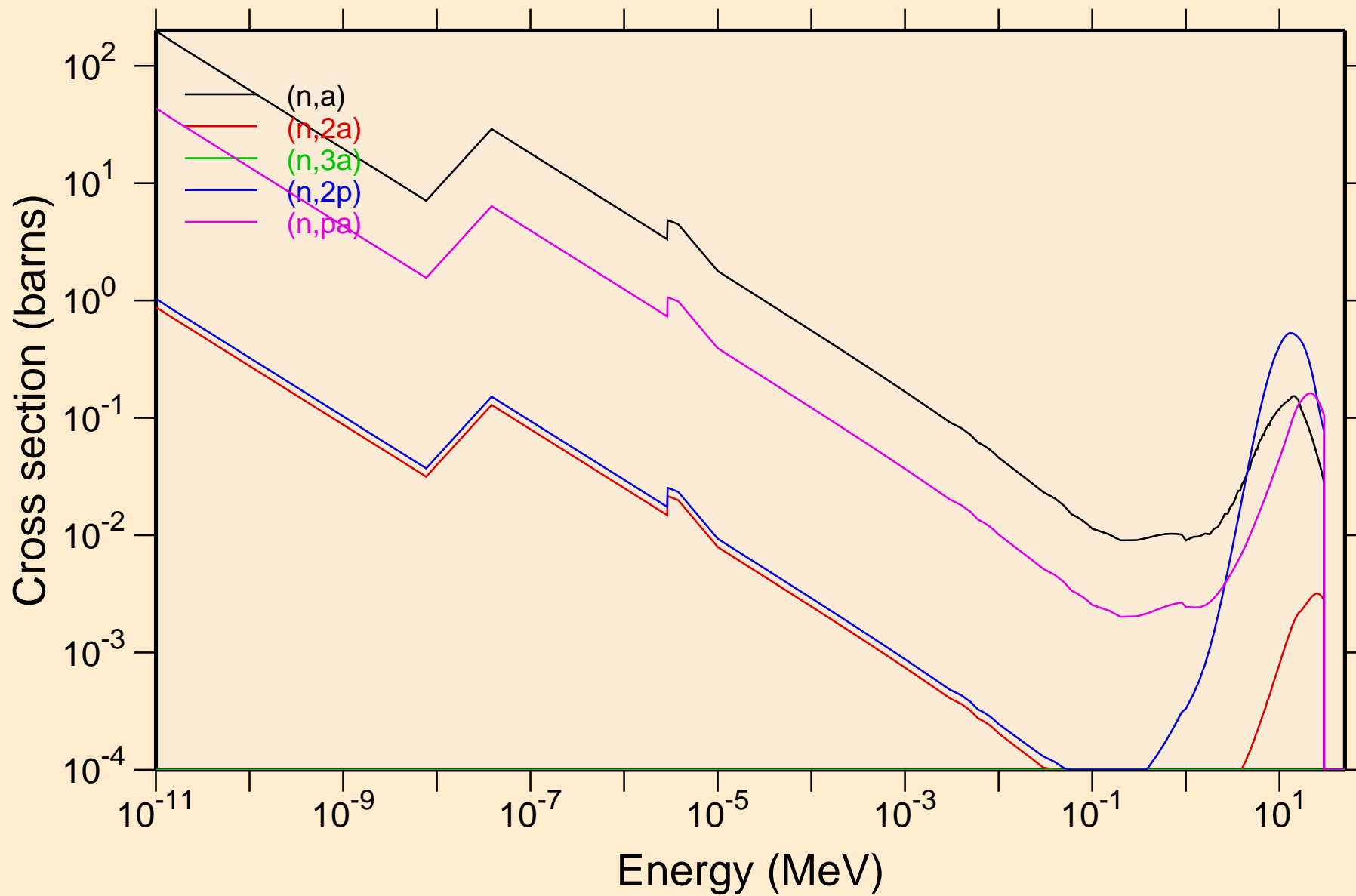

TA160 NEUTRON ACER TENDL-2023 LIBRARY; T=0.K  
Non-threshold reactions

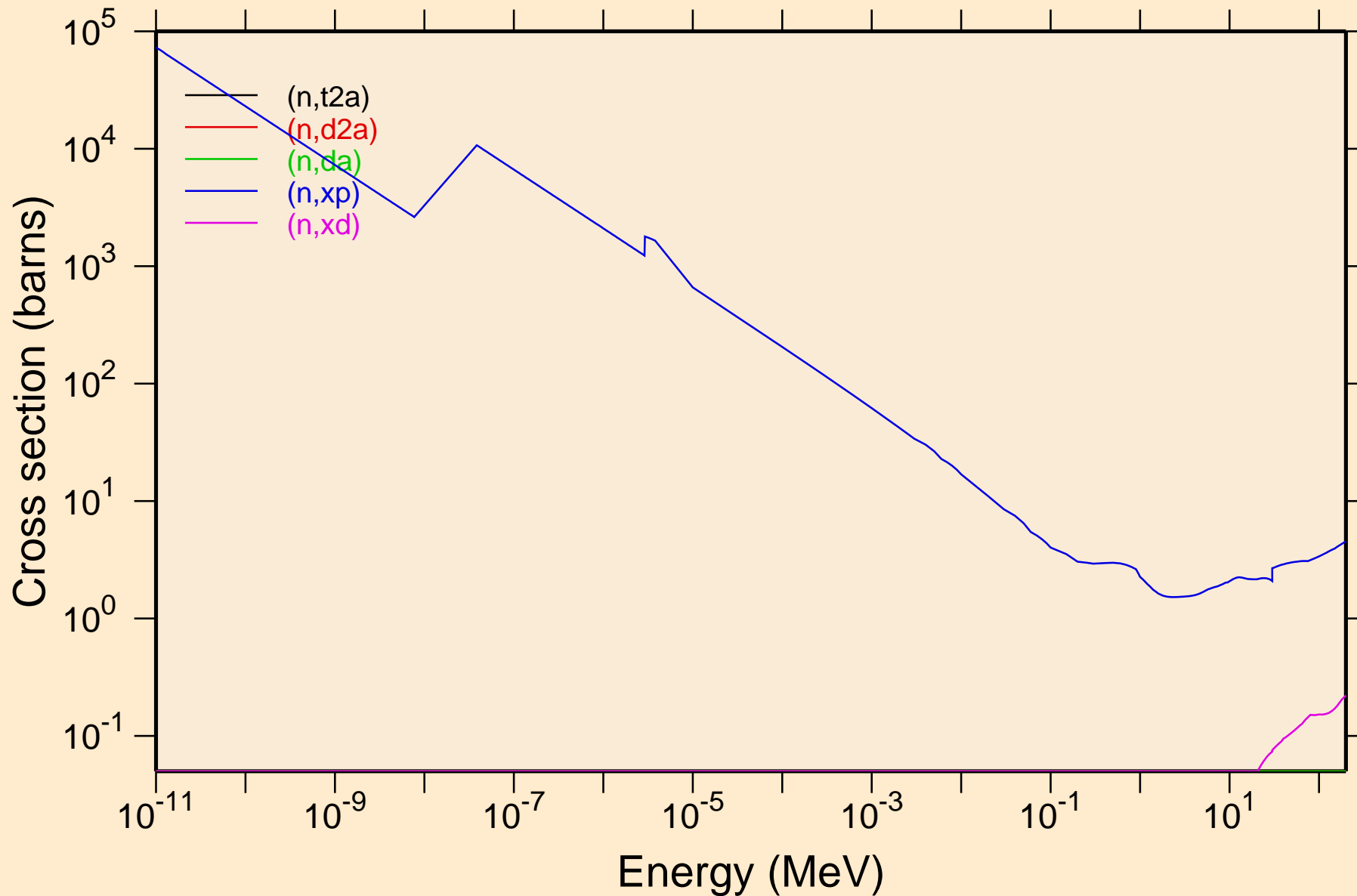

TA160 NEUTRON ACER TENDL-2023 LIBRARY; T=0.K  
Non-threshold reactions

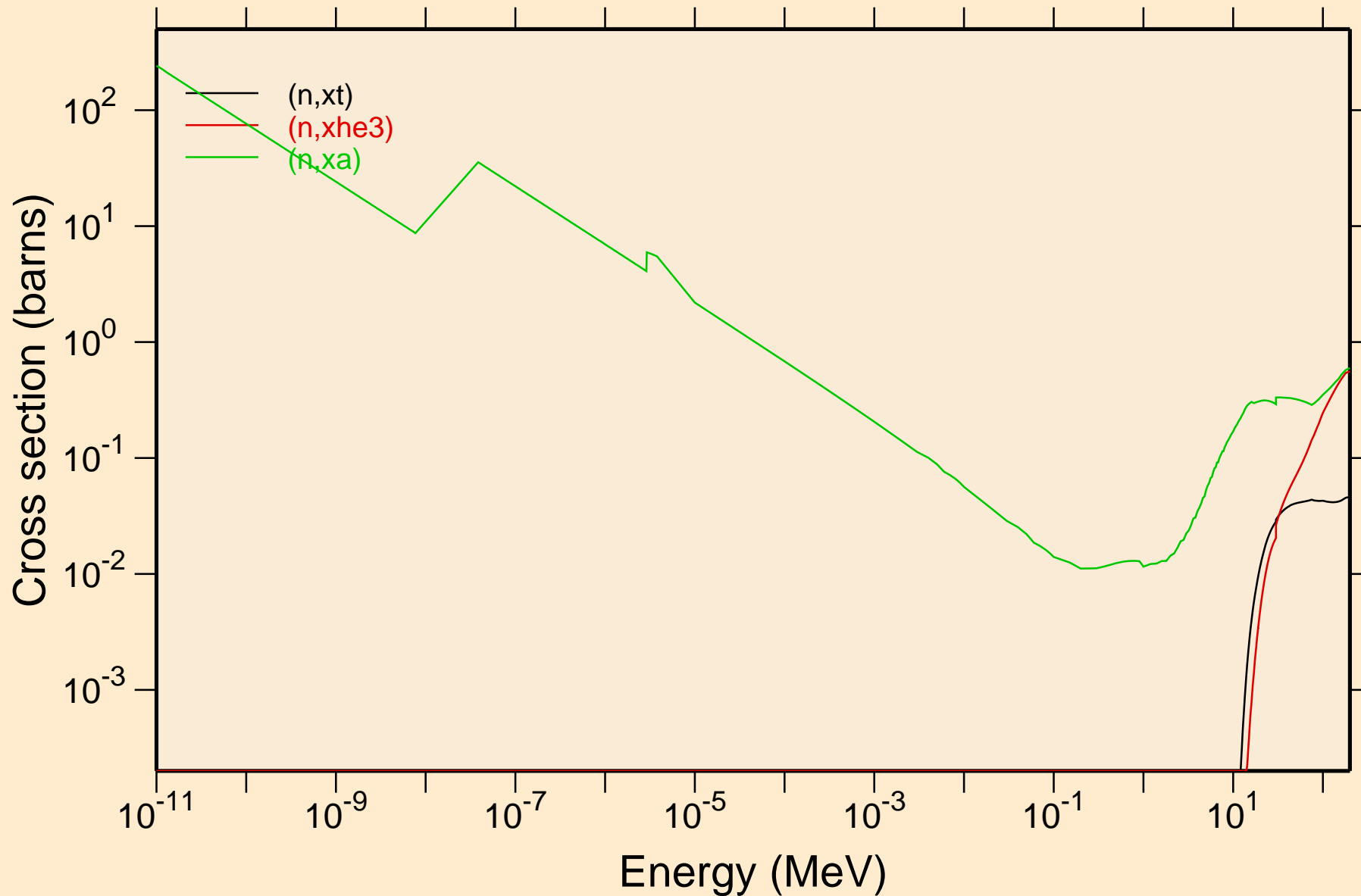



TA160 NEUTRON ACER TENDL-2023 LIBRARY; T=0.K  
Principal cross sections

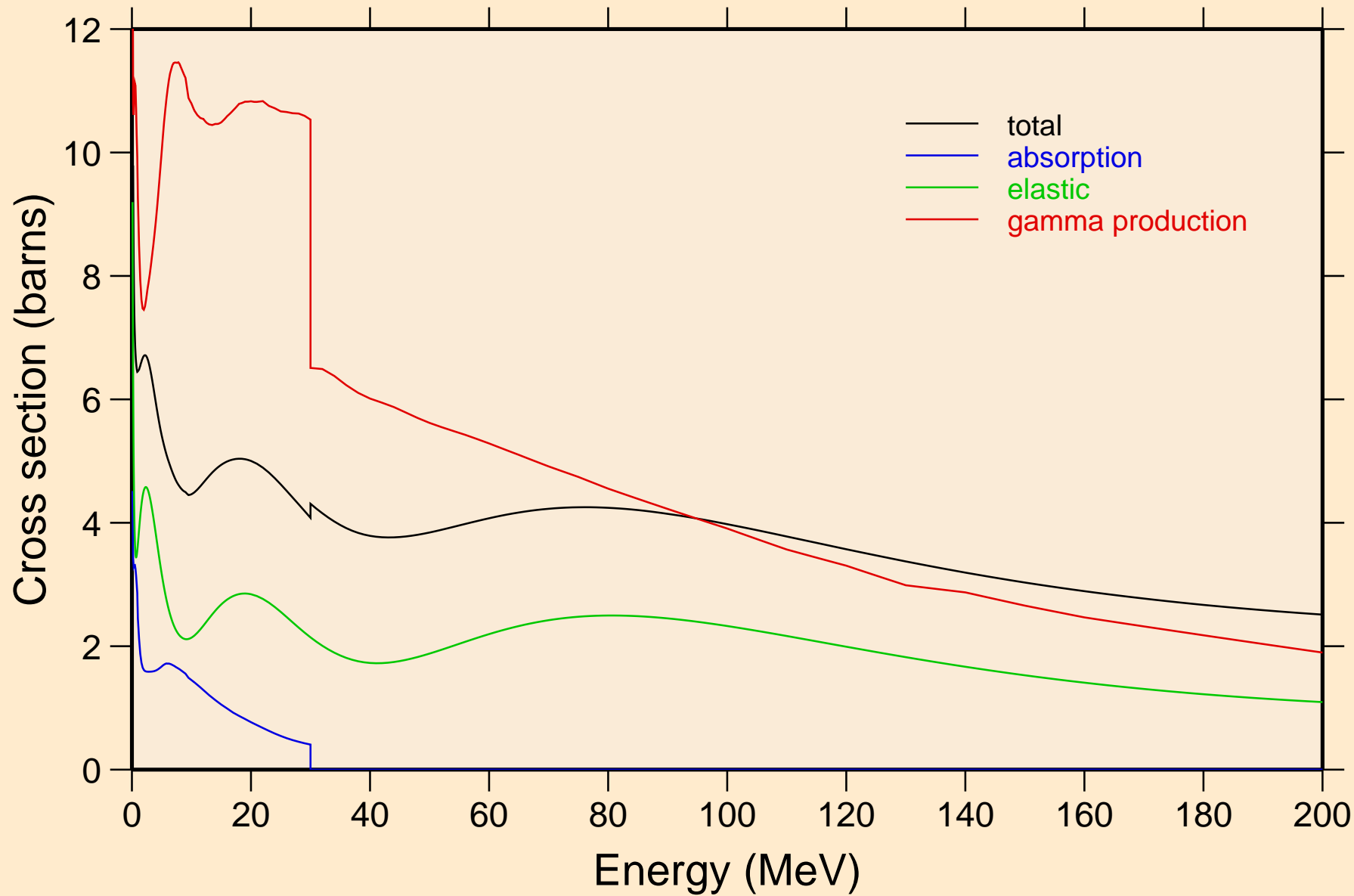

# TA160 NEUTRON ACER TENDL-2023 LIBRARY; T=0.K

## Heating

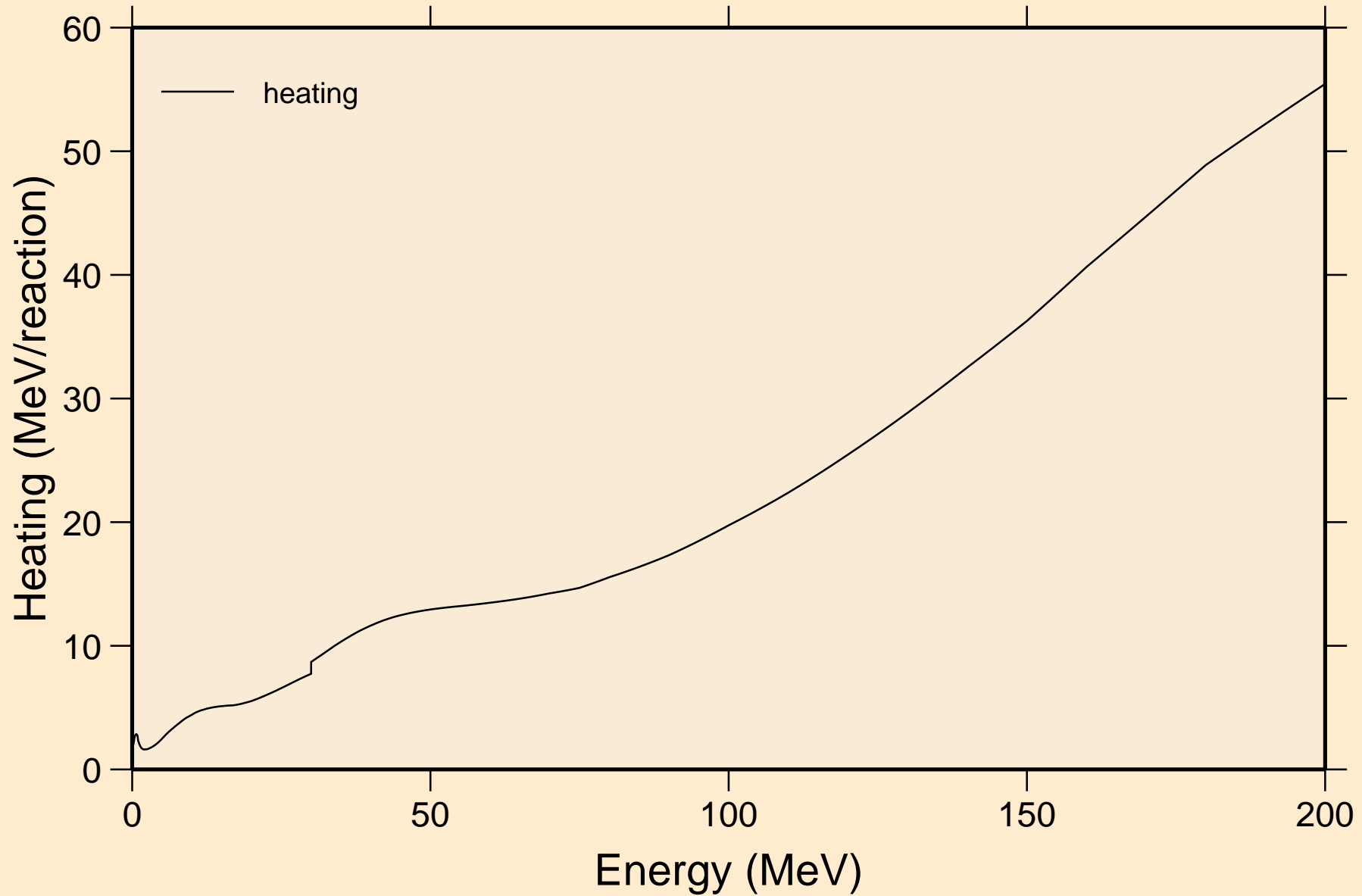

TA160 NEUTRON ACER TENDL-2023 LIBRARY; T=0.K  
Damage

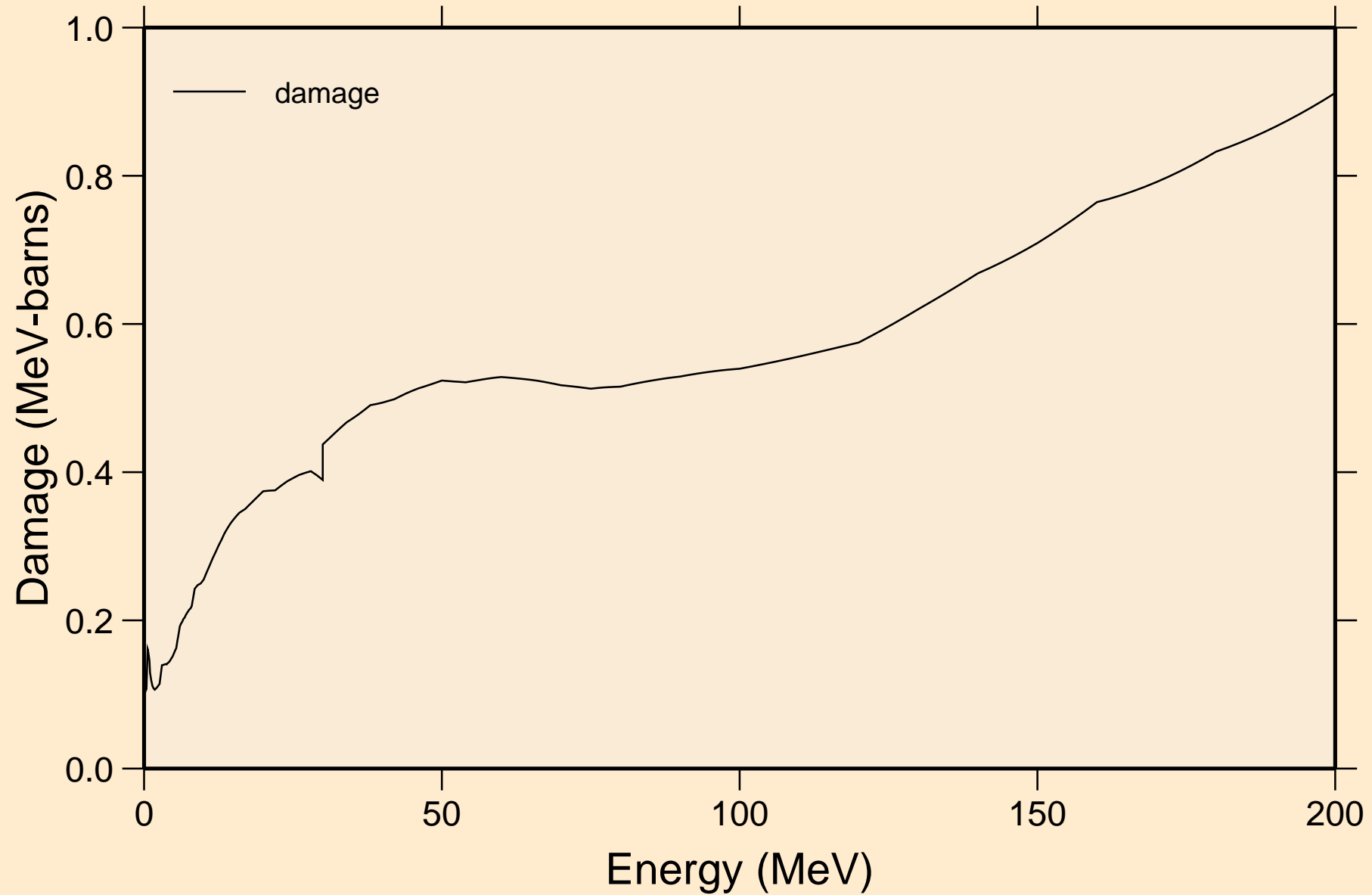

TA160 NEUTRON ACER TENDL-2023 LIBRARY; T=0.K  
Non-threshold reactions

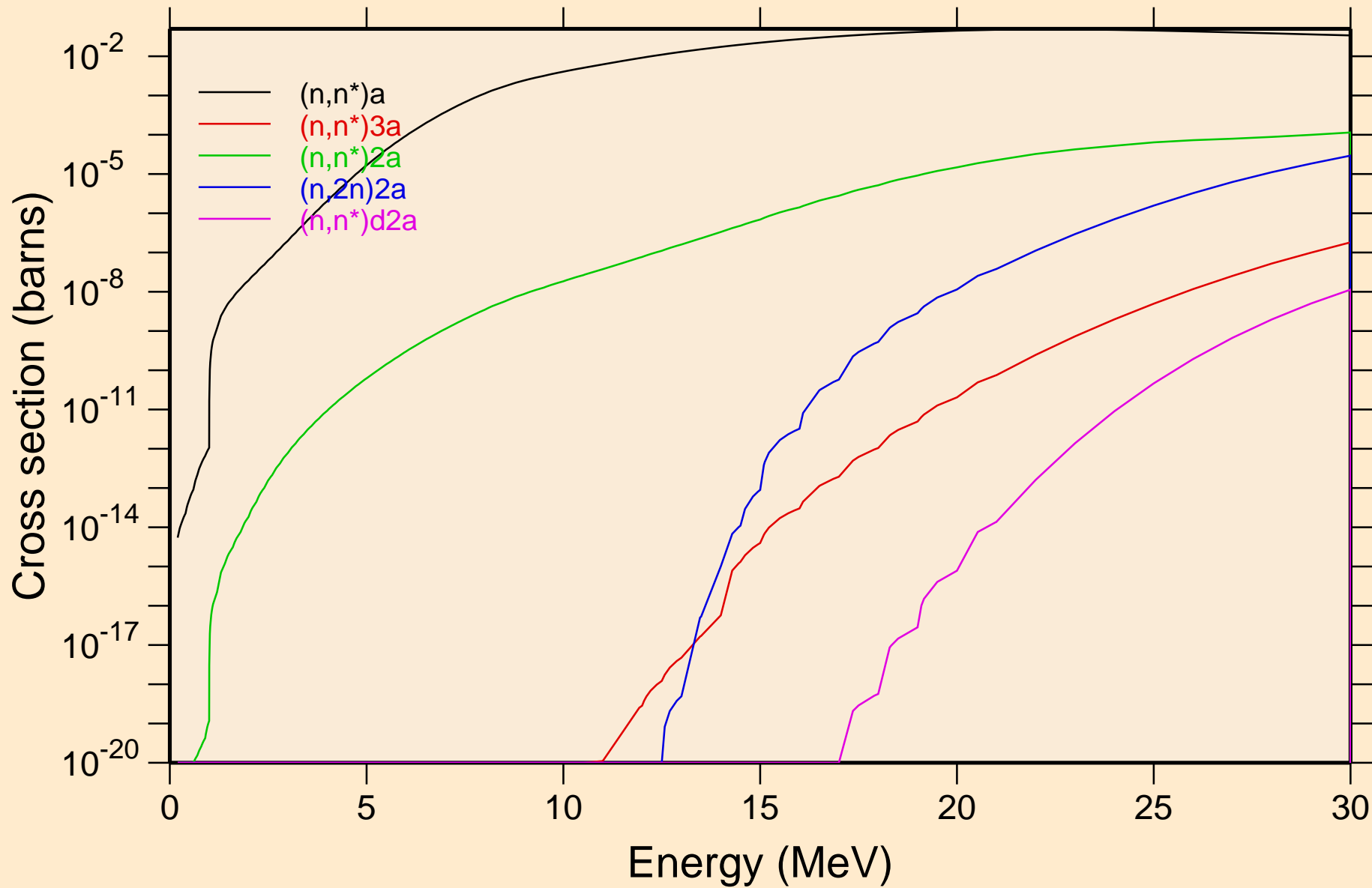

TA160 NEUTRON ACER TENDL-2023 LIBRARY; T=0.K  
Non-threshold reactions

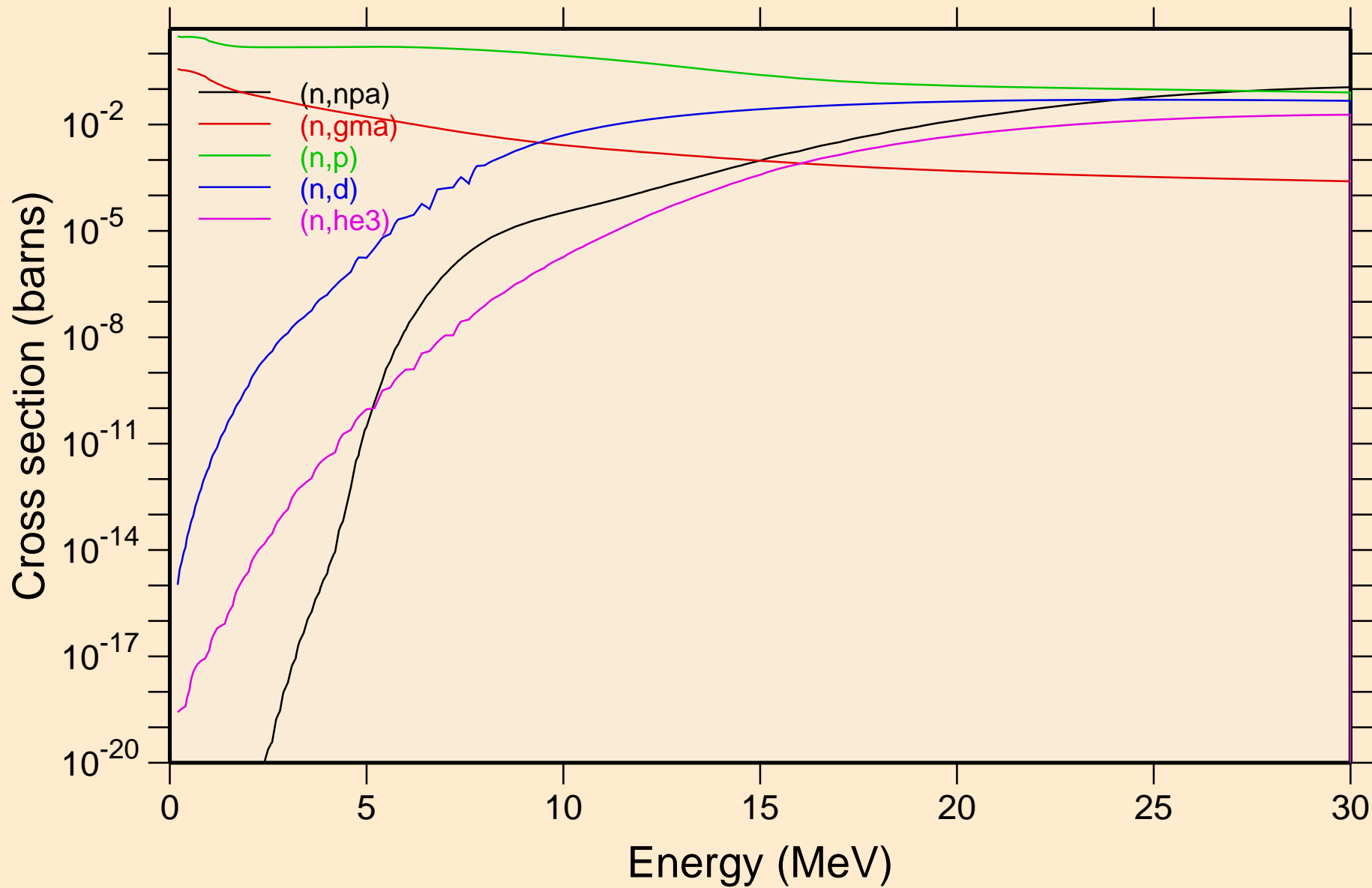

TA160 NEUTRON ACER TENDL-2023 LIBRARY; T=0.K  
Non-threshold reactions

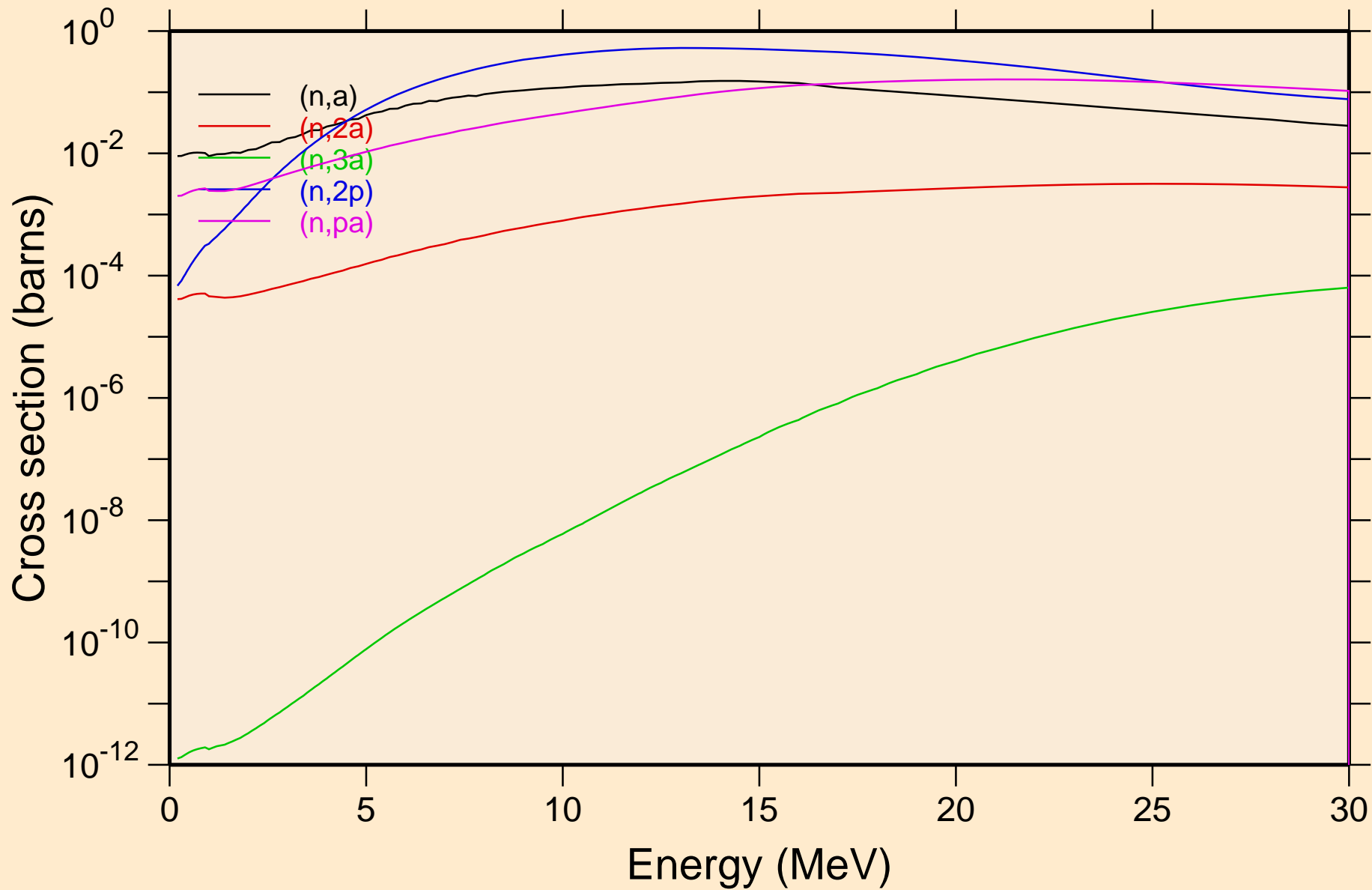

TA160 NEUTRON ACER TENDL-2023 LIBRARY; T=0.K  
Non-threshold reactions

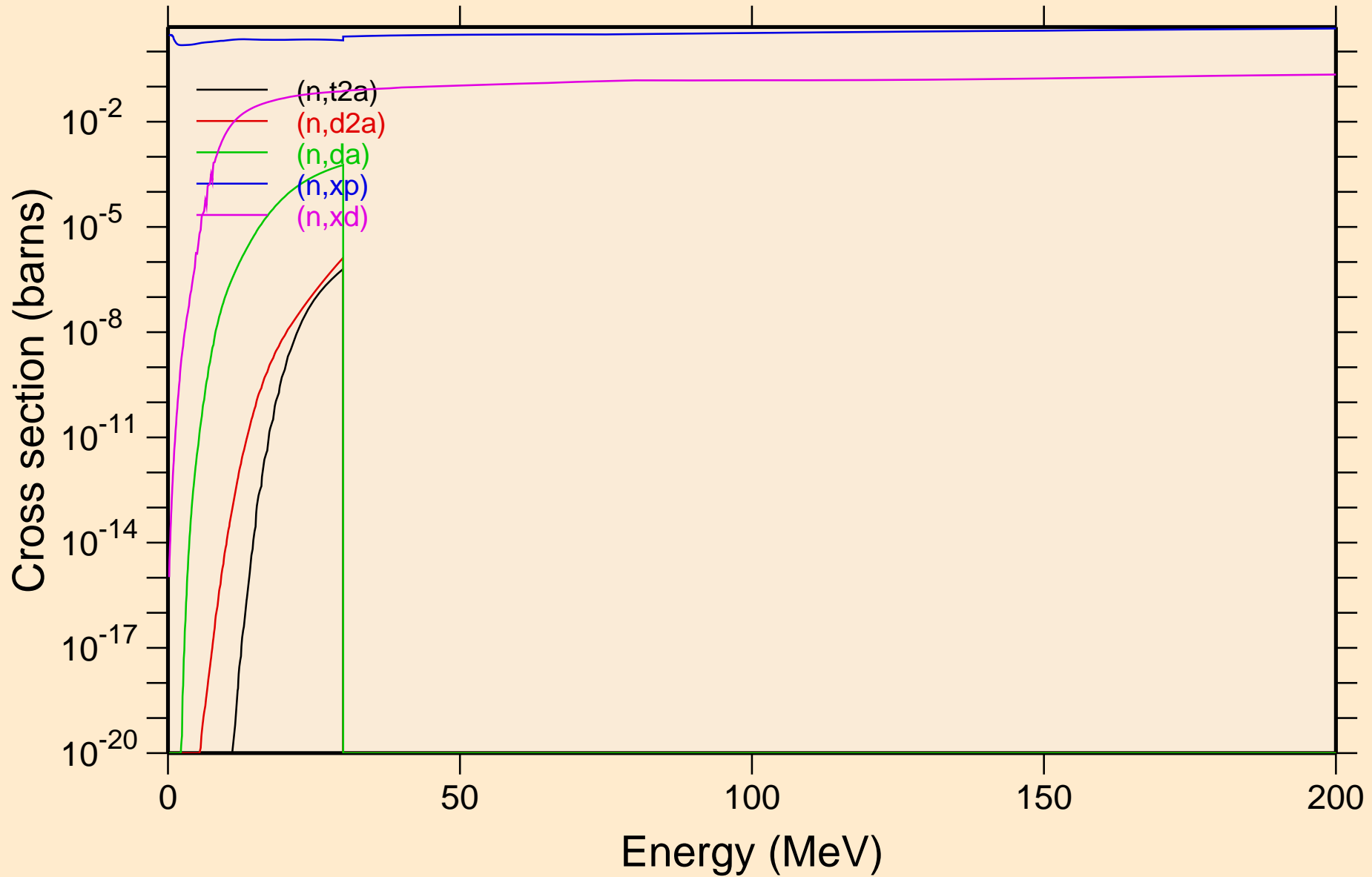

TA160 NEUTRON ACER TENDL-2023 LIBRARY; T=0.K  
Non-threshold reactions

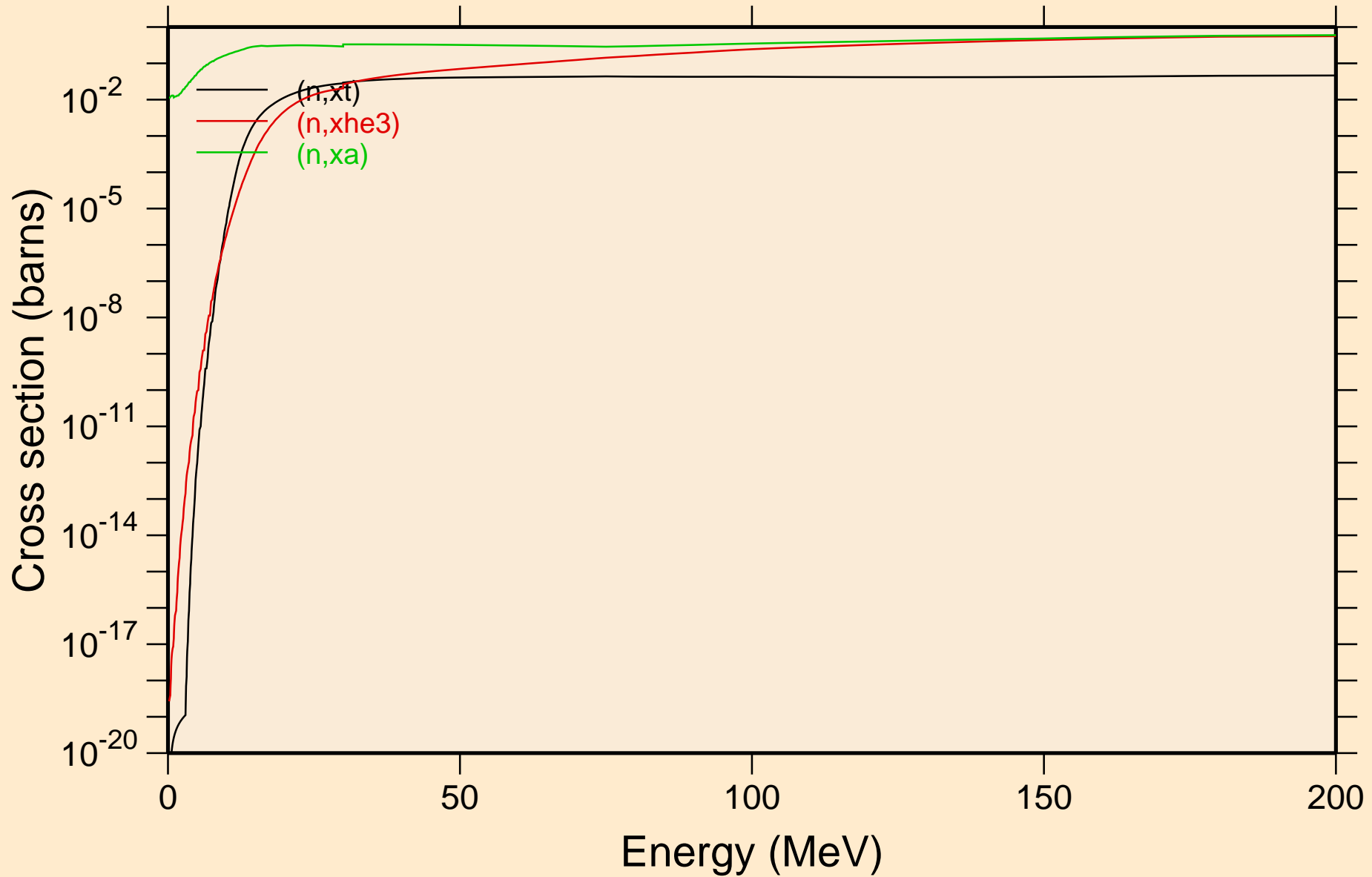



TA160 NEUTRON ACER TENDL-2023 LIBRARY; T=0.K  
Inelastic levels

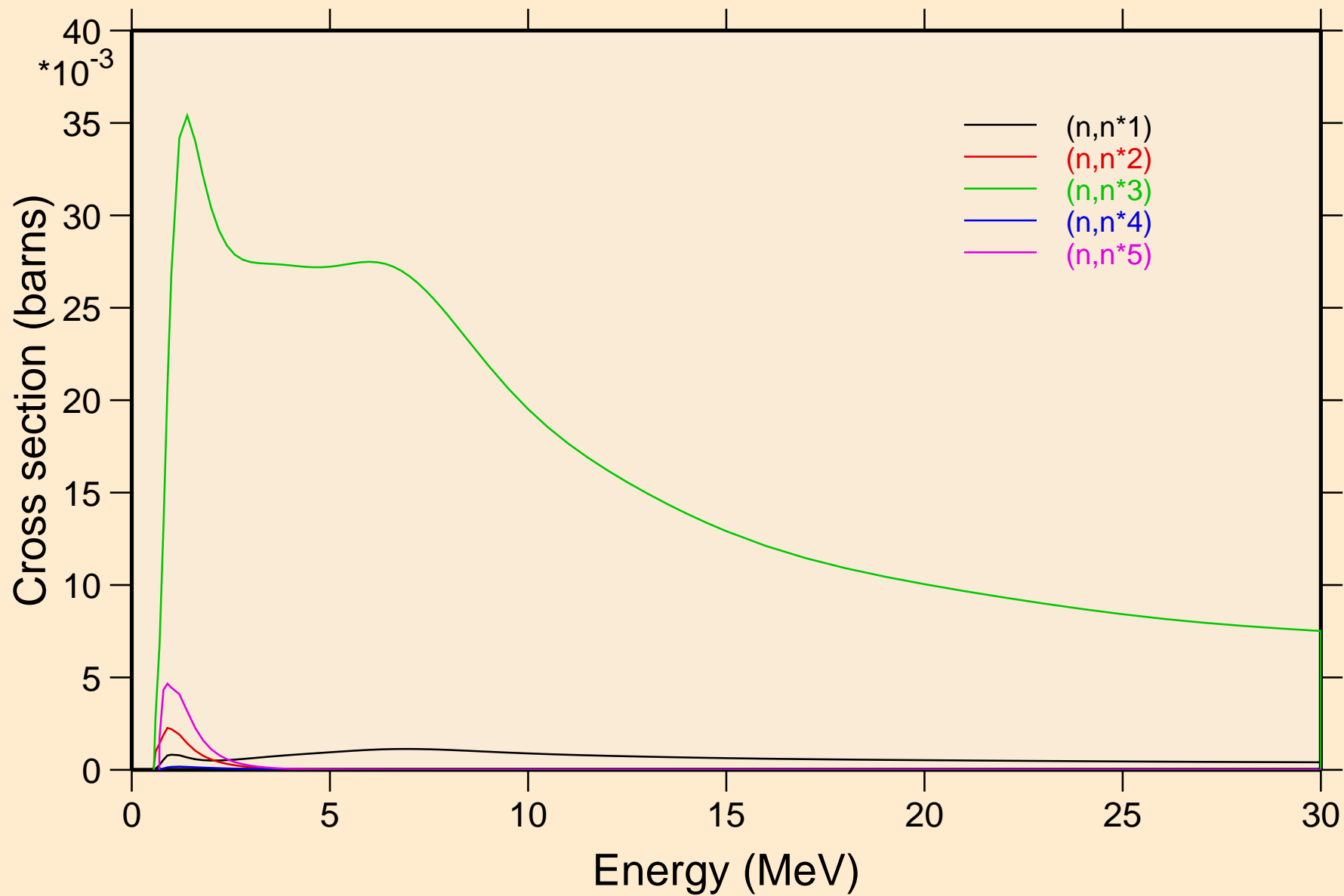

TA160 NEUTRON ACER TENDL-2023 LIBRARY; T=0.K  
Inelastic levels

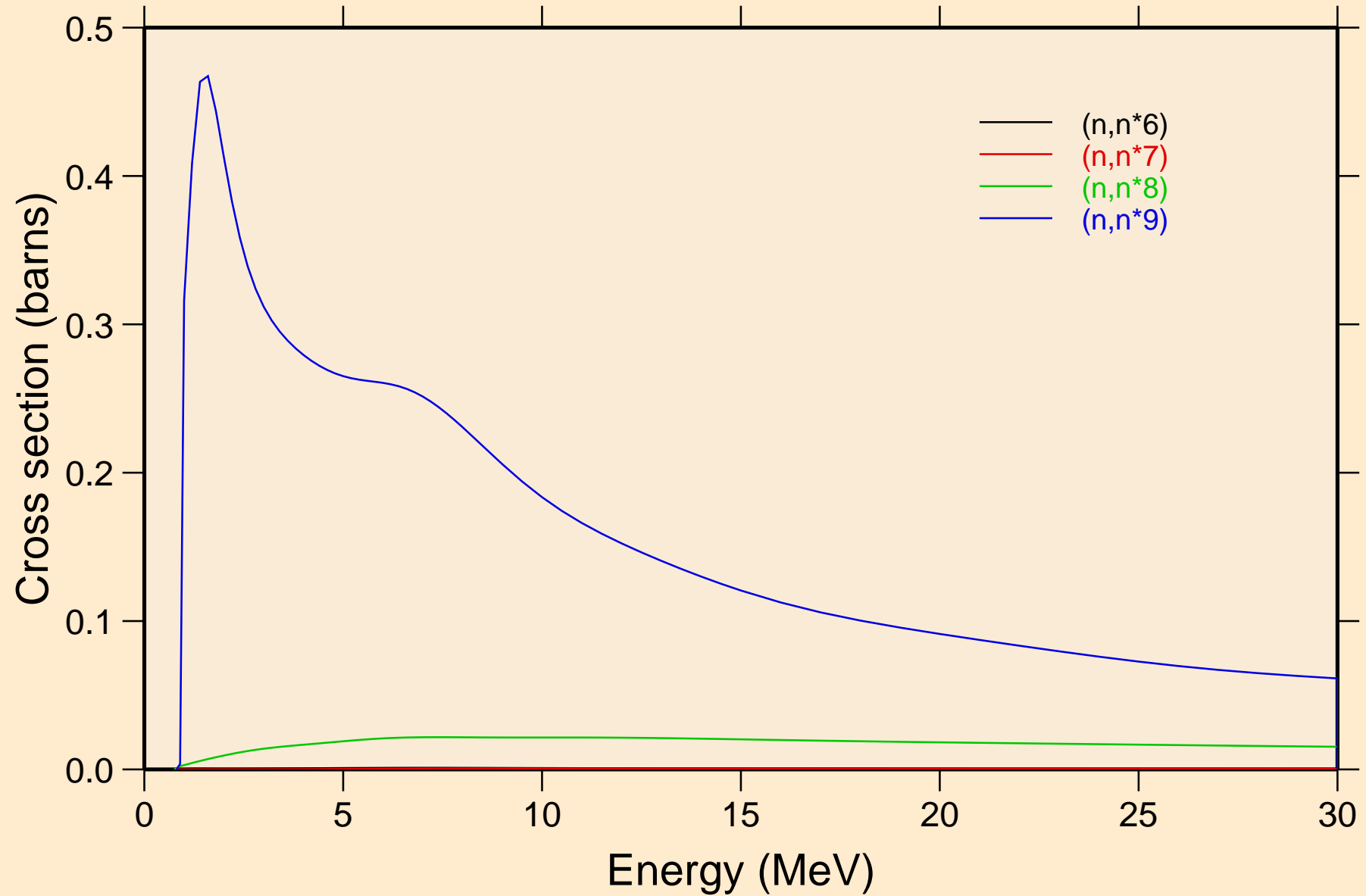

TA160 NEUTRON ACER TENDL-2023 LIBRARY; T=0.K  
Threshold reactions

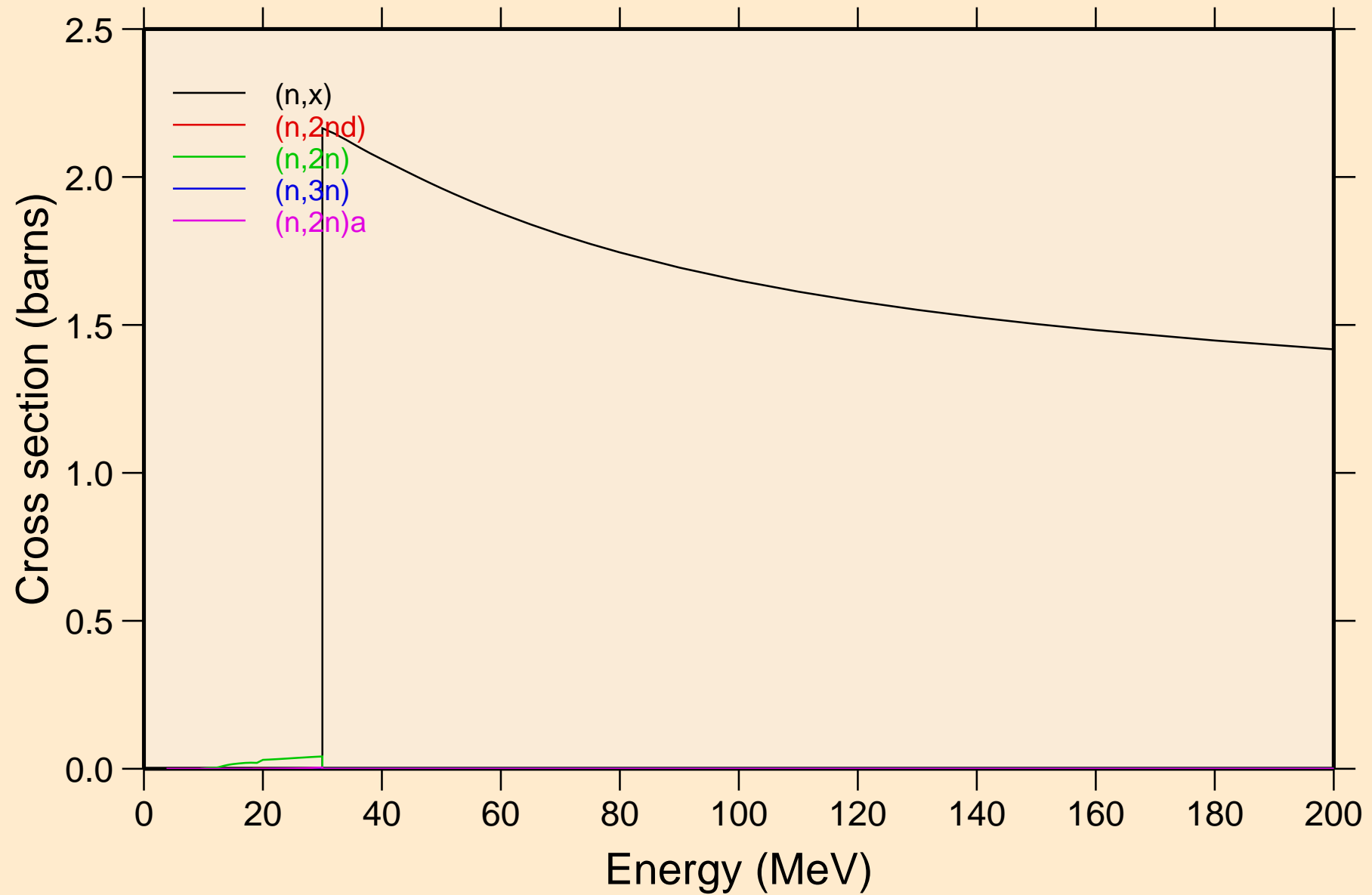

TA160 NEUTRON ACER TENDL-2023 LIBRARY; T=0.K  
Threshold reactions

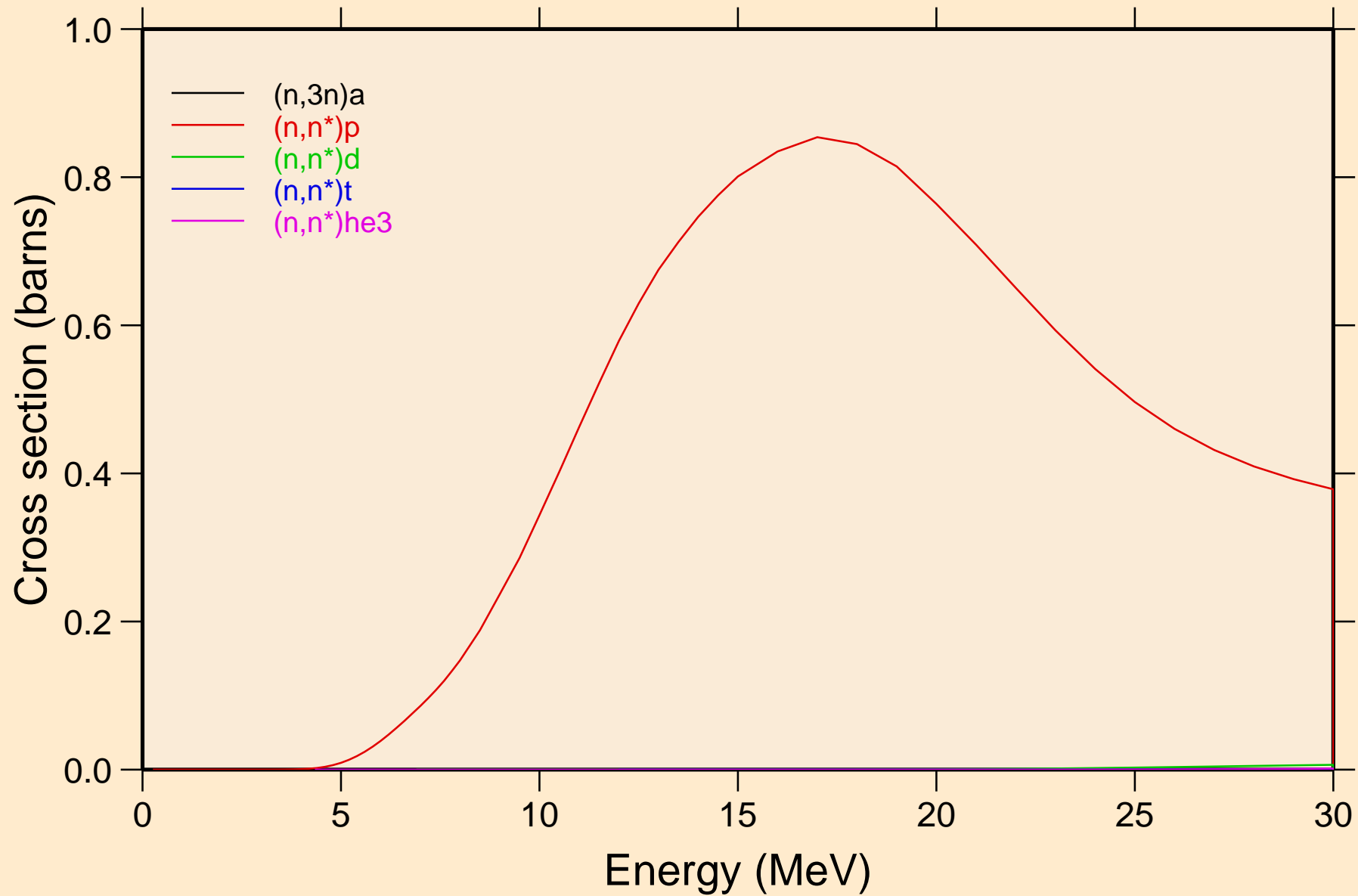

TA160 NEUTRON ACER TENDL-2023 LIBRARY; T=0.K  
Threshold reactions

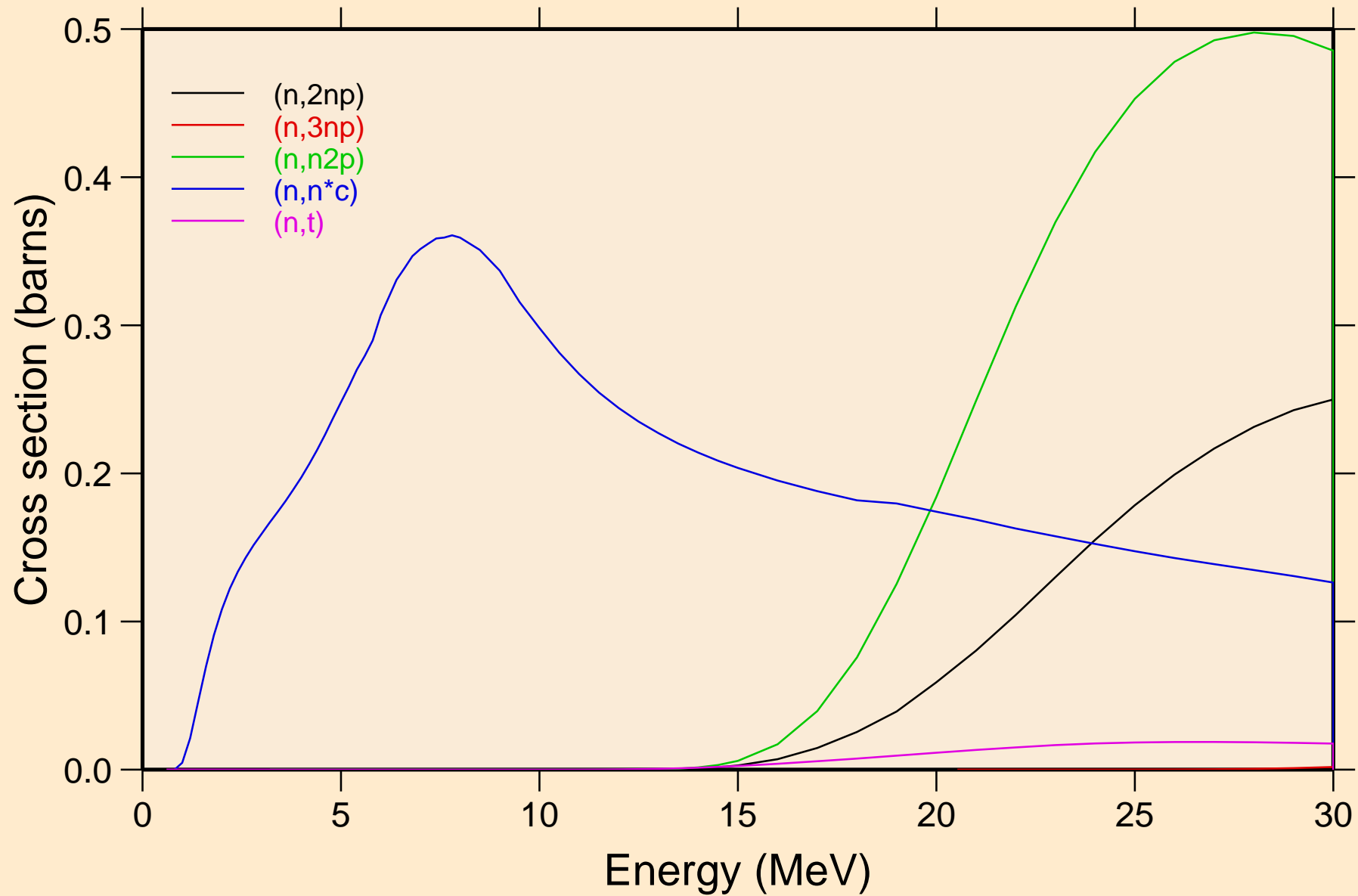

TA160 NEUTRON ACER TENDL-2023 LIBRARY; T=0.K  
Threshold reactions

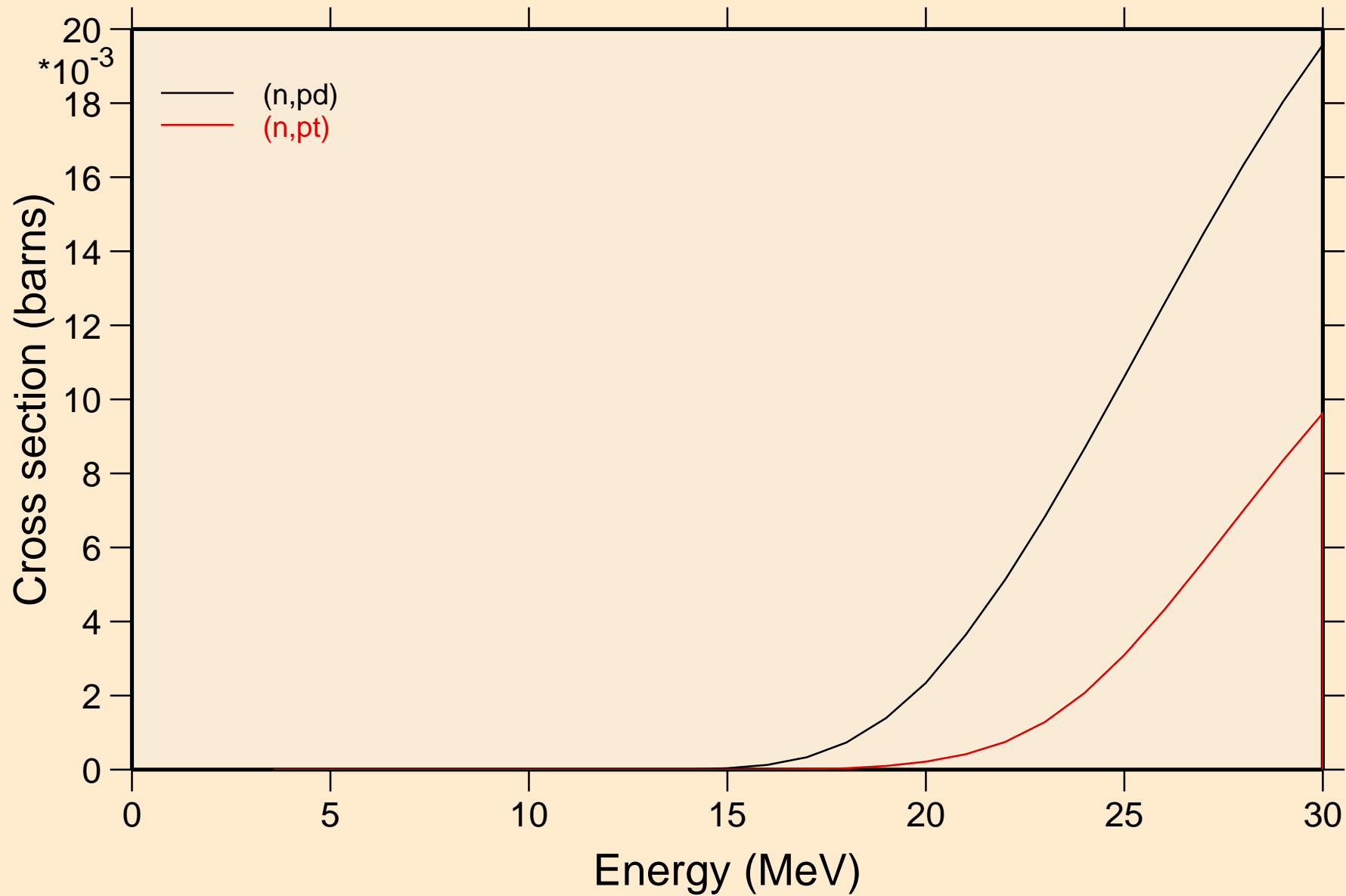

TA160 NEUTRON ACER TENDL-2023 LIBRARY; T=0.K  
angular distribution for elastic

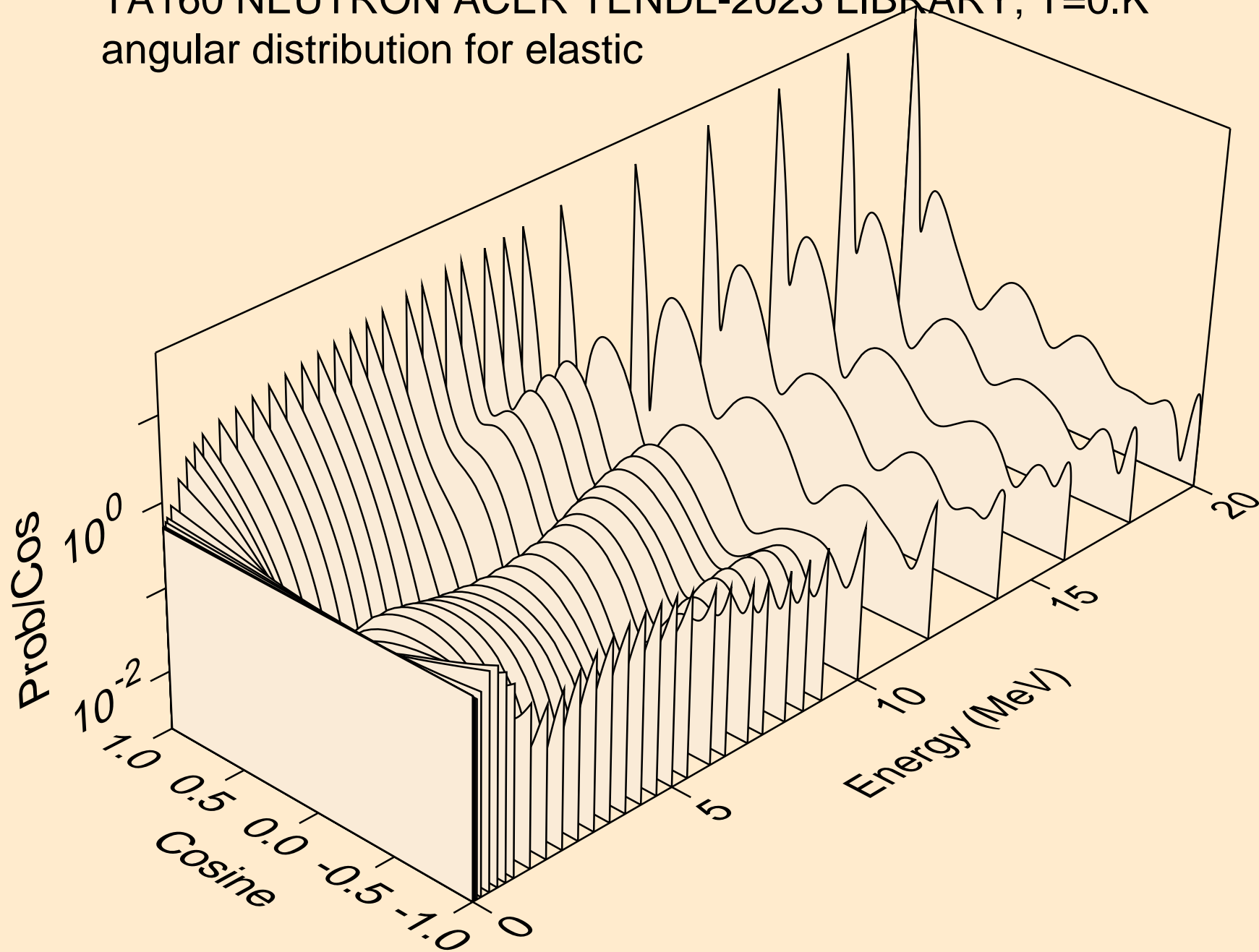

TA160 NEUTRON ACER TENDL-2023 LIBRARY; T=0.K  
angular distribution for elastic

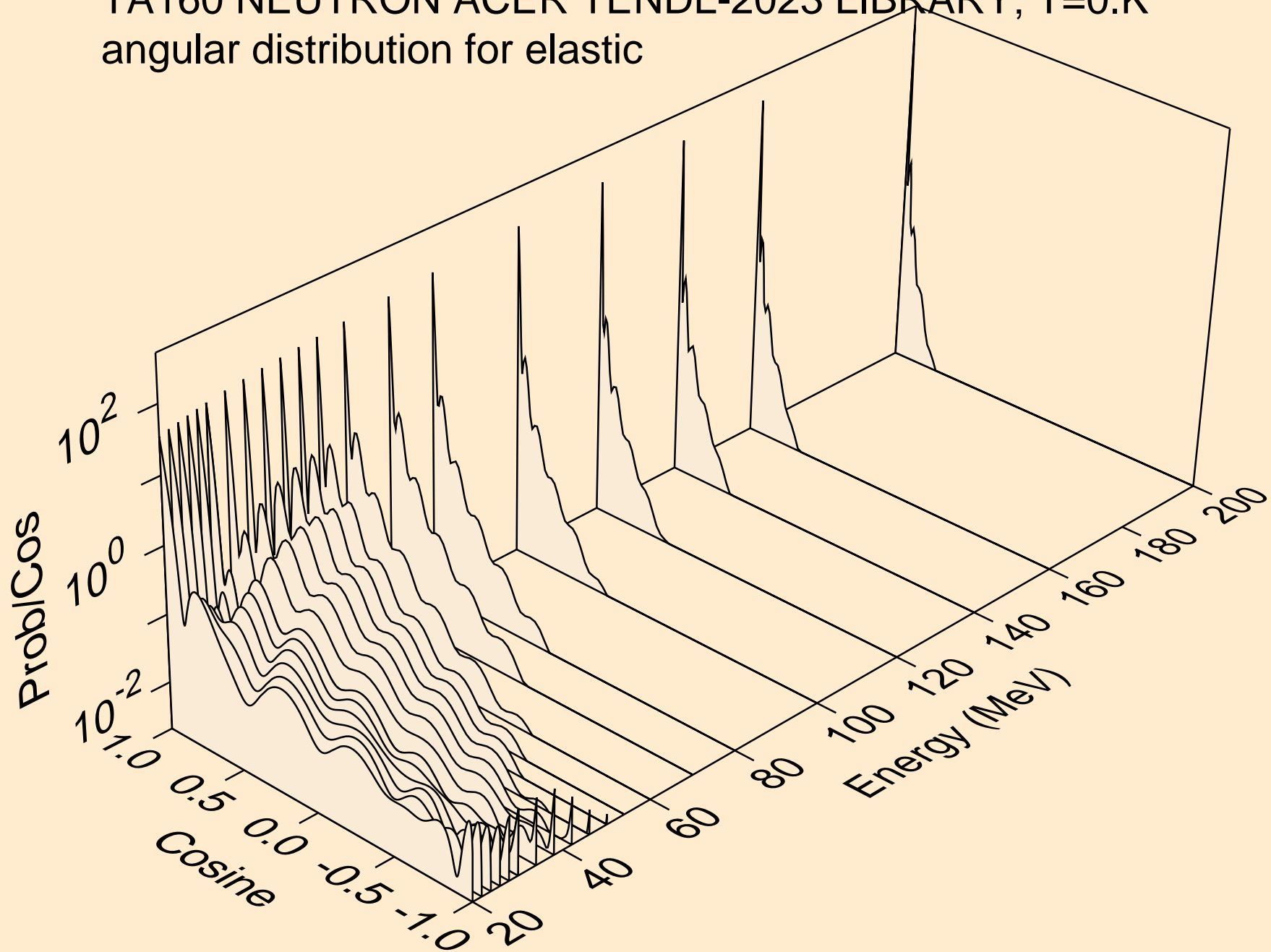



TA160 NEUTRON ACER TENDL-2023 LIBRARY; T=0.K  
angular distribution for (n,n\*1)

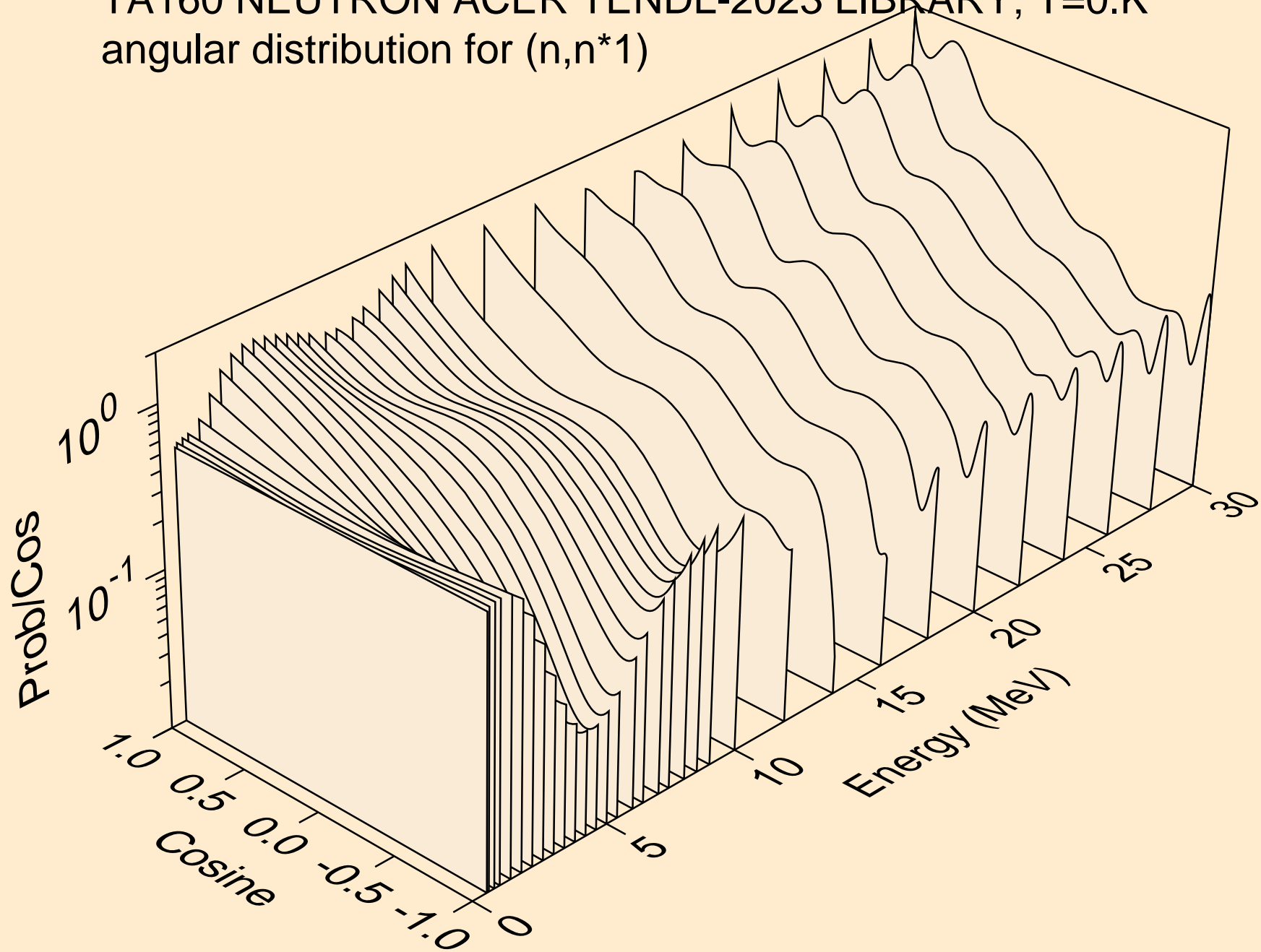

TA160 NEUTRON ACER TENDL-2023 LIBRARY; T=0.K  
angular distribution for (n,n\*2)

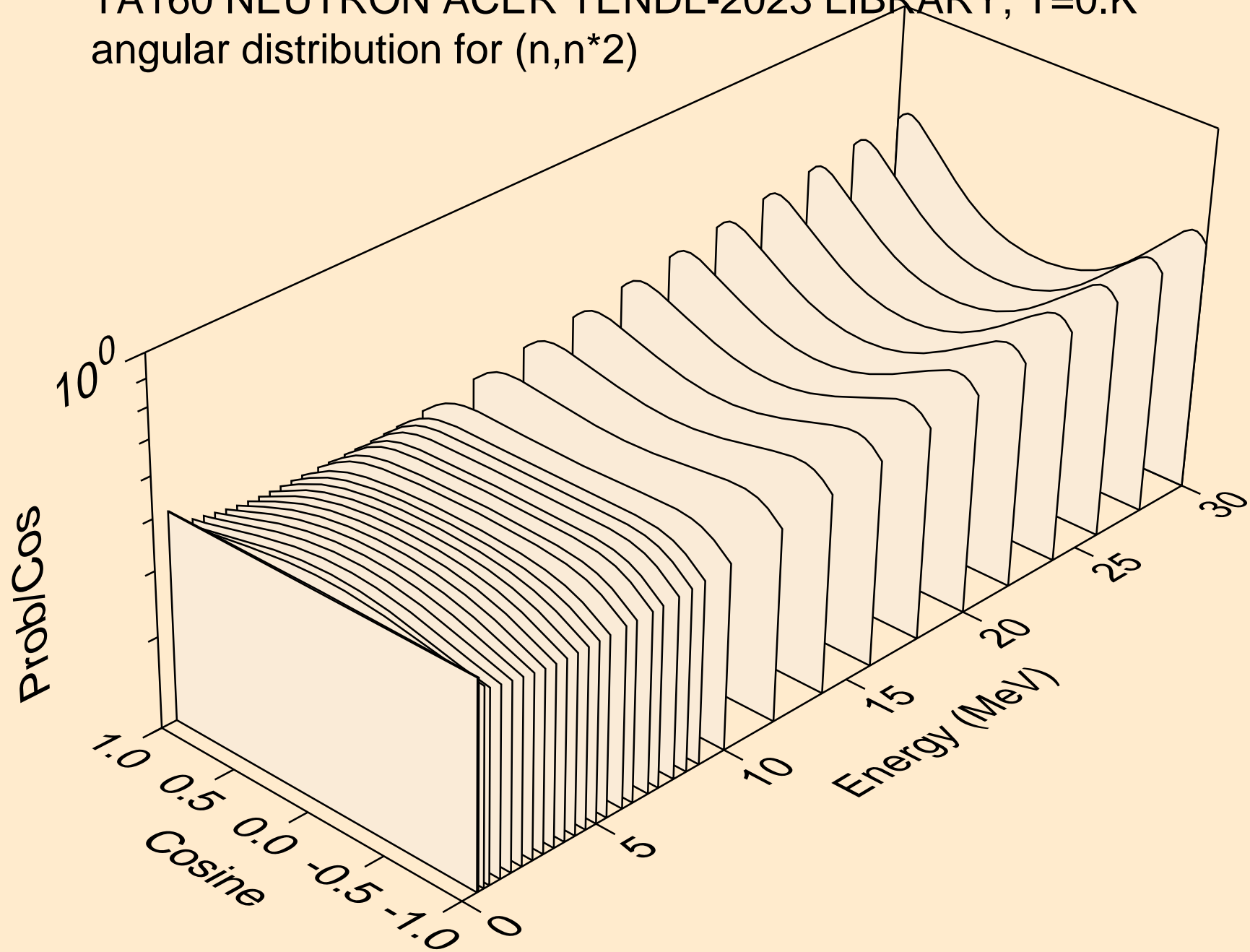

TA160 NEUTRON ACER TENDL-2023 LIBRARY; T=0.K  
angular distribution for (n,n\*3)

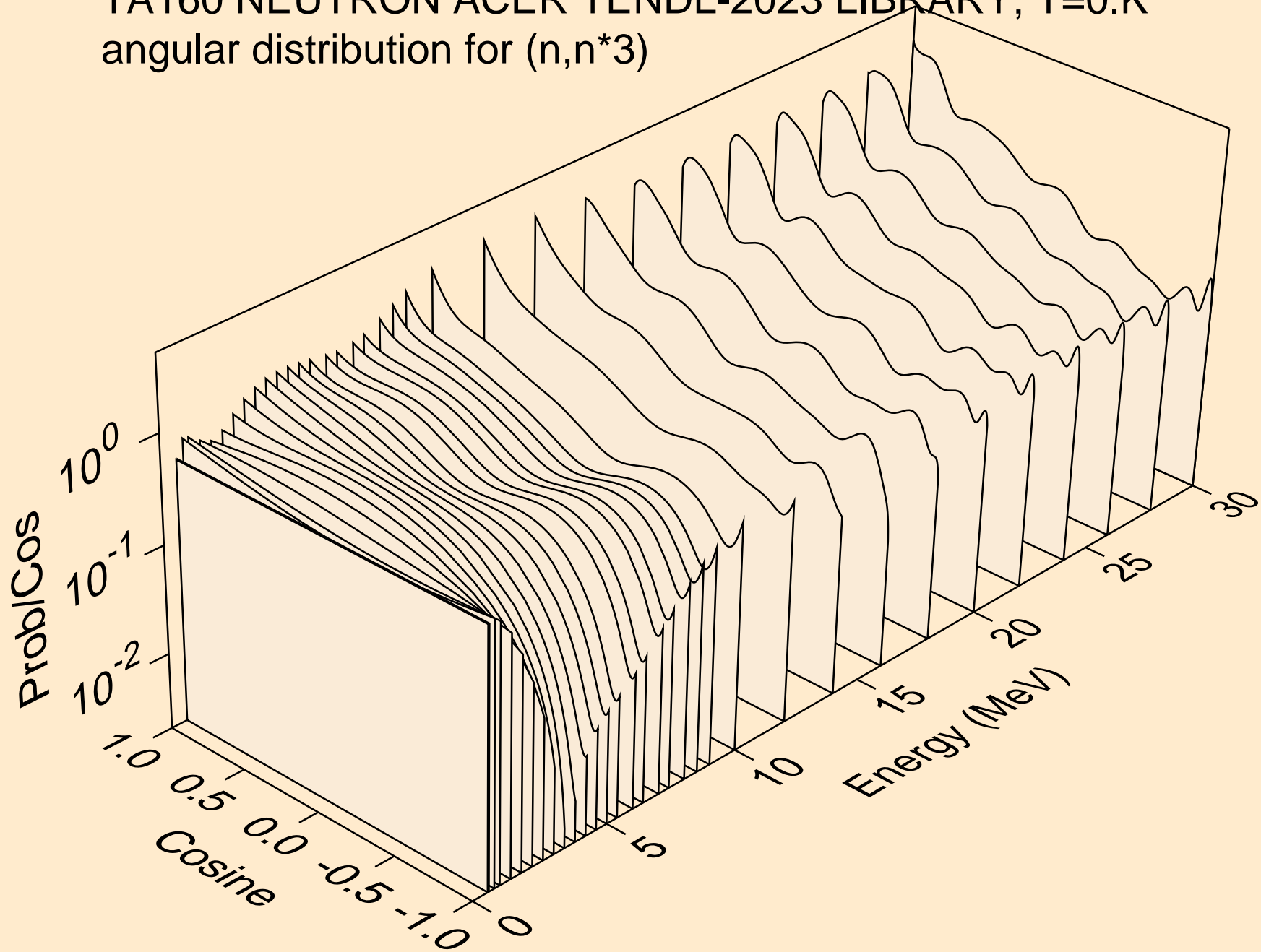

TA160 NEUTRON ACER TENDL-2023 LIBRARY; T=0.K  
angular distribution for (n,n\*4)

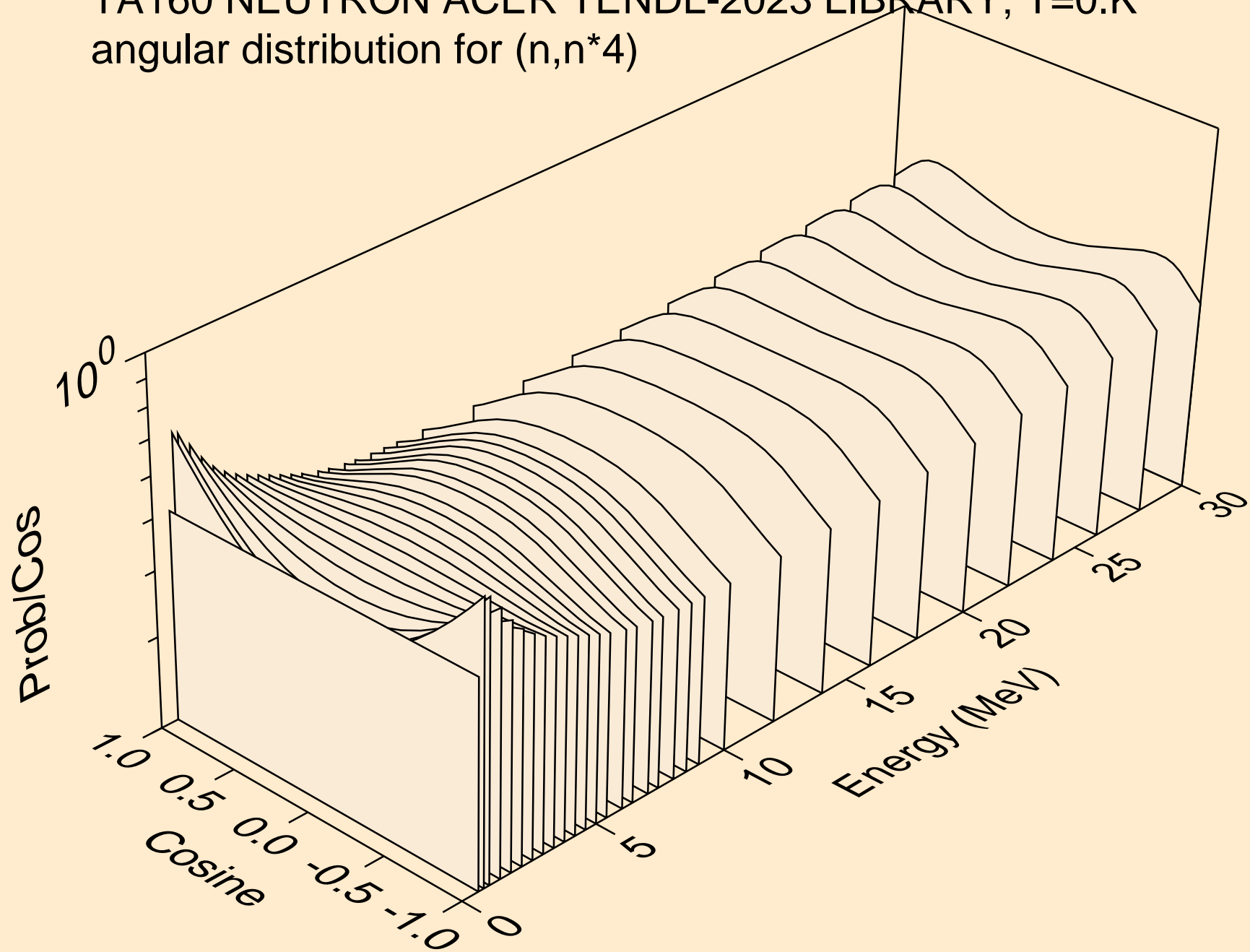

TA160 NEUTRON ACER TENDL-2023 LIBRARY; T=0.K  
angular distribution for (n,n\*5)

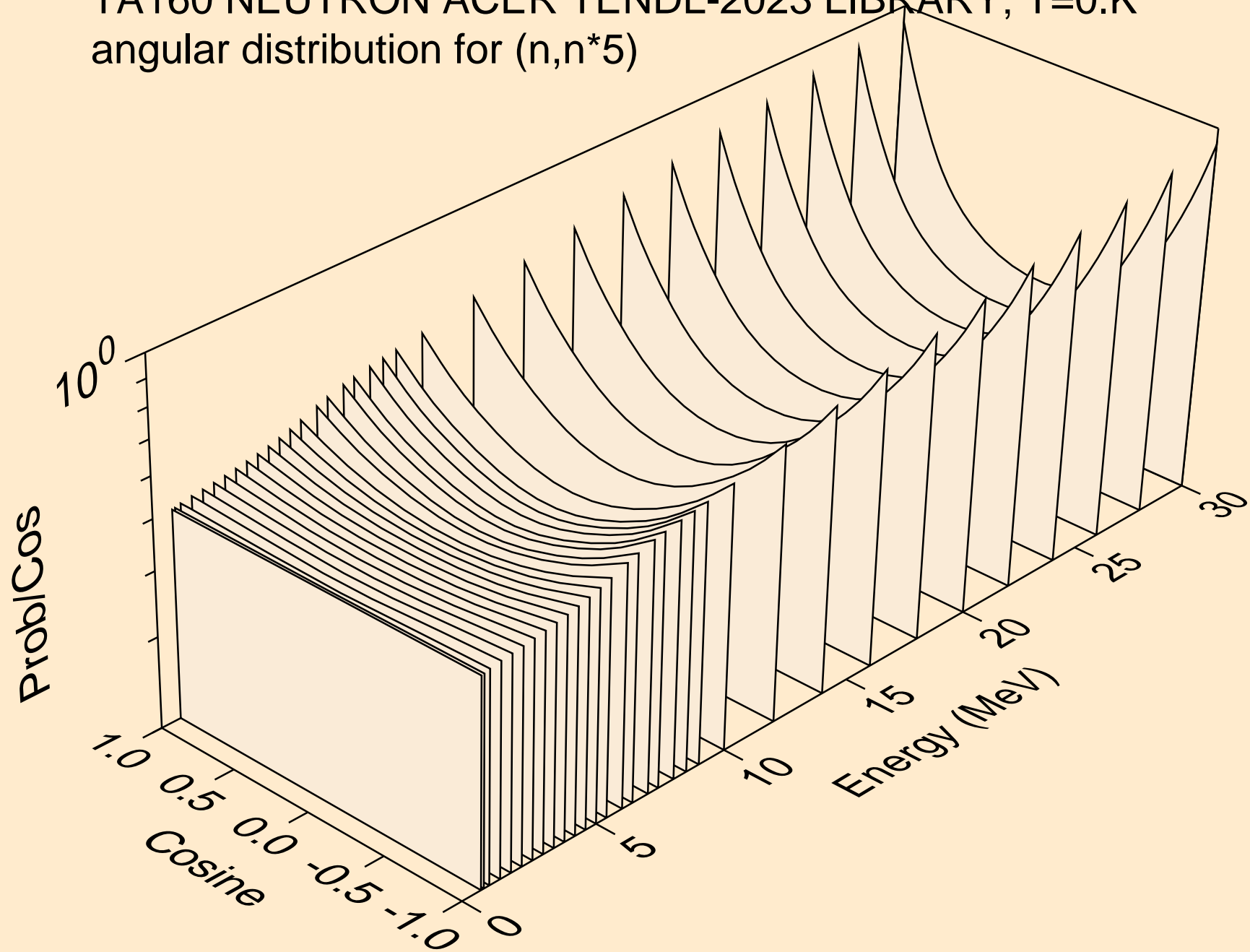

TA160 NEUTRON ACER TENDL-2023 LIBRARY; T=0.K  
angular distribution for (n,n\*6)

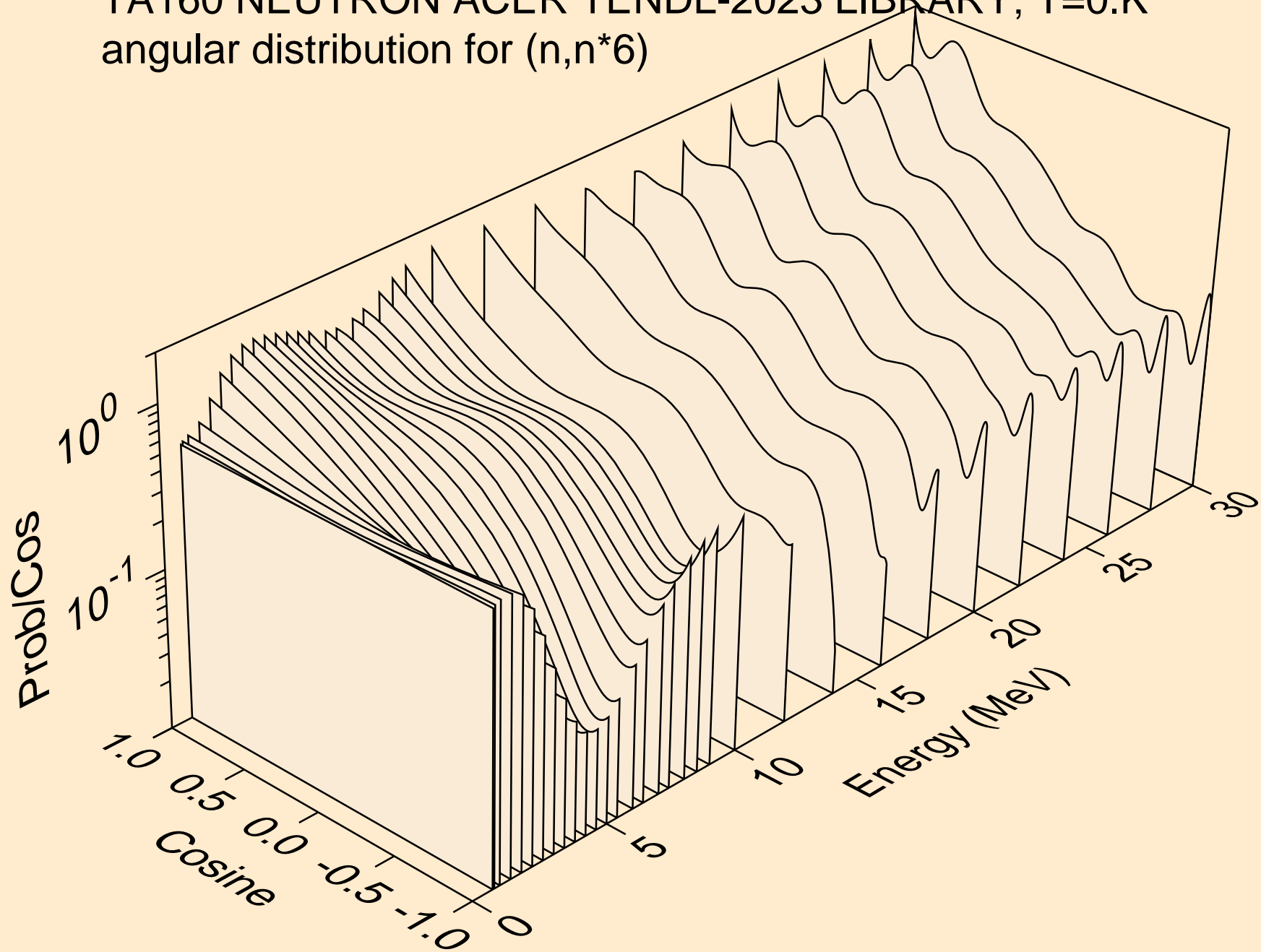

TA160 NEUTRON ACER TENDL-2023 LIBRARY; T=0.K  
angular distribution for (n,n\*7)

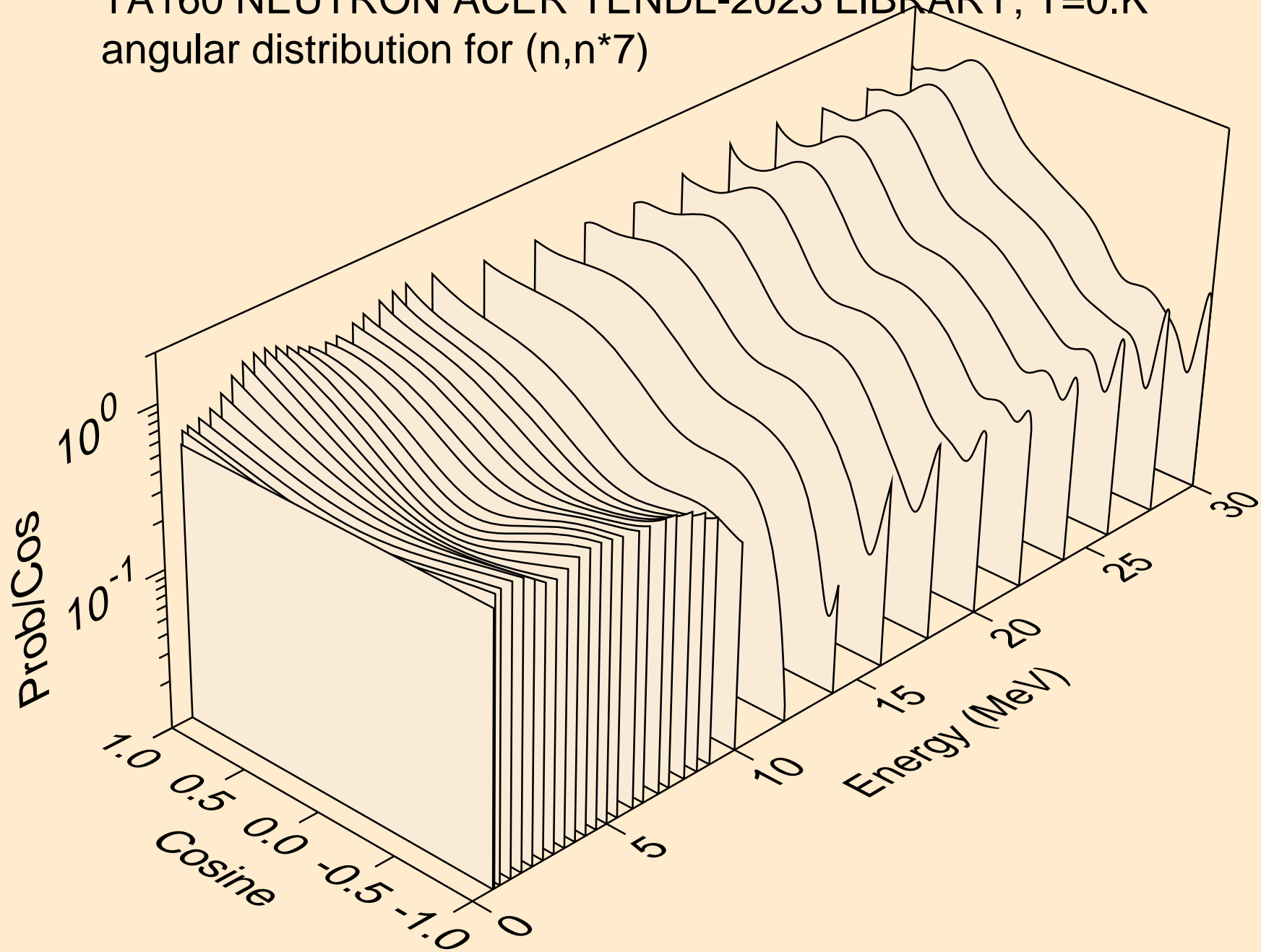

TA160 NEUTRON ACER TENDL-2023 LIBRARY; T=0.K  
angular distribution for (n,n\*8)

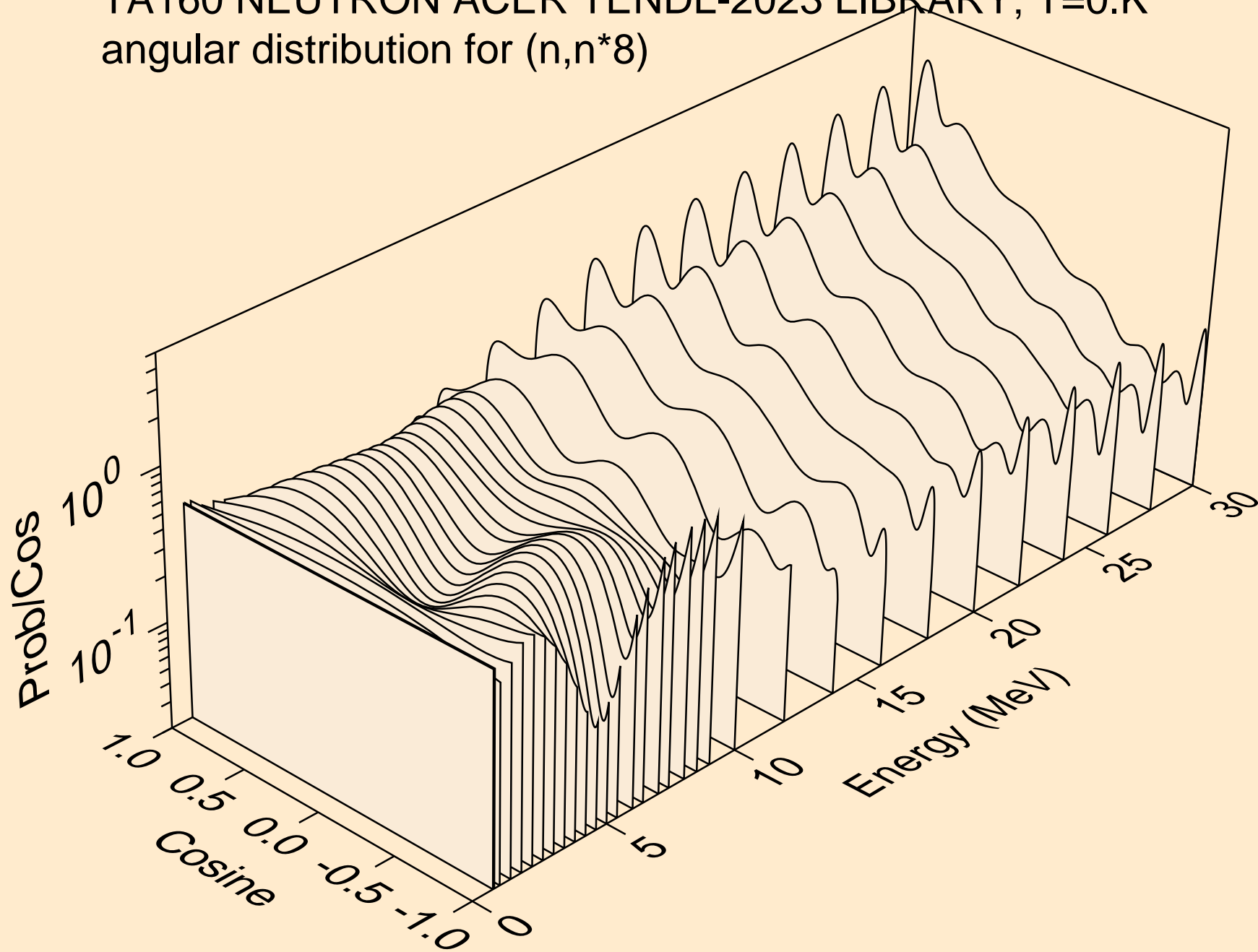



TA160 NEUTRON ACER TENDL-2023 LIBRARY; T=0.K  
angular distribution for (n,n\*9)

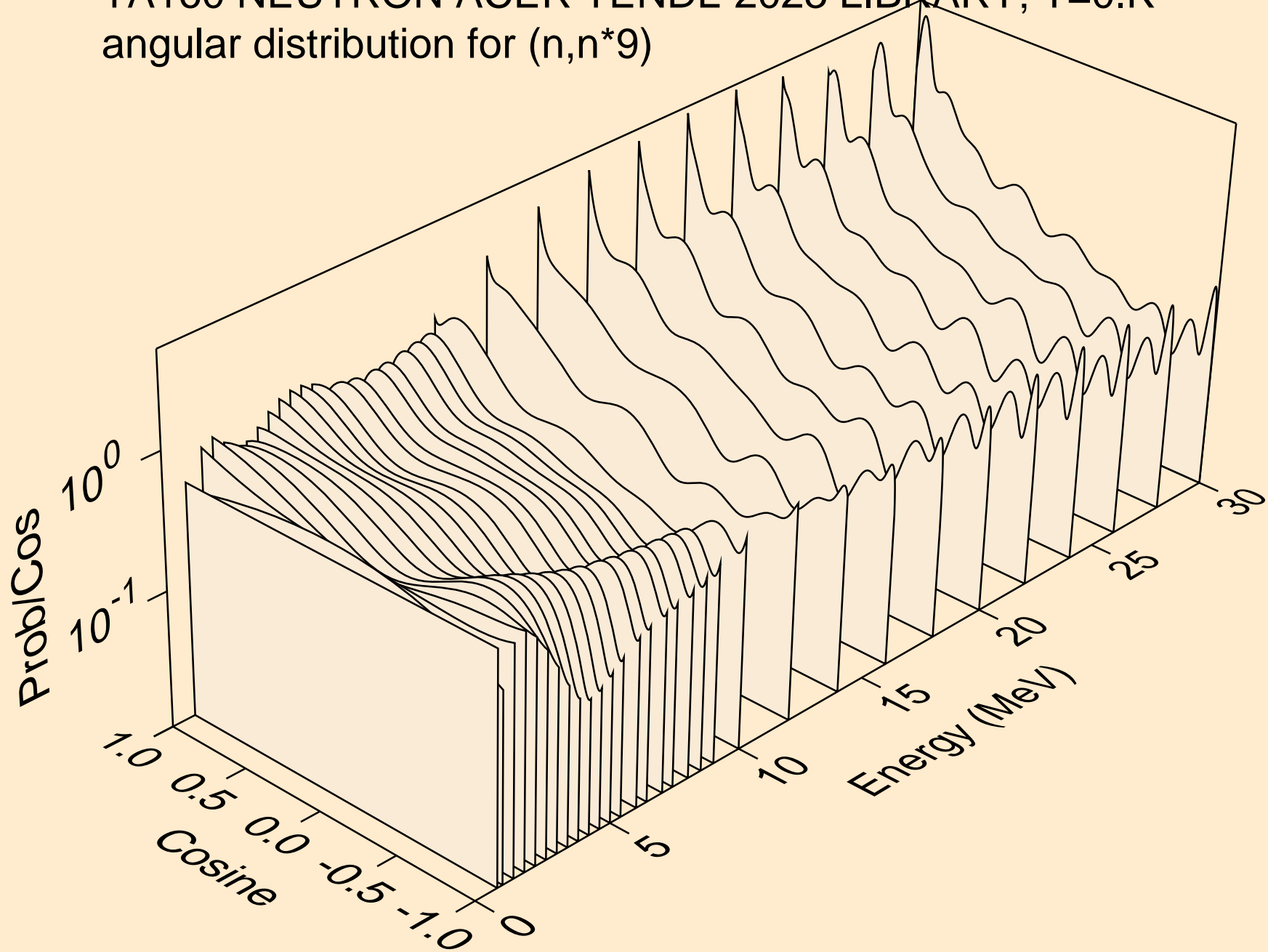

TA160 NEUTRON ACER TENDL-2023 LIBRARY; T=0.K  
Neutron emission for (n,x)

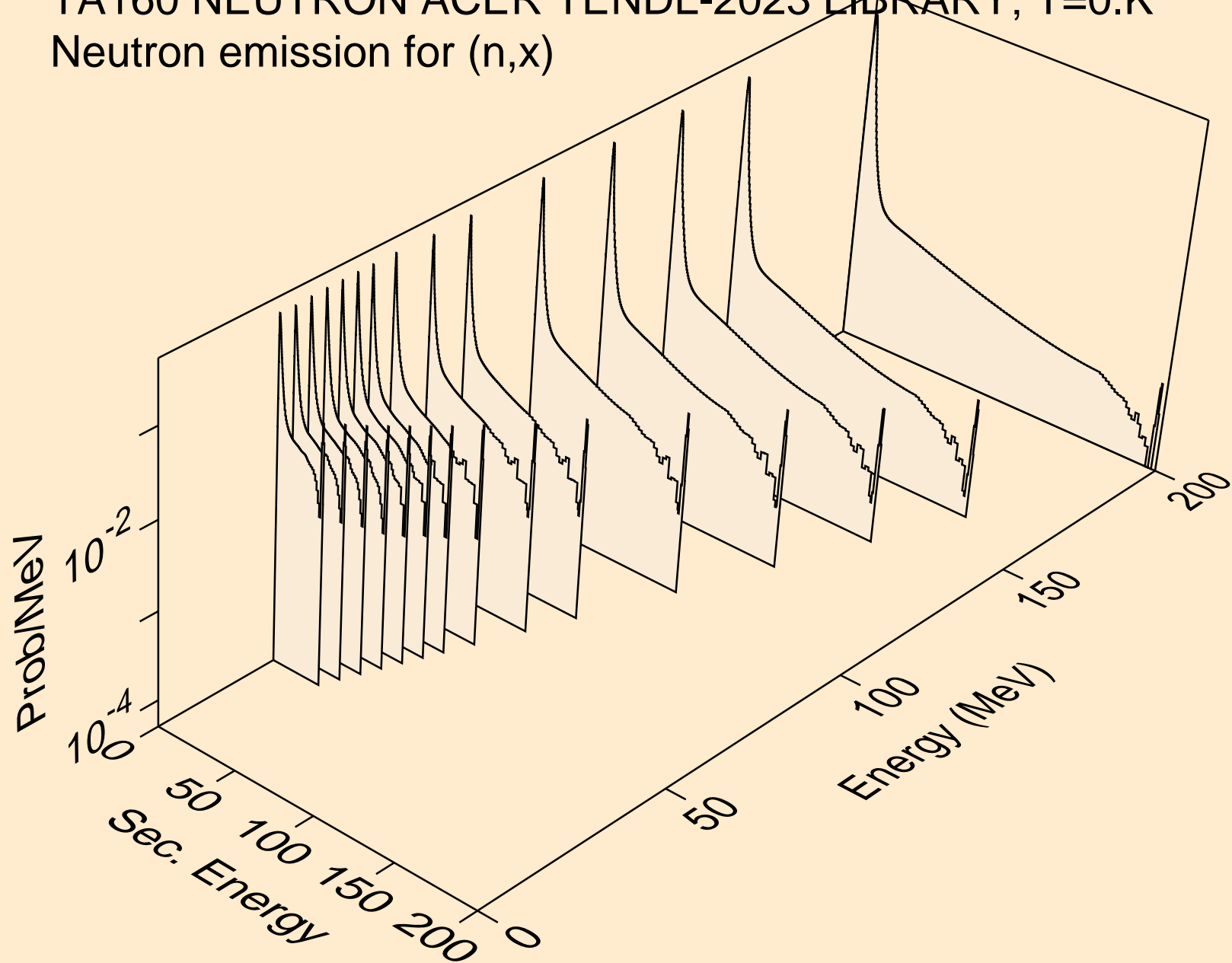

TA160 NEUTRON ACER TENDL-2023 LIBRARY; T=0.K  
Neutron emission for (n,2nd)

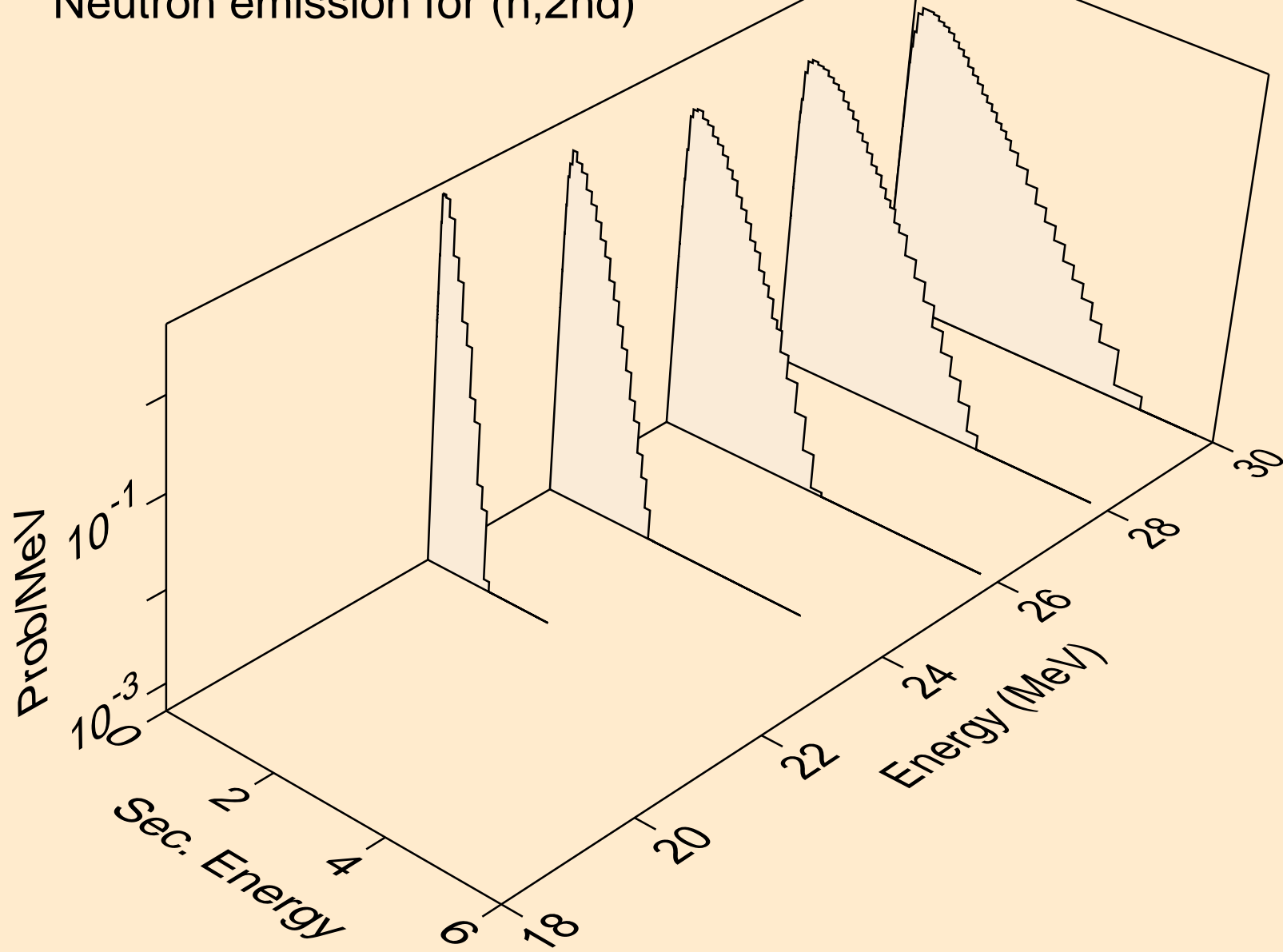

TA160 NEUTRON ACER TENDL-2023 LIBRARY; T=0.K  
Neutron emission for (n,2n)

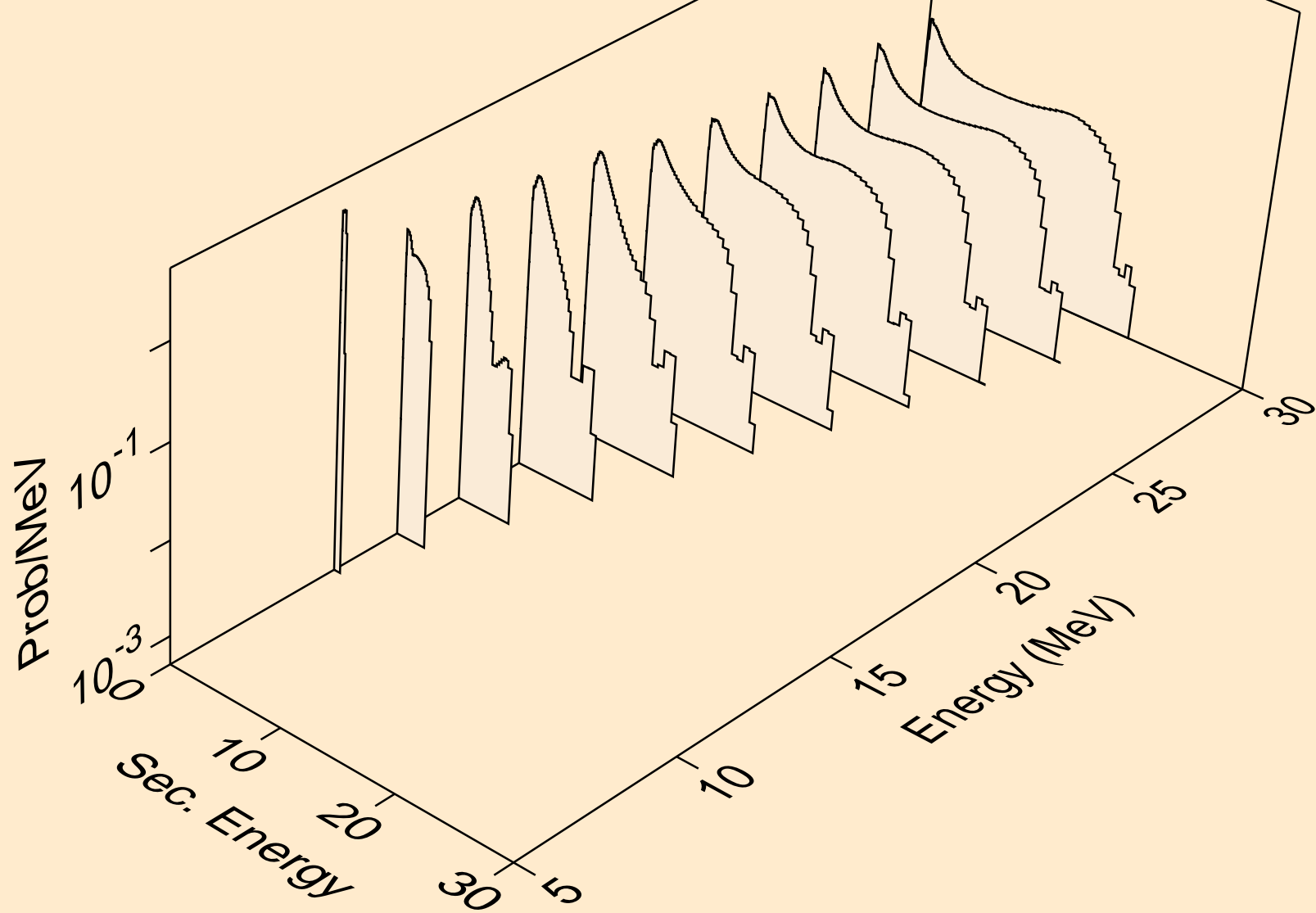

TA160 NEUTRON ACER TENDL-2023 LIBRARY; T=0.K  
Neutron emission for (n,3n)

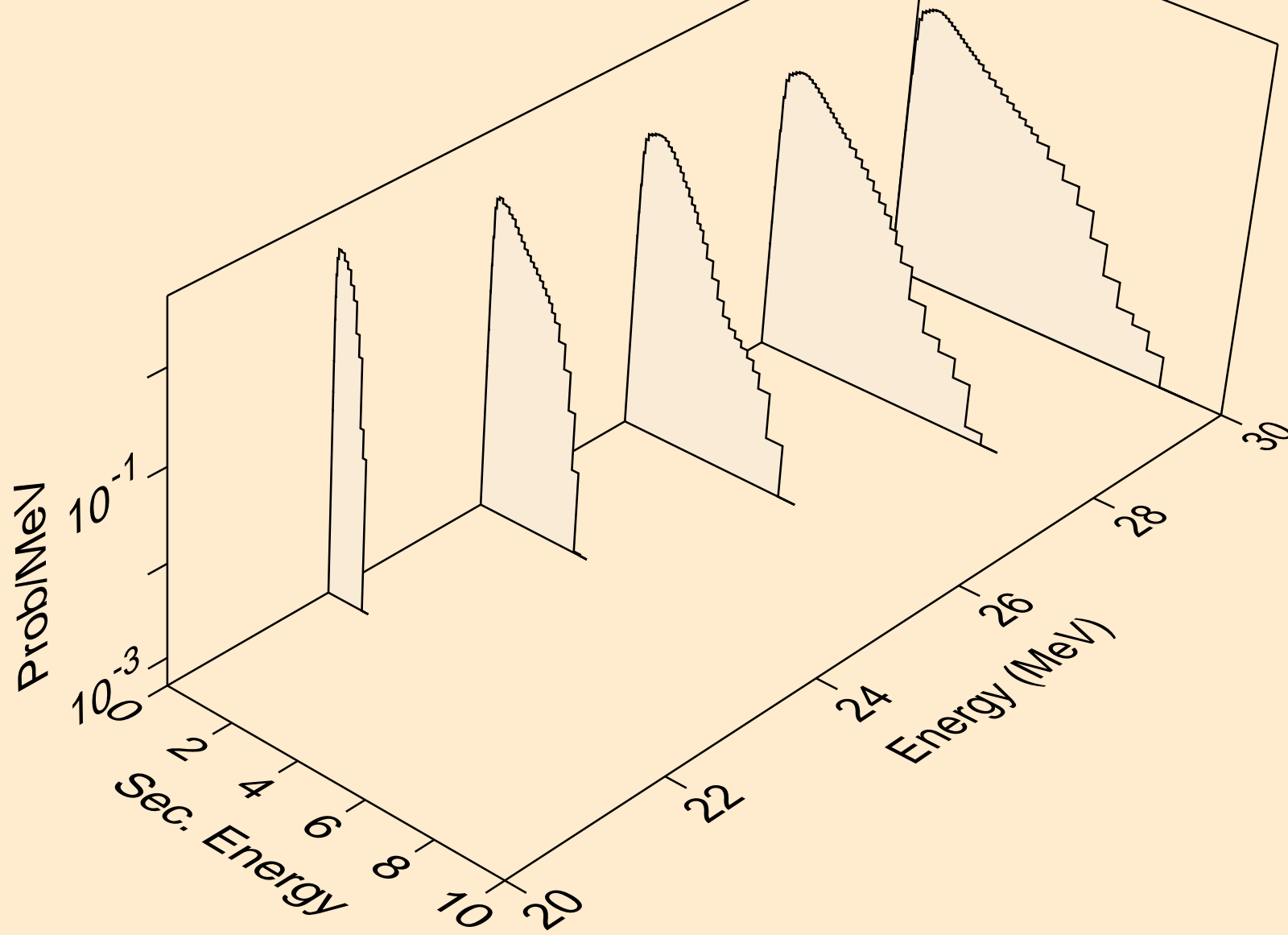

TA160 NEUTRON ACER TENDL-2023 LIBRARY; T=0.K  
Neutron emission for (n,n\*)a

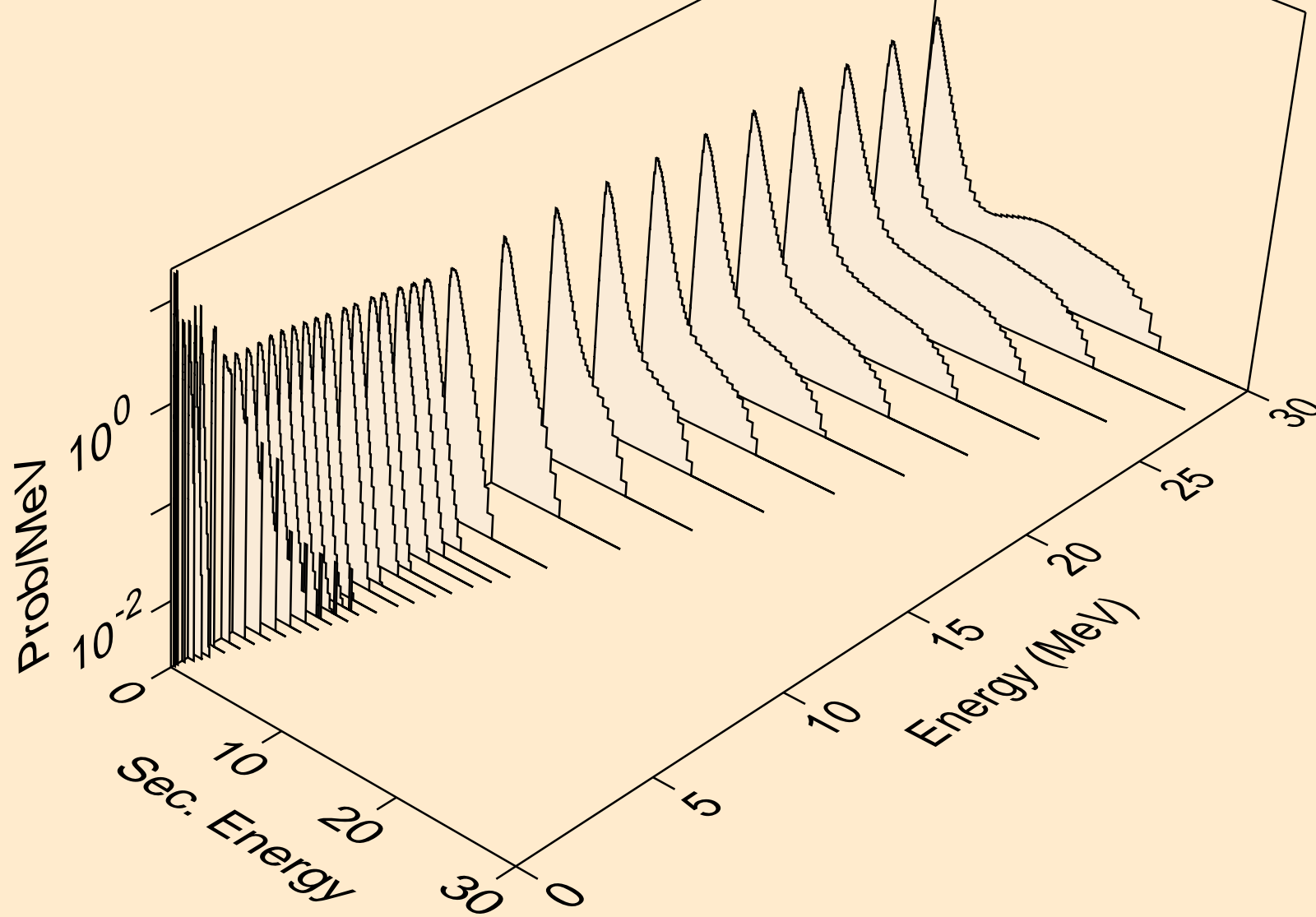

TA160 NEUTRON ACER TENDL-2023 LIBRARY; T=0.K  
Neutron emission for (n,n\*)3a

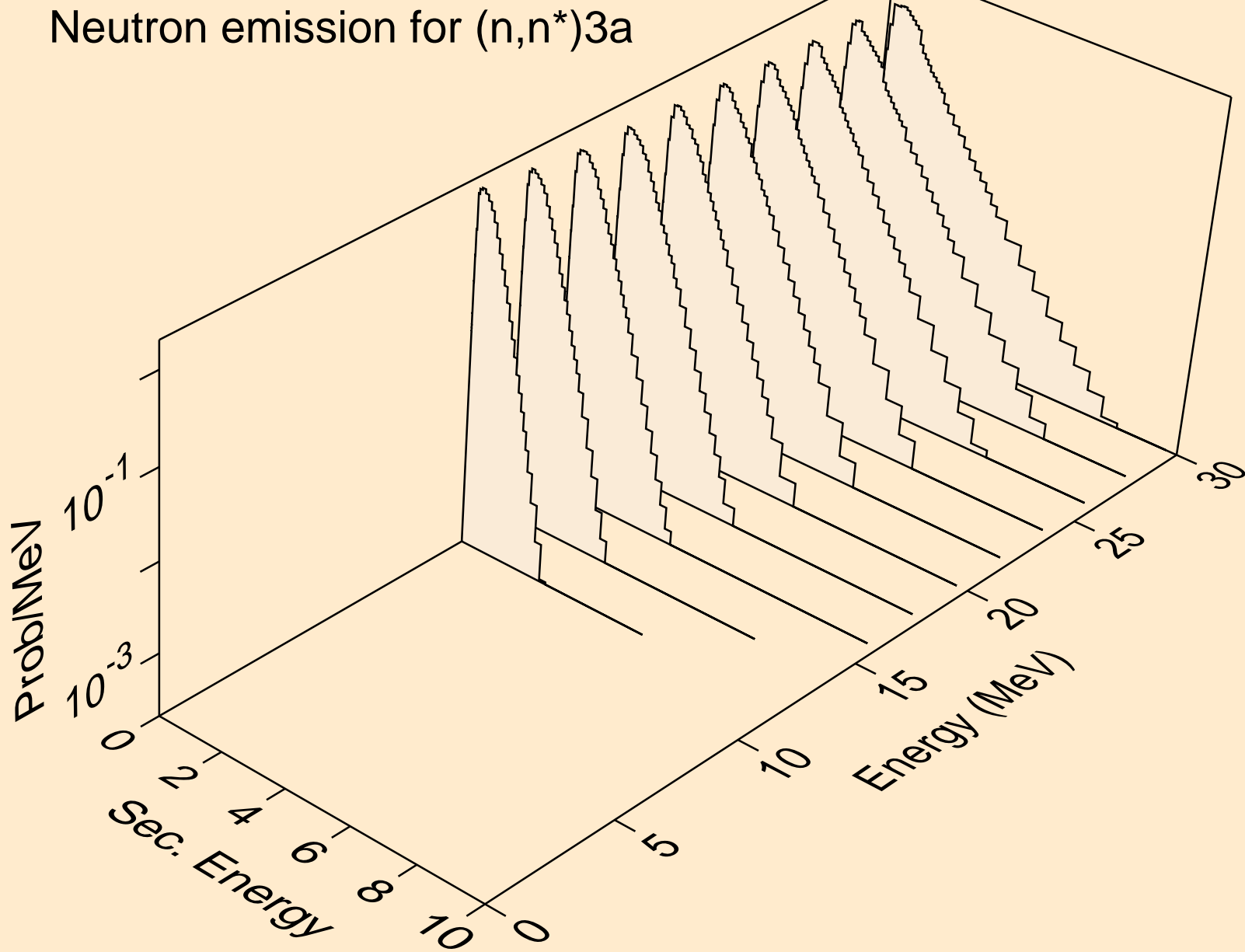

TA160 NEUTRON ACER TENDL-2023 LIBRARY; T=0.K  
Neutron emission for (n,2n)a

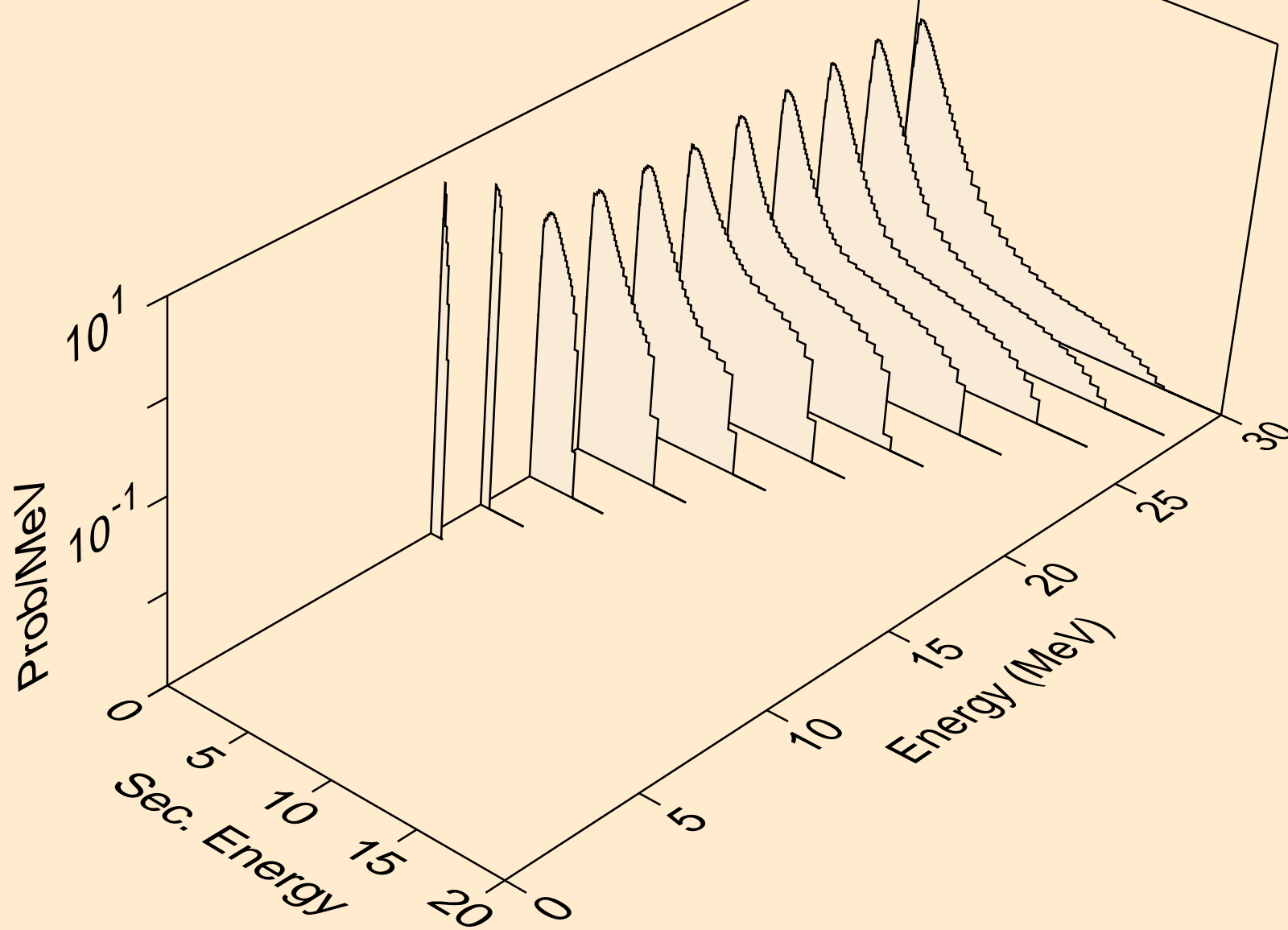



TA160 NEUTRON ACER TENDL-2023 LIBRARY; T=0.K  
Neutron emission for (n,3n)a

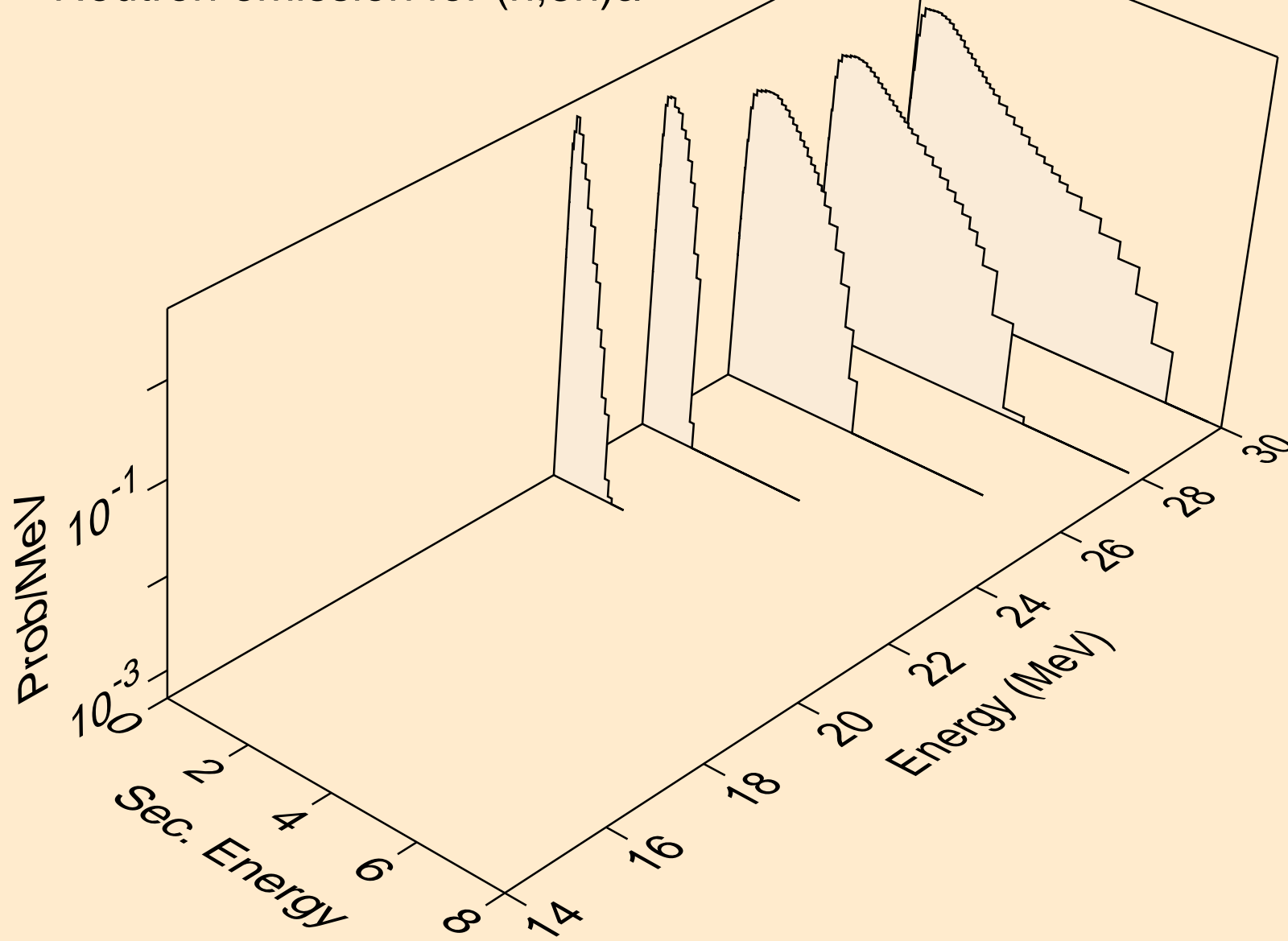

TA160 NEUTRON ACER TENDL-2023 LIBRARY; T=0.K  
Neutron emission for (n,n\*)p

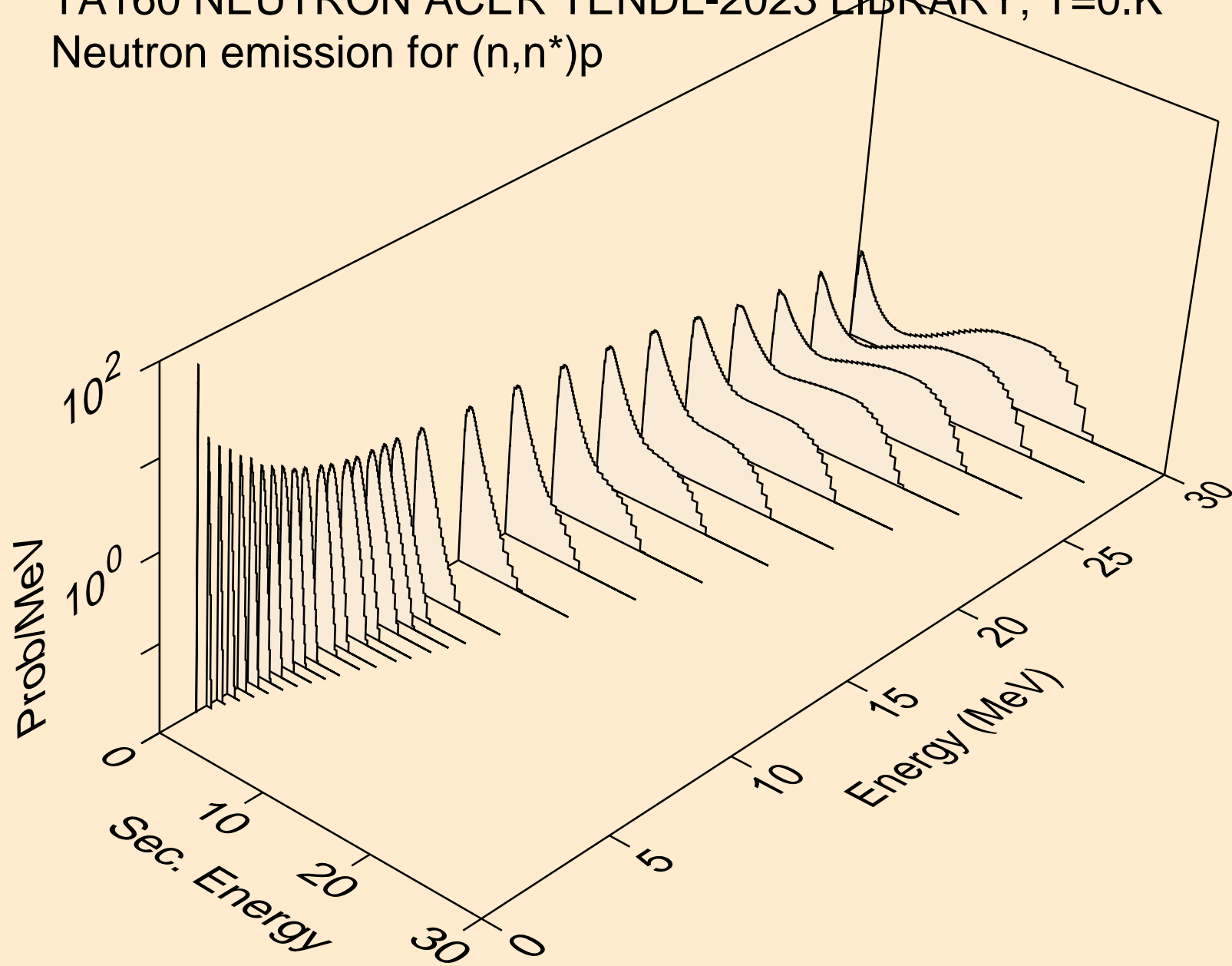

TA160 NEUTRON ACER TENDL-2023 LIBRARY; T=0.K  
Neutron emission for (n,n\*)2a

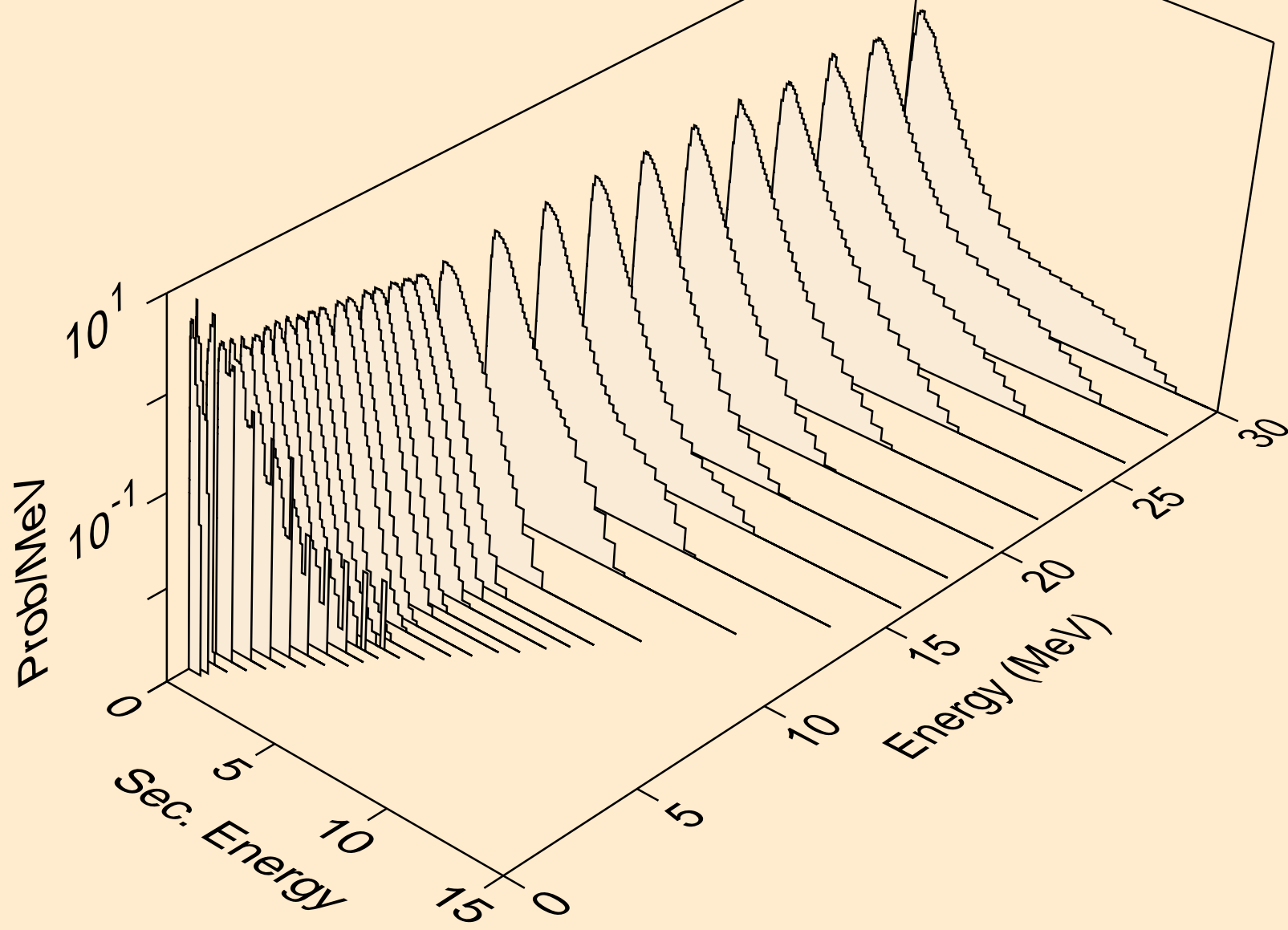

TA160 NEUTRON ACER TENDL-2023 LIBRARY; T=0.K  
Neutron emission for (n,2n)2a

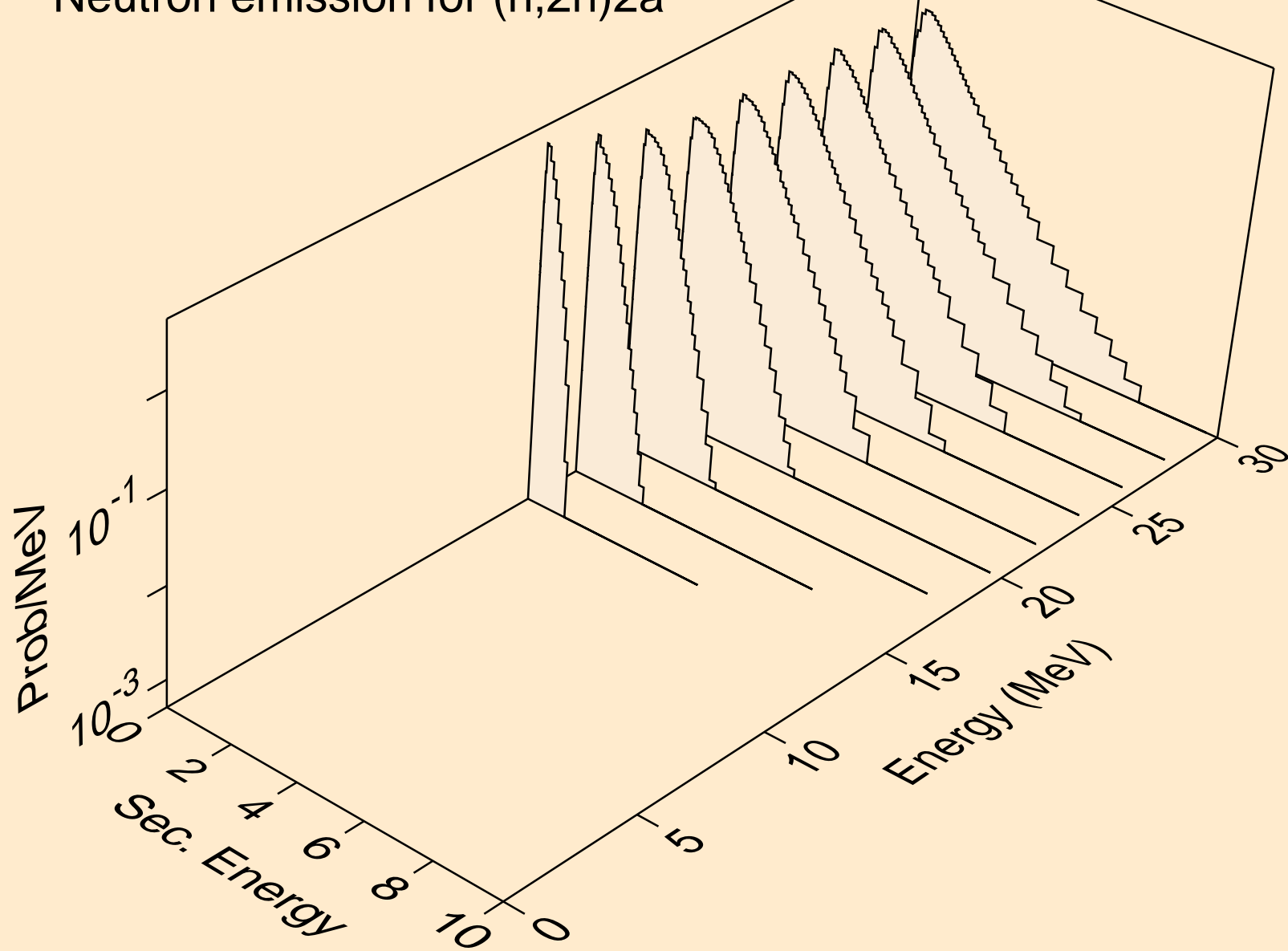

TA160 NEUTRON ACER TENDL-2023 LIBRARY; T=0.K  
Neutron emission for (n,n\*)d

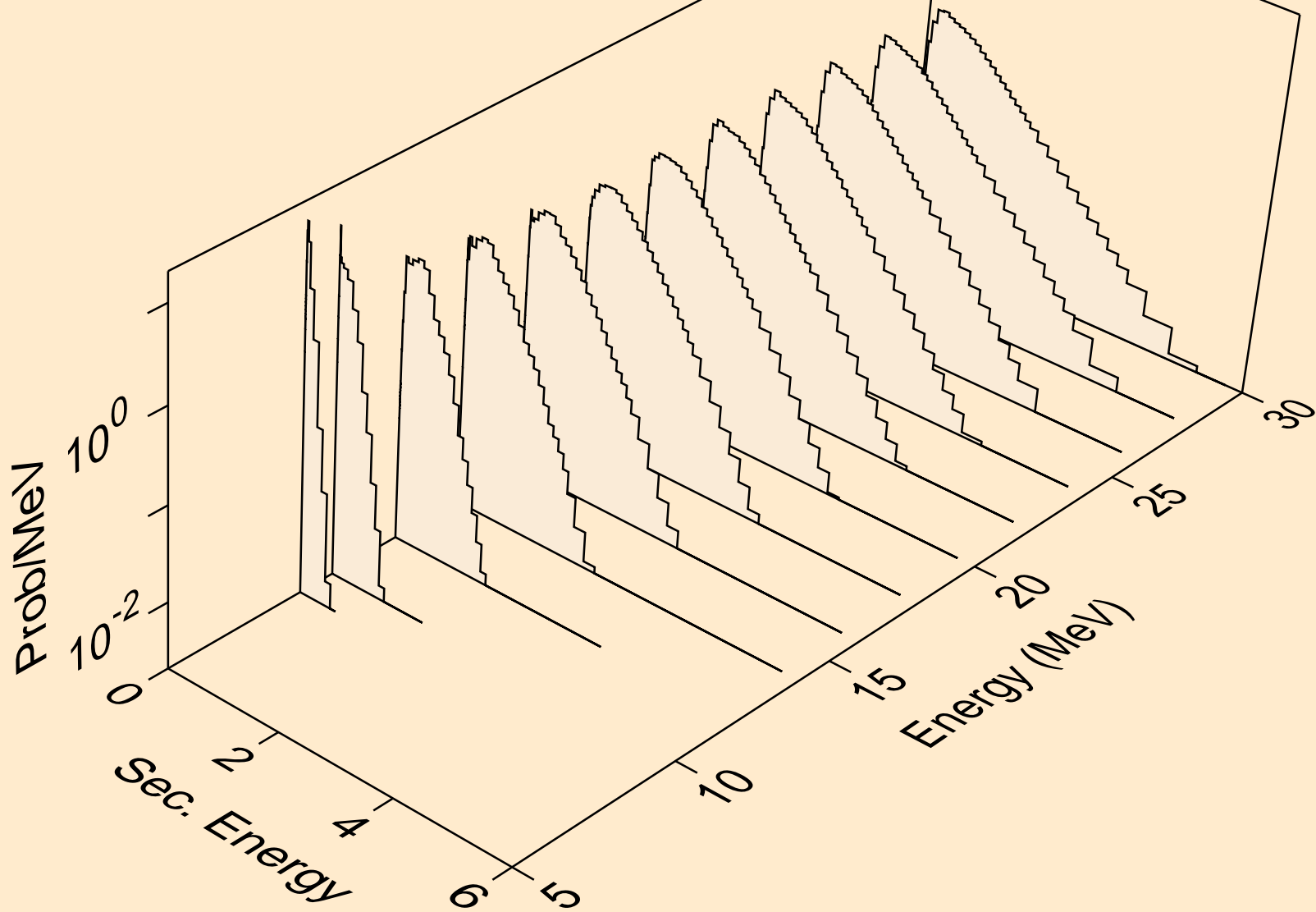

TA160 NEUTRON ACER TENDL-2023 LIBRARY; T=0.K  
Neutron emission for (n,n\*)t

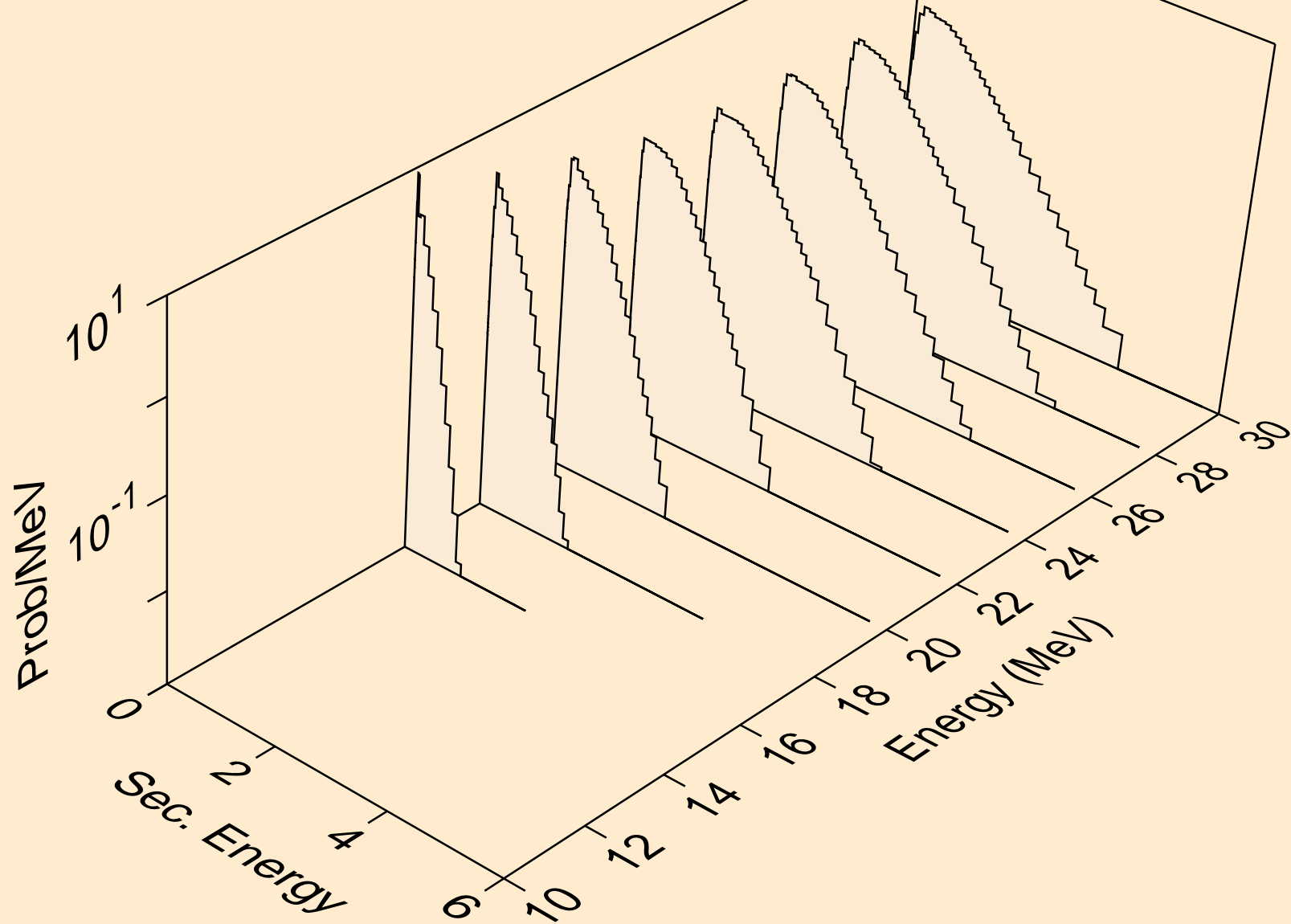

TA160 NEUTRON ACER TENDL-2023 LIBRARY; T=0.K  
Neutron emission for (n,n\*)he3

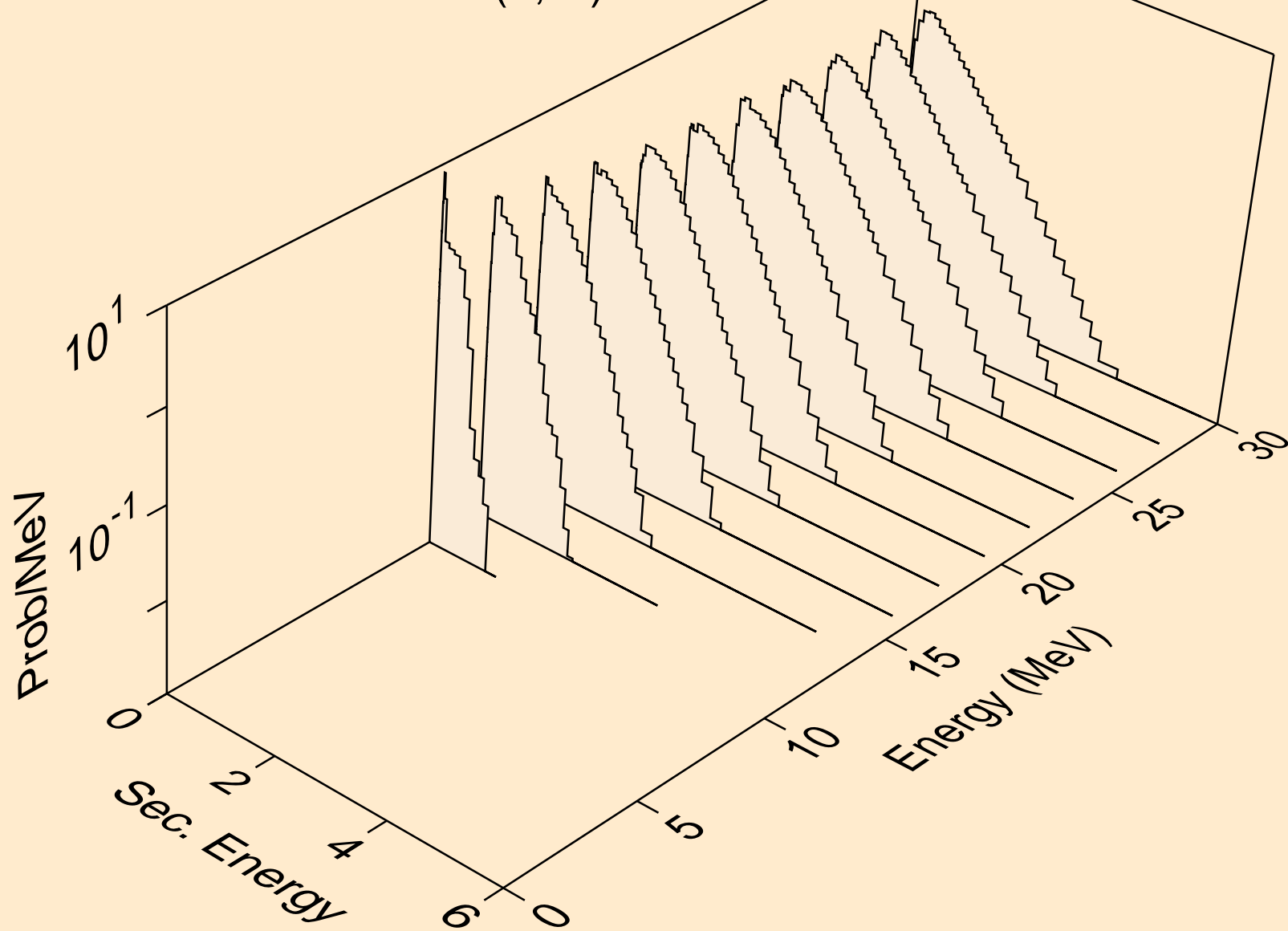

TA160 NEUTRON ACER TENDL-2023 LIBRARY; T=0.K  
Neutron emission for (n,n\*)d2a

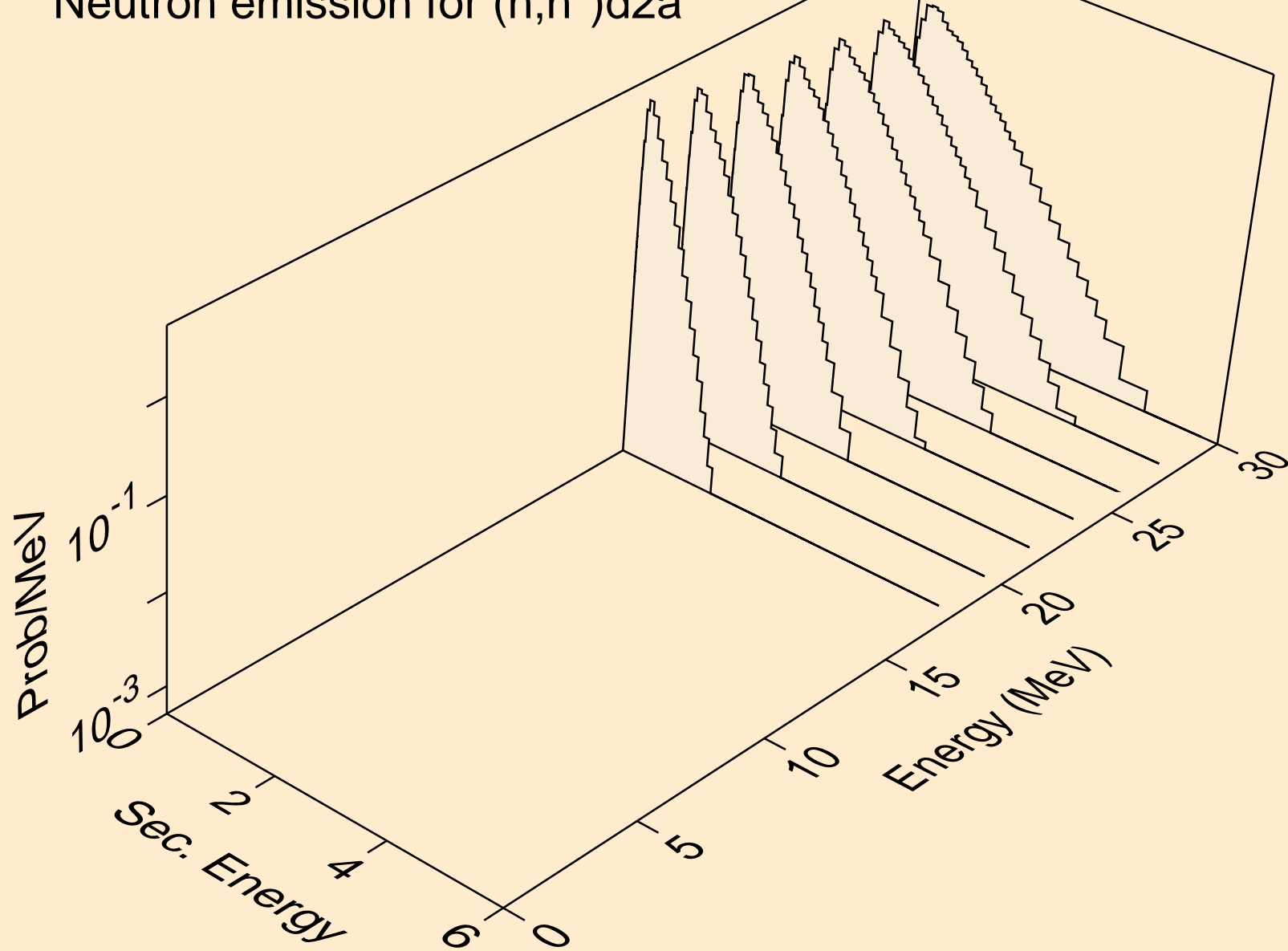



TA160 NEUTRON ACER TENDL-2023 LIBRARY; T=0.K  
Neutron emission for (n,2np)

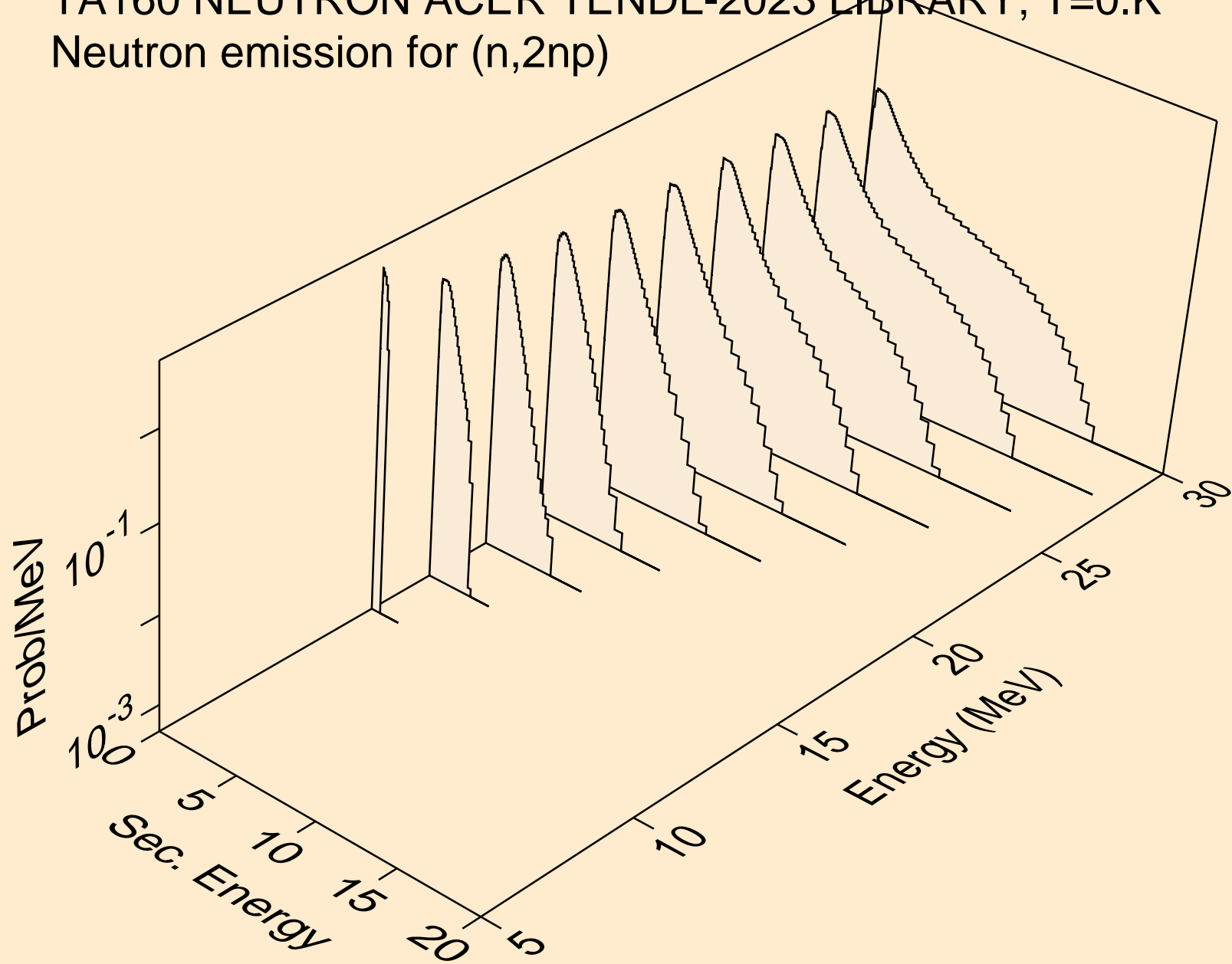

TA160 NEUTRON ACER TENDL-2023 LIBRARY; T=0.K  
Neutron emission for (n,3np)

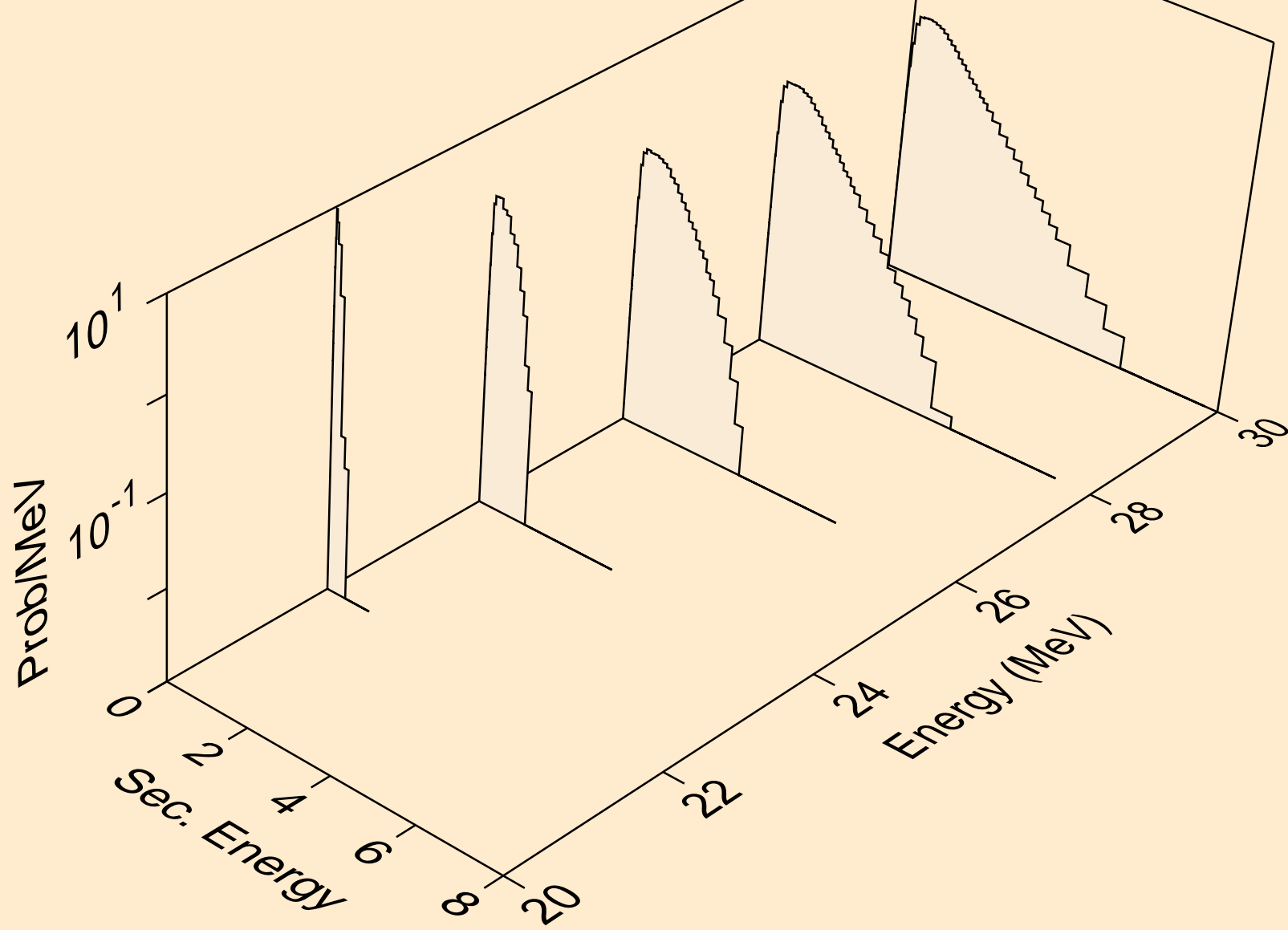

TA160 NEUTRON ACER TENDL-2023 LIBRARY; T=0.K  
Neutron emission for (n,n2p)

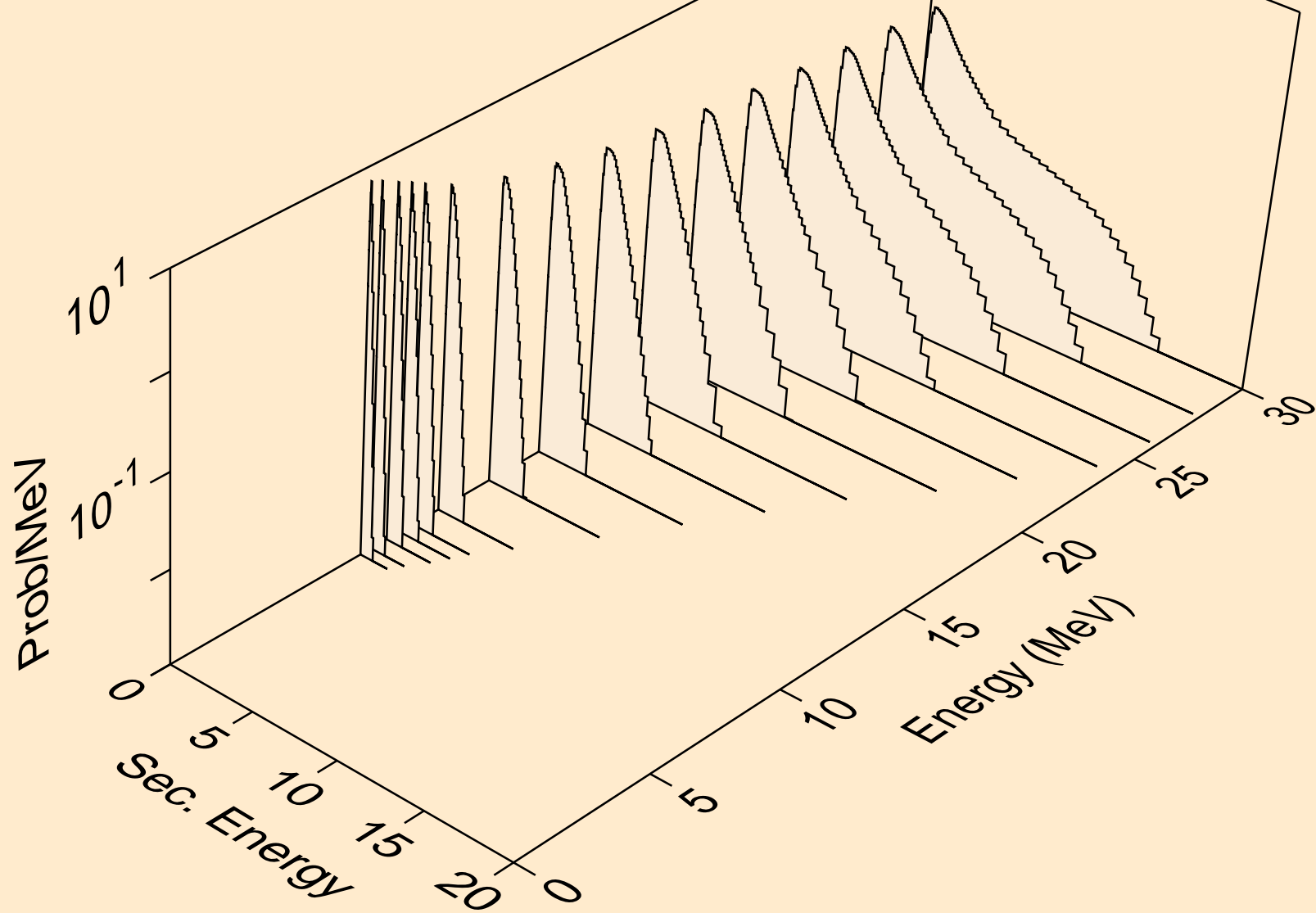

TA160 NEUTRON ACER TENDL-2023 LIBRARY; T=0.K  
Neutron emission for (n,npa)

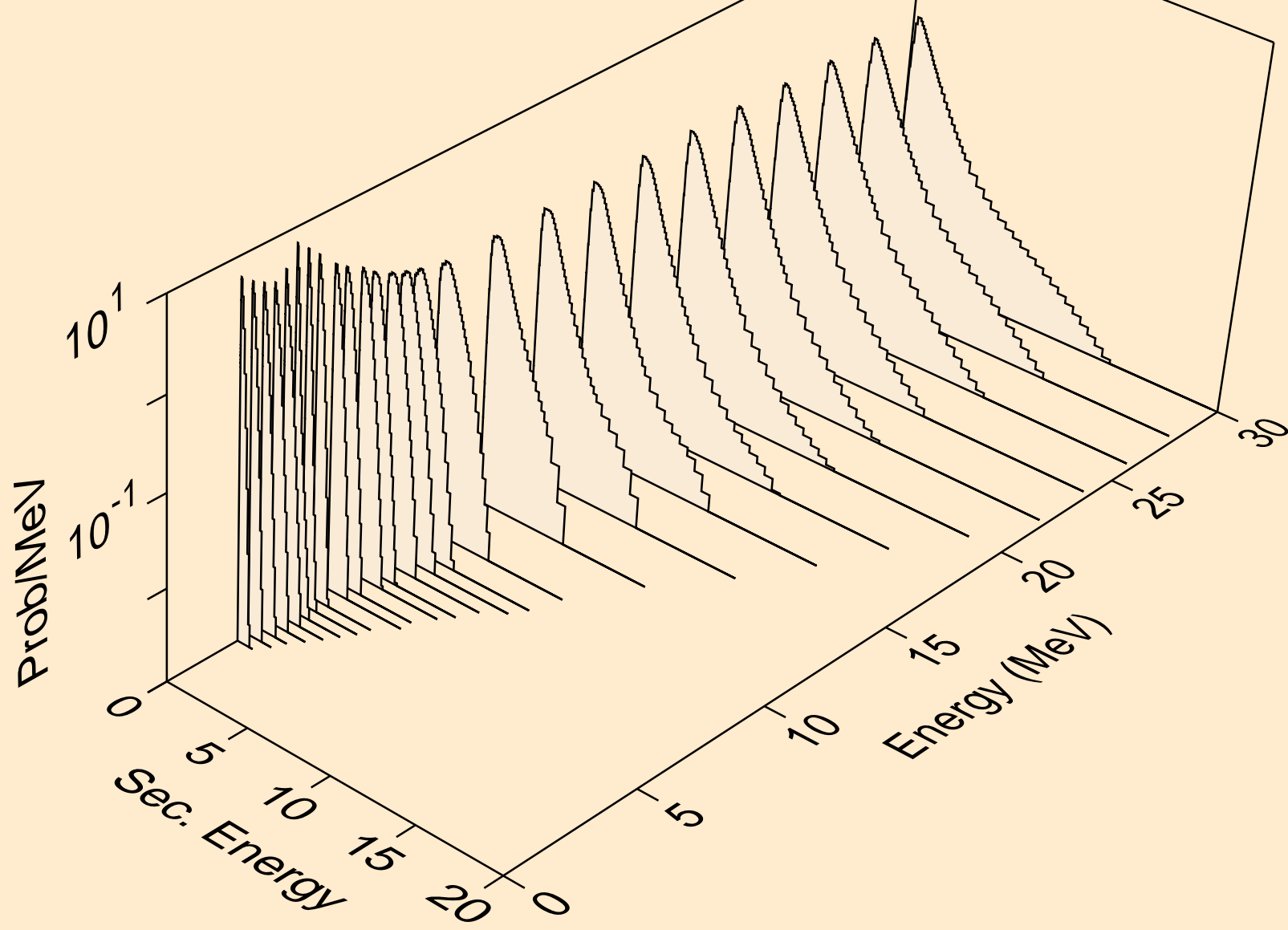

TA160 NEUTRON ACER TENDL-2023 LIBRARY; T=0.K  
Neutron emission for (n,n\*c)

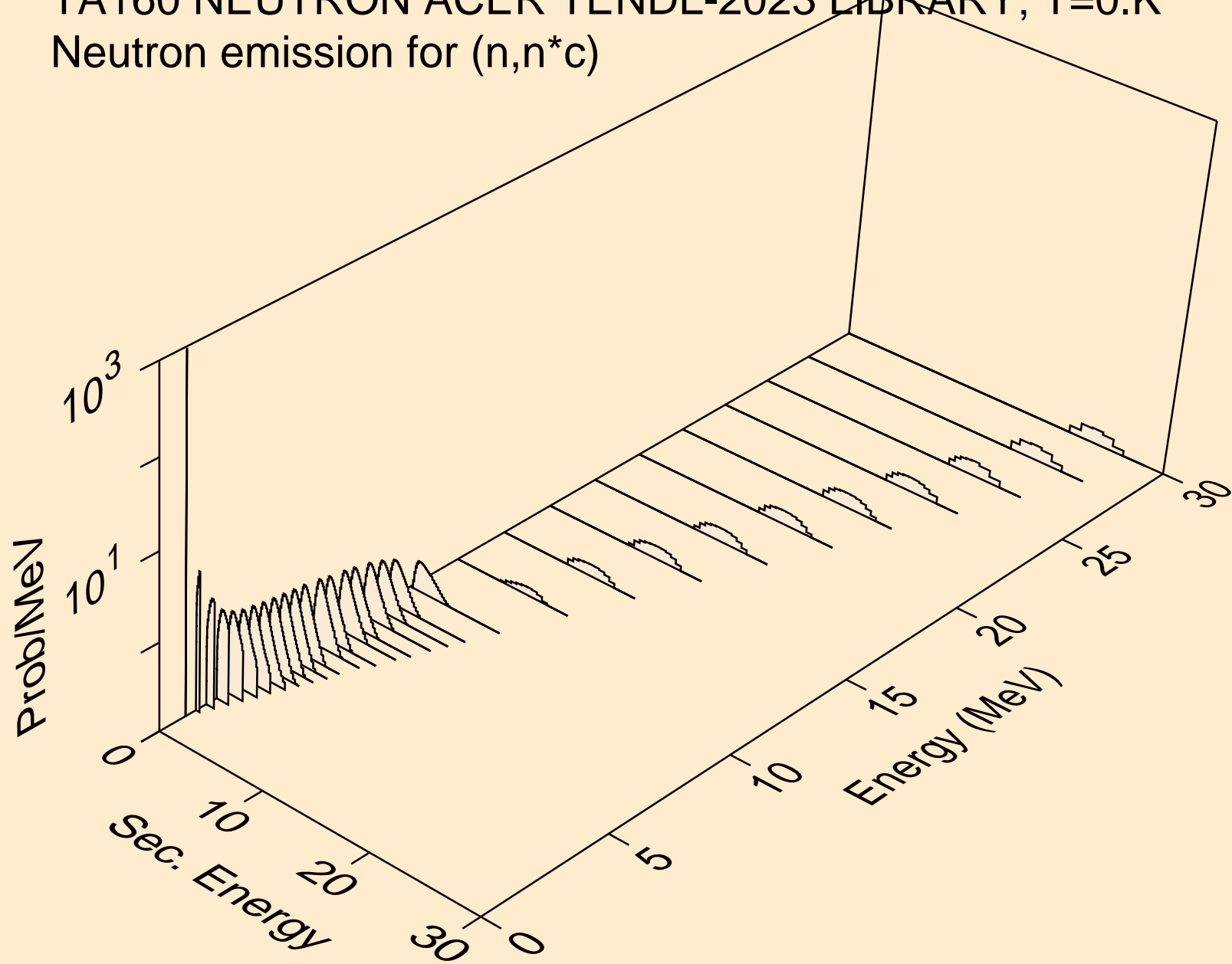

TA160 NEUTRON ACER TENDL-2023 LIBRARY; T=0.K  
Photon emission for (n,x)

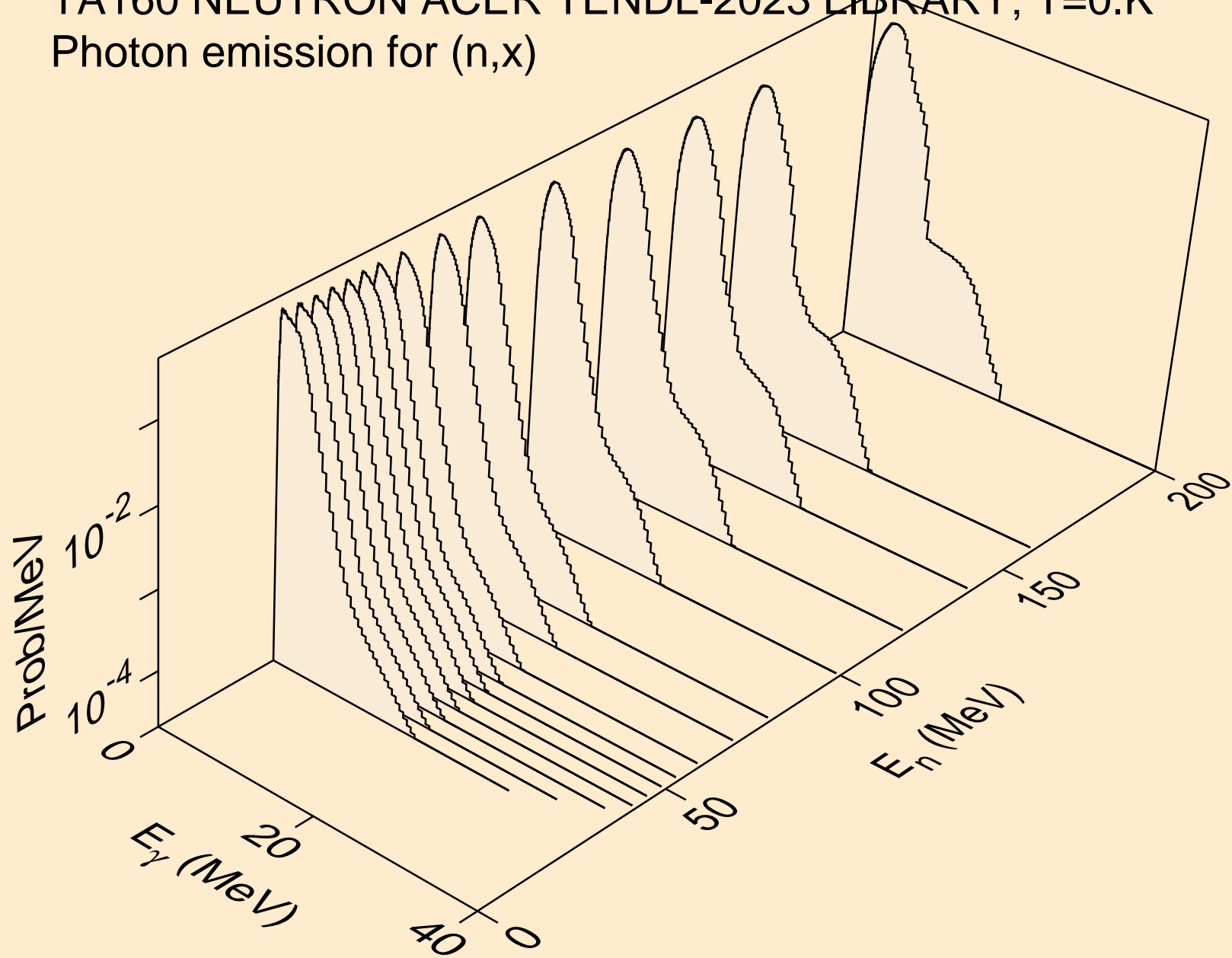

TA160 NEUTRON ACER TENDL-2023 LIBRARY; T=0.K  
Photon emission for (n,2nd)

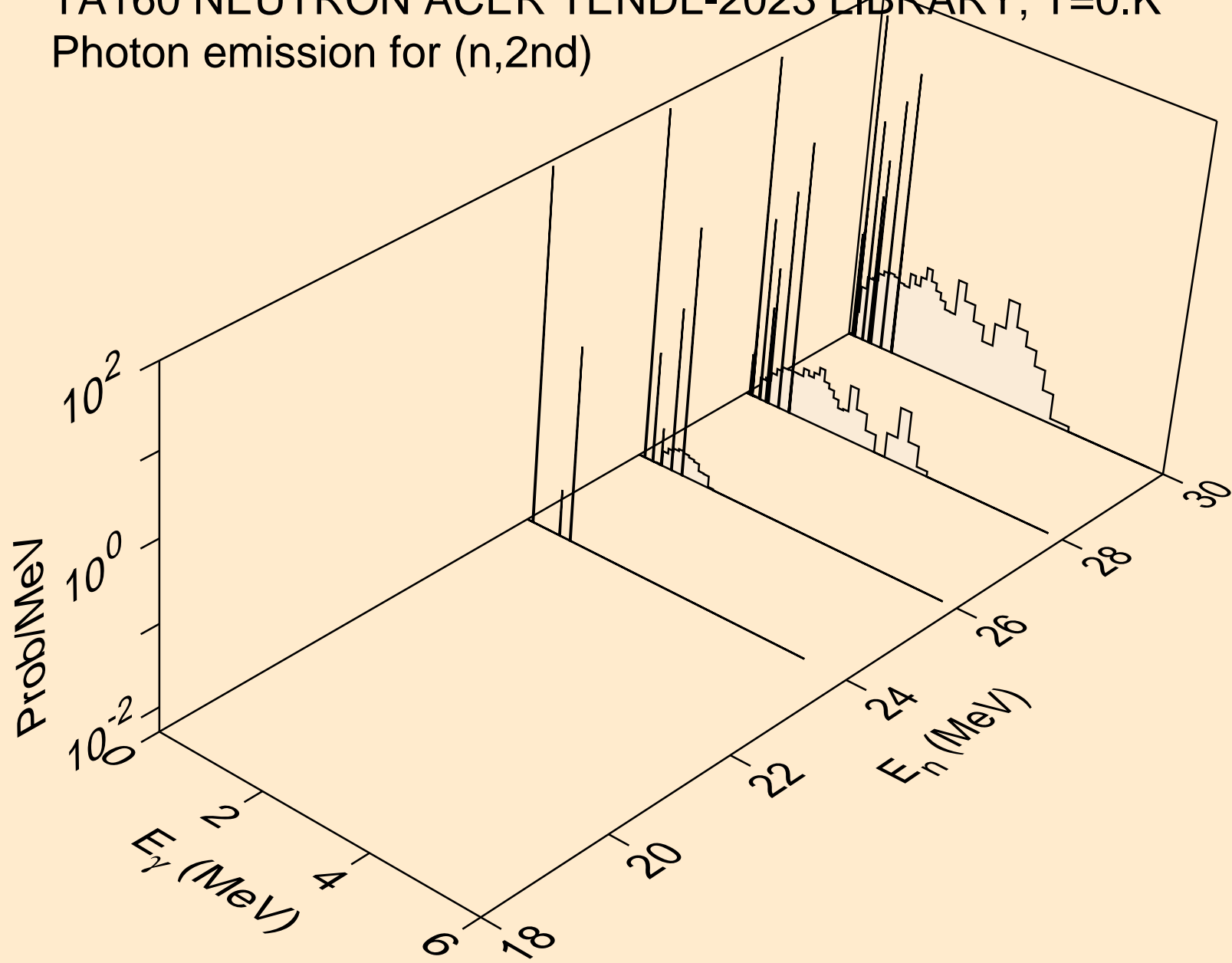

TA160 NEUTRON ACER TENDL-2023 LIBRARY; T=0.K  
Photon emission for (n,2n)

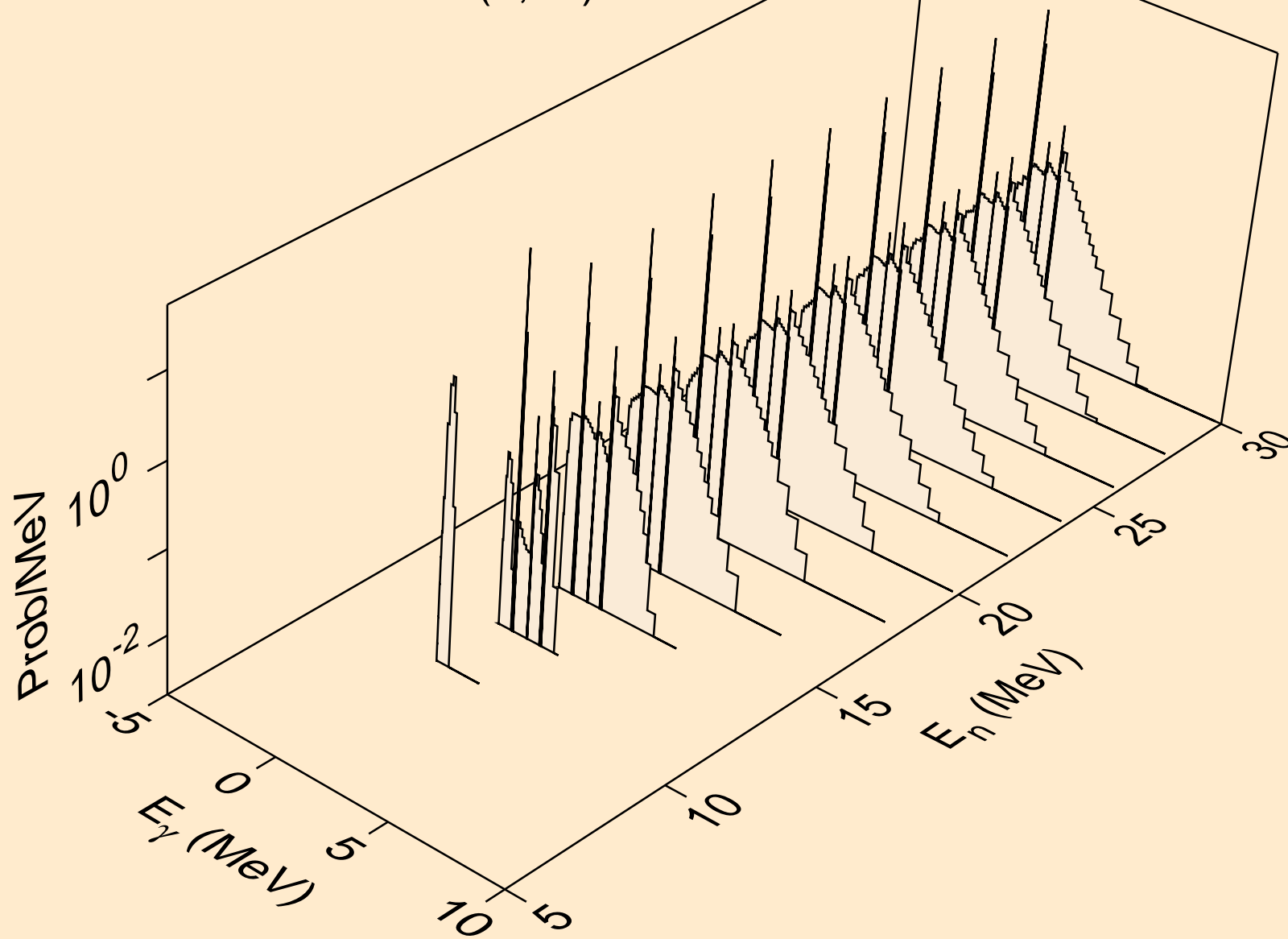



TA160 NEUTRON ACER TENDL-2023 LIBRARY; T=0.K  
Photon emission for (n,3n)

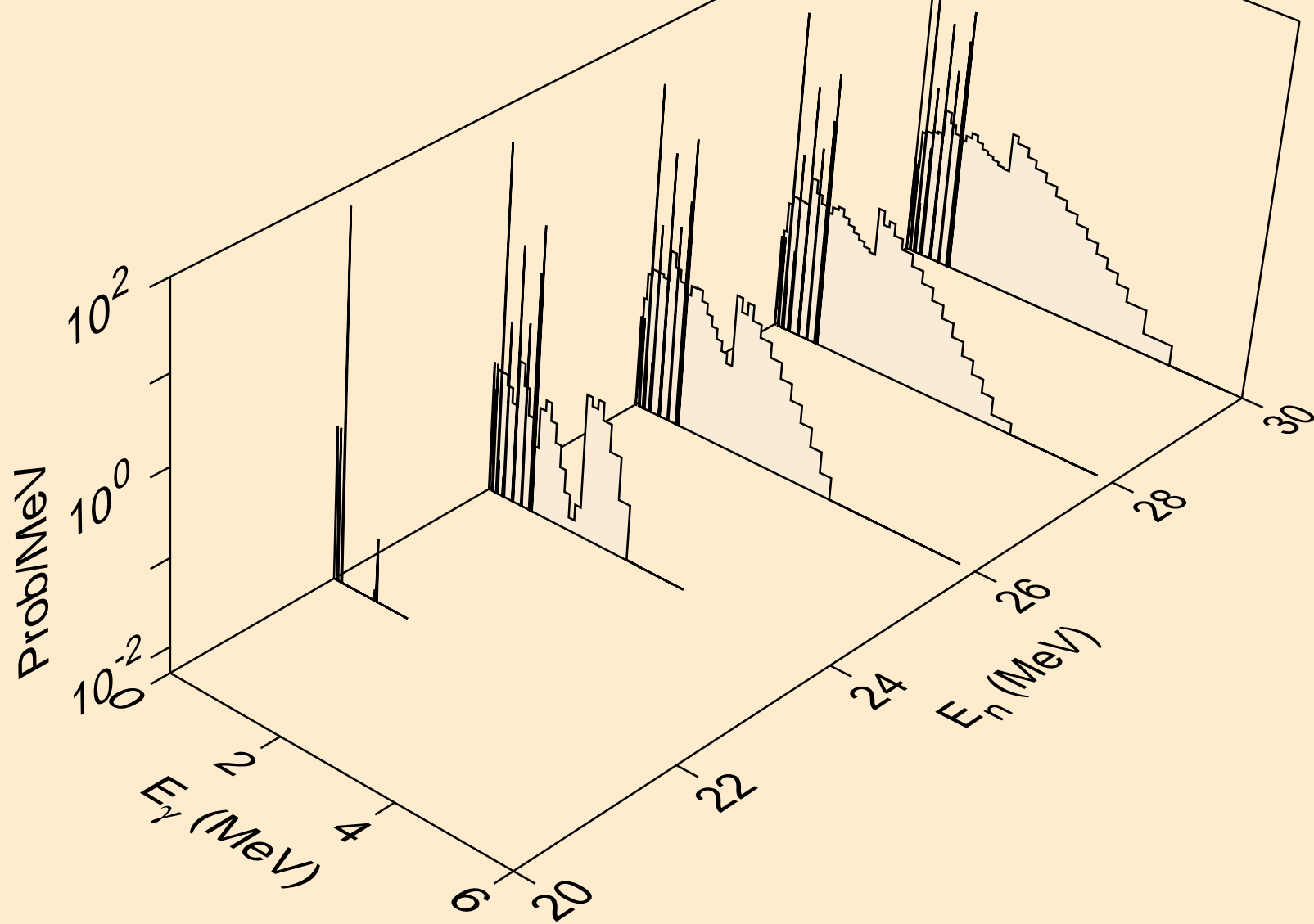

TA160 NEUTRON ACER TENDL-2023 LIBRARY; T=0.K  
Photon emission for (n,n\*)a

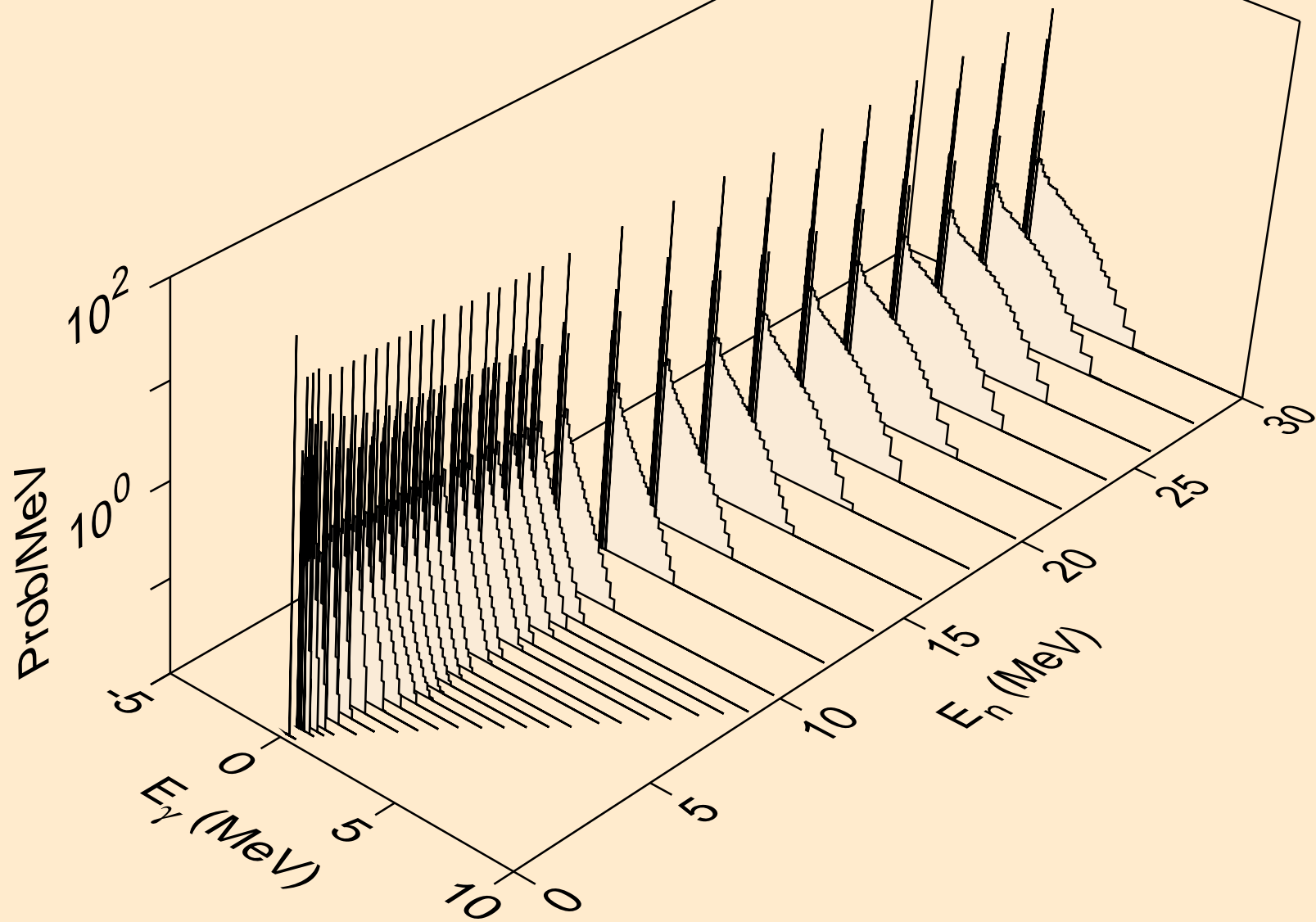

TA160 NEUTRON ACER TENDL-2023 LIBRARY; T=0.K  
Photon emission for (n,n\*)3a

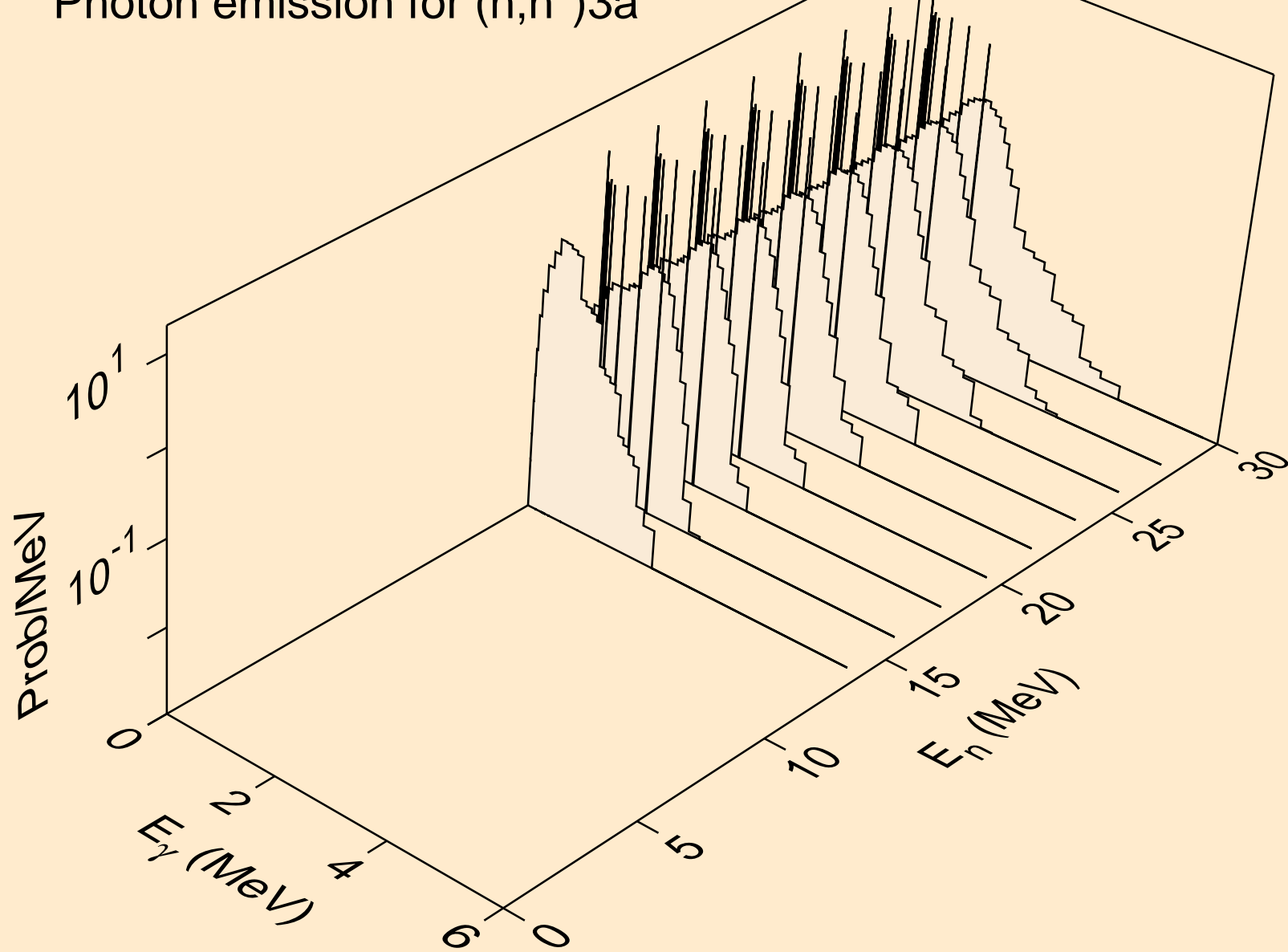

TA160 NEUTRON ACER TENDL-2023 LIBRARY; T=0.K  
Photon emission for (n,2n)a

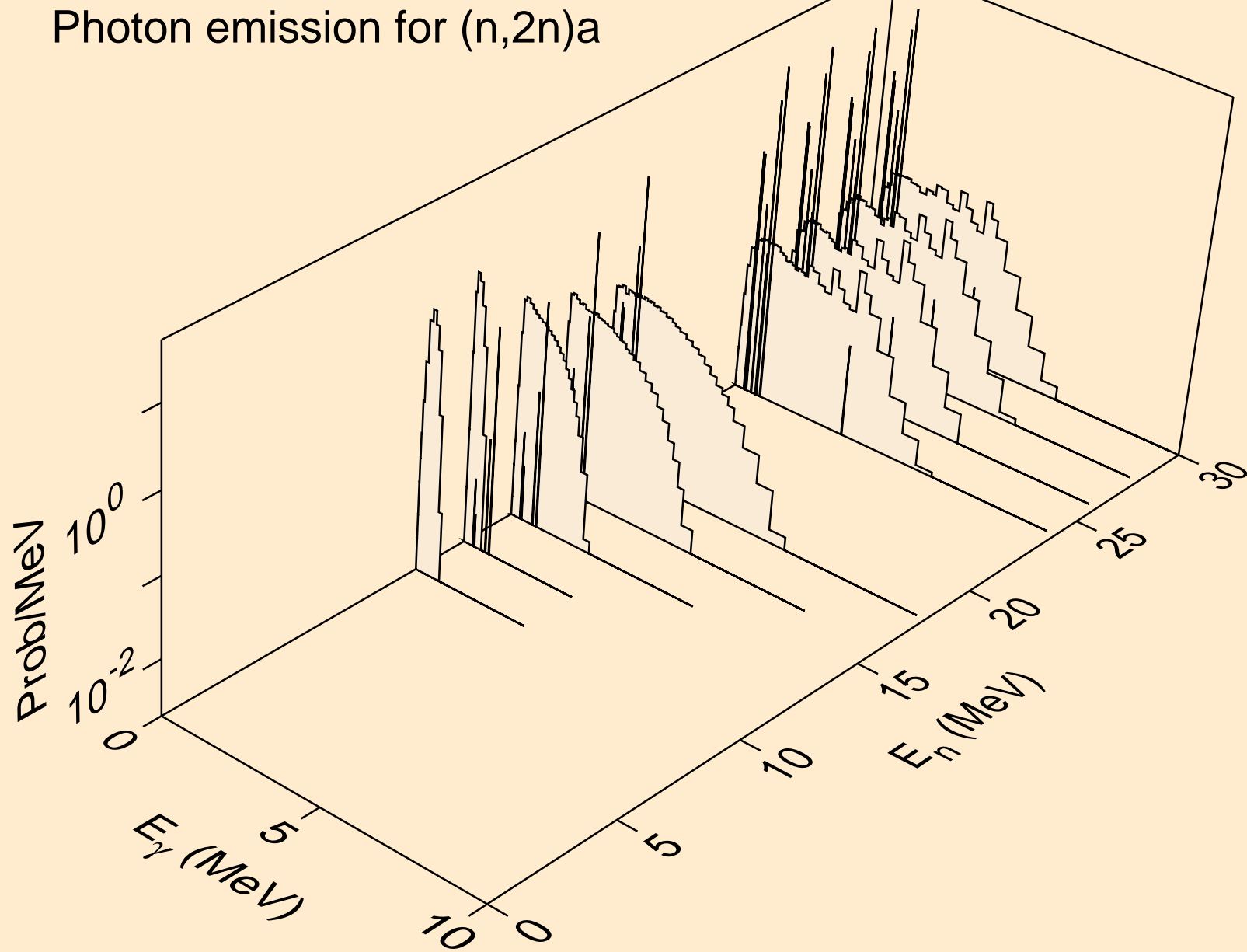

TA160 NEUTRON ACER TENDL-2023 LIBRARY; T=0.K  
Photon emission for (n,3n)a

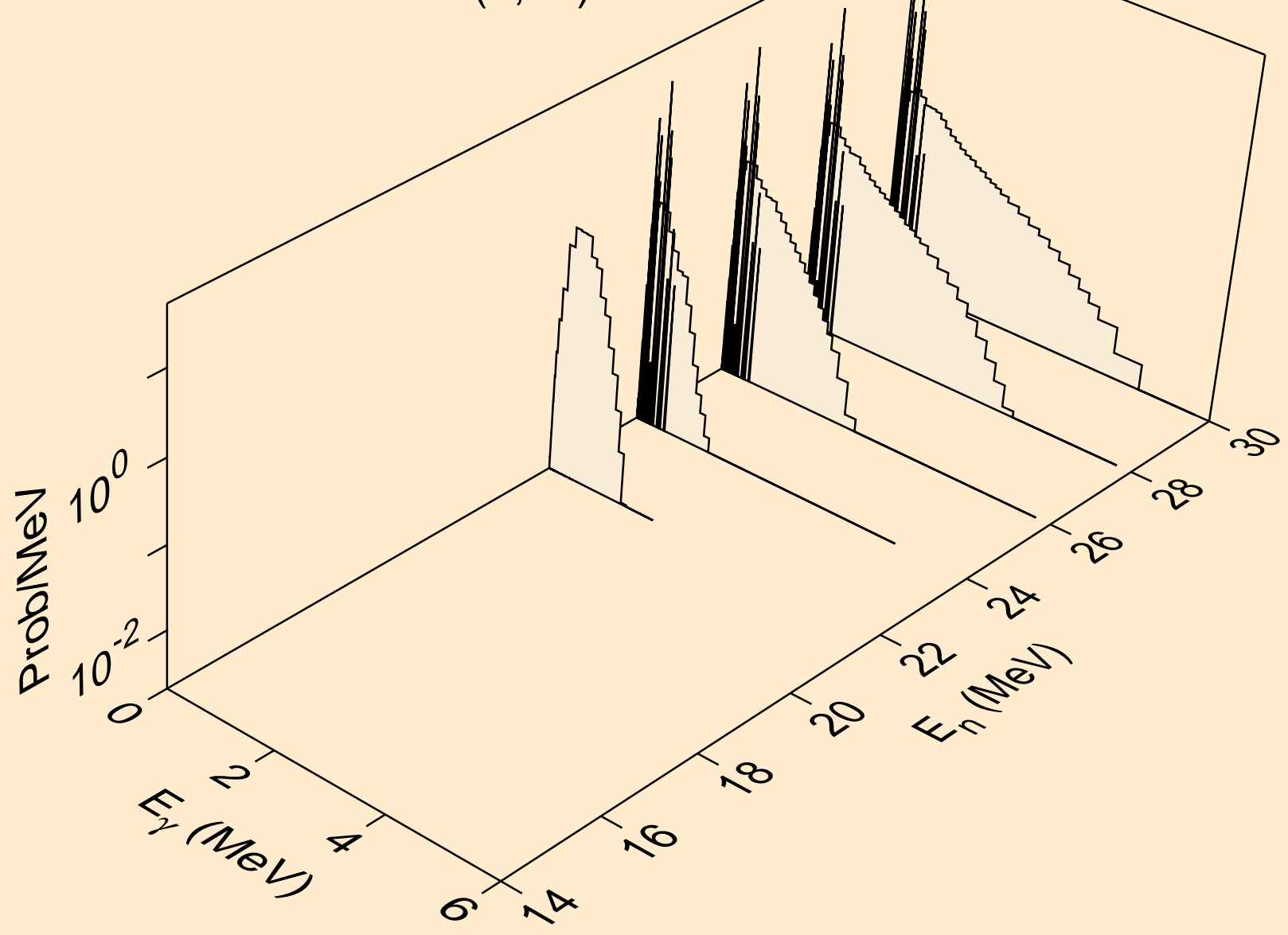

TA160 NEUTRON ACER TENDL-2023 LIBRARY; T=0.K  
Photon emission for (n,n\*)p

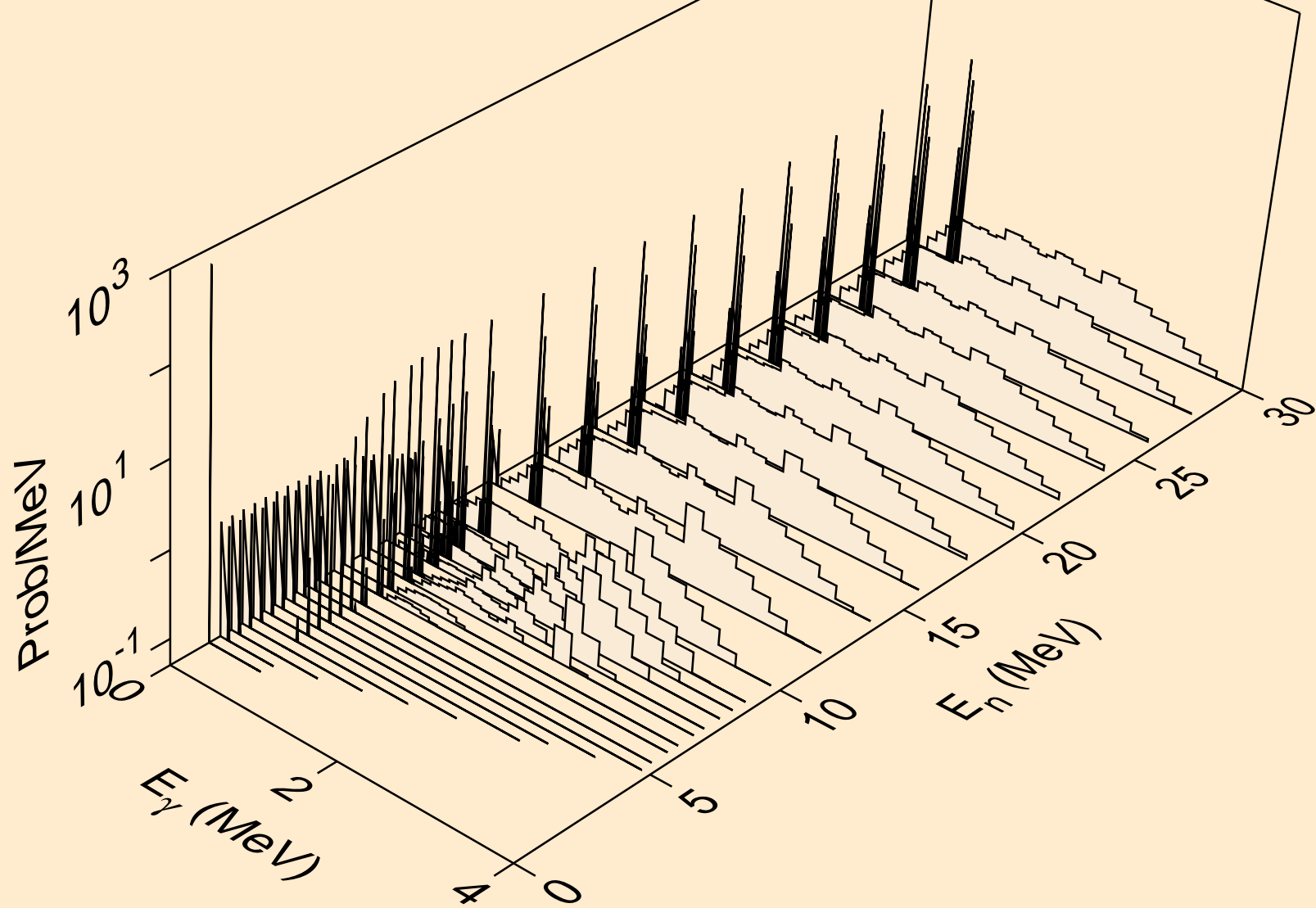

TA160 NEUTRON ACER TENDL-2023 LIBRARY; T=0.K  
Photon emission for (n,n\*)2a

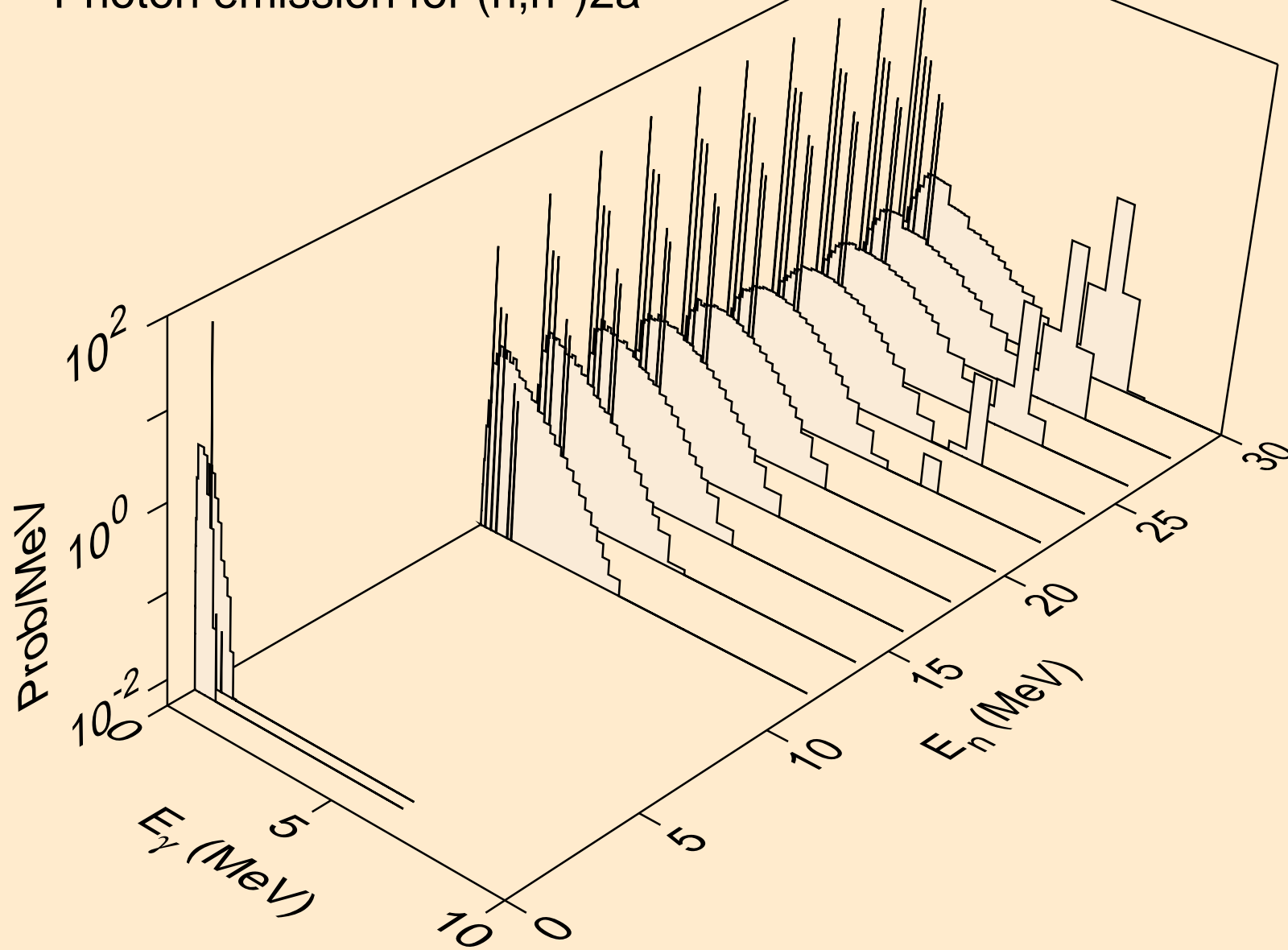

TA160 NEUTRON ACER TENDL-2023 LIBRARY; T=0.K  
Photon emission for (n,2n)2a

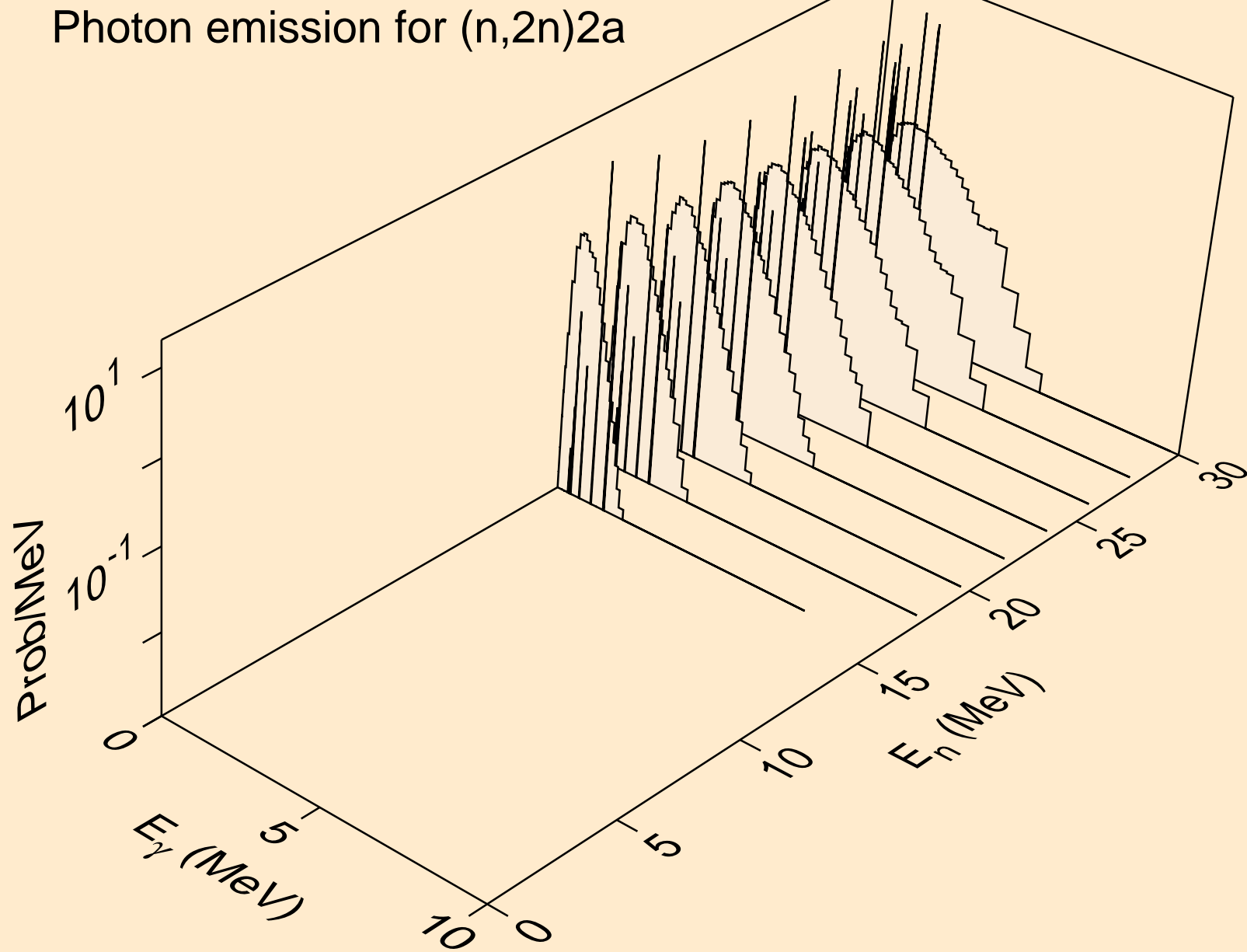



TA160 NEUTRON ACER TENDL-2023 LIBRARY; T=0.K  
Photon emission for (n,n\*)d

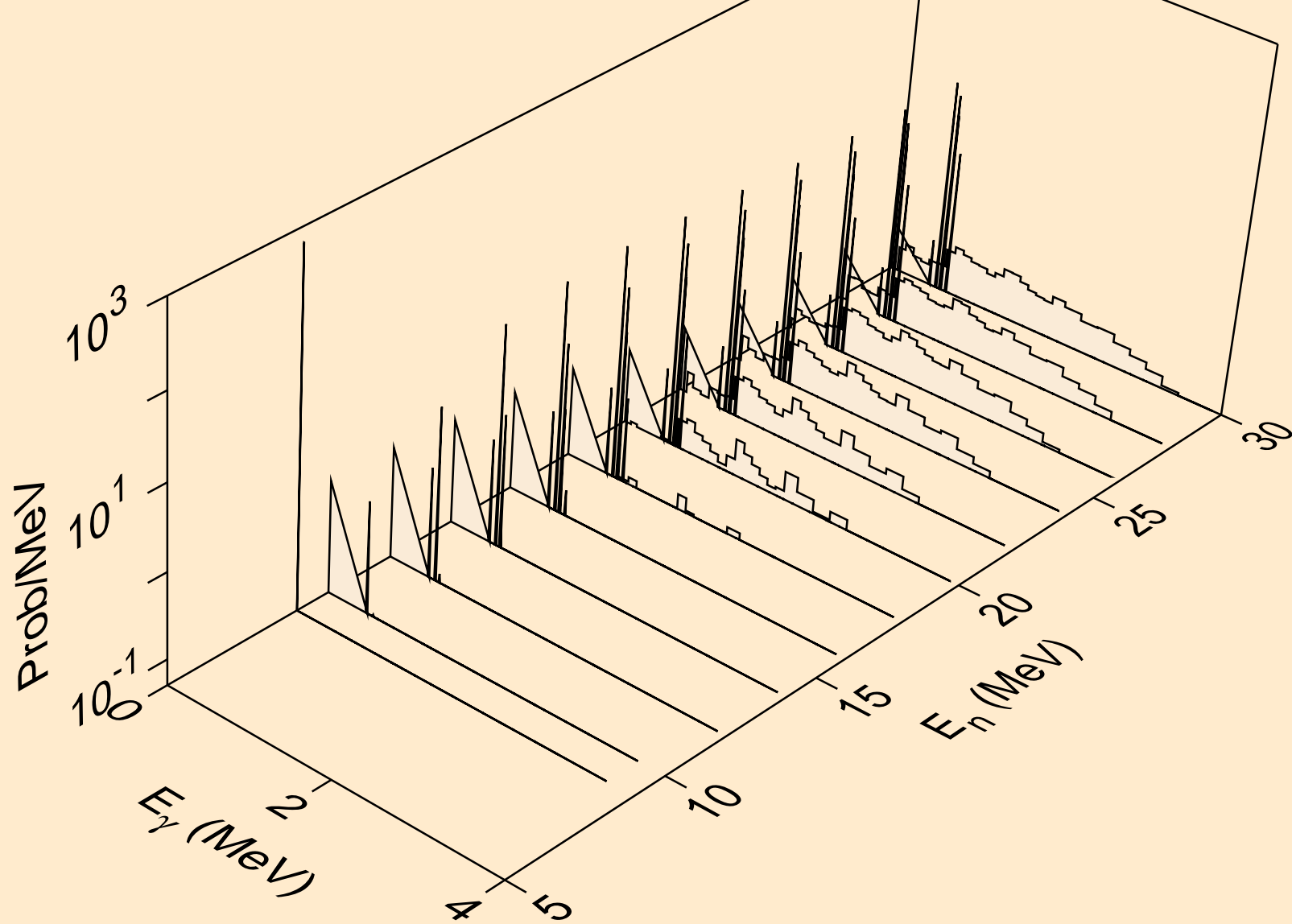

TA160 NEUTRON ACER TENDL-2023 LIBRARY; T=0.K  
Photon emission for (n,n\*)t

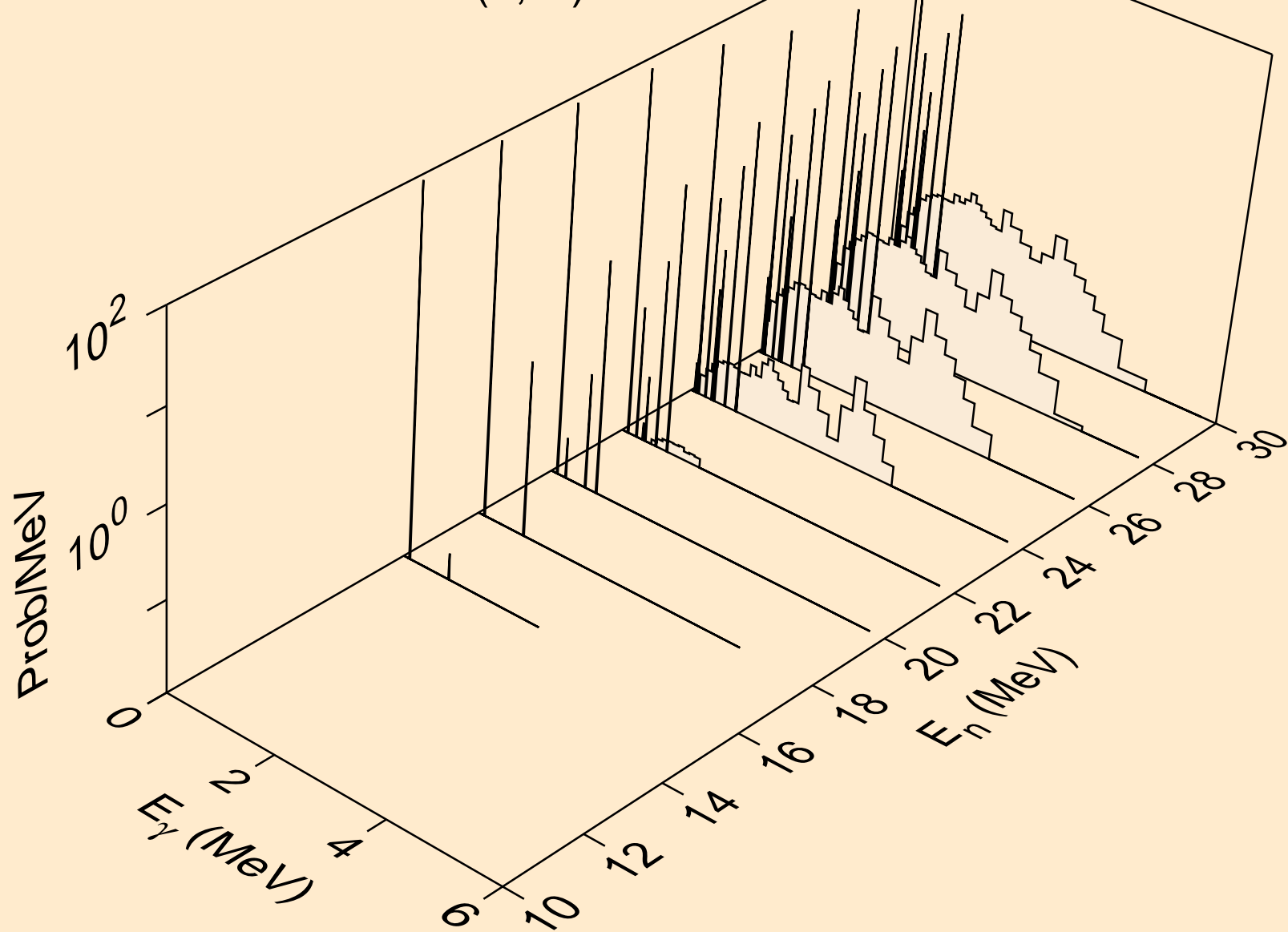

TA160 NEUTRON ACER TENDL-2023 LIBRARY; T=0.K  
Photon emission for (n,n\*)he3

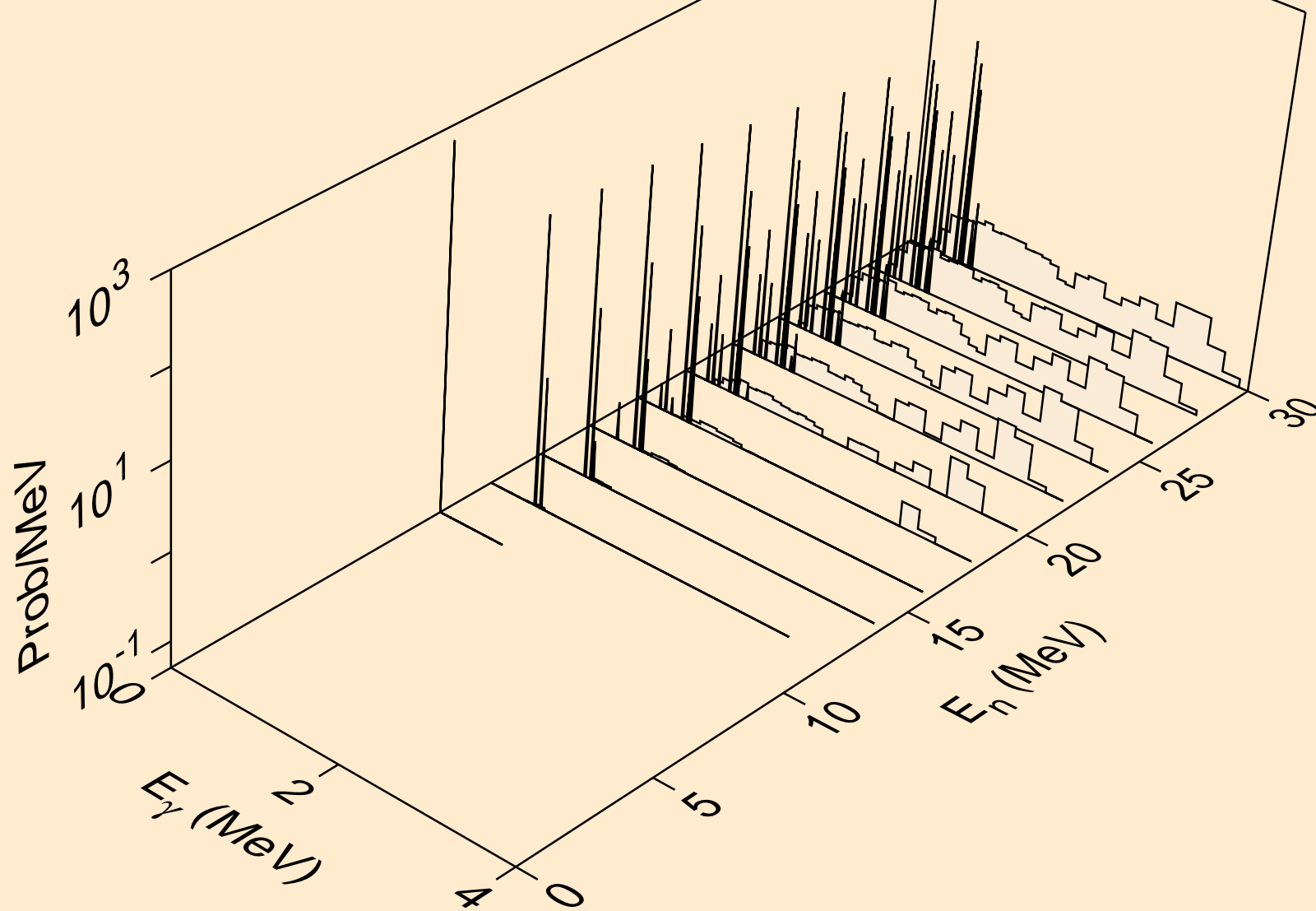

TA160 NEUTRON ACER TENDL-2023 LIBRARY; T=0.K  
Photon emission for (n,n\*)d2a

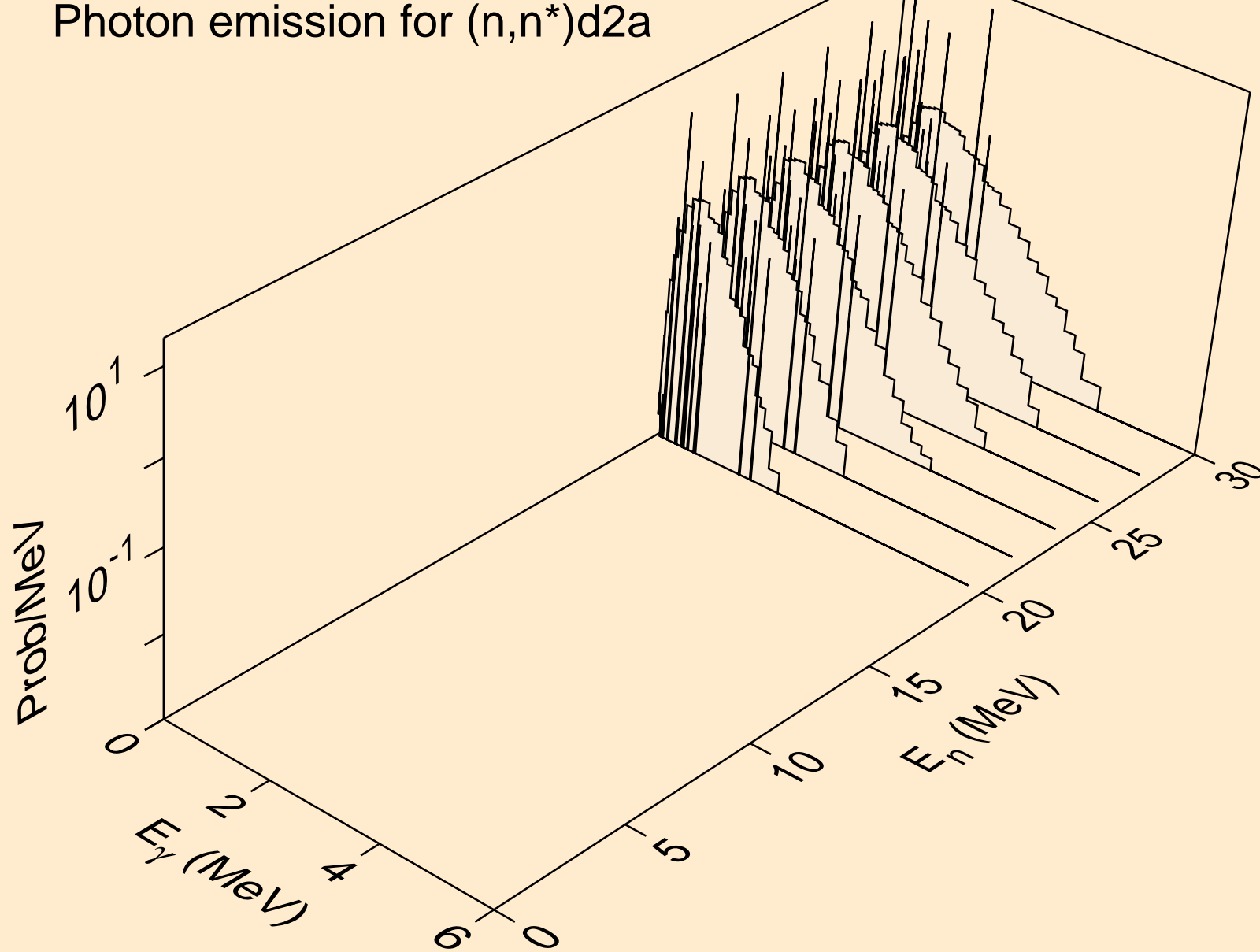

TA160 NEUTRON ACER TENDL-2023 LIBRARY; T=0.K  
Photon emission for (n,2np)

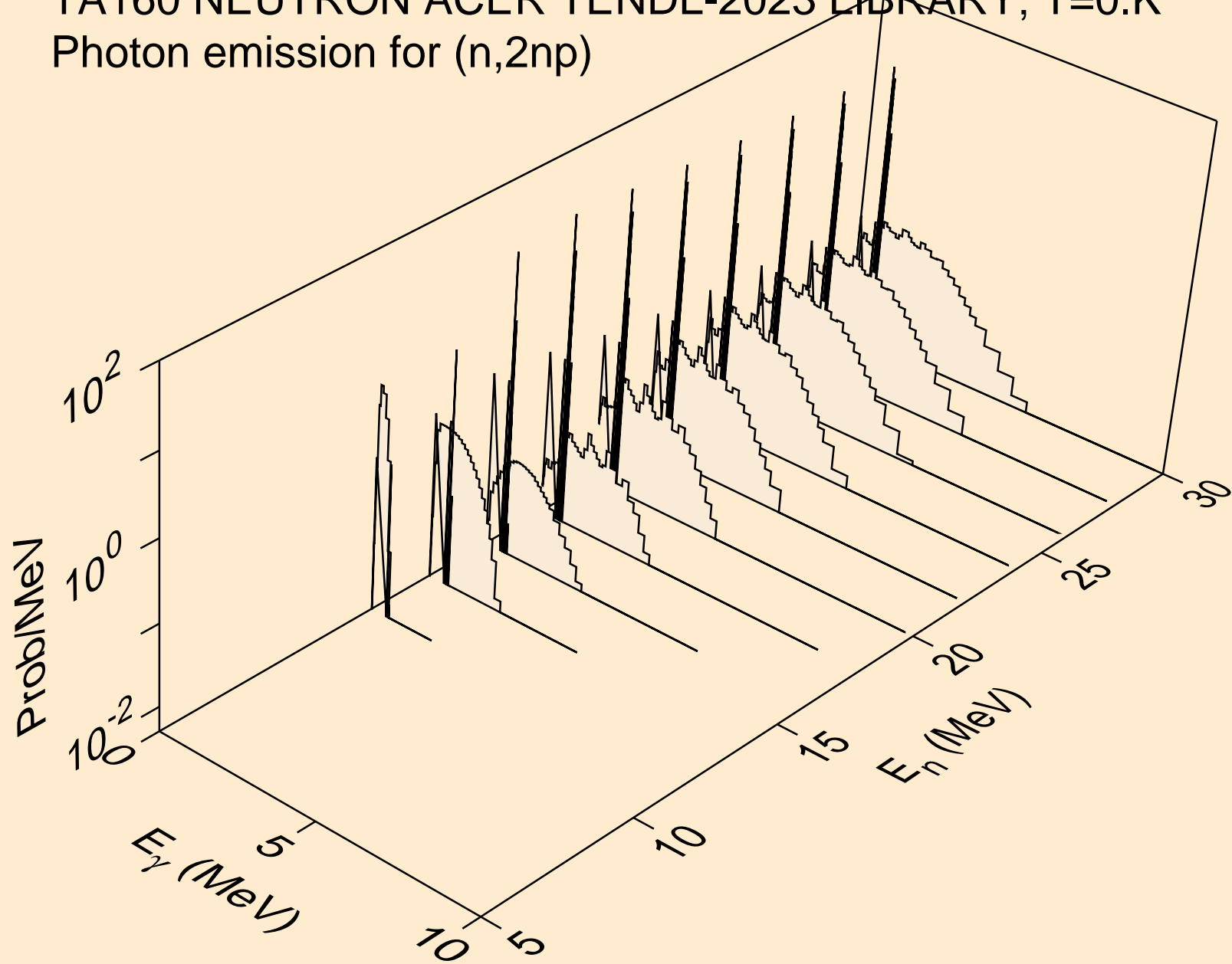

TA160 NEUTRON ACER TENDL-2023 LIBRARY; T=0.K  
Photon emission for (n,3np)

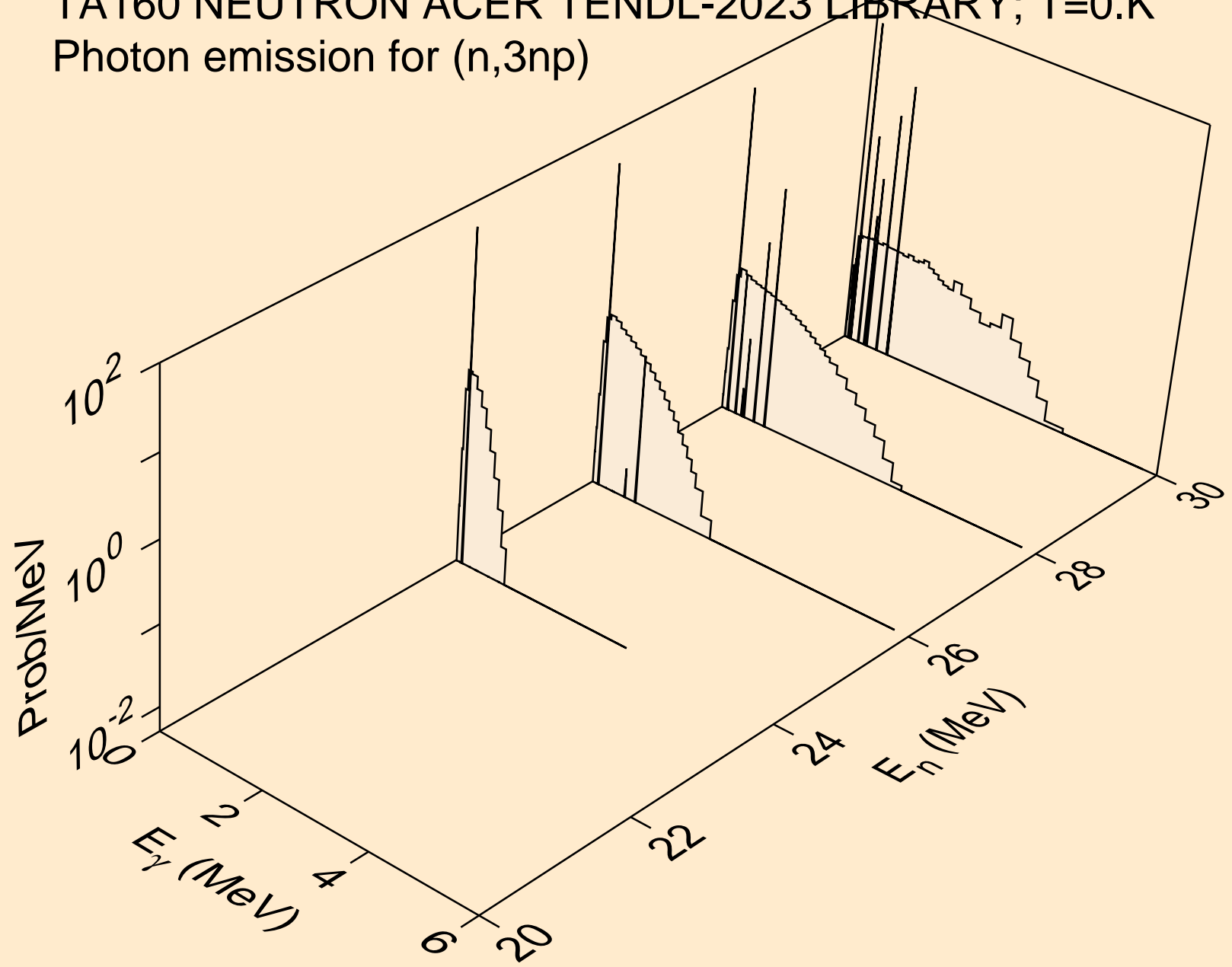

TA160 NEUTRON ACER TENDL-2023 LIBRARY; T=0.K  
Photon emission for (n,n2p)

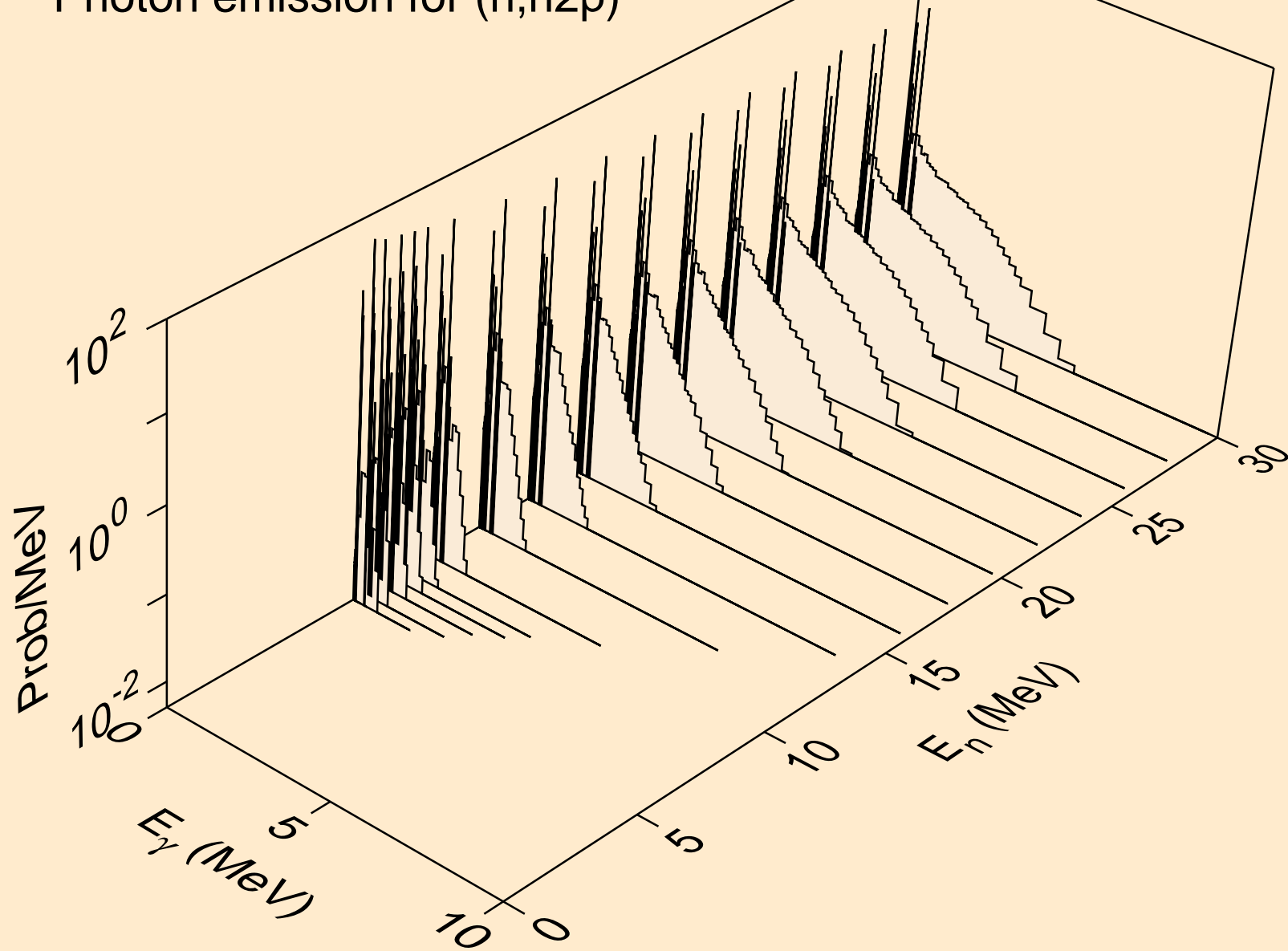

TA160 NEUTRON ACER TENDL-2023 LIBRARY; T=0.K  
Photon emission for (n,npa)

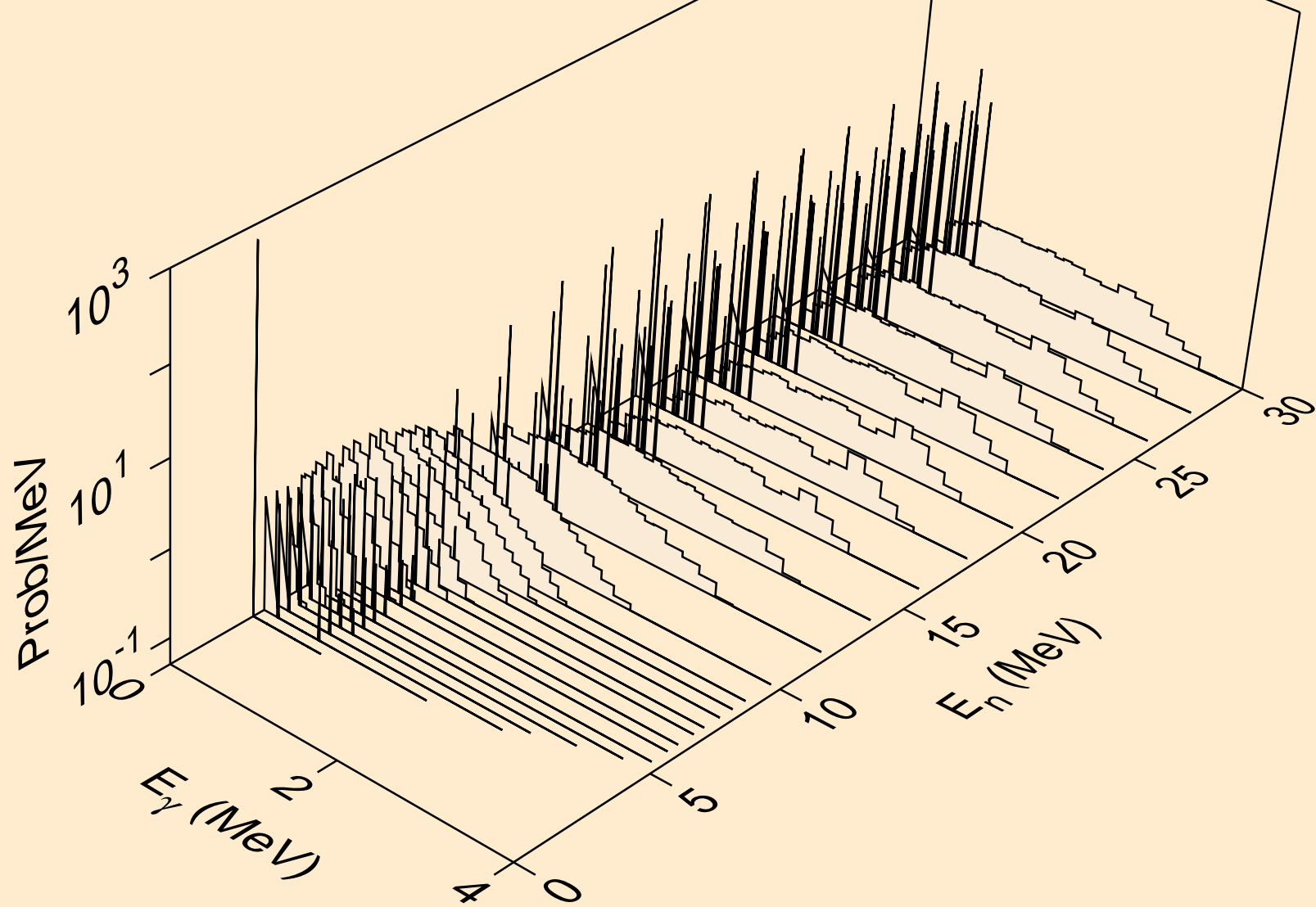



TA160 NEUTRON ACER TENDL-2023 LIBRARY; T=0.K  
Photon emission for (n,n\*c)

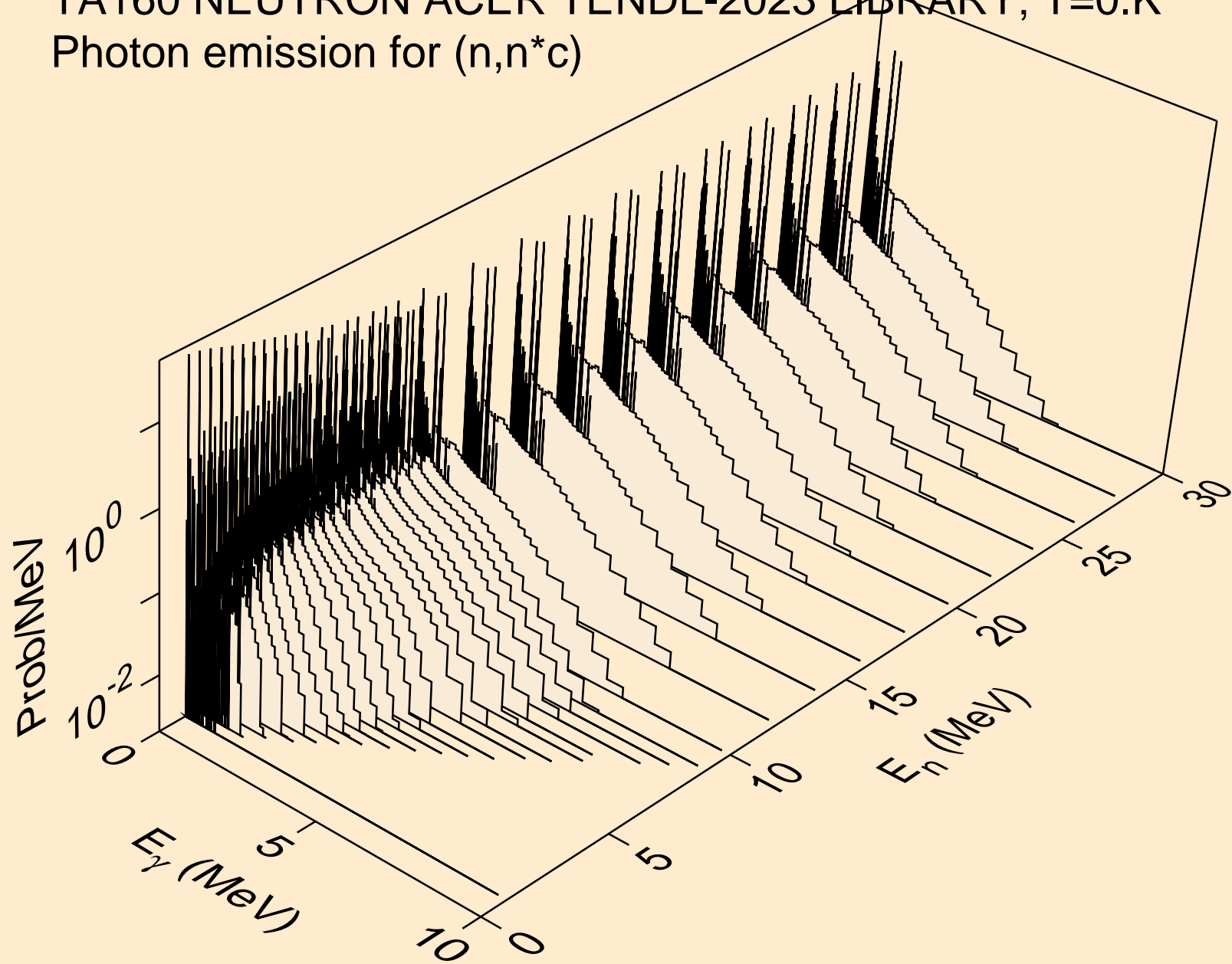

TA160 NEUTRON ACER TENDL-2023 LIBRARY; T=0.K  
Photon emission for (n,gma)

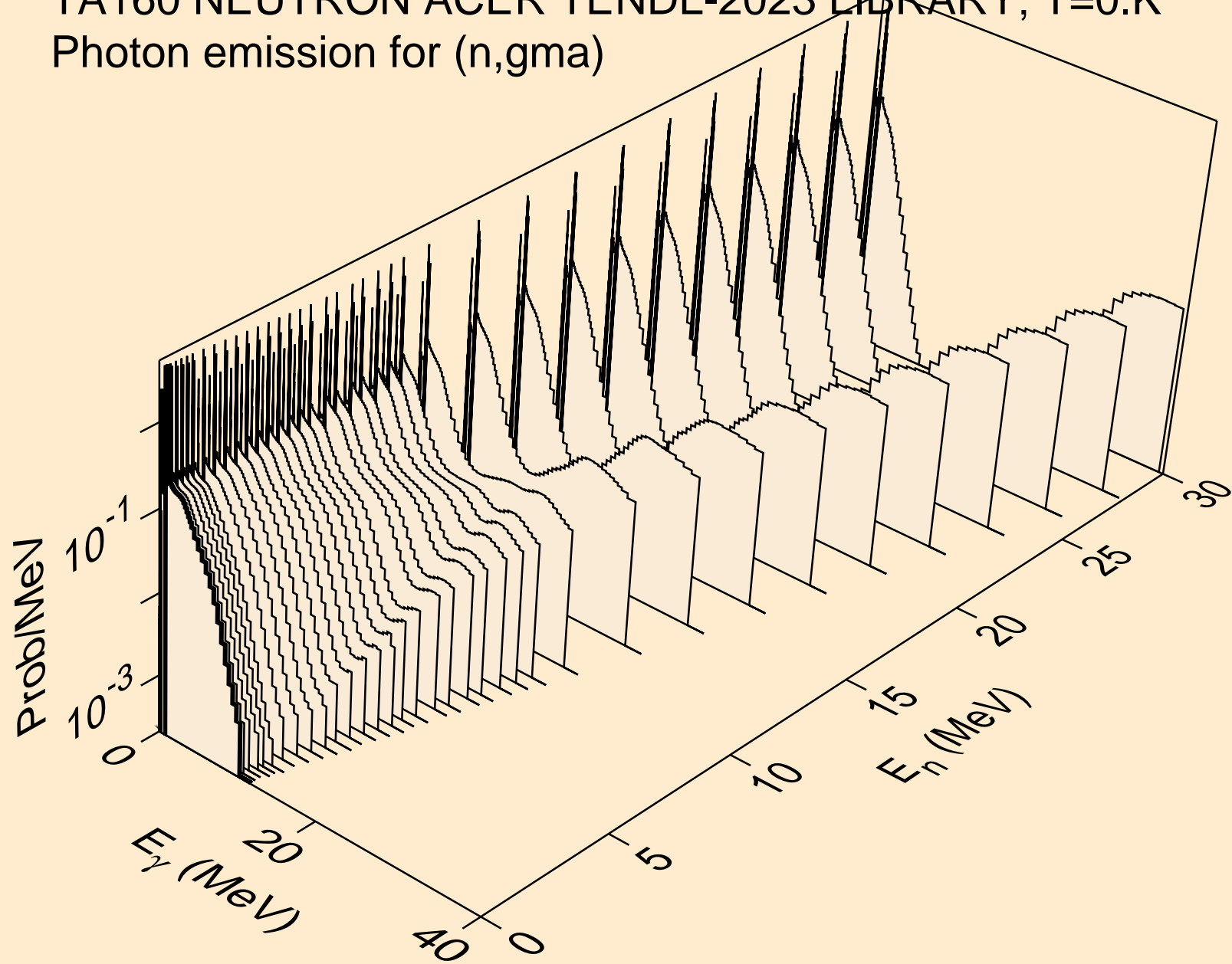

TA160 NEUTRON ACER TENDL-2023 LIBRARY; T=0.K  
Photon emission for (n,p)

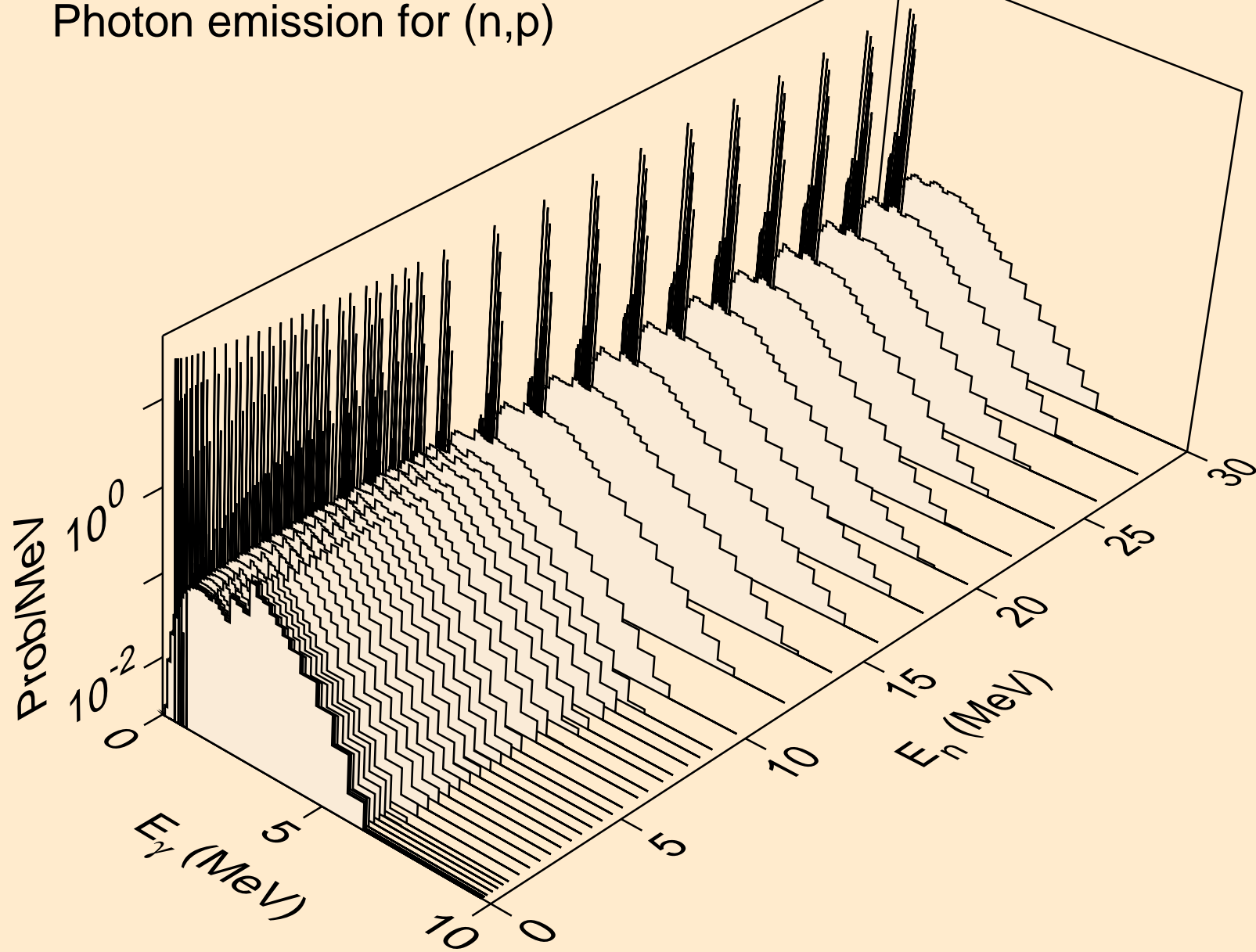

TA160 NEUTRON ACER TENDL-2023 LIBRARY; T=0.K  
Photon emission for (n,d)

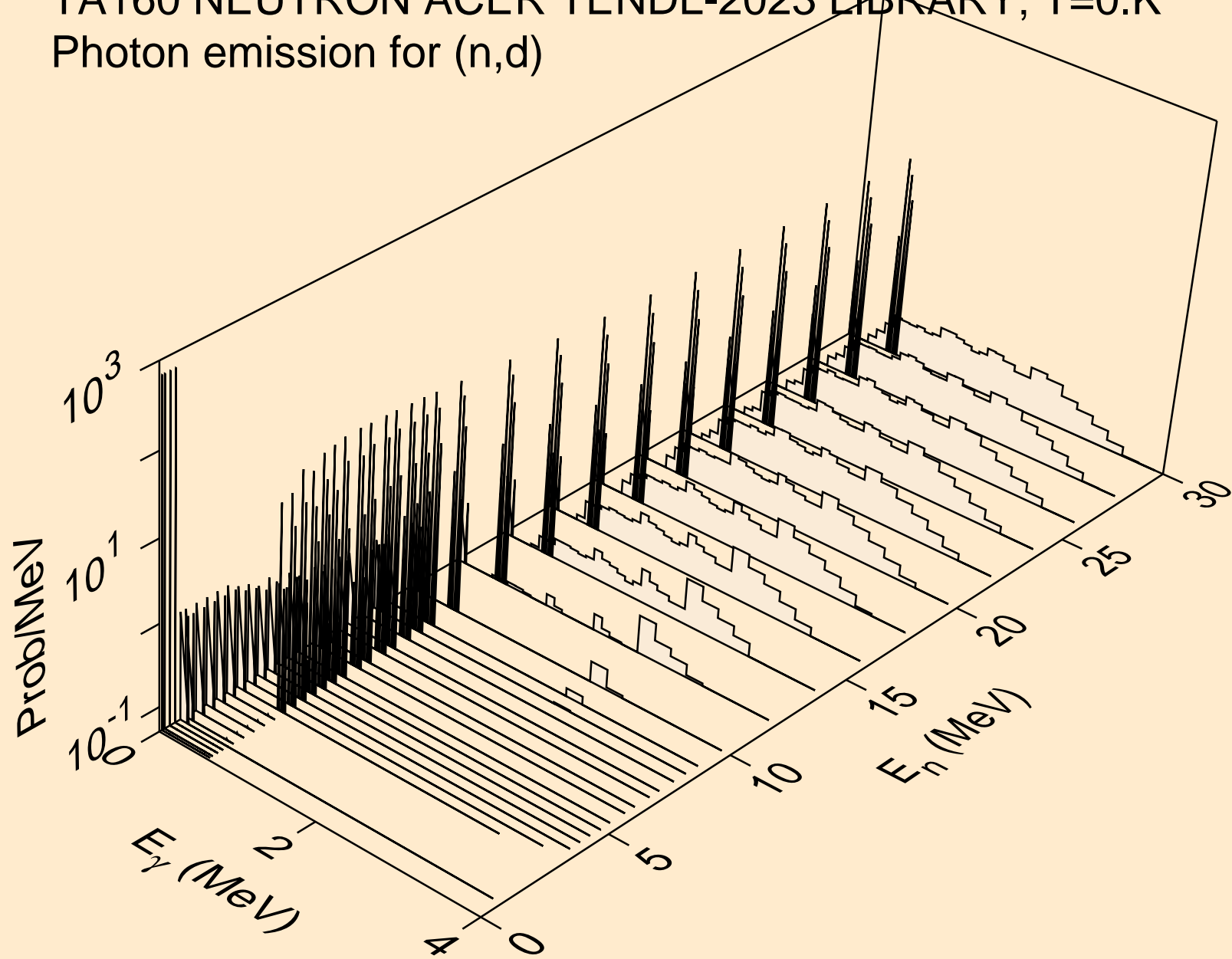

TA160 NEUTRON ACER TENDL-2023 LIBRARY; T=0.K  
Photon emission for (n,t)

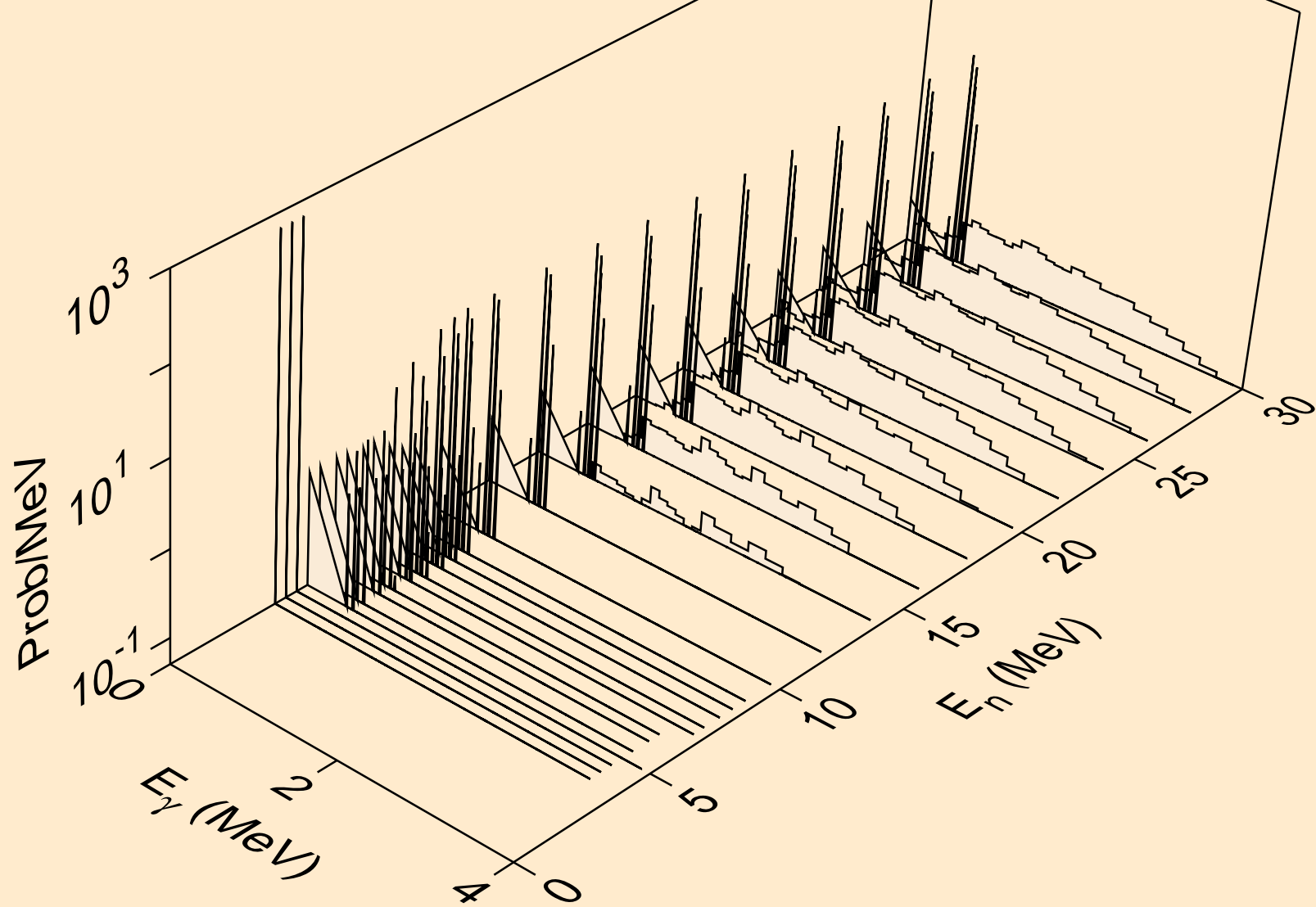

TA160 NEUTRON ACER TENDL-2023 LIBRARY; T=0.K  
Photon emission for (n,he3)

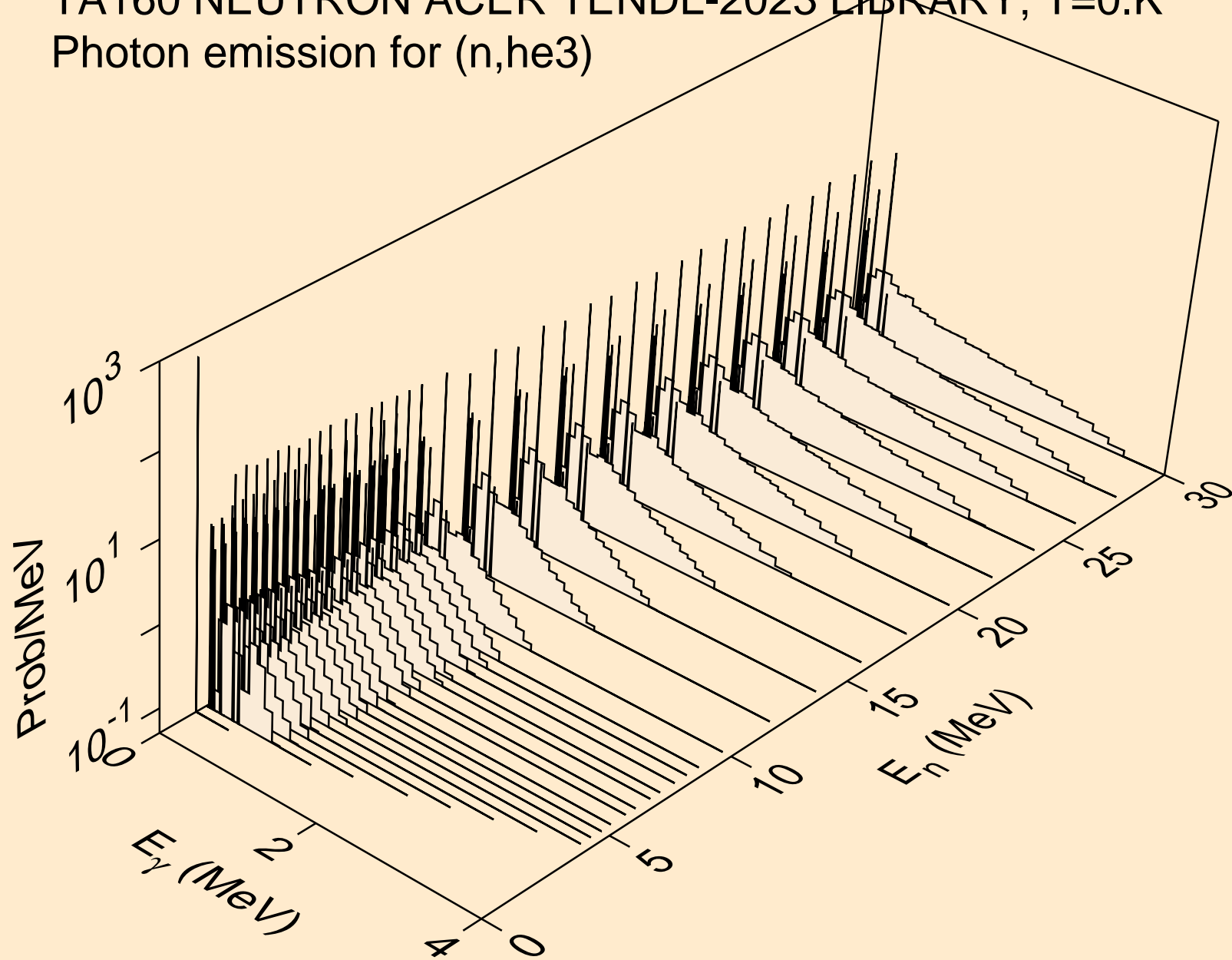

TA160 NEUTRON ACER TENDL-2023 LIBRARY; T=0.K  
Photon emission for (n,a)

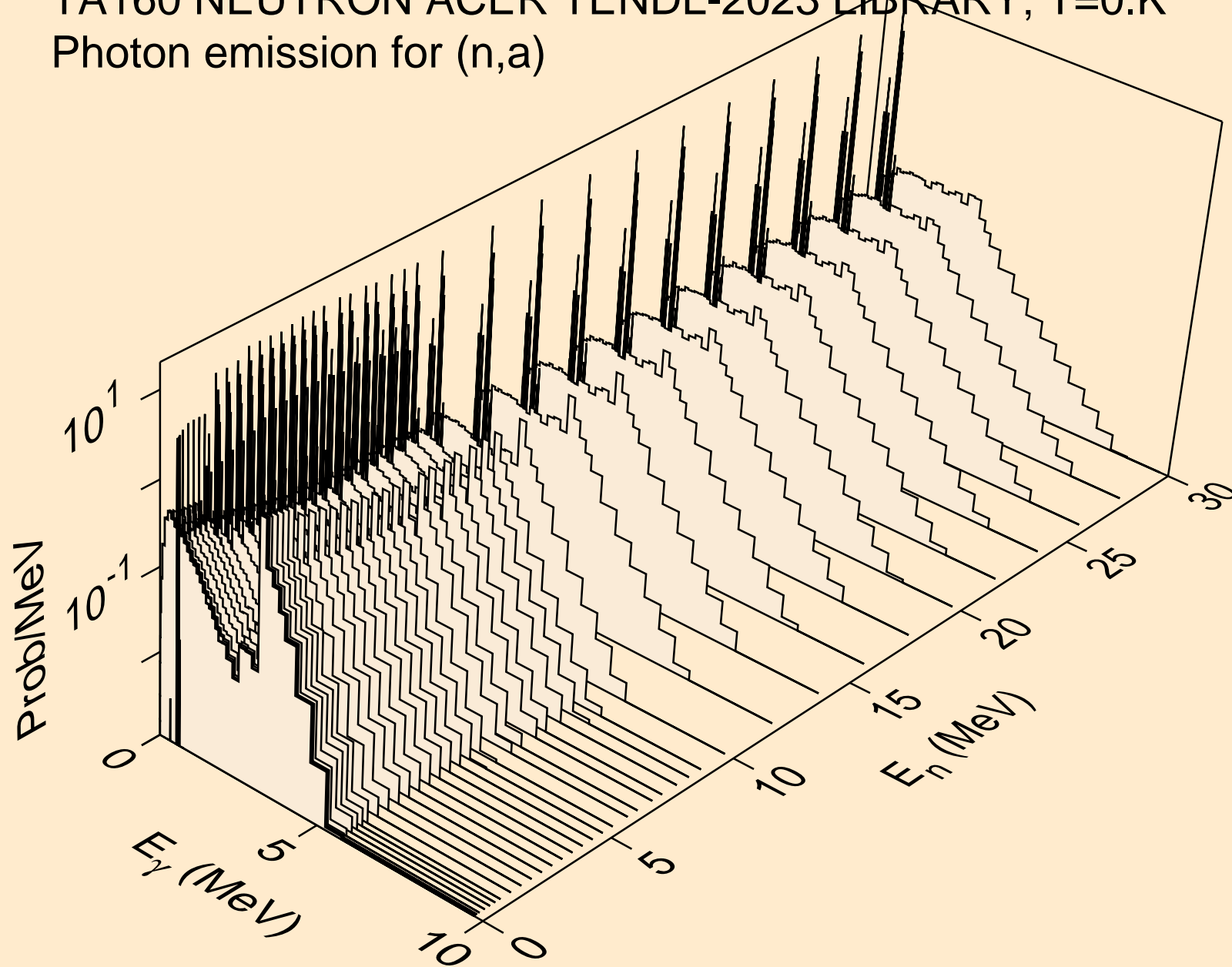

TA160 NEUTRON ACER TENDL-2023 LIBRARY; T=0.K  
Photon emission for (n,2a)

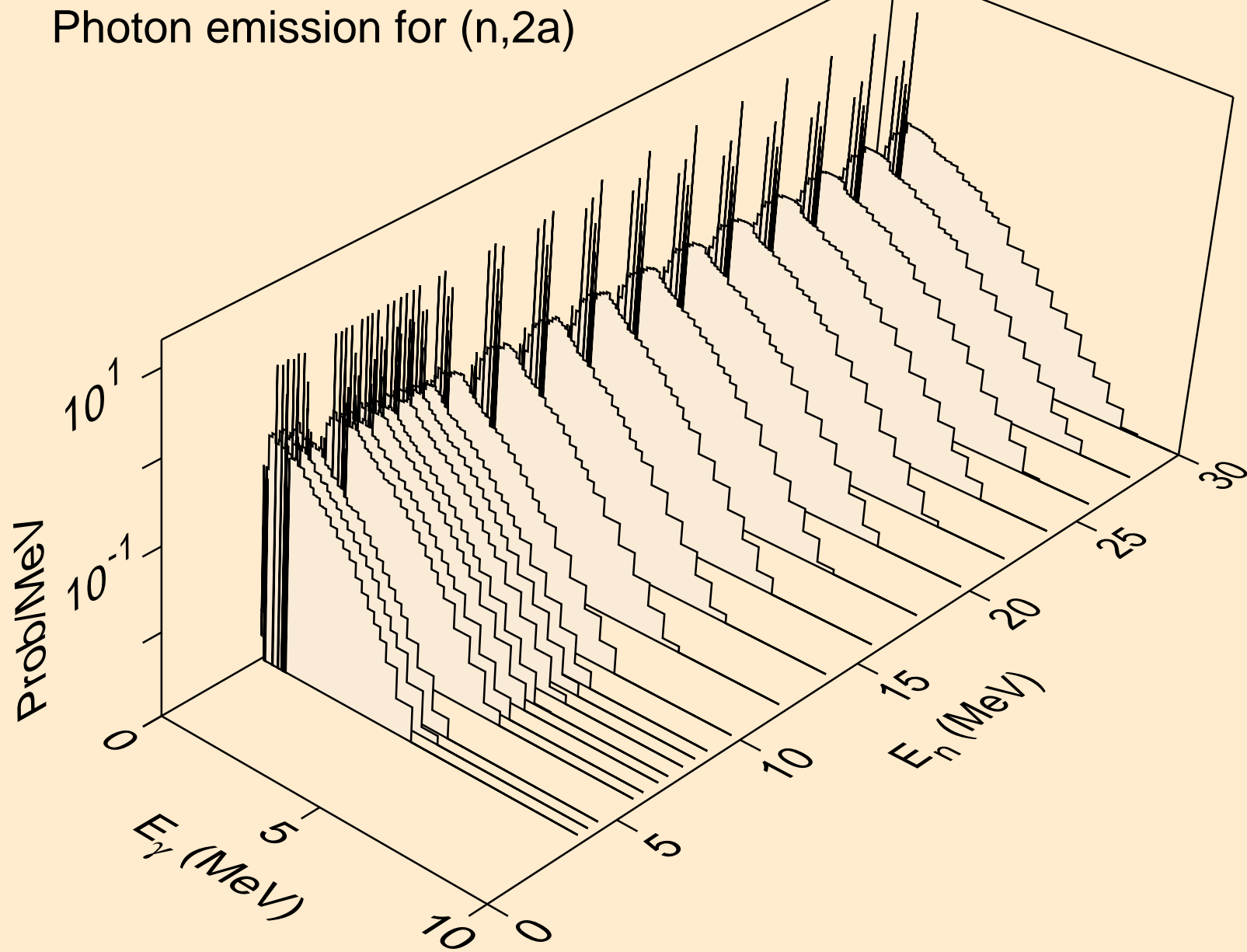



TA160 NEUTRON ACER TENDL-2023 LIBRARY; T=0.K  
Photon emission for (n,3a)

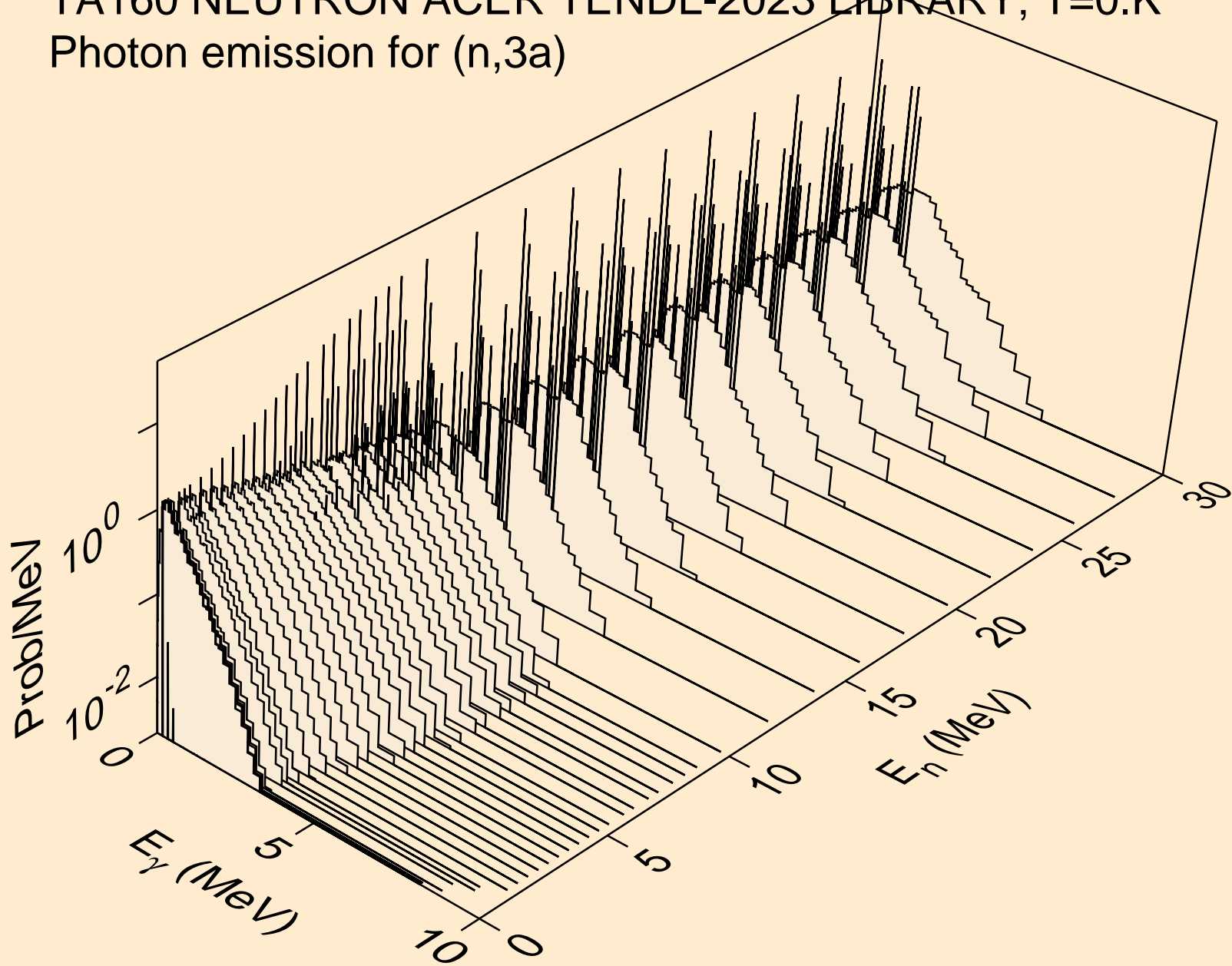

TA160 NEUTRON ACER TENDL-2023 LIBRARY; T=0.K  
Photon emission for (n,2p)

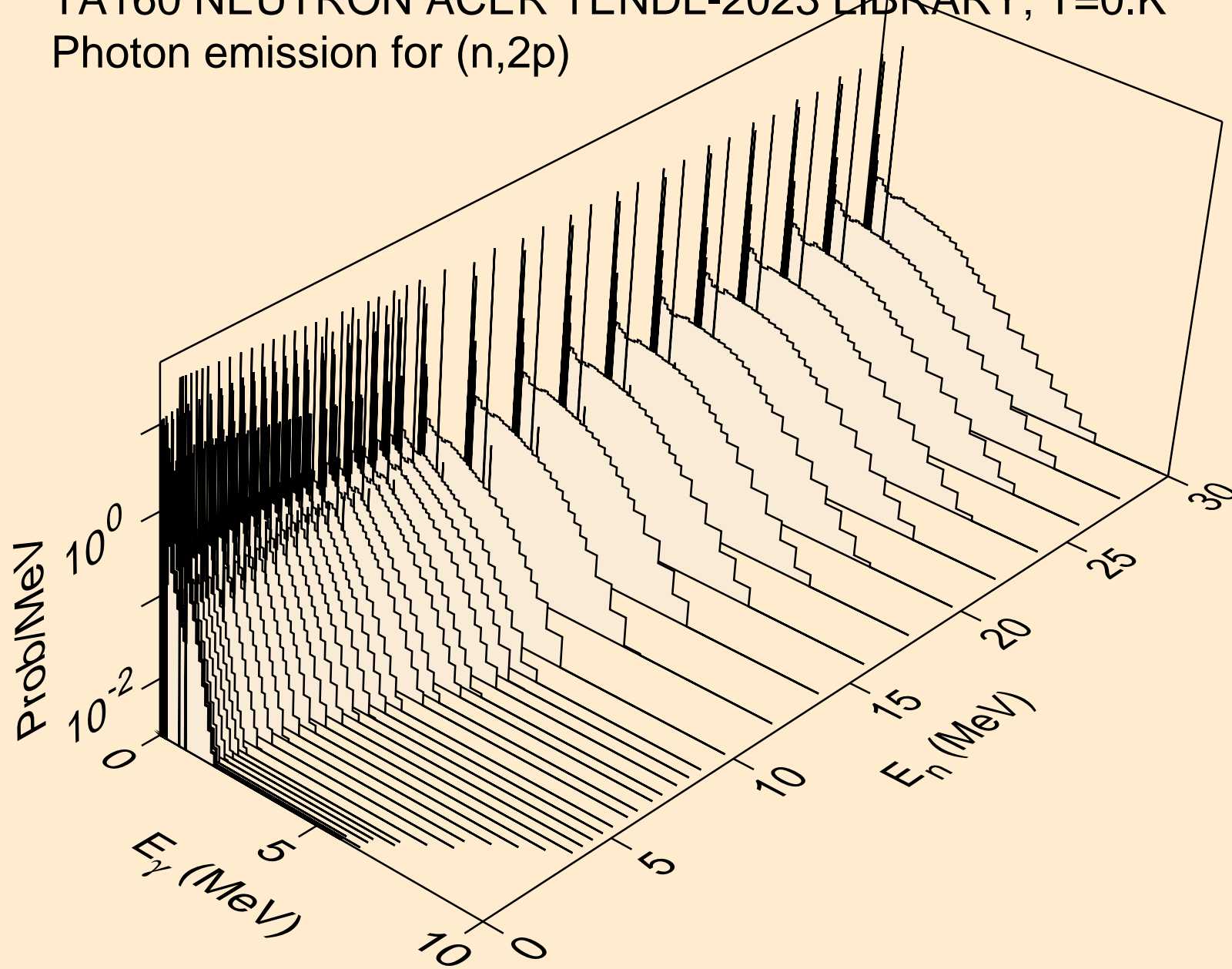

TA160 NEUTRON ACER TENDL-2023 LIBRARY; T=0.K  
Photon emission for (n,p $\alpha$ )

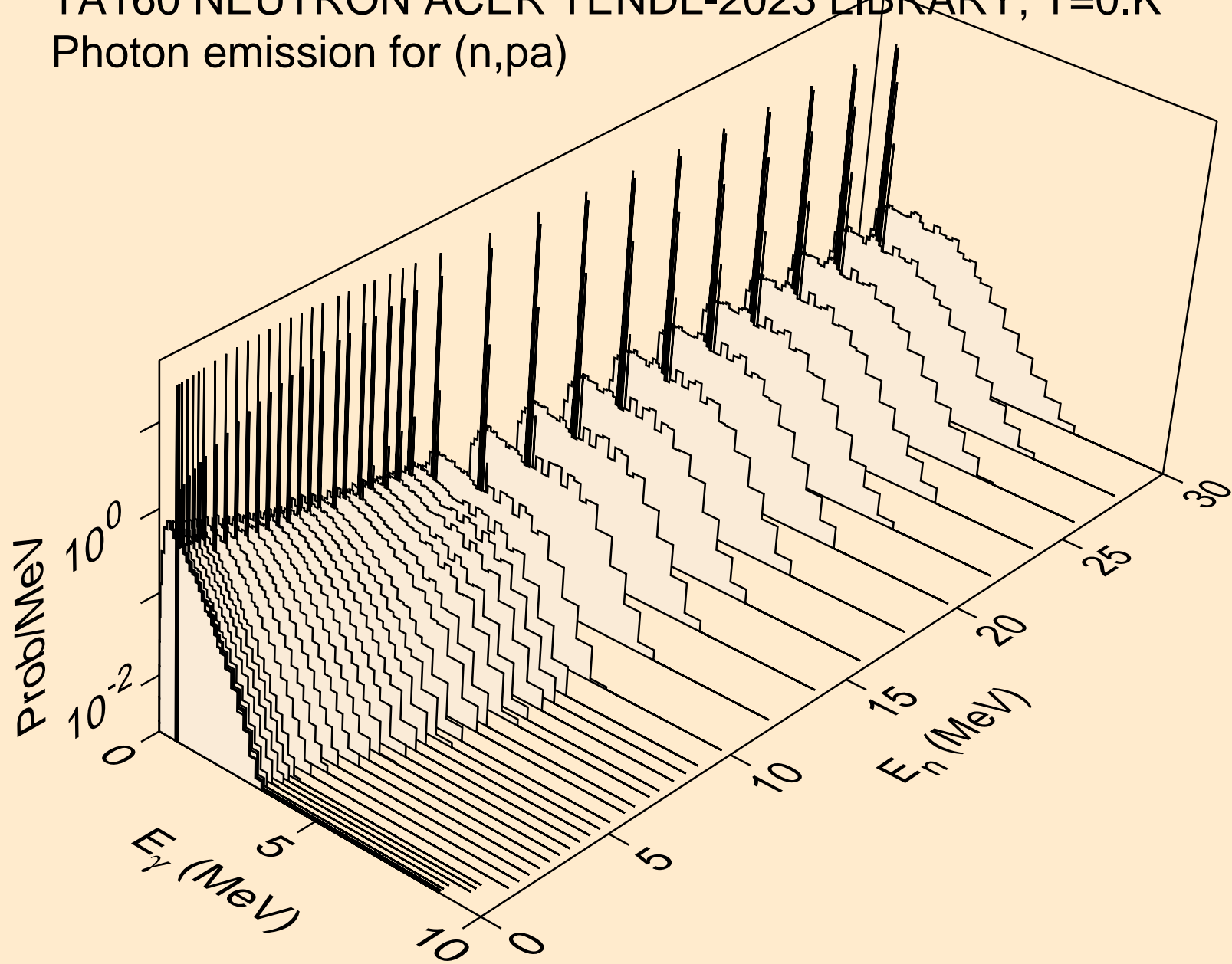

TA160 NEUTRON ACER TENDL-2023 LIBRARY; T=0.K  
Photon emission for (n,t2a)

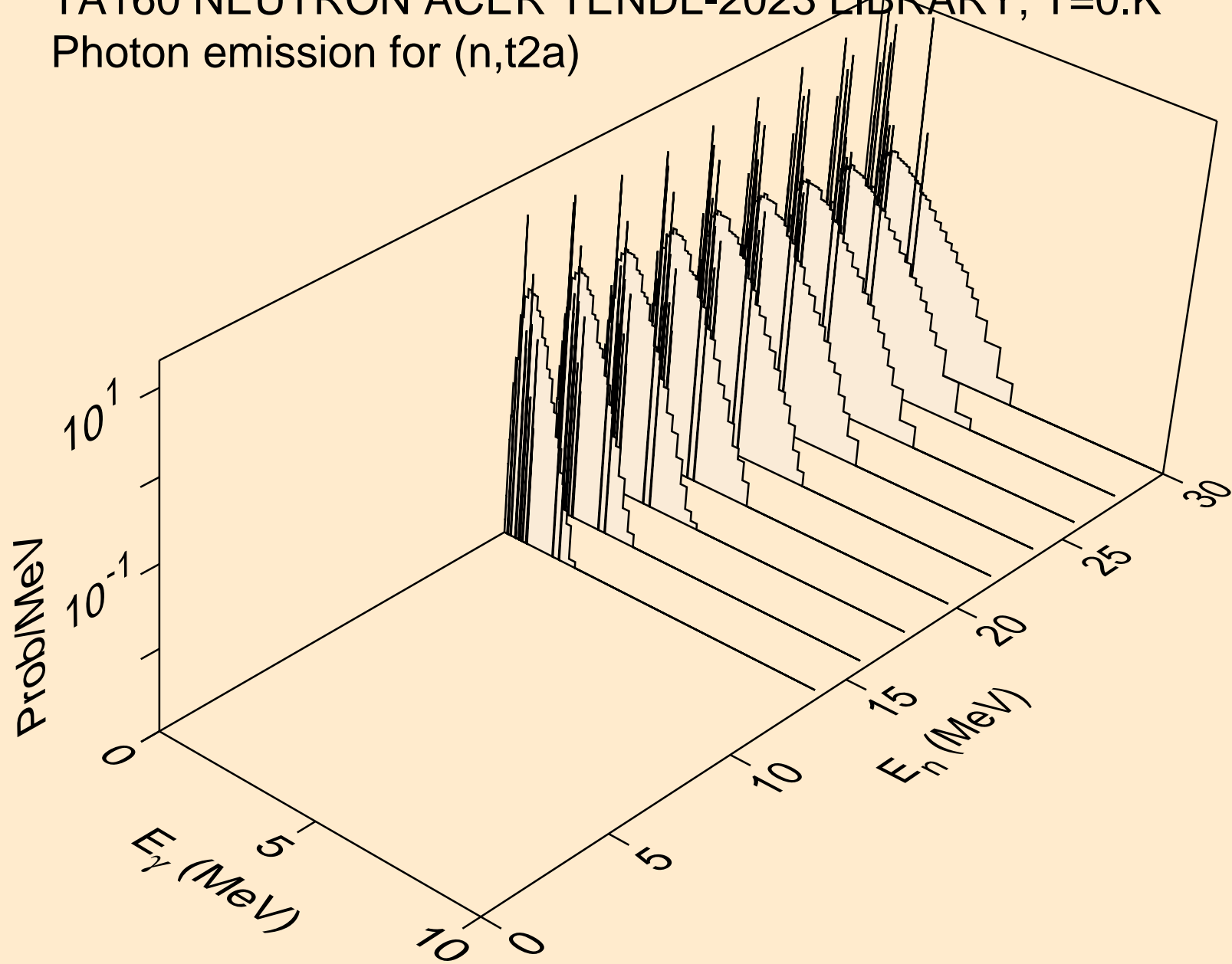

TA160 NEUTRON ACER TENDL-2023 LIBRARY; T=0.K  
Photon emission for (n,d2a)

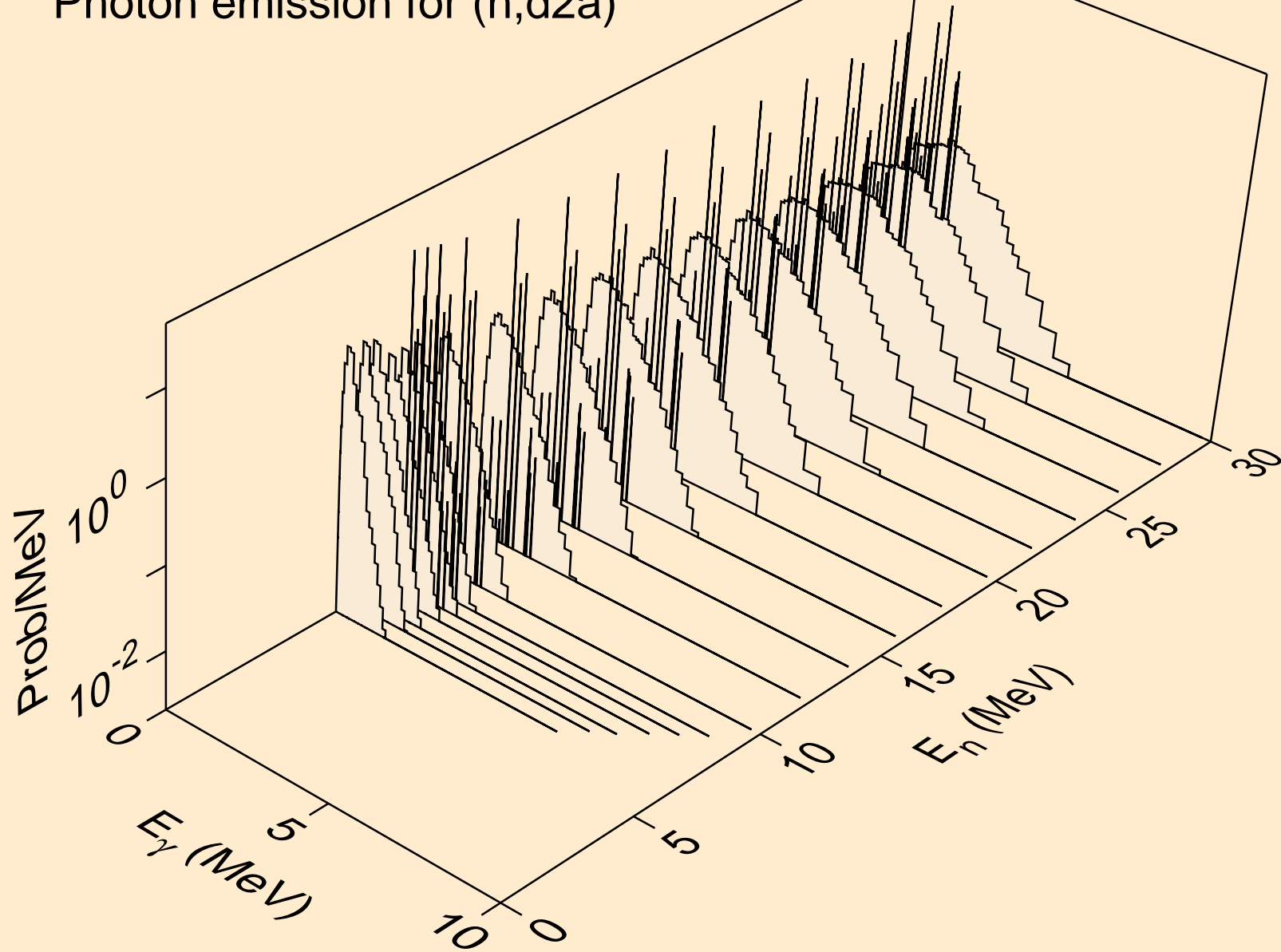

TA160 NEUTRON ACER TENDL-2023 LIBRARY; T=0.K  
Photon emission for (n,pd)

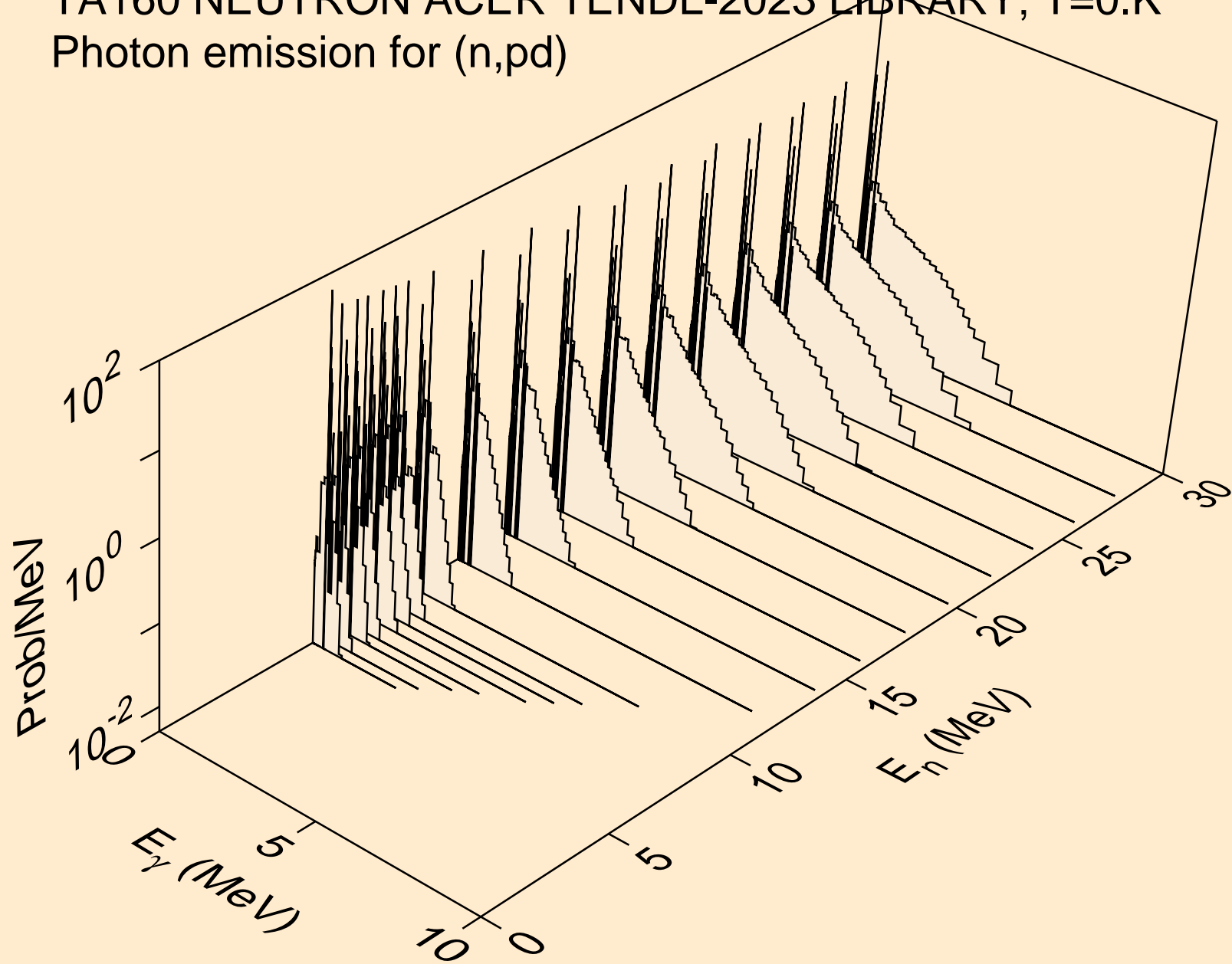

TA160 NEUTRON ACER TENDL-2023 LIBRARY; T=0.K  
Photon emission for (n,pt)

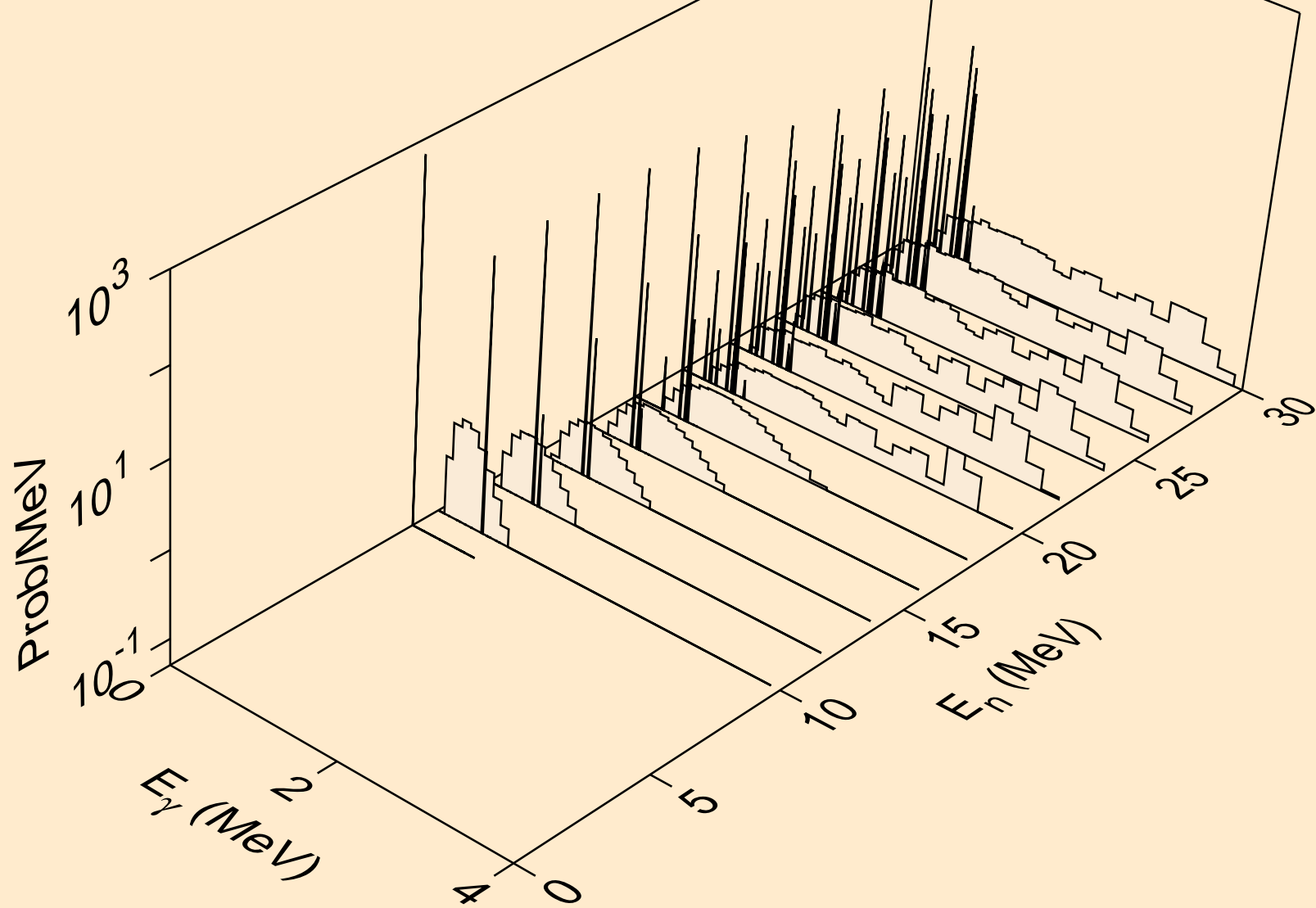

TA160 NEUTRON ACER TENDL-2023 LIBRARY; T=0.K  
Photon emission for (n,da)

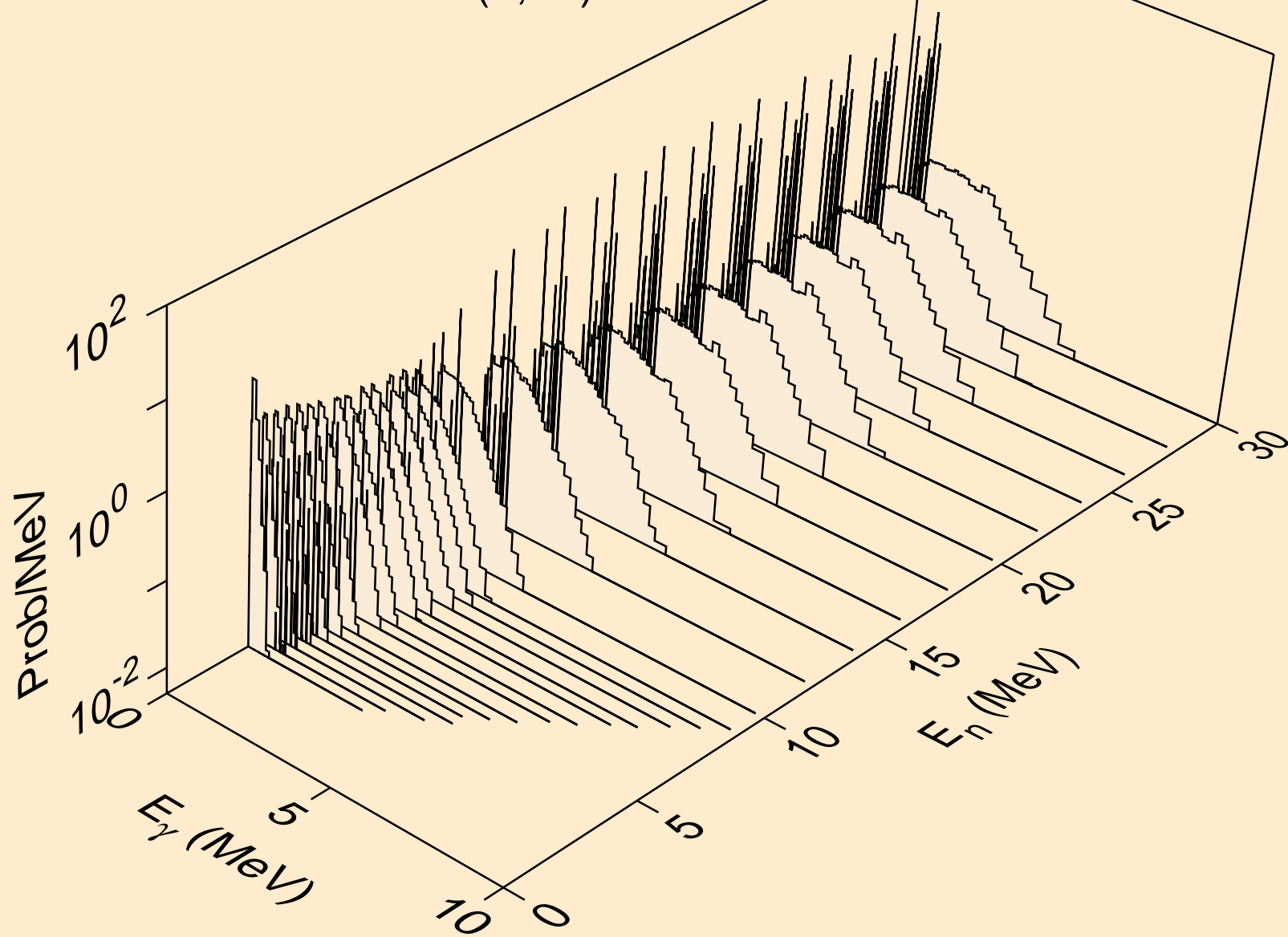



TA160 NEUTRON ACER TENDL-2023 LIBRARY; T=0.K  
thermal capture photon spectrum

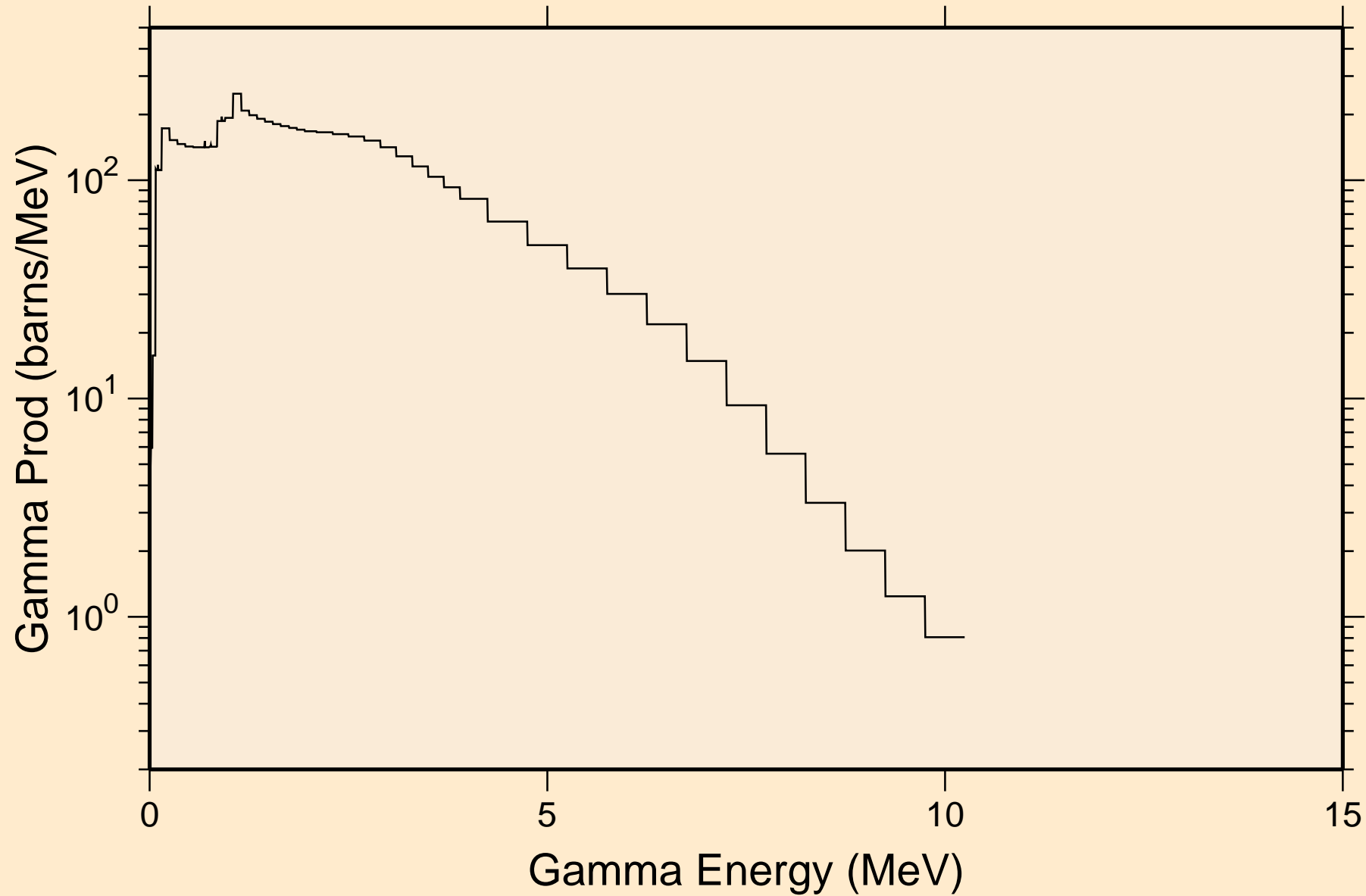

TA160 NEUTRON ACER TENDL-2023 LIBRARY; T=0.K  
14 MeV photon spectrum

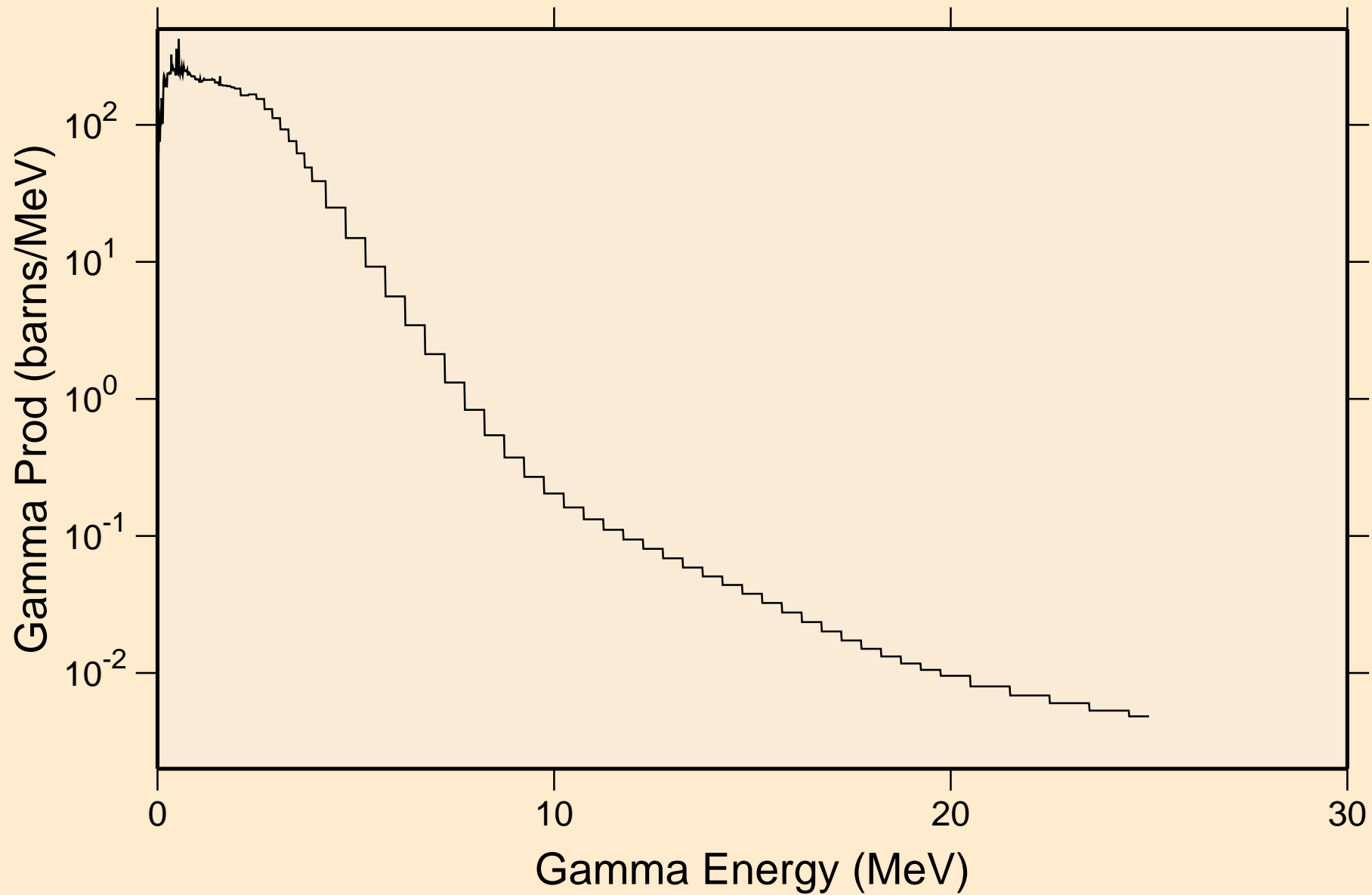

# TA160 NEUTRON ACER TENDL-2023 LIBRARY; T=0.K

## Particle heating contributions

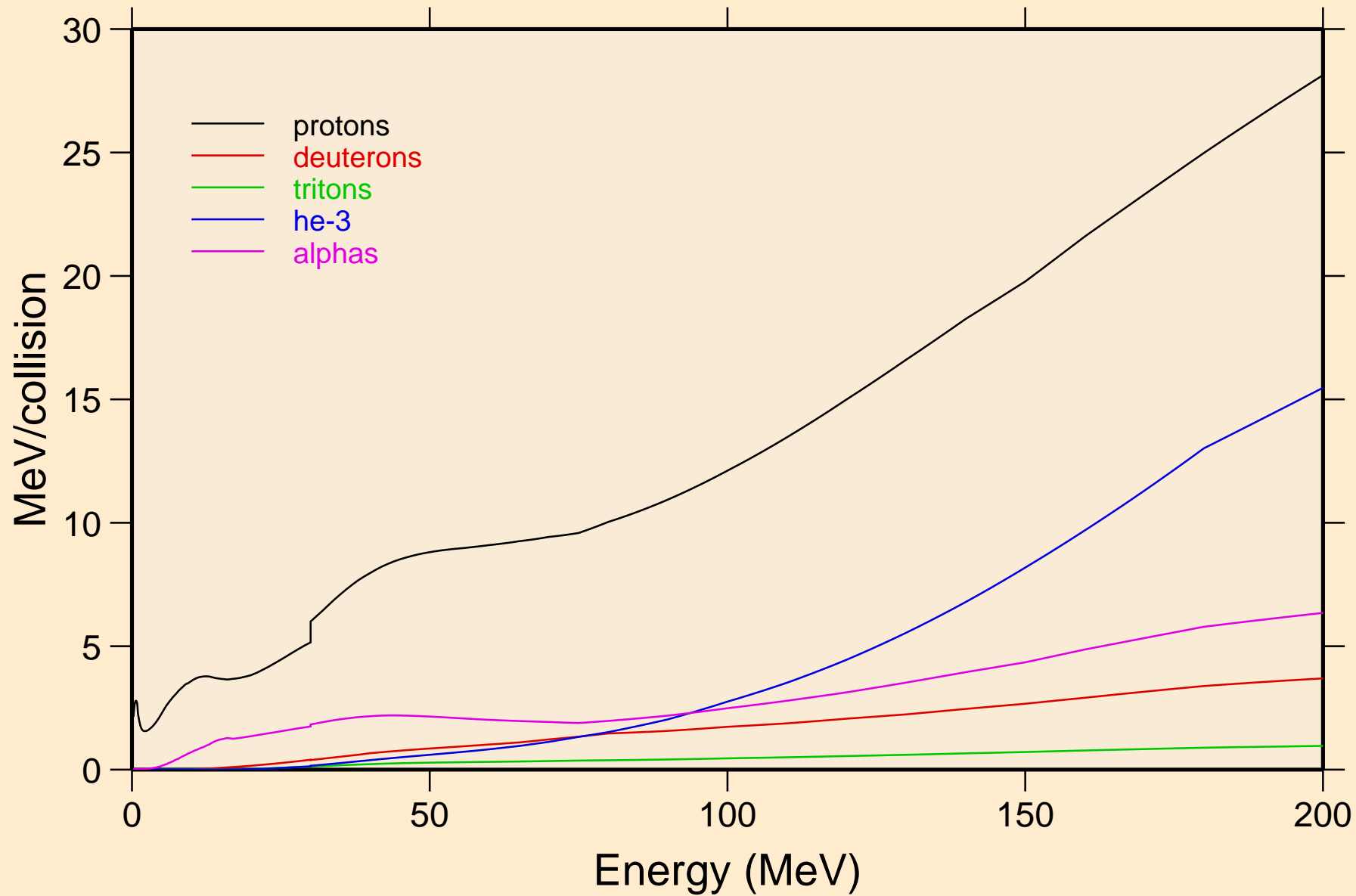

TA160 NEUTRON ACER TENDL-2023 LIBRARY; T=0.K  
Recoil Heating

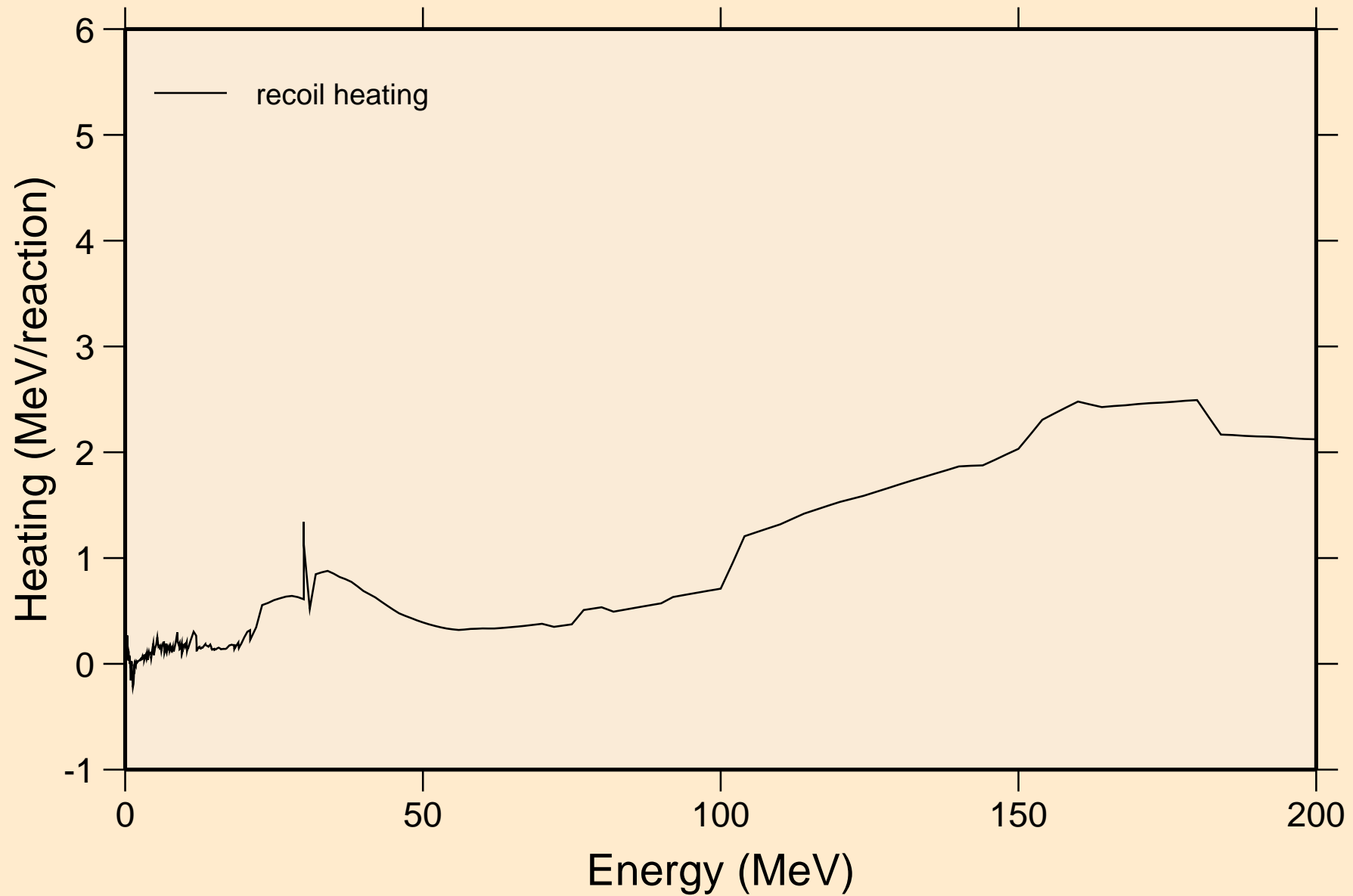

TA160 NEUTRON ACER TENDL-2023 LIBRARY; T=0.K  
Particle production cross sections

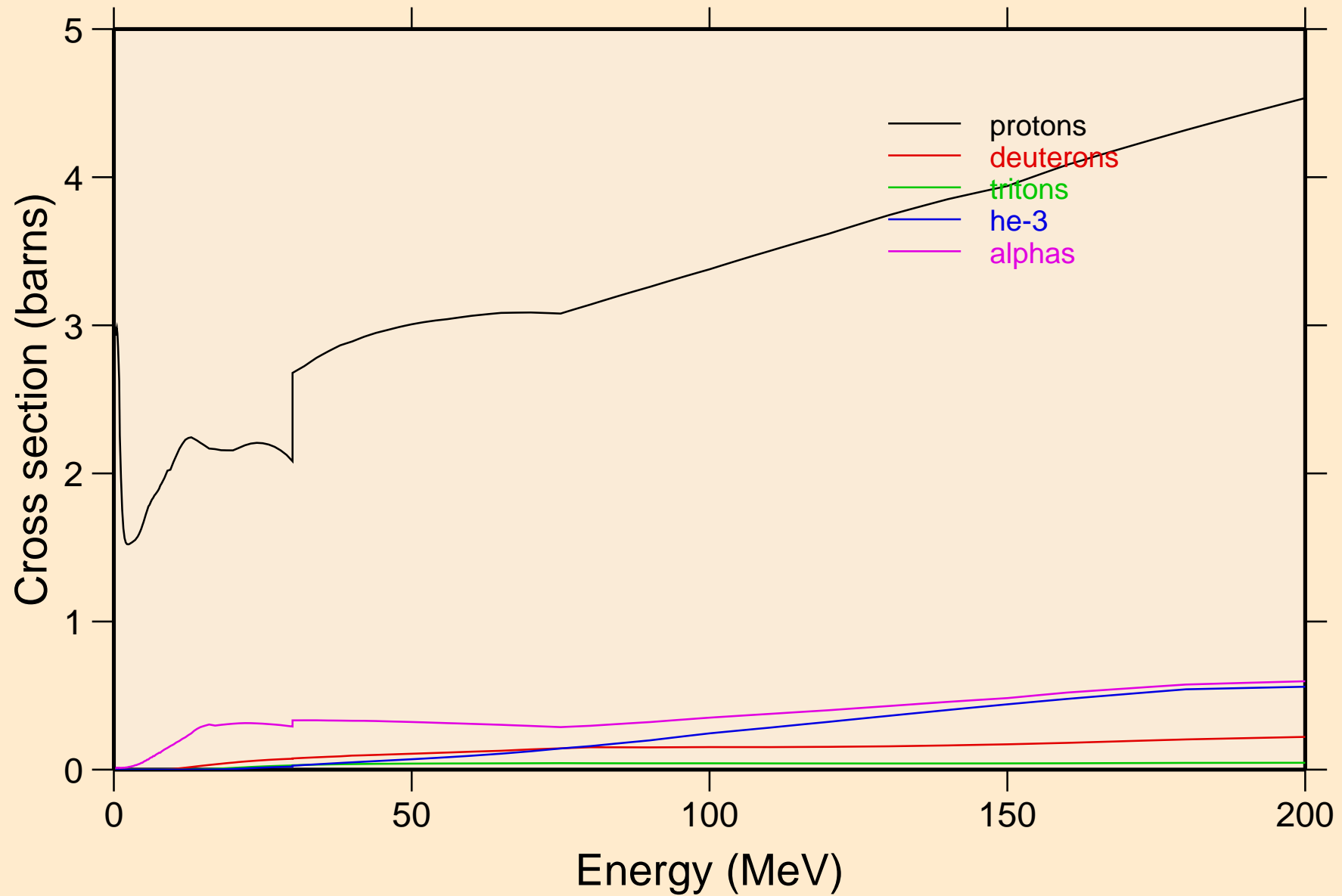

TA160 NEUTRON ACER TENDL-2023 LIBRARY; T=0.K  
protons from (n,x)

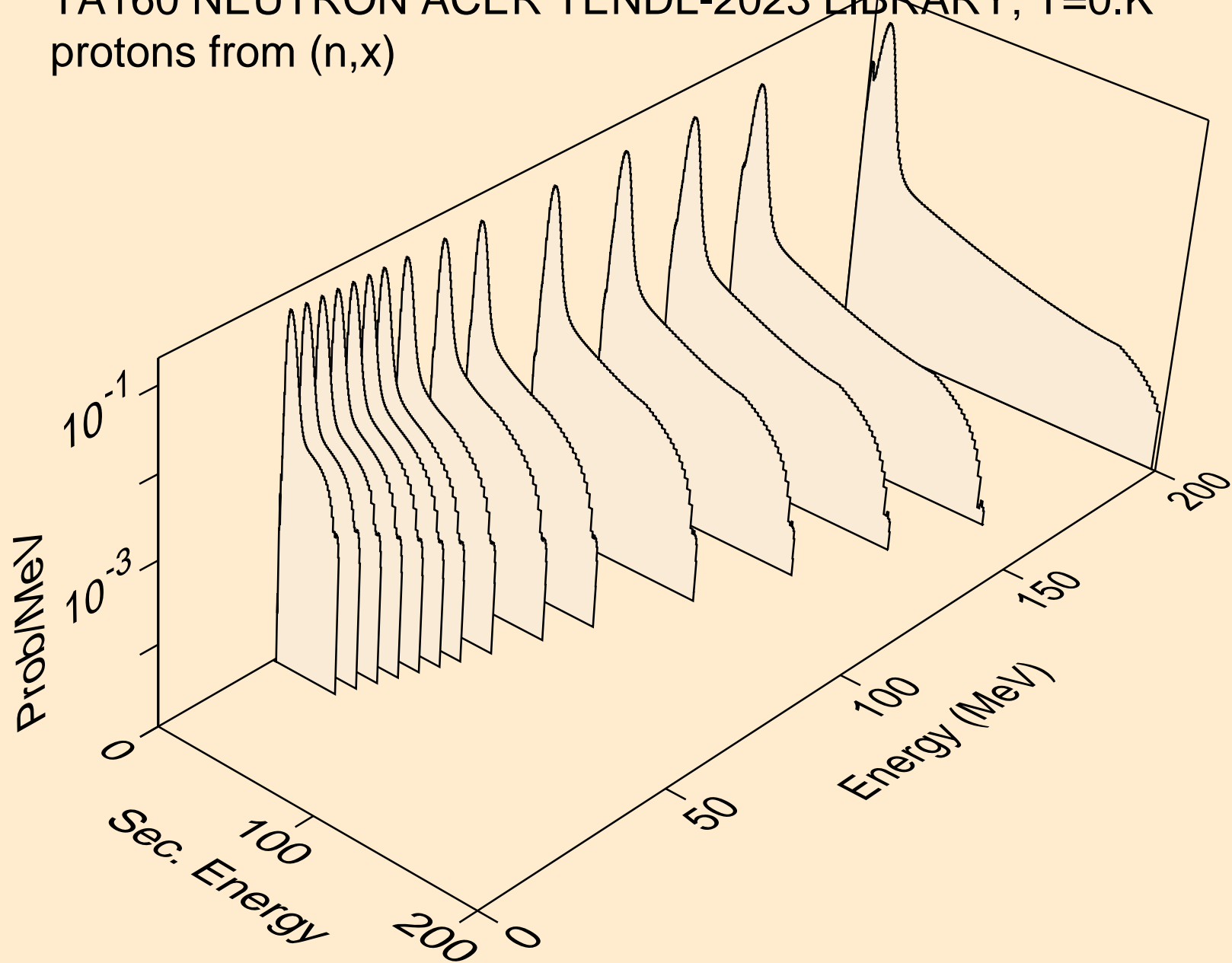

TA160 NEUTRON ACER TENDL-2023 LIBRARY; T=0.K  
protons from (n,n\*)p

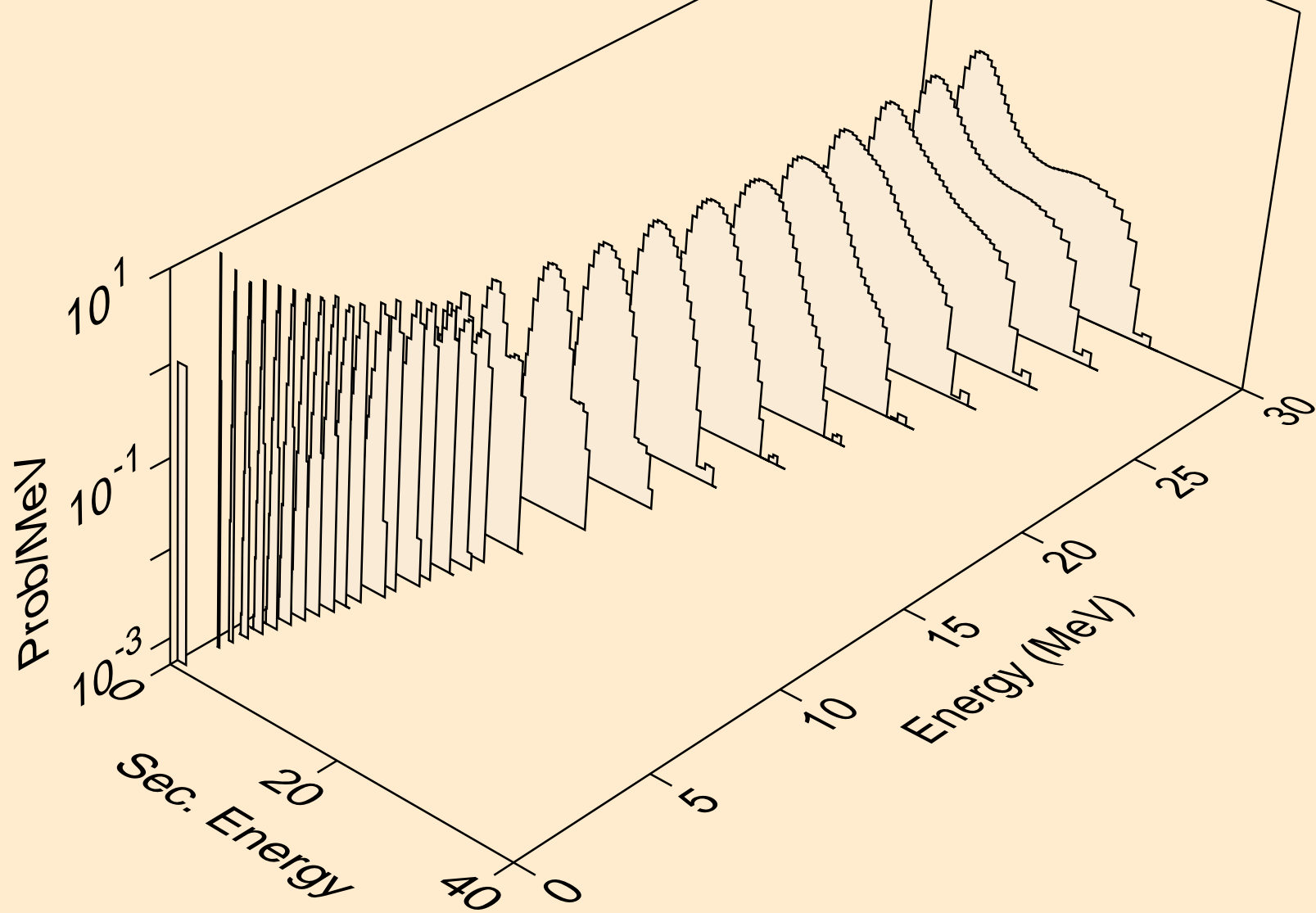

TA160 NEUTRON ACER TENDL-2023 LIBRARY; T=0.K  
protons from (n,2np)

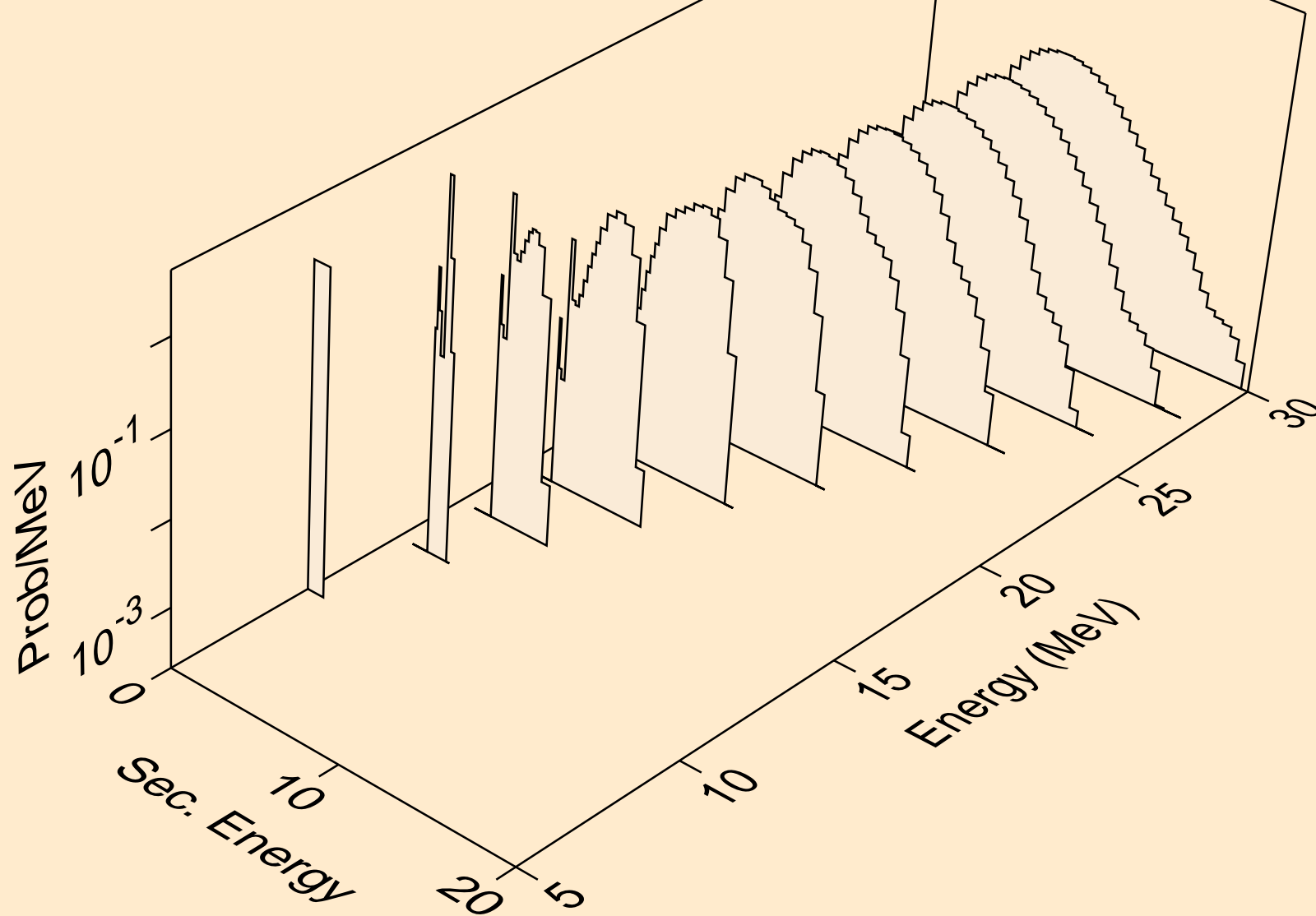



TA160 NEUTRON ACER TENDL-2023 LIBRARY; T=0.K  
protons from (n,3np)

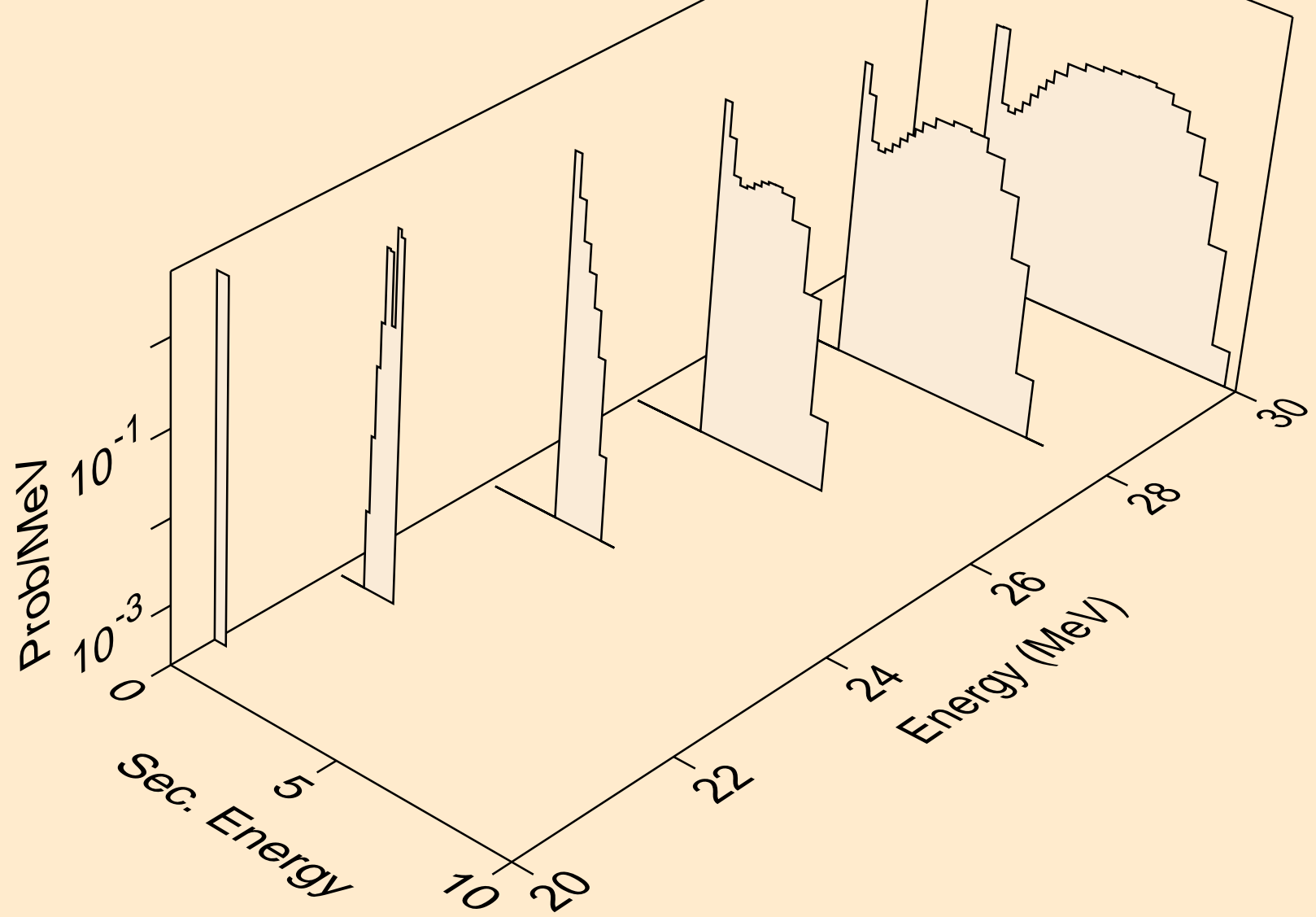

TA160 NEUTRON ACER TENDL-2023 LIBRARY; T=0.K  
protons from (n,n2p)

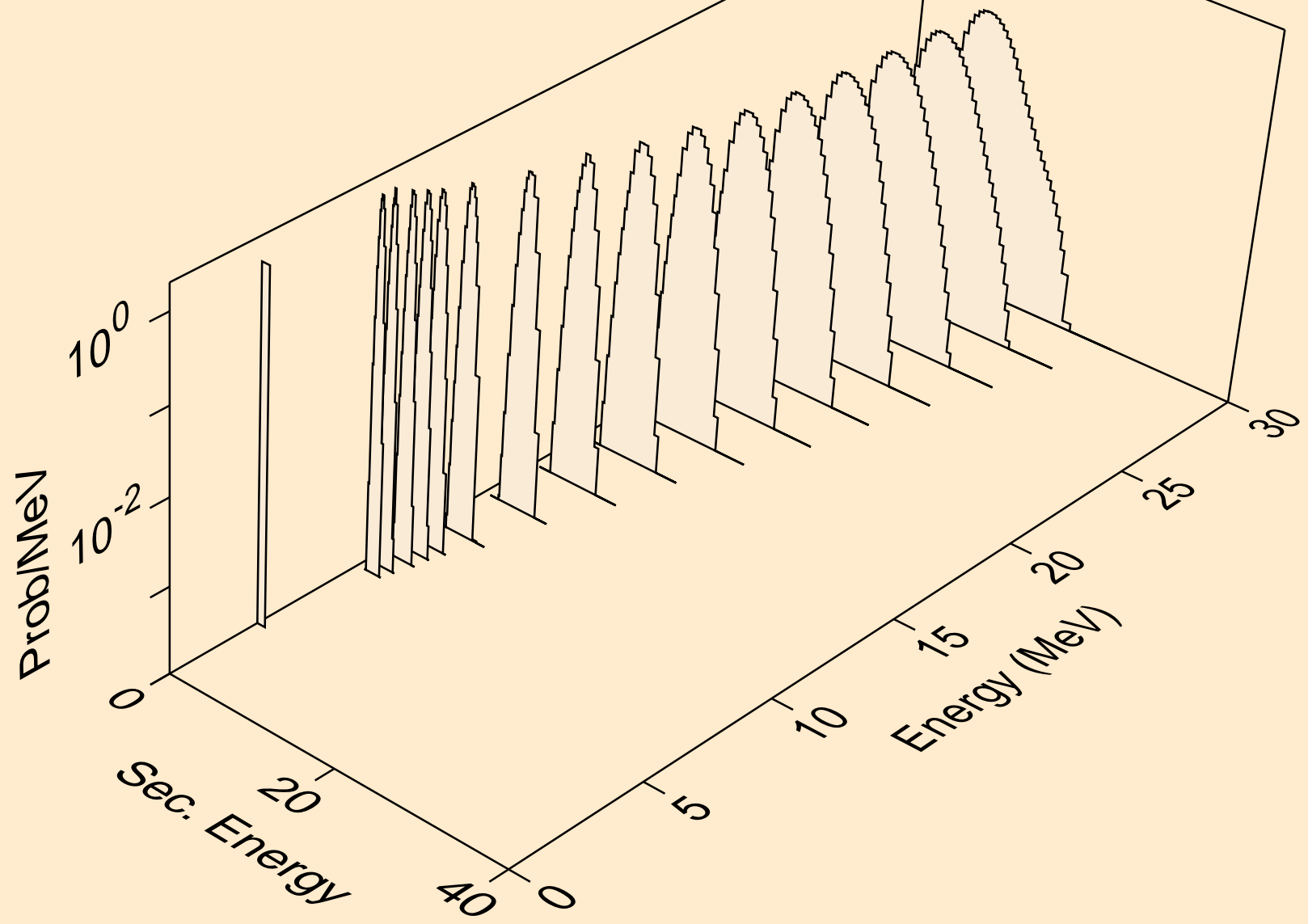

TA160 NEUTRON ACER TENDL-2023 LIBRARY; T=0.K  
protons from (n,npa)

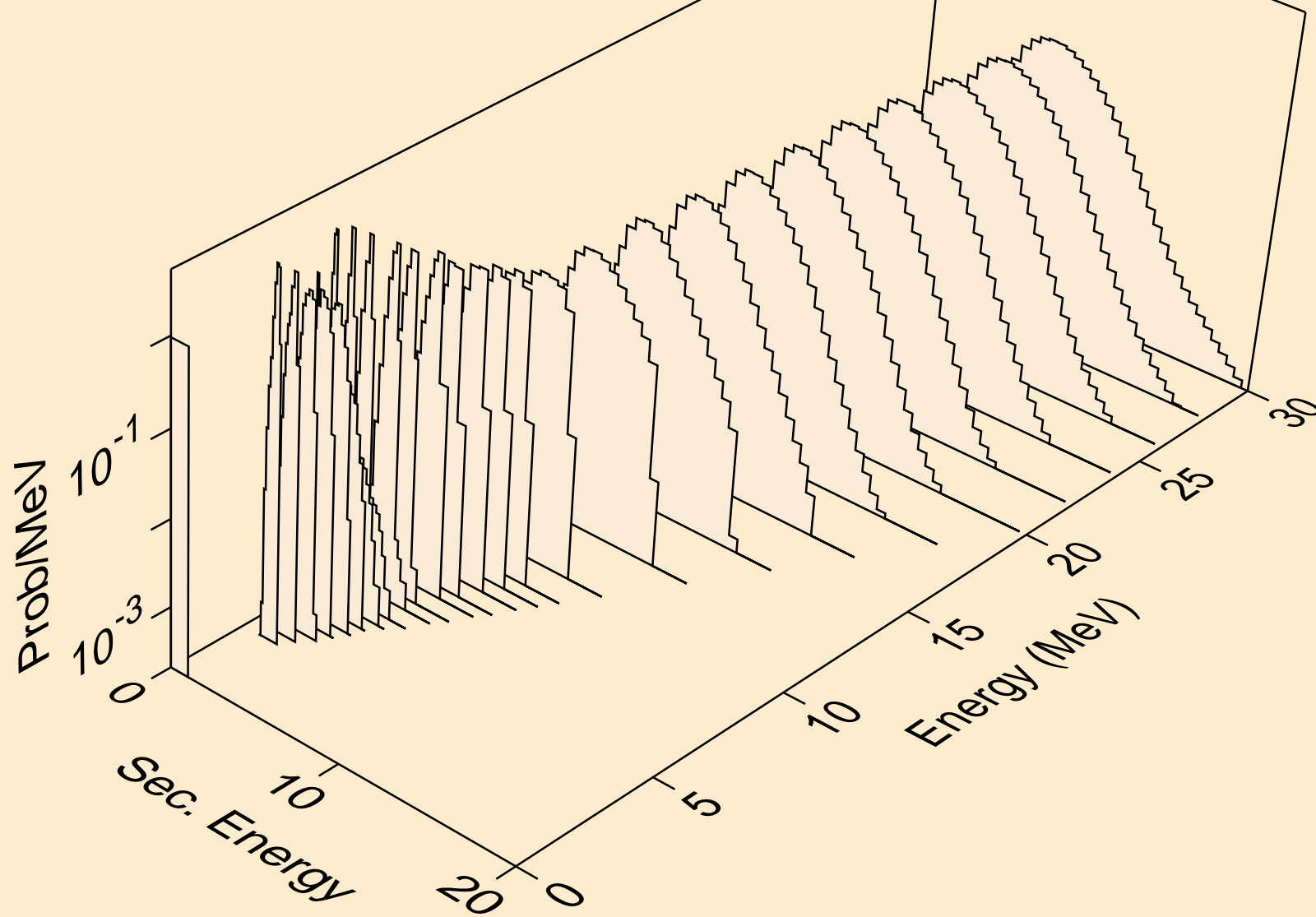

TA160 NEUTRON ACER TENDL-2023 LIBRARY; T=0.K  
protons from (n,p)

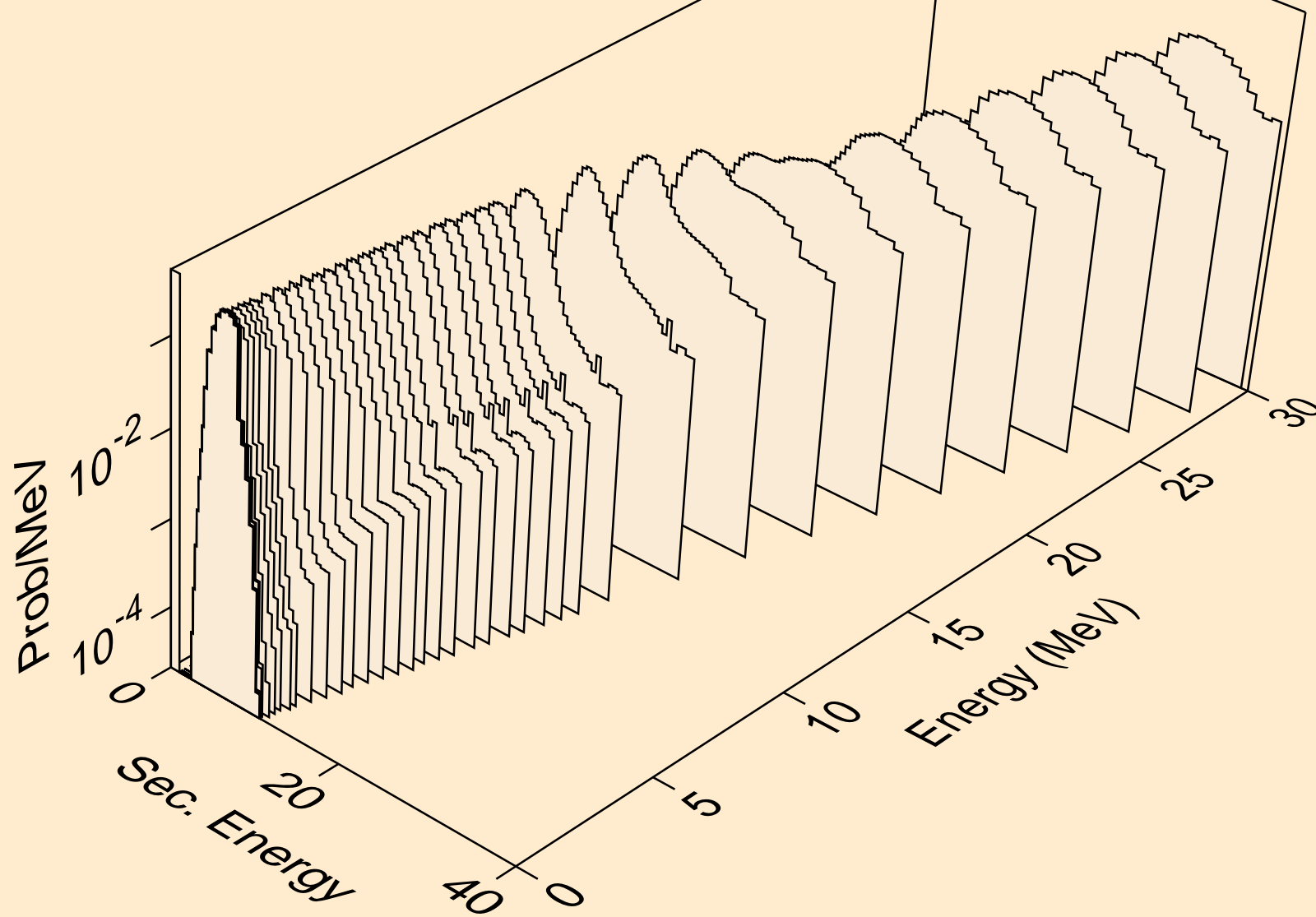

TA160 NEUTRON ACER TENDL-2023 LIBRARY; T=0.K  
protons from (n,2p)

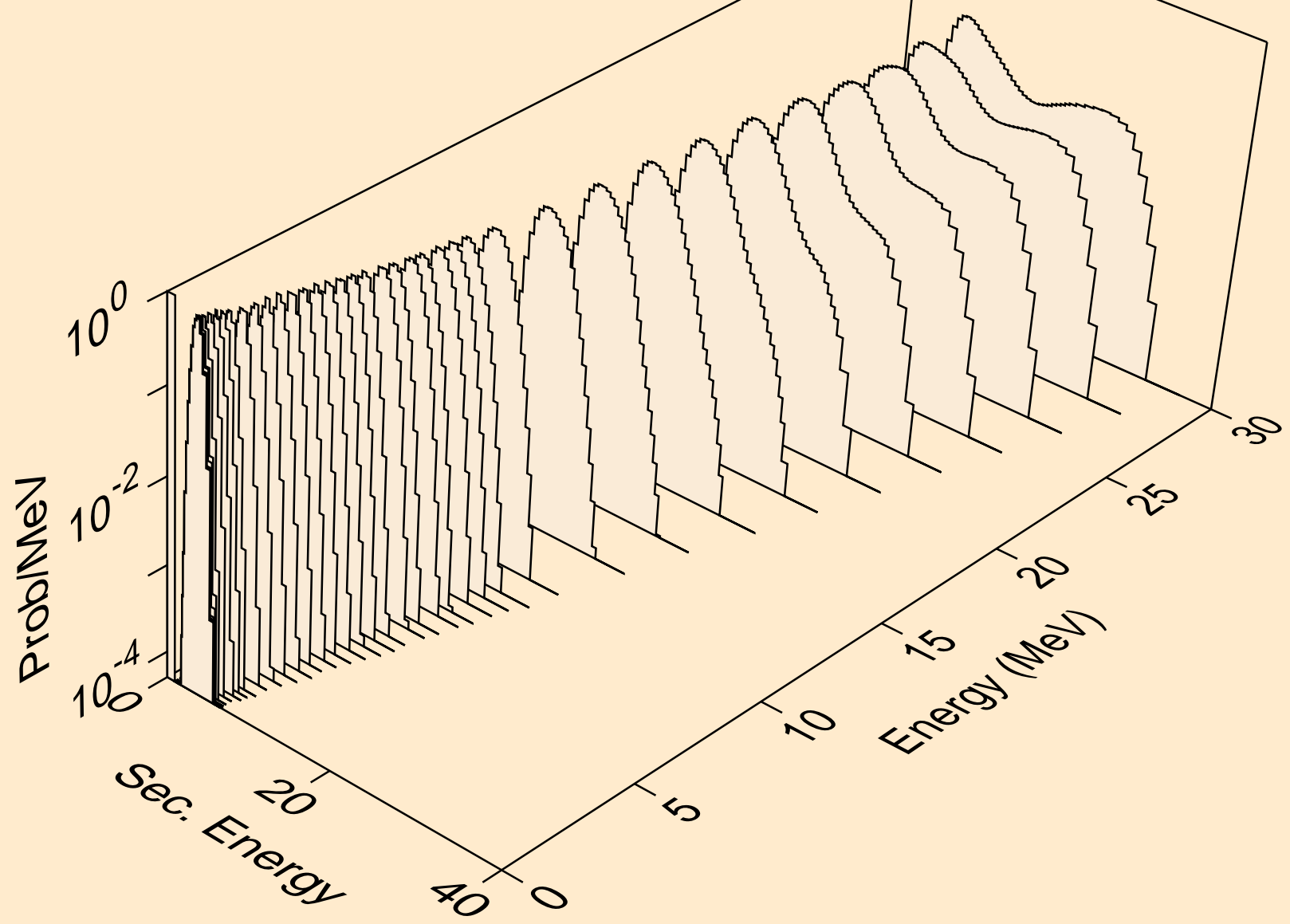

TA160 NEUTRON ACER TENDL-2023 LIBRARY; T=0.K  
protons from (n,p)

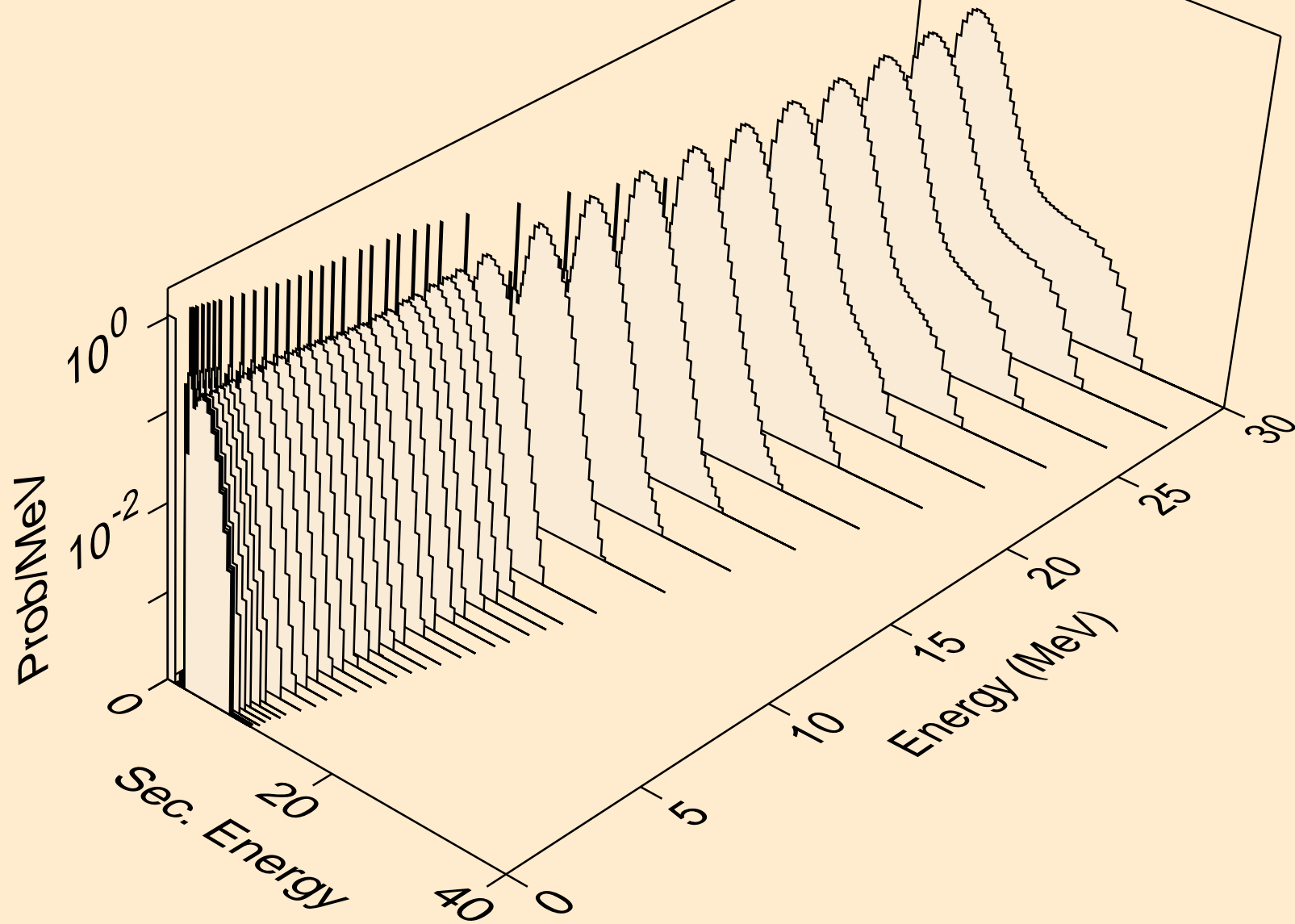

TA160 NEUTRON ACER TENDL-2023 LIBRARY; T=0.K  
protons from (n,pd)

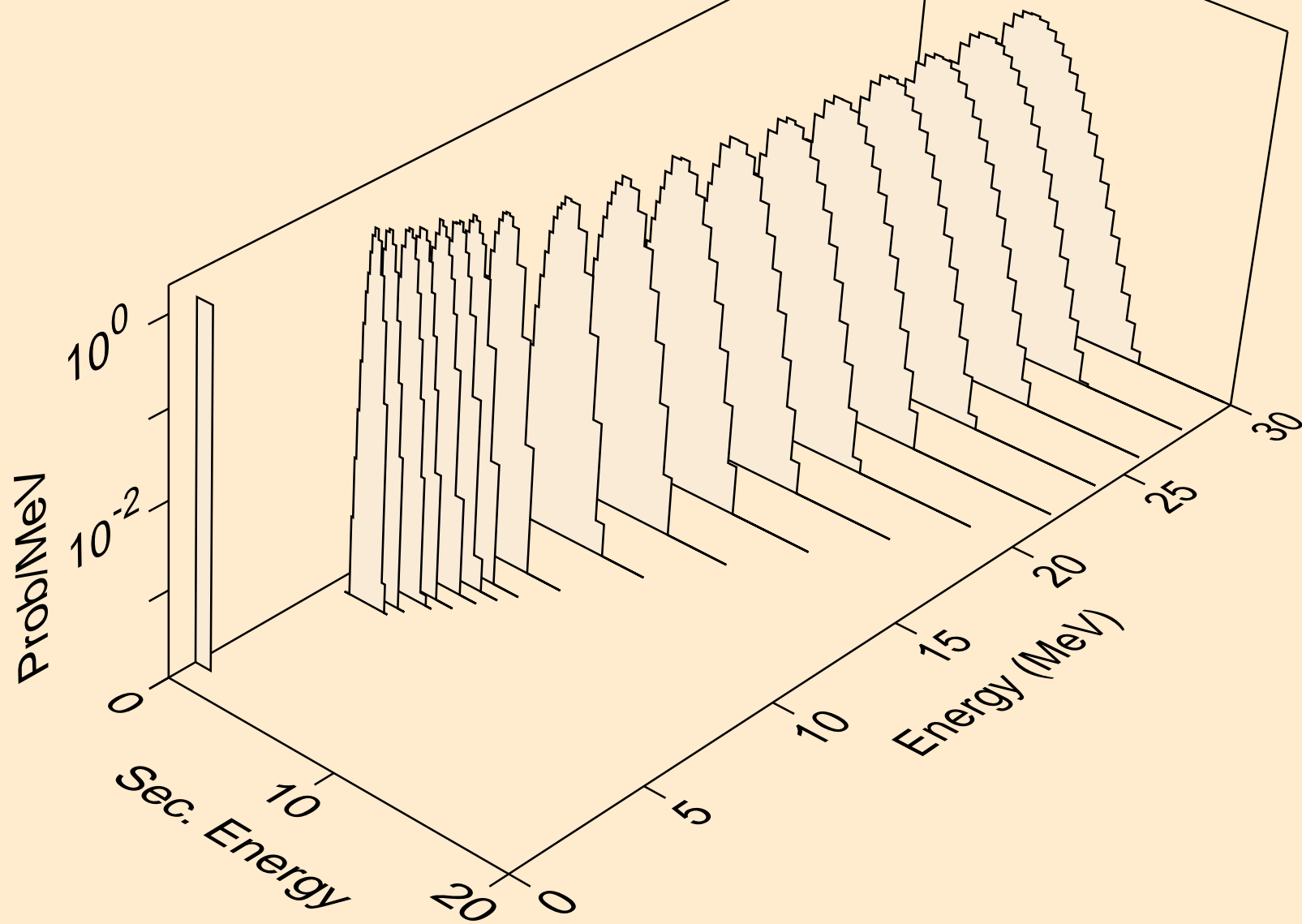

TA160 NEUTRON ACER TENDL-2023 LIBRARY; T=0.K  
protons from (n,pt)

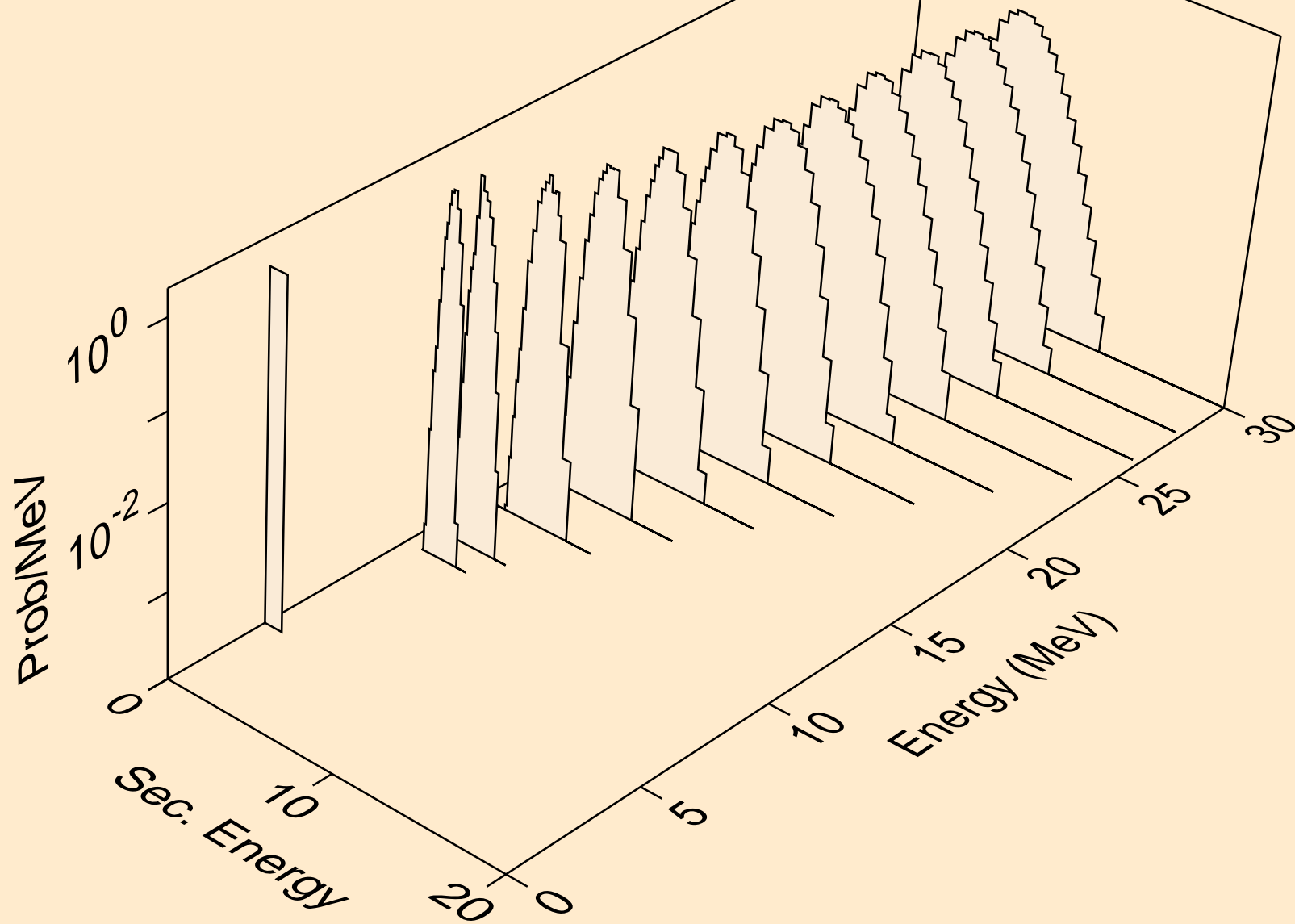



TA160 NEUTRON ACER TENDL-2023 LIBRARY; T=0.K  
deuterons from (n,x)

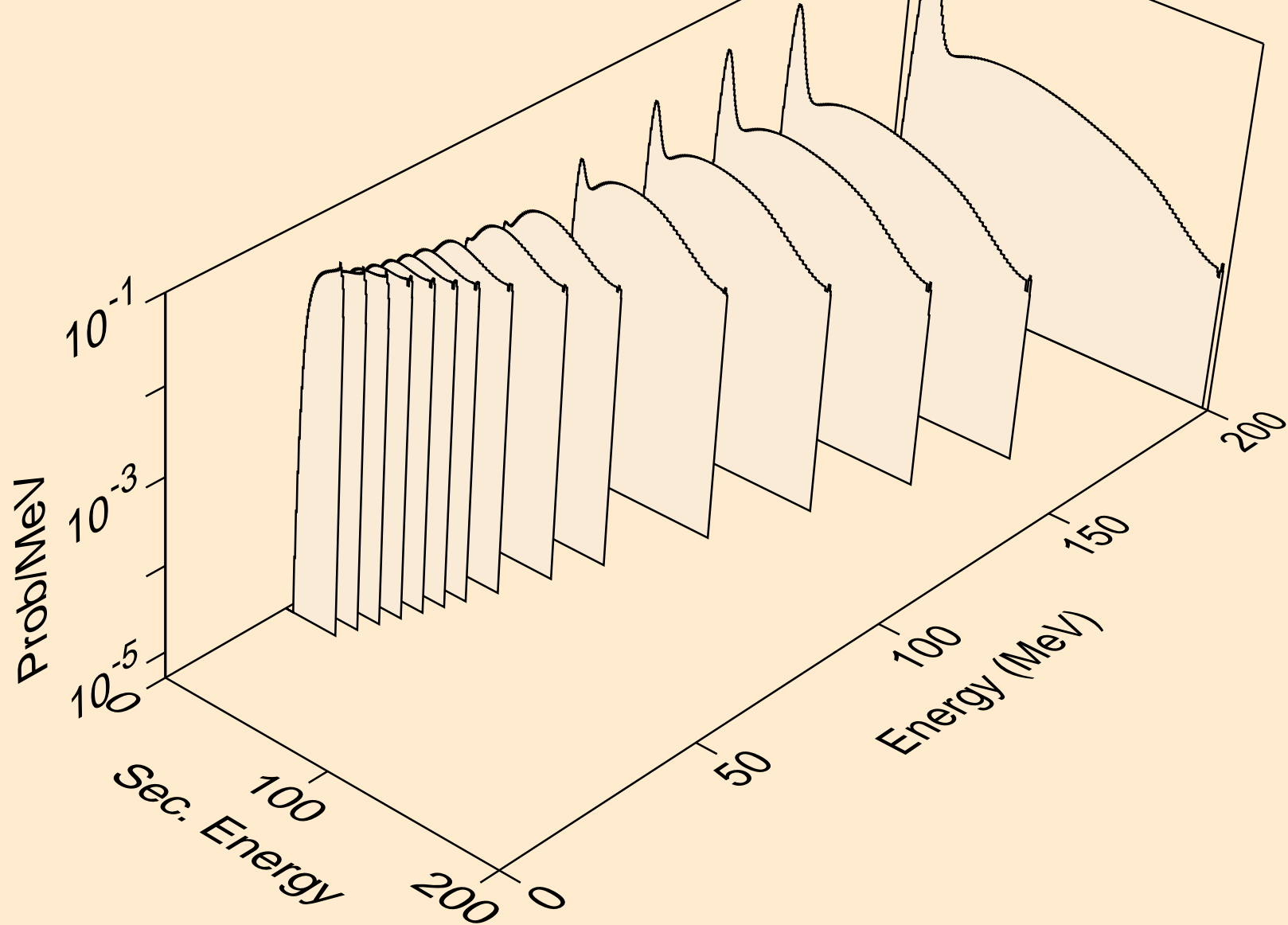

TA160 NEUTRON ACER TENDL-2023 LIBRARY; T=0.K  
deuterons from (n,2nd)

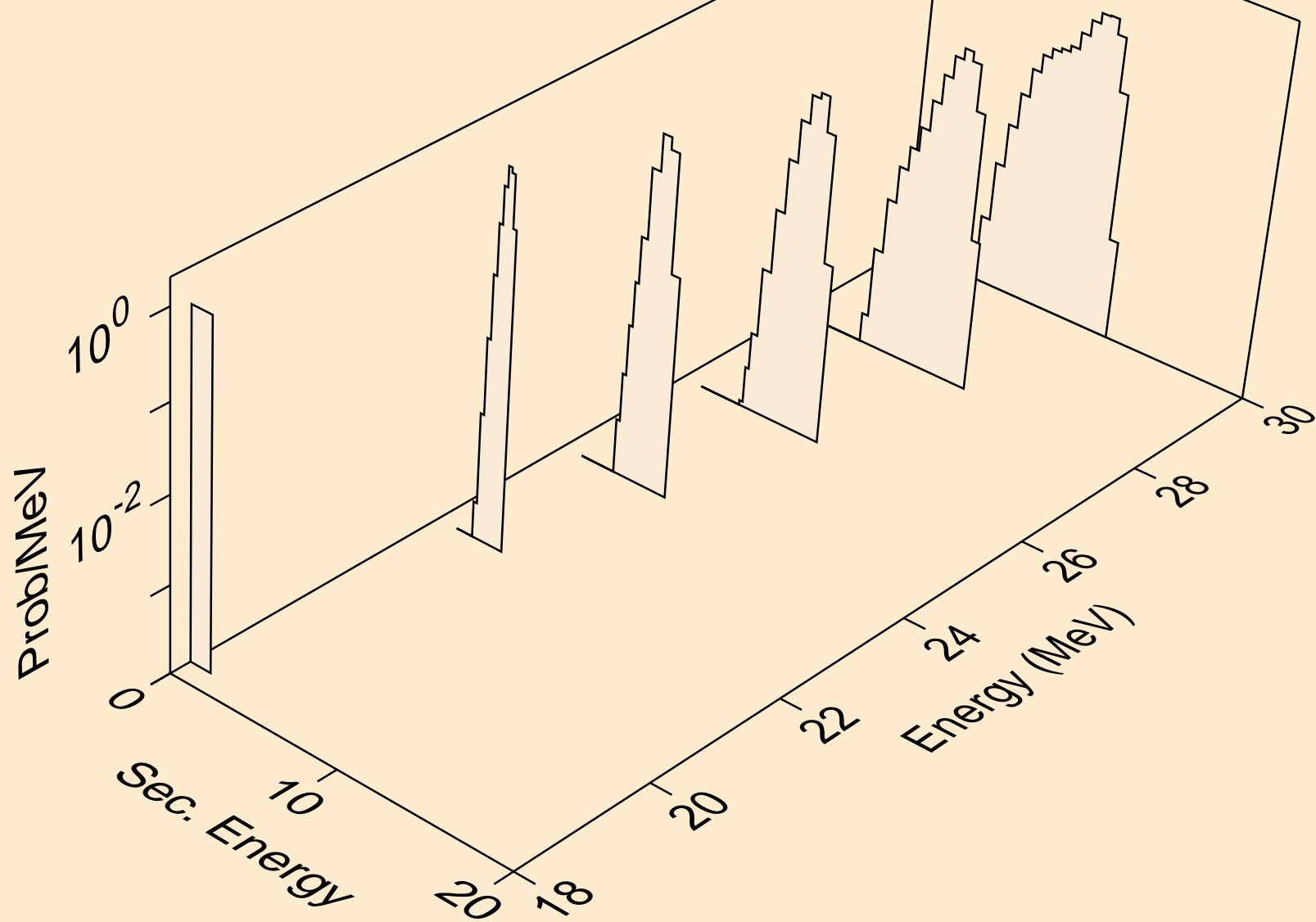

TA160 NEUTRON ACER TENDL-2023 LIBRARY; T=0.K  
deuterons from (n,n\*)d

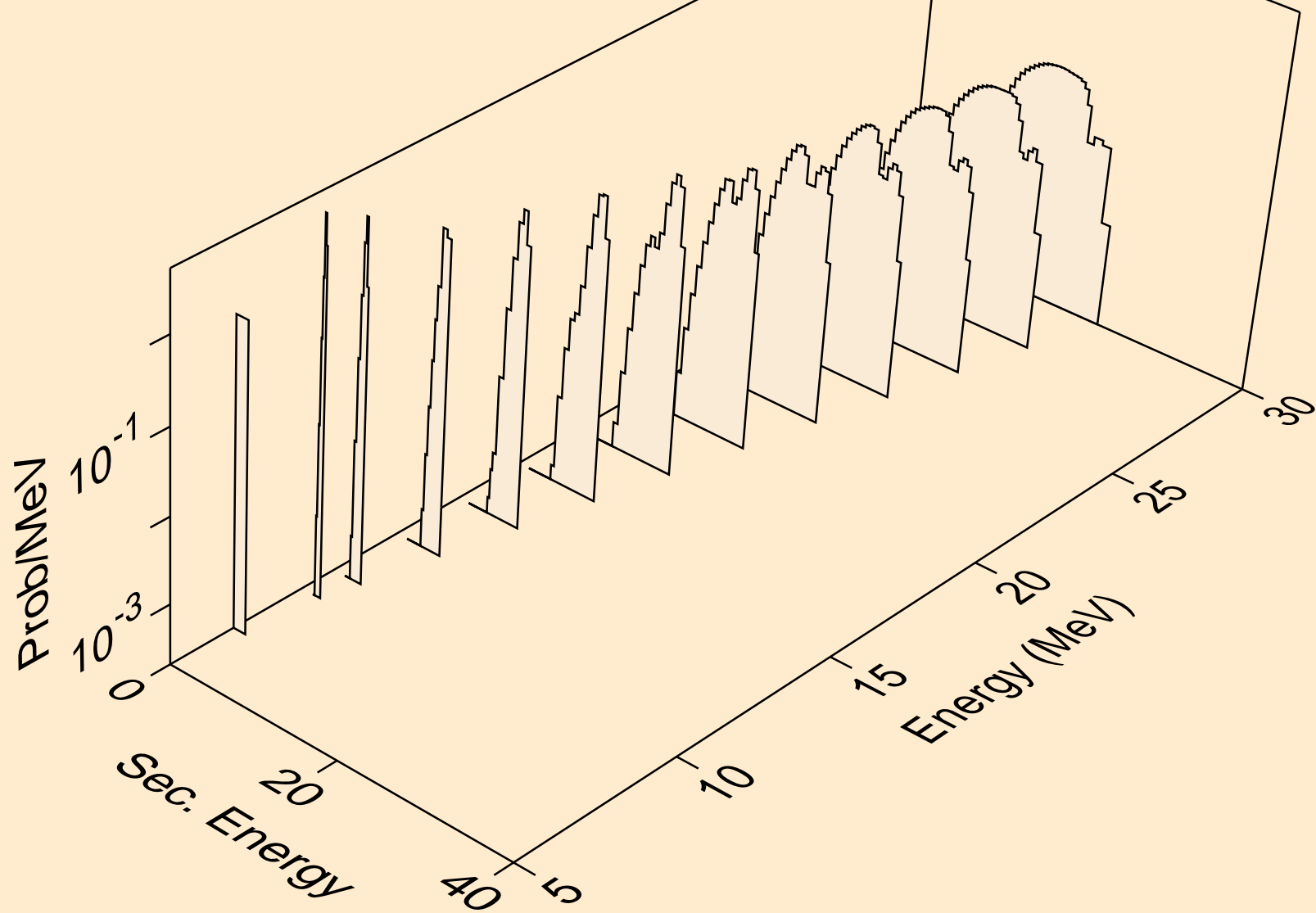

TA160 NEUTRON ACER TENDL-2023 LIBRARY; T=0.K  
deuterons from (n,n\*)d2a

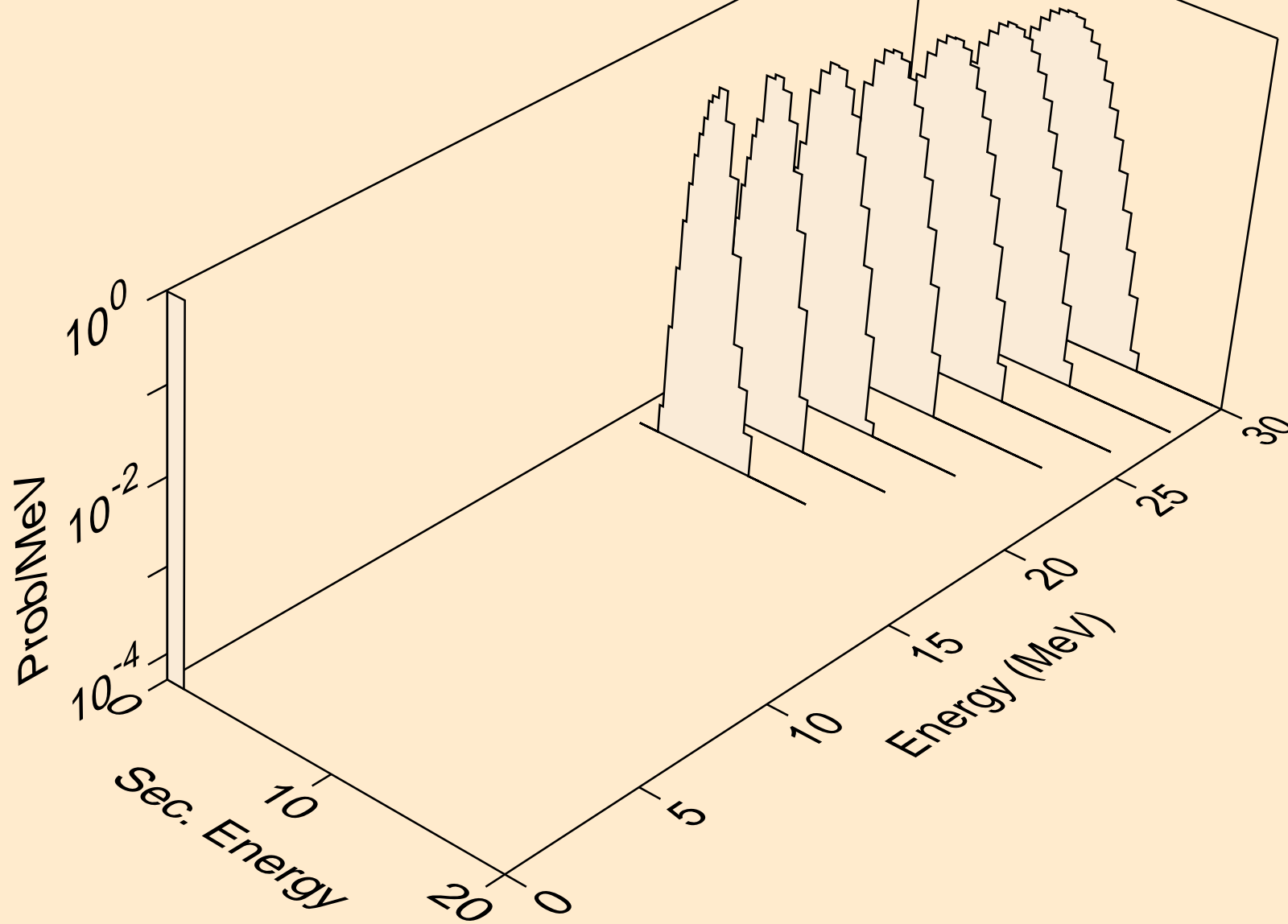

TA160 NEUTRON ACER TENDL-2023 LIBRARY; T=0.K  
deuterons from (n,d)

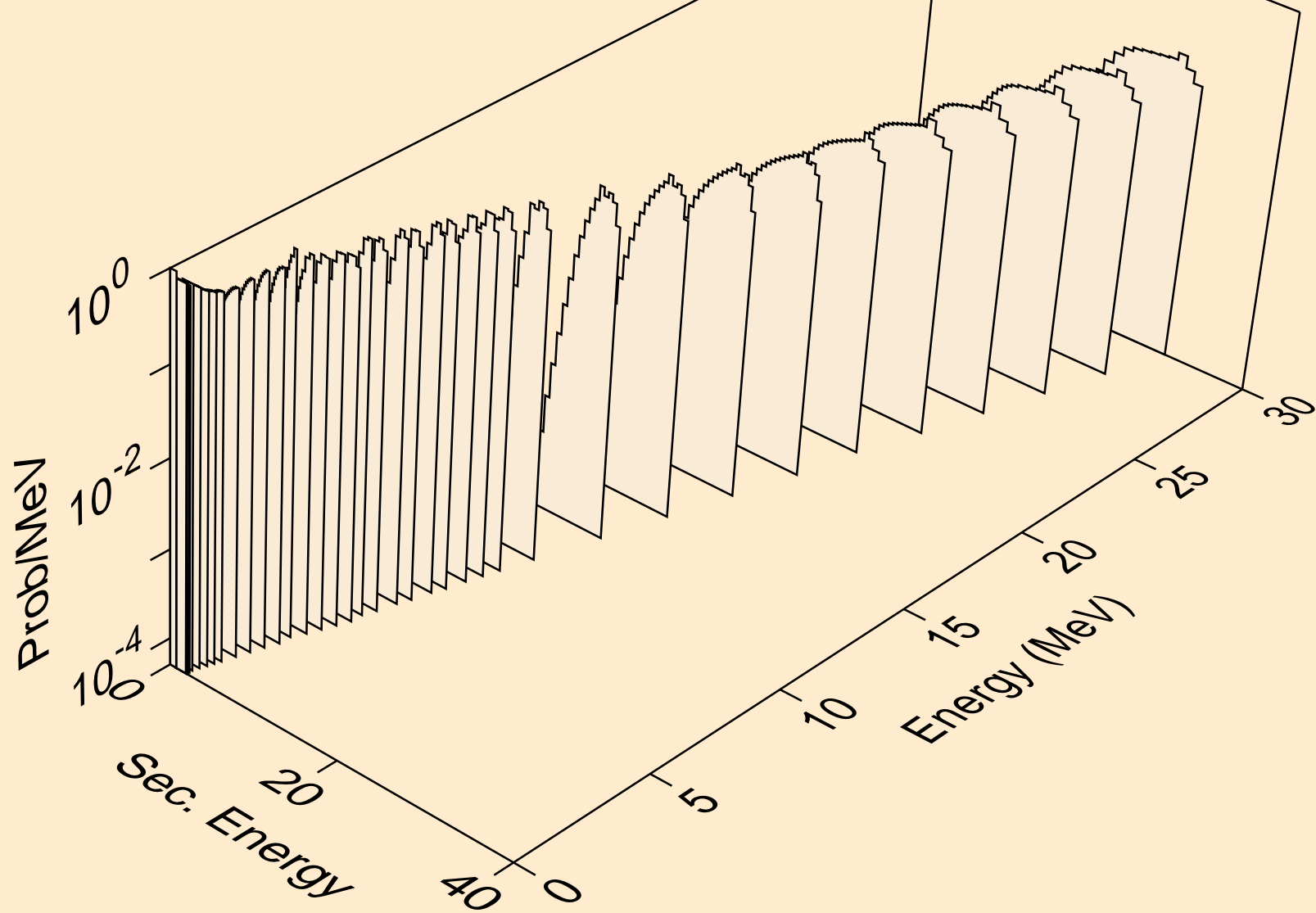

TA160 NEUTRON ACER TENDL-2023 LIBRARY; T=0.K  
deuterons from (n,d2a)

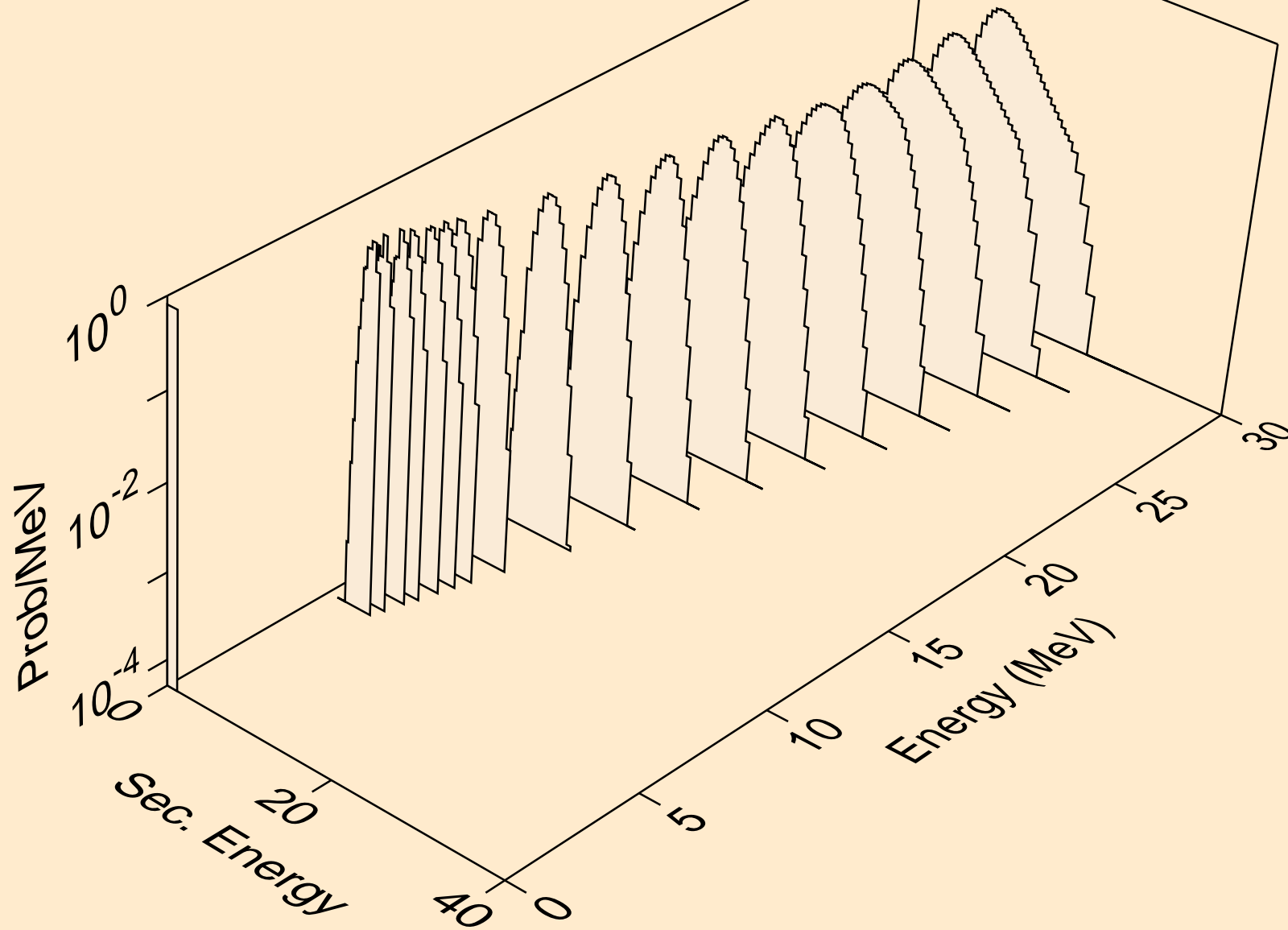

TA160 NEUTRON ACER TENDL-2023 LIBRARY; T=0.K  
deuterons from (n,pd)

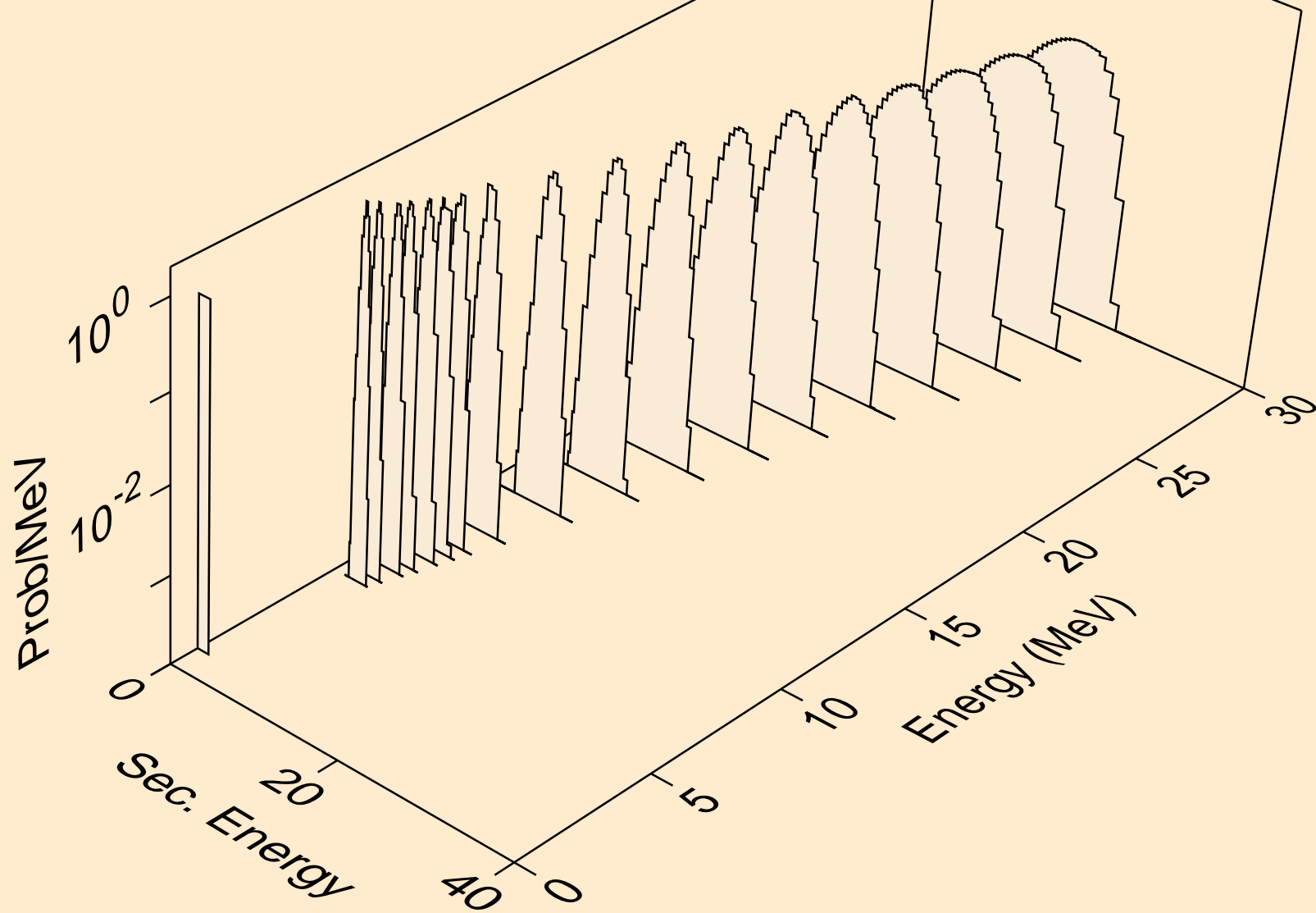

TA160 NEUTRON ACER TENDL-2023 LIBRARY; T=0.K  
deuterons from (n,da)

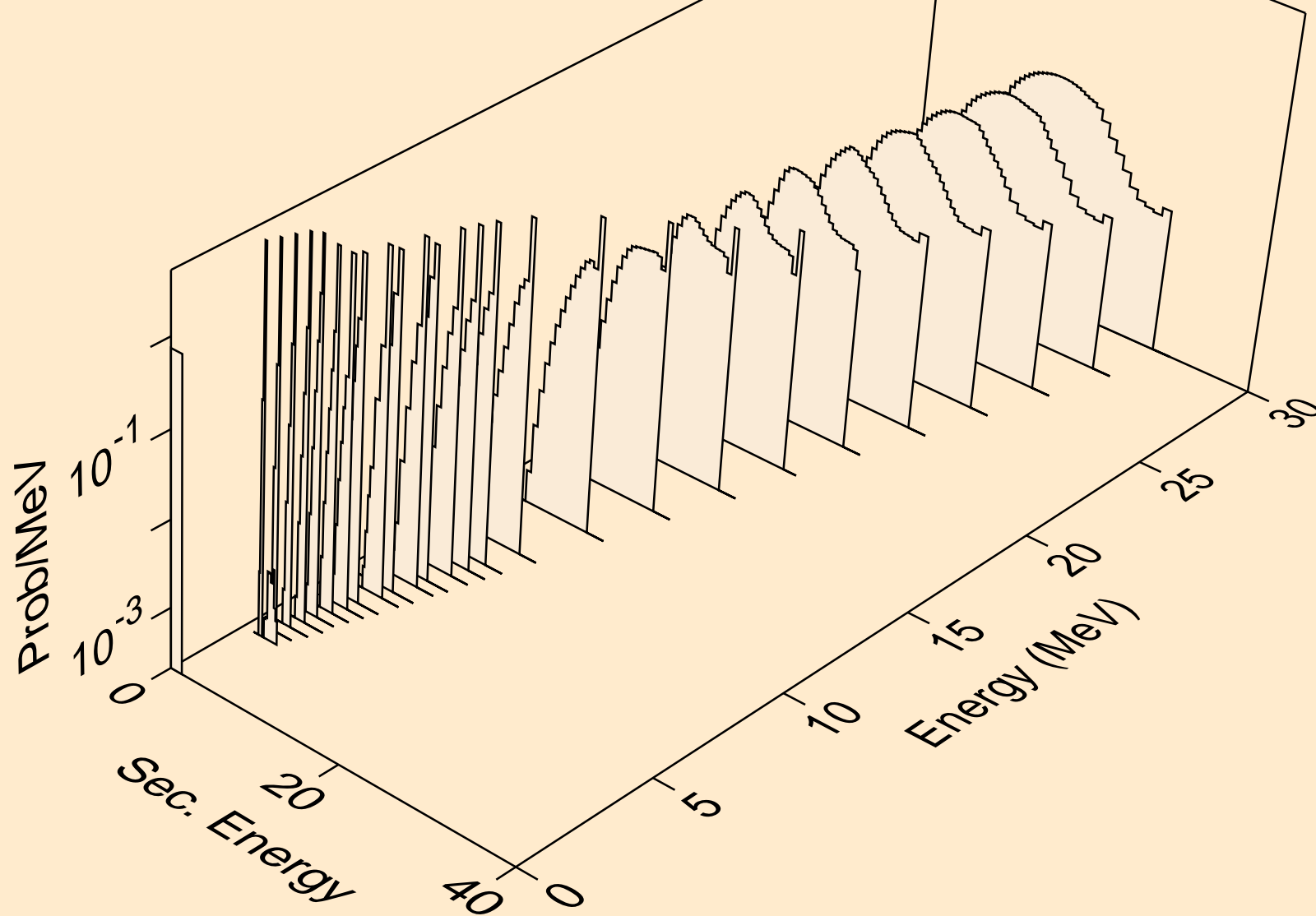



TA160 NEUTRON ACER TENDL-2023 LIBRARY; T=0.K  
tritons from (n,x)

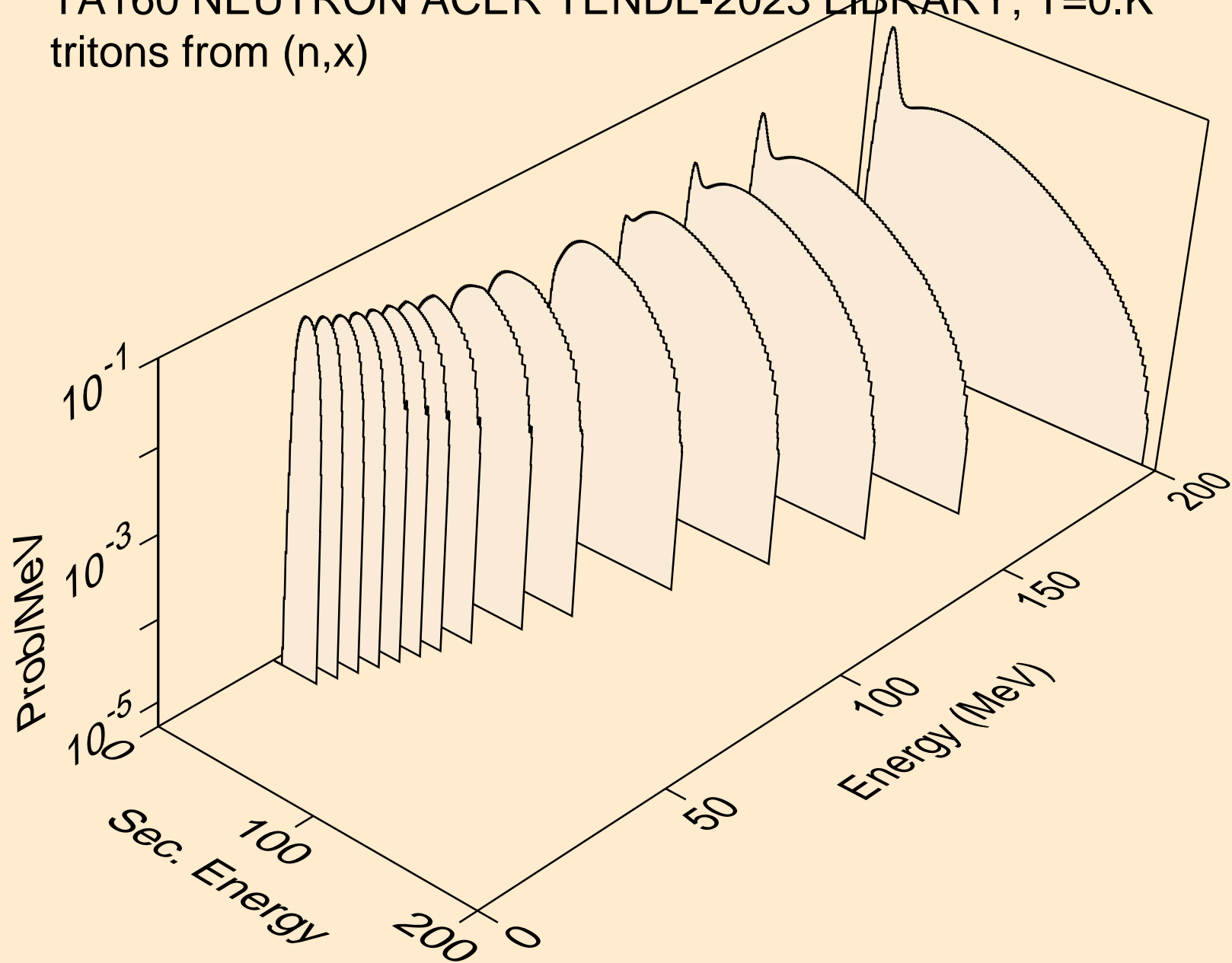

TA160 NEUTRON ACER TENDL-2023 LIBRARY; T=0.K  
tritons from (n,n\*)t

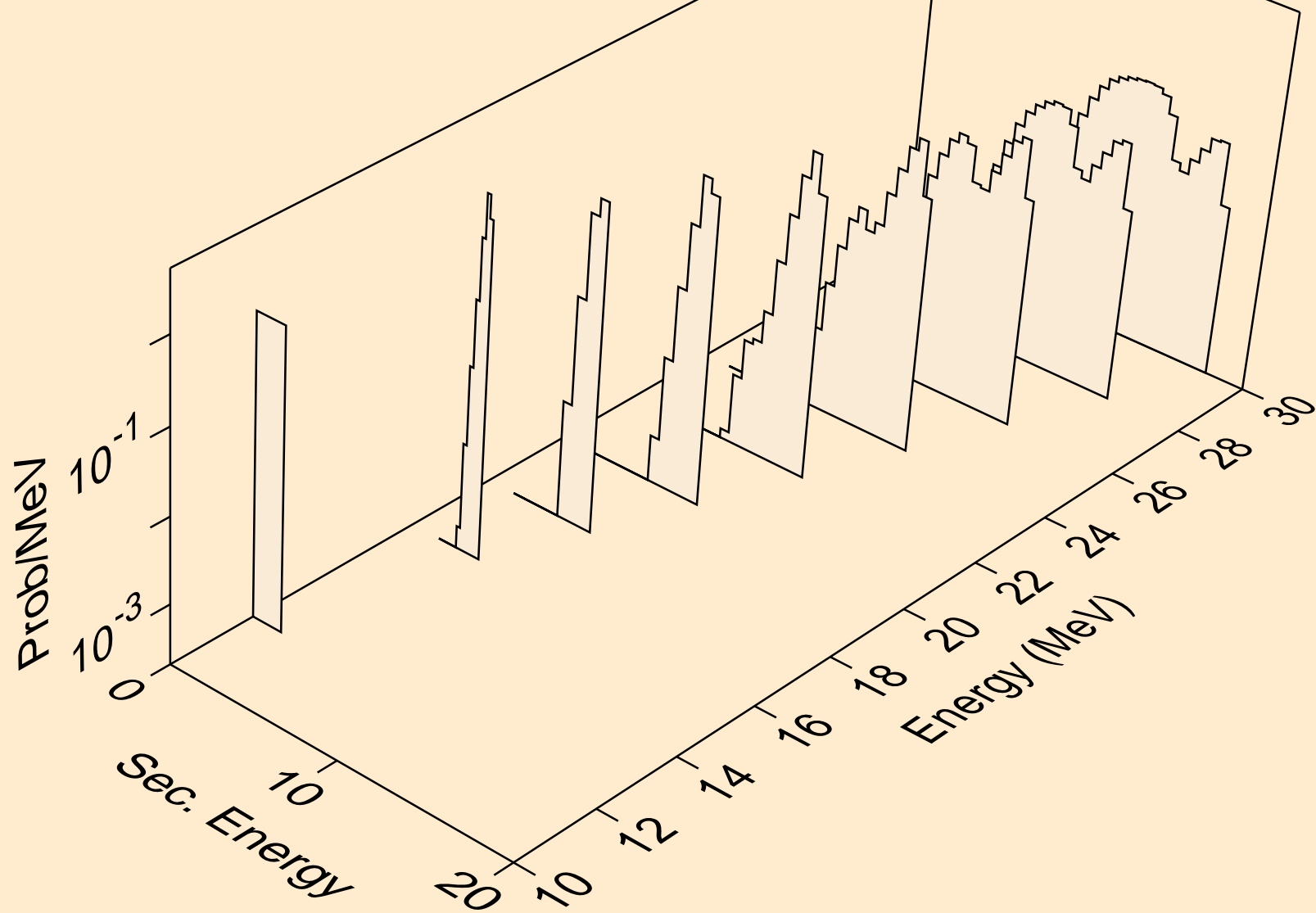

TA160 NEUTRON ACER TENDL-2023 LIBRARY; T=0.K  
tritons from (n,t)

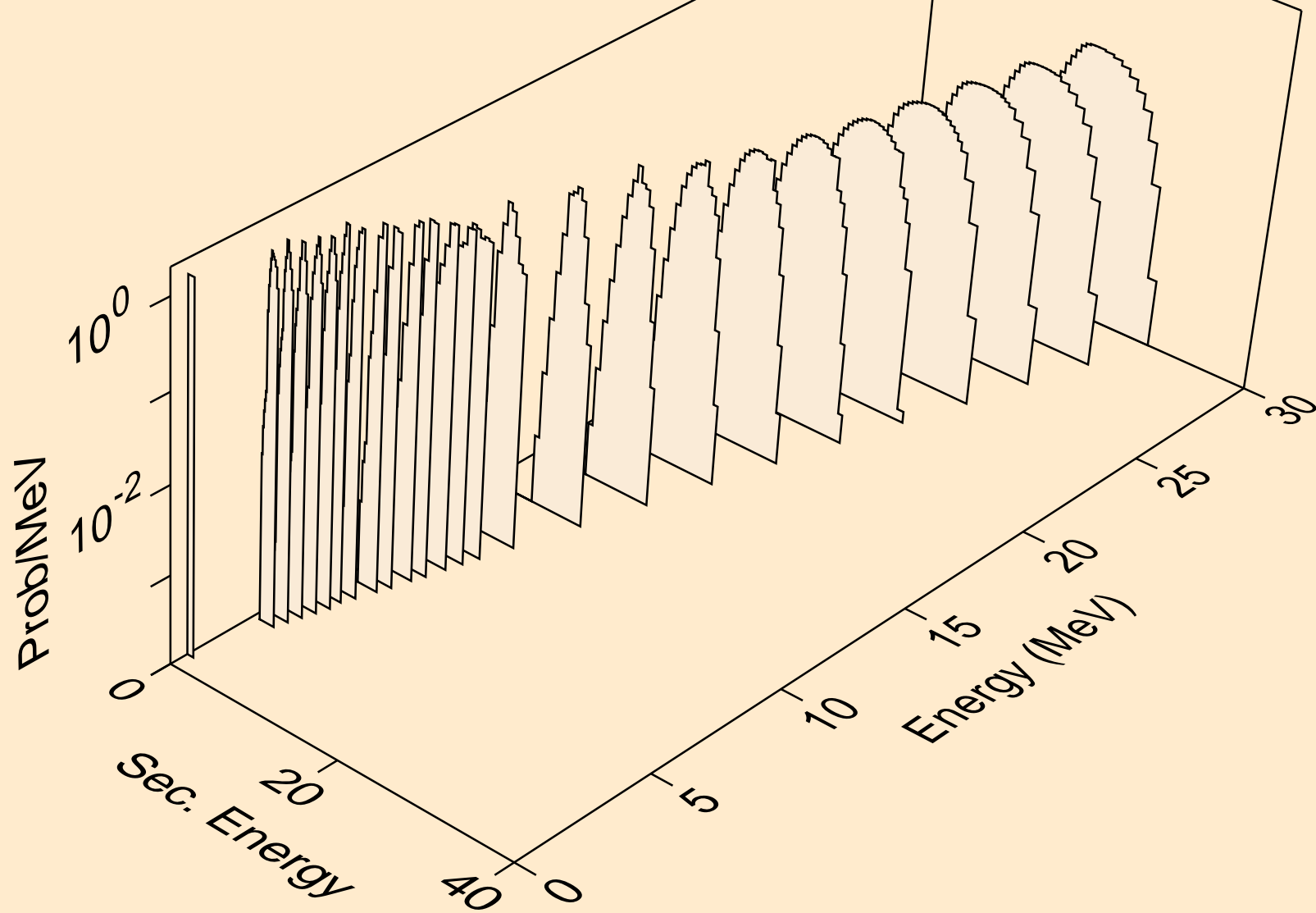

TA160 NEUTRON ACER TENDL-2023 LIBRARY; T=0.K  
tritons from (n,t2a)

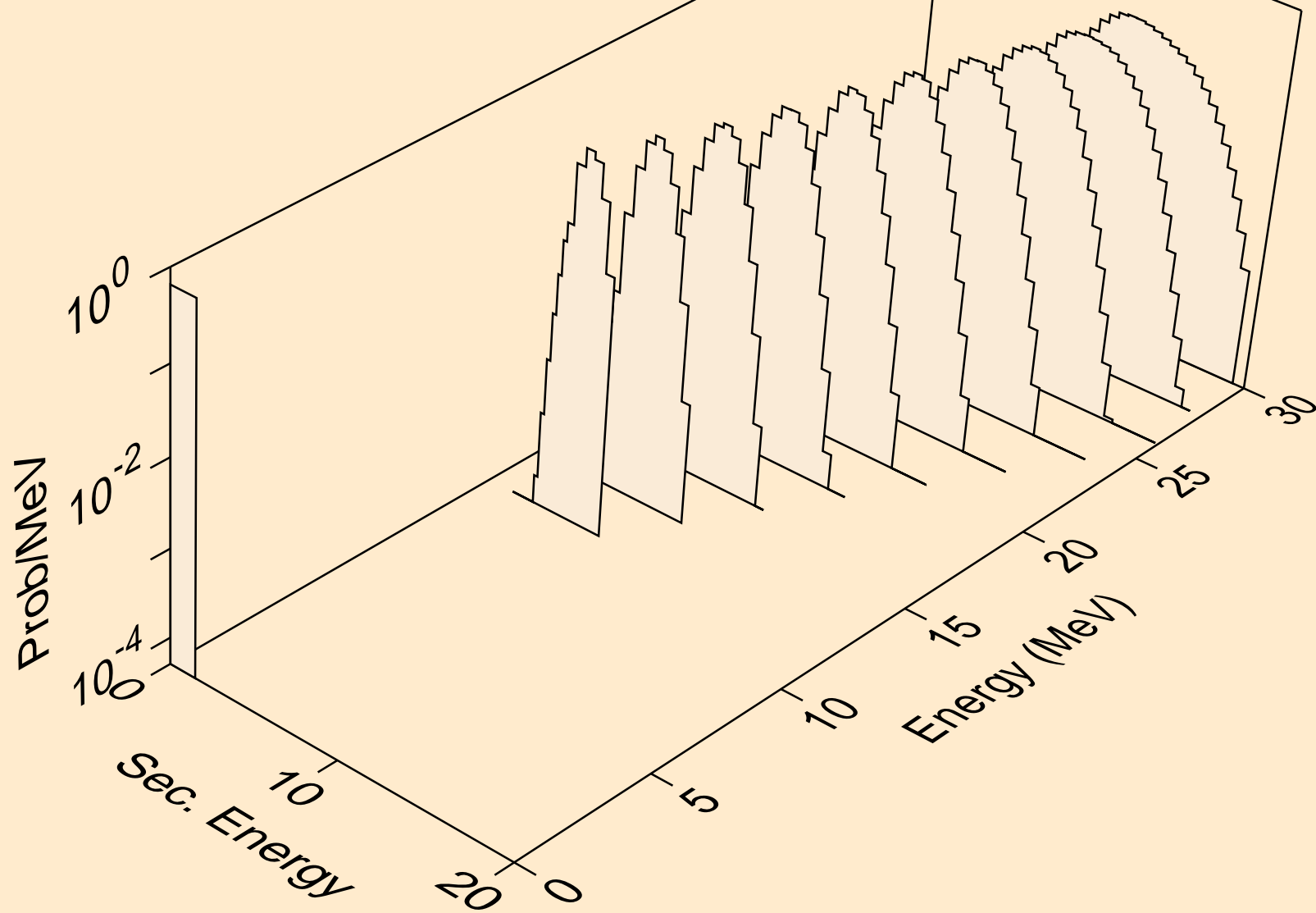

TA160 NEUTRON ACER TENDL-2023 LIBRARY; T=0.K  
tritons from (n,pt)

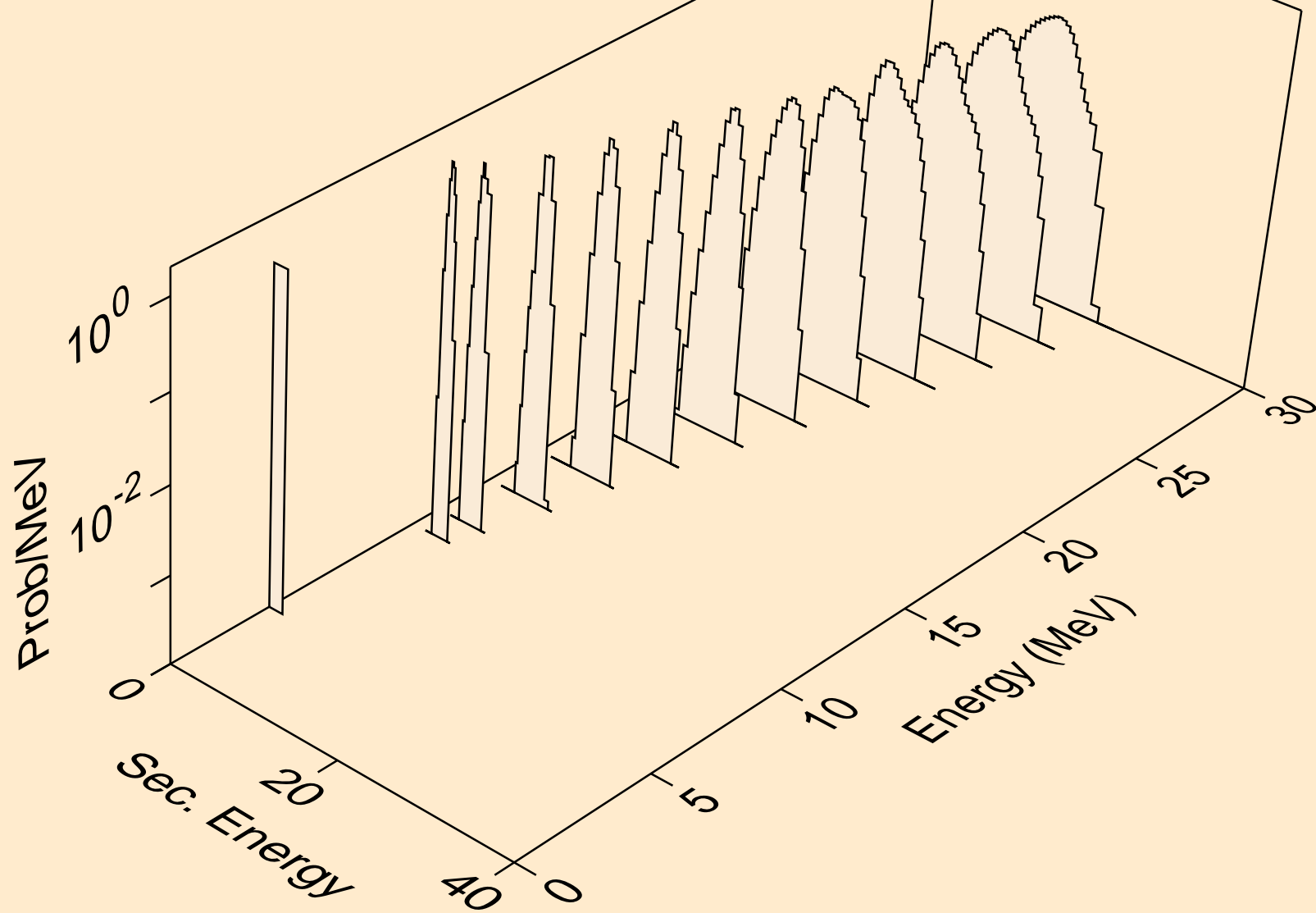

TA160 NEUTRON ACER TENDL-2023 LIBRARY; T=0.K  
he3s from (n,x)

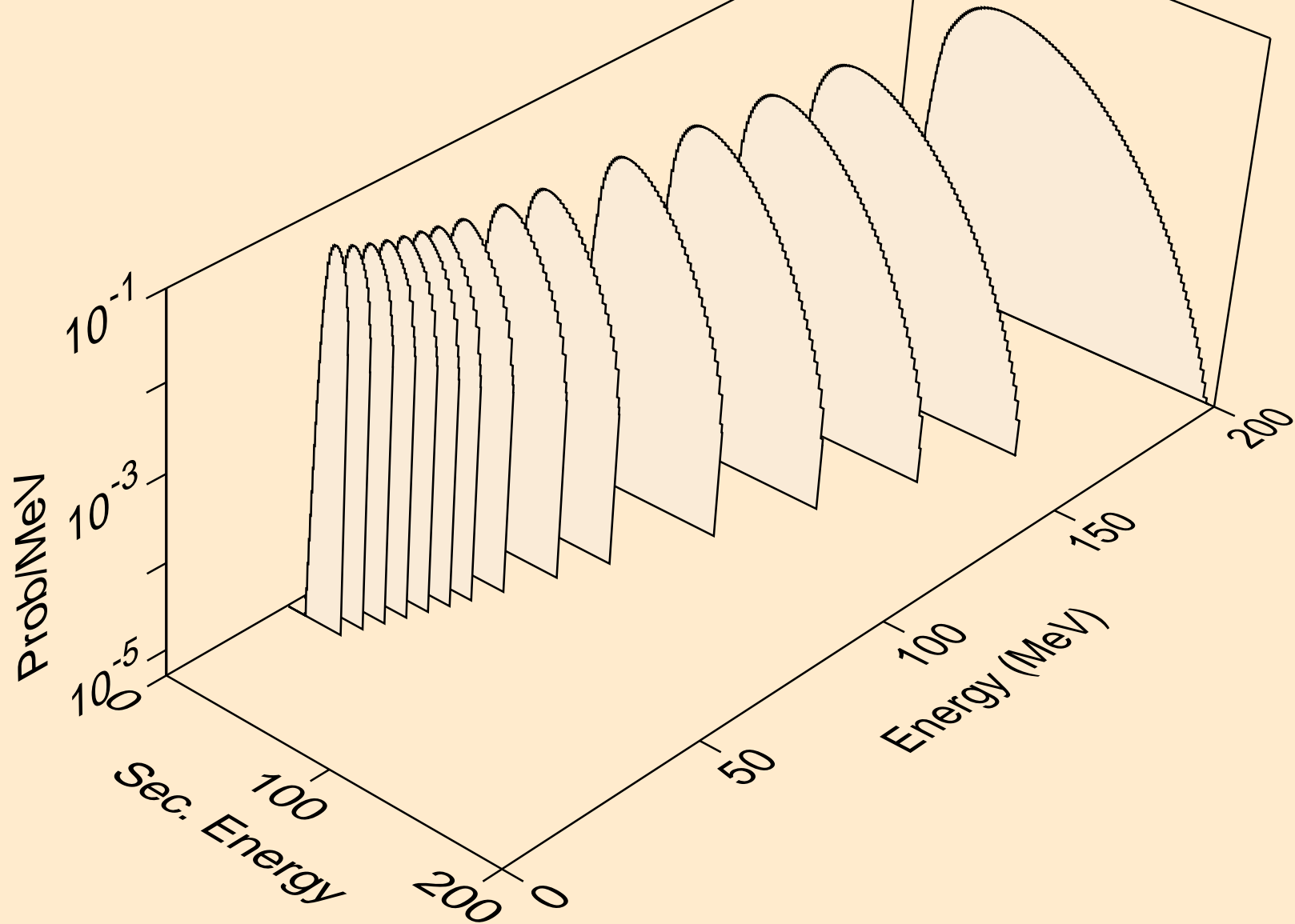

TA160 NEUTRON ACER TENDL-2023 LIBRARY; T=0.K  
he3s from (n,n\*)he3

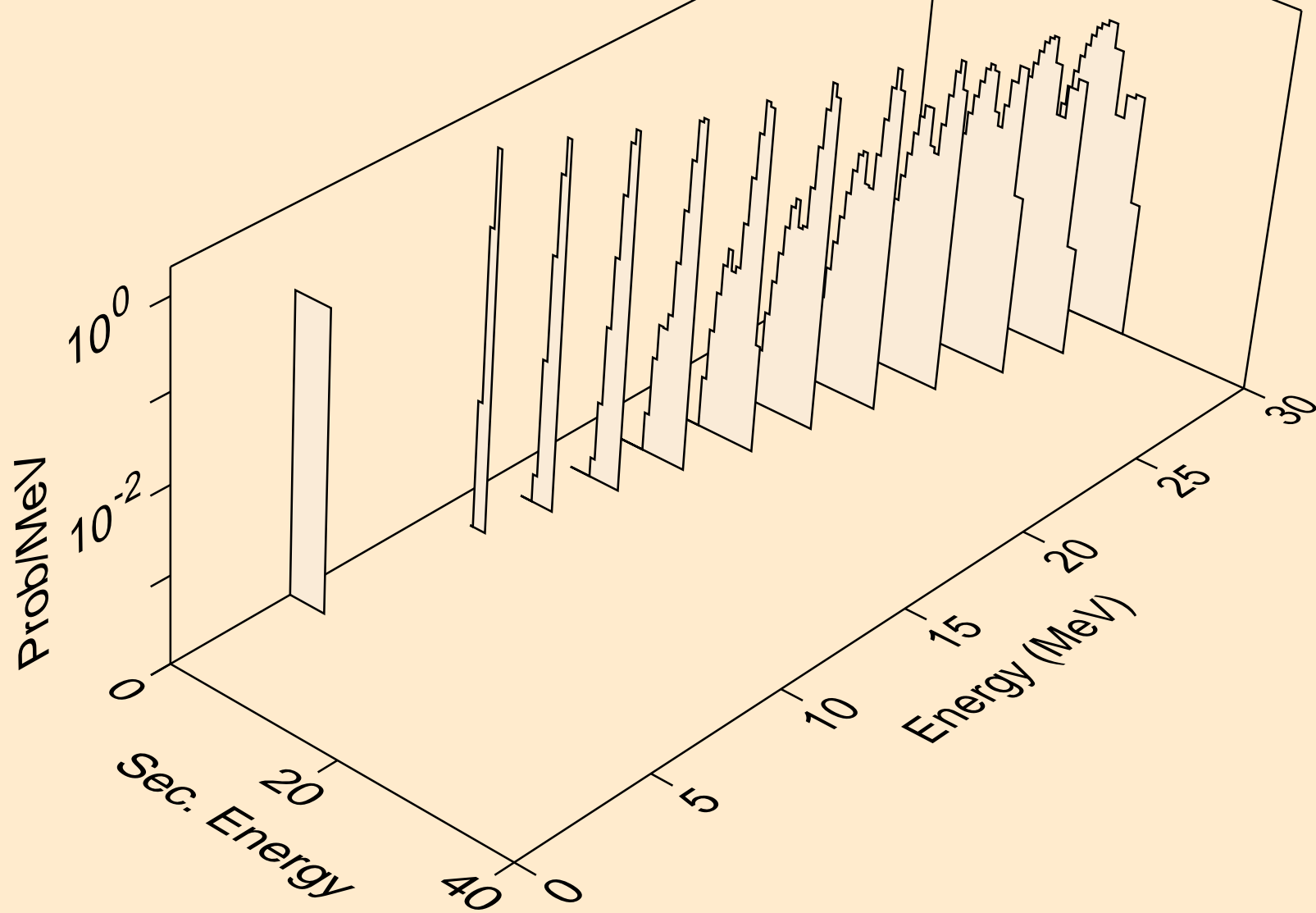

TA160 NEUTRON ACER TENDL-2023 LIBRARY; T=0.K  
he3s from (n,he3)

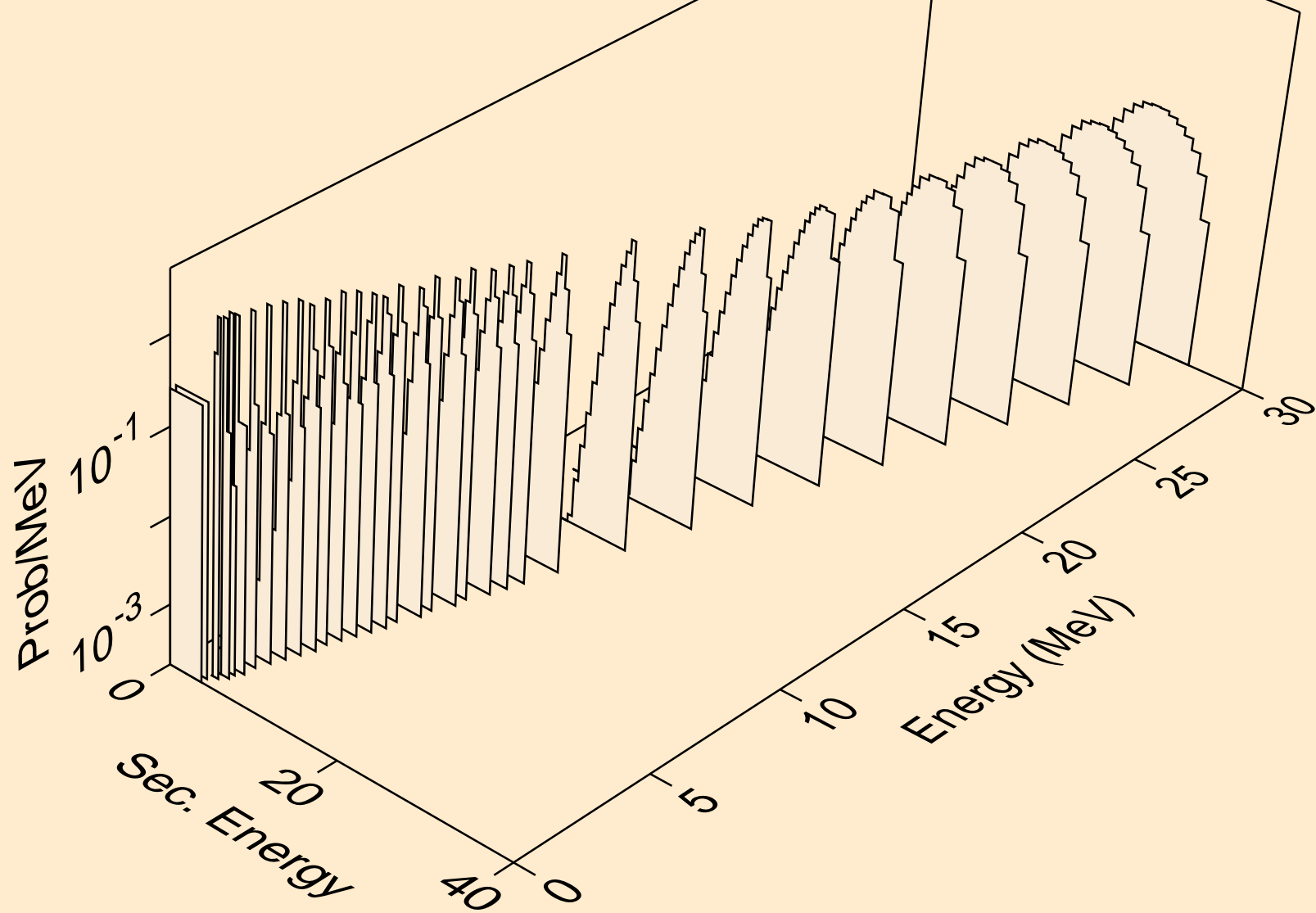



TA160 NEUTRON ACER TENDL-2023 LIBRARY; T=0.K  
alphas from (n,x)

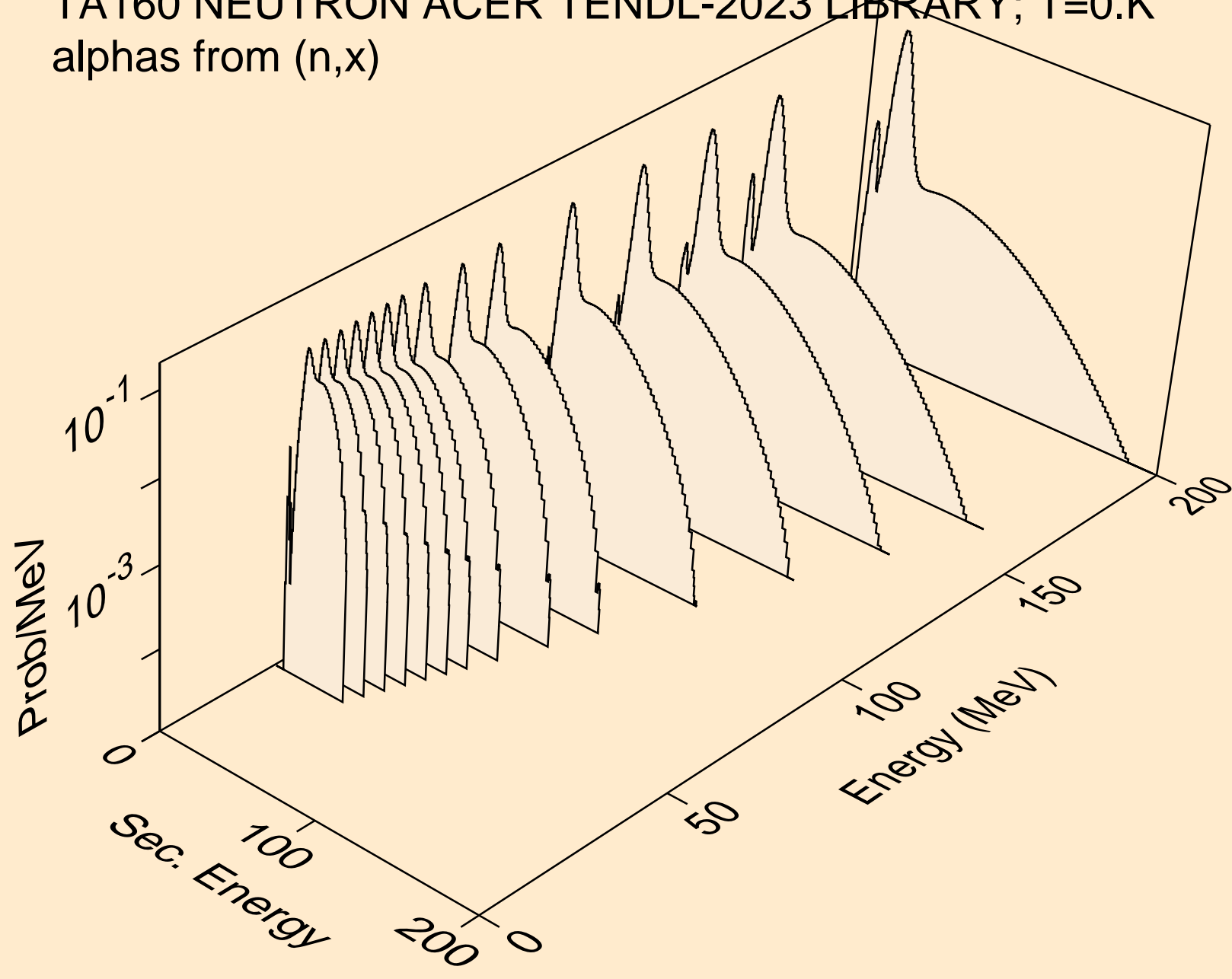

TA160 NEUTRON ACER TENDL-2023 LIBRARY; T=0.K  
alphas from (n,n\*)a

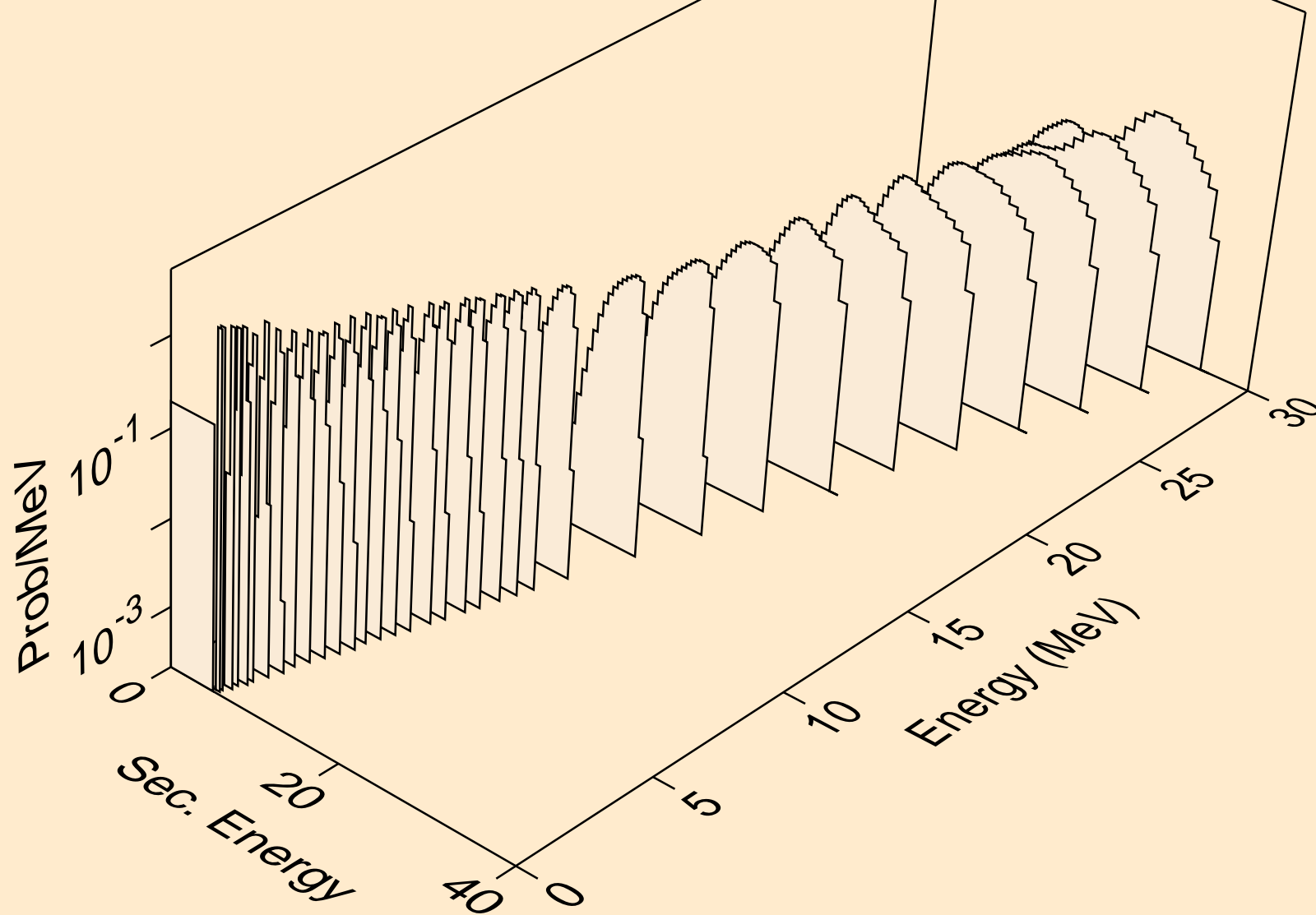

TA160 NEUTRON ACER TENDL-2023 LIBRARY; T=0.K  
alphas from (n,n\*)3a

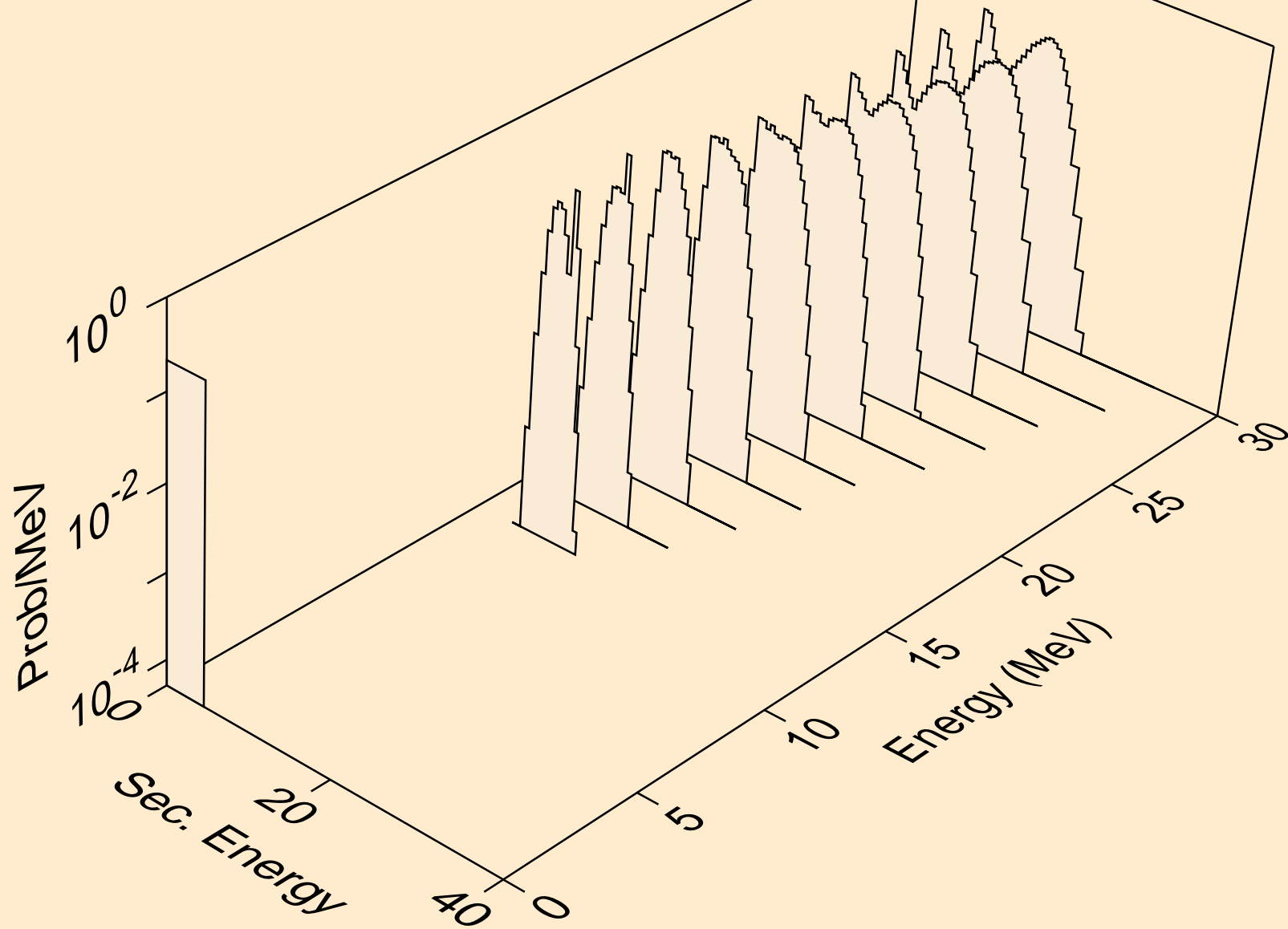

TA160 NEUTRON ACER TENDL-2023 LIBRARY; T=0.K  
alphas from (n,2n)a

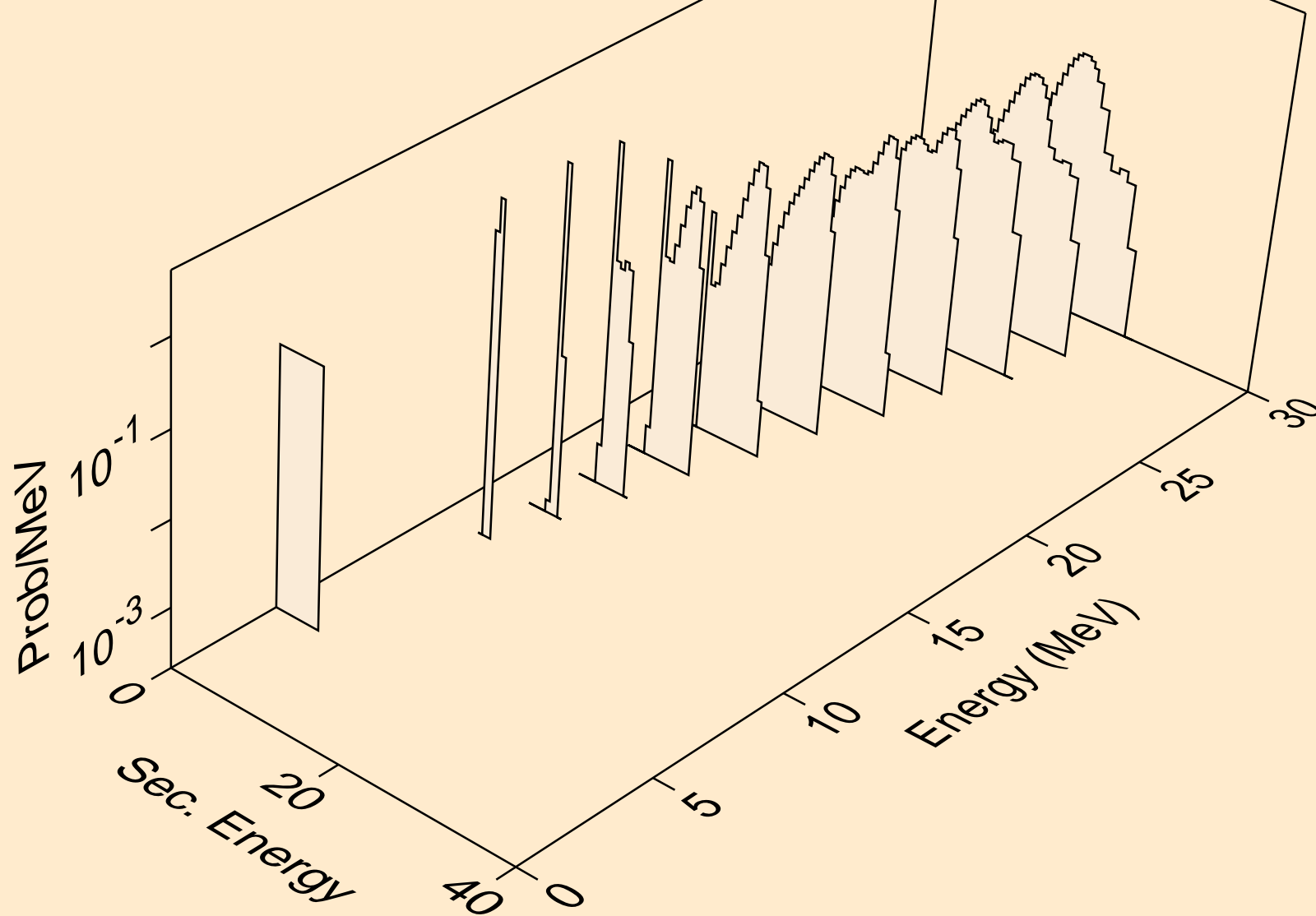

TA160 NEUTRON ACER TENDL-2023 LIBRARY; T=0.K  
alphas from (n,3n)a

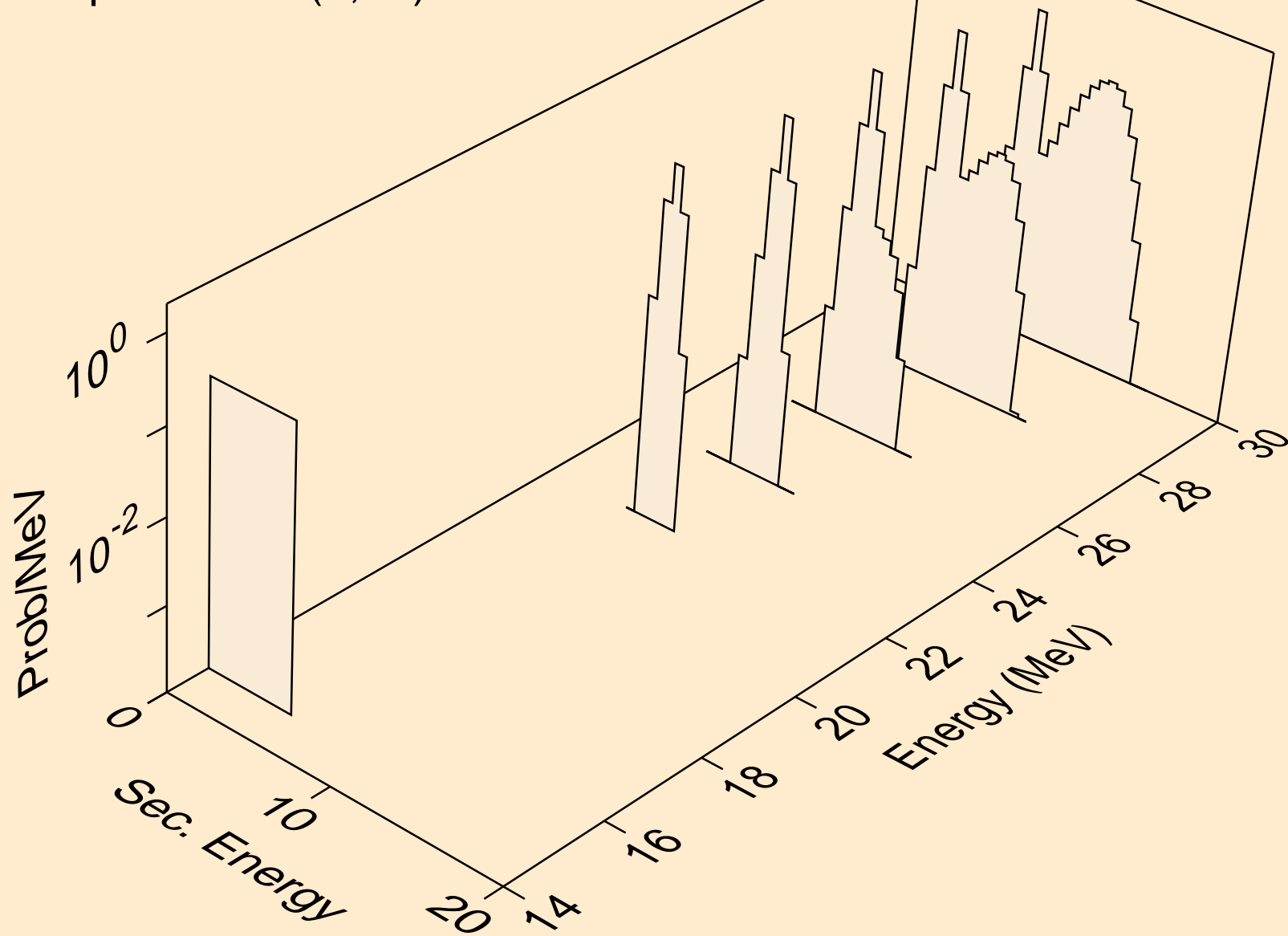

TA160 NEUTRON ACER TENDL-2023 LIBRARY; T=0.K  
alphas from (n,n\*)2a

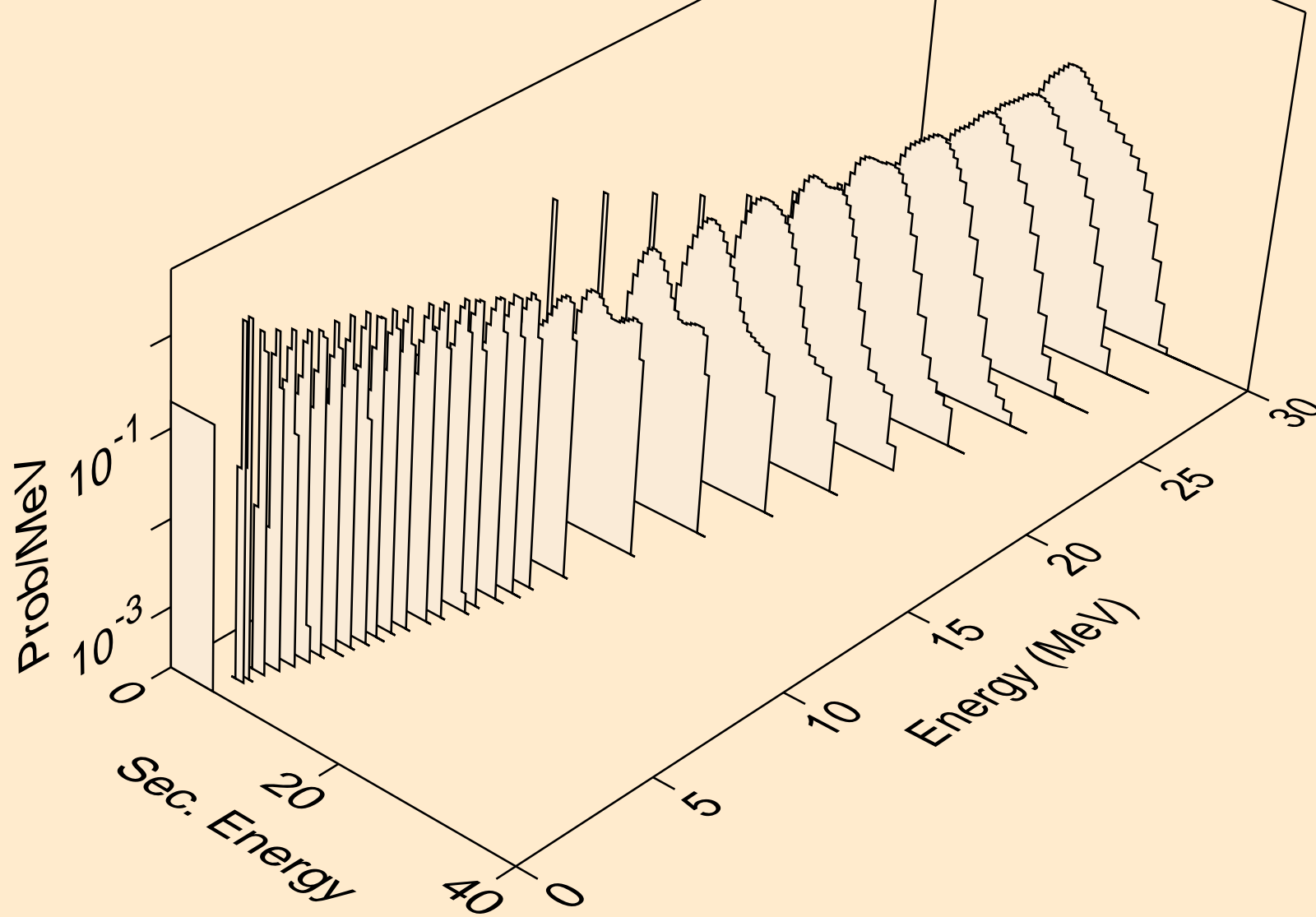

TA160 NEUTRON ACER TENDL-2023 LIBRARY; T=0.K  
alphas from (n,2n)2a

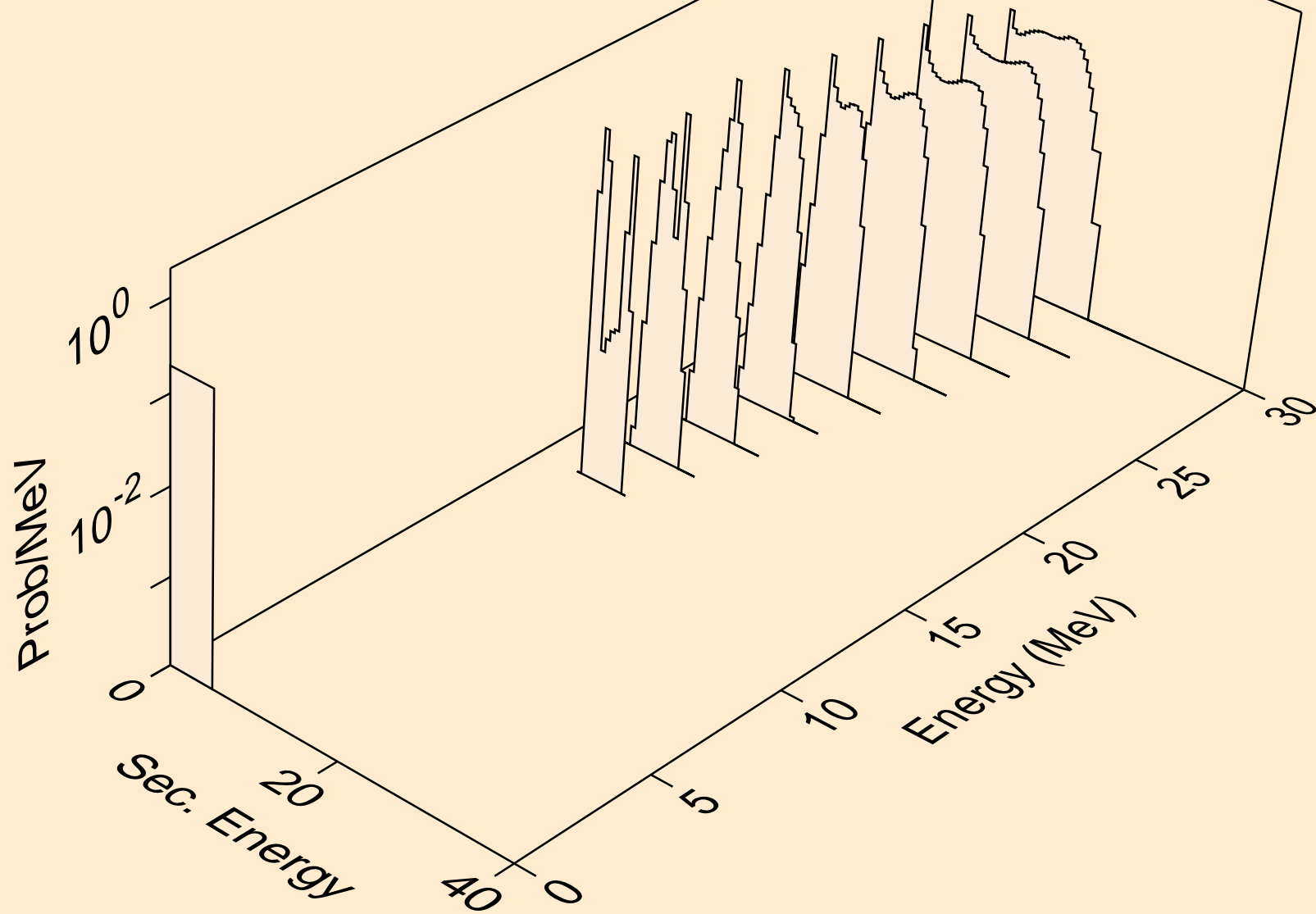

TA160 NEUTRON ACER TENDL-2023 LIBRARY; T=0.K  
alphas from (n,n\*)d2a

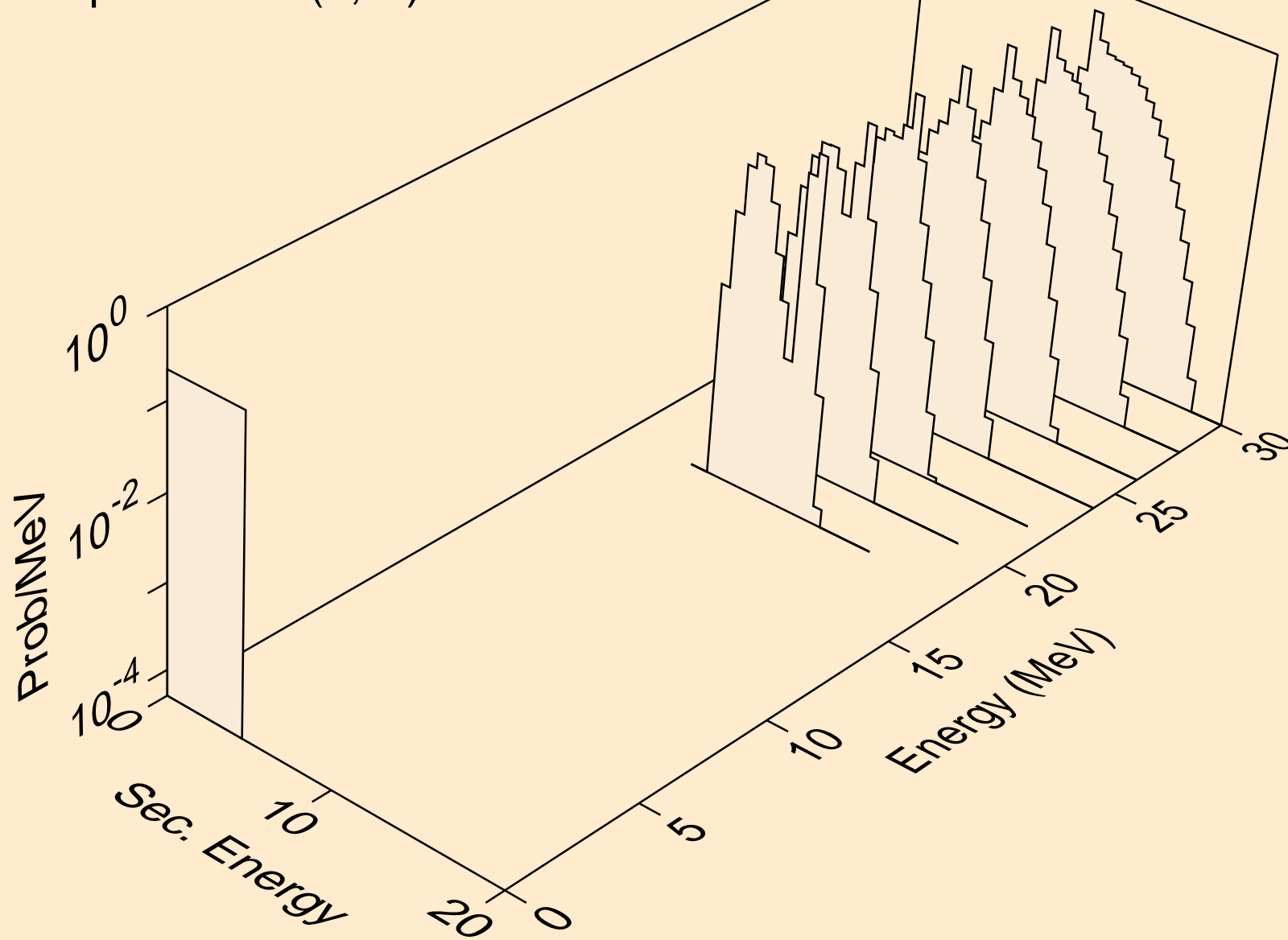



TA160 NEUTRON ACER TENDL-2023 LIBRARY; T=0.K  
alphas from (n,npa)

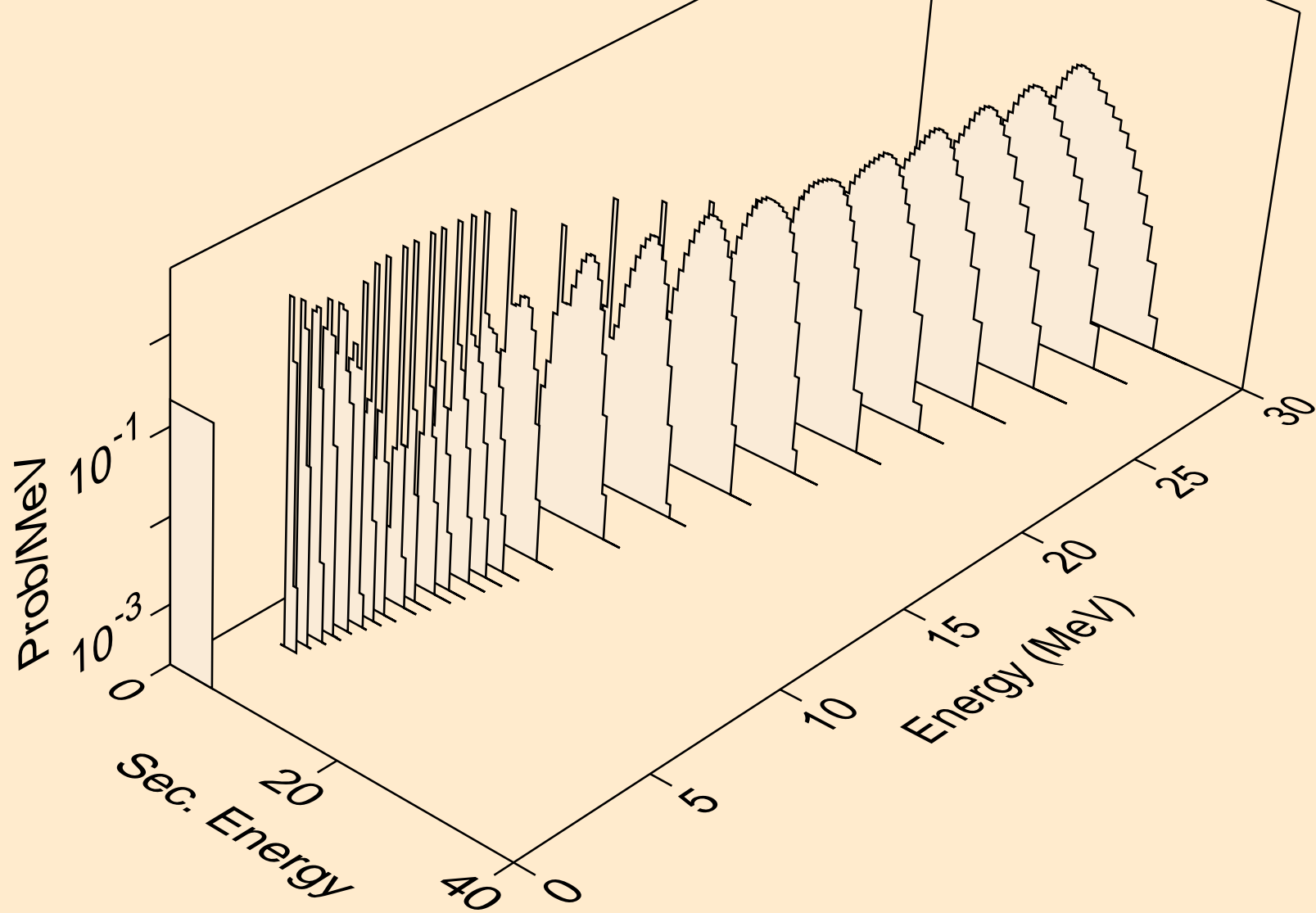

TA160 NEUTRON ACER TENDL-2023 LIBRARY; T=0.K  
alphas from (n,a)

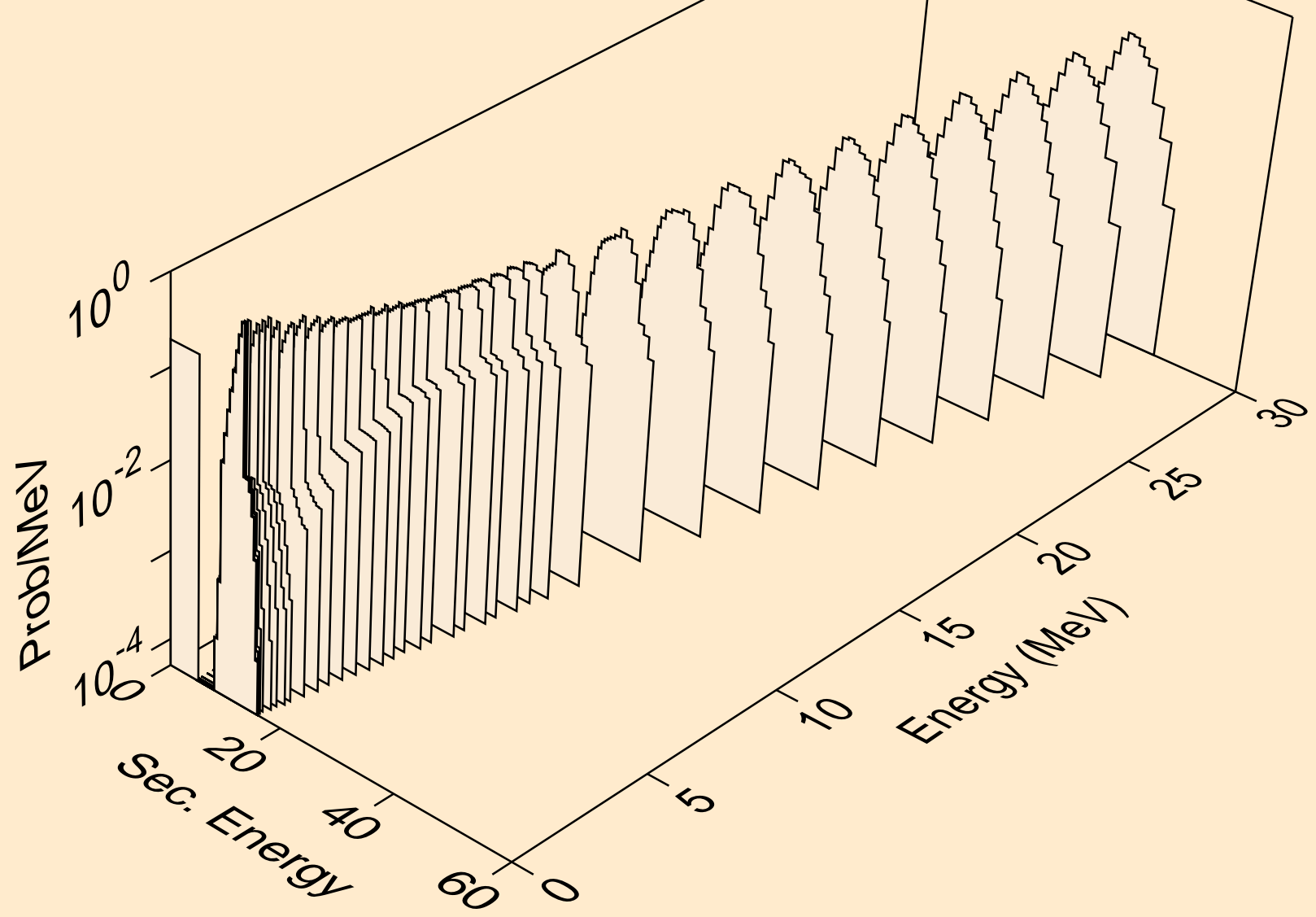

TA160 NEUTRON ACER TENDL-2023 LIBRARY; T=0.K  
alphas from (n,2a)

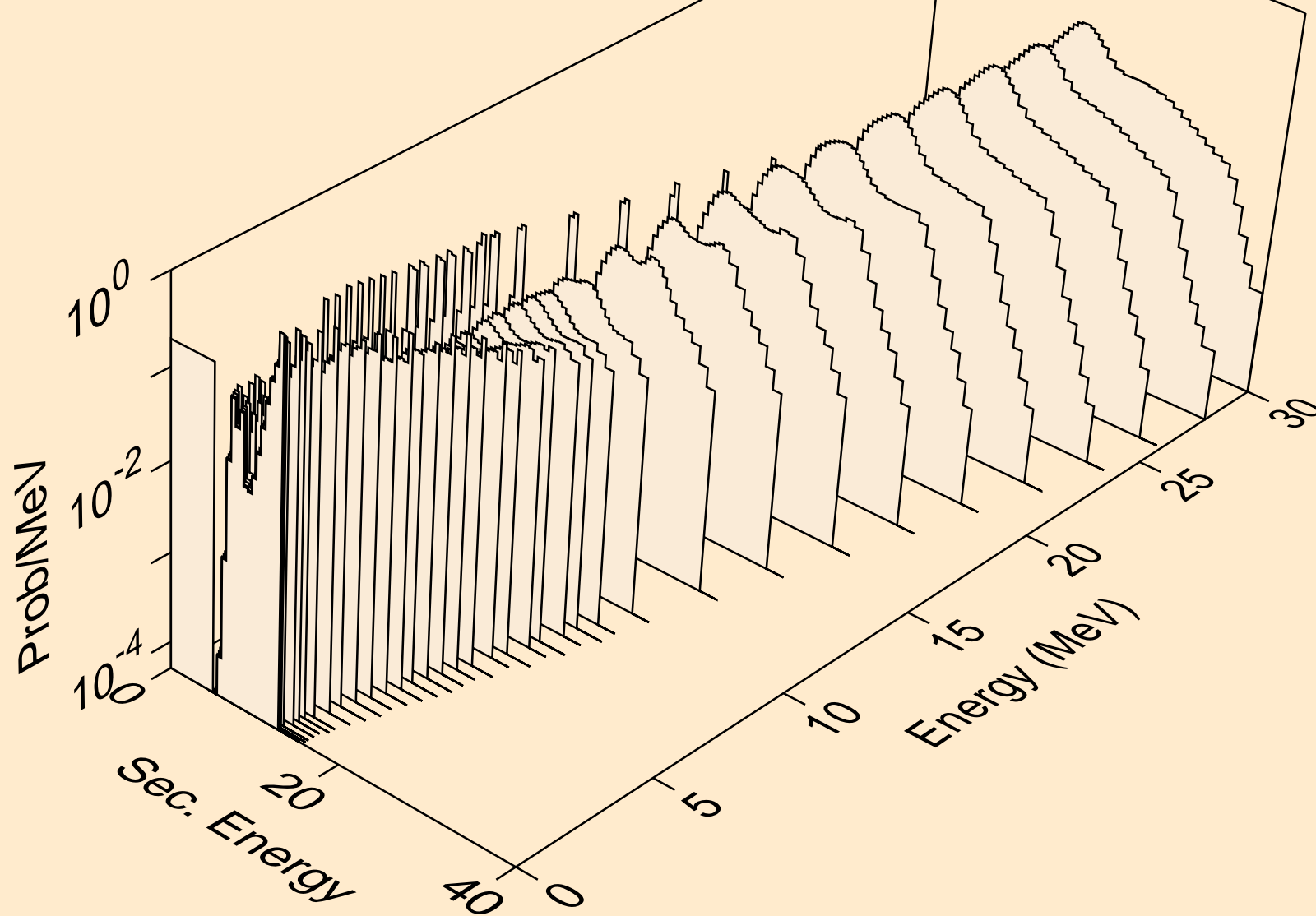

TA160 NEUTRON ACER TENDL-2023 LIBRARY; T=0.K  
alphas from (n,3a)

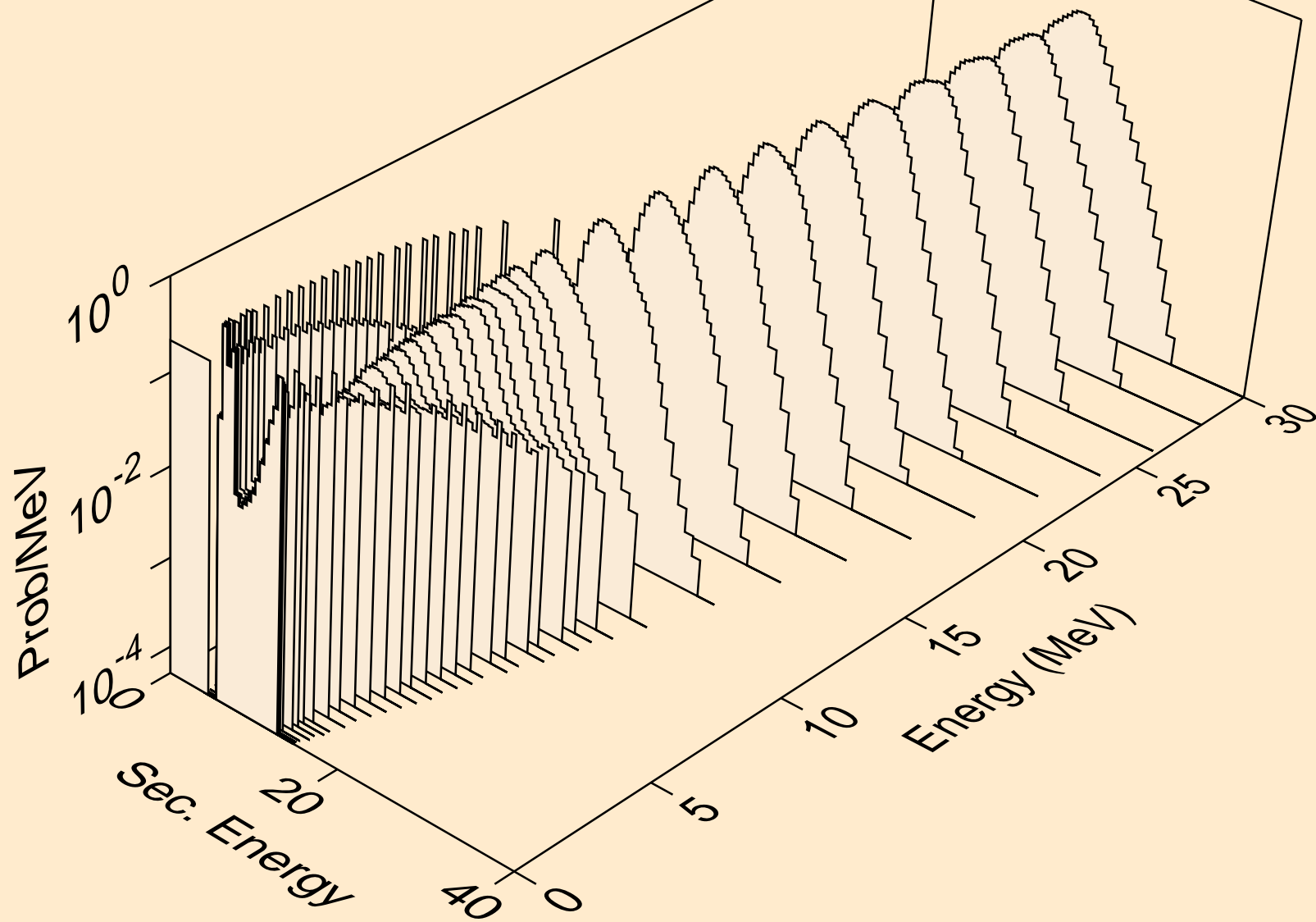

TA160 NEUTRON ACER TENDL-2023 LIBRARY; T=0.K  
alphas from (n,pa)

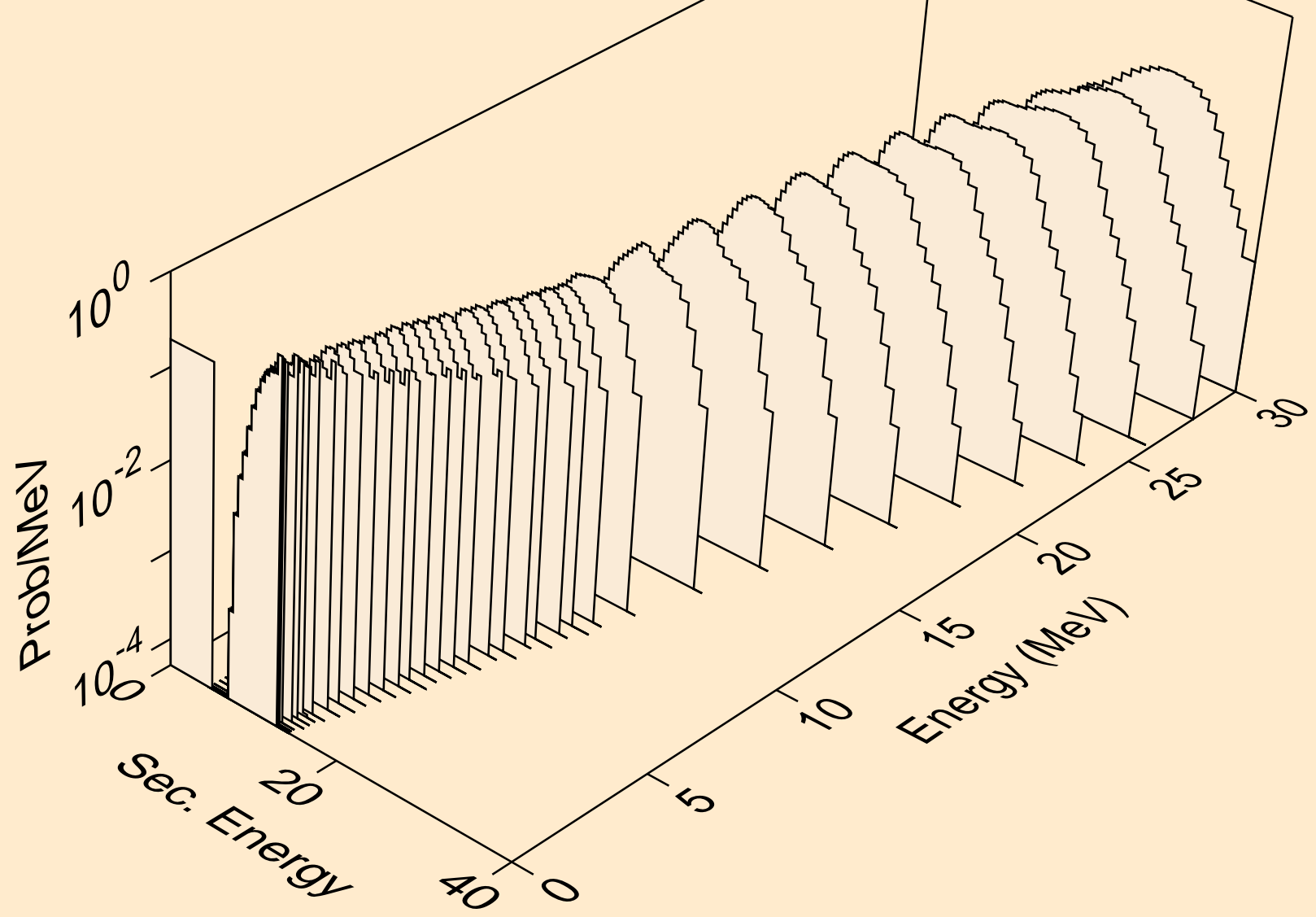

TA160 NEUTRON ACER TENDL-2023 LIBRARY; T=0.K  
alphas from (n,t2a)

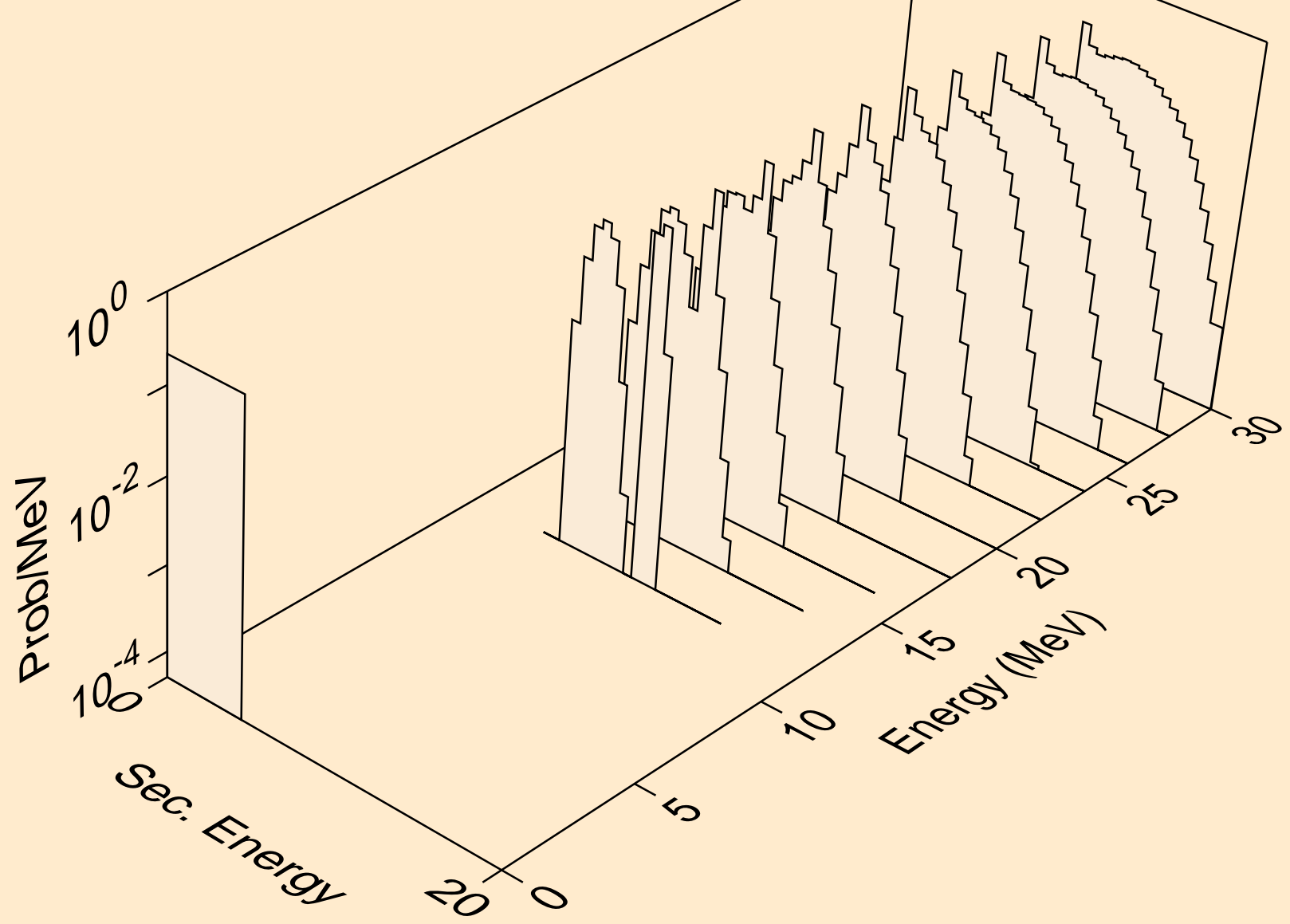

TA160 NEUTRON ACER TENDL-2023 LIBRARY; T=0.K  
alphas from (n,d2a)

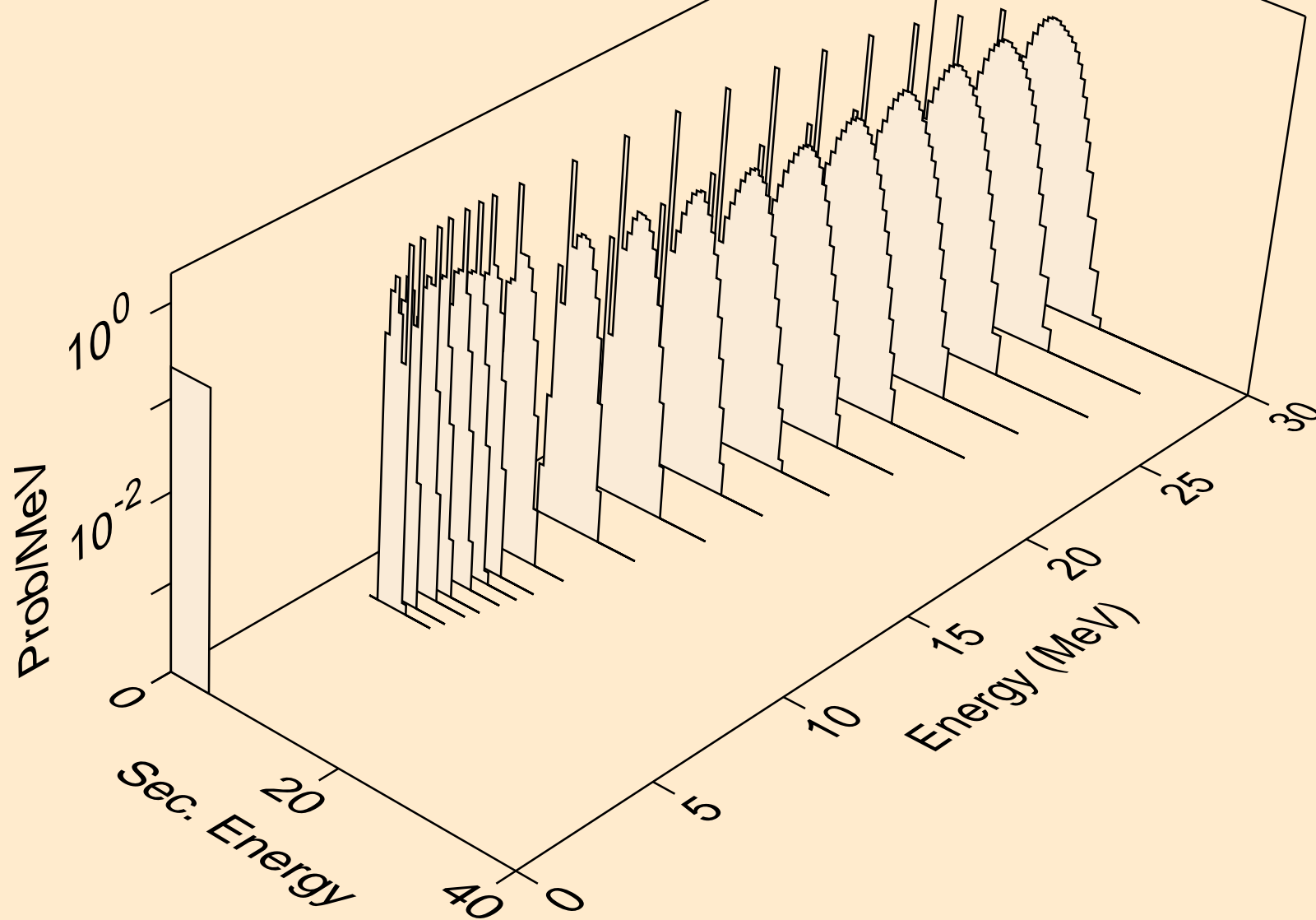

TA160 NEUTRON ACER TENDL-2023 LIBRARY; T=0.K  
alphas from (n,da)

