

TA174 NEUTRON ACER TENDL-2023 LIBRARY; T=0.K
Principal cross sections

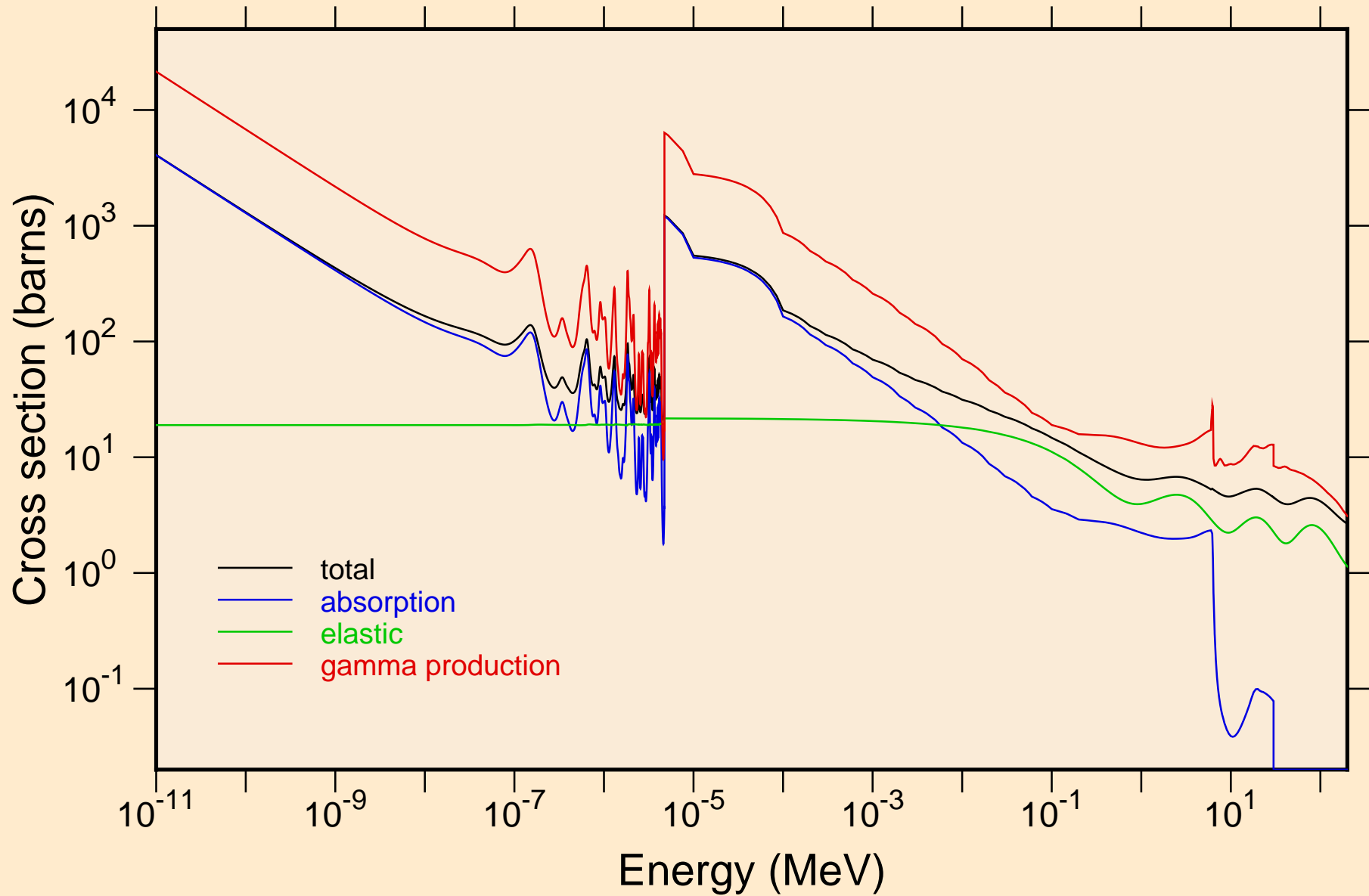

TA174 NEUTRON ACER TENDL-2023 LIBRARY; T=0.K
resonance total cross section

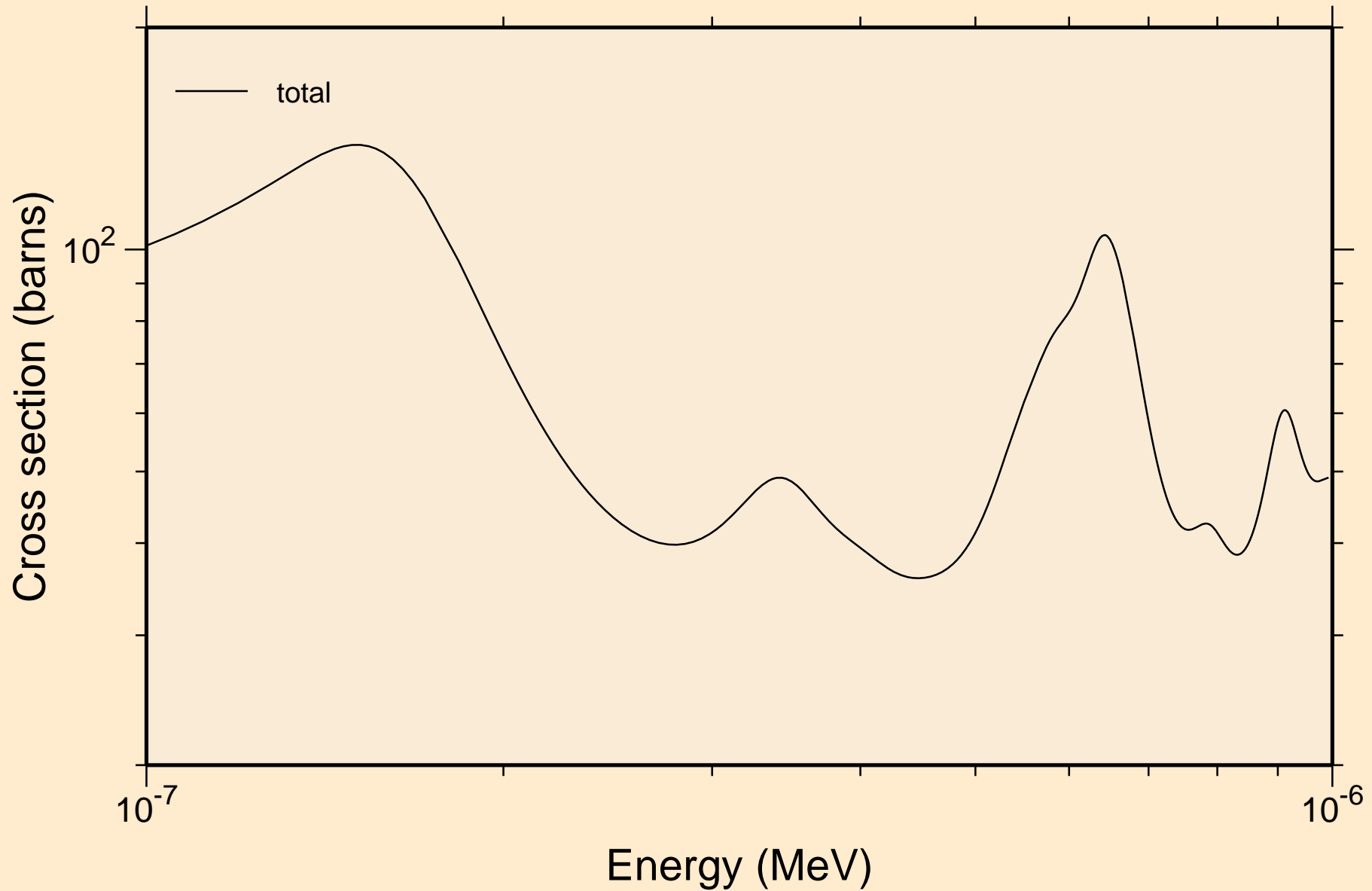

TA174 NEUTRON ACER TENDL-2023 LIBRARY; T=0.K
resonance total cross section

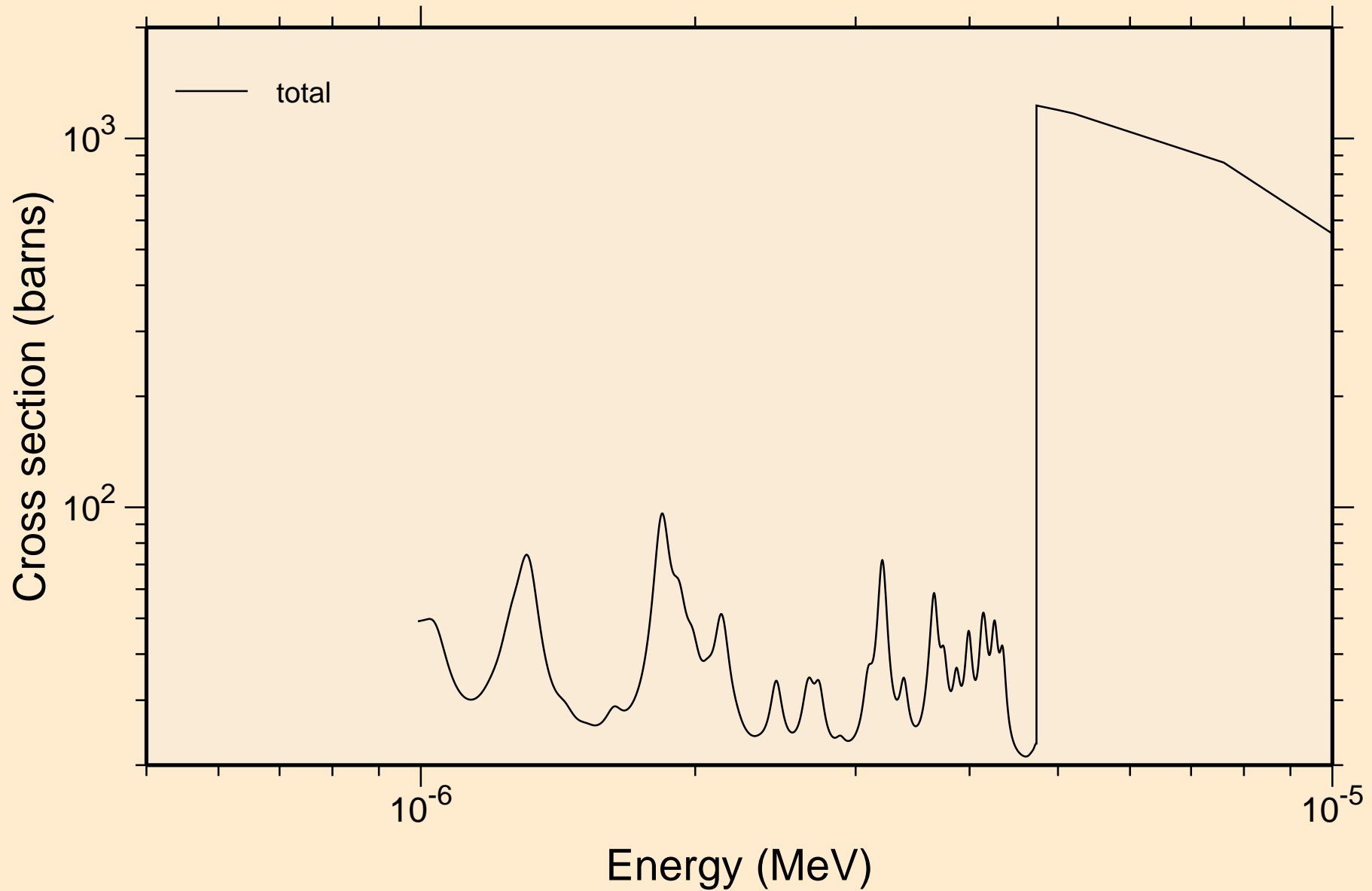

TA174 NEUTRON ACER TENDL-2023 LIBRARY; T=0.K
resonance total cross section

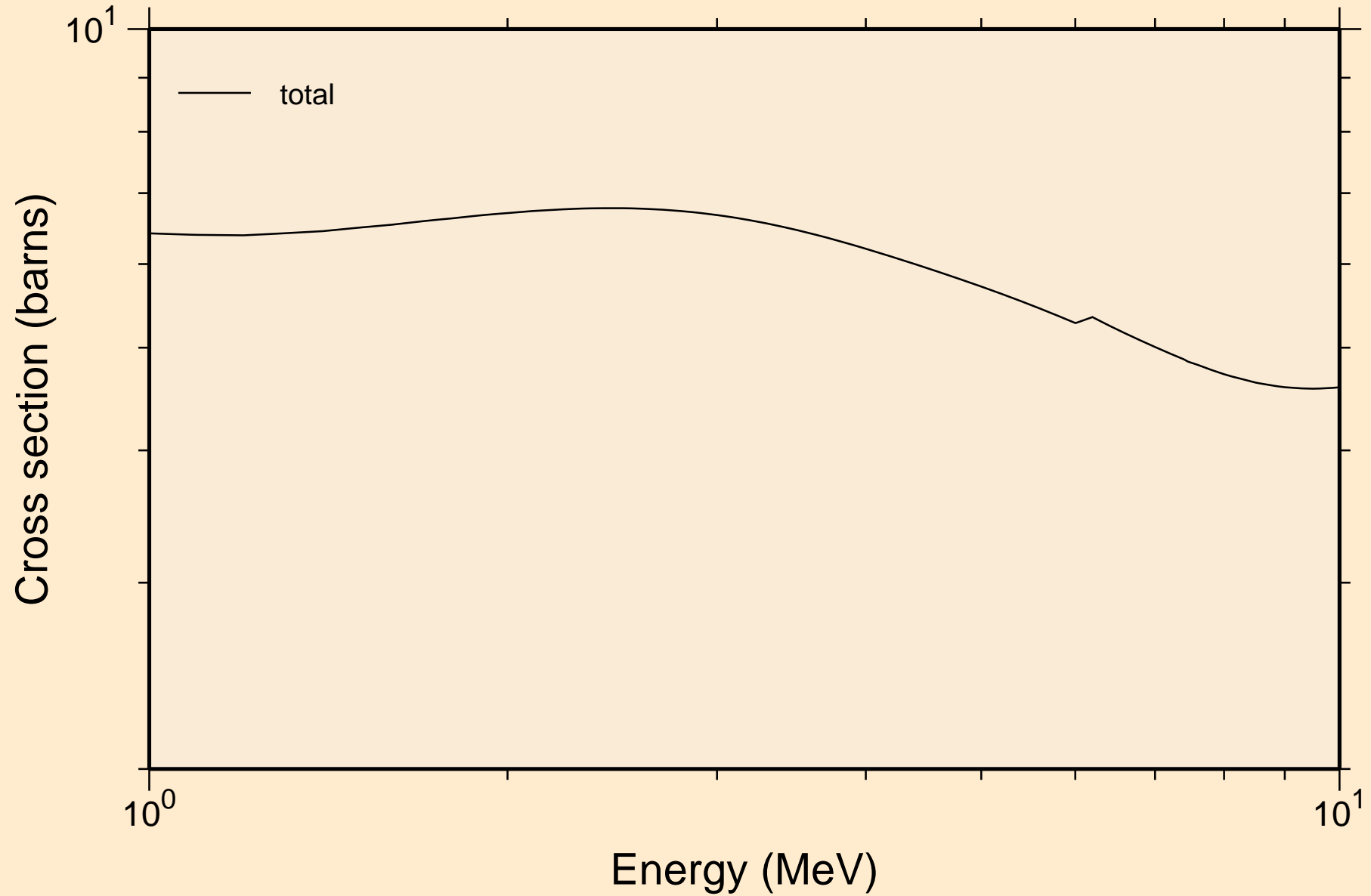

TA174 NEUTRON ACER TENDL-2023 LIBRARY; T=0.K
resonance absorption cross sections

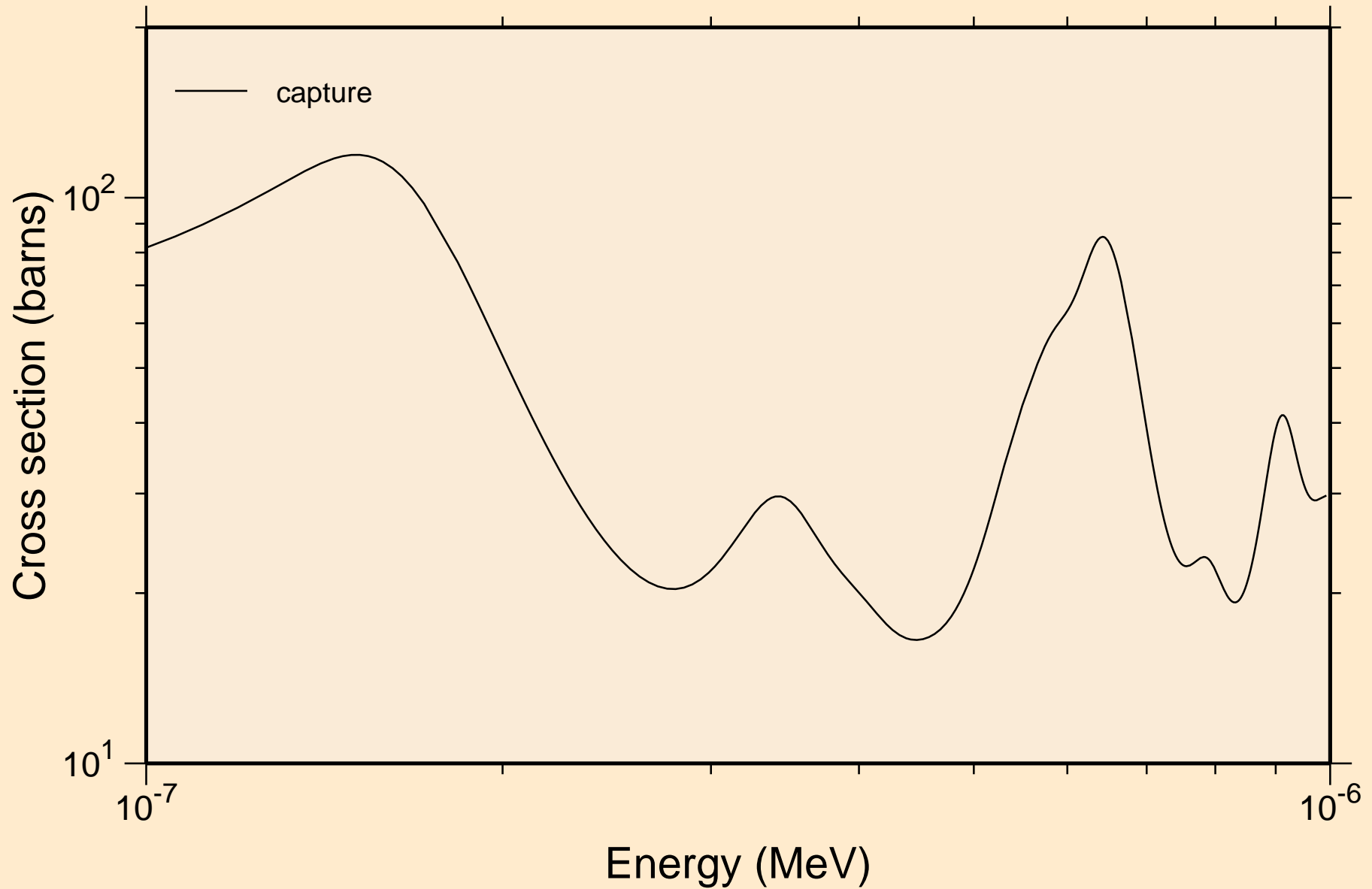

TA174 NEUTRON ACER TENDL-2023 LIBRARY; T=0.K
resonance absorption cross sections

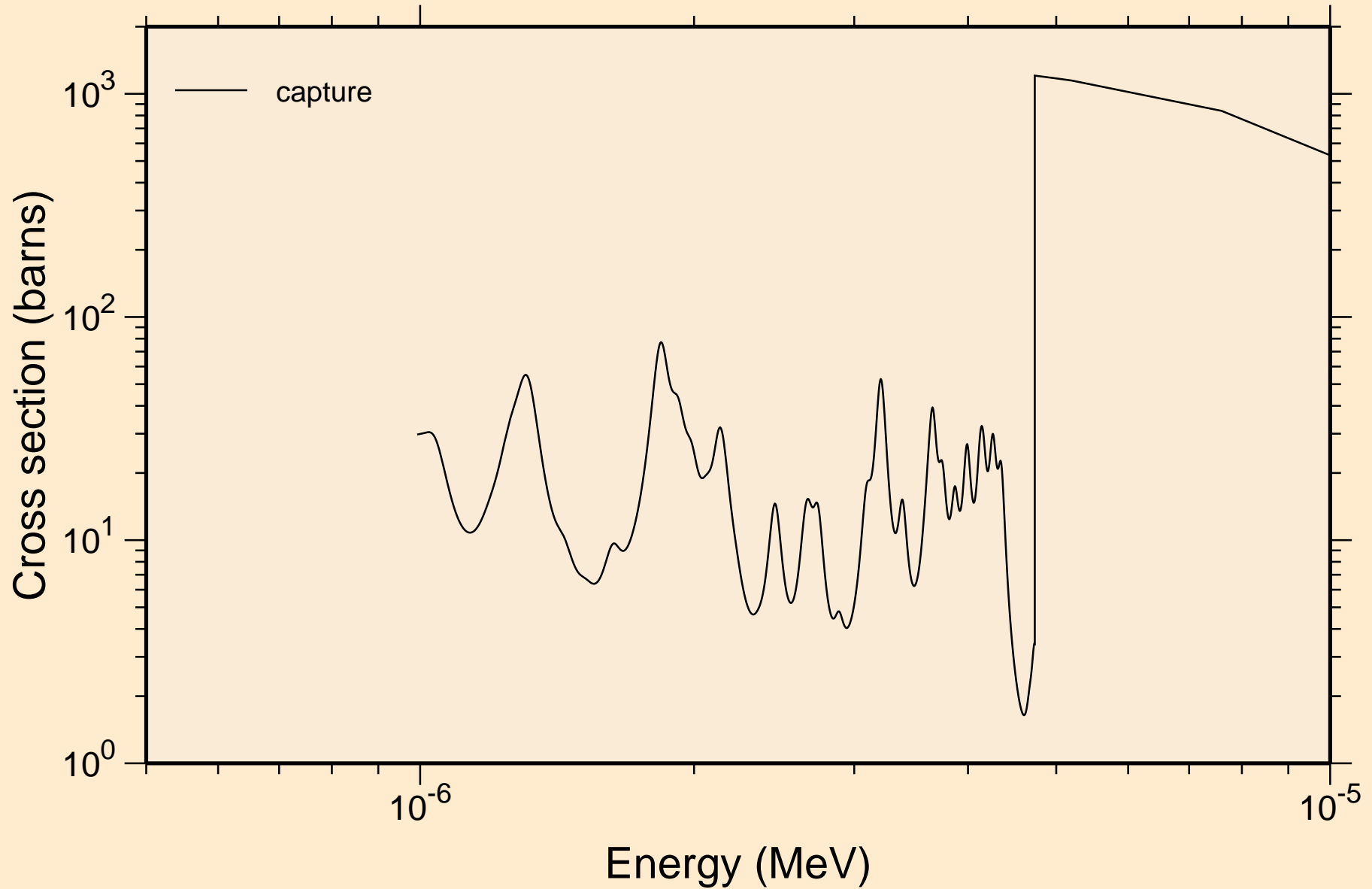

TA174 NEUTRON ACER TENDL-2023 LIBRARY; T=0.K
resonance absorption cross sections

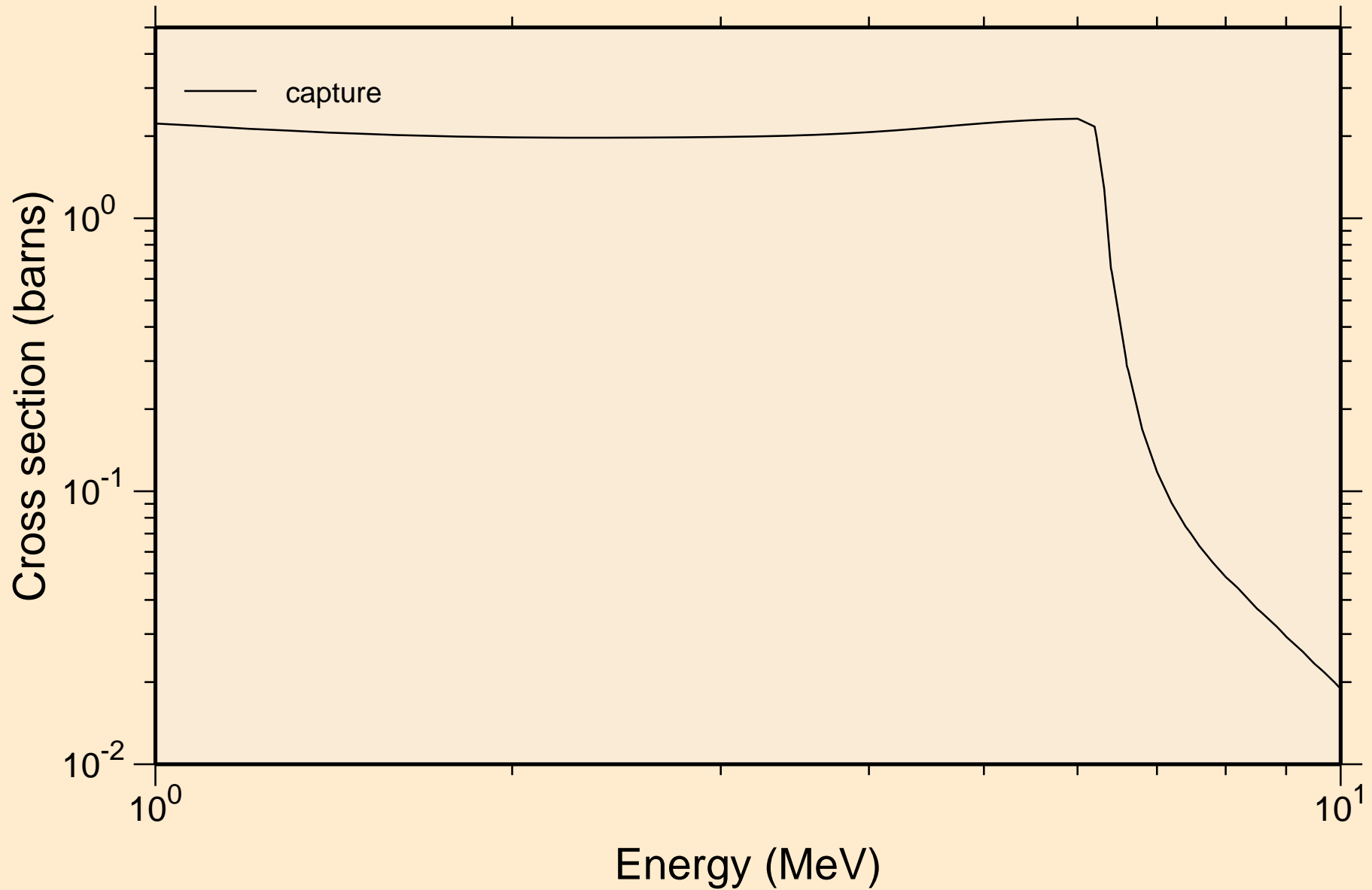

TA174 NEUTRON ACER TENDL-2023 LIBRARY; T=0.K

Heating

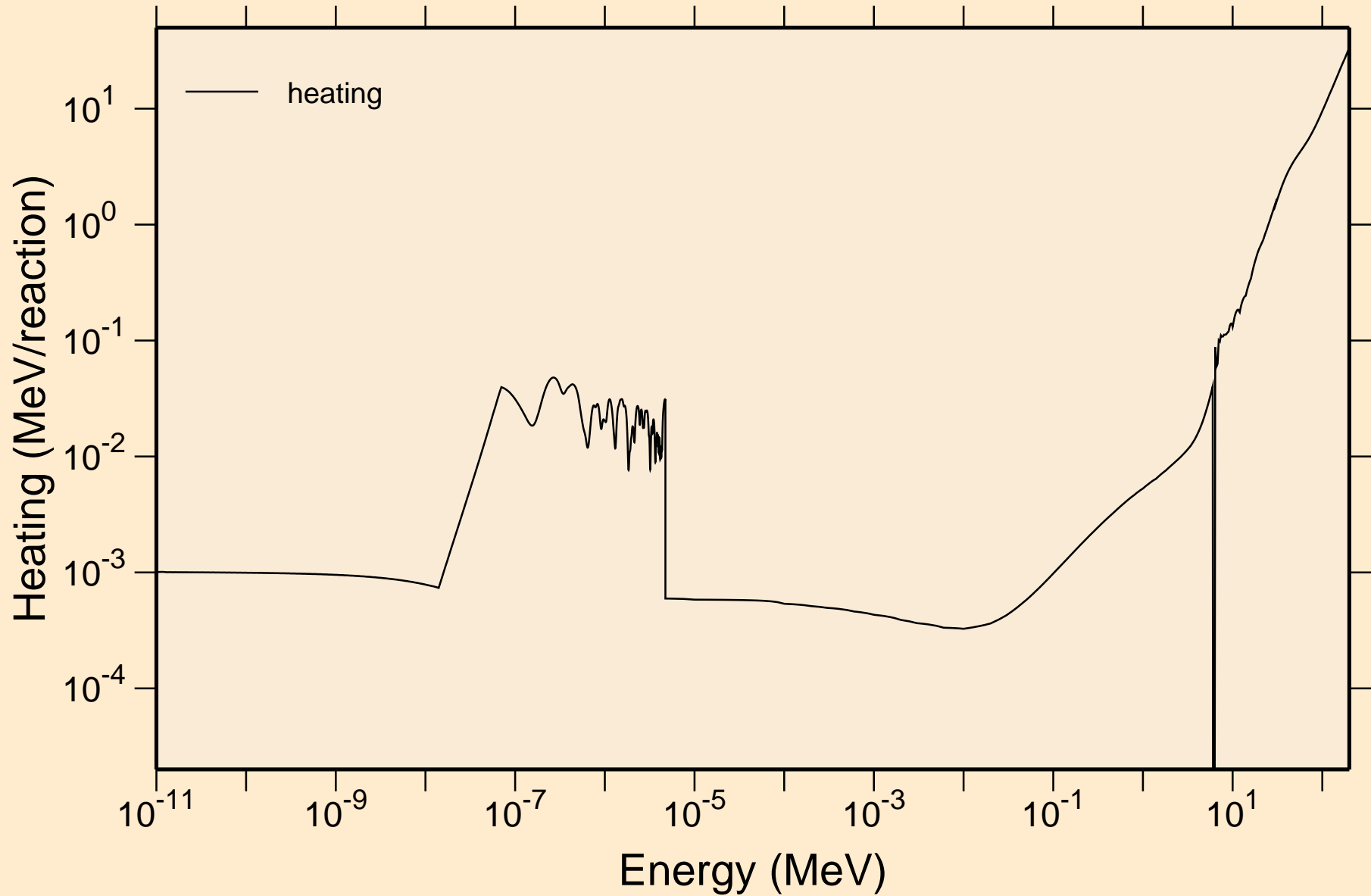

TA174 NEUTRON ACER TENDL-2023 LIBRARY; T=0.K
Damage

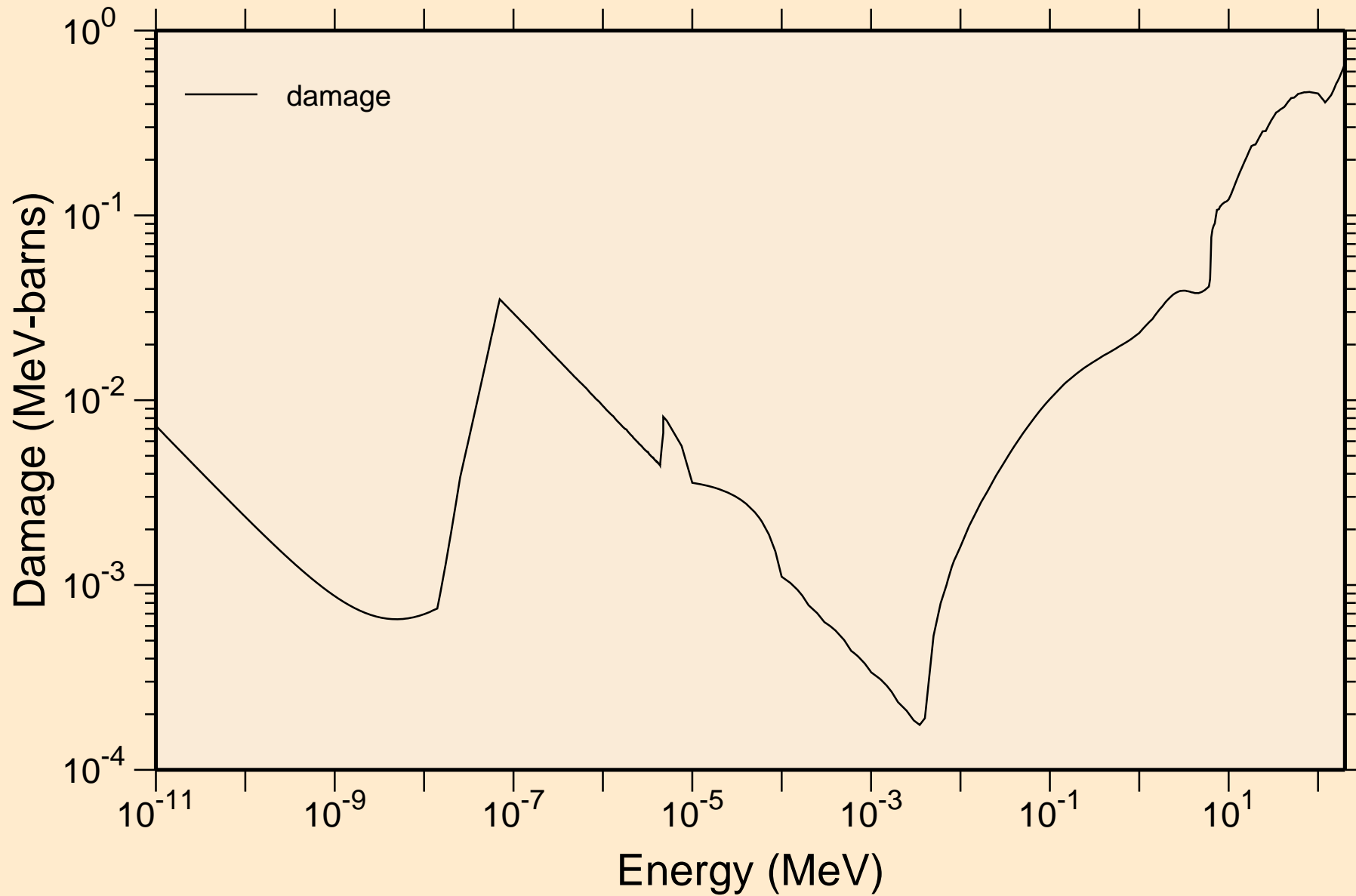

TA174 NEUTRON ACER TENDL-2023 LIBRARY; T=0.K
Non-threshold reactions

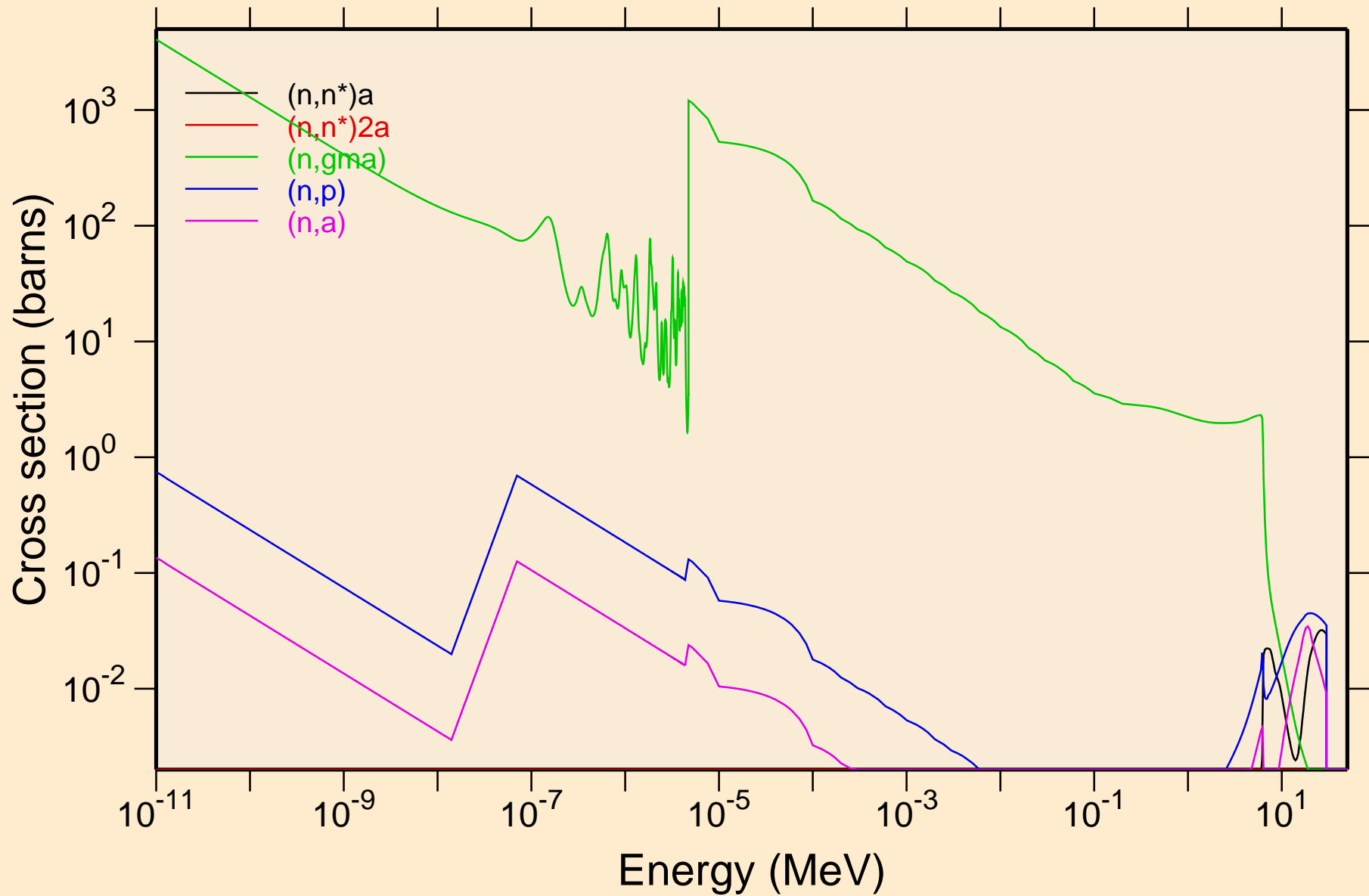

TA174 NEUTRON ACER TENDL-2023 LIBRARY; T=0.K
Non-threshold reactions

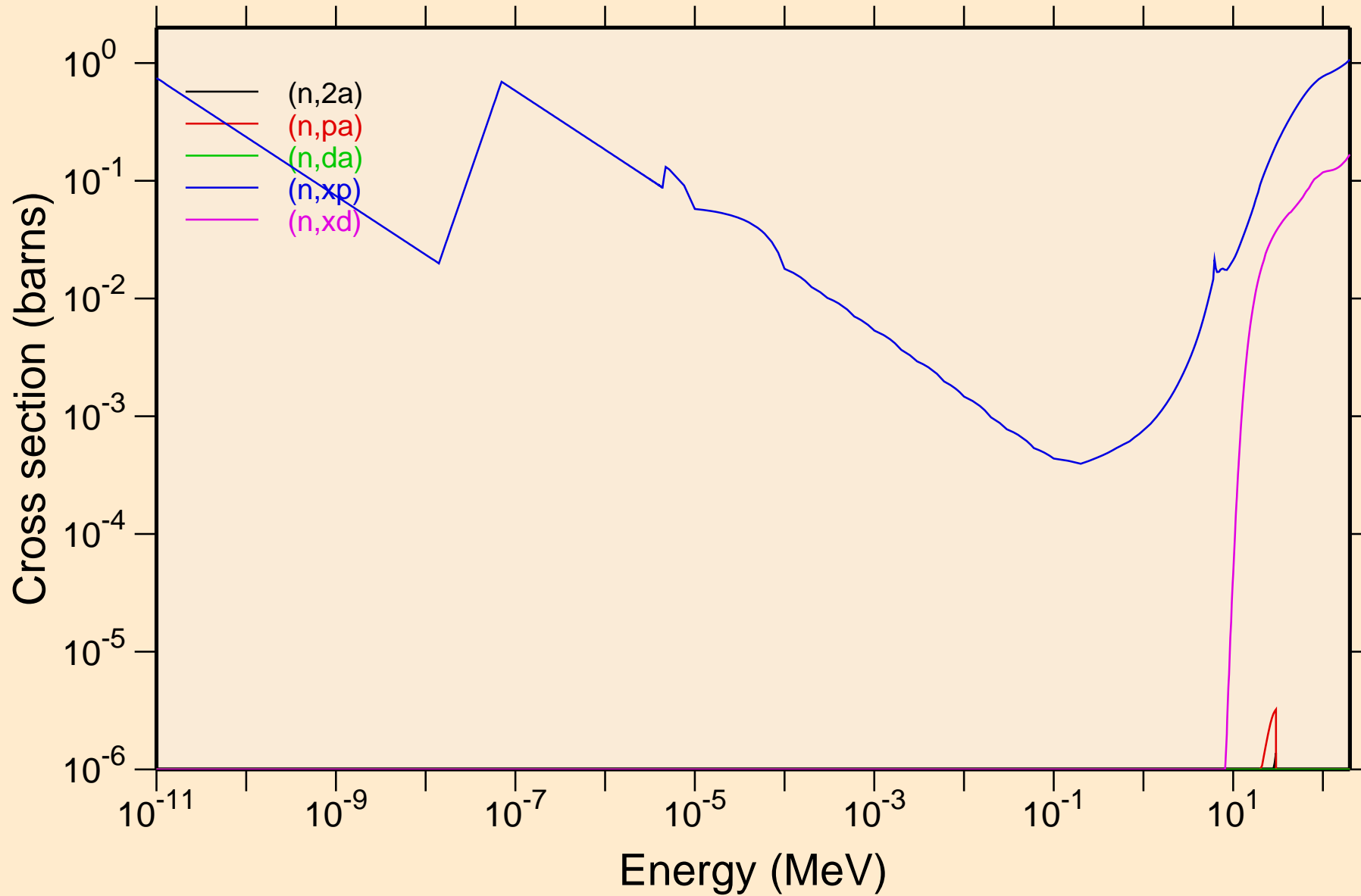

TA174 NEUTRON ACER TENDL-2023 LIBRARY; T=0.K
Non-threshold reactions

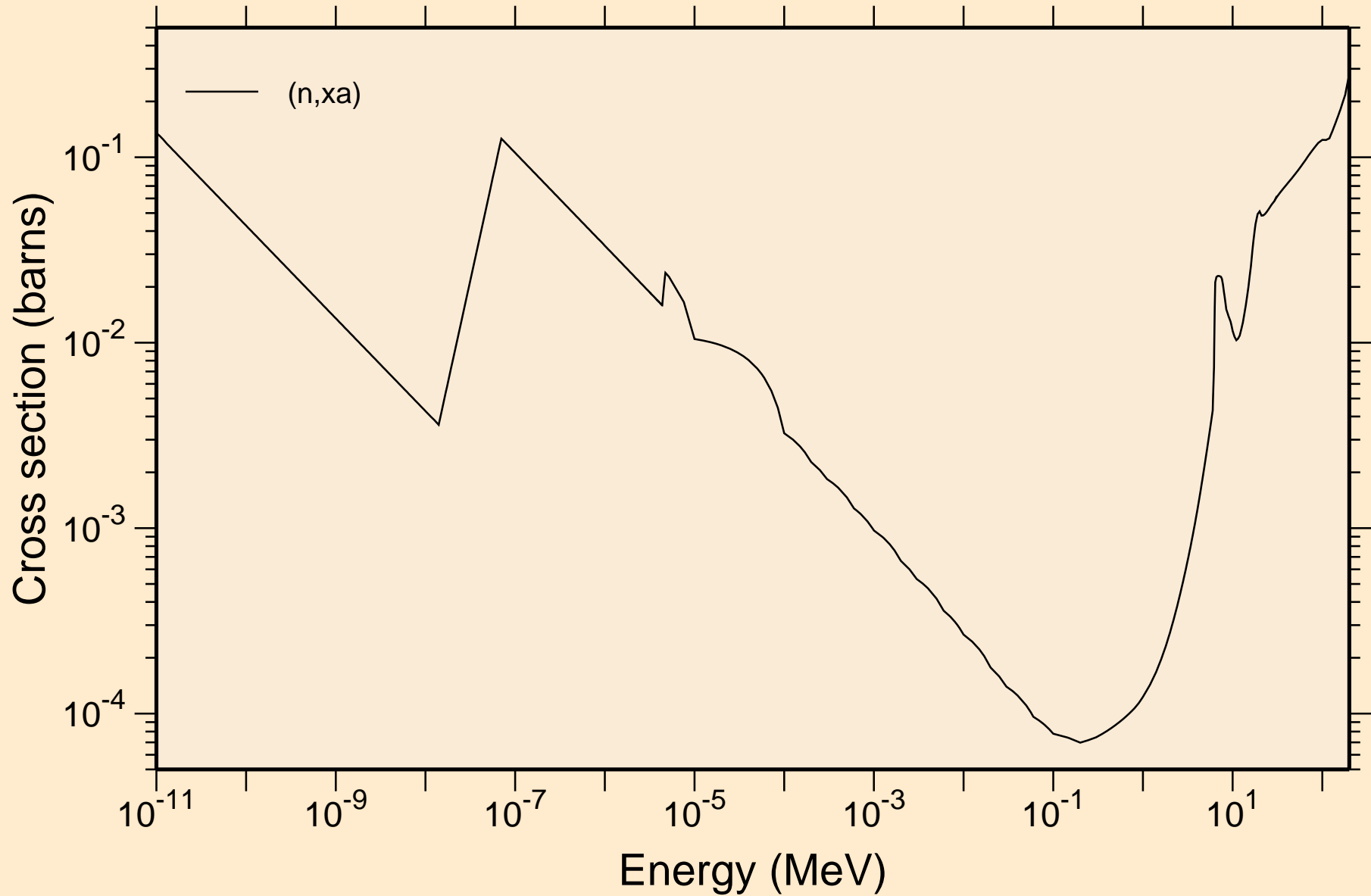

TA174 NEUTRON ACER TENDL-2023 LIBRARY; T=0.K

Principal cross sections

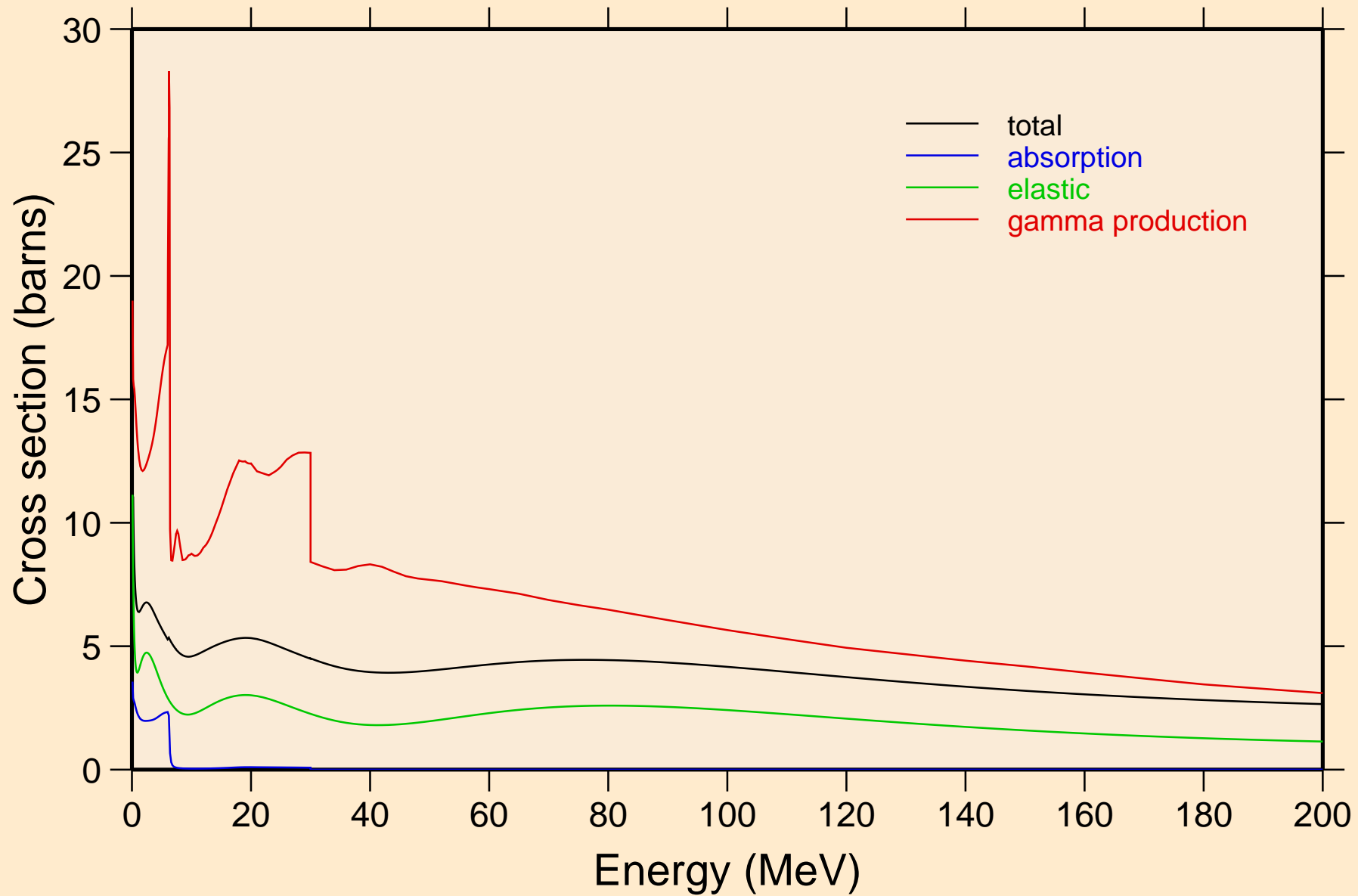

TA174 NEUTRON ACER TENDL-2023 LIBRARY; T=0.K

Heating

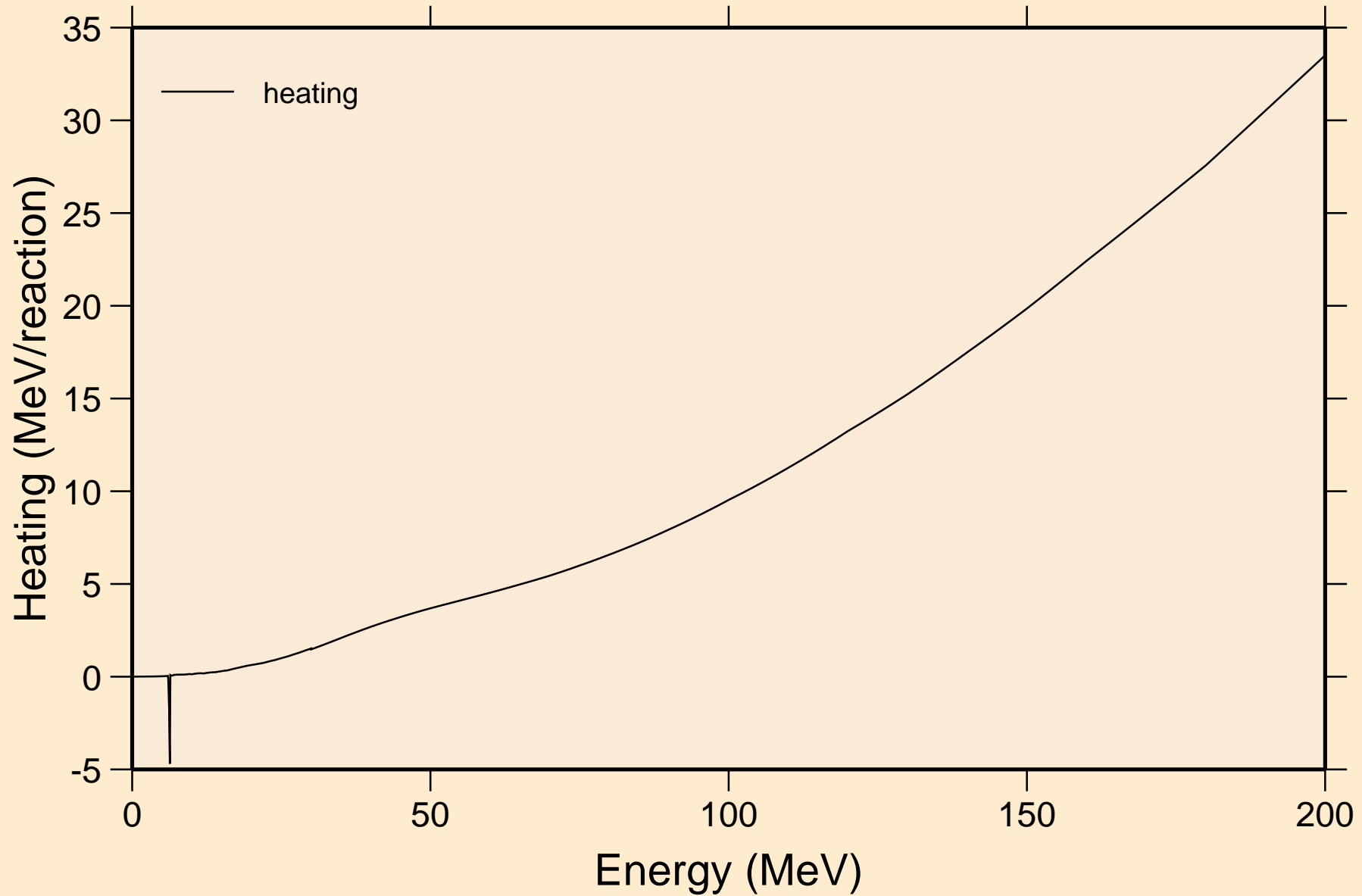

TA174 NEUTRON ACER TENDL-2023 LIBRARY; T=0.K
Damage

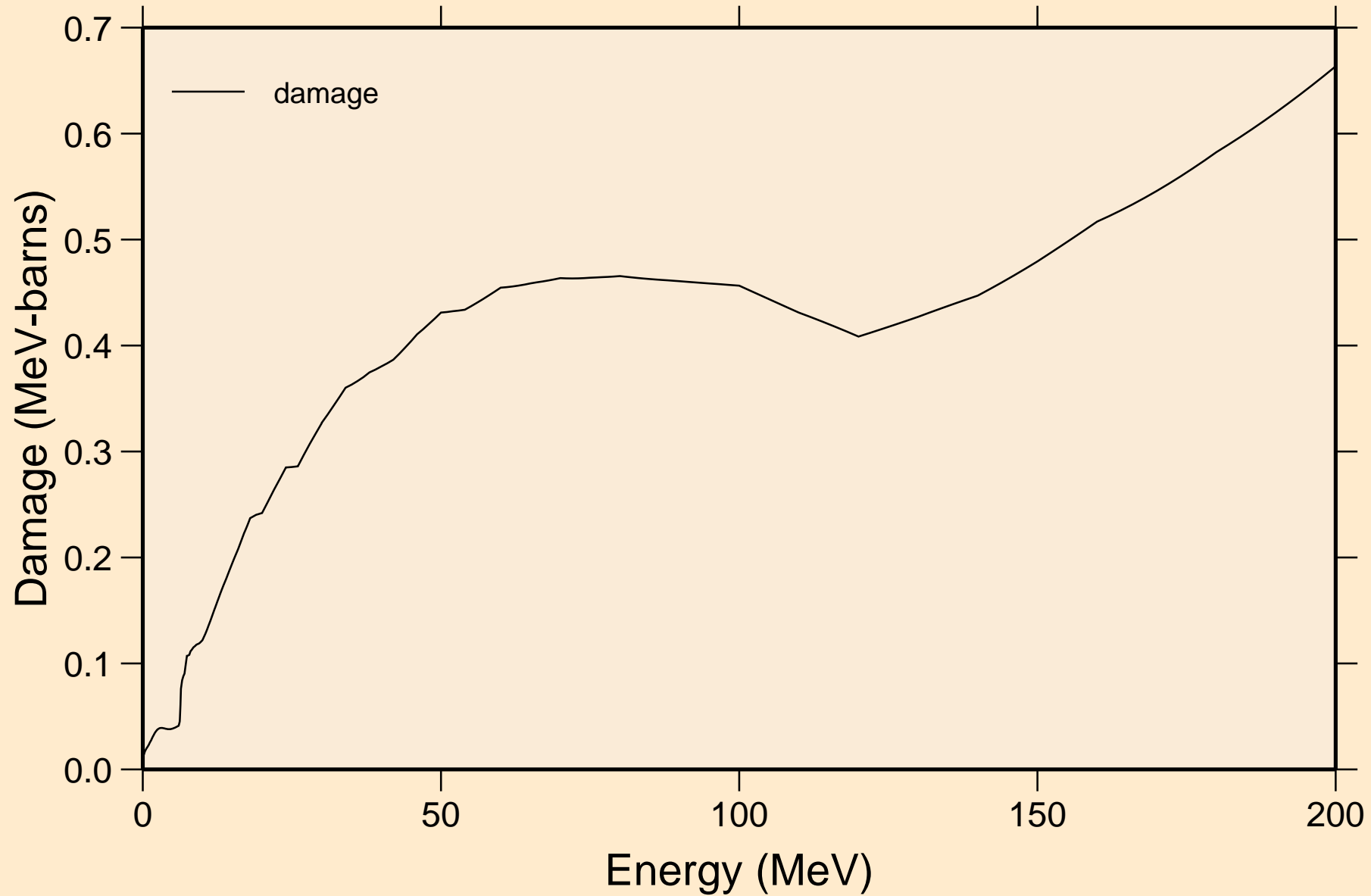

TA174 NEUTRON ACER TENDL-2023 LIBRARY; T=0.K
Non-threshold reactions

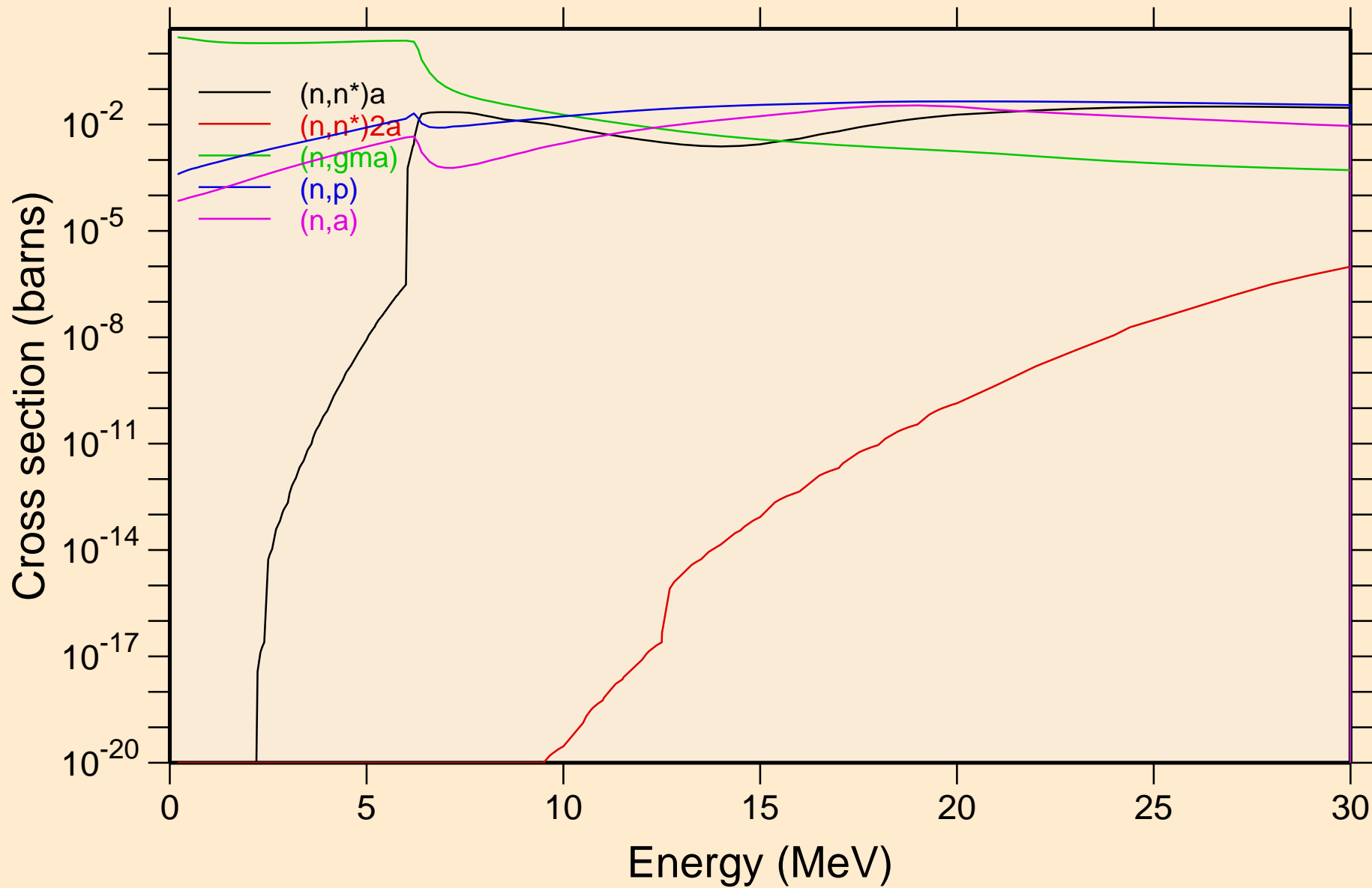

TA174 NEUTRON ACER TENDL-2023 LIBRARY; T=0.K
Non-threshold reactions

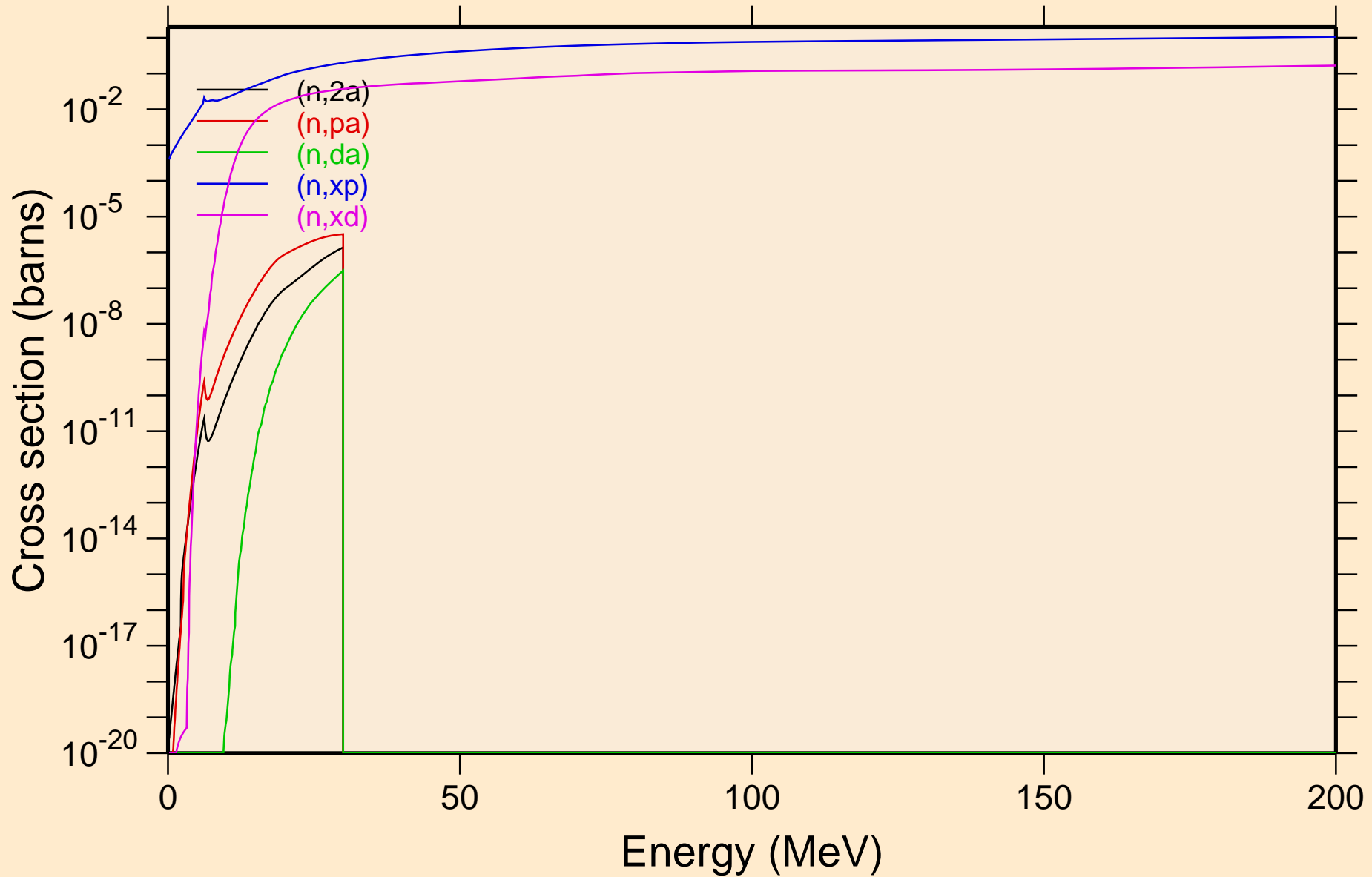

TA174 NEUTRON ACER TENDL-2023 LIBRARY; T=0.K
Non-threshold reactions

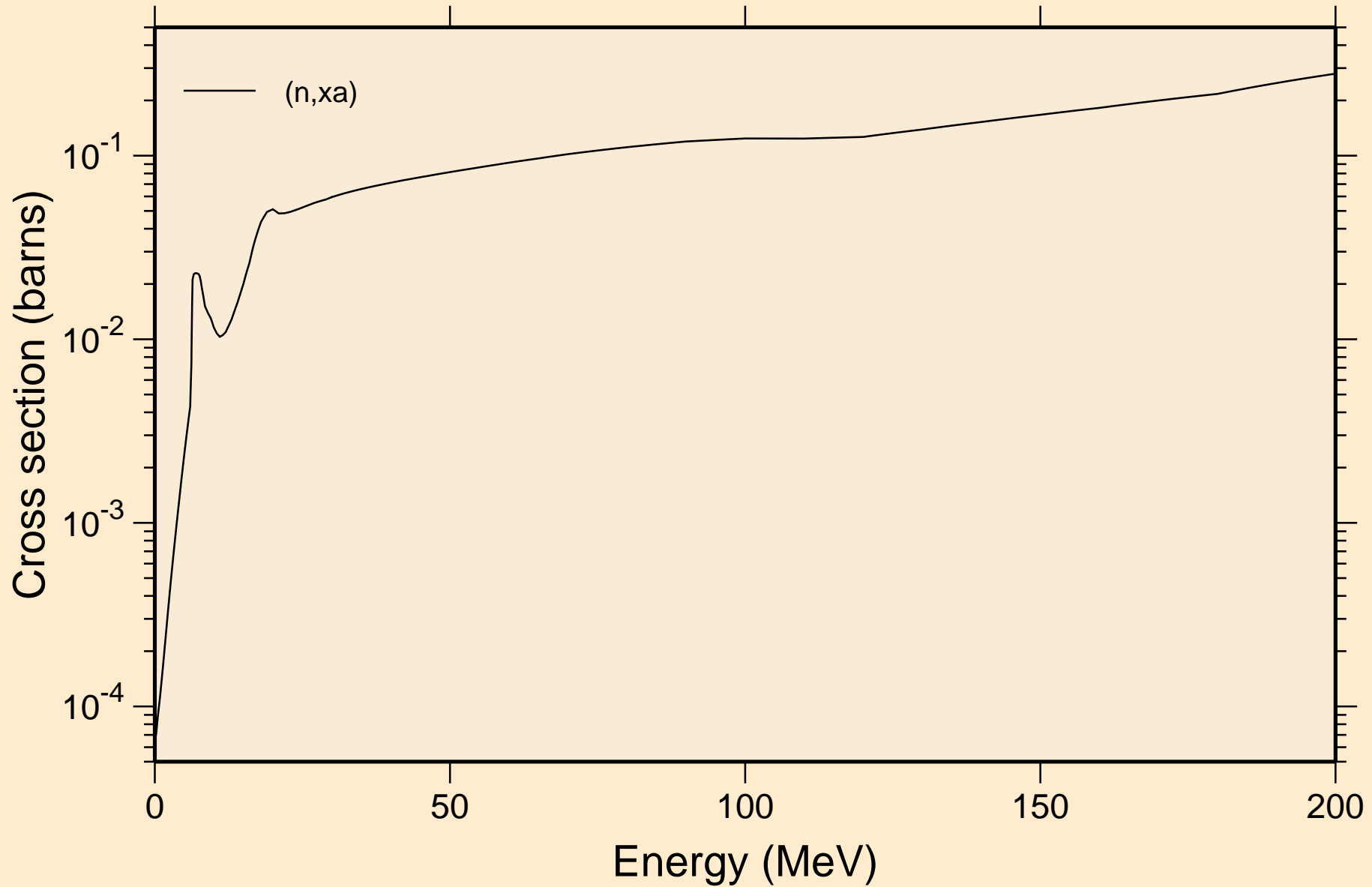

TA174 NEUTRON ACER TENDL-2023 LIBRARY; T=0.K
Inelastic levels

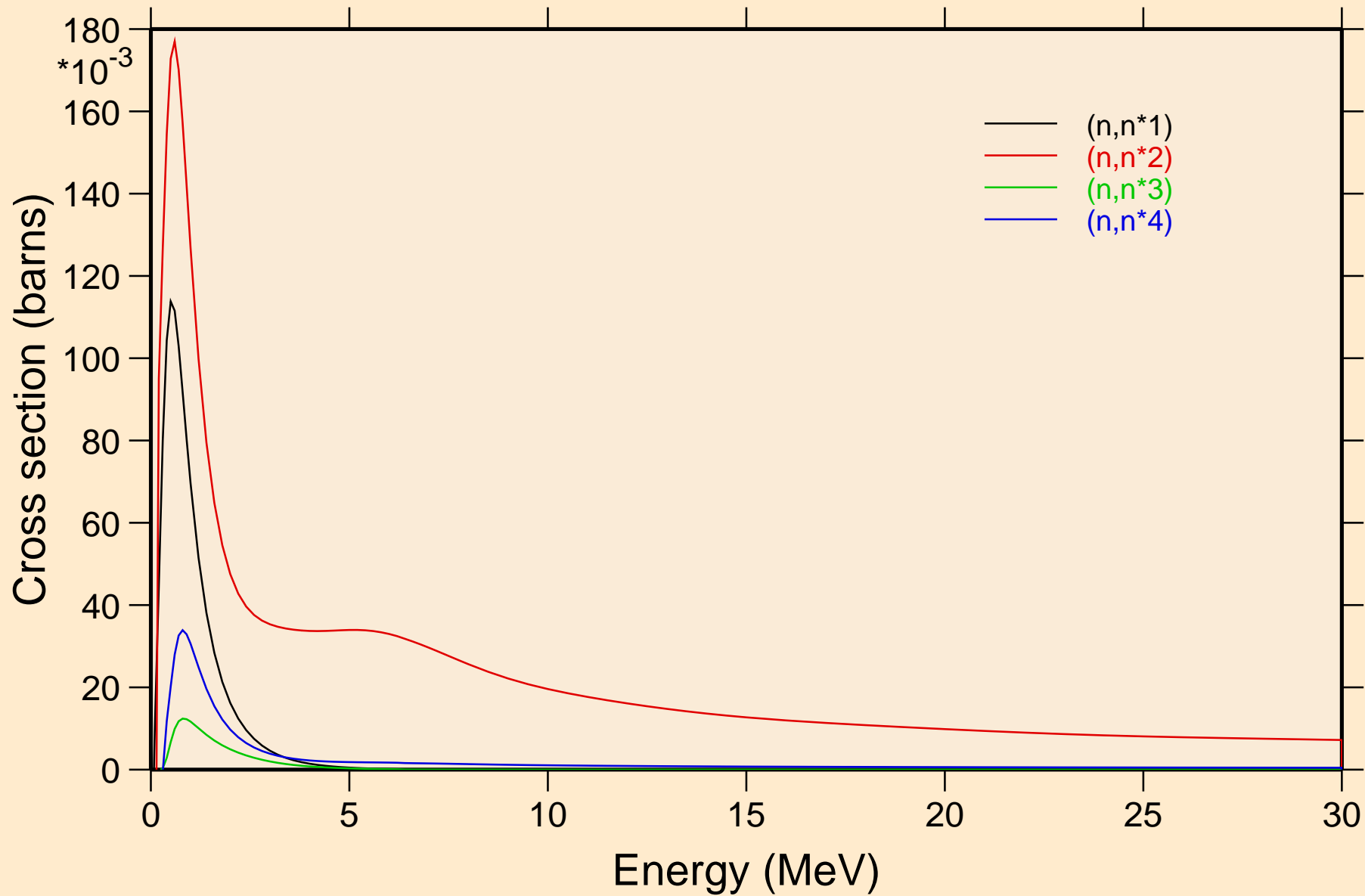

TA174 NEUTRON ACER TENDL-2023 LIBRARY; T=0.K
Threshold reactions

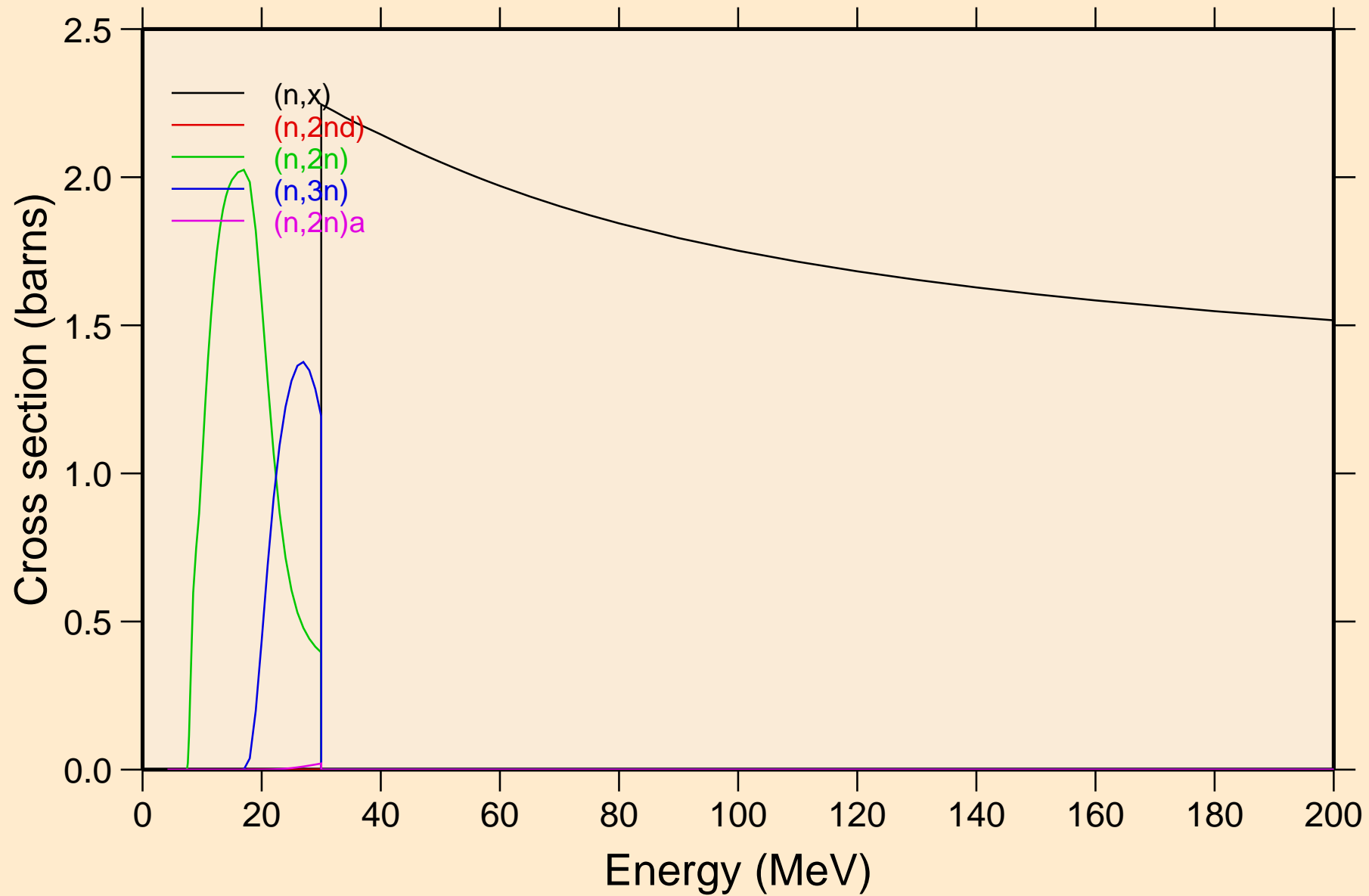

TA174 NEUTRON ACER TENDL-2023 LIBRARY; T=0.K
Threshold reactions

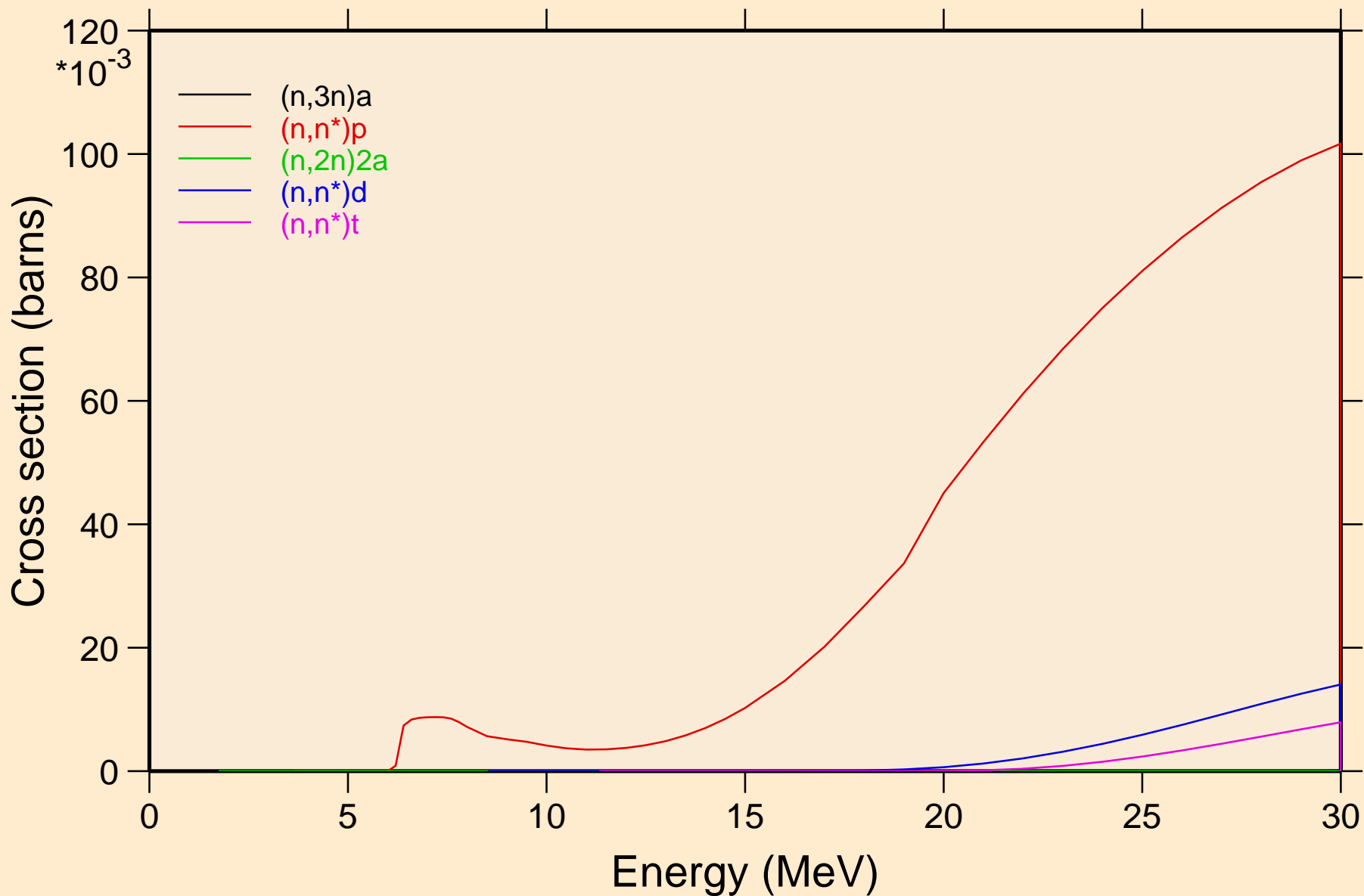

TA174 NEUTRON ACER TENDL-2023 LIBRARY; T=0.K
Threshold reactions

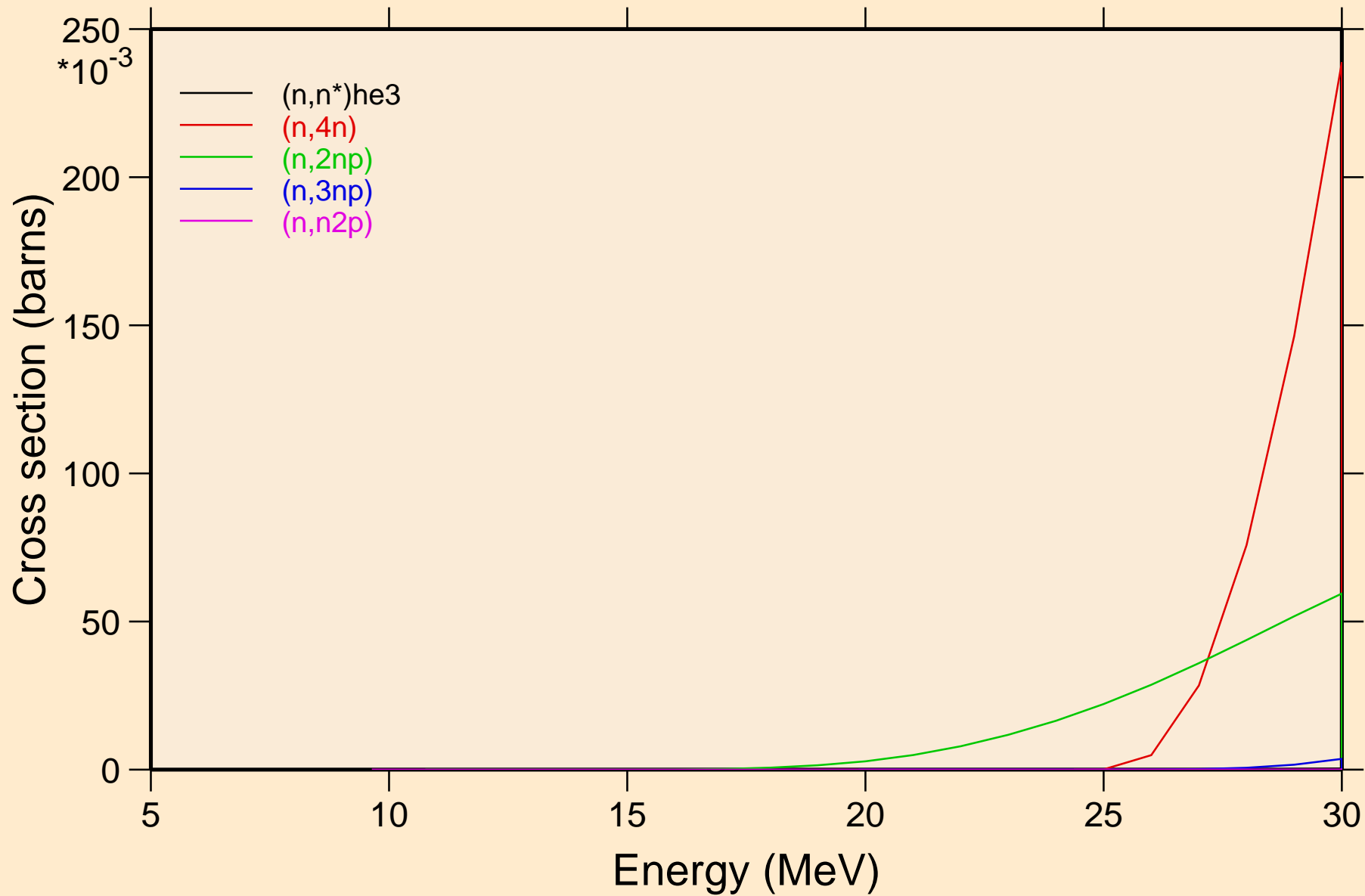

TA174 NEUTRON ACER TENDL-2023 LIBRARY; T=0.K
Threshold reactions

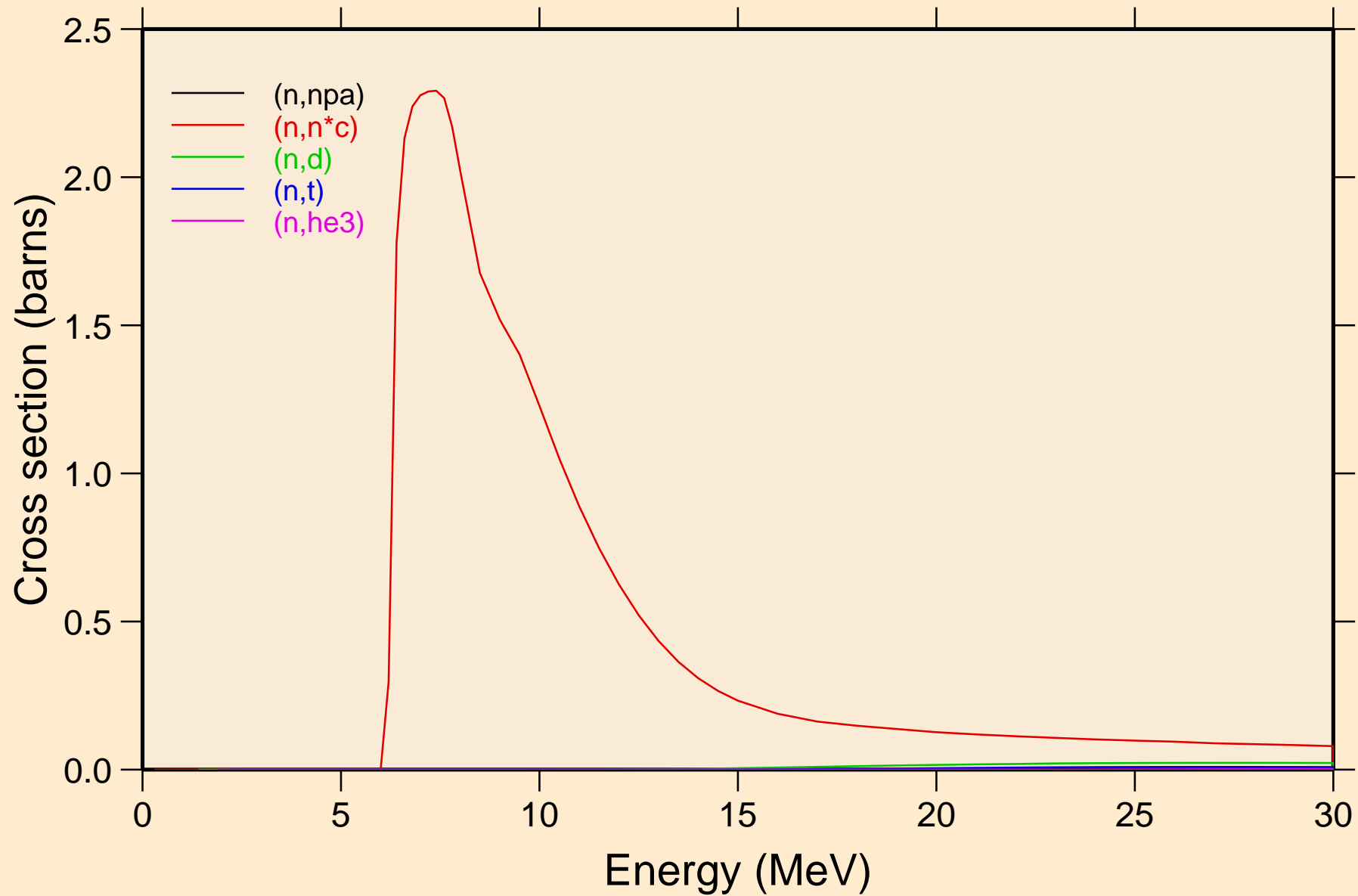

TA174 NEUTRON ACER TENDL-2023 LIBRARY; T=0.K
Threshold reactions

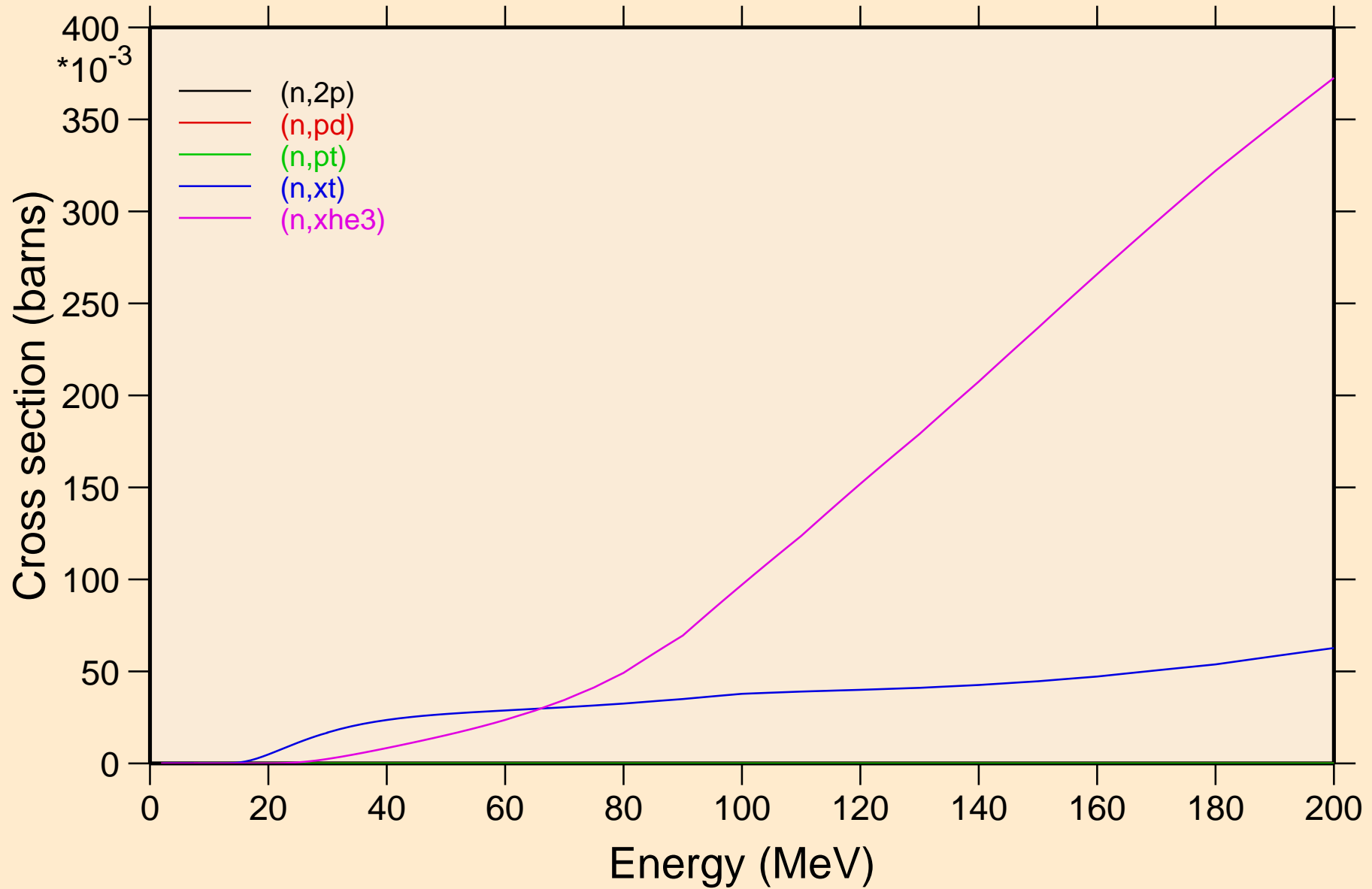

TA174 NEUTRON ACER TENDL-2023 LIBRARY; T=0.K
angular distribution for elastic

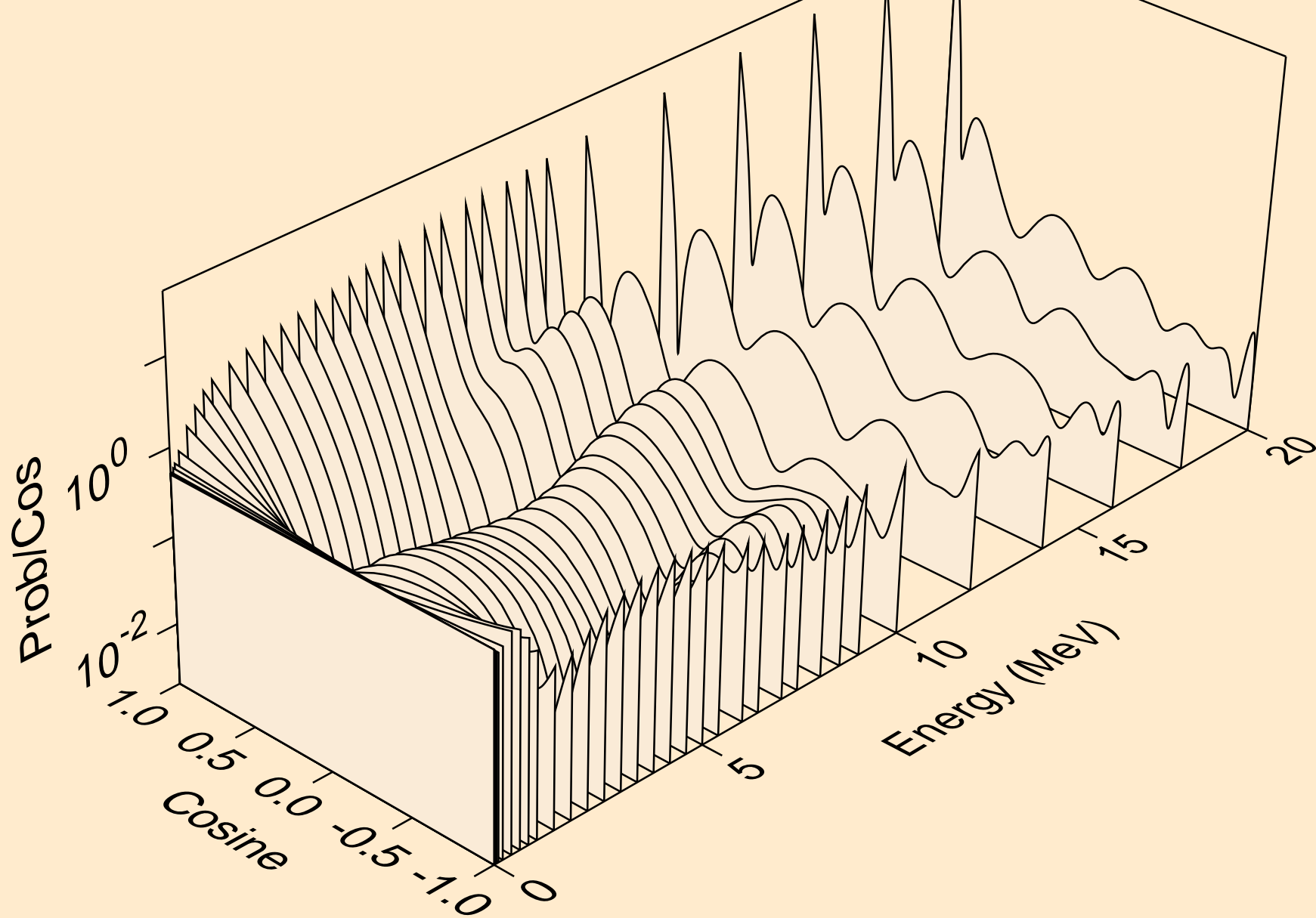

TA174 NEUTRON ACER TENDL-2023 LIBRARY; T=0.K
angular distribution for elastic

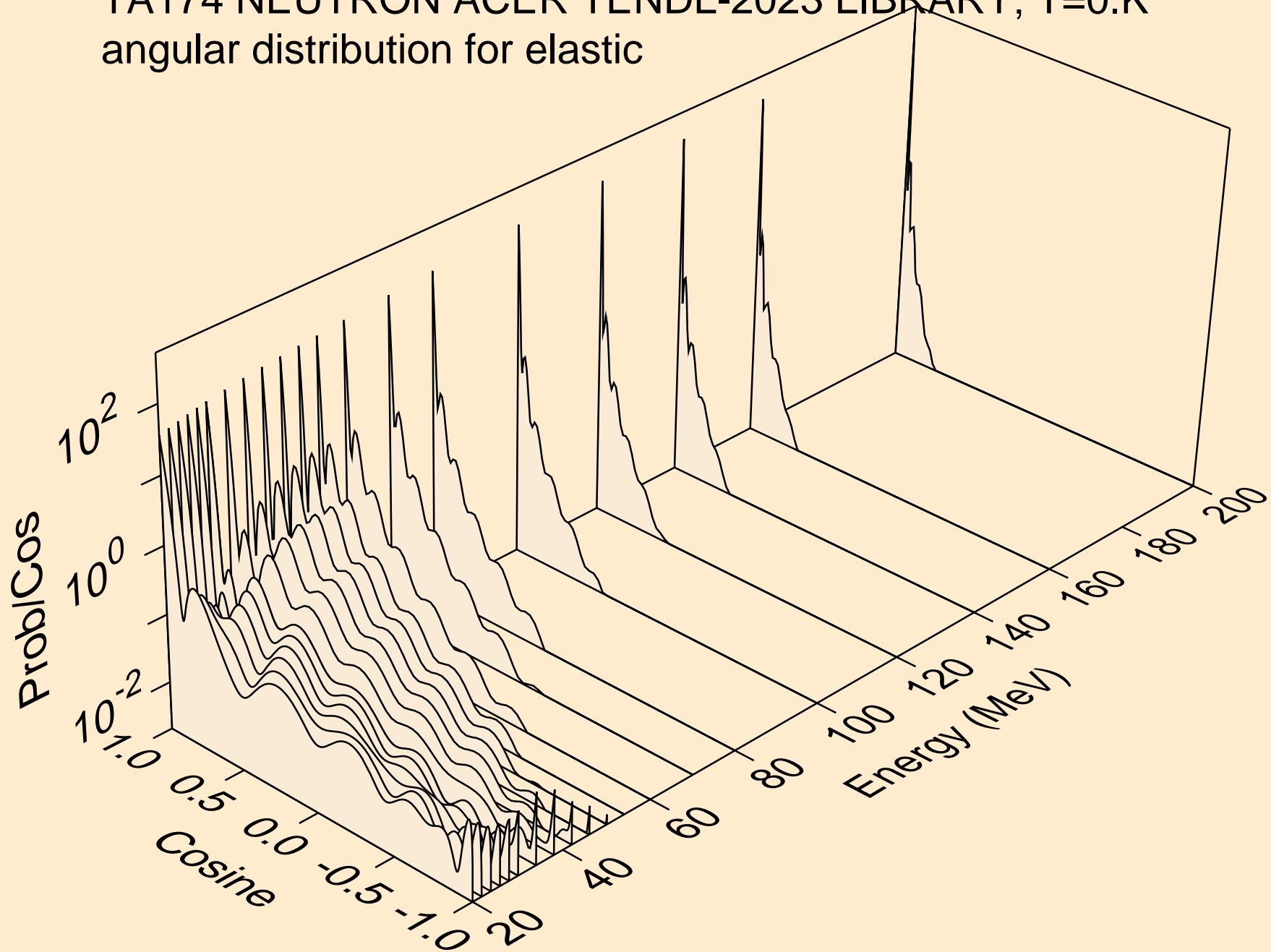

TA174 NEUTRON ACER TENDL-2023 LIBRARY; T=0.K
angular distribution for (n,n*1)

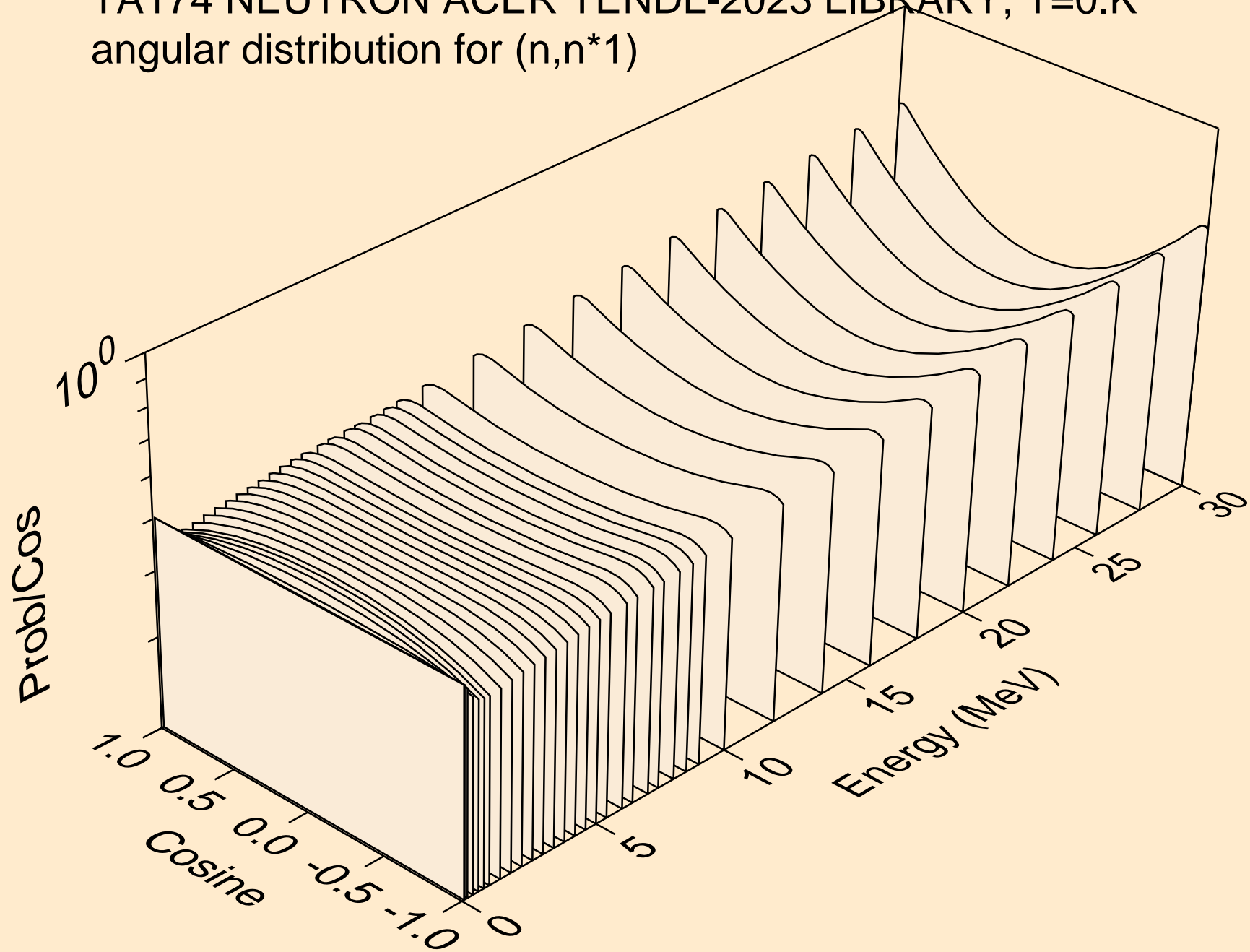

TA174 NEUTRON ACER TENDL-2023 LIBRARY; T=0.K
angular distribution for (n,n*2)

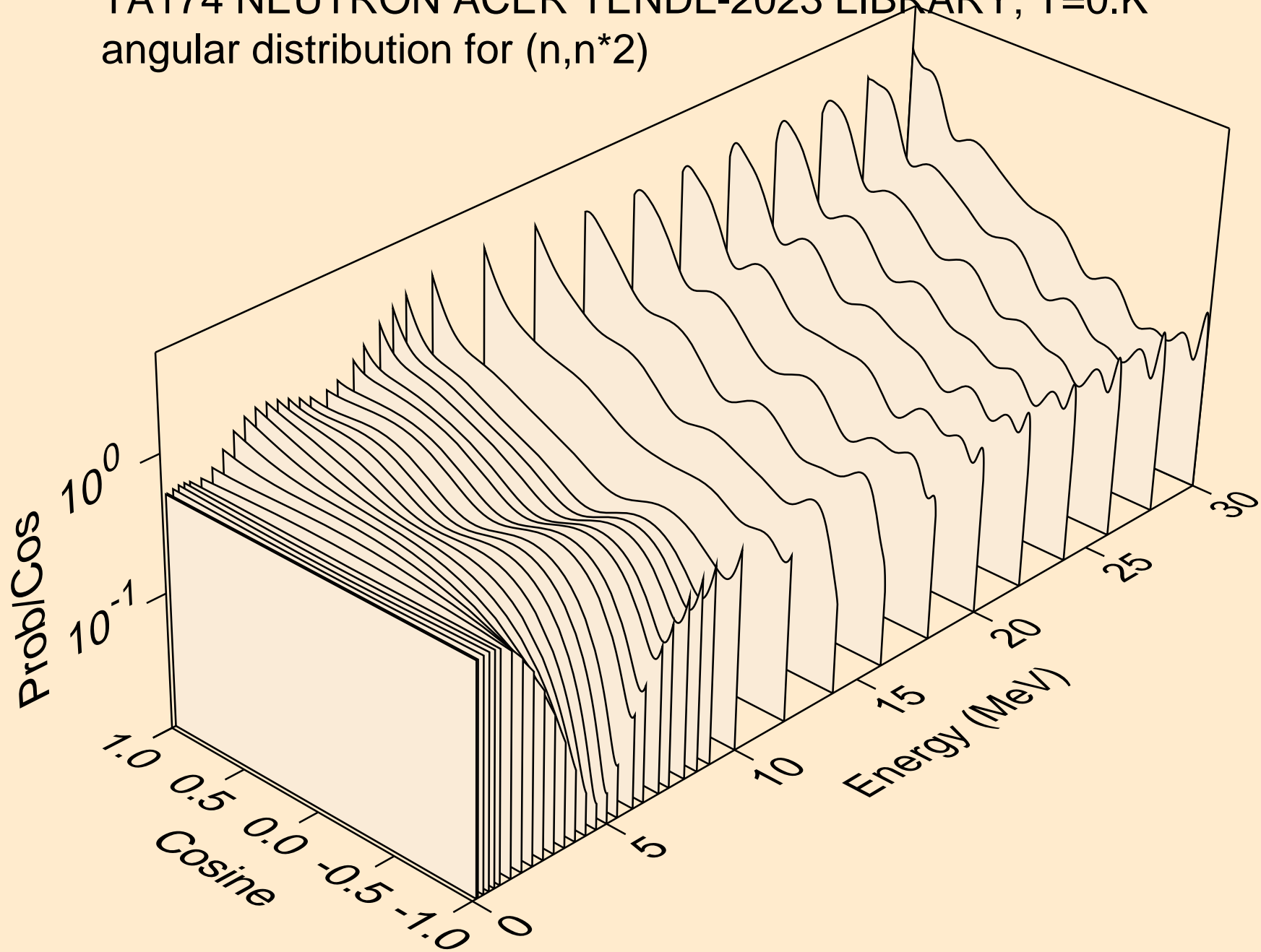

TA174 NEUTRON ACER TENDL-2023 LIBRARY; T=0.K
angular distribution for (n,n*3)

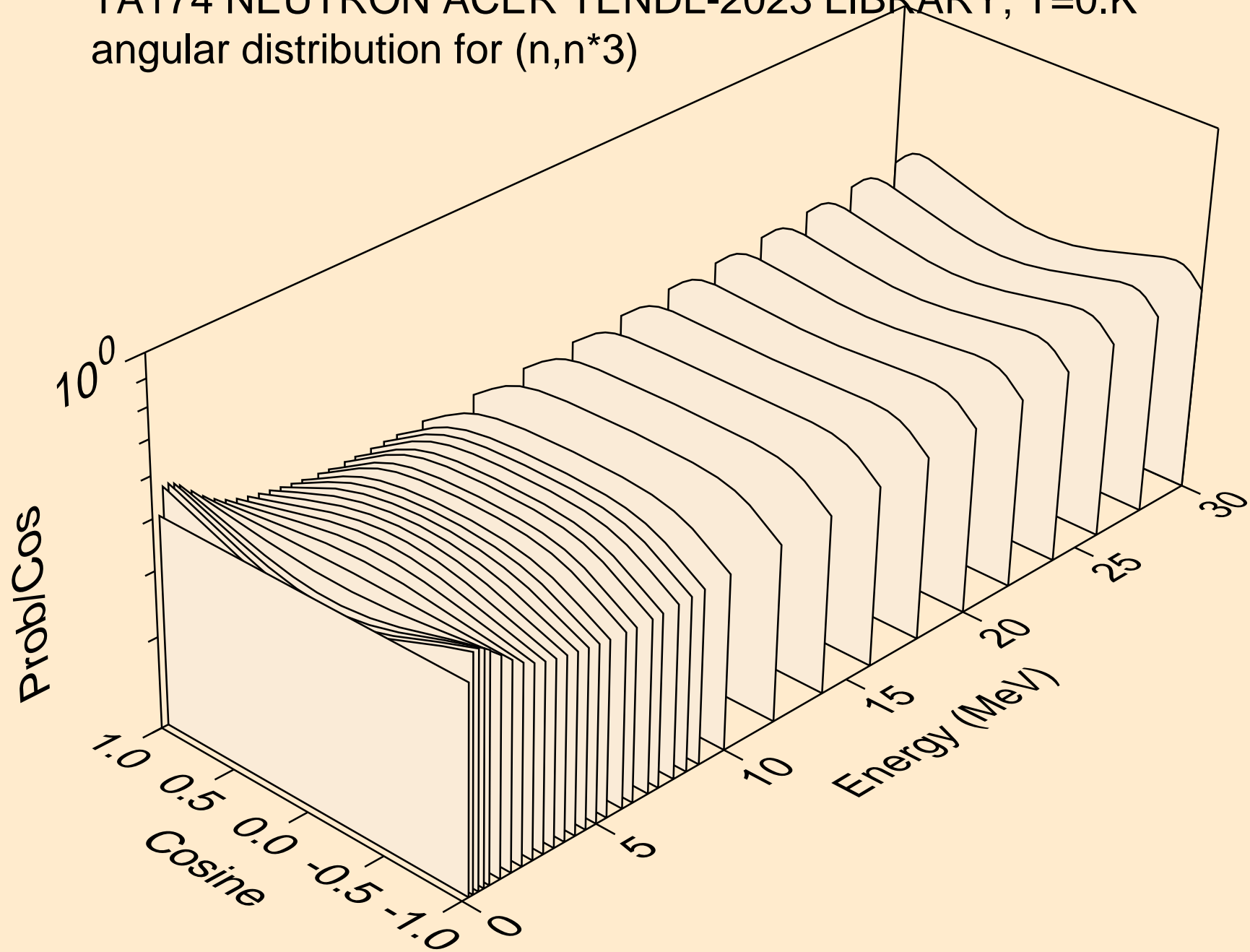

TA174 NEUTRON ACER TENDL-2023 LIBRARY; T=0.K
angular distribution for (n,n*4)

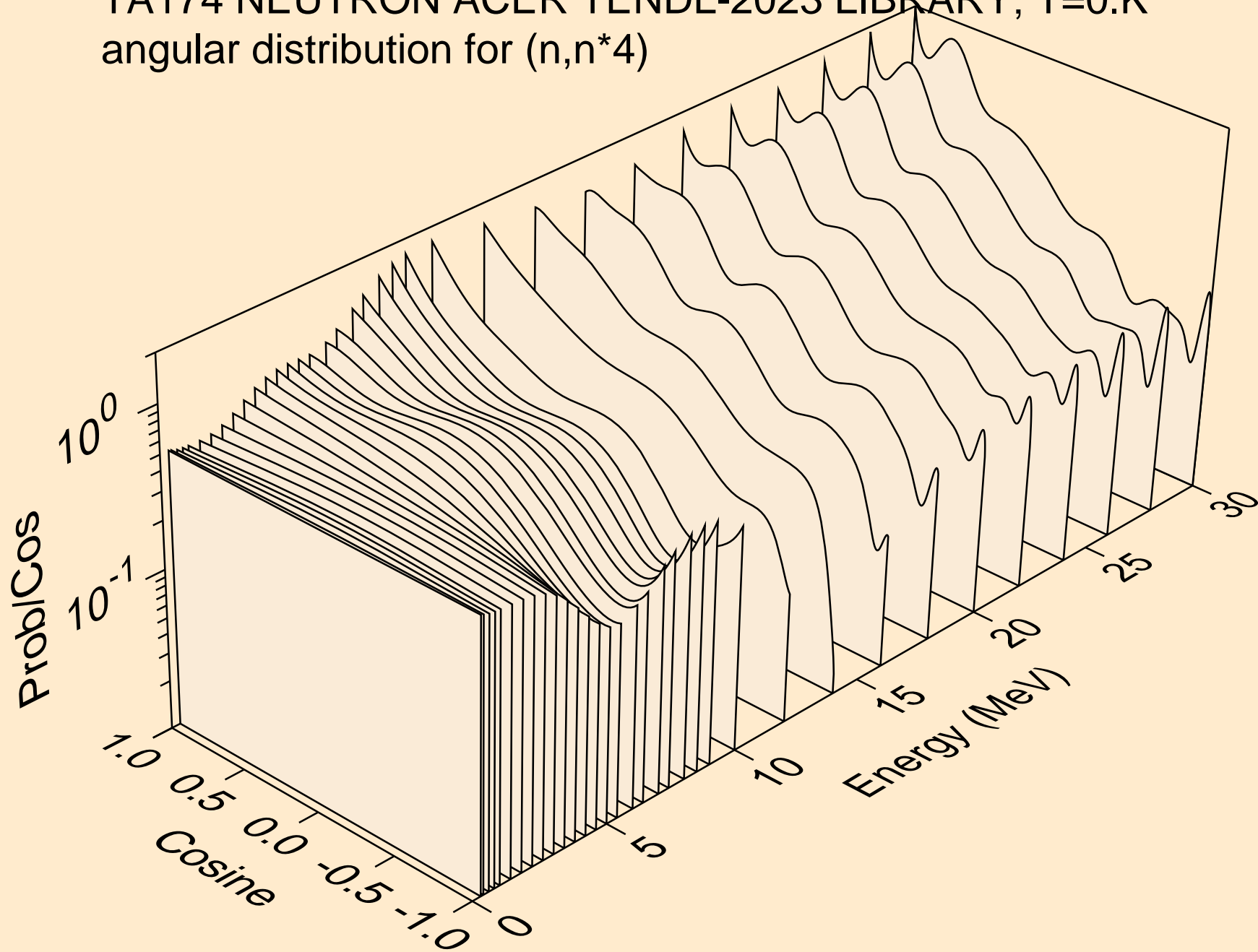

TA174 NEUTRON ACER TENDL-2023 LIBRARY; T=0.K
Neutron emission for (n,x)

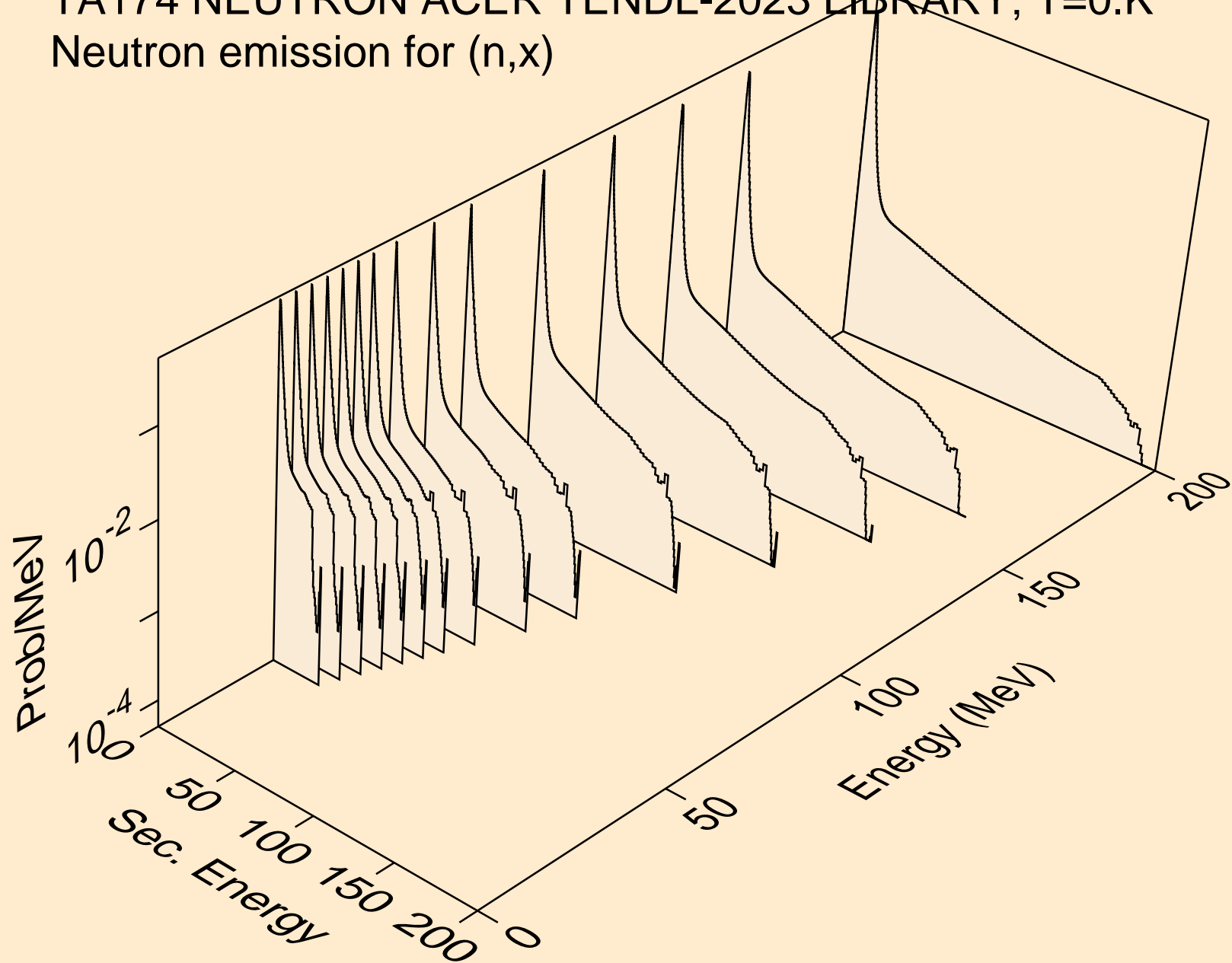

TA174 NEUTRON ACER TENDL-2023 LIBRARY; T=0.K
Neutron emission for (n,2nd)

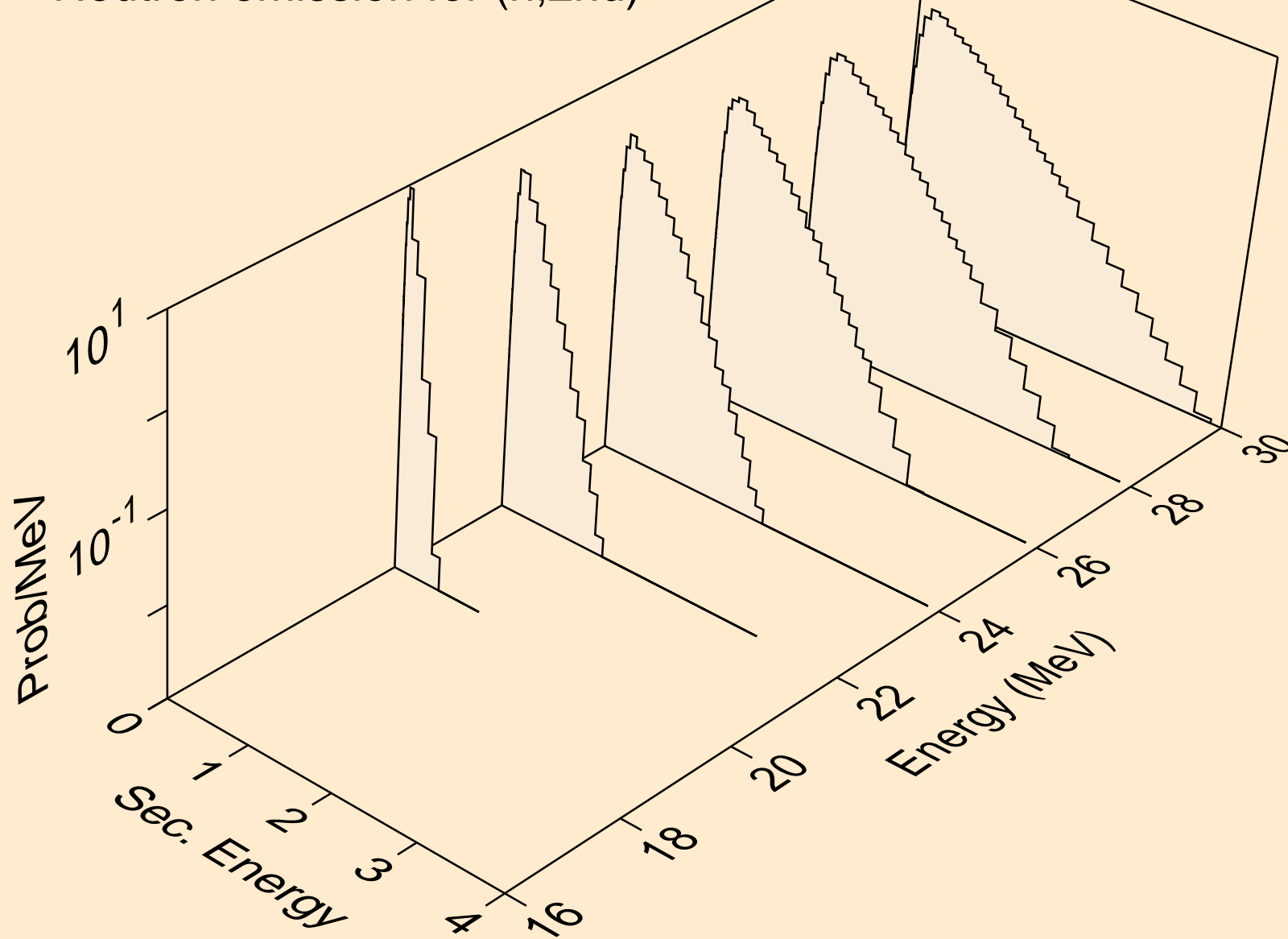

TA174 NEUTRON ACER TENDL-2023 LIBRARY; T=0.K
Neutron emission for (n,2n)

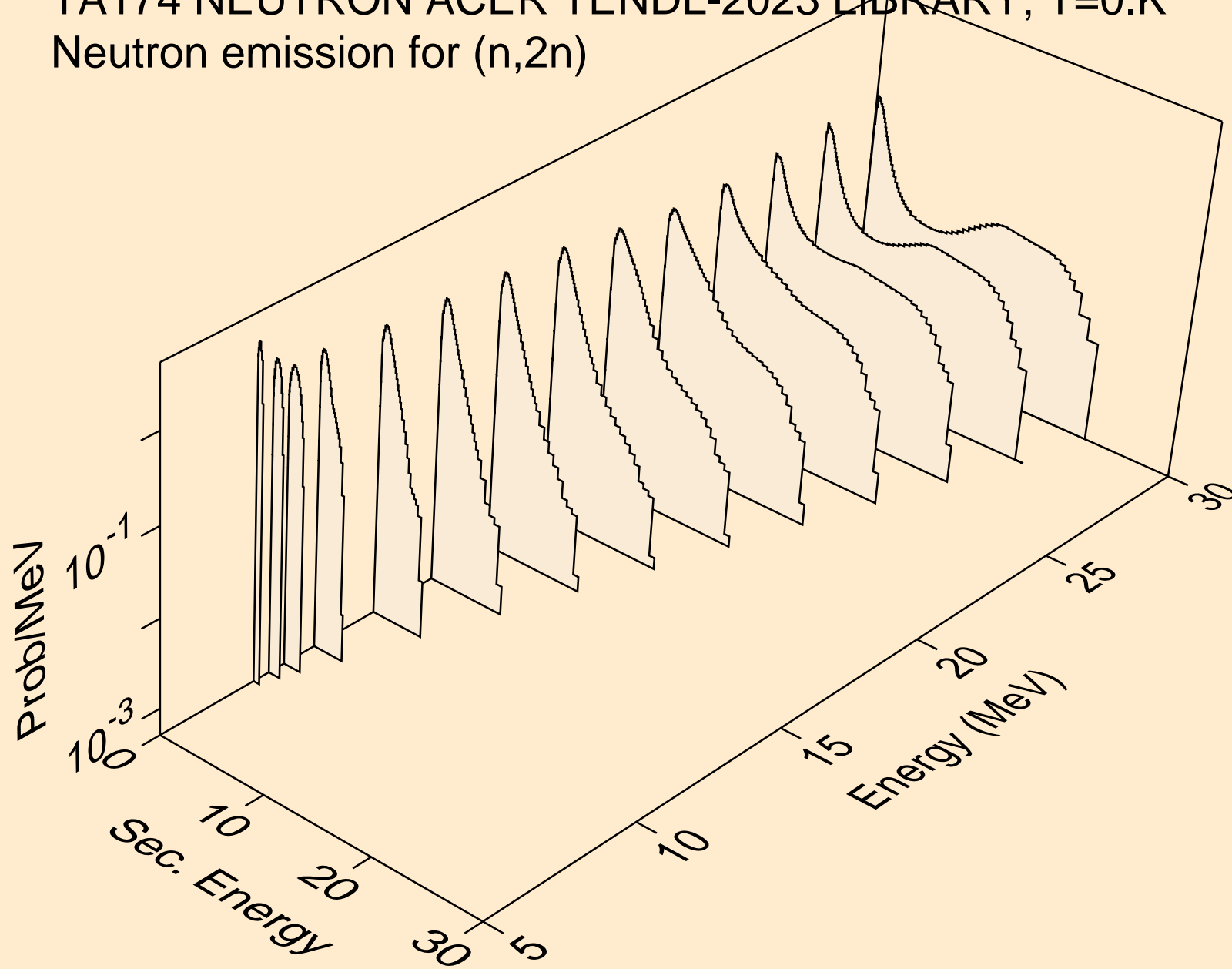

TA174 NEUTRON ACER TENDL-2023 LIBRARY; T=0.K
Neutron emission for (n,3n)

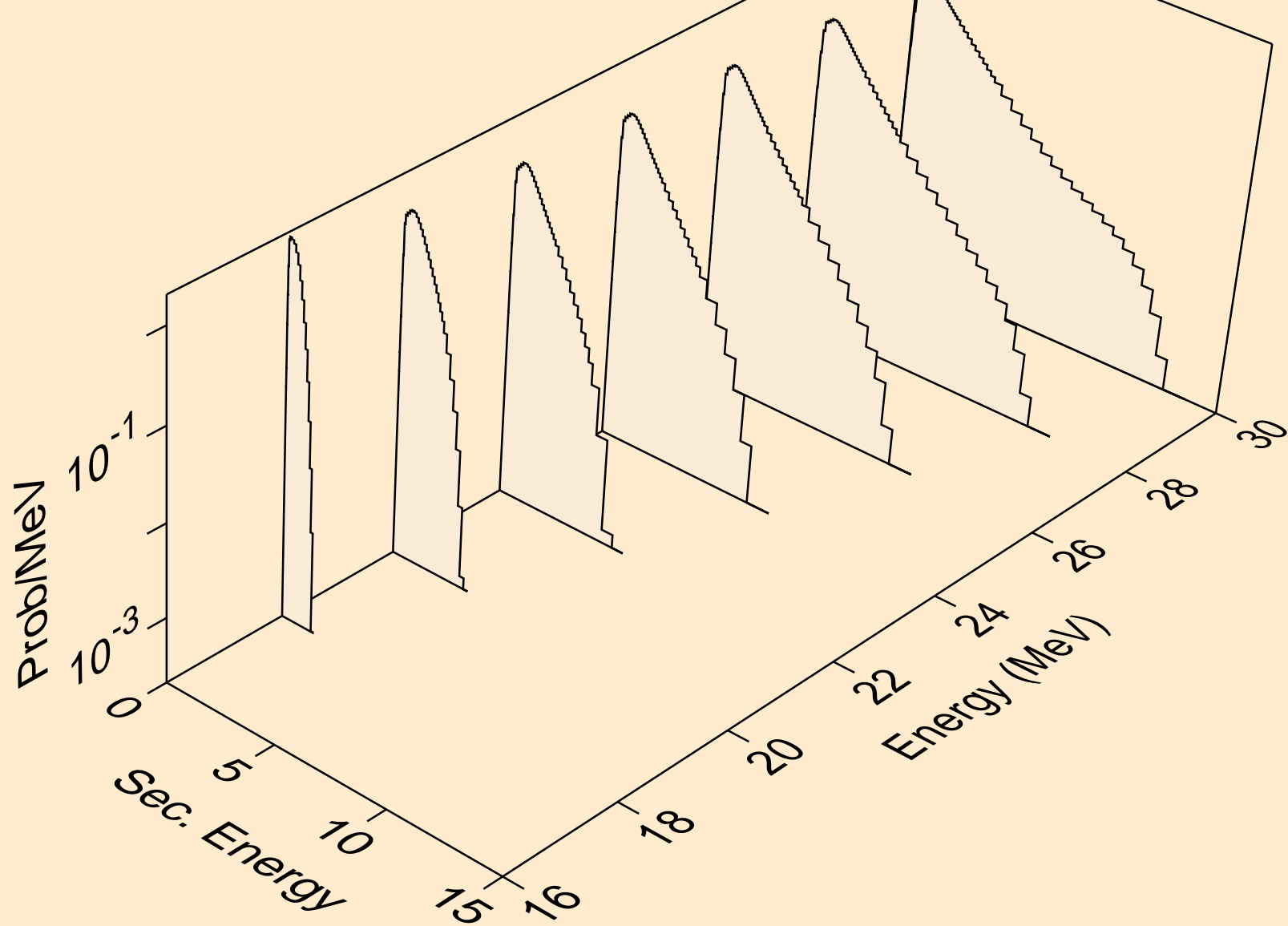

TA174 NEUTRON ACER TENDL-2023 LIBRARY; T=0.K
Neutron emission for (n,n*)a

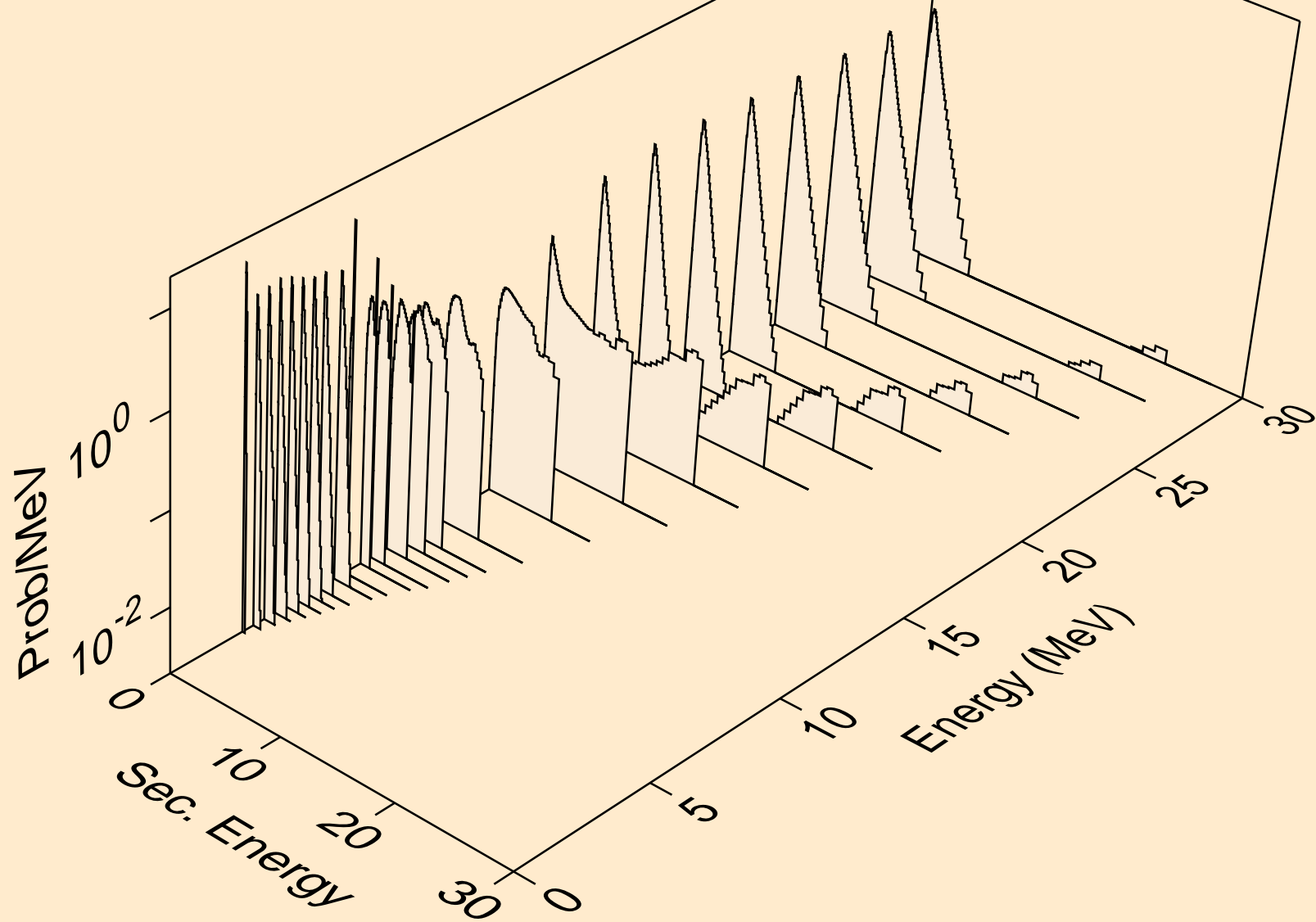

TA174 NEUTRON ACER TENDL-2023 LIBRARY; T=0.K
Neutron emission for (n,2n)a

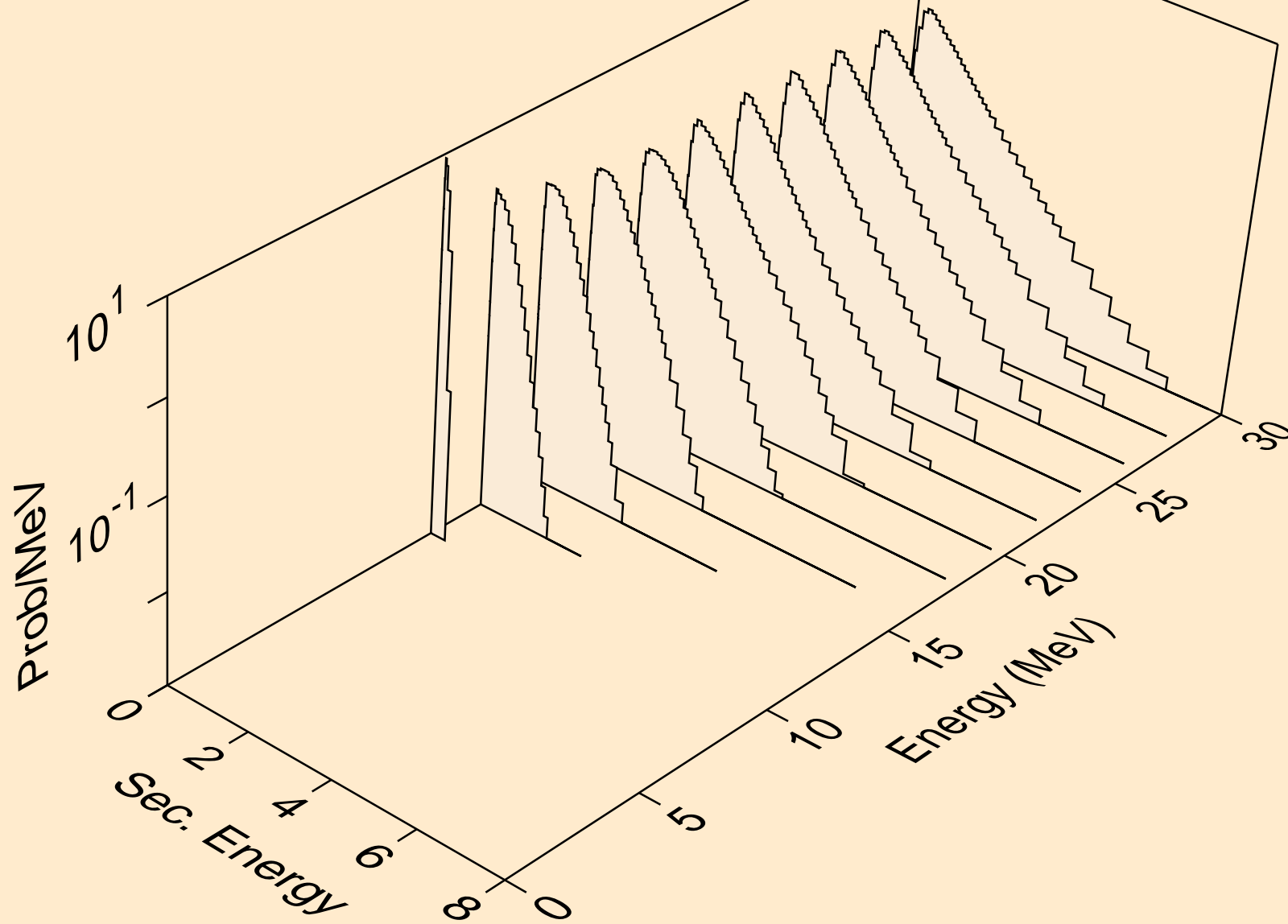

TA174 NEUTRON ACER TENDL-2023 LIBRARY; T=0.K
Neutron emission for (n,3n)a

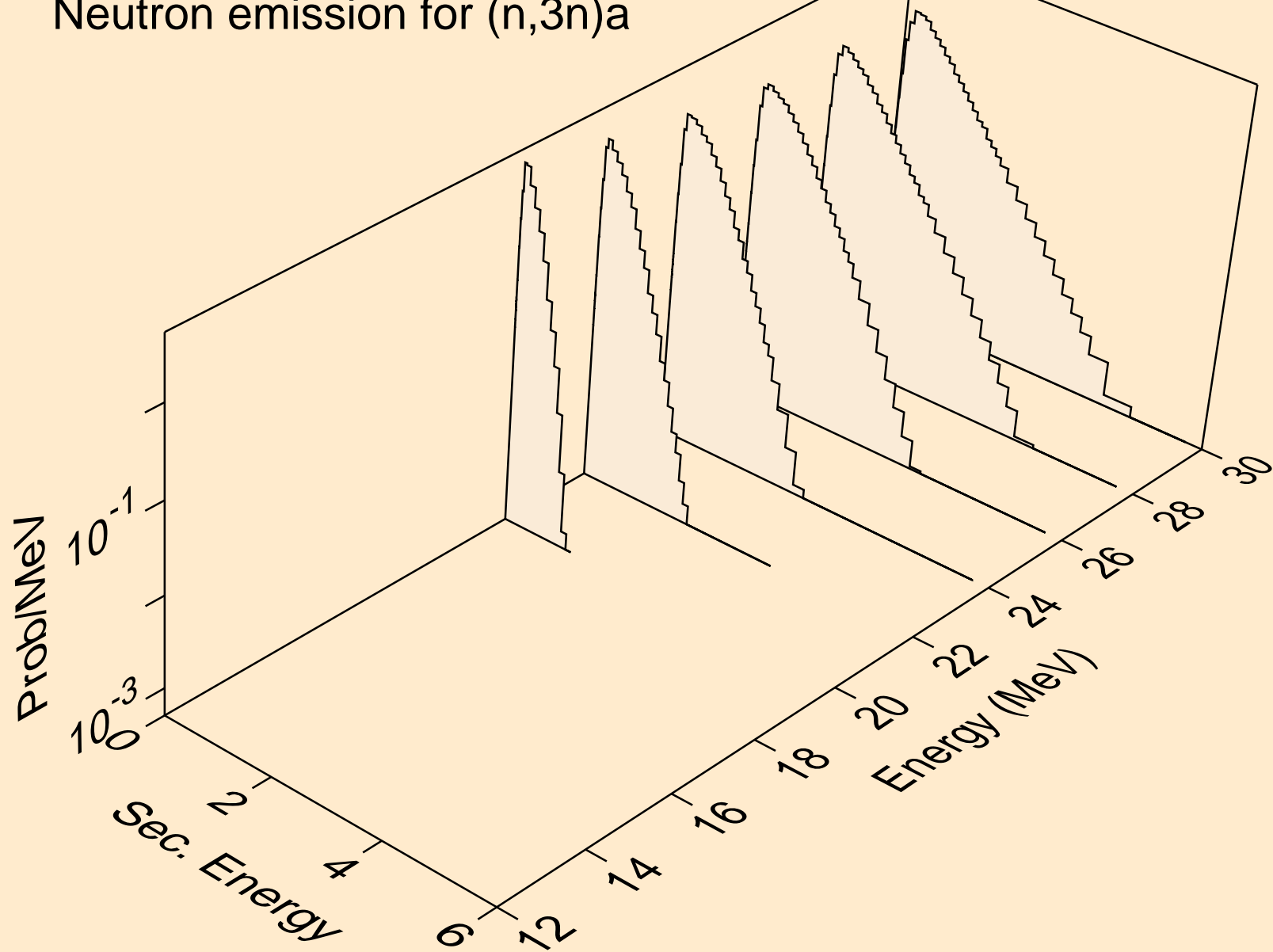

TA174 NEUTRON ACER TENDL-2023 LIBRARY; T=0.K
Neutron emission for (n,n*)p

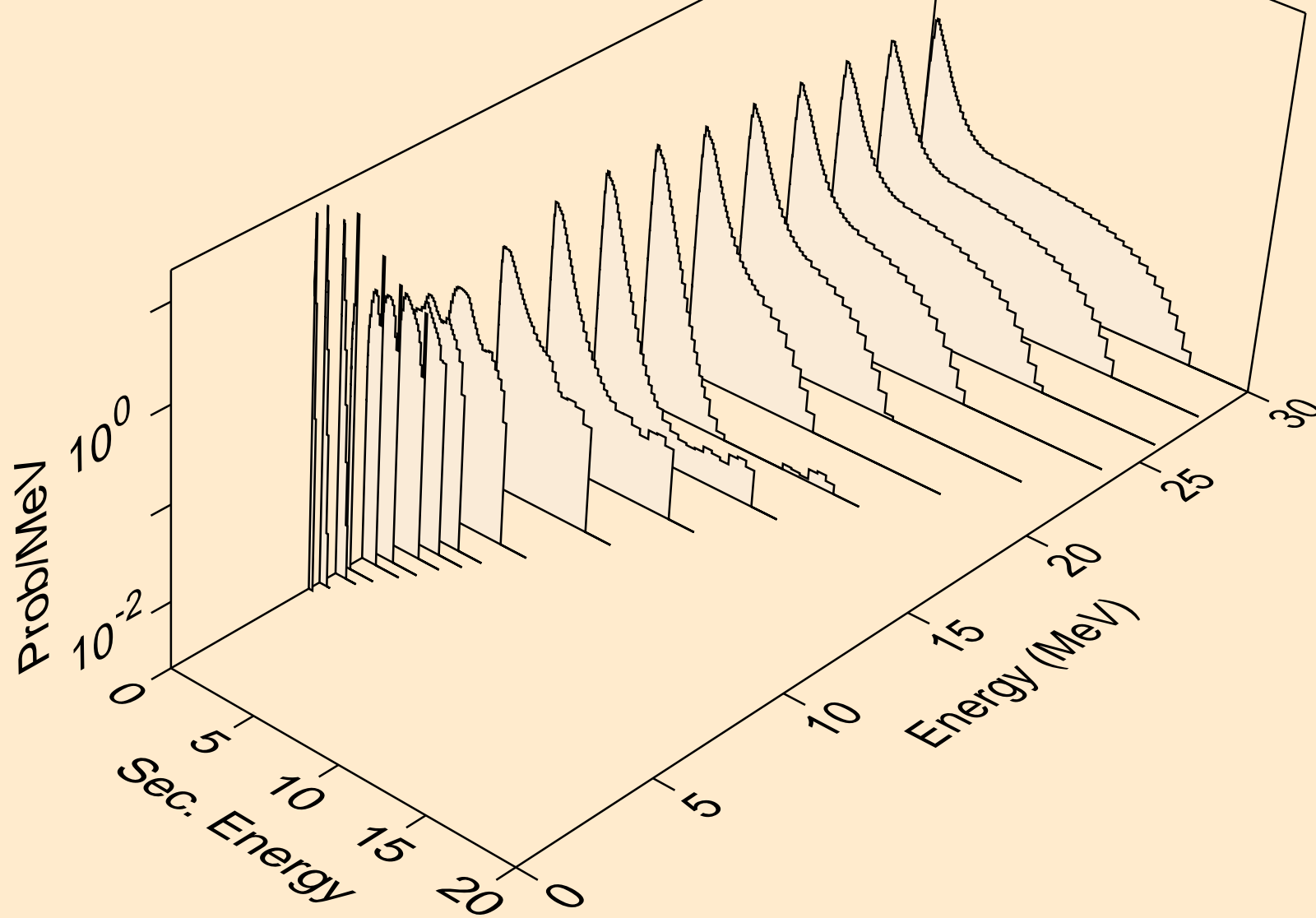

TA174 NEUTRON ACER TENDL-2023 LIBRARY; T=0.K
Neutron emission for (n,n*)2a

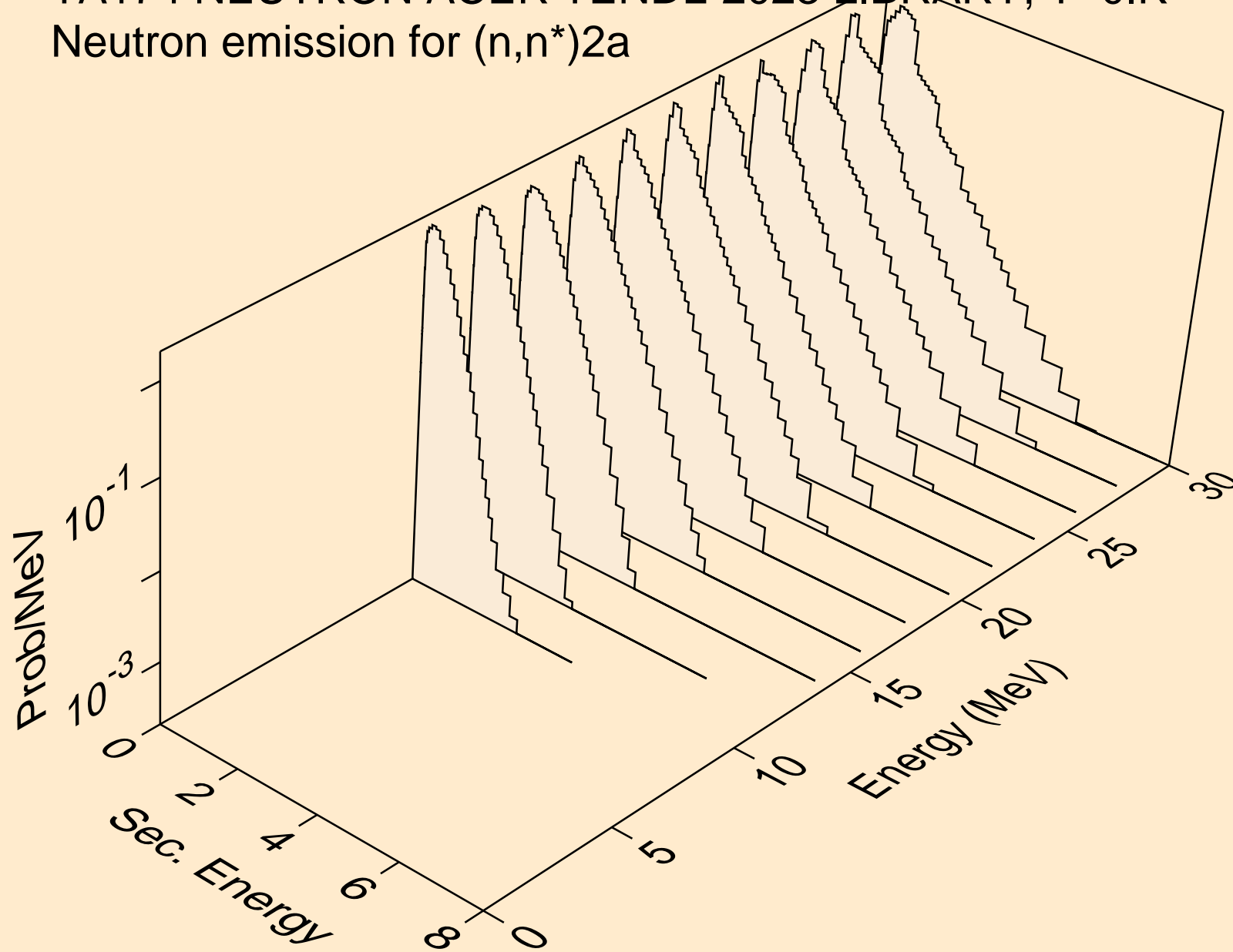

TA174 NEUTRON ACER TENDL-2023 LIBRARY; T=0.K
Neutron emission for (n,2n)2a

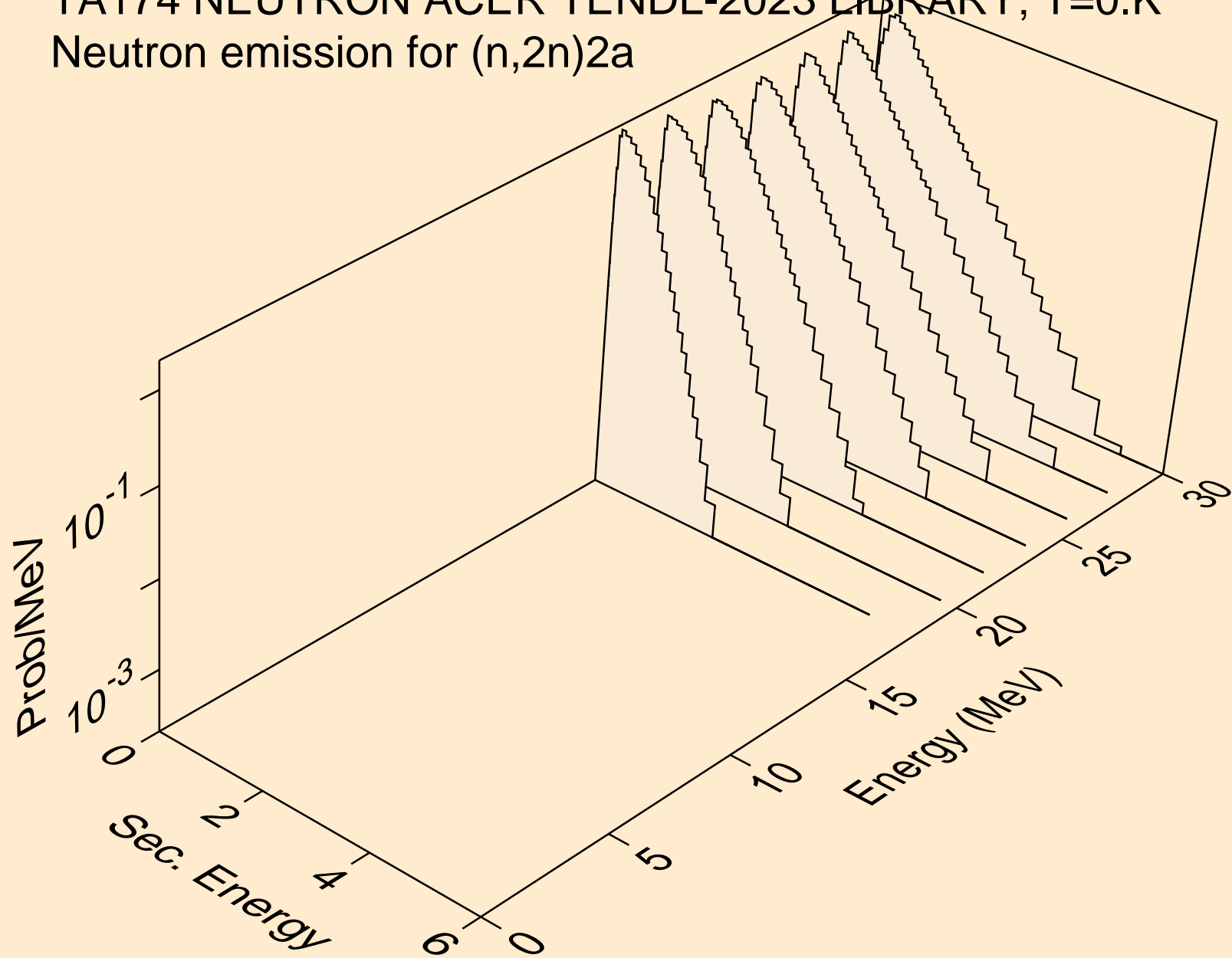

TA174 NEUTRON ACER TENDL-2023 LIBRARY; T=0.K
Neutron emission for (n,n*)d

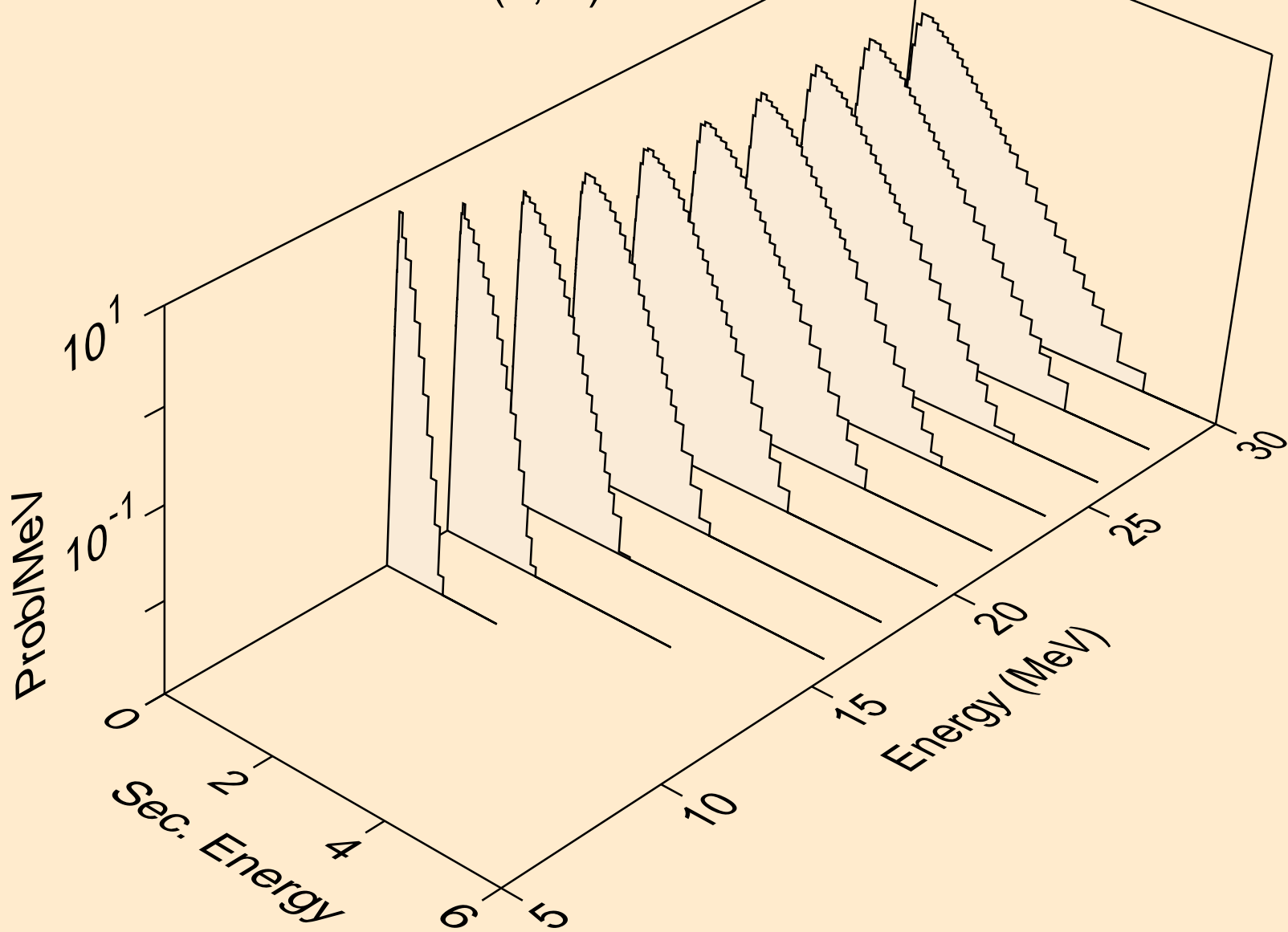

TA174 NEUTRON ACER TENDL-2023 LIBRARY; T=0.K
Neutron emission for (n,n*)t

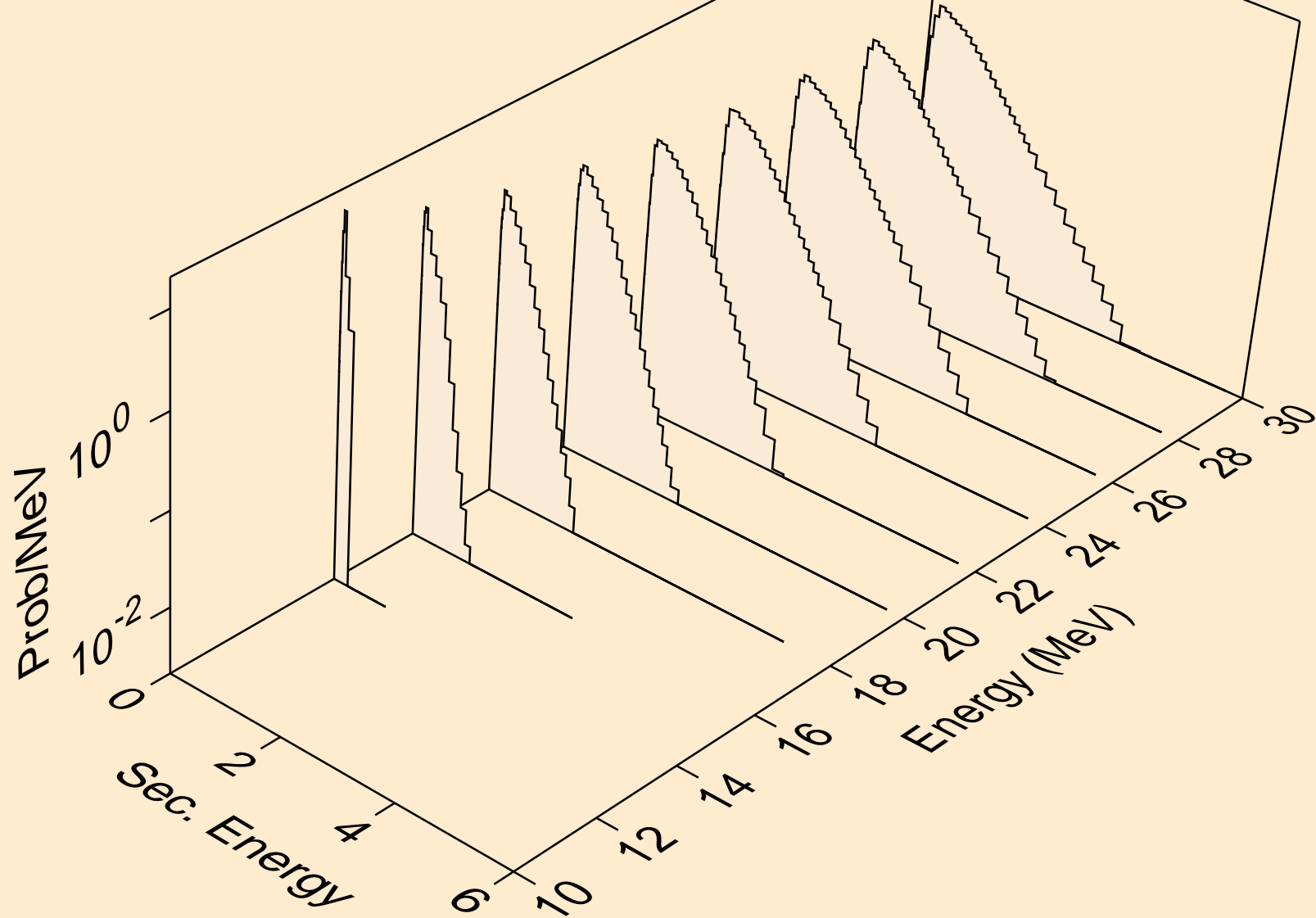

TA174 NEUTRON ACER TENDL-2023 LIBRARY; T=0.K
Neutron emission for (n,n*)he3

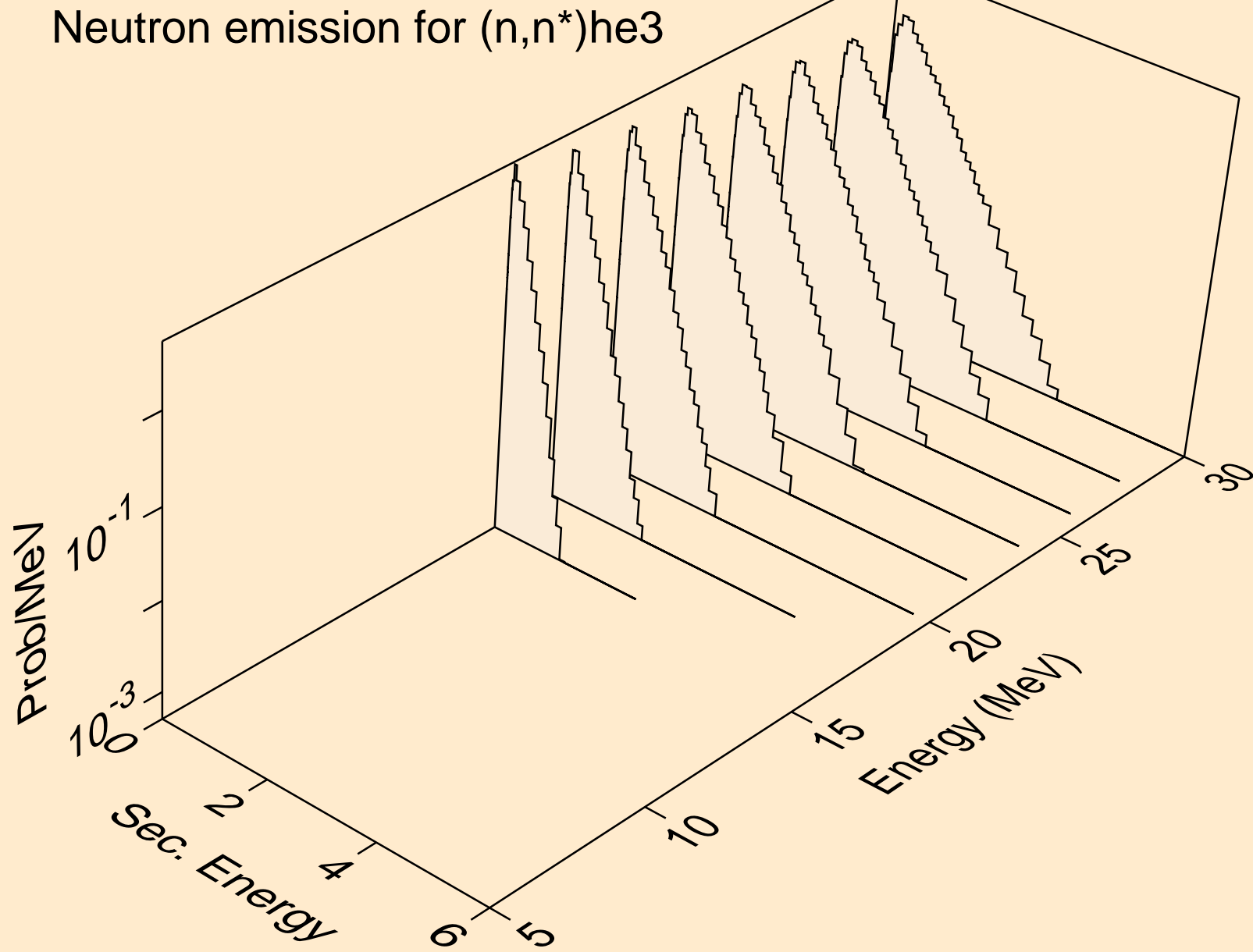

TA174 NEUTRON ACER TENDL-2023 LIBRARY; T=0.K
Neutron emission for (n,4n)

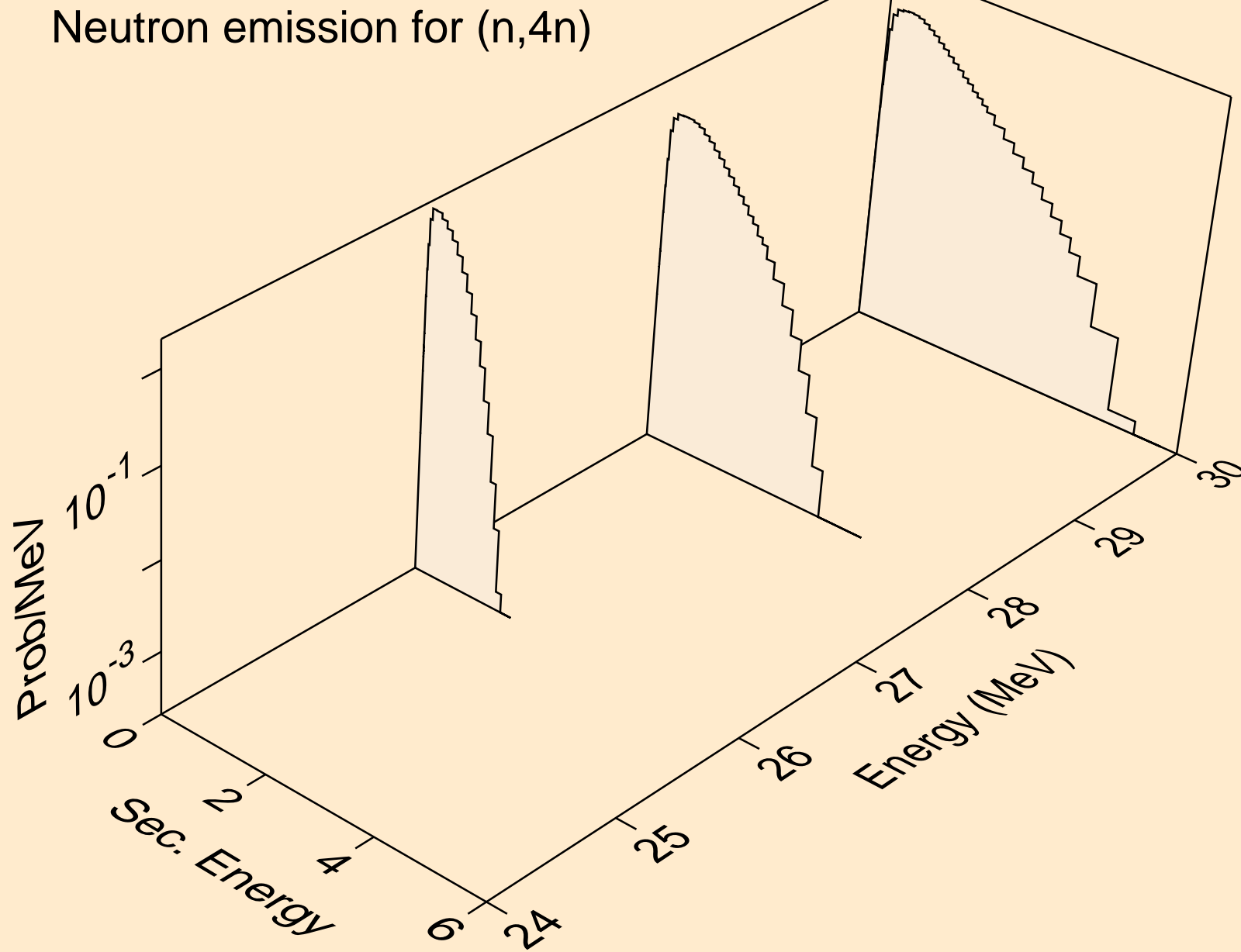

TA174 NEUTRON ACER TENDL-2023 LIBRARY; T=0.K
Neutron emission for (n,2np)

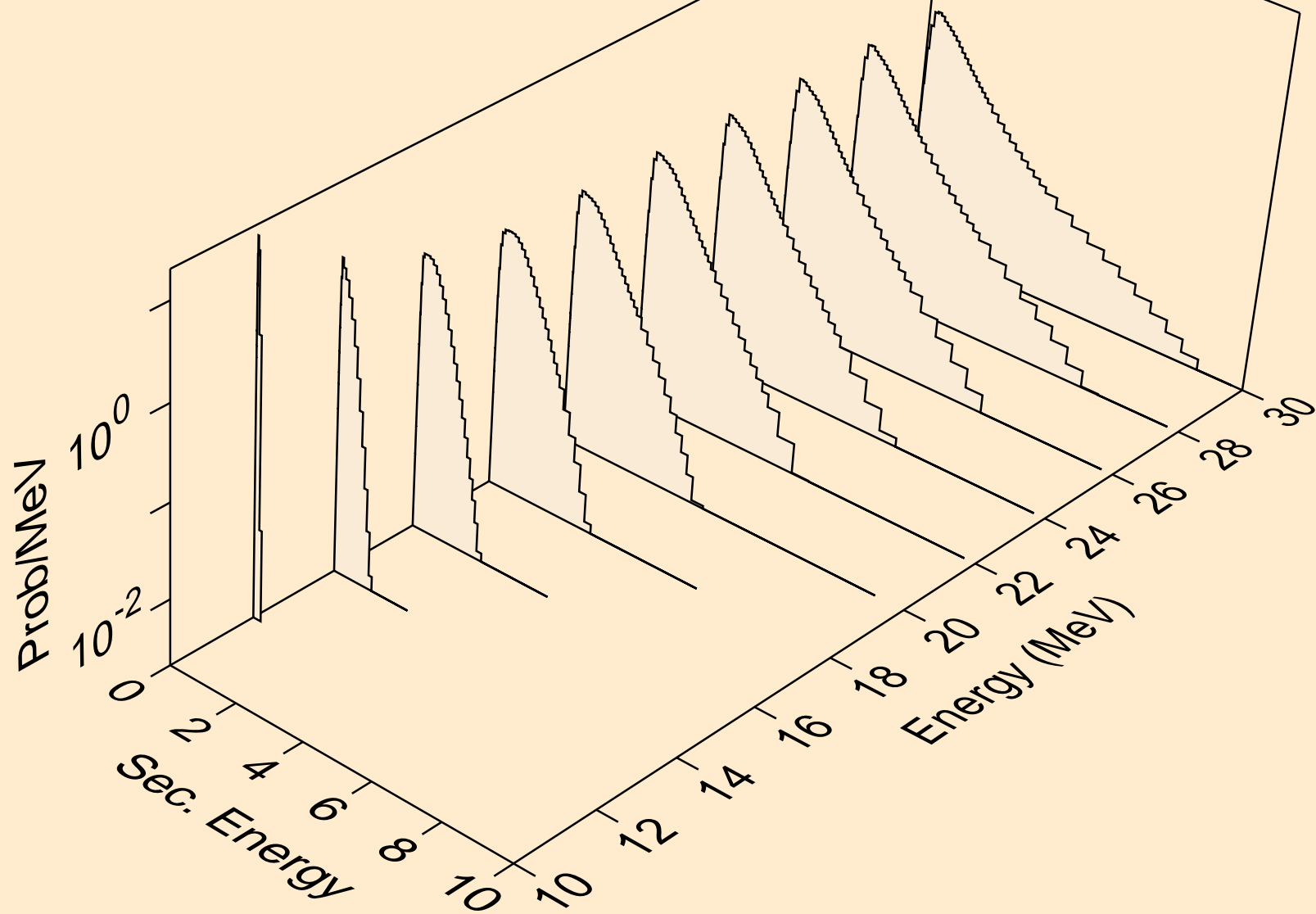

TA174 NEUTRON ACER TENDL-2023 LIBRARY; T=0.K
Neutron emission for (n,3np)

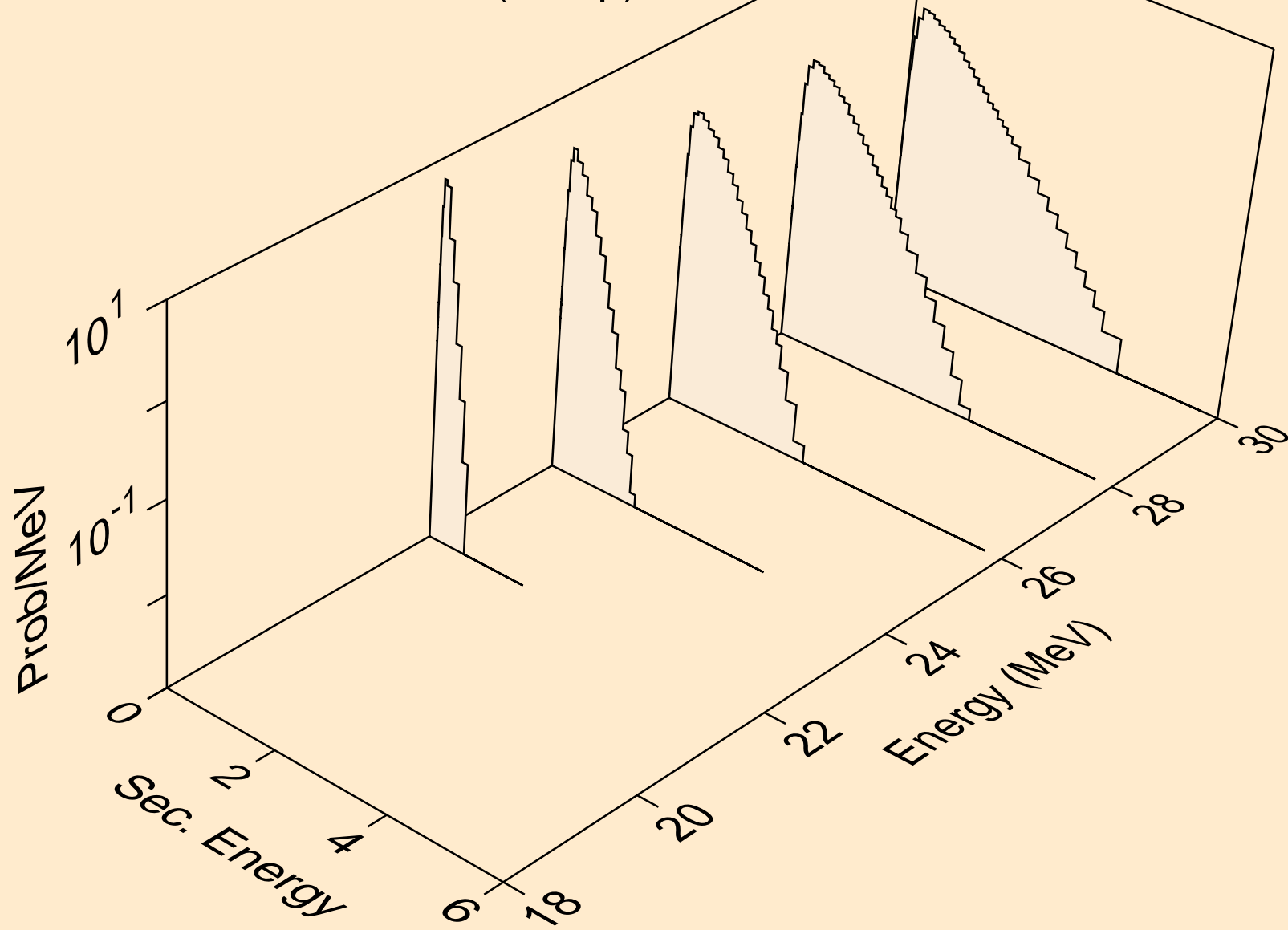

TA174 NEUTRON ACER TENDL-2023 LIBRARY; T=0.K
Neutron emission for (n,n2p)

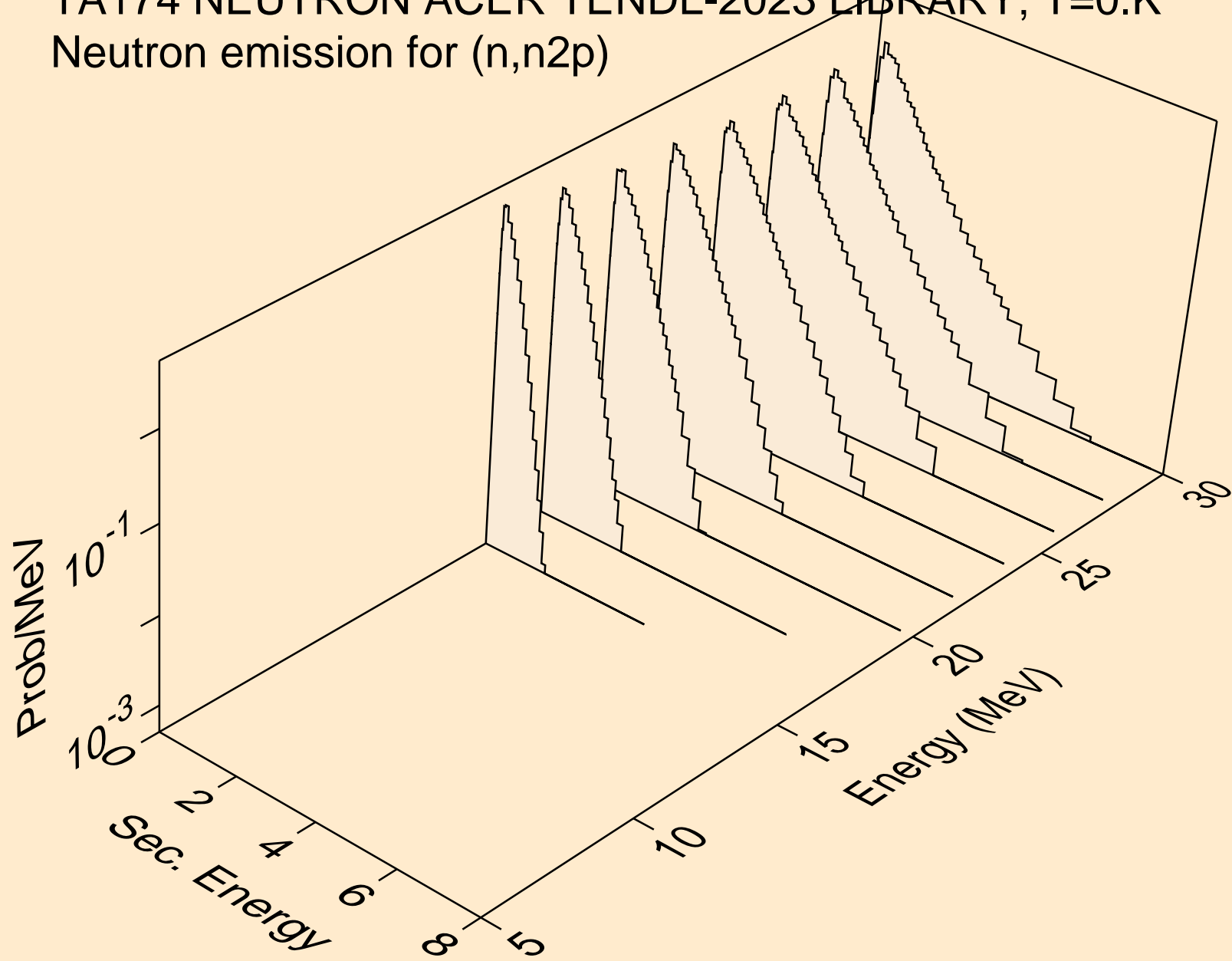

TA174 NEUTRON ACER TENDL-2023 LIBRARY; T=0.K
Neutron emission for (n,npa)

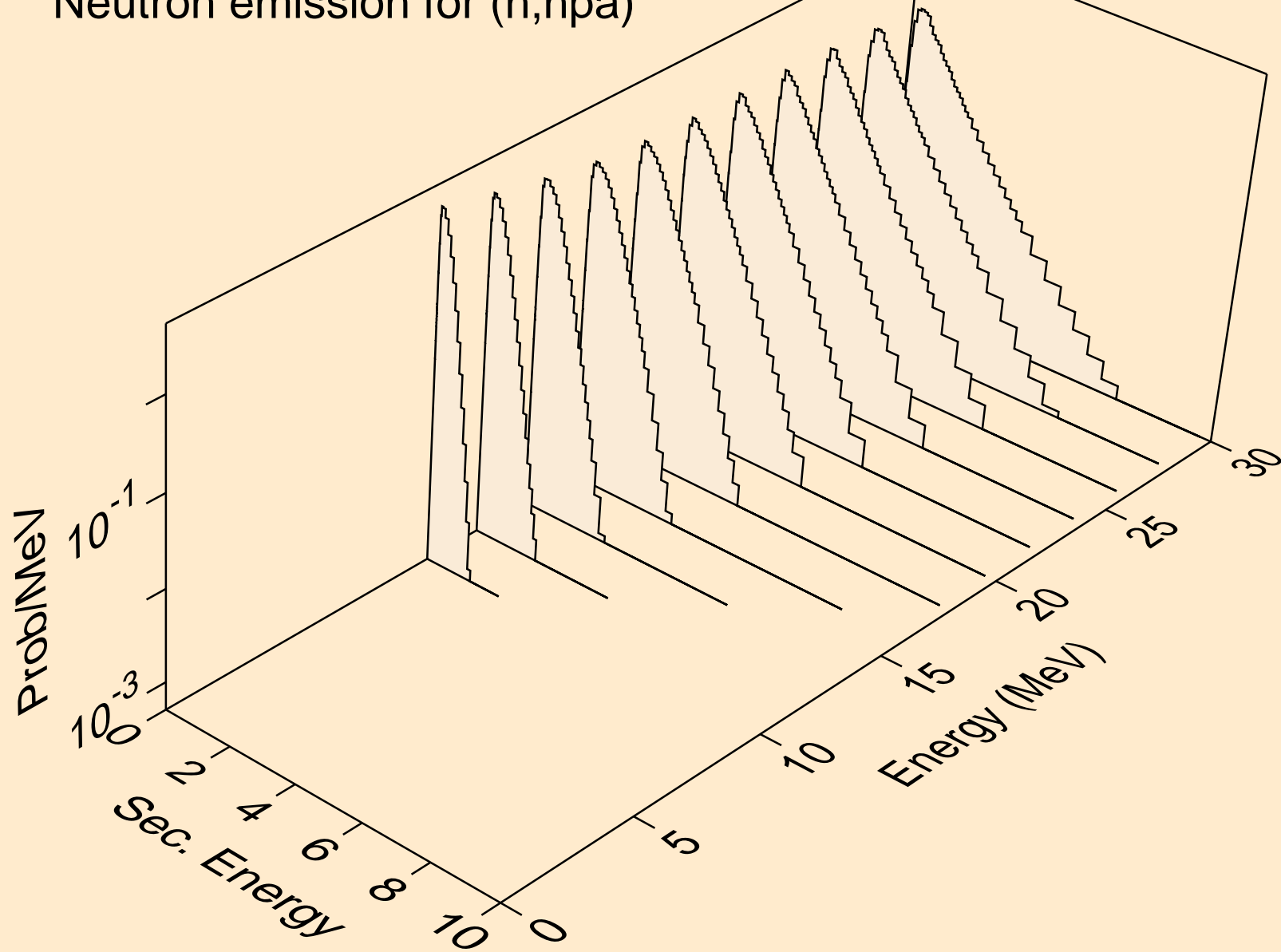

TA174 NEUTRON ACER TENDL-2023 LIBRARY; T=0.K
Neutron emission for (n,n*c)

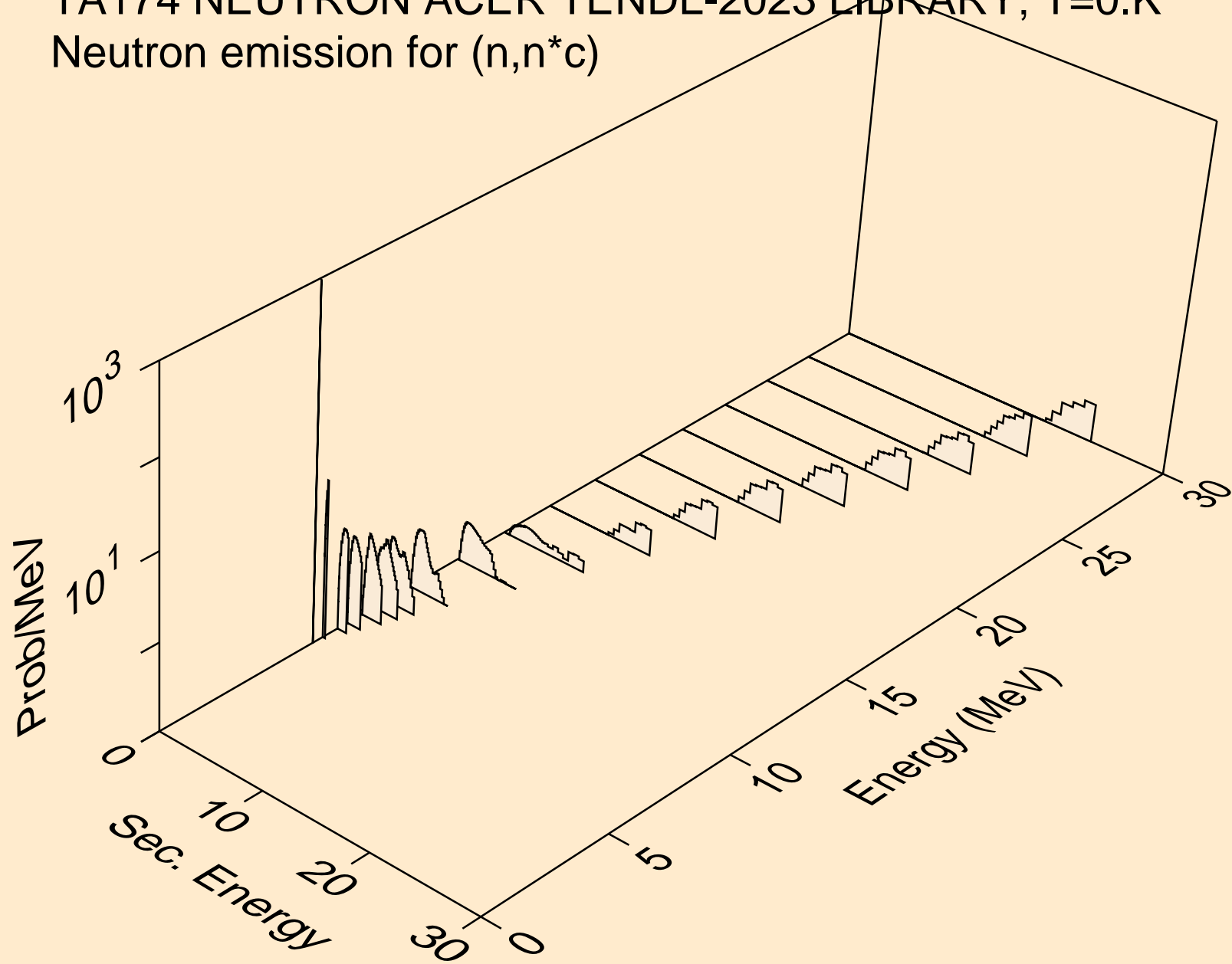

TA174 NEUTRON ACER TENDL-2023 LIBRARY; T=0.K
Photon emission for (n,x)

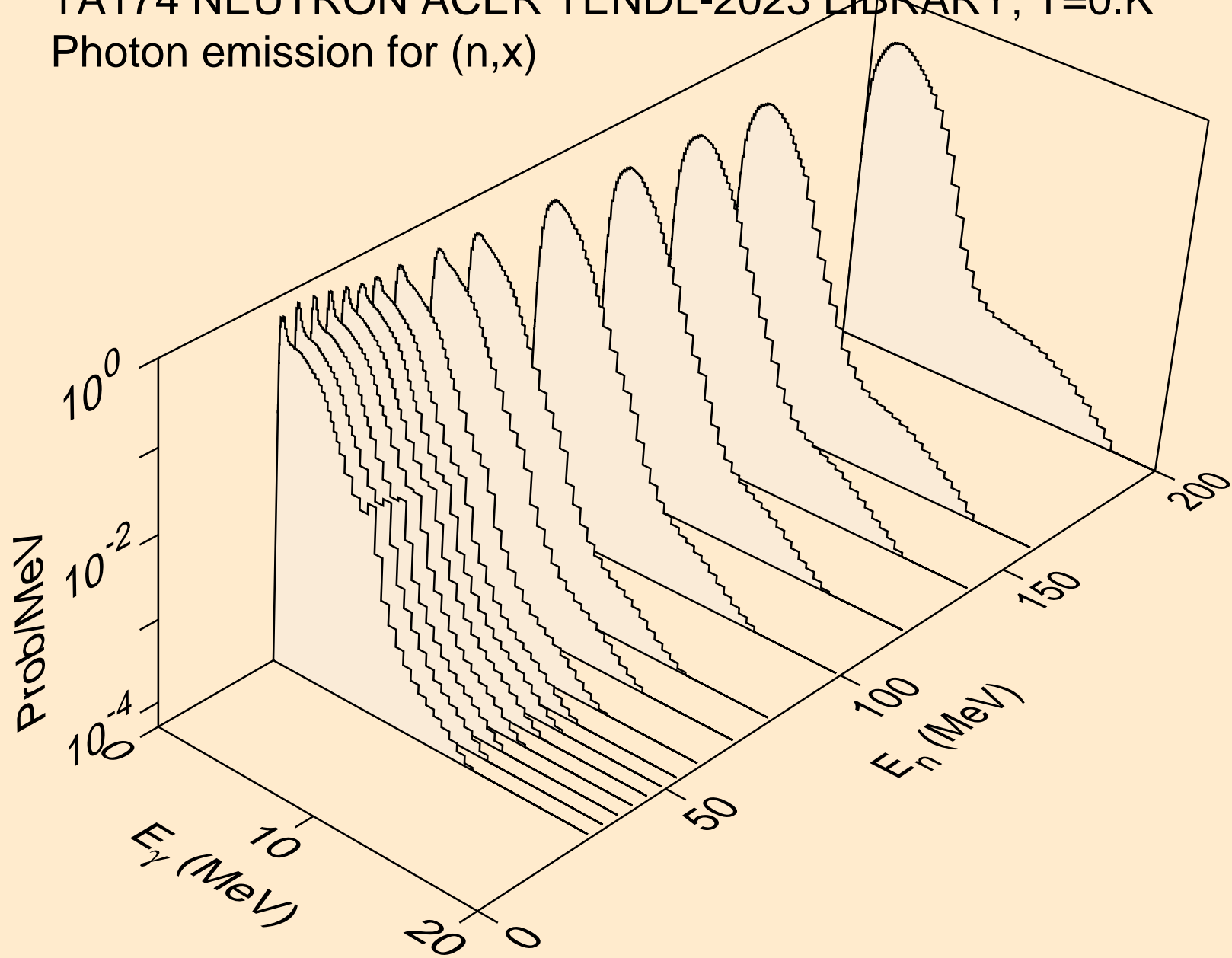

TA174 NEUTRON ACER TENDL-2023 LIBRARY; T=0.K
Photon emission for (n,2nd)

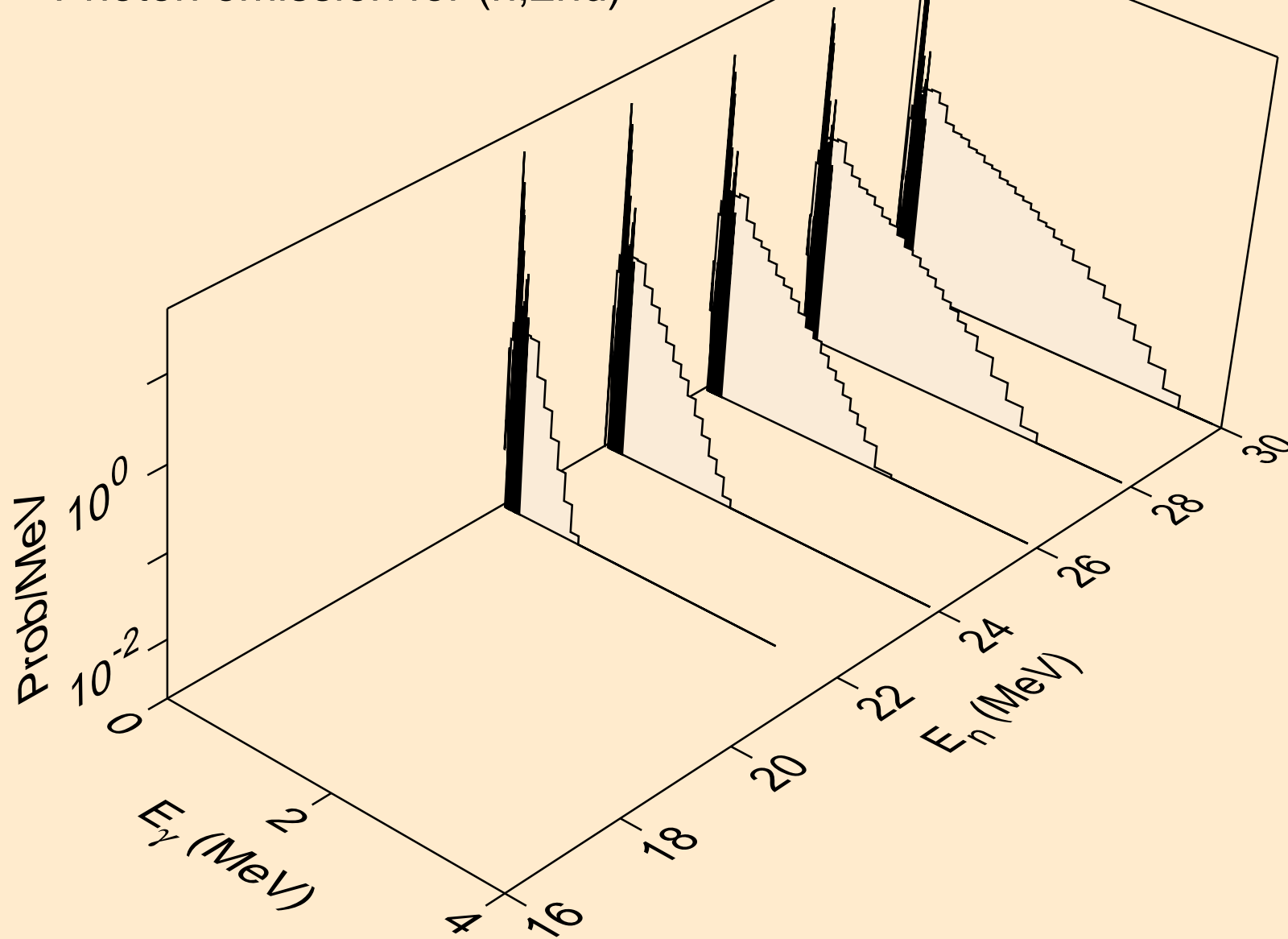

TA174 NEUTRON ACER TENDL-2023 LIBRARY; T=0.K
Photon emission for (n,2n)

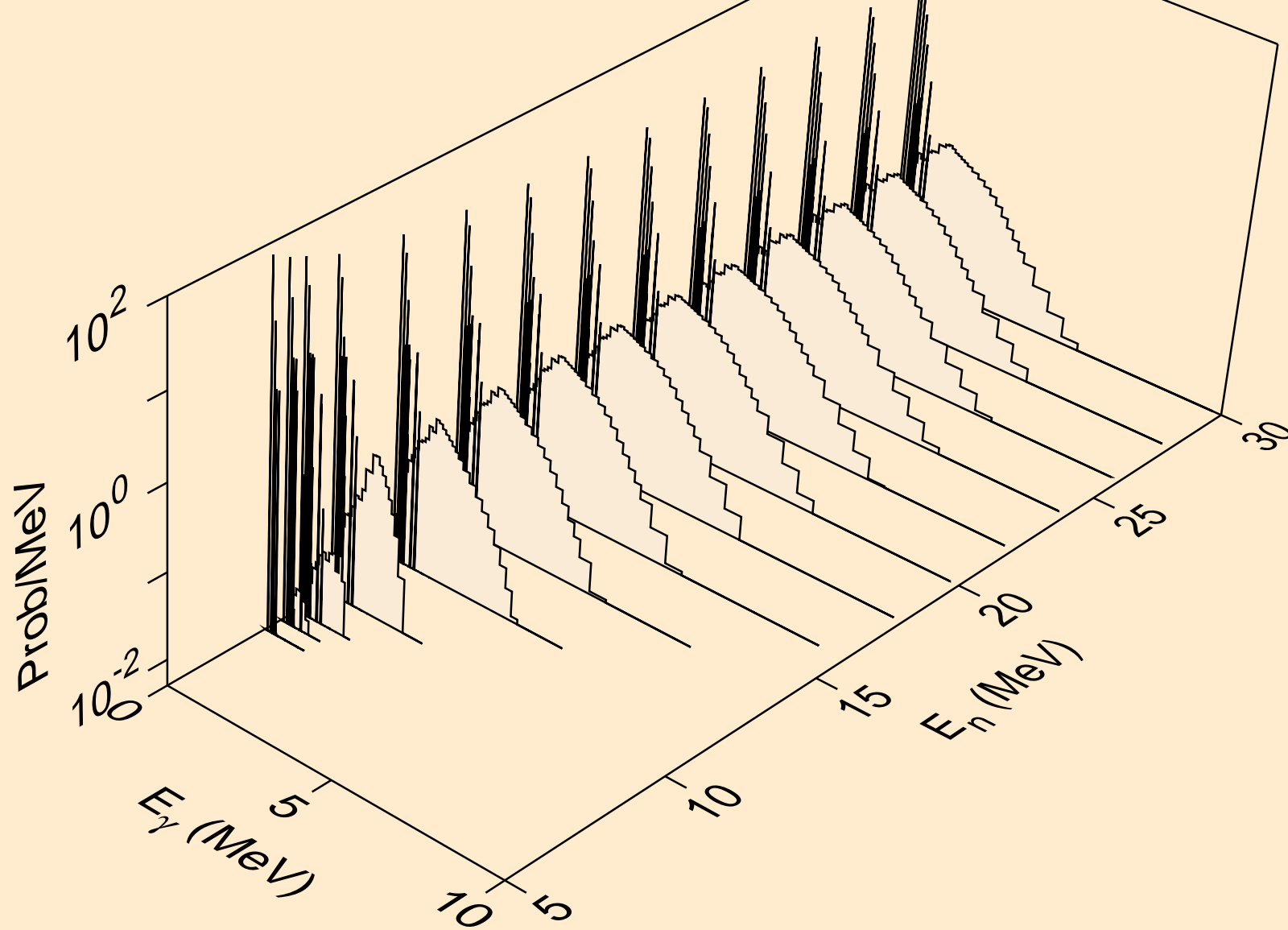

TA174 NEUTRON ACER TENDL-2023 LIBRARY; T=0.K
Photon emission for (n,3n)

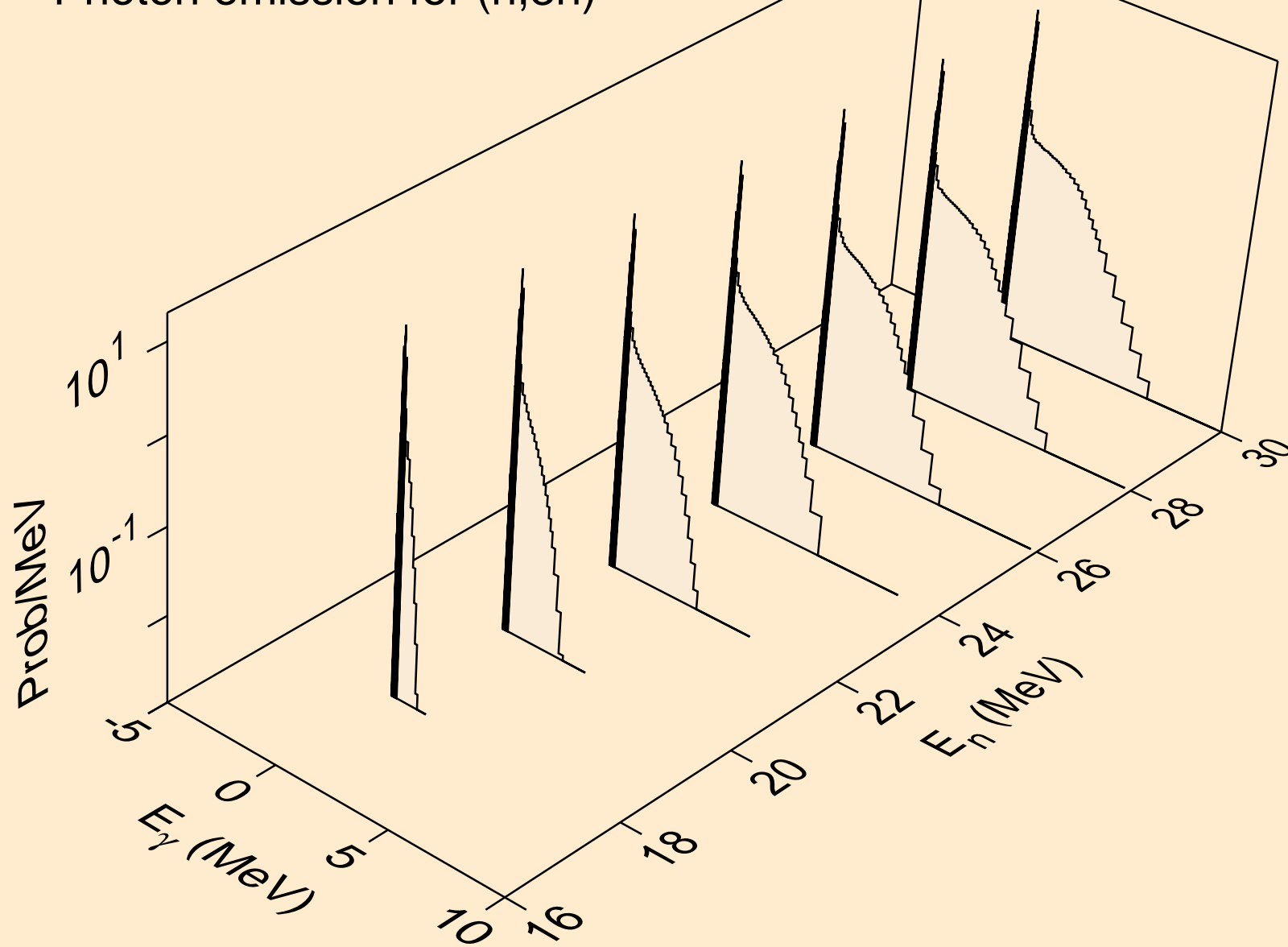

TA174 NEUTRON ACER TENDL-2023 LIBRARY; T=0.K
Photon emission for (n,n*)a

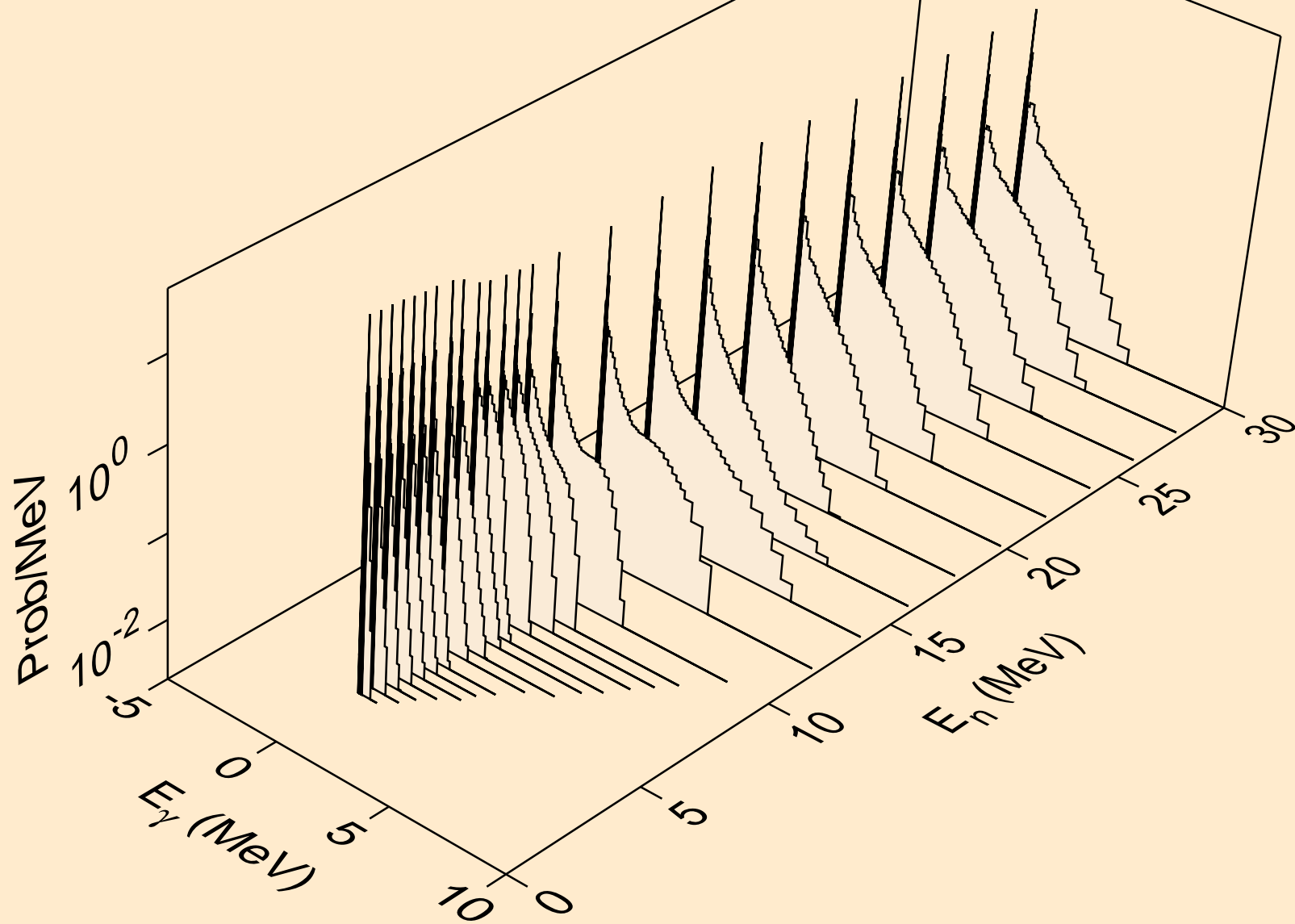

TA174 NEUTRON ACER TENDL-2023 LIBRARY; T=0.K
Photon emission for (n,2n)a

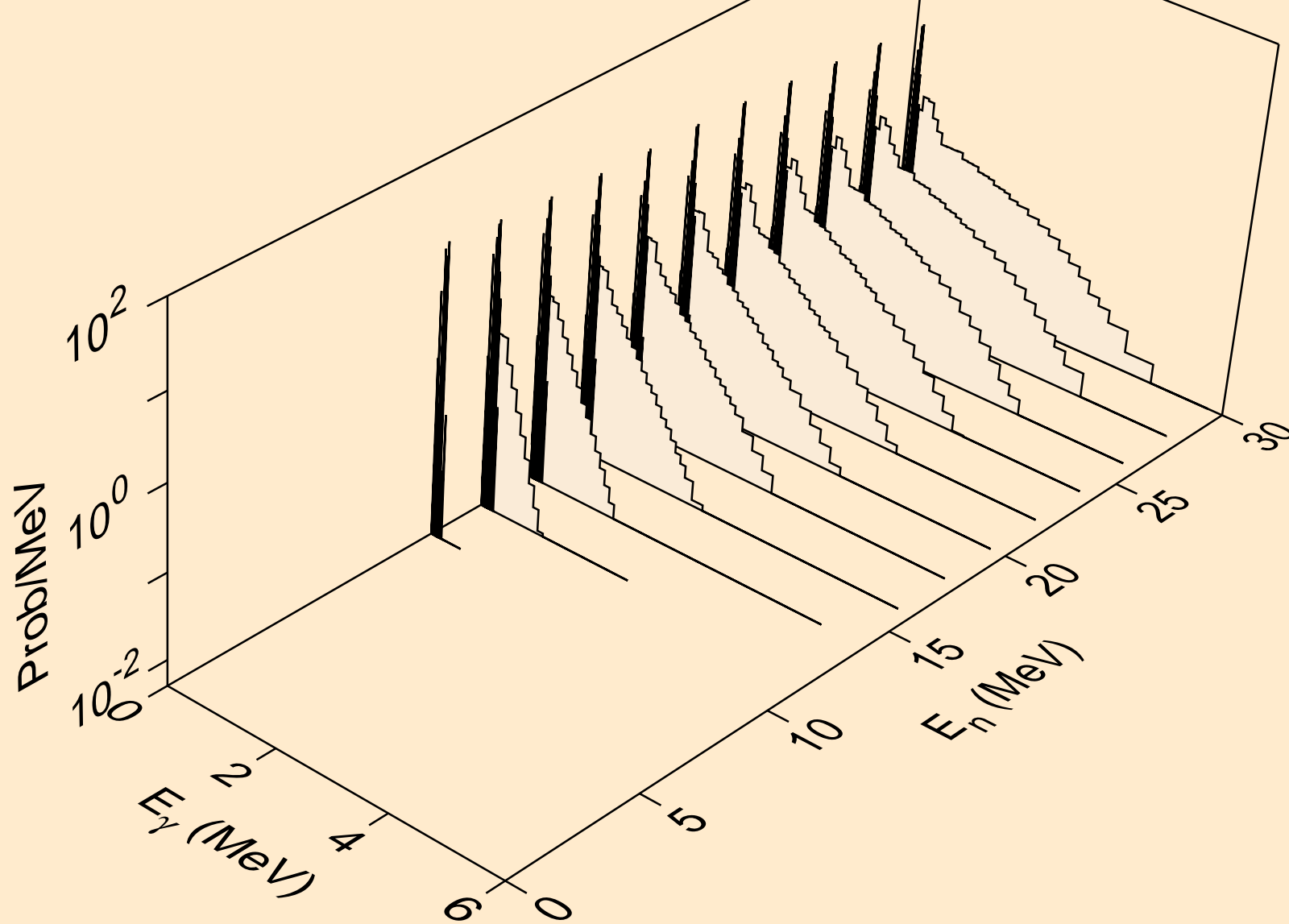

TA174 NEUTRON ACER TENDL-2023 LIBRARY; T=0.K
Photon emission for (n,3n)a

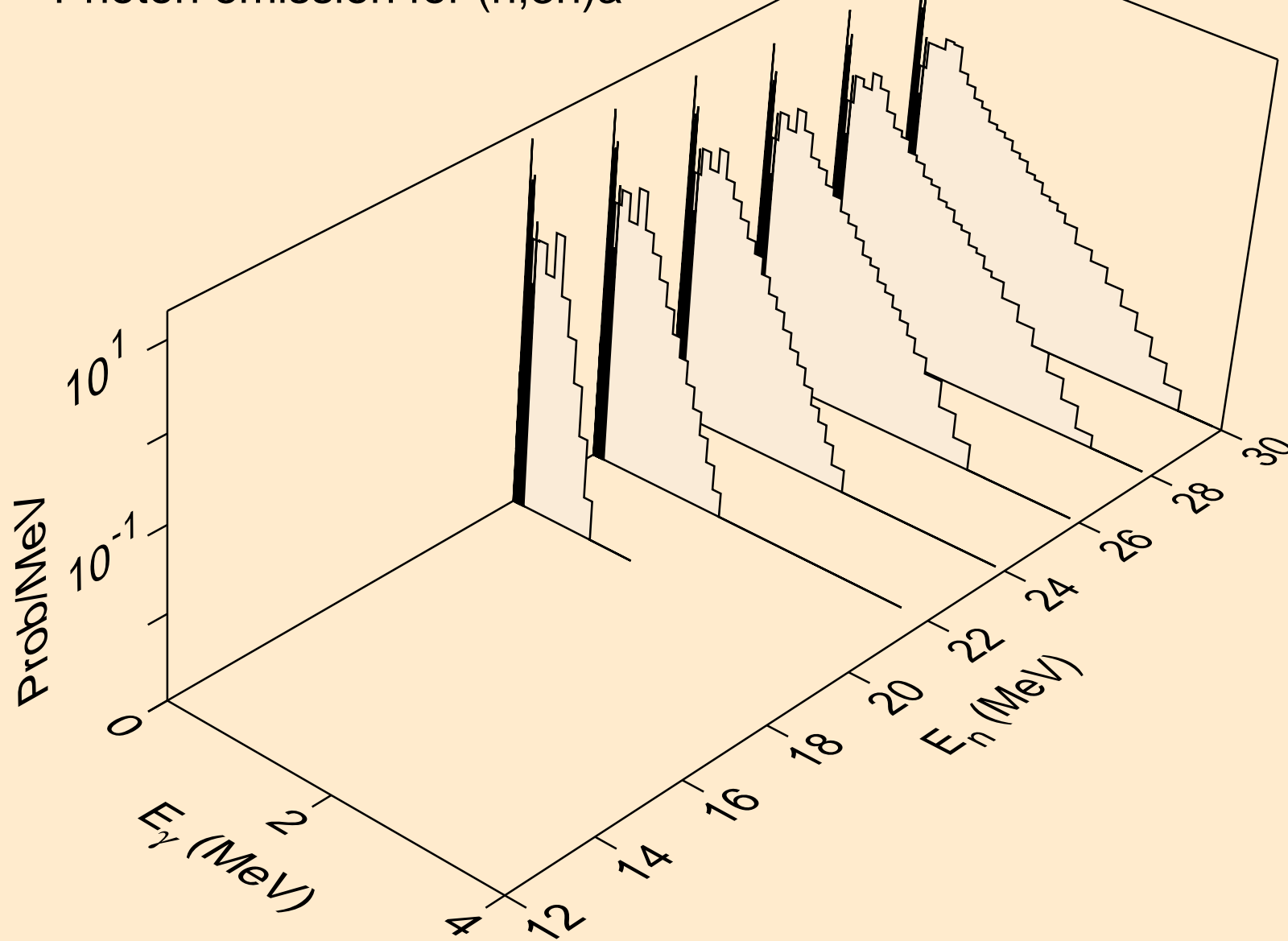

TA174 NEUTRON ACER TENDL-2023 LIBRARY; T=0.K
Photon emission for (n,n*)p

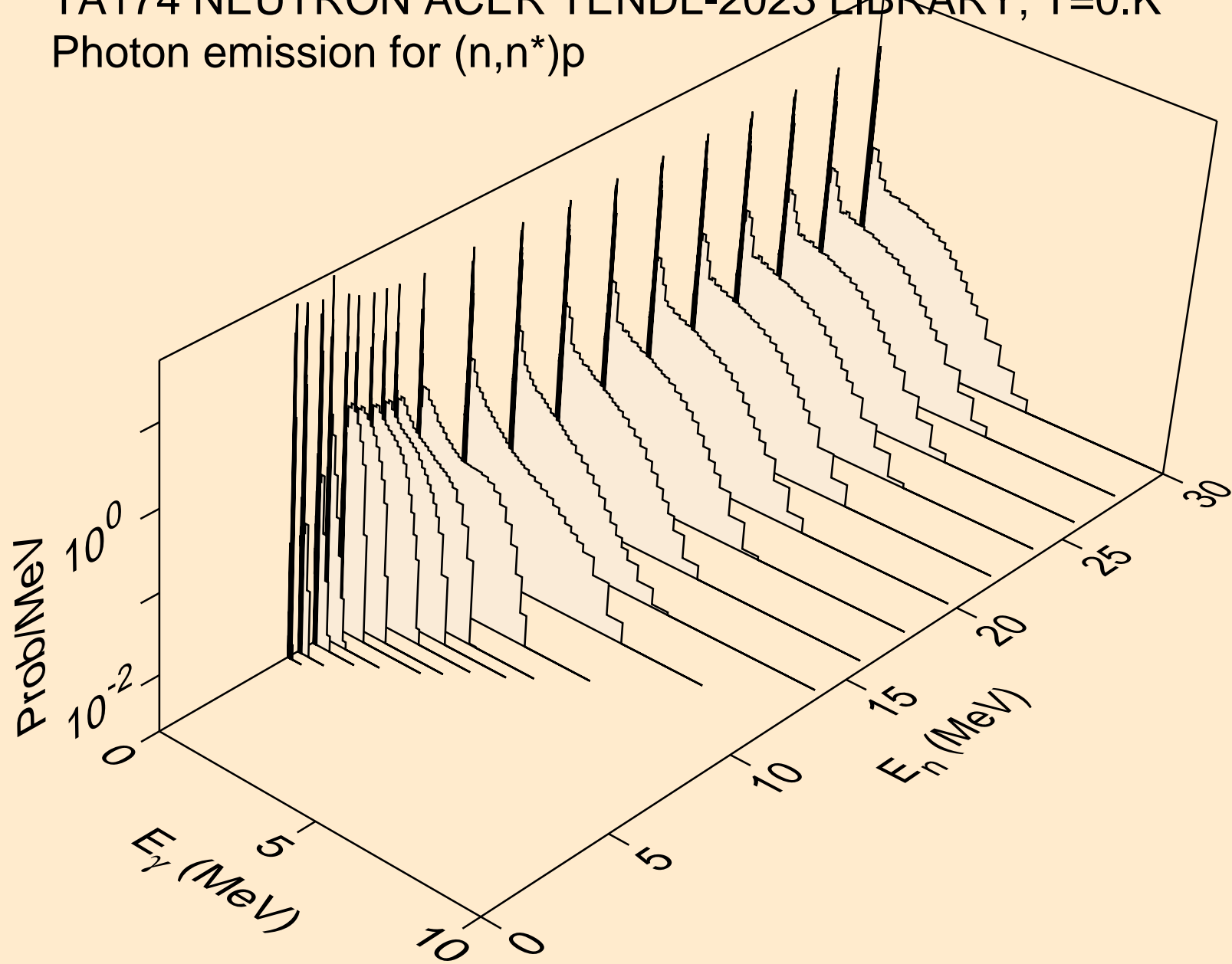

TA174 NEUTRON ACER TENDL-2023 LIBRARY; T=0.K
Photon emission for (n,n*)2a

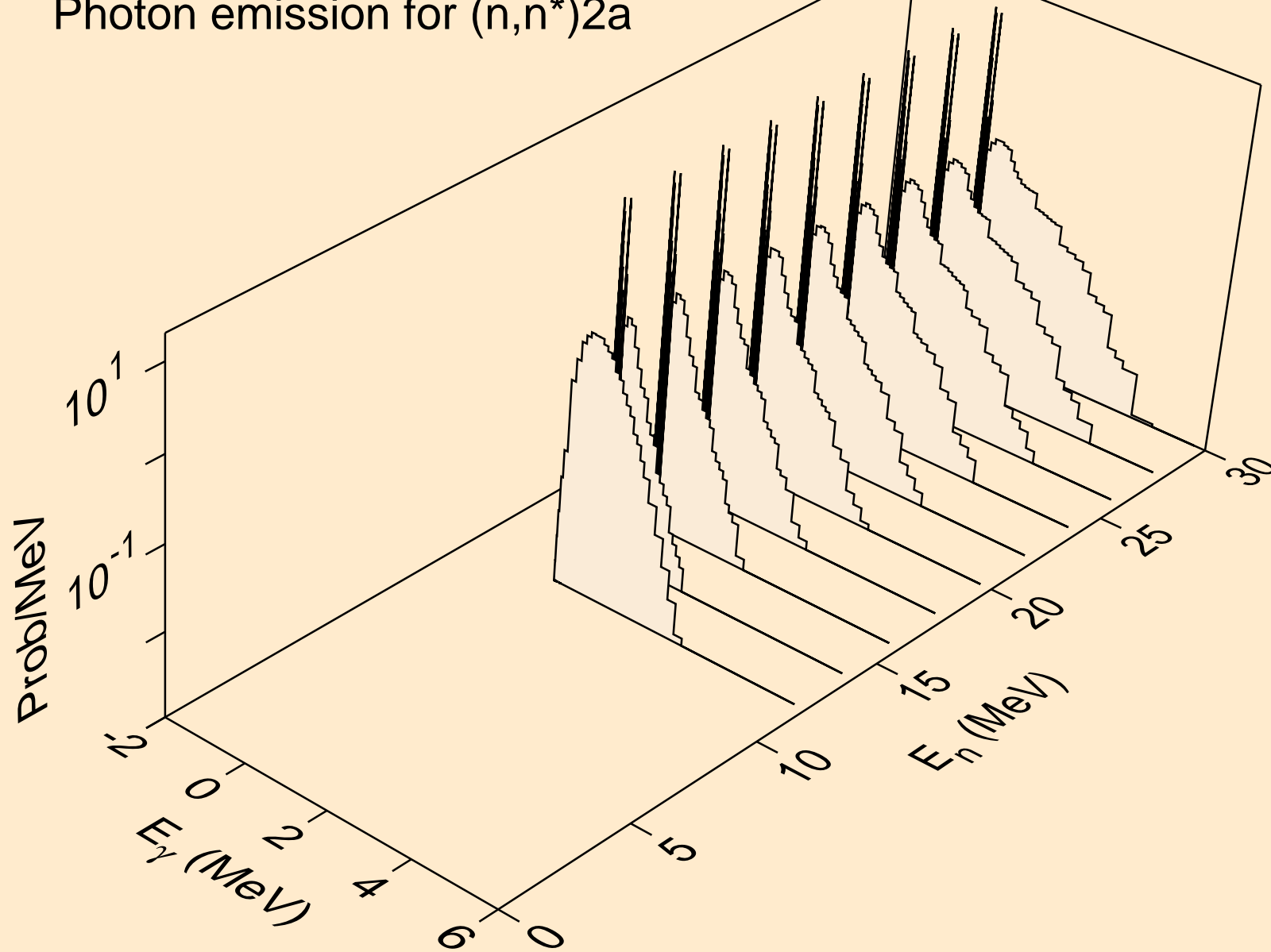

TA174 NEUTRON ACER TENDL-2023 LIBRARY; T=0.K
Photon emission for (n,2n)2a

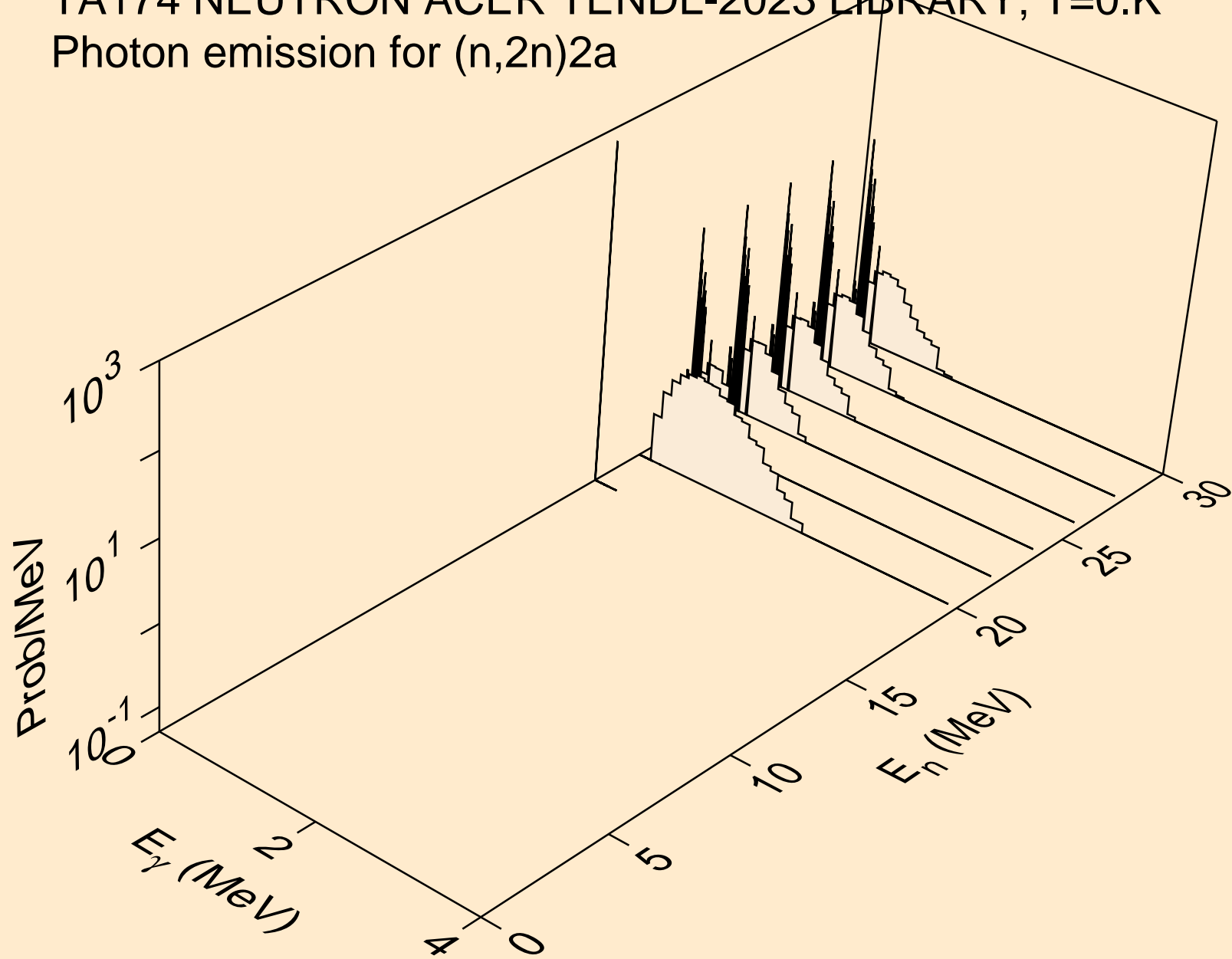

TA174 NEUTRON ACER TENDL-2023 LIBRARY; T=0.K
Photon emission for (n,n*)d

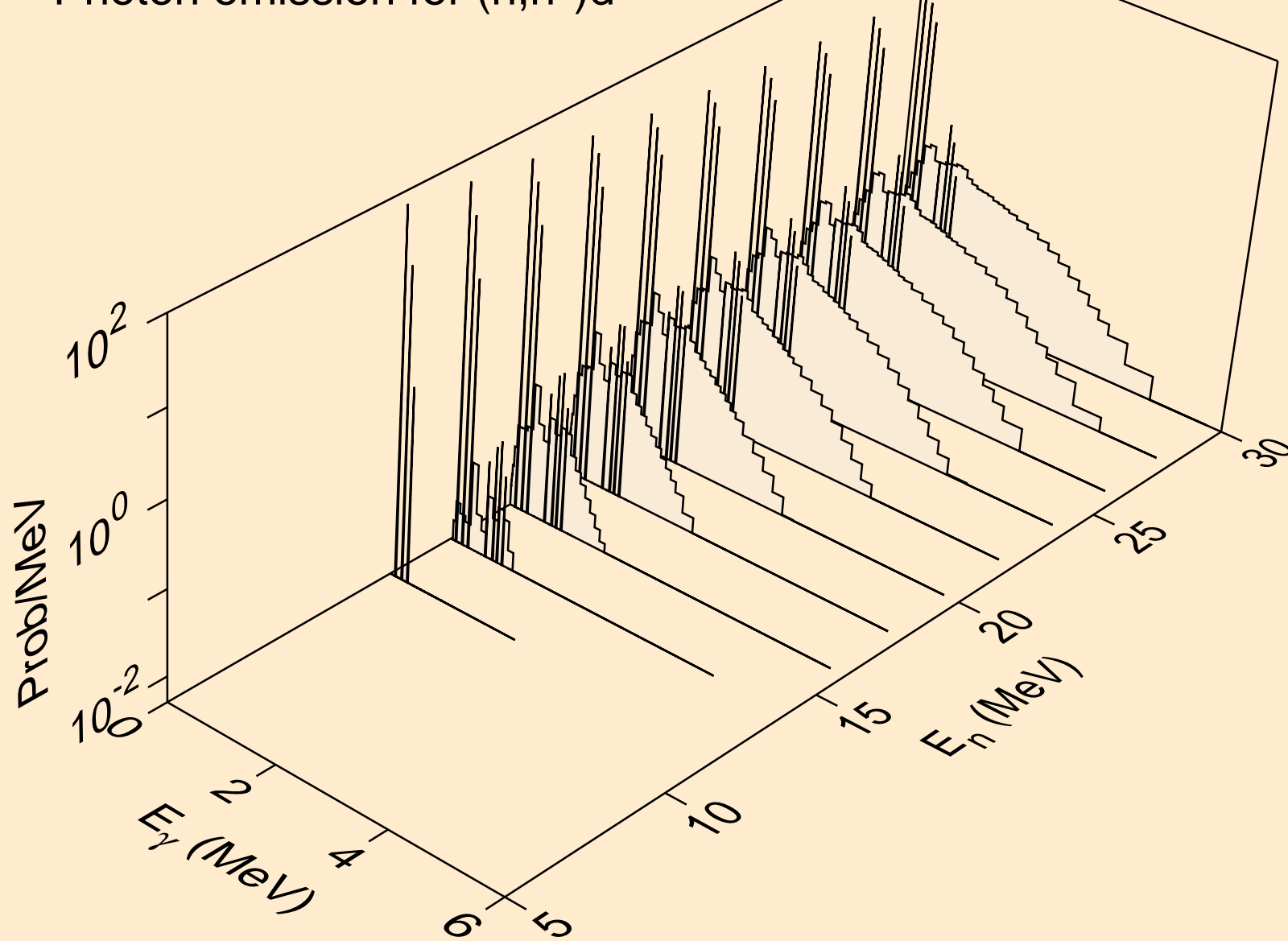

TA174 NEUTRON ACER TENDL-2023 LIBRARY; T=0.K
Photon emission for (n,n*)t

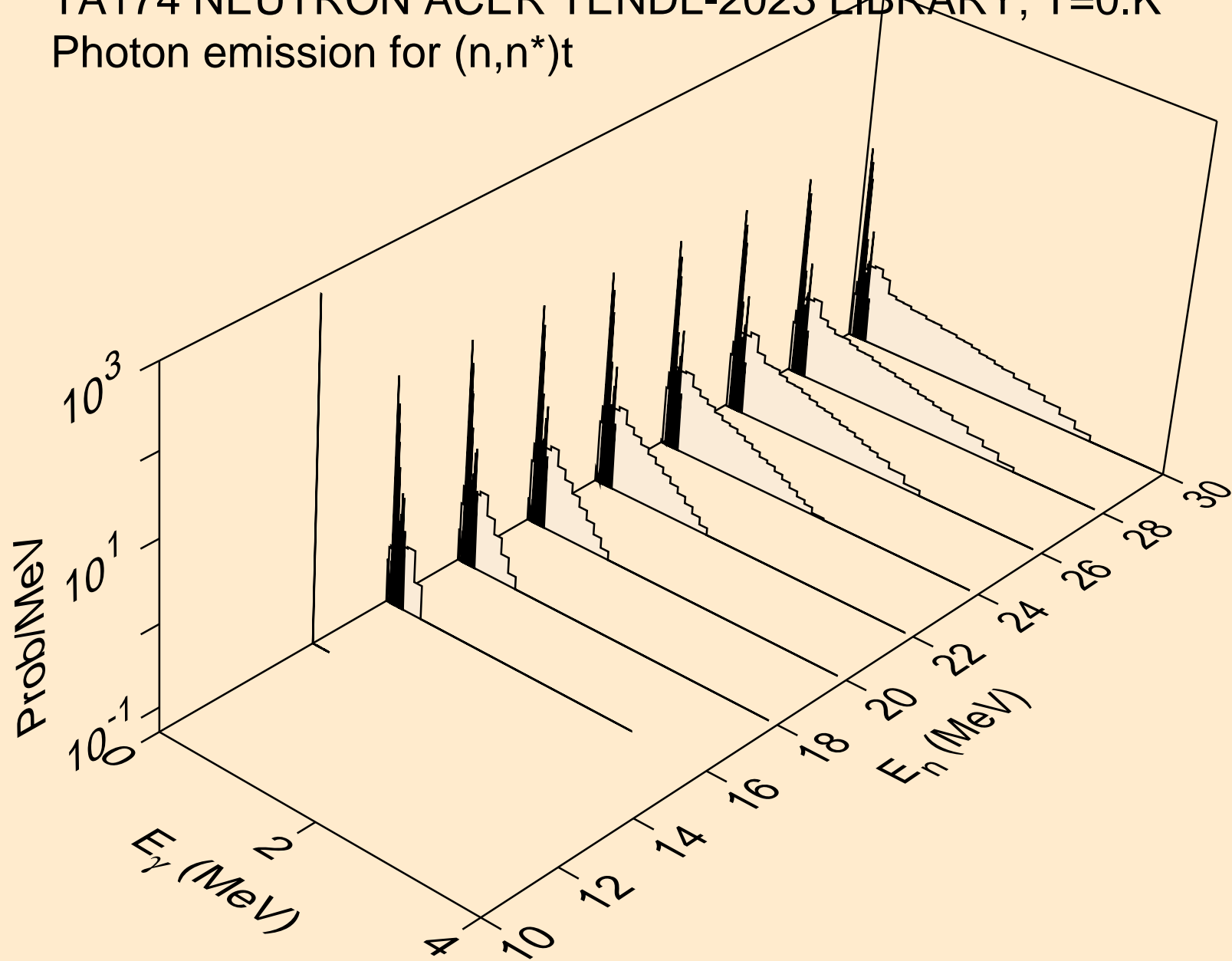

TA174 NEUTRON ACER TENDL-2023 LIBRARY; T=0.K
Photon emission for (n,n*)he3

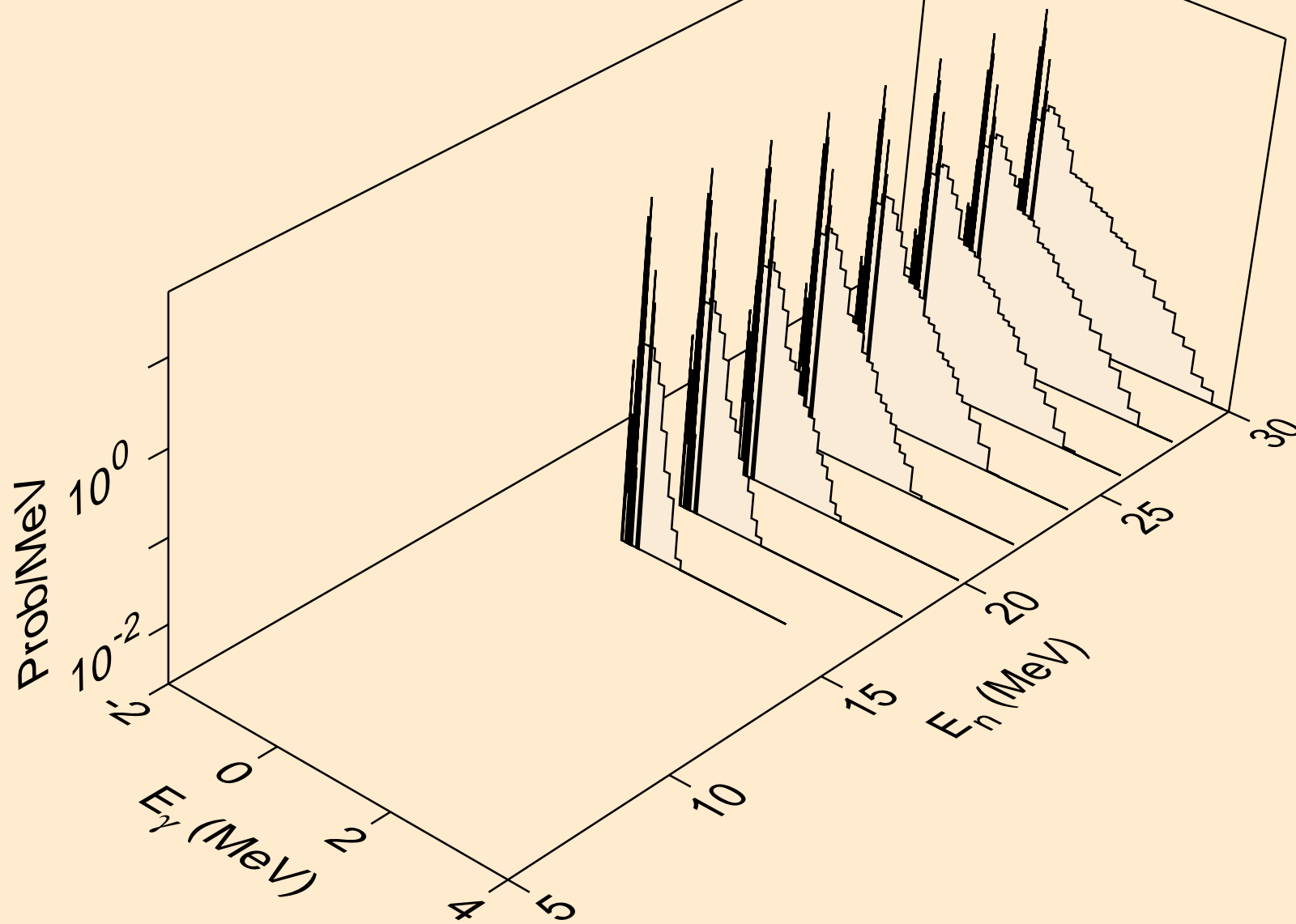

TA174 NEUTRON ACER TENDL-2023 LIBRARY; T=0.K
Photon emission for (n,4n)

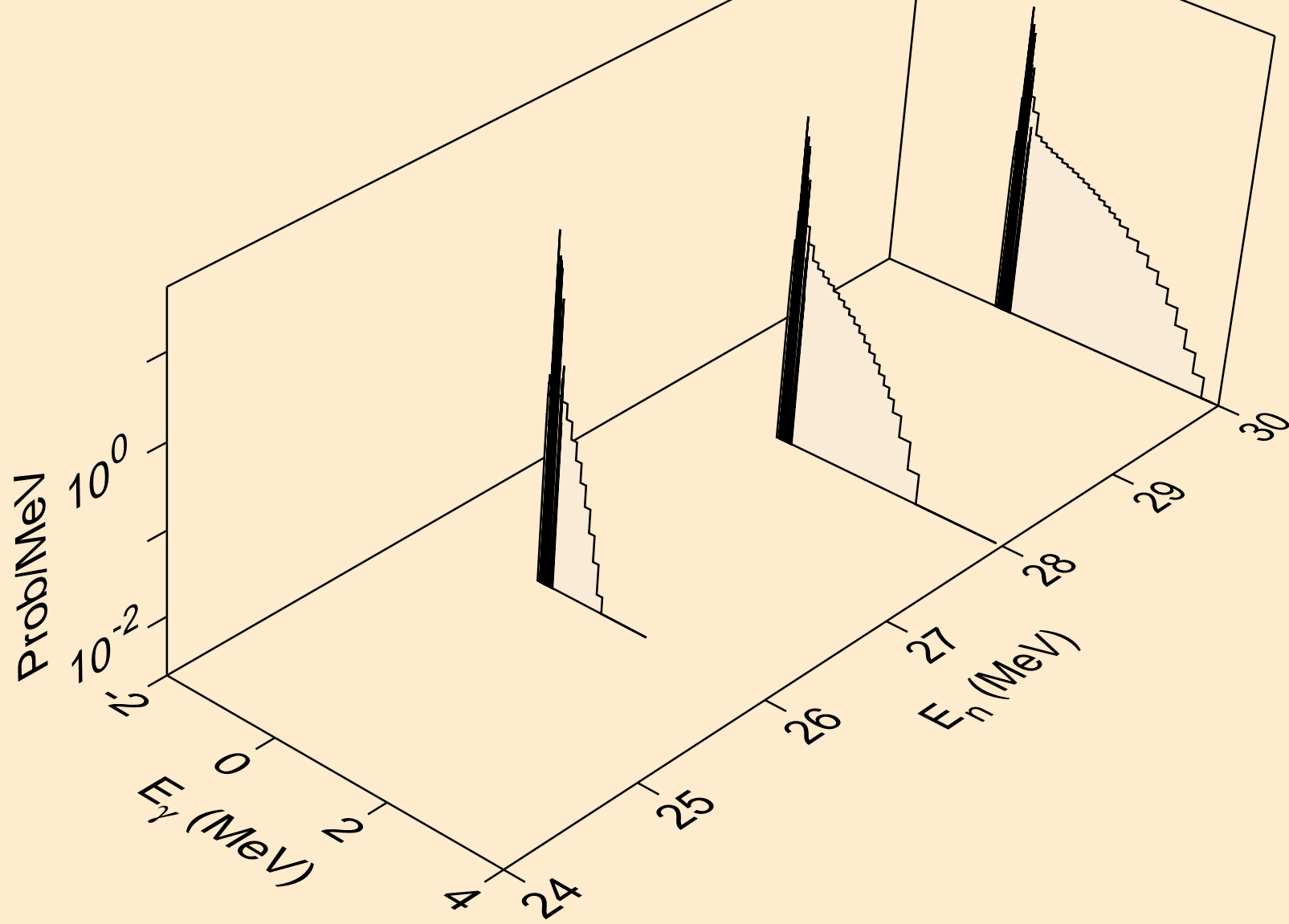

TA174 NEUTRON ACER TENDL-2023 LIBRARY; T=0.K
Photon emission for (n,2np)

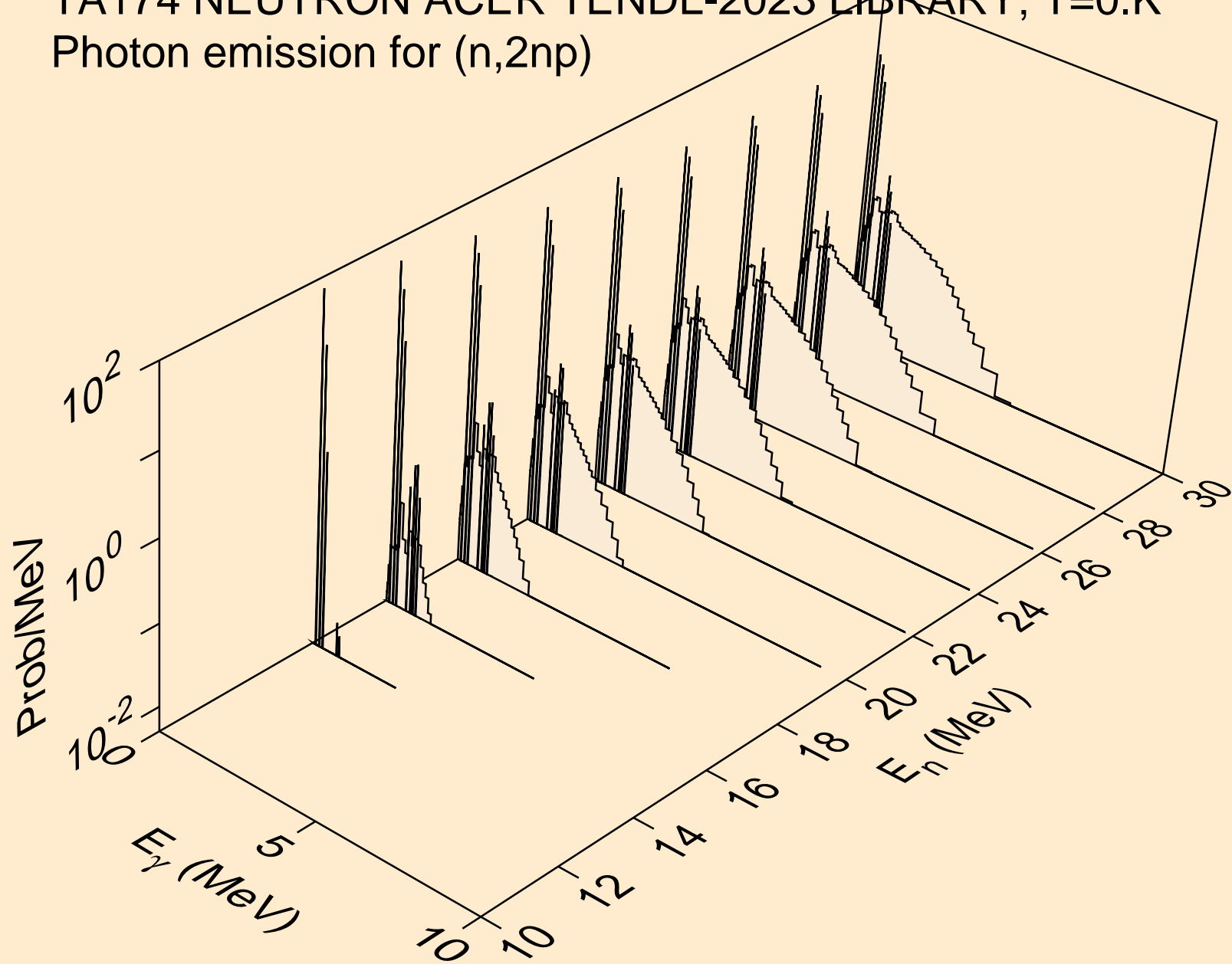

TA174 NEUTRON ACER TENDL-2023 LIBRARY; T=0.K
Photon emission for (n,3np)

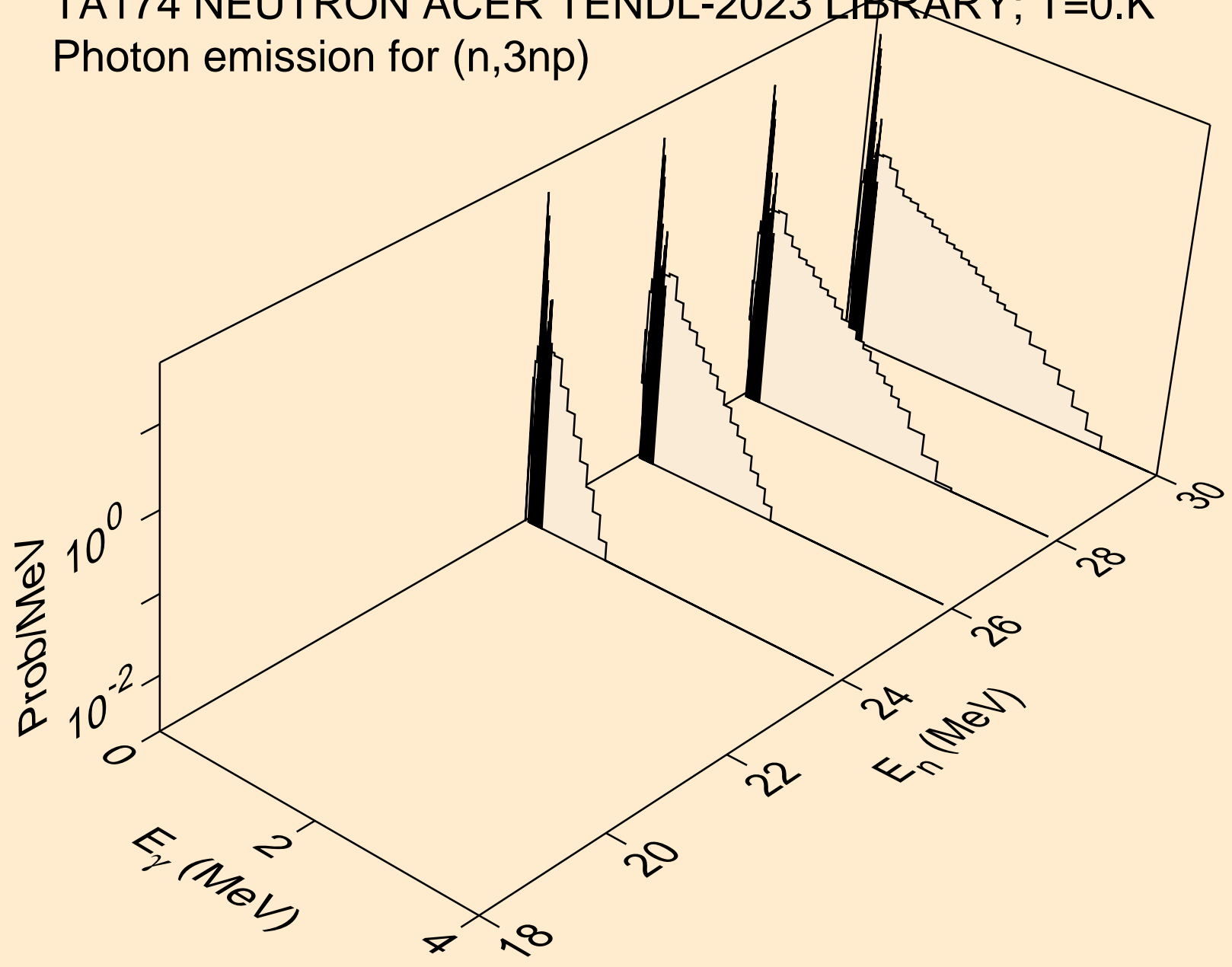

TA174 NEUTRON ACER TENDL-2023 LIBRARY; T=0.K
Photon emission for (n,n2p)

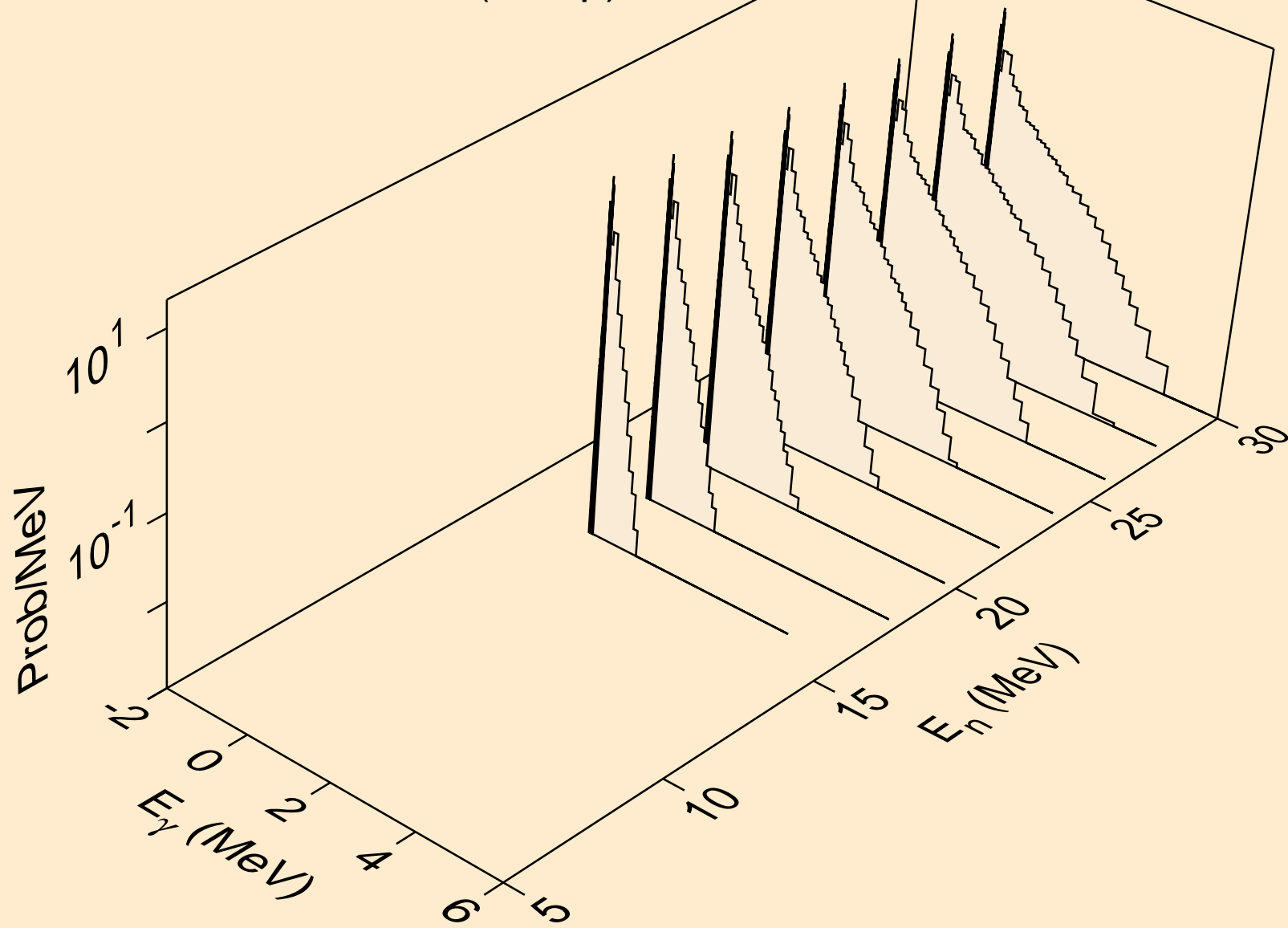

TA174 NEUTRON ACER TENDL-2023 LIBRARY; T=0.K
Photon emission for (n,npa)

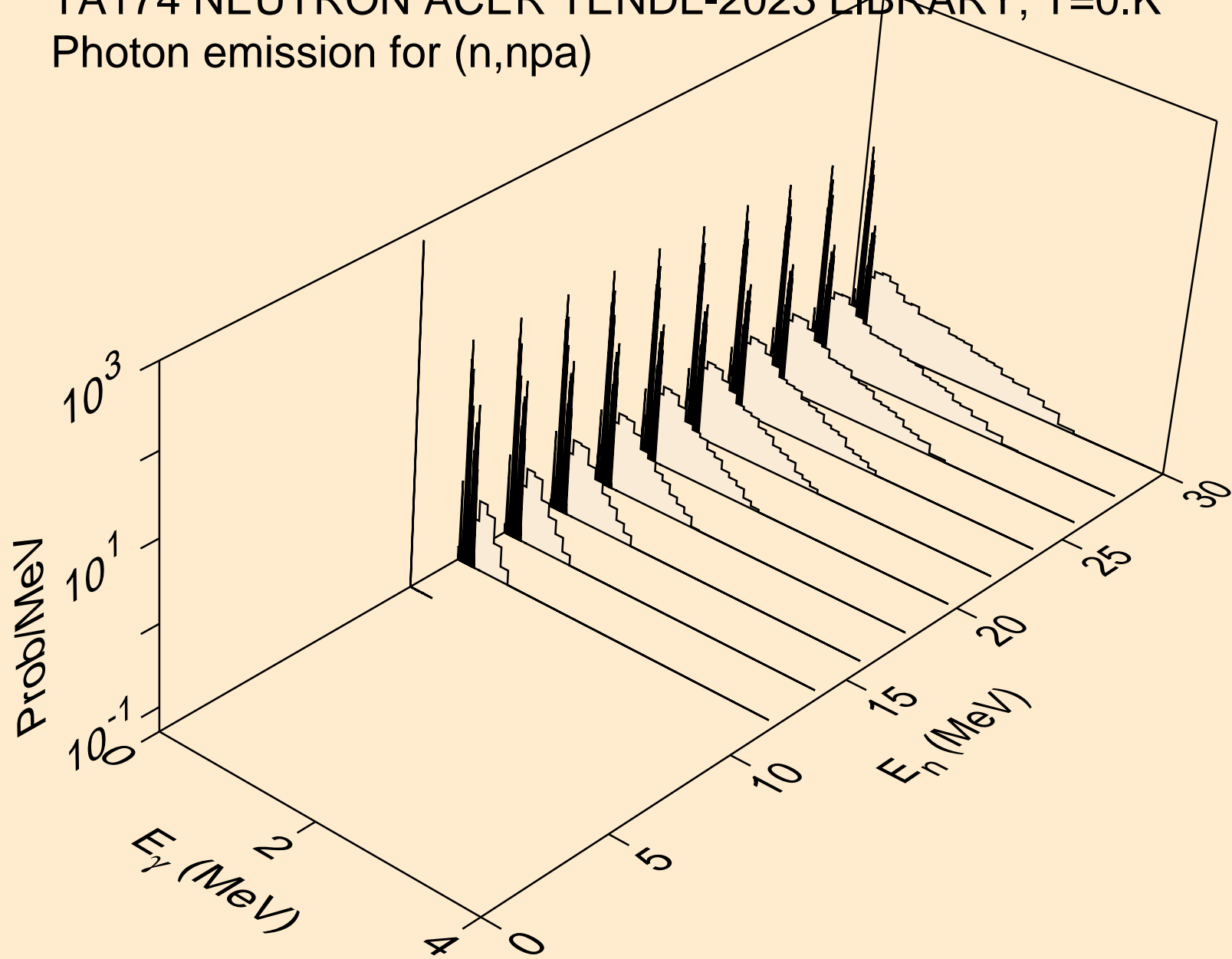

TA174 NEUTRON ACER TENDL-2023 LIBRARY; T=0.K
Photon emission for (n,n*c)

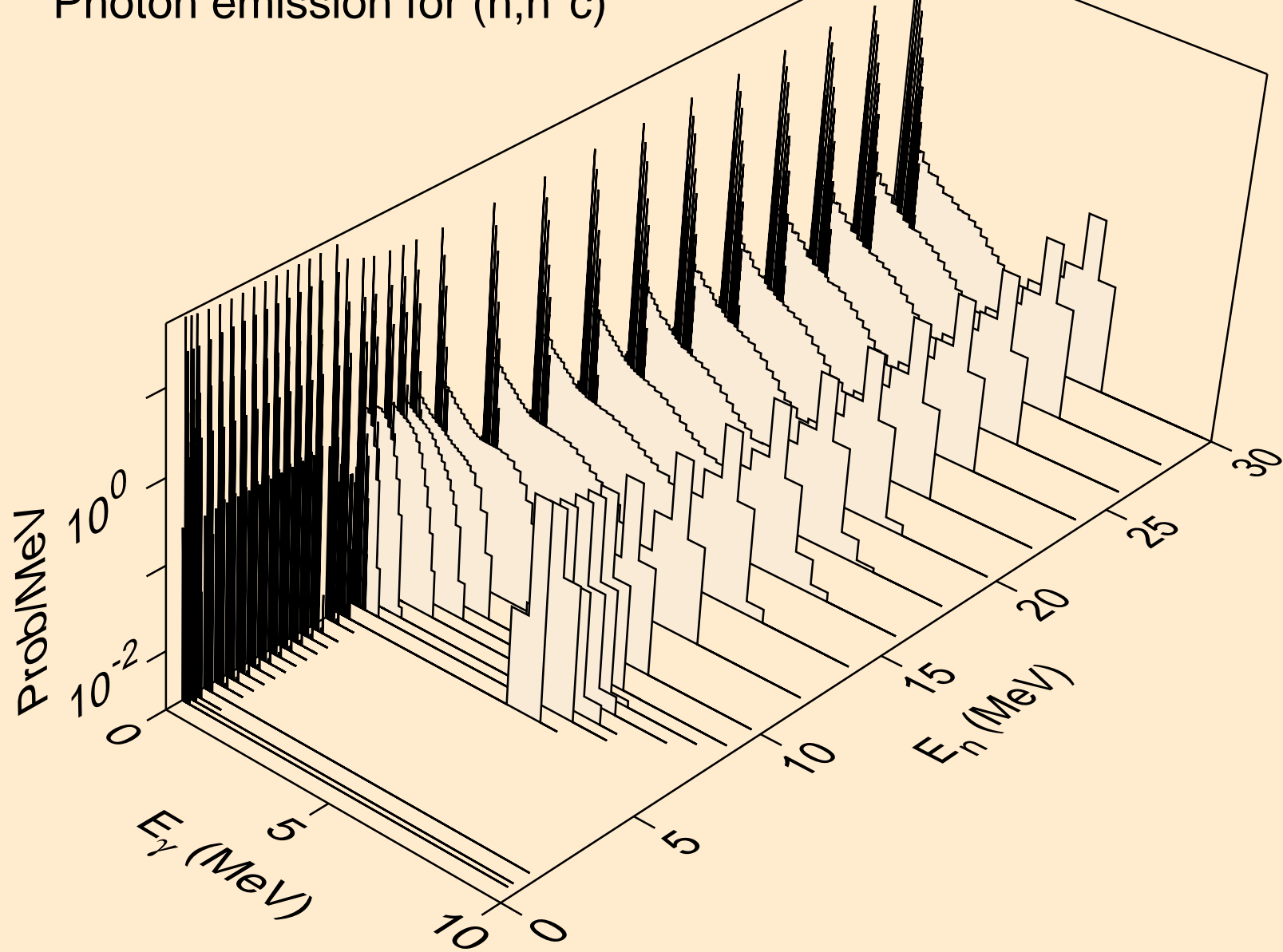

TA174 NEUTRON ACER TENDL-2023 LIBRARY; T=0.K
Photon emission for (n,gma)

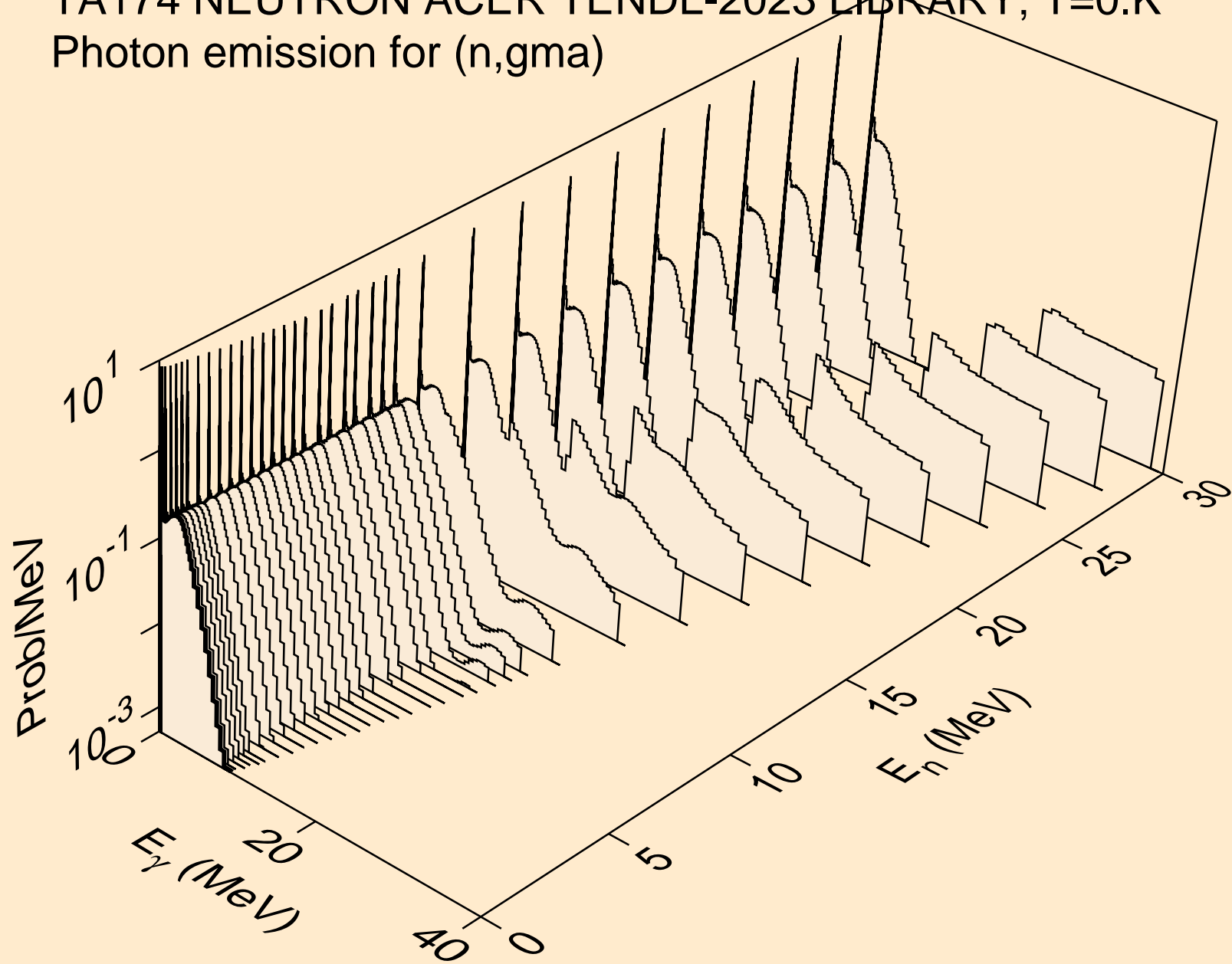

TA174 NEUTRON ACER TENDL-2023 LIBRARY; T=0.K
Photon emission for (n,p)

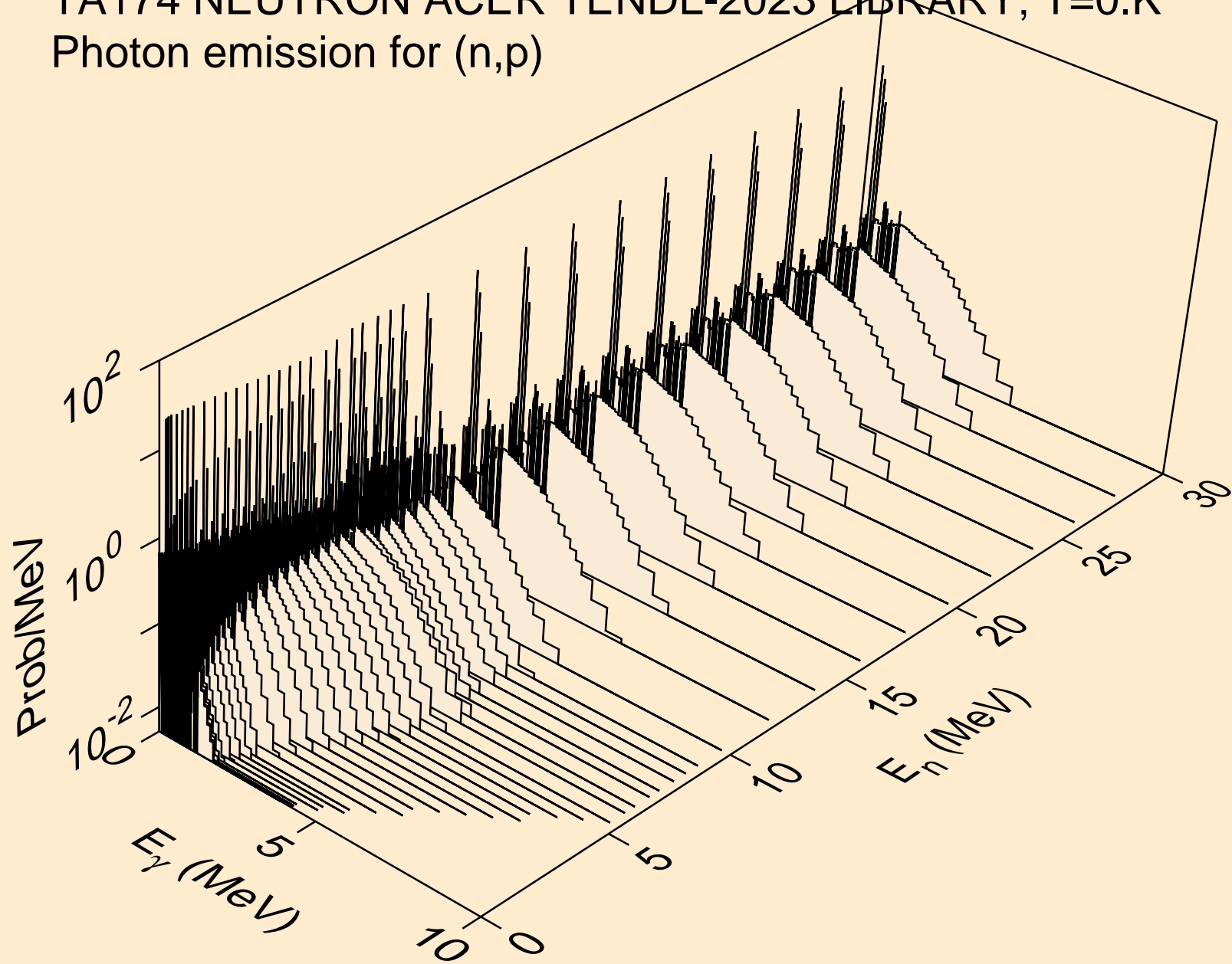

TA174 NEUTRON ACER TENDL-2023 LIBRARY; T=0.K
Photon emission for (n,d)

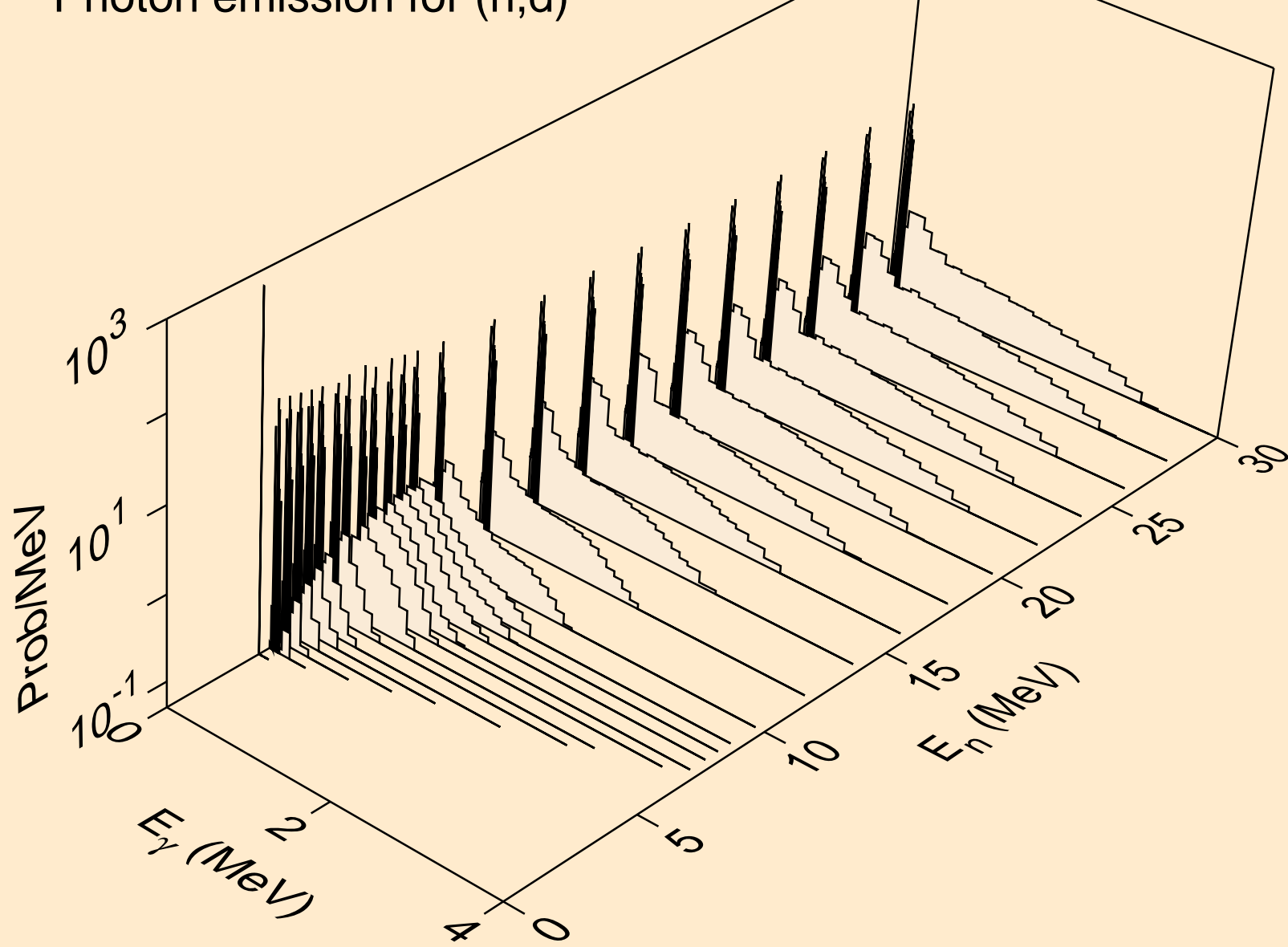

TA174 NEUTRON ACER TENDL-2023 LIBRARY; T=0.K
Photon emission for (n,t)

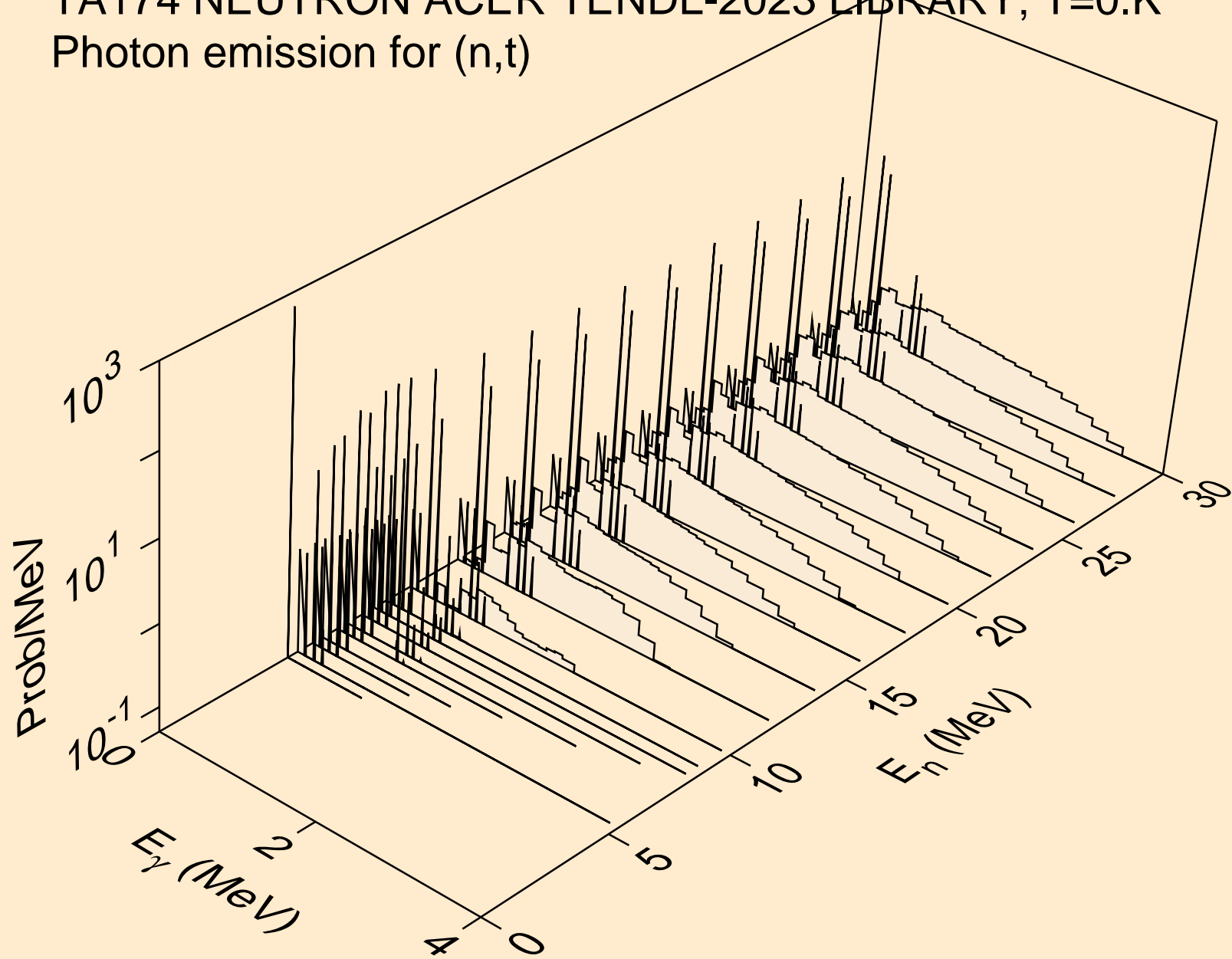

TA174 NEUTRON ACER TENDL-2023 LIBRARY; T=0.K
Photon emission for (n,he3)

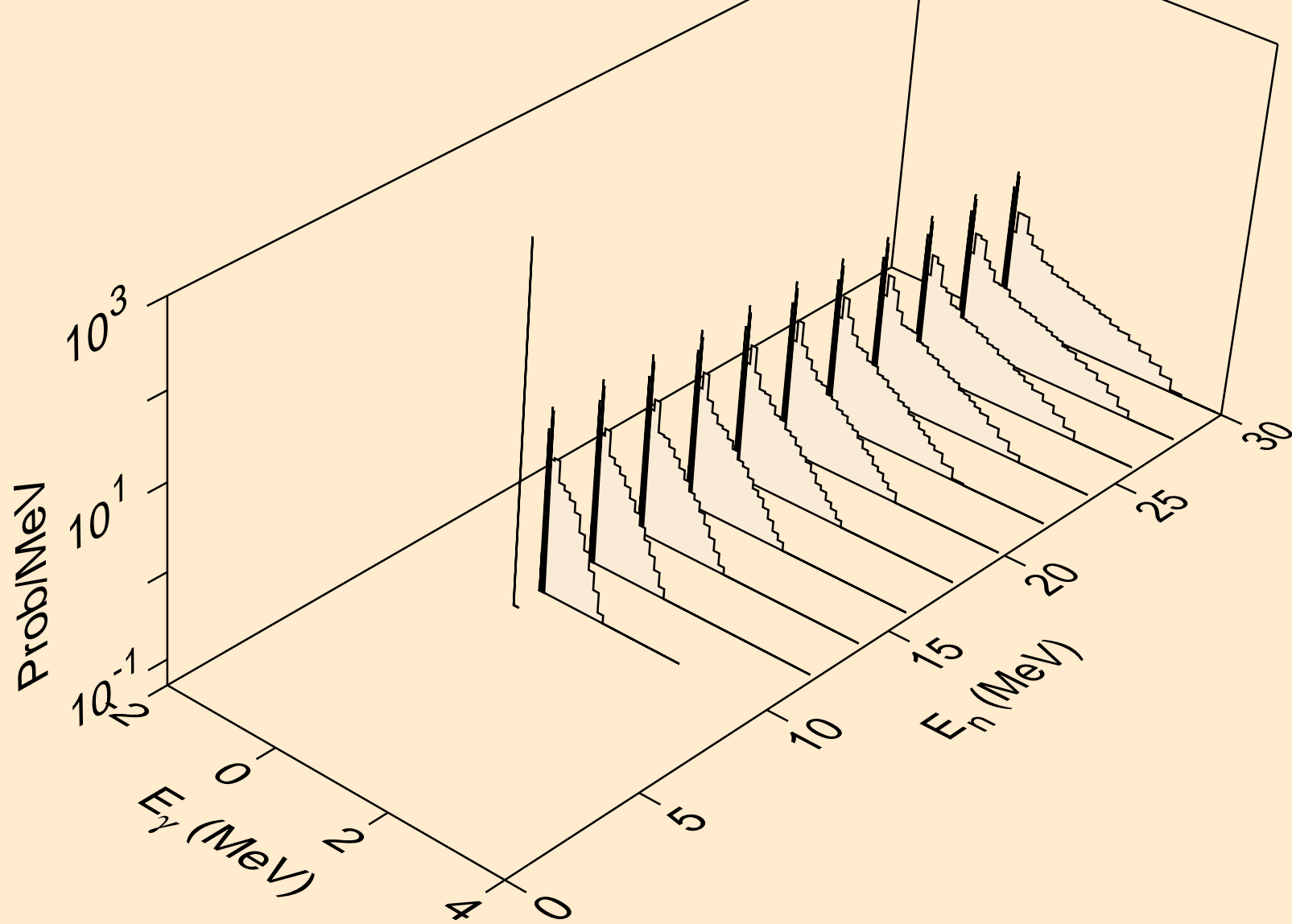

TA174 NEUTRON ACER TENDL-2023 LIBRARY; T=0.K
Photon emission for (n,a)

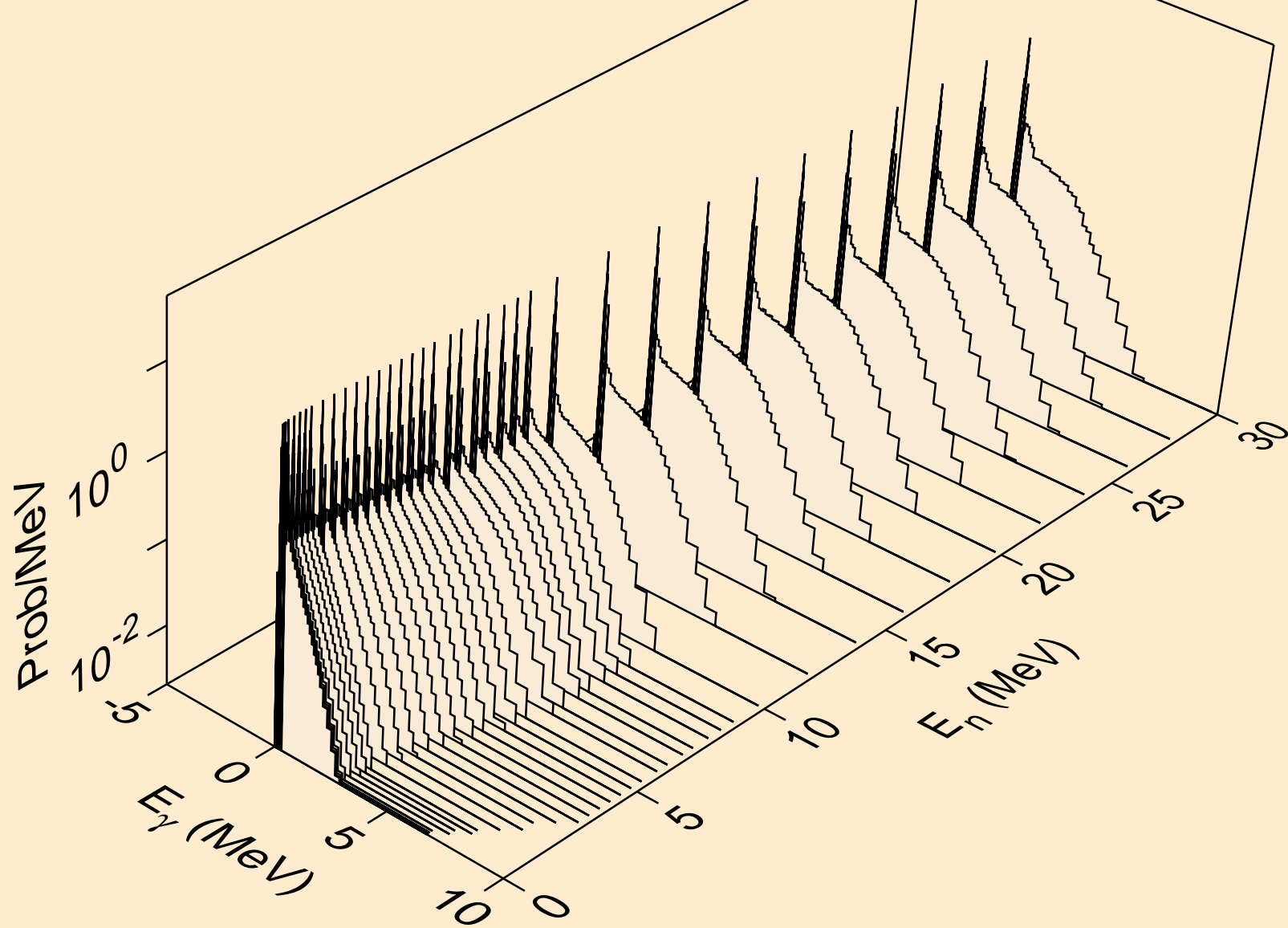

TA174 NEUTRON ACER TENDL-2023 LIBRARY; T=0.K
Photon emission for (n,2a)

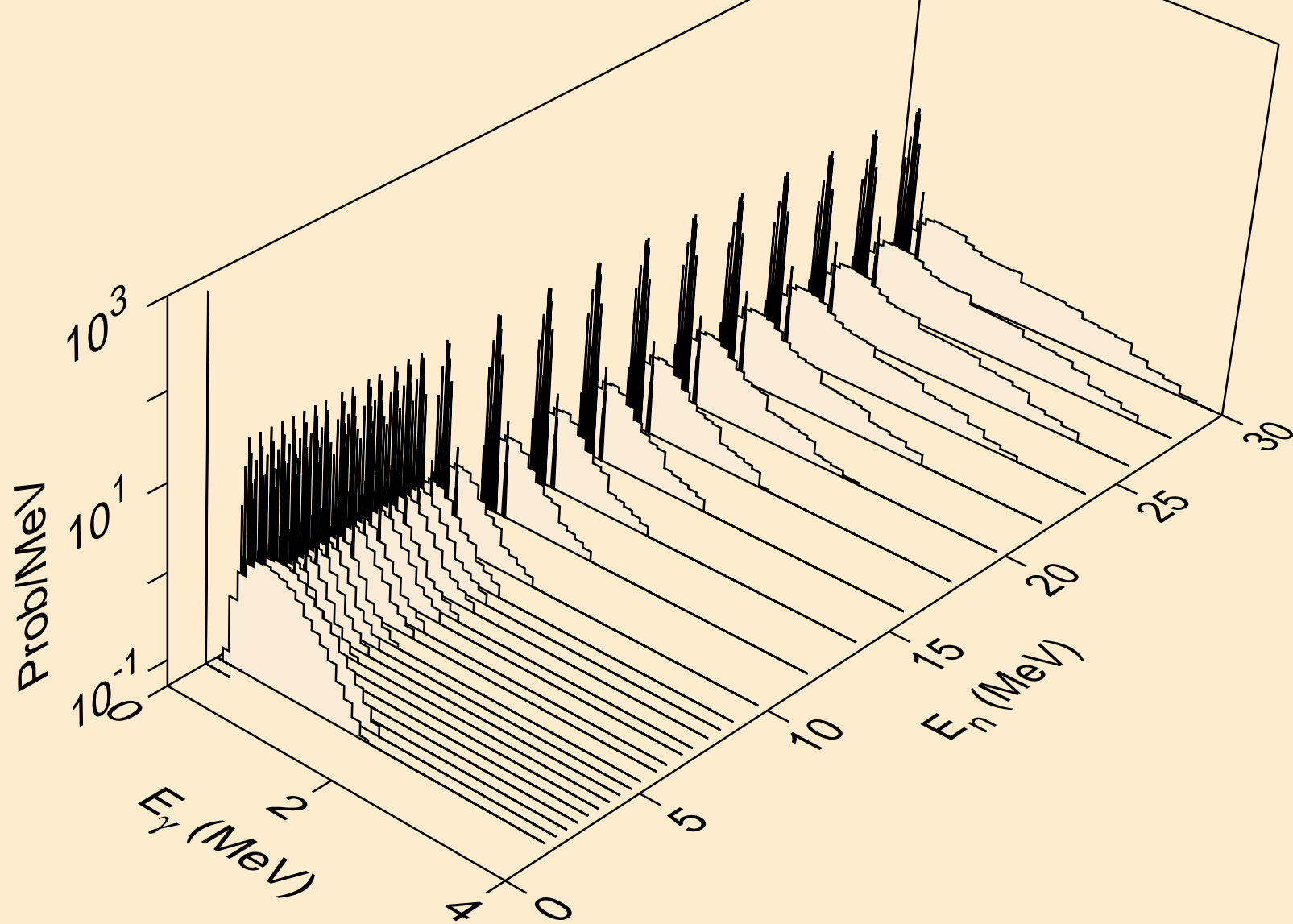

TA174 NEUTRON ACER TENDL-2023 LIBRARY; T=0.K
Photon emission for (n,2p)

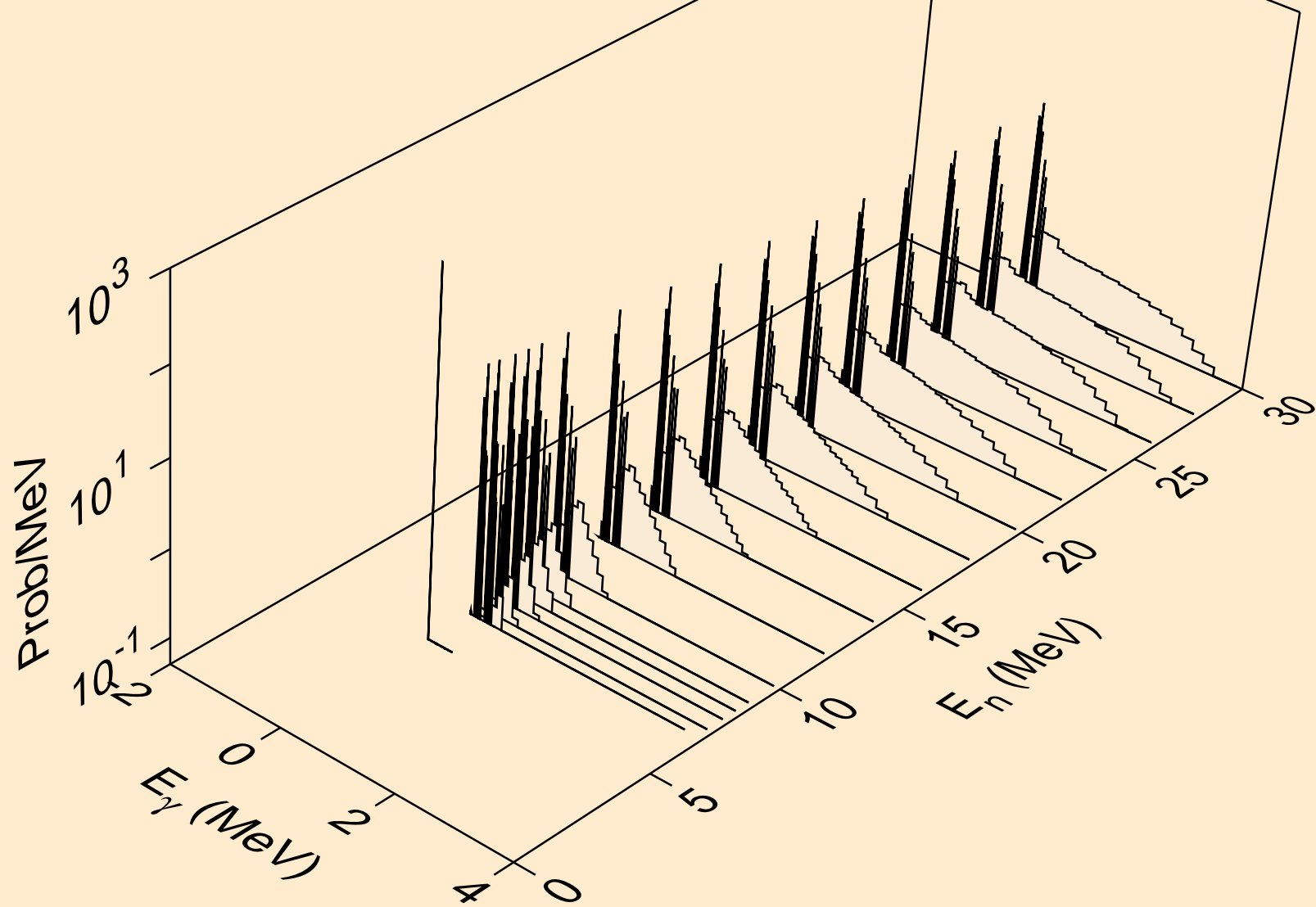

TA174 NEUTRON ACER TENDL-2023 LIBRARY; T=0.K
Photon emission for (n,p α)

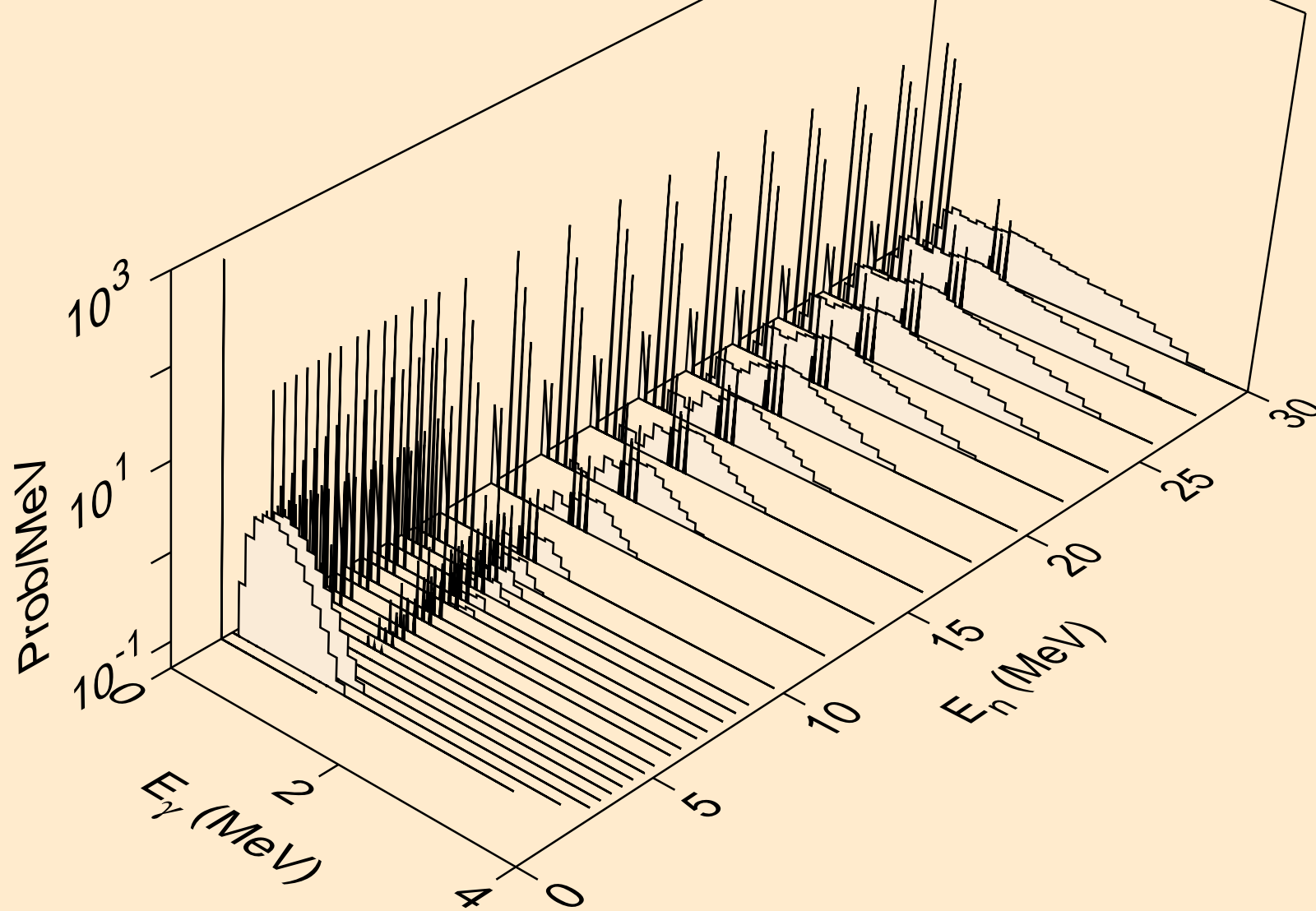

TA174 NEUTRON ACER TENDL-2023 LIBRARY; T=0.K
Photon emission for (n,pd)

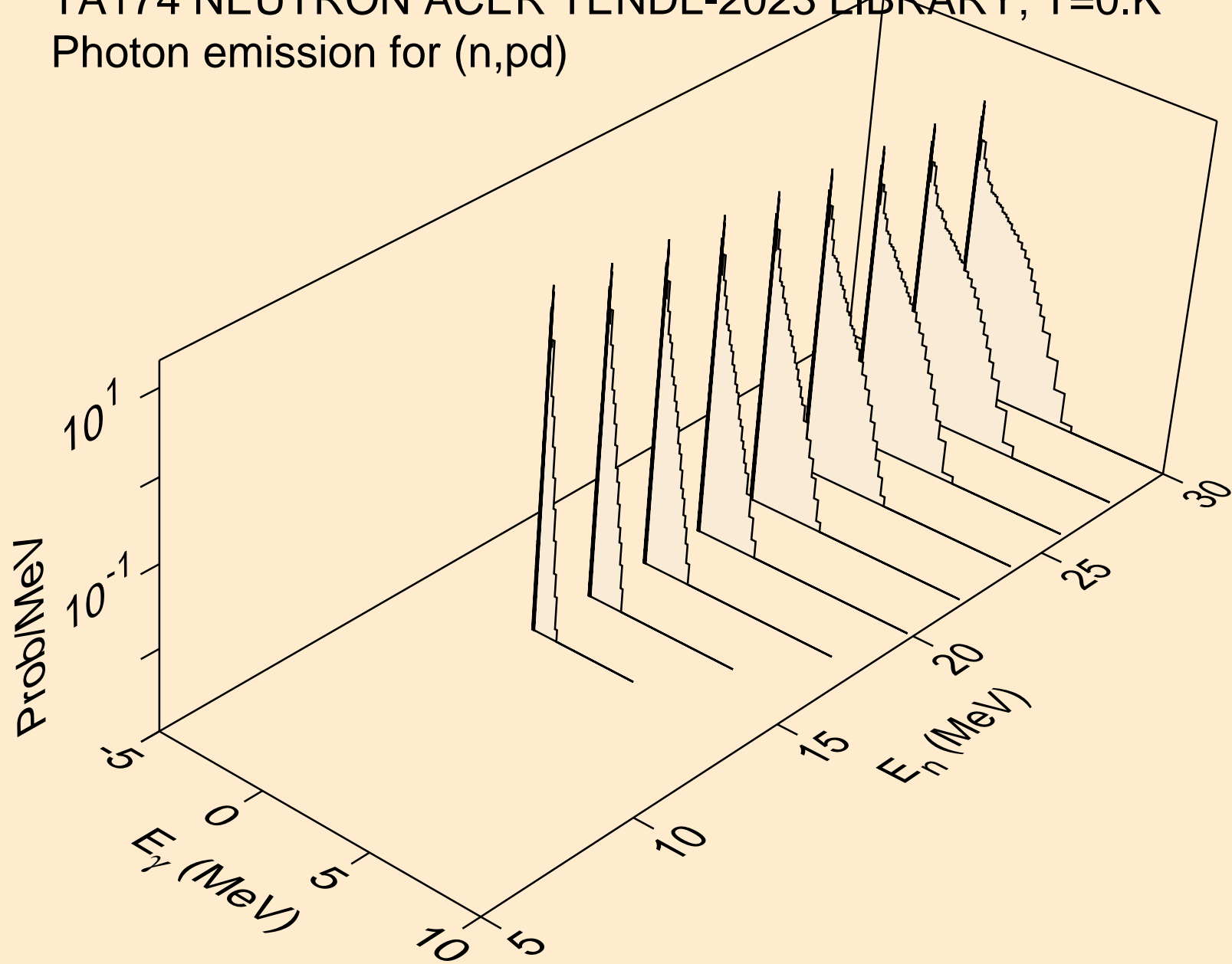

TA174 NEUTRON ACER TENDL-2023 LIBRARY; T=0.K
Photon emission for (n,pt)

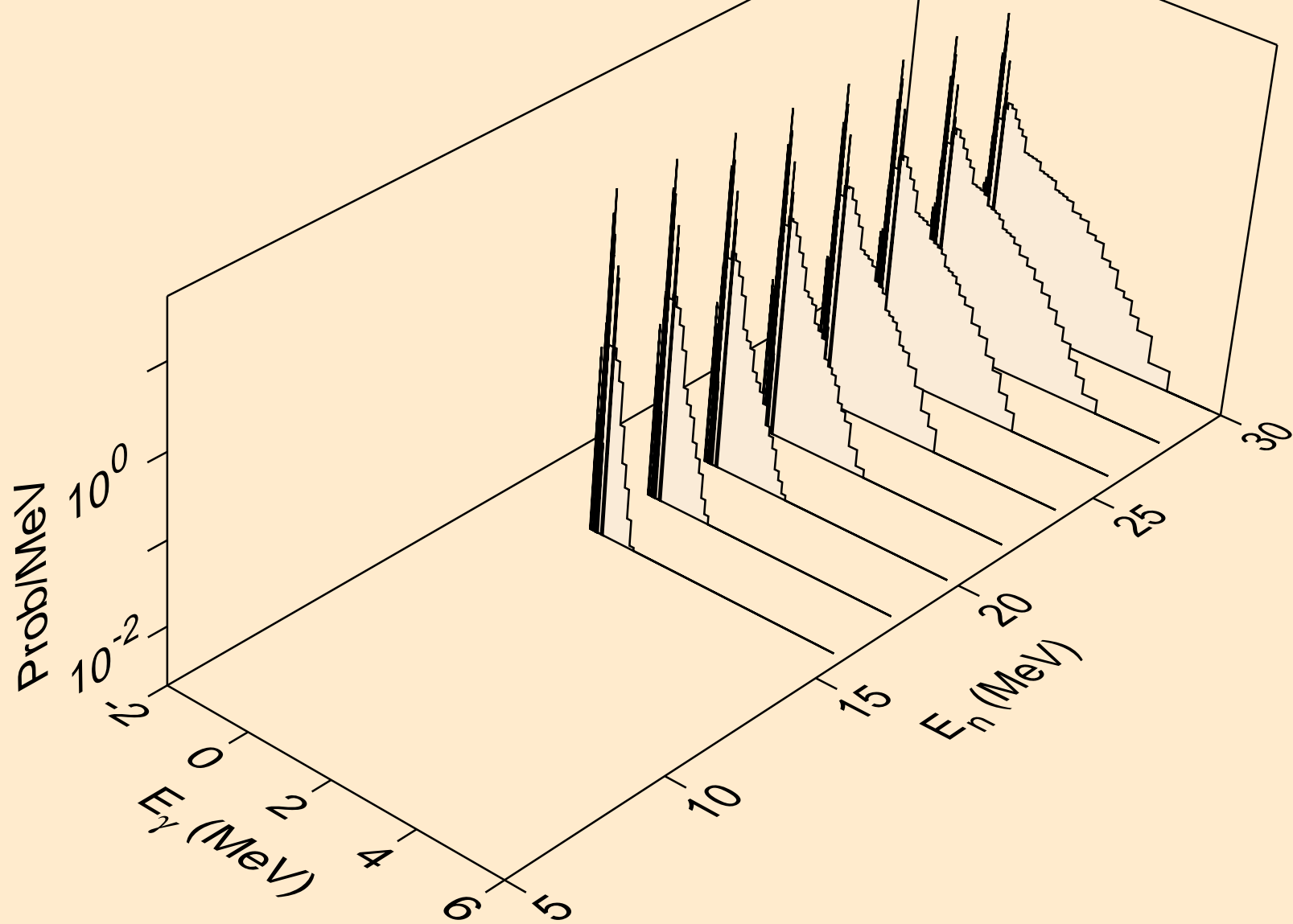

TA174 NEUTRON ACER TENDL-2023 LIBRARY; T=0.K
Photon emission for (n,da)

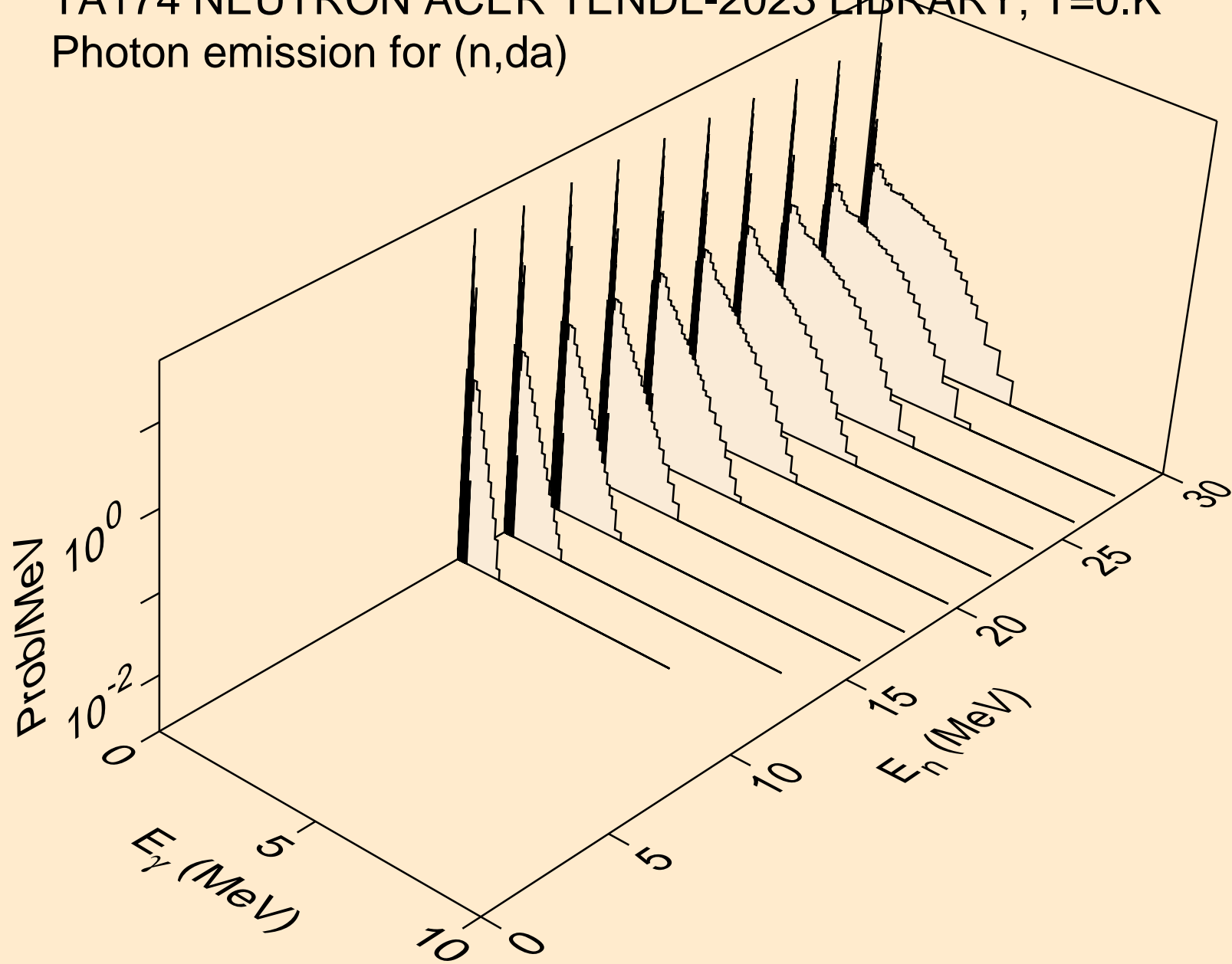

TA174 NEUTRON ACER TENDL-2023 LIBRARY; T=0.K
thermal capture photon spectrum

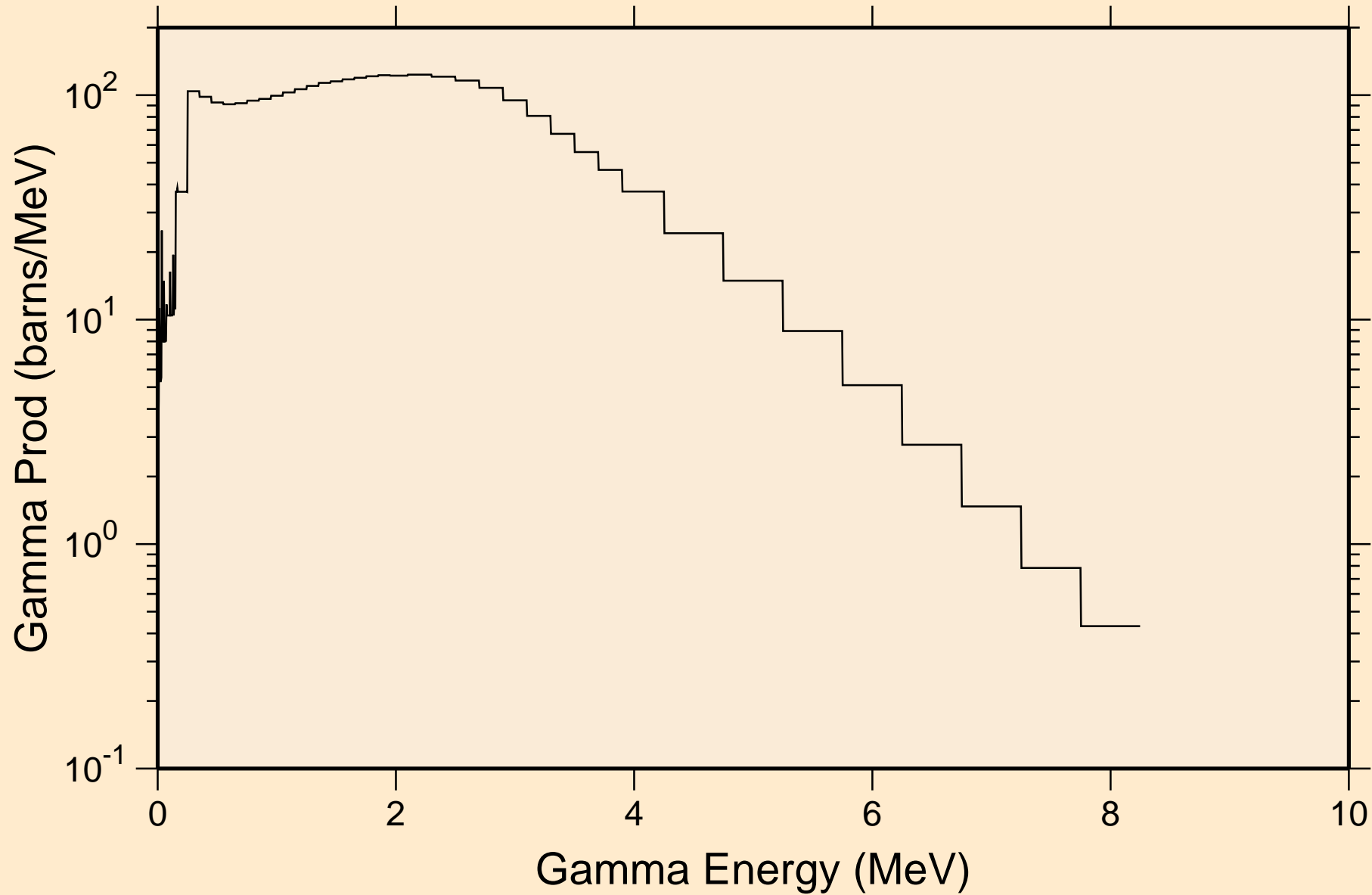

TA174 NEUTRON ACER TENDL-2023 LIBRARY; T=0.K
14 MeV photon spectrum

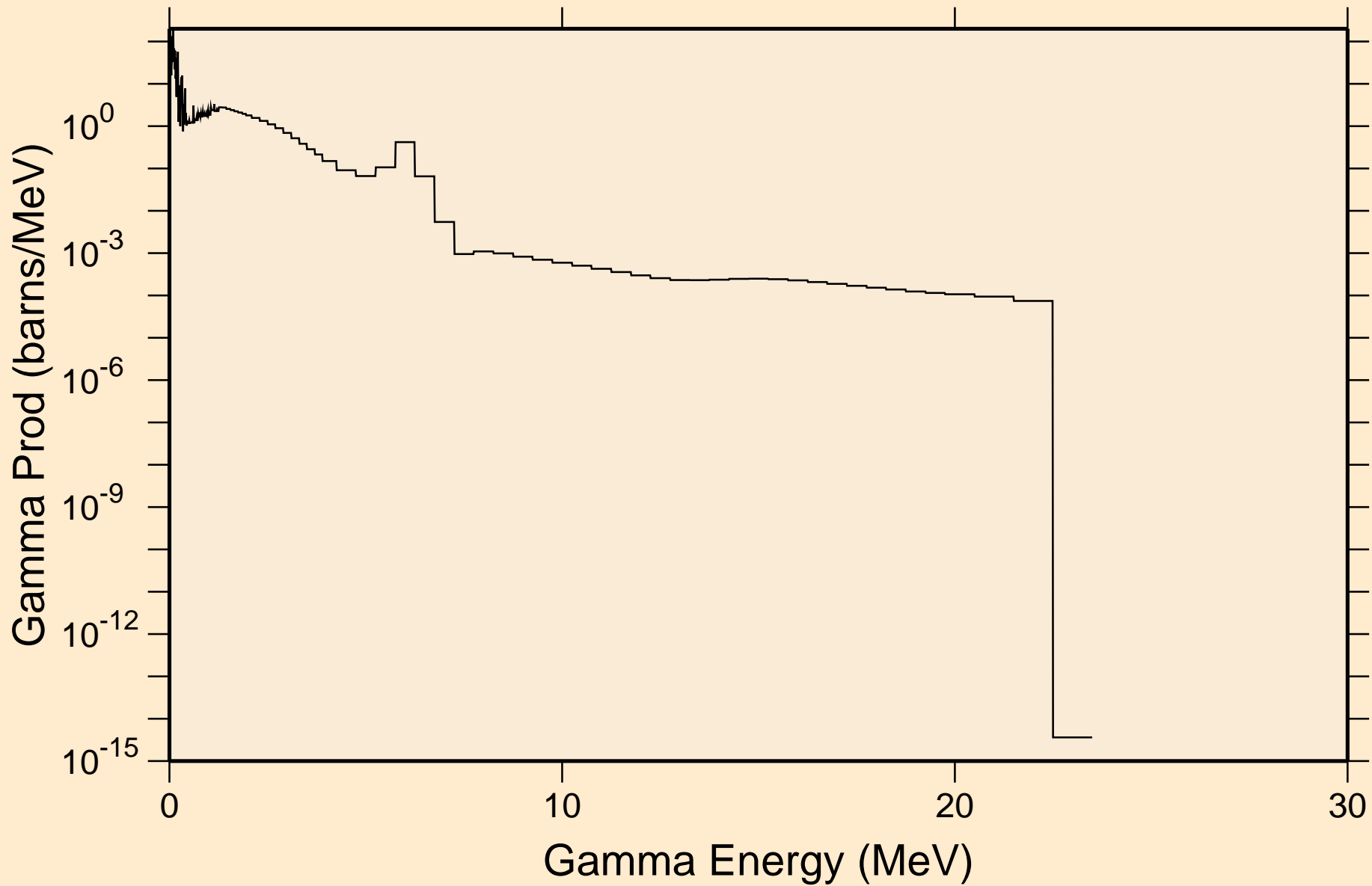

TA174 NEUTRON ACER TENDL-2023 LIBRARY; T=0.K
Particle heating contributions

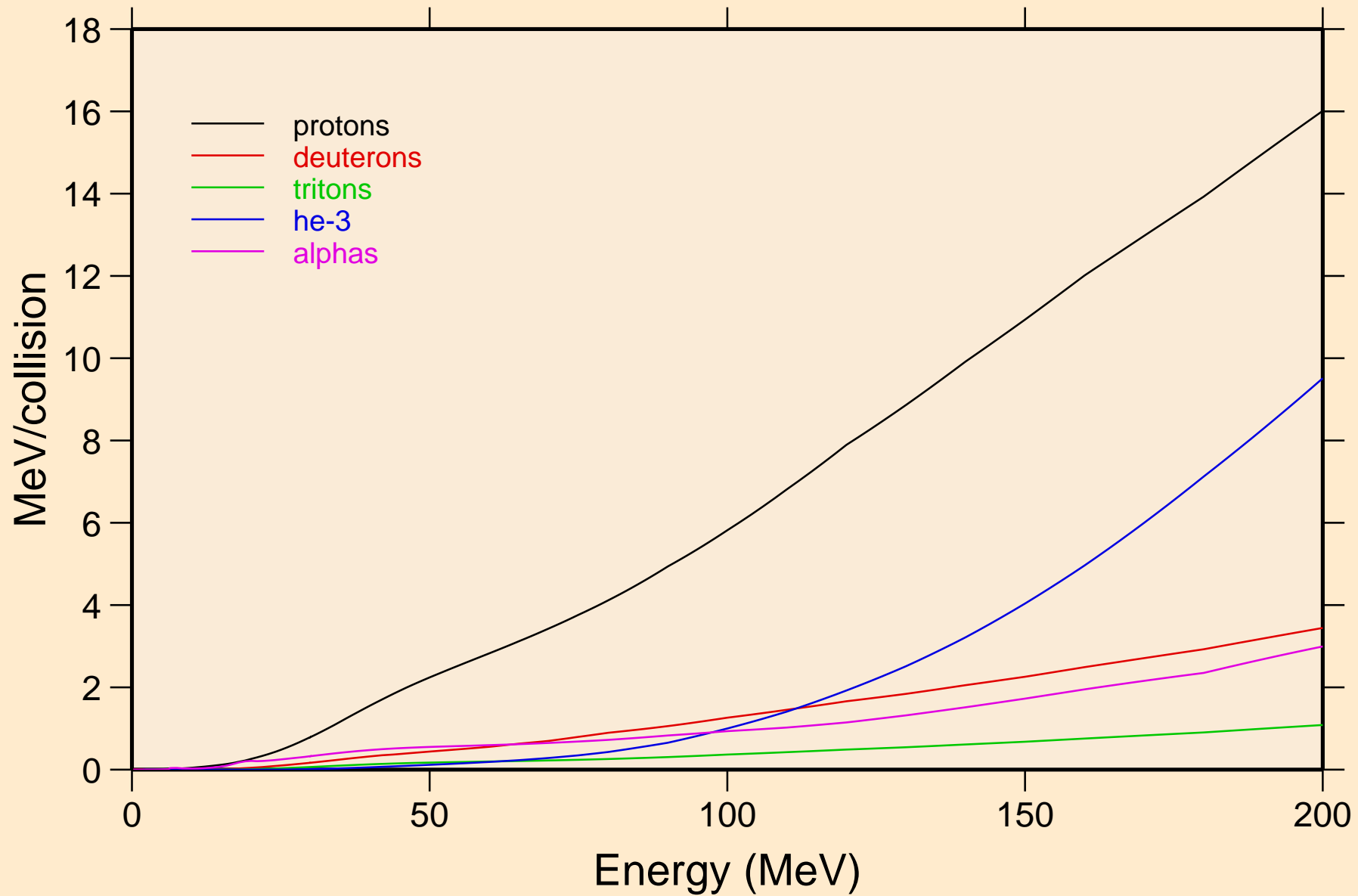

TA174 NEUTRON ACER TENDL-2023 LIBRARY; T=0.K
Recoil Heating

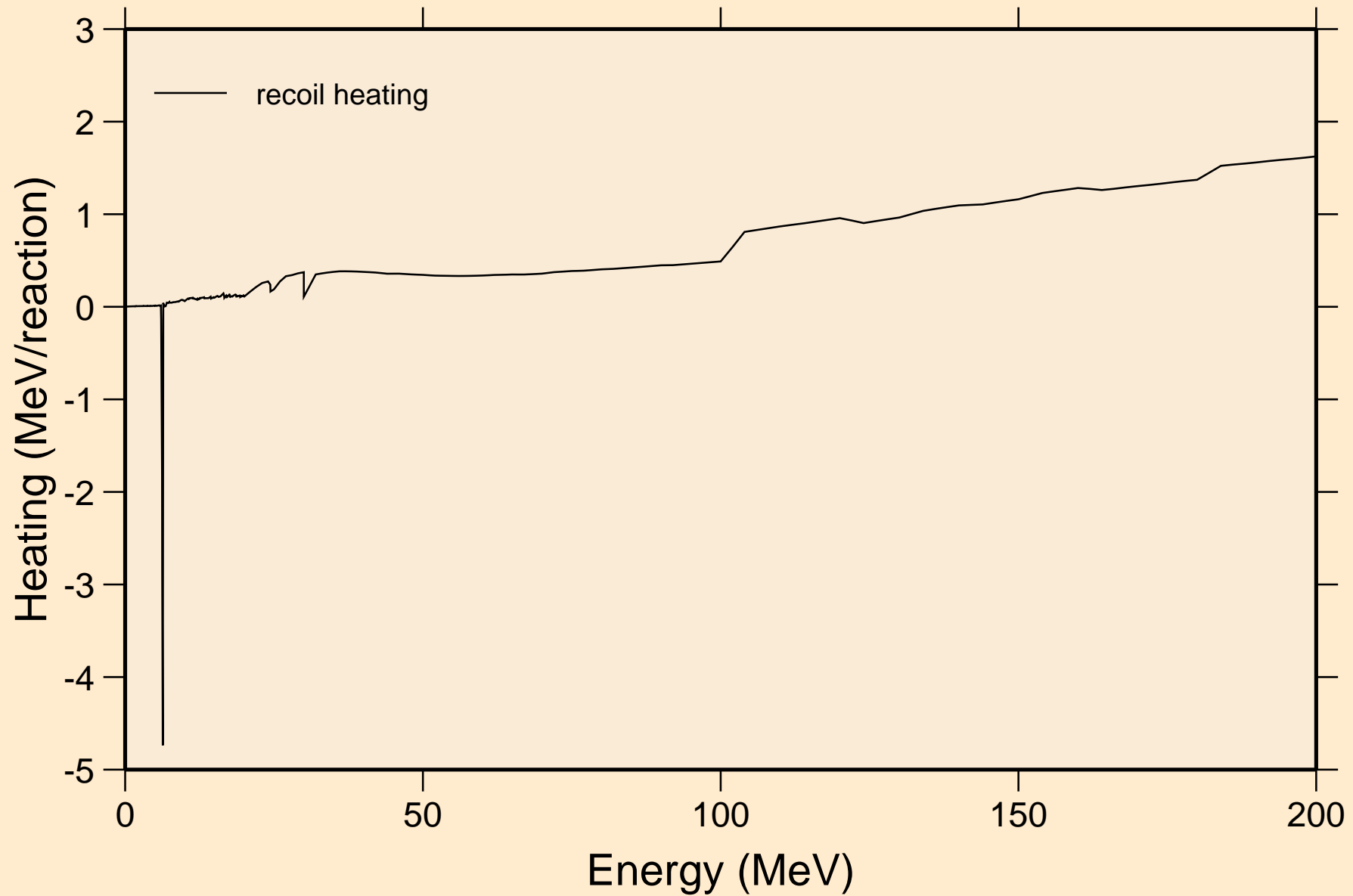

TA174 NEUTRON ACER TENDL-2023 LIBRARY; T=0.K
Particle production cross sections

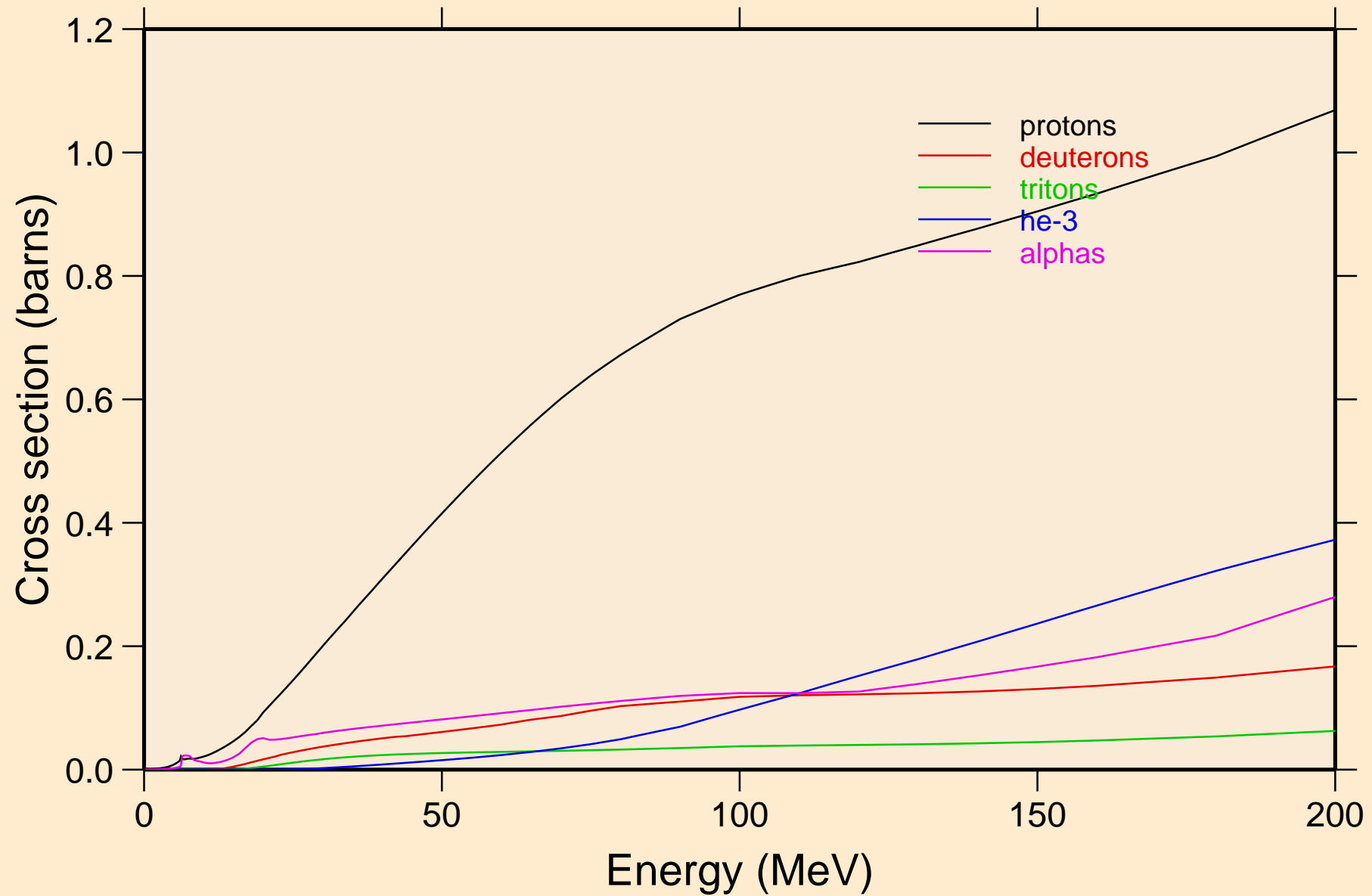

TA174 NEUTRON ACER TENDL-2023 LIBRARY; T=0.K
protons from (n,x)

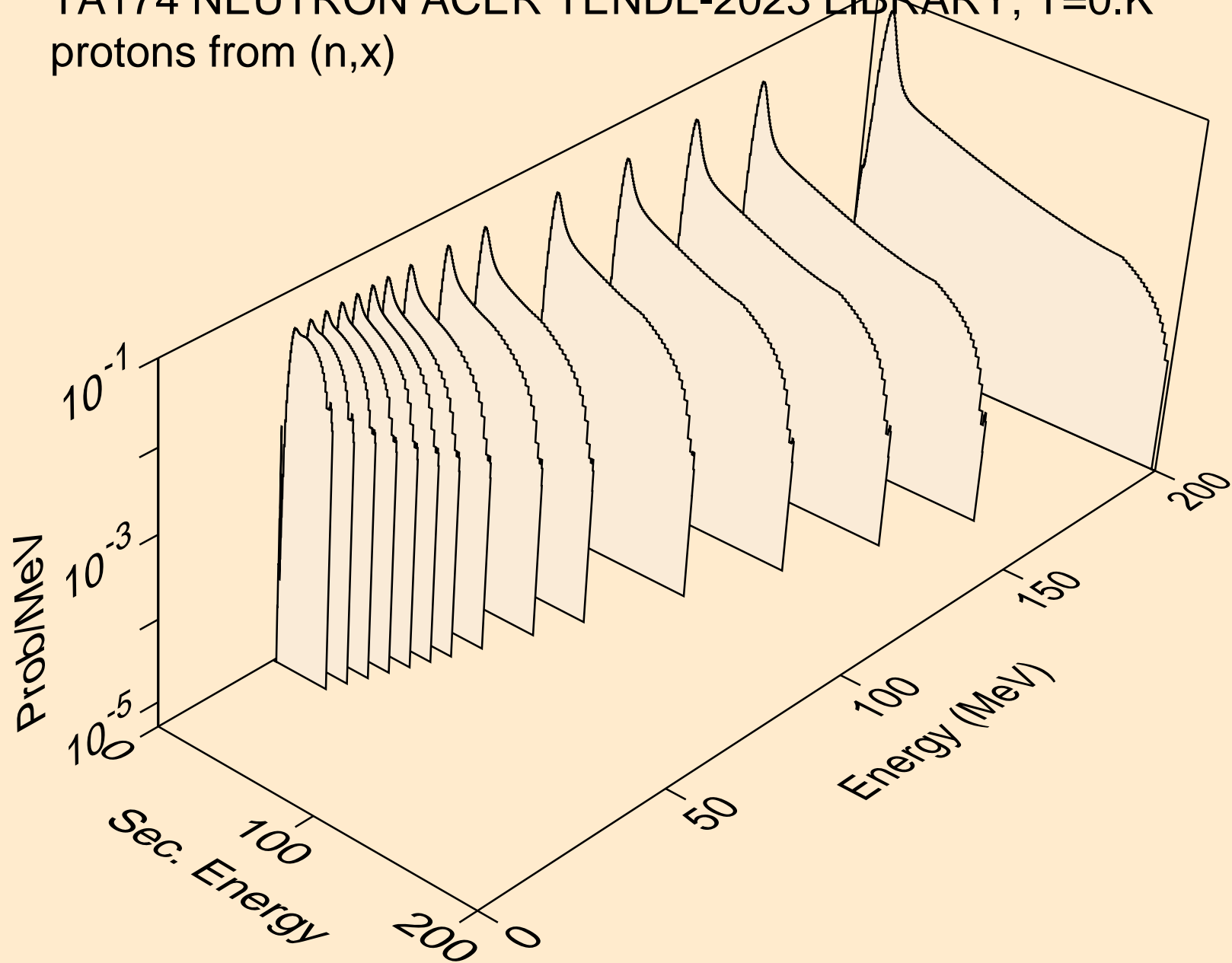

TA174 NEUTRON ACER TENDL-2023 LIBRARY; T=0.K
protons from (n,n*)p

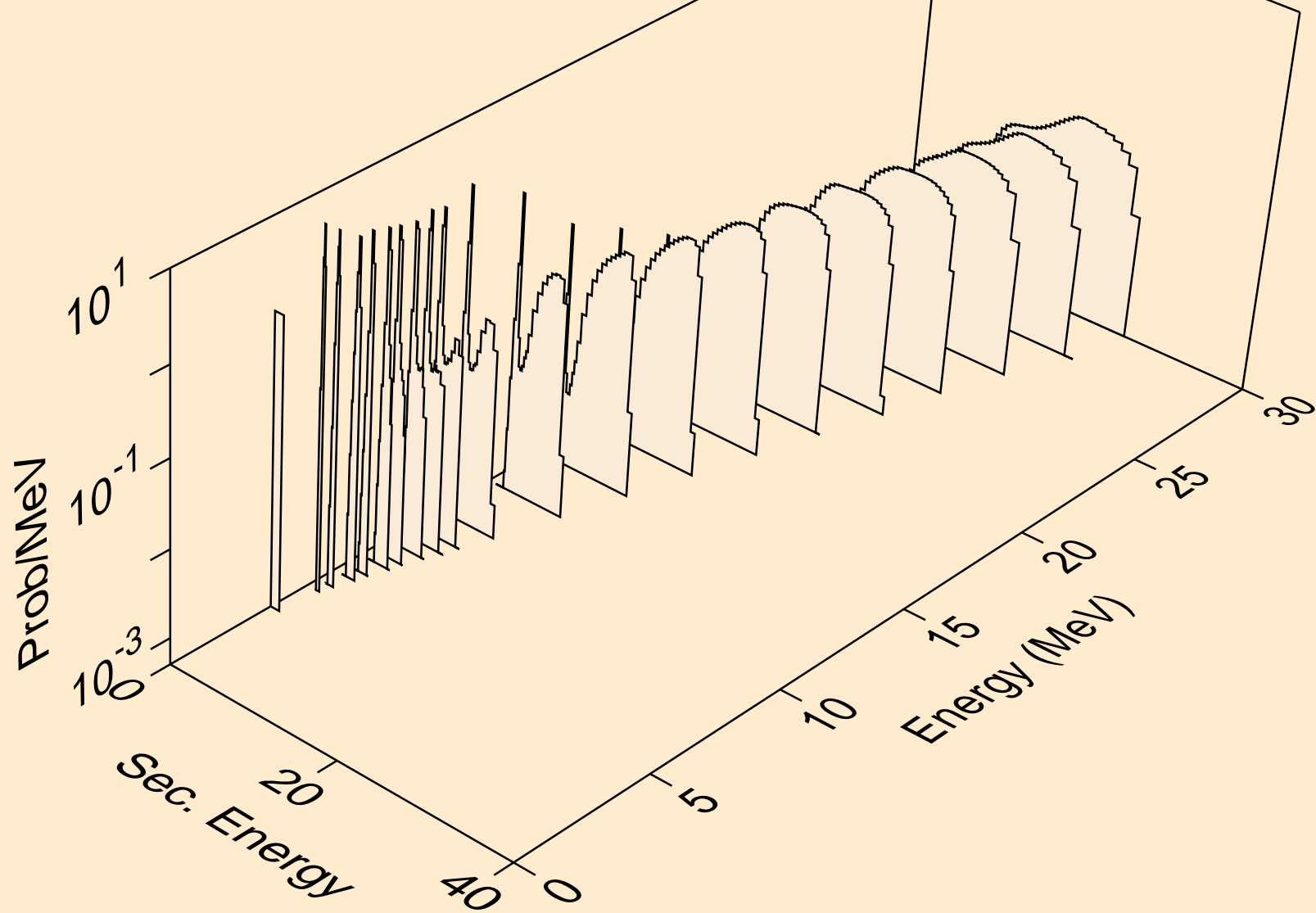

TA174 NEUTRON ACER TENDL-2023 LIBRARY; T=0.K
protons from (n,2np)

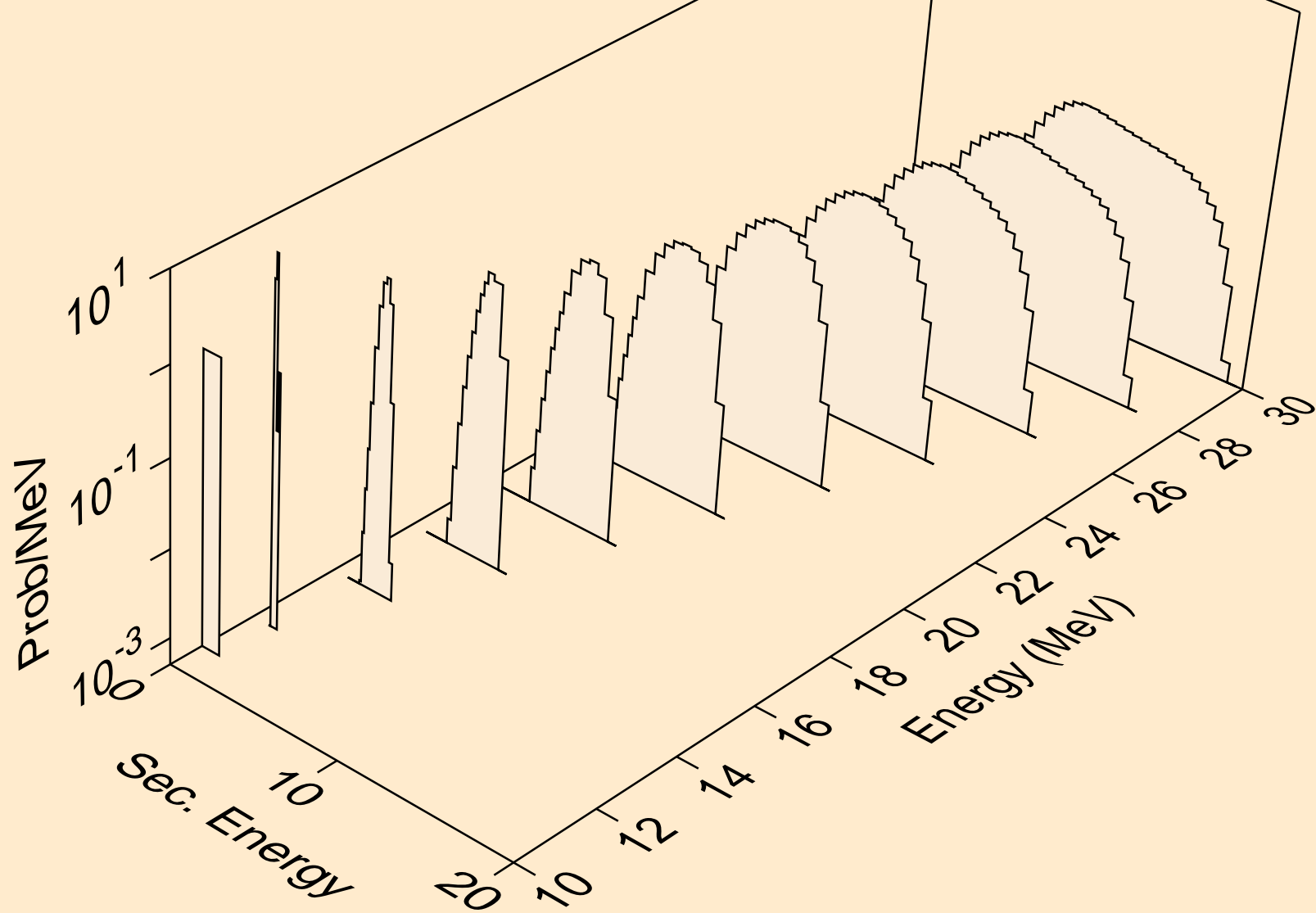

TA174 NEUTRON ACER TENDL-2023 LIBRARY; T=0.K
protons from (n,3np)

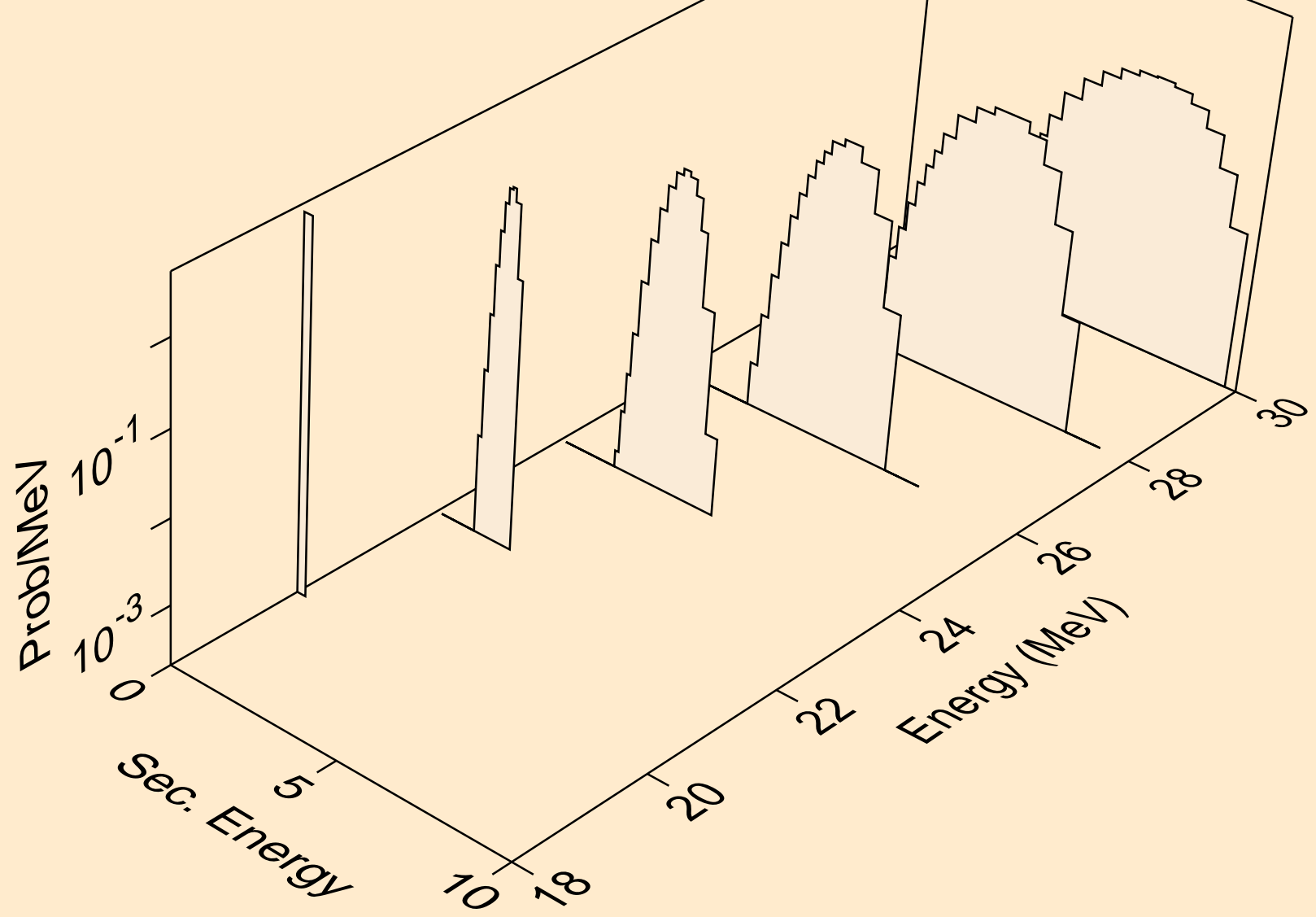

TA174 NEUTRON ACER TENDL-2023 LIBRARY; T=0.K
protons from (n,n2p)

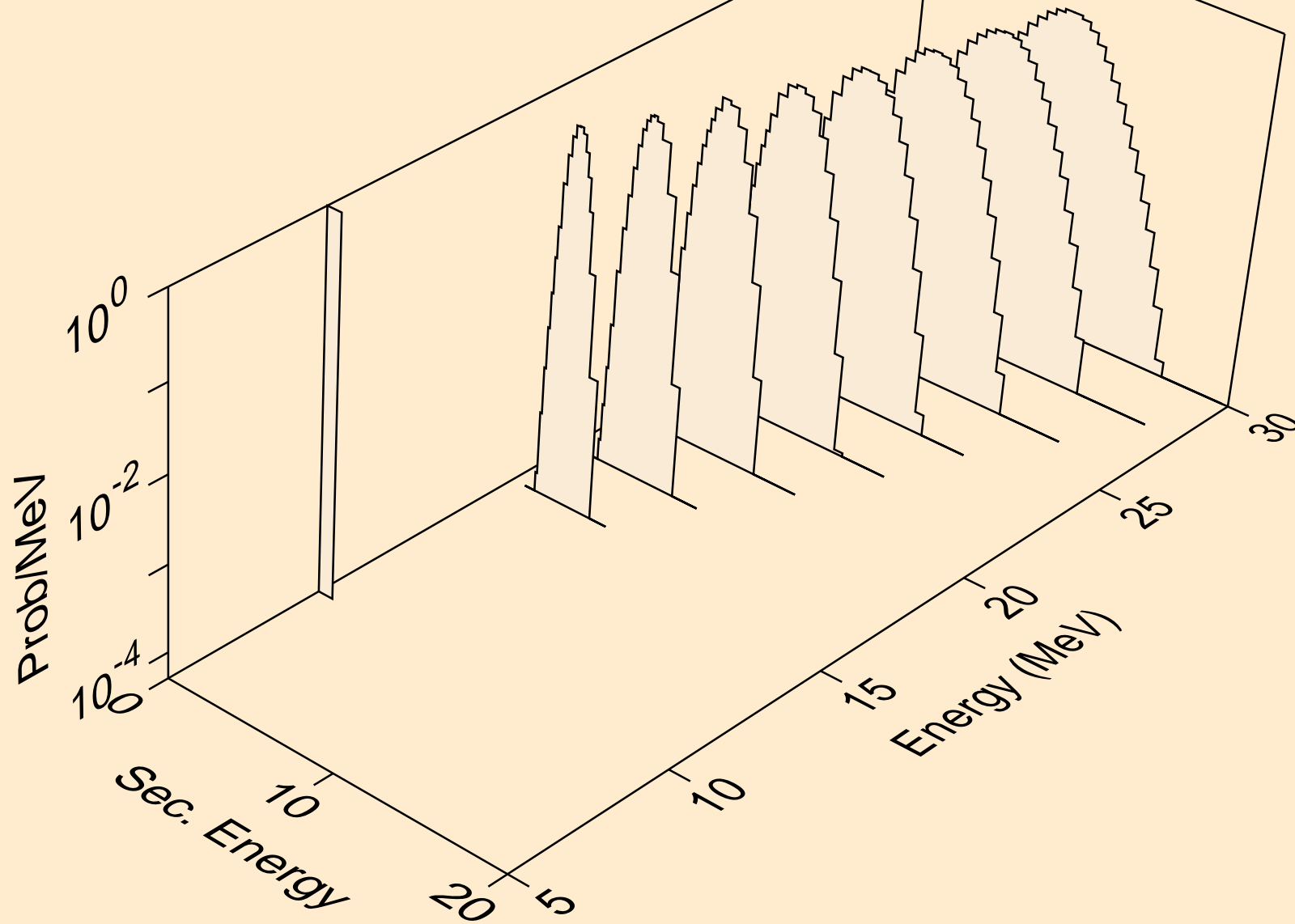

TA174 NEUTRON ACER TENDL-2023 LIBRARY; T=0.K
protons from (n,npa)

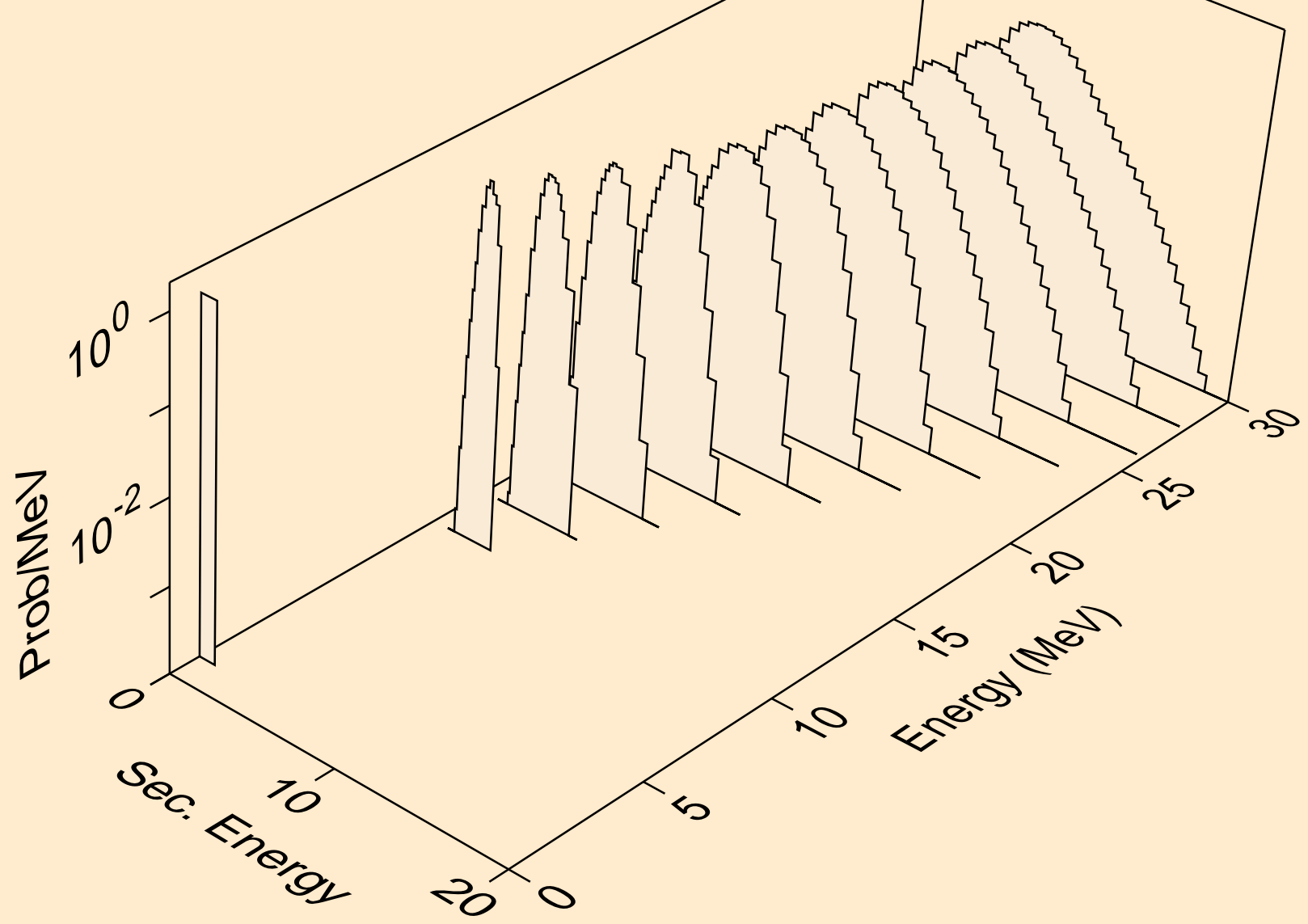

TA174 NEUTRON ACER TENDL-2023 LIBRARY; T=0.K
protons from (n,p)

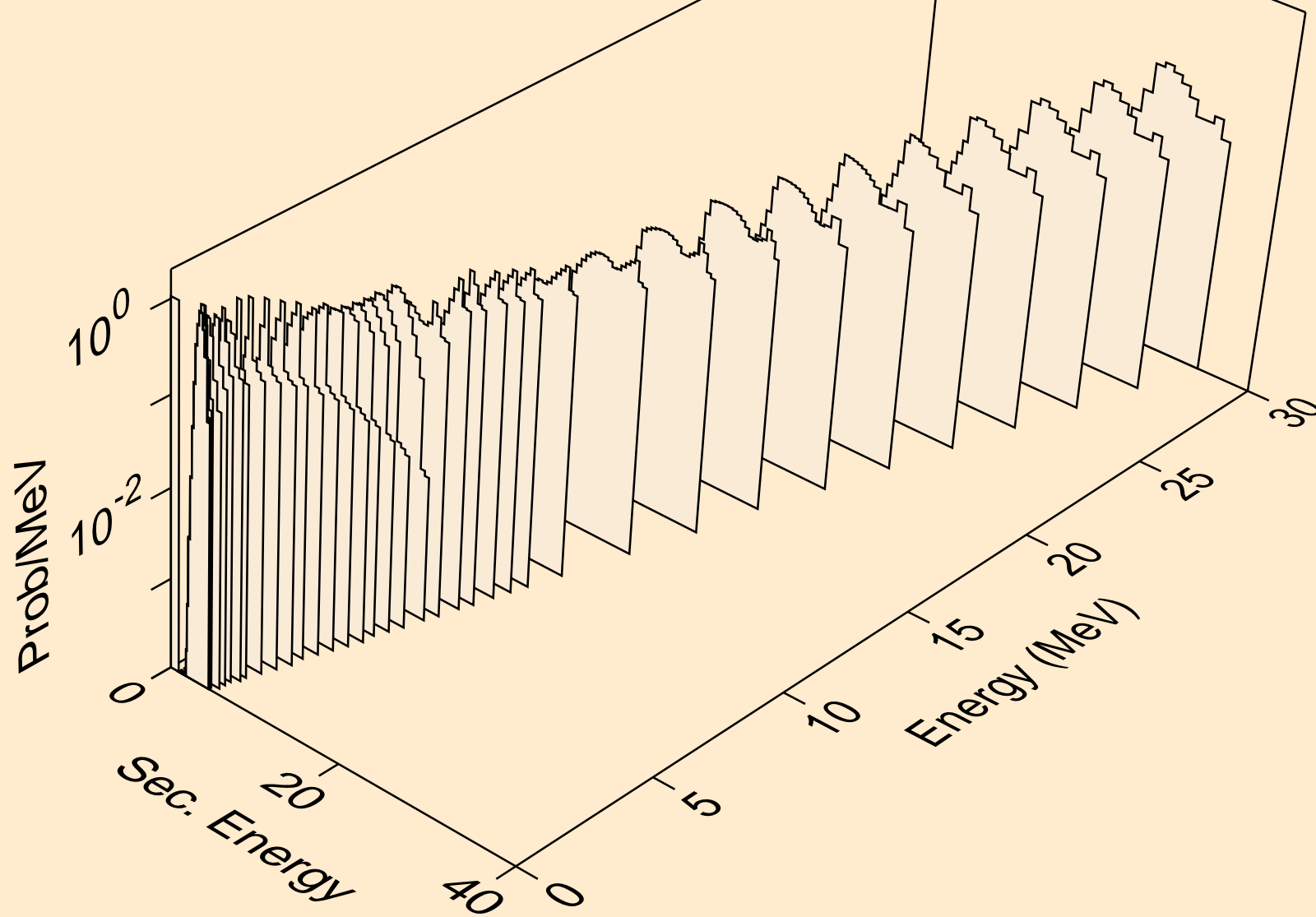

TA174 NEUTRON ACER TENDL-2023 LIBRARY; T=0.K
protons from (n,2p)

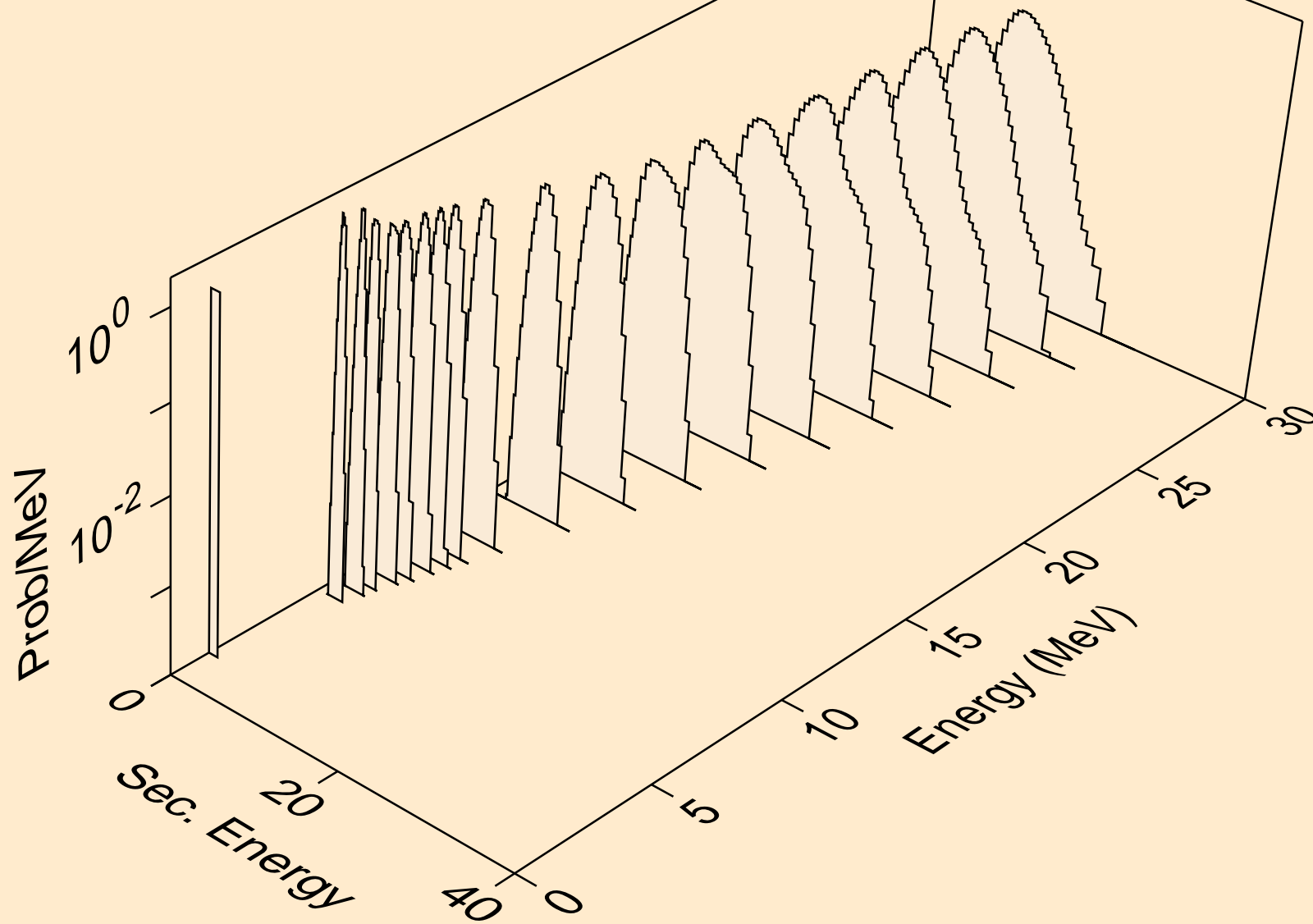

TA174 NEUTRON ACER TENDL-2023 LIBRARY; T=0.K
protons from (n,p)

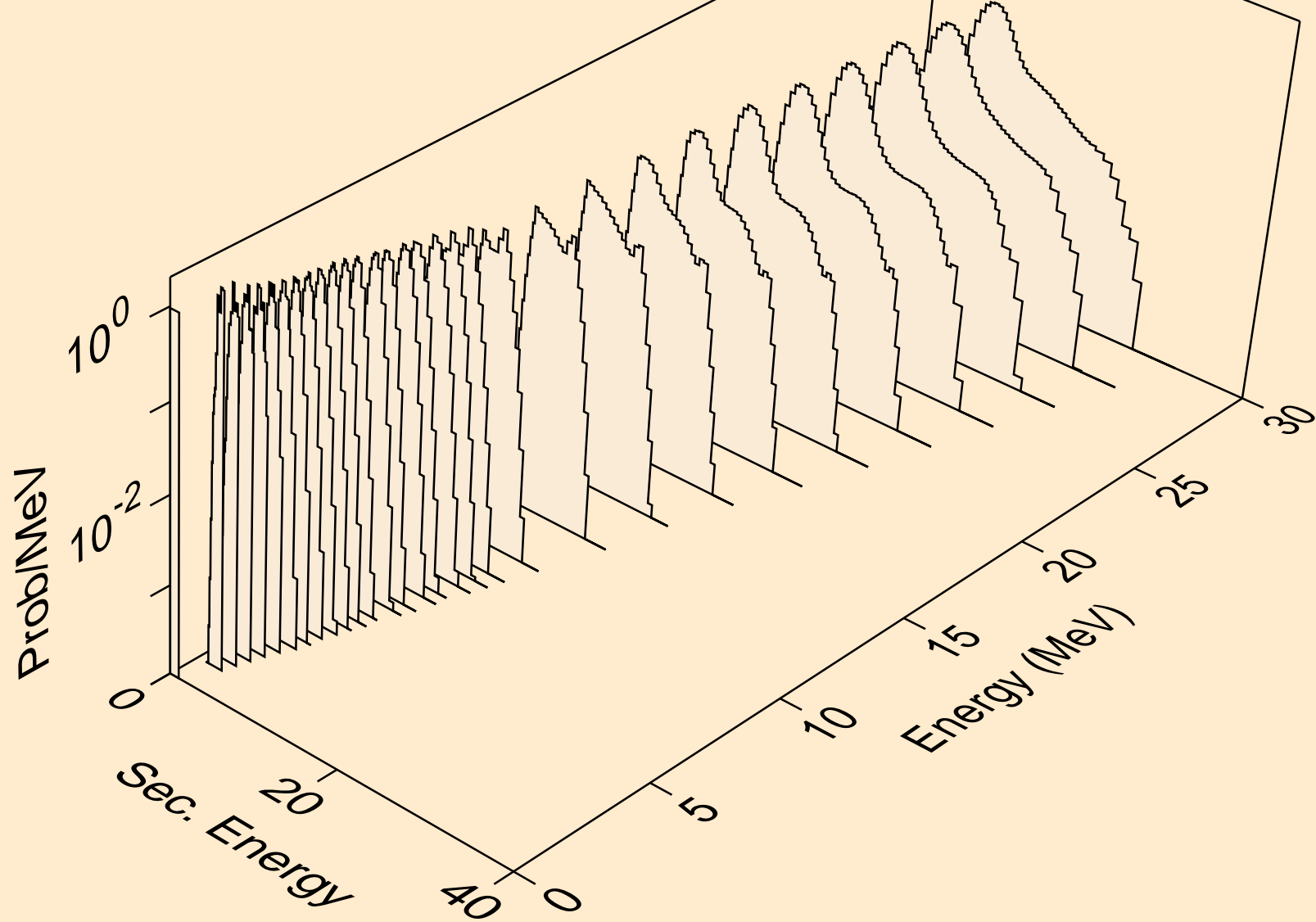

TA174 NEUTRON ACER TENDL-2023 LIBRARY; T=0.K
protons from (n,pd)

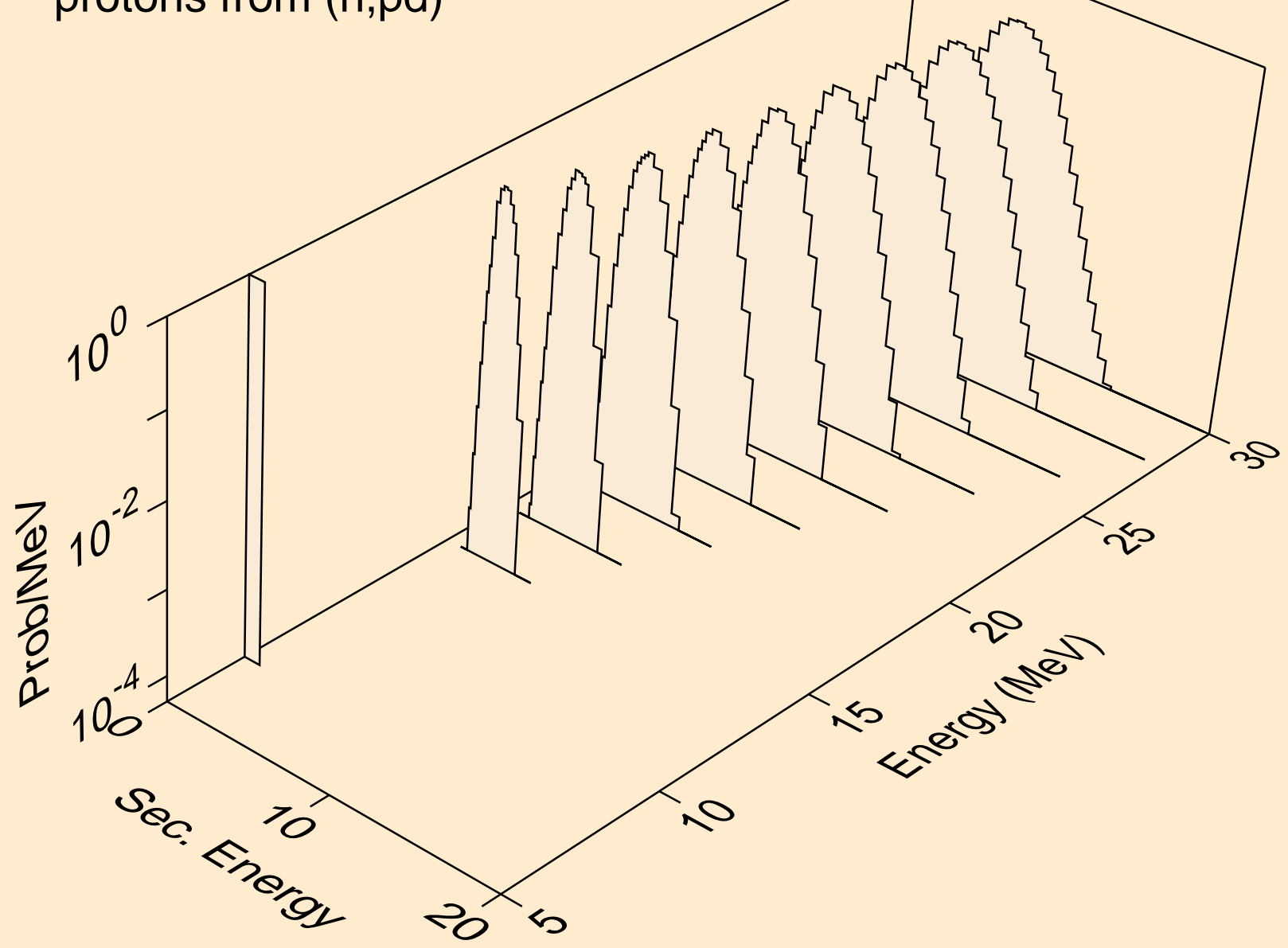

TA174 NEUTRON ACER TENDL-2023 LIBRARY; T=0.K
protons from (n,pt)

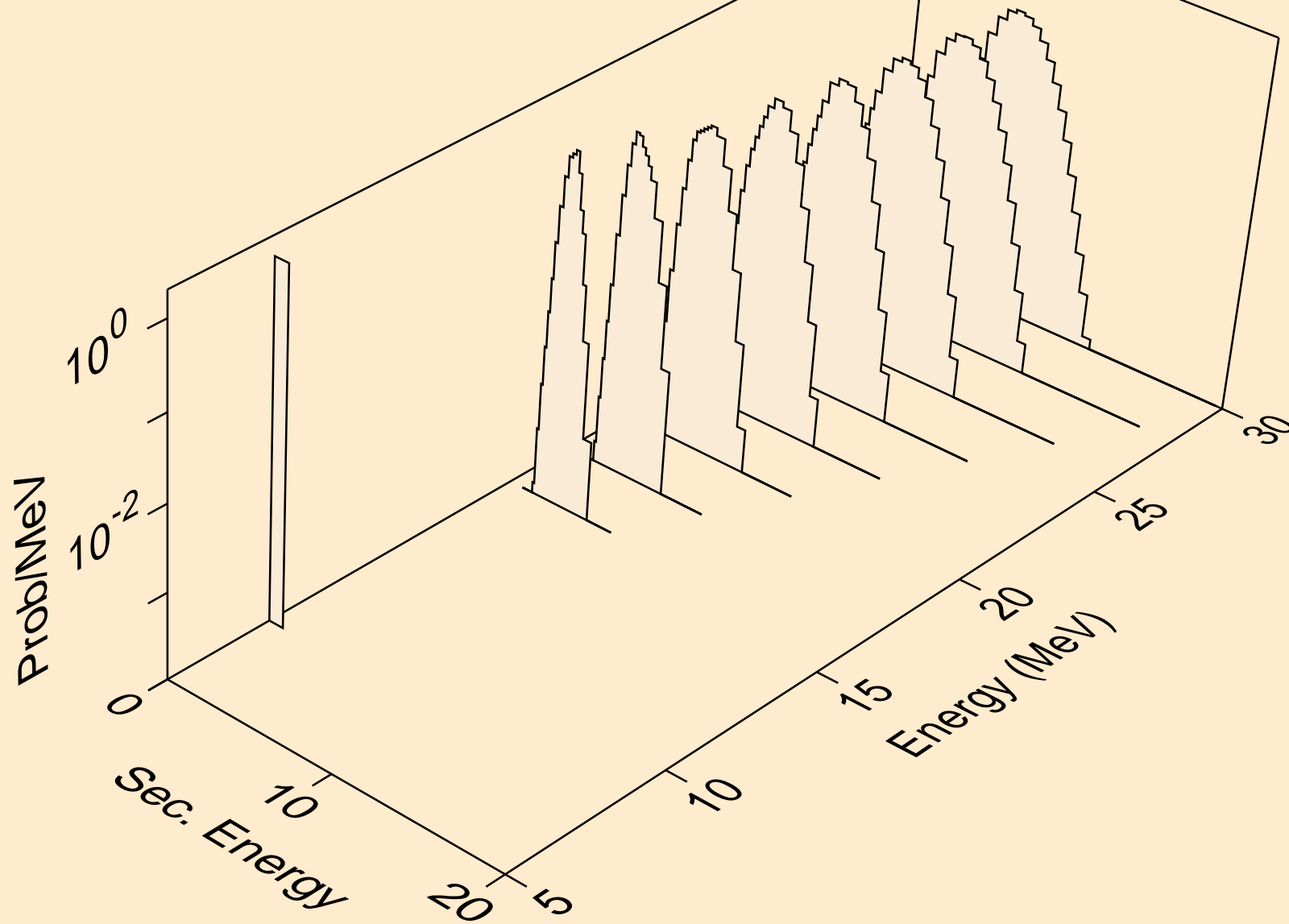

TA174 NEUTRON ACER TENDL-2023 LIBRARY; T=0.K
deuterons from (n,x)

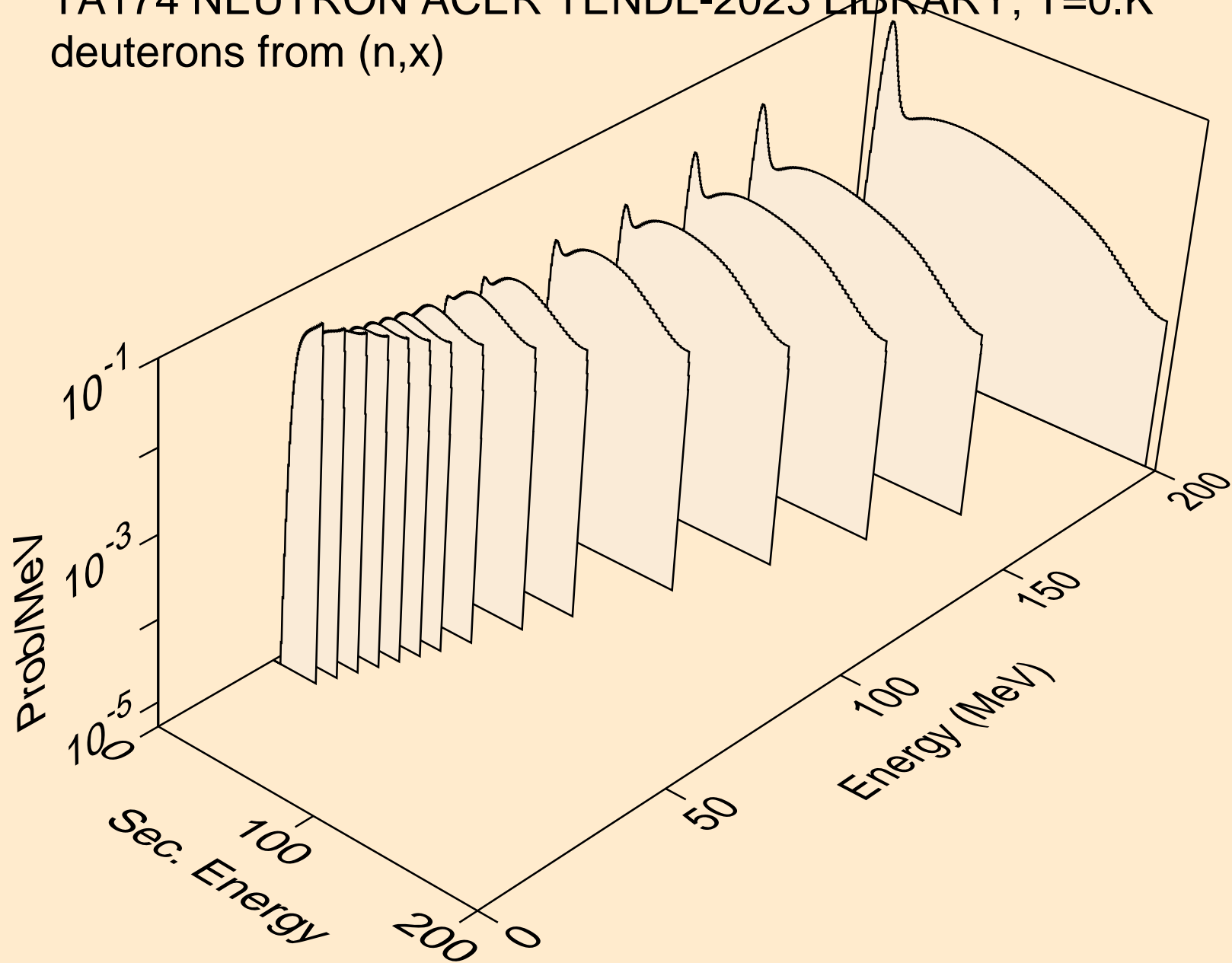

TA174 NEUTRON ACER TENDL-2023 LIBRARY; T=0.K
deuterons from (n,2nd)

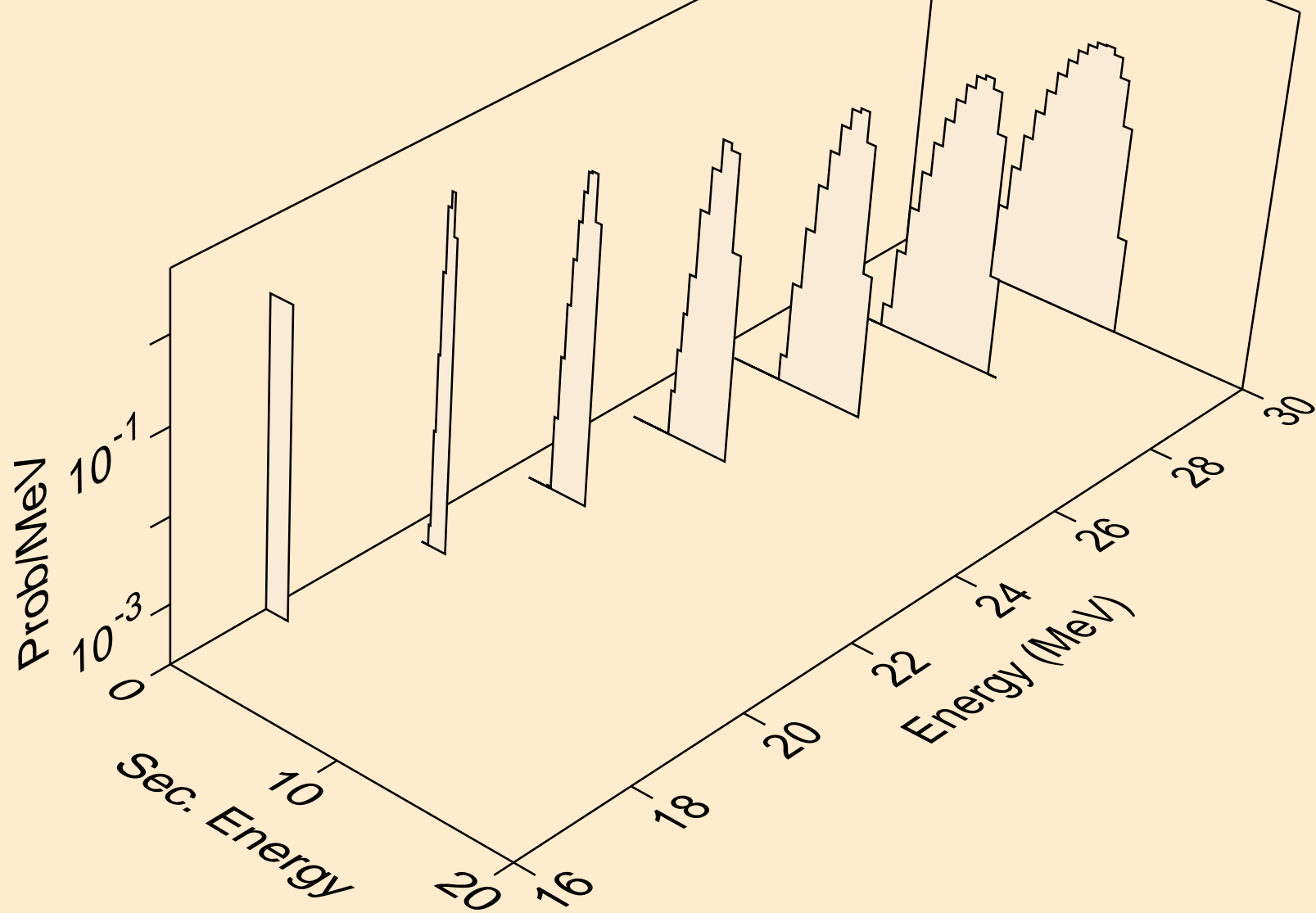

TA174 NEUTRON ACER TENDL-2023 LIBRARY; T=0.K
deuterons from (n,n*)d

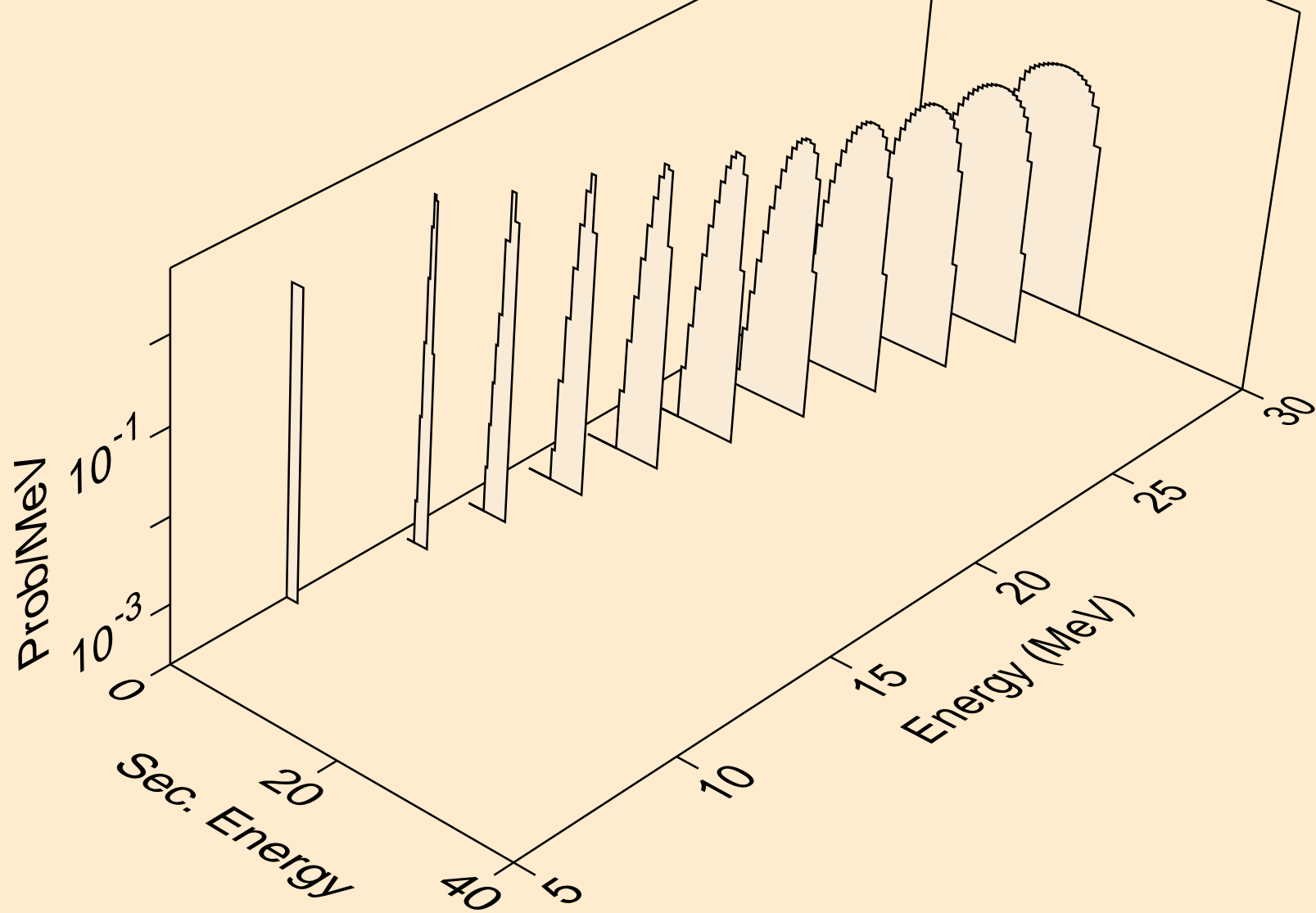

TA174 NEUTRON ACER TENDL-2023 LIBRARY; T=0.K
deuterons from (n,d)

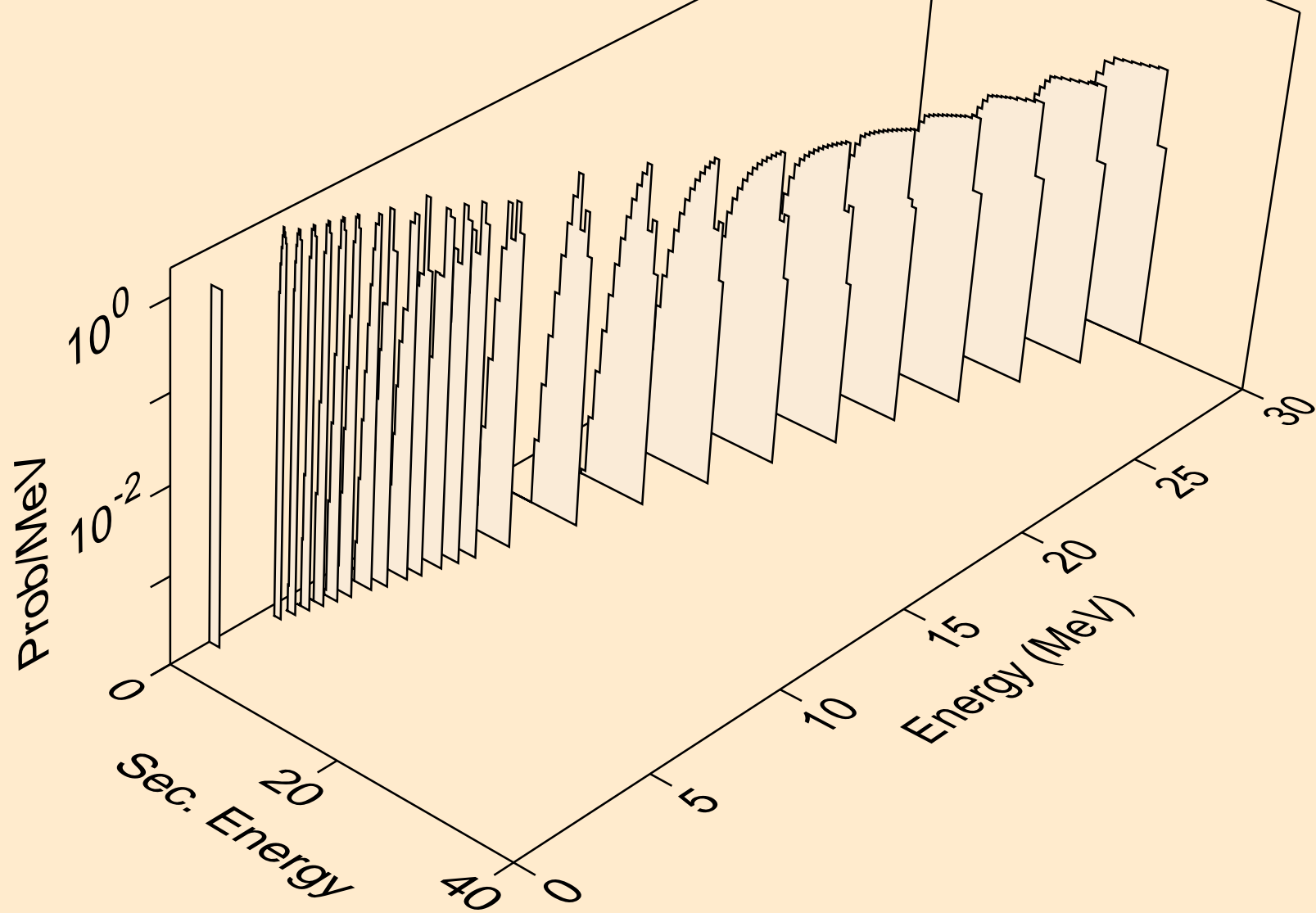

TA174 NEUTRON ACER TENDL-2023 LIBRARY; T=0.K
deuterons from (n,pd)

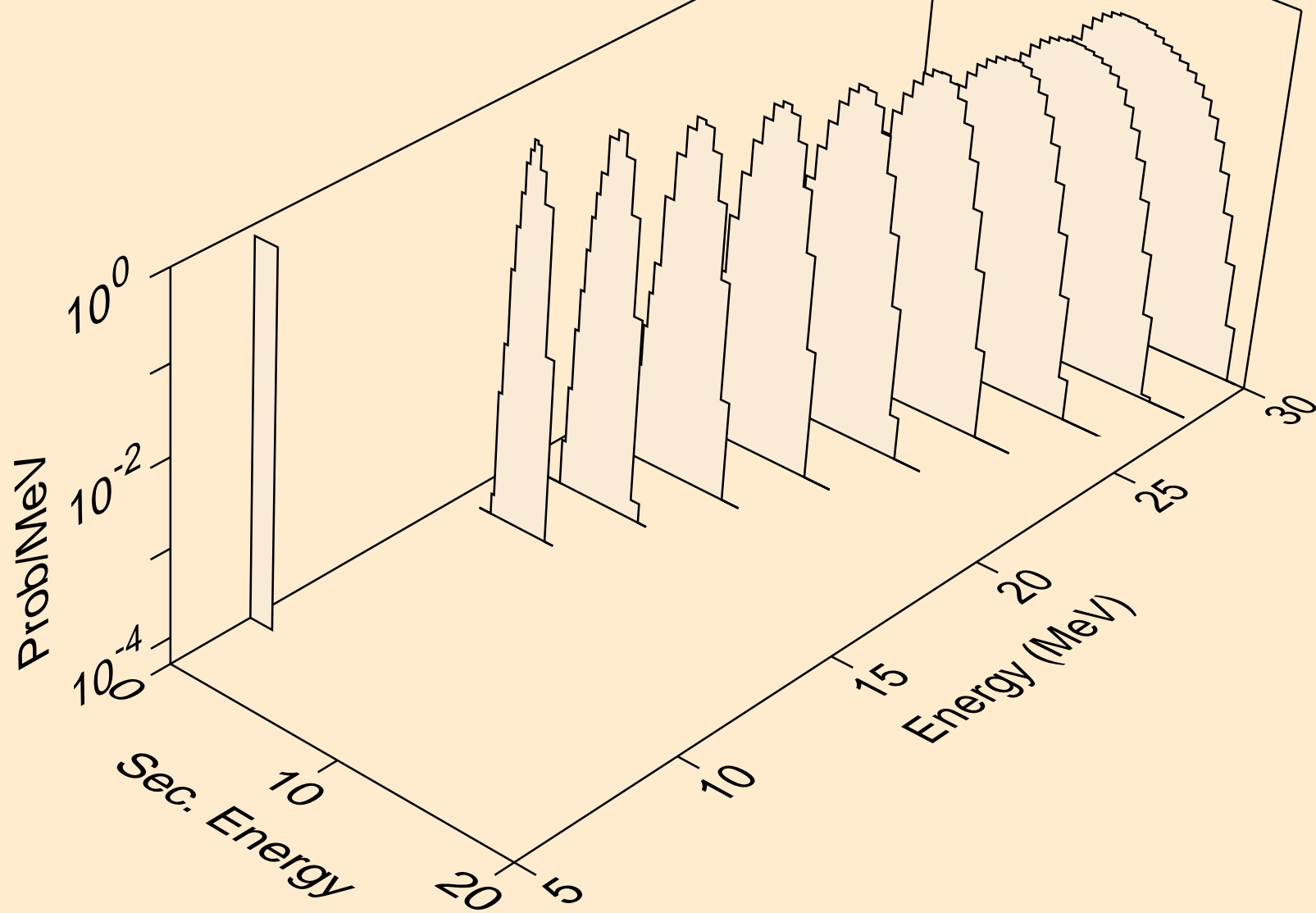

TA174 NEUTRON ACER TENDL-2023 LIBRARY; T=0.K
deuterons from (n,da)

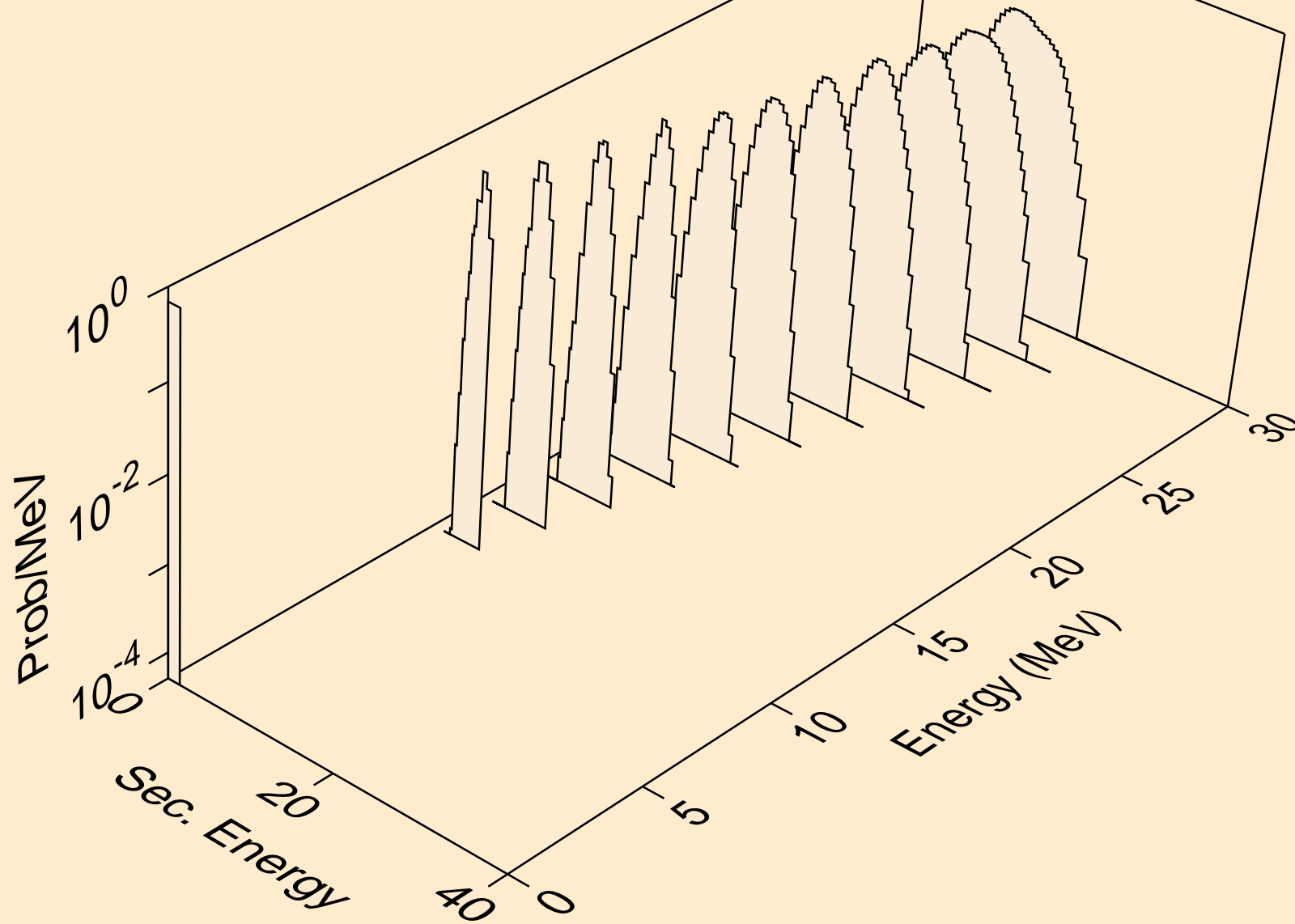

TA174 NEUTRON ACER TENDL-2023 LIBRARY; T=0.K
tritons from (n,x)

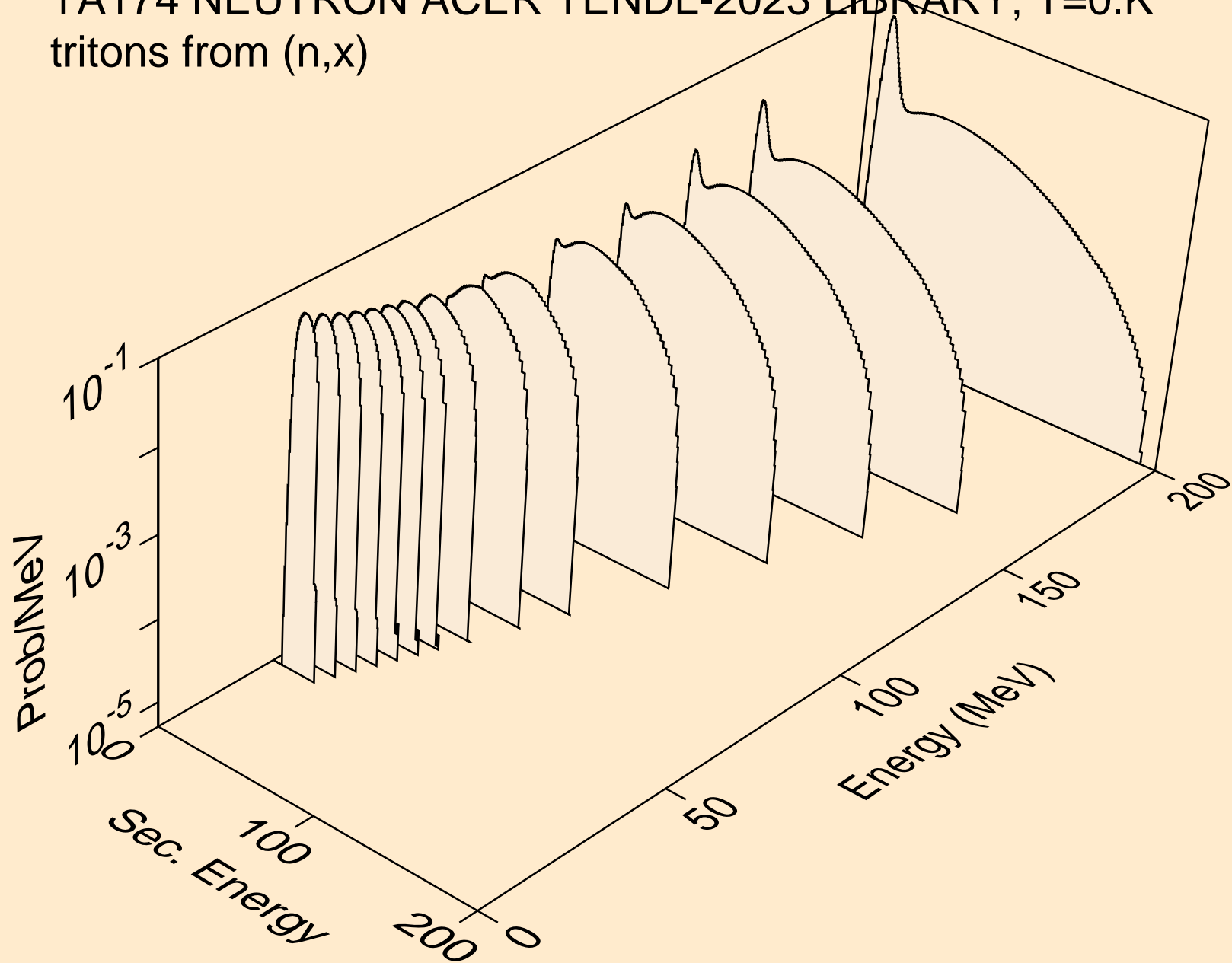

TA174 NEUTRON ACER TENDL-2023 LIBRARY; T=0.K
tritons from (n,n*)t

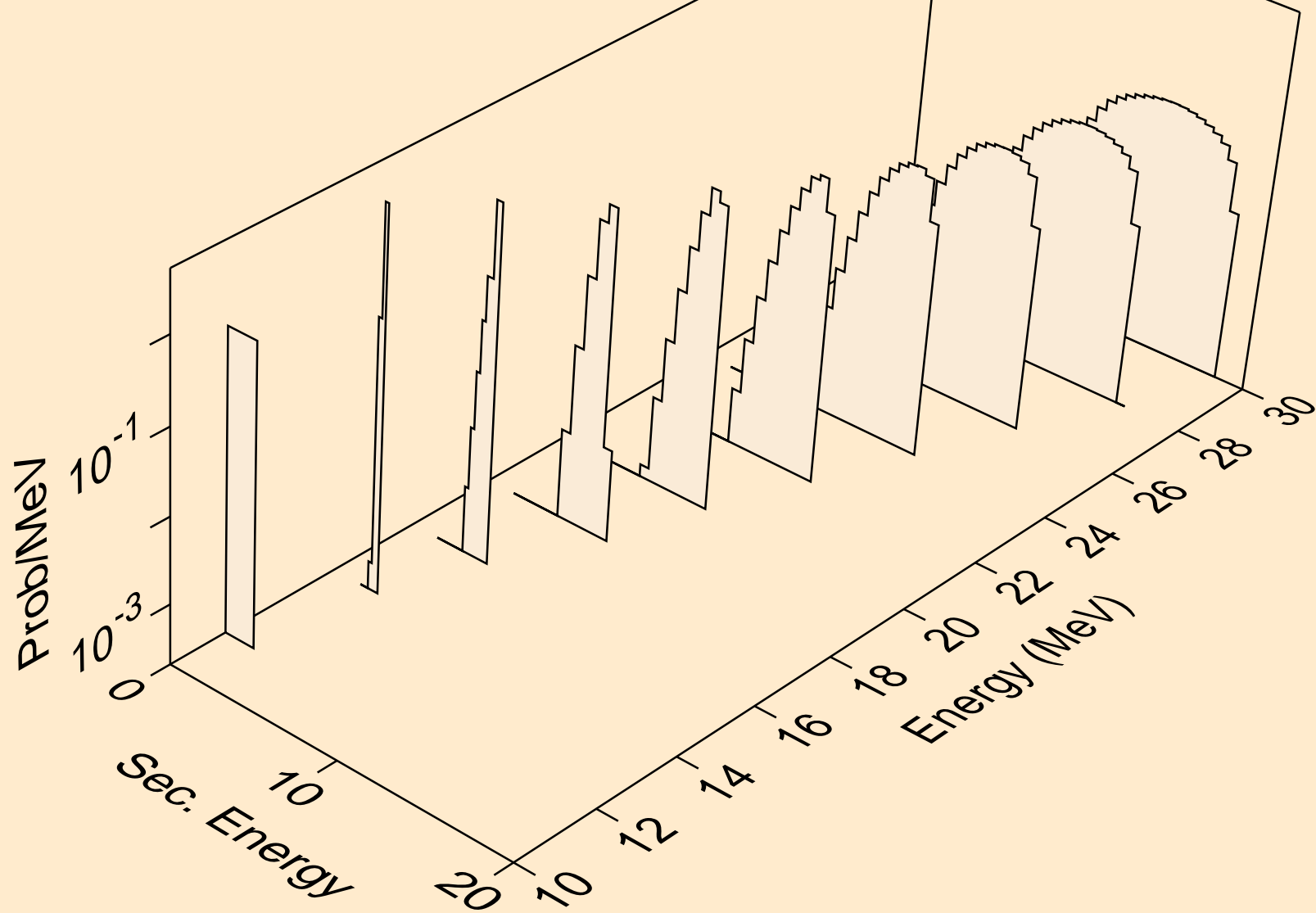

TA174 NEUTRON ACER TENDL-2023 LIBRARY; T=0.K
tritons from (n,t)

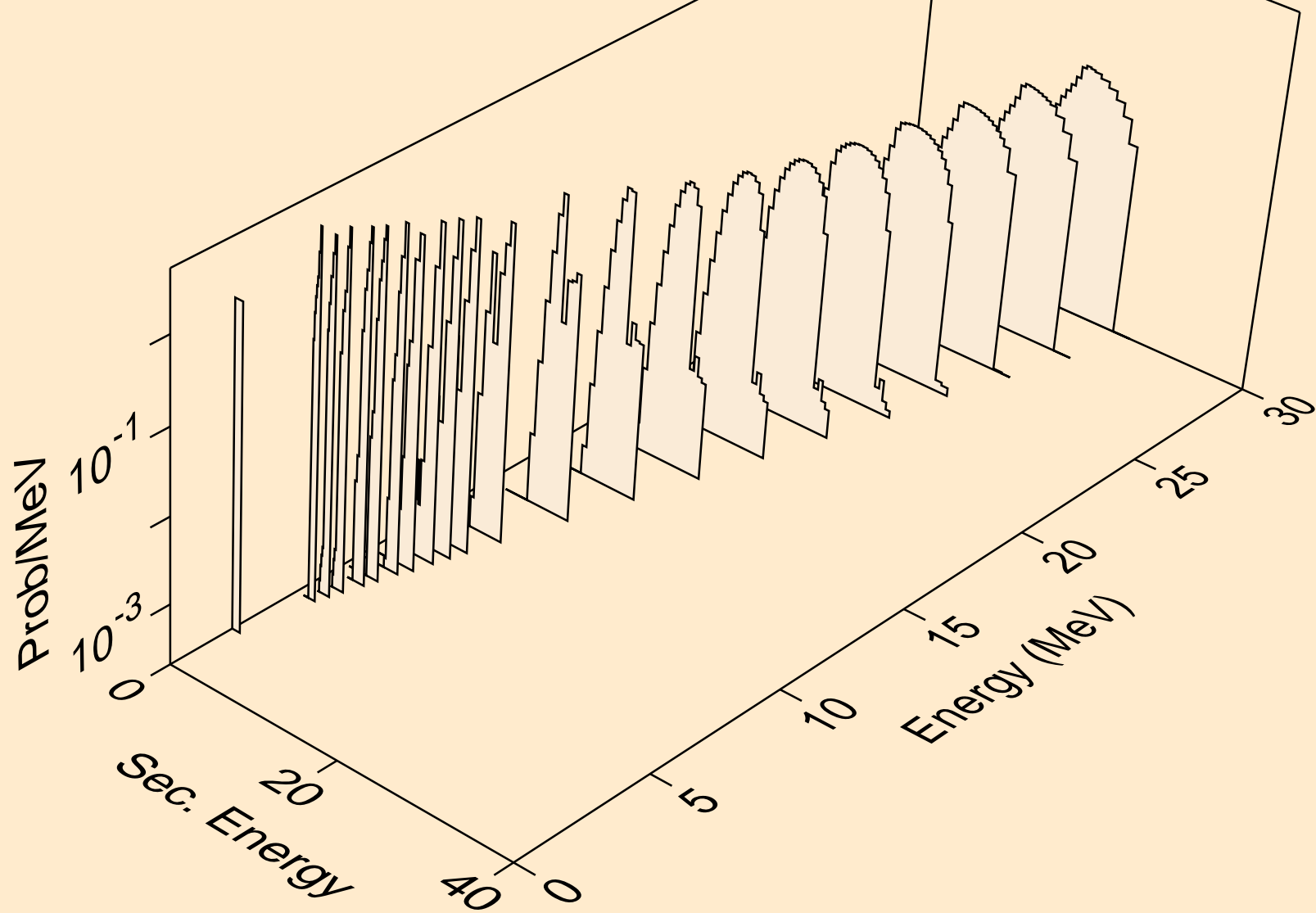

TA174 NEUTRON ACER TENDL-2023 LIBRARY; T=0.K
tritons from (n,pt)

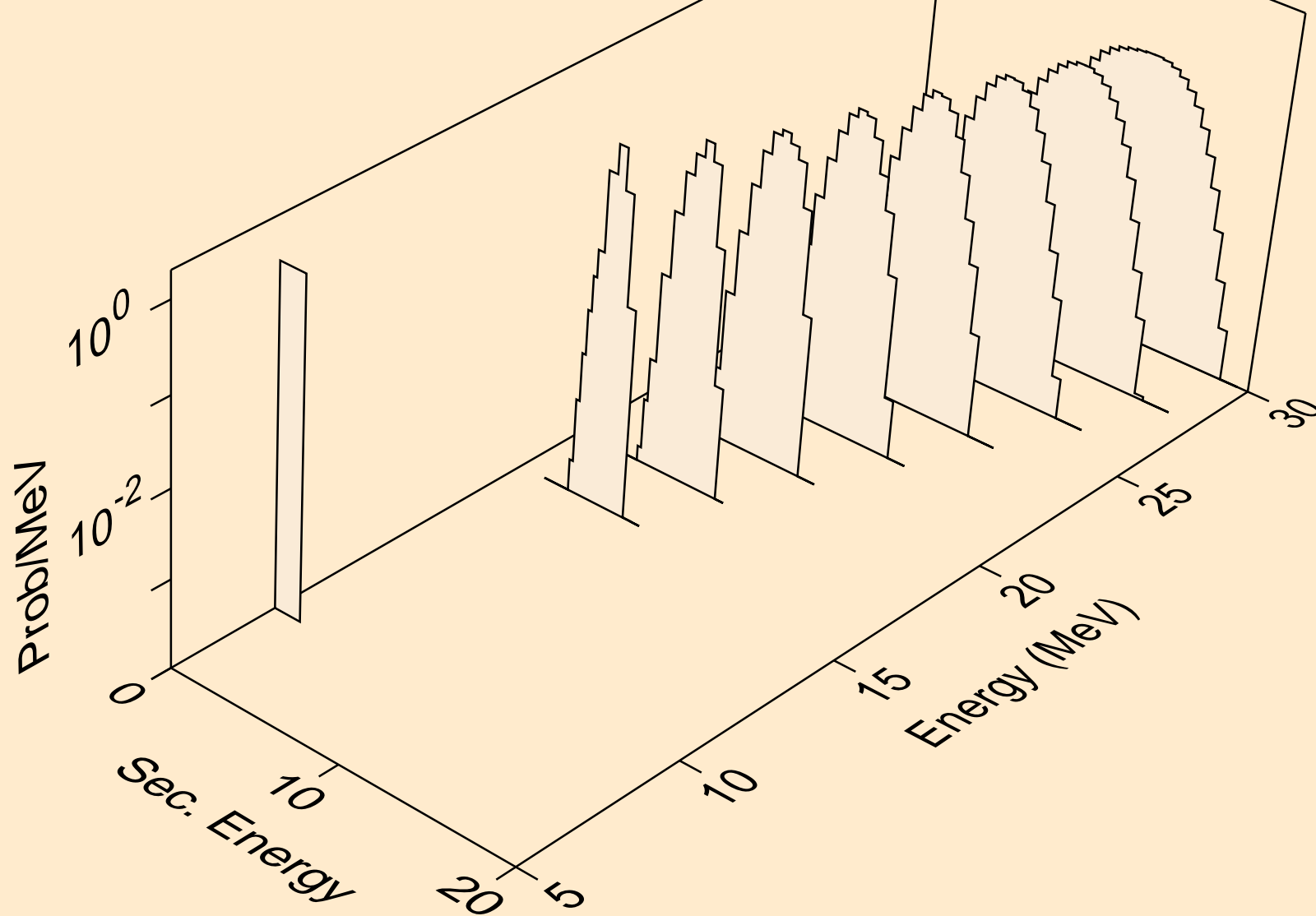

TA174 NEUTRON ACER TENDL-2023 LIBRARY; T=0.K
he3s from (n,x)

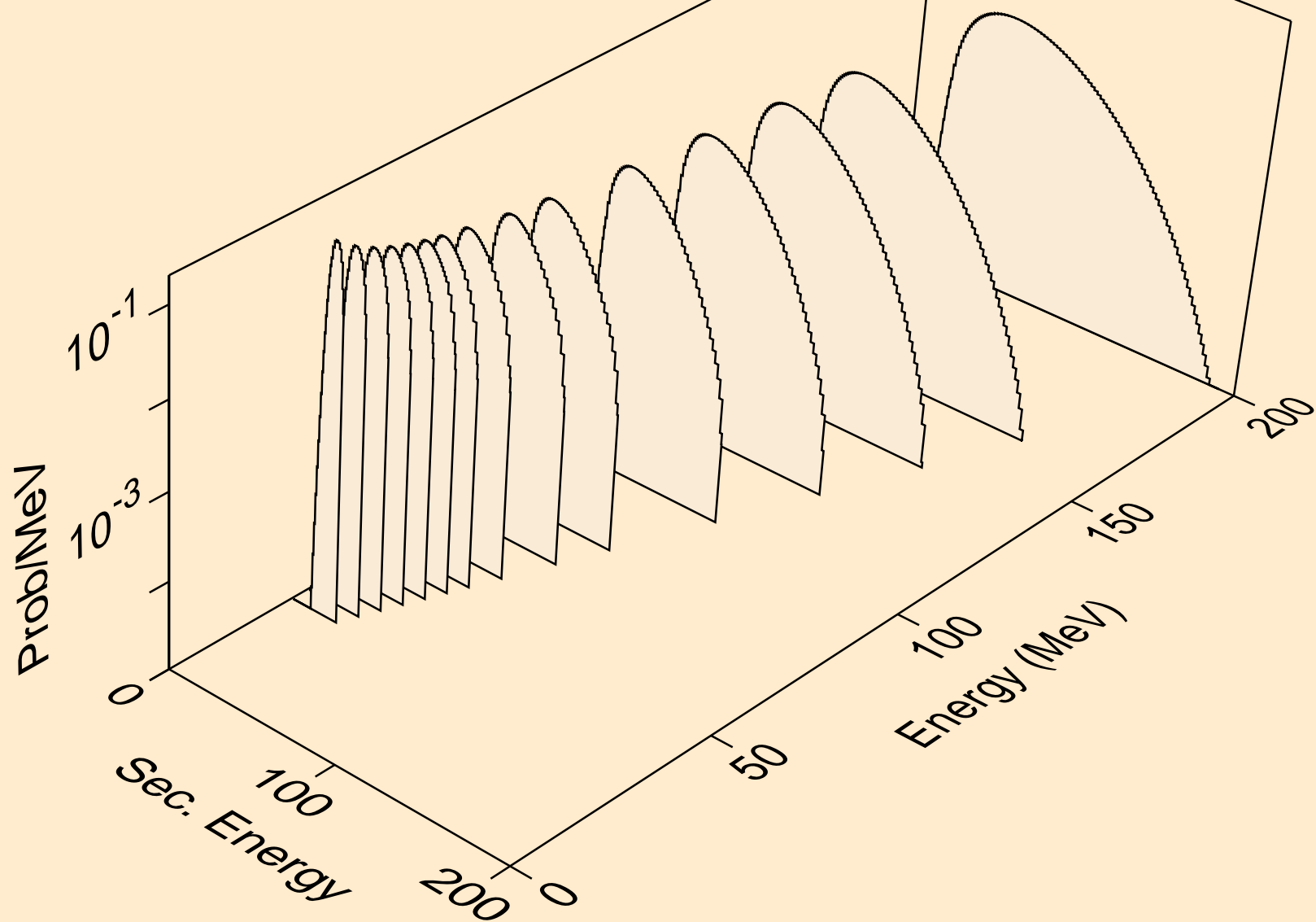

TA174 NEUTRON ACER TENDL-2023 LIBRARY; T=0.K
he3s from (n,n*)he3

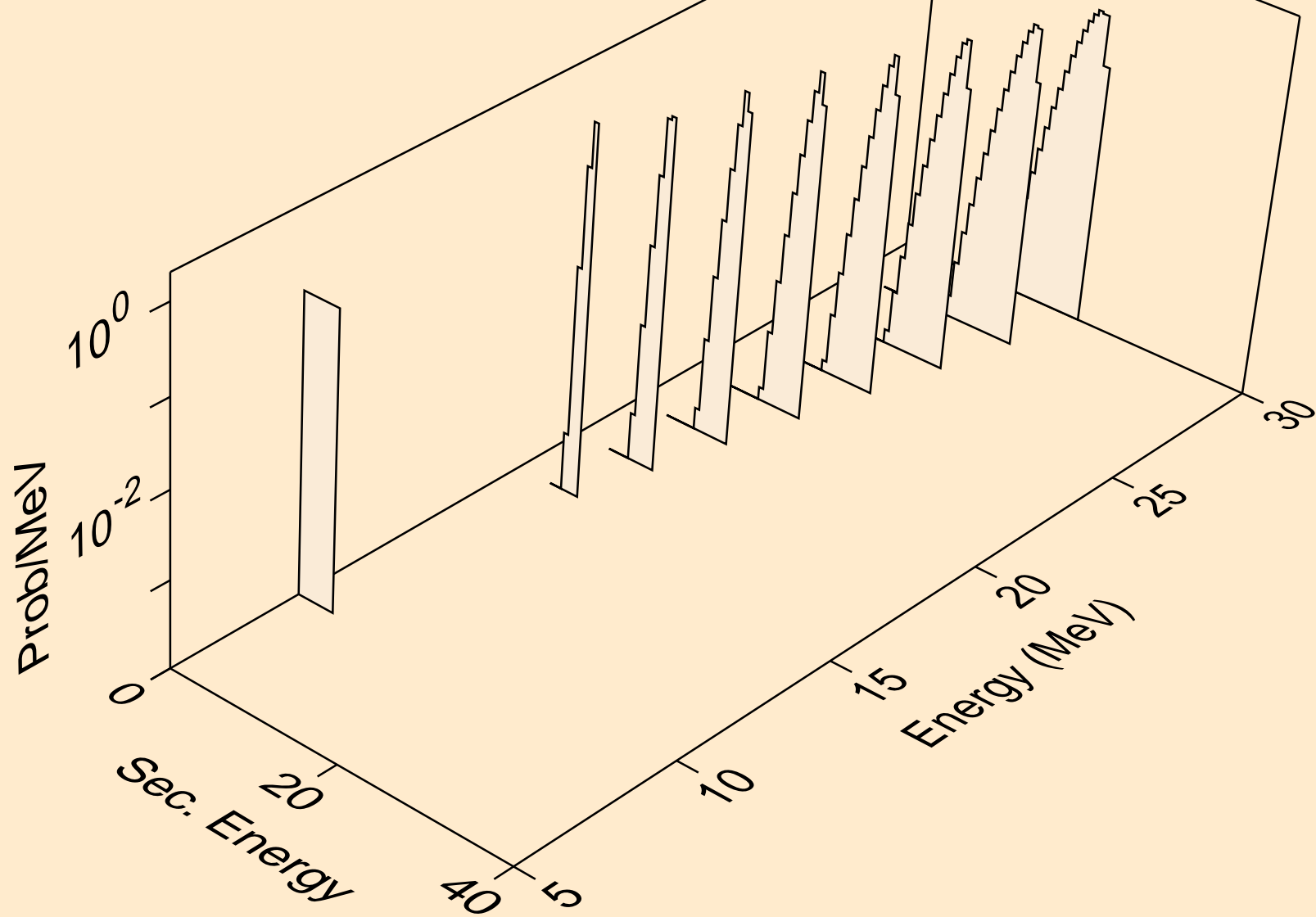

TA174 NEUTRON ACER TENDL-2023 LIBRARY; T=0.K
he3s from (n,he3)

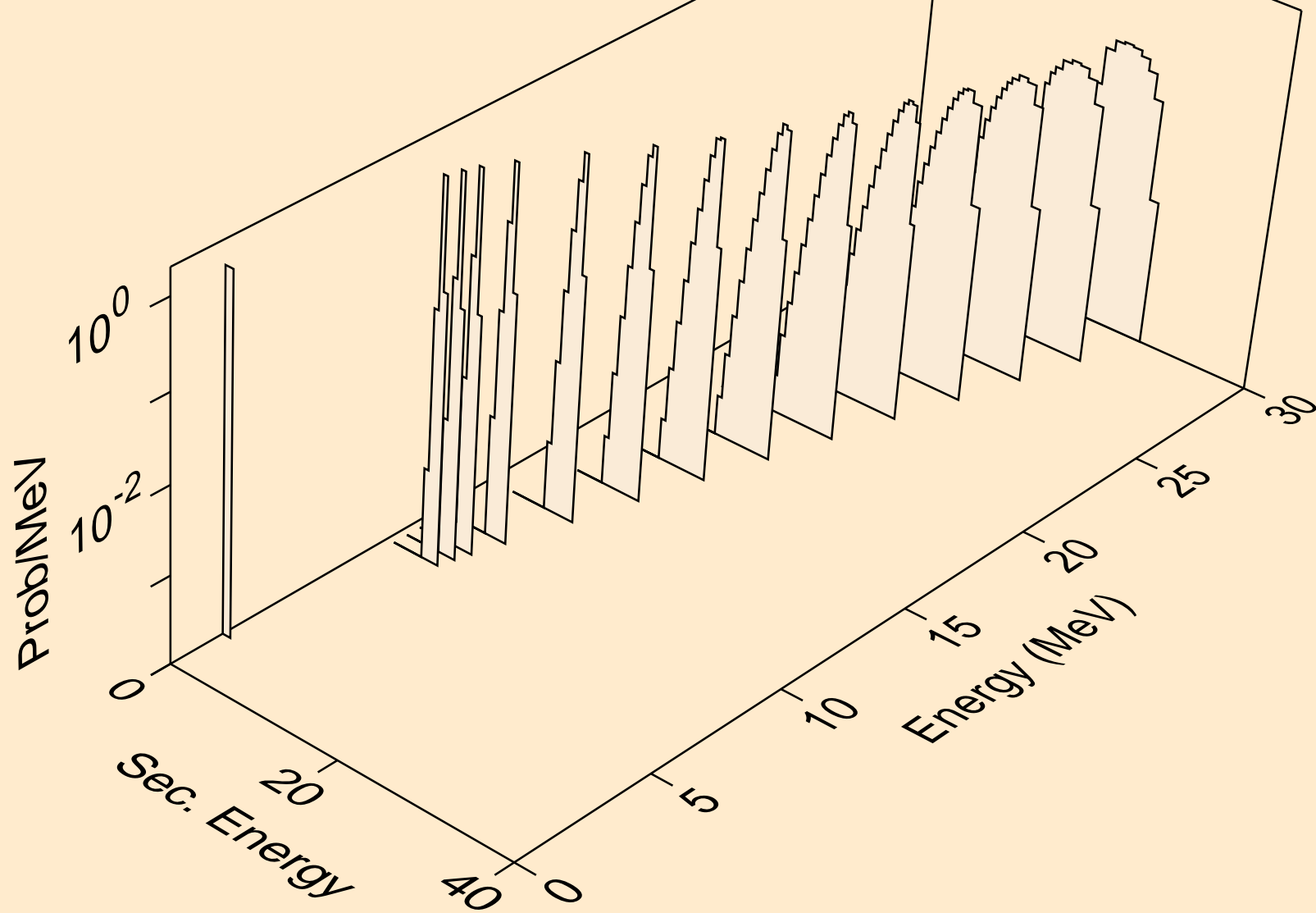

TA174 NEUTRON ACER TENDL-2023 LIBRARY; T=0.K
alphas from (n,x)

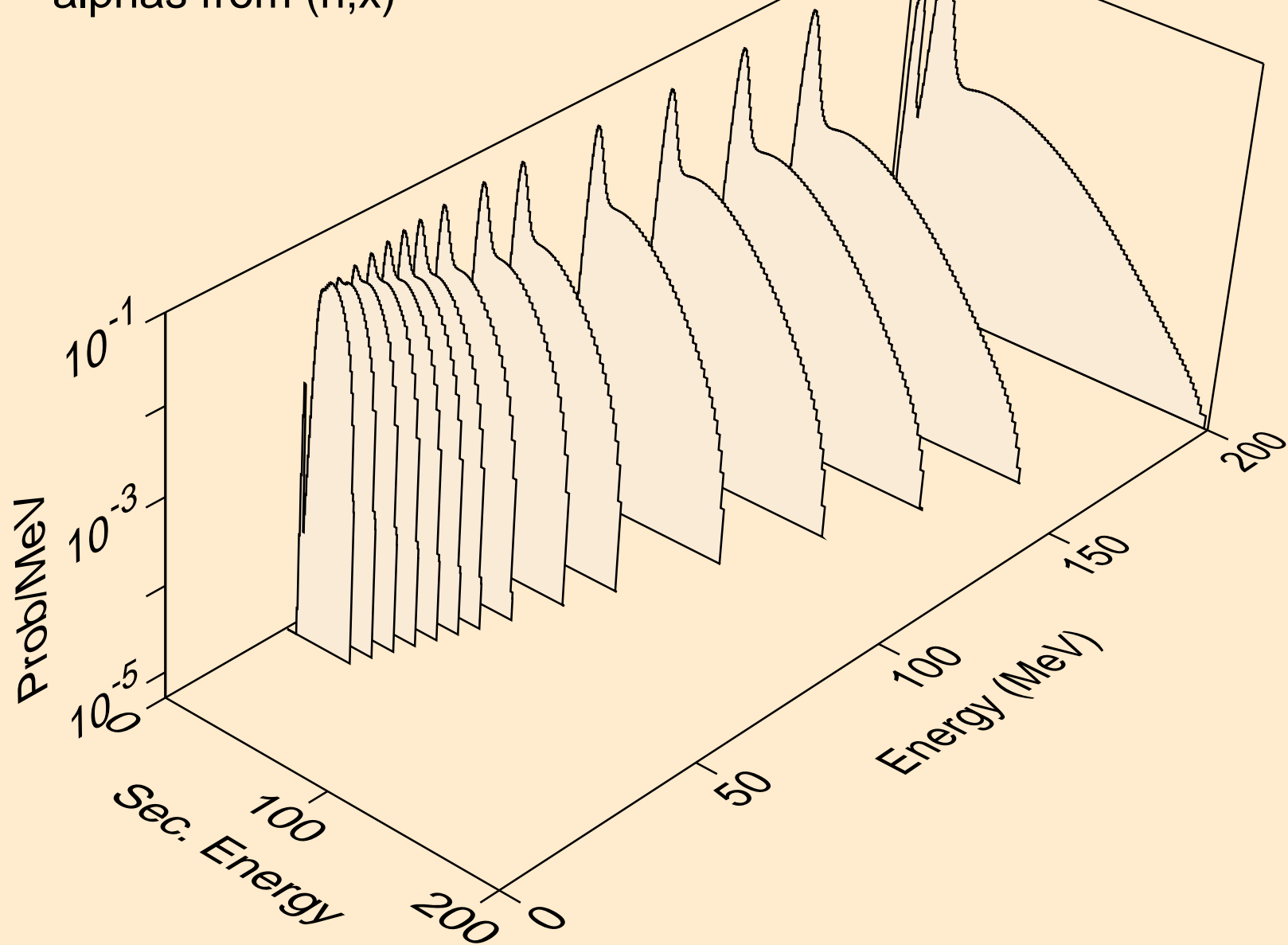

TA174 NEUTRON ACER TENDL-2023 LIBRARY; T=0.K
alphas from (n,n*)a

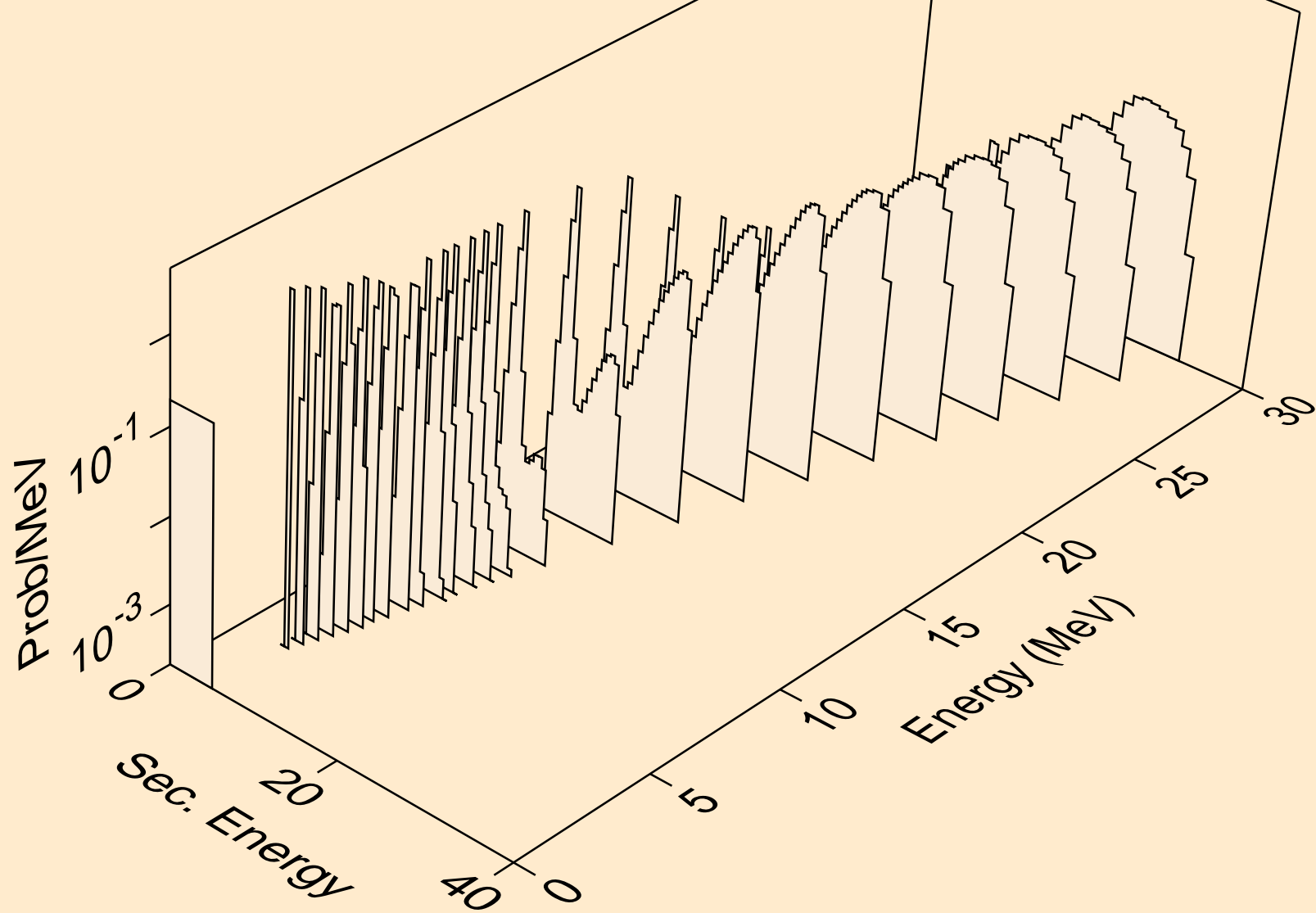

TA174 NEUTRON ACER TENDL-2023 LIBRARY; T=0.K
alphas from (n,2n)a

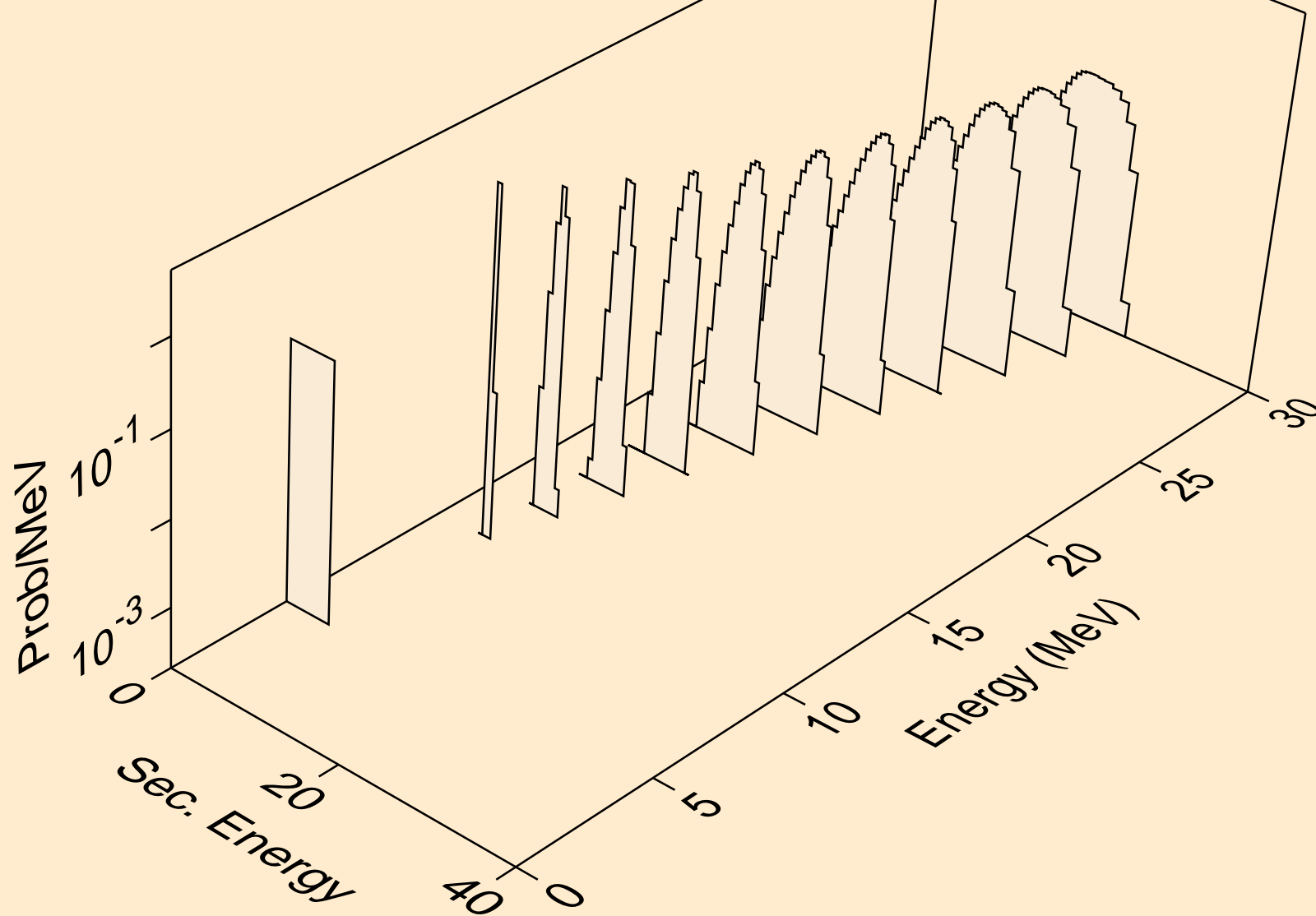

TA174 NEUTRON ACER TENDL-2023 LIBRARY; T=0.K
alphas from (n,3n)a

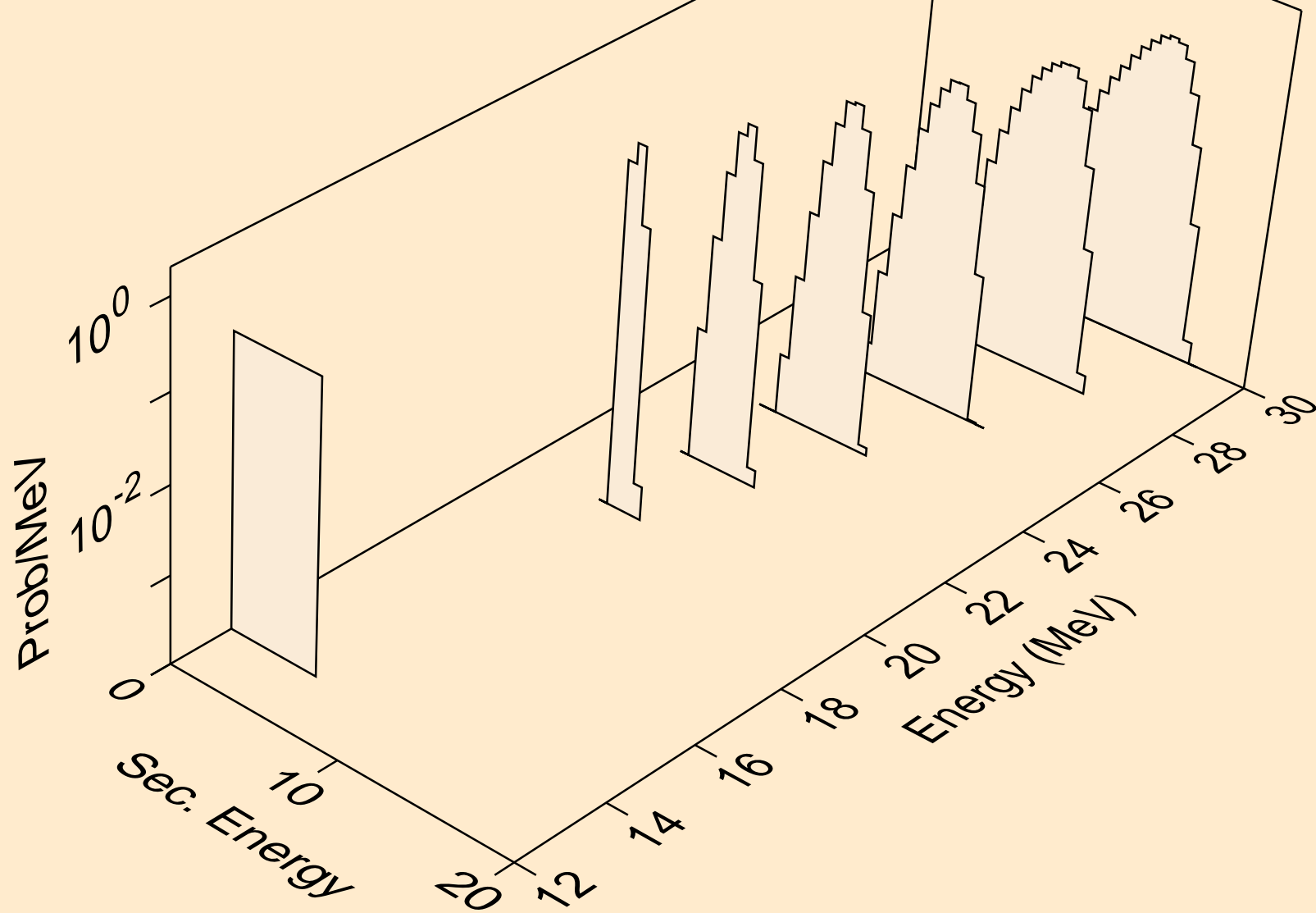

TA174 NEUTRON ACER TENDL-2023 LIBRARY; T=0.K
alphas from (n,n*)2a

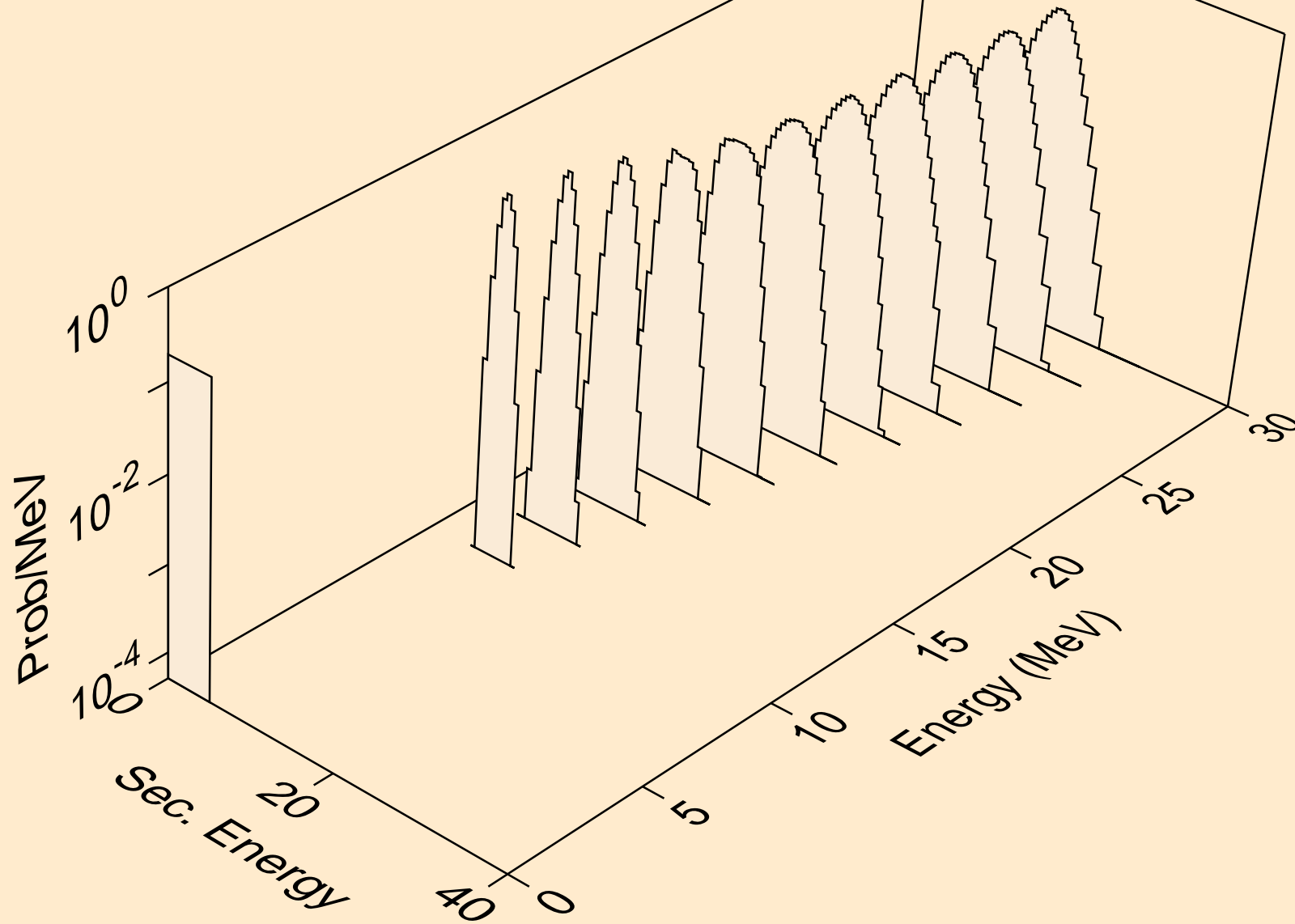

TA174 NEUTRON ACER TENDL-2023 LIBRARY; T=0.K
alphas from (n,2n)2a

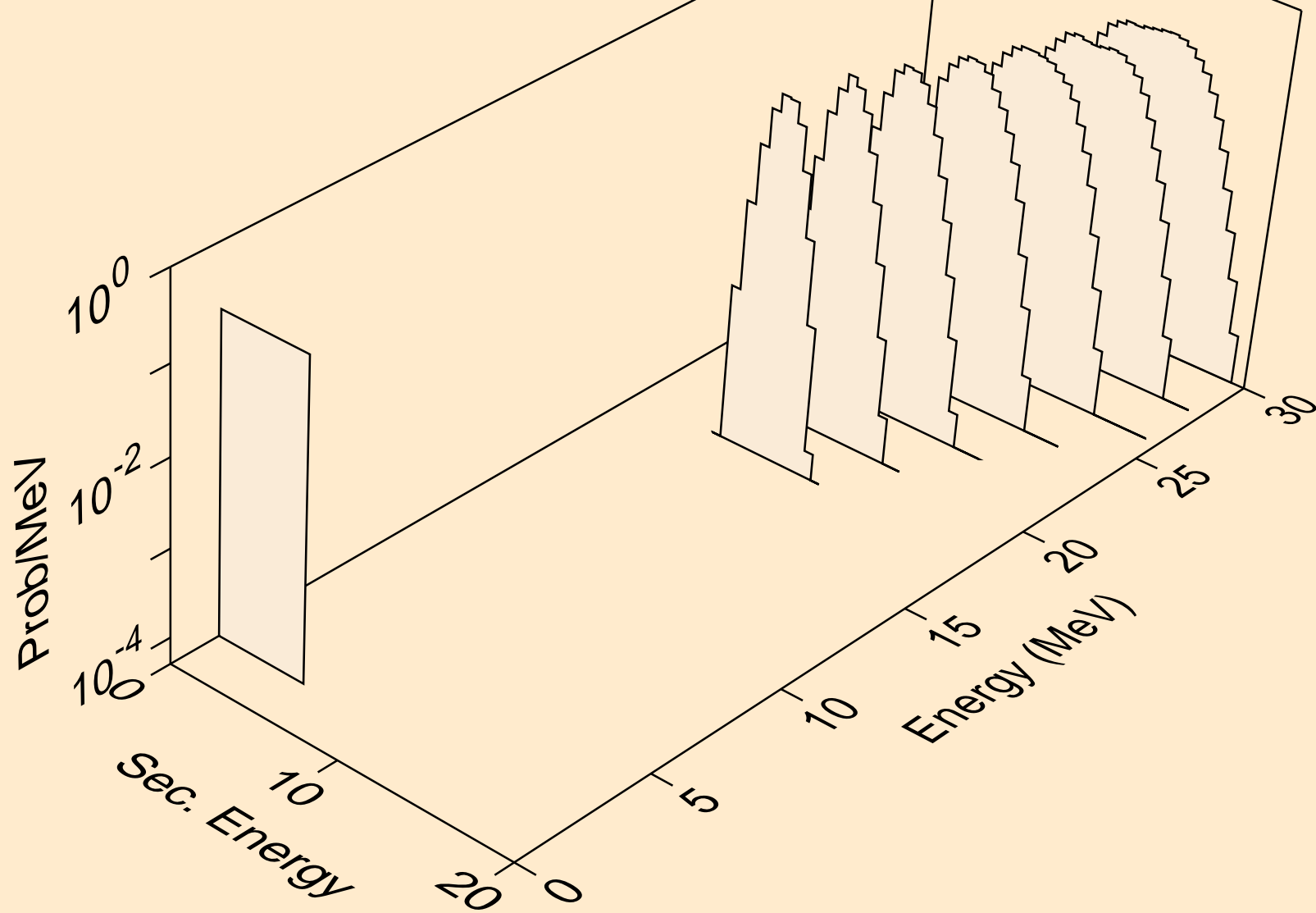

TA174 NEUTRON ACER TENDL-2023 LIBRARY; T=0.K
alphas from (n,npa)

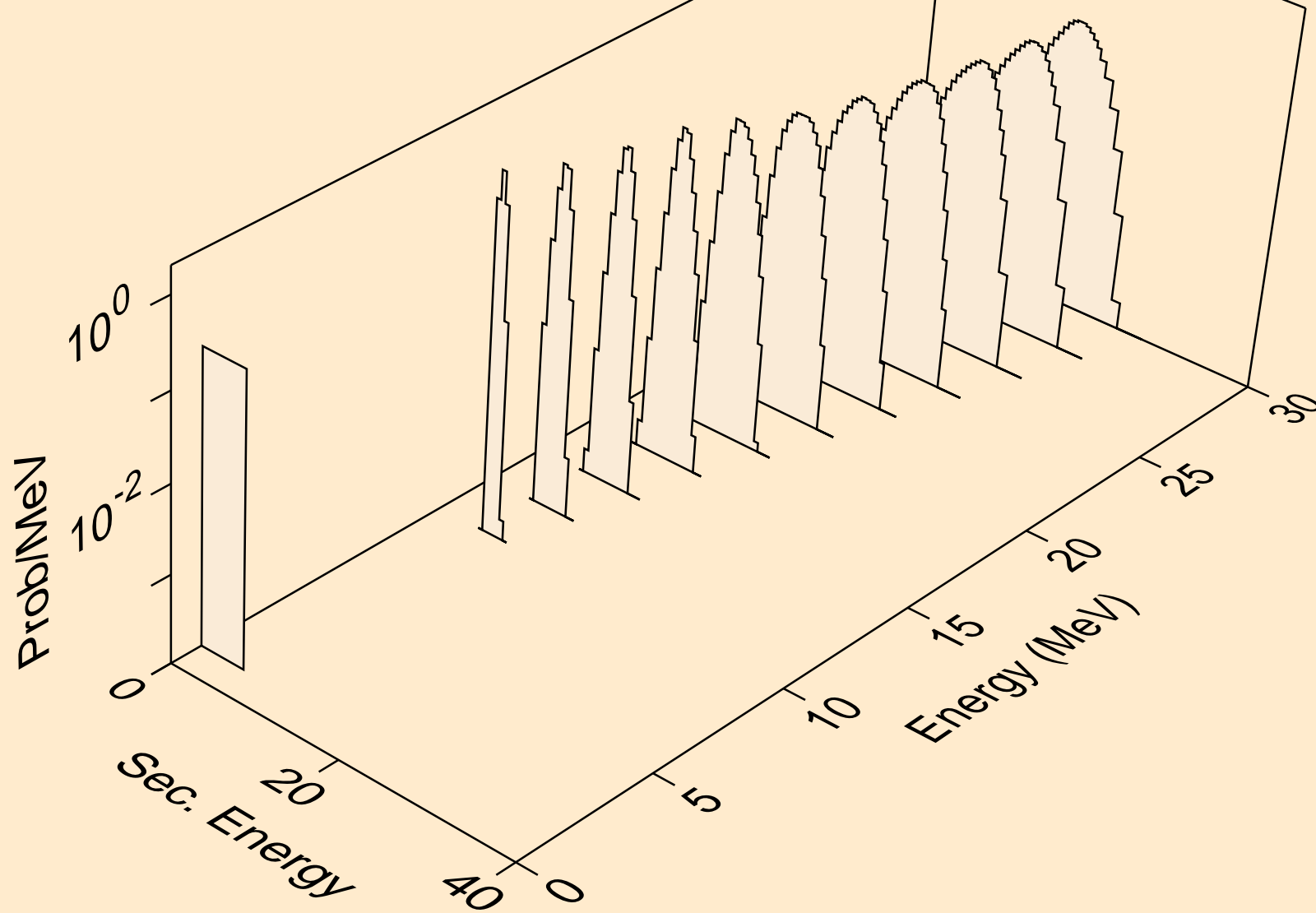

TA174 NEUTRON ACER TENDL-2023 LIBRARY; T=0.K
alphas from (n,a)

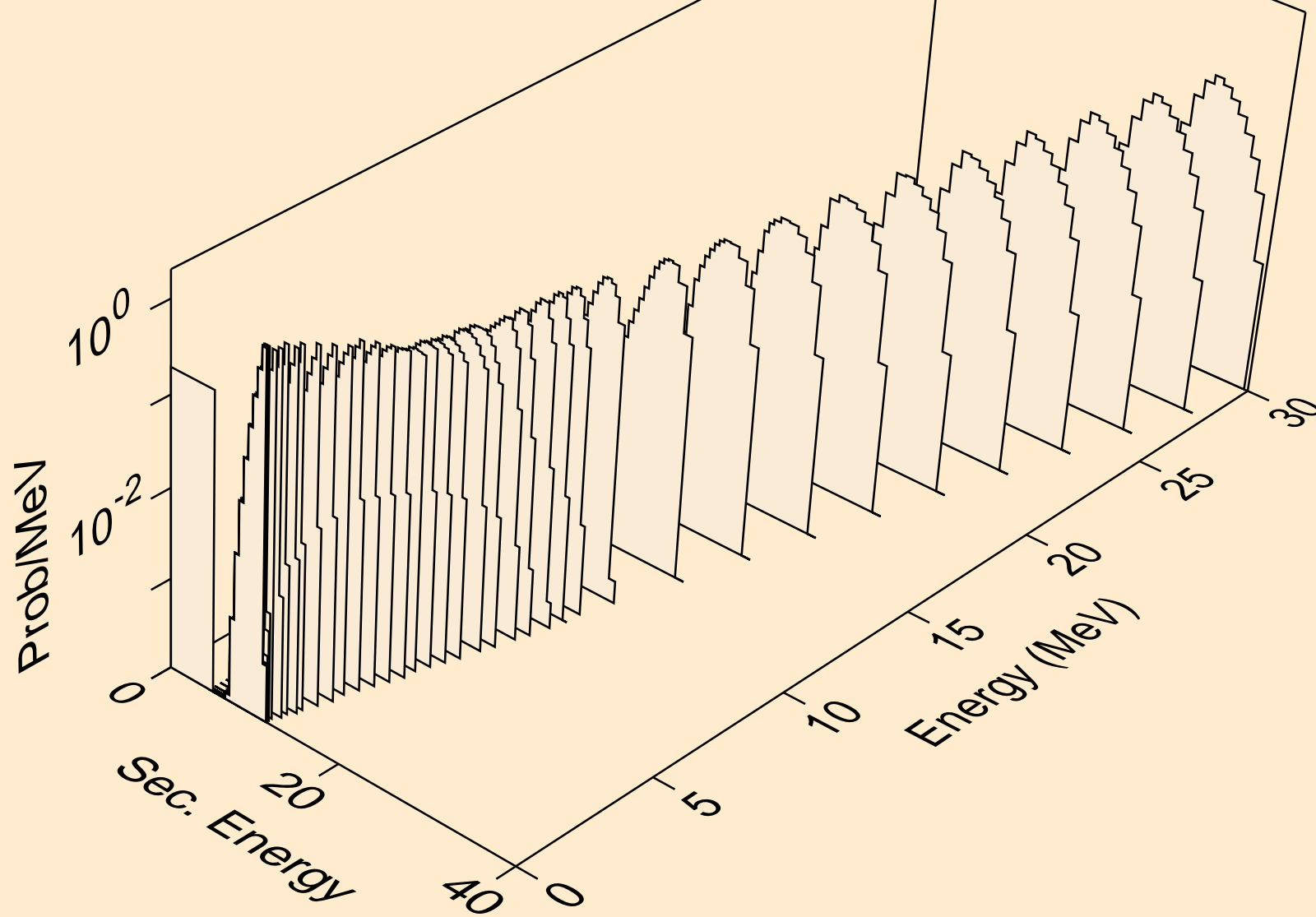

TA174 NEUTRON ACER TENDL-2023 LIBRARY; T=0.K
alphas from (n,2a)

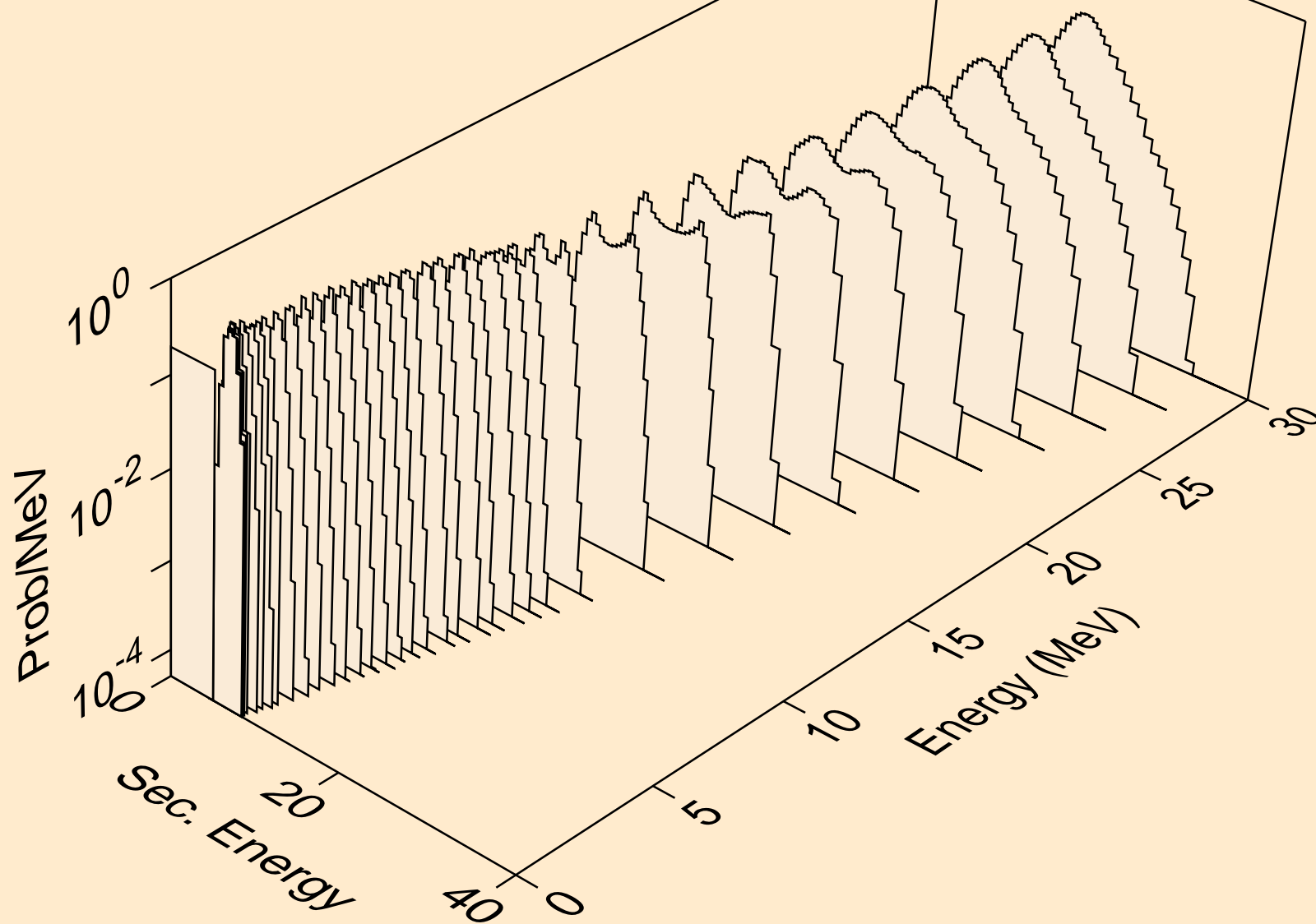

TA174 NEUTRON ACER TENDL-2023 LIBRARY; T=0.K
alphas from (n,pa)

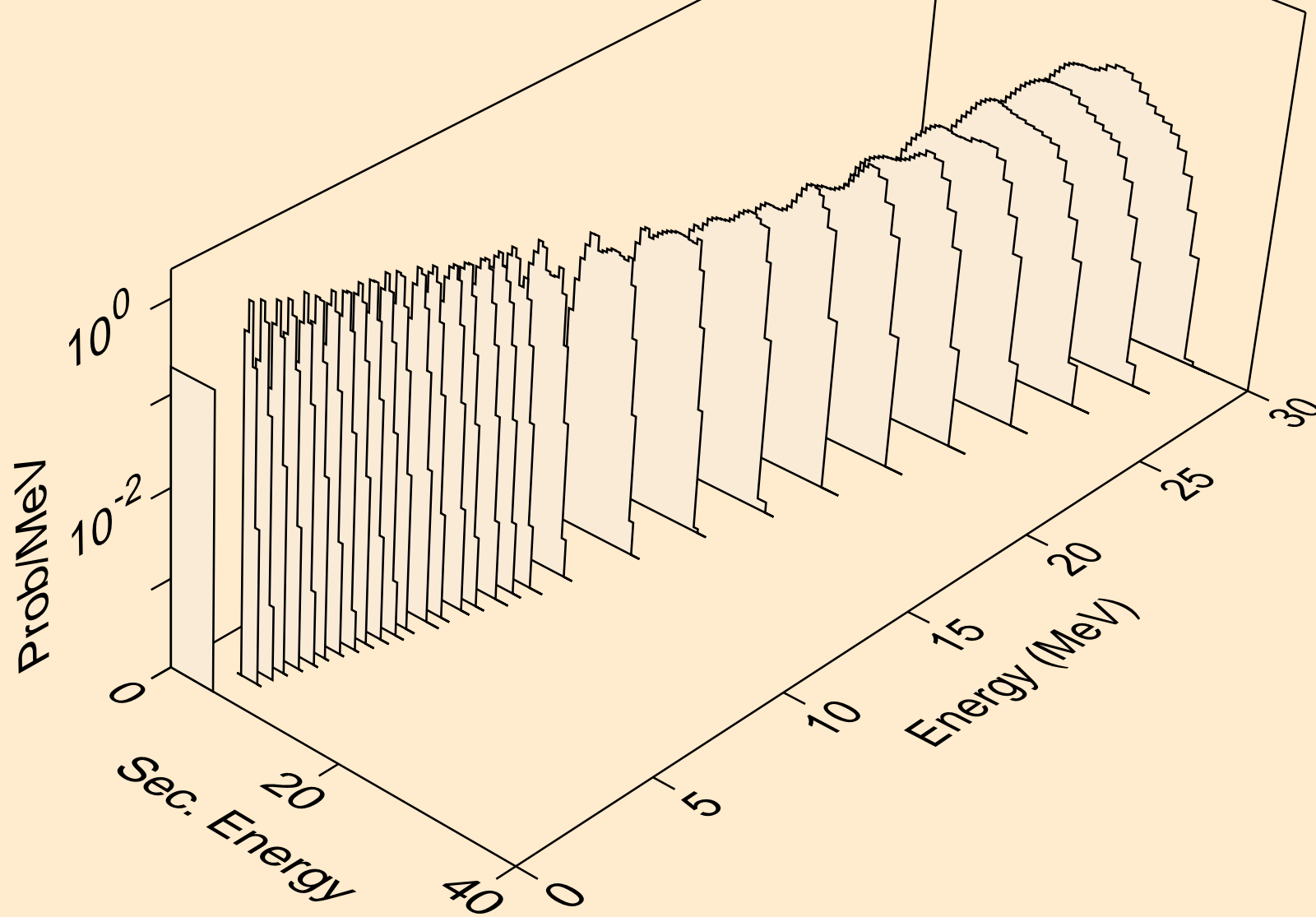

TA174 NEUTRON ACER TENDL-2023 LIBRARY; T=0.K
alphas from (n,da)

