

TB141 NEUTRON ACER TENDL-2023 LIBRARY; T=0.K  
Principal cross sections

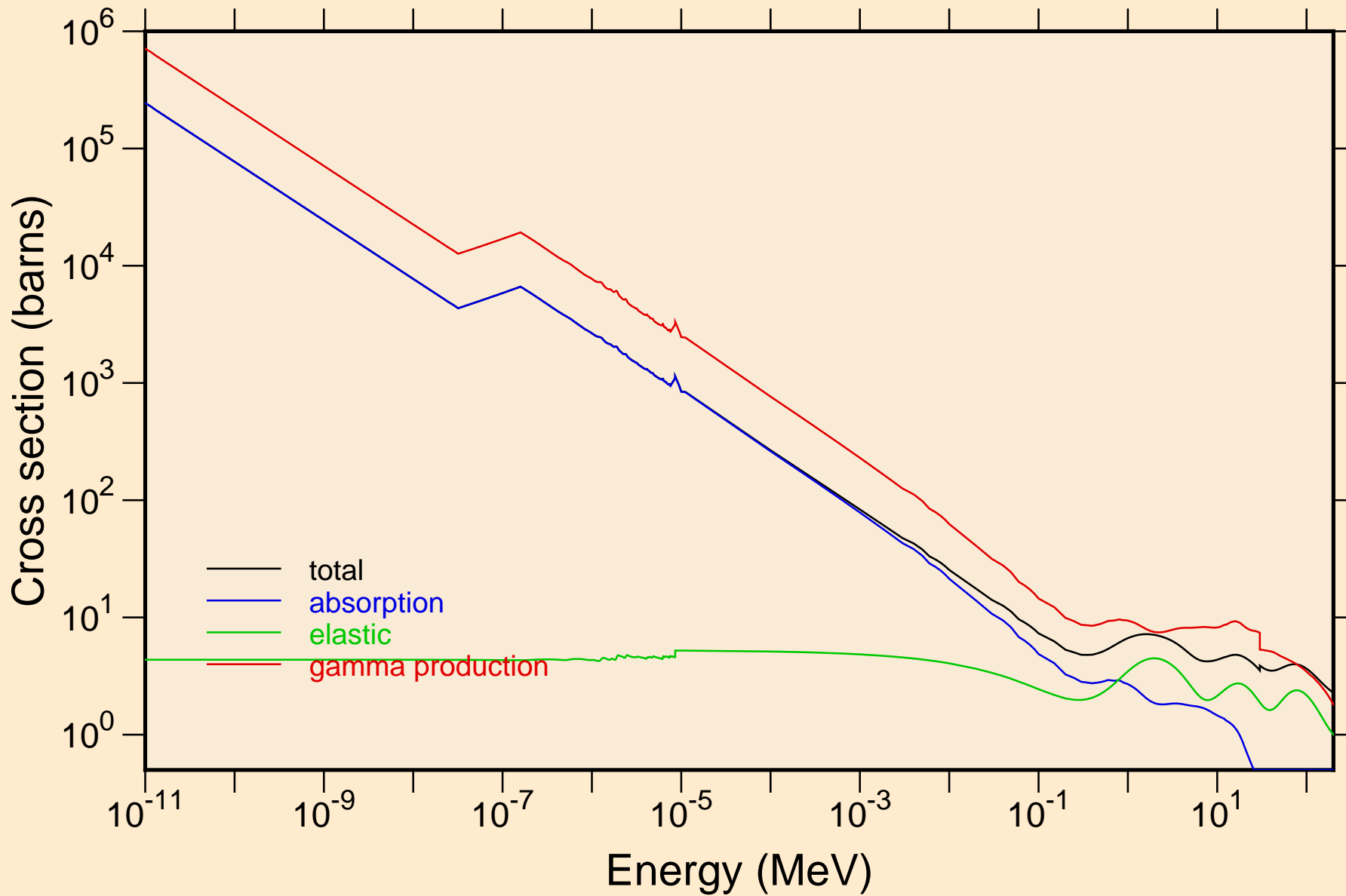

# TB141 NEUTRON ACER TENDL-2023 LIBRARY; T=0.K

## Heating

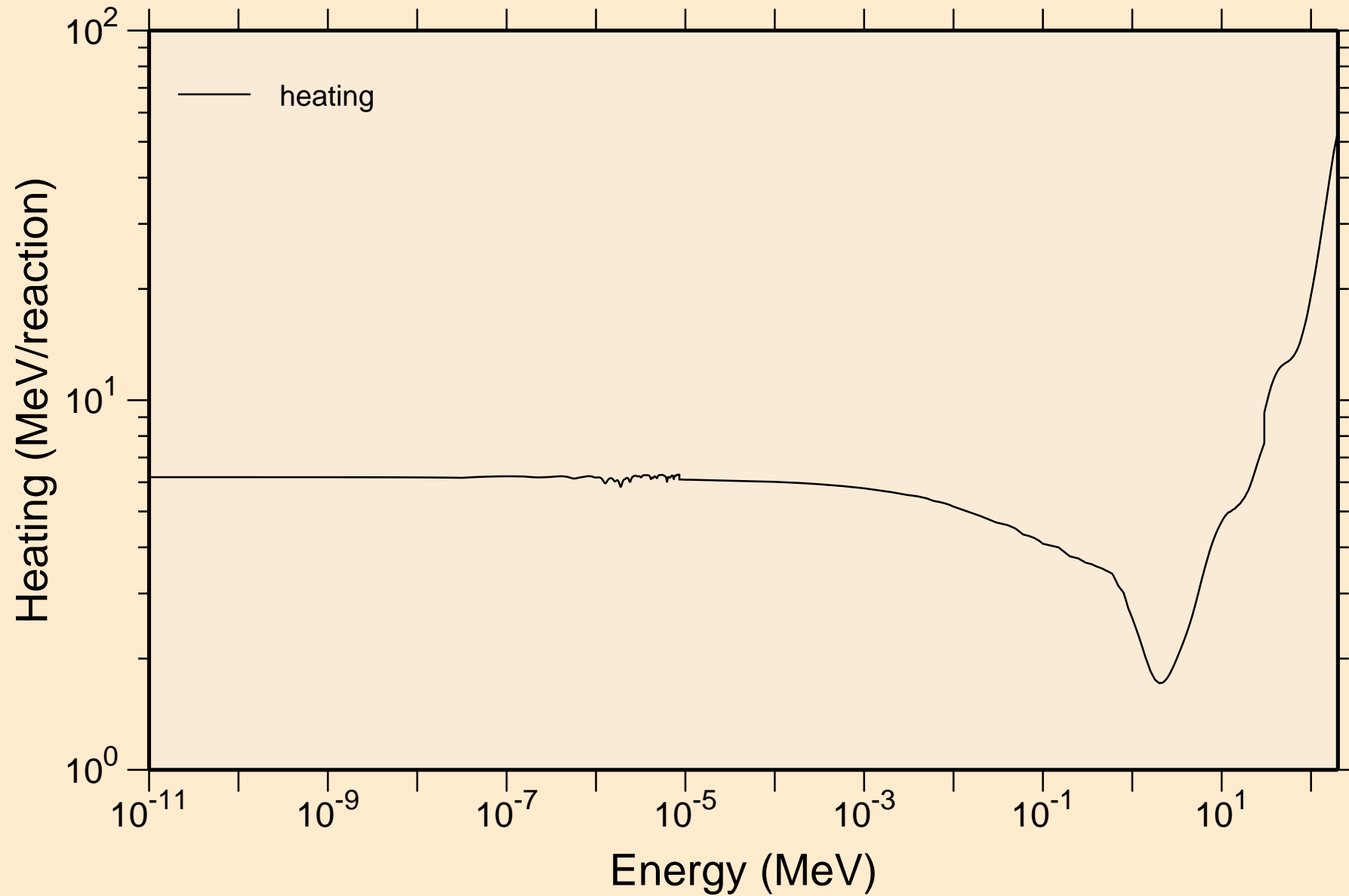

TB141 NEUTRON ACER TENDL-2023 LIBRARY; T=0.K  
Damage

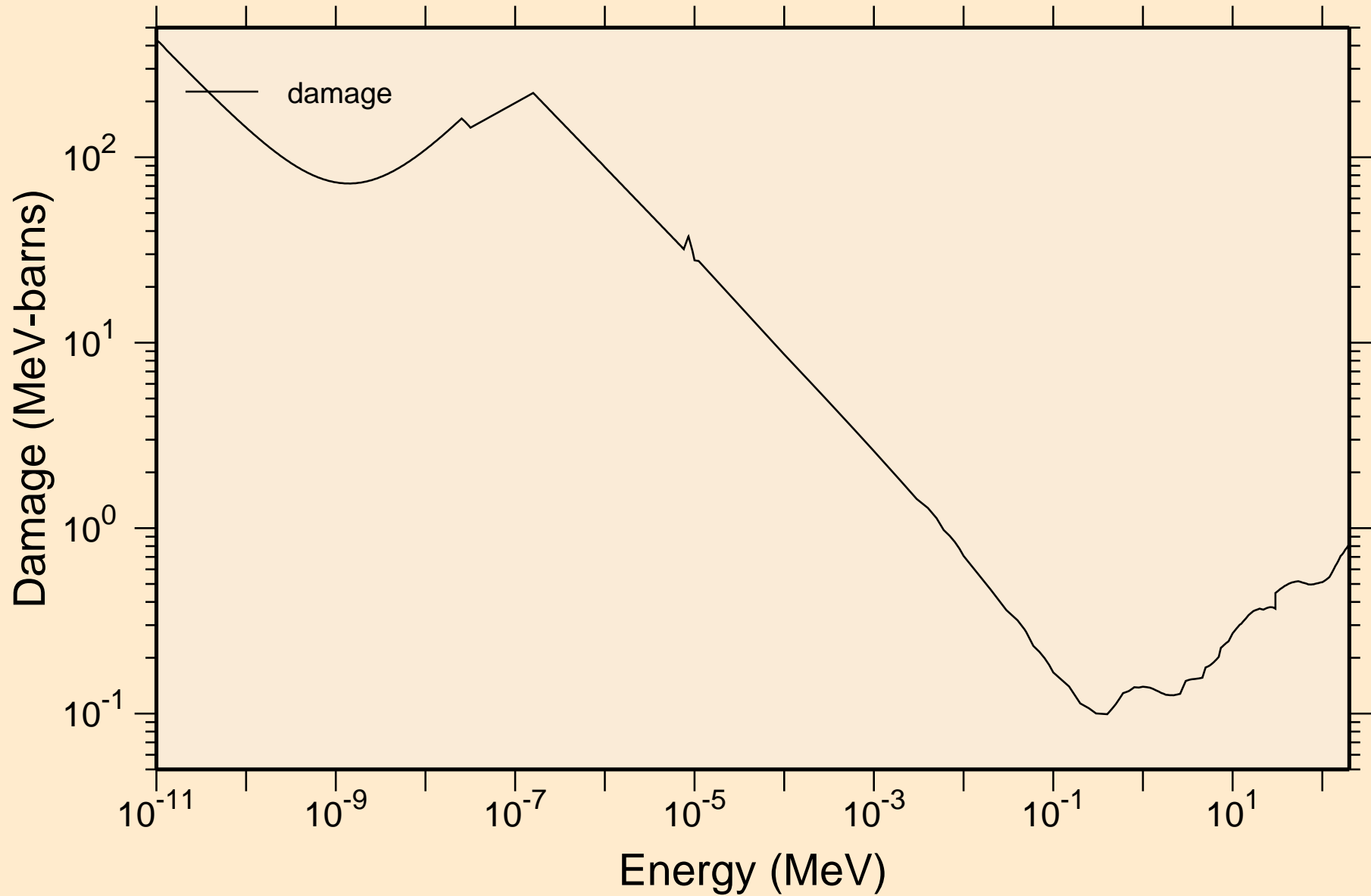

TB141 NEUTRON ACER TENDL-2023 LIBRARY; T=0.K  
Non-threshold reactions

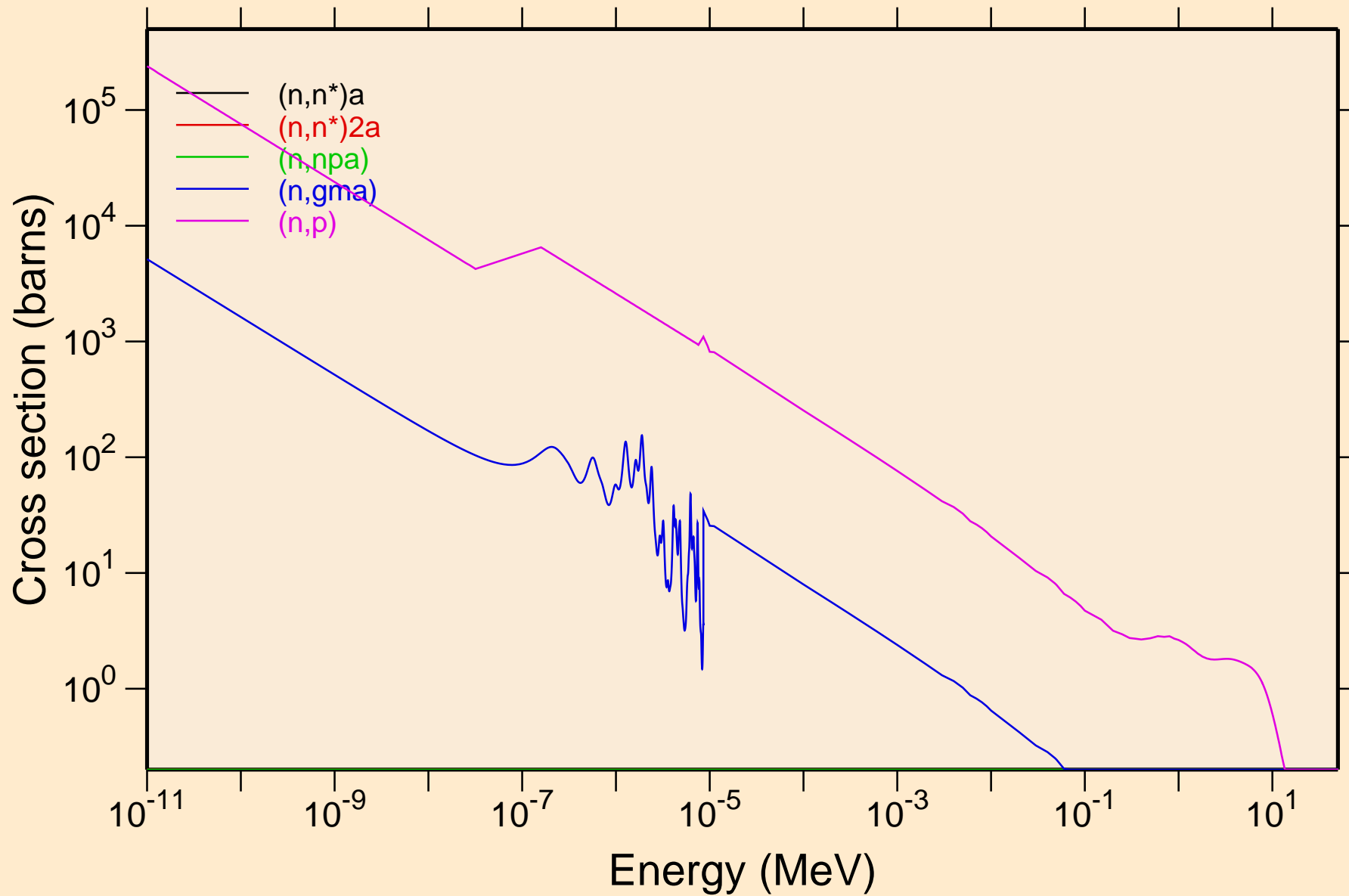

TB141 NEUTRON ACER TENDL-2023 LIBRARY; T=0.K  
Non-threshold reactions

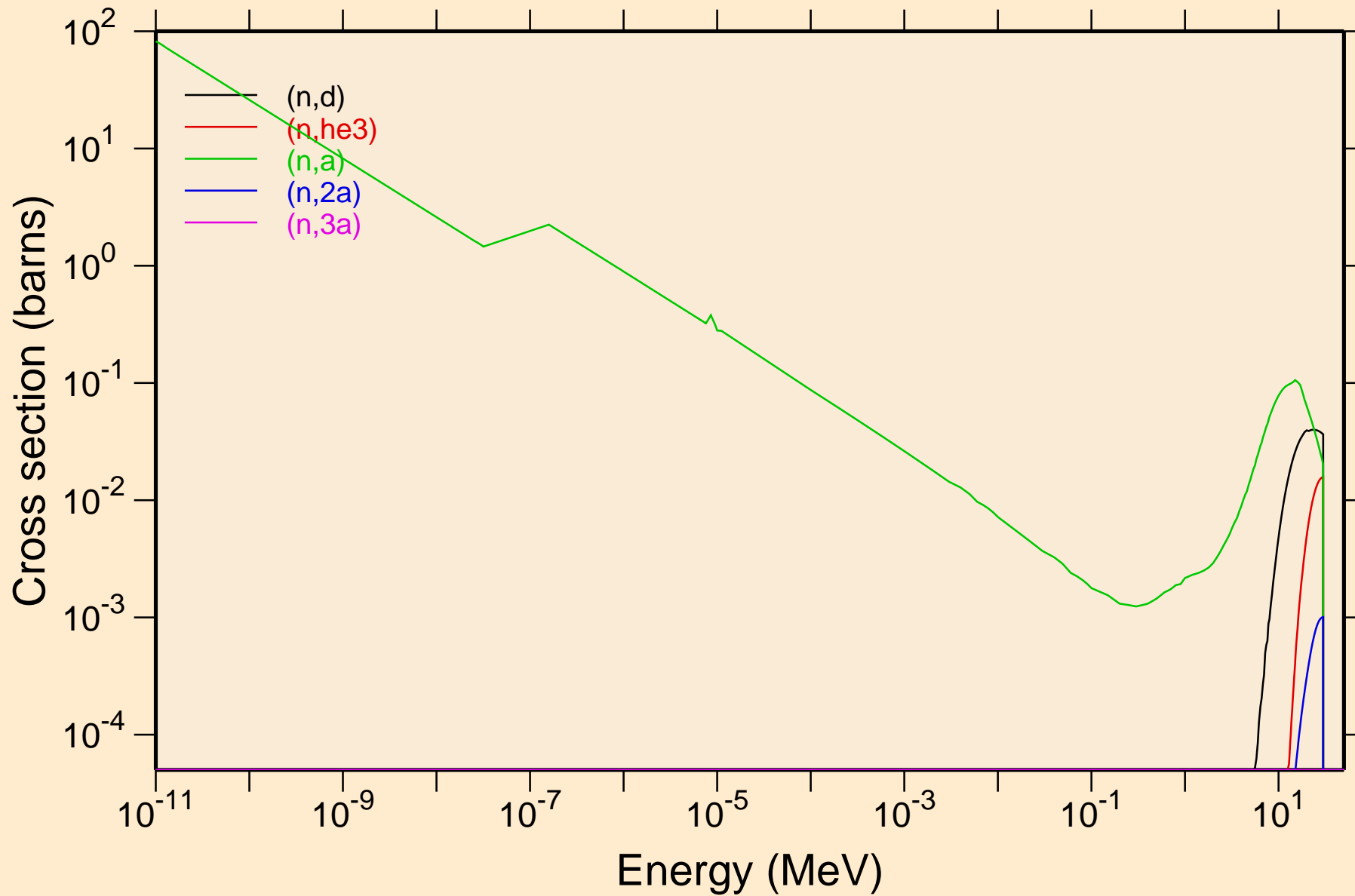

TB141 NEUTRON ACER TENDL-2023 LIBRARY; T=0.K  
Non-threshold reactions

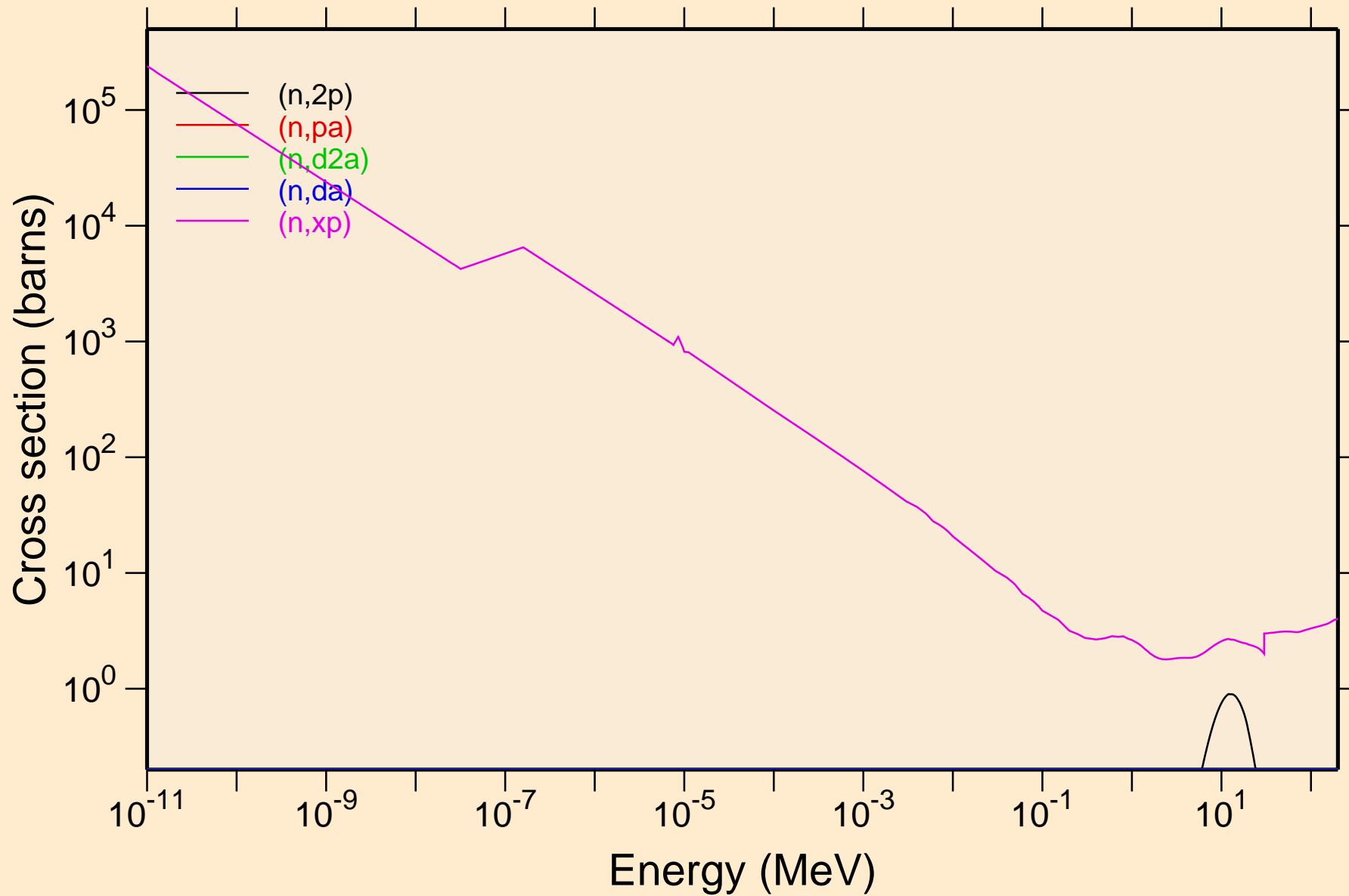

TB141 NEUTRON ACER TENDL-2023 LIBRARY; T=0.K  
Non-threshold reactions

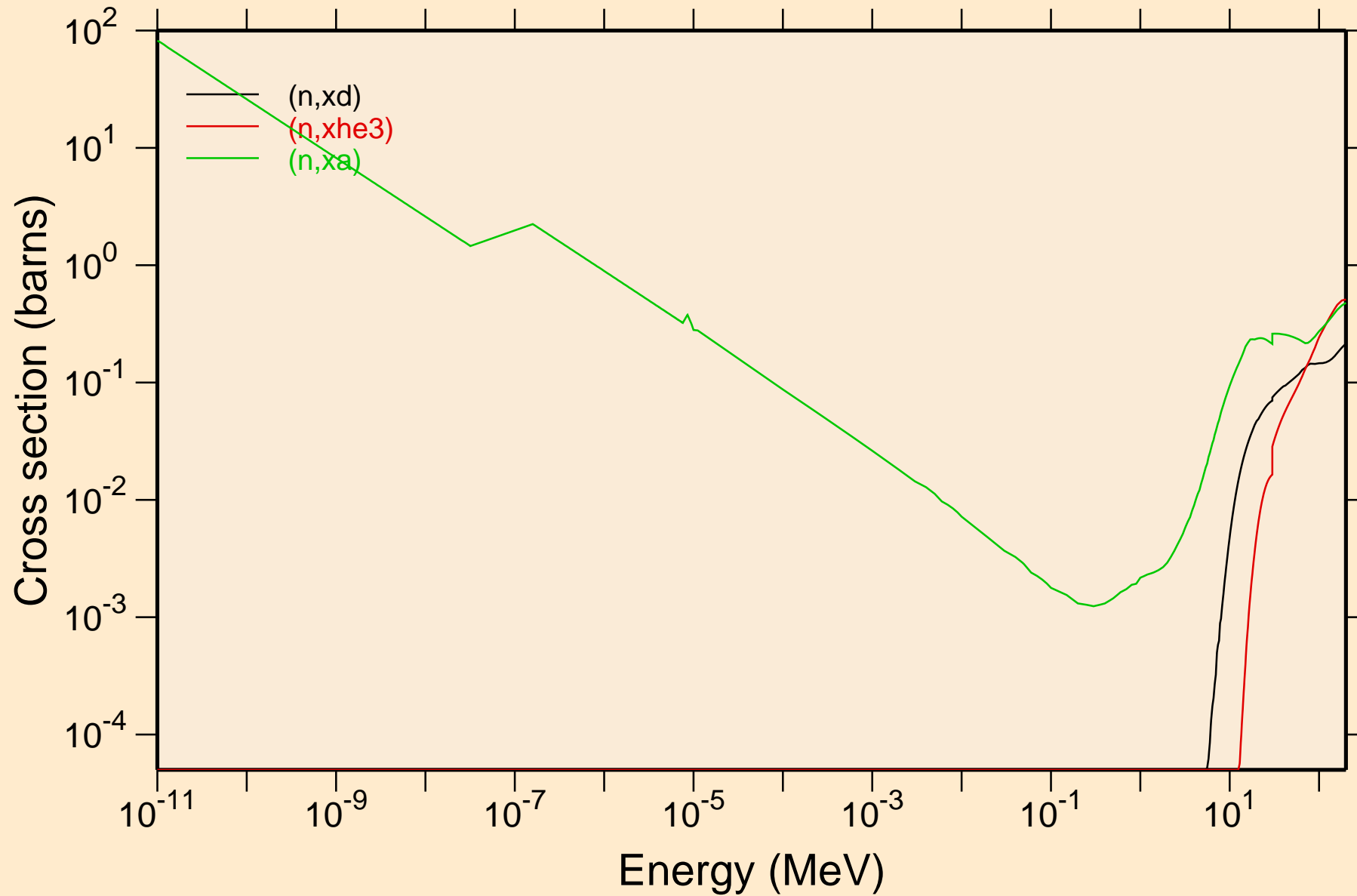

# TB141 NEUTRON ACER TENDL-2023 LIBRARY; T=0.K

## Principal cross sections

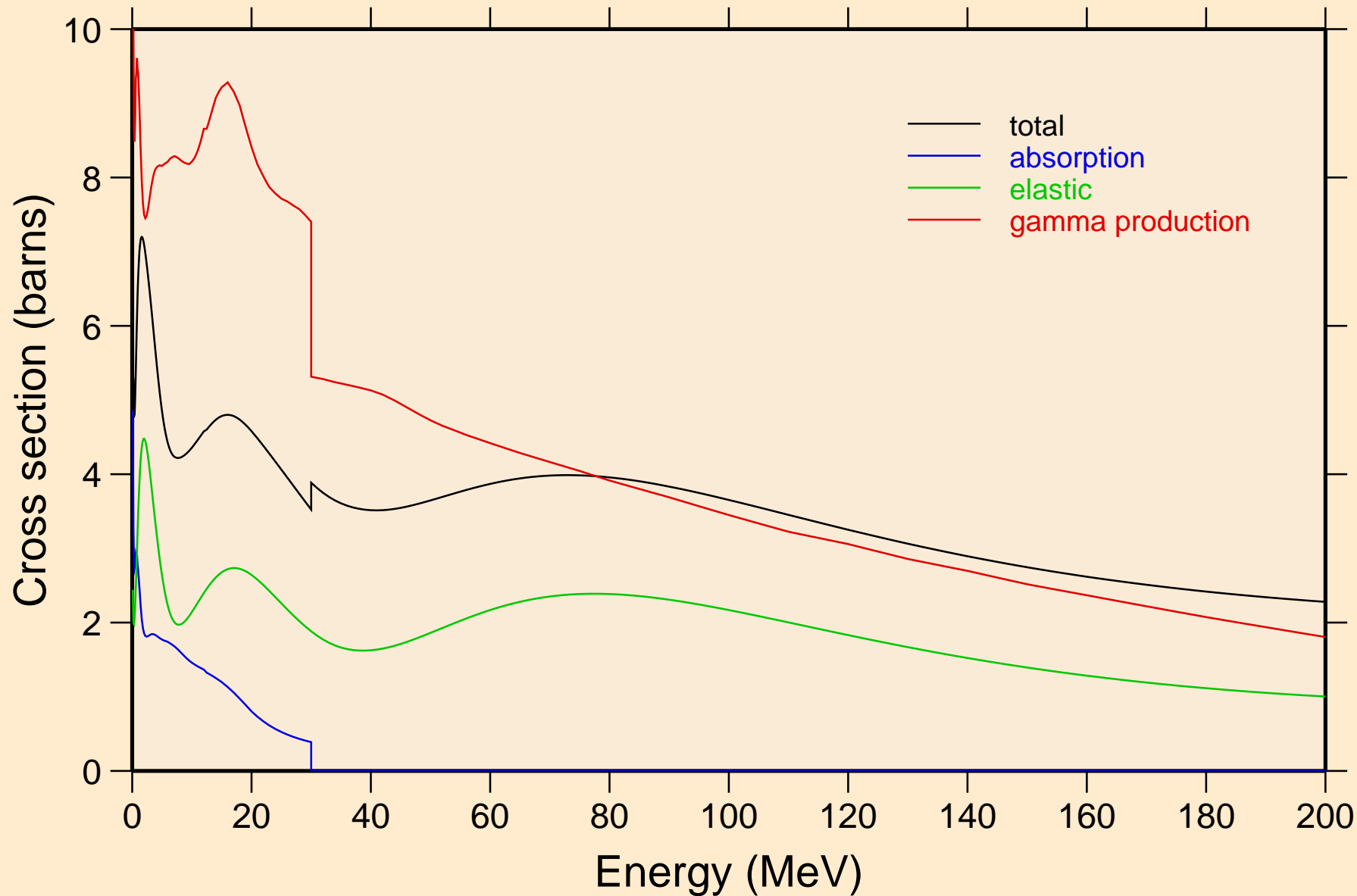



# TB141 NEUTRON ACER TENDL-2023 LIBRARY; T=0.K

## Heating

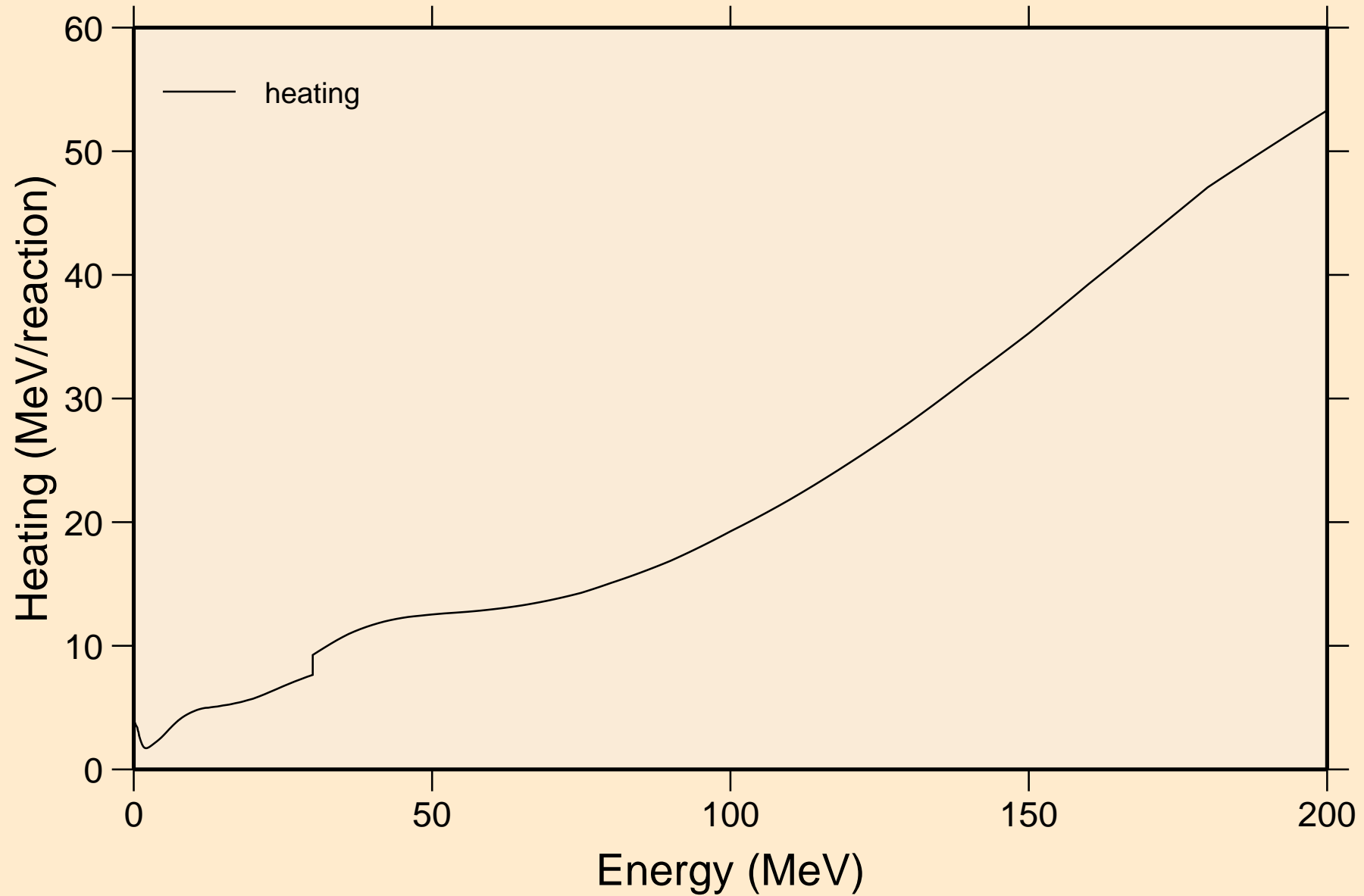

TB141 NEUTRON ACER TENDL-2023 LIBRARY; T=0.K  
Damage

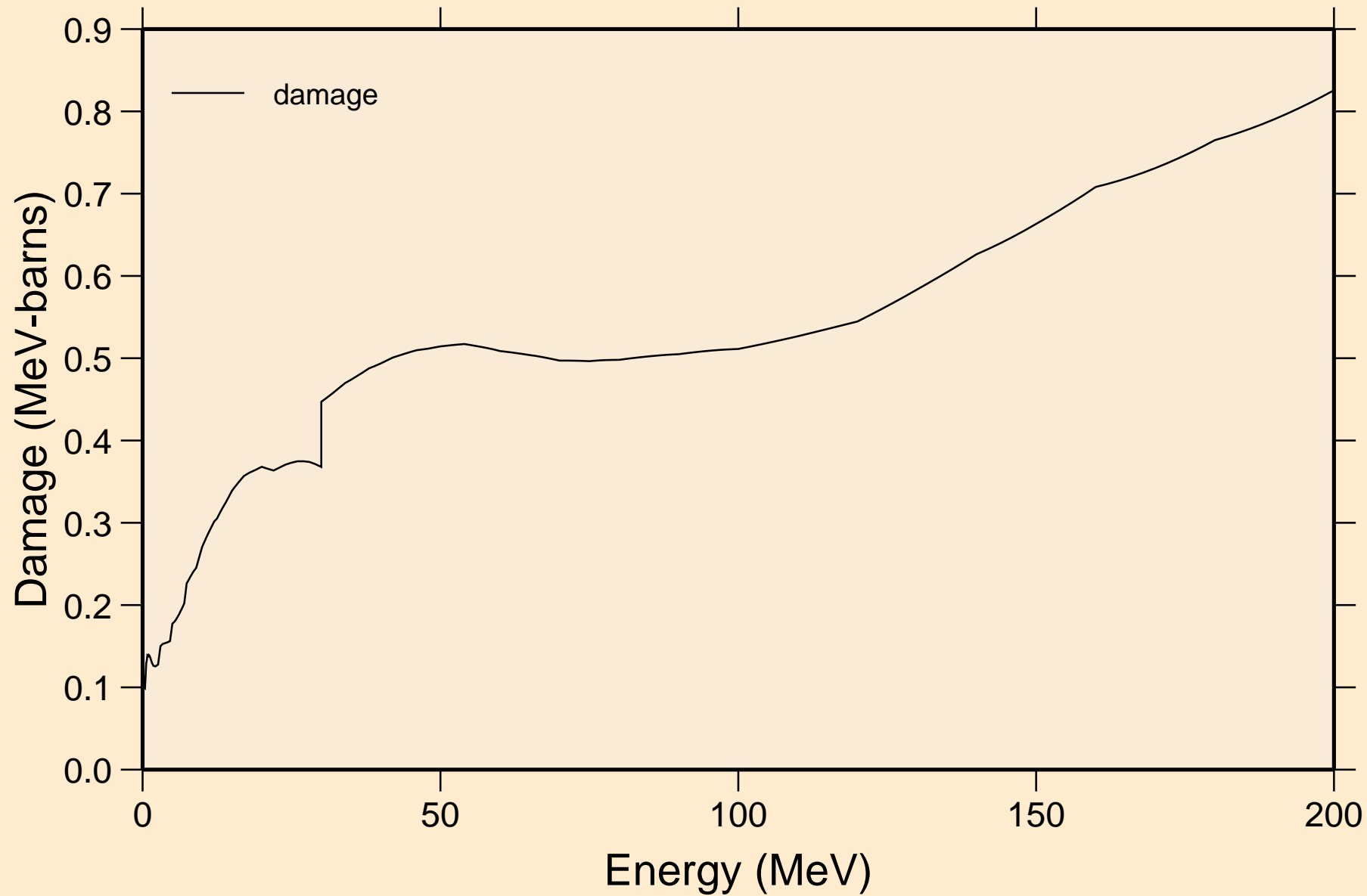

TB141 NEUTRON ACER TENDL-2023 LIBRARY; T=0.K  
Non-threshold reactions

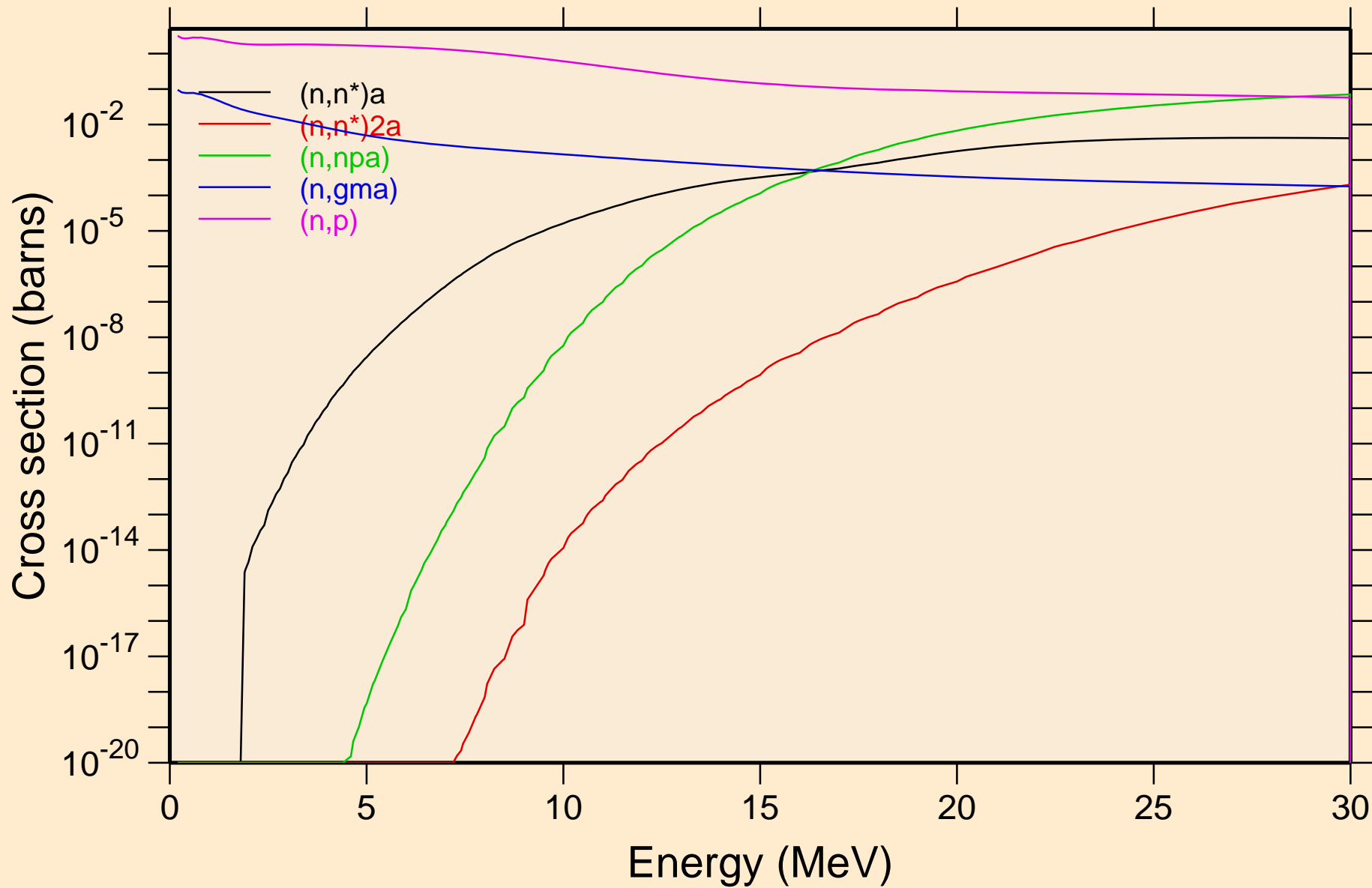

TB141 NEUTRON ACER TENDL-2023 LIBRARY; T=0.K  
Non-threshold reactions

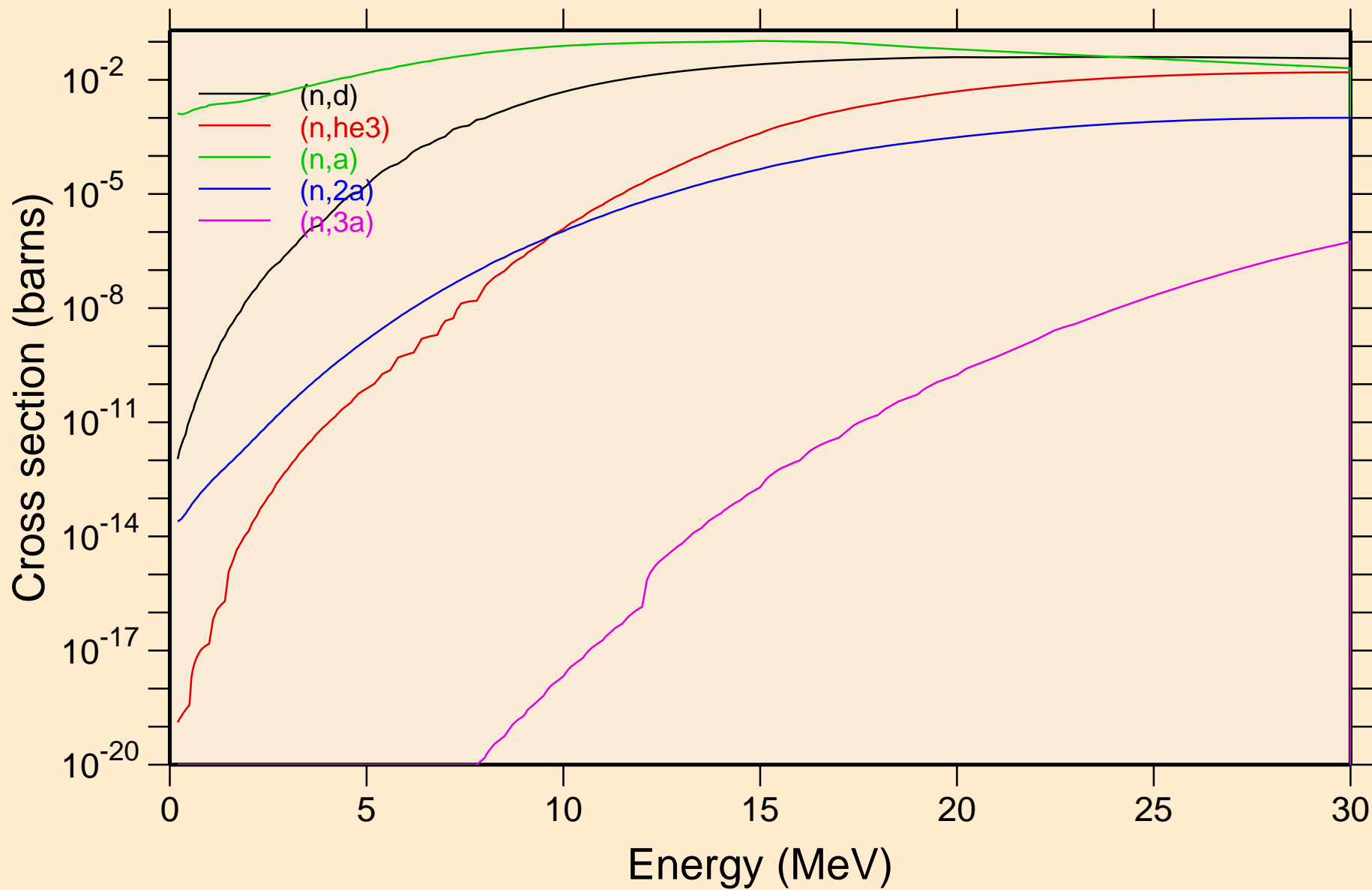

TB141 NEUTRON ACER TENDL-2023 LIBRARY; T=0.K  
Non-threshold reactions

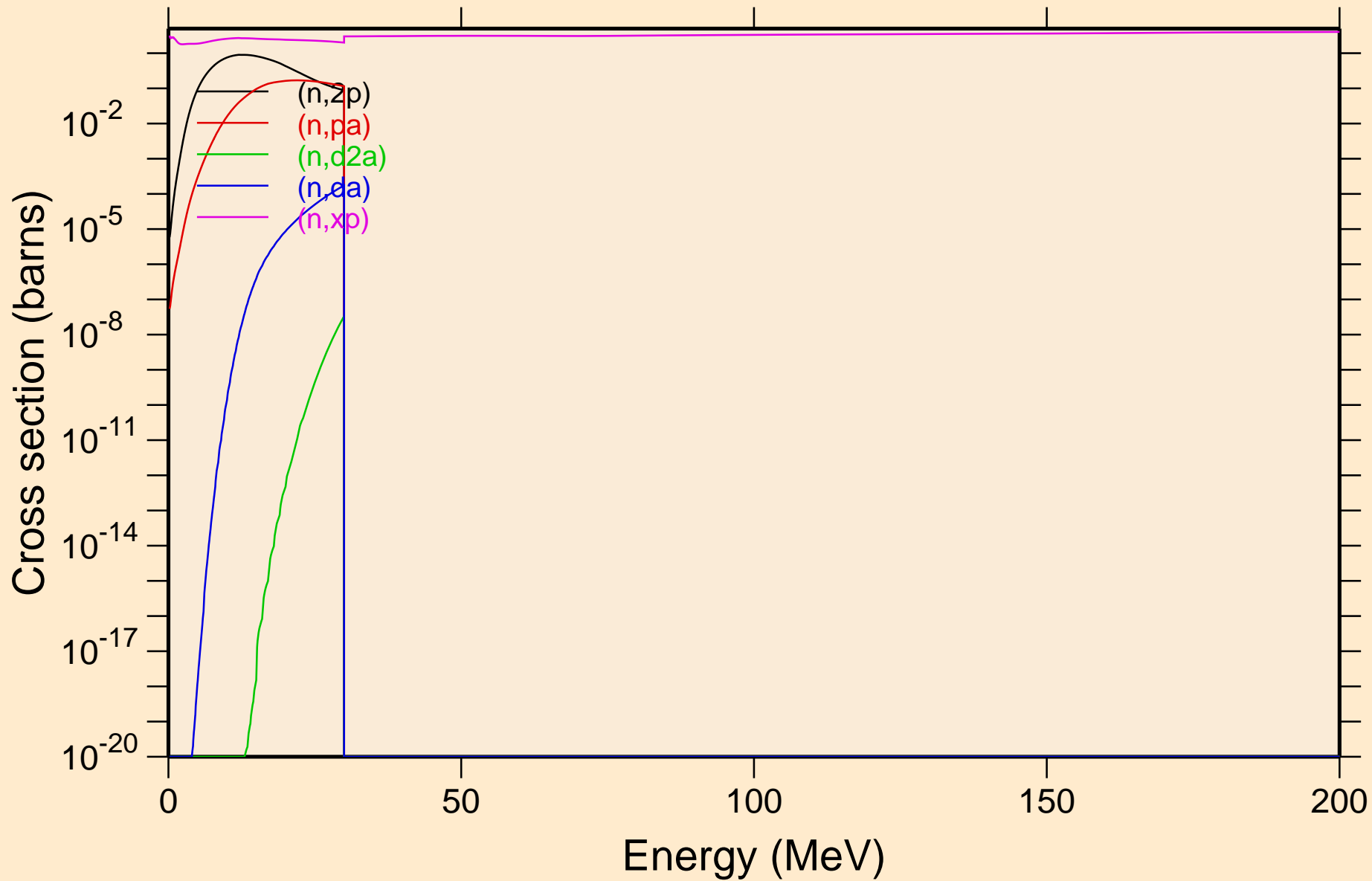

TB141 NEUTRON ACER TENDL-2023 LIBRARY; T=0.K  
Non-threshold reactions

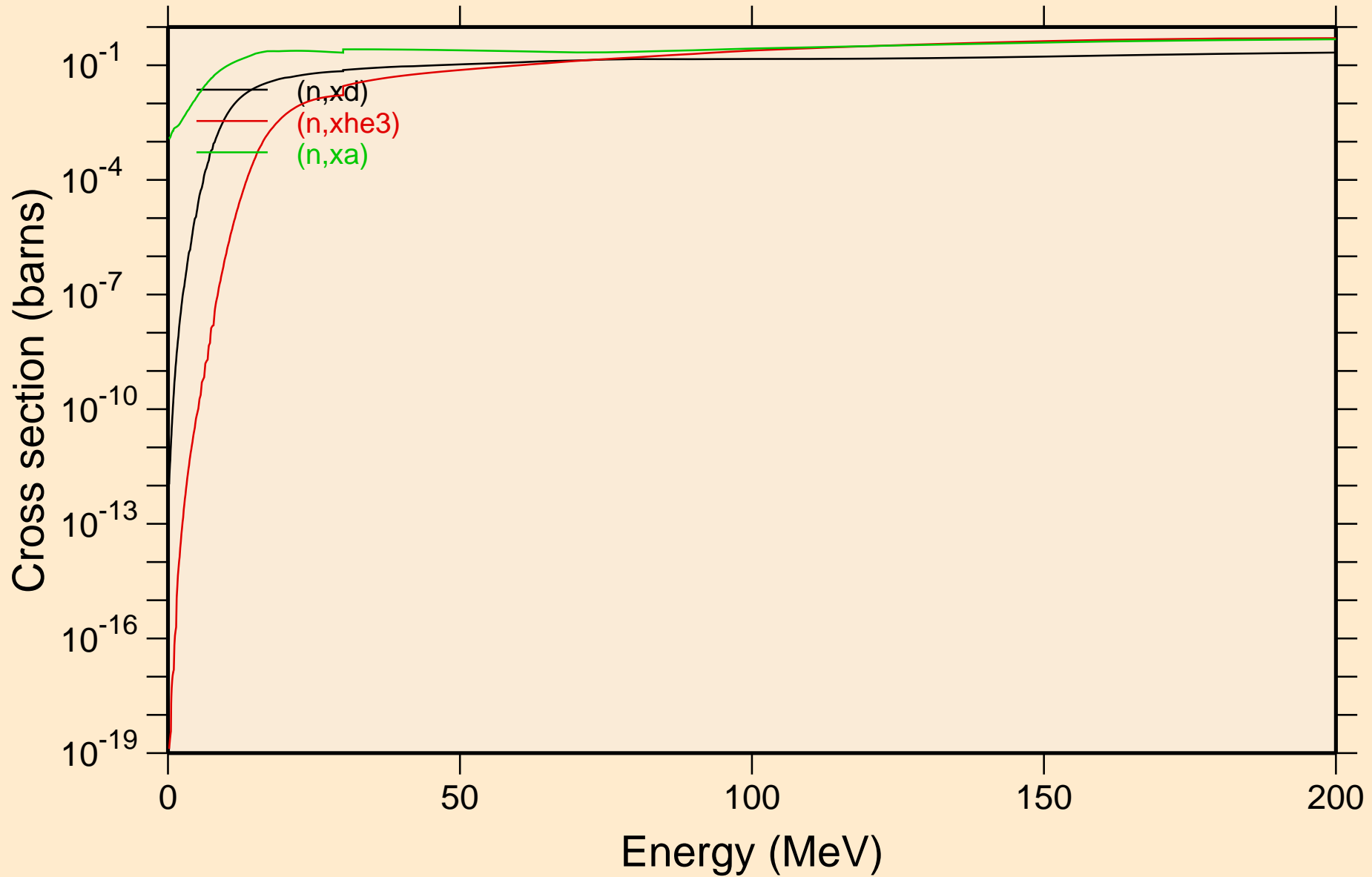

TB141 NEUTRON ACER TENDL-2023 LIBRARY; T=0.K  
Inelastic levels

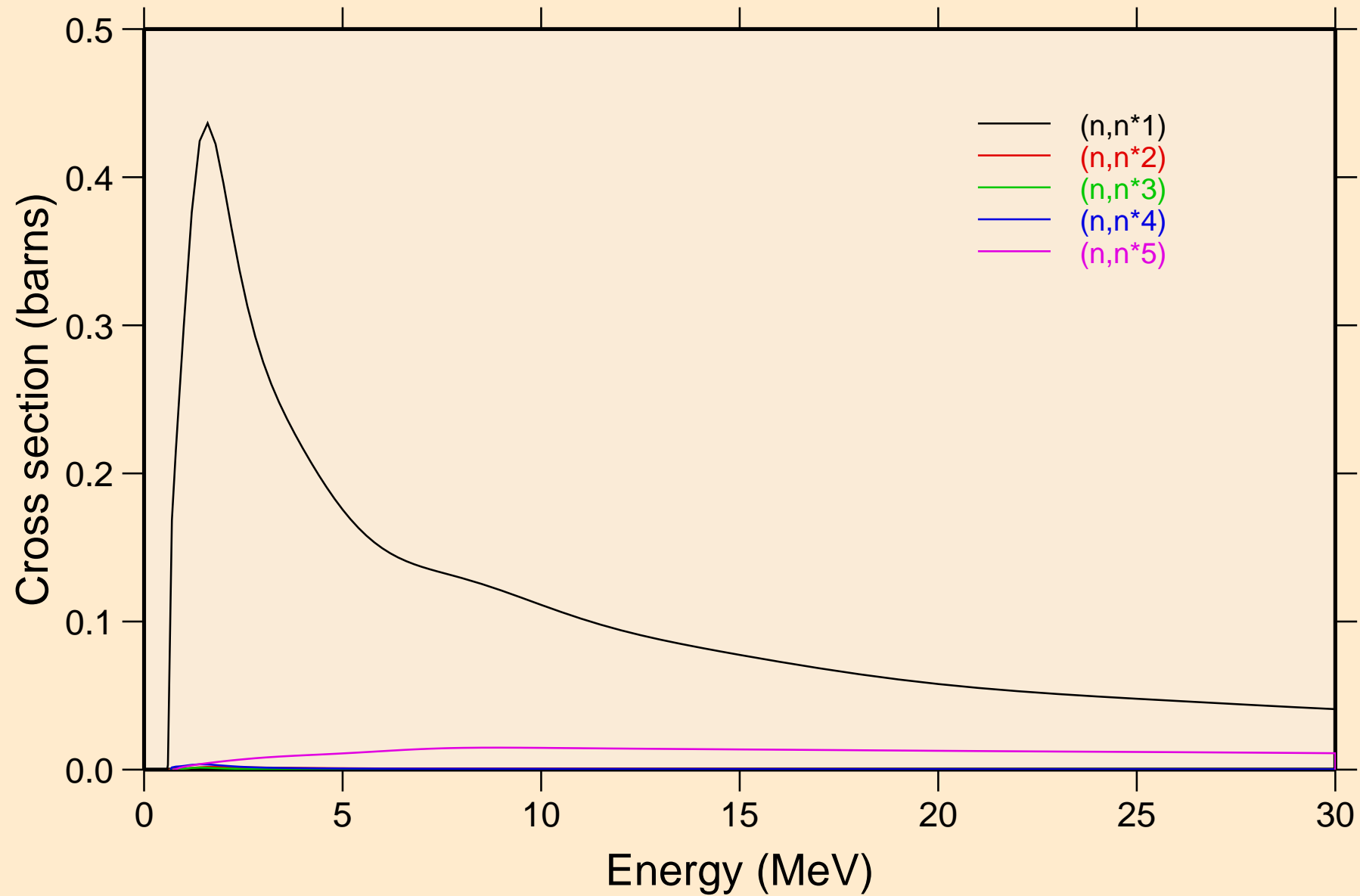

TB141 NEUTRON ACER TENDL-2023 LIBRARY; T=0.K  
Inelastic levels

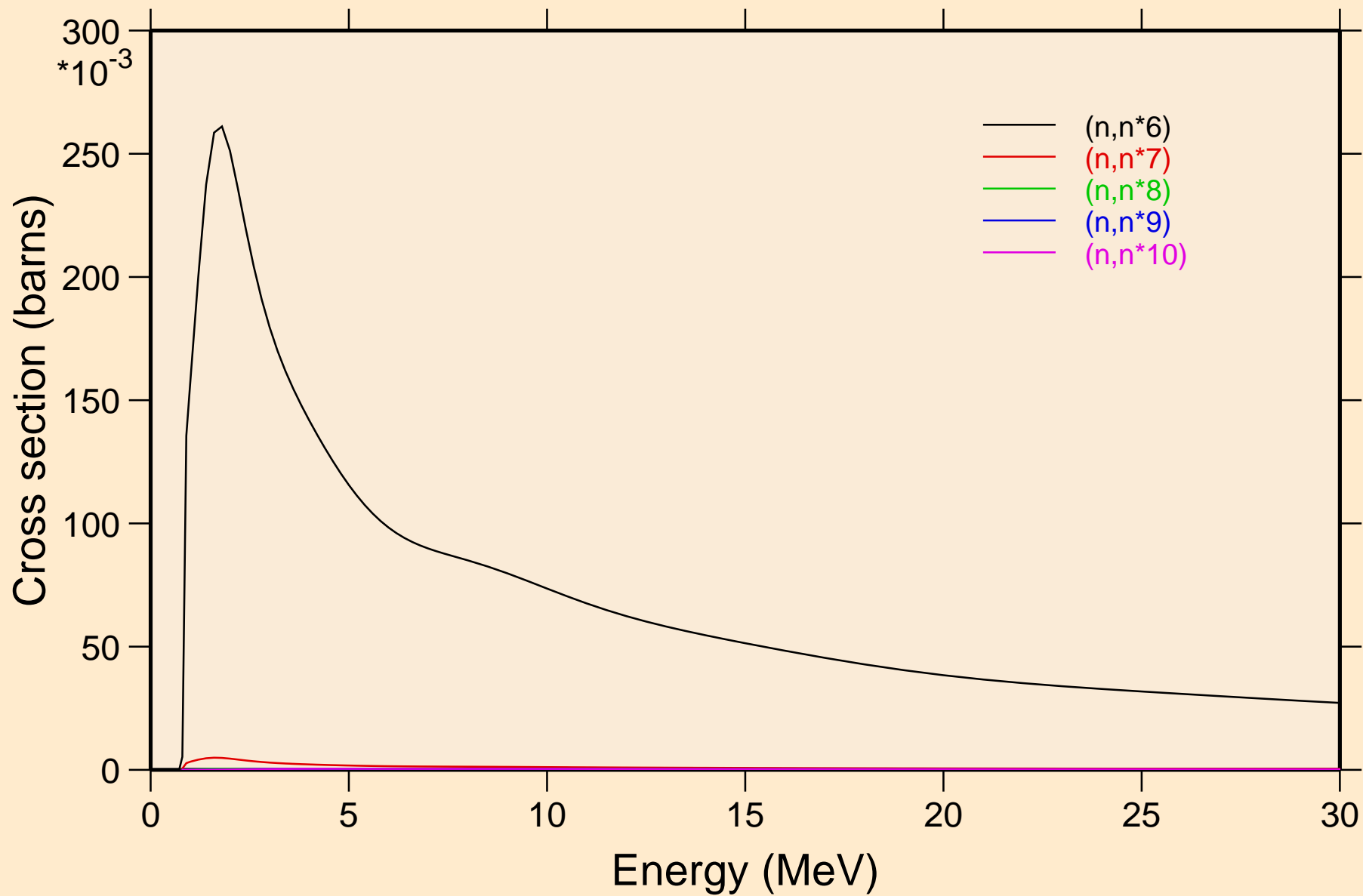



TB141 NEUTRON ACER TENDL-2023 LIBRARY; T=0.K  
Inelastic levels

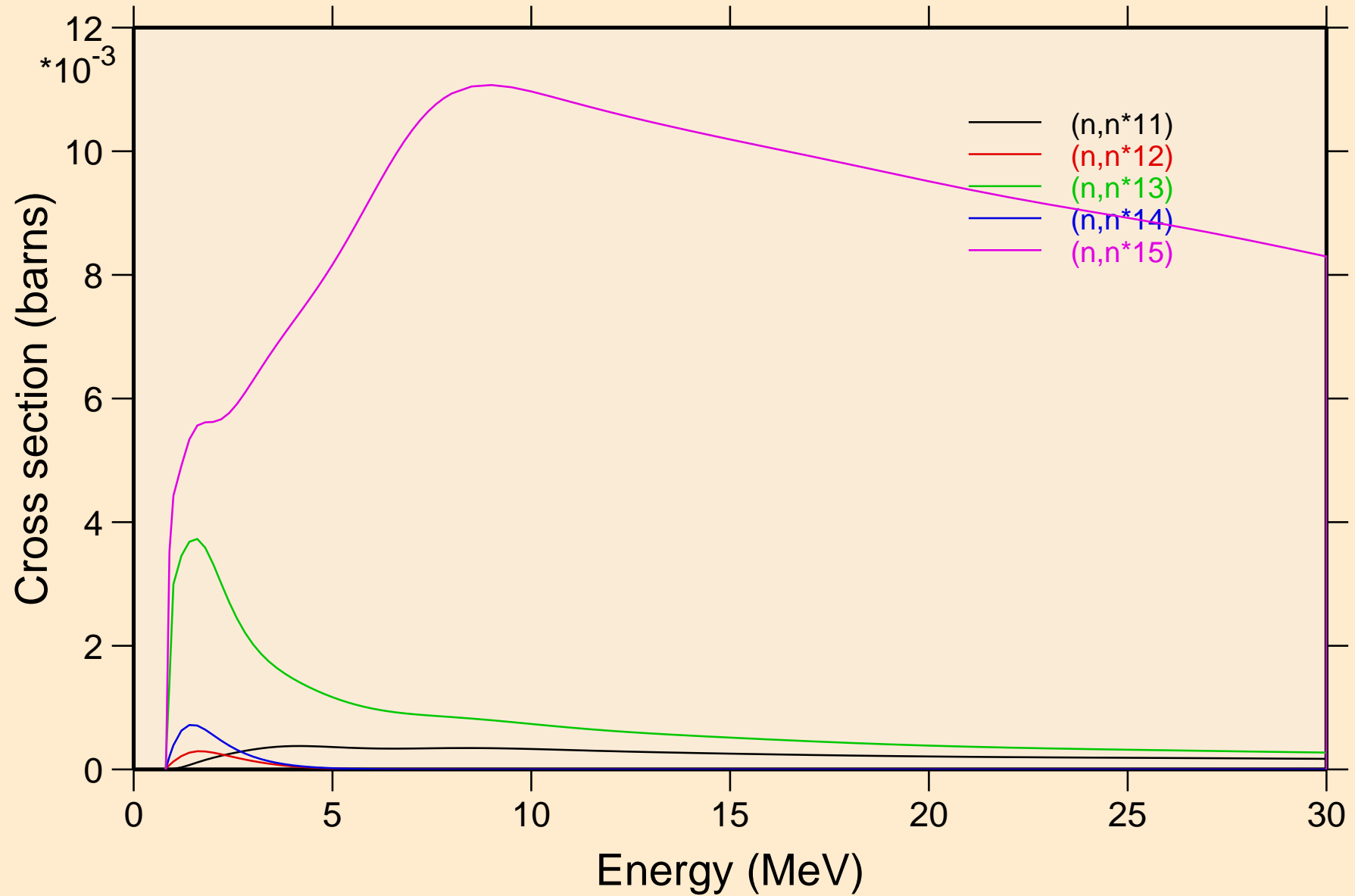

TB141 NEUTRON ACER TENDL-2023 LIBRARY; T=0.K  
Inelastic levels

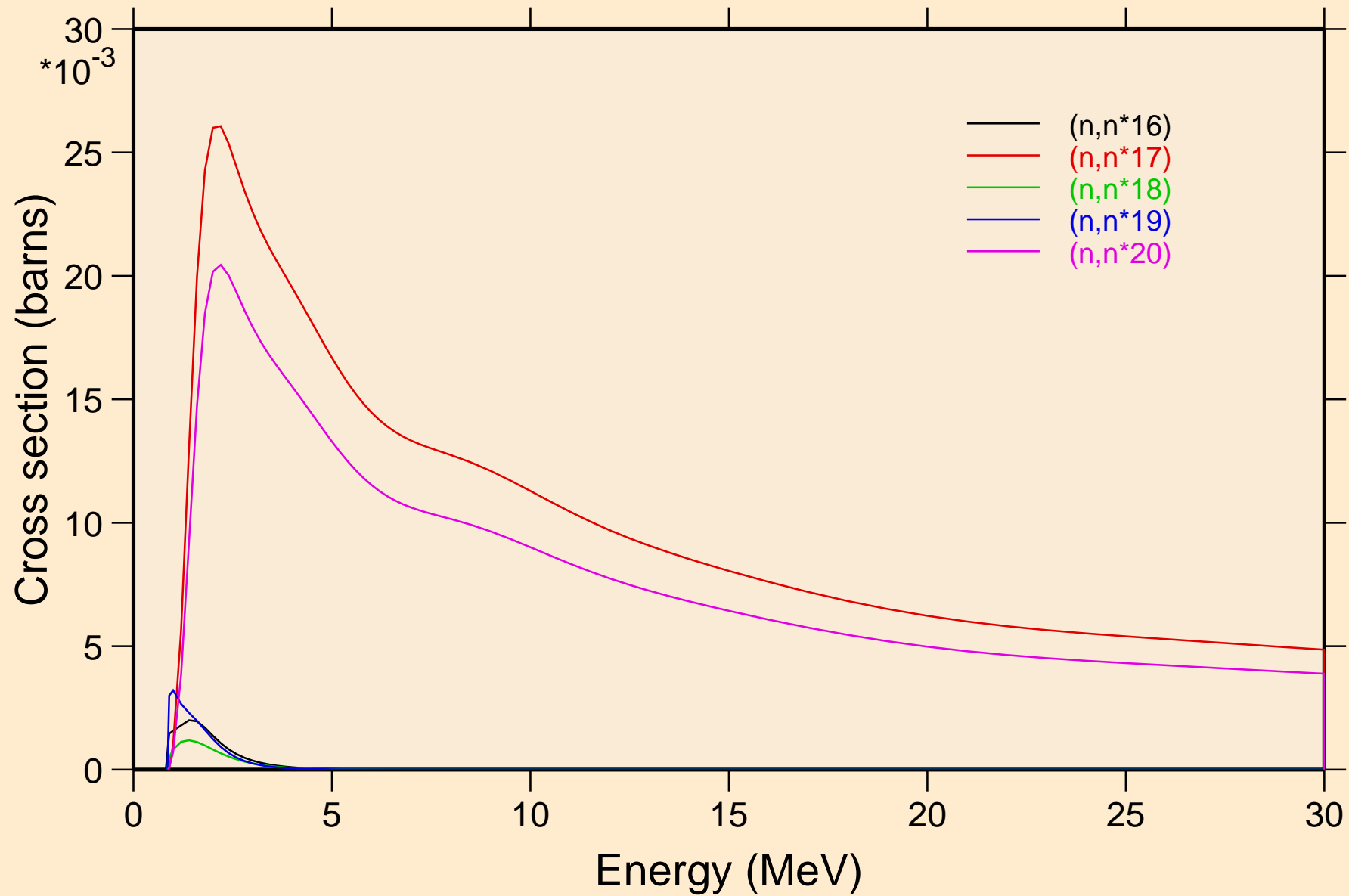

TB141 NEUTRON ACER TENDL-2023 LIBRARY; T=0.K  
Threshold reactions

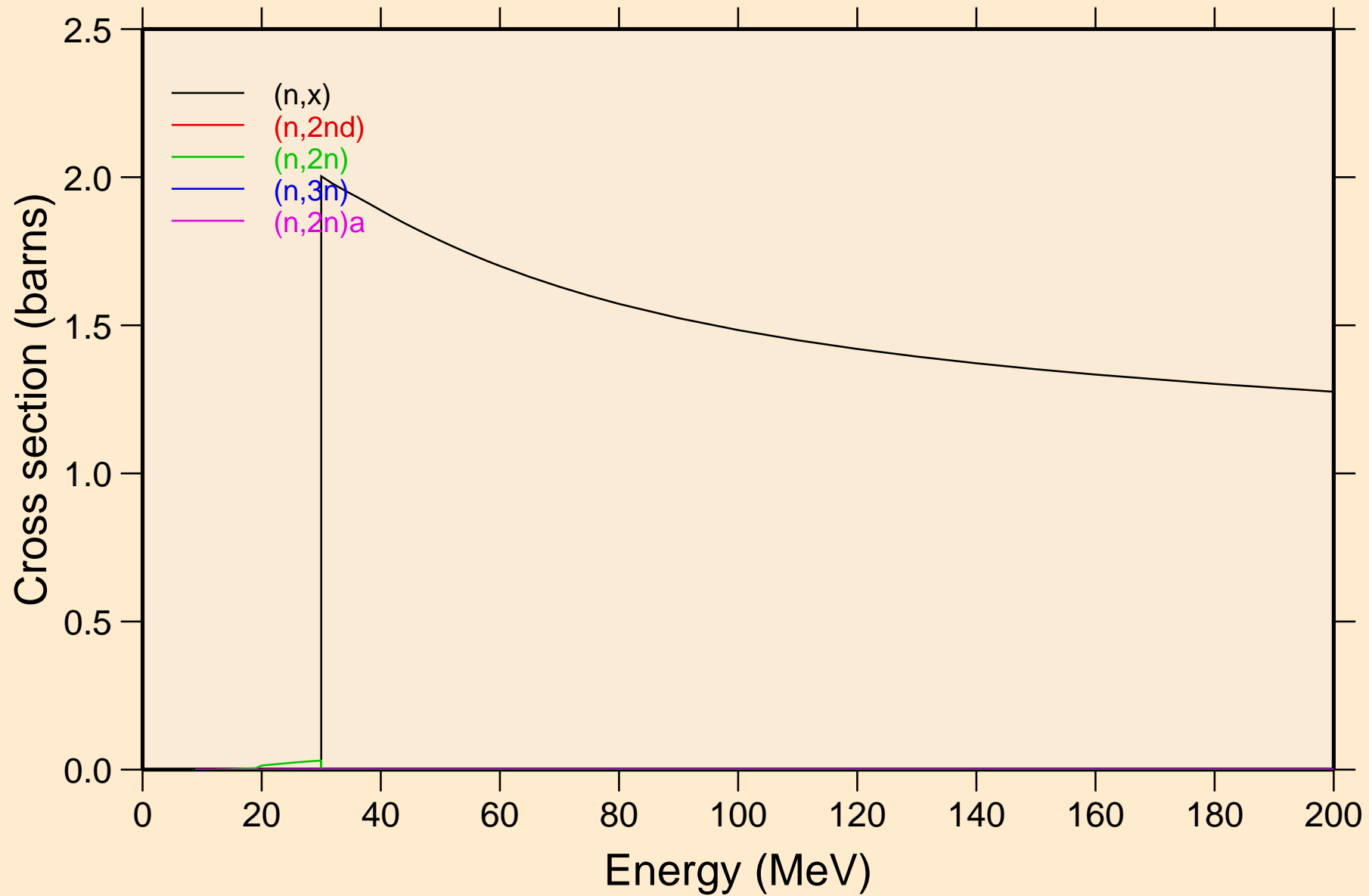

TB141 NEUTRON ACER TENDL-2023 LIBRARY; T=0.K  
Threshold reactions

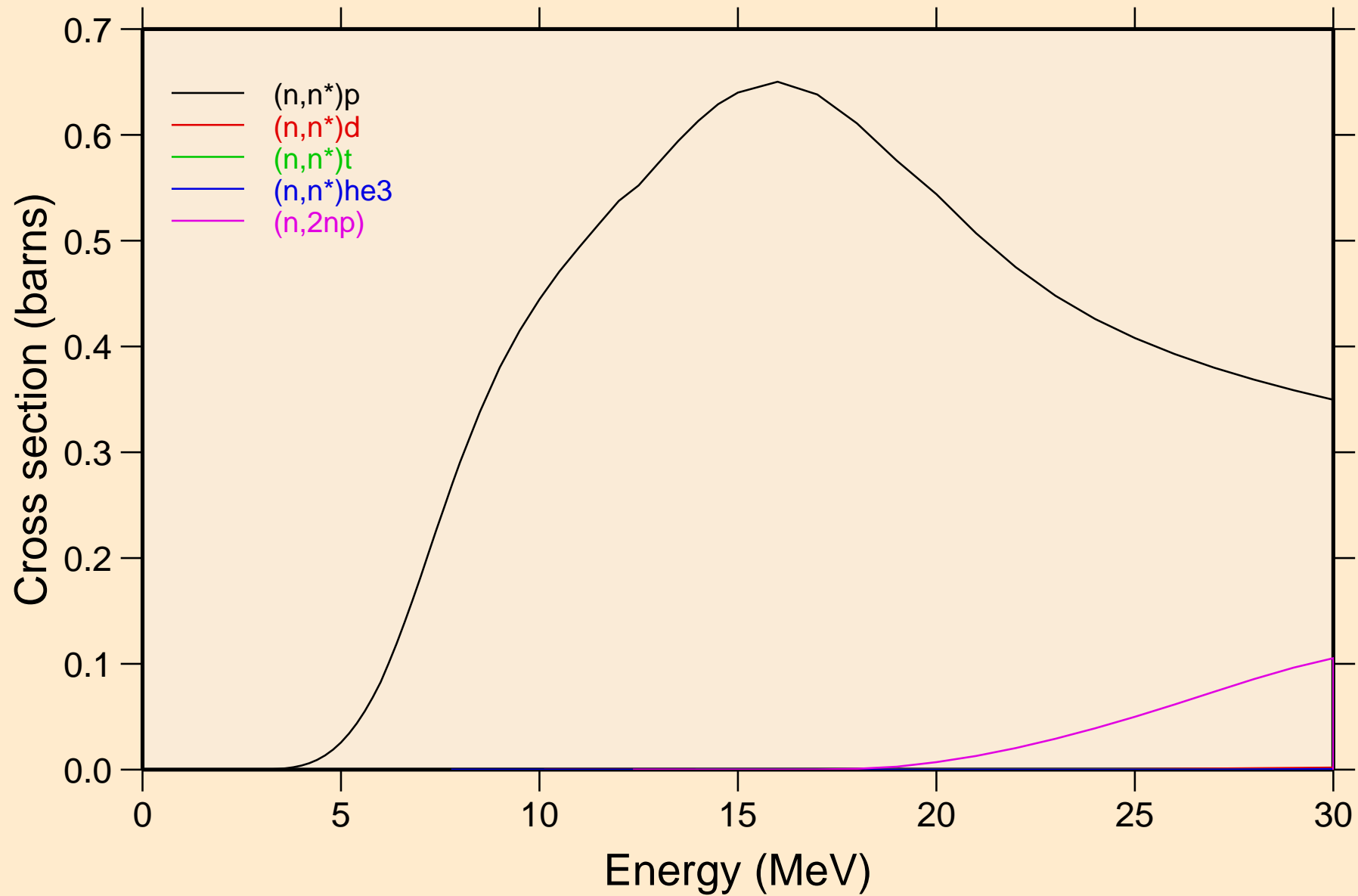

TB141 NEUTRON ACER TENDL-2023 LIBRARY; T=0.K  
Threshold reactions

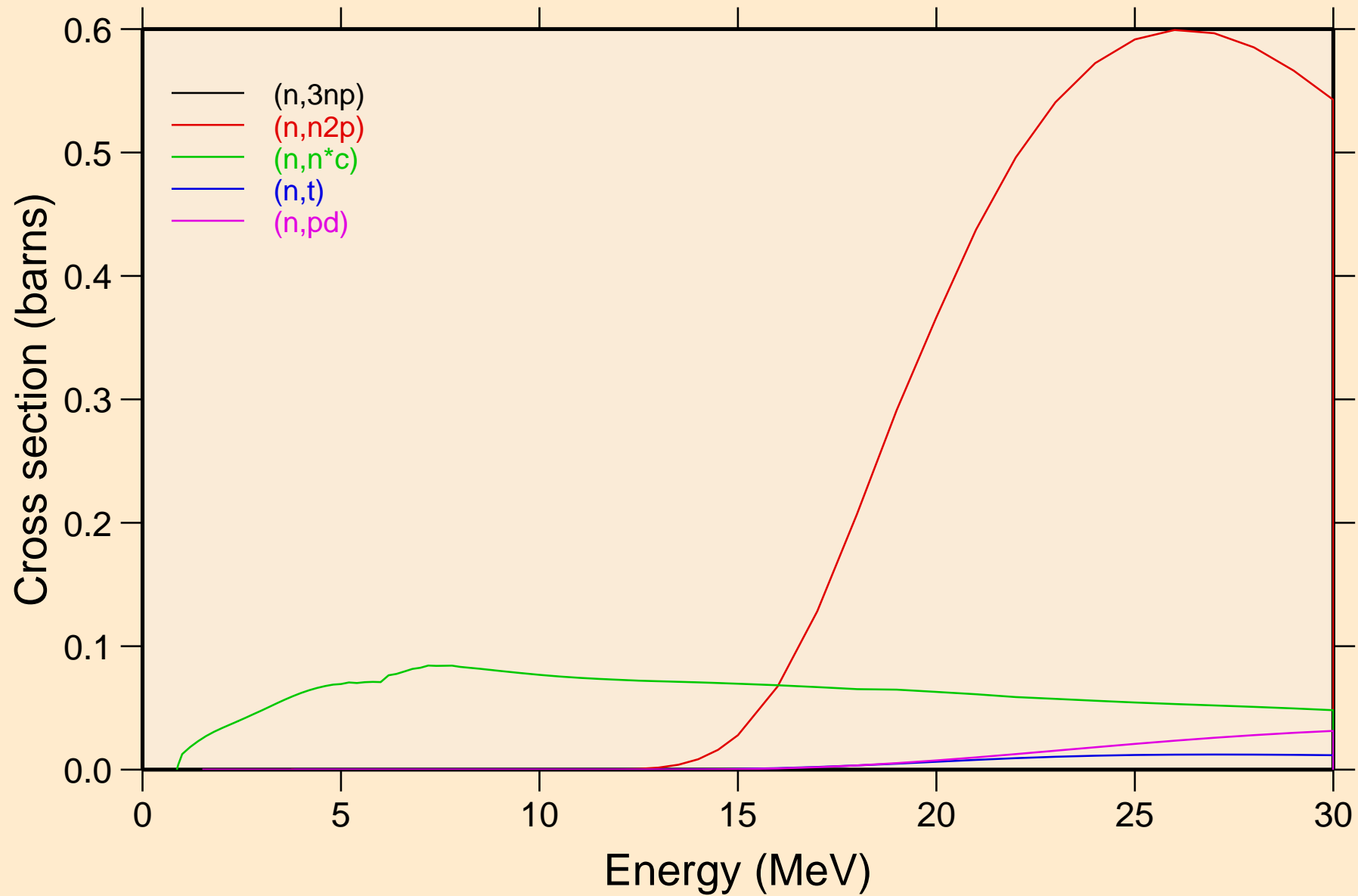

TB141 NEUTRON ACER TENDL-2023 LIBRARY; T=0.K  
Threshold reactions

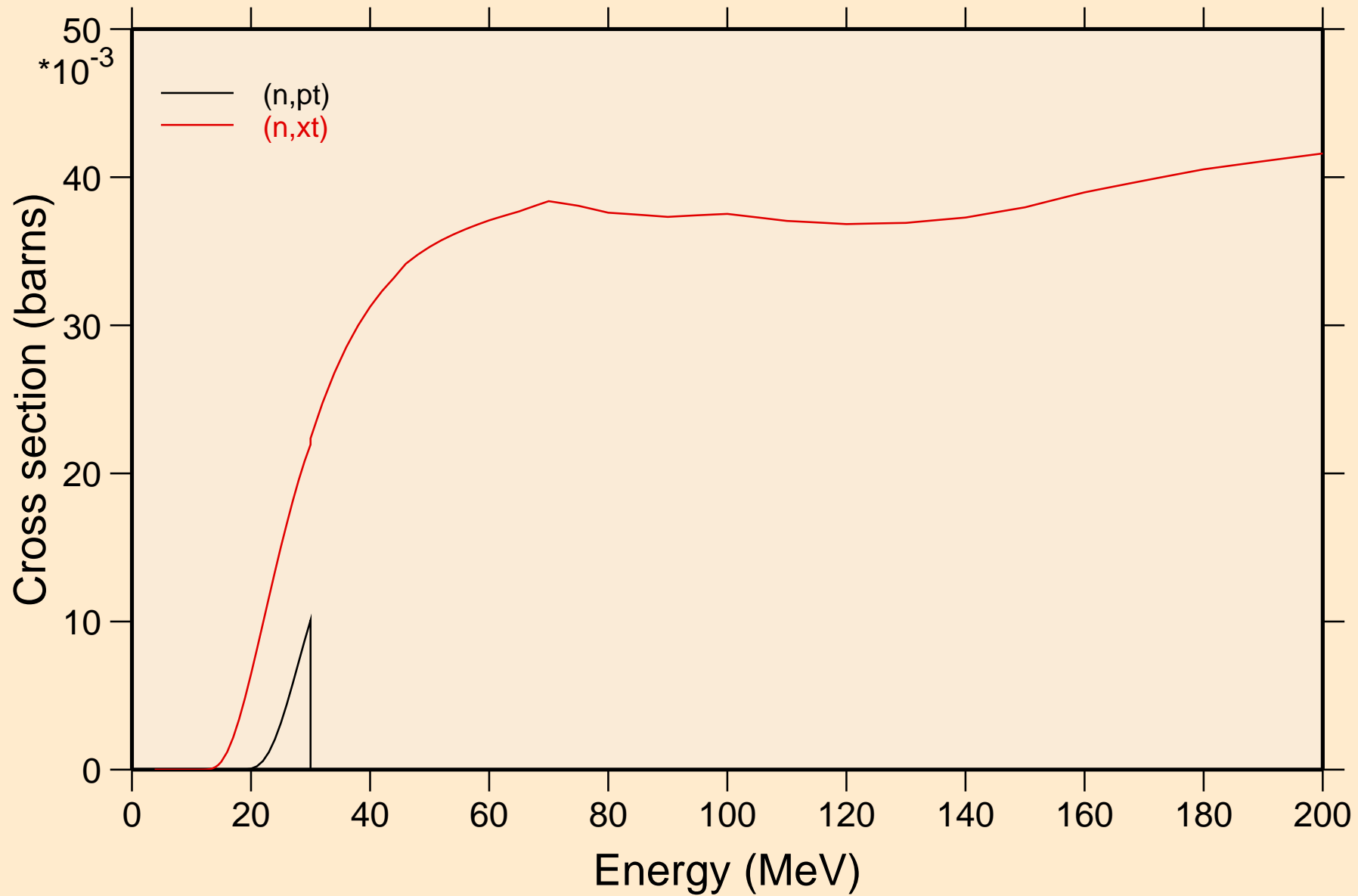

TB141 NEUTRON ACER TENDL-2023 LIBRARY; T=0.K  
angular distribution for elastic

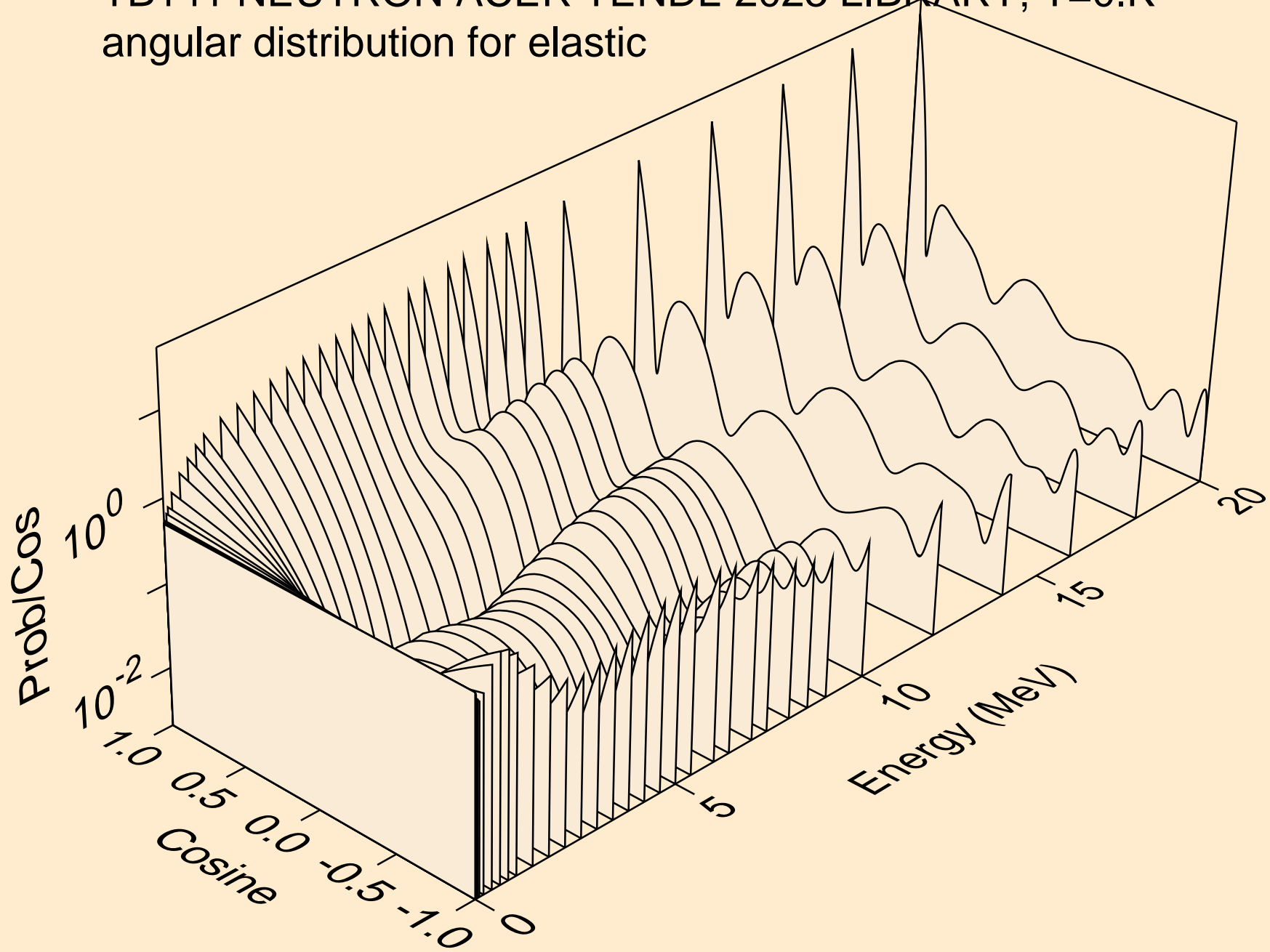

TB141 NEUTRON ACER TENDL-2023 LIBRARY; T=0.K  
angular distribution for elastic

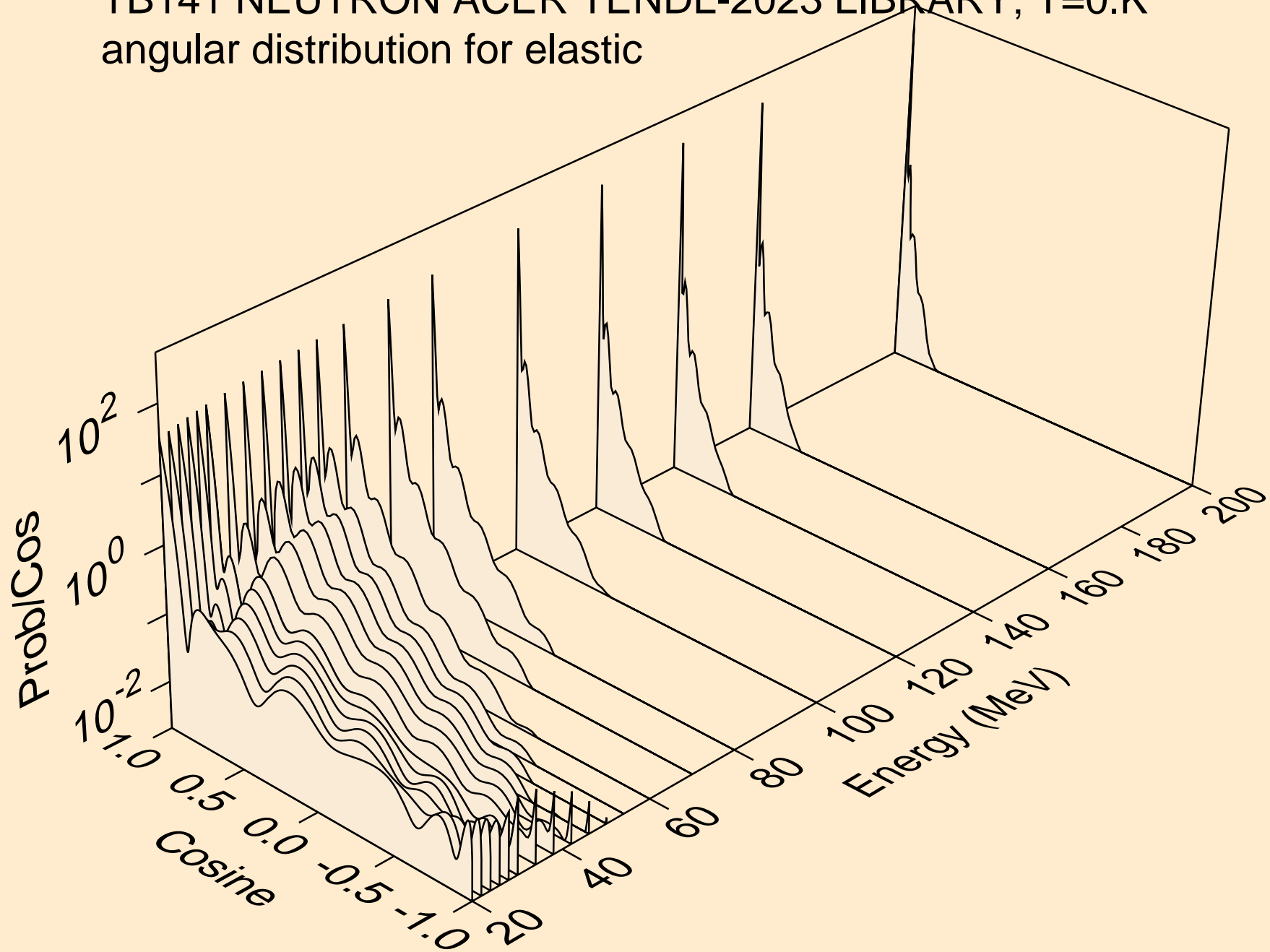



TB141 NEUTRON ACER TENDL-2023 LIBRARY; T=0.K  
angular distribution for (n,n\*1)

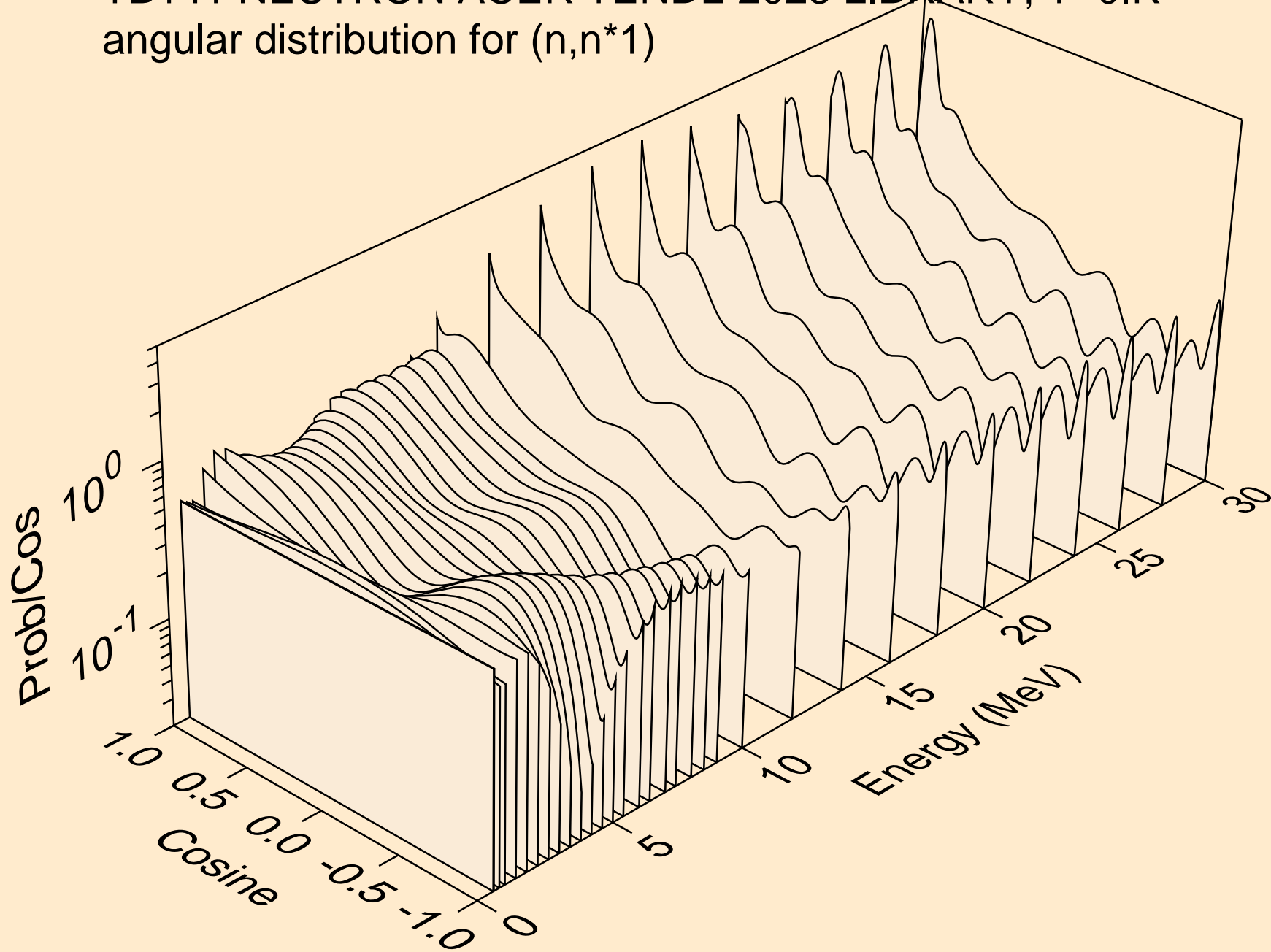

TB141 NEUTRON ACER TENDL-2023 LIBRARY; T=0.K  
angular distribution for (n,n\*2)

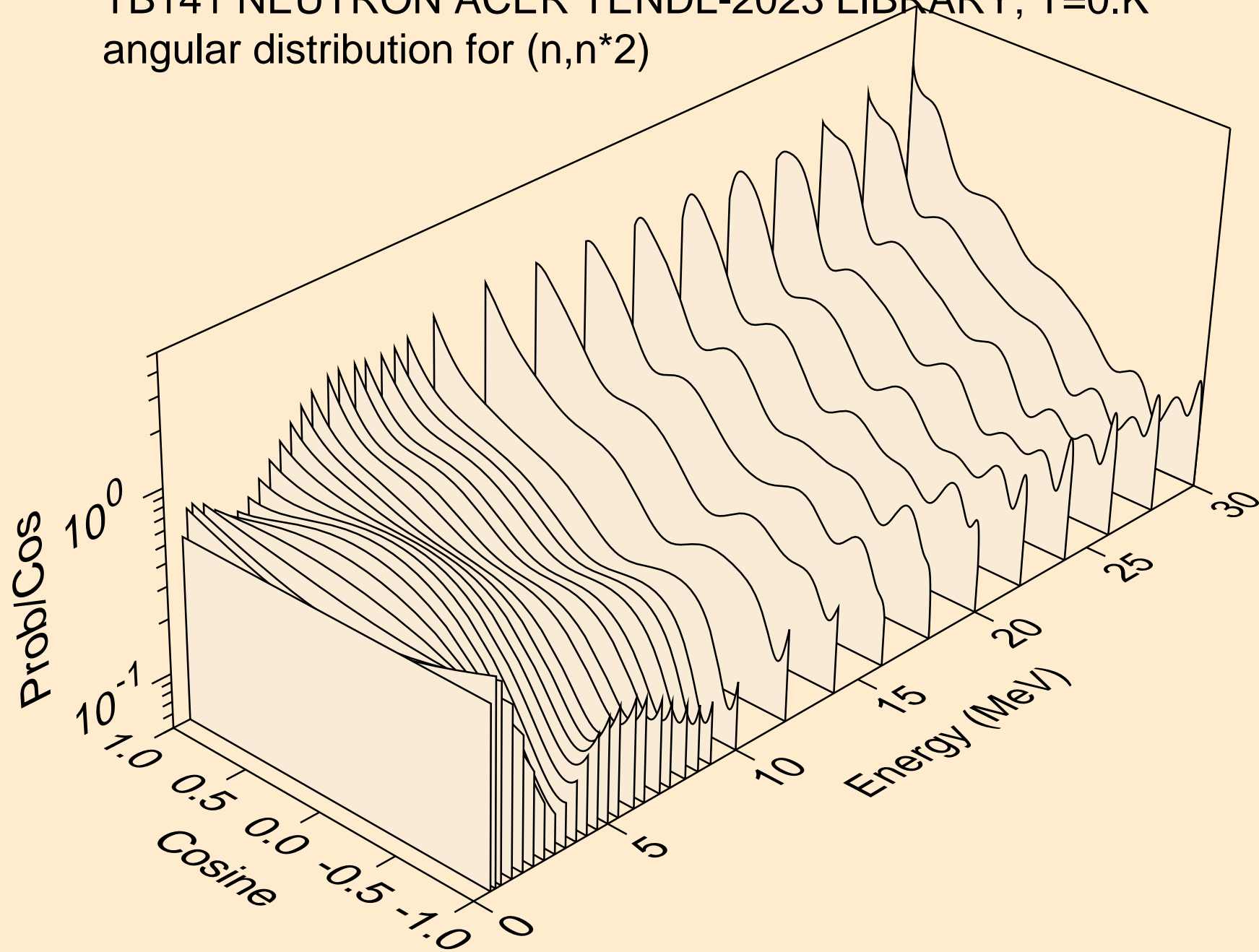

TB141 NEUTRON ACER TENDL-2023 LIBRARY; T=0.K  
angular distribution for (n,n\*3)

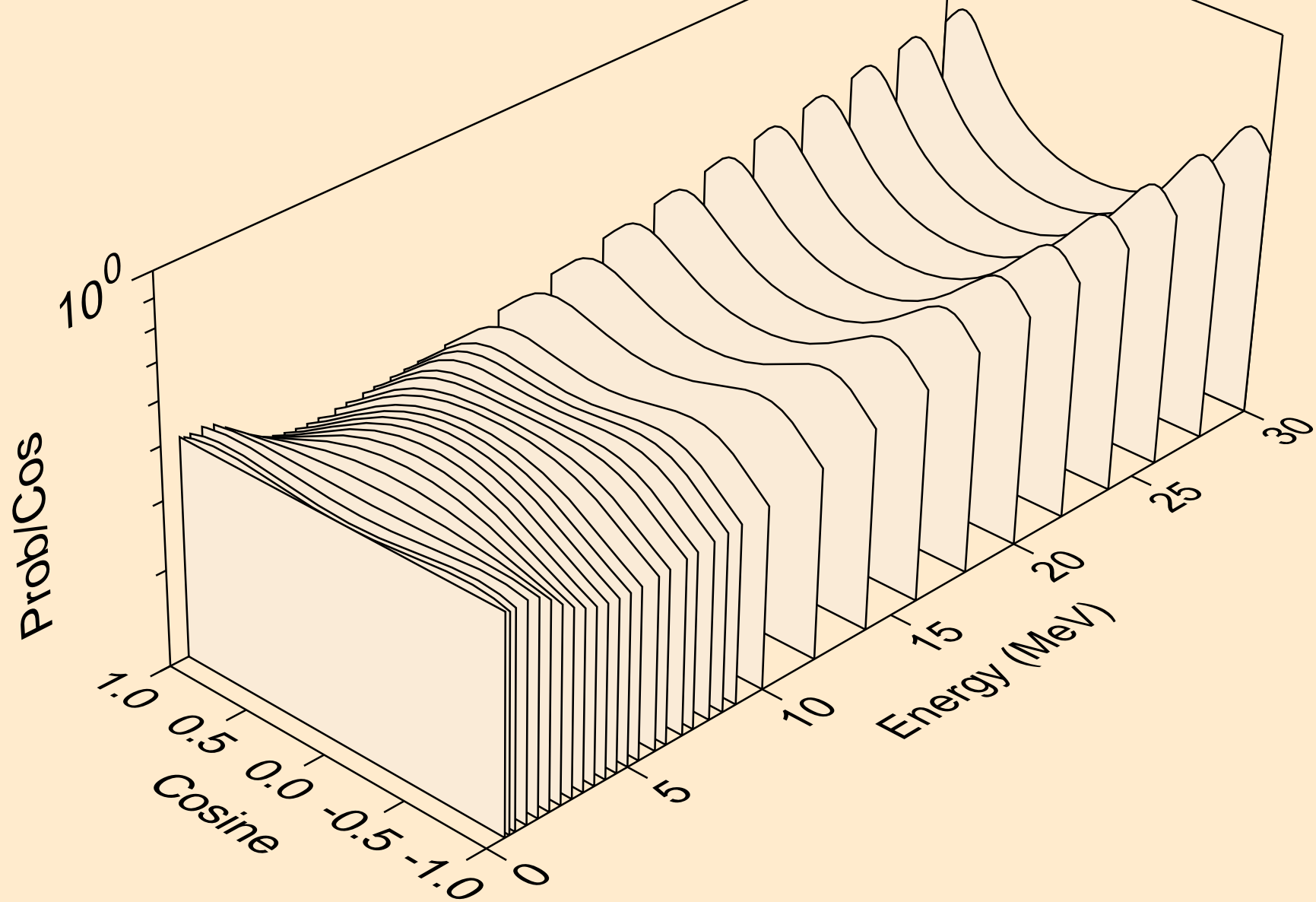

TB141 NEUTRON ACER TENDL-2023 LIBRARY; T=0.K  
angular distribution for (n,n\*4)

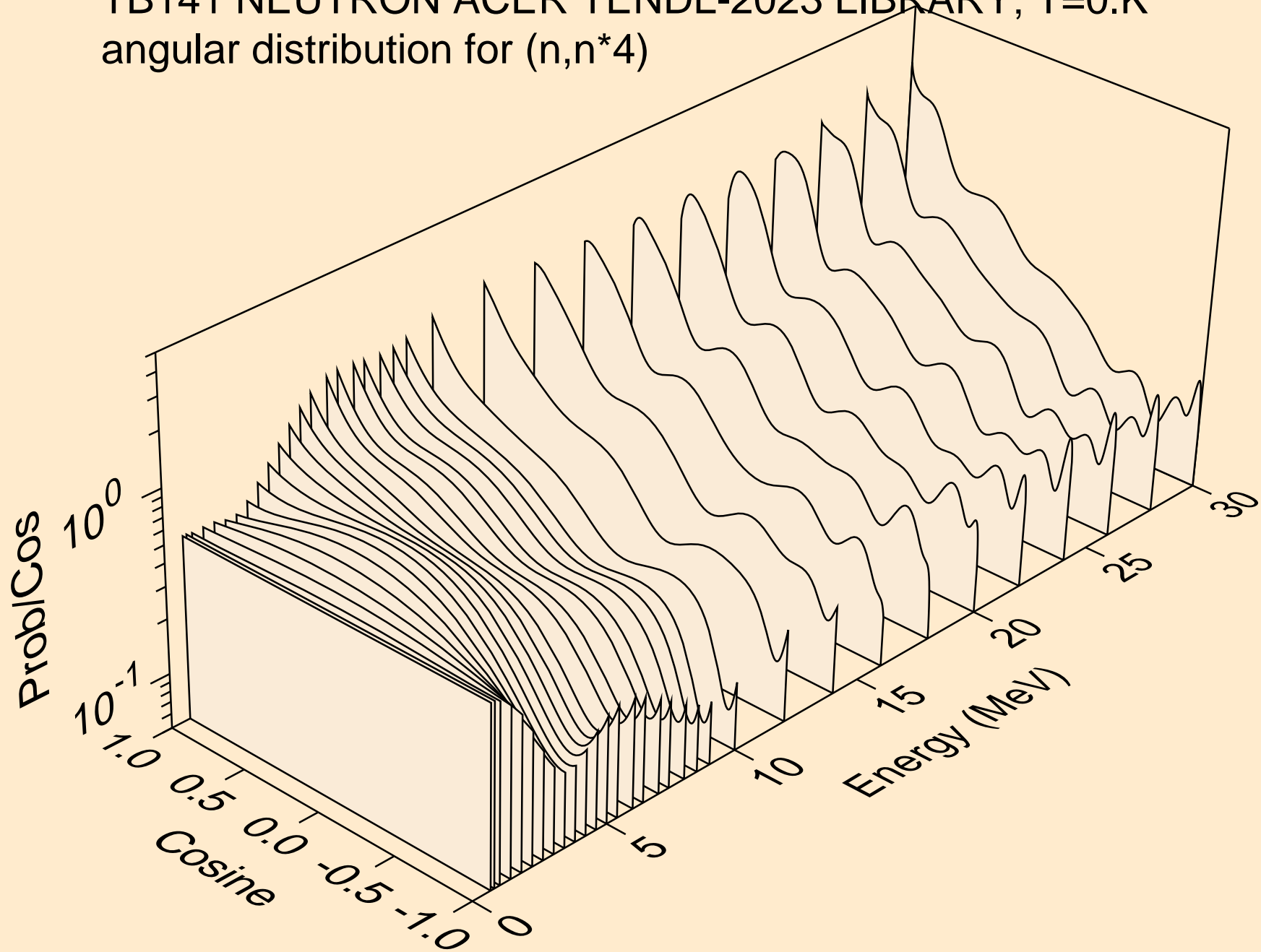

TB141 NEUTRON ACER TENDL-2023 LIBRARY; T=0.K  
angular distribution for (n,n\*5)

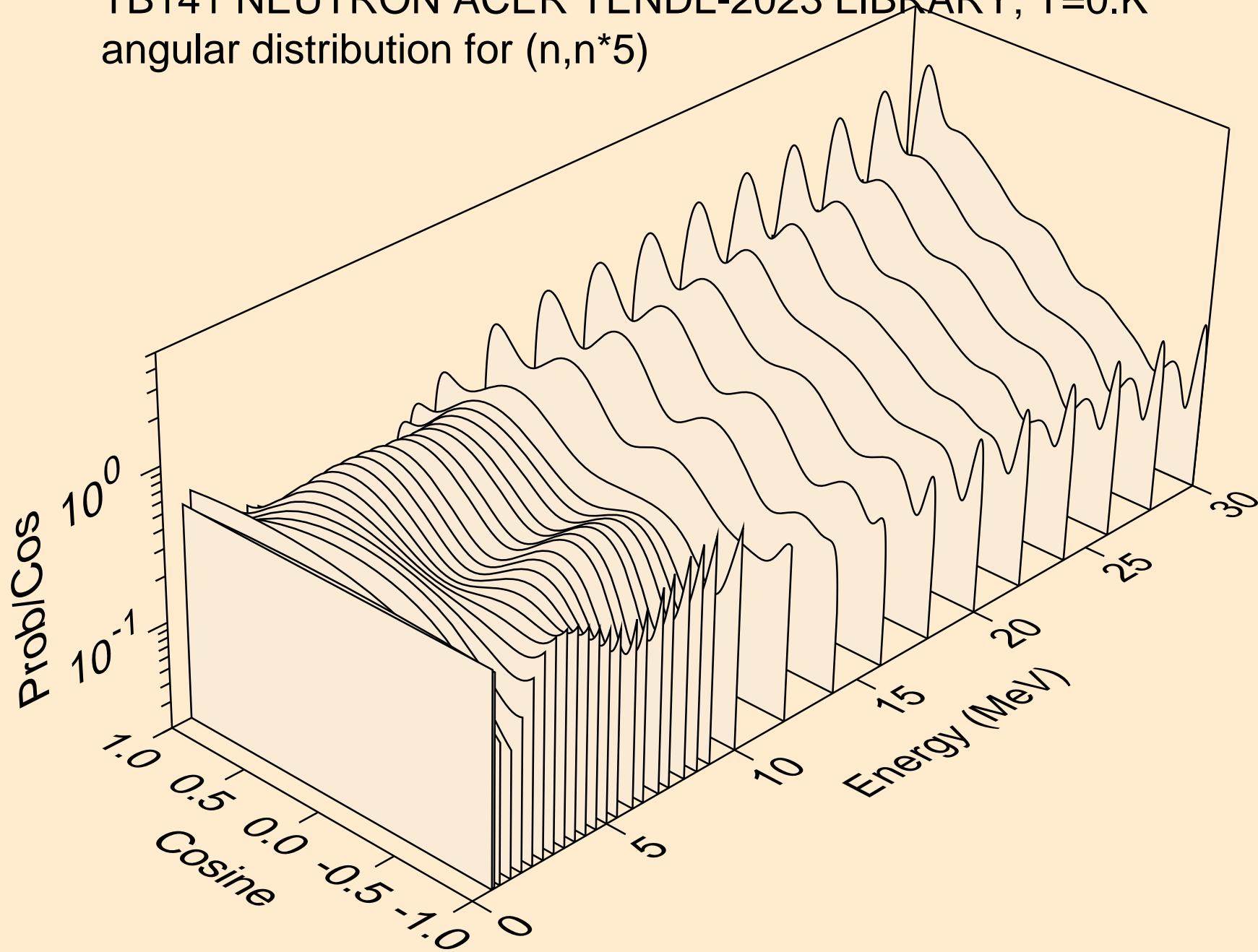

TB141 NEUTRON ACER TENDL-2023 LIBRARY; T=0.K  
angular distribution for (n,n\*6)

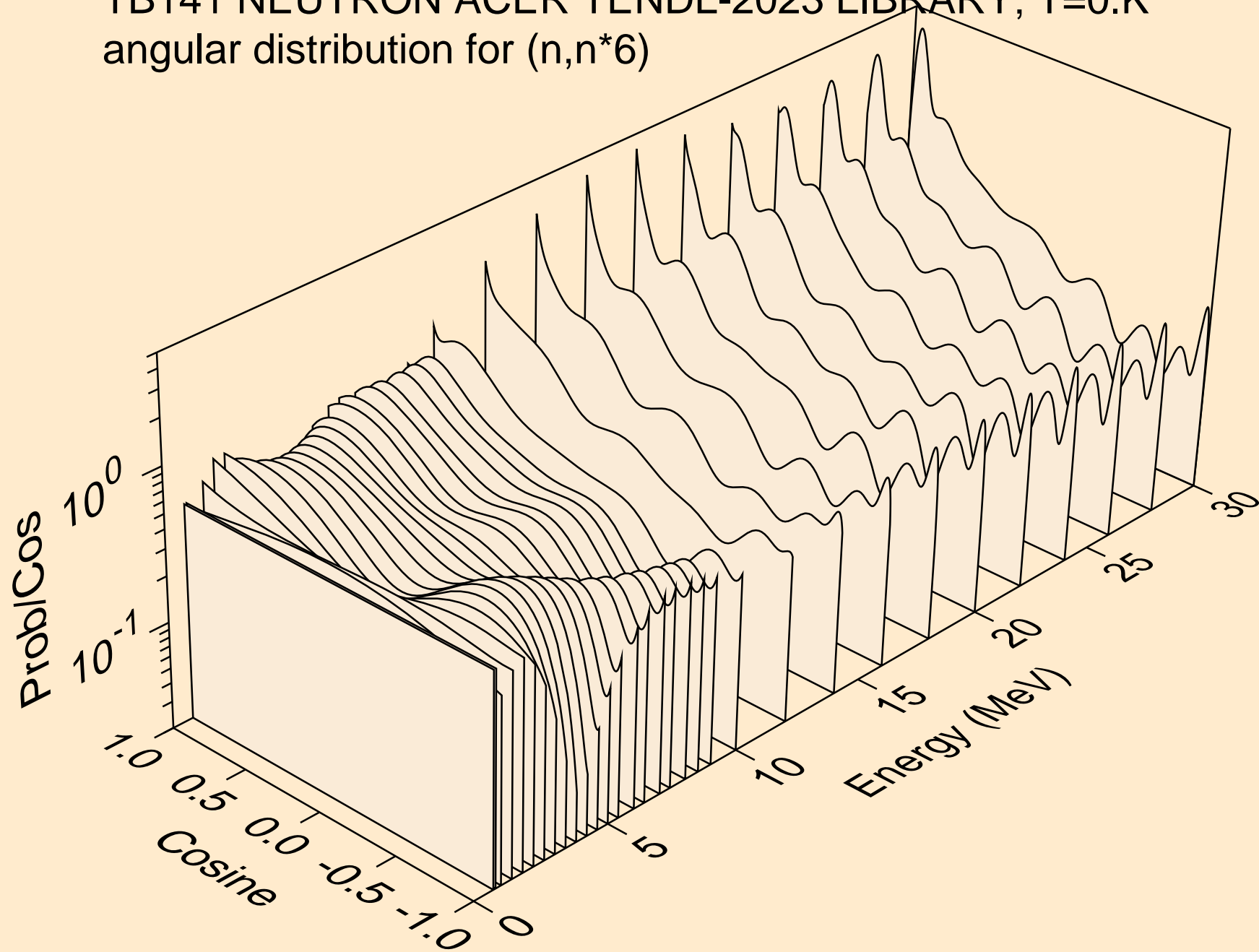

TB141 NEUTRON ACER TENDL-2023 LIBRARY; T=0.K  
angular distribution for (n,n\*7)

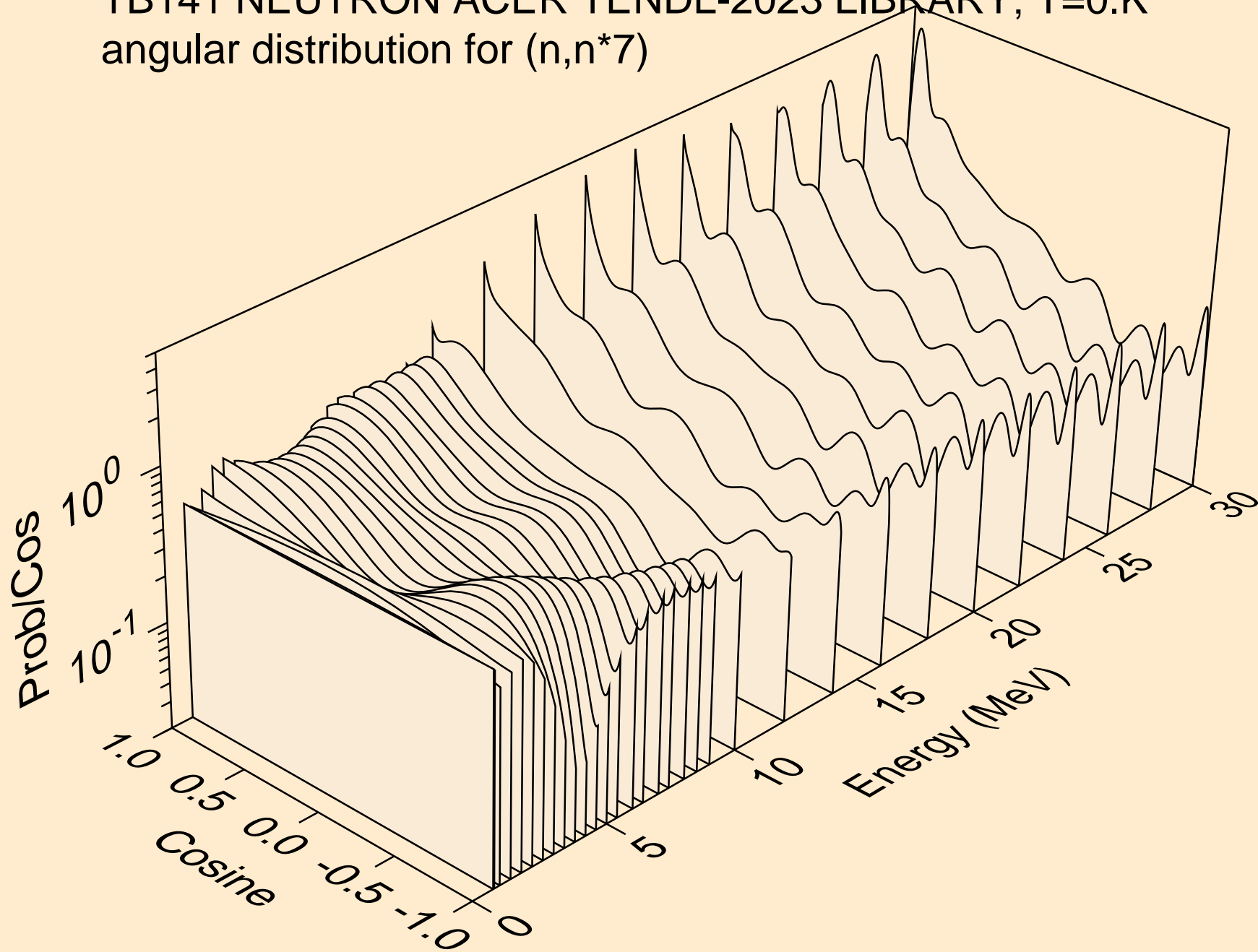

TB141 NEUTRON ACER TENDL-2023 LIBRARY; T=0.K  
angular distribution for (n,n\*8)

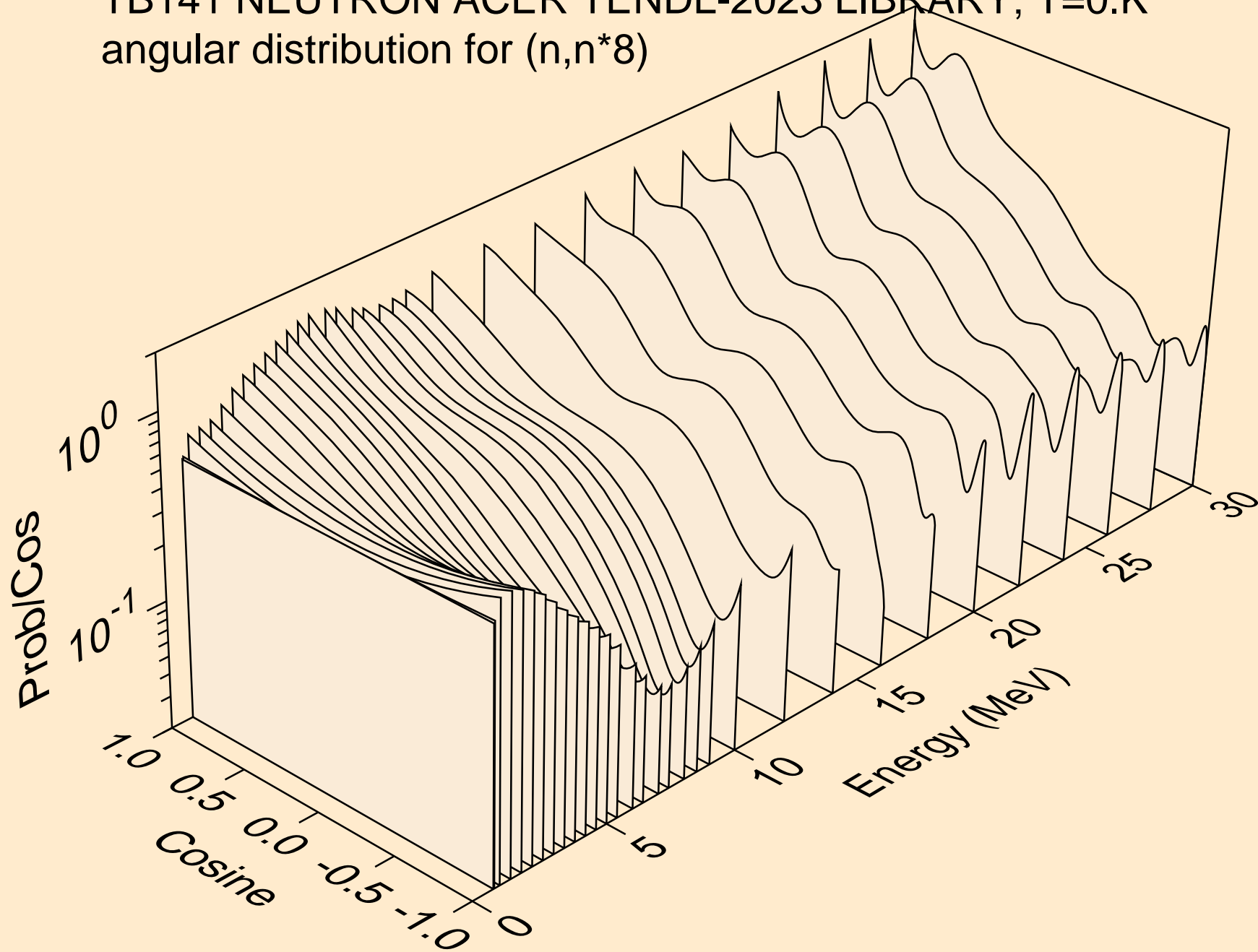



TB141 NEUTRON ACER TENDL-2023 LIBRARY; T=0.K  
angular distribution for (n,n\*9)

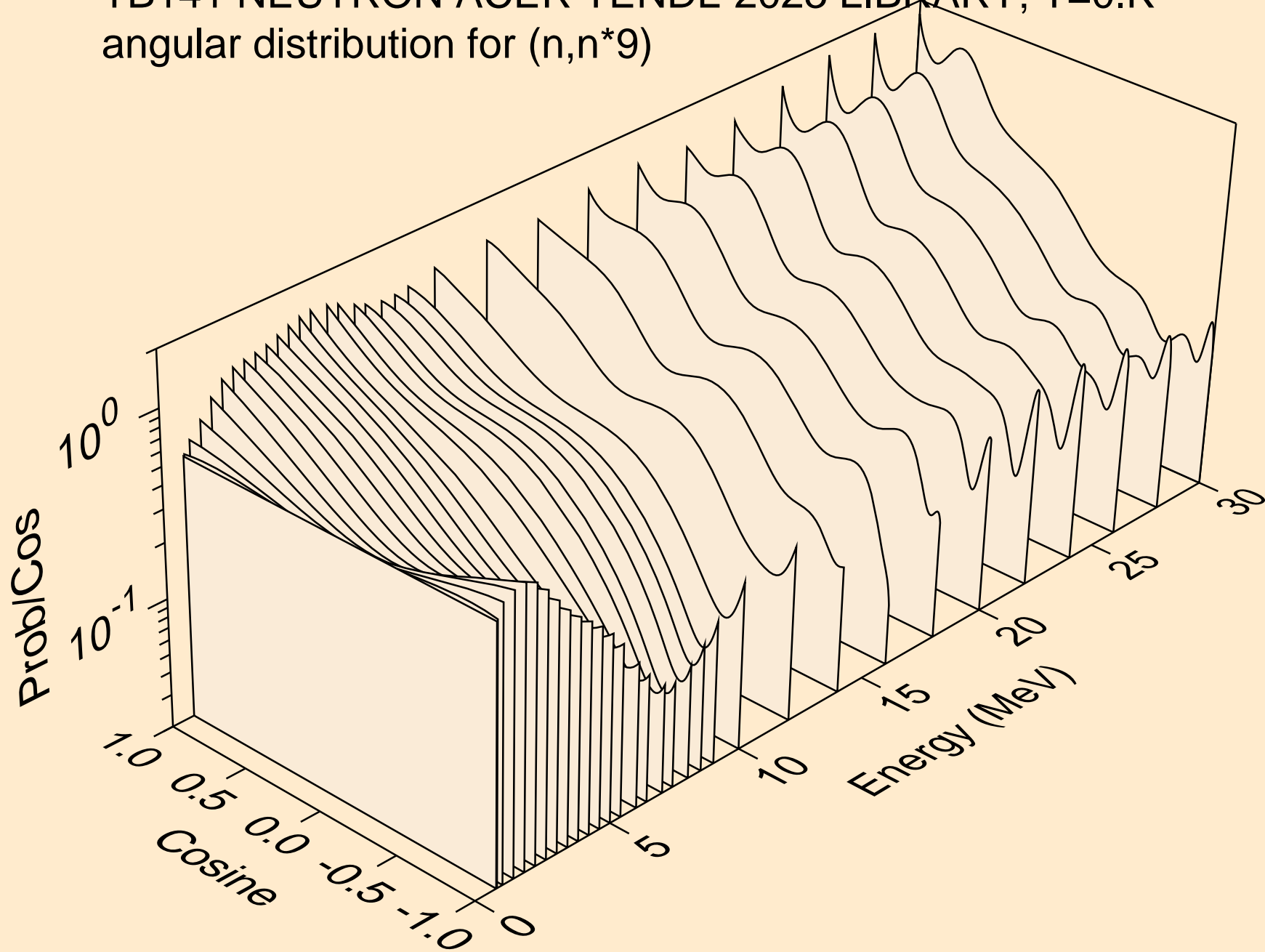

TB141 NEUTRON ACER TENDL-2023 LIBRARY; T=0.K  
angular distribution for (n,n\*10)

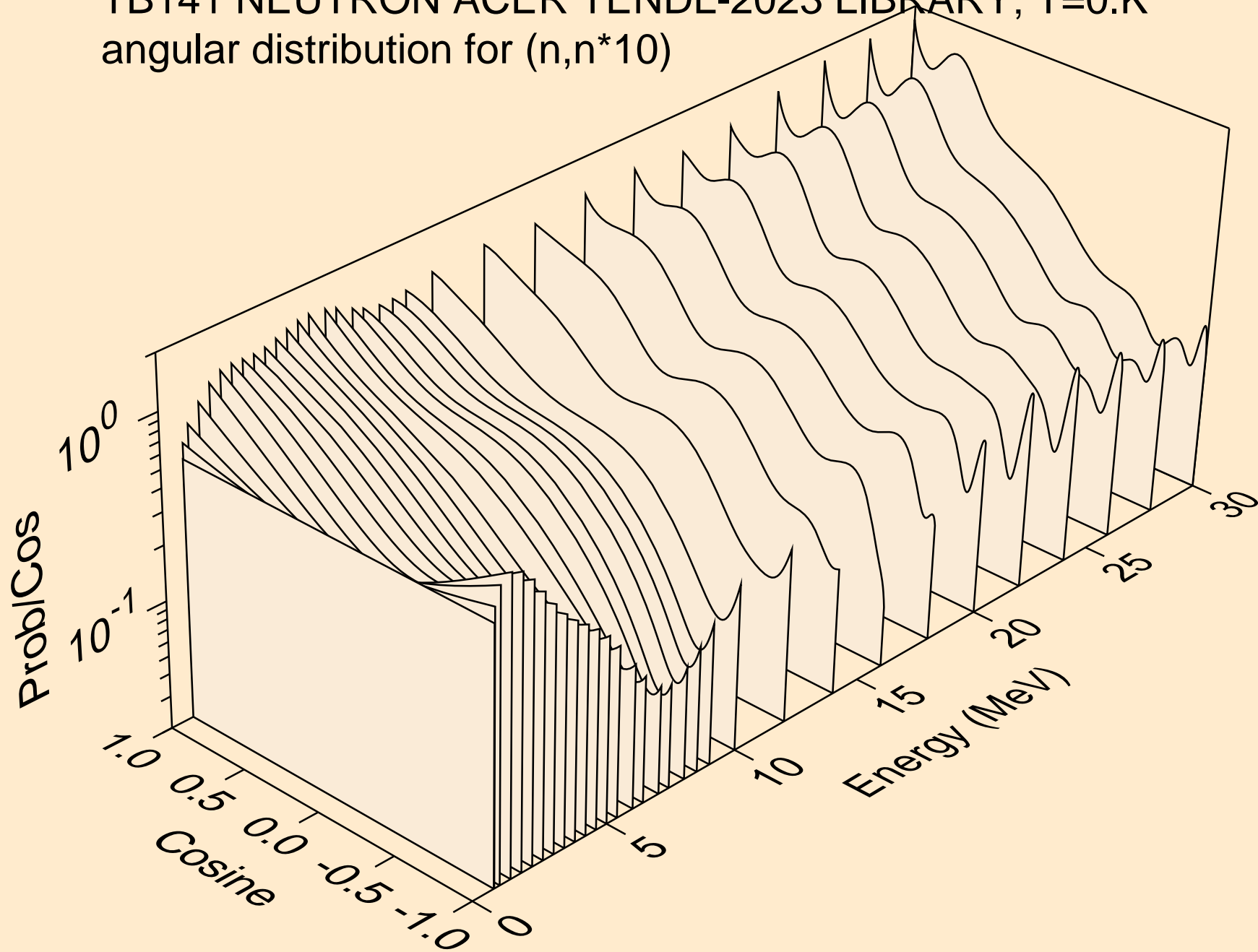

TB141 NEUTRON ACER TENDL-2023 LIBRARY; T=0.K  
angular distribution for (n,n\*11)

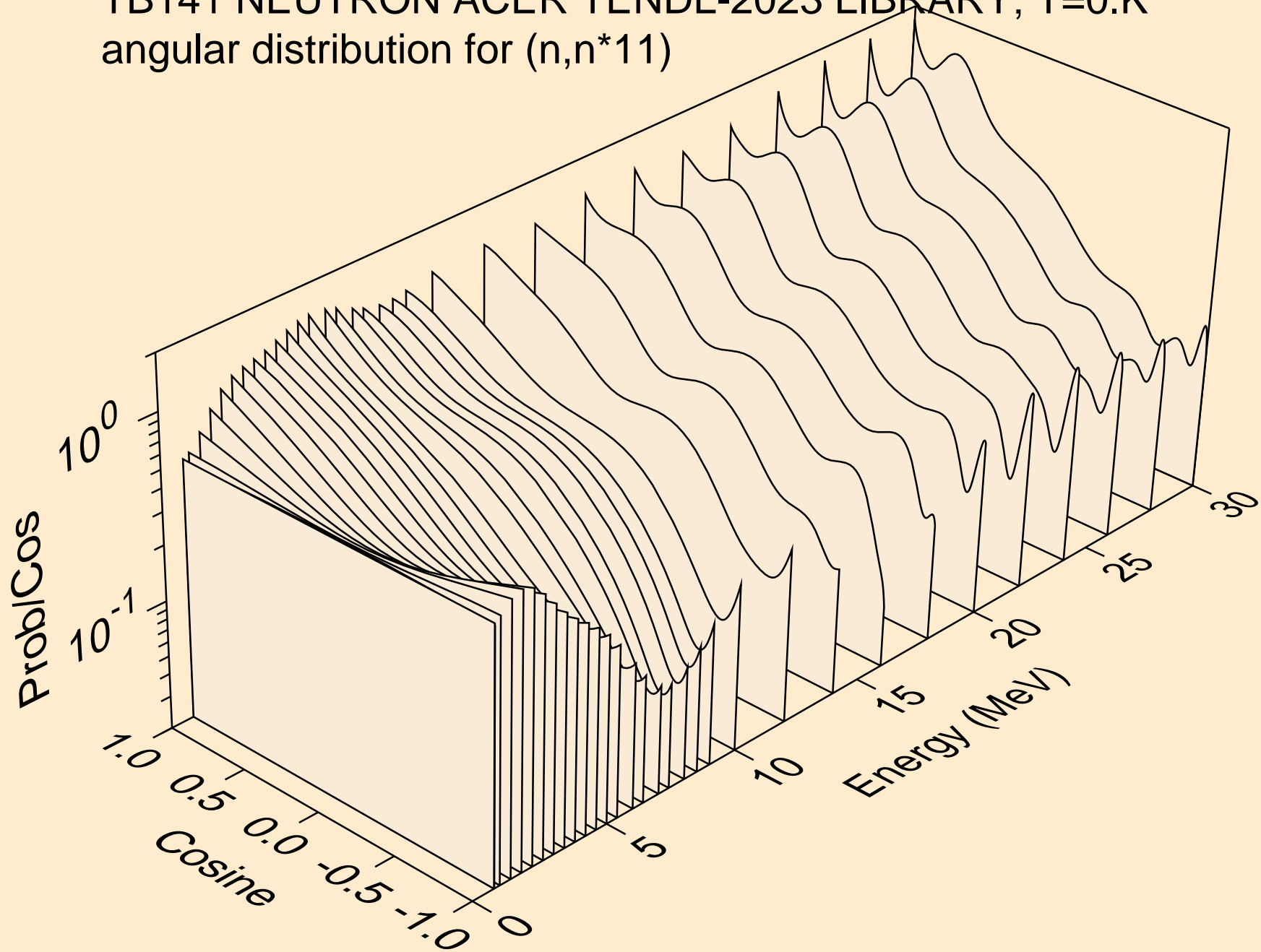

TB141 NEUTRON ACER TENDL-2023 LIBRARY; T=0.K  
angular distribution for (n,n\*12)

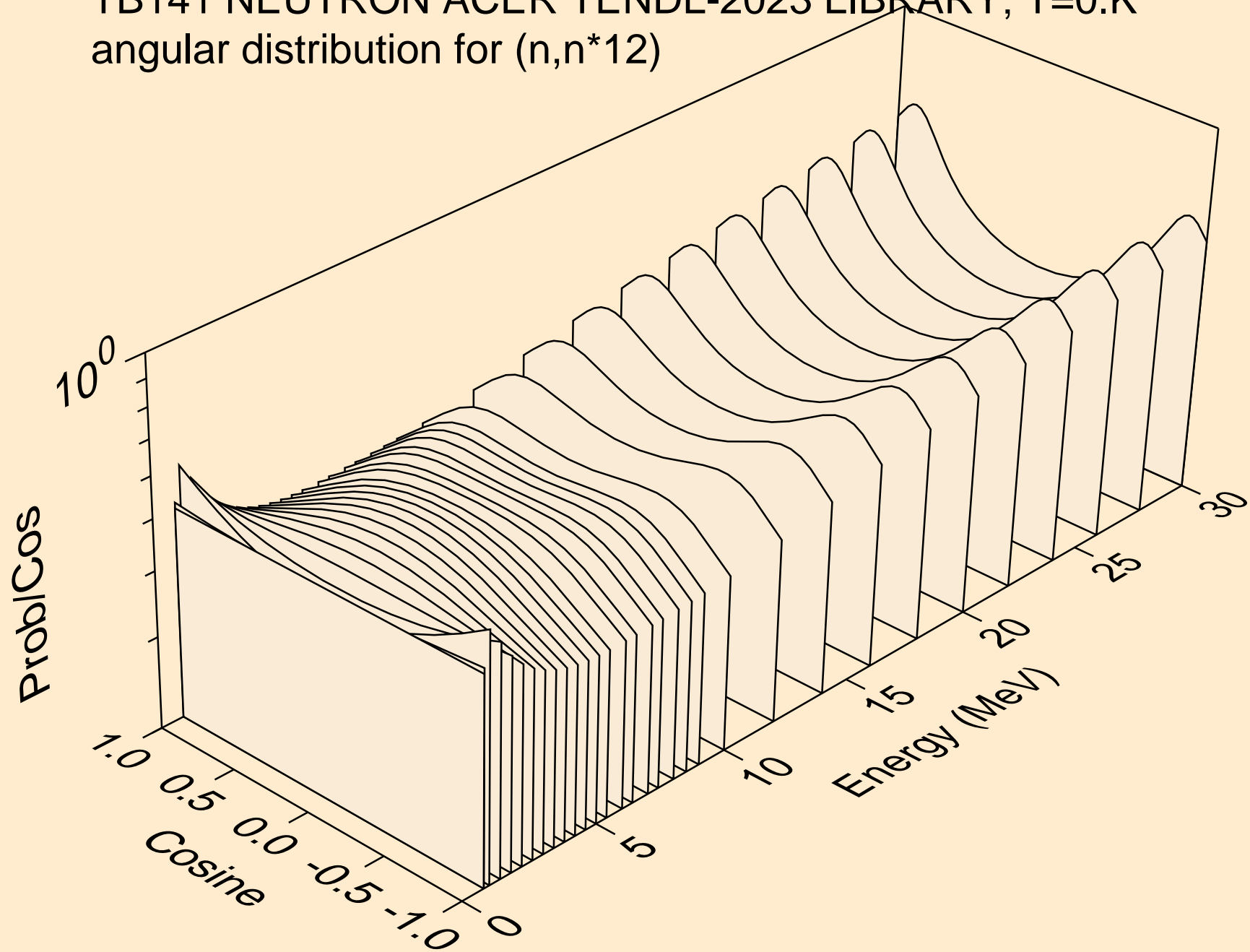

TB141 NEUTRON ACER TENDL-2023 LIBRARY; T=0.K  
angular distribution for (n,n\*13)

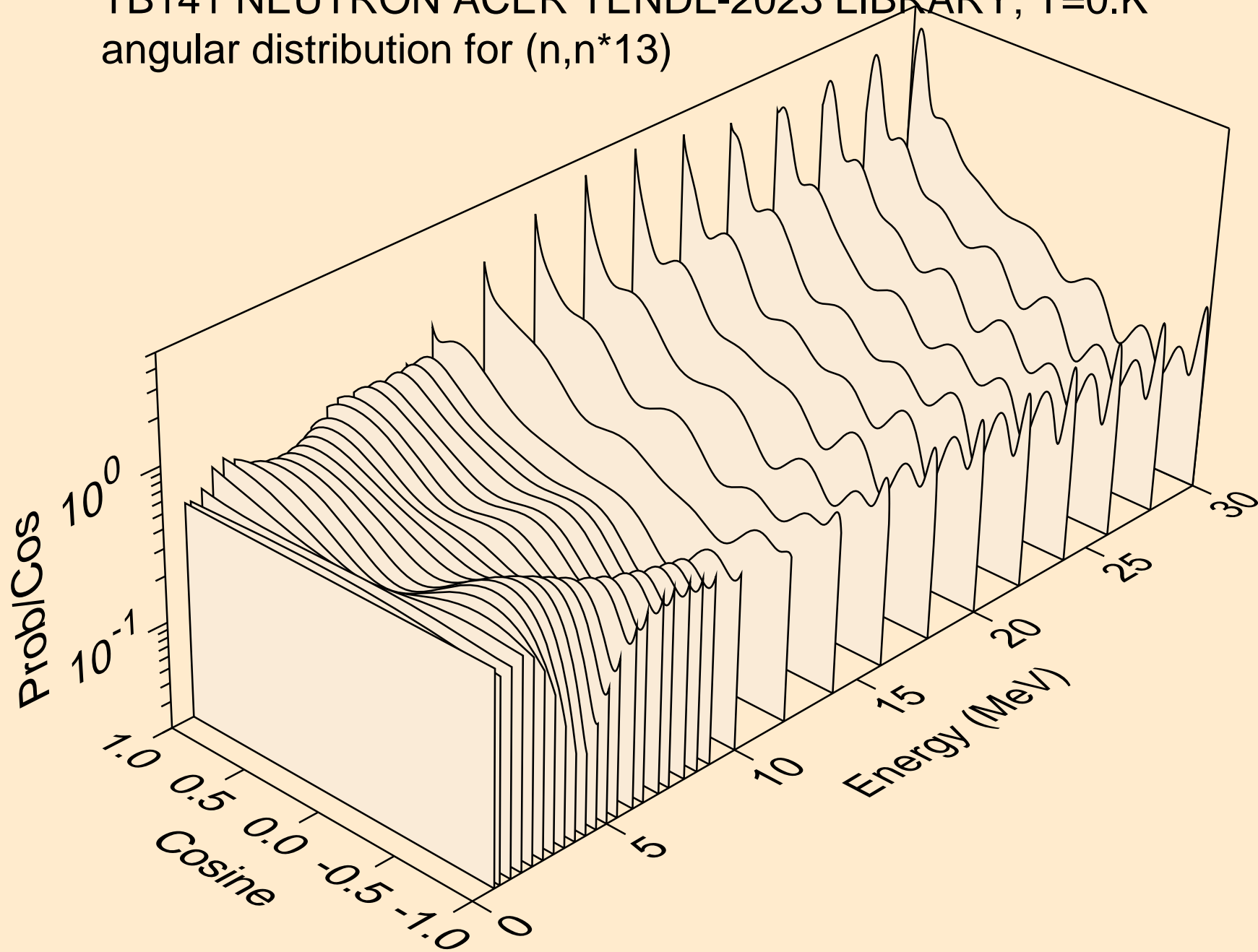

TB141 NEUTRON ACER TENDL-2023 LIBRARY; T=0.K  
angular distribution for (n,n\*14)

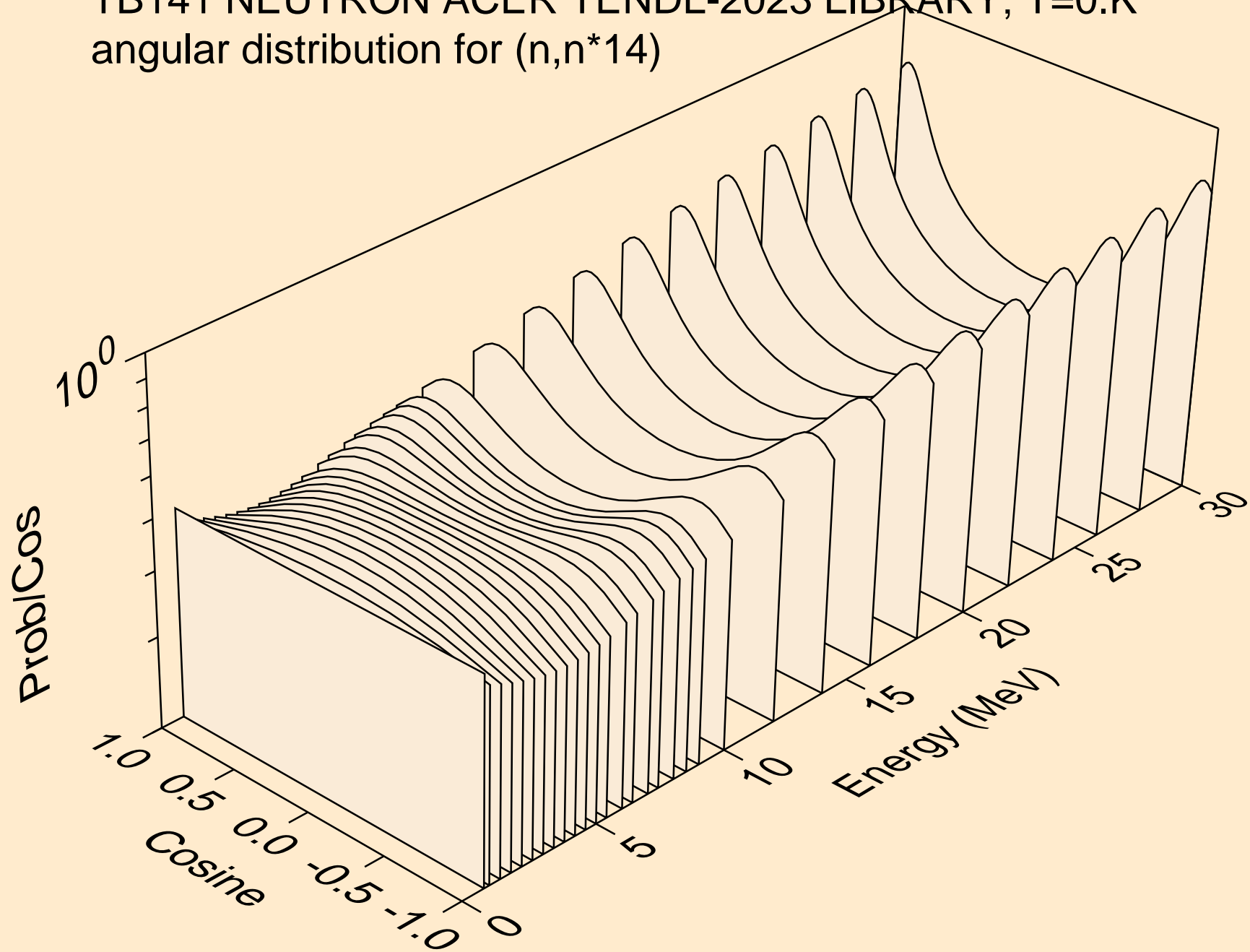

TB141 NEUTRON ACER TENDL-2023 LIBRARY; T=0.K  
angular distribution for (n,n\*15)

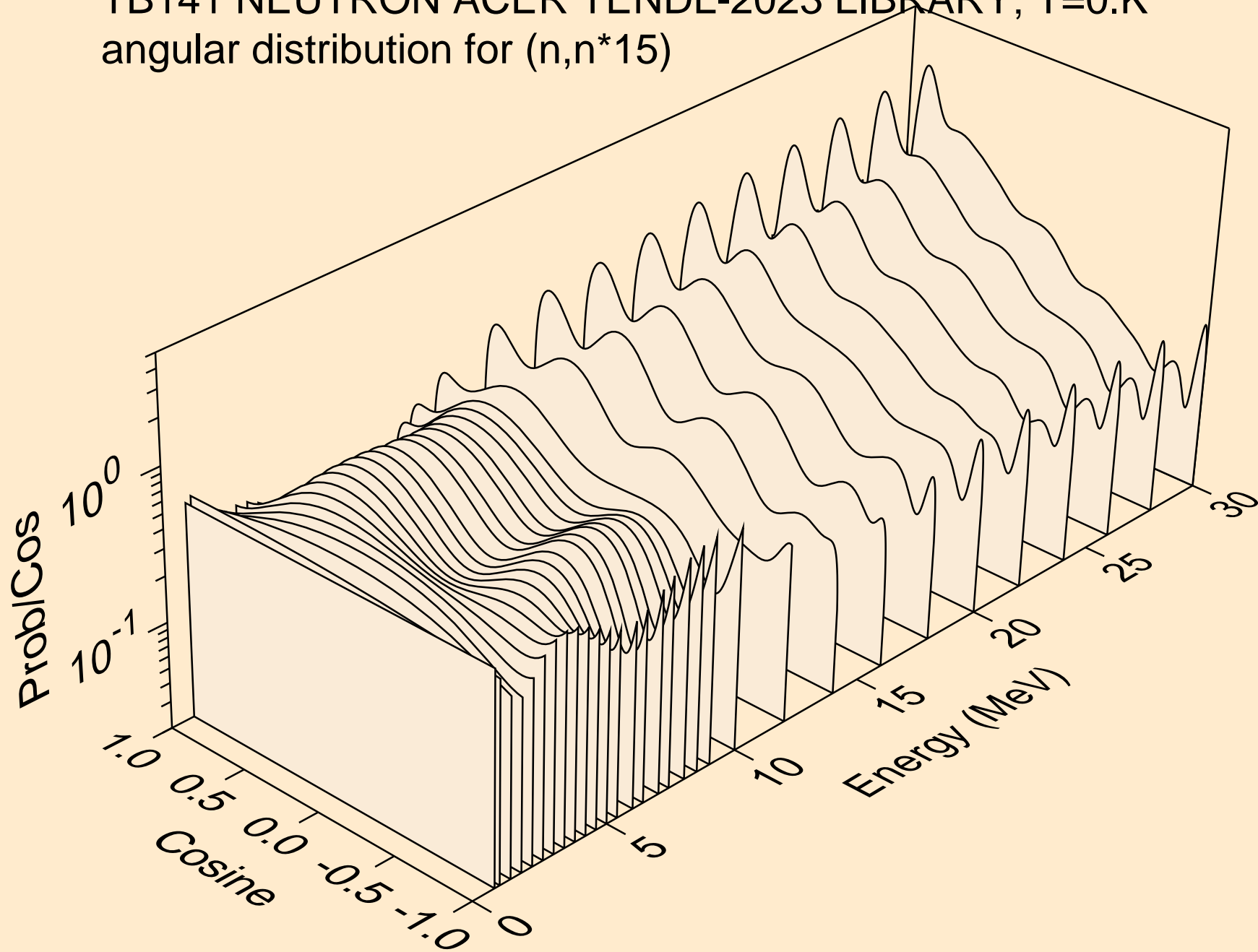

TB141 NEUTRON ACER TENDL-2023 LIBRARY; T=0.K  
angular distribution for (n,n\*16)

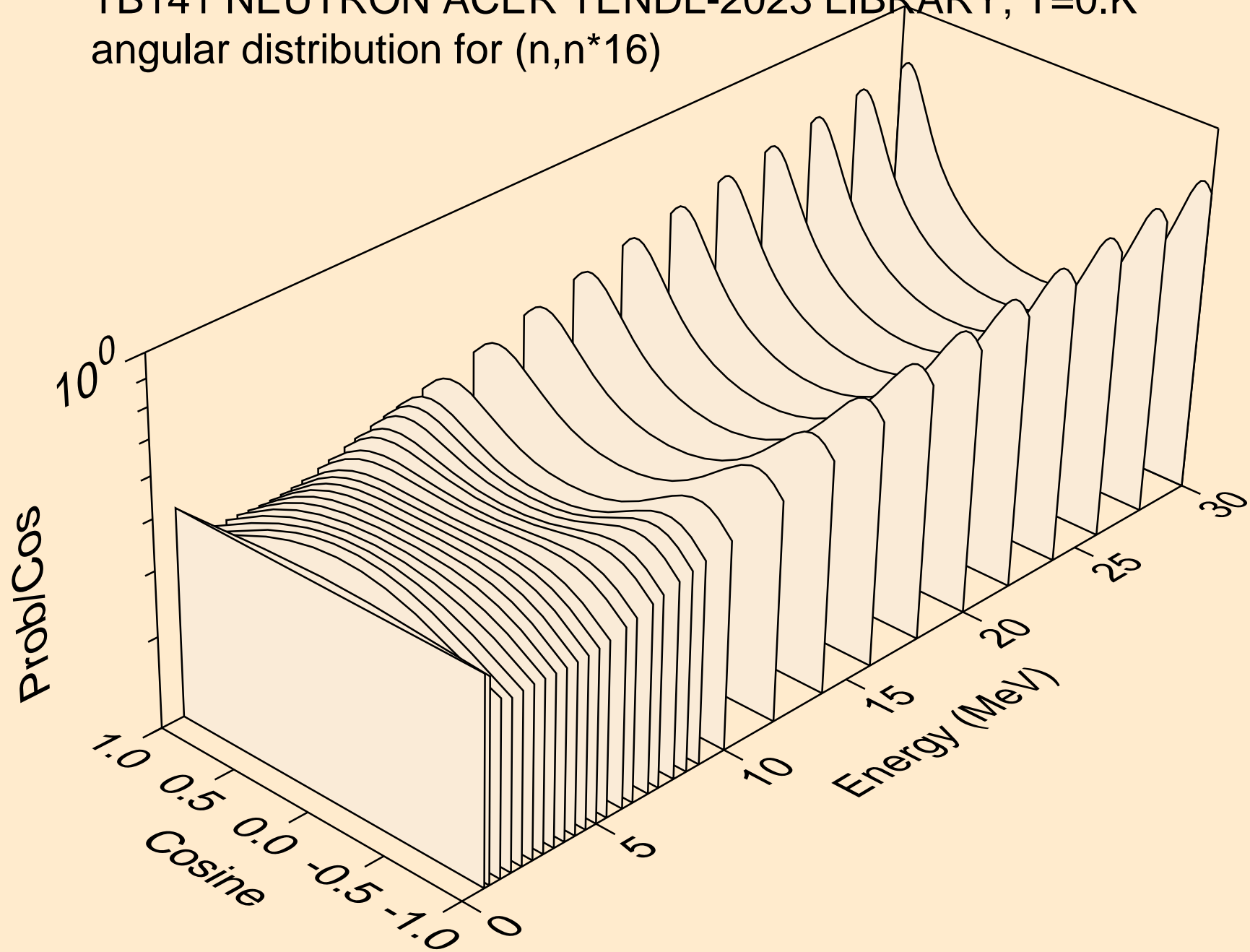



TB141 NEUTRON ACER TENDL-2023 LIBRARY; T=0.K  
angular distribution for (n,n\*17)

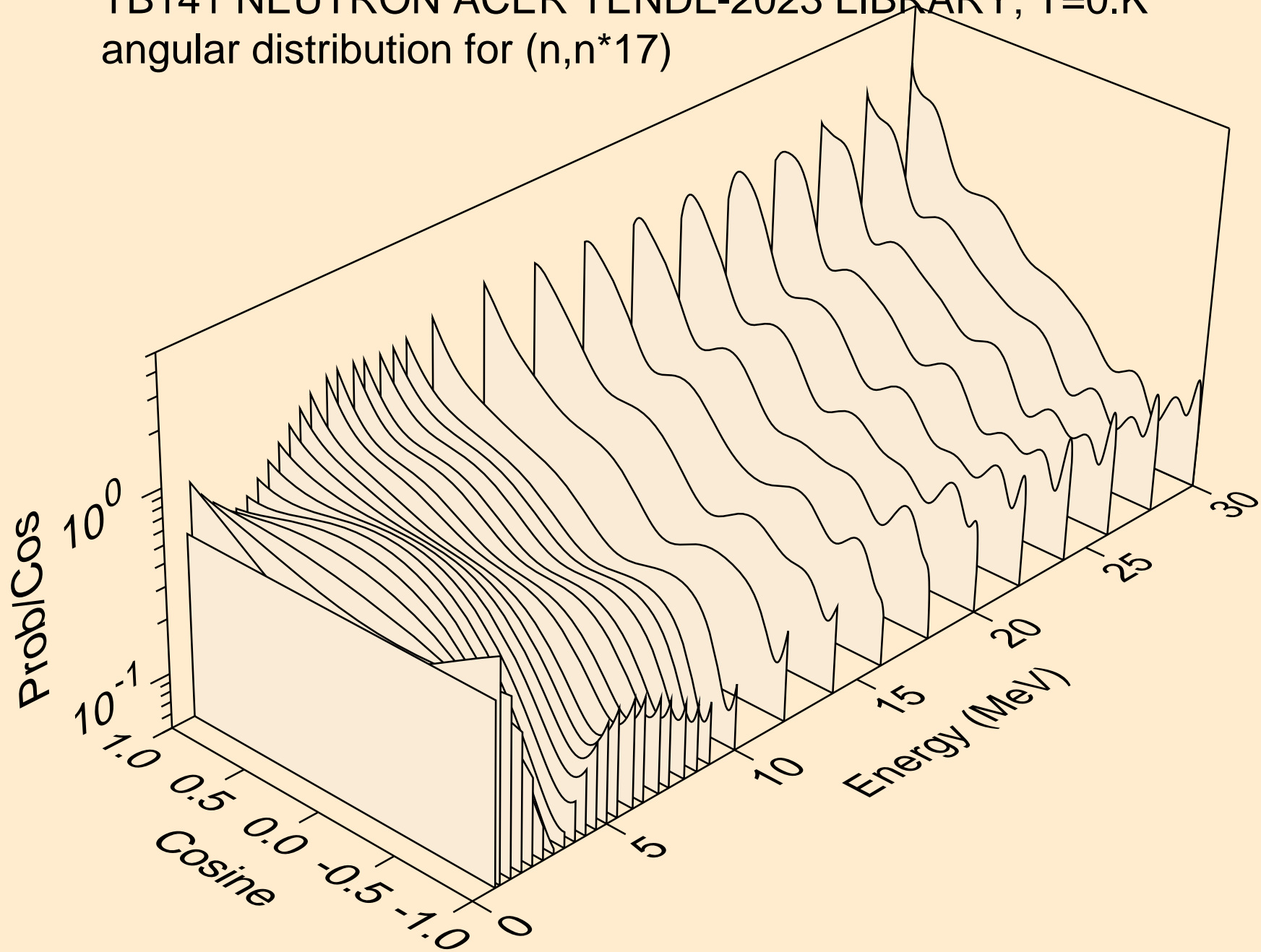

TB141 NEUTRON ACER TENDL-2023 LIBRARY; T=0.K  
angular distribution for (n,n\*18)

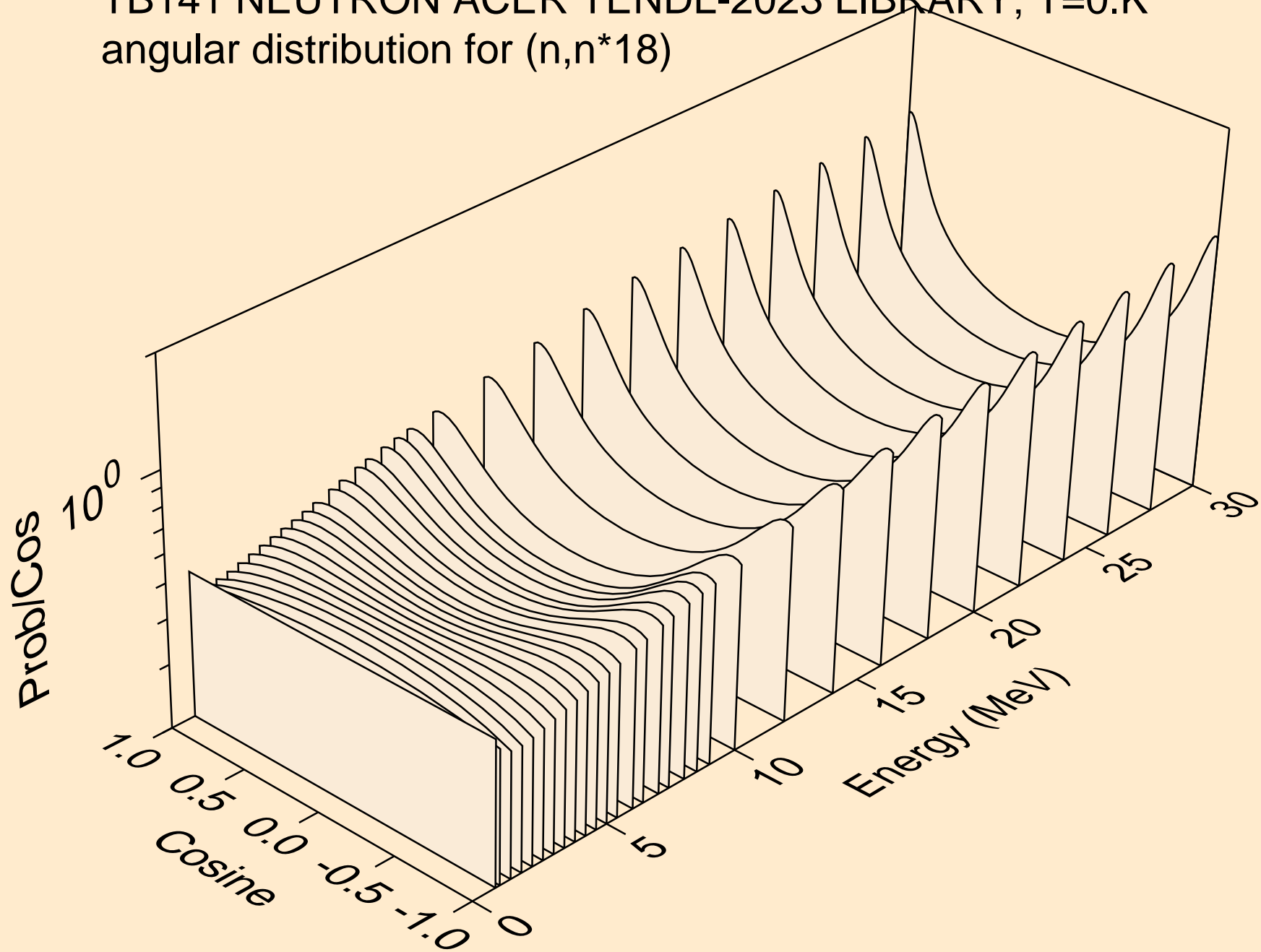

TB141 NEUTRON ACER TENDL-2023 LIBRARY; T=0.K  
angular distribution for (n,n\*19)

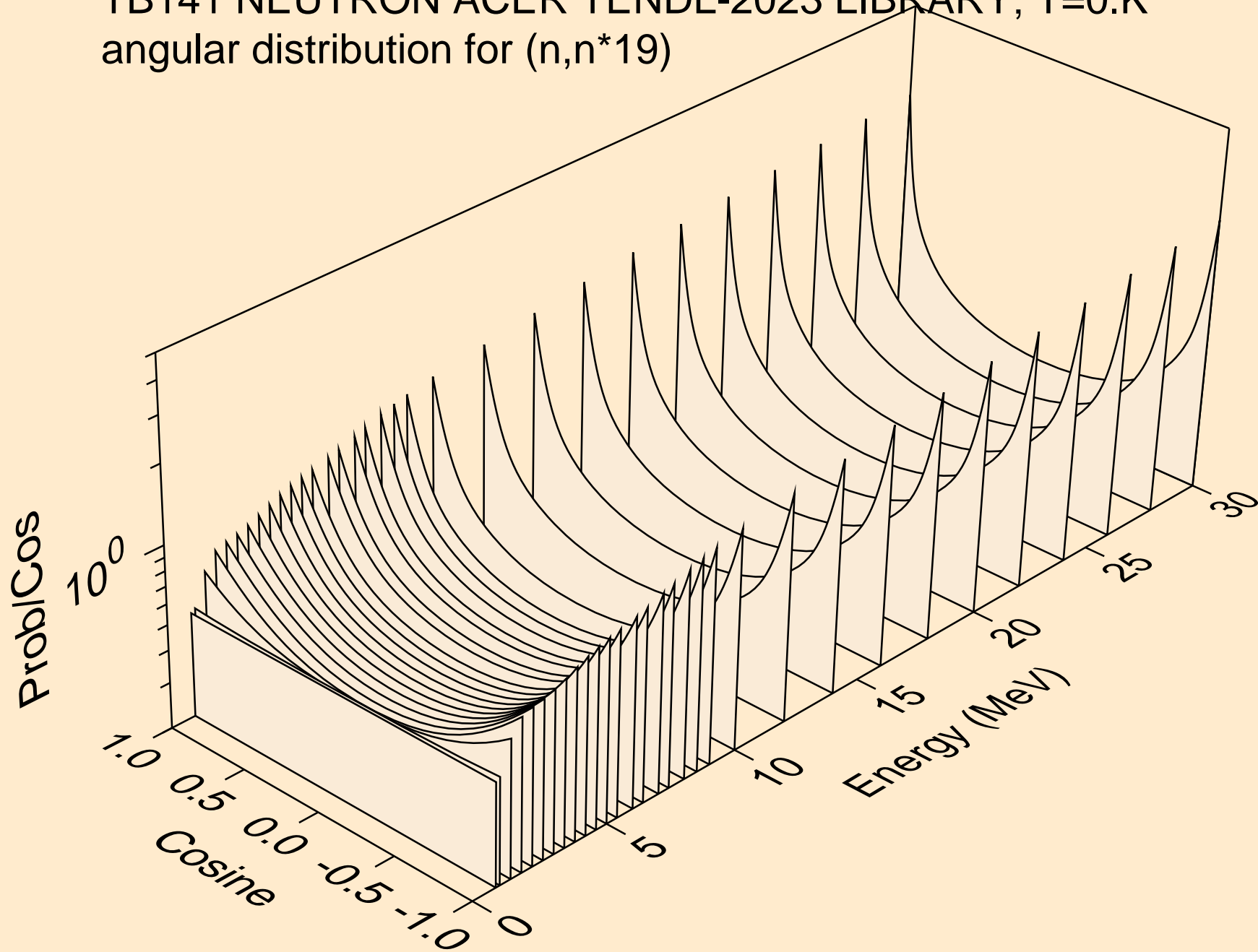

TB141 NEUTRON ACER TENDL-2023 LIBRARY; T=0.K  
angular distribution for (n,n\*20)

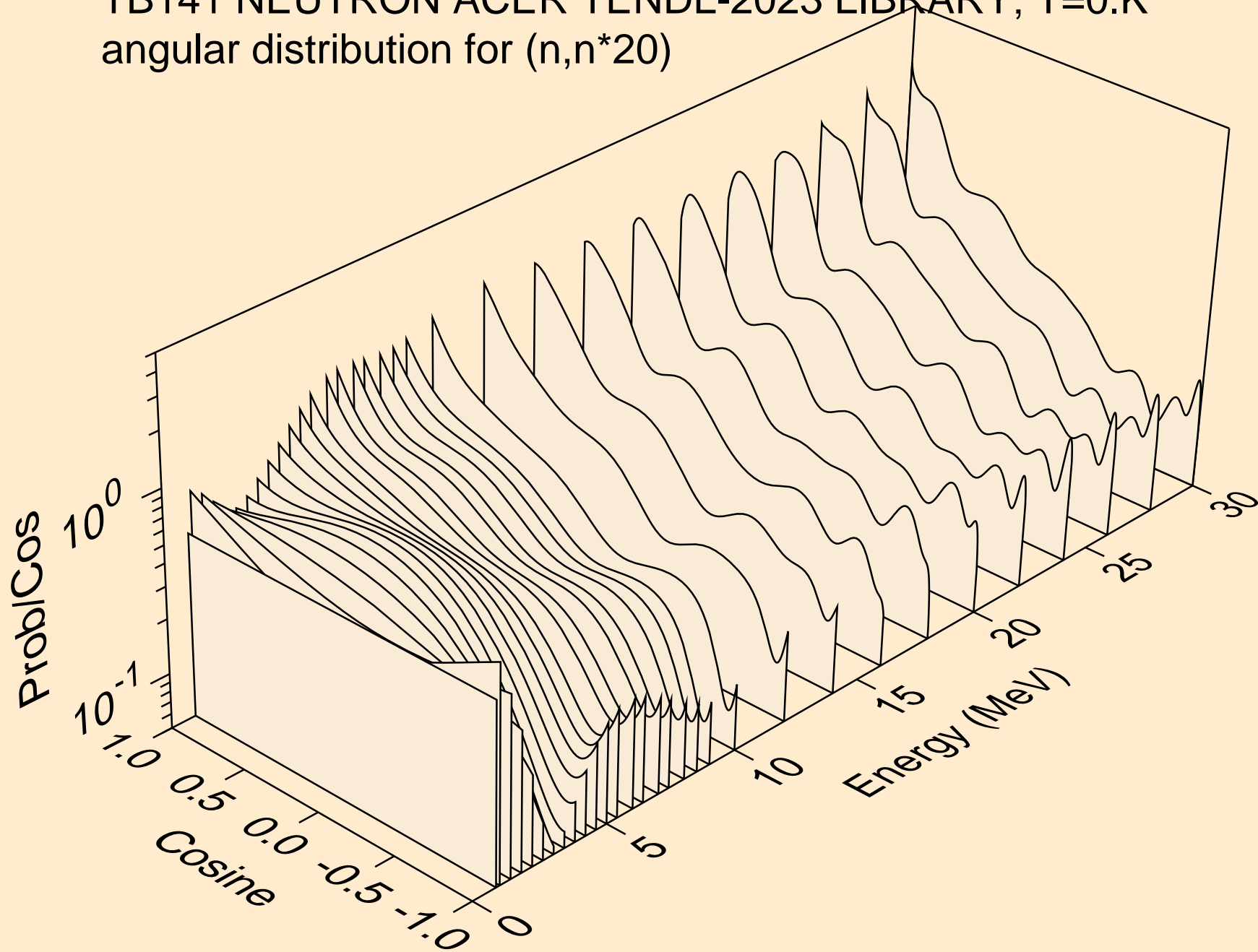

TB141 NEUTRON ACER TENDL-2023 LIBRARY; T=0.K  
Neutron emission for (n,x)

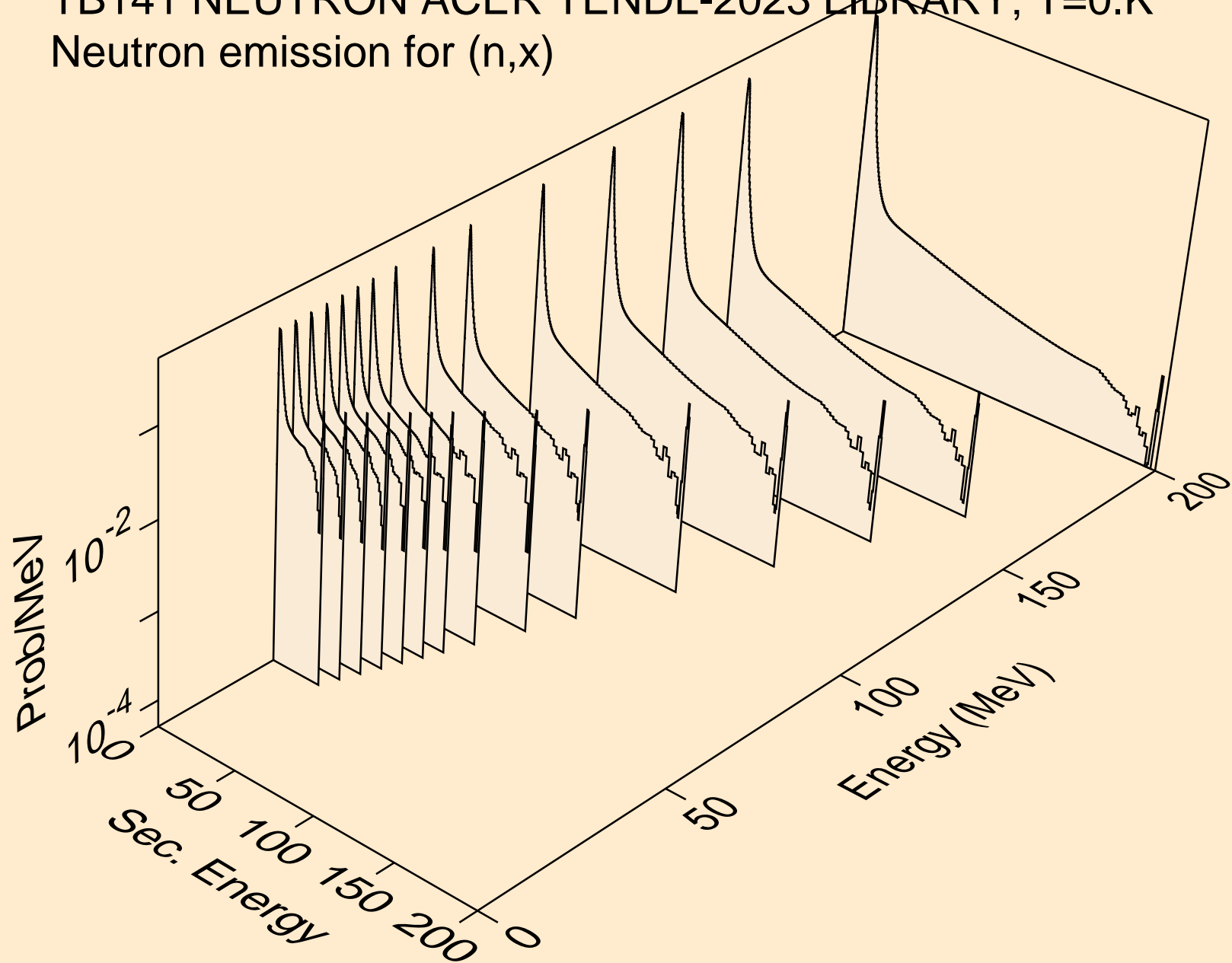

TB141 NEUTRON ACER TENDL-2023 LIBRARY; T=0.K  
Neutron emission for (n,2nd)

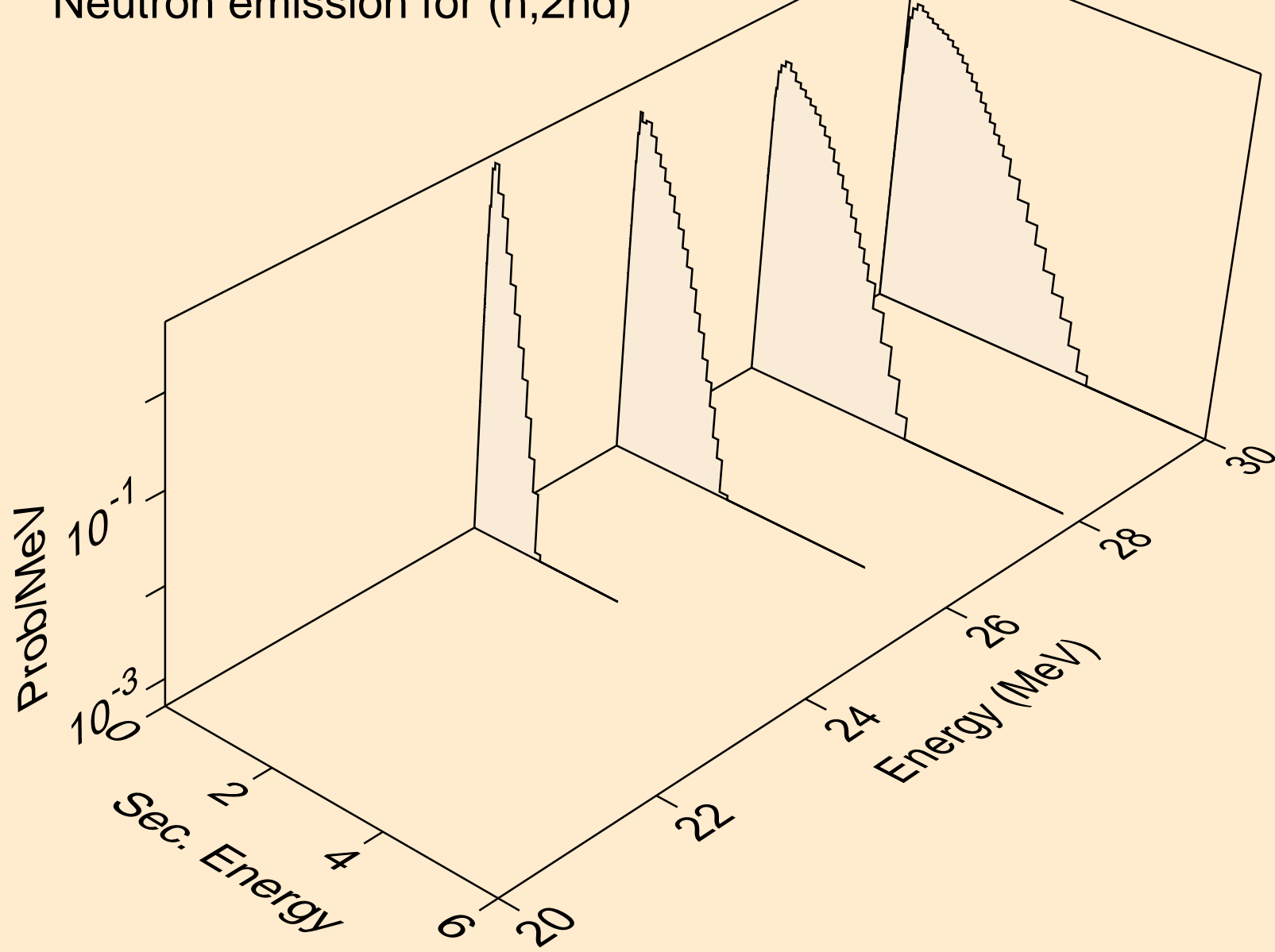

TB141 NEUTRON ACER TENDL-2023 LIBRARY; T=0.K  
Neutron emission for (n,2n)

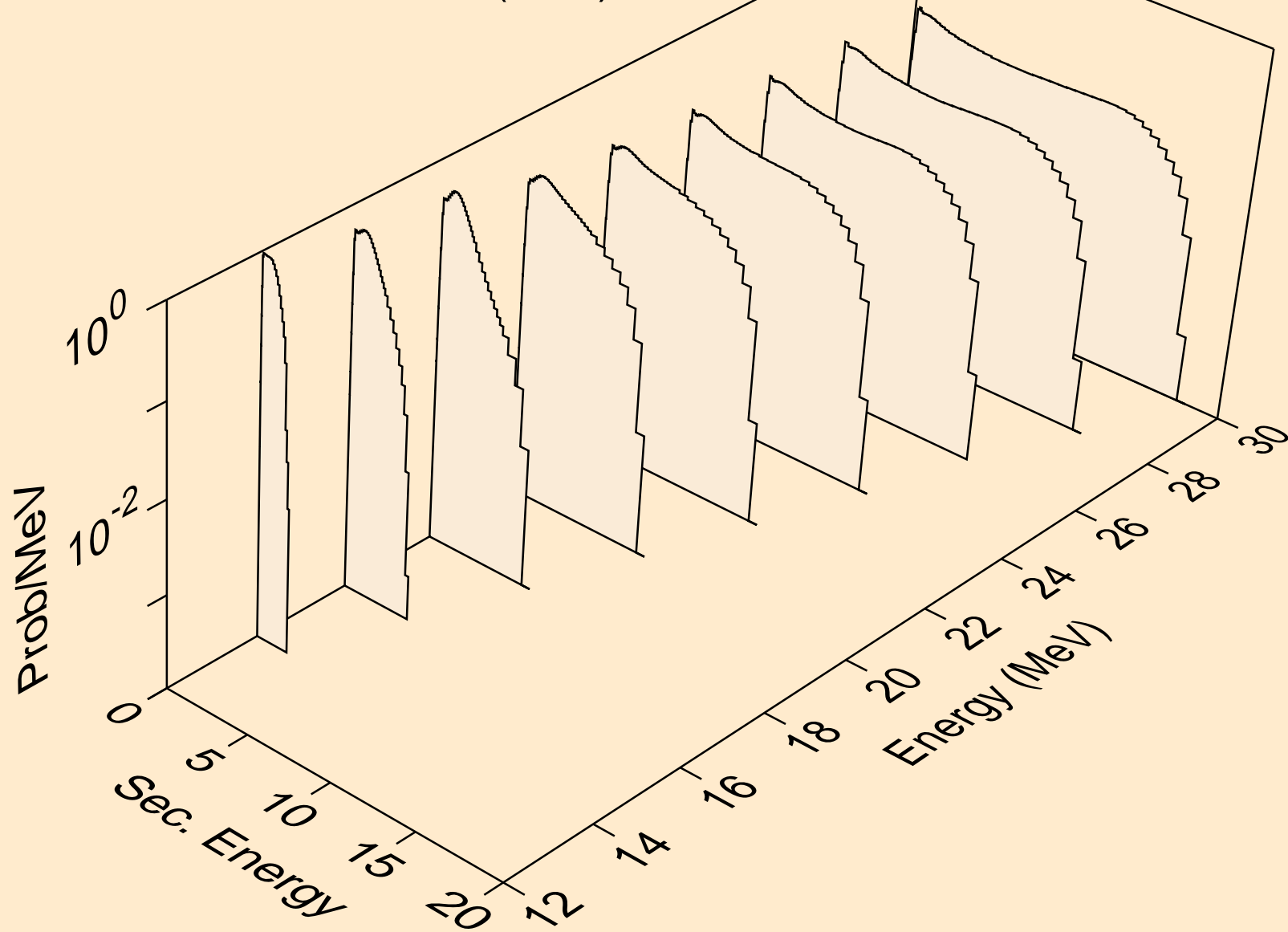

TB141 NEUTRON ACER TENDL-2023 LIBRARY; T=0.K  
Neutron emission for (n,3n)

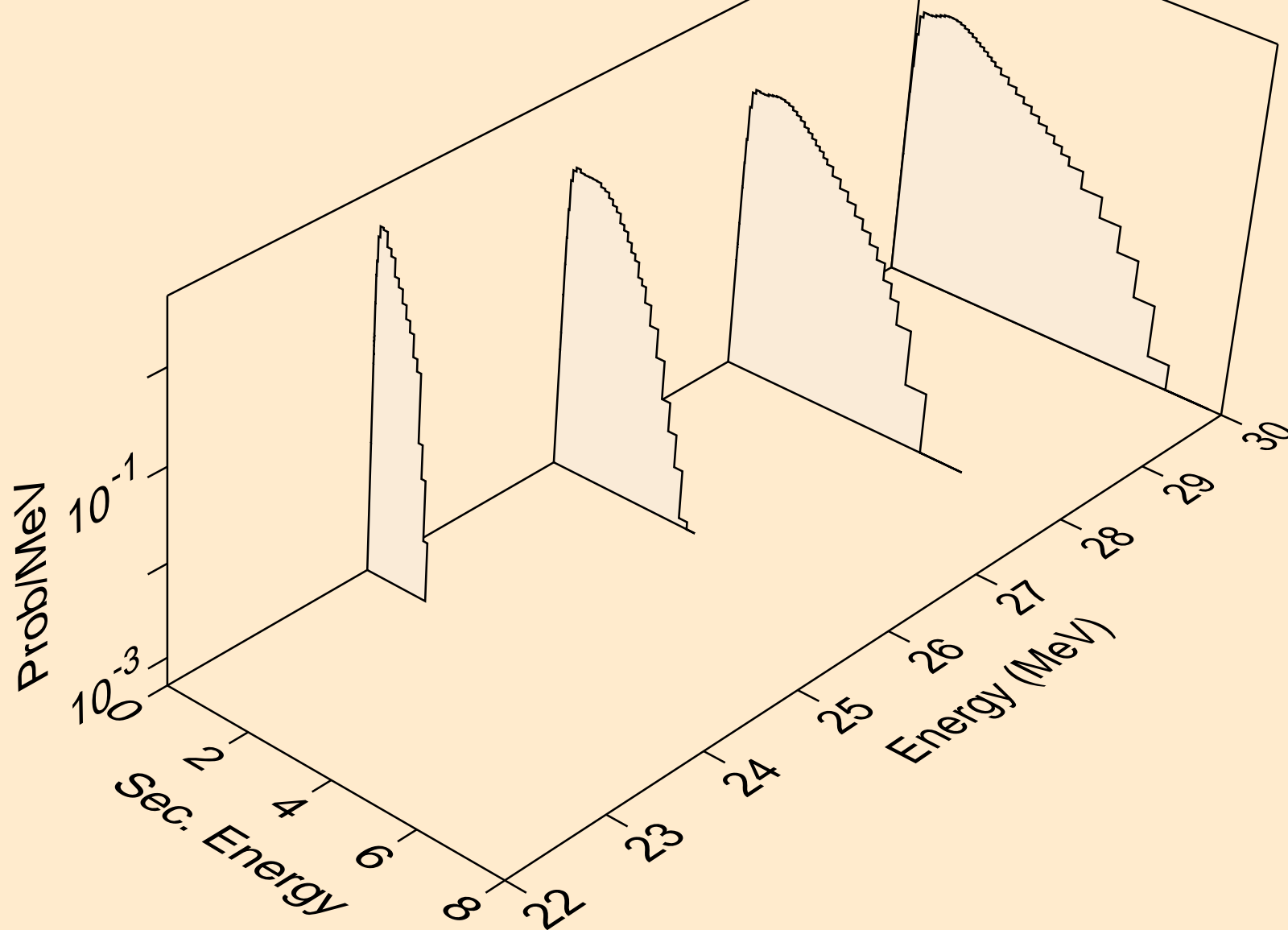



TB141 NEUTRON ACER TENDL-2023 LIBRARY; T=0.K  
Neutron emission for (n,n\*)a

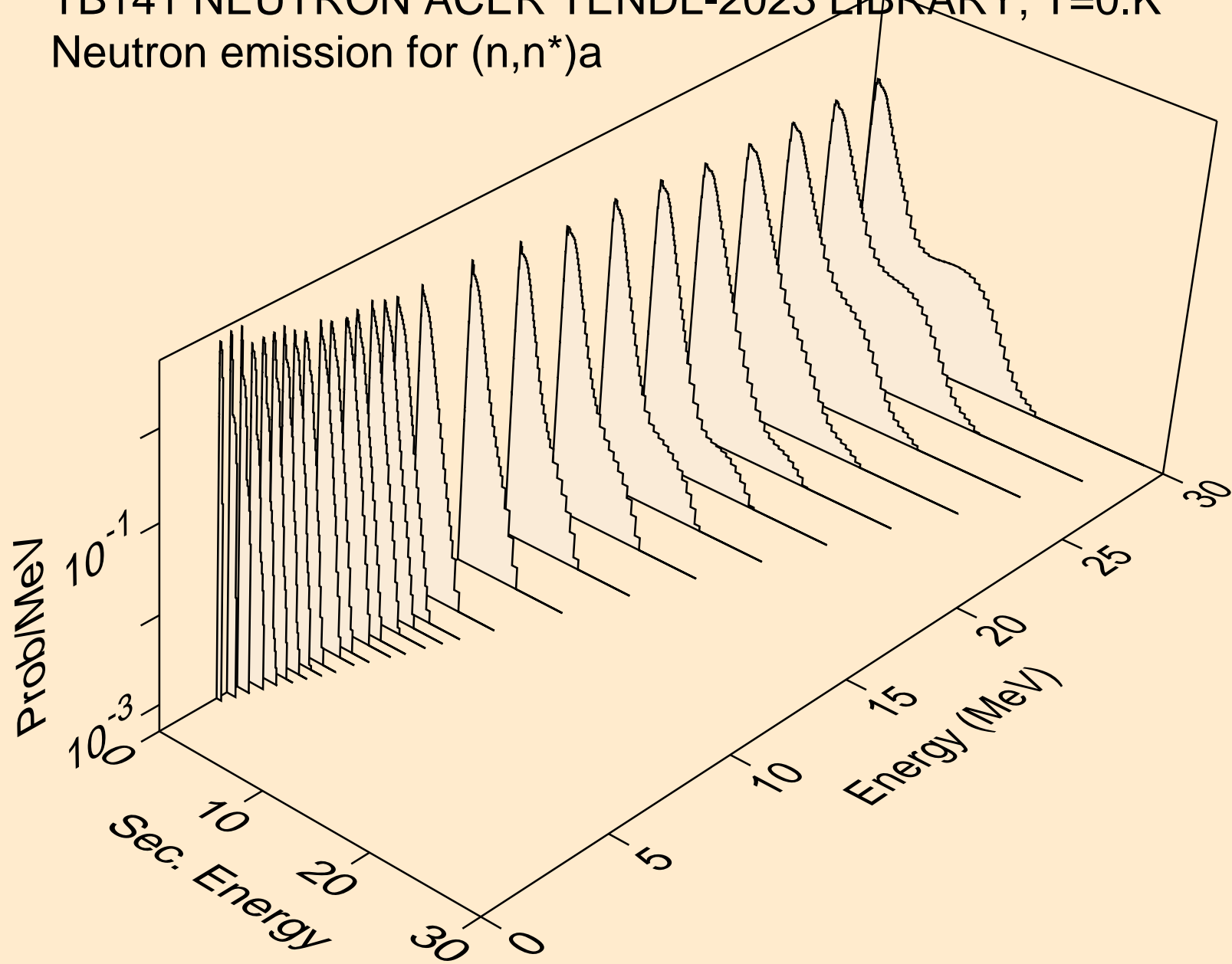

TB141 NEUTRON ACER TENDL-2023 LIBRARY; T=0.K  
Neutron emission for (n,2n)a

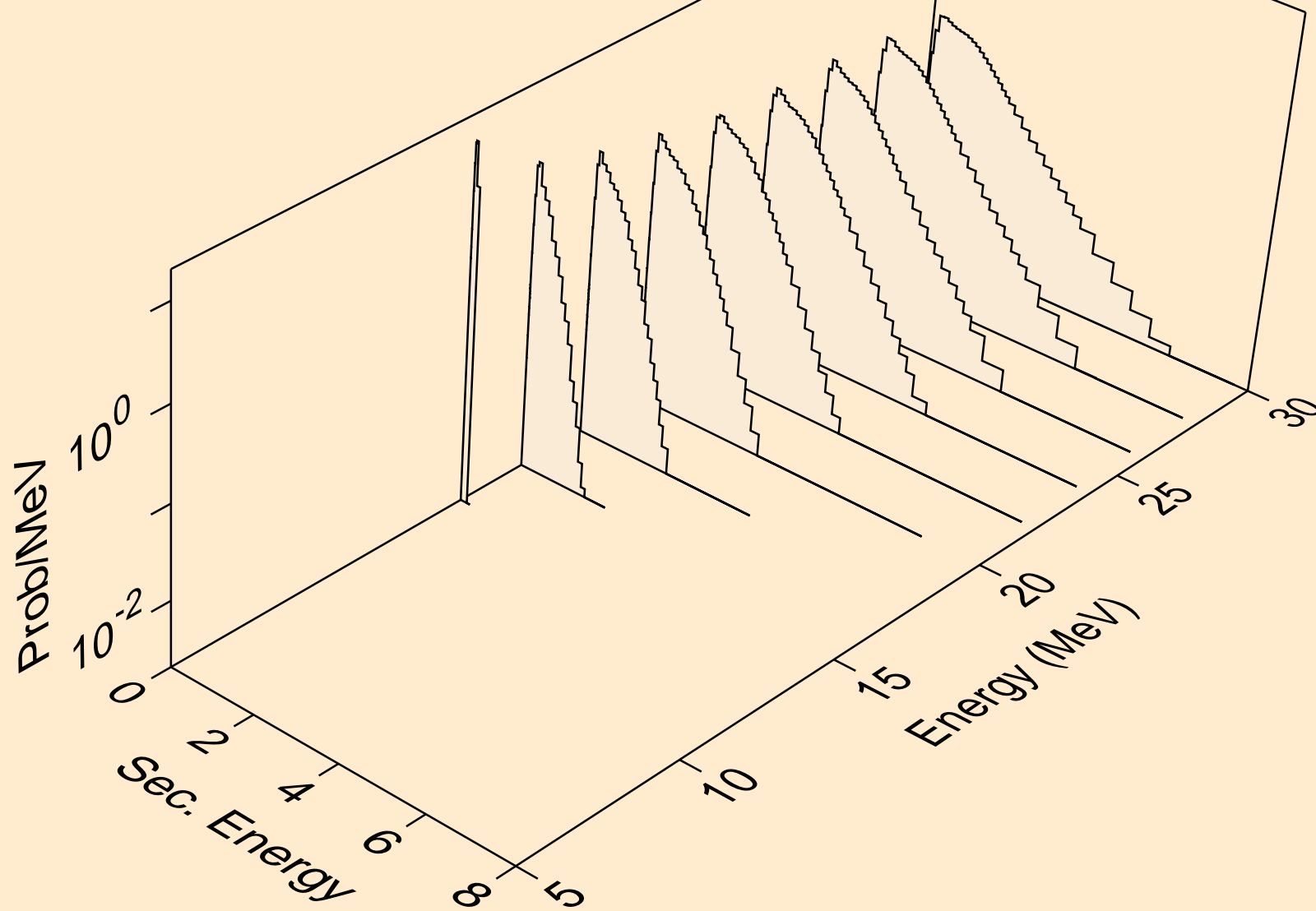

TB141 NEUTRON ACER TENDL-2023 LIBRARY; T=0.K  
Neutron emission for (n,n\*)p

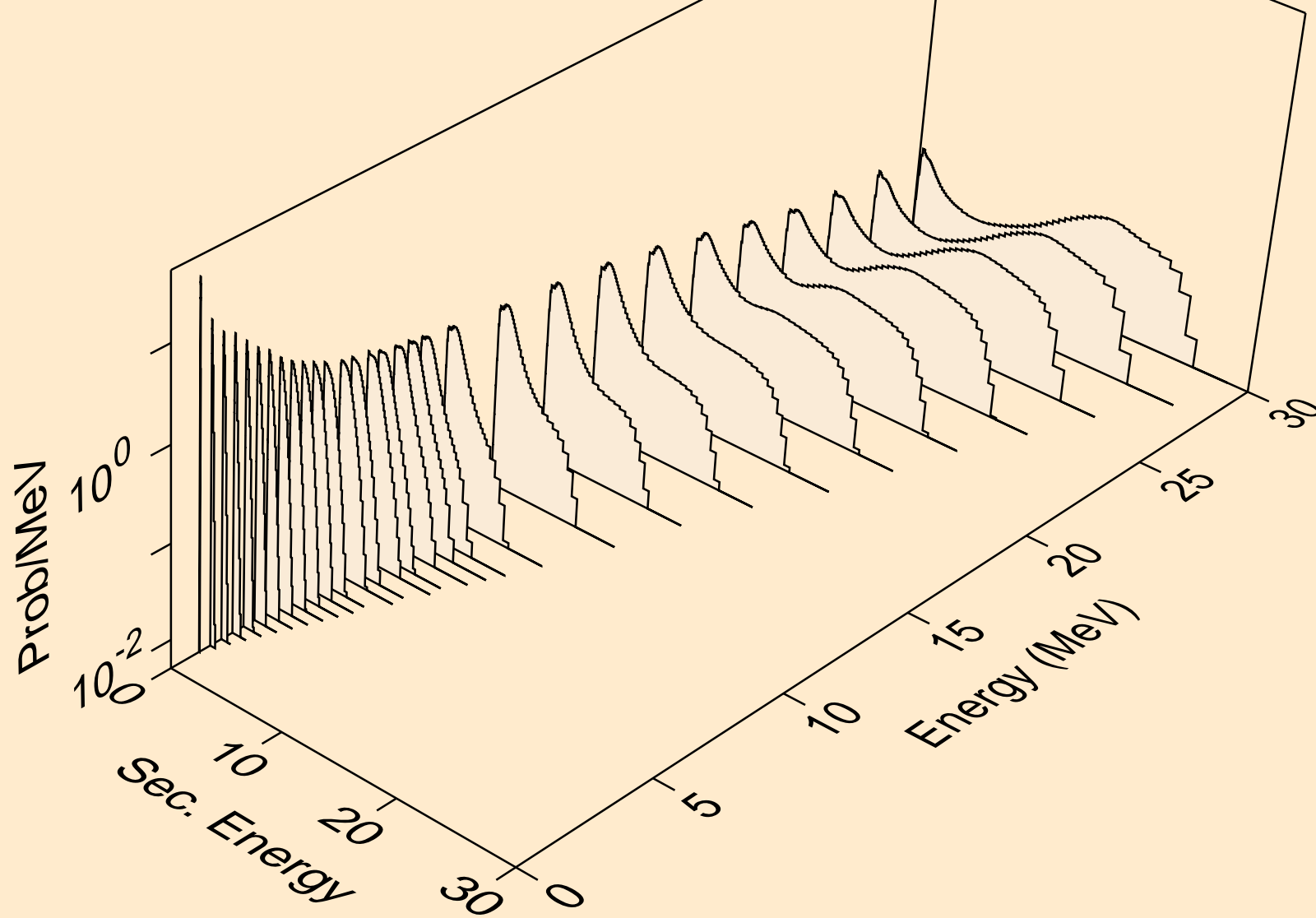

TB141 NEUTRON ACER TENDL-2023 LIBRARY; T=0.K  
Neutron emission for (n,n\*)2a

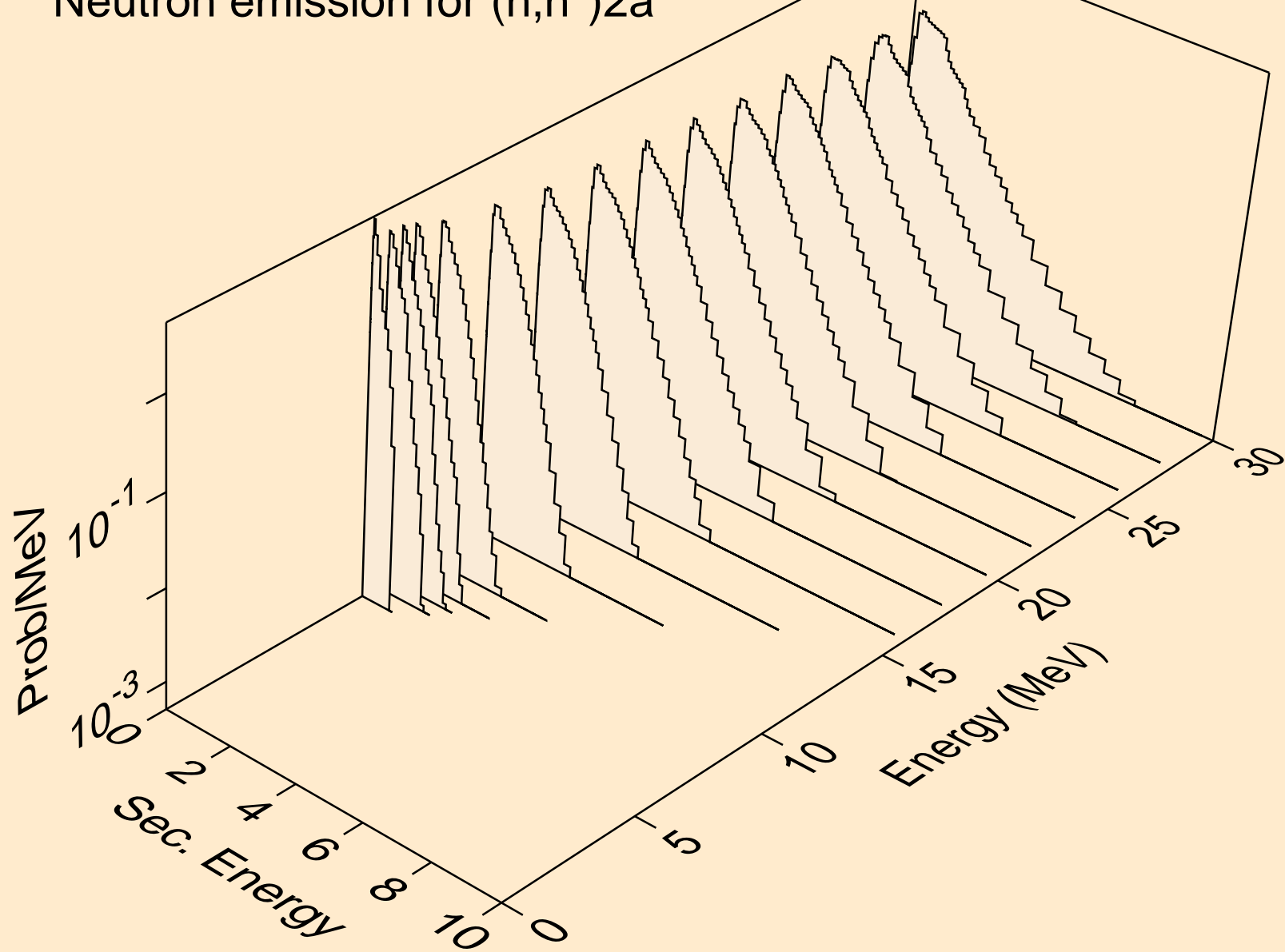

TB141 NEUTRON ACER TENDL-2023 LIBRARY; T=0.K  
Neutron emission for (n,n\*)d

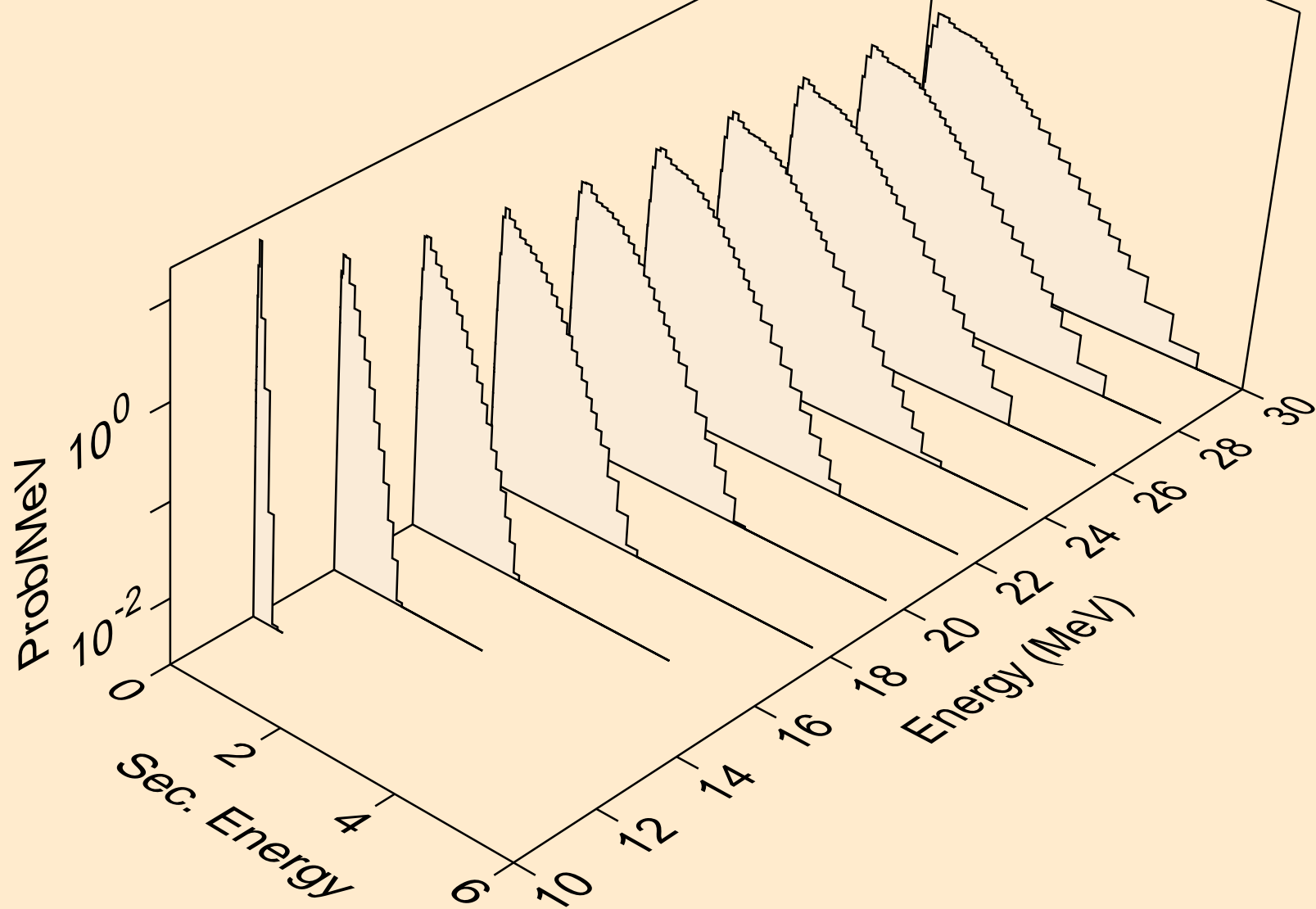

TB141 NEUTRON ACER TENDL-2023 LIBRARY; T=0.K  
Neutron emission for (n,n\*)t

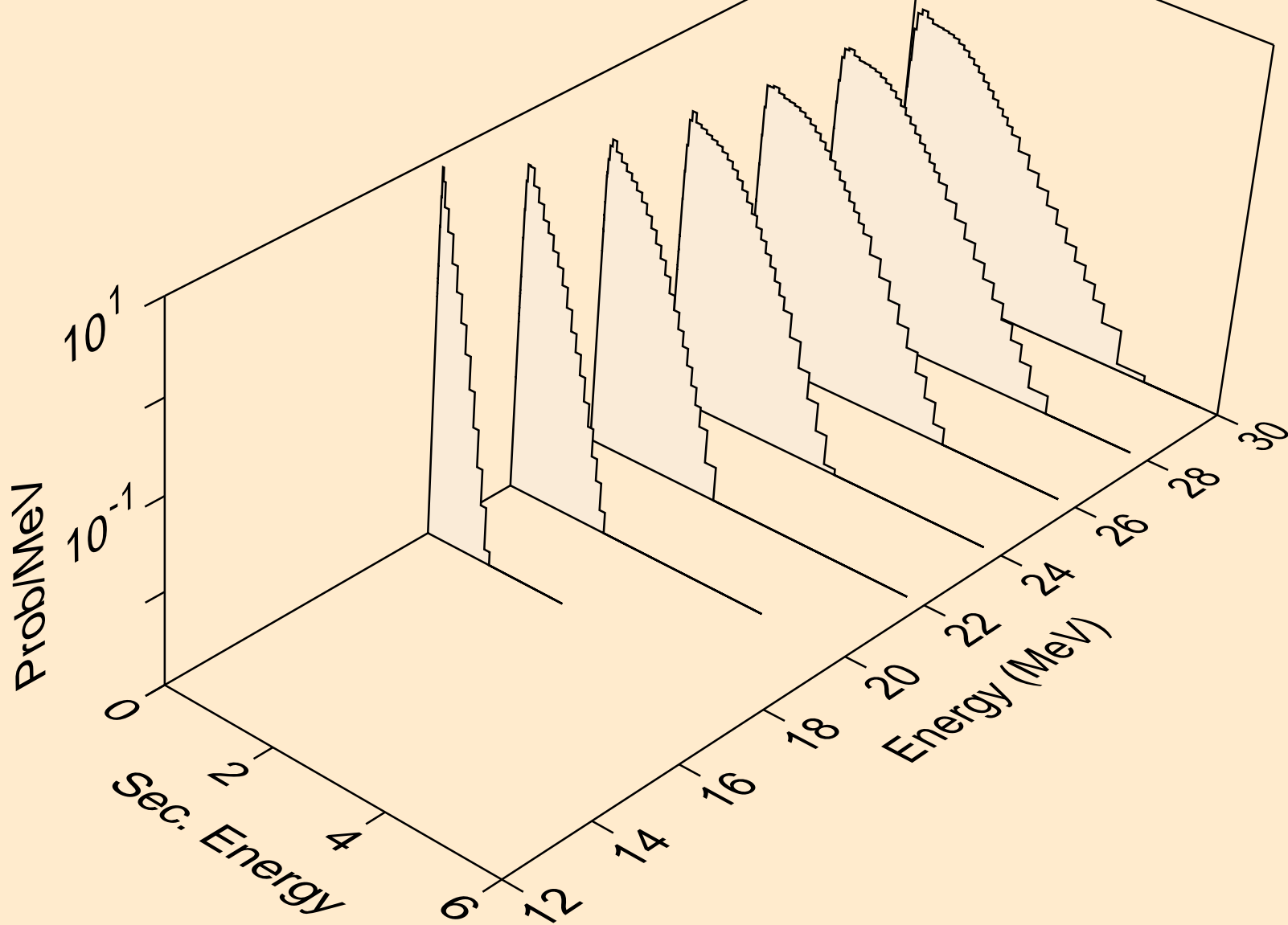

TB141 NEUTRON ACER TENDL-2023 LIBRARY; T=0.K  
Neutron emission for (n,n\*)he3

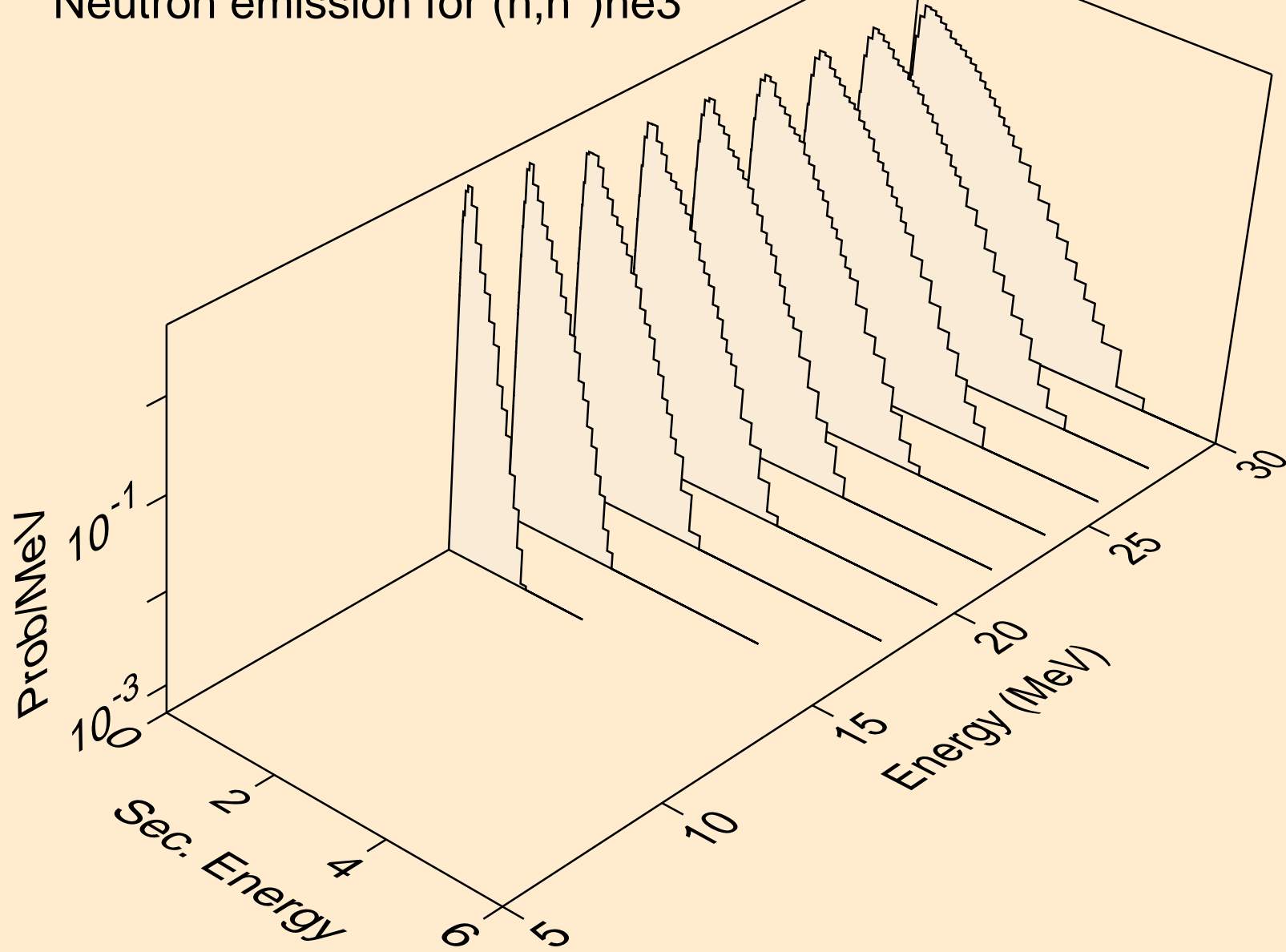

TB141 NEUTRON ACER TENDL-2023 LIBRARY; T=0.K  
Neutron emission for (n,2np)

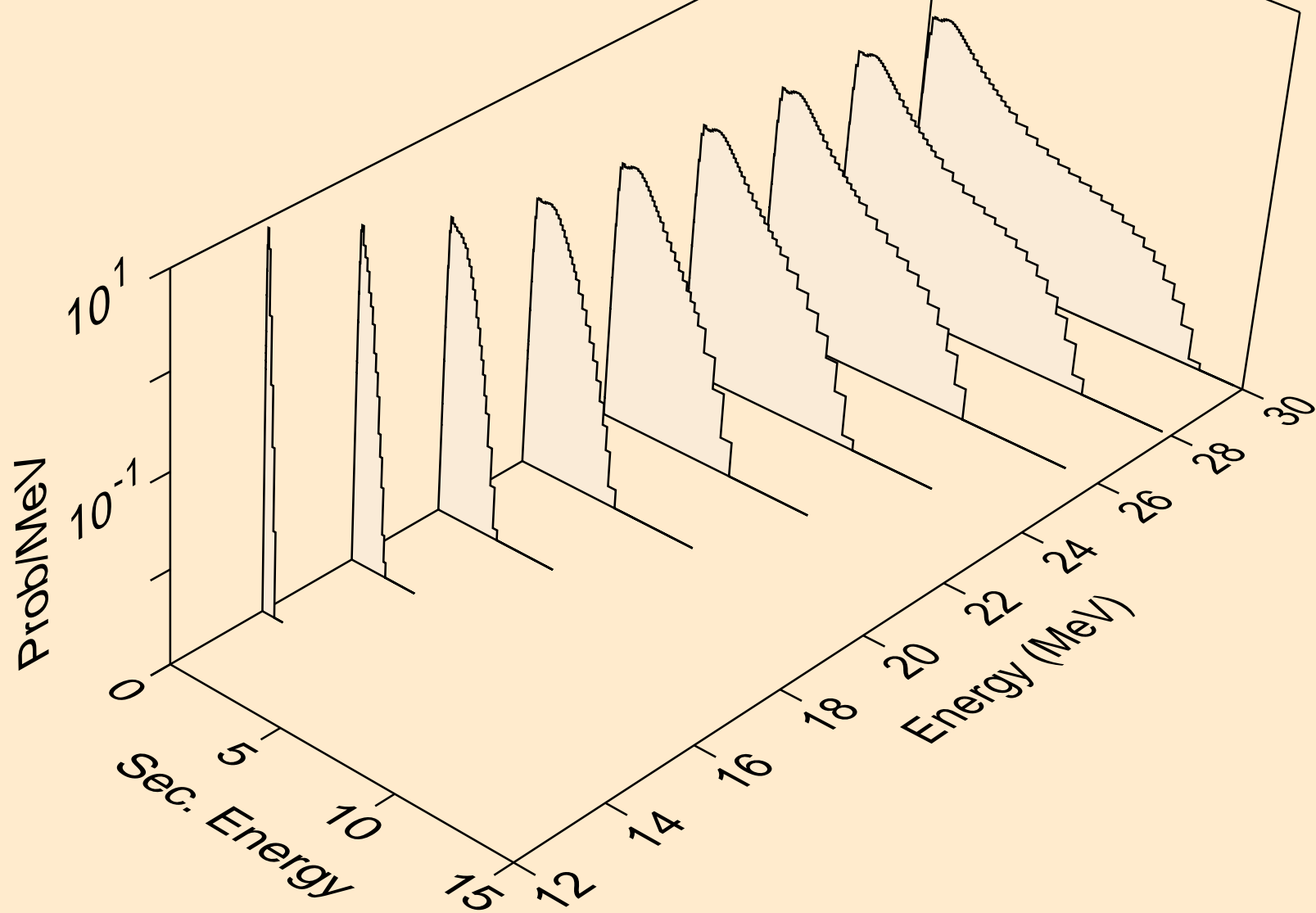



TB141 NEUTRON ACER TENDL-2023 LIBRARY; T=0.K  
Neutron emission for (n,3np)

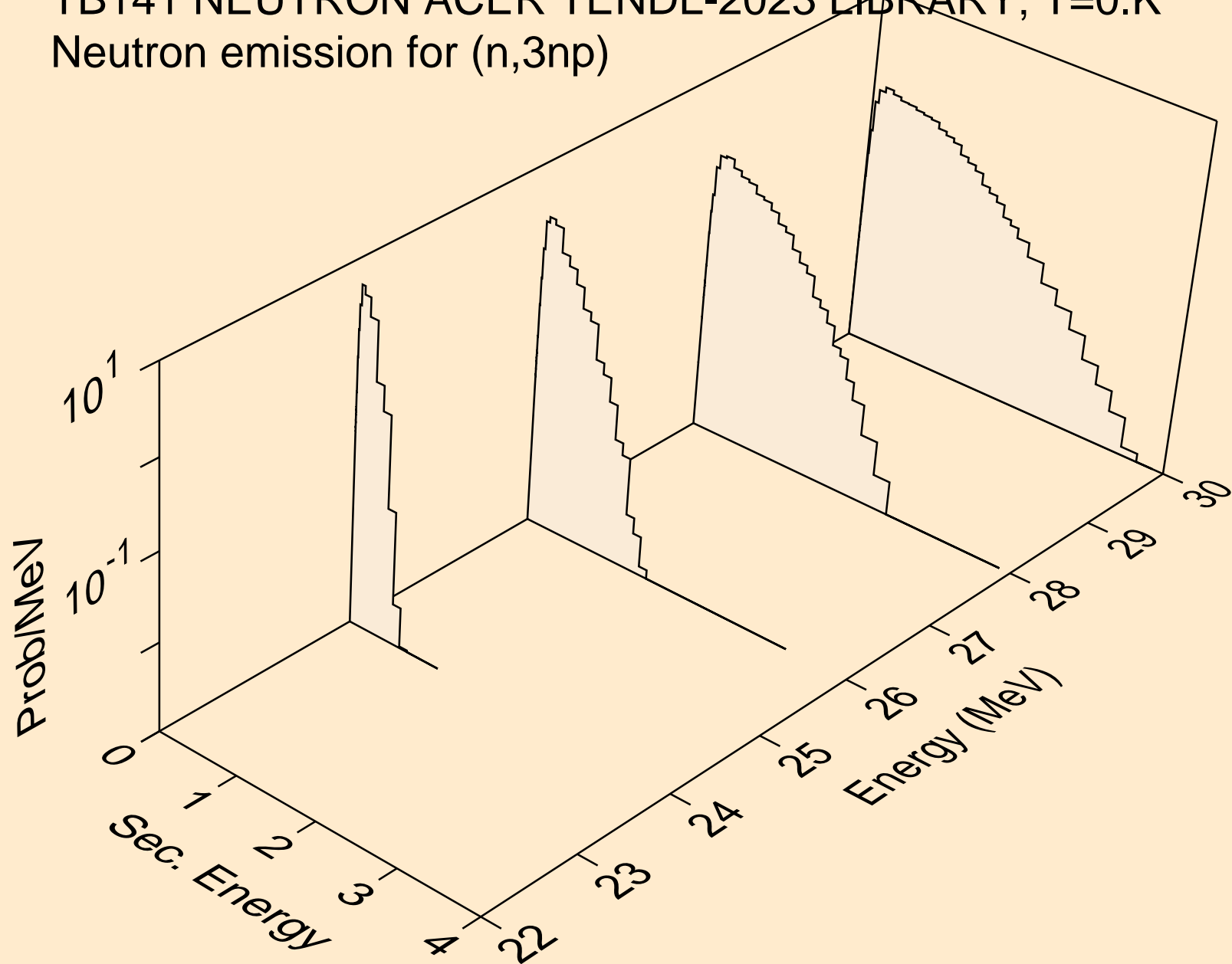

TB141 NEUTRON ACER TENDL-2023 LIBRARY; T=0.K  
Neutron emission for (n,n2p)

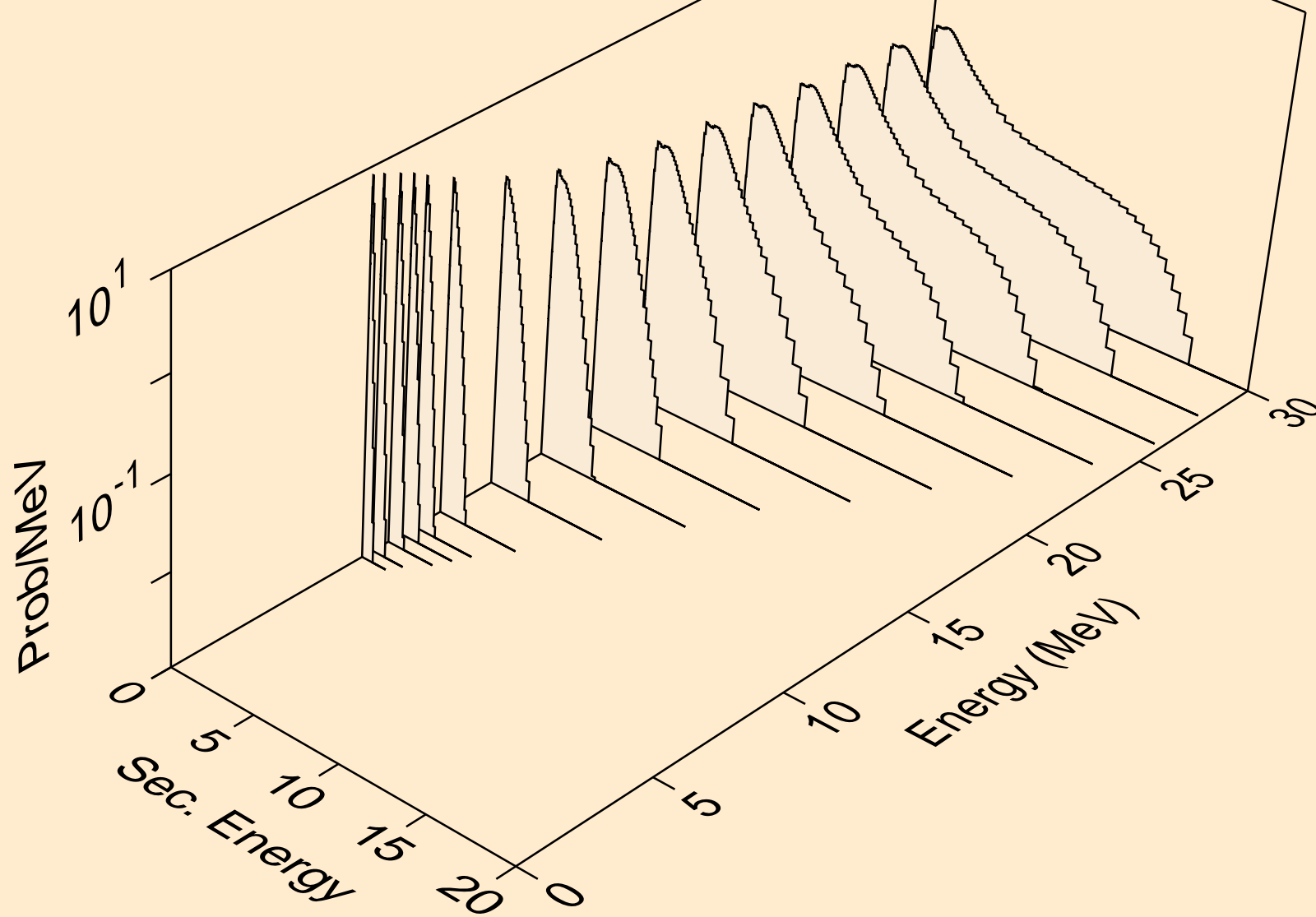

TB141 NEUTRON ACER TENDL-2023 LIBRARY; T=0.K  
Neutron emission for (n,npa)

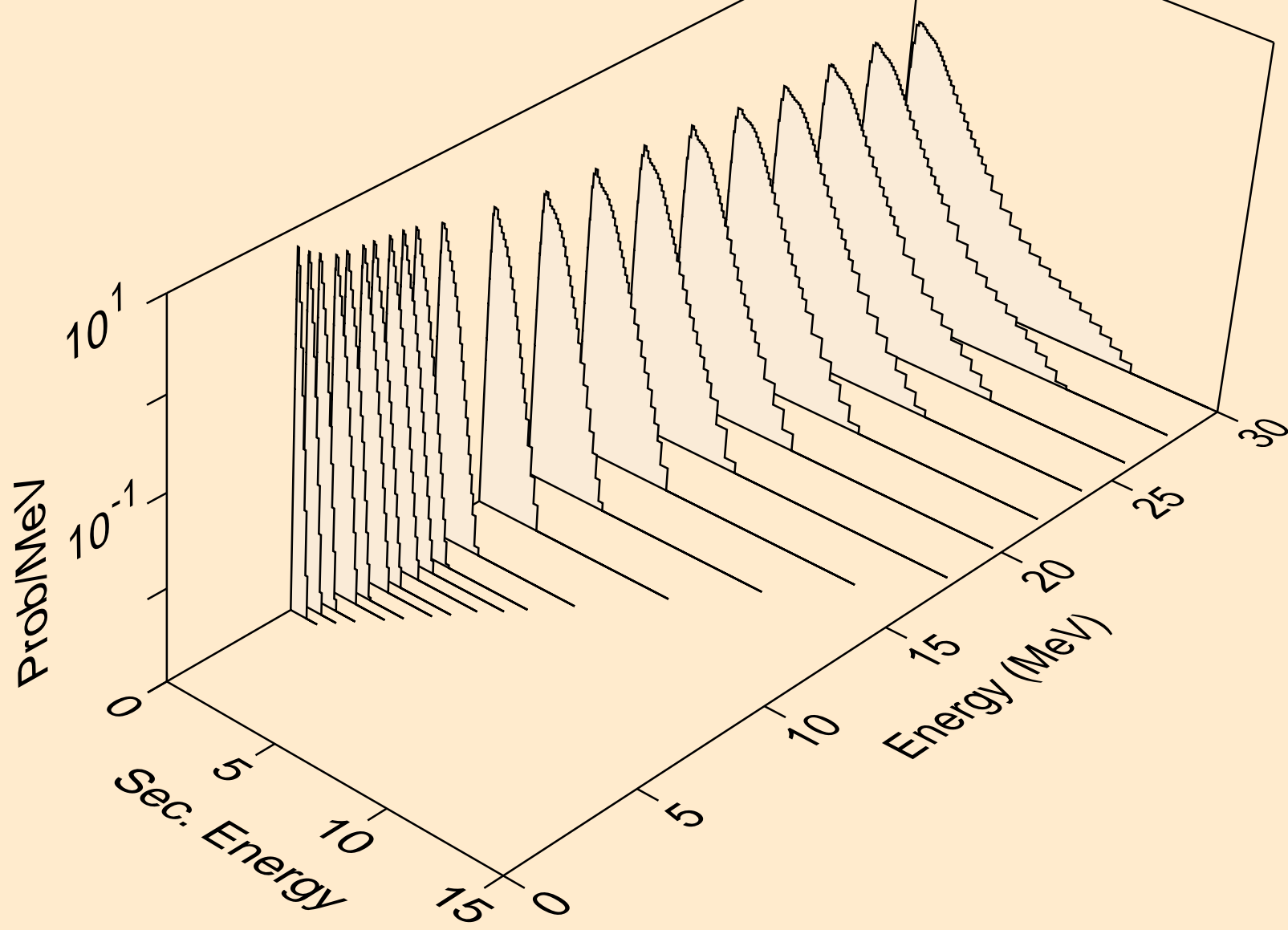

TB141 NEUTRON ACER TENDL-2023 LIBRARY; T=0.K  
Neutron emission for (n,n\*c)

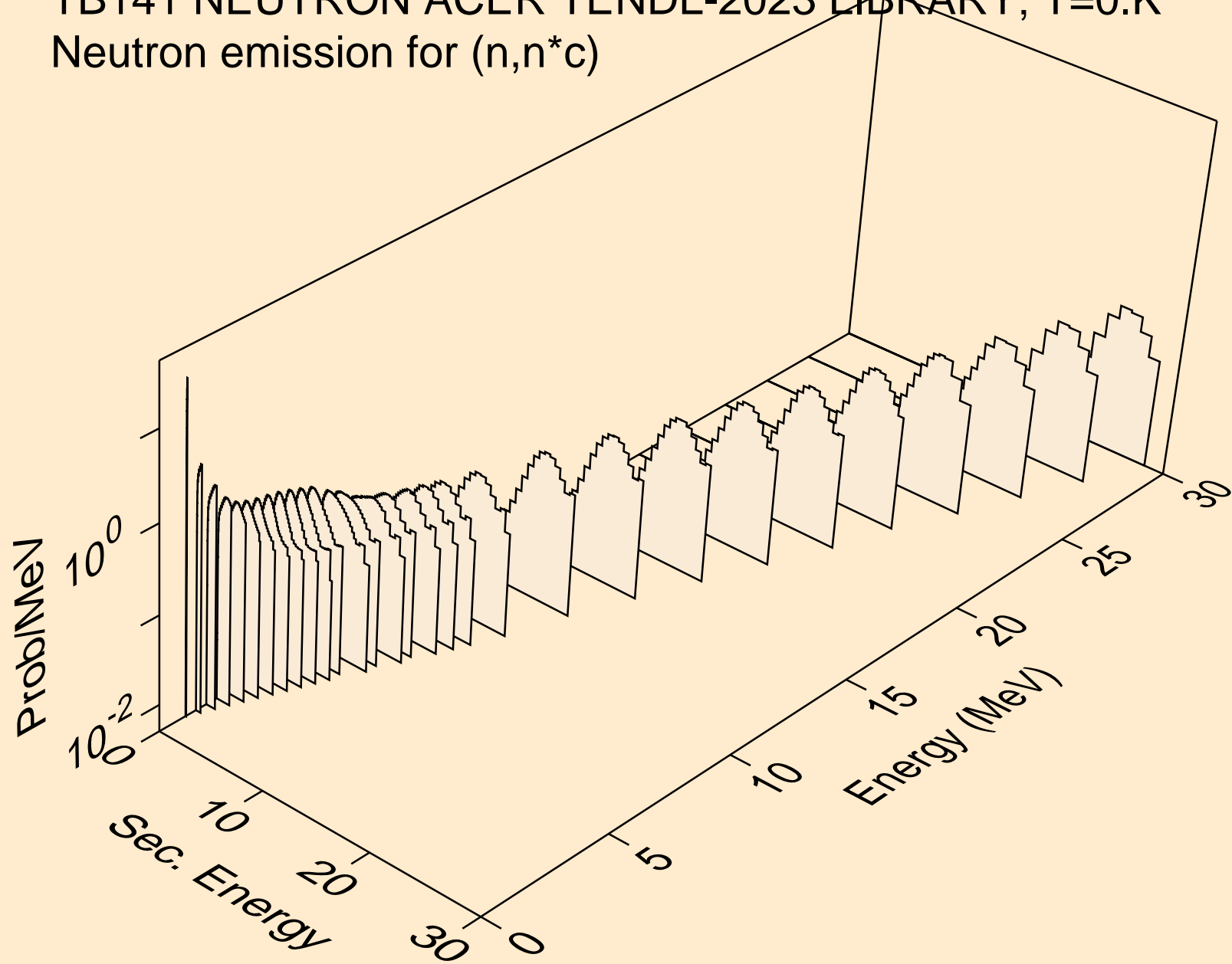

TB141 NEUTRON ACER TENDL-2023 LIBRARY; T=0.K  
Photon emission for (n,x)

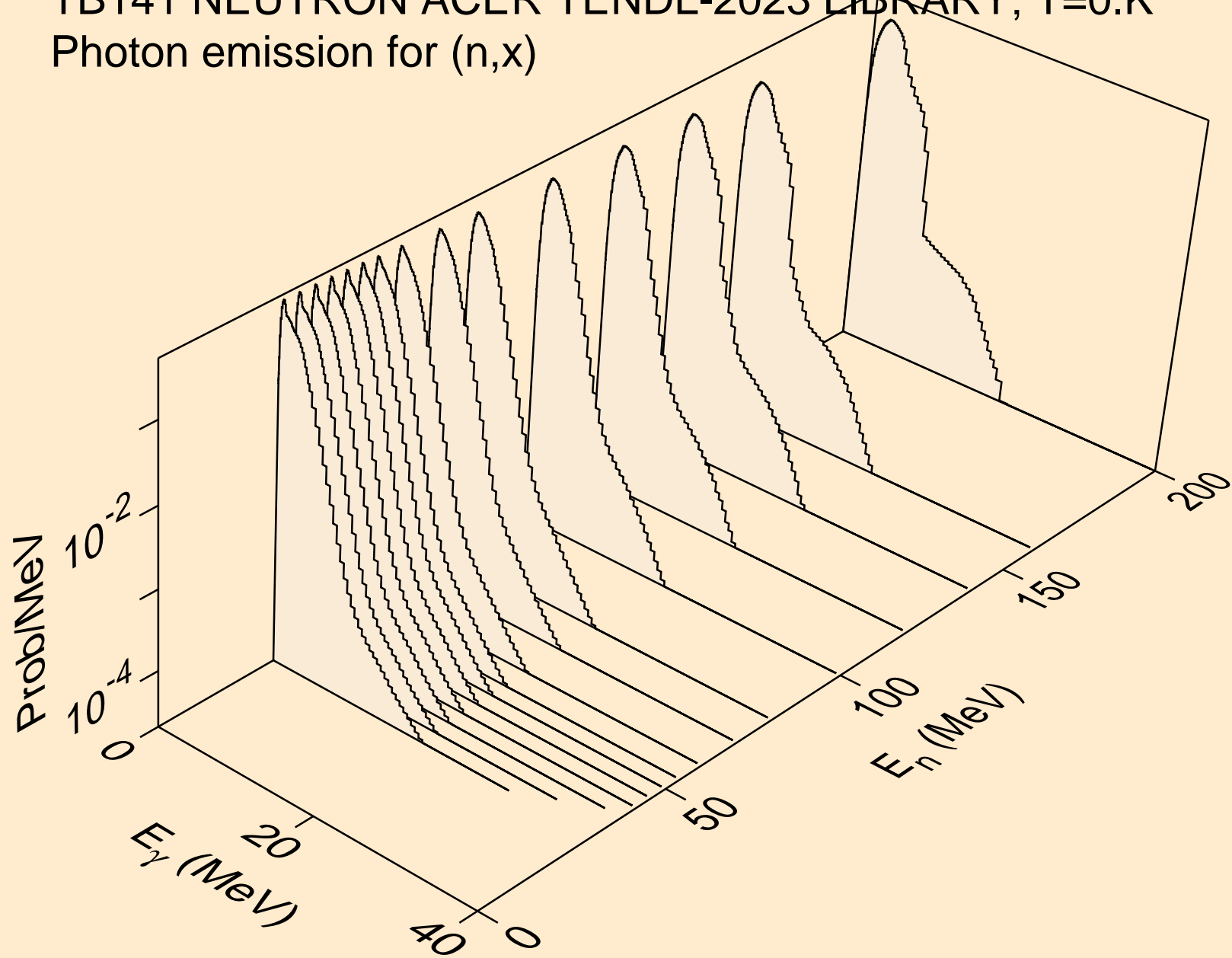

TB141 NEUTRON ACER TENDL-2023 LIBRARY; T=0.K  
Photon emission for (n,2nd)

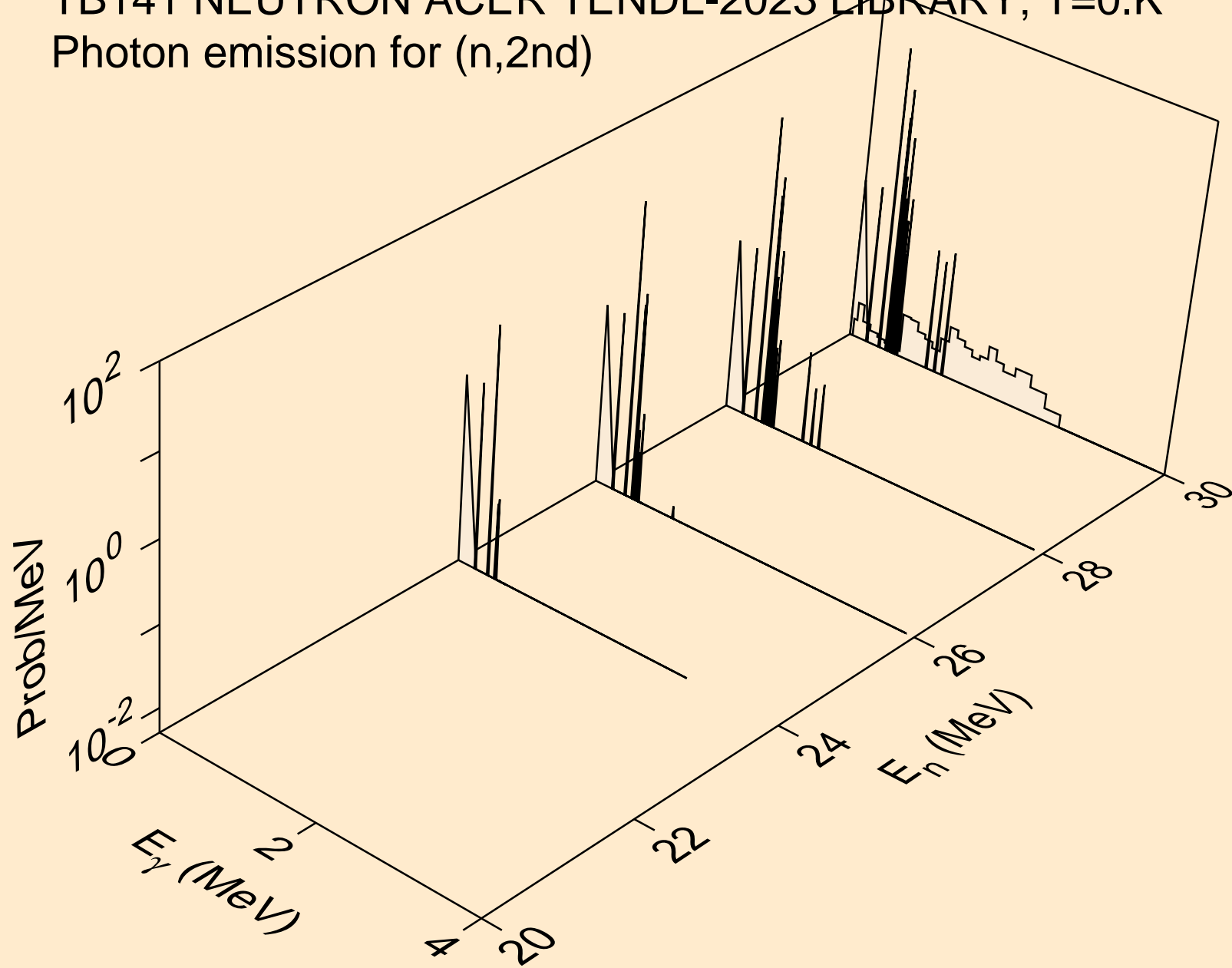

TB141 NEUTRON ACER TENDL-2023 LIBRARY; T=0.K  
Photon emission for (n,2n)

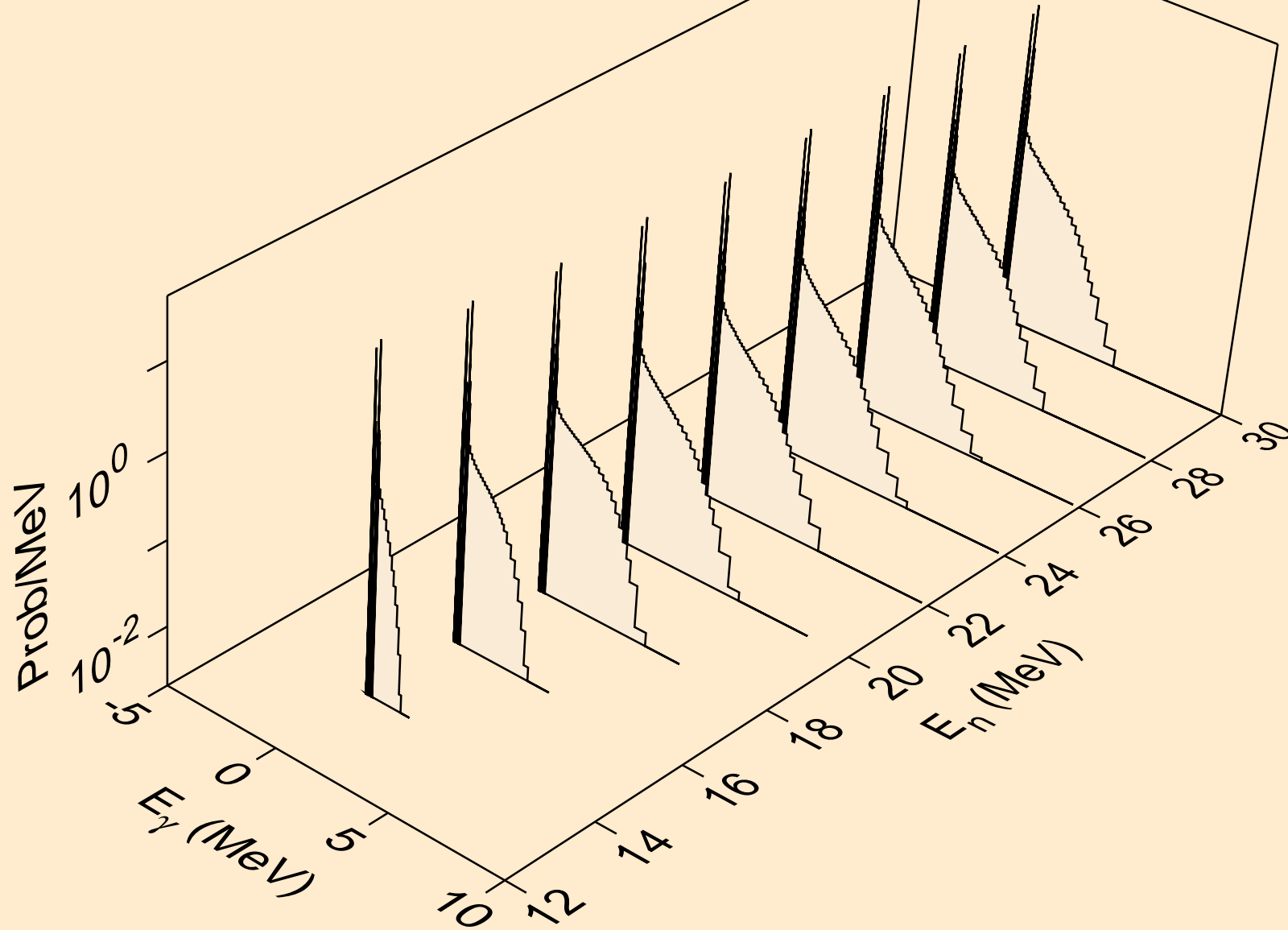

TB141 NEUTRON ACER TENDL-2023 LIBRARY; T=0.K  
Photon emission for (n,3n)

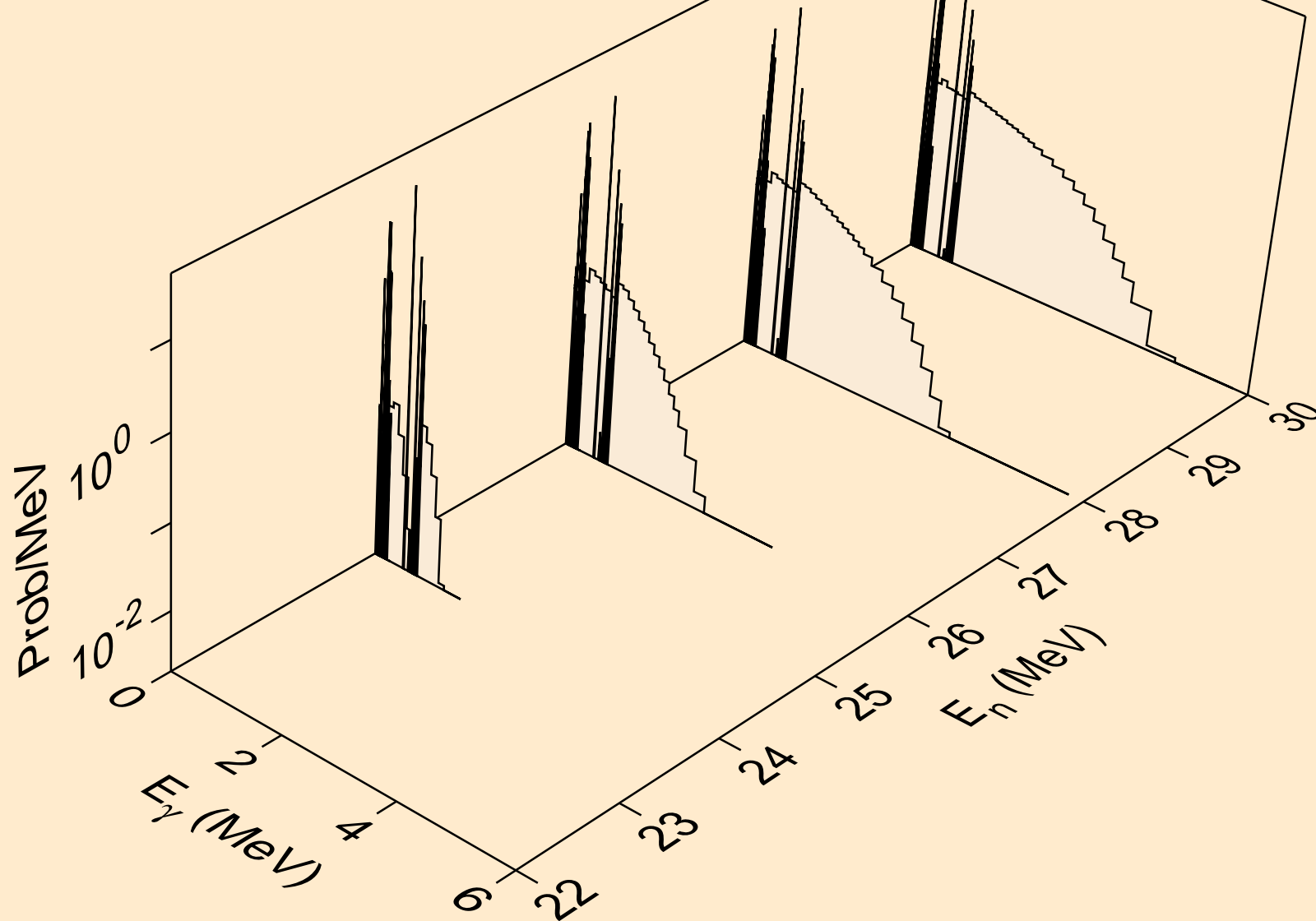



TB141 NEUTRON ACER TENDL-2023 LIBRARY; T=0.K  
Photon emission for (n,n\*)a

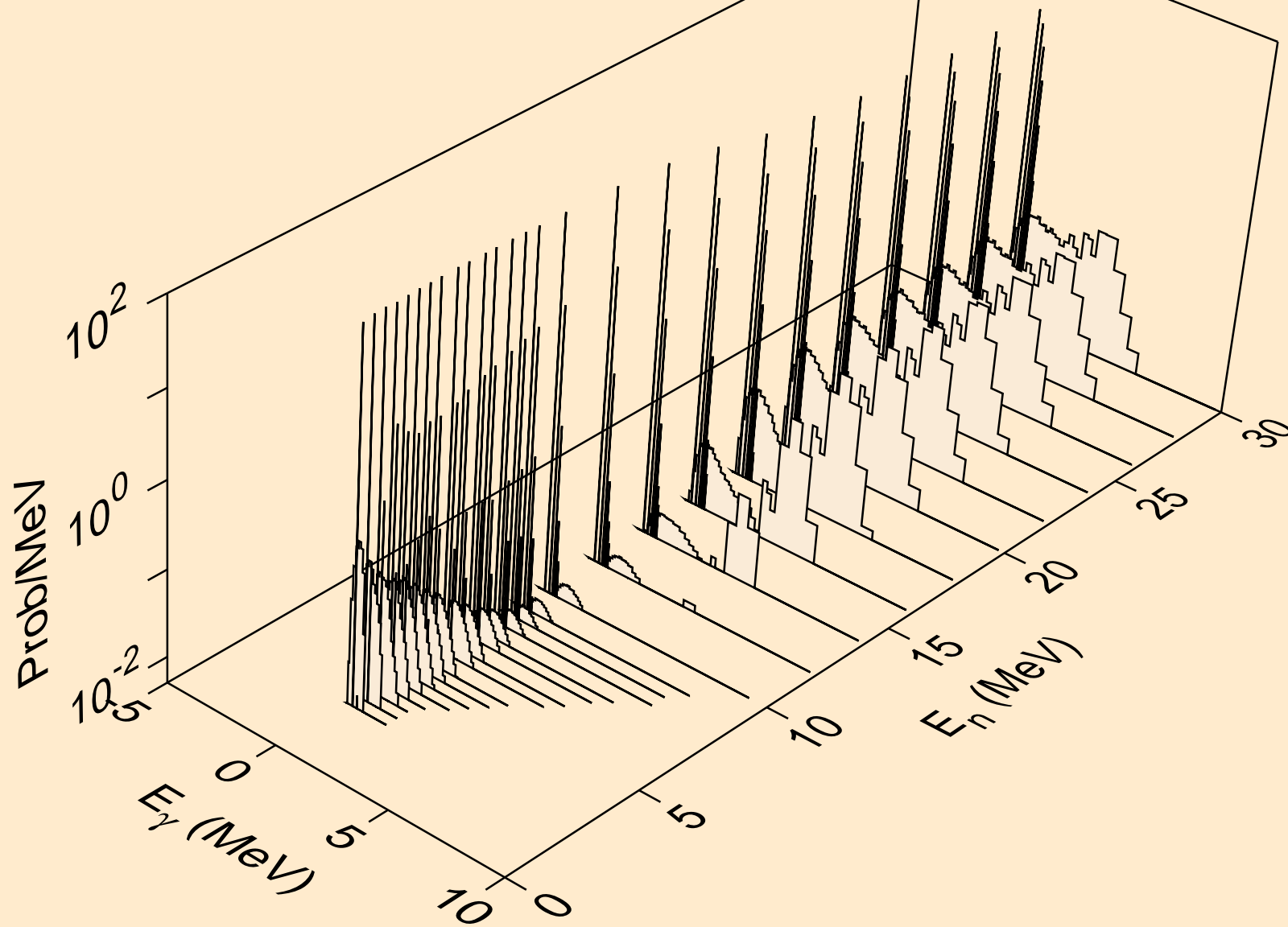

TB141 NEUTRON ACER TENDL-2023 LIBRARY; T=0.K  
Photon emission for (n,2n)a

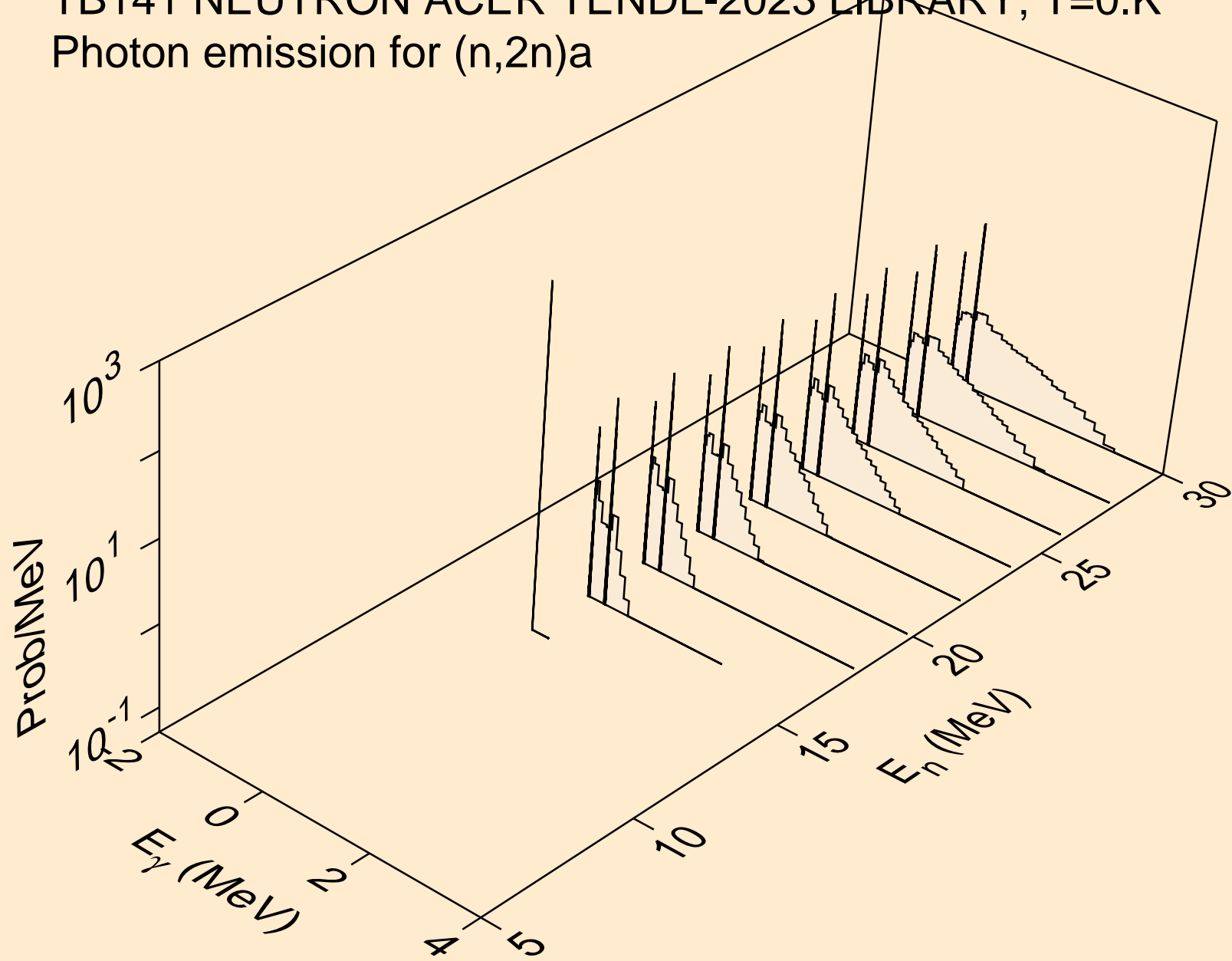

TB141 NEUTRON ACER TENDL-2023 LIBRARY; T=0.K  
Photon emission for (n,n\*)p

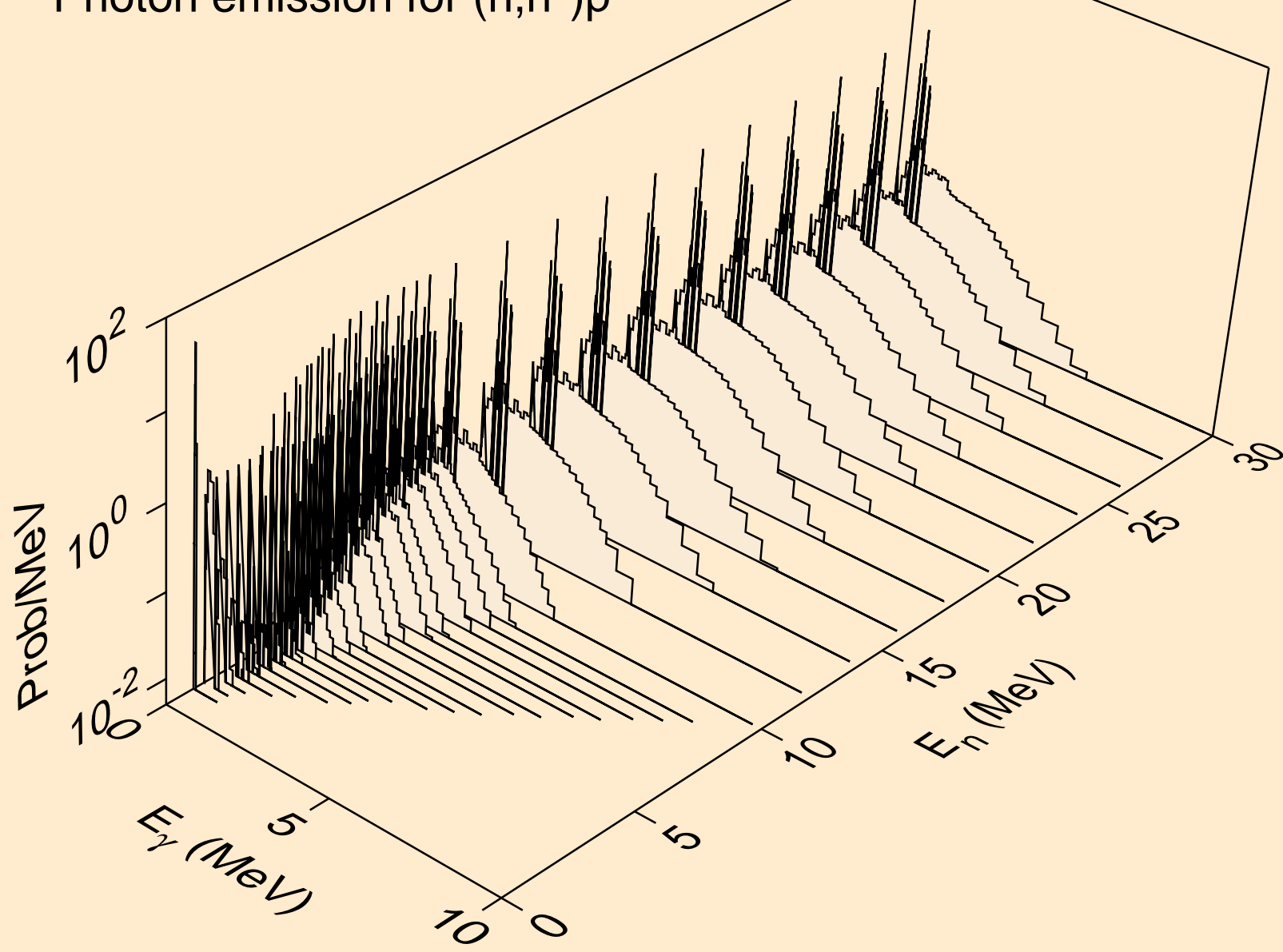

TB141 NEUTRON ACER TENDL-2023 LIBRARY; T=0.K  
Photon emission for (n,n\*)2a

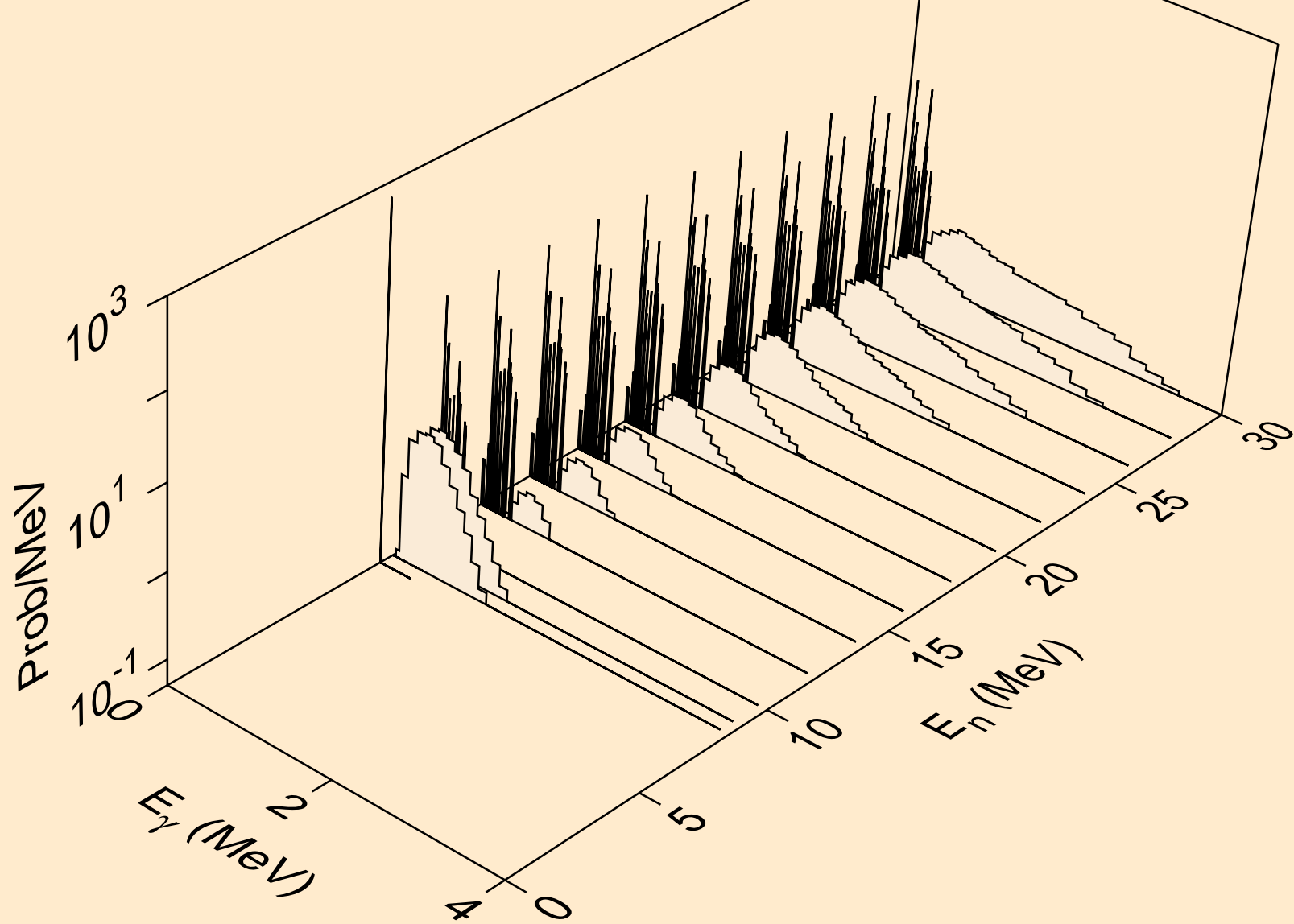

TB141 NEUTRON ACER TENDL-2023 LIBRARY; T=0.K  
Photon emission for (n,n\*)d

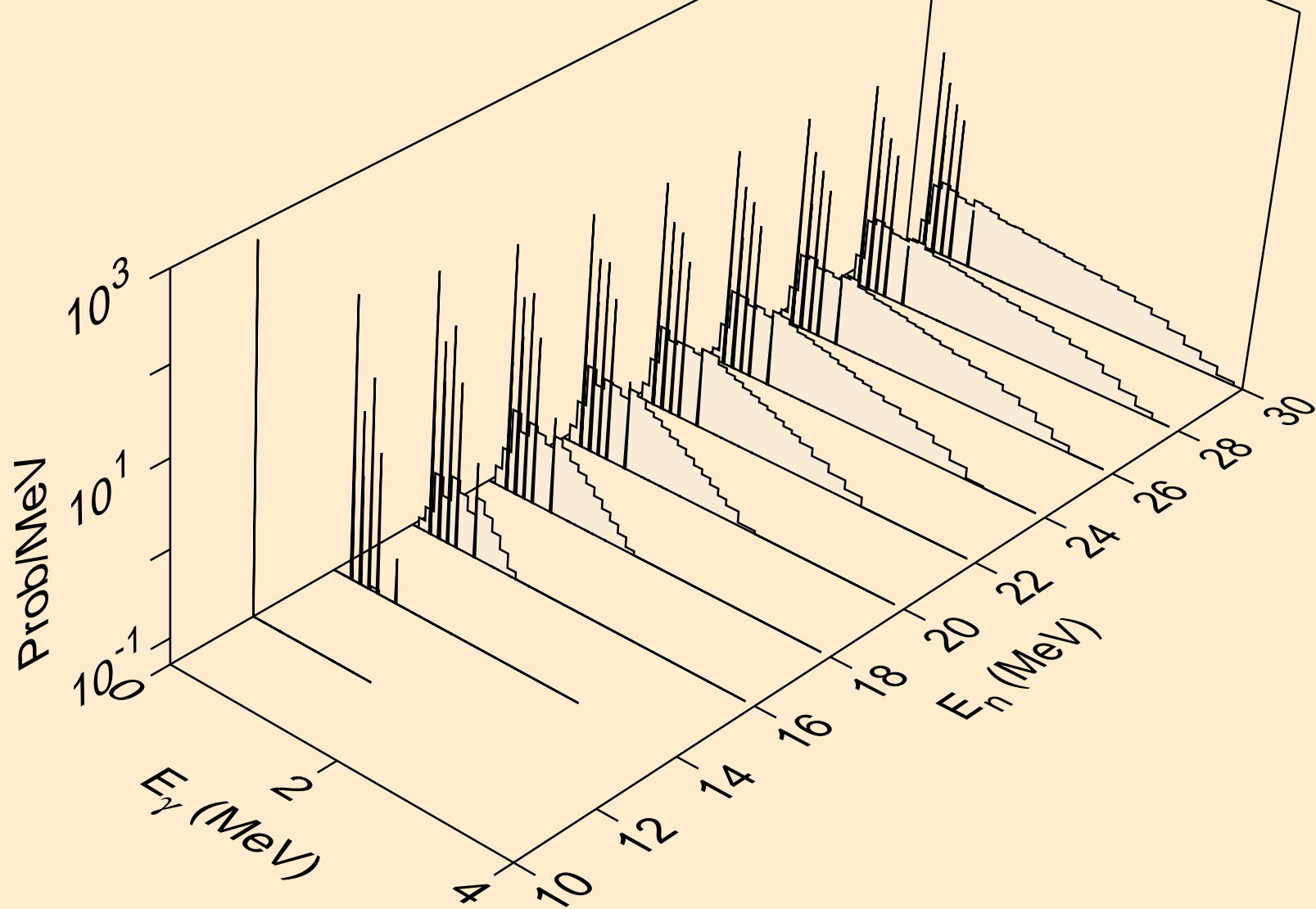

TB141 NEUTRON ACER TENDL-2023 LIBRARY; T=0.K  
Photon emission for (n,n\*)t

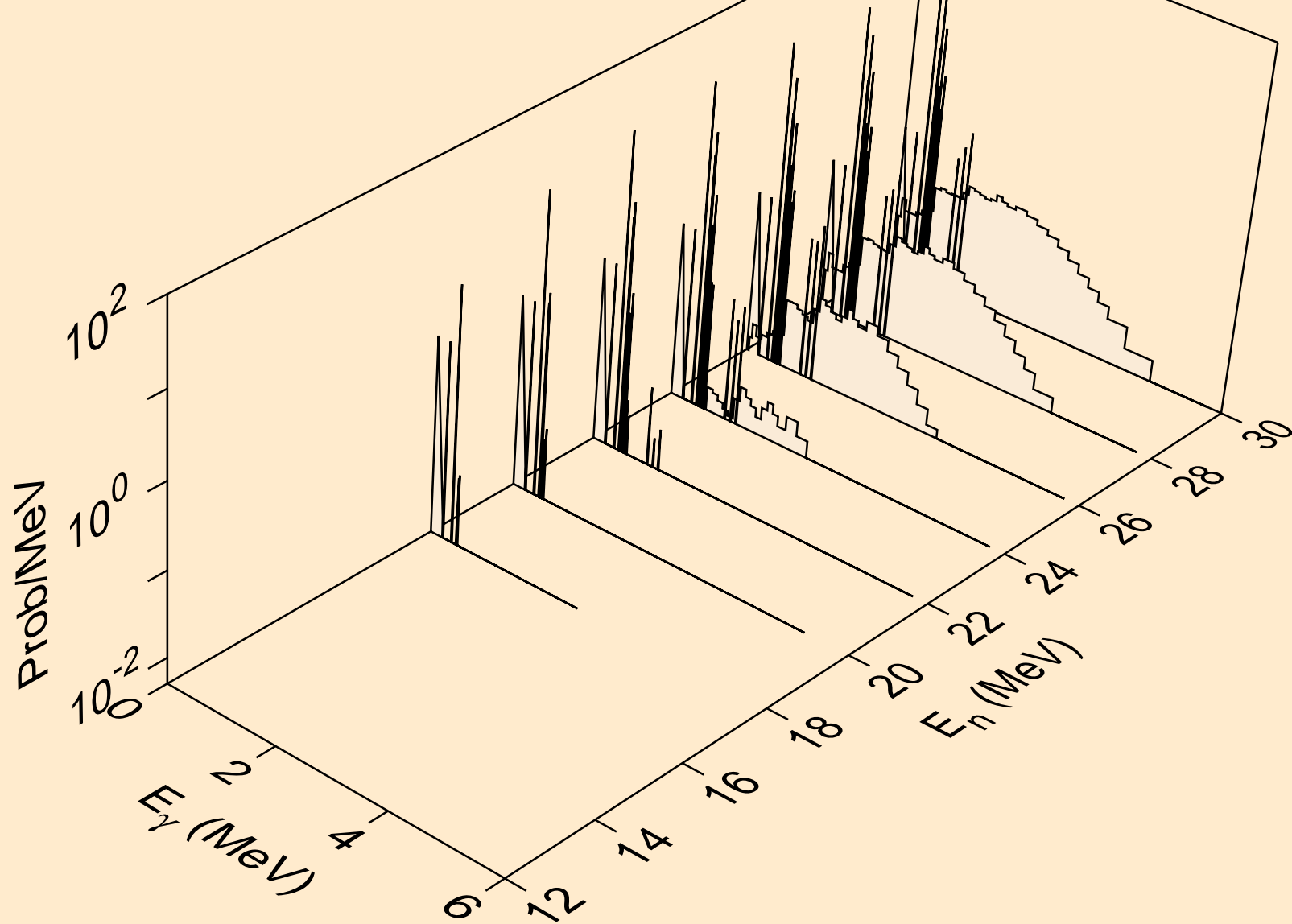

TB141 NEUTRON ACER TENDL-2023 LIBRARY; T=0.K  
Photon emission for (n,n\*)he3

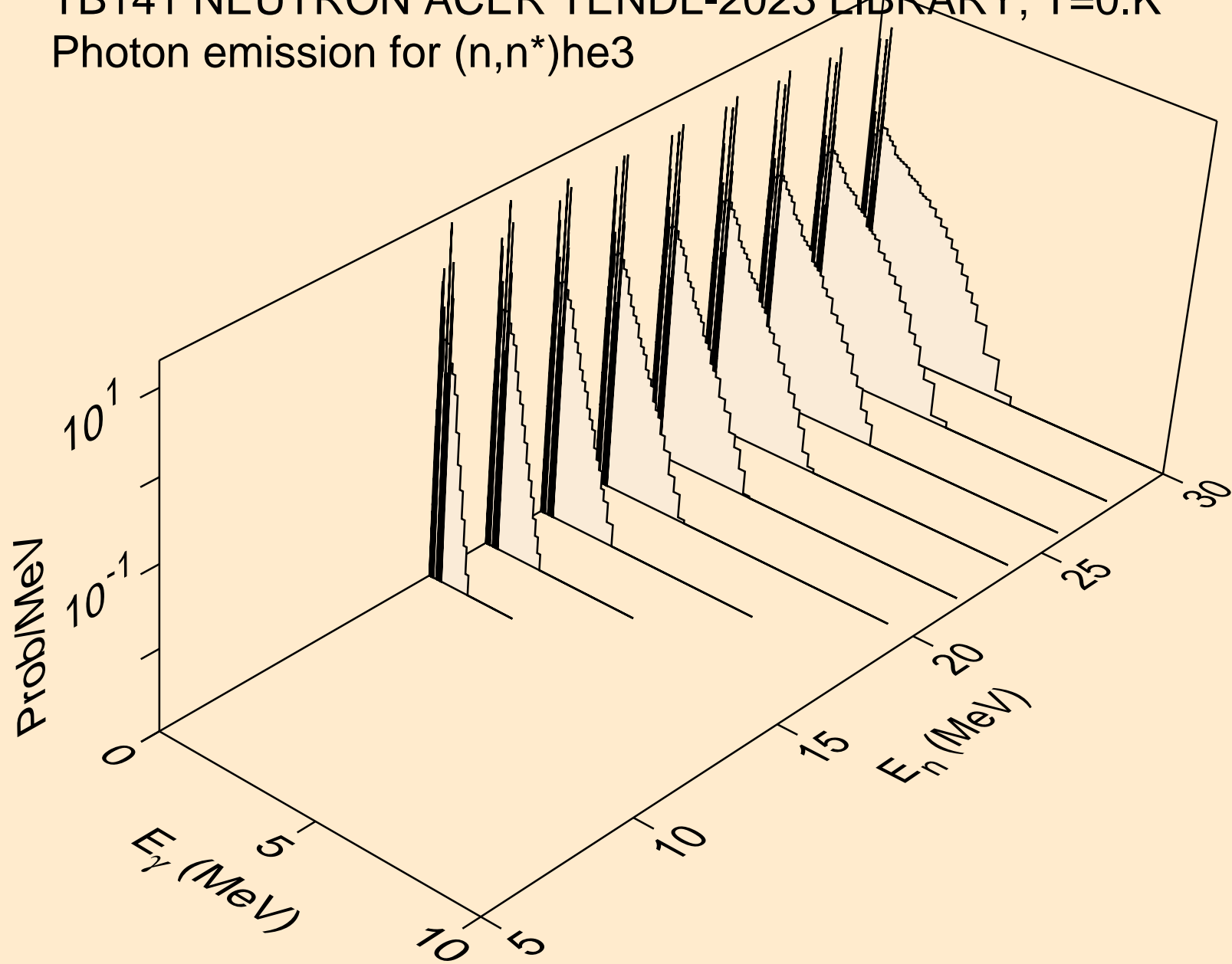

TB141 NEUTRON ACER TENDL-2023 LIBRARY; T=0.K  
Photon emission for (n,2np)

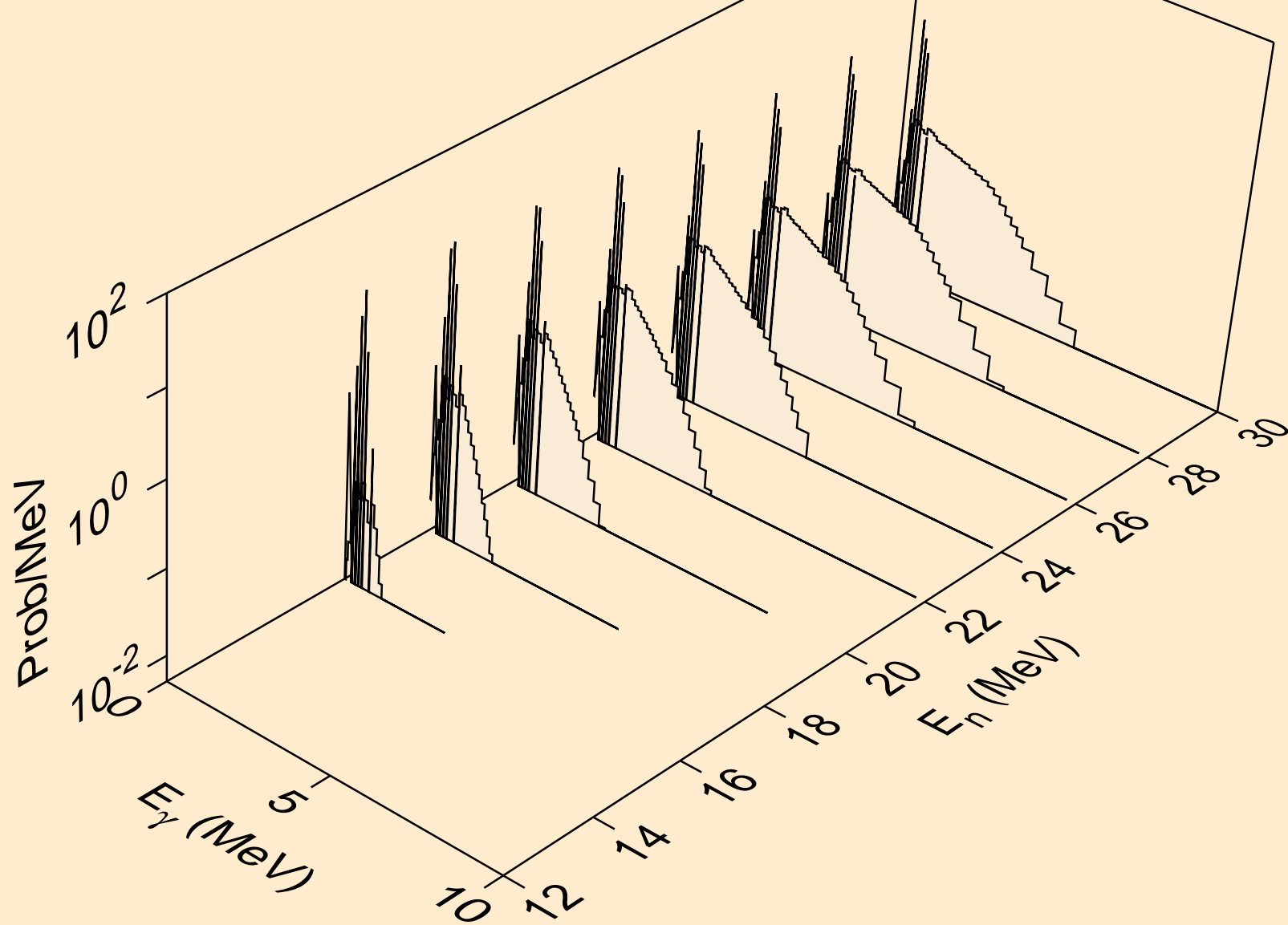



TB141 NEUTRON ACER TENDL-2023 LIBRARY; T=0.K  
Photon emission for (n,3np)

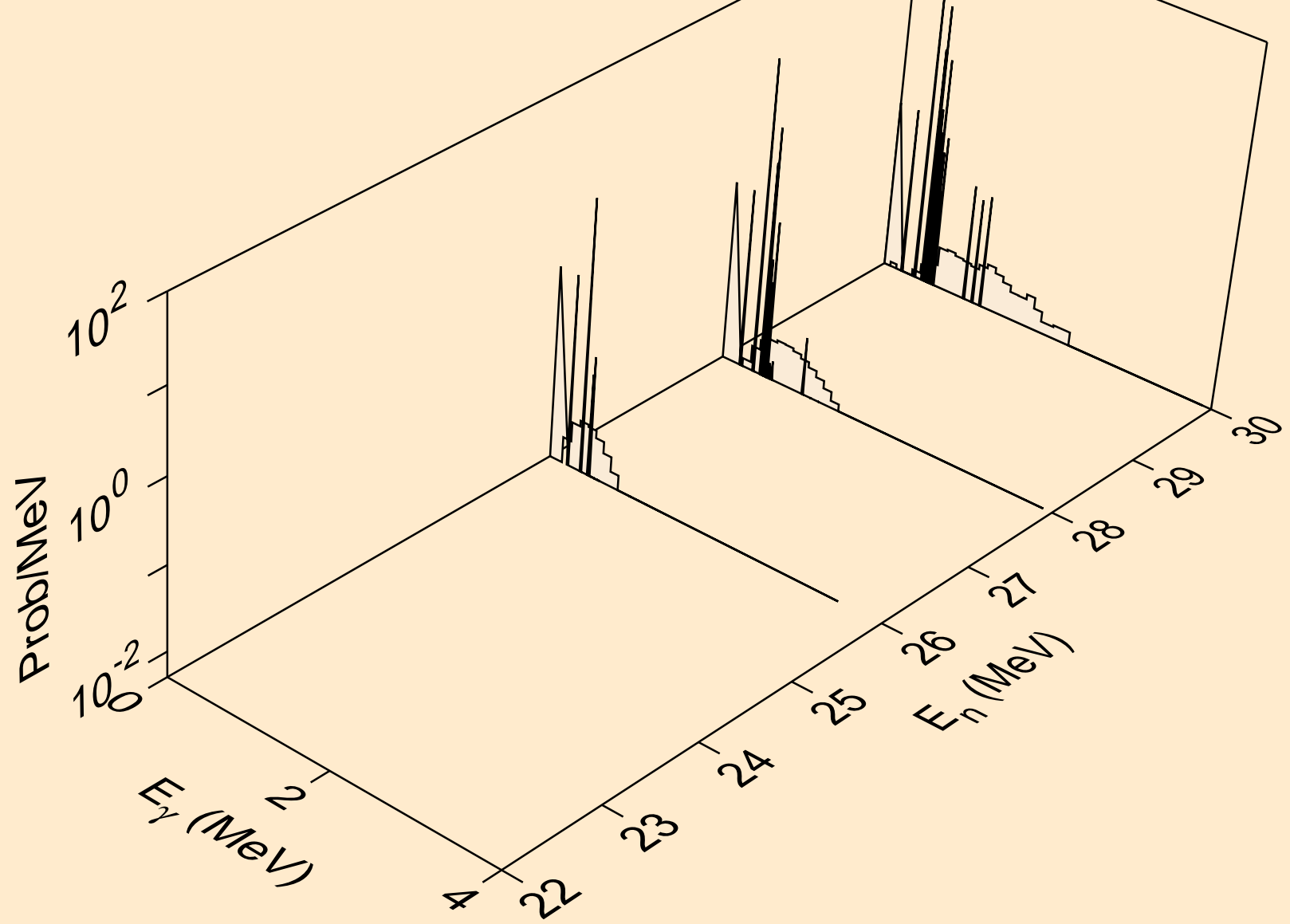

TB141 NEUTRON ACER TENDL-2023 LIBRARY; T=0.K  
Photon emission for (n,n2p)

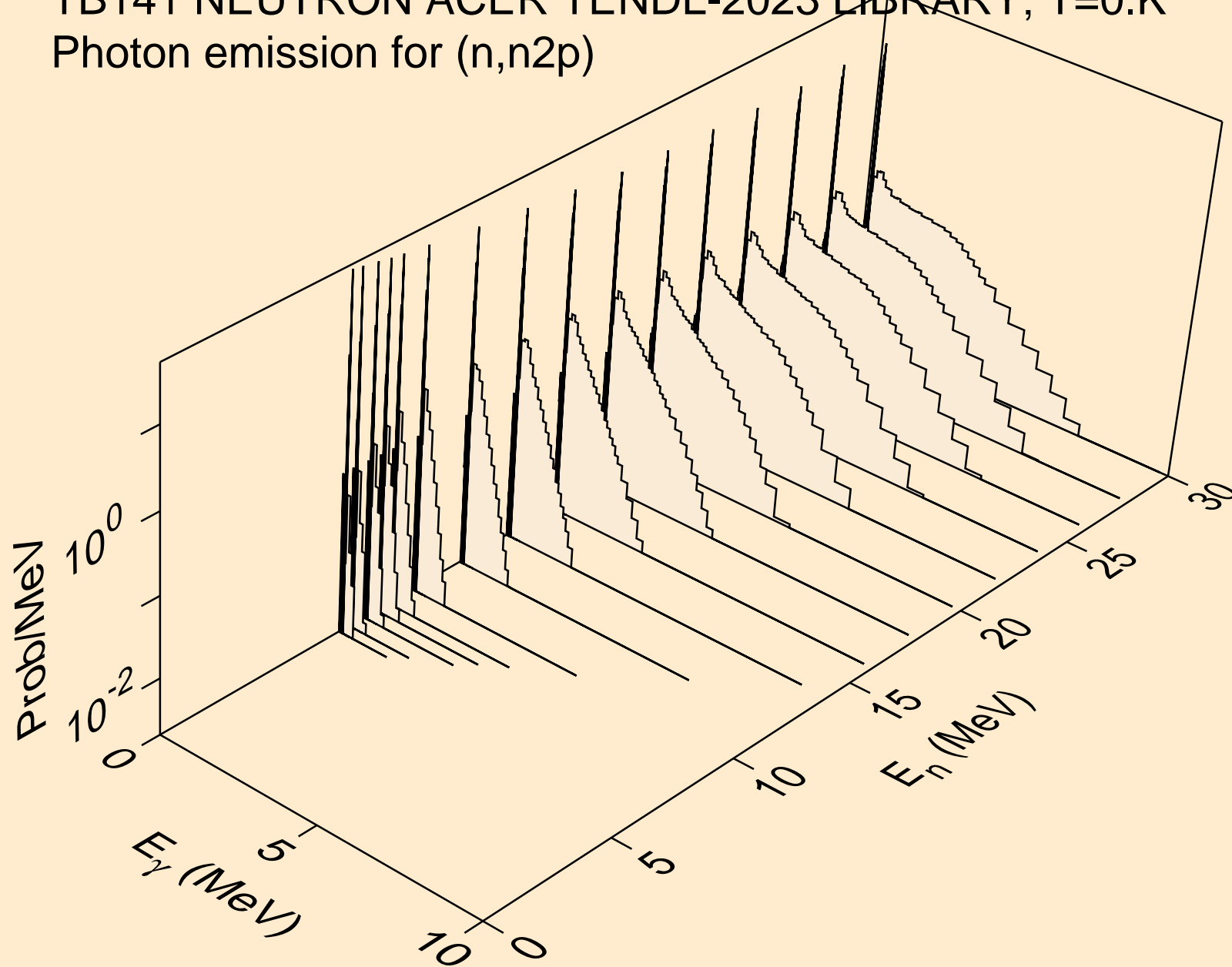

TB141 NEUTRON ACER TENDL-2023 LIBRARY; T=0.K  
Photon emission for (n,npa)

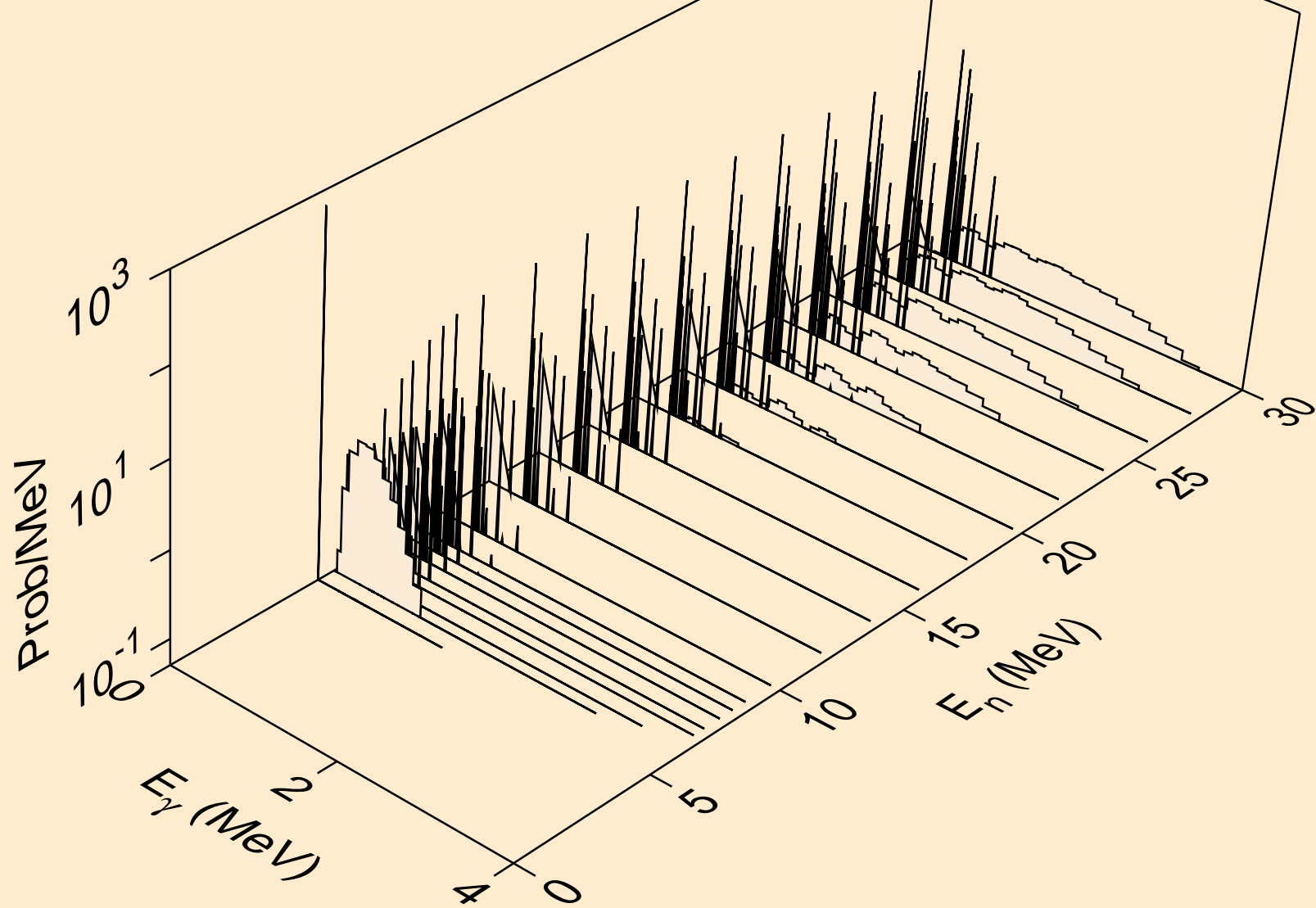

TB141 NEUTRON ACER TENDL-2023 LIBRARY; T=0.K  
Photon emission for (n,n\*c)

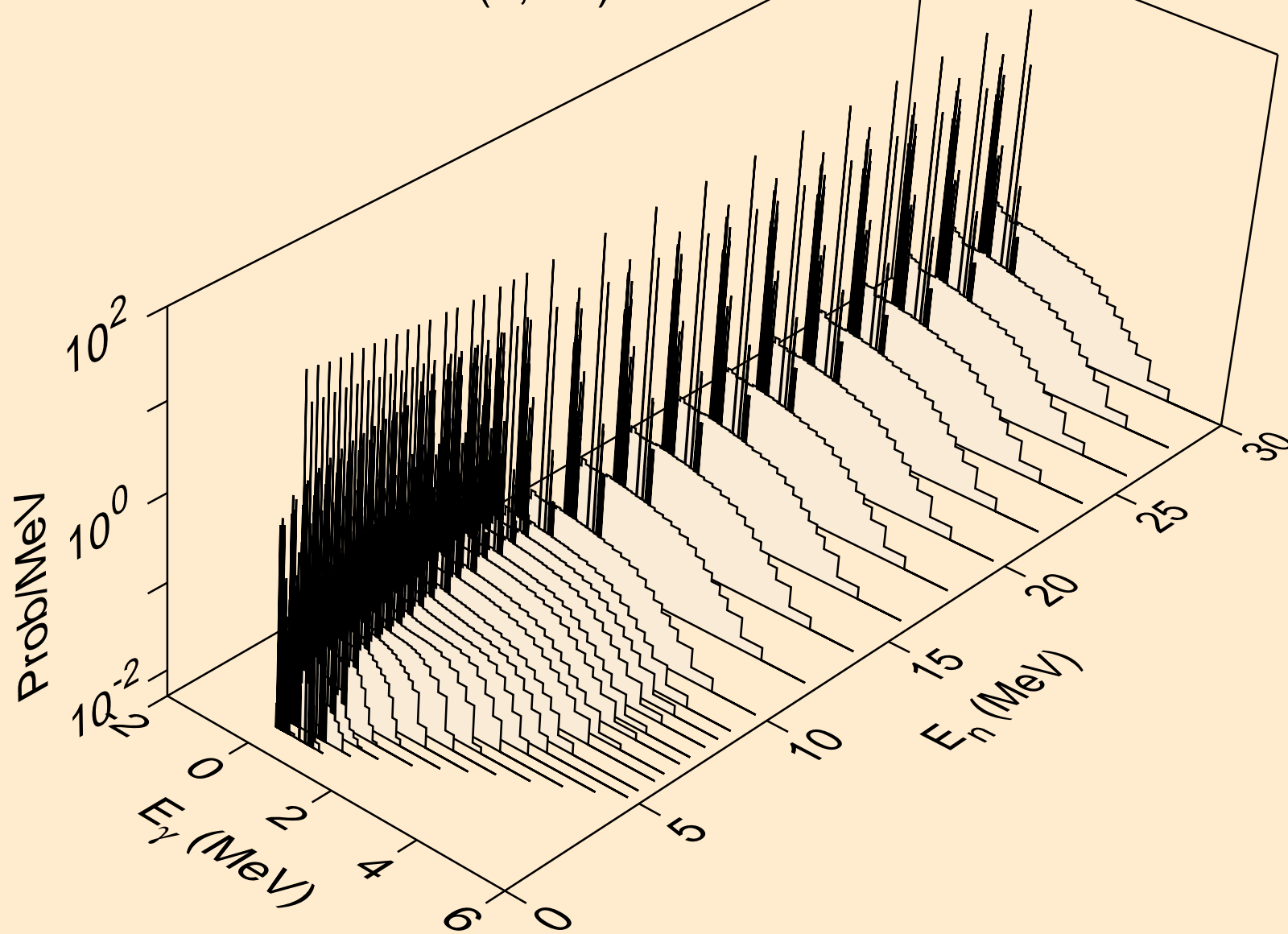

TB141 NEUTRON ACER TENDL-2023 LIBRARY; T=0.K  
Photon emission for (n,gma)

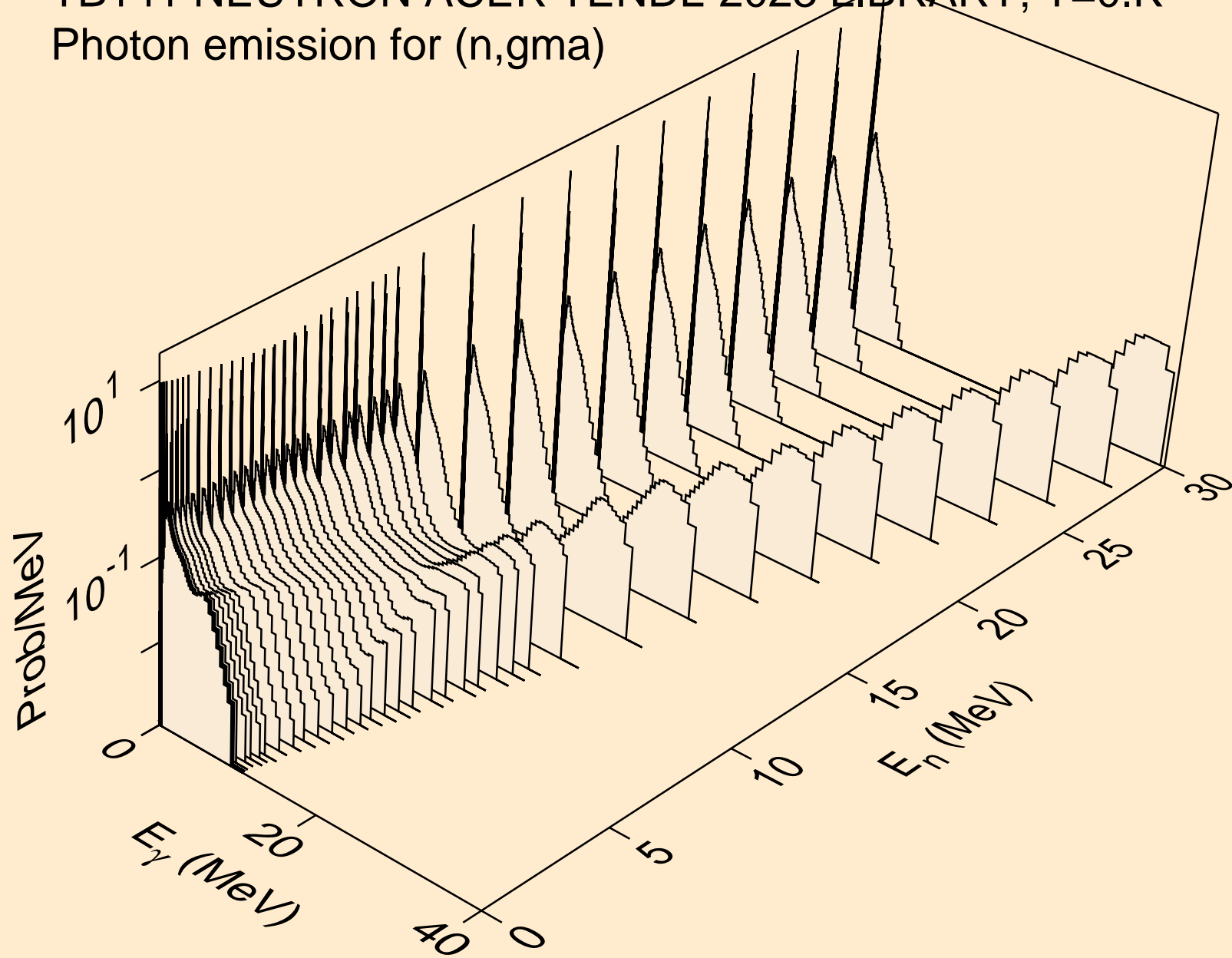

TB141 NEUTRON ACER TENDL-2023 LIBRARY; T=0.K  
Photon emission for (n,p)

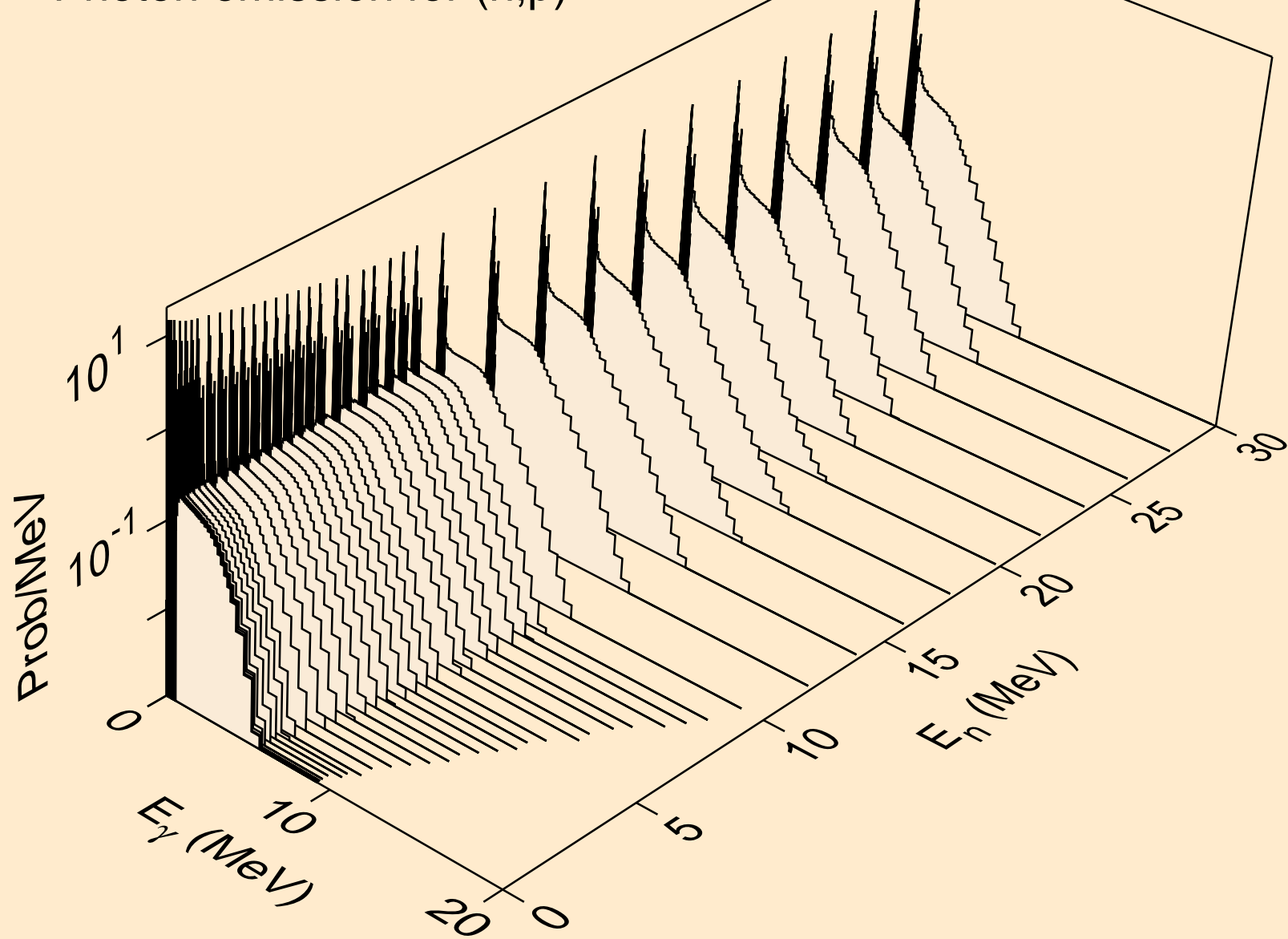

TB141 NEUTRON ACER TENDL-2023 LIBRARY; T=0.K  
Photon emission for (n,d)

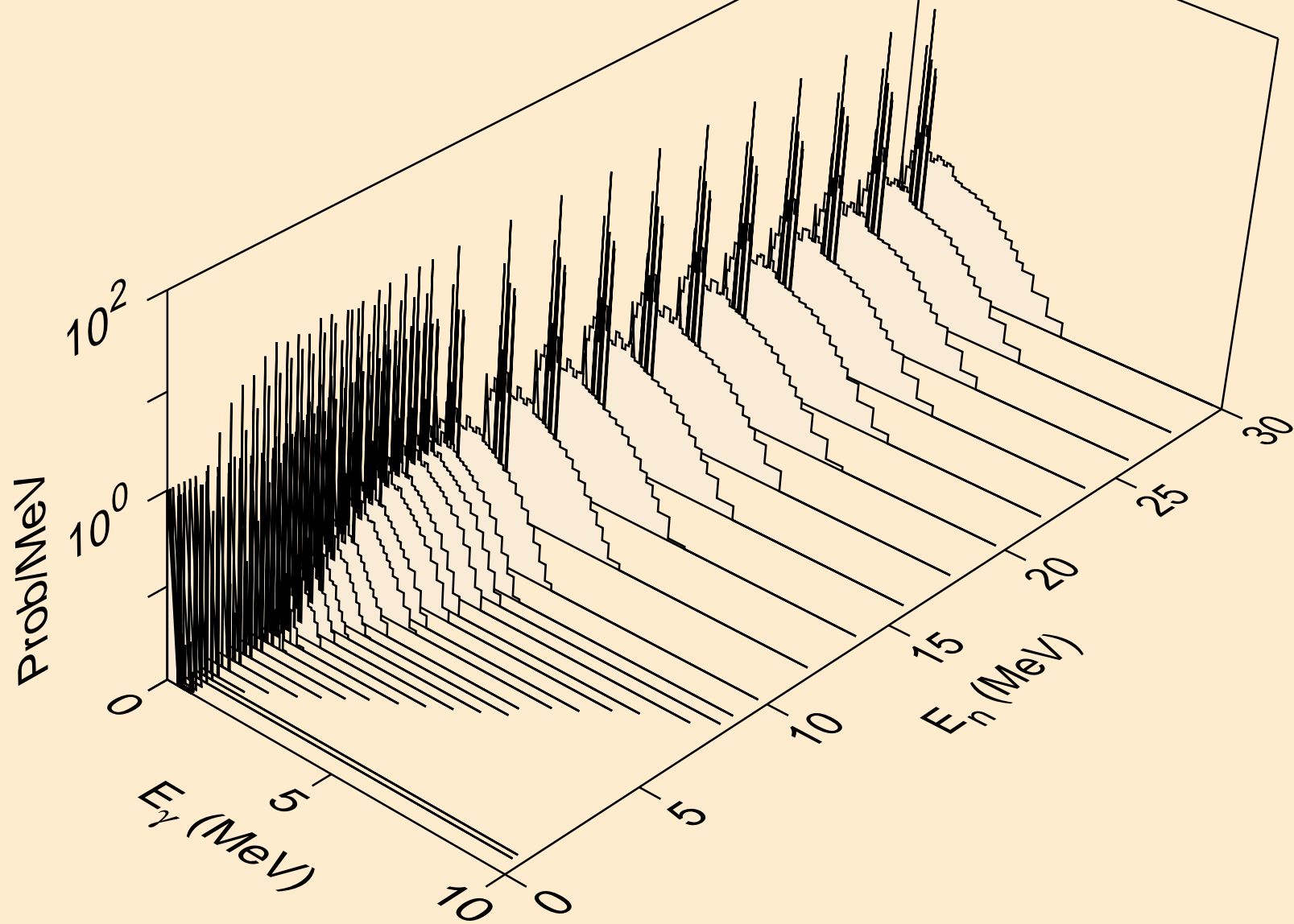

TB141 NEUTRON ACER TENDL-2023 LIBRARY; T=0.K  
Photon emission for (n,t)

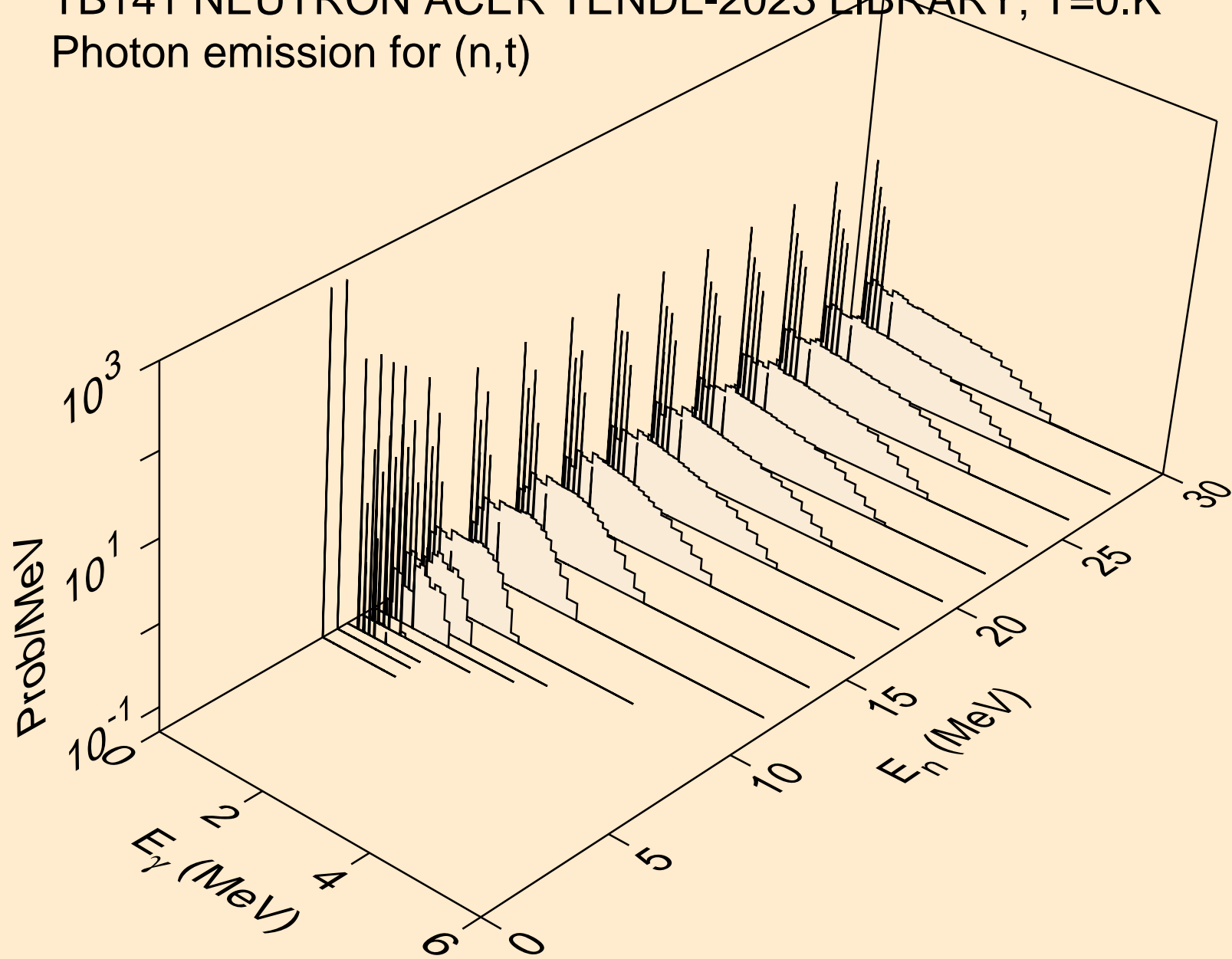



TB141 NEUTRON ACER TENDL-2023 LIBRARY; T=0.K  
Photon emission for (n,he3)

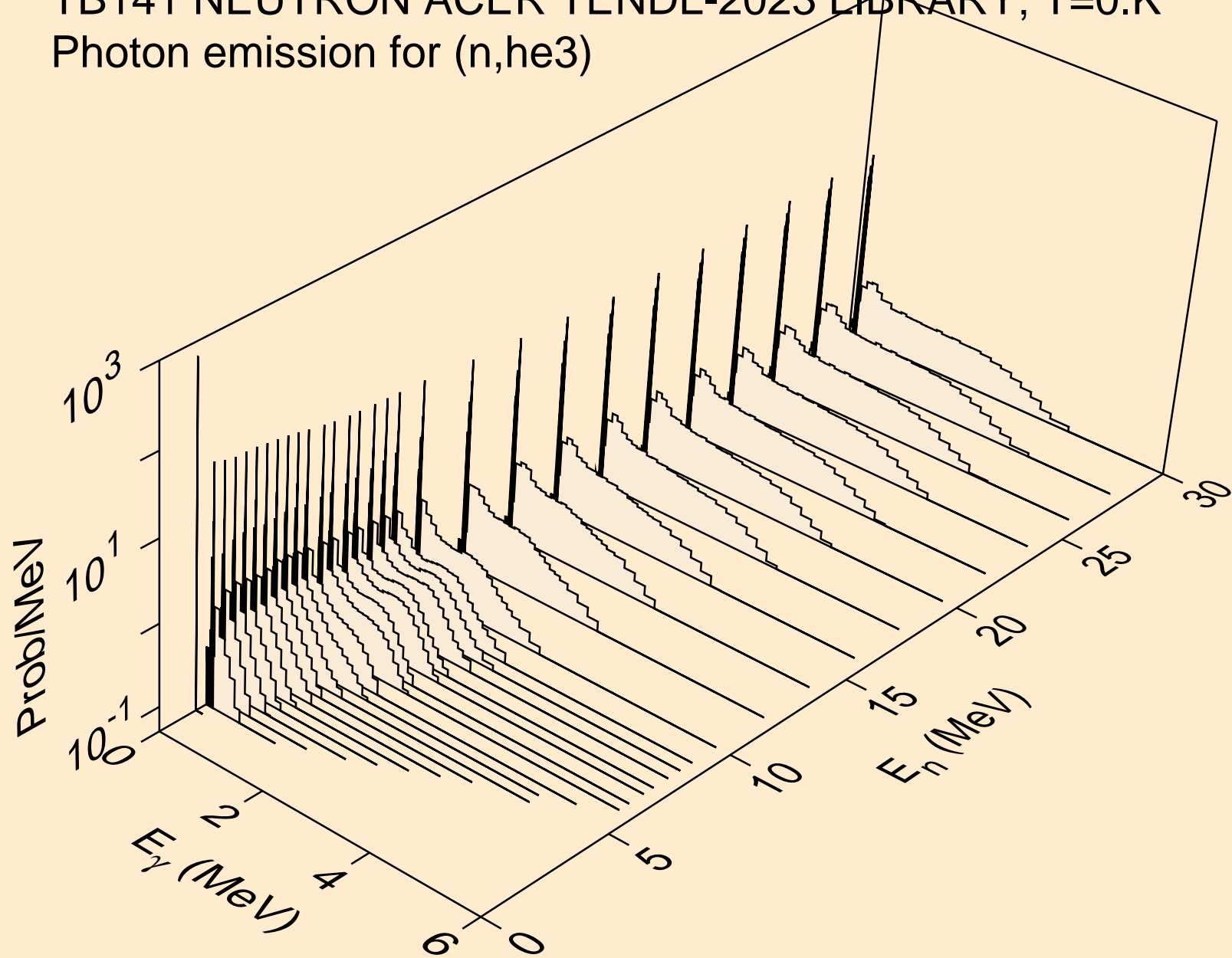

TB141 NEUTRON ACER TENDL-2023 LIBRARY; T=0.K  
Photon emission for (n,a)

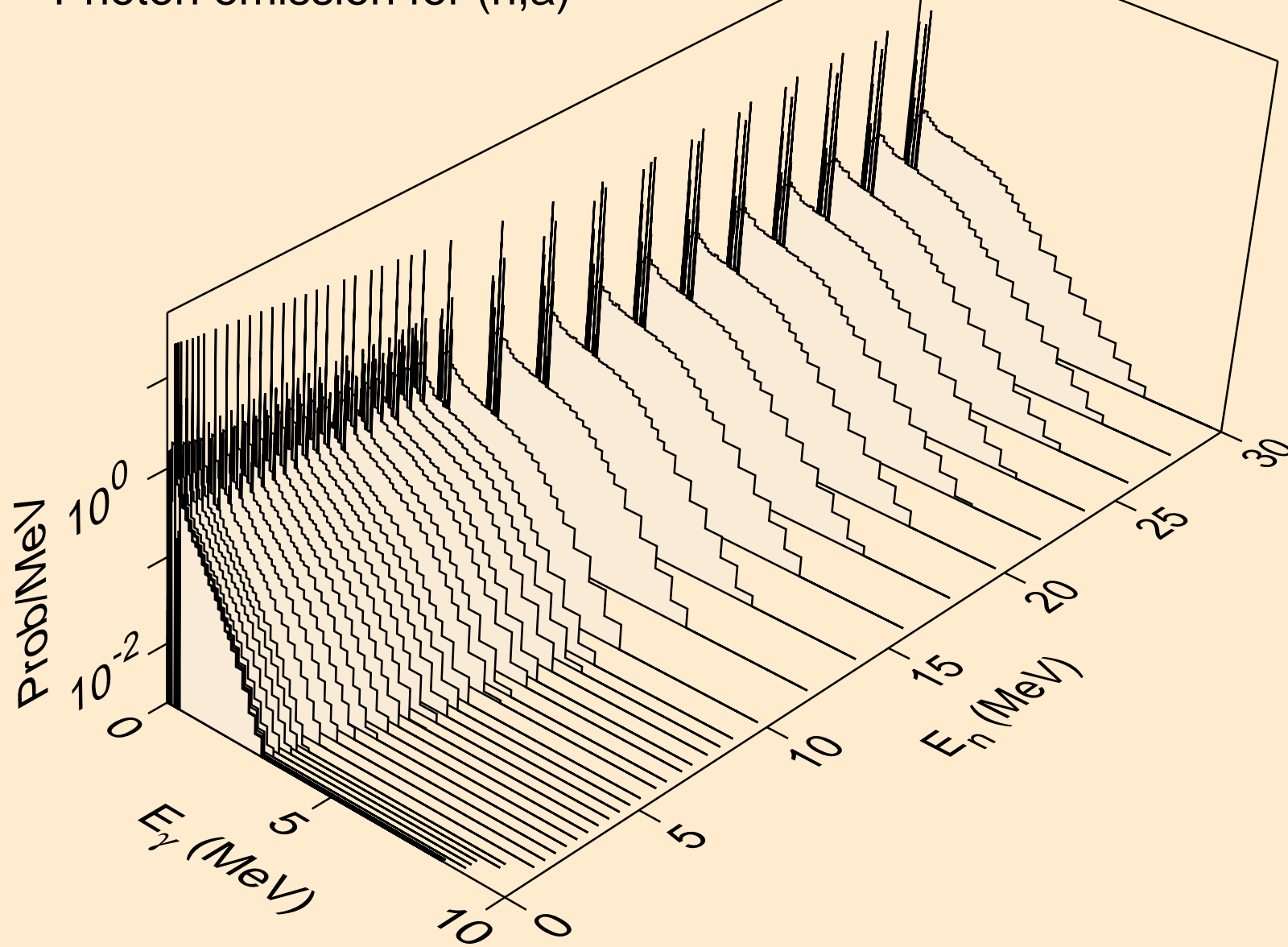

TB141 NEUTRON ACER TENDL-2023 LIBRARY; T=0.K  
Photon emission for (n,2a)

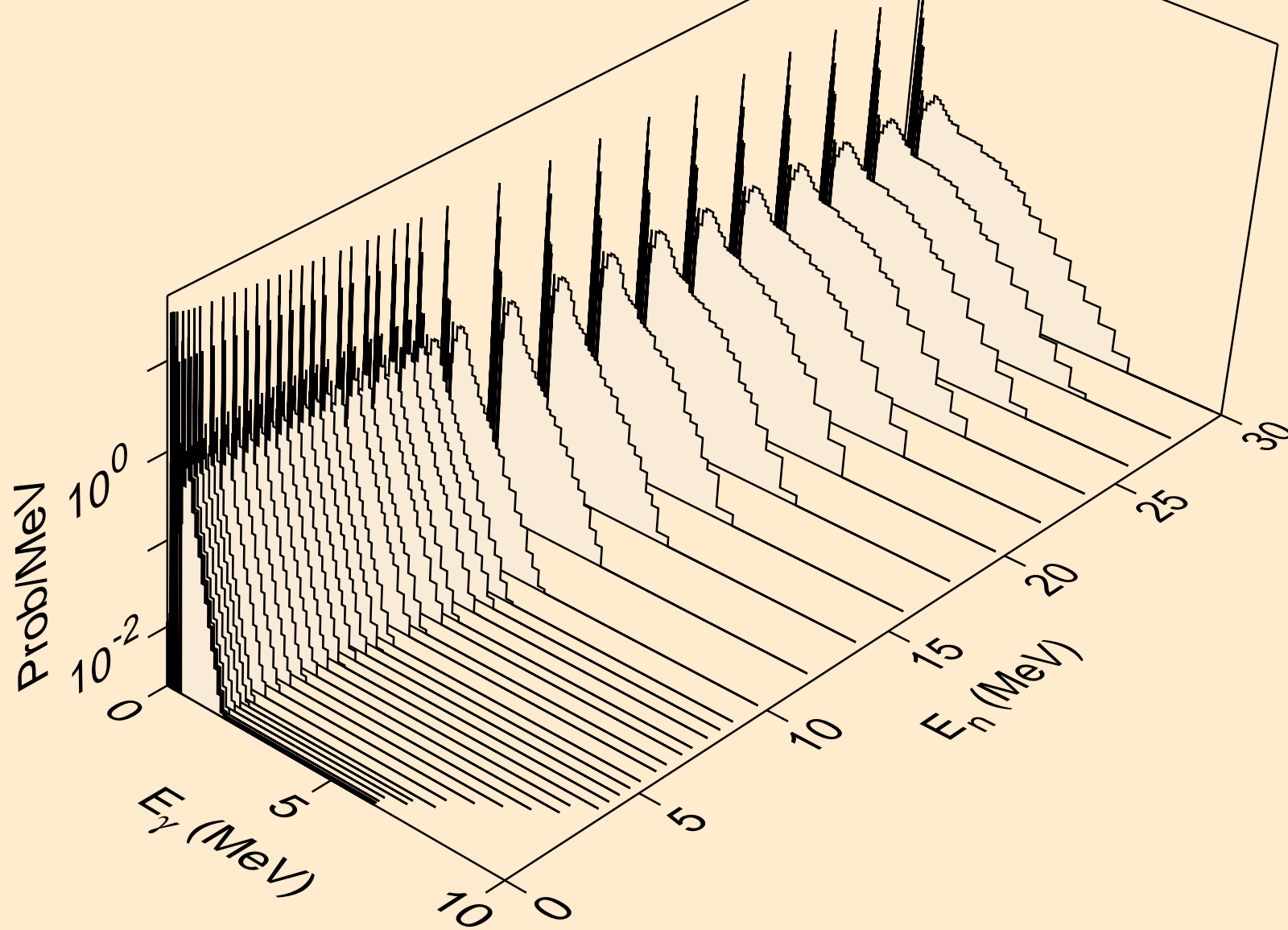

TB141 NEUTRON ACER TENDL-2023 LIBRARY; T=0.K  
Photon emission for (n,3a)

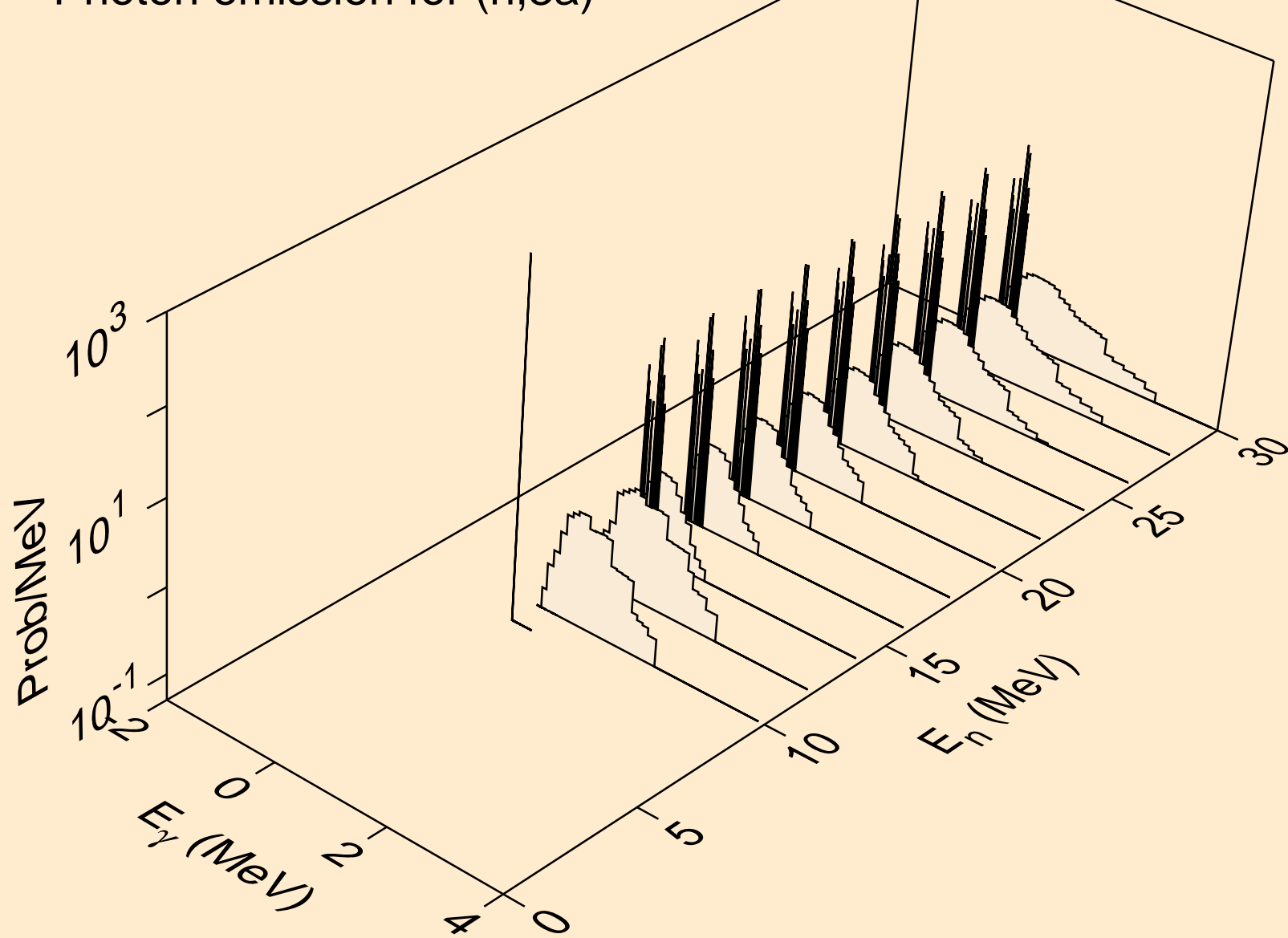

TB141 NEUTRON ACER TENDL-2023 LIBRARY; T=0.K  
Photon emission for (n,2p)

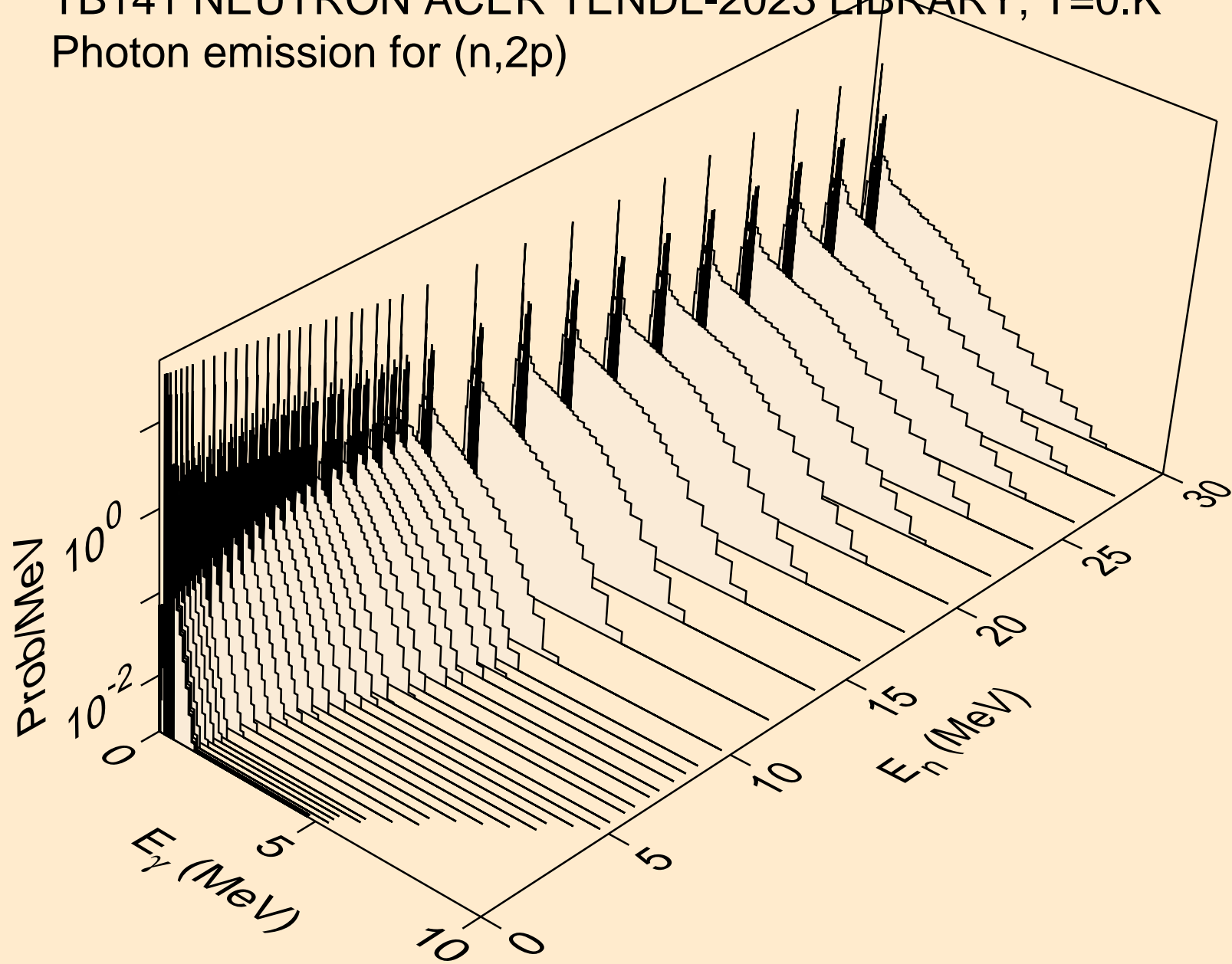

TB141 NEUTRON ACER TENDL-2023 LIBRARY; T=0.K  
Photon emission for (n,p $\alpha$ )

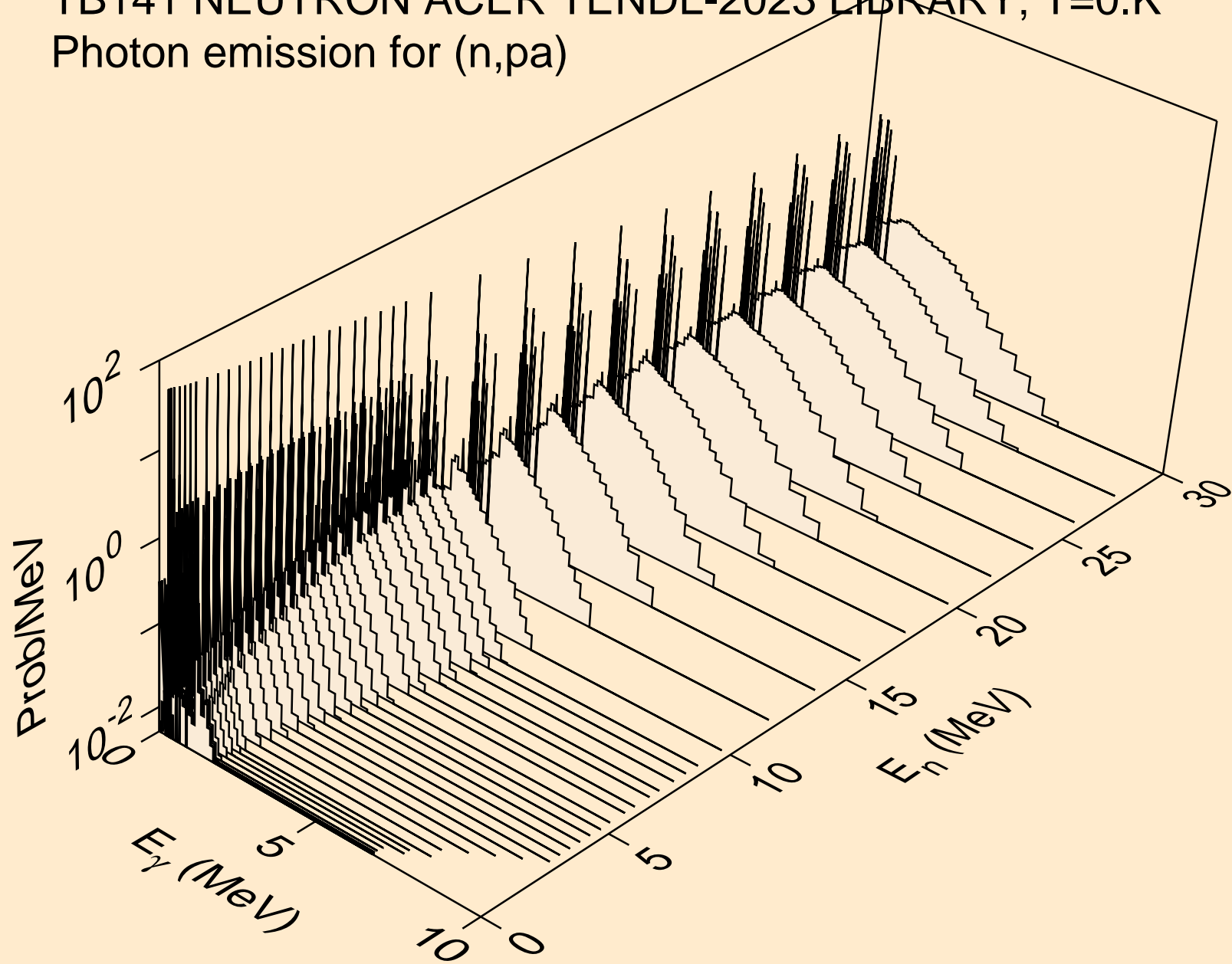

TB141 NEUTRON ACER TENDL-2023 LIBRARY; T=0.K  
Photon emission for (n,d2a)

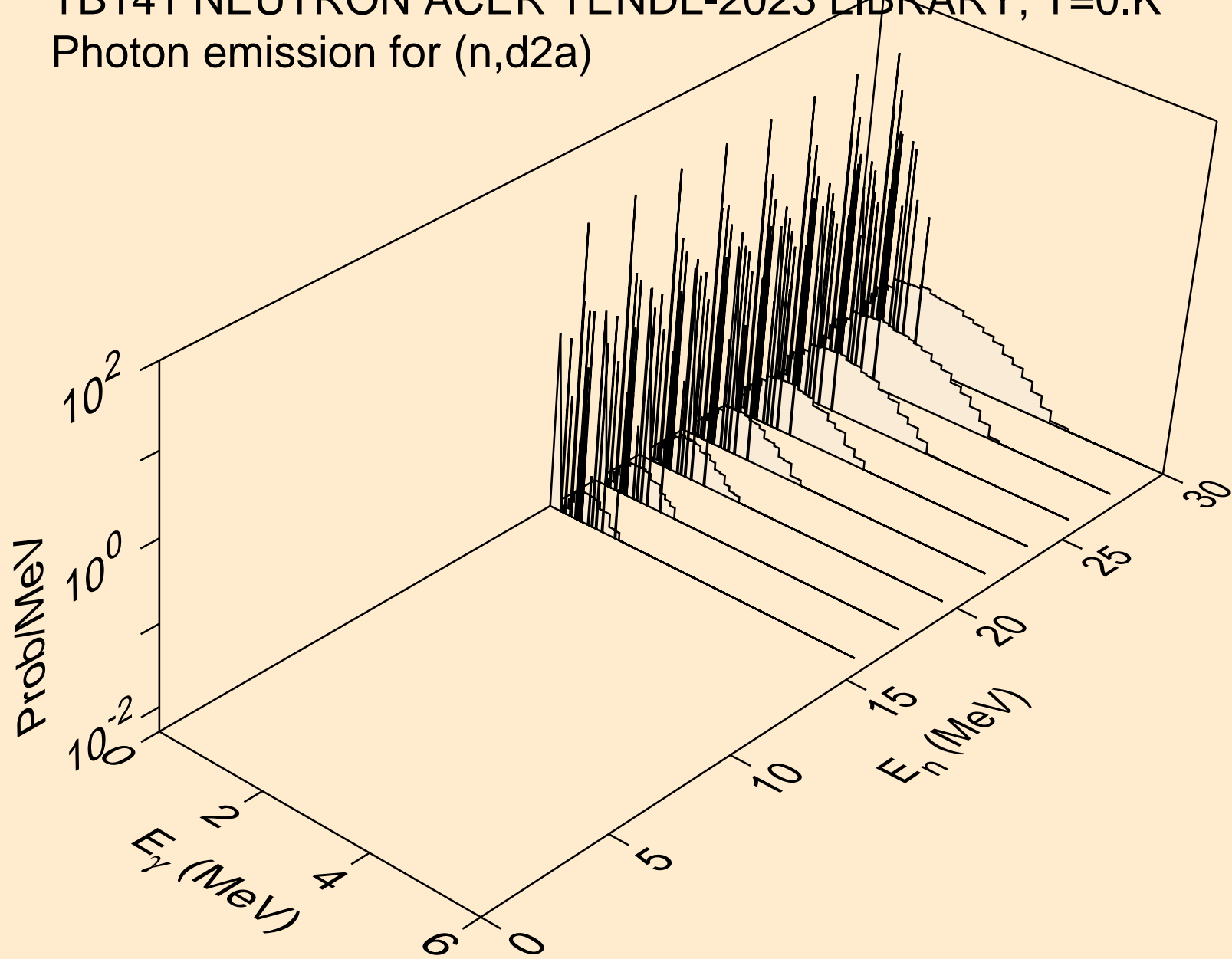

TB141 NEUTRON ACER TENDL-2023 LIBRARY; T=0.K  
Photon emission for (n,pd)

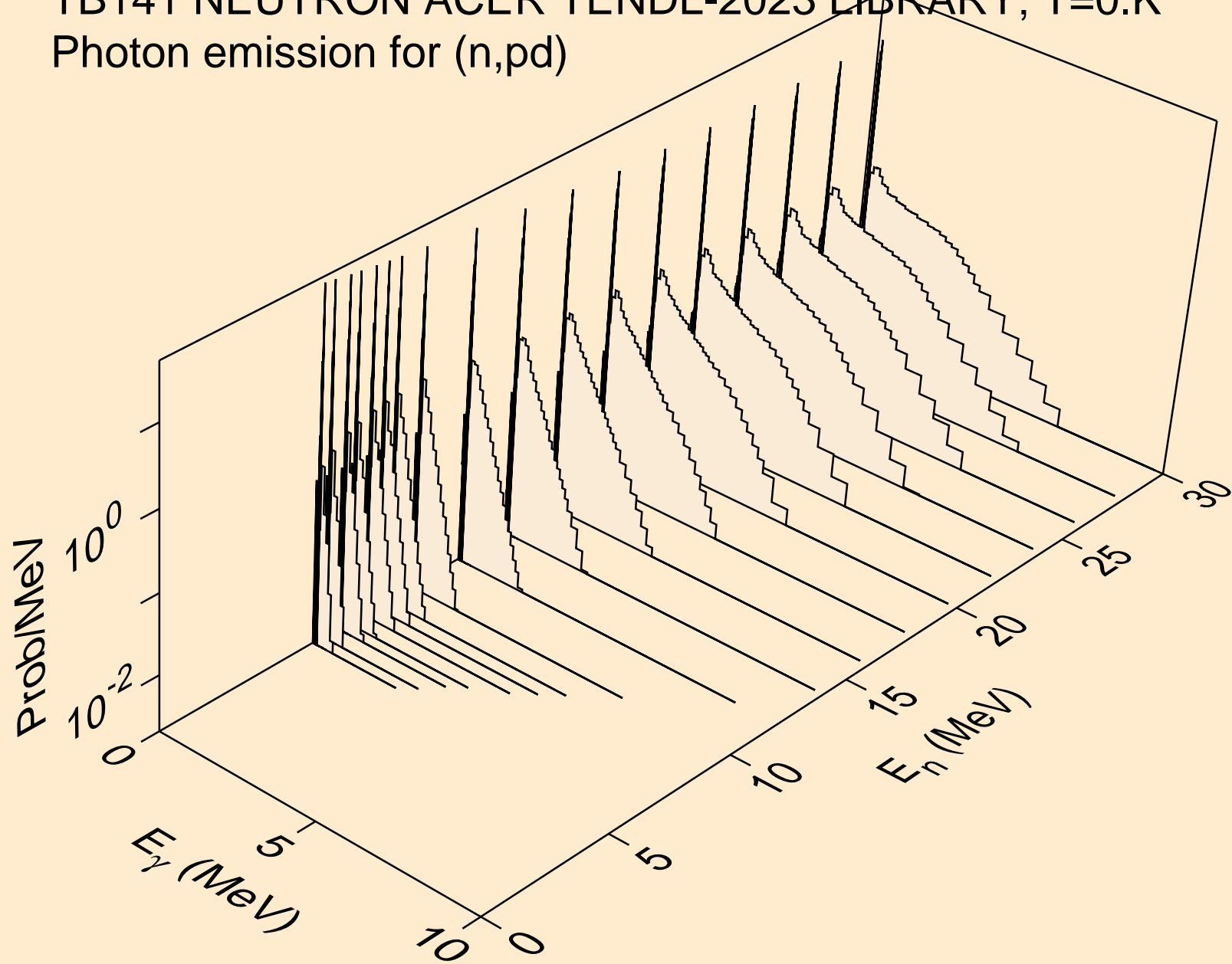



TB141 NEUTRON ACER TENDL-2023 LIBRARY; T=0.K  
Photon emission for (n,pt)

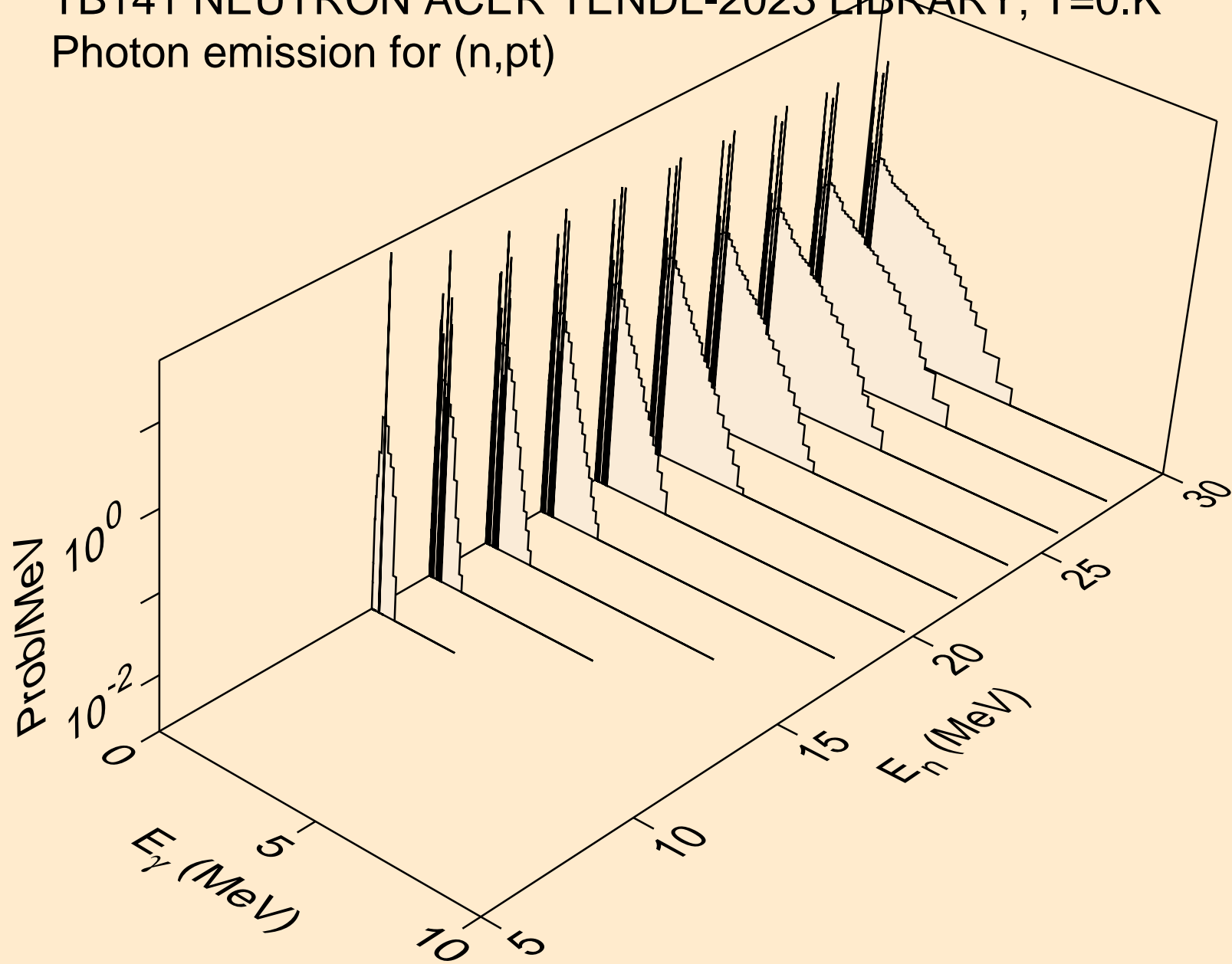

TB141 NEUTRON ACER TENDL-2023 LIBRARY; T=0.K  
Photon emission for (n,da)

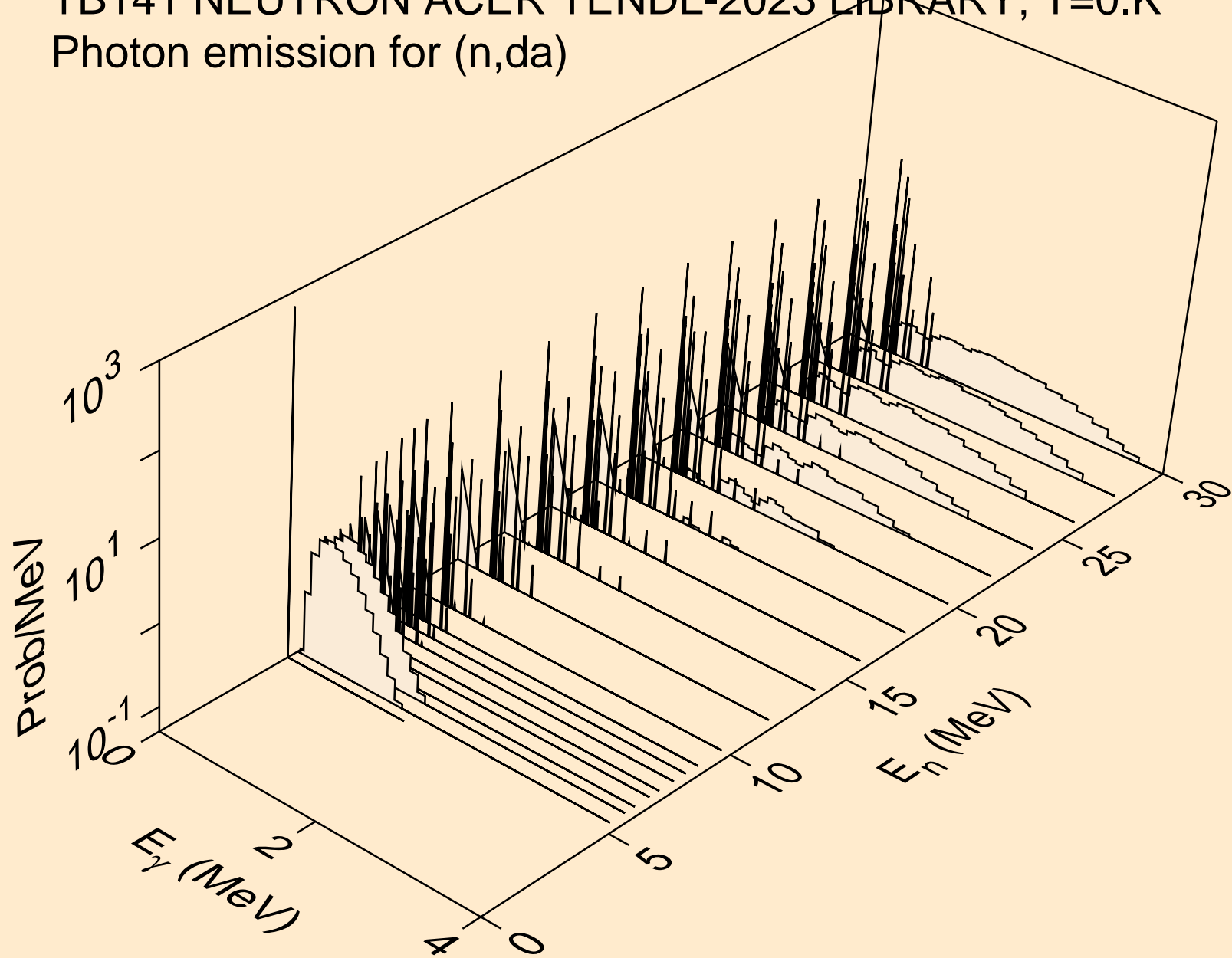

TB141 NEUTRON ACER TENDL-2023 LIBRARY; T=0.K  
thermal capture photon spectrum

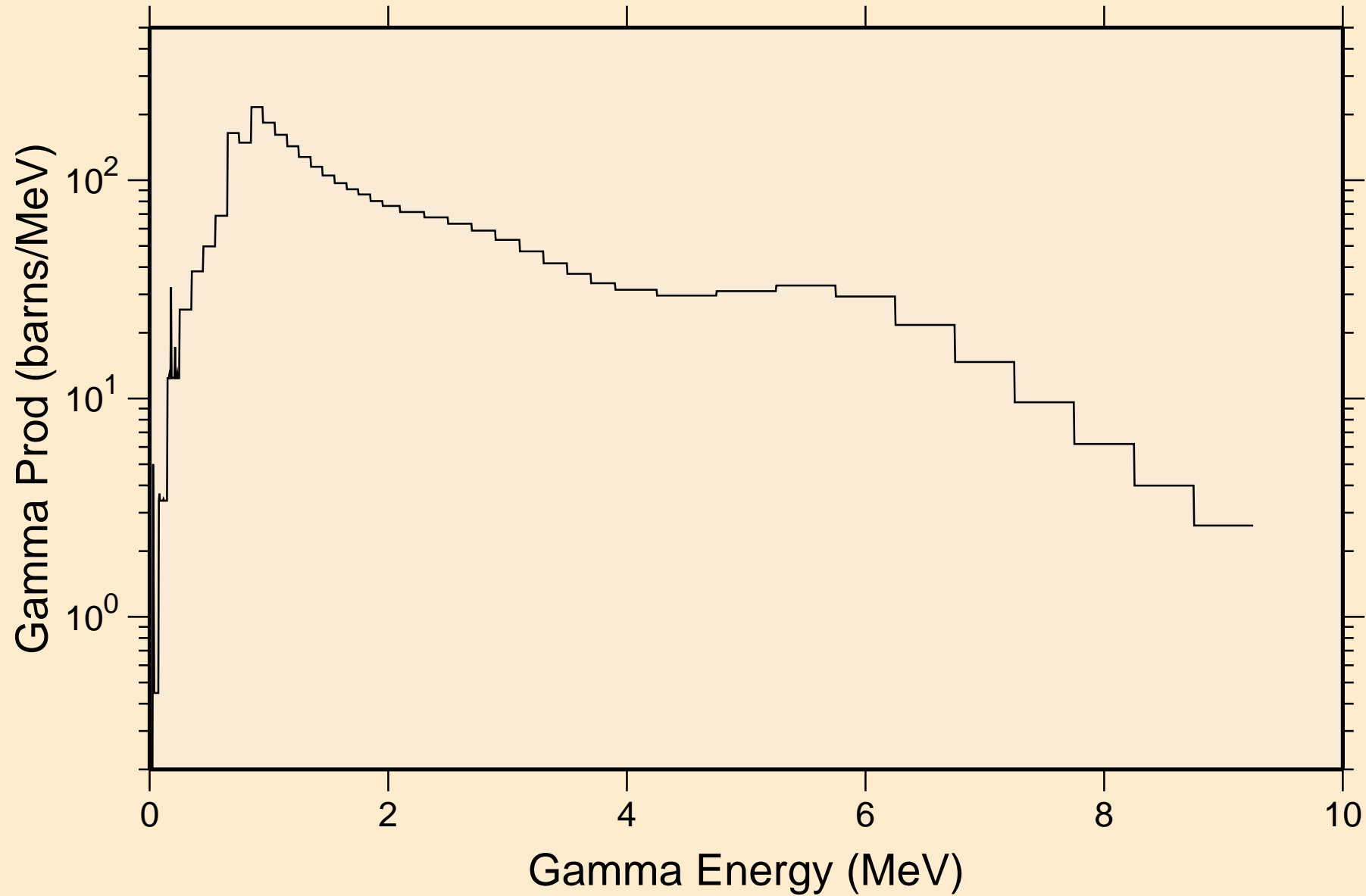

TB141 NEUTRON ACER TENDL-2023 LIBRARY; T=0.K  
14 MeV photon spectrum

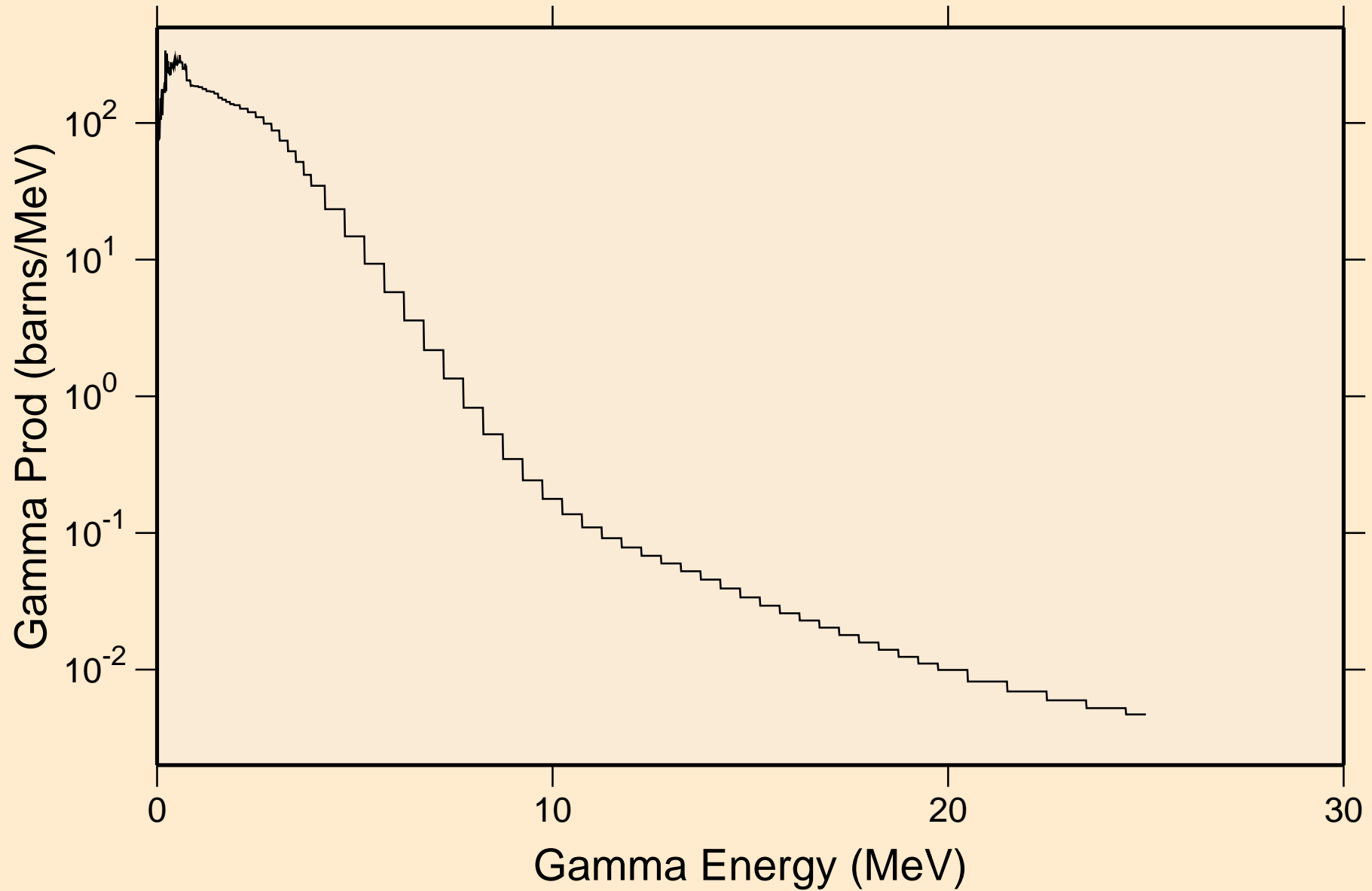

# TB141 NEUTRON ACER TENDL-2023 LIBRARY; T=0.K

## Particle heating contributions

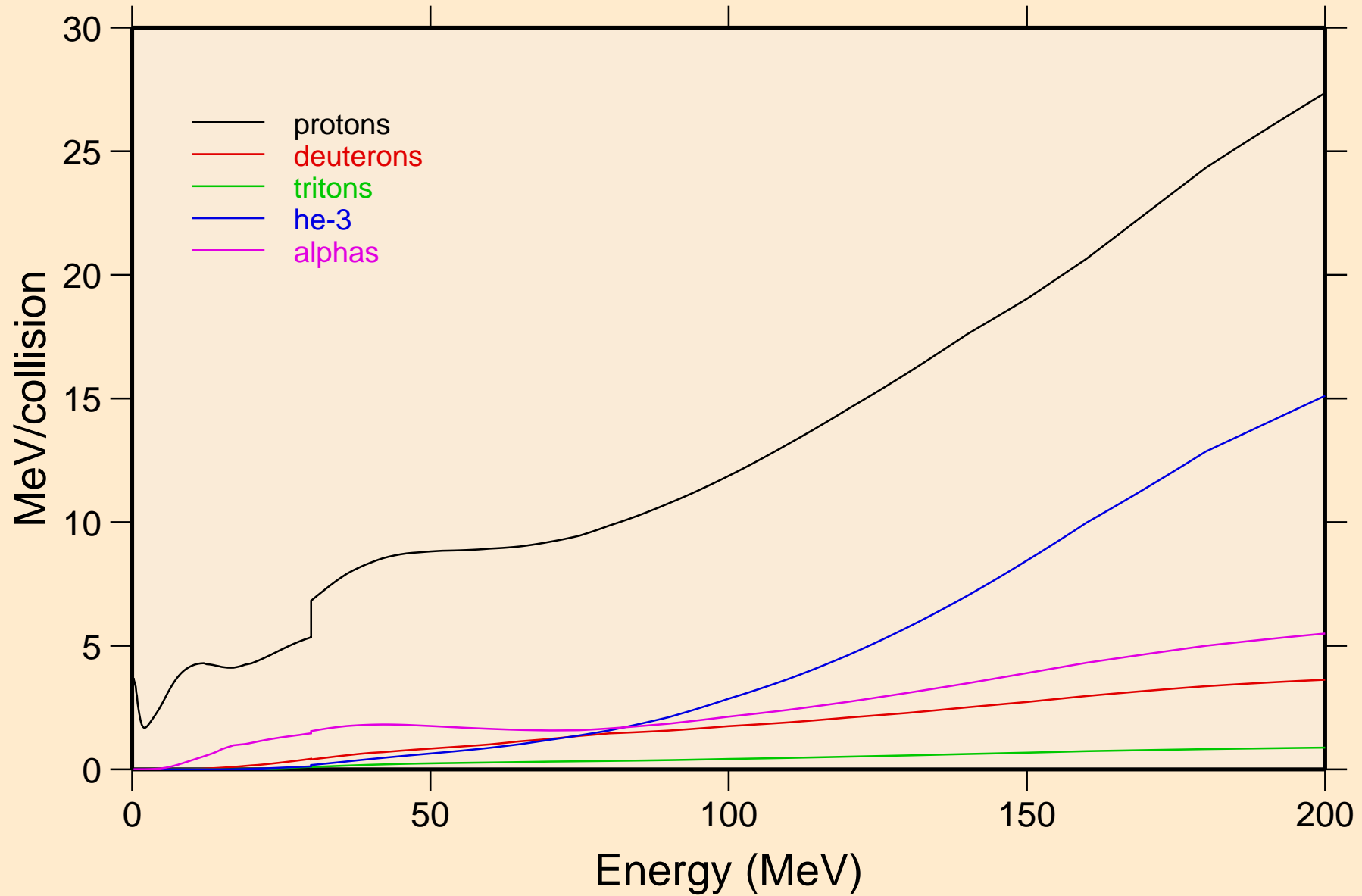

TB141 NEUTRON ACER TENDL-2023 LIBRARY; T=0.K  
Recoil Heating

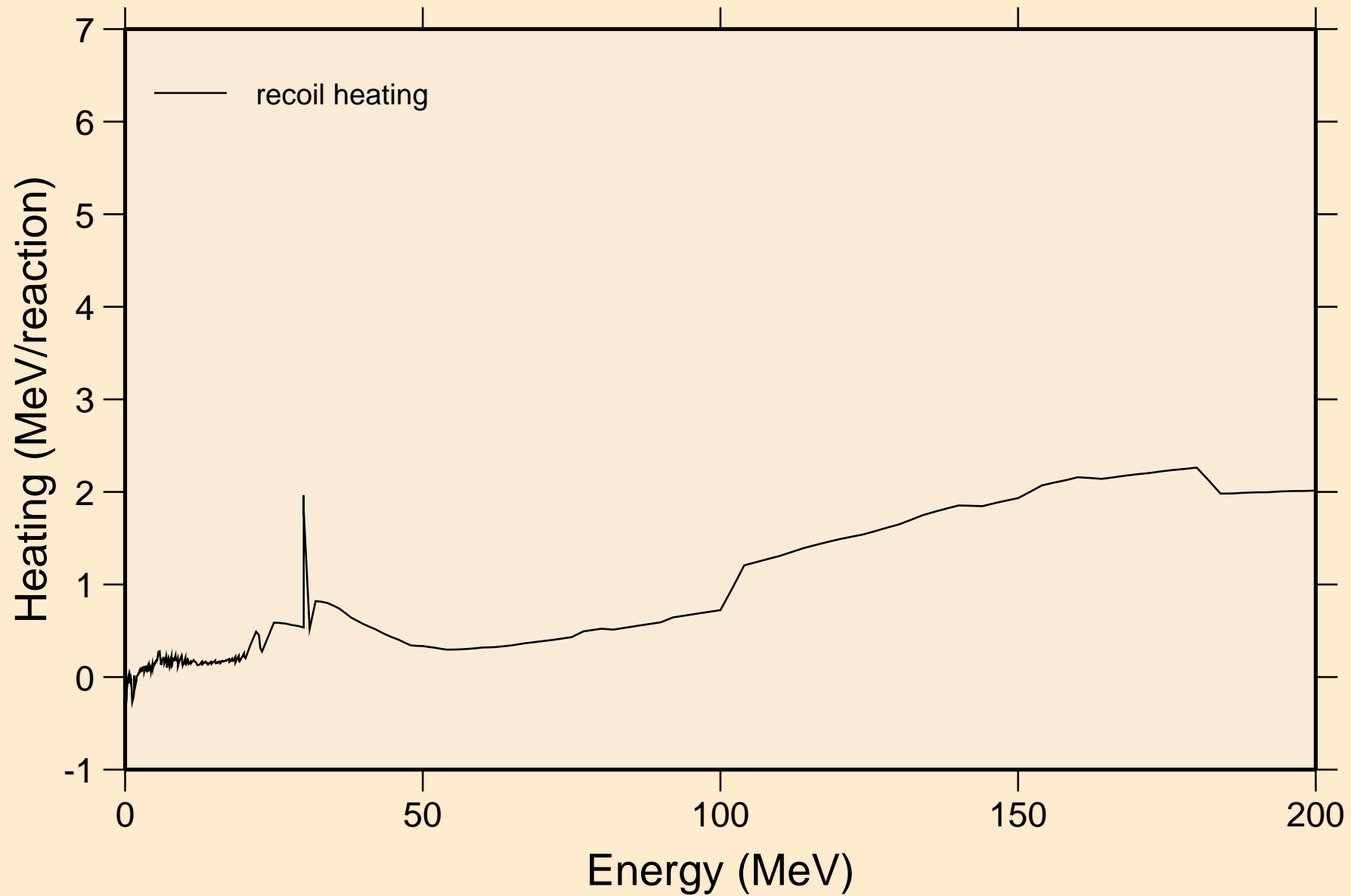

TB141 NEUTRON ACER TENDL-2023 LIBRARY; T=0.K  
Particle production cross sections

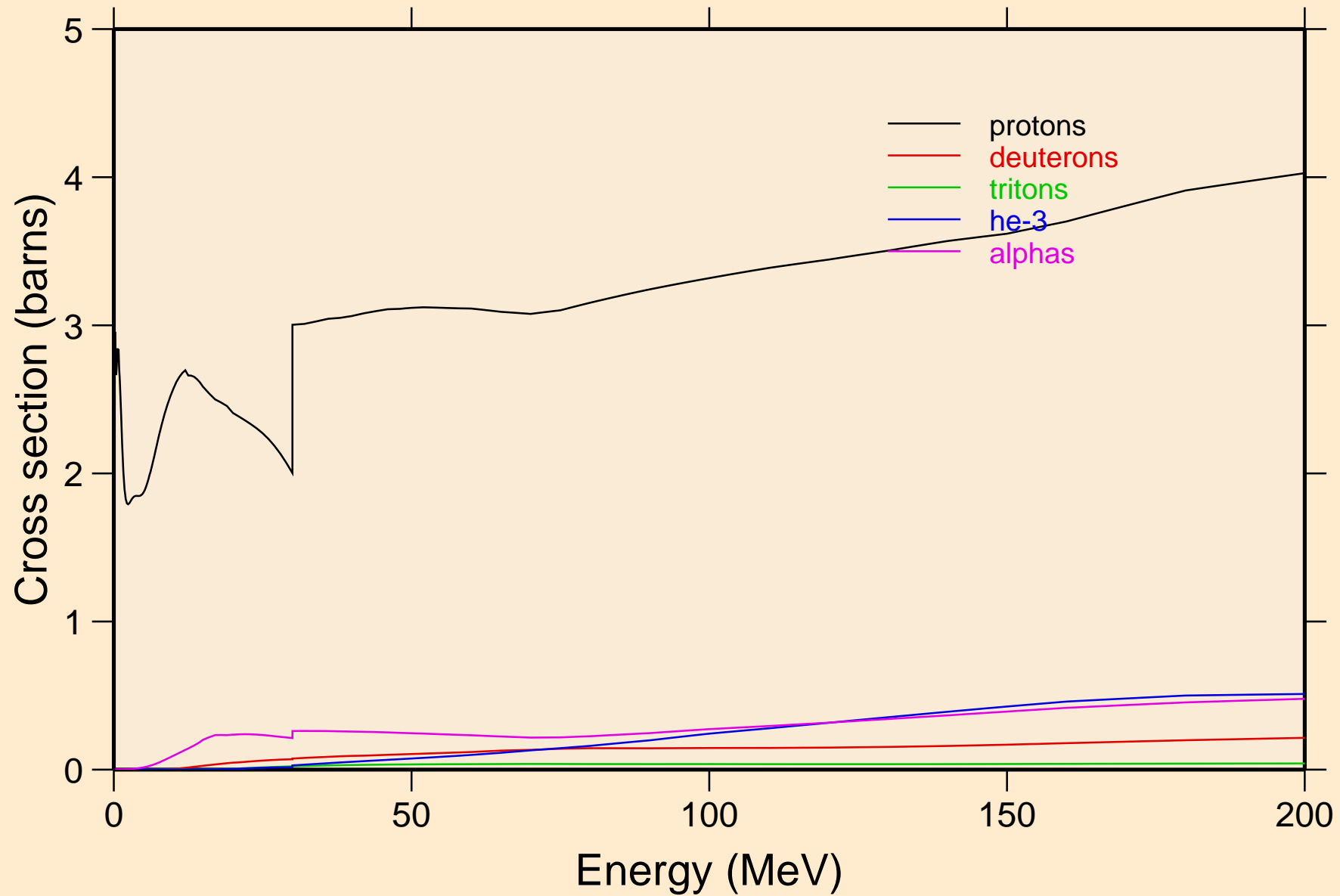

TB141 NEUTRON ACER TENDL-2023 LIBRARY; T=0.K  
protons from (n,x)

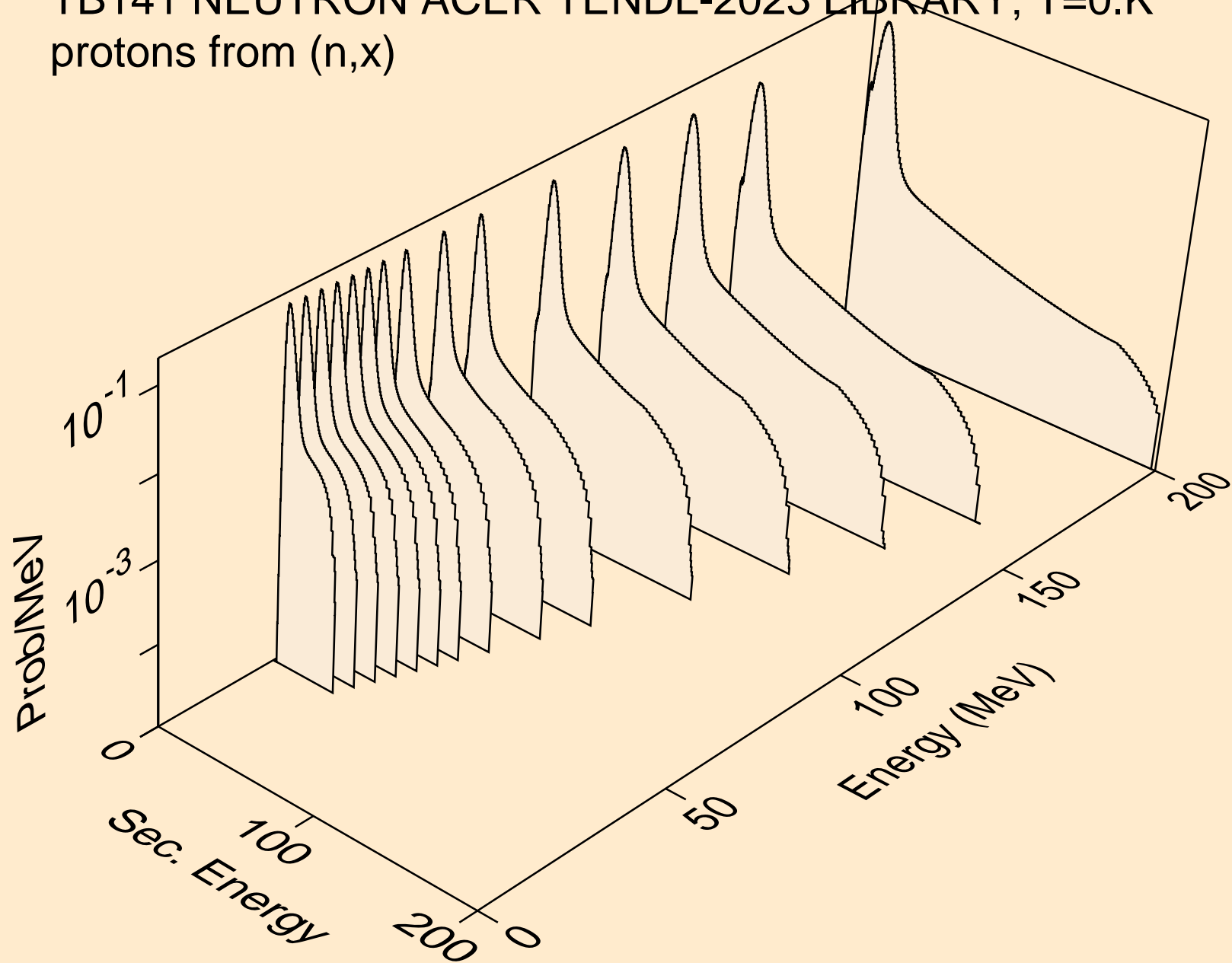



TB141 NEUTRON ACER TENDL-2023 LIBRARY; T=0.K  
protons from (n,n\*)p

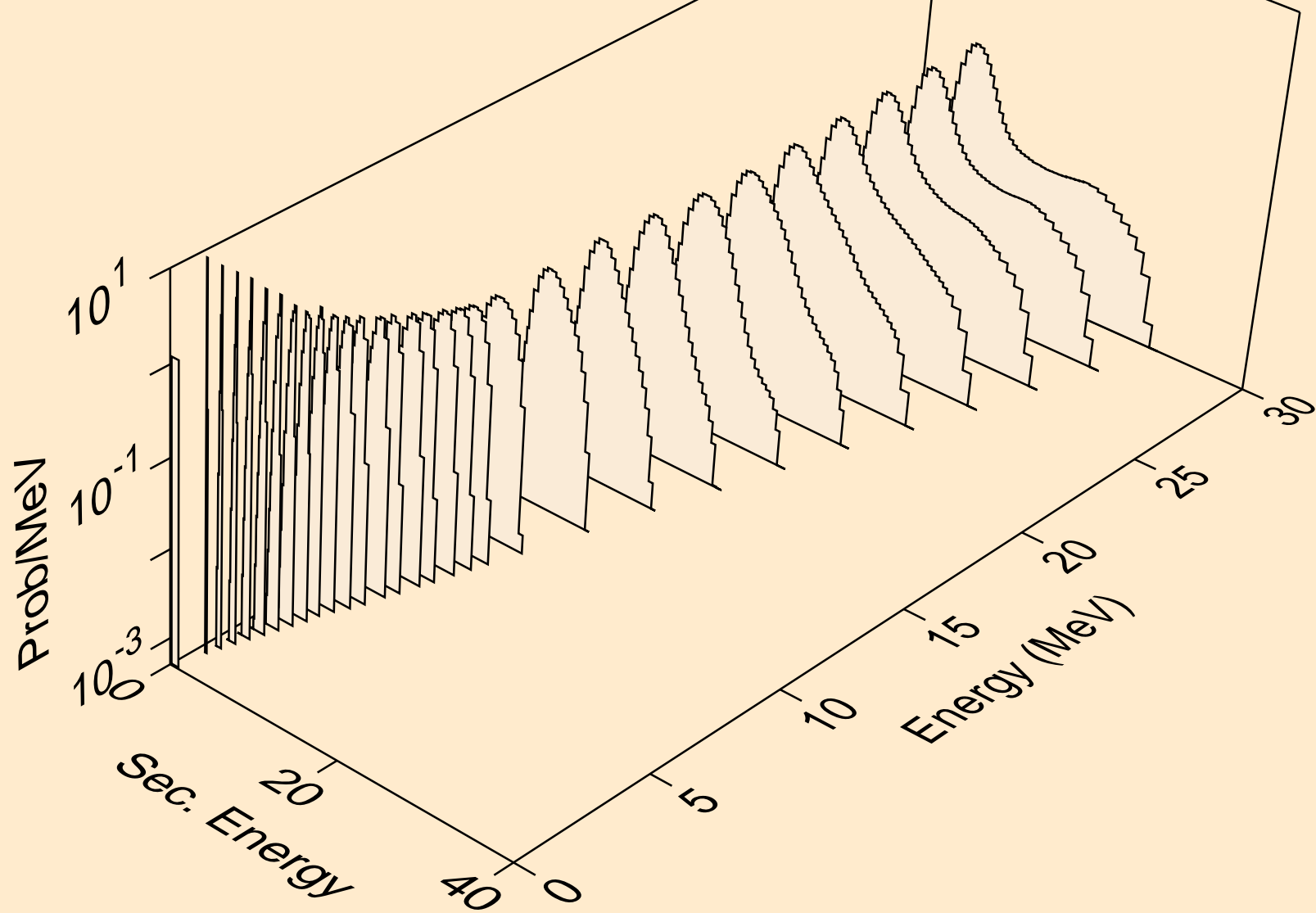

TB141 NEUTRON ACER TENDL-2023 LIBRARY; T=0.K  
protons from (n,2np)

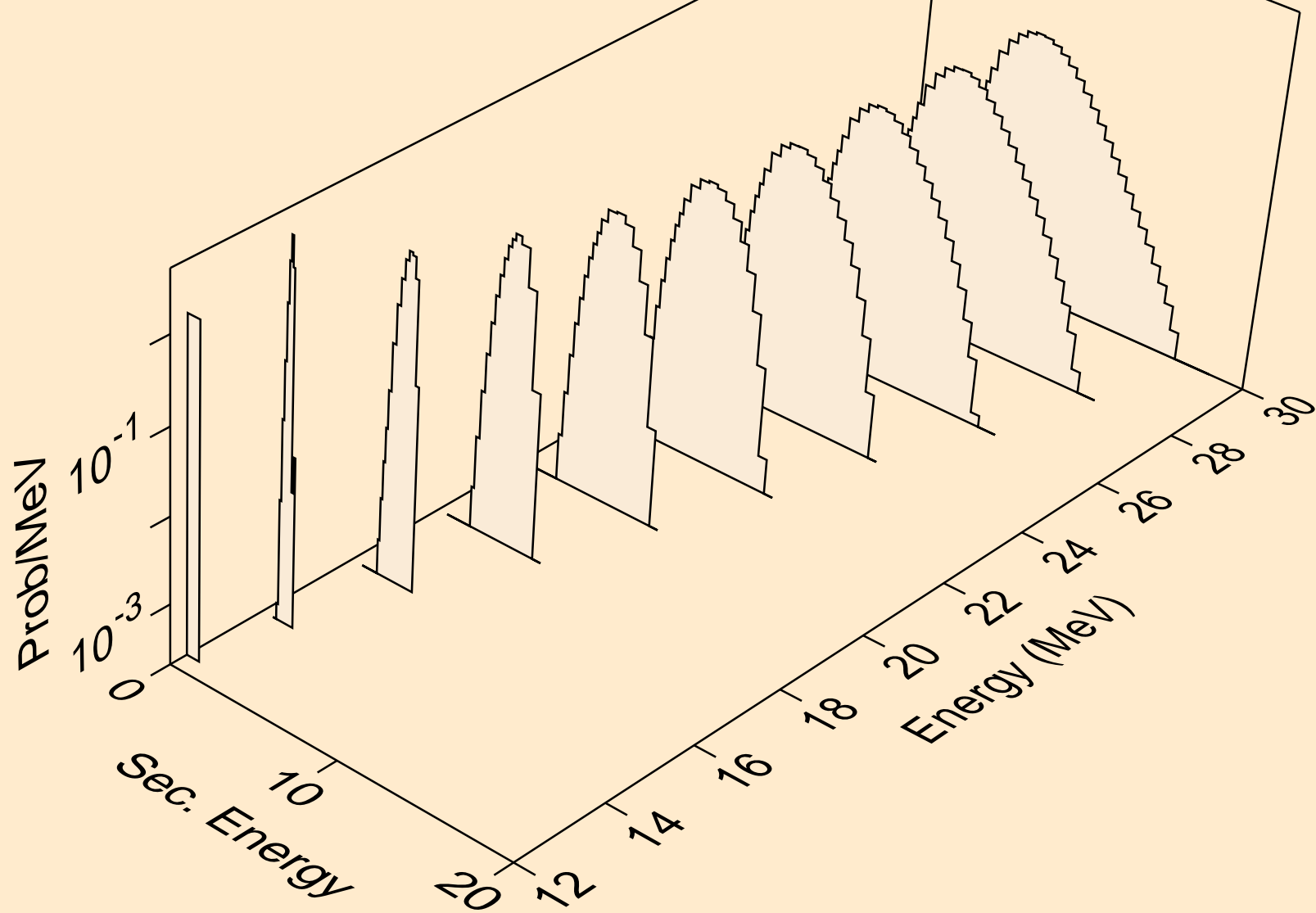

TB141 NEUTRON ACER TENDL-2023 LIBRARY; T=0.K  
protons from (n,3np)

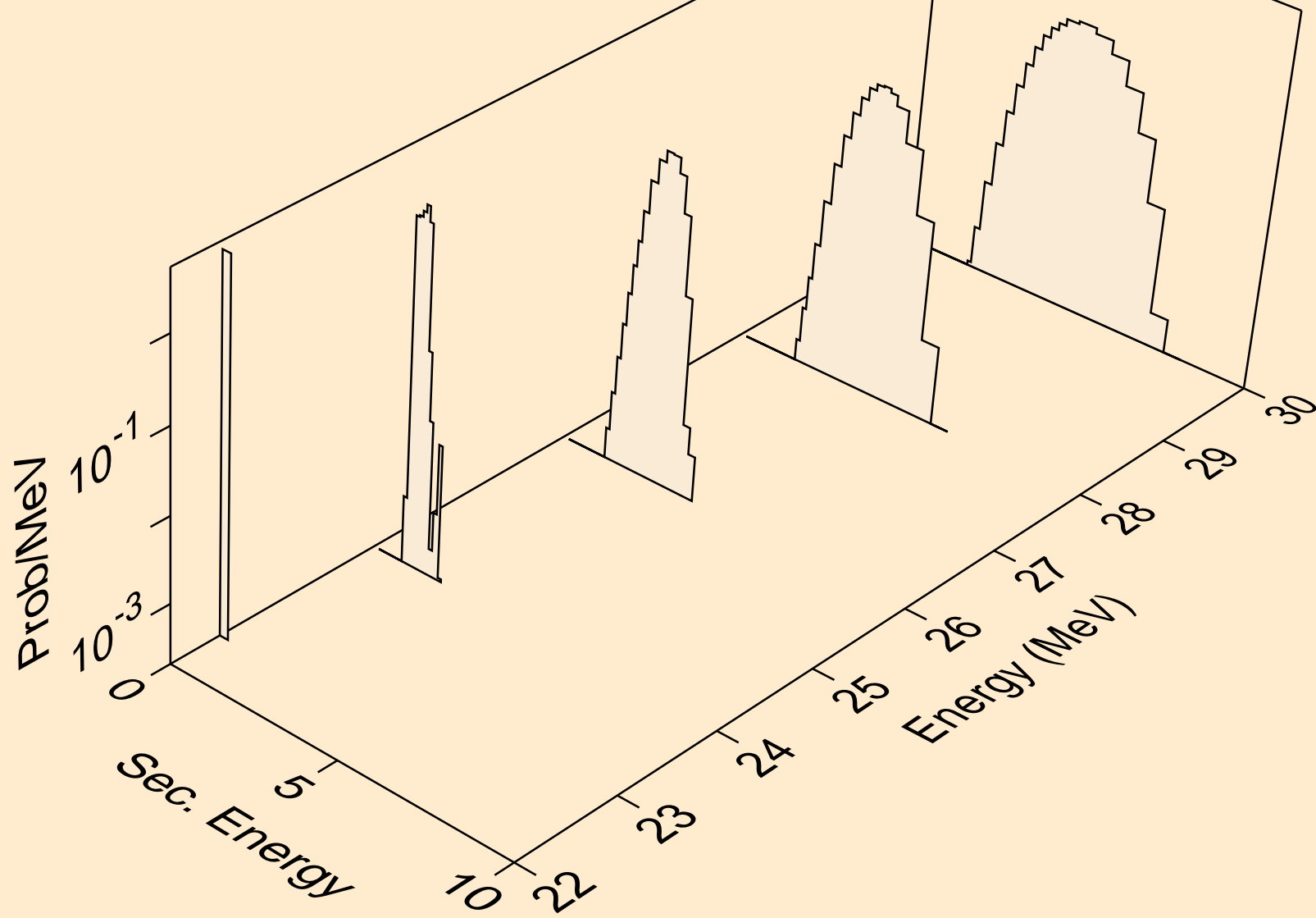

TB141 NEUTRON ACER TENDL-2023 LIBRARY; T=0.K  
protons from (n,n2p)

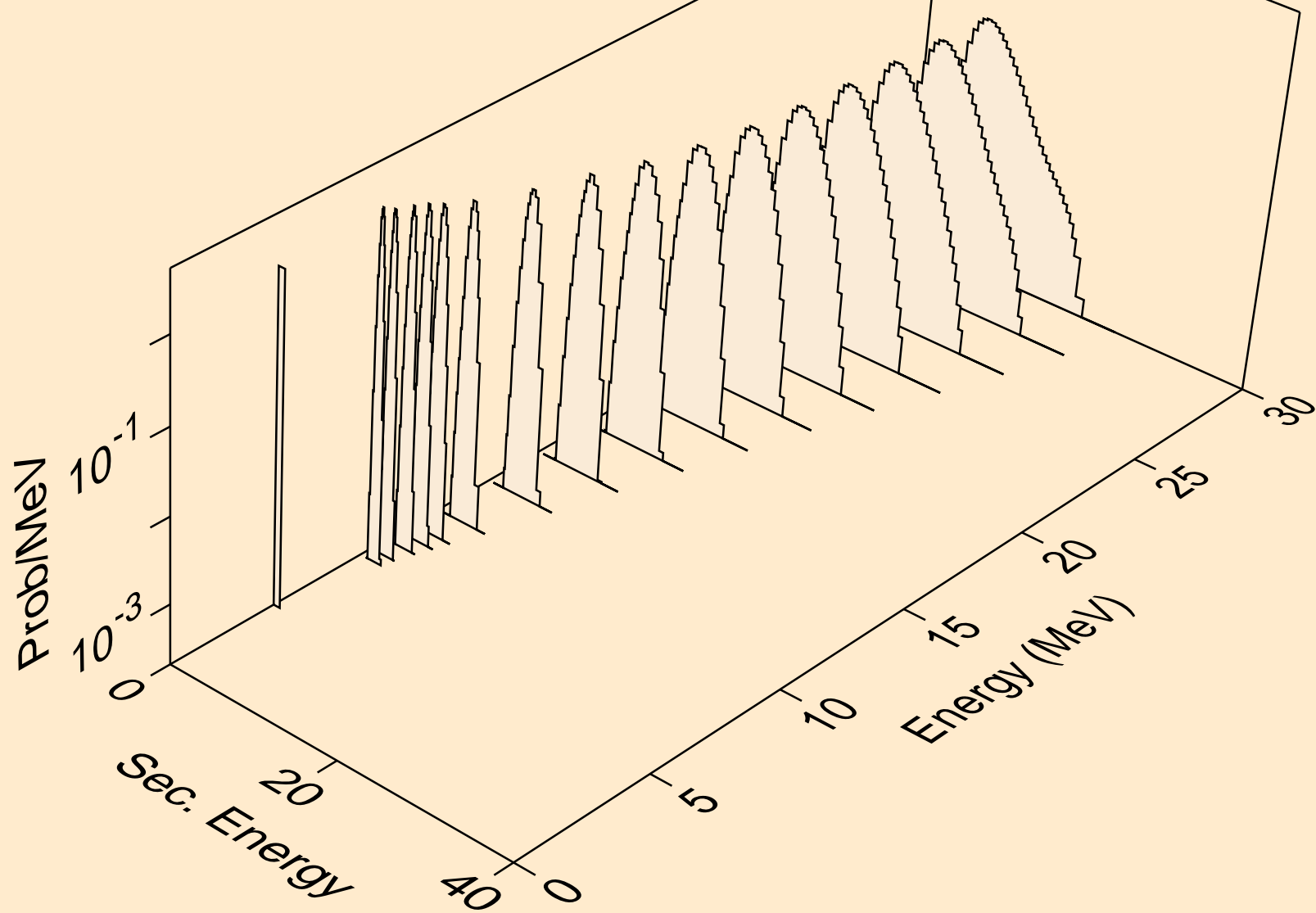

TB141 NEUTRON ACER TENDL-2023 LIBRARY; T=0.K  
protons from (n,npa)

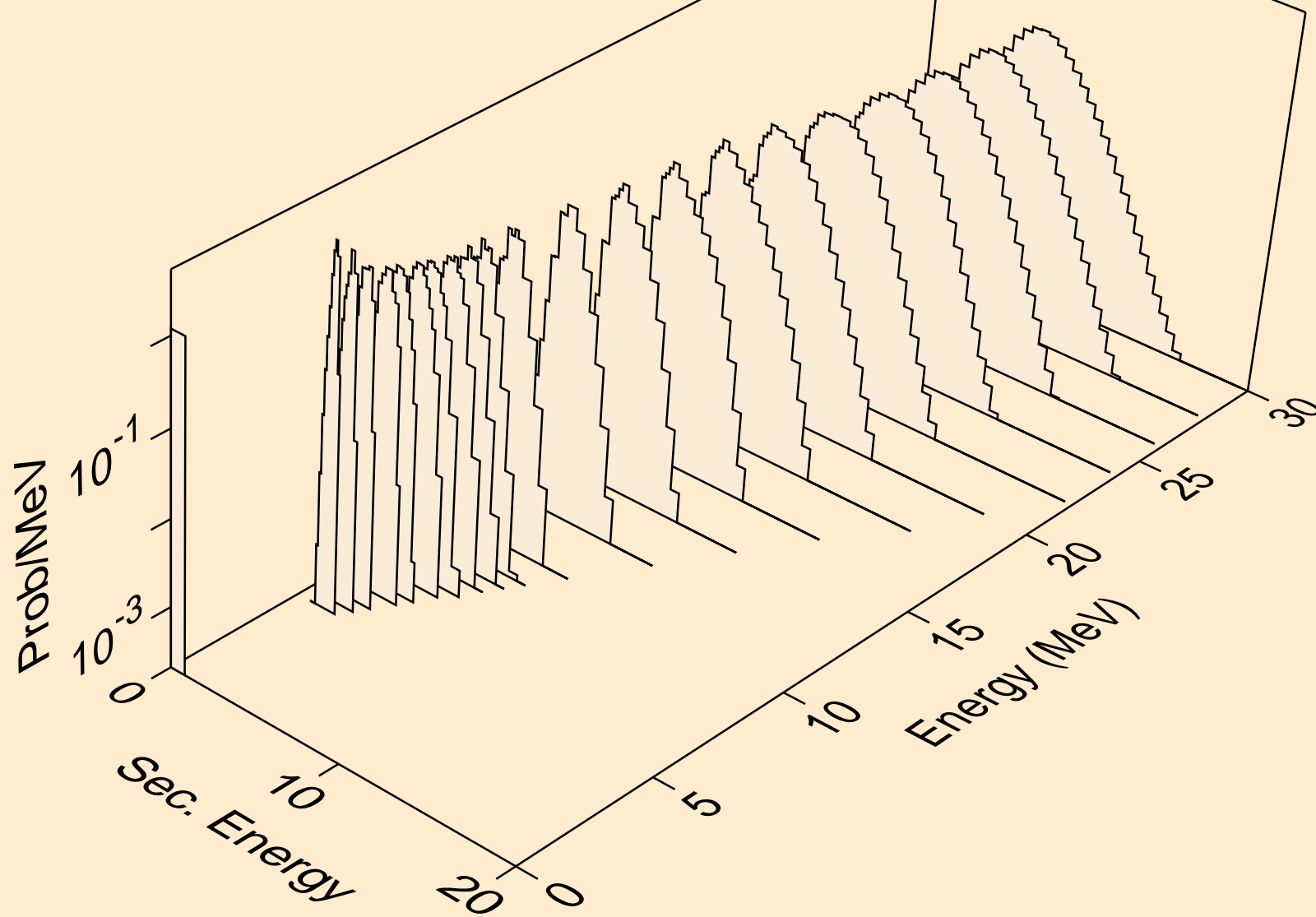

TB141 NEUTRON ACER TENDL-2023 LIBRARY; T=0.K  
protons from (n,p)

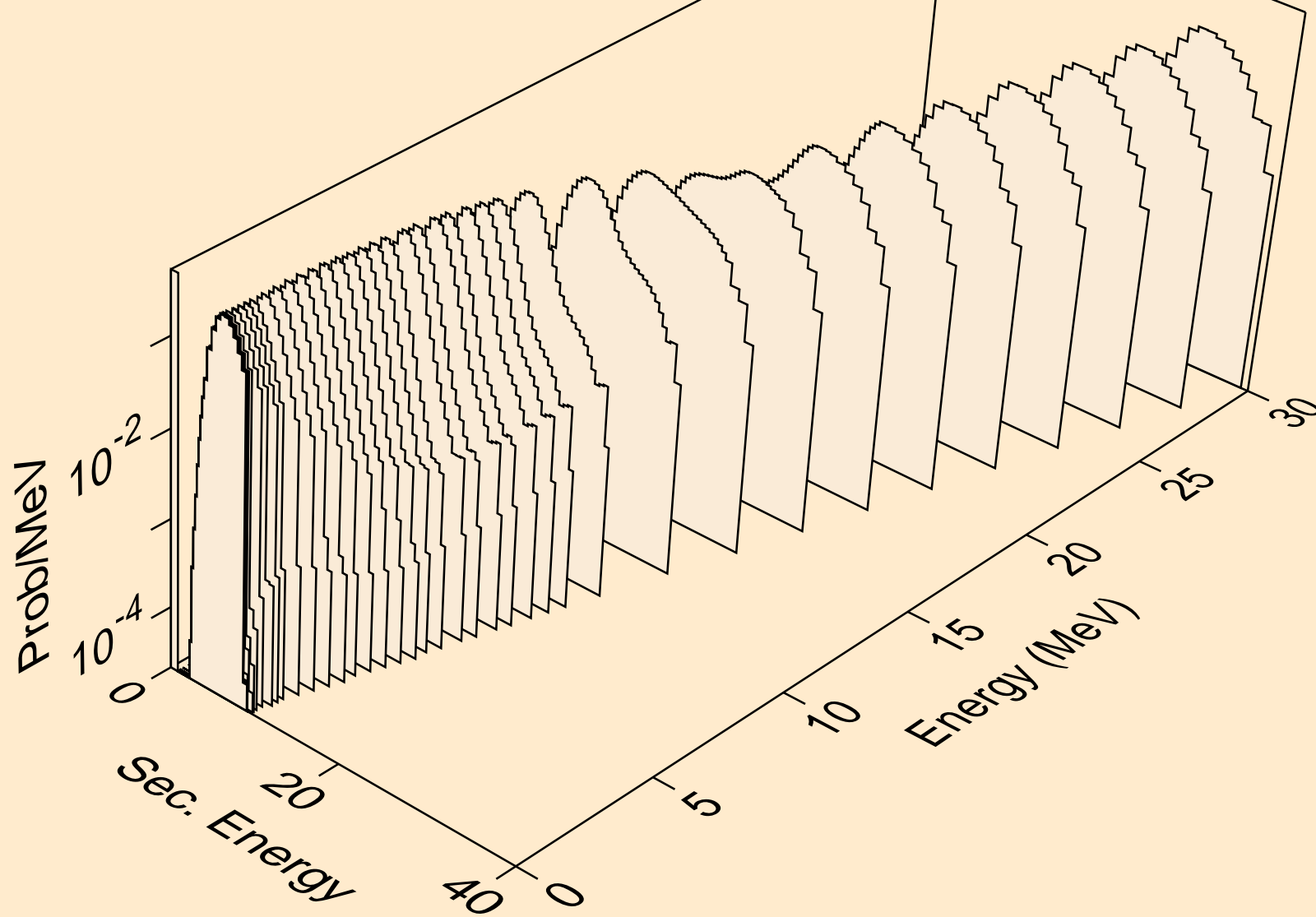

TB141 NEUTRON ACER TENDL-2023 LIBRARY; T=0.K  
protons from (n,2p)

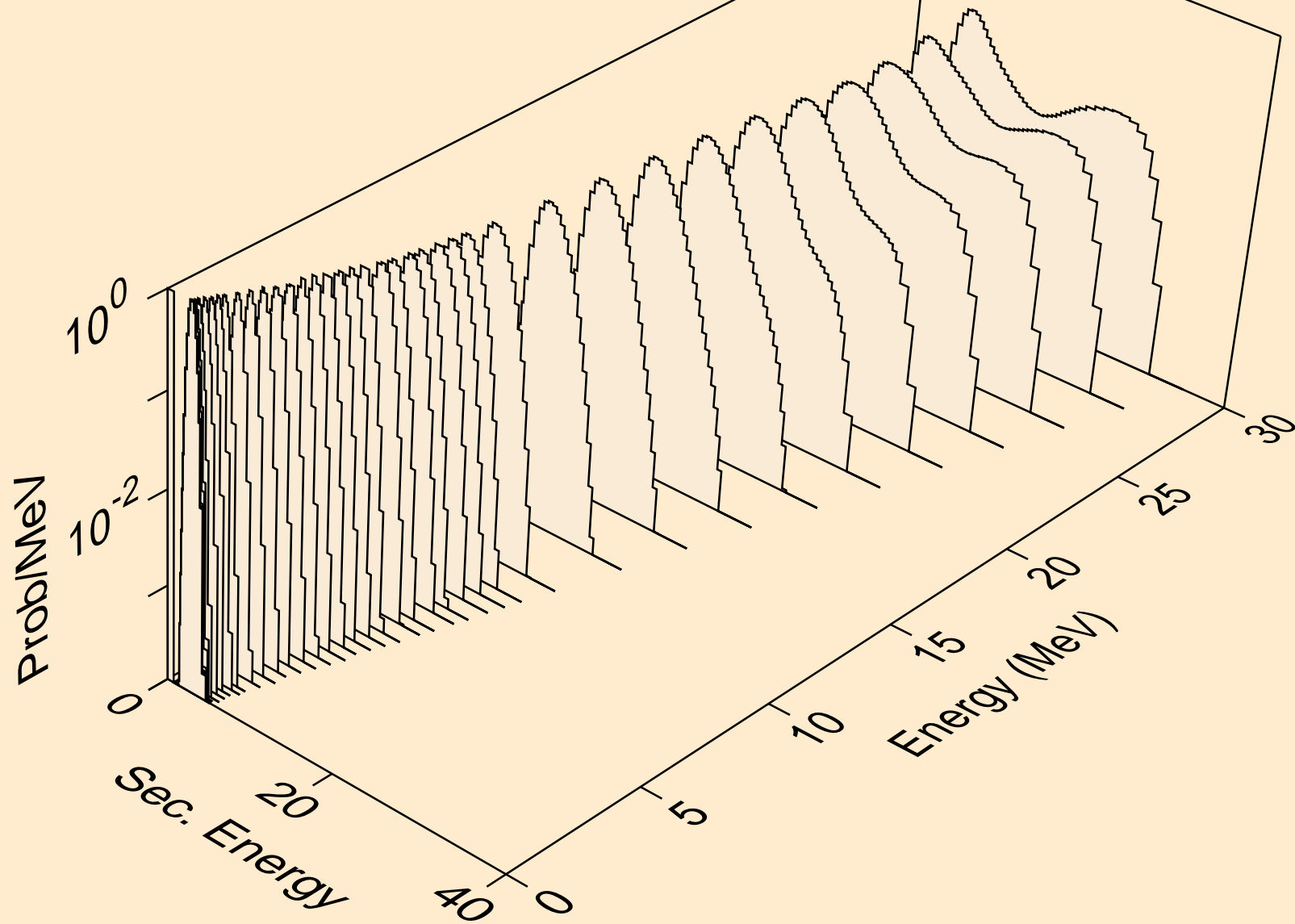

TB141 NEUTRON ACER TENDL-2023 LIBRARY; T=0.K  
protons from (n,p)

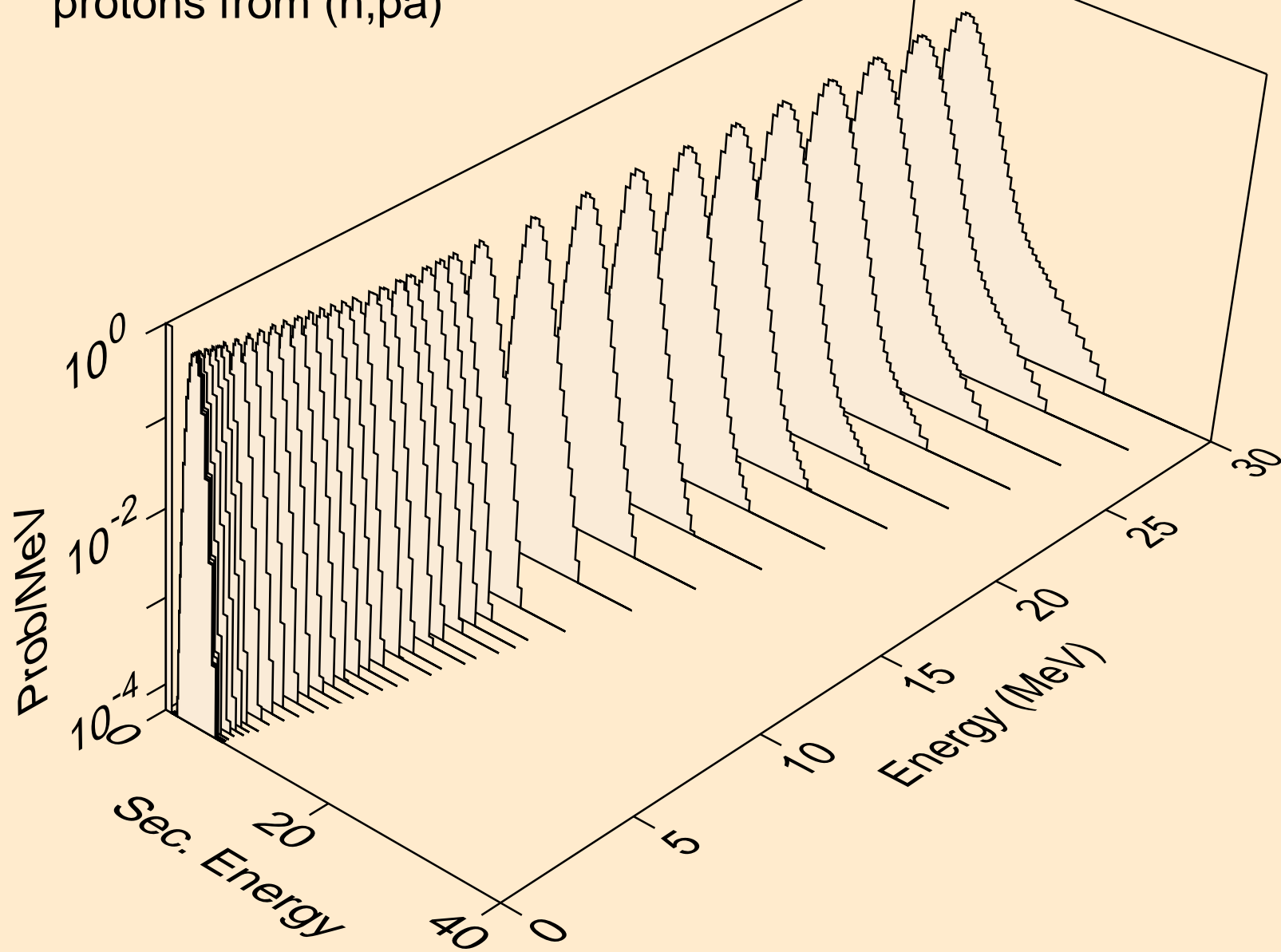



TB141 NEUTRON ACER TENDL-2023 LIBRARY; T=0.K  
protons from (n,pd)

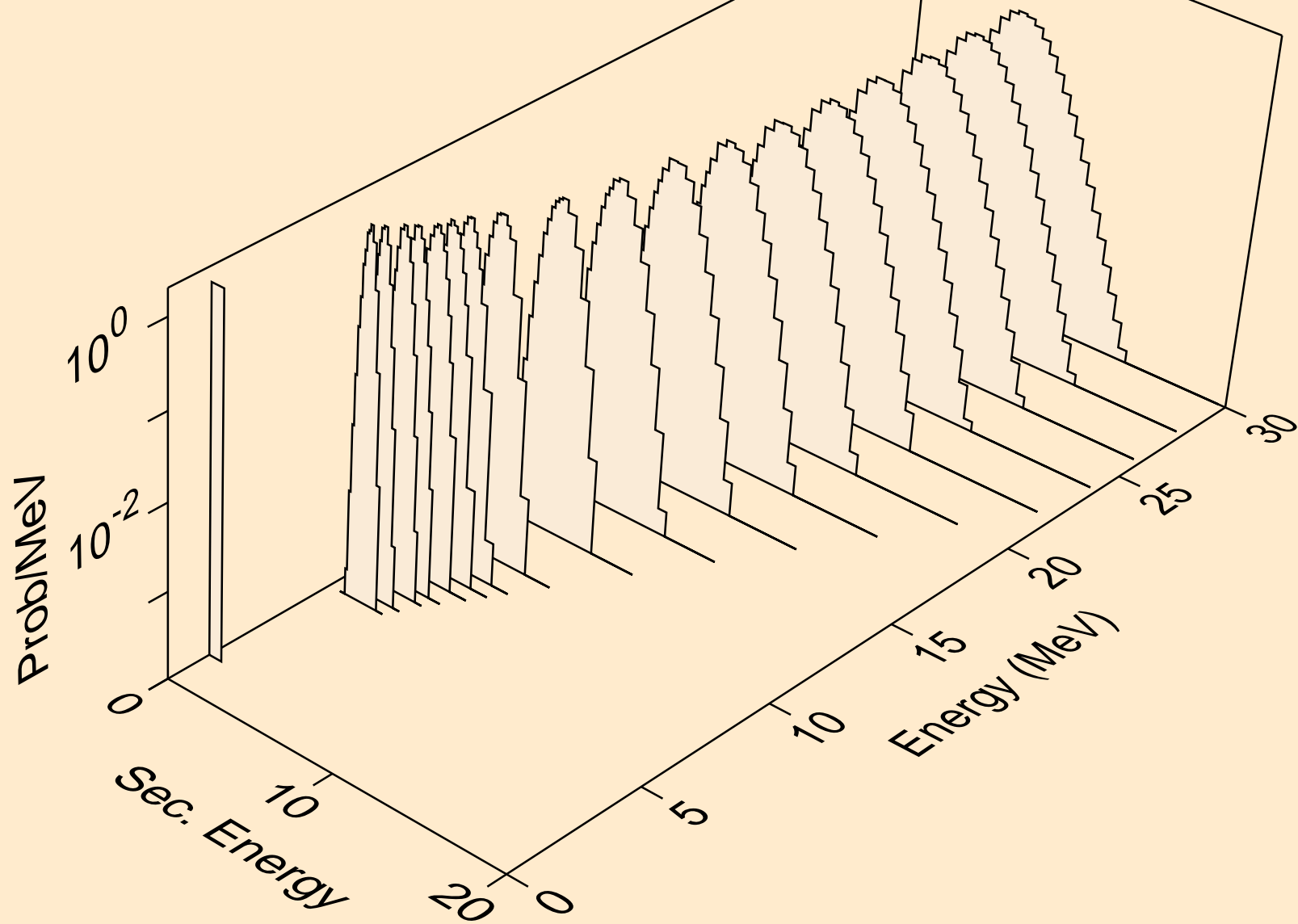

TB141 NEUTRON ACER TENDL-2023 LIBRARY; T=0.K  
protons from (n,pt)

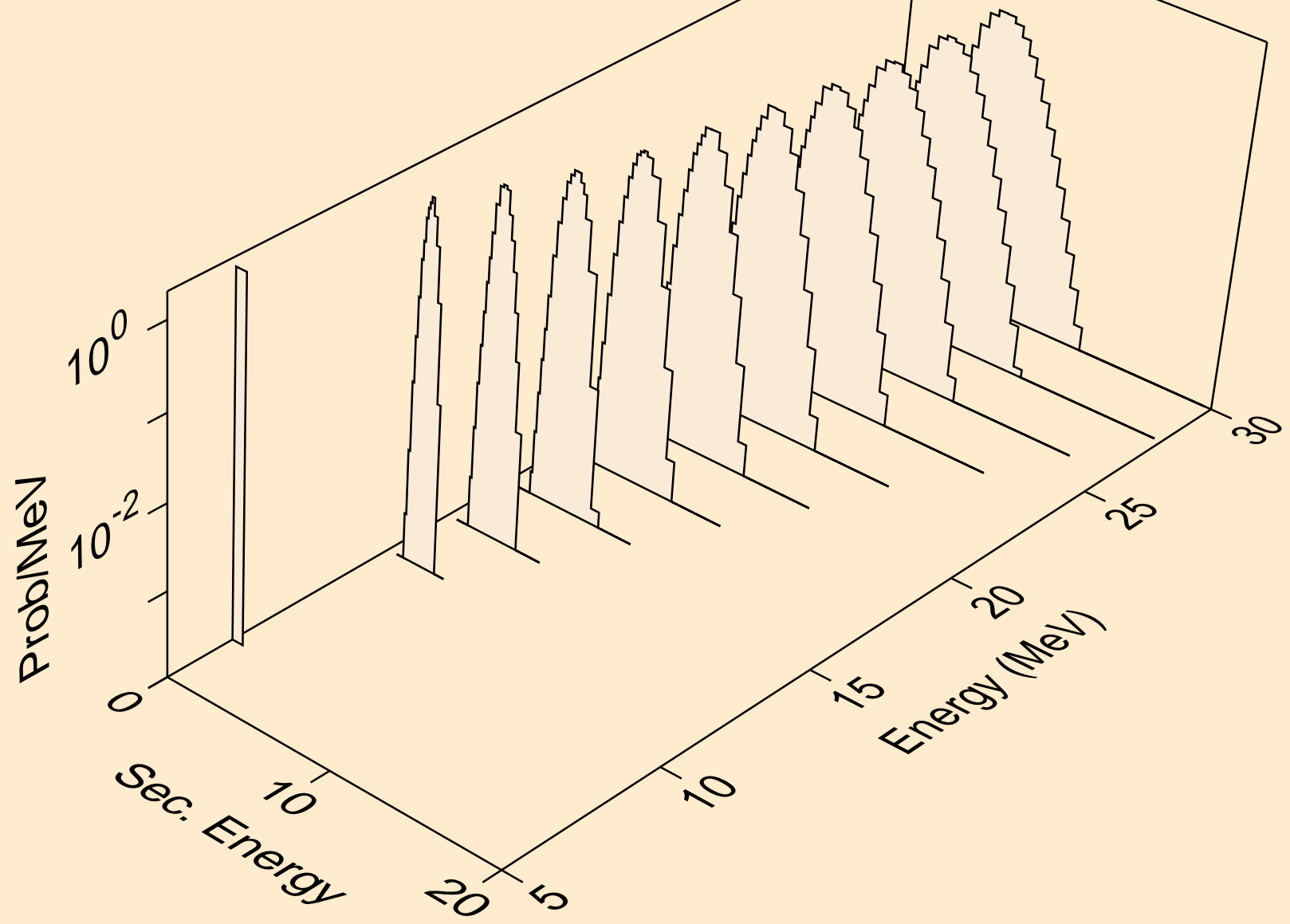

TB141 NEUTRON ACER TENDL-2023 LIBRARY; T=0.K  
deuterons from (n,x)

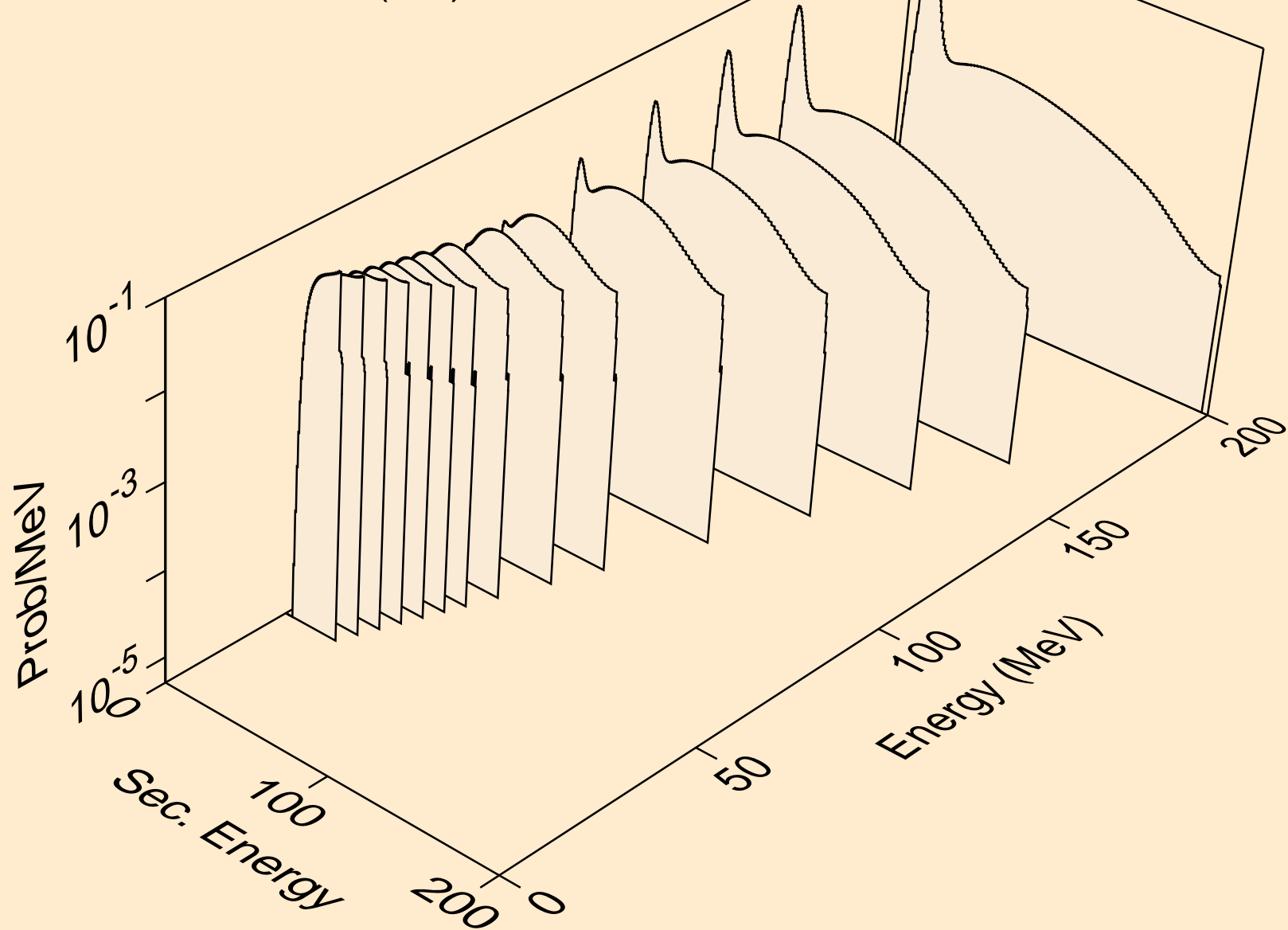

TB141 NEUTRON ACER TENDL-2023 LIBRARY; T=0.K  
deuterons from (n,2nd)

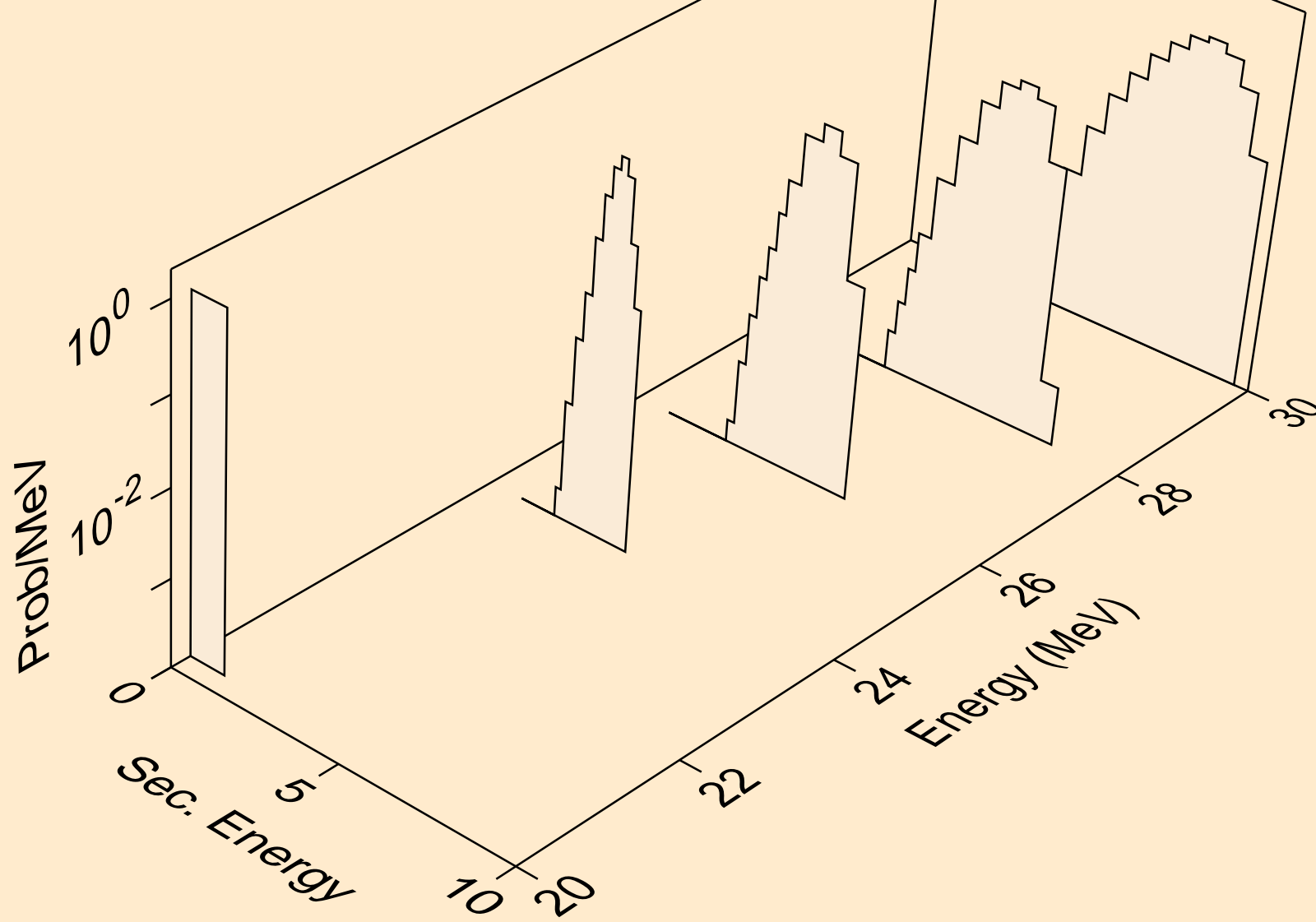

TB141 NEUTRON ACER TENDL-2023 LIBRARY; T=0.K  
deuterons from (n,n\*)d

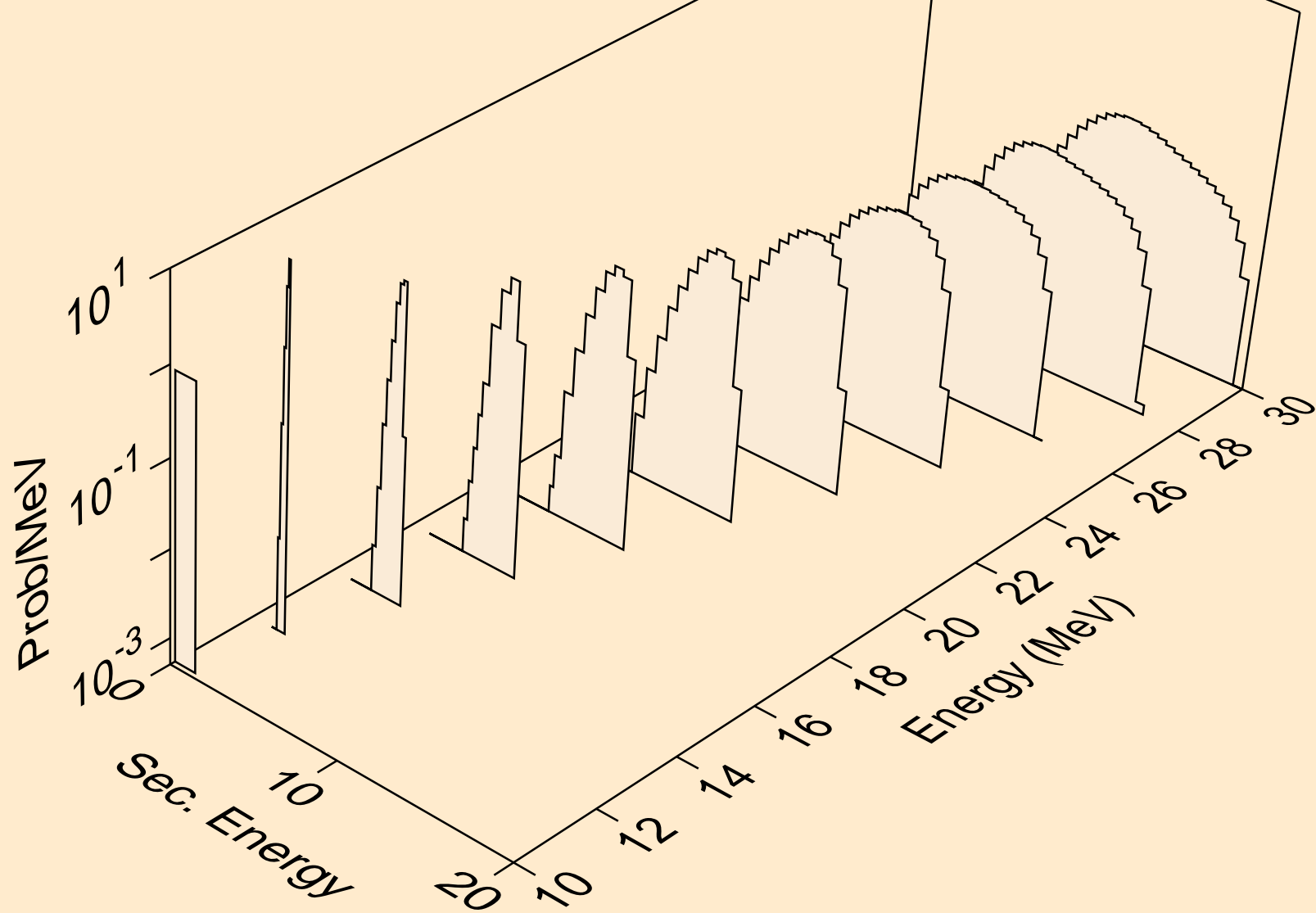

TB141 NEUTRON ACER TENDL-2023 LIBRARY; T=0.K  
deuterons from (n,d)

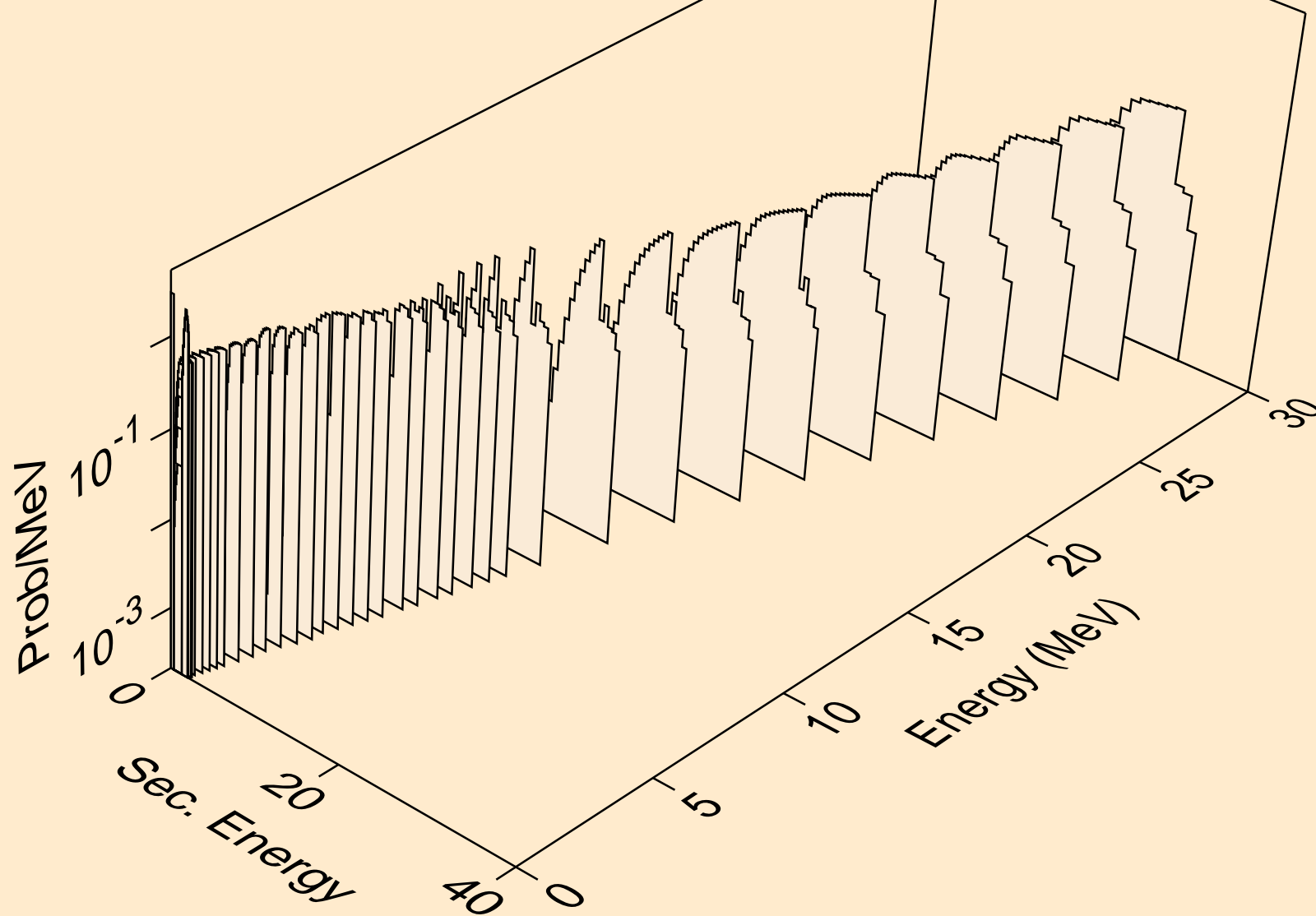

TB141 NEUTRON ACER TENDL-2023 LIBRARY; T=0.K  
deuterons from (n,d2a)

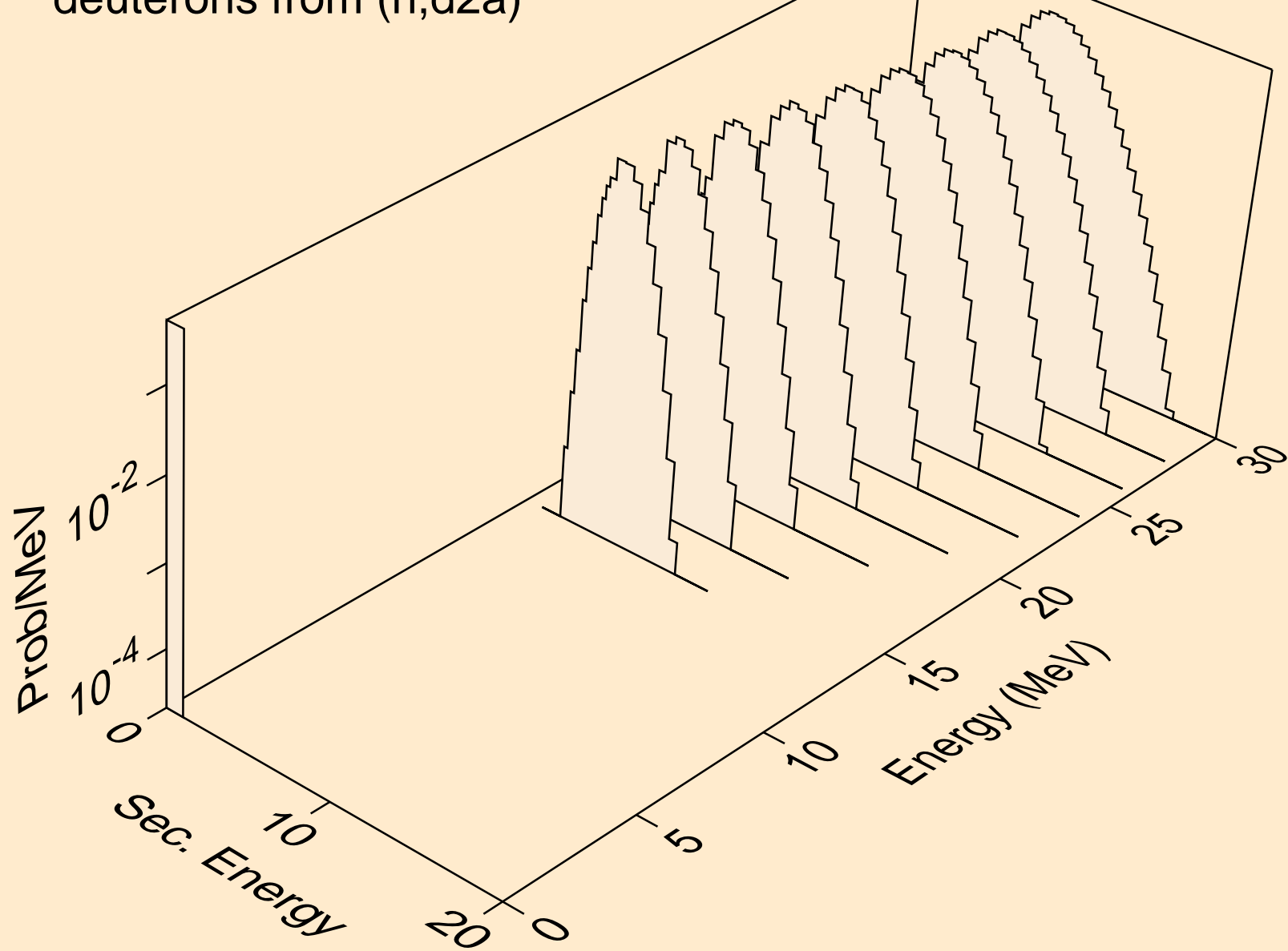

TB141 NEUTRON ACER TENDL-2023 LIBRARY; T=0.K  
deuterons from (n,pd)

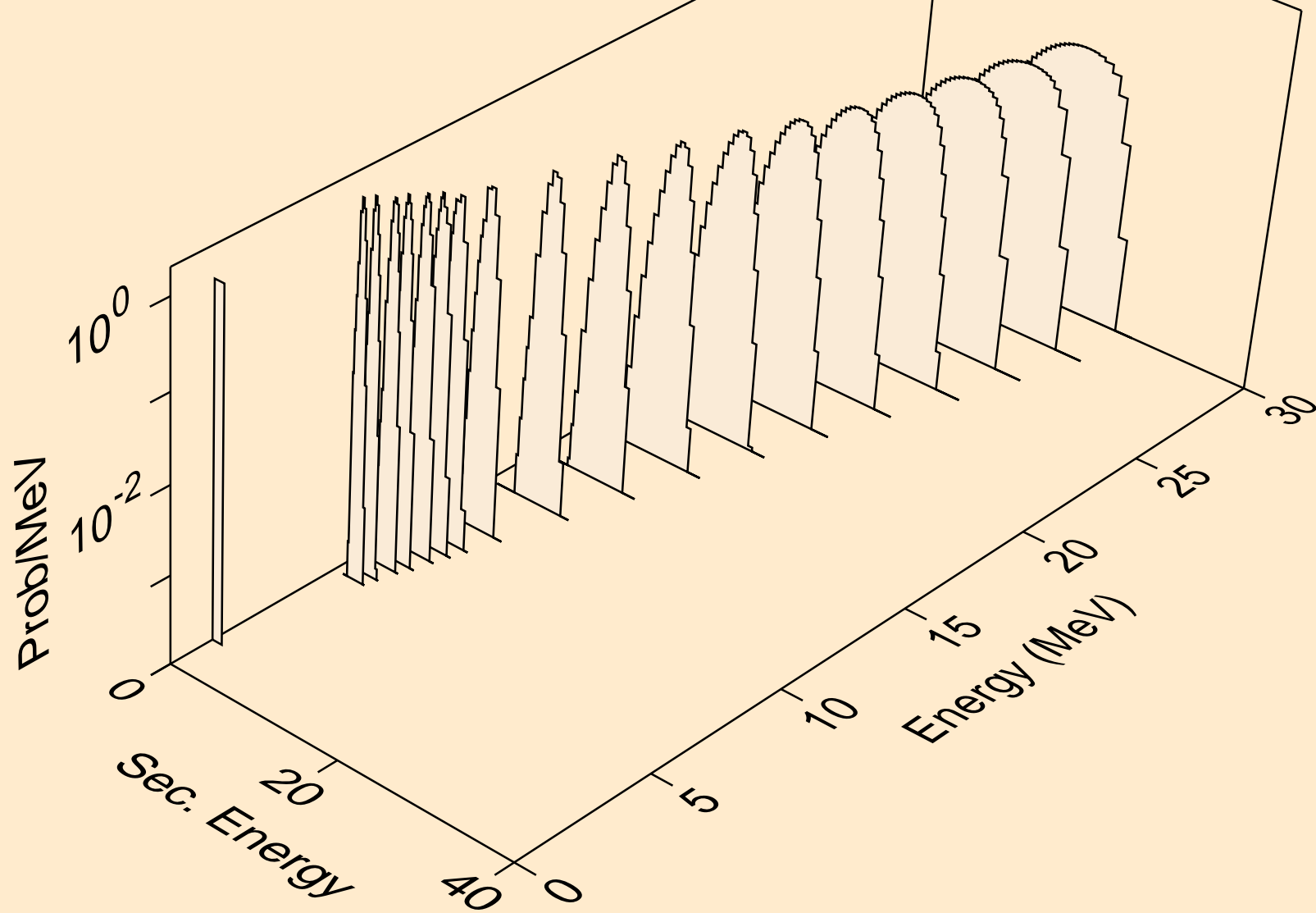



TB141 NEUTRON ACER TENDL-2023 LIBRARY; T=0.K  
deuterons from (n,da)

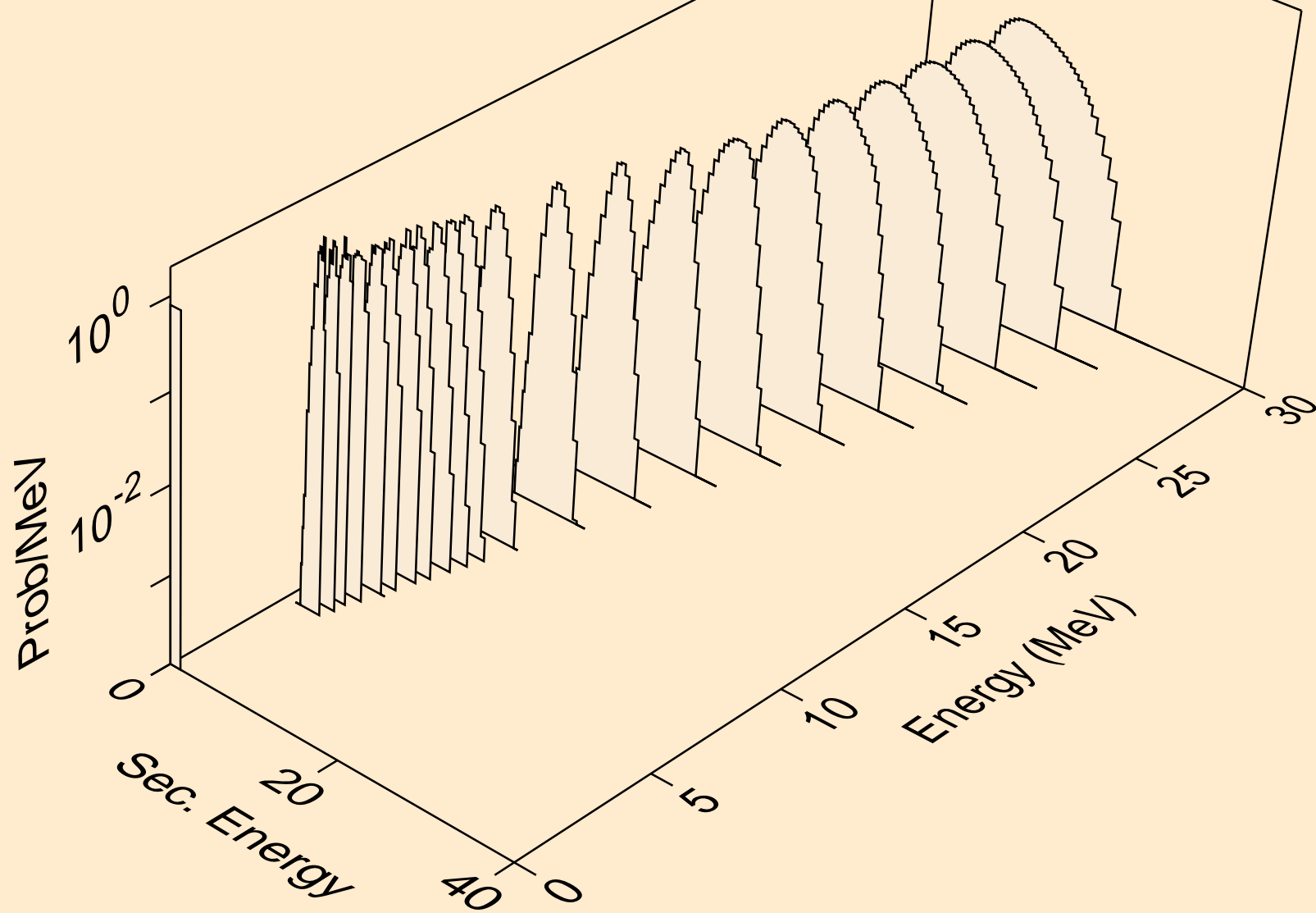

TB141 NEUTRON ACER TENDL-2023 LIBRARY; T=0.K  
tritons from (n,x)

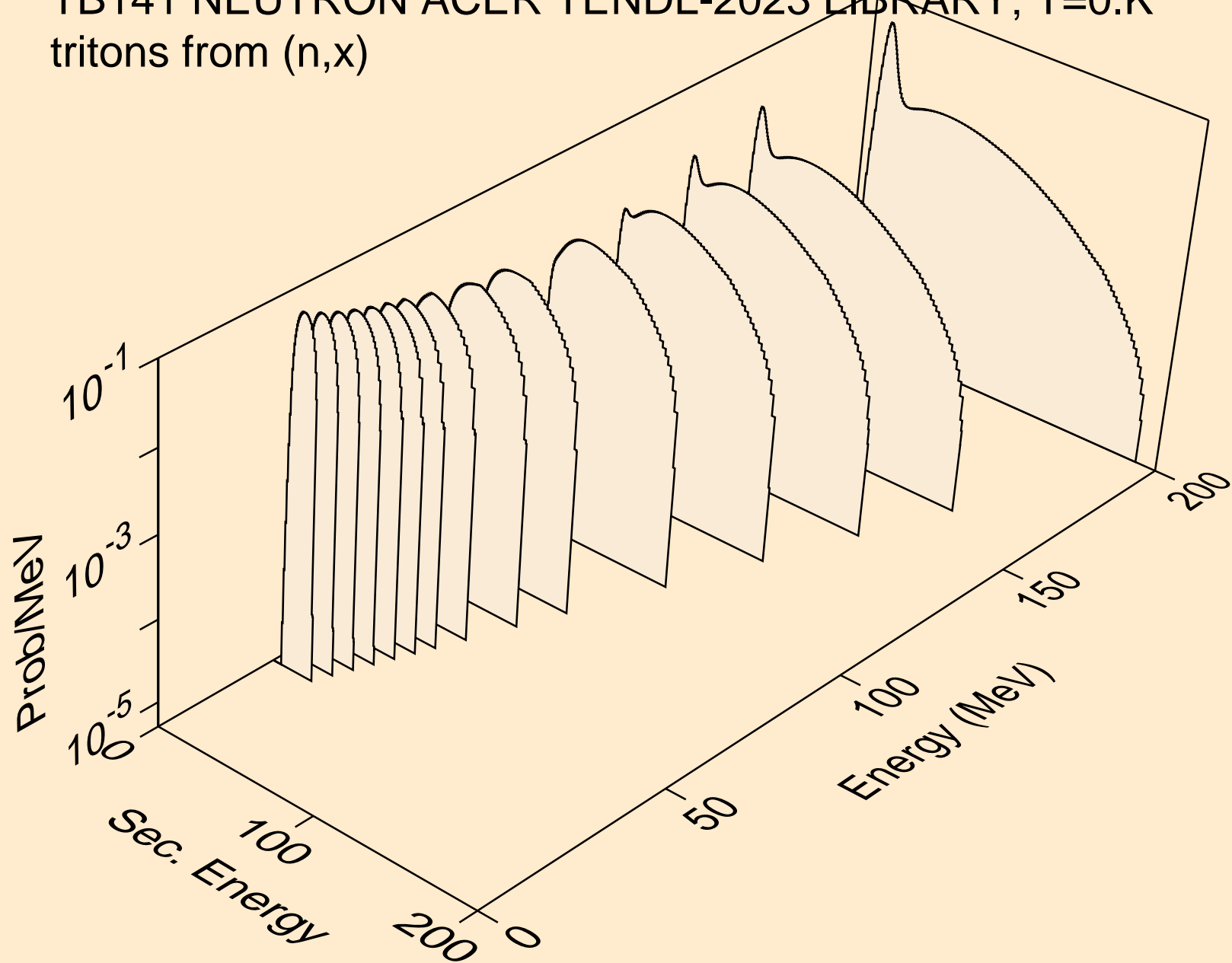

TB141 NEUTRON ACER TENDL-2023 LIBRARY; T=0.K  
tritons from (n,n\*)t

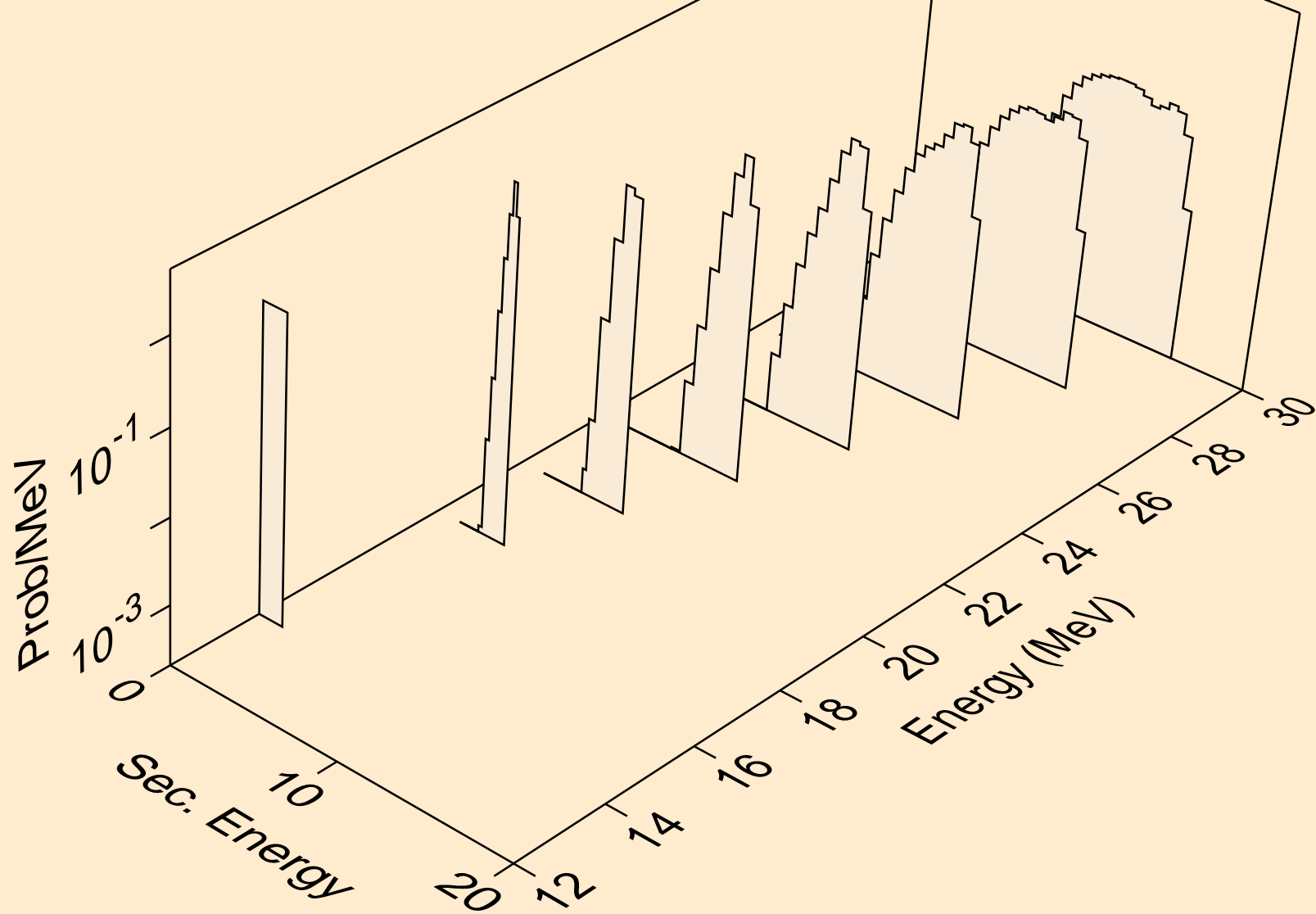

TB141 NEUTRON ACER TENDL-2023 LIBRARY; T=0.K  
tritons from (n,t)

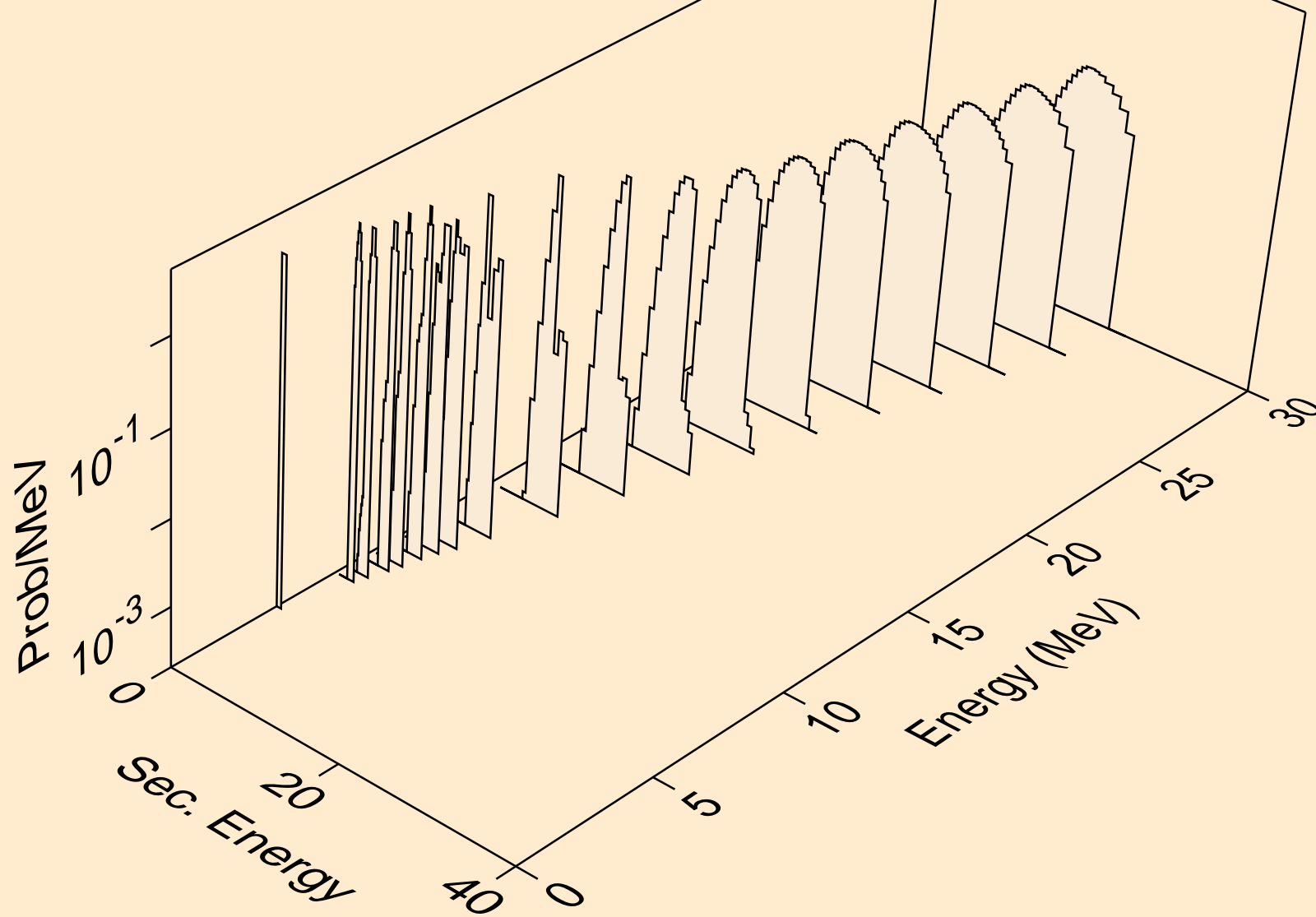

TB141 NEUTRON ACER TENDL-2023 LIBRARY; T=0.K  
tritons from (n,pt)

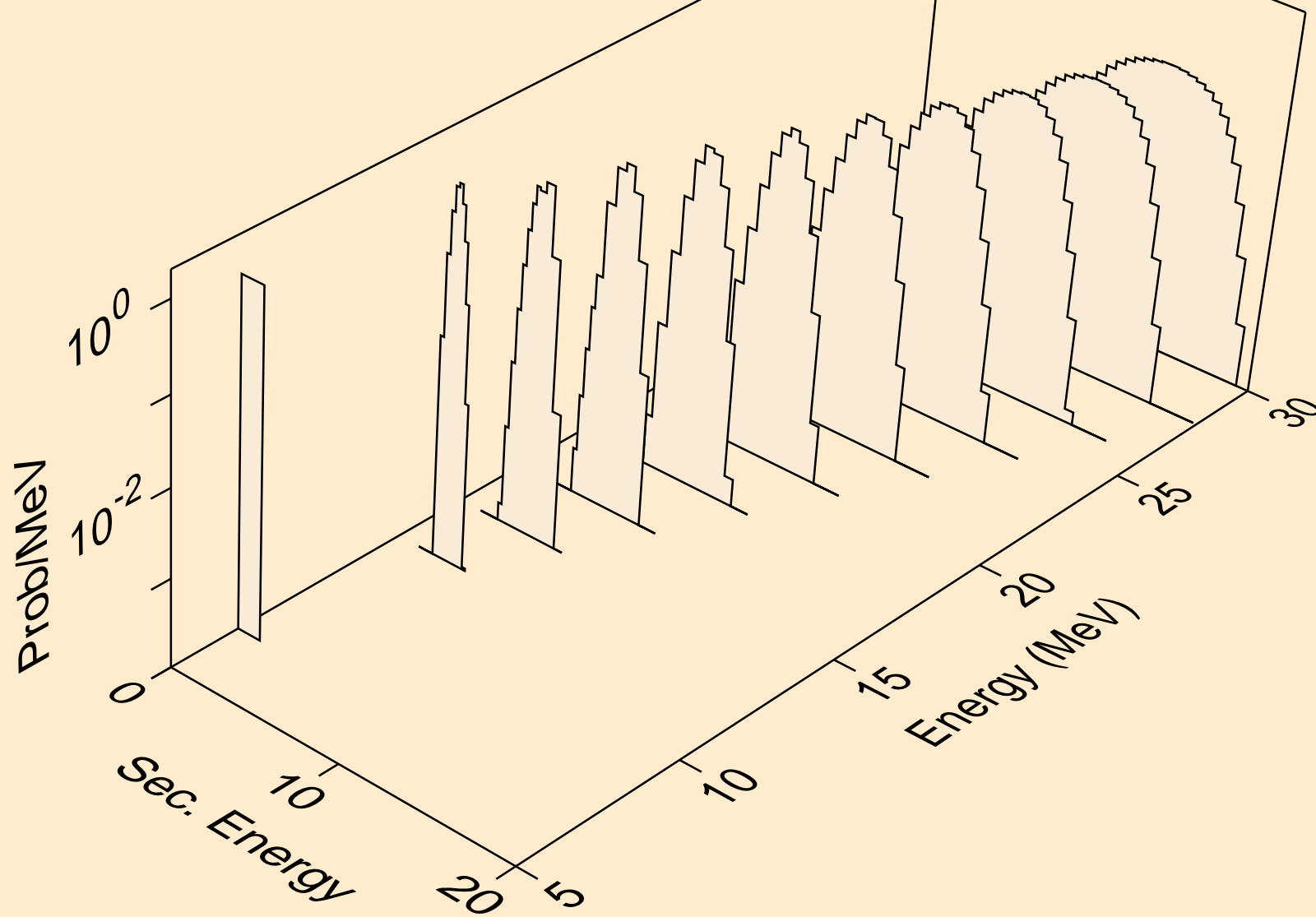

TB141 NEUTRON ACER TENDL-2023 LIBRARY; T=0.K  
he3s from (n,x)

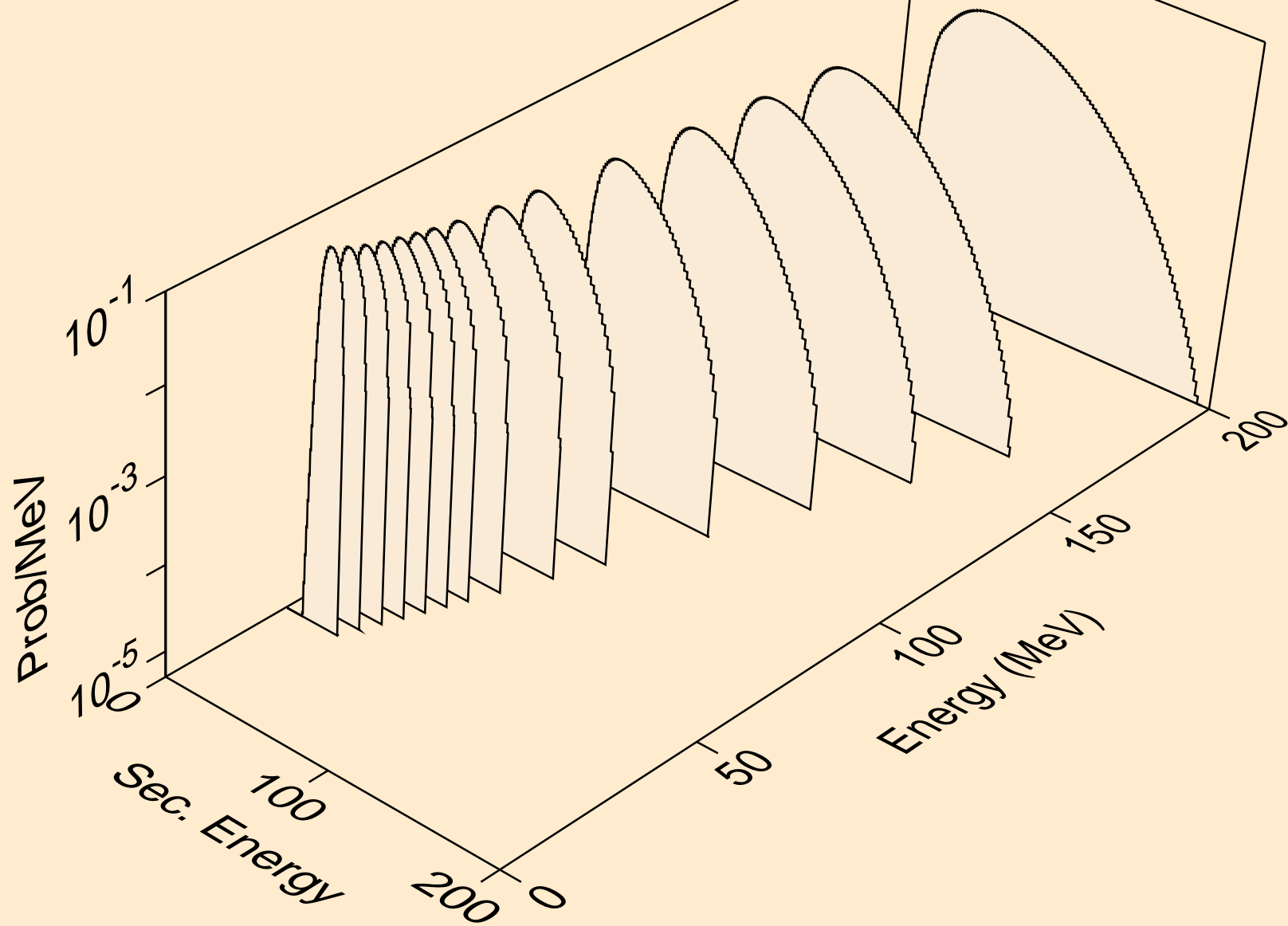

TB141 NEUTRON ACER TENDL-2023 LIBRARY; T=0.K  
he3s from (n,n\*)he3

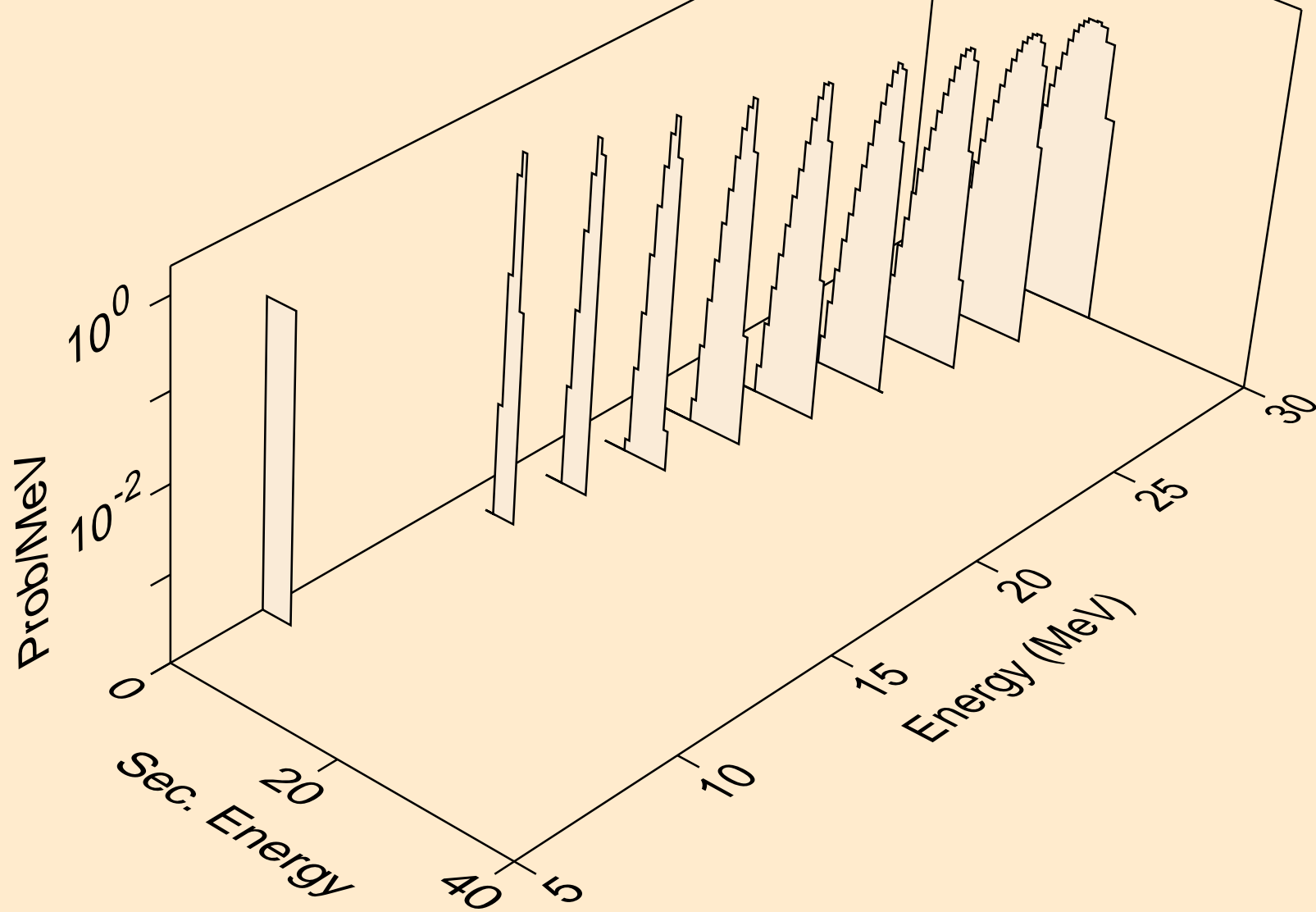

TB141 NEUTRON ACER TENDL-2023 LIBRARY; T=0.K  
he3s from (n,he3)

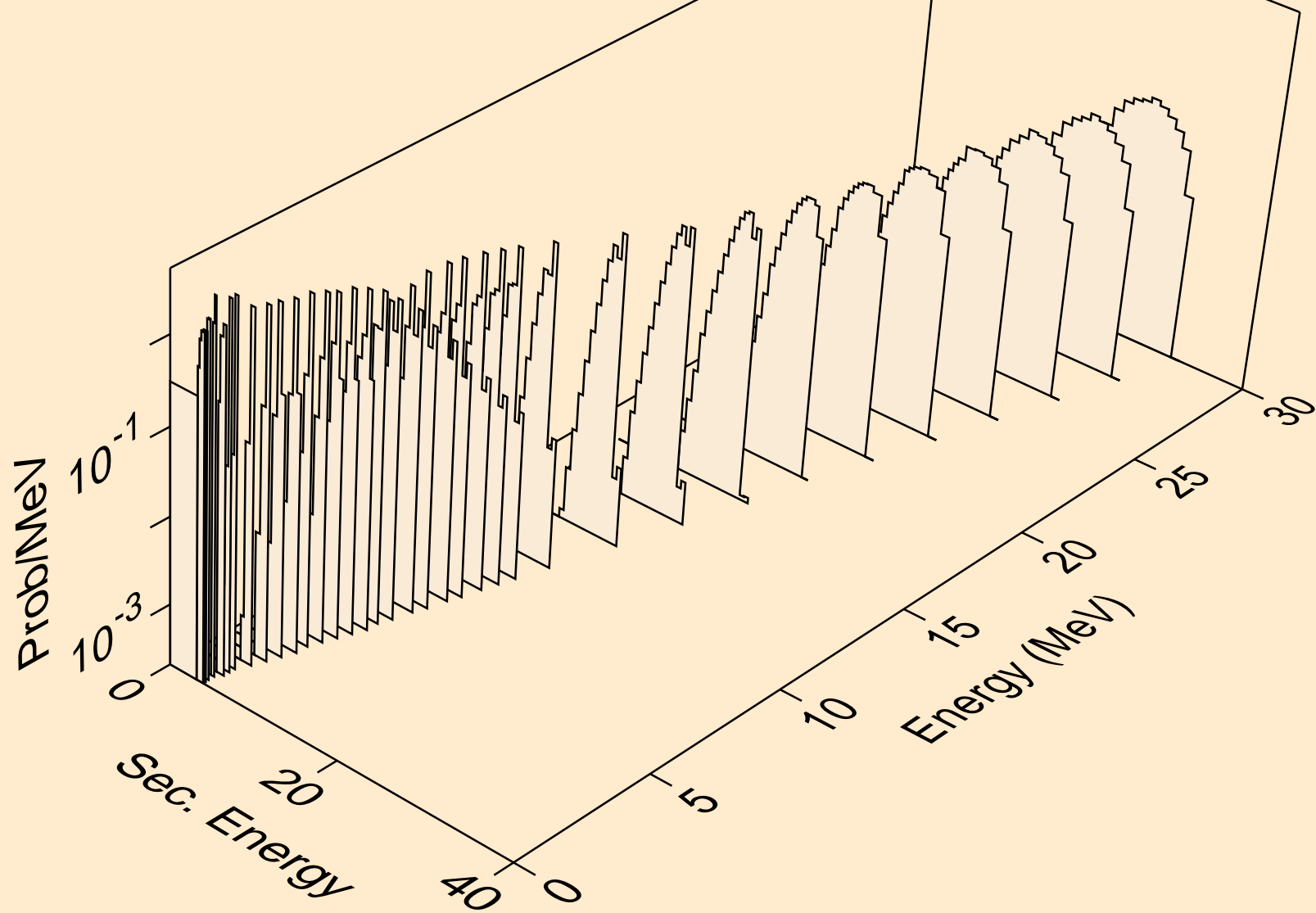



TB141 NEUTRON ACER TENDL-2023 LIBRARY; T=0.K  
alphas from (n,x)

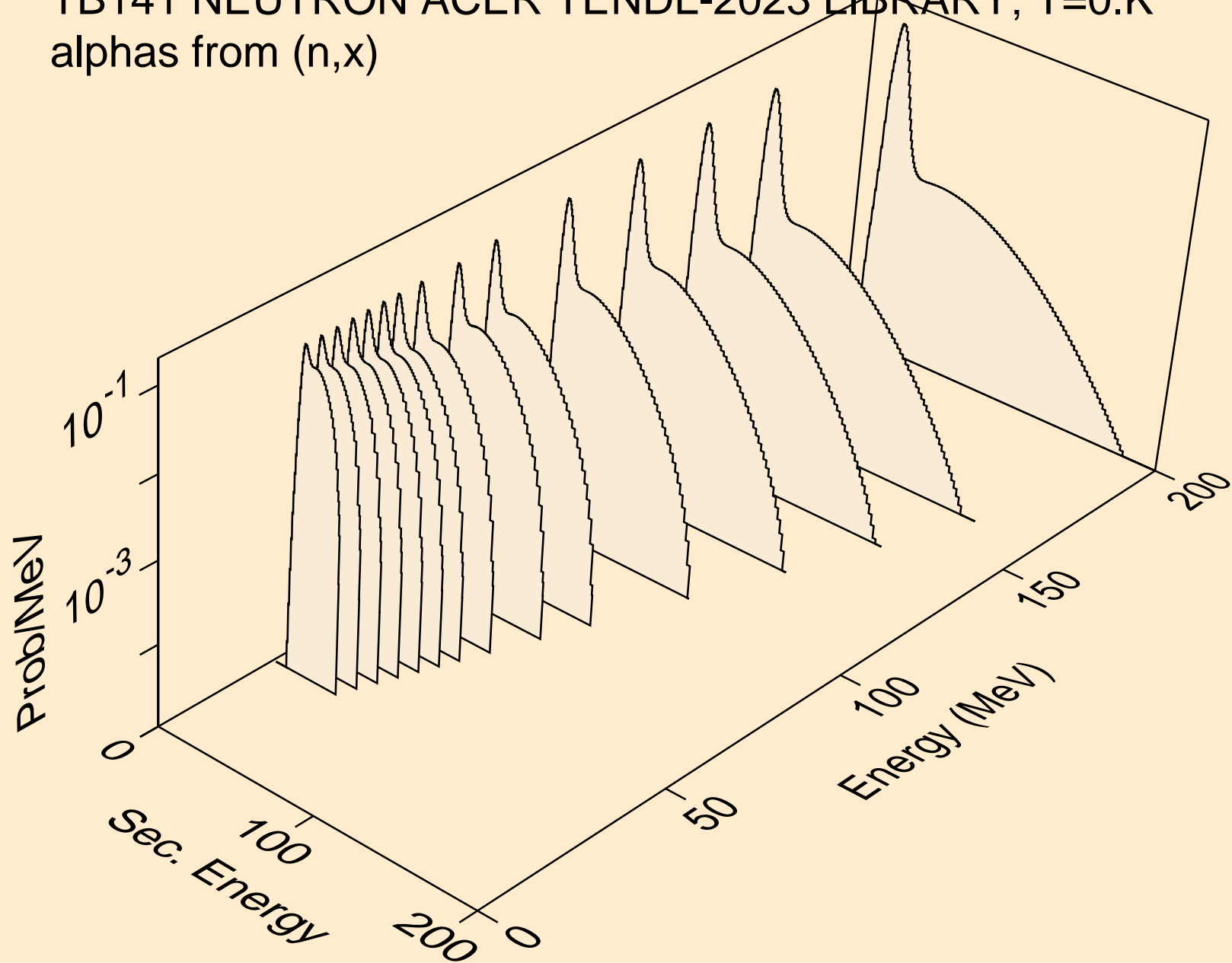

TB141 NEUTRON ACER TENDL-2023 LIBRARY; T=0.K  
alphas from (n,n\*)a

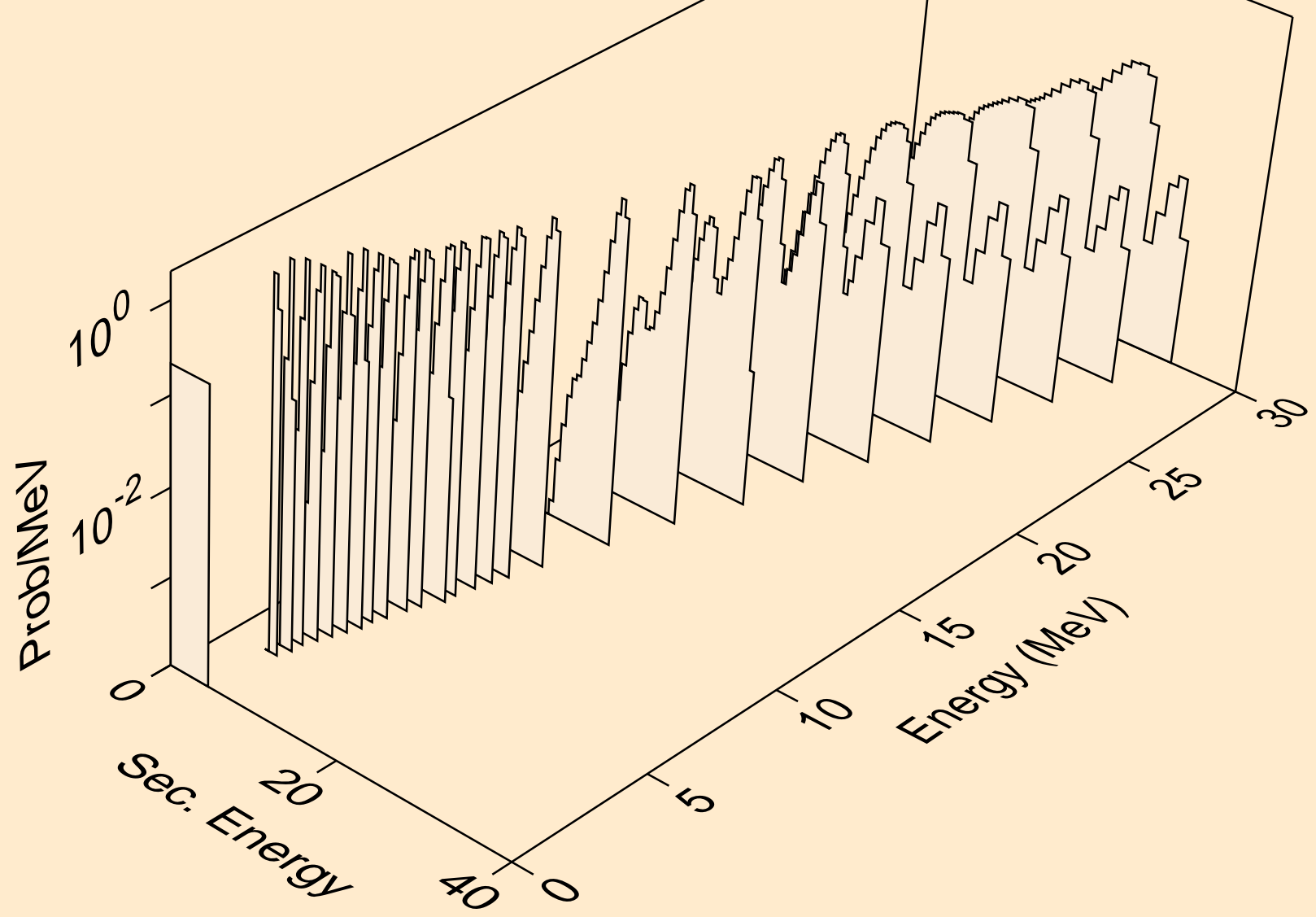

TB141 NEUTRON ACER TENDL-2023 LIBRARY; T=0.K  
alphas from (n,2n)a

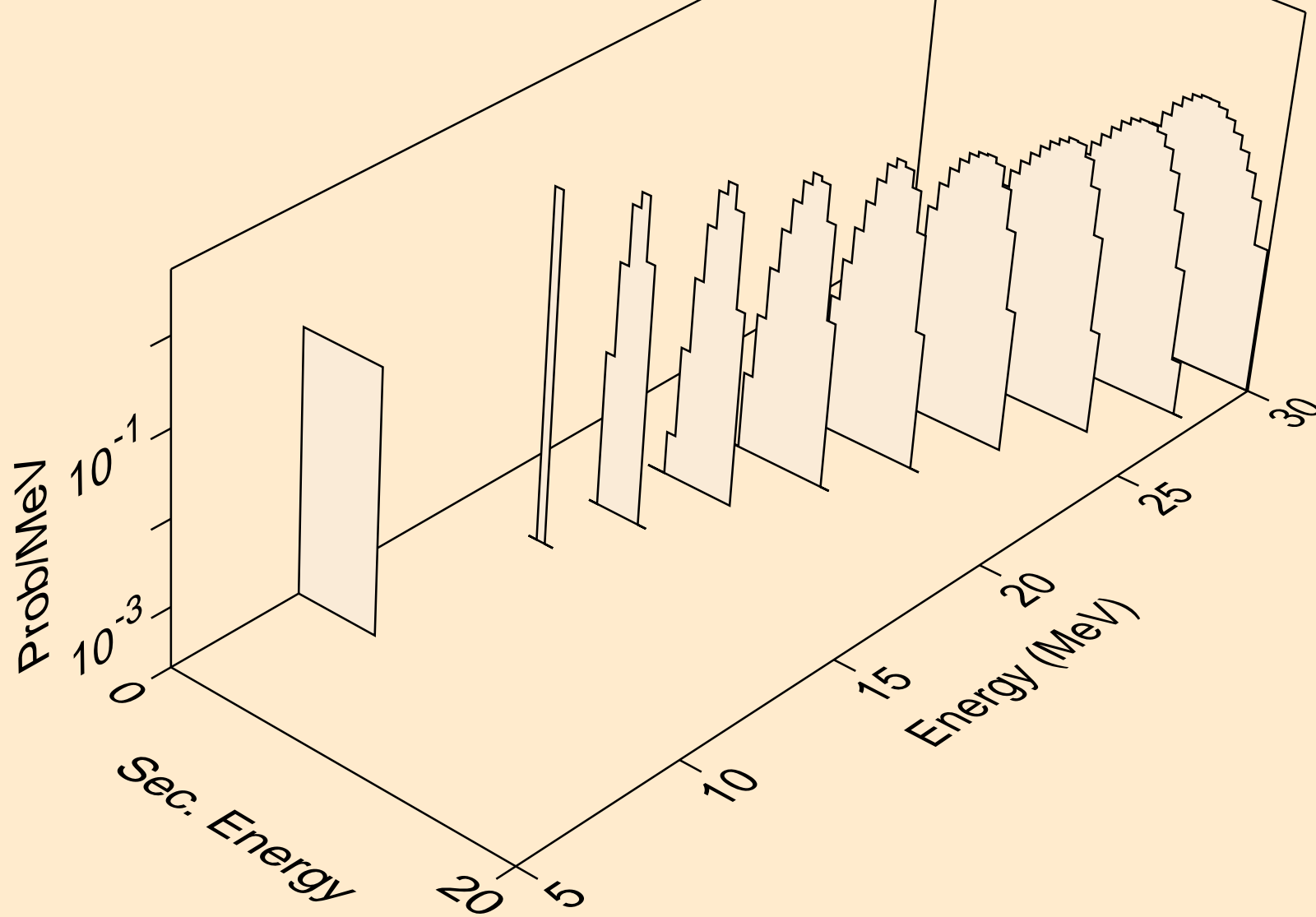

TB141 NEUTRON ACER TENDL-2023 LIBRARY; T=0.K  
alphas from (n,n\*)2a

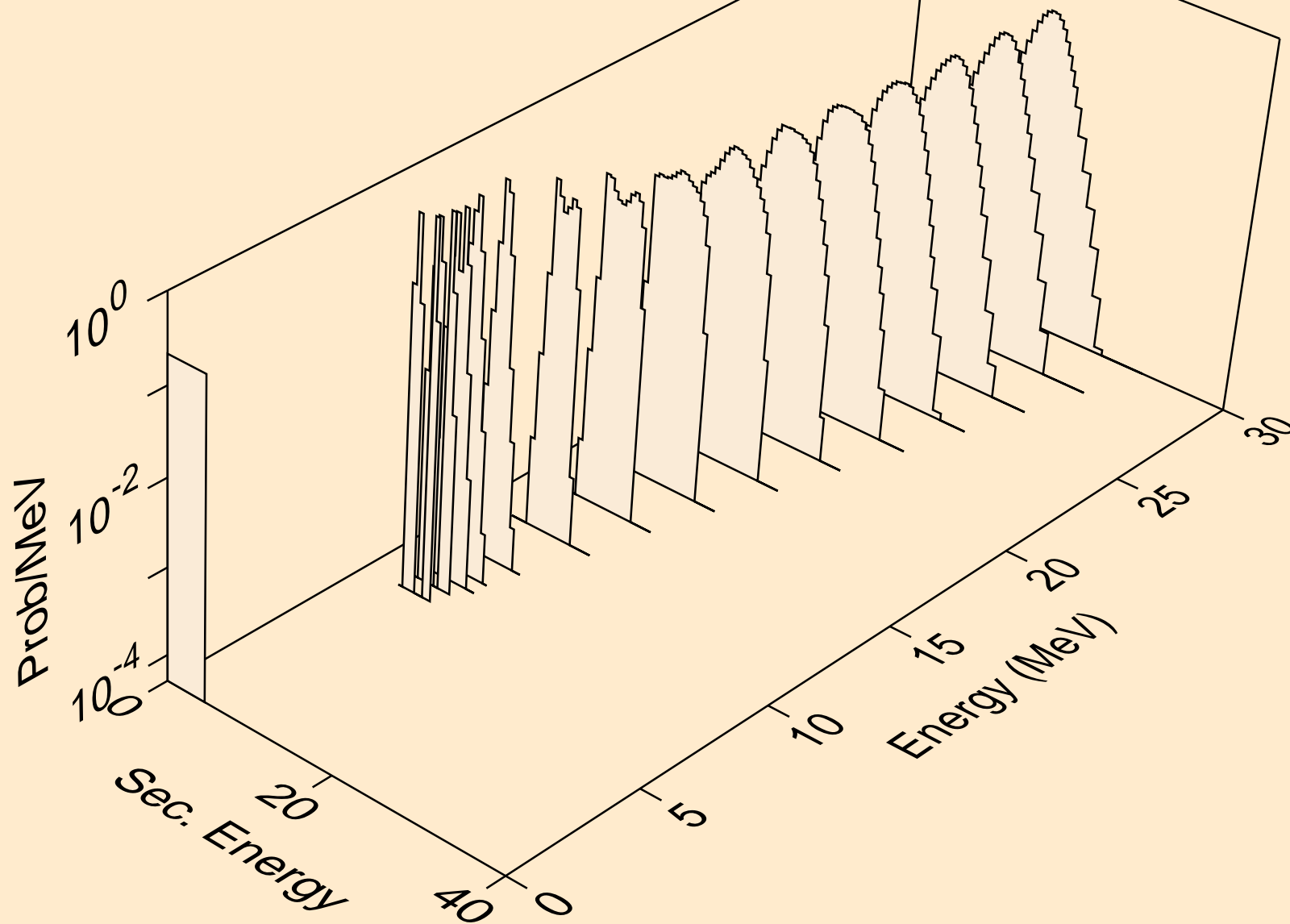

TB141 NEUTRON ACER TENDL-2023 LIBRARY; T=0.K  
alphas from (n,npa)

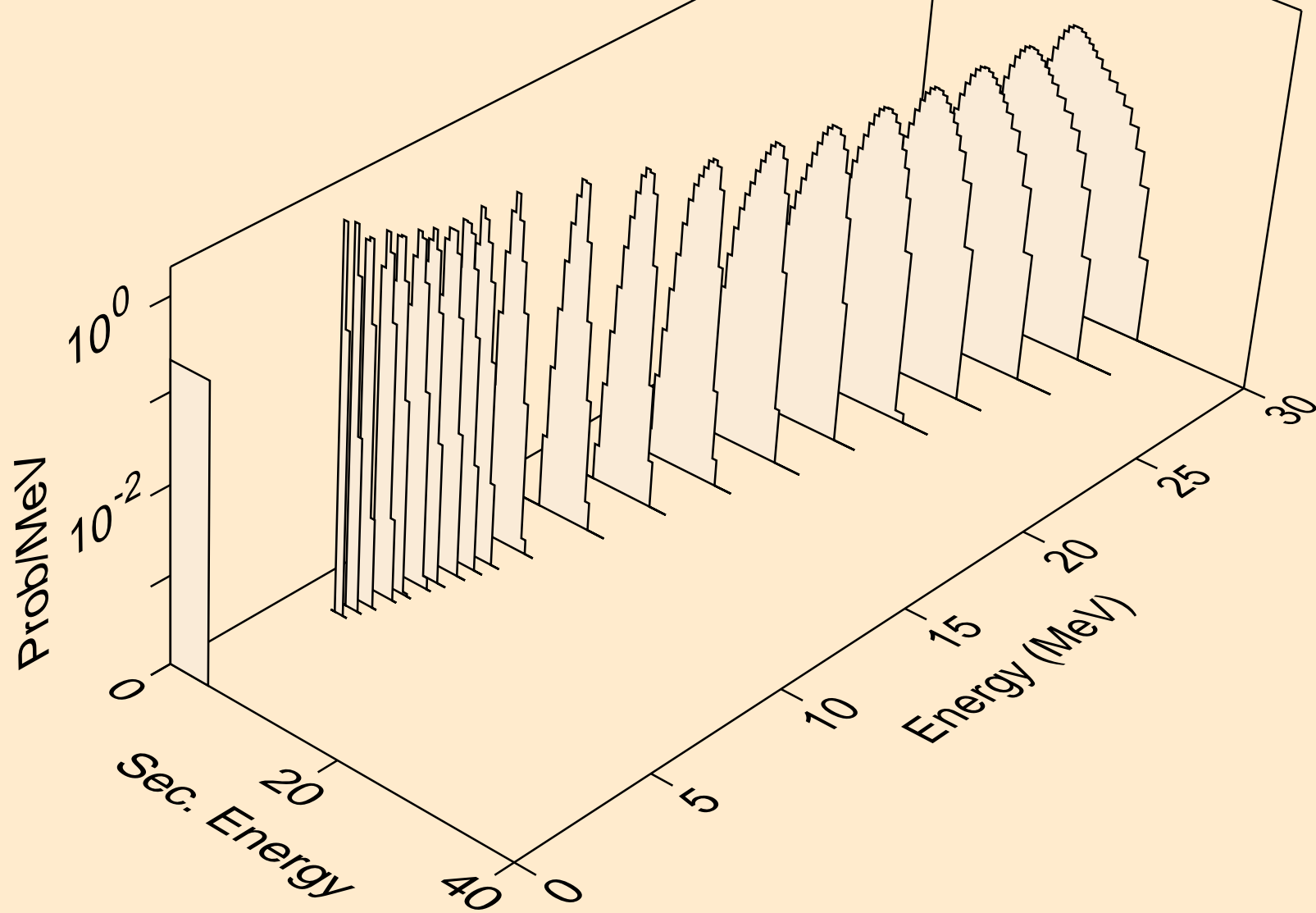

TB141 NEUTRON ACER TENDL-2023 LIBRARY; T=0.K  
alphas from (n,a)

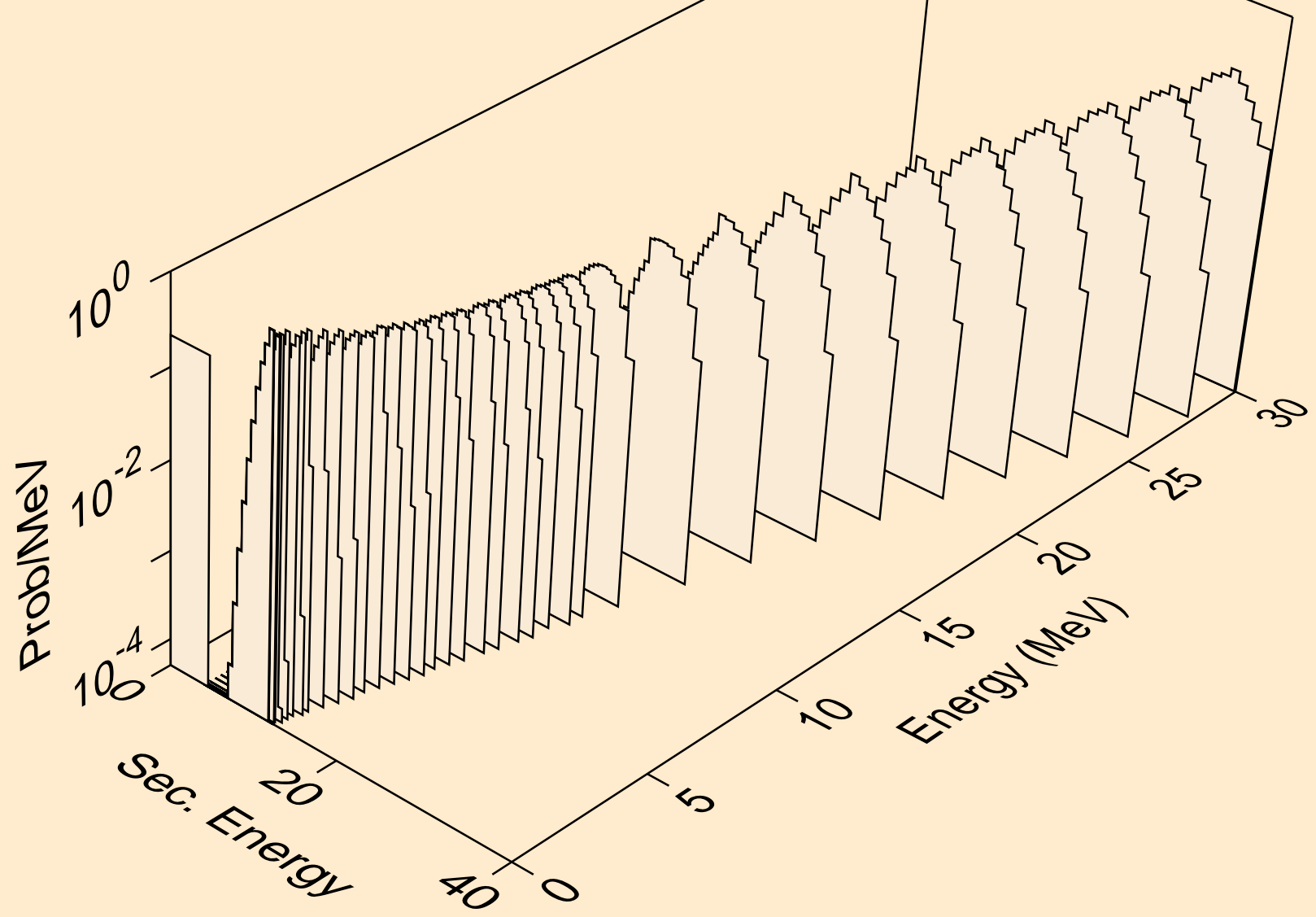

TB141 NEUTRON ACER TENDL-2023 LIBRARY; T=0.K  
alphas from (n,2a)

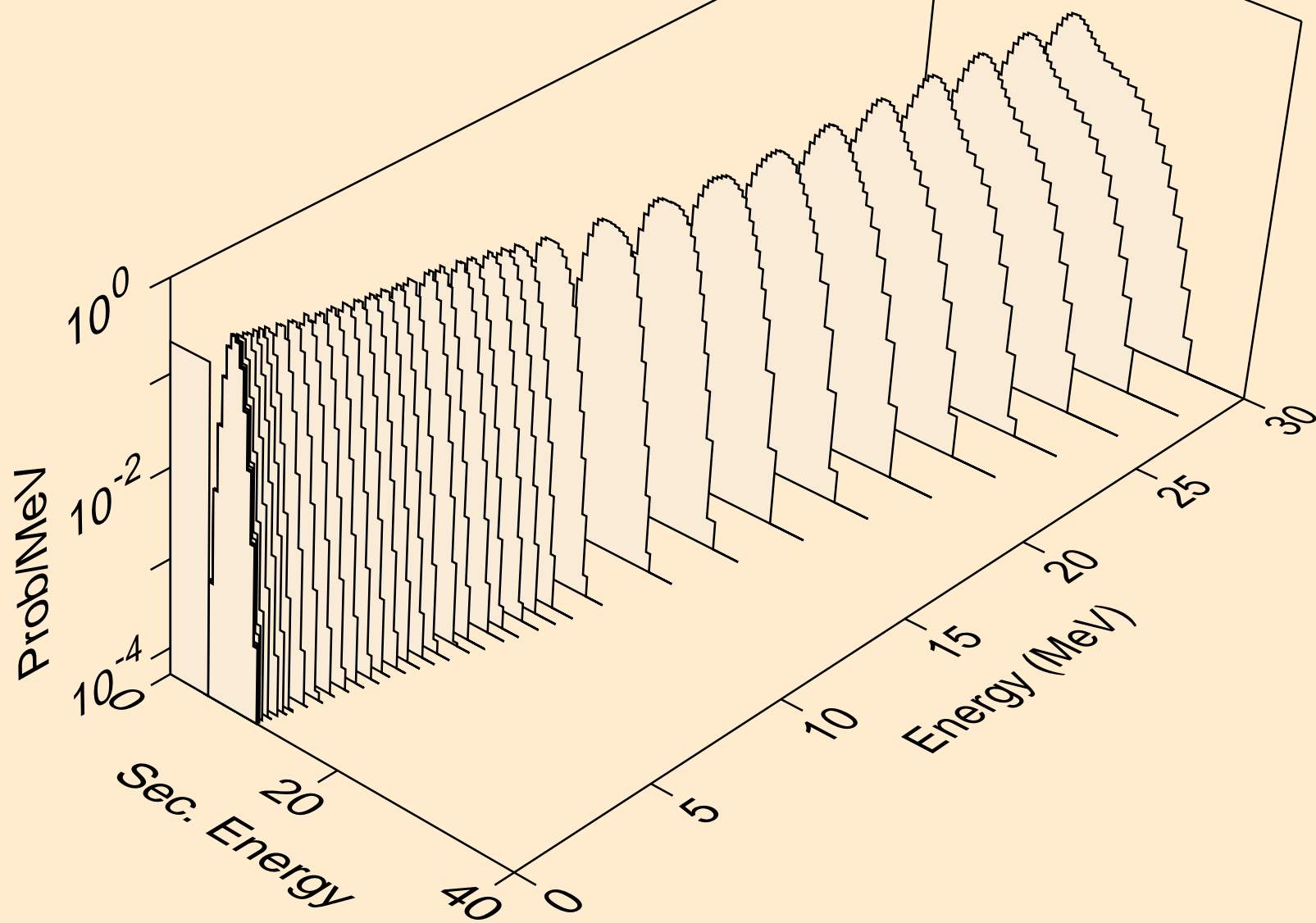

TB141 NEUTRON ACER TENDL-2023 LIBRARY; T=0.K  
alphas from (n,3a)

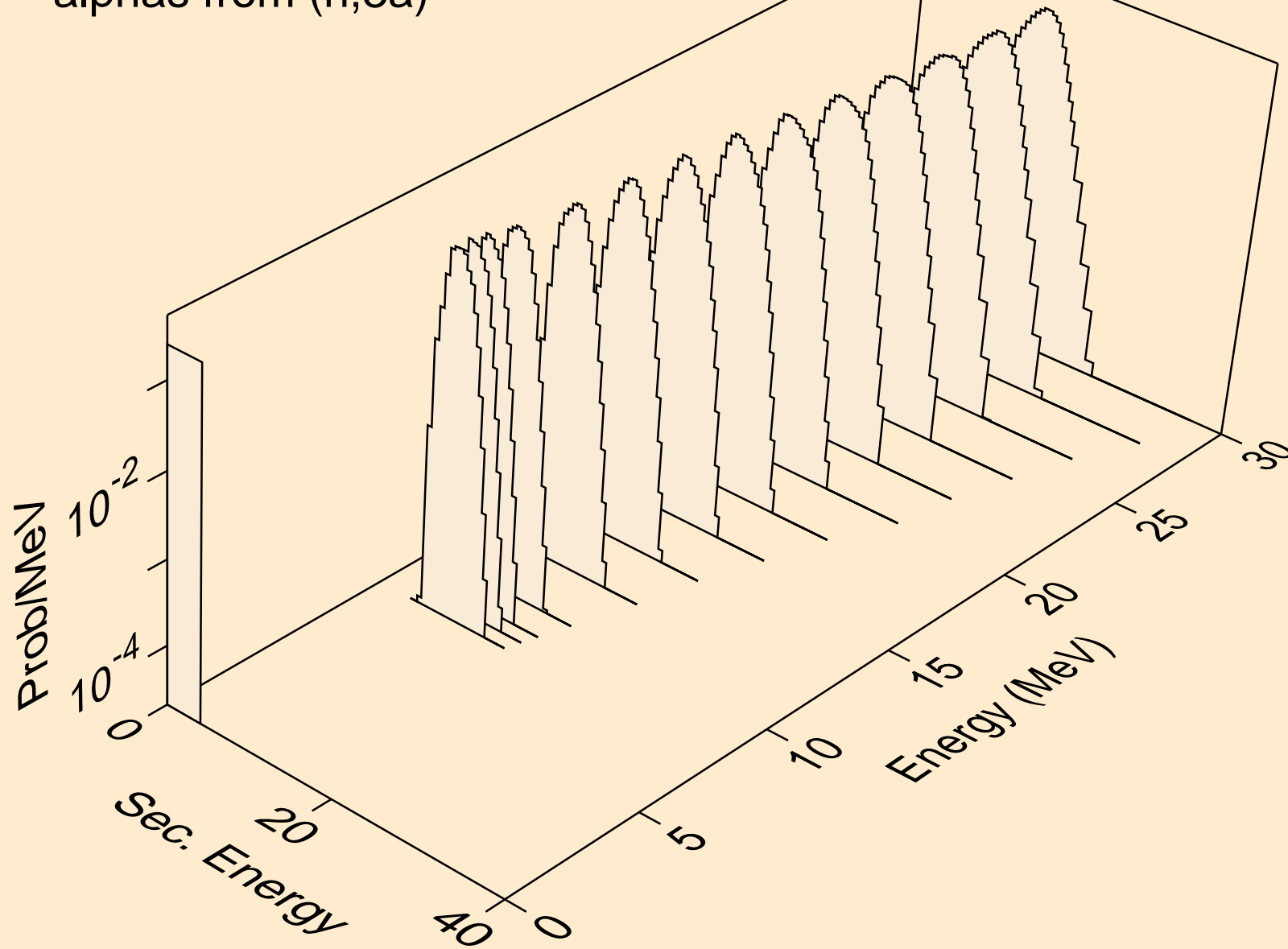



TB141 NEUTRON ACER TENDL-2023 LIBRARY; T=0.K  
alphas from (n,pa)

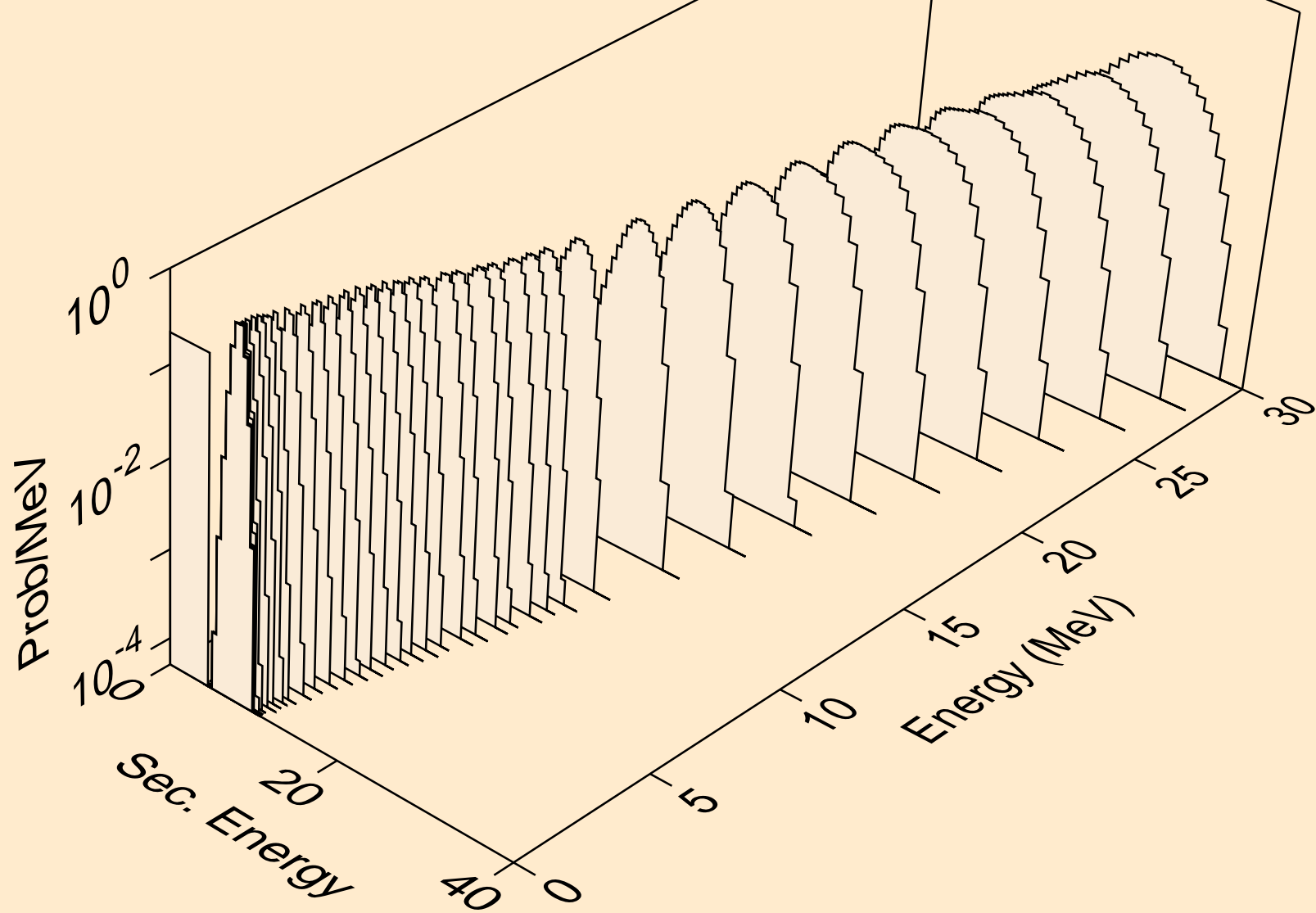

TB141 NEUTRON ACER TENDL-2023 LIBRARY; T=0.K  
alphas from (n,d2a)

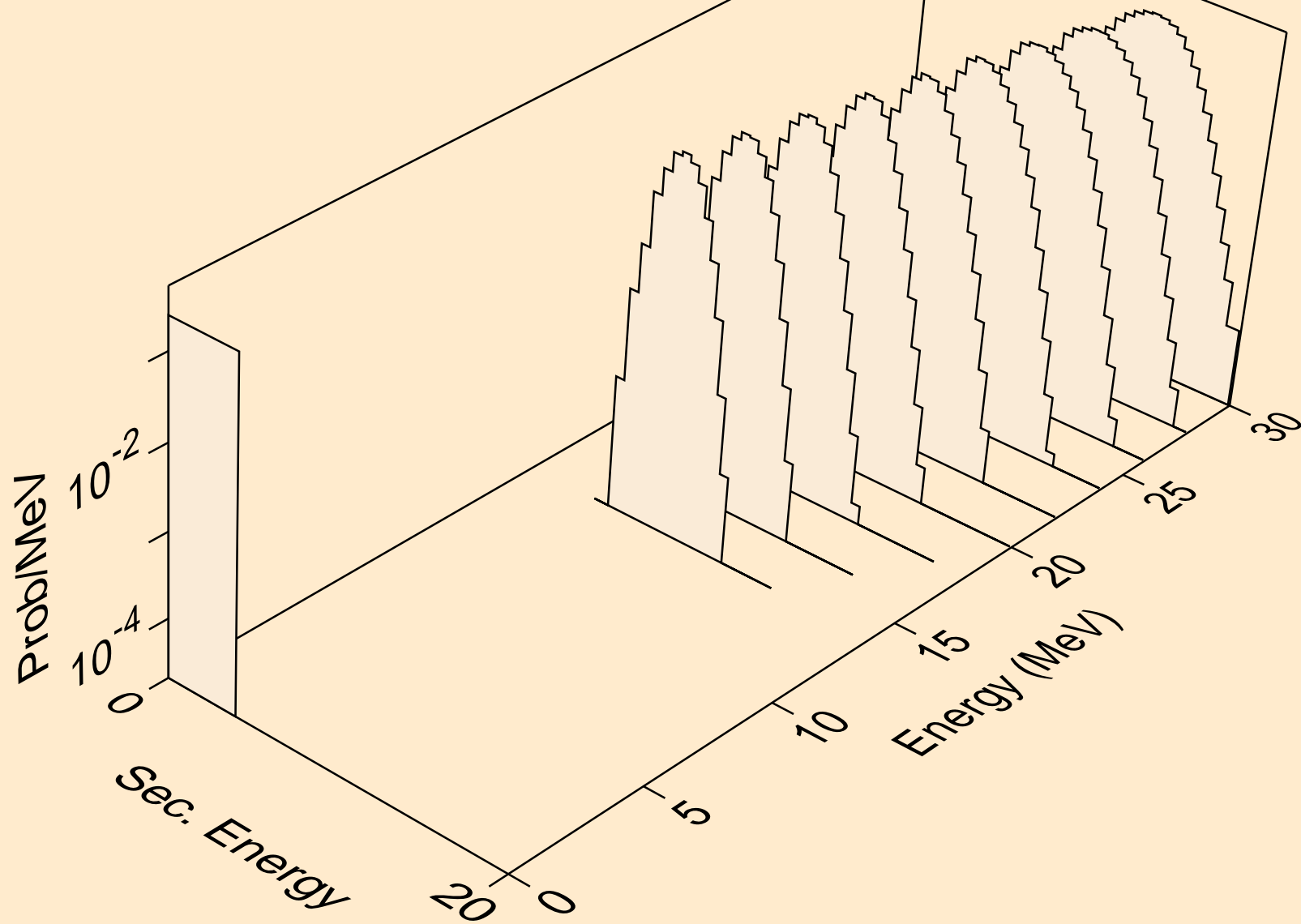

TB141 NEUTRON ACER TENDL-2023 LIBRARY; T=0.K  
alphas from (n,da)

