

TB152 NEUTRON ACER TENDL-2023 LIBRARY; T=0.K
Principal cross sections

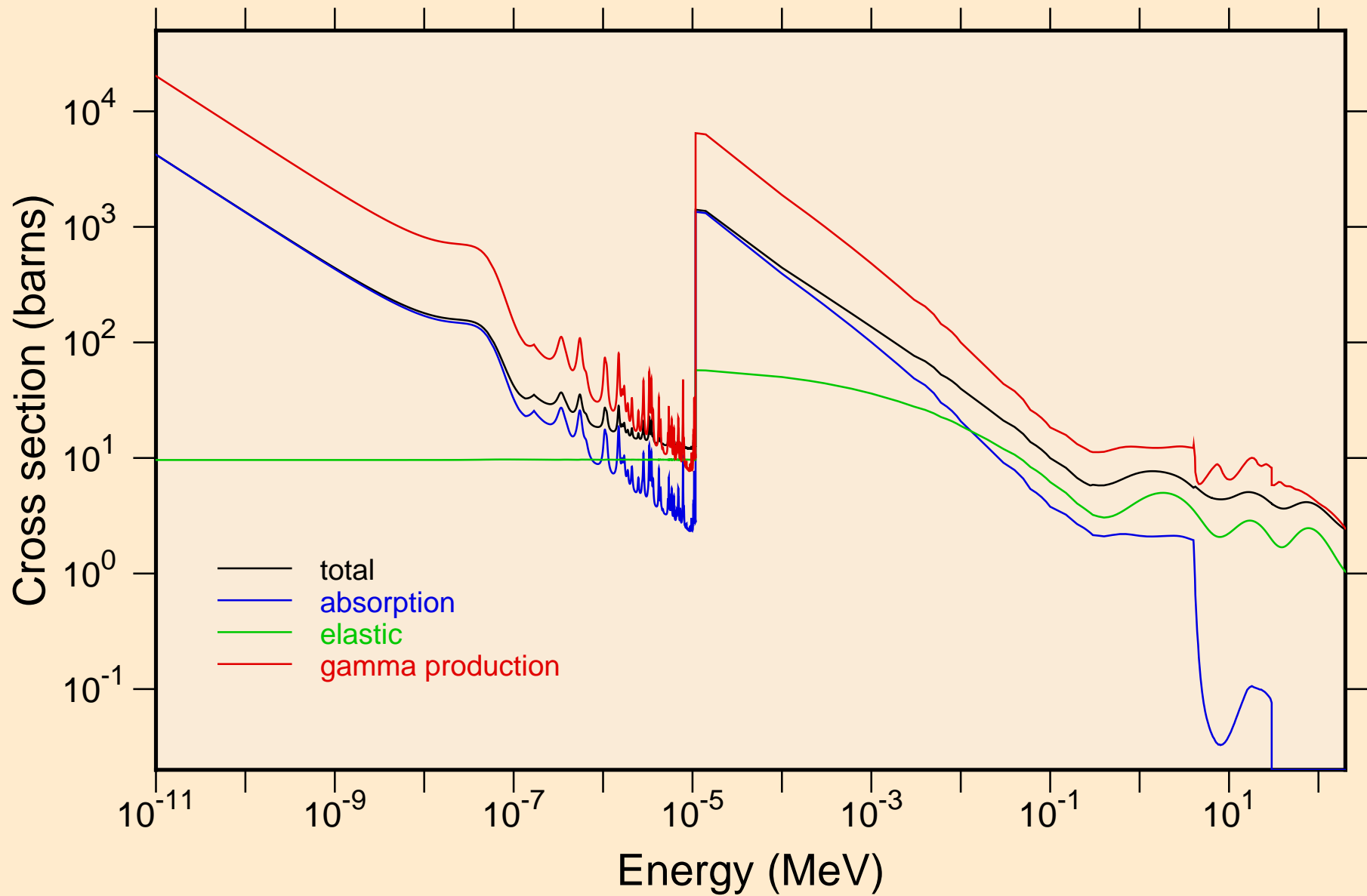

TB152 NEUTRON ACER TENDL-2023 LIBRARY; T=0.K
resonance total cross section

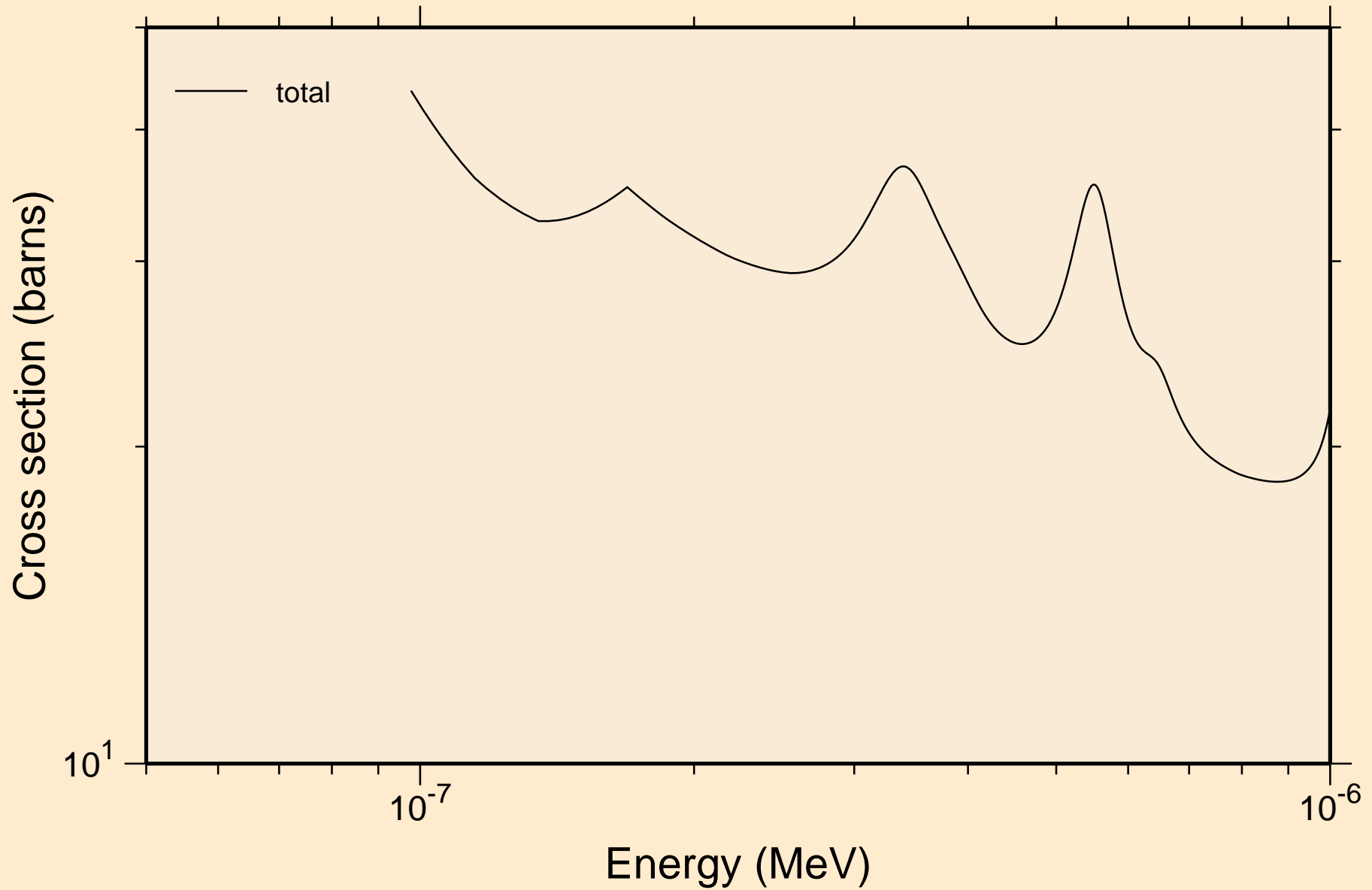

TB152 NEUTRON ACER TENDL-2023 LIBRARY; T=0.K
resonance total cross section

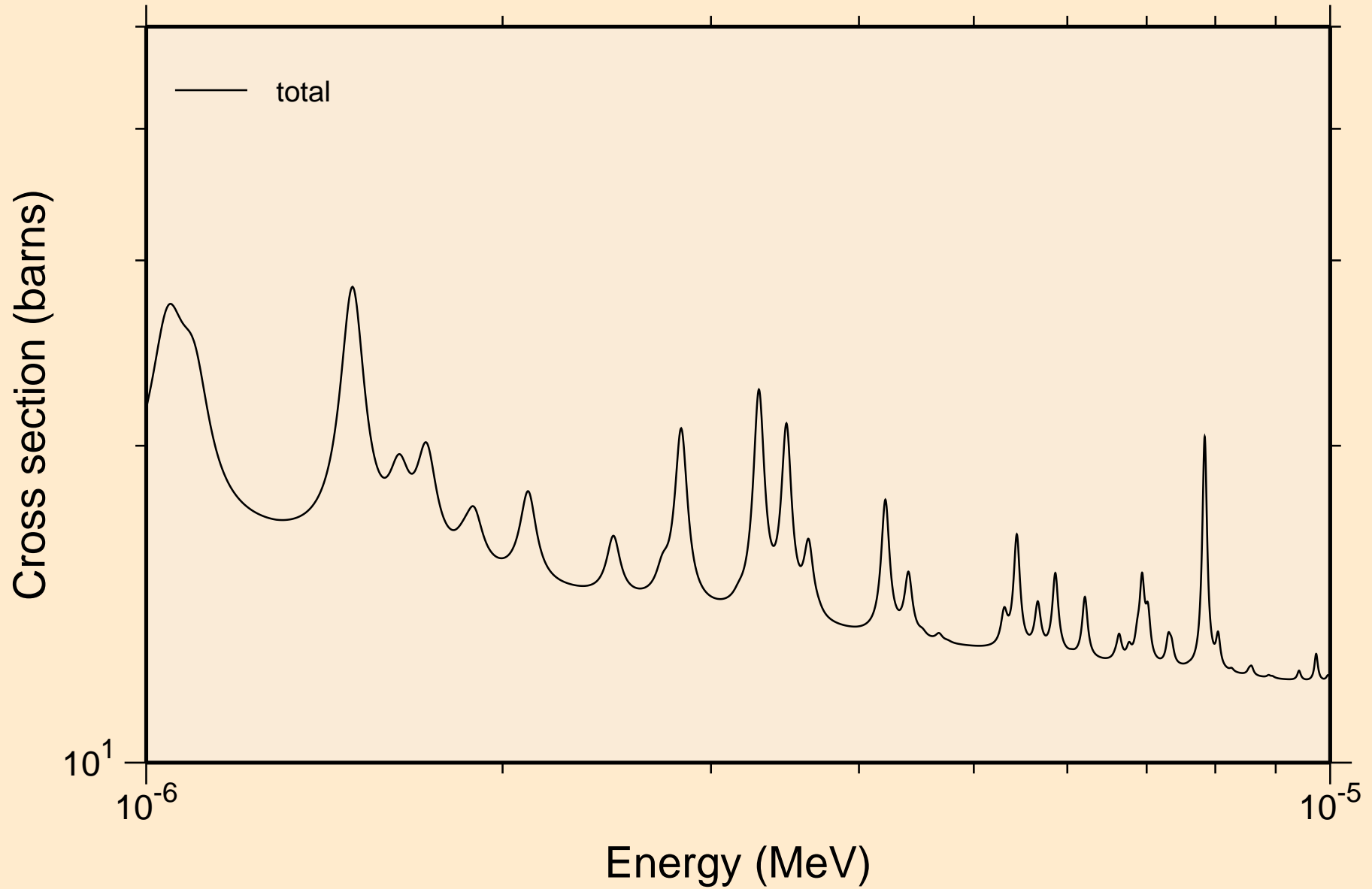

TB152 NEUTRON ACER TENDL-2023 LIBRARY; T=0.K
resonance total cross section

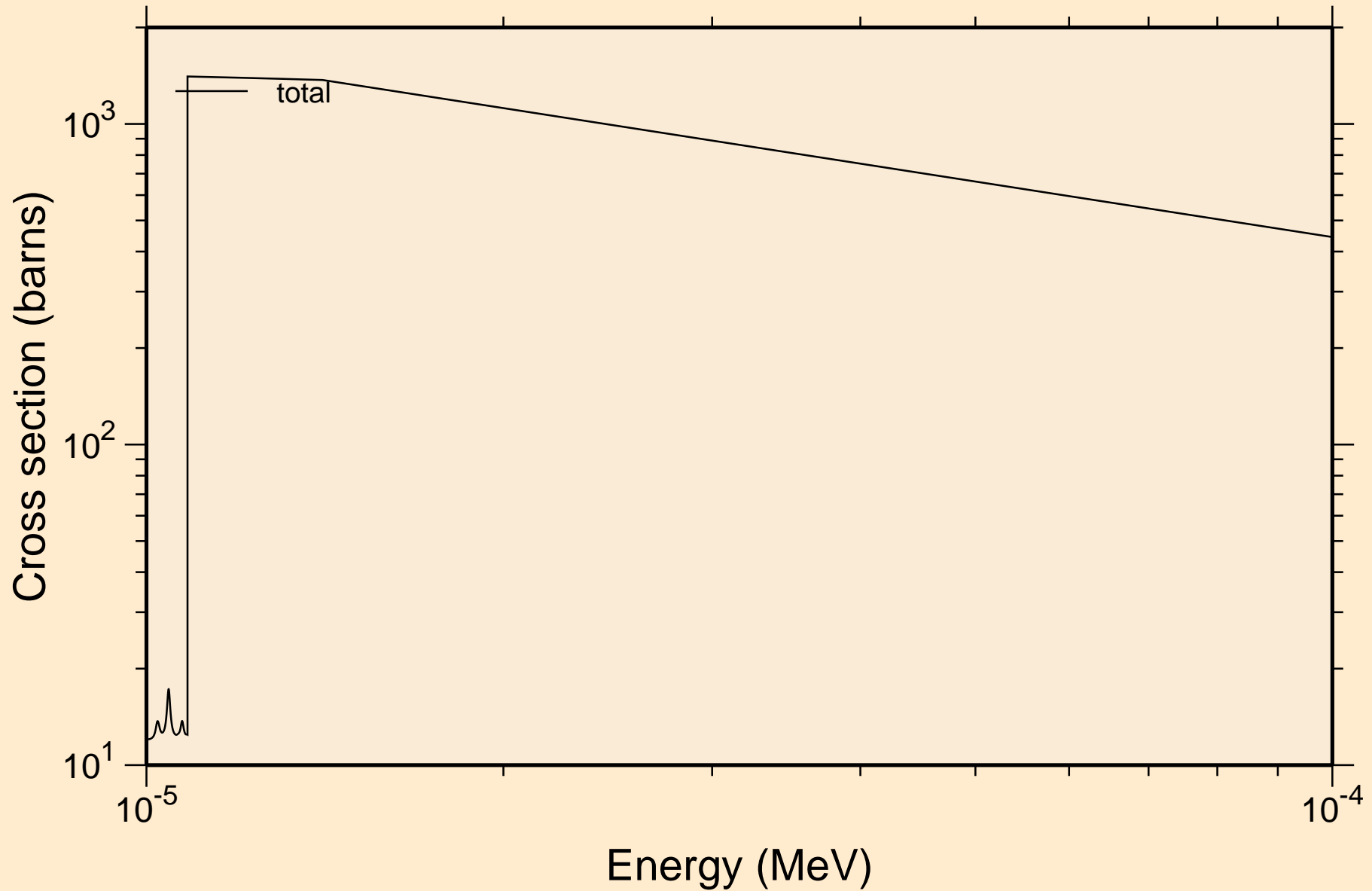

TB152 NEUTRON ACER TENDL-2023 LIBRARY; T=0.K
resonance total cross section

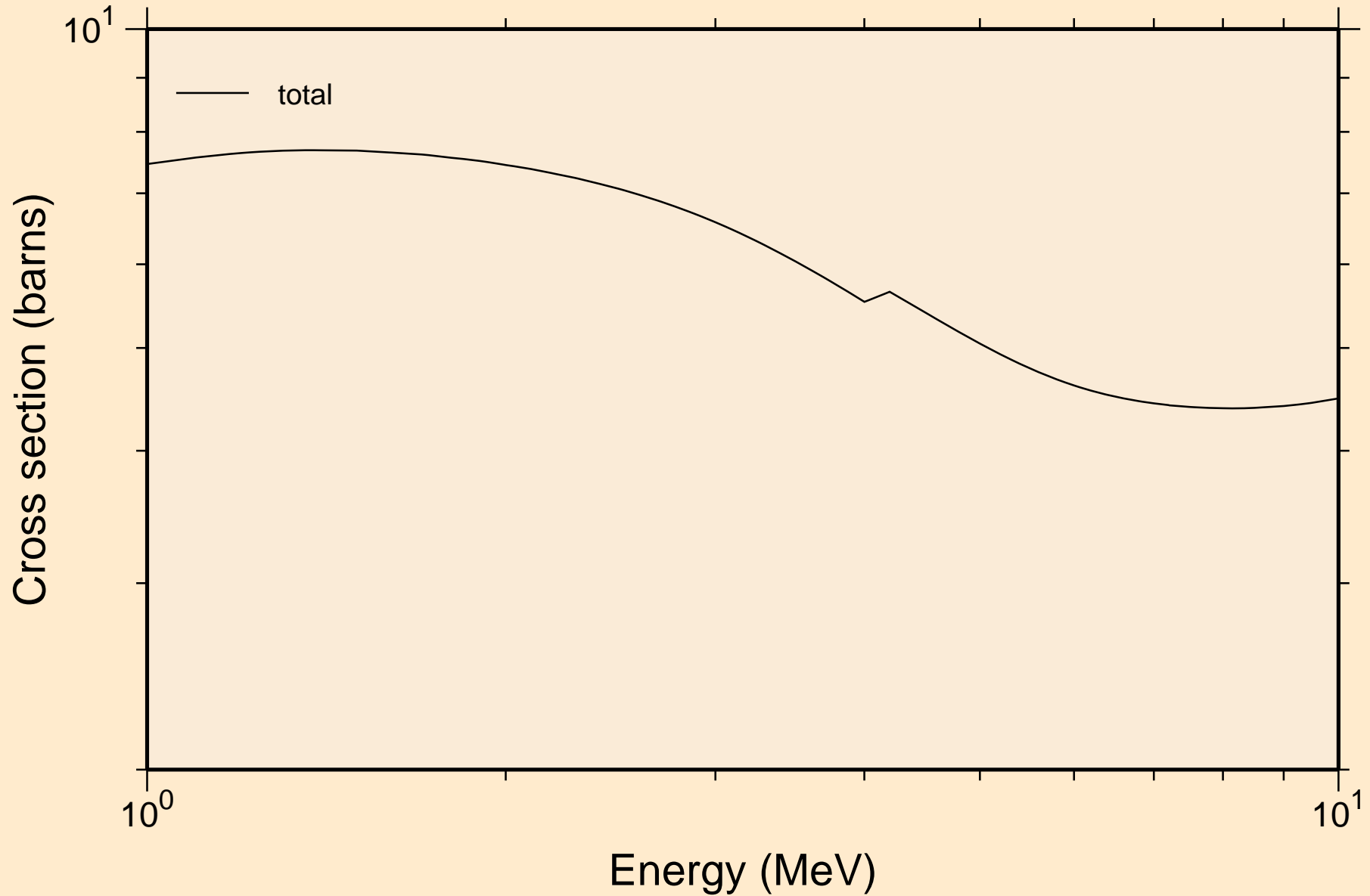

TB152 NEUTRON ACER TENDL-2023 LIBRARY; T=0.K
resonance absorption cross sections

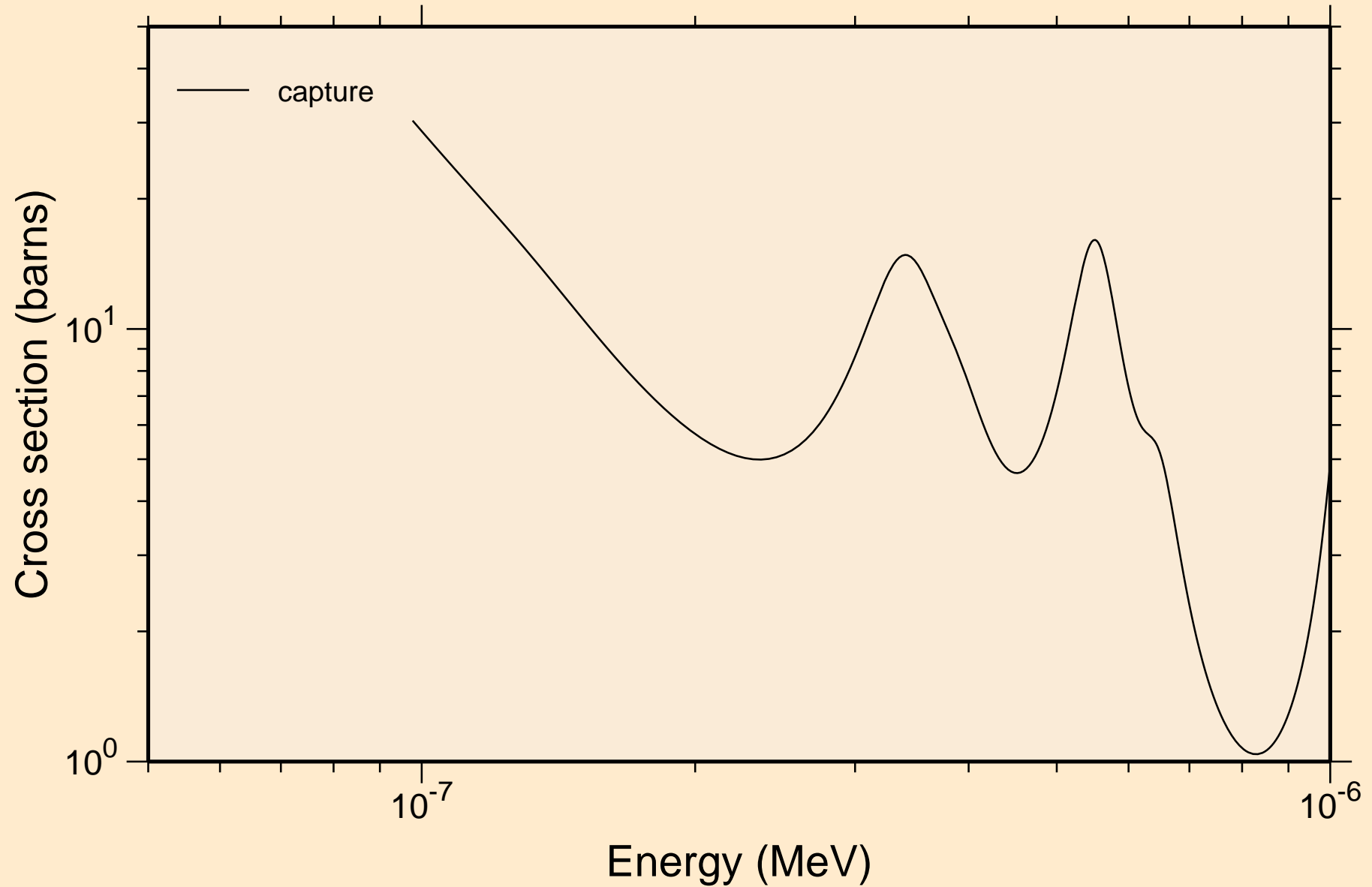

TB152 NEUTRON ACER TENDL-2023 LIBRARY; T=0.K
resonance absorption cross sections

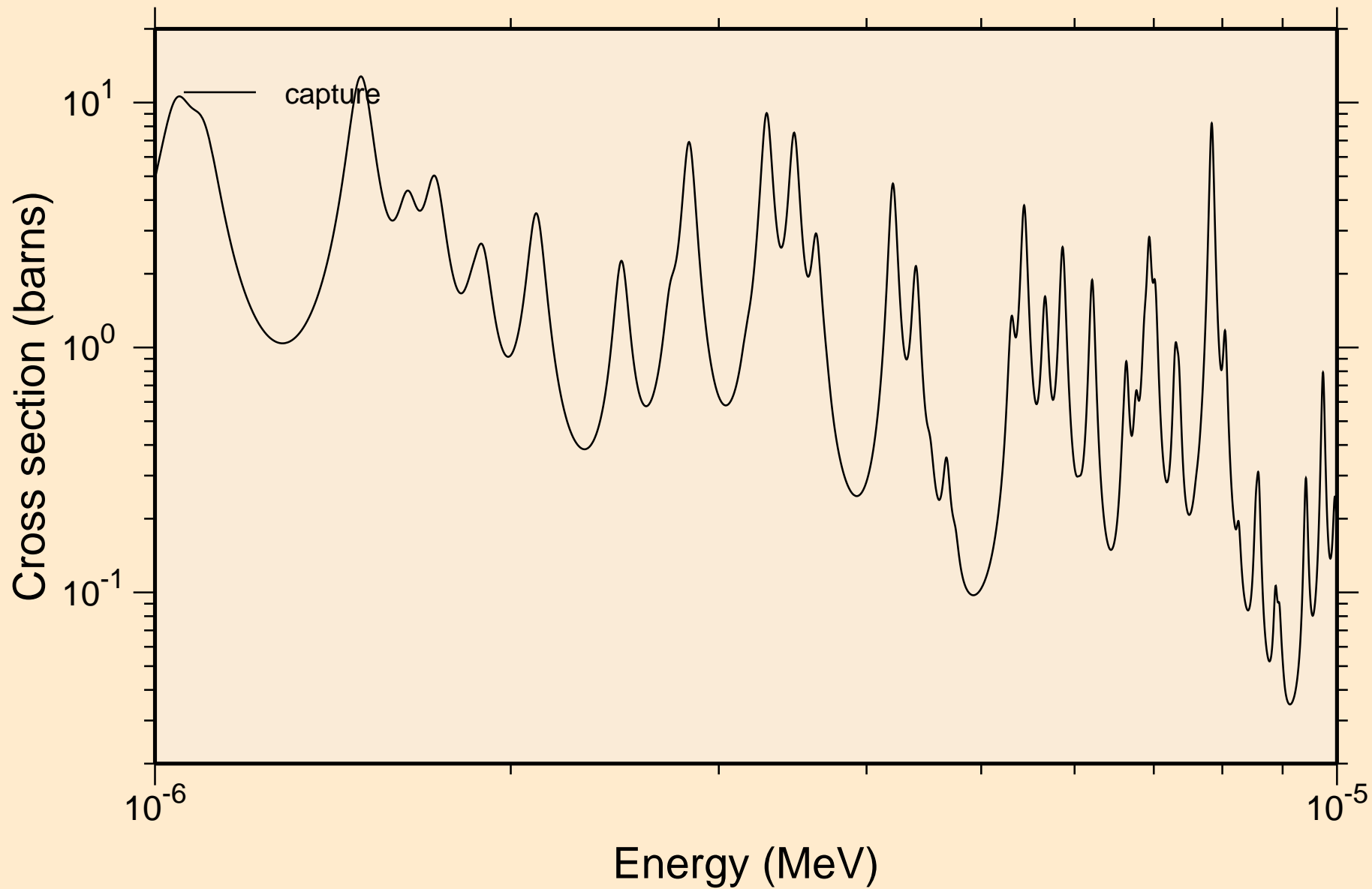

TB152 NEUTRON ACER TENDL-2023 LIBRARY; T=0.K
resonance absorption cross sections

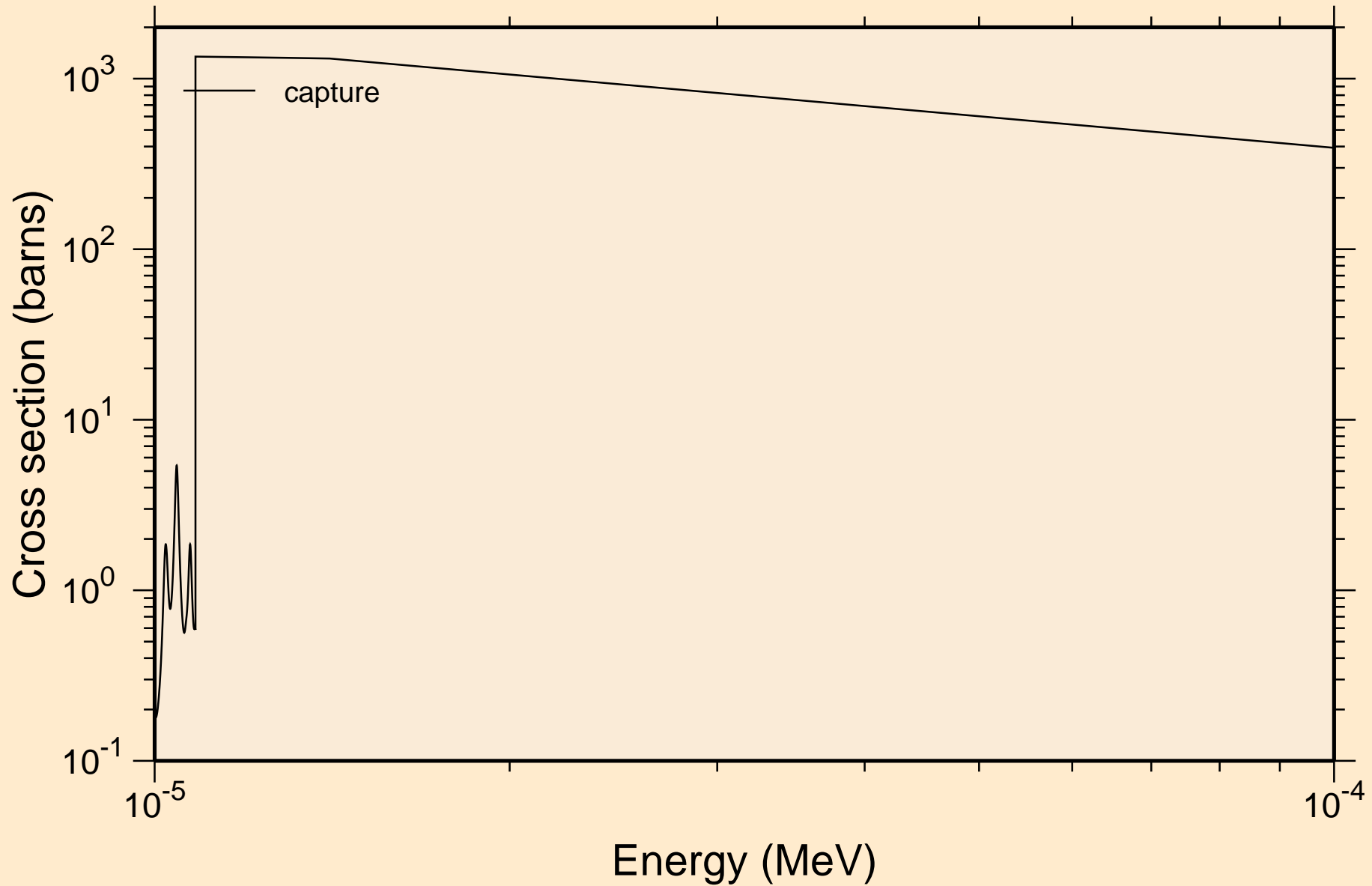

TB152 NEUTRON ACER TENDL-2023 LIBRARY; T=0.K
resonance absorption cross sections

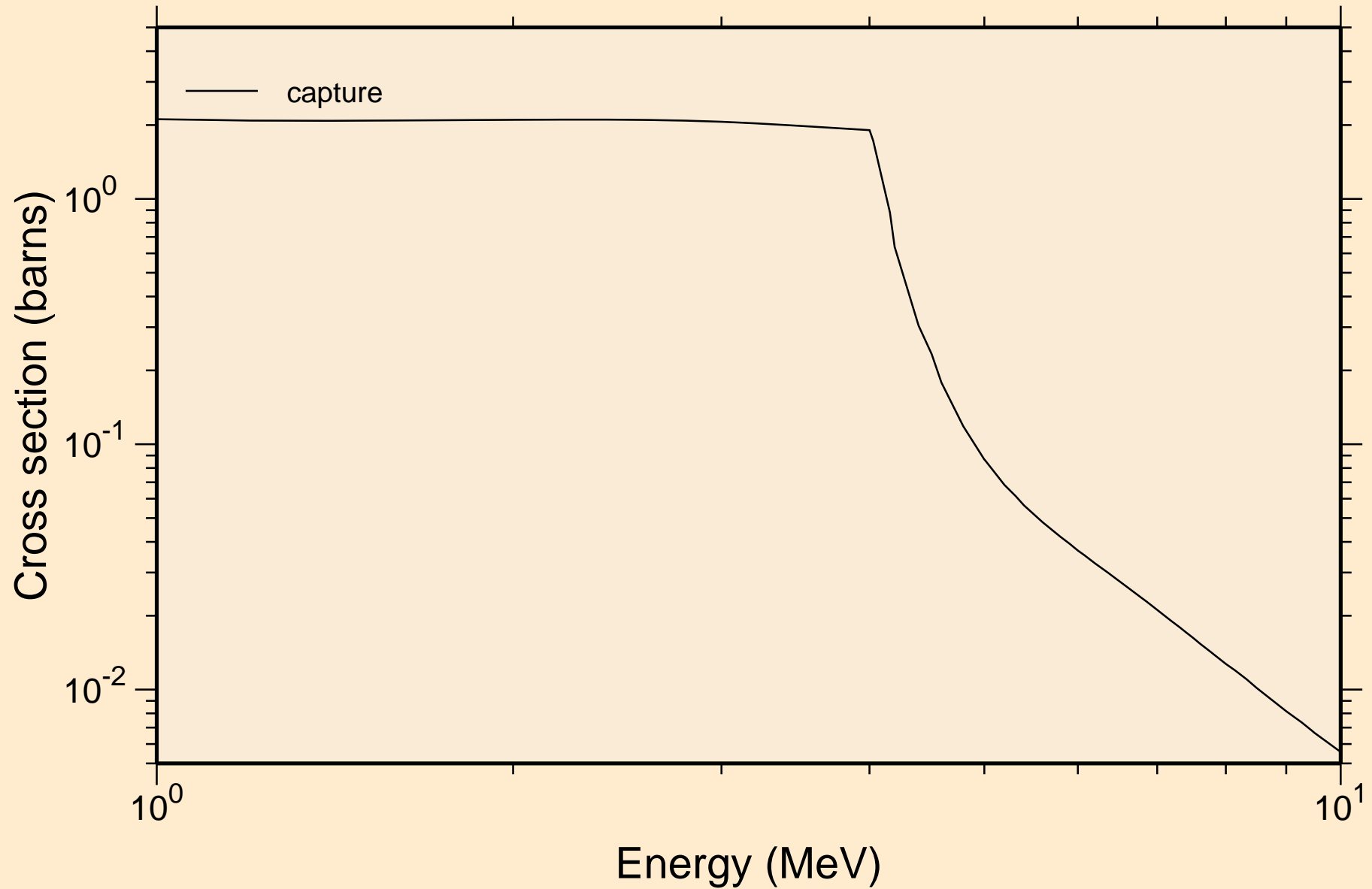

TB152 NEUTRON ACER TENDL-2023 LIBRARY; T=0.K

Heating

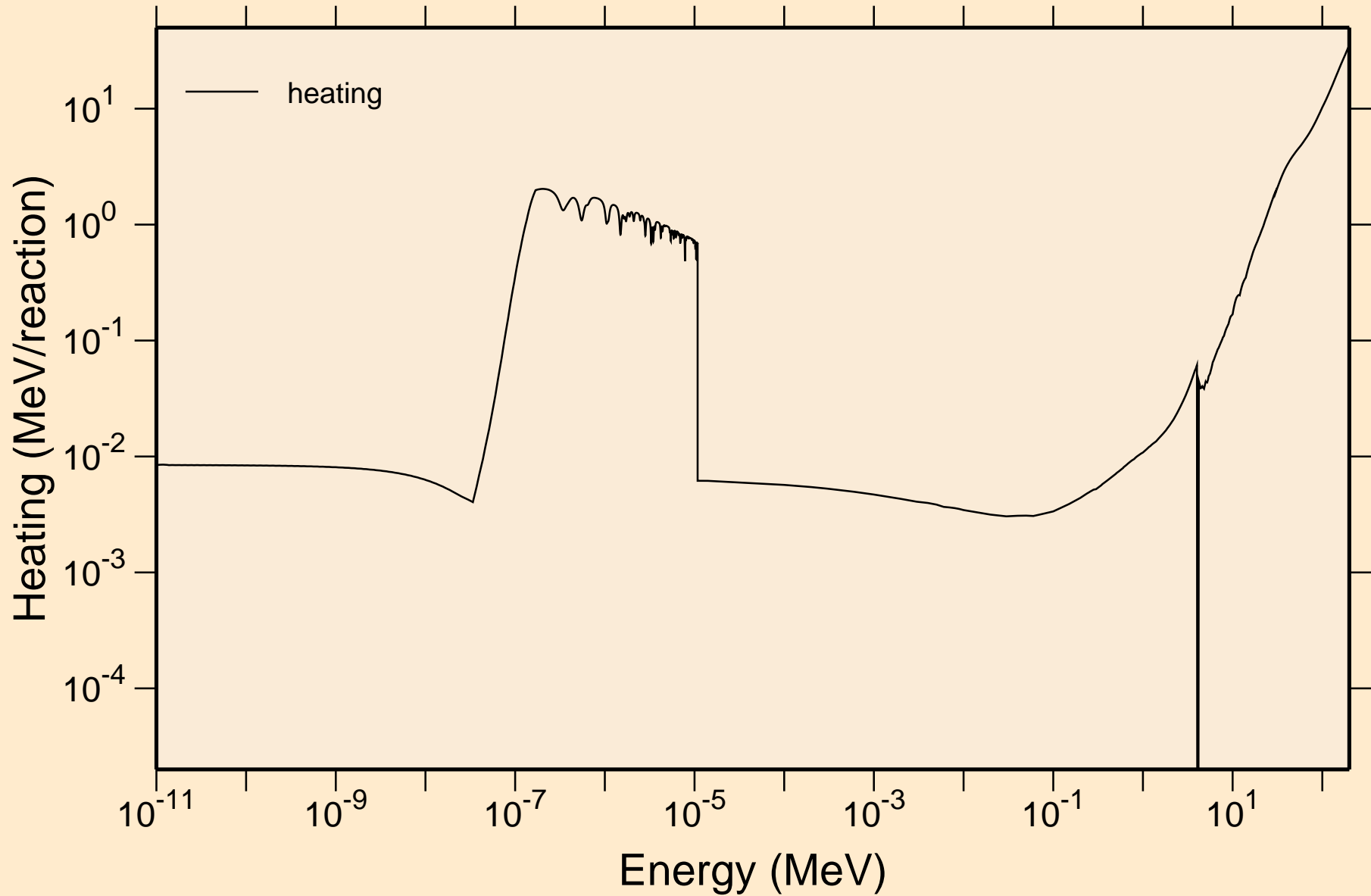

TB152 NEUTRON ACER TENDL-2023 LIBRARY; T=0.K
Damage

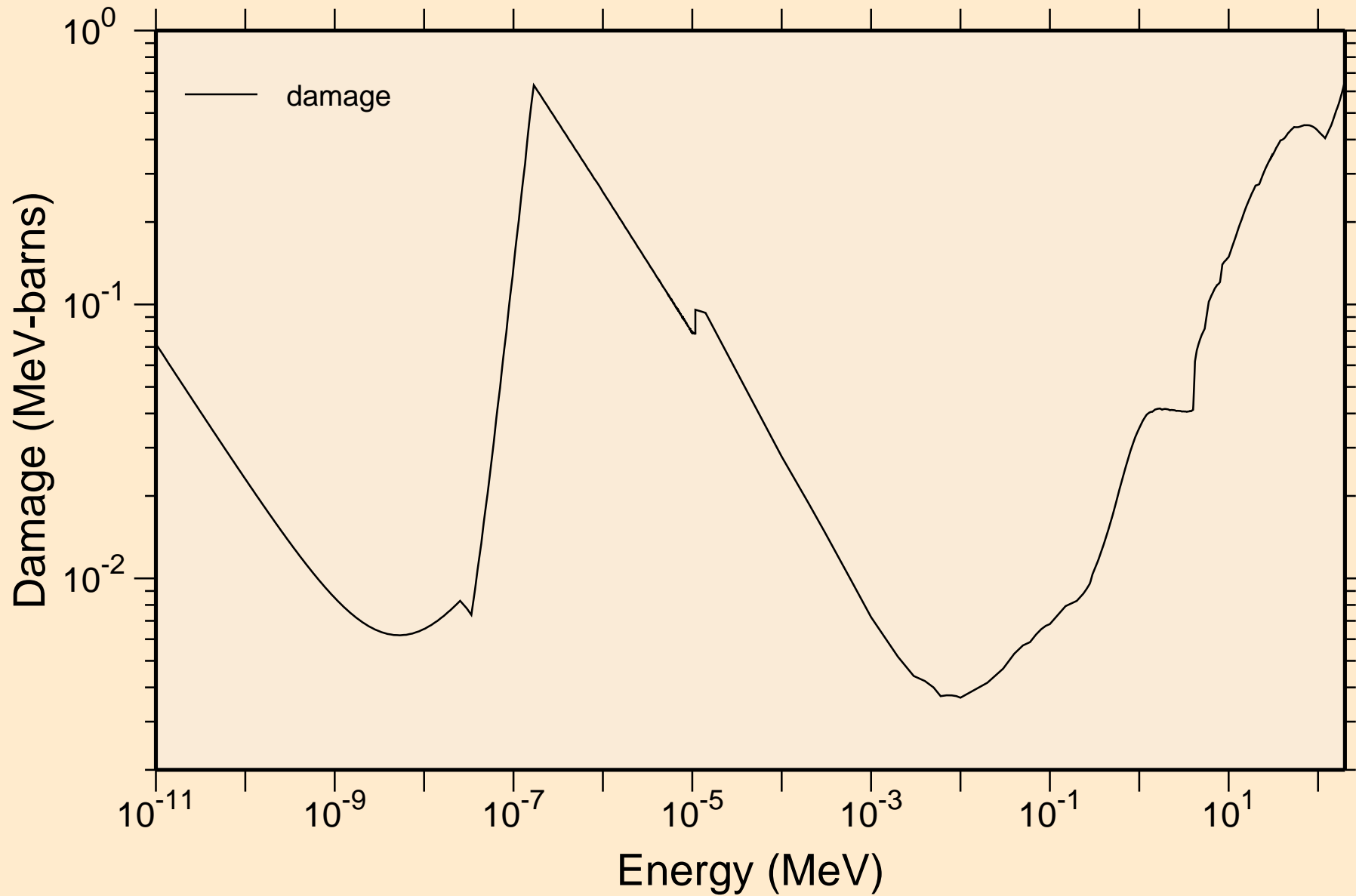

TB152 NEUTRON ACER TENDL-2023 LIBRARY; T=0.K
Non-threshold reactions

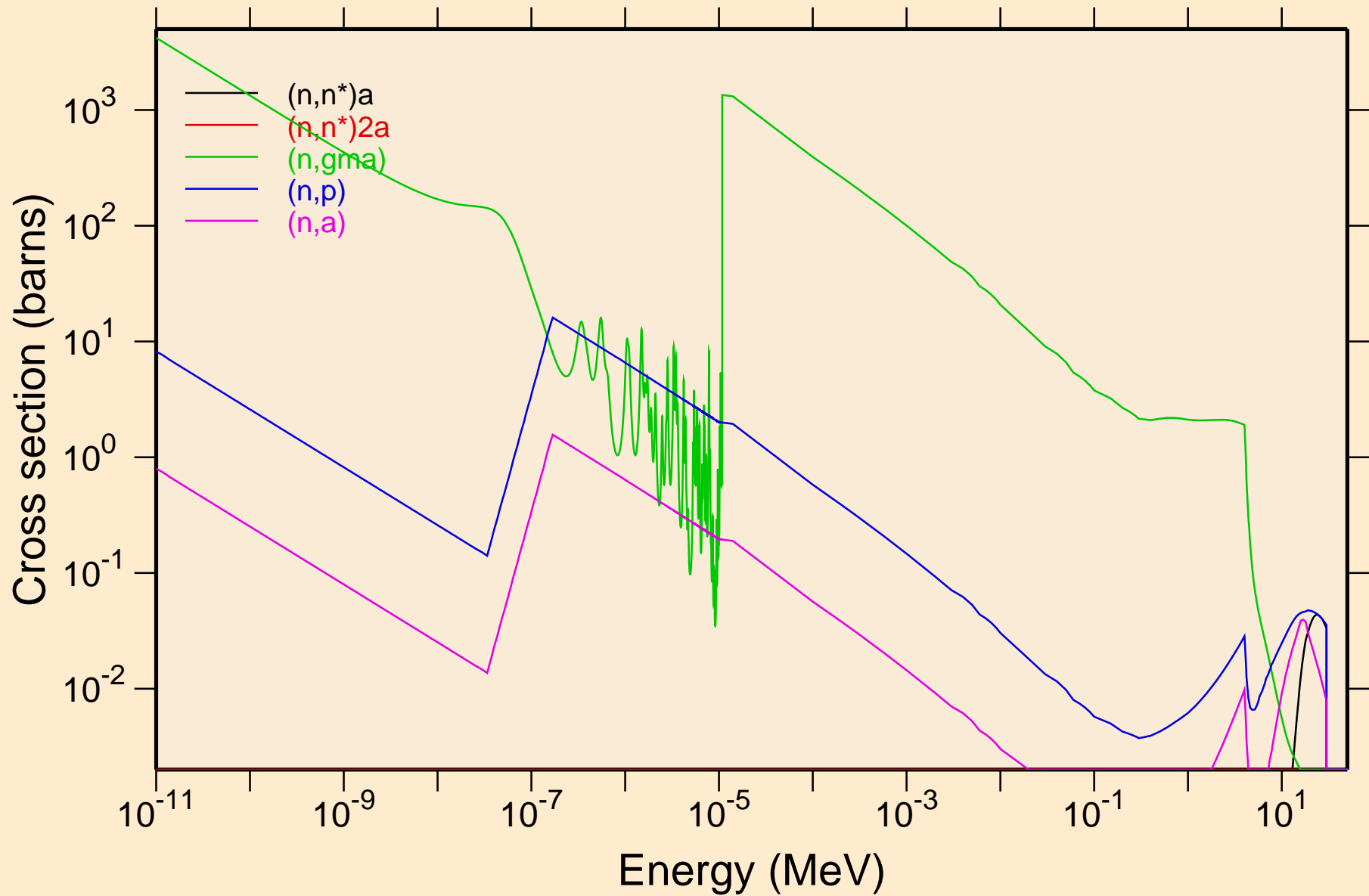

TB152 NEUTRON ACER TENDL-2023 LIBRARY; T=0.K
Non-threshold reactions

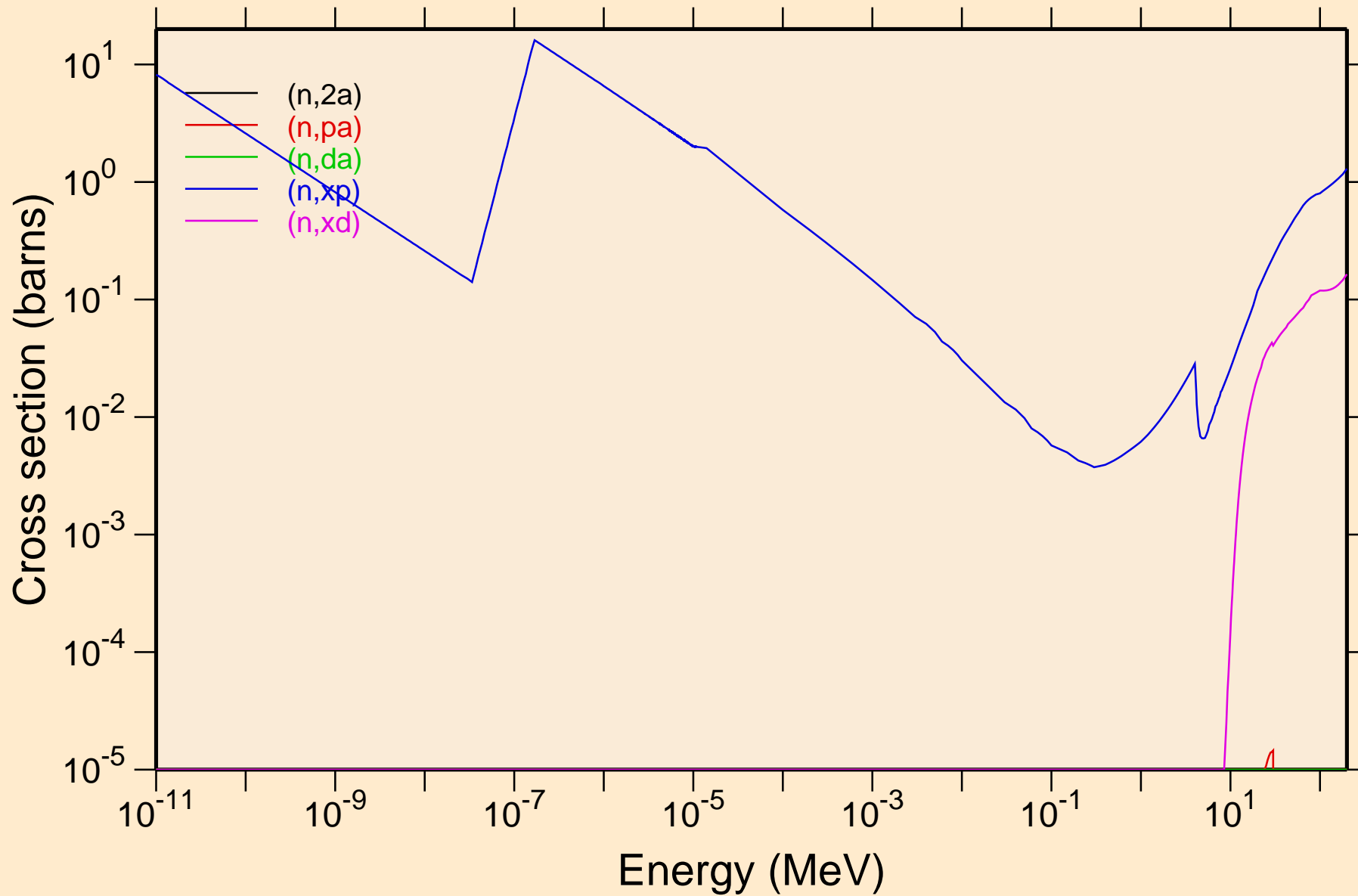

TB152 NEUTRON ACER TENDL-2023 LIBRARY; T=0.K
Non-threshold reactions

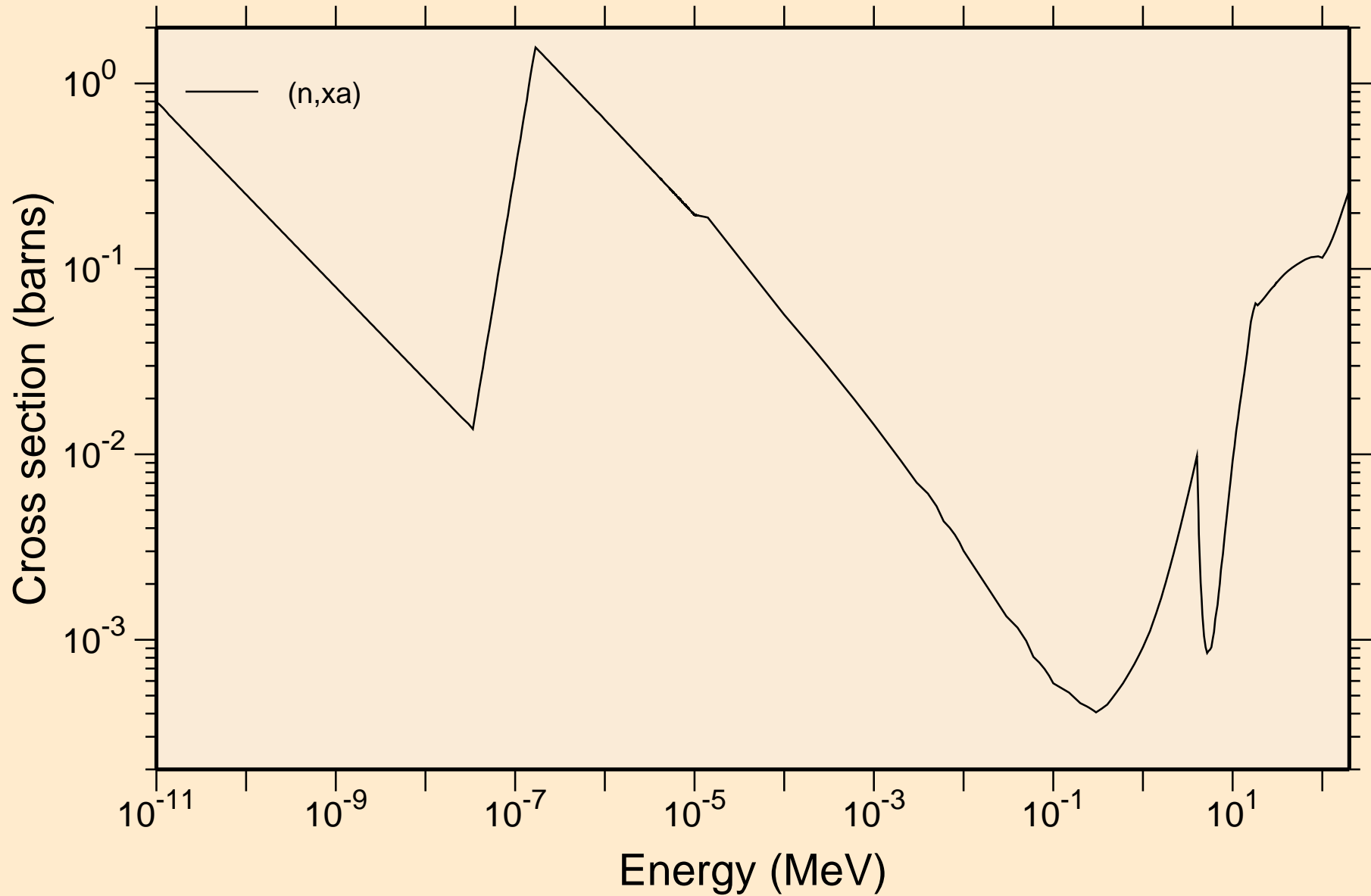

TB152 NEUTRON ACER TENDL-2023 LIBRARY; T=0.K

Principal cross sections

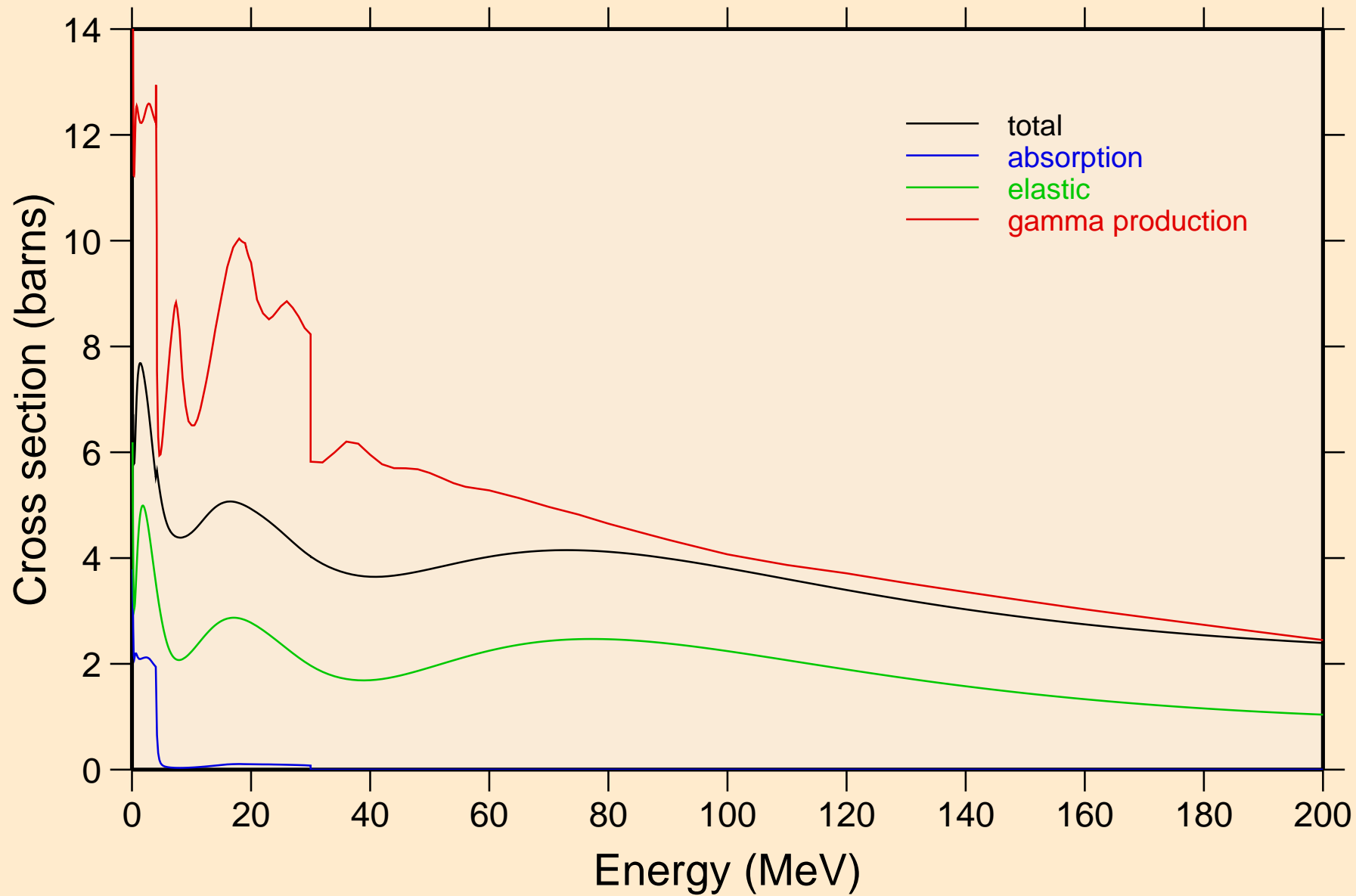

TB152 NEUTRON ACER TENDL-2023 LIBRARY; T=0.K

Heating

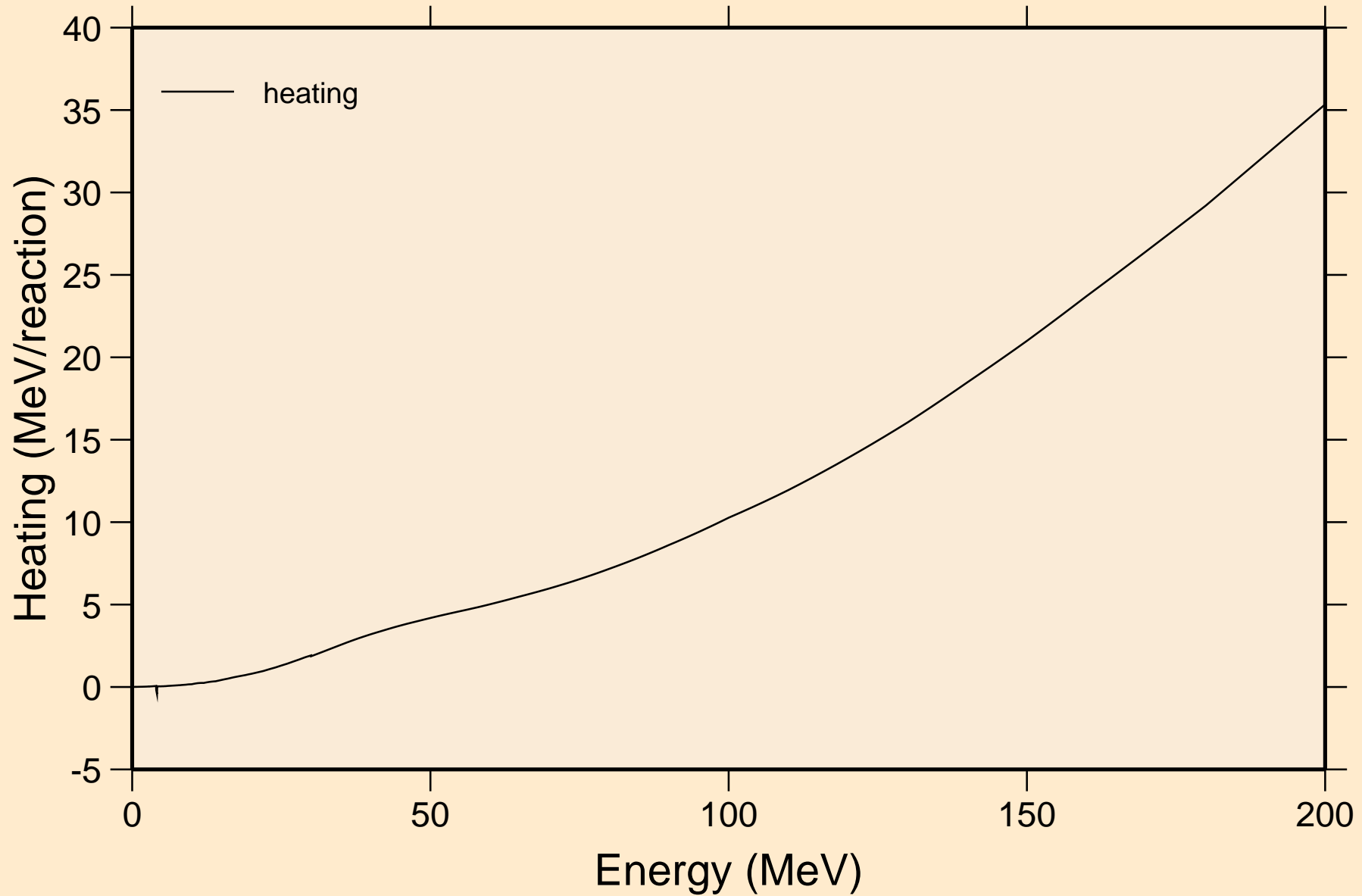

TB152 NEUTRON ACER TENDL-2023 LIBRARY; T=0.K

Damage

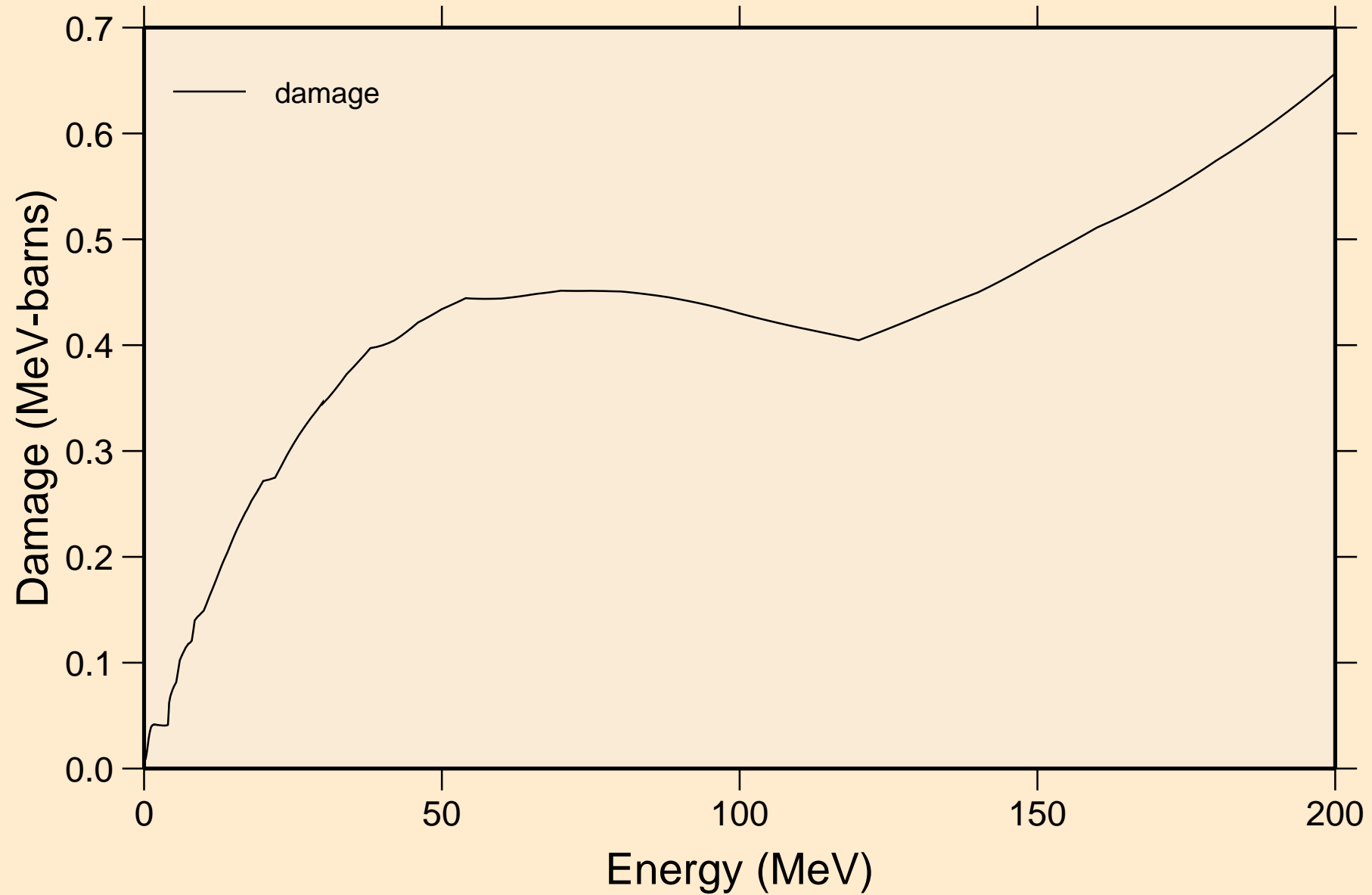

TB152 NEUTRON ACER TENDL-2023 LIBRARY; T=0.K
Non-threshold reactions

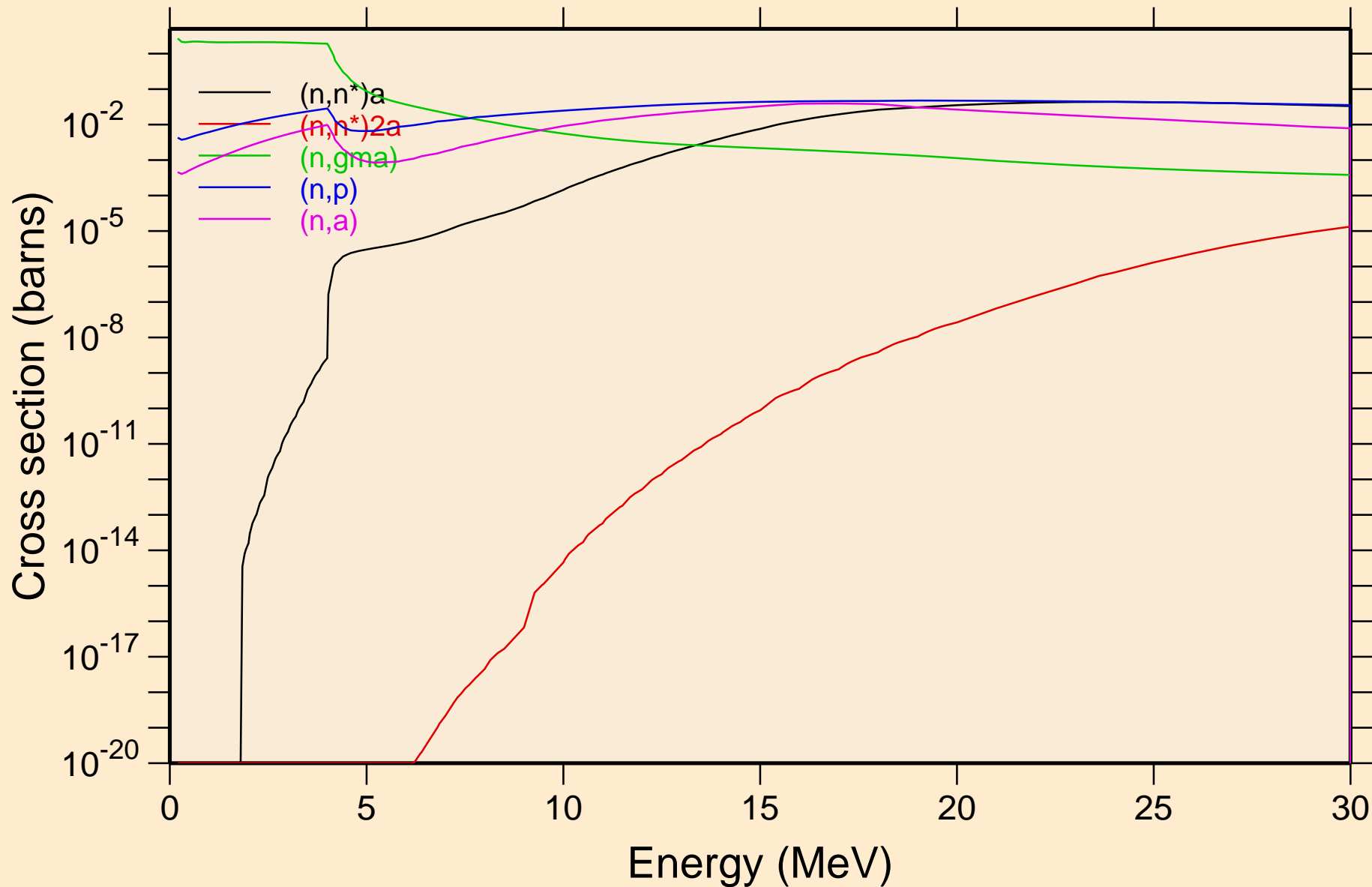

TB152 NEUTRON ACER TENDL-2023 LIBRARY; T=0.K
Non-threshold reactions

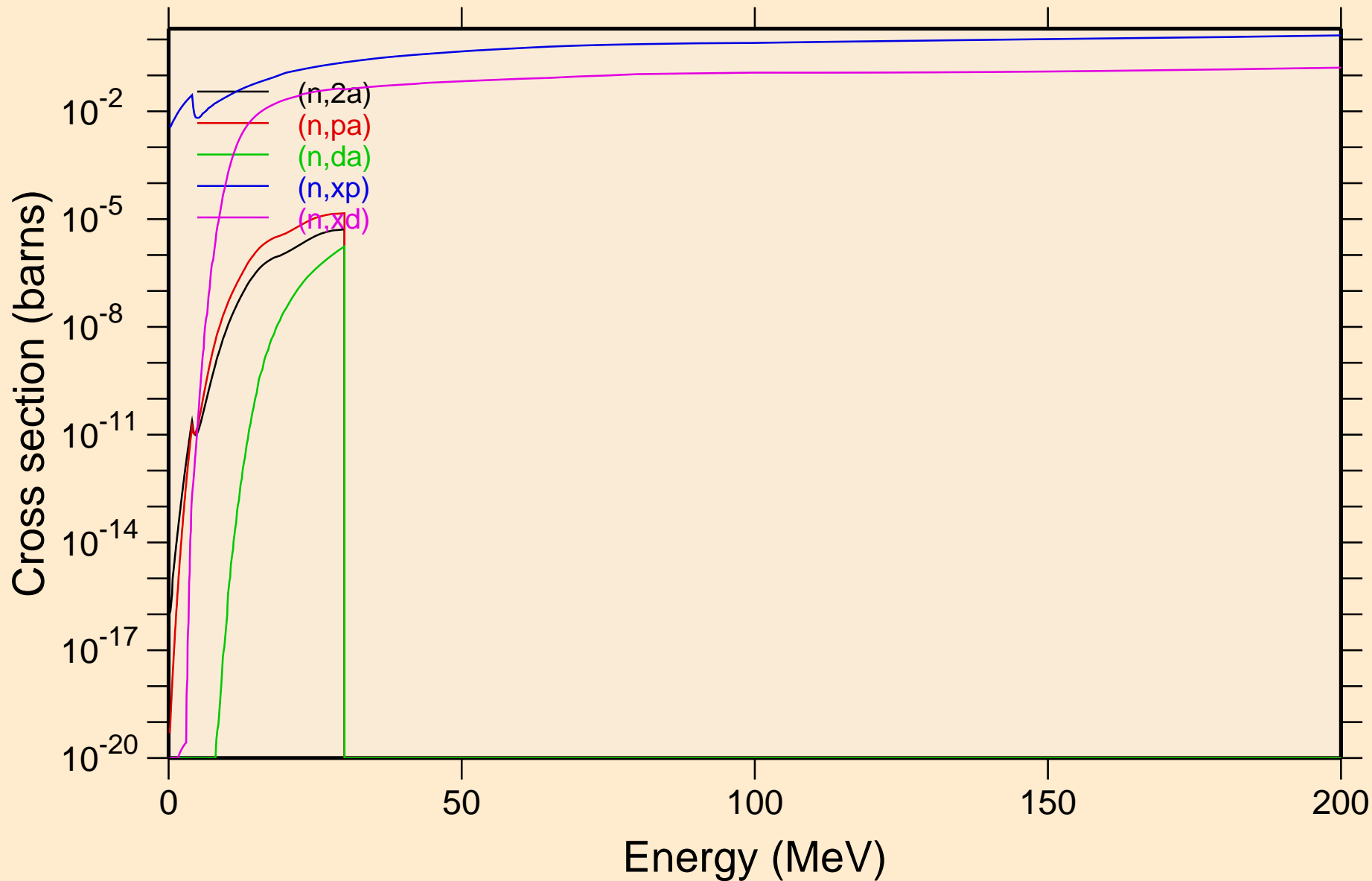

TB152 NEUTRON ACER TENDL-2023 LIBRARY; T=0.K
Non-threshold reactions

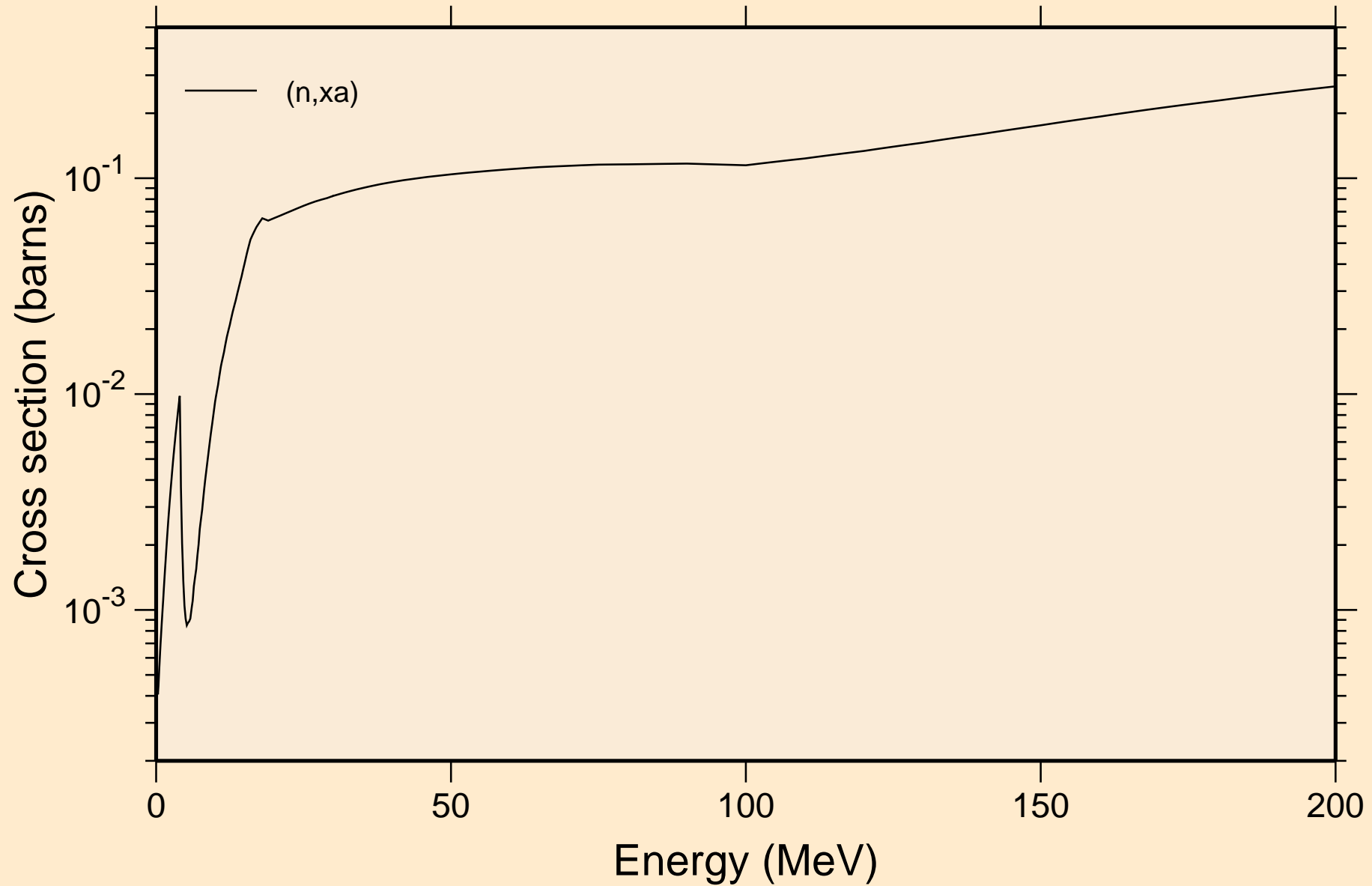

TB152 NEUTRON ACER TENDL-2023 LIBRARY; T=0.K
Inelastic levels

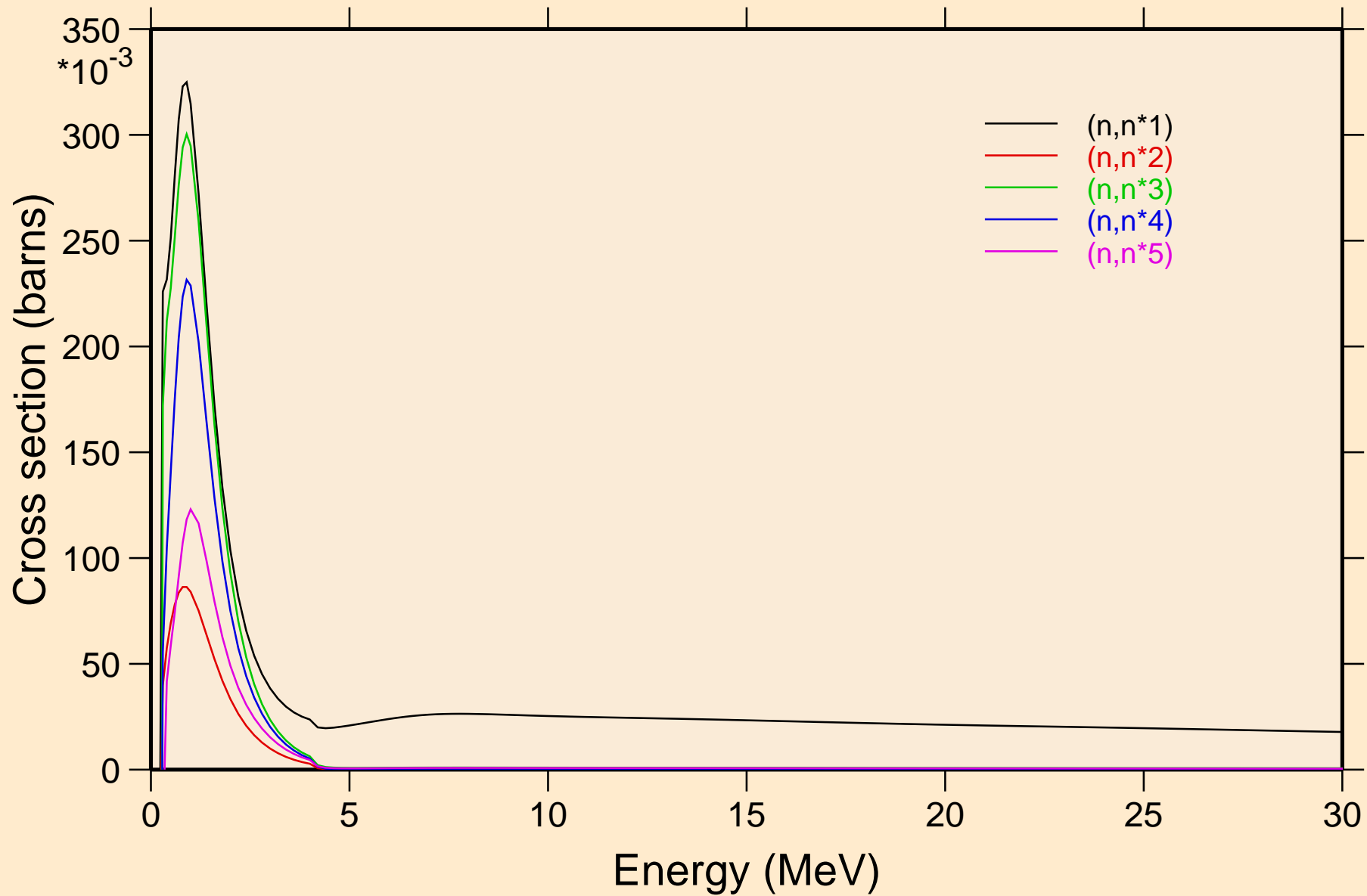

TB152 NEUTRON ACER TENDL-2023 LIBRARY; T=0.K
Threshold reactions

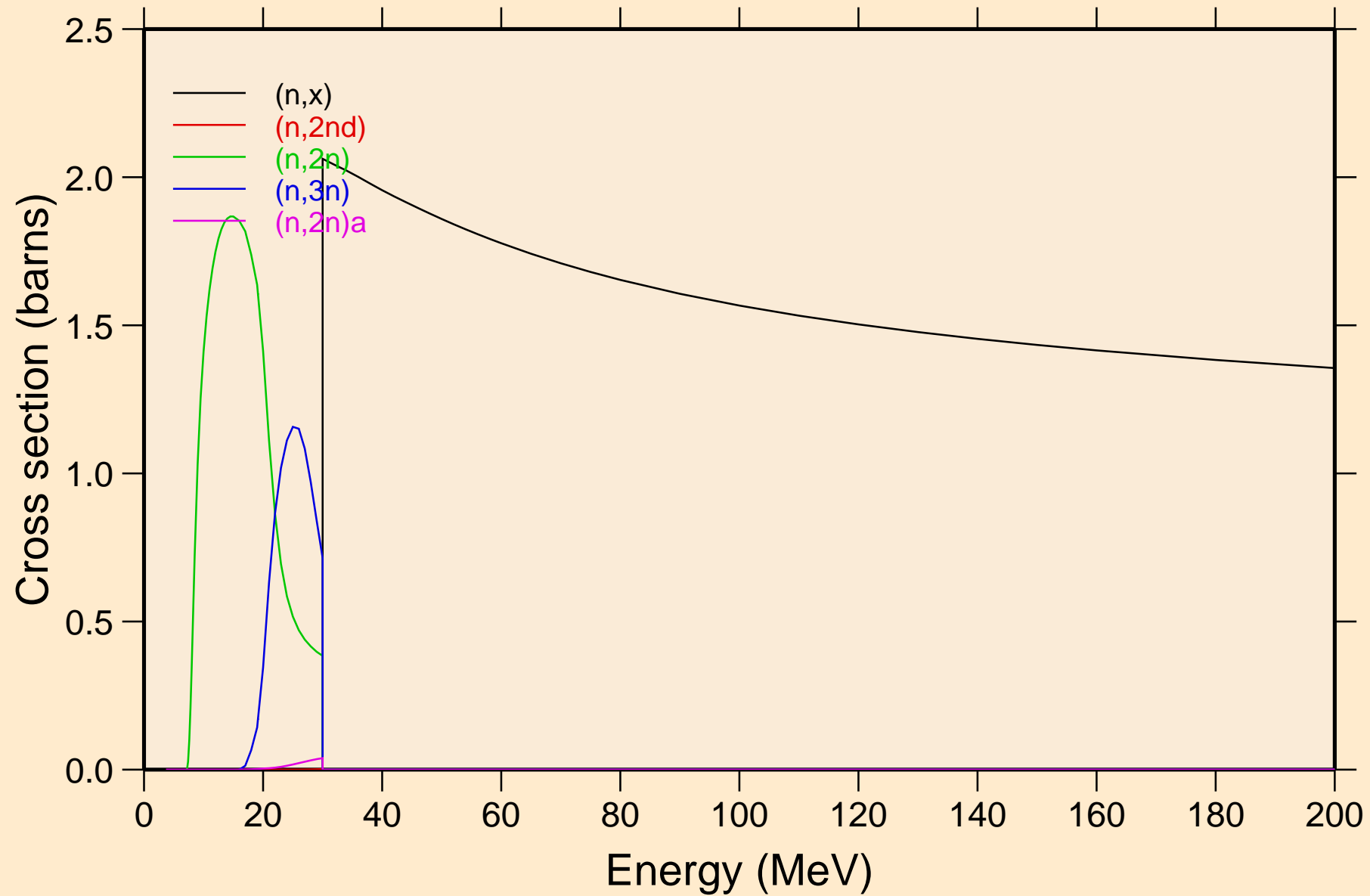

TB152 NEUTRON ACER TENDL-2023 LIBRARY; T=0.K
Threshold reactions

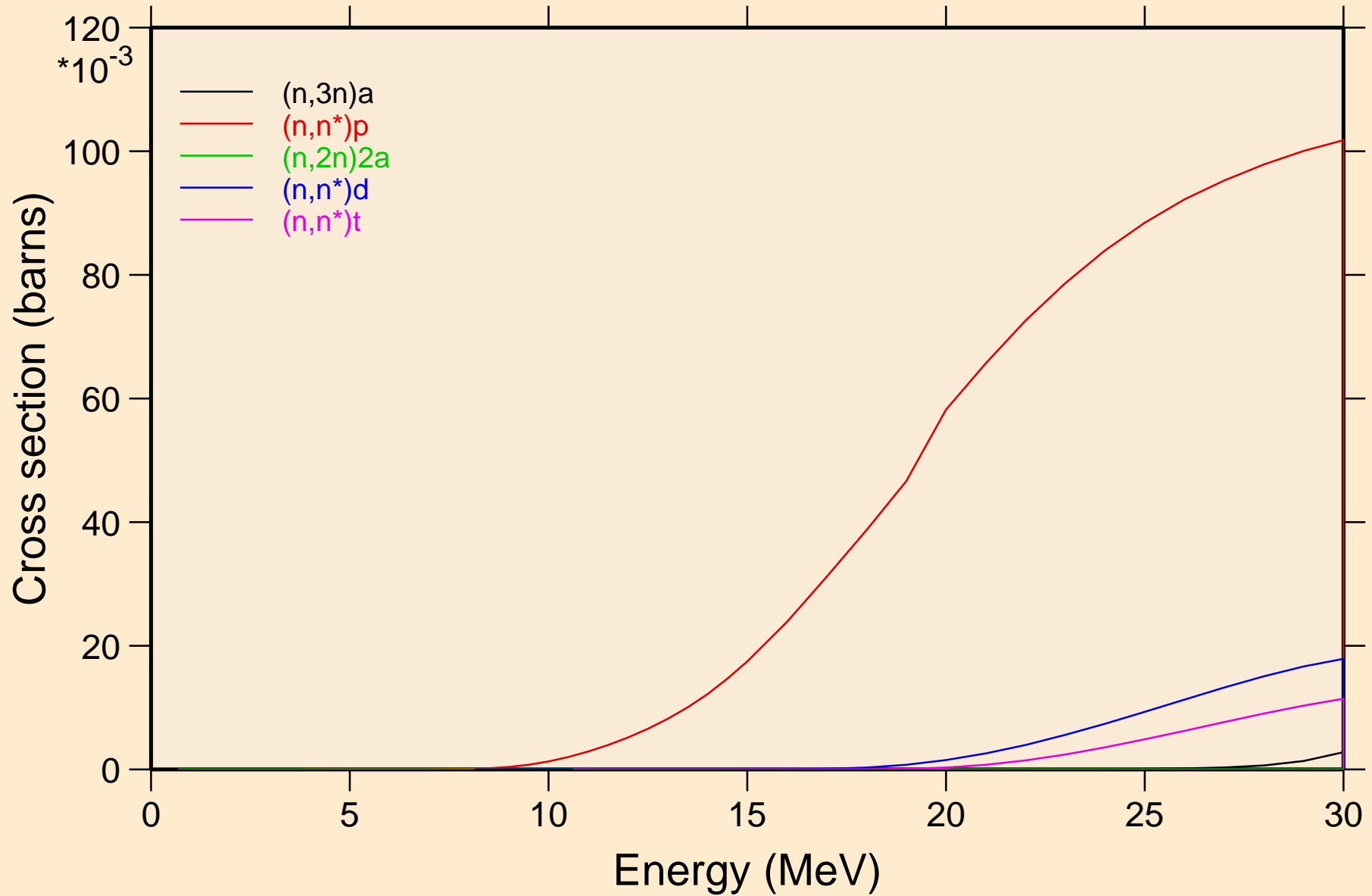

TB152 NEUTRON ACER TENDL-2023 LIBRARY; T=0.K
Threshold reactions

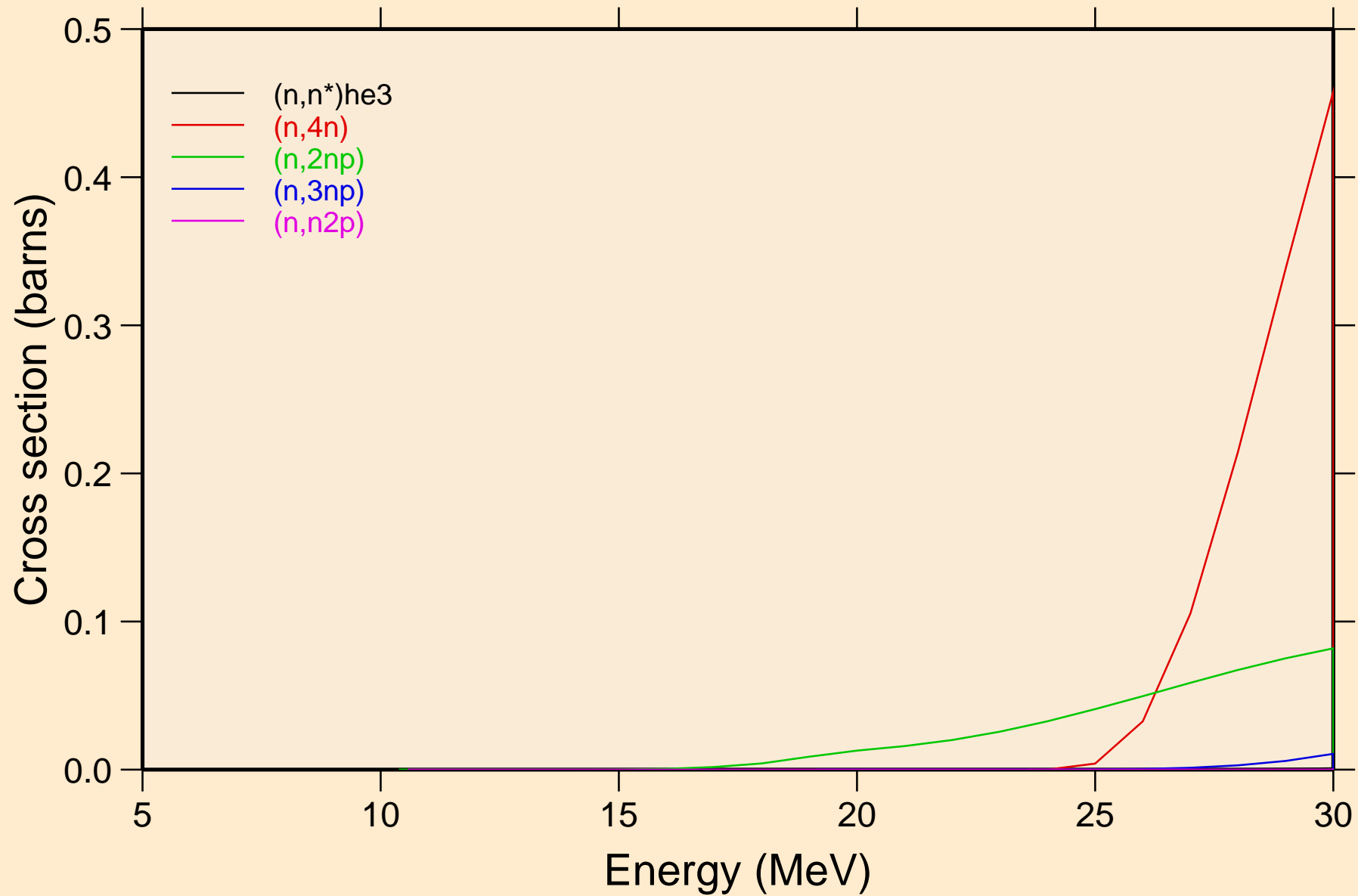

TB152 NEUTRON ACER TENDL-2023 LIBRARY; T=0.K
Threshold reactions

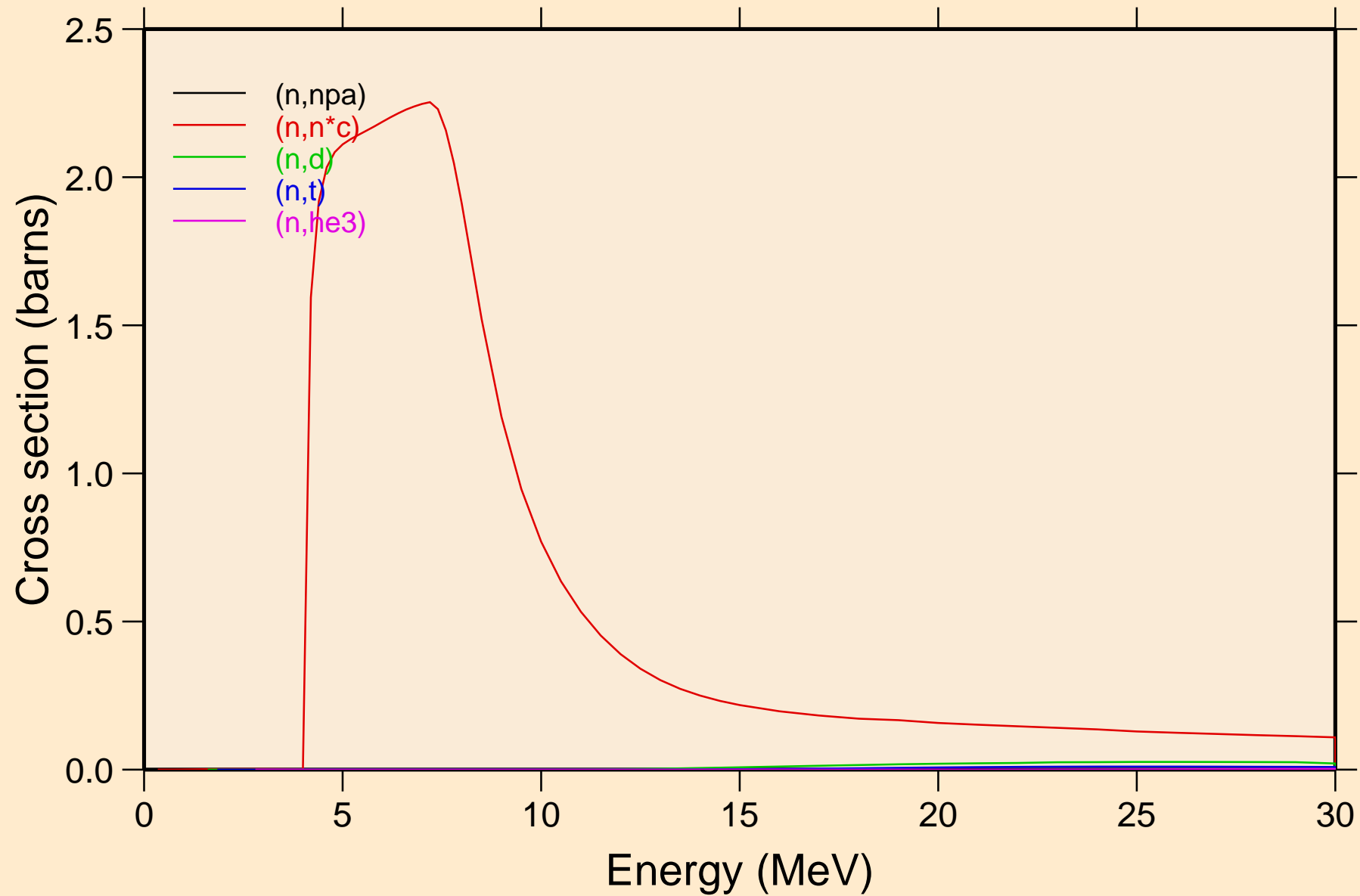

TB152 NEUTRON ACER TENDL-2023 LIBRARY; T=0.K
Threshold reactions

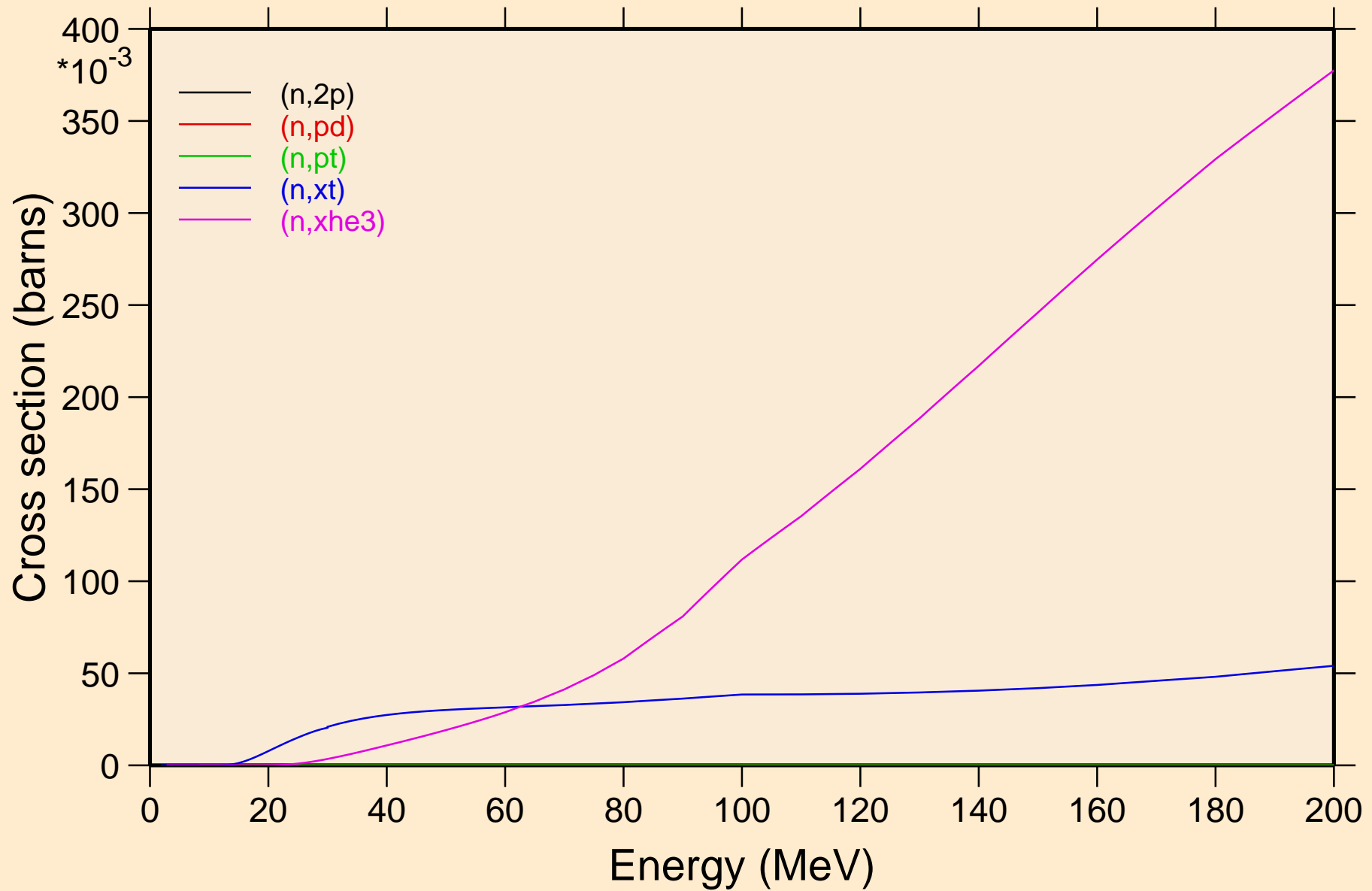

TB152 NEUTRON ACER TENDL-2023 LIBRARY; T=0.K
angular distribution for elastic

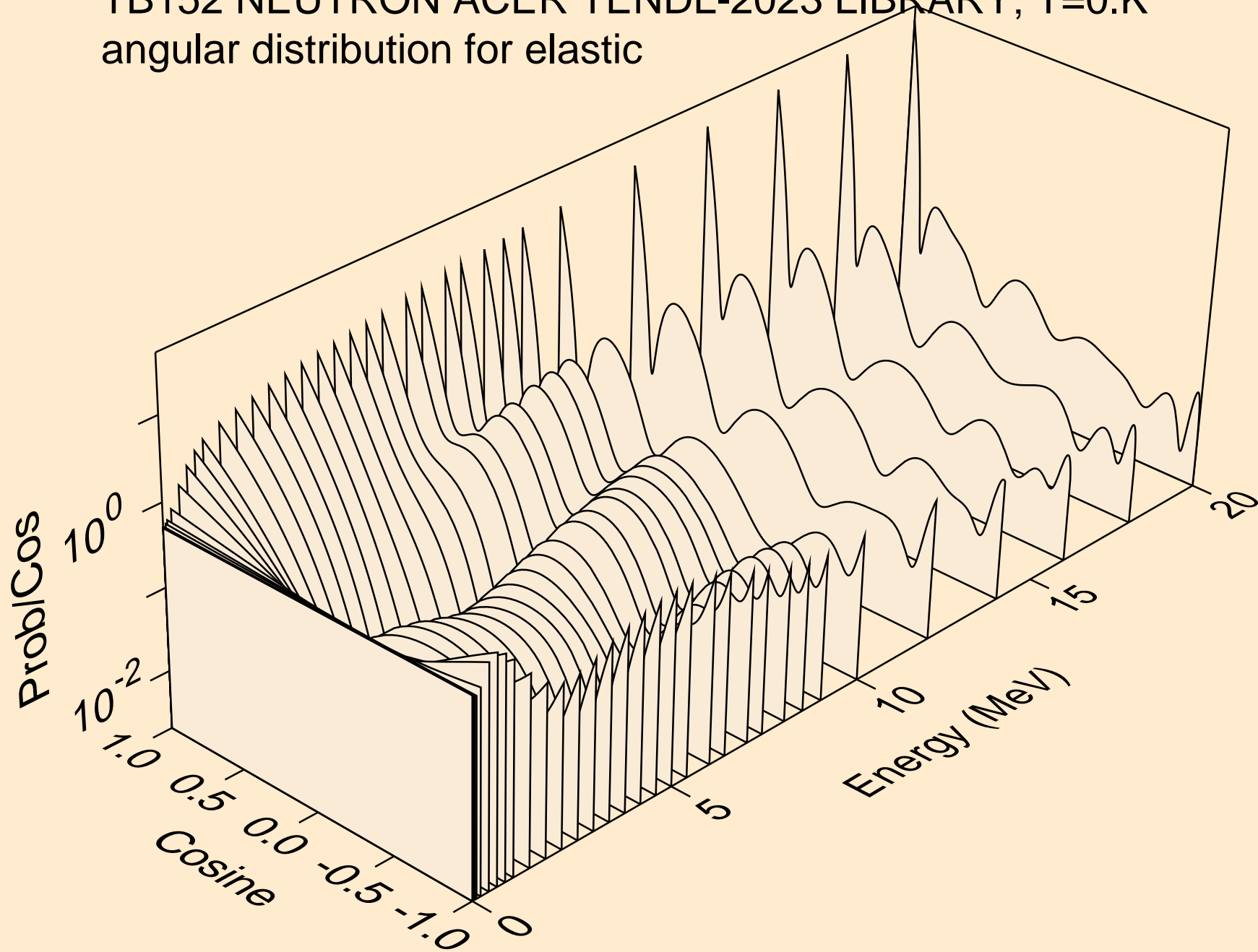

TB152 NEUTRON ACER TENDL-2023 LIBRARY; T=0.K
angular distribution for elastic

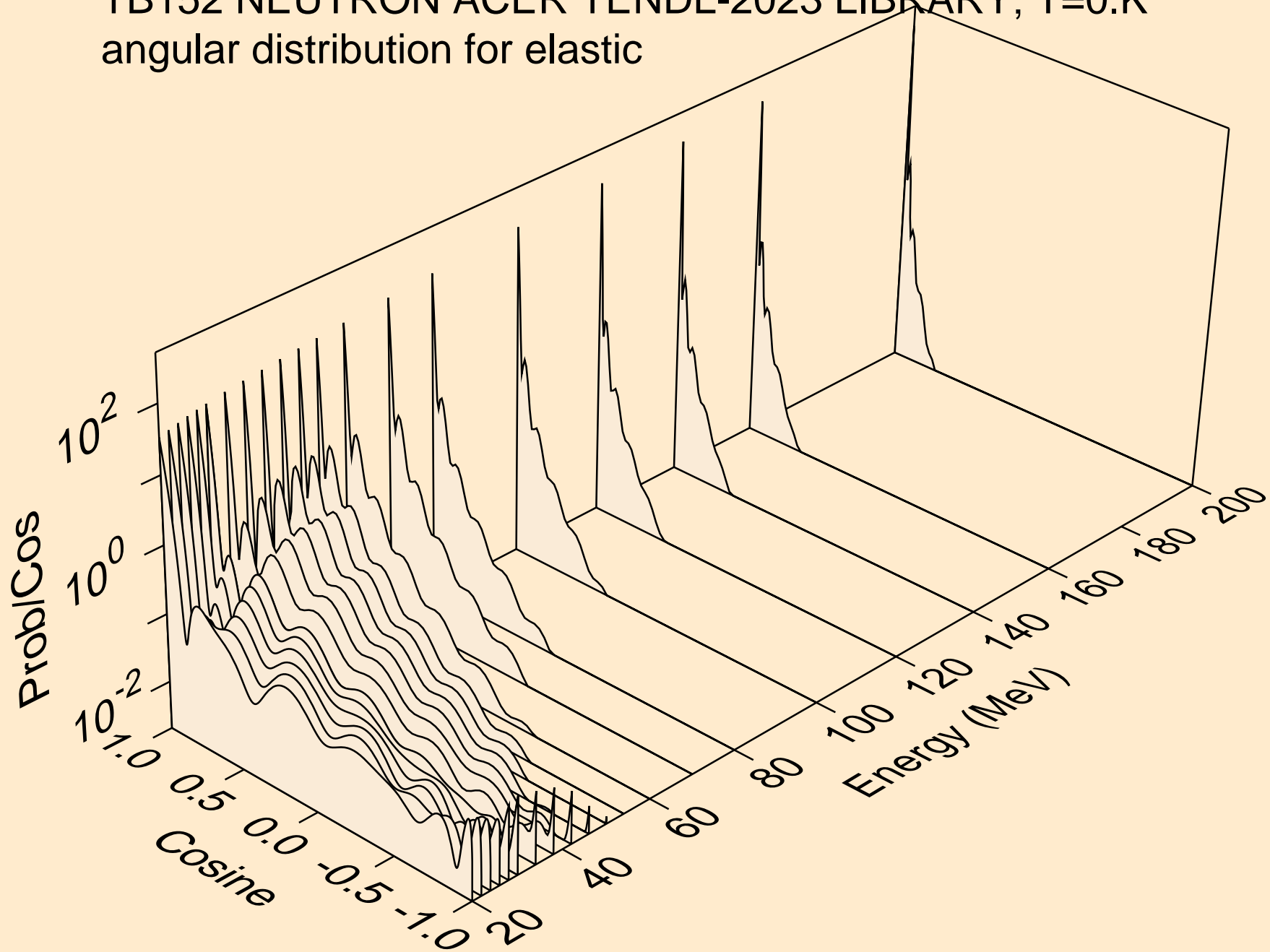

TB152 NEUTRON ACER TENDL-2023 LIBRARY; T=0.K
angular distribution for (n,n*1)

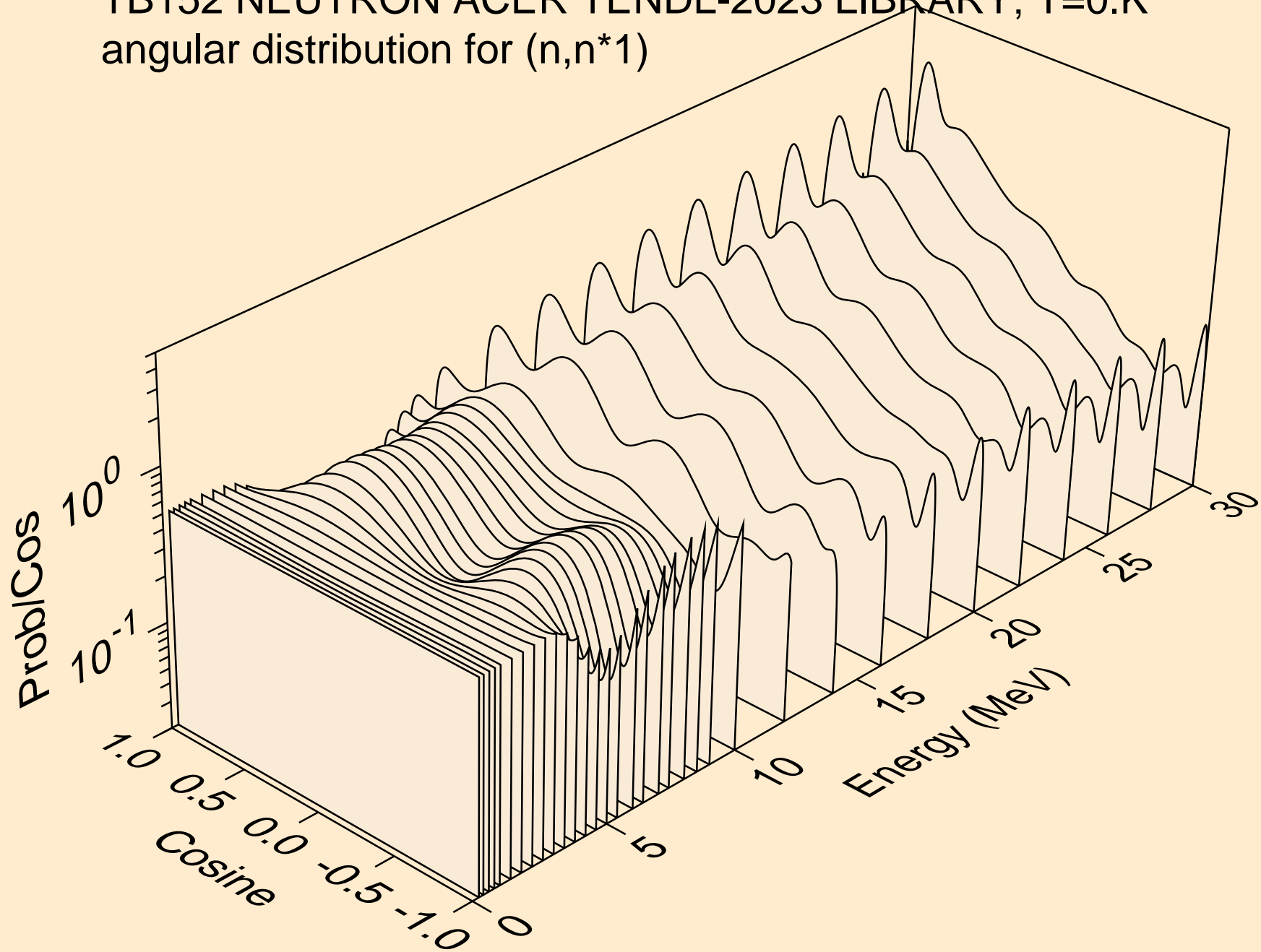

TB152 NEUTRON ACER TENDL-2023 LIBRARY; T=0.K
angular distribution for (n,n*2)

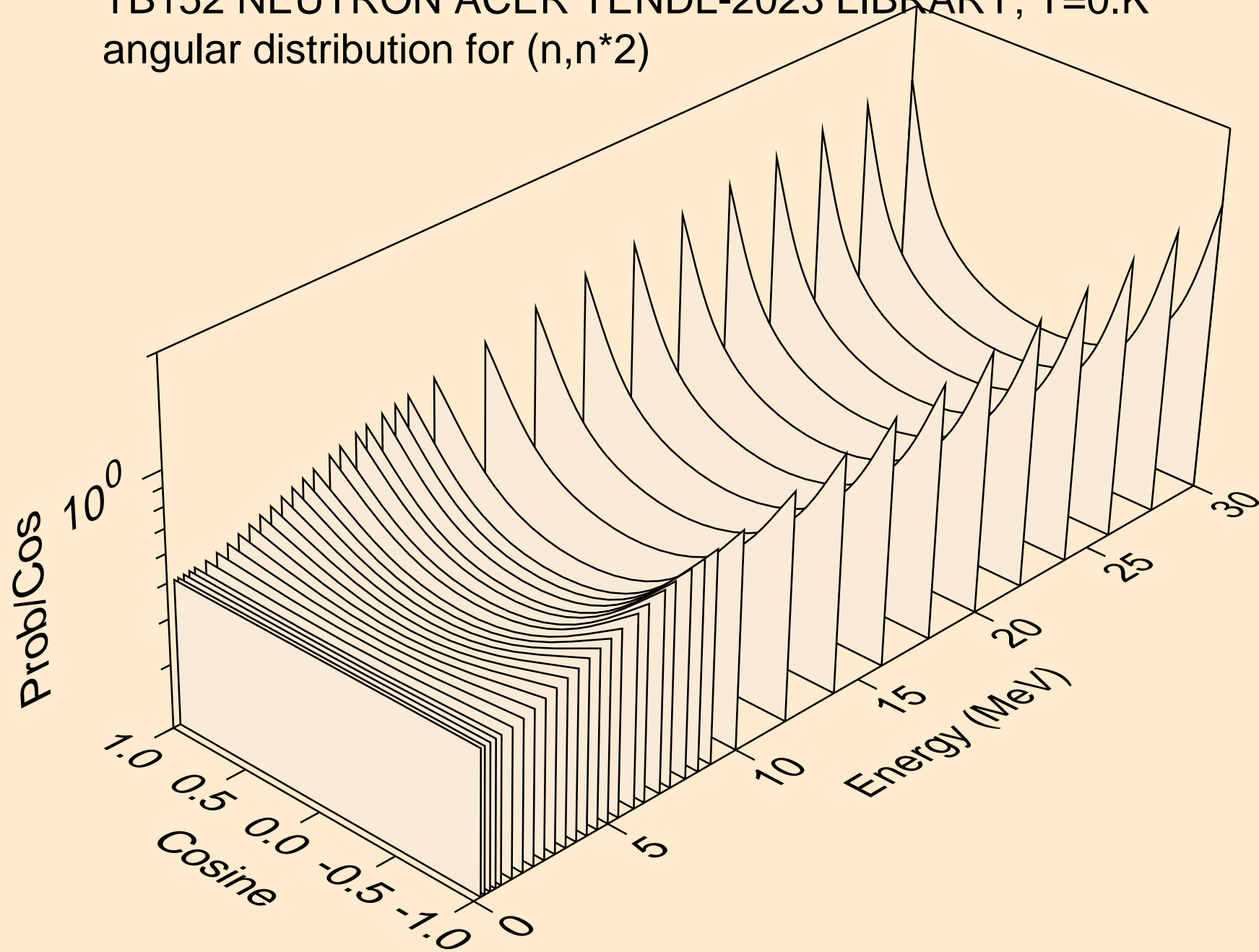

TB152 NEUTRON ACER TENDL-2023 LIBRARY; T=0.K
angular distribution for (n,n*3)

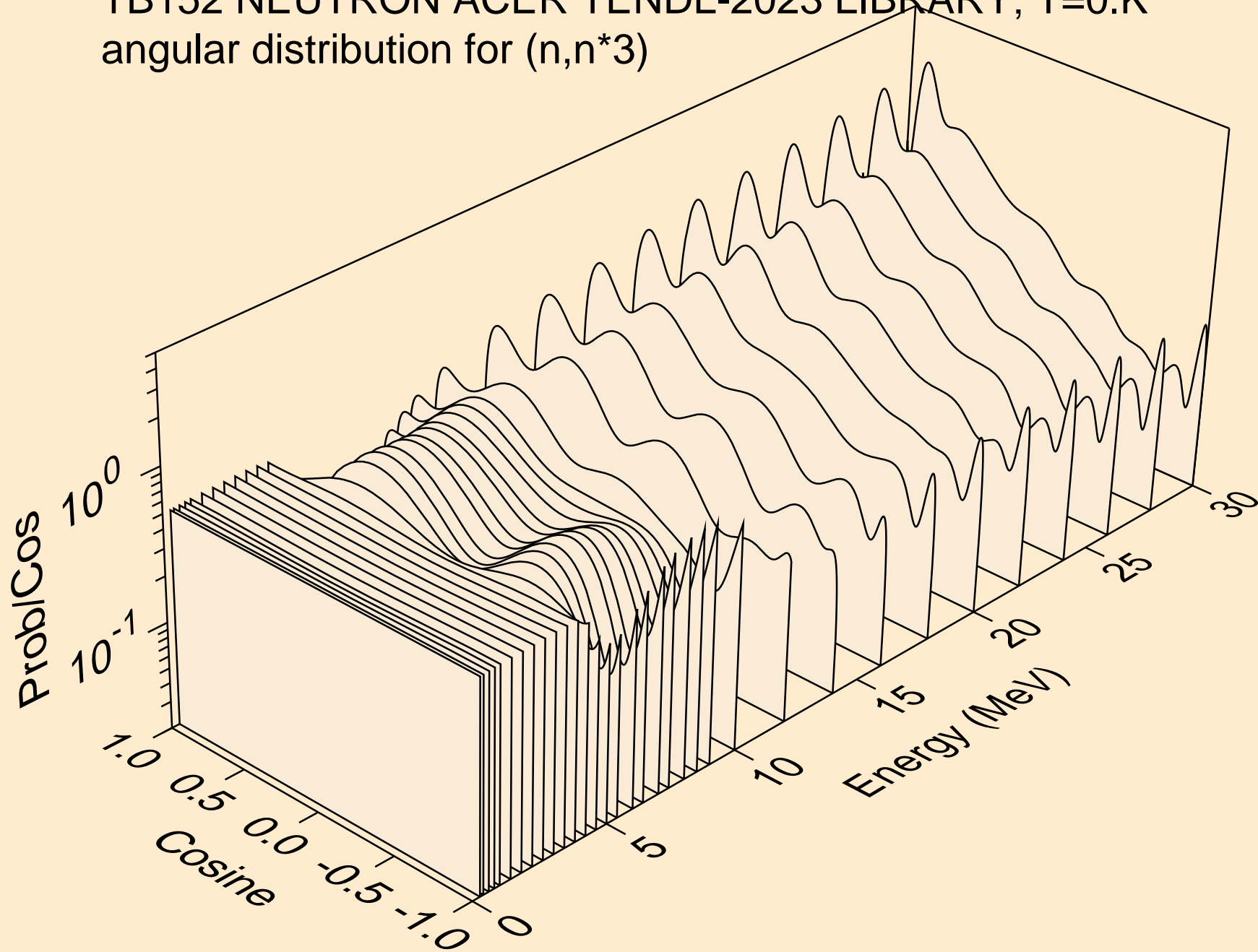

TB152 NEUTRON ACER TENDL-2023 LIBRARY; T=0.K
angular distribution for (n,n*4)

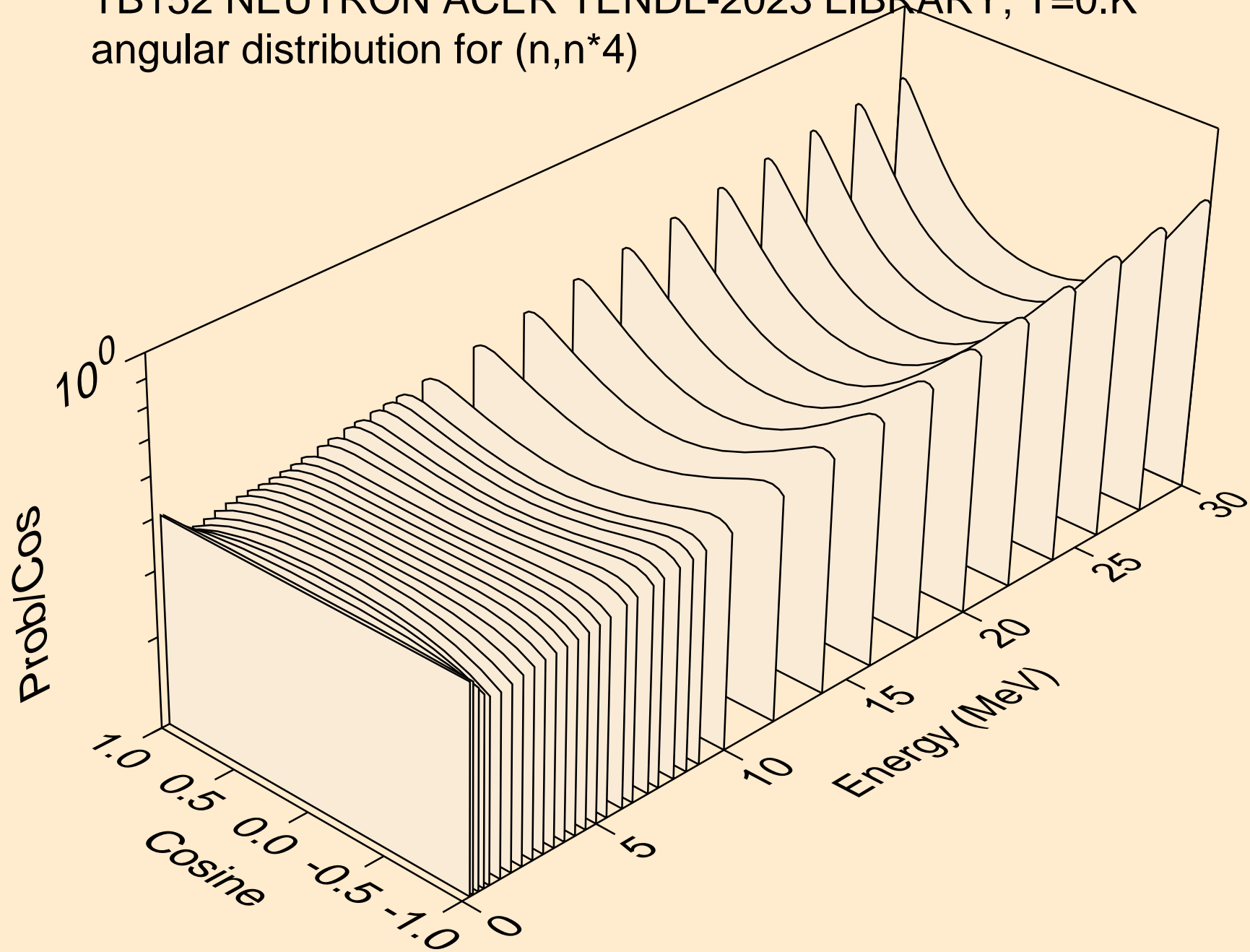

TB152 NEUTRON ACER TENDL-2023 LIBRARY; T=0.K
angular distribution for (n,n*5)

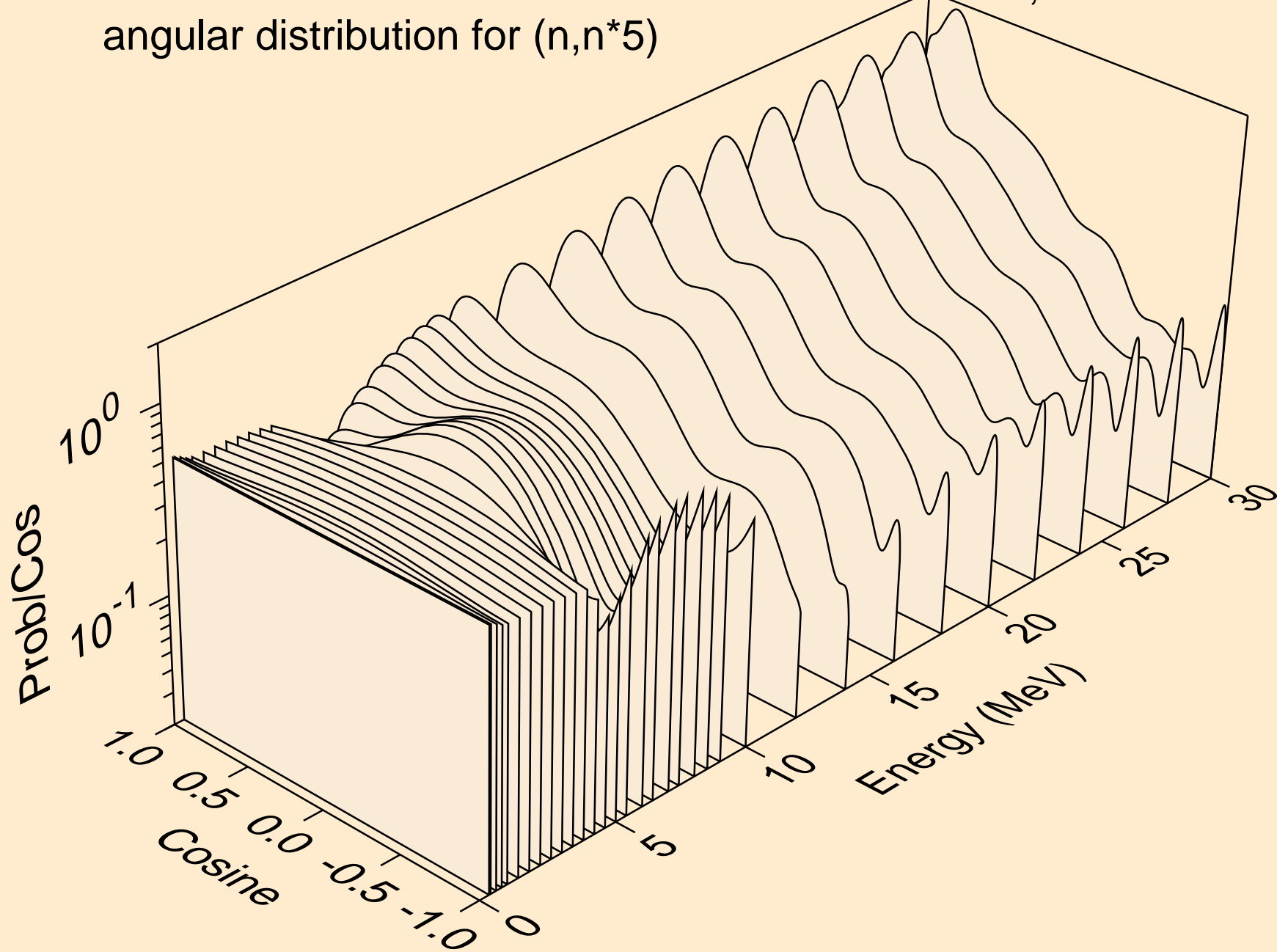

TB152 NEUTRON ACER TENDL-2023 LIBRARY; T=0.K
Neutron emission for (n,x)

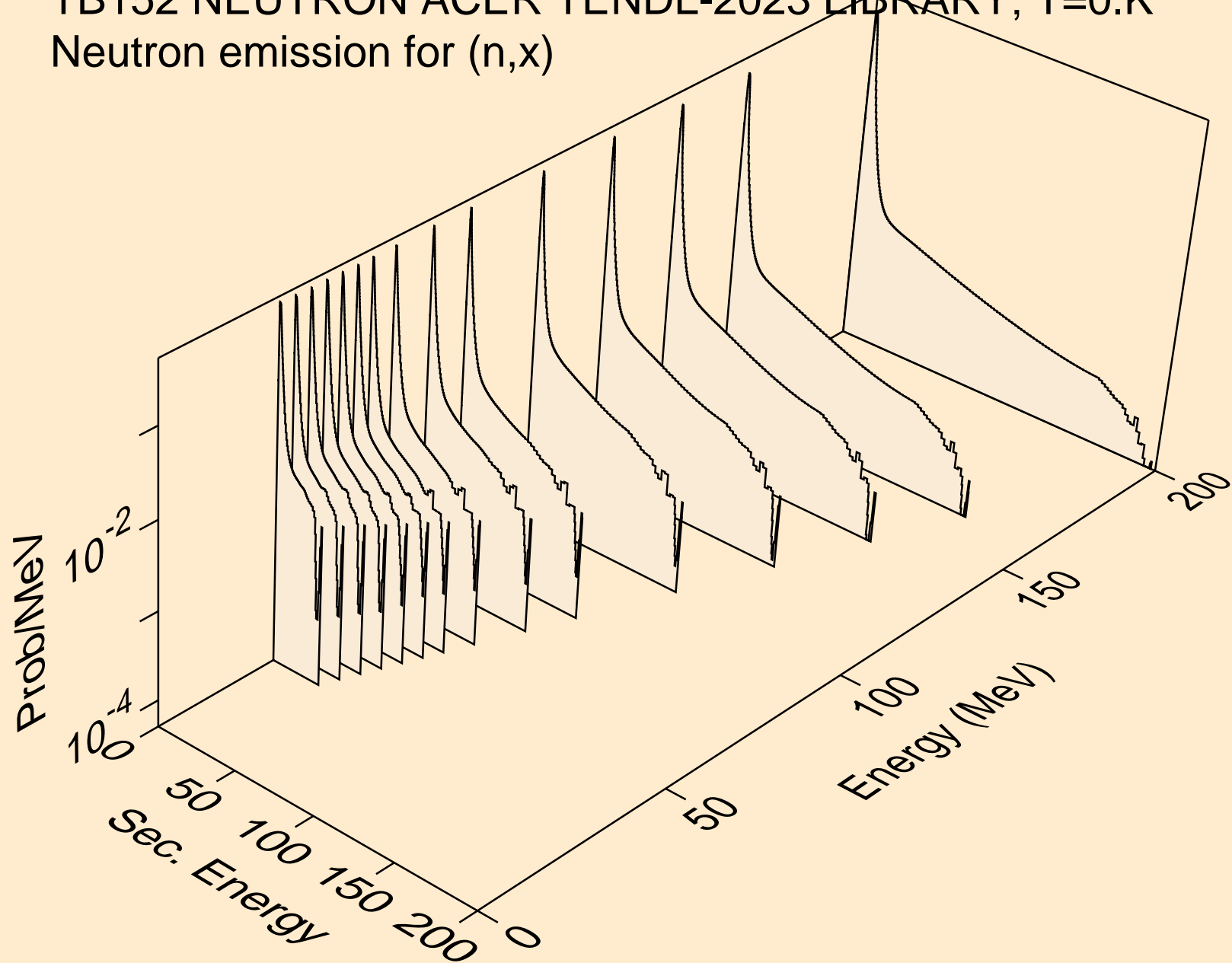

TB152 NEUTRON ACER TENDL-2023 LIBRARY; T=0.K
Neutron emission for (n,2nd)

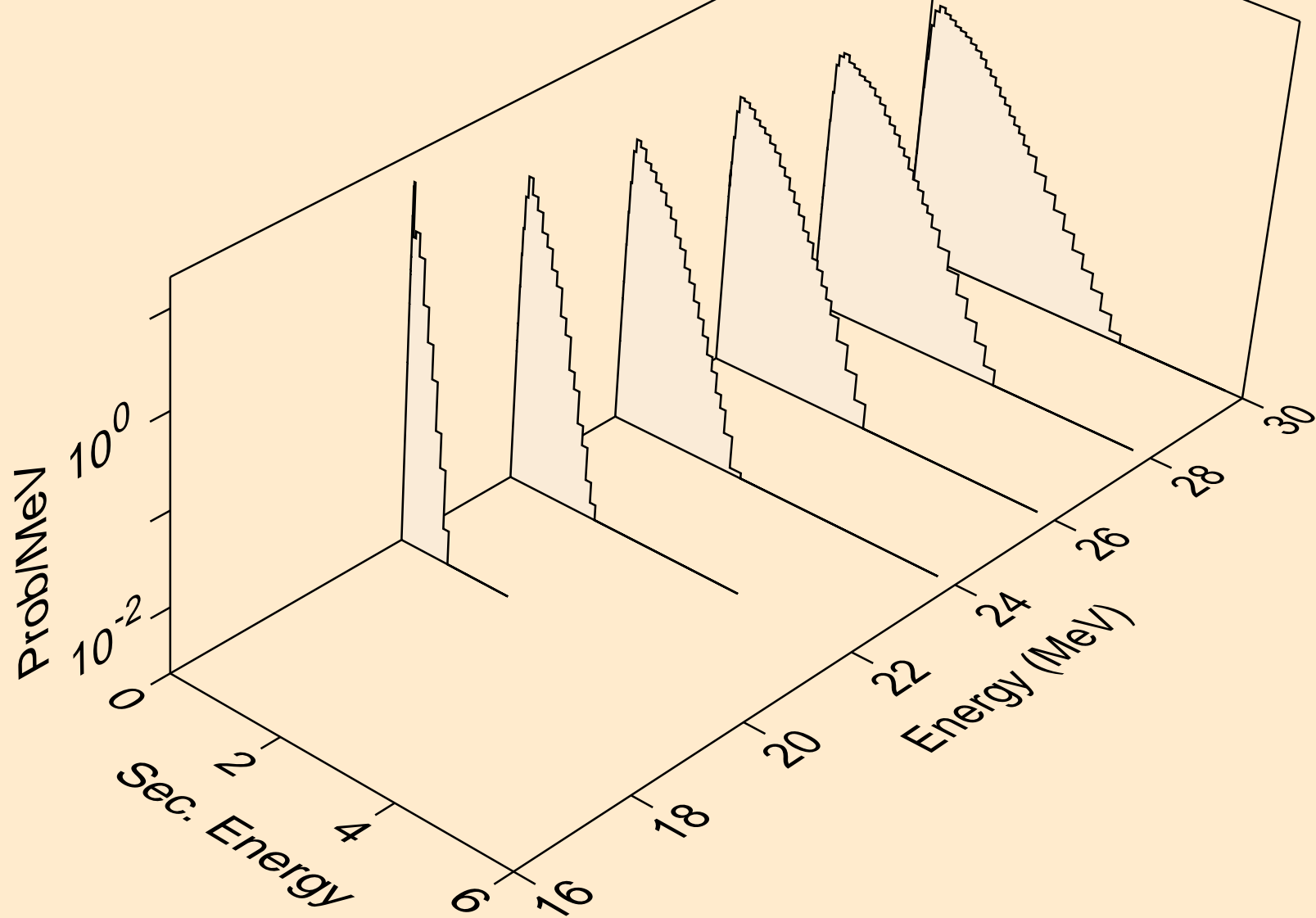

TB152 NEUTRON ACER TENDL-2023 LIBRARY; T=0.K
Neutron emission for (n,2n)

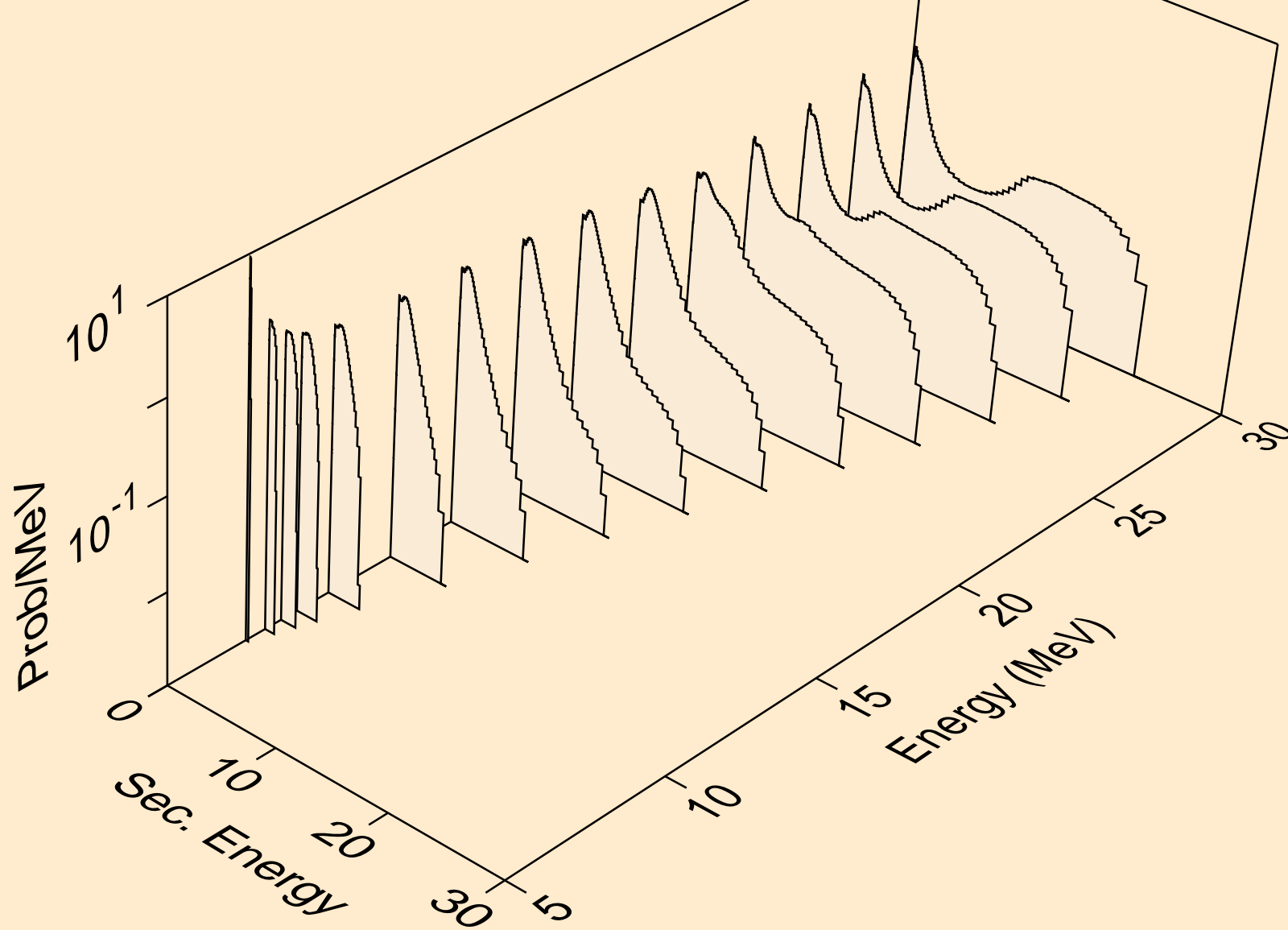

TB152 NEUTRON ACER TENDL-2023 LIBRARY; T=0.K
Neutron emission for (n,3n)

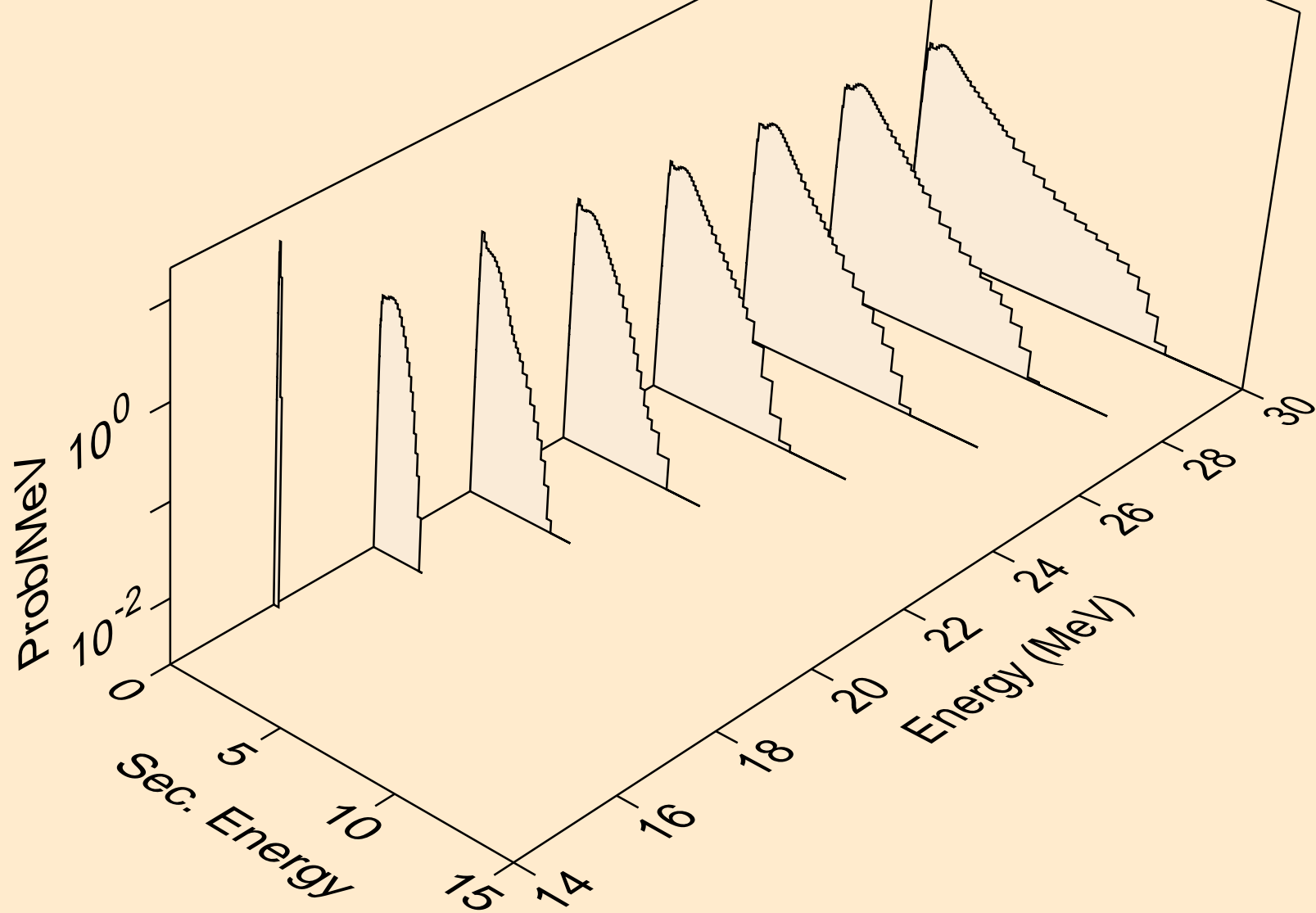

TB152 NEUTRON ACER TENDL-2023 LIBRARY; T=0.K
Neutron emission for (n,n*)a

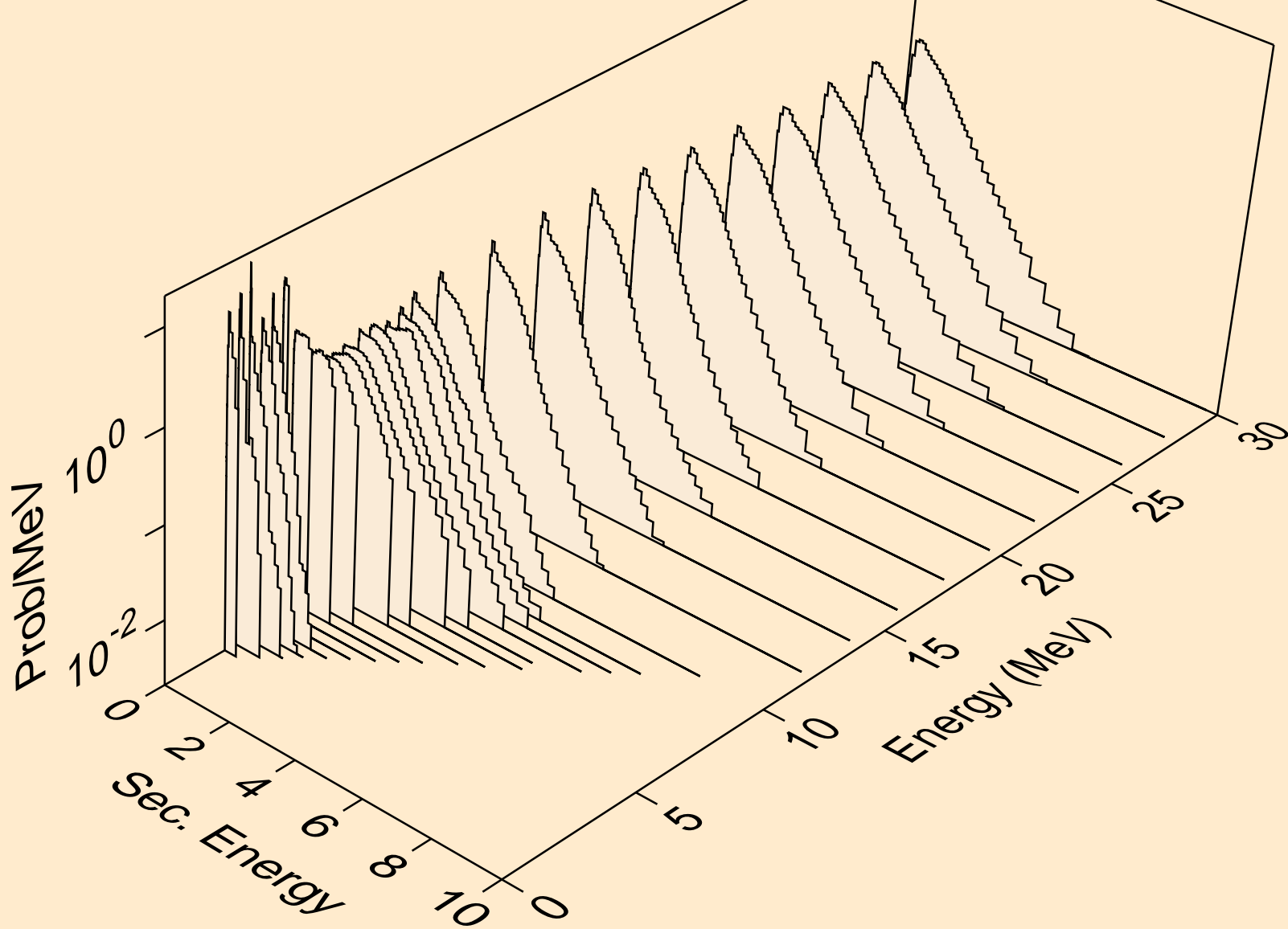

TB152 NEUTRON ACER TENDL-2023 LIBRARY; T=0.K
Neutron emission for (n,2n)a

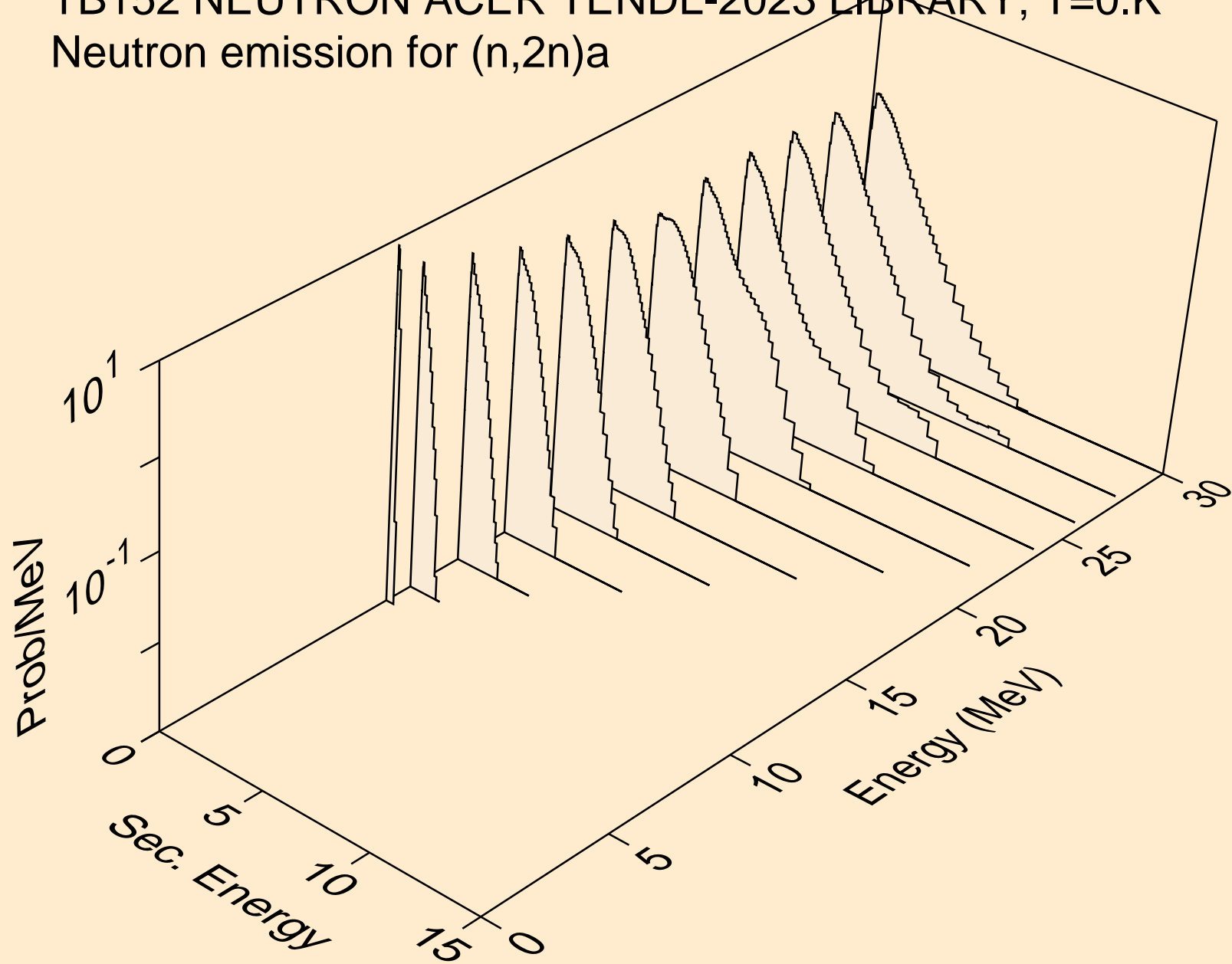

TB152 NEUTRON ACER TENDL-2023 LIBRARY; T=0.K
Neutron emission for (n,3n)a

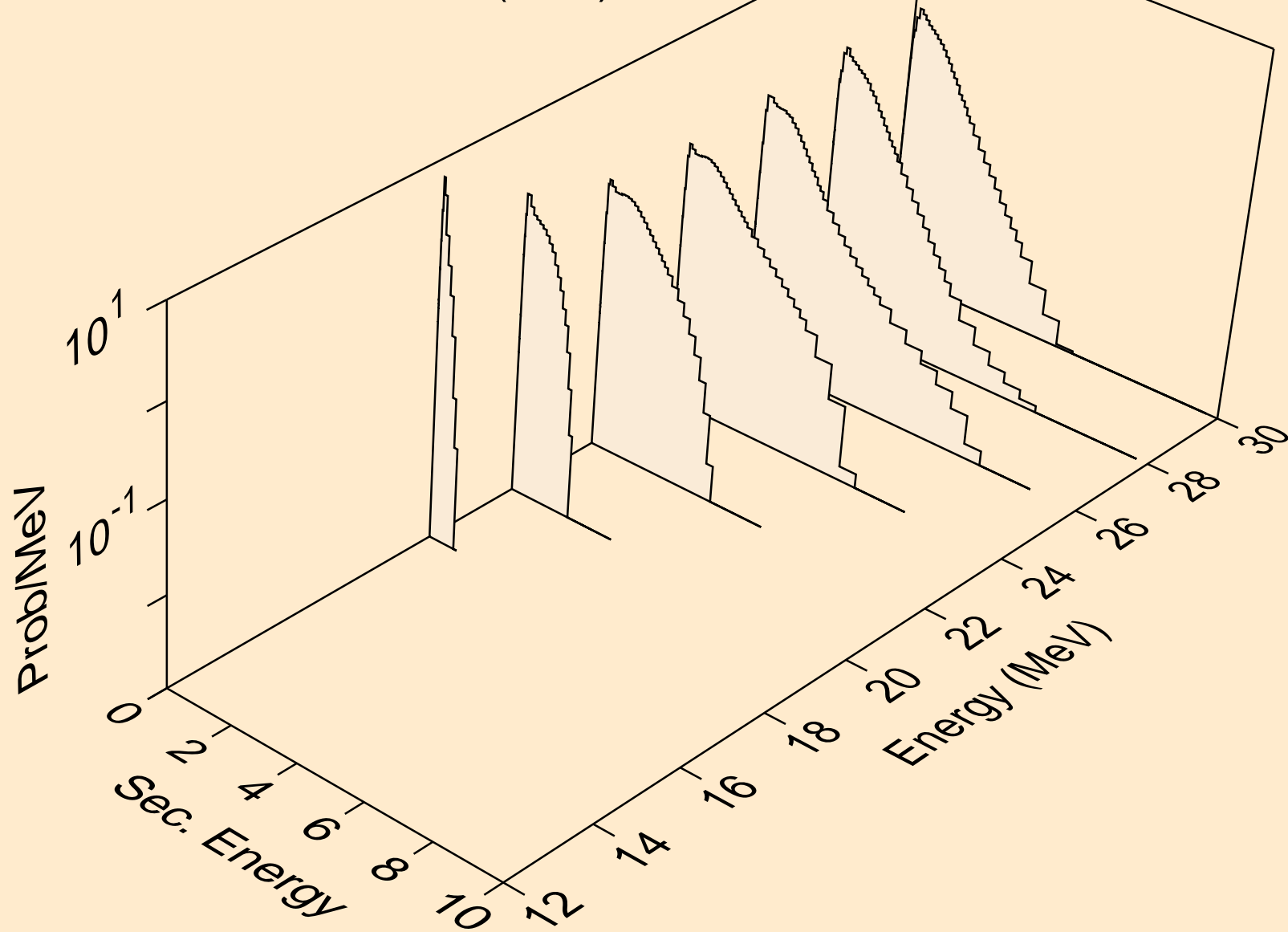

TB152 NEUTRON ACER TENDL-2023 LIBRARY; T=0.K
Neutron emission for (n,n*)p

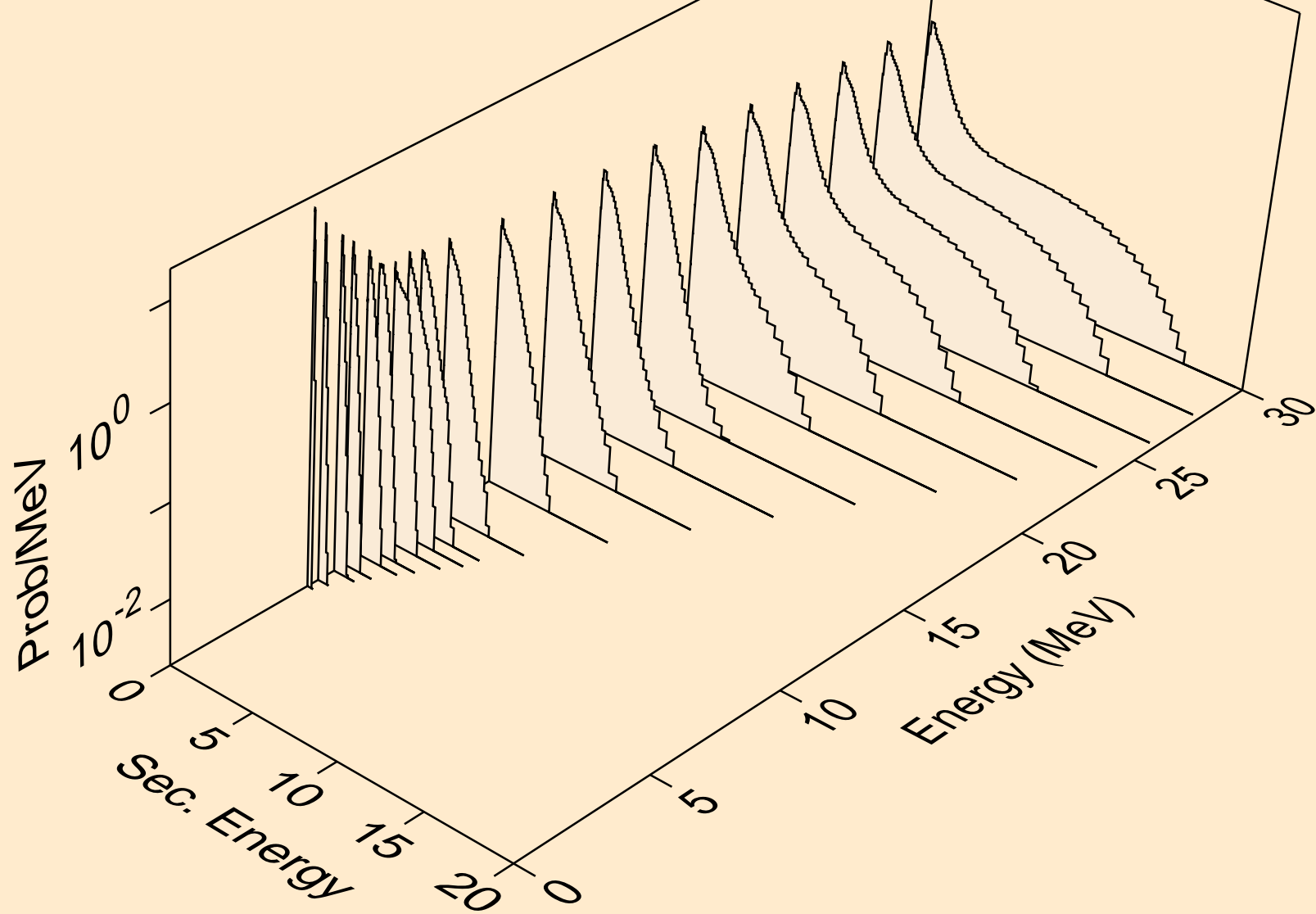

TB152 NEUTRON ACER TENDL-2023 LIBRARY; T=0.K
Neutron emission for (n,n*)2a

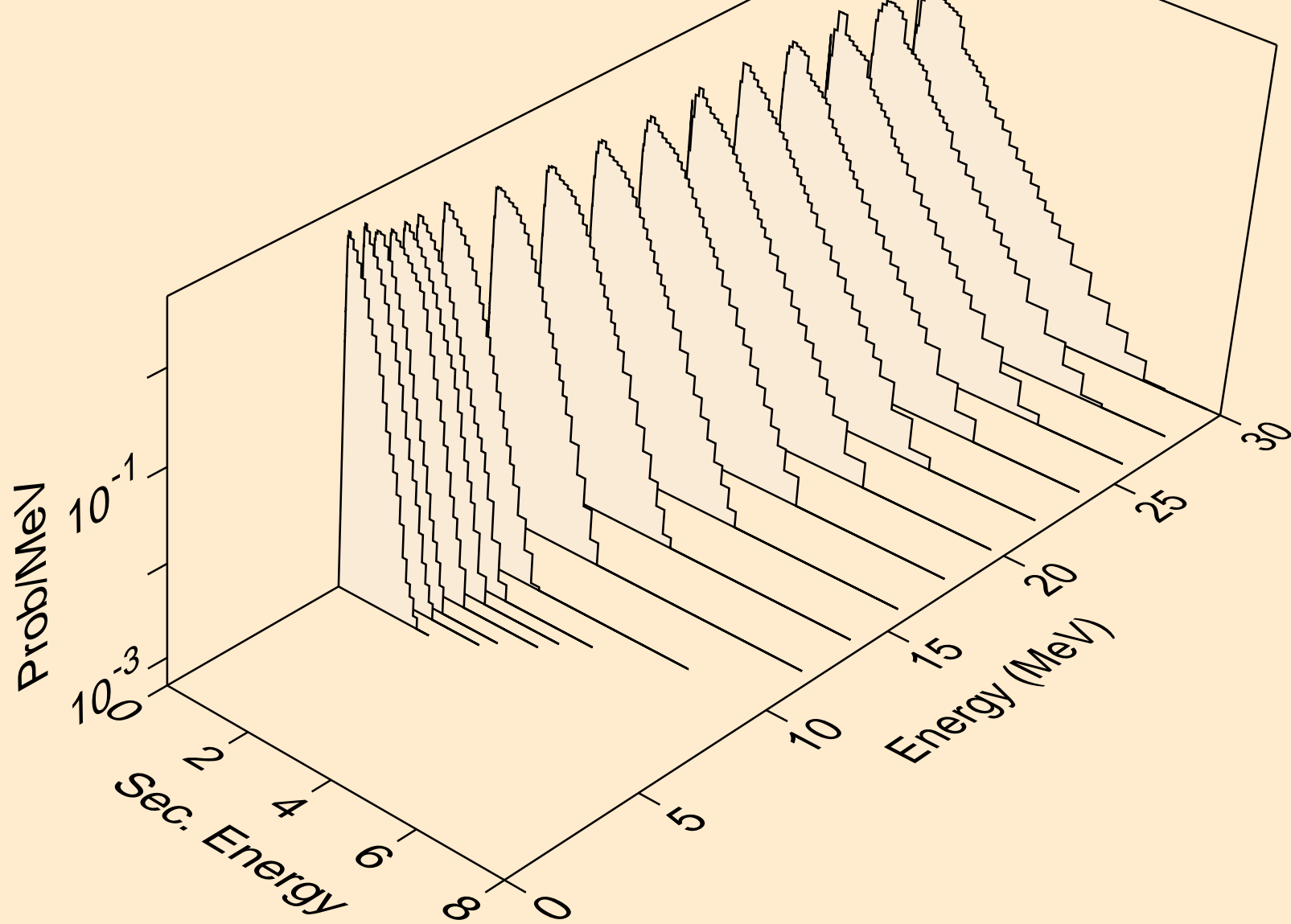

TB152 NEUTRON ACER TENDL-2023 LIBRARY; T=0.K
Neutron emission for (n,2n)2a

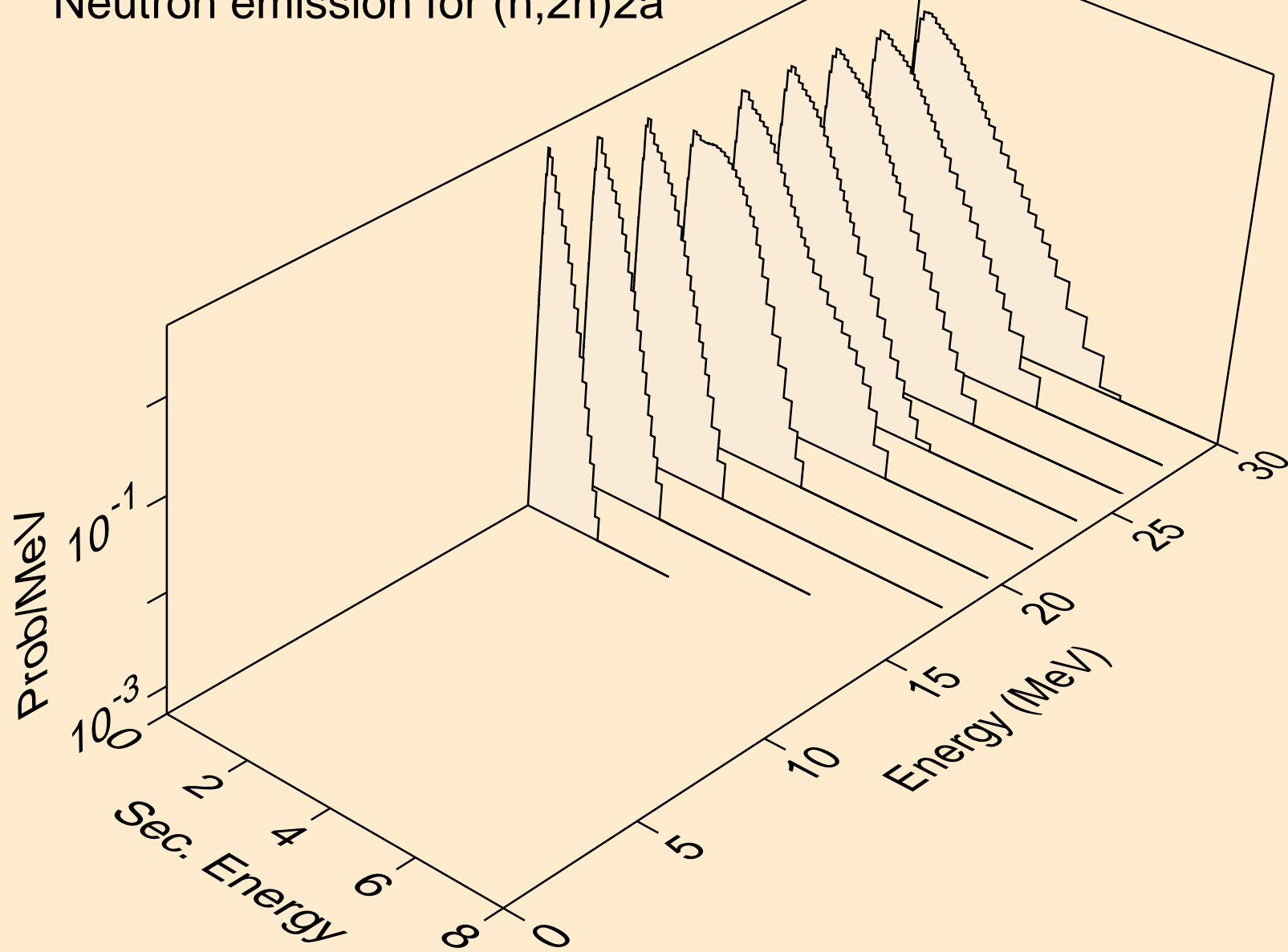

TB152 NEUTRON ACER TENDL-2023 LIBRARY; T=0.K
Neutron emission for (n,n*)d

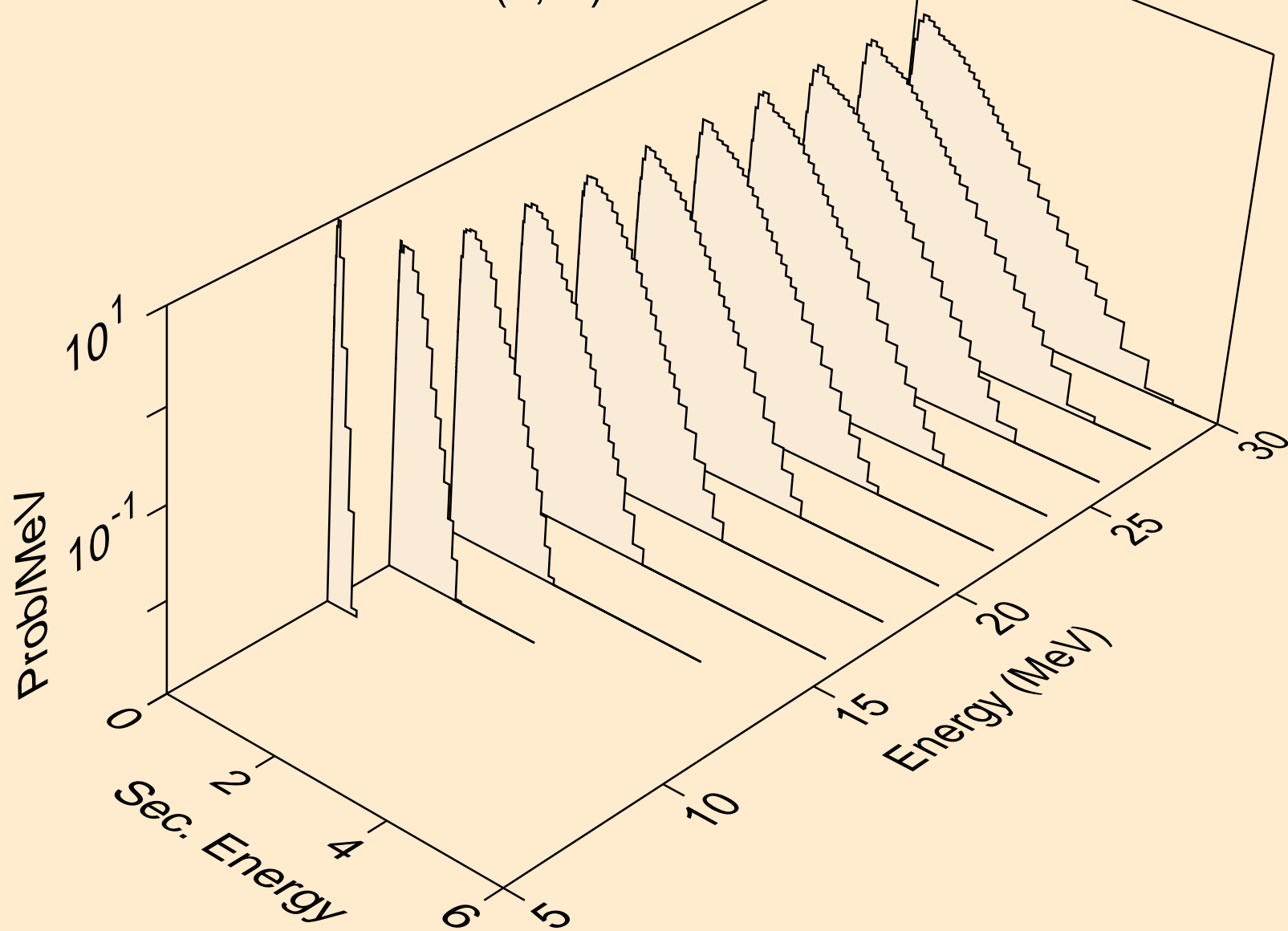

TB152 NEUTRON ACER TENDL-2023 LIBRARY; T=0.K
Neutron emission for (n,n*)t

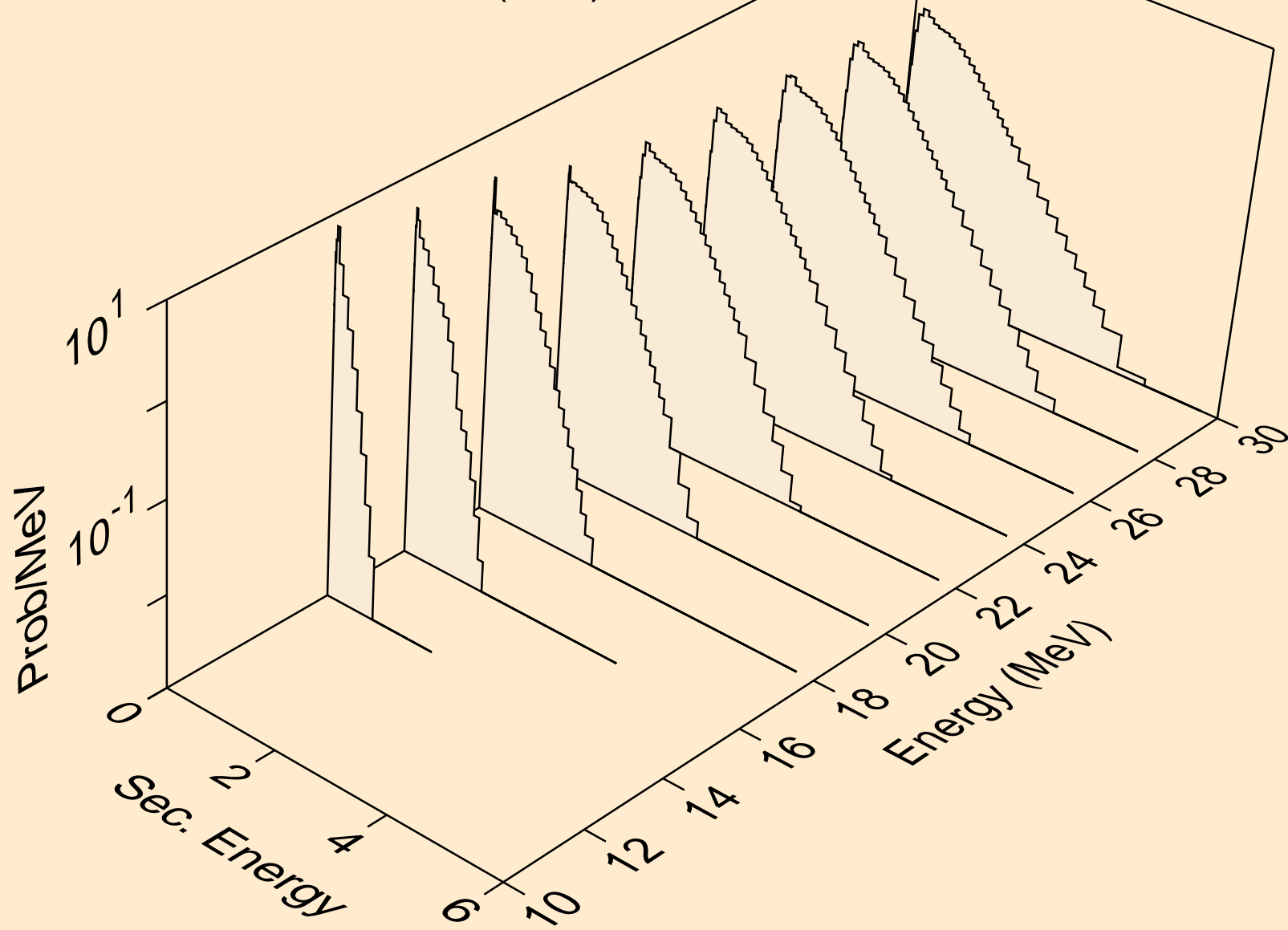

TB152 NEUTRON ACER TENDL-2023 LIBRARY; T=0.K
Neutron emission for (n,n*)he3

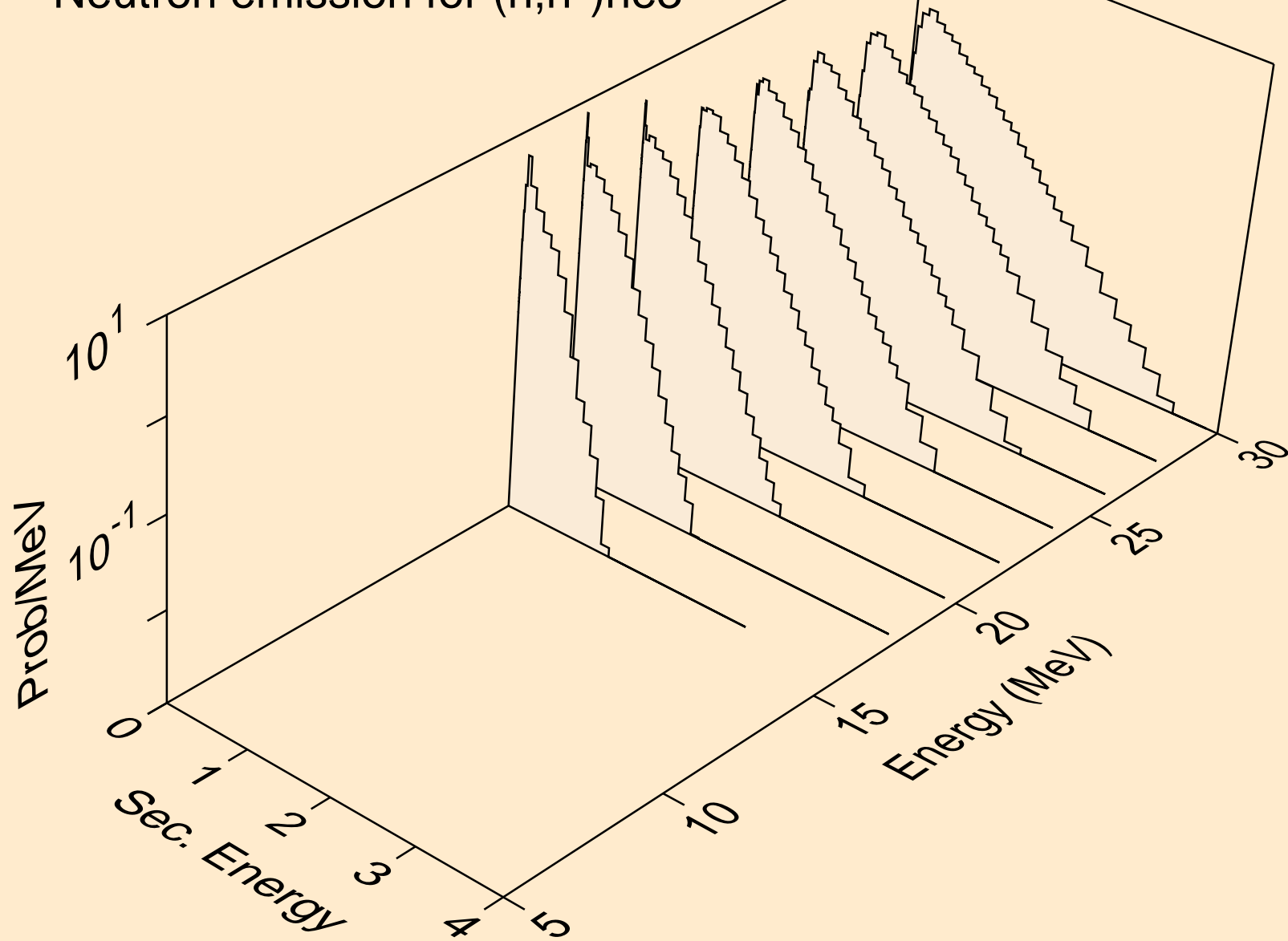

TB152 NEUTRON ACER TENDL-2023 LIBRARY; T=0.K
Neutron emission for (n,4n)

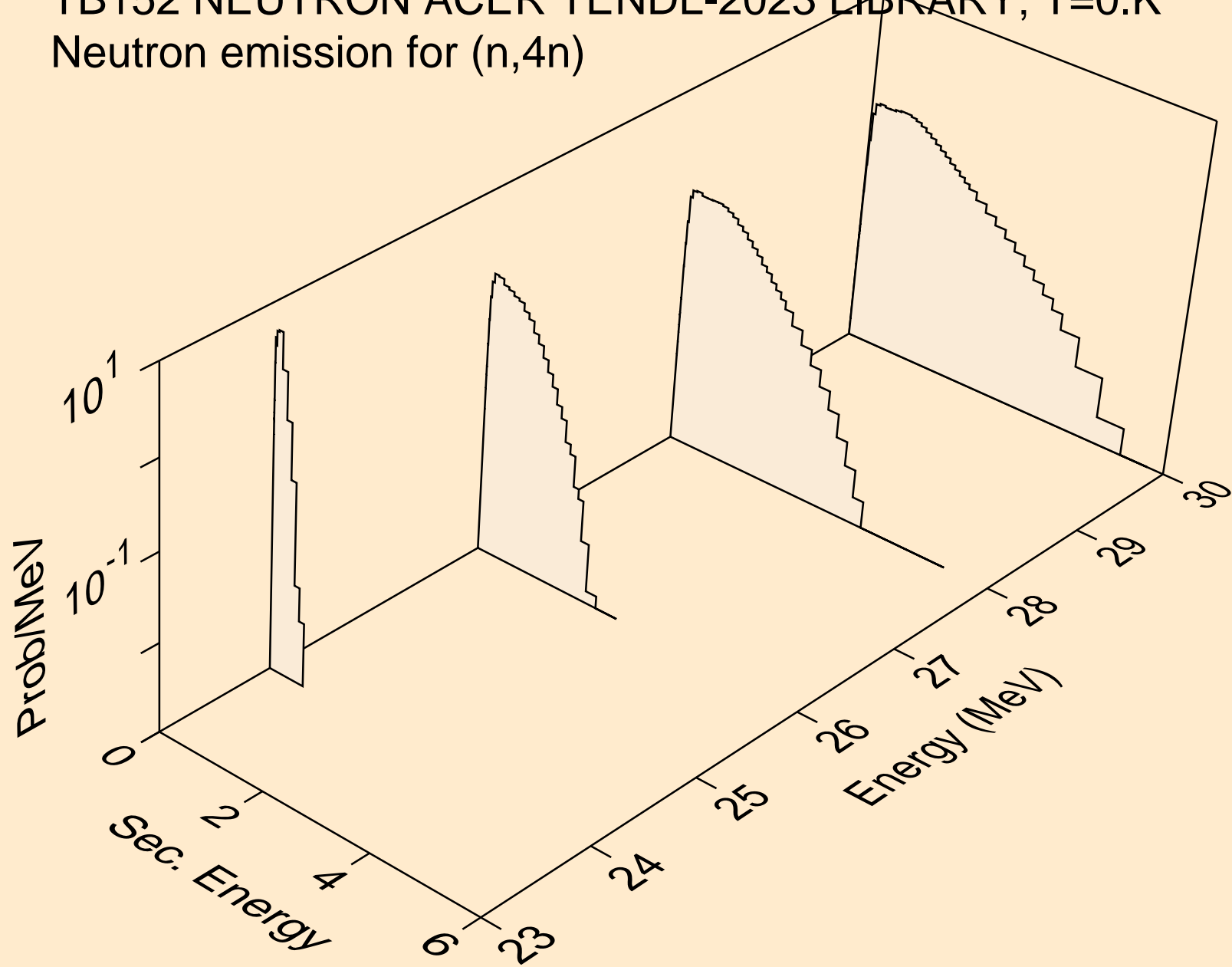

TB152 NEUTRON ACER TENDL-2023 LIBRARY; T=0.K
Neutron emission for (n,2np)

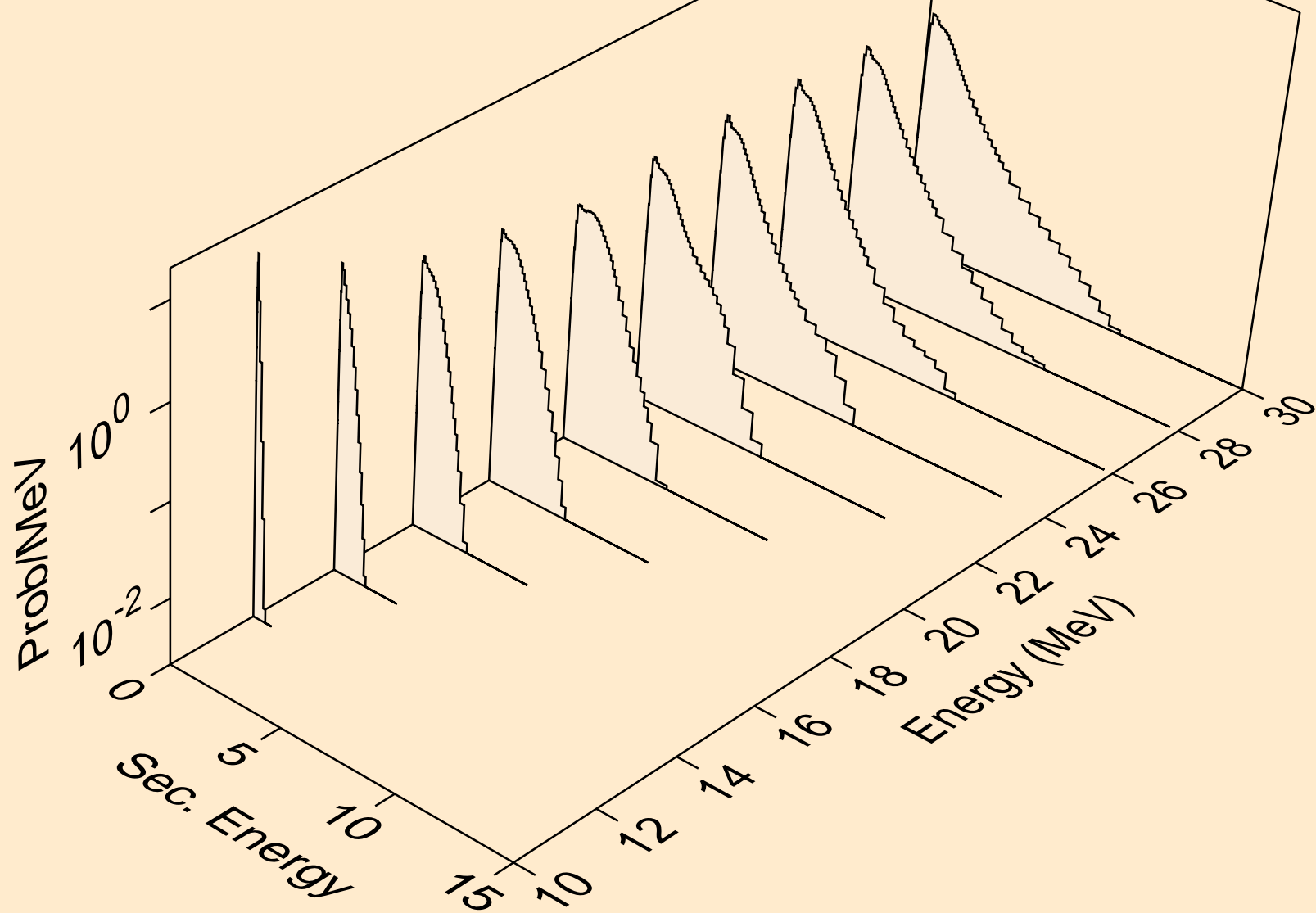

TB152 NEUTRON ACER TENDL-2023 LIBRARY; T=0.K
Neutron emission for (n,3np)

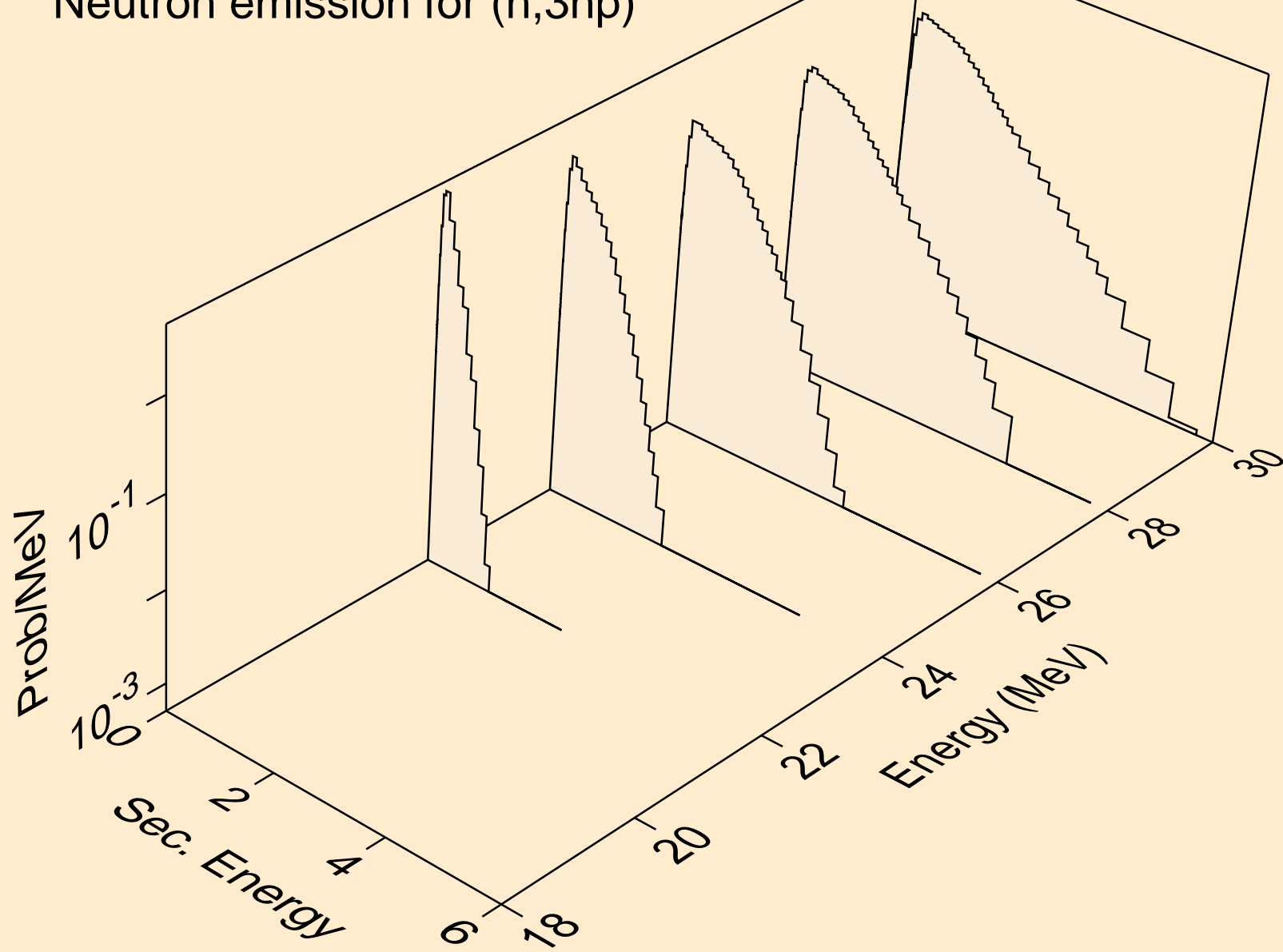

TB152 NEUTRON ACER TENDL-2023 LIBRARY; T=0.K
Neutron emission for (n,n2p)

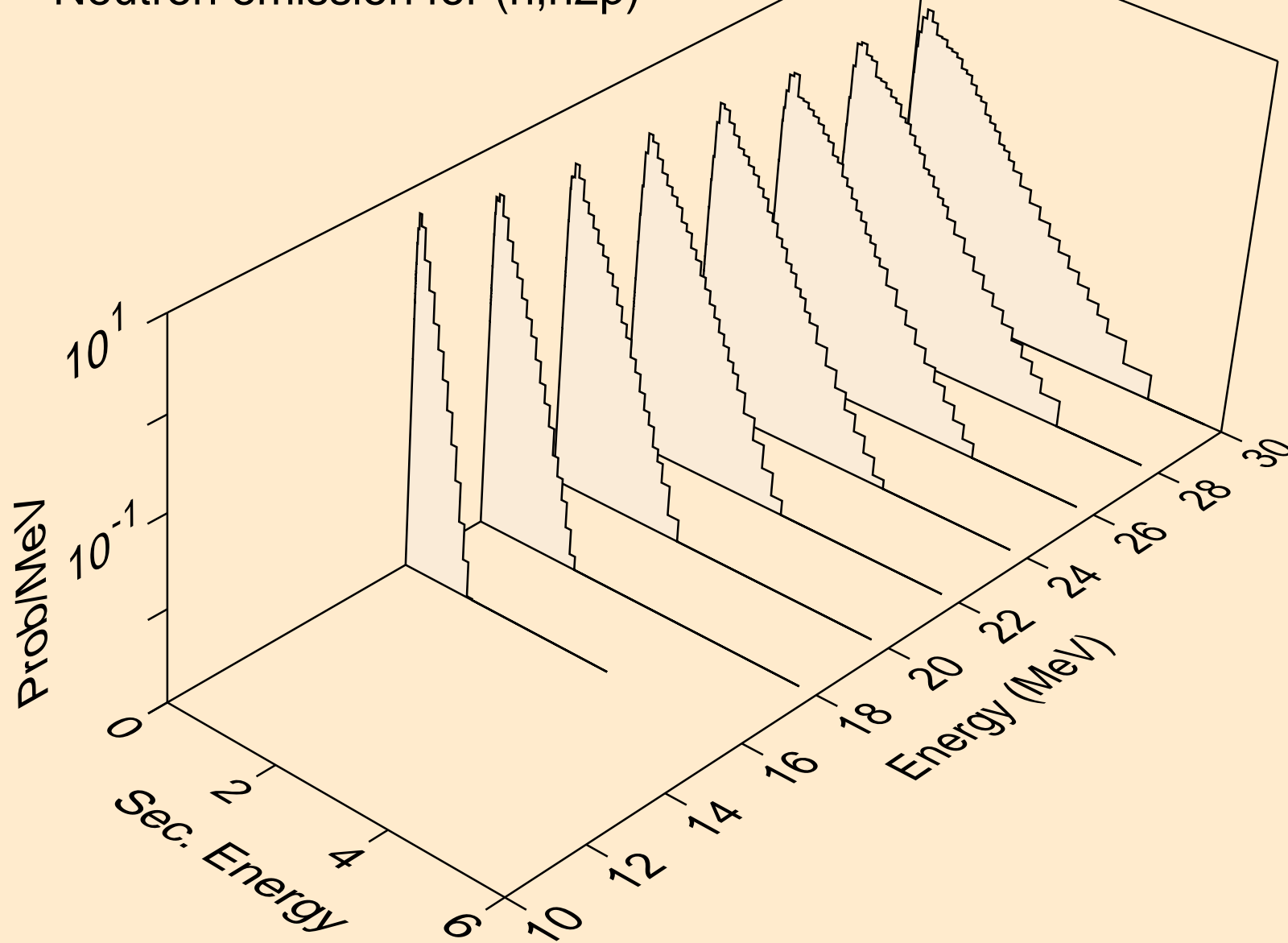

TB152 NEUTRON ACER TENDL-2023 LIBRARY; T=0.K
Neutron emission for (n,npa)

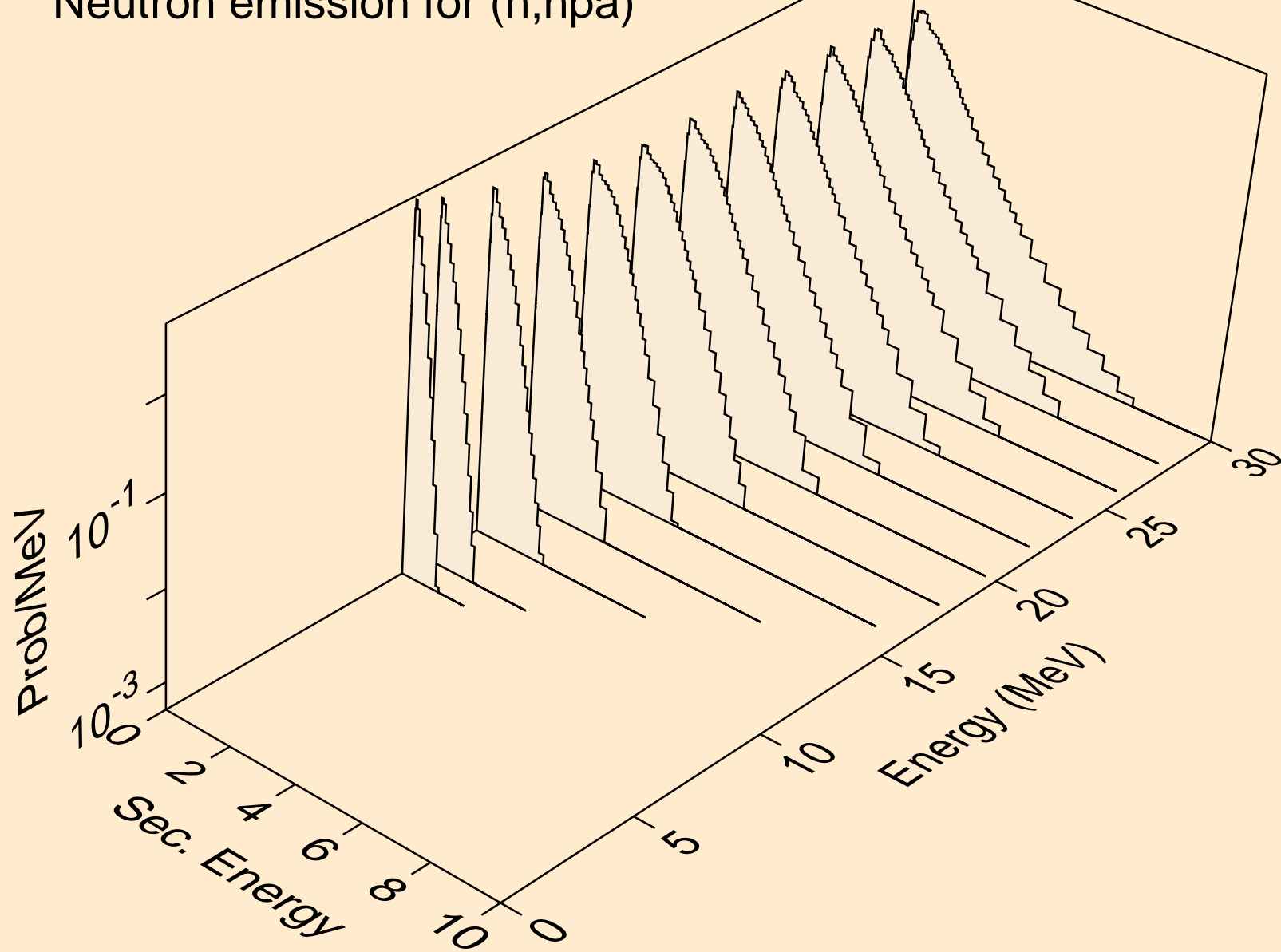

TB152 NEUTRON ACER TENDL-2023 LIBRARY; T=0.K
Neutron emission for (n,n*c)

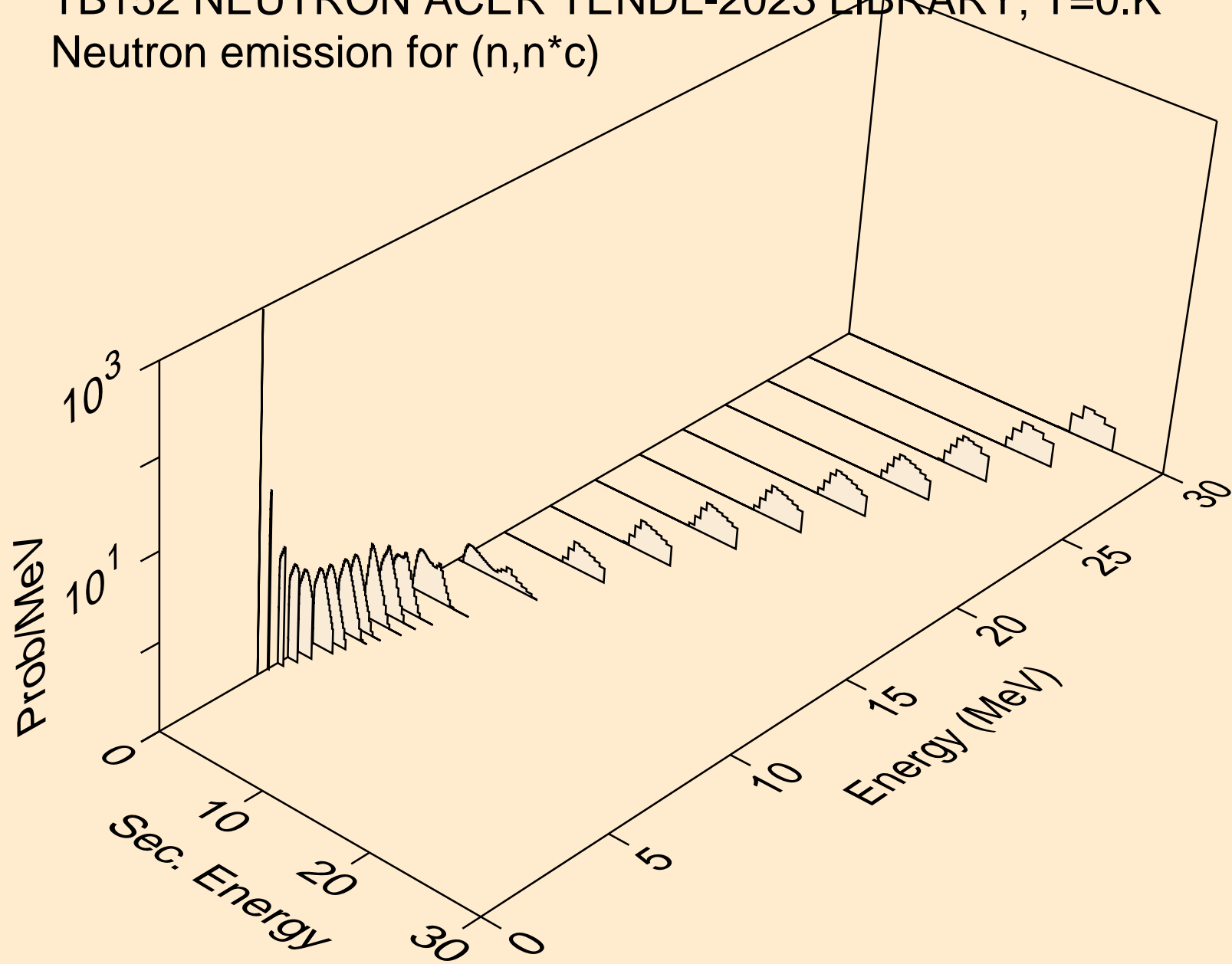

TB152 NEUTRON ACER TENDL-2023 LIBRARY; T=0.K
Photon emission for (n,x)

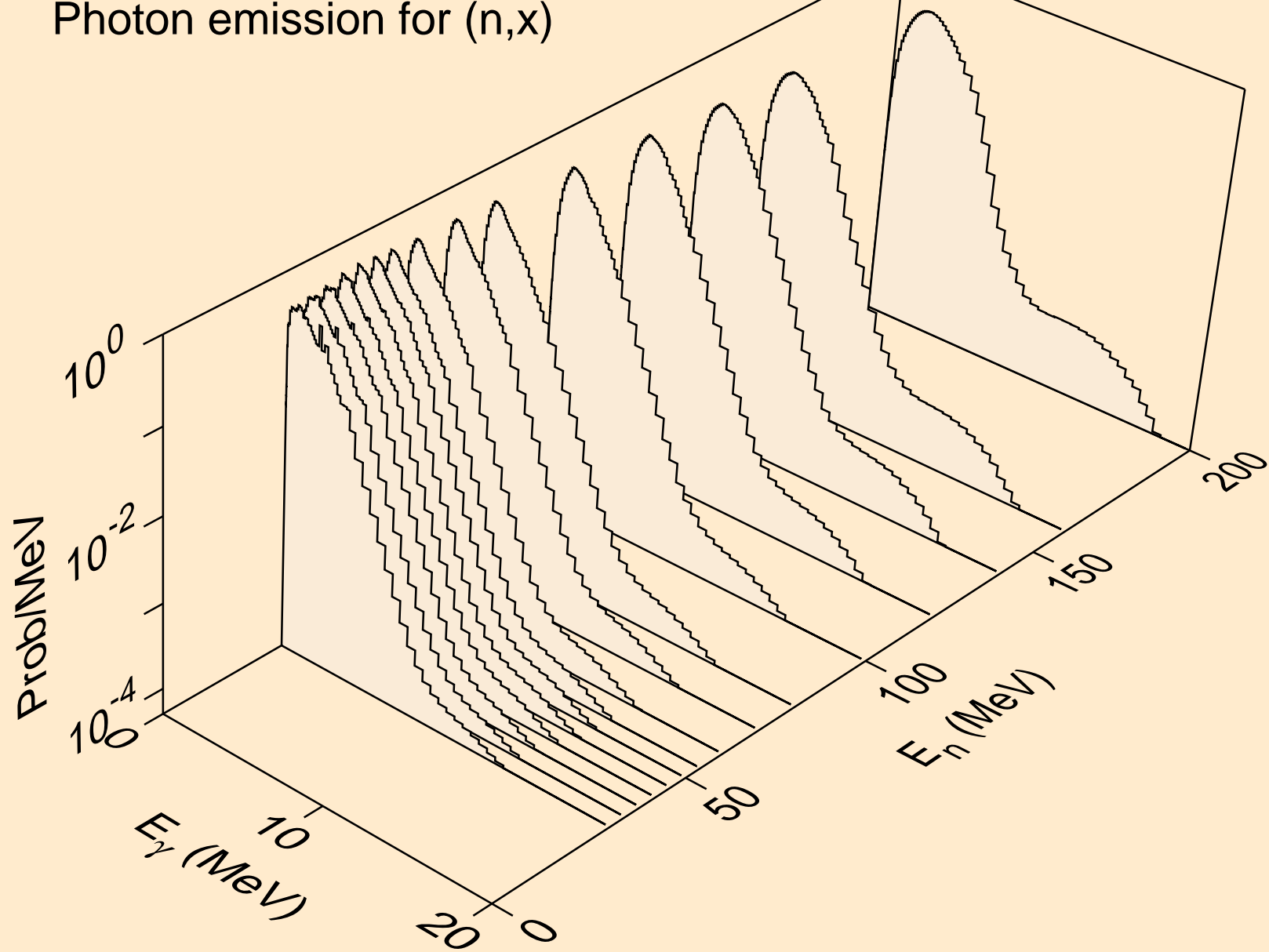

TB152 NEUTRON ACER TENDL-2023 LIBRARY; T=0.K
Photon emission for (n,2nd)

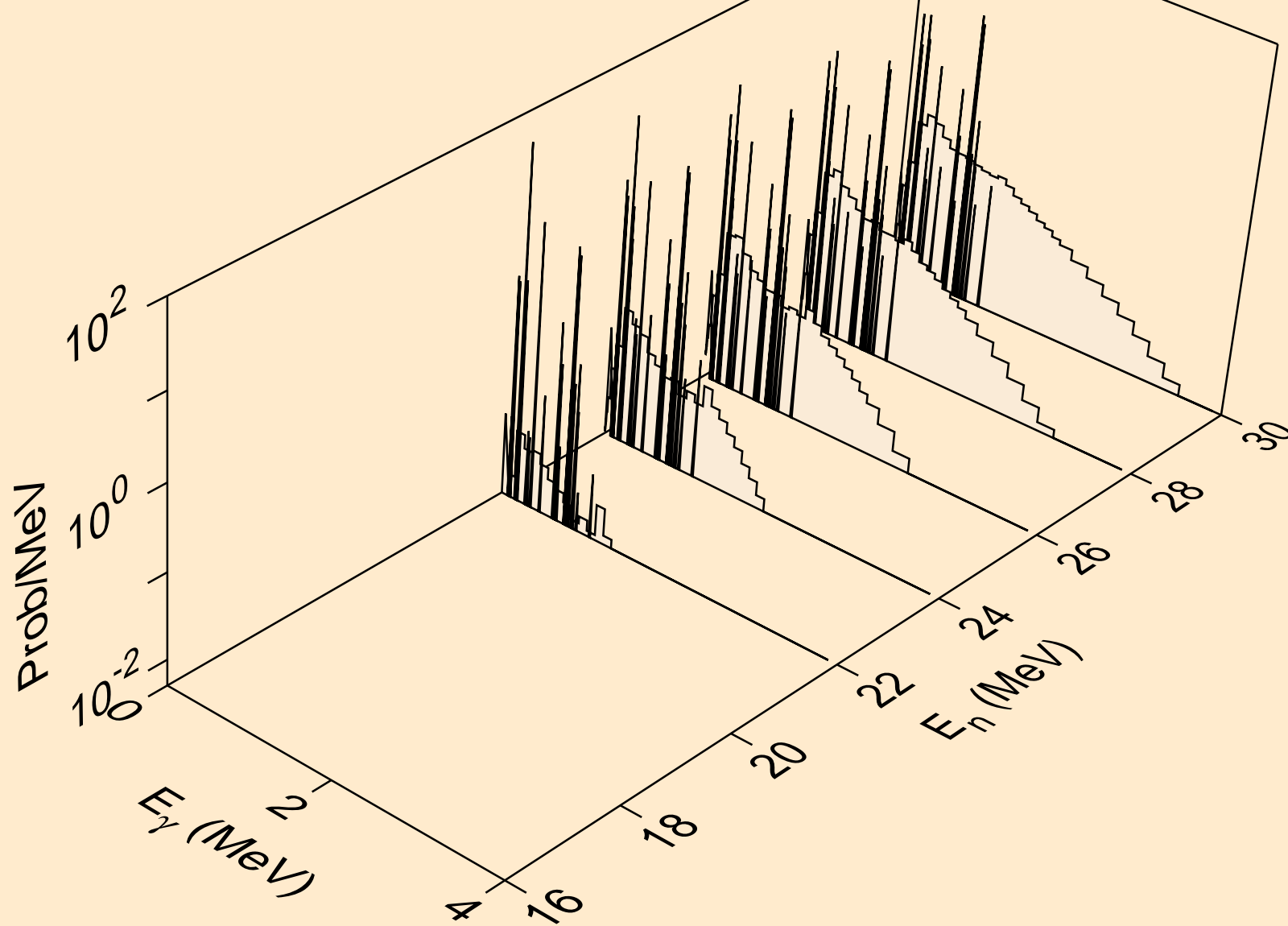

TB152 NEUTRON ACER TENDL-2023 LIBRARY; T=0.K
Photon emission for (n,2n)

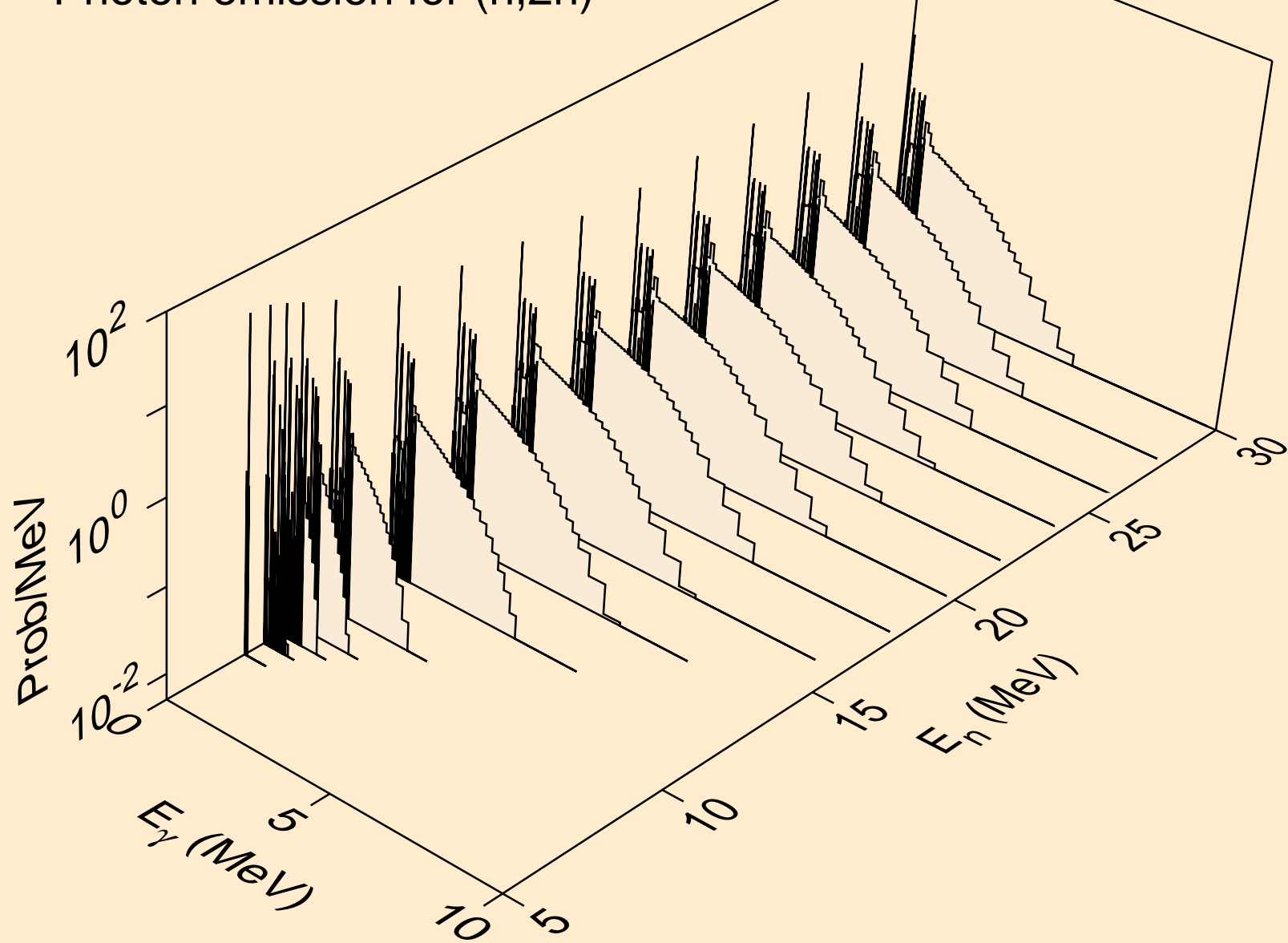

TB152 NEUTRON ACER TENDL-2023 LIBRARY; T=0.K
Photon emission for (n,3n)

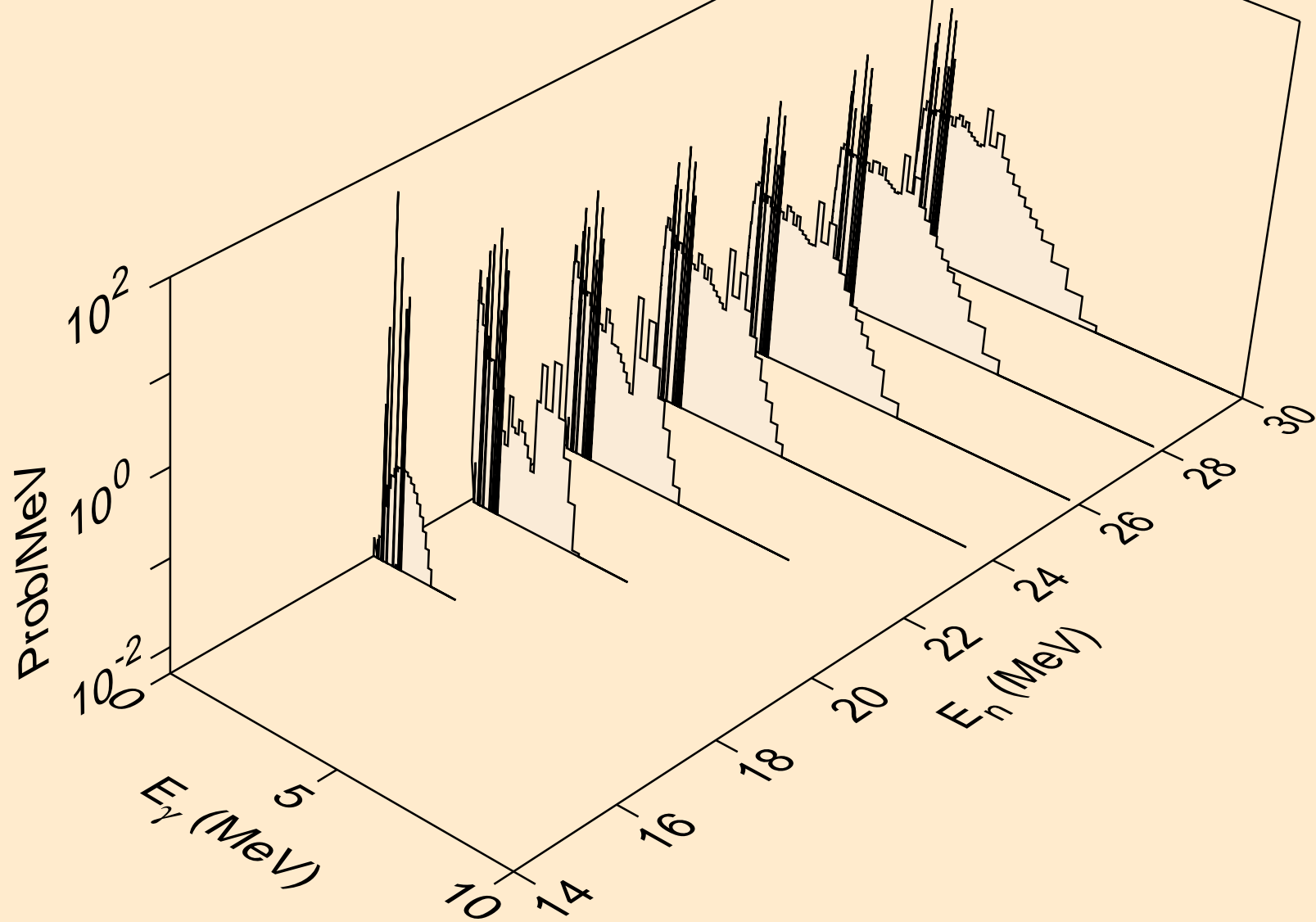

TB152 NEUTRON ACER TENDL-2023 LIBRARY; T=0.K
Photon emission for (n,n*)a

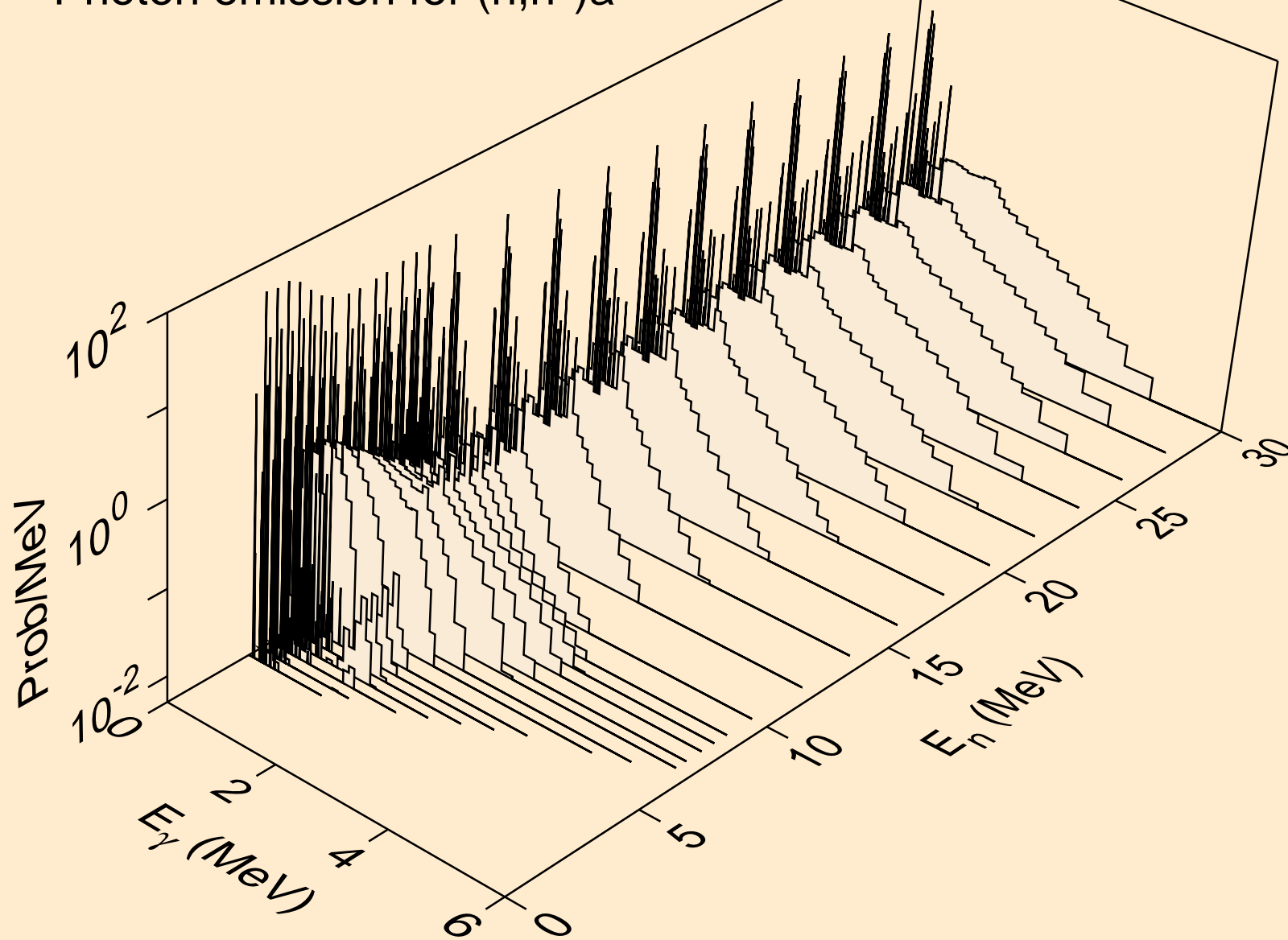

TB152 NEUTRON ACER TENDL-2023 LIBRARY; T=0.K
Photon emission for (n,2n)a

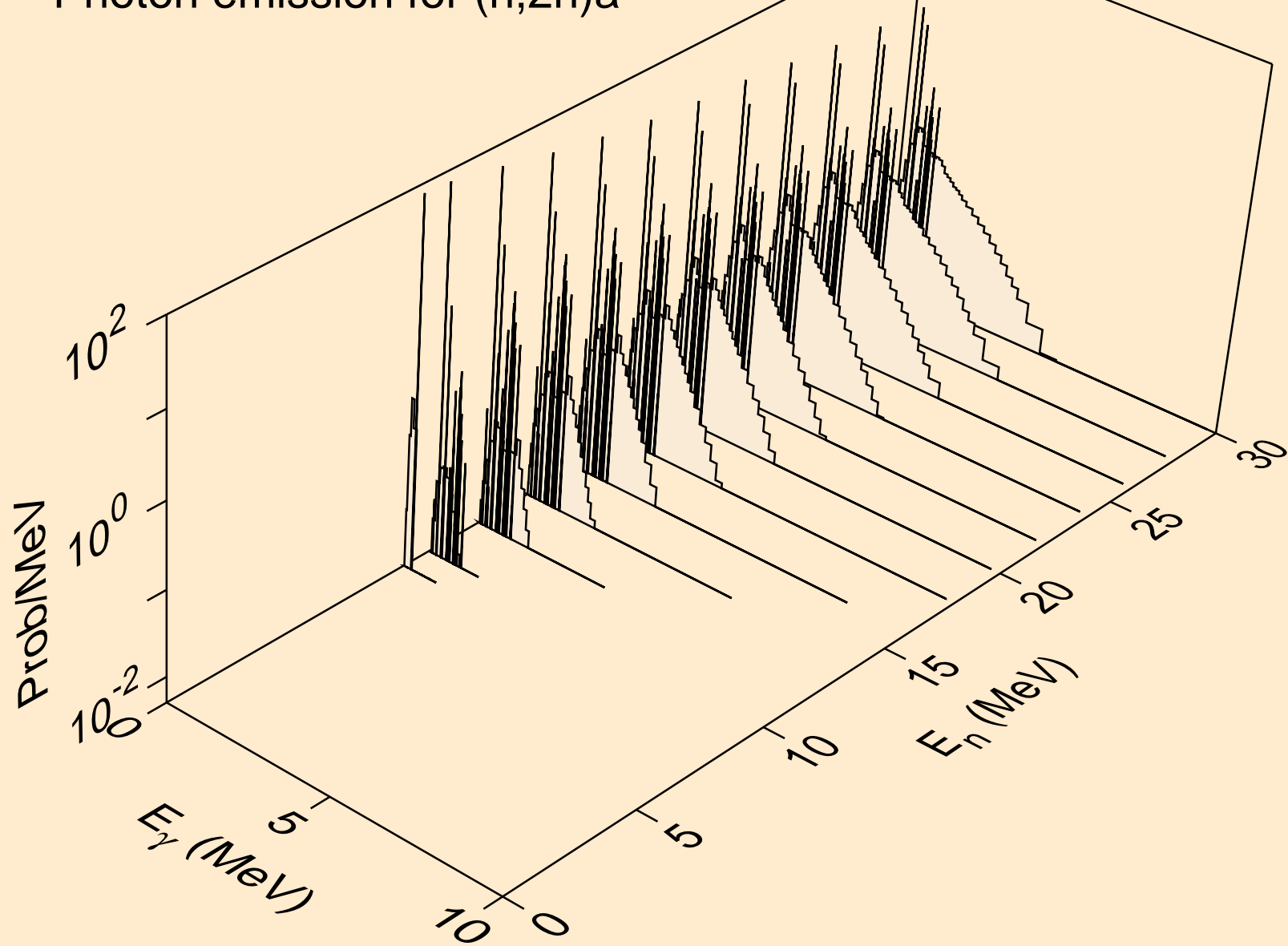

TB152 NEUTRON ACER TENDL-2023 LIBRARY; T=0.K
Photon emission for (n,3n)a

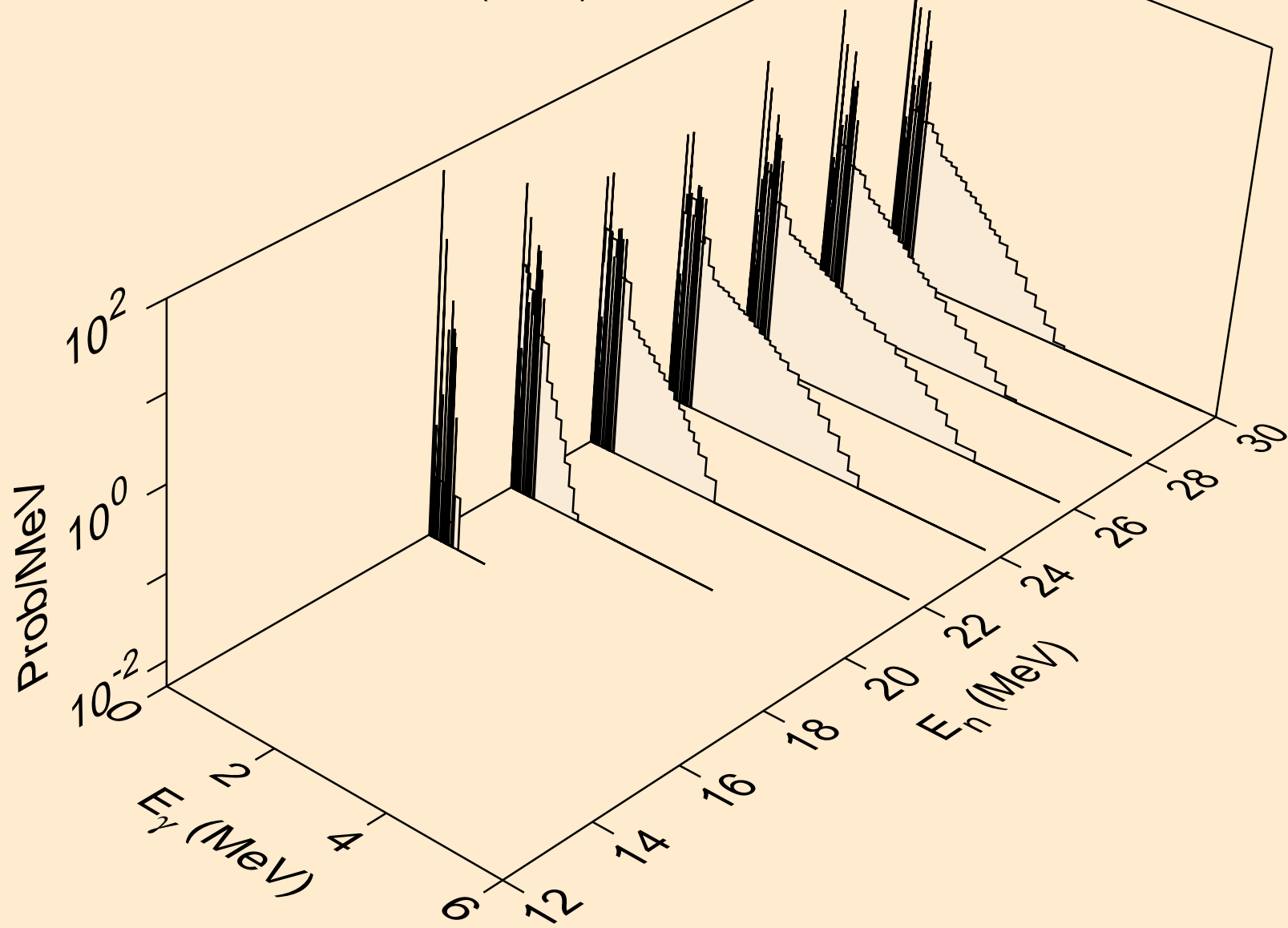

TB152 NEUTRON ACER TENDL-2023 LIBRARY; T=0.K
Photon emission for (n,n*)p

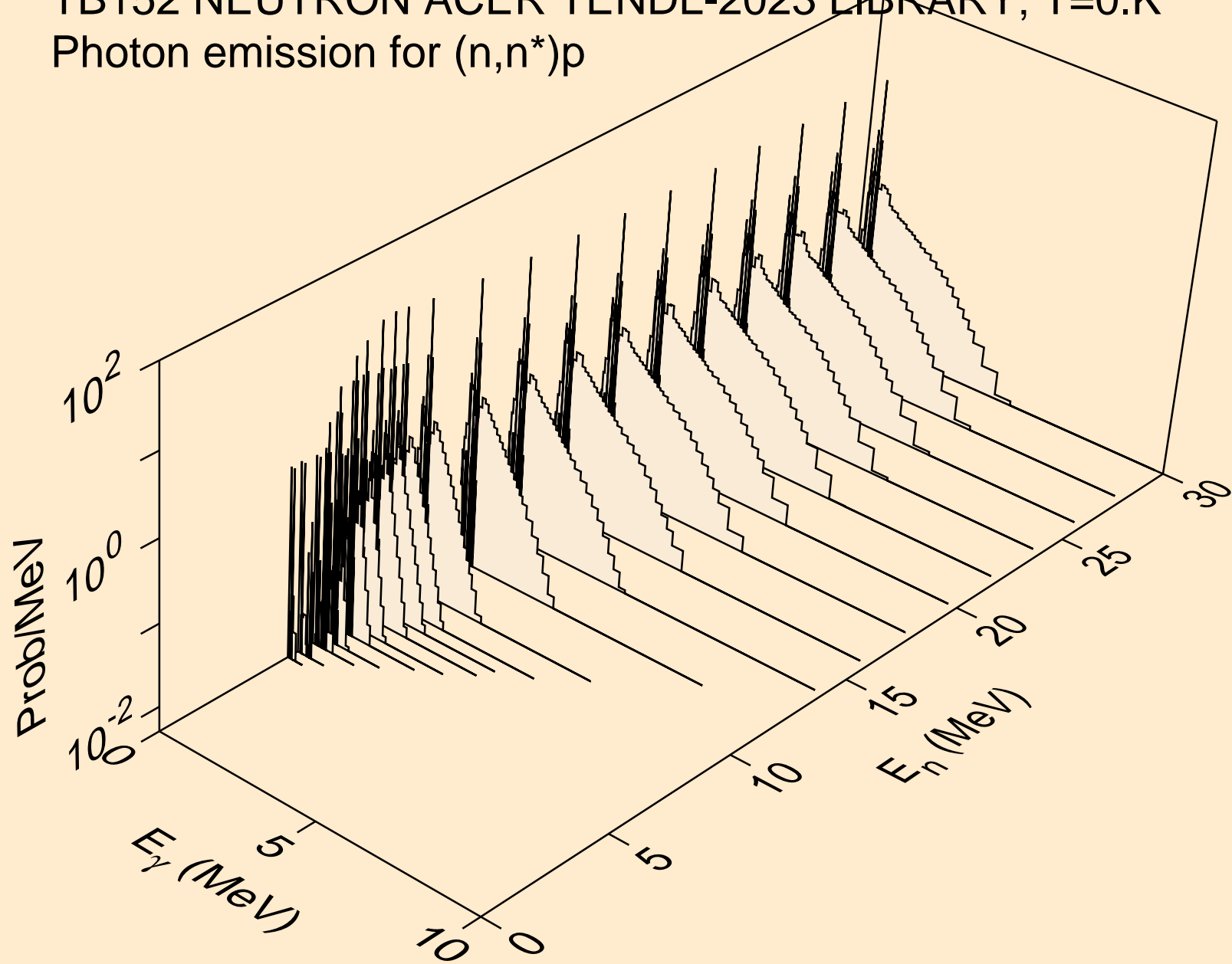

TB152 NEUTRON ACER TENDL-2023 LIBRARY; T=0.K
Photon emission for (n,n*)2a

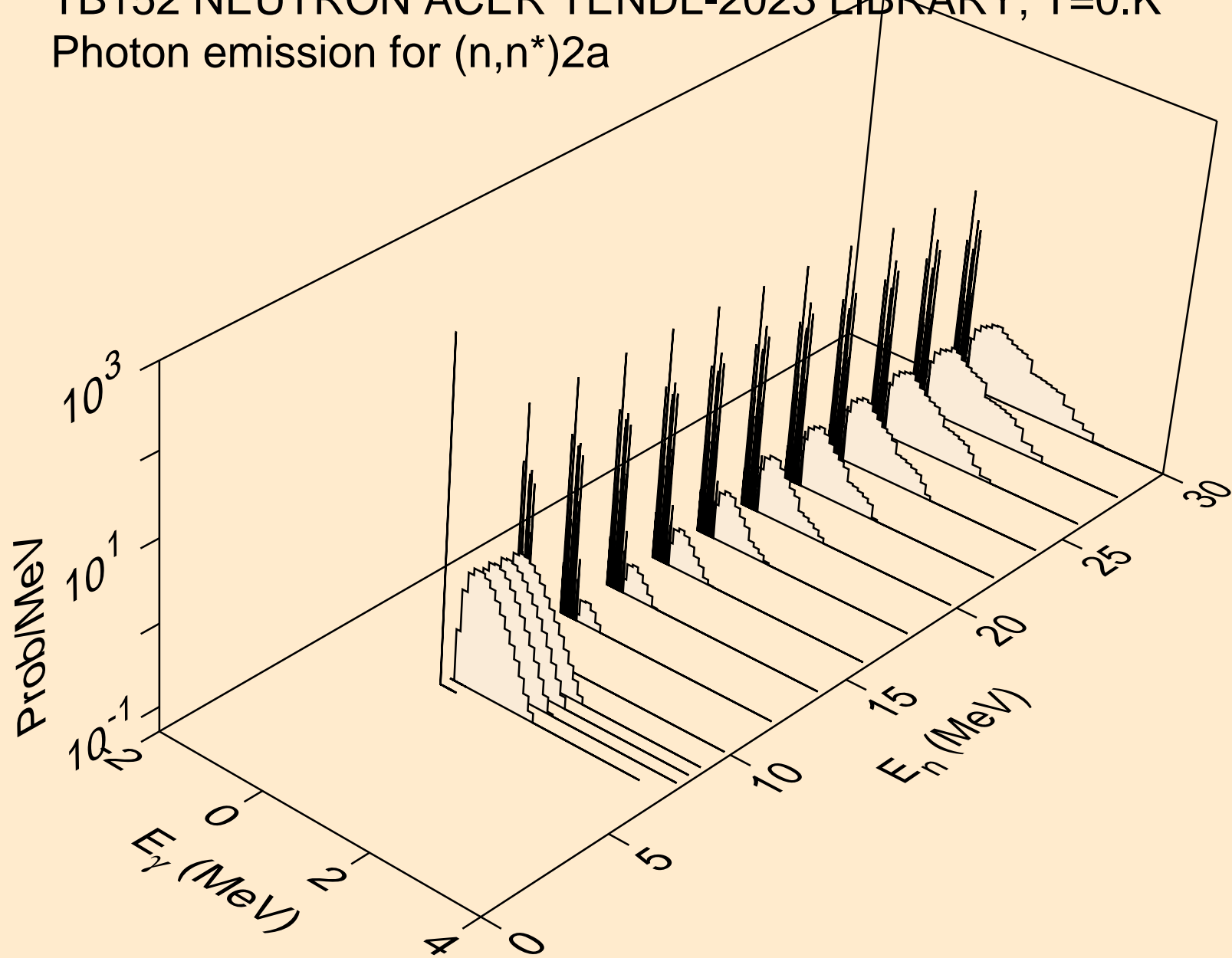

TB152 NEUTRON ACER TENDL-2023 LIBRARY; T=0.K
Photon emission for (n,2n)2a

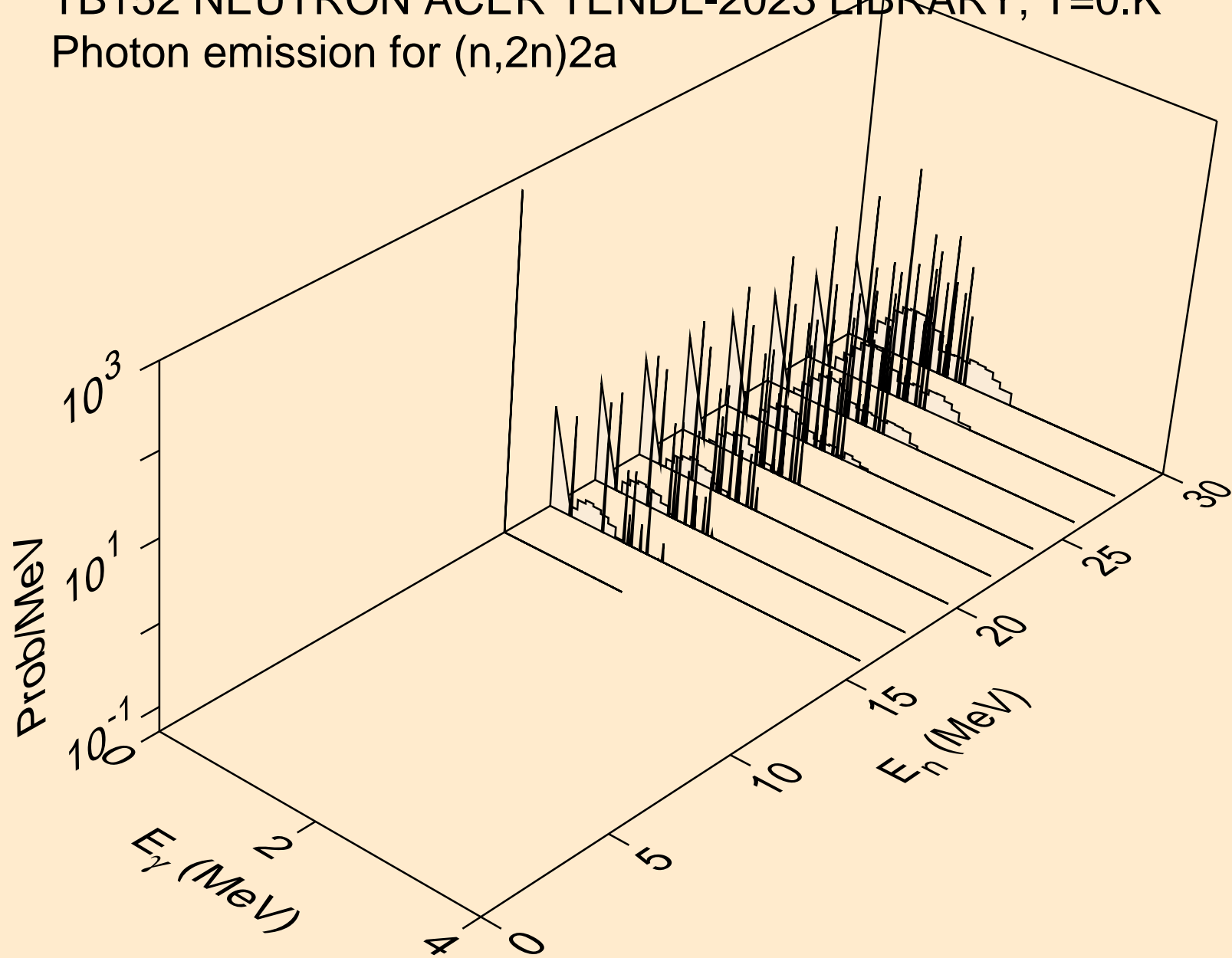

TB152 NEUTRON ACER TENDL-2023 LIBRARY; T=0.K
Photon emission for (n,n*)d

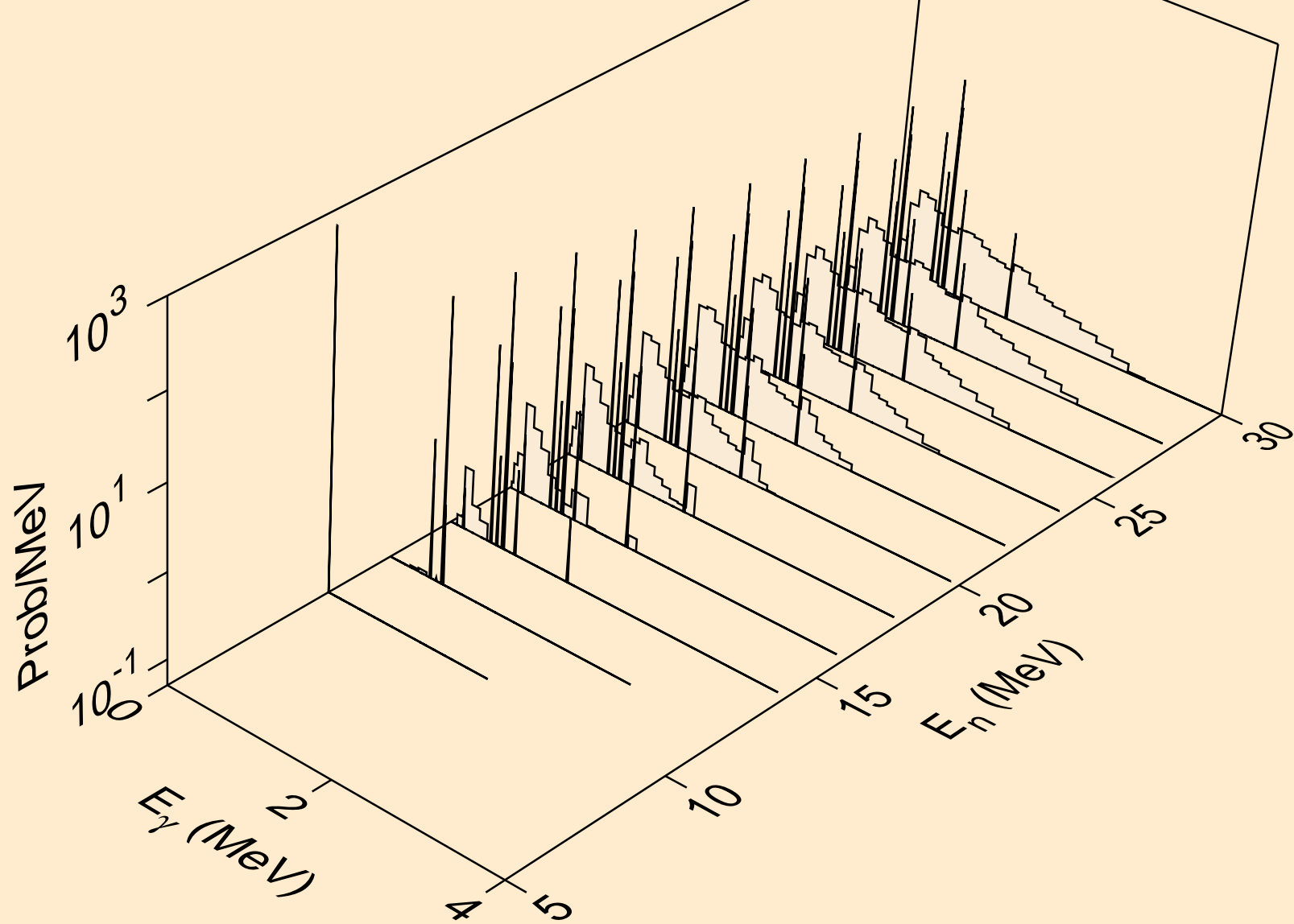

TB152 NEUTRON ACER TENDL-2023 LIBRARY; T=0.K
Photon emission for (n,n*)t

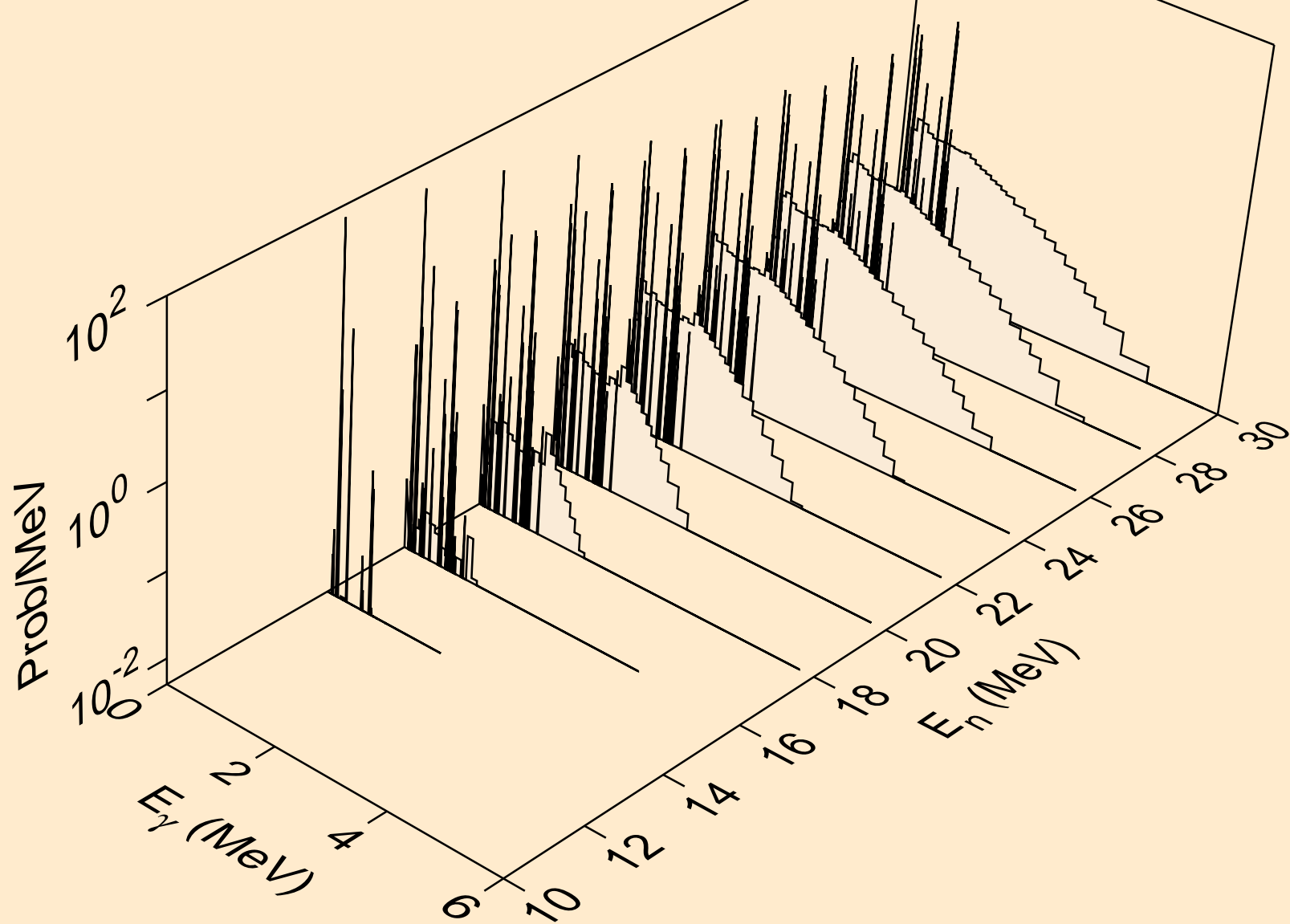

TB152 NEUTRON ACER TENDL-2023 LIBRARY; T=0.K
Photon emission for (n,n*)he3

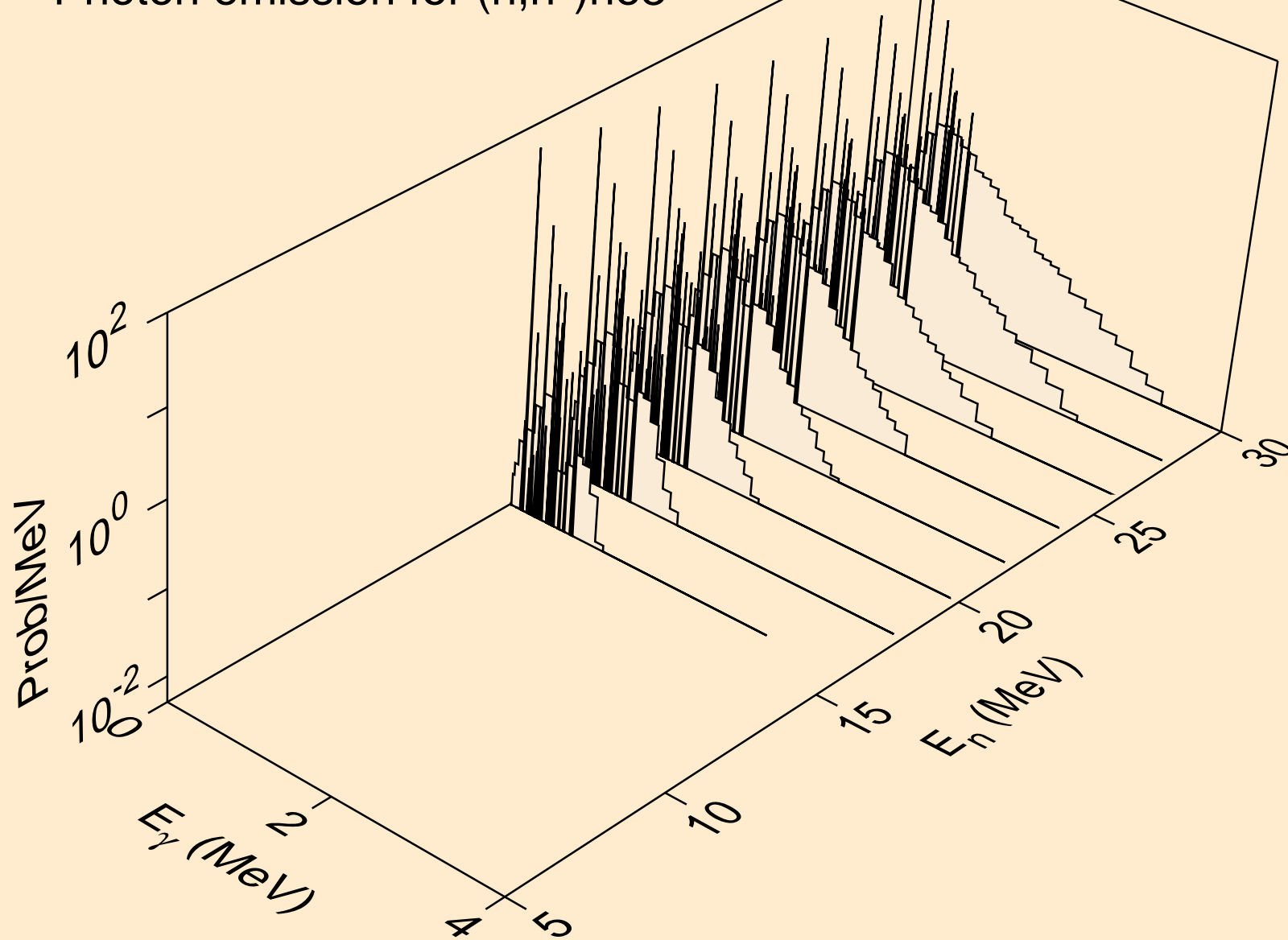

TB152 NEUTRON ACER TENDL-2023 LIBRARY; T=0.K
Photon emission for (n,4n)

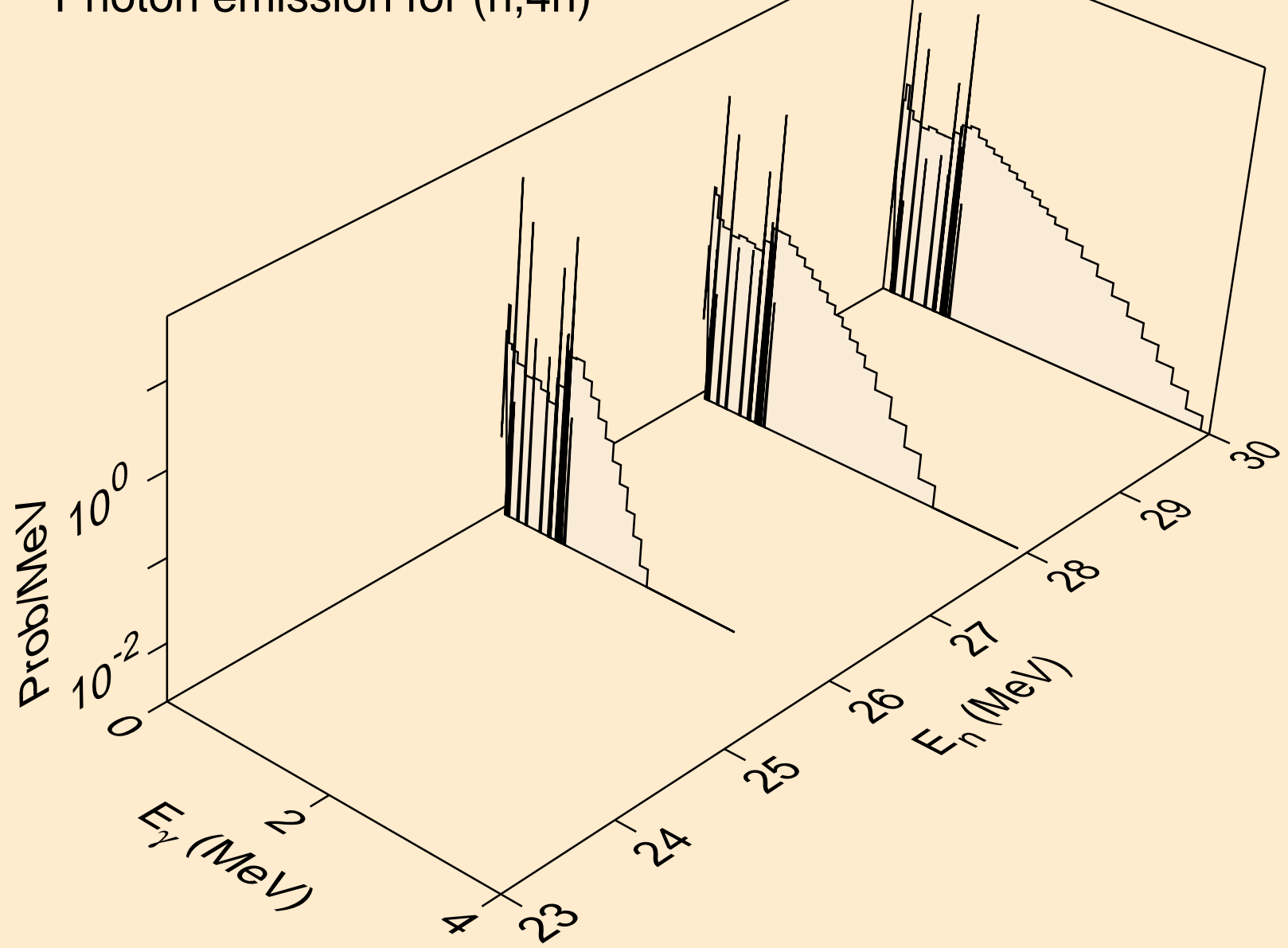

TB152 NEUTRON ACER TENDL-2023 LIBRARY; T=0.K
Photon emission for (n,2np)

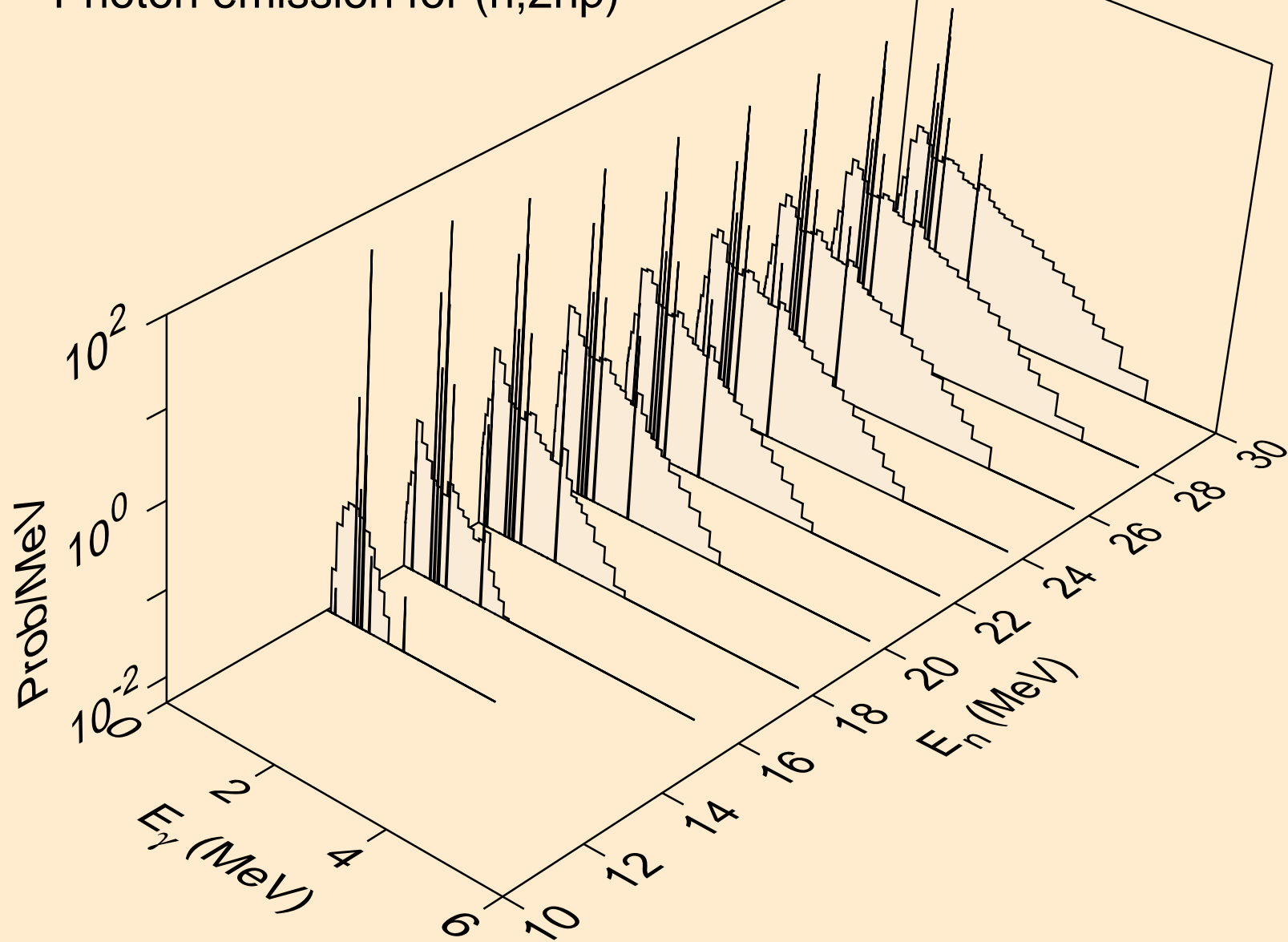

TB152 NEUTRON ACER TENDL-2023 LIBRARY; T=0.K
Photon emission for (n,3np)

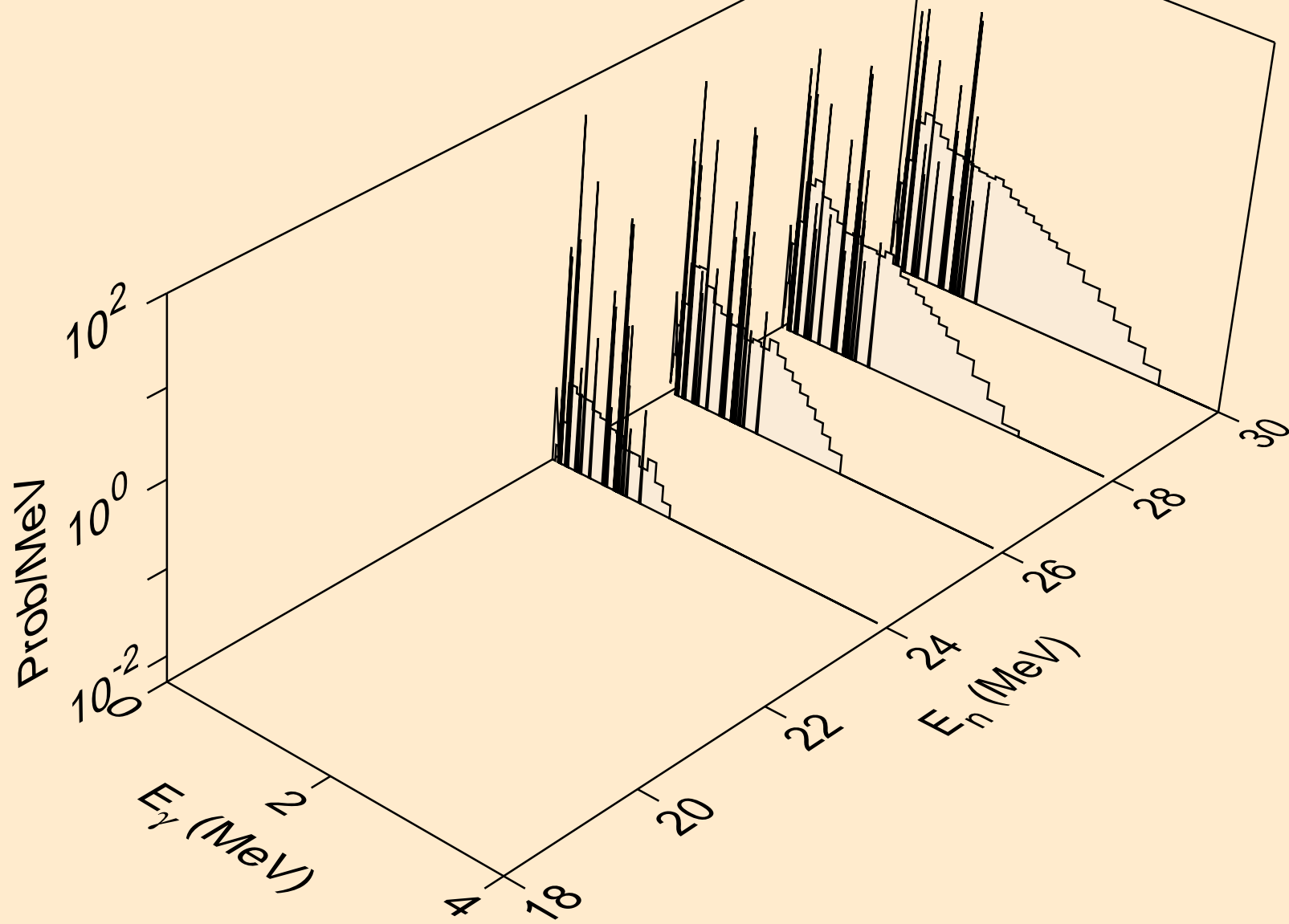

TB152 NEUTRON ACER TENDL-2023 LIBRARY; T=0.K
Photon emission for (n,n2p)

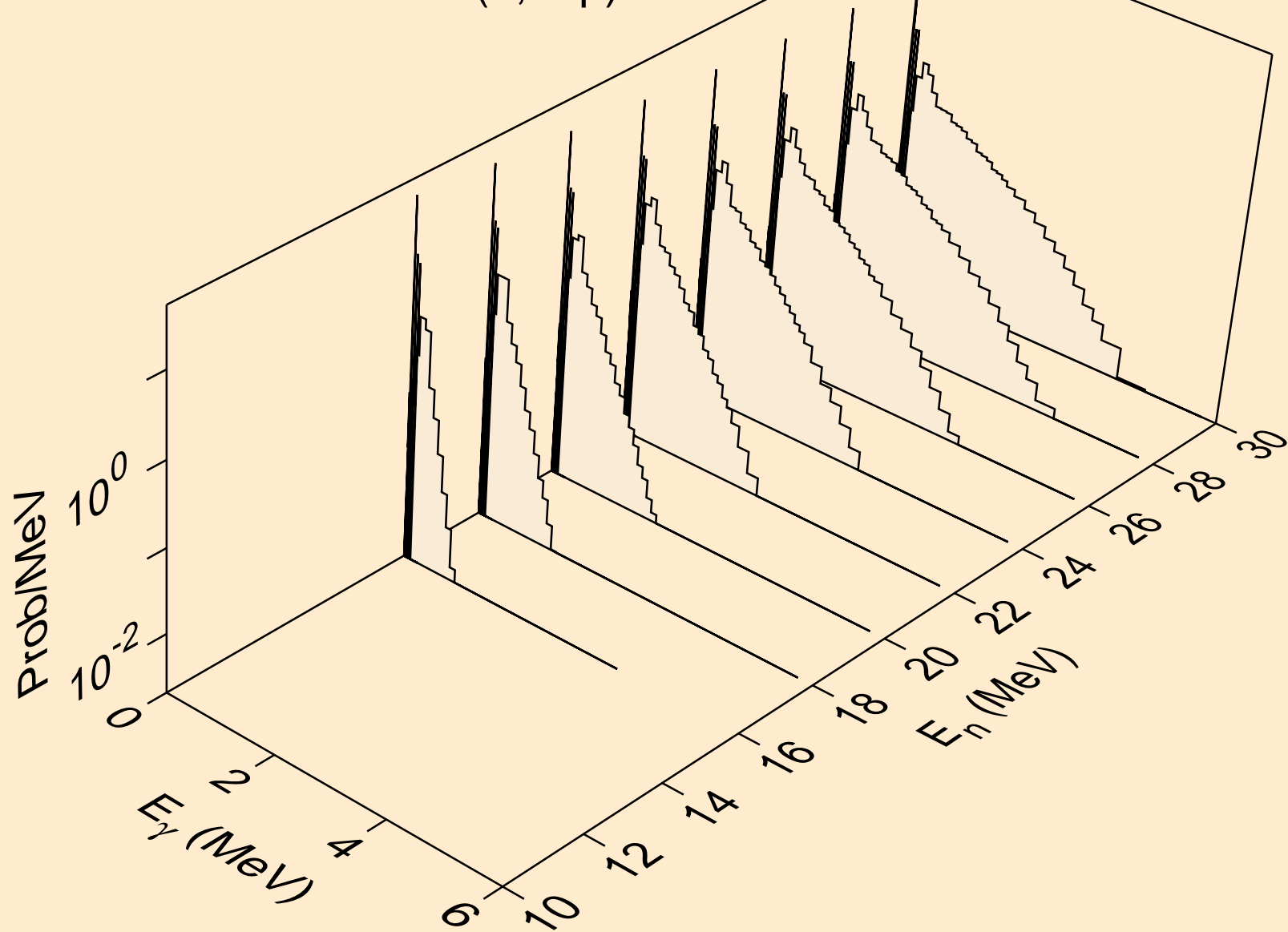

TB152 NEUTRON ACER TENDL-2023 LIBRARY; T=0.K
Photon emission for (n,npa)

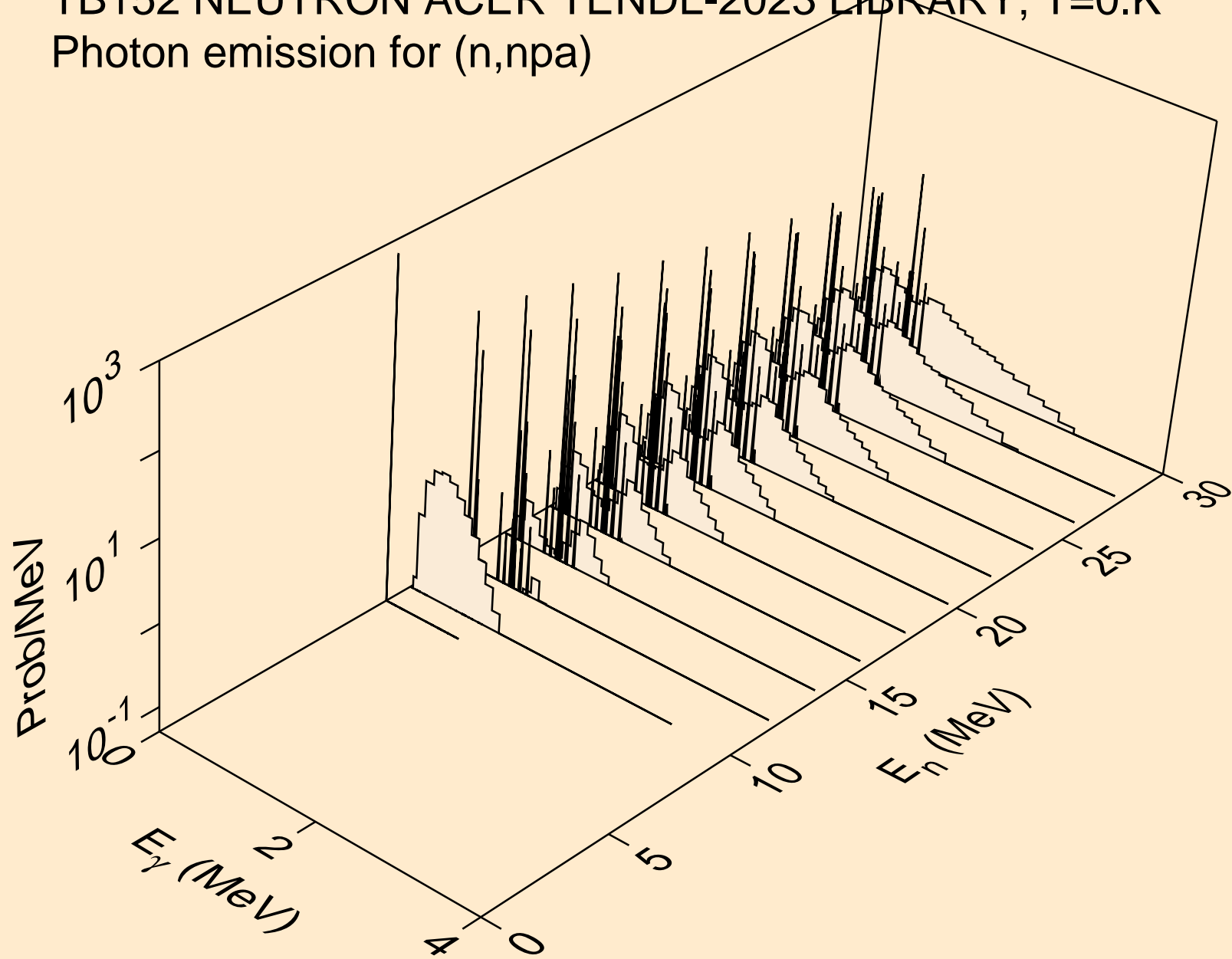

TB152 NEUTRON ACER TENDL-2023 LIBRARY; T=0.K
Photon emission for (n,n*c)

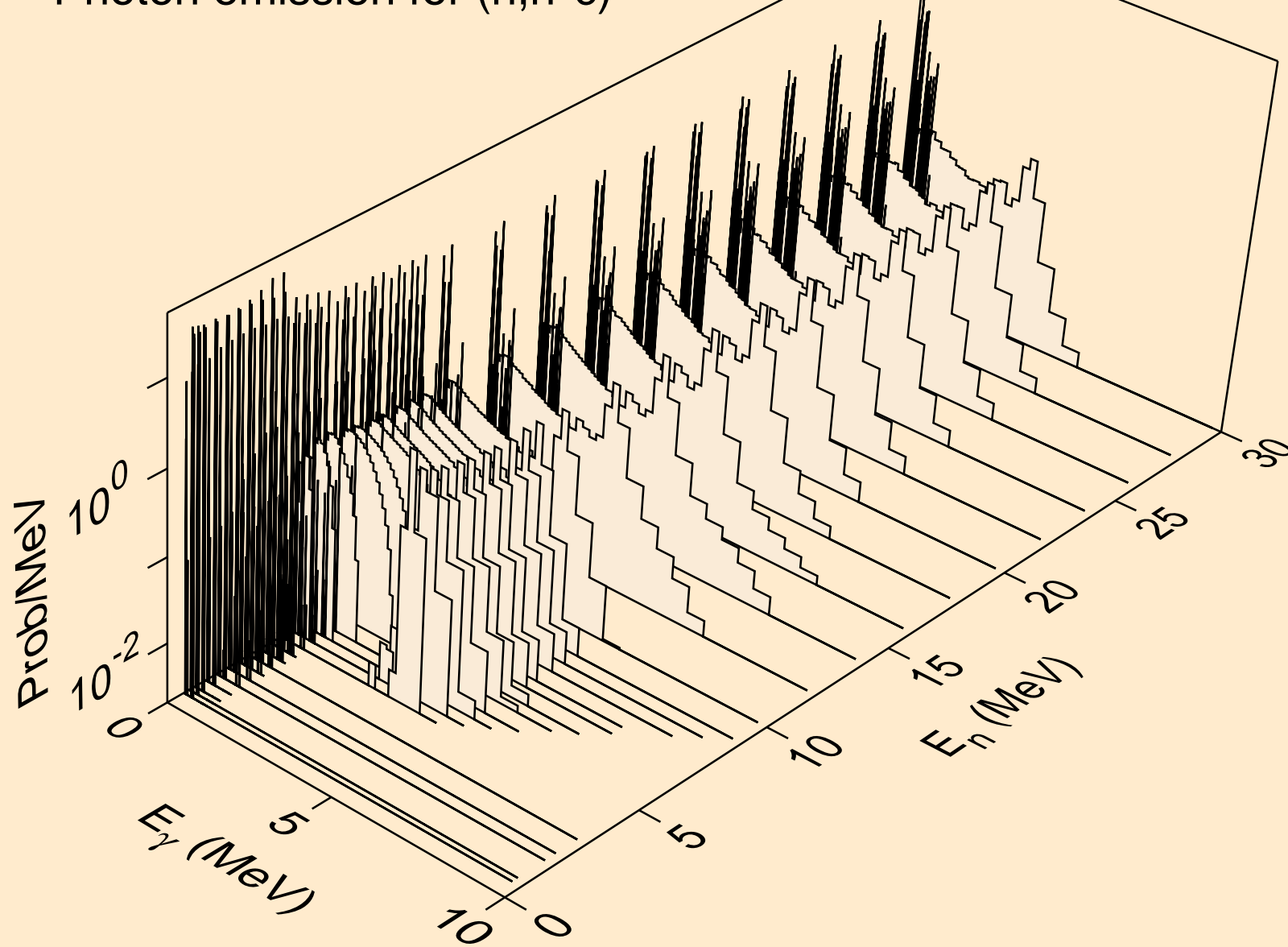

TB152 NEUTRON ACER TENDL-2023 LIBRARY; T=0.K
Photon emission for (n,gma)

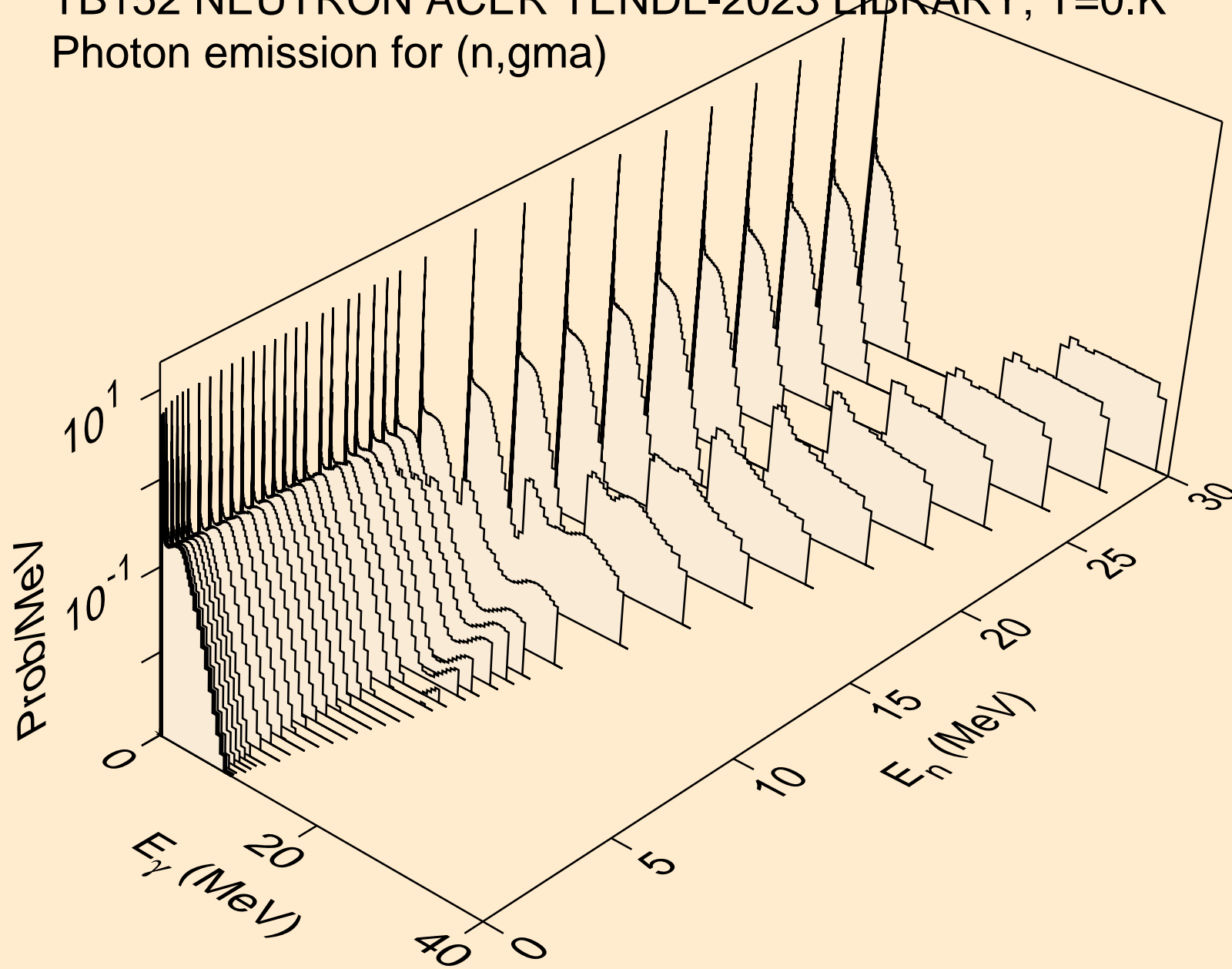

TB152 NEUTRON ACER TENDL-2023 LIBRARY; T=0.K
Photon emission for (n,p)

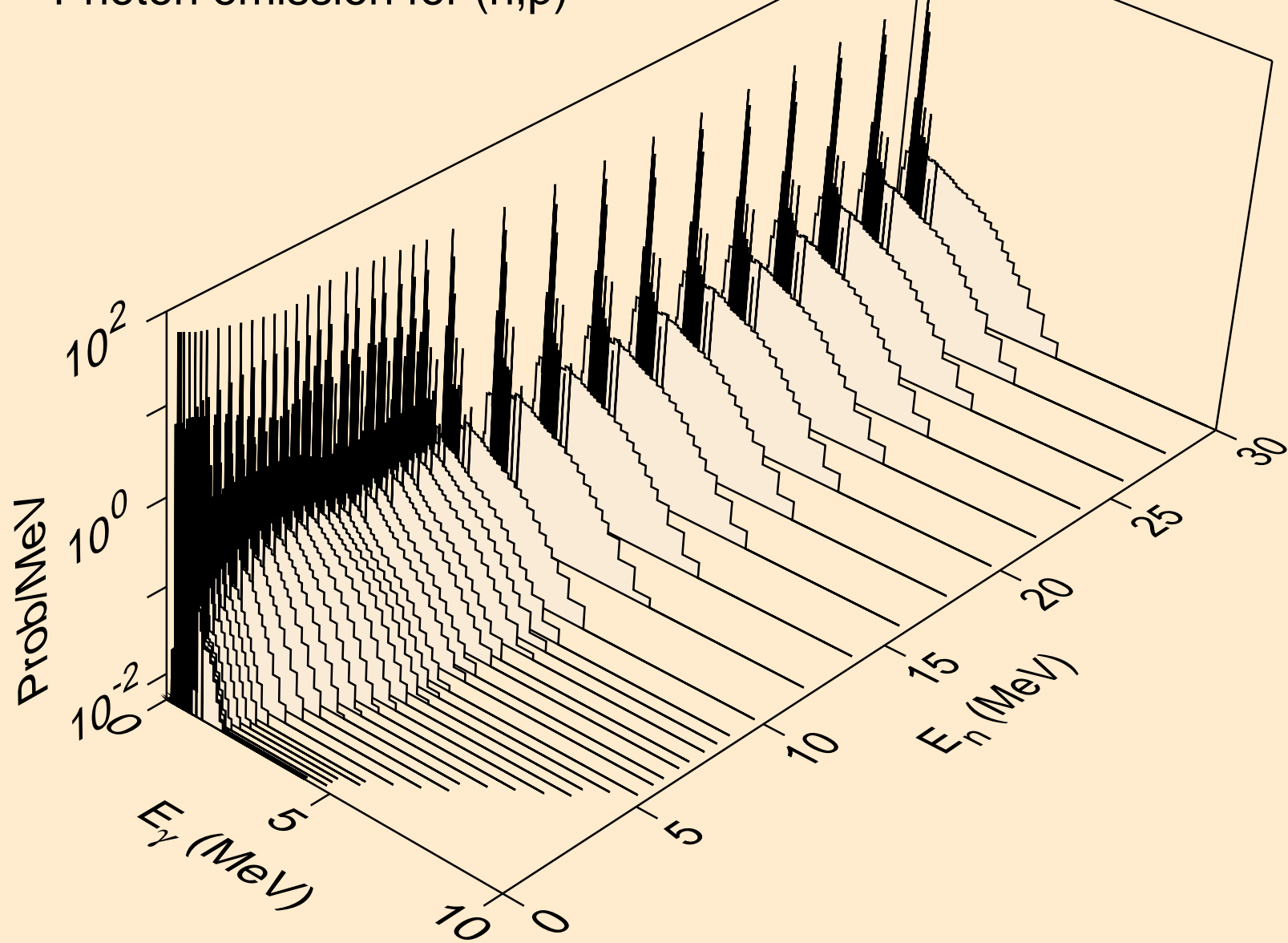

TB152 NEUTRON ACER TENDL-2023 LIBRARY; T=0.K
Photon emission for (n,d)

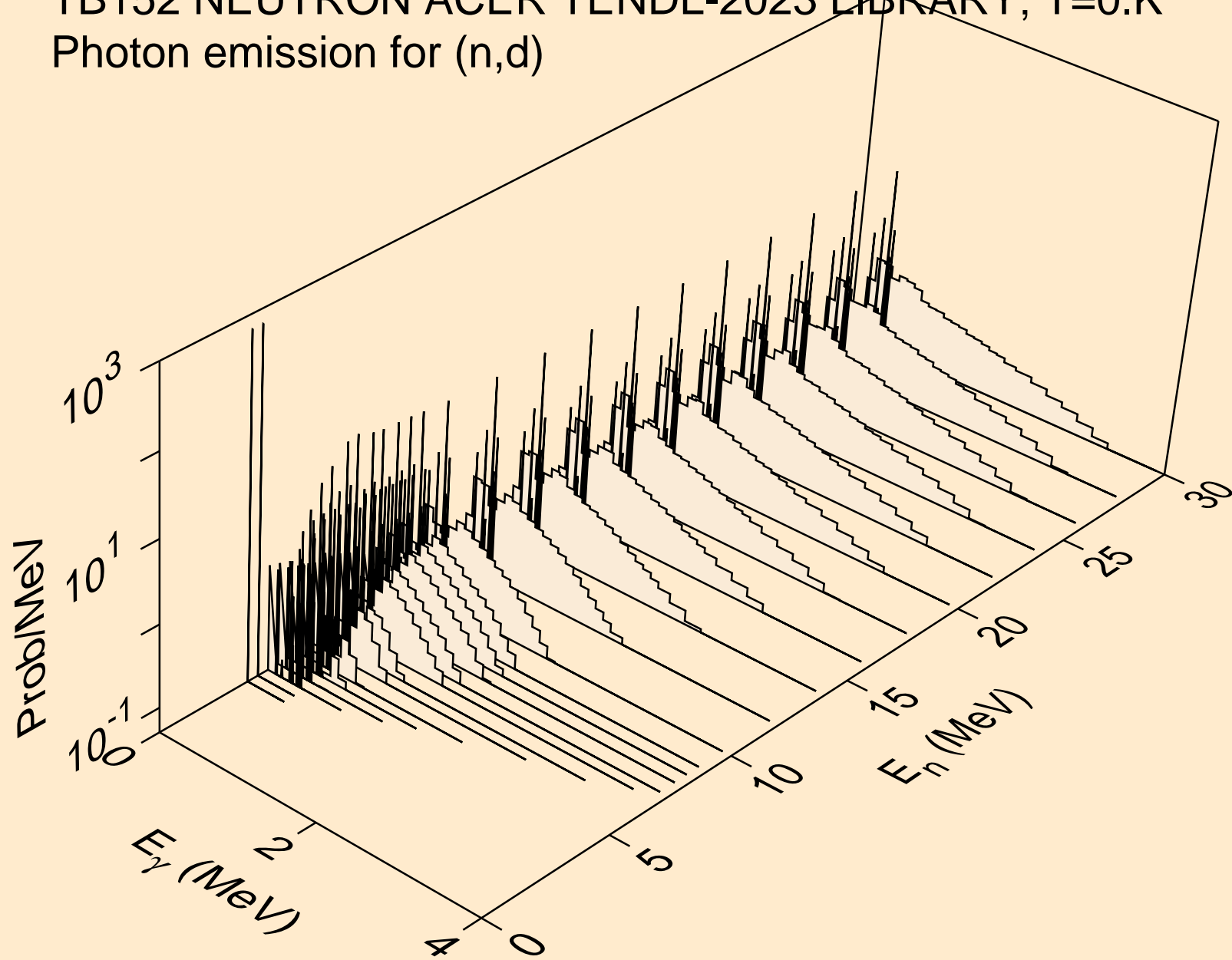

TB152 NEUTRON ACER TENDL-2023 LIBRARY; T=0.K
Photon emission for (n,t)

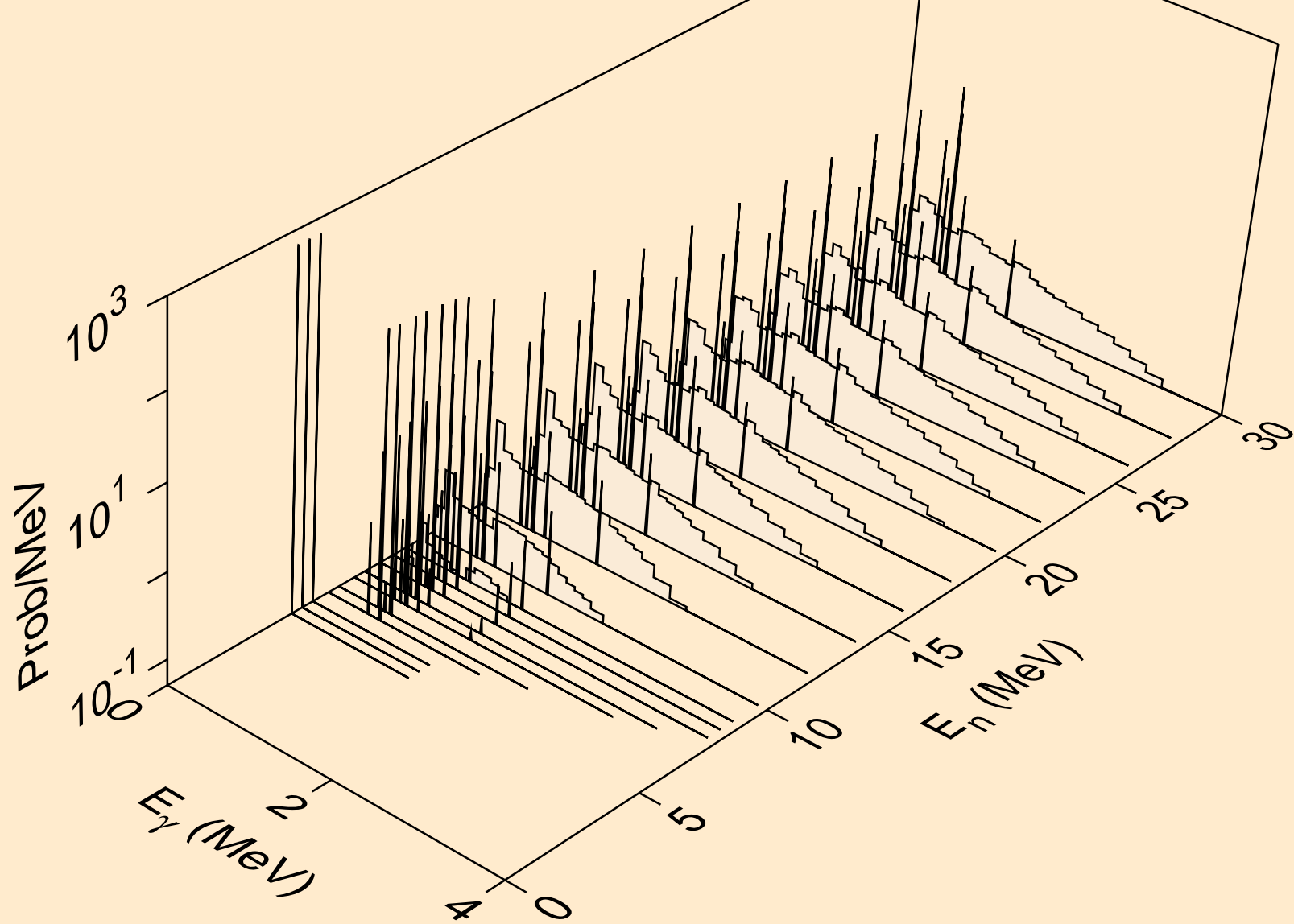

TB152 NEUTRON ACER TENDL-2023 LIBRARY; T=0.K
Photon emission for (n,he3)

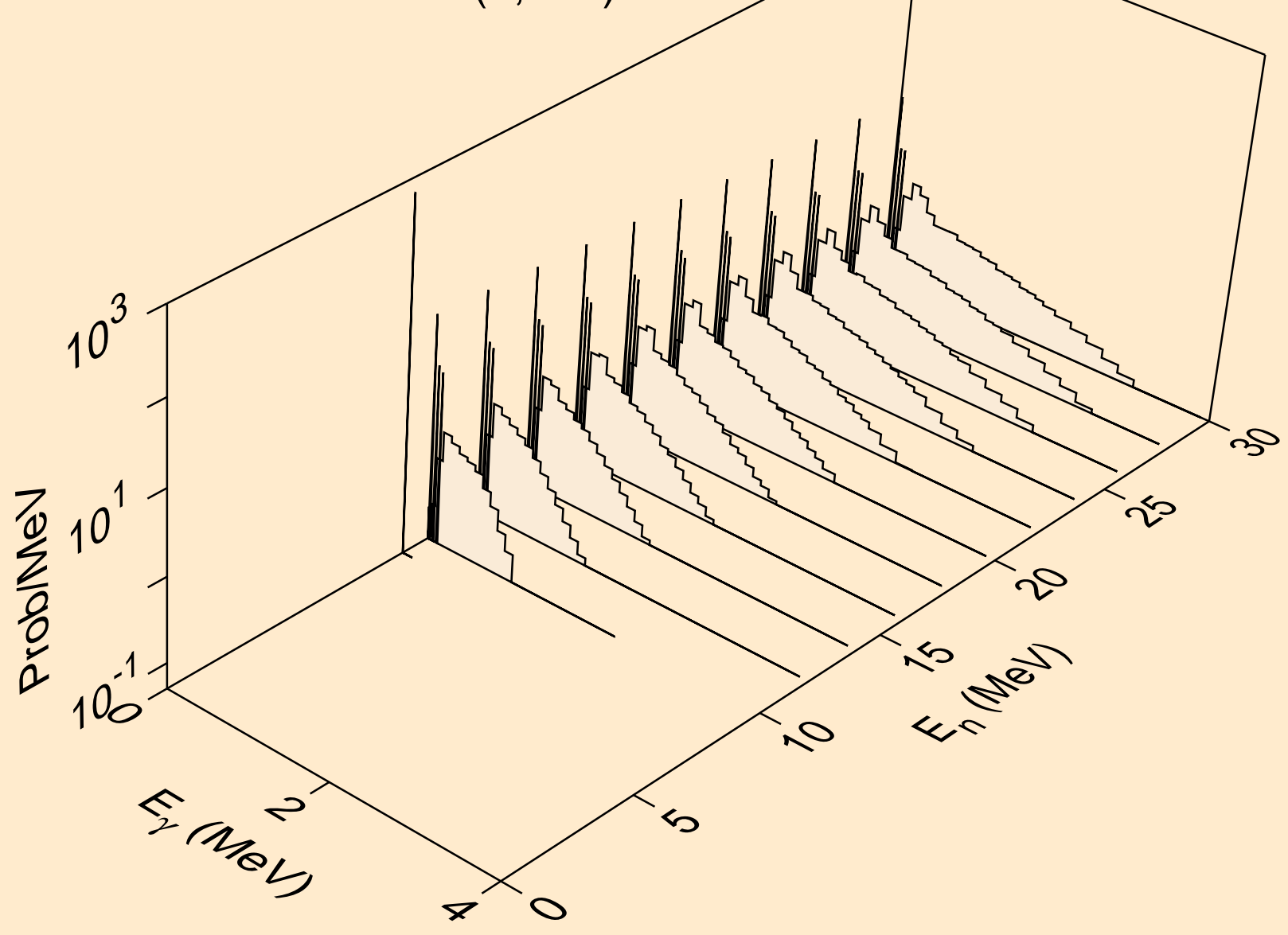

TB152 NEUTRON ACER TENDL-2023 LIBRARY; T=0.K
Photon emission for (n,a)

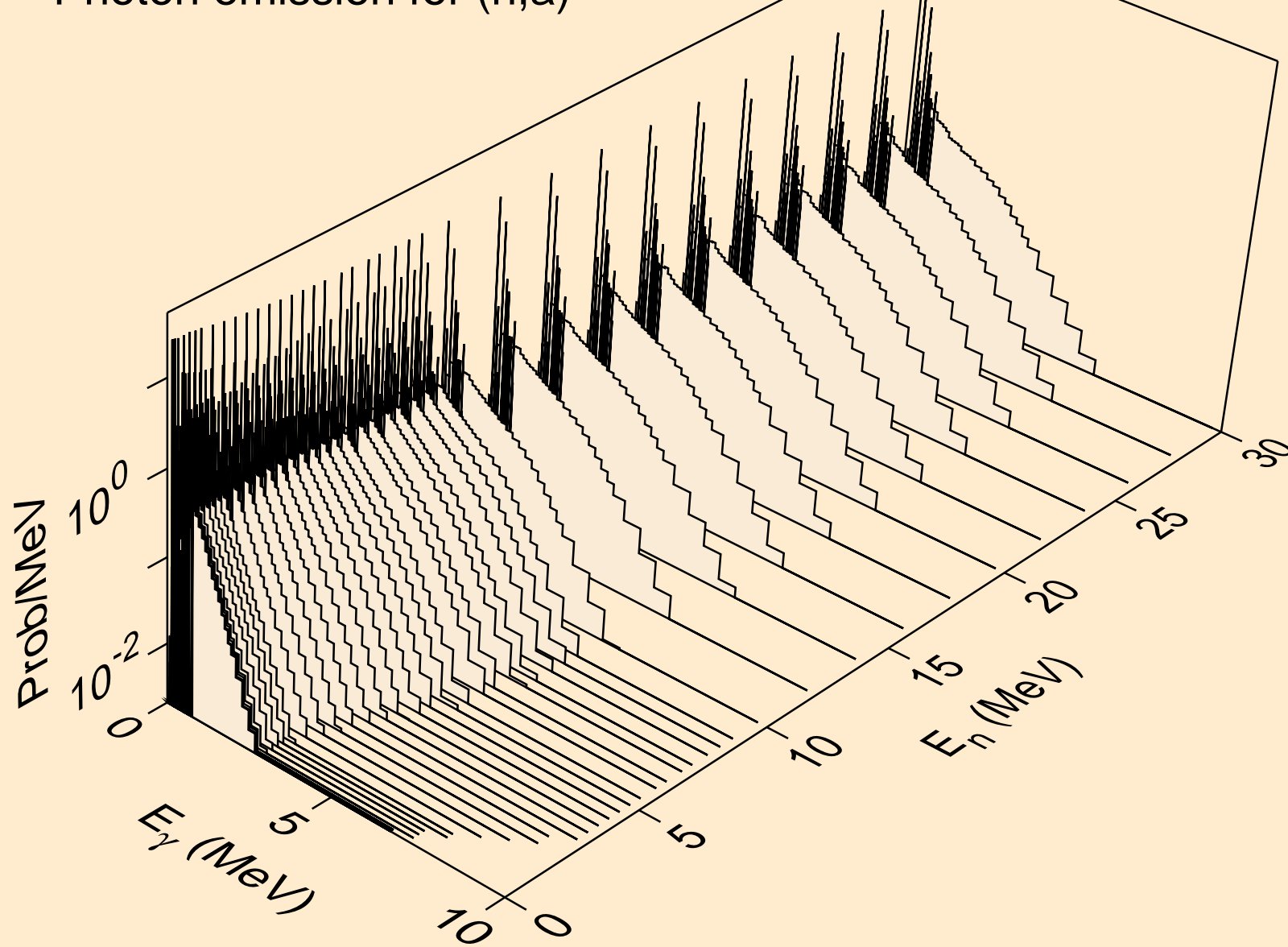

TB152 NEUTRON ACER TENDL-2023 LIBRARY; T=0.K
Photon emission for (n,2a)

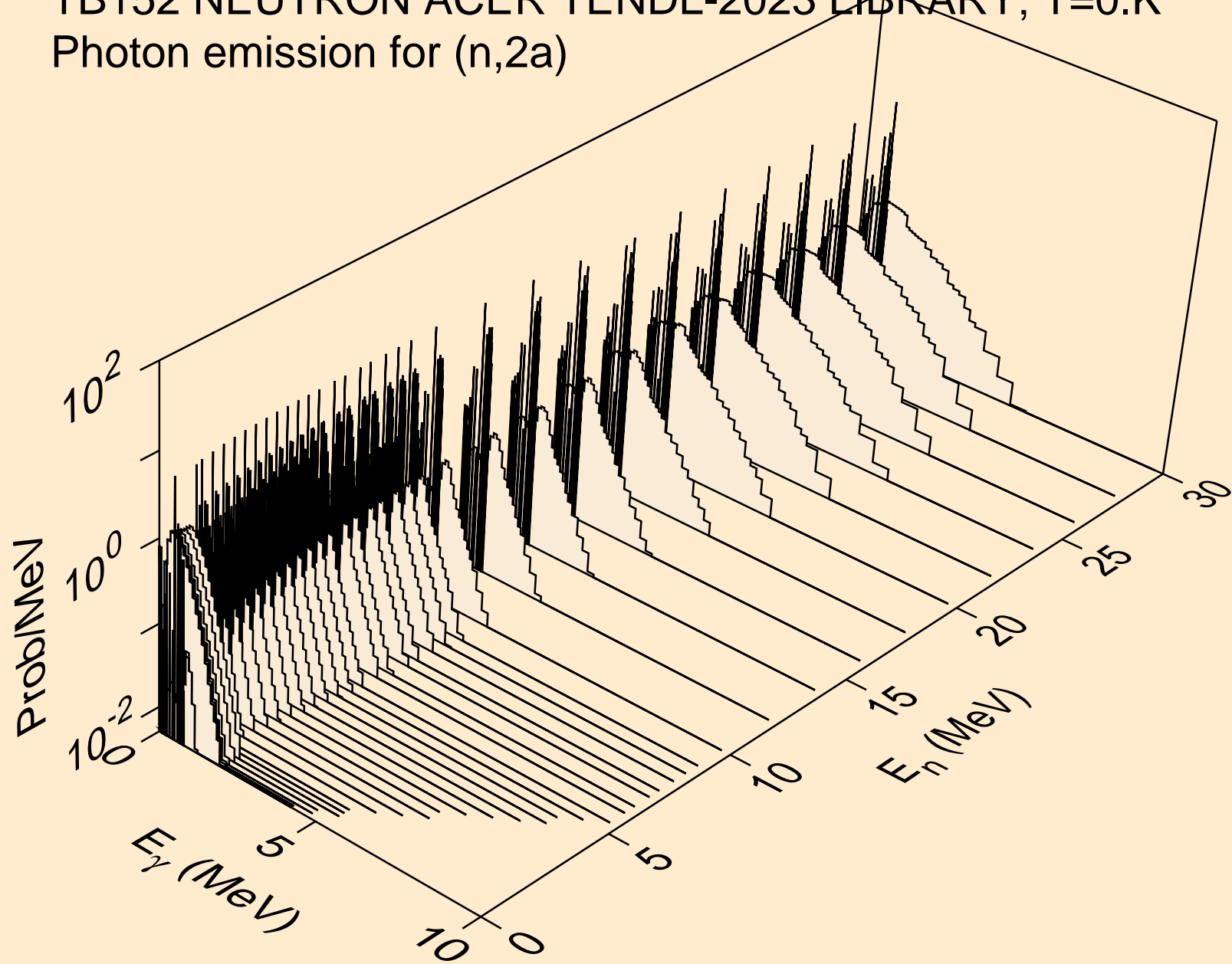

TB152 NEUTRON ACER TENDL-2023 LIBRARY; T=0.K
Photon emission for (n,2p)

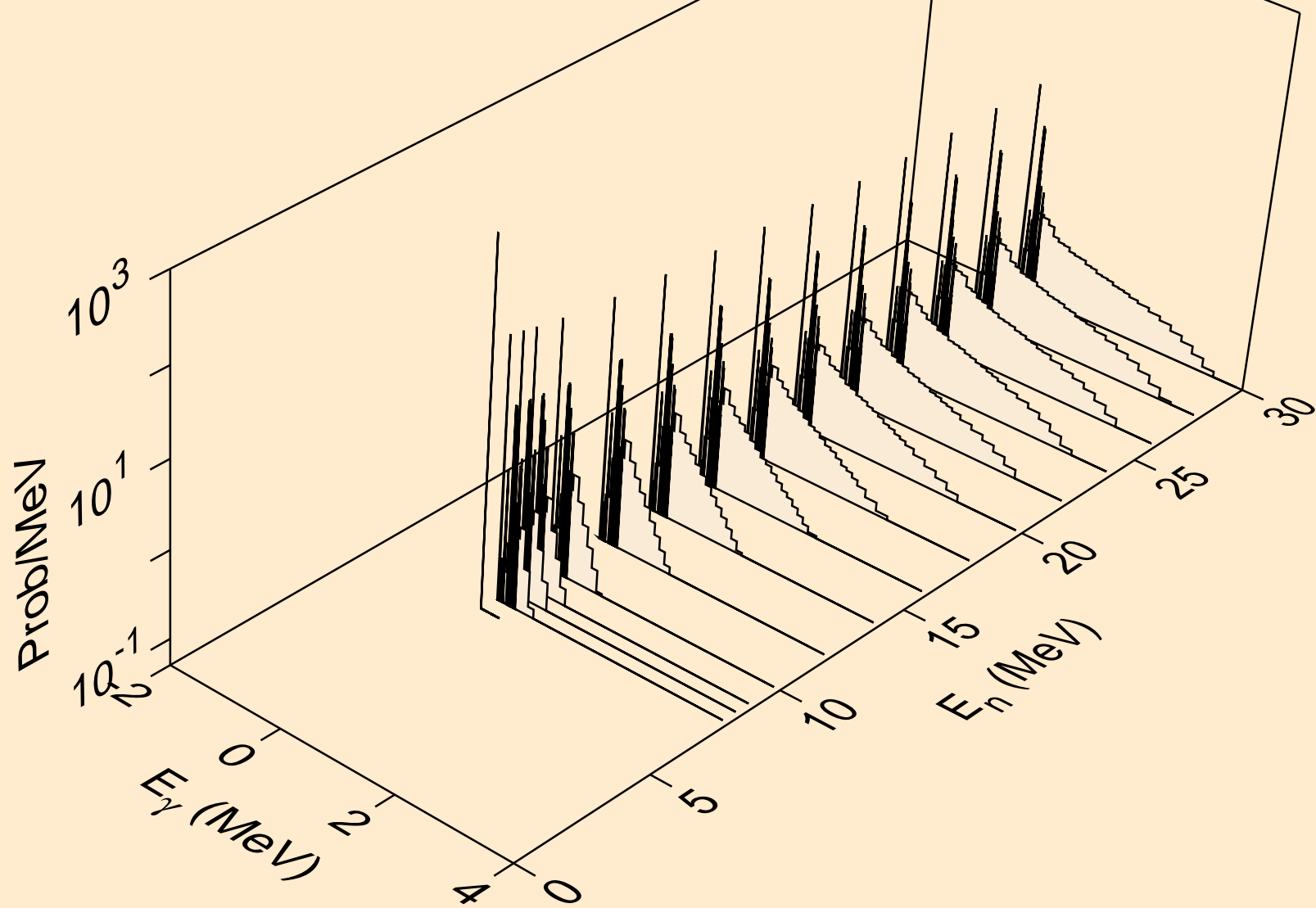

TB152 NEUTRON ACER TENDL-2023 LIBRARY; T=0.K
Photon emission for (n,p α)

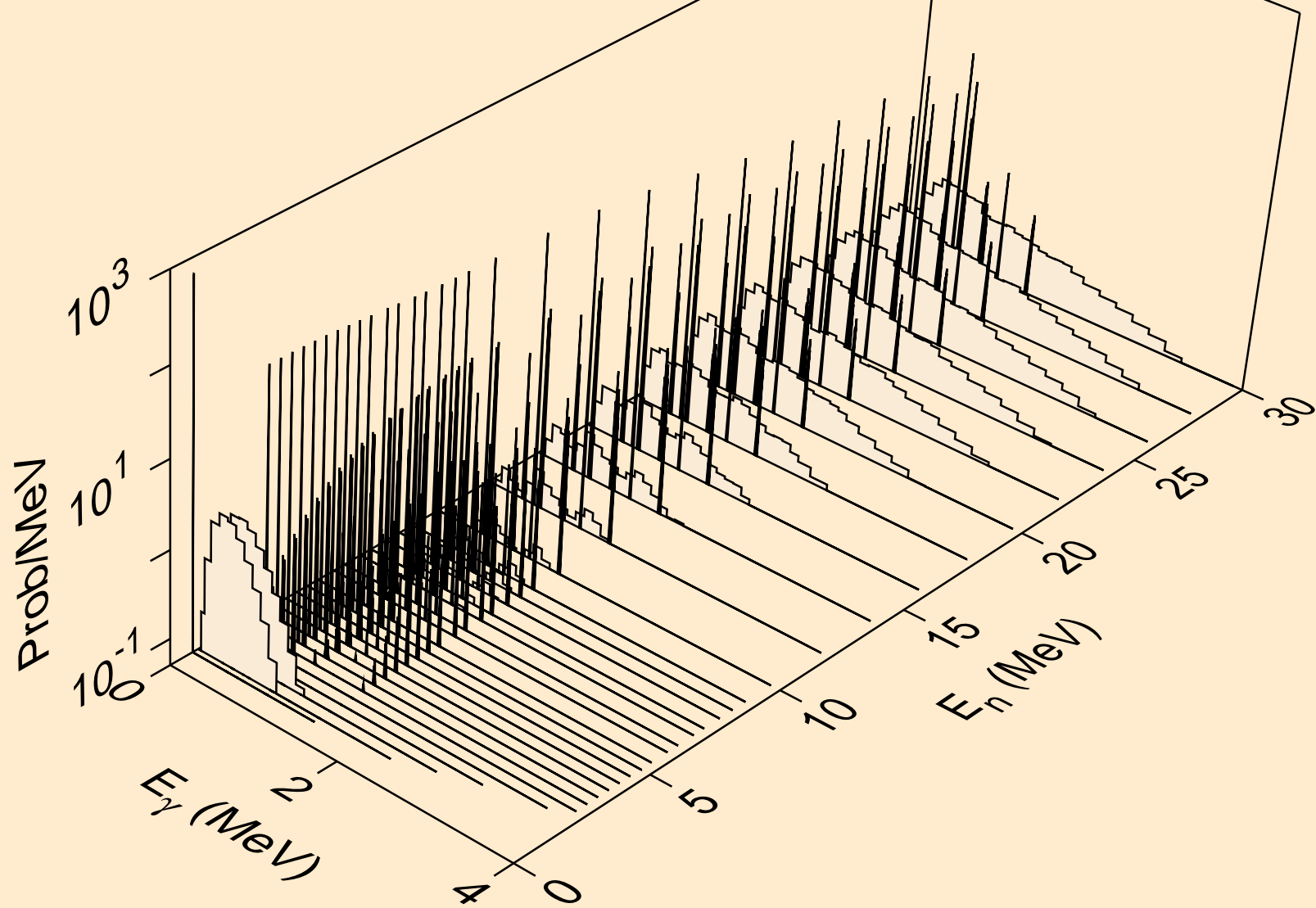

TB152 NEUTRON ACER TENDL-2023 LIBRARY; T=0.K
Photon emission for (n,pd)

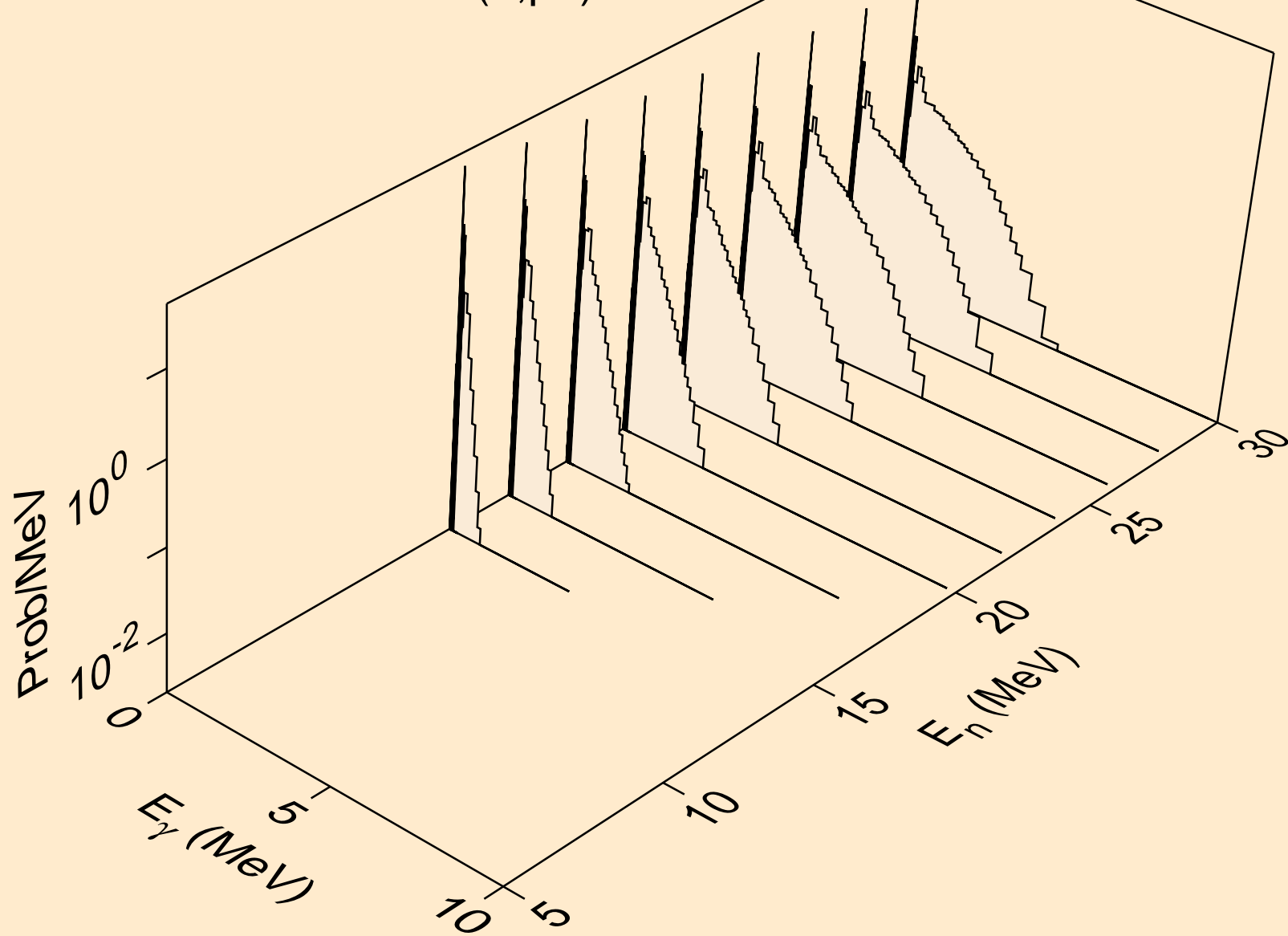

TB152 NEUTRON ACER TENDL-2023 LIBRARY; T=0.K
Photon emission for (n,pt)

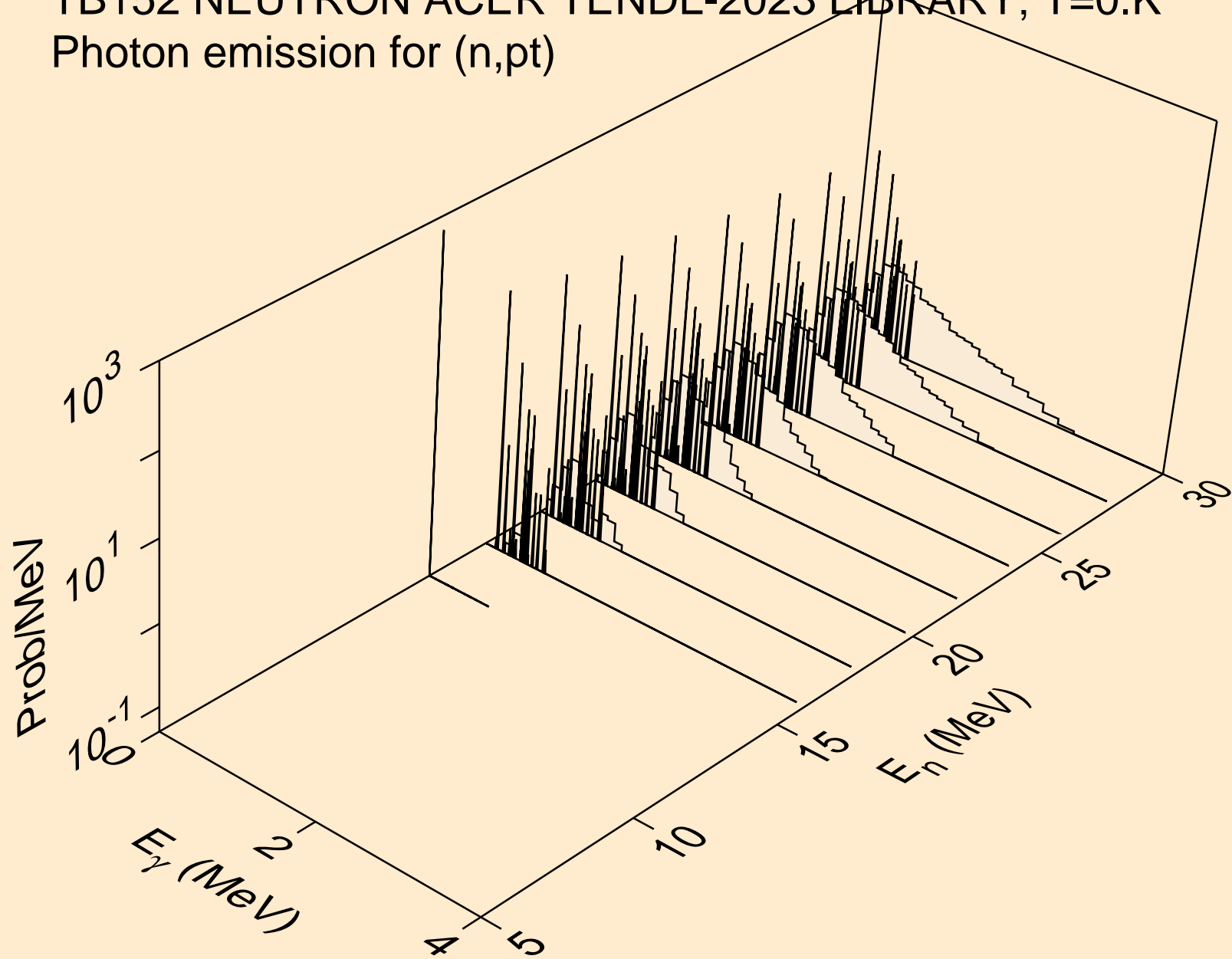

TB152 NEUTRON ACER TENDL-2023 LIBRARY; T=0.K
Photon emission for (n,da)

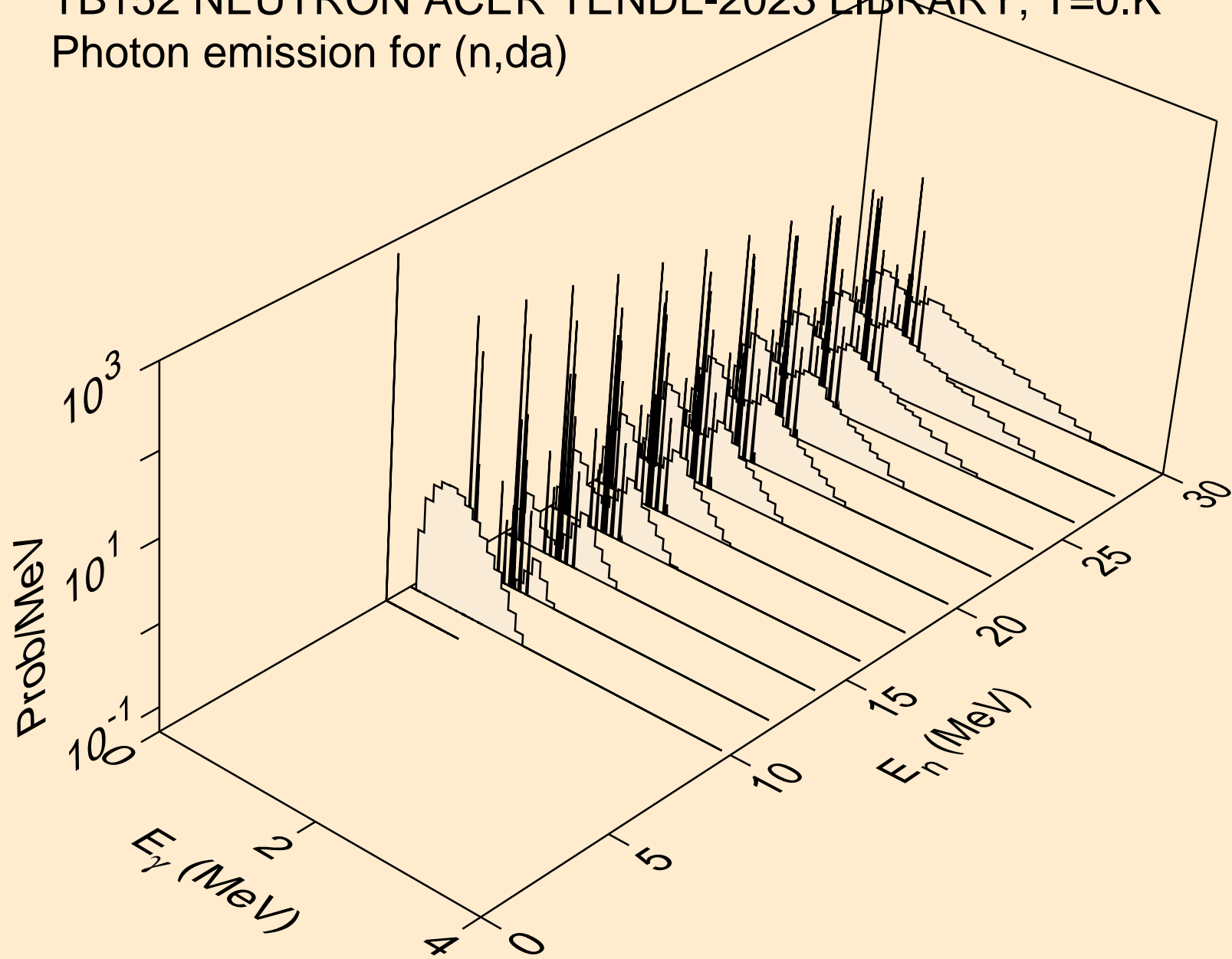

TB152 NEUTRON ACER TENDL-2023 LIBRARY; T=0.K
thermal capture photon spectrum

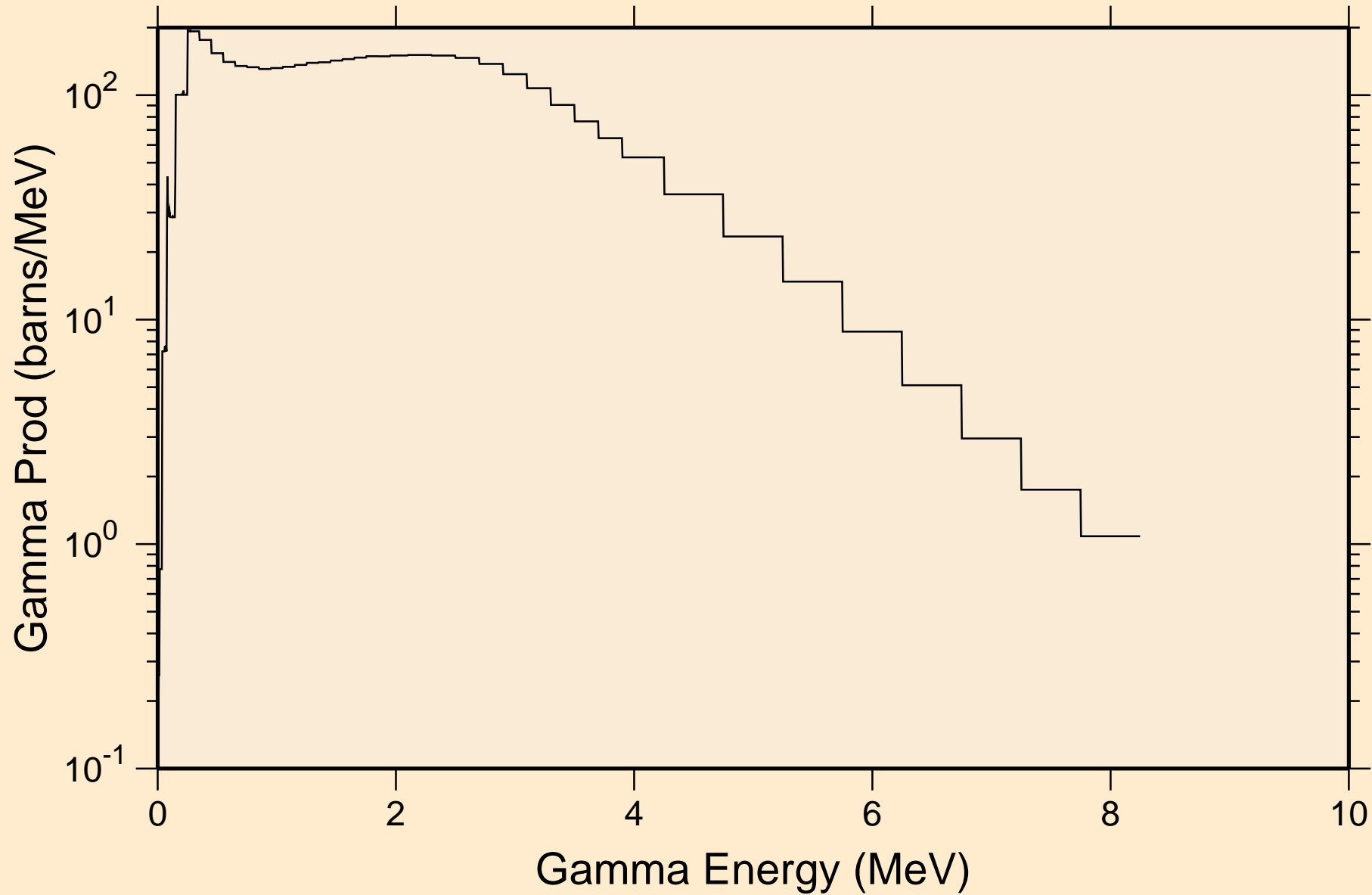

TB152 NEUTRON ACER TENDL-2023 LIBRARY; T=0.K
14 MeV photon spectrum

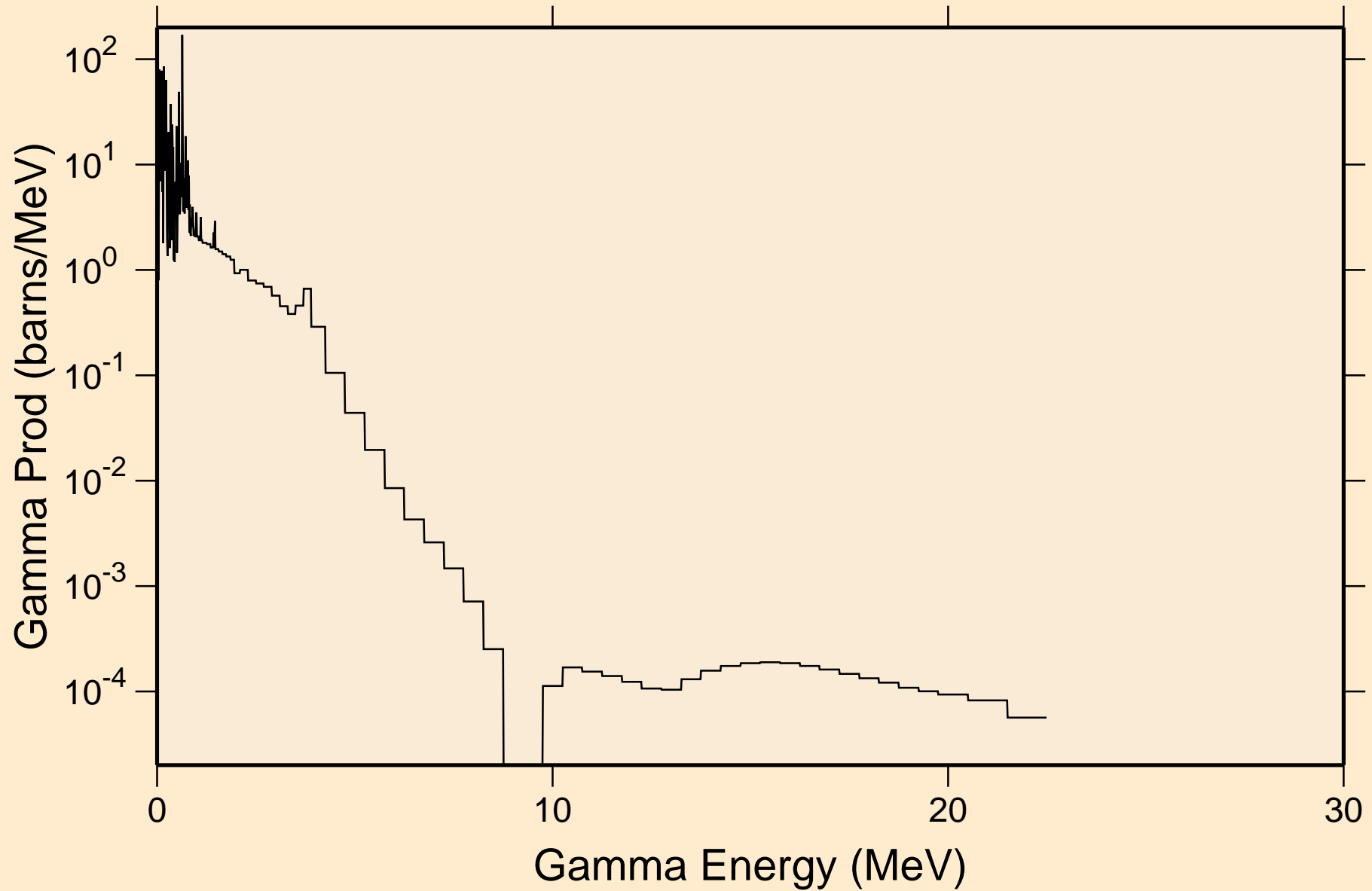

TB152 NEUTRON ACER TENDL-2023 LIBRARY; T=0.K
Particle heating contributions

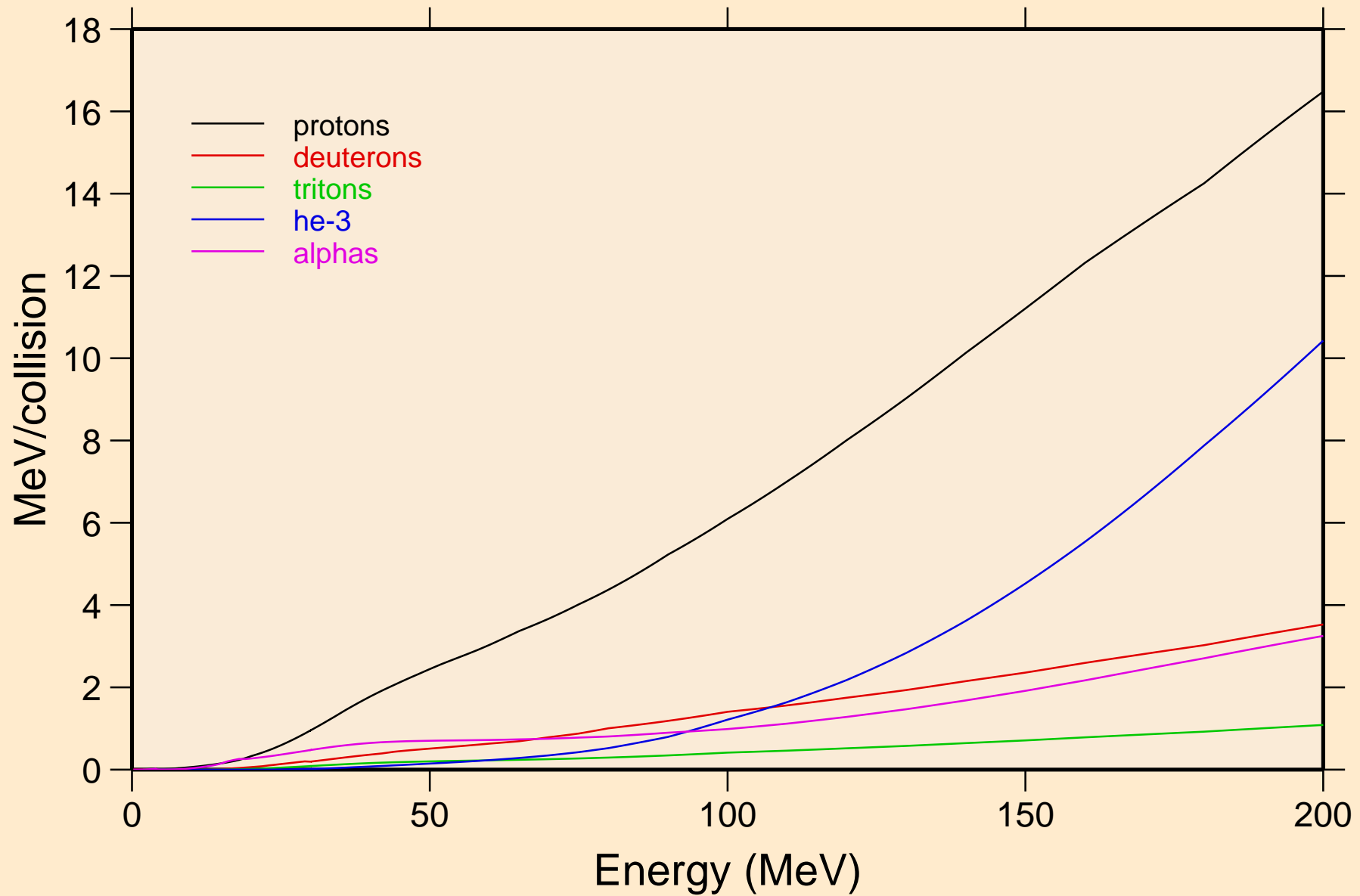

TB152 NEUTRON ACER TENDL-2023 LIBRARY; T=0.K
Recoil Heating

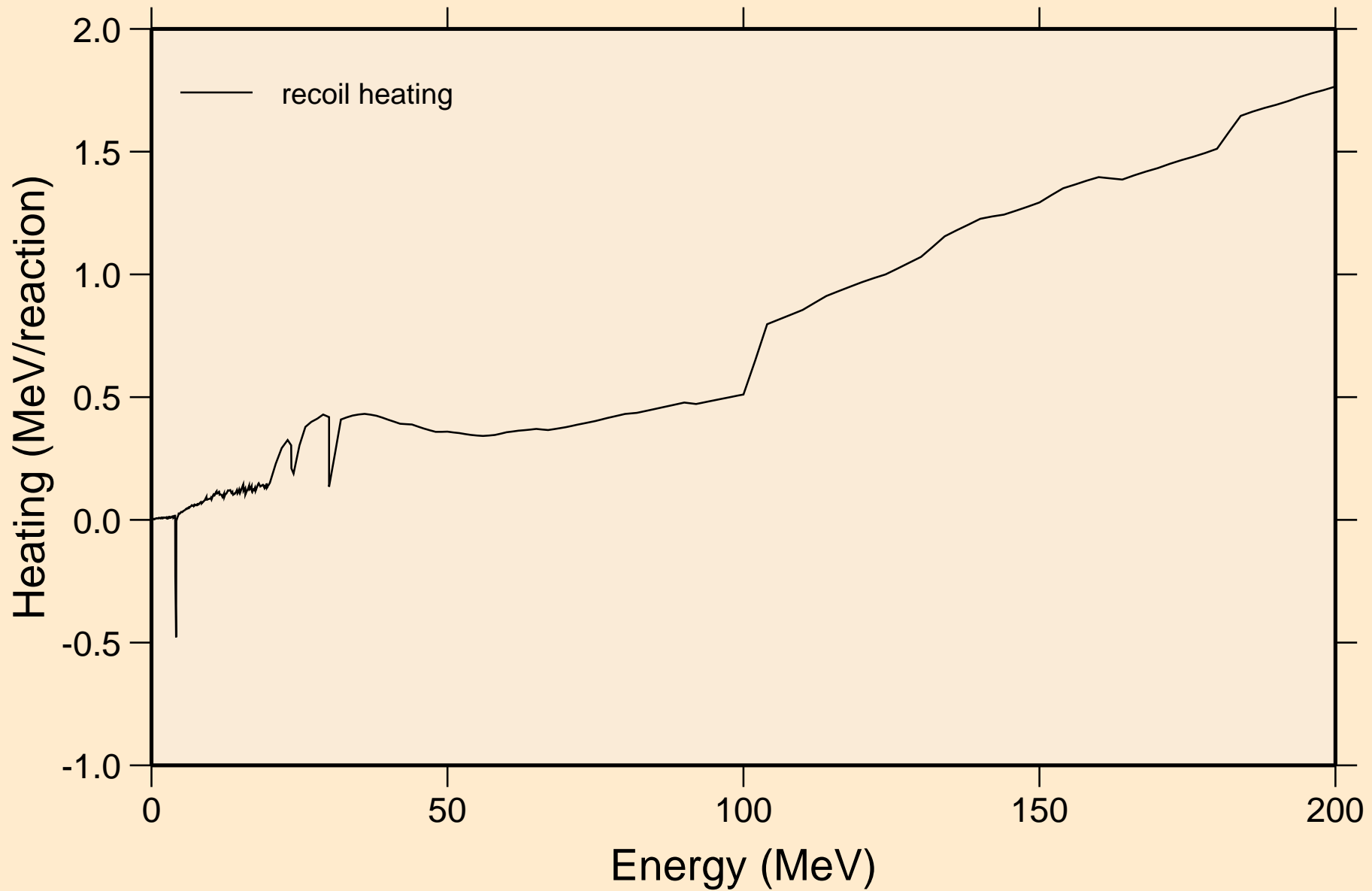

TB152 NEUTRON ACER TENDL-2023 LIBRARY; T=0.K
Particle production cross sections

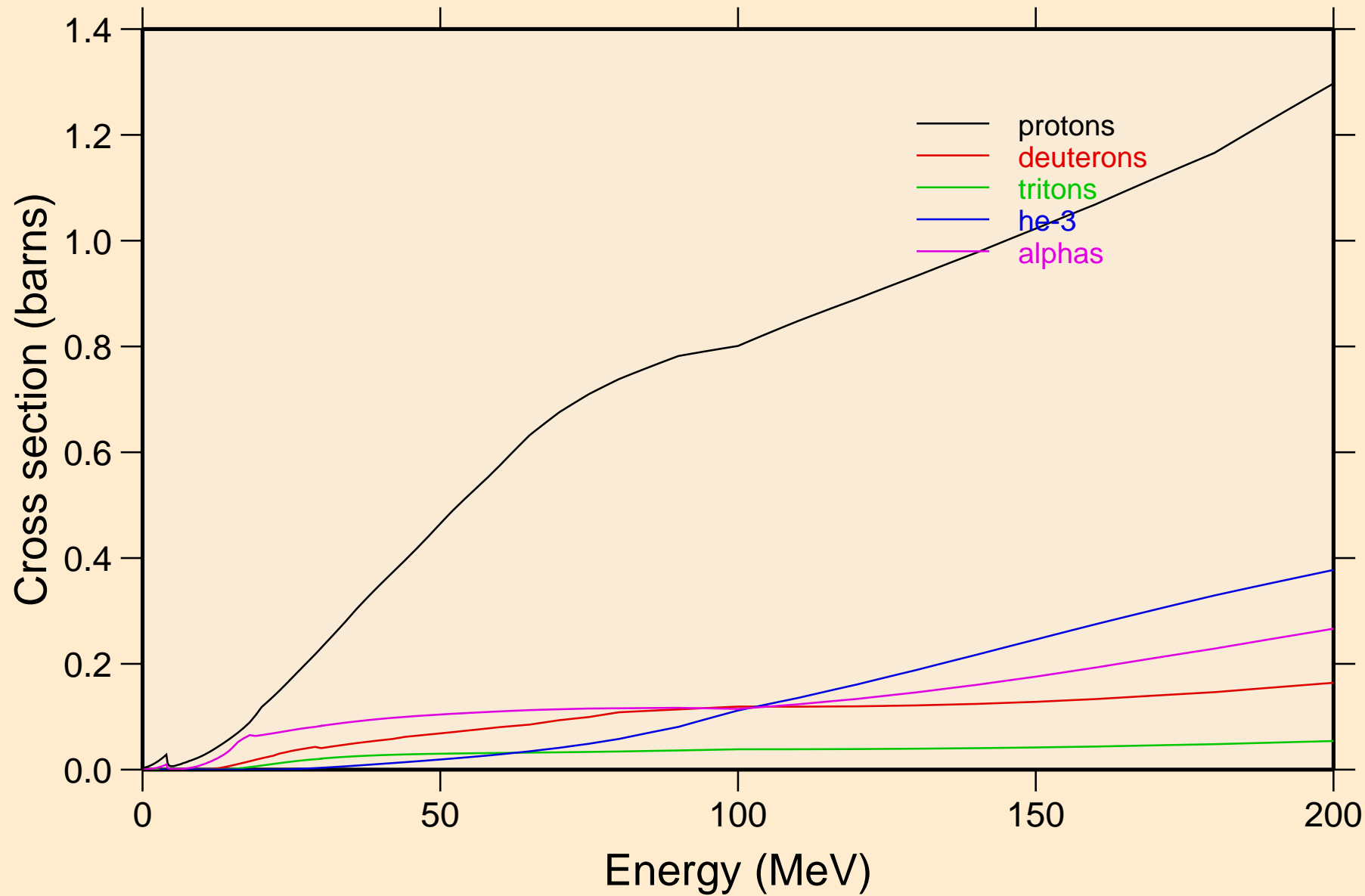

TB152 NEUTRON ACER TENDL-2023 LIBRARY; T=0.K
protons from (n,x)

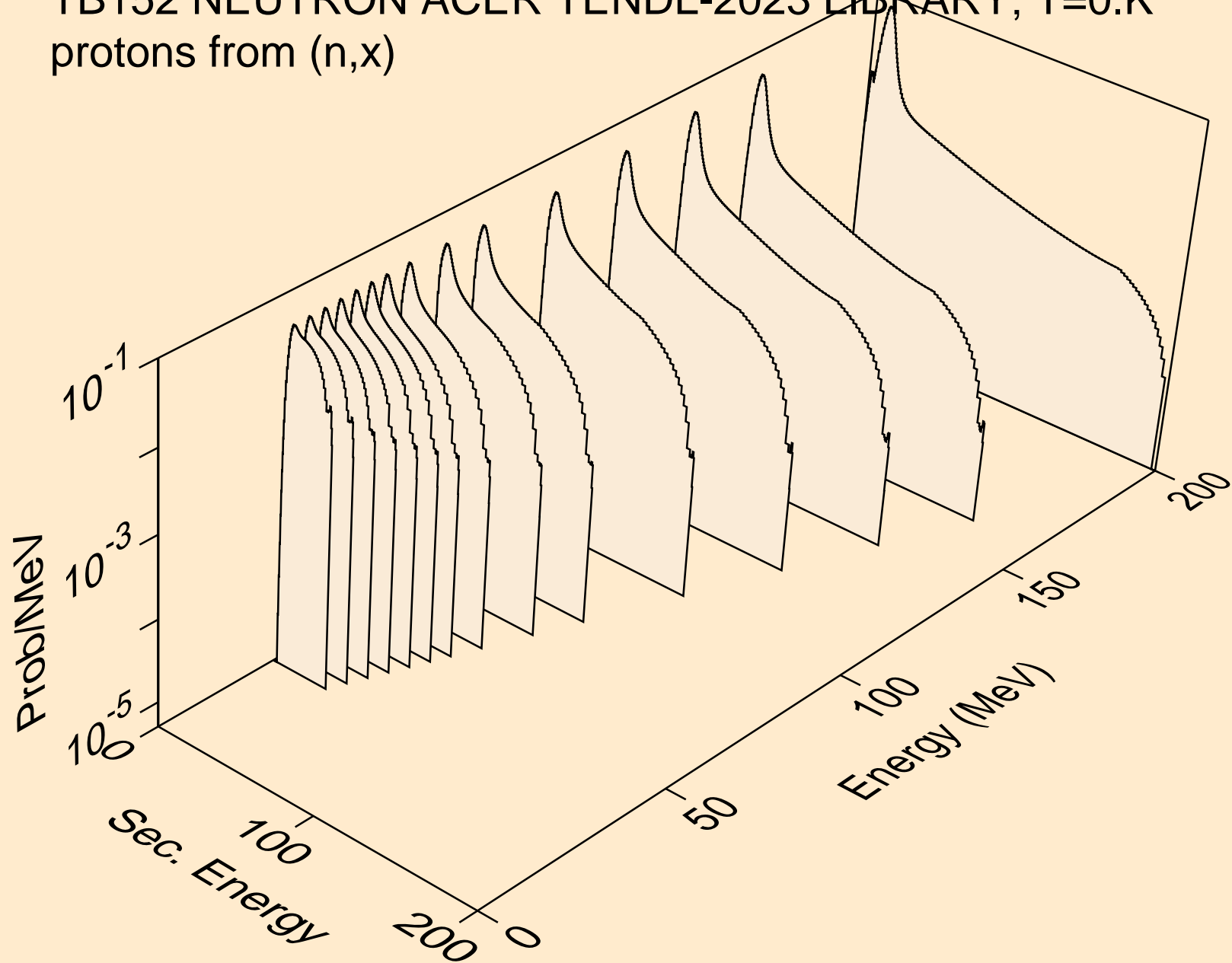

TB152 NEUTRON ACER TENDL-2023 LIBRARY; T=0.K
protons from (n,n*)p

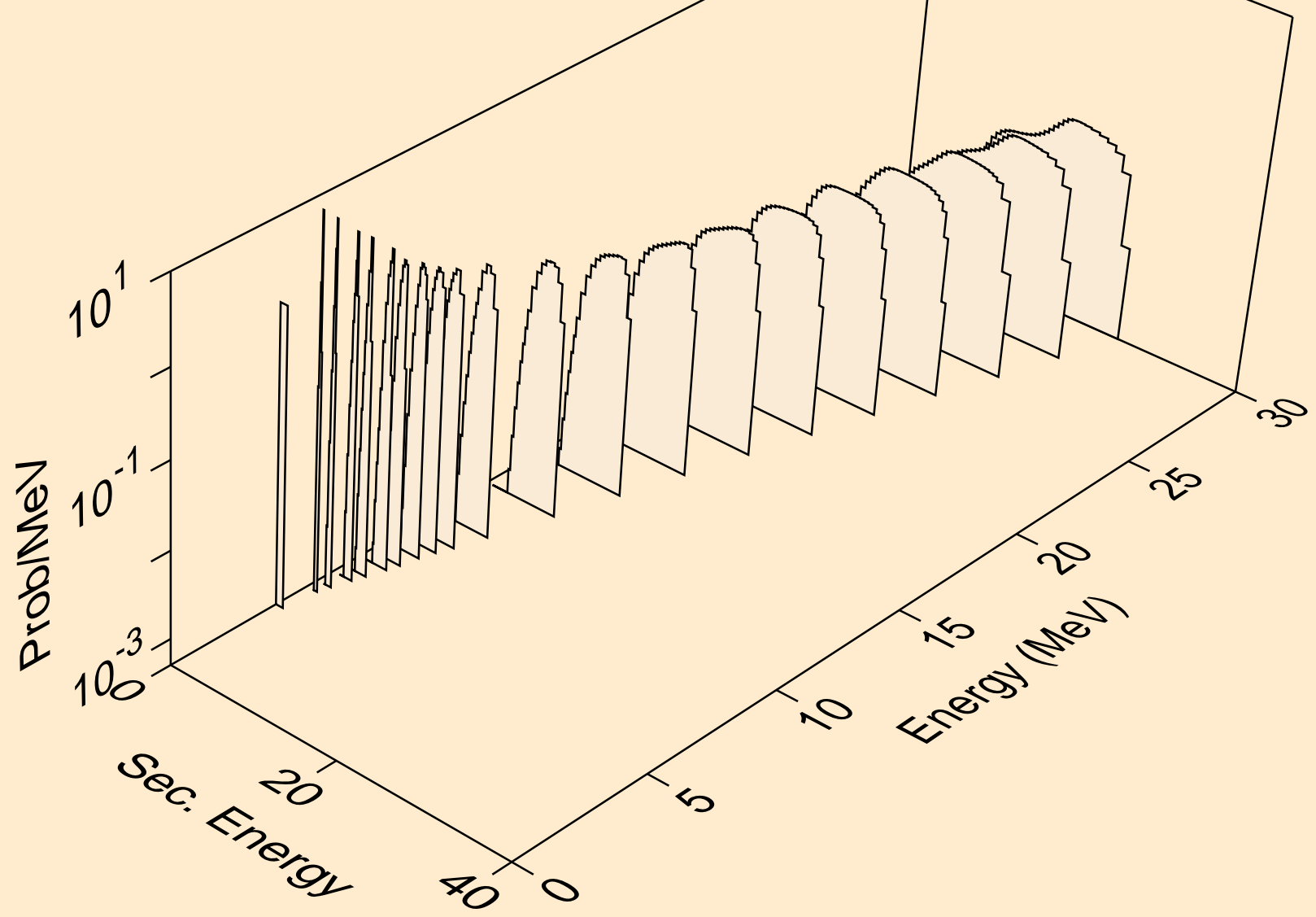

TB152 NEUTRON ACER TENDL-2023 LIBRARY; T=0.K
protons from (n,2np)

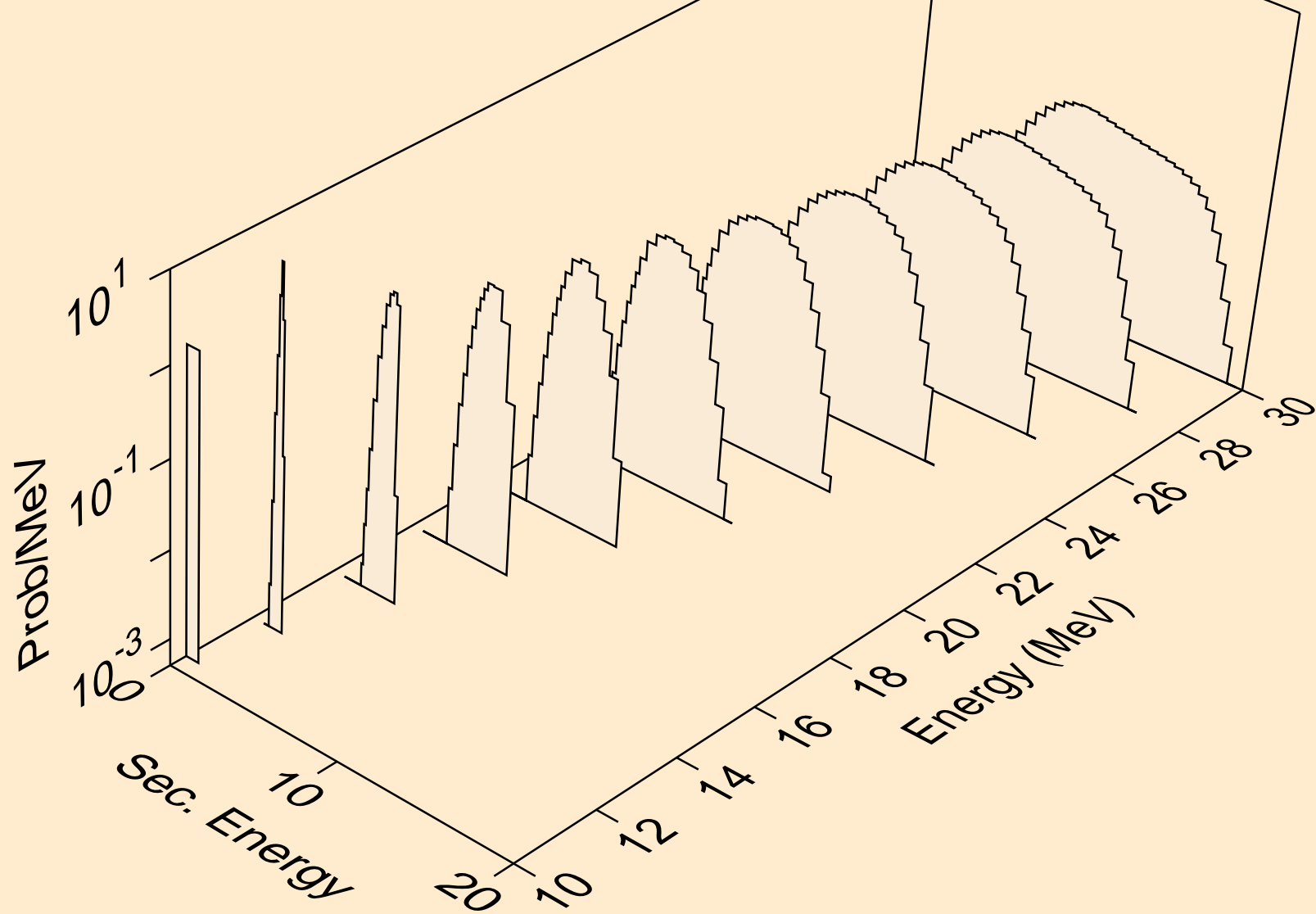

TB152 NEUTRON ACER TENDL-2023 LIBRARY; T=0.K
protons from (n,3np)

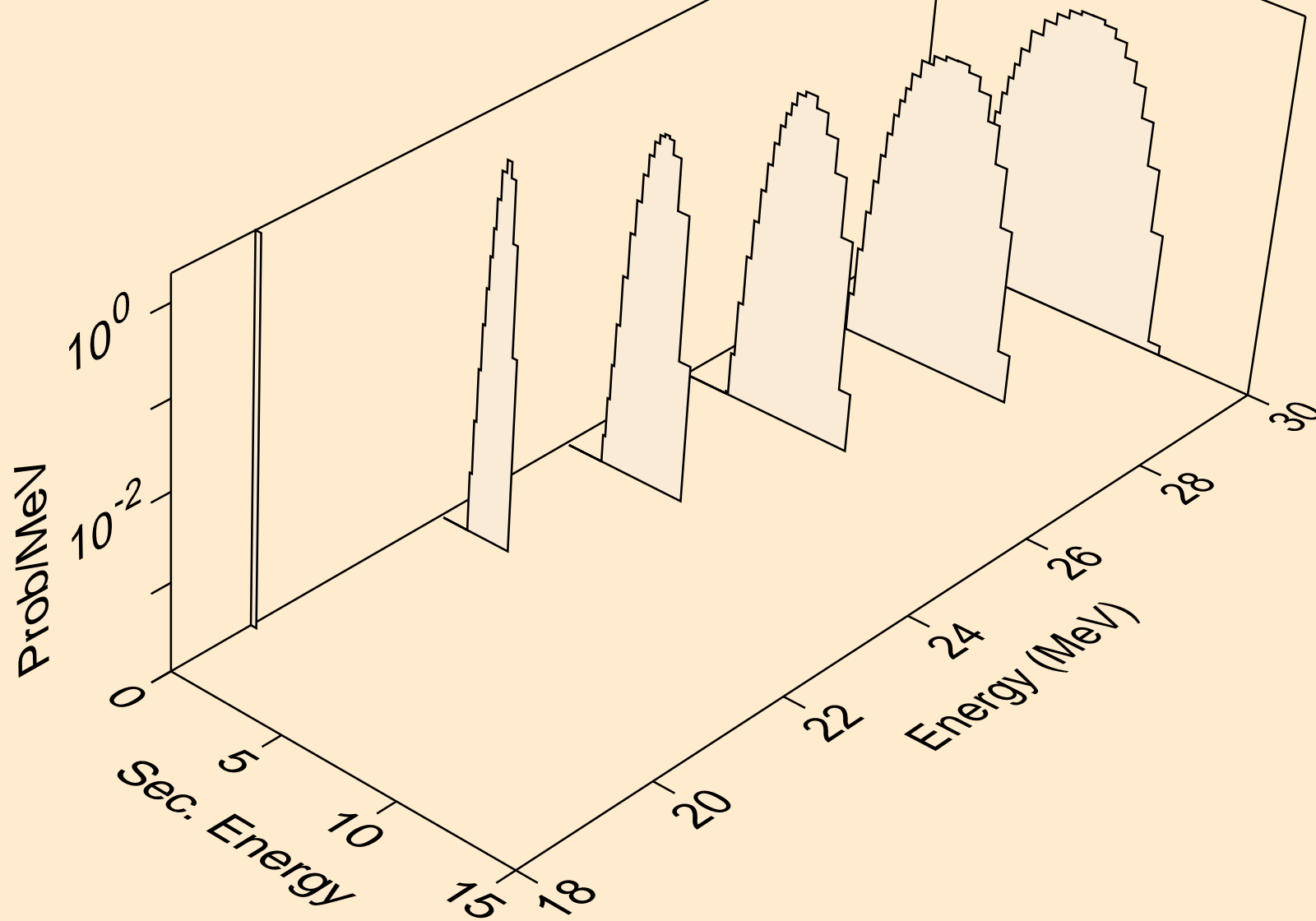

TB152 NEUTRON ACER TENDL-2023 LIBRARY; T=0.K
protons from (n,n2p)

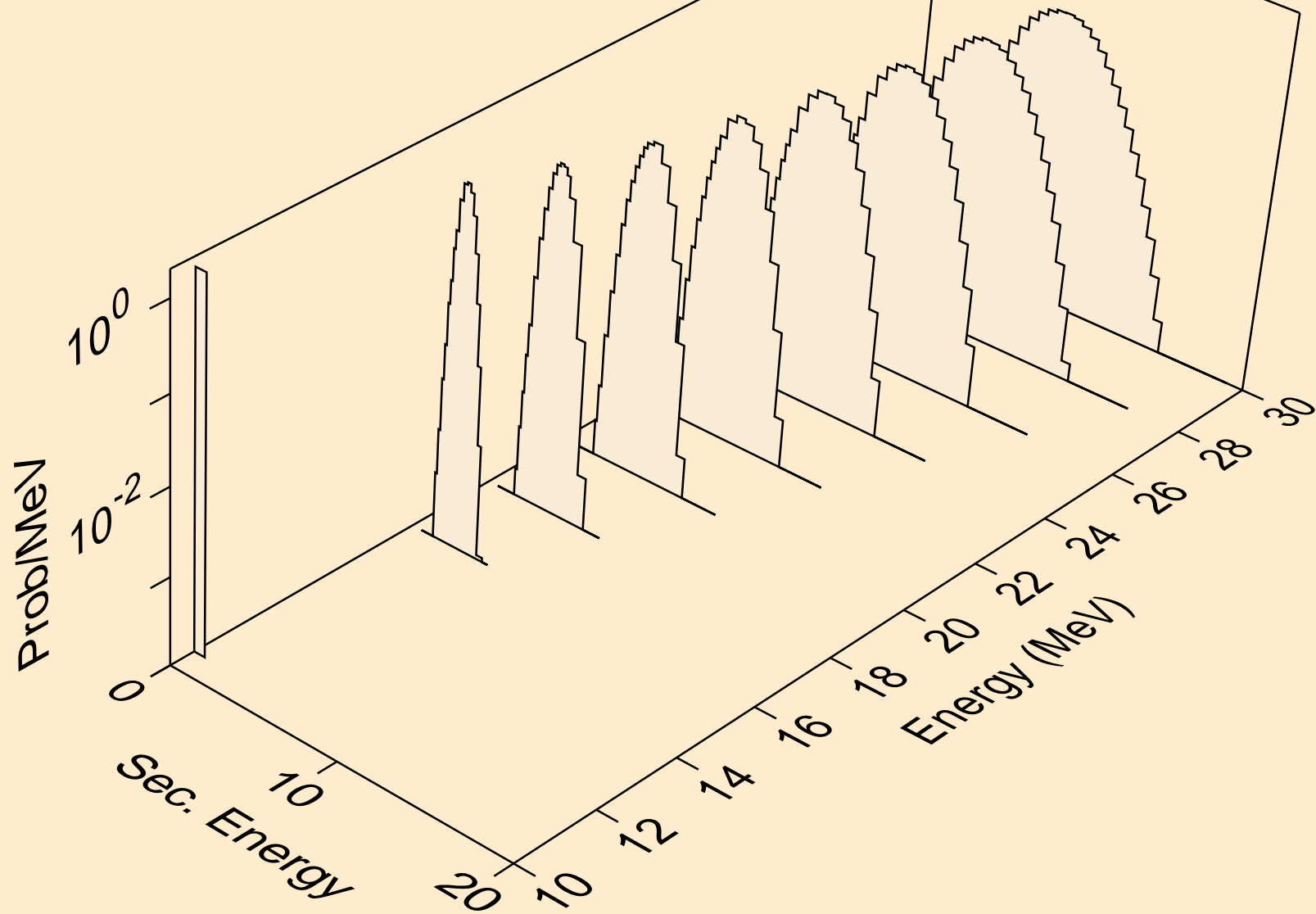

TB152 NEUTRON ACER TENDL-2023 LIBRARY; T=0.K
protons from (n,npa)

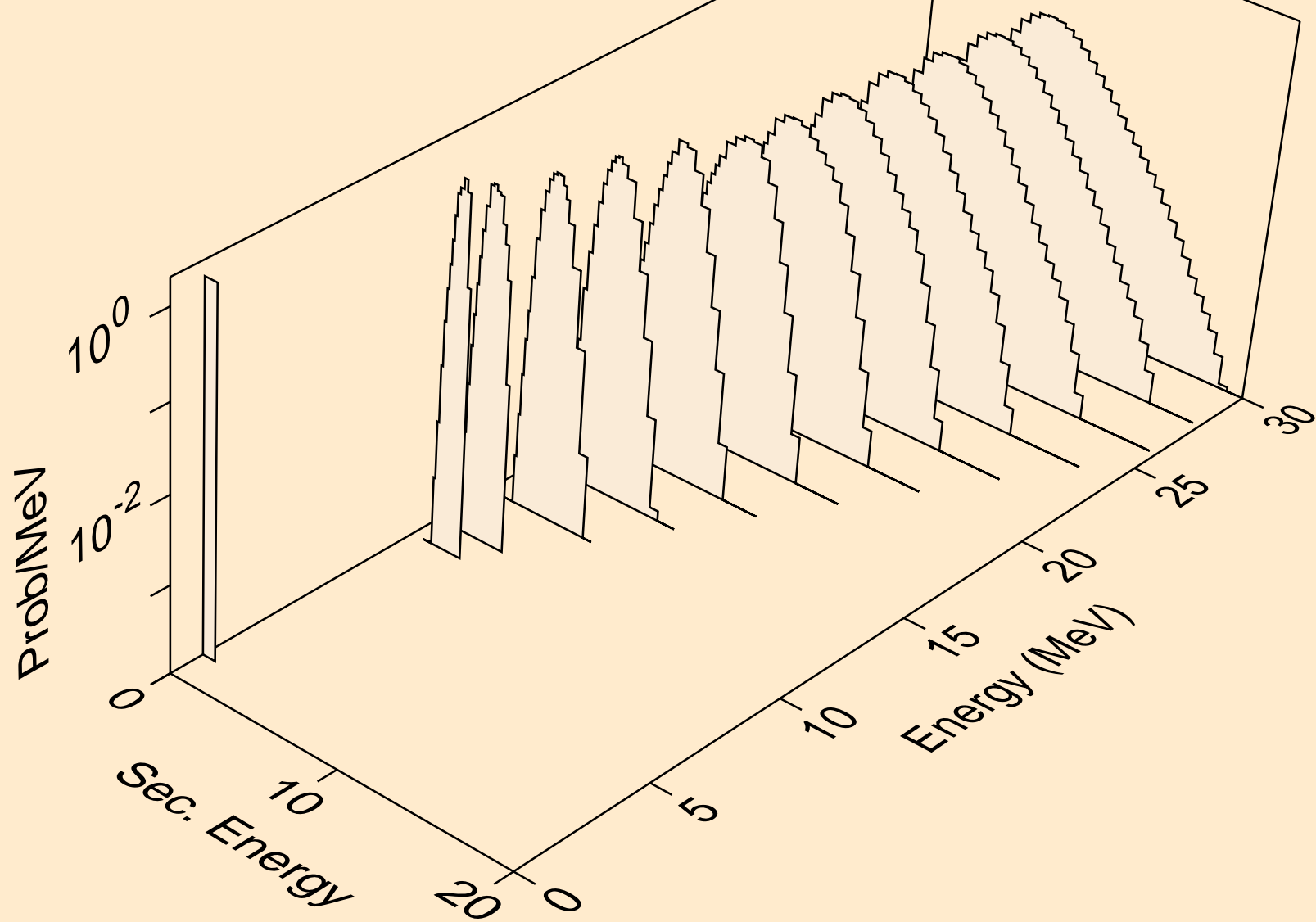

TB152 NEUTRON ACER TENDL-2023 LIBRARY; T=0.K
protons from (n,p)

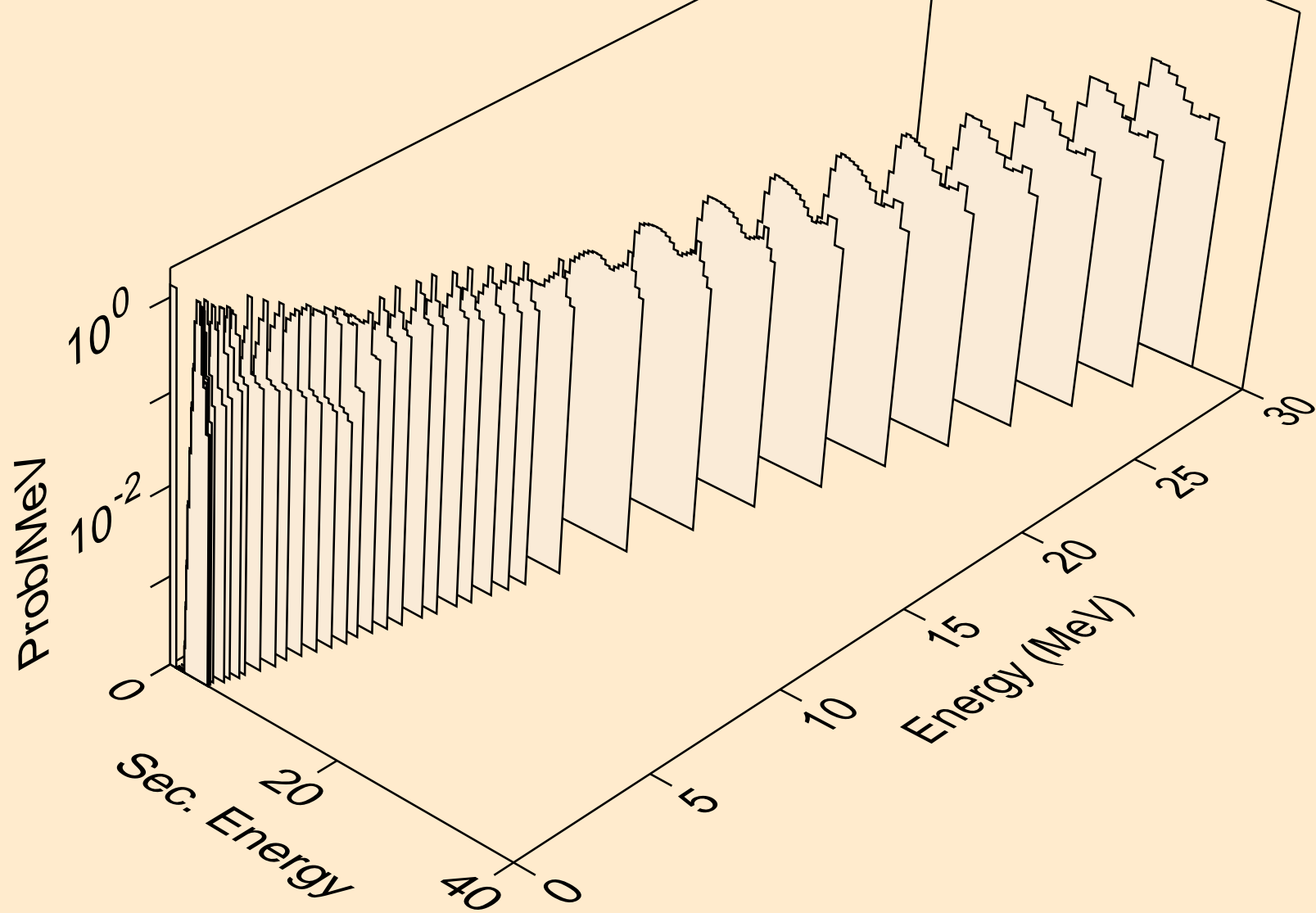

TB152 NEUTRON ACER TENDL-2023 LIBRARY; T=0.K
protons from (n,2p)

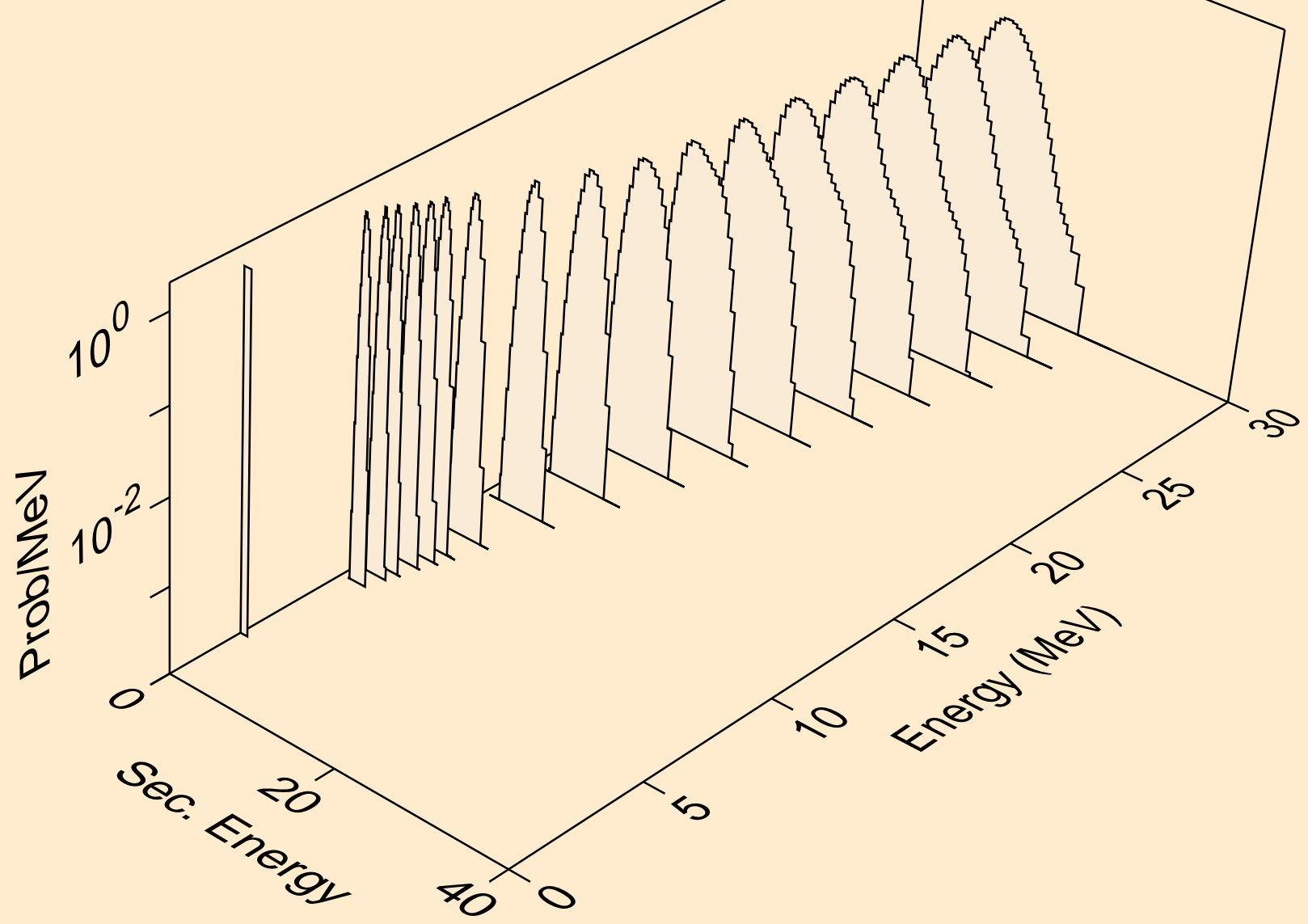

TB152 NEUTRON ACER TENDL-2023 LIBRARY; T=0.K
protons from (n,p)

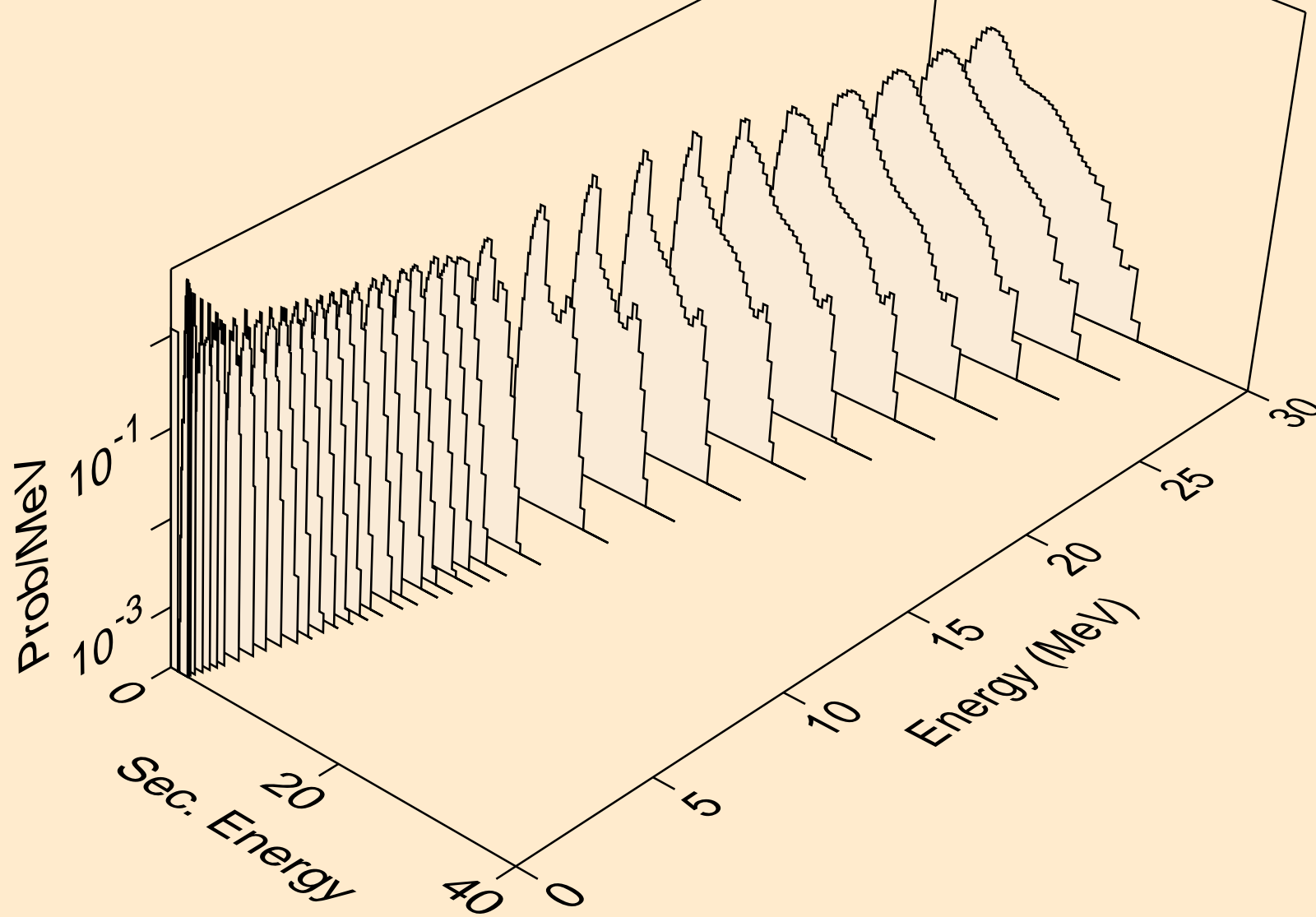

TB152 NEUTRON ACER TENDL-2023 LIBRARY; T=0.K
protons from (n,pd)

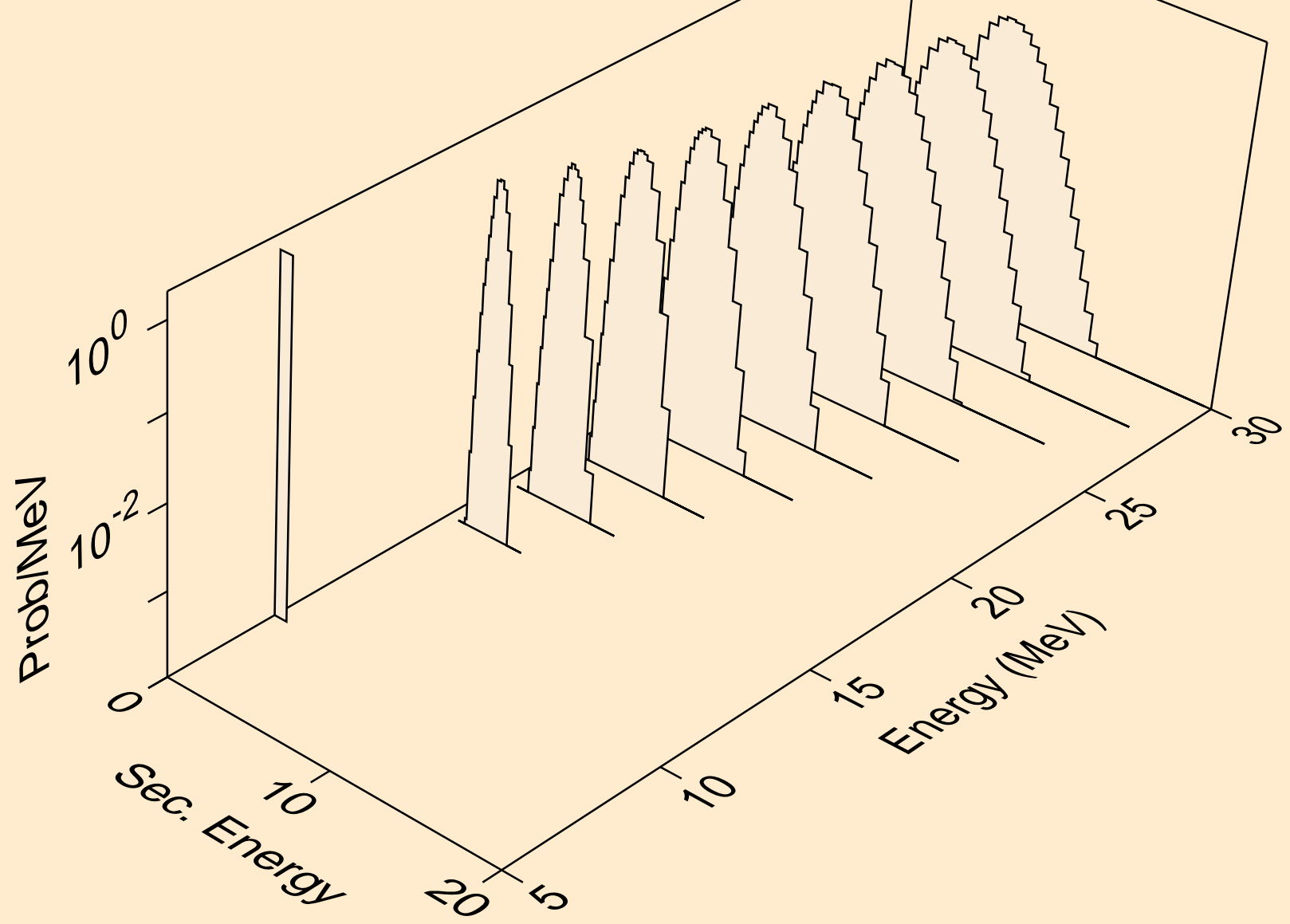

TB152 NEUTRON ACER TENDL-2023 LIBRARY; T=0.K
protons from (n,pt)

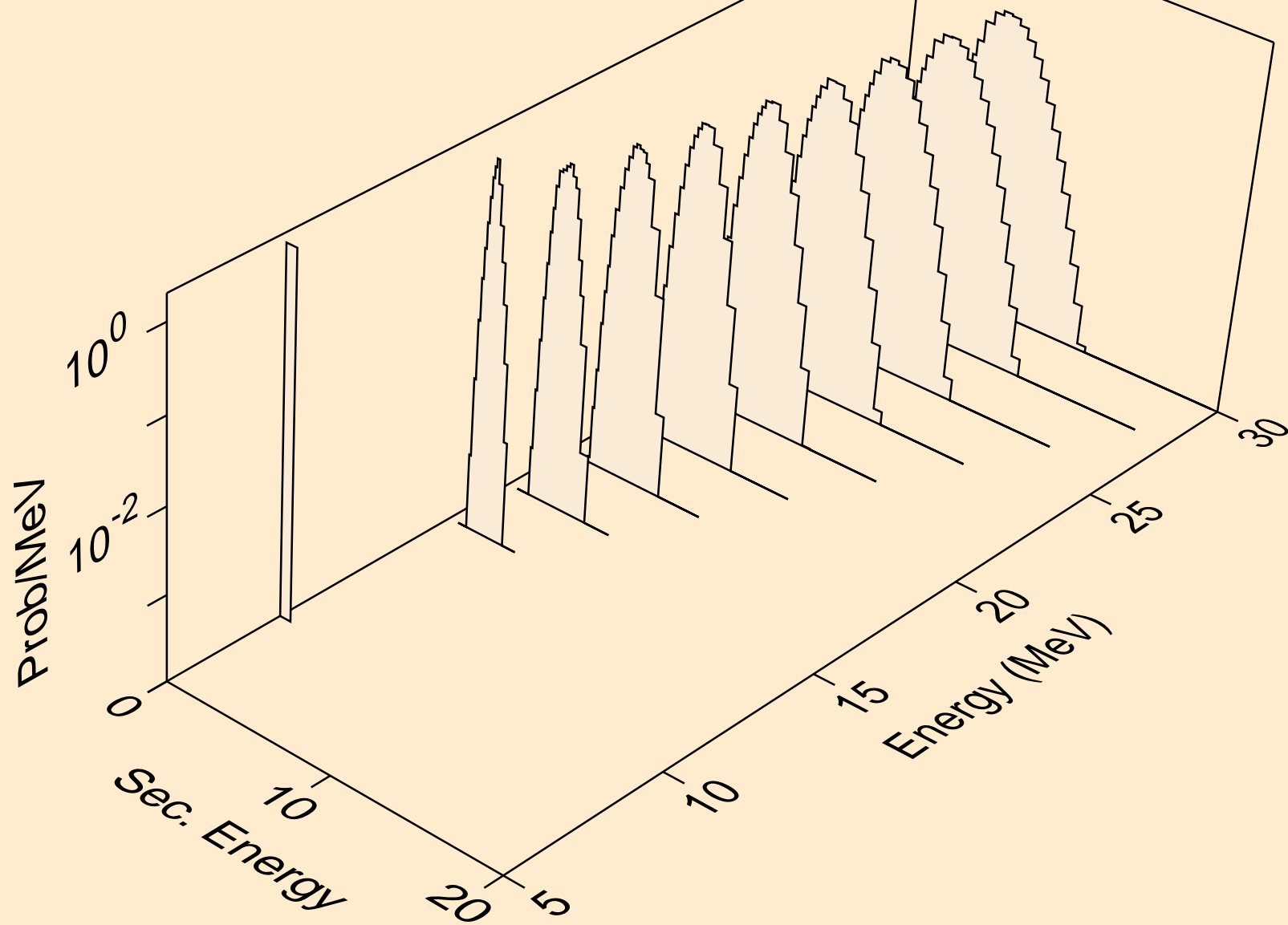

TB152 NEUTRON ACER TENDL-2023 LIBRARY; T=0.K
deuterons from (n,x)

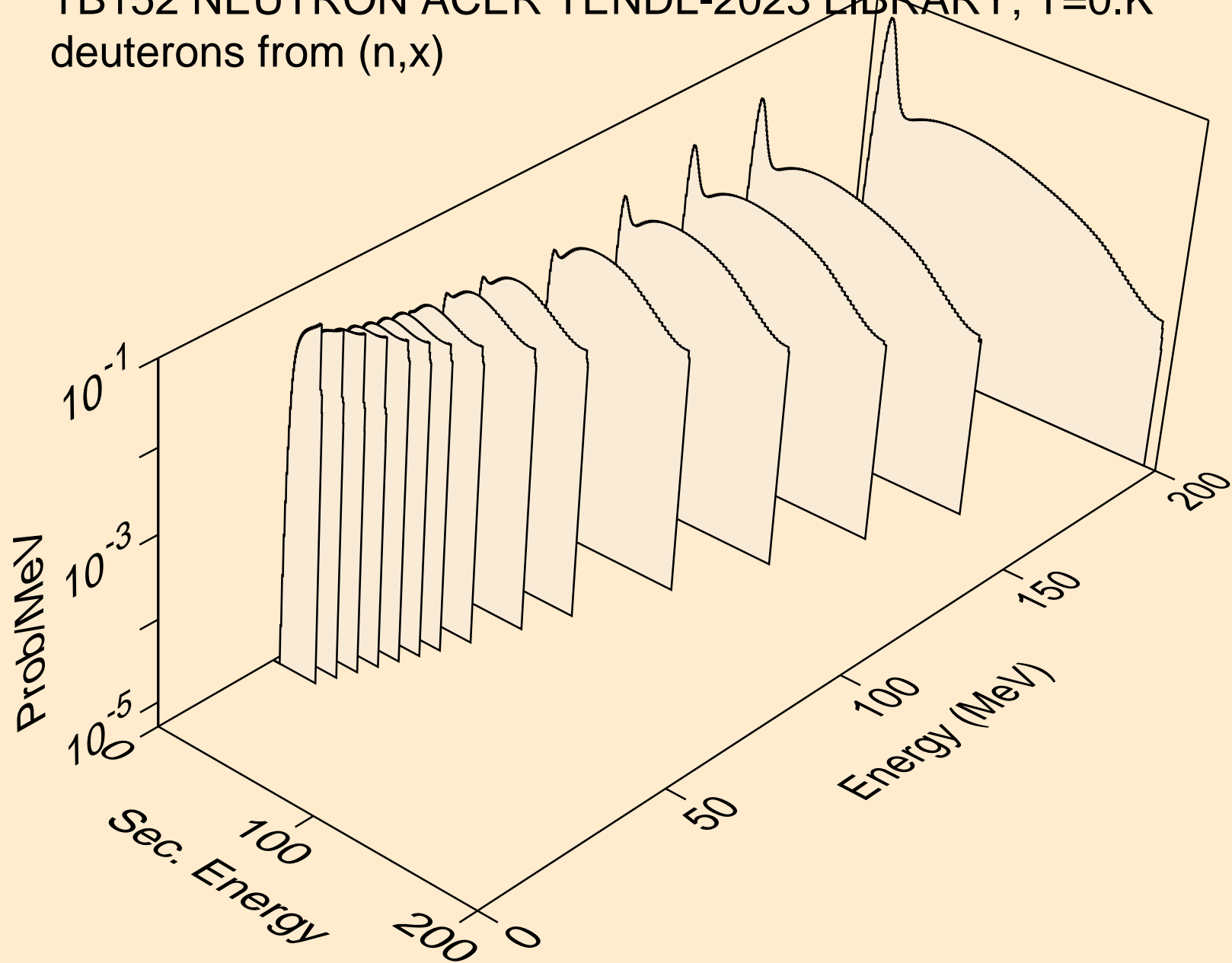

TB152 NEUTRON ACER TENDL-2023 LIBRARY; T=0.K
deuterons from (n,2nd)

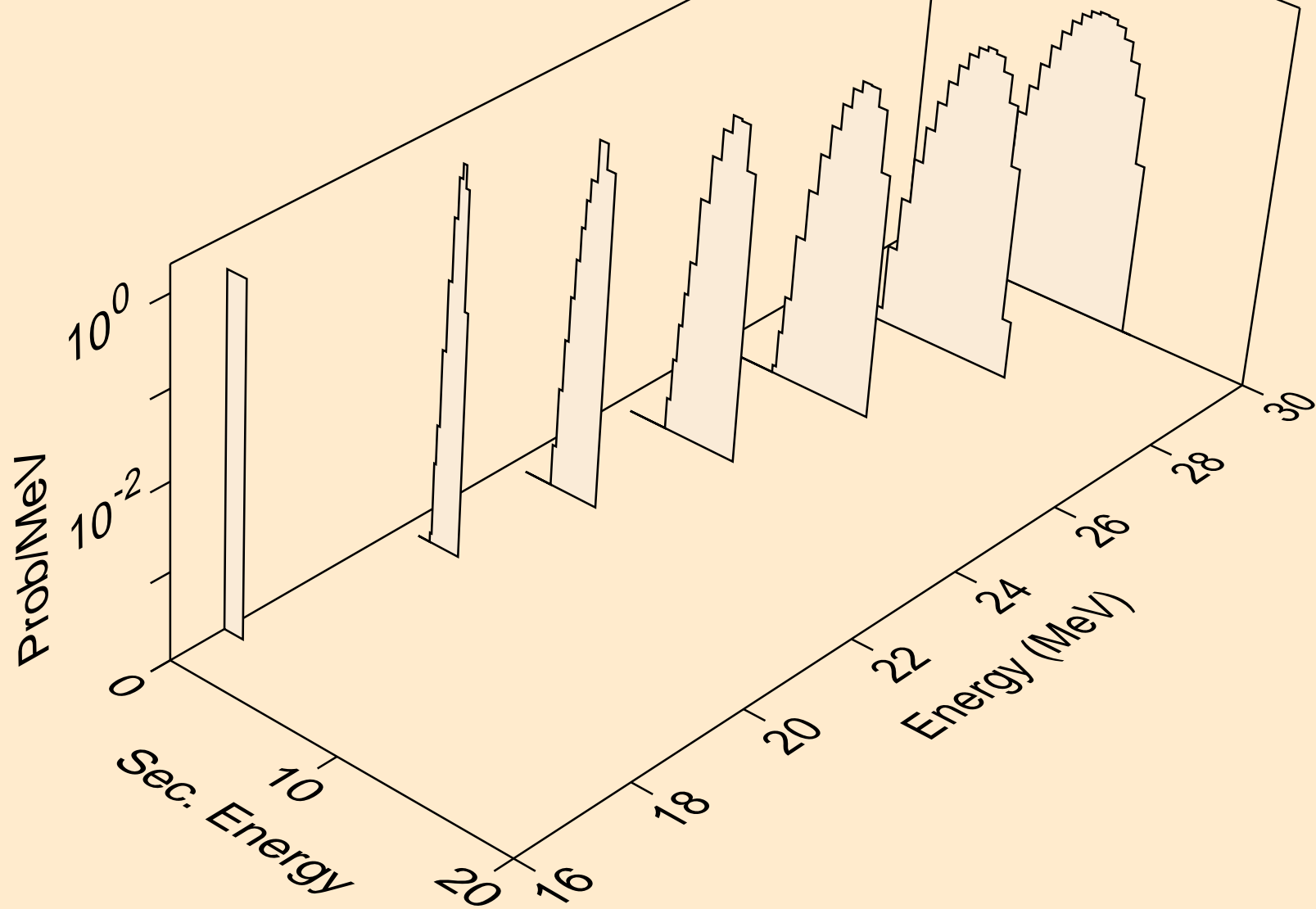

TB152 NEUTRON ACER TENDL-2023 LIBRARY; T=0.K
deuterons from (n,n*)d

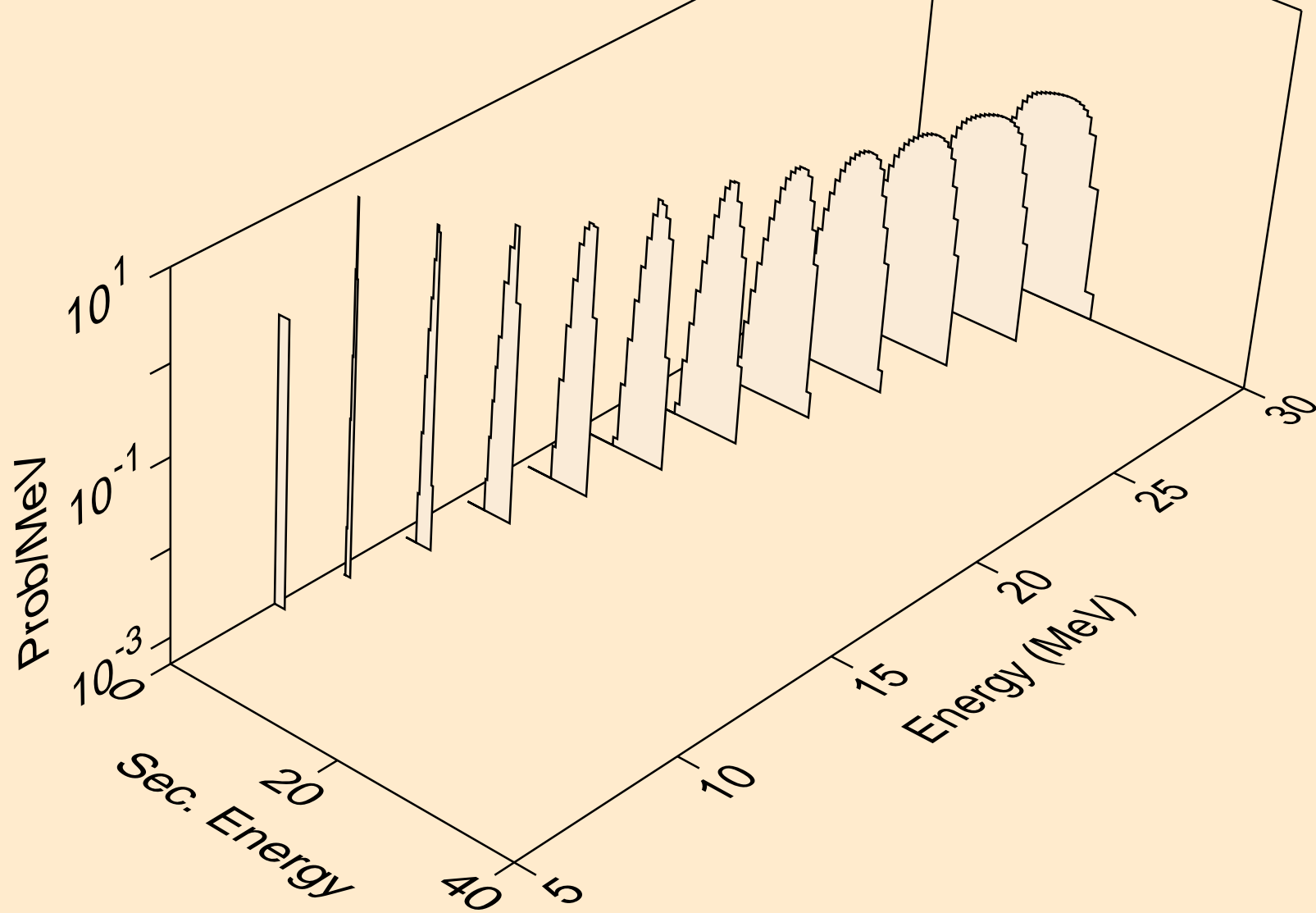

TB152 NEUTRON ACER TENDL-2023 LIBRARY; T=0.K
deuterons from (n,d)

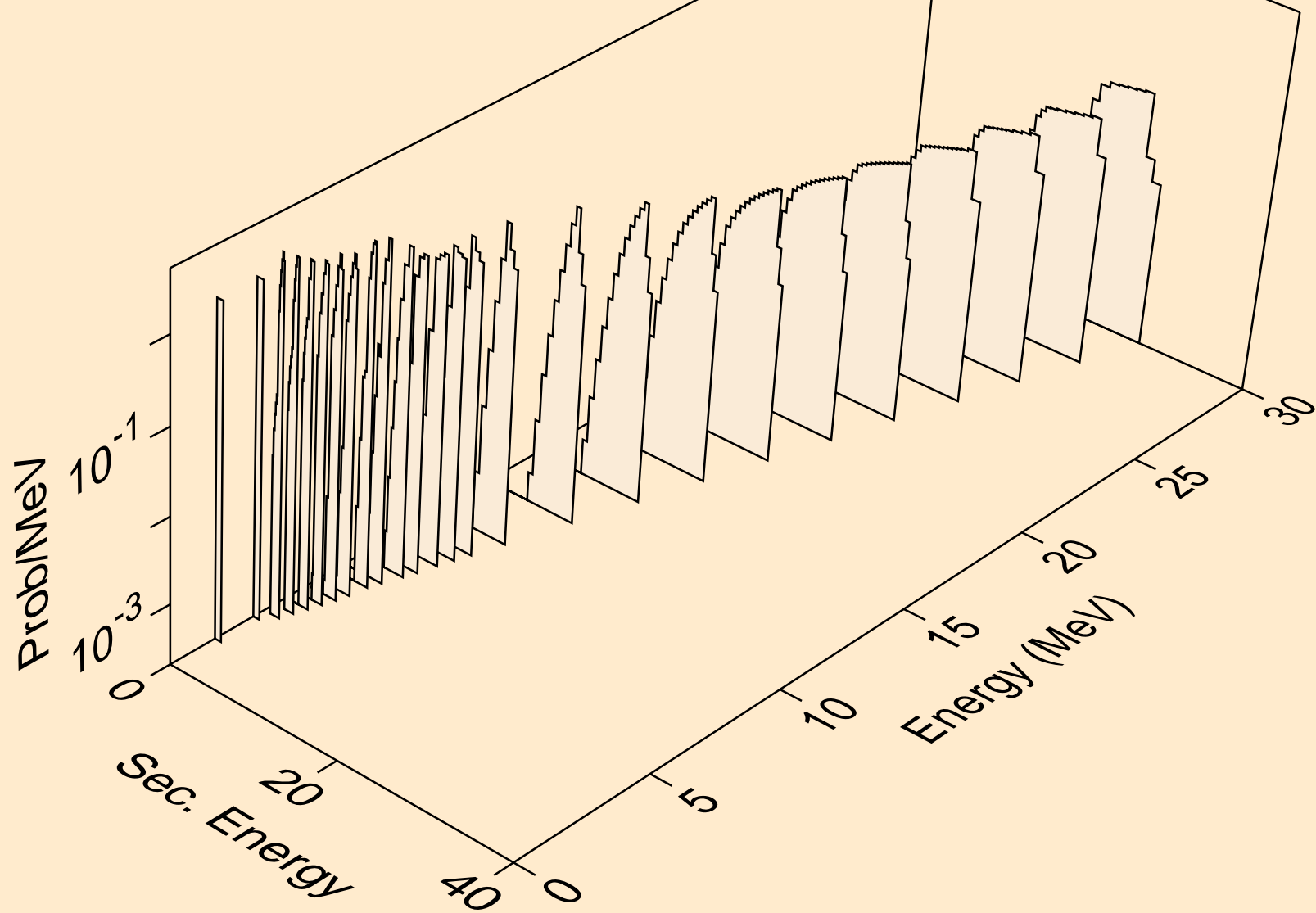

TB152 NEUTRON ACER TENDL-2023 LIBRARY; T=0.K
deuterons from (n,pd)

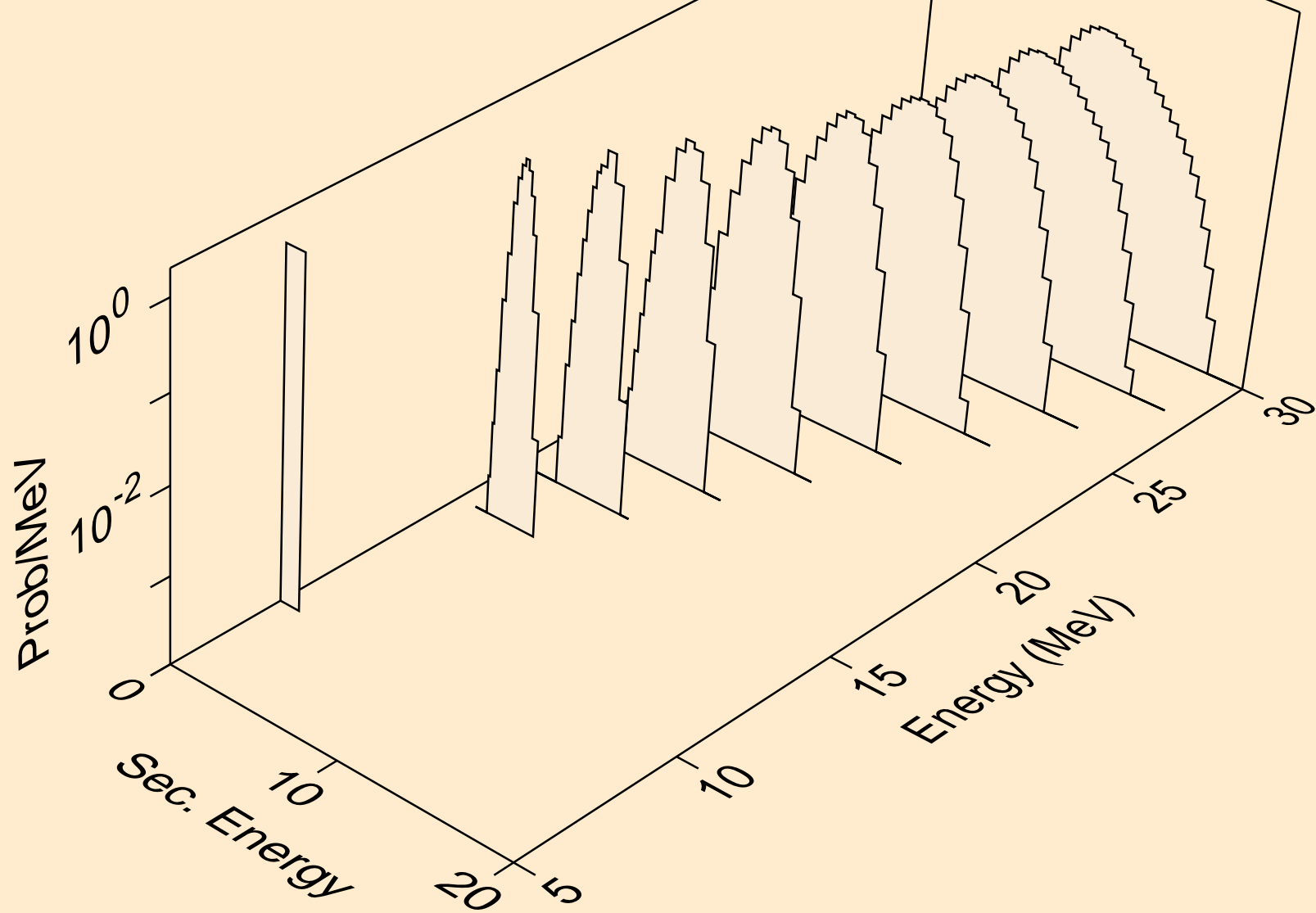

TB152 NEUTRON ACER TENDL-2023 LIBRARY; T=0.K
deuterons from (n,da)

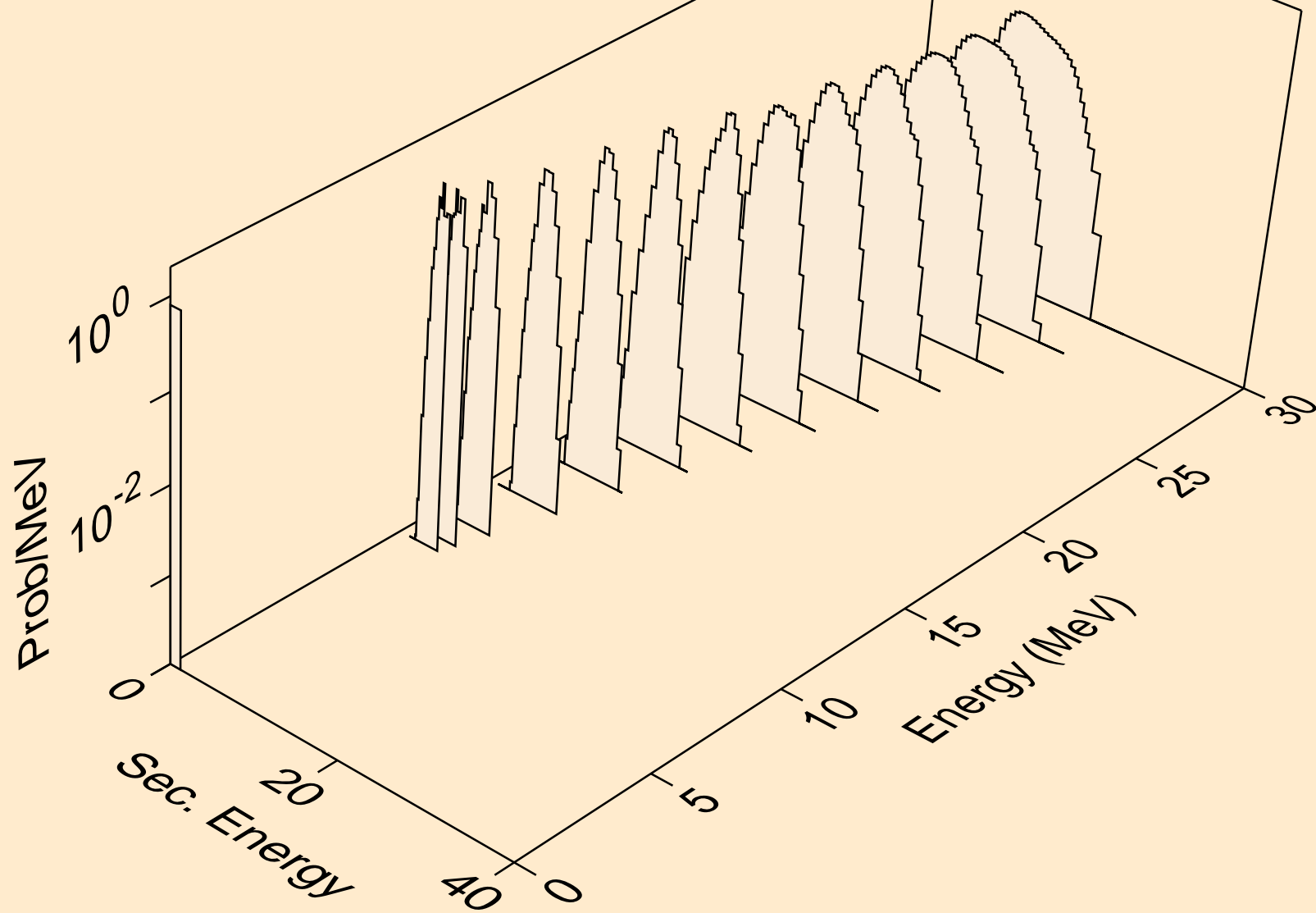

TB152 NEUTRON ACER TENDL-2023 LIBRARY; T=0.K
tritons from (n,x)

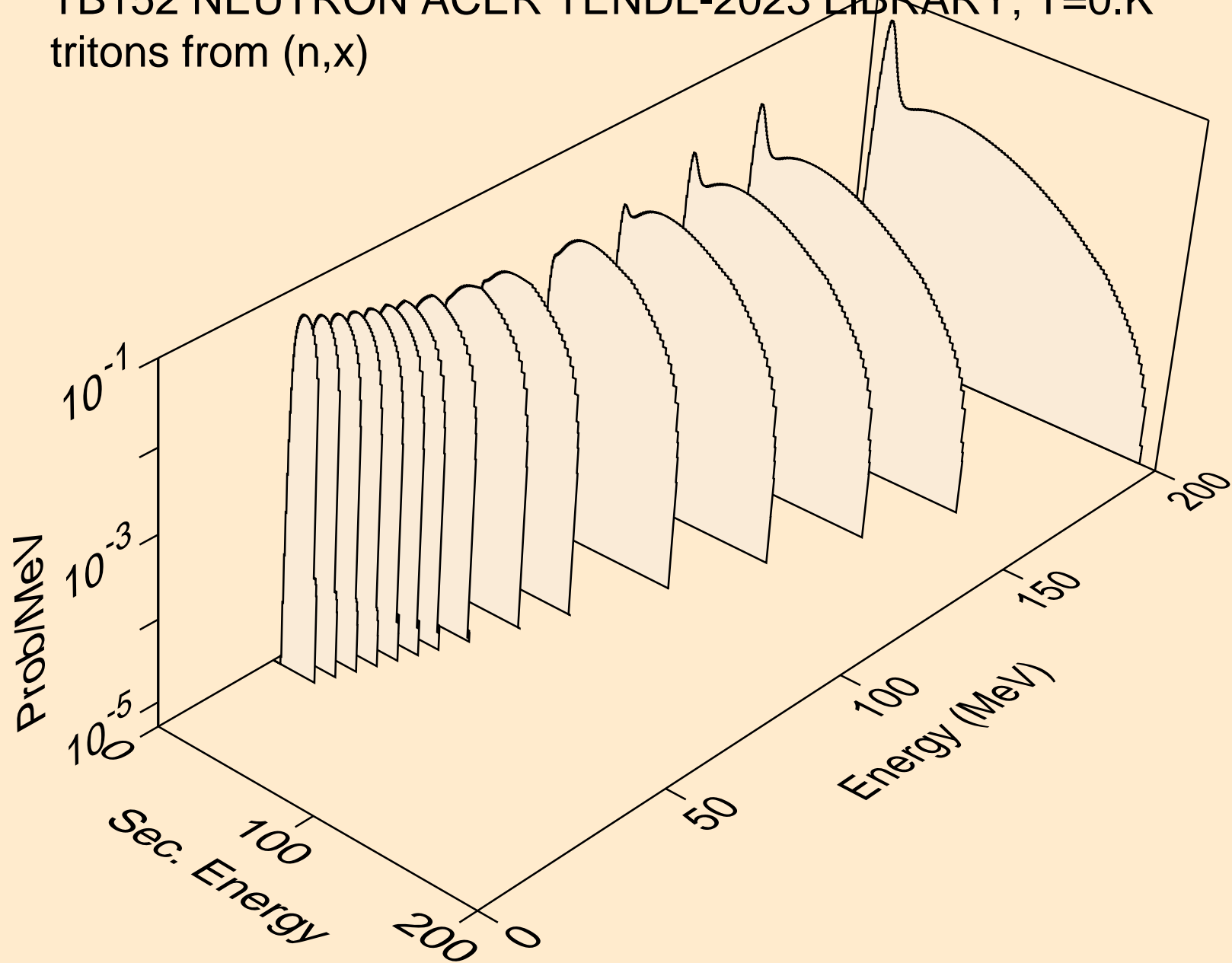

TB152 NEUTRON ACER TENDL-2023 LIBRARY; T=0.K
tritons from (n,n*)t

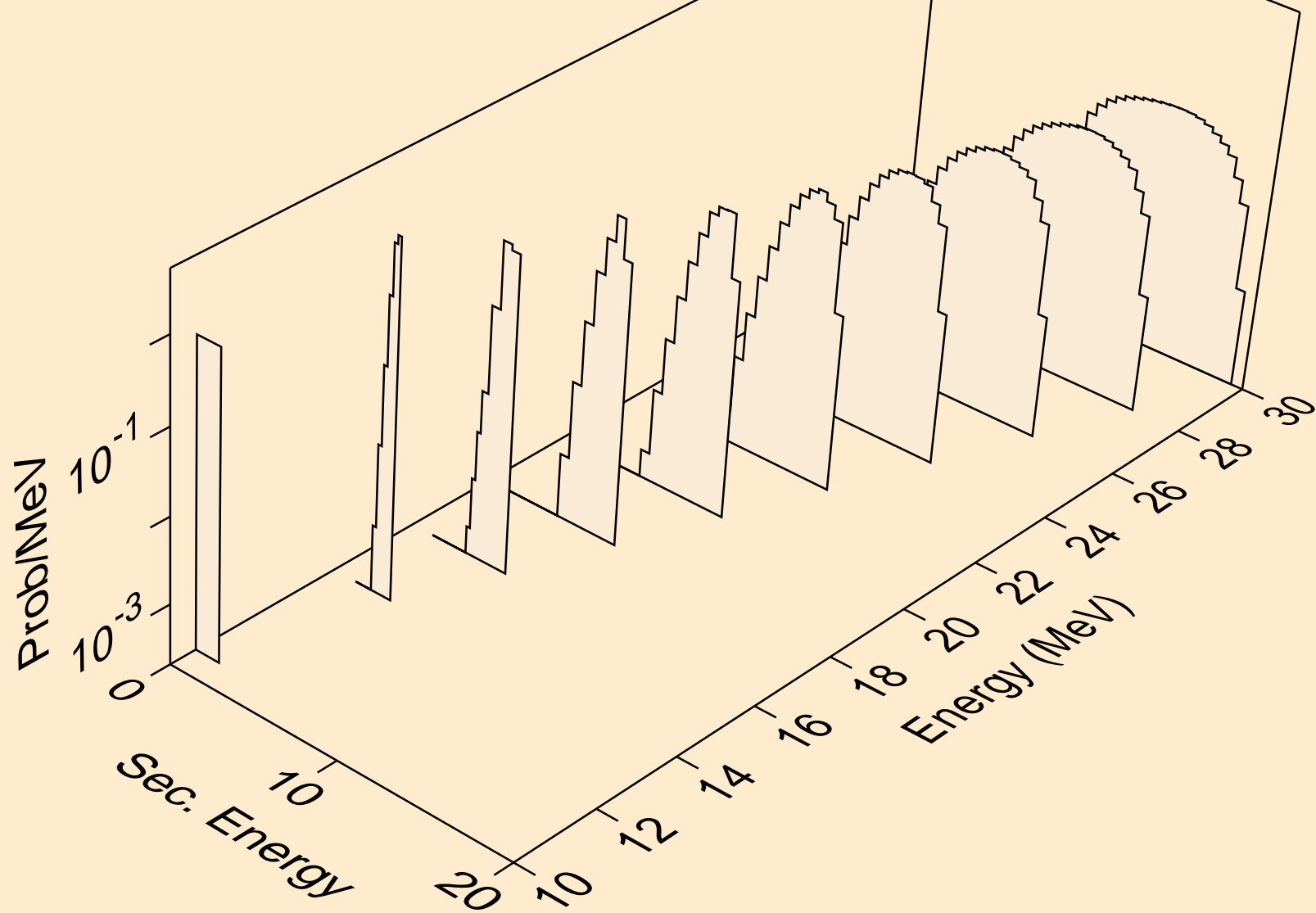

TB152 NEUTRON ACER TENDL-2023 LIBRARY; T=0.K
tritons from (n,t)

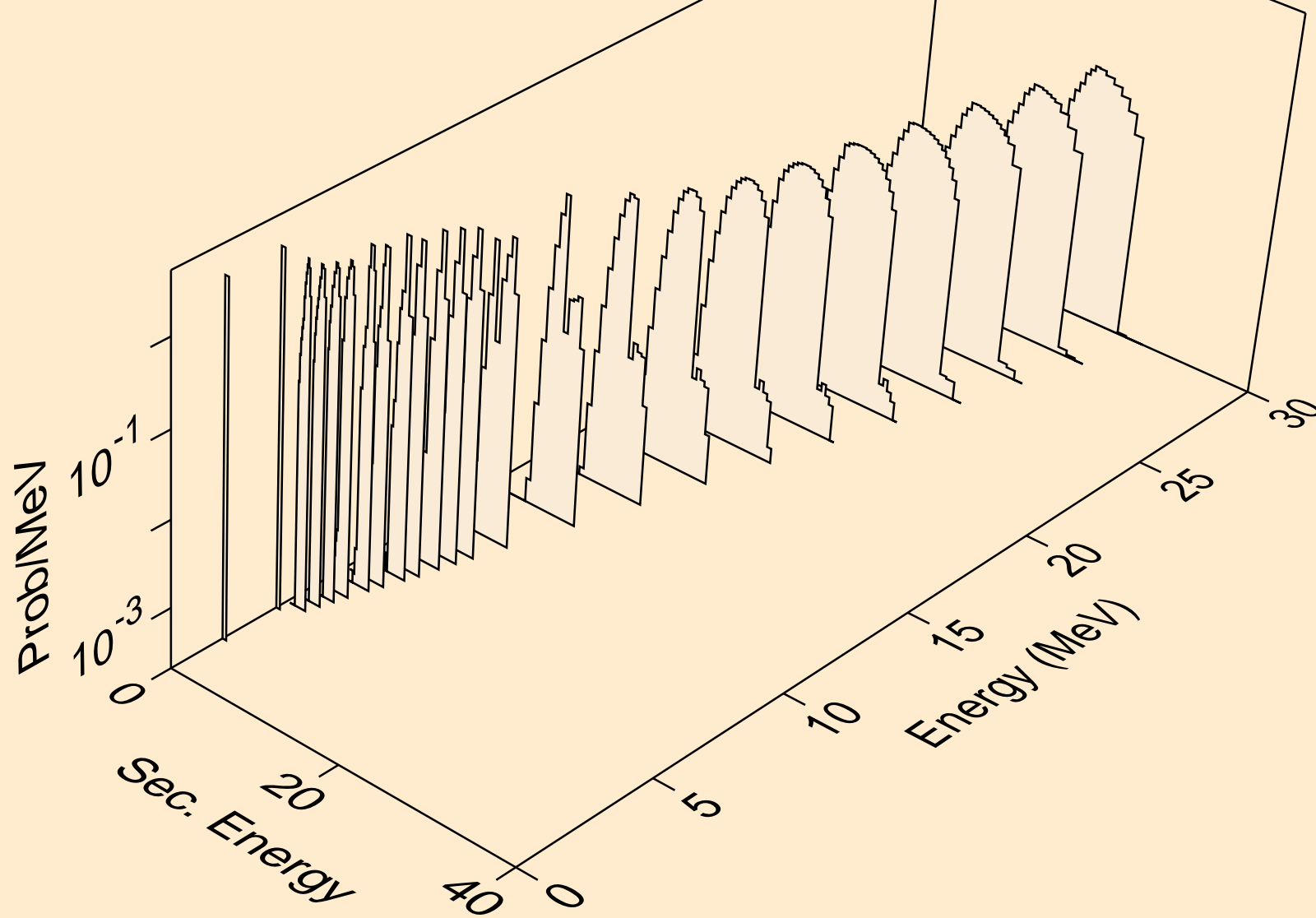

TB152 NEUTRON ACER TENDL-2023 LIBRARY; T=0.K
tritons from (n,pt)

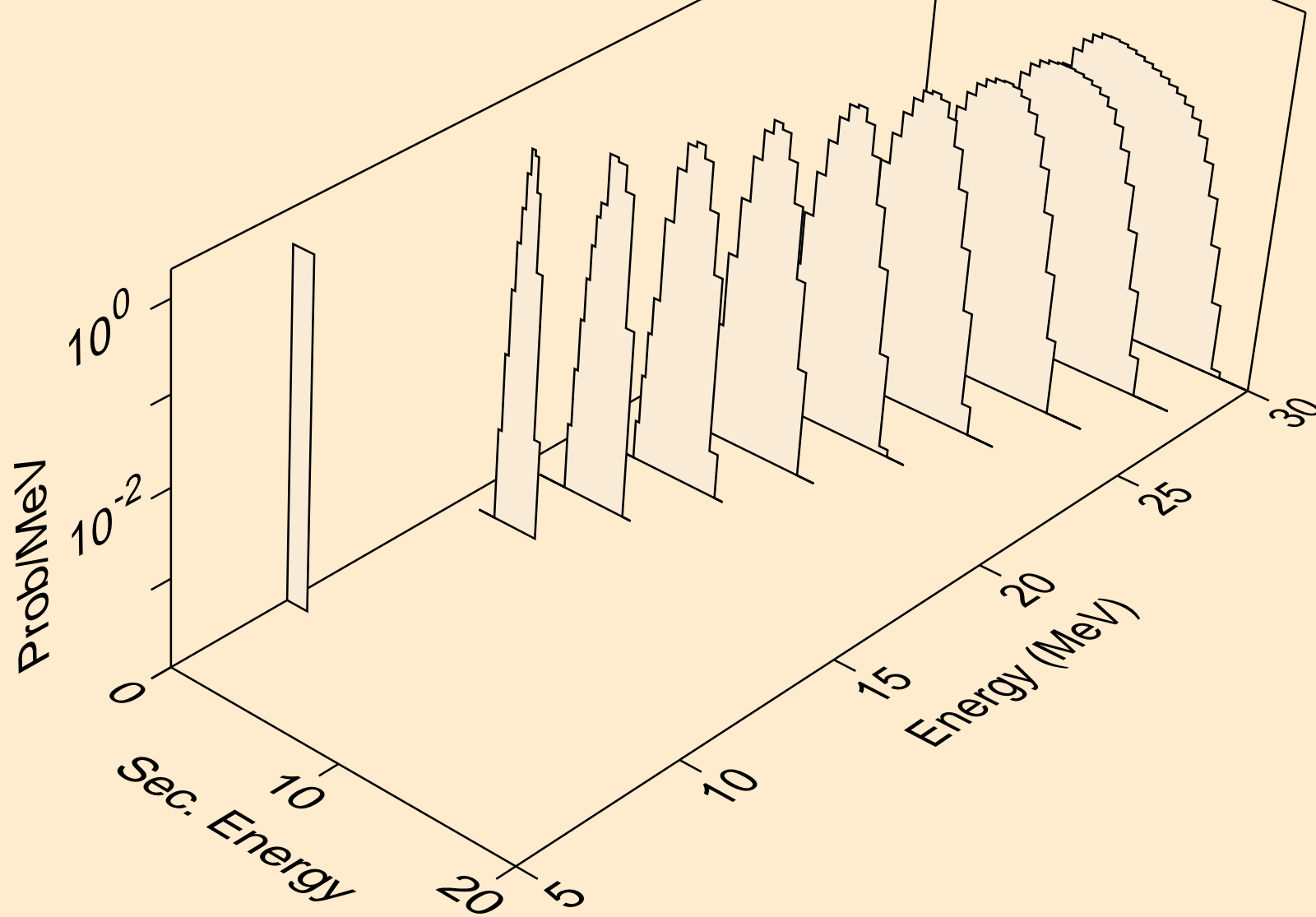

TB152 NEUTRON ACER TENDL-2023 LIBRARY; T=0.K
he3s from (n,x)

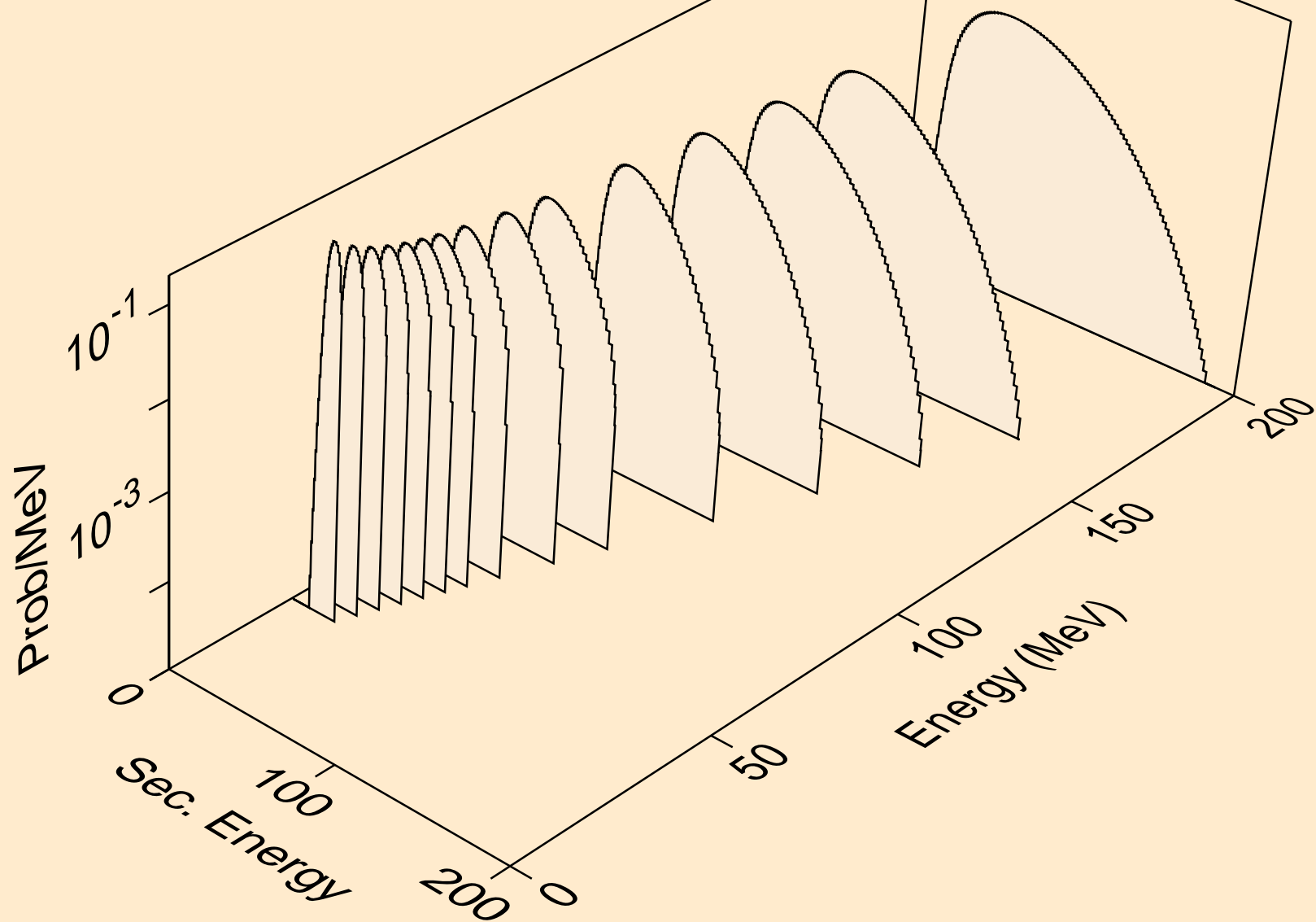

TB152 NEUTRON ACER TENDL-2023 LIBRARY; T=0.K
he3s from (n,n*)he3

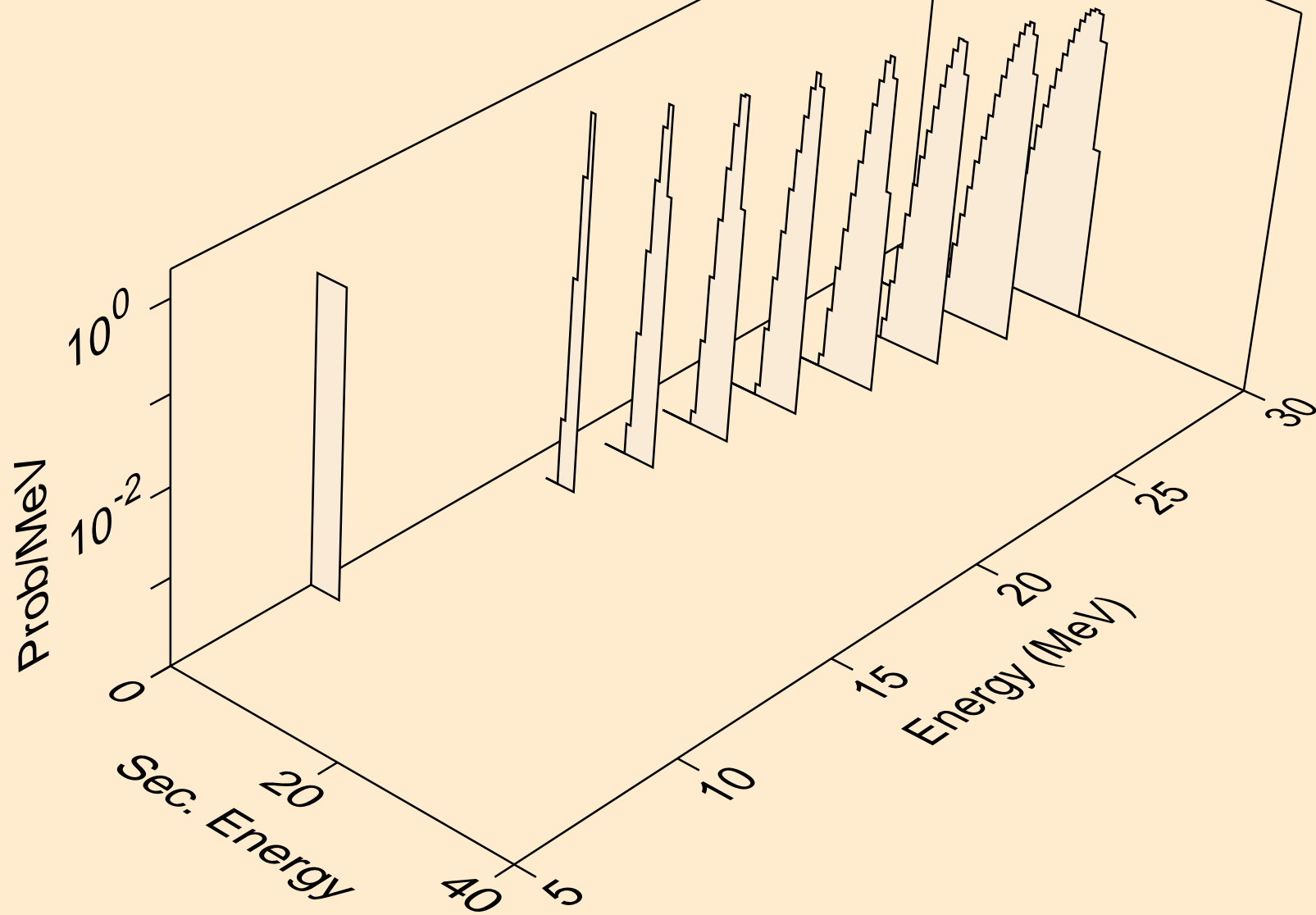

TB152 NEUTRON ACER TENDL-2023 LIBRARY; T=0.K
he3s from (n,he3)

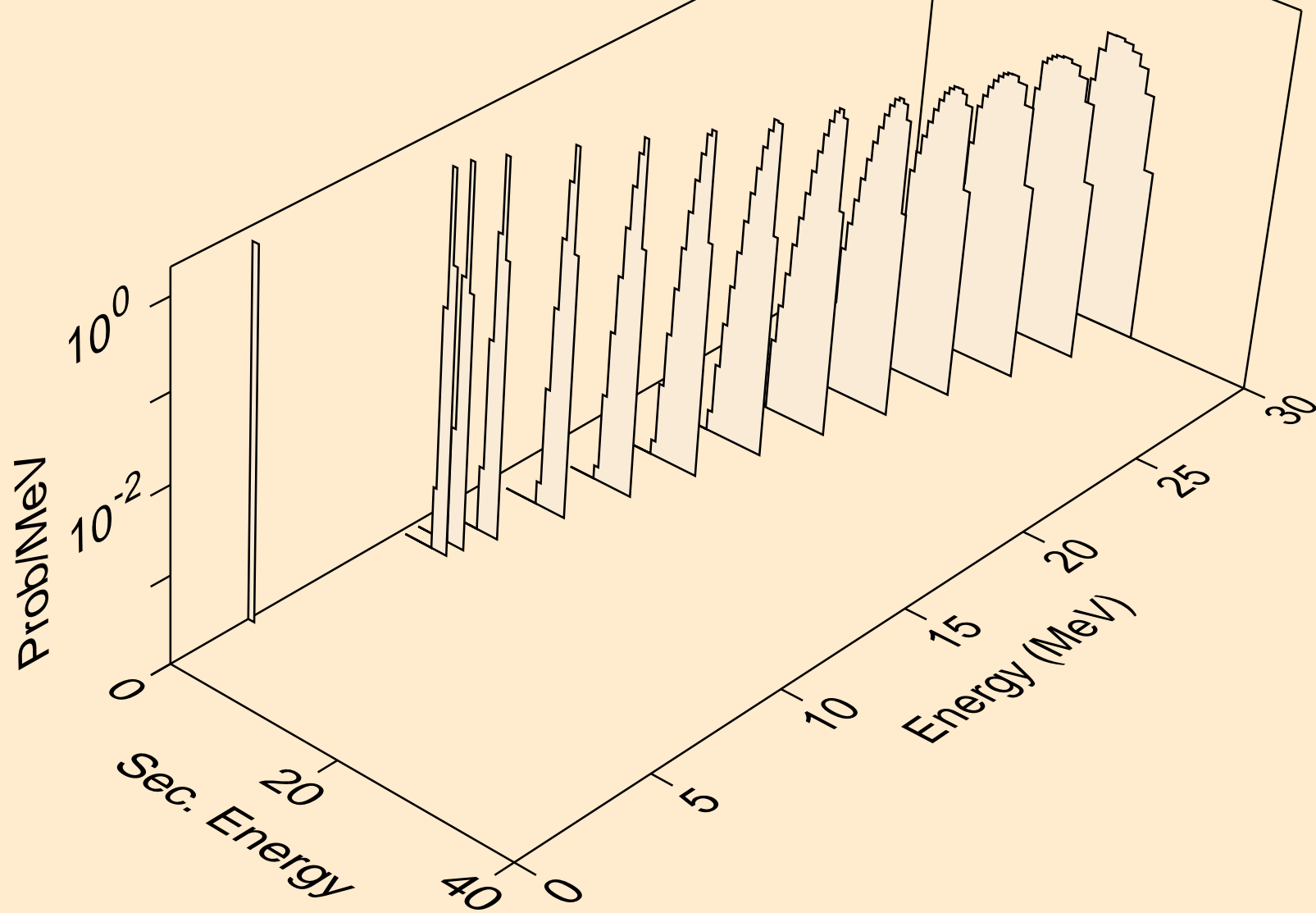

TB152 NEUTRON ACER TENDL-2023 LIBRARY; T=0.K
alphas from (n,x)

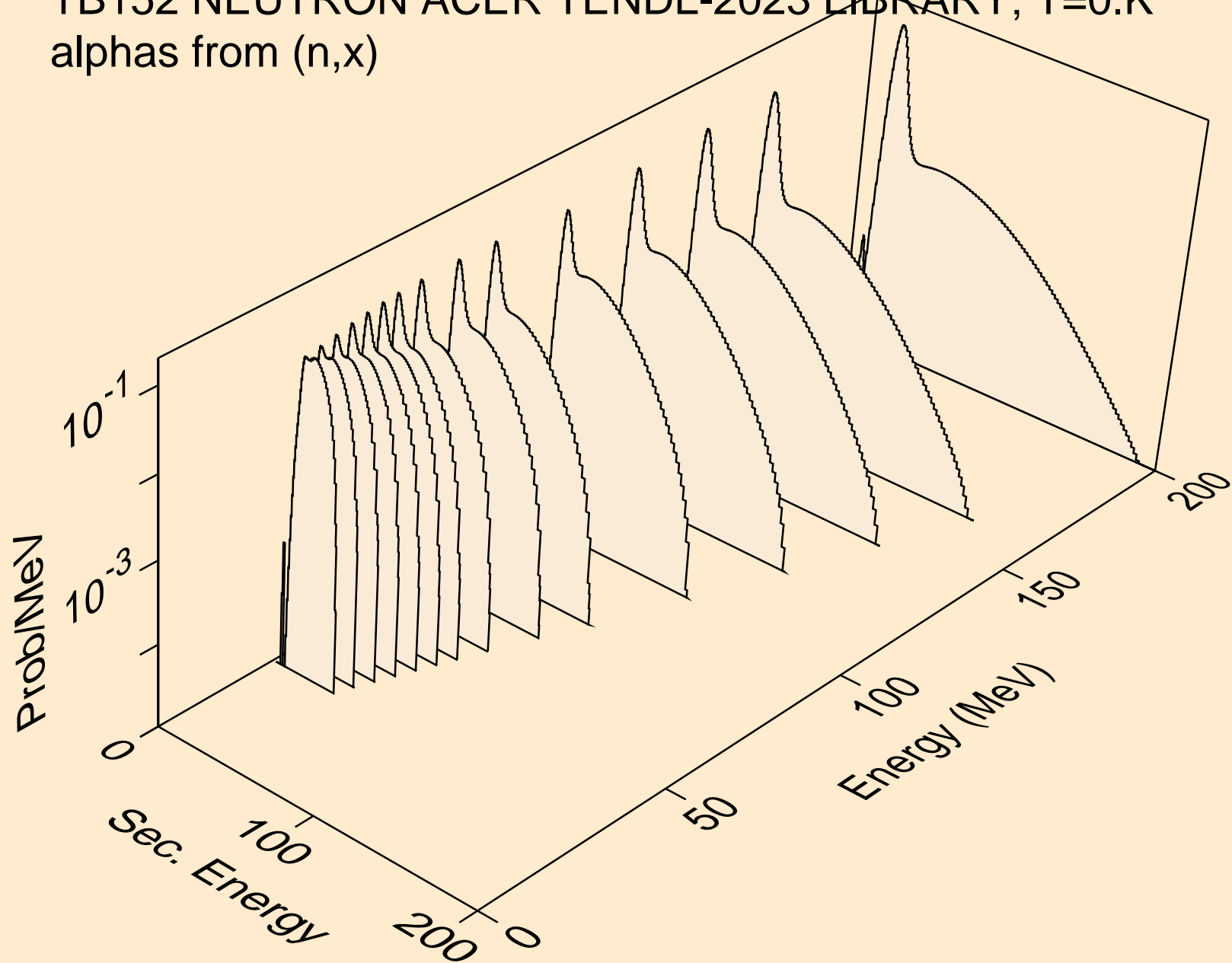

TB152 NEUTRON ACER TENDL-2023 LIBRARY; T=0.K
alphas from (n,n*)a

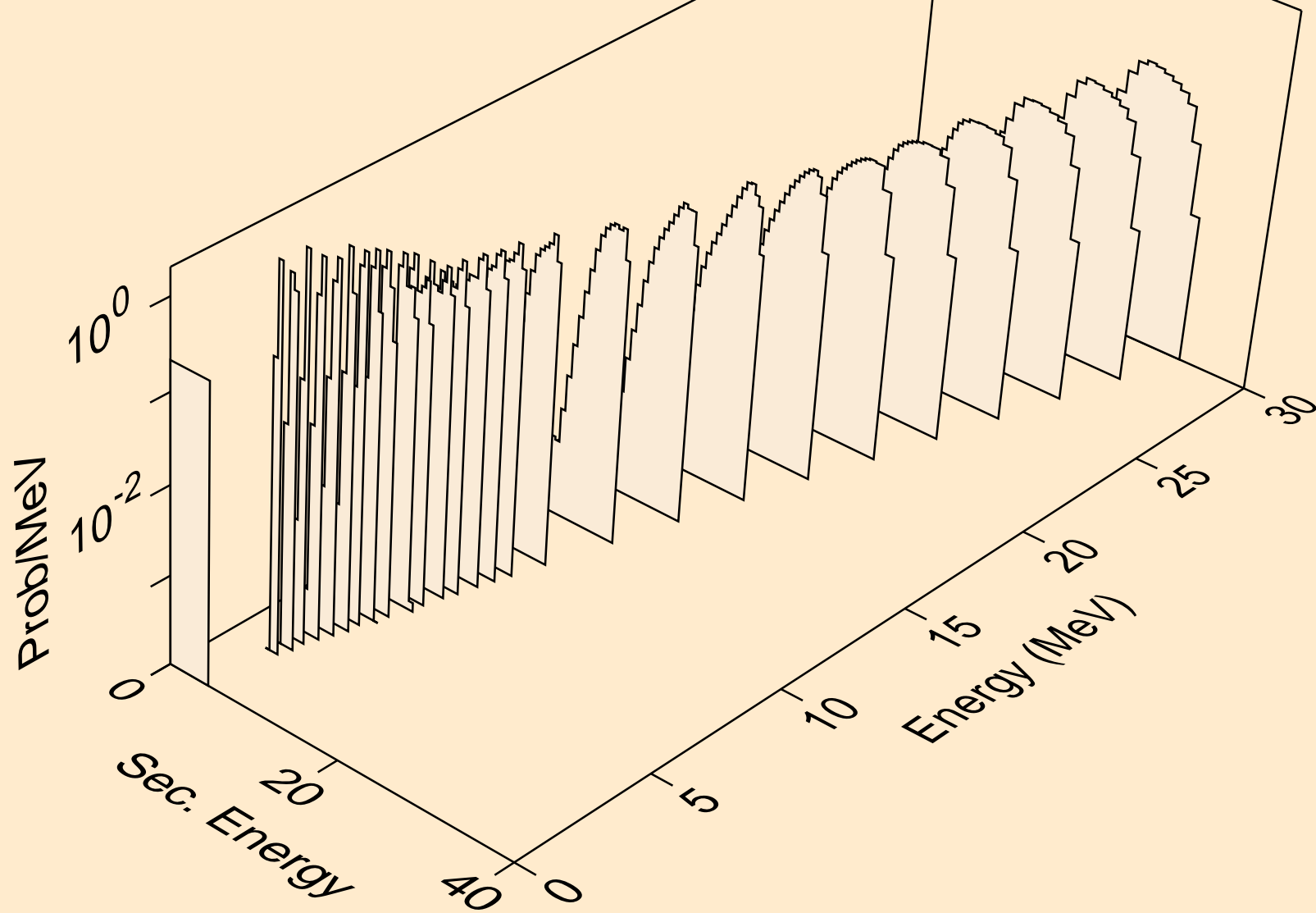

TB152 NEUTRON ACER TENDL-2023 LIBRARY; T=0.K
alphas from (n,2n)a

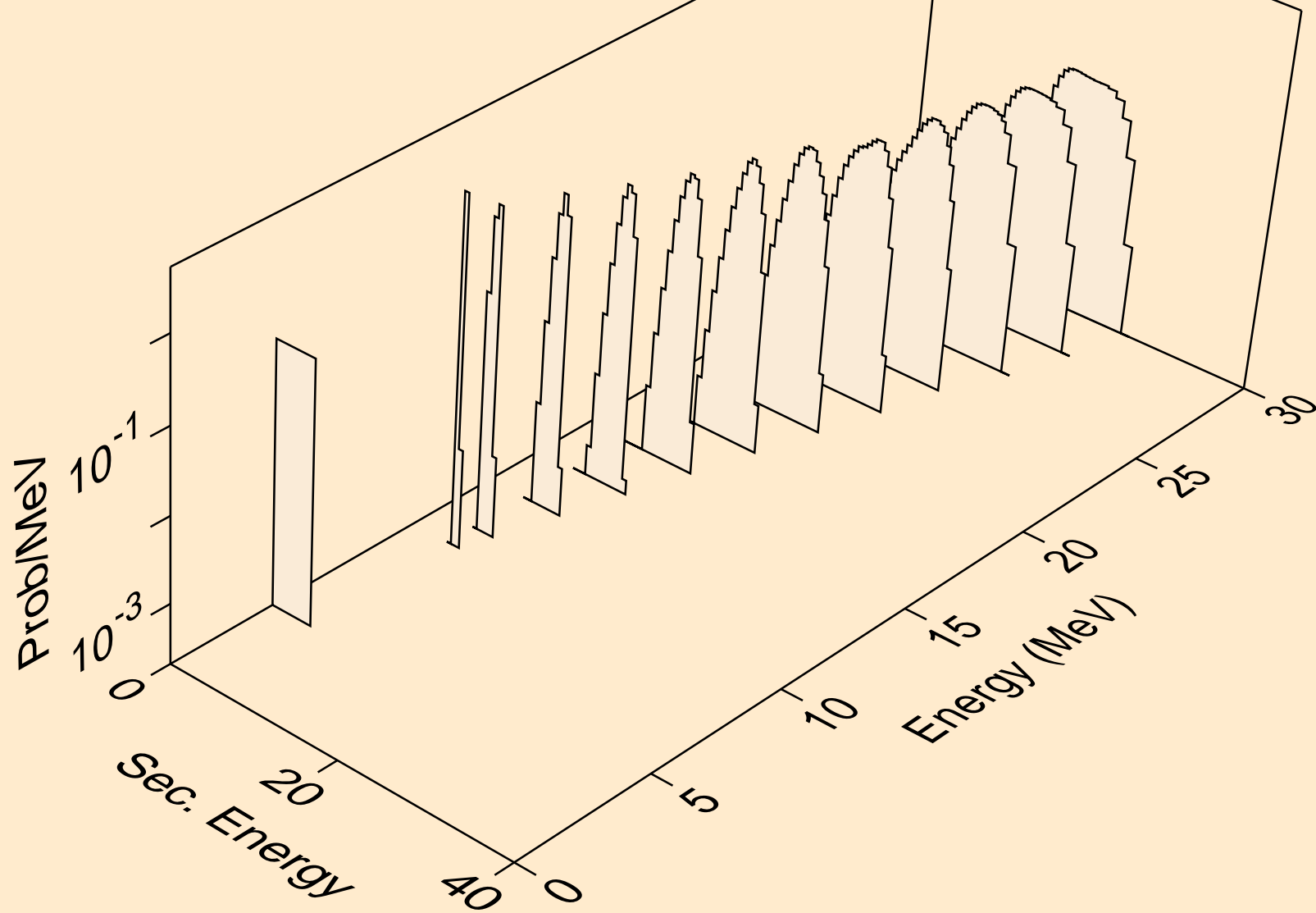

TB152 NEUTRON ACER TENDL-2023 LIBRARY; T=0.K
alphas from (n,3n)a

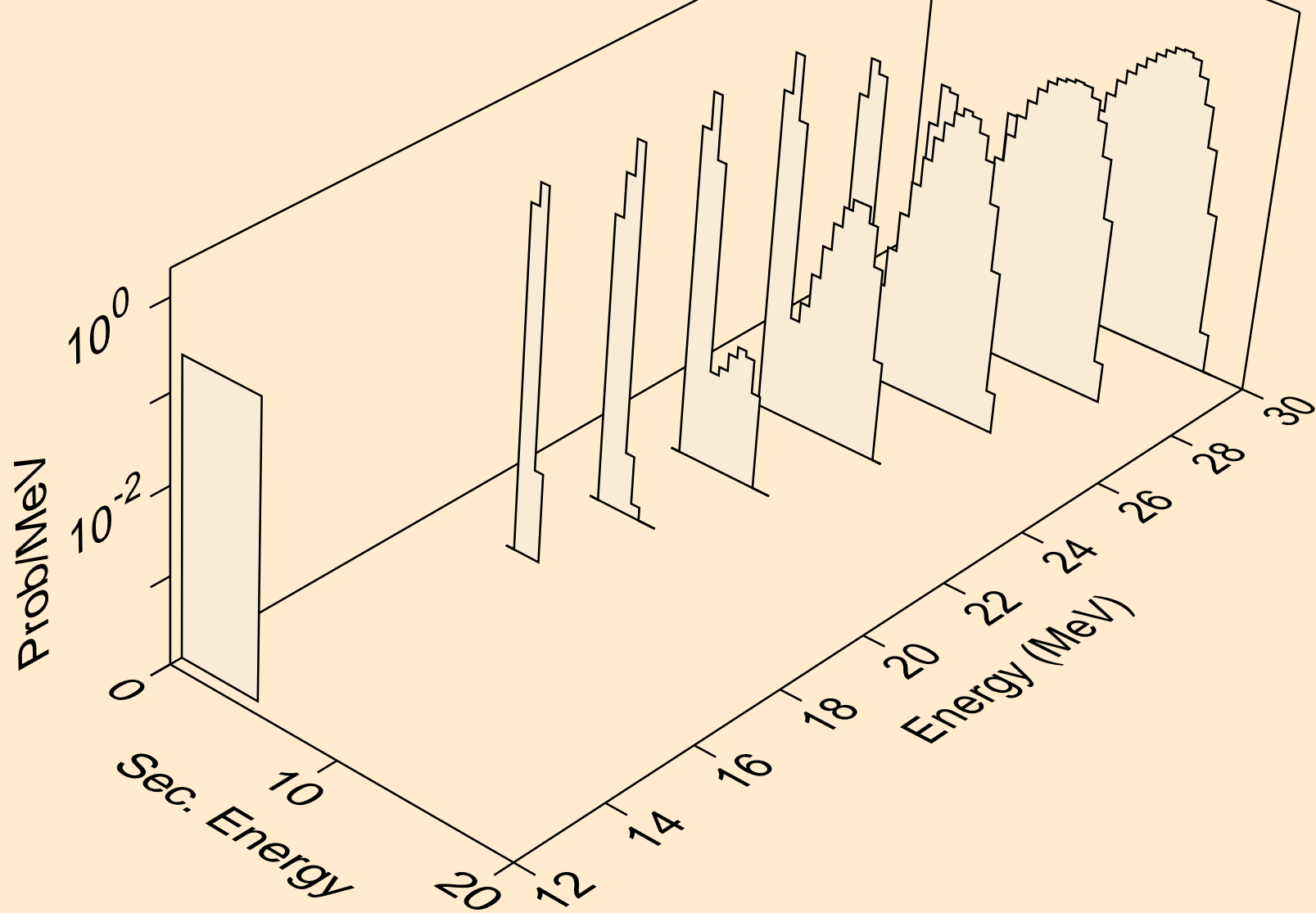

TB152 NEUTRON ACER TENDL-2023 LIBRARY; T=0.K
alphas from (n,n*)2a

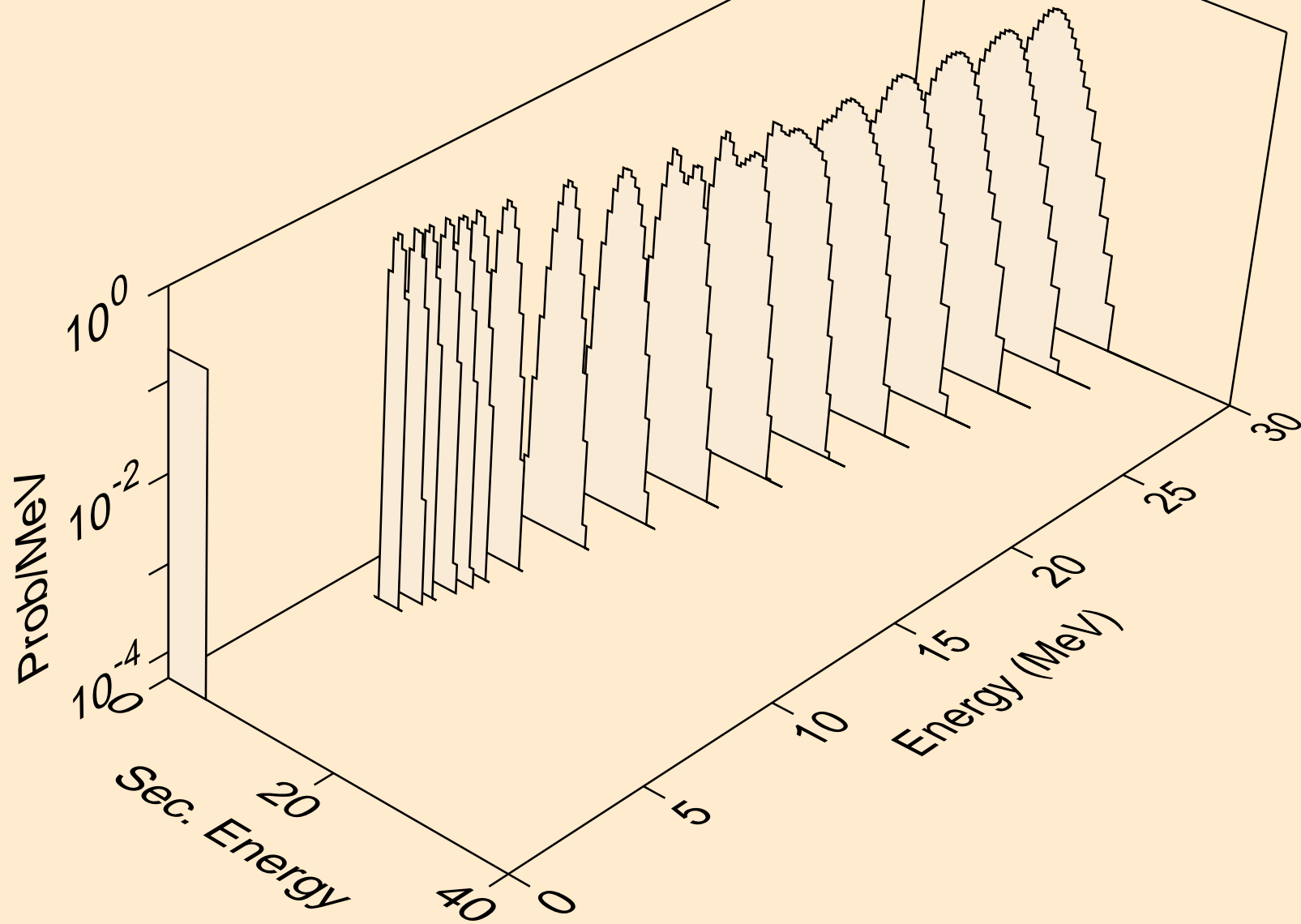

TB152 NEUTRON ACER TENDL-2023 LIBRARY; T=0.K
alphas from (n,2n)2a

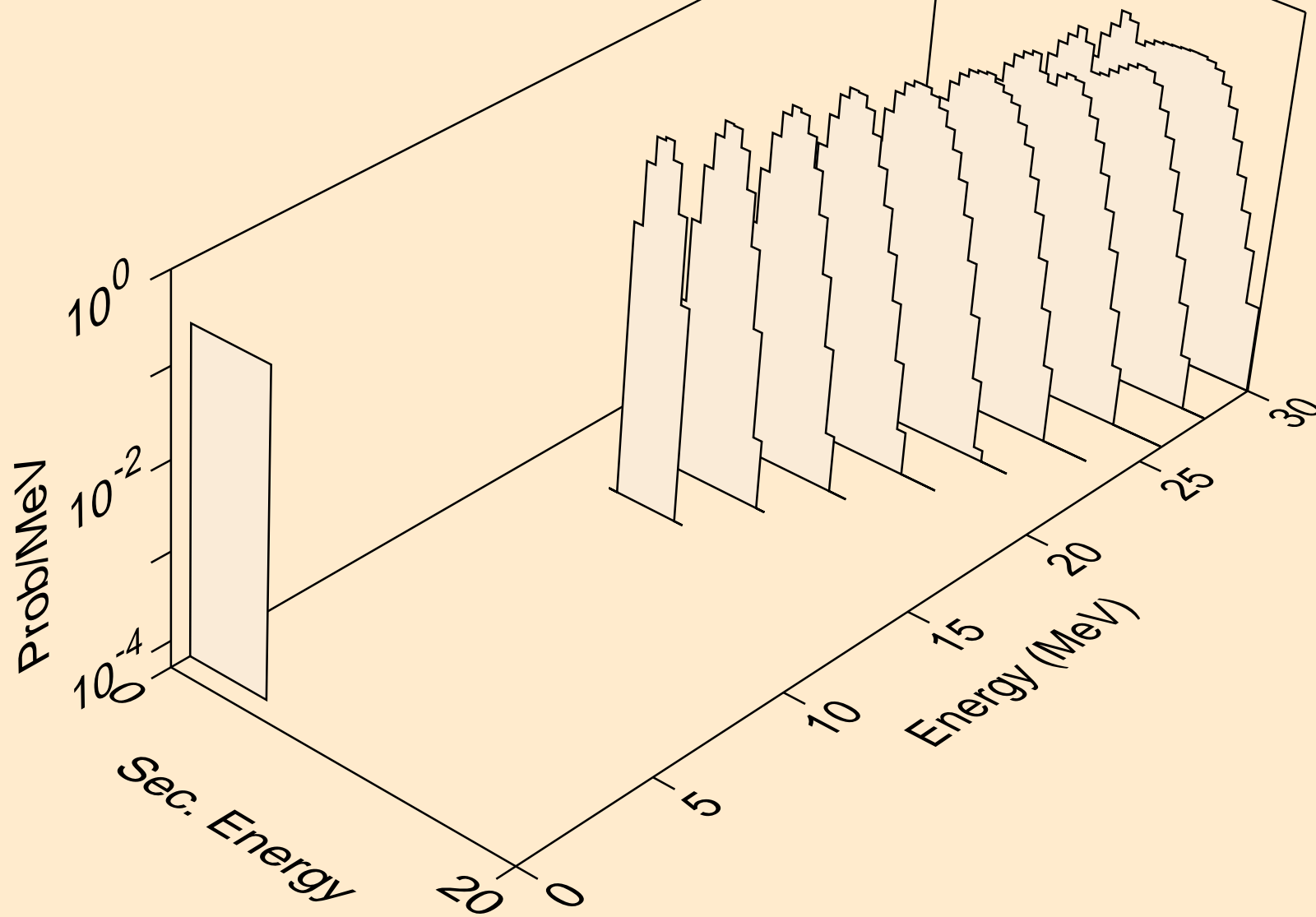

TB152 NEUTRON ACER TENDL-2023 LIBRARY; T=0.K
alphas from (n,npa)

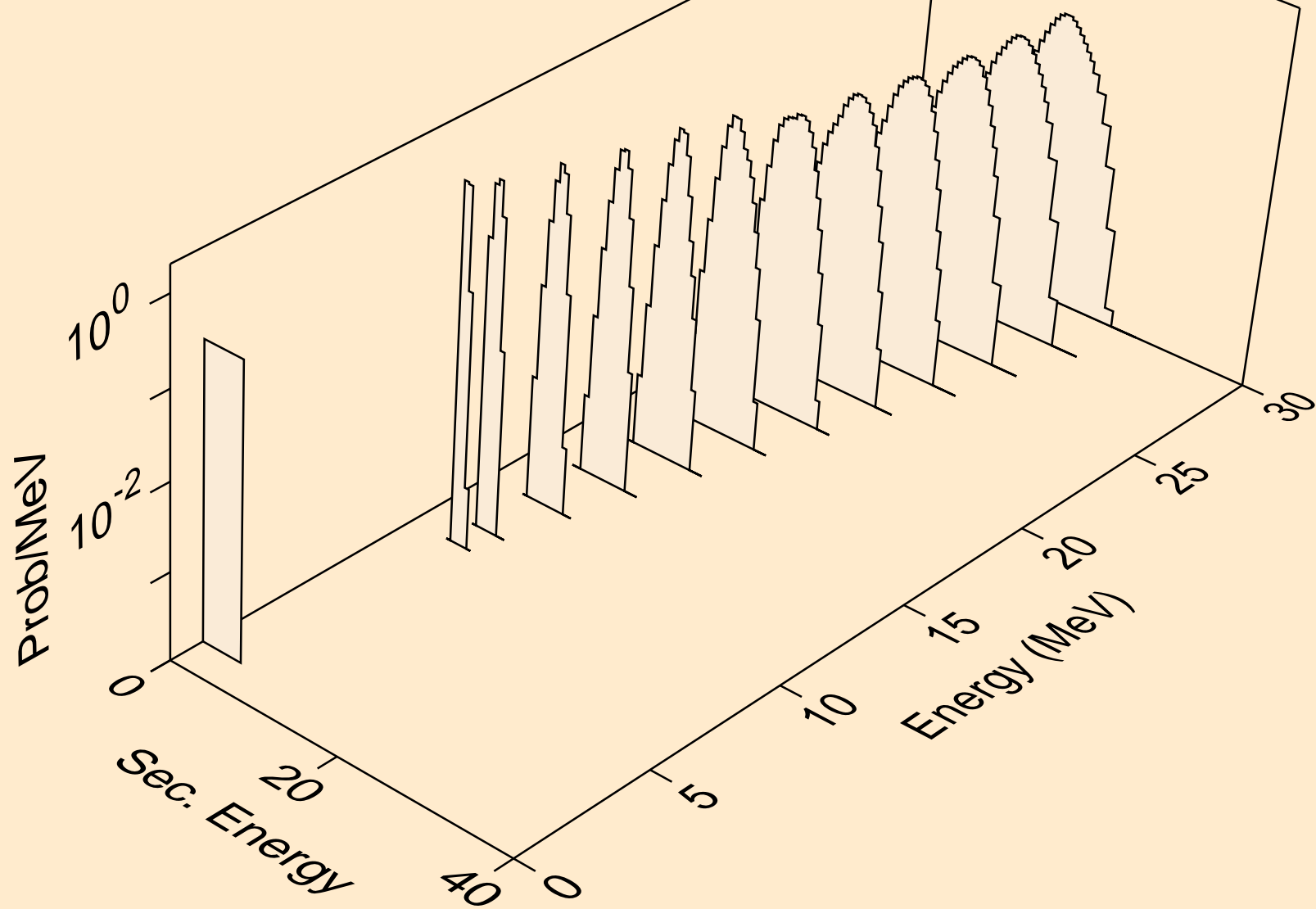

TB152 NEUTRON ACER TENDL-2023 LIBRARY; T=0.K
alphas from (n,a)

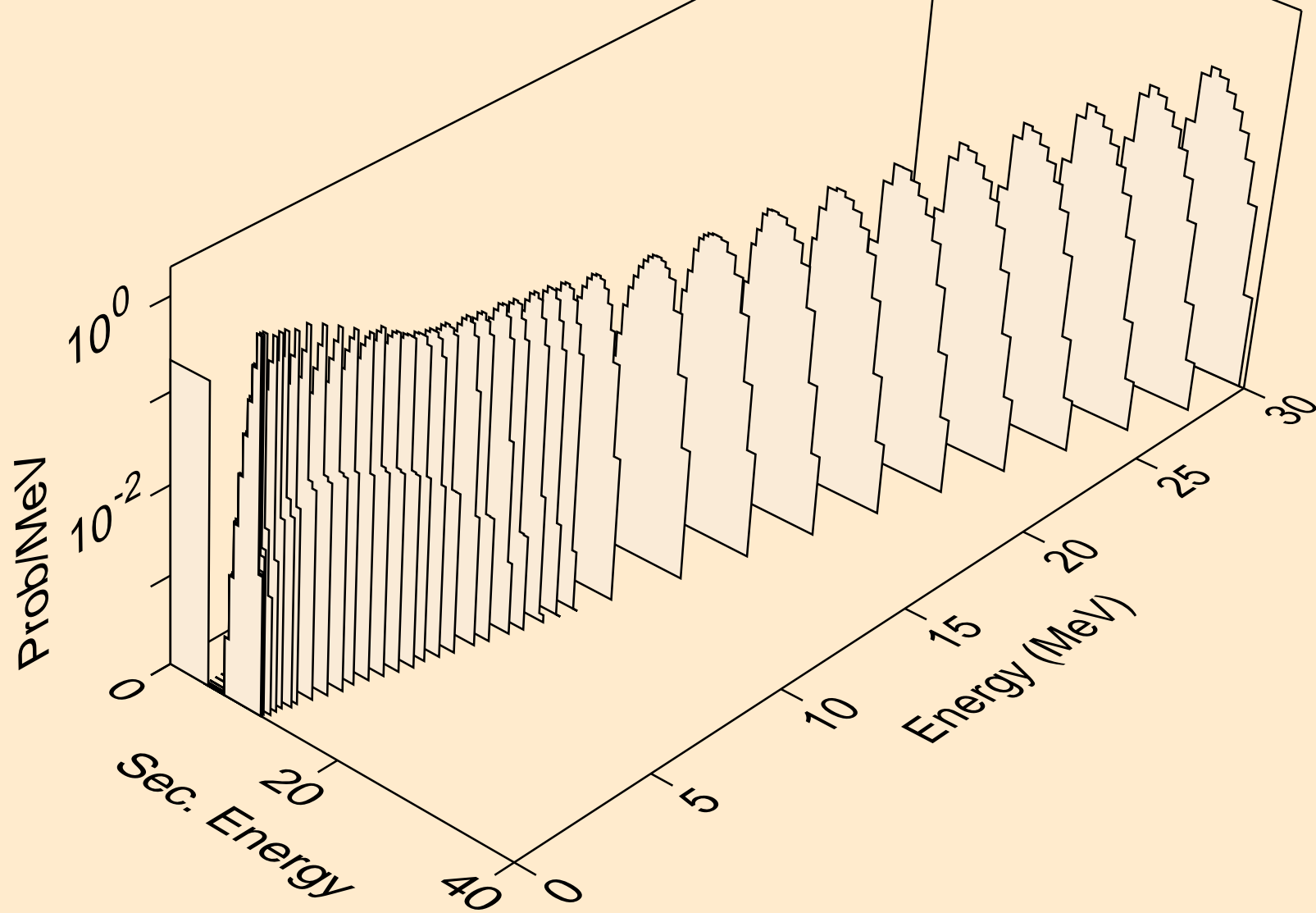

TB152 NEUTRON ACER TENDL-2023 LIBRARY; T=0.K
alphas from (n,2a)

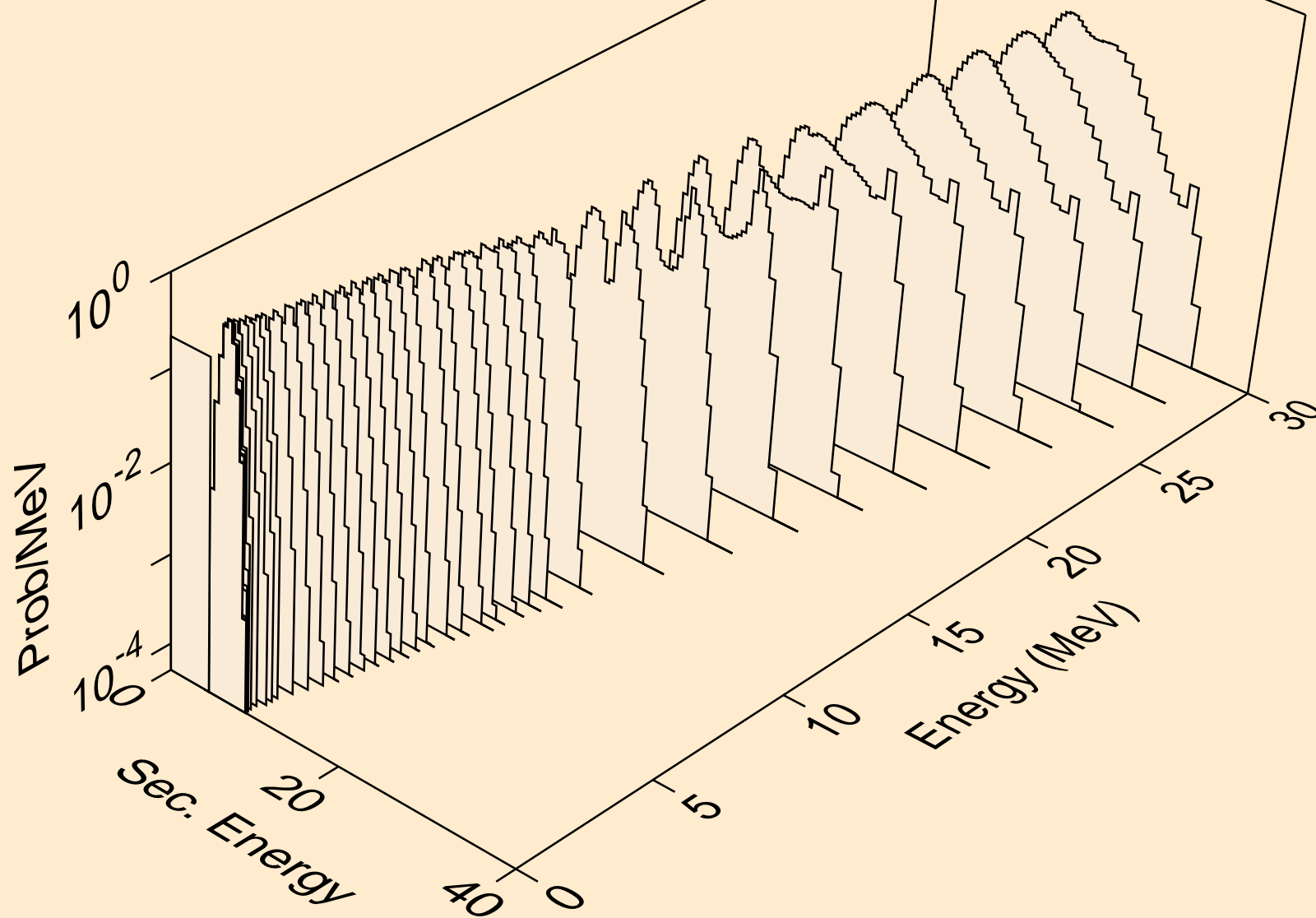

TB152 NEUTRON ACER TENDL-2023 LIBRARY; T=0.K
alphas from (n,pa)

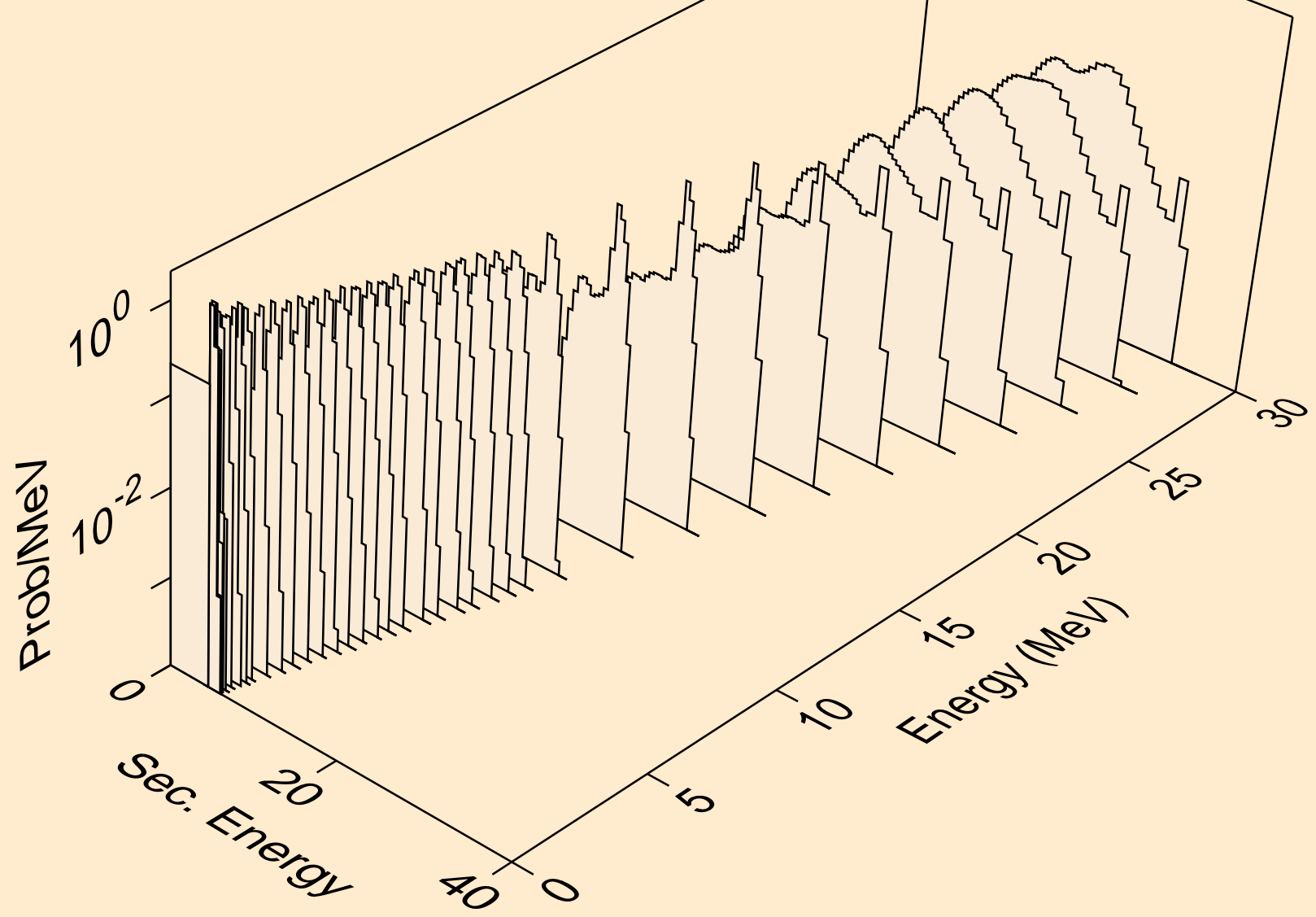

TB152 NEUTRON ACER TENDL-2023 LIBRARY; T=0.K
alphas from (n,da)

