

TC090 NEUTRON ACER TENDL-2023 LIBRARY; T=0.K  
Principal cross sections

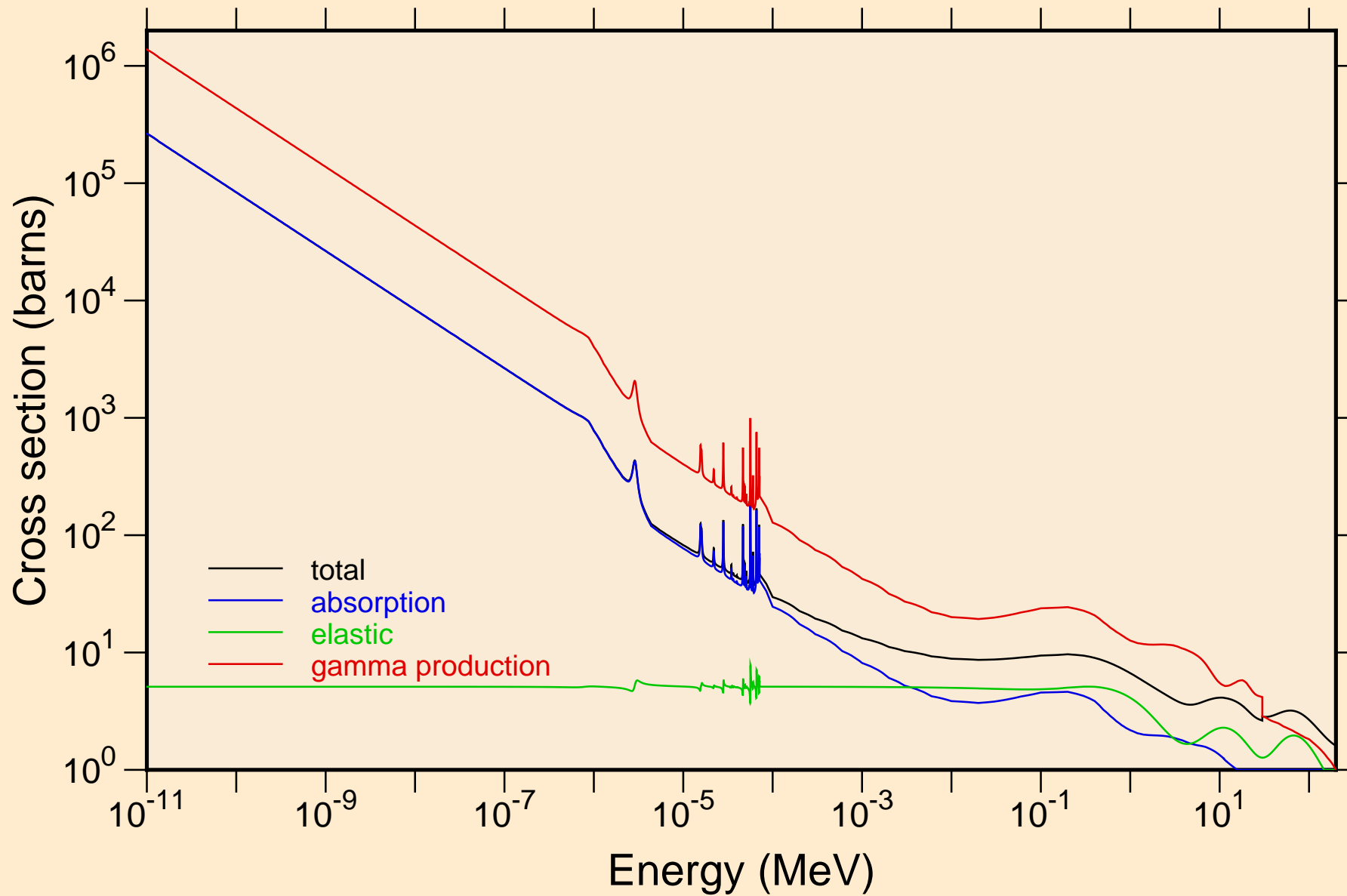

TC090 NEUTRON ACER TENDL-2023 LIBRARY; T=0.K  
resonance total cross section

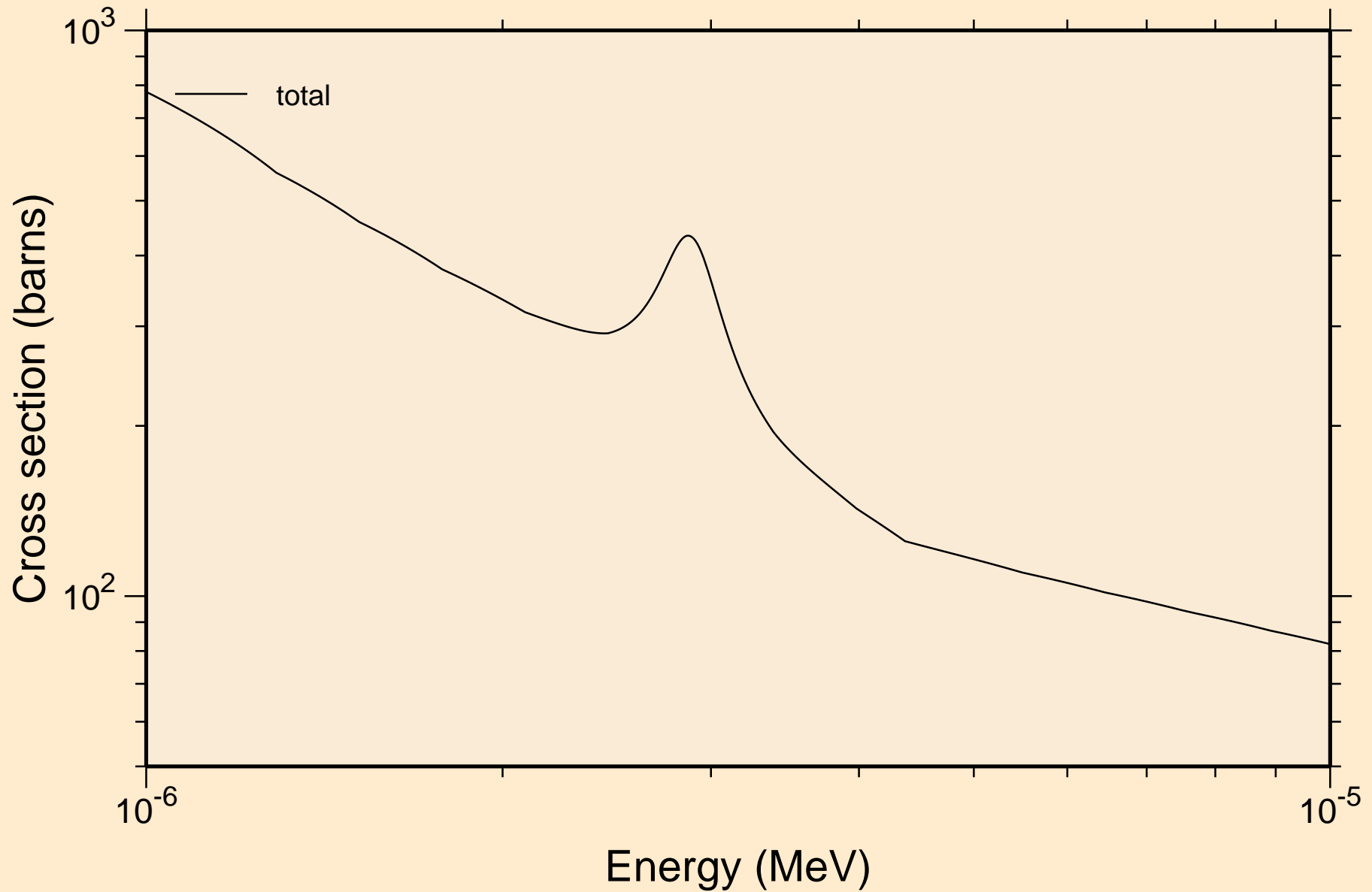

TC090 NEUTRON ACER TENDL-2023 LIBRARY; T=0.K  
resonance total cross section

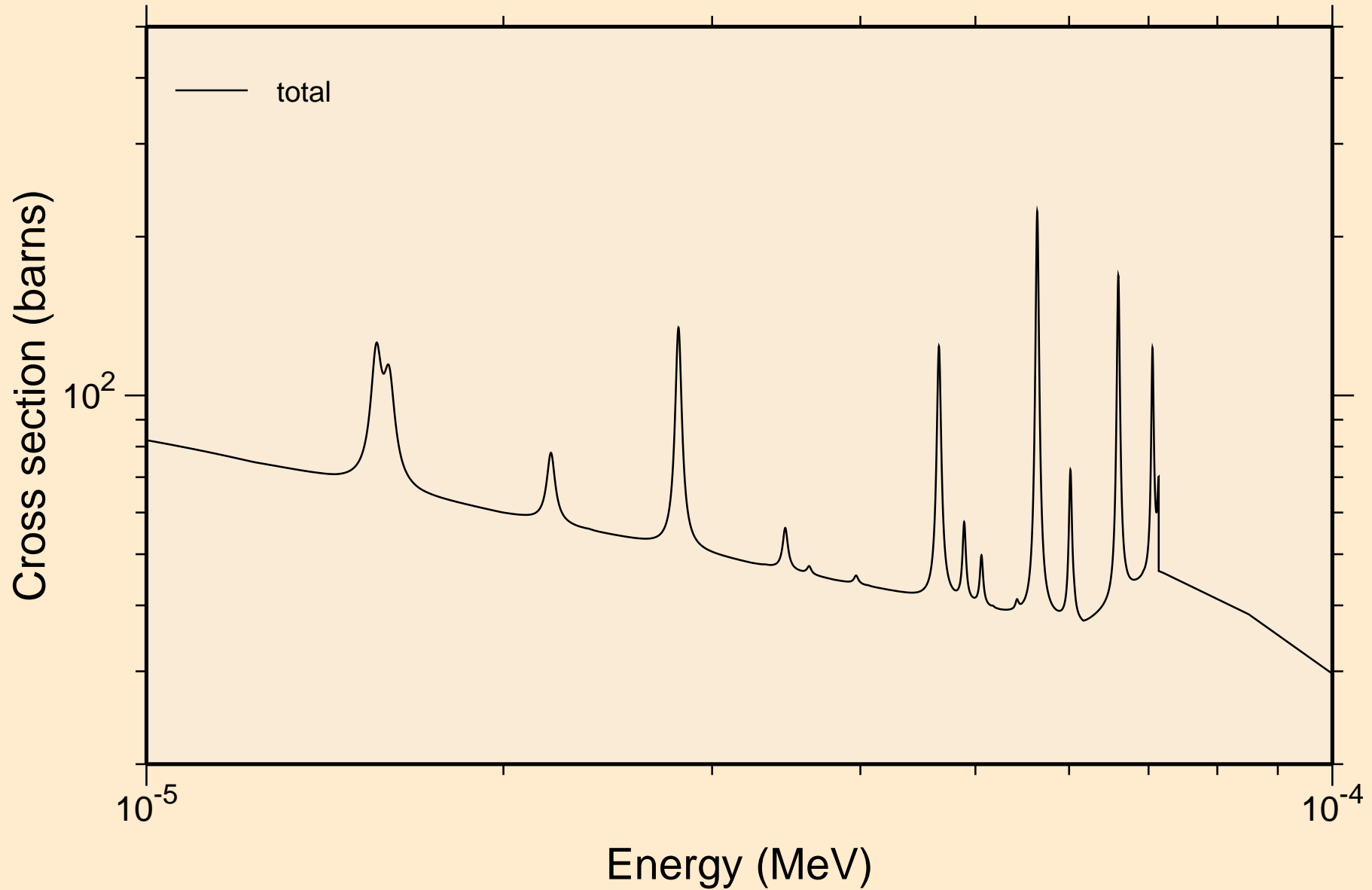

TC090 NEUTRON ACER TENDL-2023 LIBRARY; T=0.K  
resonance total cross section

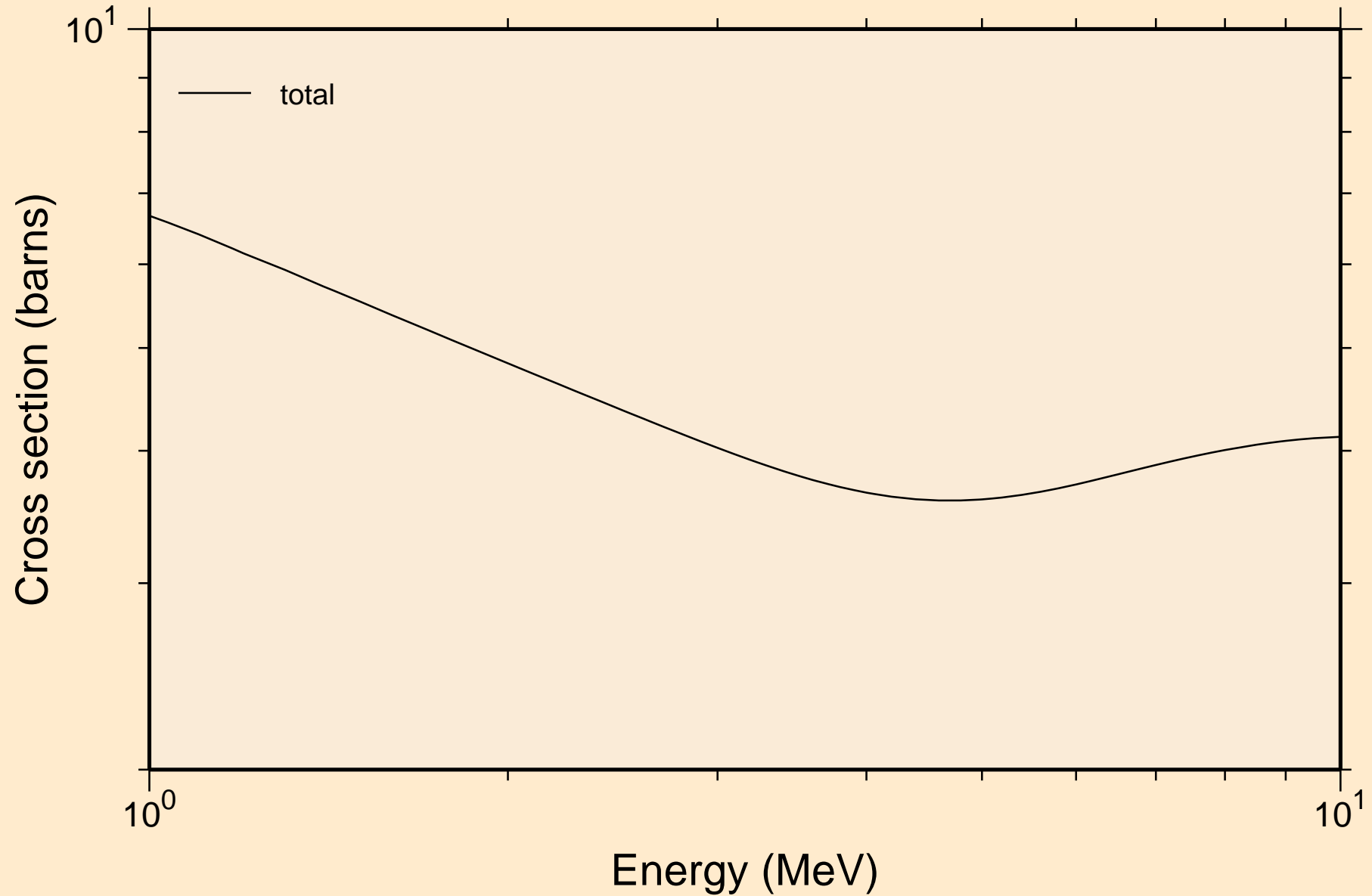

TC090 NEUTRON ACER TENDL-2023 LIBRARY; T=0.K  
resonance absorption cross sections

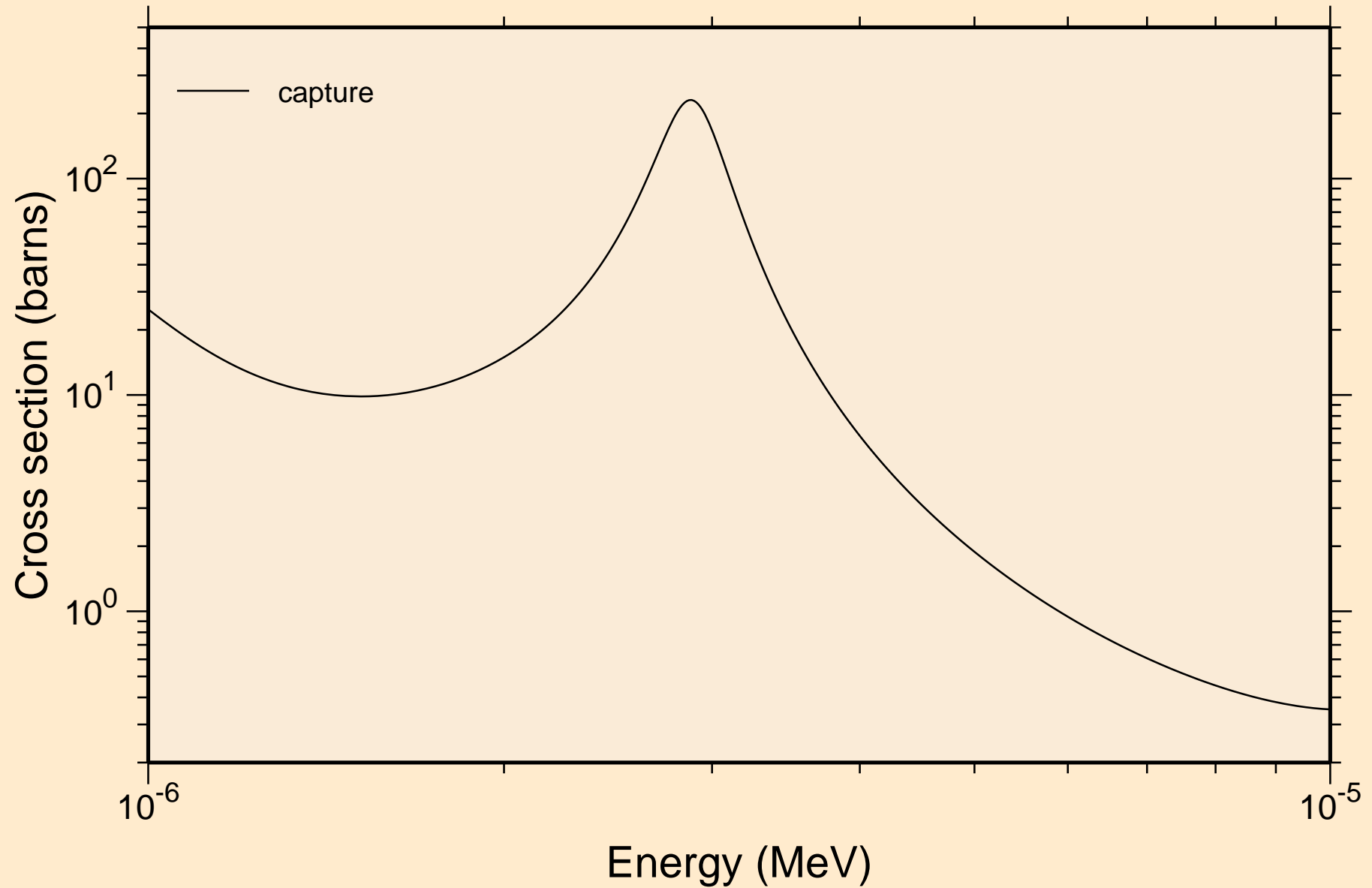

TC090 NEUTRON ACER TENDL-2023 LIBRARY; T=0.K  
resonance absorption cross sections

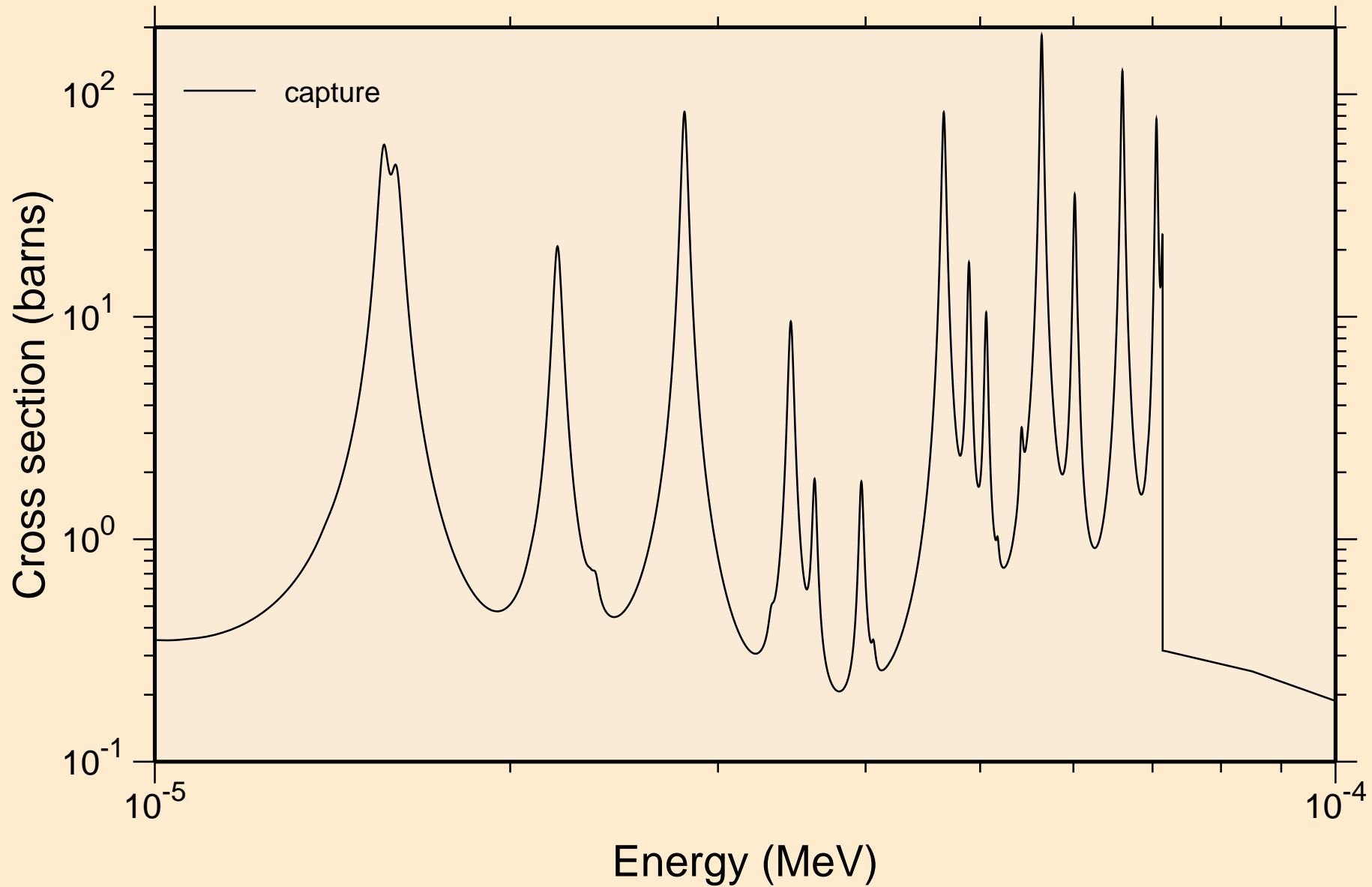

TC090 NEUTRON ACER TENDL-2023 LIBRARY; T=0.K  
resonance absorption cross sections

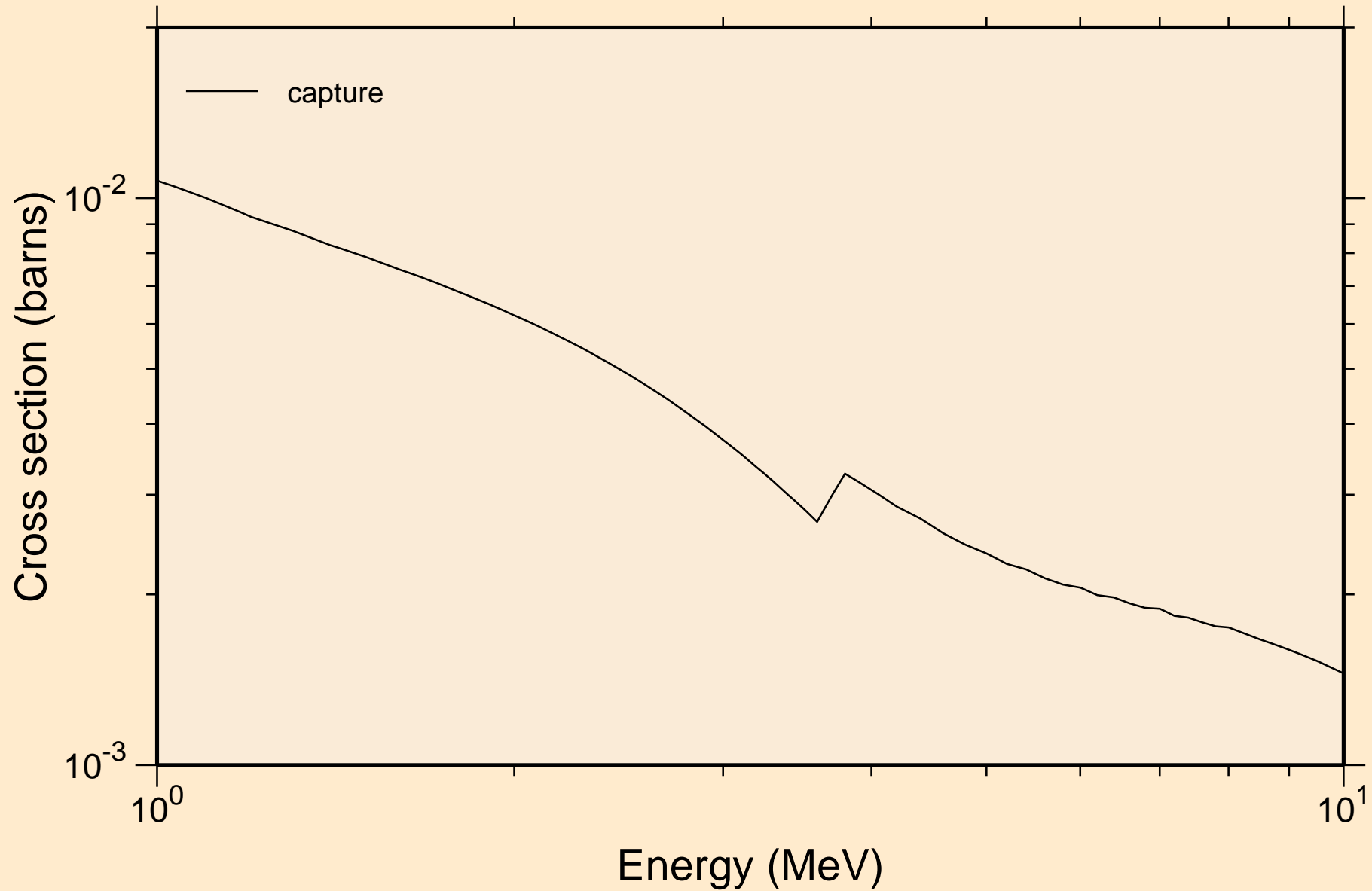

# TC090 NEUTRON ACER TENDL-2023 LIBRARY; T=0.K

## Heating

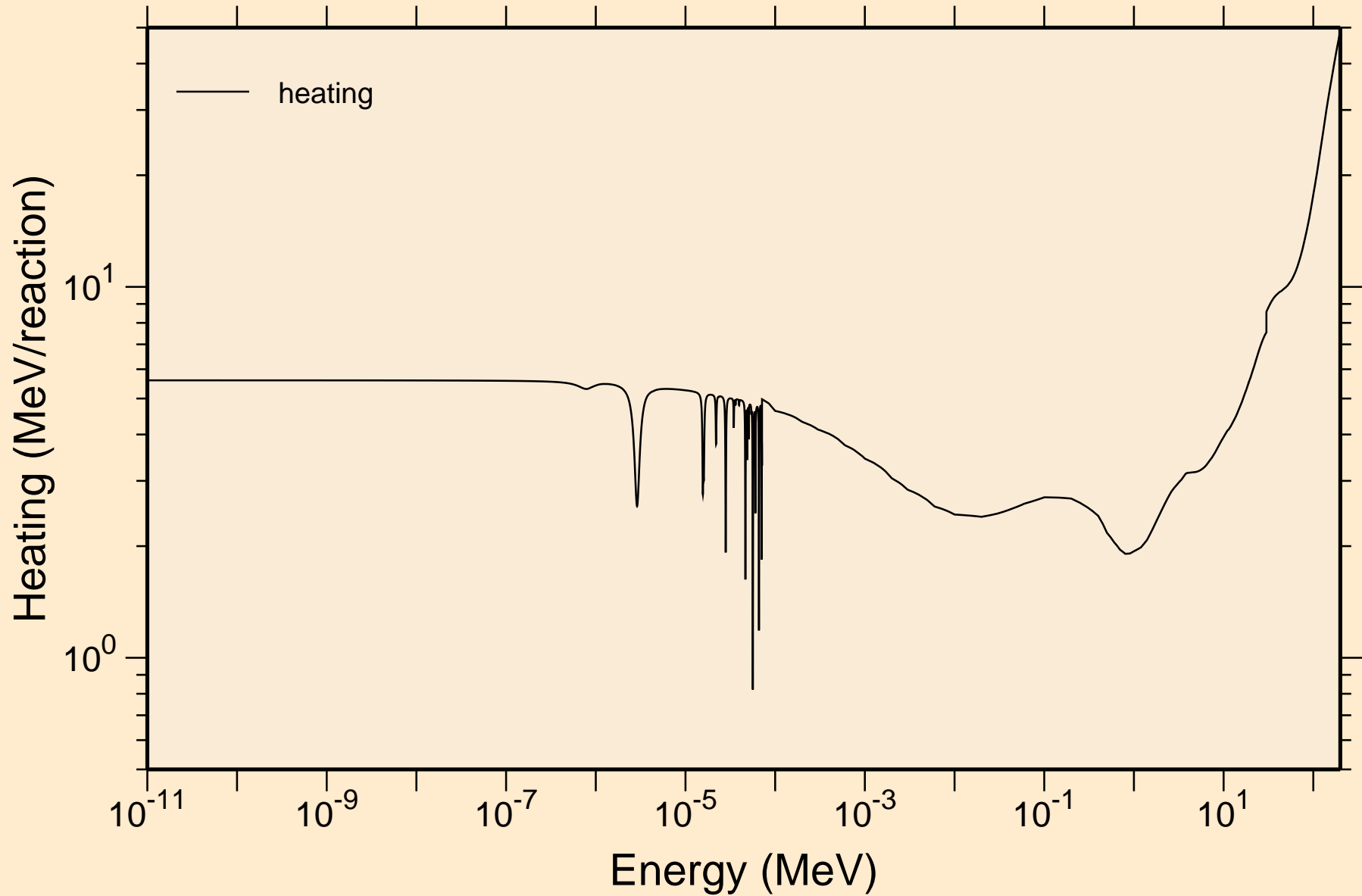



TC090 NEUTRON ACER TENDL-2023 LIBRARY; T=0.K  
Damage

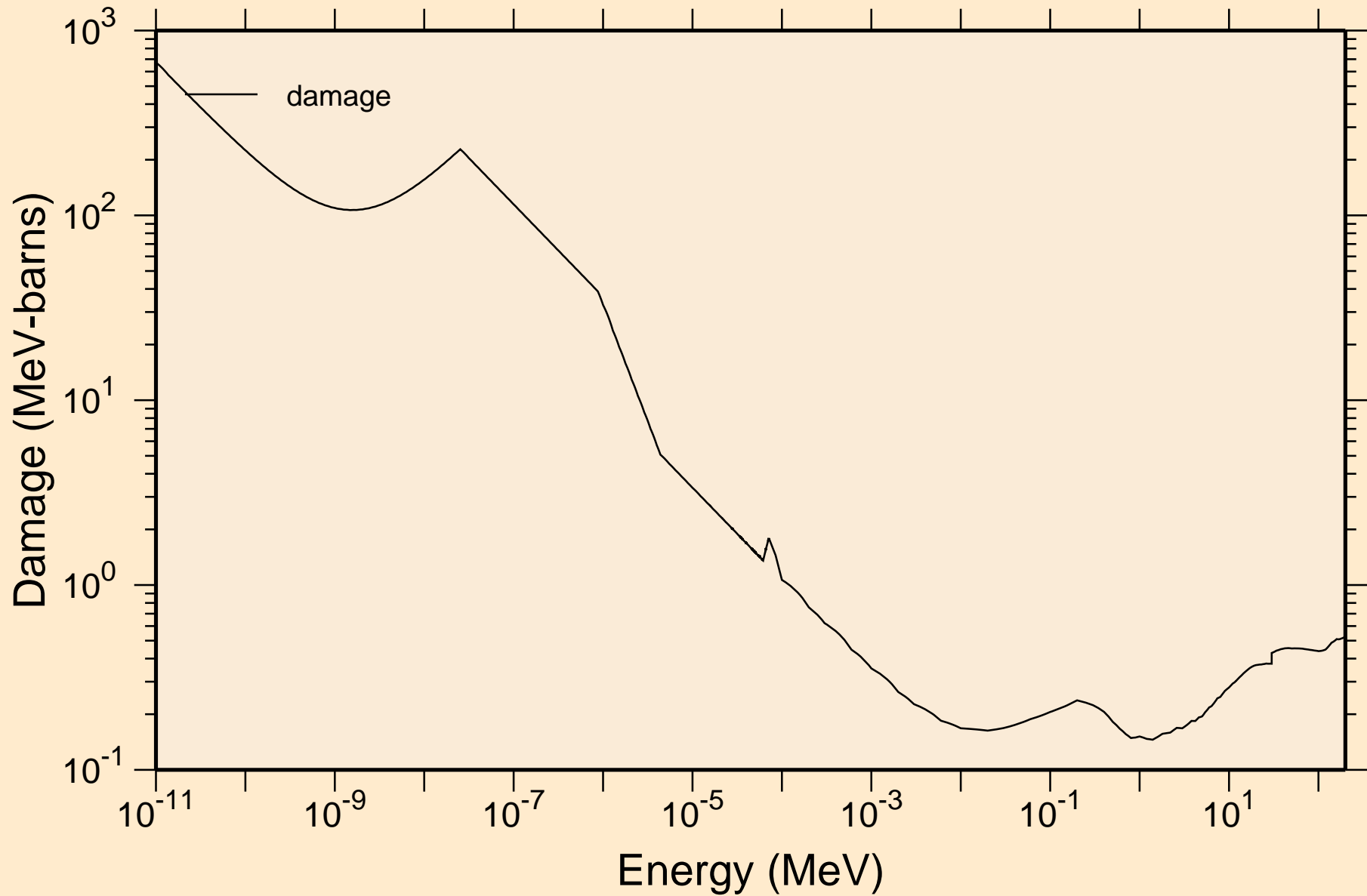

TC090 NEUTRON ACER TENDL-2023 LIBRARY; T=0.K  
Non-threshold reactions

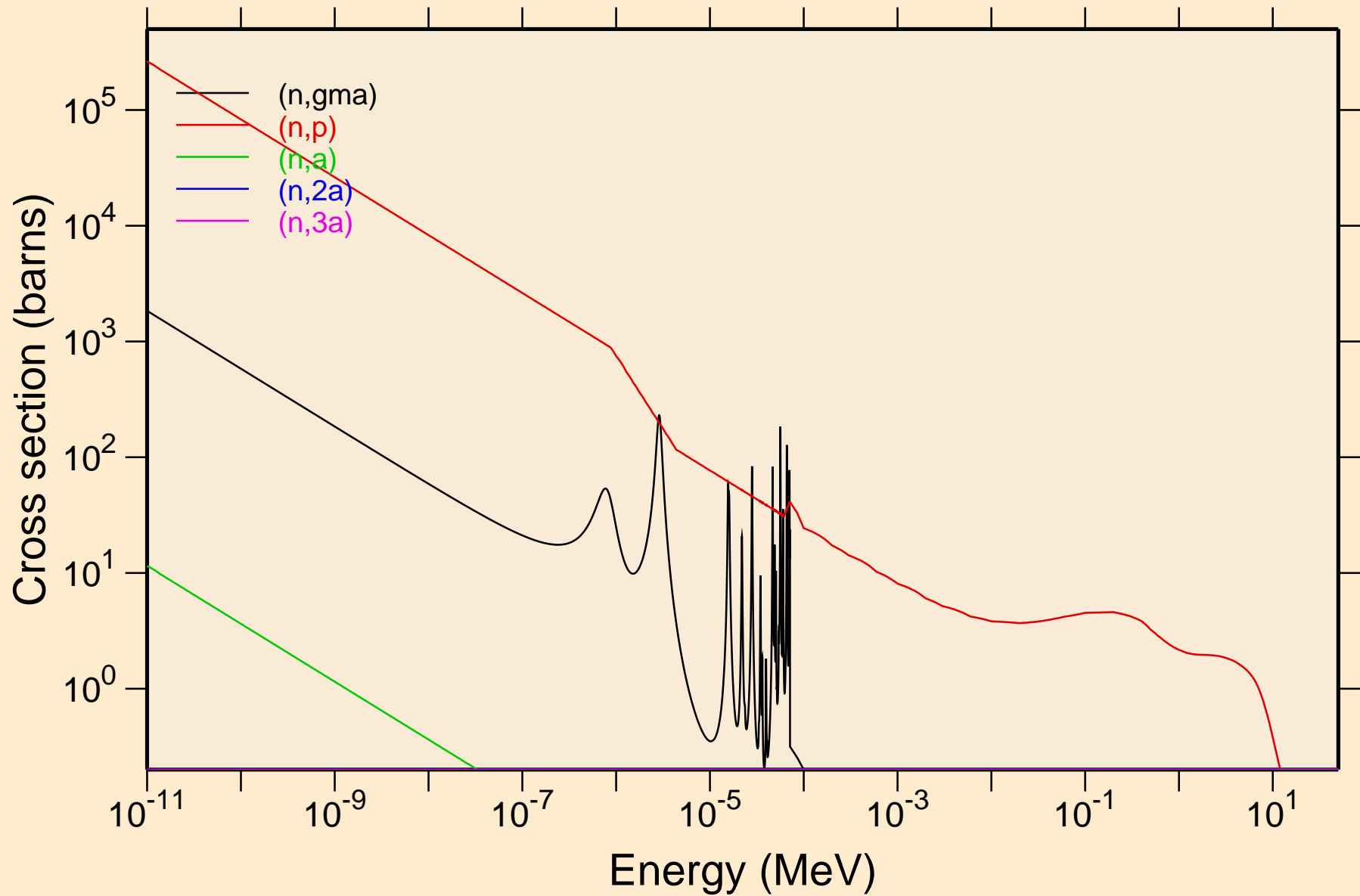

TC090 NEUTRON ACER TENDL-2023 LIBRARY; T=0.K  
Non-threshold reactions

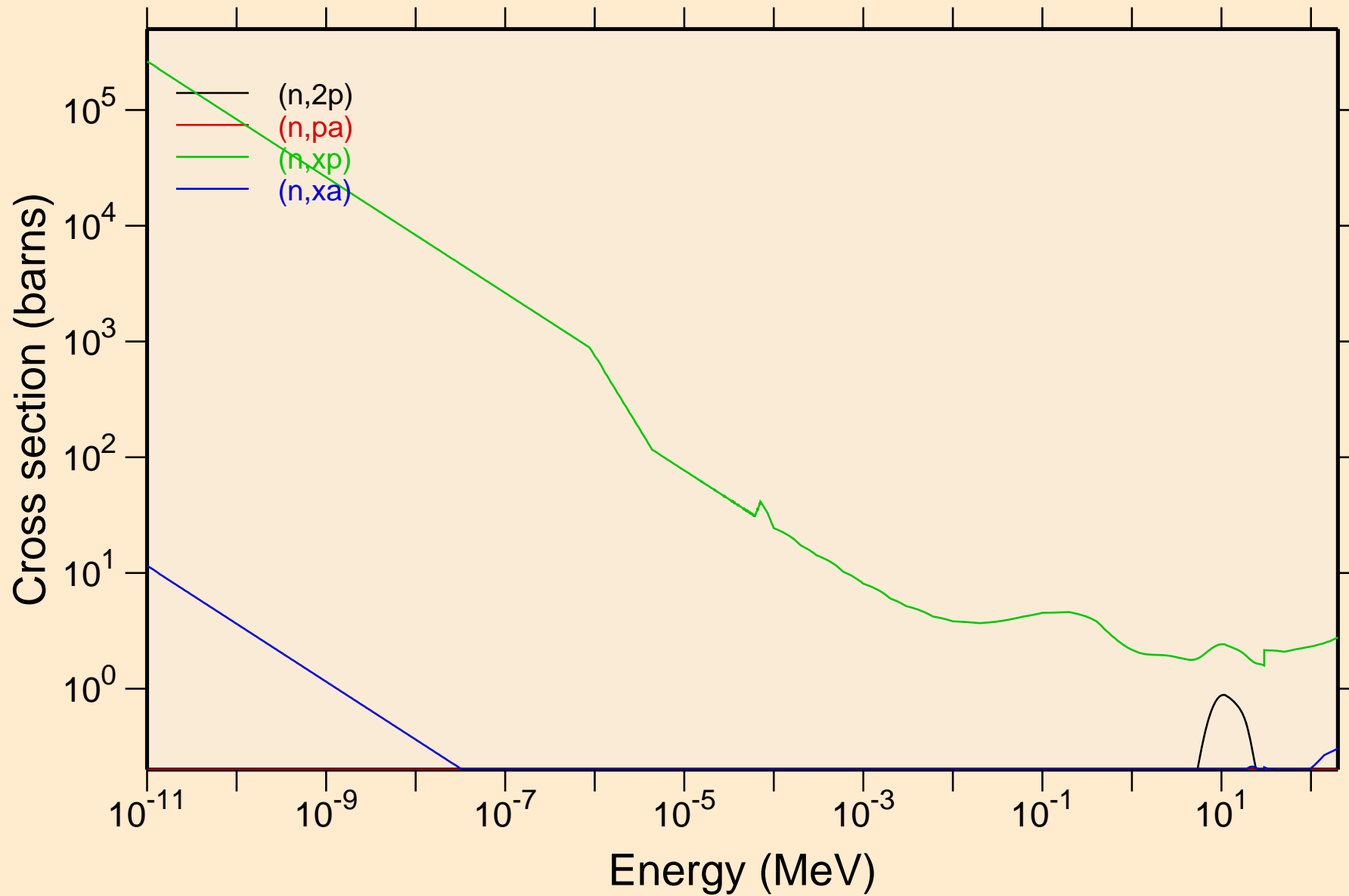

# TC090 NEUTRON ACER TENDL-2023 LIBRARY; T=0.K

## Principal cross sections

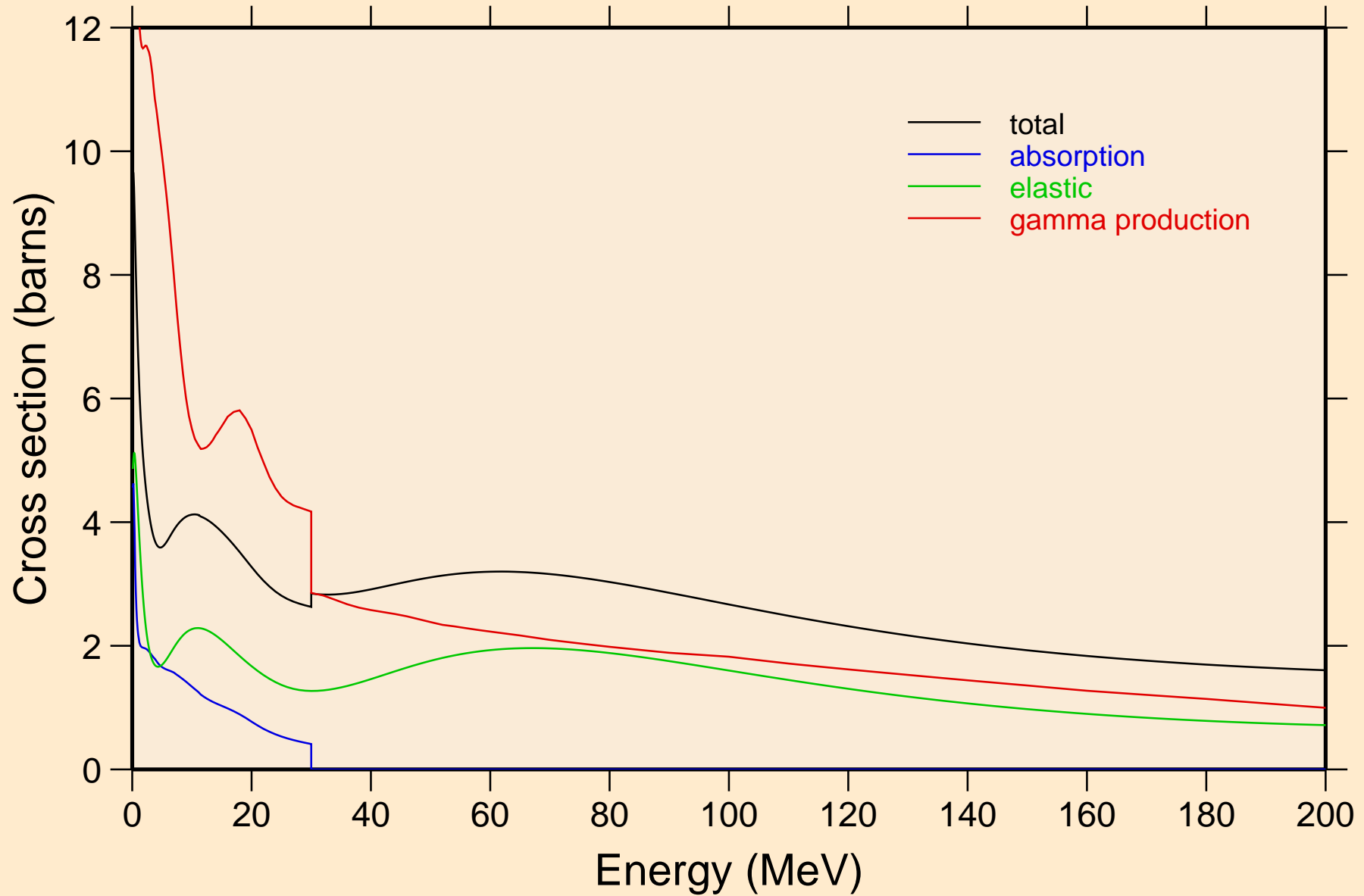

# TC090 NEUTRON ACER TENDL-2023 LIBRARY; T=0.K

## Heating

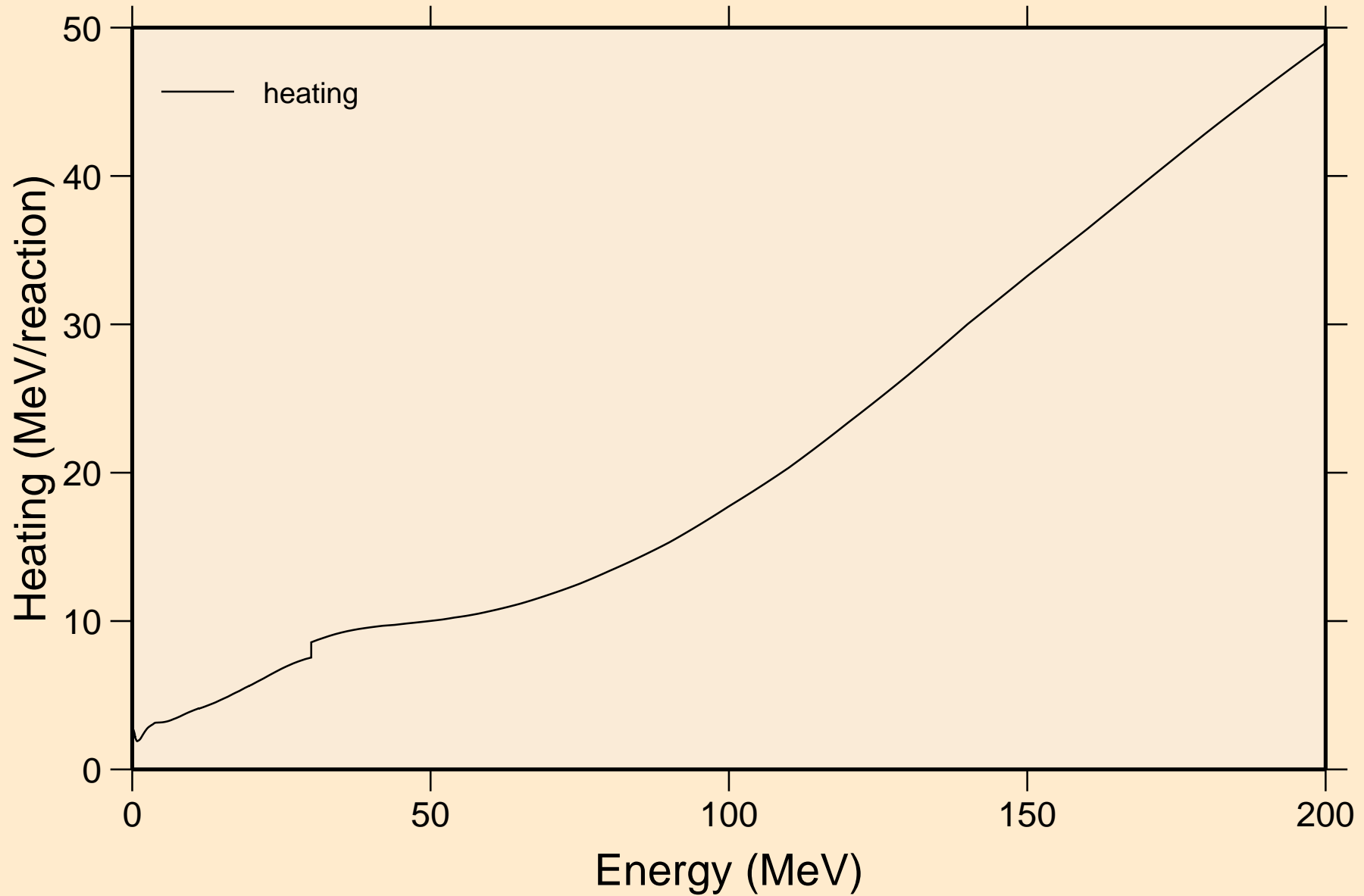

TC090 NEUTRON ACER TENDL-2023 LIBRARY; T=0.K  
Damage

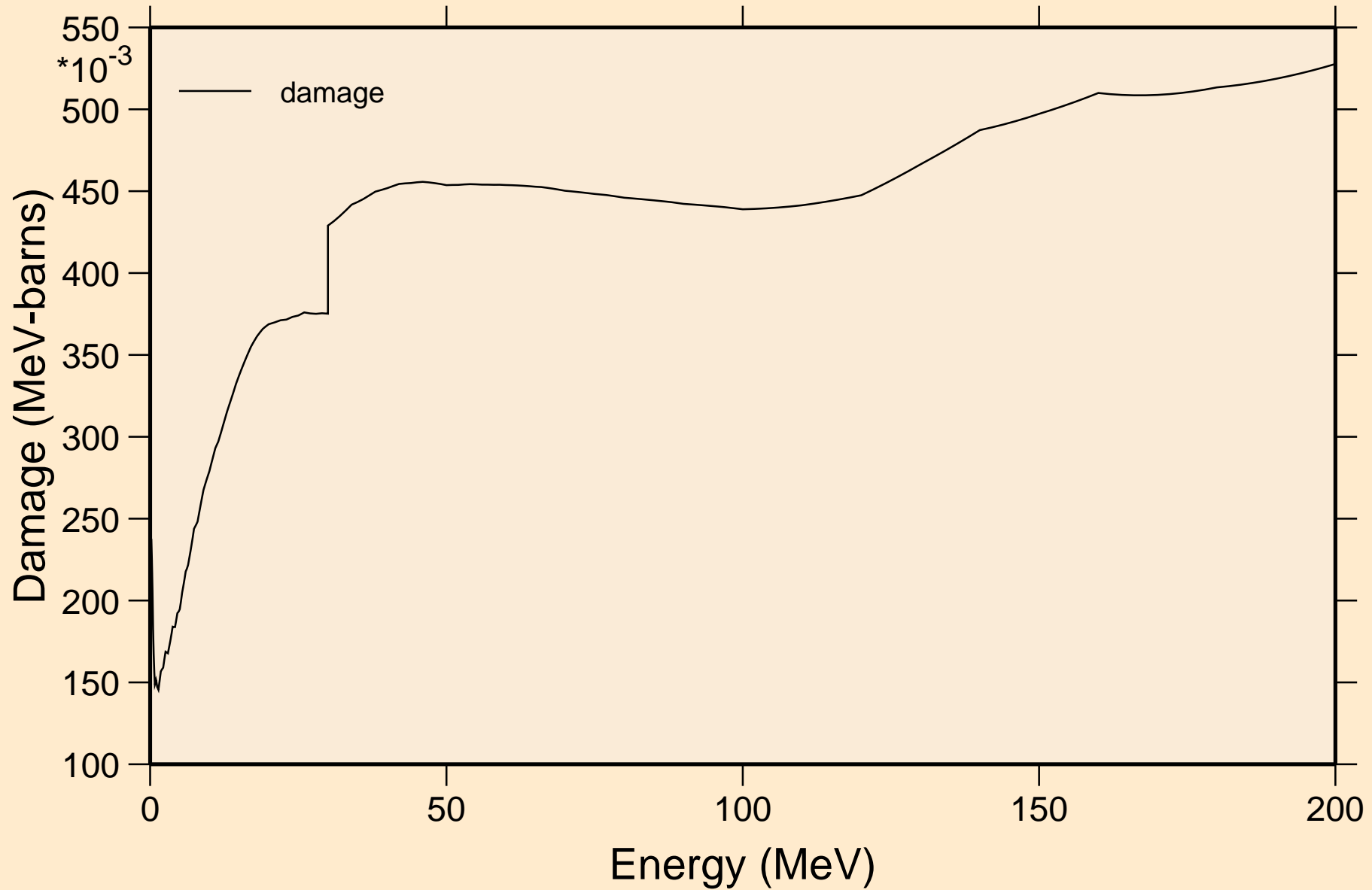

TC090 NEUTRON ACER TENDL-2023 LIBRARY; T=0.K  
Non-threshold reactions

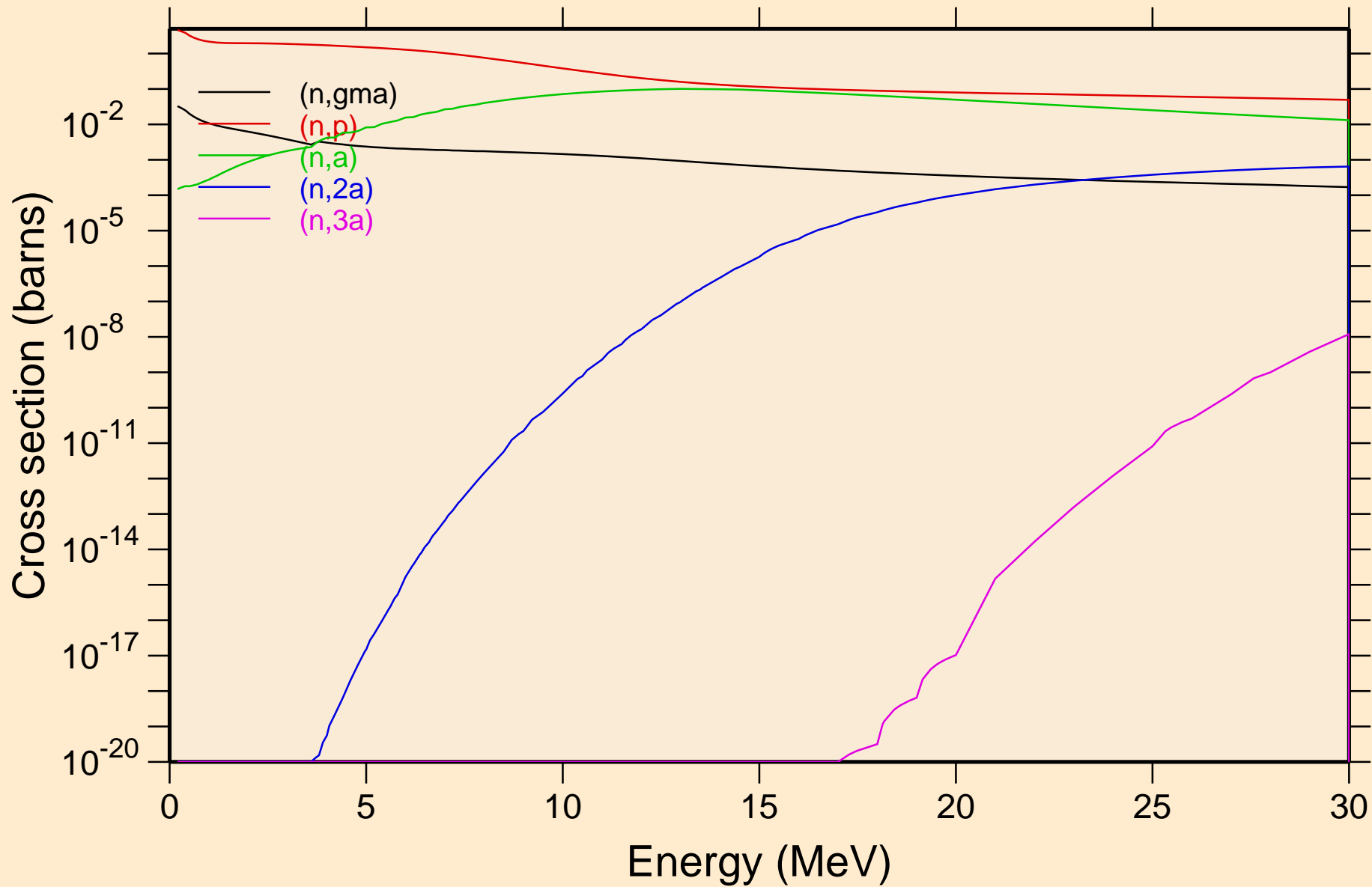

TC090 NEUTRON ACER TENDL-2023 LIBRARY; T=0.K  
Non-threshold reactions

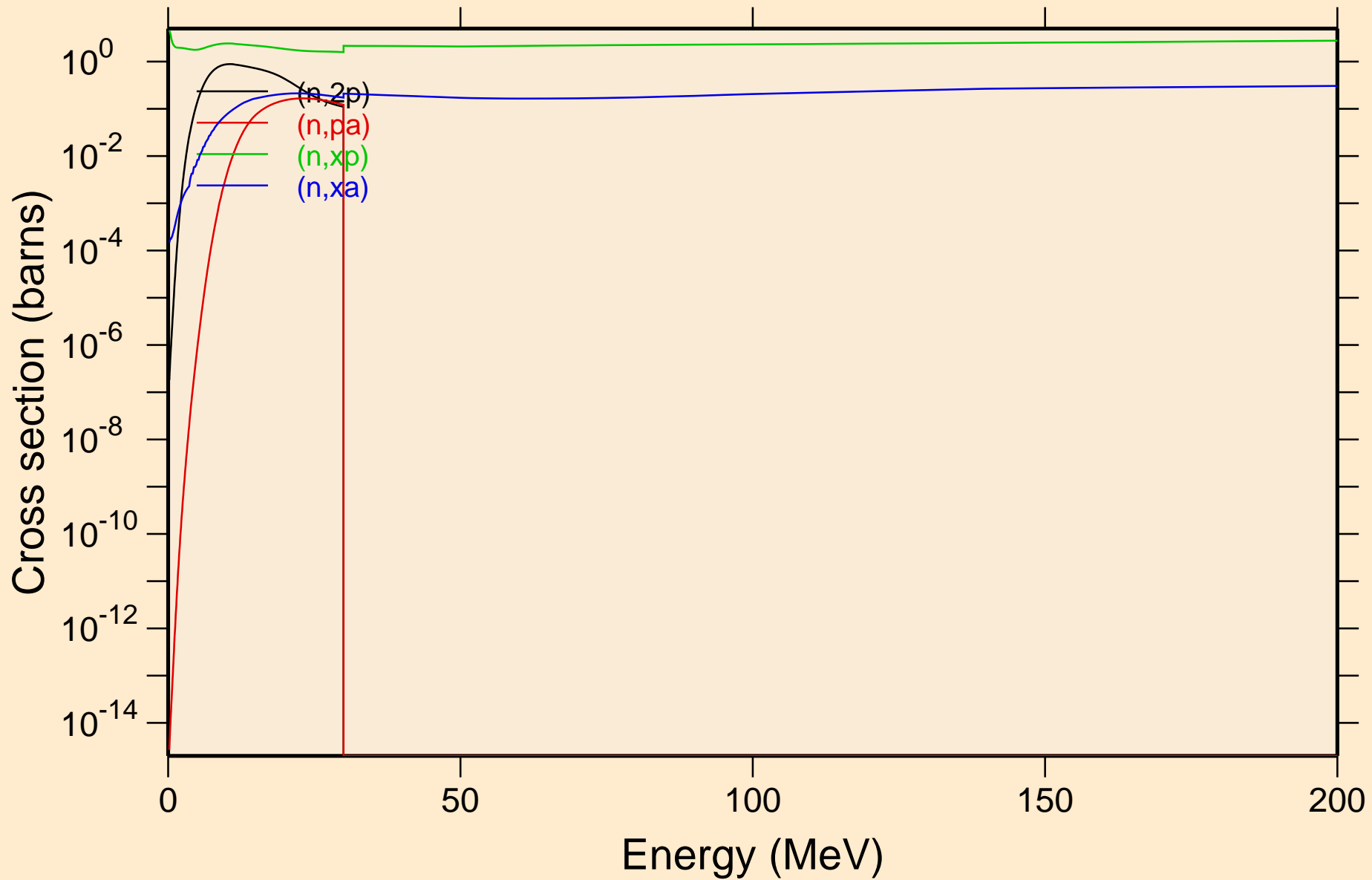



TC090 NEUTRON ACER TENDL-2023 LIBRARY; T=0.K  
Inelastic levels

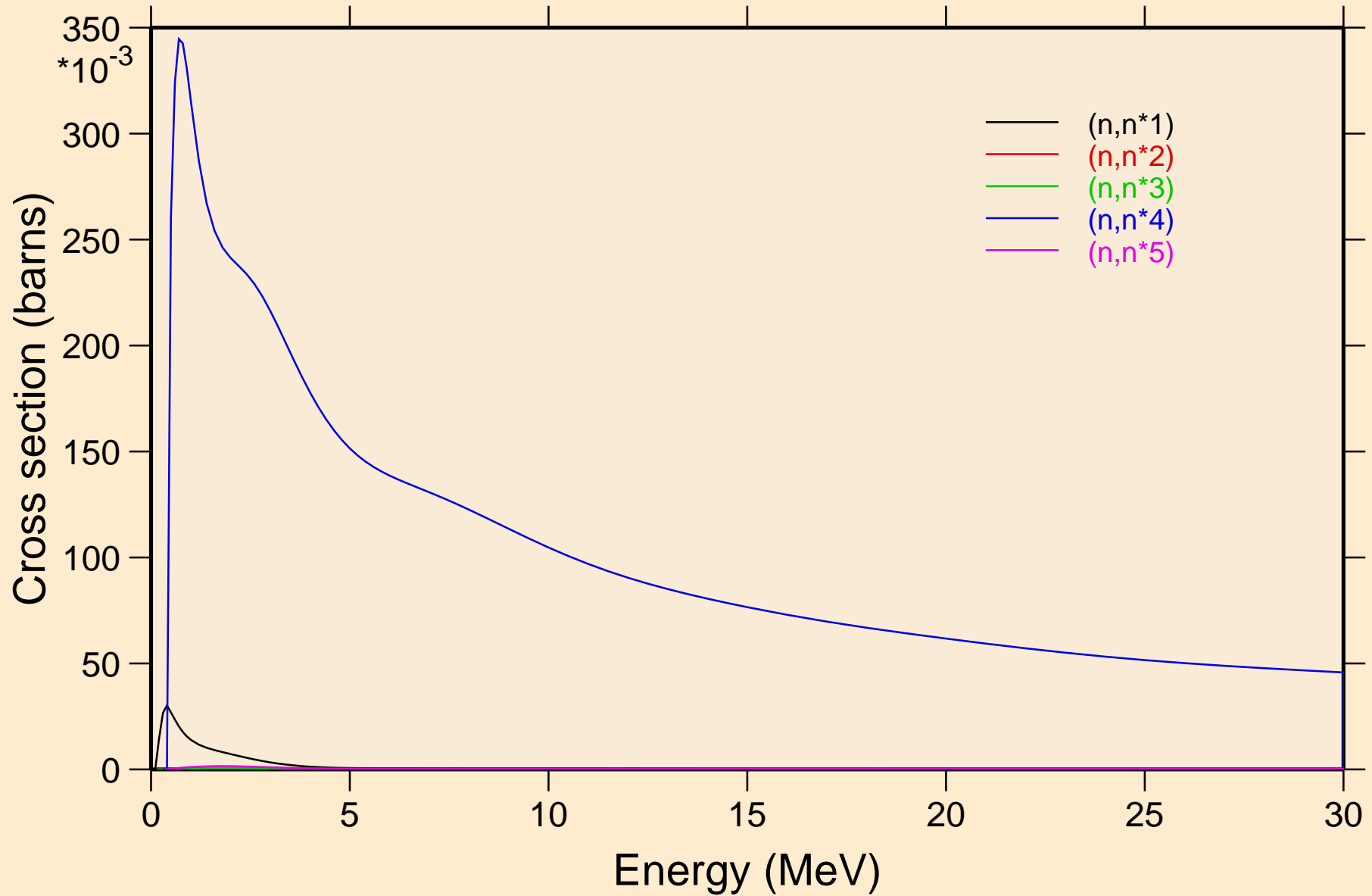

TC090 NEUTRON ACER TENDL-2023 LIBRARY; T=0.K  
Inelastic levels

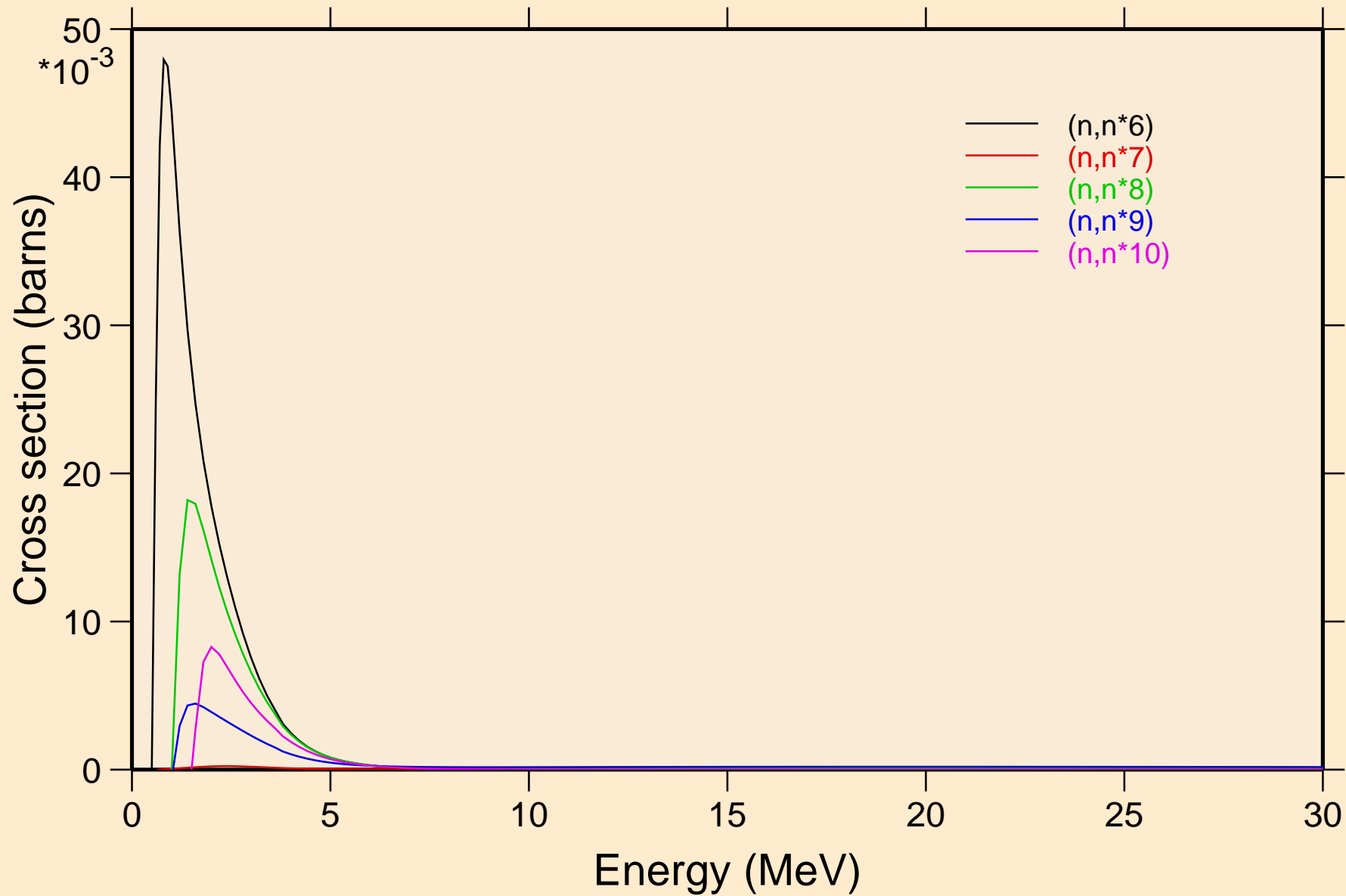

TC090 NEUTRON ACER TENDL-2023 LIBRARY; T=0.K  
Inelastic levels

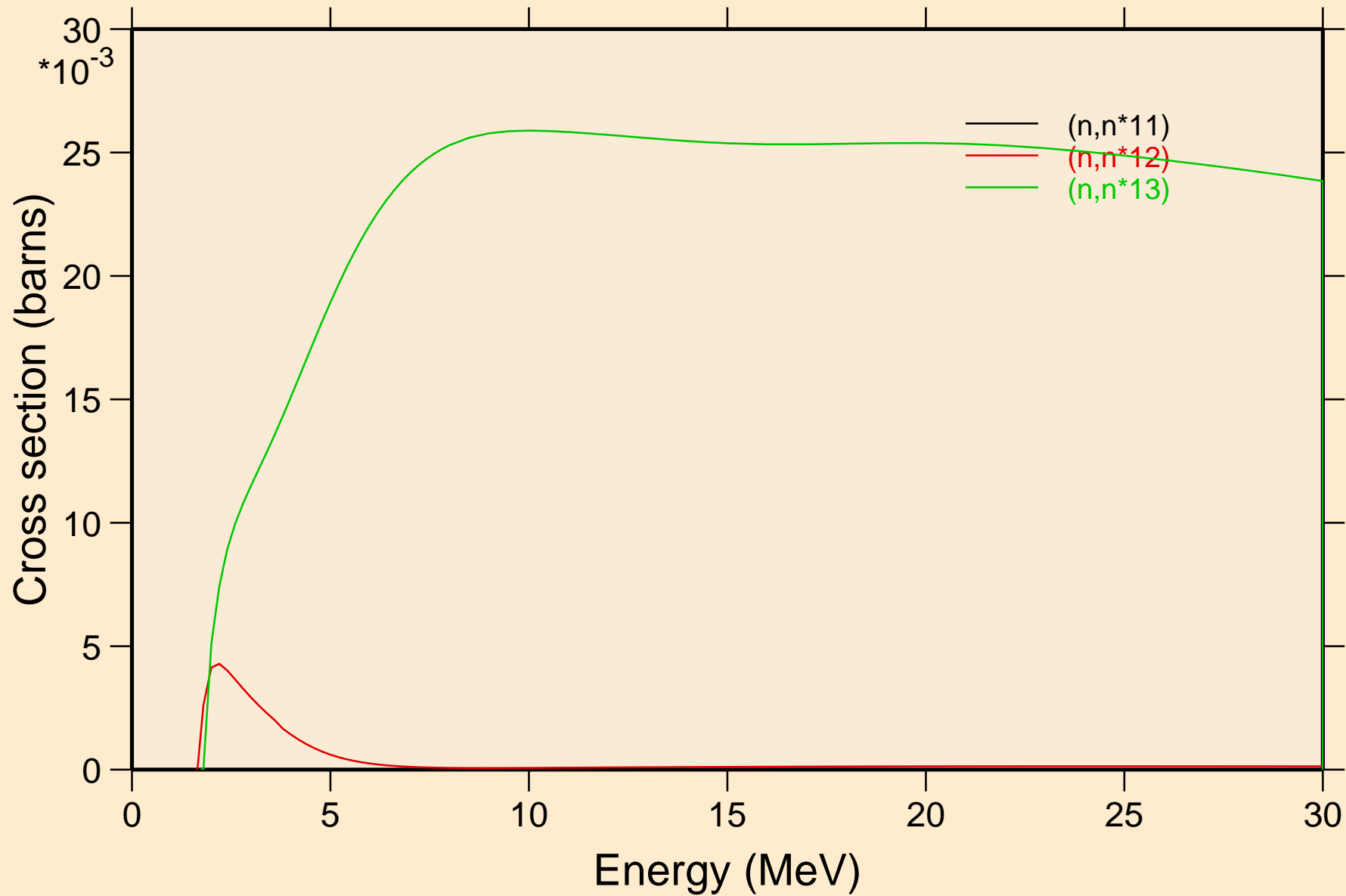

TC090 NEUTRON ACER TENDL-2023 LIBRARY; T=0.K  
Threshold reactions

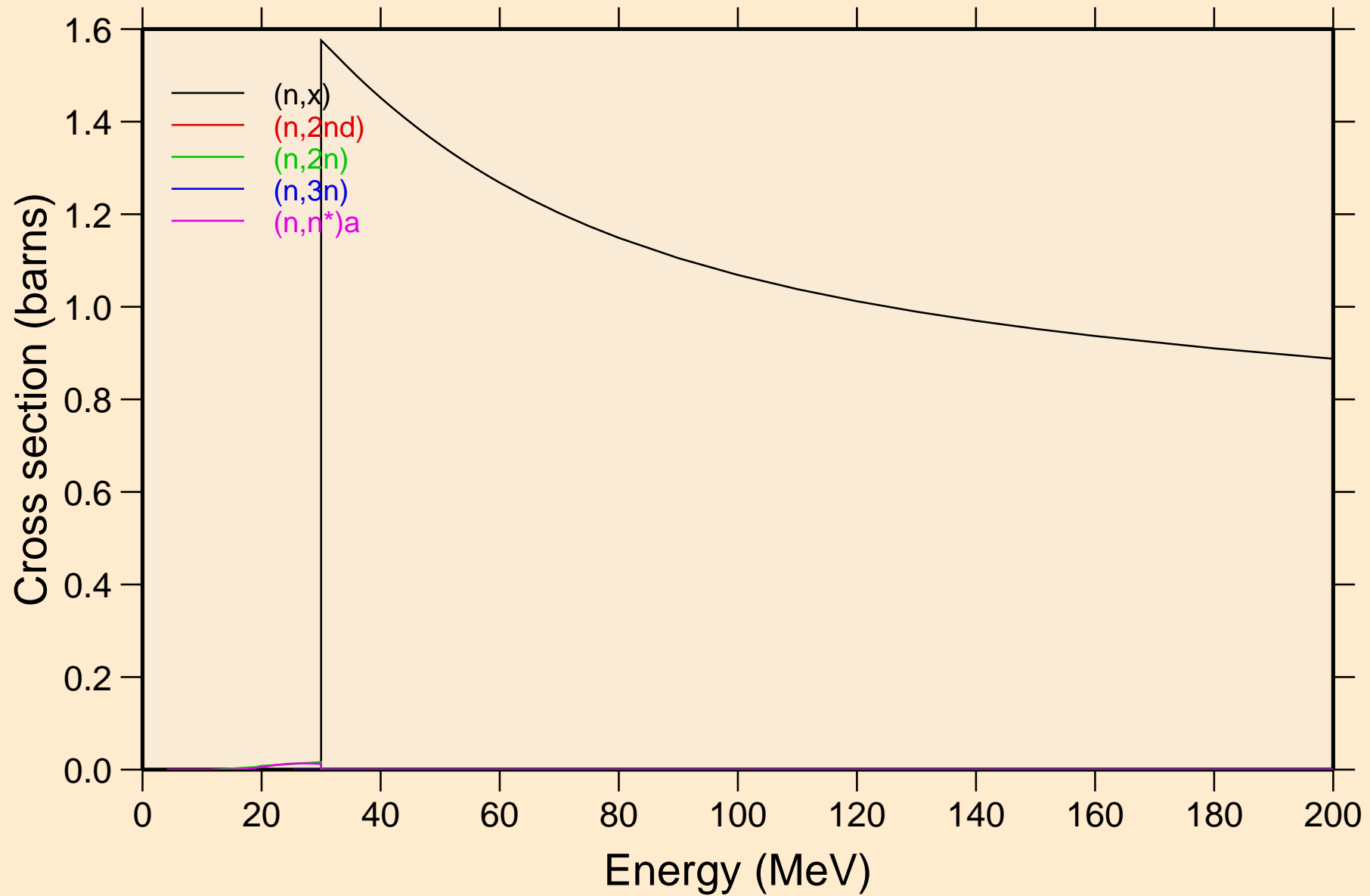

TC090 NEUTRON ACER TENDL-2023 LIBRARY; T=0.K  
Threshold reactions

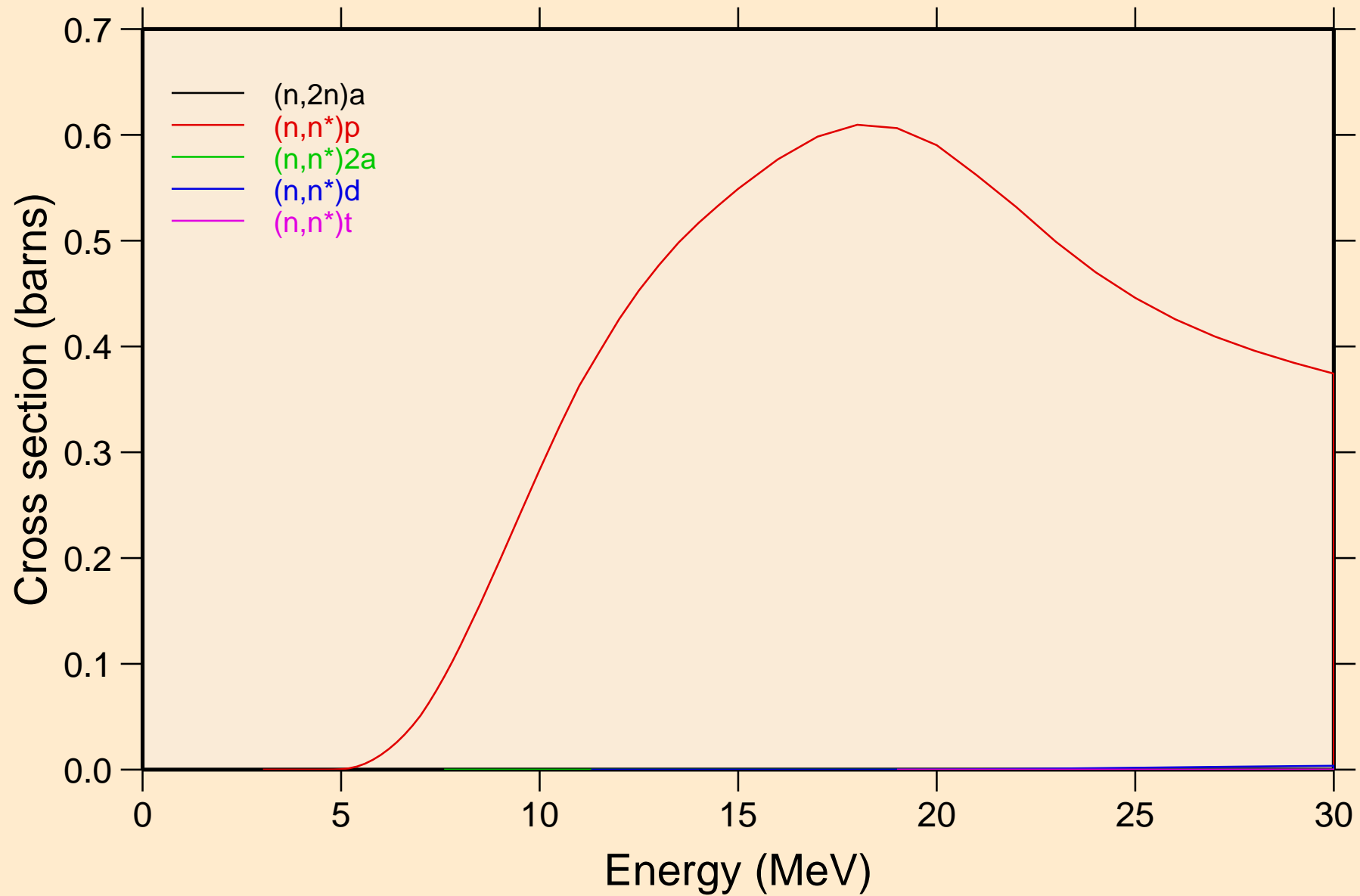

TC090 NEUTRON ACER TENDL-2023 LIBRARY; T=0.K  
Threshold reactions

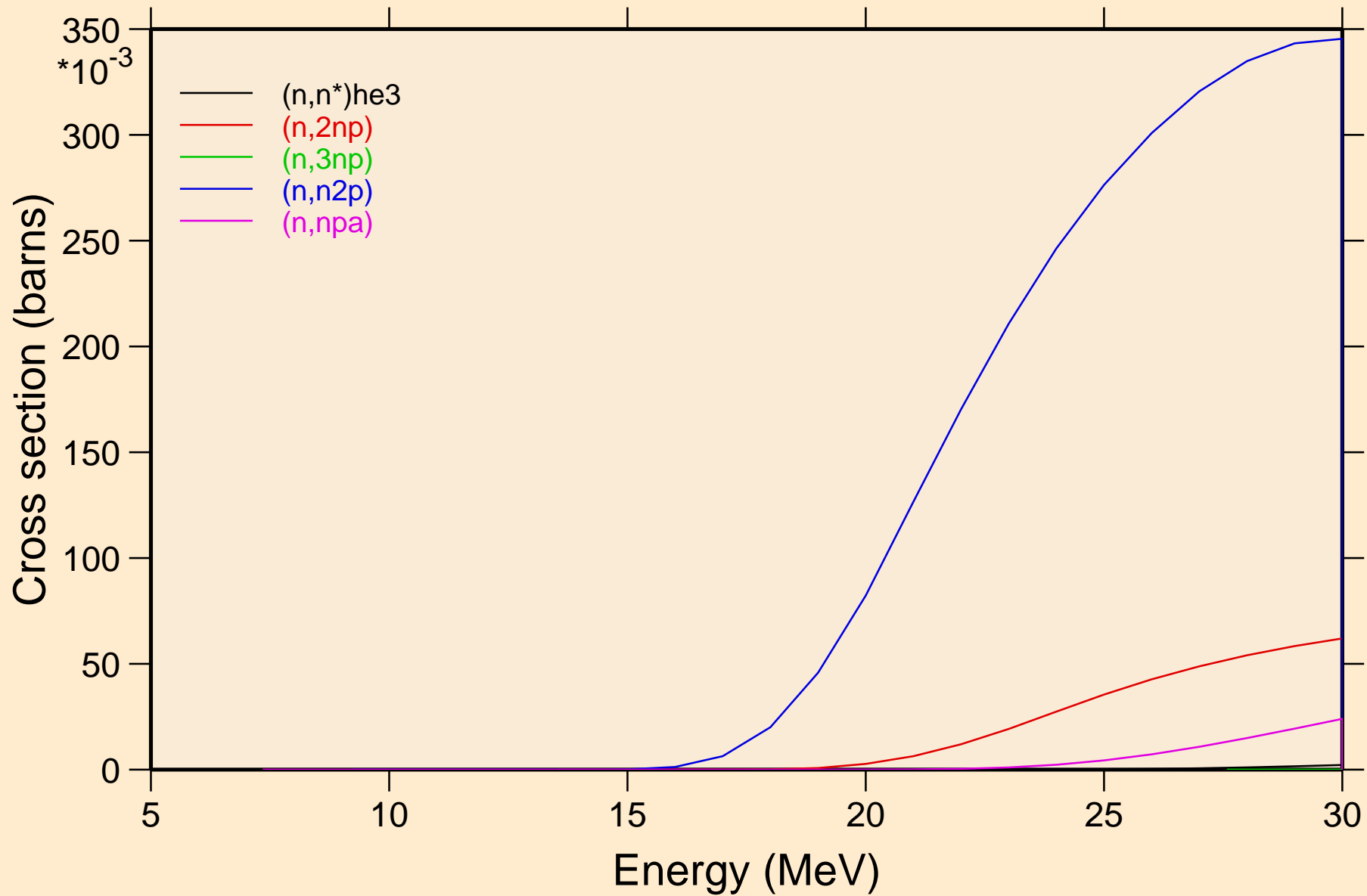

TC090 NEUTRON ACER TENDL-2023 LIBRARY; T=0.K  
Threshold reactions

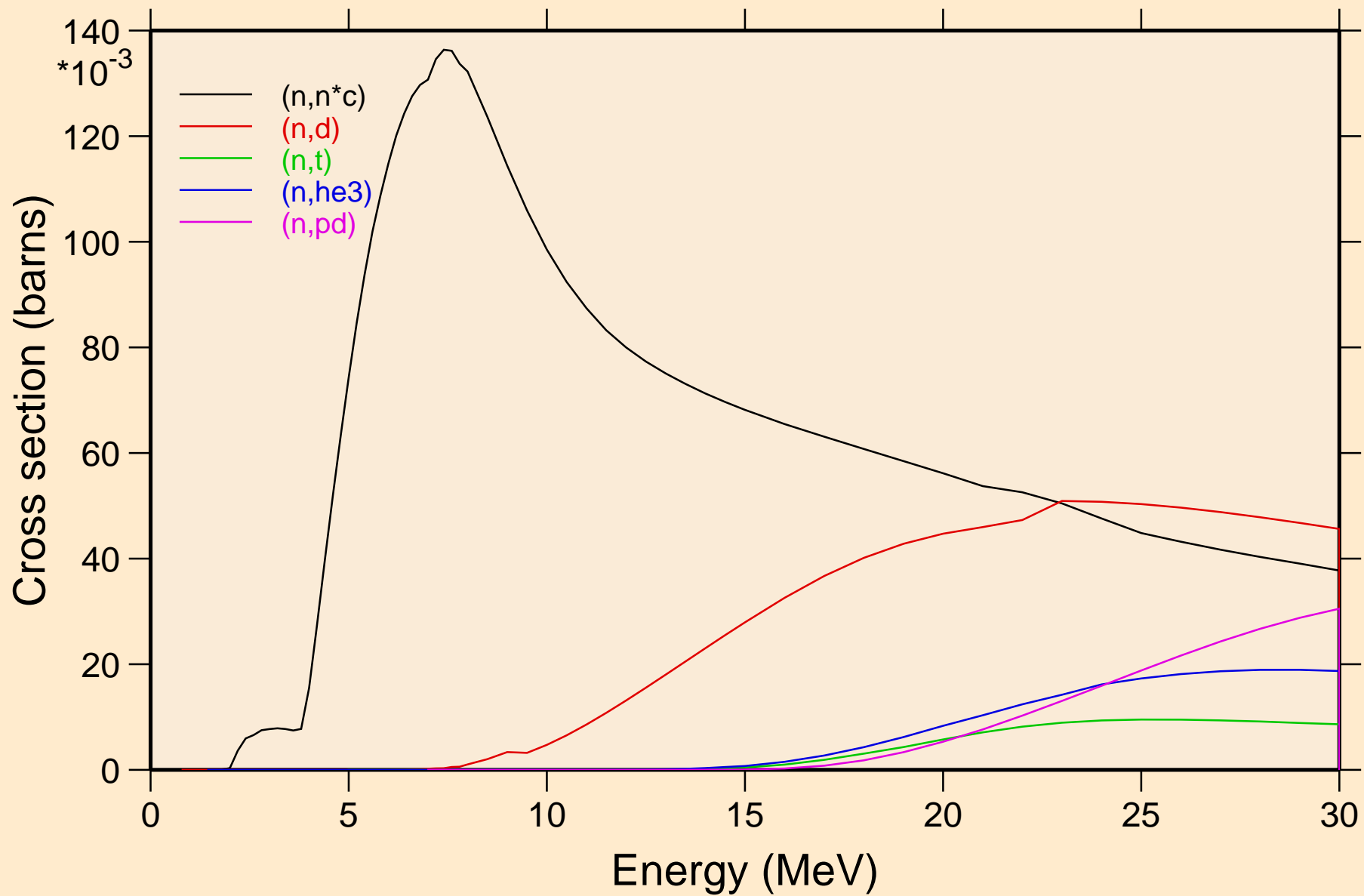

TC090 NEUTRON ACER TENDL-2023 LIBRARY; T=0.K  
Threshold reactions

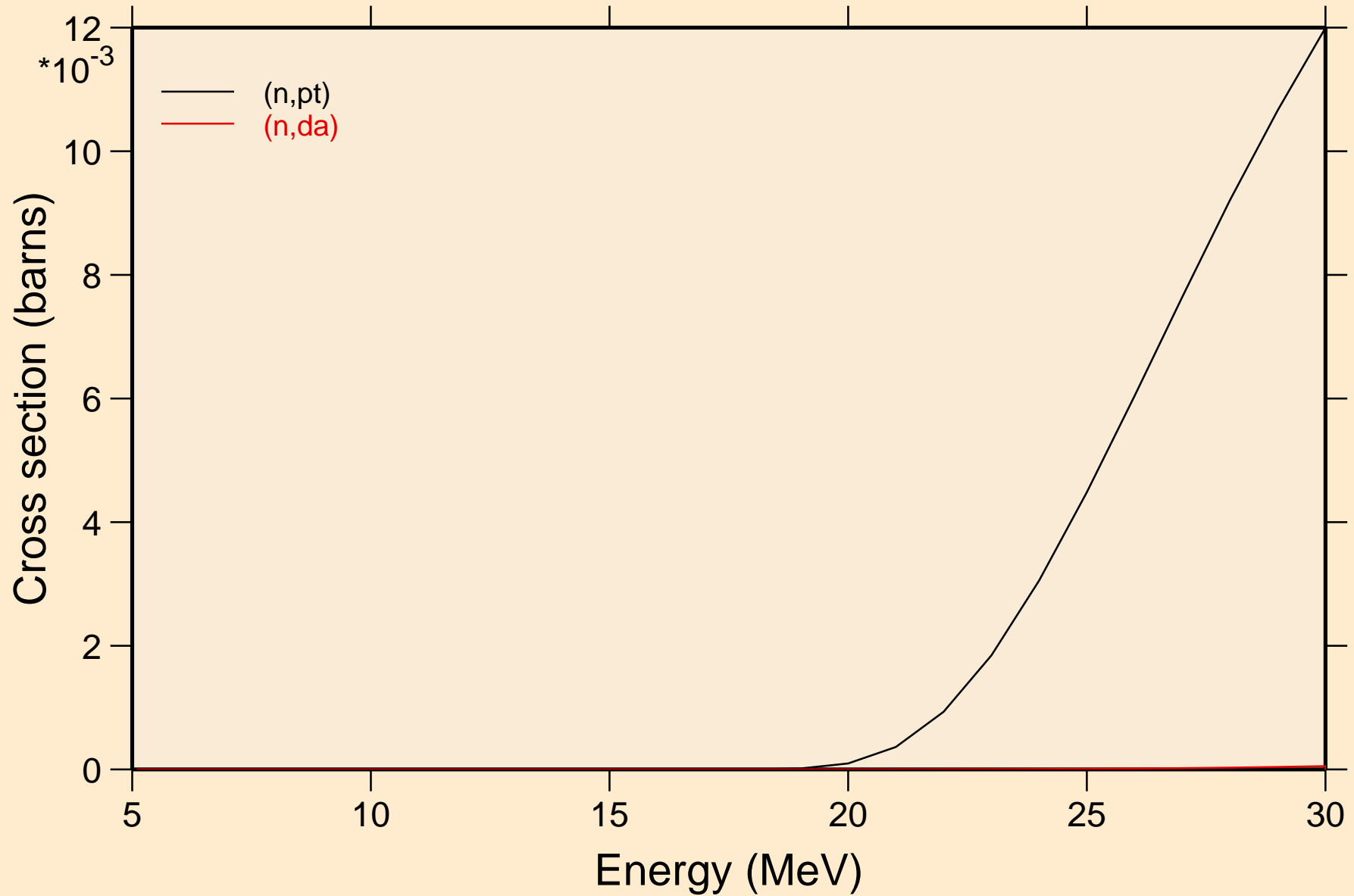



TC090 NEUTRON ACER TENDL-2023 LIBRARY; T=0.K  
Threshold reactions

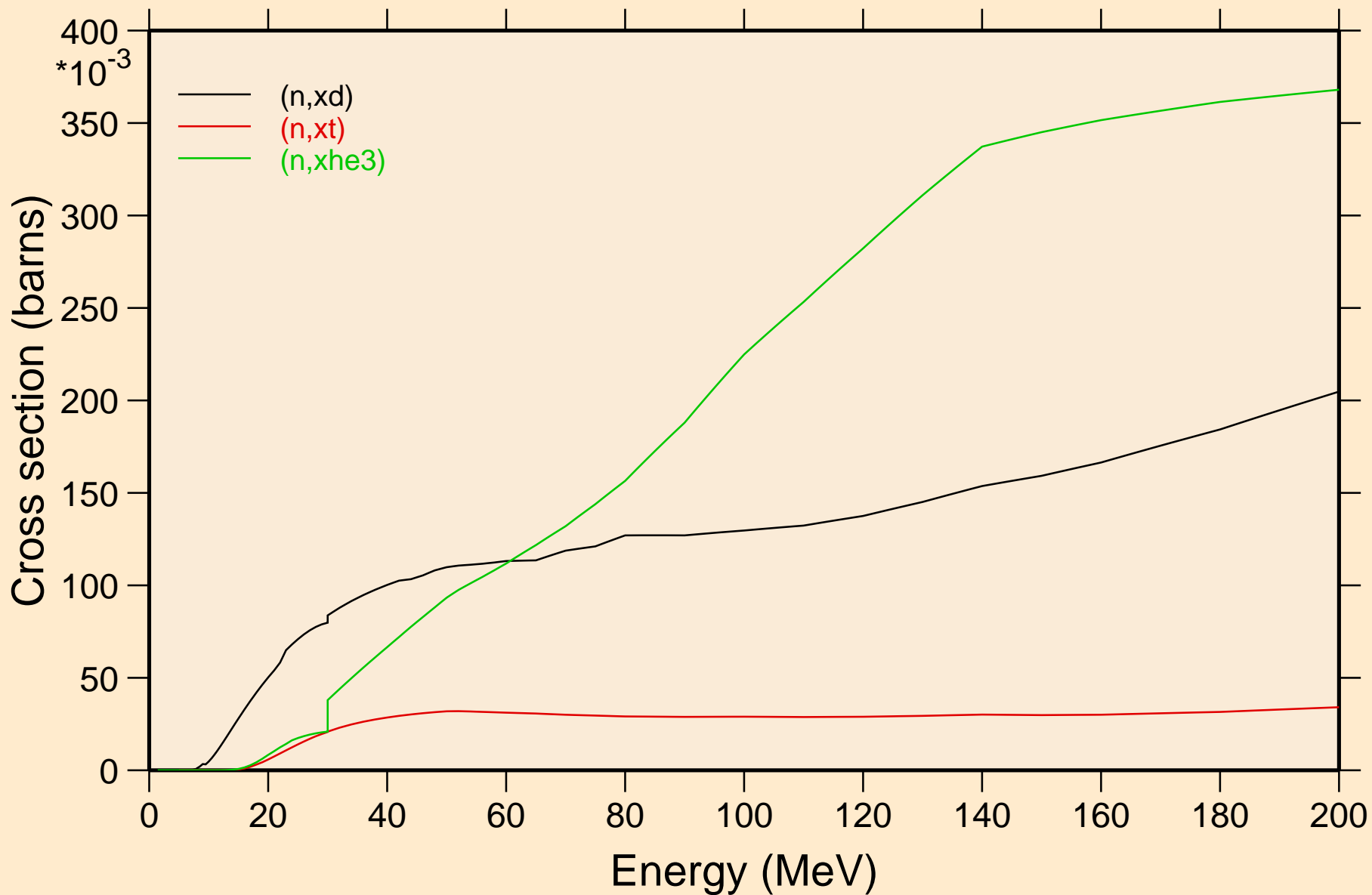

TC090 NEUTRON ACER TENDL-2023 LIBRARY; T=0.K  
angular distribution for elastic

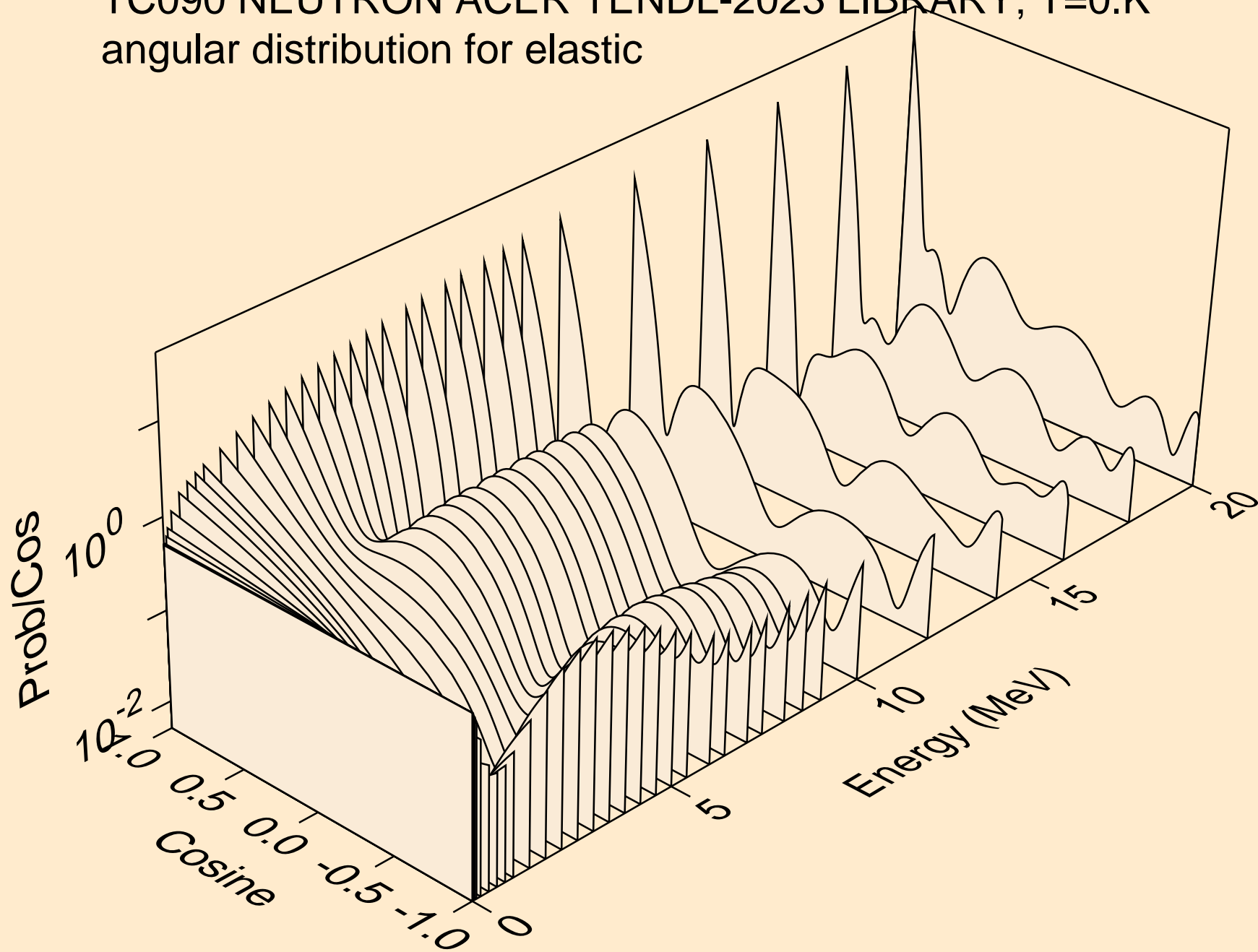

TC090 NEUTRON ACER TENDL-2023 LIBRARY; T=0.K  
angular distribution for elastic

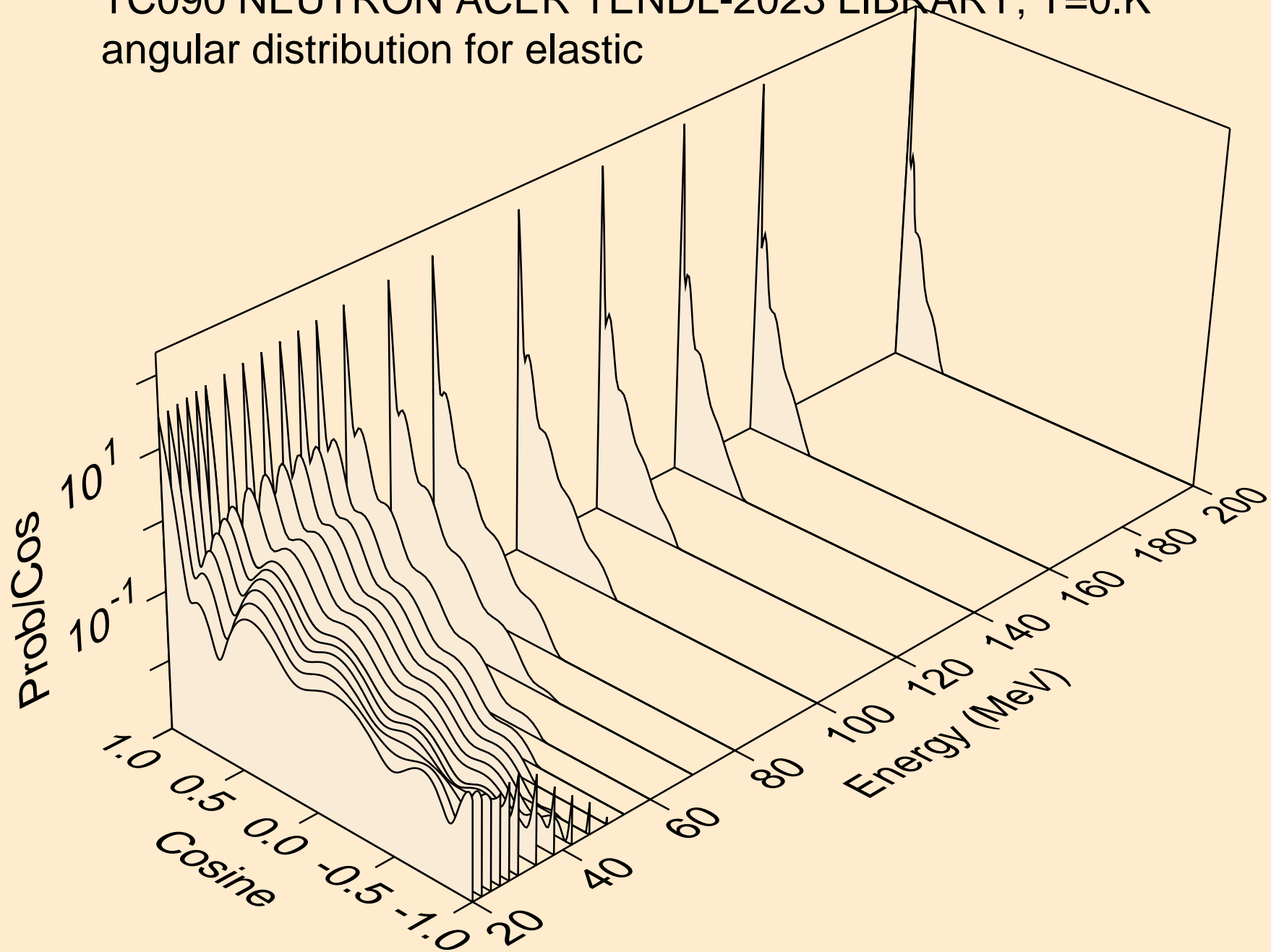

TC090 NEUTRON ACER TENDL-2023 LIBRARY; T=0.K  
angular distribution for (n,n\*1)

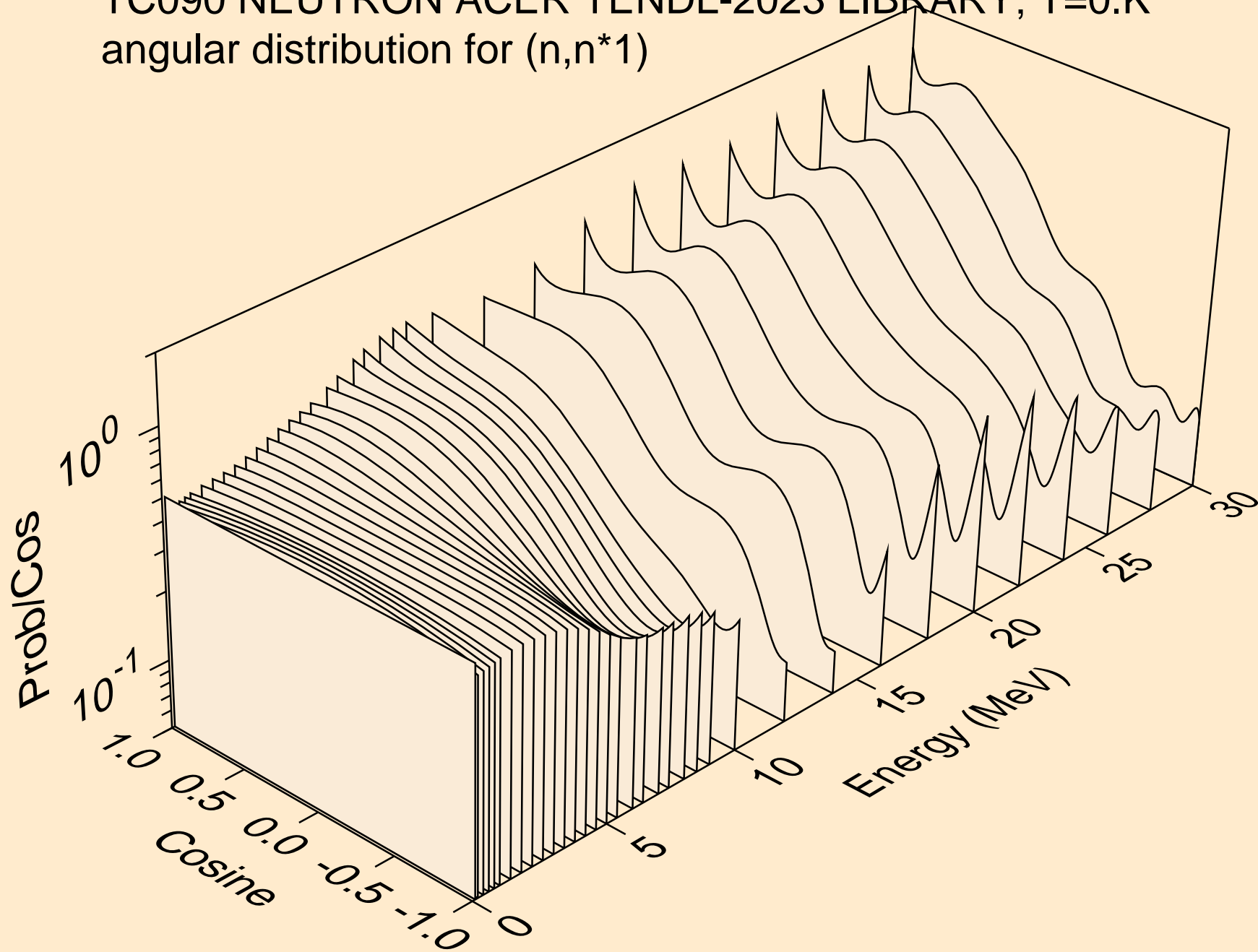

TC090 NEUTRON ACER TENDL-2023 LIBRARY; T=0.K  
angular distribution for (n,n\*2)

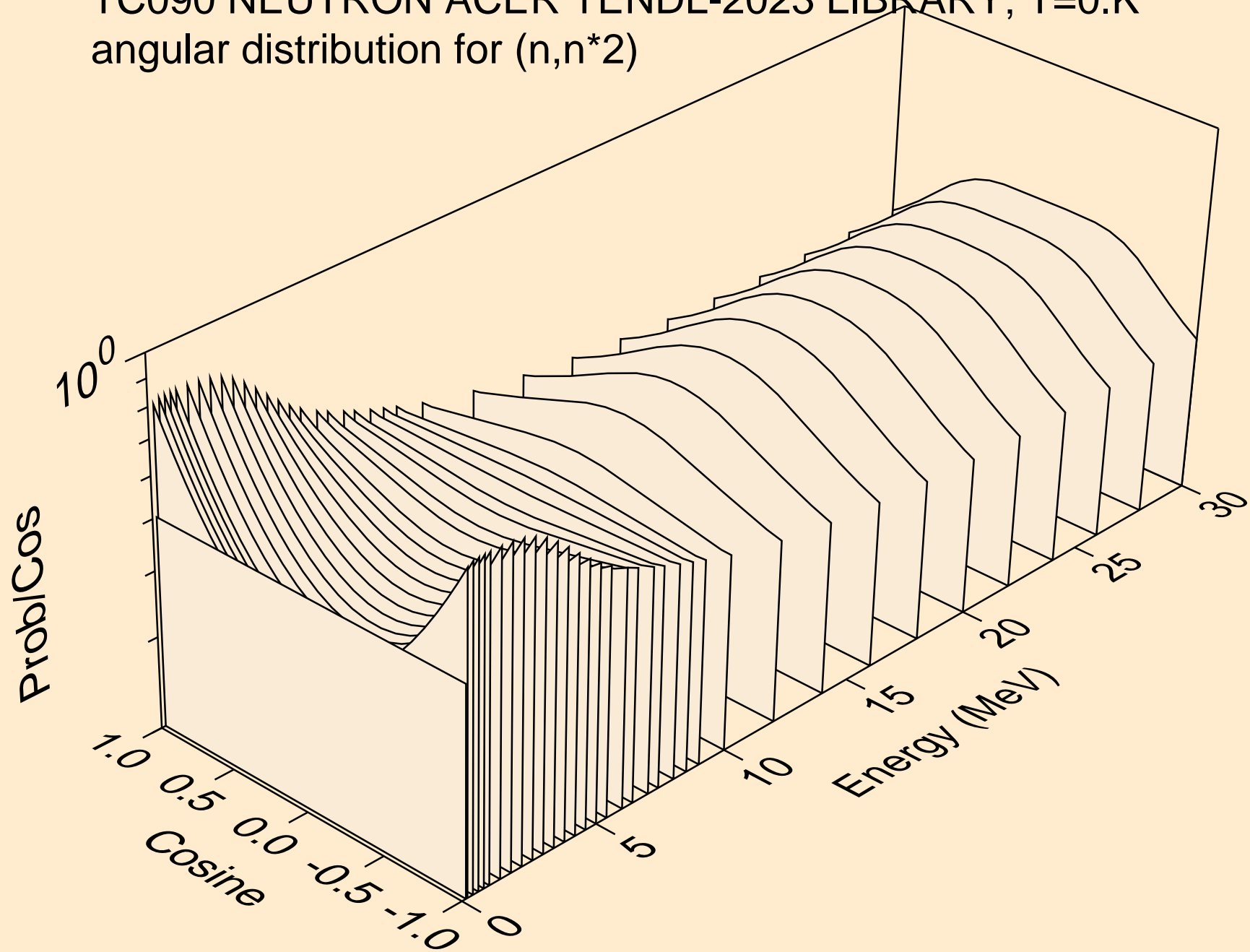

TC090 NEUTRON ACER TENDL-2023 LIBRARY; T=0.K  
angular distribution for (n,n\*3)

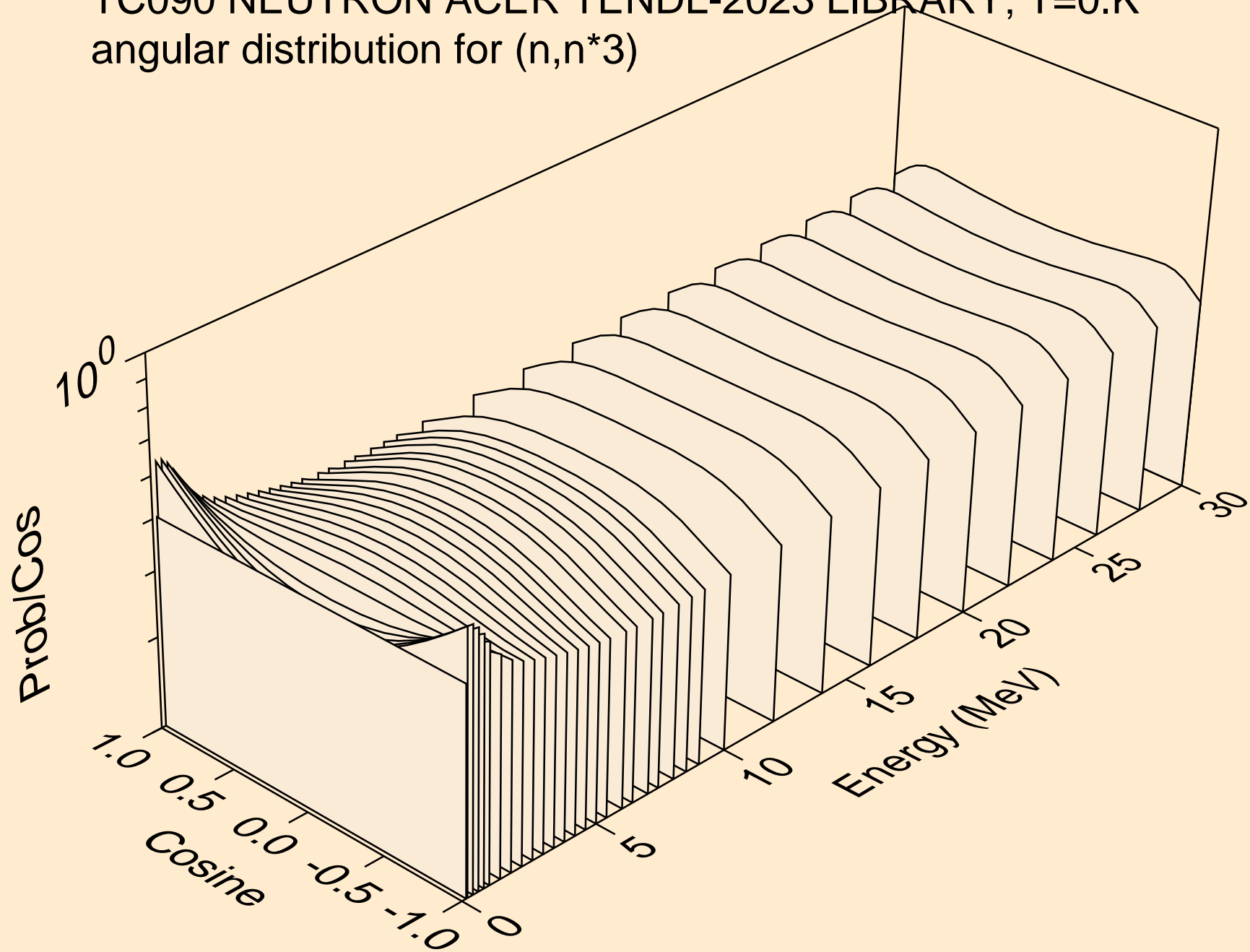

TC090 NEUTRON ACER TENDL-2023 LIBRARY; T=0.K  
angular distribution for (n,n\*4)

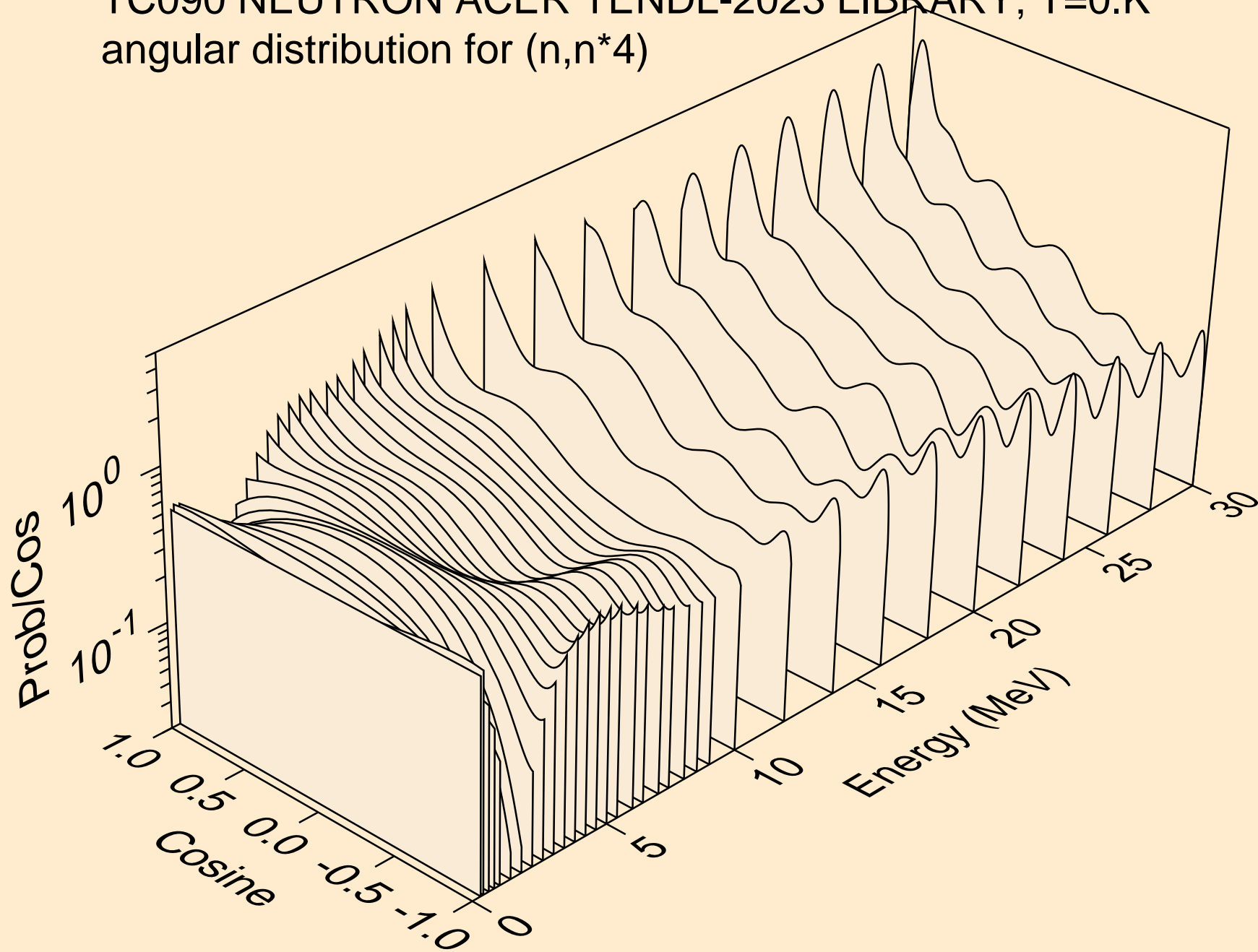

TC090 NEUTRON ACER TENDL-2023 LIBRARY; T=0.K  
angular distribution for (n,n\*5)

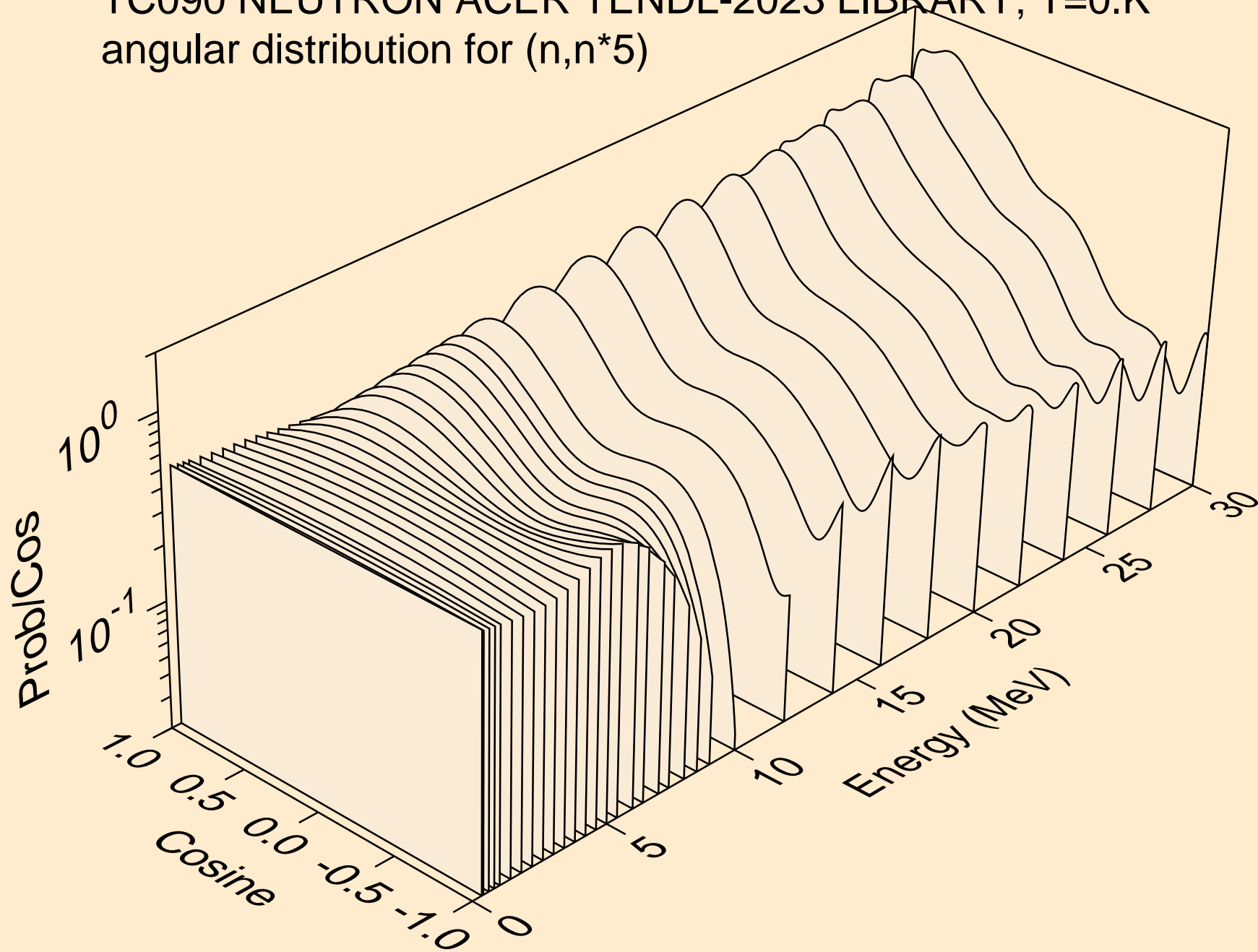



TC090 NEUTRON ACER TENDL-2023 LIBRARY; T=0.K  
angular distribution for (n,n\*6)

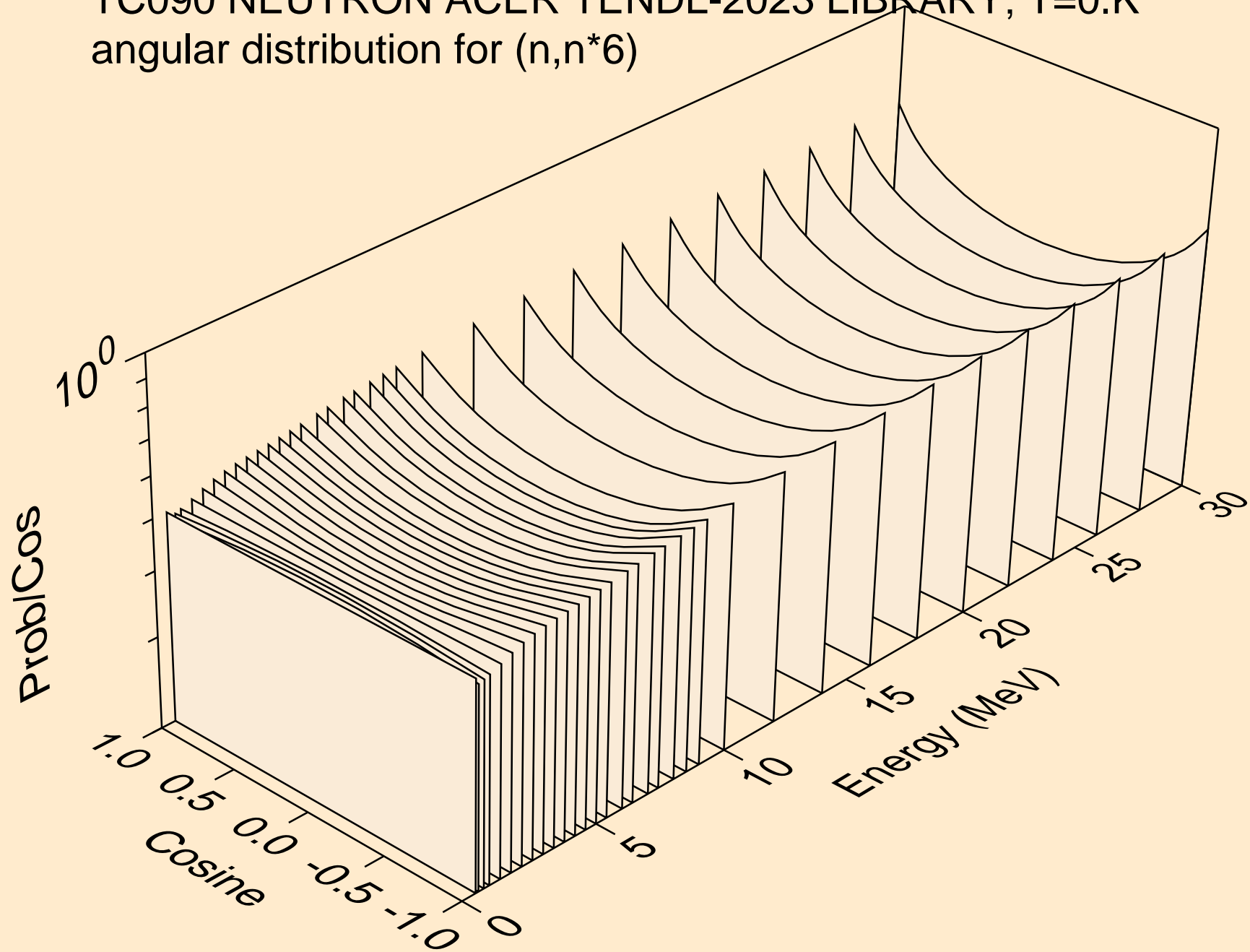

TC090 NEUTRON ACER TENDL-2023 LIBRARY; T=0.K  
angular distribution for (n,n\*7)

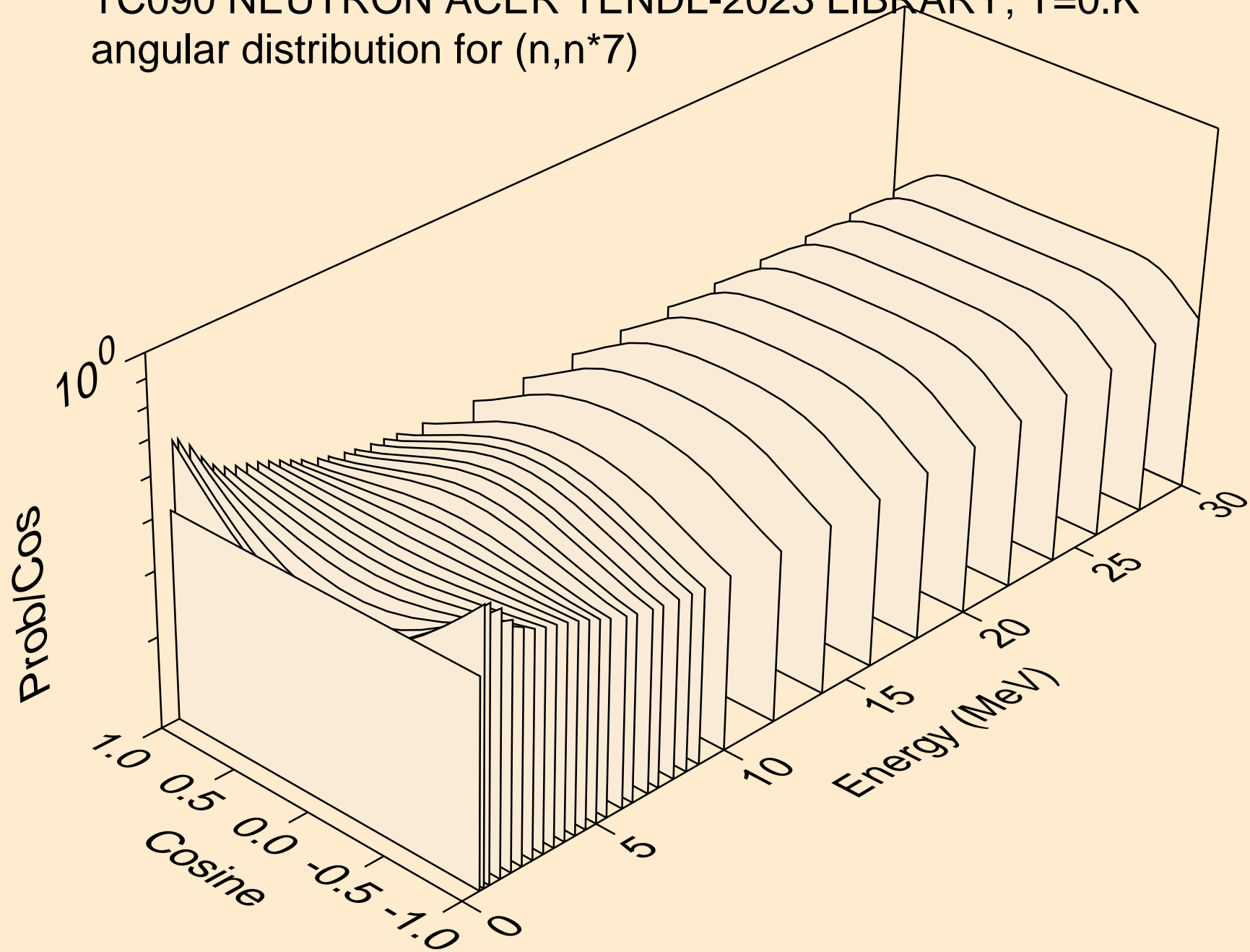

TC090 NEUTRON ACER TENDL-2023 LIBRARY; T=0.K  
angular distribution for (n,n\*8)

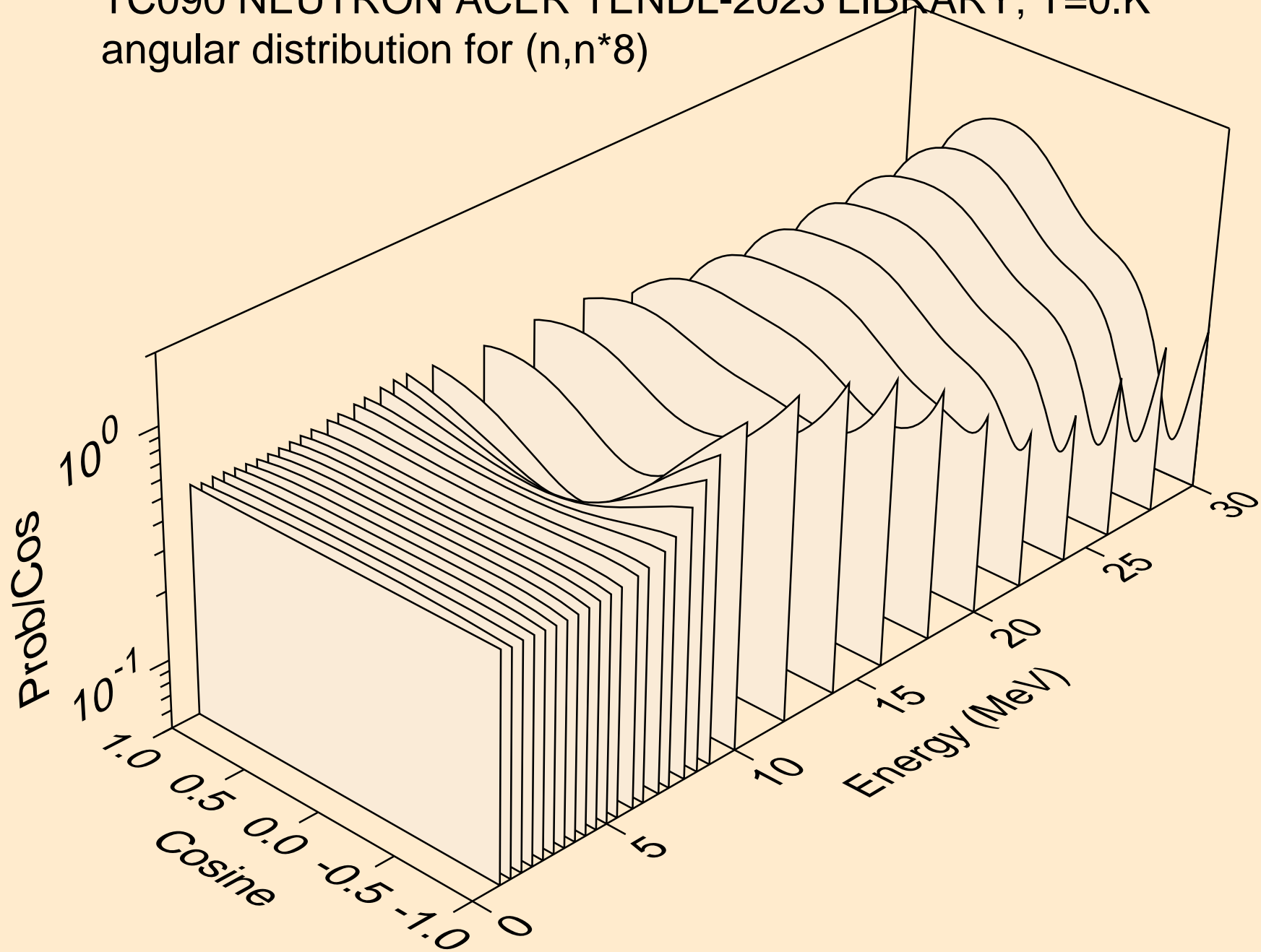

TC090 NEUTRON ACER TENDL-2023 LIBRARY; T=0.K  
angular distribution for (n,n\*9)

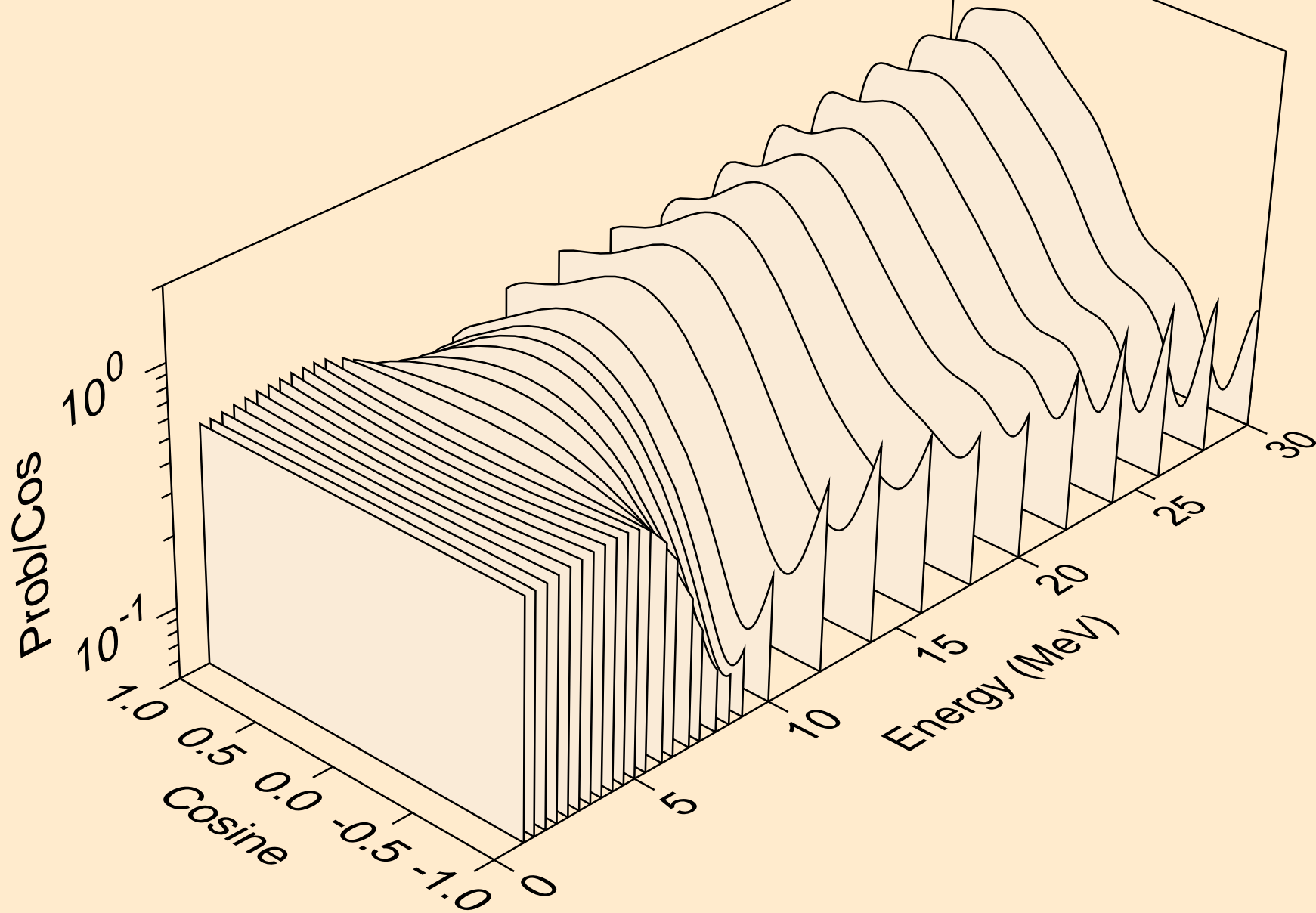

TC090 NEUTRON ACER TENDL-2023 LIBRARY; T=0.K  
angular distribution for (n,n\*10)

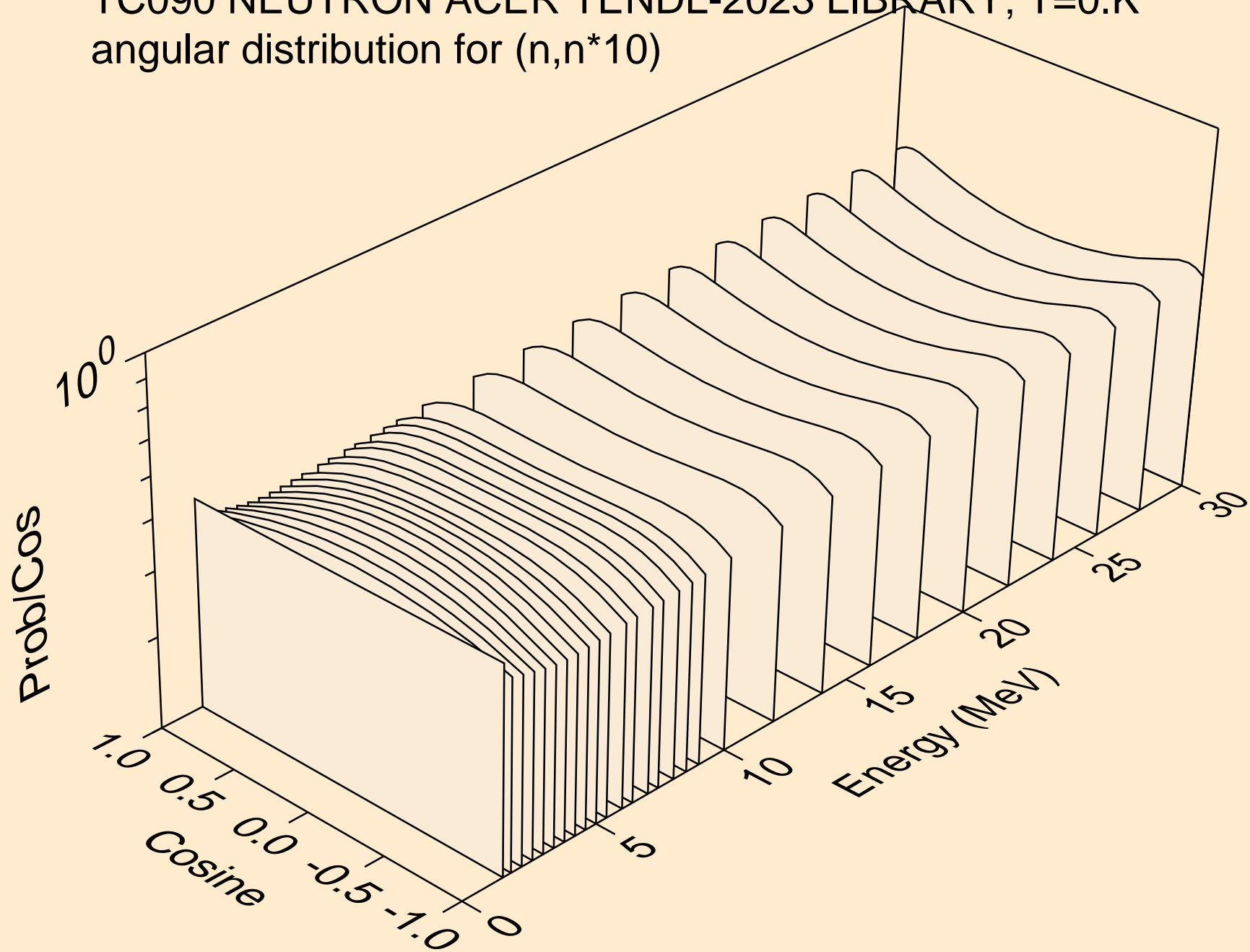

TC090 NEUTRON ACER TENDL-2023 LIBRARY; T=0.K  
angular distribution for (n,n\*11)

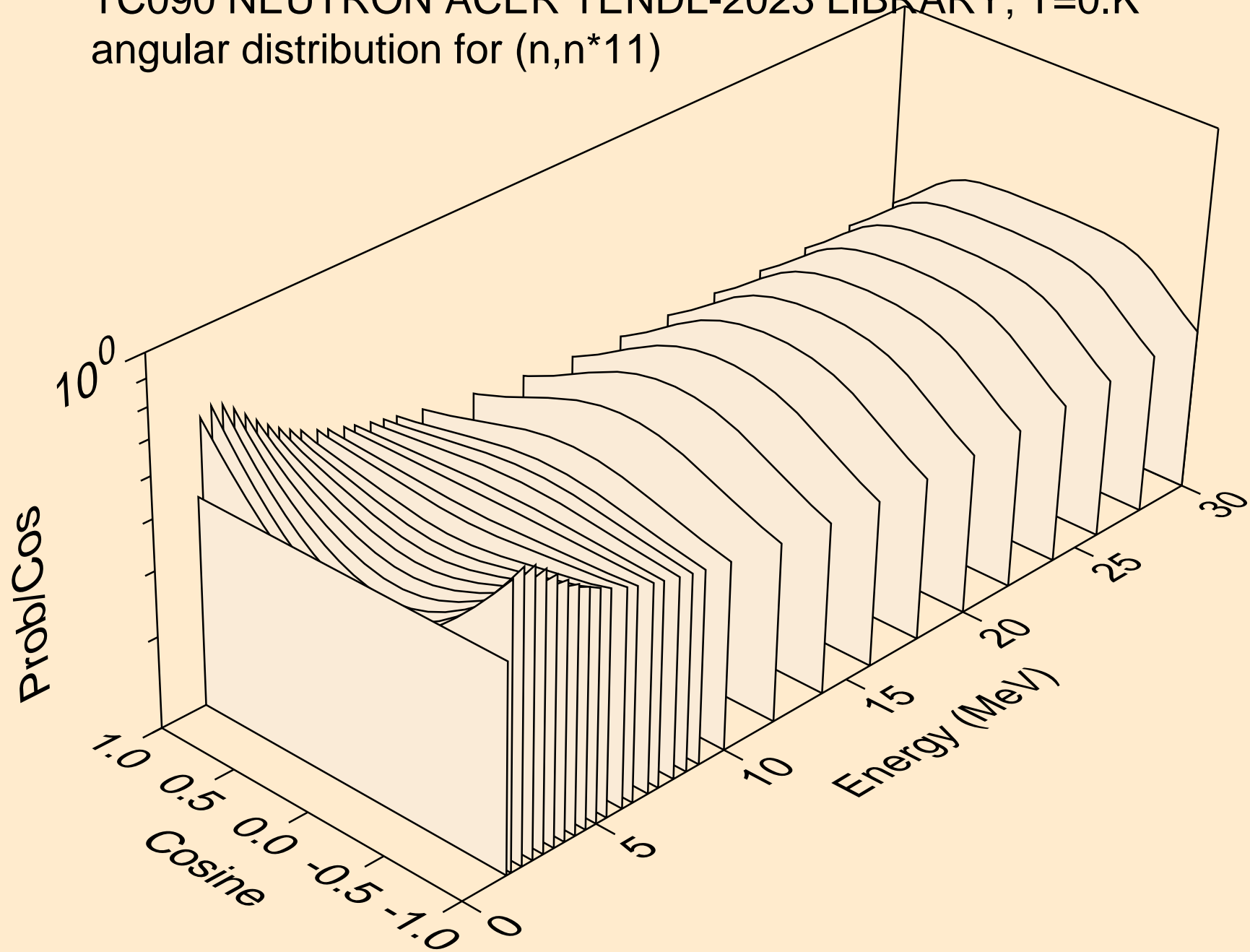

TC090 NEUTRON ACER TENDL-2023 LIBRARY; T=0.K  
angular distribution for (n,n\*12)

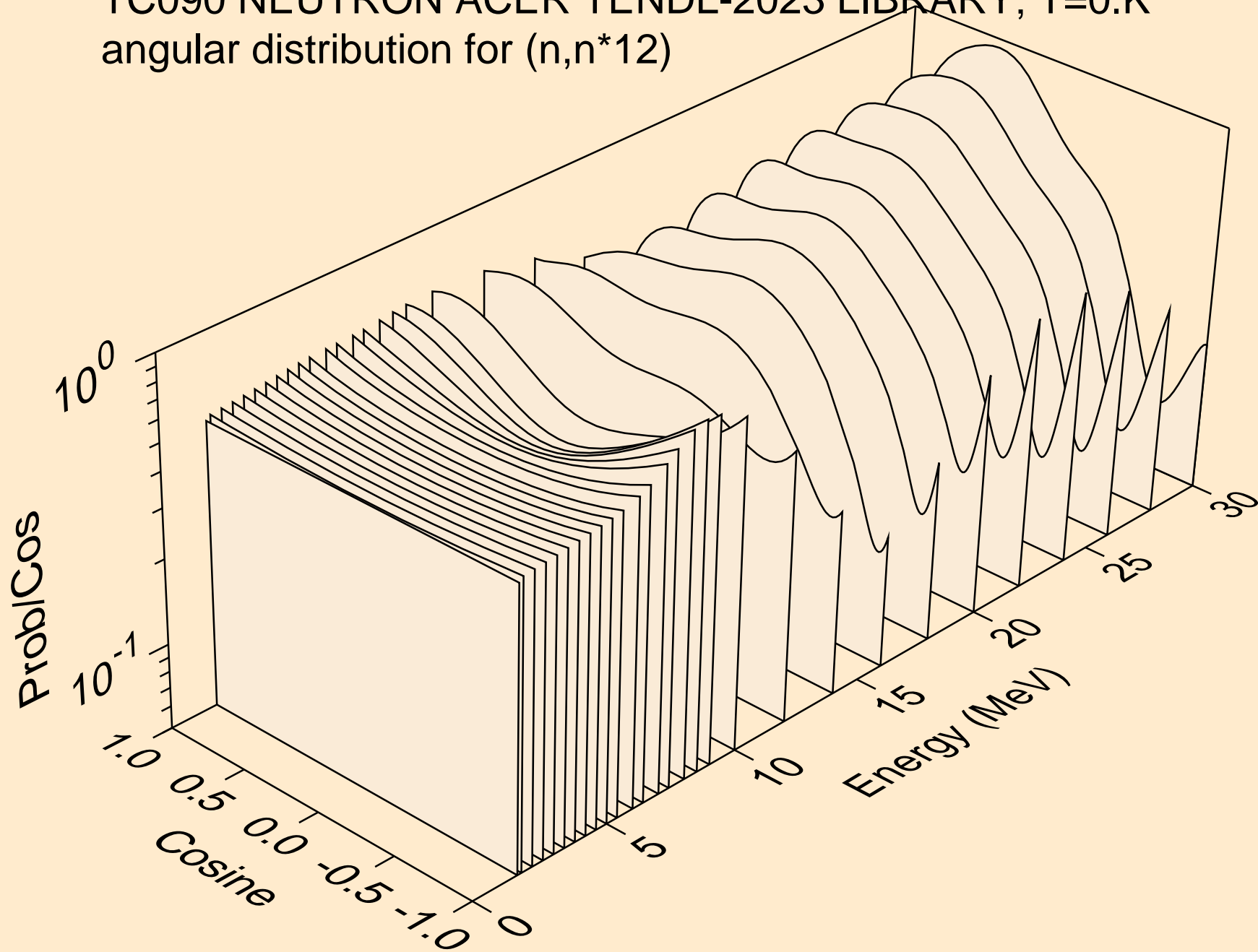

TC090 NEUTRON ACER TENDL-2023 LIBRARY; T=0.K  
angular distribution for (n,n\*13)

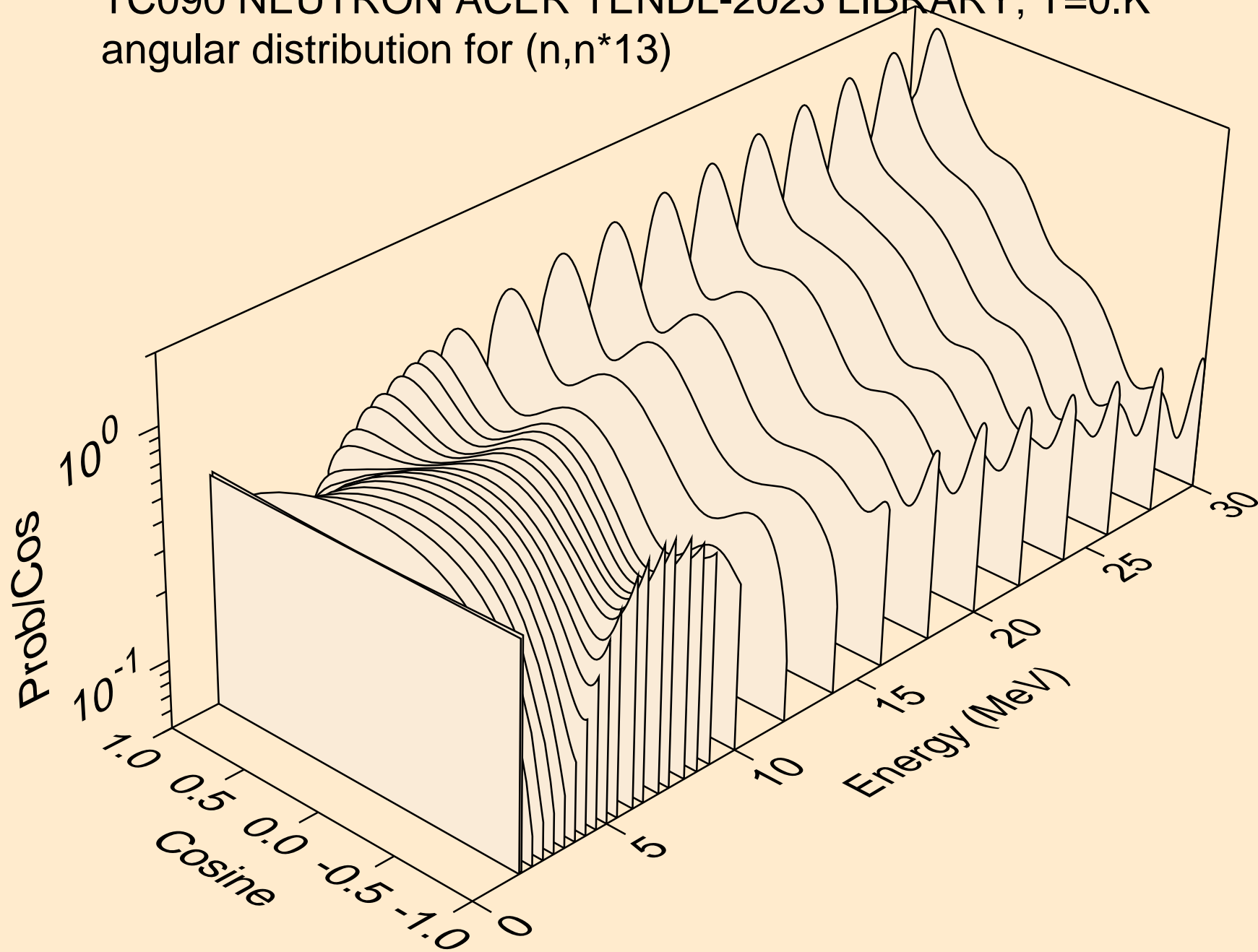



TC090 NEUTRON ACER TENDL-2023 LIBRARY; T=0.K  
Neutron emission for (n,x)

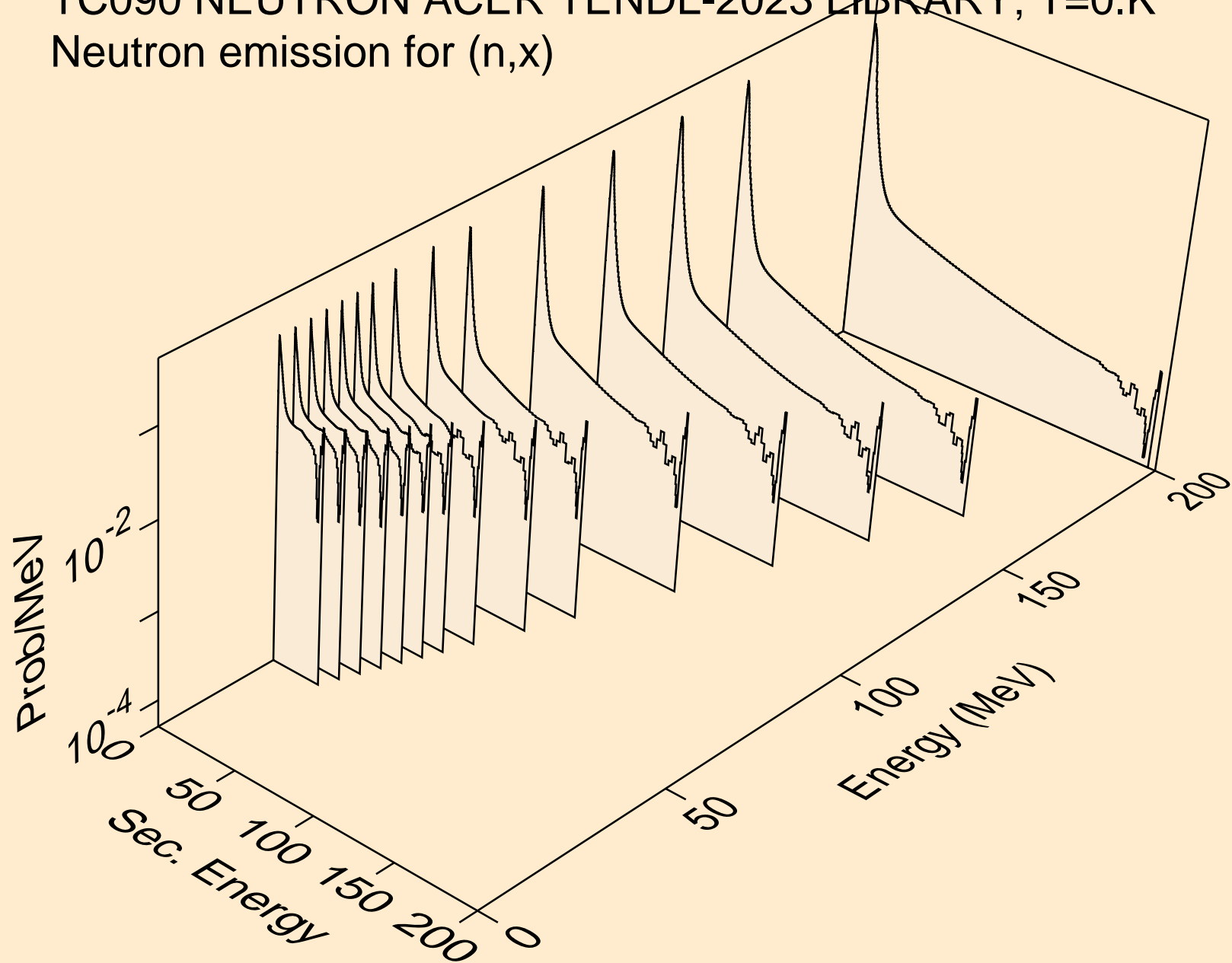

TC090 NEUTRON ACER TENDL-2023 LIBRARY; T=0.K  
Neutron emission for (n,2nd)

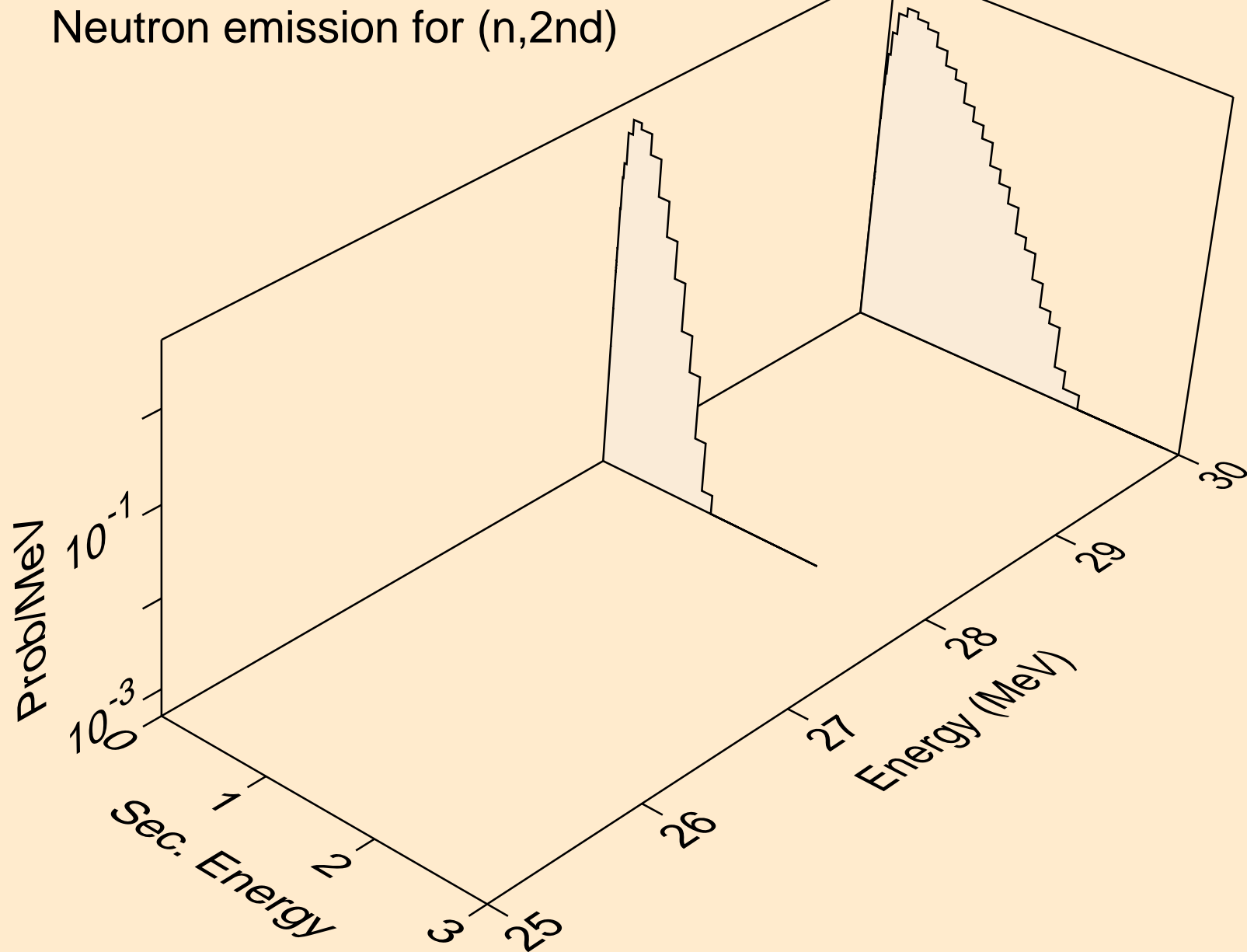

TC090 NEUTRON ACER TENDL-2023 LIBRARY; T=0.K  
Neutron emission for (n,2n)

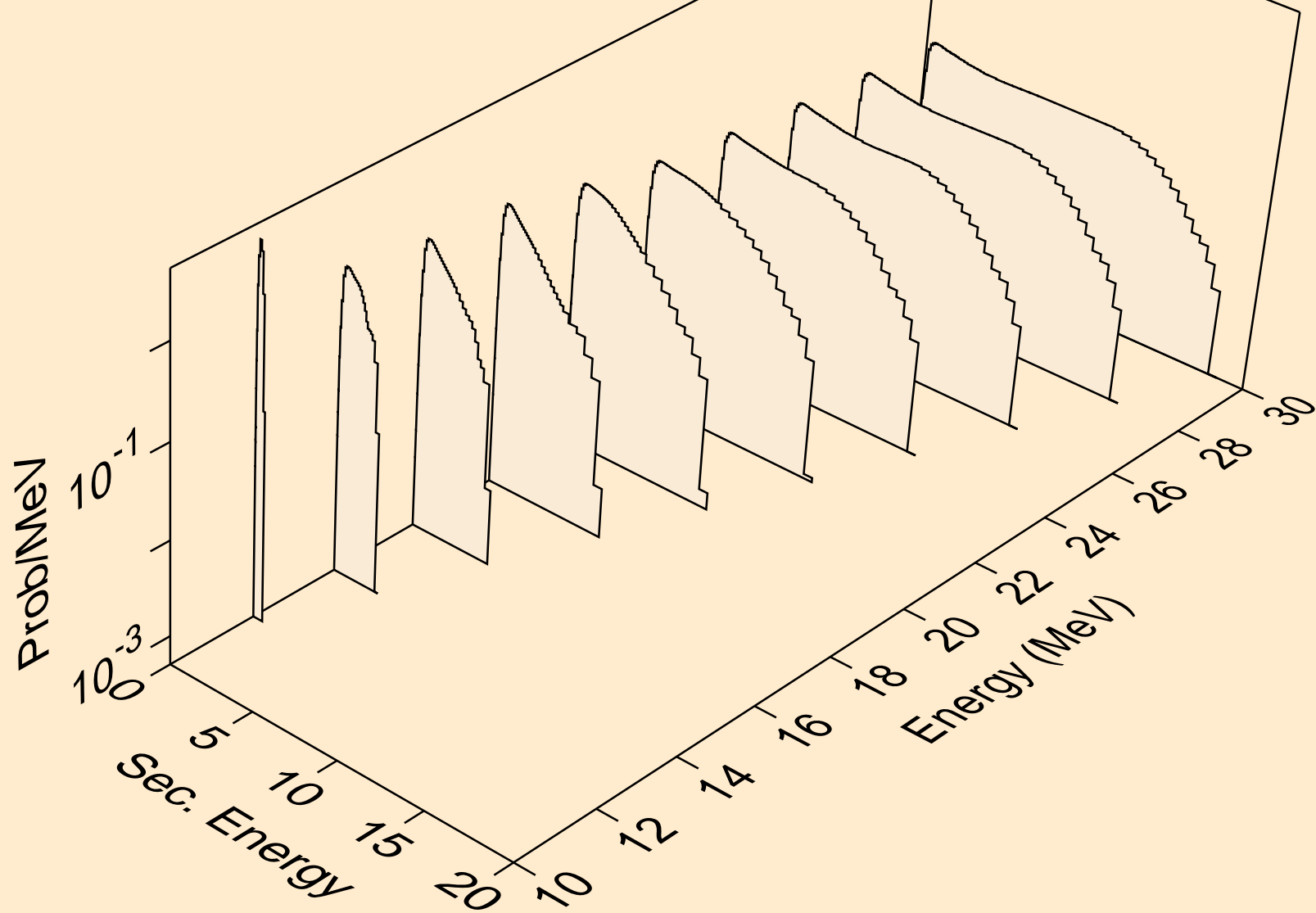

TC090 NEUTRON ACER TENDL-2023 LIBRARY; T=0.K  
Neutron emission for (n,3n)

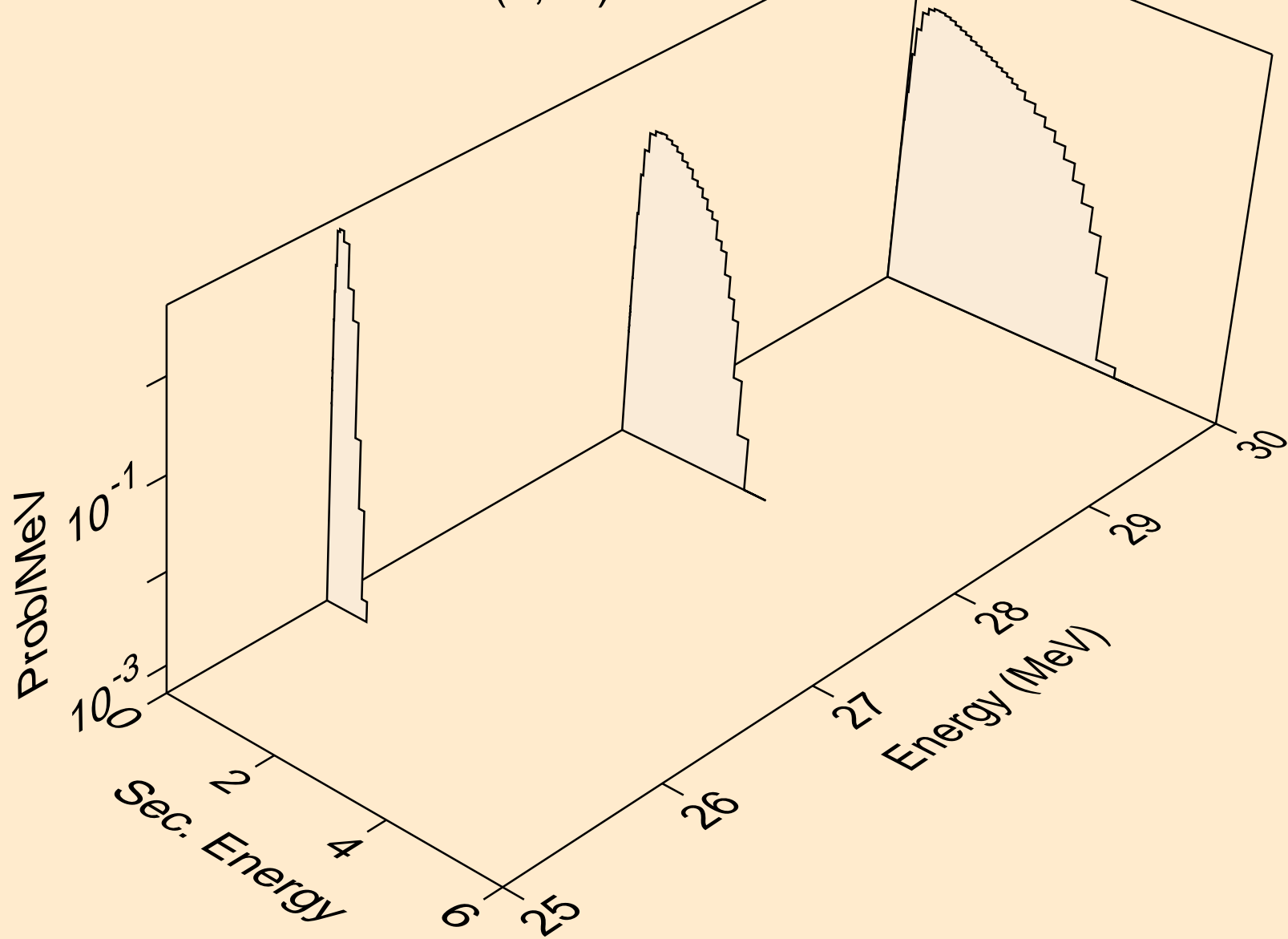

TC090 NEUTRON ACER TENDL-2023 LIBRARY; T=0.K  
Neutron emission for (n,n\*)a

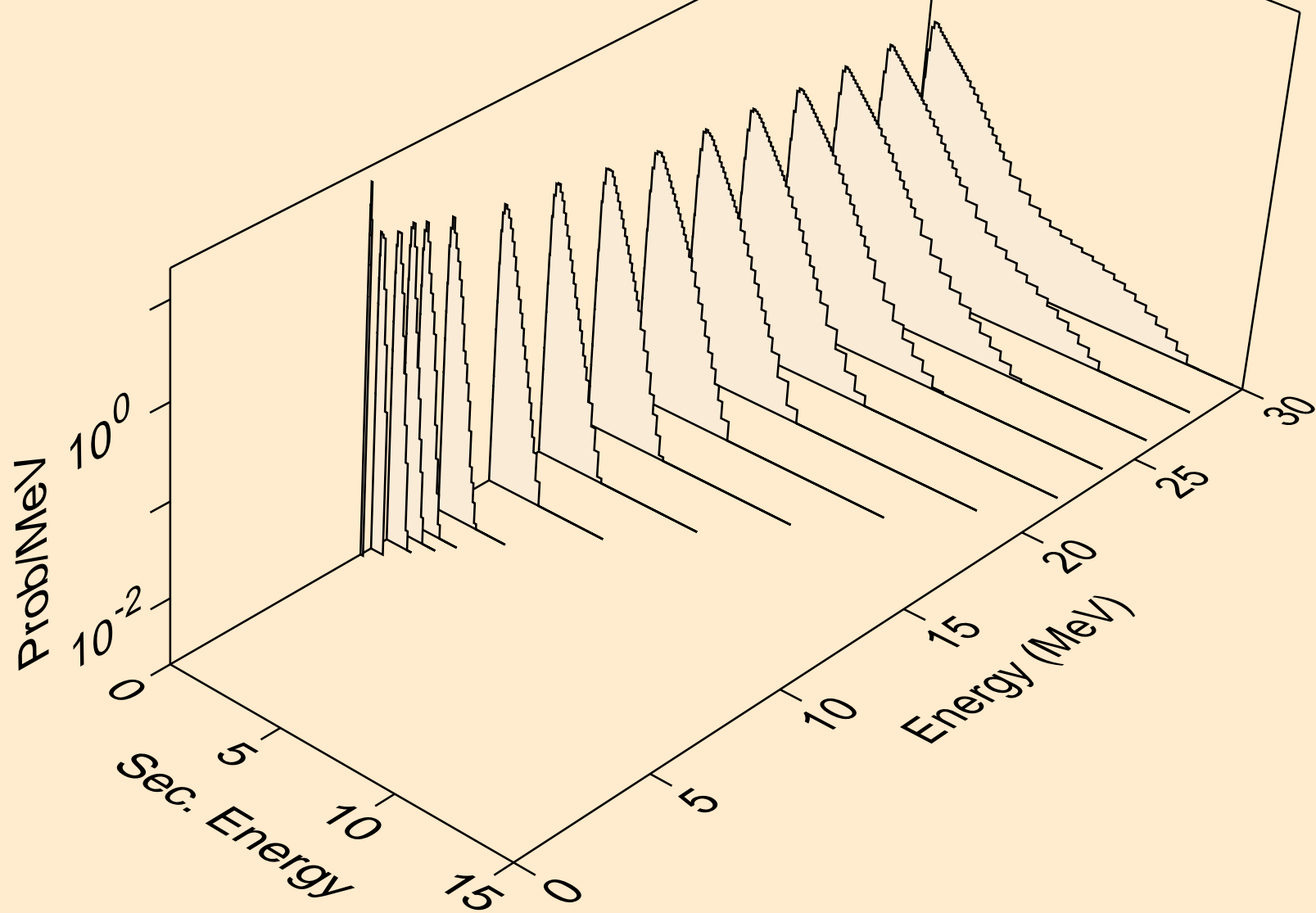

TC090 NEUTRON ACER TENDL-2023 LIBRARY; T=0.K  
Neutron emission for (n,2n)a

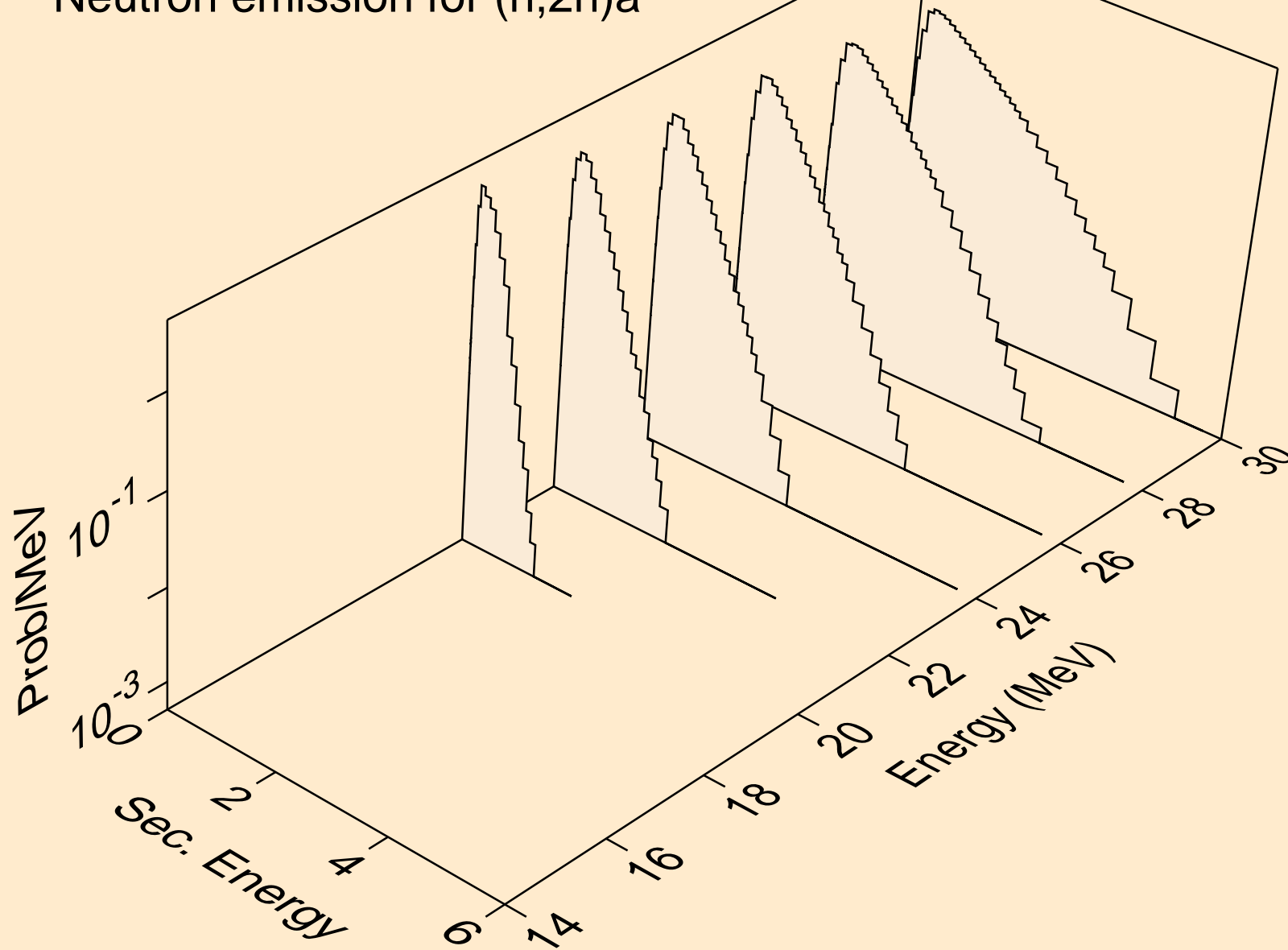

TC090 NEUTRON ACER TENDL-2023 LIBRARY; T=0.K  
Neutron emission for (n,n\*)p

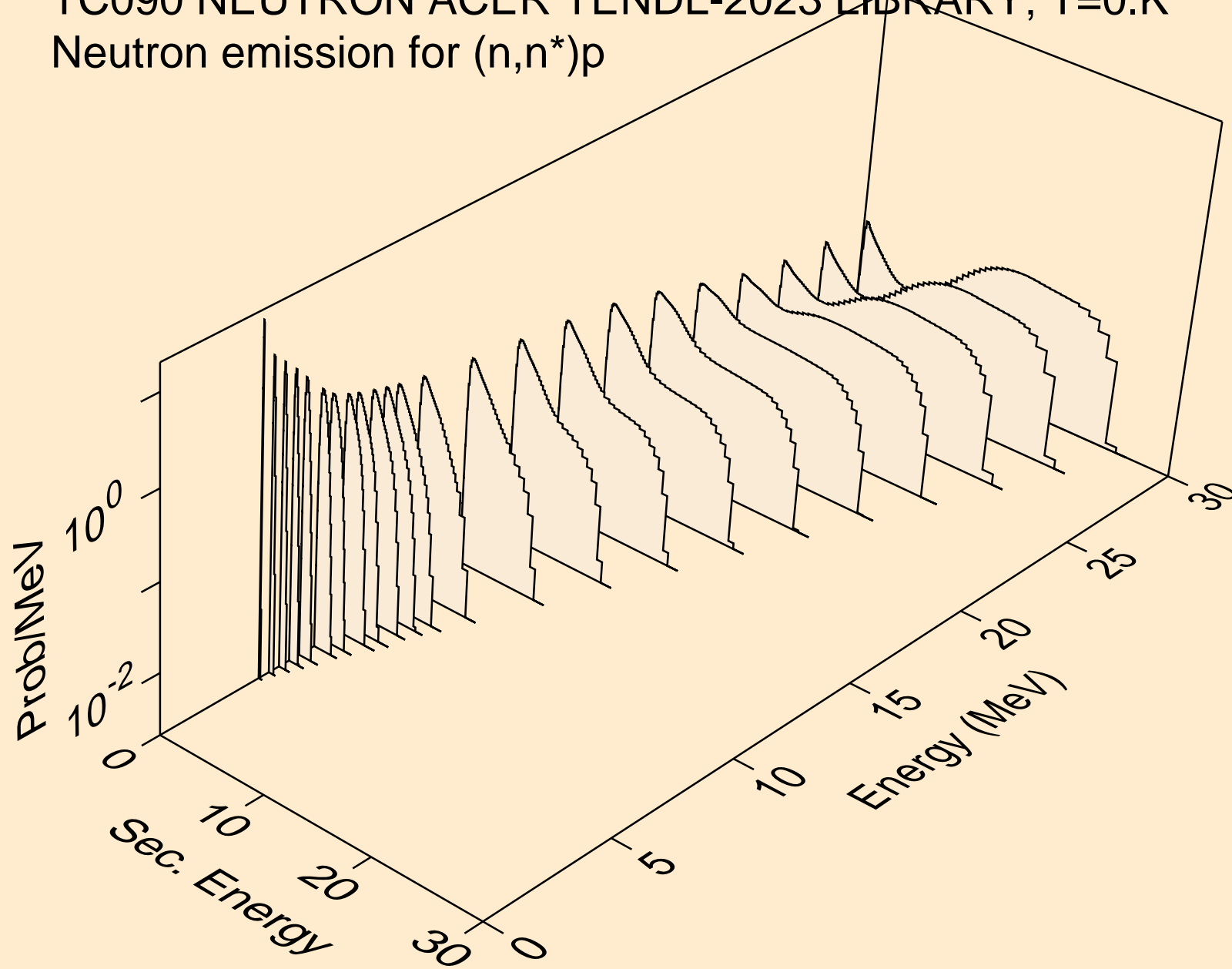

TC090 NEUTRON ACER TENDL-2023 LIBRARY; T=0.K  
Neutron emission for (n,n\*)2a

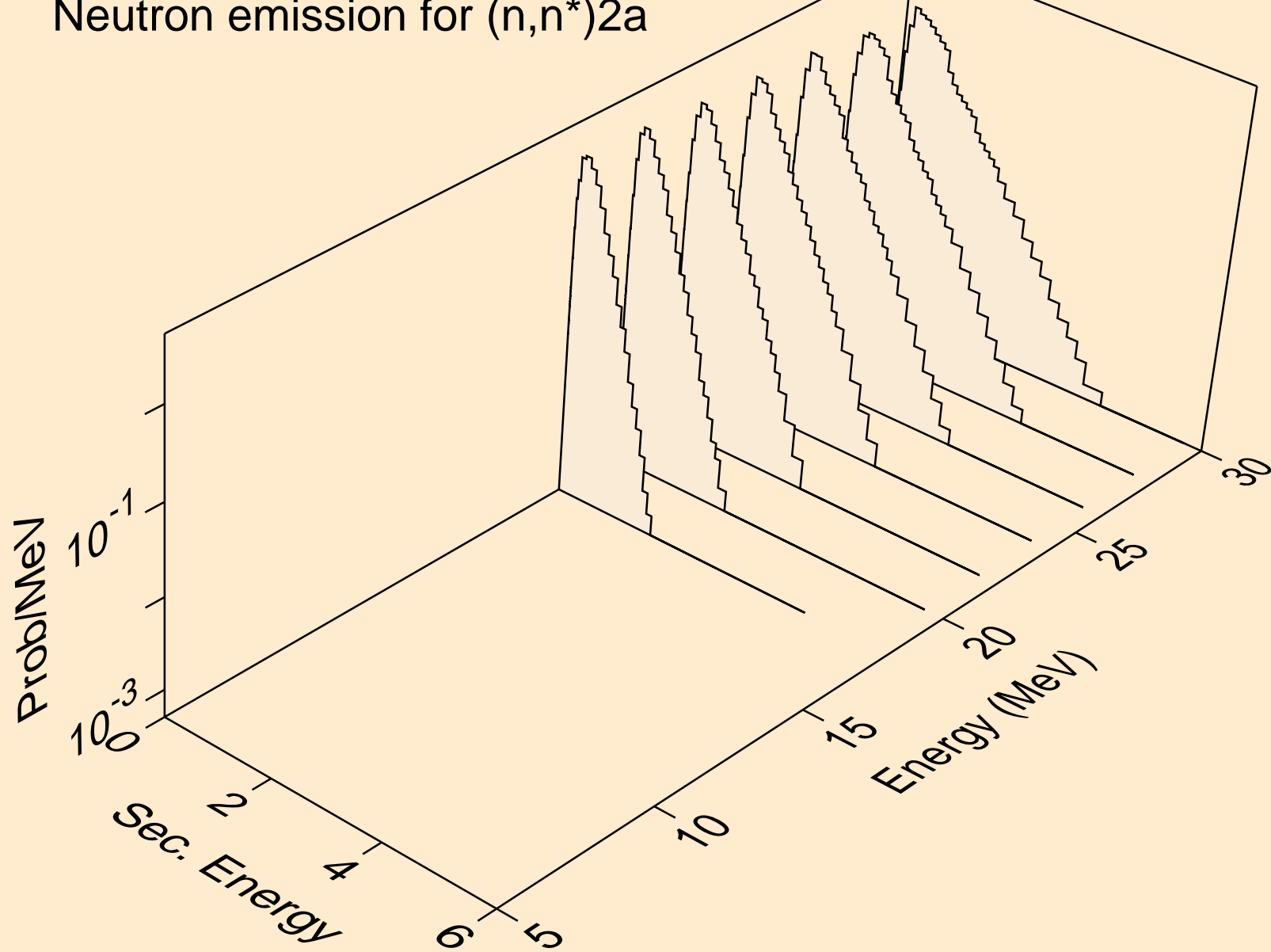



TC090 NEUTRON ACER TENDL-2023 LIBRARY; T=0.K  
Neutron emission for (n,n\*)d

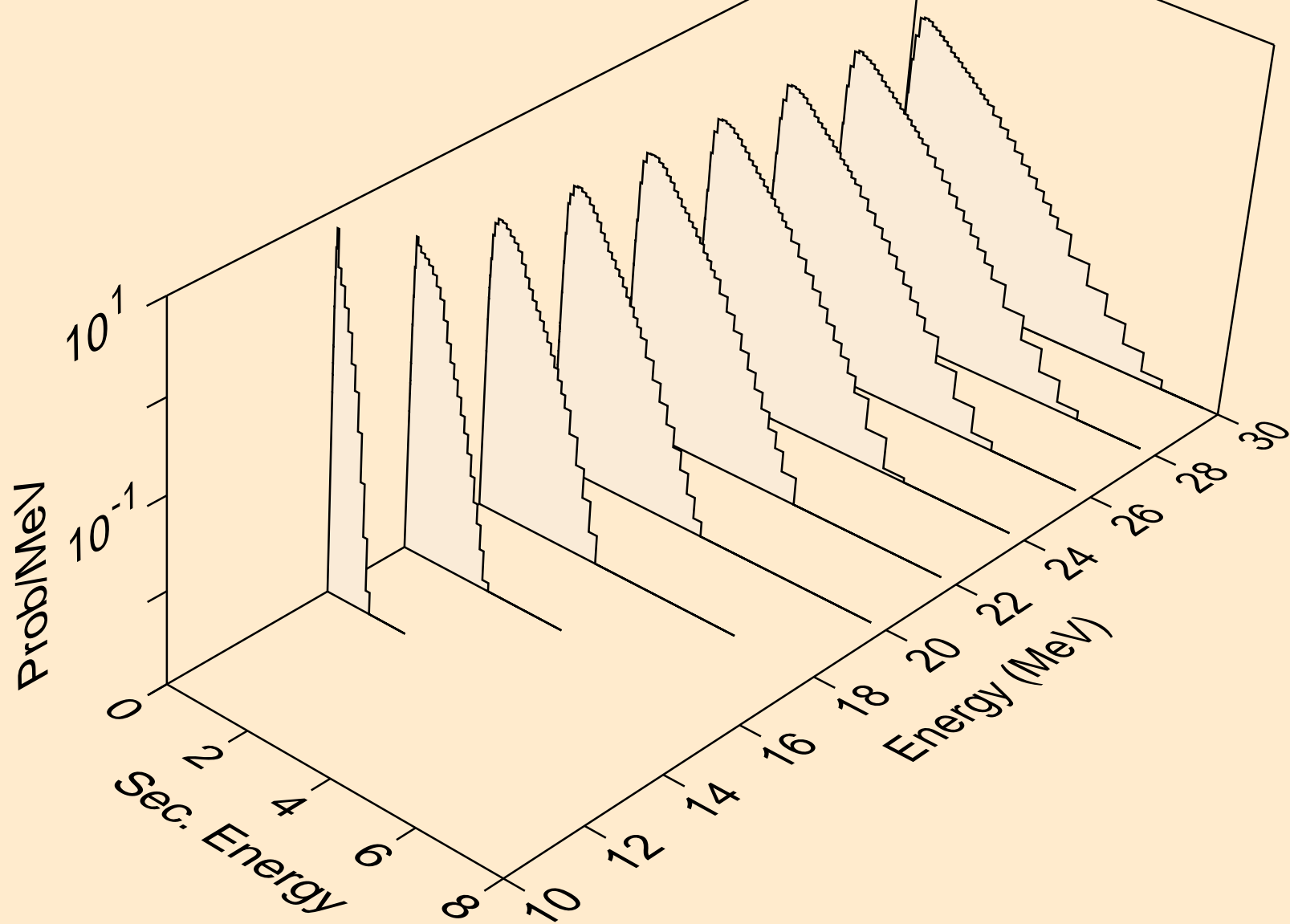

TC090 NEUTRON ACER TENDL-2023 LIBRARY; T=0.K  
Neutron emission for (n,n\*)t

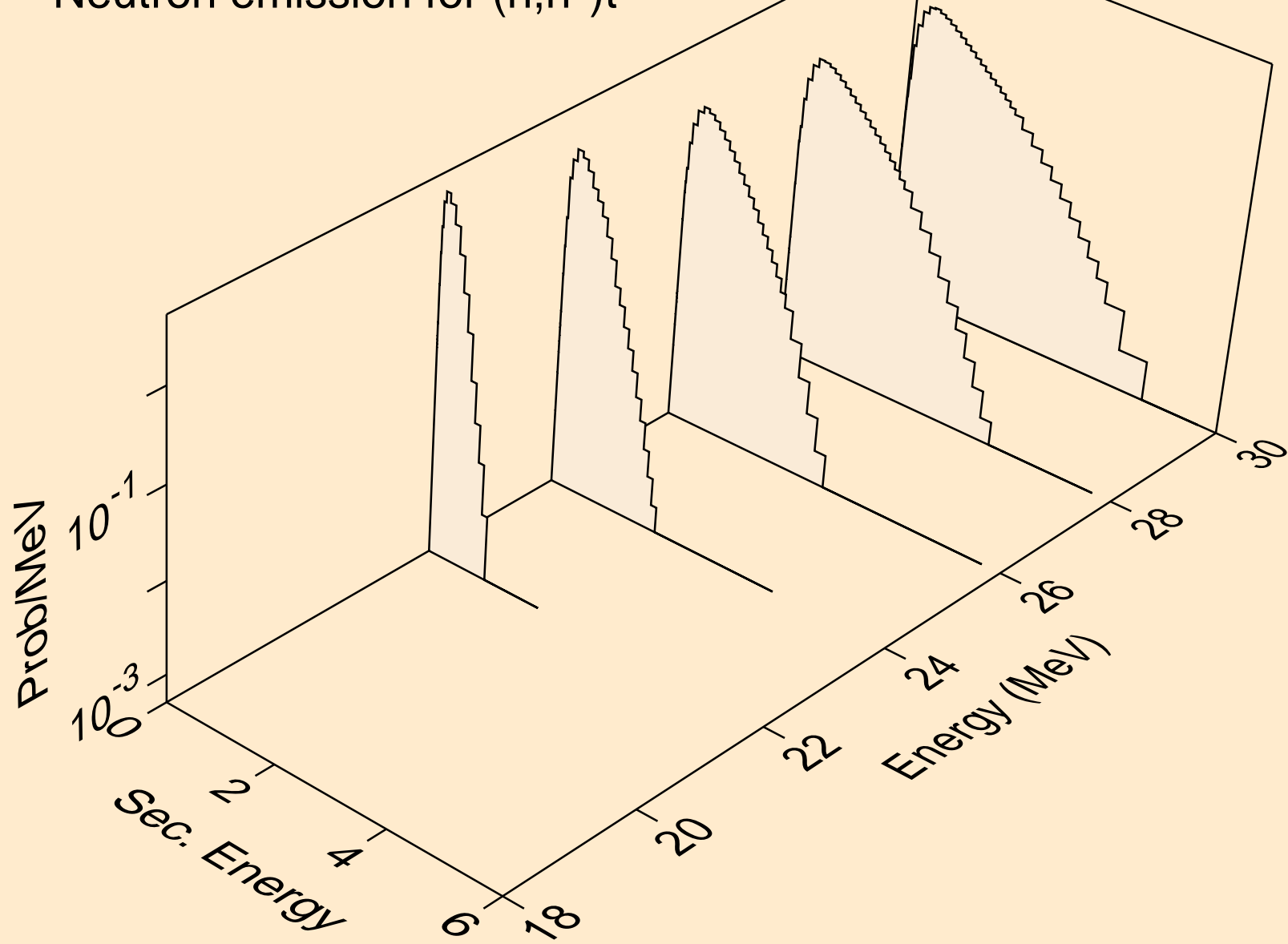

TC090 NEUTRON ACER TENDL-2023 LIBRARY; T=0.K  
Neutron emission for (n,n\*)he3

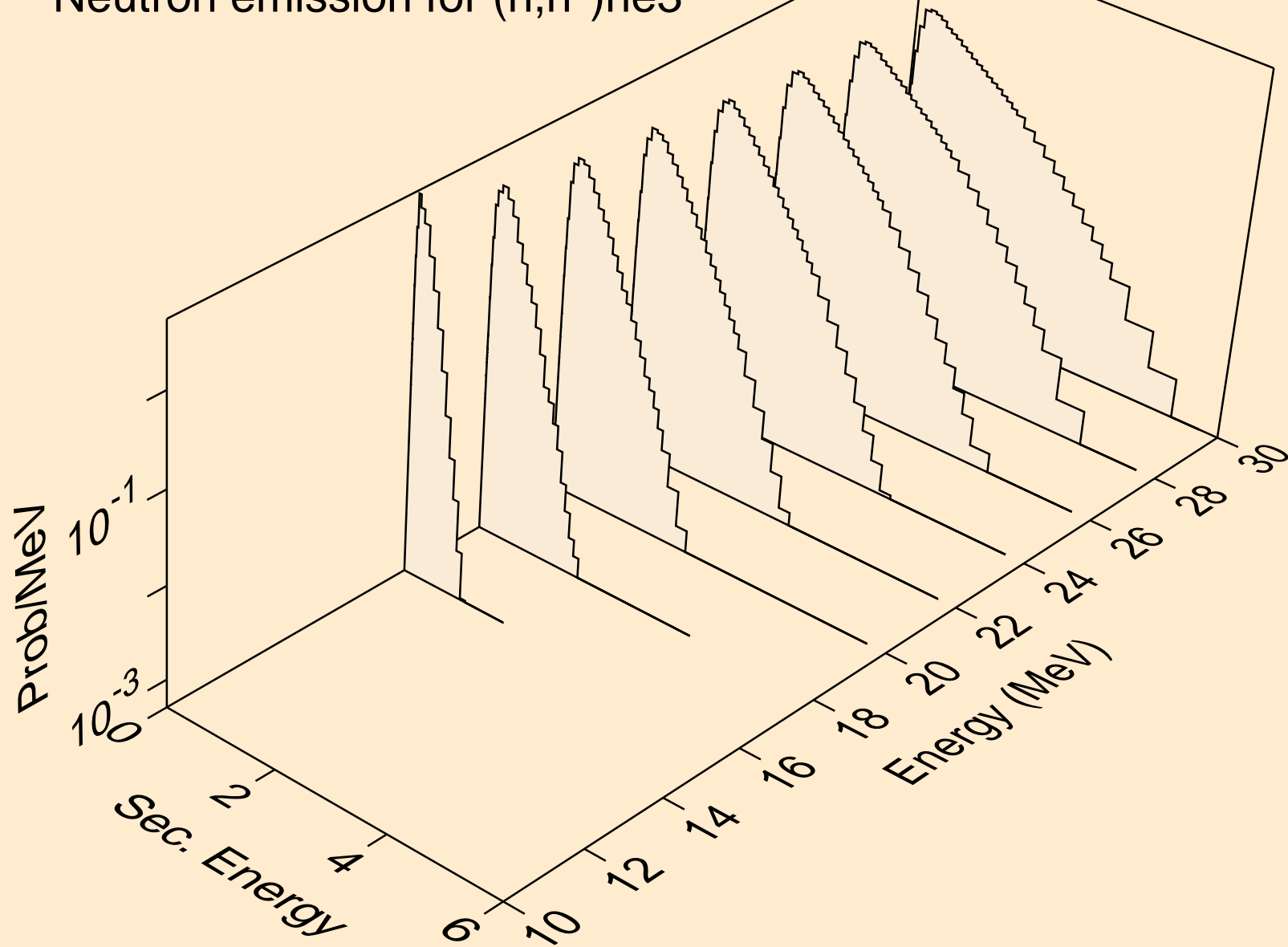

TC090 NEUTRON ACER TENDL-2023 LIBRARY; T=0.K  
Neutron emission for (n,2np)

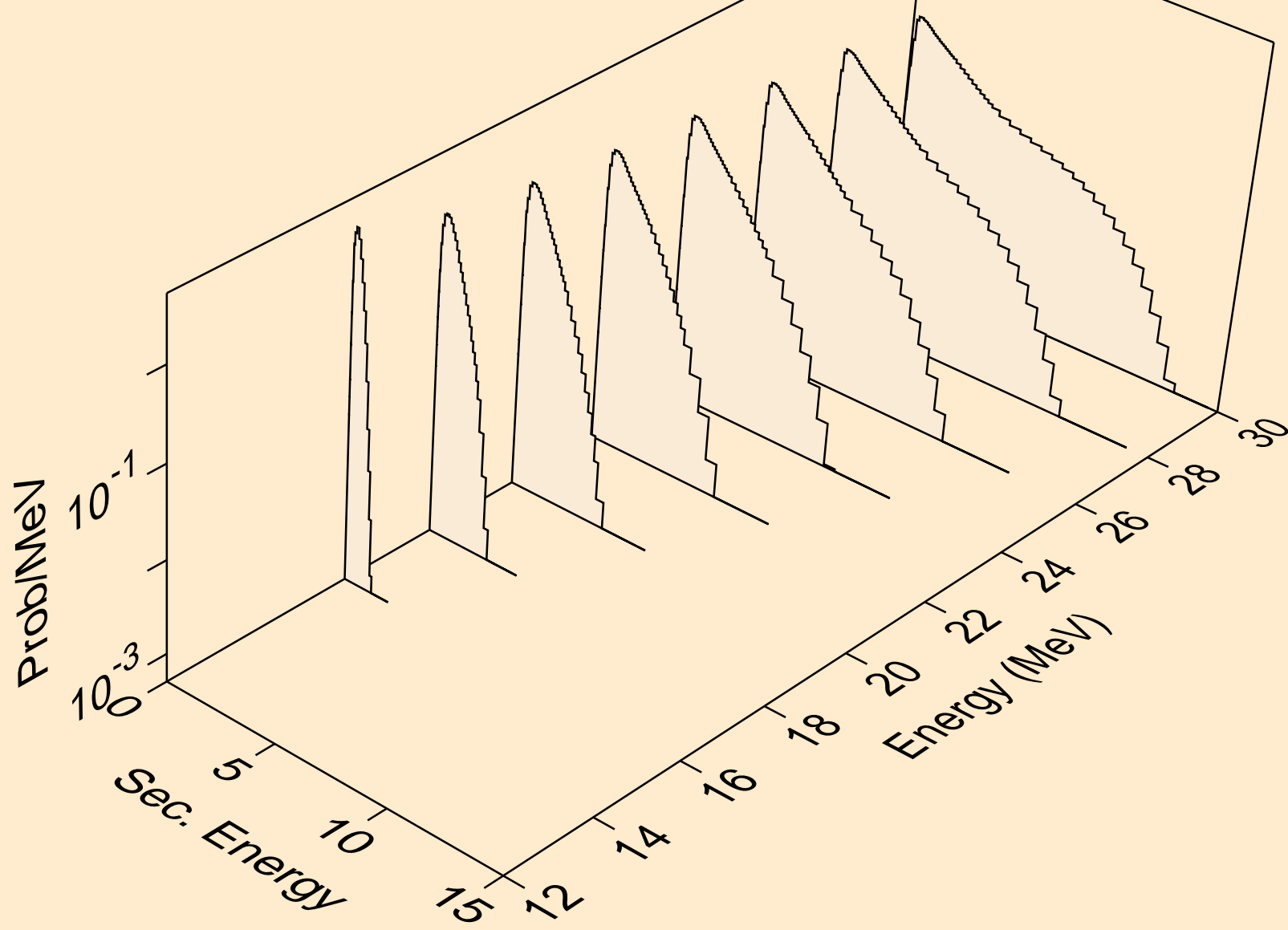

TC090 NEUTRON ACER TENDL-2023 LIBRARY; T=0.K  
Neutron emission for (n,3np)

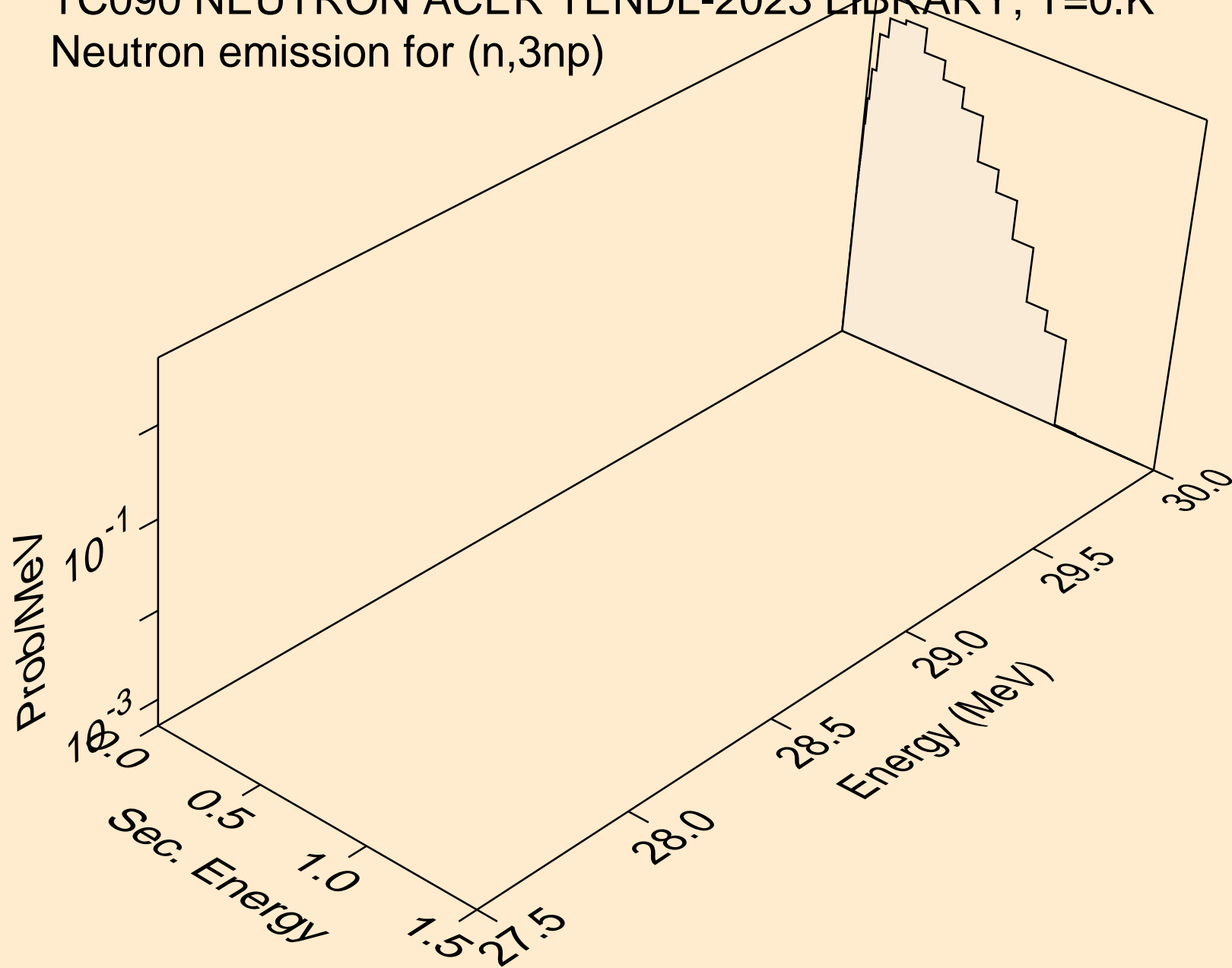

TC090 NEUTRON ACER TENDL-2023 LIBRARY; T=0.K  
Neutron emission for (n,n2p)

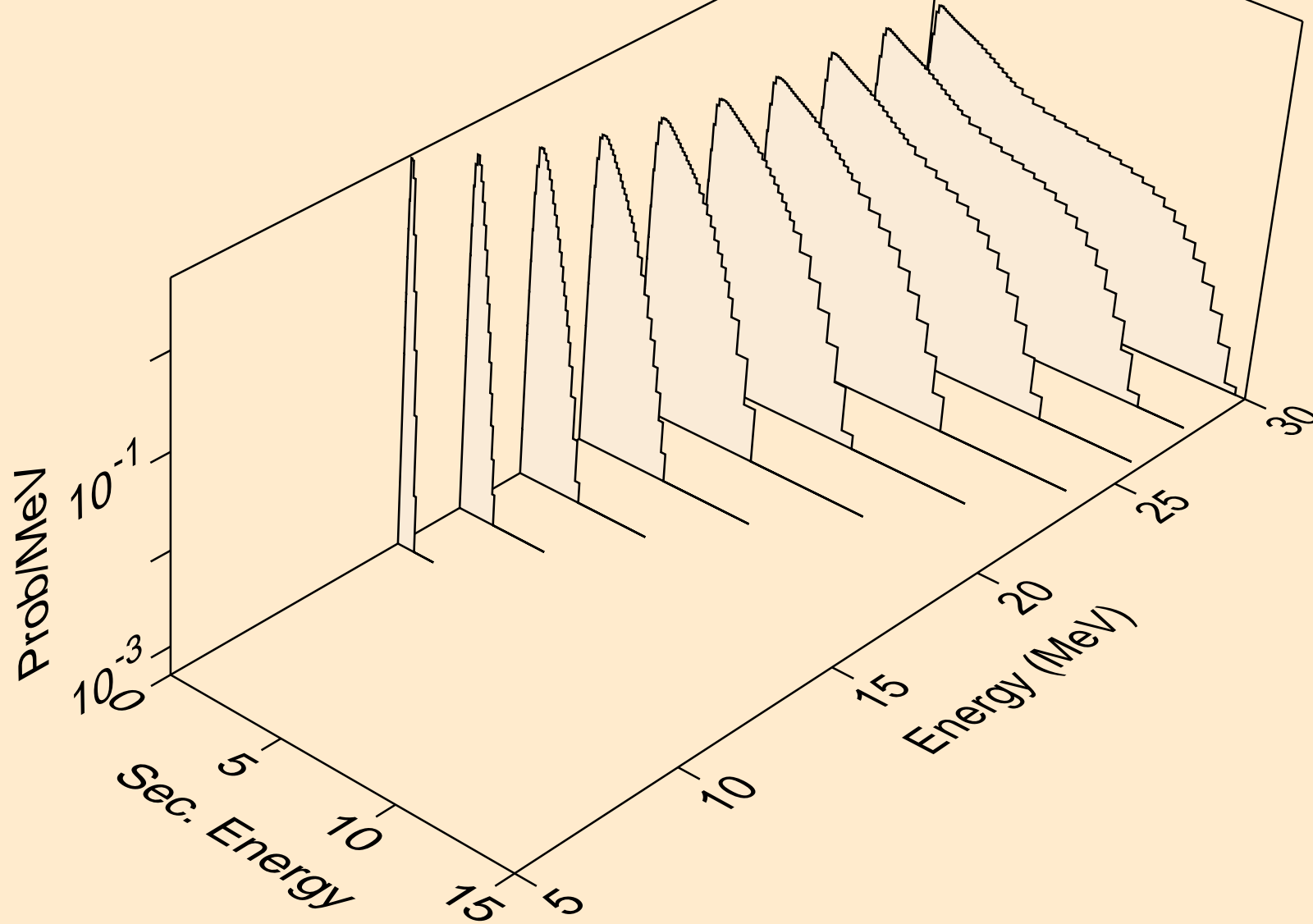

TC090 NEUTRON ACER TENDL-2023 LIBRARY; T=0.K  
Neutron emission for (n,npa)

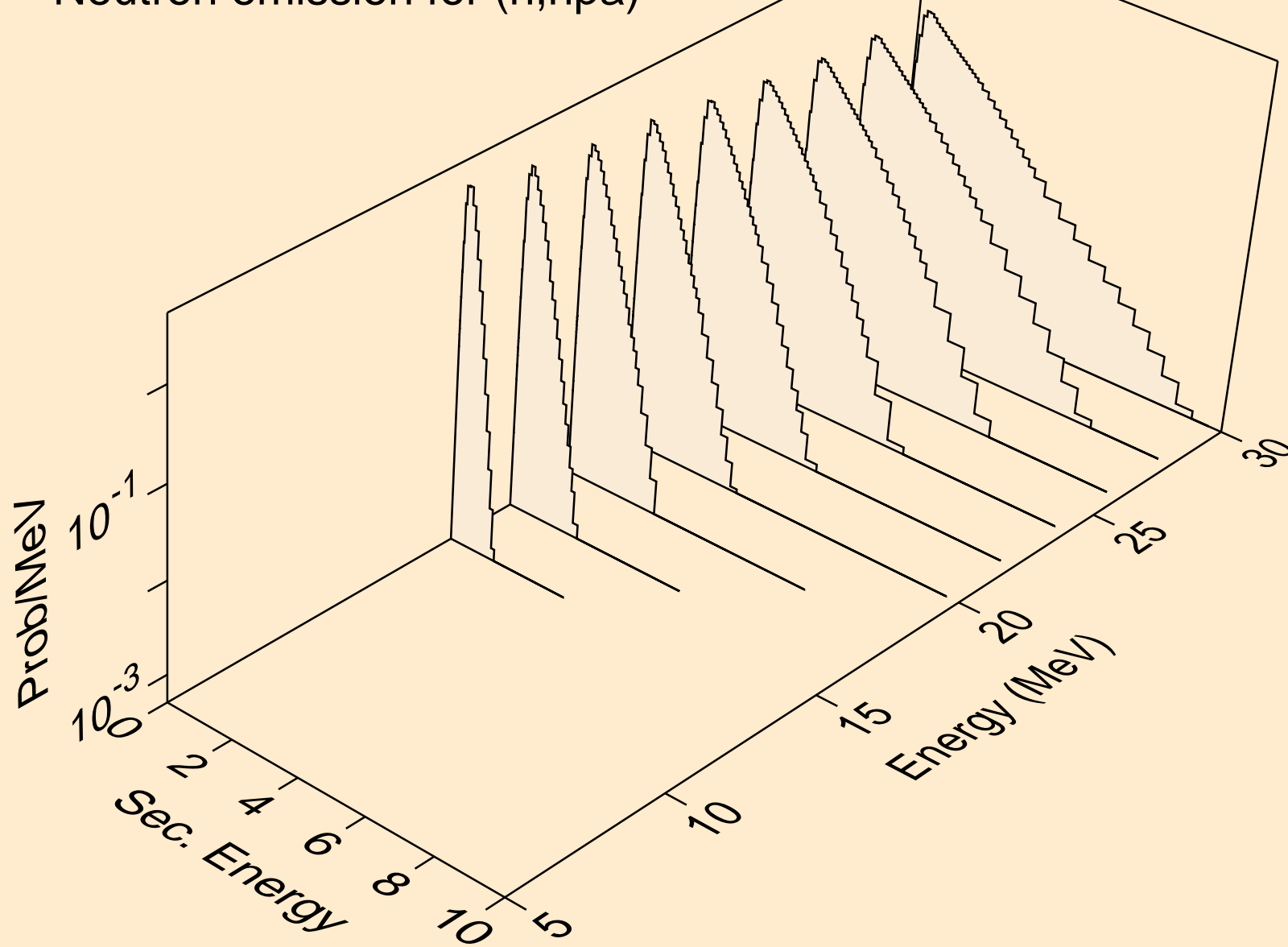

TC090 NEUTRON ACER TENDL-2023 LIBRARY; T=0.K  
Neutron emission for (n,n\*c)

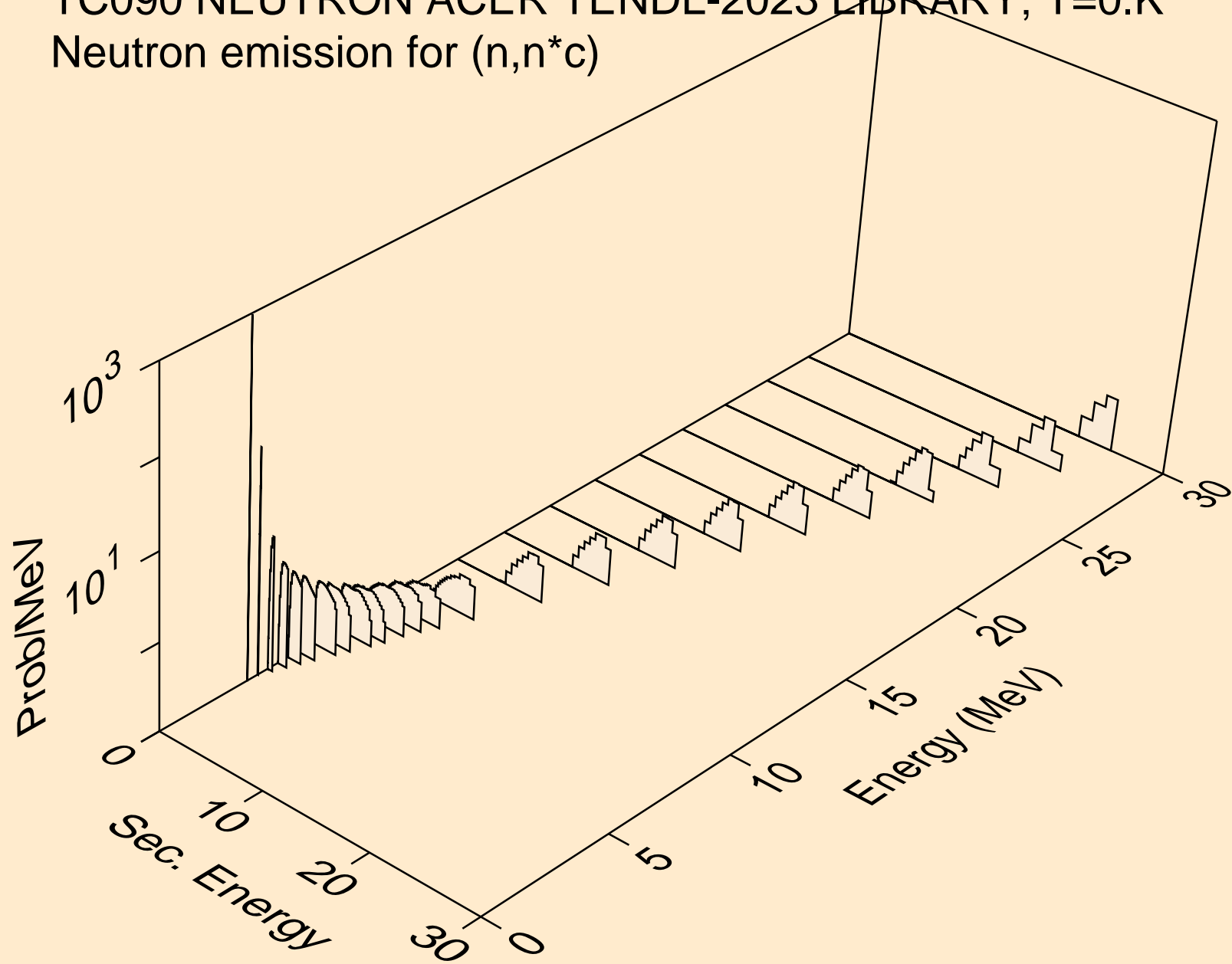



TC090 NEUTRON ACER TENDL-2023 LIBRARY; T=0.K  
Photon emission for (n,x)

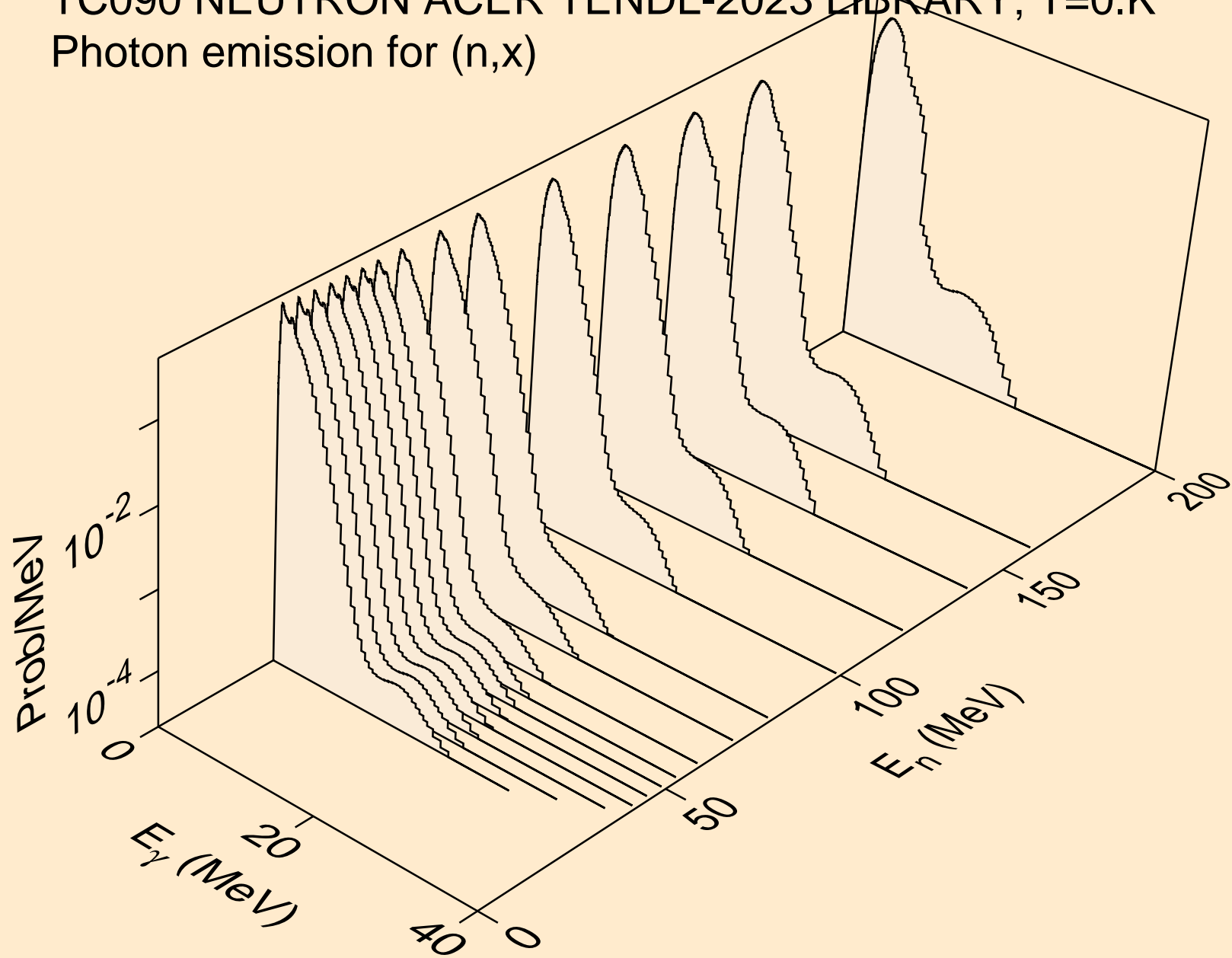

TC090 NEUTRON ACER TENDL-2023 LIBRARY; T=0.K  
Photon emission for (n,2nd)

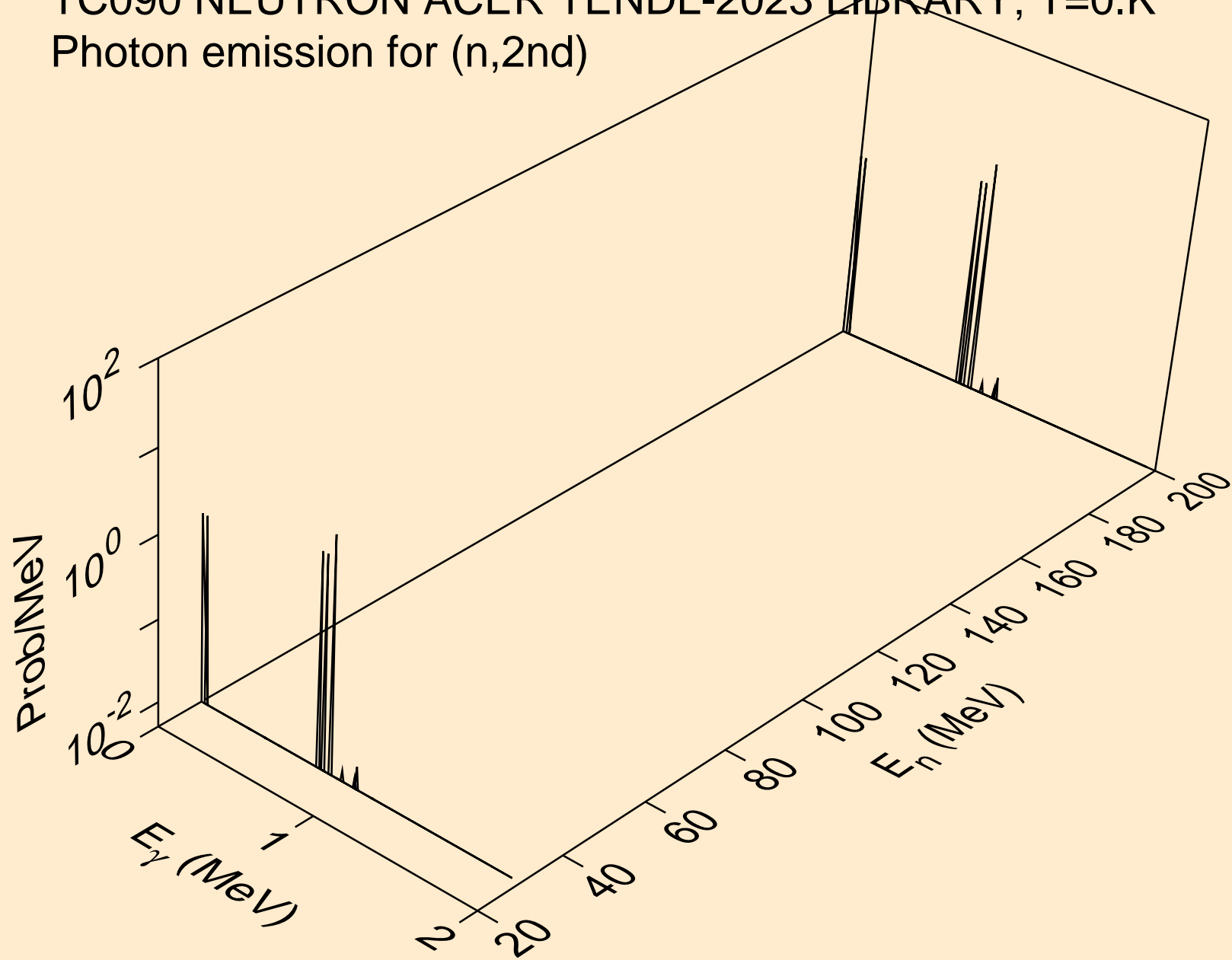

TC090 NEUTRON ACER TENDL-2023 LIBRARY; T=0.K  
Photon emission for (n,2n)

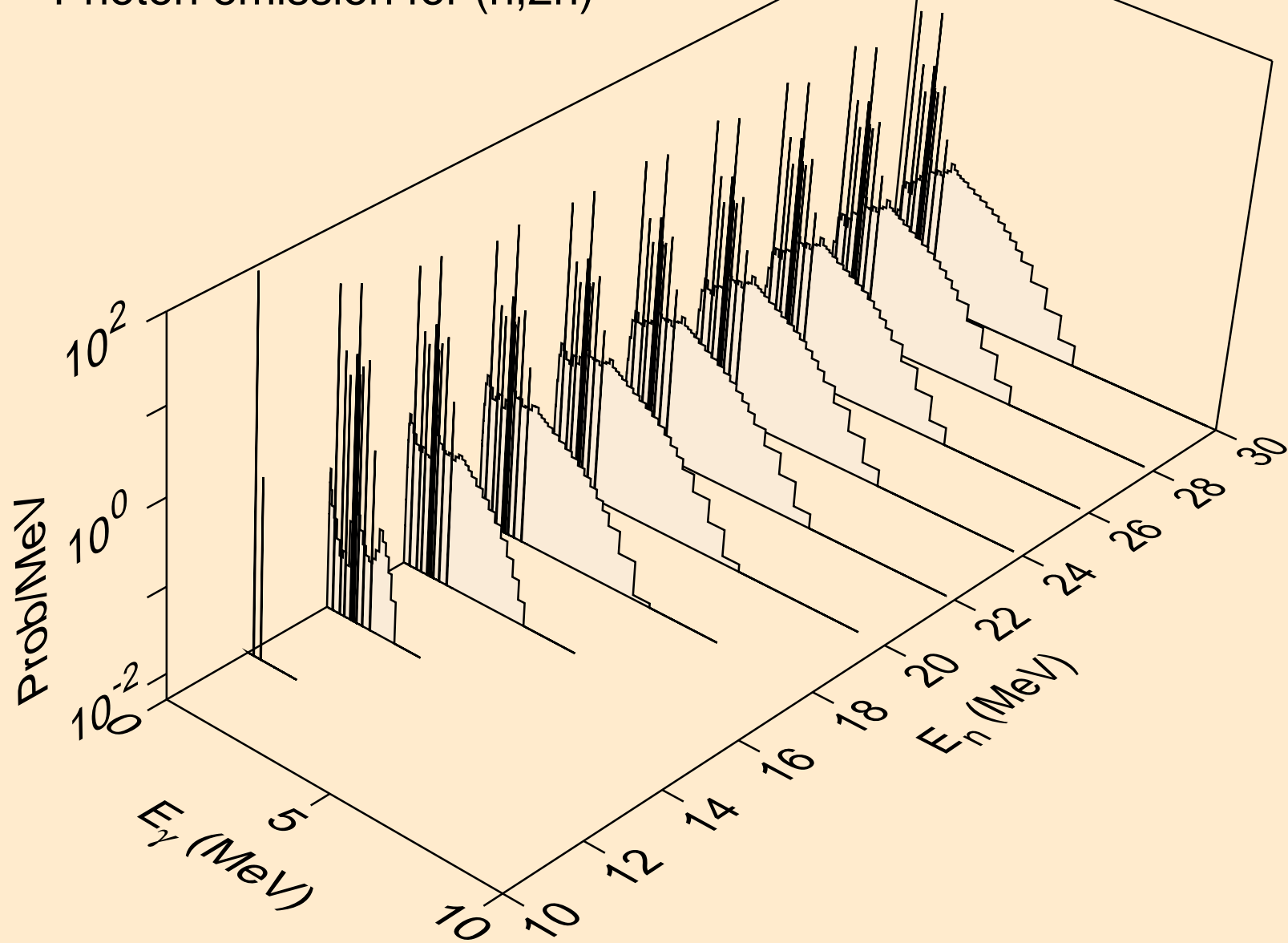

TC090 NEUTRON ACER TENDL-2023 LIBRARY; T=0.K  
Photon emission for (n,3n)

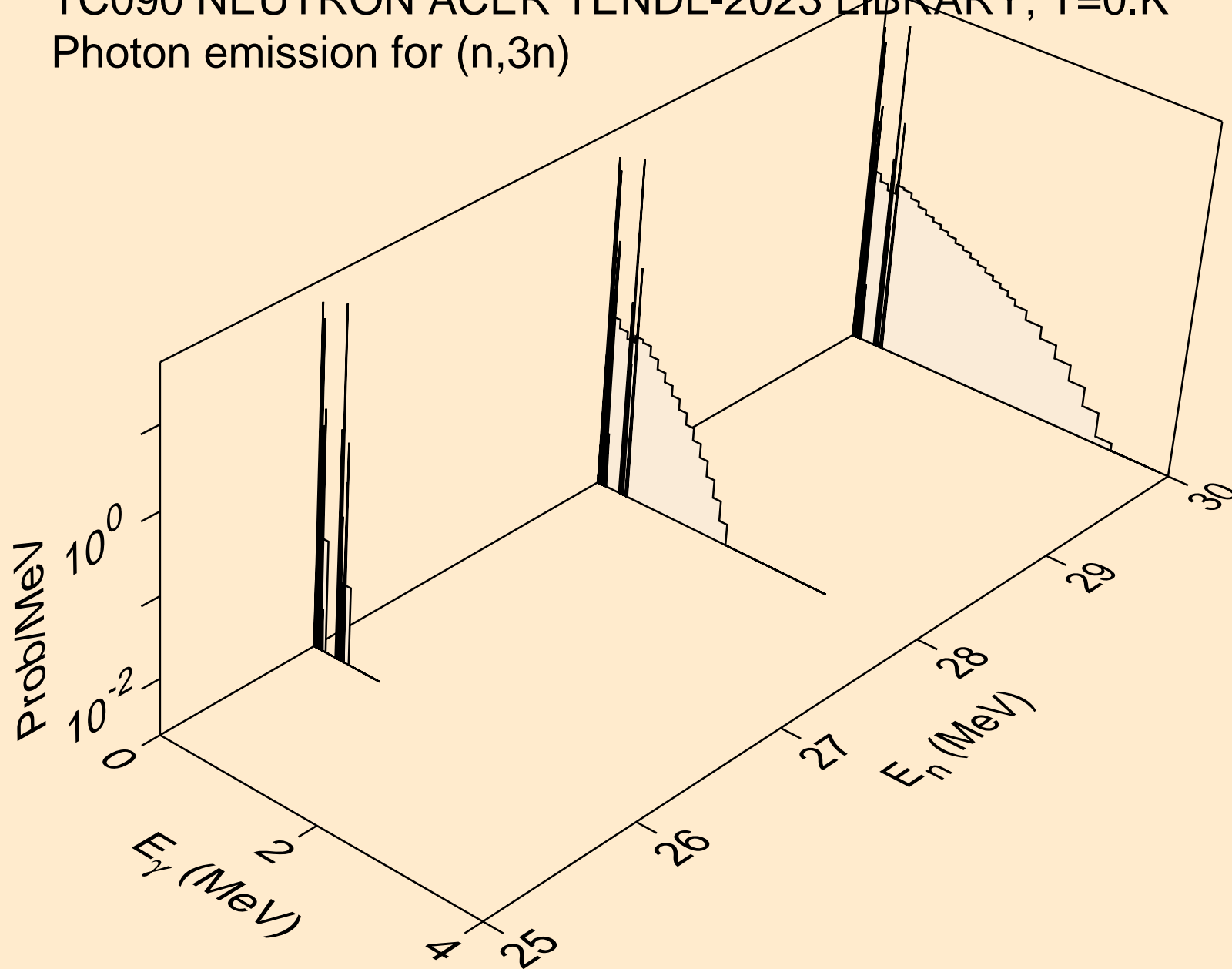

TC090 NEUTRON ACER TENDL-2023 LIBRARY; T=0.K  
Photon emission for (n,n\*)a

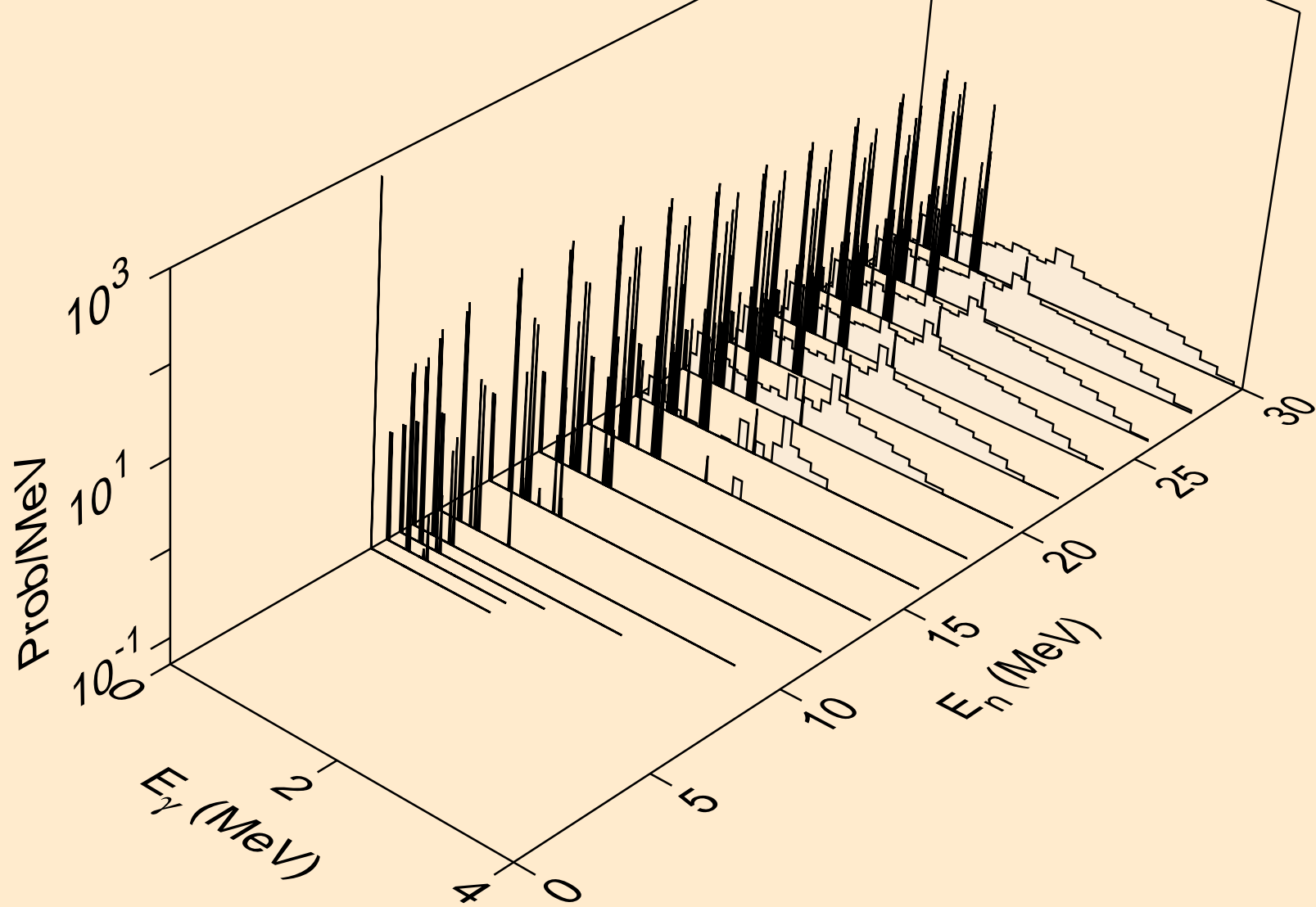

TC090 NEUTRON ACER TENDL-2023 LIBRARY; T=0.K  
Photon emission for (n,2n)a

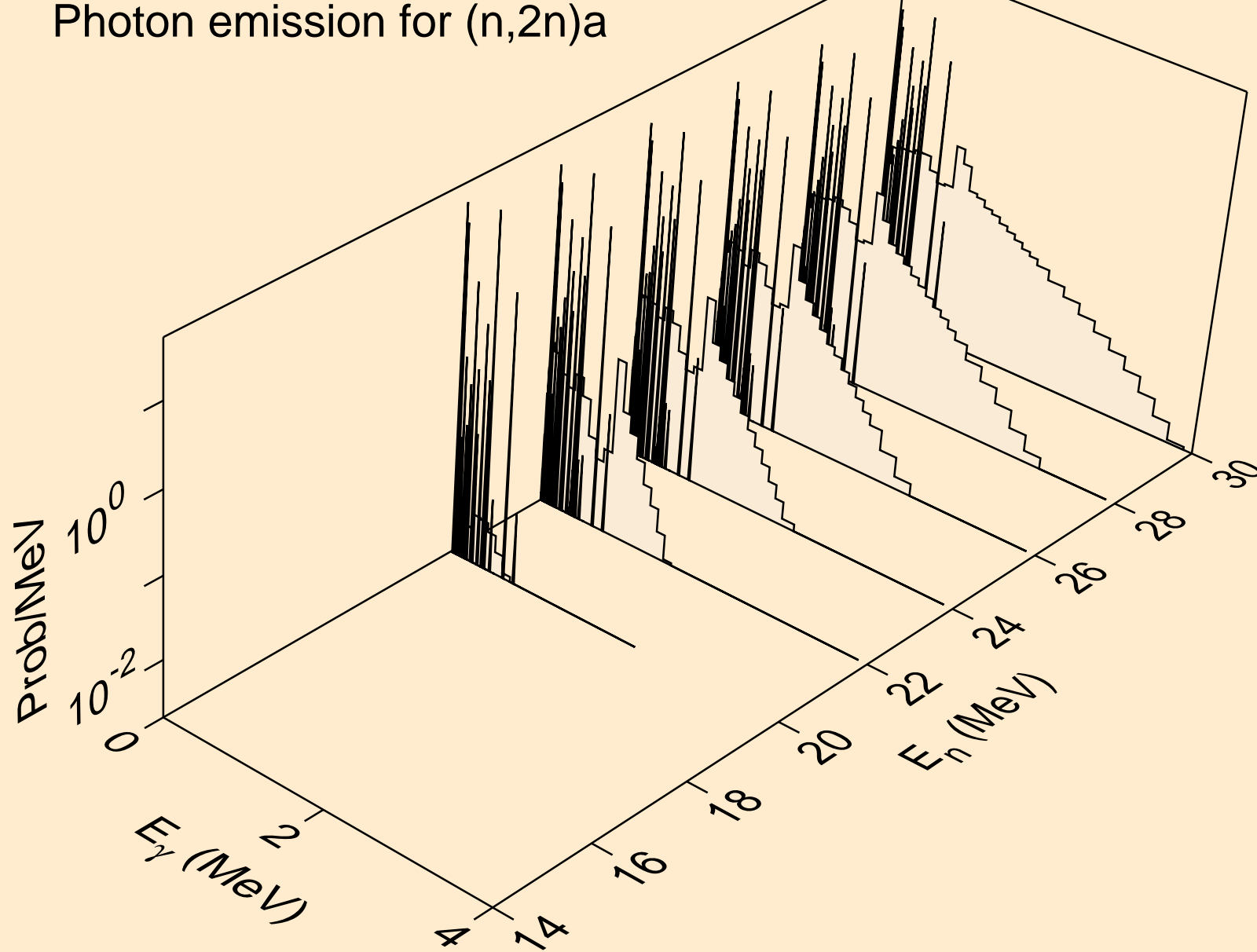

TC090 NEUTRON ACER TENDL-2023 LIBRARY; T=0.K  
Photon emission for (n,n\*)p

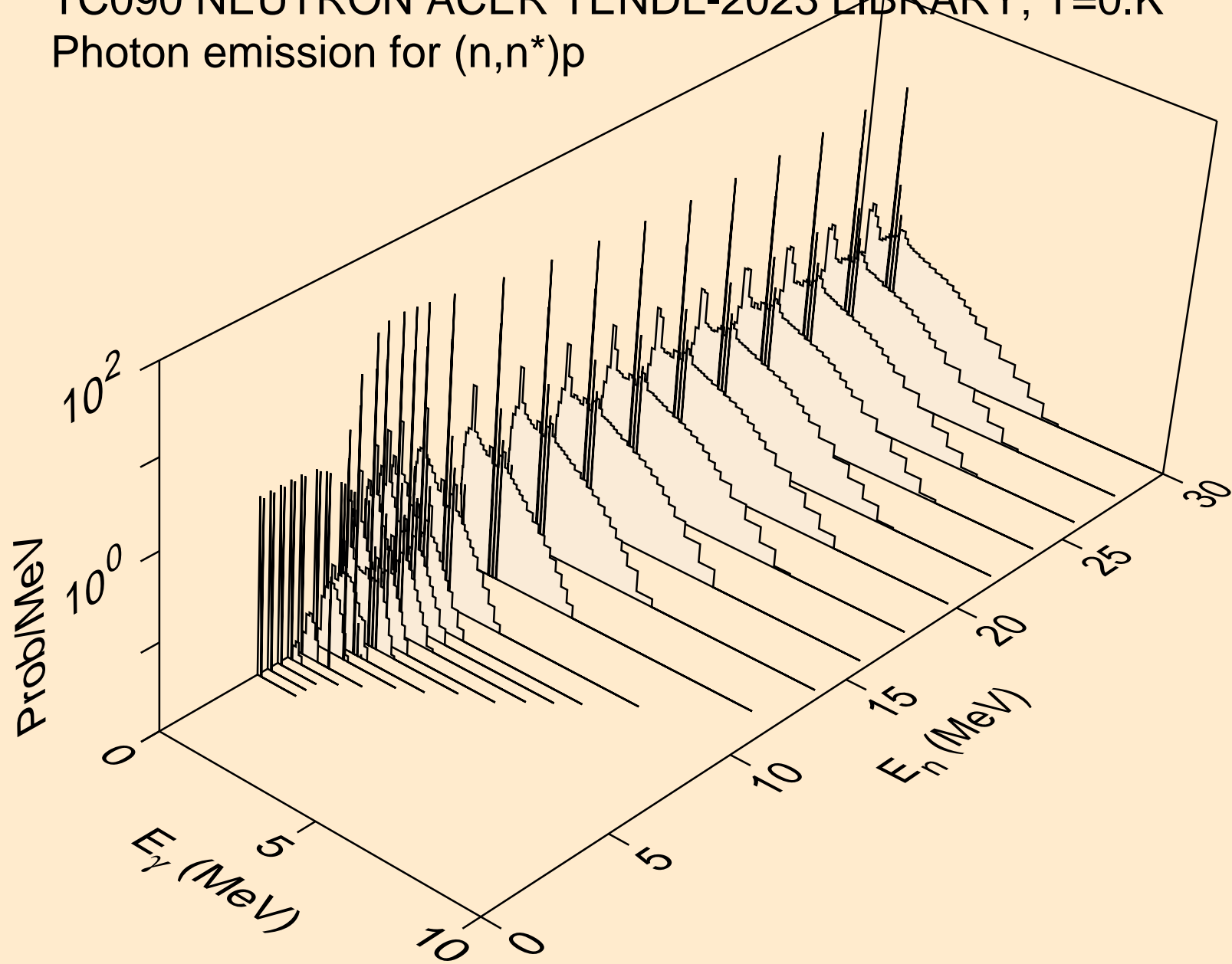

TC090 NEUTRON ACER TENDL-2023 LIBRARY; T=0.K  
Photon emission for (n,n\*)2a

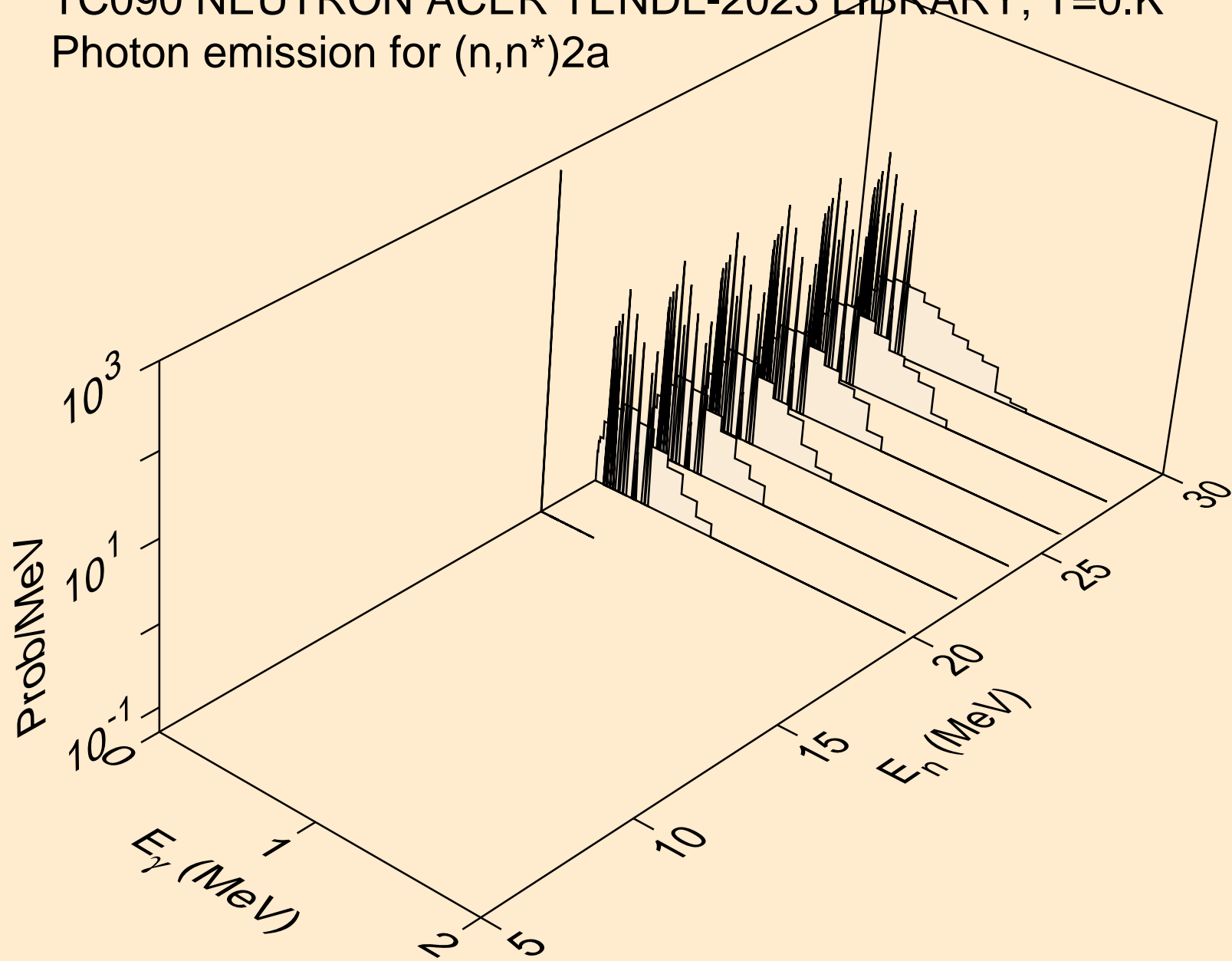



TC090 NEUTRON ACER TENDL-2023 LIBRARY; T=0.K  
Photon emission for (n,n\*)d

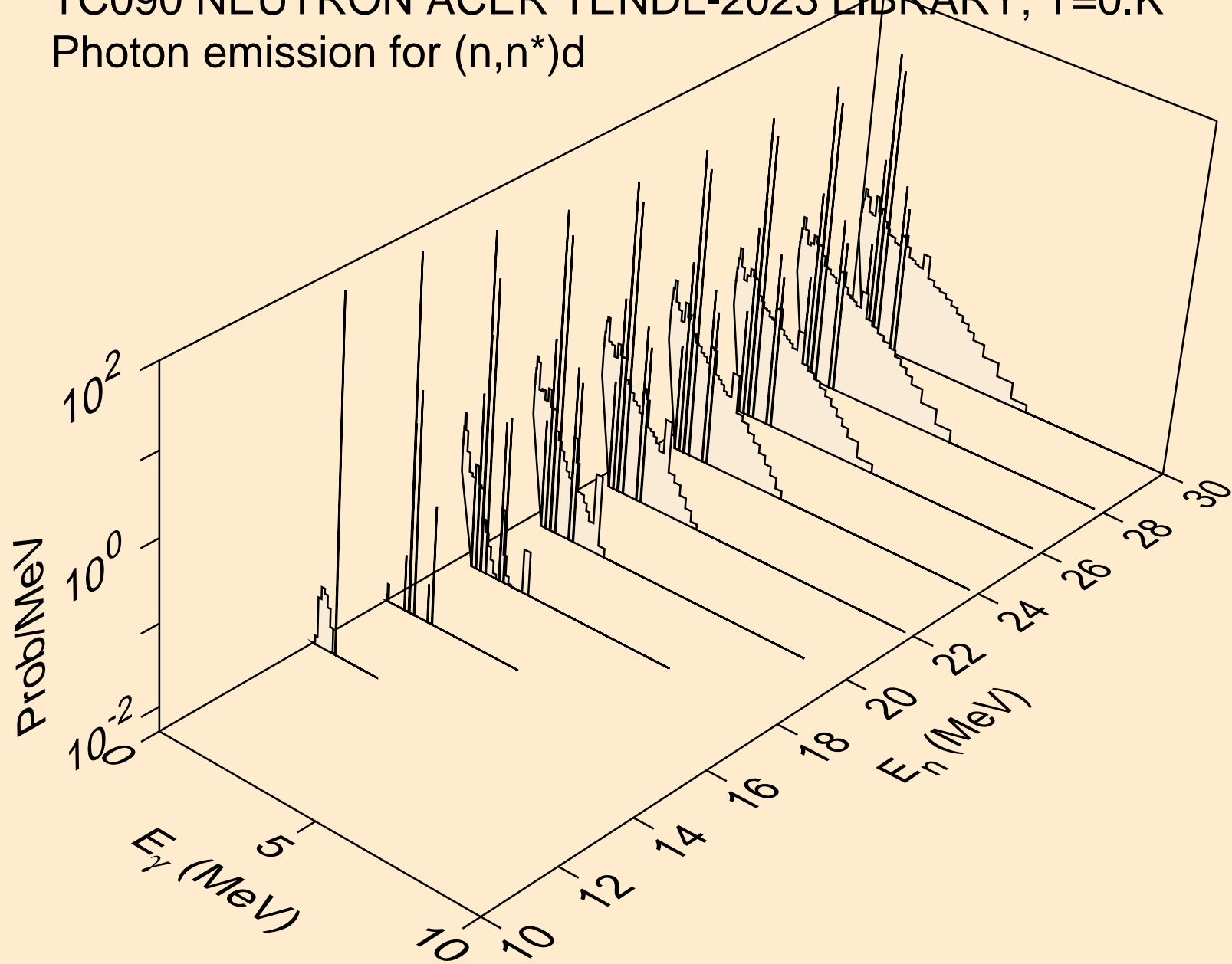

TC090 NEUTRON ACER TENDL-2023 LIBRARY; T=0.K  
Photon emission for (n,n\*)t

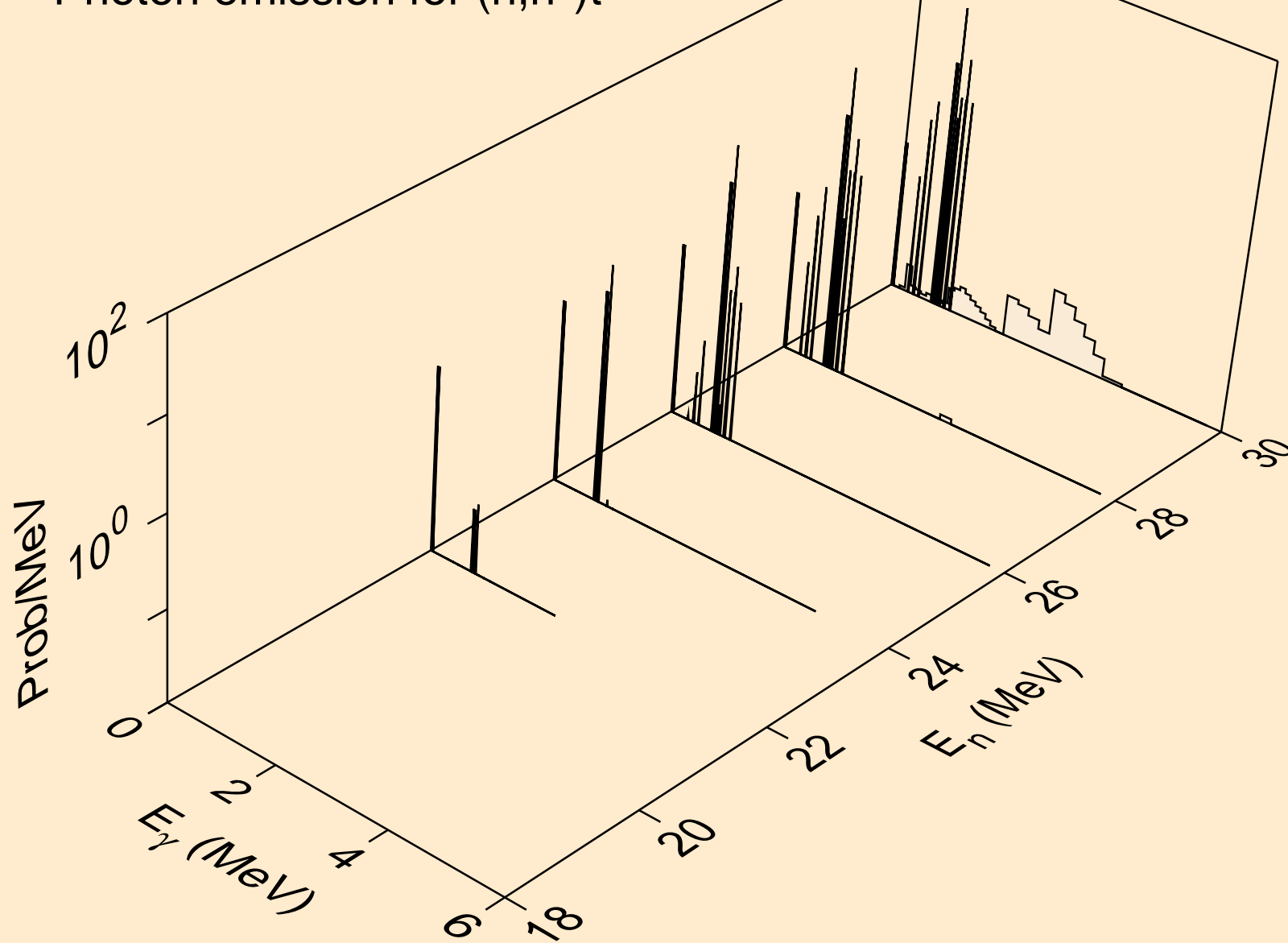

TC090 NEUTRON ACER TENDL-2023 LIBRARY; T=0.K  
Photon emission for (n,n\*)he3

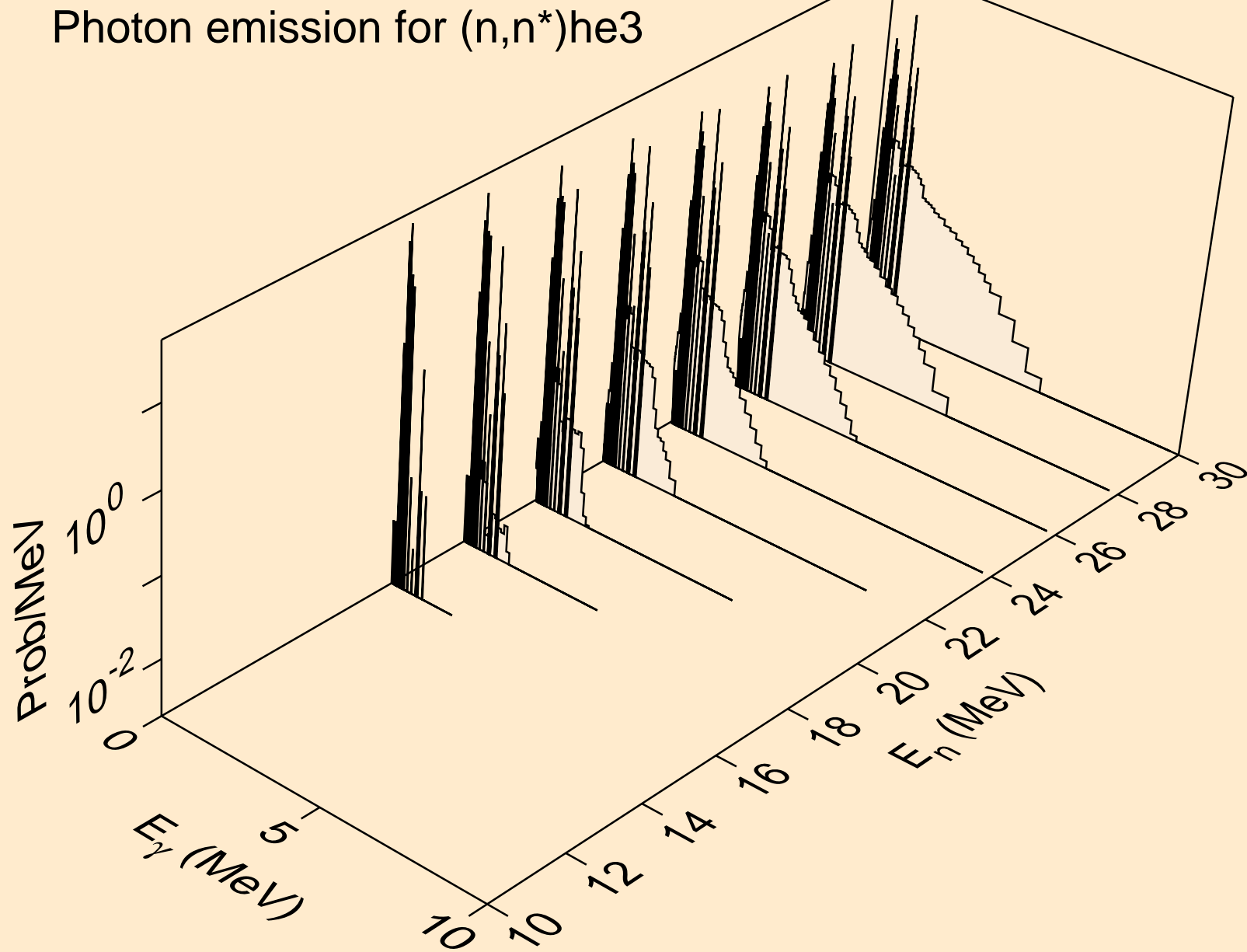

TC090 NEUTRON ACER TENDL-2023 LIBRARY; T=0.K  
Photon emission for (n,2np)

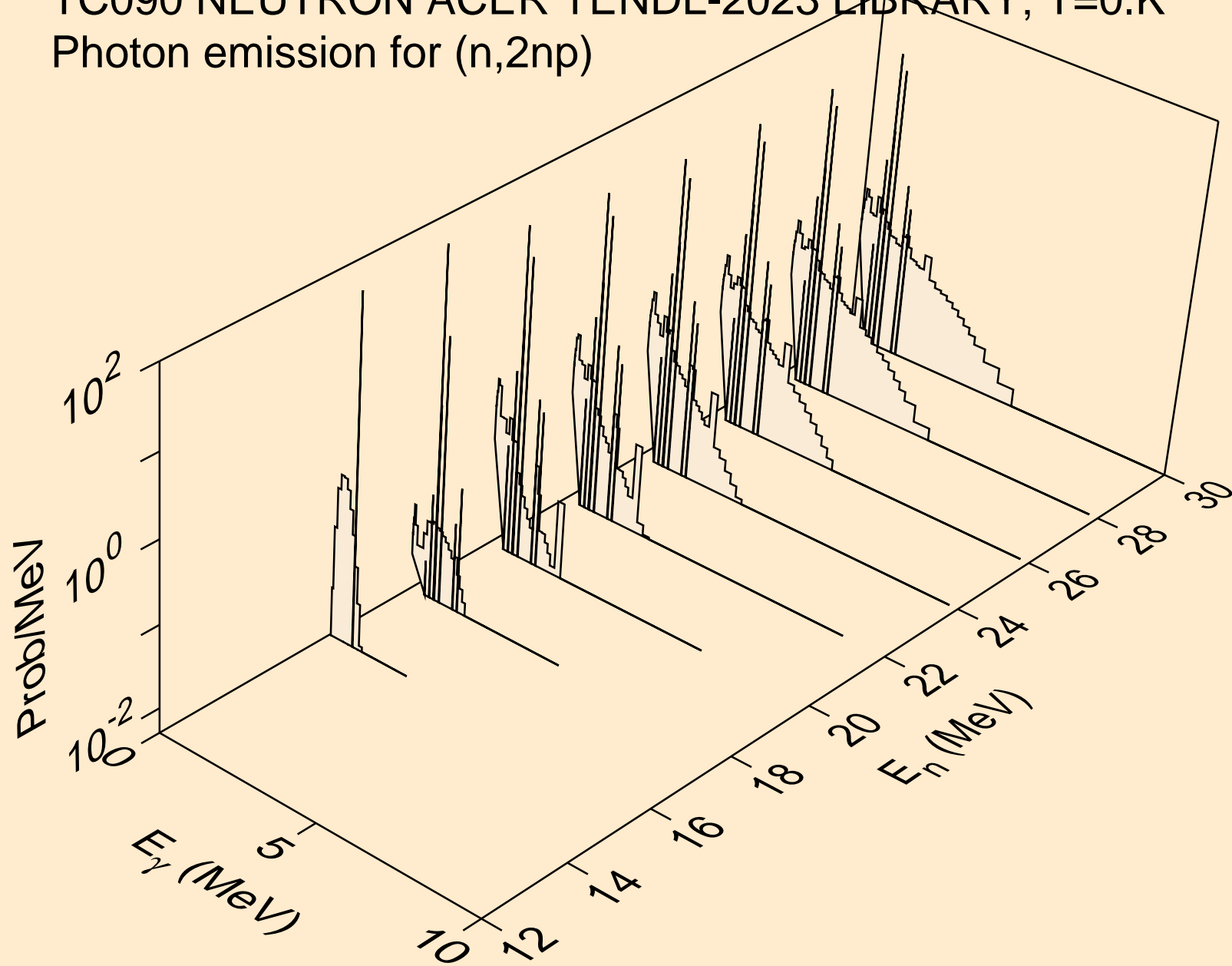

TC090 NEUTRON ACER TENDL-2023 LIBRARY; T=0.K  
Photon emission for (n,3np)

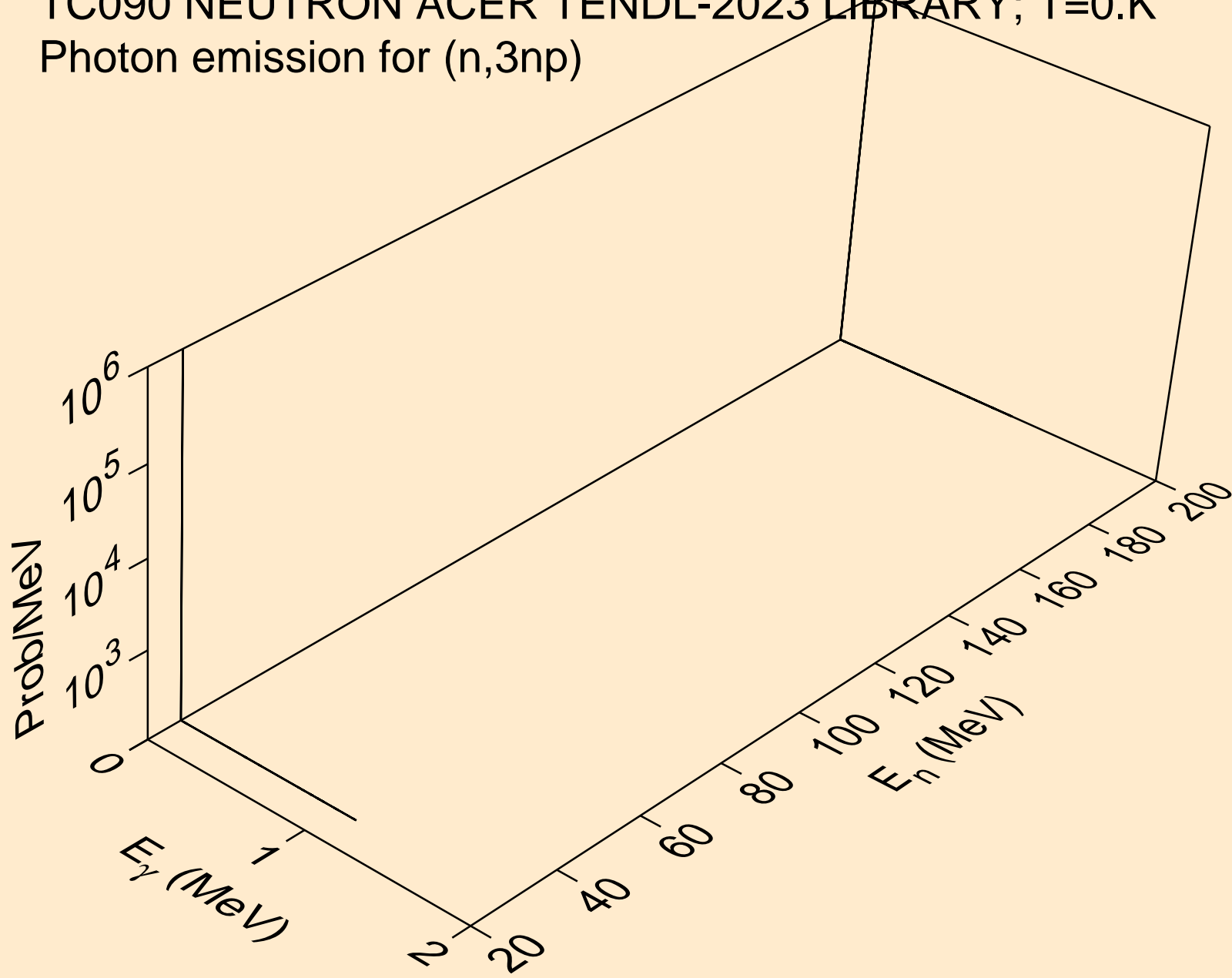

TC090 NEUTRON ACER TENDL-2023 LIBRARY; T=0.K  
Photon emission for (n,n2p)

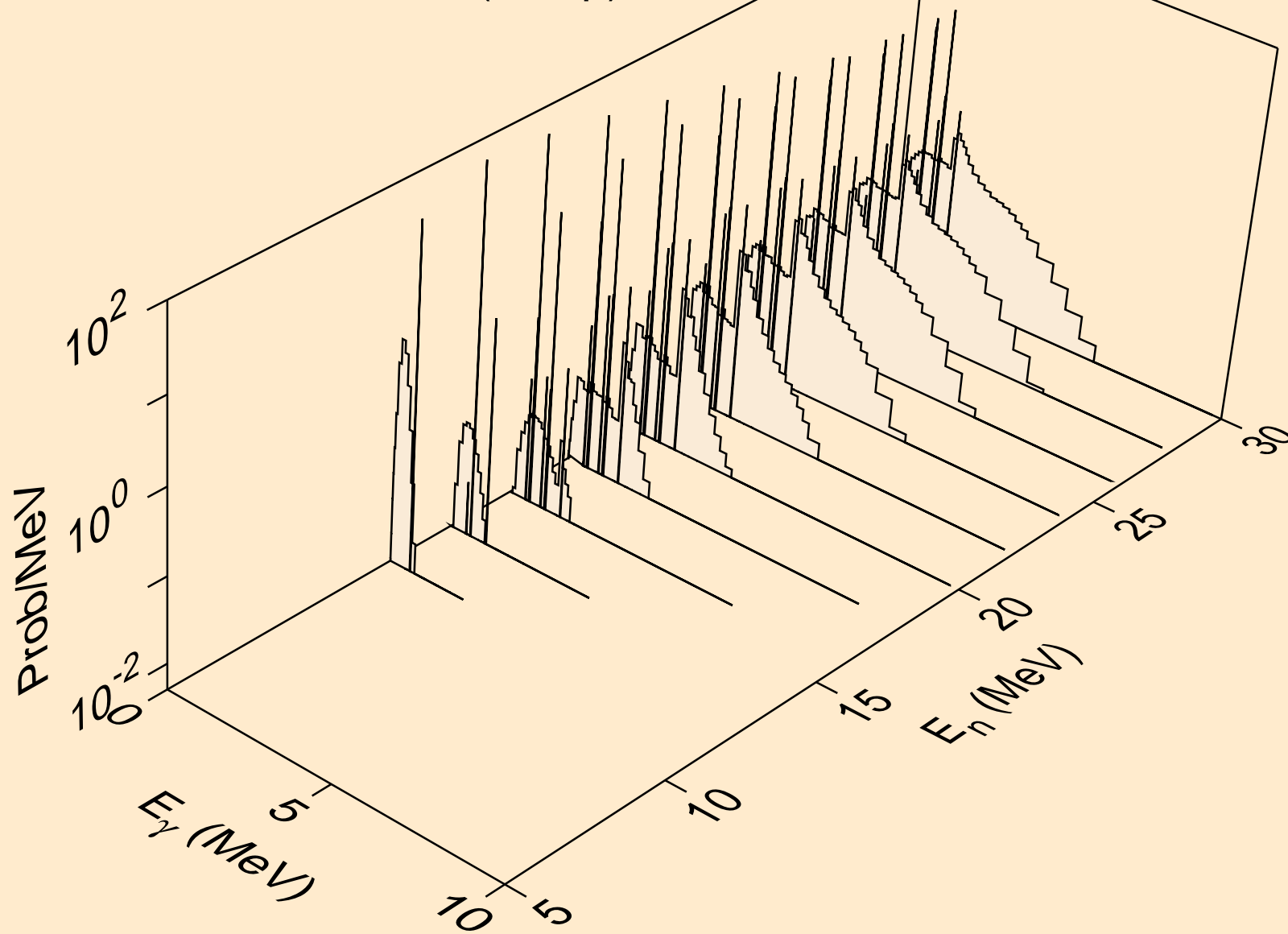

TC090 NEUTRON ACER TENDL-2023 LIBRARY; T=0.K  
Photon emission for (n,npa)

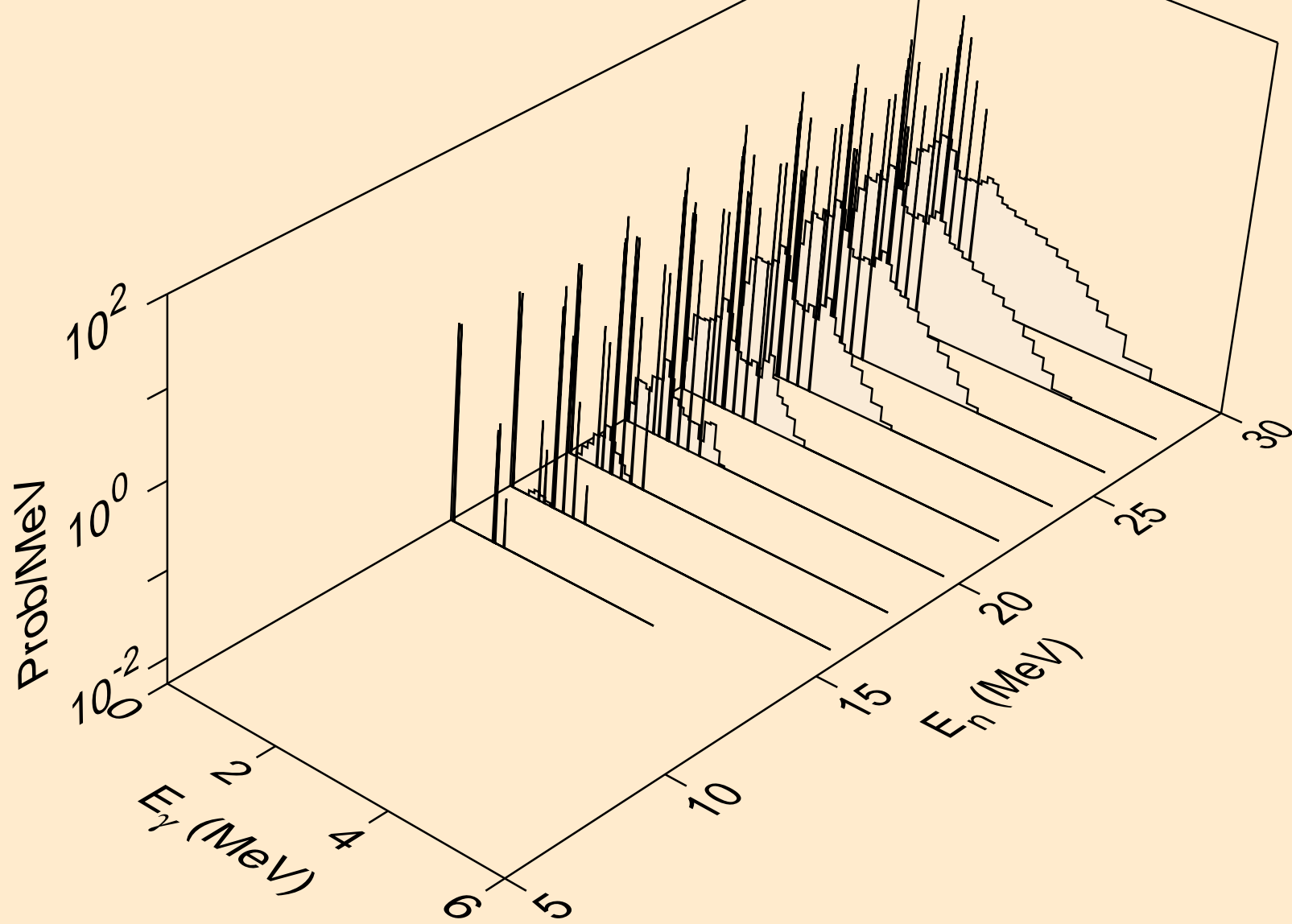

TC090 NEUTRON ACER TENDL-2023 LIBRARY; T=0.K  
Photon emission for (n,n\*c)

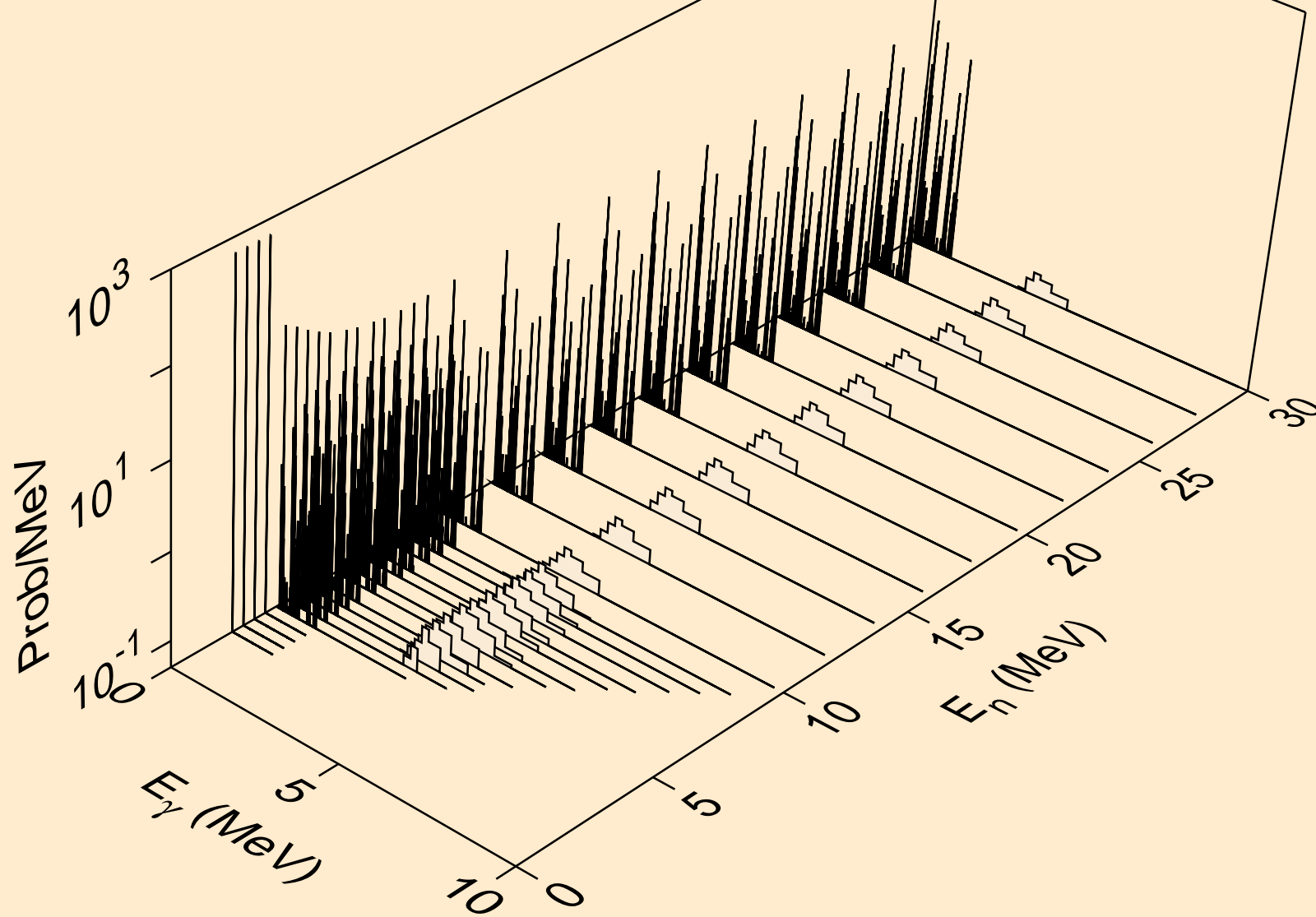



TC090 NEUTRON ACER TENDL-2023 LIBRARY; T=0.K  
Photon emission for (n,gma)

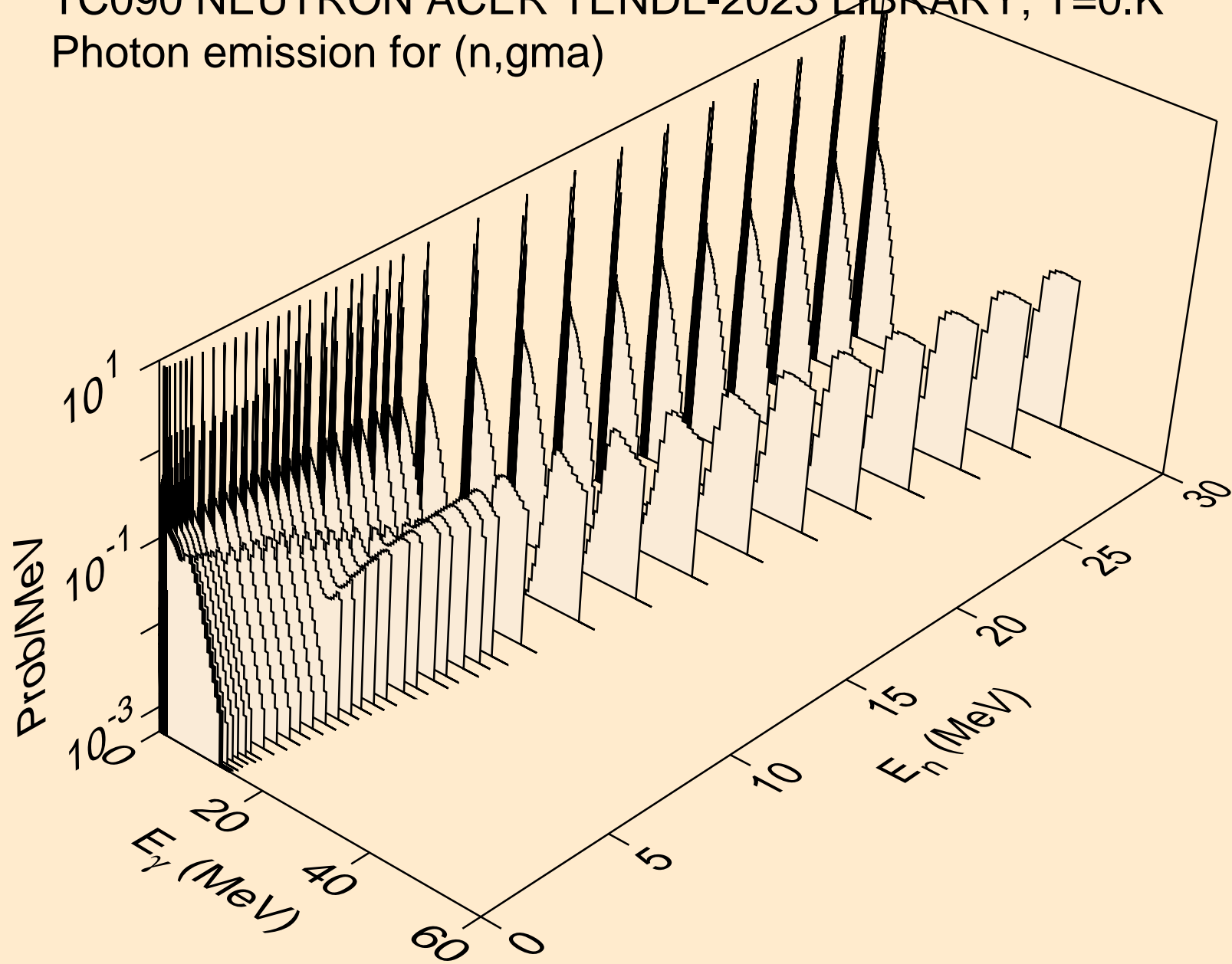

TC090 NEUTRON ACER TENDL-2023 LIBRARY; T=0.K  
Photon emission for (n,p)

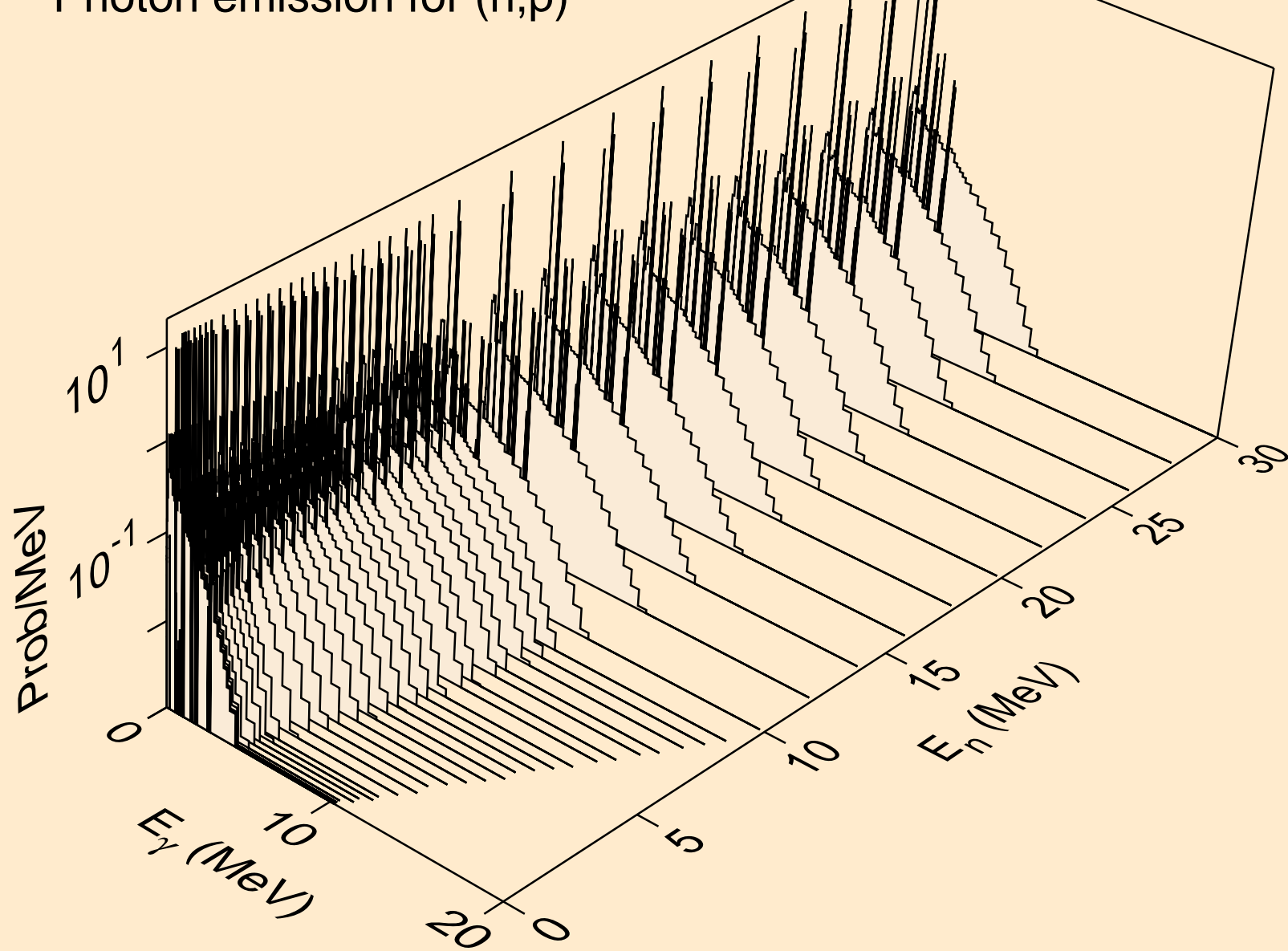

TC090 NEUTRON ACER TENDL-2023 LIBRARY; T=0.K  
Photon emission for (n,d)

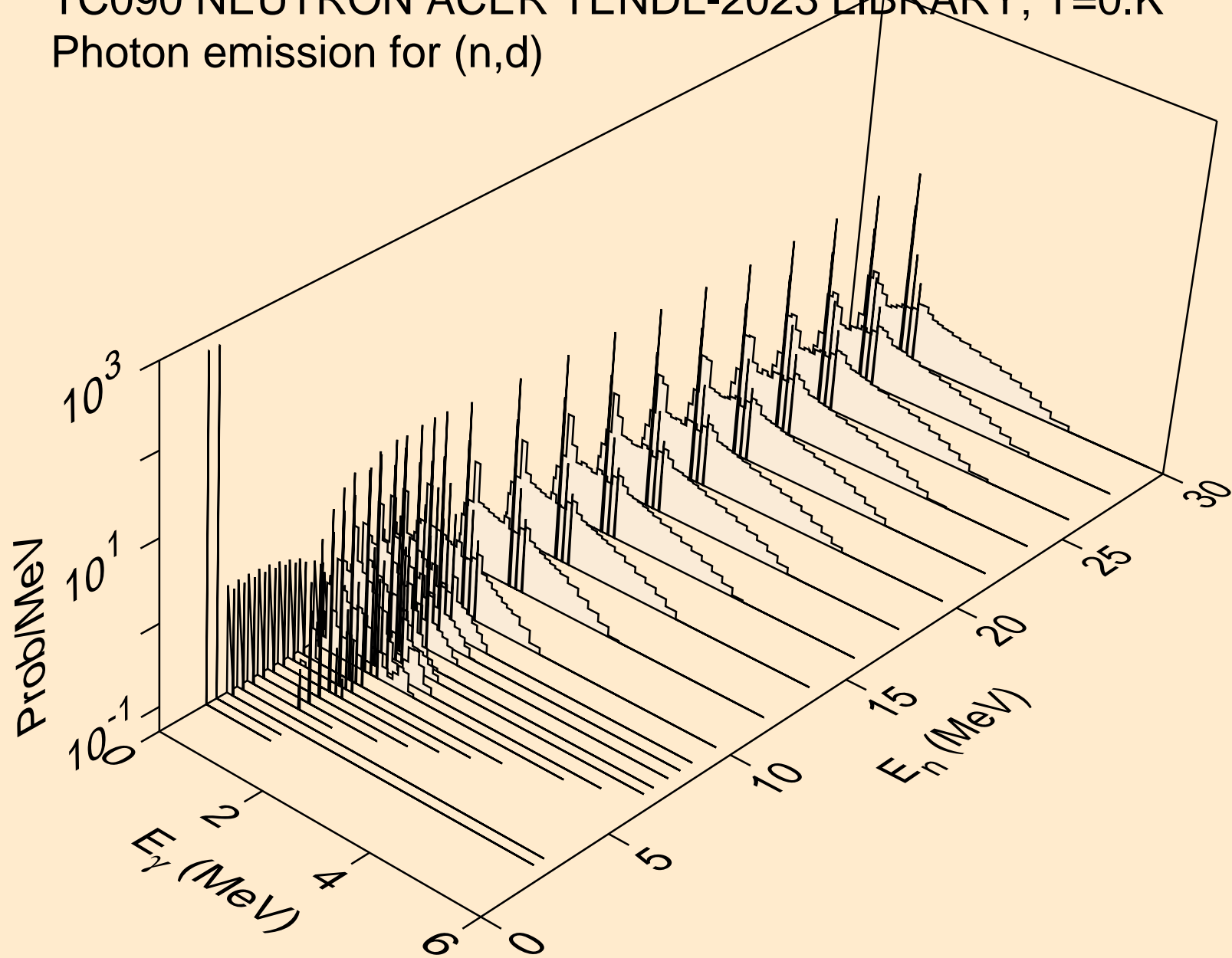

TC090 NEUTRON ACER TENDL-2023 LIBRARY; T=0.K  
Photon emission for (n,t)

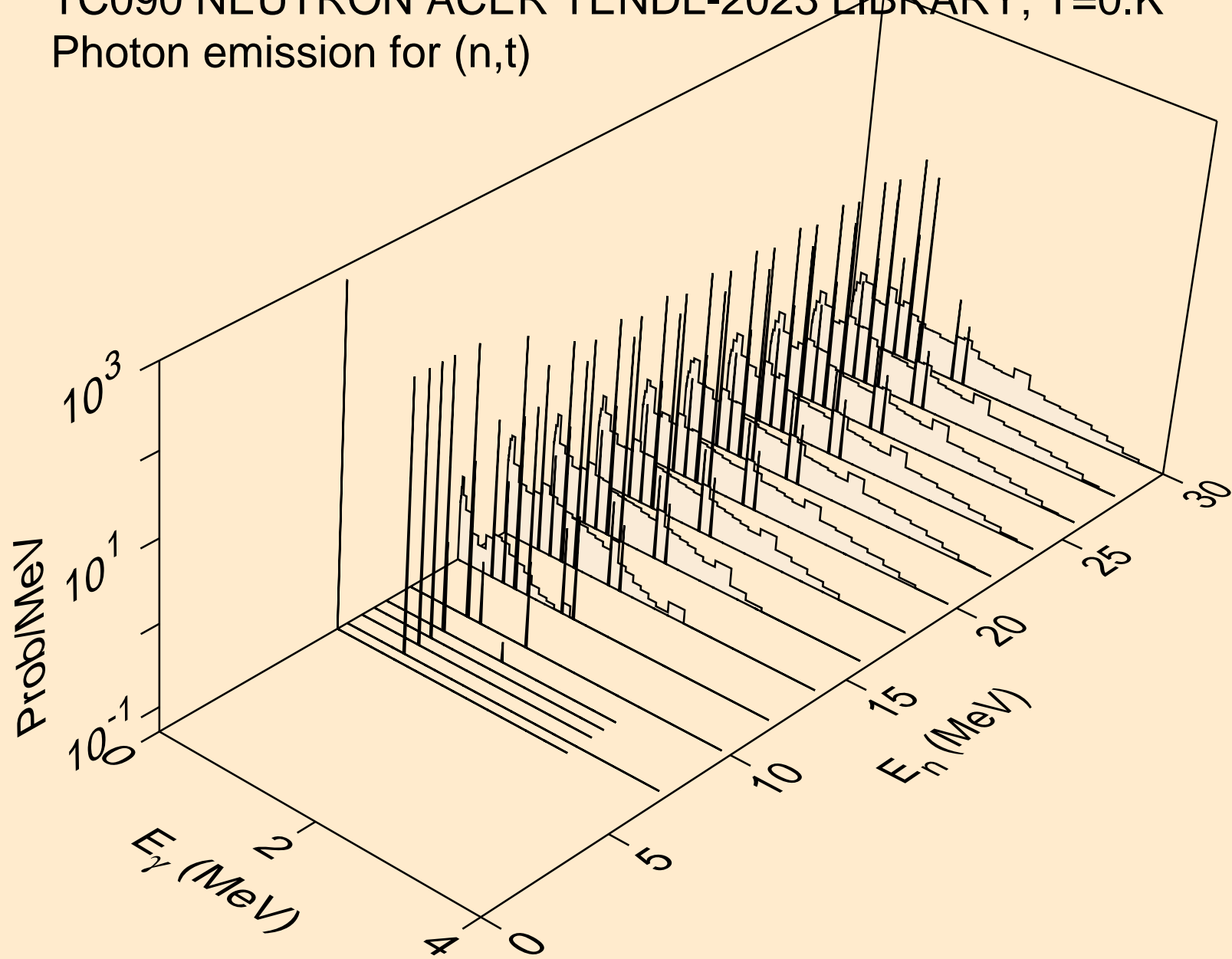

TC090 NEUTRON ACER TENDL-2023 LIBRARY; T=0.K  
Photon emission for (n,he3)

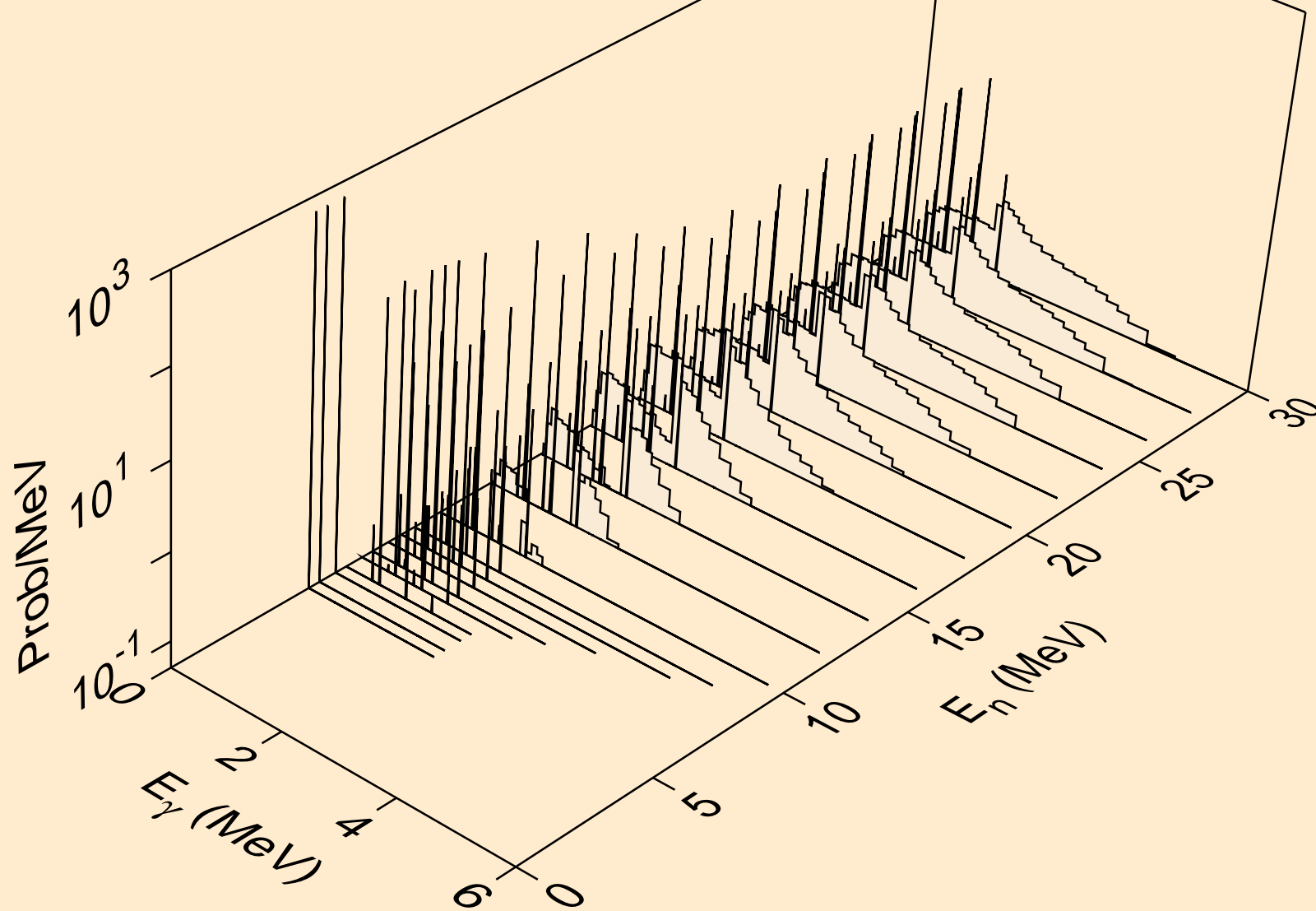

TC090 NEUTRON ACER TENDL-2023 LIBRARY; T=0.K  
Photon emission for (n,a)

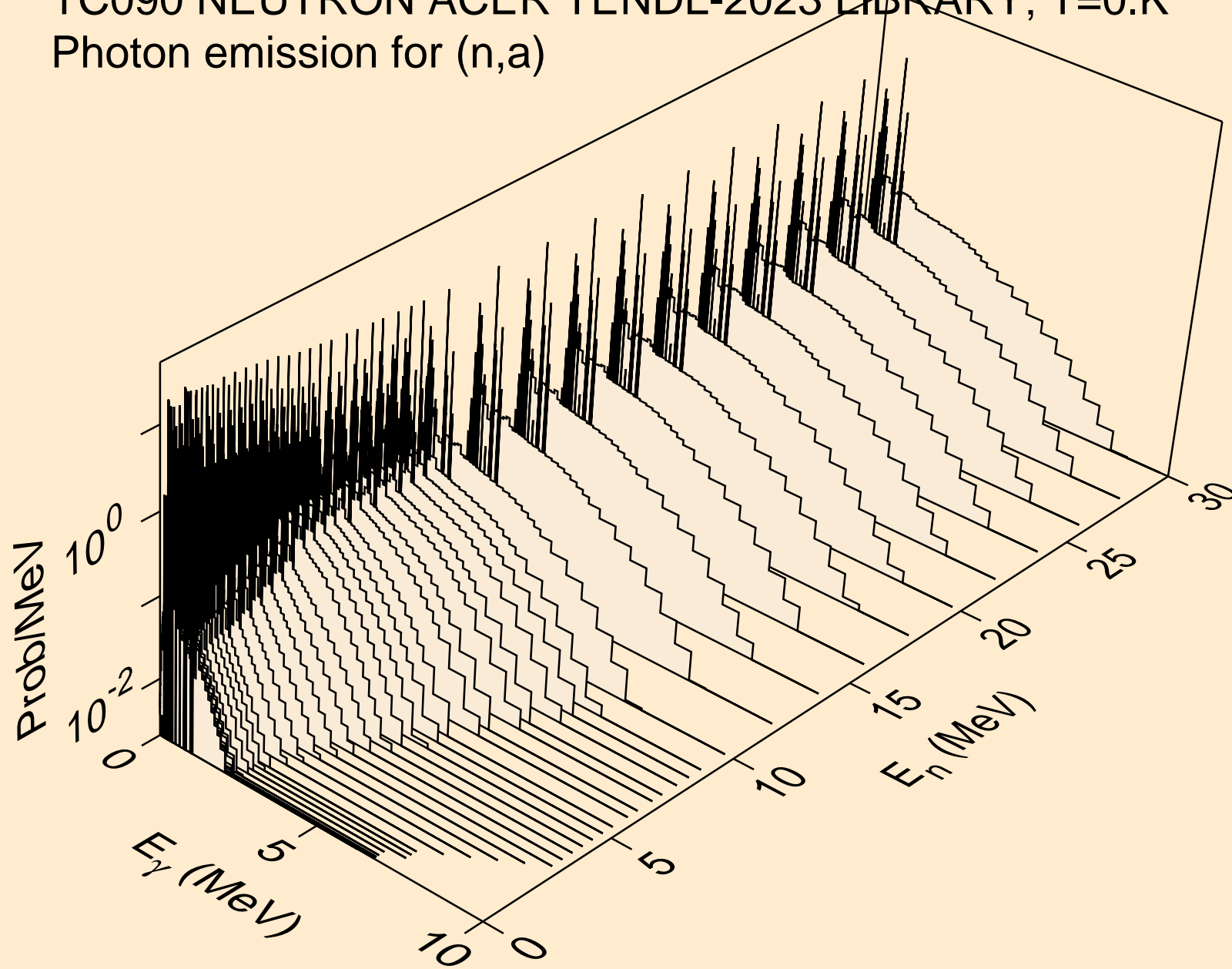

TC090 NEUTRON ACER TENDL-2023 LIBRARY; T=0.K  
Photon emission for (n,2a)

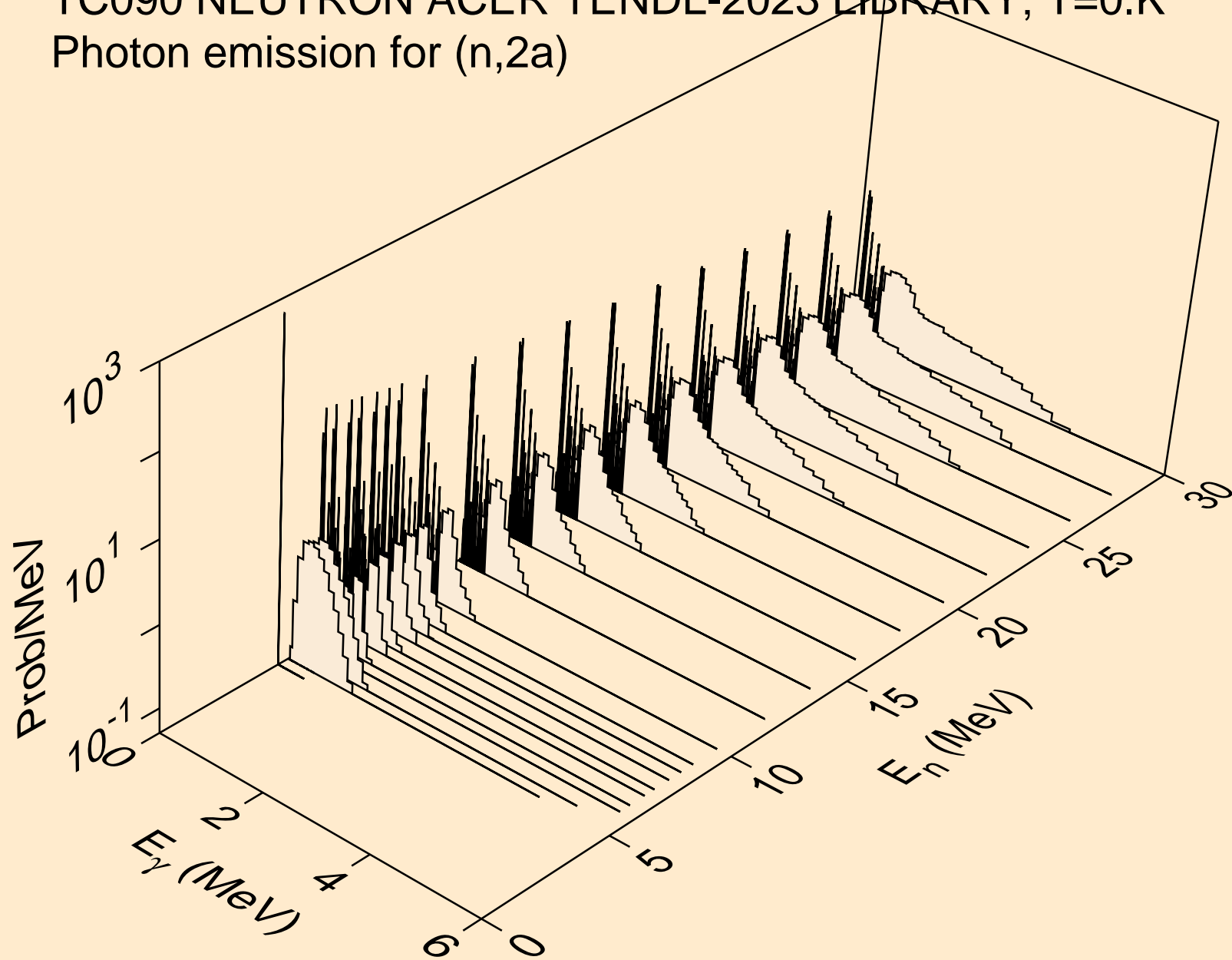

TC090 NEUTRON ACER TENDL-2023 LIBRARY; T=0.K  
Photon emission for (n,3a)

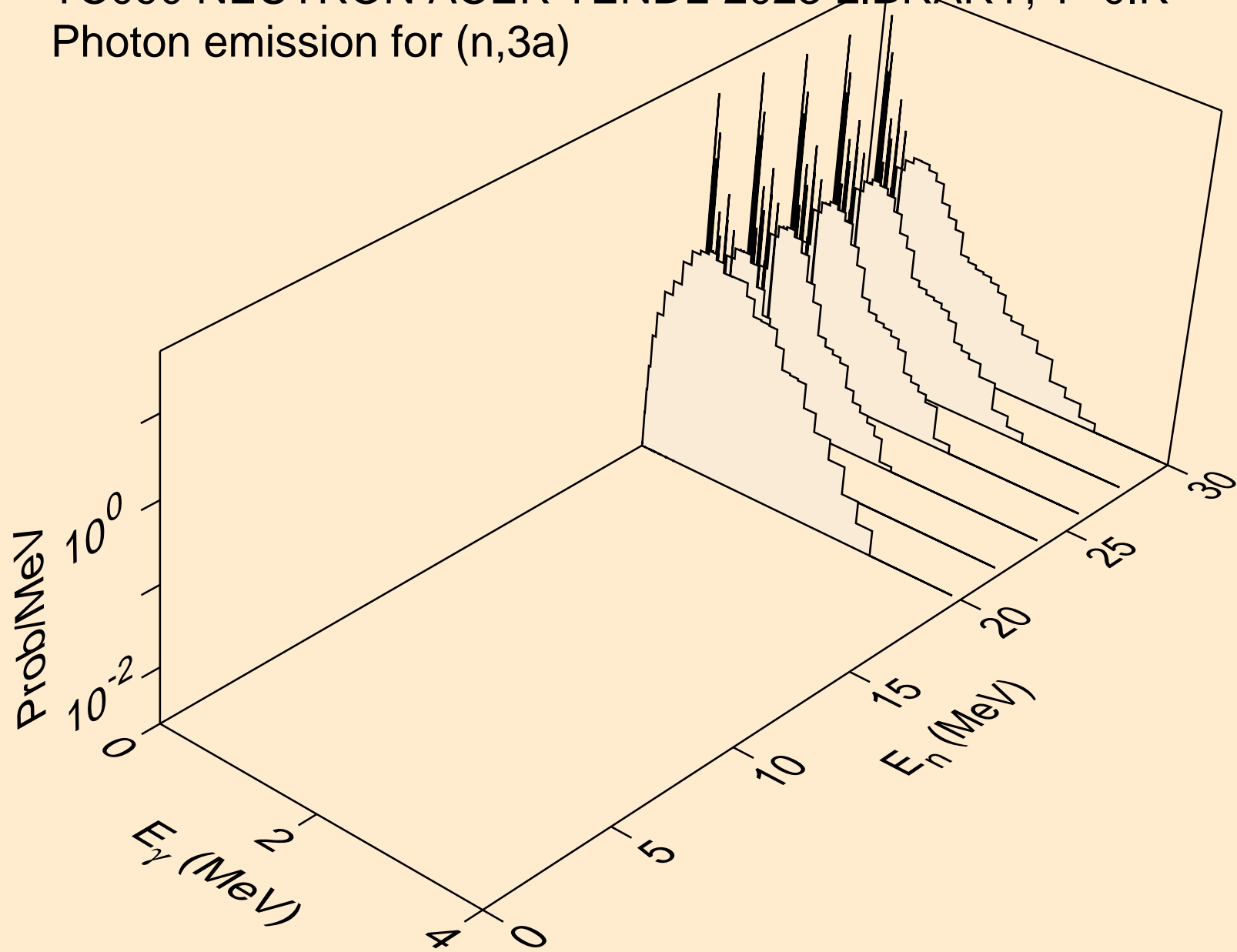



TC090 NEUTRON ACER TENDL-2023 LIBRARY; T=0.K  
Photon emission for (n,2p)

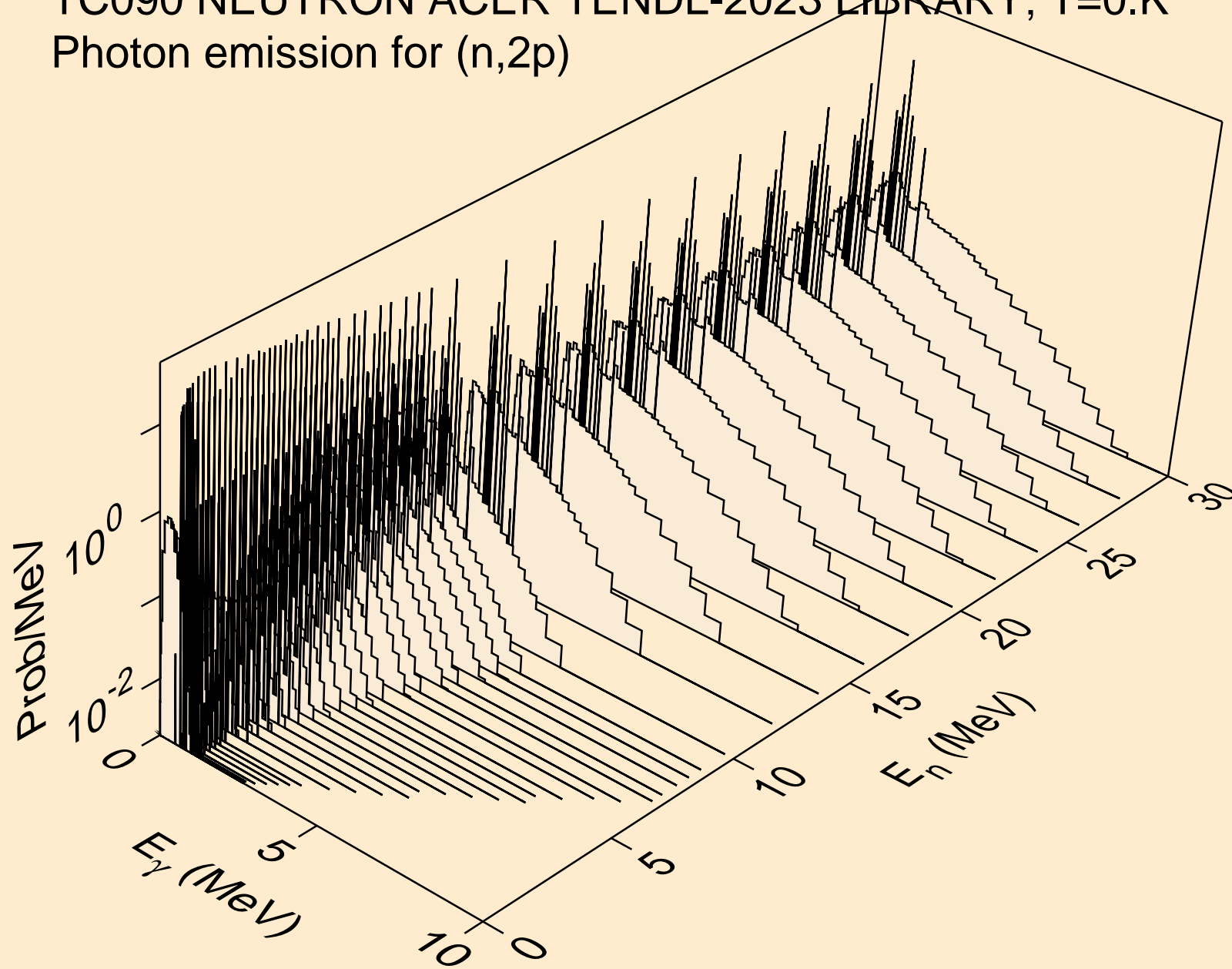

TC090 NEUTRON ACER TENDL-2023 LIBRARY; T=0.K  
Photon emission for (n,p $\alpha$ )

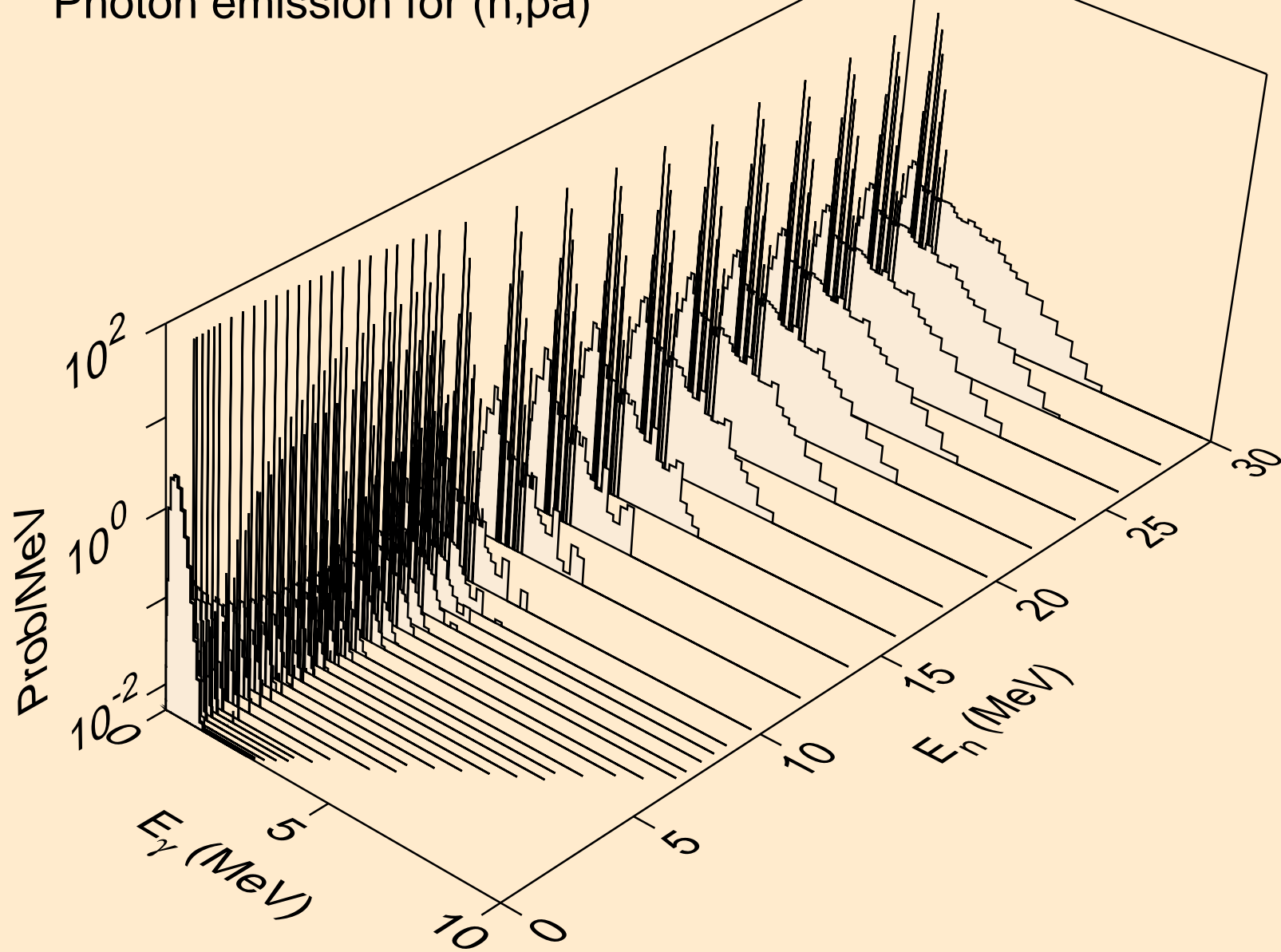

TC090 NEUTRON ACER TENDL-2023 LIBRARY; T=0.K  
Photon emission for (n,pd)

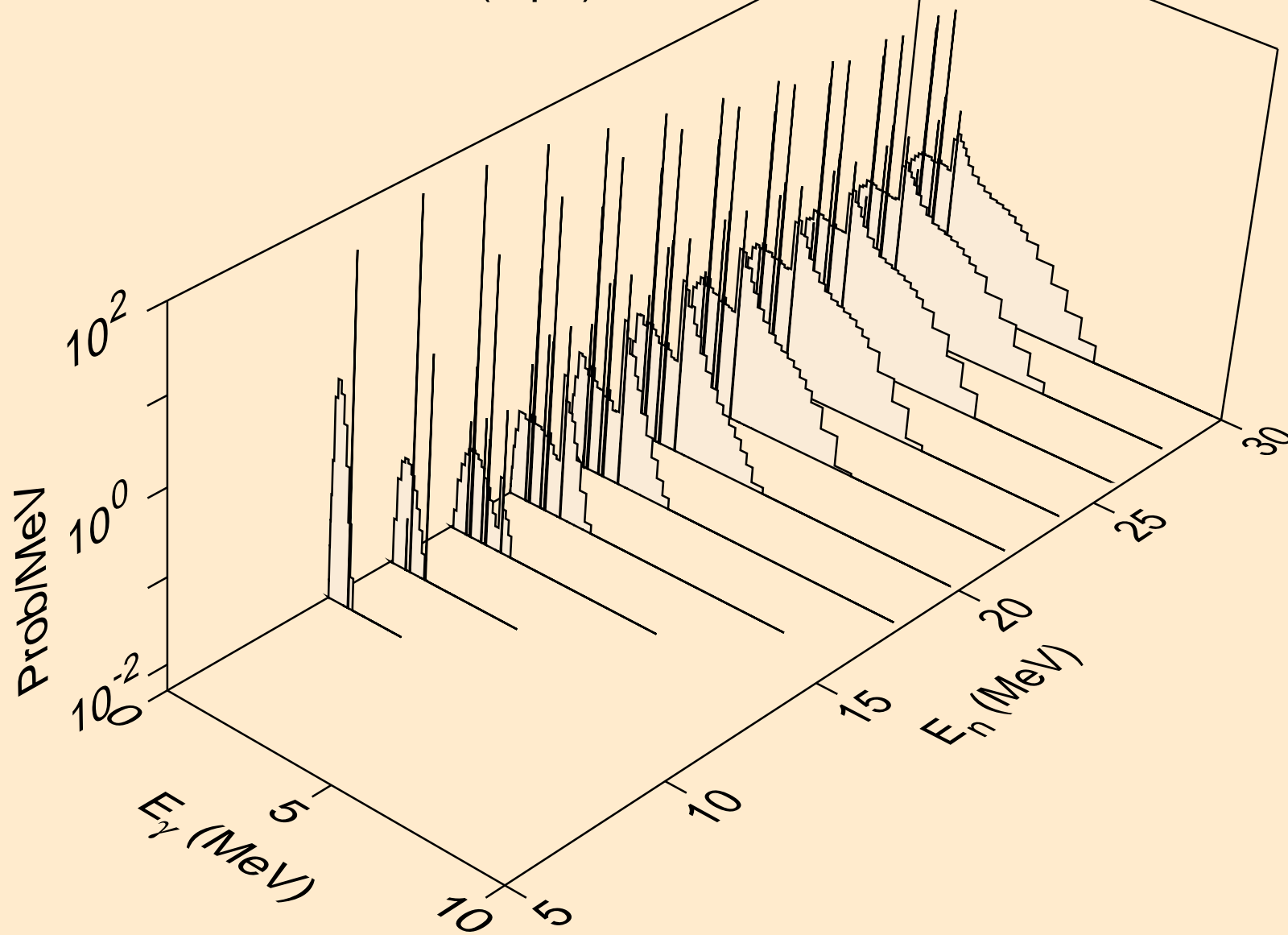

TC090 NEUTRON ACER TENDL-2023 LIBRARY; T=0.K  
Photon emission for (n,pt)

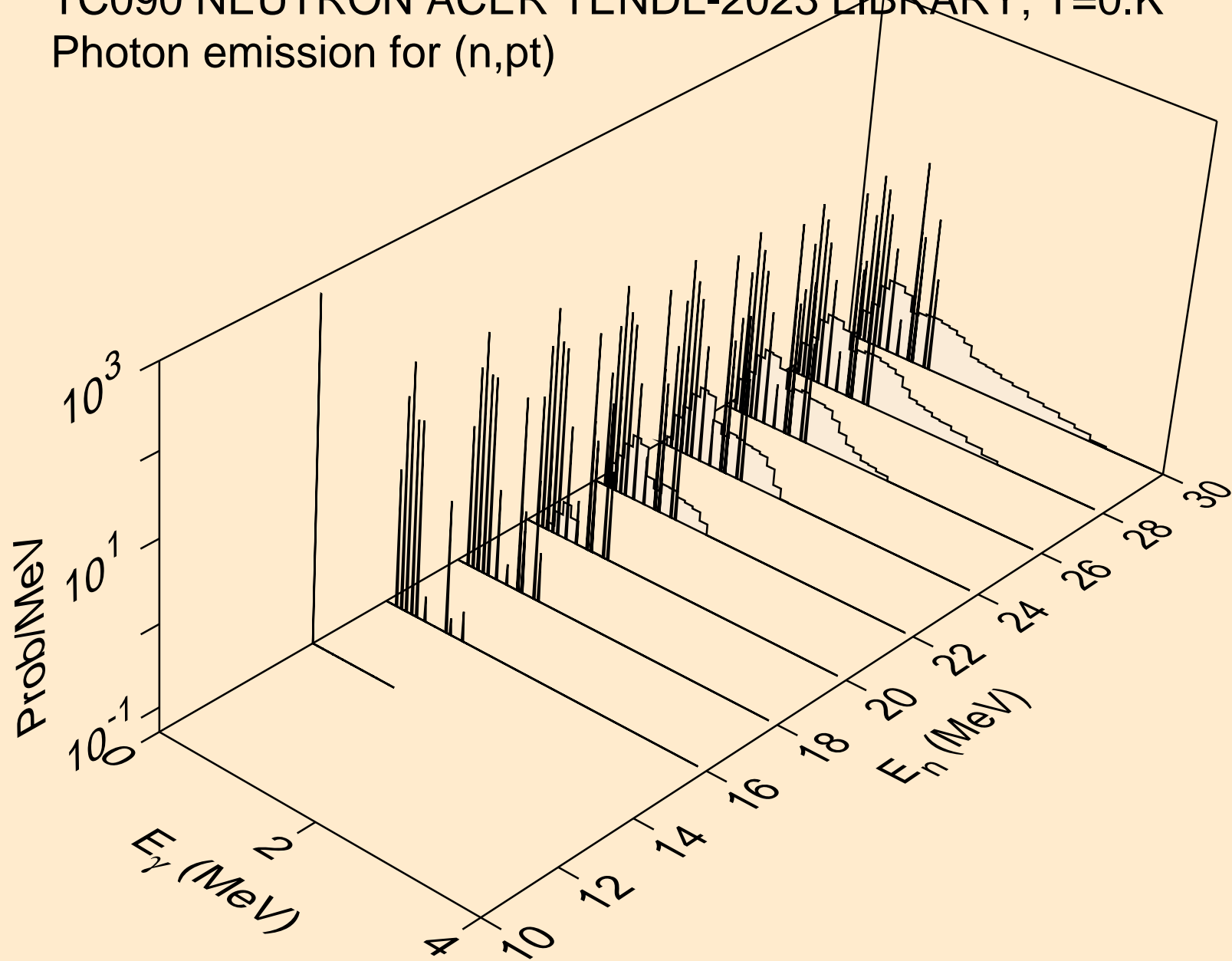

TC090 NEUTRON ACER TENDL-2023 LIBRARY; T=0.K  
Photon emission for (n,da)

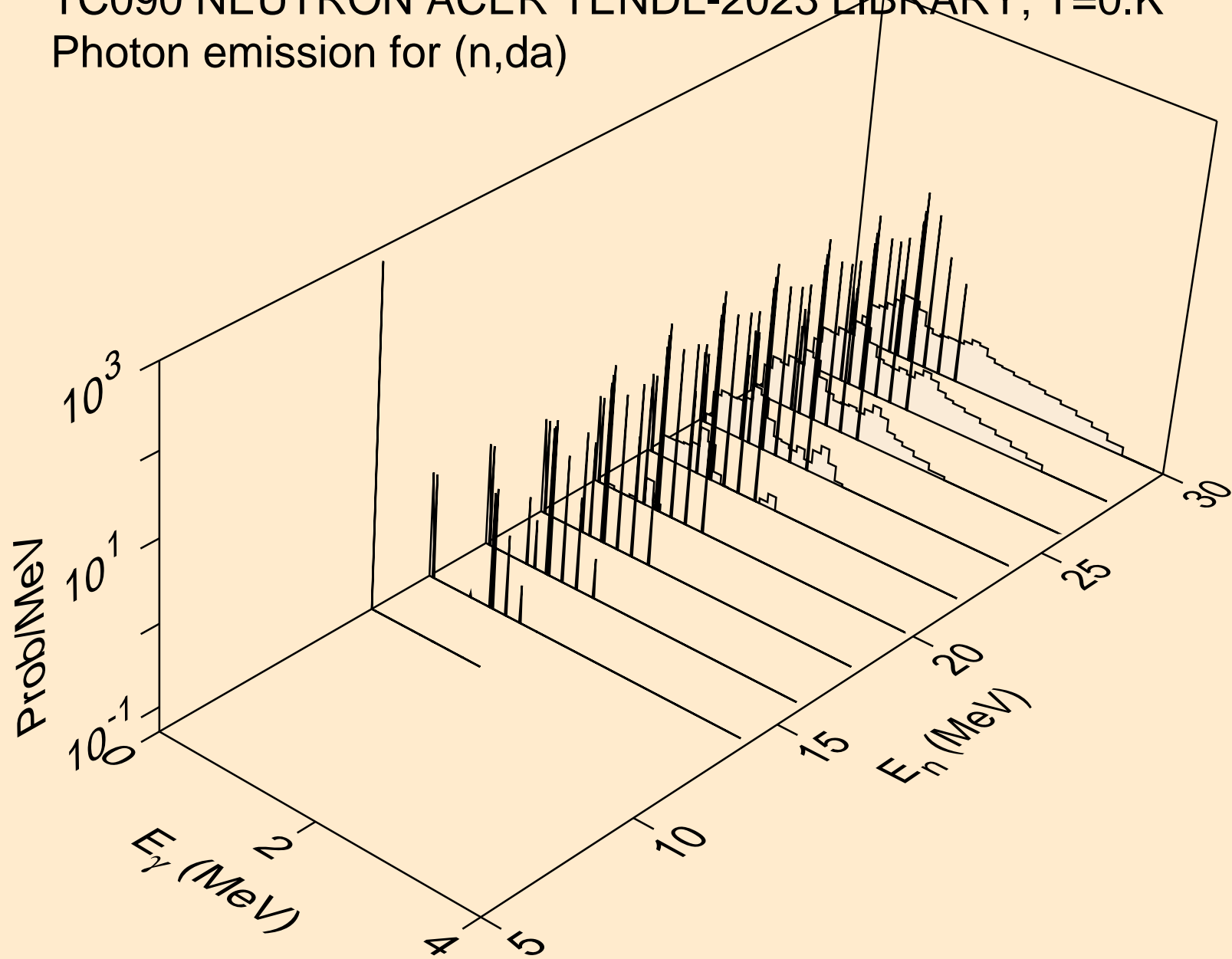

TC090 NEUTRON ACER TENDL-2023 LIBRARY; T=0.K  
thermal capture photon spectrum

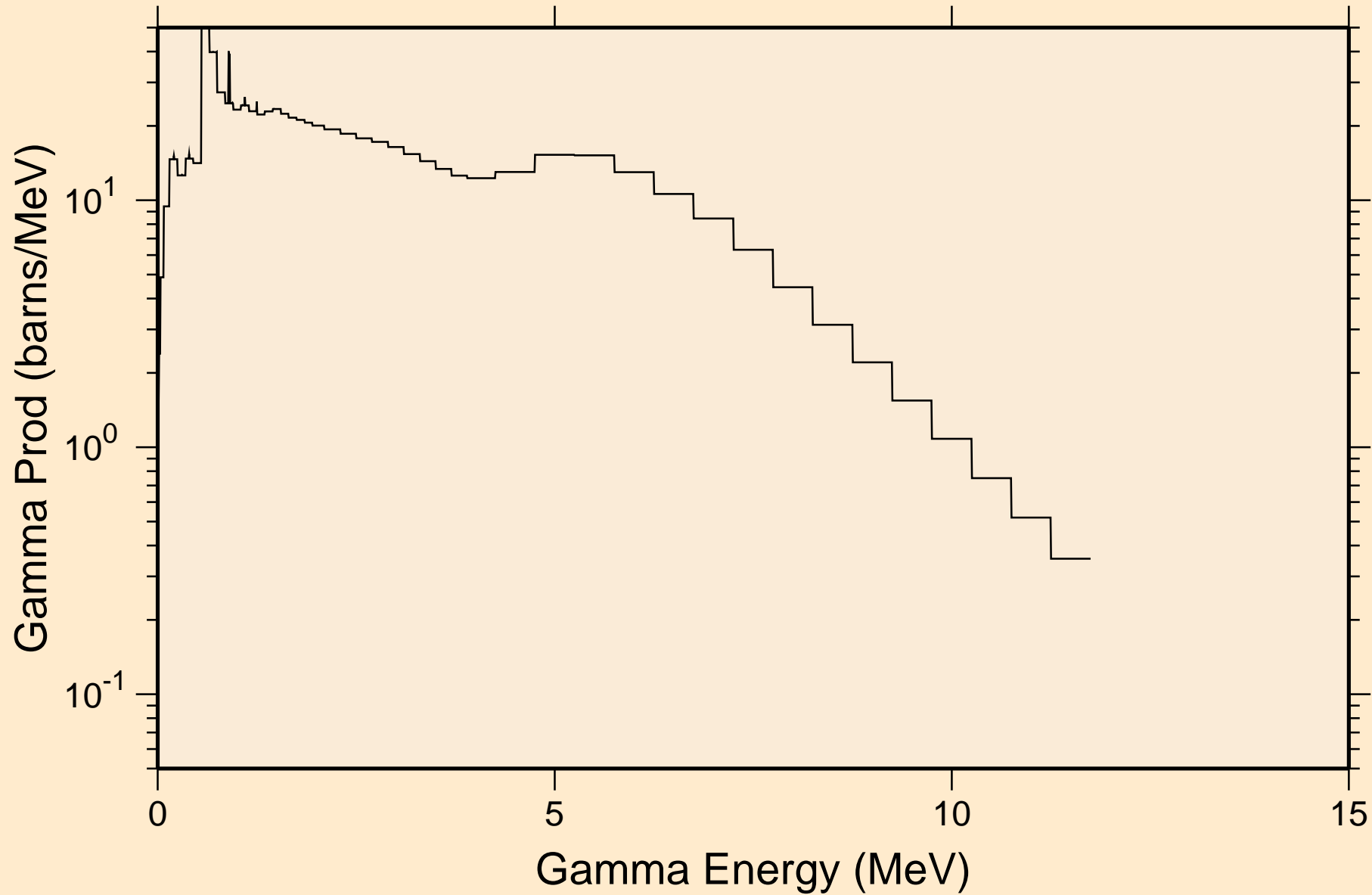

TC090 NEUTRON ACER TENDL-2023 LIBRARY; T=0.K  
14 MeV photon spectrum

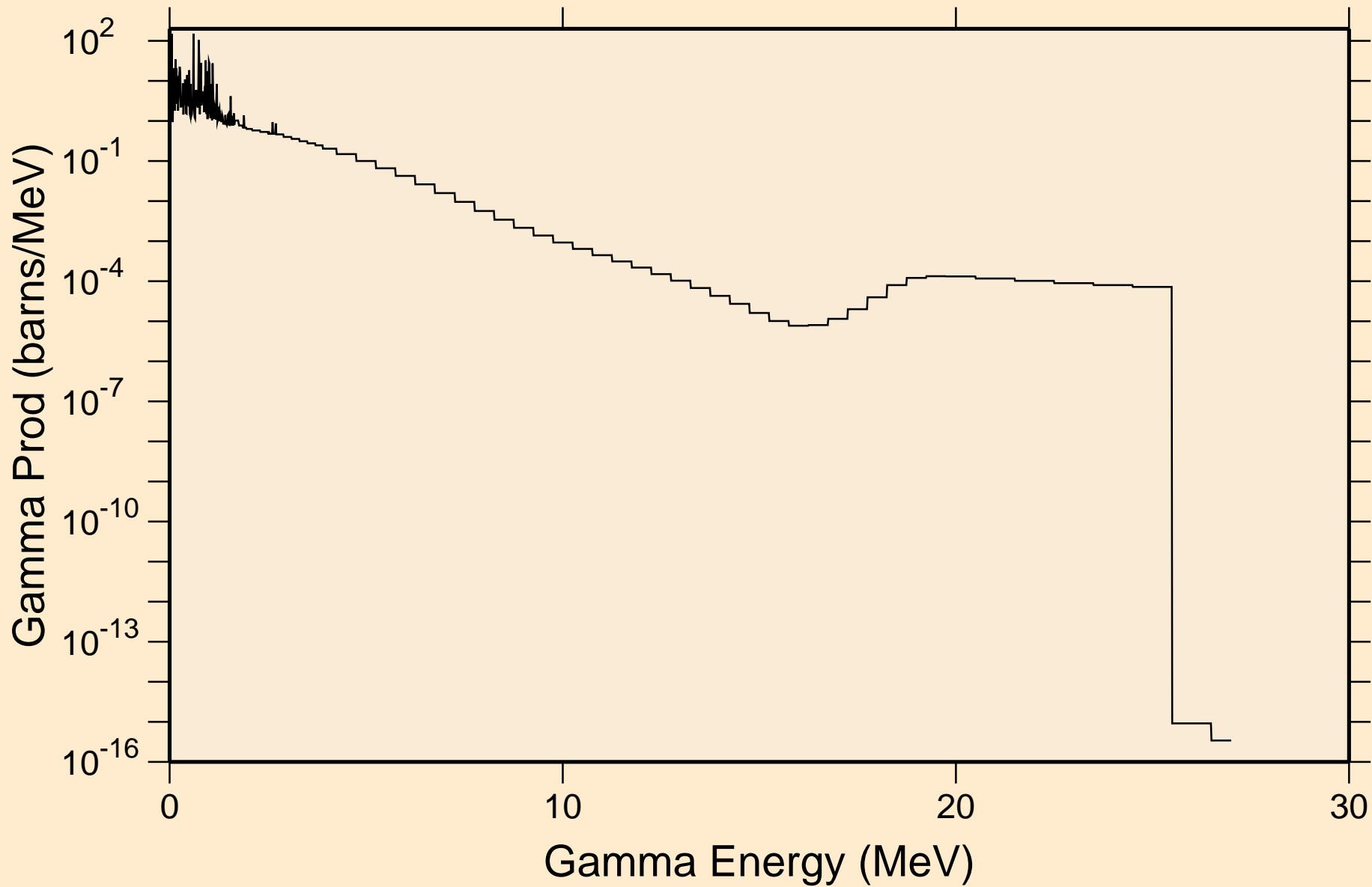

# TC090 NEUTRON ACER TENDL-2023 LIBRARY; T=0.K

## Particle heating contributions

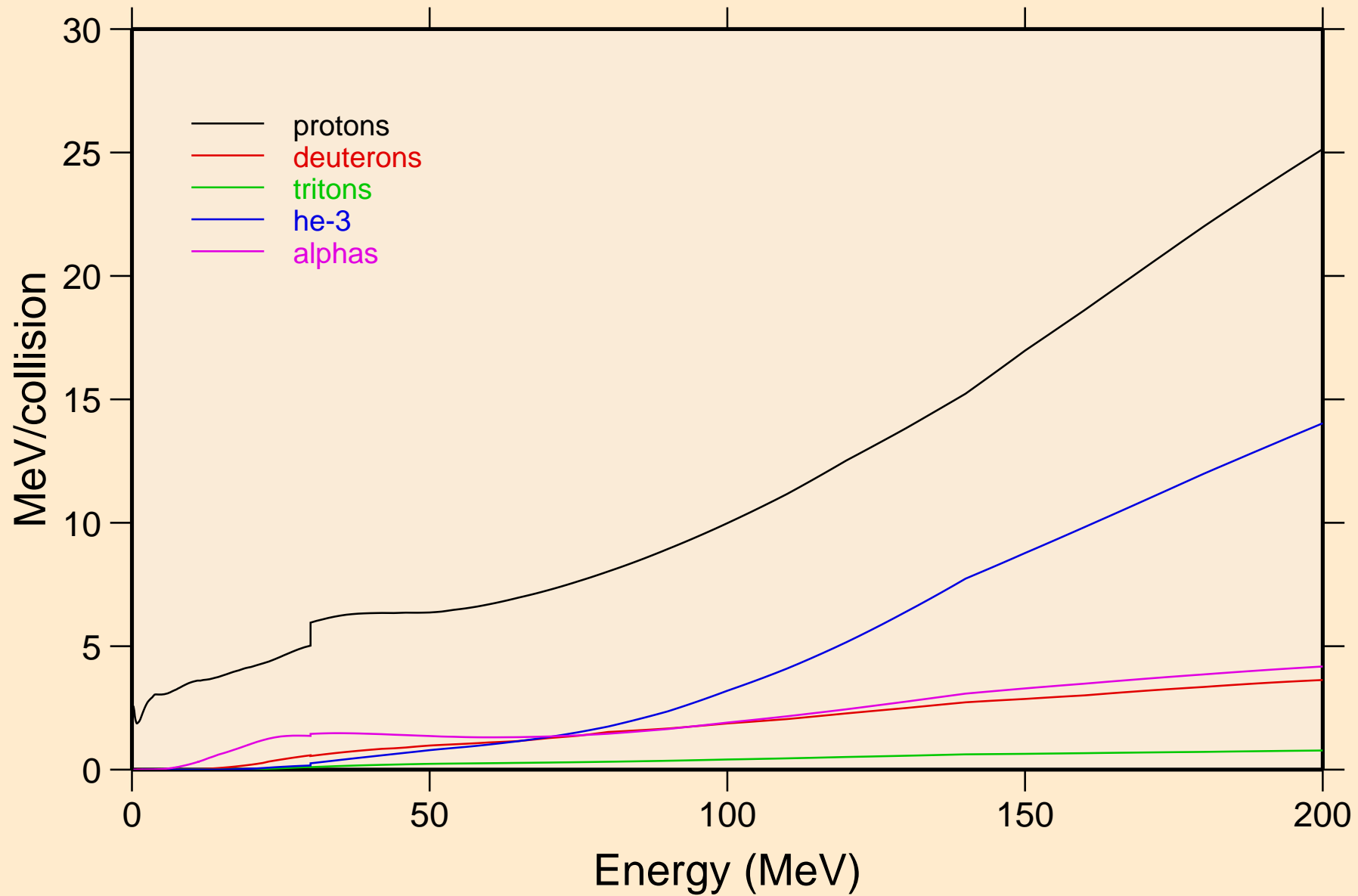



TC090 NEUTRON ACER TENDL-2023 LIBRARY; T=0.K  
Recoil Heating

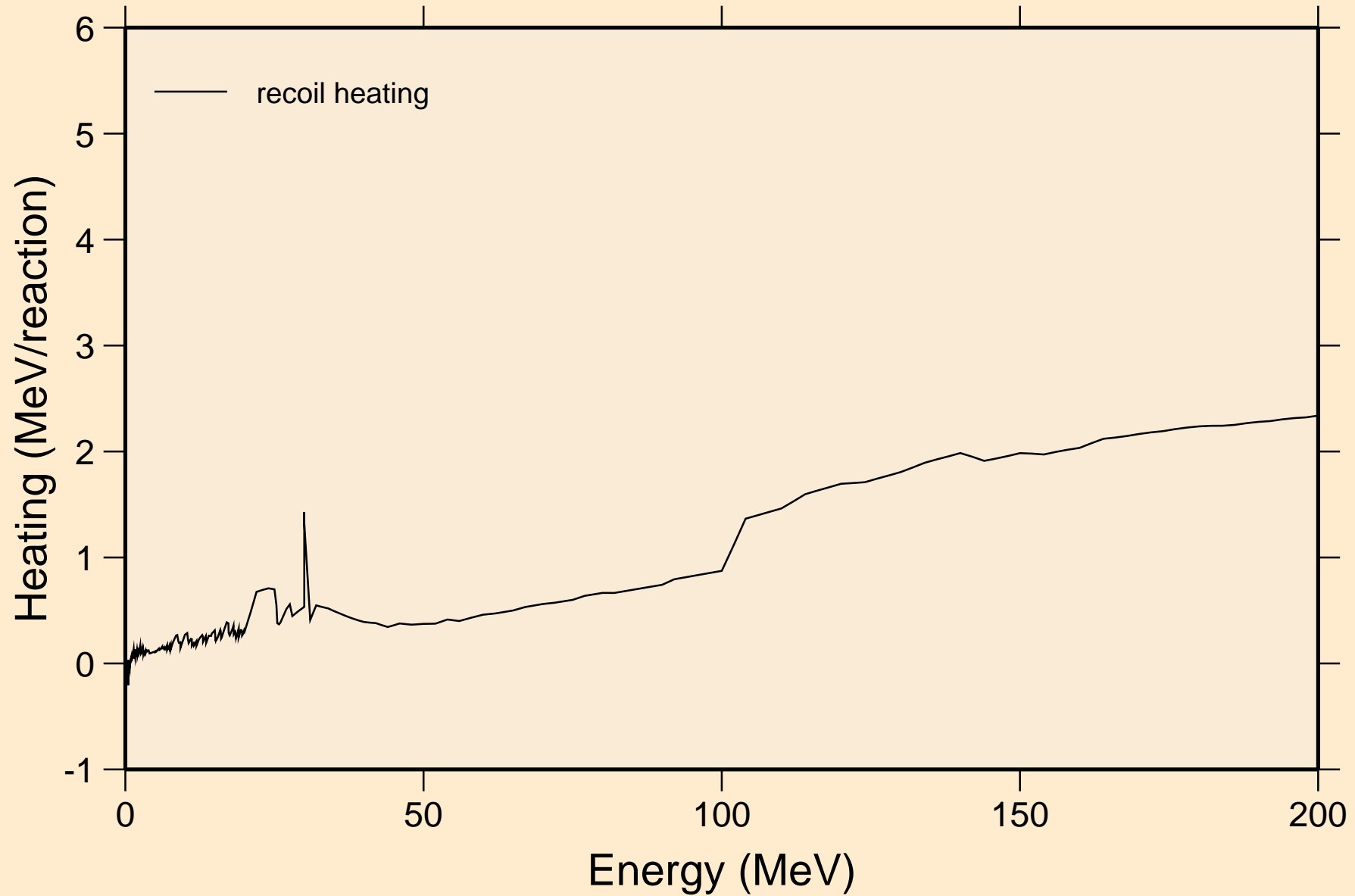

TC090 NEUTRON ACER TENDL-2023 LIBRARY; T=0.K  
Particle production cross sections

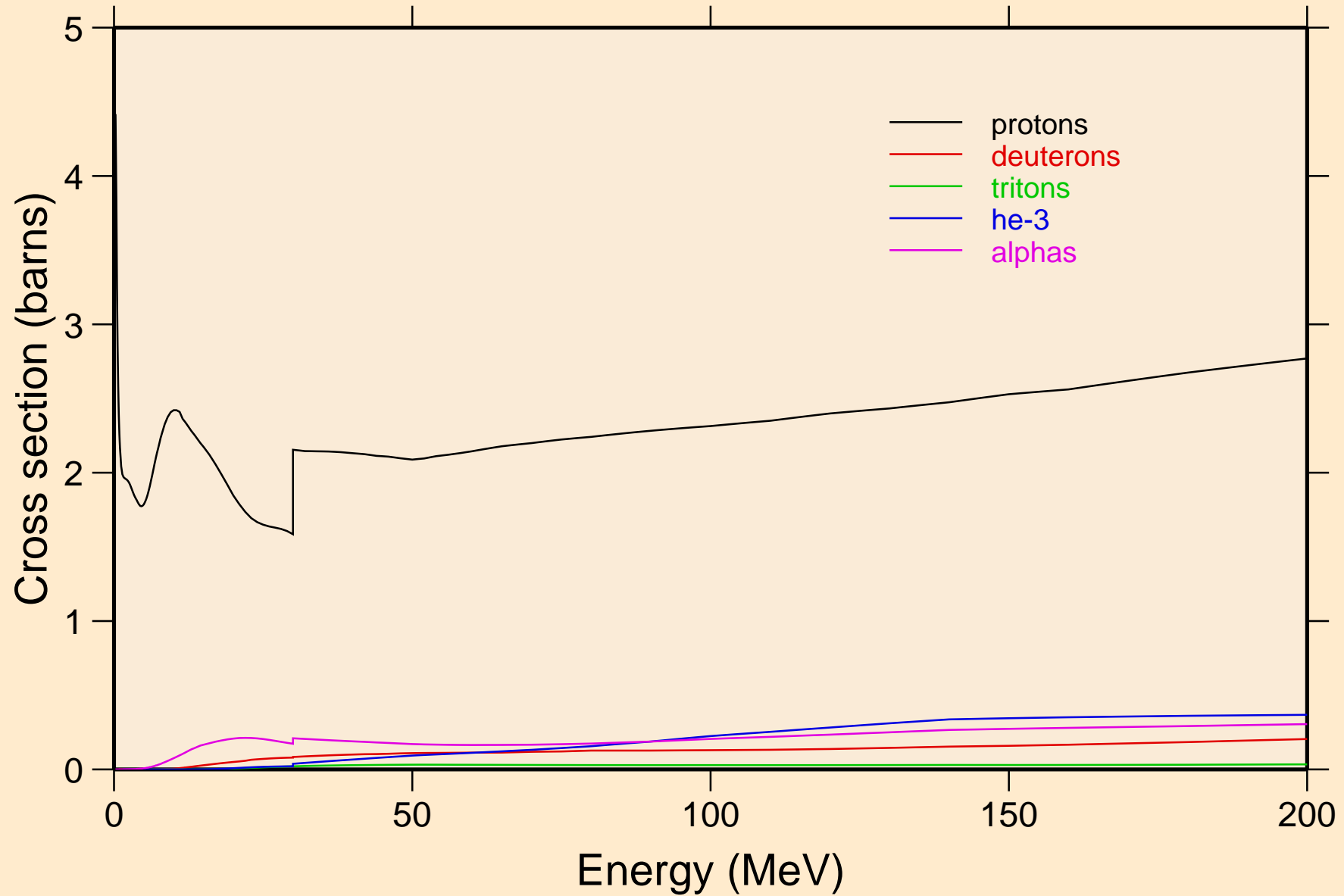

TC090 NEUTRON ACER TENDL-2023 LIBRARY; T=0.K  
protons from (n,x)

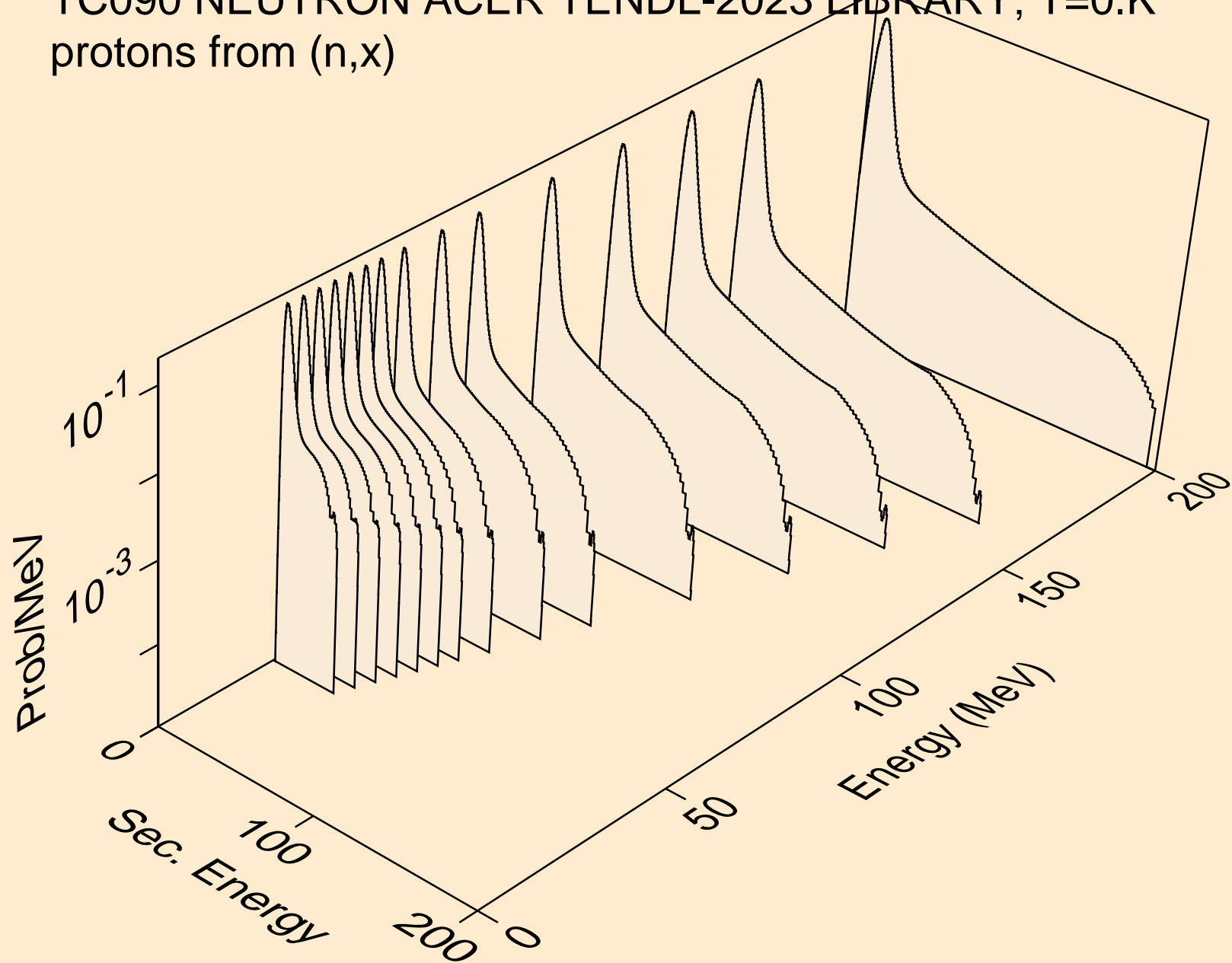

TC090 NEUTRON ACER TENDL-2023 LIBRARY; T=0.K  
protons from (n,n\*)p

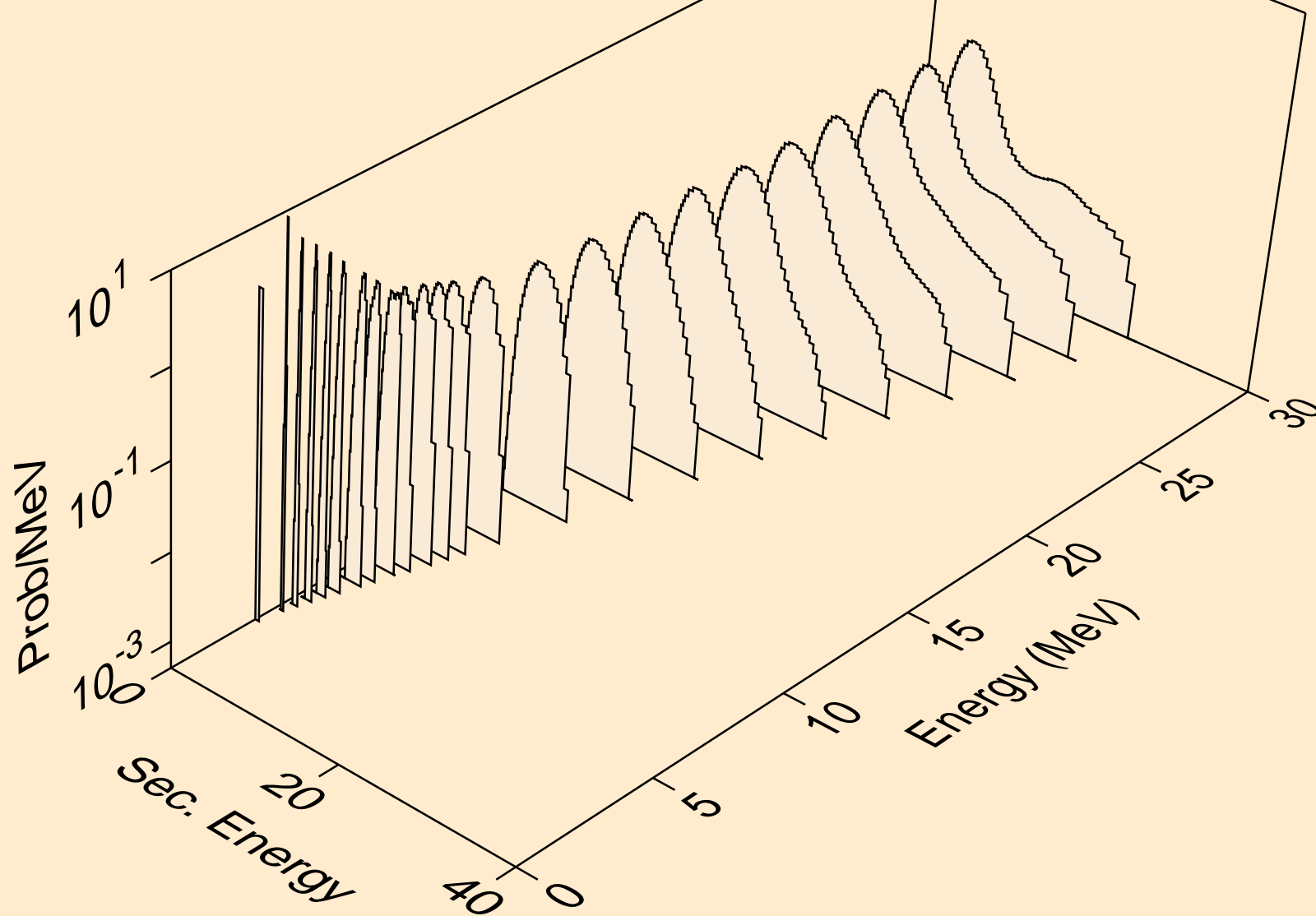

TC090 NEUTRON ACER TENDL-2023 LIBRARY; T=0.K  
protons from (n,2np)

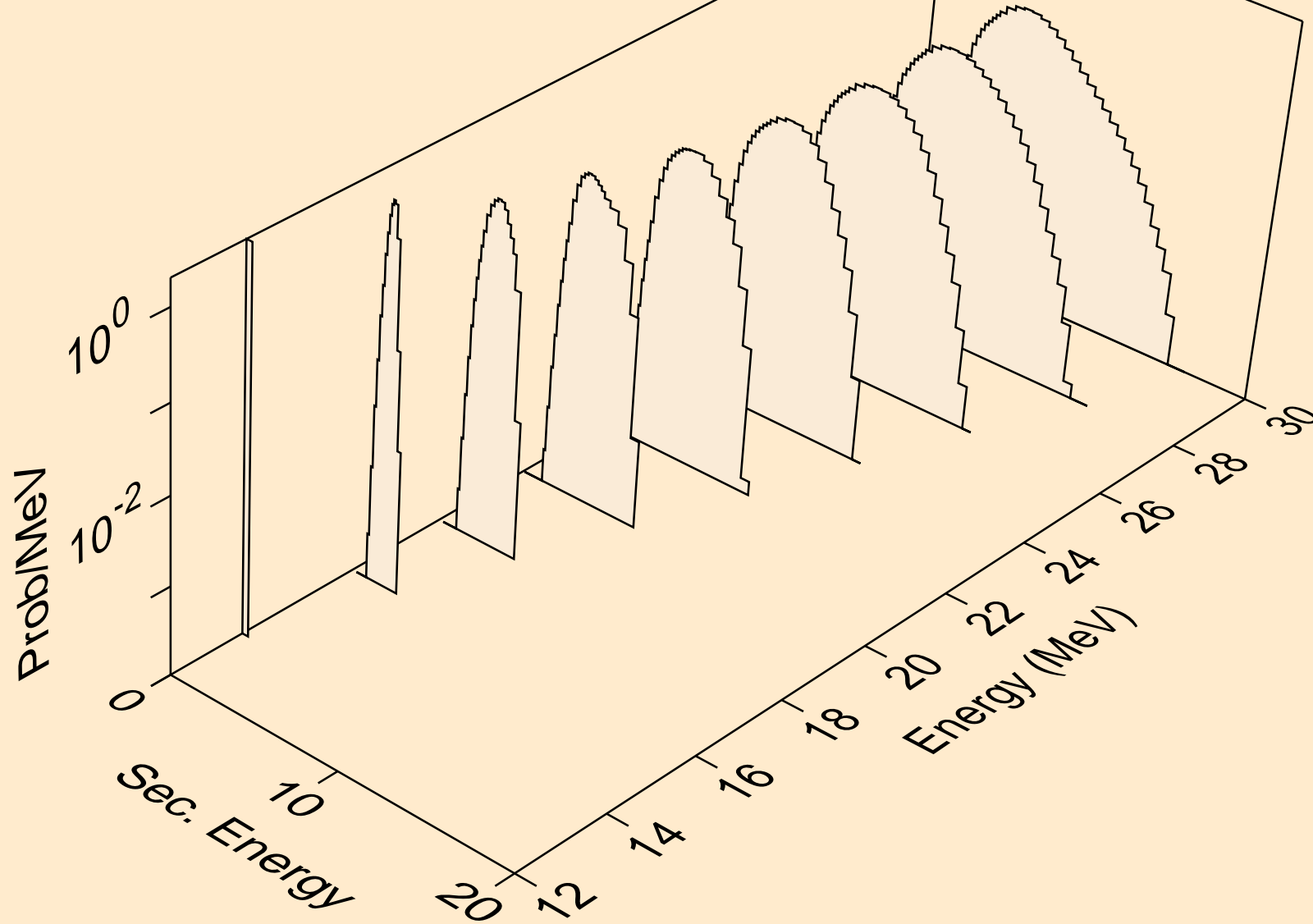

TC090 NEUTRON ACER TENDL-2023 LIBRARY; T=0.K  
protons from (n,3np)

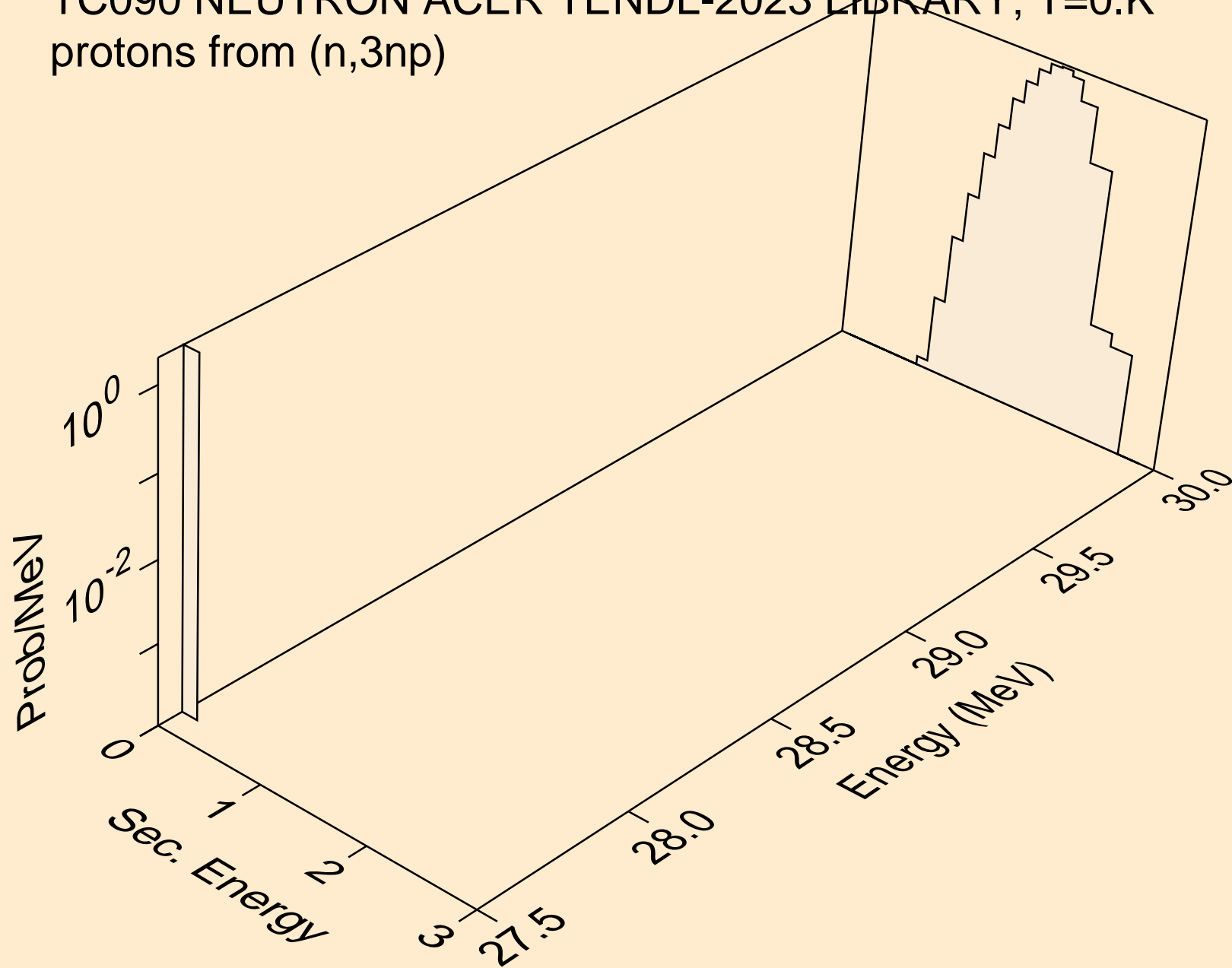

TC090 NEUTRON ACER TENDL-2023 LIBRARY; T=0.K  
protons from (n,n2p)

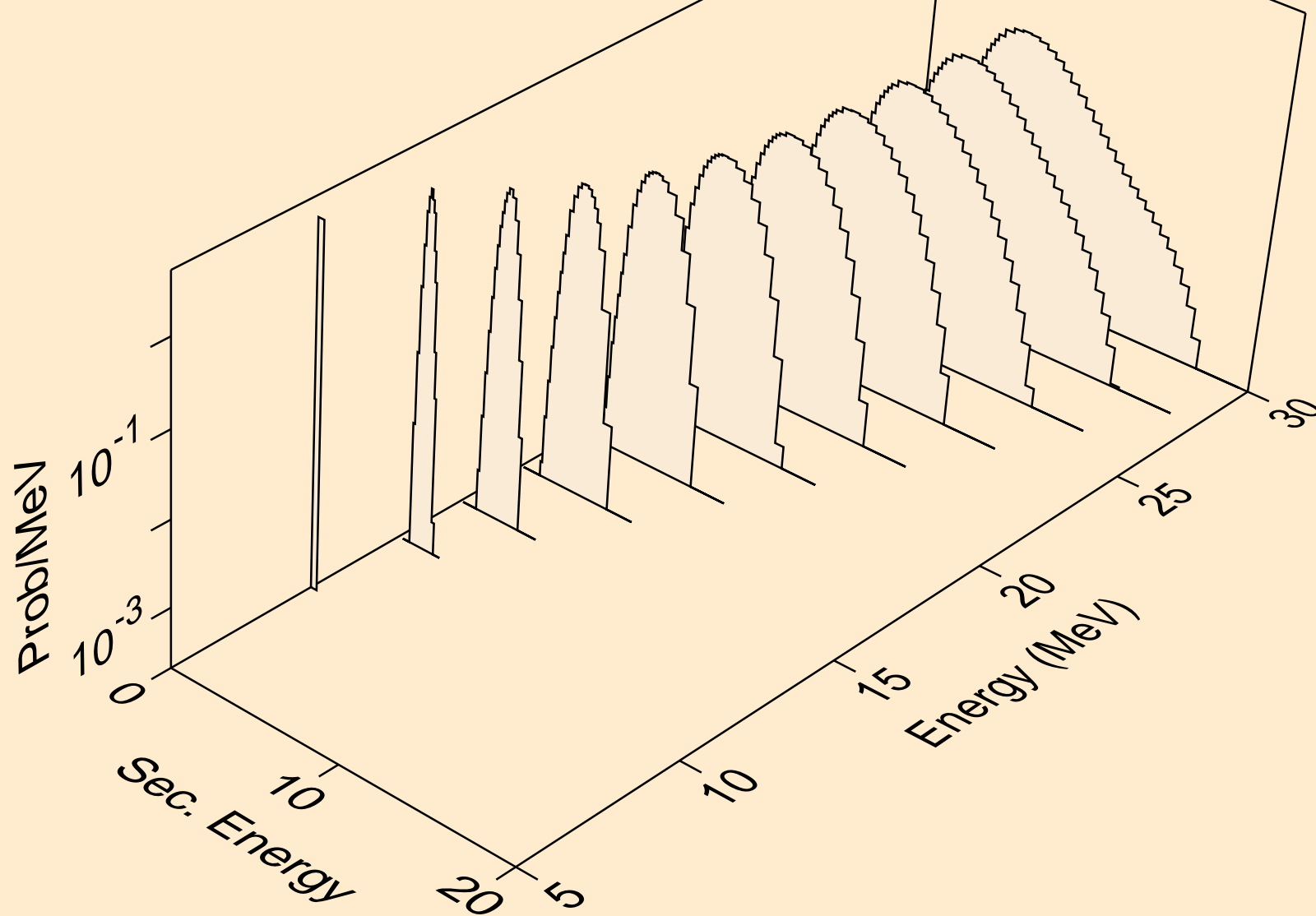

TC090 NEUTRON ACER TENDL-2023 LIBRARY; T=0.K  
protons from (n,npa)

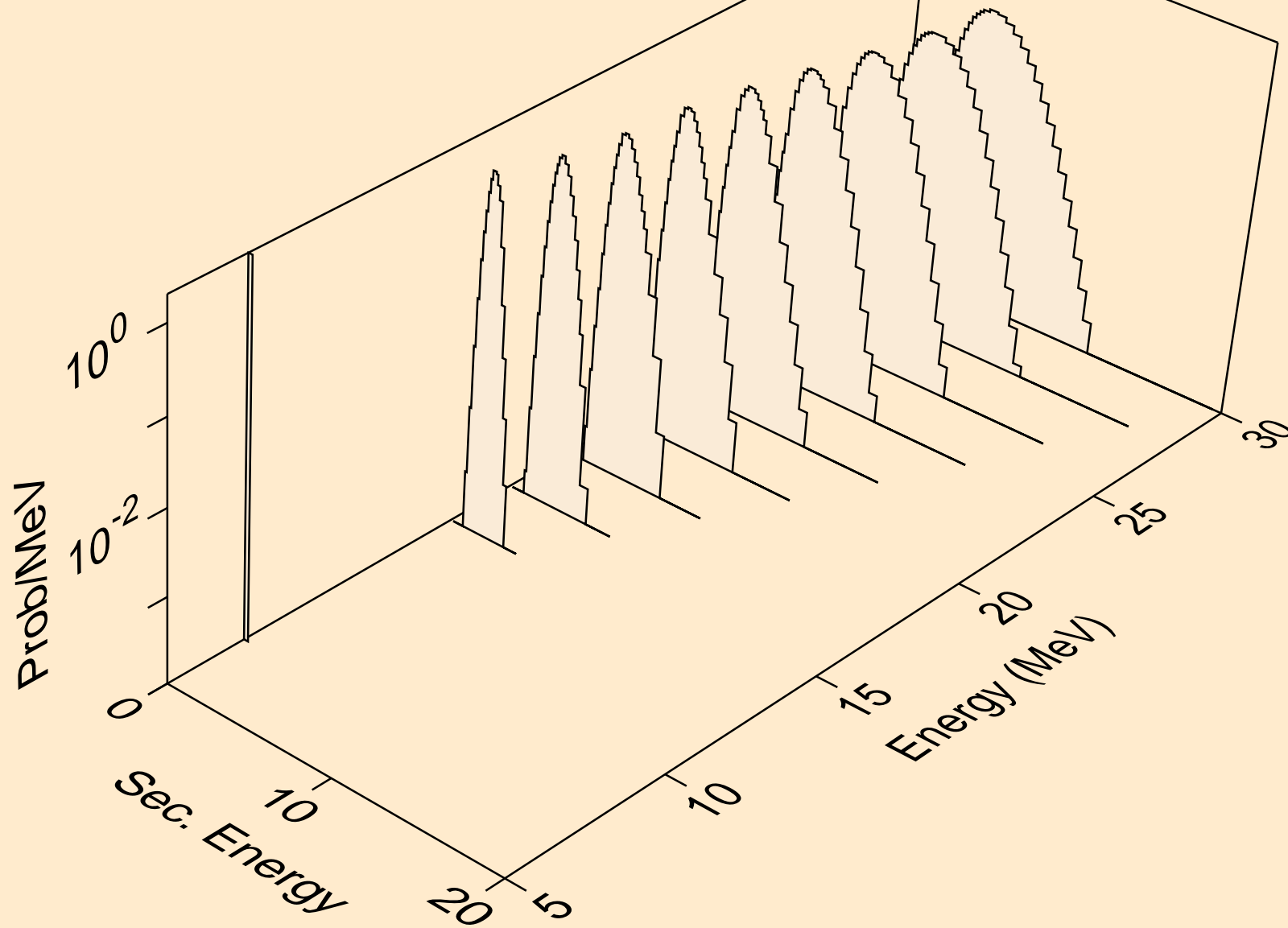



TC090 NEUTRON ACER TENDL-2023 LIBRARY; T=0.K  
protons from (n,p)

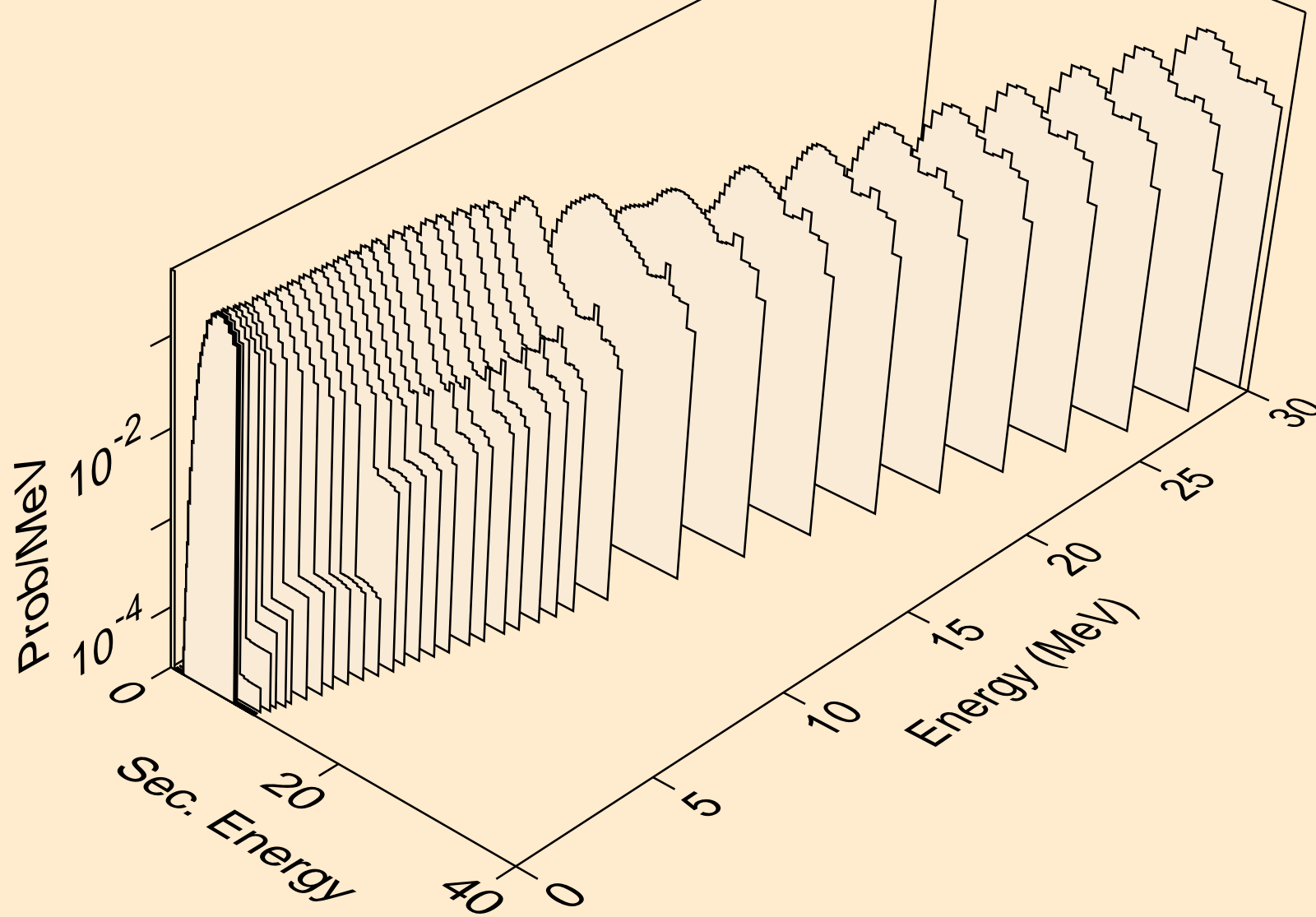

TC090 NEUTRON ACER TENDL-2023 LIBRARY; T=0.K  
protons from (n,2p)

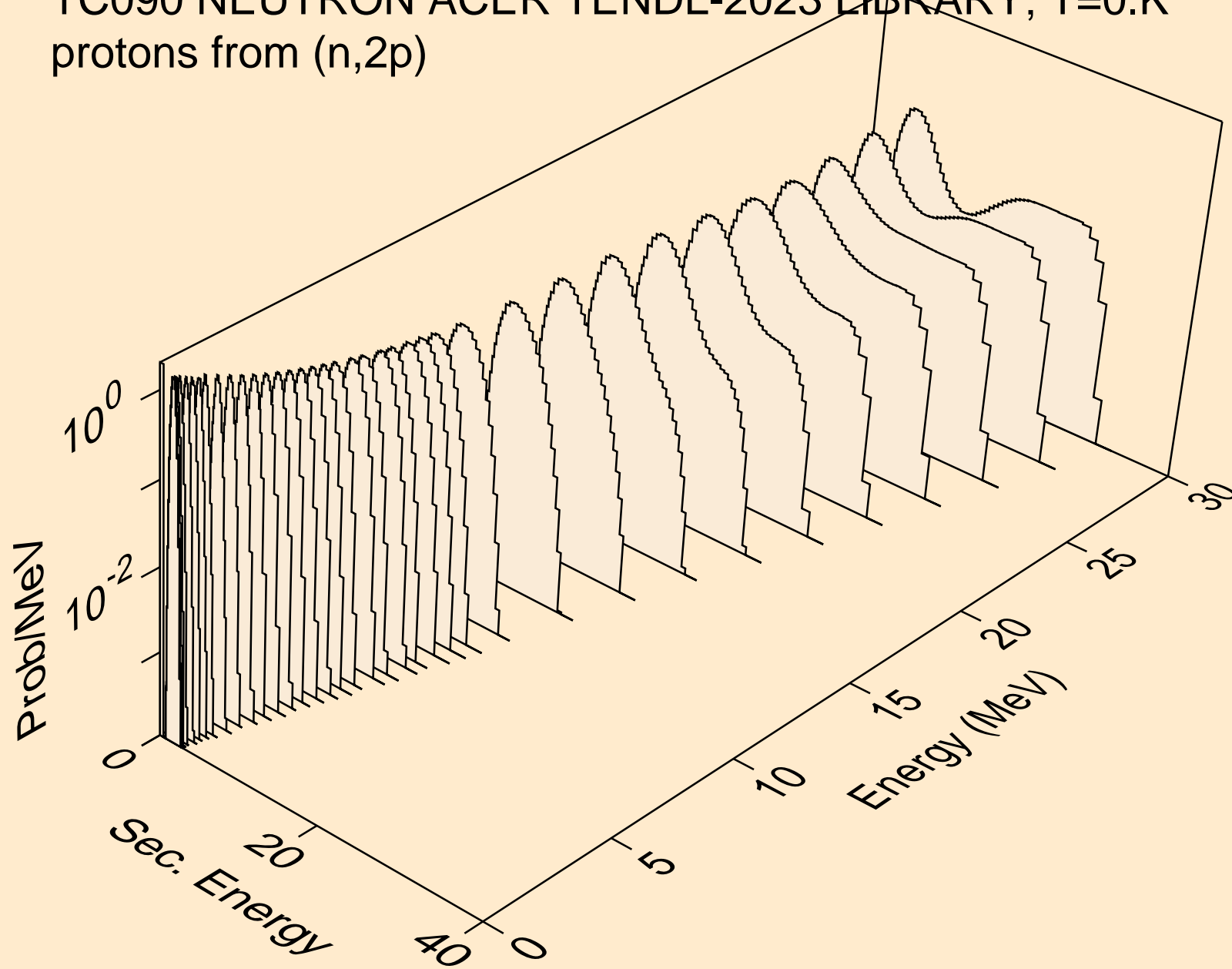

TC090 NEUTRON ACER TENDL-2023 LIBRARY; T=0.K  
protons from (n,p)

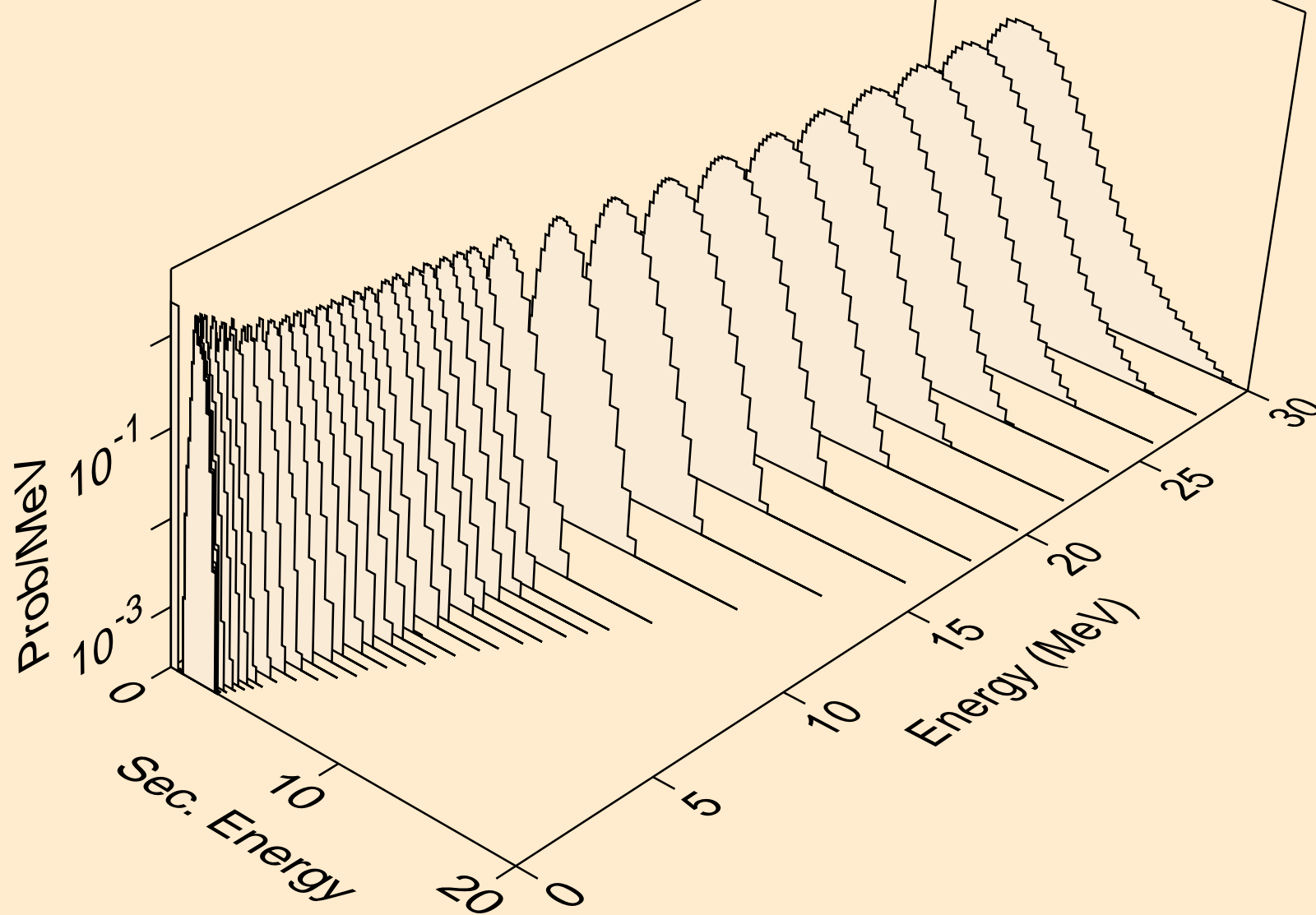

TC090 NEUTRON ACER TENDL-2023 LIBRARY; T=0.K  
protons from (n,pd)

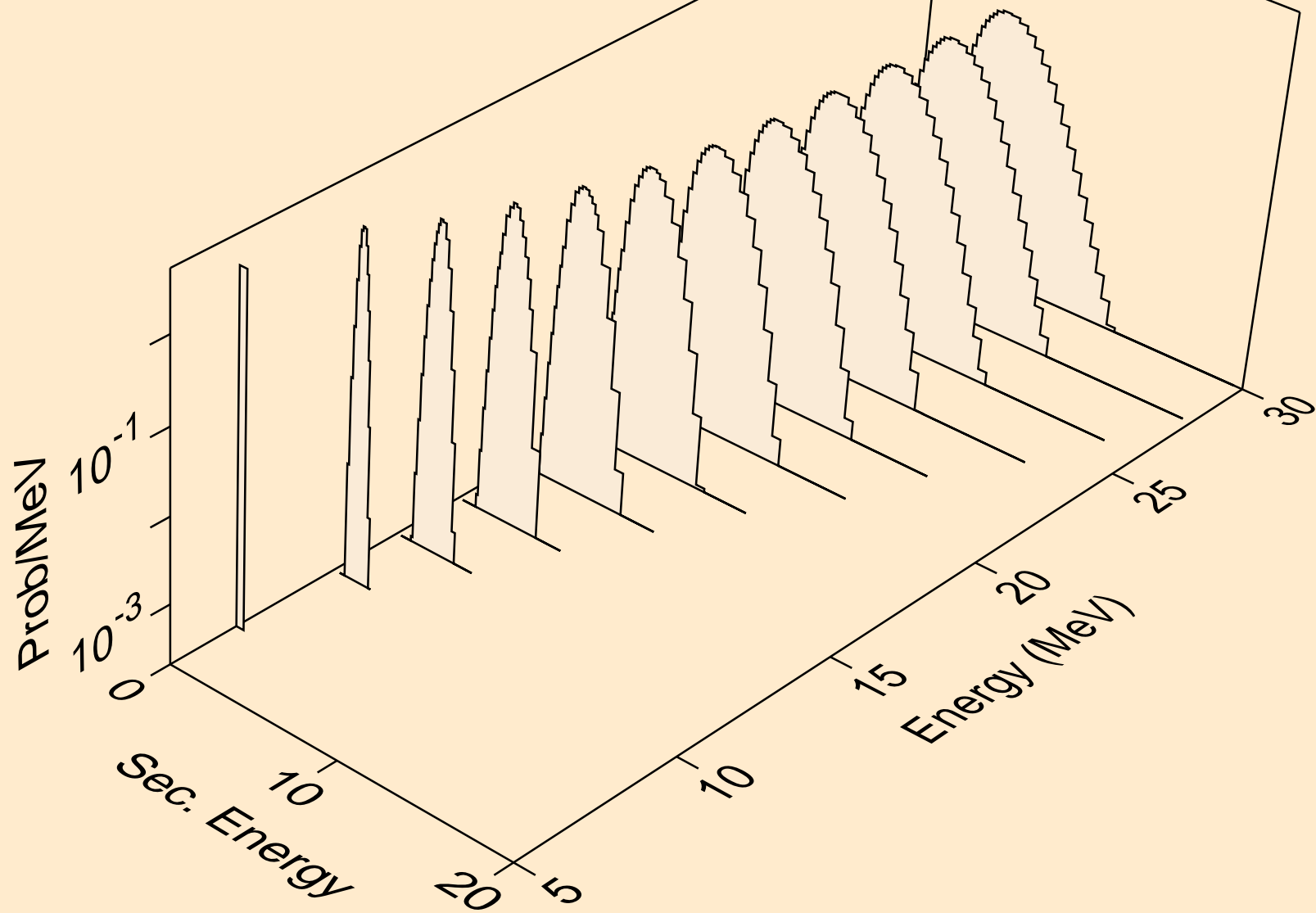

TC090 NEUTRON ACER TENDL-2023 LIBRARY; T=0.K  
protons from (n,pt)

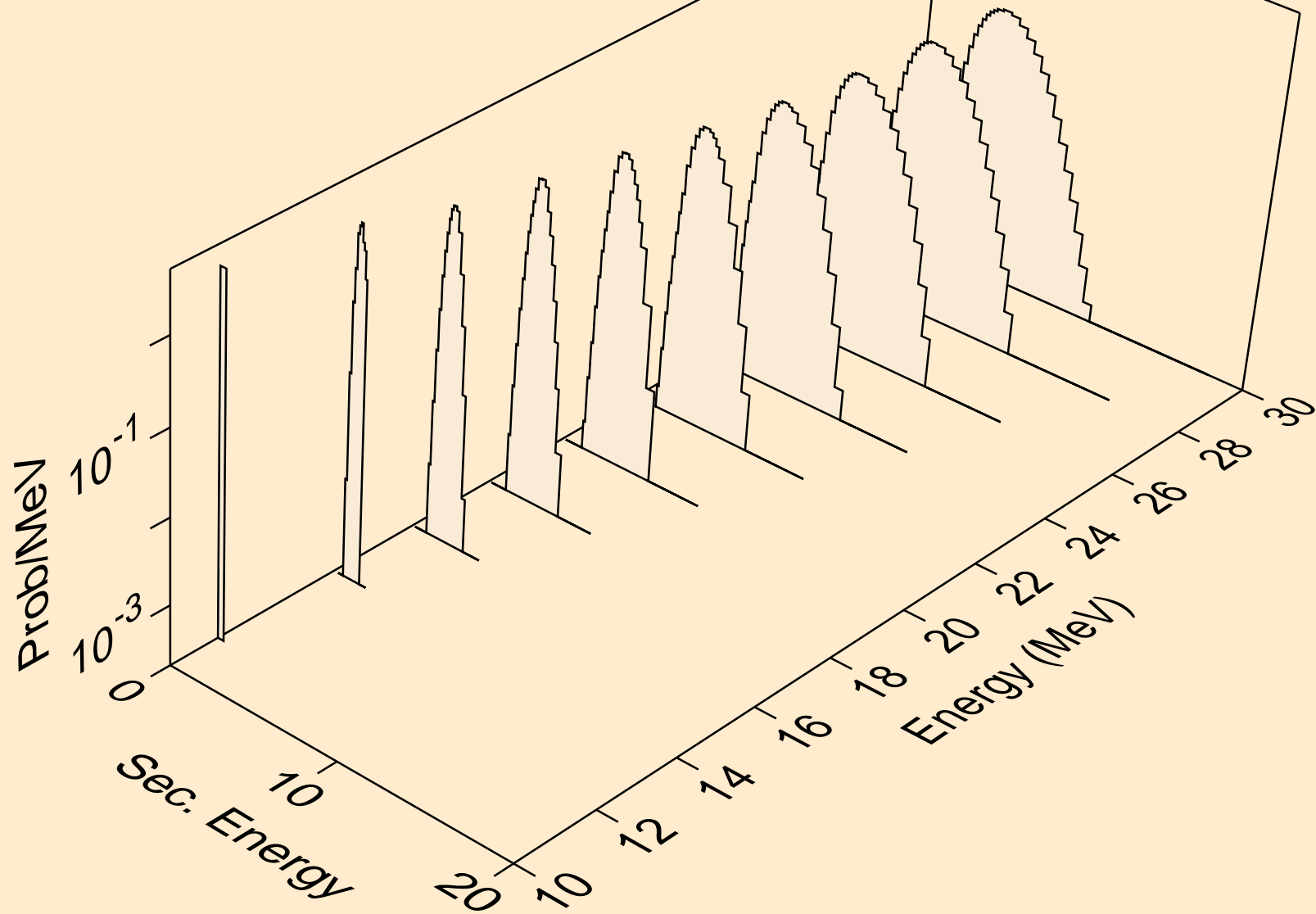

TC090 NEUTRON ACER TENDL-2023 LIBRARY; T=0.K  
deuterons from (n,x)

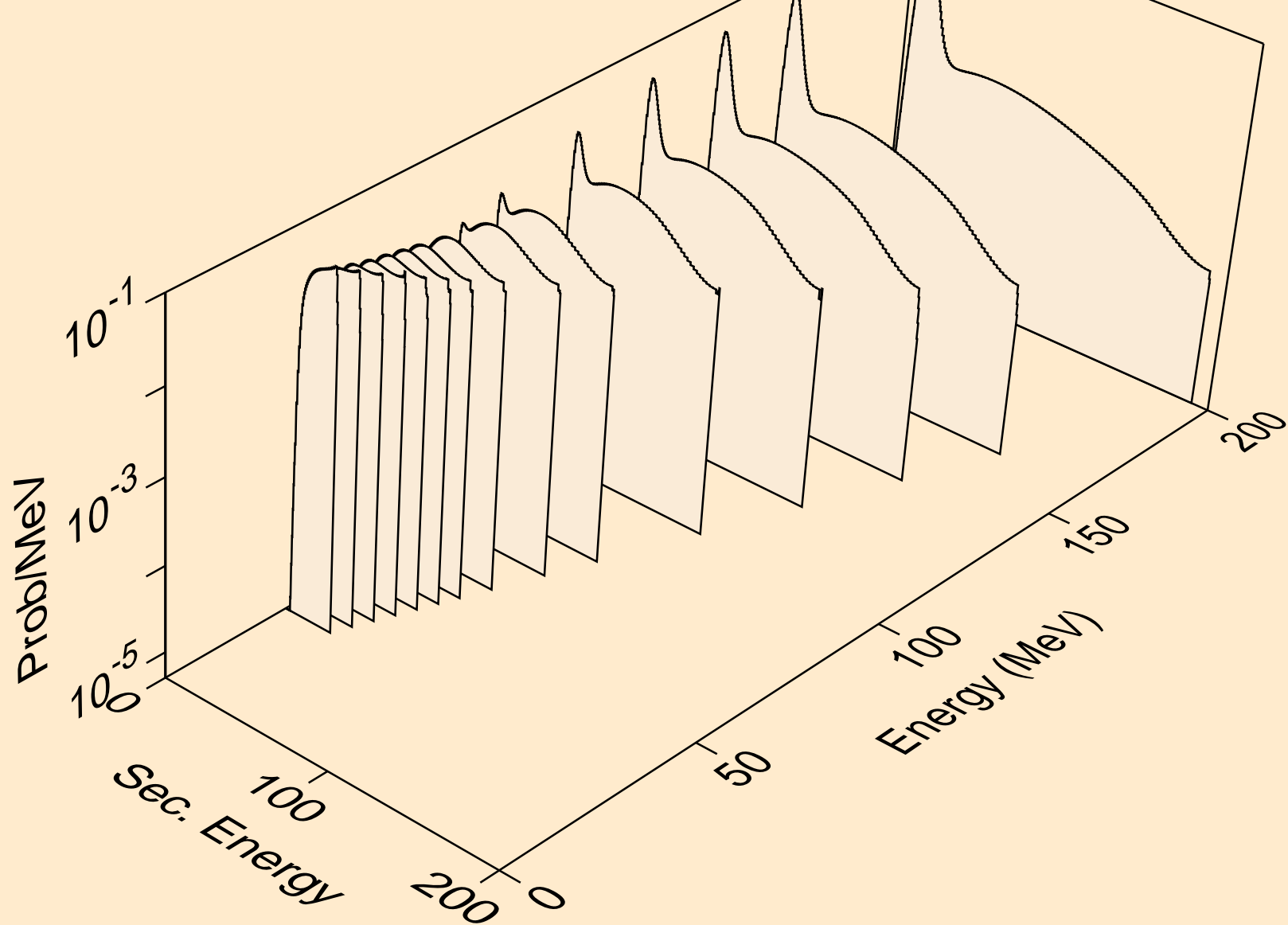

TC090 NEUTRON ACER TENDL-2023 LIBRARY; T=0.K  
deuterons from (n,2nd)

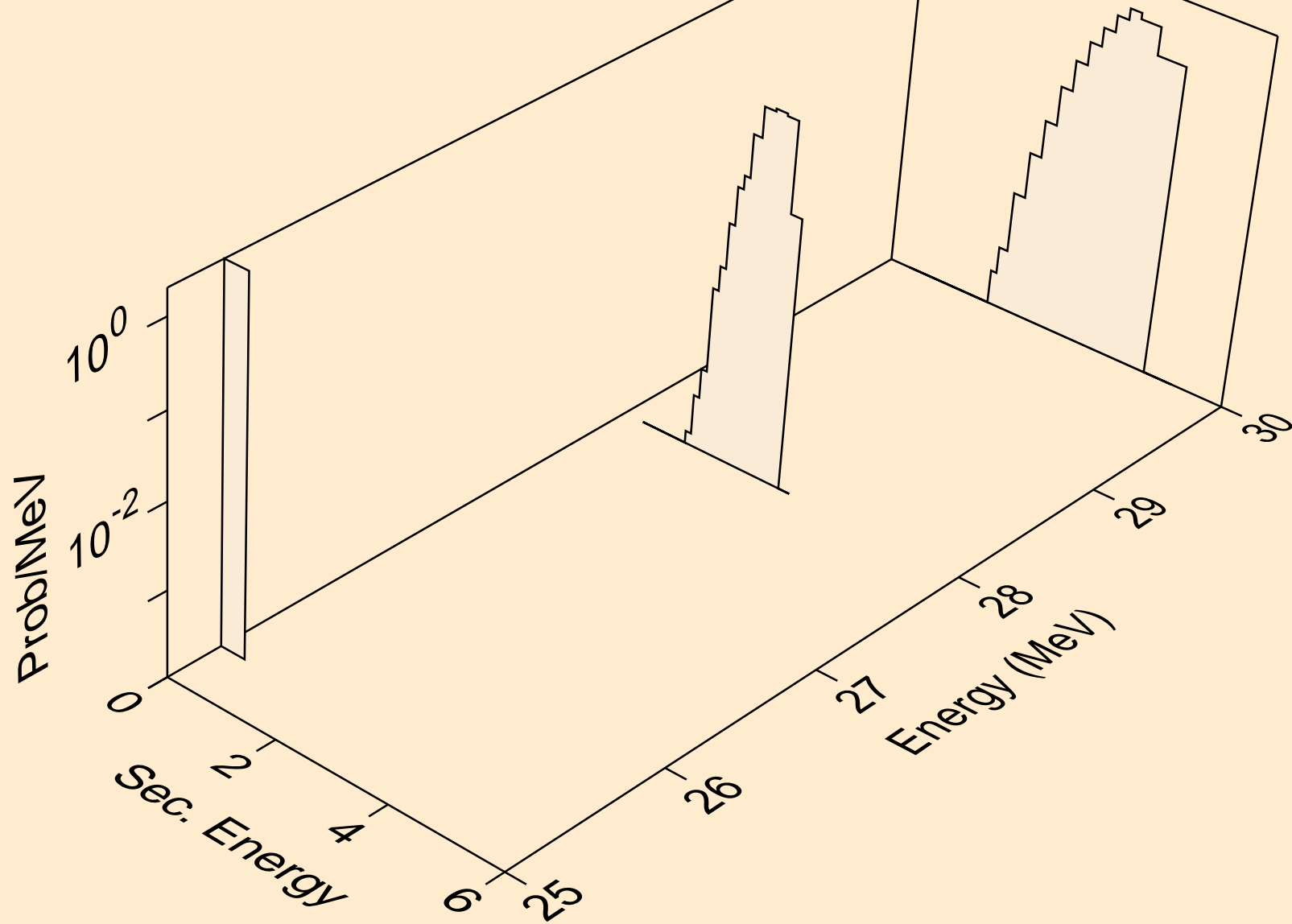

TC090 NEUTRON ACER TENDL-2023 LIBRARY; T=0.K  
deuterons from (n,n\*)d

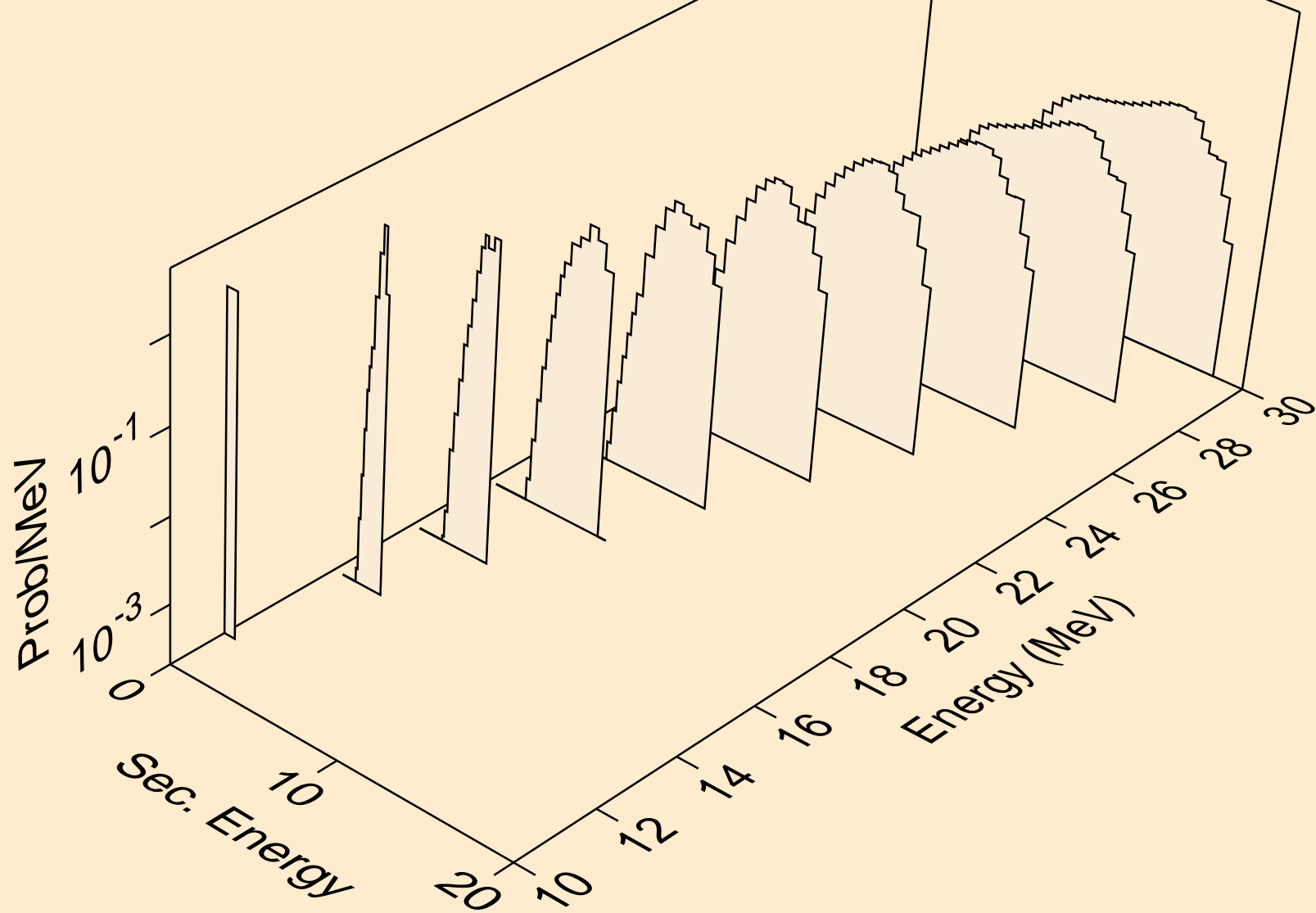



TC090 NEUTRON ACER TENDL-2023 LIBRARY; T=0.K  
deuterons from (n,d)

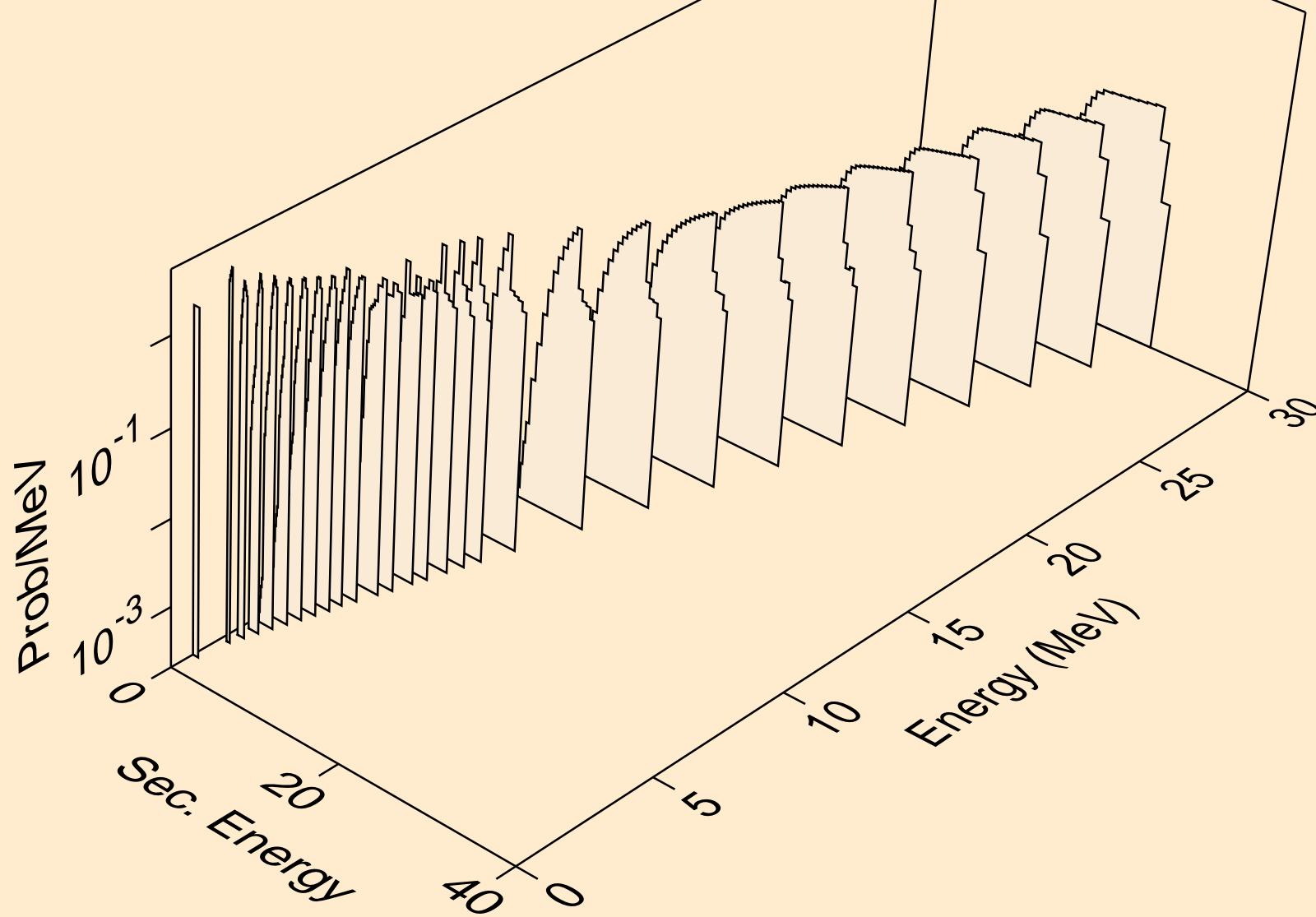

TC090 NEUTRON ACER TENDL-2023 LIBRARY; T=0.K  
deuterons from (n,pd)

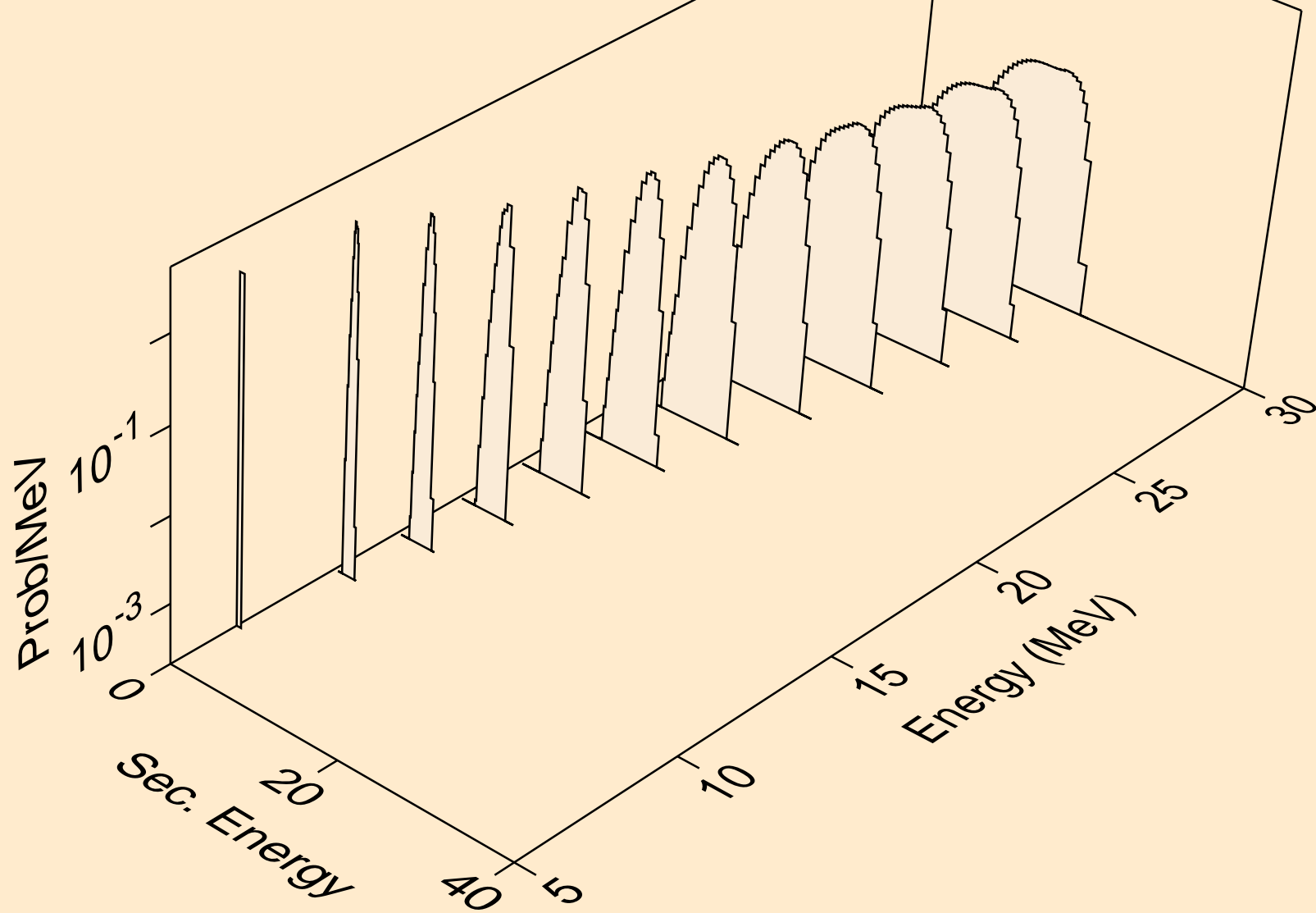

TC090 NEUTRON ACER TENDL-2023 LIBRARY; T=0.K  
deuterons from (n,da)

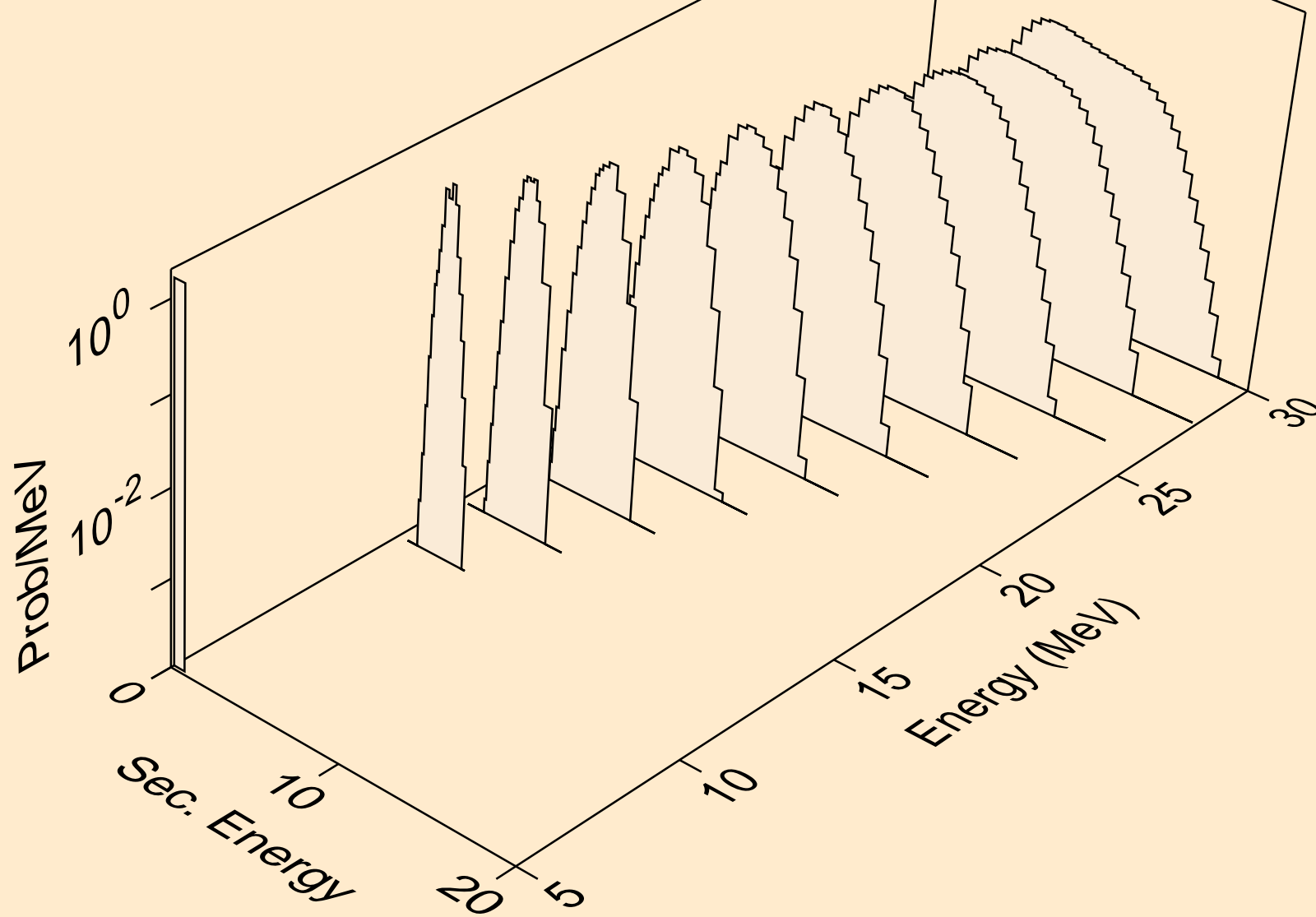

TC090 NEUTRON ACER TENDL-2023 LIBRARY; T=0.K  
tritons from (n,x)

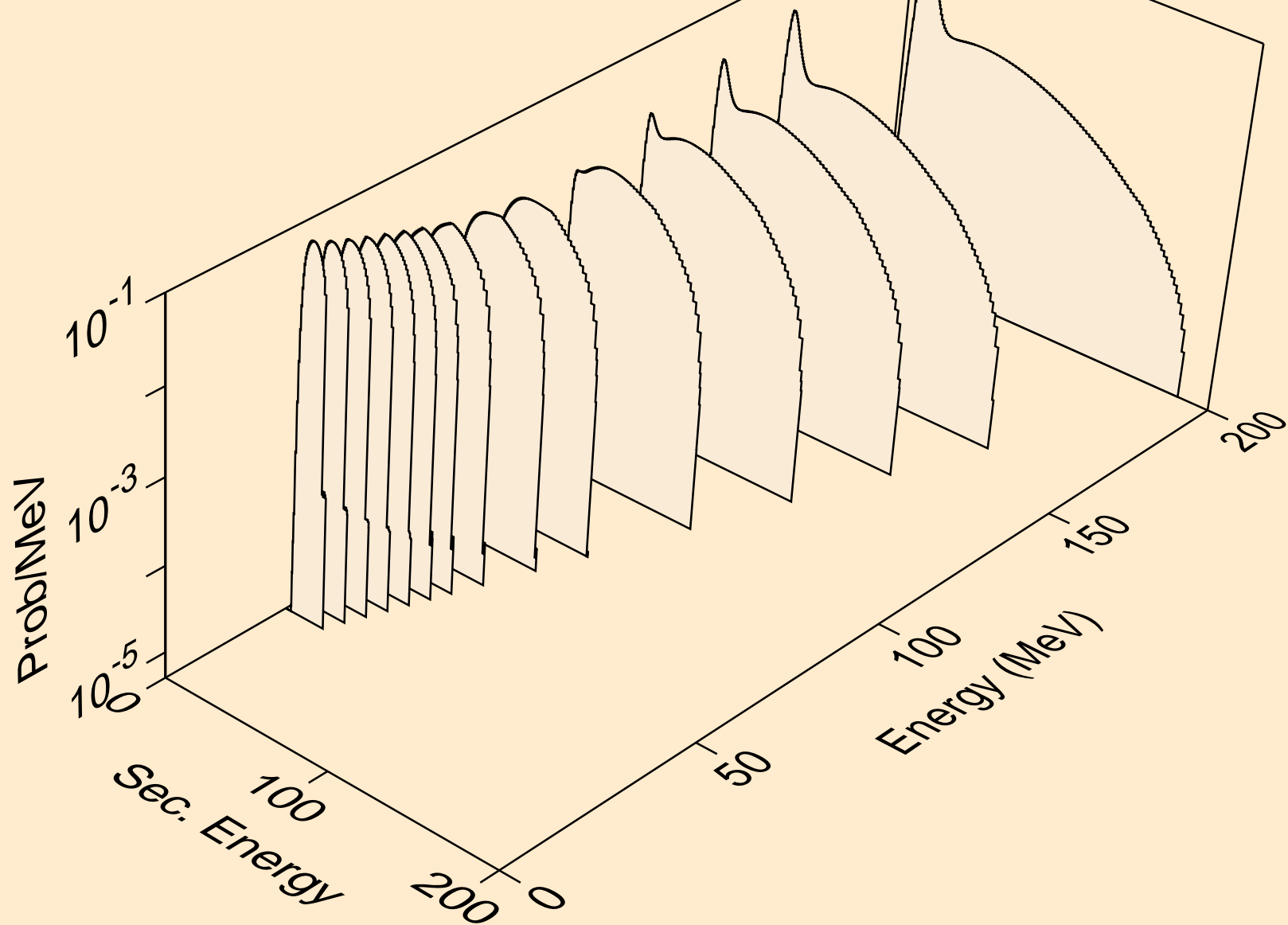

TC090 NEUTRON ACER TENDL-2023 LIBRARY; T=0.K  
tritons from (n,n\*)t

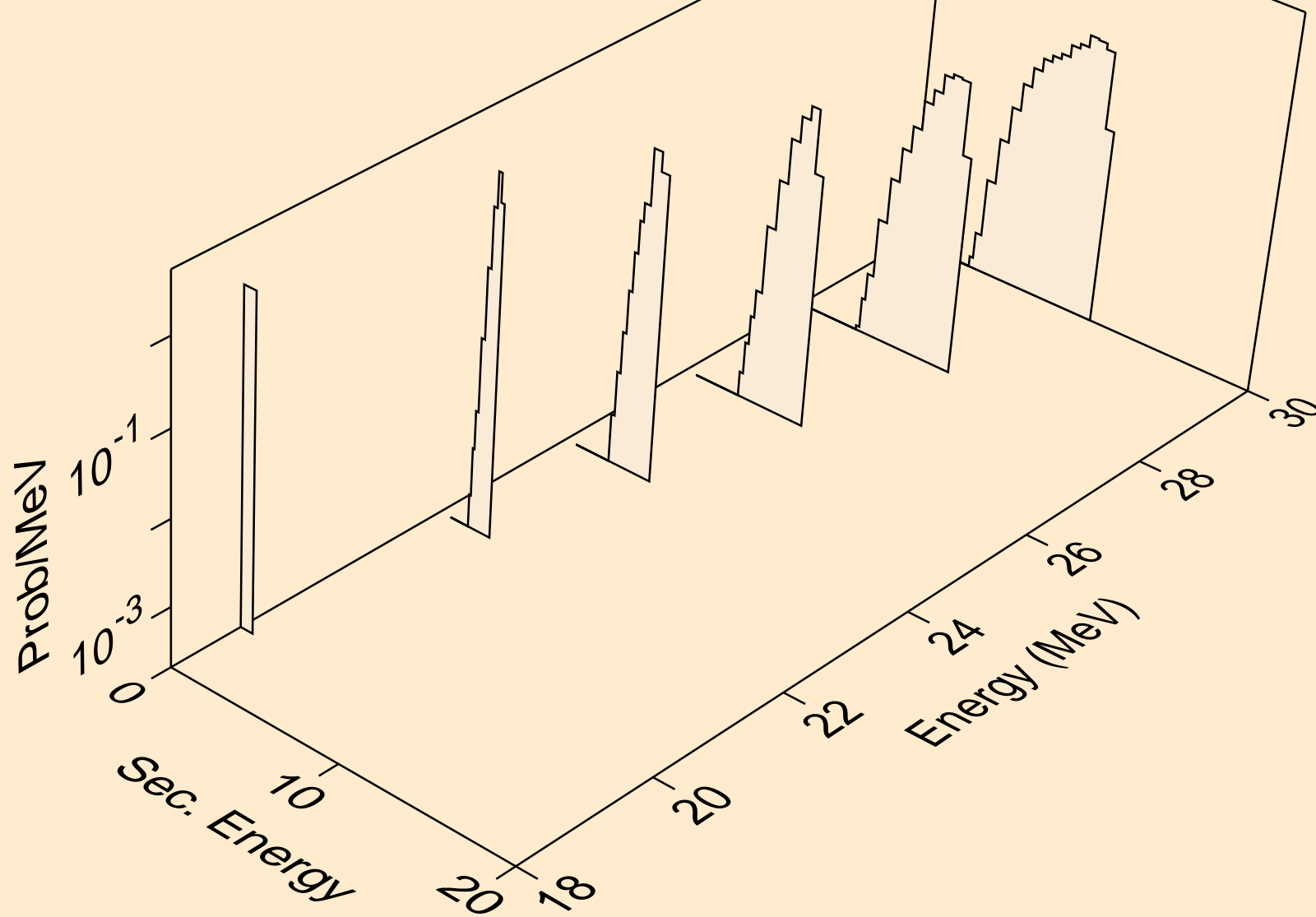

TC090 NEUTRON ACER TENDL-2023 LIBRARY; T=0.K  
tritons from (n,t)

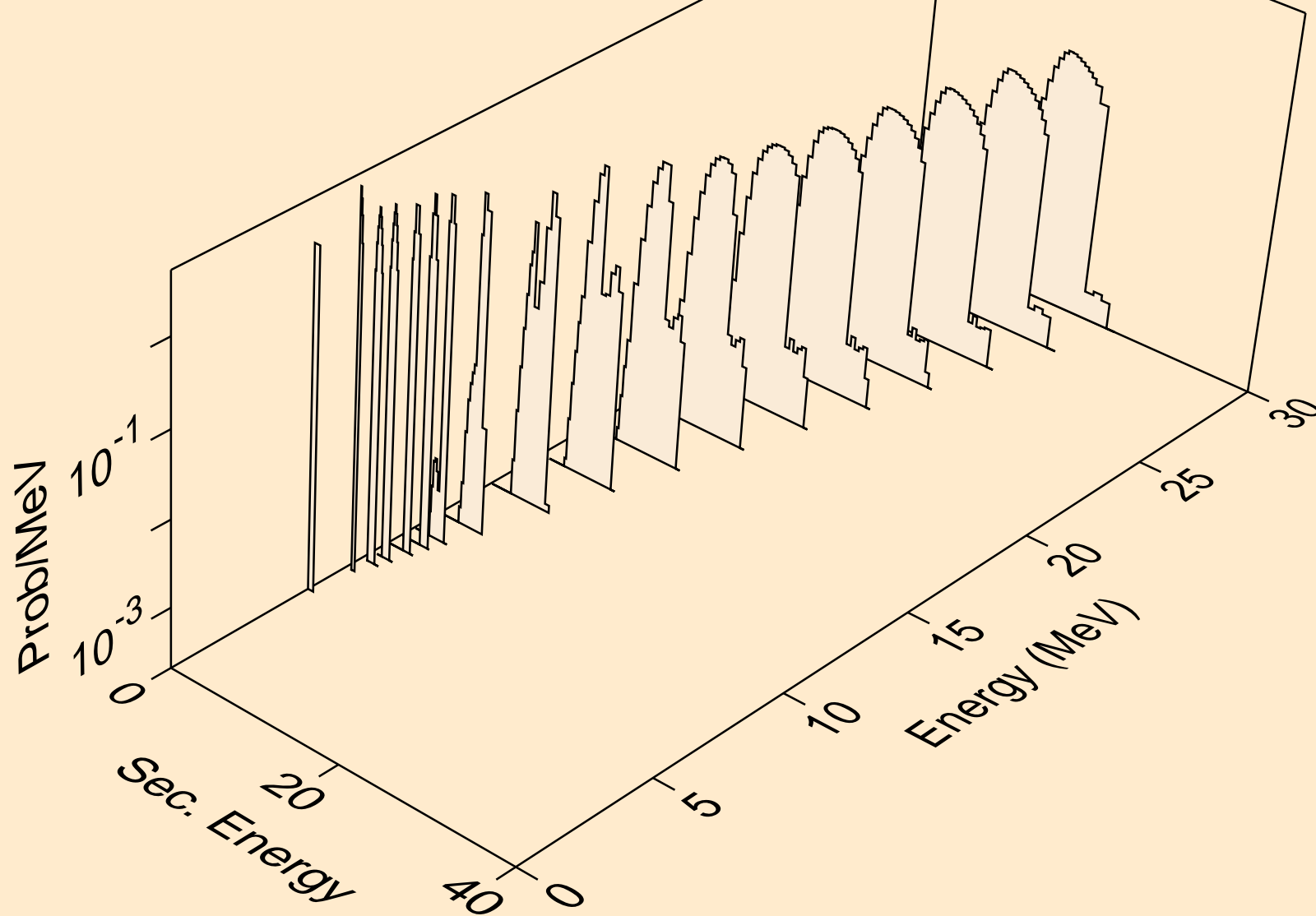

TC090 NEUTRON ACER TENDL-2023 LIBRARY; T=0.K  
tritons from (n,pt)

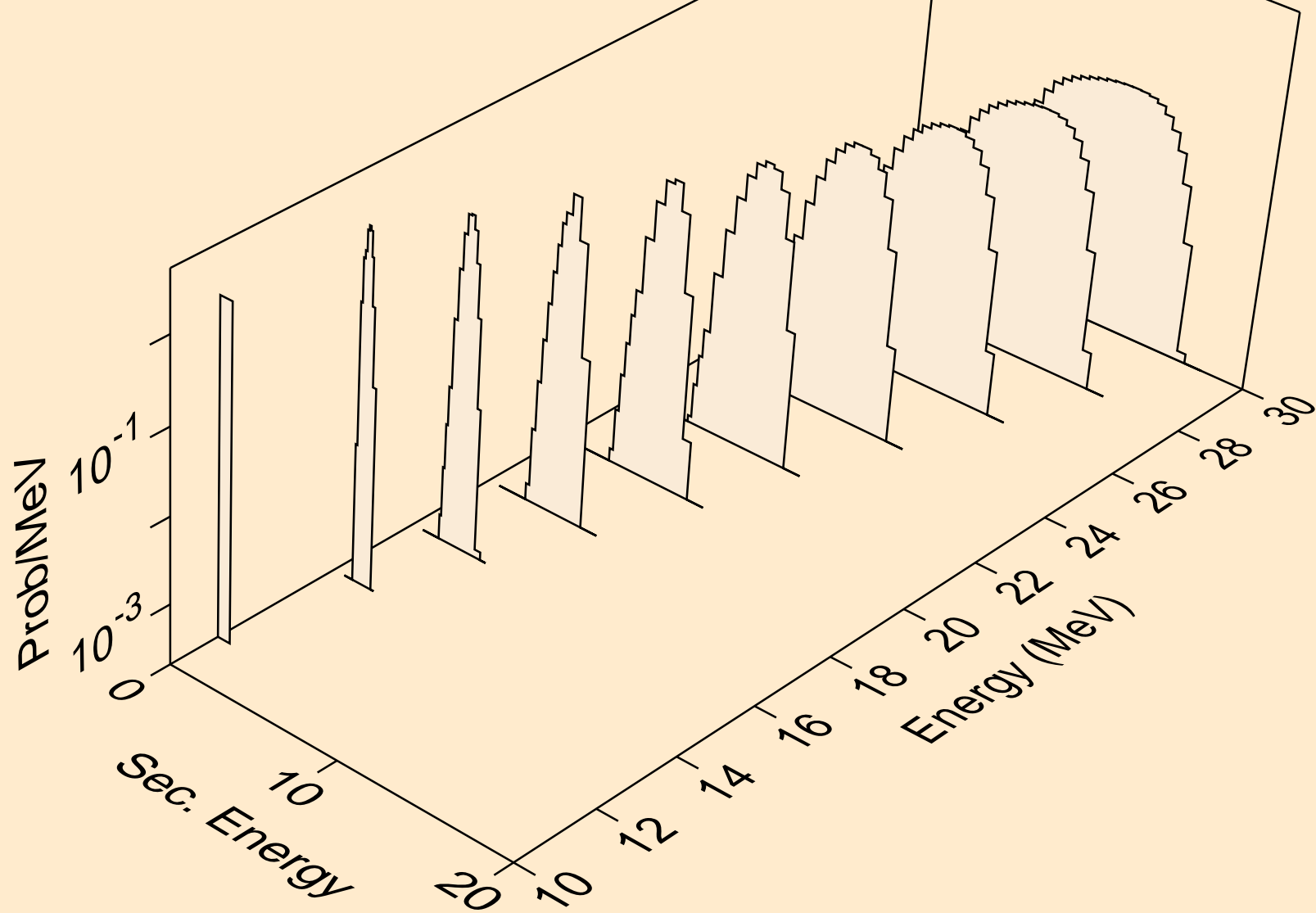

TC090 NEUTRON ACER TENDL-2023 LIBRARY; T=0.K  
he3s from (n,x)

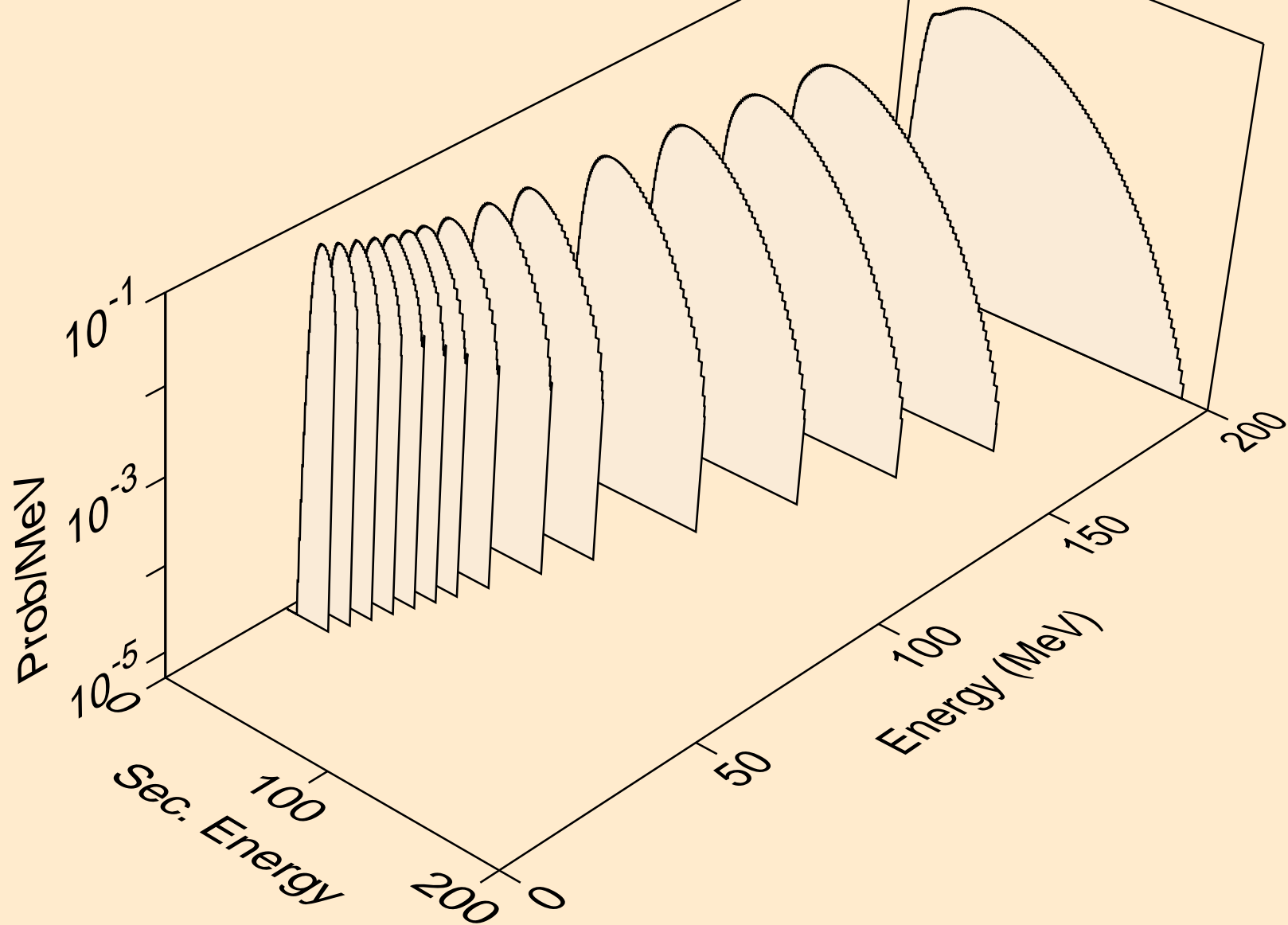



TC090 NEUTRON ACER TENDL-2023 LIBRARY; T=0.K  
he3s from (n,n\*)he3

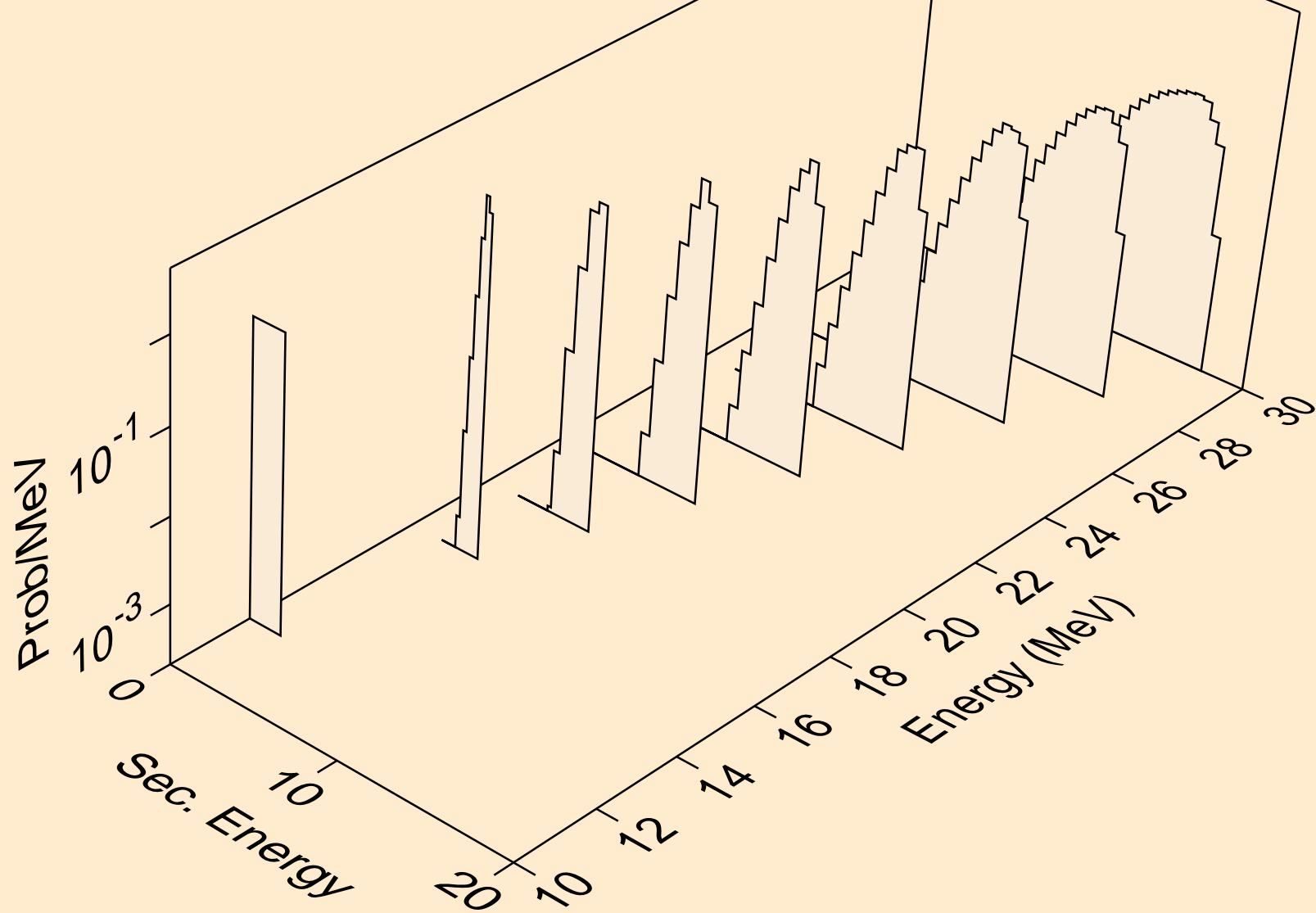

TC090 NEUTRON ACER TENDL-2023 LIBRARY; T=0.K  
he3s from (n,he3)

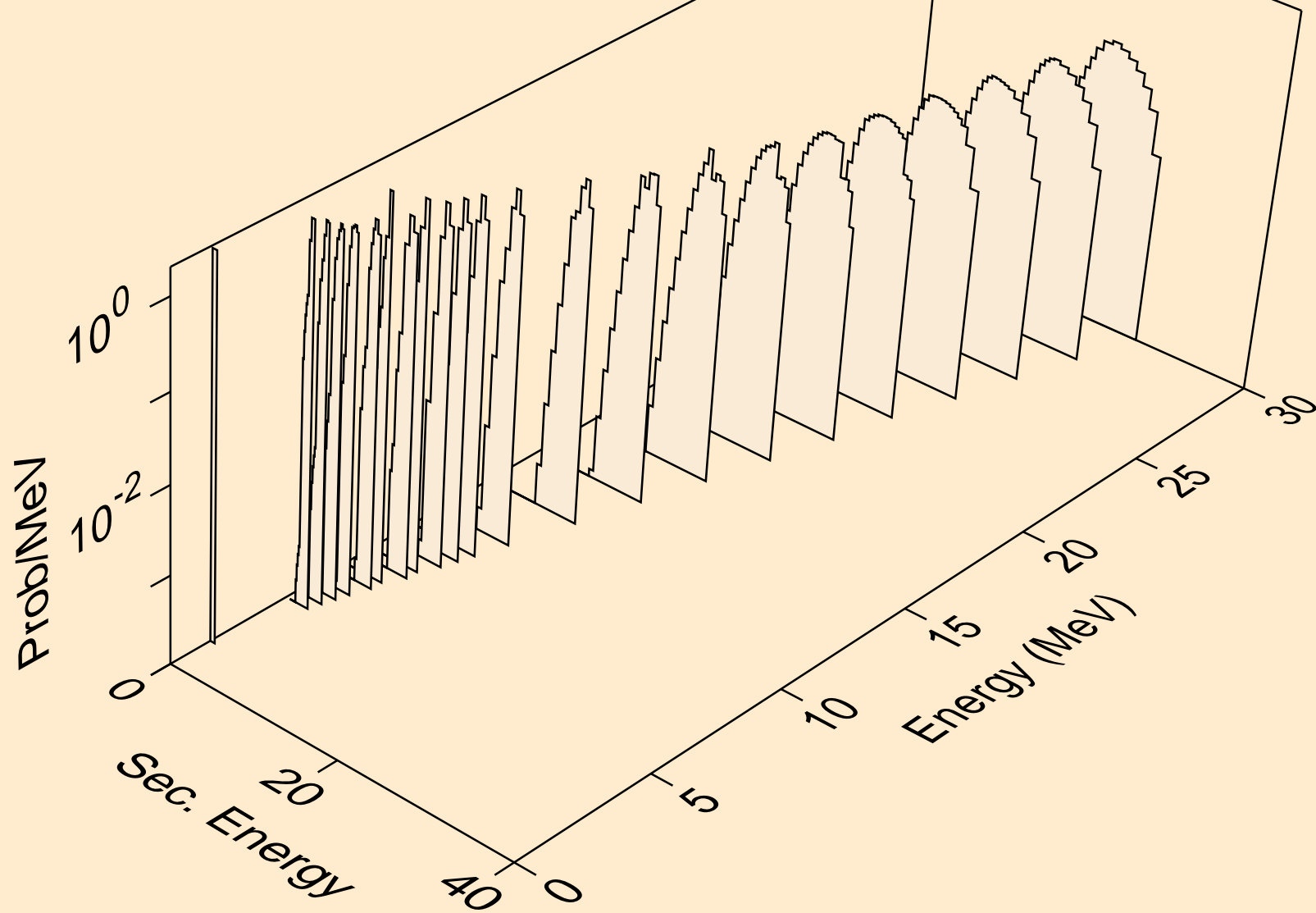

TC090 NEUTRON ACER TENDL-2023 LIBRARY; T=0.K  
alphas from (n,x)

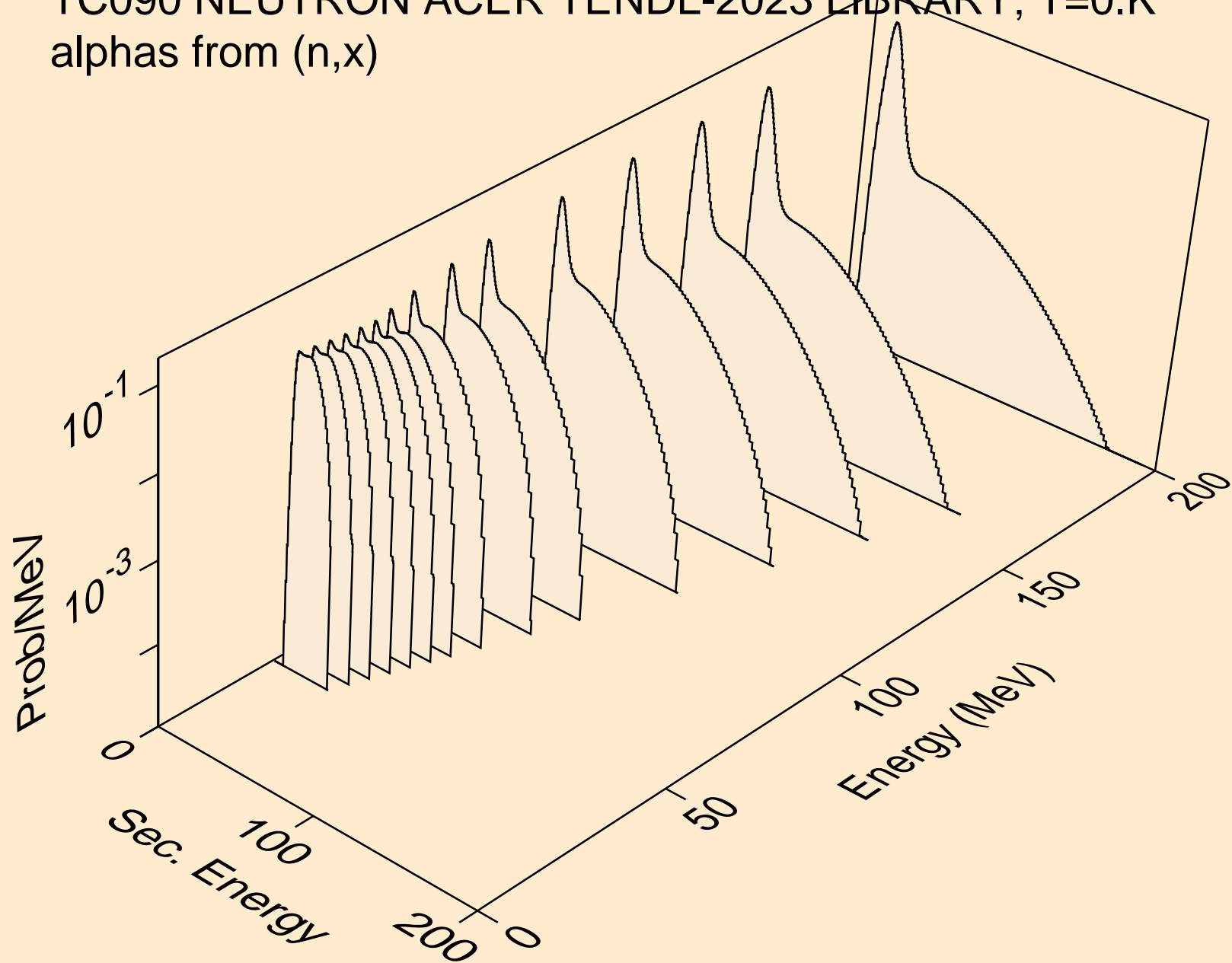

TC090 NEUTRON ACER TENDL-2023 LIBRARY; T=0.K  
alphas from (n,n\*)a

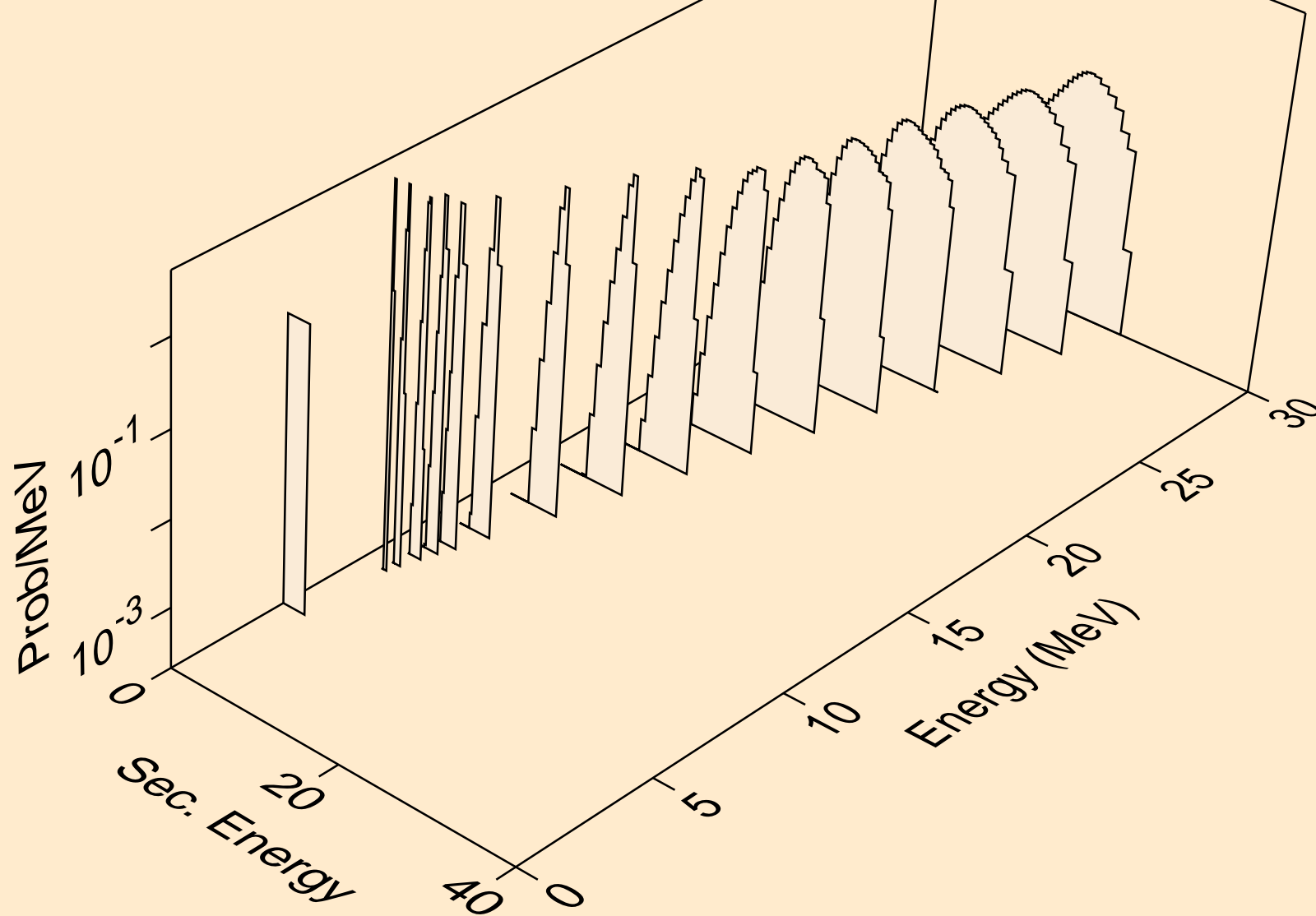

TC090 NEUTRON ACER TENDL-2023 LIBRARY; T=0.K  
alphas from (n,2n)a

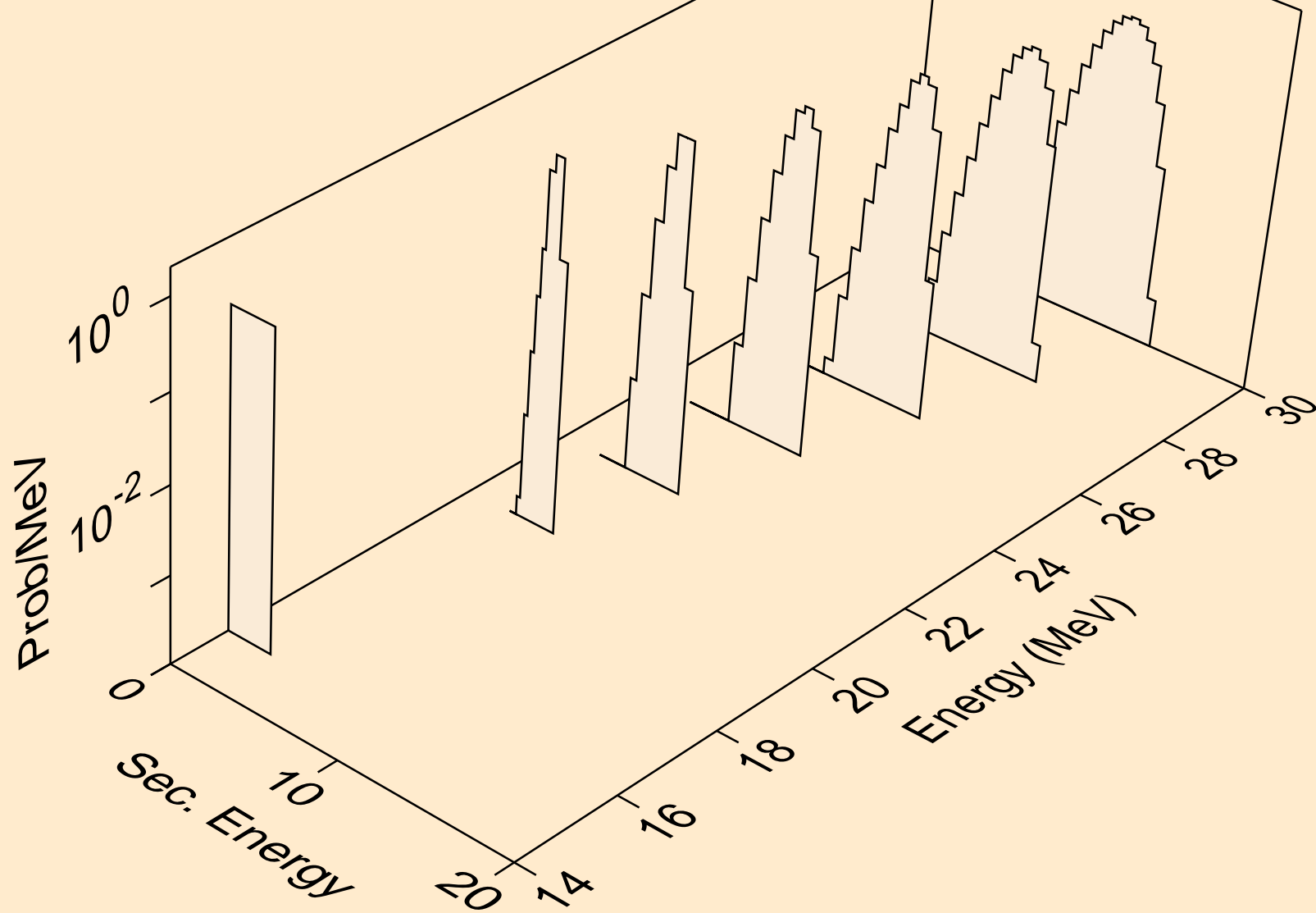

TC090 NEUTRON ACER TENDL-2023 LIBRARY; T=0.K  
alphas from (n,n\*)2a

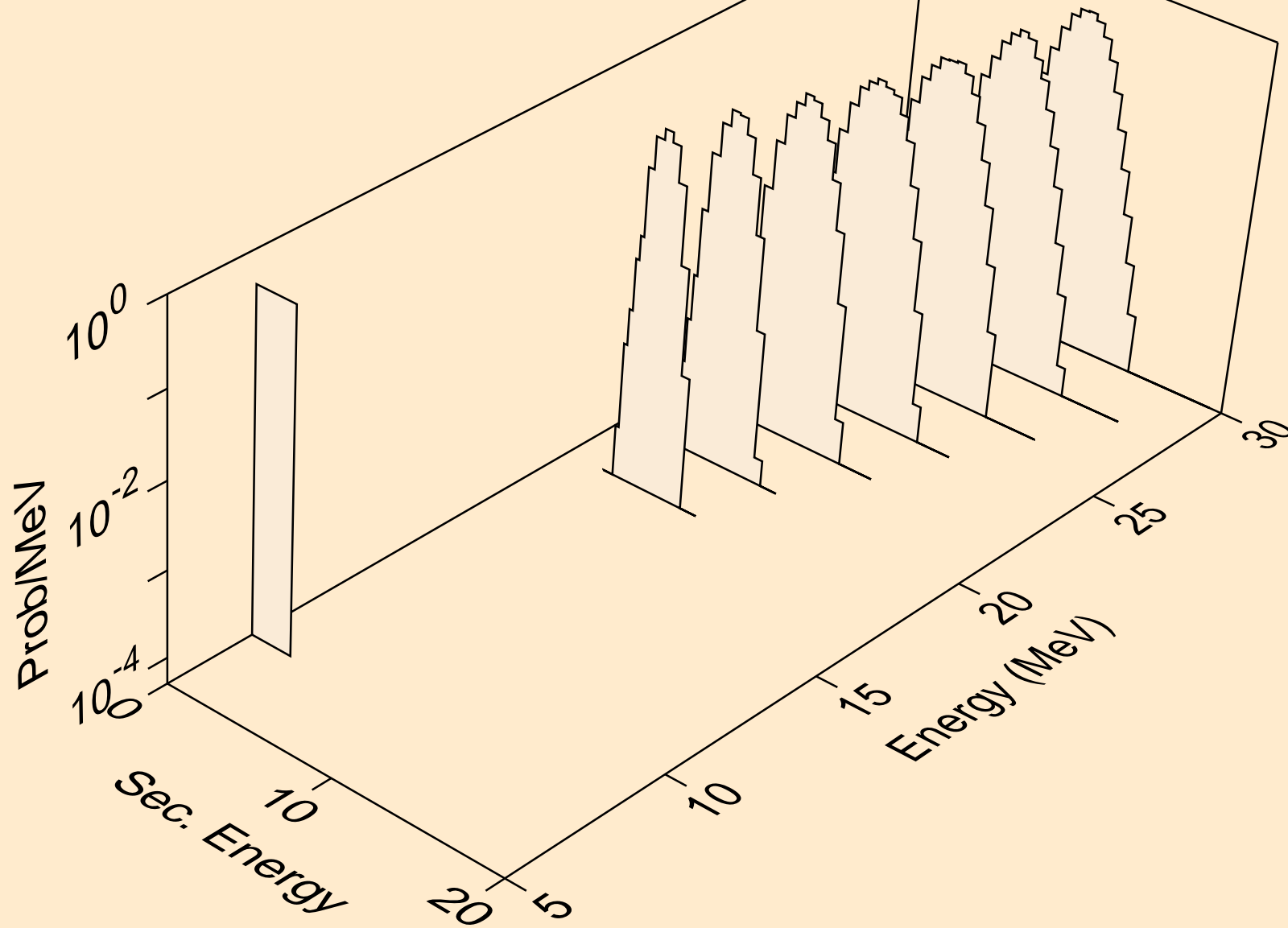

TC090 NEUTRON ACER TENDL-2023 LIBRARY; T=0.K  
alphas from (n,npa)

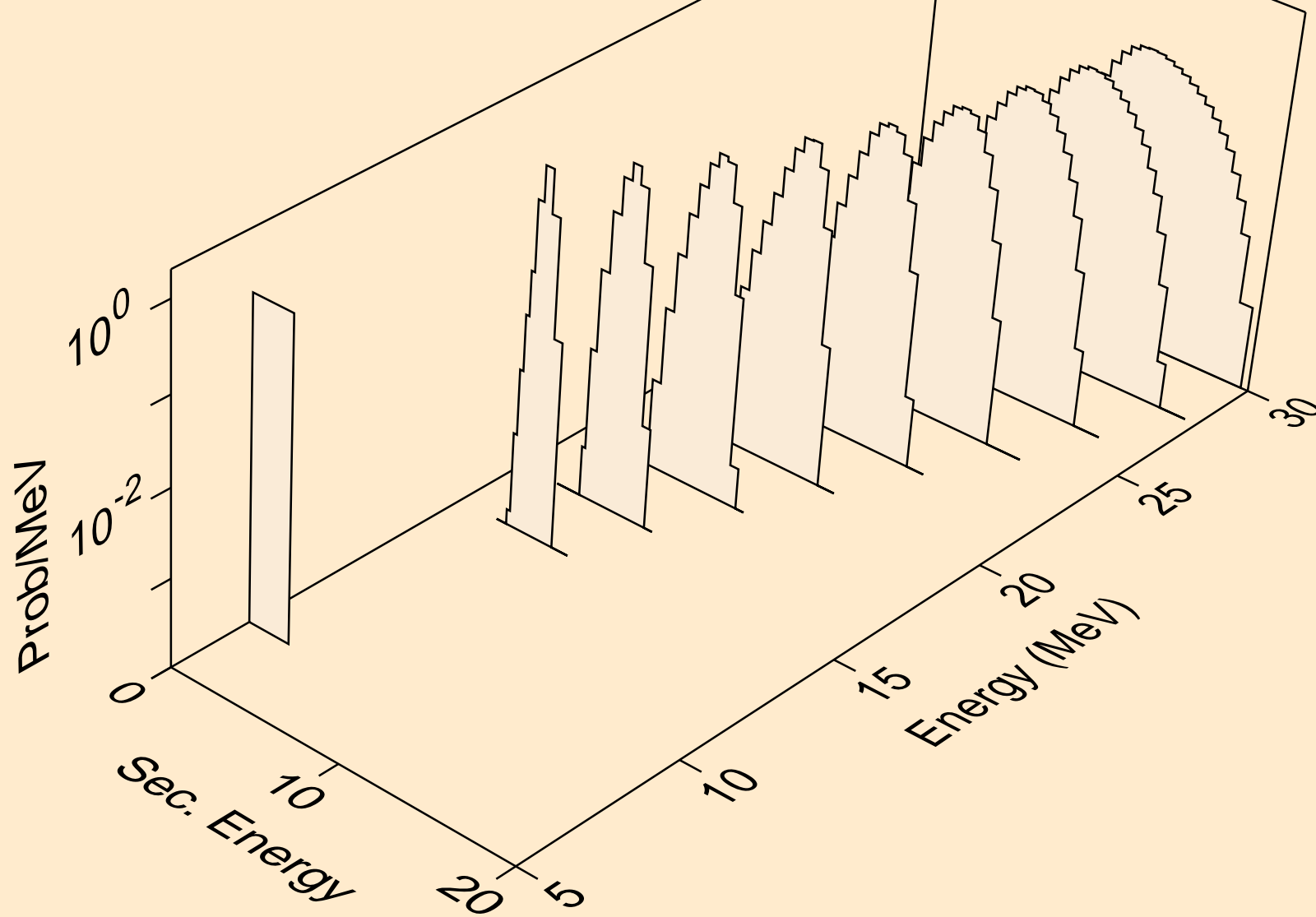

TC090 NEUTRON ACER TENDL-2023 LIBRARY; T=0.K  
alphas from (n,a)

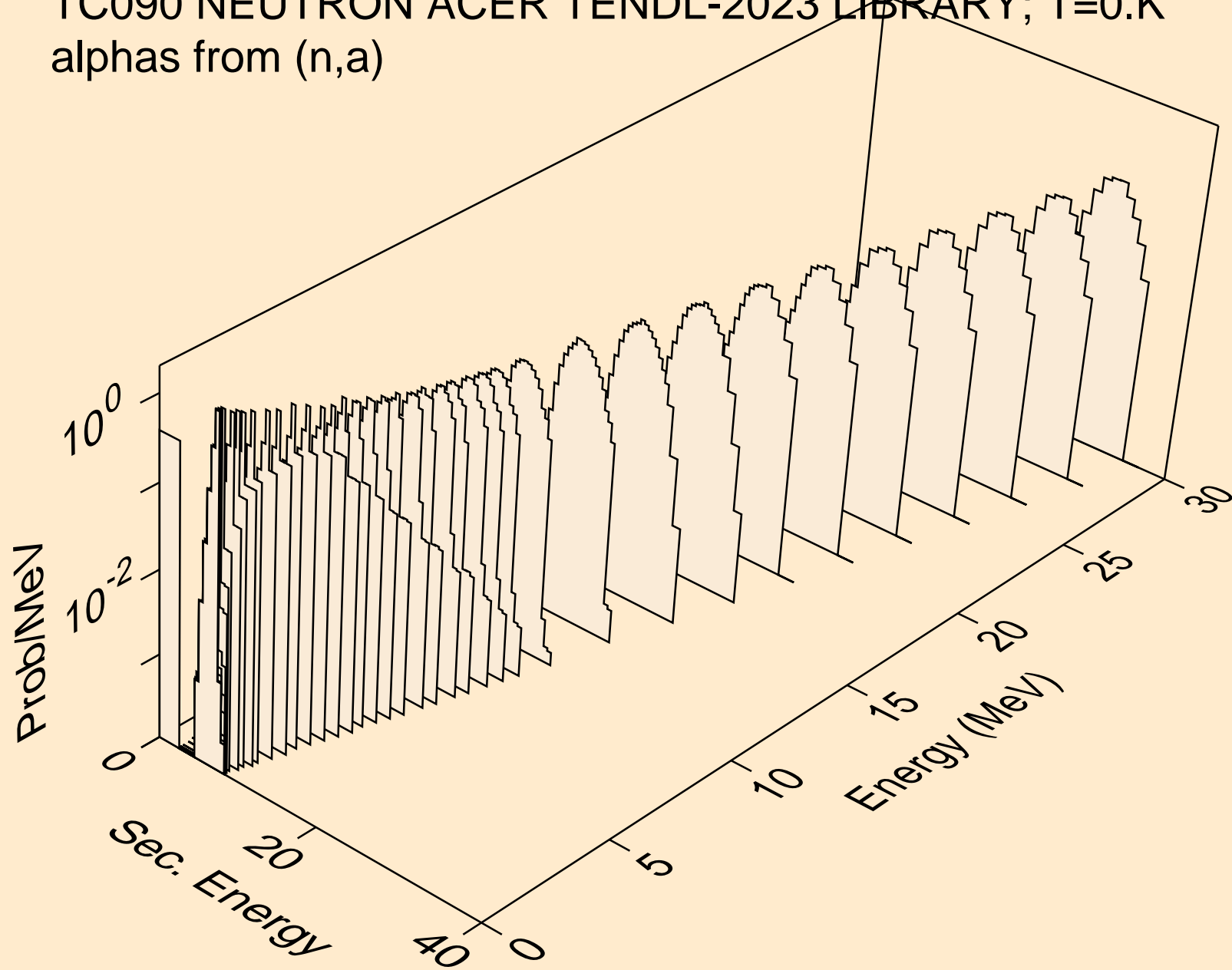



TC090 NEUTRON ACER TENDL-2023 LIBRARY; T=0.K  
alphas from (n,2a)

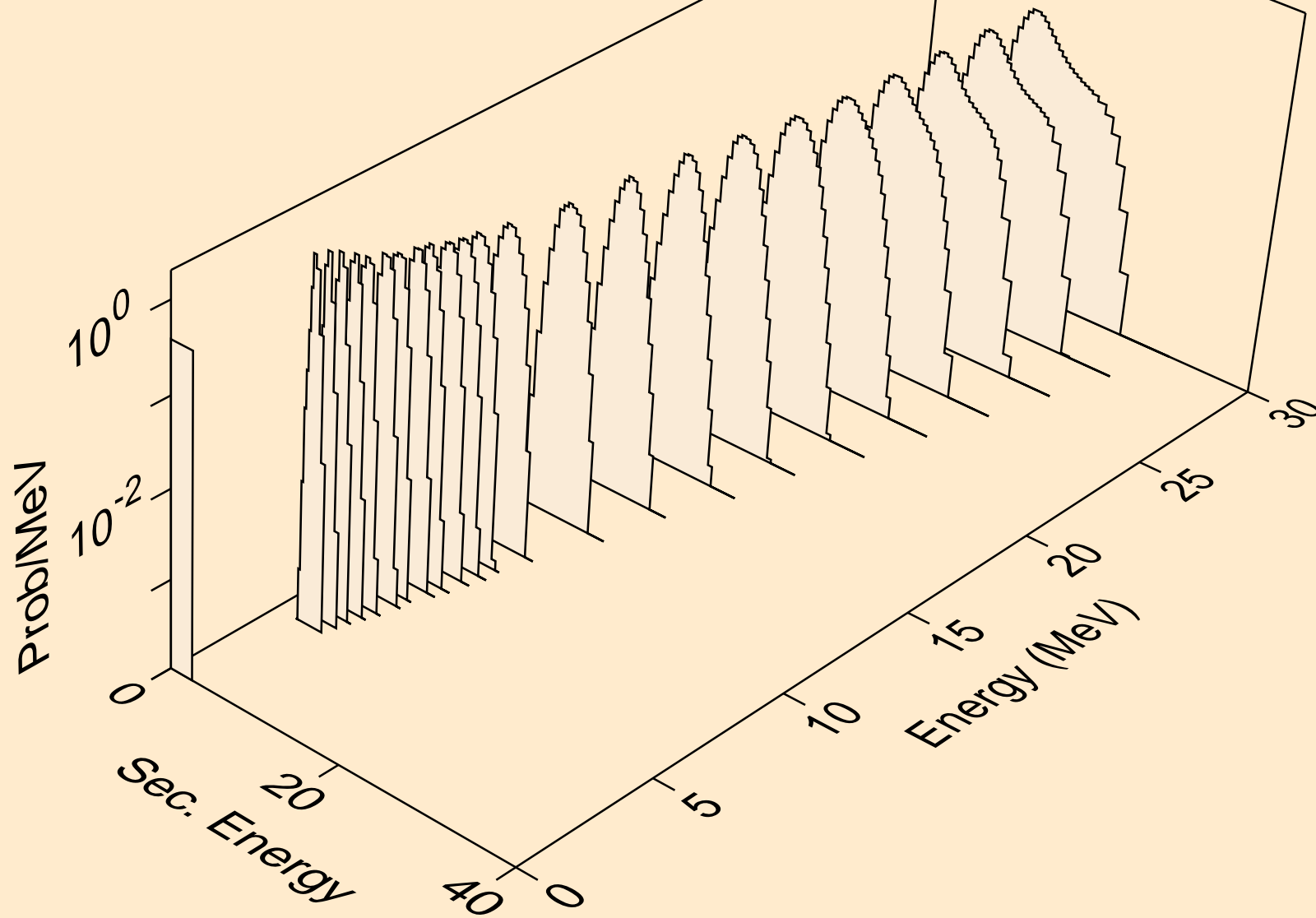

TC090 NEUTRON ACER TENDL-2023 LIBRARY; T=0.K  
alphas from (n,3a)

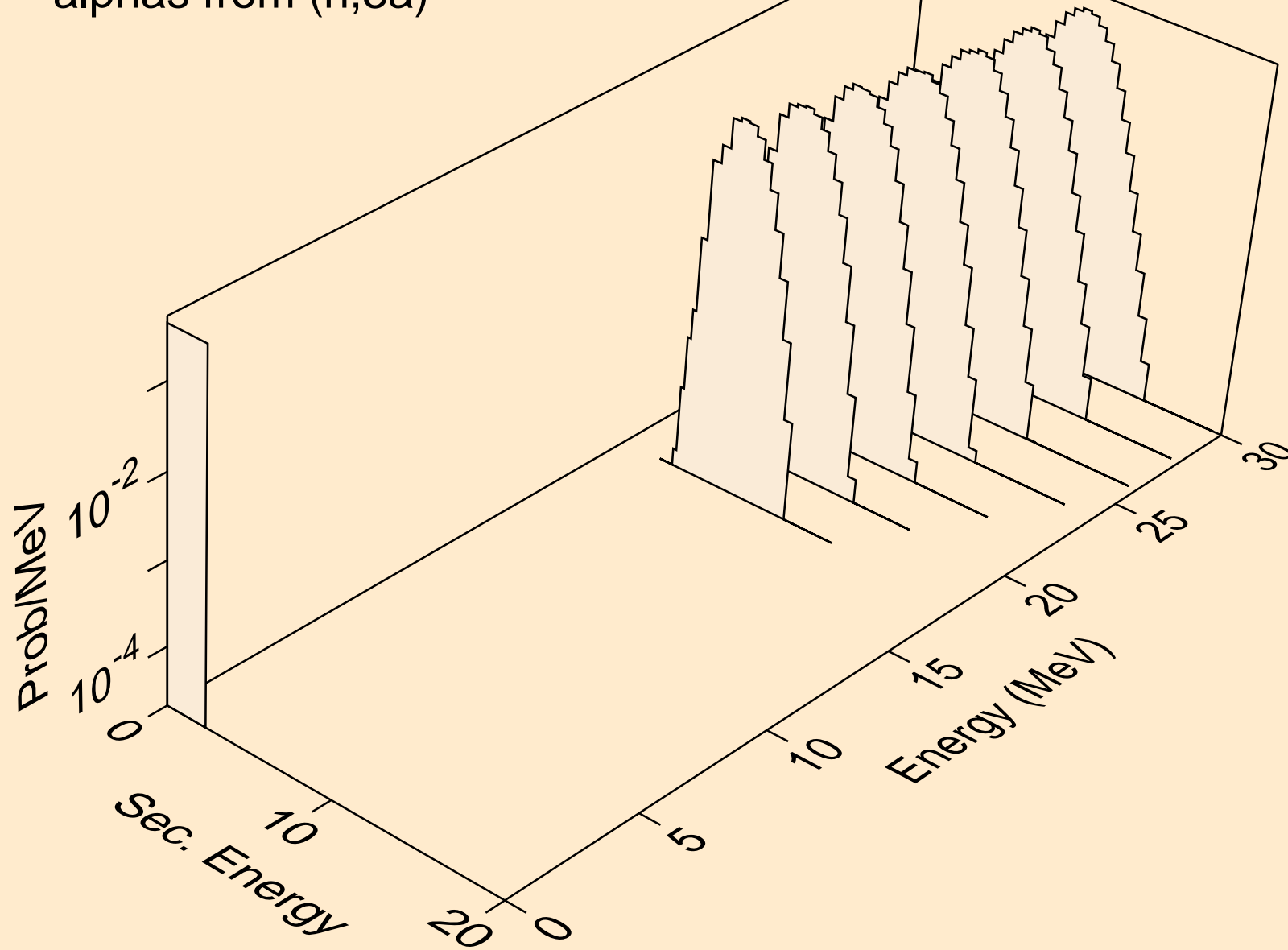

TC090 NEUTRON ACER TENDL-2023 LIBRARY; T=0.K  
alphas from (n,pa)

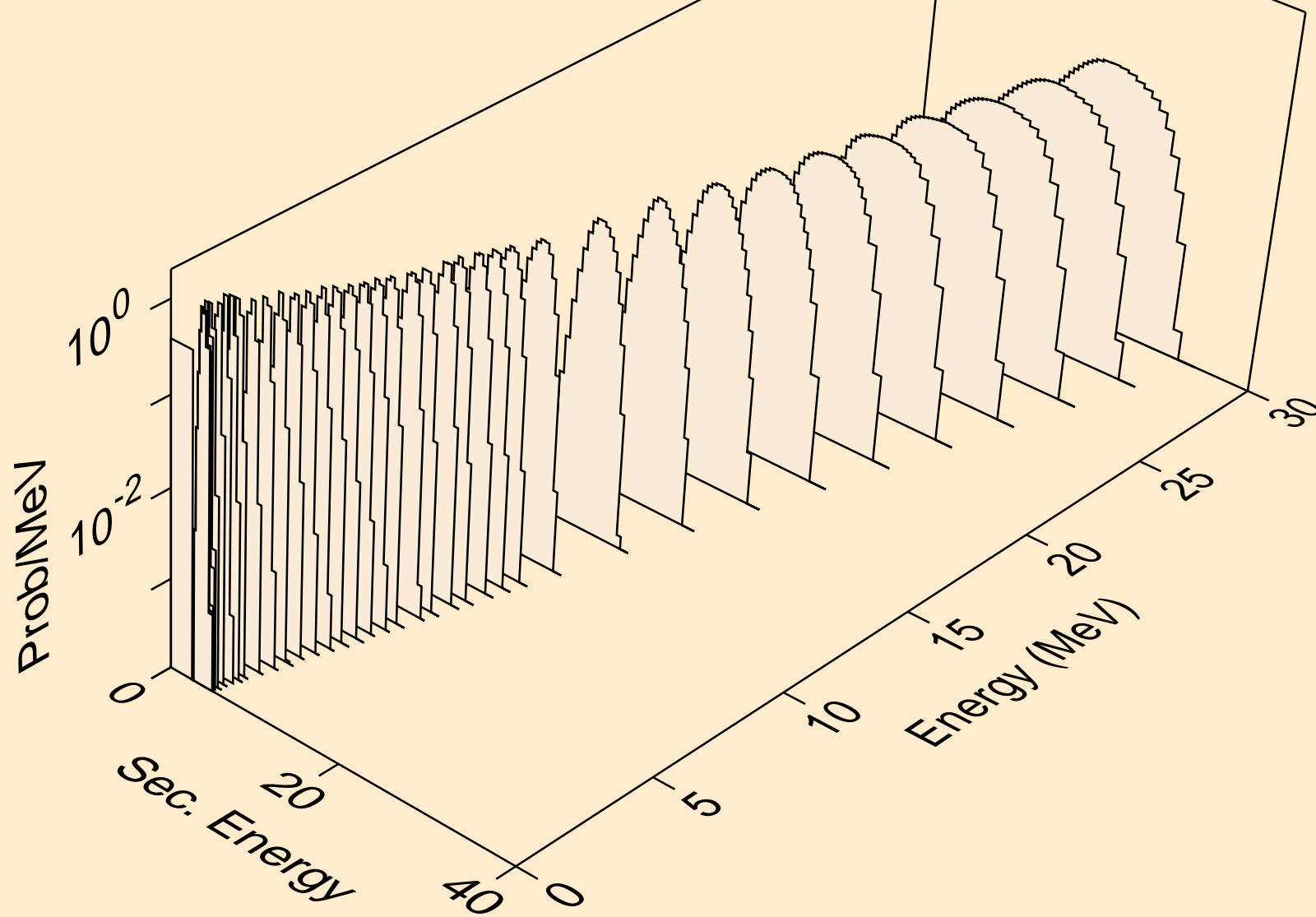

TC090 NEUTRON ACER TENDL-2023 LIBRARY; T=0.K  
alphas from (n,da)

