

TC097M NEUTRON ACER TENDL-2023 LIBRARY; T=0.K
Principal cross sections

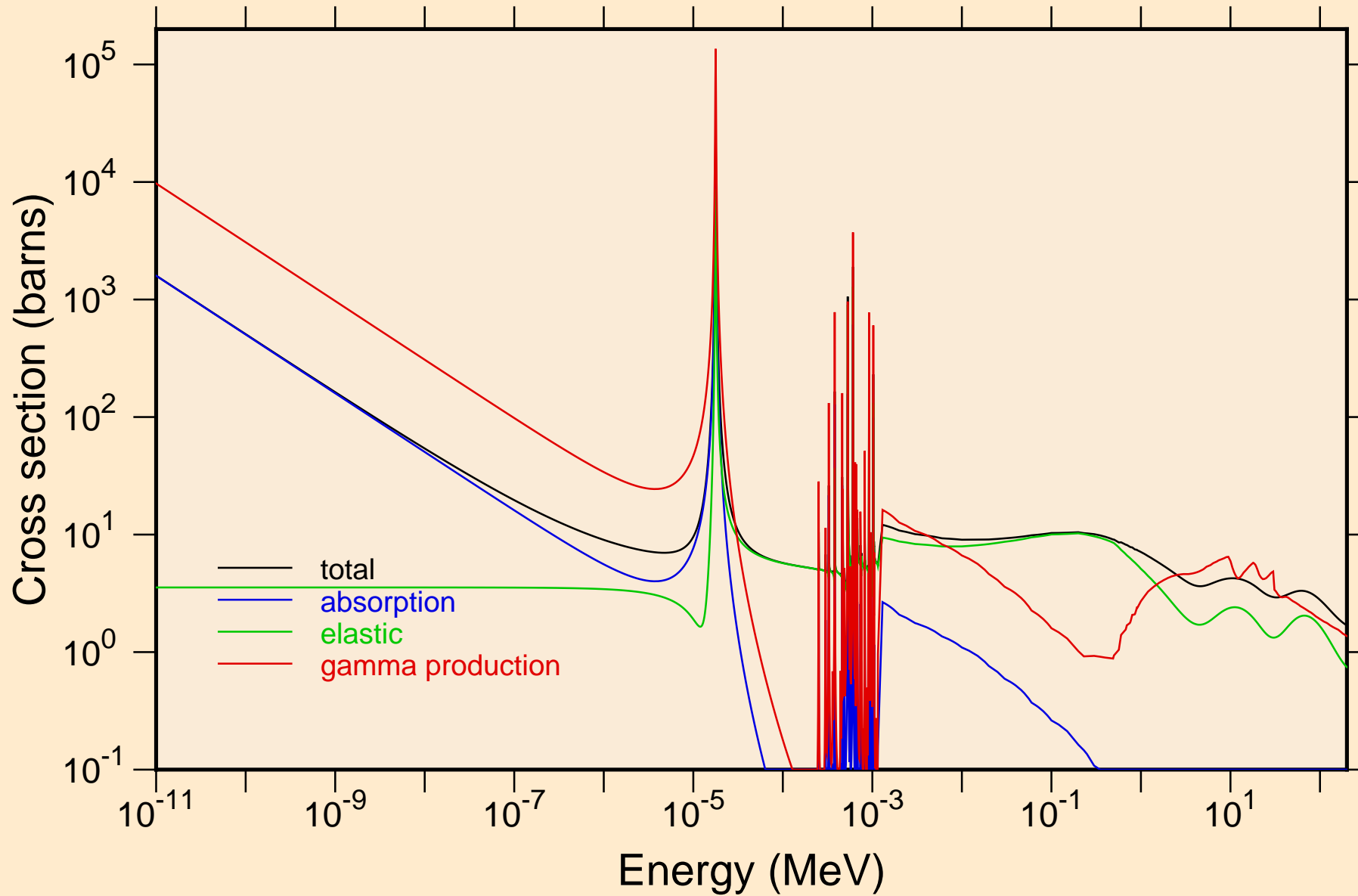

TC097M NEUTRON ACER TENDL-2023 LIBRARY; T=0.K
resonance total cross section

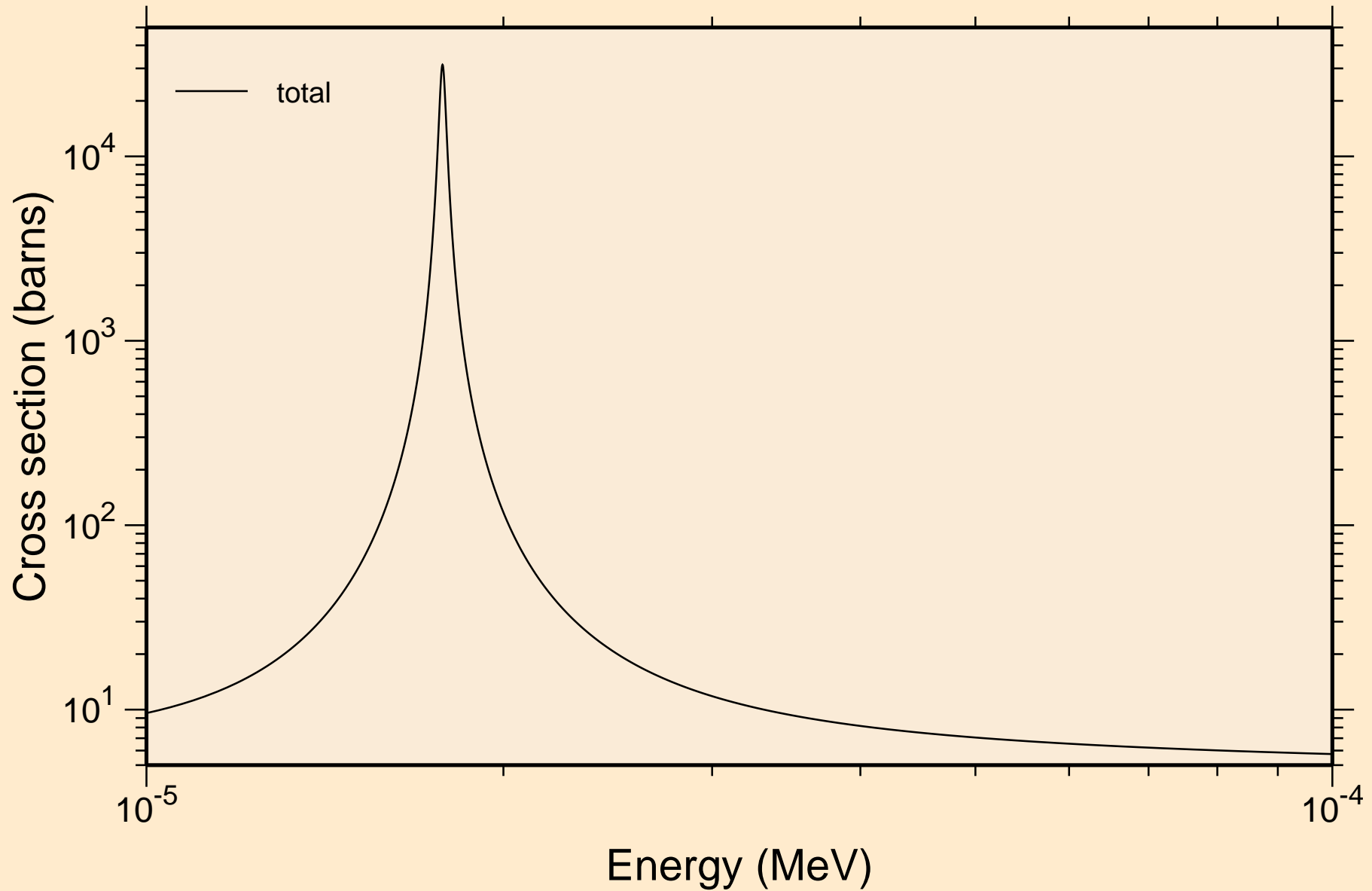

TC097M NEUTRON ACER TENDL-2023 LIBRARY; T=0.K
resonance total cross section

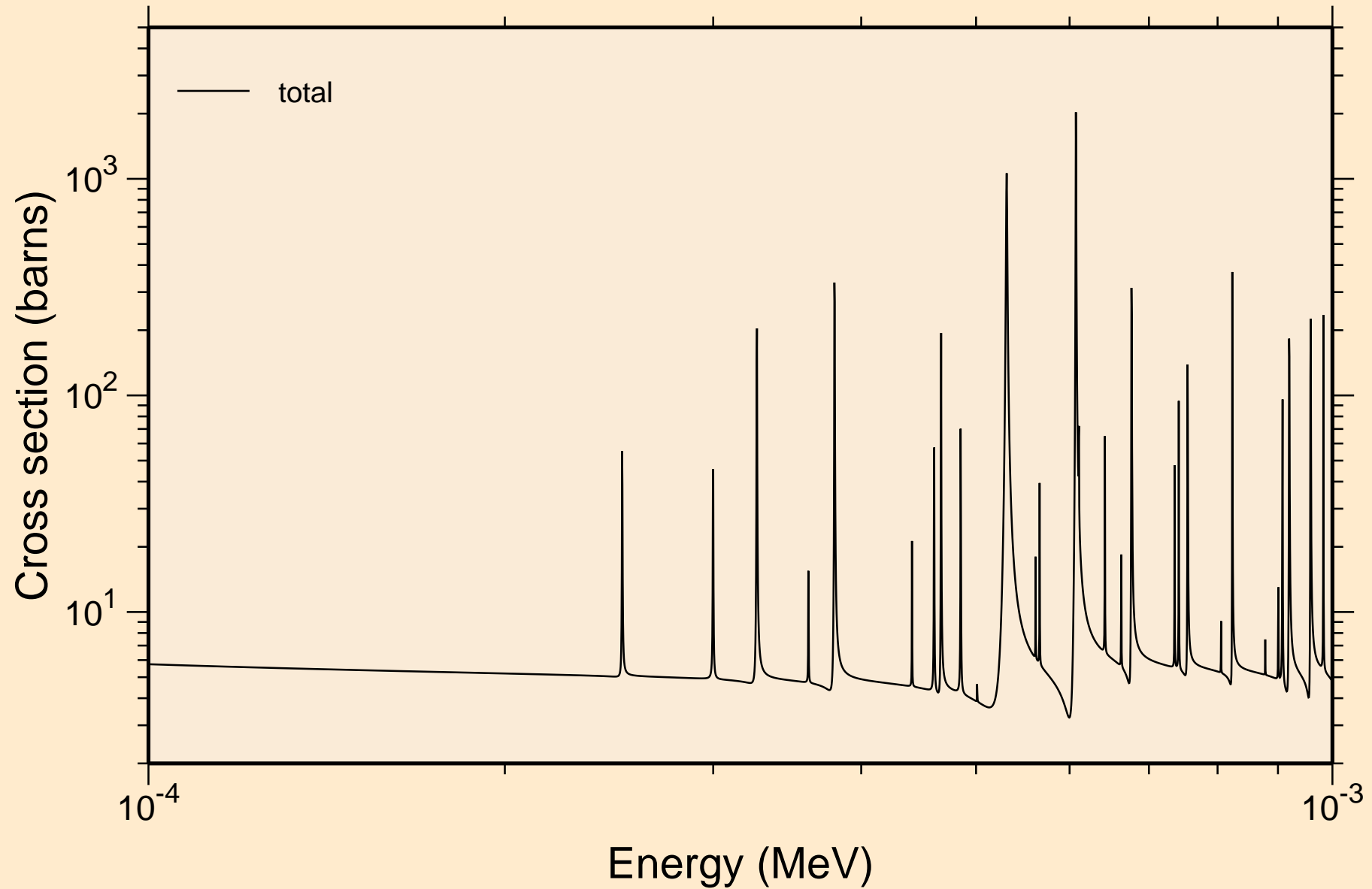

TC097M NEUTRON ACER TENDL-2023 LIBRARY; T=0.K
resonance total cross section

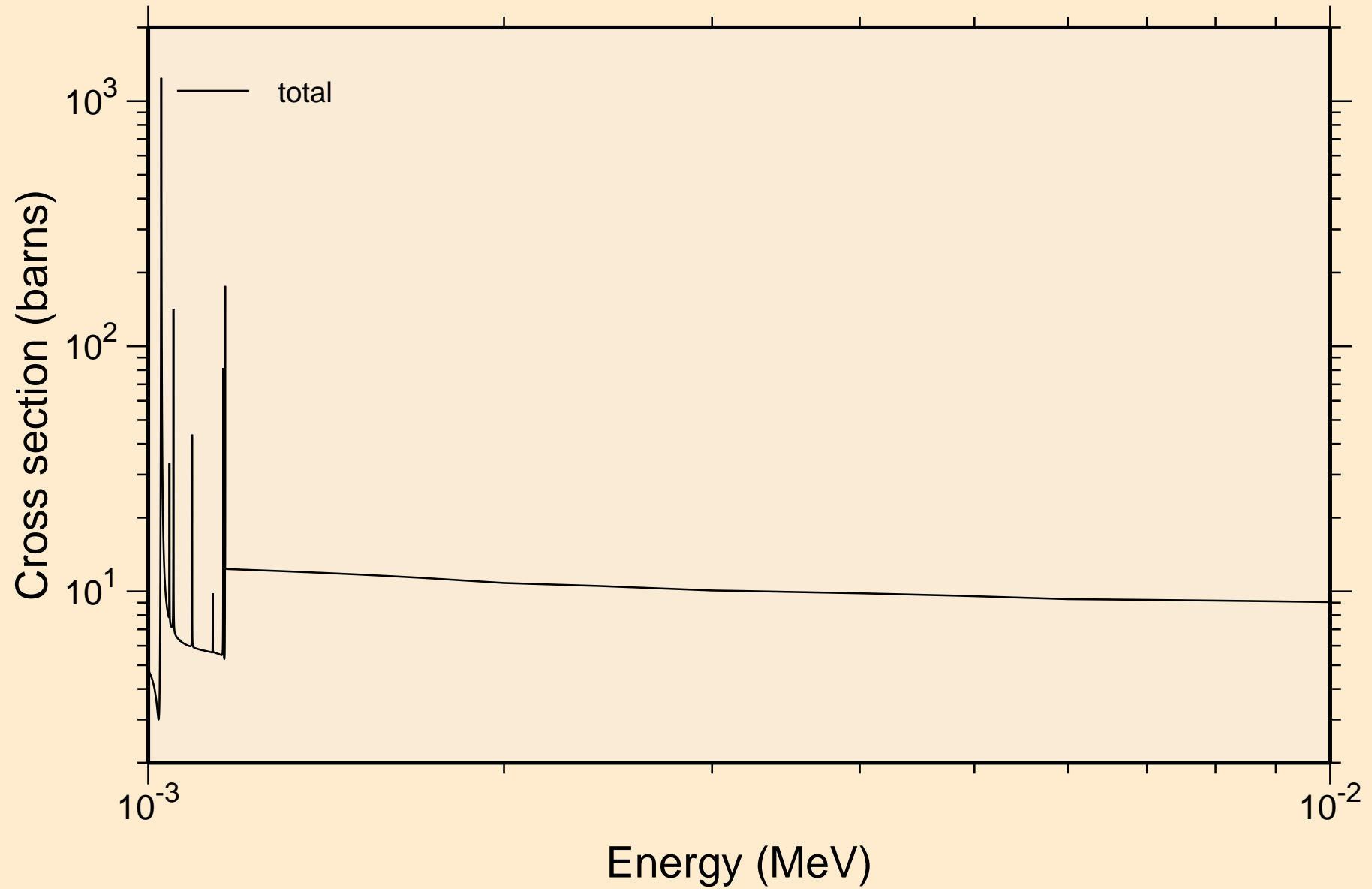

T̄C097M NEUTRON ACER TENDL-2023 LIBRARY; T=0.K
resonance total cross section

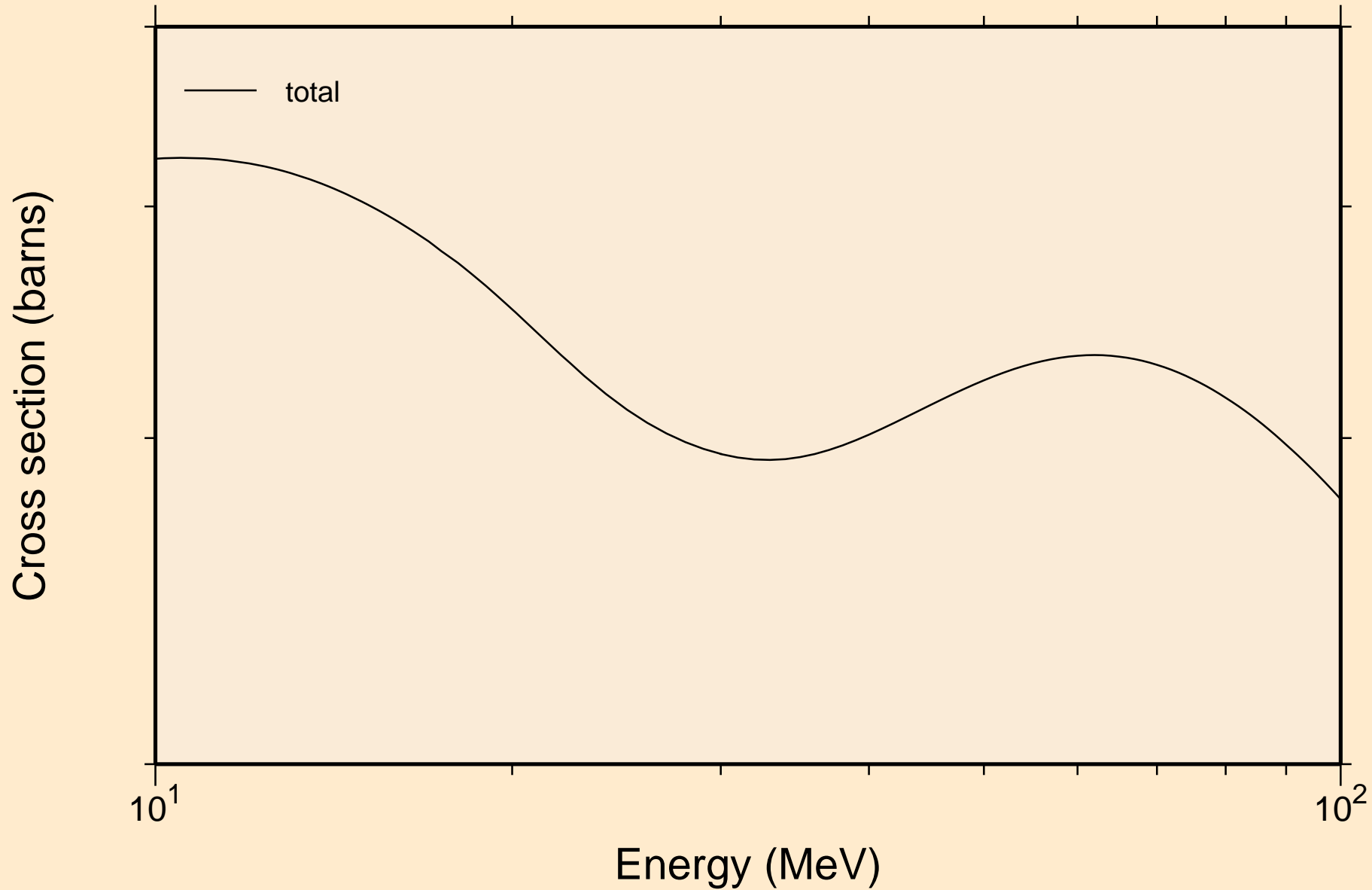

TC097M NEUTRON ACER TENDL-2023 LIBRARY; T=0.K
resonance absorption cross sections

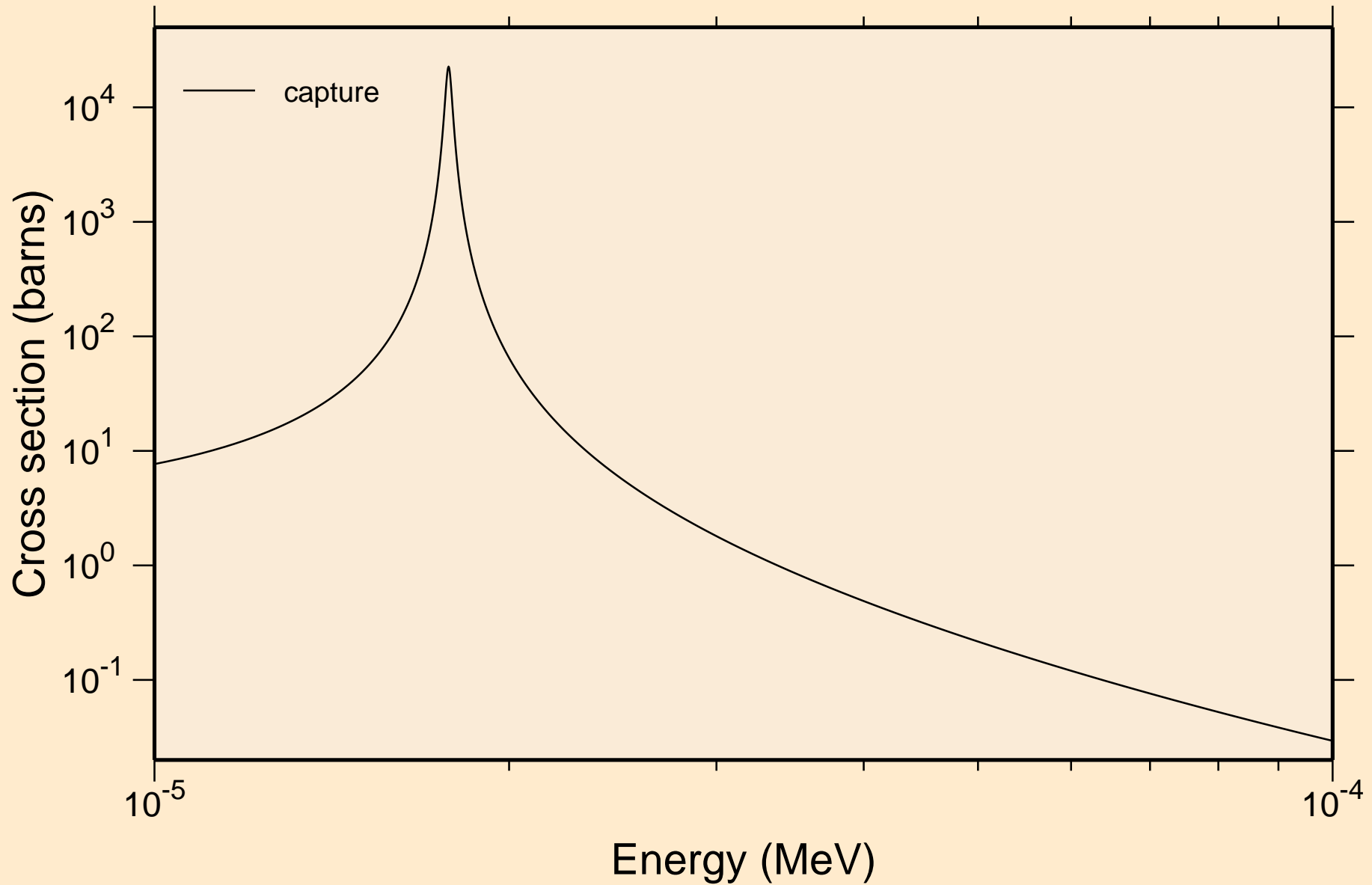

TC097M NEUTRON ACER TENDL-2023 LIBRARY; T=0.K
resonance absorption cross sections

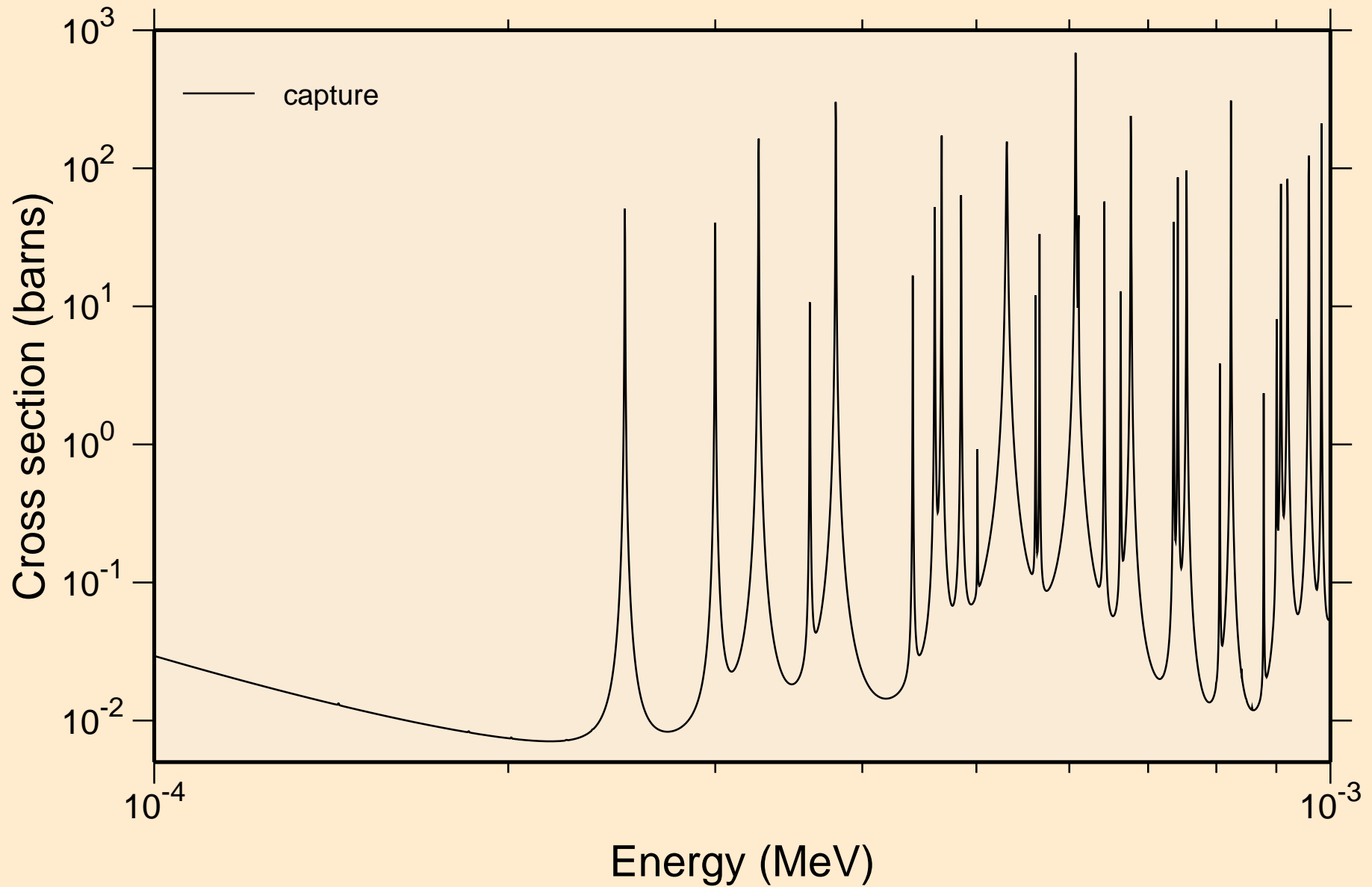

TC097M NEUTRON ACER TENDL-2023 LIBRARY; T=0.K
resonance absorption cross sections

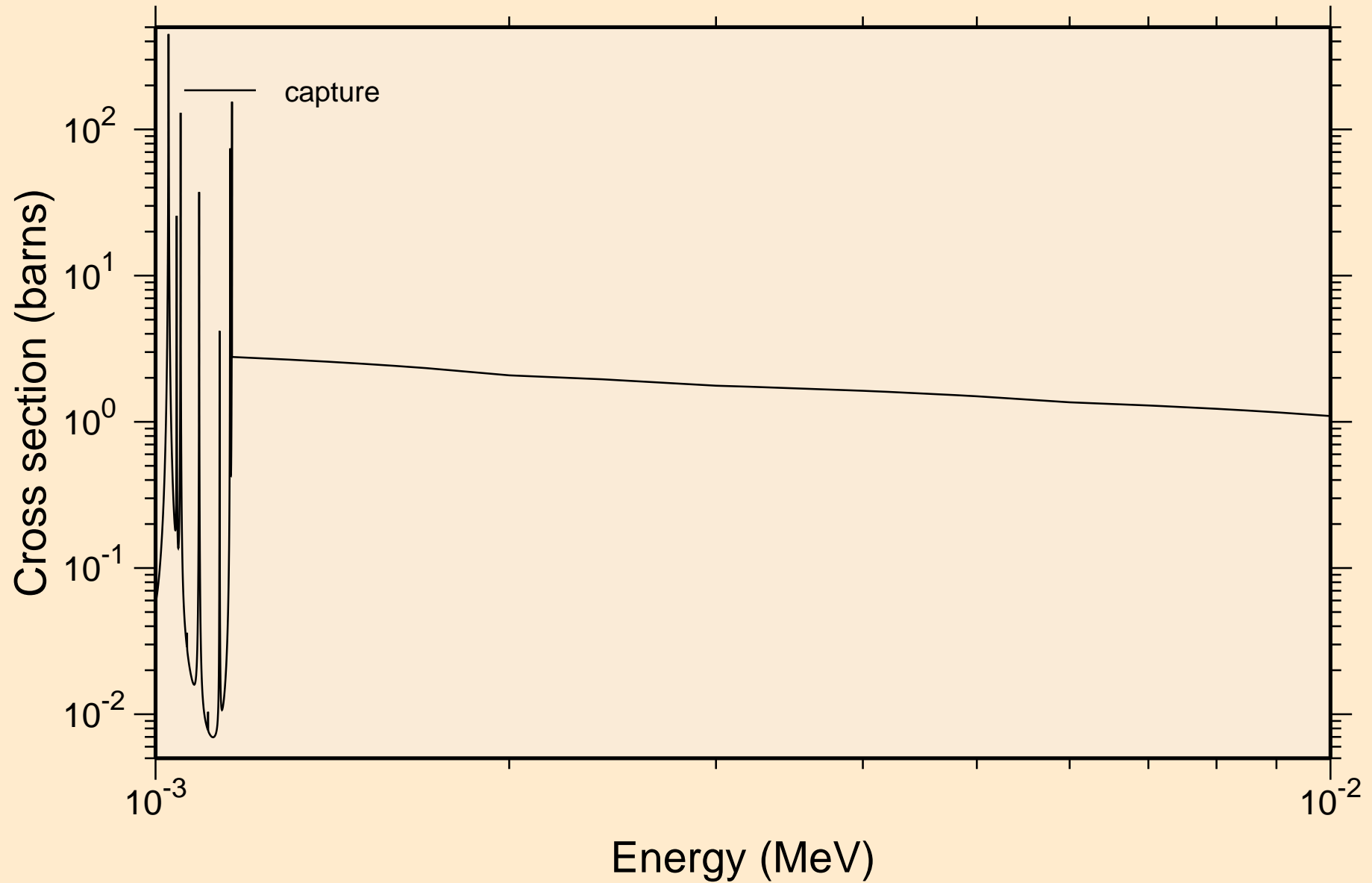

TC097M NEUTRON ACER TENDL-2023 LIBRARY; T=0.K
resonance absorption cross sections

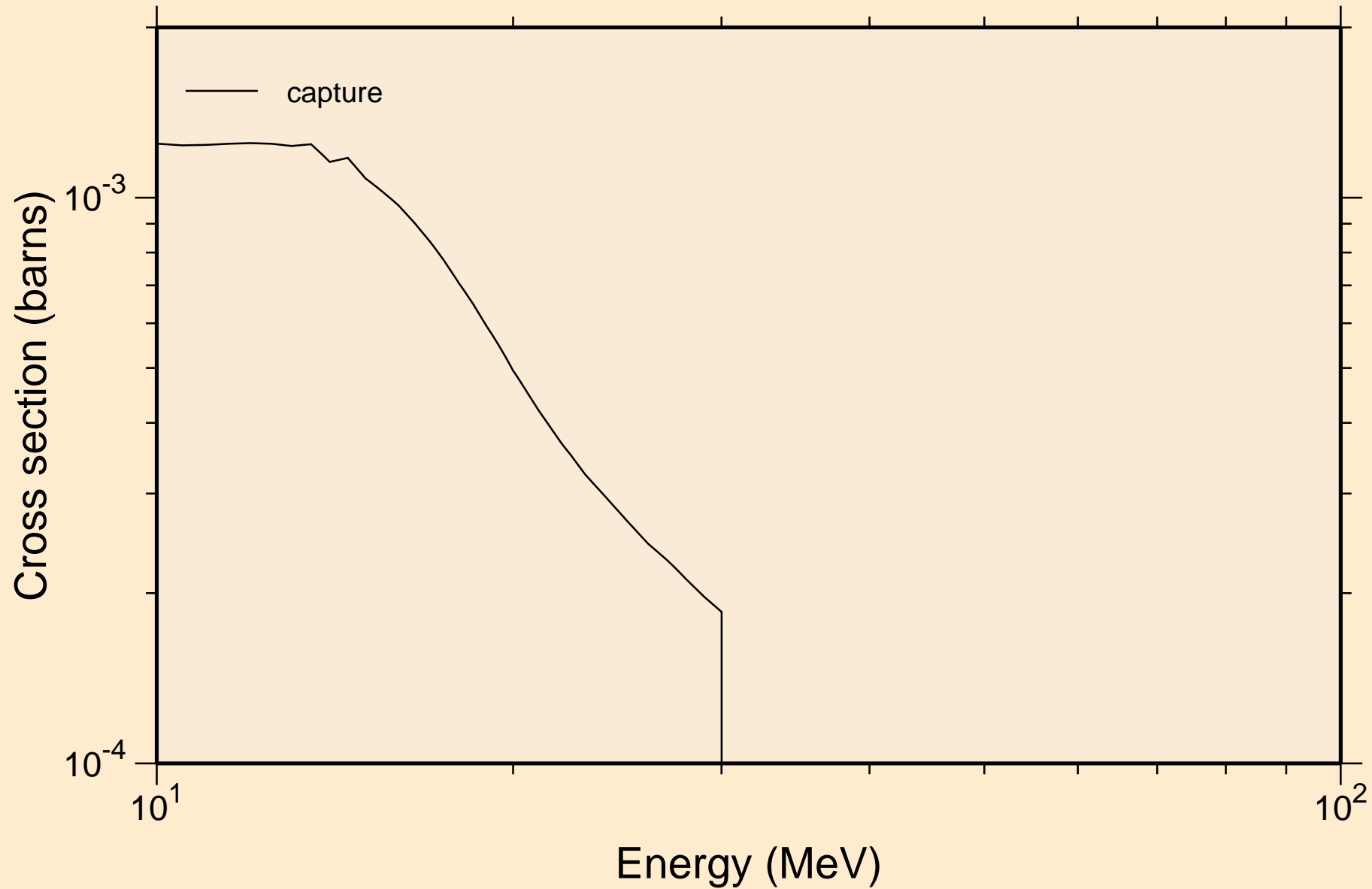

TC097M NEUTRON ACER TENDL-2023 LIBRARY; T=0.K
Heating

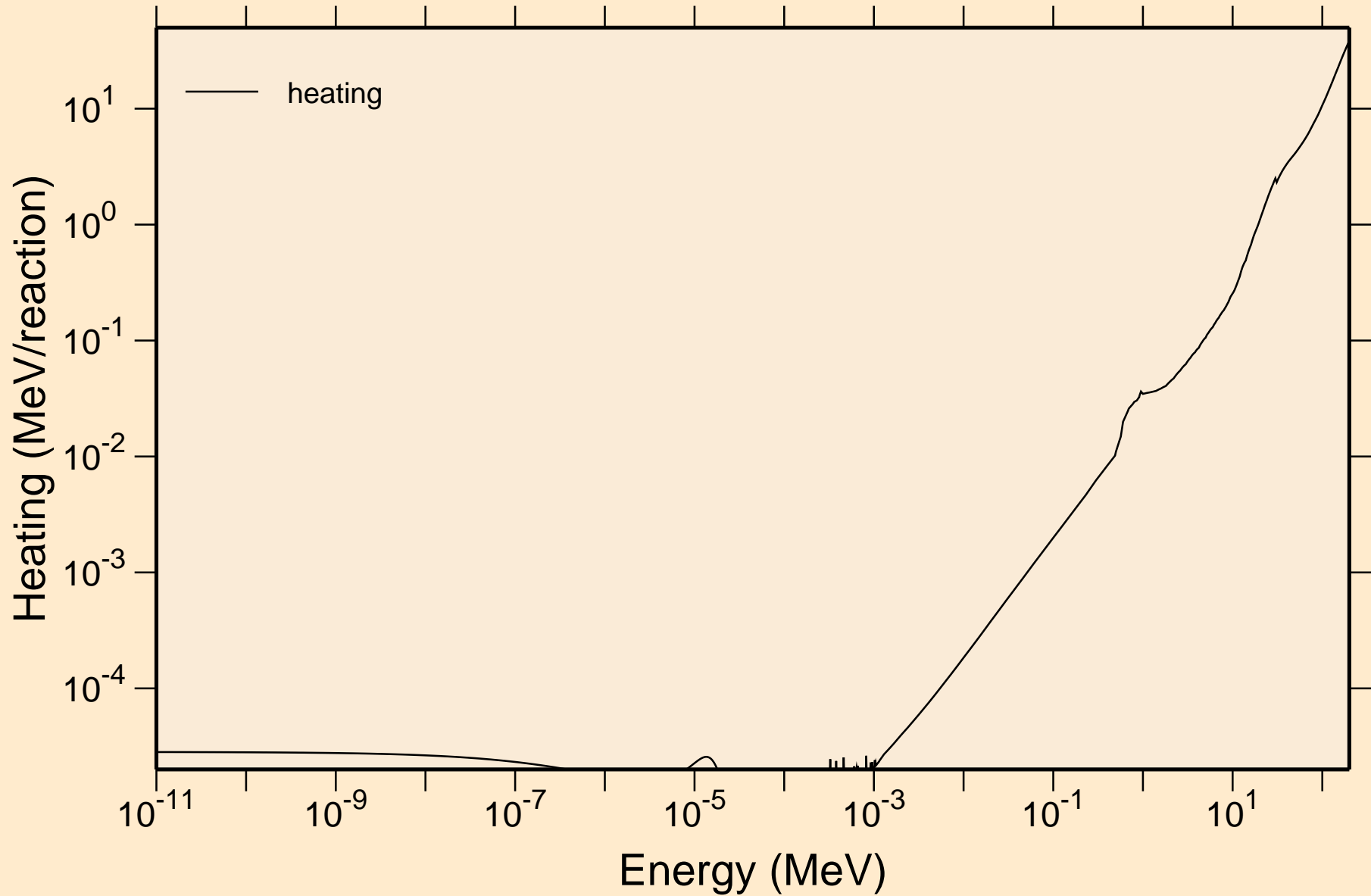

TC097M NEUTRON ACER TENDL-2023 LIBRARY; T=0.K
Damage

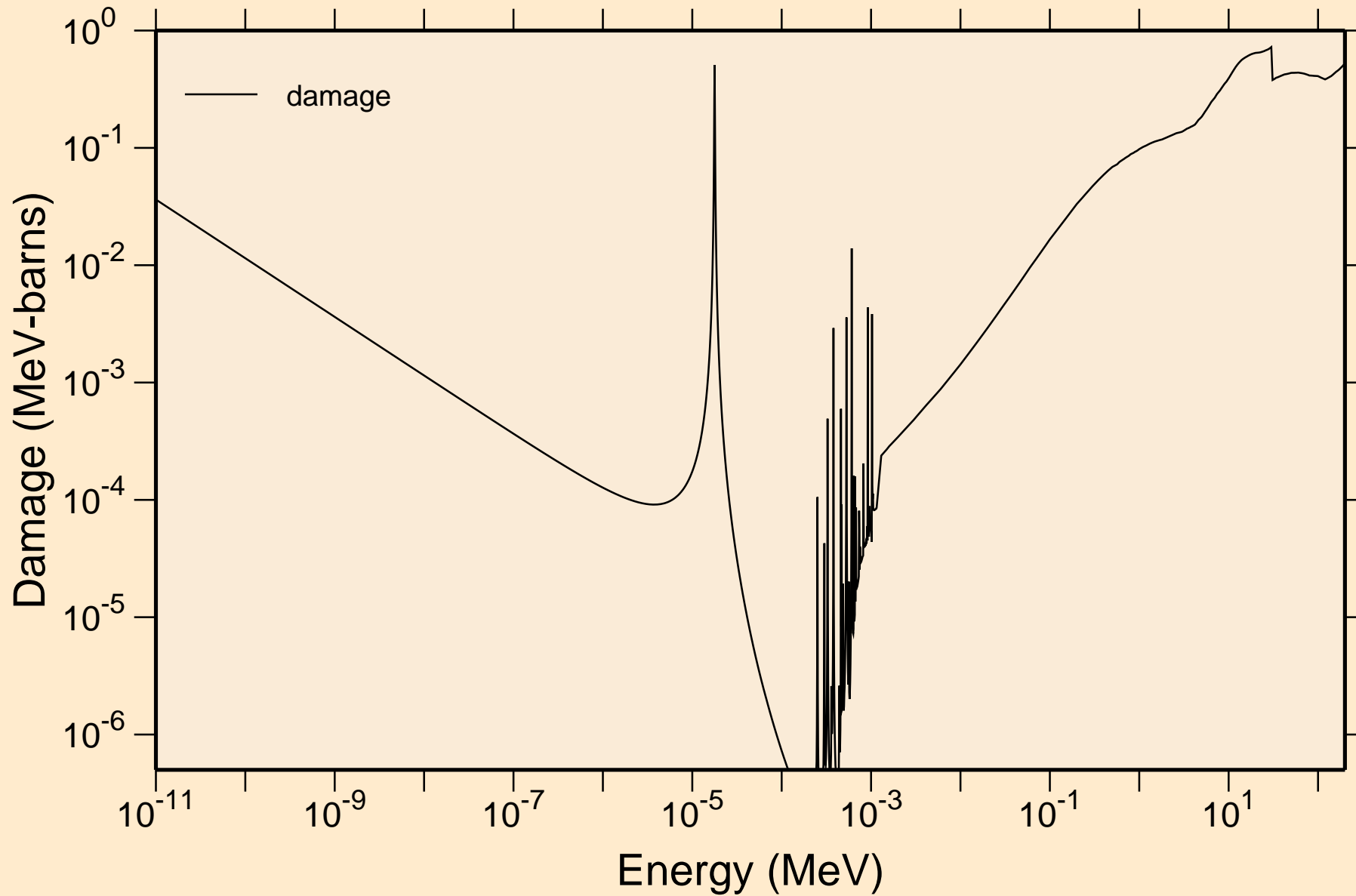

TC097M NEUTRON ACER TENDL-2023 LIBRARY; T=0.K
Non-threshold reactions

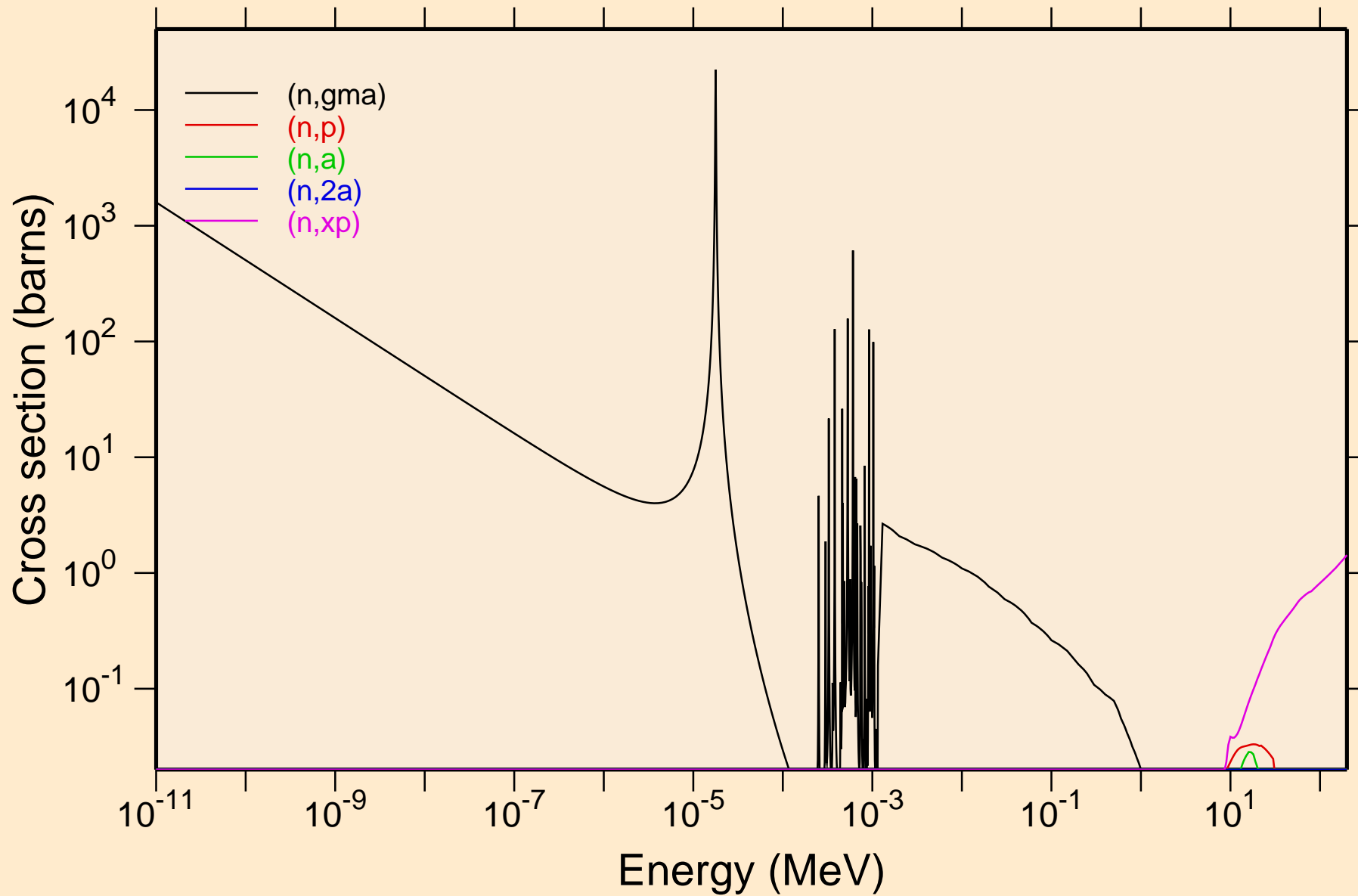

TC097M NEUTRON ACER TENDL-2023 LIBRARY; T=0.K
Non-threshold reactions

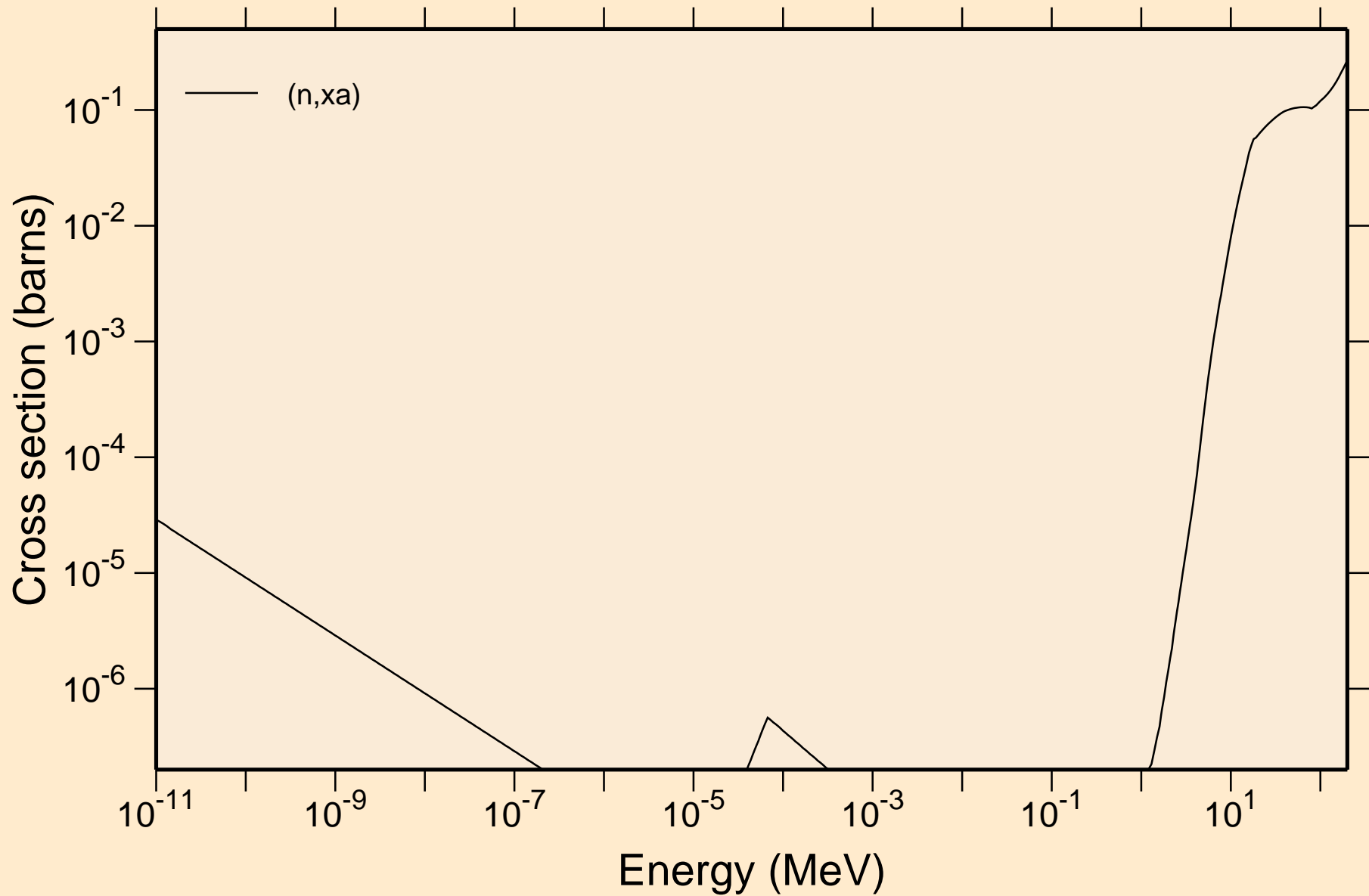

TC097M NEUTRON ACER TENDL-2023 LIBRARY; T=0.K

Principal cross sections

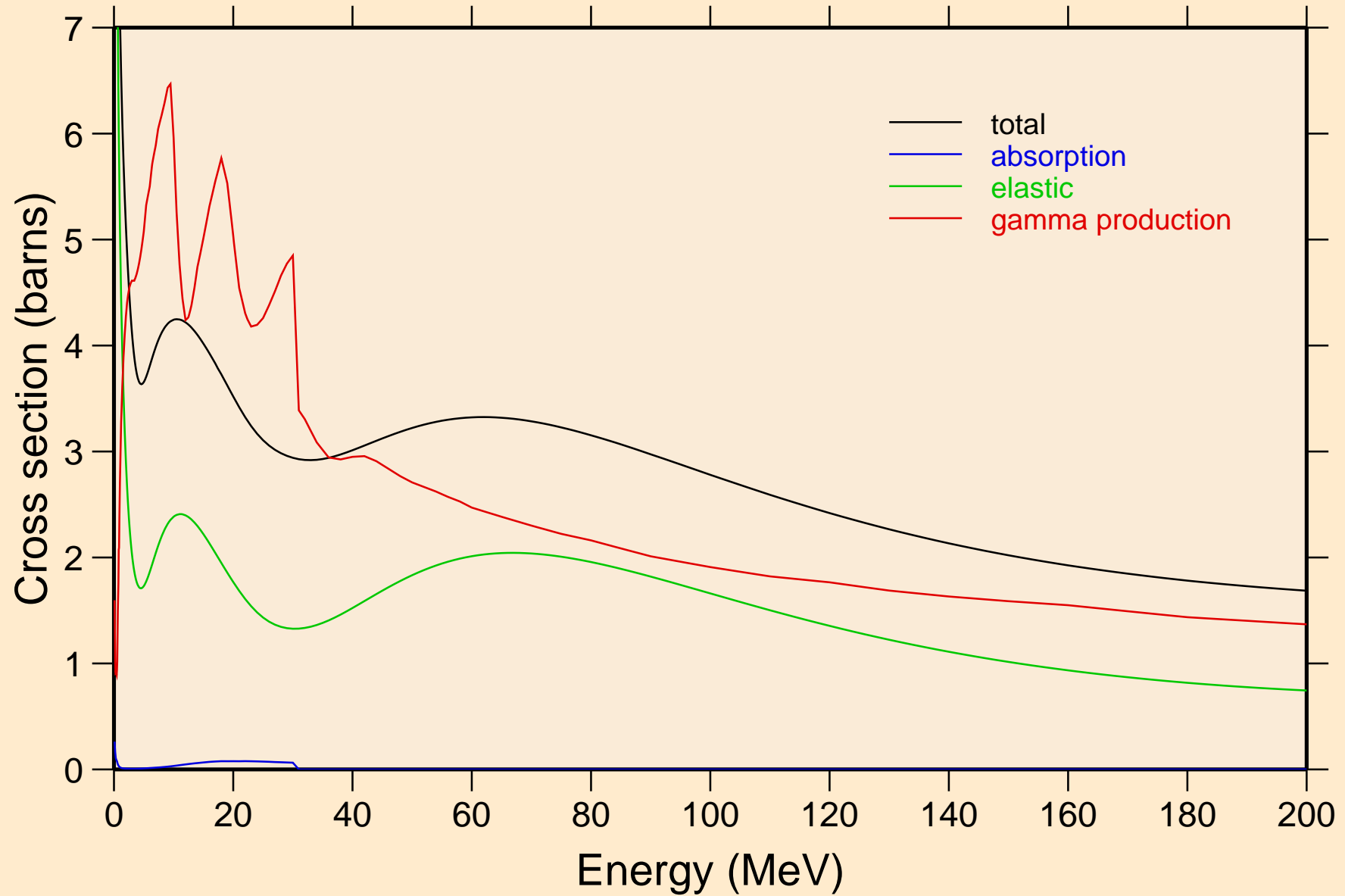

TC097M NEUTRON ACER TENDL-2023 LIBRARY; T=0.K

Heating

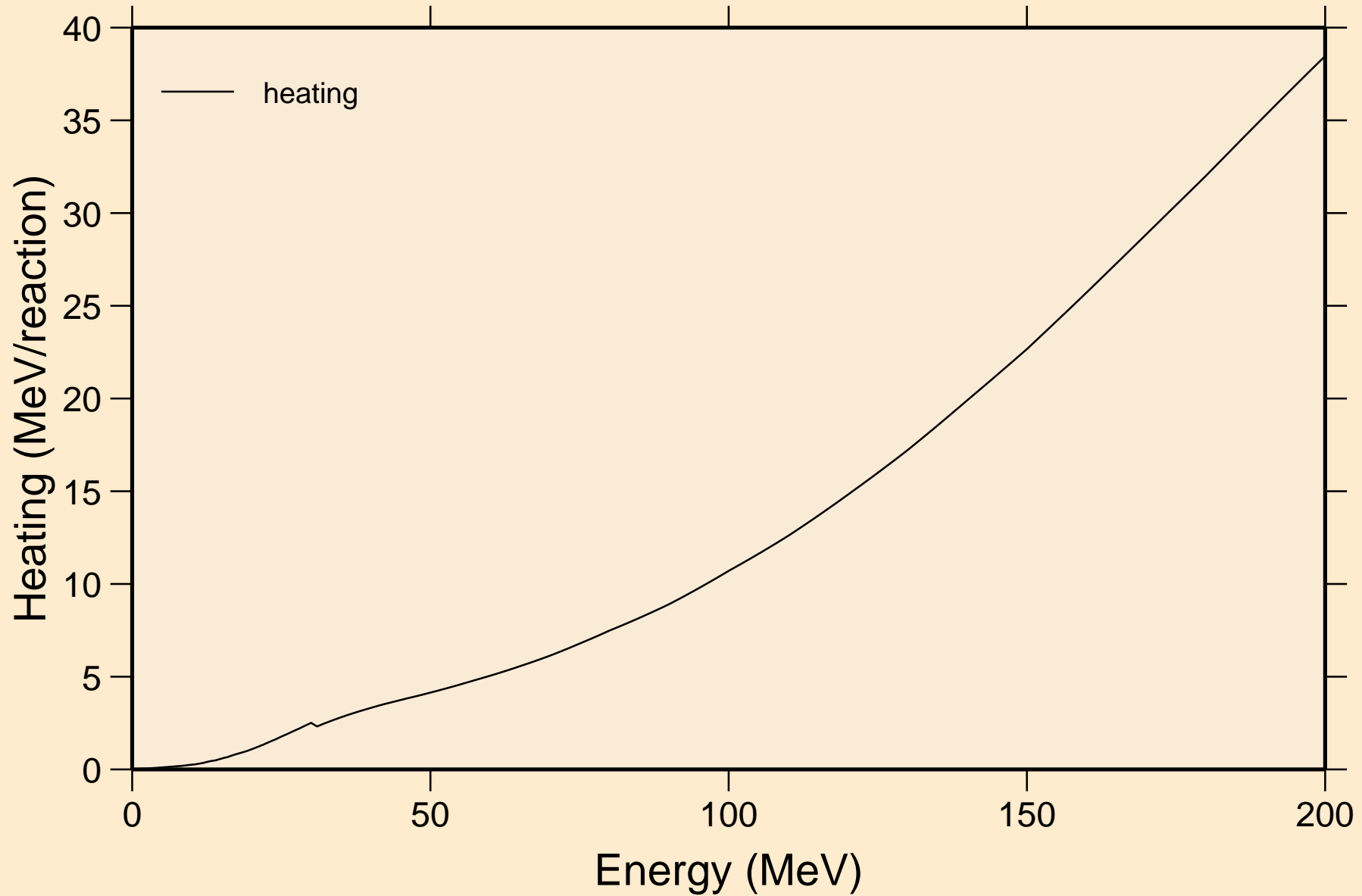

TC097M NEUTRON ACER TENDL-2023 LIBRARY; T=0.K
Damage

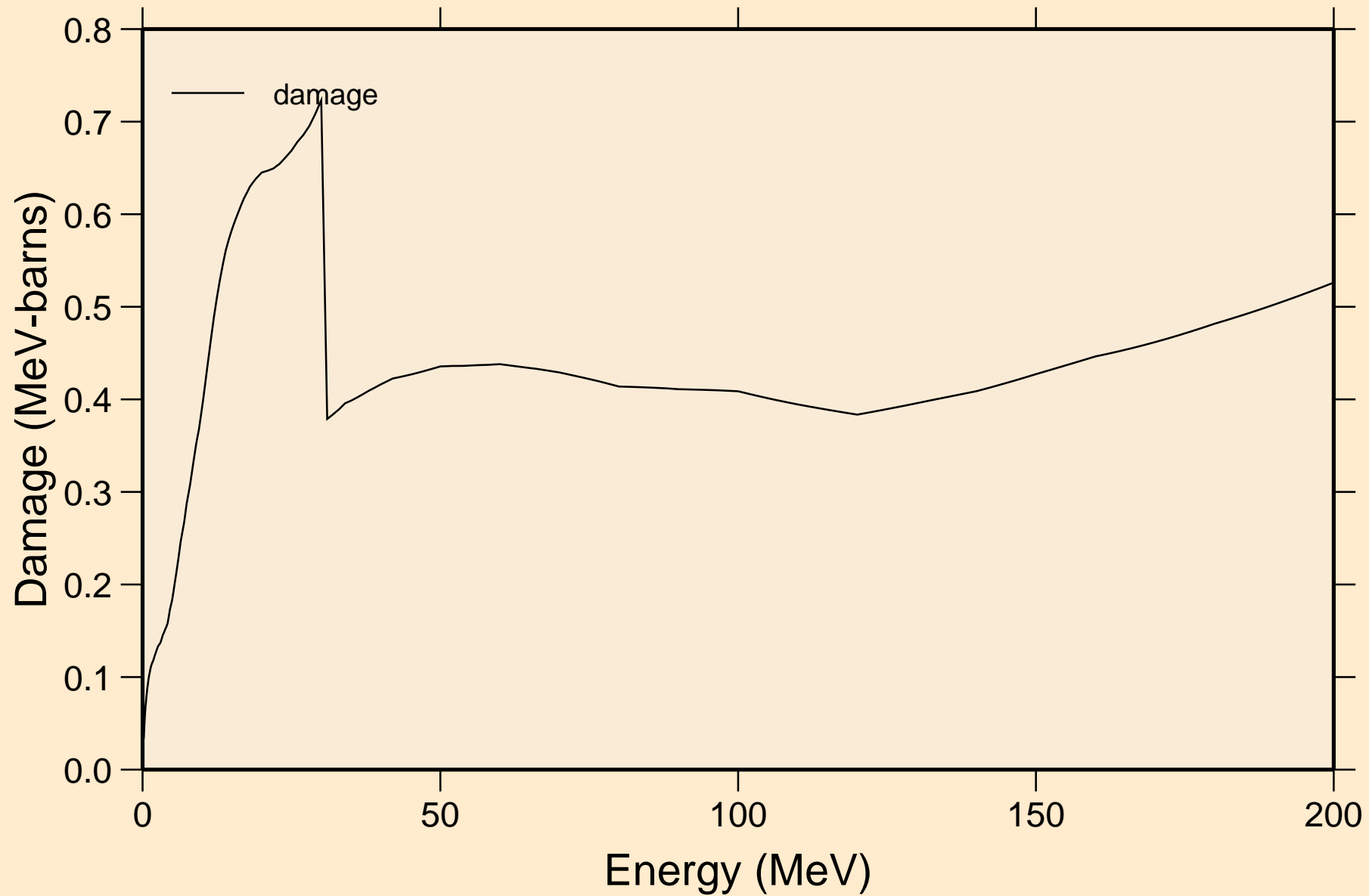

TC097M NEUTRON ACER TENDL-2023 LIBRARY; T=0.K
Non-threshold reactions

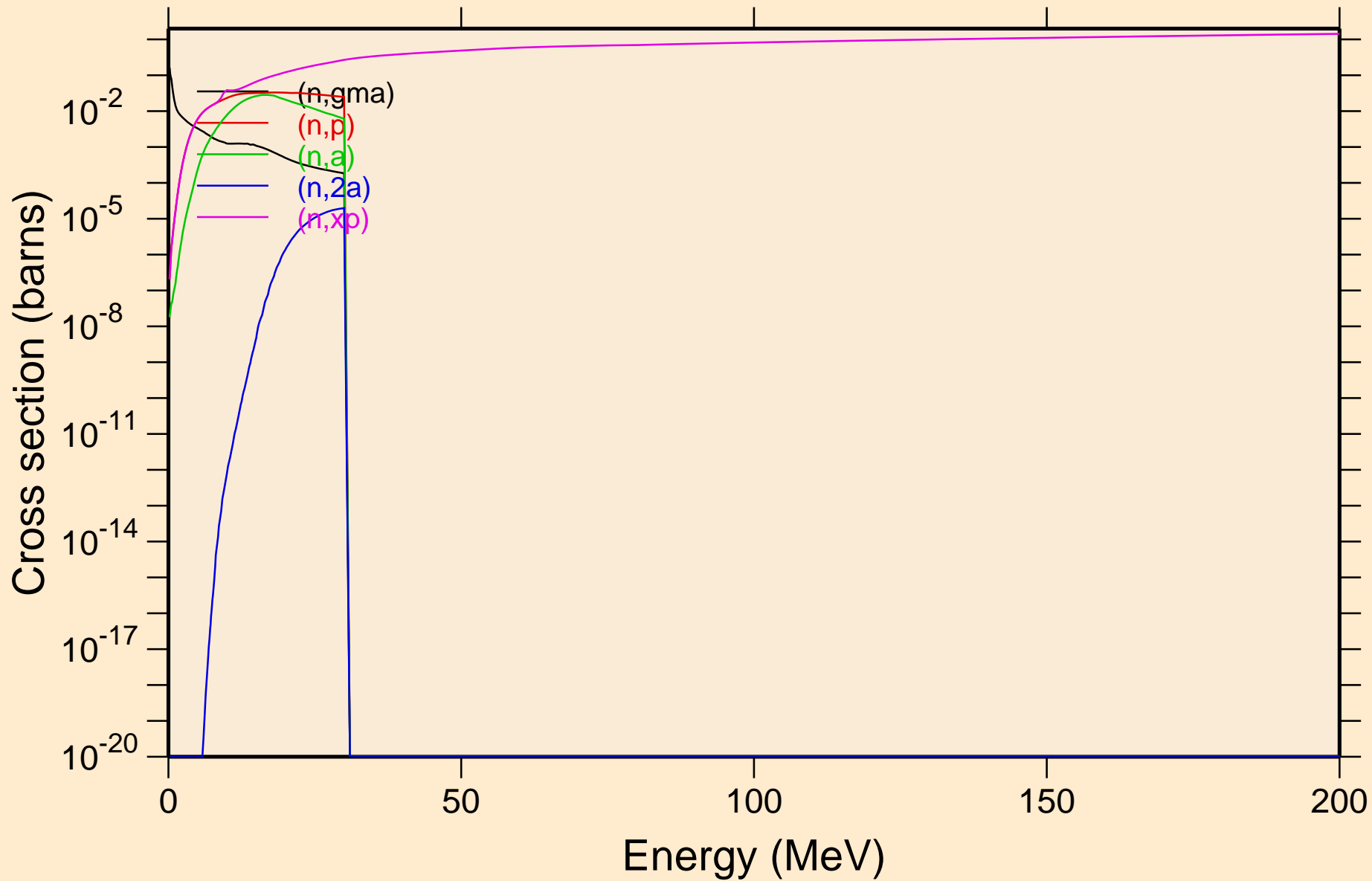

TC097M NEUTRON ACER TENDL-2023 LIBRARY; T=0.K
Non-threshold reactions

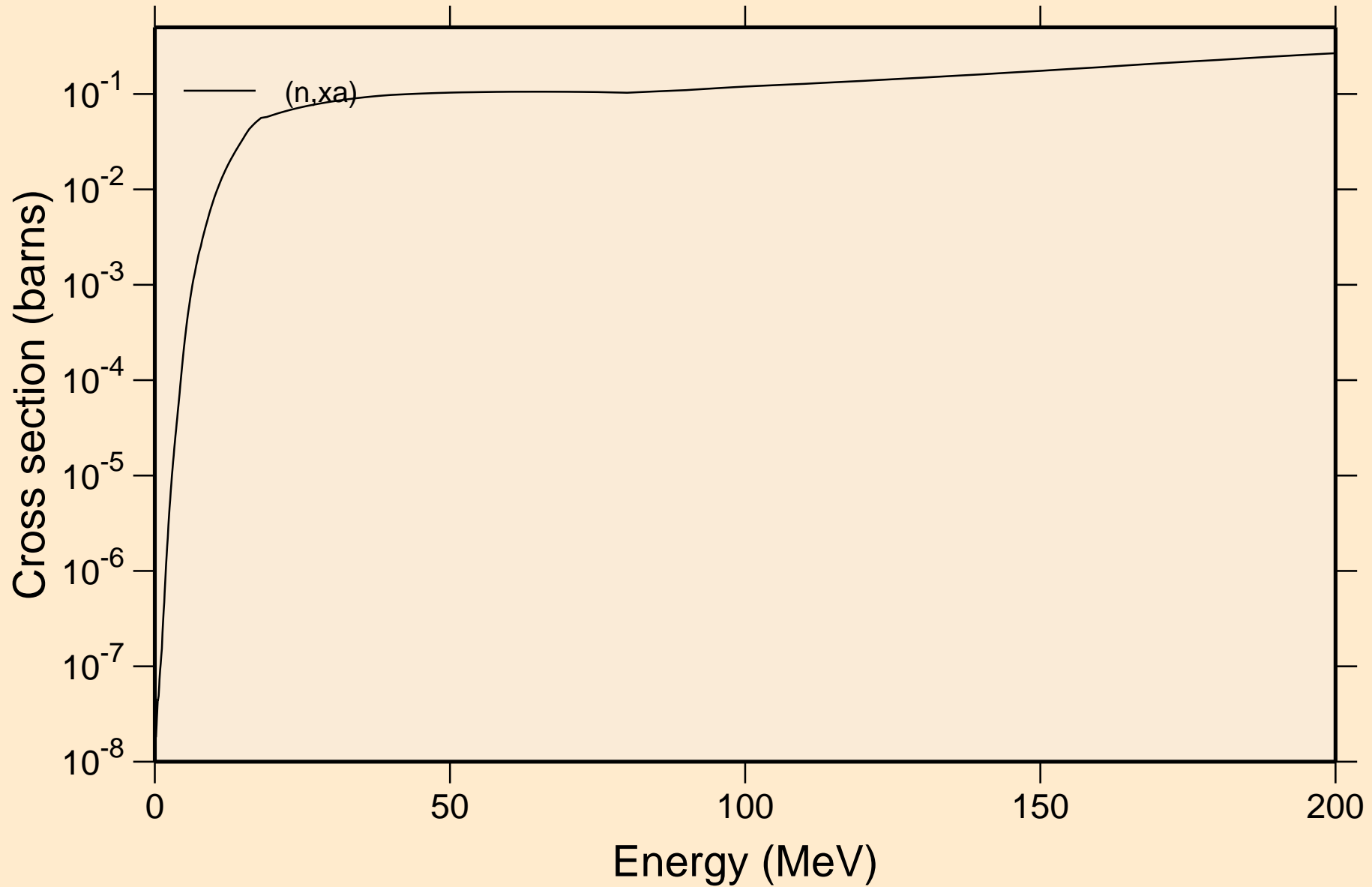

TC097M NEUTRON ACER TENDL-2023 LIBRARY; T=0.K
Inelastic levels

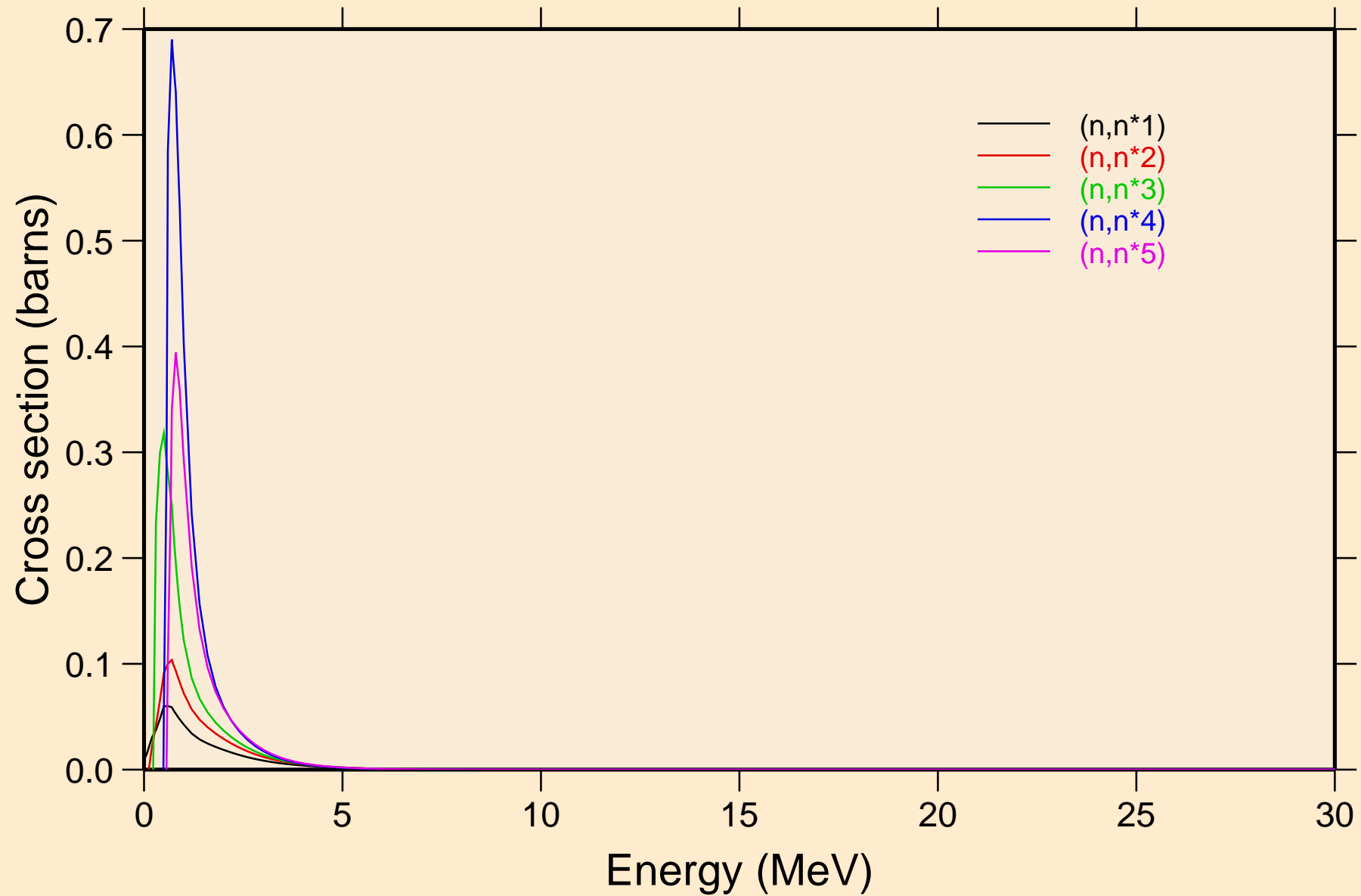

TC097M NEUTRON ACER TENDL-2023 LIBRARY; T=0.K
Inelastic levels

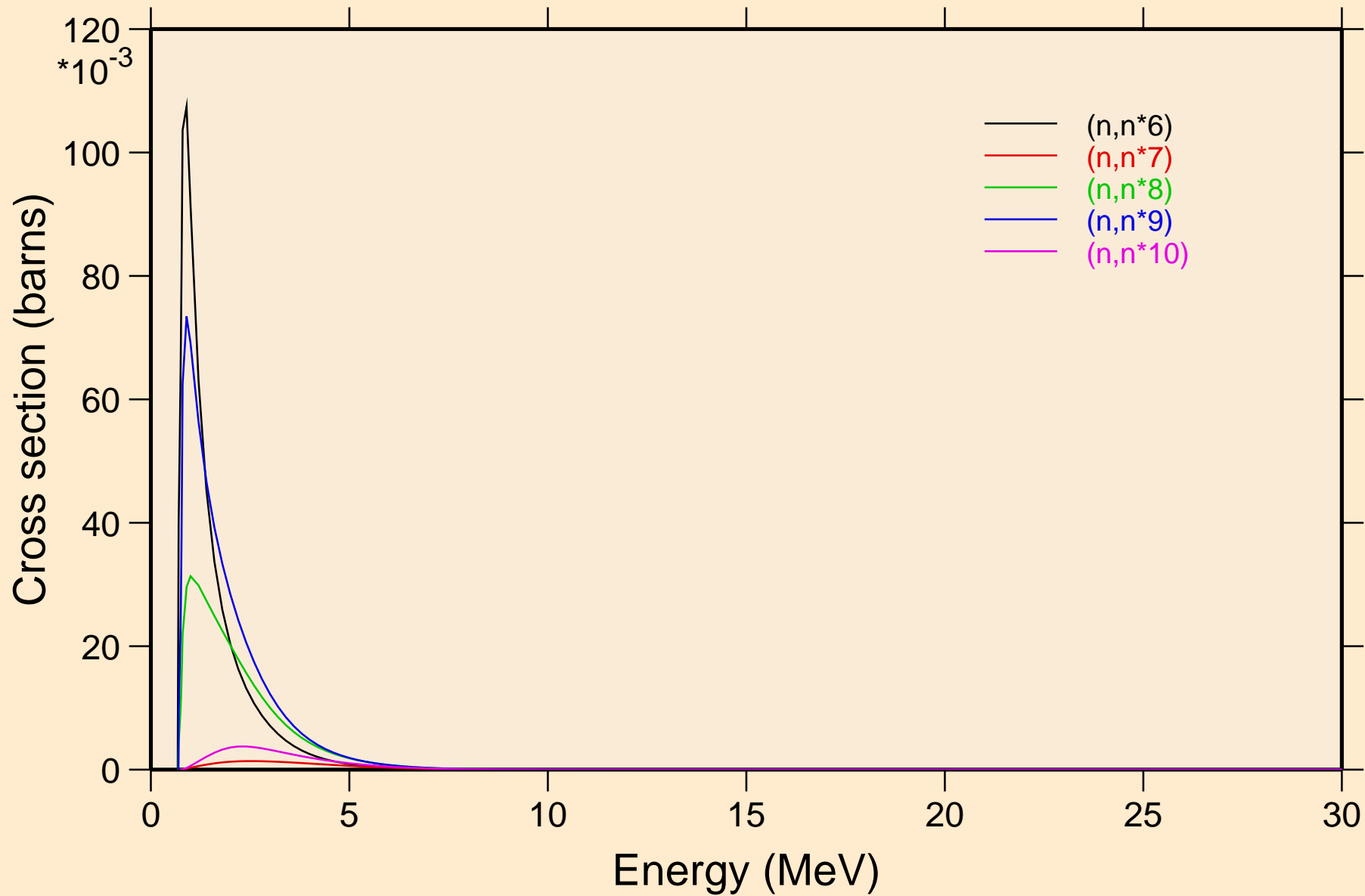

TC097M NEUTRON ACER TENDL-2023 LIBRARY; T=0.K
Inelastic levels

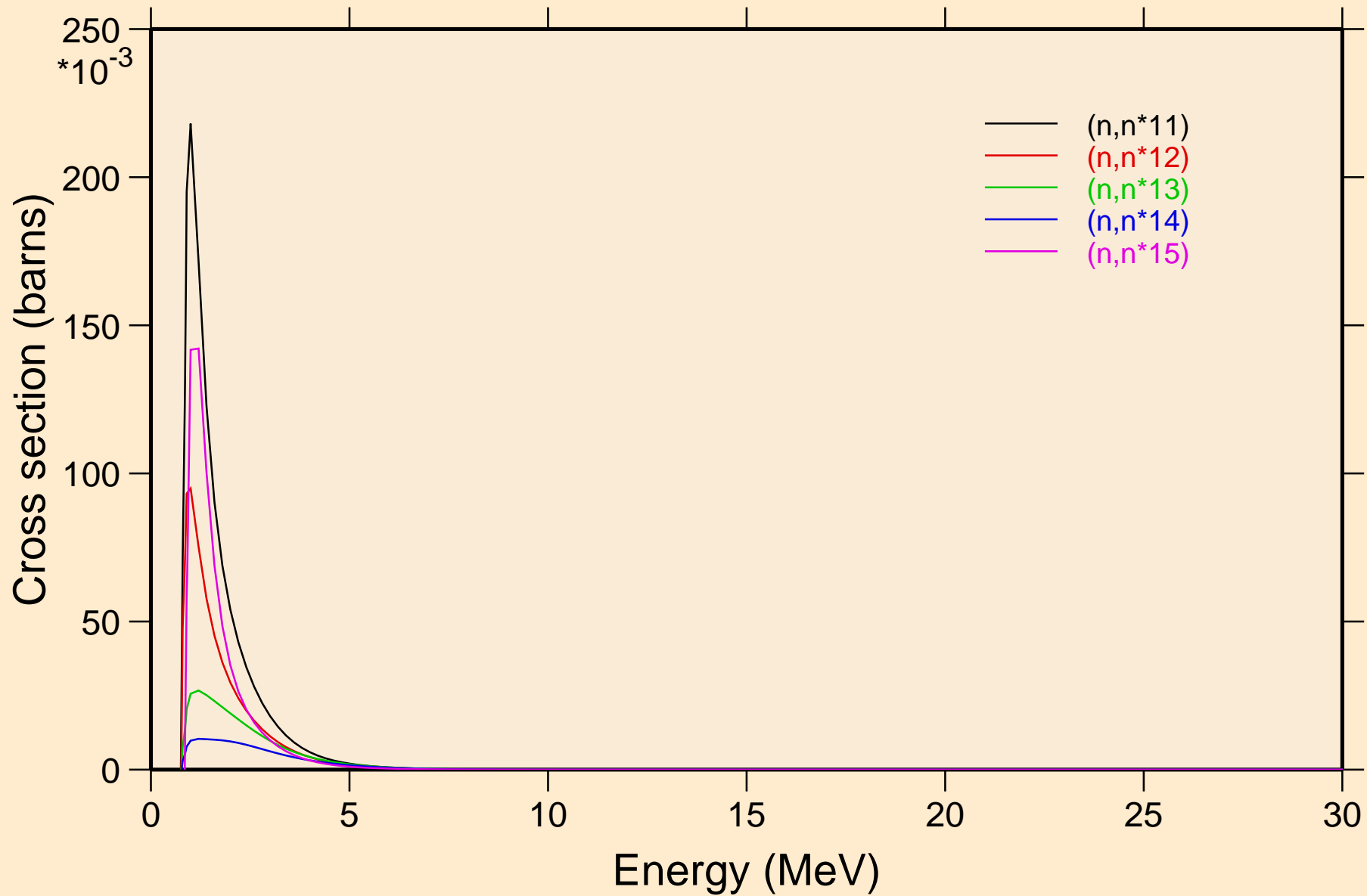

TC097M NEUTRON ACER TENDL-2023 LIBRARY; T=0.K
Inelastic levels

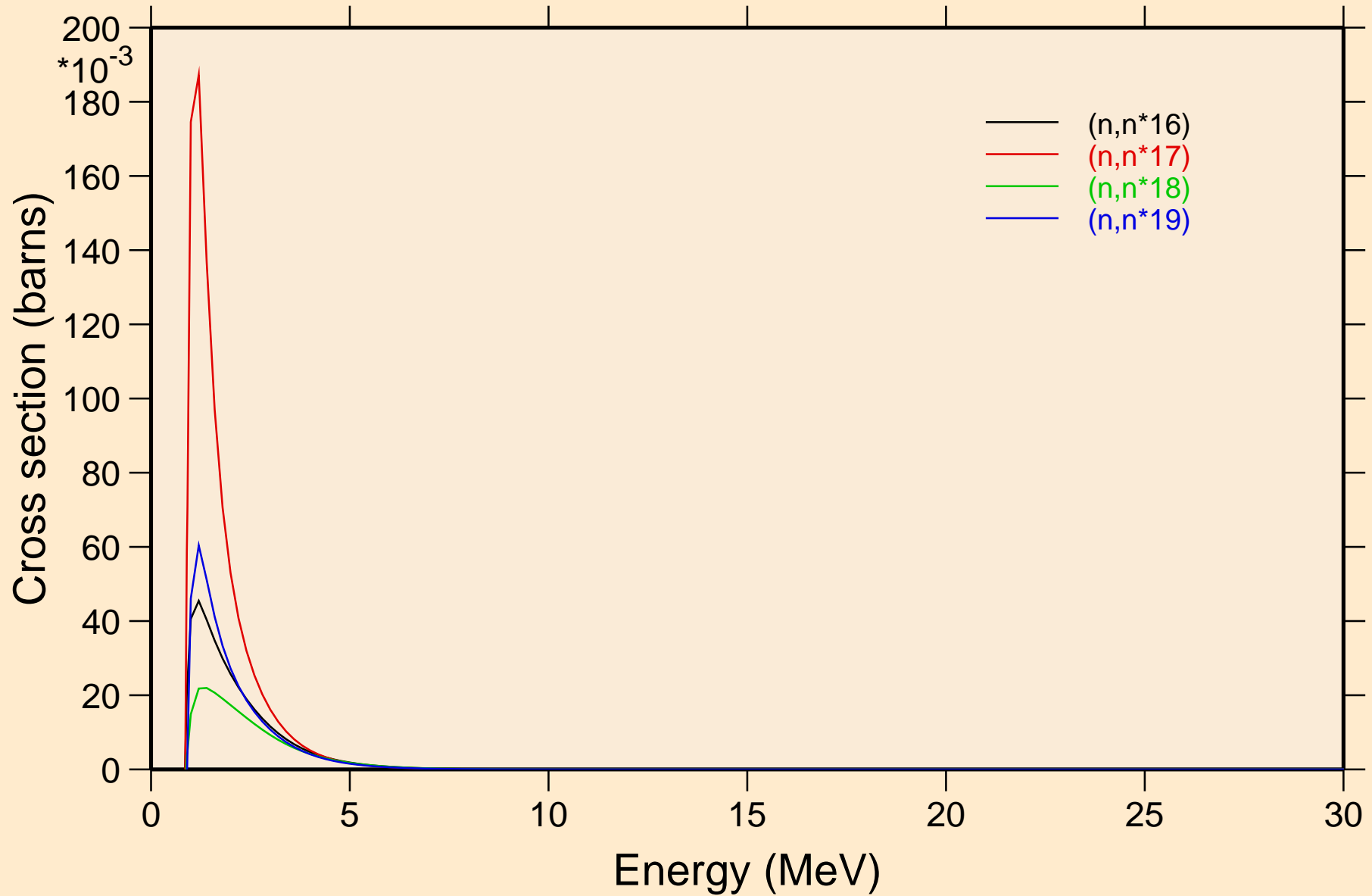

TC097M NEUTRON ACER TENDL-2023 LIBRARY; T=0.K
Threshold reactions

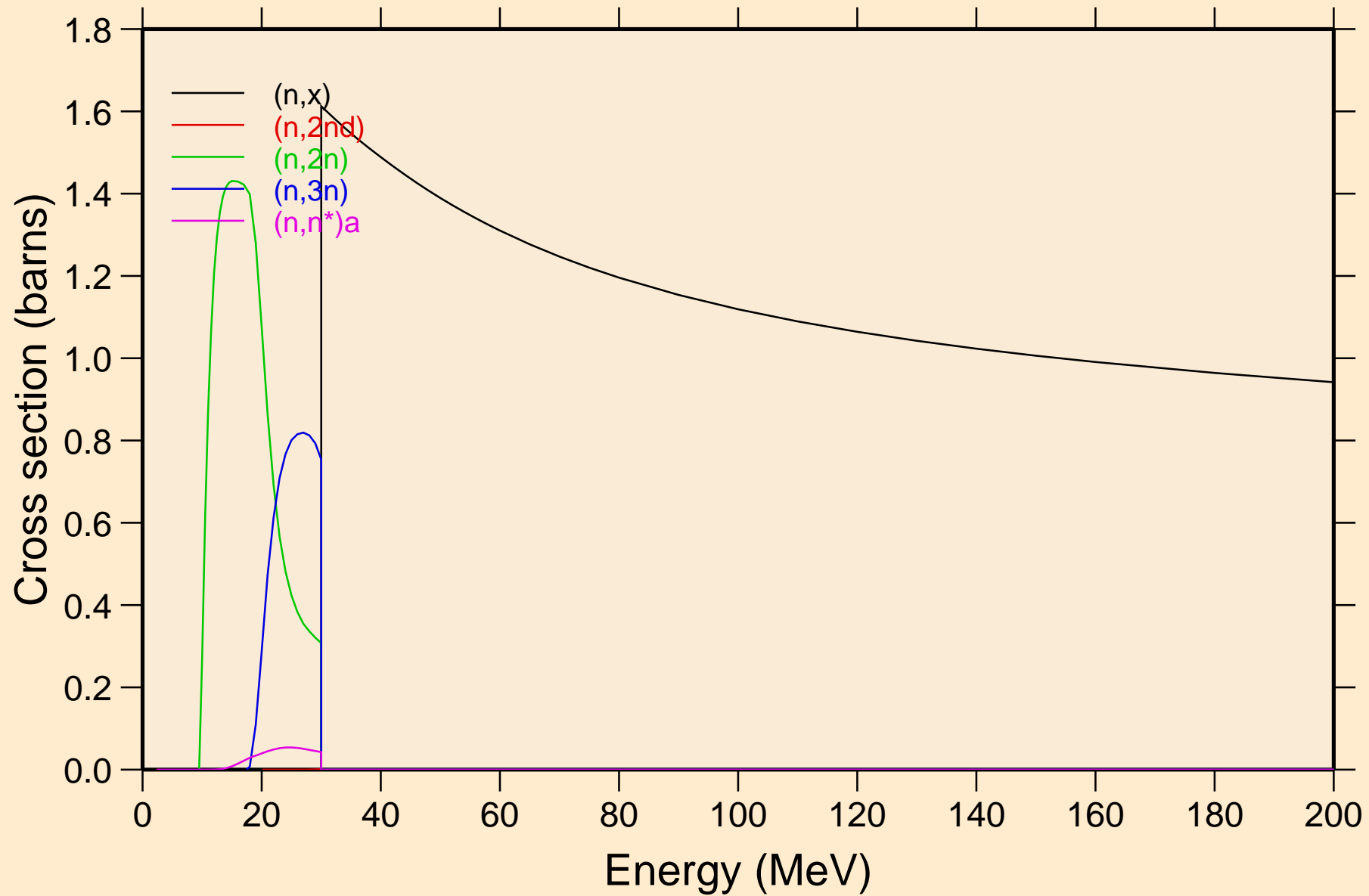

TC097M NEUTRON ACER TENDL-2023 LIBRARY; T=0.K
Threshold reactions

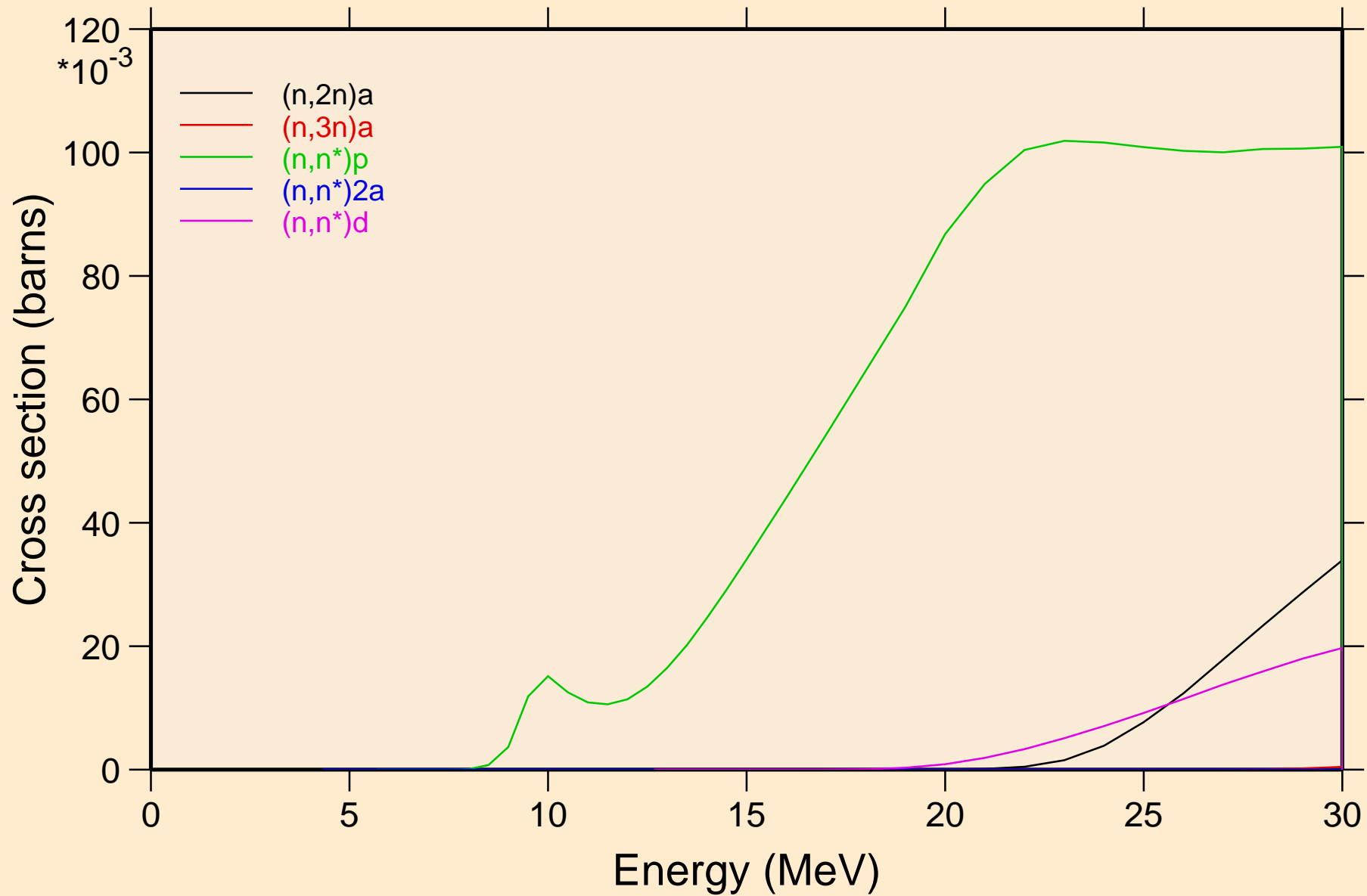

TC097M NEUTRON ACER TENDL-2023 LIBRARY; T=0.K
Threshold reactions

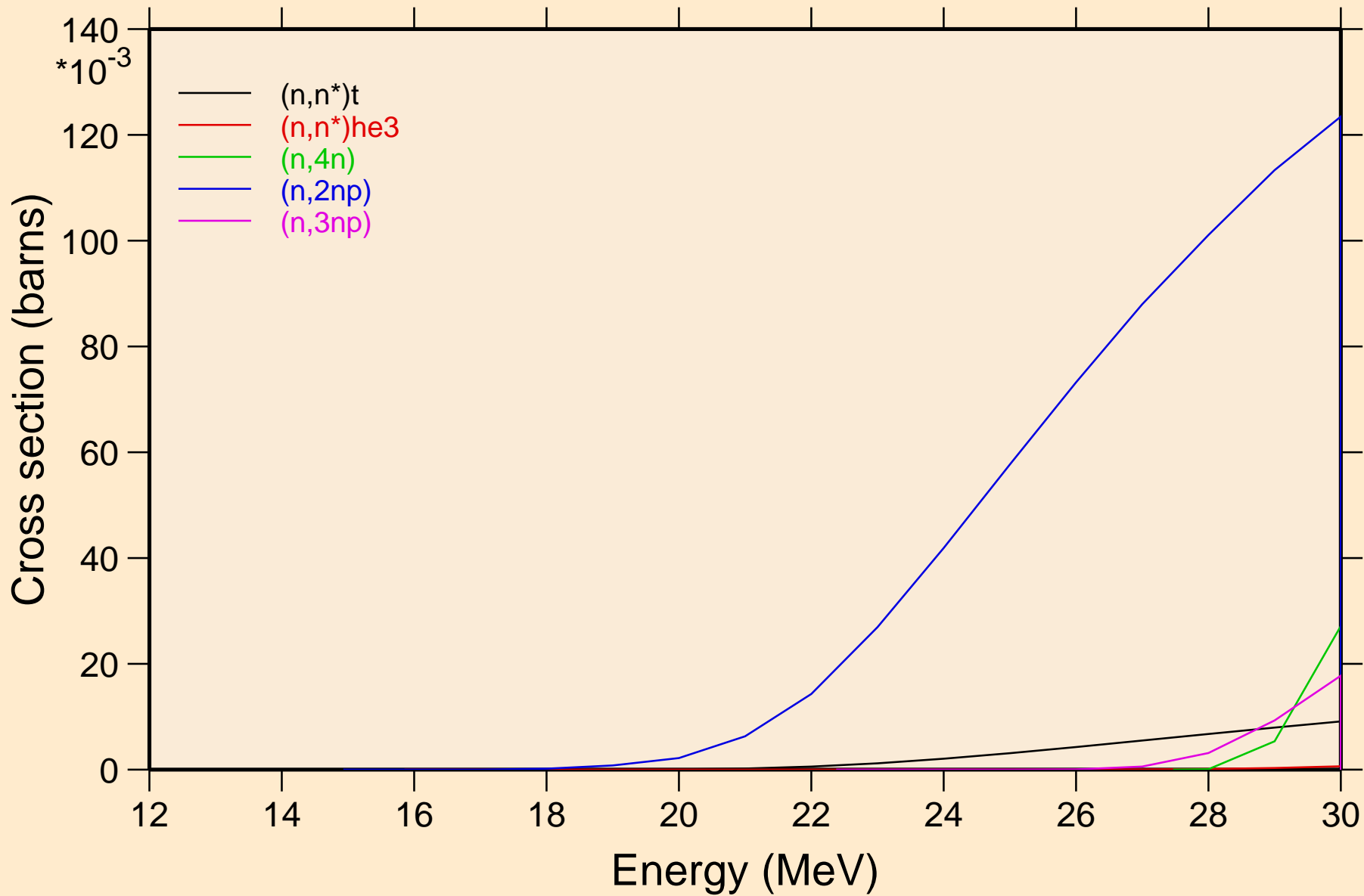

TC097M NEUTRON ACER TENDL-2023 LIBRARY; T=0.K
Threshold reactions

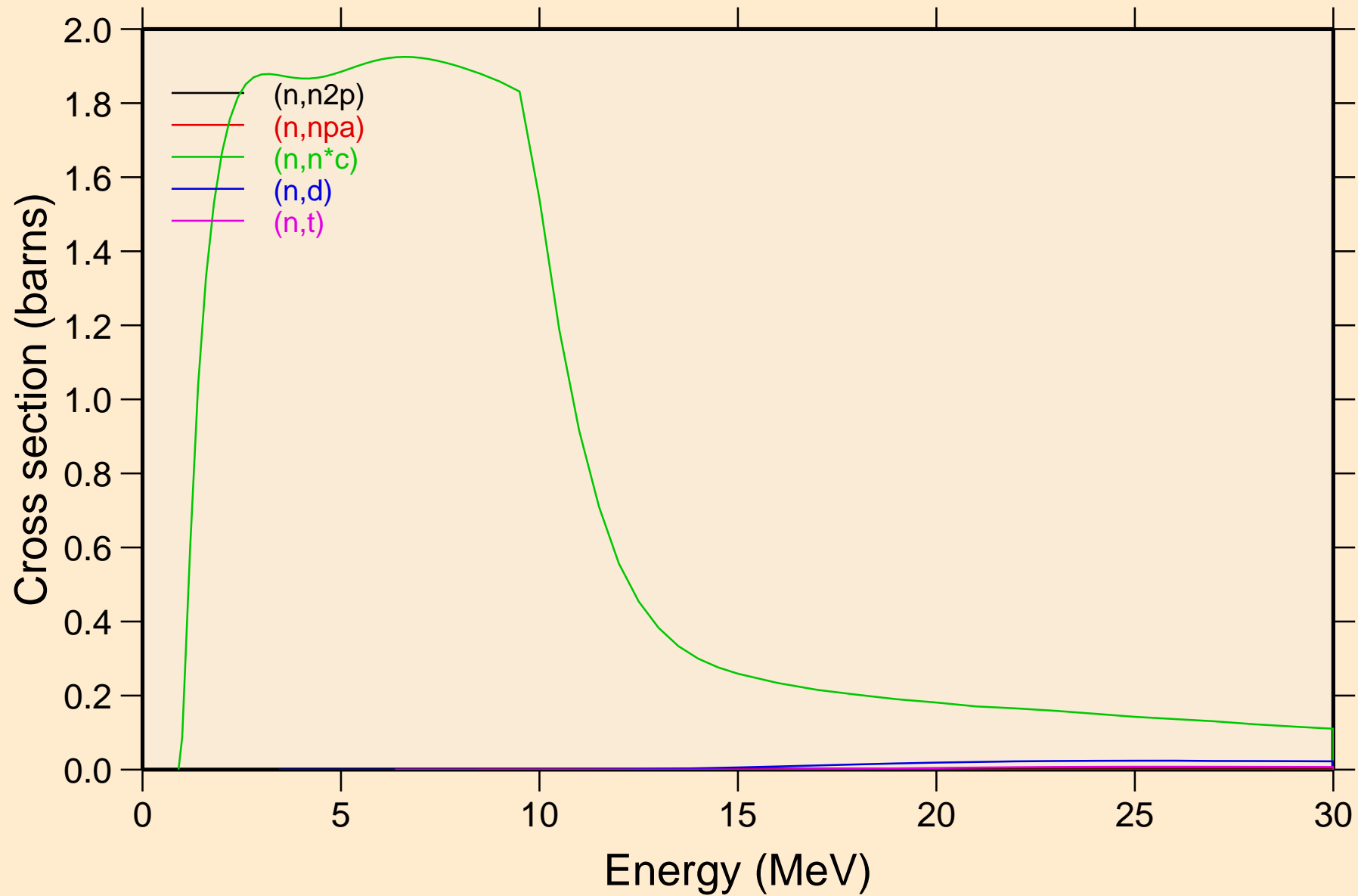

TC097M NEUTRON ACER TENDL-2023 LIBRARY; T=0.K
Threshold reactions

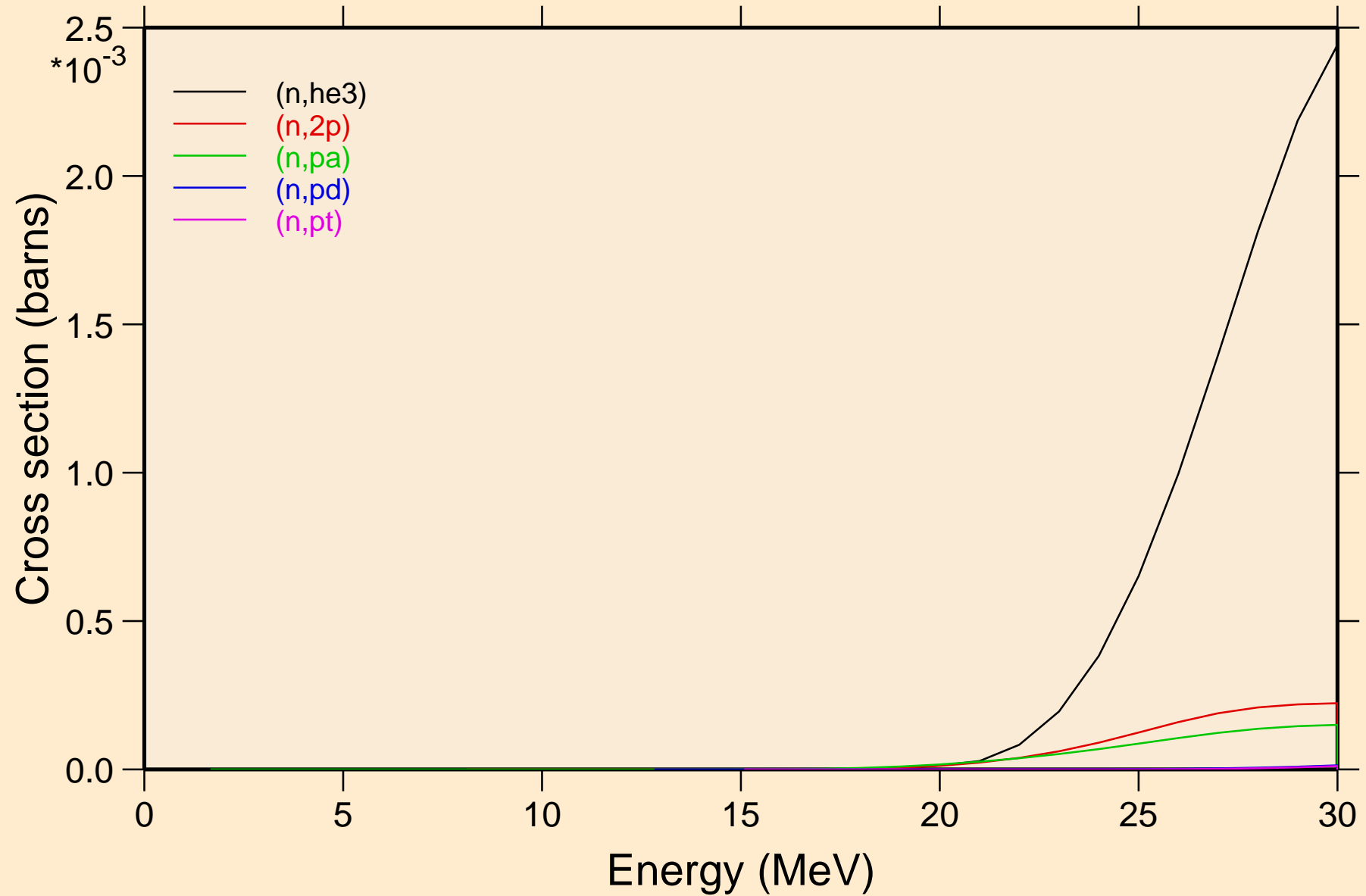

TC097M NEUTRON ACER TENDL-2023 LIBRARY; T=0.K
Threshold reactions

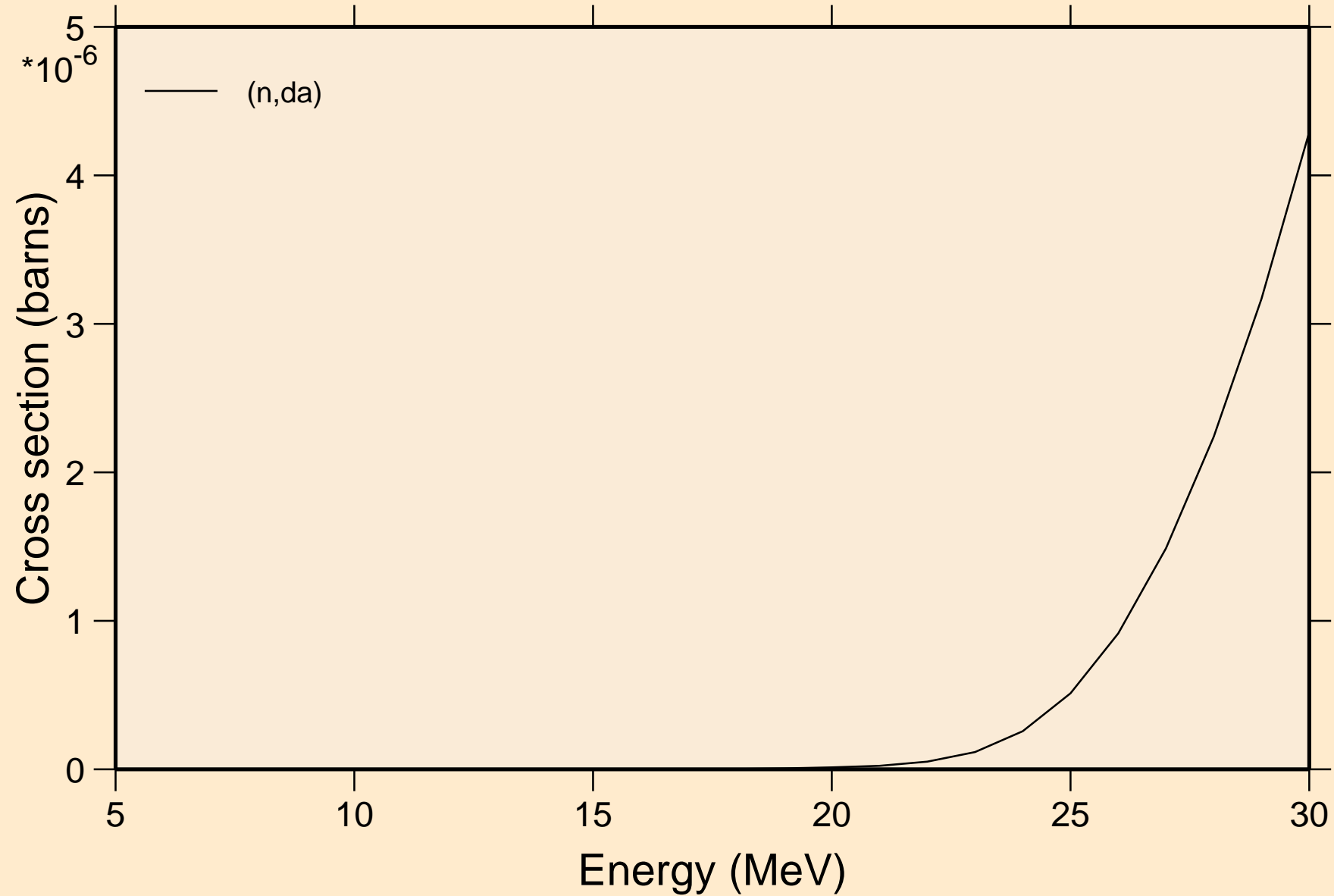

TC097M NEUTRON ACER TENDL-2023 LIBRARY; T=0.K
Threshold reactions

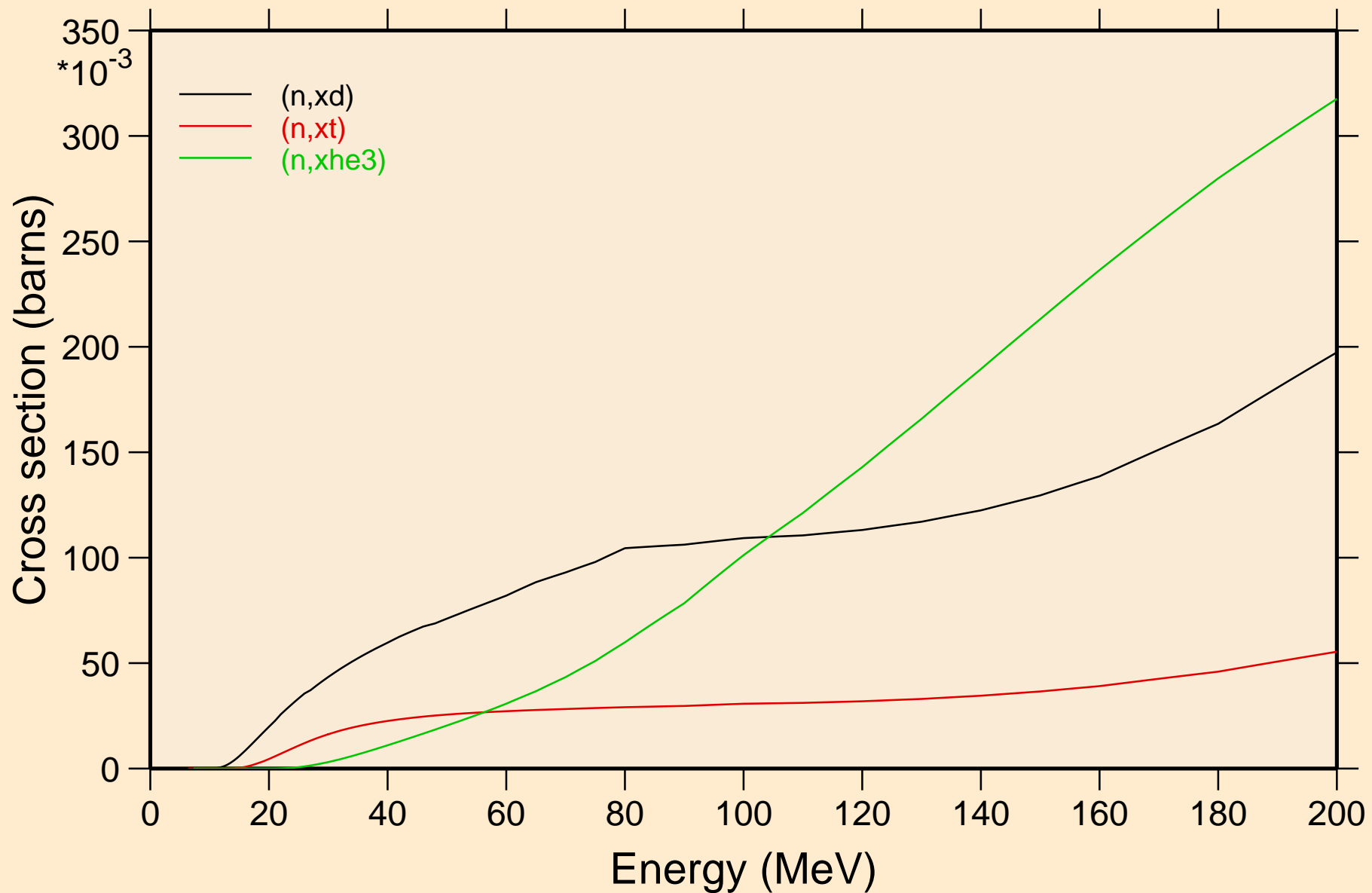

TC097M NEUTRON ACER TENDL-2023 LIBRARY; T=0.K
angular distribution for elastic

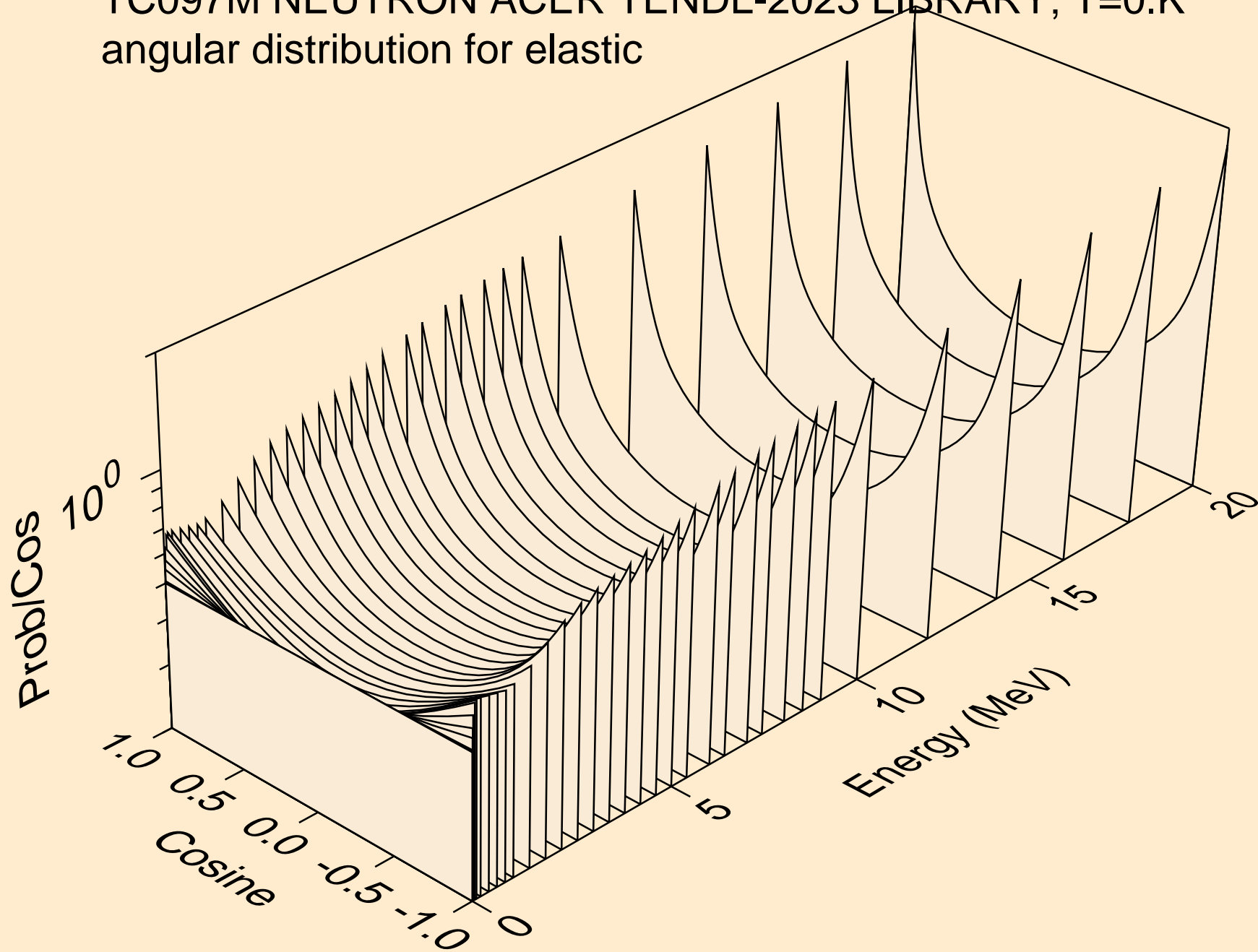

TC097M NEUTRON ACER TENDL-2023 LIBRARY; T=0.K
angular distribution for elastic

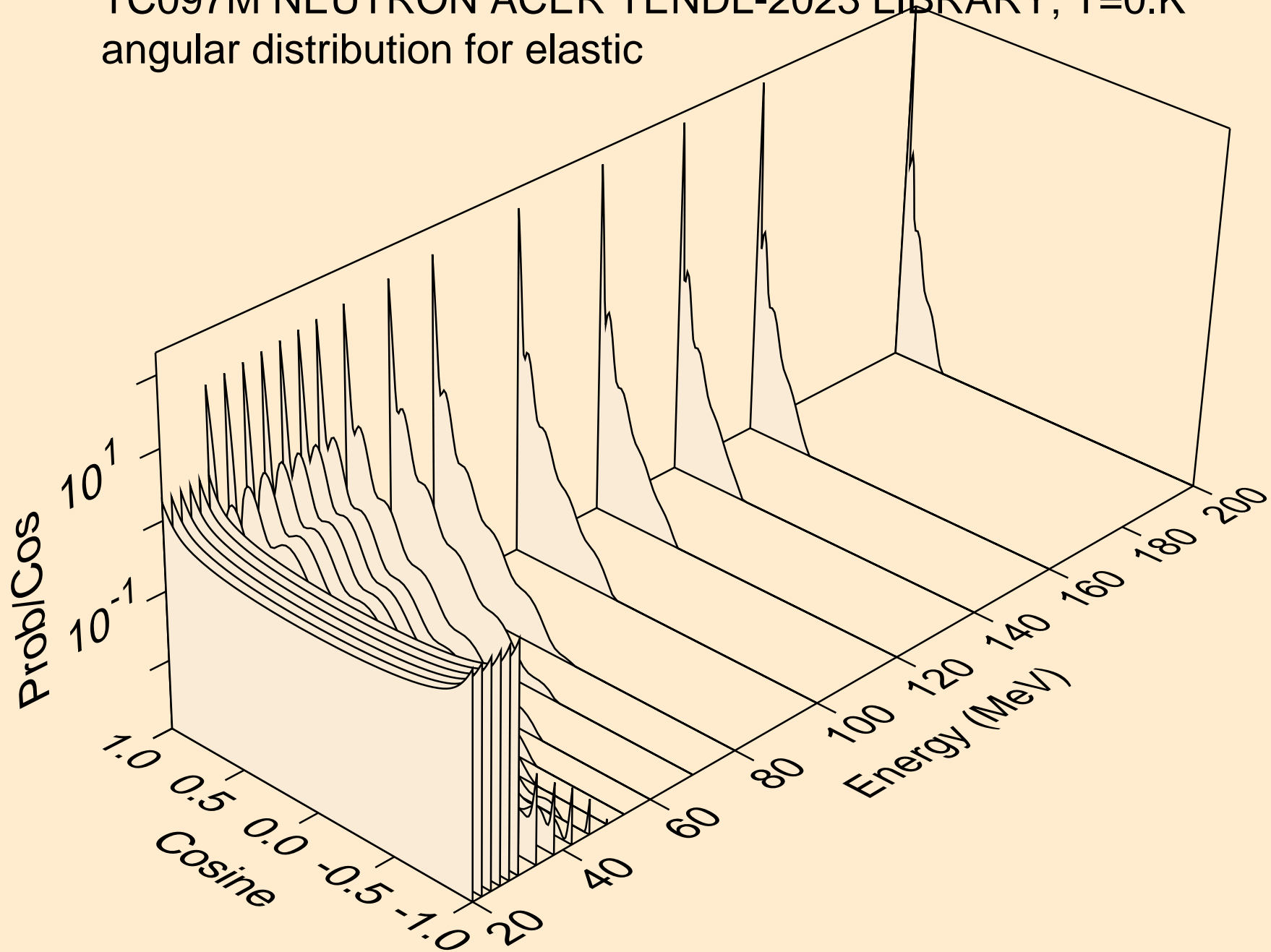

TC097M NEUTRON ACER TENDL-2023 LIBRARY; T=0.K
angular distribution for (n,n*1)

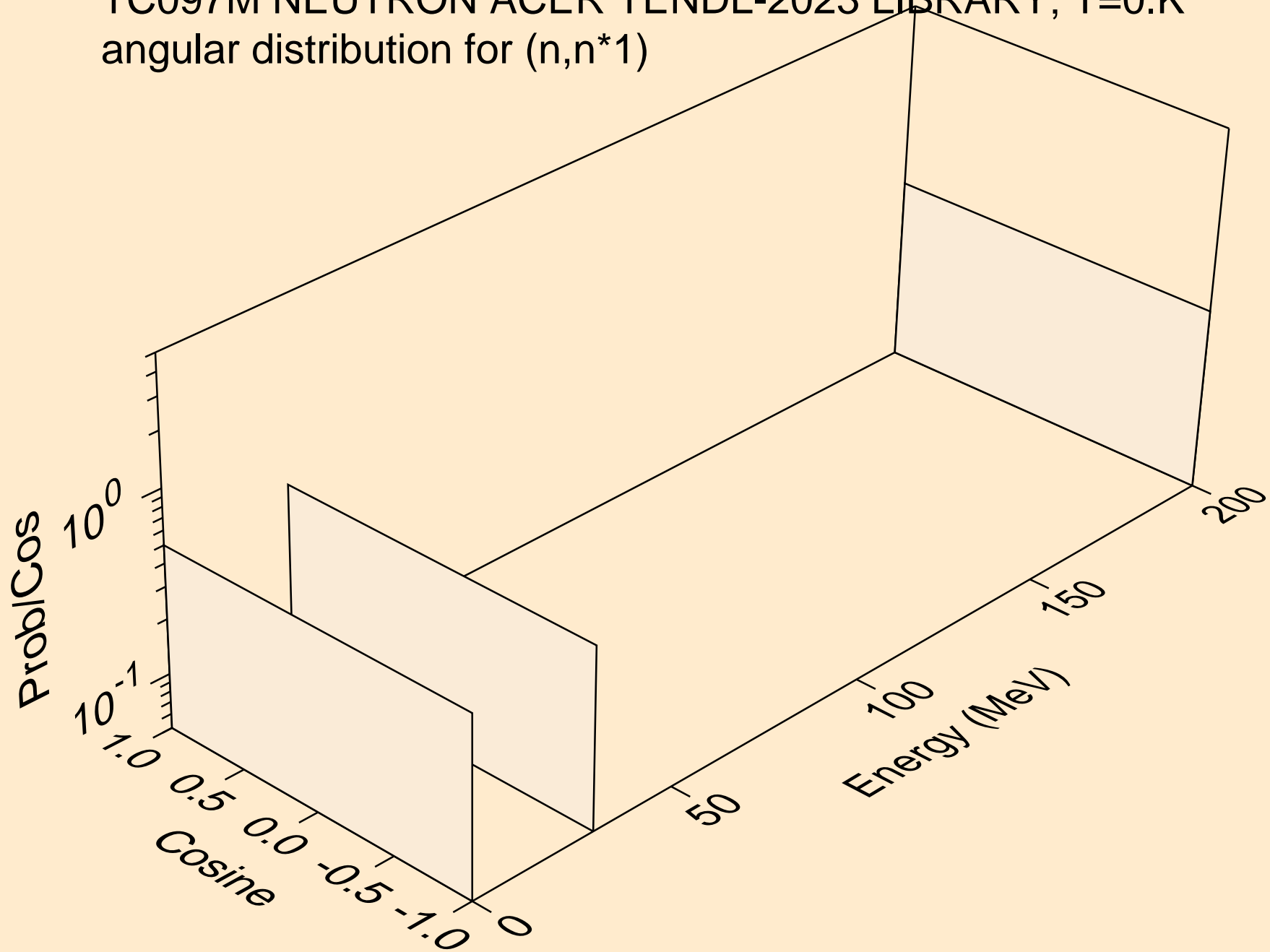

TC097M NEUTRON ACER TENDL-2023 LIBRARY; T=0.K
angular distribution for (n,n*2)

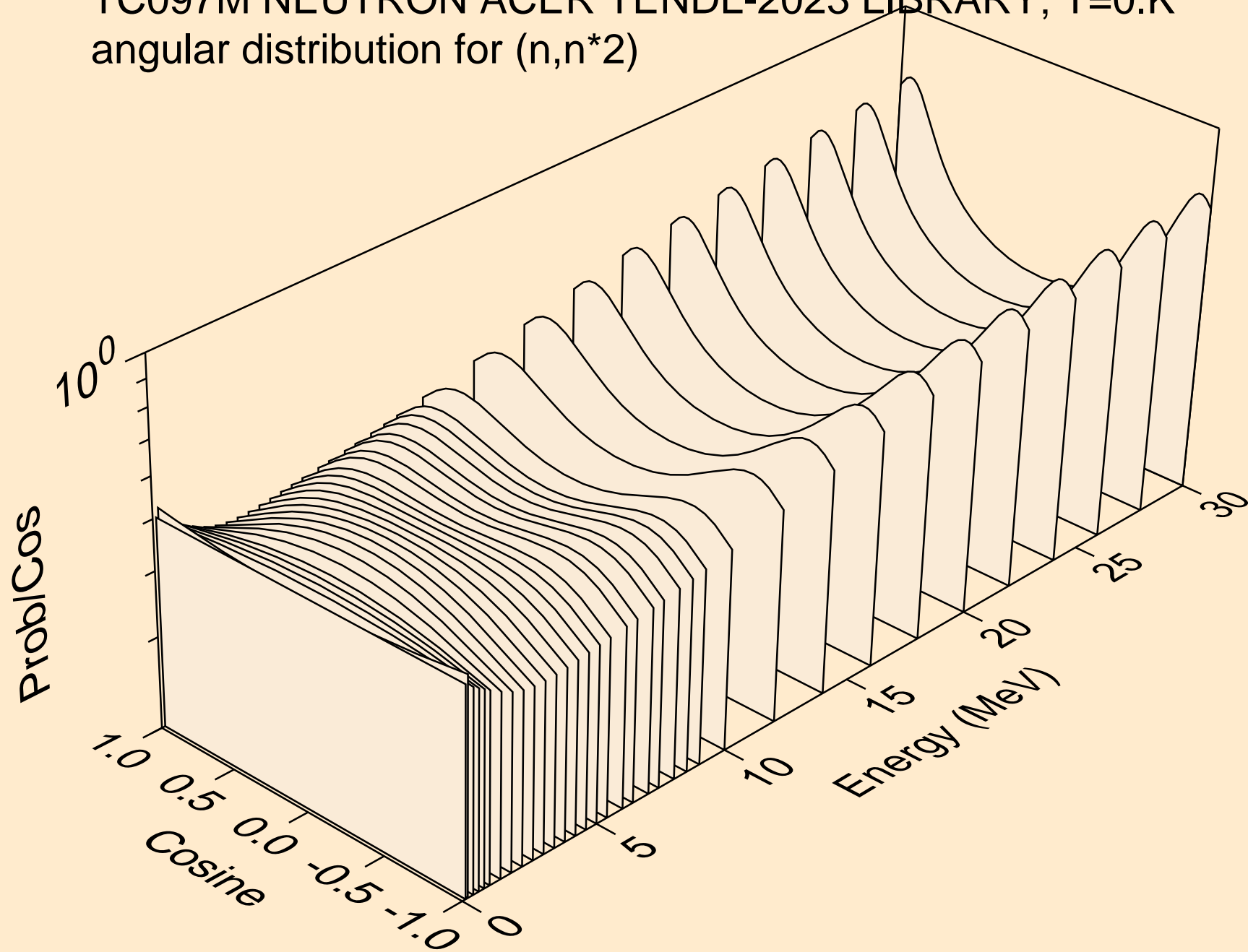

TC097M NEUTRON ACER TENDL-2023 LIBRARY; T=0.K
angular distribution for (n,n*3)

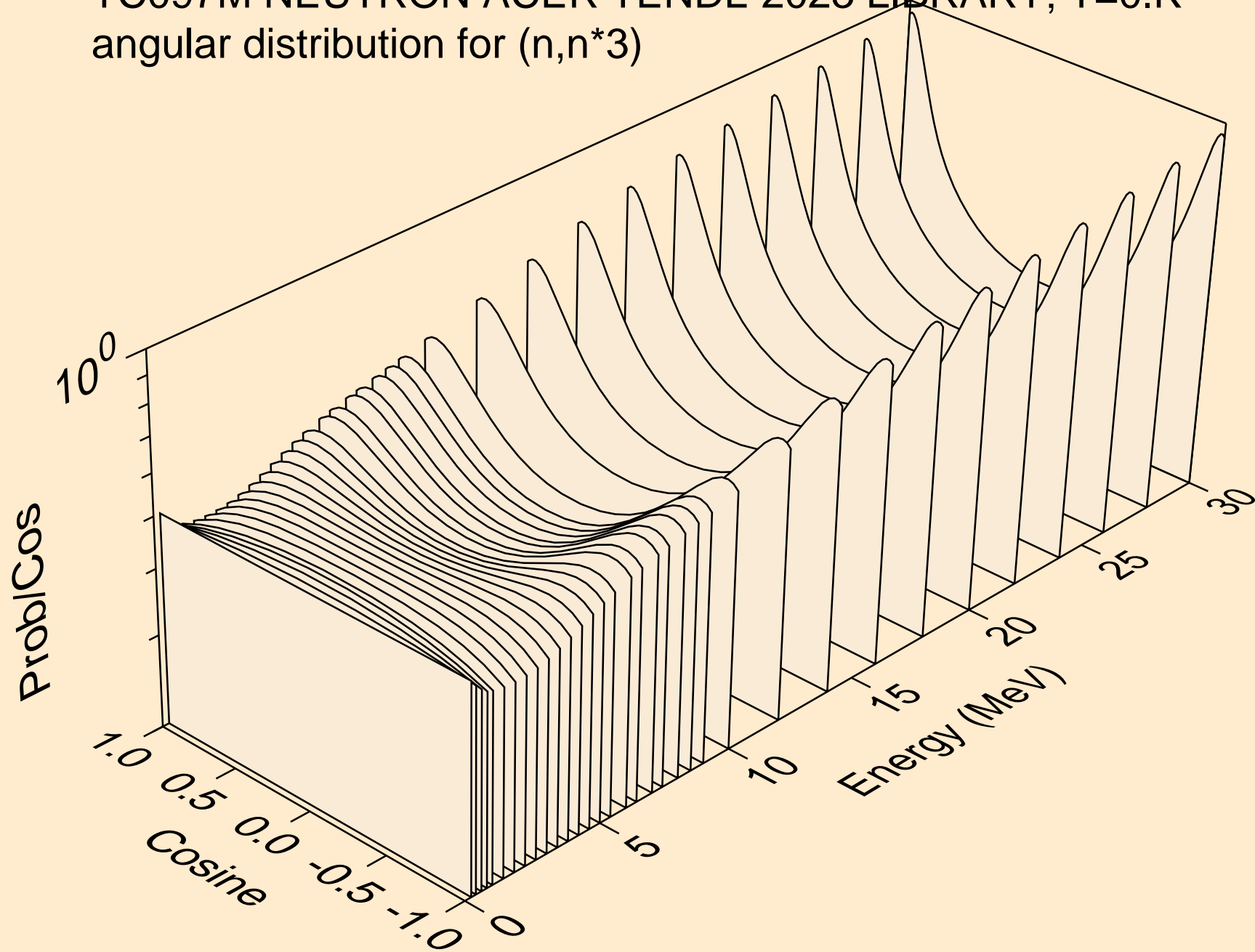

TC097M NEUTRON ACER TENDL-2023 LIBRARY; T=0.K
angular distribution for (n,n*4)

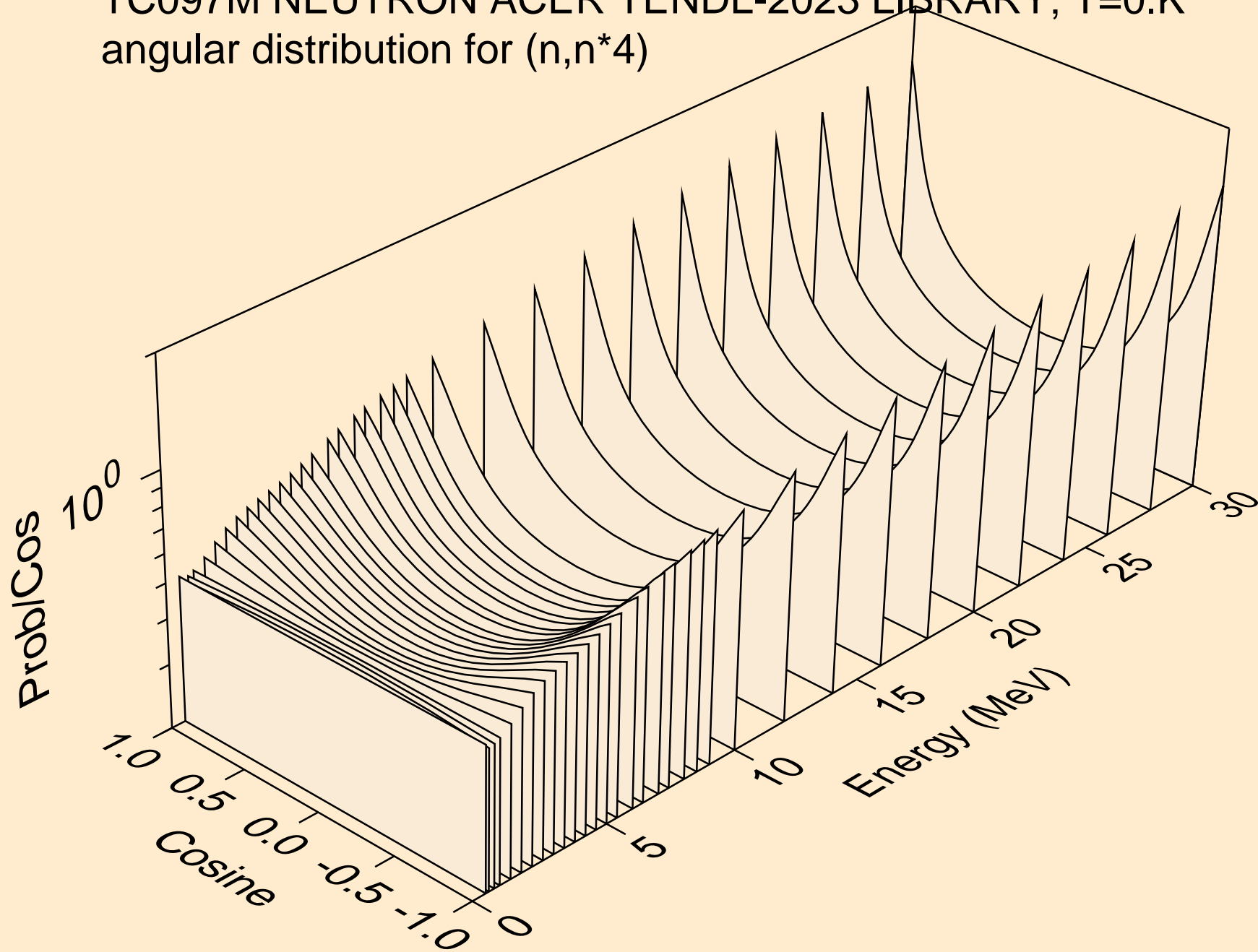

TC097M NEUTRON ACER TENDL-2023 LIBRARY; T=0.K
angular distribution for (n,n*5)

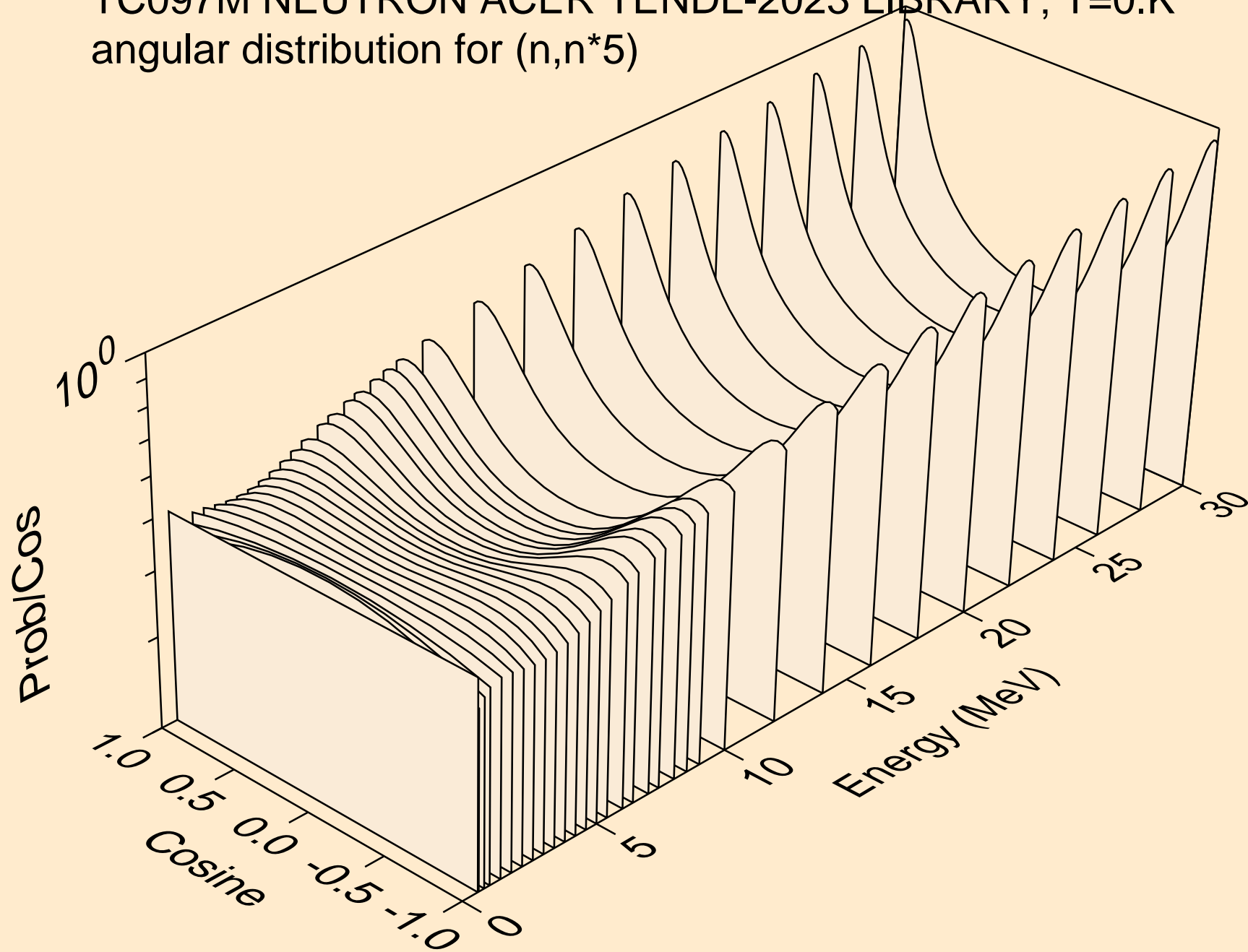

TC097M NEUTRON ACER TENDL-2023 LIBRARY; T=0.K
angular distribution for (n,n*6)

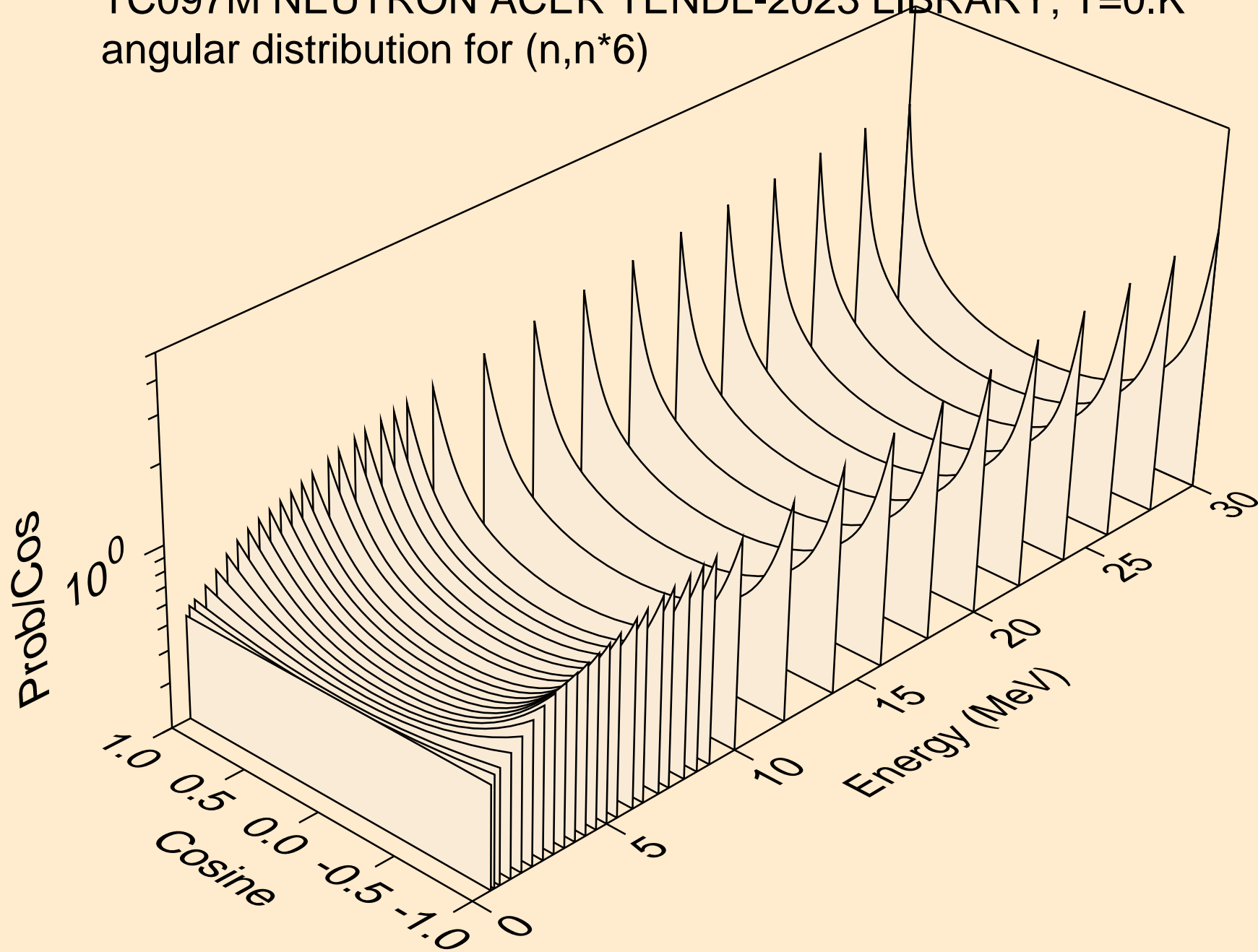

TC097M NEUTRON ACER TENDL-2023 LIBRARY; T=0.K
angular distribution for (n,n*7)

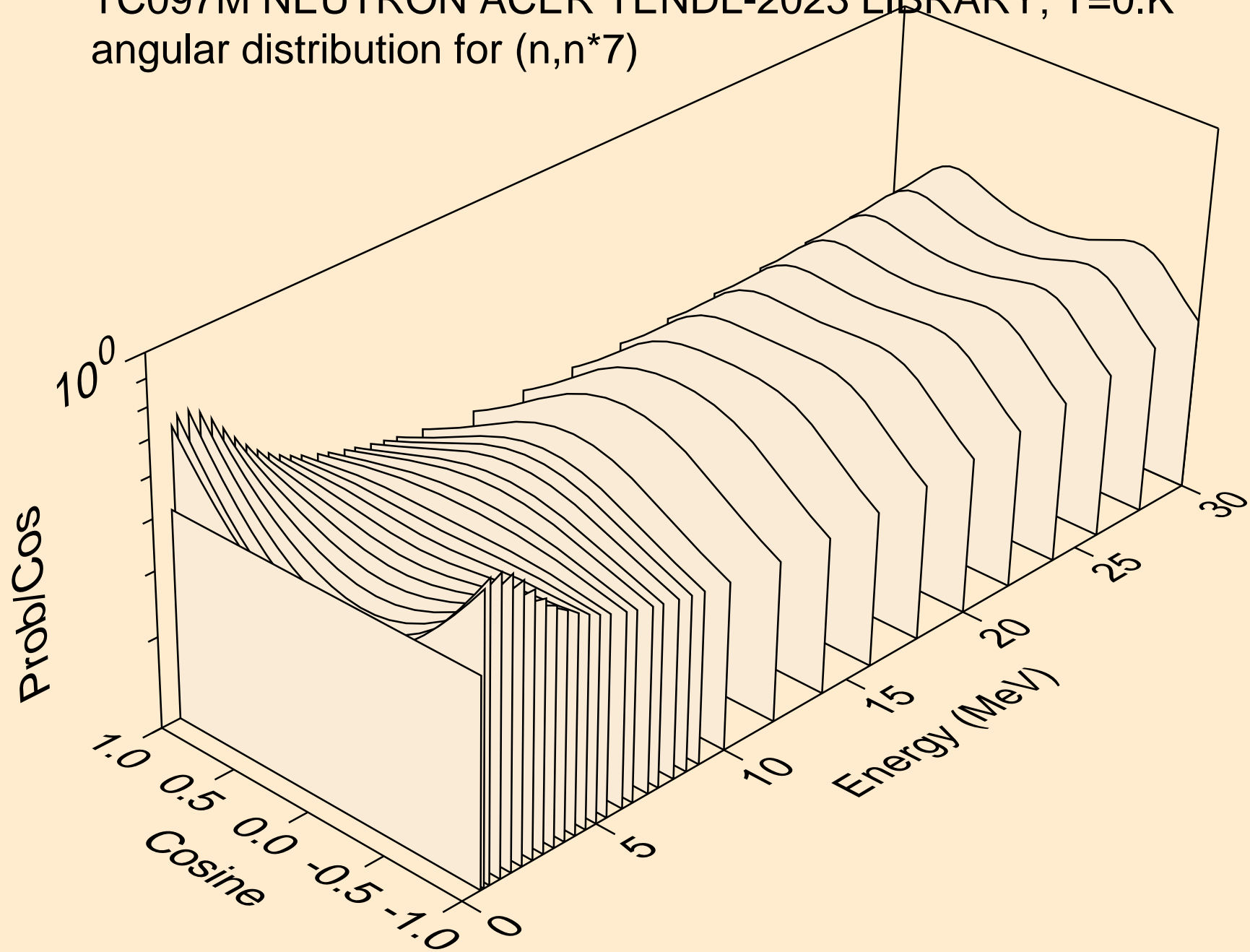

TC097M NEUTRON ACER TENDL-2023 LIBRARY; T=0.K
angular distribution for (n,n*8)

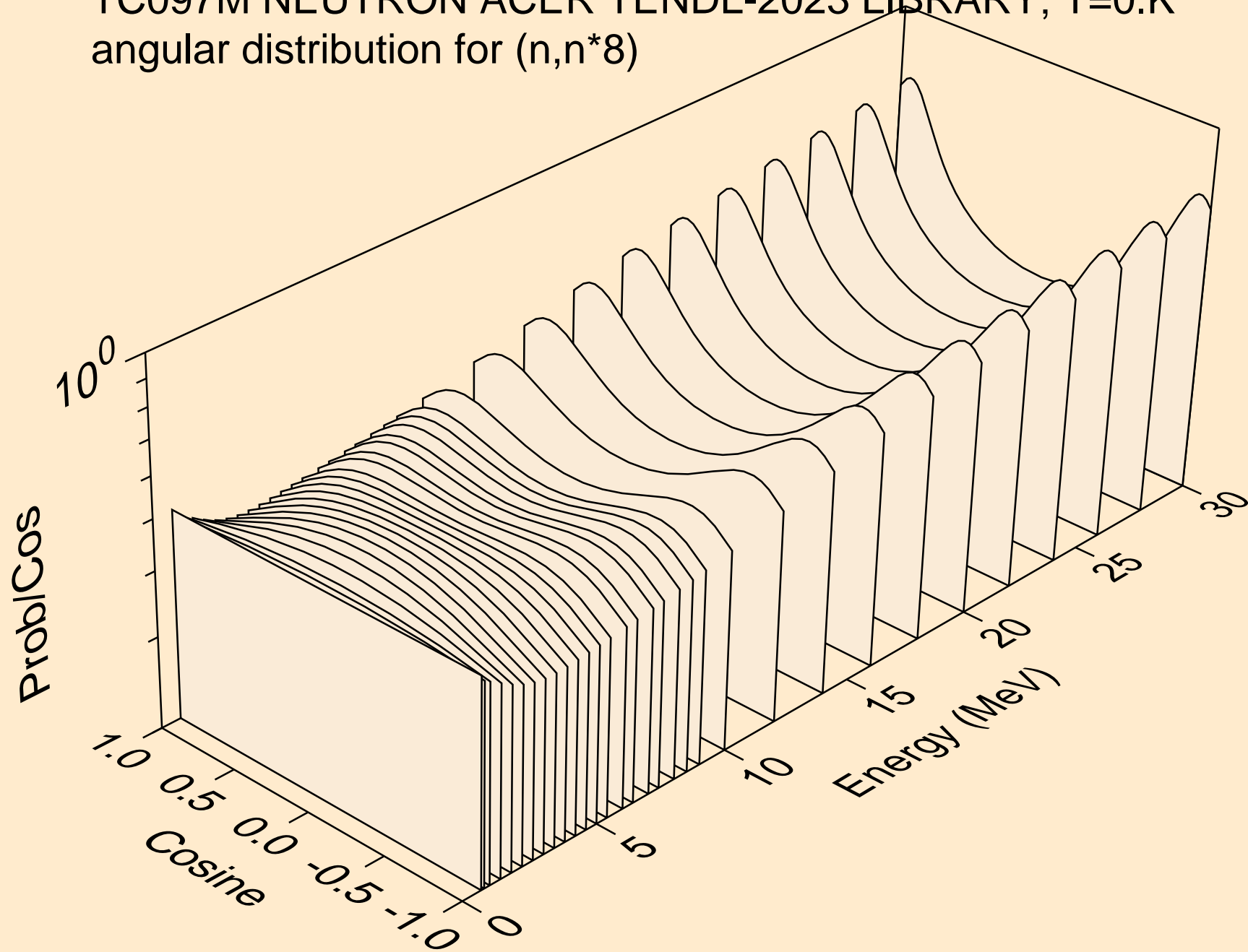

TC097M NEUTRON ACER TENDL-2023 LIBRARY; T=0.K
angular distribution for (n,n*9)

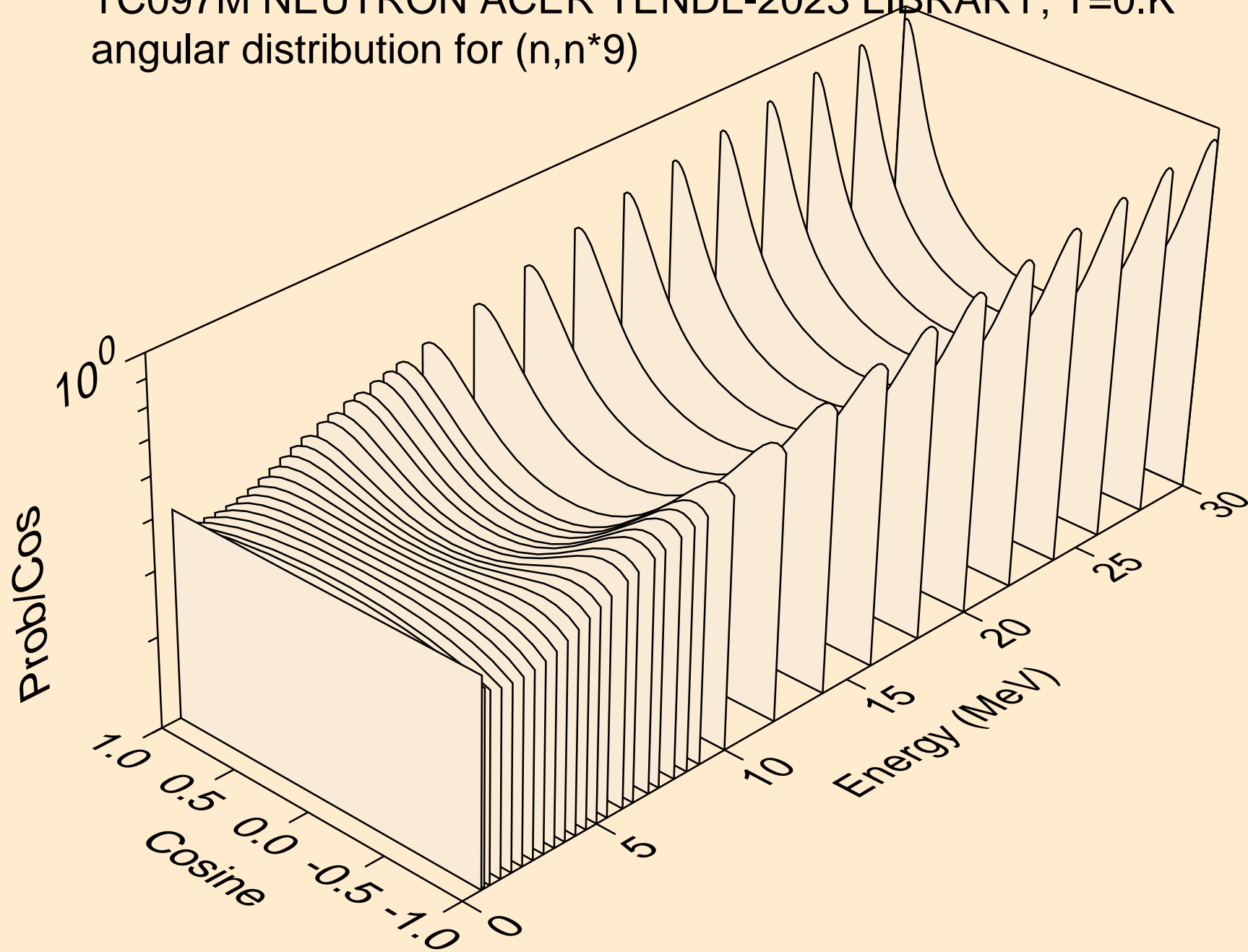

TC097M NEUTRON ACER TENDL-2023 LIBRARY; T=0.K
angular distribution for (n,n*10)

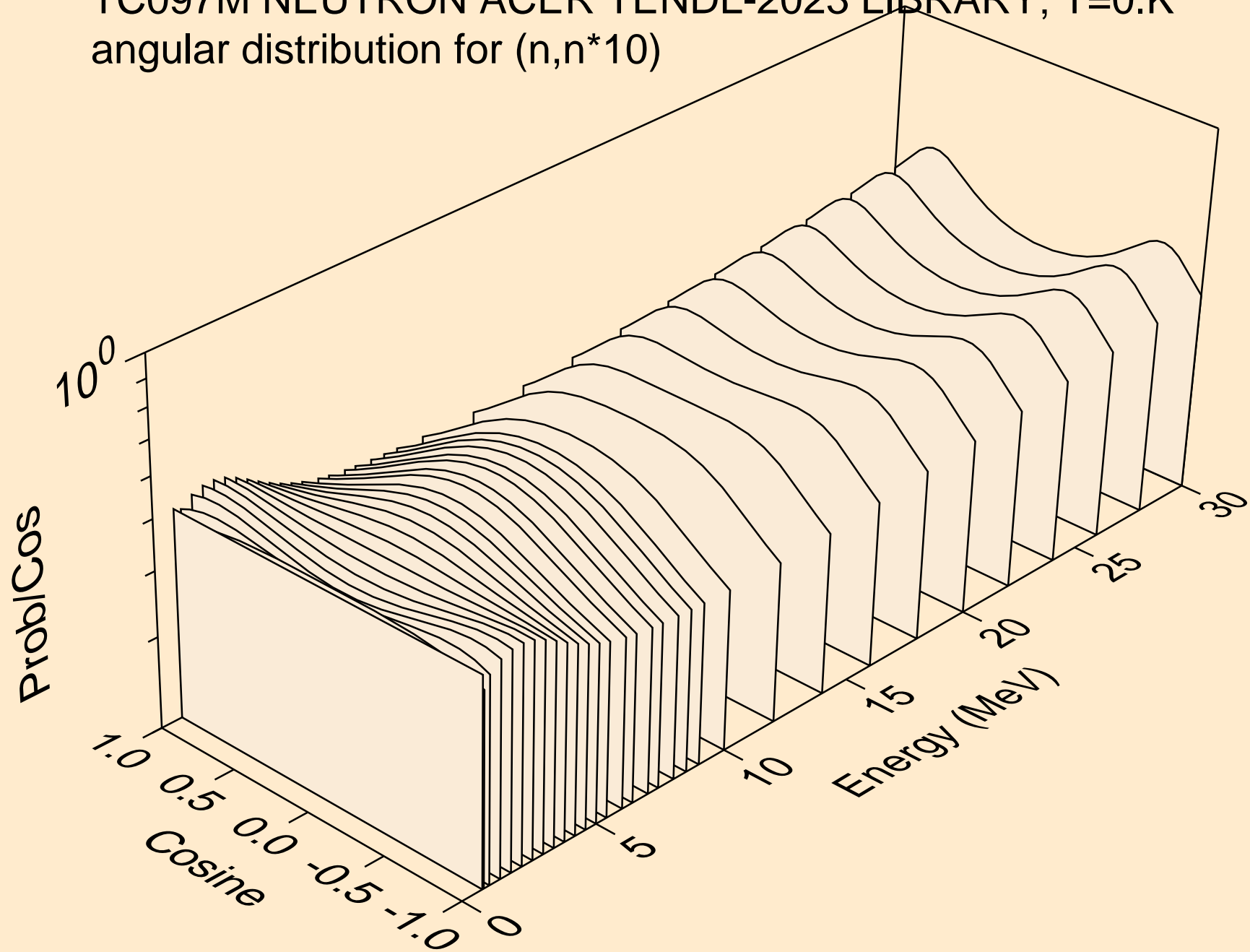

TC097M NEUTRON ACER TENDL-2023 LIBRARY; T=0.K
angular distribution for (n,n*11)

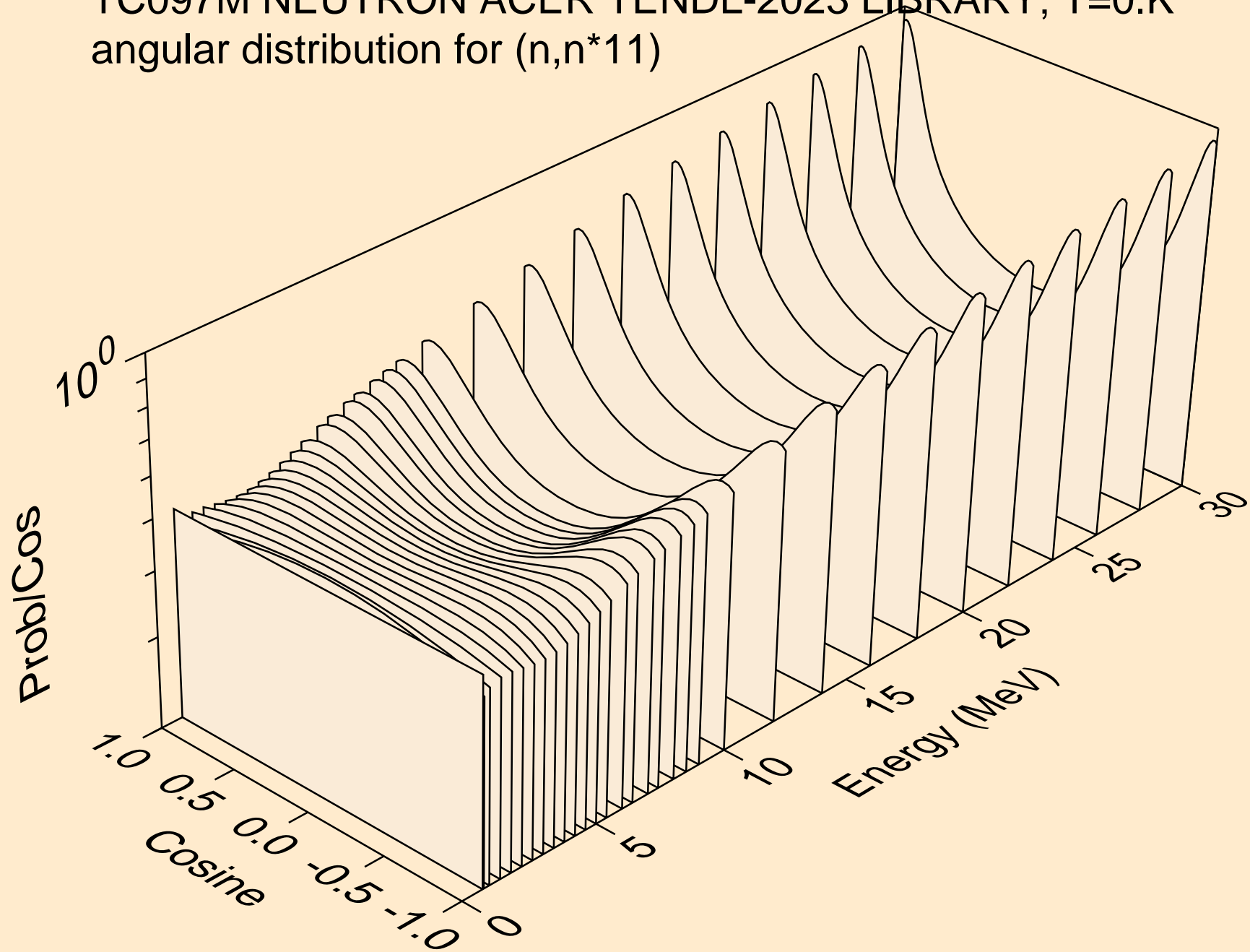

TC097M NEUTRON ACER TENDL-2023 LIBRARY; T=0.K
angular distribution for (n,n*12)

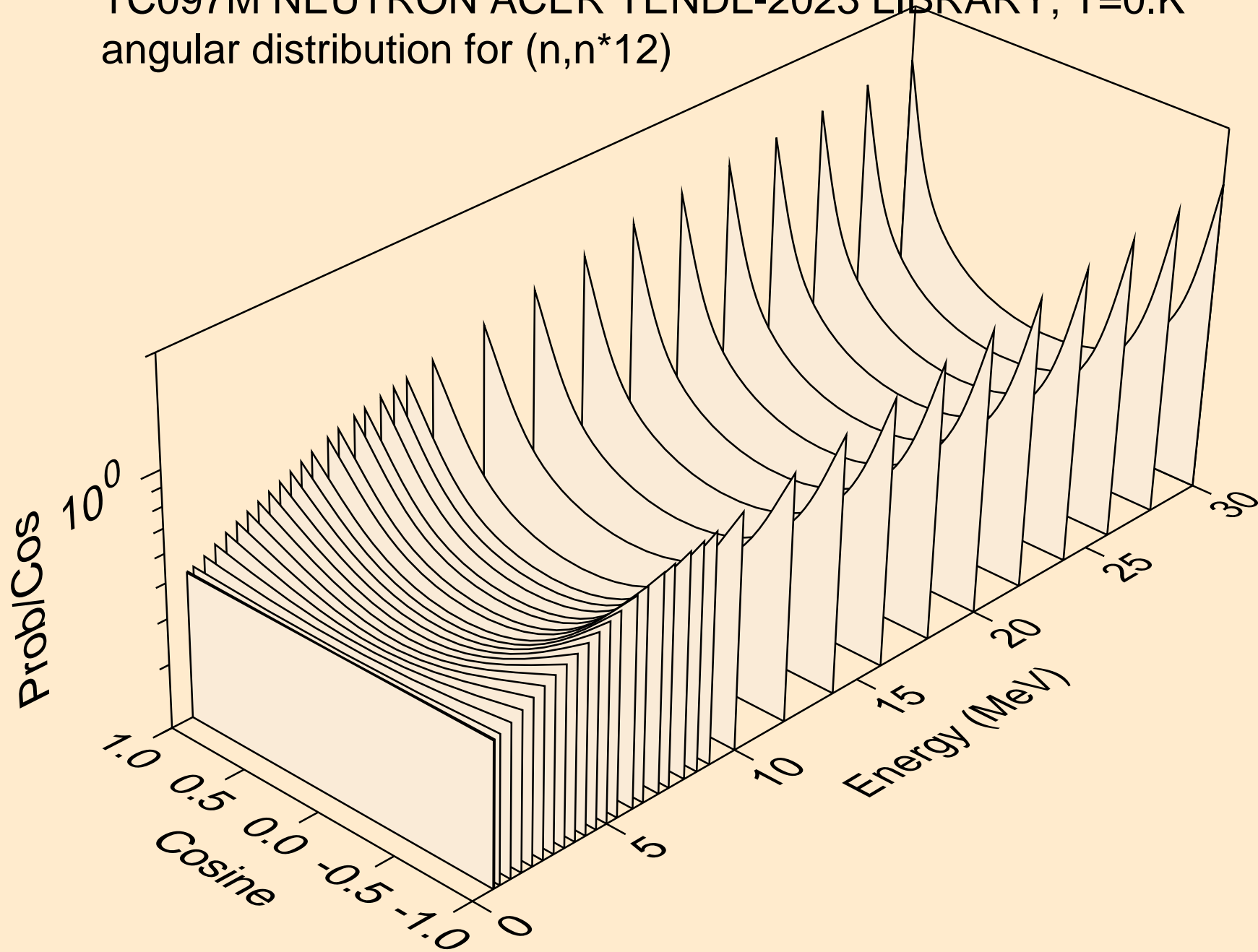

TC097M NEUTRON ACER TENDL-2023 LIBRARY; T=0.K
angular distribution for (n,n*13)

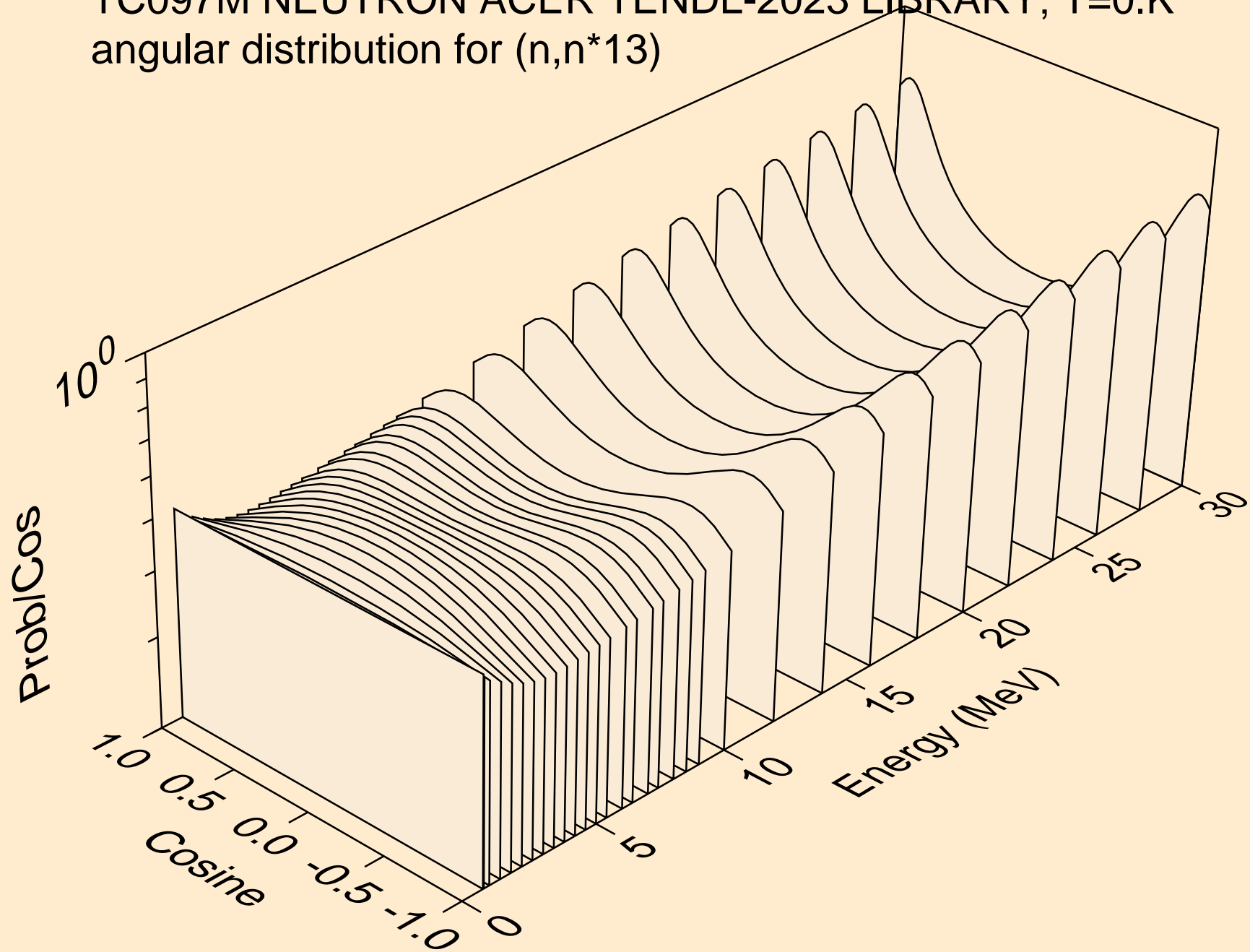

TC097M NEUTRON ACER TENDL-2023 LIBRARY; T=0.K
angular distribution for (n,n*14)

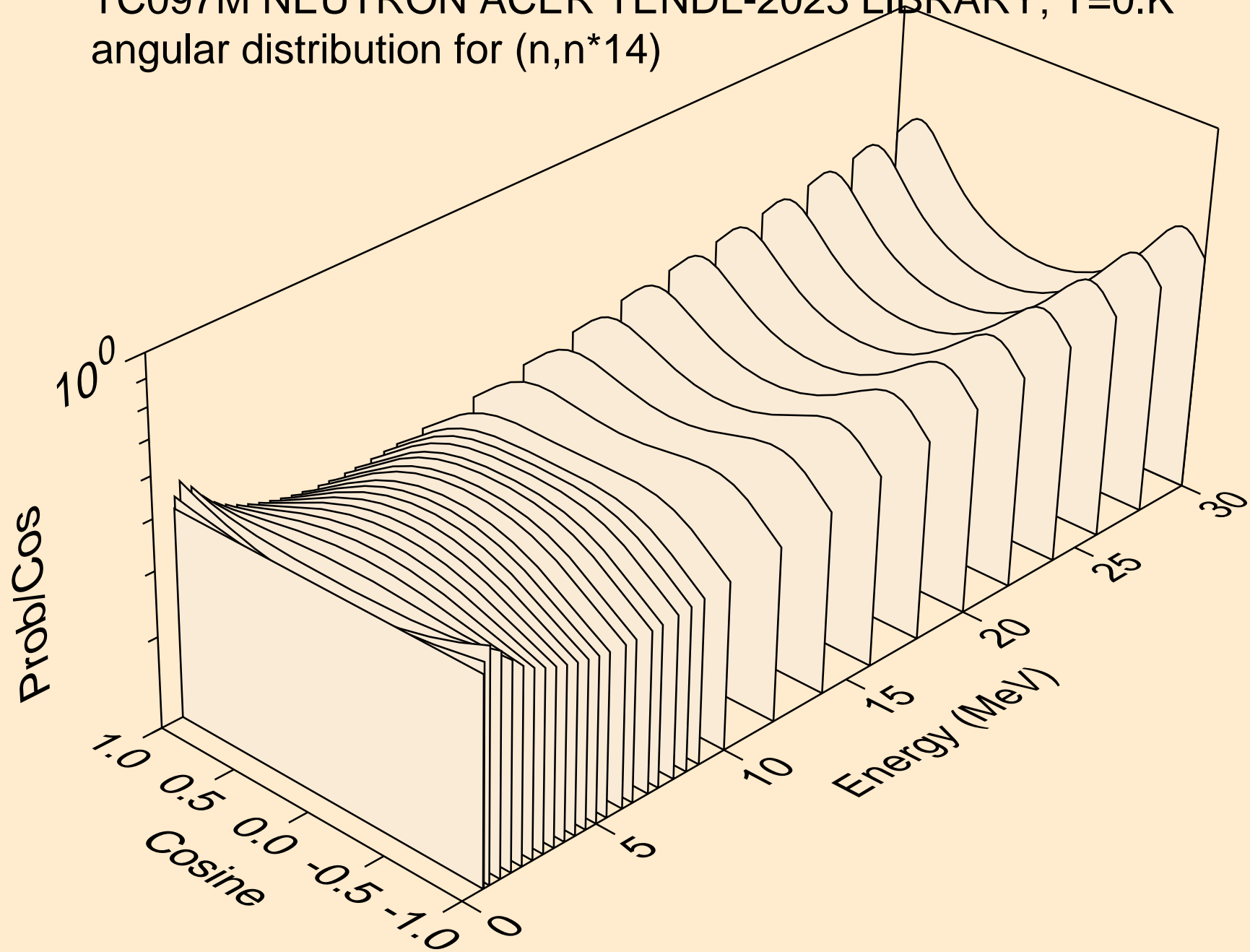

TC097M NEUTRON ACER TENDL-2023 LIBRARY; T=0.K
angular distribution for (n,n*15)

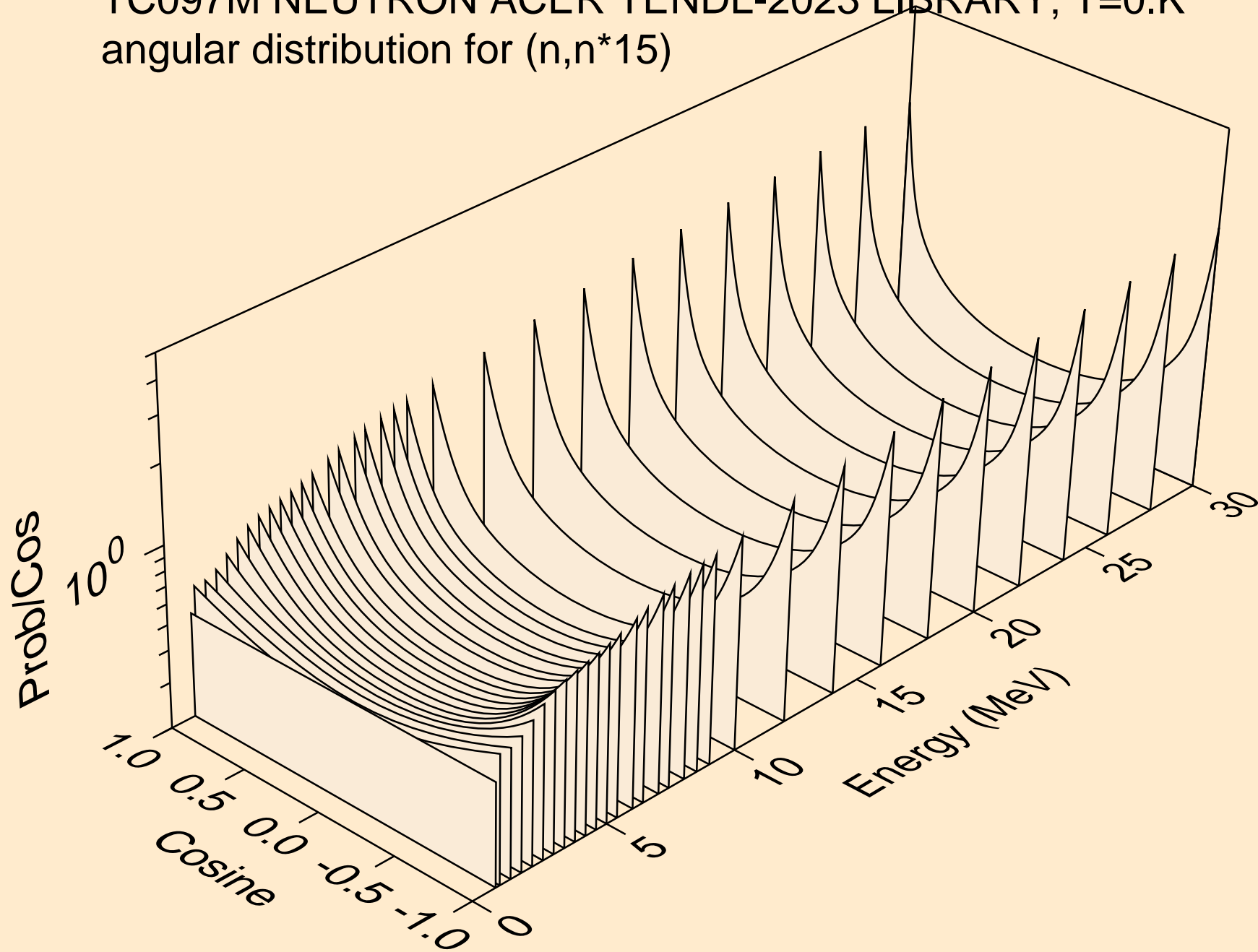

TC097M NEUTRON ACER TENDL-2023 LIBRARY; T=0.K
angular distribution for (n,n*16)

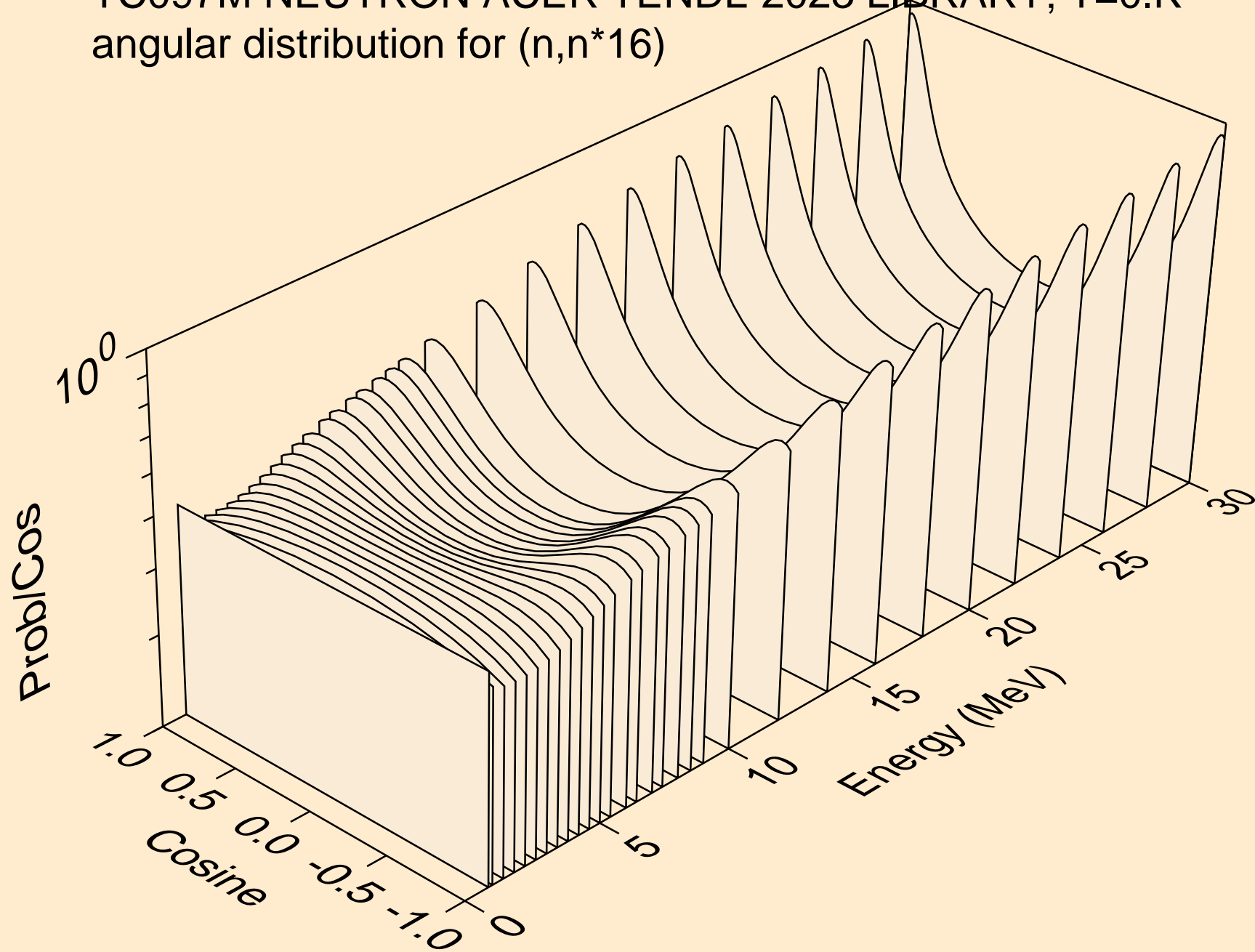

TC097M NEUTRON ACER TENDL-2023 LIBRARY; T=0.K
angular distribution for (n,n*17)

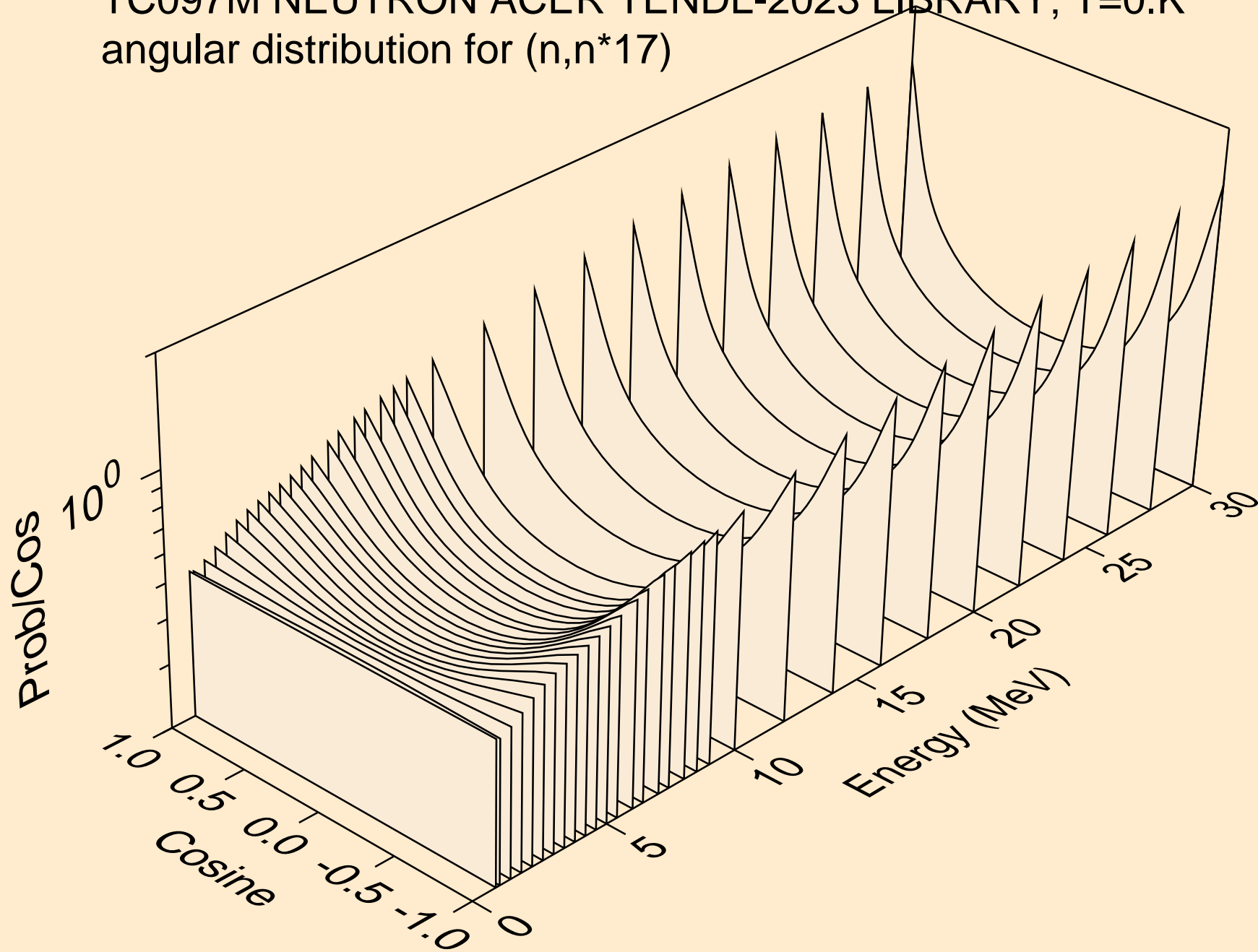

TC097M NEUTRON ACER TENDL-2023 LIBRARY; T=0.K
angular distribution for (n,n*18)

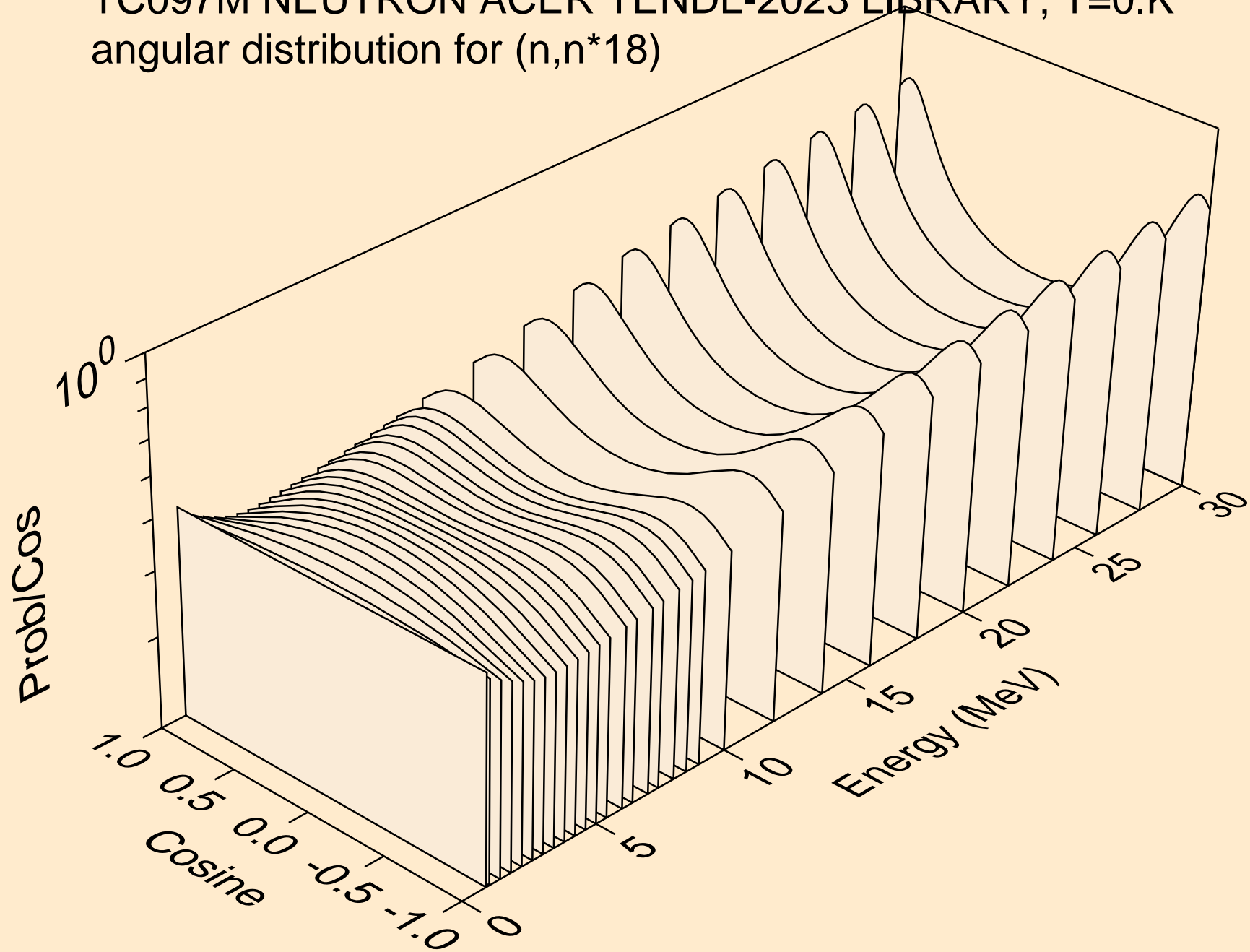

TC097M NEUTRON ACER TENDL-2023 LIBRARY; T=0.K
angular distribution for (n,n*19)

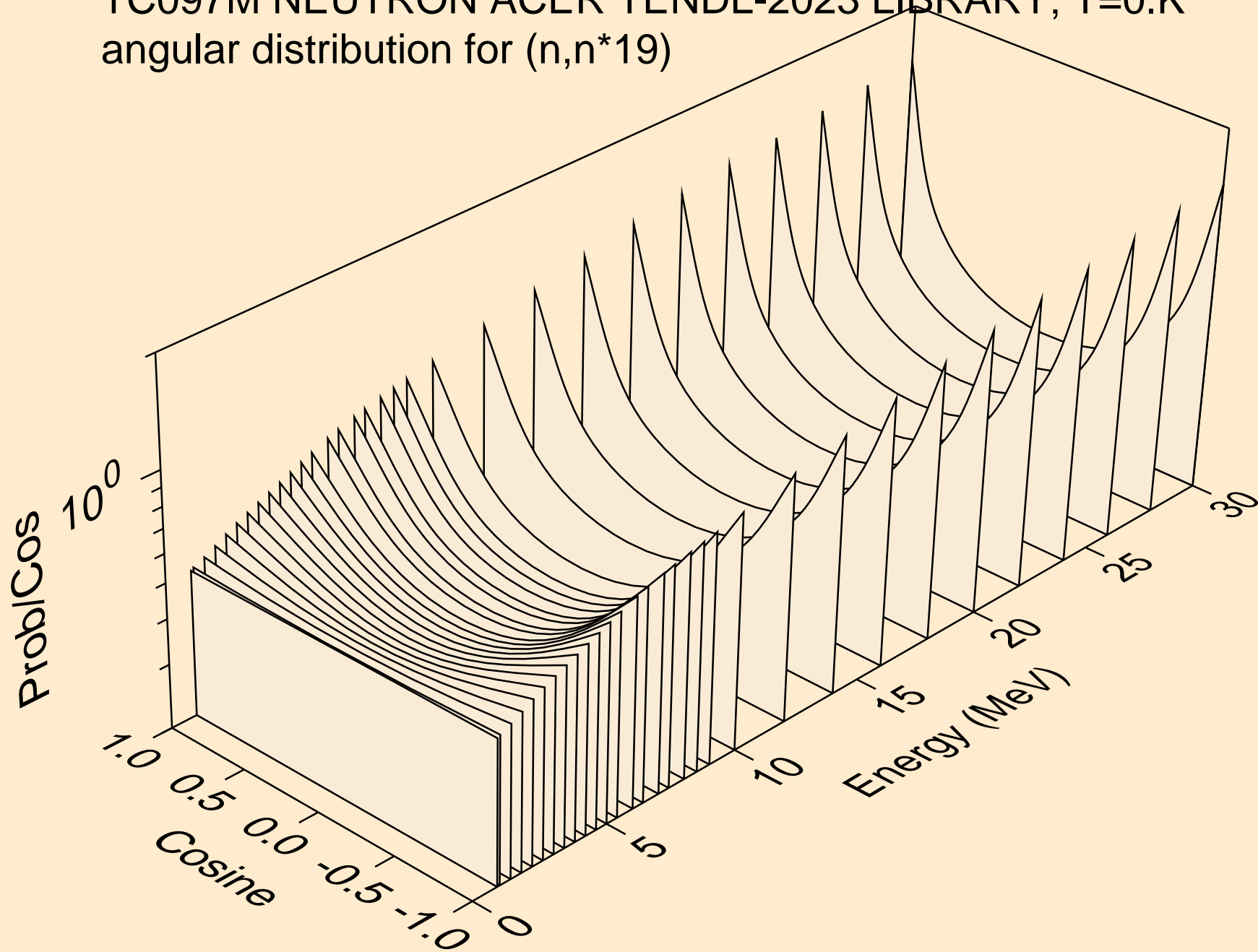

TC097M NEUTRON ACER TENDL-2023 LIBRARY; T=0.K
Neutron emission for (n,x)

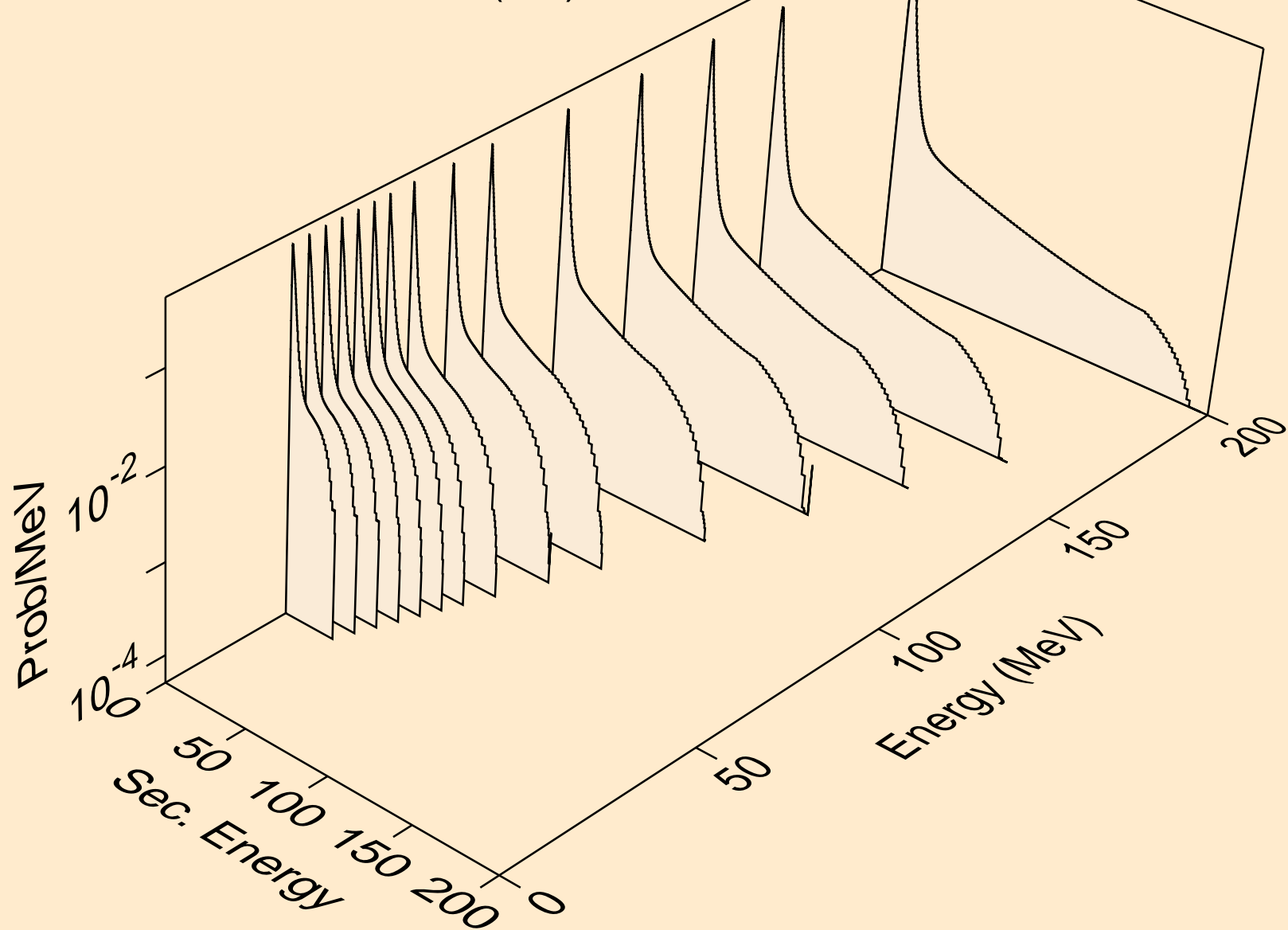

TC097M NEUTRON ACER TENDL-2023 LIBRARY; T=0.K
Neutron emission for (n,2nd)

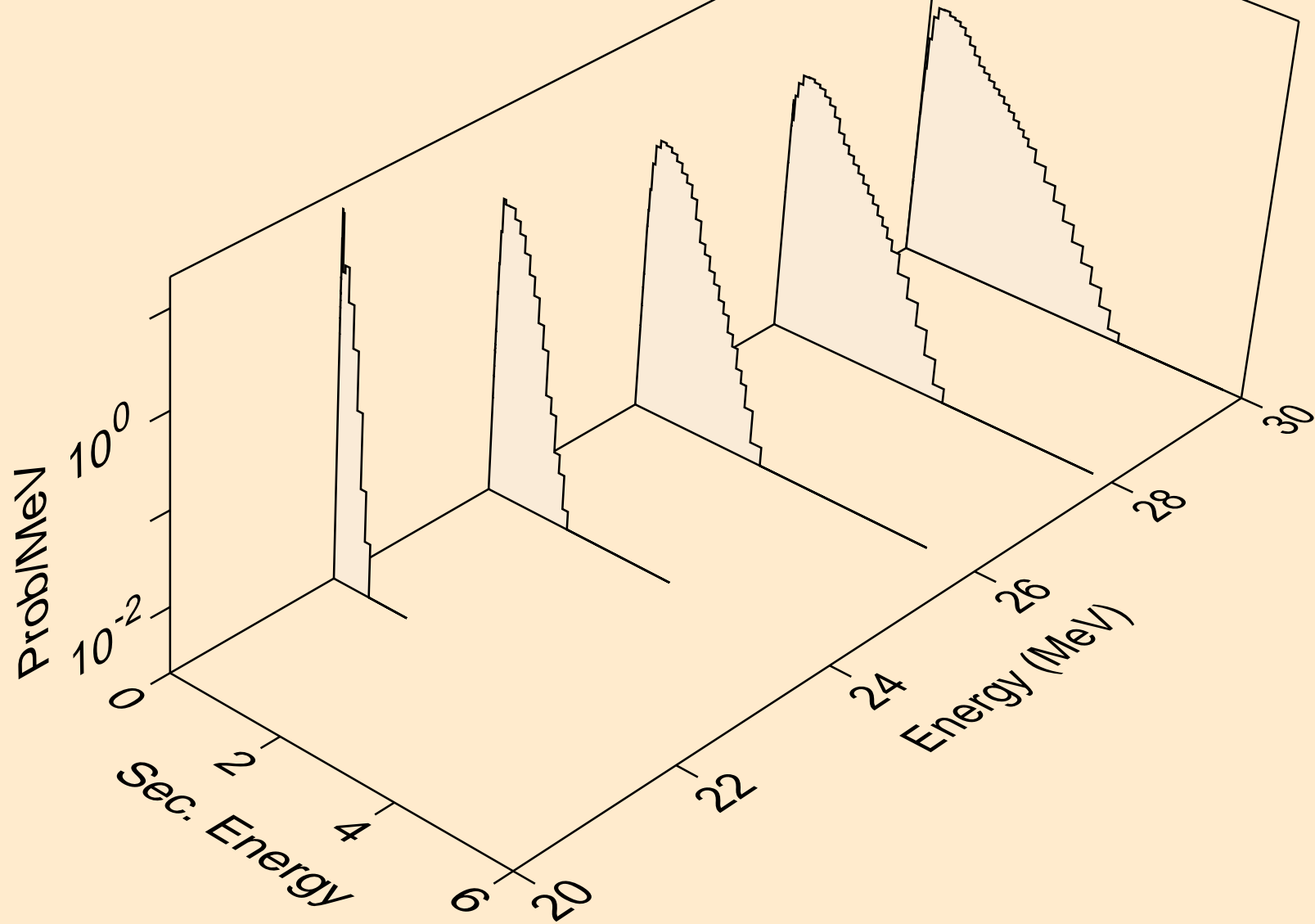

TC097M NEUTRON ACER TENDL-2023 LIBRARY; T=0.K
Neutron emission for (n,2n)

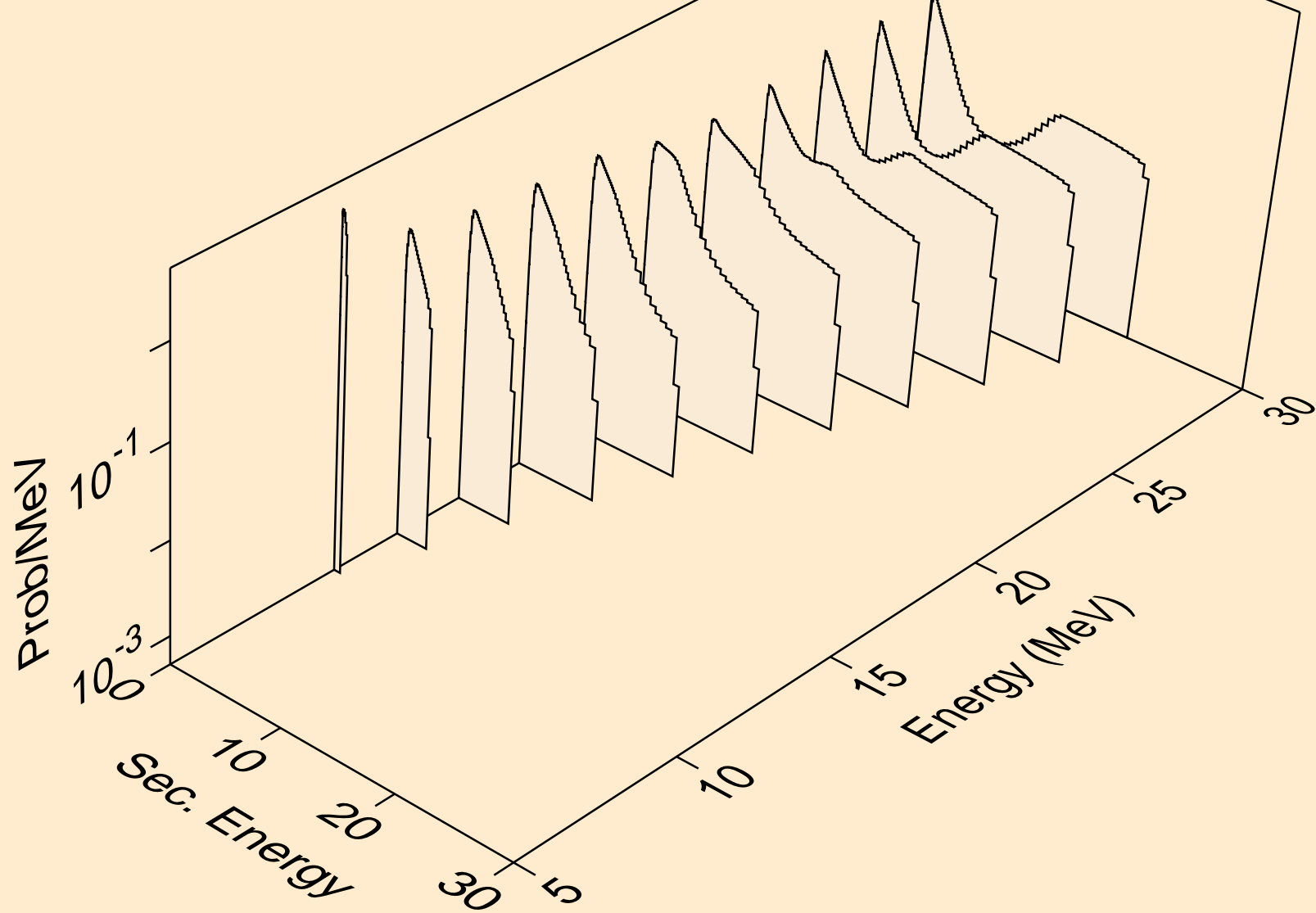

TC097M NEUTRON ACER TENDL-2023 LIBRARY; T=0.K
Neutron emission for (n,3n)

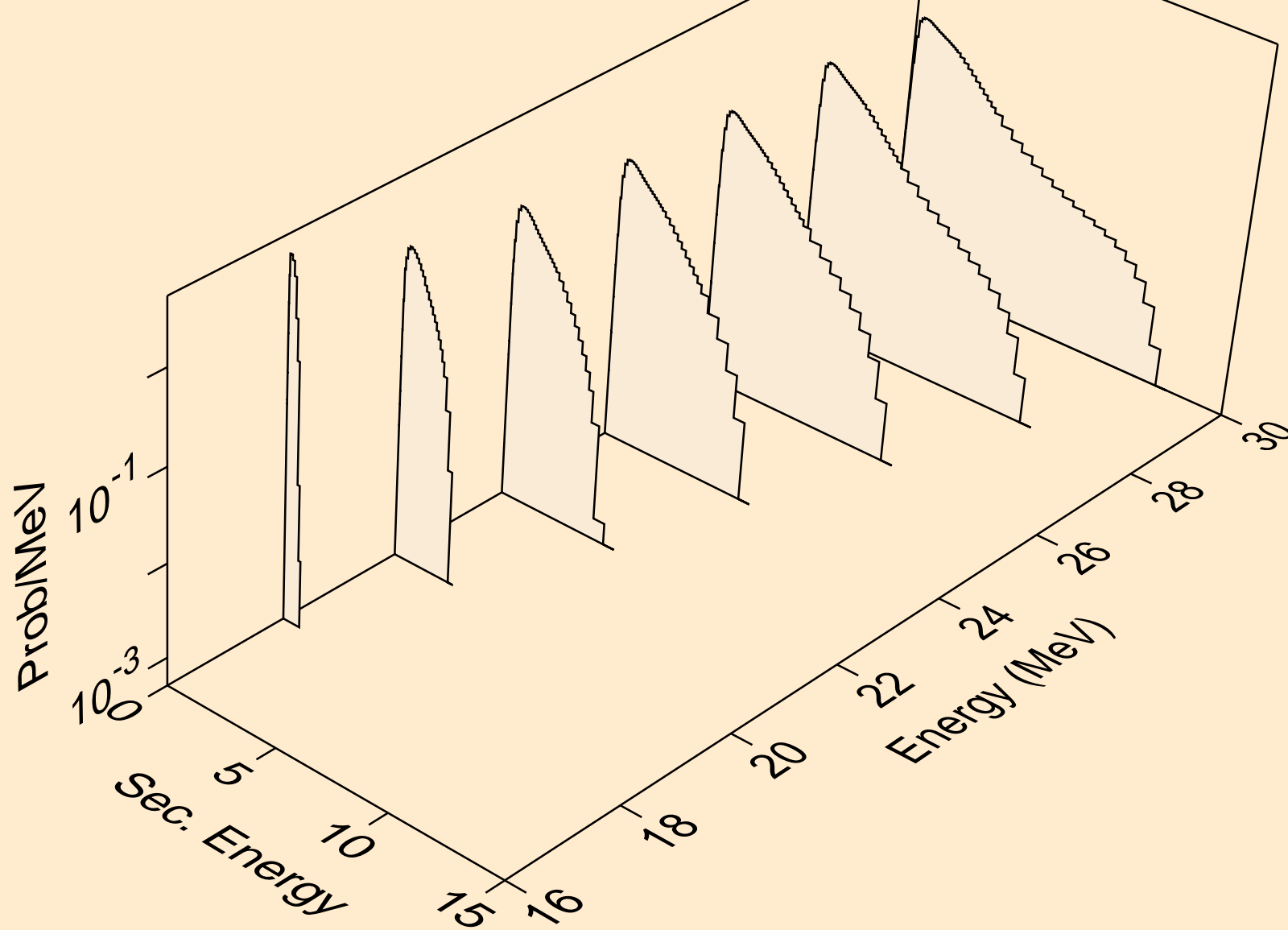

TC097M NEUTRON ACER TENDL-2023 LIBRARY; T=0.K
Neutron emission for (n,n*)a

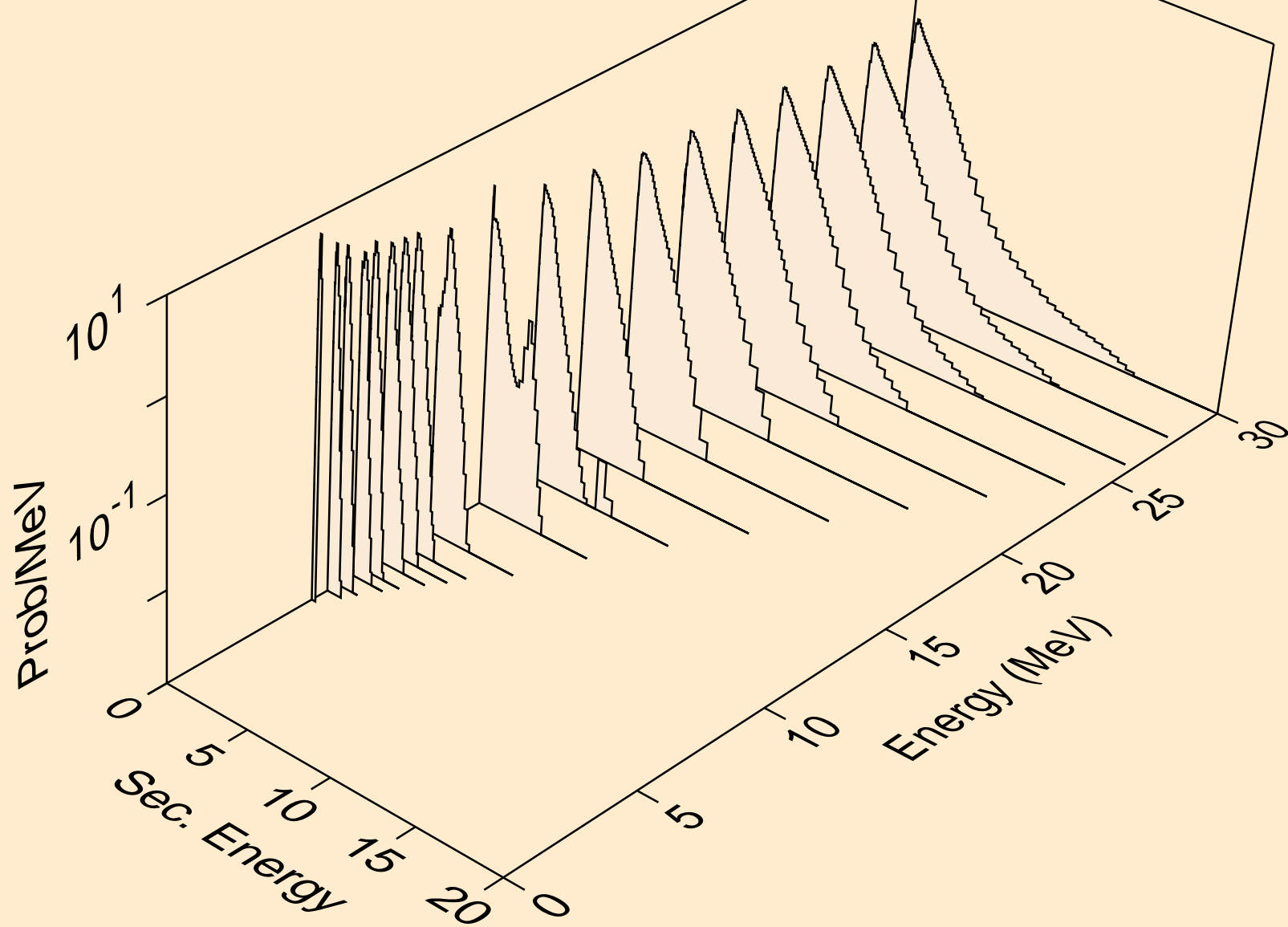

TC097M NEUTRON ACER TENDL-2023 LIBRARY; T=0.K
Neutron emission for (n,2n)a

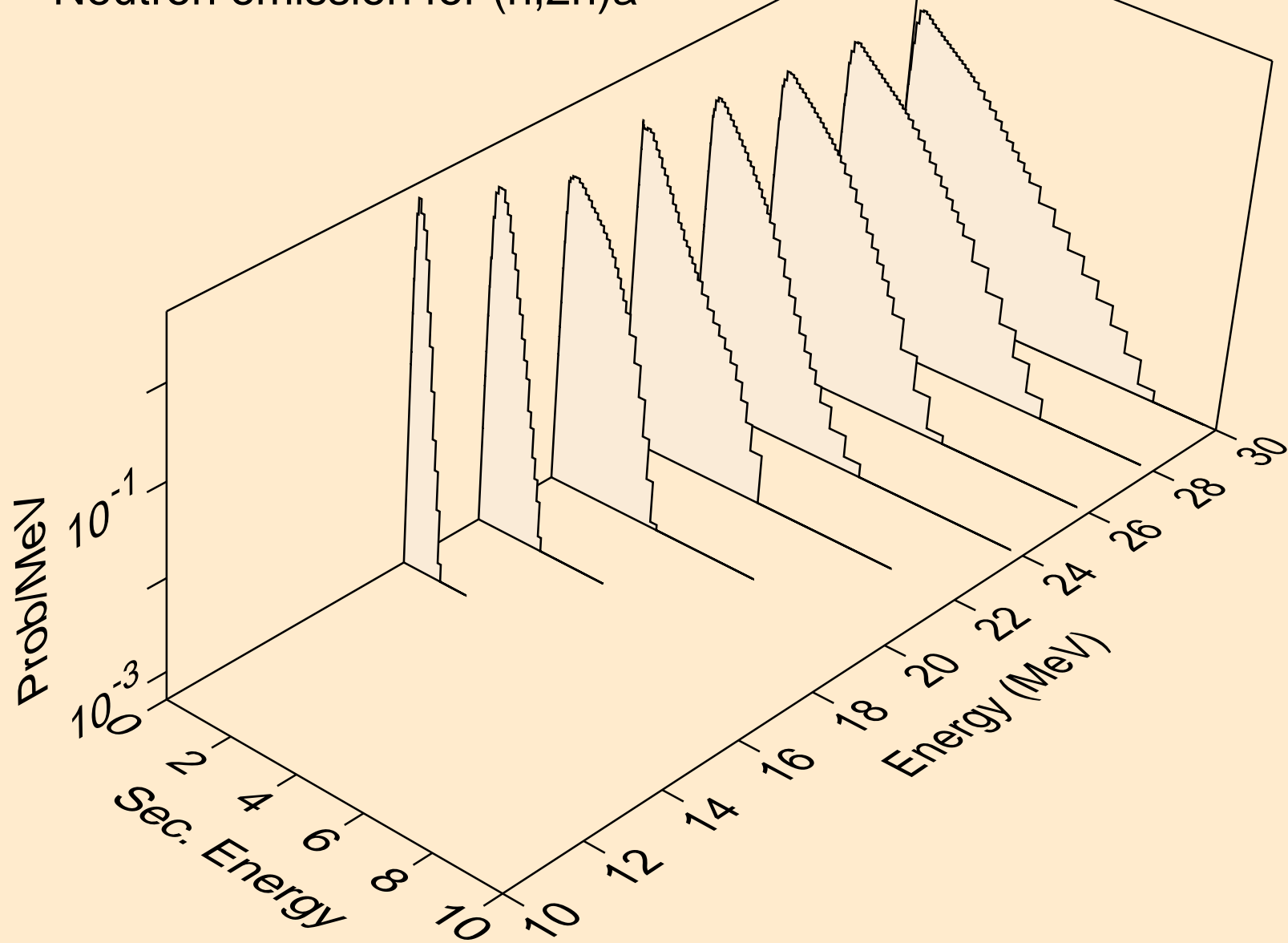

TC097M NEUTRON ACER TENDL-2023 LIBRARY; T=0.K
Neutron emission for (n,3n)a

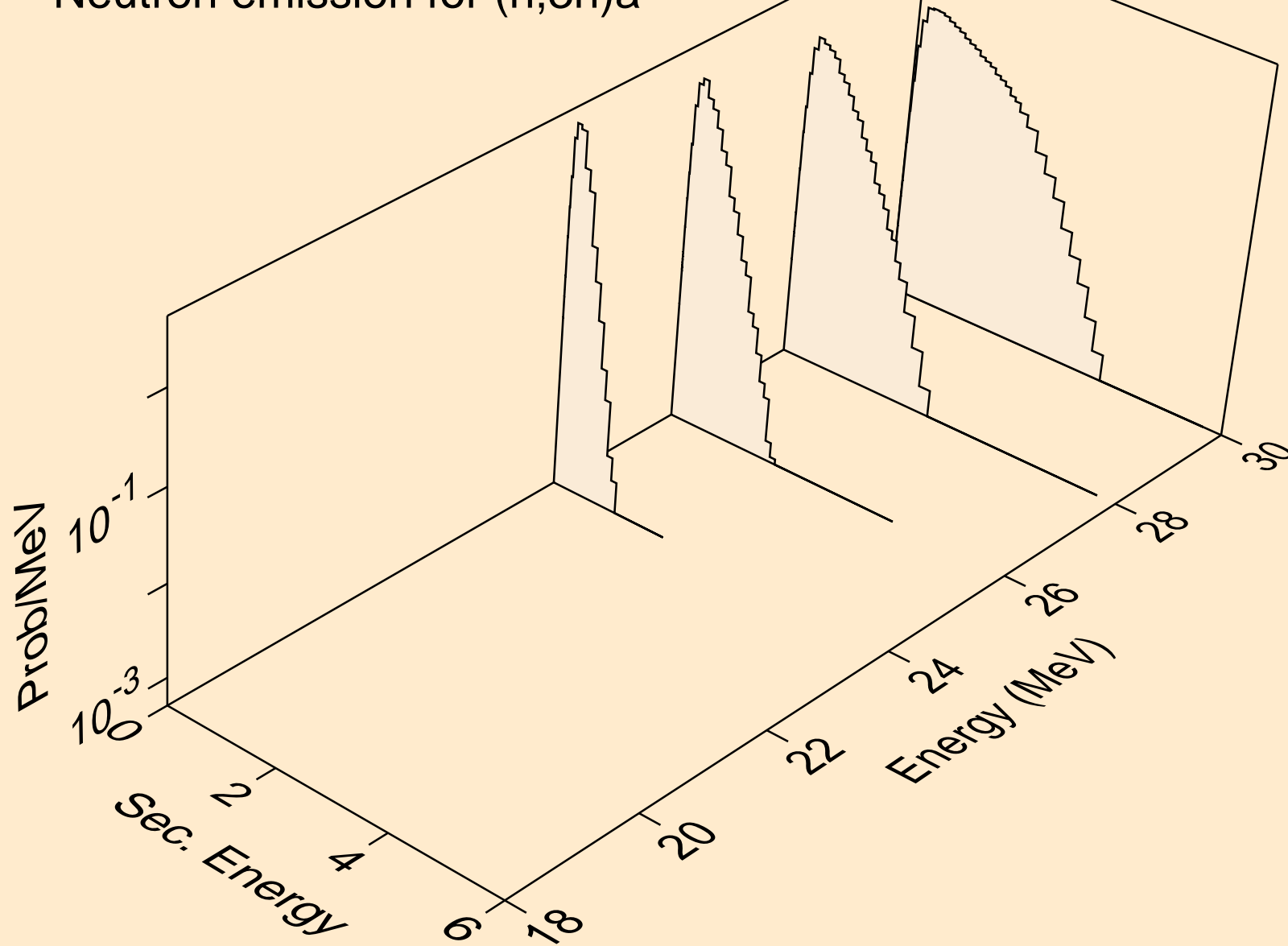

TC097M NEUTRON ACER TENDL-2023 LIBRARY; T=0.K
Neutron emission for (n,n*)p

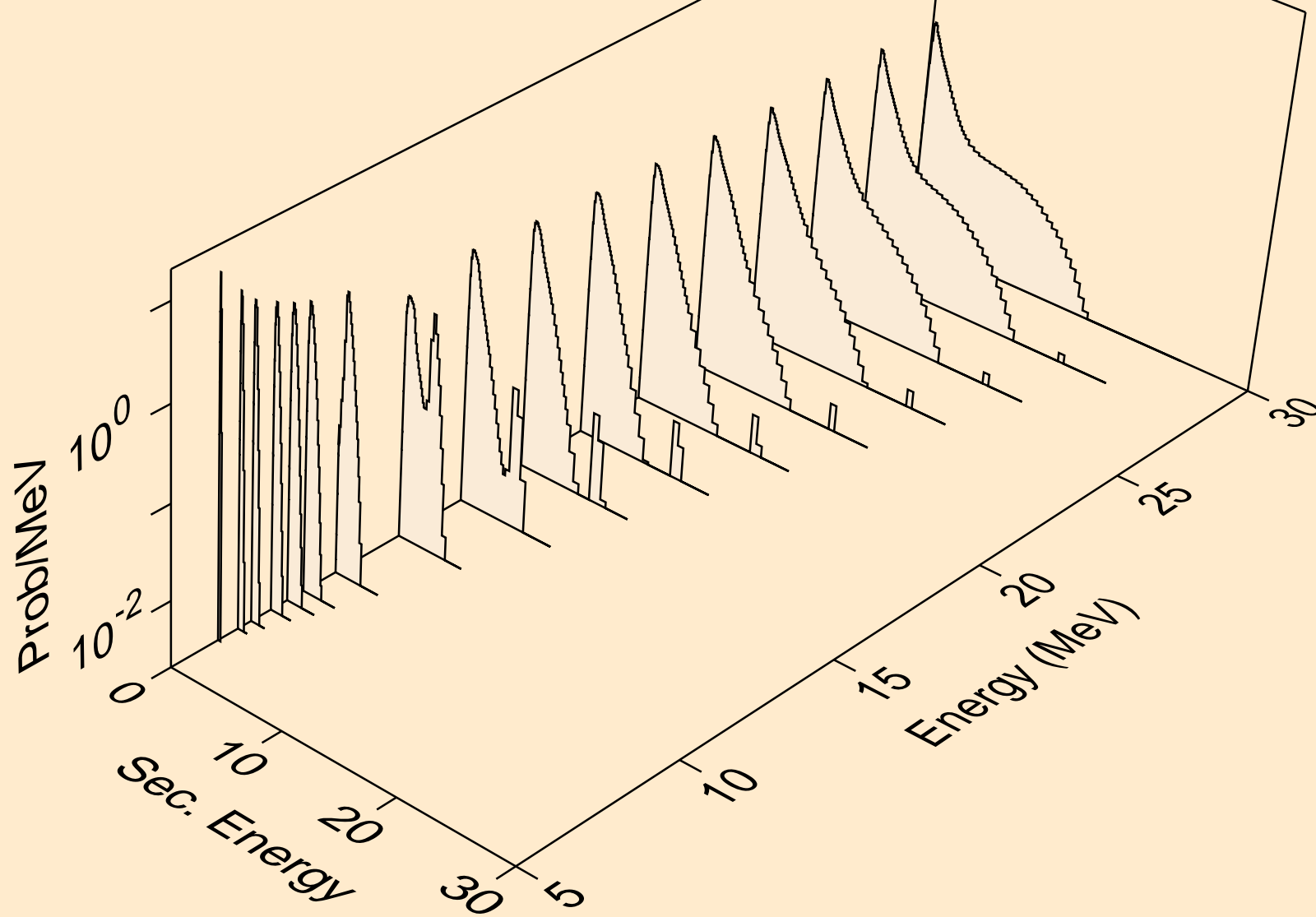

TC097M NEUTRON ACER TENDL-2023 LIBRARY; T=0.K
Neutron emission for (n,n*)2a

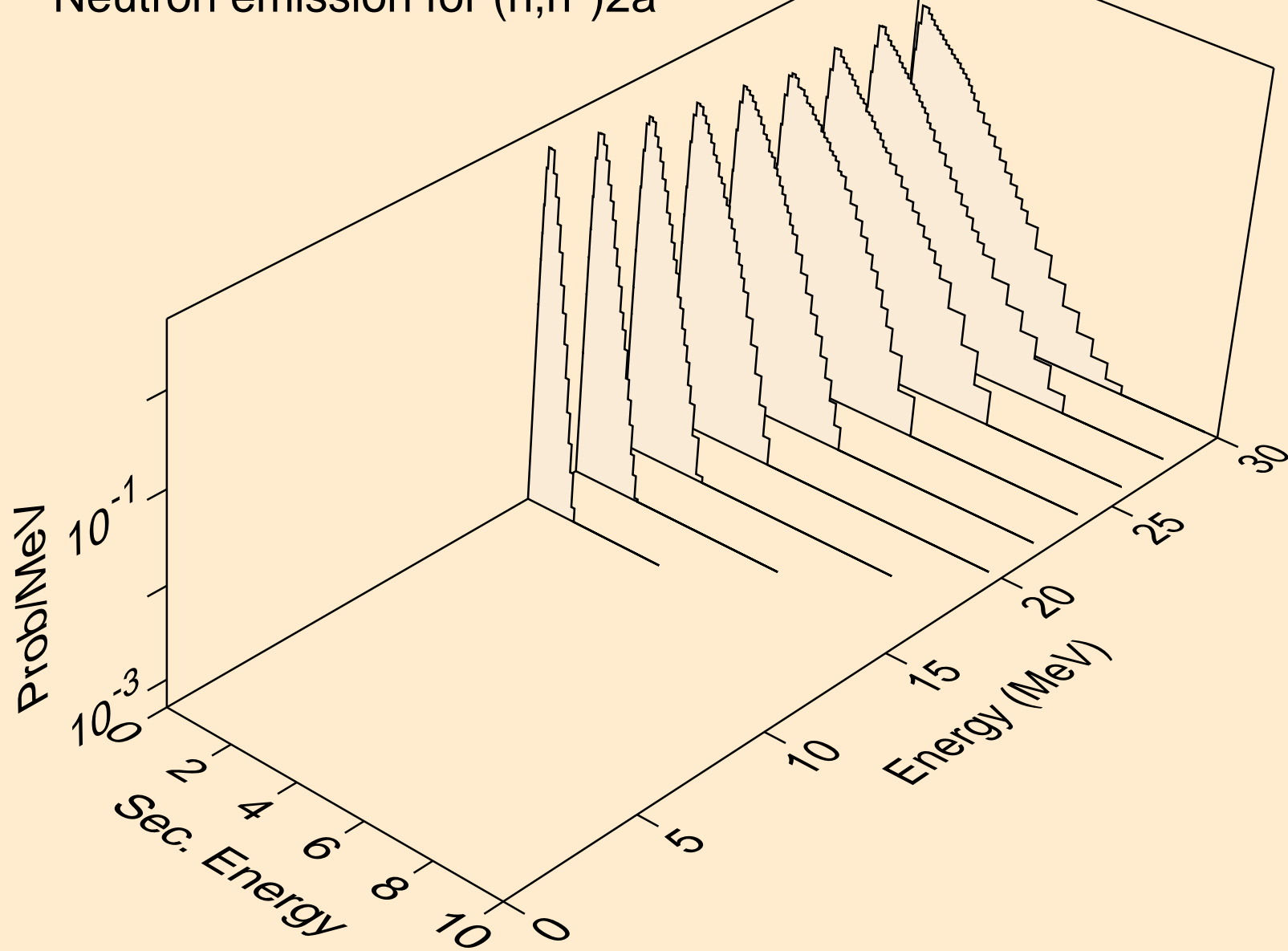

TC097M NEUTRON ACER TENDL-2023 LIBRARY; T=0.K
Neutron emission for (n,n*)d

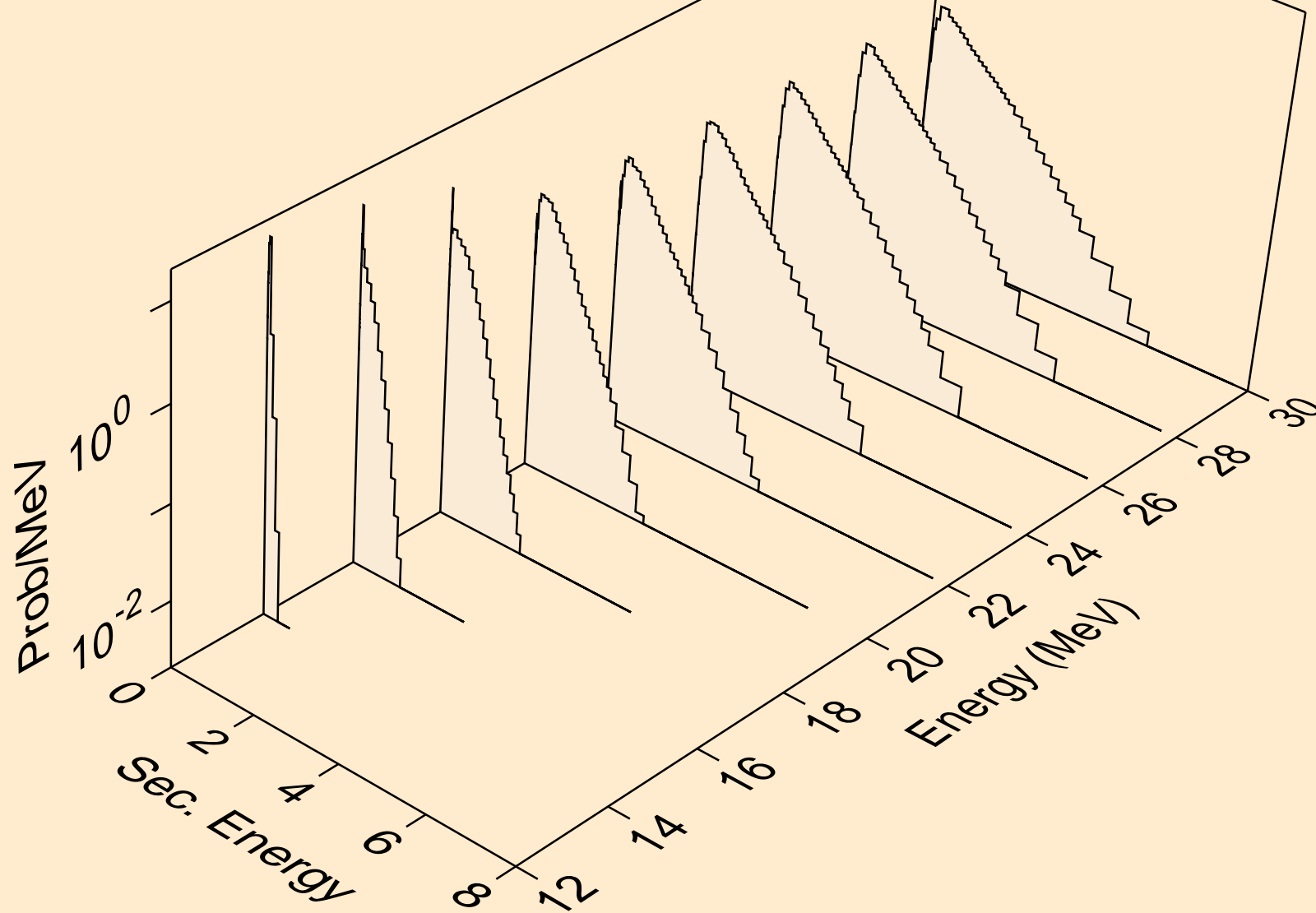

TC097M NEUTRON ACER TENDL-2023 LIBRARY; T=0.K
Neutron emission for (n,n*)t

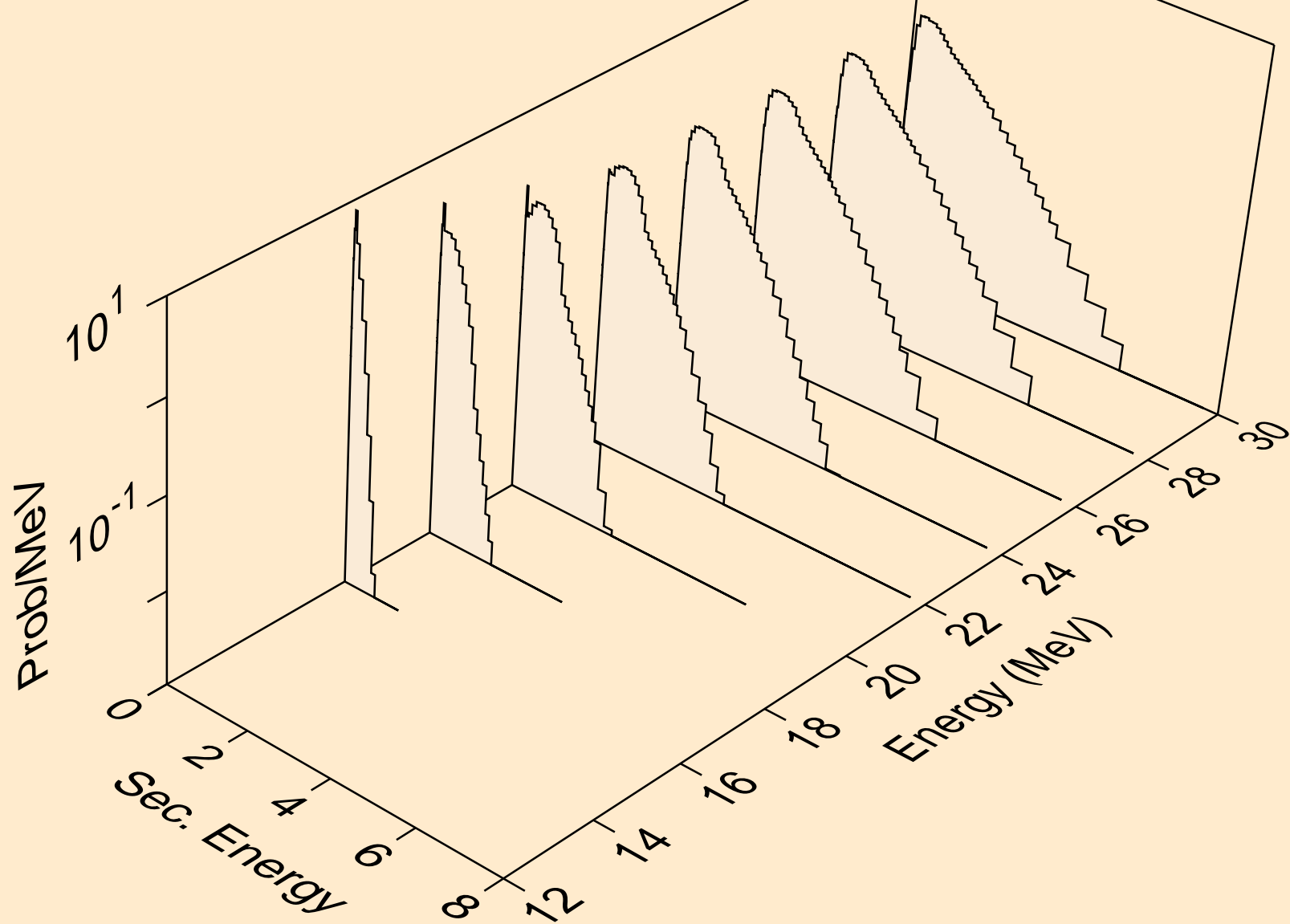

TC097M NEUTRON ACER TENDL-2023 LIBRARY; T=0.K
Neutron emission for (n,n*)he3

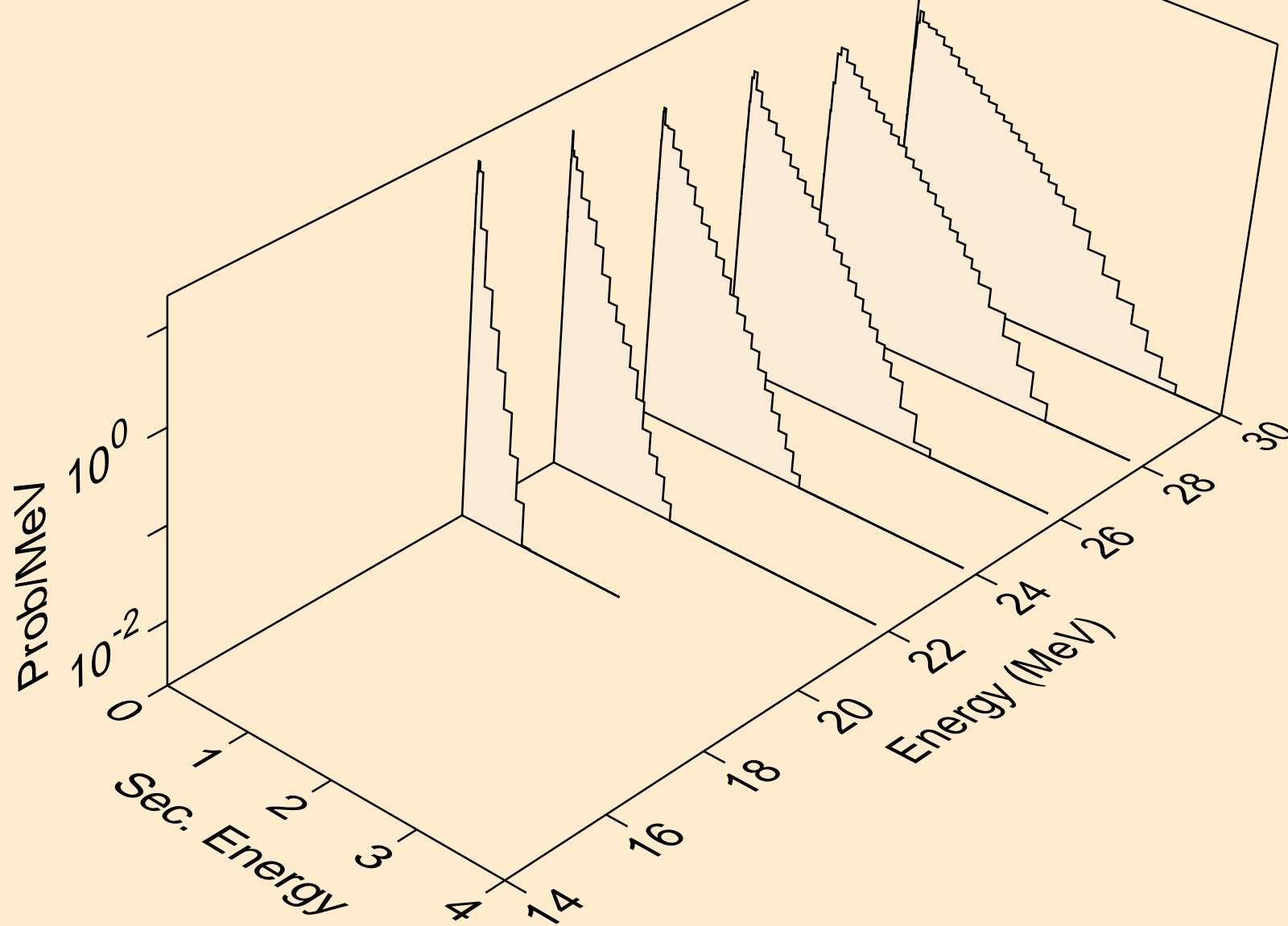

TC097M NEUTRON ACER TENDL-2023 LIBRARY; T=0.K
Neutron emission for (n,4n)

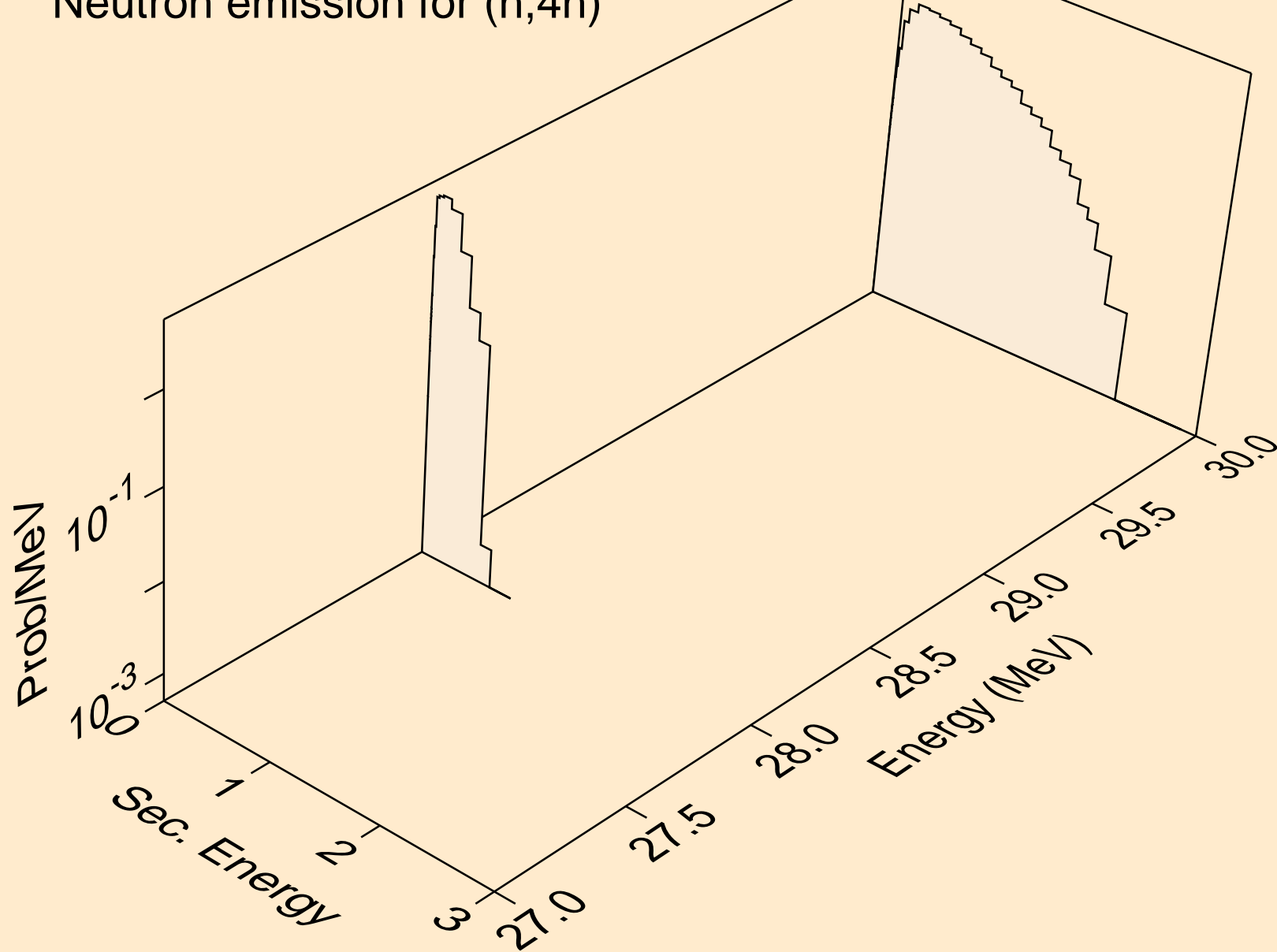

TC097M NEUTRON ACER TENDL-2023 LIBRARY; T=0.K
Neutron emission for (n,2np)

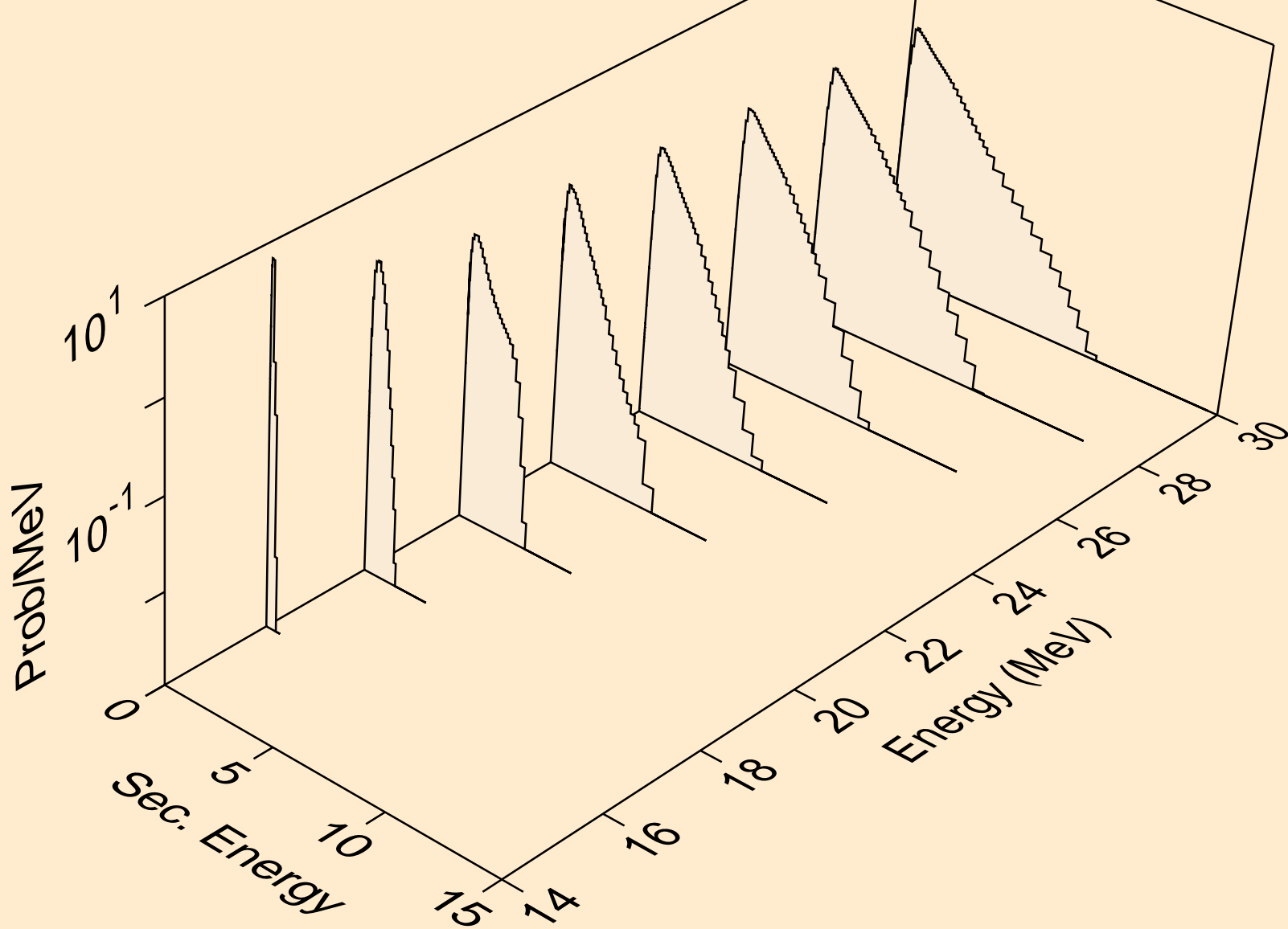

TC097M NEUTRON ACER TENDL-2023 LIBRARY; T=0.K
Neutron emission for (n,3np)

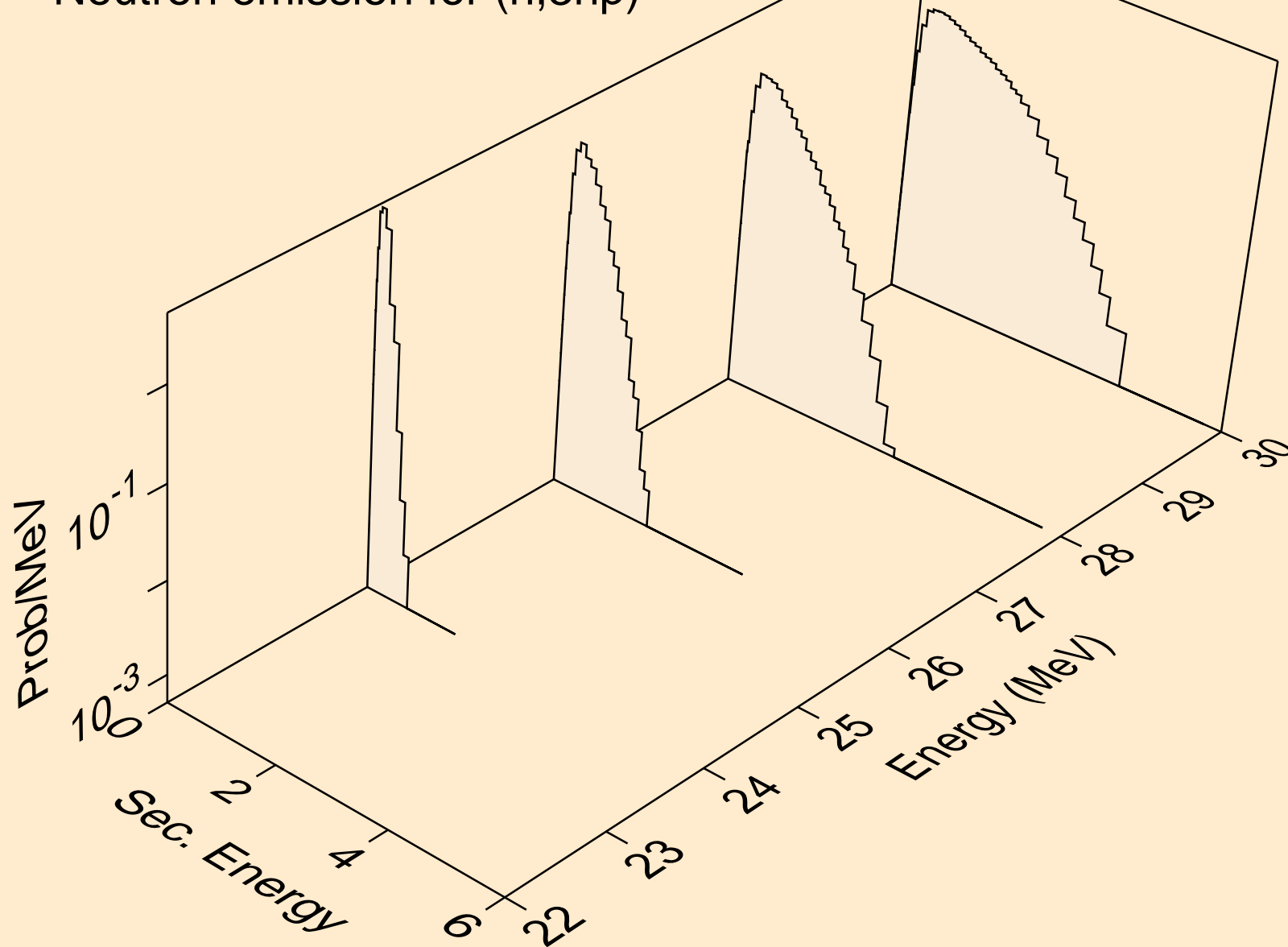

TC097M NEUTRON ACER TENDL-2023 LIBRARY; T=0.K
Neutron emission for (n,n2p)

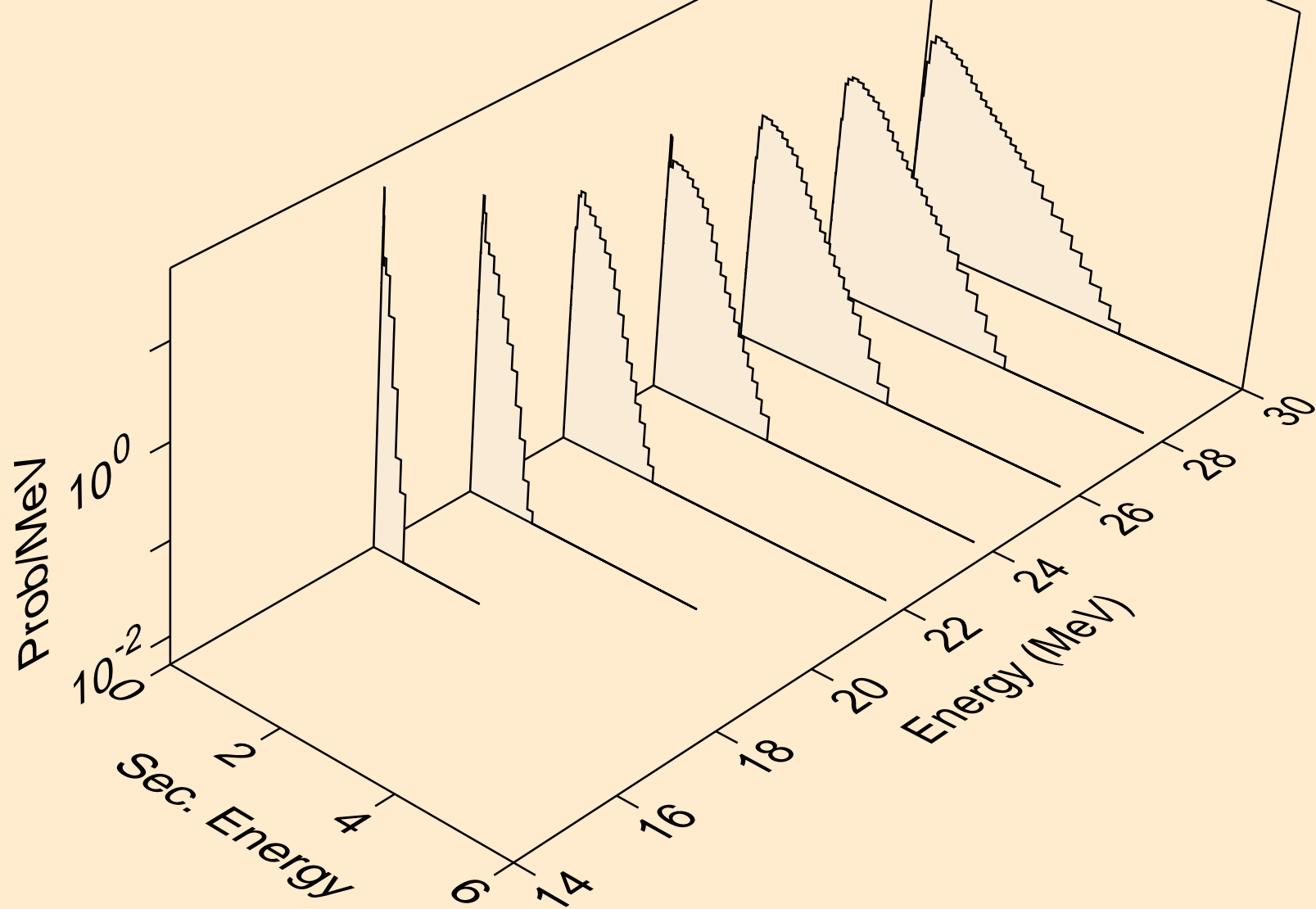

TC097M NEUTRON ACER TENDL-2023 LIBRARY; T=0.K
Neutron emission for (n,npa)

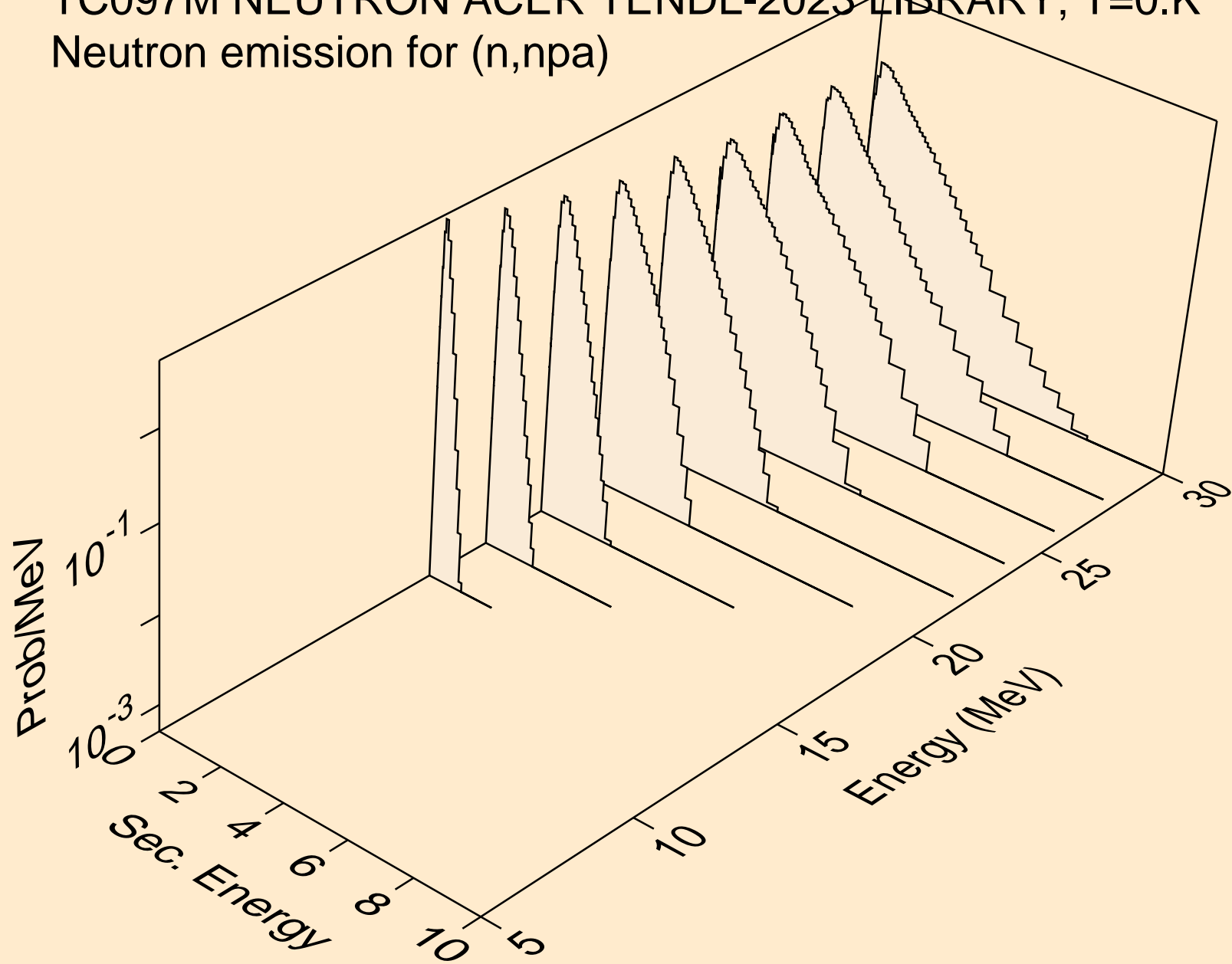

TC097M NEUTRON ACER TENDL-2023 LIBRARY; T=0.K
Neutron emission for (n,n*c)

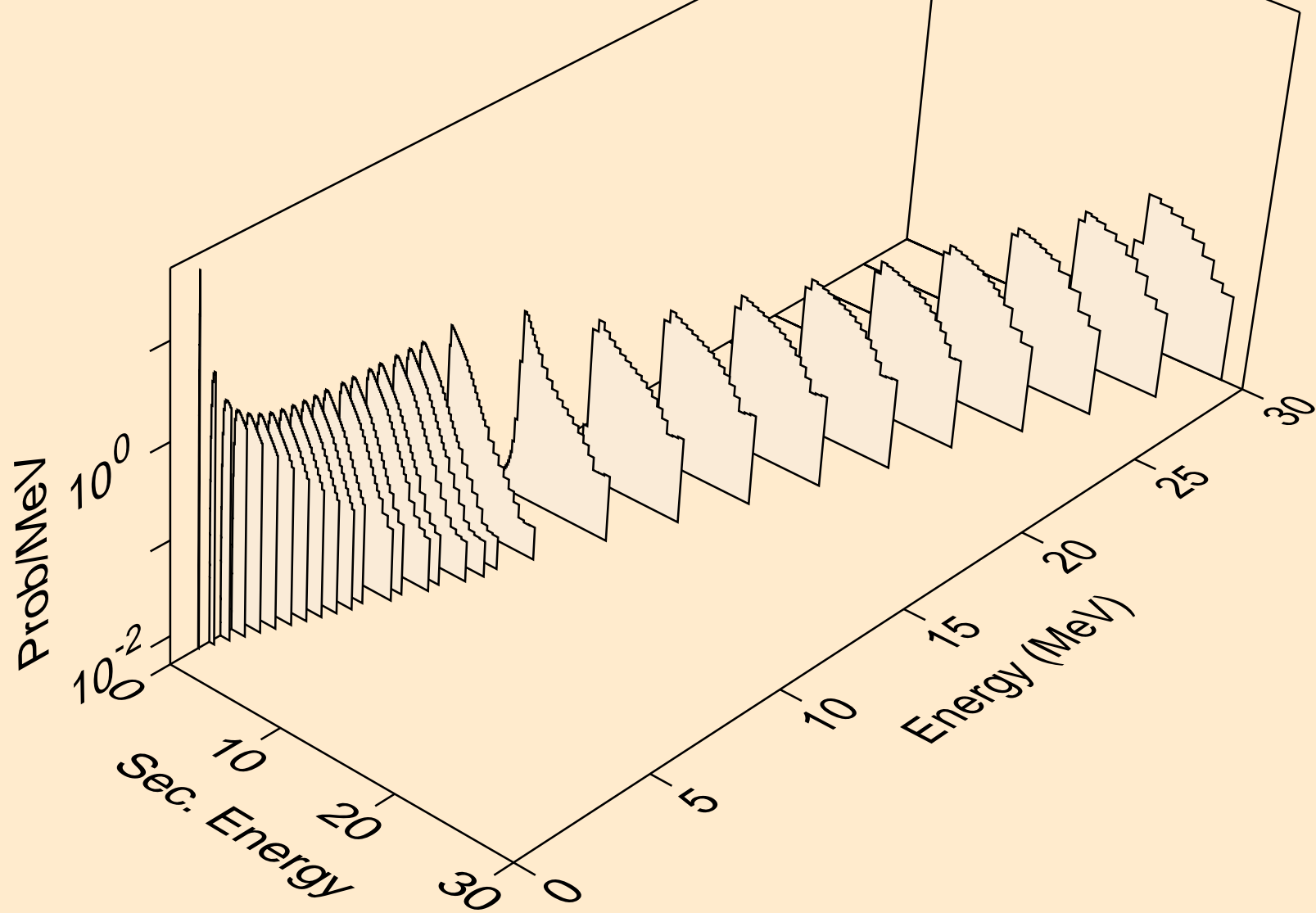

TC097M NEUTRON ACER TENDL-2023 LIBRARY; T=0.K
Photon emission for (n,x)

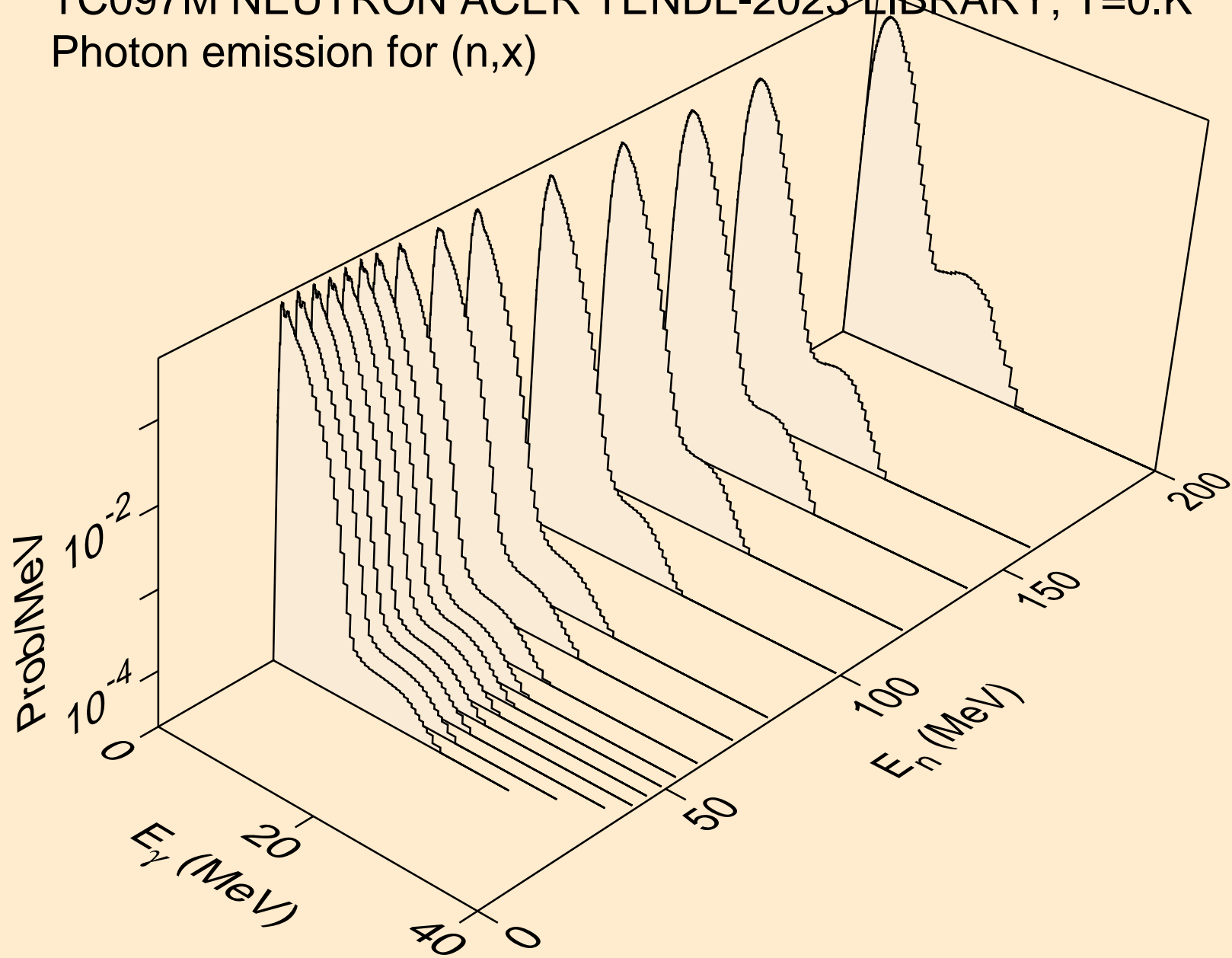

TC097M NEUTRON ACER TENDL-2023 LIBRARY; T=0.K
Photon emission for (n,2nd)

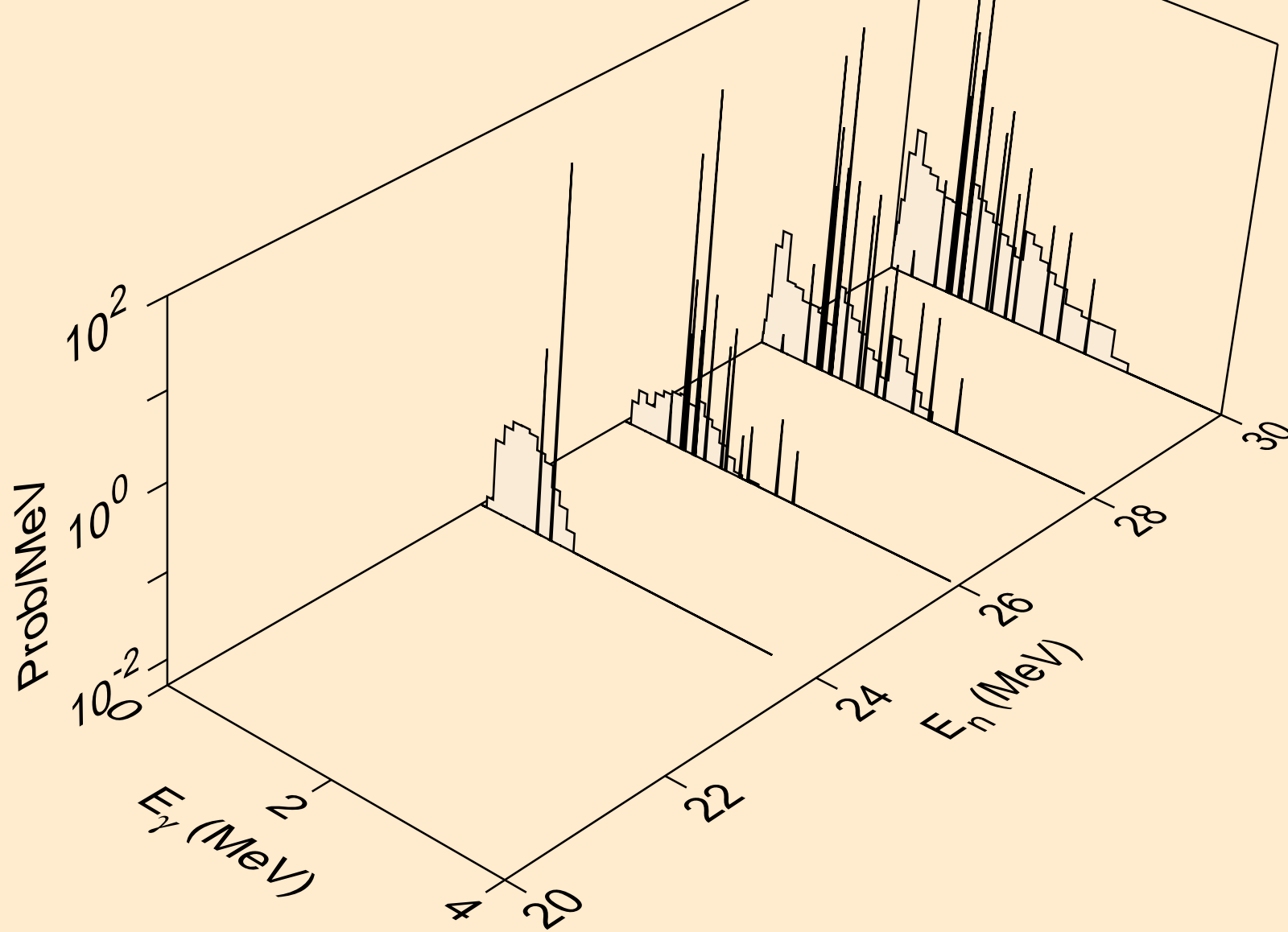

TC097M NEUTRON ACER TENDL-2023 LIBRARY; T=0.K
Photon emission for (n,2n)

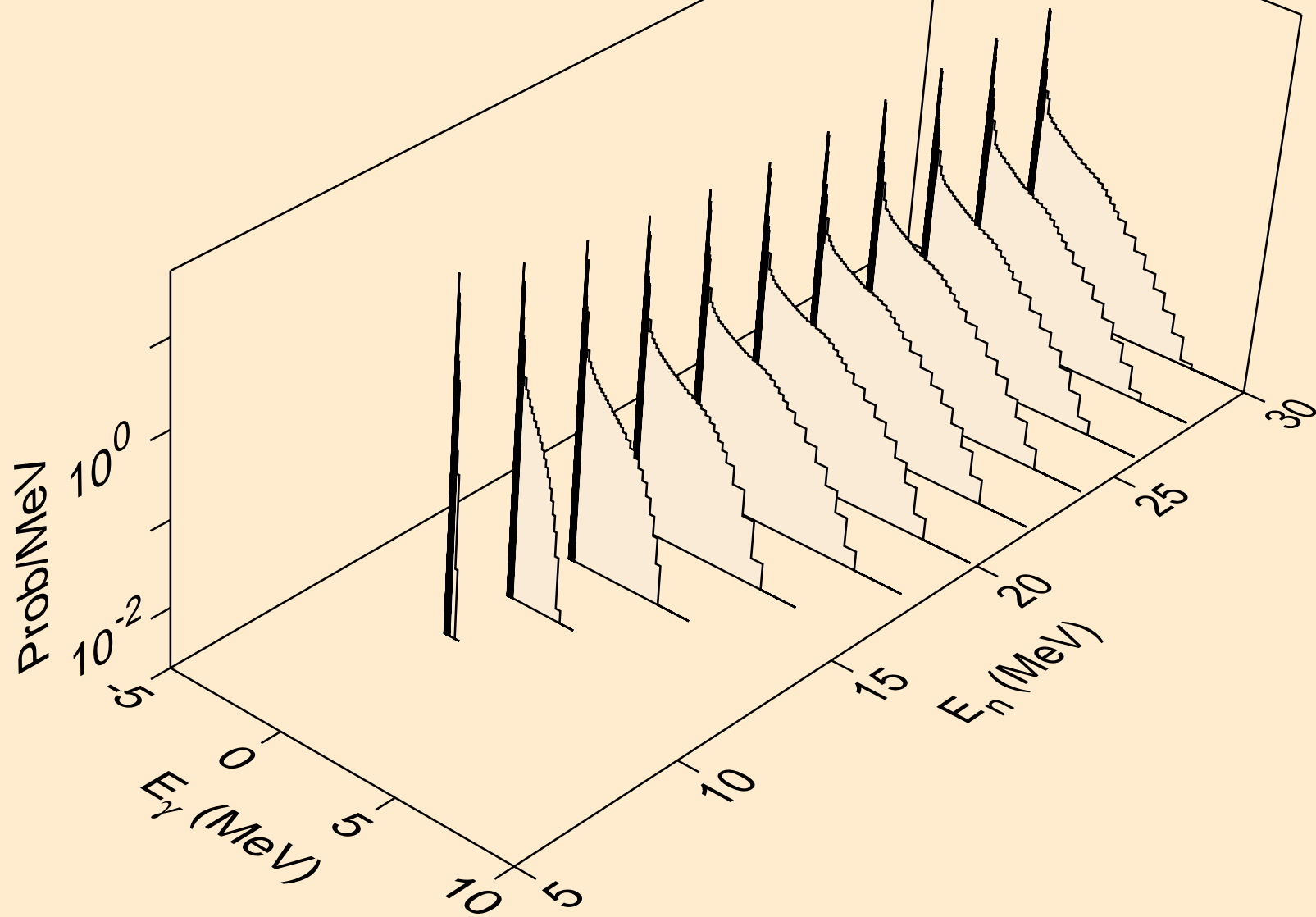

TC097M NEUTRON ACER TENDL-2023 LIBRARY; T=0.K
Photon emission for (n,3n)

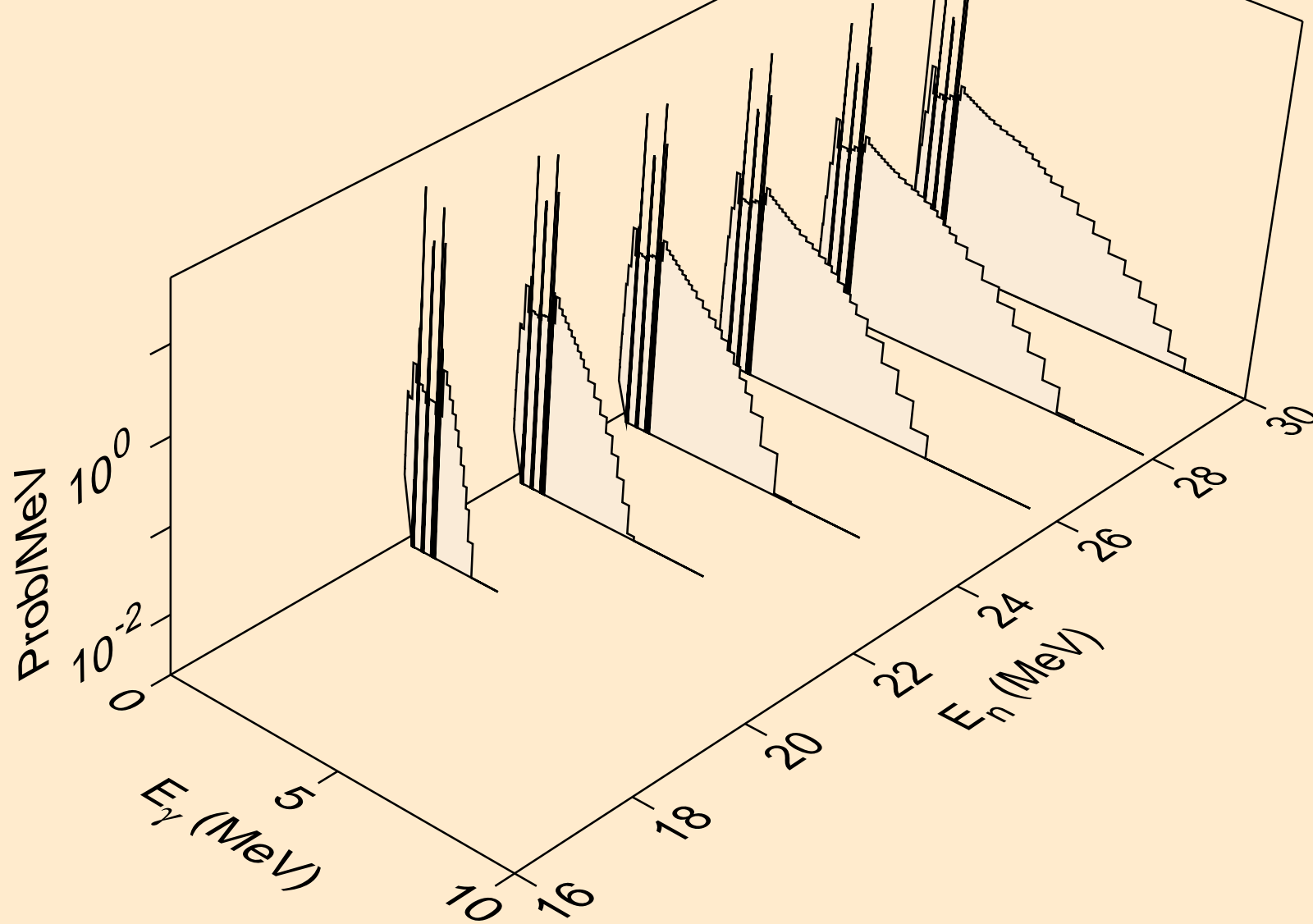

TC097M NEUTRON ACER TENDL-2023 LIBRARY; T=0.K
Photon emission for (n,n*)a

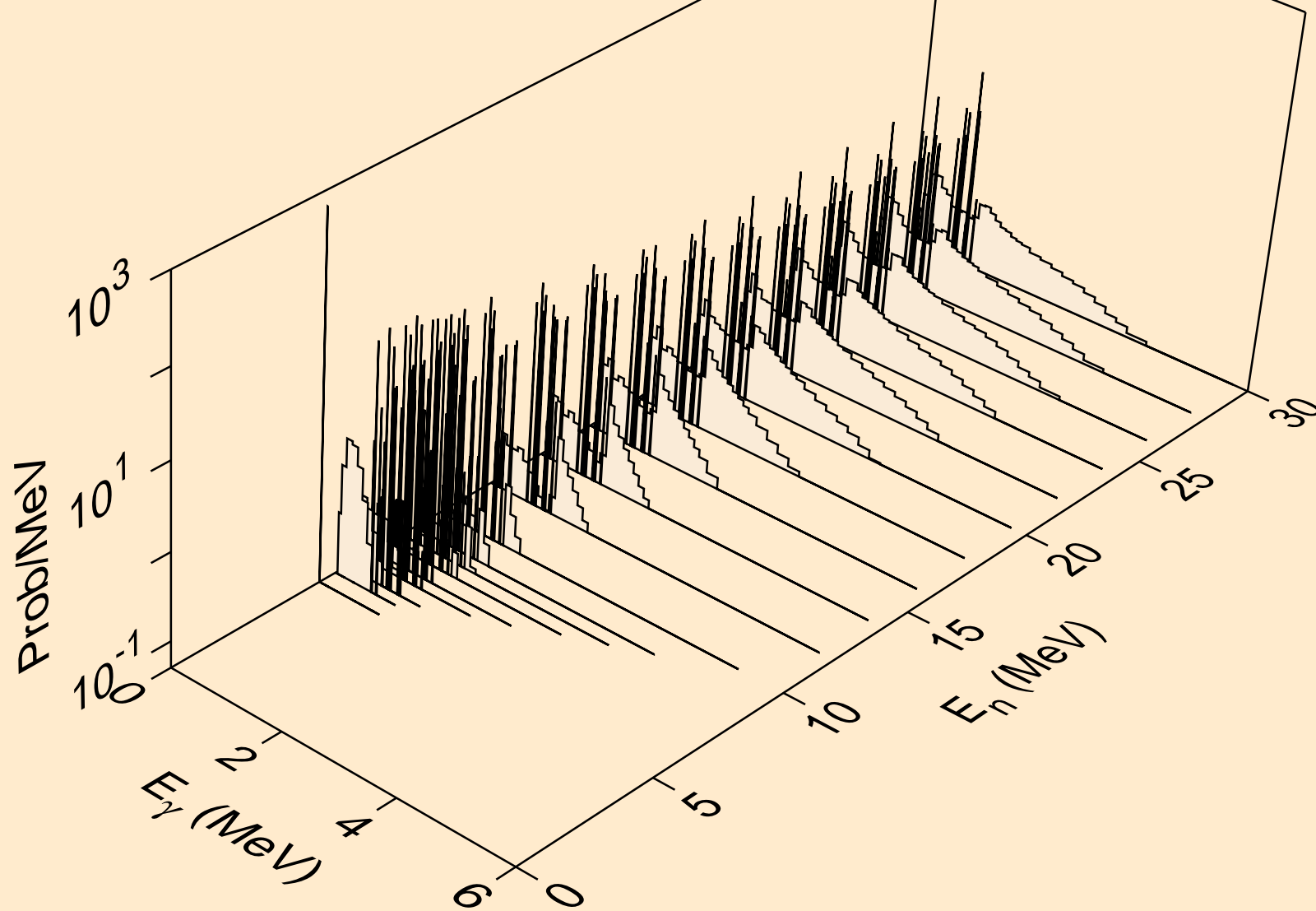

TC097M NEUTRON ACER TENDL-2023 LIBRARY; T=0.K
Photon emission for (n,2n)a

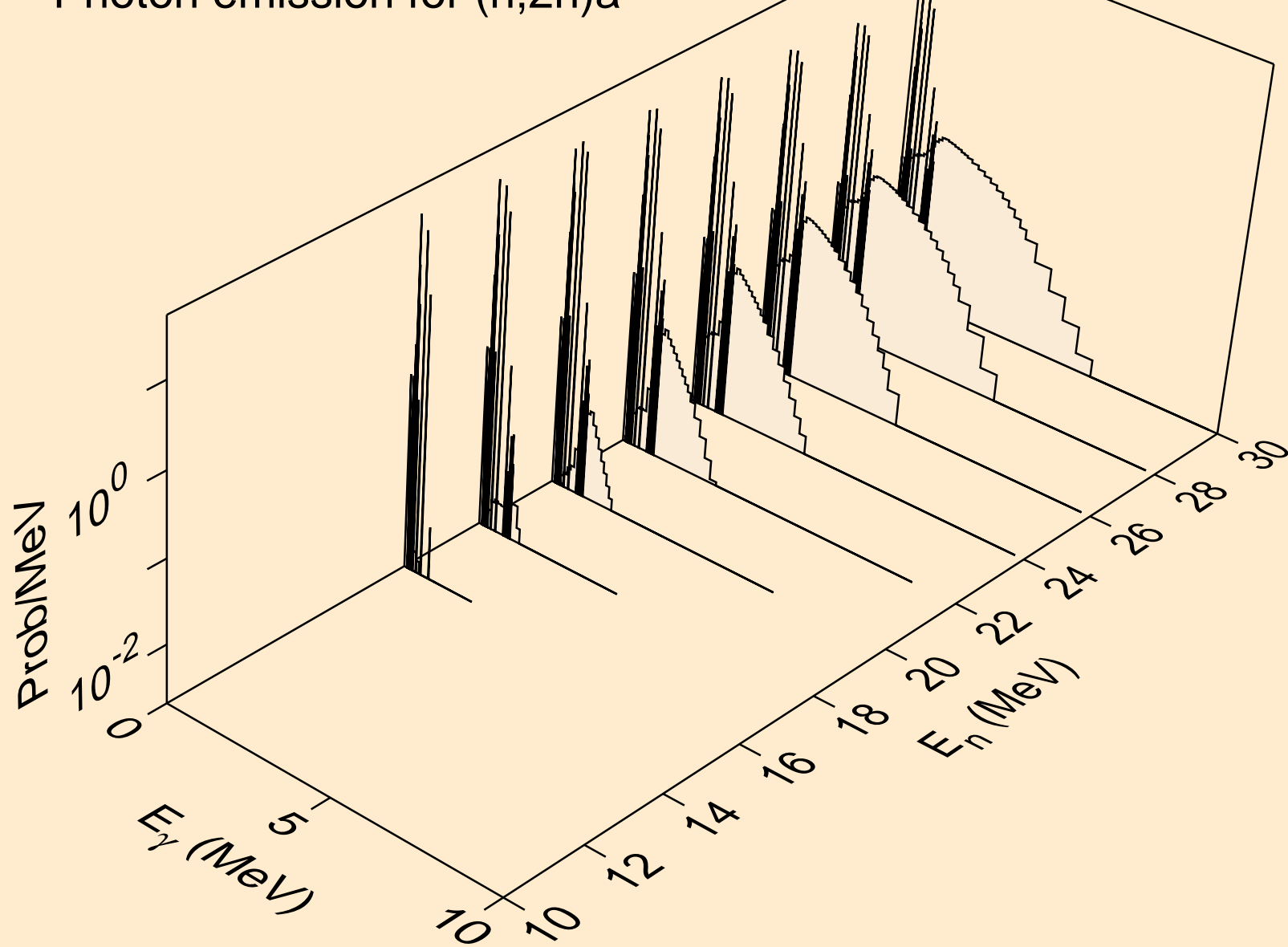

TC097M NEUTRON ACER TENDL-2023 LIBRARY; T=0.K
Photon emission for (n,3n)a

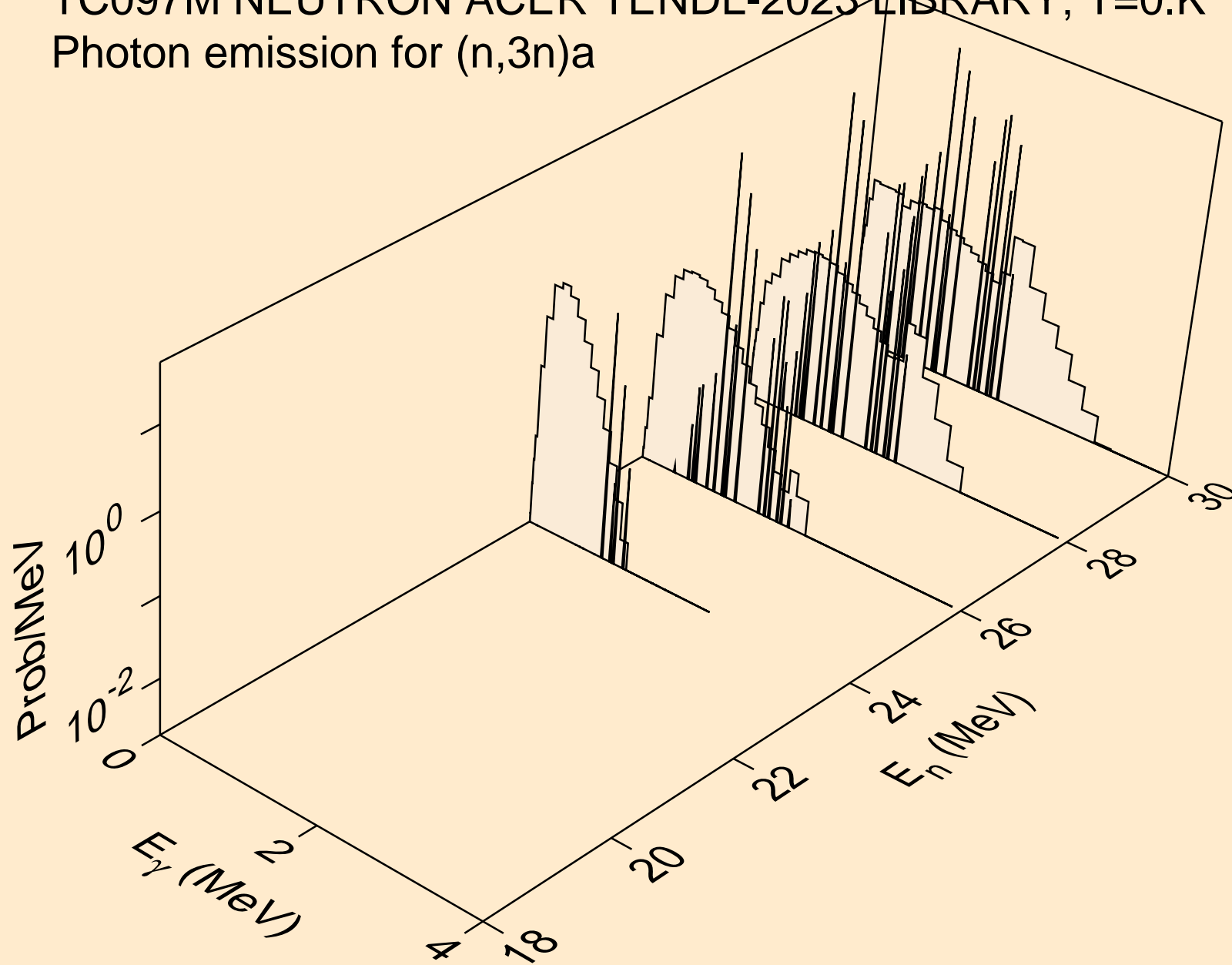

TC097M NEUTRON ACER TENDL-2023 LIBRARY; T=0.K
Photon emission for (n,n*)p

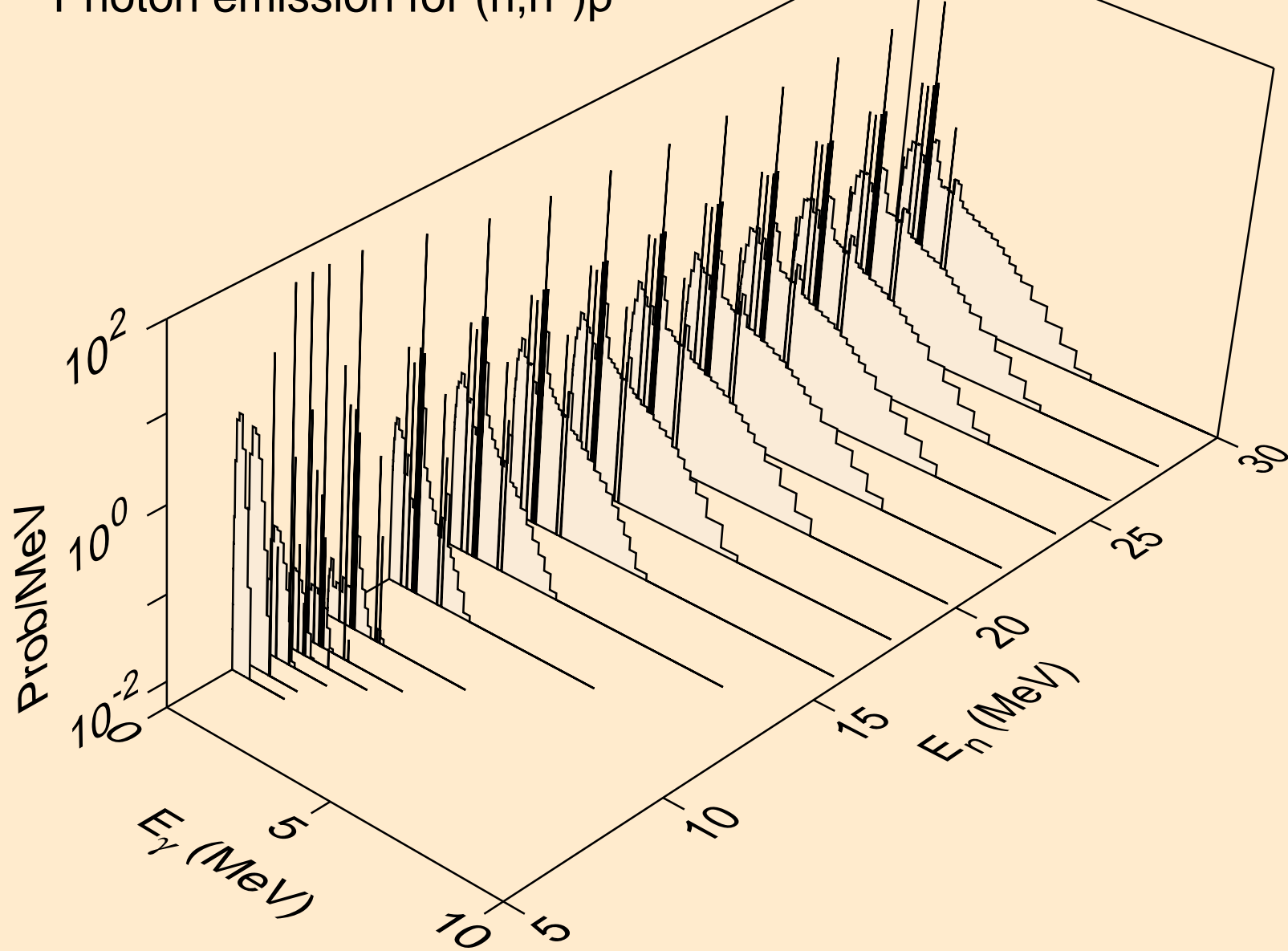

TC097M NEUTRON ACER TENDL-2023 LIBRARY; T=0.K
Photon emission for (n,n*)2a

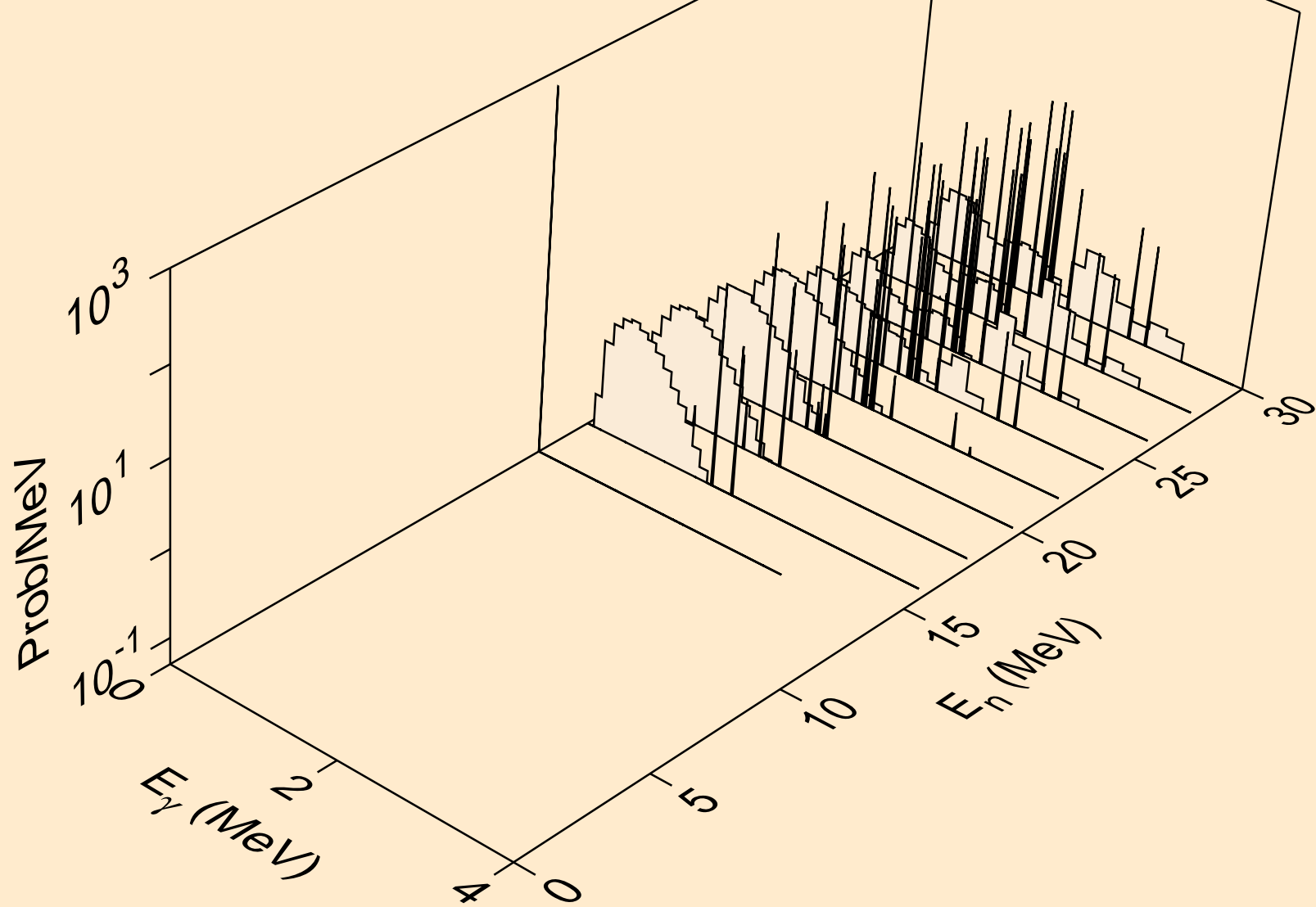

TC097M NEUTRON ACER TENDL-2023 LIBRARY; T=0.K
Photon emission for (n,n*)d

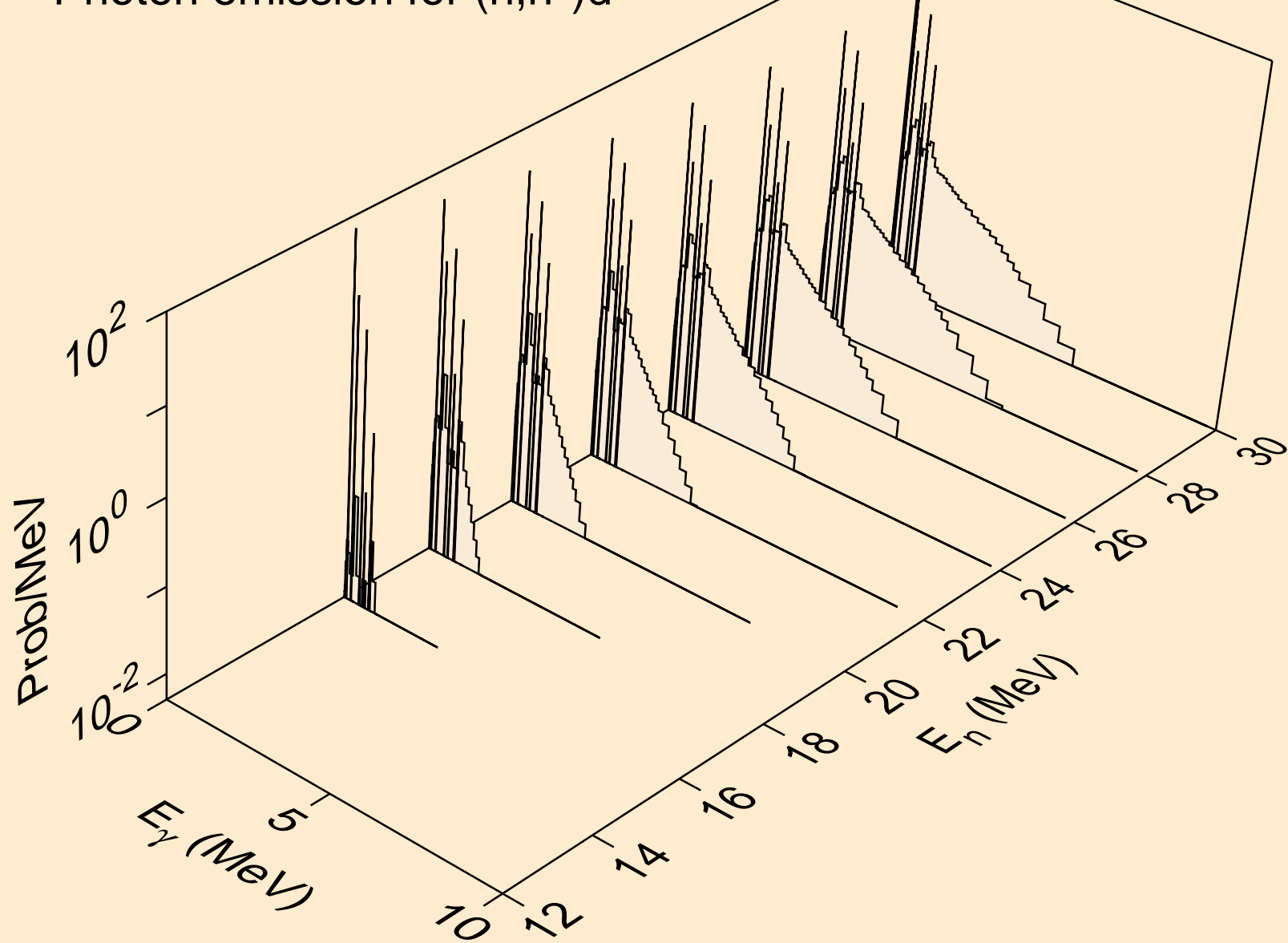

TC097M NEUTRON ACER TENDL-2023 LIBRARY; T=0.K
Photon emission for (n,n*)t

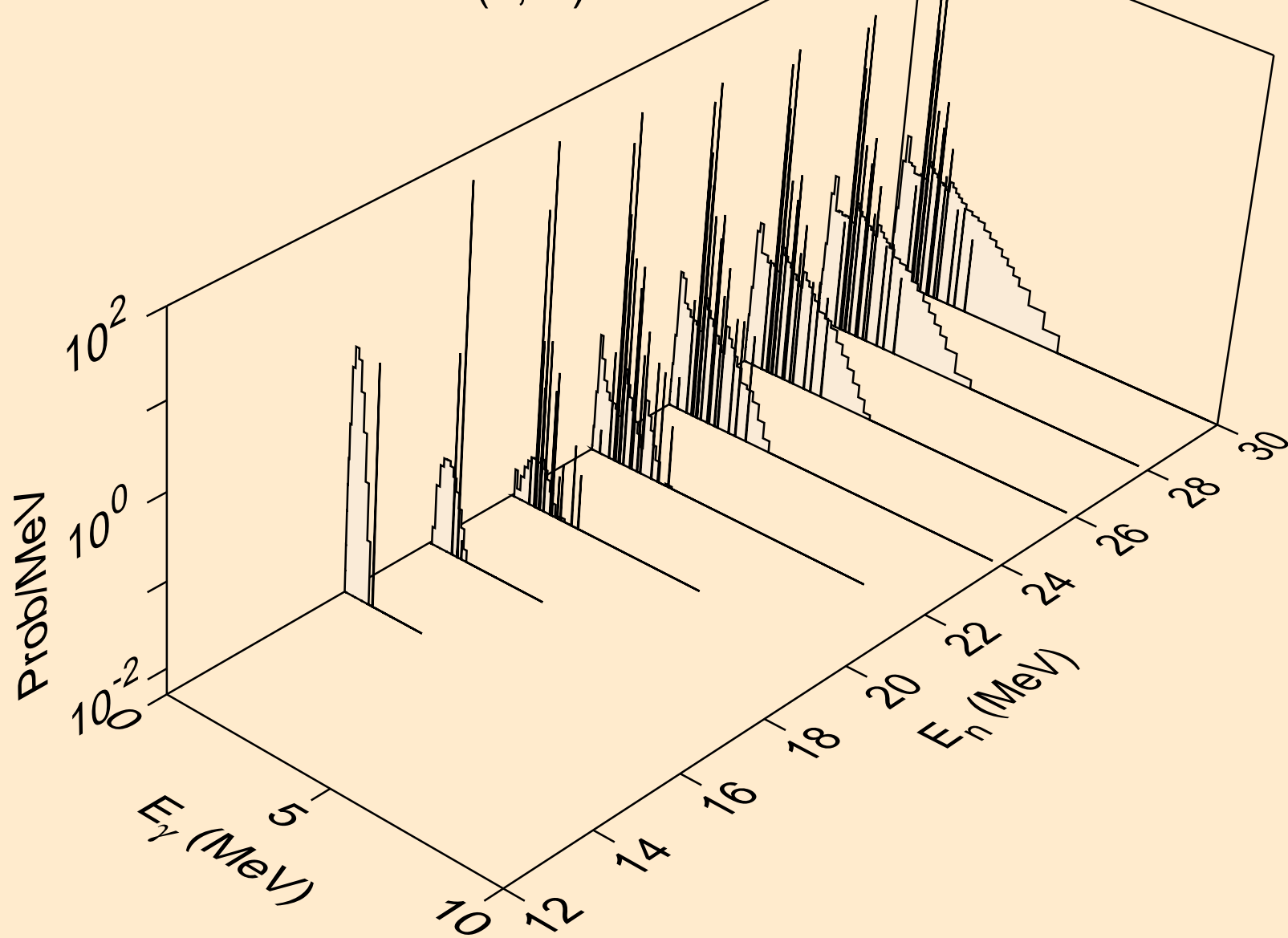

TC097M NEUTRON ACER TENDL-2023 LIBRARY; T=0.K
Photon emission for (n,n*)he3

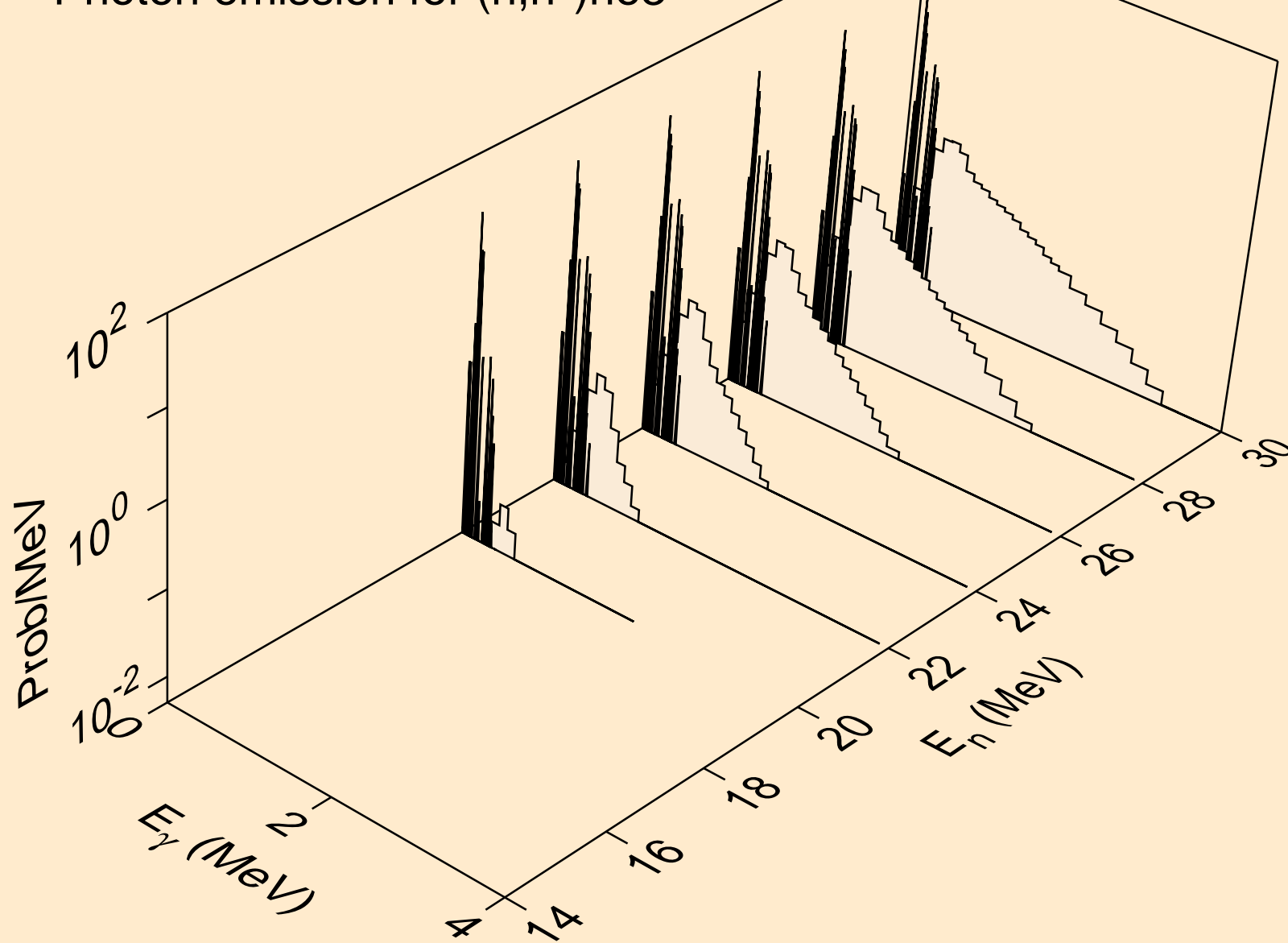

TC097M NEUTRON ACER TENDL-2023 LIBRARY; T=0.K
Photon emission for (n,4n)

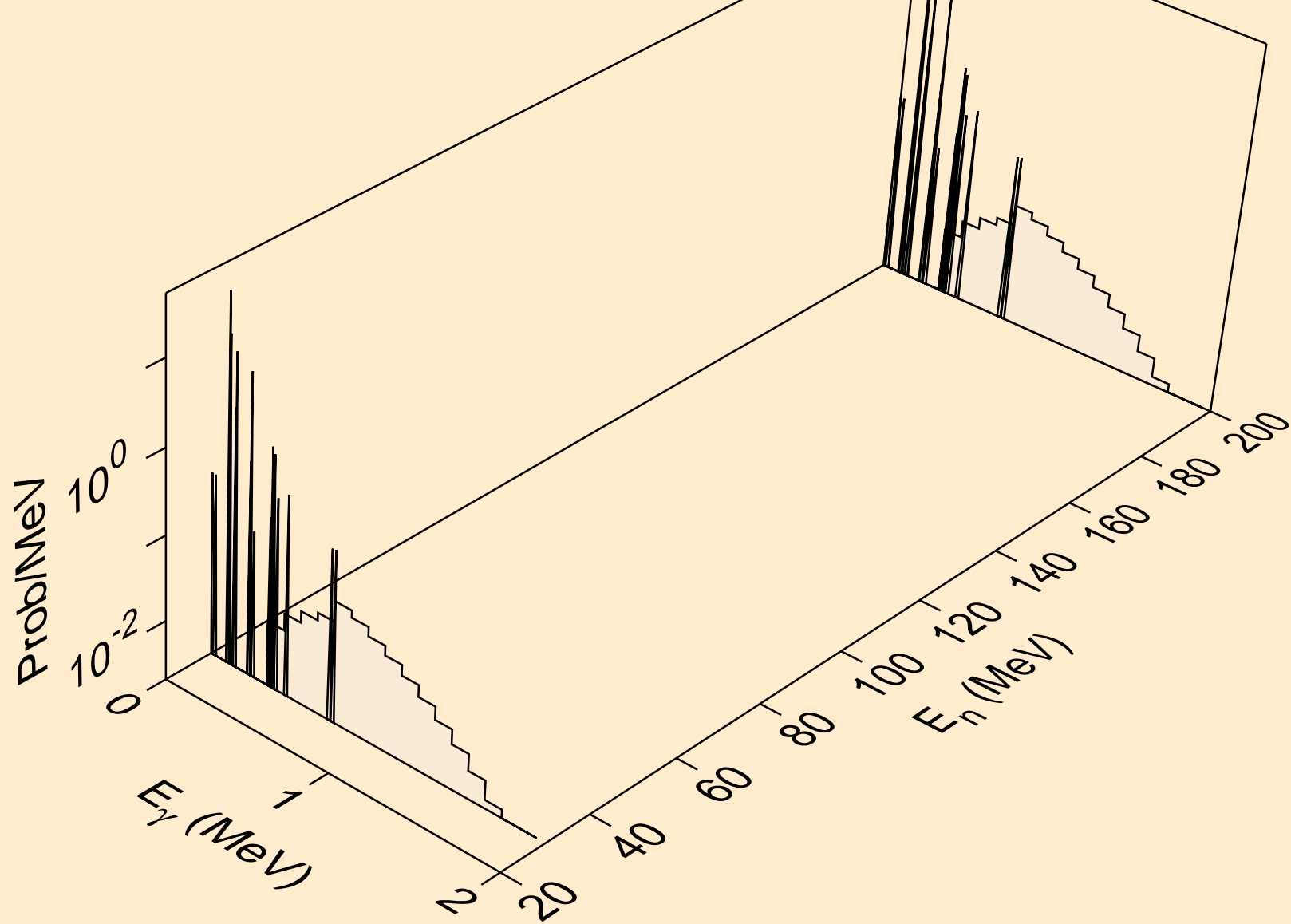

TC097M NEUTRON ACER TENDL-2023 LIBRARY; T=0.K
Photon emission for (n,2np)

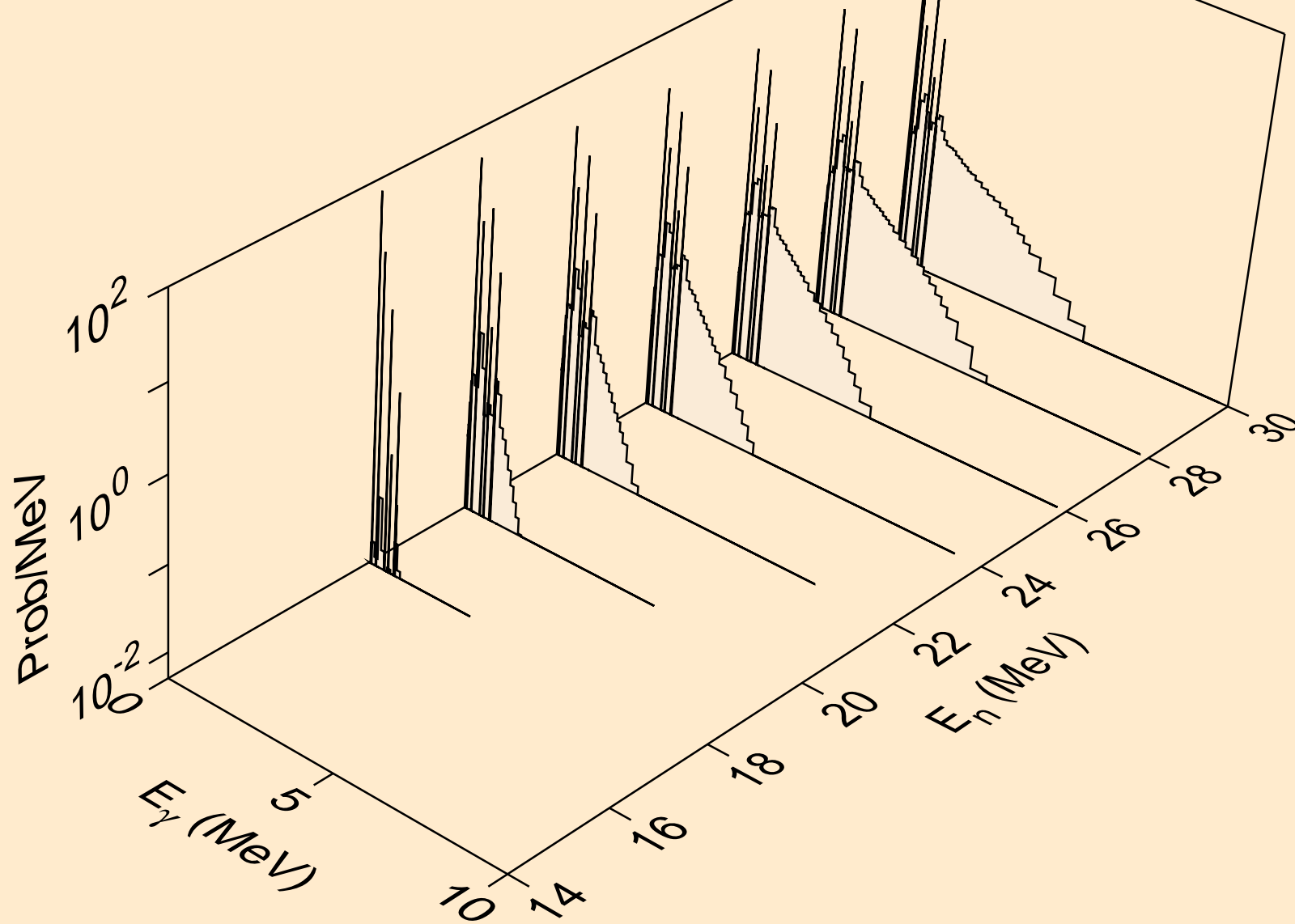

TC097M NEUTRON ACER TENDL-2023 LIBRARY; T=0.K
Photon emission for (n,3np)

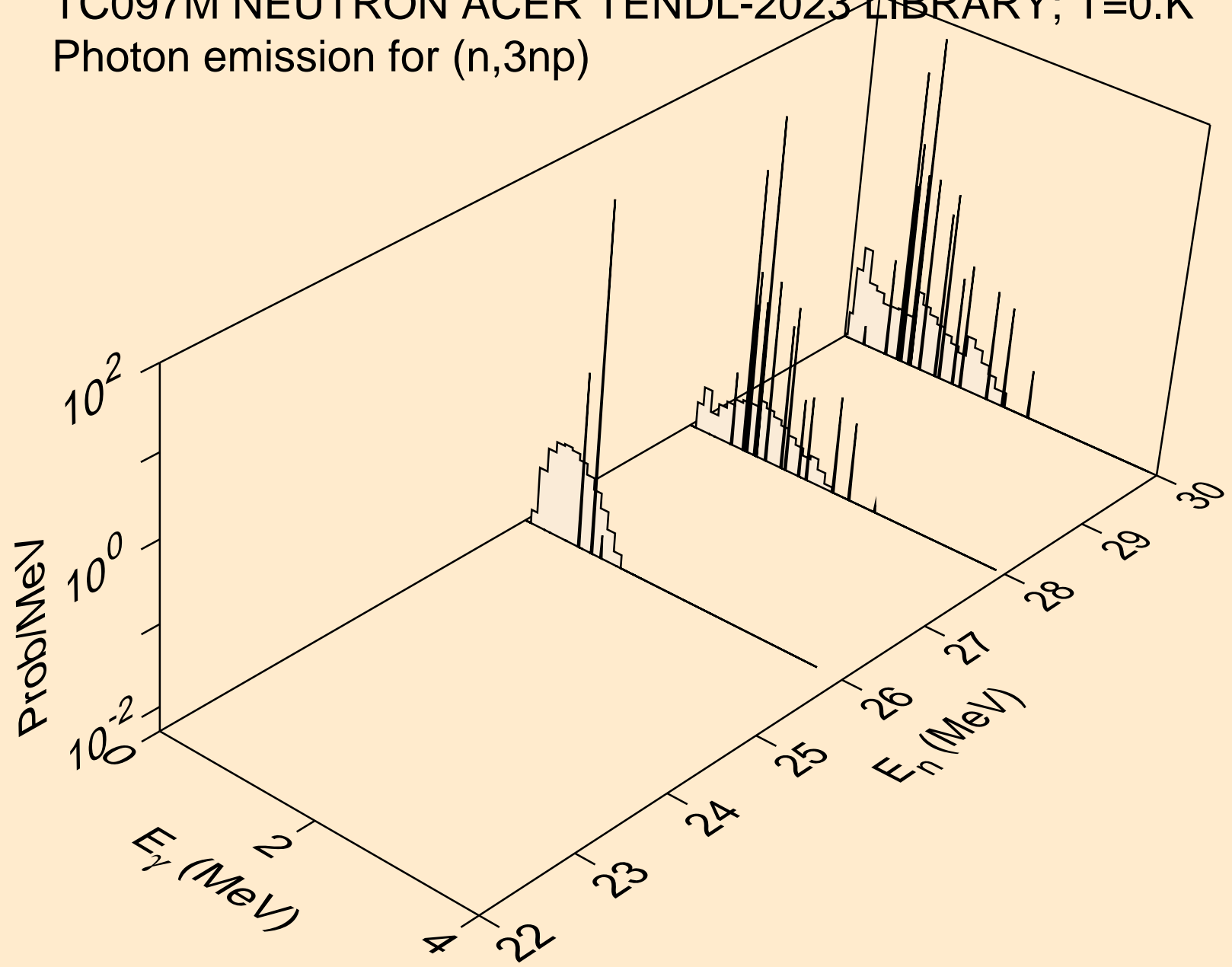

TC097M NEUTRON ACER TENDL-2023 LIBRARY; T=0.K
Photon emission for (n,n2p)

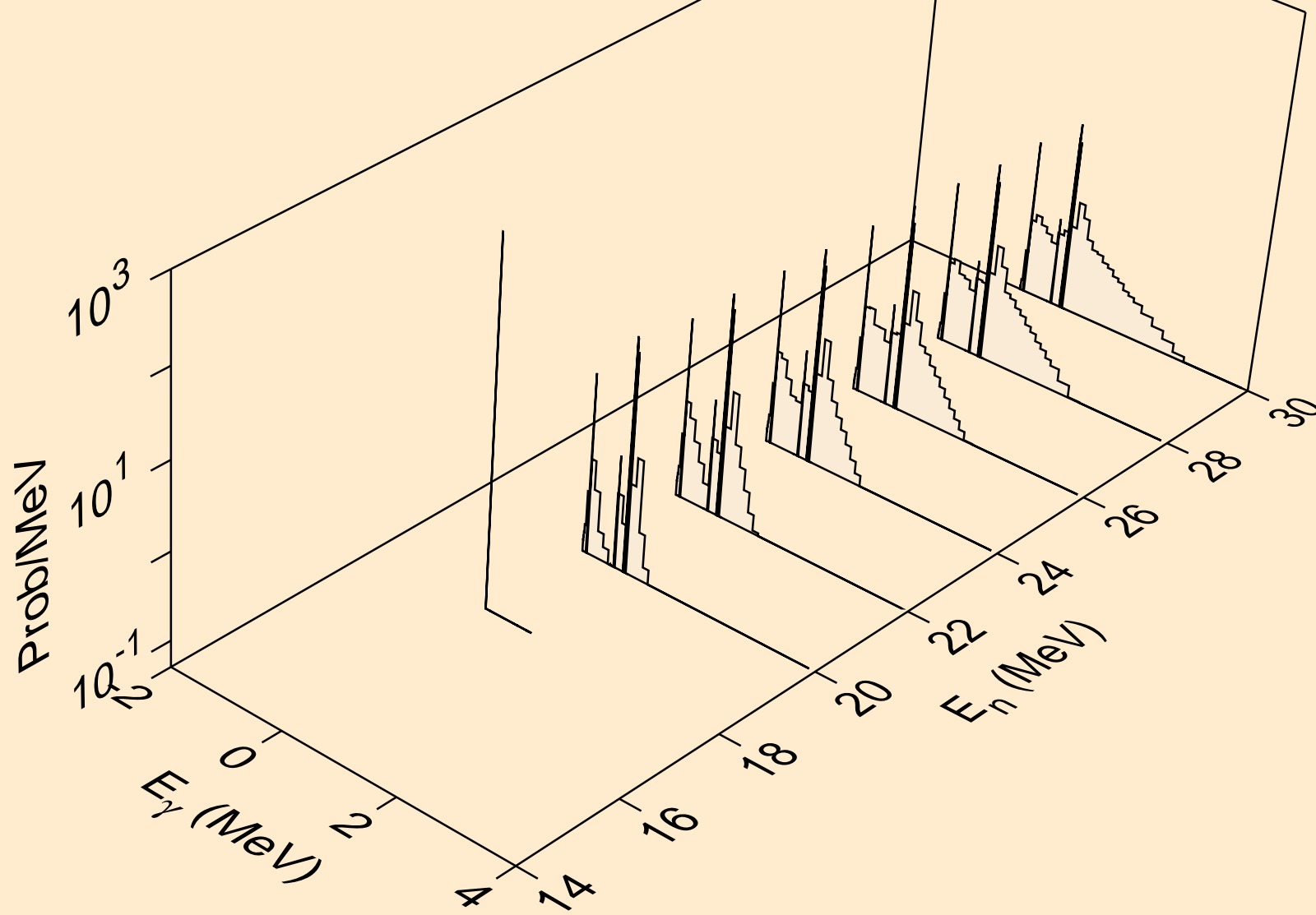

TC097M NEUTRON ACER TENDL-2023 LIBRARY; T=0.K
Photon emission for (n,npa)

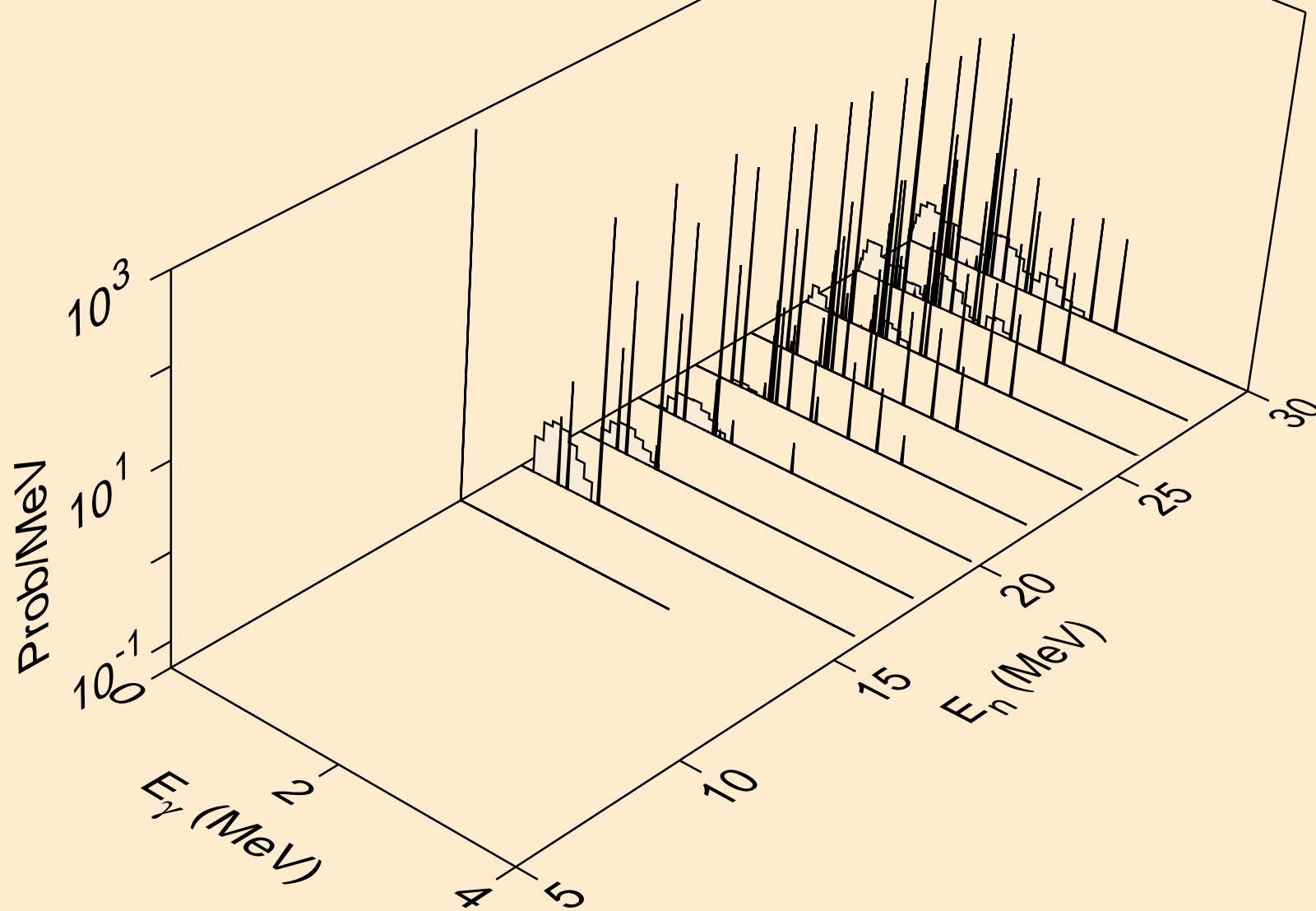

TC097M NEUTRON ACER TENDL-2023 LIBRARY; T=0.K
Photon emission for (n,n*2)

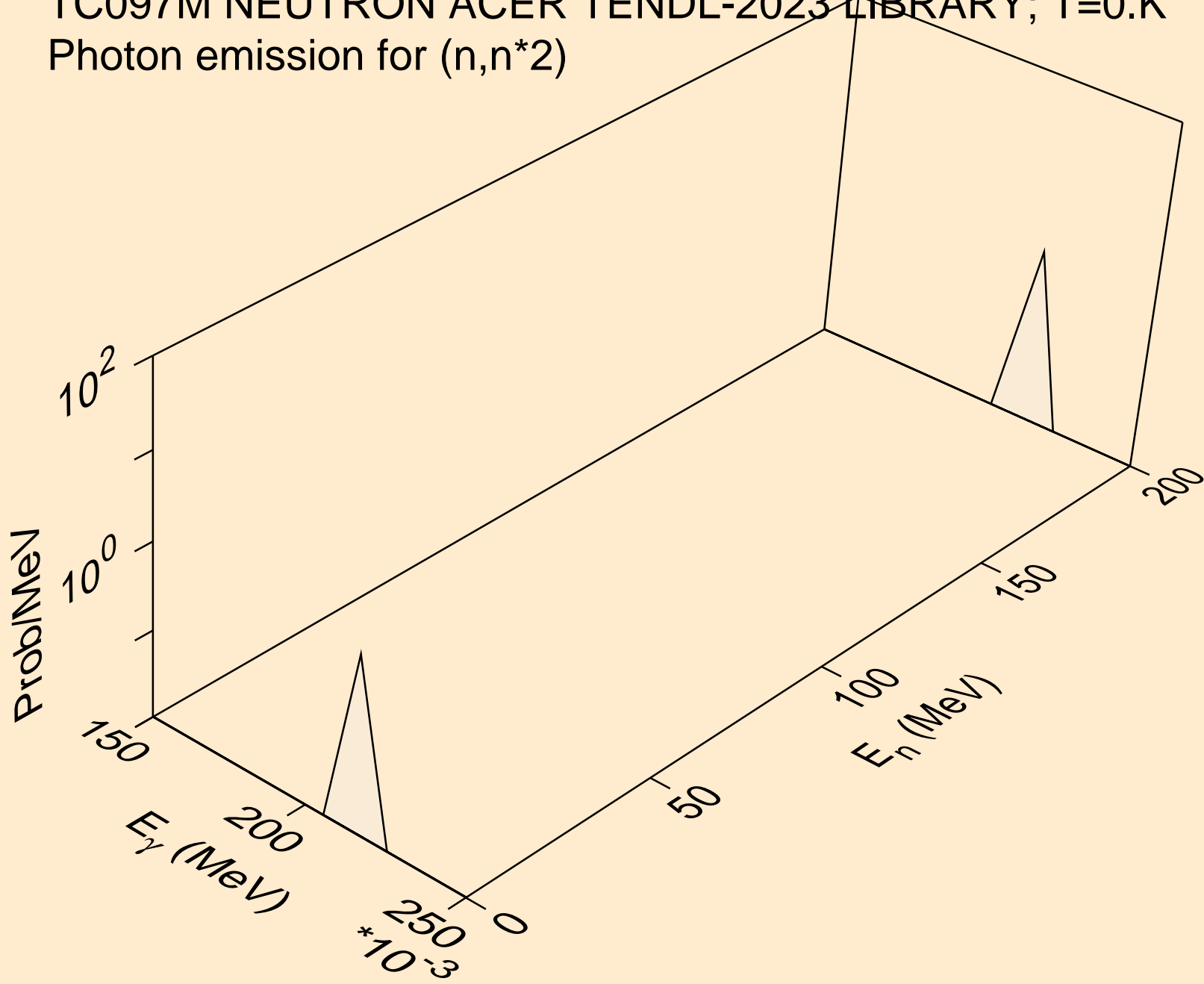

TC097M NEUTRON ACER TENDL-2023 LIBRARY; T=0.K
Photon emission for (n,n*3)

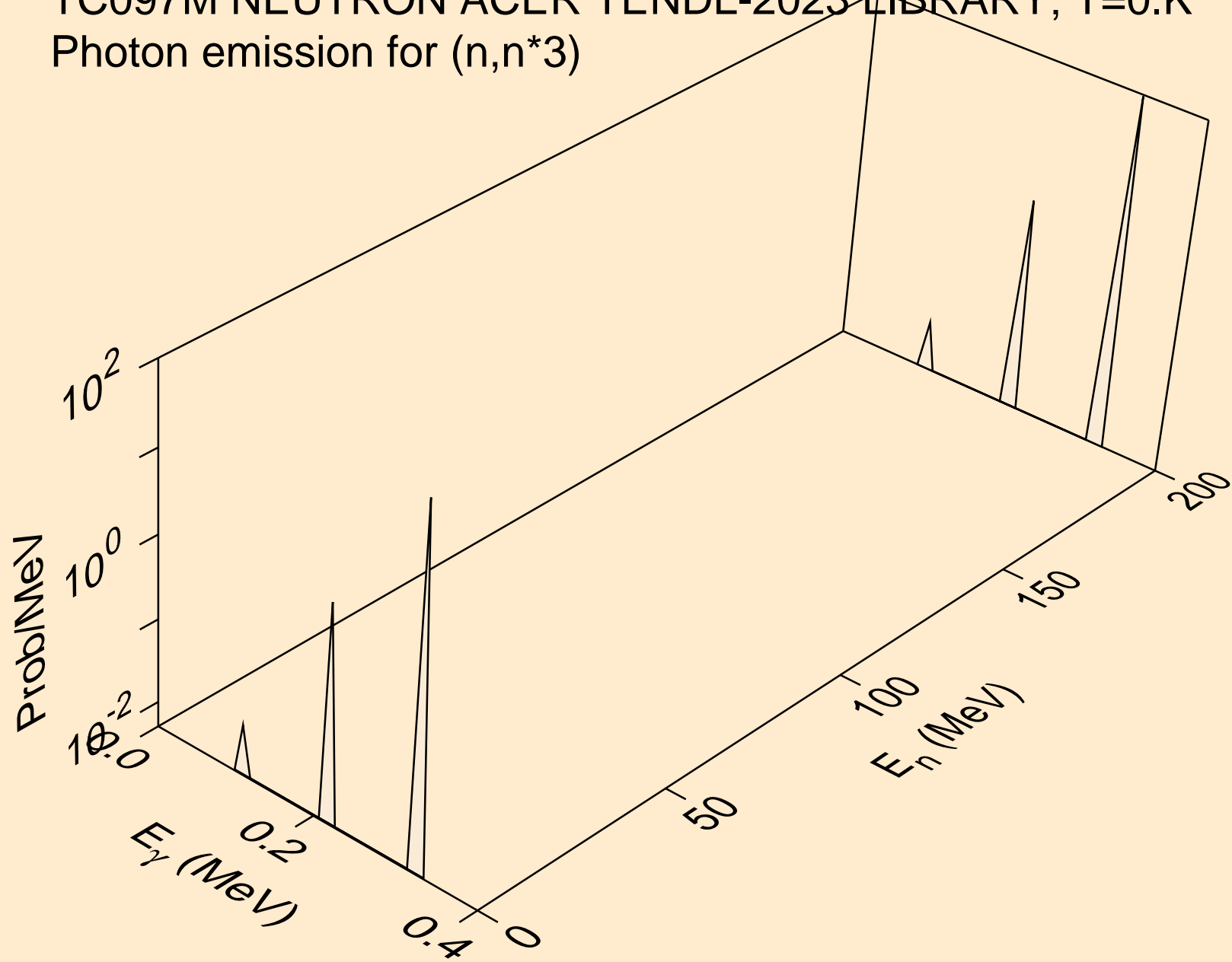

TC097M NEUTRON ACER TENDL-2023 LIBRARY; T=0.K
Photon emission for (n,n*4)

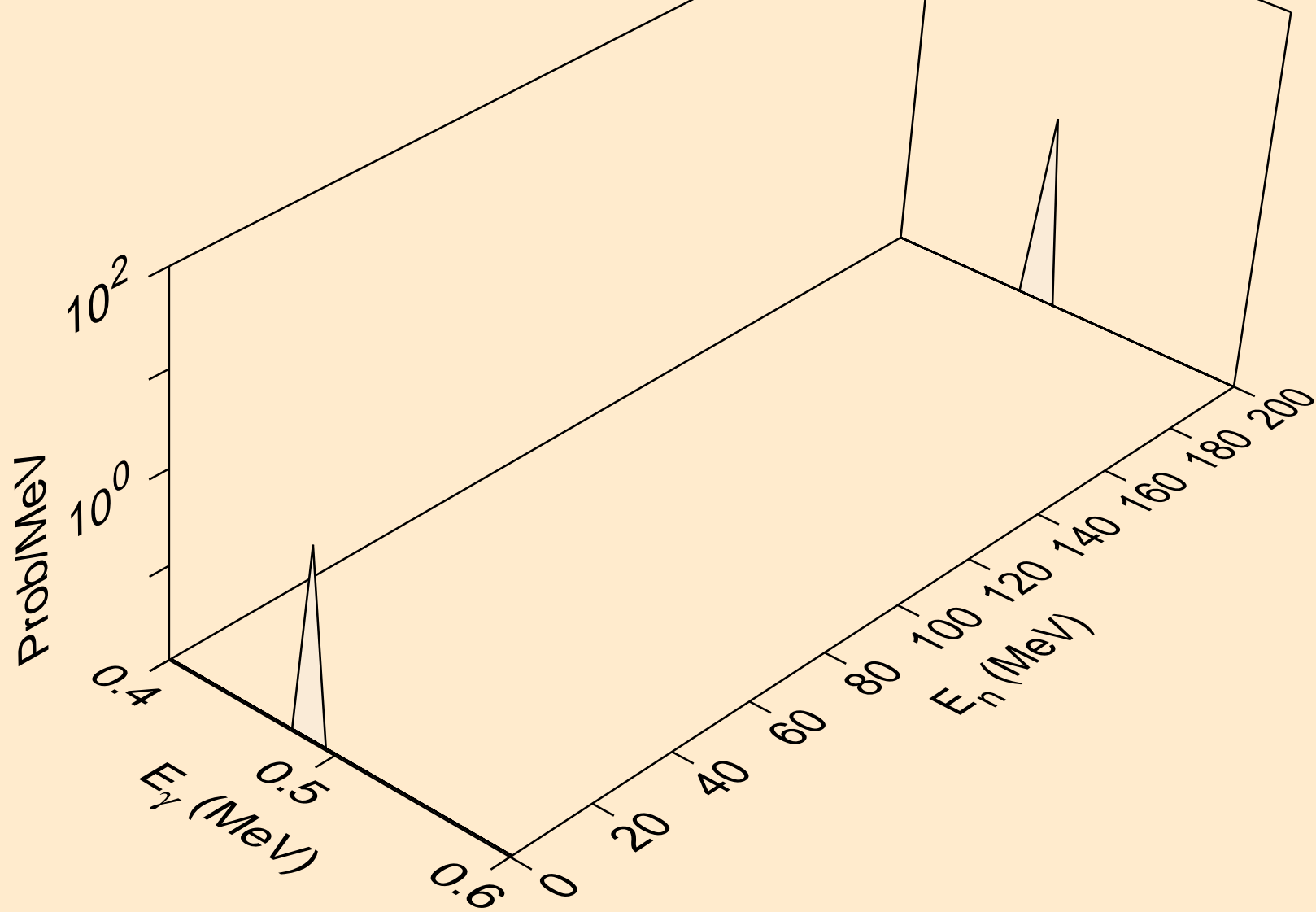

TC097M NEUTRON ACER TENDL-2023 LIBRARY; T=0.K
Photon emission for (n,n*5)

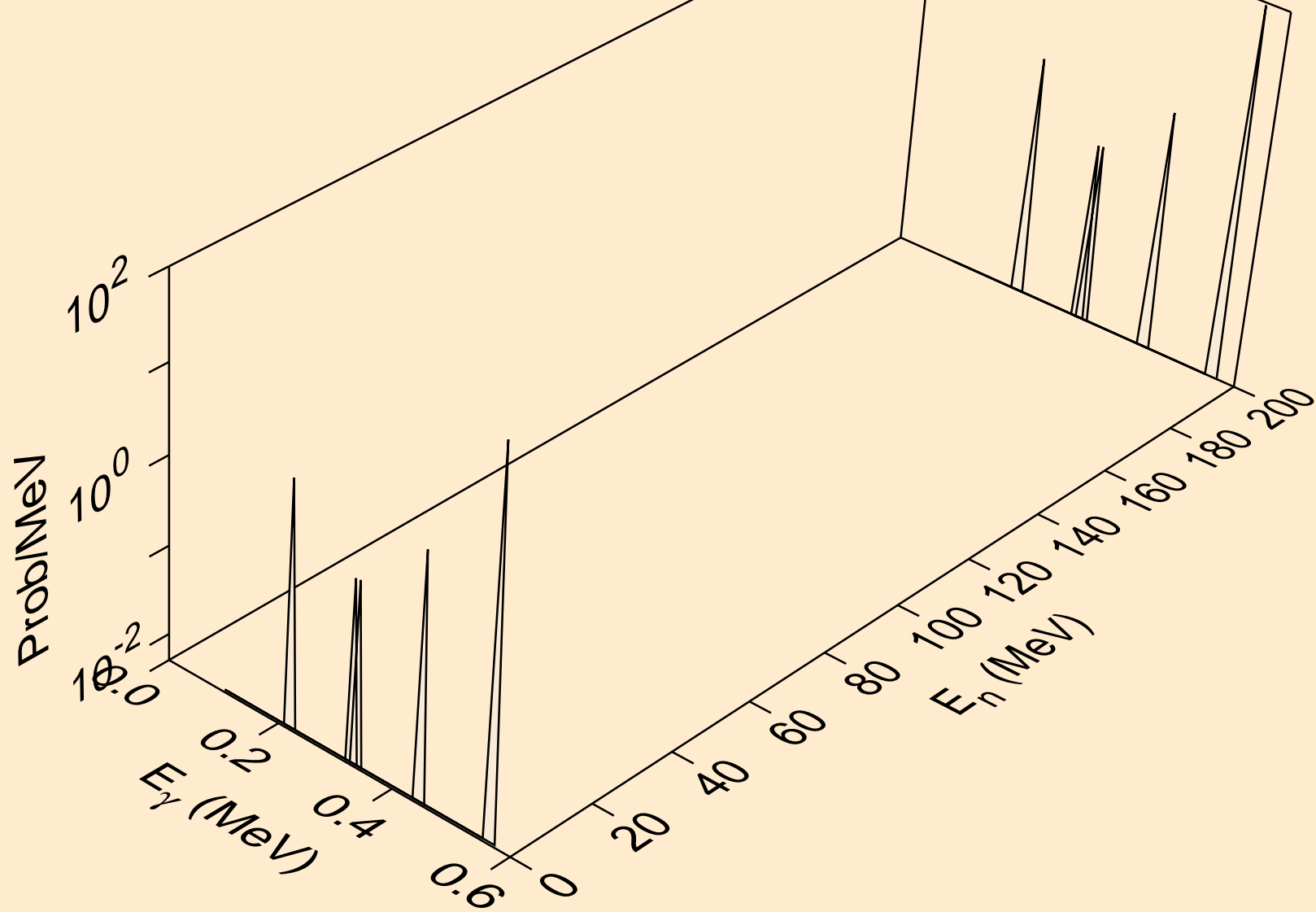

TC097M NEUTRON ACER TENDL-2023 LIBRARY; T=0.K
Photon emission for (n,n*6)

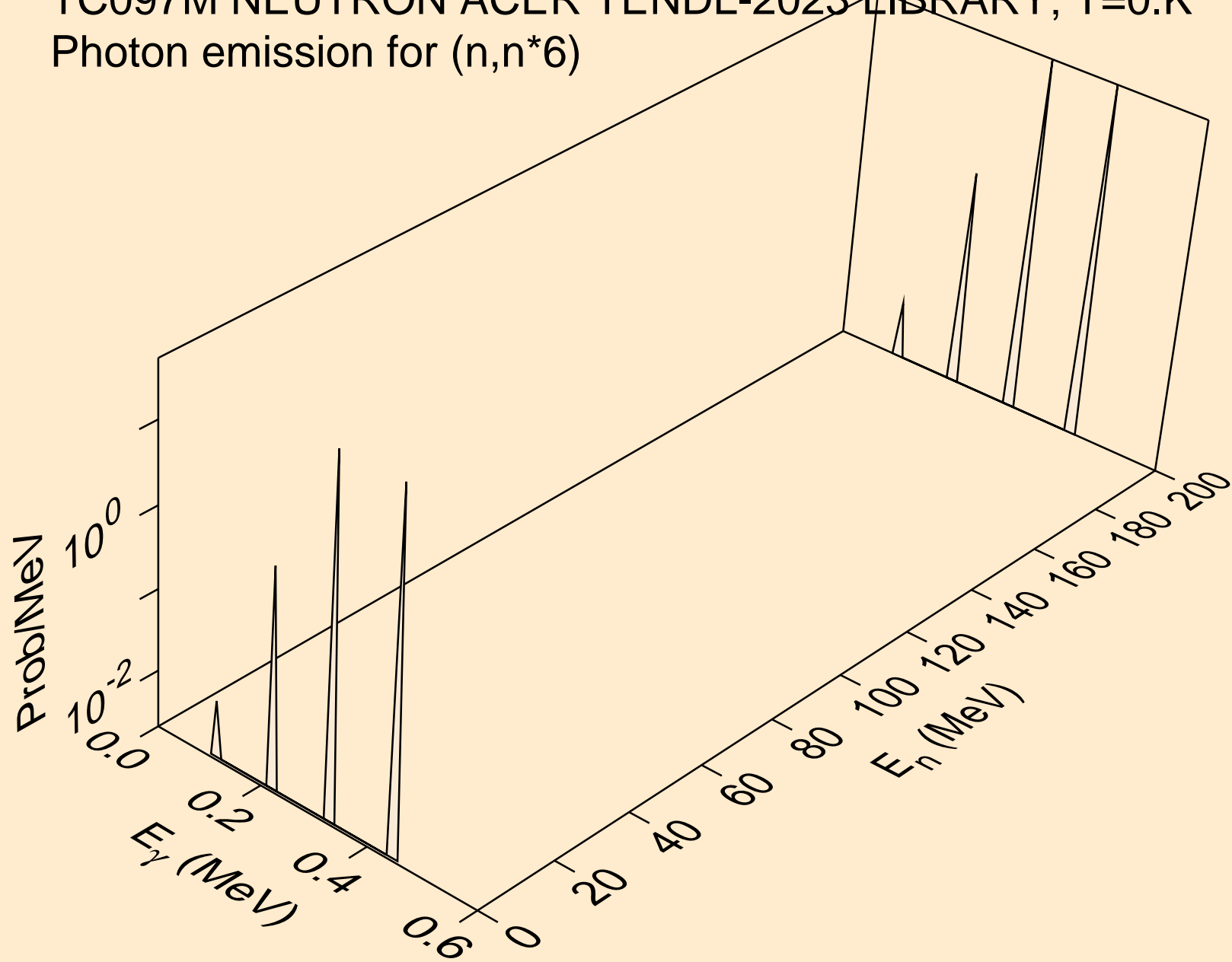

TC097M NEUTRON ACER TENDL-2023 LIBRARY; T=0.K
Photon emission for (n,n*7)

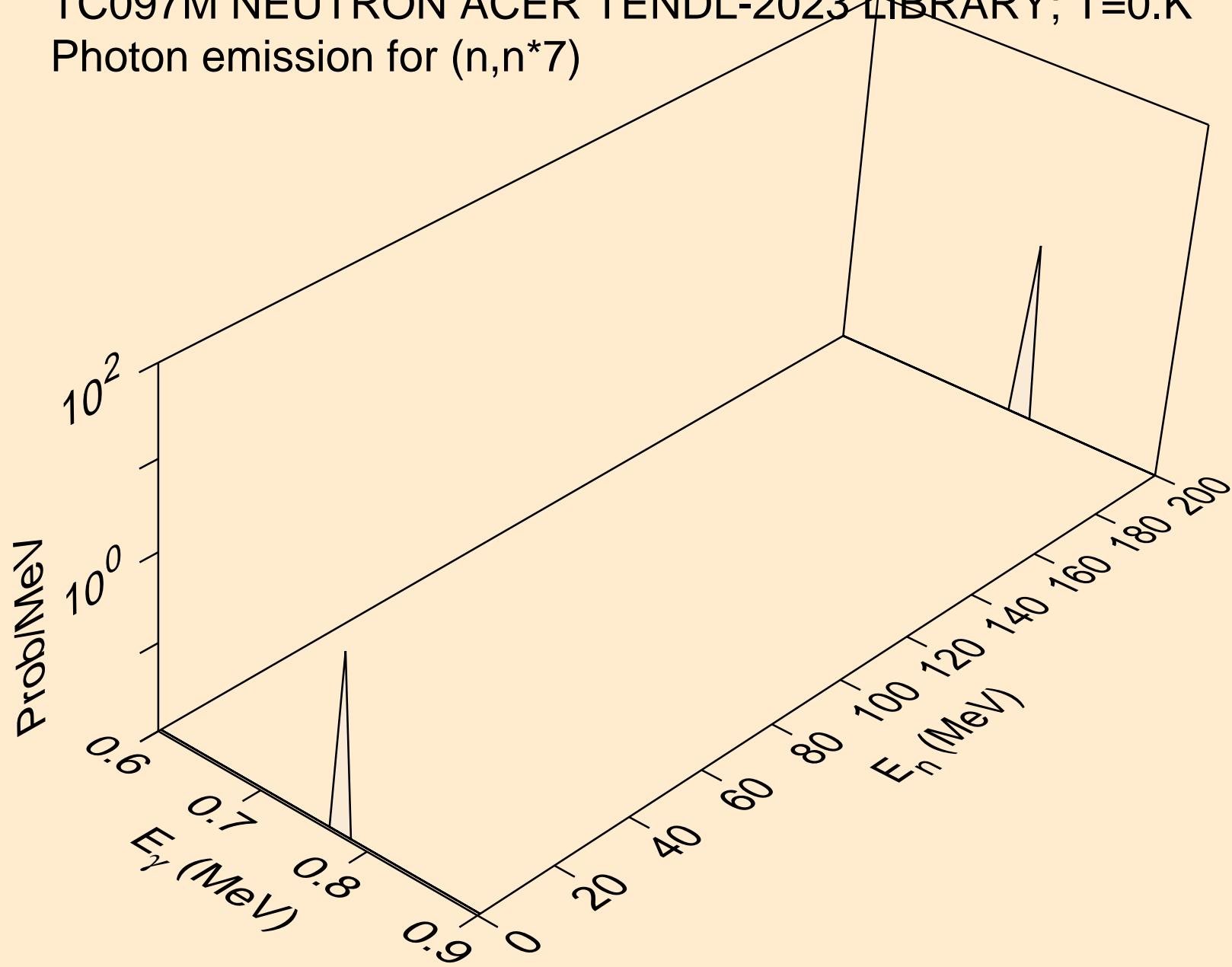

TC097M NEUTRON ACER TENDL-2023 LIBRARY; T=0.K
Photon emission for (n,n*8)

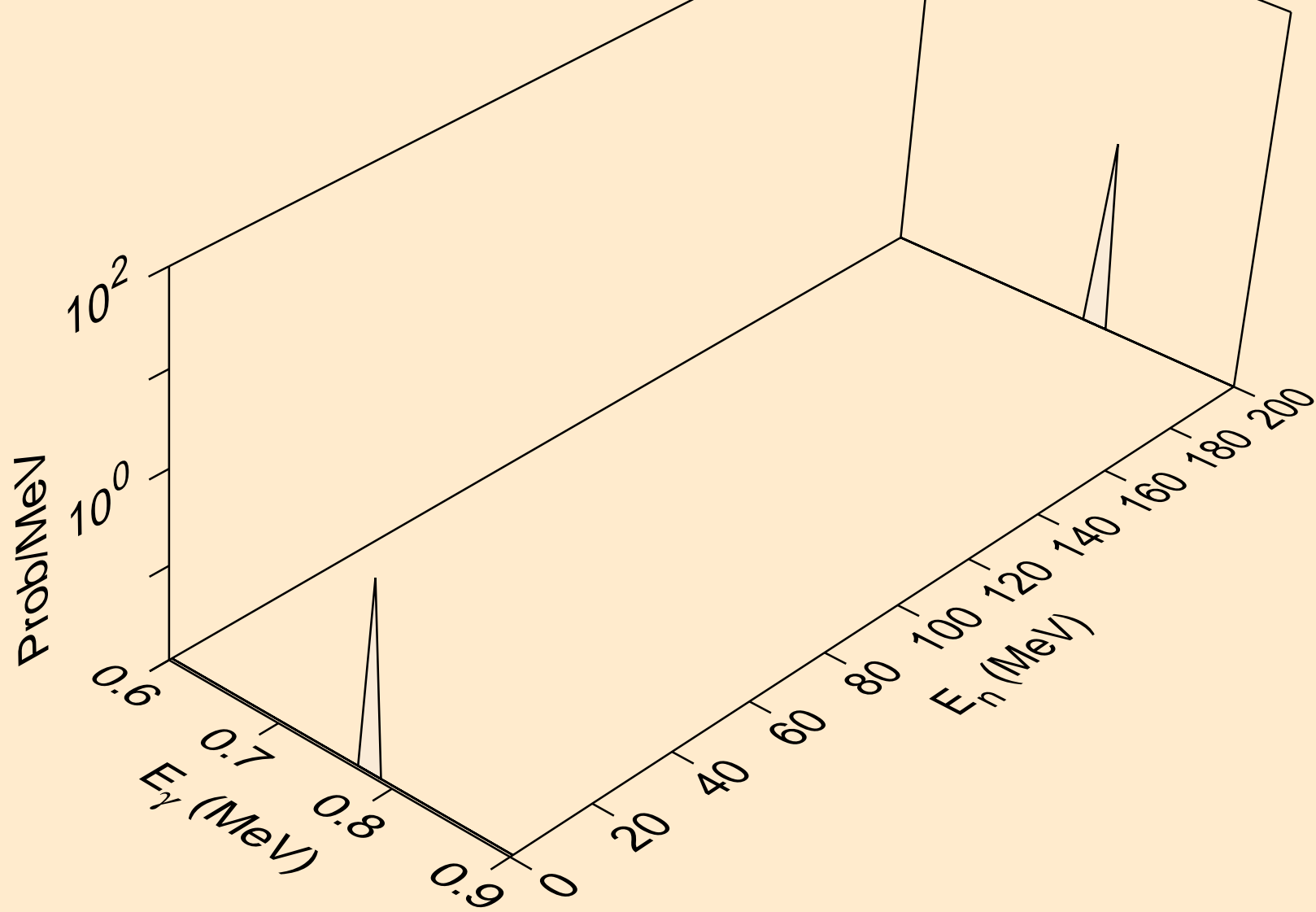

TC097M NEUTRON ACER TENDL-2023 LIBRARY; T=0.K
Photon emission for (n,n*9)

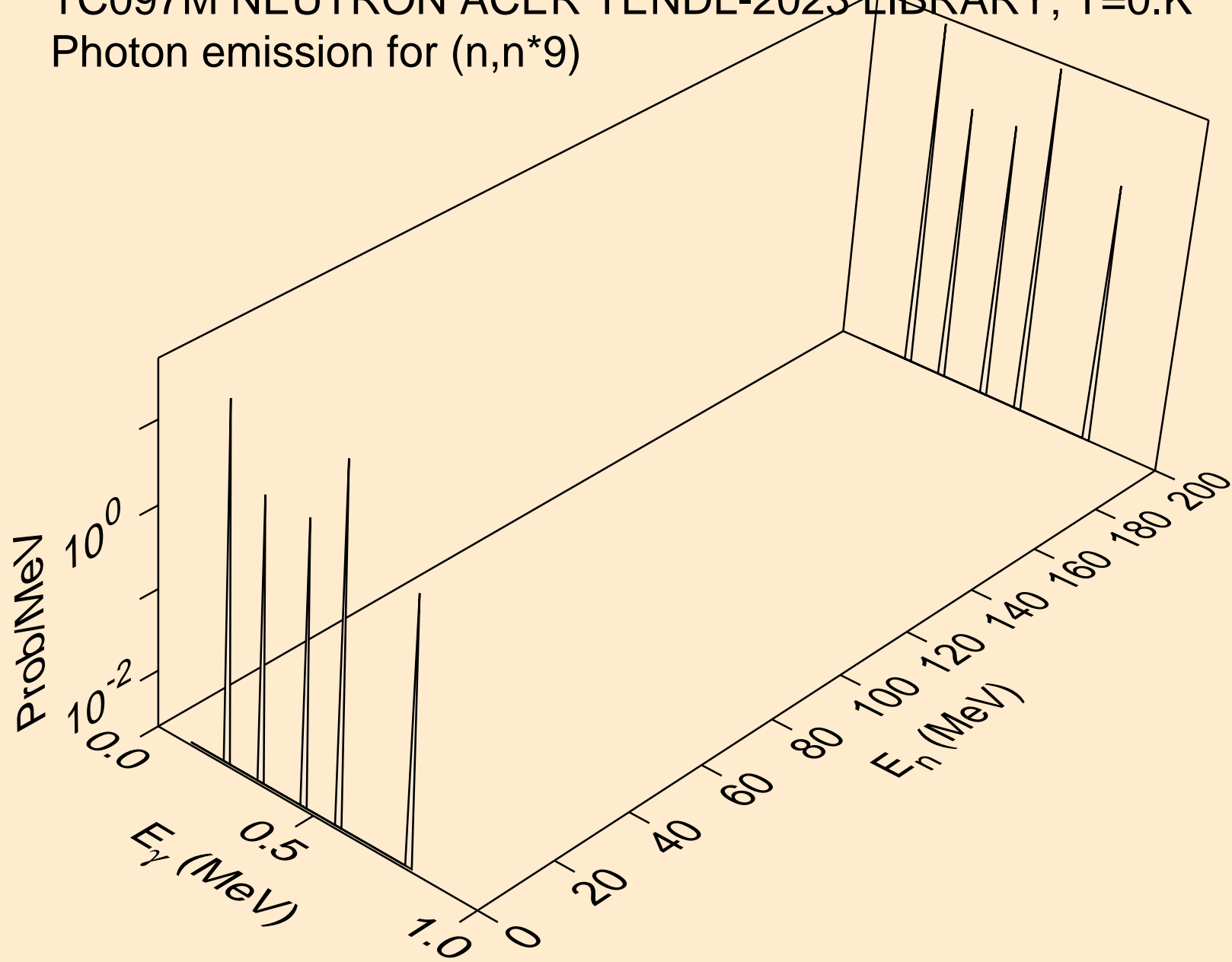

TC097M NEUTRON ACER TENDL-2023 LIBRARY; T=0.K
Photon emission for (n,n*10)

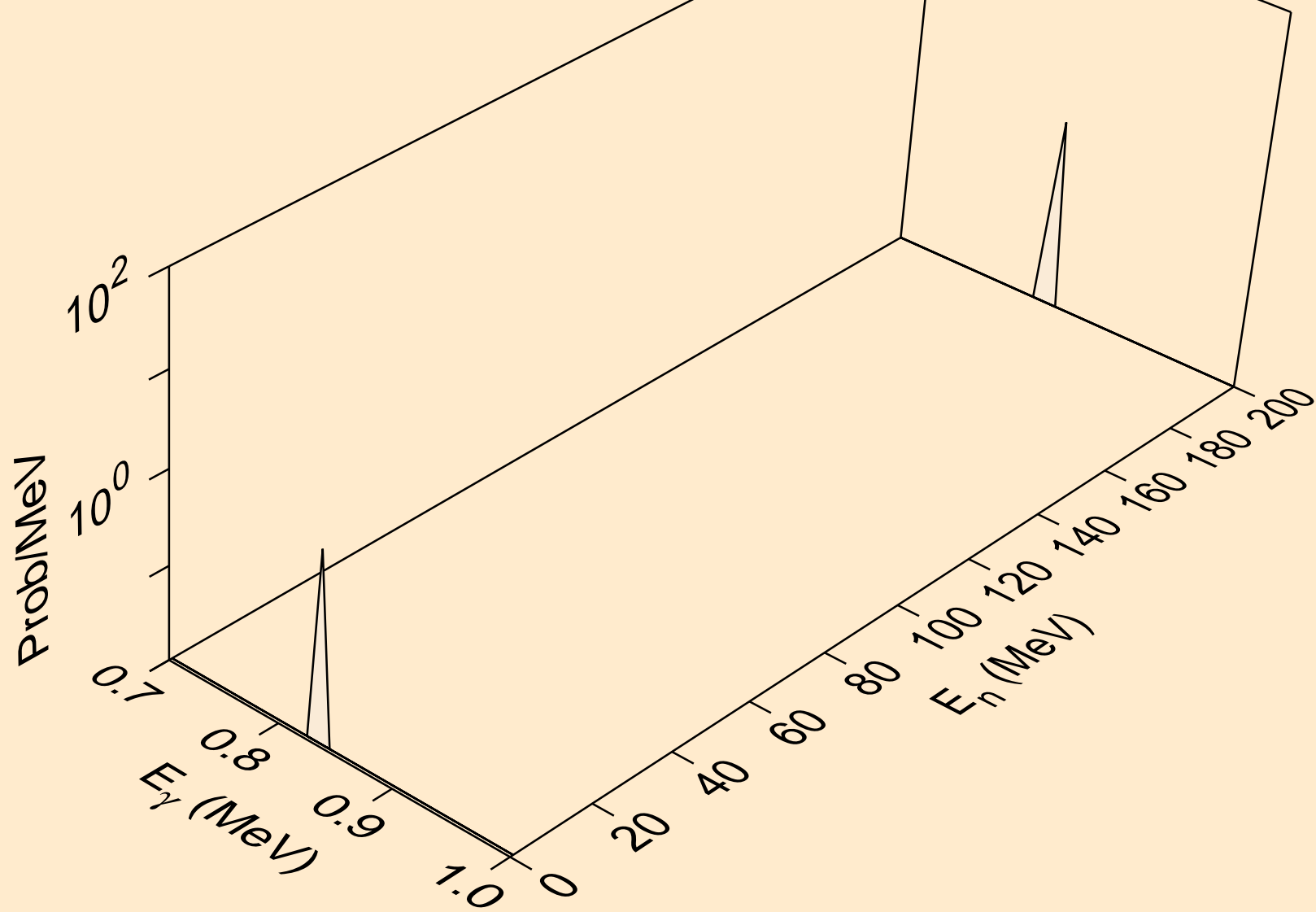

TC097M NEUTRON ACER TENDL-2023 LIBRARY; T=0.K
Photon emission for (n,n*11)

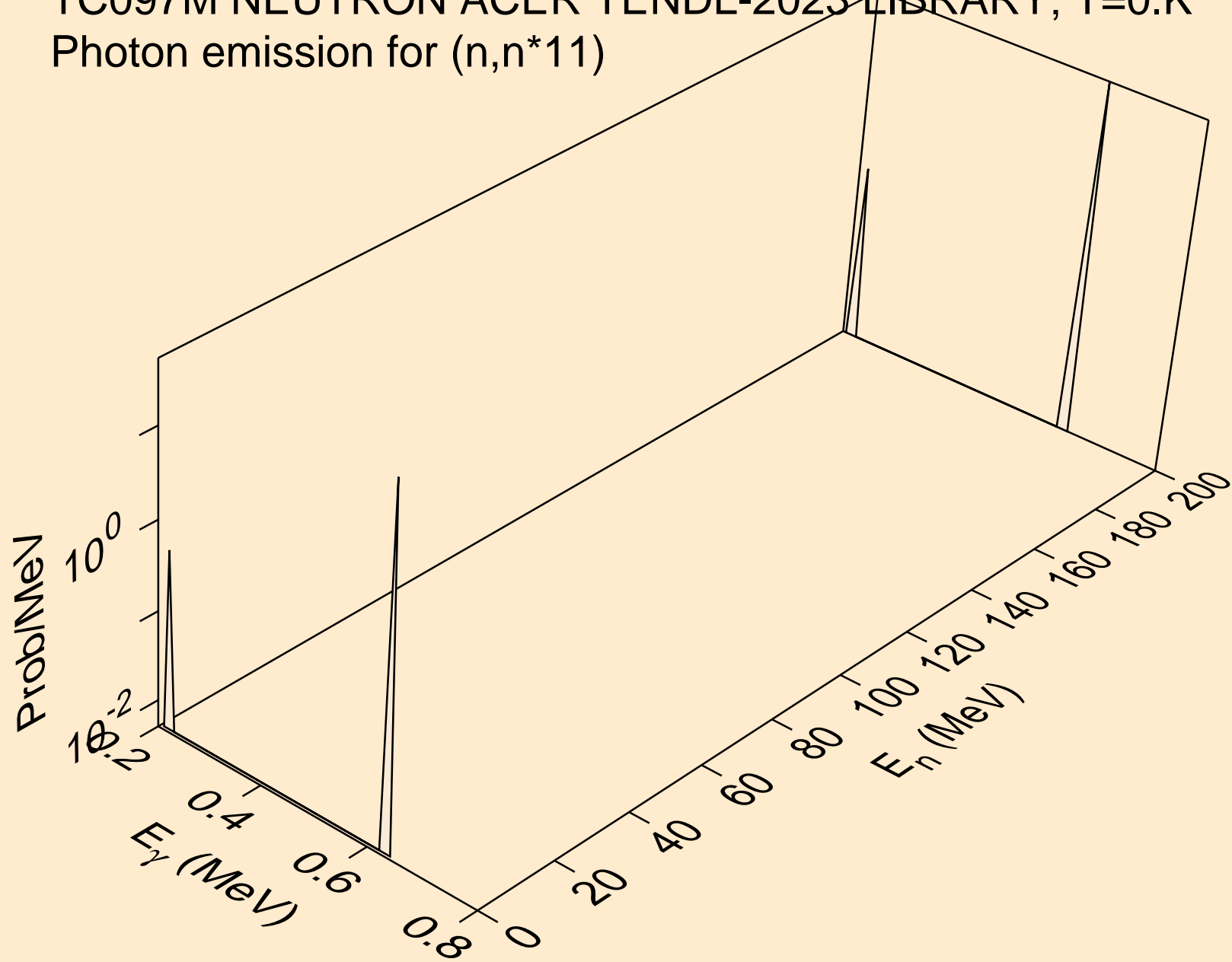

TC097M NEUTRON ACER TENDL-2023 LIBRARY; T=0.K
Photon emission for (n,n*12)

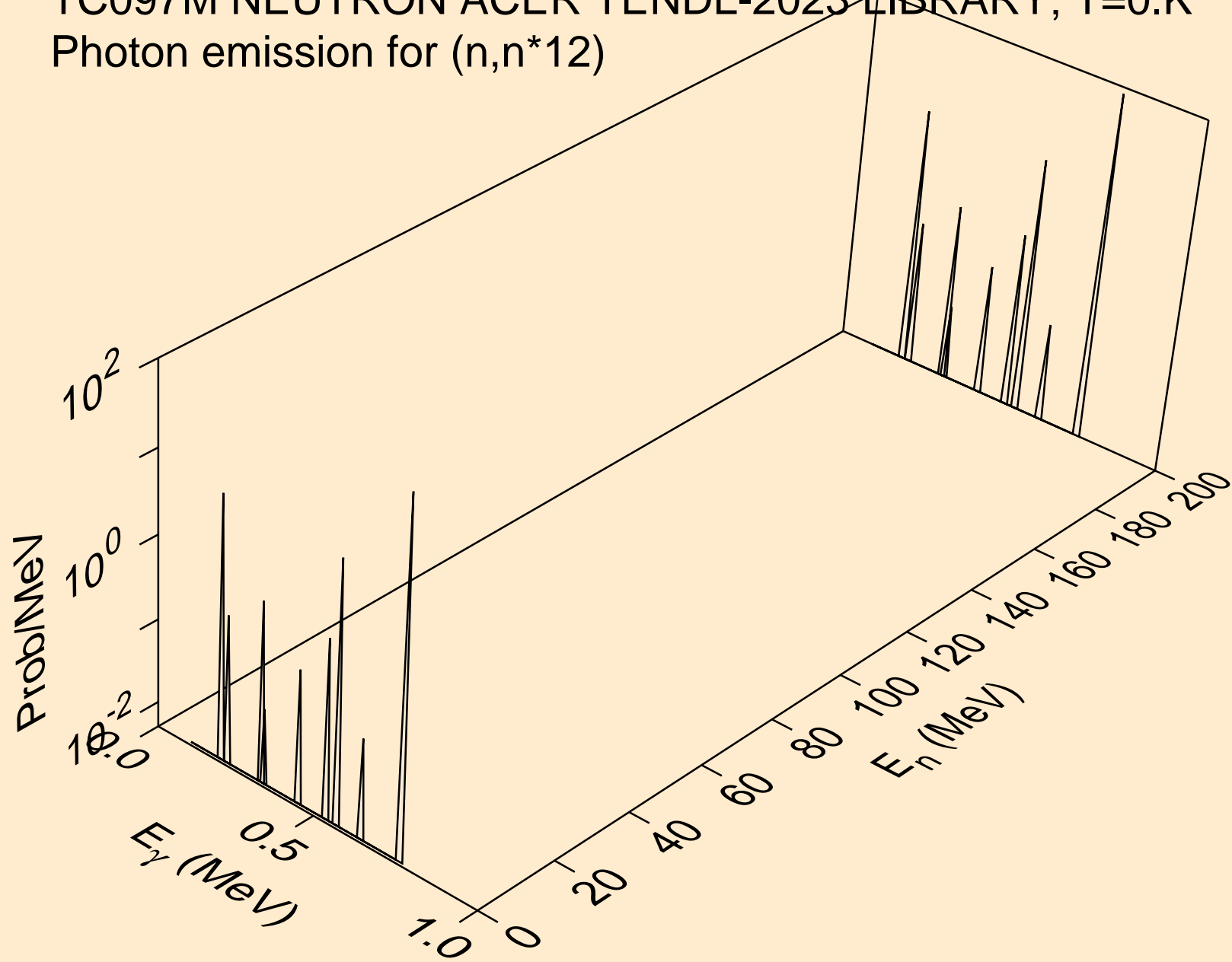

TC097M NEUTRON ACER TENDL-2023 LIBRARY; T=0.K
Photon emission for (n,n*13)

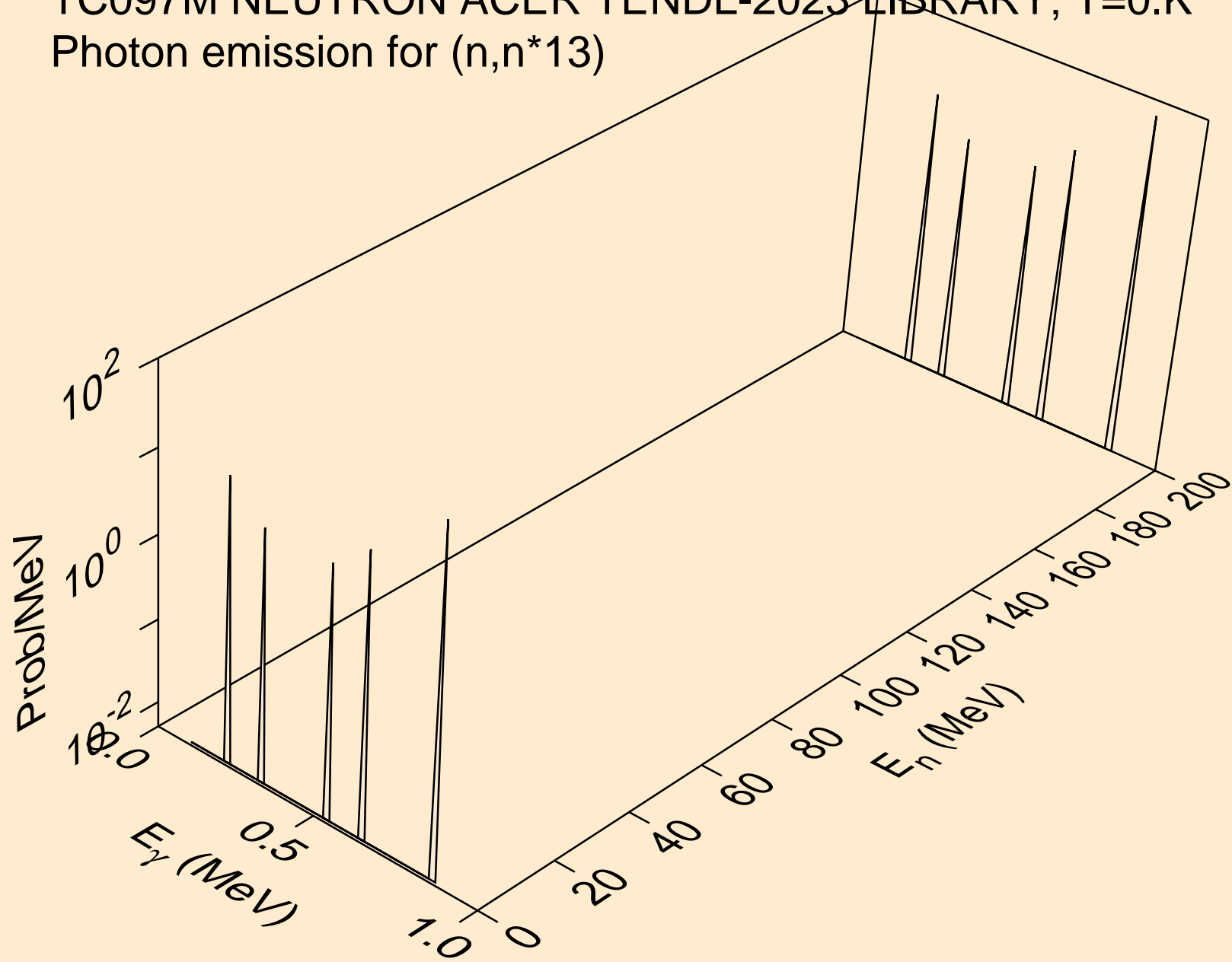

TC097M NEUTRON ACER TENDL-2023 LIBRARY; T=0.K
Photon emission for (n,n*14)

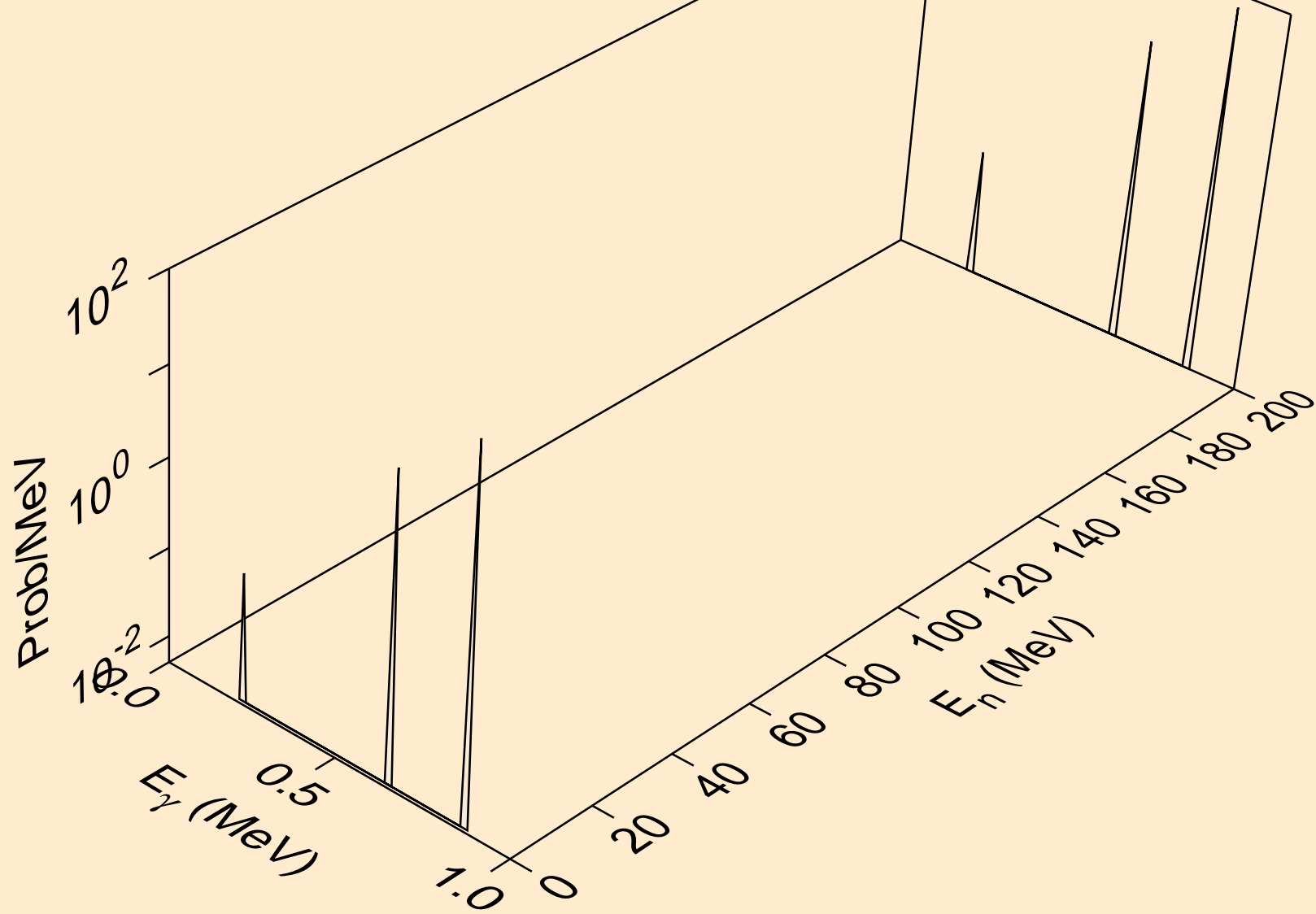

TC097M NEUTRON ACER TENDL-2023 LIBRARY; T=0.K
Photon emission for (n,n*15)

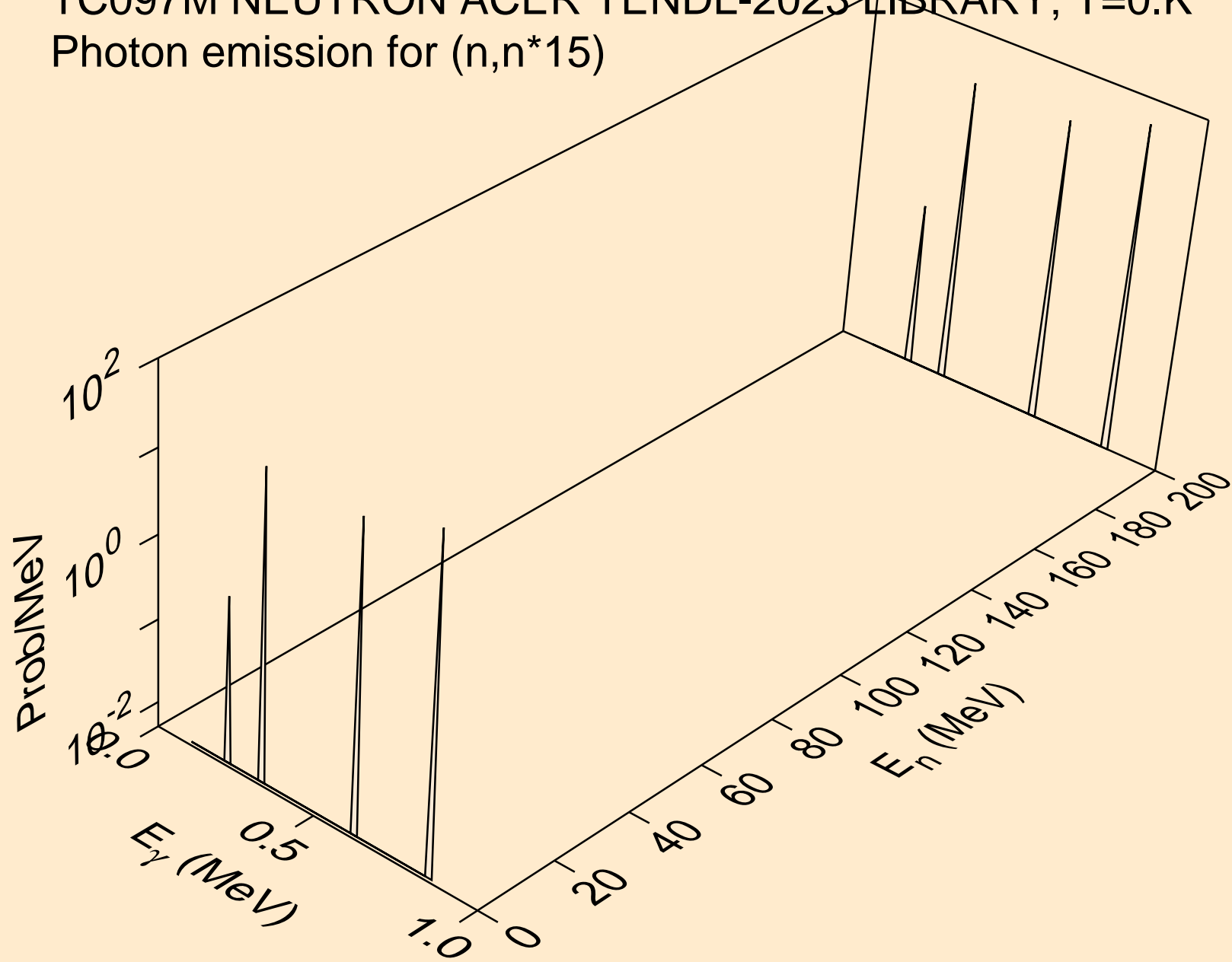

TC097M NEUTRON ACER TENDL-2023 LIBRARY; T=0.K
Photon emission for (n,n*16)

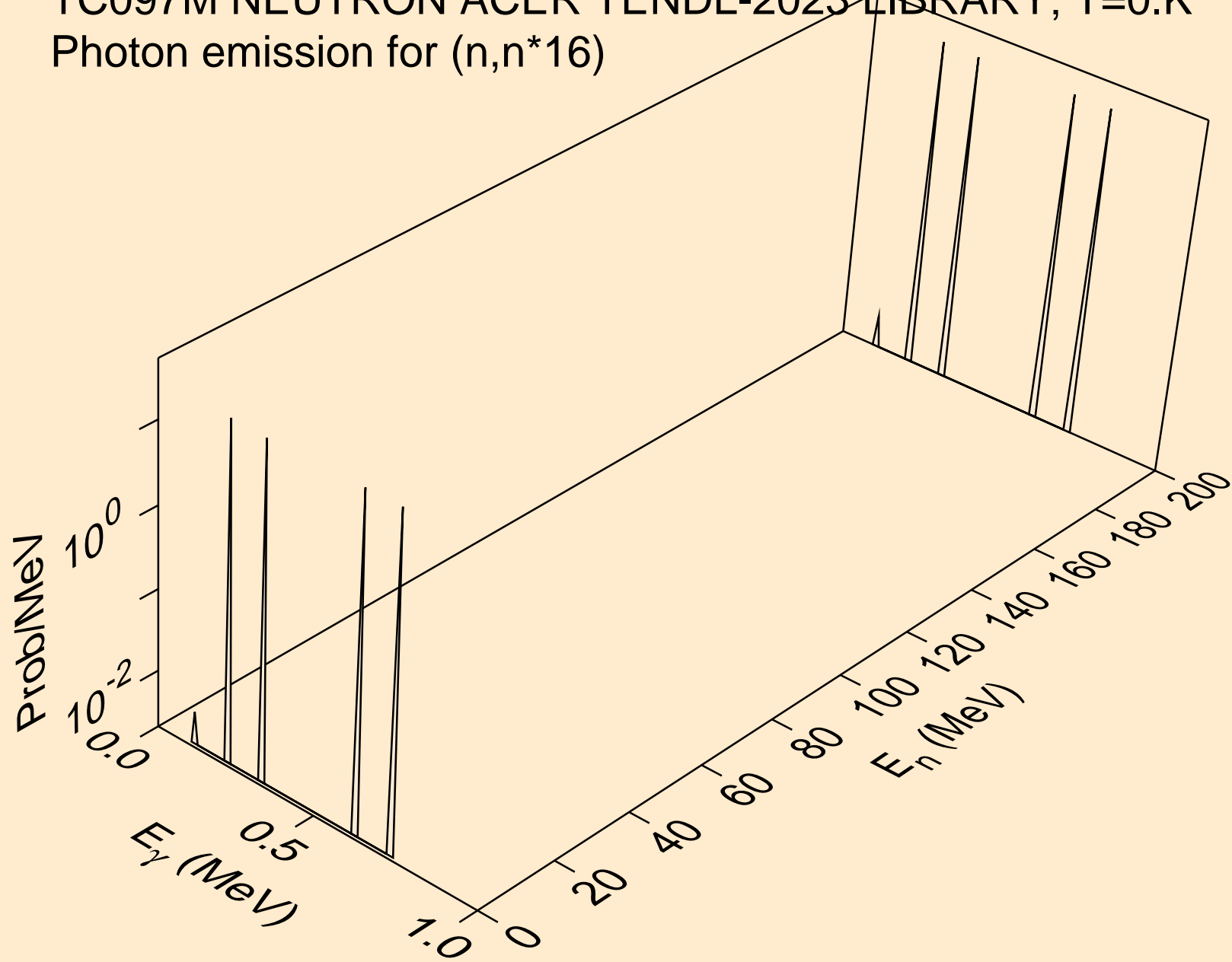

TC097M NEUTRON ACER TENDL-2023 LIBRARY; T=0.K
Photon emission for (n,n*17)

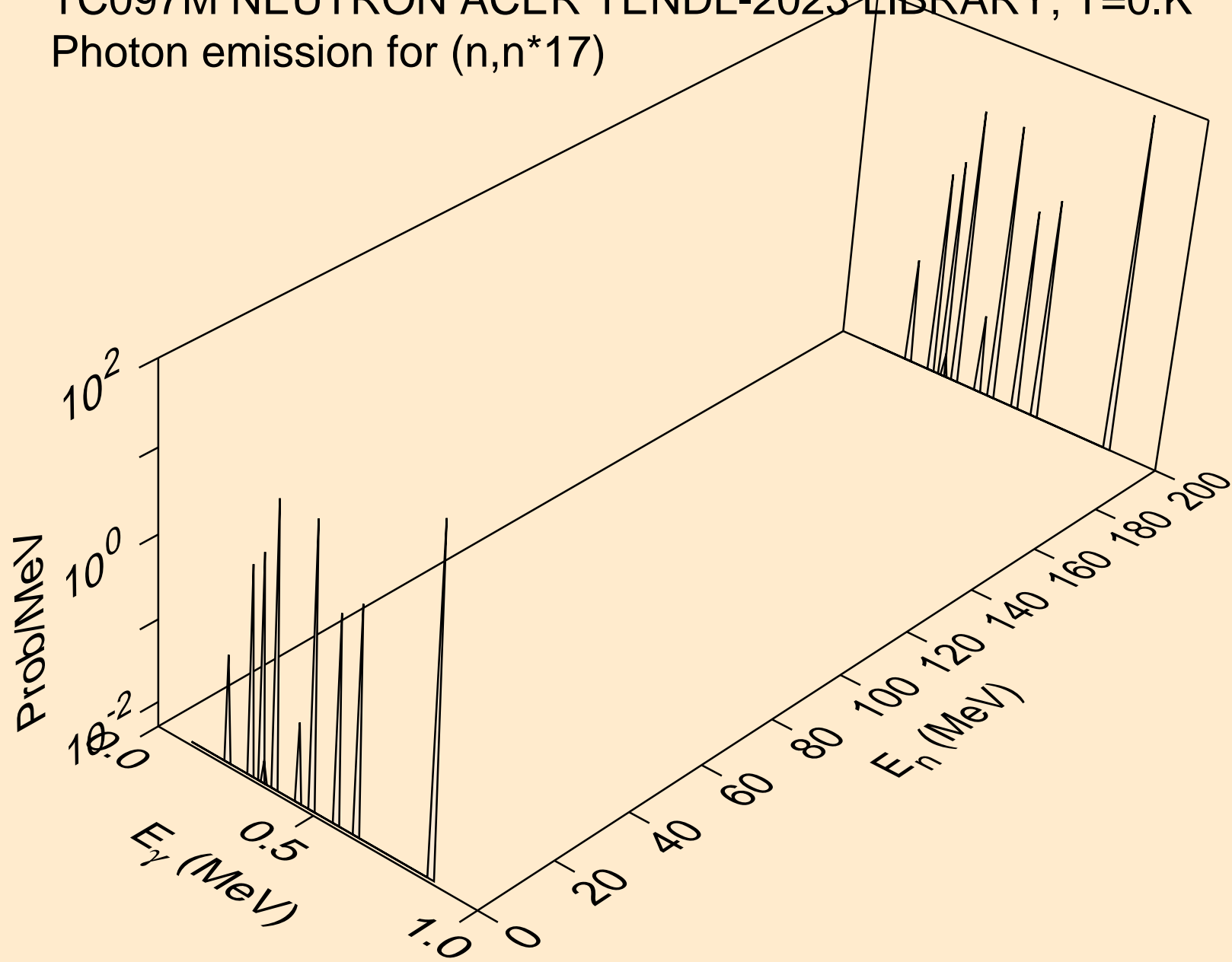

TC097M NEUTRON ACER TENDL-2023 LIBRARY; T=0.K
Photon emission for (n,n*18)

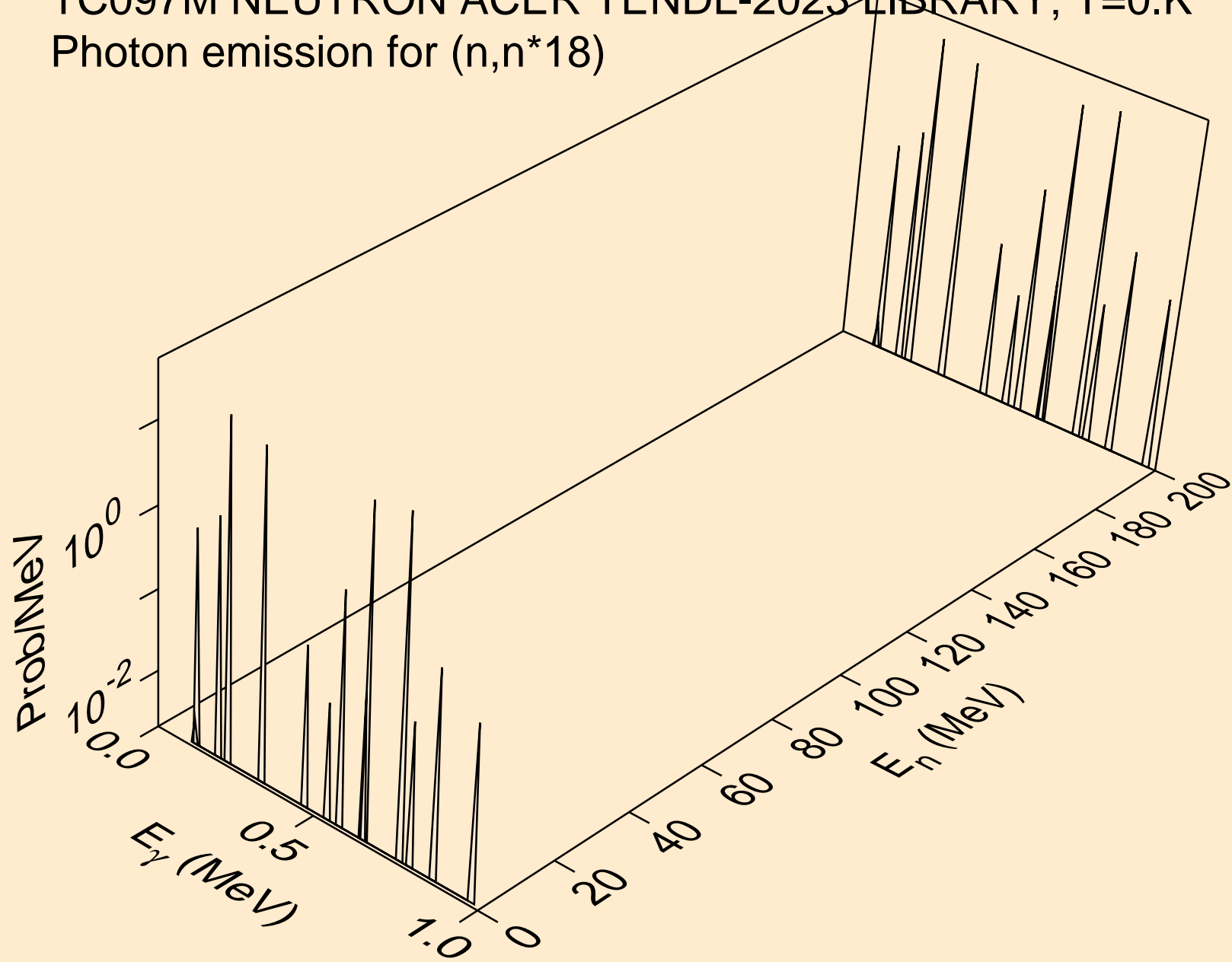

TC097M NEUTRON ACER TENDL-2023 LIBRARY; T=0.K
Photon emission for (n,n*19)

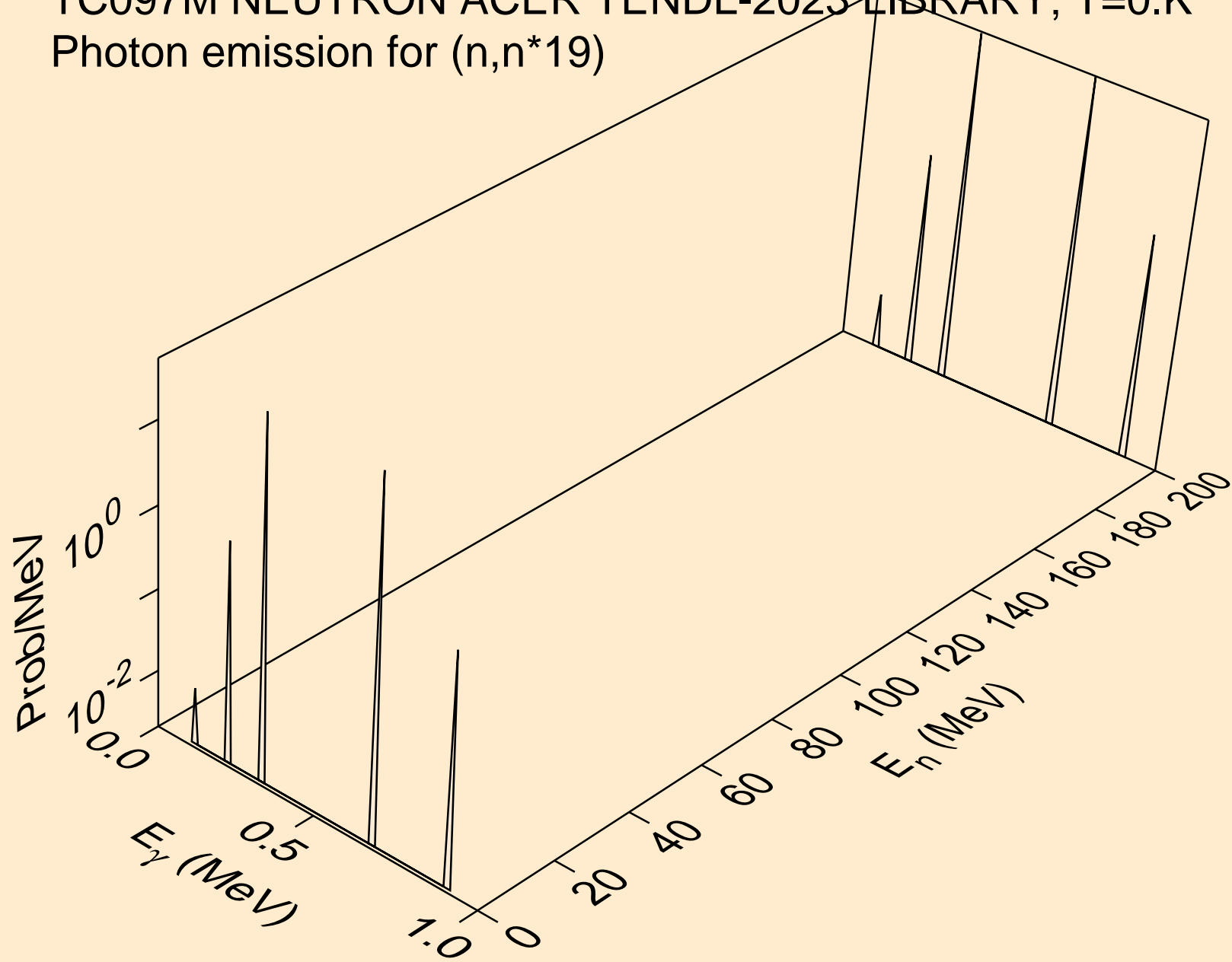

TC097M NEUTRON ACER TENDL-2023 LIBRARY; T=0.K
Photon emission for (n,n*c)

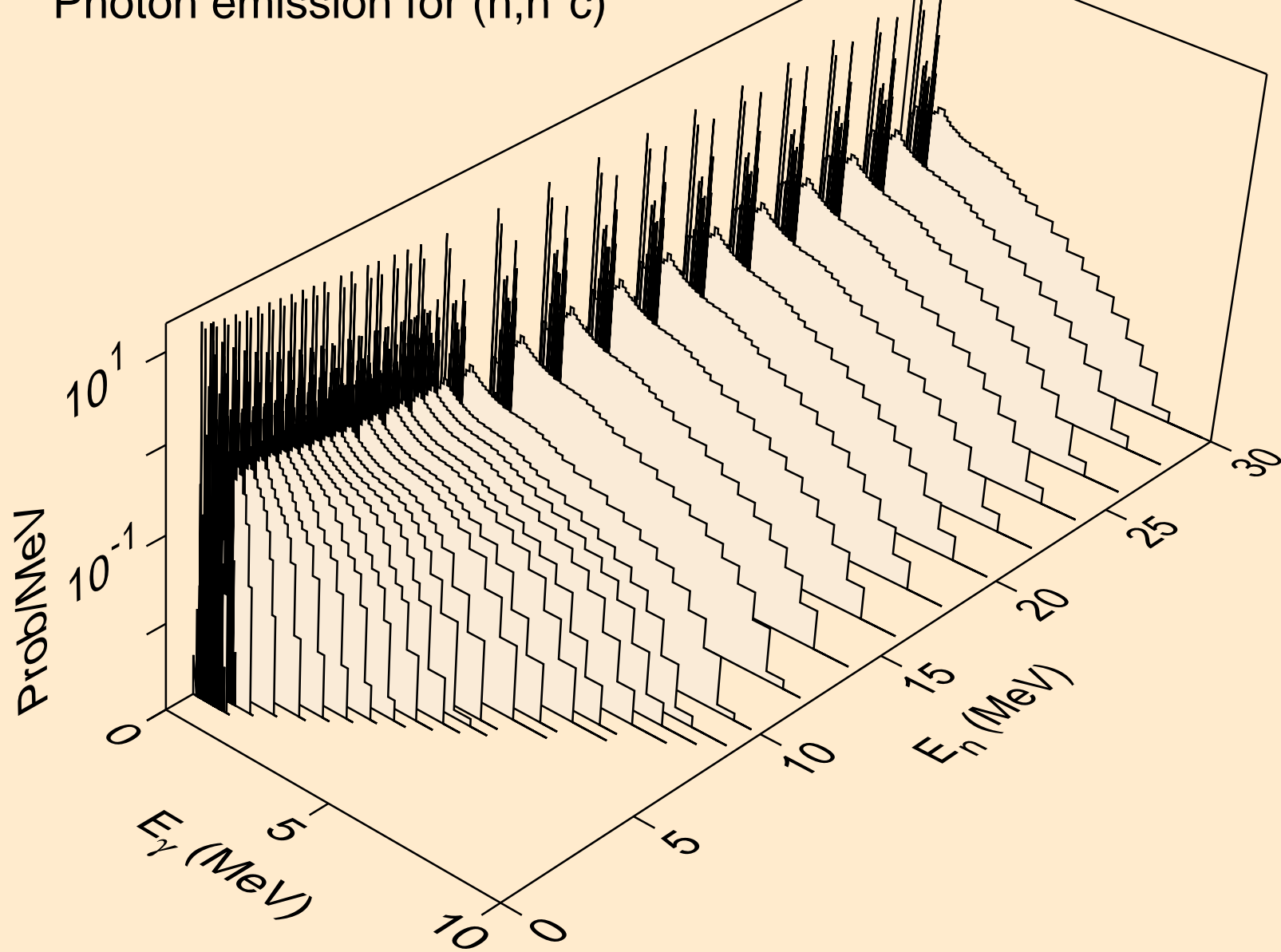

TC097M NEUTRON ACER TENDL-2023 LIBRARY; T=0.K
Photon emission for (n,gma)

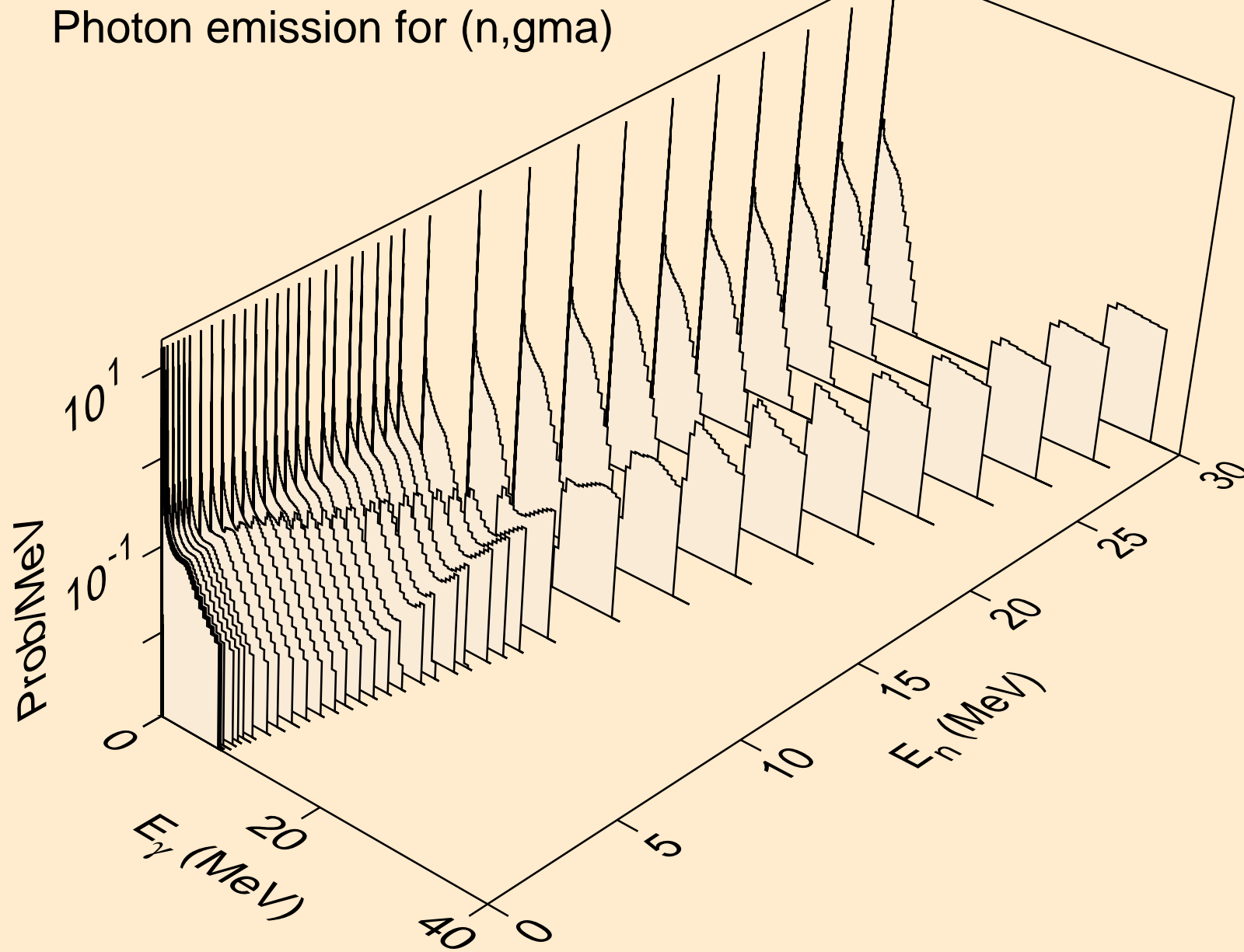

TC097M NEUTRON ACER TENDL-2023 LIBRARY; T=0.K
Photon emission for (n,p)

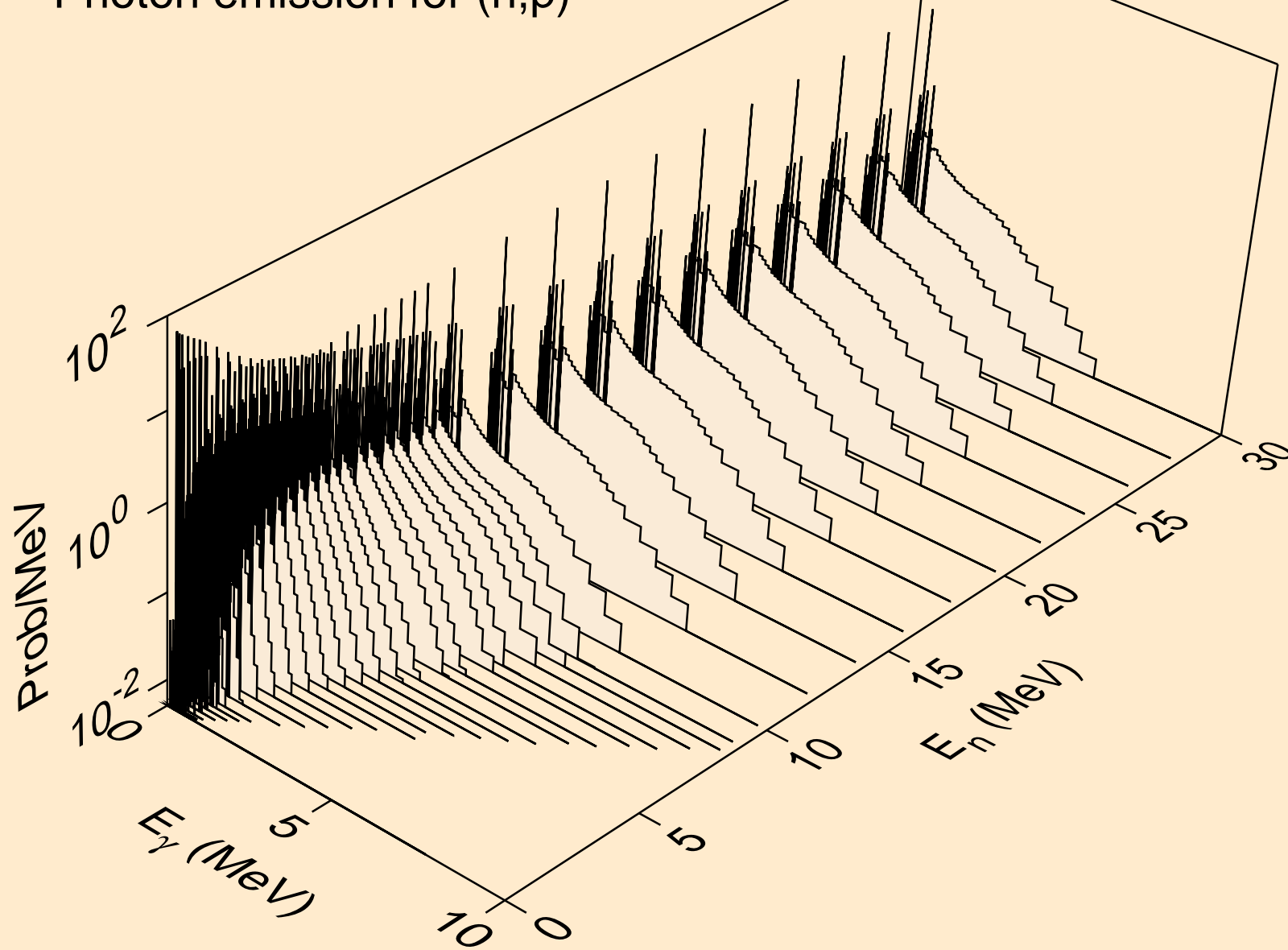

TC097M NEUTRON ACER TENDL-2023 LIBRARY; T=0.K
Photon emission for (n,d)

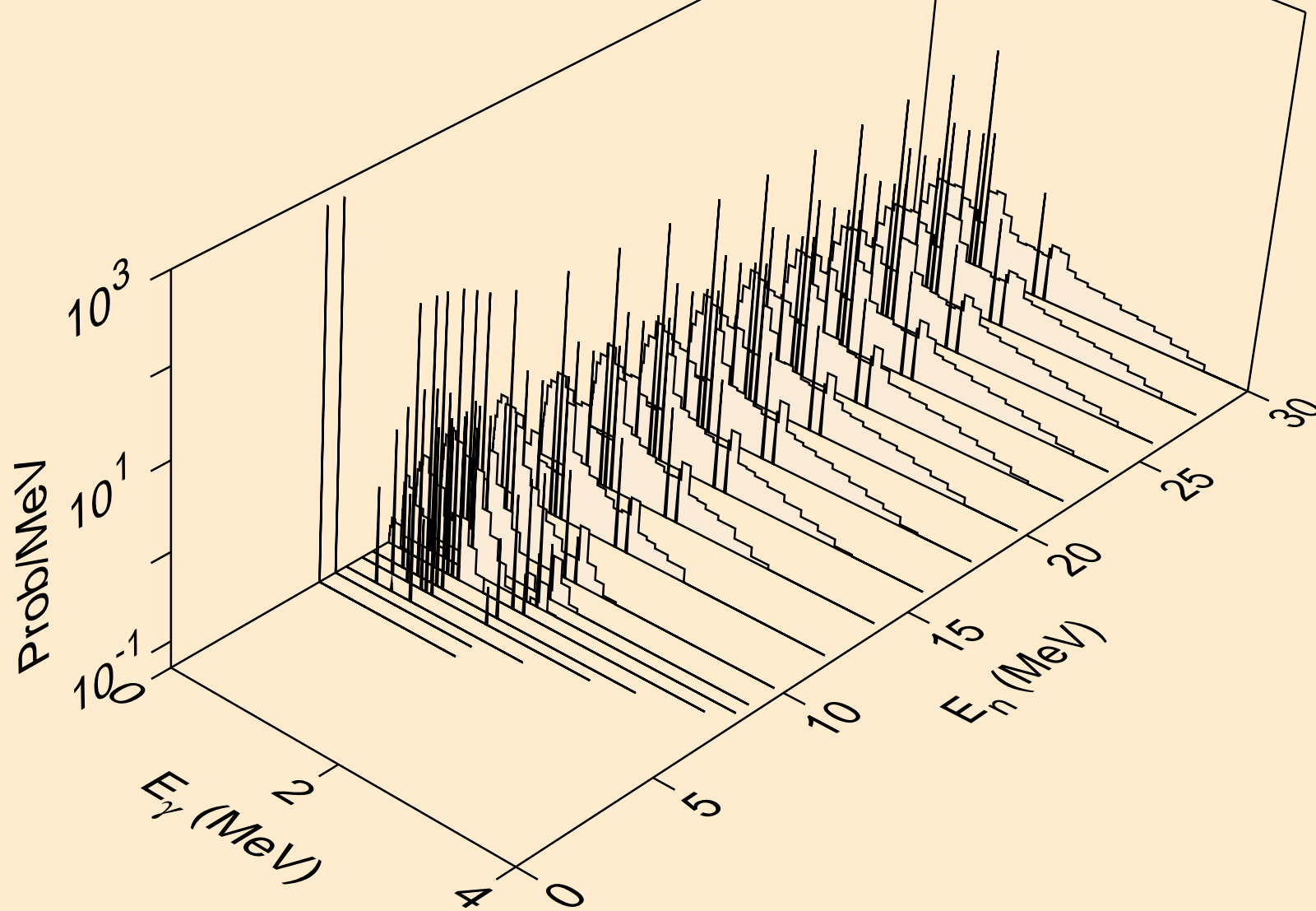

TC097M NEUTRON ACER TENDL-2023 LIBRARY; T=0.K
Photon emission for (n,t)

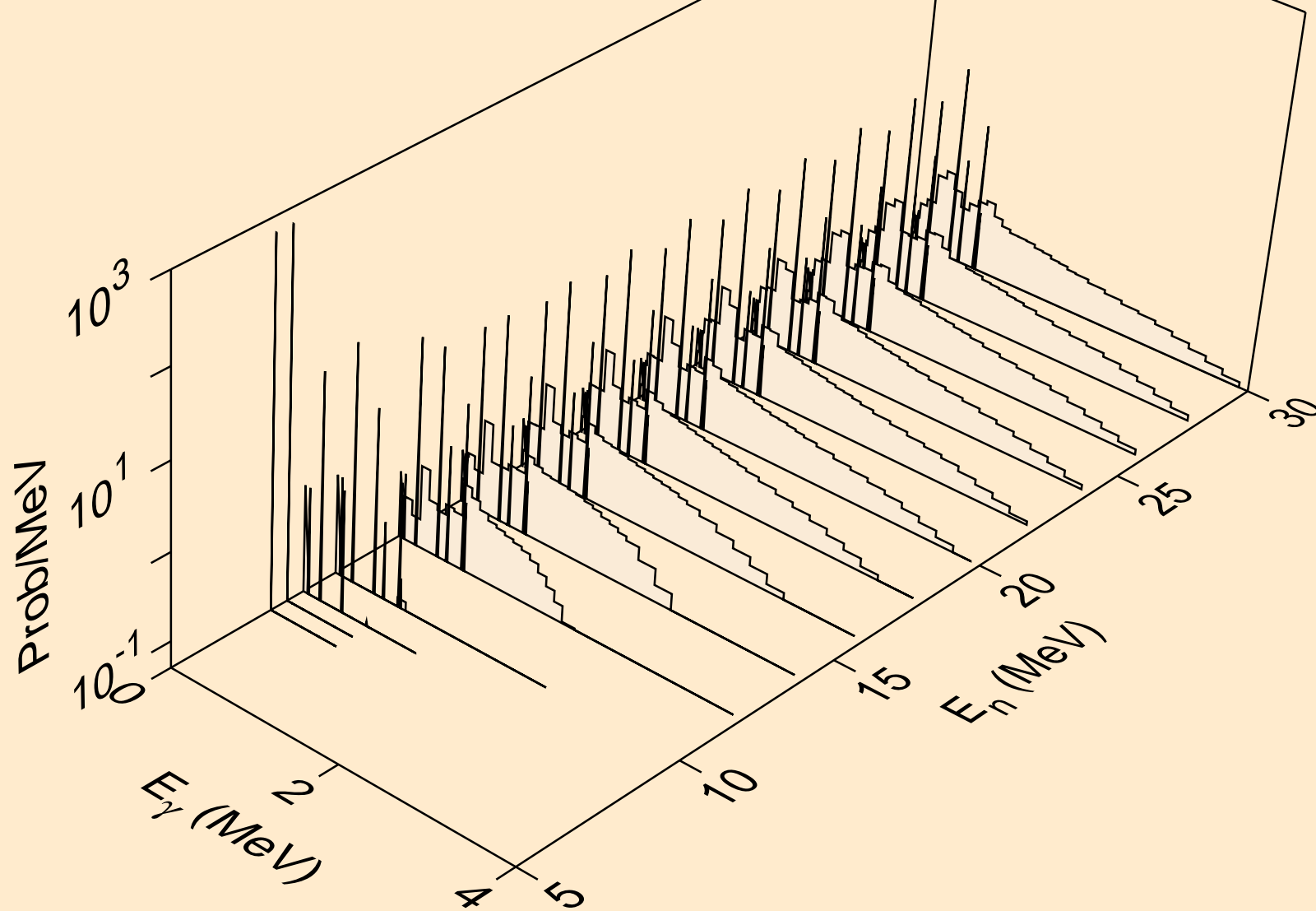

TC097M NEUTRON ACER TENDL-2023 LIBRARY; T=0.K
Photon emission for (n,he3)

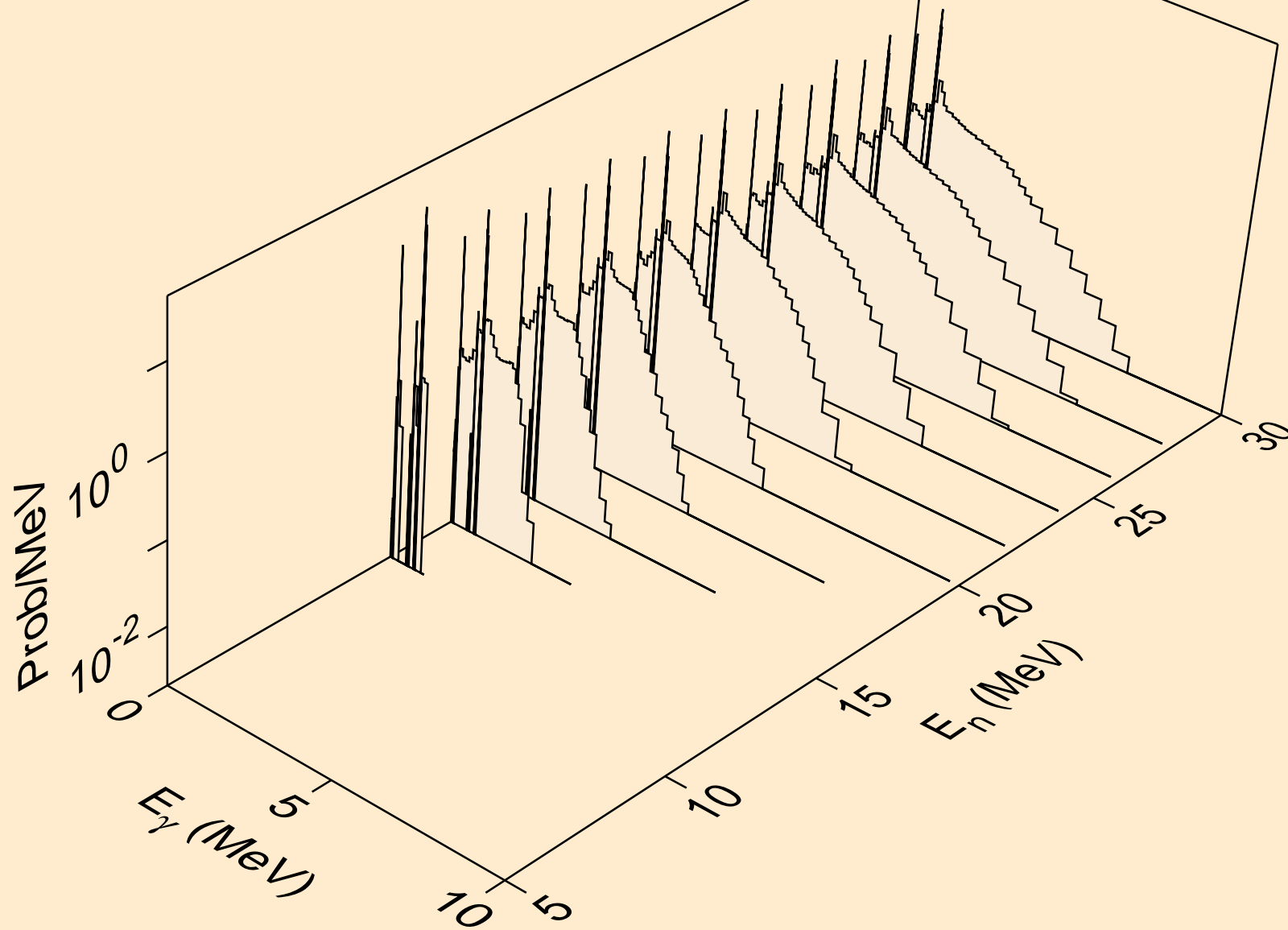

TC097M NEUTRON ACER TENDL-2023 LIBRARY; T=0.K
Photon emission for (n,a)

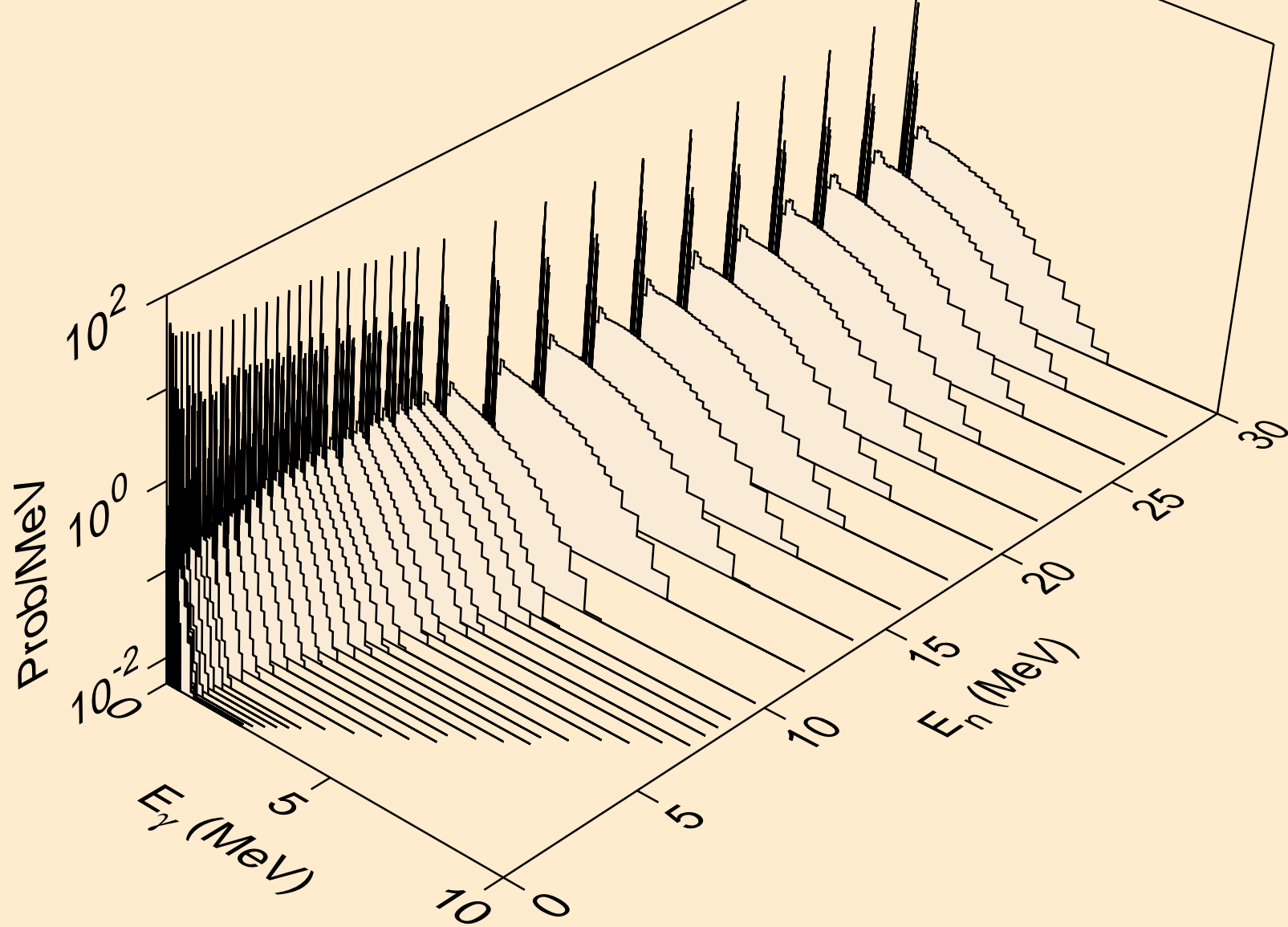

TC097M NEUTRON ACER TENDL-2023 LIBRARY; T=0.K
Photon emission for (n,2a)

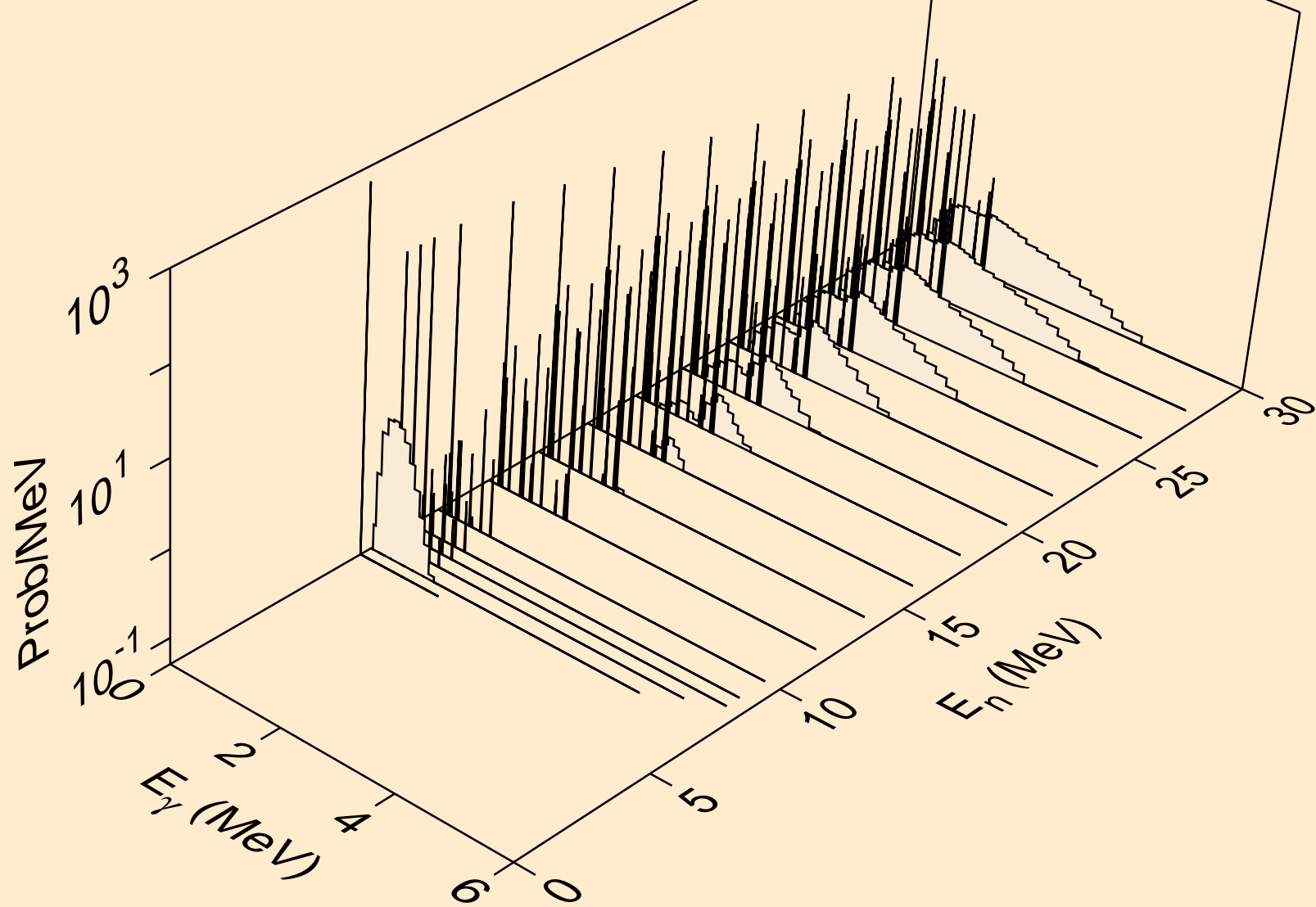

TC097M NEUTRON ACER TENDL-2023 LIBRARY; T=0.K
Photon emission for (n,2p)

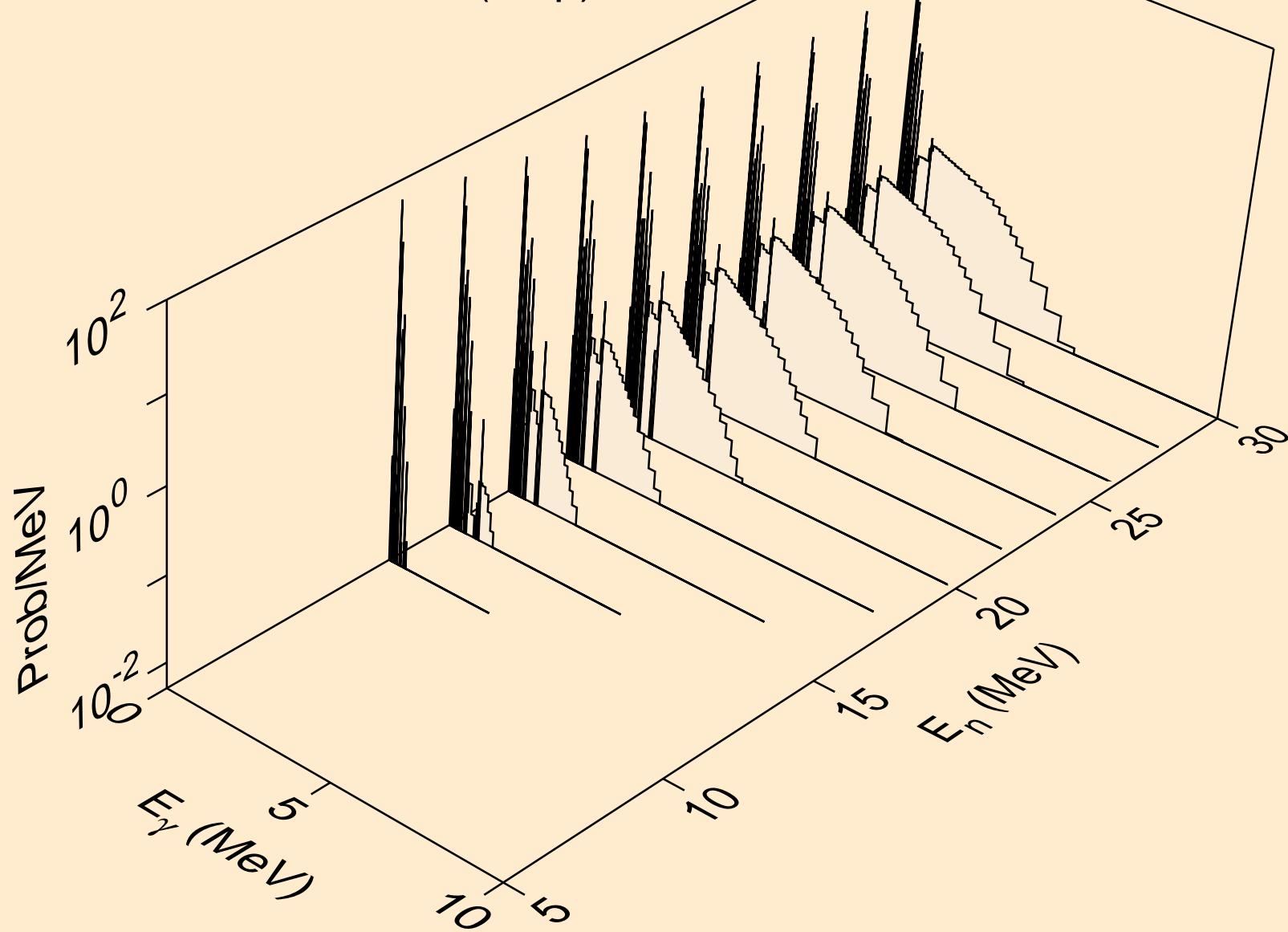

TC097M NEUTRON ACER TENDL-2023 LIBRARY; T=0.K
Photon emission for (n,p α)

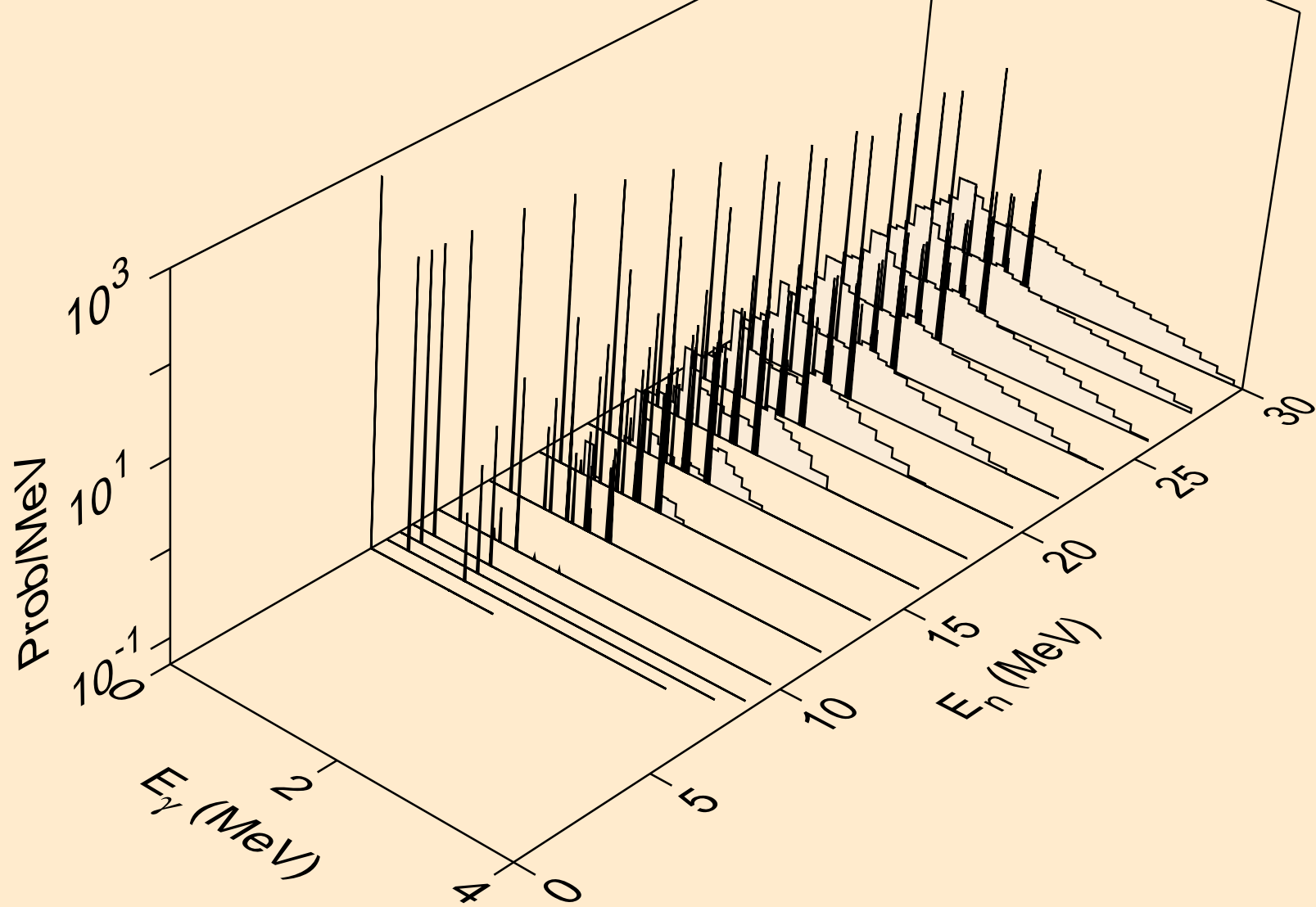

TC097M NEUTRON ACER TENDL-2023 LIBRARY; T=0.K
Photon emission for (n,pd)

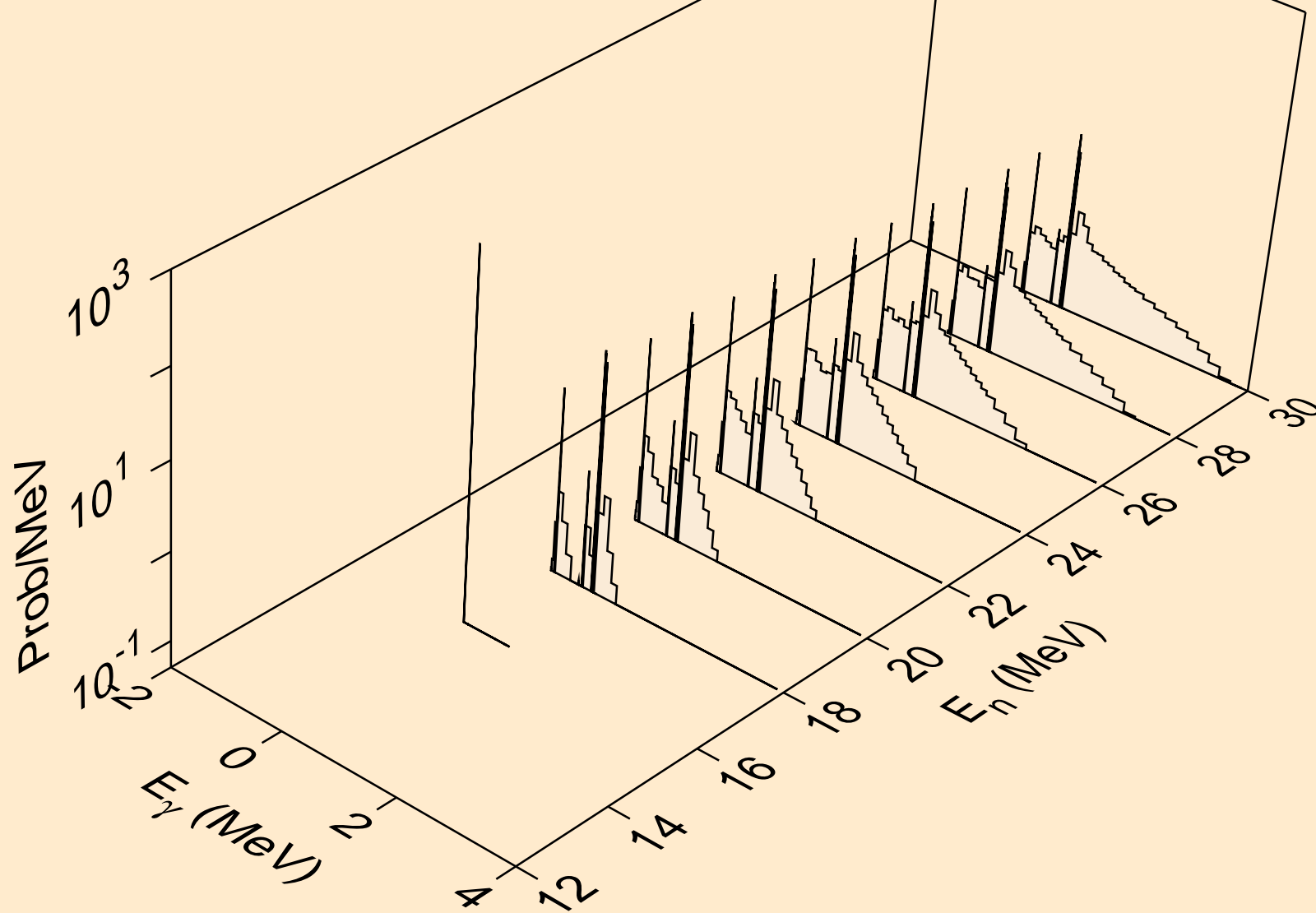

TC097M NEUTRON ACER TENDL-2023 LIBRARY; T=0.K
Photon emission for (n,pt)

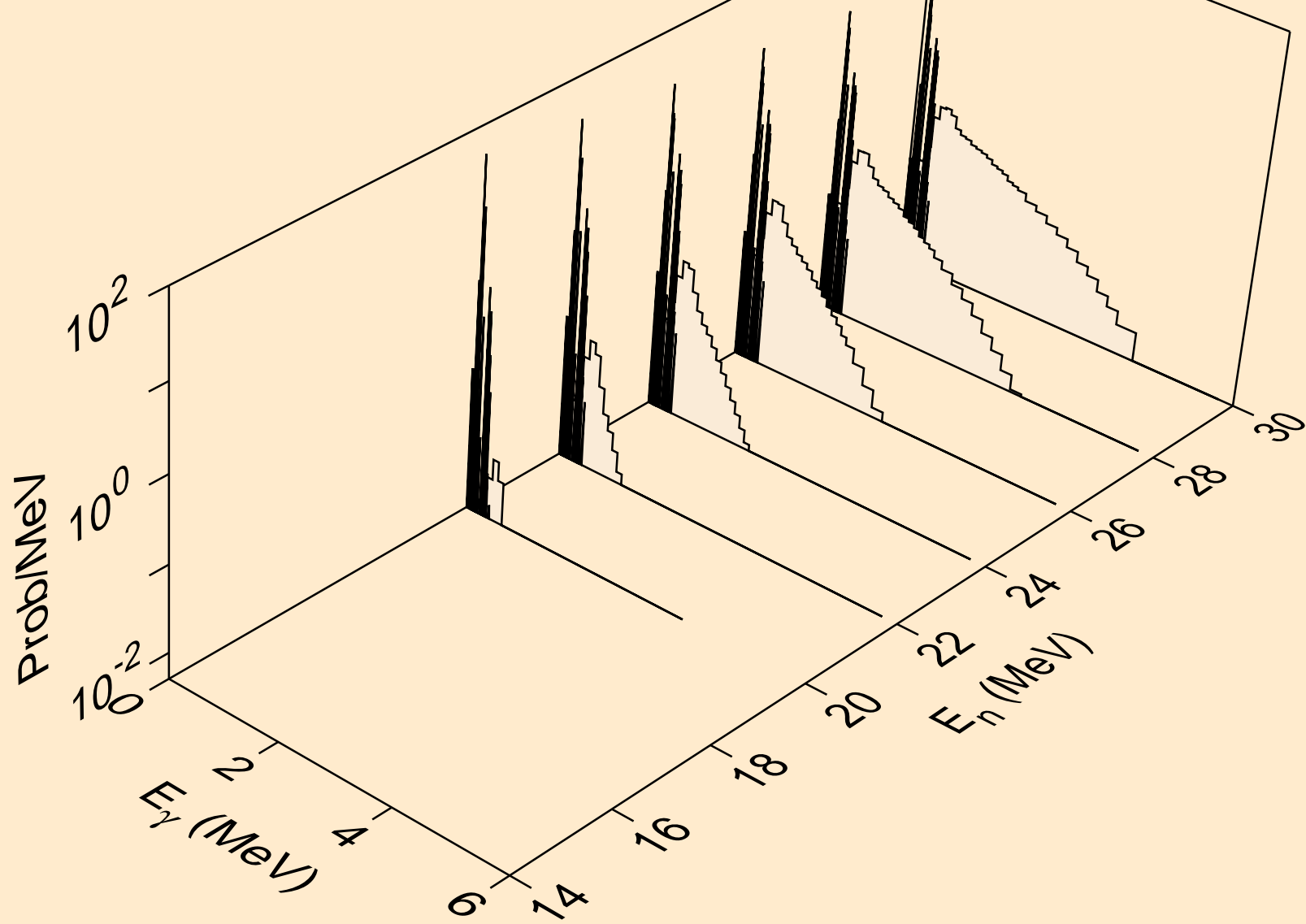

TC097M NEUTRON ACER TENDL-2023 LIBRARY; T=0.K
Photon emission for (n,da)

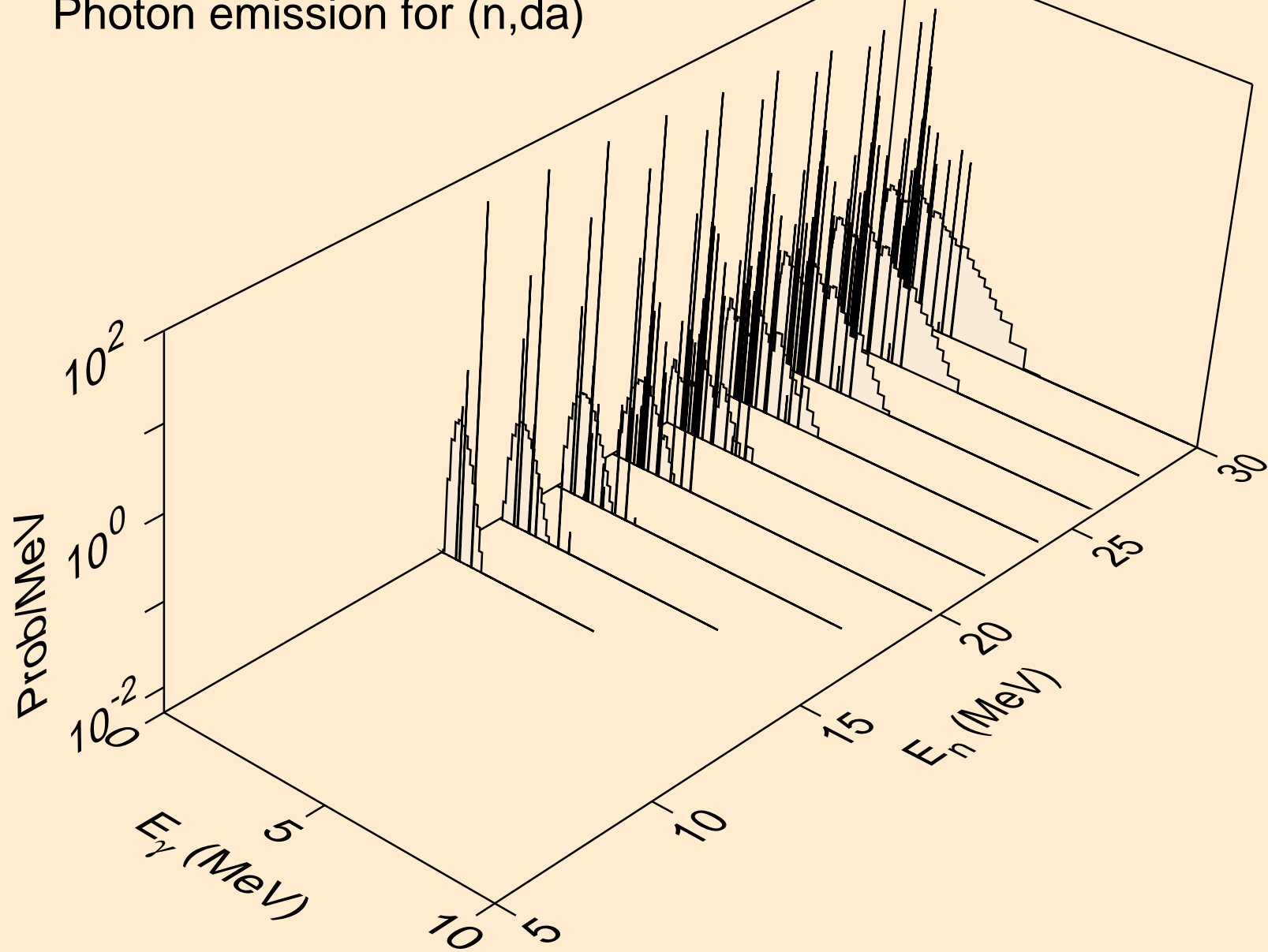

TC097M NEUTRON ACER TENDL-2023 LIBRARY; T=0.K
thermal capture photon spectrum

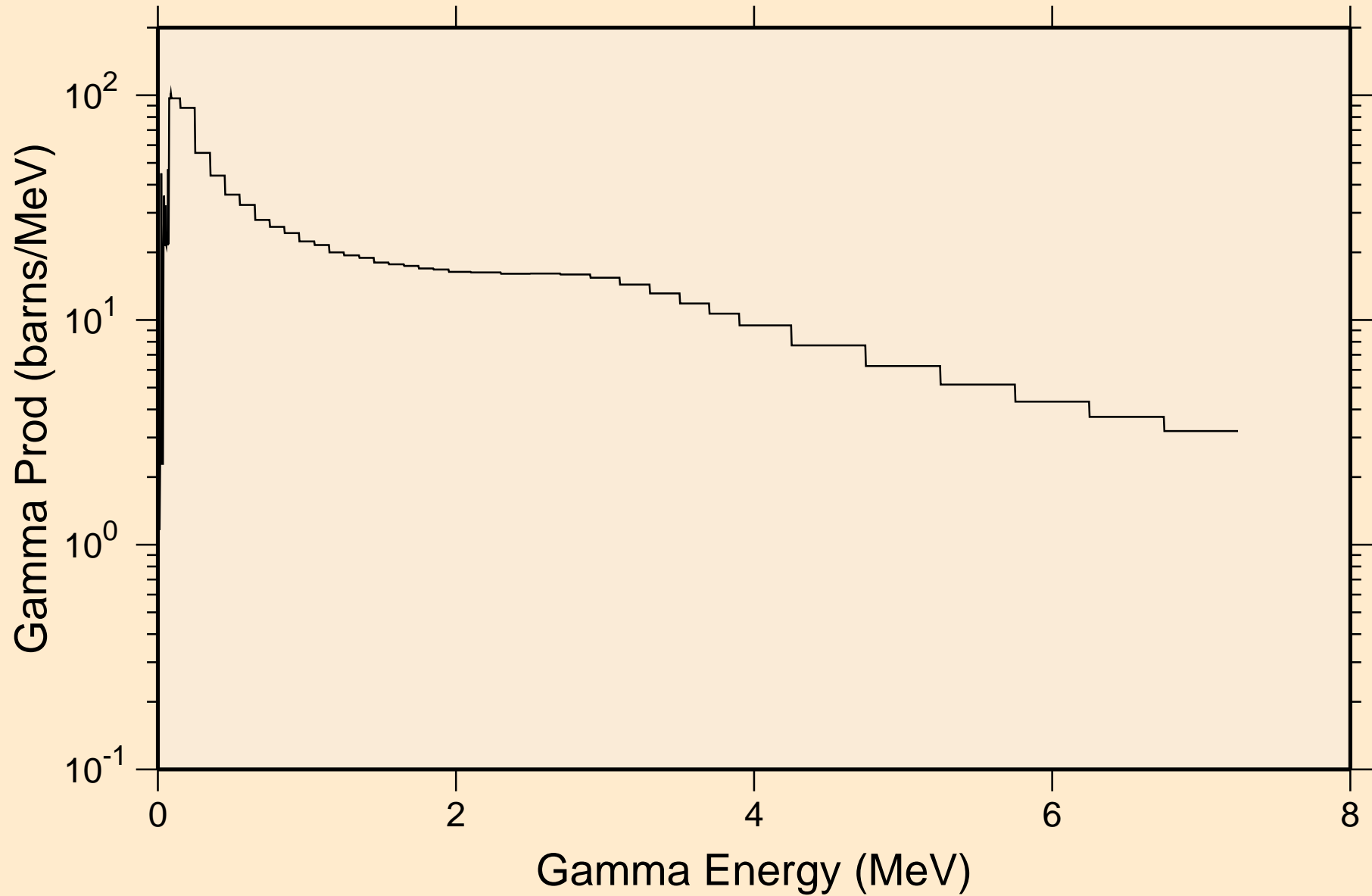

TC097M NEUTRON ACER TENDL-2023 LIBRARY; T=0.K
14 MeV photon spectrum

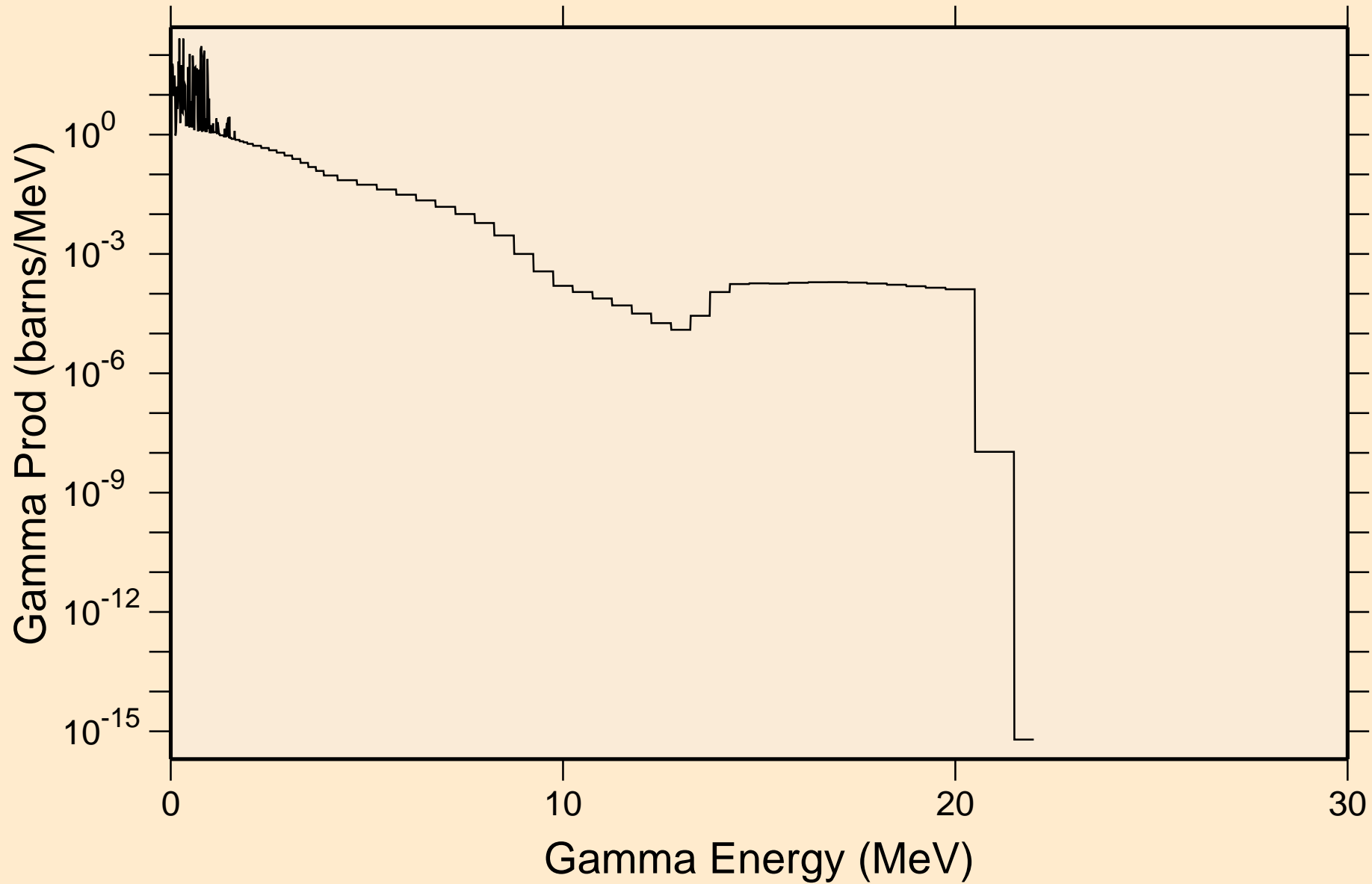

TC097M NEUTRON ACER TENDL-2023 LIBRARY; T=0.K
Particle heating contributions

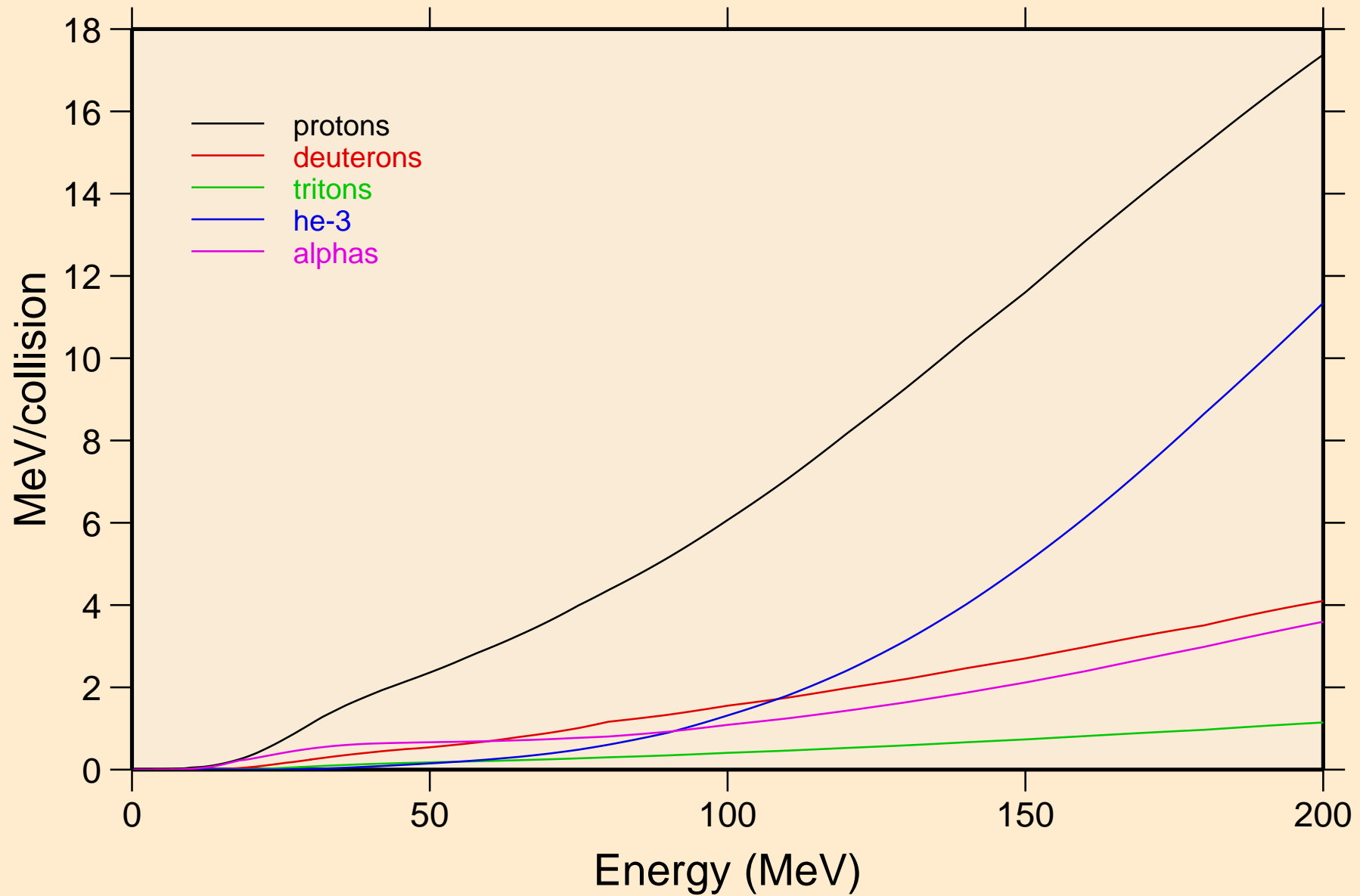

TC097M NEUTRON ACER TENDL-2023 LIBRARY; T=0.K
Recoil Heating

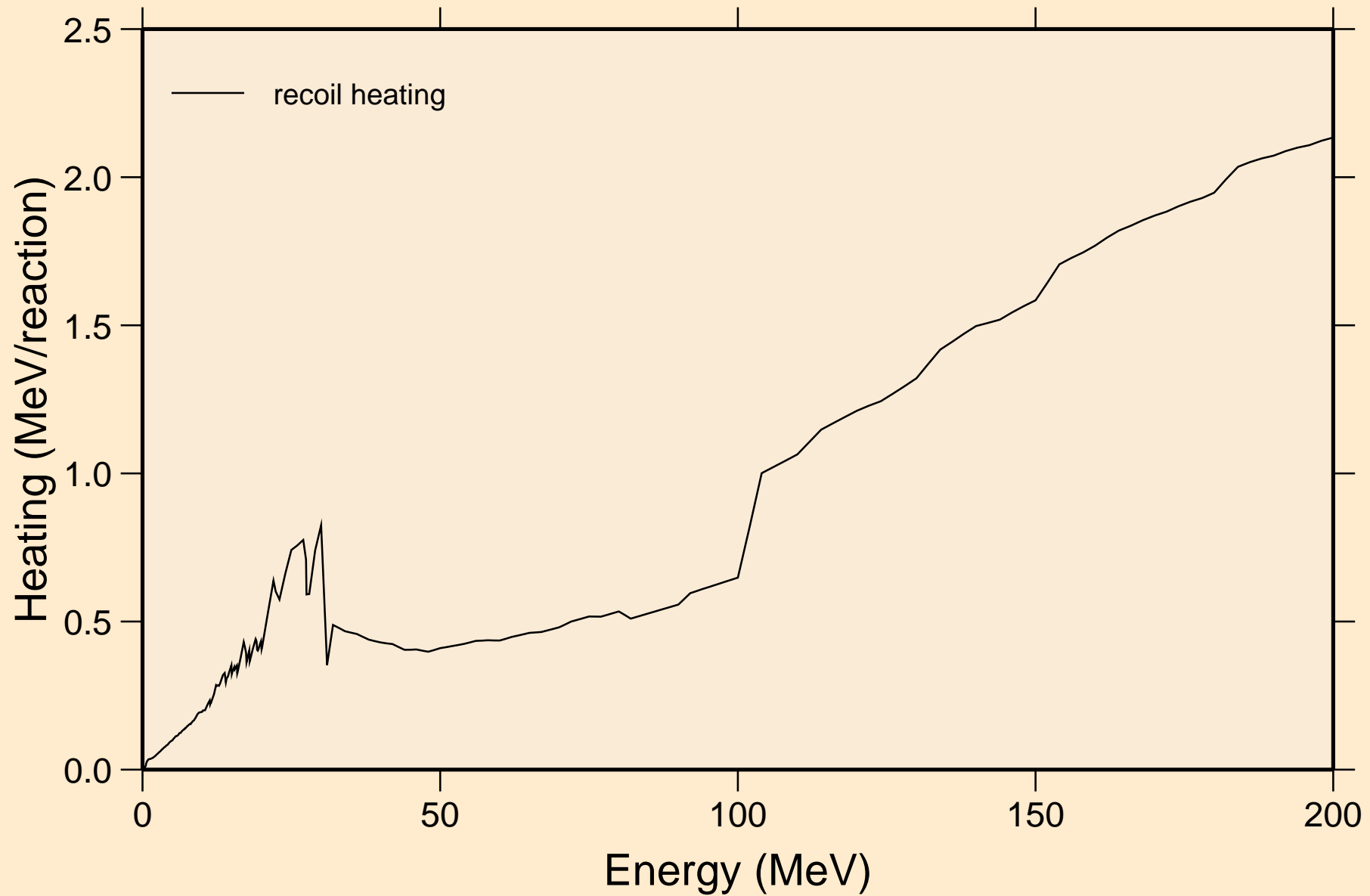

TC097M NEUTRON ACER TENDL-2023 LIBRARY; T=0.K
Particle production cross sections

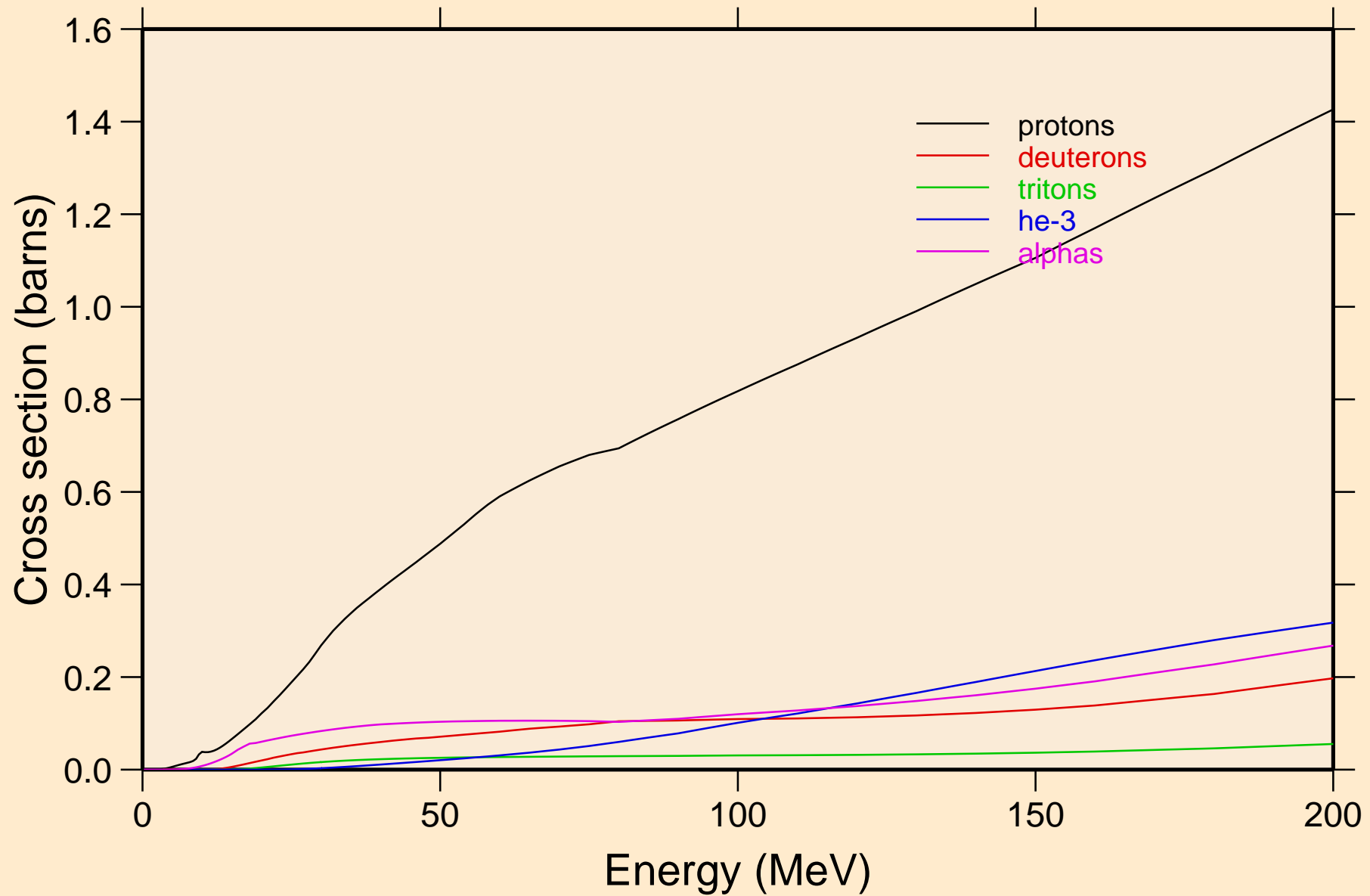

TC097M NEUTRON ACER TENDL-2023 LIBRARY; T=0.K
protons from (n,x)

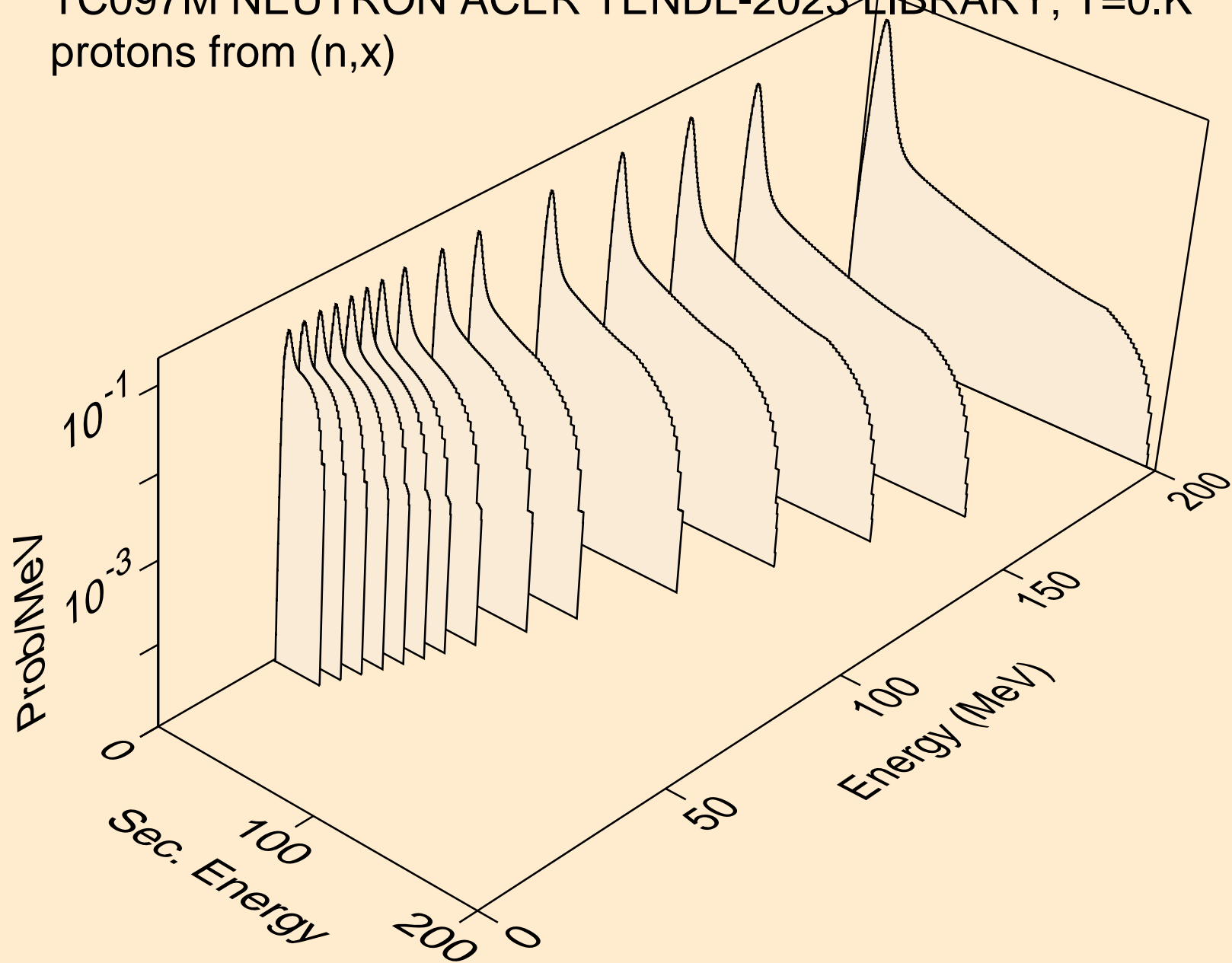

TC097M NEUTRON ACER TENDL-2023 LIBRARY; T=0.K
protons from (n,n*)p

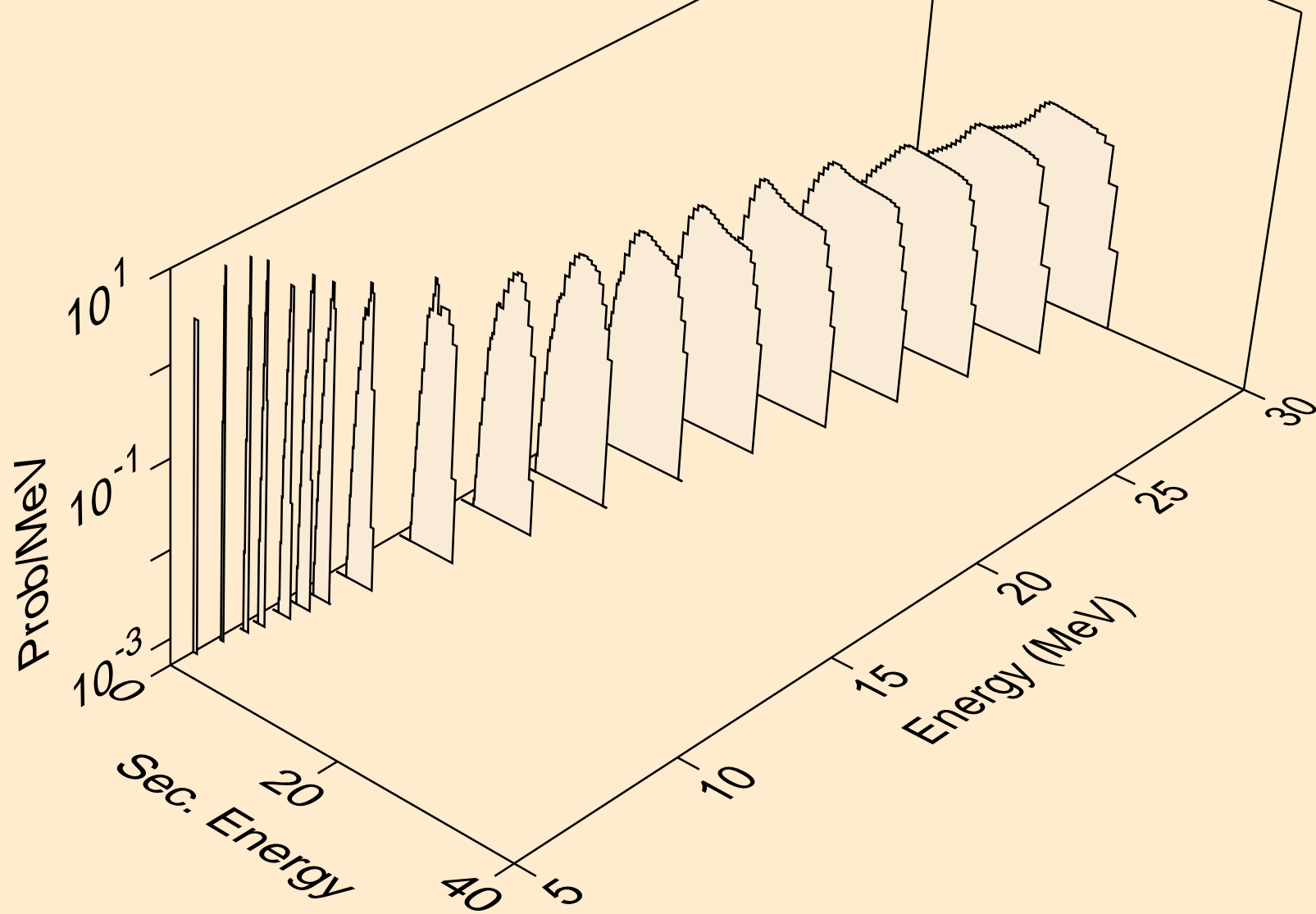

TC097M NEUTRON ACER TENDL-2023 LIBRARY; T=0.K
protons from (n,2np)

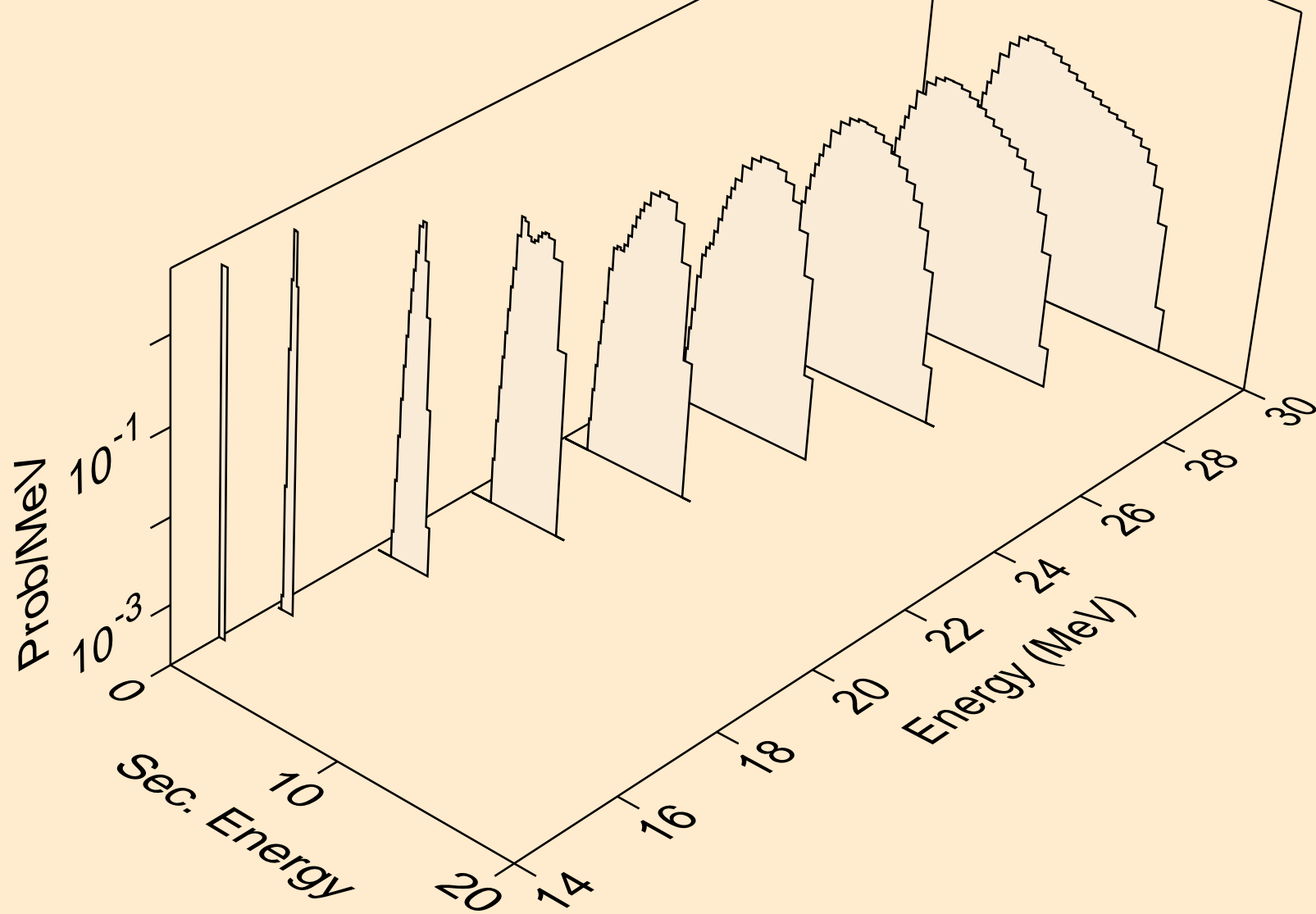

TC097M NEUTRON ACER TENDL-2023 LIBRARY; T=0.K
protons from (n,3np)

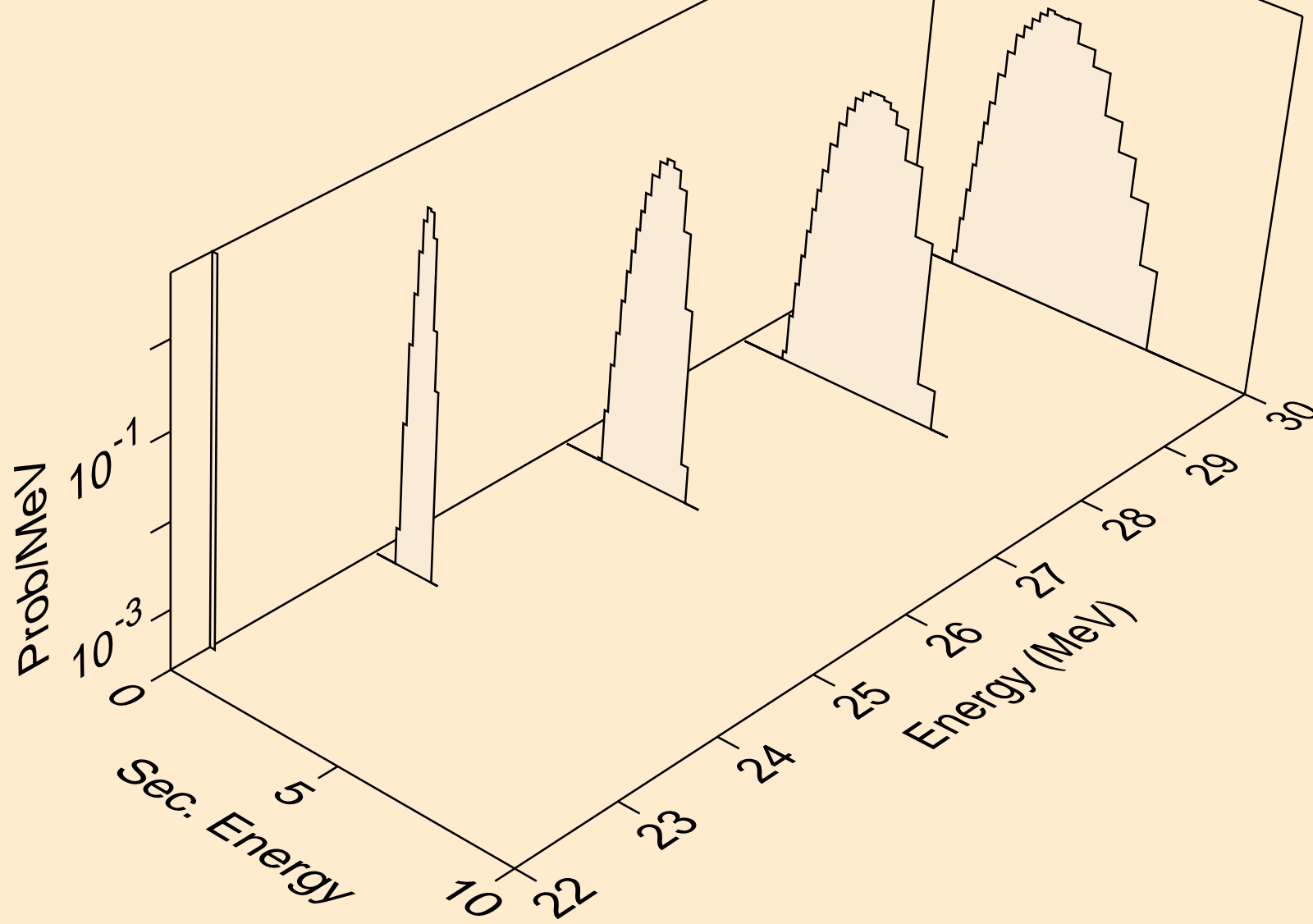

TC097M NEUTRON ACER TENDL-2023 LIBRARY; T=0.K
protons from (n,n2p)

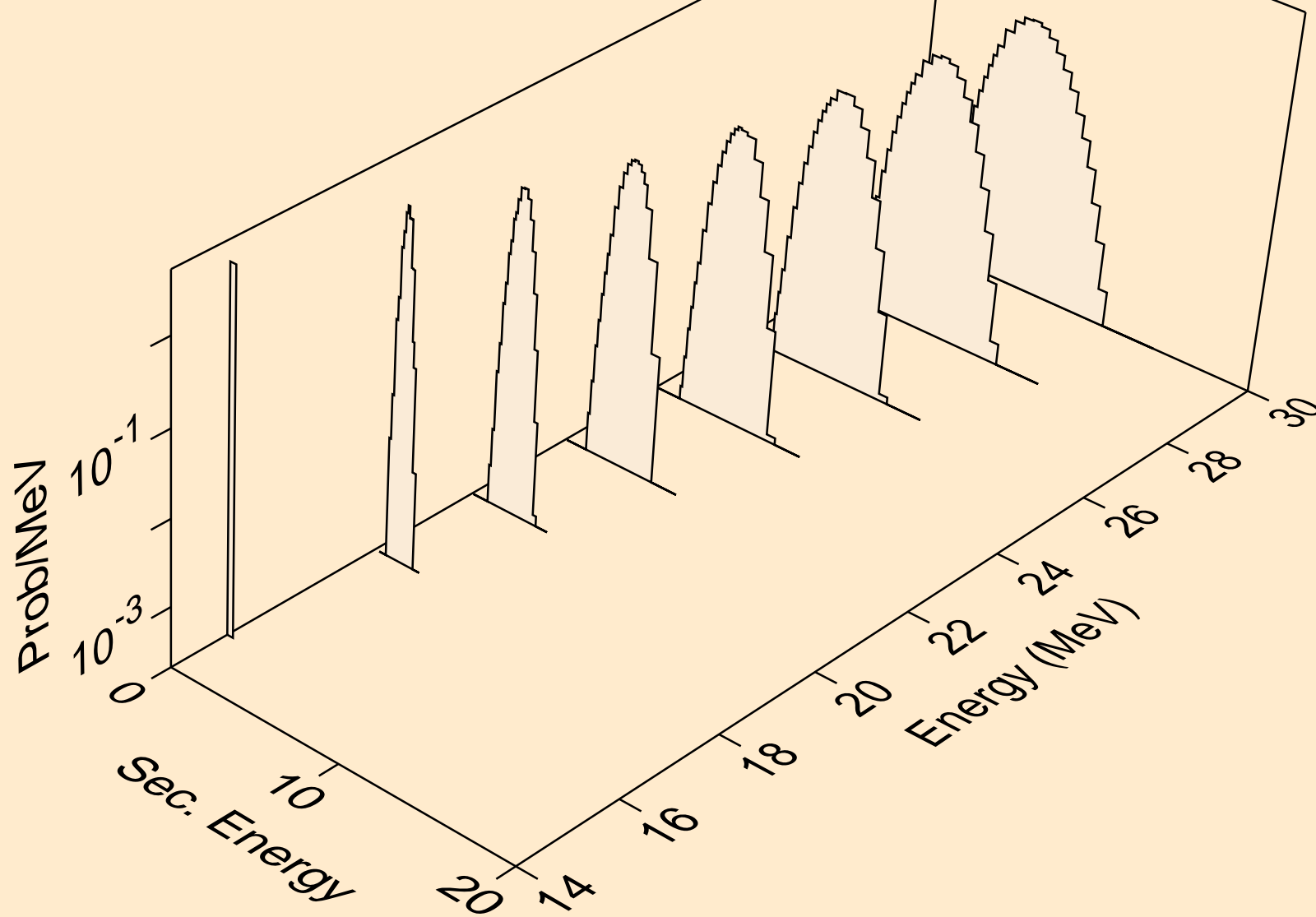

TC097M NEUTRON ACER TENDL-2023 LIBRARY; T=0.K
protons from (n,npa)

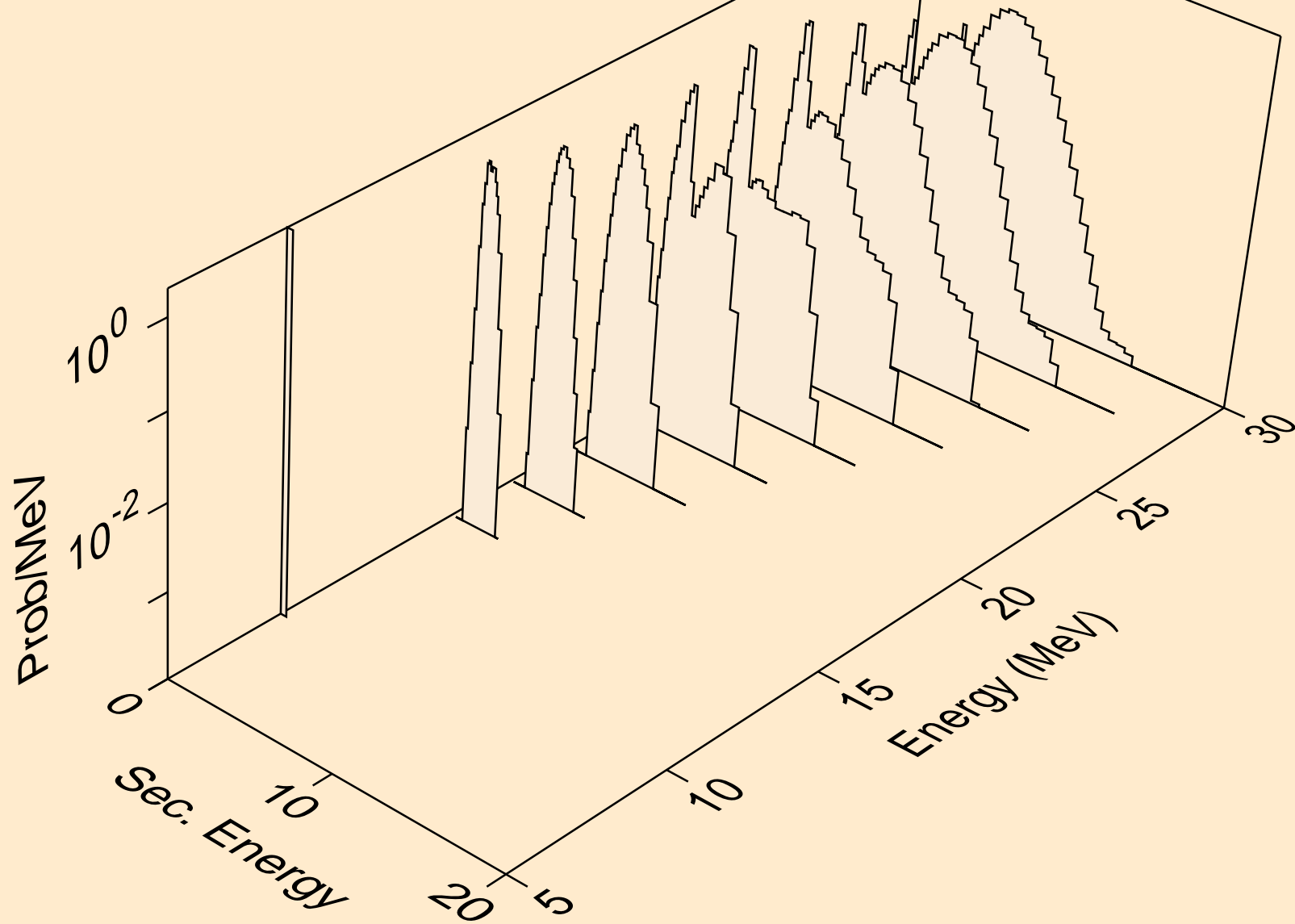

TC097M NEUTRON ACER TENDL-2023 LIBRARY; T=0.K
protons from (n,p)

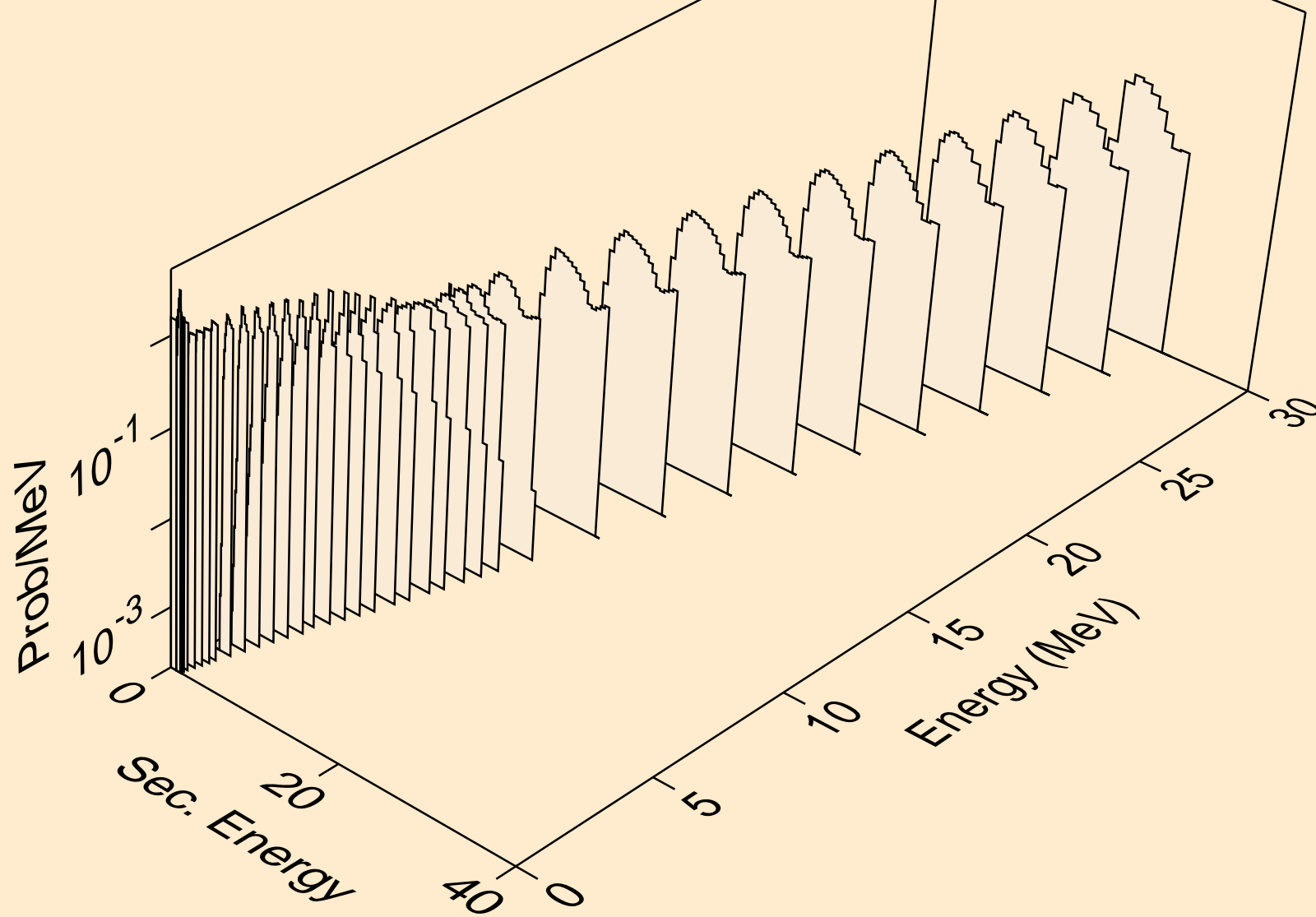

TC097M NEUTRON ACER TENDL-2023 LIBRARY; T=0.K
protons from (n,2p)

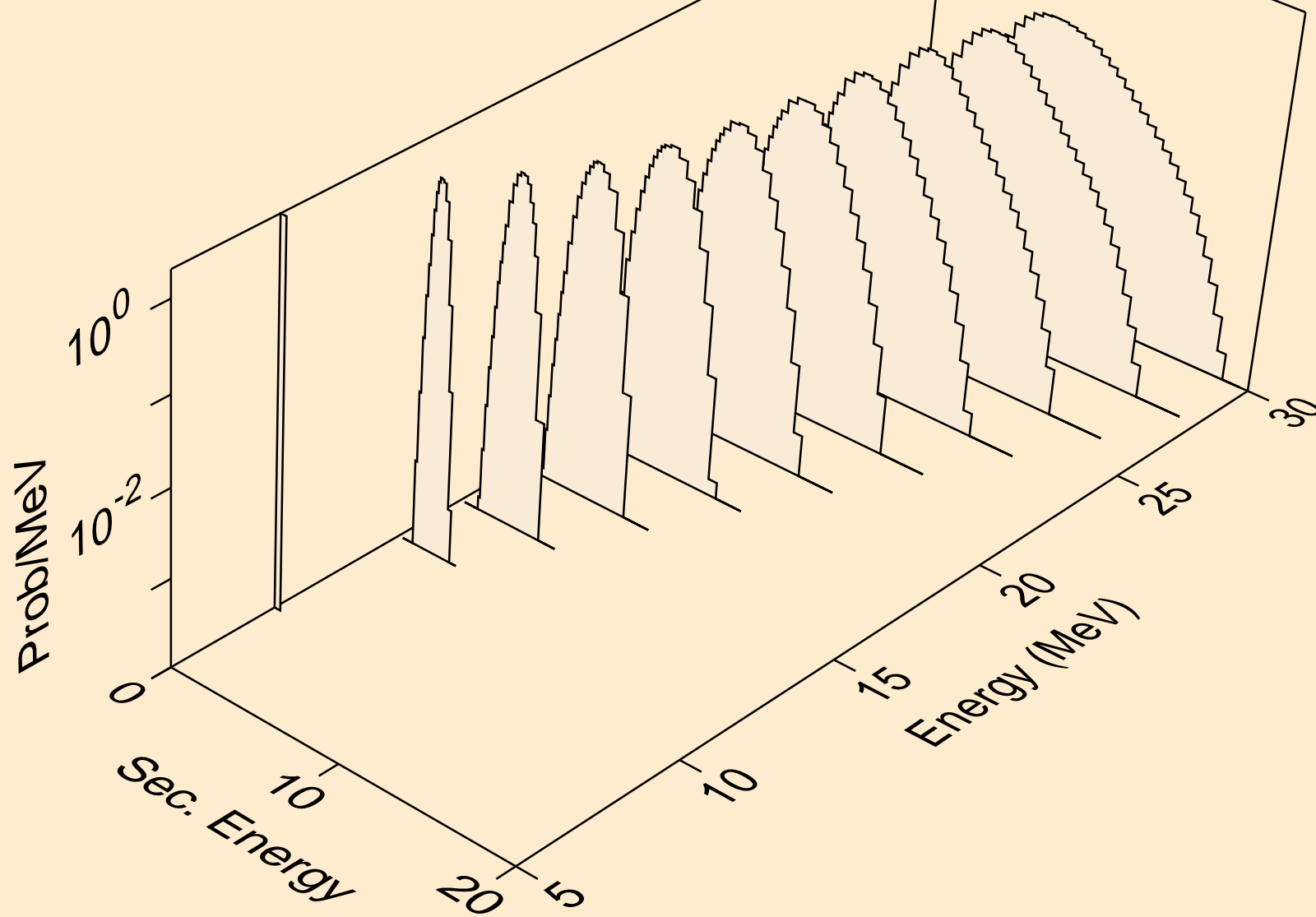

TC097M NEUTRON ACER TENDL-2023 LIBRARY; T=0.K
protons from (n,p)

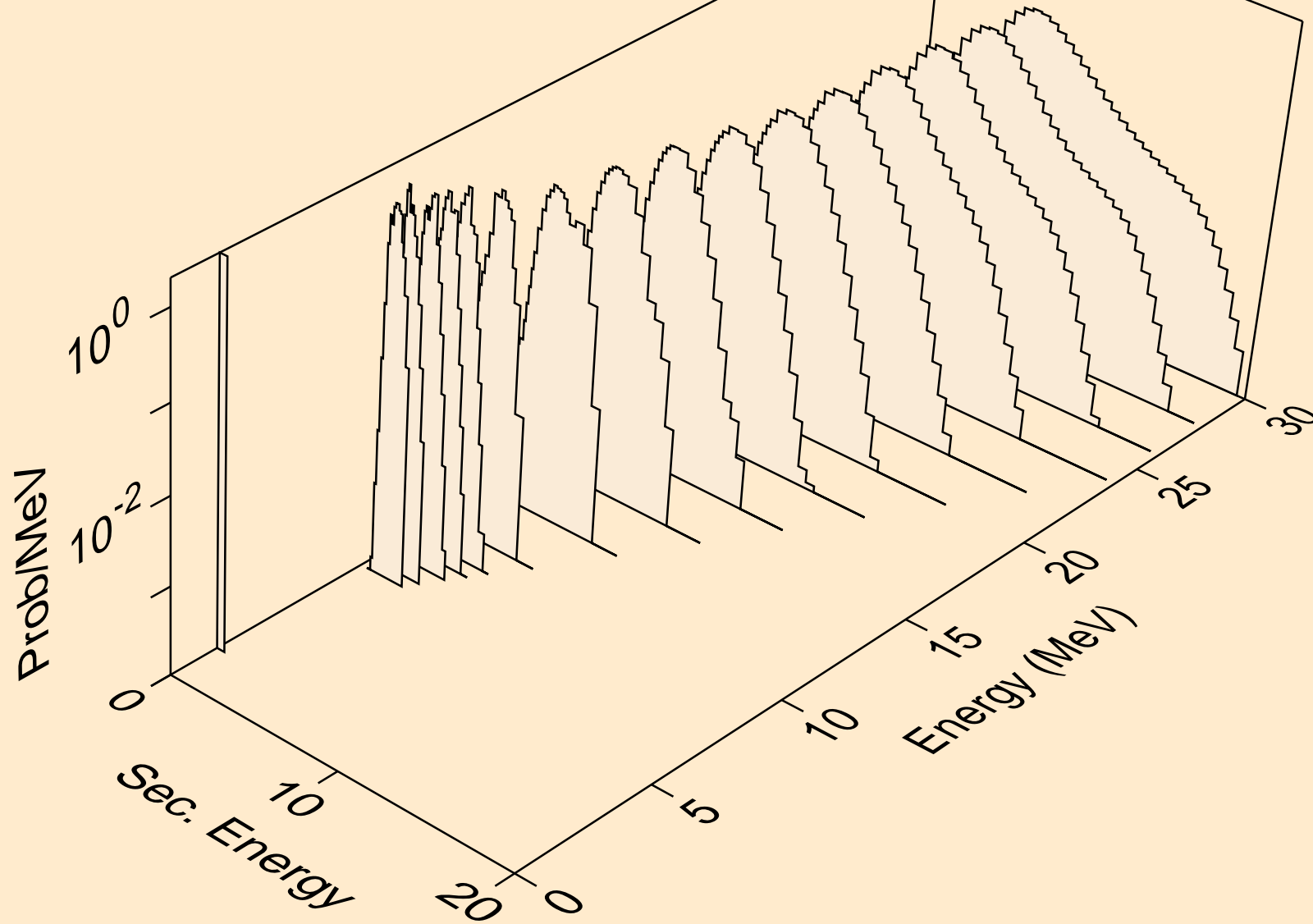

TC097M NEUTRON ACER TENDL-2023 LIBRARY; T=0.K
protons from (n,pd)

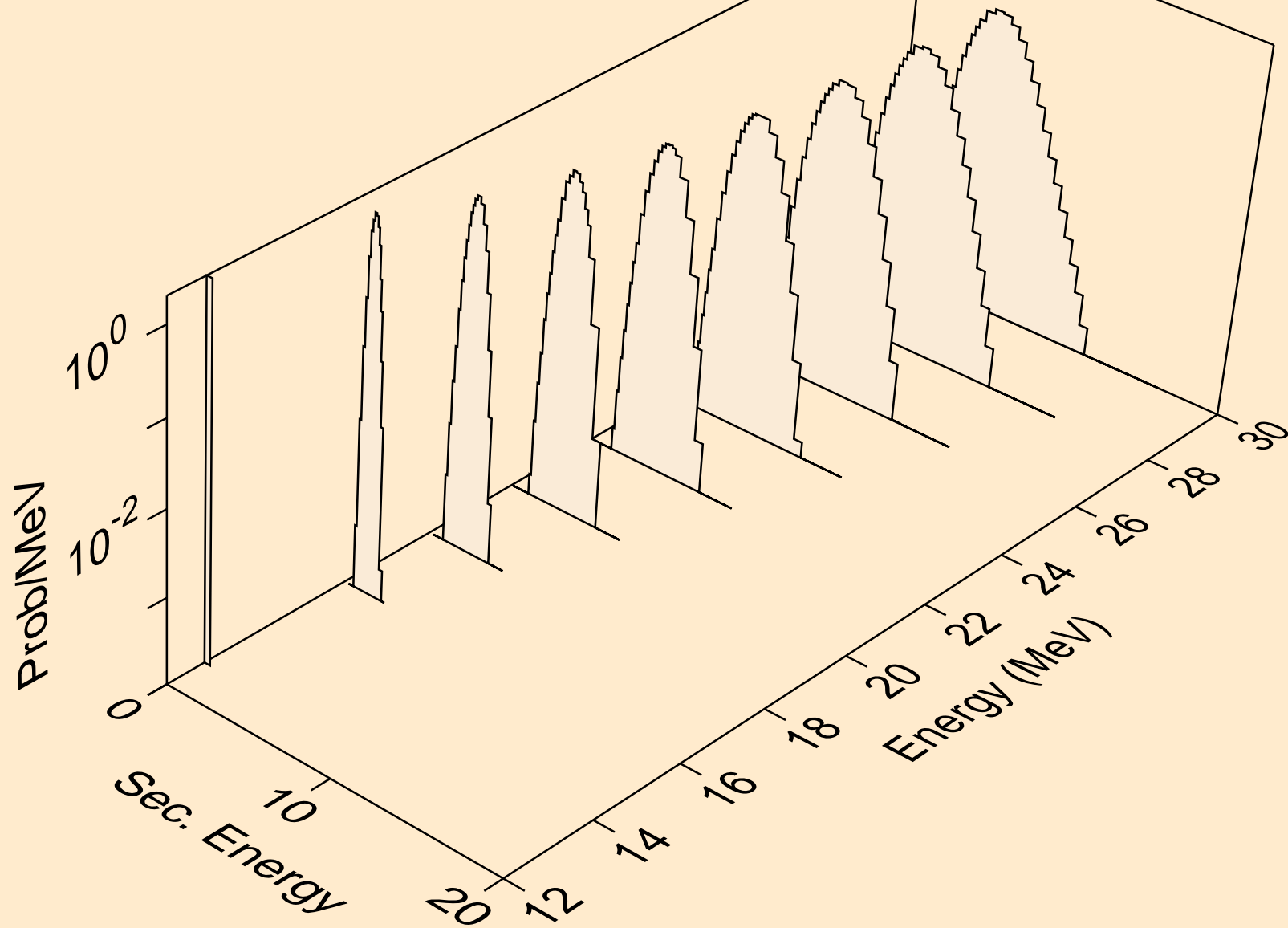

TC097M NEUTRON ACER TENDL-2023 LIBRARY; T=0.K
protons from (n,pt)

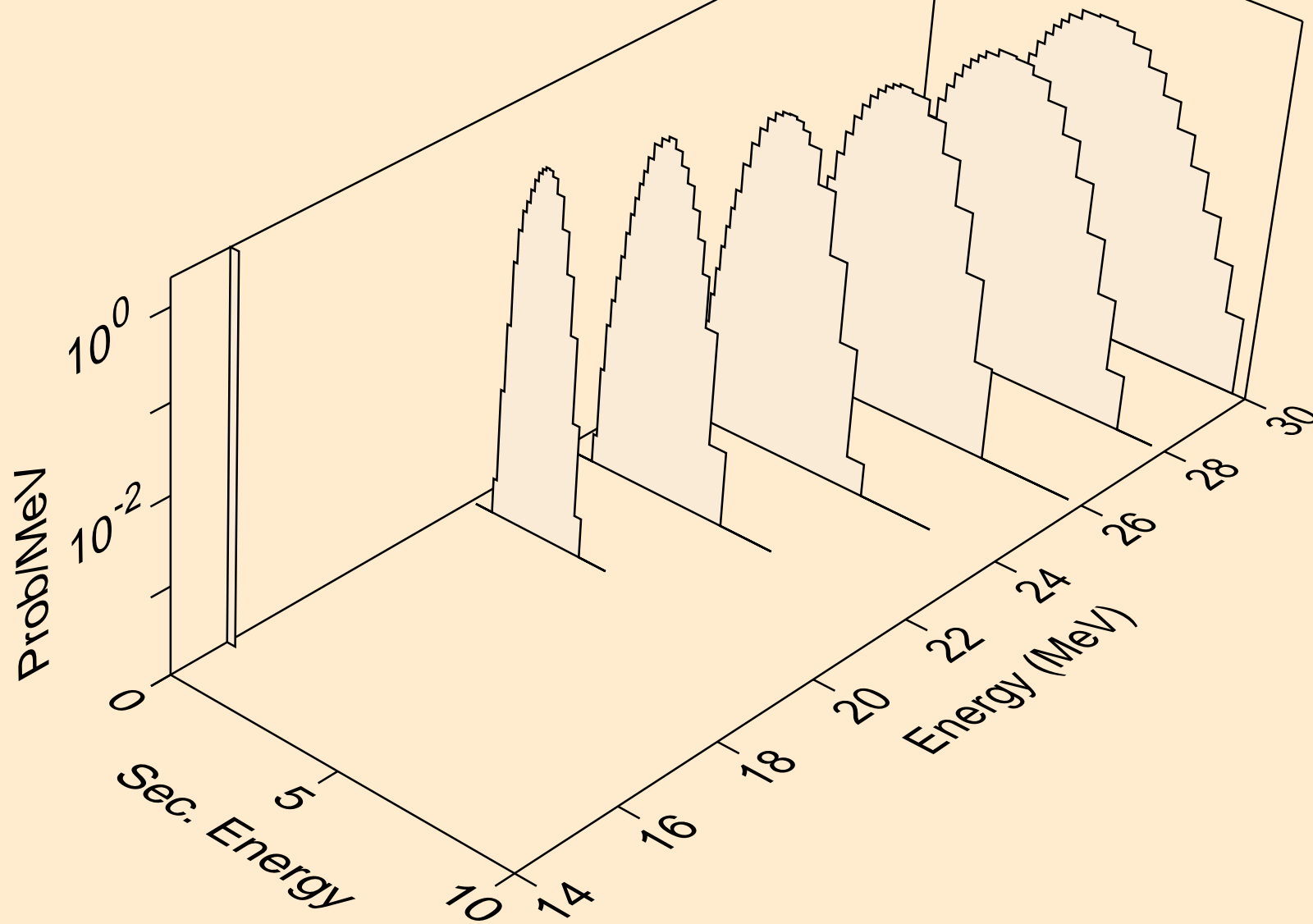

TC097M NEUTRON ACER TENDL-2023 LIBRARY; T=0.K
deuterons from (n,x)

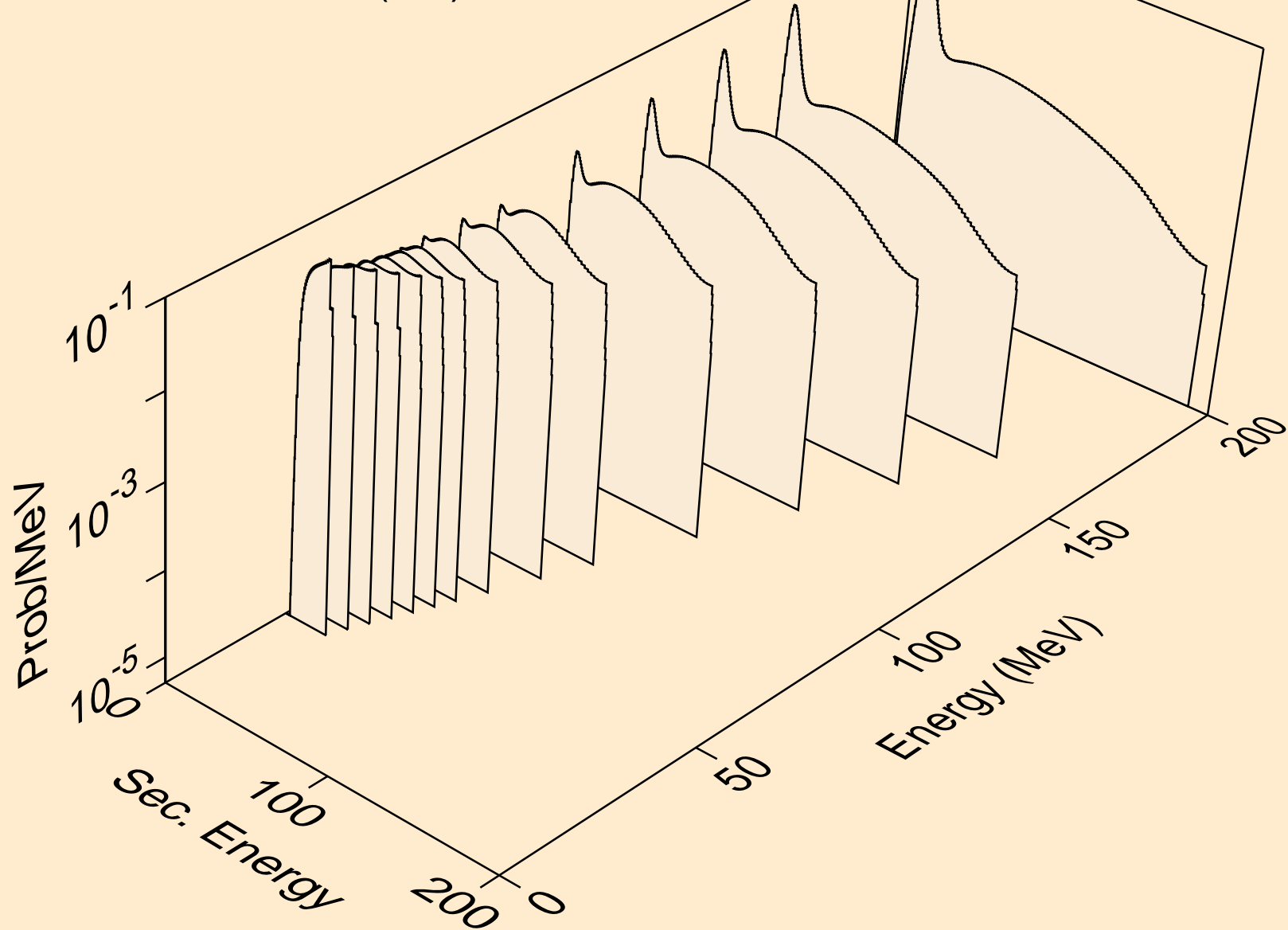

TC097M NEUTRON ACER TENDL-2023 LIBRARY; T=0.K
deuterons from (n,2nd)

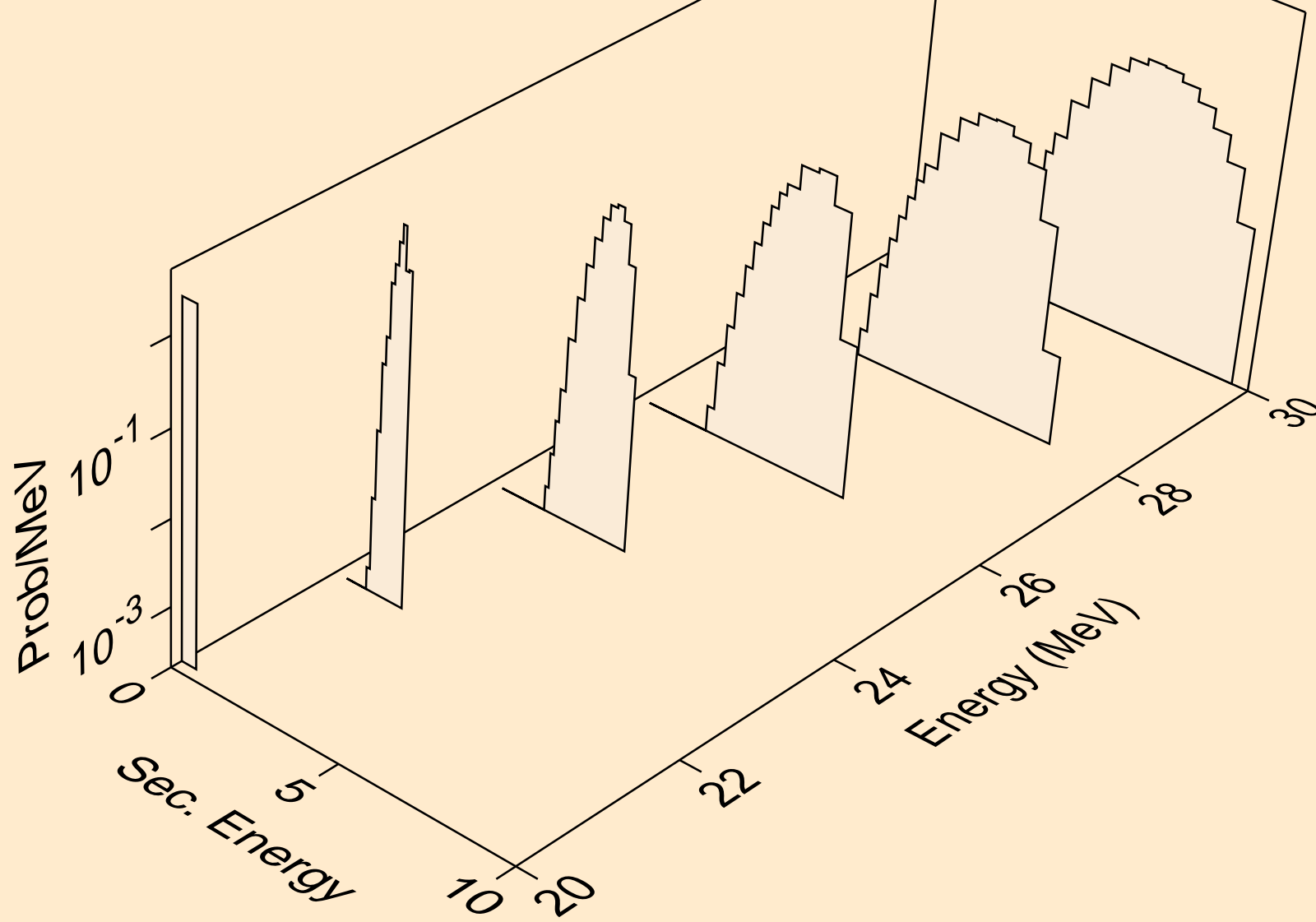

TC097M NEUTRON ACER TENDL-2023 LIBRARY; T=0.K
deuterons from (n,n*)d

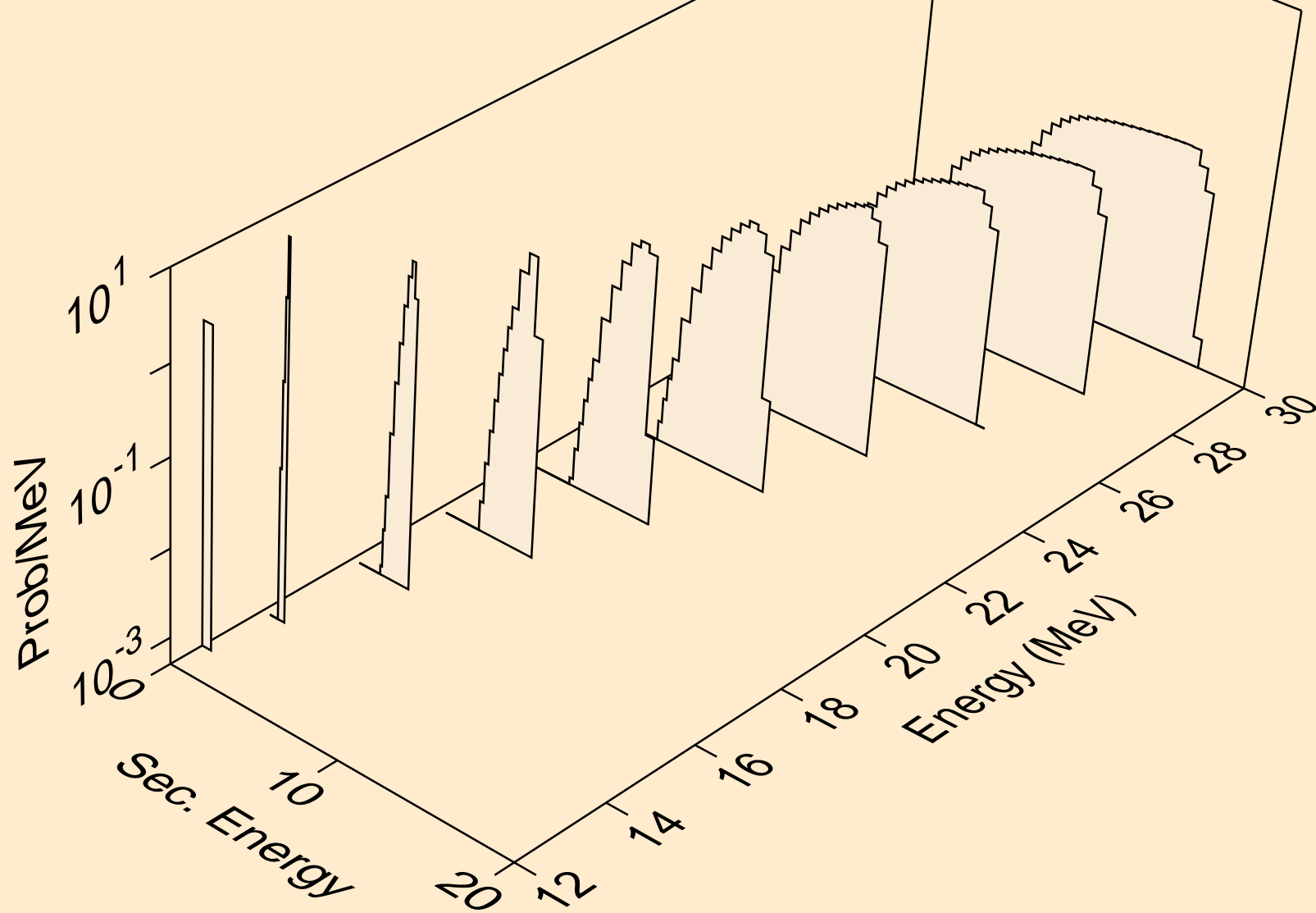

TC097M NEUTRON ACER TENDL-2023 LIBRARY; T=0.K
deuterons from (n,d)

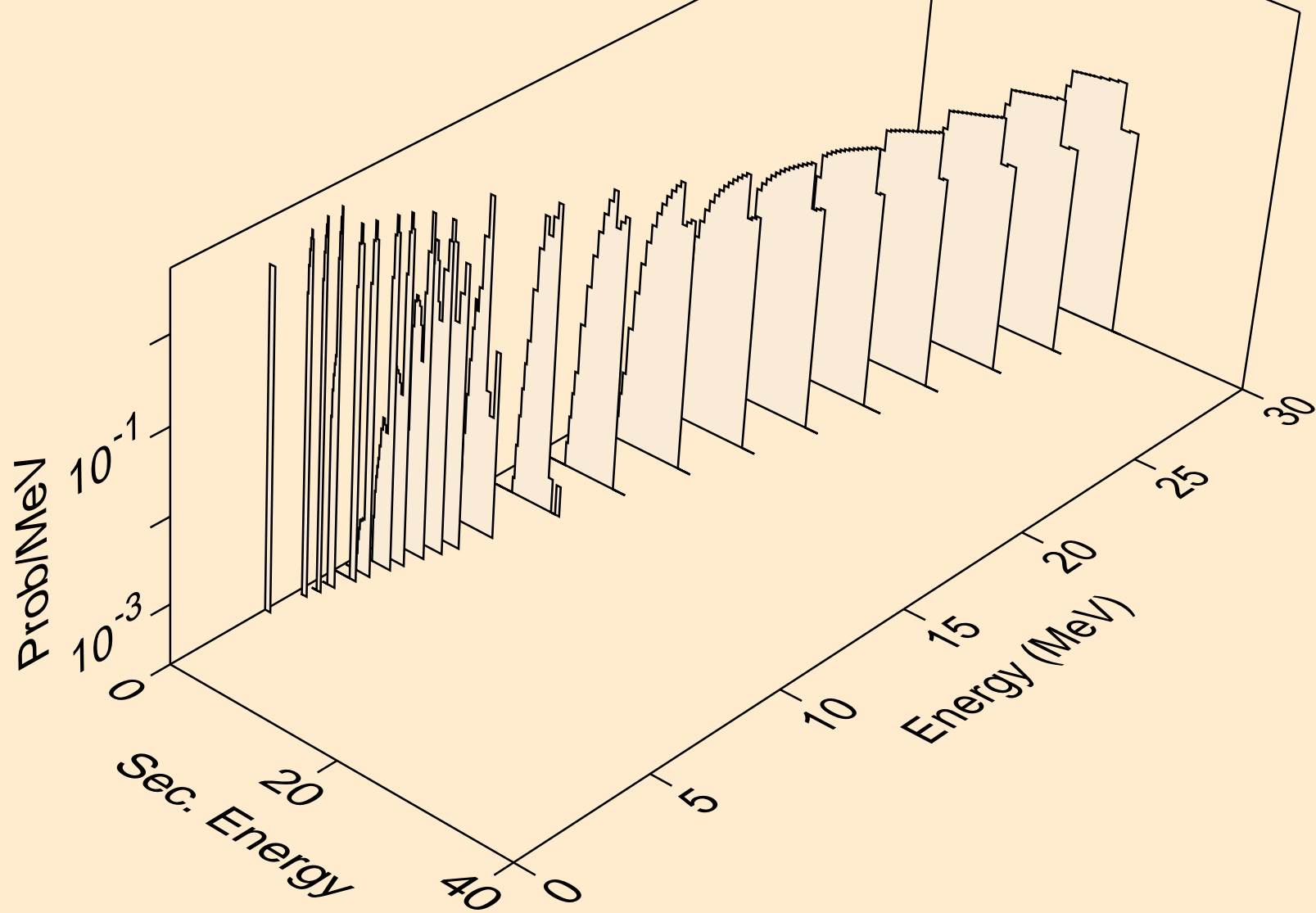

TC097M NEUTRON ACER TENDL-2023 LIBRARY; T=0.K
deuterons from (n,pd)

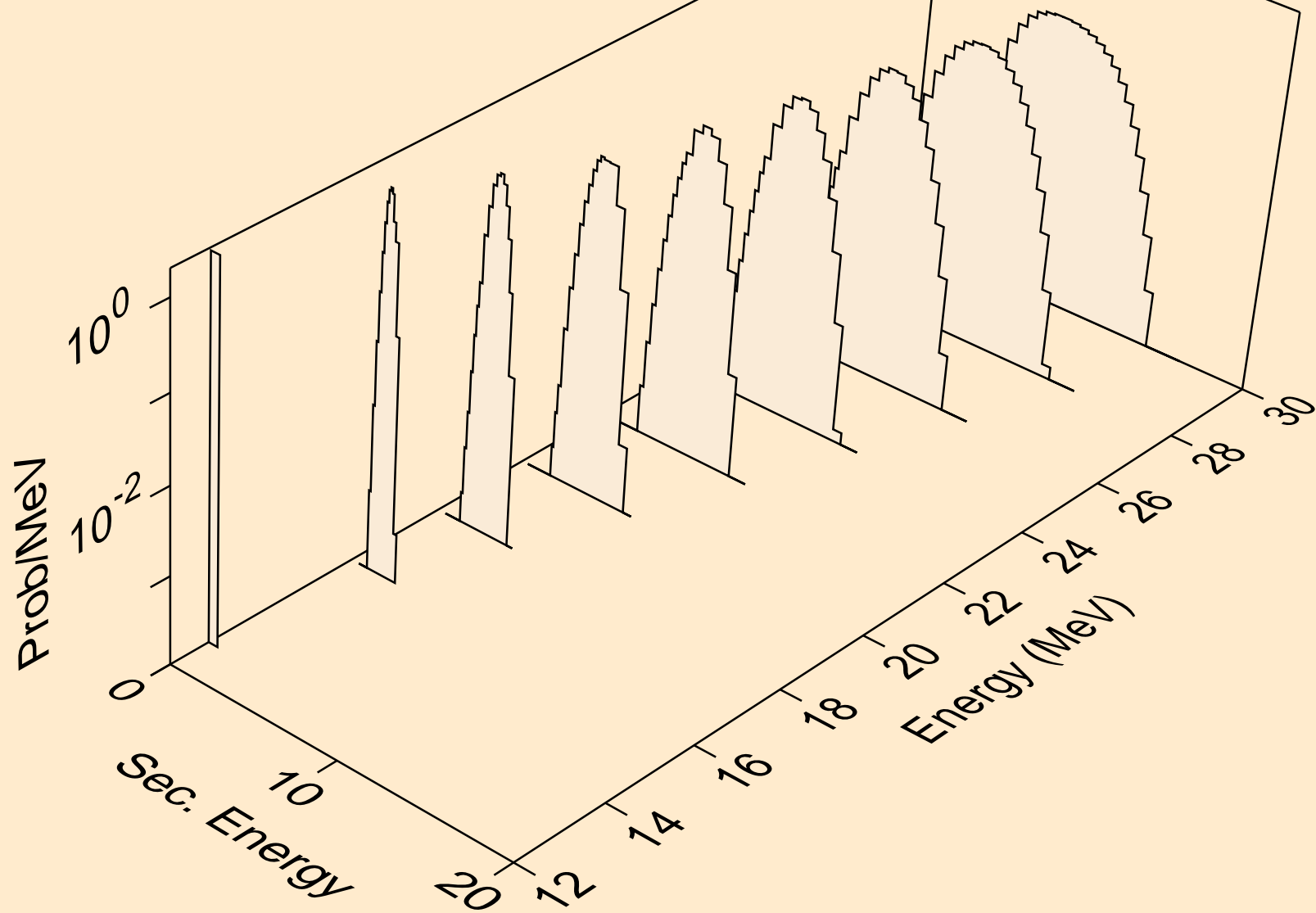

TC097M NEUTRON ACER TENDL-2023 LIBRARY; T=0.K
deuterons from (n,da)

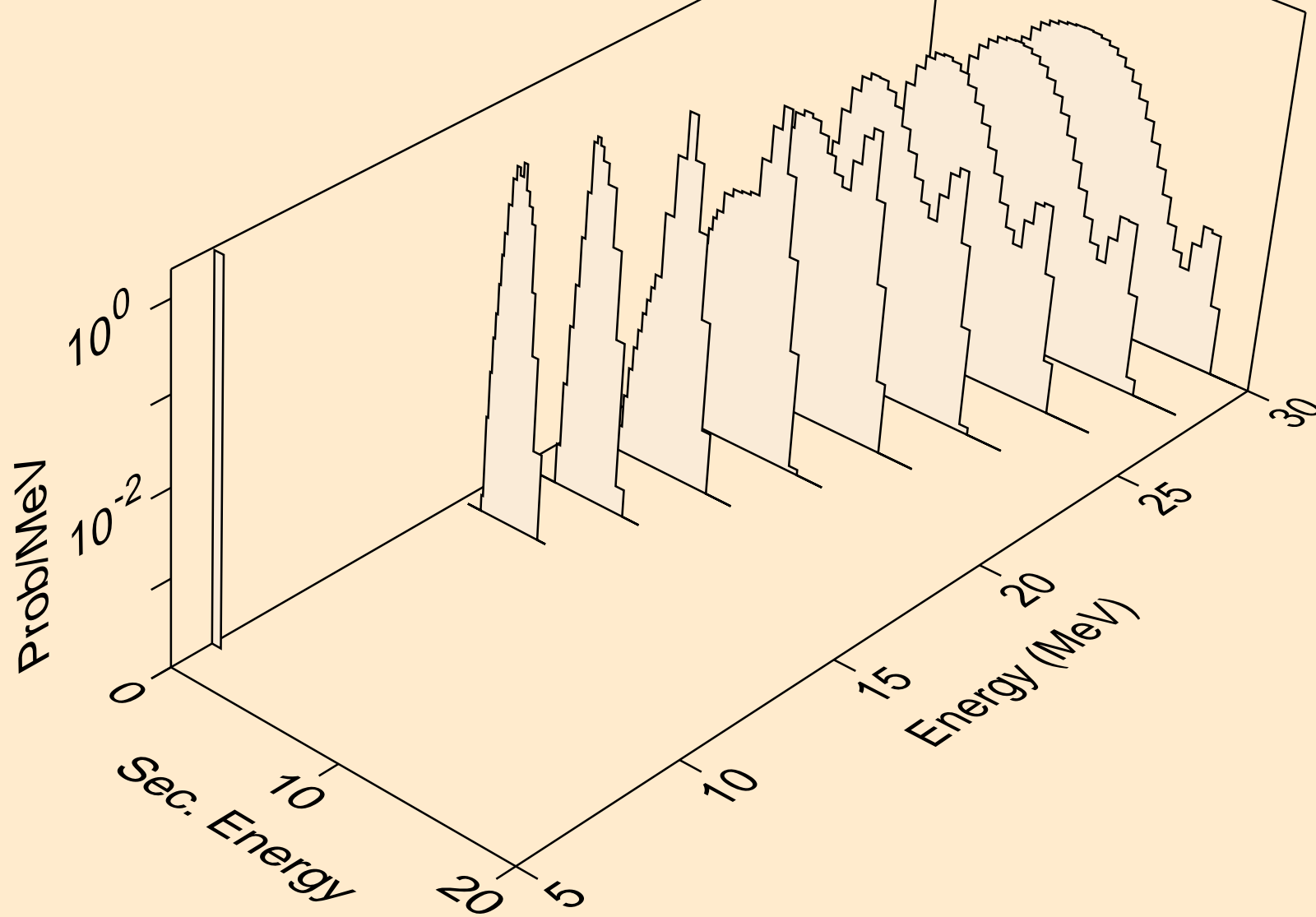

TC097M NEUTRON ACER TENDL-2023 LIBRARY; T=0.K
tritons from (n,x)

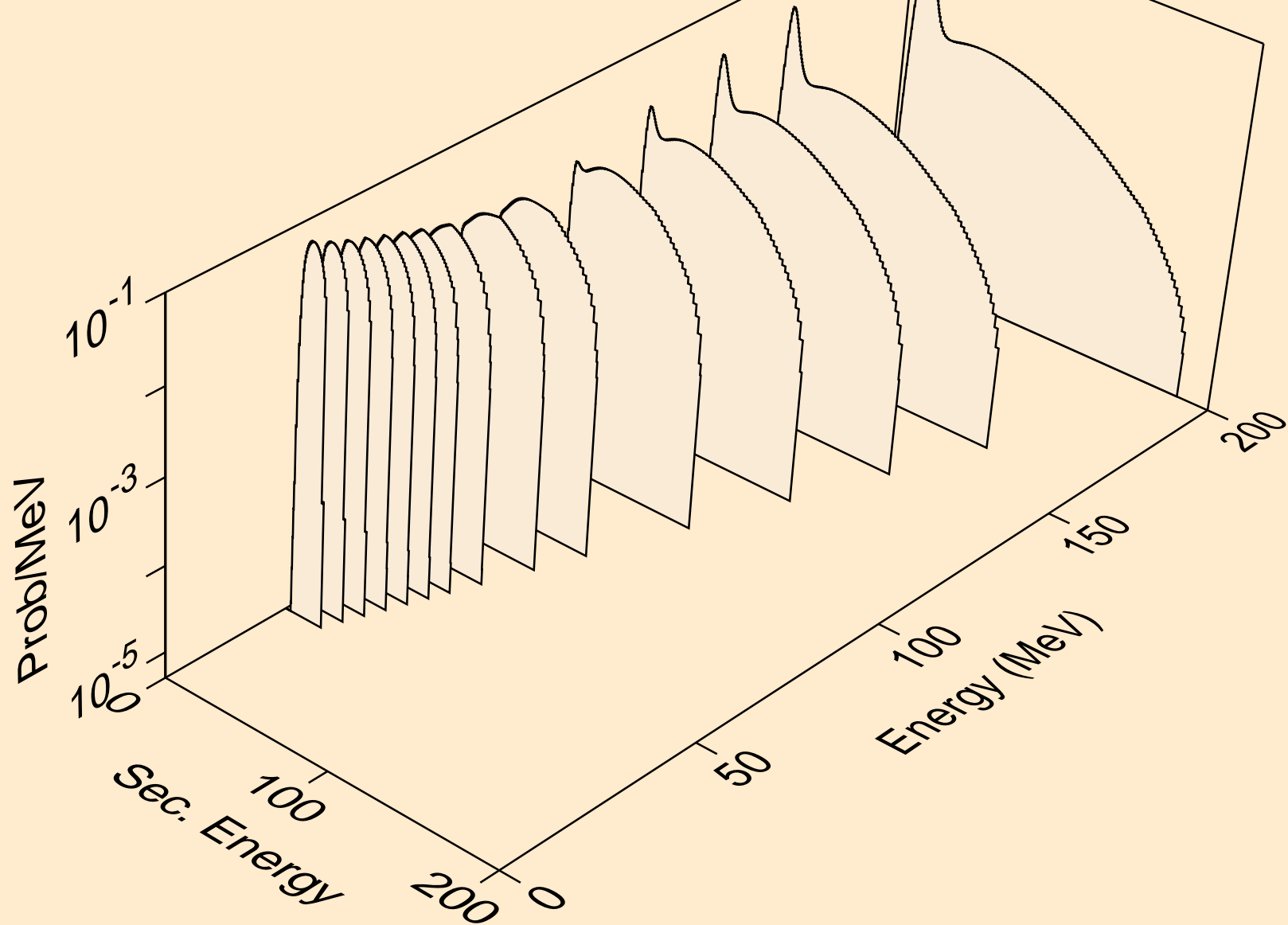

TC097M NEUTRON ACER TENDL-2023 LIBRARY; T=0.K
tritons from (n,n*)t

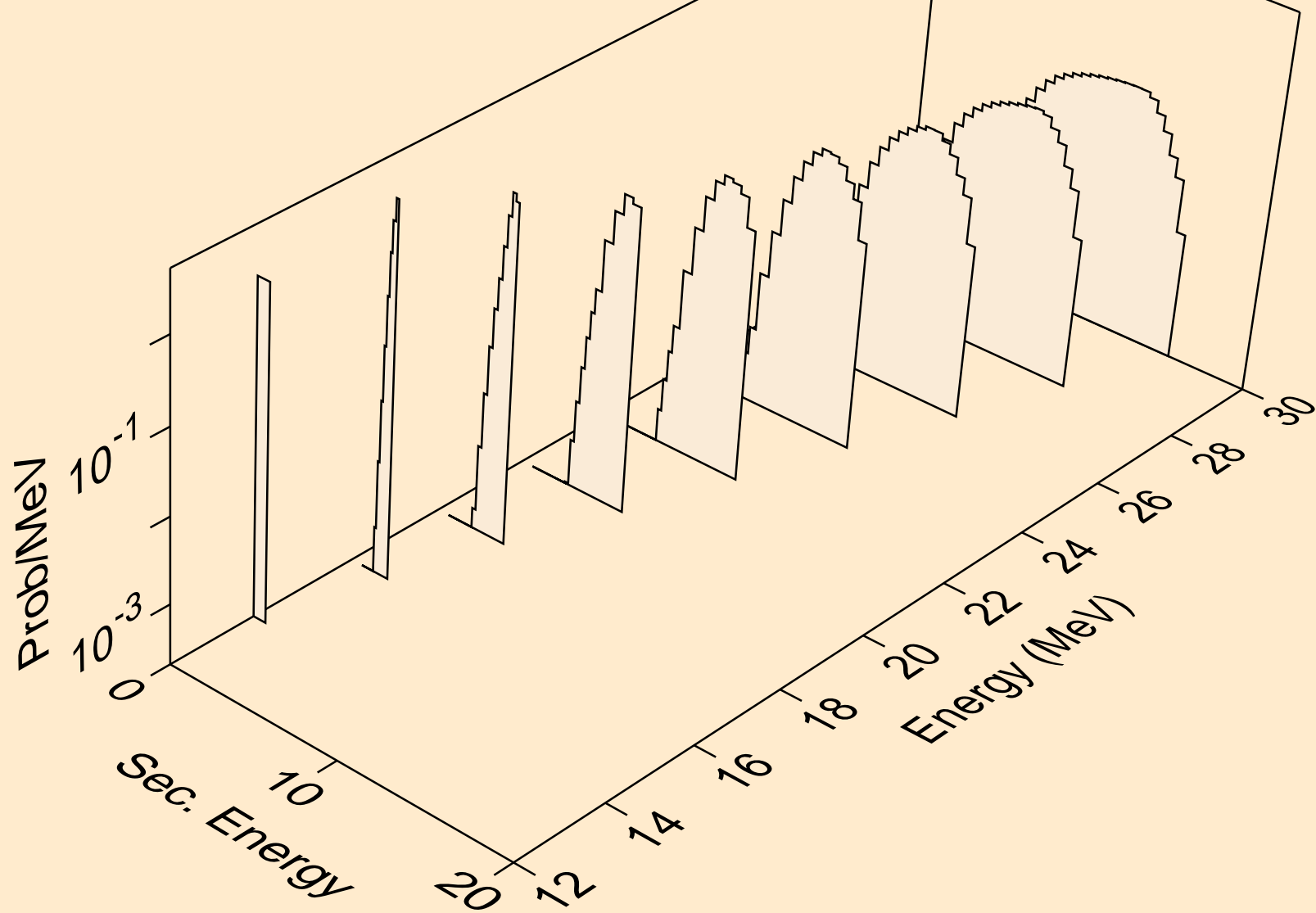

TC097M NEUTRON ACER TENDL-2023 LIBRARY; T=0.K
tritons from (n,t)

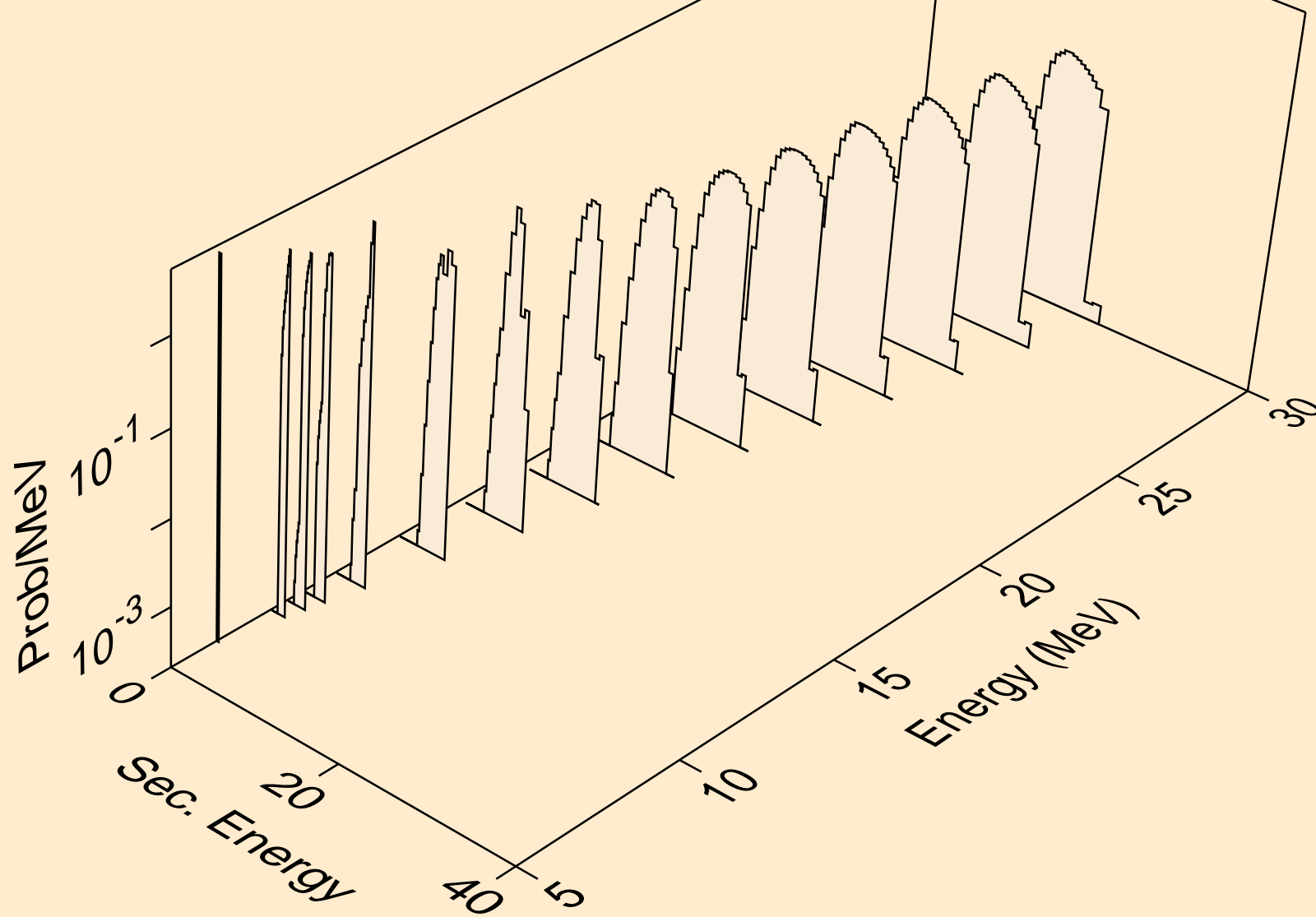

TC097M NEUTRON ACER TENDL-2023 LIBRARY; T=0.K
tritons from (n,pt)

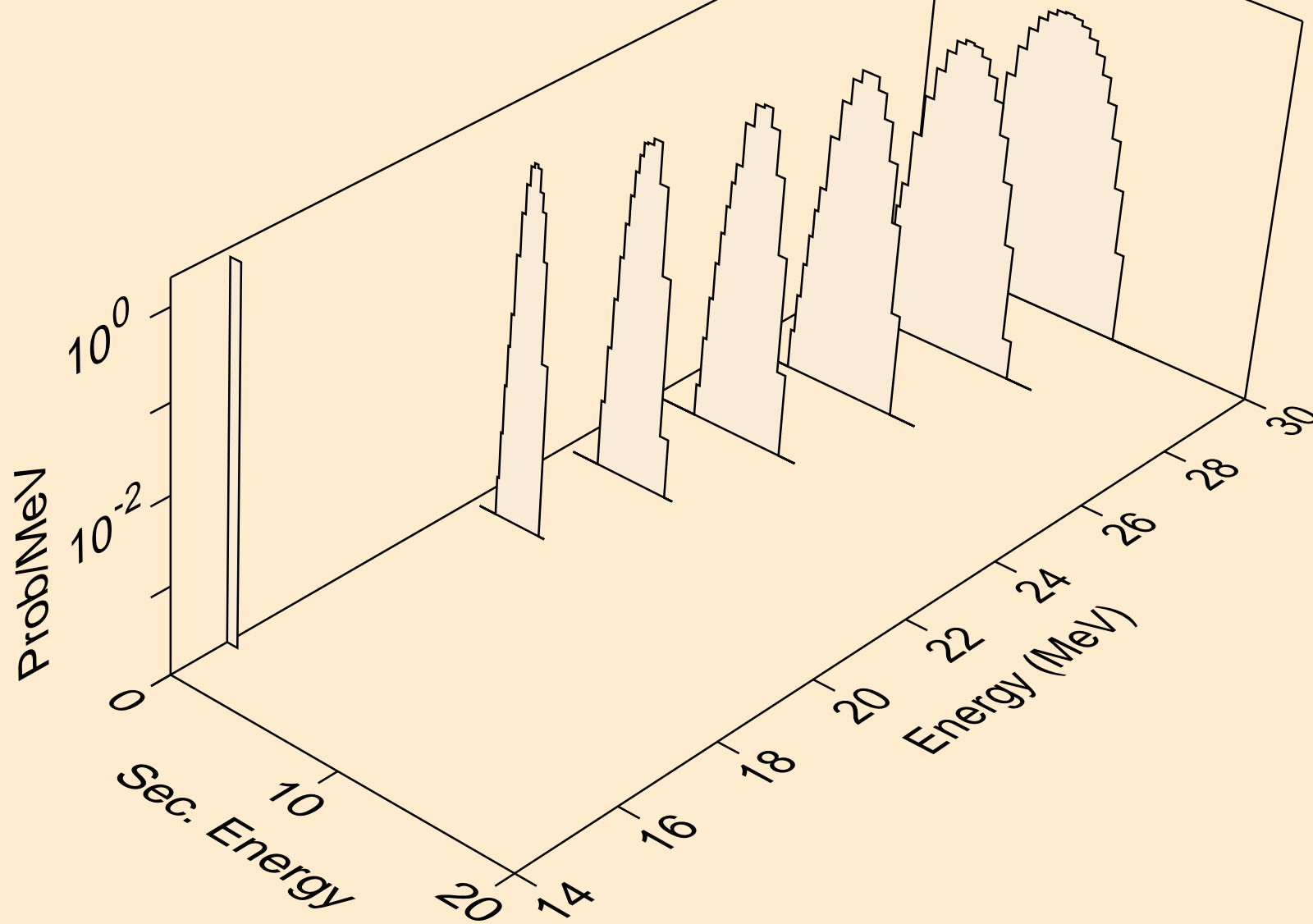

TC097M NEUTRON ACER TENDL-2023 LIBRARY; T=0.K
he3s from (n,x)

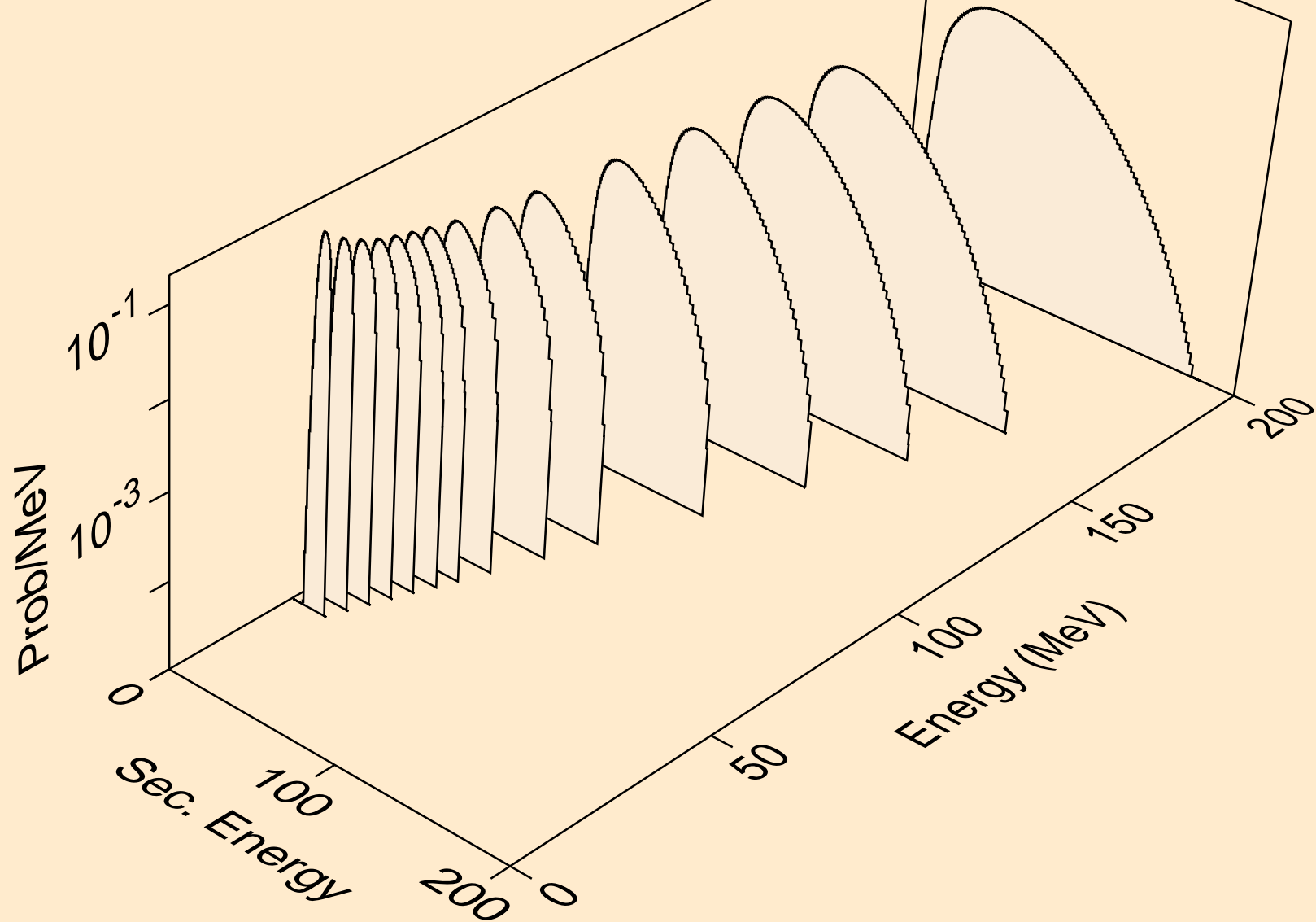

TC097M NEUTRON ACER TENDL-2023 LIBRARY; T=0.K
he3s from (n,n*)he3

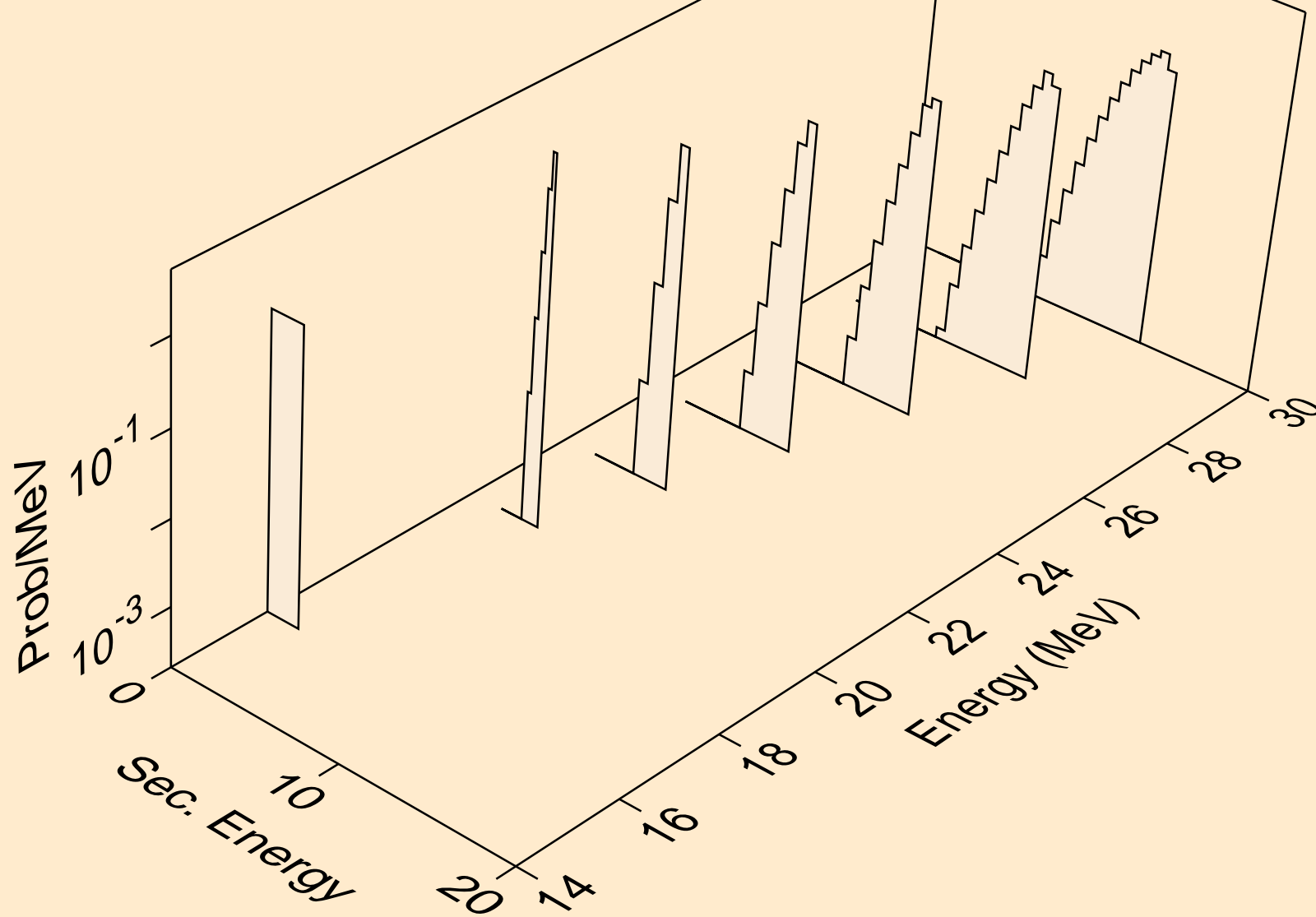

TC097M NEUTRON ACER TENDL-2023 LIBRARY; T=0.K
he3s from (n,he3)

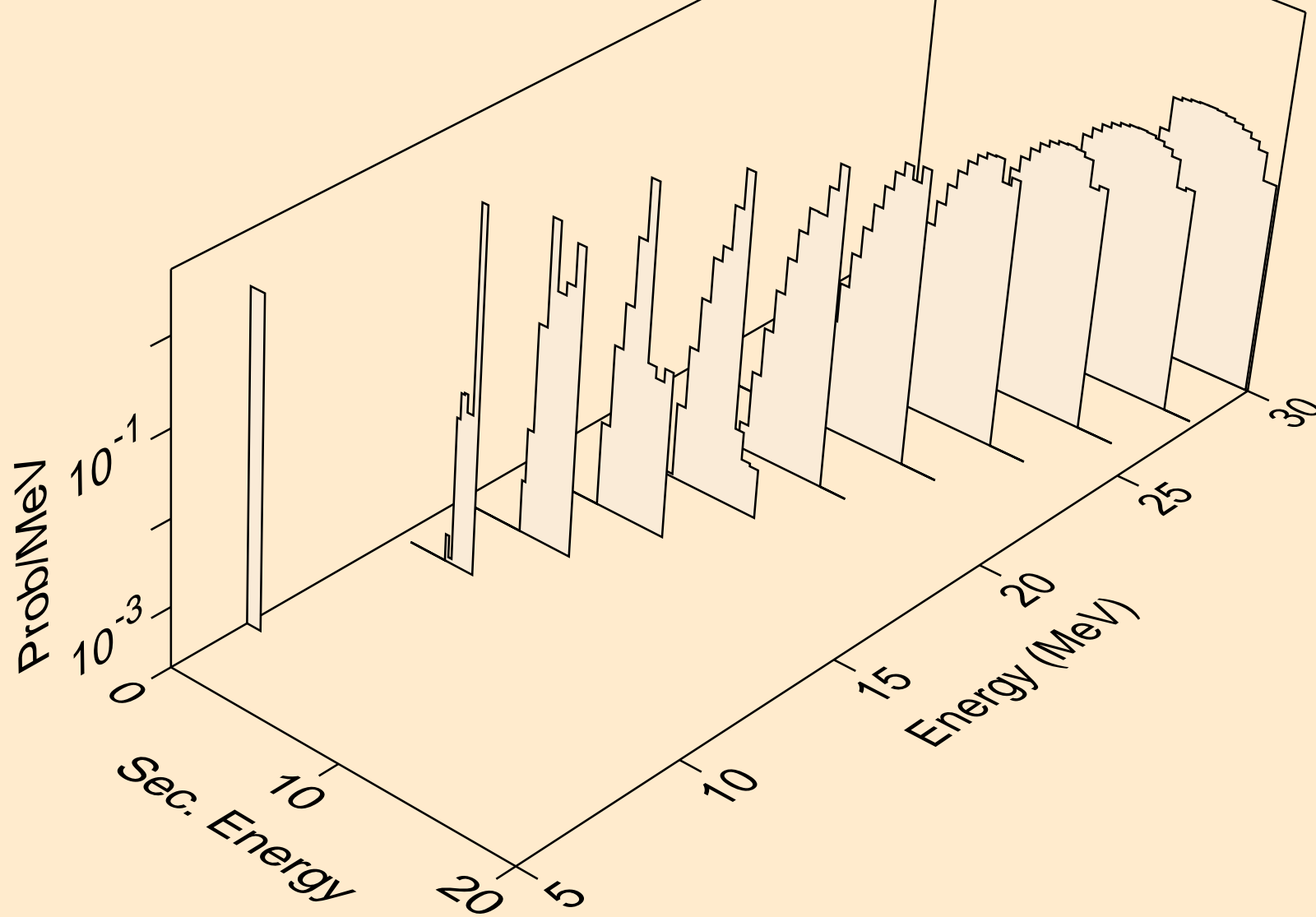

TC097M NEUTRON ACER TENDL-2023 LIBRARY; T=0.K
alphas from (n,x)

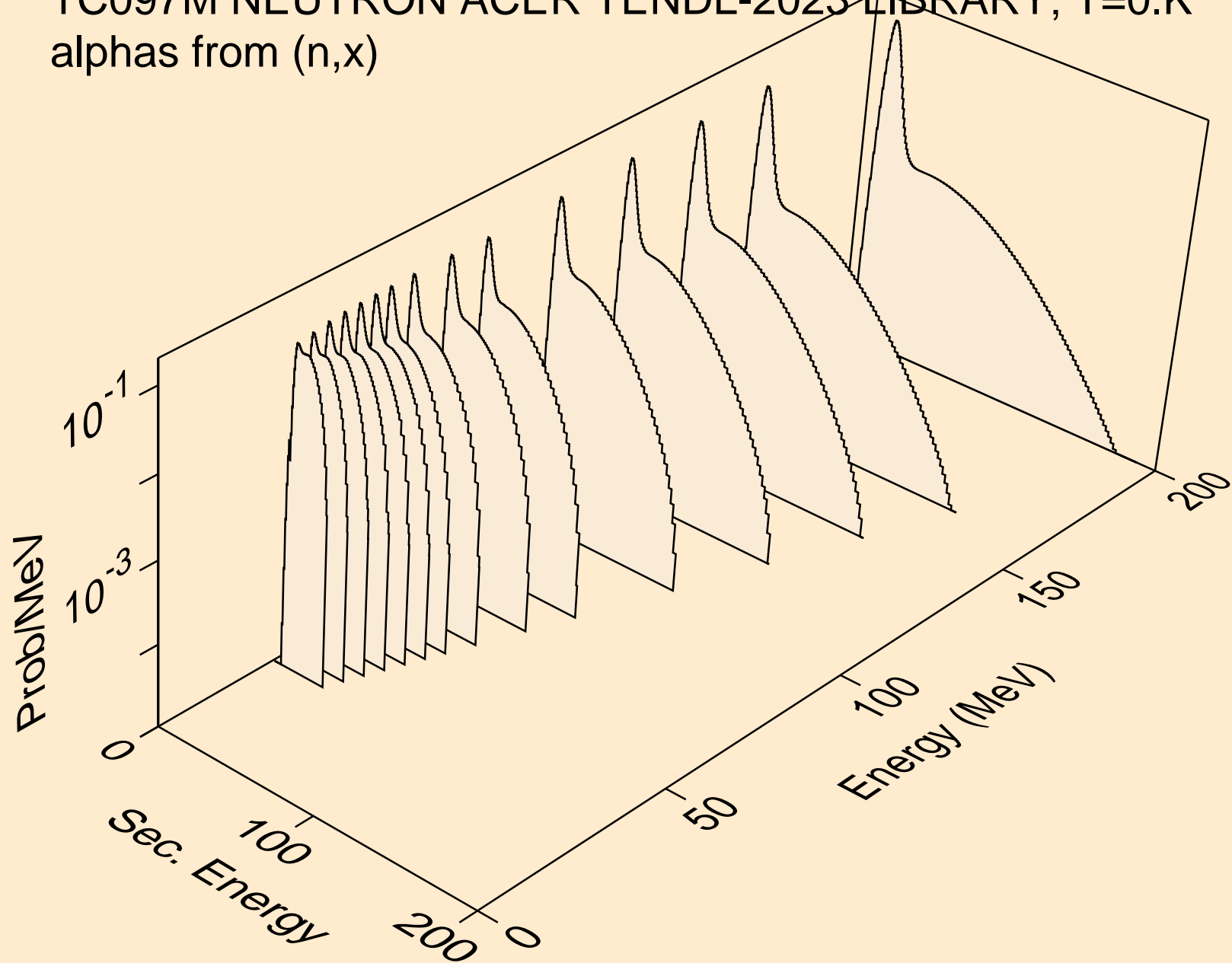

TC097M NEUTRON ACER TENDL-2023 LIBRARY; T=0.K
alphas from (n,n*)a

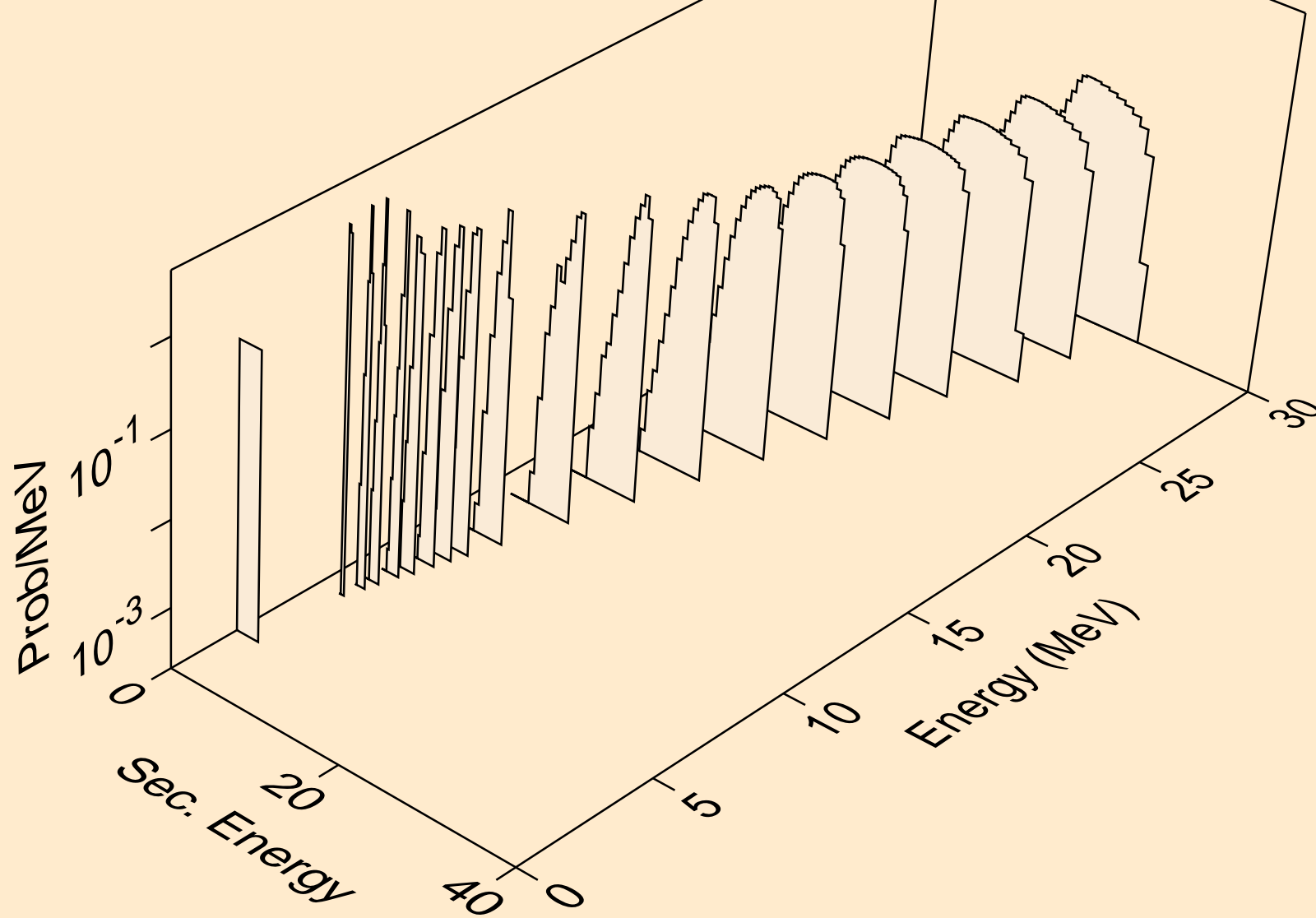

TC097M NEUTRON ACER TENDL-2023 LIBRARY; T=0.K
alphas from (n,2n)a

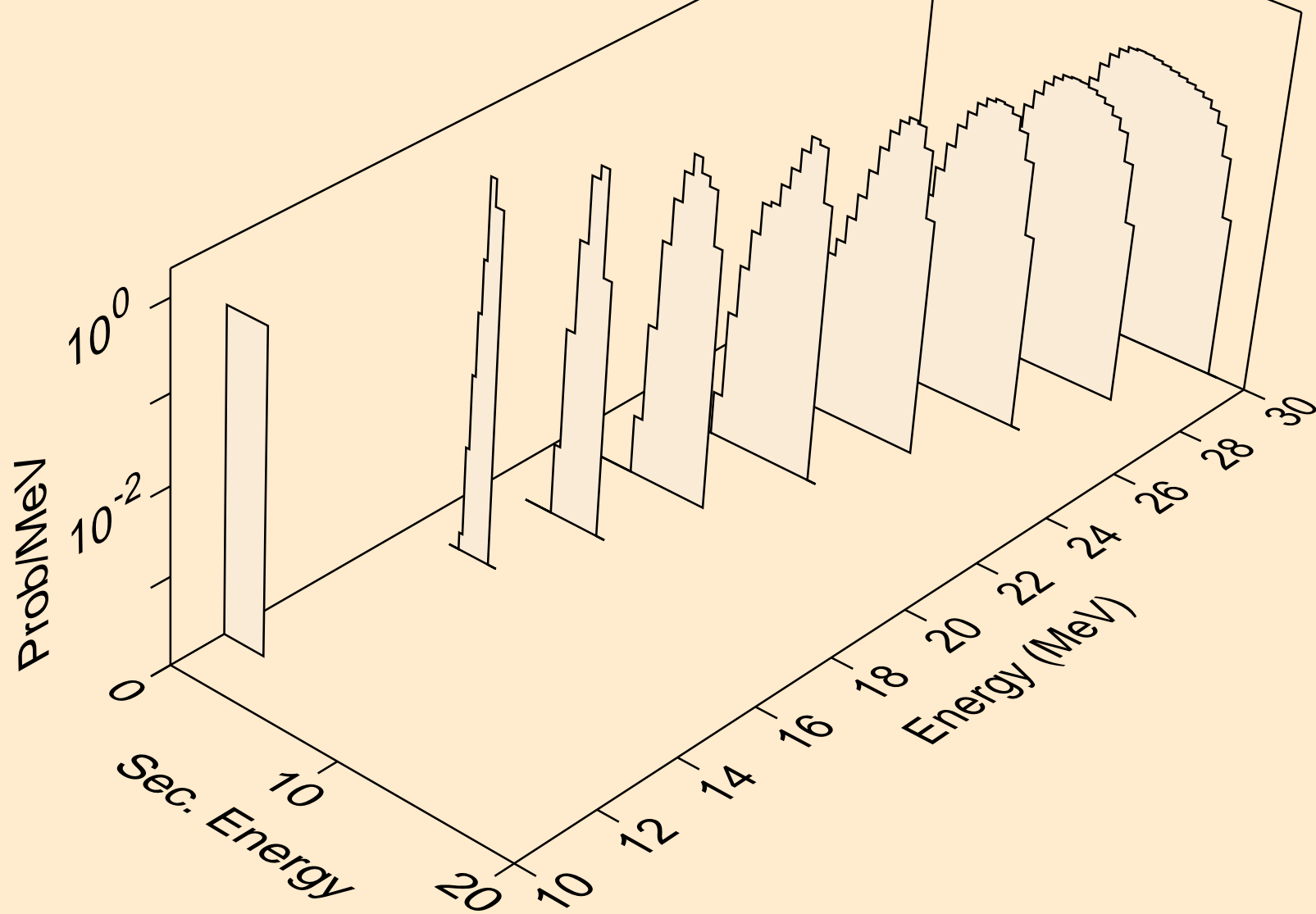

TC097M NEUTRON ACER TENDL-2023 LIBRARY; T=0.K
alphas from (n,3n)a

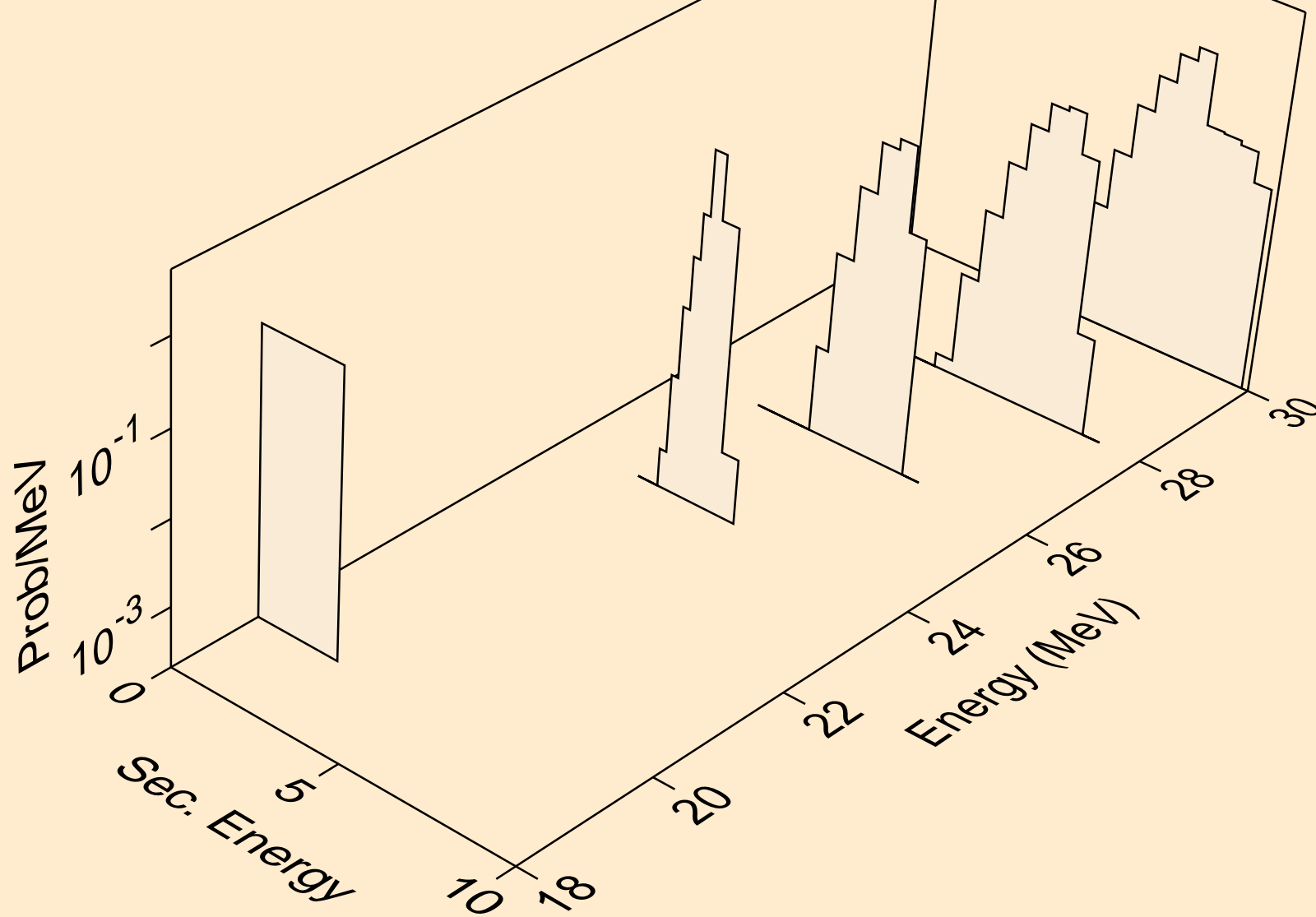

TC097M NEUTRON ACER TENDL-2023 LIBRARY; T=0.K
alphas from (n,n*)2a

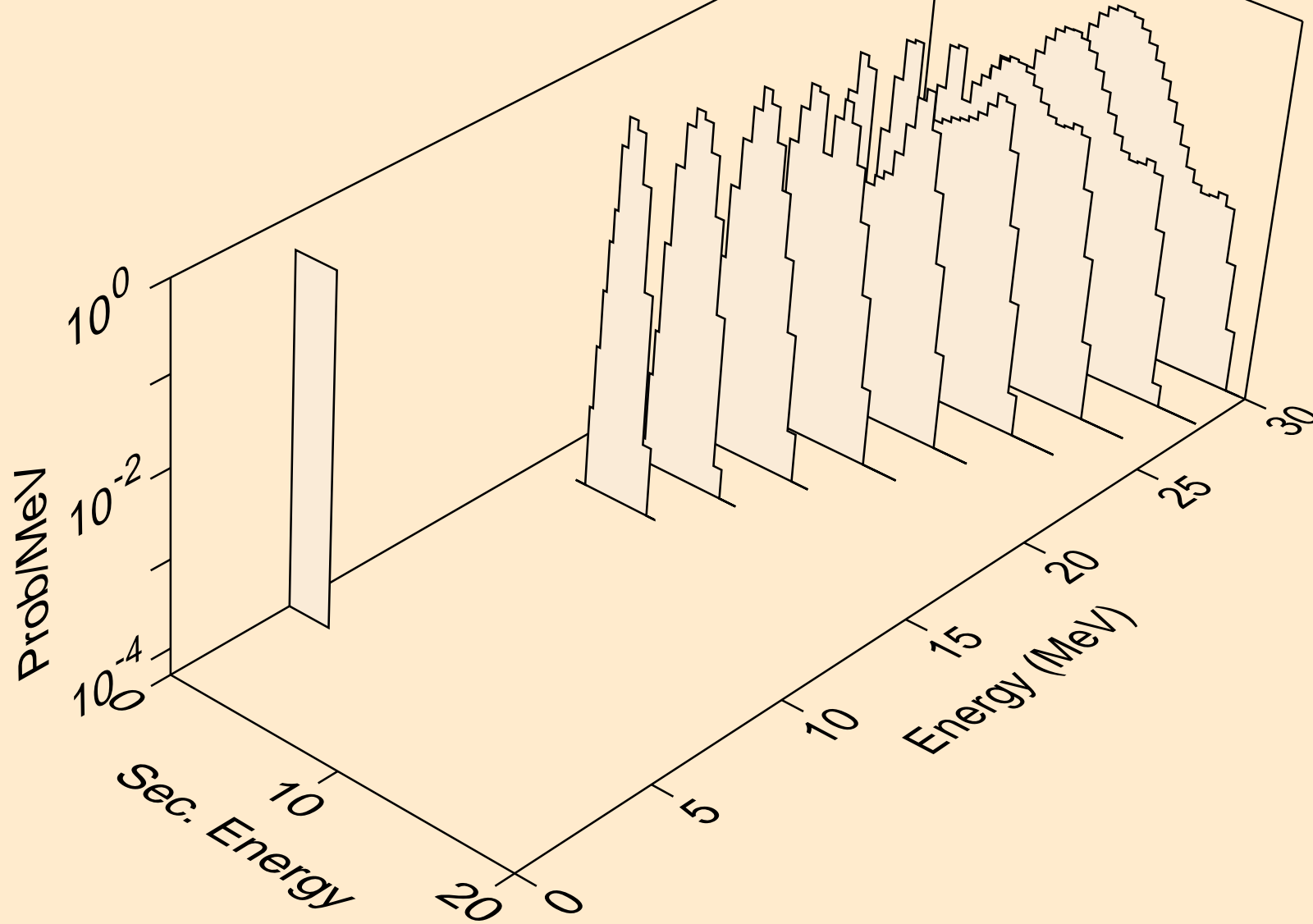

TC097M NEUTRON ACER TENDL-2023 LIBRARY; T=0.K
alphas from (n,npa)

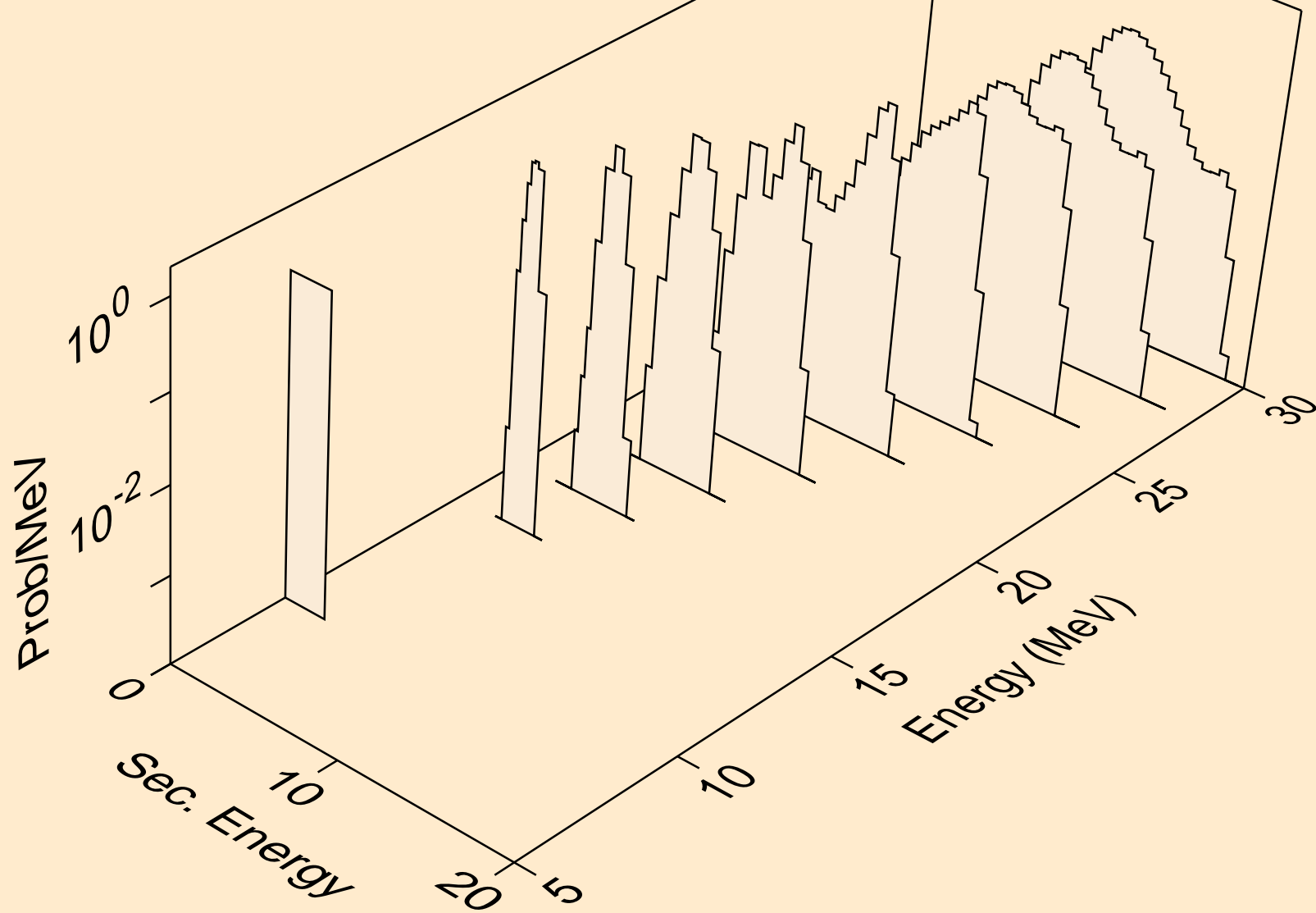

TC097M NEUTRON ACER TENDL-2023 LIBRARY; T=0.K
alphas from (n,a)

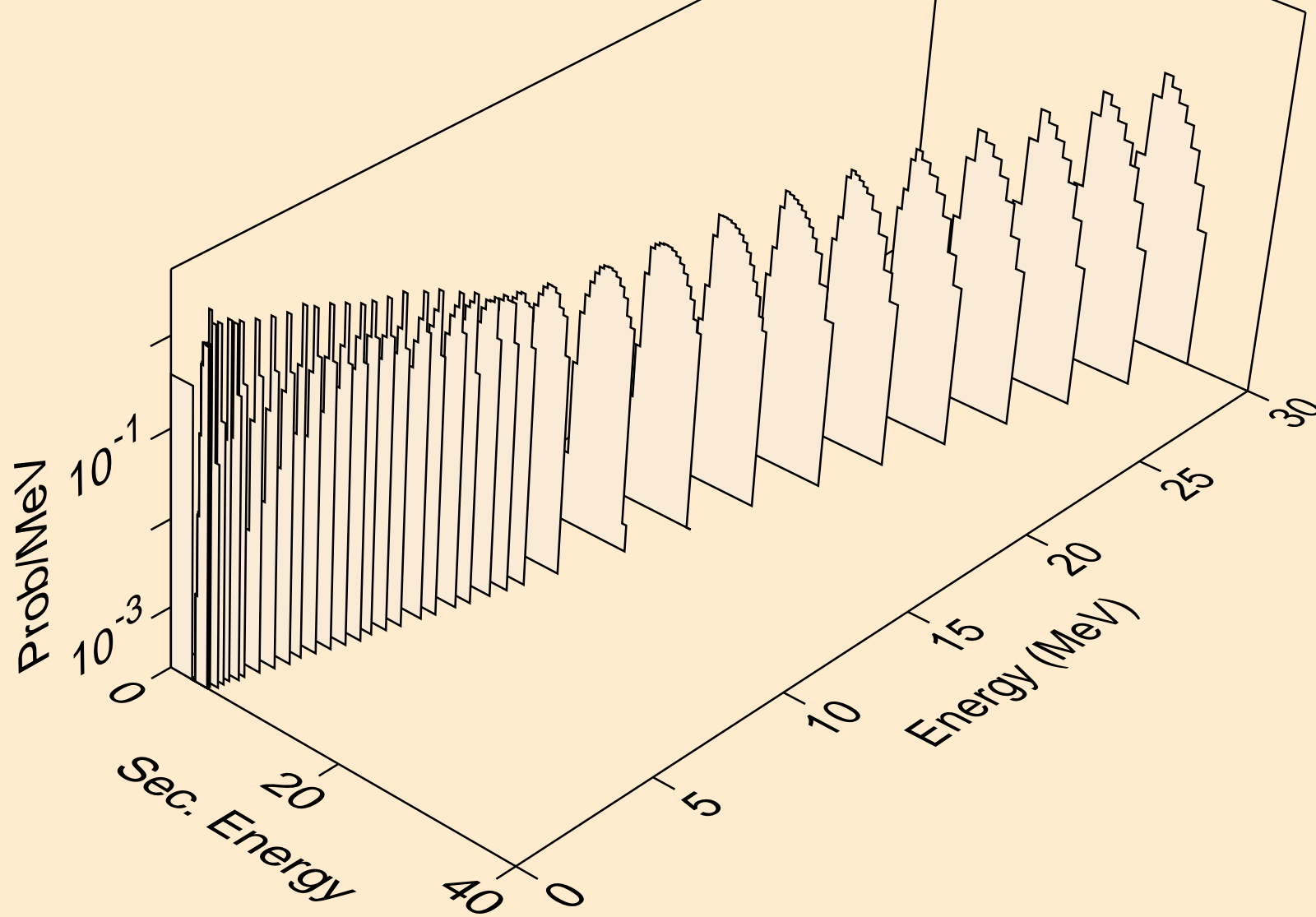

TC097M NEUTRON ACER TENDL-2023 LIBRARY; T=0.K
alphas from (n,2a)

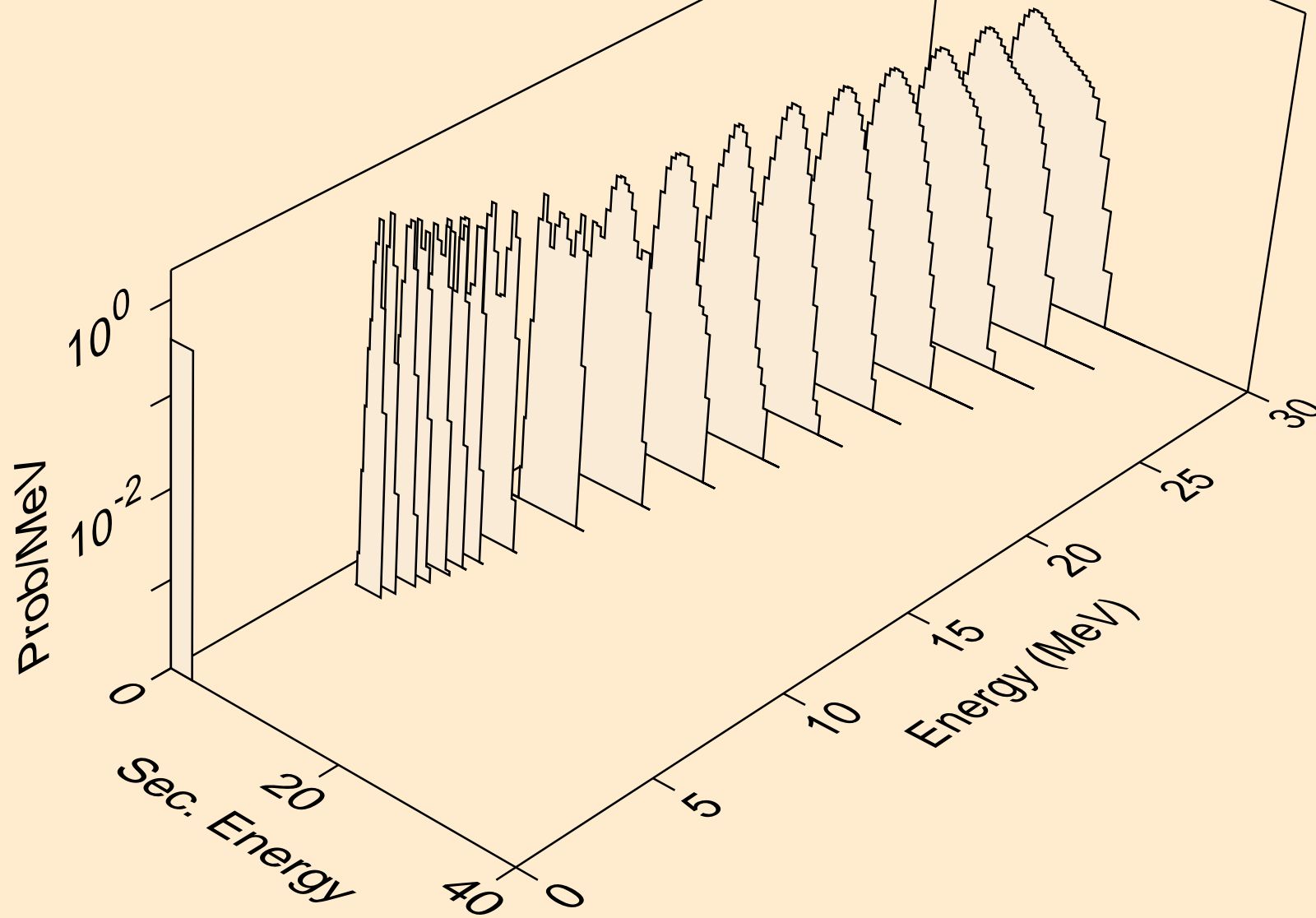

TC097M NEUTRON ACER TENDL-2023 LIBRARY; T=0.K
alphas from (n,pa)

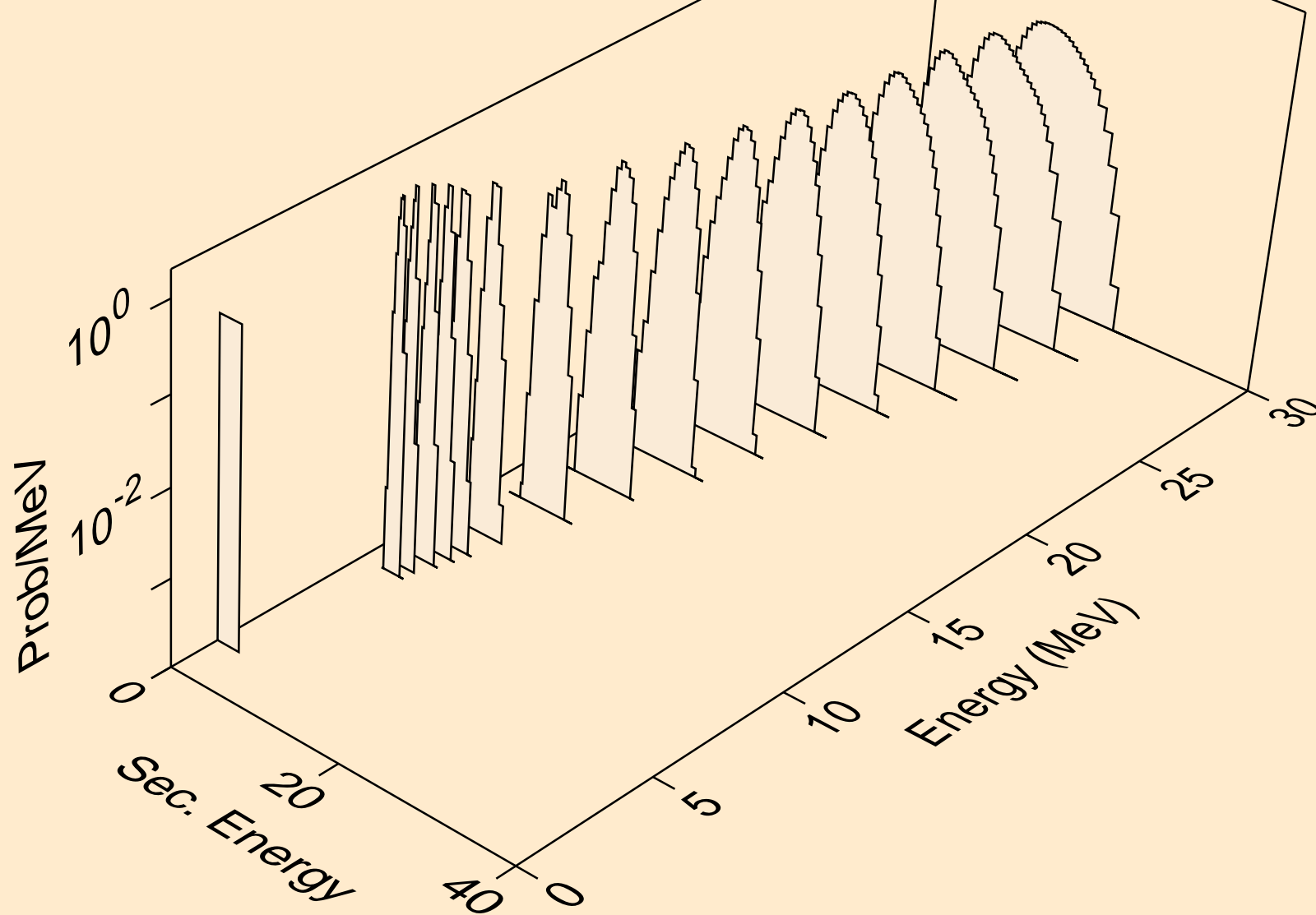

TC097M NEUTRON ACER TENDL-2023 LIBRARY; T=0.K
alphas from (n,da)

