

TC103 NEUTRON ACER TENDL-2023 LIBRARY; T=0.K  
Principal cross sections

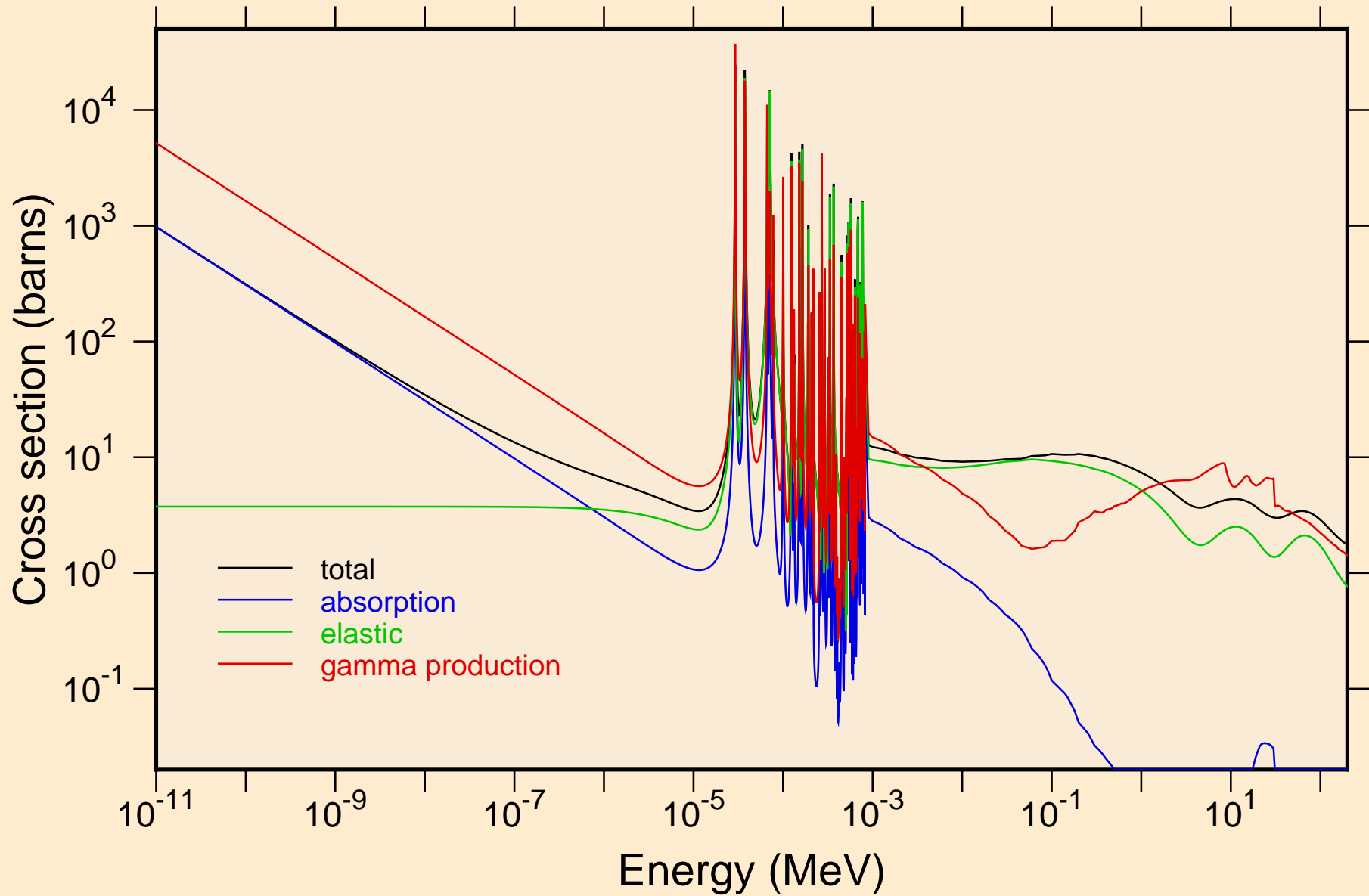

TC103 NEUTRON ACER TENDL-2023 LIBRARY; T=0.K  
resonance total cross section

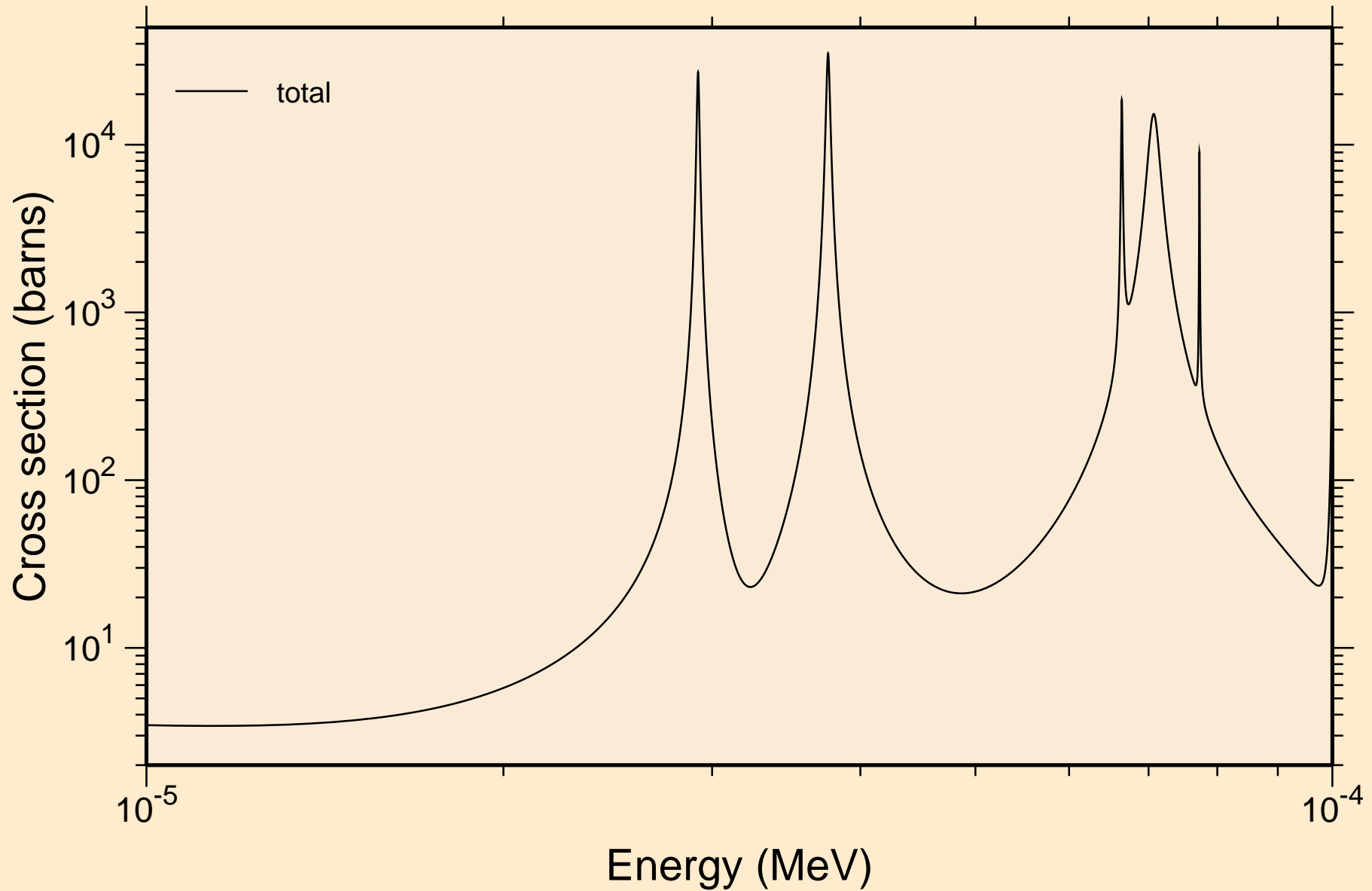

TC103 NEUTRON ACER TENDL-2023 LIBRARY; T=0.K  
resonance total cross section

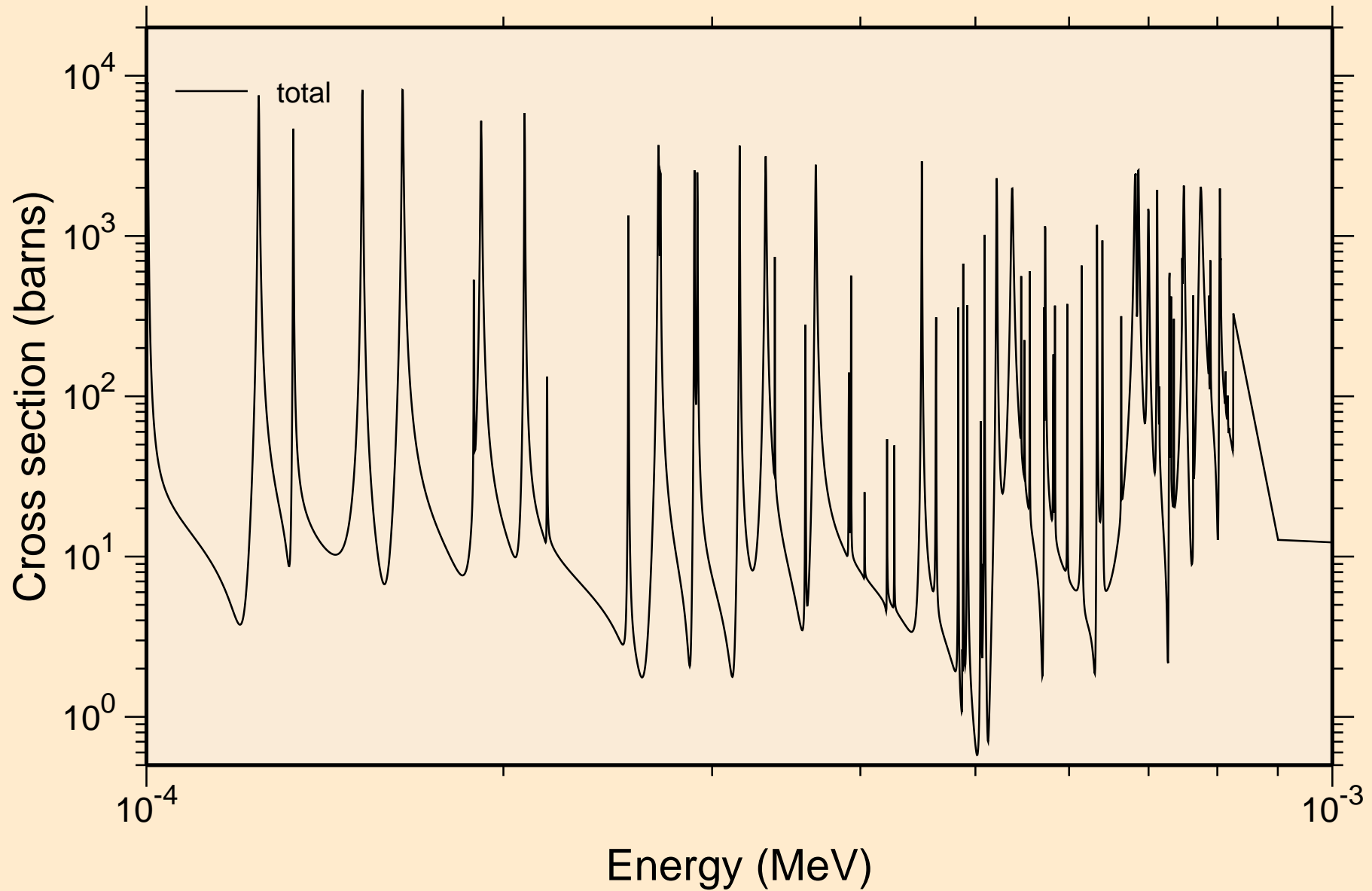

Tc103 NEUTRON ACER TENDL-2023 LIBRARY; T=0.K  
resonance total cross section

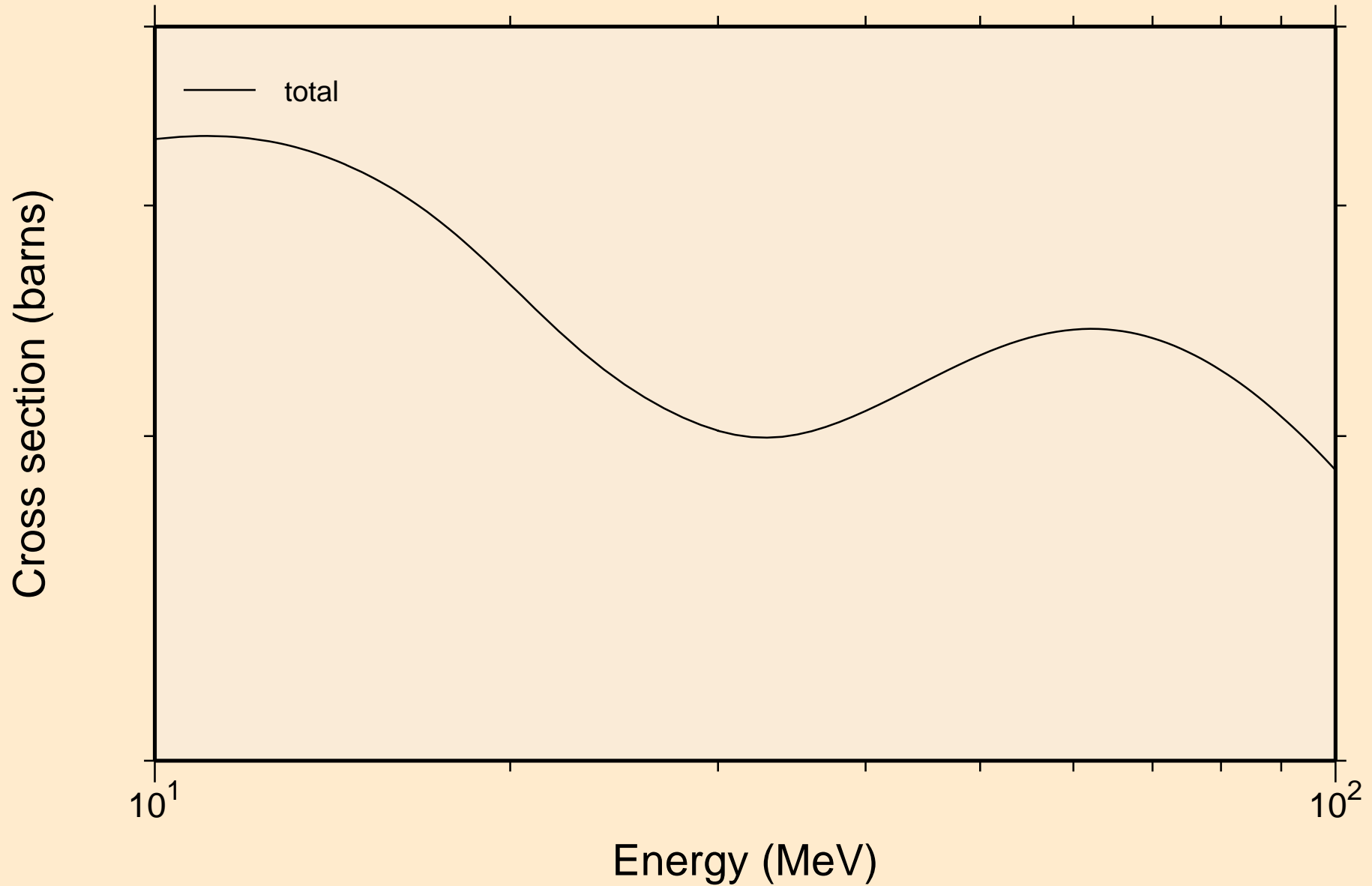

TC103 NEUTRON ACER TENDL-2023 LIBRARY; T=0.K  
resonance absorption cross sections

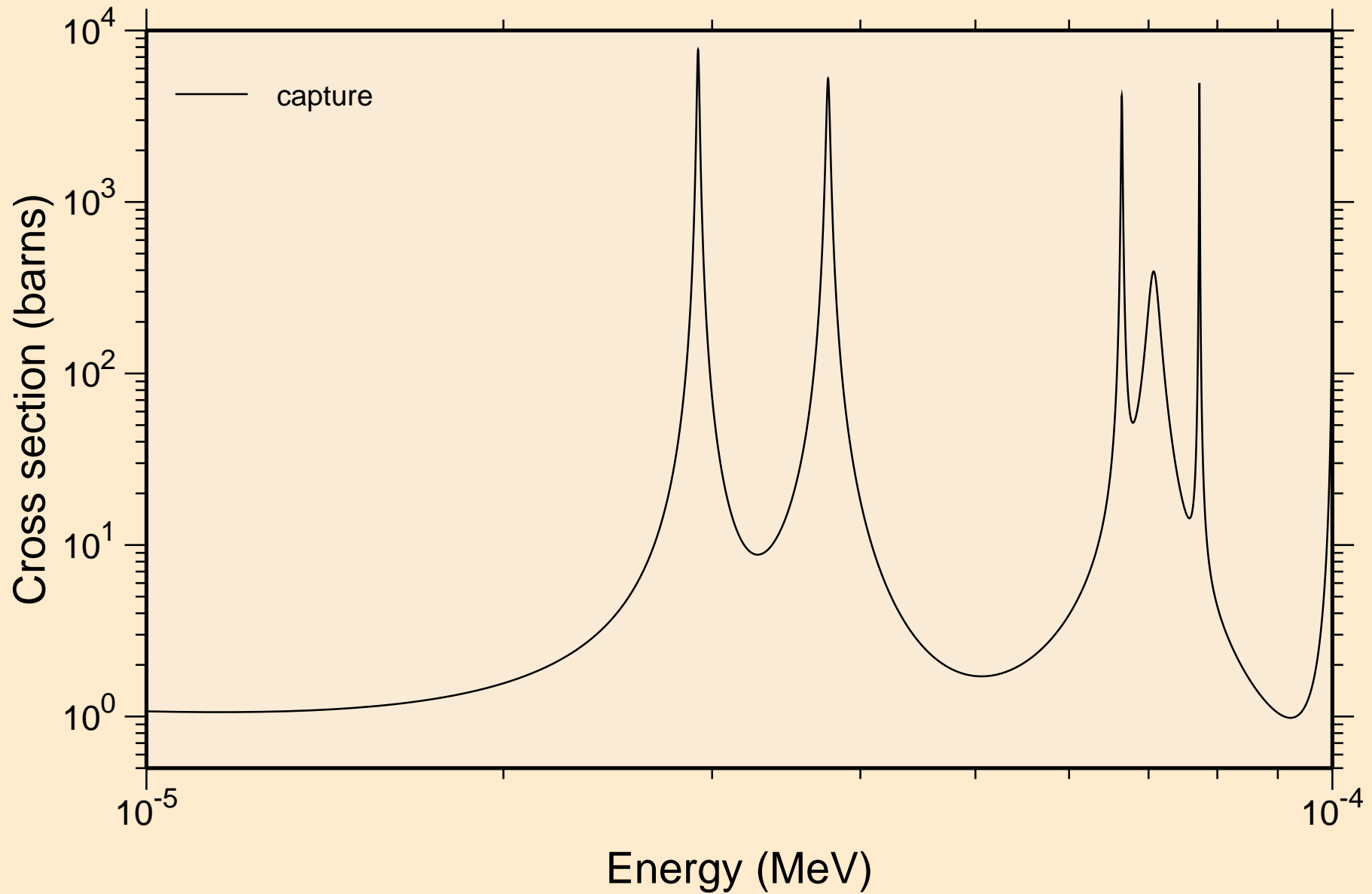

TC103 NEUTRON ACER TENDL-2023 LIBRARY; T=0.K  
resonance absorption cross sections

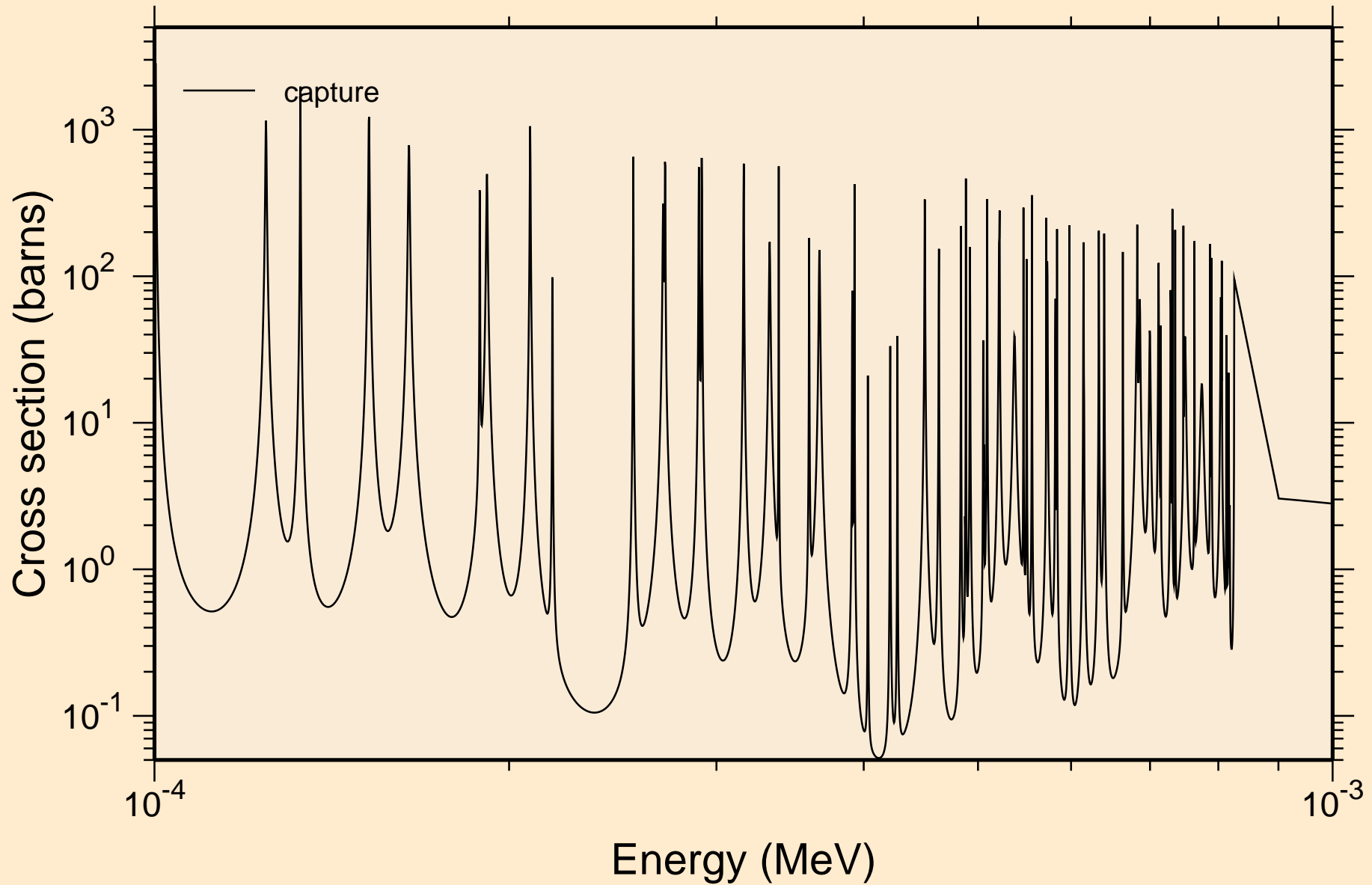

TC103 NEUTRON ACER TENDL-2023 LIBRARY; T=0.K  
resonance absorption cross sections

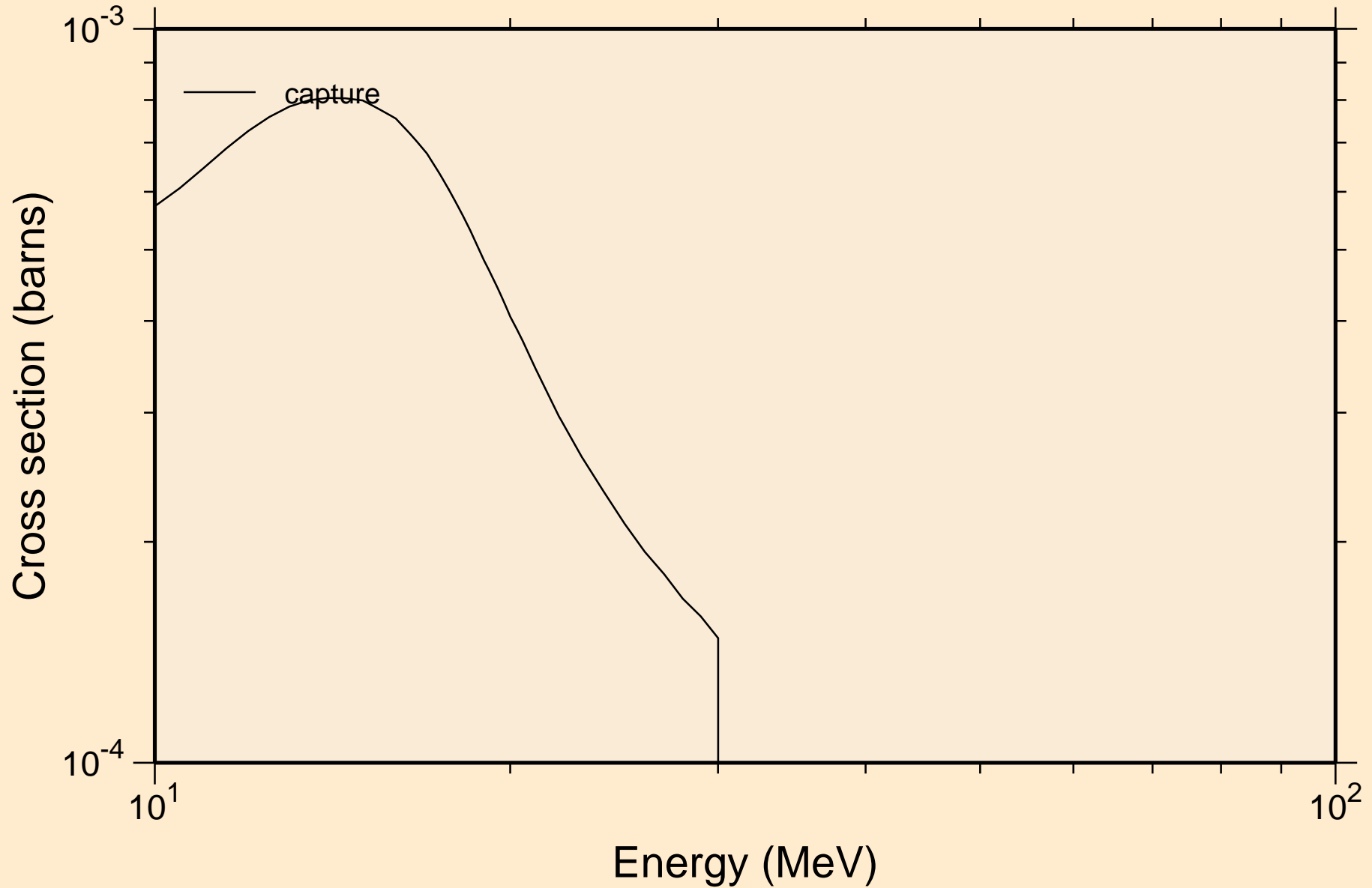

# TC103 NEUTRON ACER TENDL-2023 LIBRARY; T=0.K

## Heating

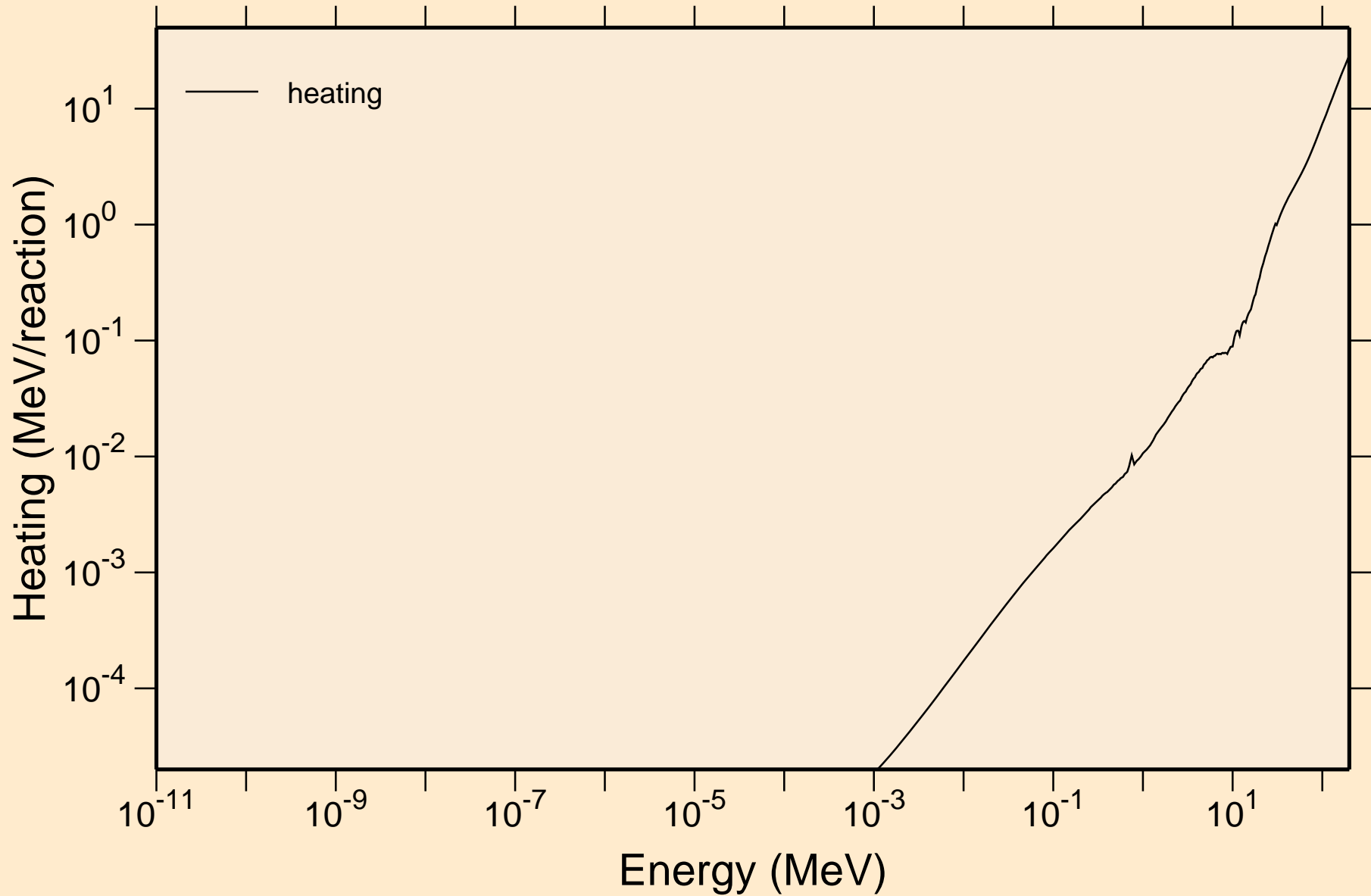



TC103 NEUTRON ACER TENDL-2023 LIBRARY; T=0.K  
Damage

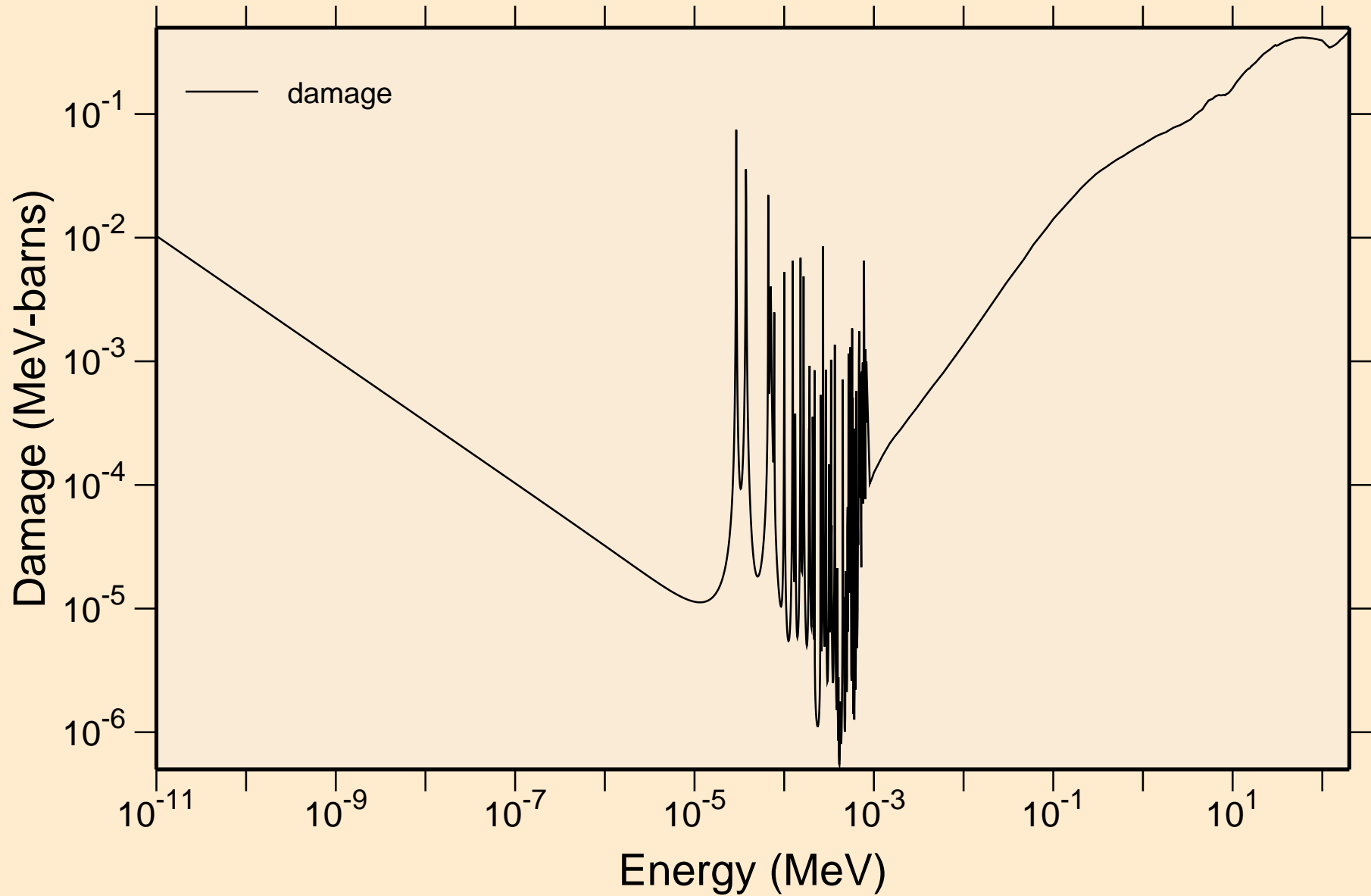

TC103 NEUTRON ACER TENDL-2023 LIBRARY; T=0.K  
Non-threshold reactions

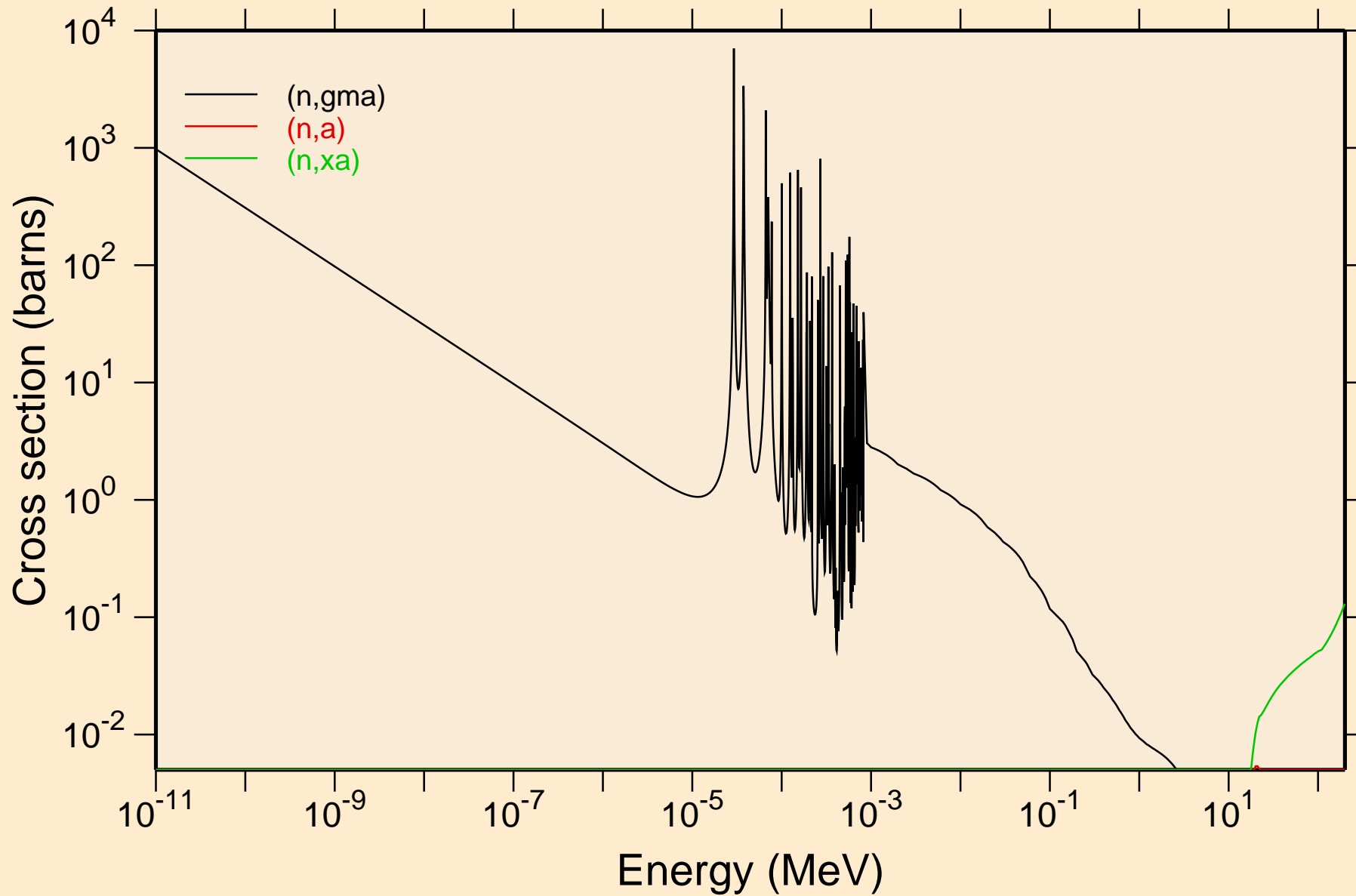

TC103 NEUTRON ACER TENDL-2023 LIBRARY; T=0.K  
Principal cross sections

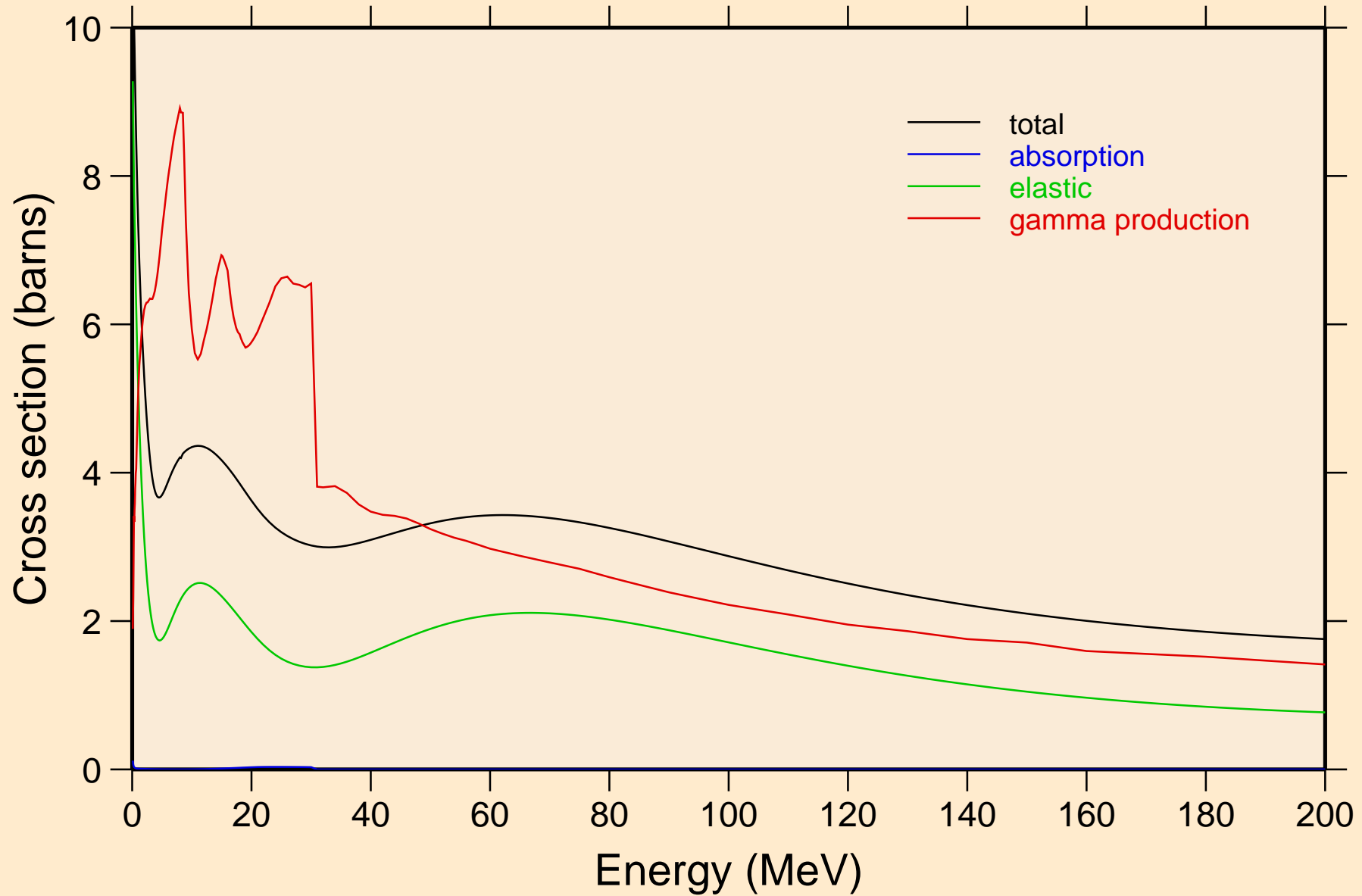

# TC103 NEUTRON ACER TENDL-2023 LIBRARY; T=0.K

## Heating

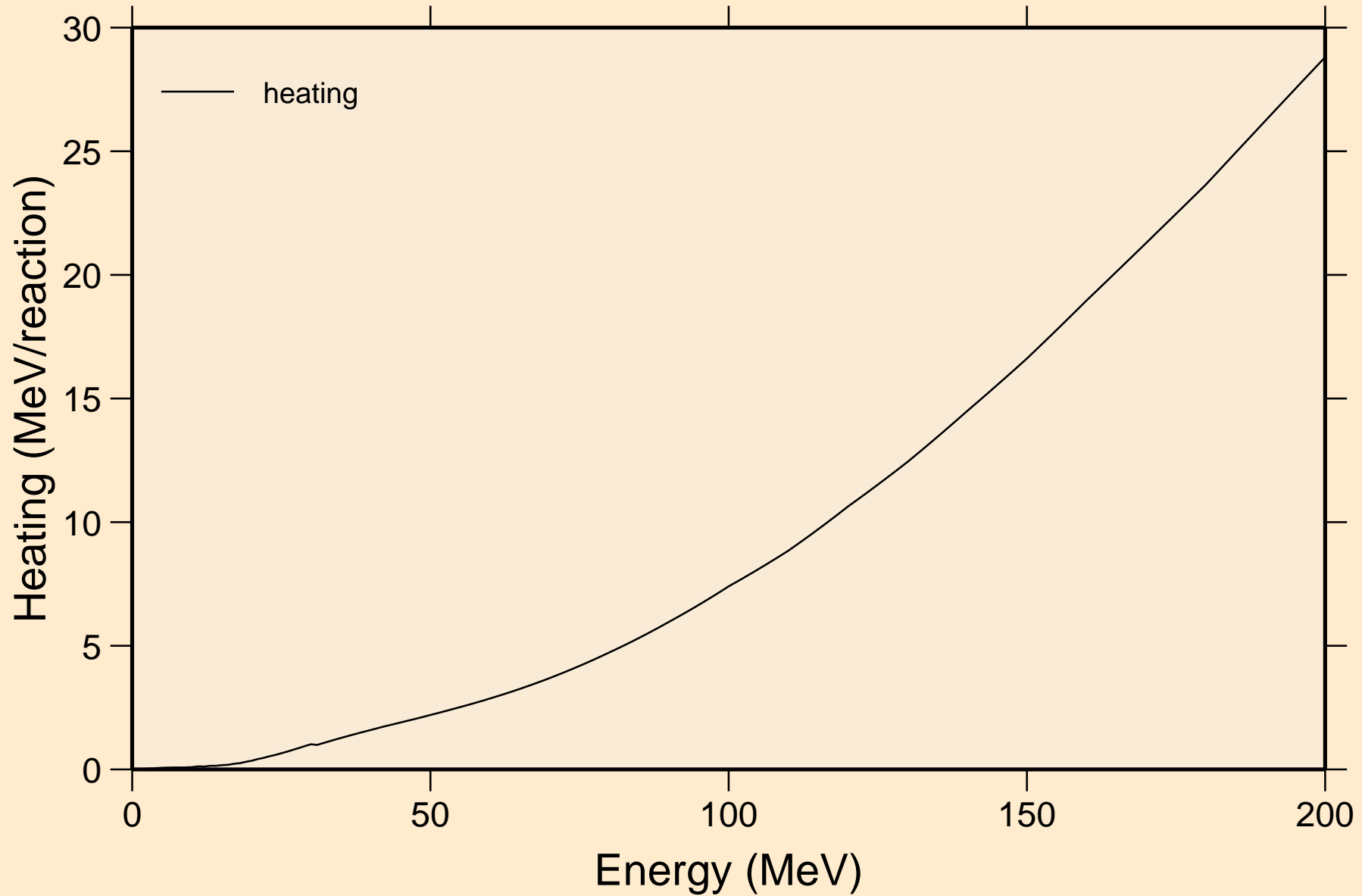

TC103 NEUTRON ACER TENDL-2023 LIBRARY; T=0.K  
Damage

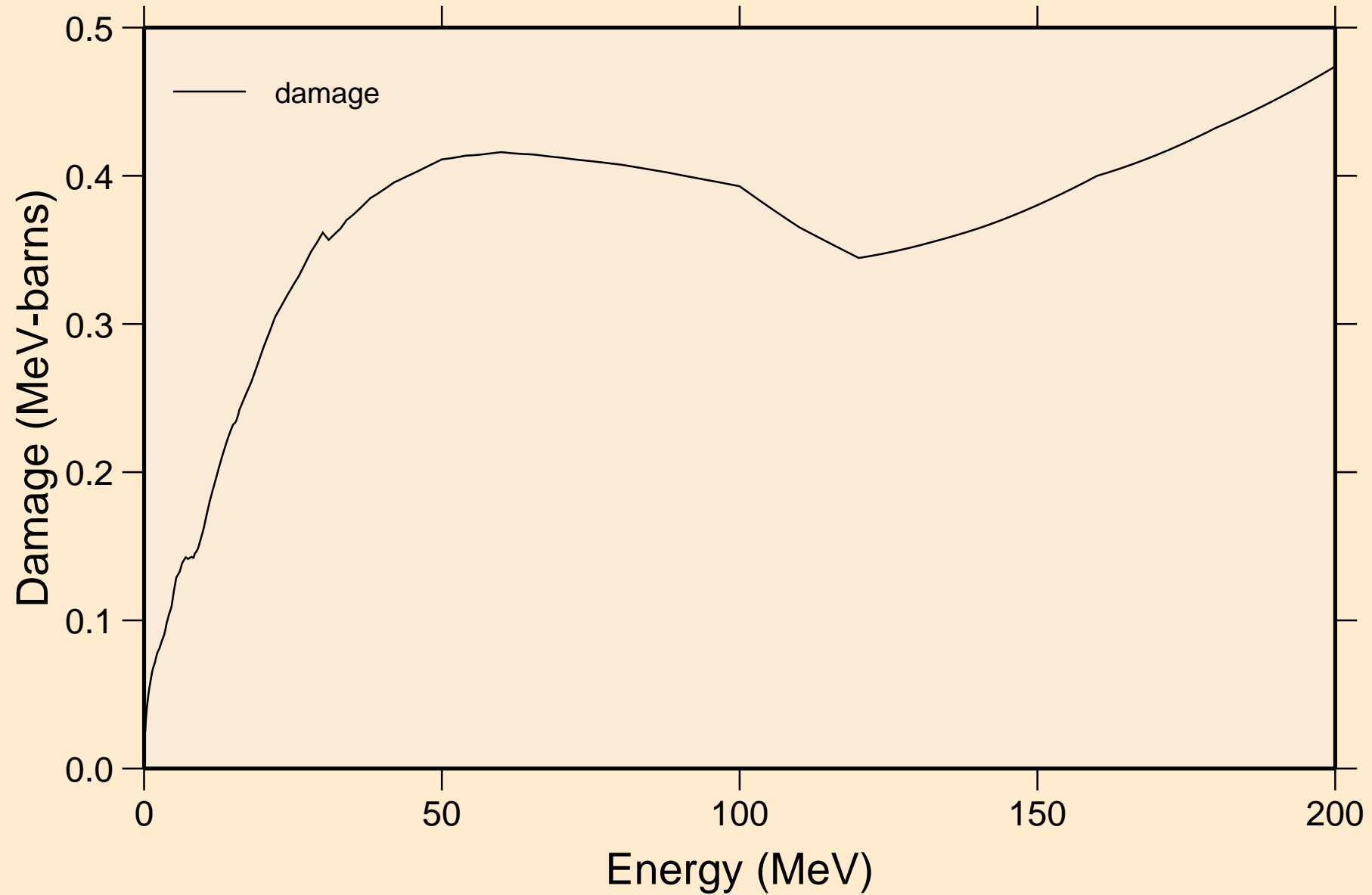

TC103 NEUTRON ACER TENDL-2023 LIBRARY; T=0.K  
Non-threshold reactions

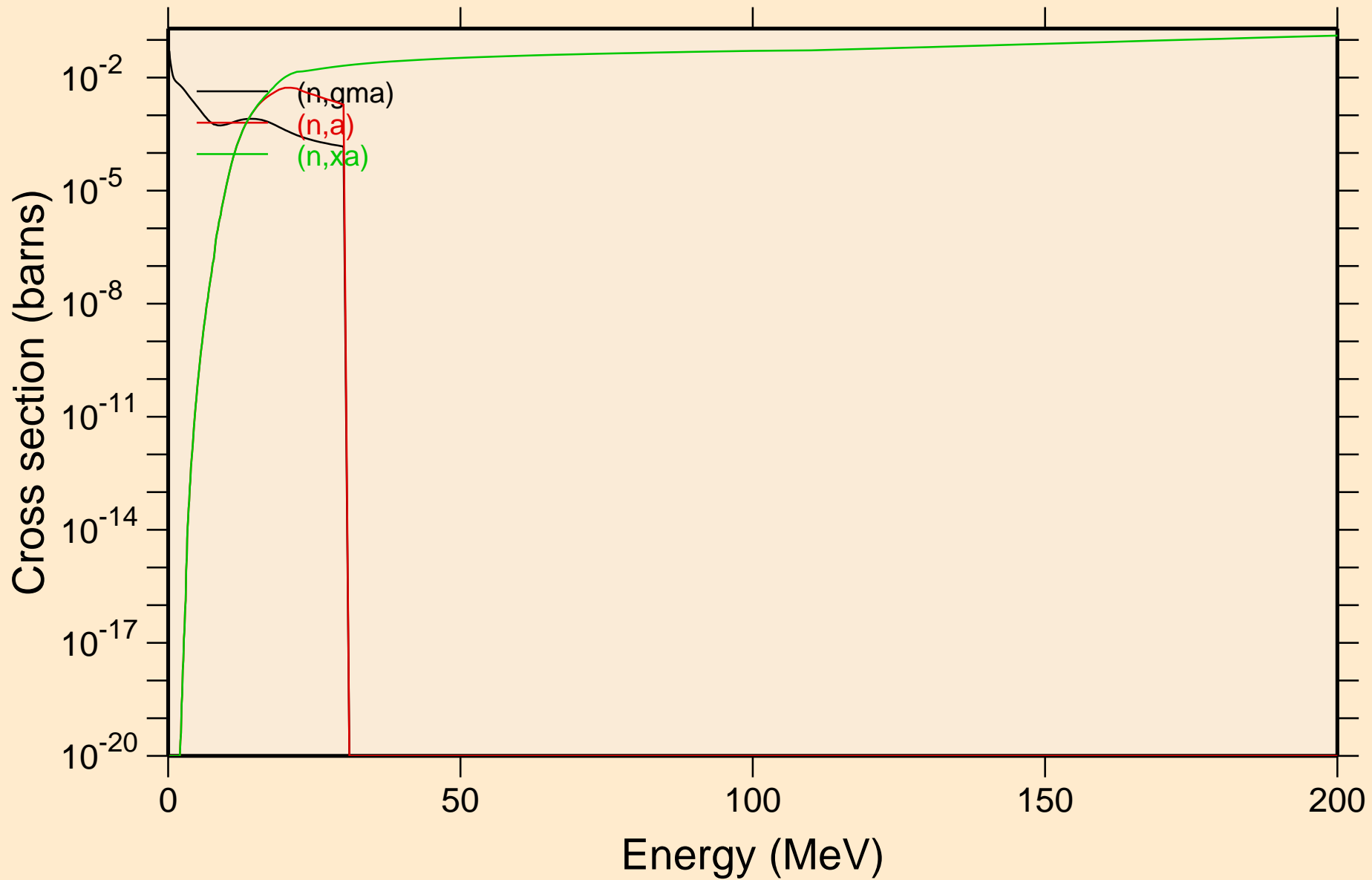

TC103 NEUTRON ACER TENDL-2023 LIBRARY; T=0.K  
Inelastic levels

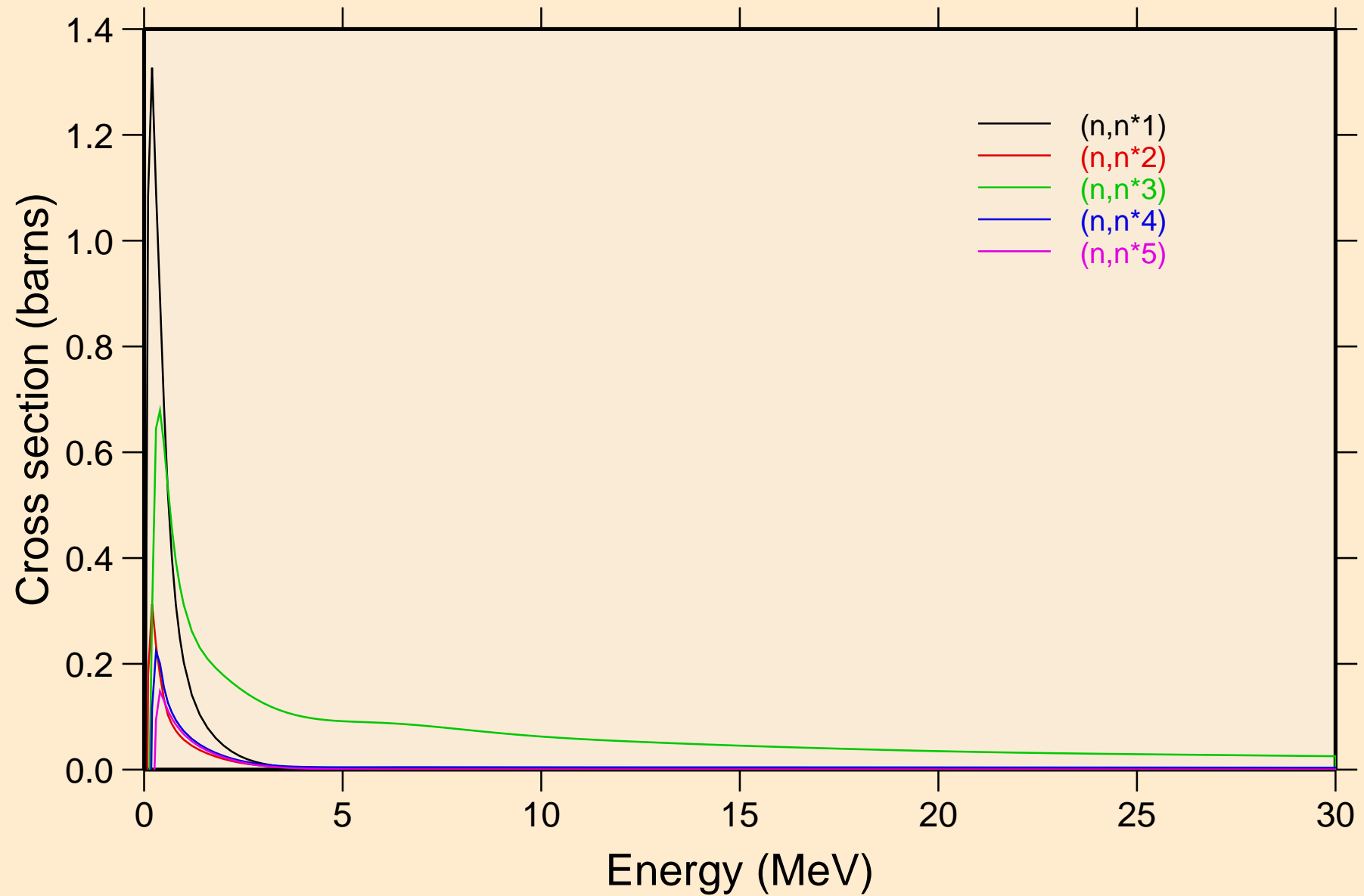

TC103 NEUTRON ACER TENDL-2023 LIBRARY; T=0.K  
Inelastic levels

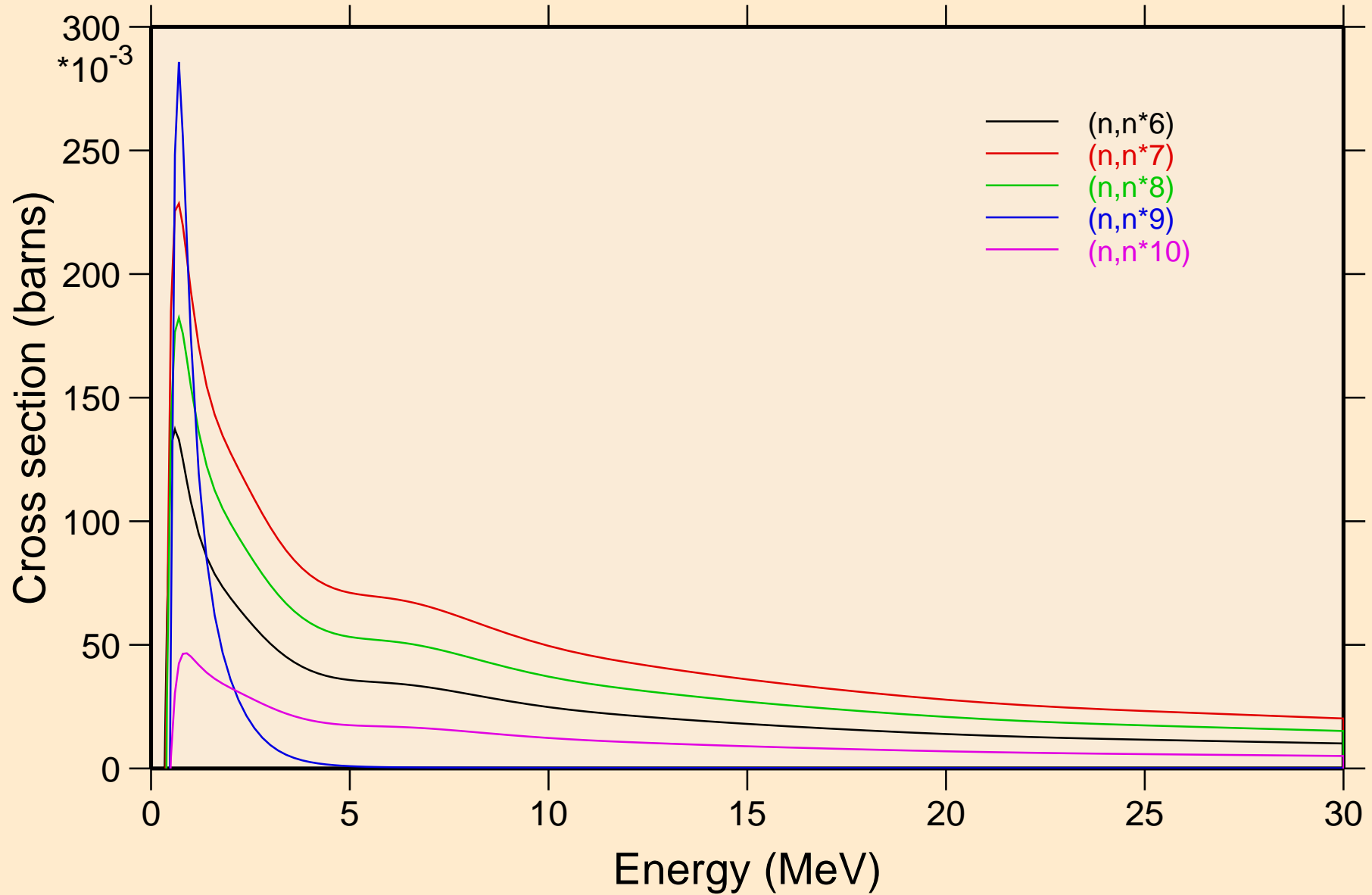



TC103 NEUTRON ACER TENDL-2023 LIBRARY; T=0.K  
Inelastic levels

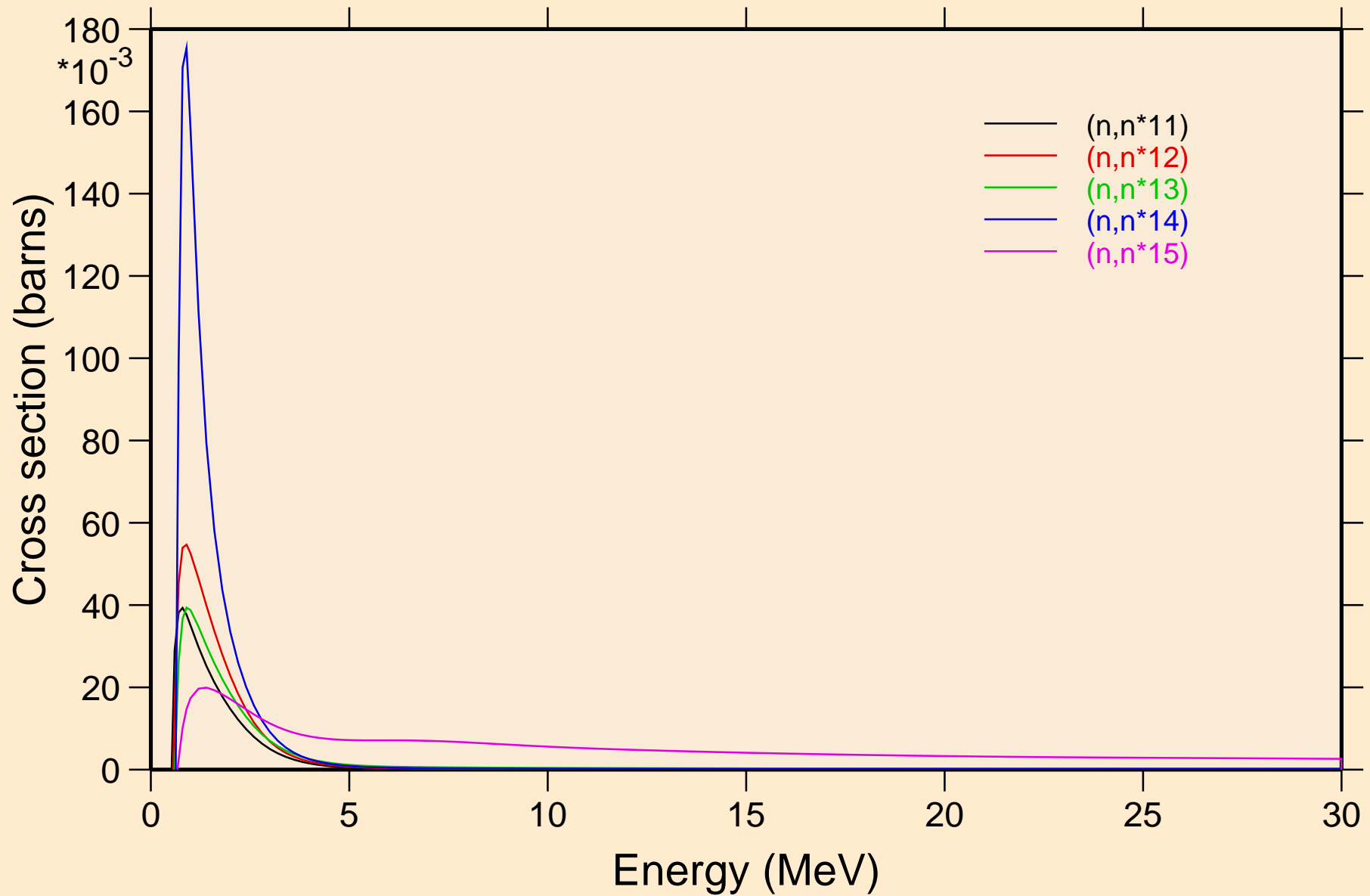

TC103 NEUTRON ACER TENDL-2023 LIBRARY; T=0.K  
Threshold reactions

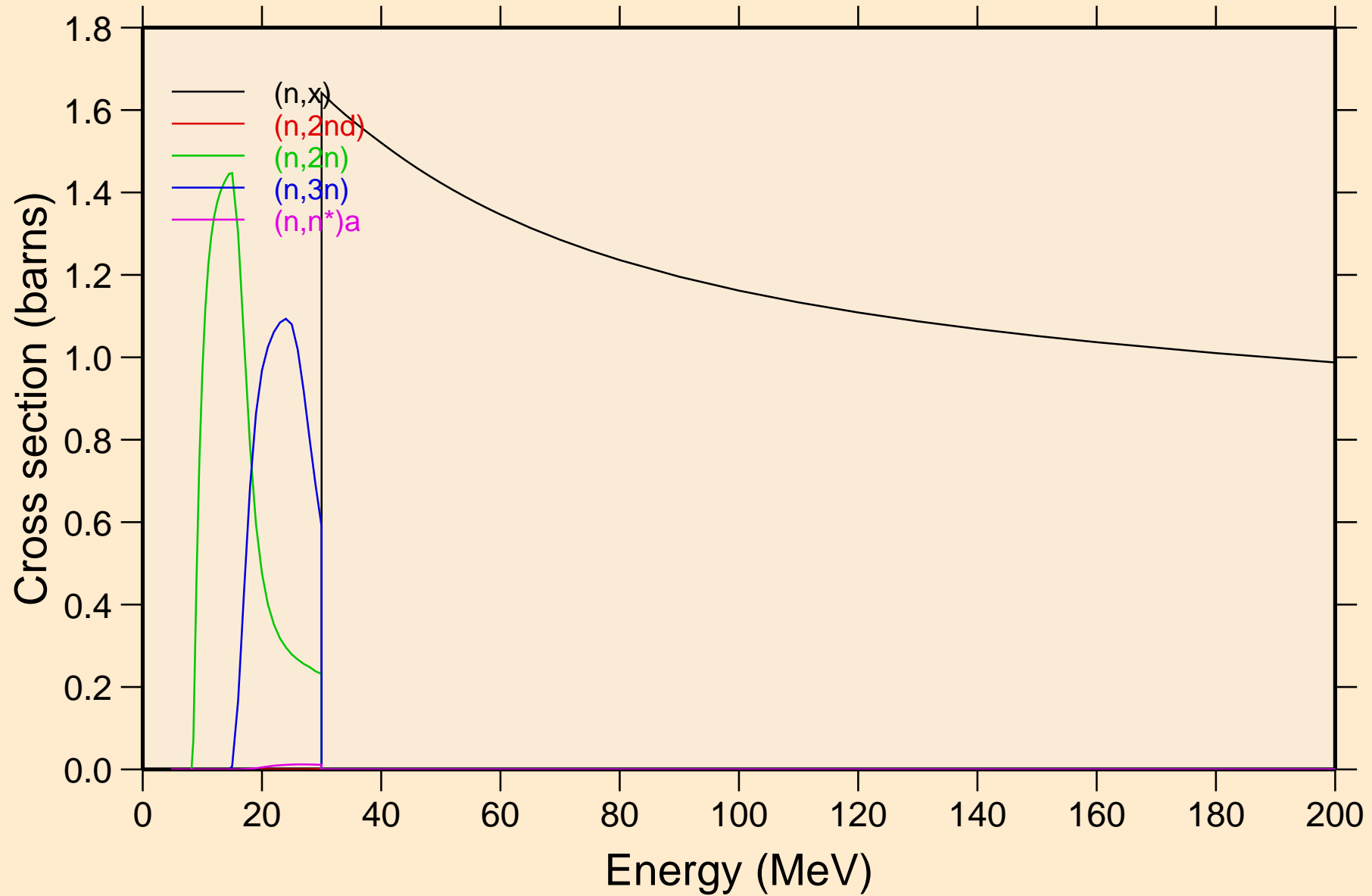

TC103 NEUTRON ACER TENDL-2023 LIBRARY; T=0.K  
Threshold reactions

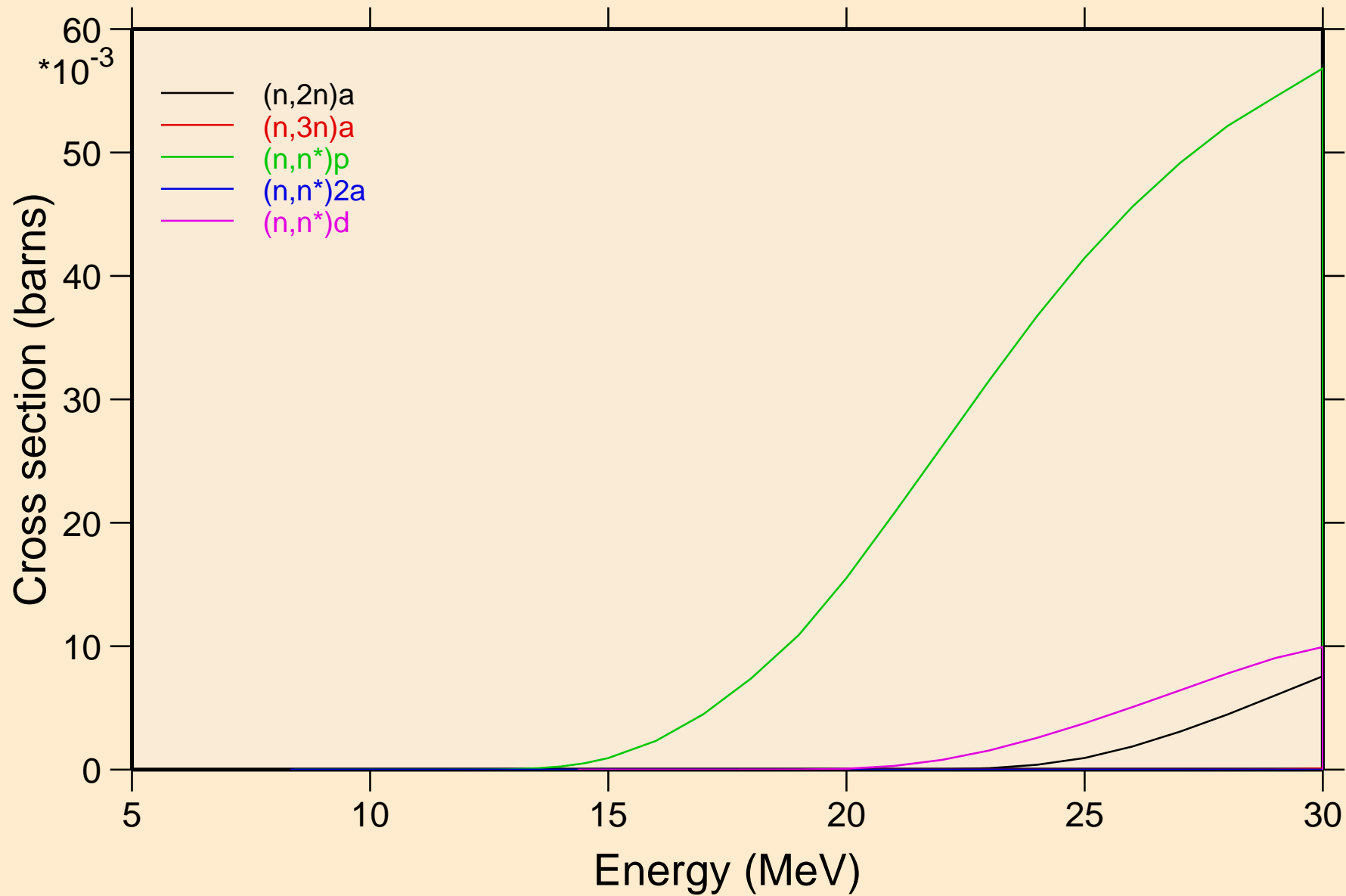

TC103 NEUTRON ACER TENDL-2023 LIBRARY; T=0.K  
Threshold reactions

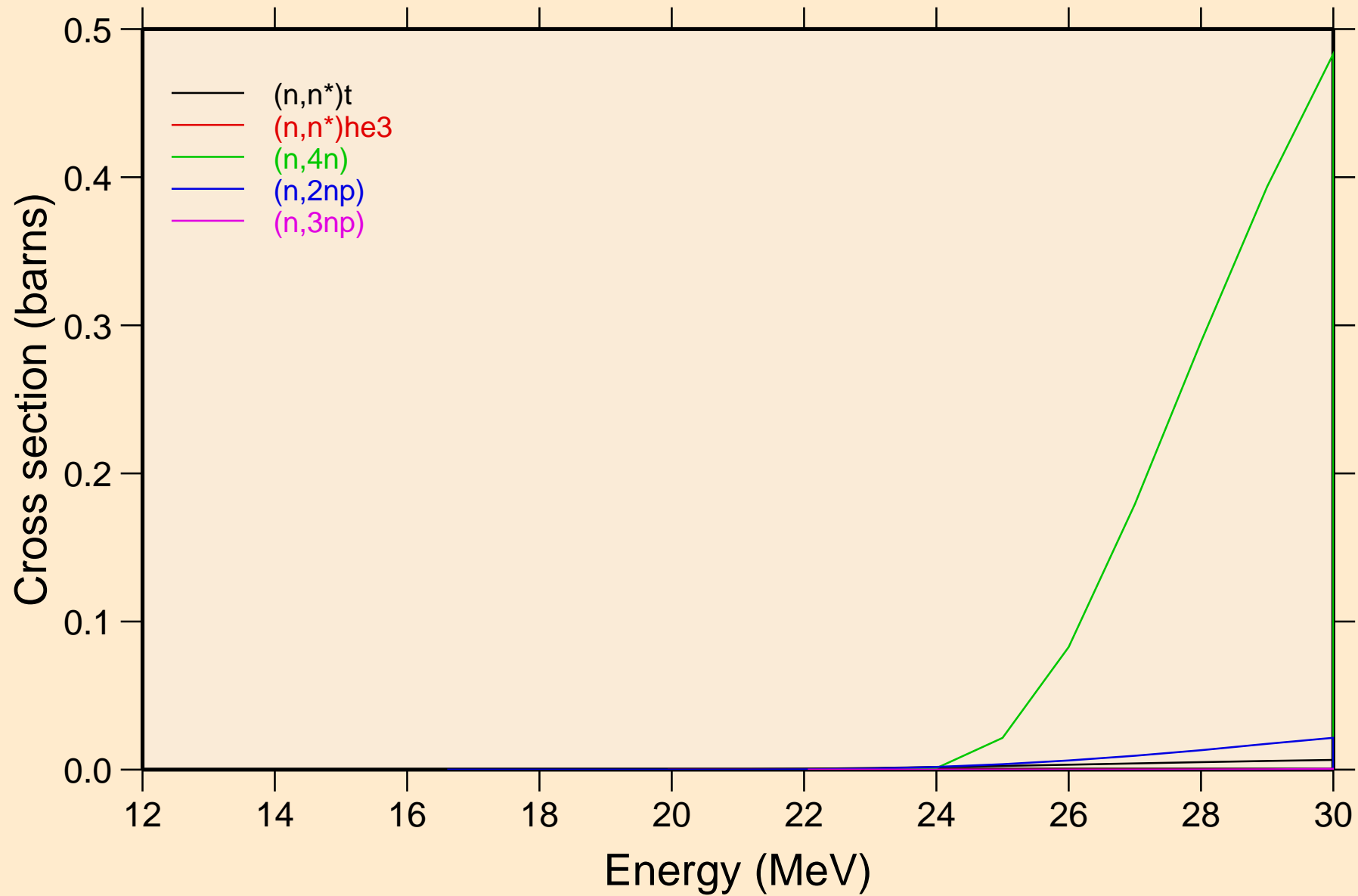

TC103 NEUTRON ACER TENDL-2023 LIBRARY; T=0.K  
Threshold reactions

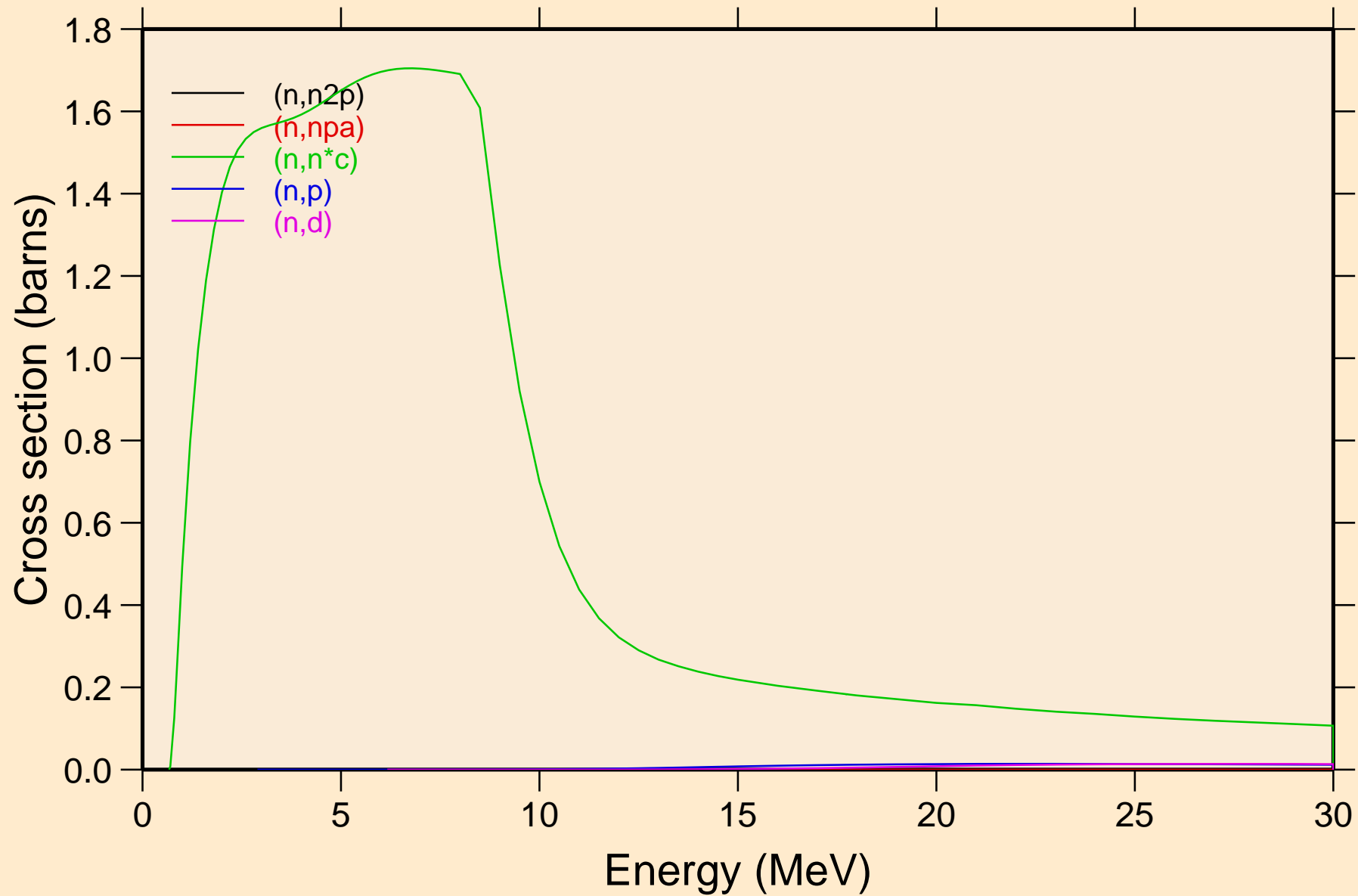

TC103 NEUTRON ACER TENDL-2023 LIBRARY; T=0.K  
Threshold reactions

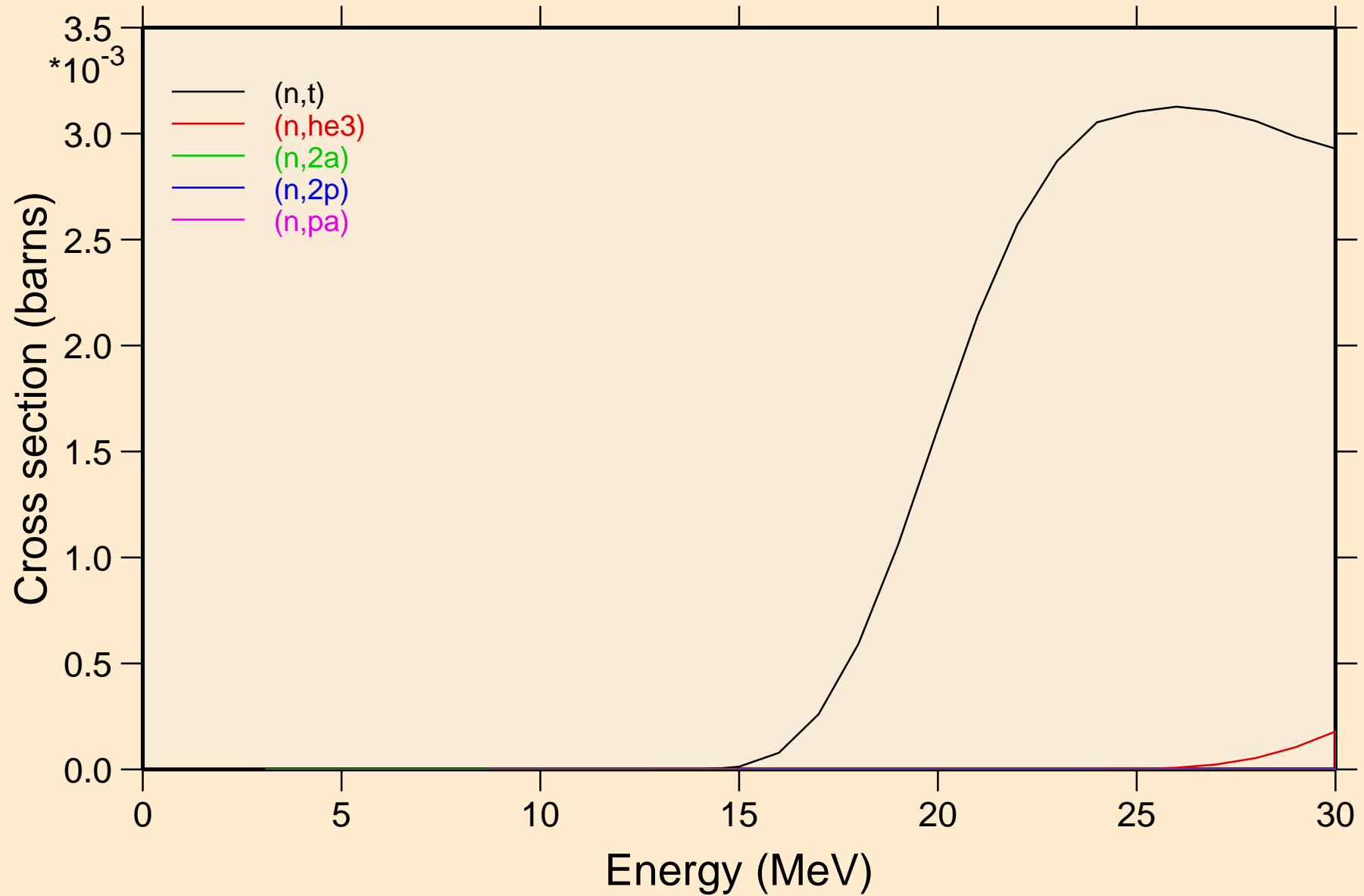

# TC103 NEUTRON ACER TENDL-2023 LIBRARY; T=0.K

## Threshold reactions

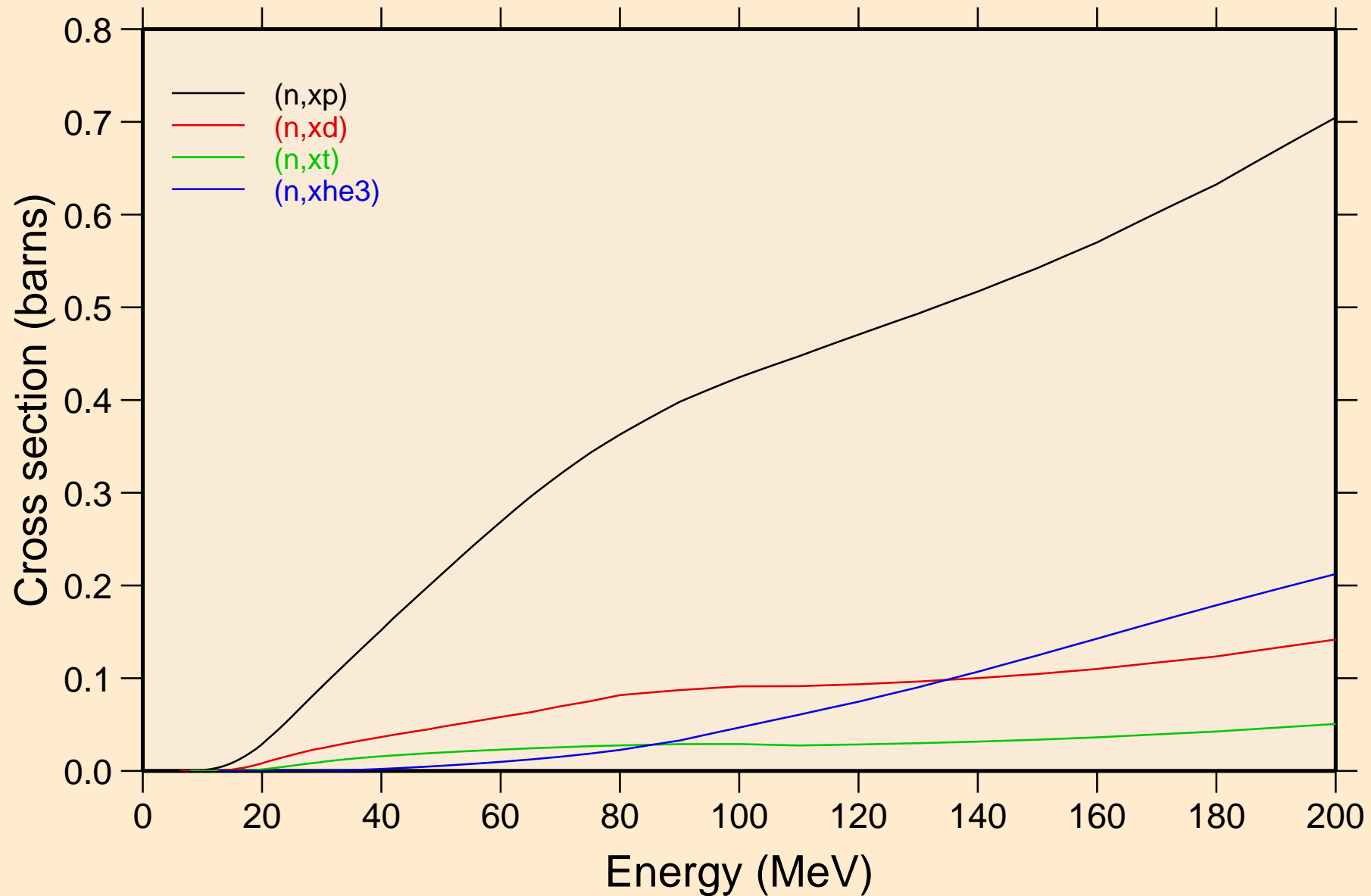

TC103 NEUTRON ACER TENDL-2023 LIBRARY; T=0.K  
angular distribution for elastic

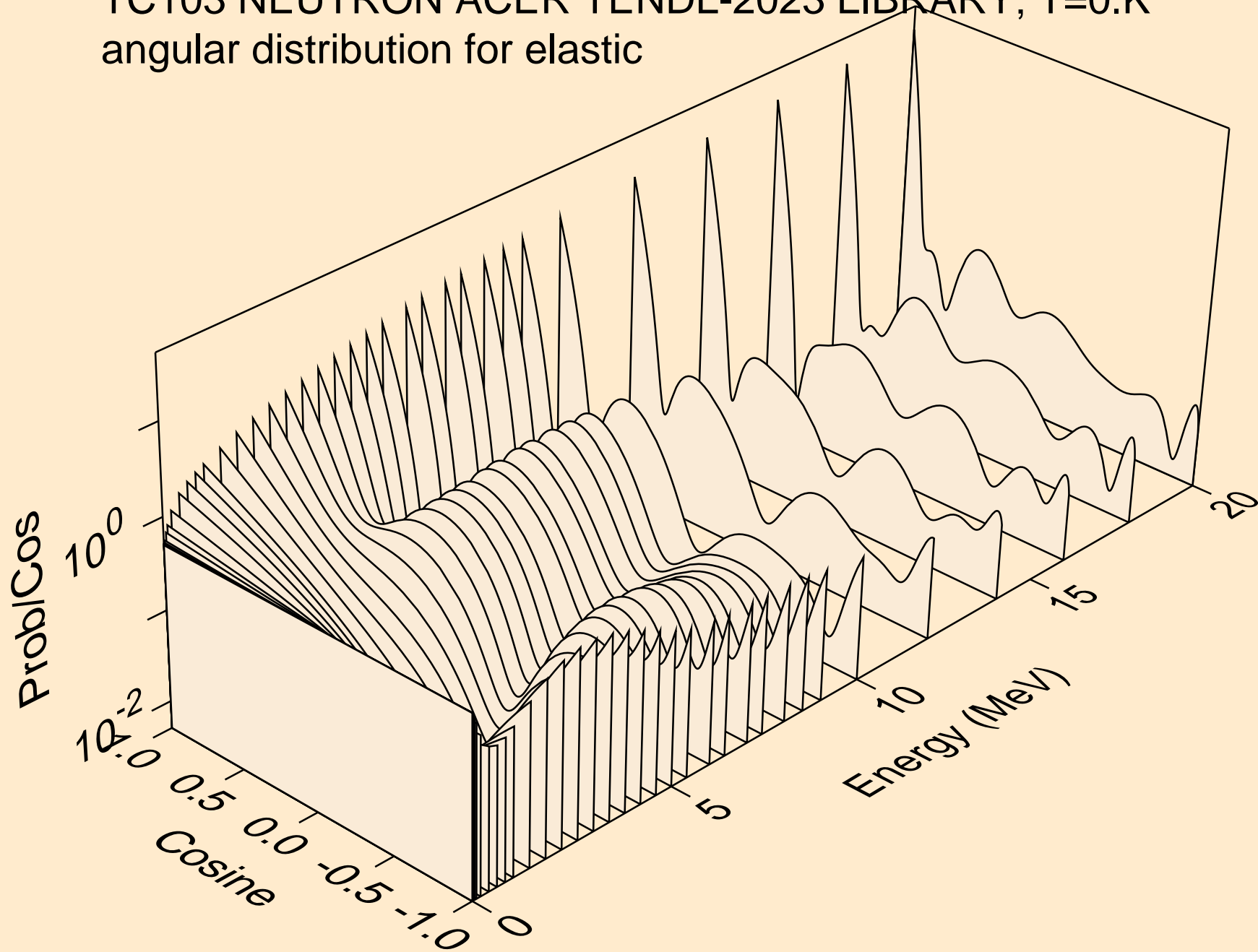



TC103 NEUTRON ACER TENDL-2023 LIBRARY; T=0.K  
angular distribution for elastic

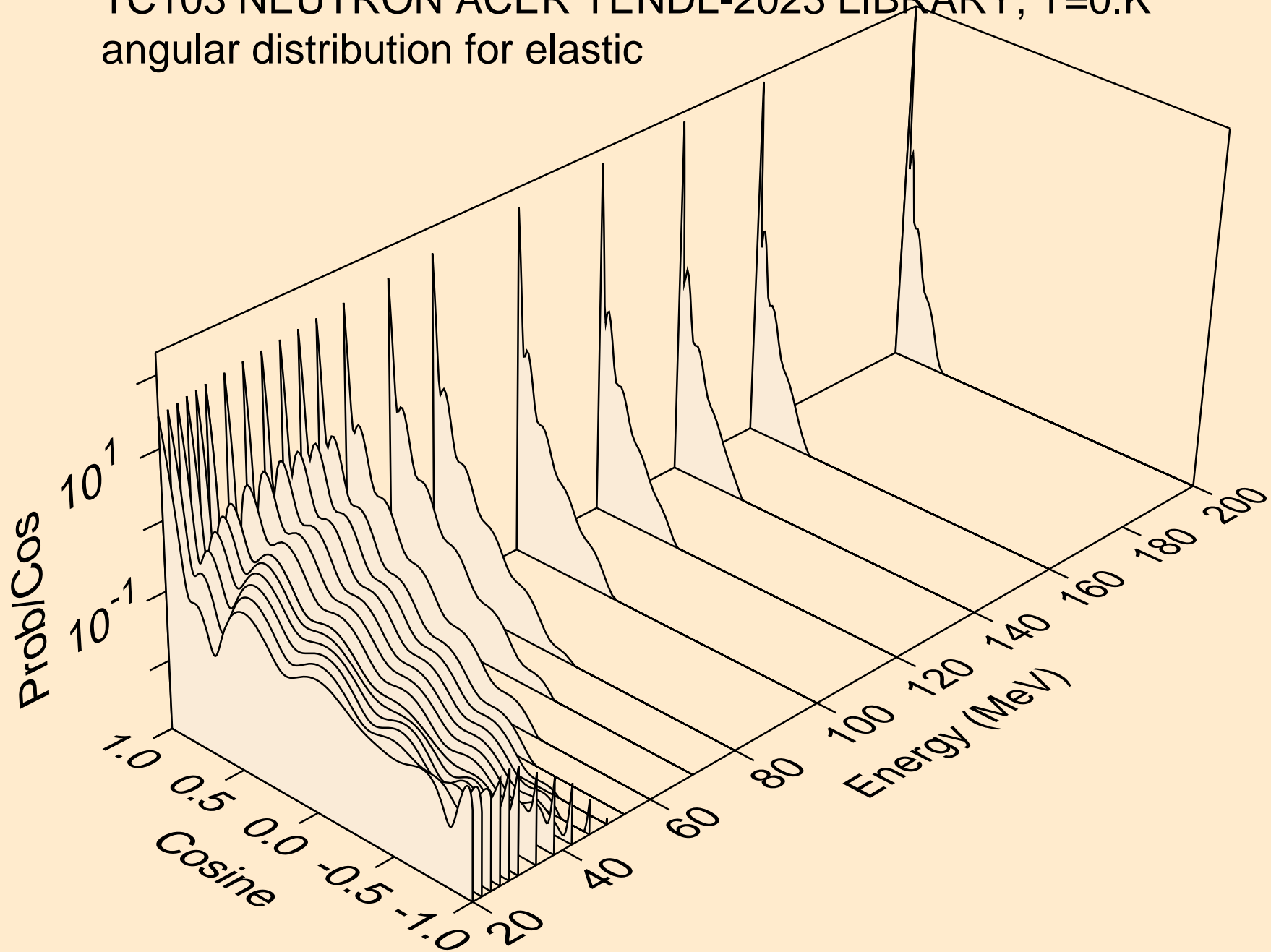

TC103 NEUTRON ACER TENDL-2023 LIBRARY; T=0.K  
angular distribution for (n,n\*1)

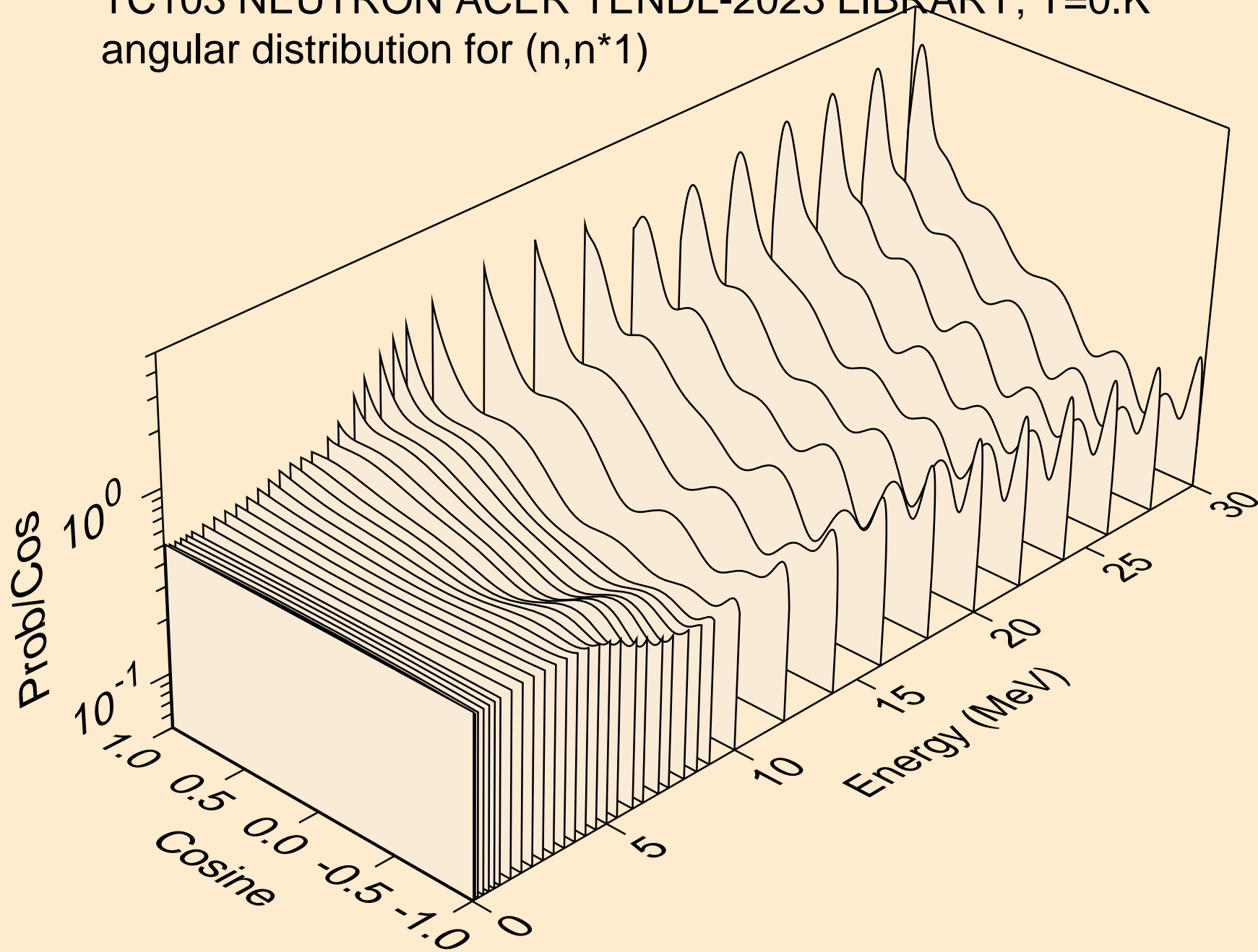

TC103 NEUTRON ACER TENDL-2023 LIBRARY; T=0.K  
angular distribution for (n,n\*2)

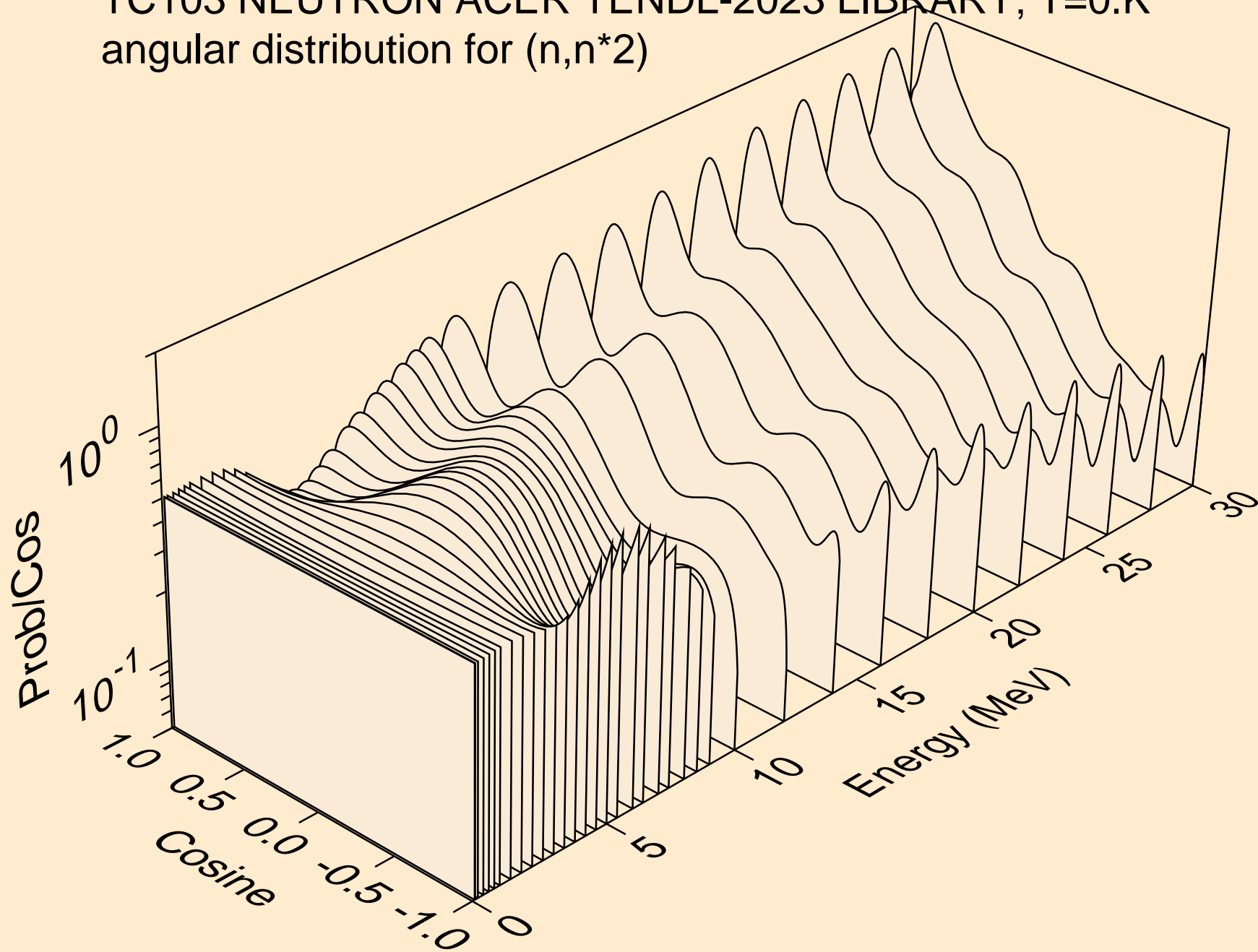

TC103 NEUTRON ACER TENDL-2023 LIBRARY; T=0.K  
angular distribution for (n,n\*3)

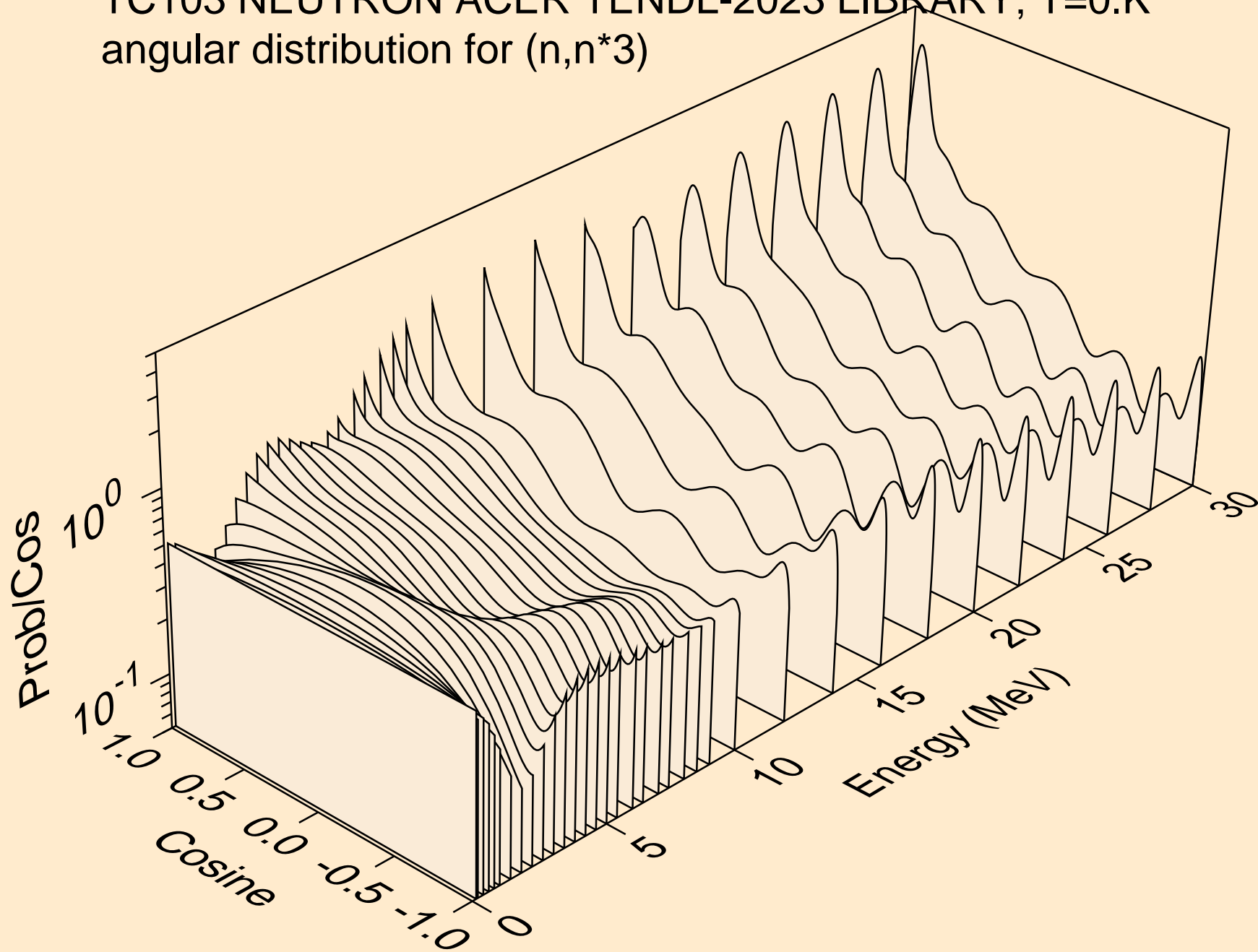

TC103 NEUTRON ACER TENDL-2023 LIBRARY; T=0.K  
angular distribution for (n,n\*4)

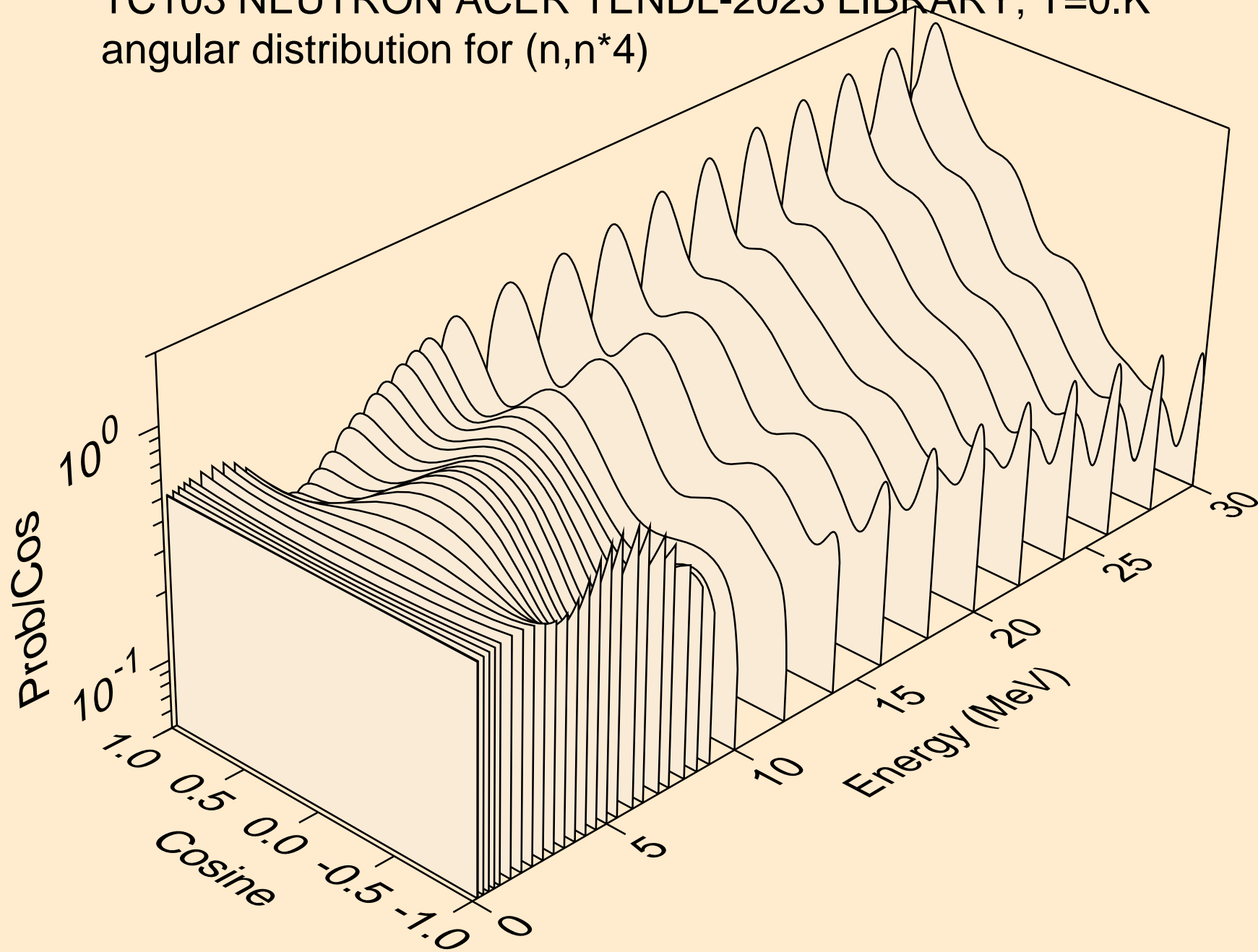

TC103 NEUTRON ACER TENDL-2023 LIBRARY; T=0.K  
angular distribution for (n,n\*5)

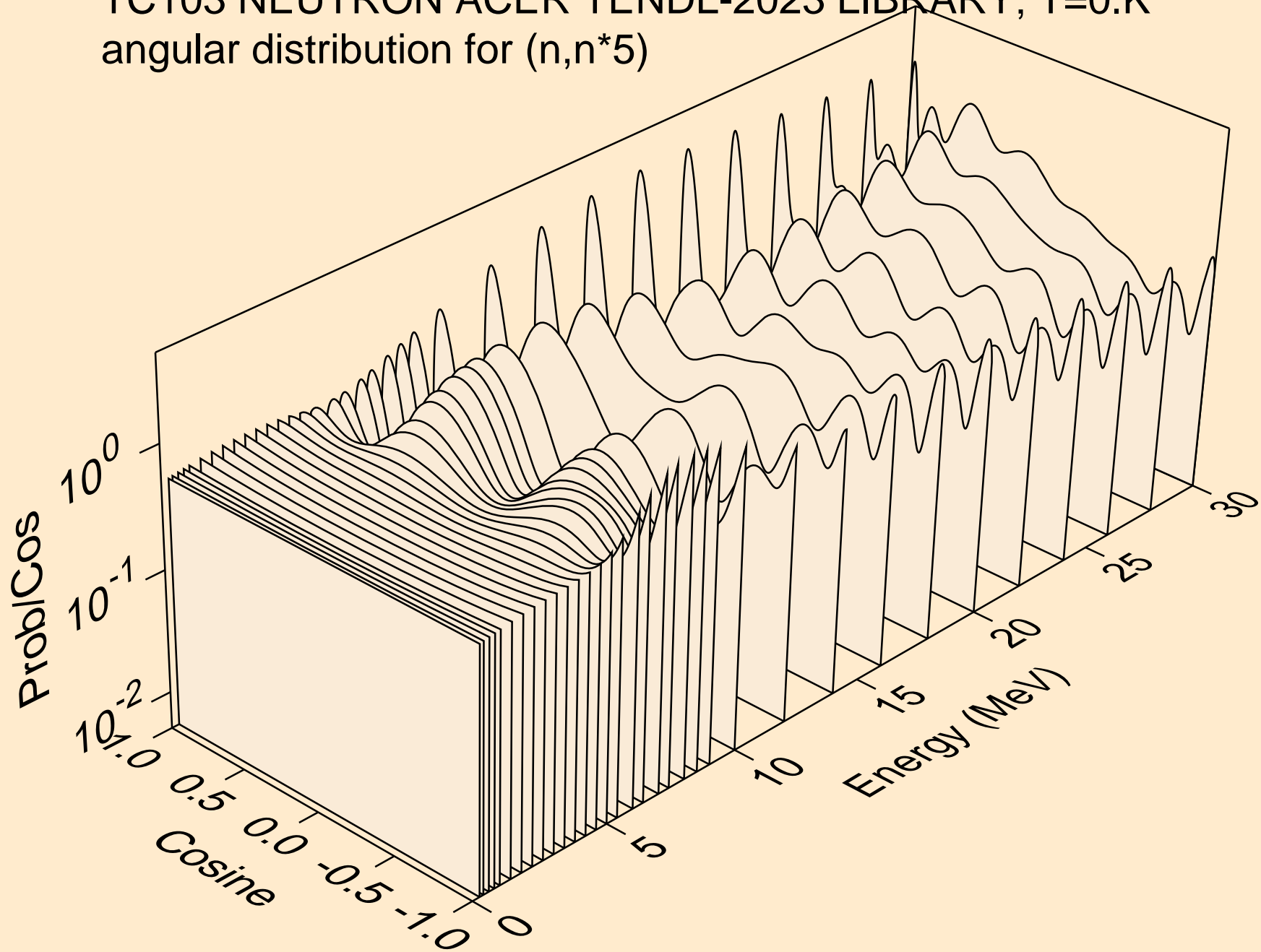

TC103 NEUTRON ACER TENDL-2023 LIBRARY; T=0.K  
angular distribution for (n,n\*6)

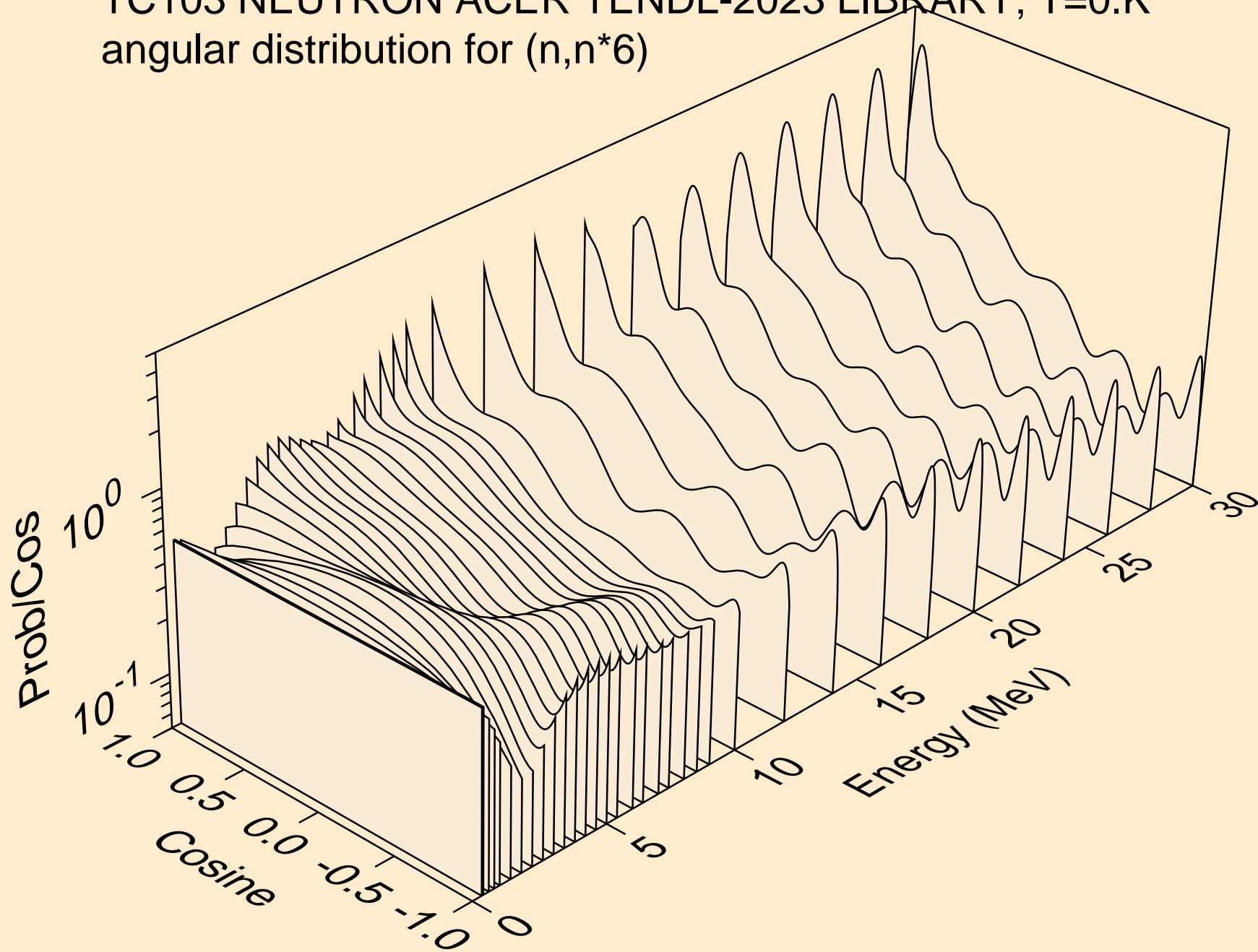

TC103 NEUTRON ACER TENDL-2023 LIBRARY; T=0.K  
angular distribution for (n,n\*7)

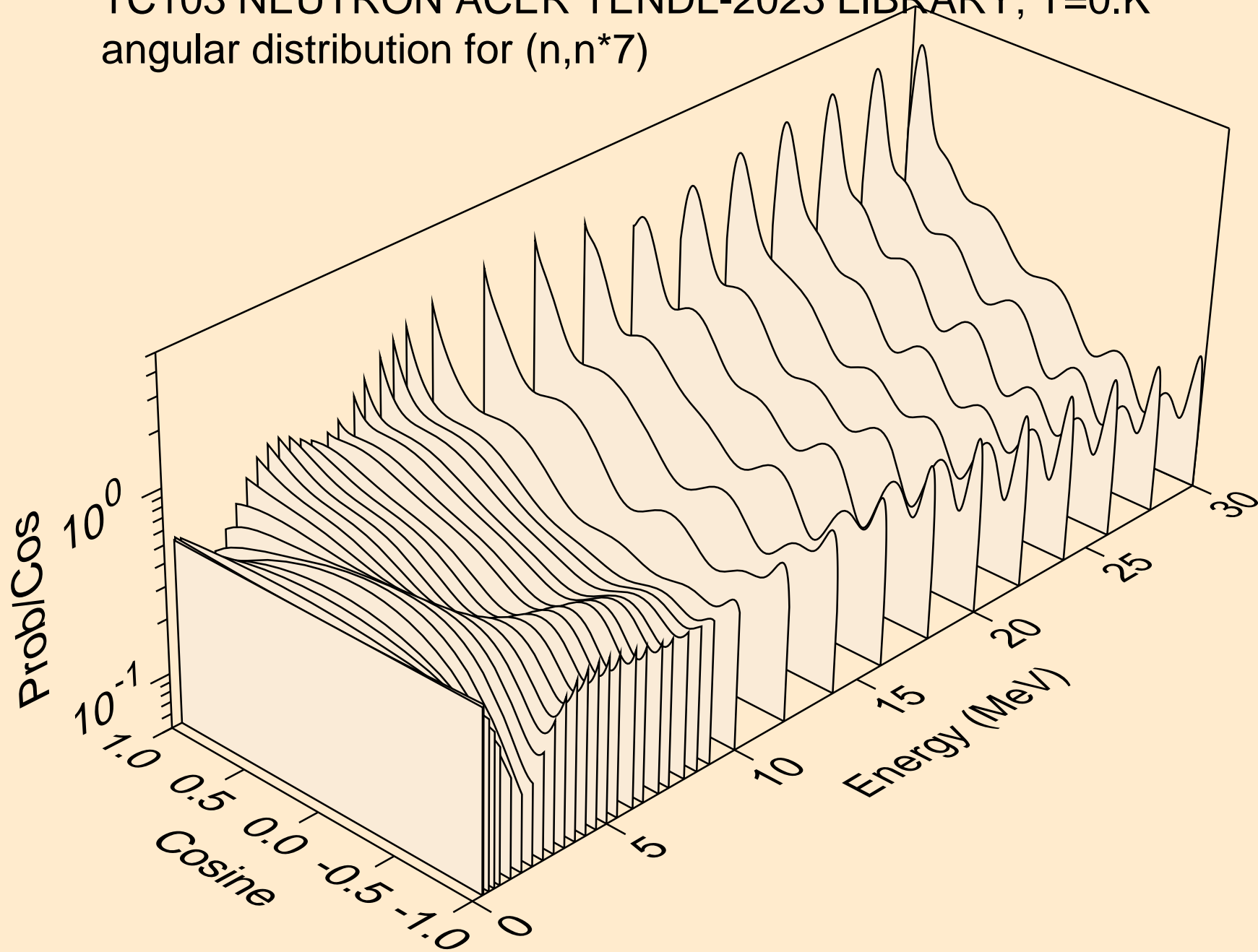



TC103 NEUTRON ACER TENDL-2023 LIBRARY; T=0.K  
angular distribution for (n,n\*8)

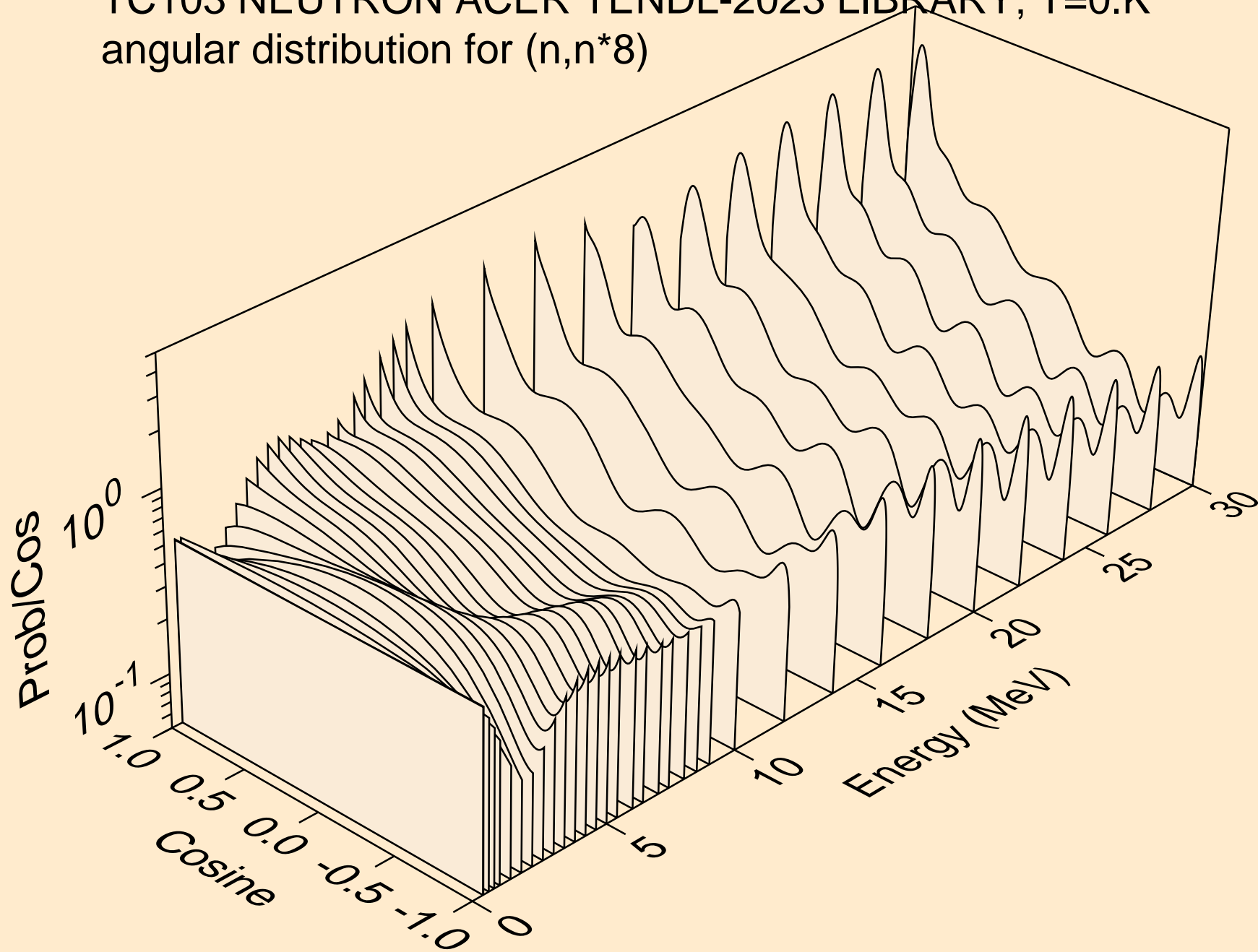

TC103 NEUTRON ACER TENDL-2023 LIBRARY; T=0.K  
angular distribution for (n,n\*9)

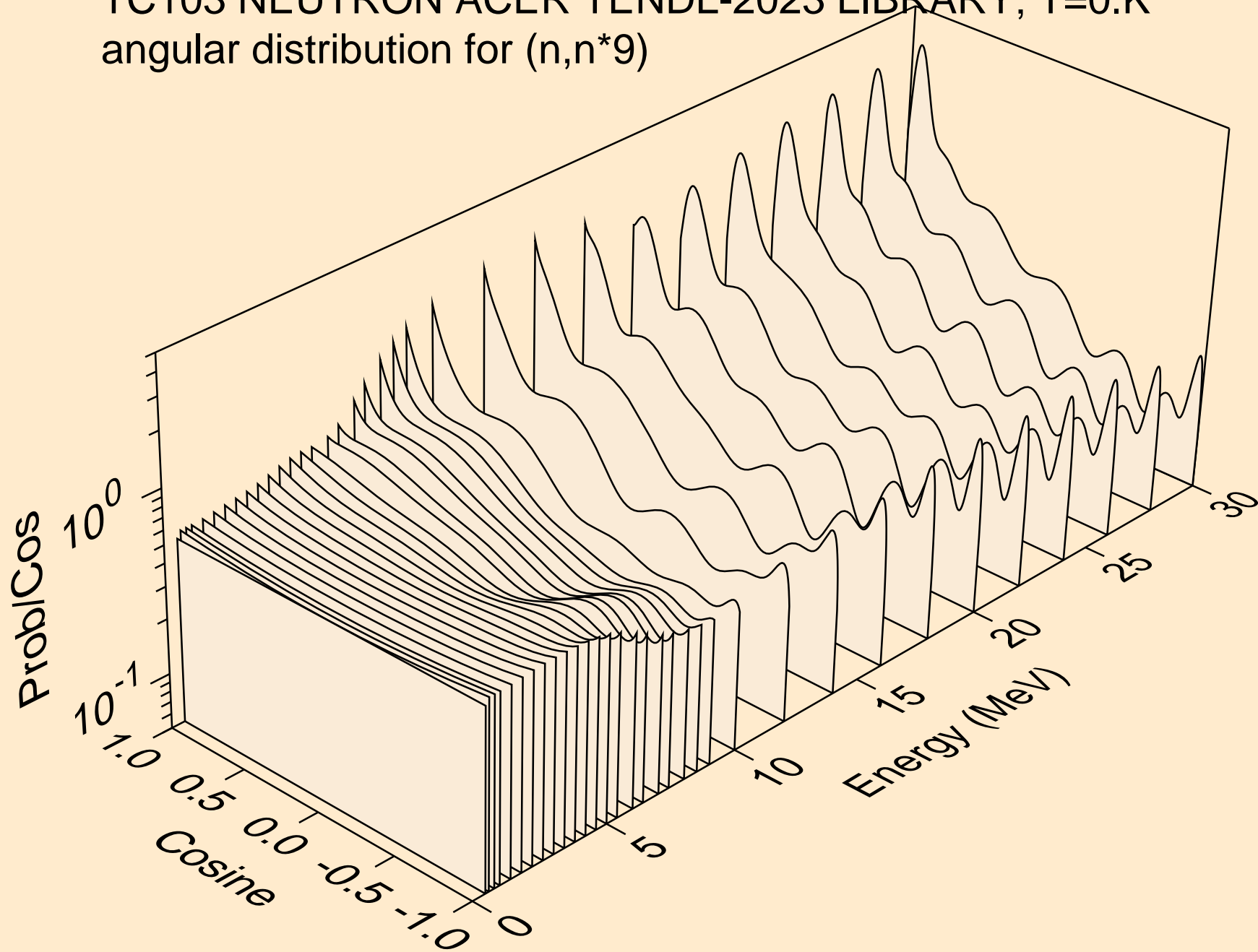

TC103 NEUTRON ACER TENDL-2023 LIBRARY; T=0.K  
angular distribution for (n,n\*10)

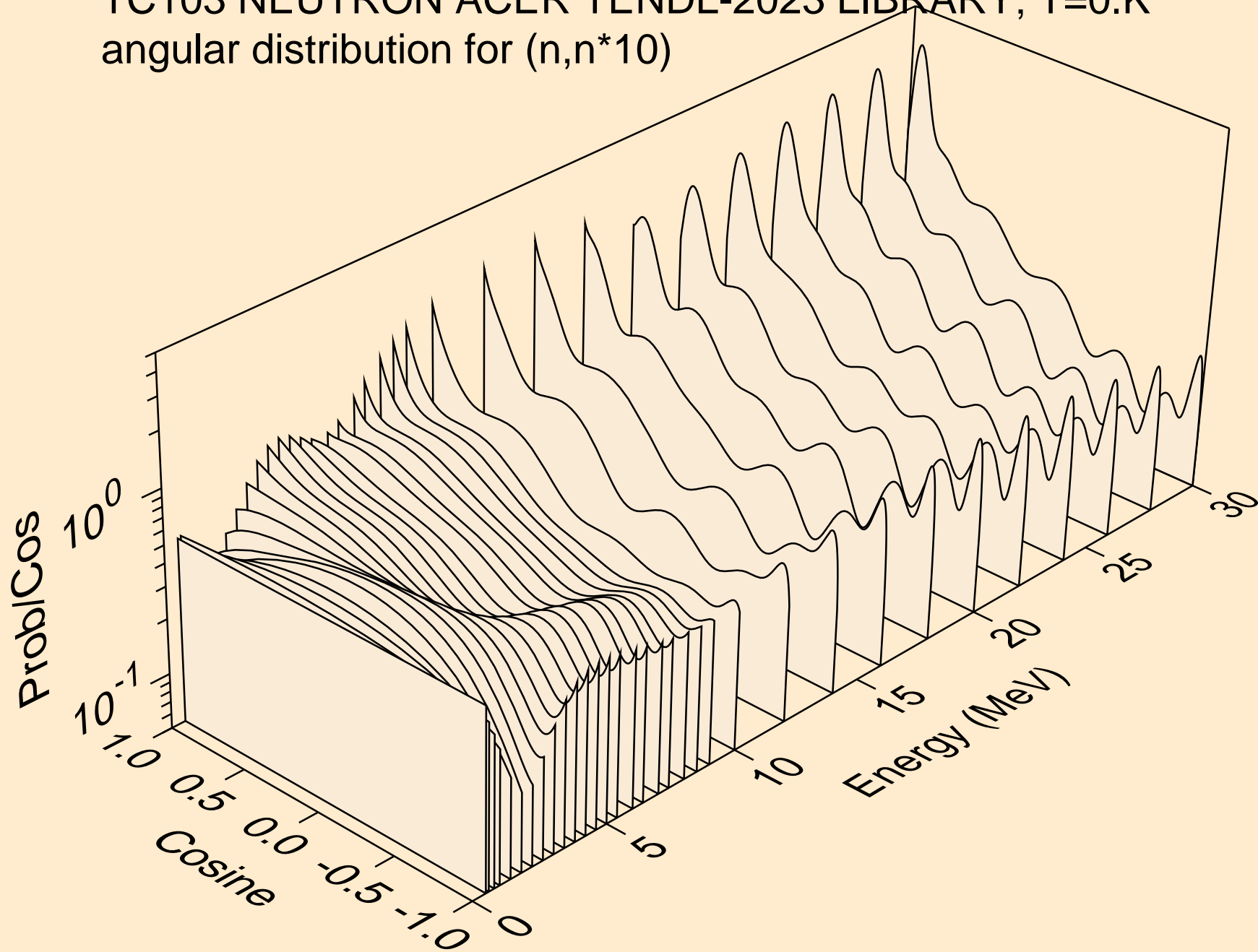

TC103 NEUTRON ACER TENDL-2023 LIBRARY; T=0.K  
angular distribution for (n,n\*11)

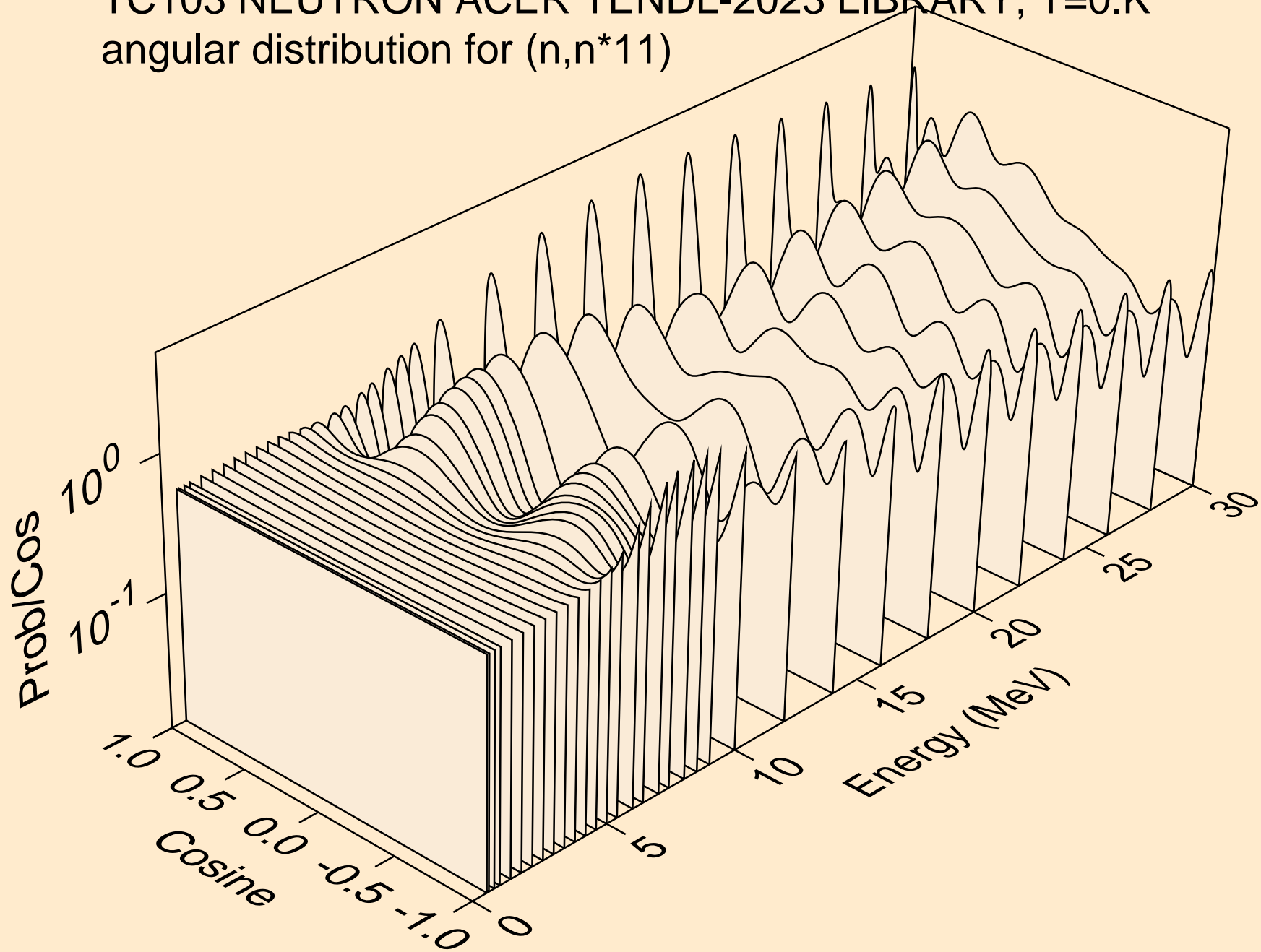

TC103 NEUTRON ACER TENDL-2023 LIBRARY; T=0.K  
angular distribution for (n,n\*12)

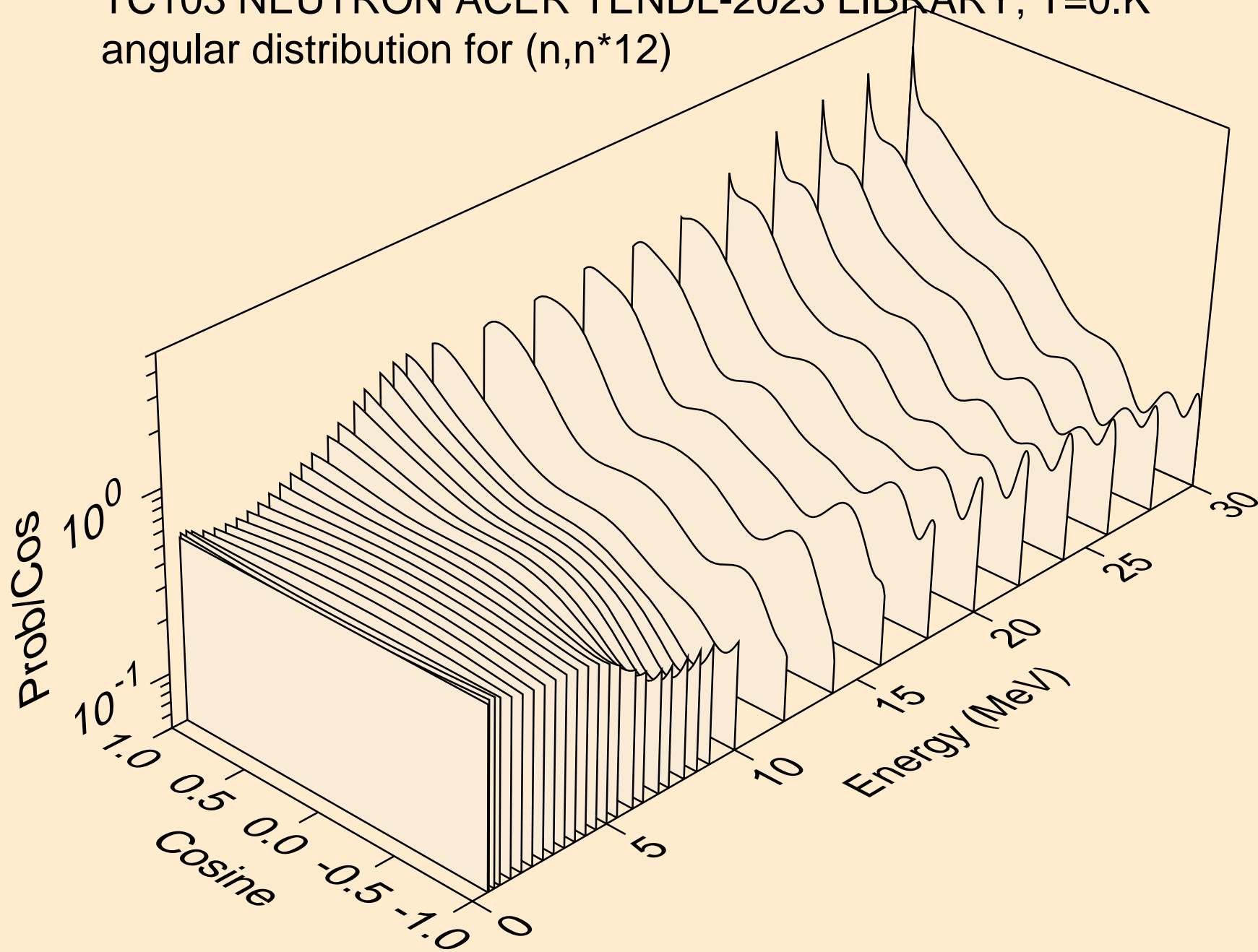

TC103 NEUTRON ACER TENDL-2023 LIBRARY; T=0.K  
angular distribution for (n,n\*13)

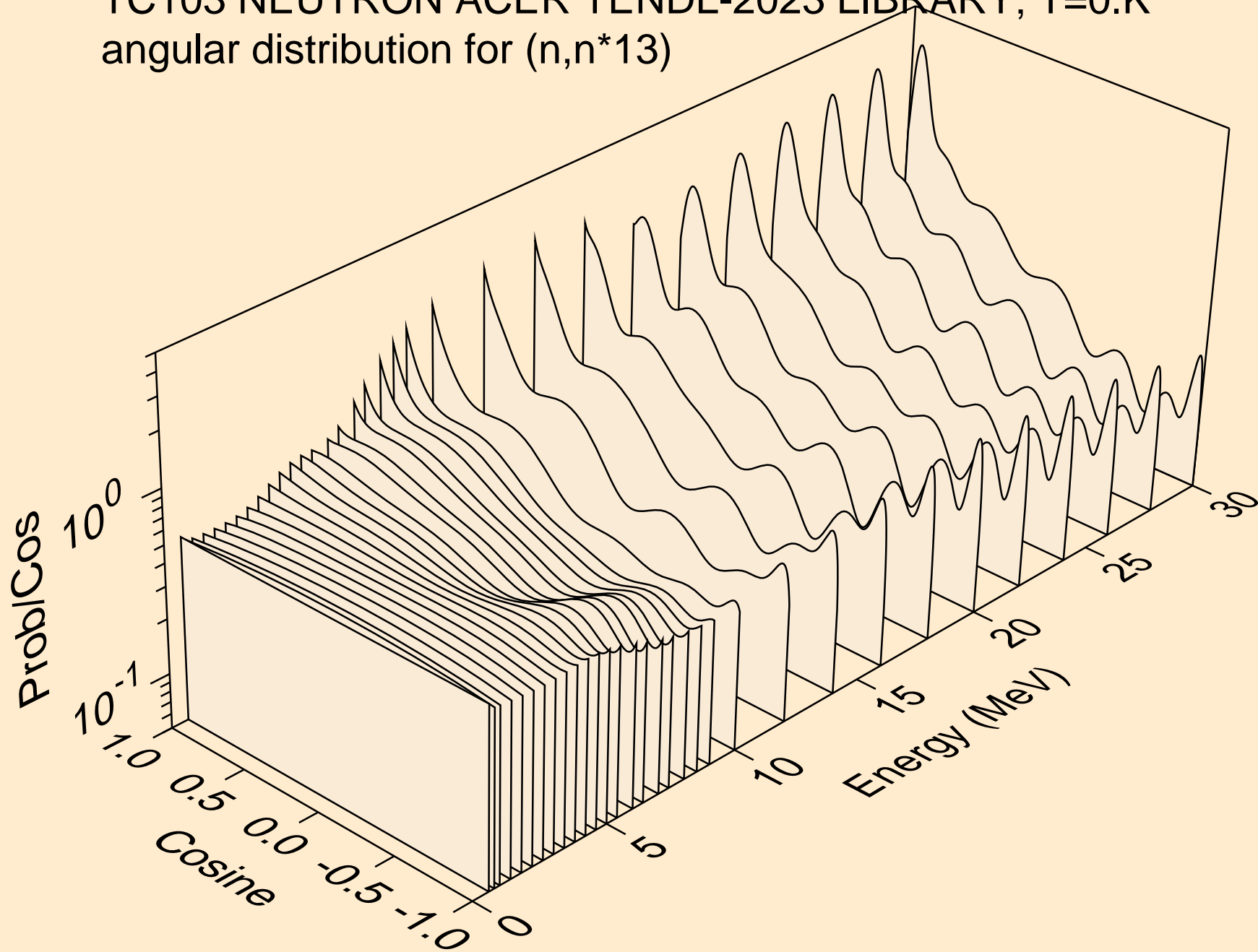

TC103 NEUTRON ACER TENDL-2023 LIBRARY; T=0.K  
angular distribution for (n,n\*14)

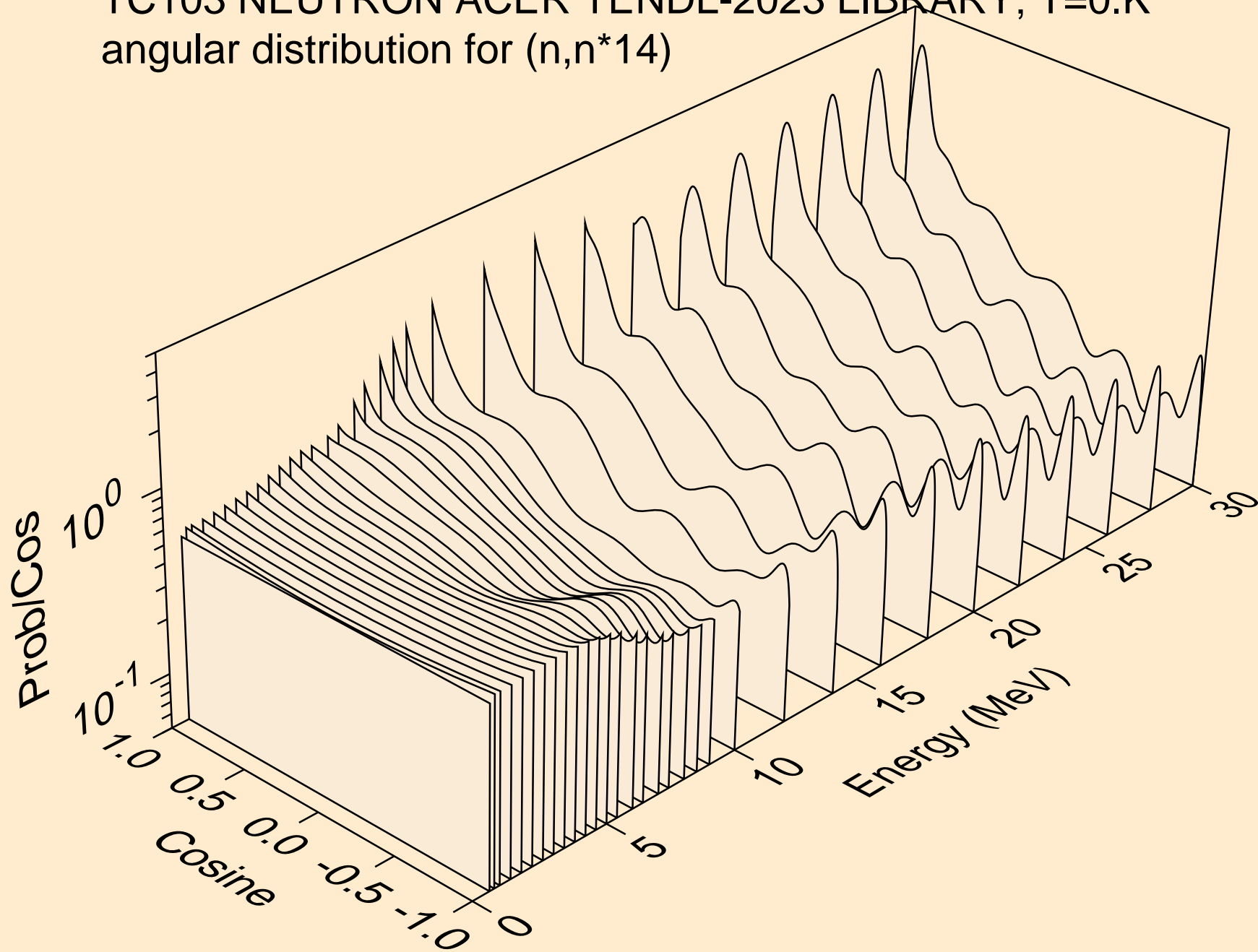

TC103 NEUTRON ACER TENDL-2023 LIBRARY; T=0.K  
angular distribution for (n,n\*15)

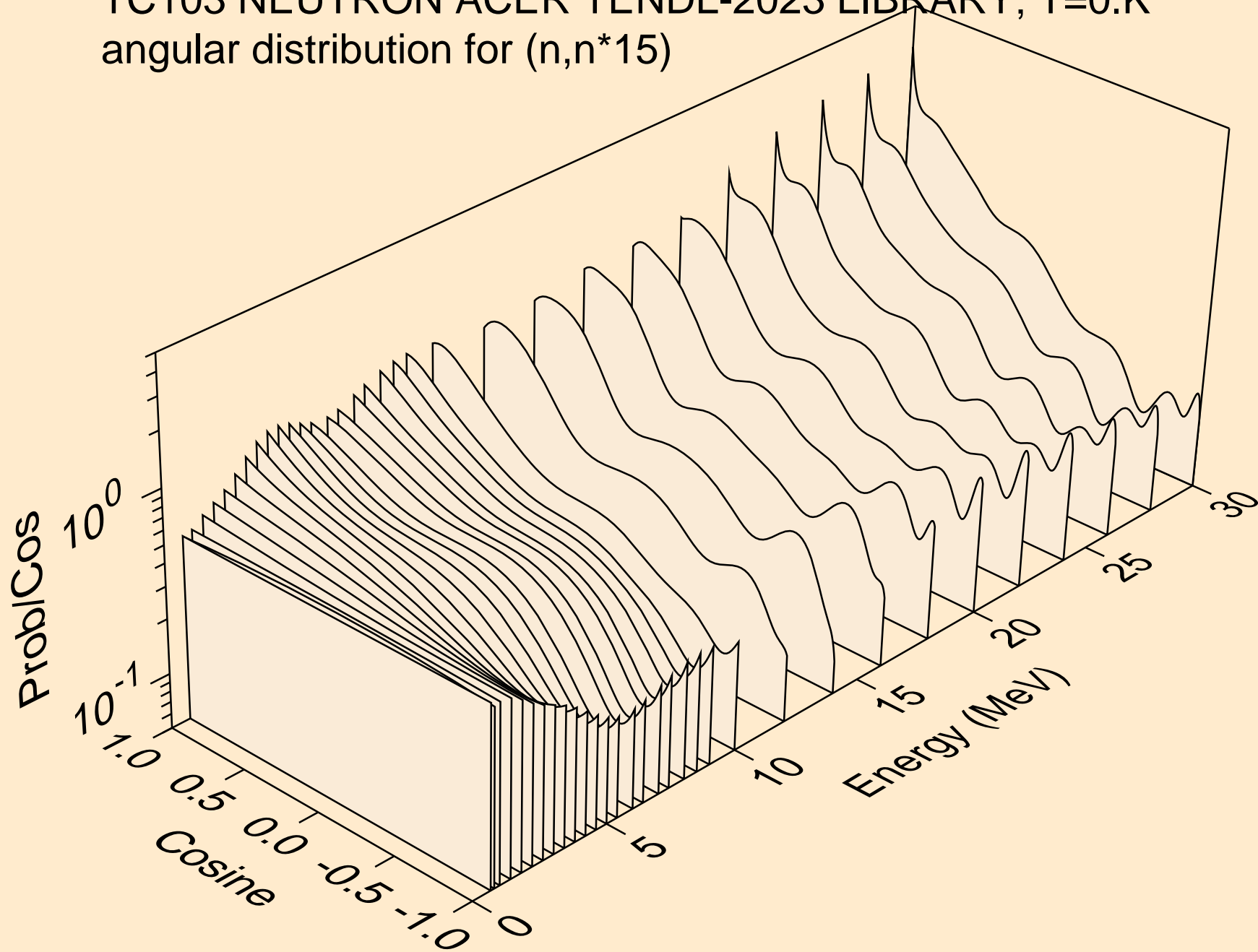



TC103 NEUTRON ACER TENDL-2023 LIBRARY; T=0.K  
Neutron emission for (n,x)

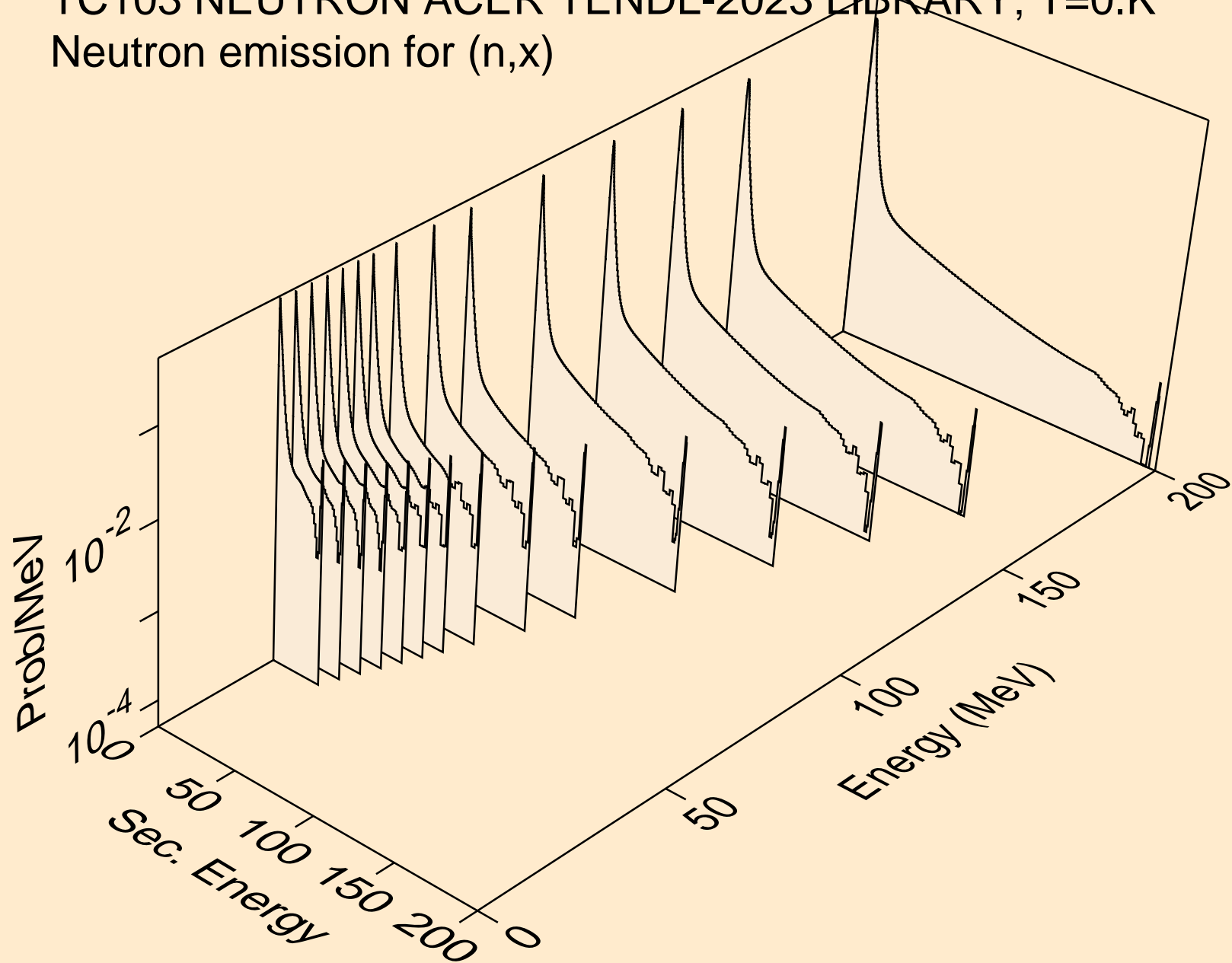

TC103 NEUTRON ACER TENDL-2023 LIBRARY; T=0.K  
Neutron emission for (n,2nd)

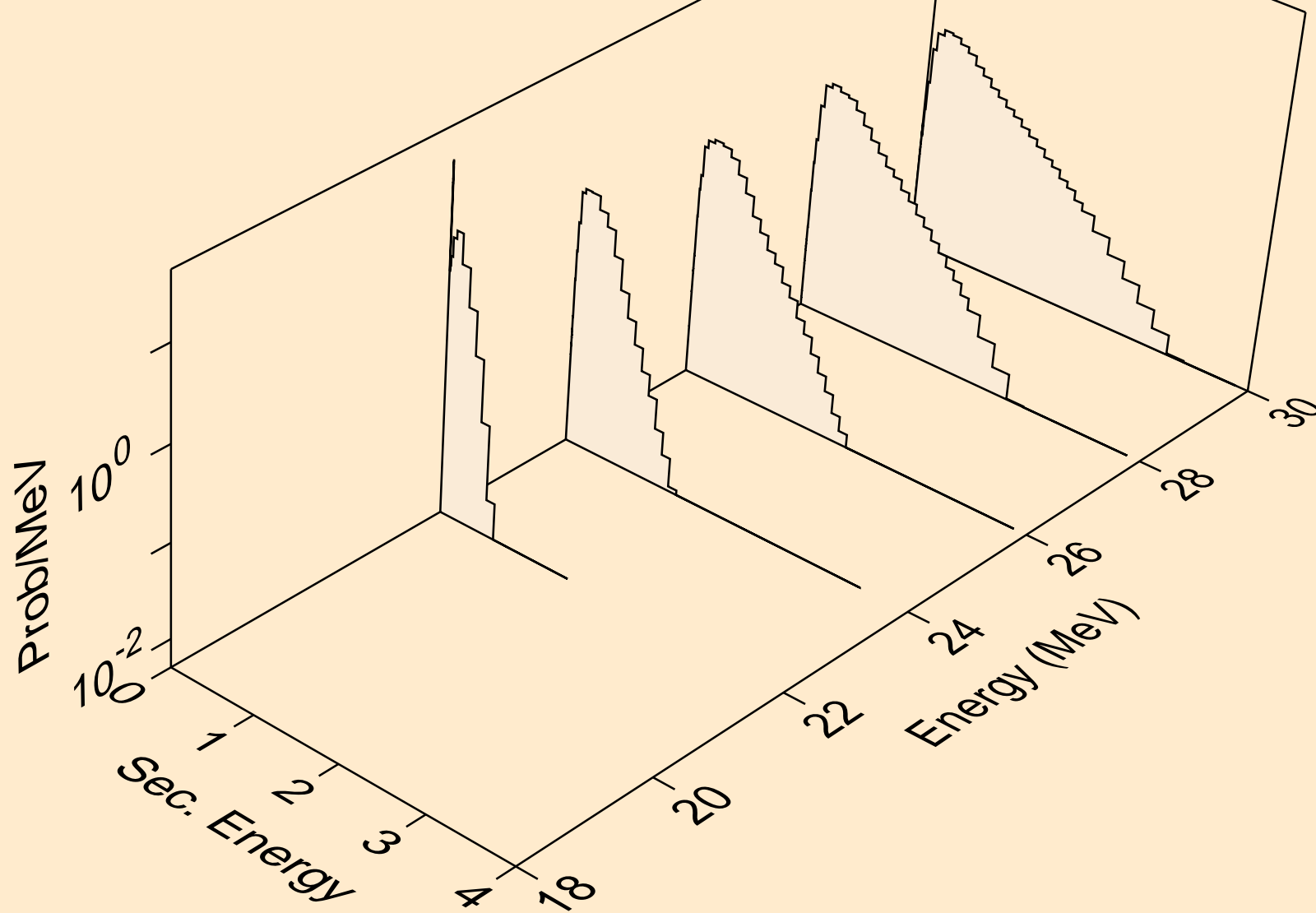

TC103 NEUTRON ACER TENDL-2023 LIBRARY; T=0.K  
Neutron emission for (n,2n)

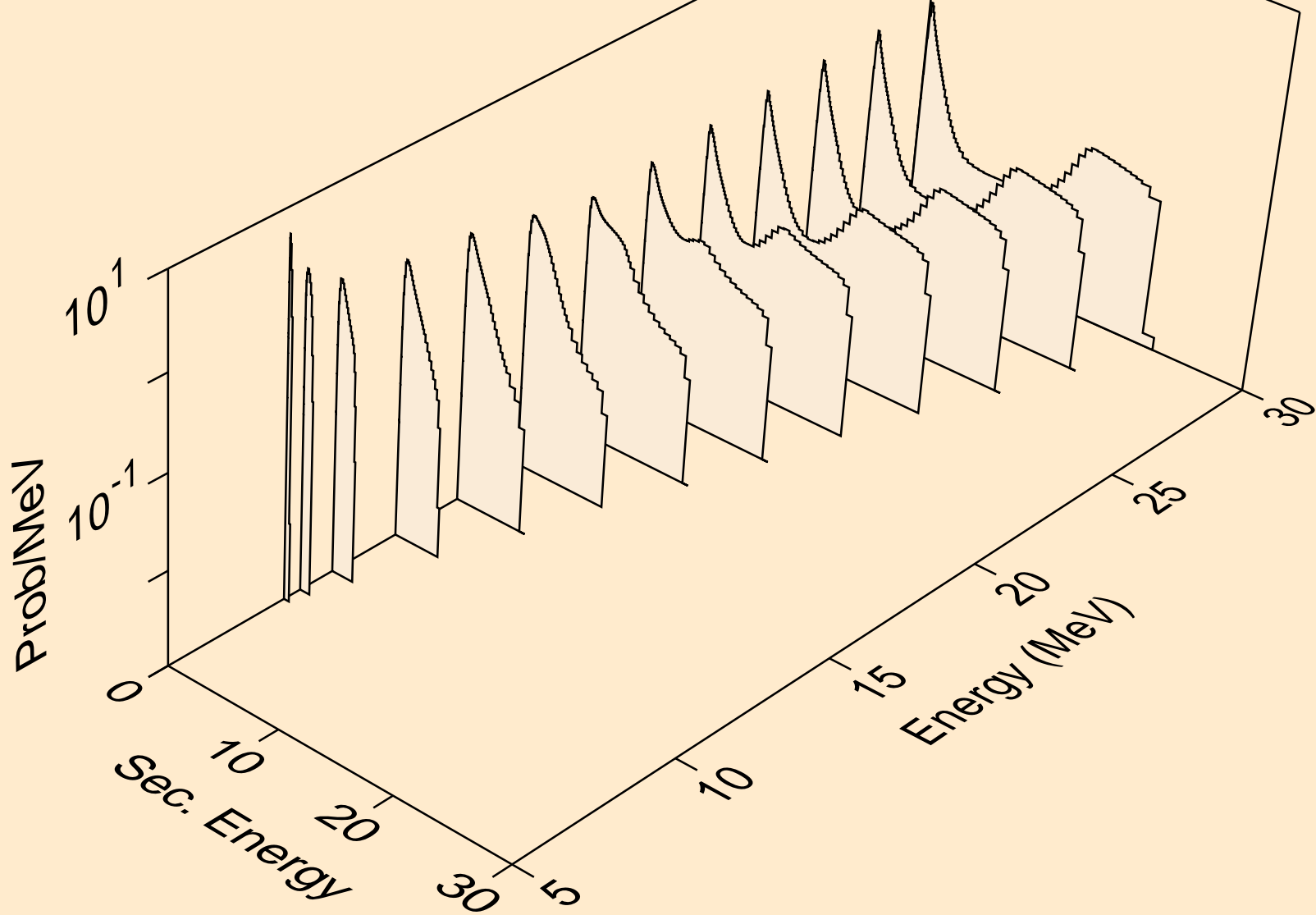

TC103 NEUTRON ACER TENDL-2023 LIBRARY; T=0.K  
Neutron emission for (n,3n)

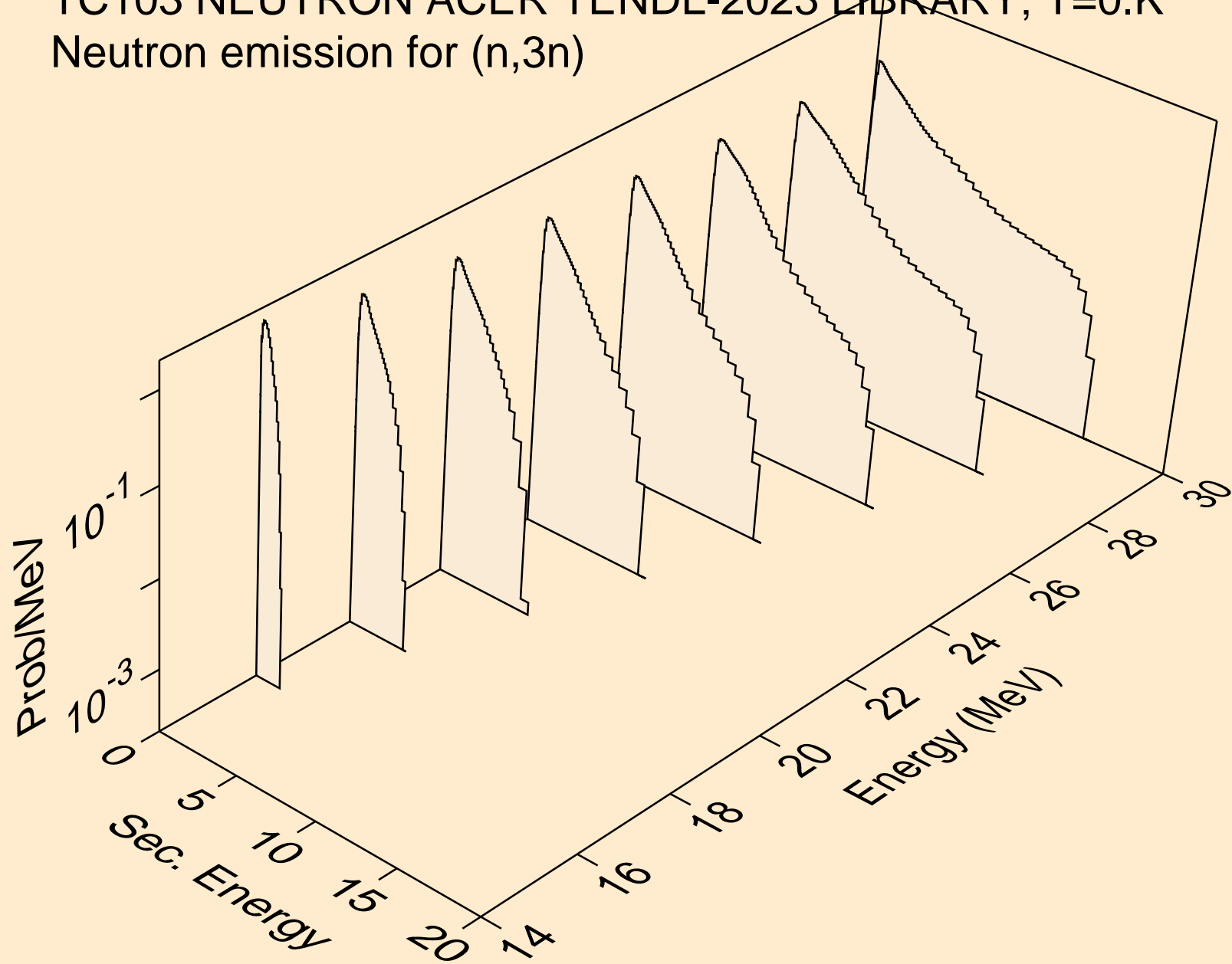

TC103 NEUTRON ACER TENDL-2023 LIBRARY; T=0.K  
Neutron emission for (n,n\*)a

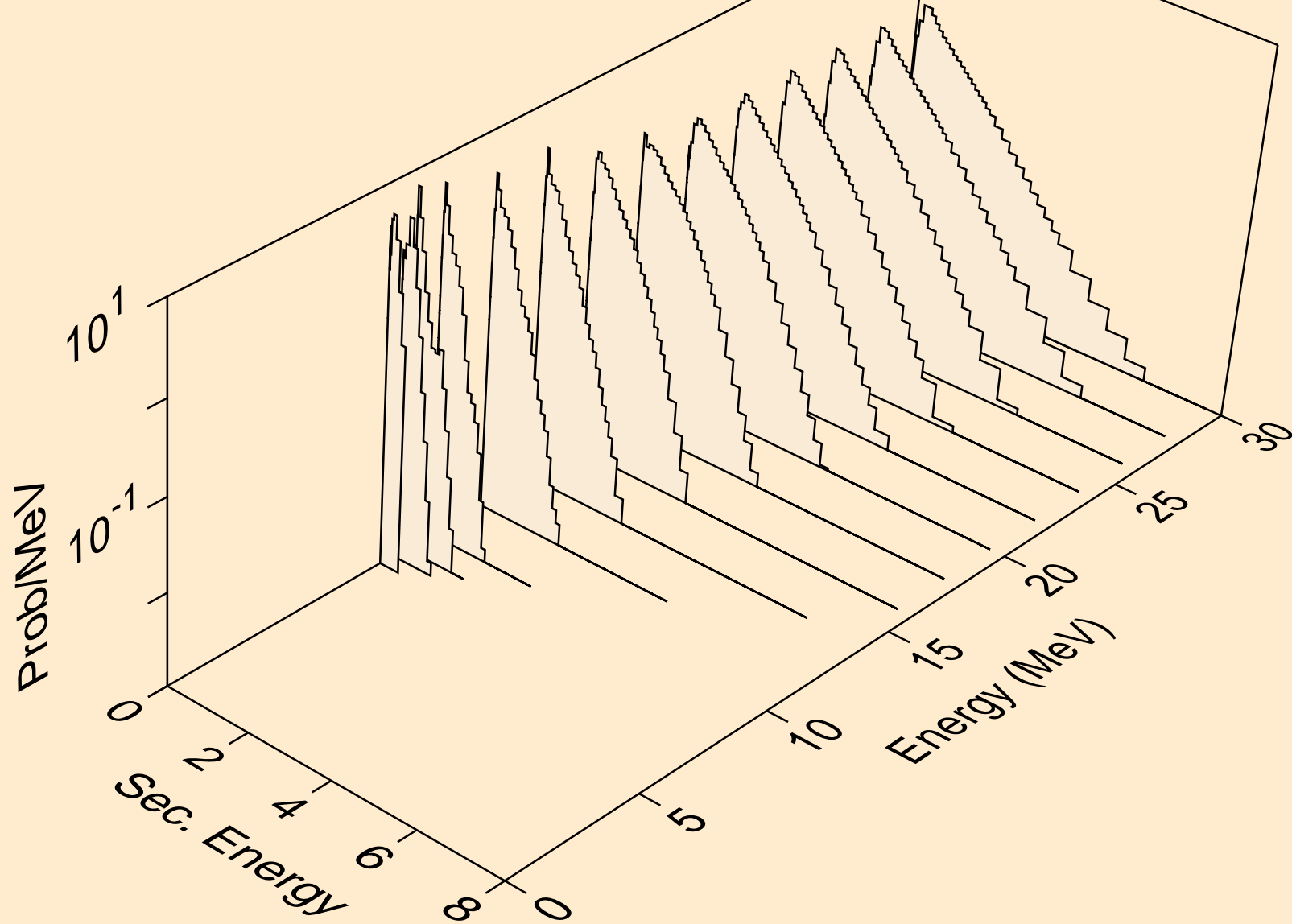

TC103 NEUTRON ACER TENDL-2023 LIBRARY; T=0.K  
Neutron emission for (n,2n)<sub>a</sub>

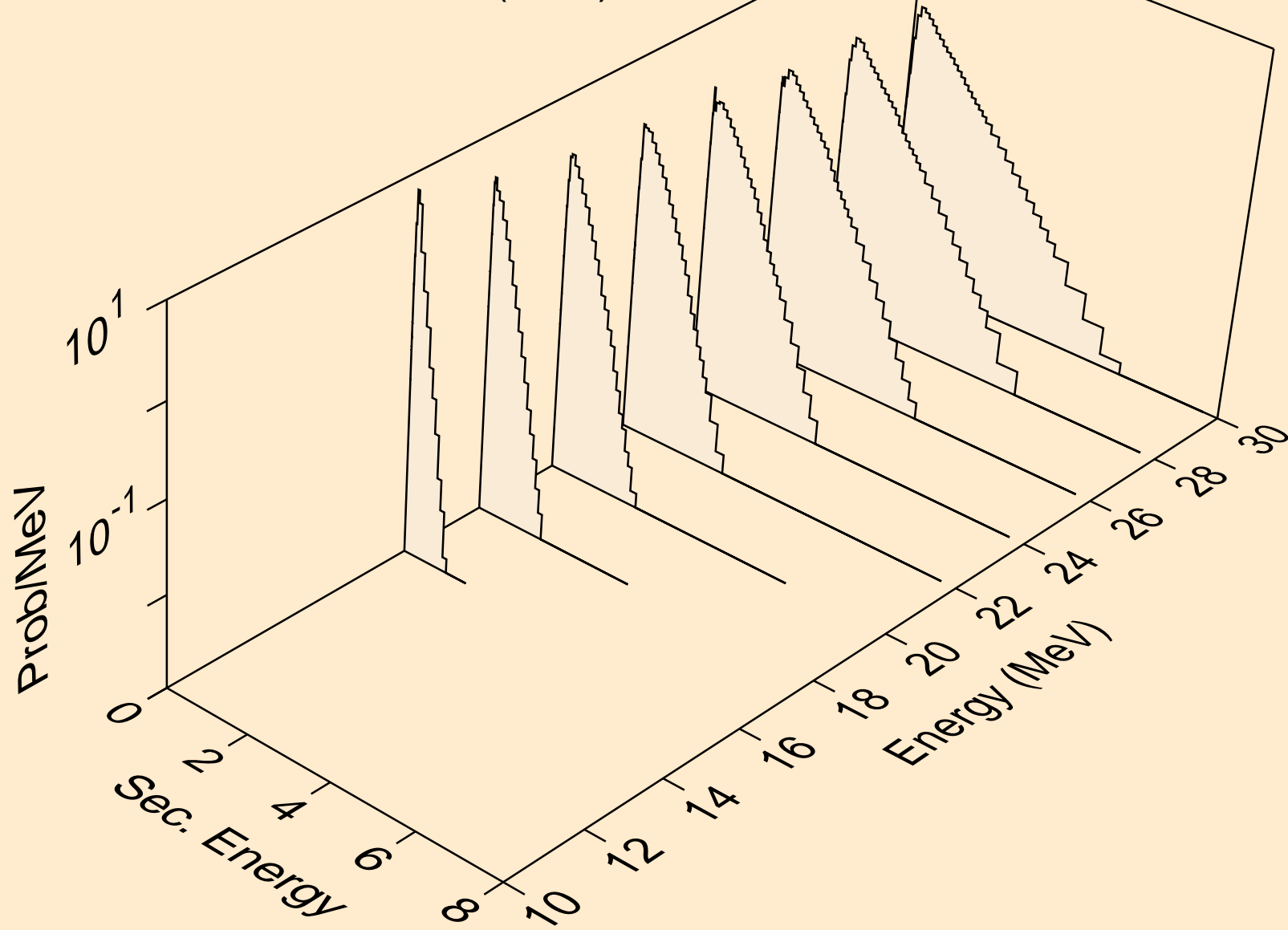

TC103 NEUTRON ACER TENDL-2023 LIBRARY; T=0.K  
Neutron emission for (n,3n)a

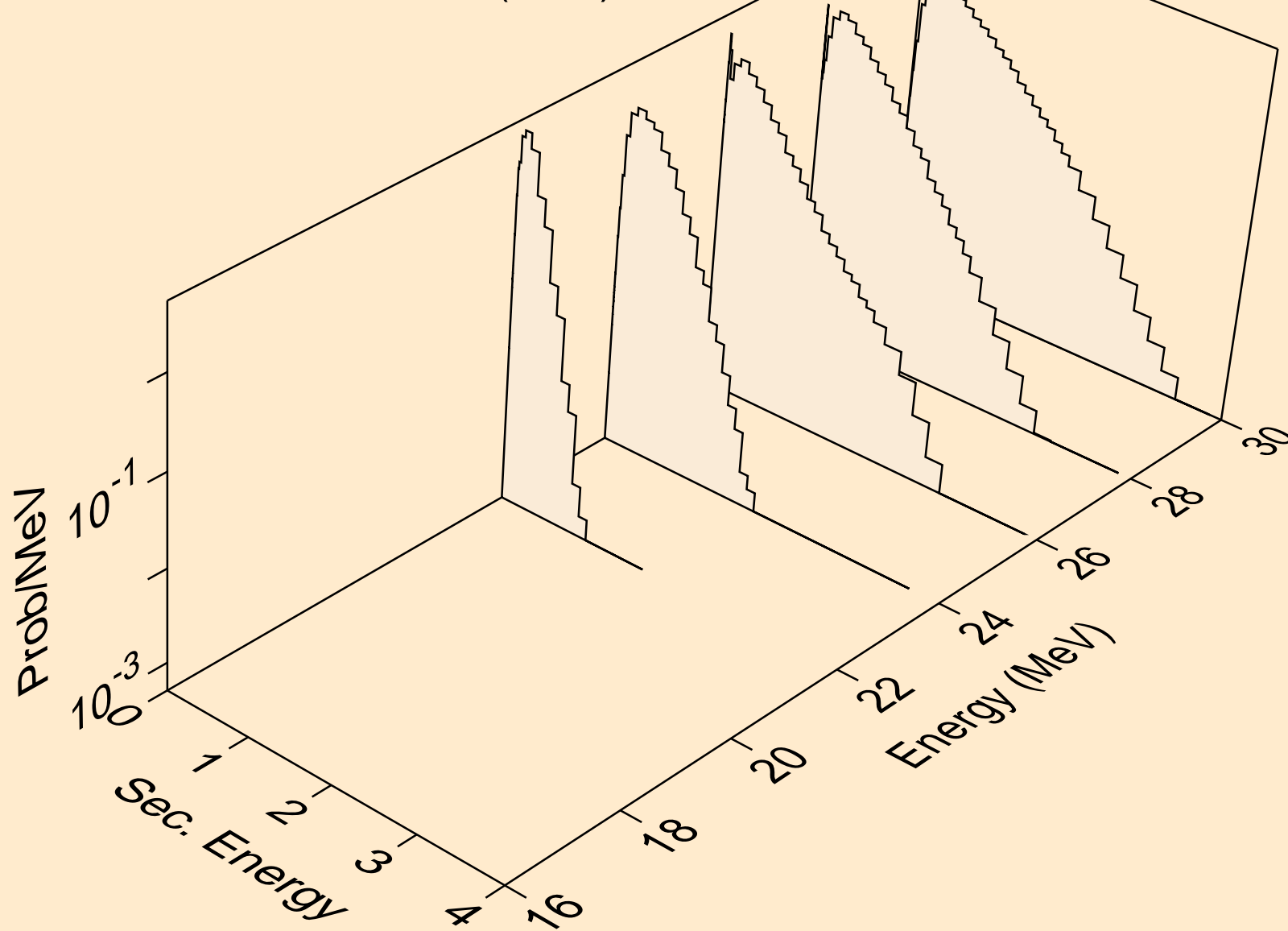

TC103 NEUTRON ACER TENDL-2023 LIBRARY; T=0.K  
Neutron emission for (n,n\*)p

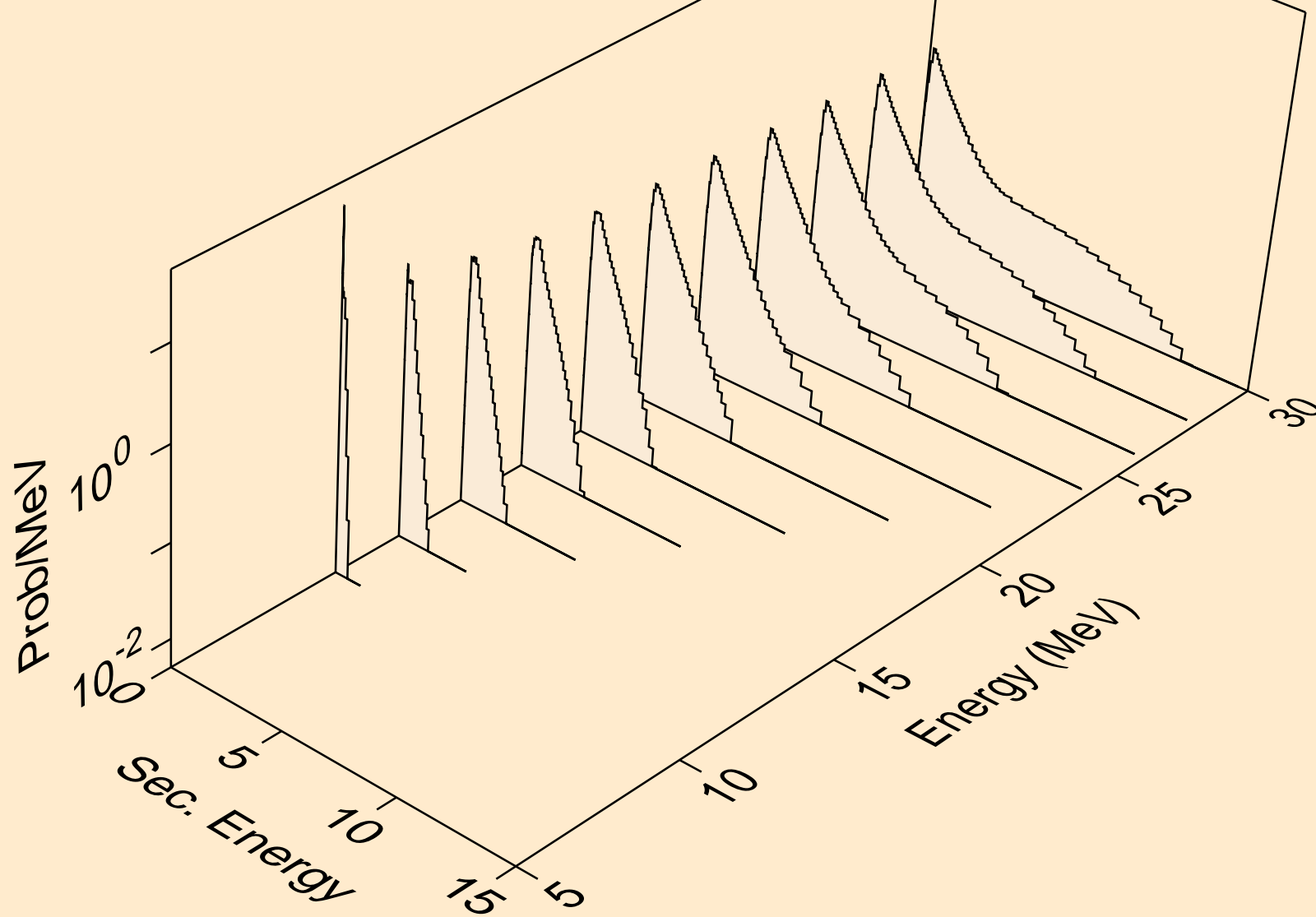



TC103 NEUTRON ACER TENDL-2023 LIBRARY; T=0.K  
Neutron emission for (n,n\*)2a

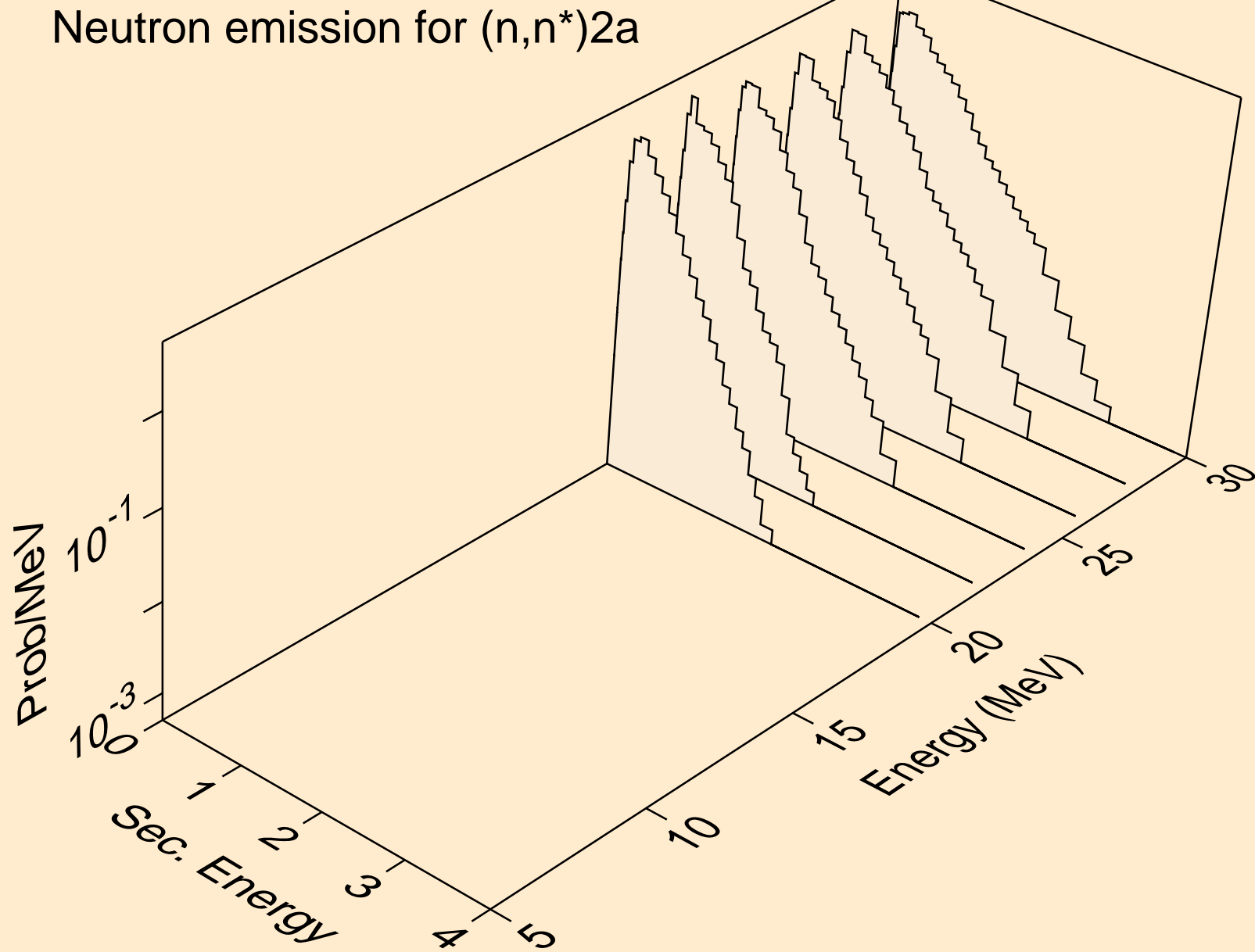

TC103 NEUTRON ACER TENDL-2023 LIBRARY; T=0.K  
Neutron emission for (n,n\*)d

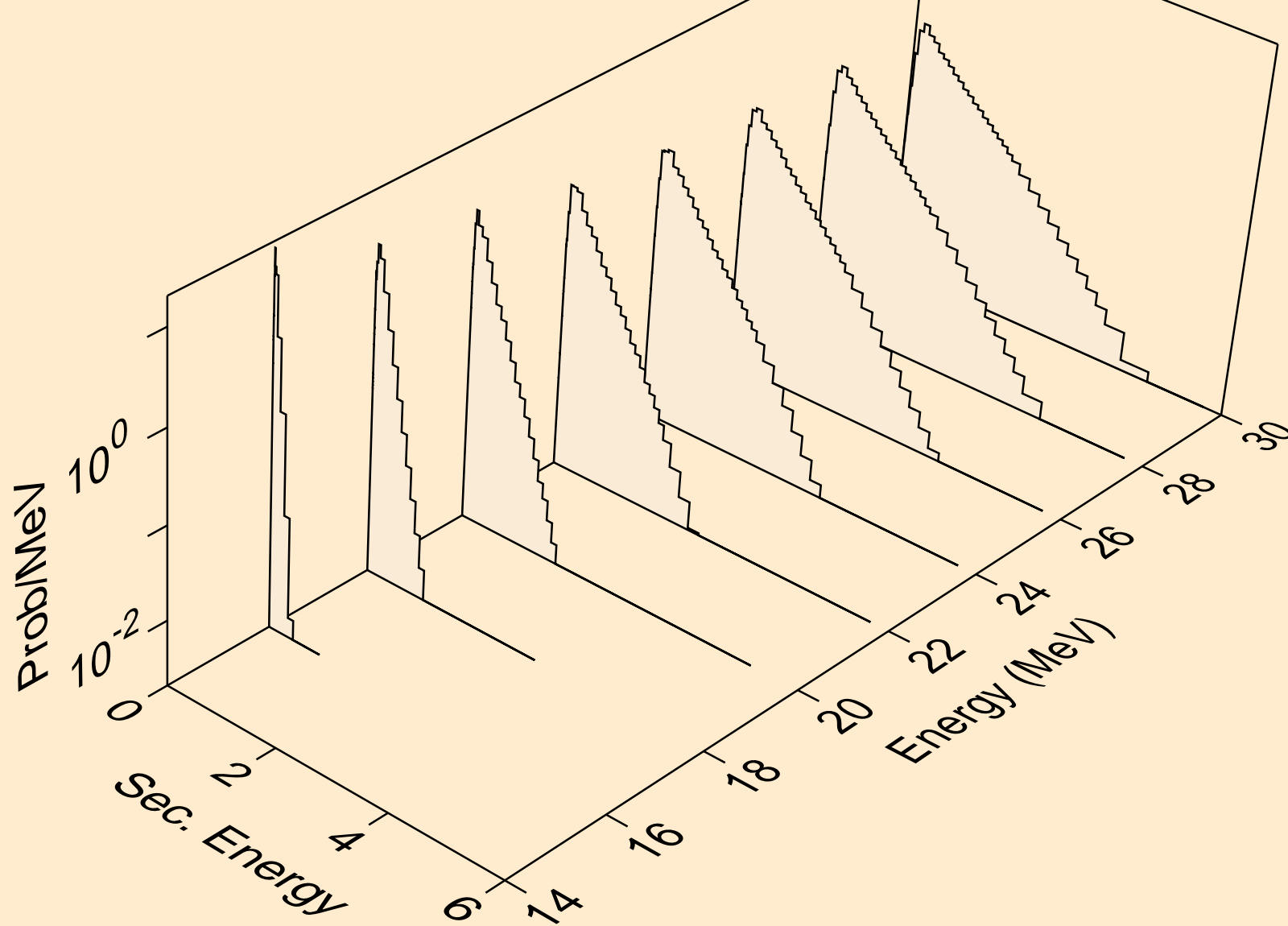

TC103 NEUTRON ACER TENDL-2023 LIBRARY; T=0.K  
Neutron emission for (n,n\*)t

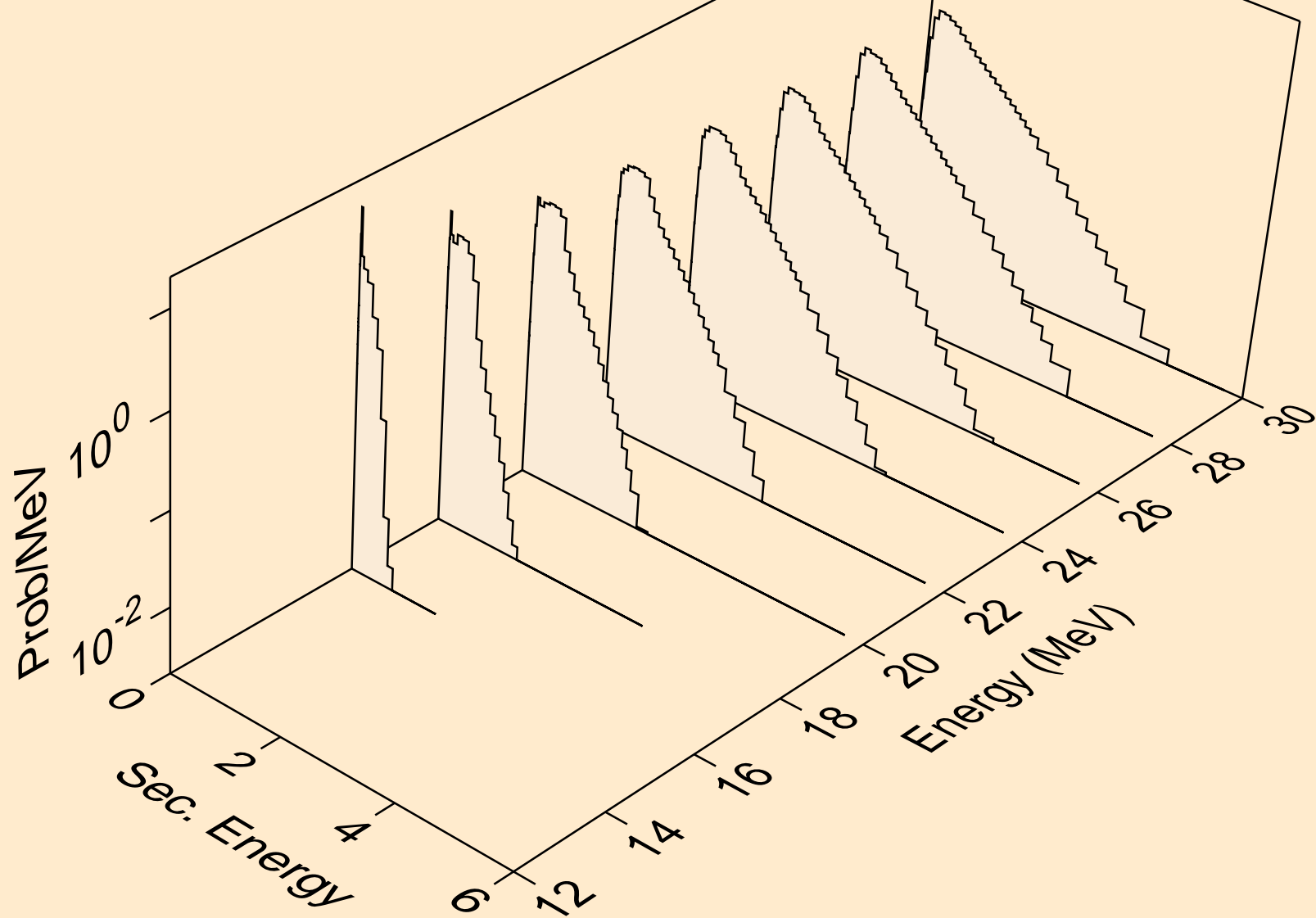

TC103 NEUTRON ACER TENDL-2023 LIBRARY; T=0.K  
Neutron emission for (n,n\*)he3

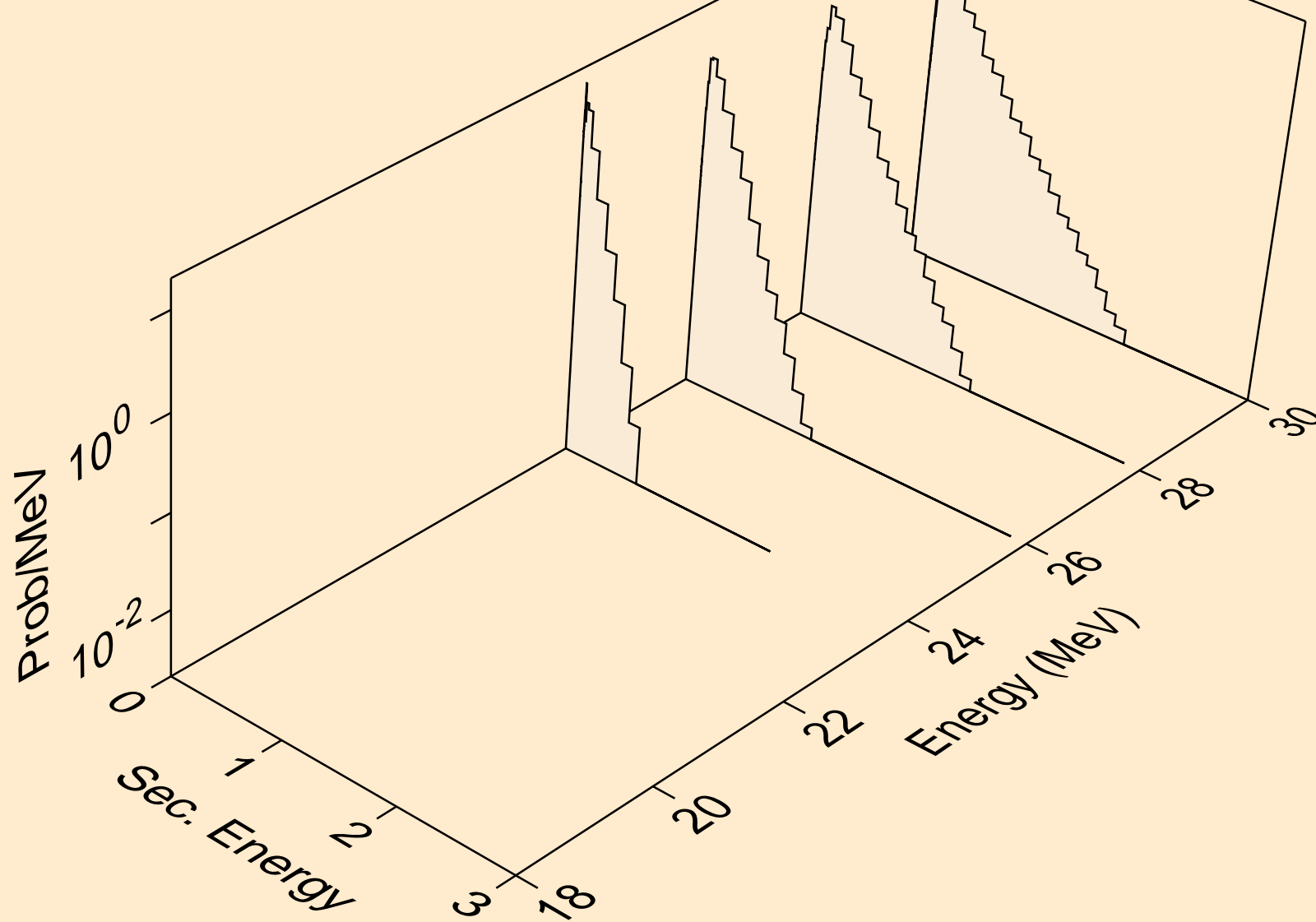

TC103 NEUTRON ACER TENDL-2023 LIBRARY; T=0.K  
Neutron emission for (n,4n)

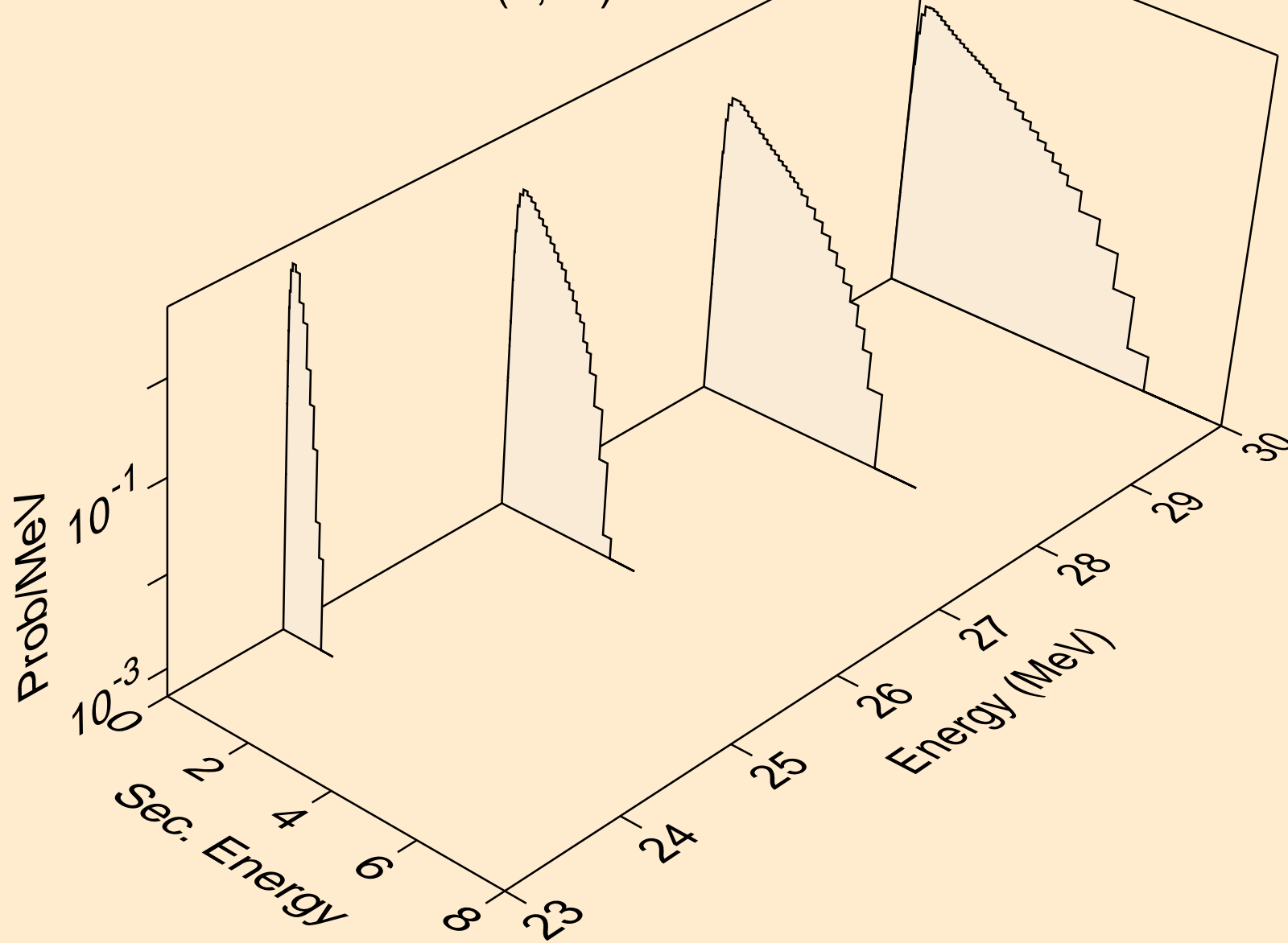

TC103 NEUTRON ACER TENDL-2023 LIBRARY; T=0.K  
Neutron emission for (n,2np)

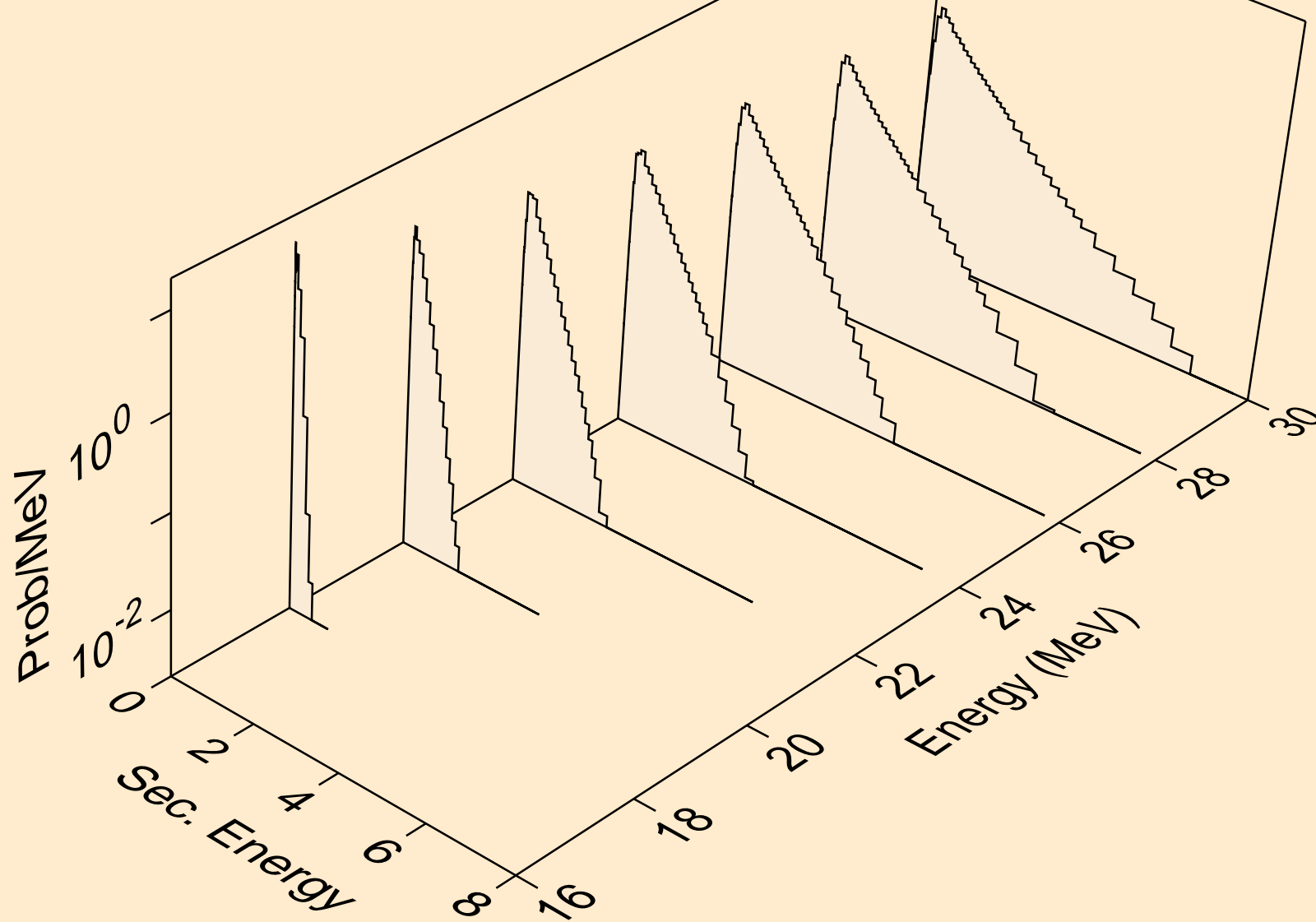

TC103 NEUTRON ACER TENDL-2023 LIBRARY; T=0.K  
Neutron emission for (n,3np)

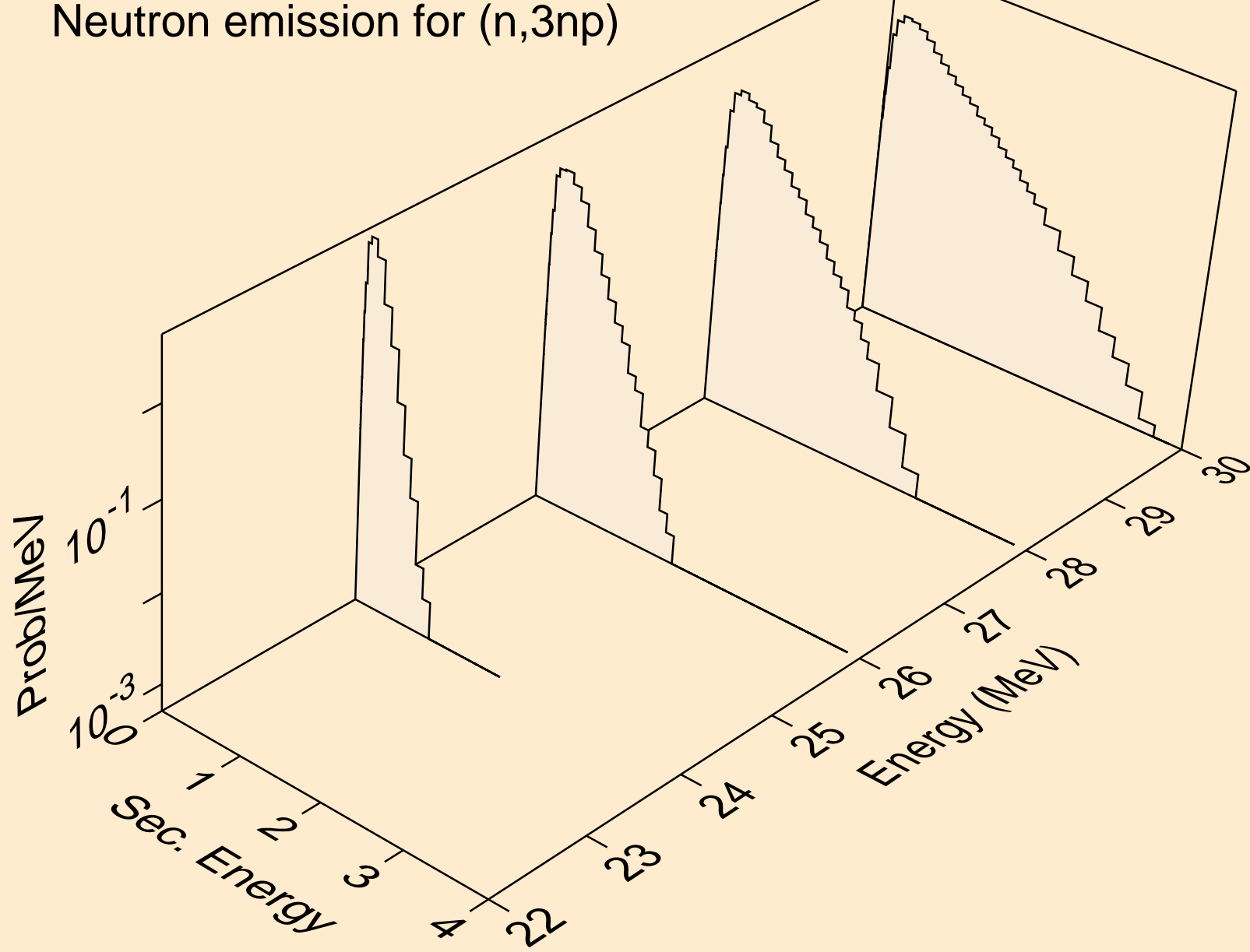

TC103 NEUTRON ACER TENDL-2023 LIBRARY; T=0.K  
Neutron emission for (n,n2p)

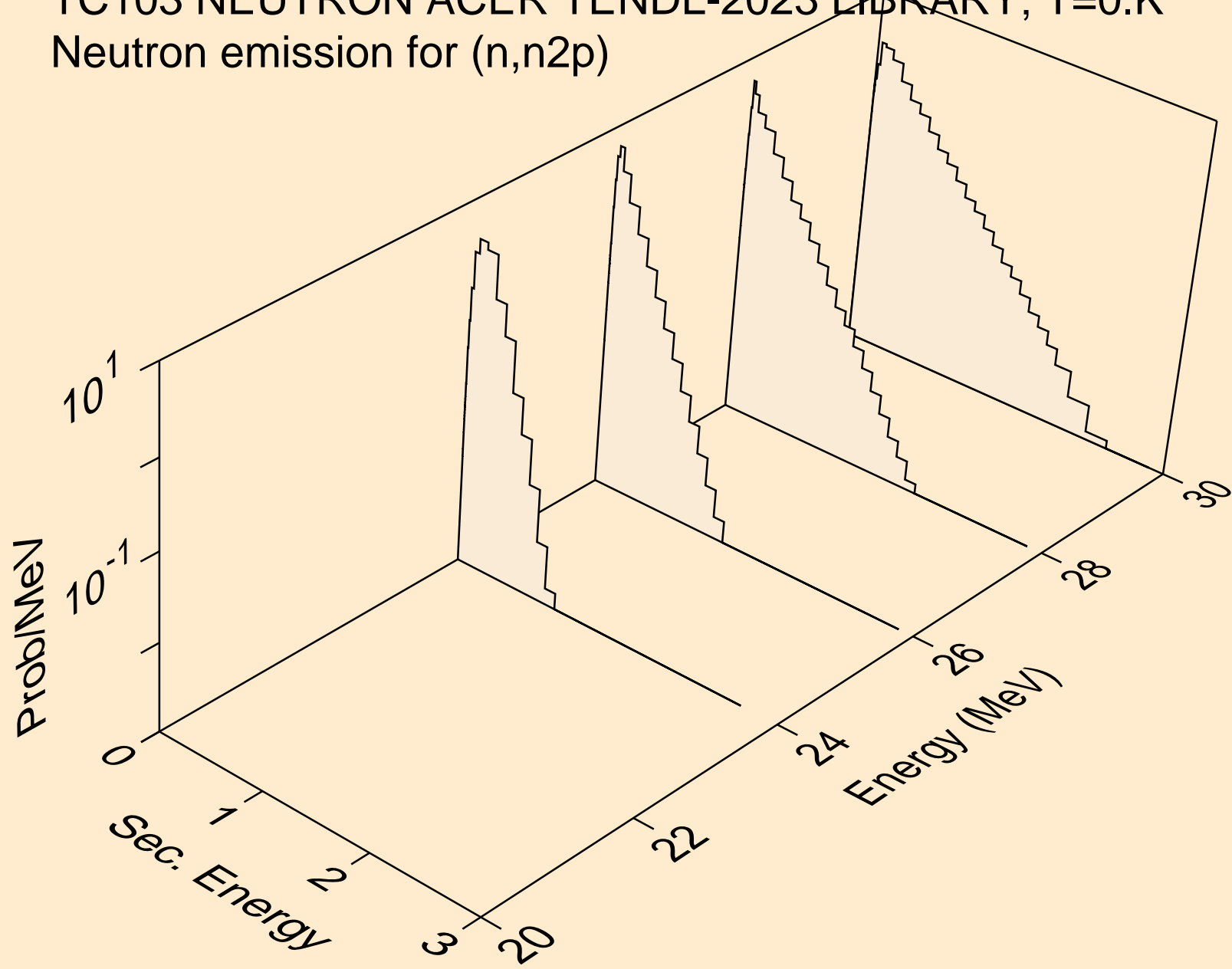



TC103 NEUTRON ACER TENDL-2023 LIBRARY; T=0.K  
Neutron emission for (n,npa)

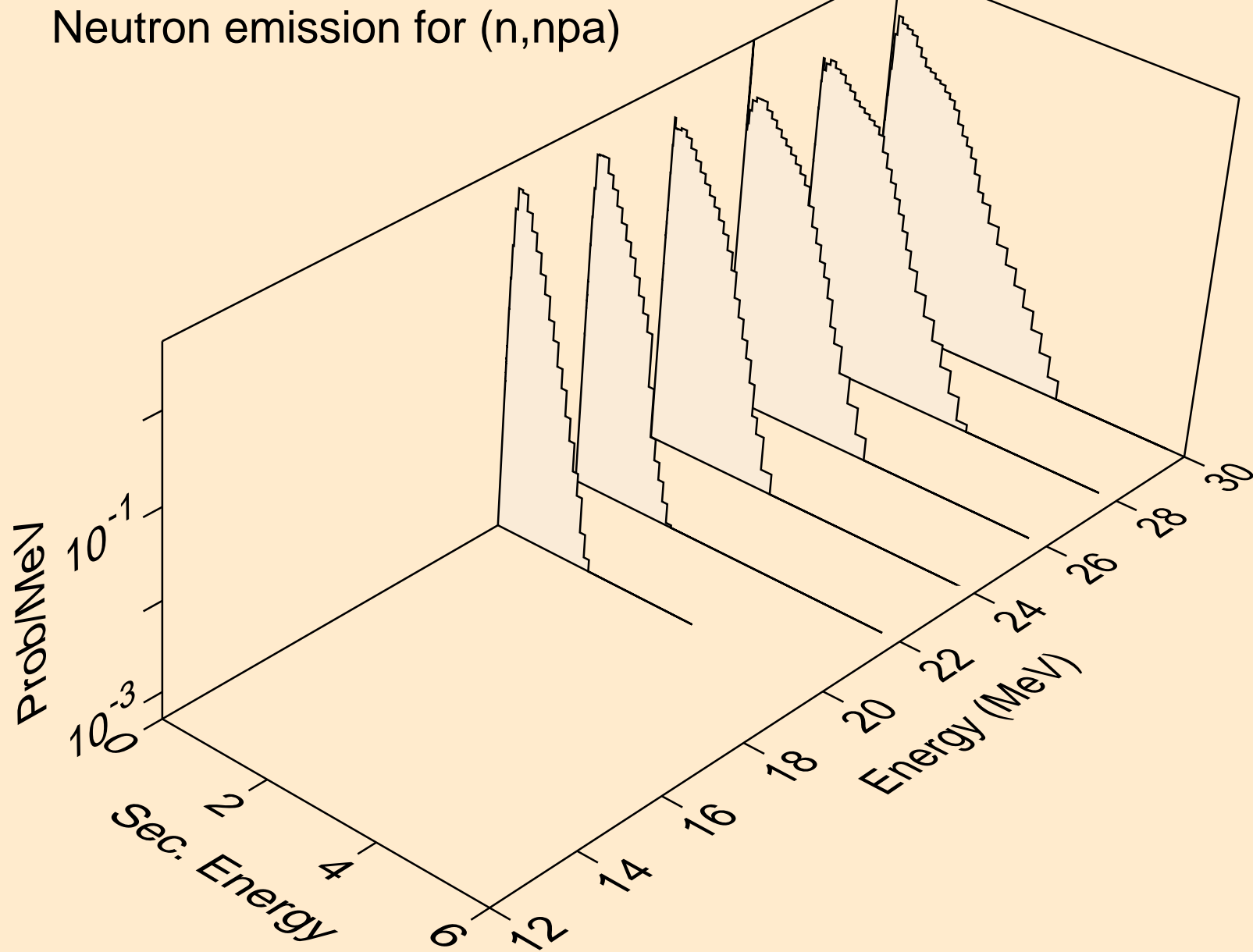

TC103 NEUTRON ACER TENDL-2023 LIBRARY; T=0.K  
Neutron emission for (n,n\*c)

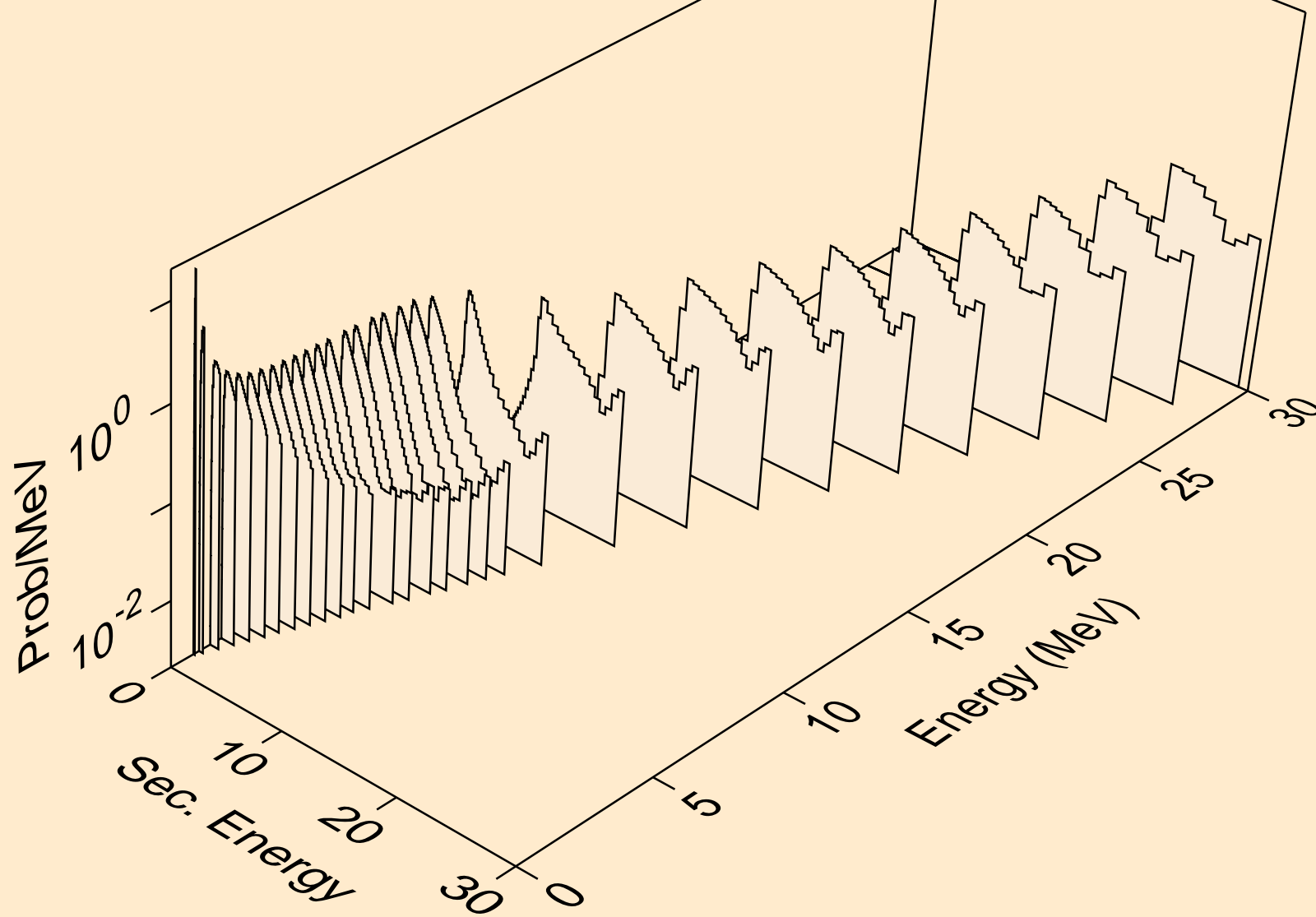

TC103 NEUTRON ACER TENDL-2023 LIBRARY; T=0.K  
Photon emission for (n,x)

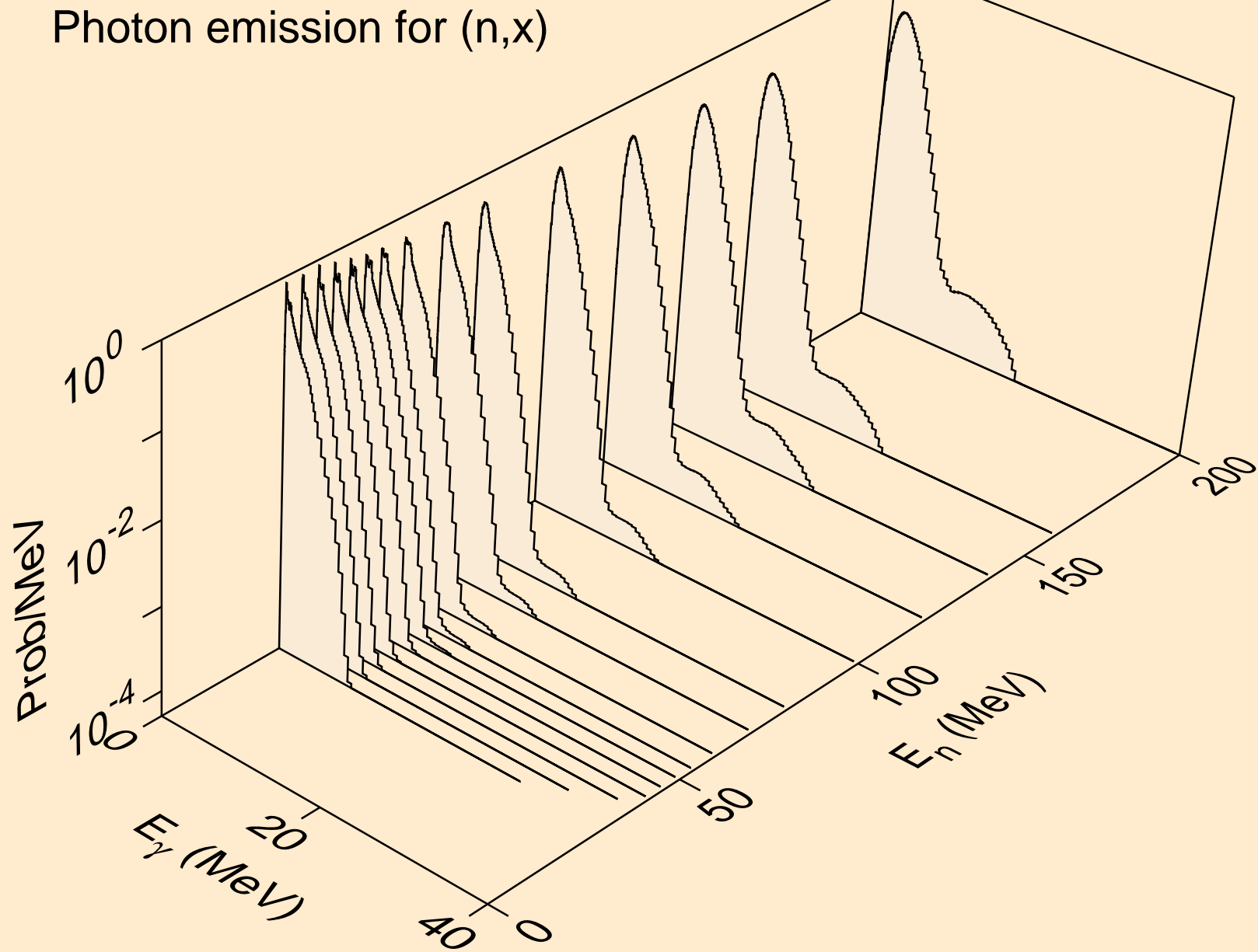

TC103 NEUTRON ACER TENDL-2023 LIBRARY; T=0.K  
Photon emission for (n,2nd)

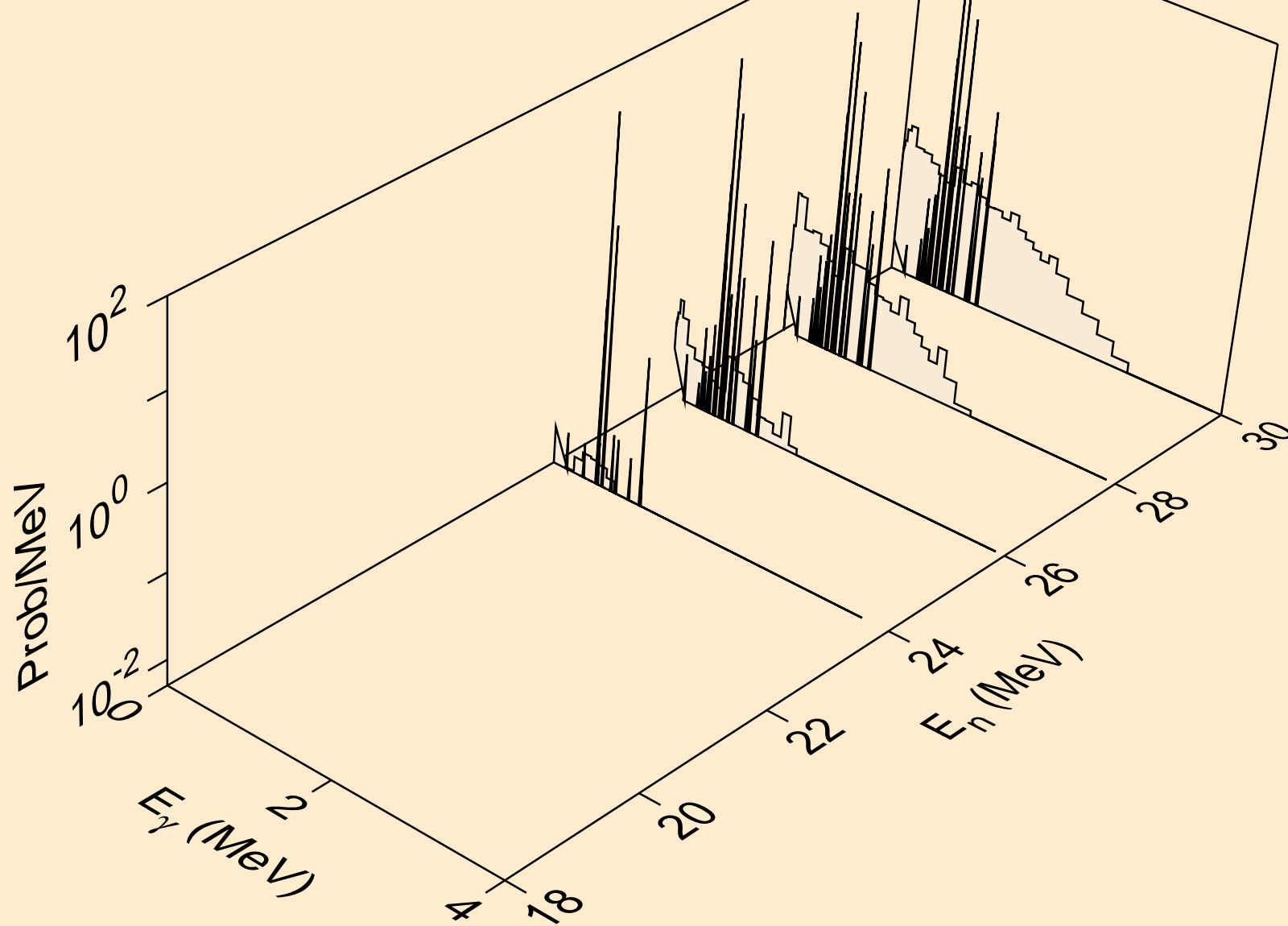

TC103 NEUTRON ACER TENDL-2023 LIBRARY; T=0.K  
Photon emission for (n,2n)

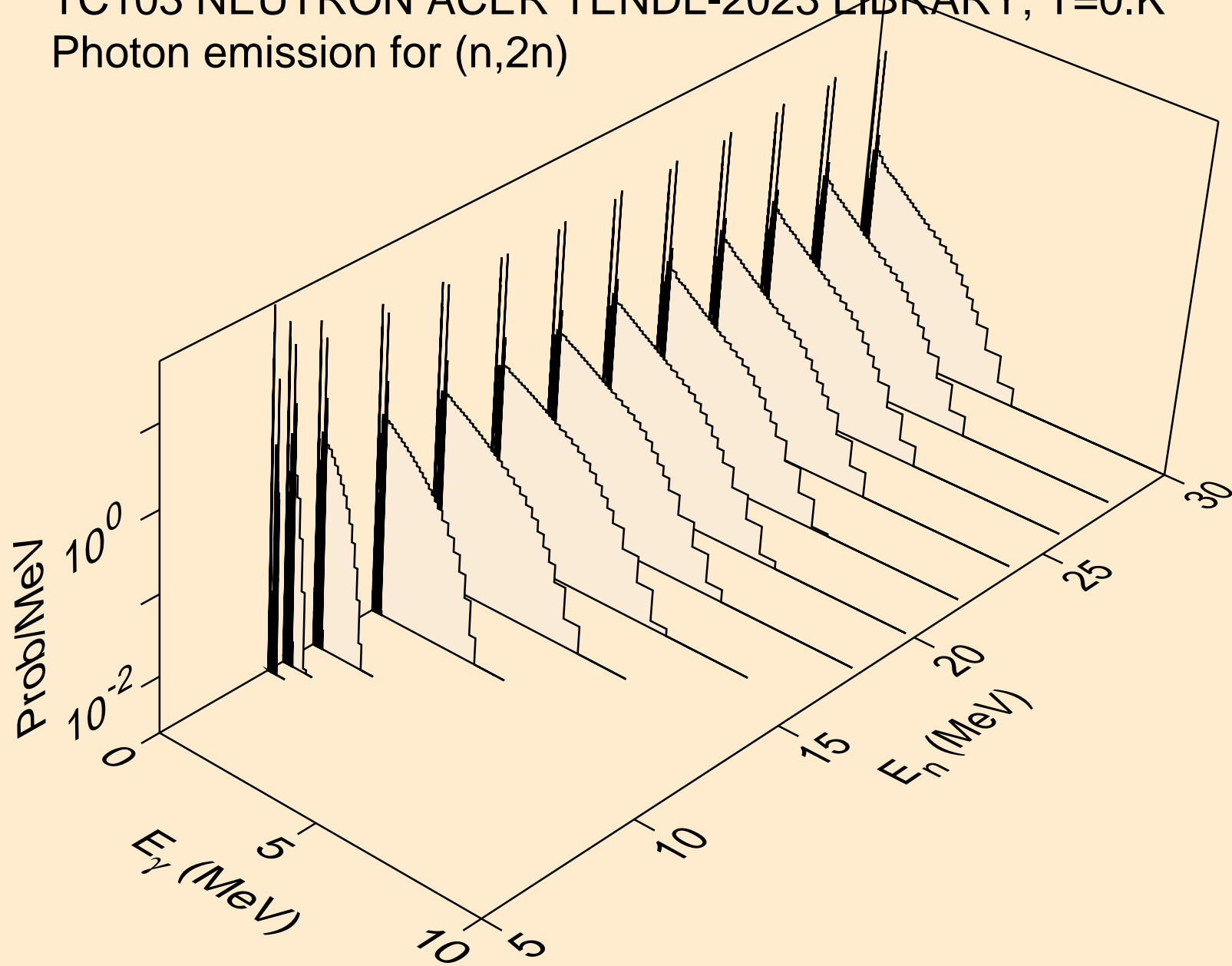

TC103 NEUTRON ACER TENDL-2023 LIBRARY; T=0.K  
Photon emission for (n,3n)

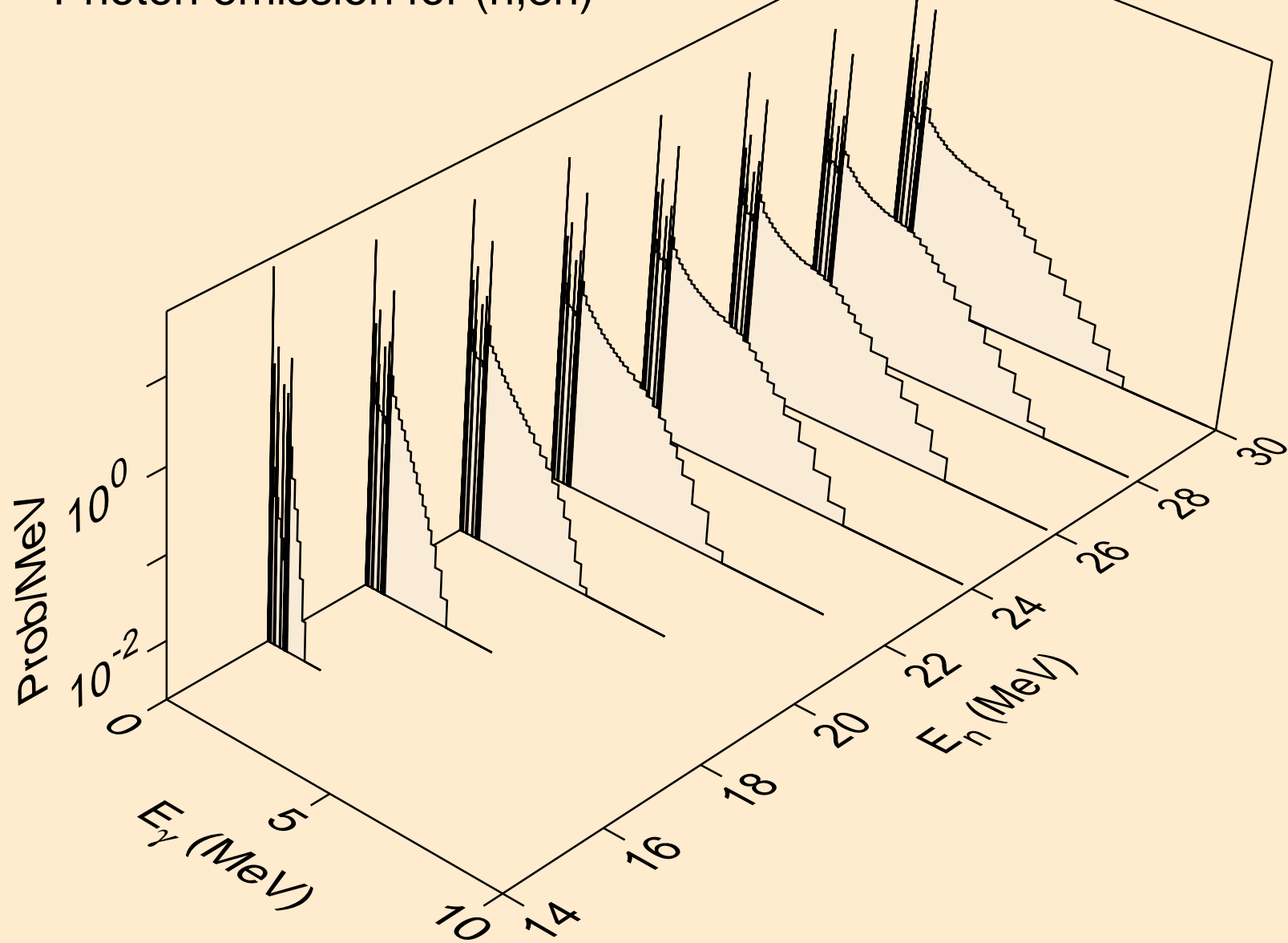

TC103 NEUTRON ACER TENDL-2023 LIBRARY; T=0.K  
Photon emission for (n,n\*)a

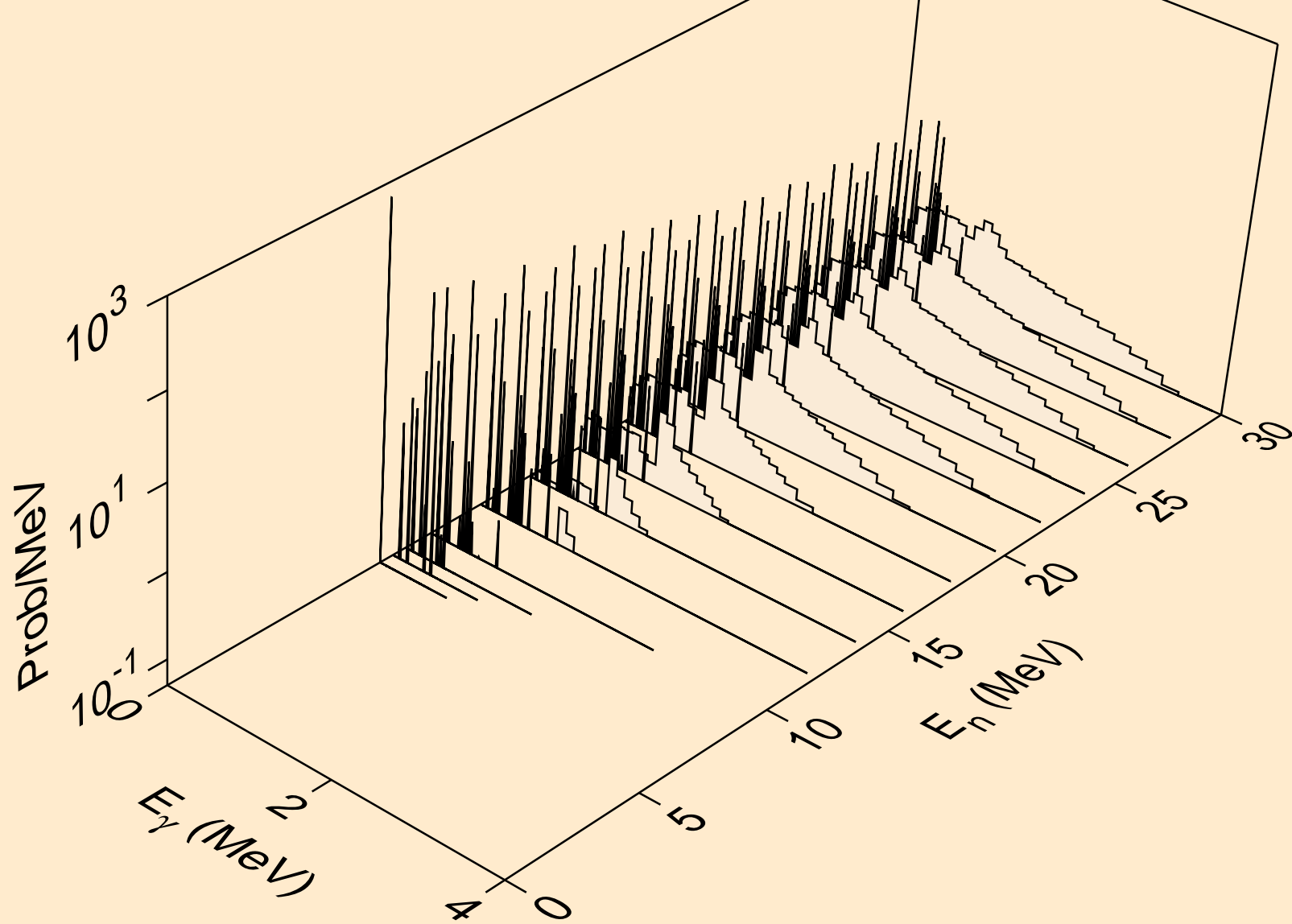

TC103 NEUTRON ACER TENDL-2023 LIBRARY; T=0.K  
Photon emission for (n,2n)a

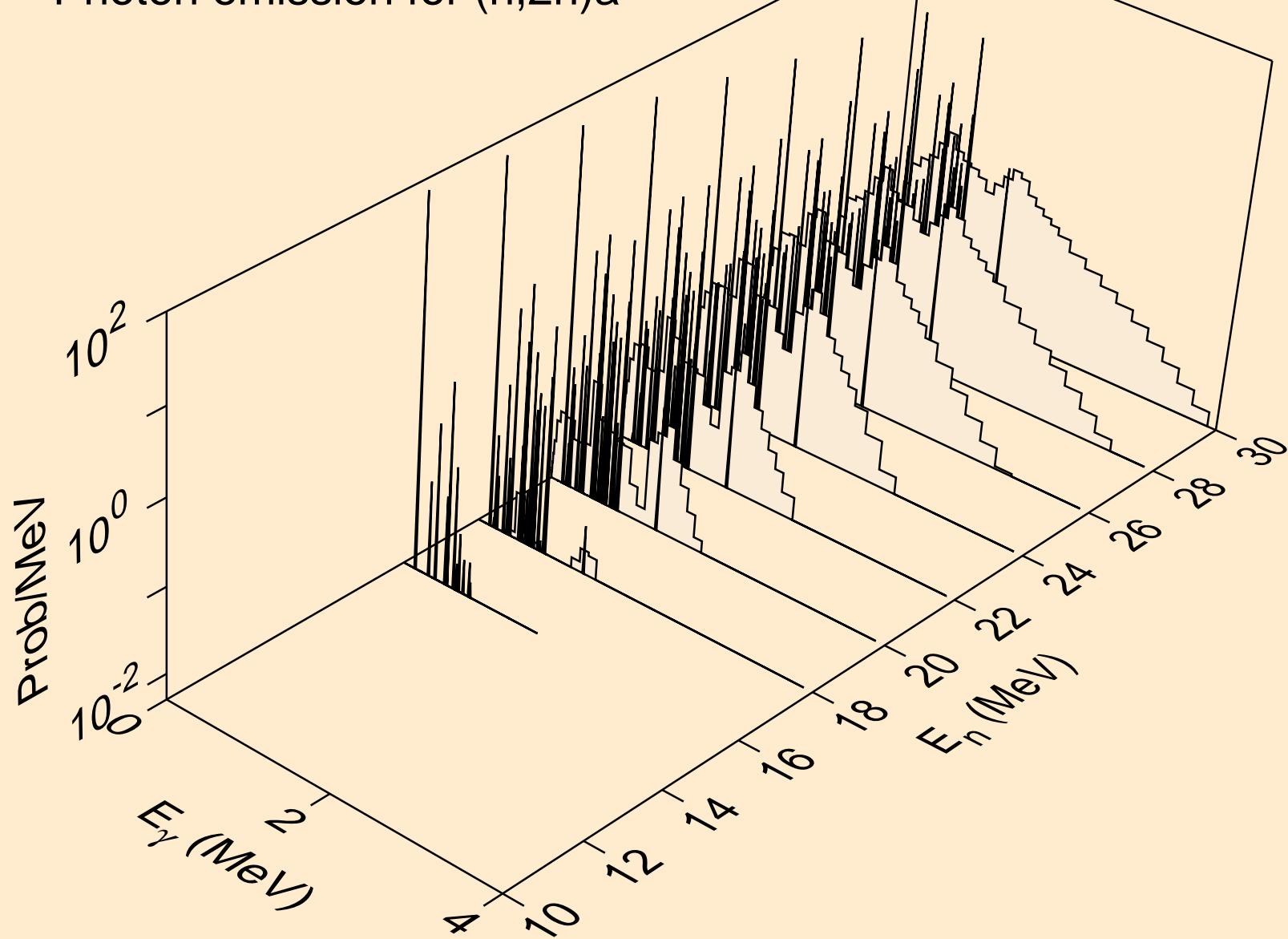



TC103 NEUTRON ACER TENDL-2023 LIBRARY; T=0.K  
Photon emission for (n,3n)a

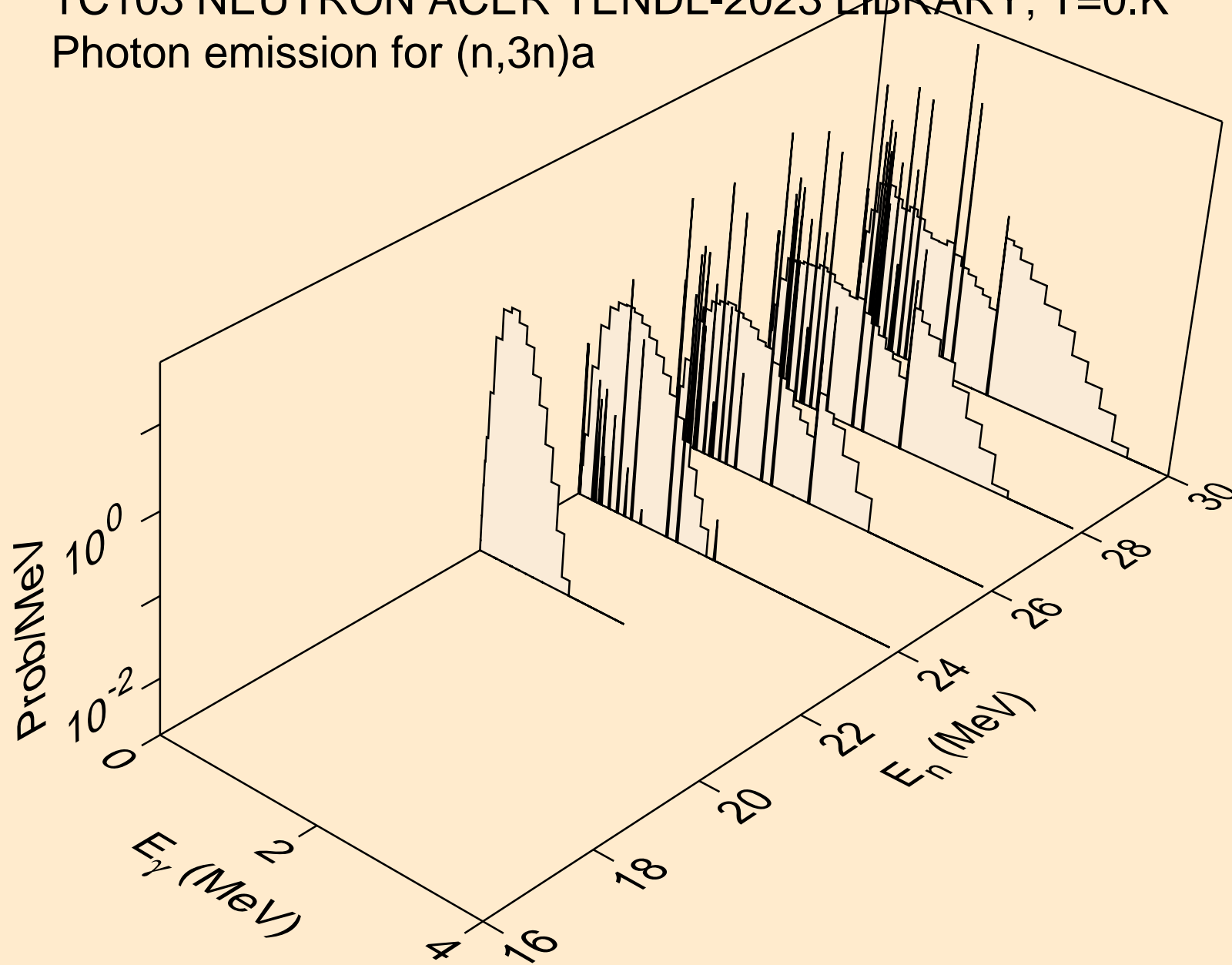

TC103 NEUTRON ACER TENDL-2023 LIBRARY; T=0.K  
Photon emission for (n,n\*)p

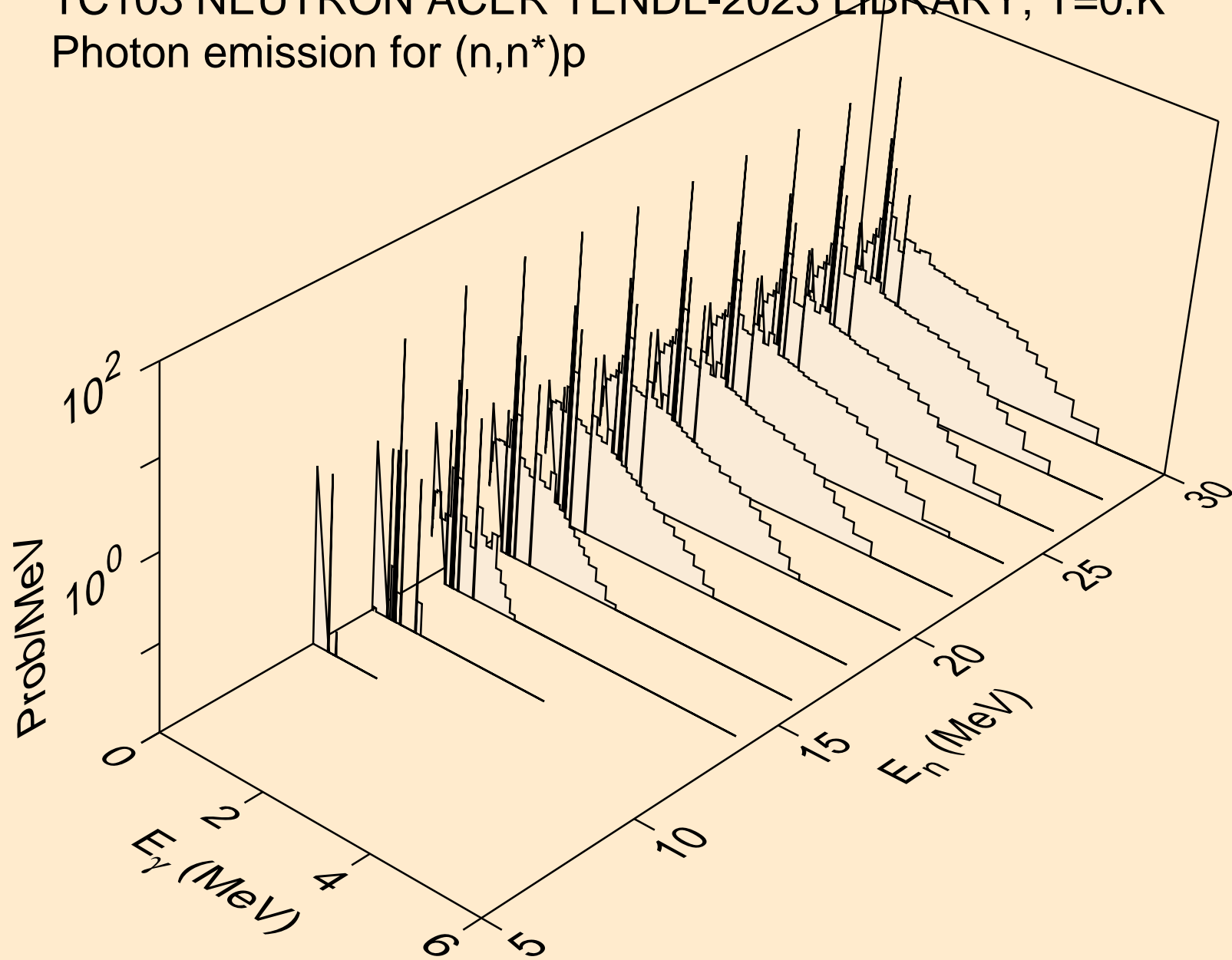

TC103 NEUTRON ACER TENDL-2023 LIBRARY; T=0.K  
Photon emission for (n,n\*)2a

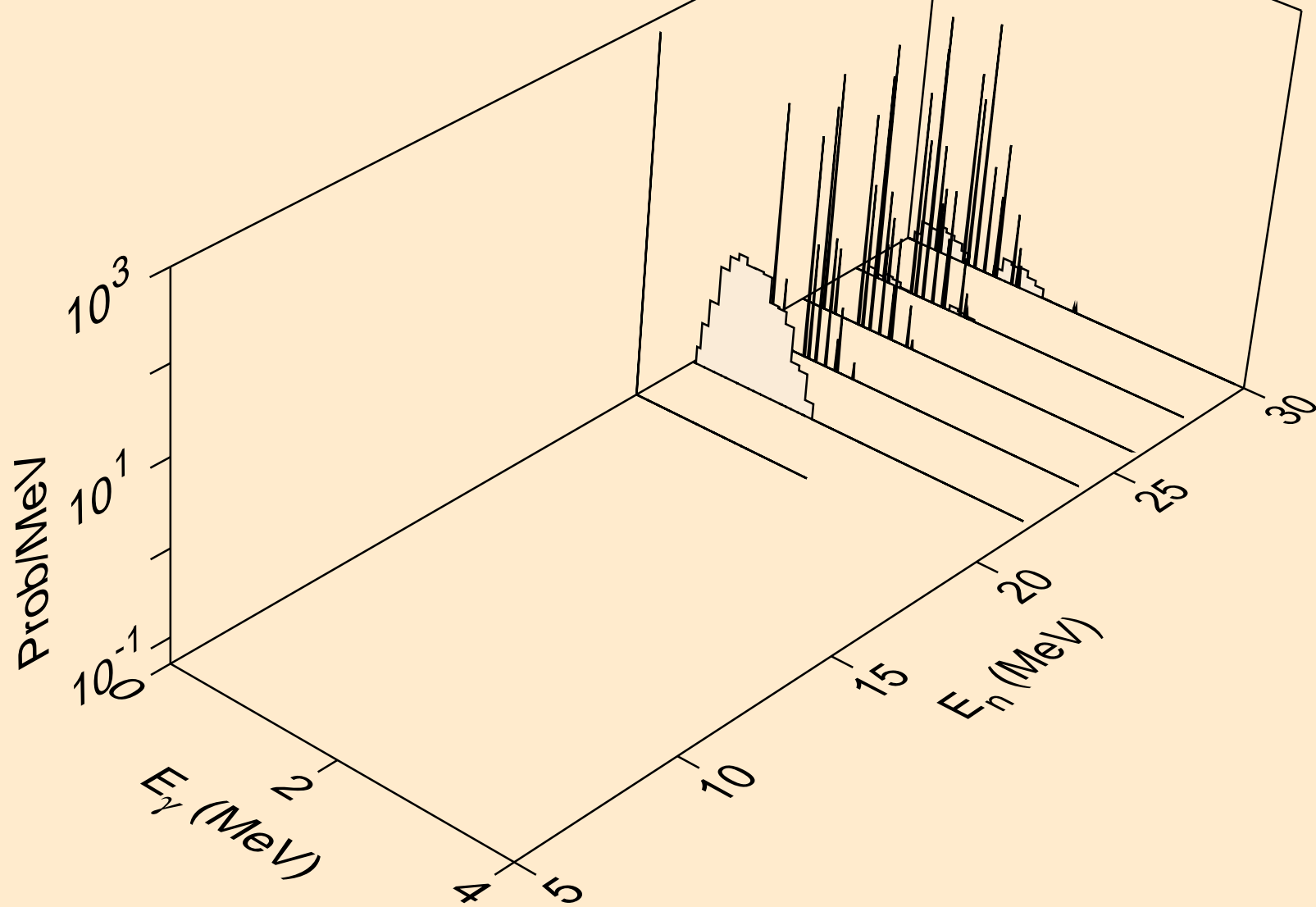

TC103 NEUTRON ACER TENDL-2023 LIBRARY; T=0.K  
Photon emission for (n,n\*)d

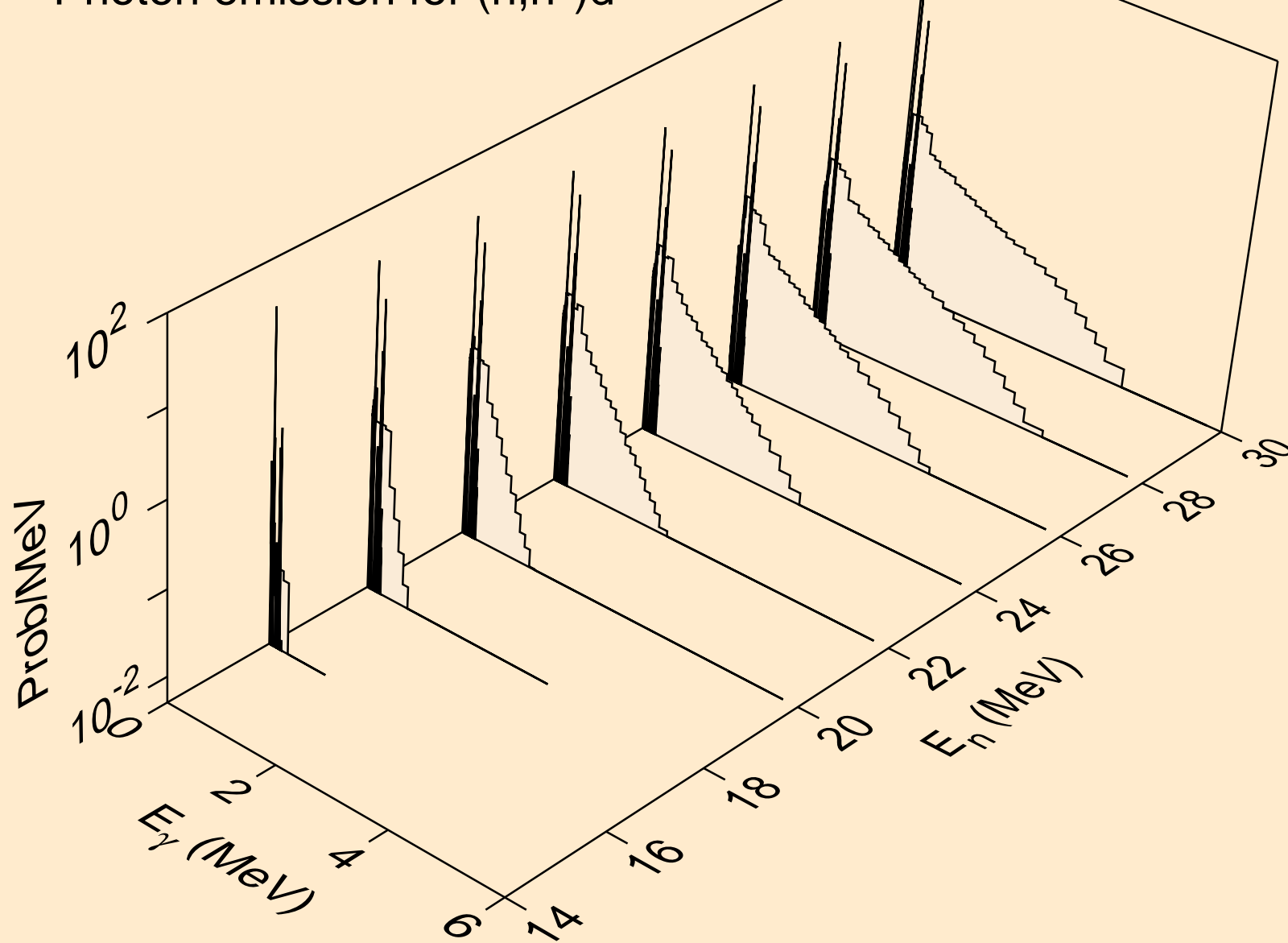

TC103 NEUTRON ACER TENDL-2023 LIBRARY; T=0.K  
Photon emission for (n,n\*)t

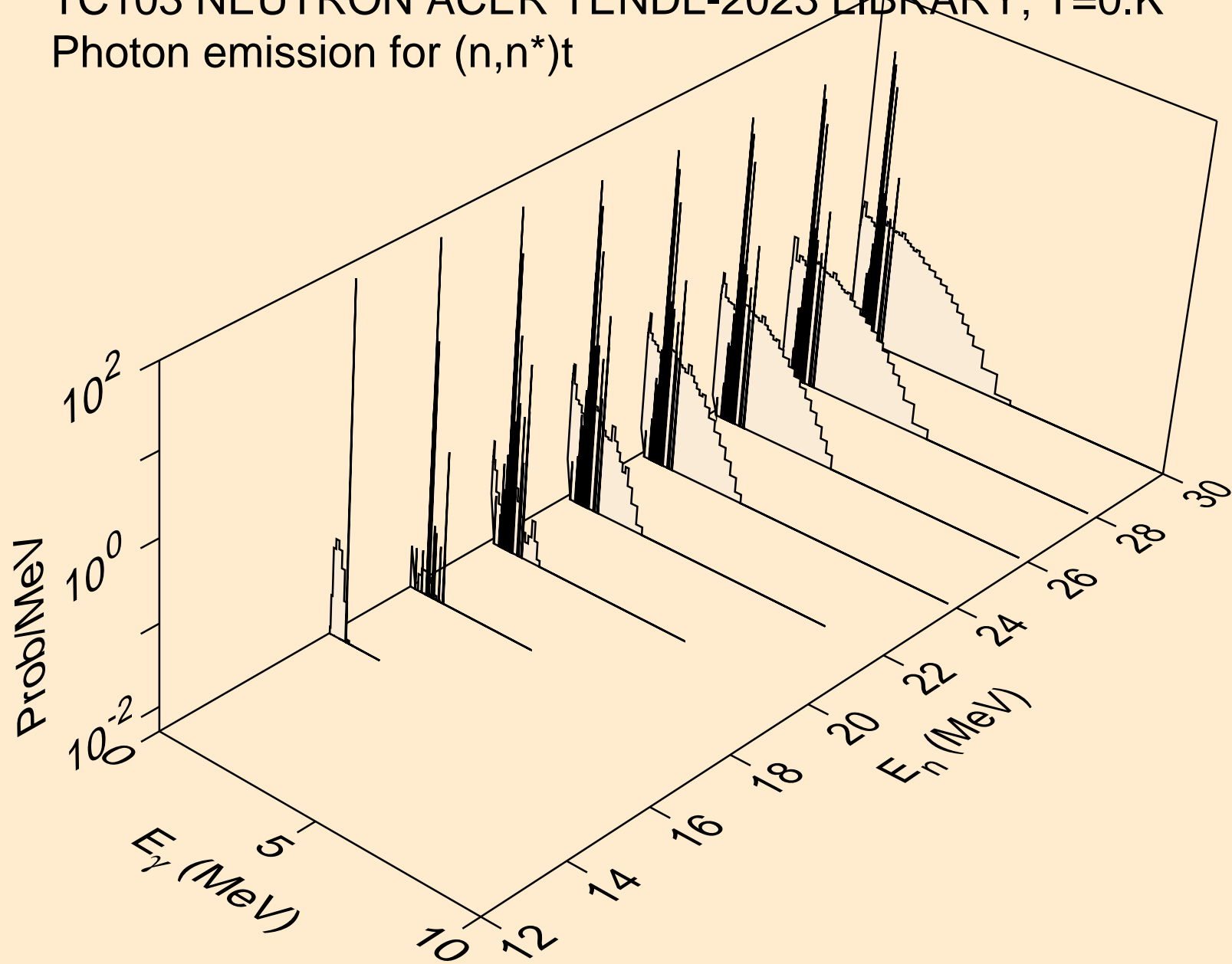

TC103 NEUTRON ACER TENDL-2023 LIBRARY; T=0.K  
Photon emission for (n,n\*)he3

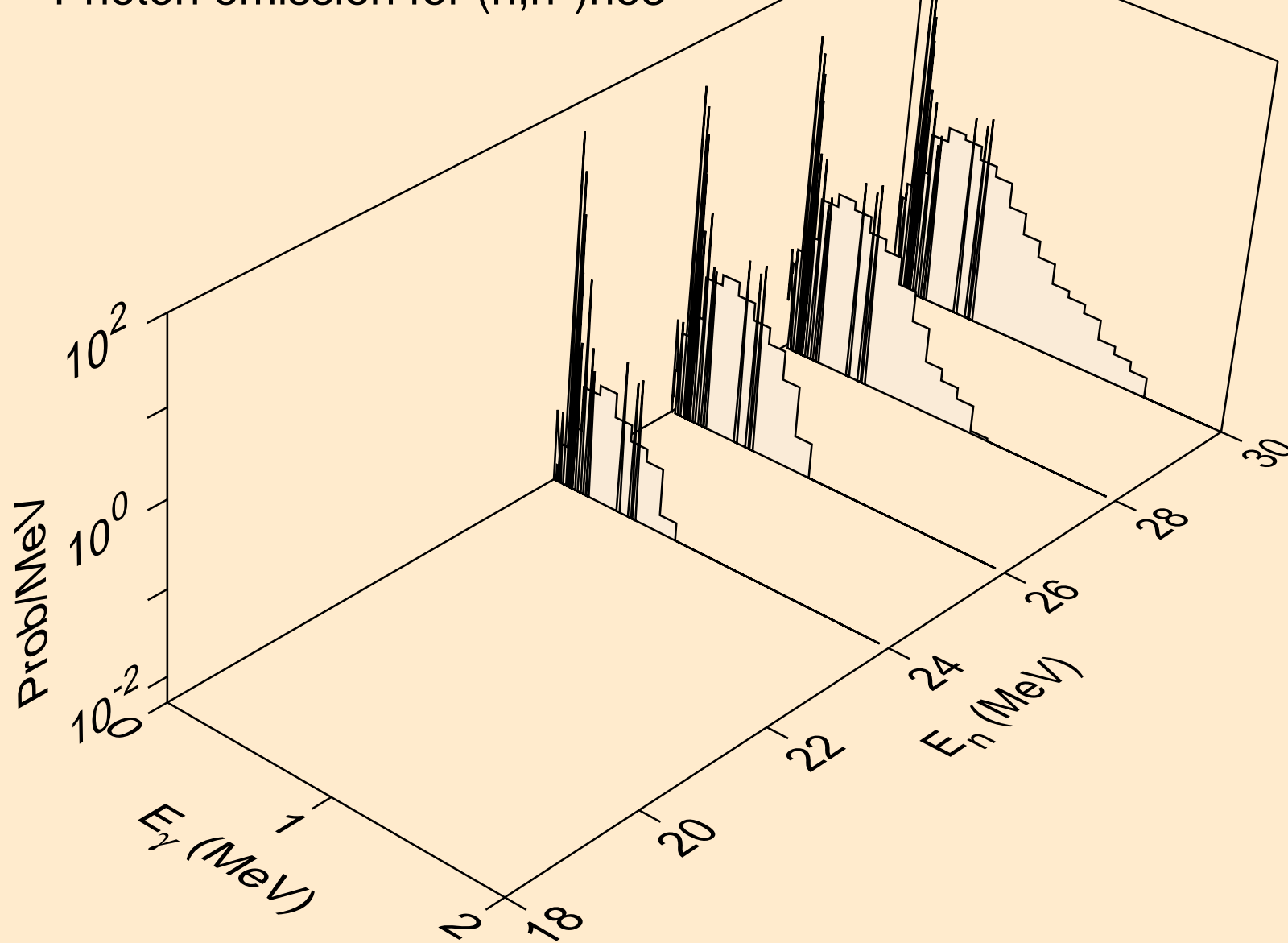

TC103 NEUTRON ACER TENDL-2023 LIBRARY; T=0.K  
Photon emission for (n,4n)

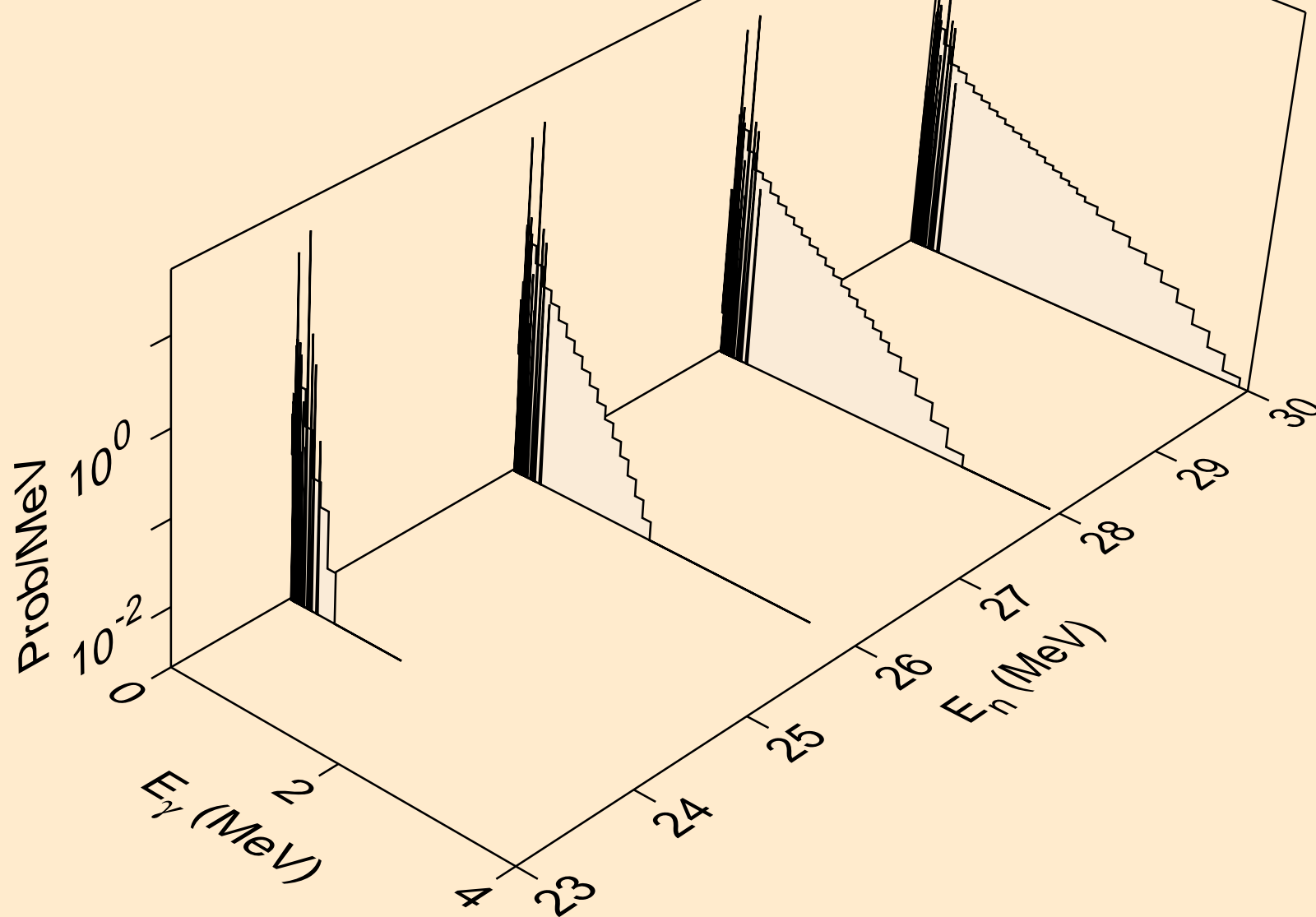

TC103 NEUTRON ACER TENDL-2023 LIBRARY; T=0.K  
Photon emission for (n,2np)

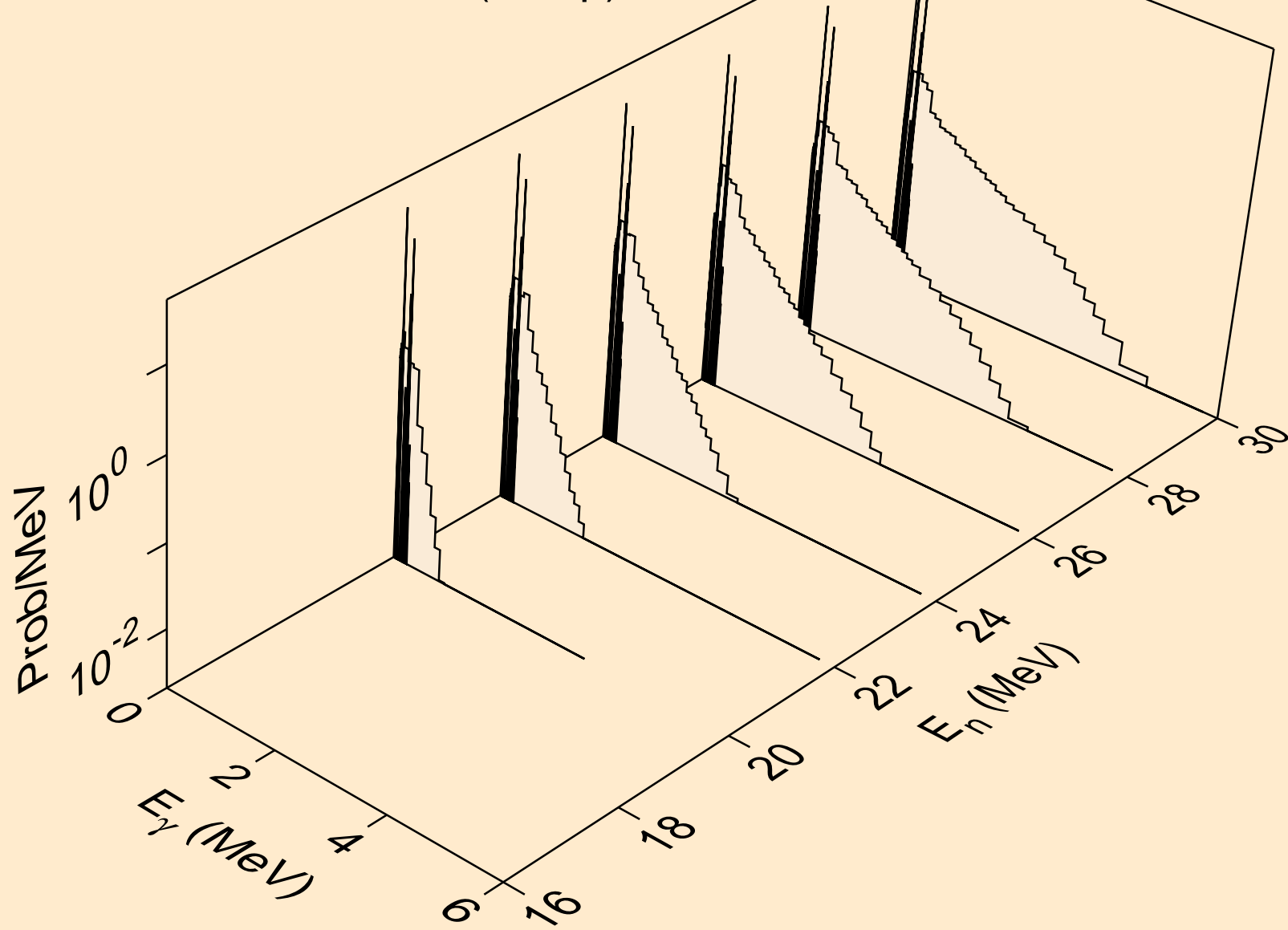



TC103 NEUTRON ACER TENDL-2023 LIBRARY; T=0.K  
Photon emission for (n,3np)

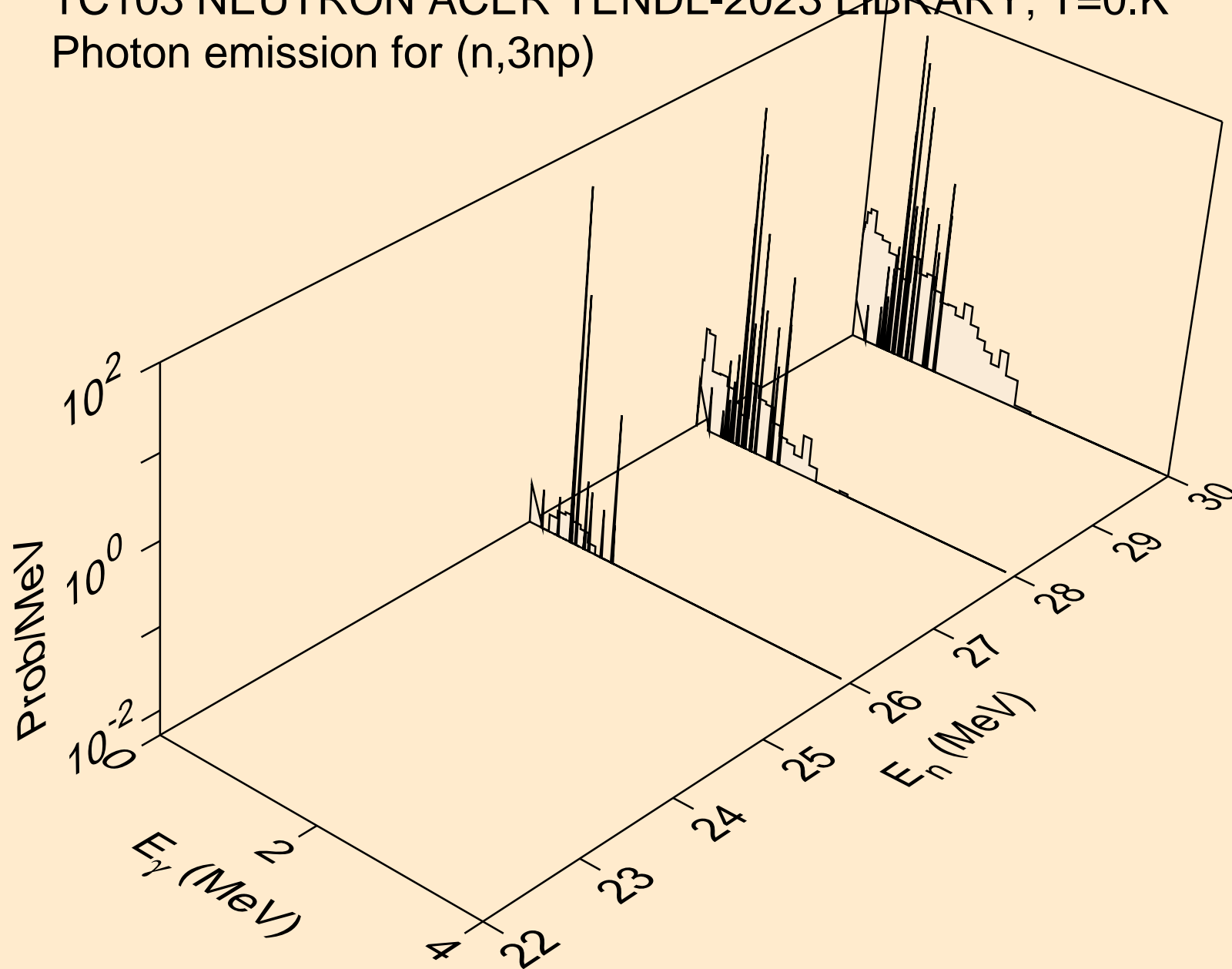

TC103 NEUTRON ACER TENDL-2023 LIBRARY; T=0.K  
Photon emission for (n,n2p)

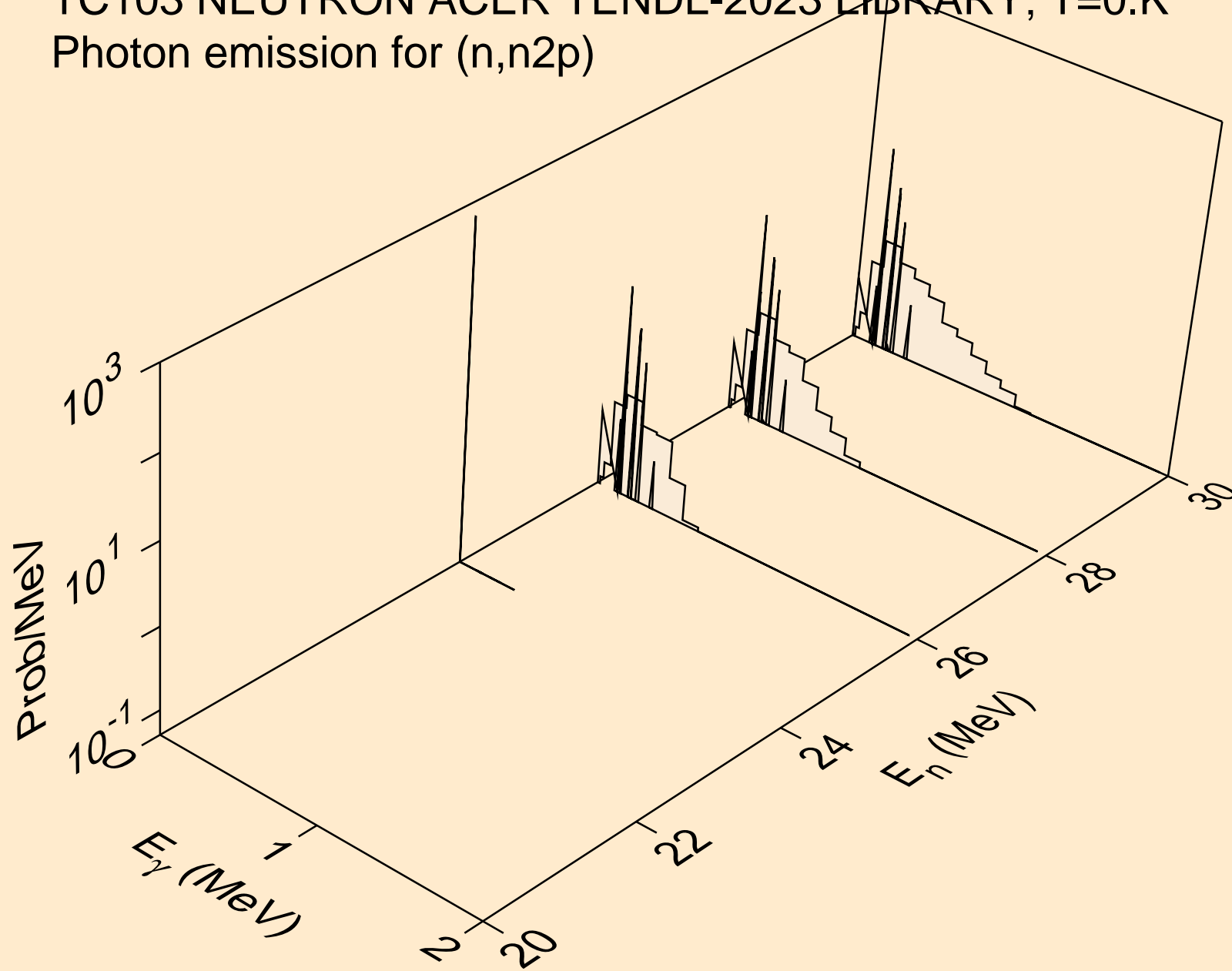

TC103 NEUTRON ACER TENDL-2023 LIBRARY; T=0.K  
Photon emission for (n,npa)

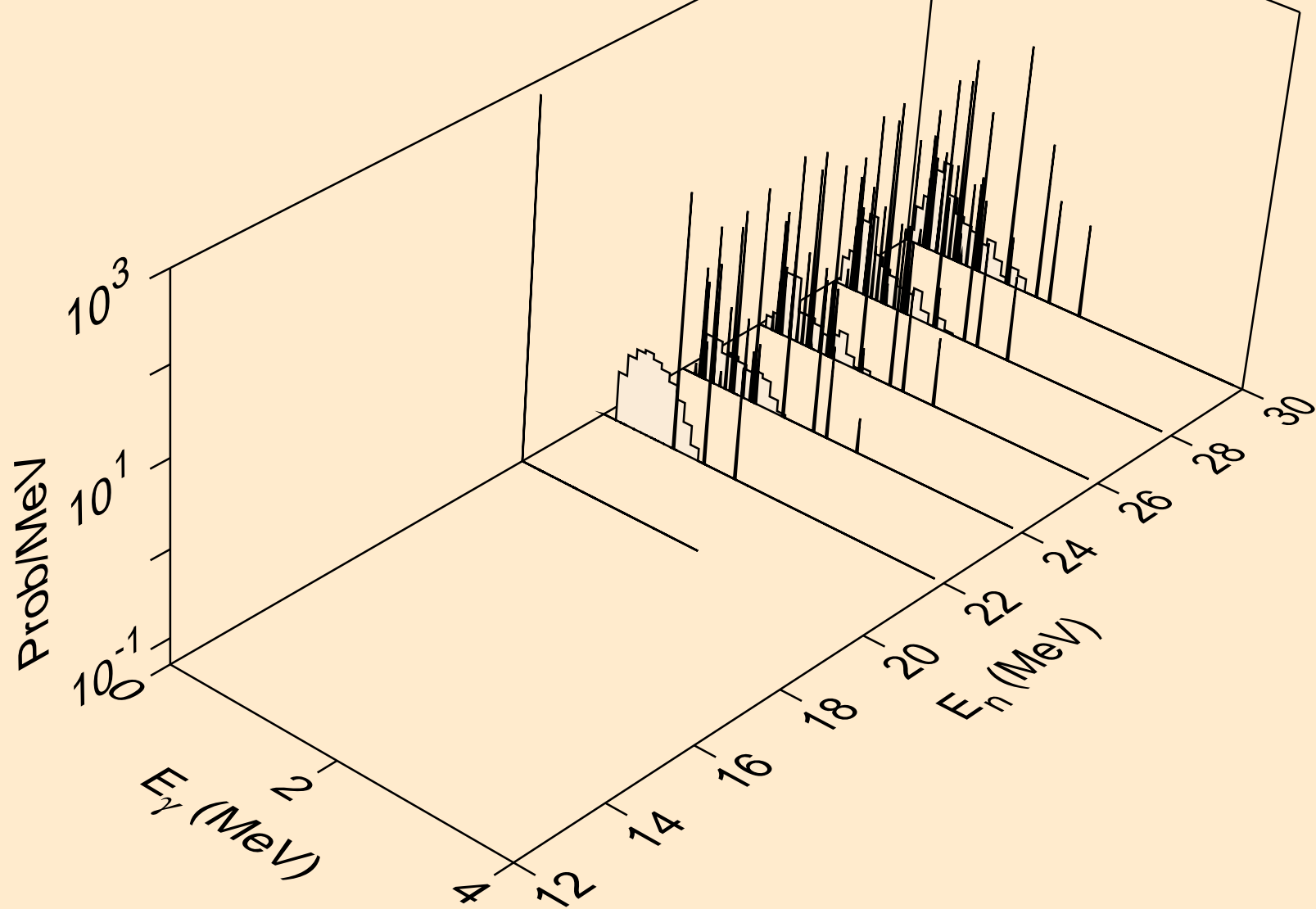

TC103 NEUTRON ACER TENDL-2023 LIBRARY; T=0.K  
Photon emission for (n,n\*c)

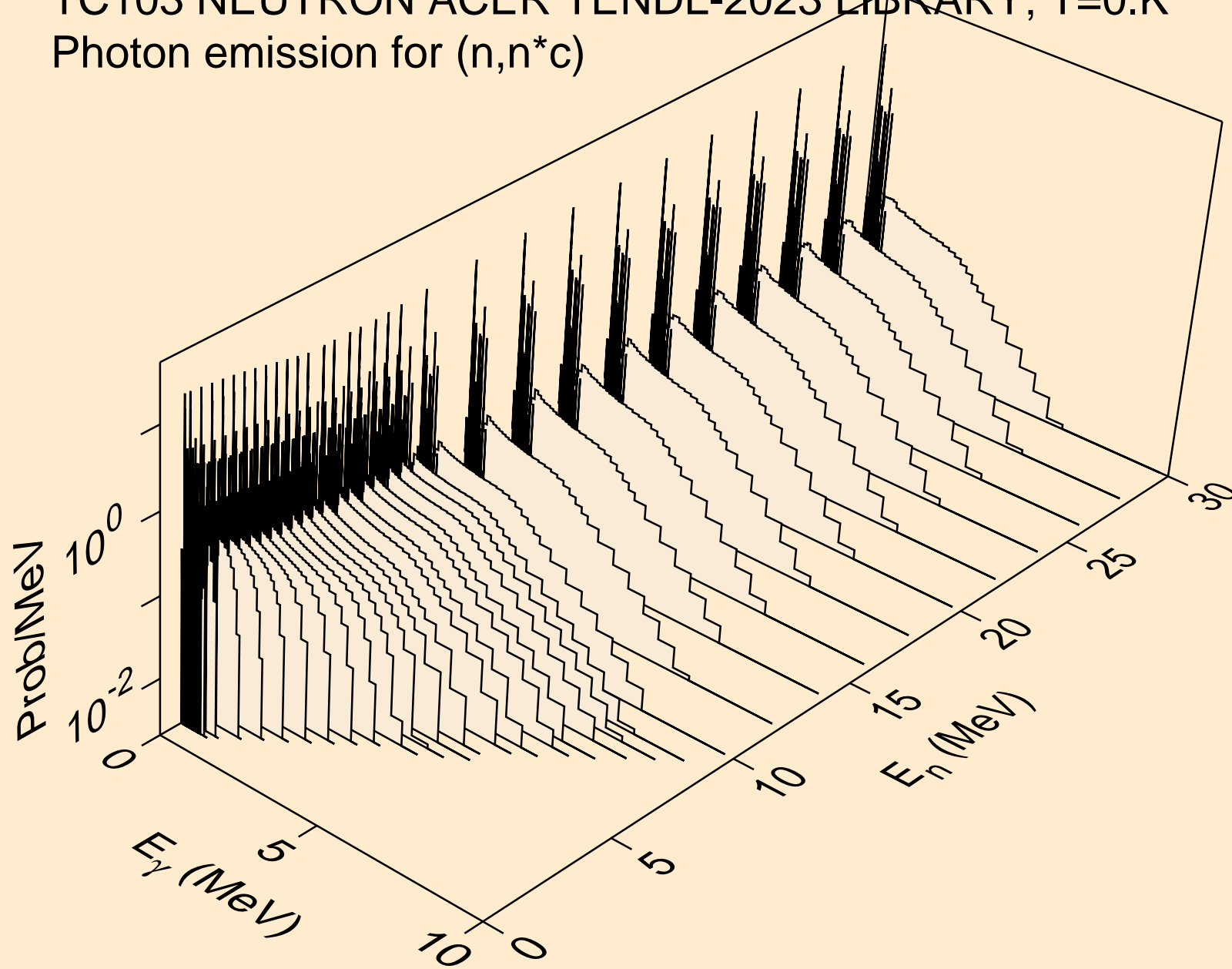

TC103 NEUTRON ACER TENDL-2023 LIBRARY; T=0.K  
Photon emission for (n,gma)

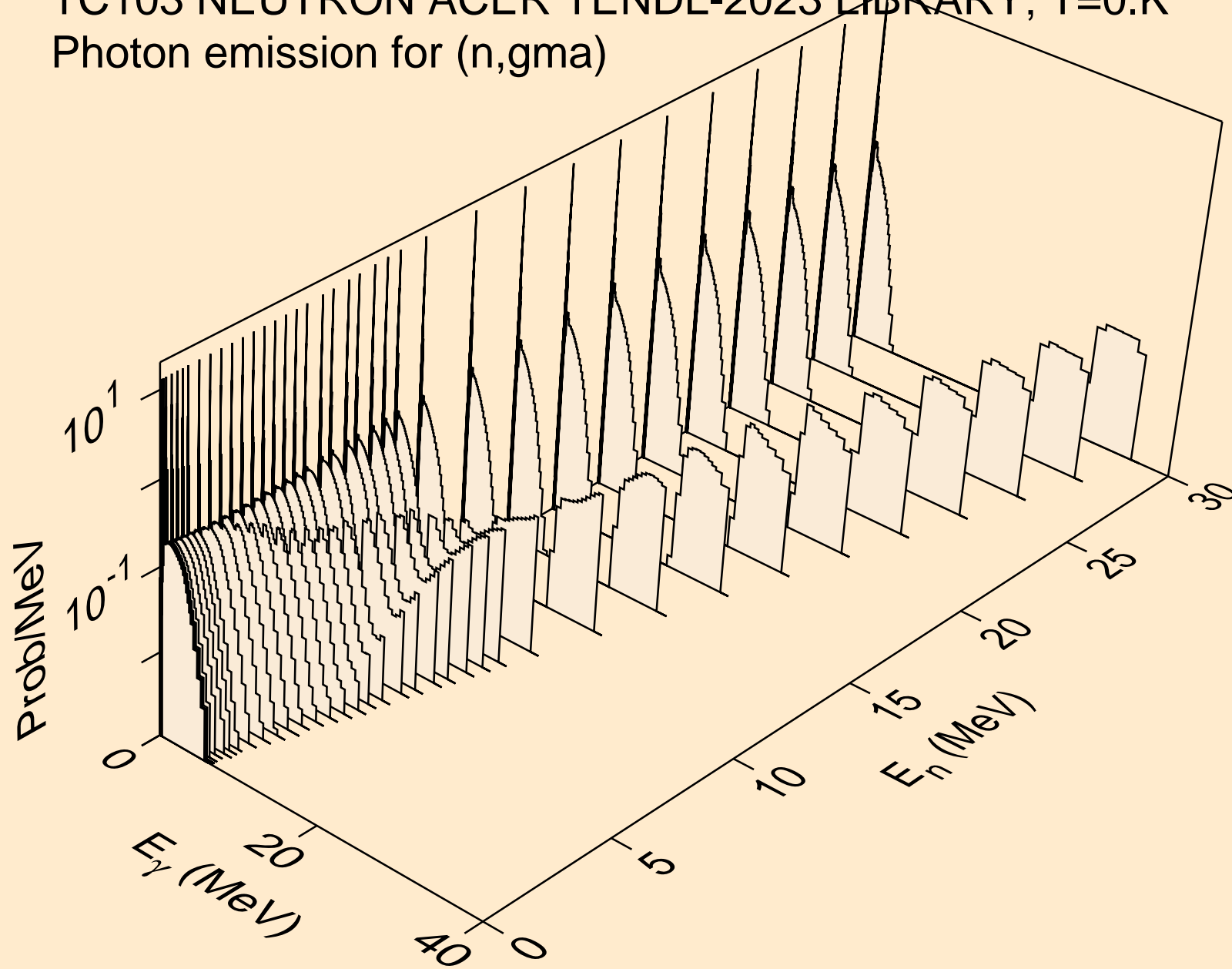

TC103 NEUTRON ACER TENDL-2023 LIBRARY; T=0.K  
Photon emission for (n,p)

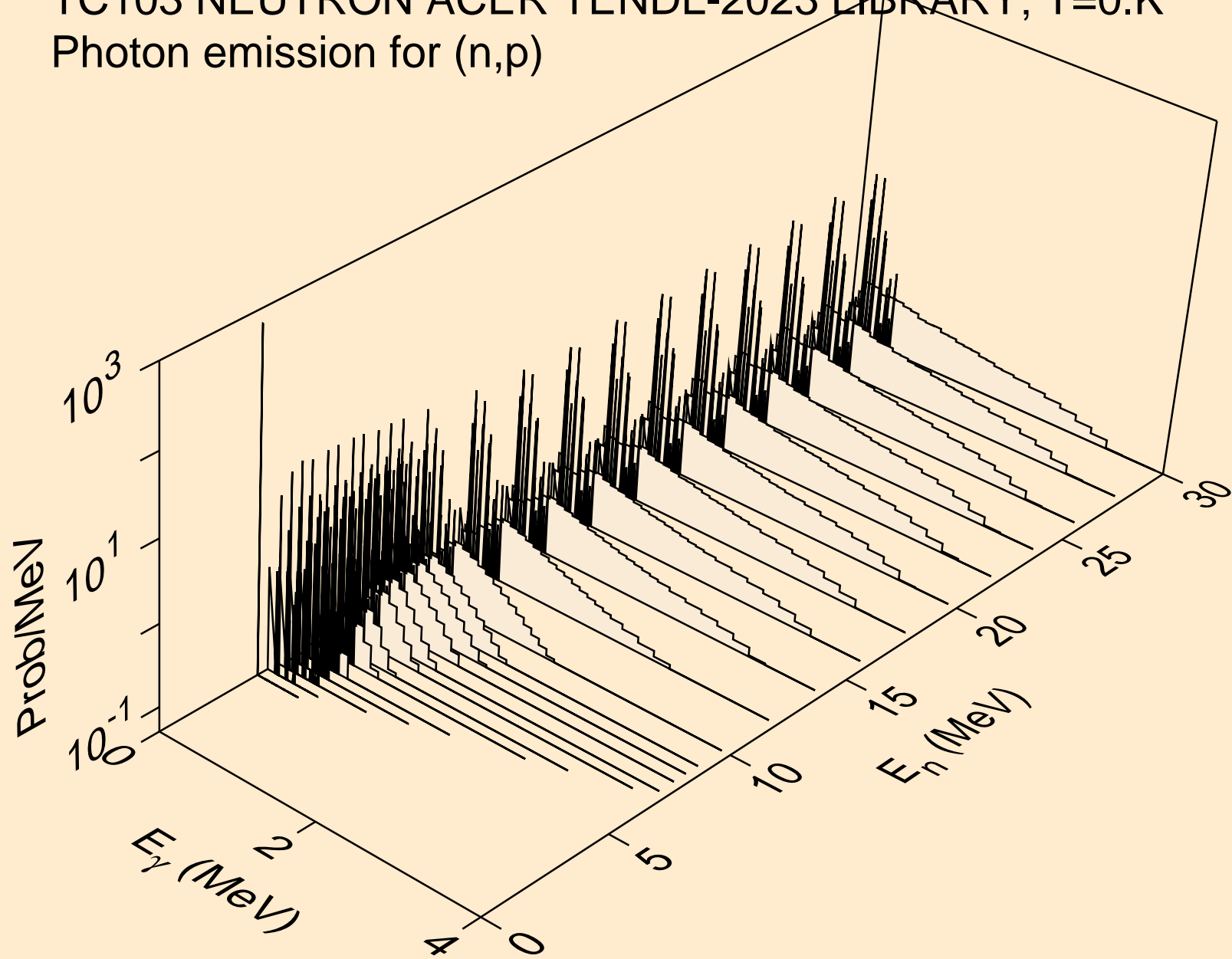

TC103 NEUTRON ACER TENDL-2023 LIBRARY; T=0.K  
Photon emission for (n,d)

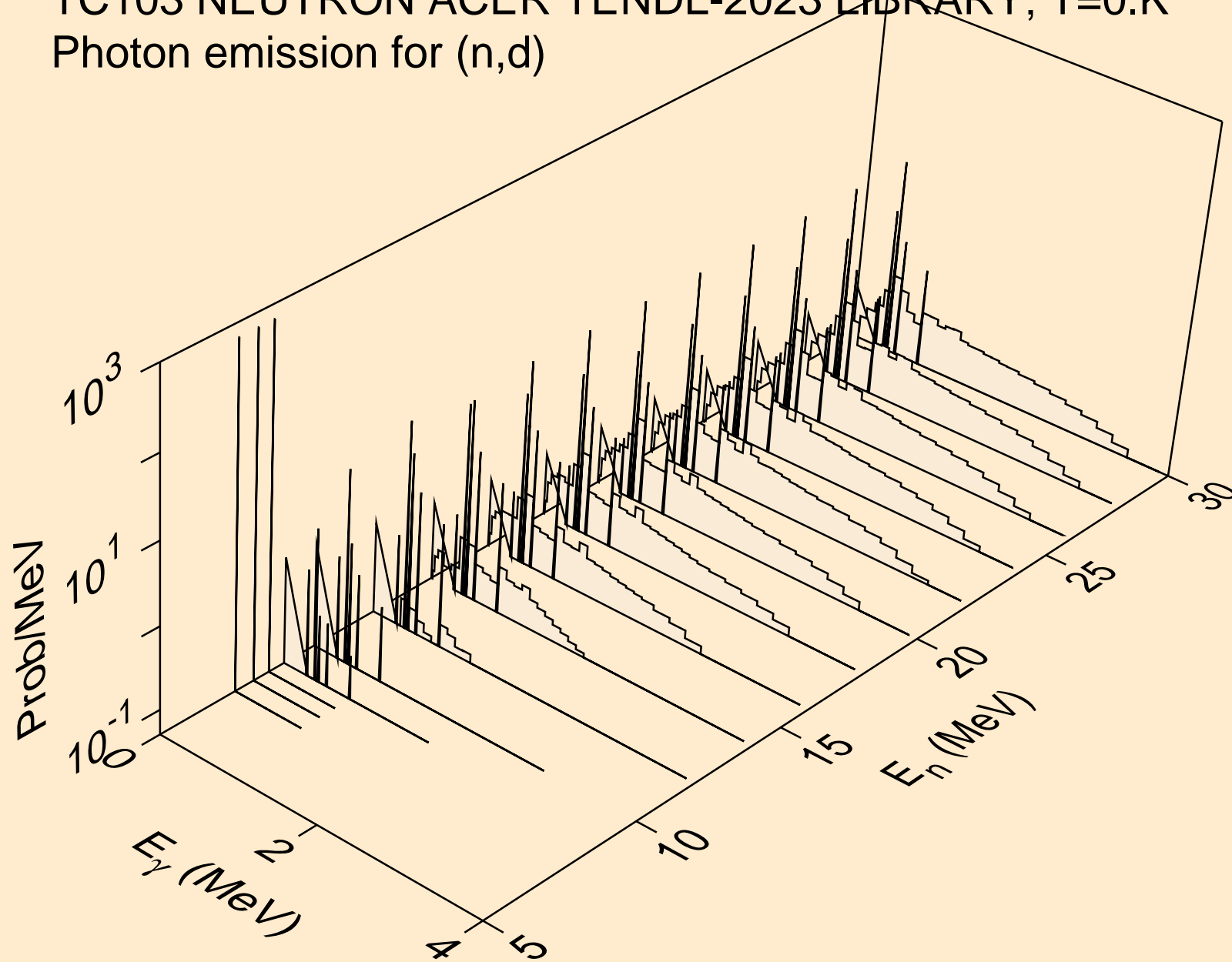

TC103 NEUTRON ACER TENDL-2023 LIBRARY; T=0.K  
Photon emission for (n,t)

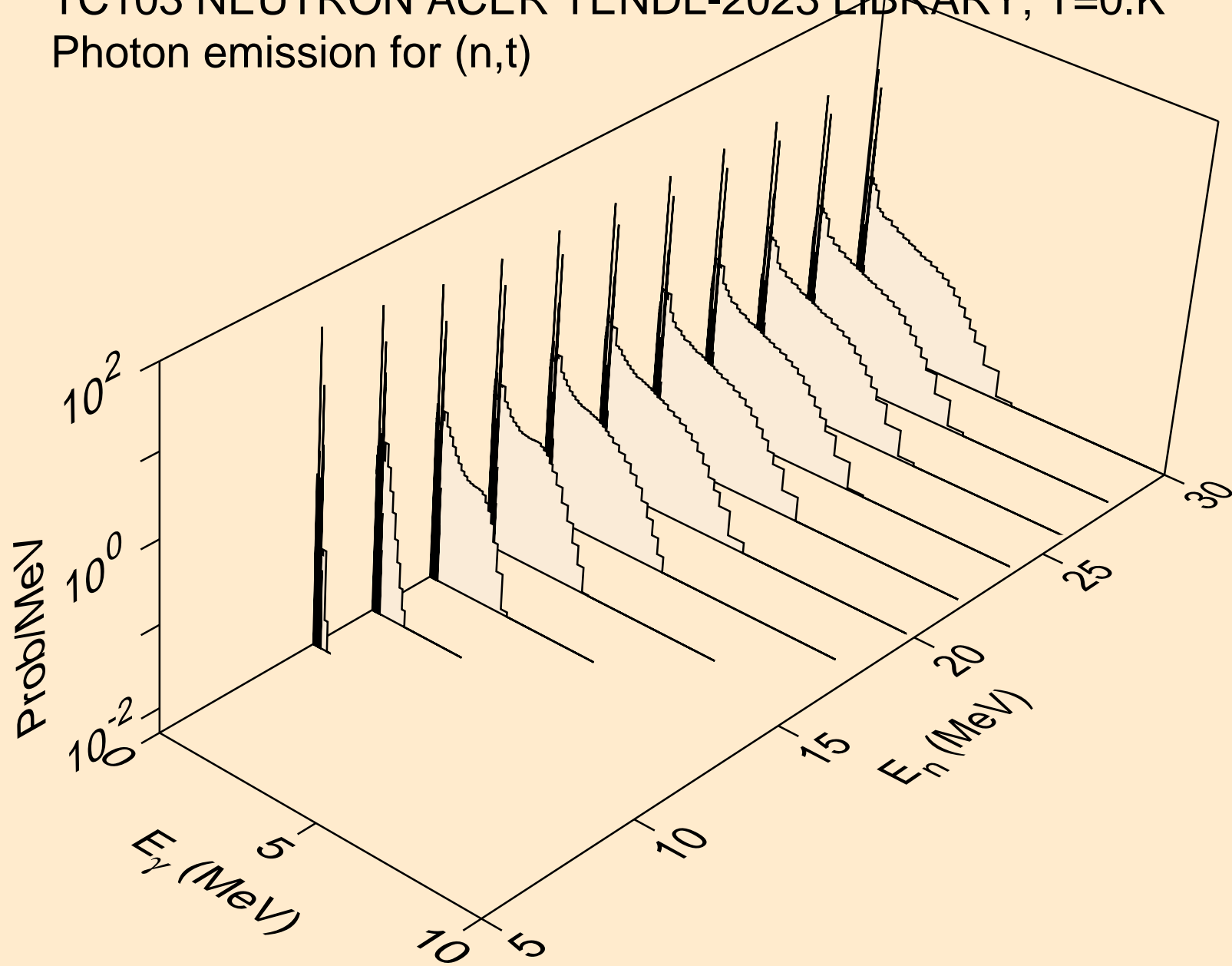



TC103 NEUTRON ACER TENDL-2023 LIBRARY; T=0.K  
Photon emission for (n,he3)

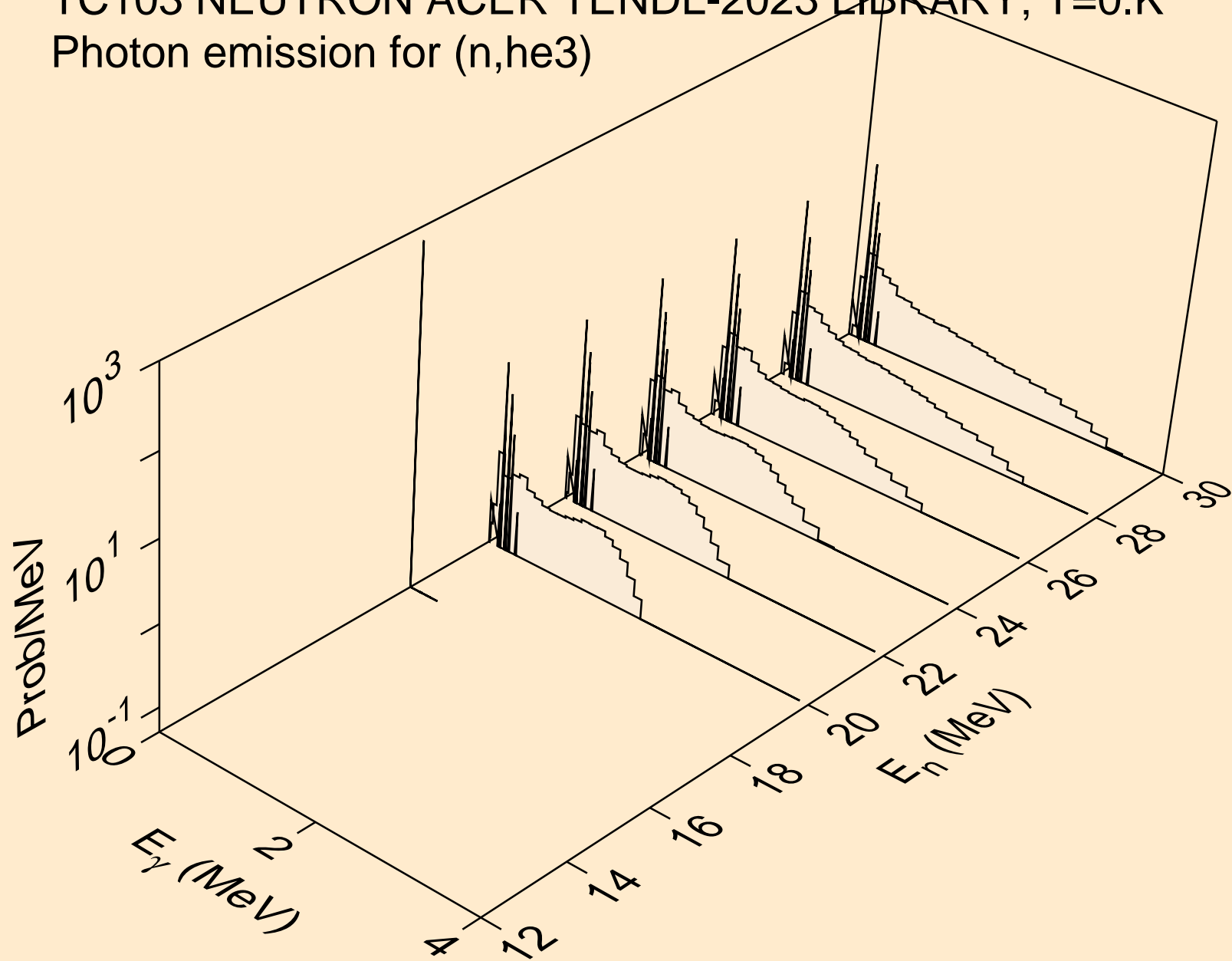

TC103 NEUTRON ACER TENDL-2023 LIBRARY; T=0.K  
Photon emission for (n,a)

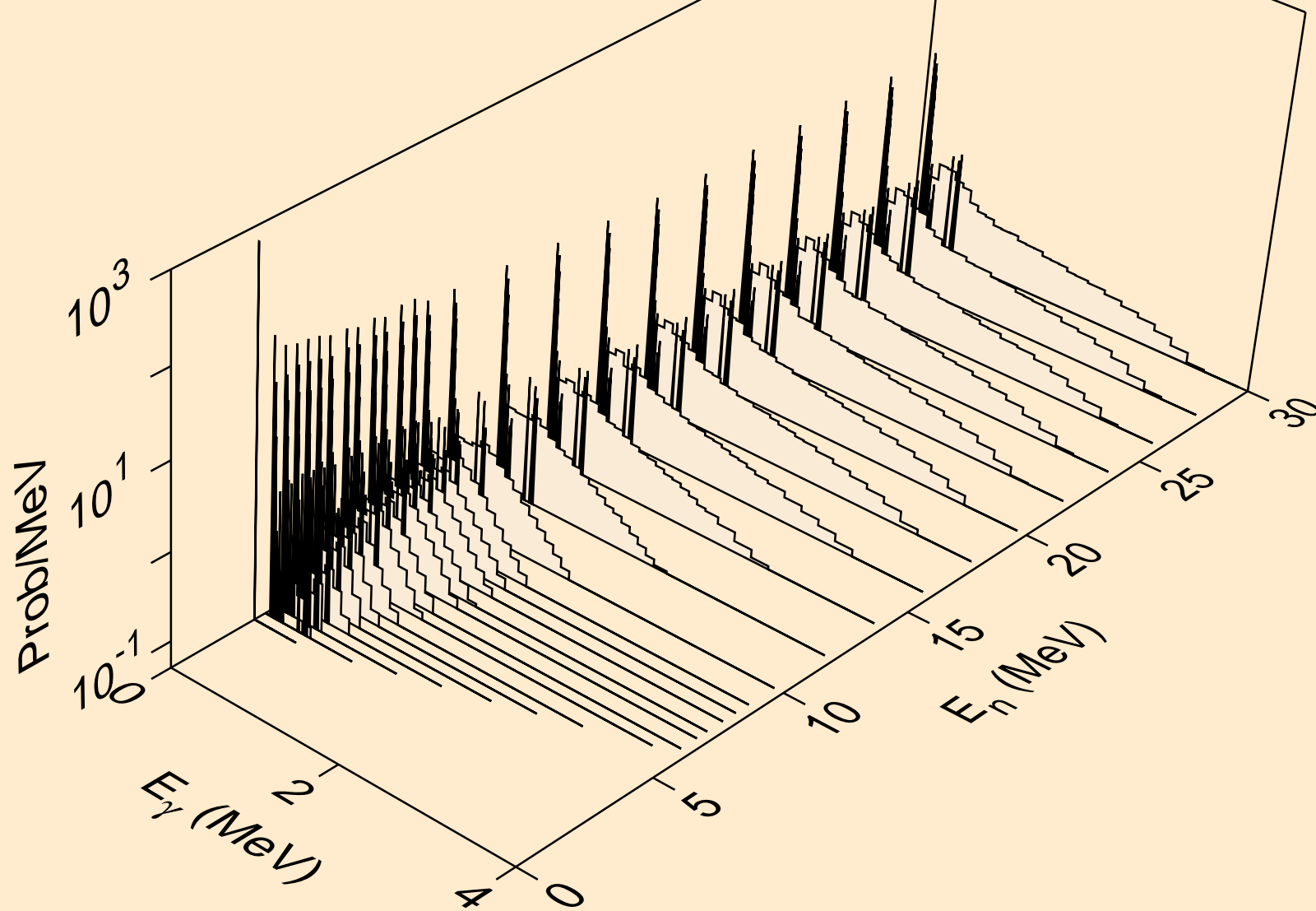

TC103 NEUTRON ACER TENDL-2023 LIBRARY; T=0.K  
Photon emission for (n,2a)

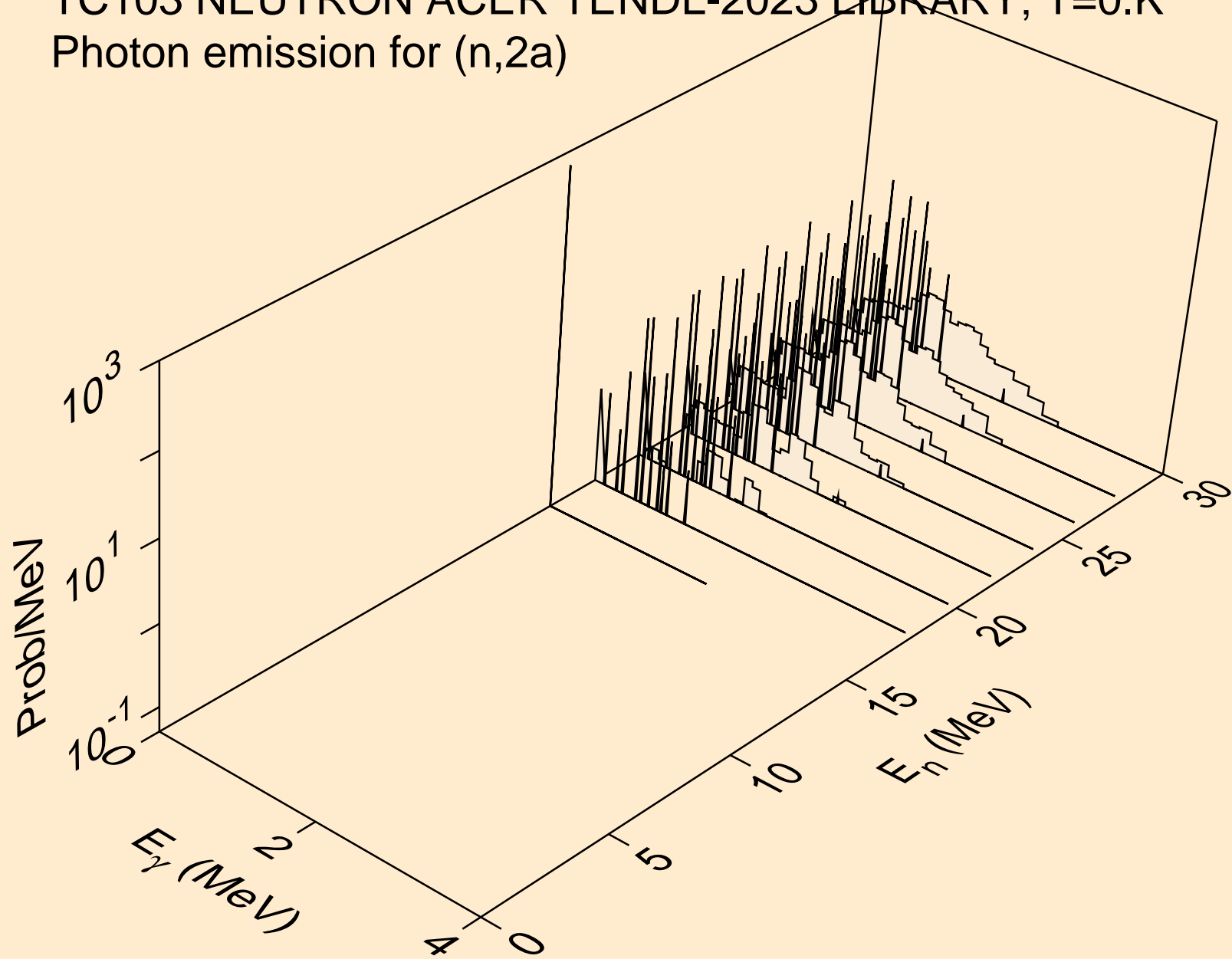

TC103 NEUTRON ACER TENDL-2023 LIBRARY; T=0.K  
Photon emission for (n,2p)

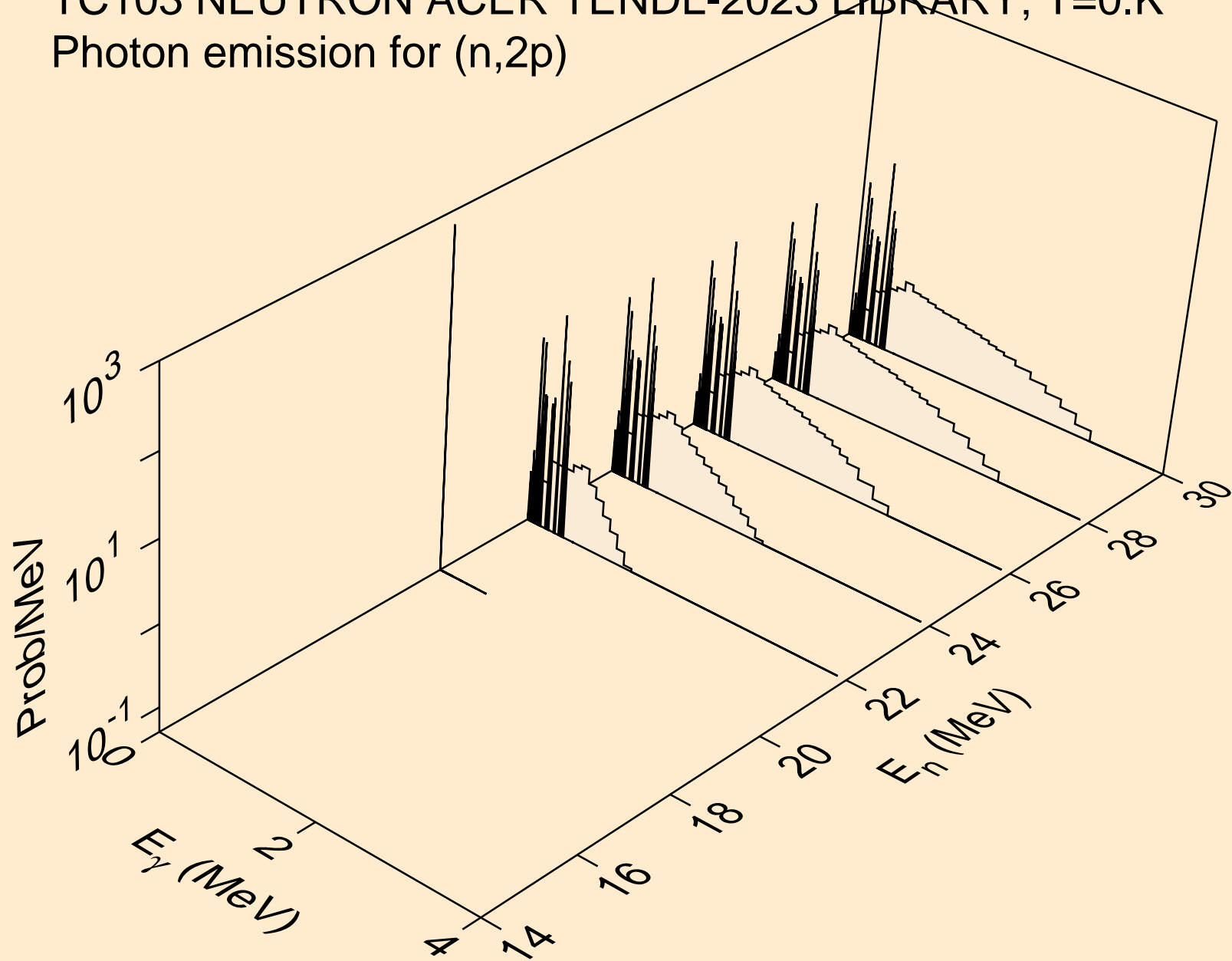

TC103 NEUTRON ACER TENDL-2023 LIBRARY; T=0.K  
Photon emission for (n,p $\alpha$ )

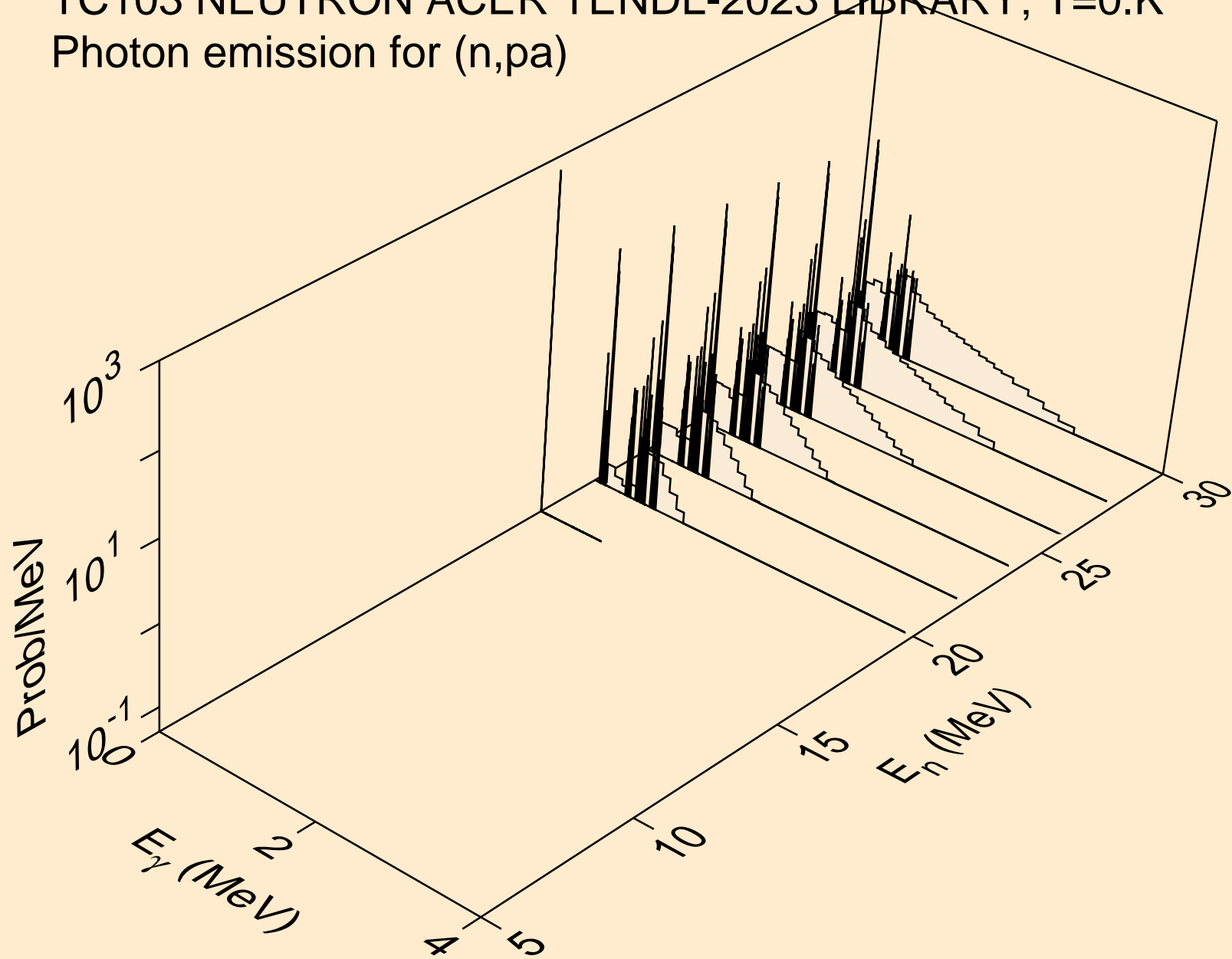

TC103 NEUTRON ACER TENDL-2023 LIBRARY; T=0.K  
thermal capture photon spectrum

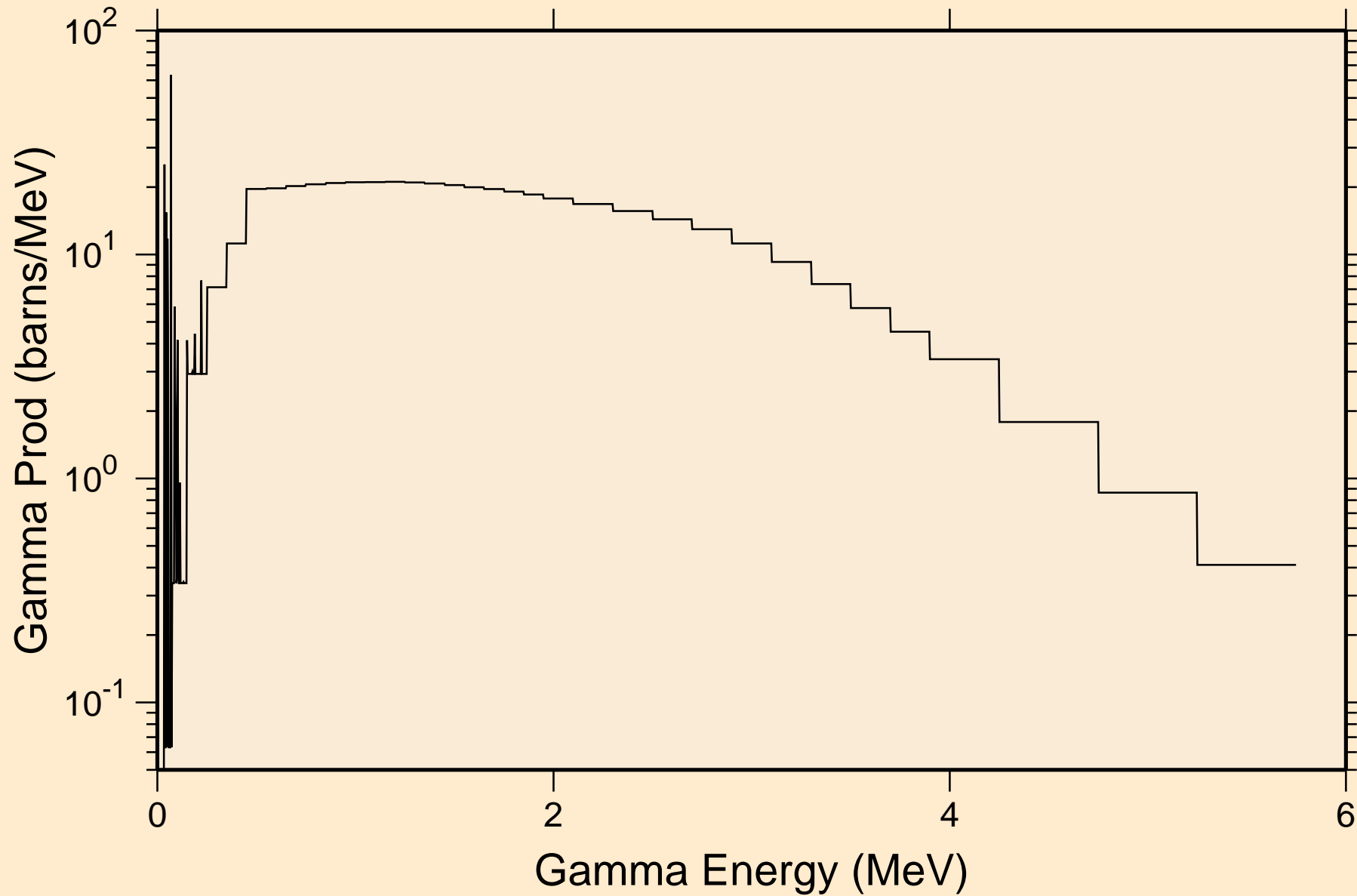

TC103 NEUTRON ACER TENDL-2023 LIBRARY; T=0.K  
14 MeV photon spectrum

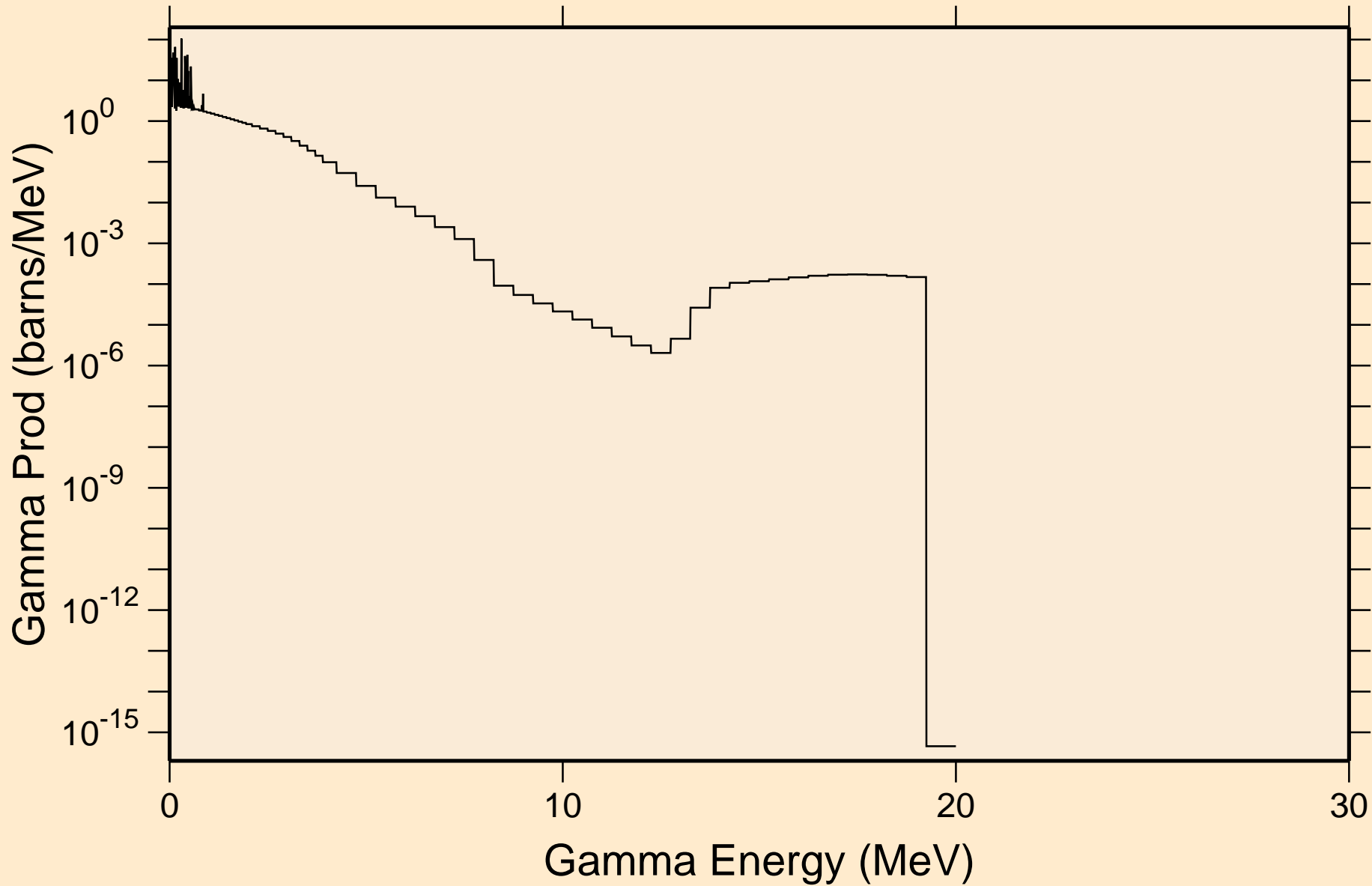

# TC103 NEUTRON ACER TENDL-2023 LIBRARY; T=0.K

## Particle heating contributions

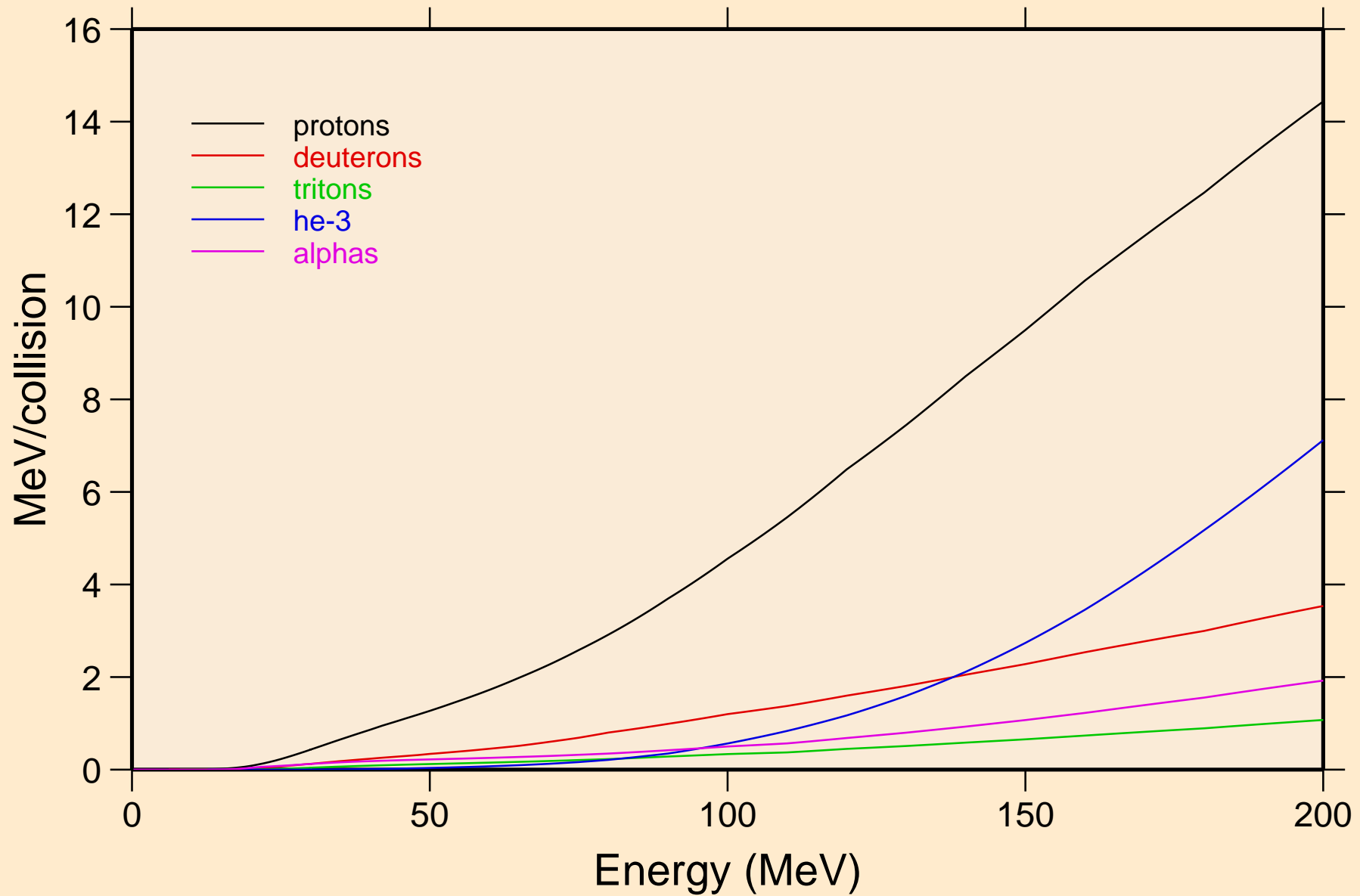



TC103 NEUTRON ACER TENDL-2023 LIBRARY; T=0.K  
Recoil Heating

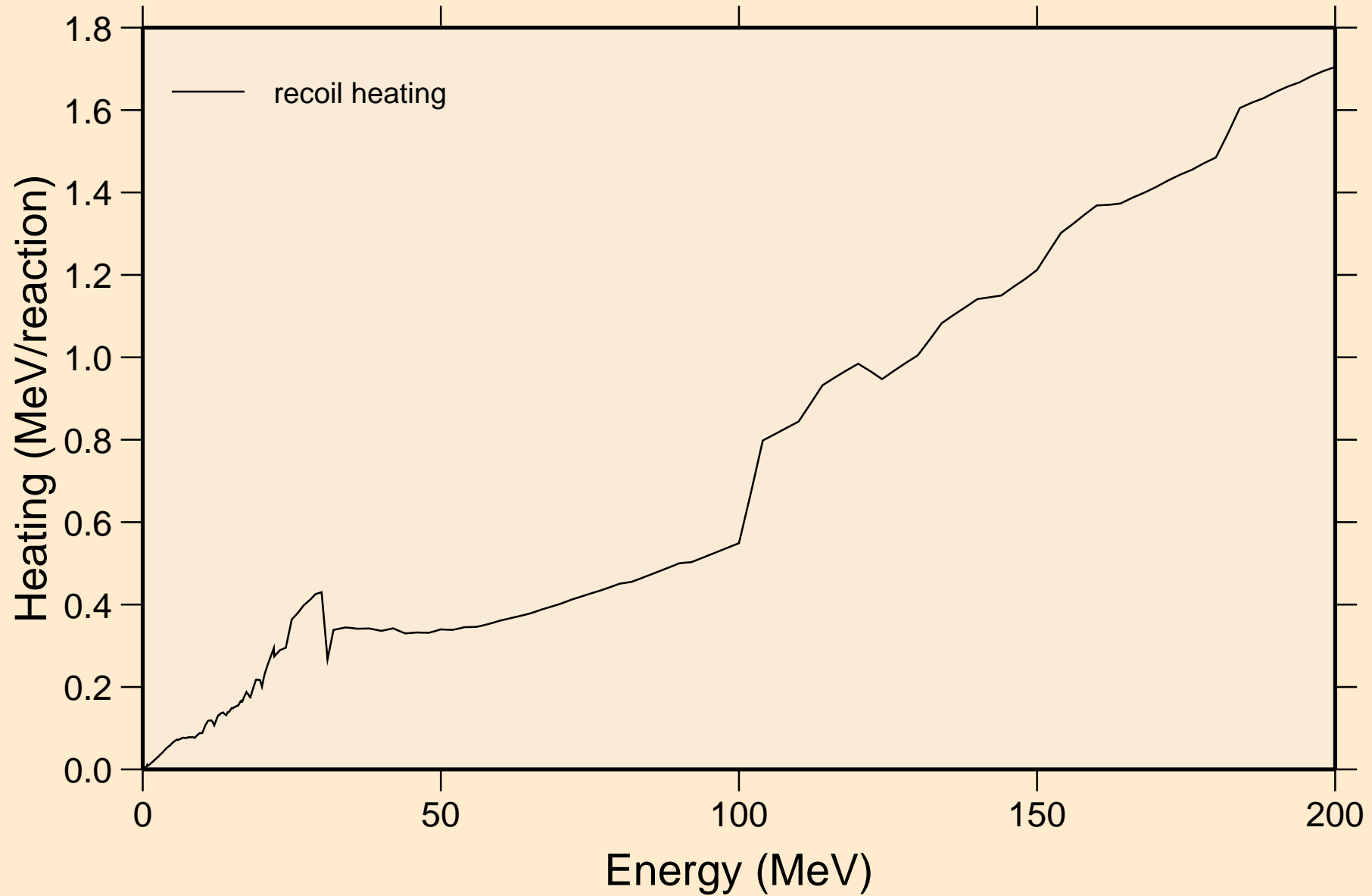

# TC103 NEUTRON ACER TENDL-2023 LIBRARY; T=0.K

## Particle production cross sections

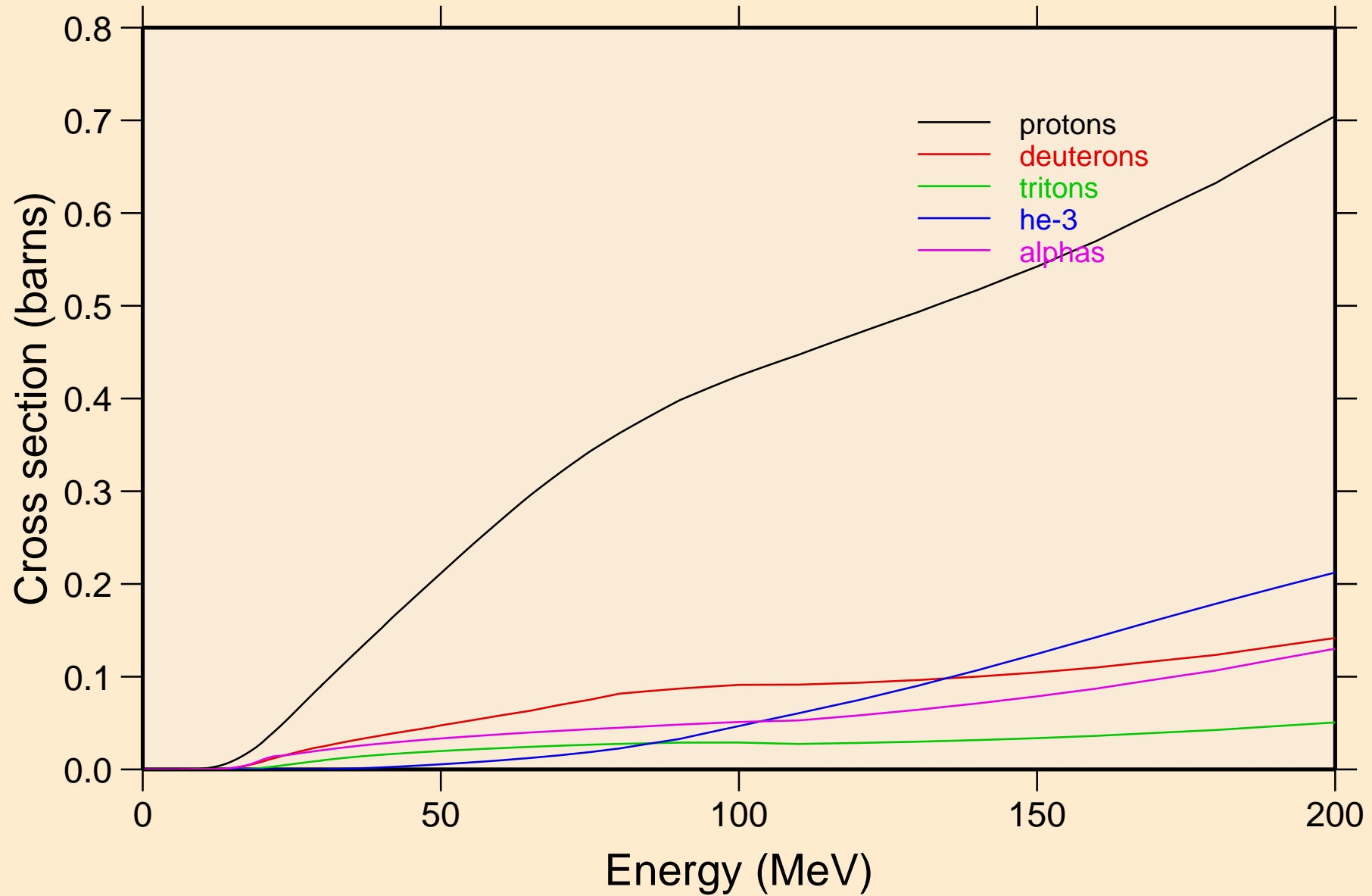

TC103 NEUTRON ACER TENDL-2023 LIBRARY; T=0.K  
protons from (n,x)

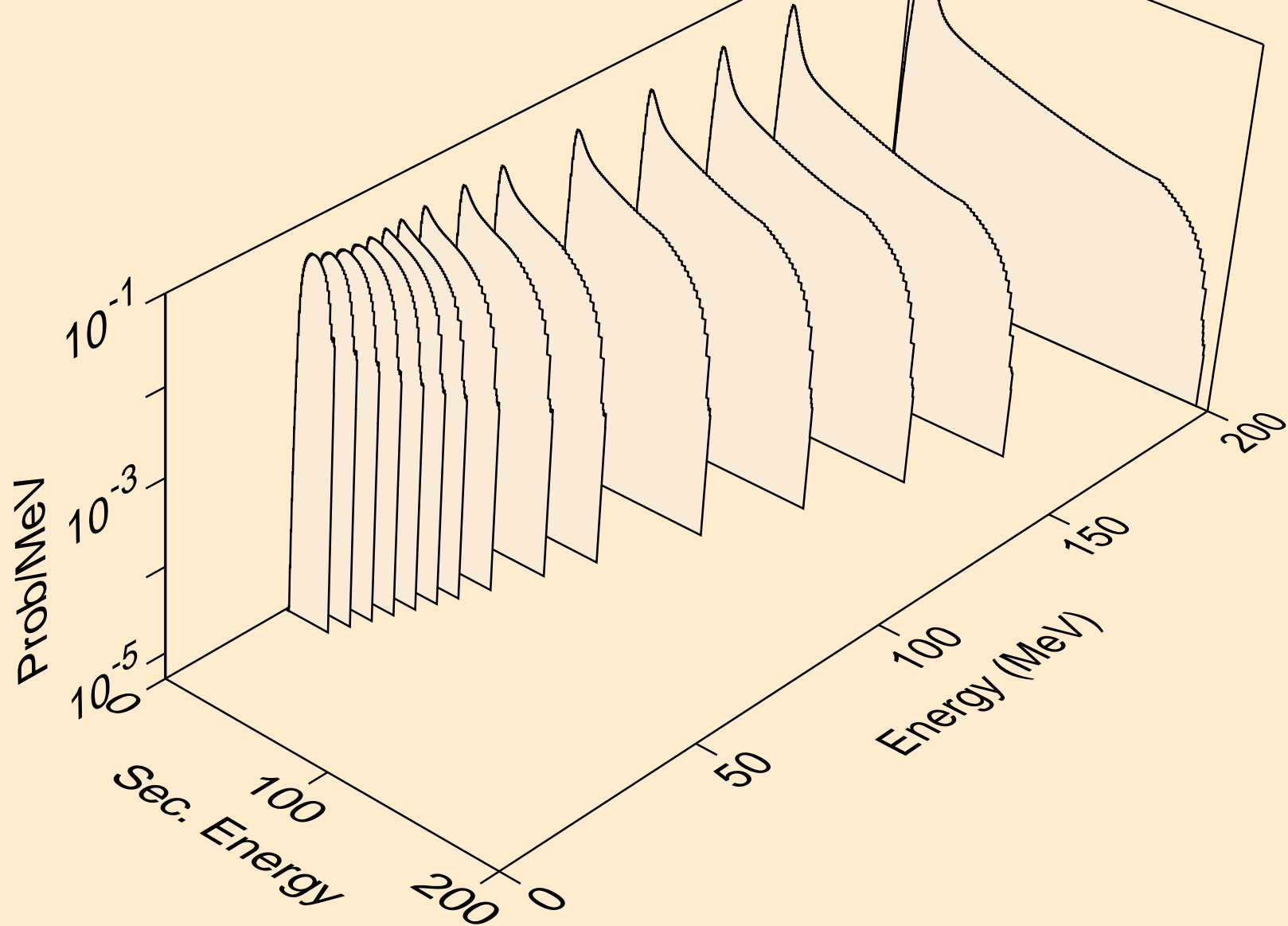

TC103 NEUTRON ACER TENDL-2023 LIBRARY; T=0.K  
protons from (n,n\*)p

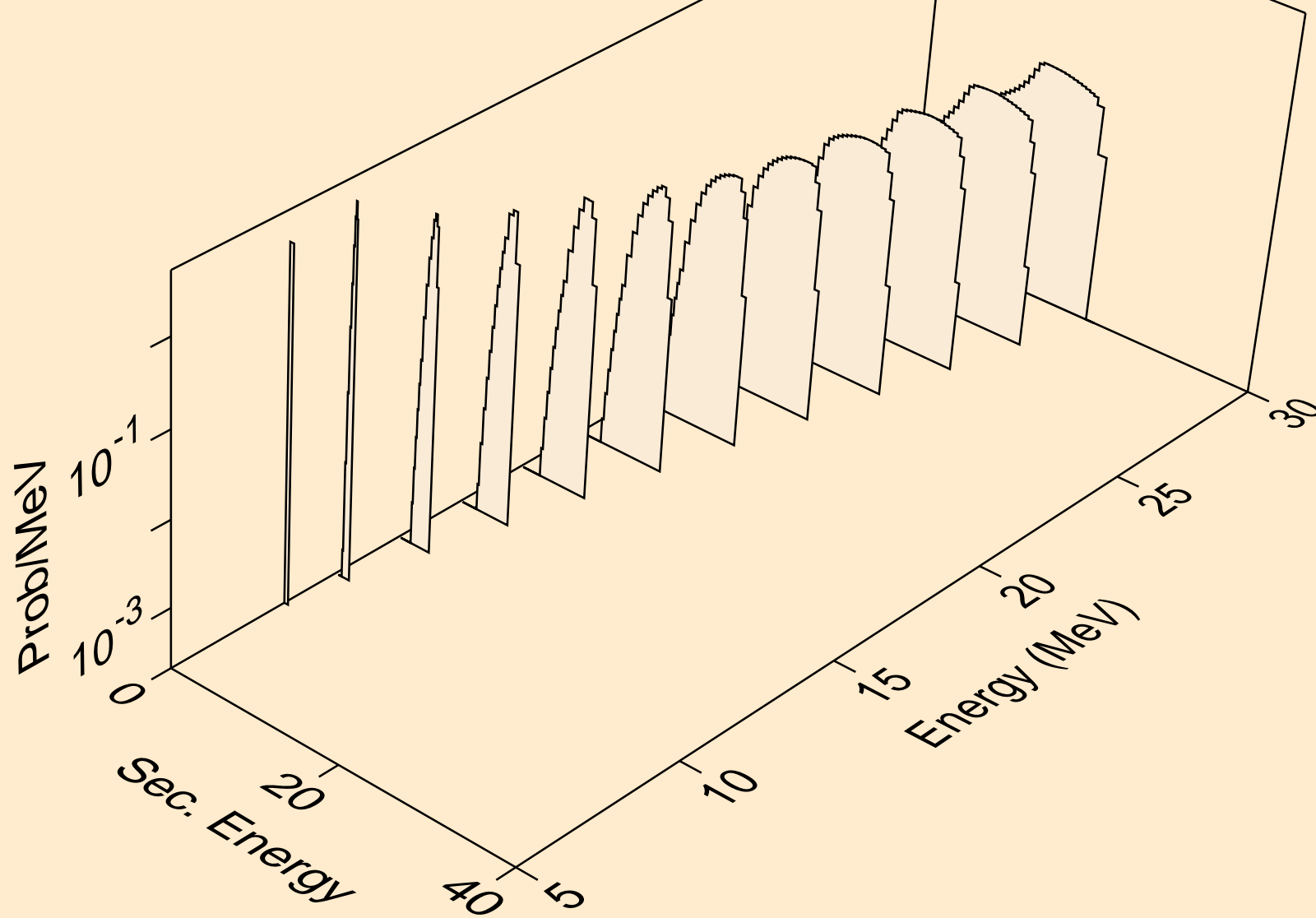

TC103 NEUTRON ACER TENDL-2023 LIBRARY; T=0.K  
protons from (n,2np)

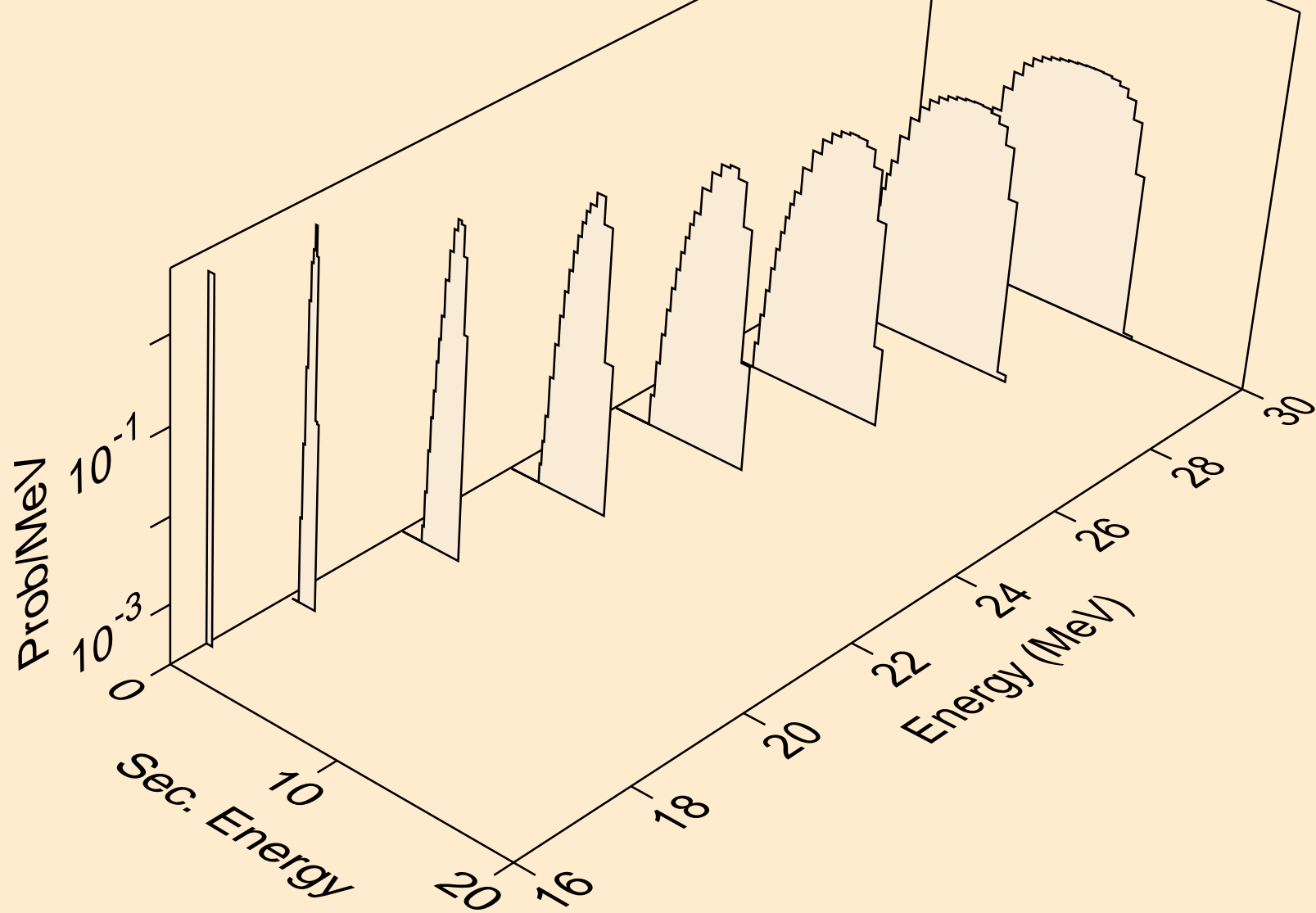

TC103 NEUTRON ACER TENDL-2023 LIBRARY; T=0.K  
protons from (n,3np)

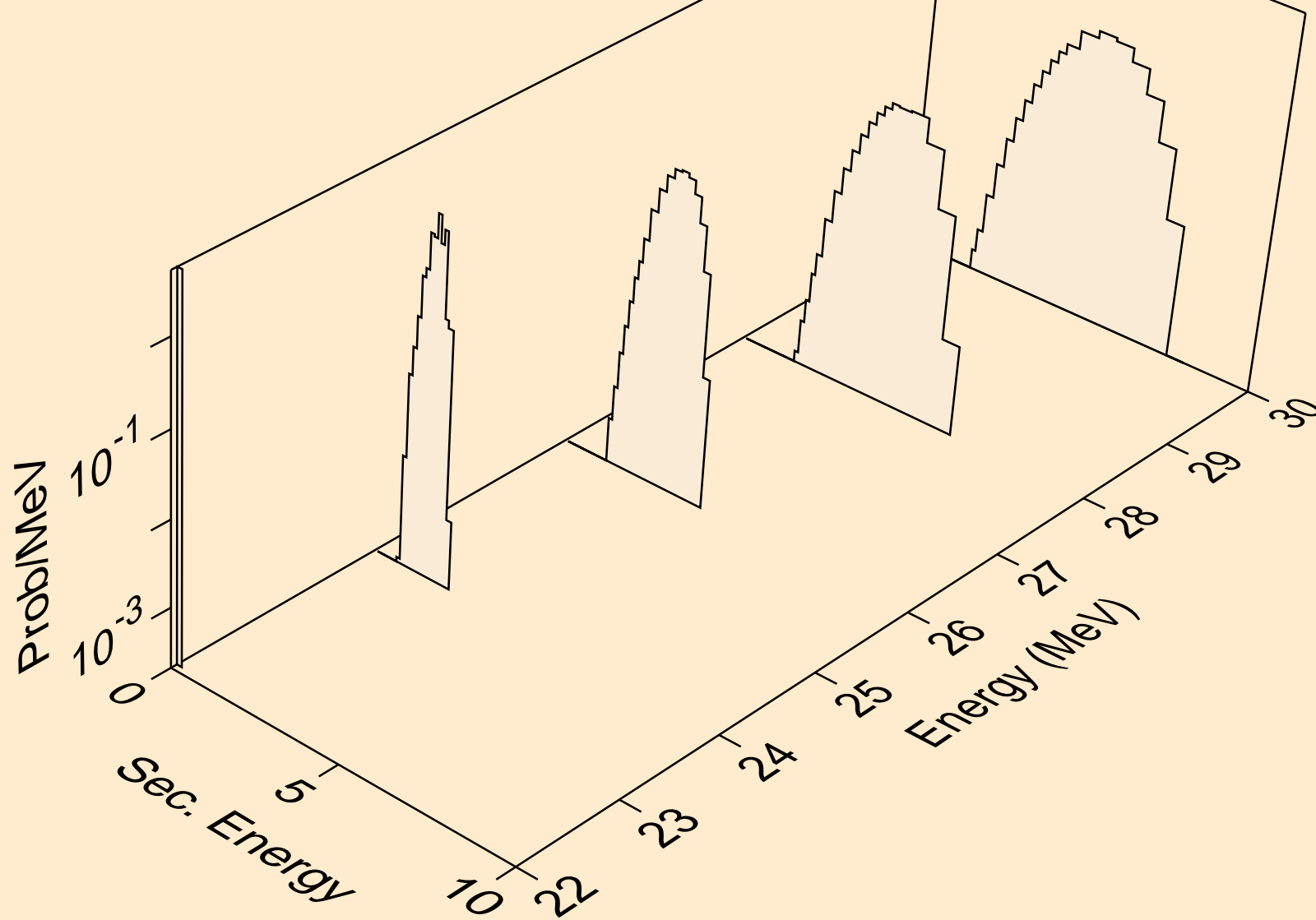

TC103 NEUTRON ACER TENDL-2023 LIBRARY; T=0.K  
protons from (n,n2p)

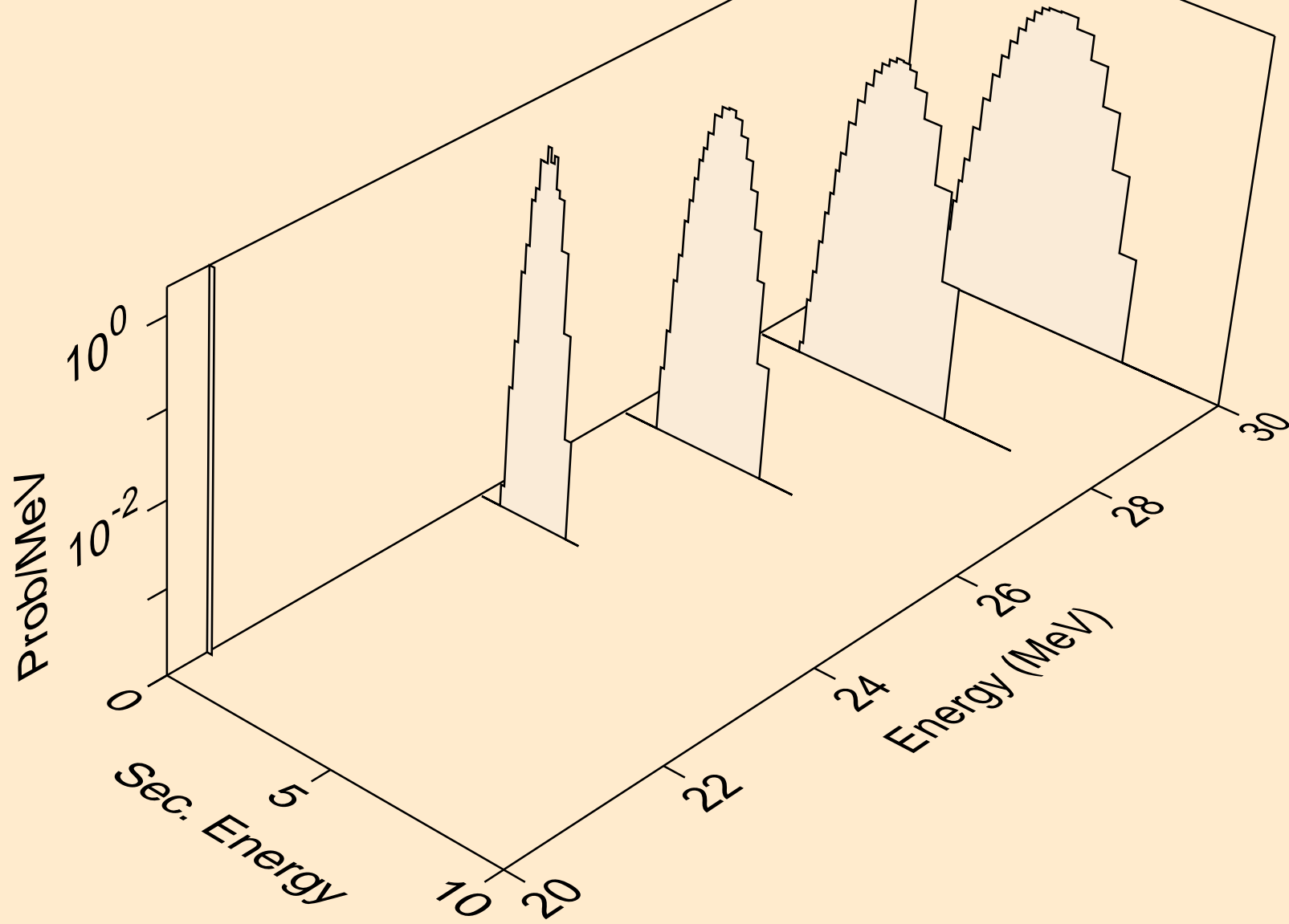

TC103 NEUTRON ACER TENDL-2023 LIBRARY; T=0.K  
protons from (n,npa)

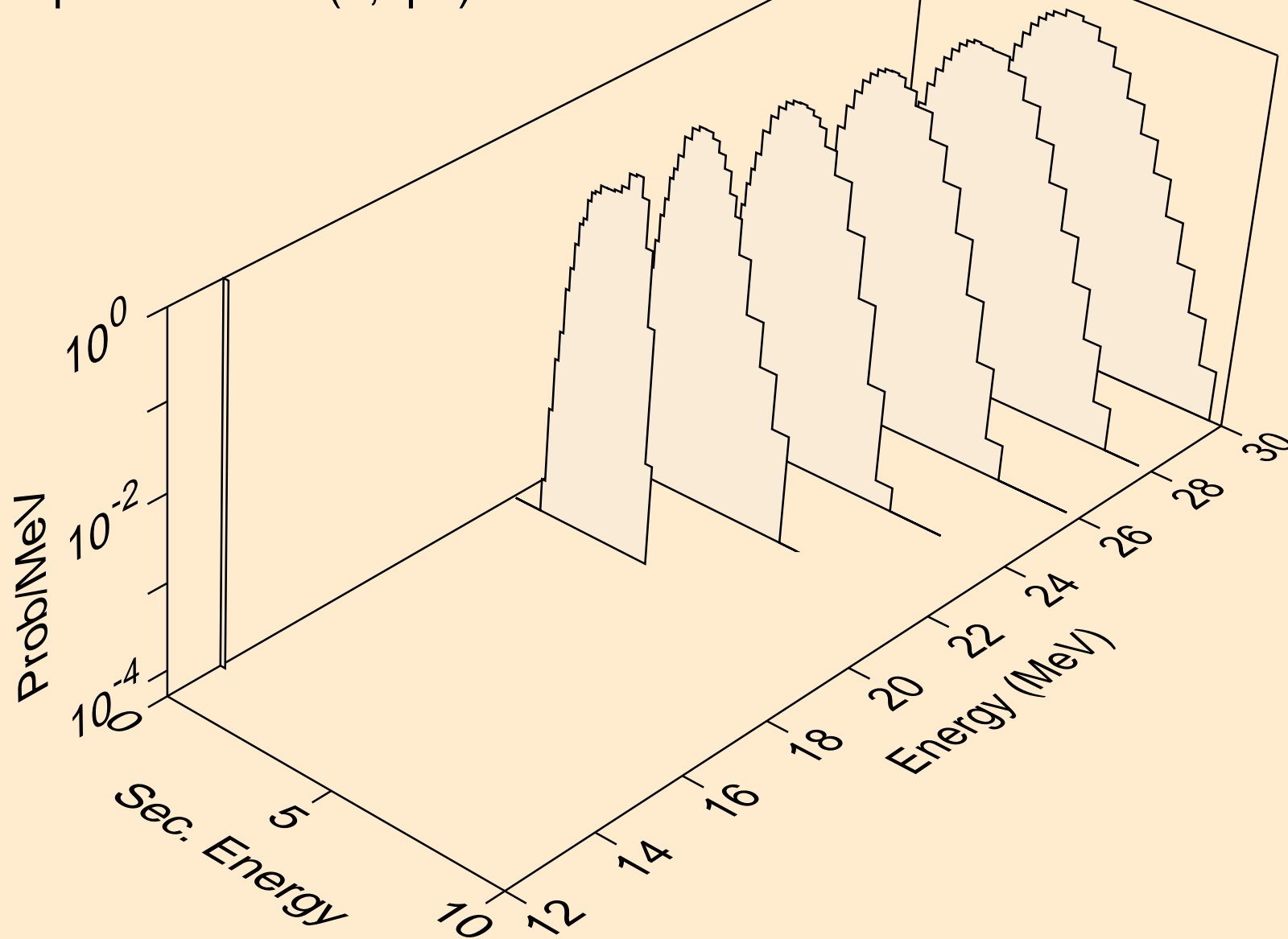



TC103 NEUTRON ACER TENDL-2023 LIBRARY; T=0.K  
protons from (n,p)

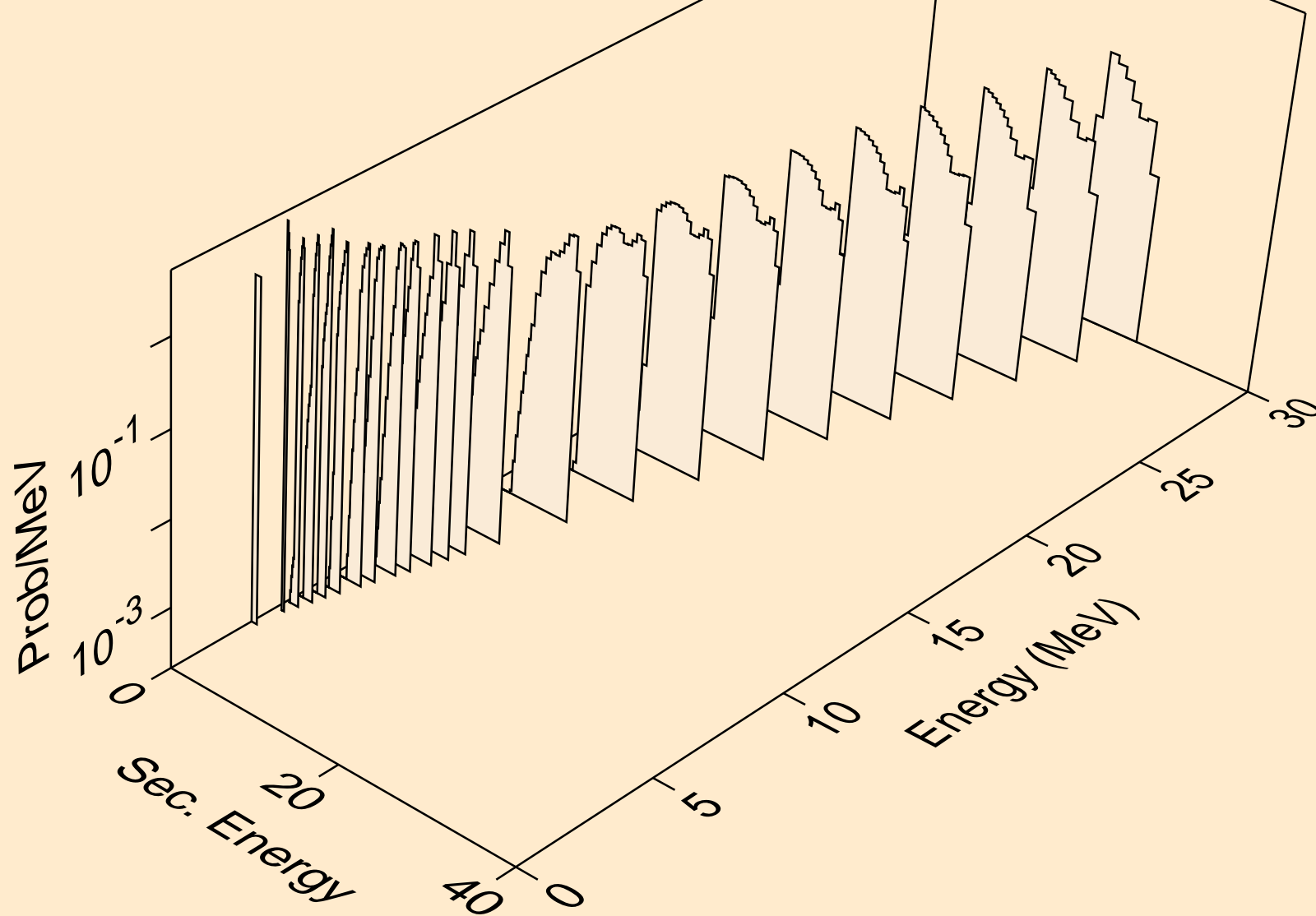

TC103 NEUTRON ACER TENDL-2023 LIBRARY; T=0.K  
protons from (n,2p)

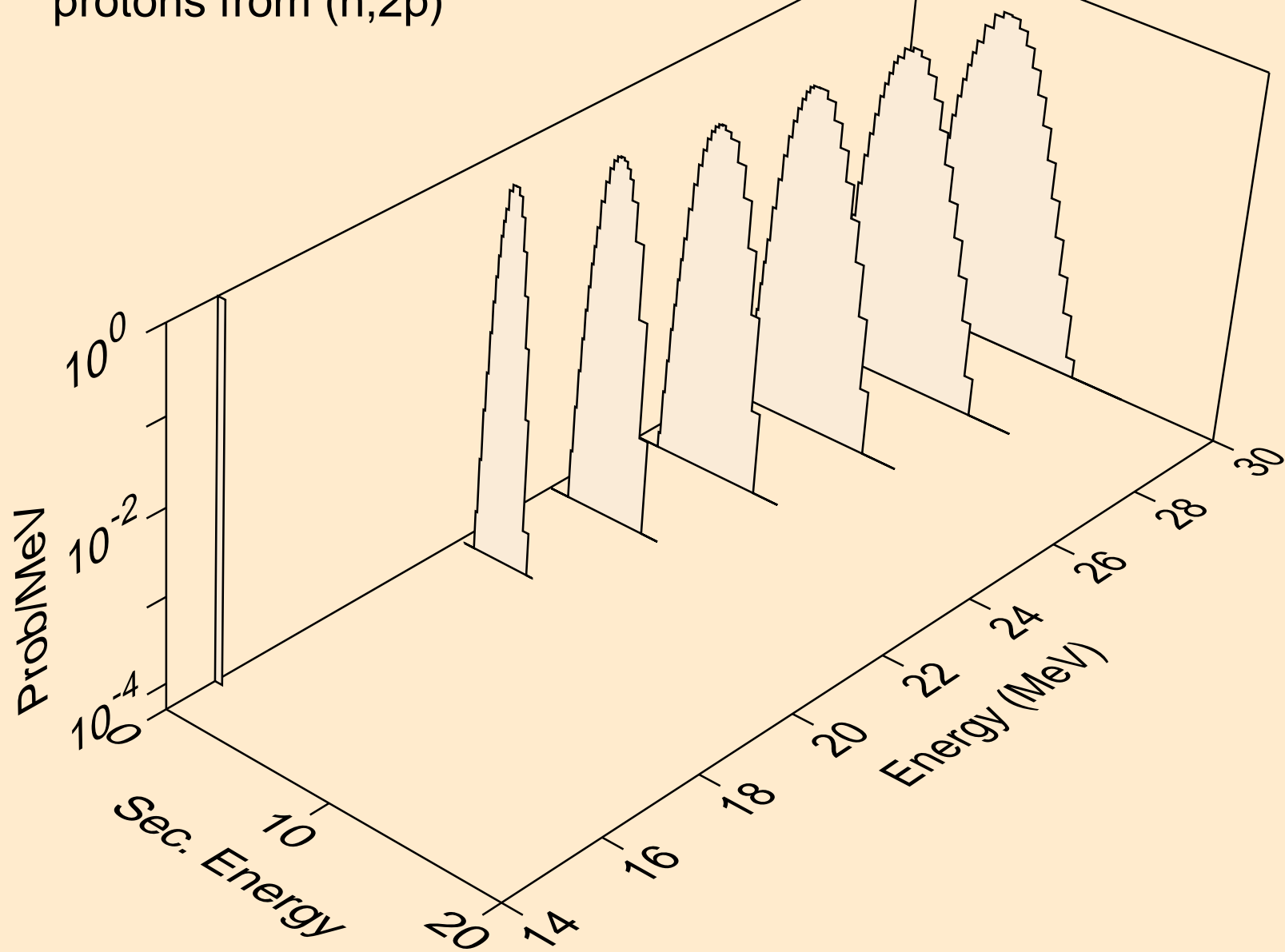

TC103 NEUTRON ACER TENDL-2023 LIBRARY; T=0.K  
protons from (n,pa)

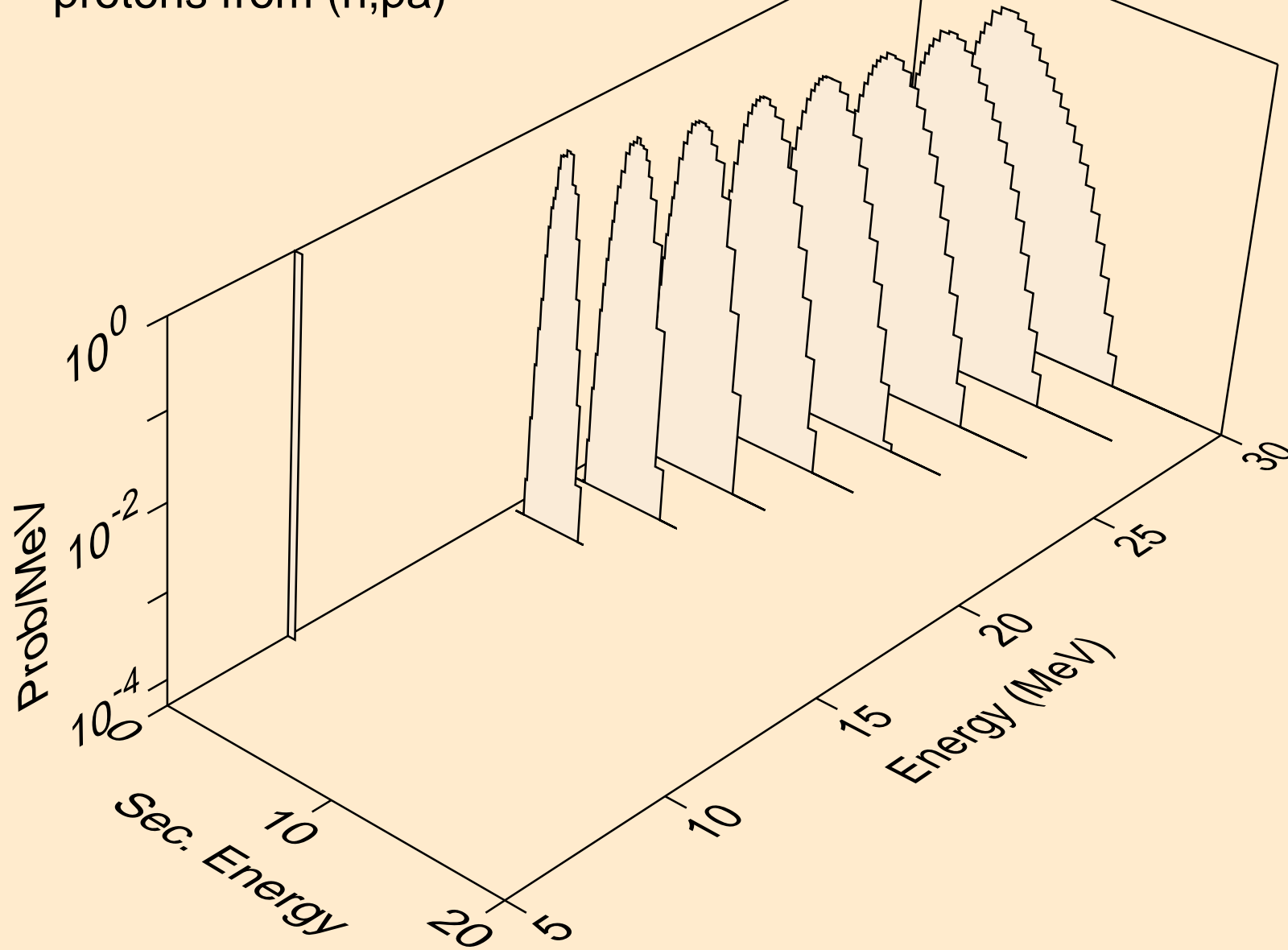

TC103 NEUTRON ACER TENDL-2023 LIBRARY; T=0.K  
deuterons from (n,x)

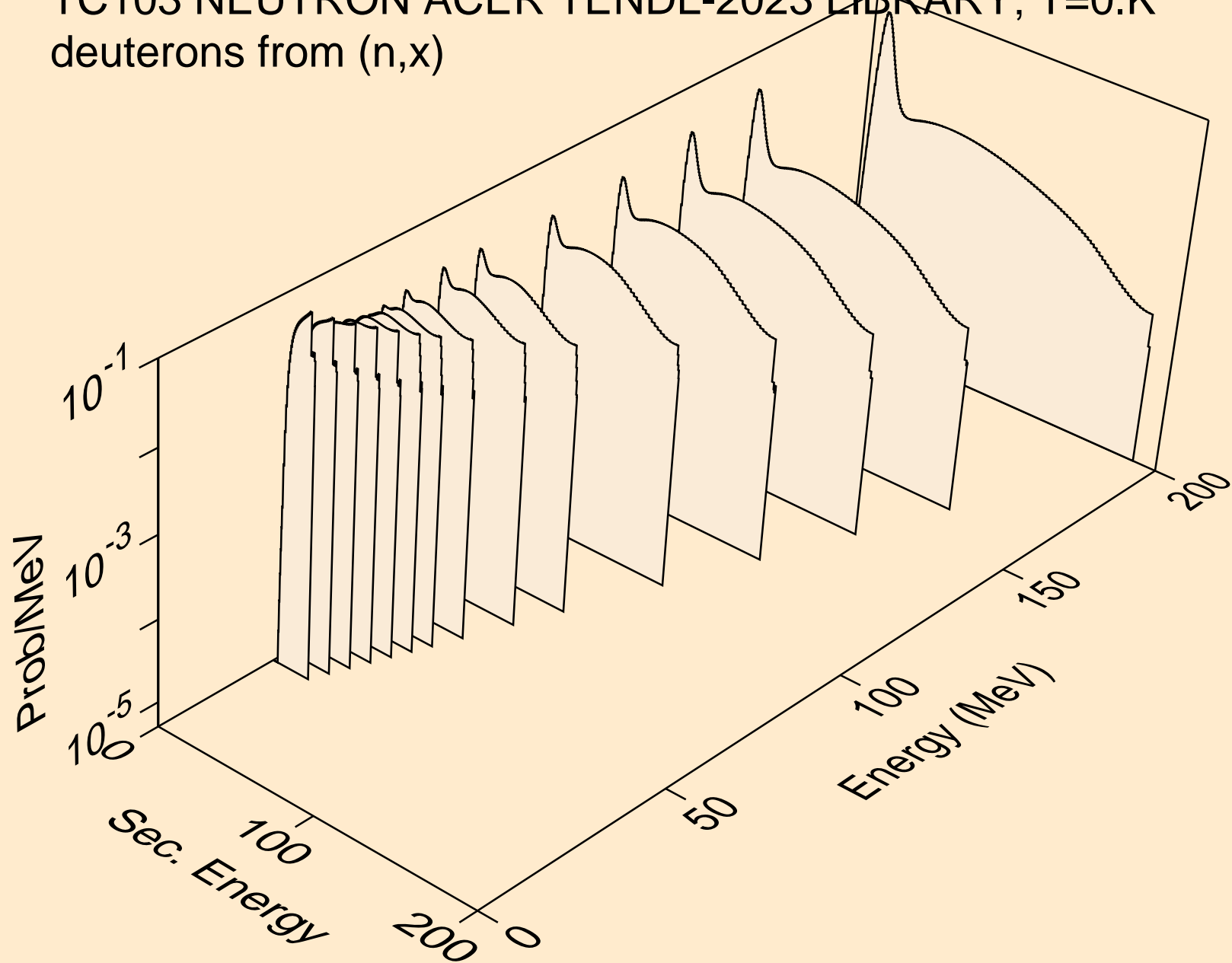

TC103 NEUTRON ACER TENDL-2023 LIBRARY; T=0.K  
deuterons from (n,2nd)

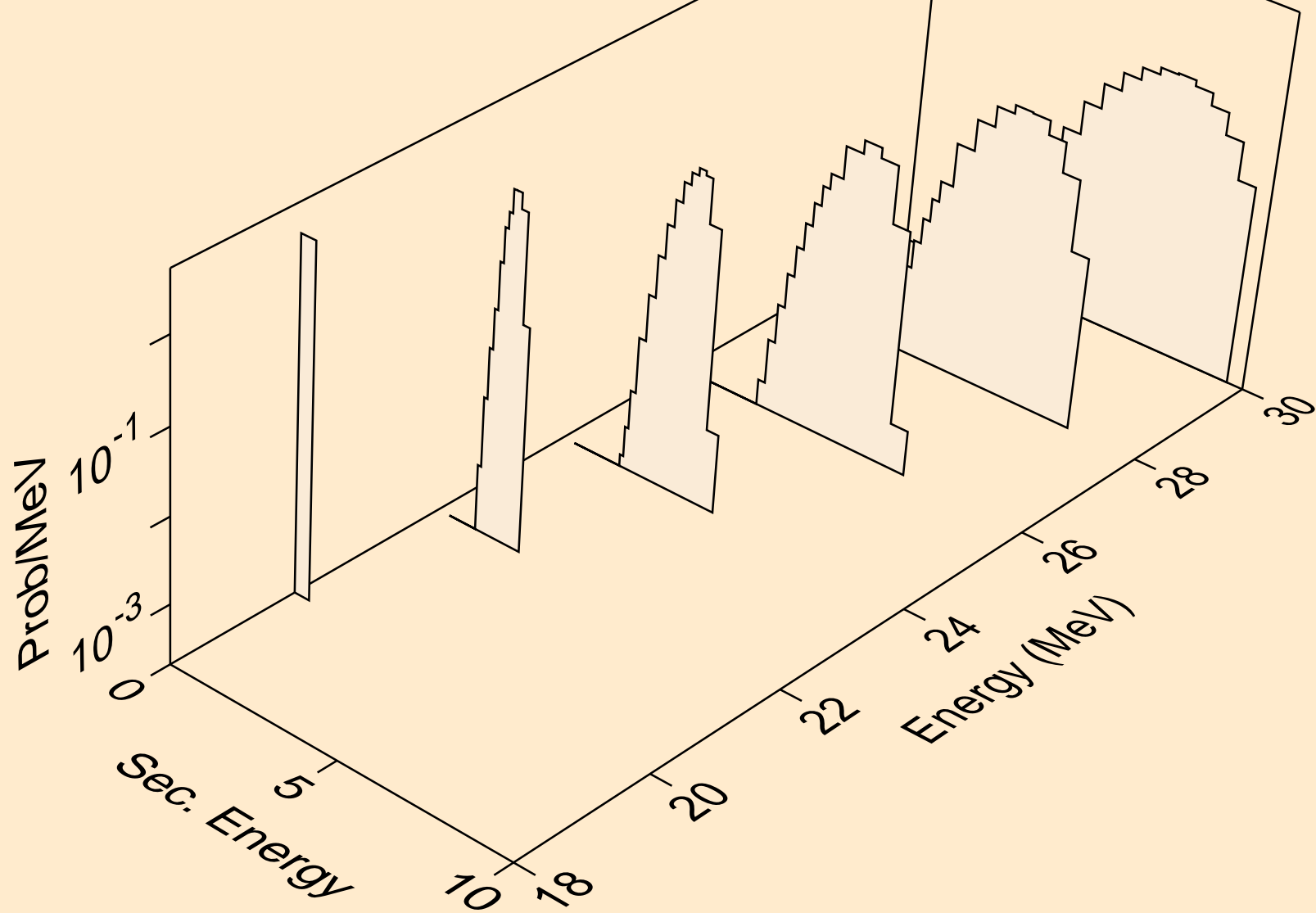

TC103 NEUTRON ACER TENDL-2023 LIBRARY; T=0.K  
deuterons from (n,n\*)d

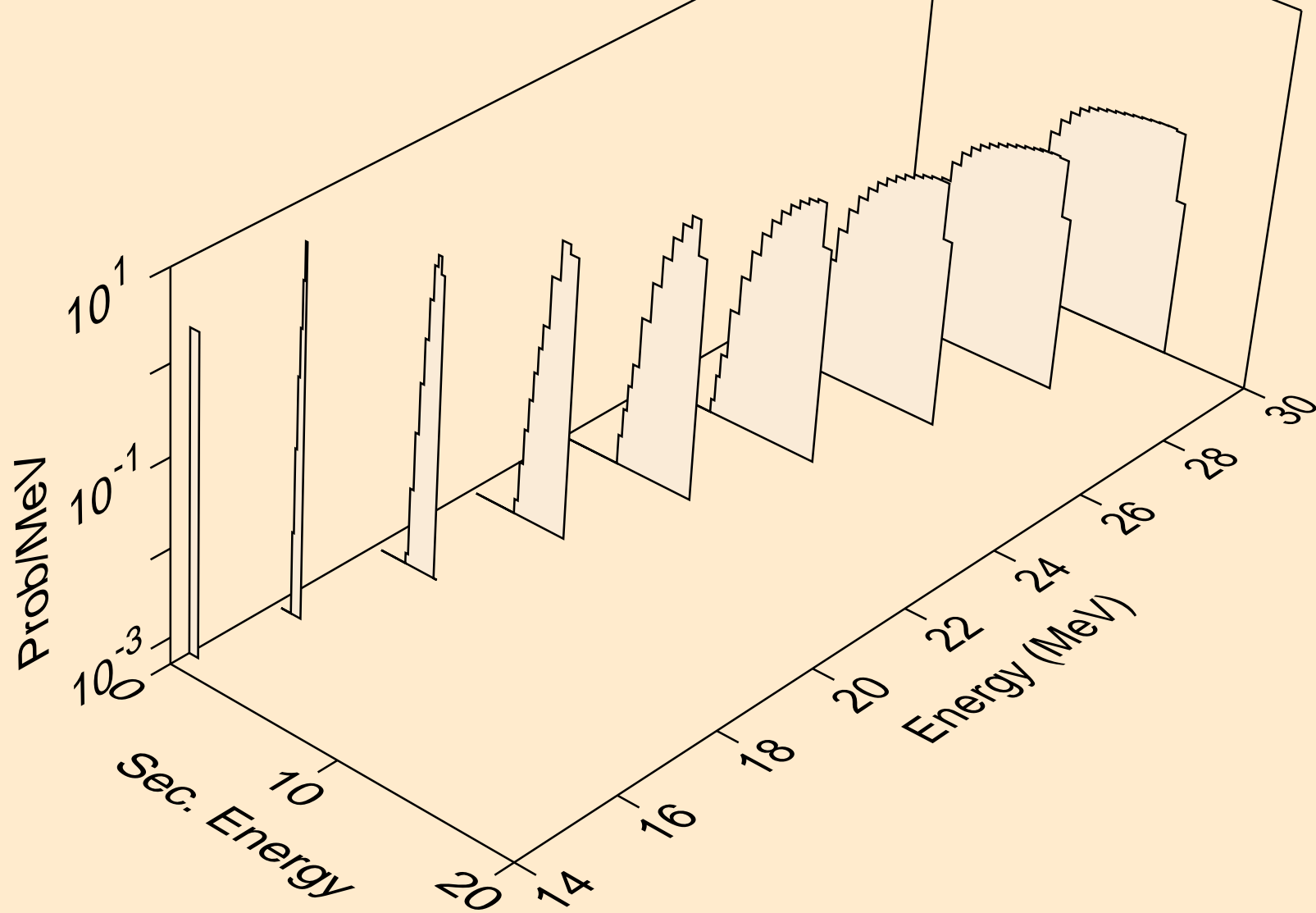

TC103 NEUTRON ACER TENDL-2023 LIBRARY; T=0.K  
deuterons from (n,d)

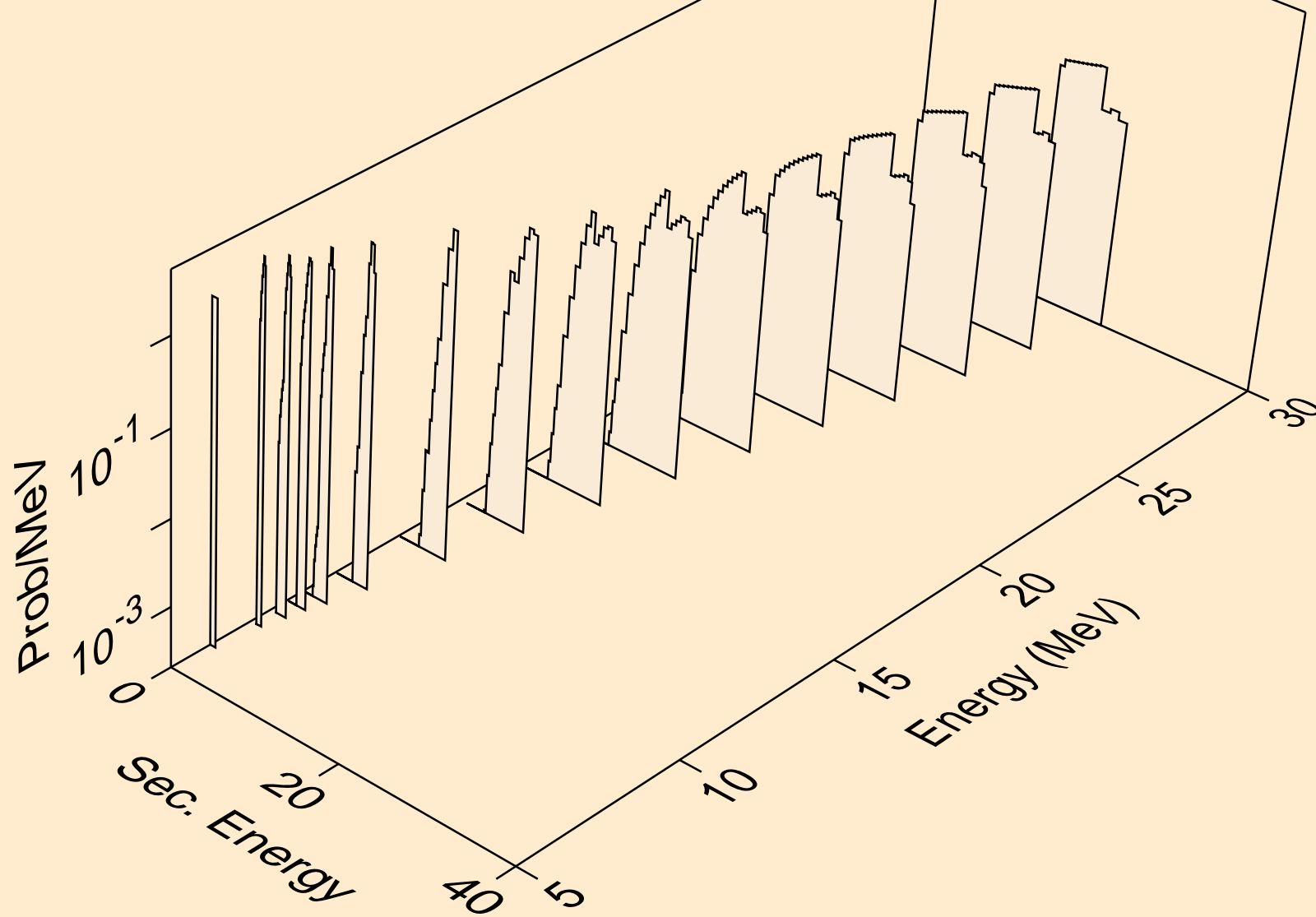

TC103 NEUTRON ACER TENDL-2023 LIBRARY; T=0.K  
tritons from (n,x)

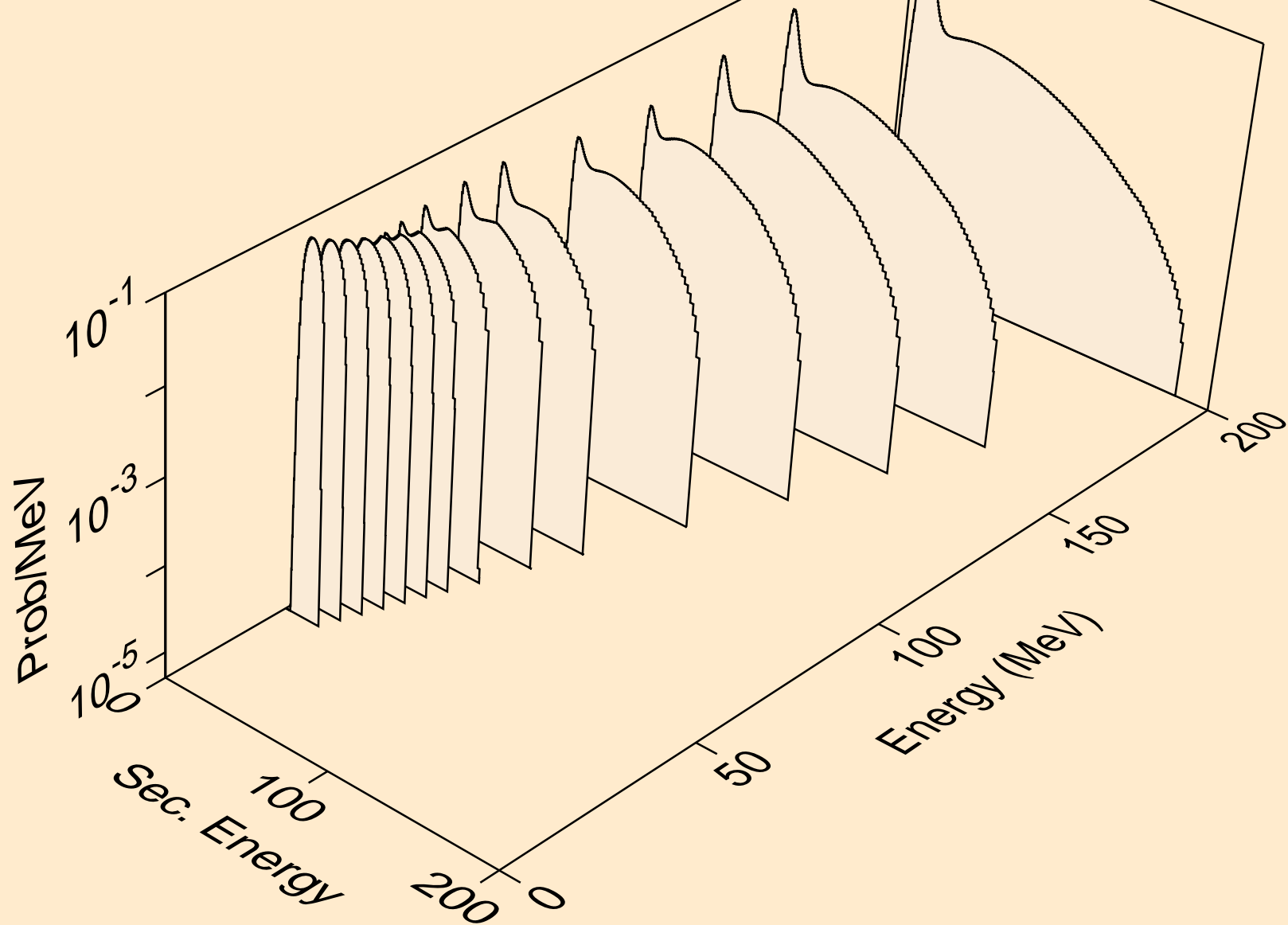



TC103 NEUTRON ACER TENDL-2023 LIBRARY; T=0.K  
tritons from (n,n\*)t

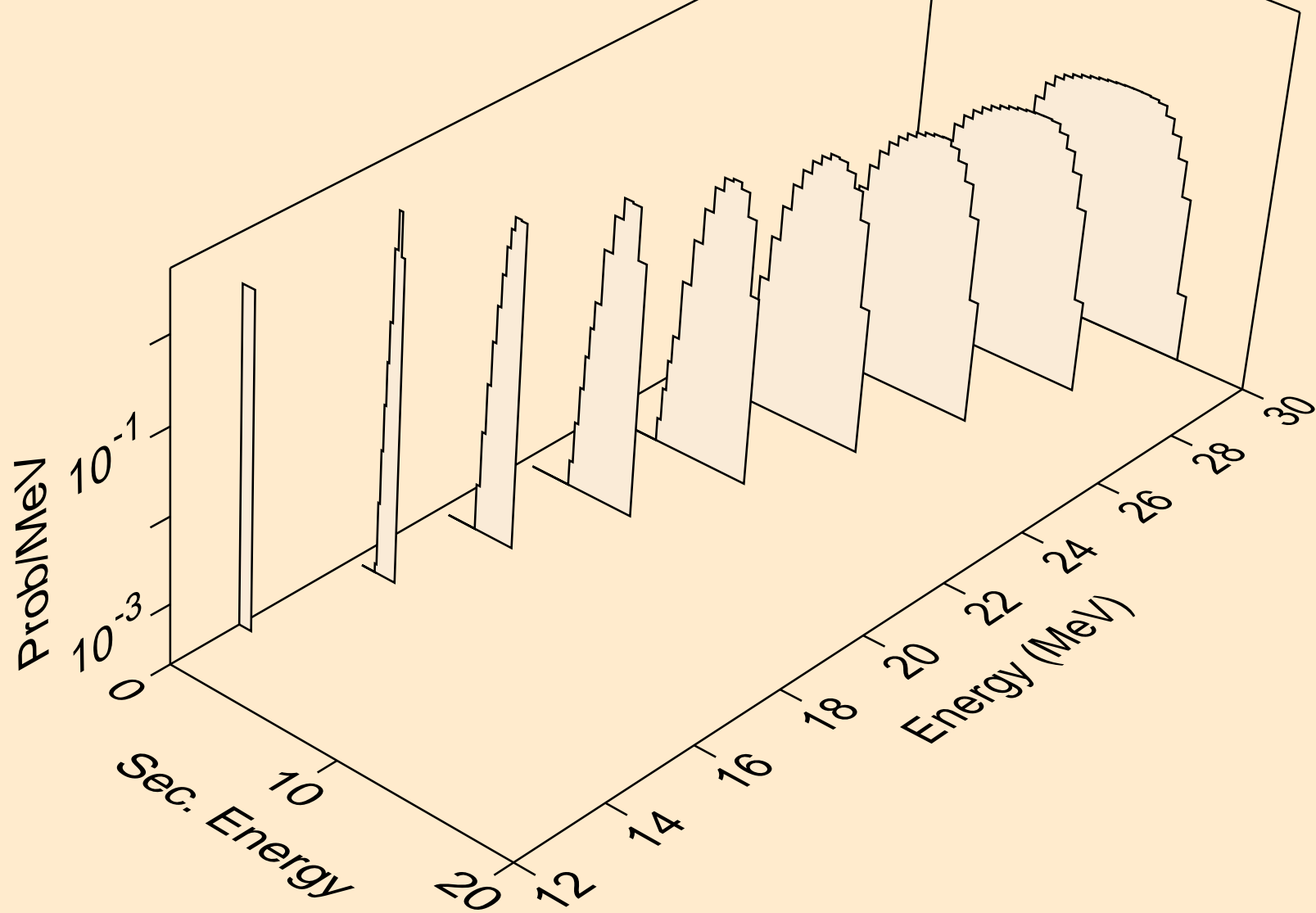

TC103 NEUTRON ACER TENDL-2023 LIBRARY; T=0.K  
tritons from (n,t)

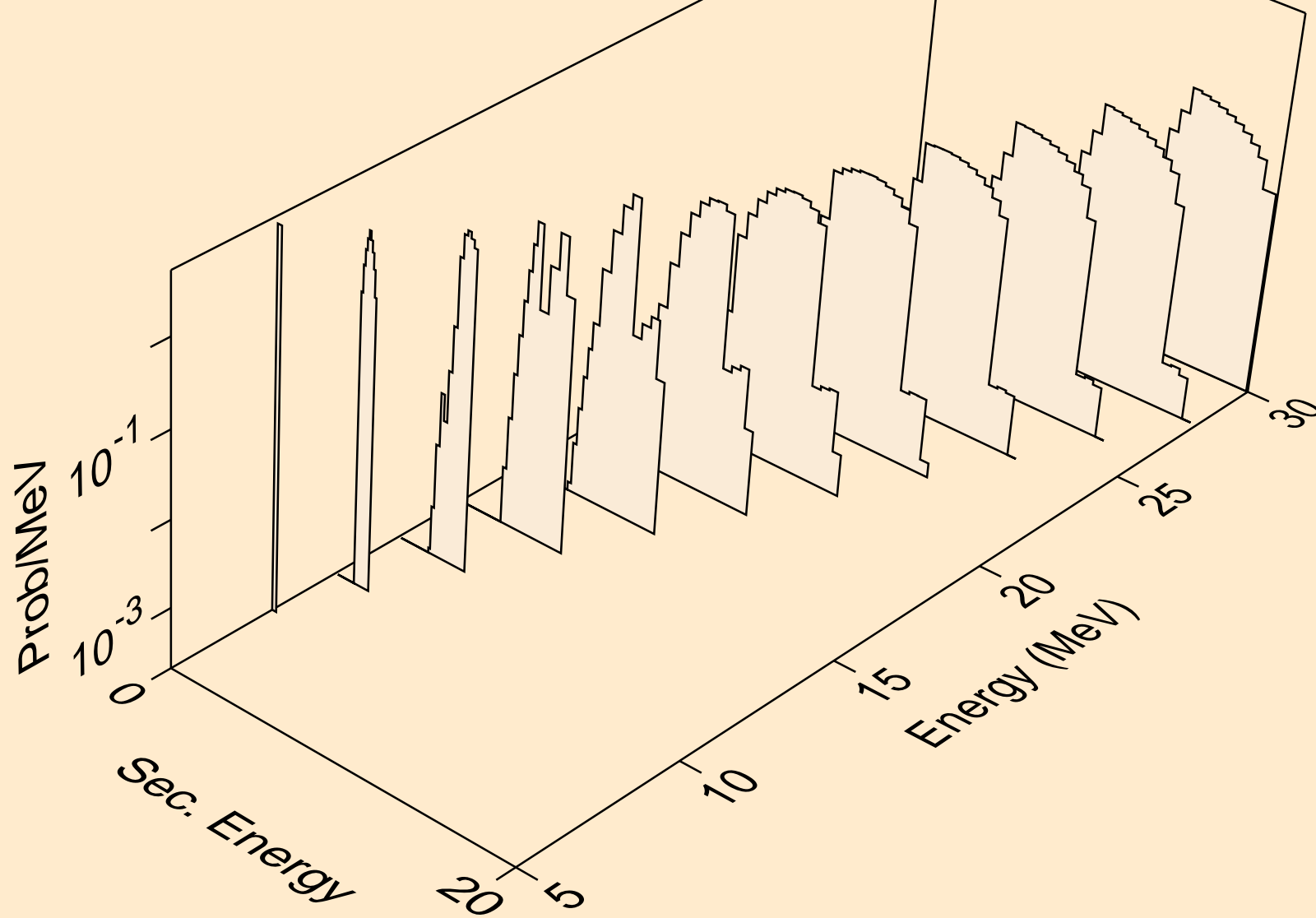

TC103 NEUTRON ACER TENDL-2023 LIBRARY; T=0.K  
he3s from (n,x)

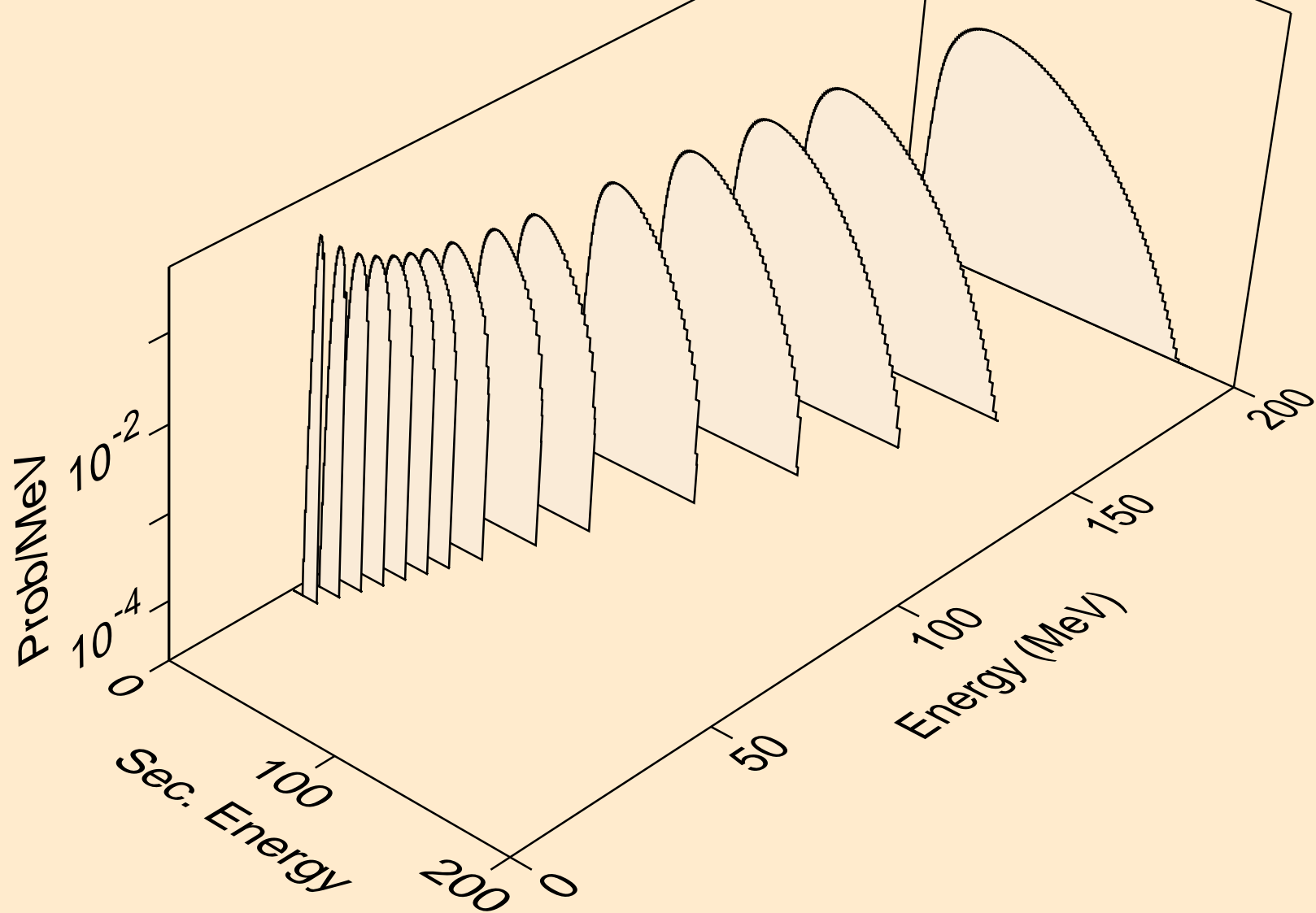

TC103 NEUTRON ACER TENDL-2023 LIBRARY; T=0.K  
he3s from (n,n\*)he3

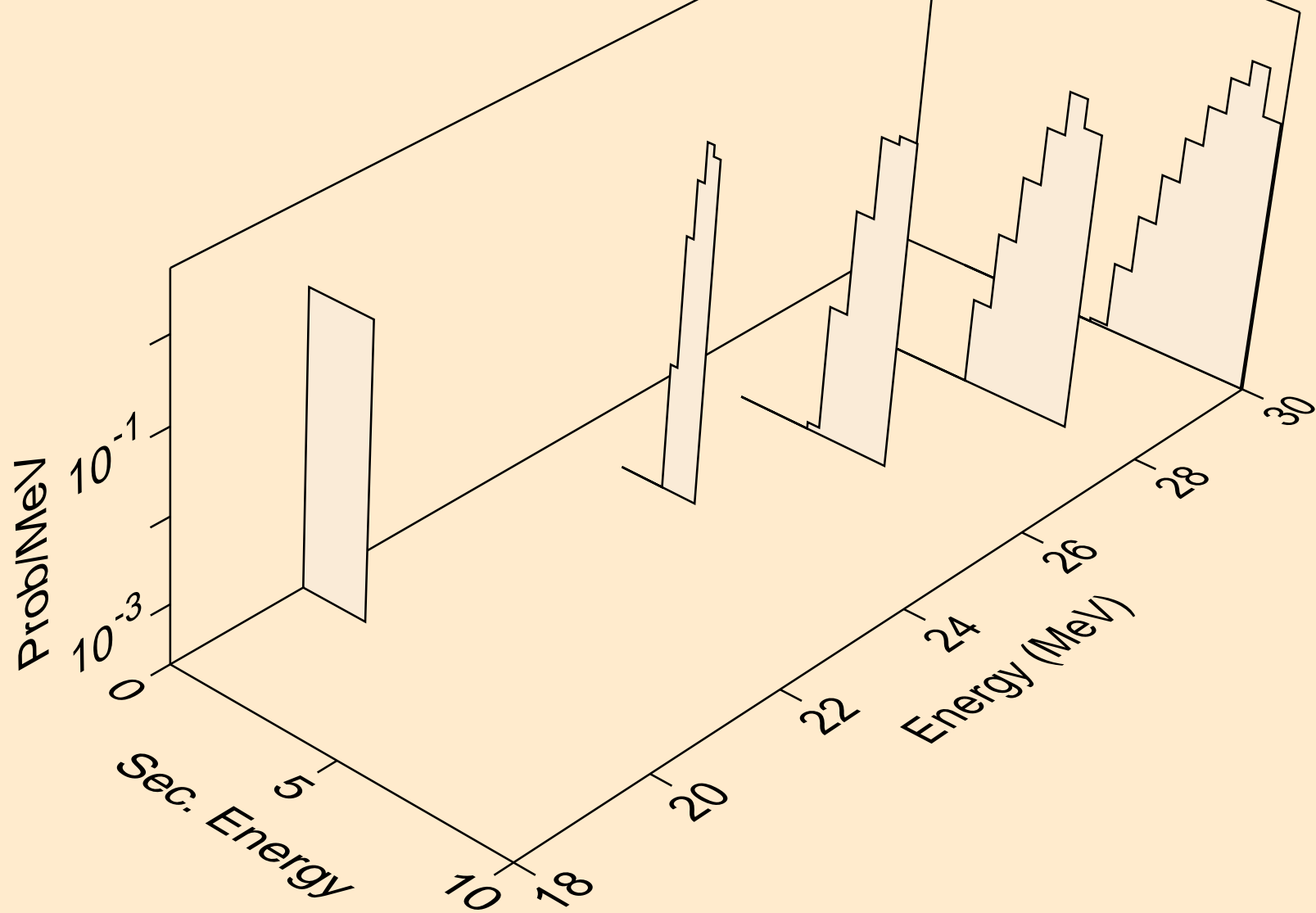

TC103 NEUTRON ACER TENDL-2023 LIBRARY; T=0.K  
he3s from (n,he3)

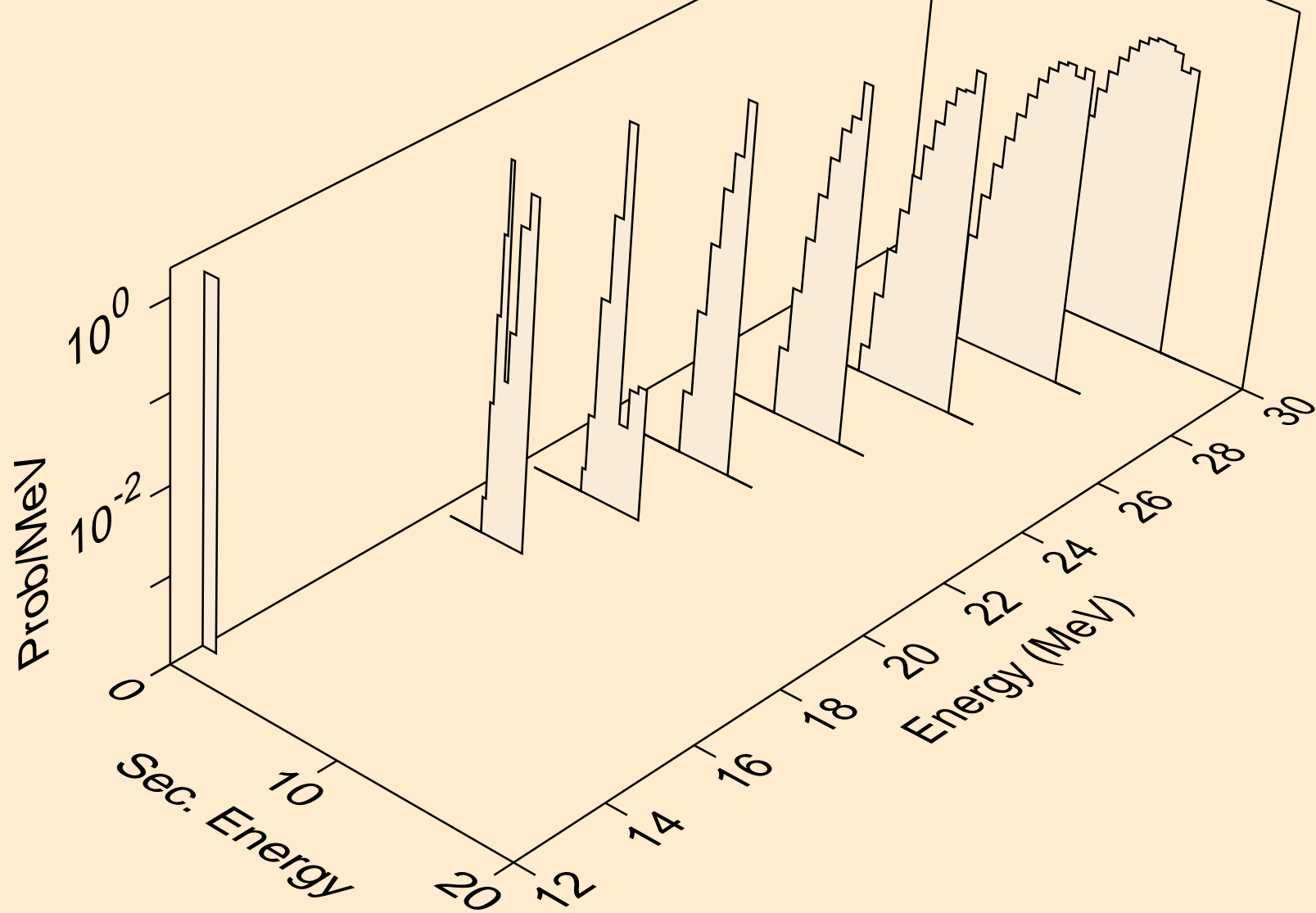

TC103 NEUTRON ACER TENDL-2023 LIBRARY; T=0.K  
alphas from (n,x)

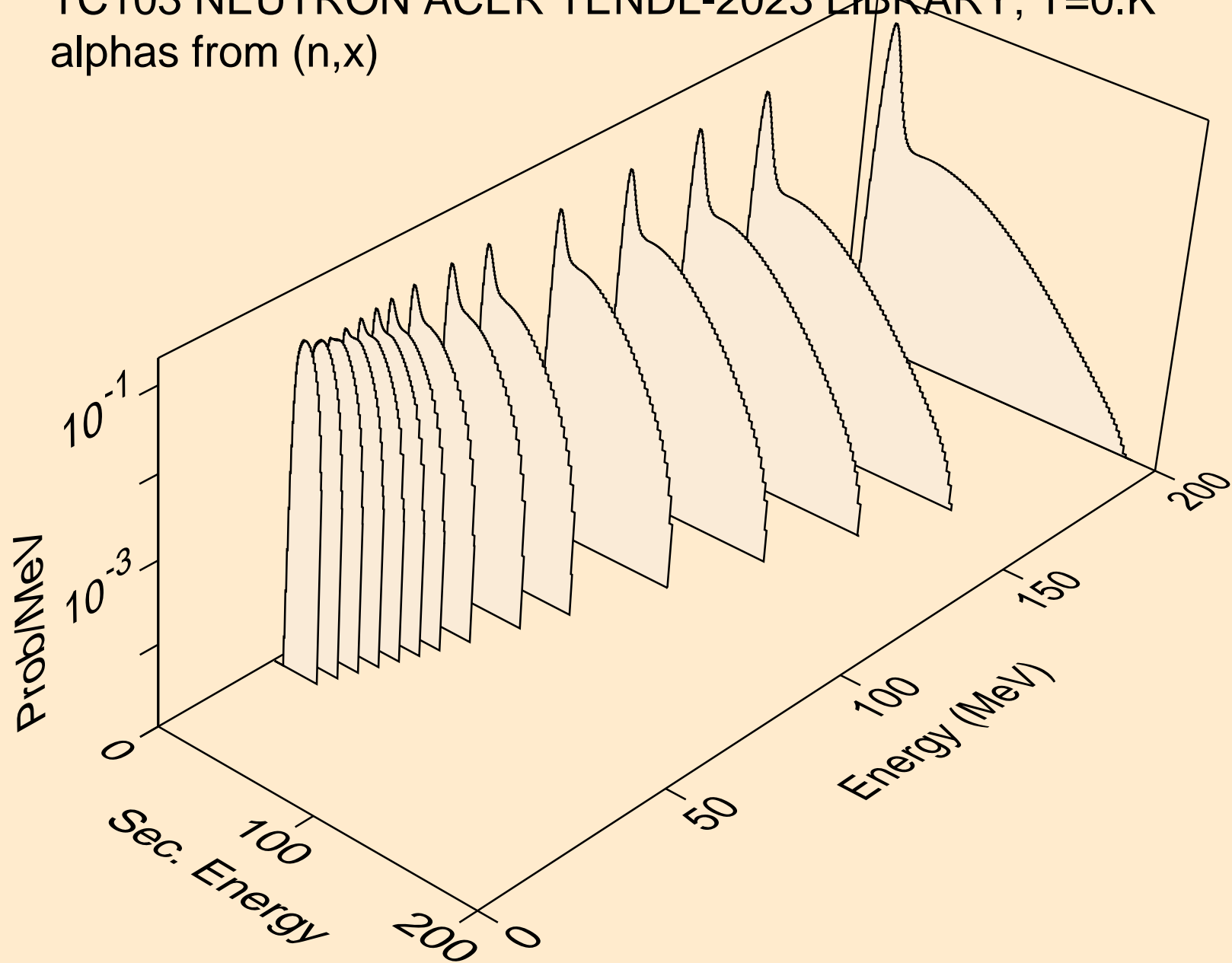

TC103 NEUTRON ACER TENDL-2023 LIBRARY; T=0.K  
alphas from (n,n\*)a

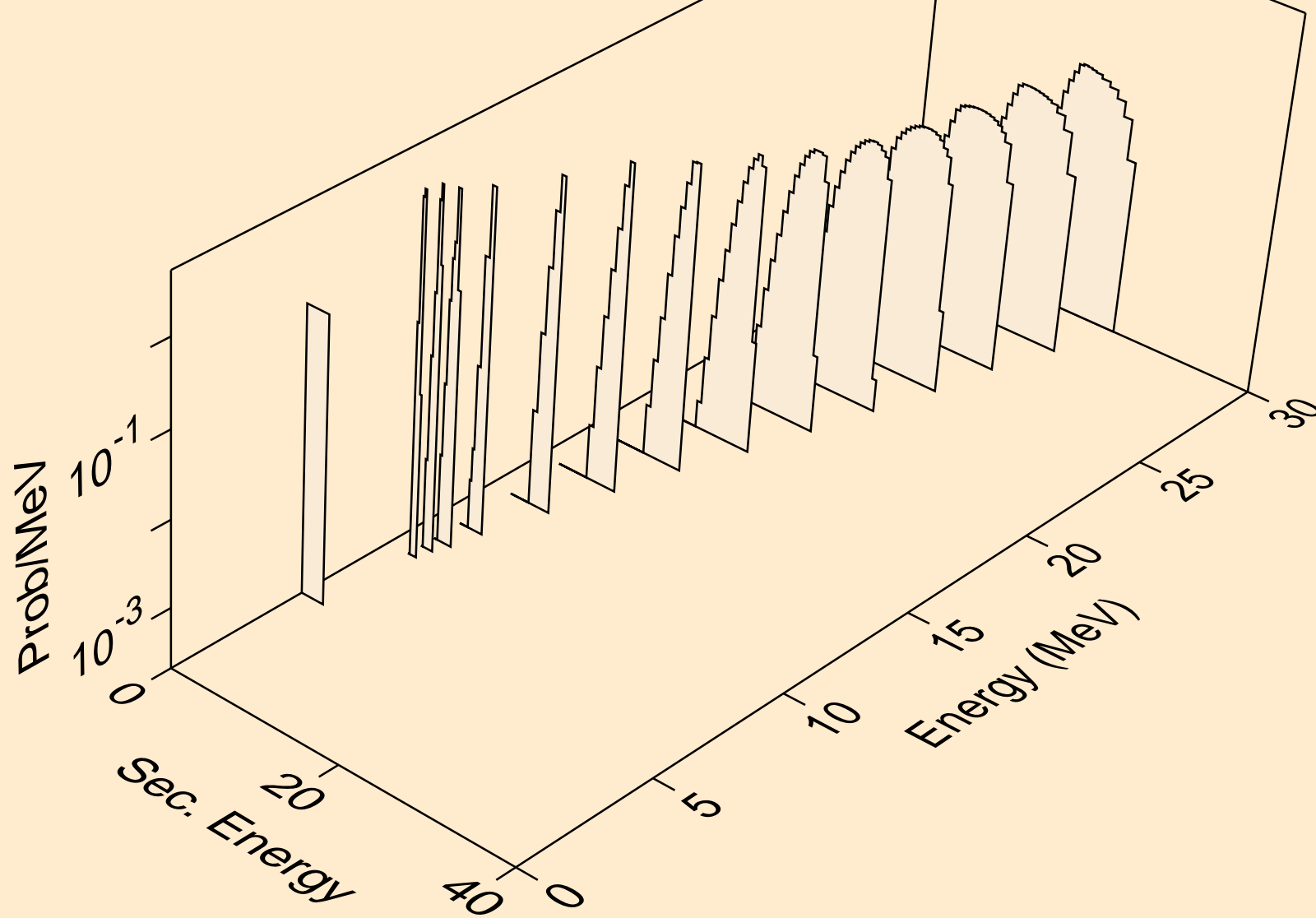

TC103 NEUTRON ACER TENDL-2023 LIBRARY; T=0.K  
alphas from (n,2n)a

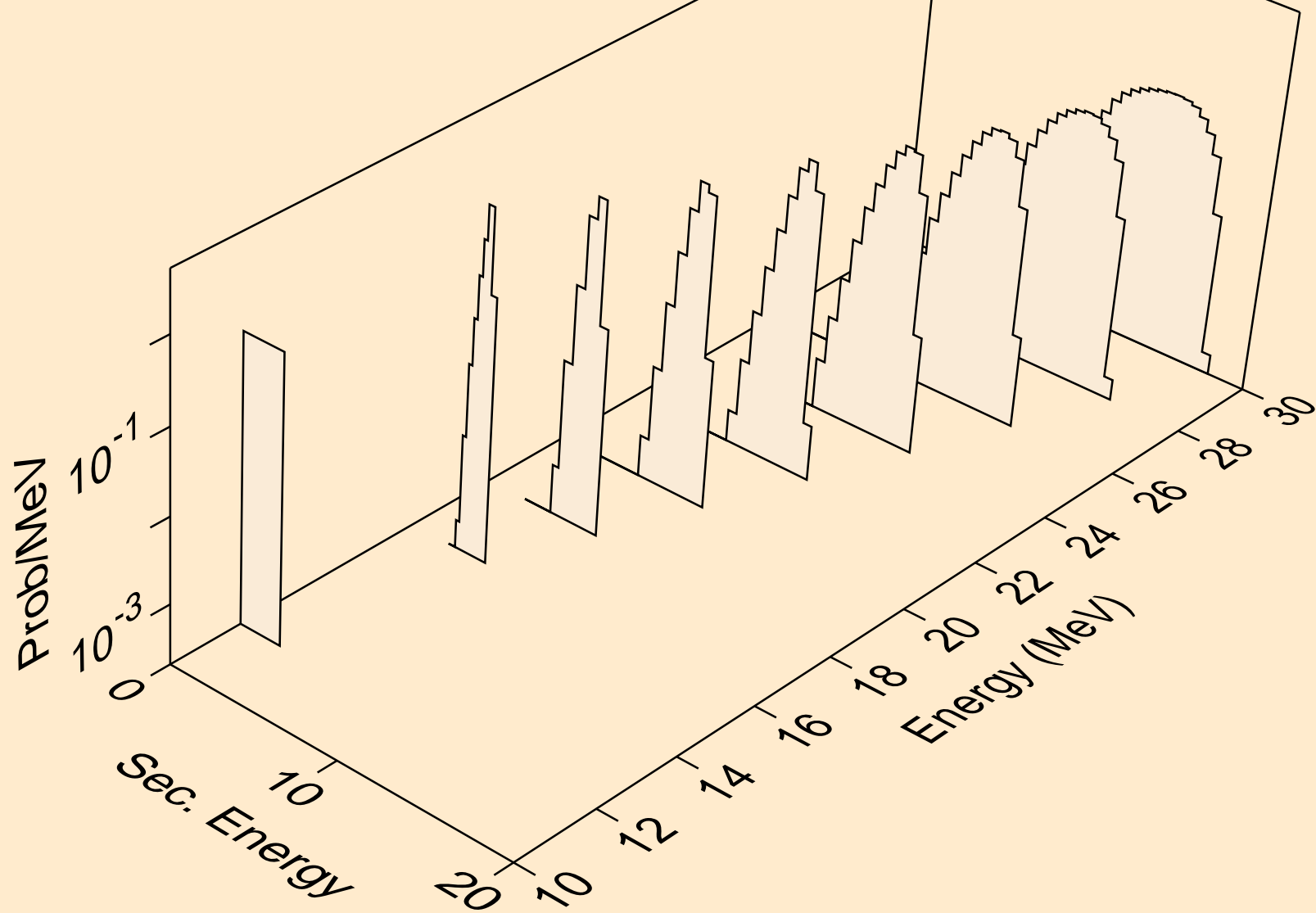



TC103 NEUTRON ACER TENDL-2023 LIBRARY; T=0.K  
alphas from (n,3n)a

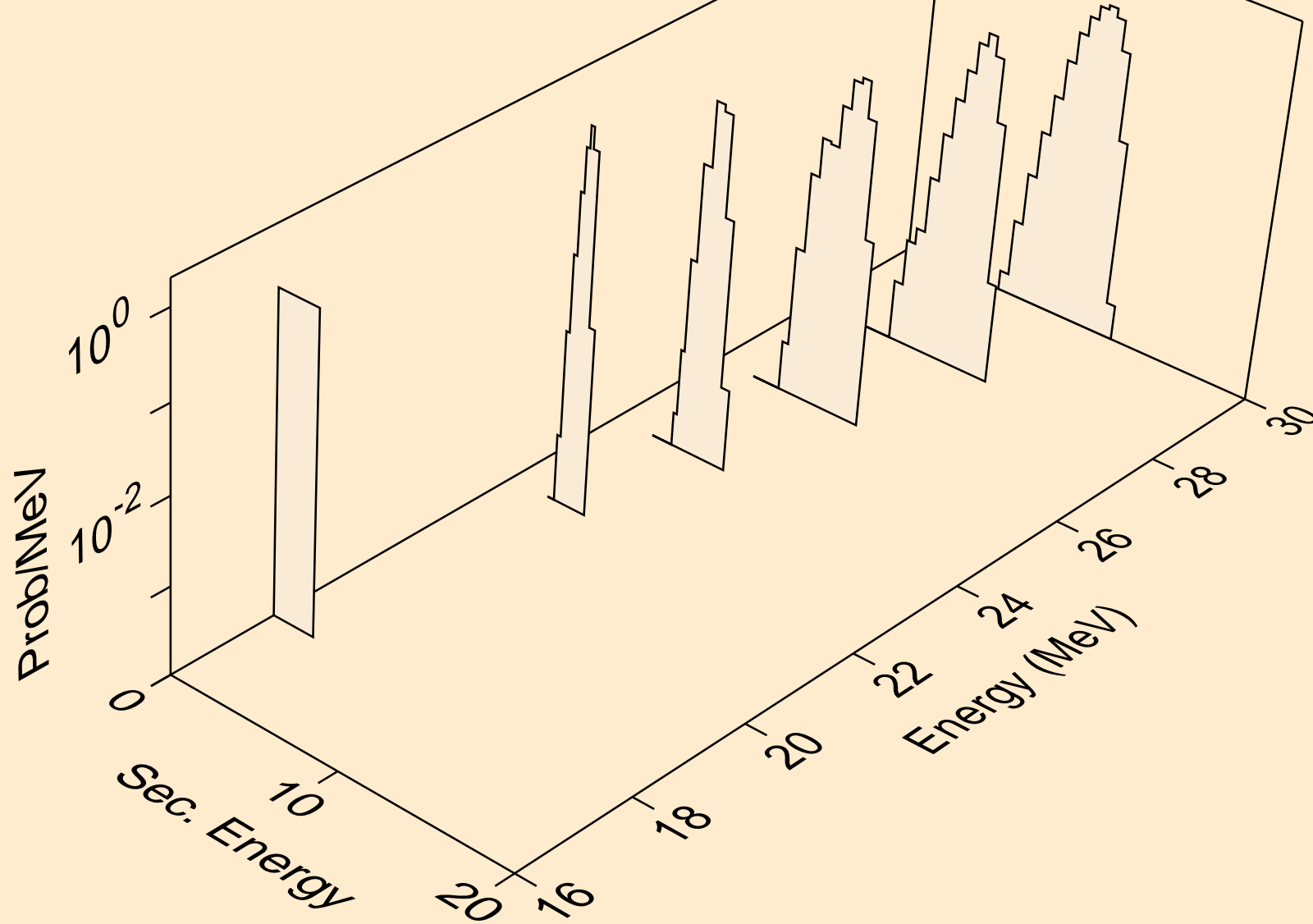

TC103 NEUTRON ACER TENDL-2023 LIBRARY; T=0.K  
alphas from (n,n\*)2a

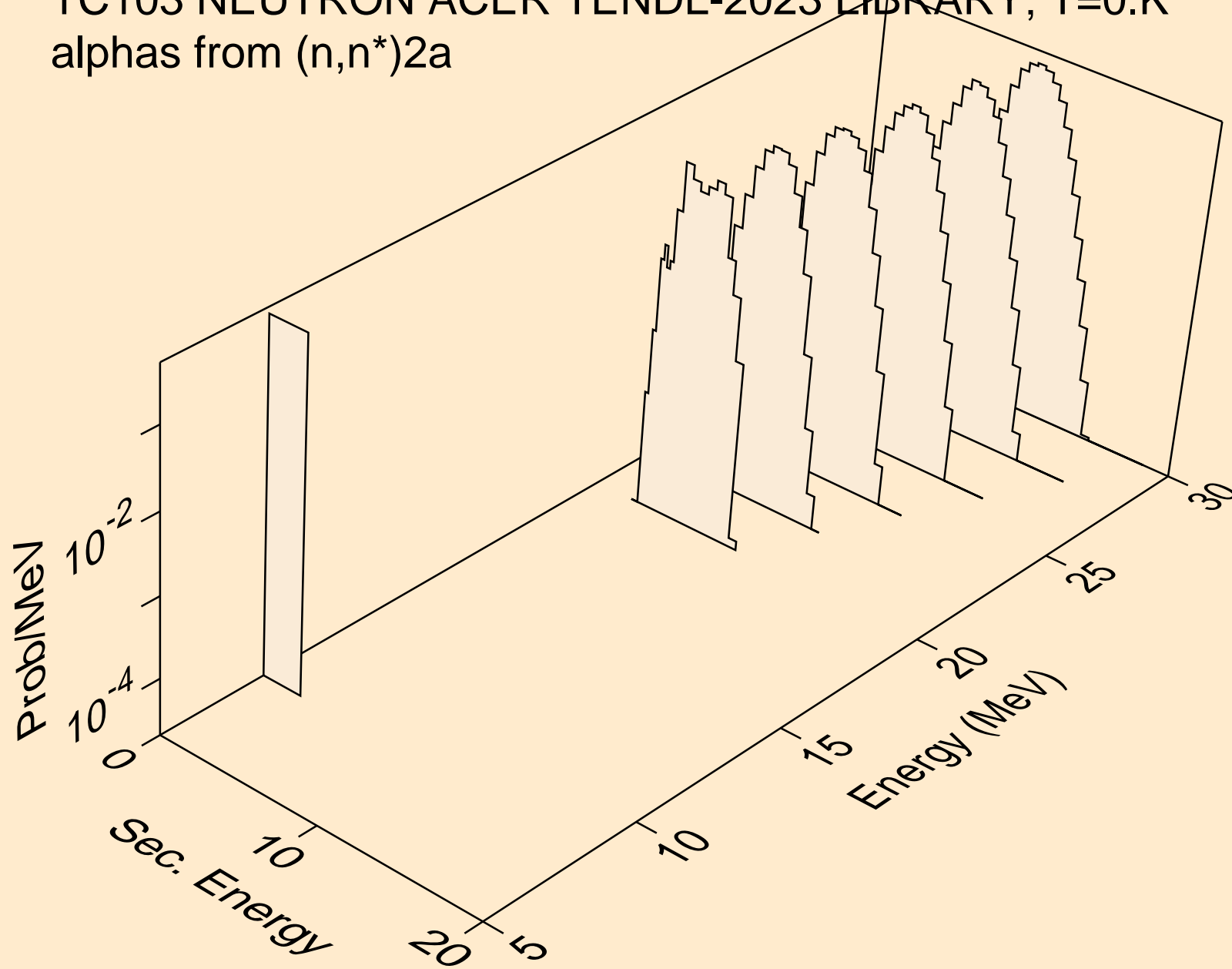

TC103 NEUTRON ACER TENDL-2023 LIBRARY; T=0.K  
alphas from (n,npa)

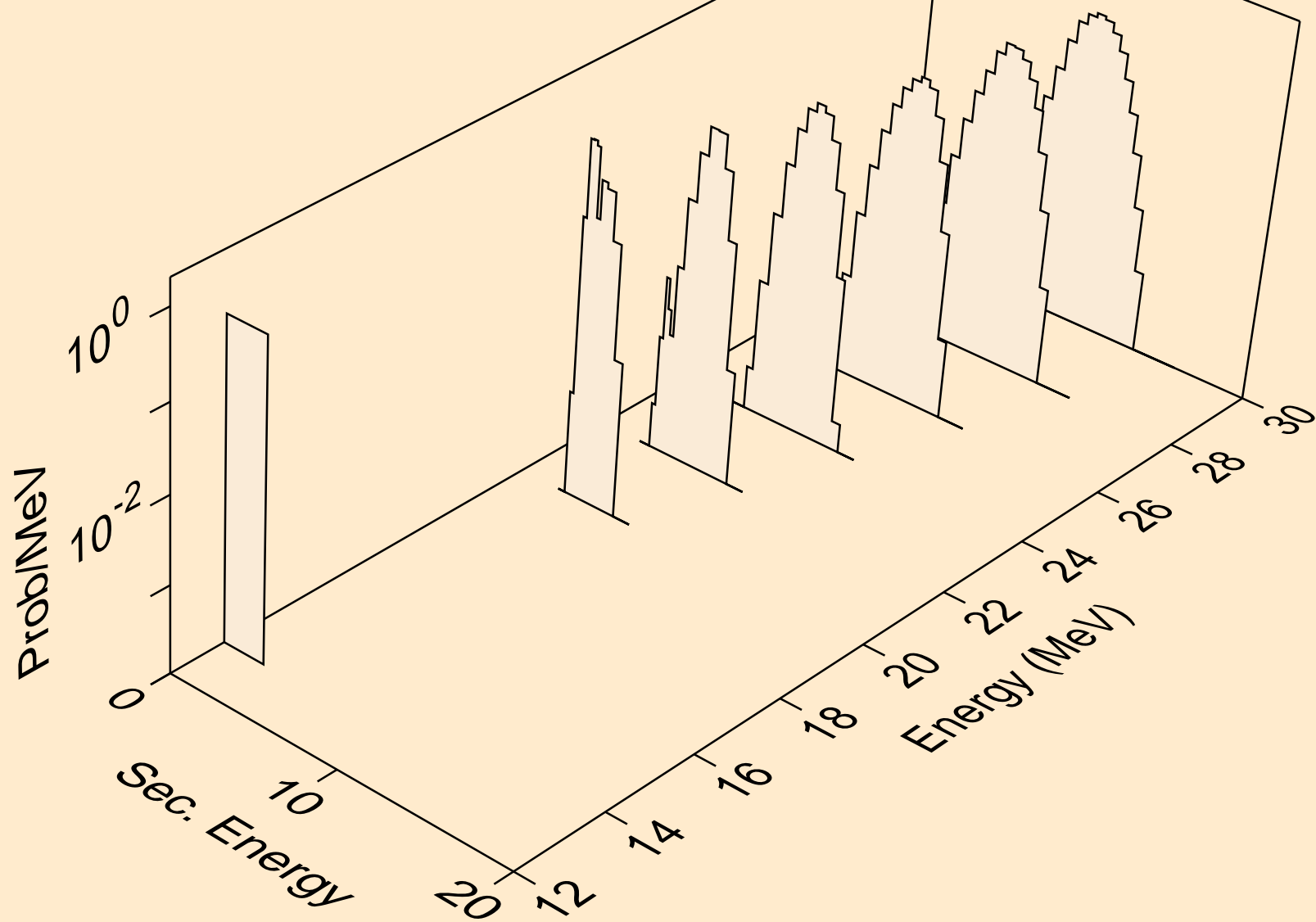

TC103 NEUTRON ACER TENDL-2023 LIBRARY; T=0.K  
alphas from (n,a)

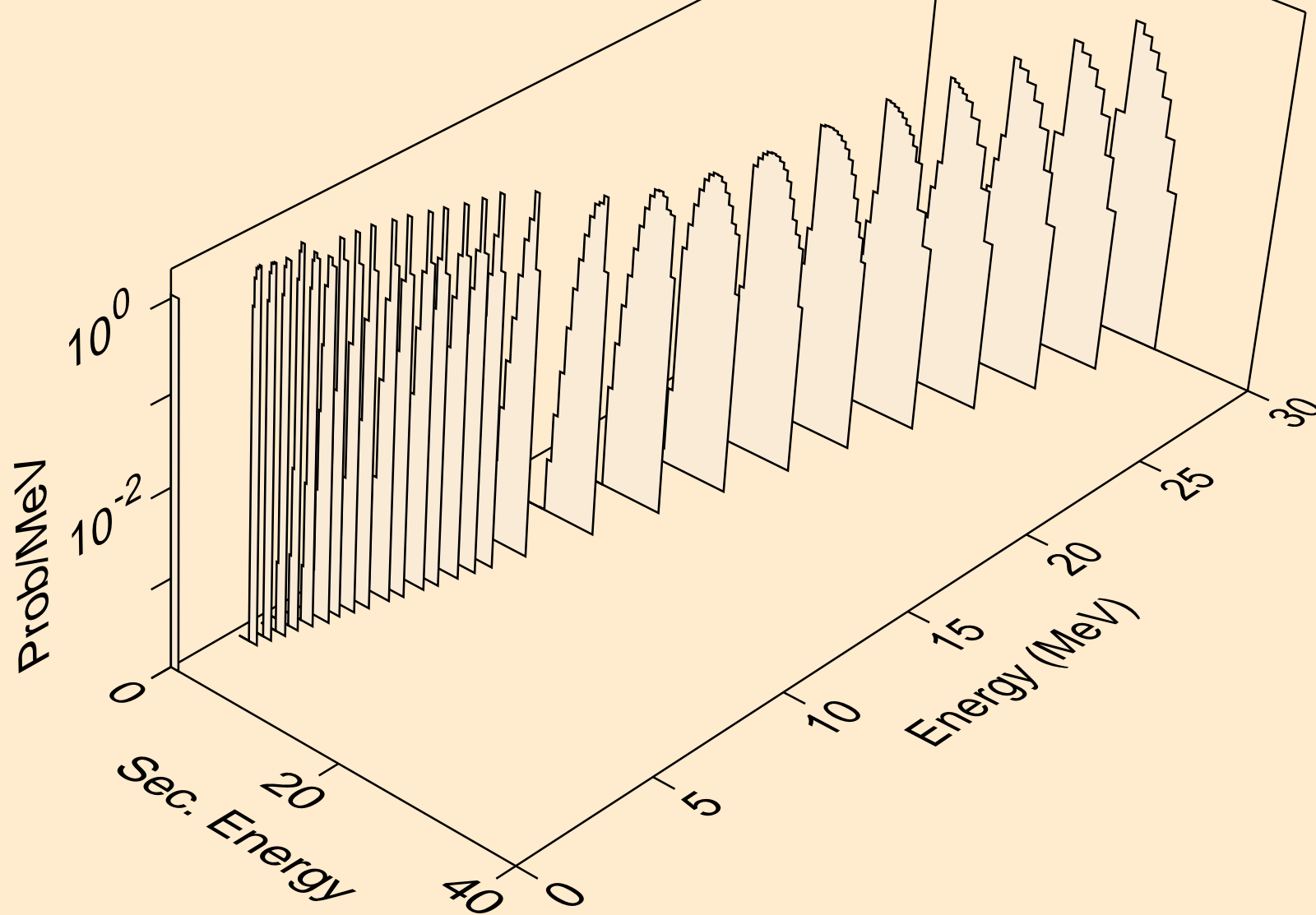

TC103 NEUTRON ACER TENDL-2023 LIBRARY; T=0.K  
alphas from (n,2a)

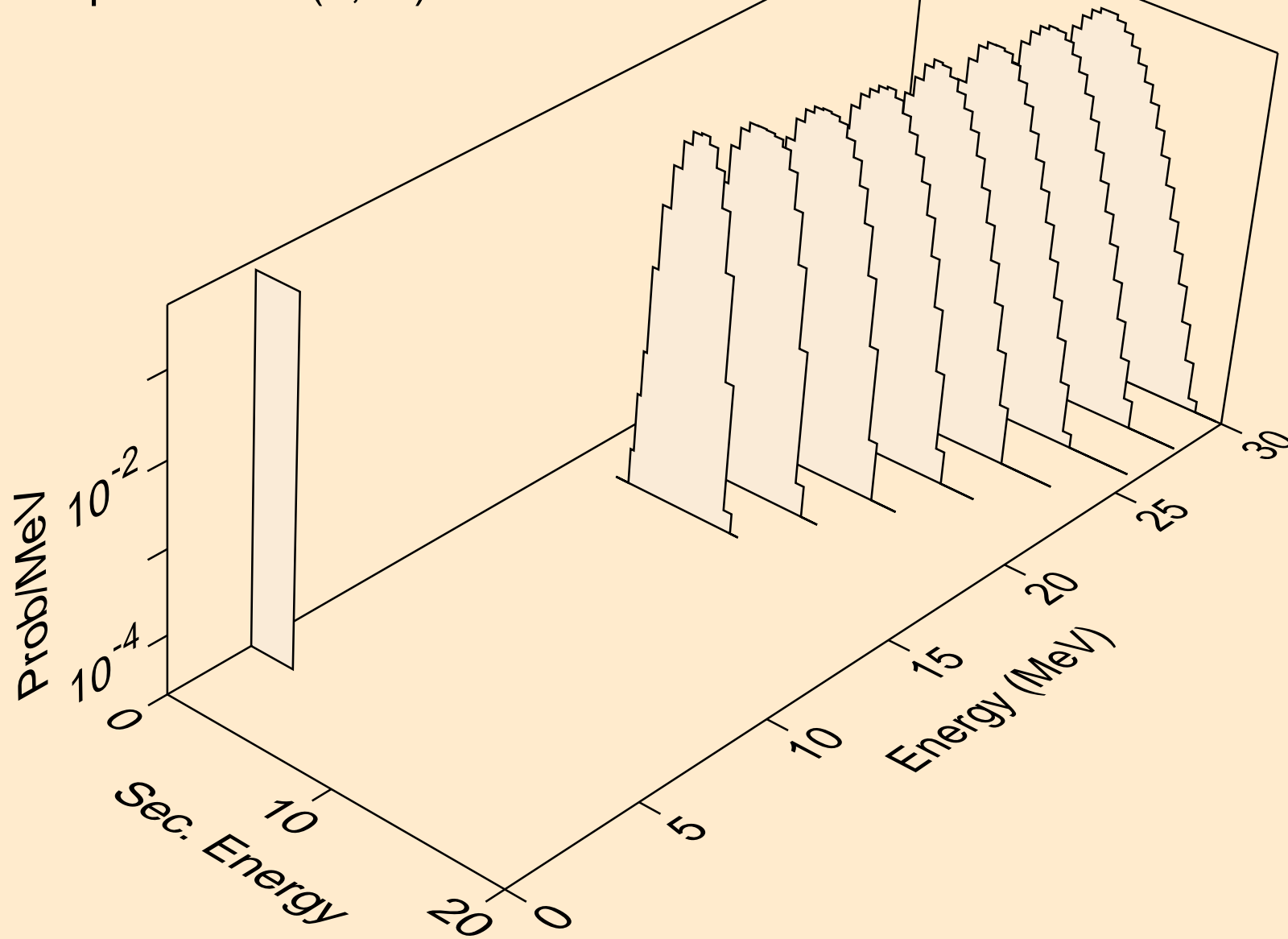

TC103 NEUTRON ACER TENDL-2023 LIBRARY; T=0.K  
alphas from (n,pa)

