

# TE138 NEUTRON ACER TENDL-2023 LIBRARY; T=0.K

## Principal cross sections

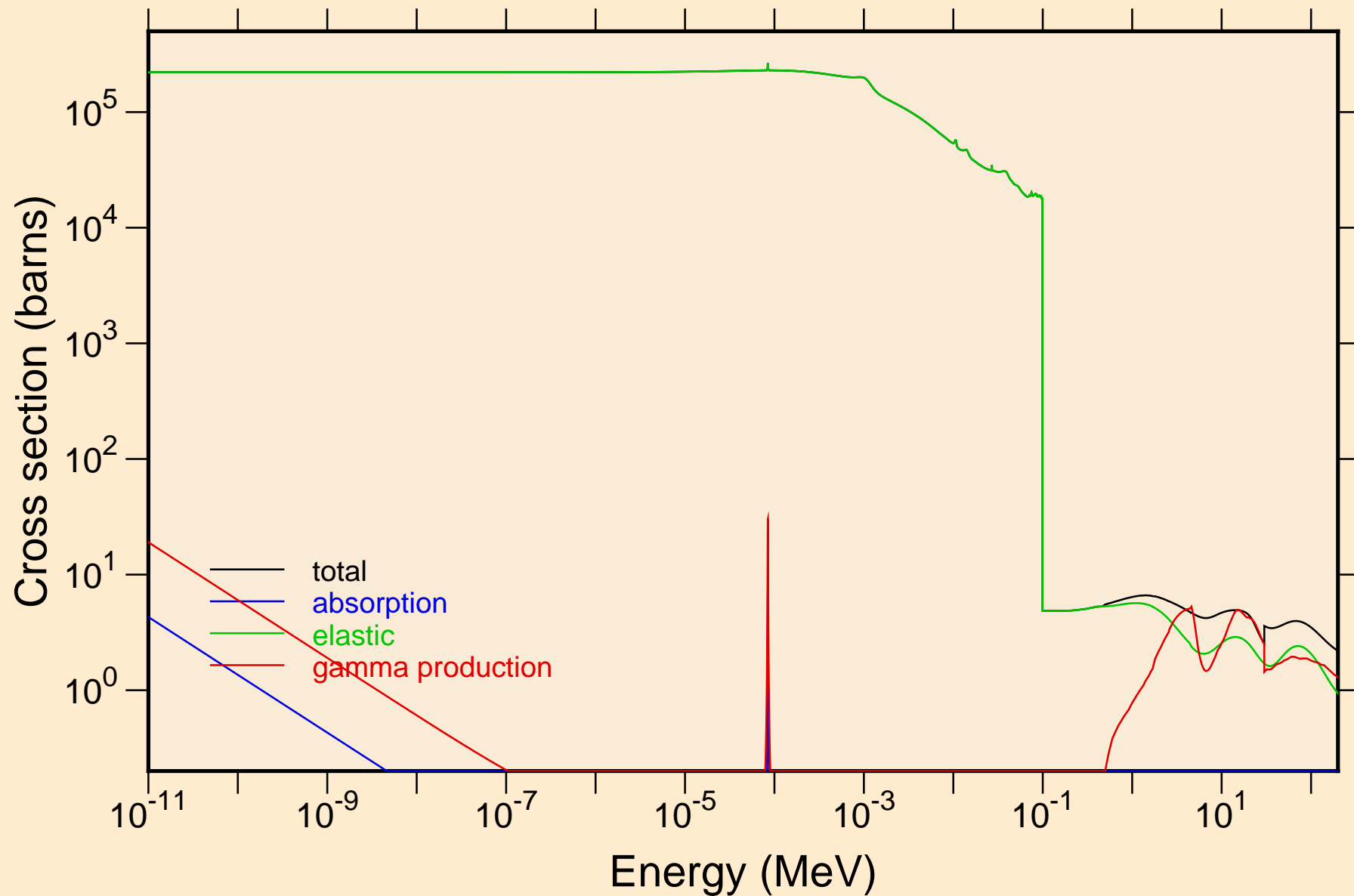

T<sub>E</sub>138 NEUTRON ACER TENDL-2023 LIBRARY; T=0.K  
resonance total cross section

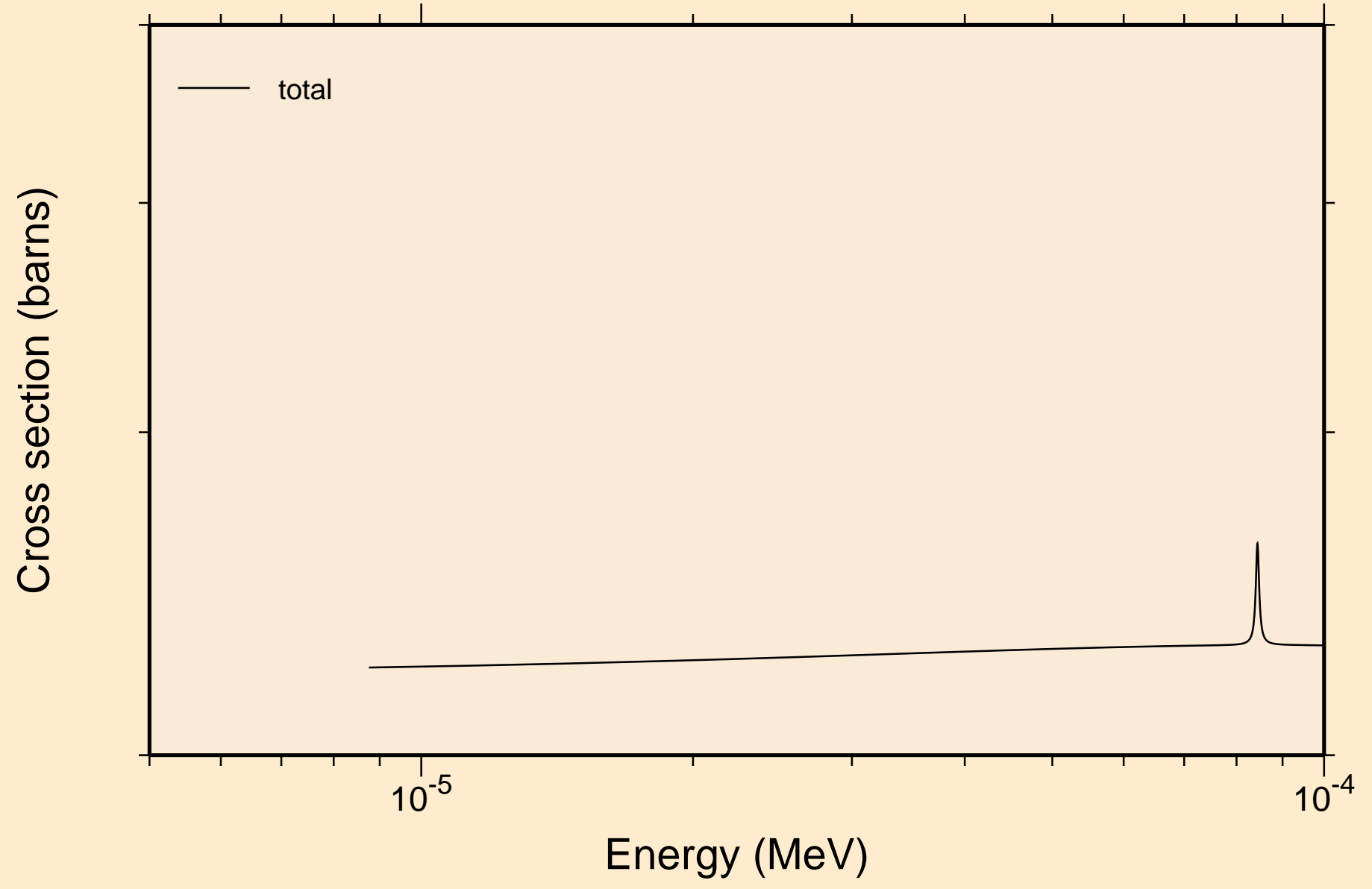

TE138 NEUTRON ACER TENDL-2023 LIBRARY; T=0.K  
resonance total cross section

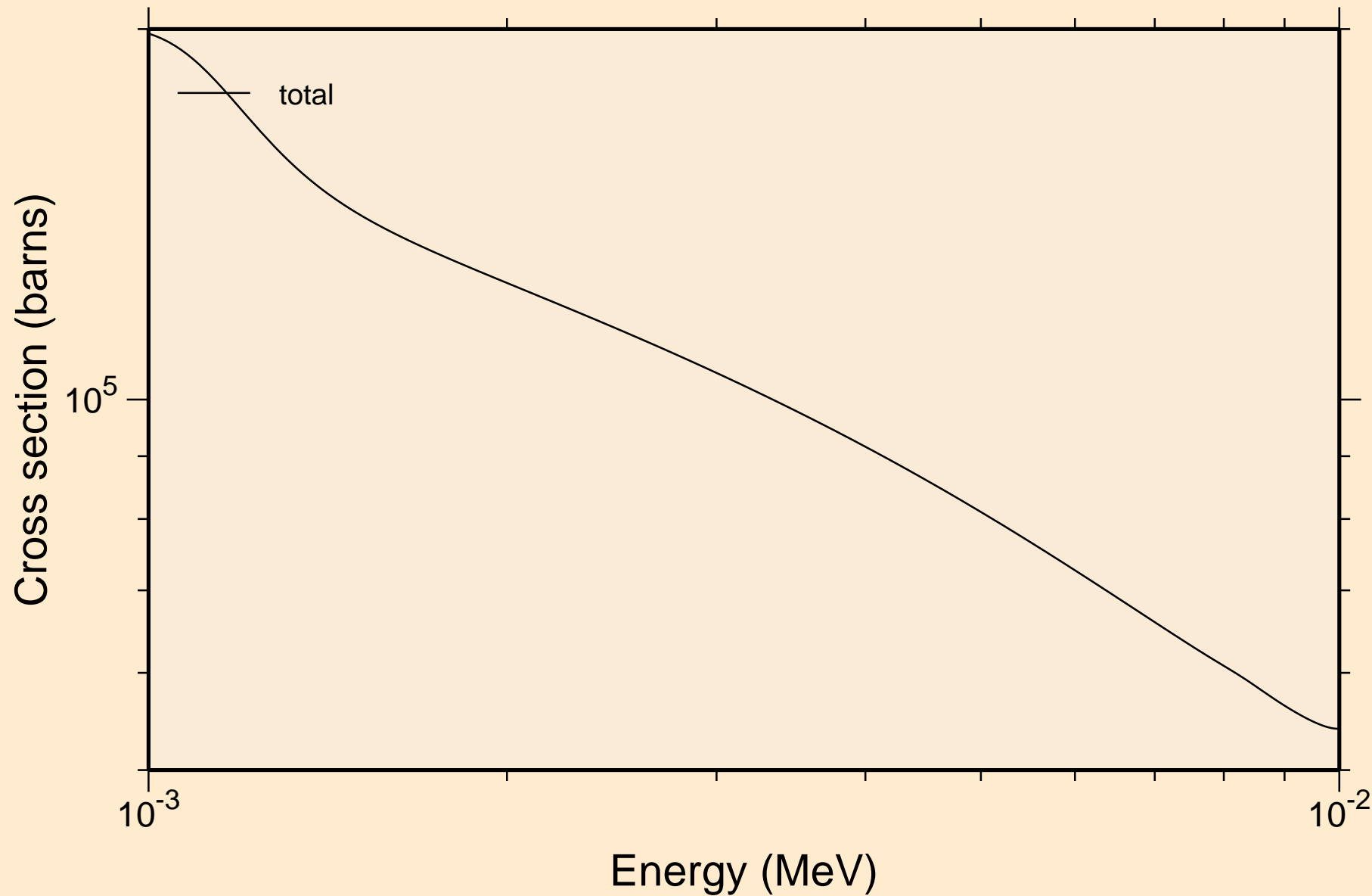

TE138 NEUTRON ACER TENDL-2023 LIBRARY; T=0.K  
resonance total cross section

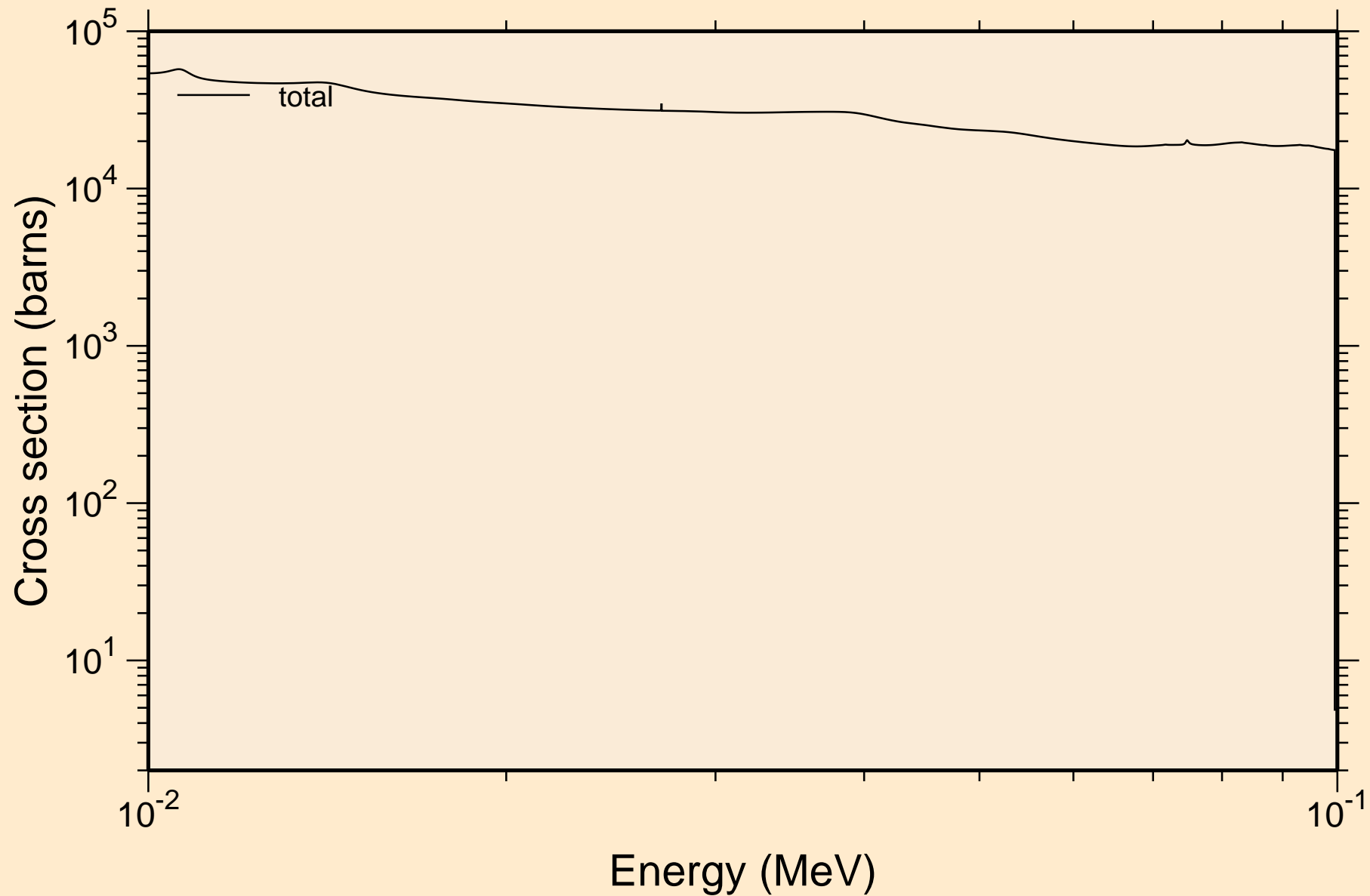

TE138 NEUTRON ACER TENDL-2023 LIBRARY; T=0.K  
resonance total cross section

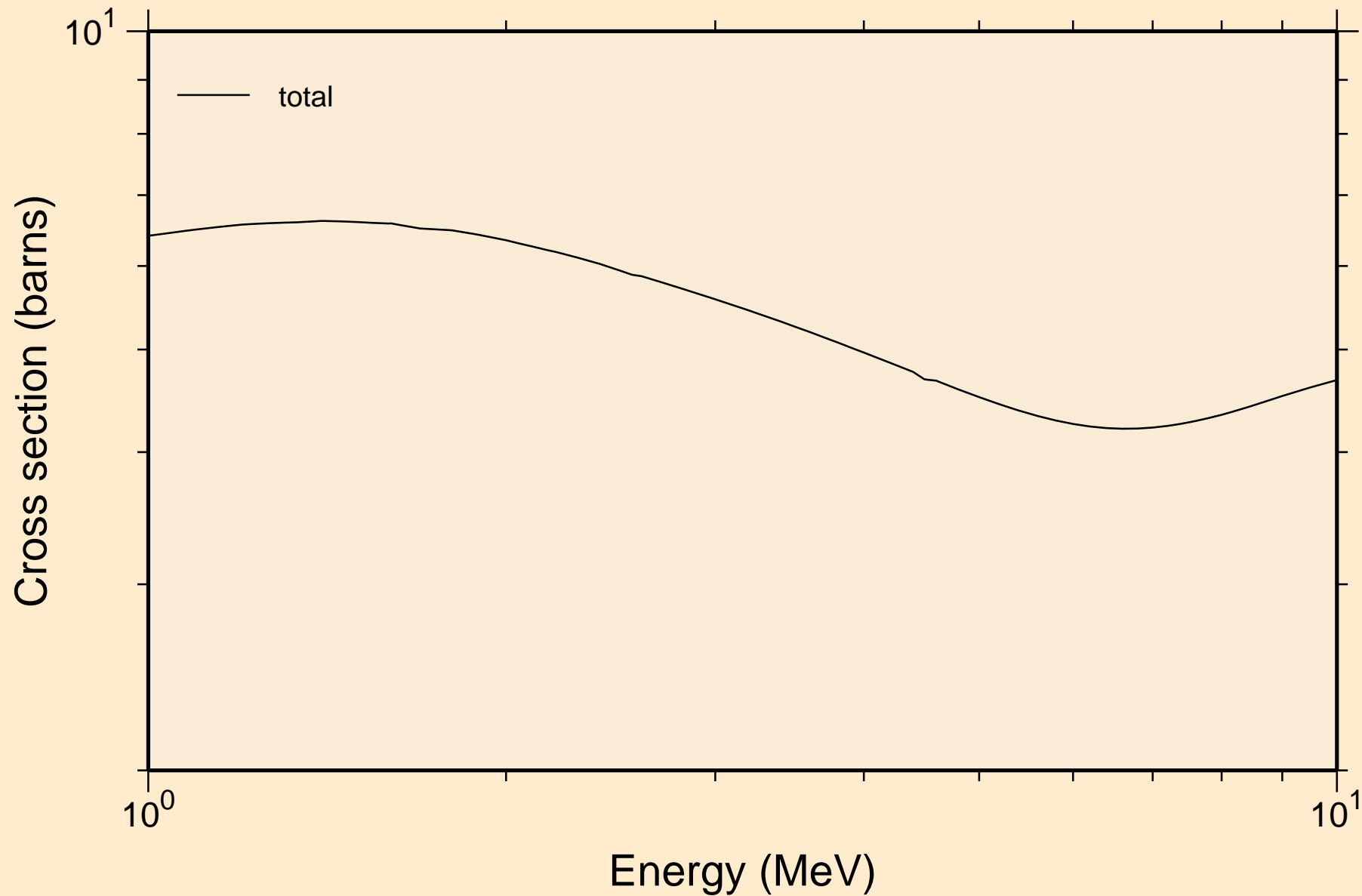

TE138 NEUTRON ACER TENDL-2023 LIBRARY; T=0.K  
resonance absorption cross sections

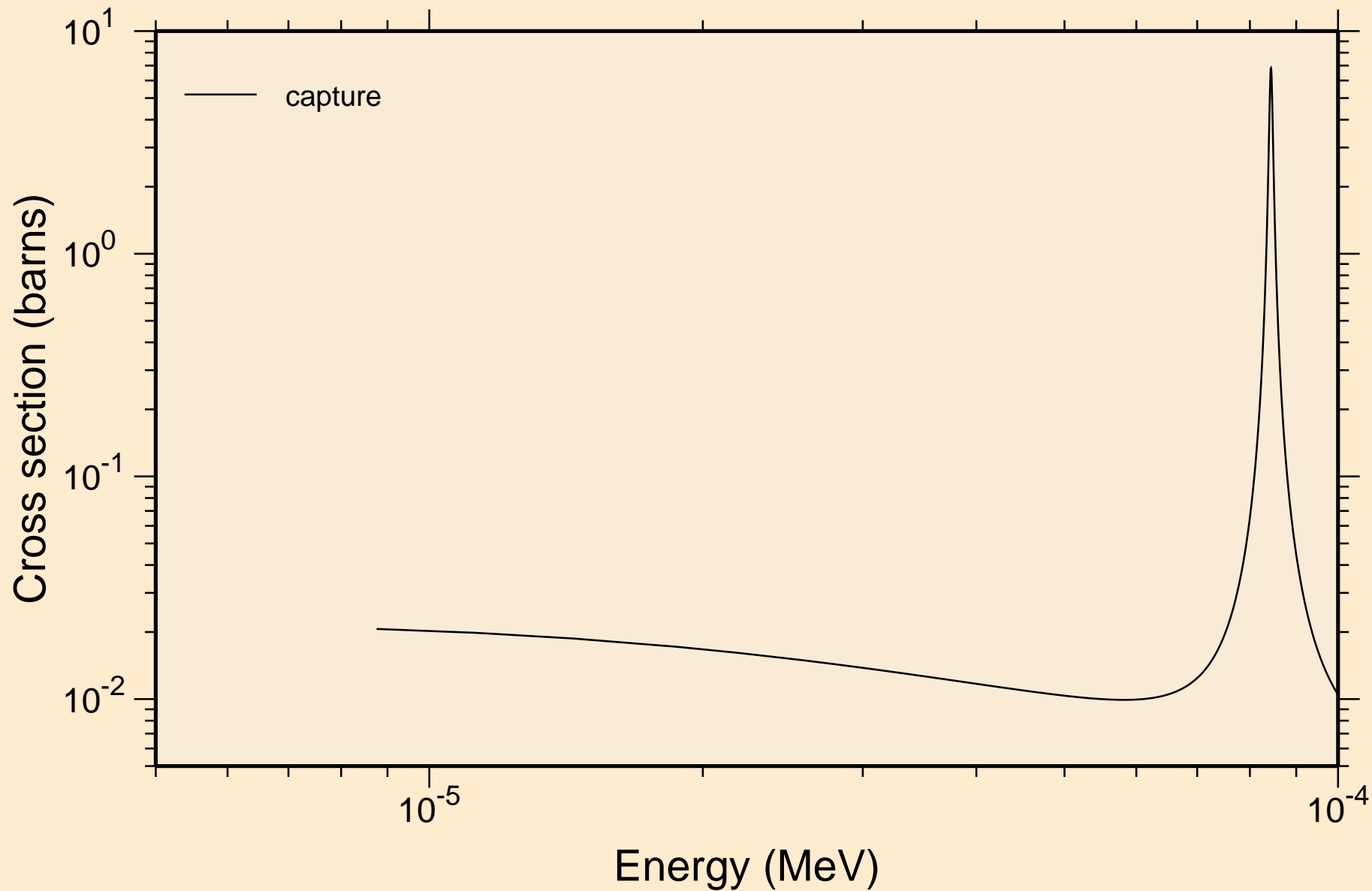

TE138 NEUTRON ACER TENDL-2023 LIBRARY; T=0.K  
resonance absorption cross sections

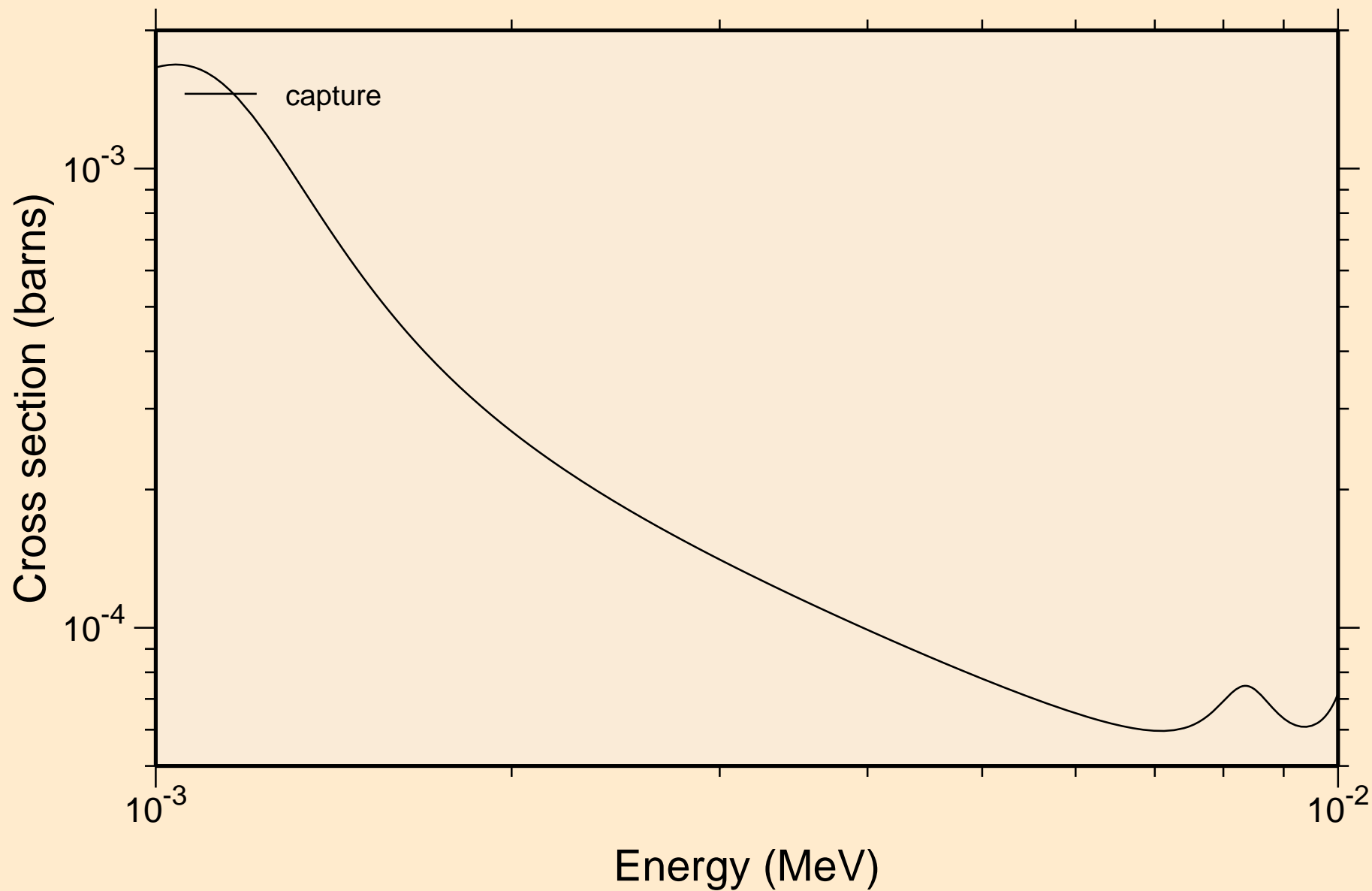

TE138 NEUTRON ACER TENDL-2023 LIBRARY; T=0.K  
resonance absorption cross sections

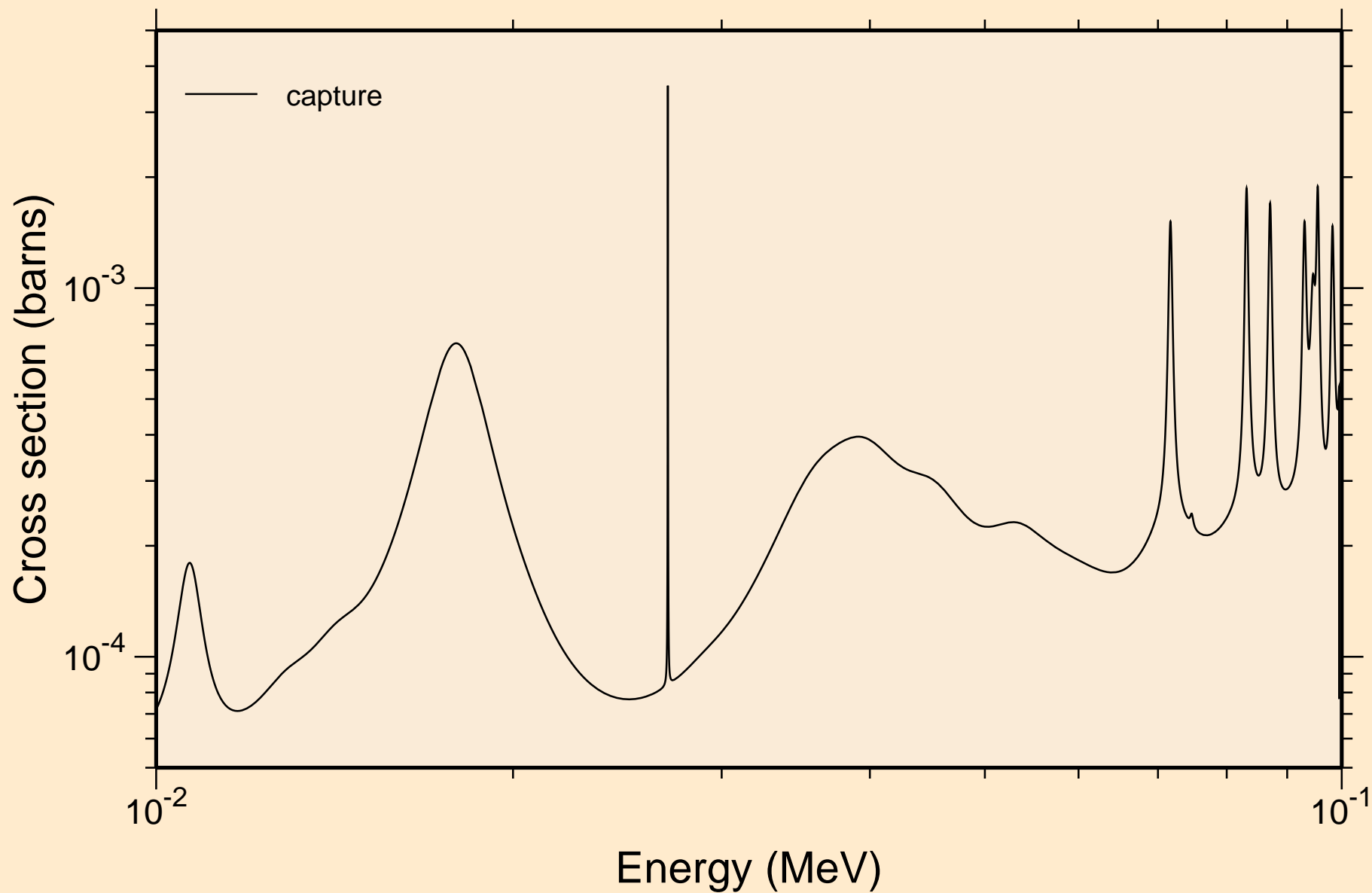



TE138 NEUTRON ACER TENDL-2023 LIBRARY; T=0.K  
resonance absorption cross sections

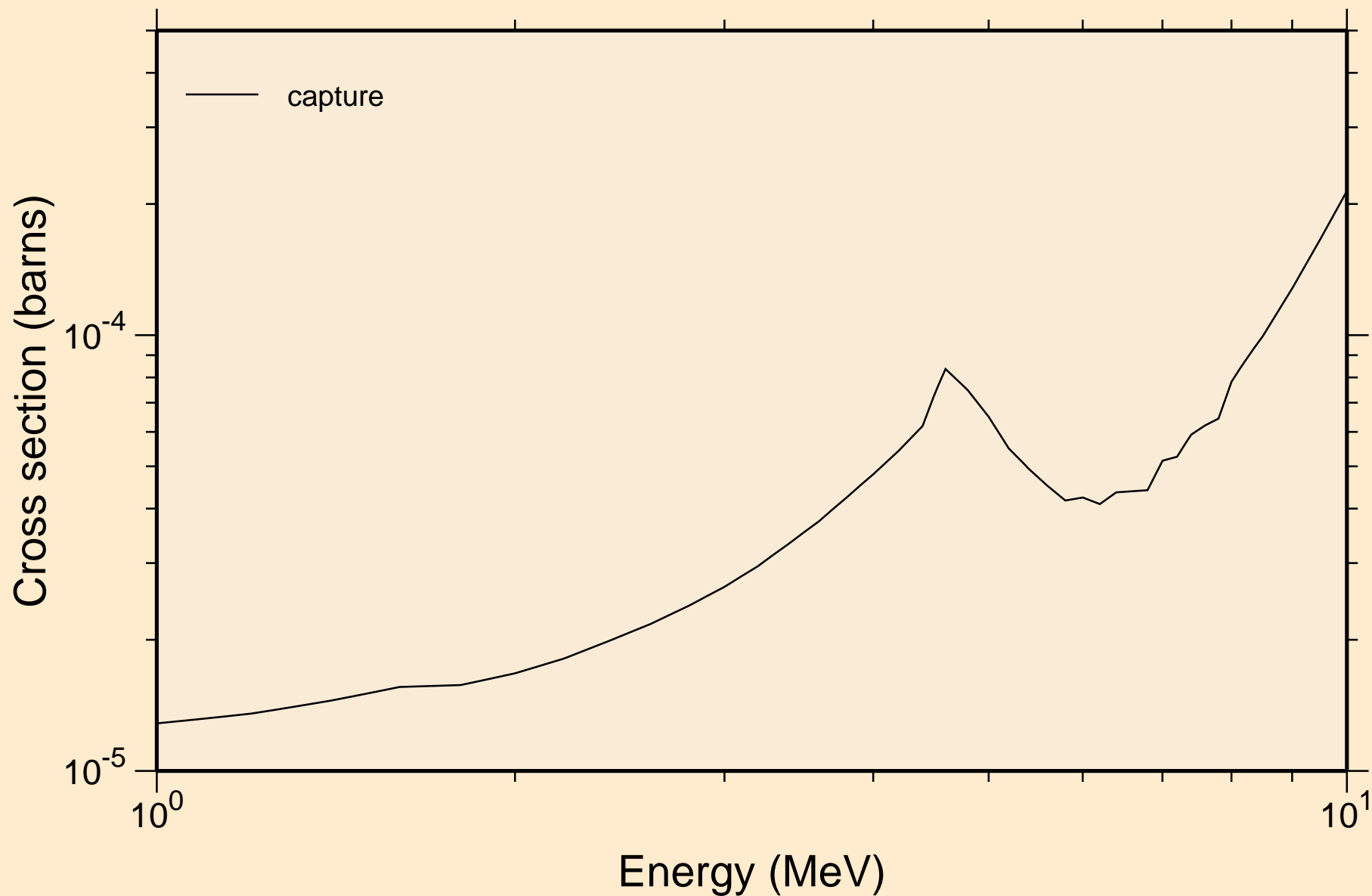

TE138 NEUTRON ACER TENDL-2023 LIBRARY; T=0.K  
Heating

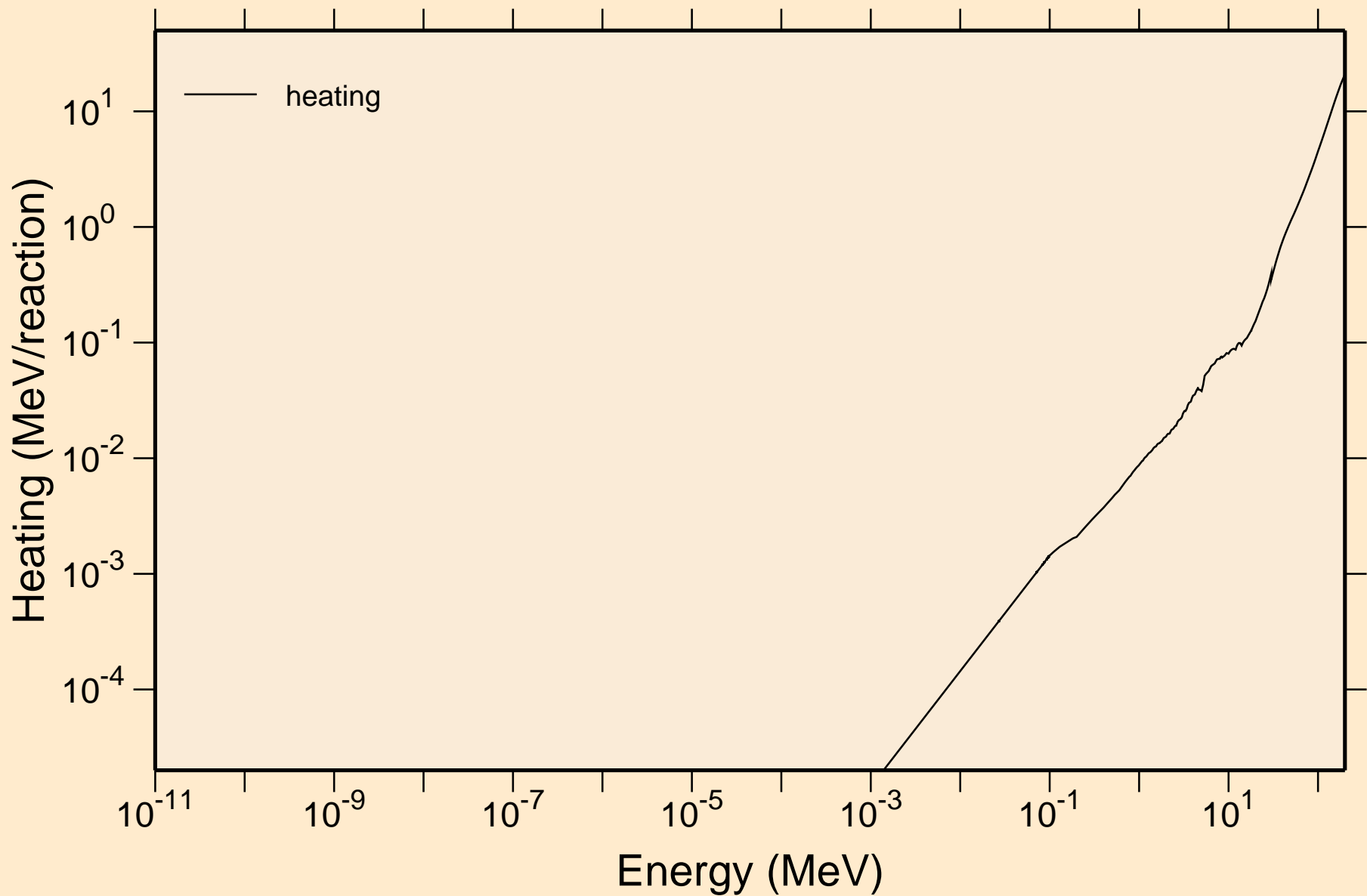

TE138 NEUTRON ACER TENDL-2023 LIBRARY; T=0.K  
Damage

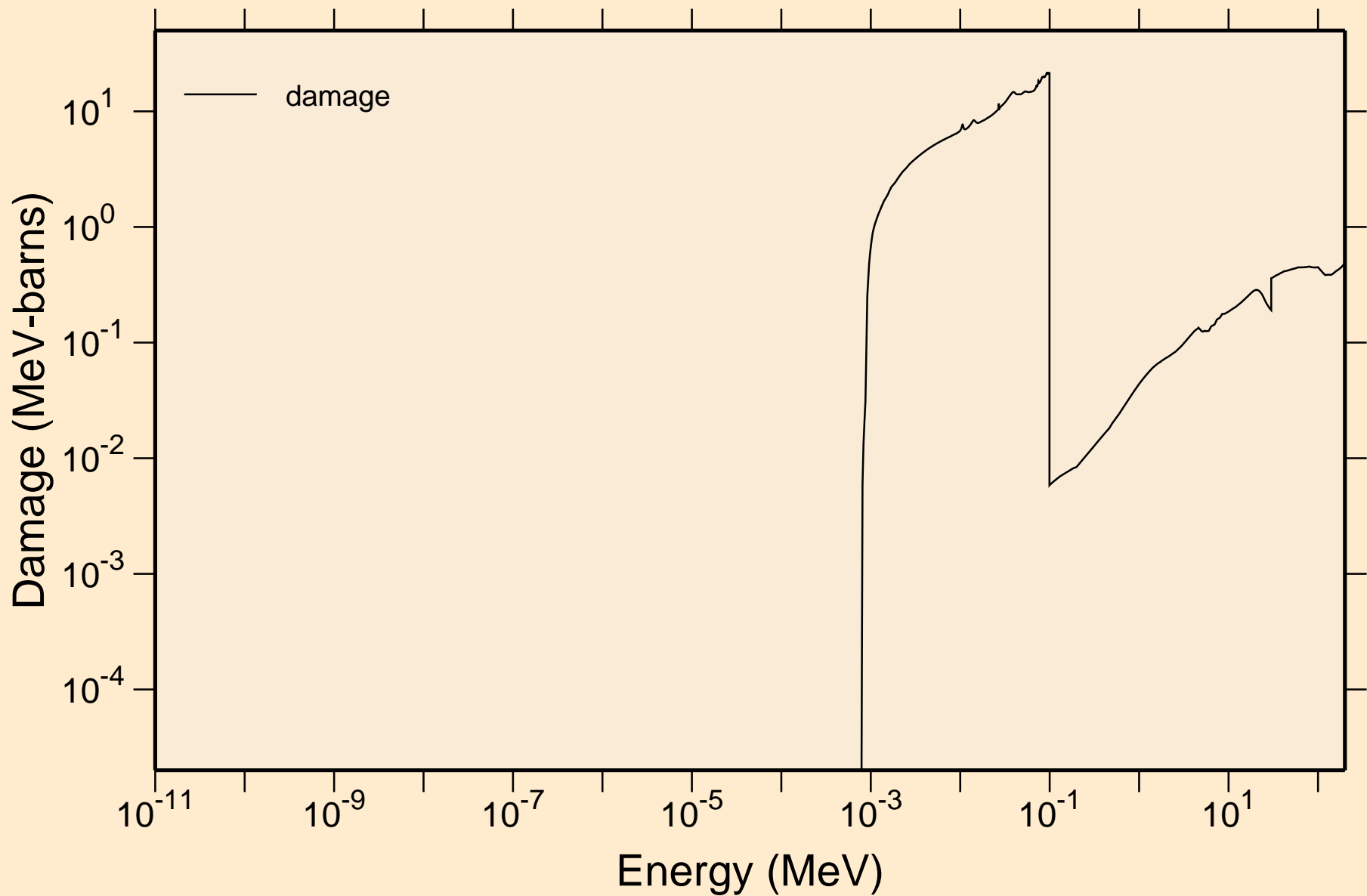

TE138 NEUTRON ACER TENDL-2023 LIBRARY; T=0.K  
Non-threshold reactions

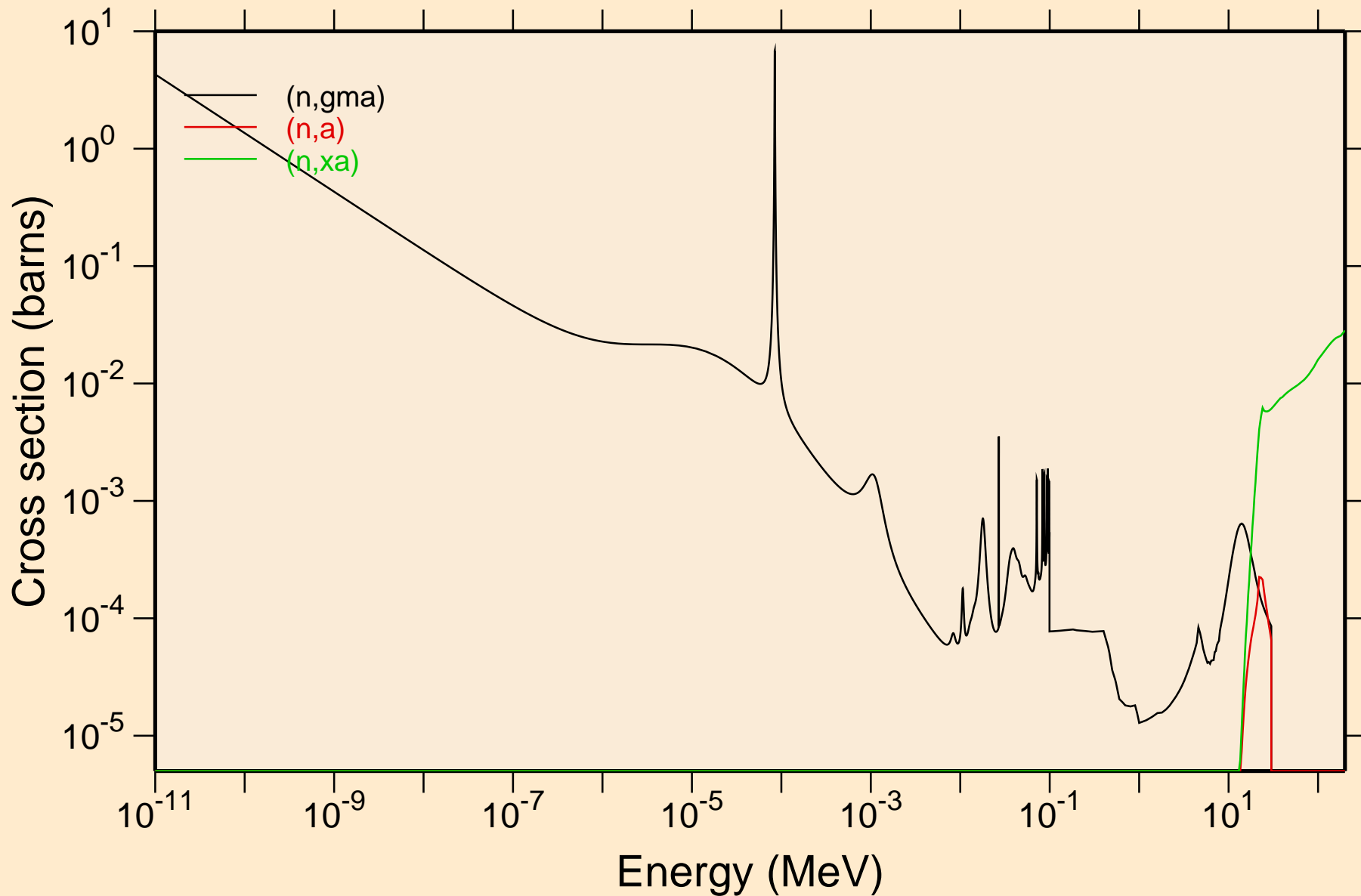

TE138 NEUTRON ACER TENDL-2023 LIBRARY; T=0.K  
Principal cross sections

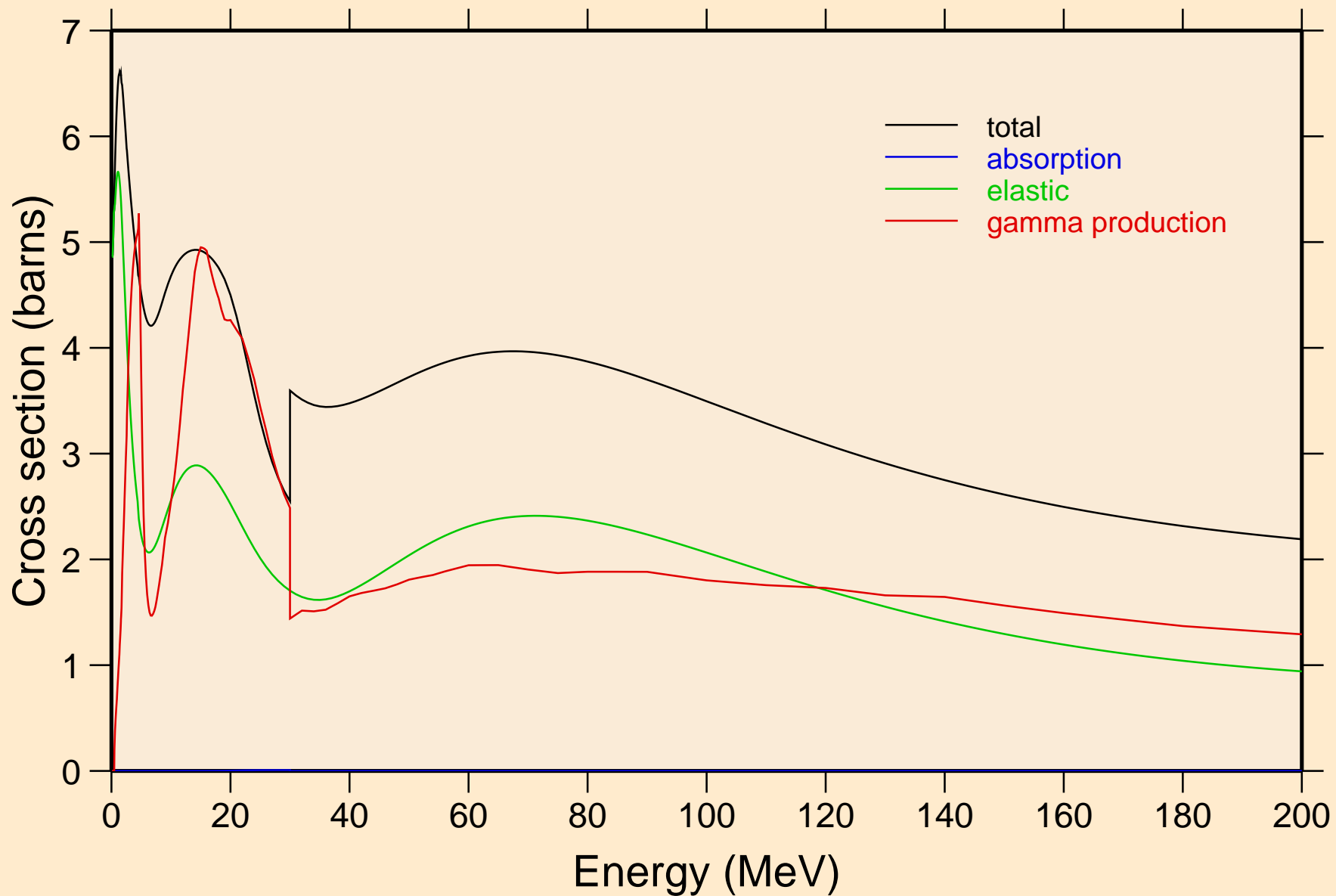

TE138 NEUTRON ACER TENDL-2023 LIBRARY; T=0.K  
Heating

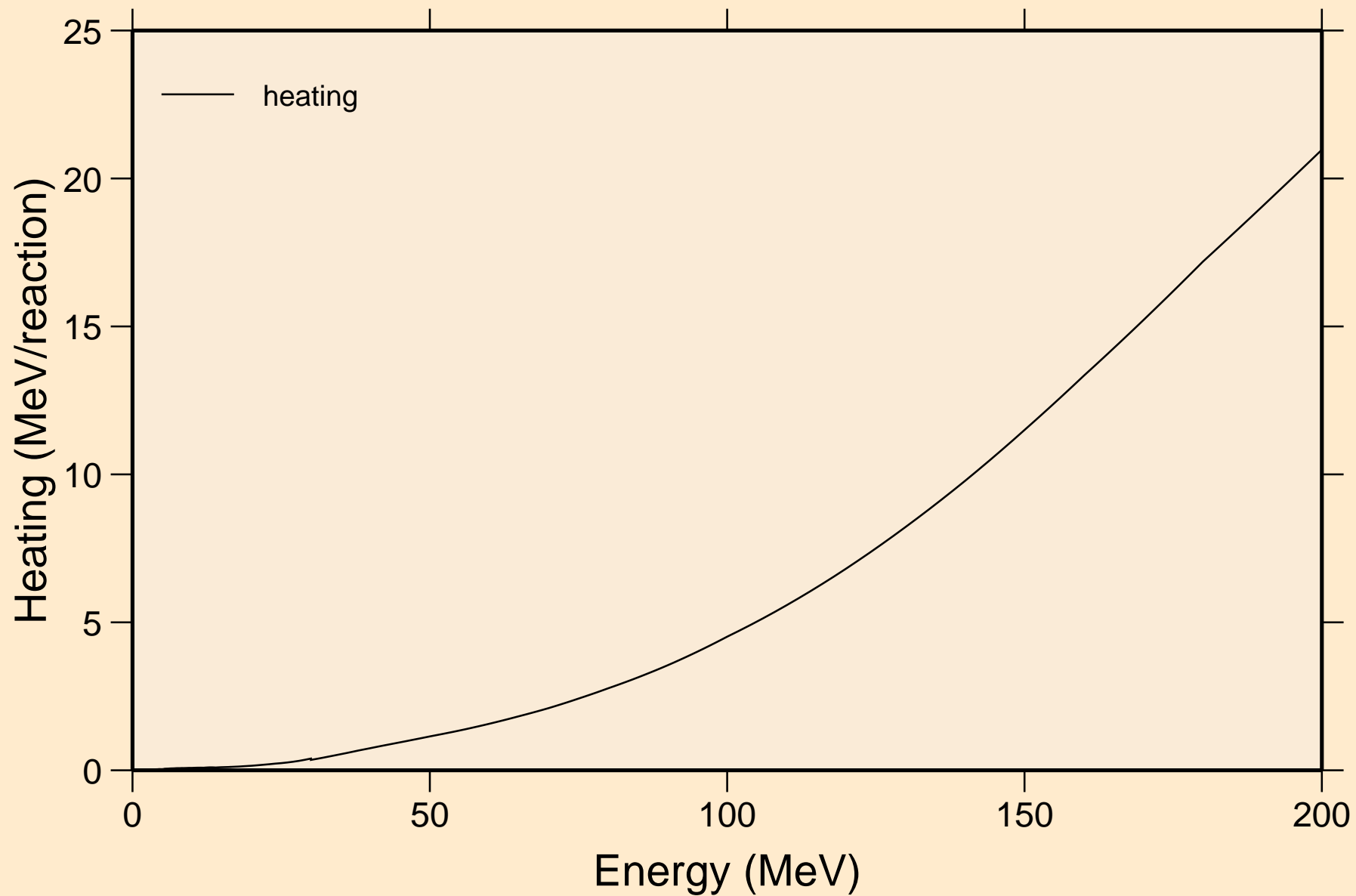

TE138 NEUTRON ACER TENDL-2023 LIBRARY; T=0.K  
Damage

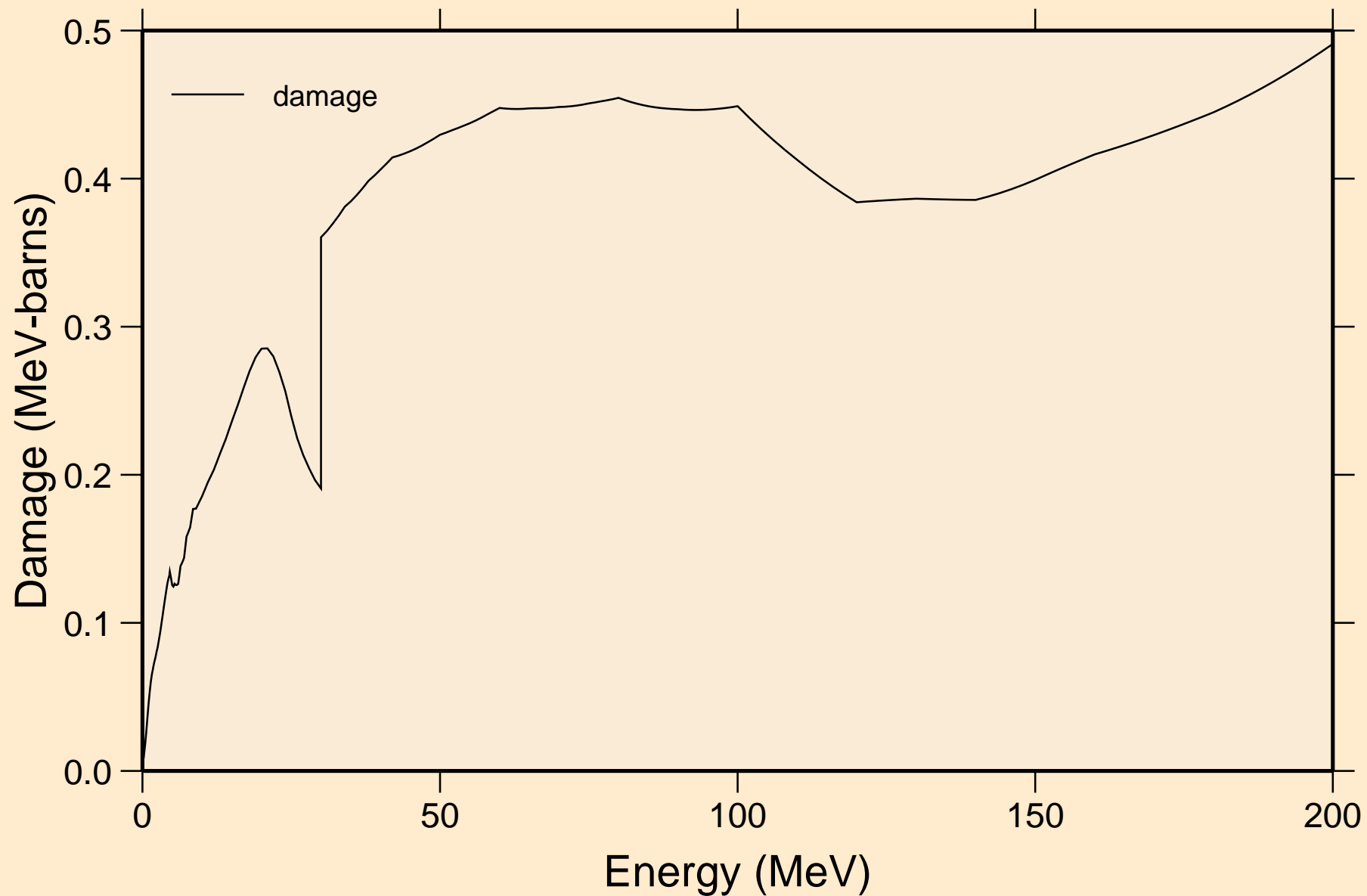

TE138 NEUTRON ACER TENDL-2023 LIBRARY; T=0.K  
Non-threshold reactions

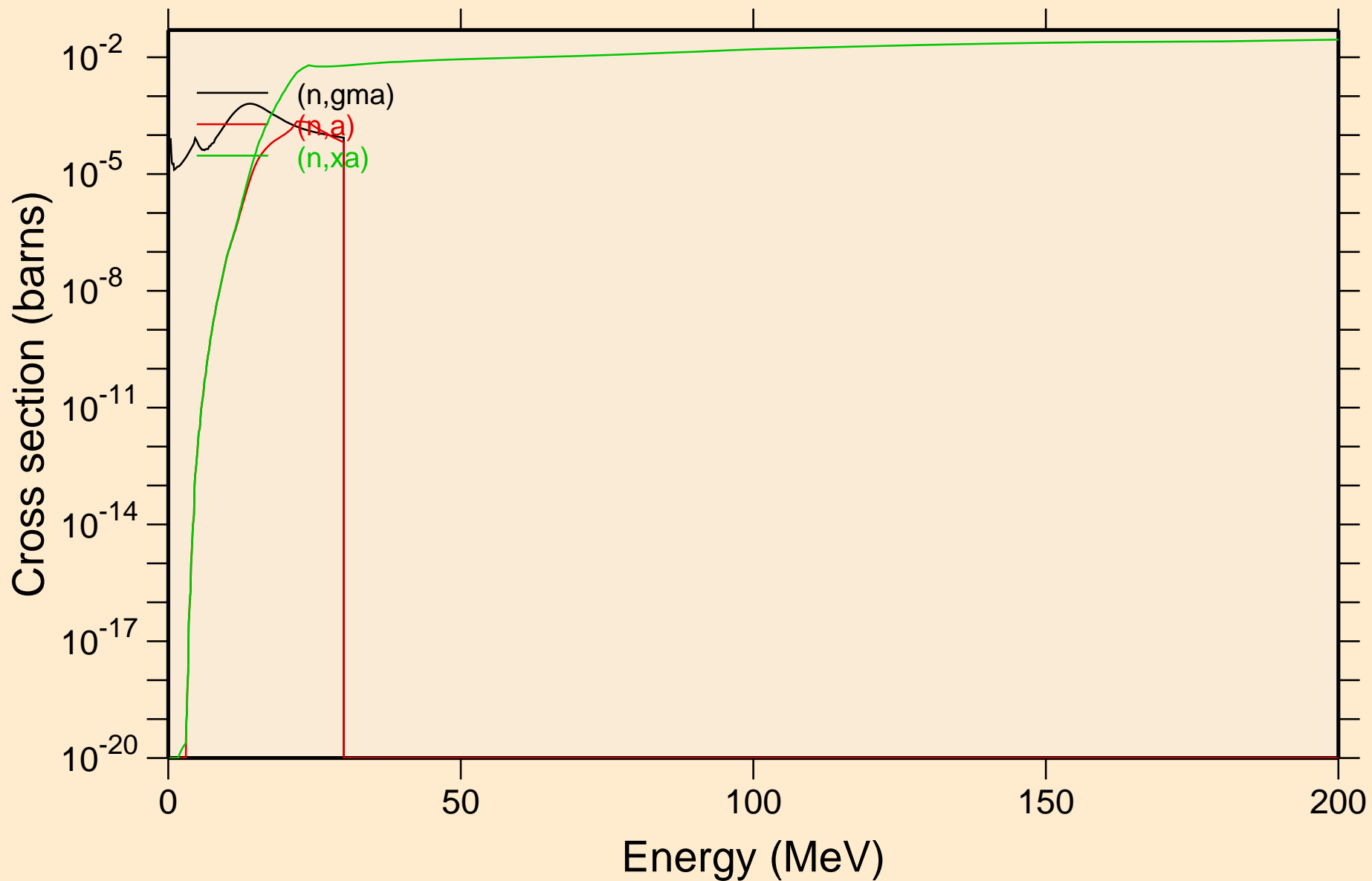



TE138 NEUTRON ACER TENDL-2023 LIBRARY; T=0.K  
Inelastic levels

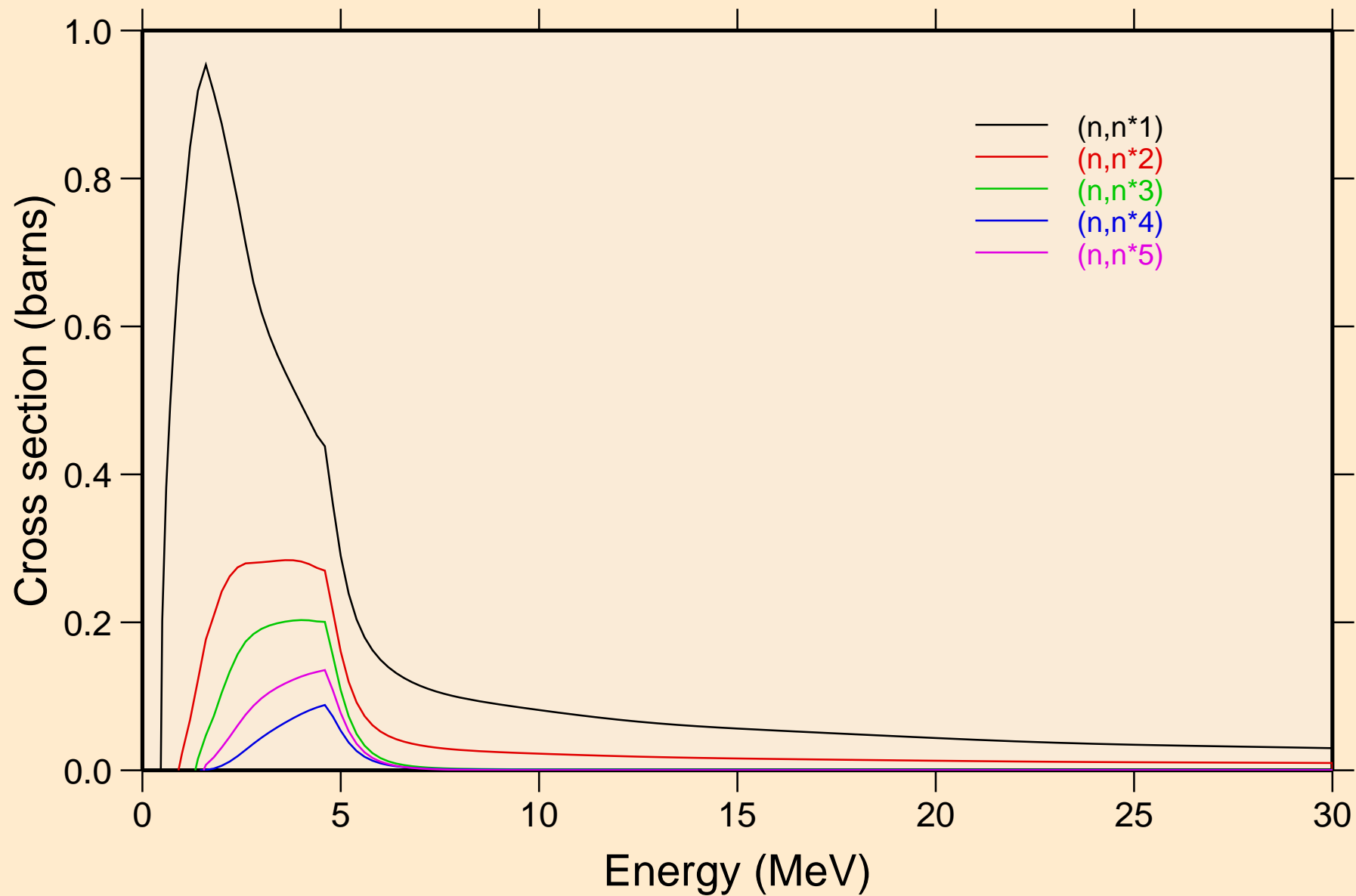

TE138 NEUTRON ACER TENDL-2023 LIBRARY; T=0.K  
Inelastic levels

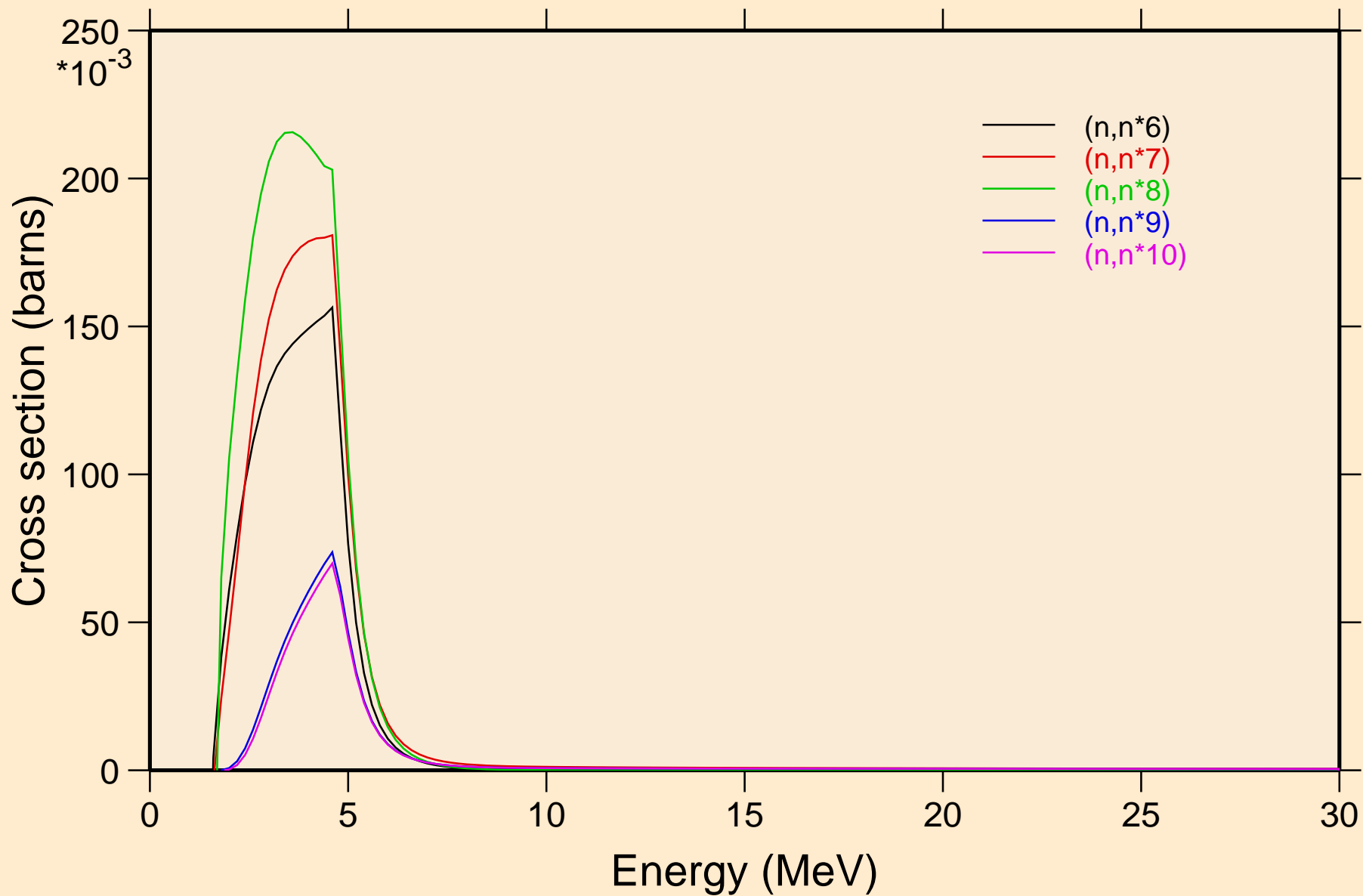

TE138 NEUTRON ACER TENDL-2023 LIBRARY; T=0.K  
Inelastic levels

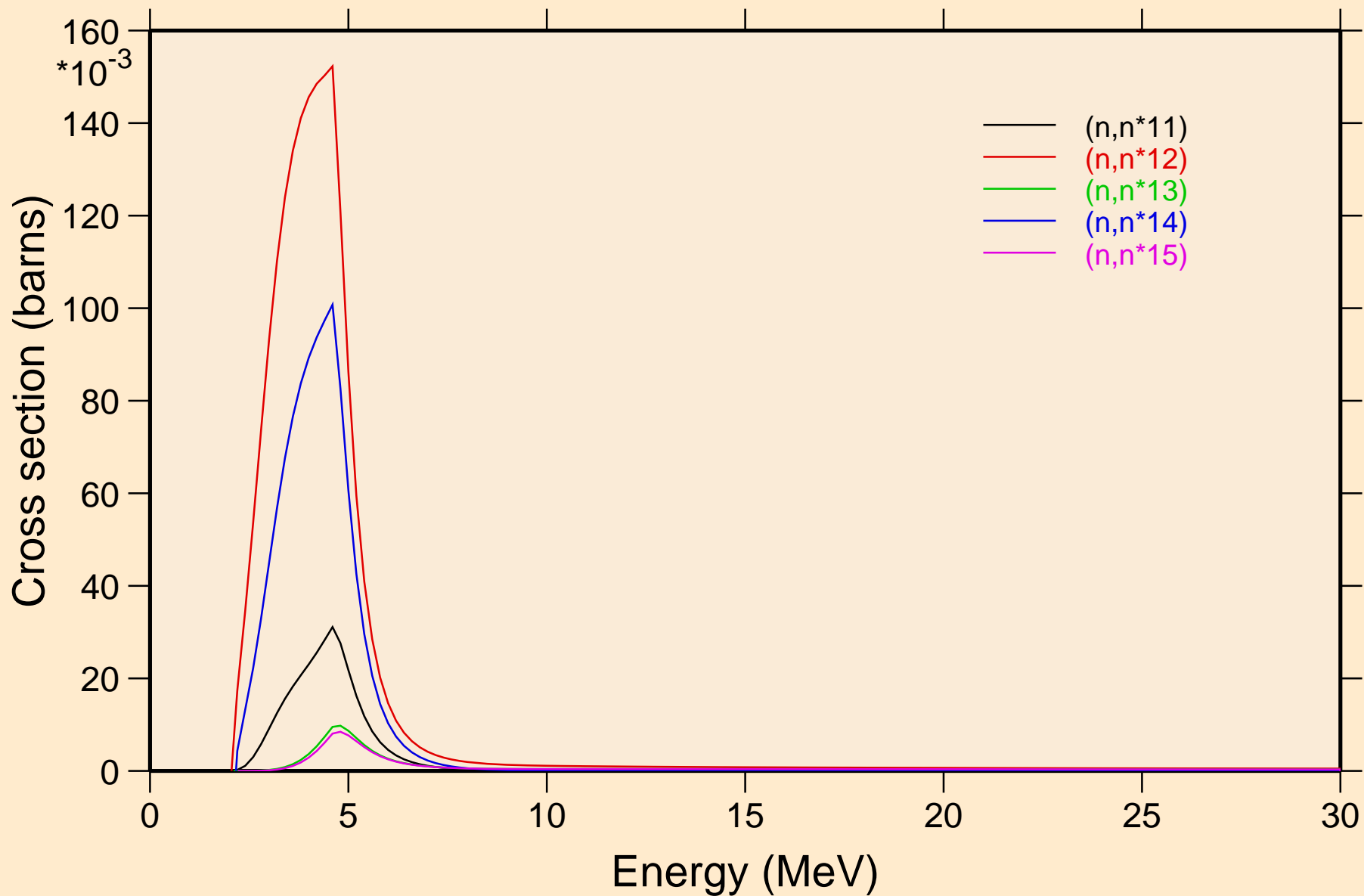

TE138 NEUTRON ACER TENDL-2023 LIBRARY; T=0.K  
Inelastic levels

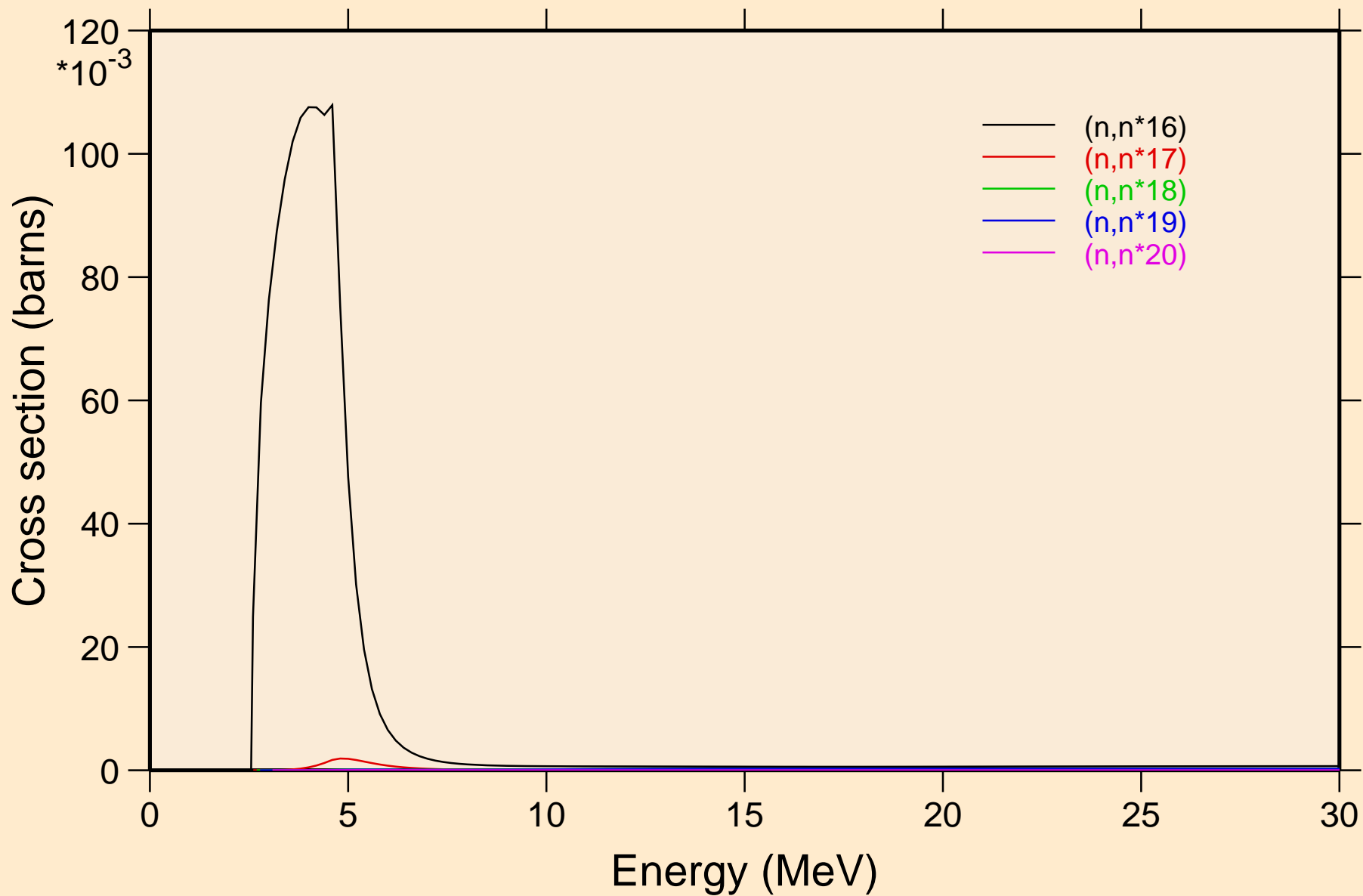

TE138 NEUTRON ACER TENDL-2023 LIBRARY; T=0.K  
Inelastic levels

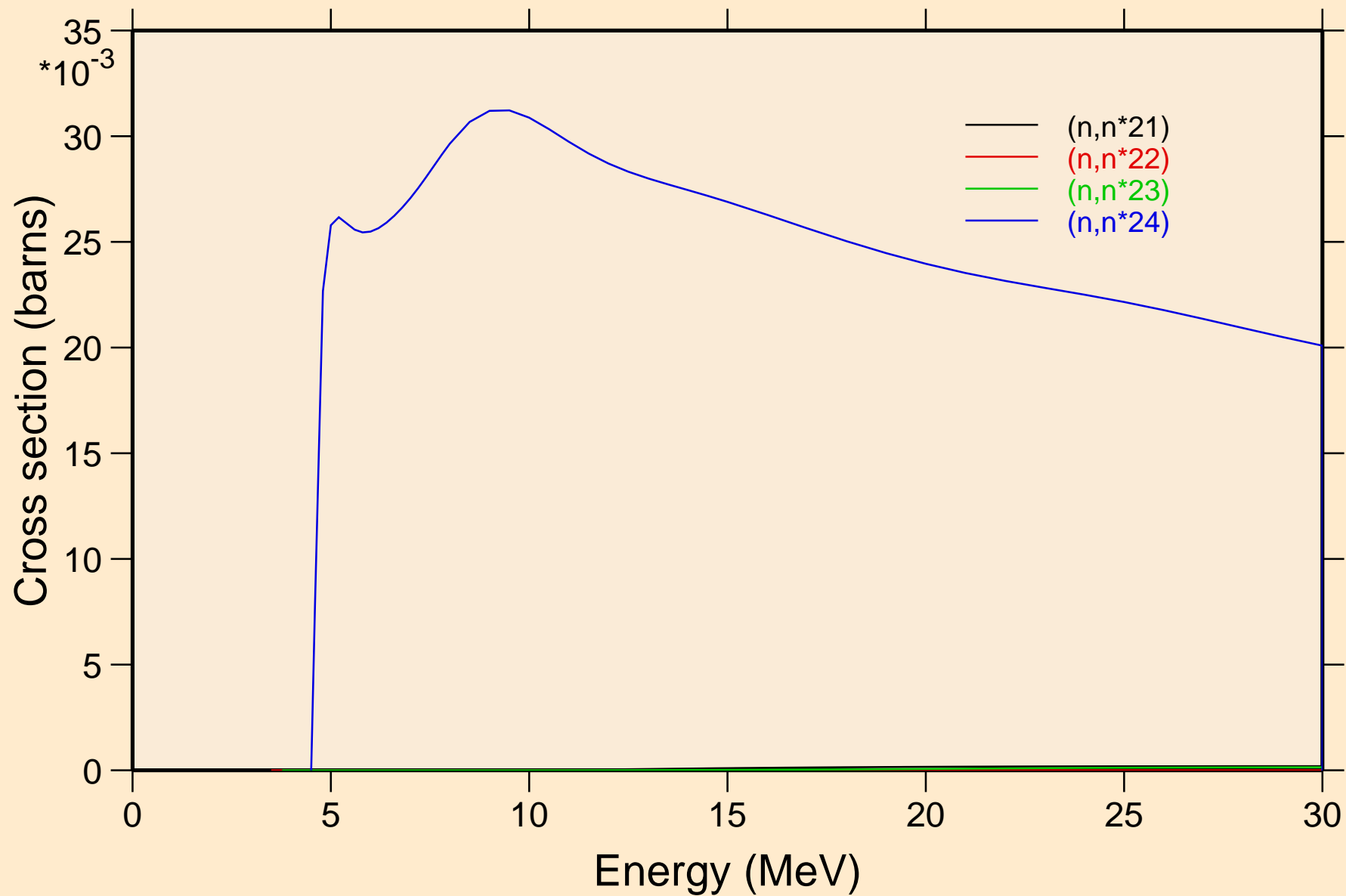

TE138 NEUTRON ACER TENDL-2023 LIBRARY; T=0.K  
Threshold reactions

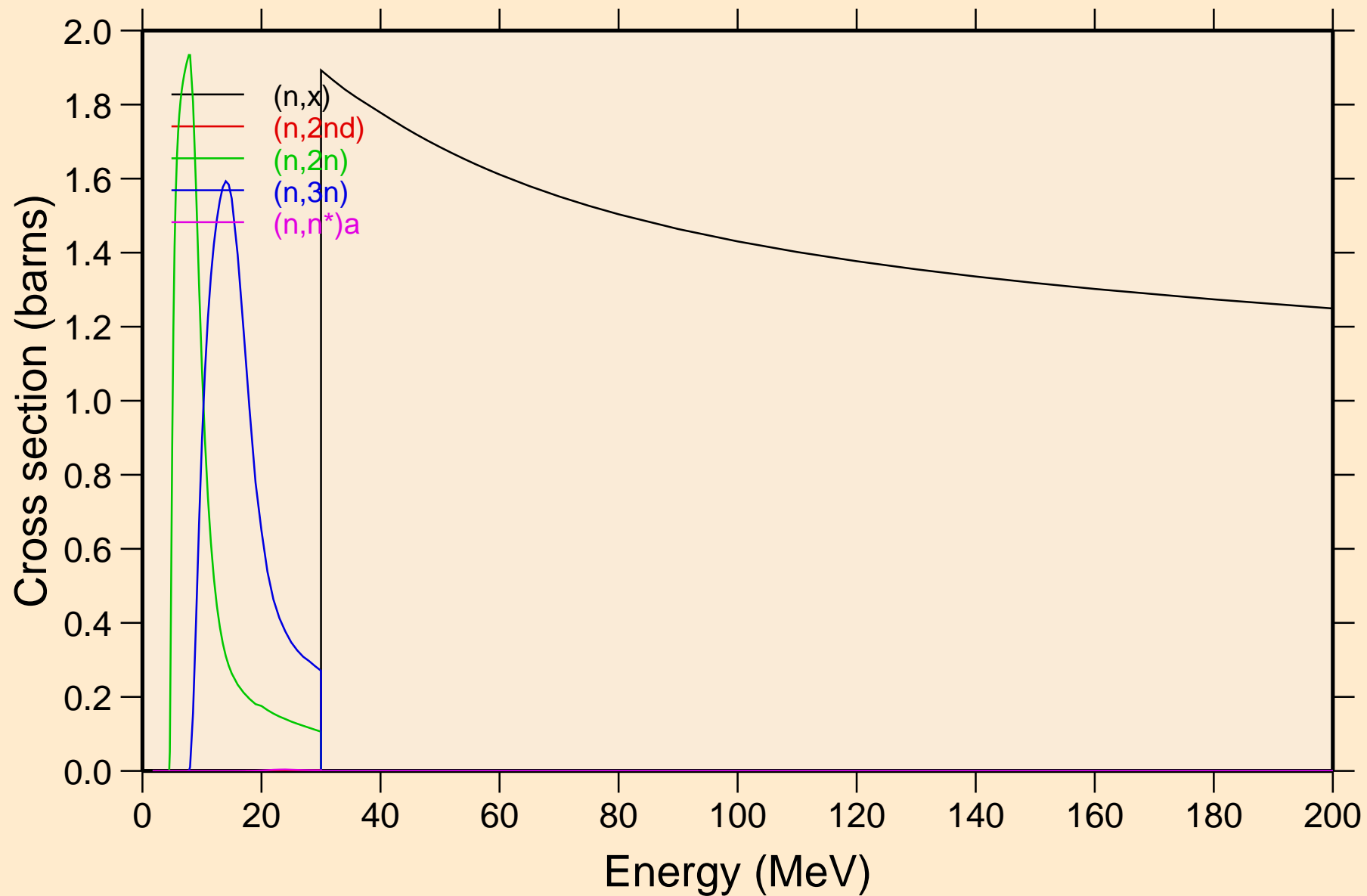

TE138 NEUTRON ACER TENDL-2023 LIBRARY; T=0.K  
Threshold reactions

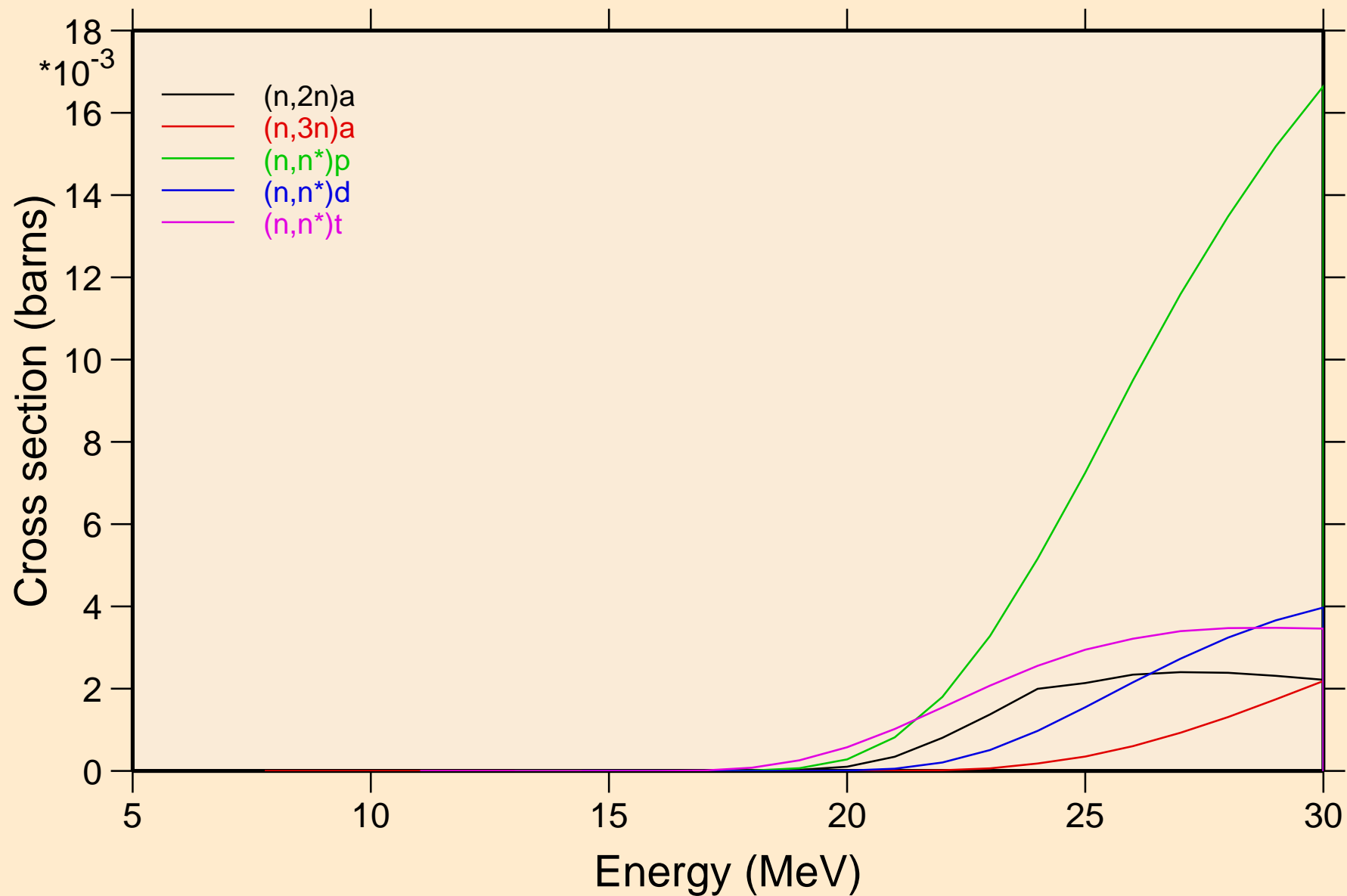

TE138 NEUTRON ACER TENDL-2023 LIBRARY; T=0.K  
Threshold reactions

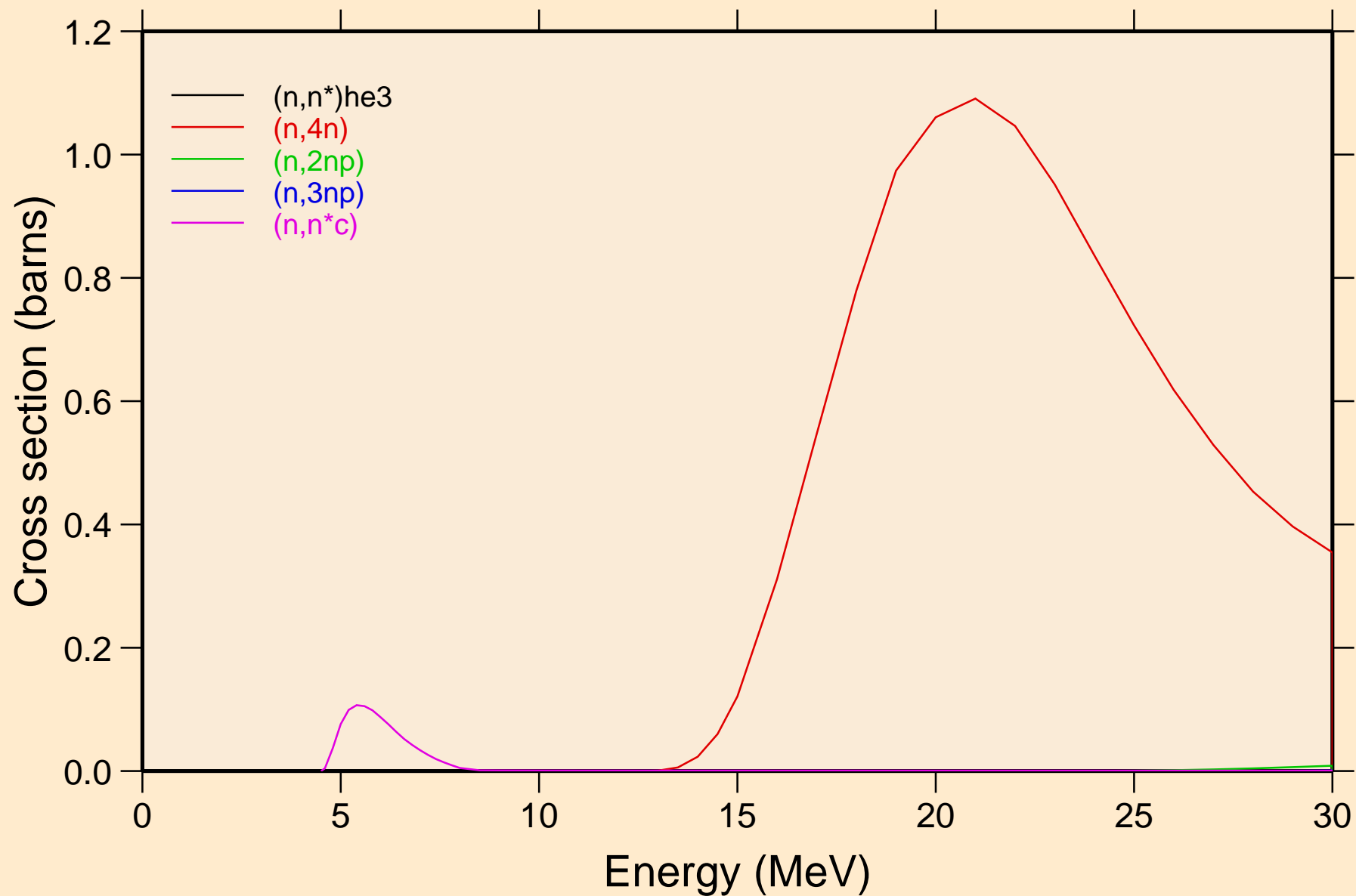



TE138 NEUTRON ACER TENDL-2023 LIBRARY; T=0.K  
Threshold reactions

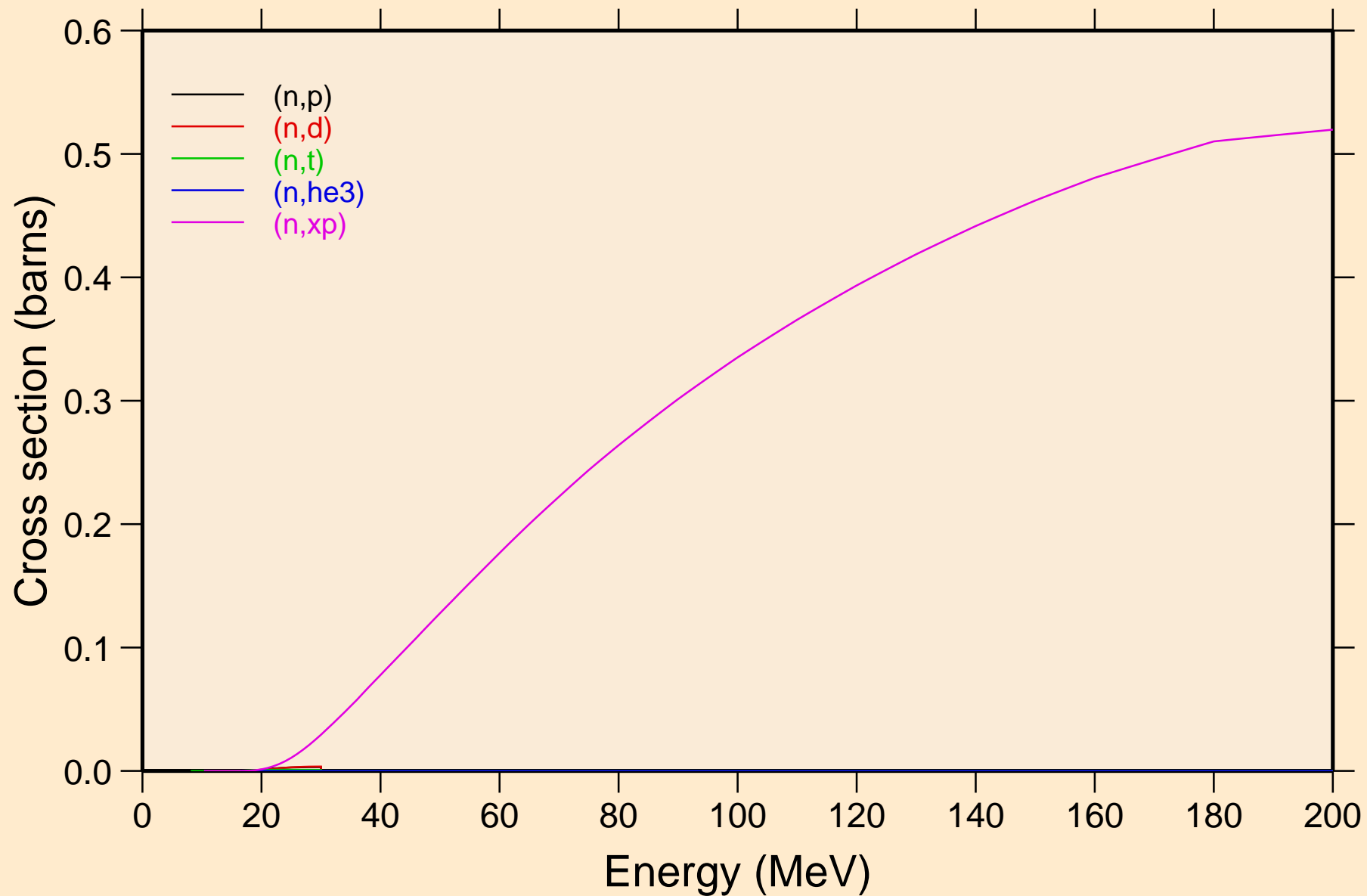

TE138 NEUTRON ACER TENDL-2023 LIBRARY; T=0.K  
Threshold reactions

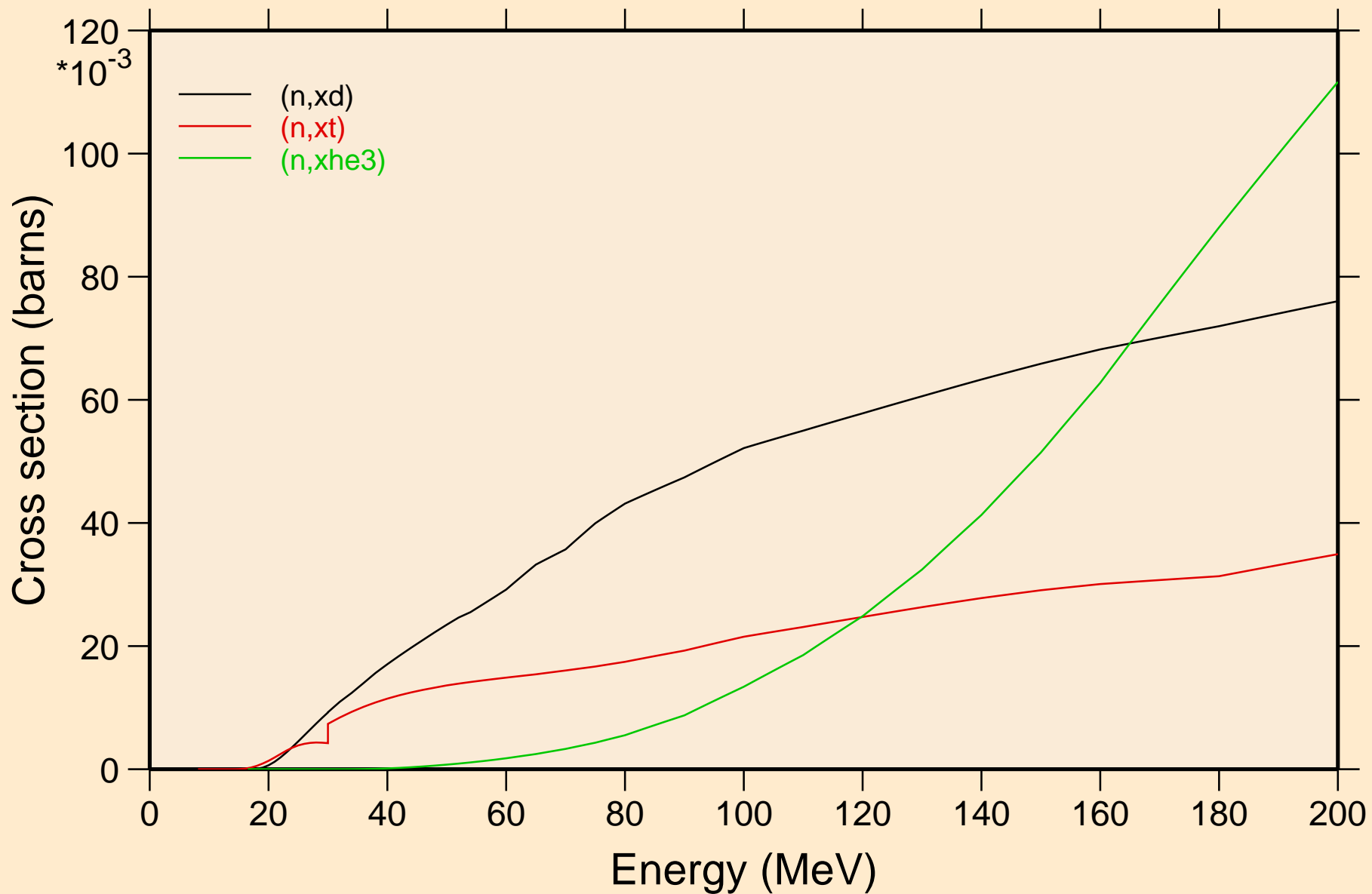

TE138 NEUTRON ACER TENDL-2023 LIBRARY; T=0.K  
angular distribution for elastic

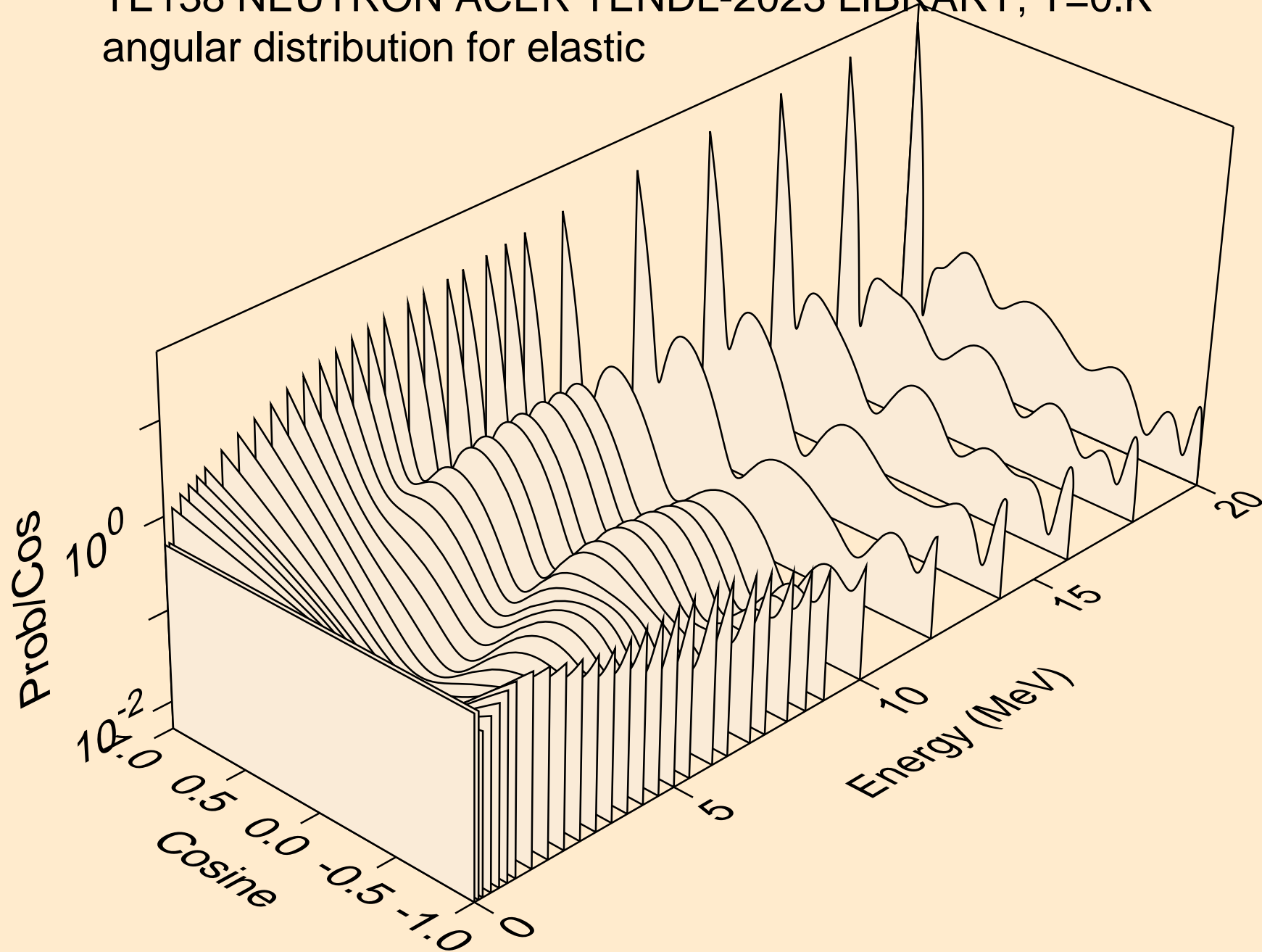

TE138 NEUTRON ACER TENDL-2023 LIBRARY; T=0.K  
angular distribution for elastic

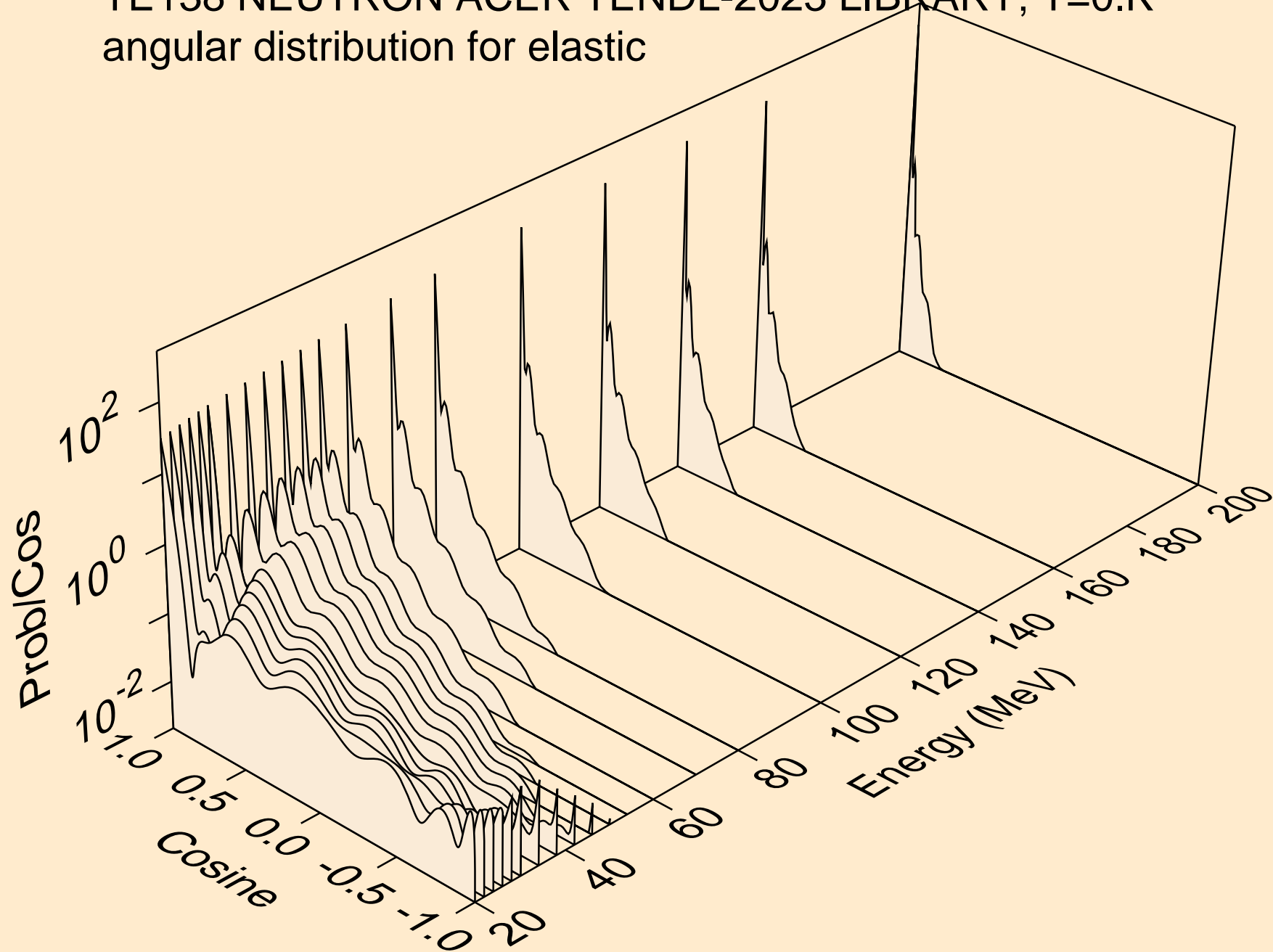

TE138 NEUTRON ACER TENDL-2023 LIBRARY; T=0.K  
angular distribution for (n,n\*1)

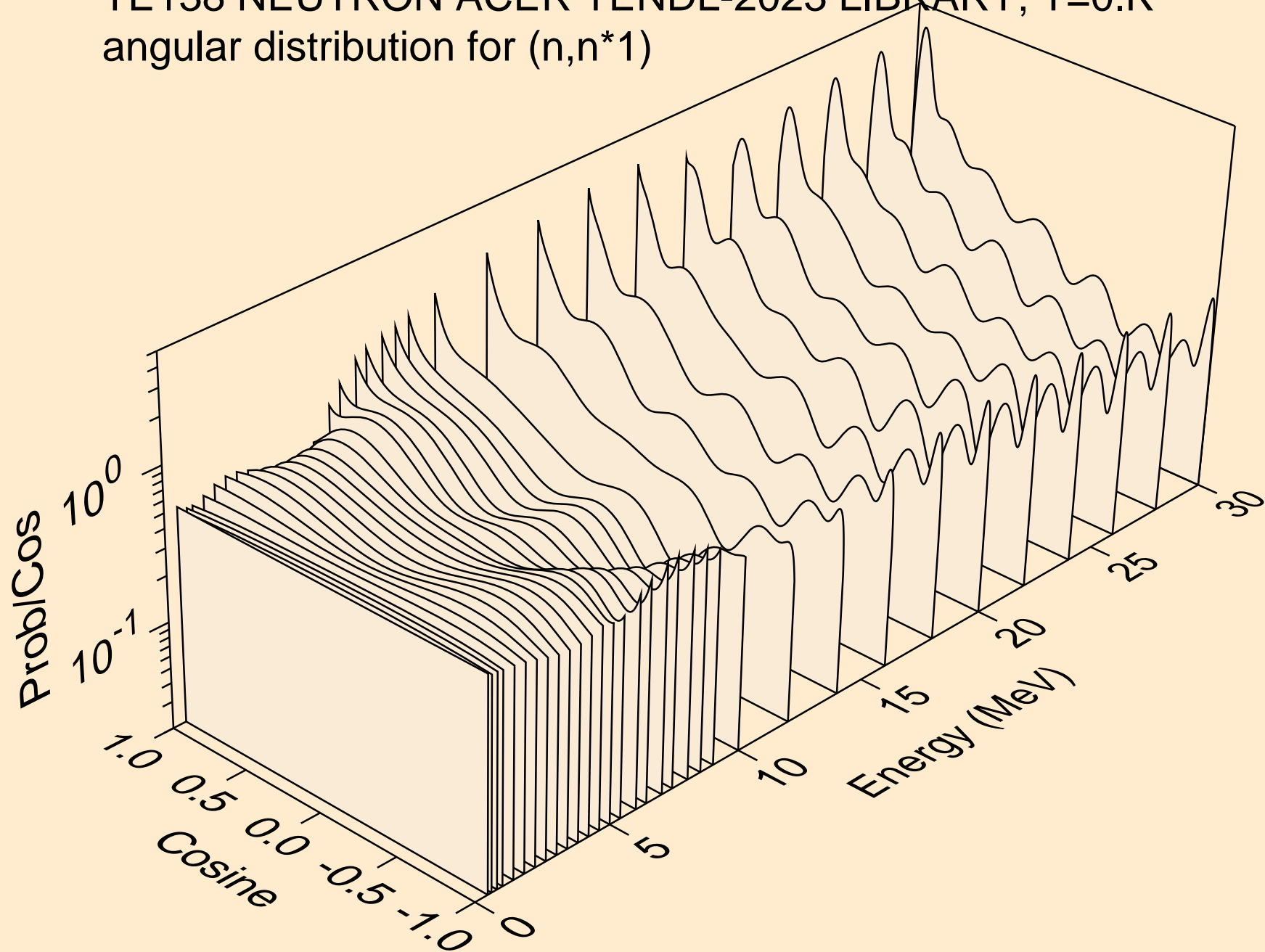

TE138 NEUTRON ACER TENDL-2023 LIBRARY; T=0.K  
angular distribution for (n,n\*2)

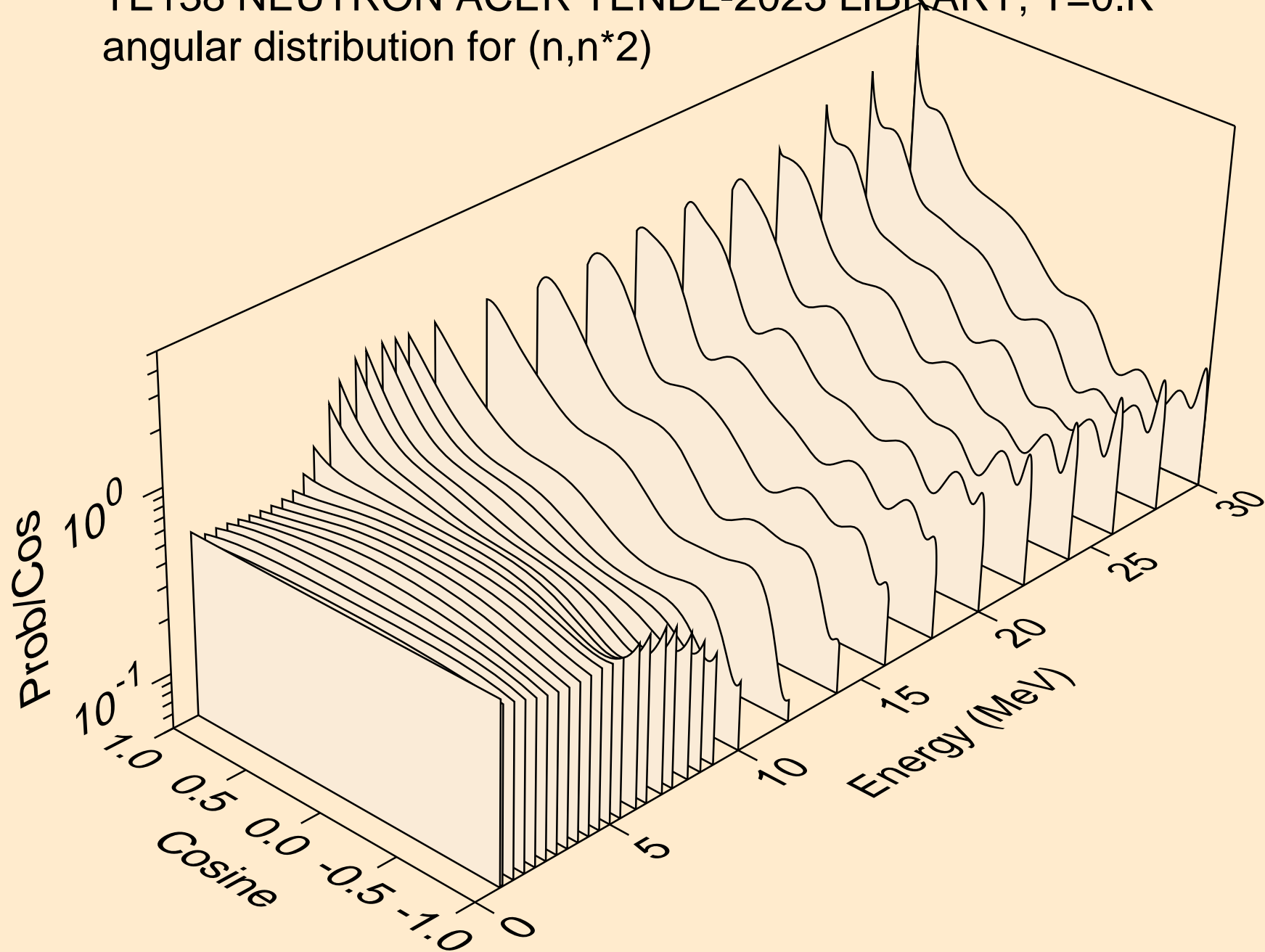

TE138 NEUTRON ACER TENDL-2023 LIBRARY; T=0.K  
angular distribution for (n,n\*3)

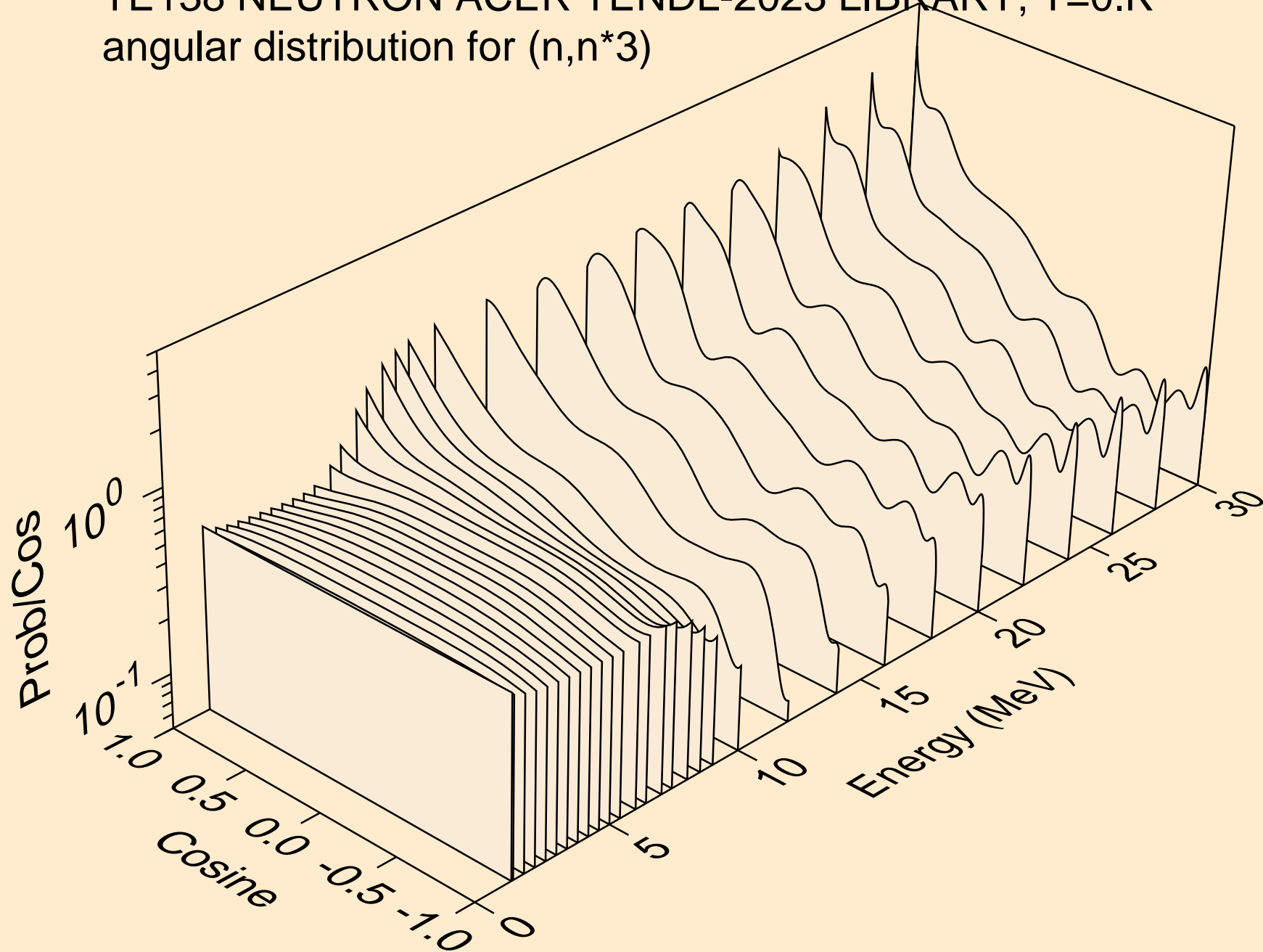

TE138 NEUTRON ACER TENDL-2023 LIBRARY; T=0.K  
angular distribution for (n,n\*4)

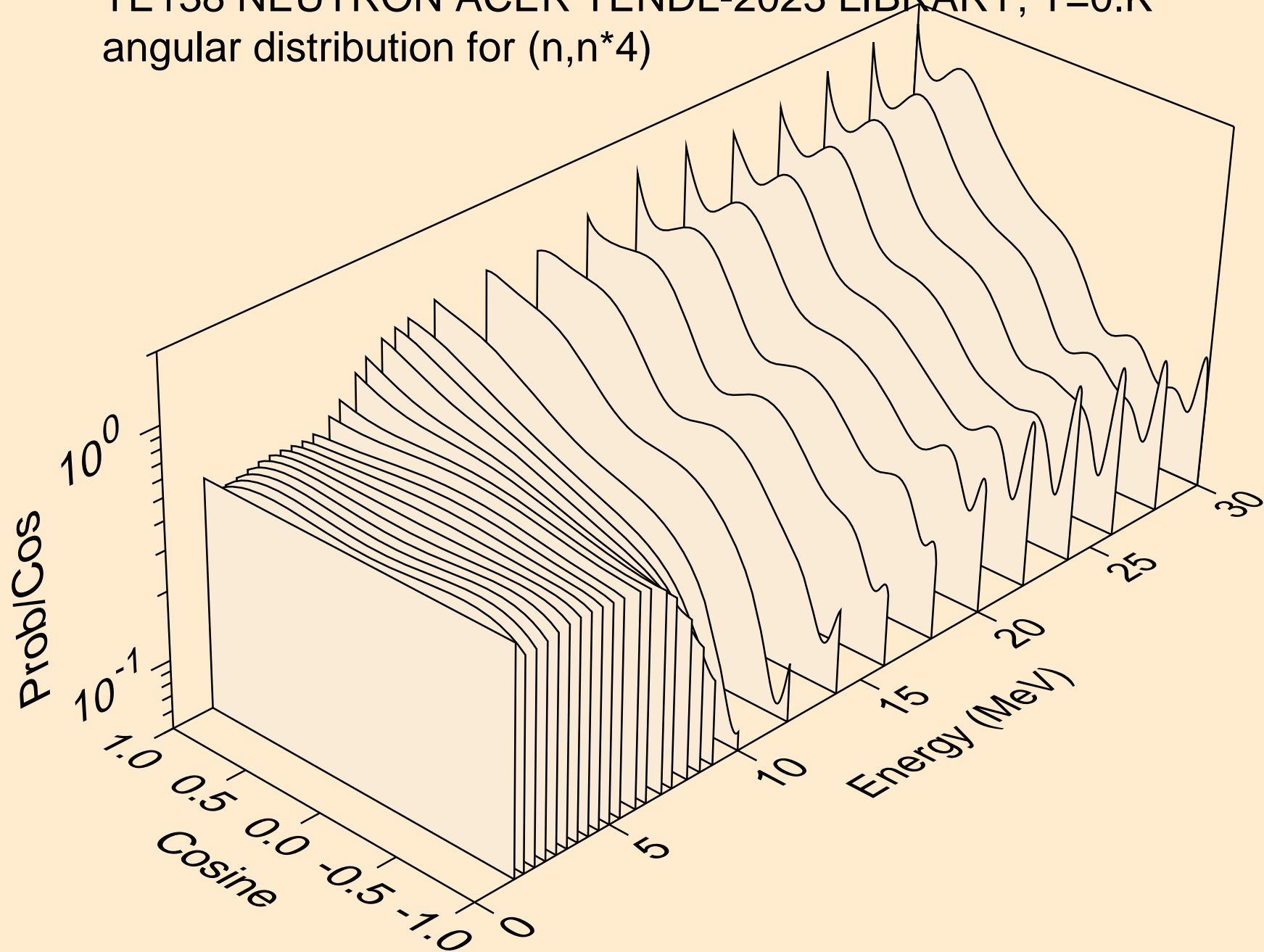



TE138 NEUTRON ACER TENDL-2023 LIBRARY; T=0.K  
angular distribution for (n,n\*5)

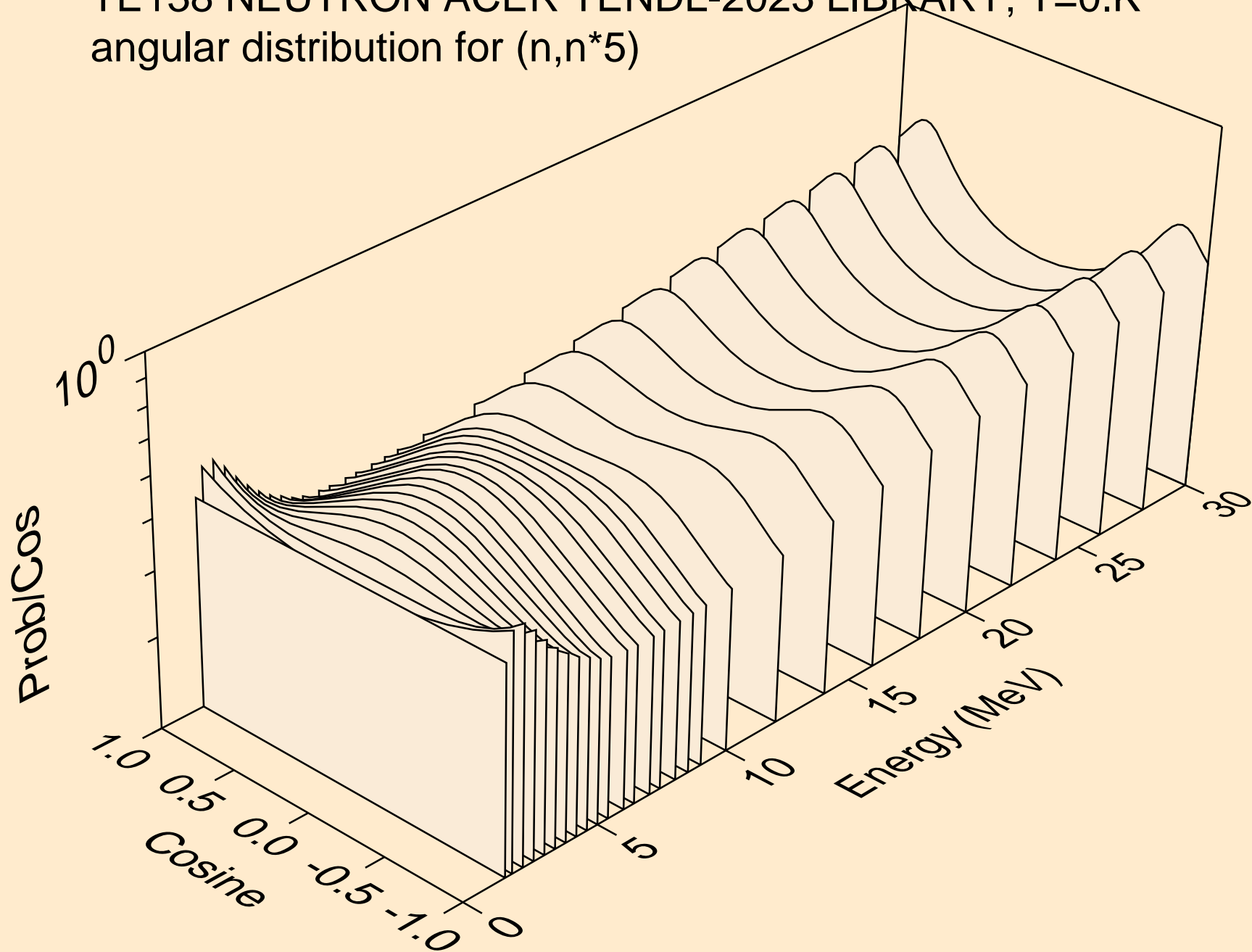

TE138 NEUTRON ACER TENDL-2023 LIBRARY; T=0.K  
angular distribution for (n,n\*6)

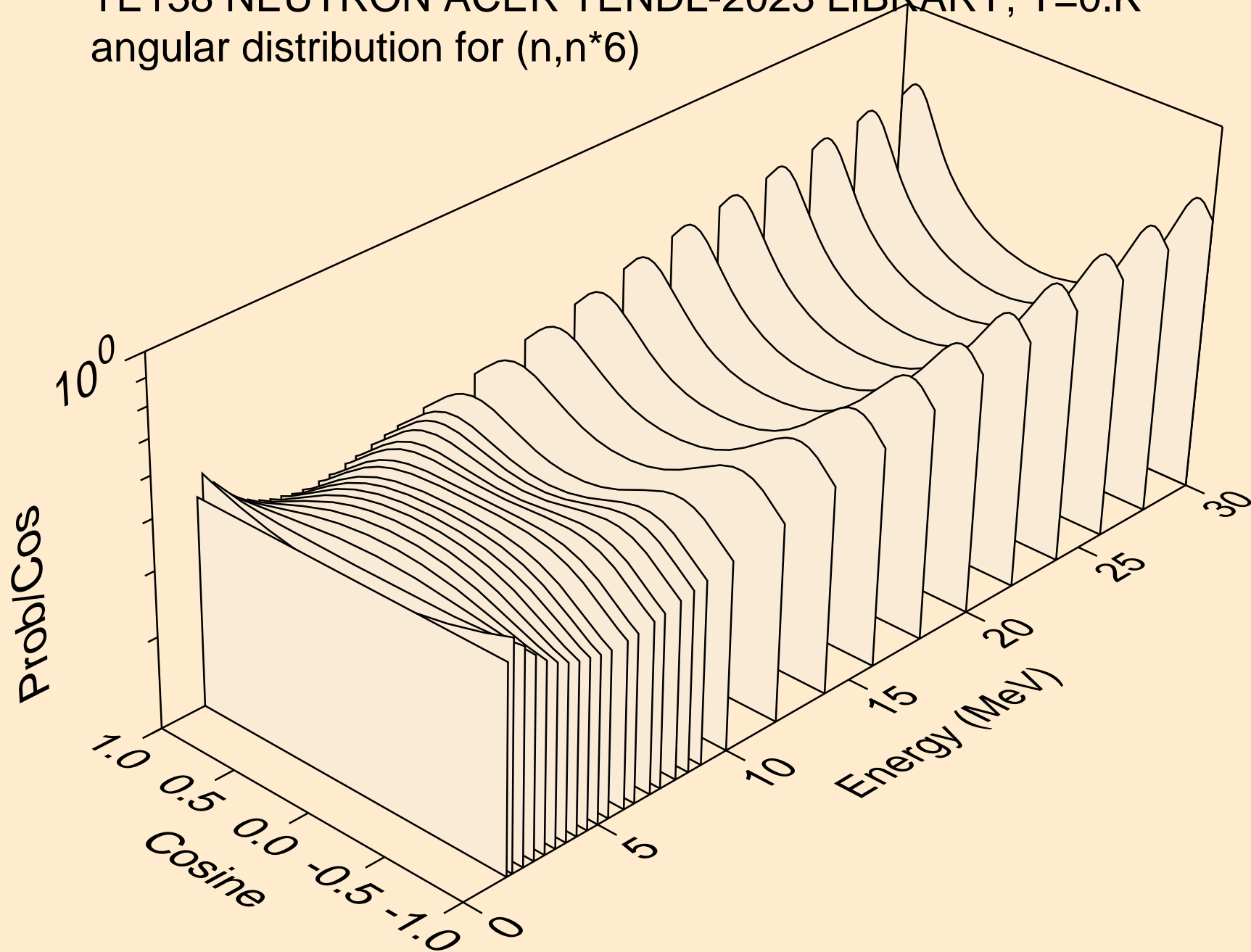

TE138 NEUTRON ACER TENDL-2023 LIBRARY; T=0.K  
angular distribution for (n,n\*7)

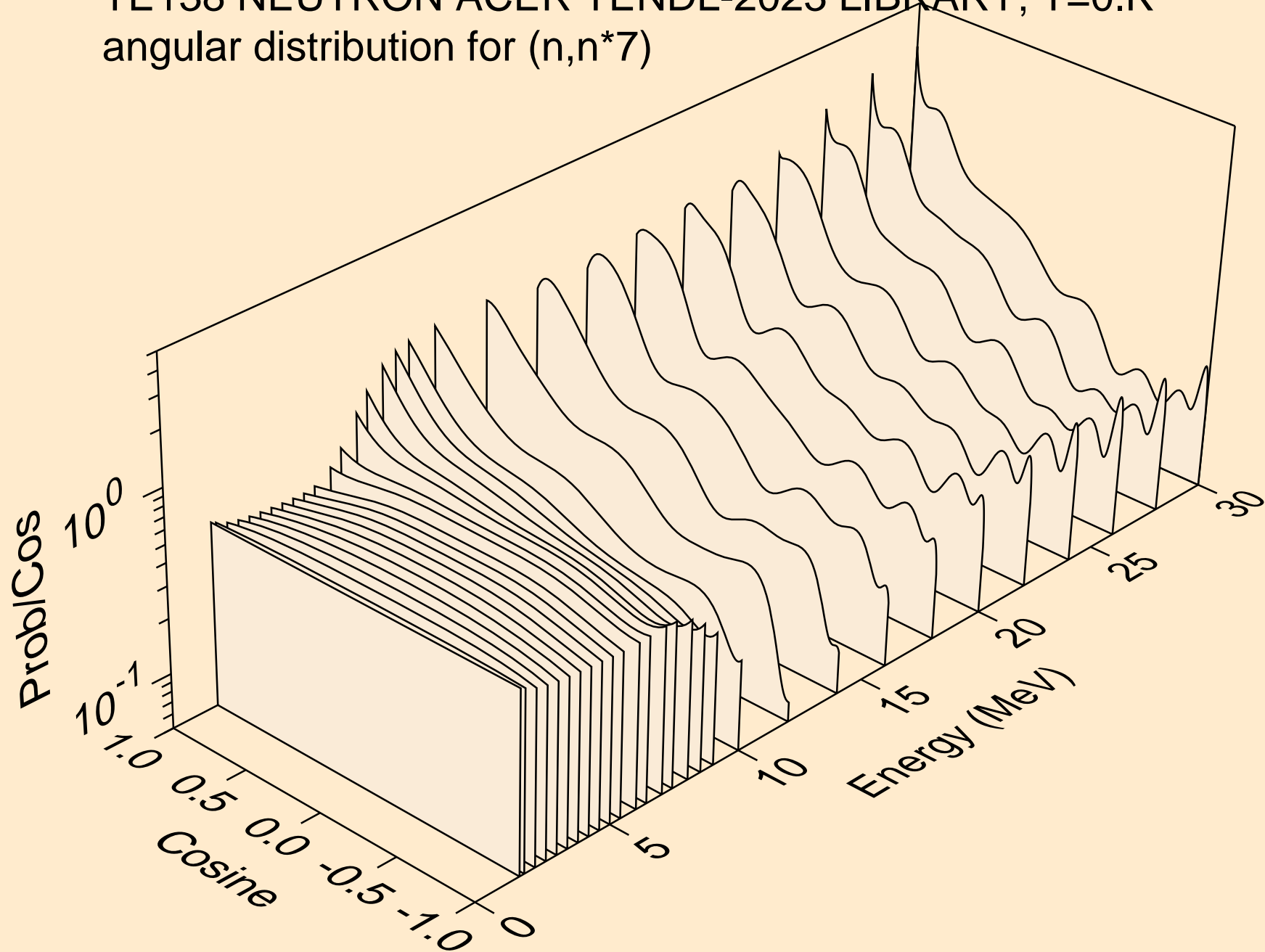

TE138 NEUTRON ACER TENDL-2023 LIBRARY; T=0.K  
angular distribution for (n,n\*8)

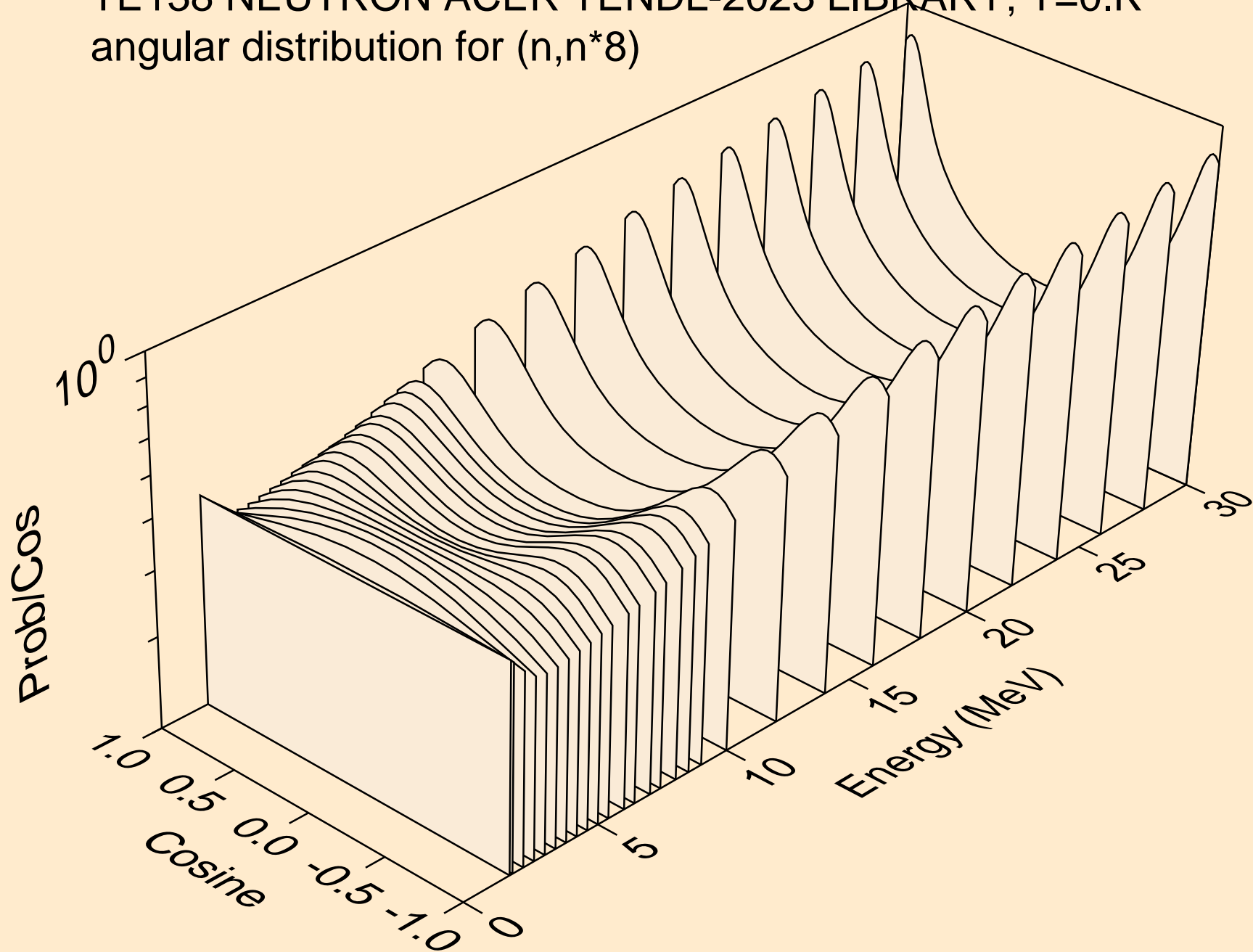

TE138 NEUTRON ACER TENDL-2023 LIBRARY; T=0.K  
angular distribution for (n,n\*9)

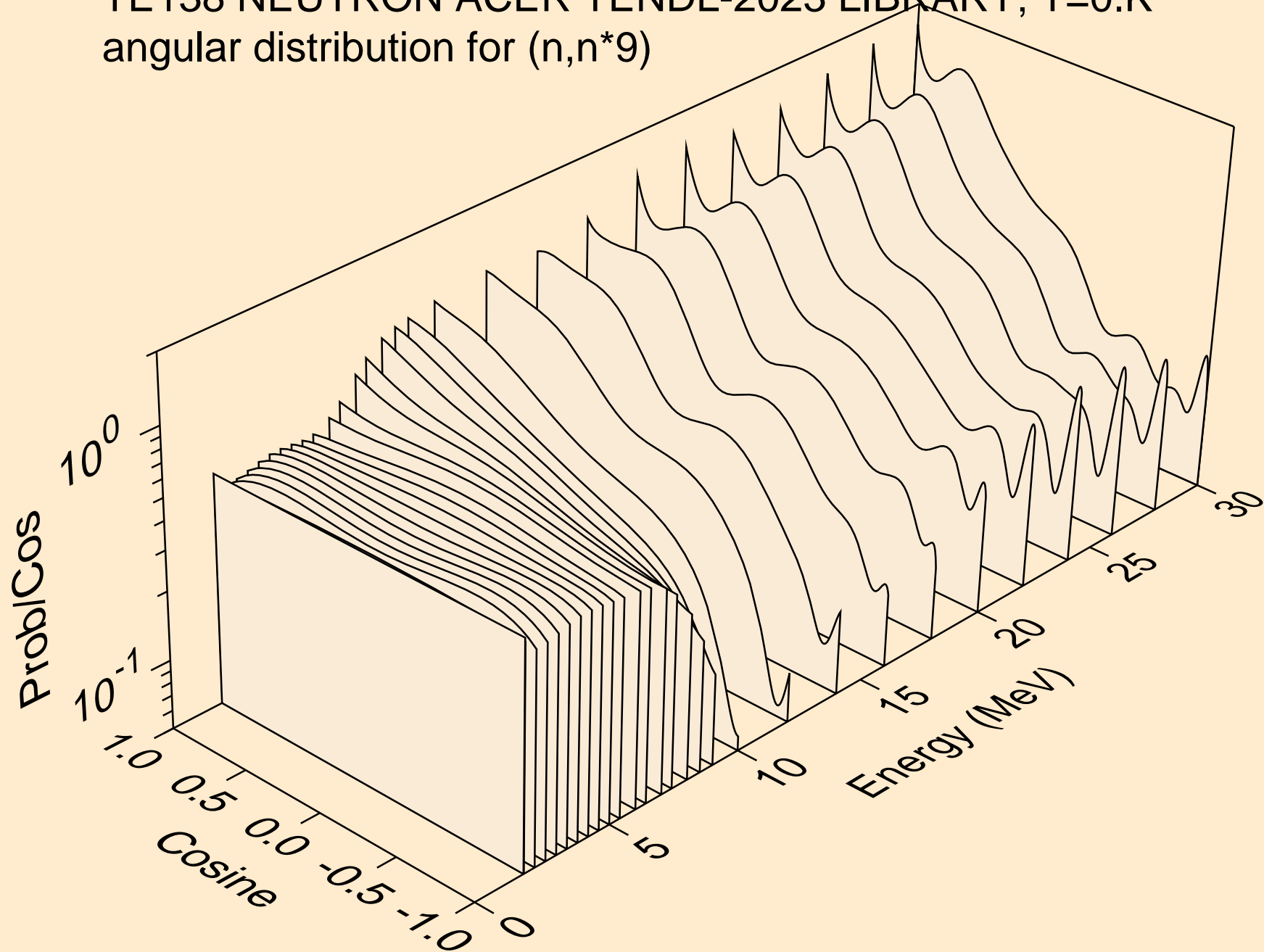

TE138 NEUTRON ACER TENDL-2023 LIBRARY; T=0.K  
angular distribution for (n,n\*10)

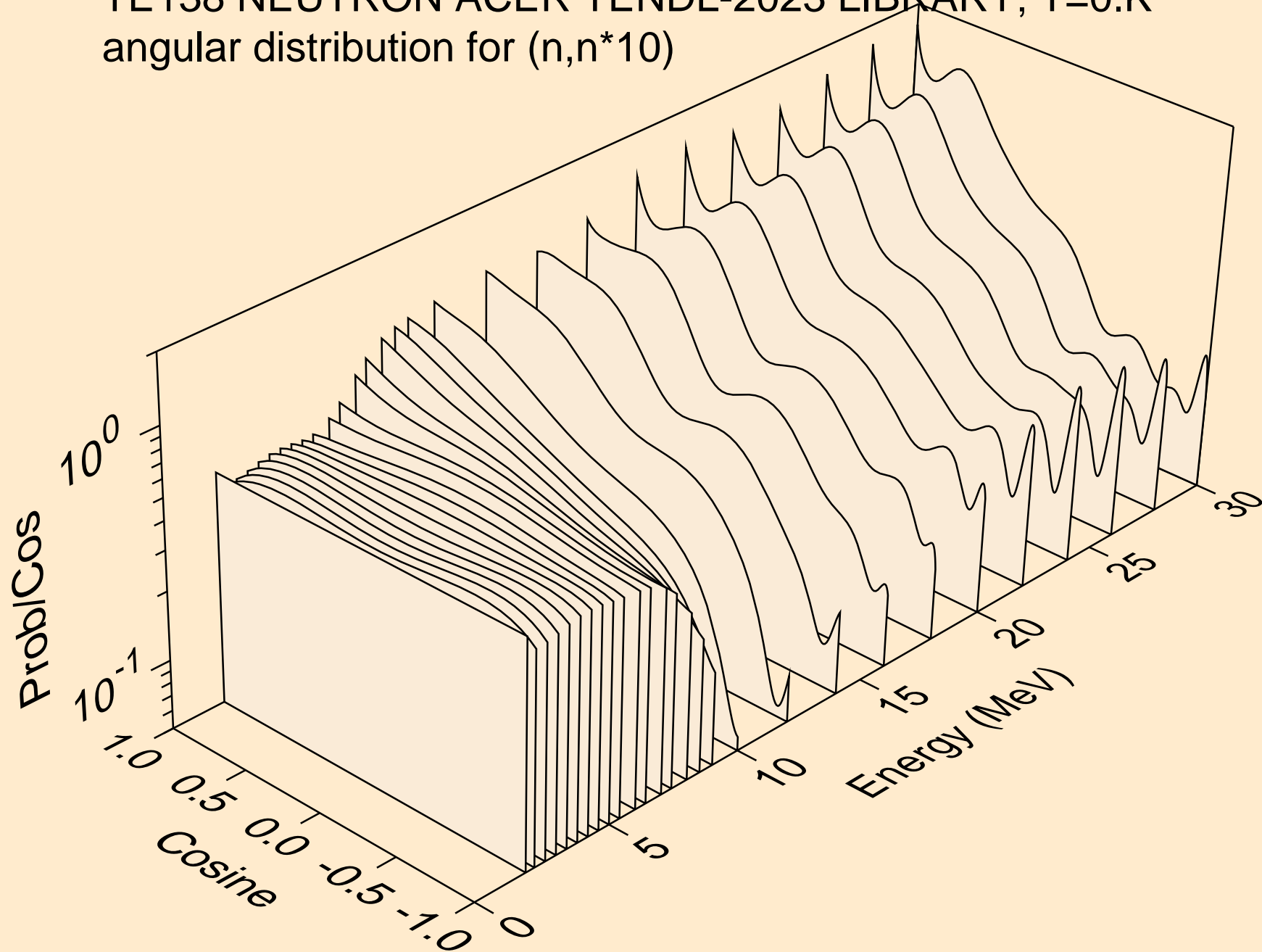

TE138 NEUTRON ACER TENDL-2023 LIBRARY; T=0.K  
angular distribution for (n,n\*11)

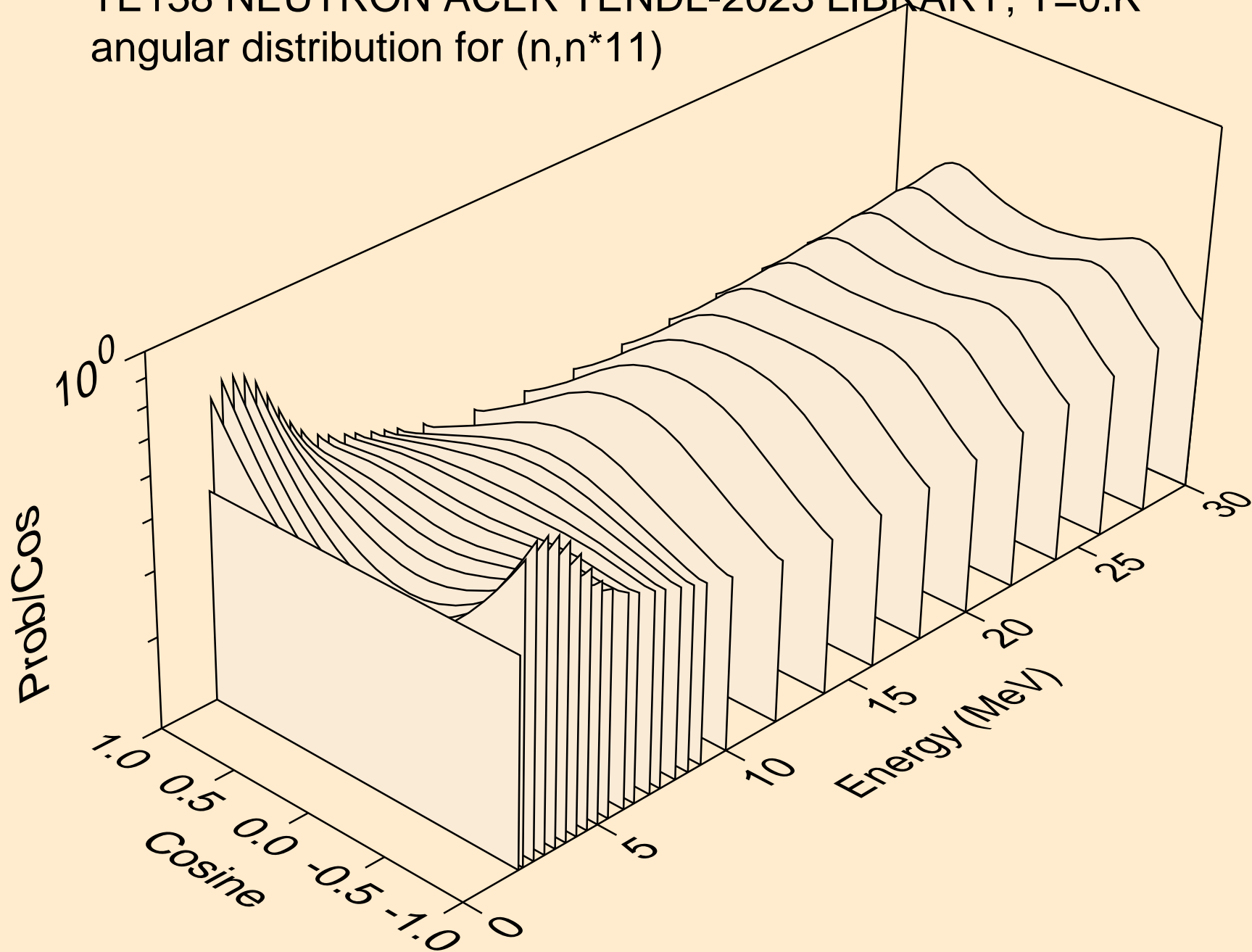

TE138 NEUTRON ACER TENDL-2023 LIBRARY; T=0.K  
angular distribution for (n,n\*12)

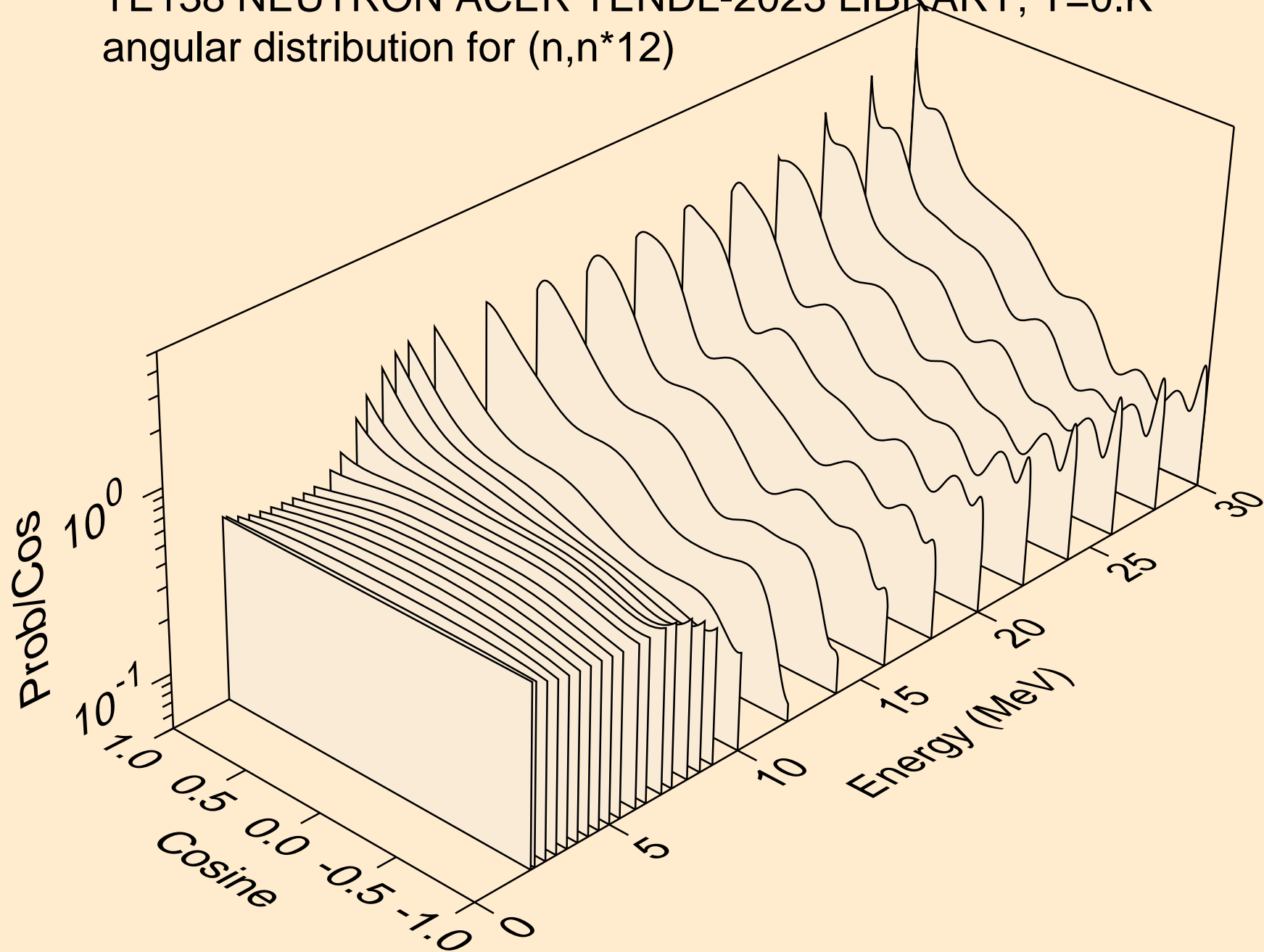



TE138 NEUTRON ACER TENDL-2023 LIBRARY; T=0.K  
angular distribution for (n,n\*13)

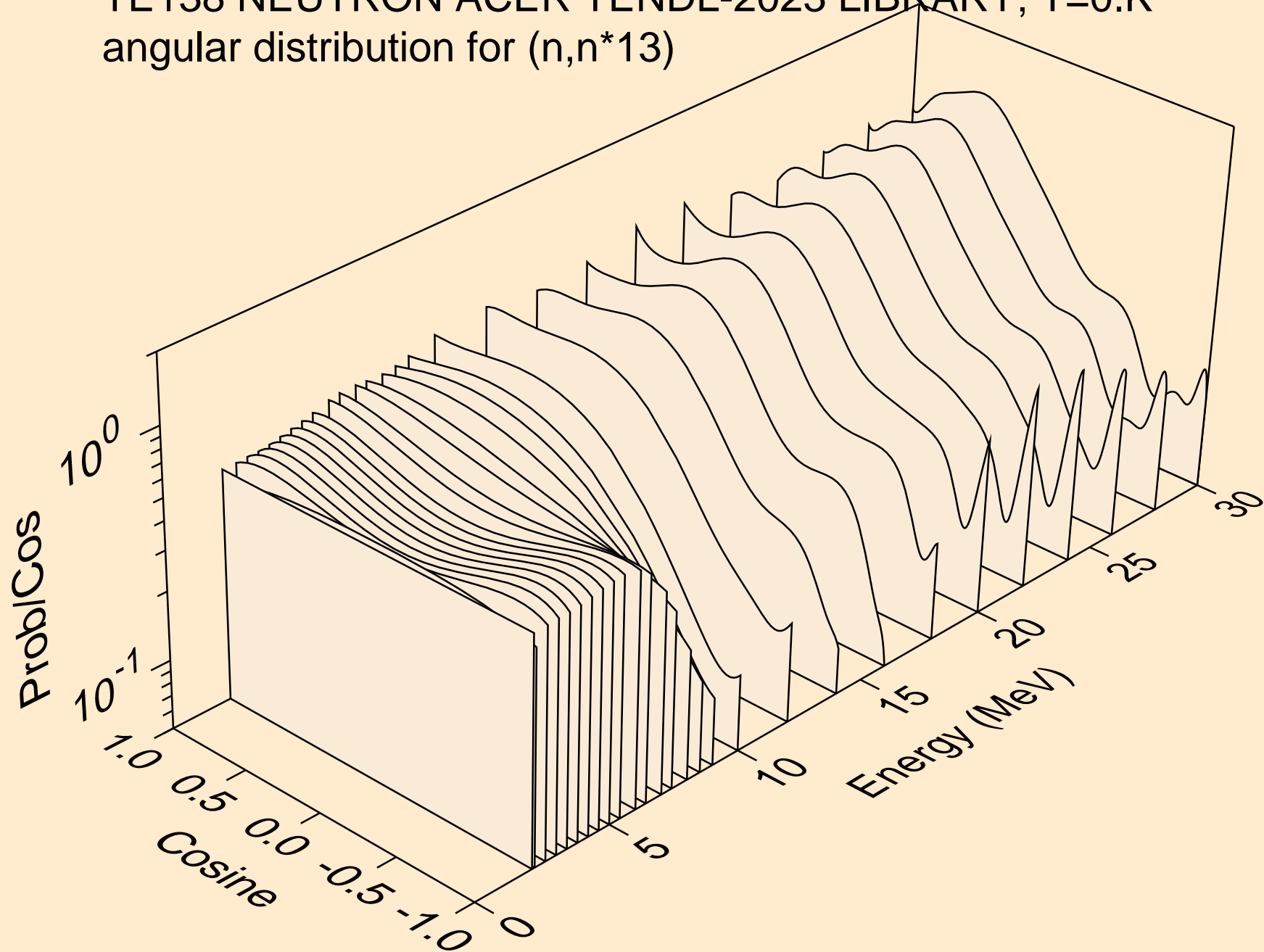

TE138 NEUTRON ACER TENDL-2023 LIBRARY; T=0.K  
angular distribution for (n,n\*14)

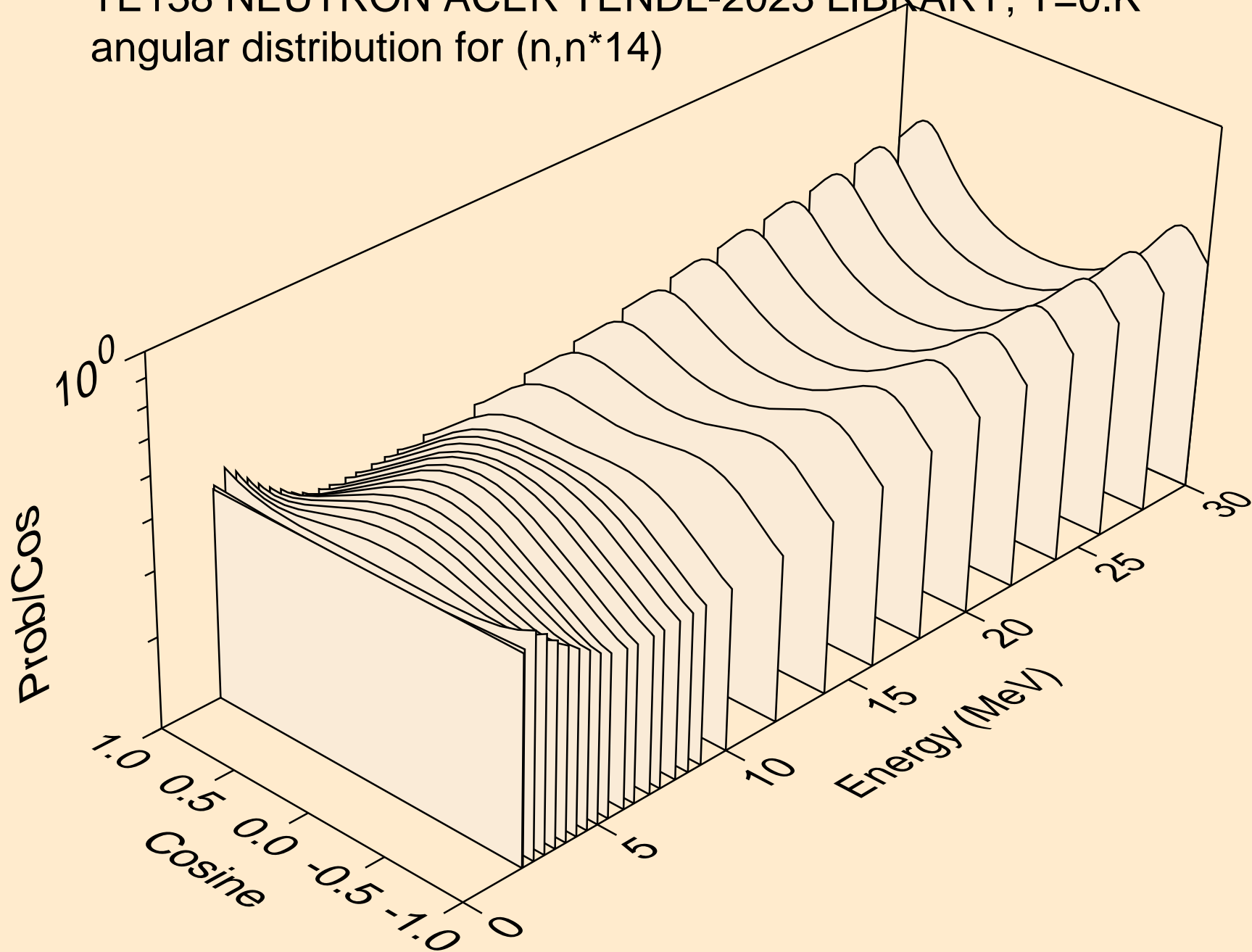

TE138 NEUTRON ACER TENDL-2023 LIBRARY; T=0.K  
angular distribution for (n,n\*15)

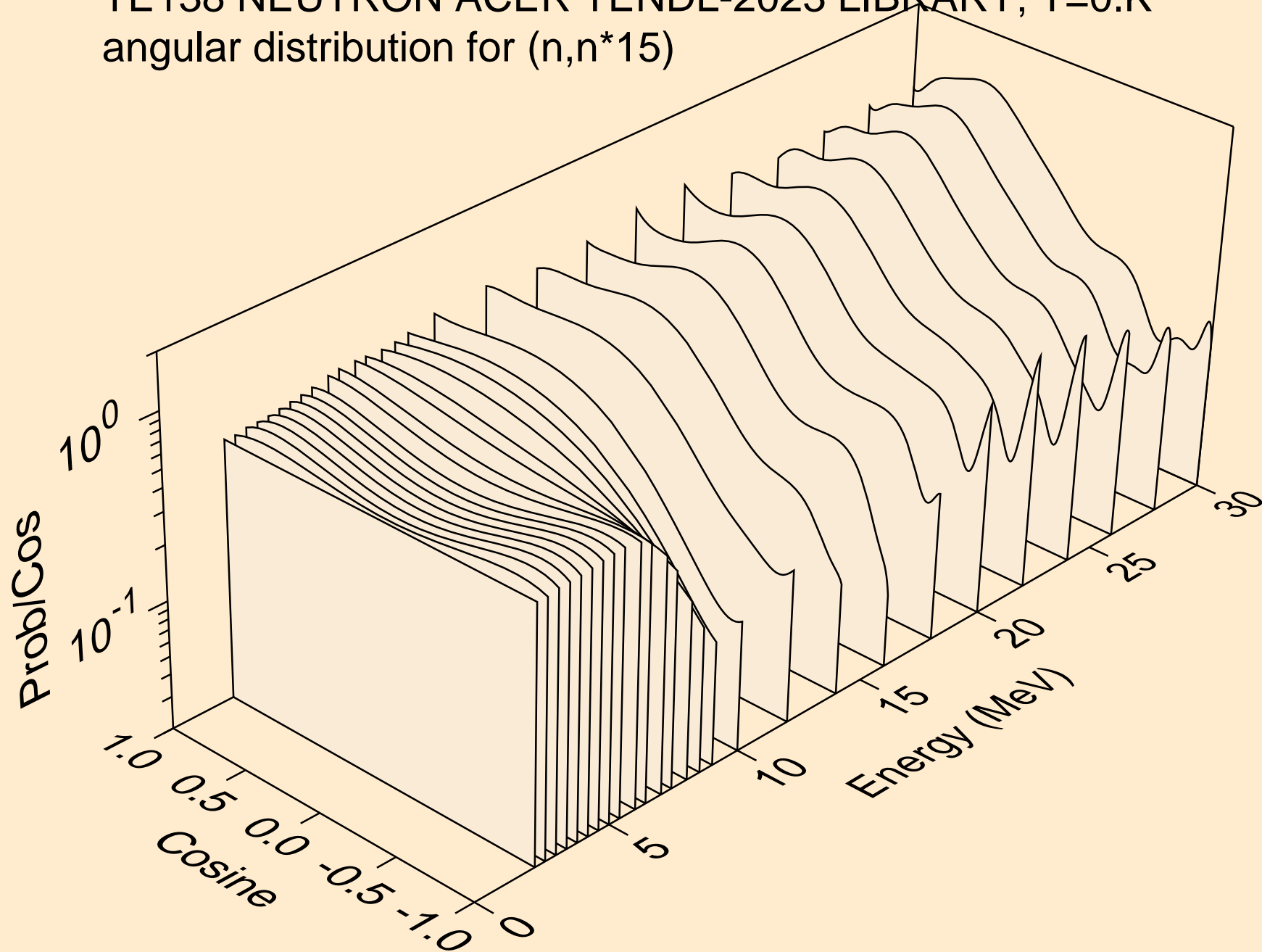

TE138 NEUTRON ACER TENDL-2023 LIBRARY; T=0.K  
angular distribution for (n,n\*16)

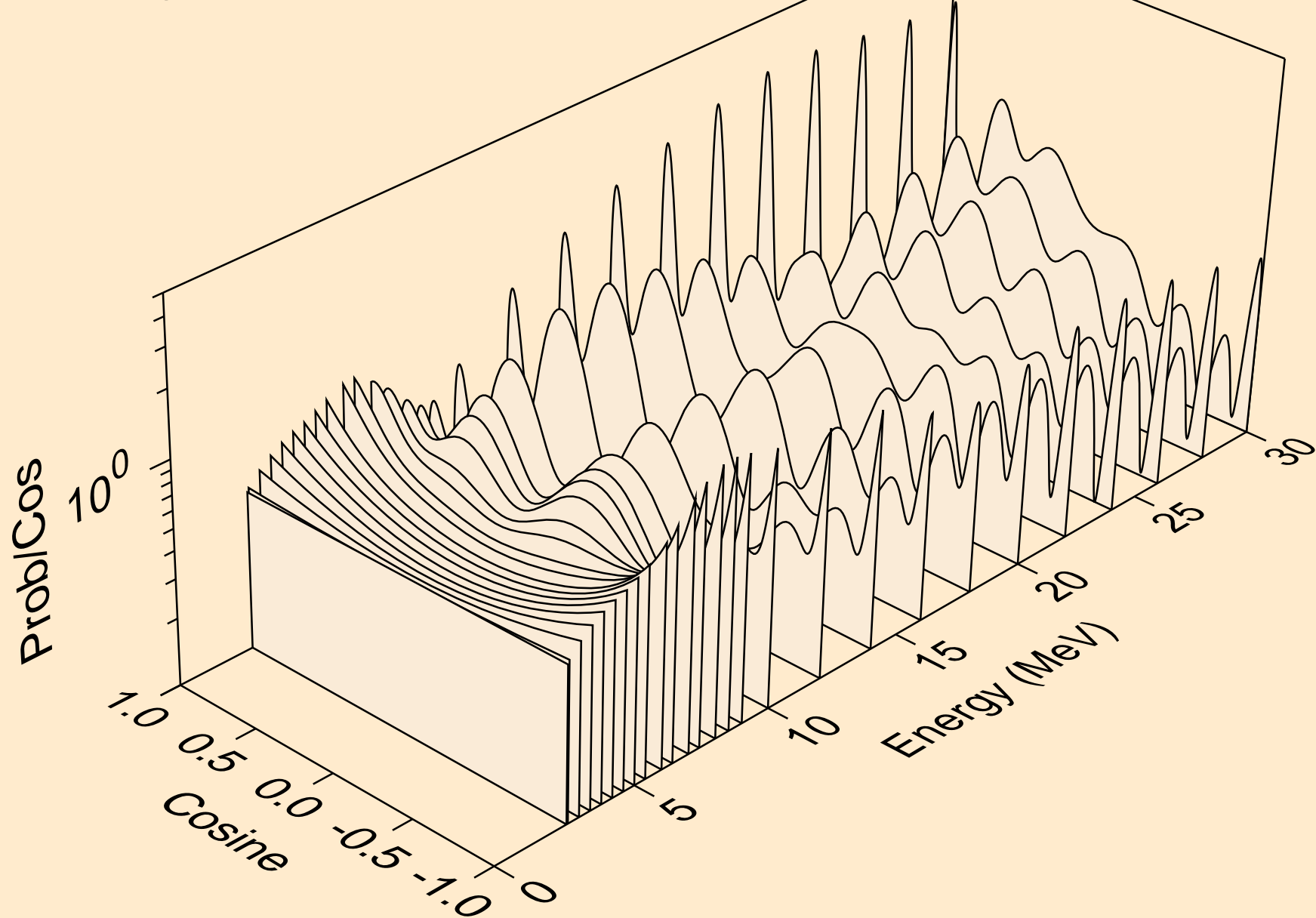

TE138 NEUTRON ACER TENDL-2023 LIBRARY; T=0.K  
angular distribution for (n,n\*17)

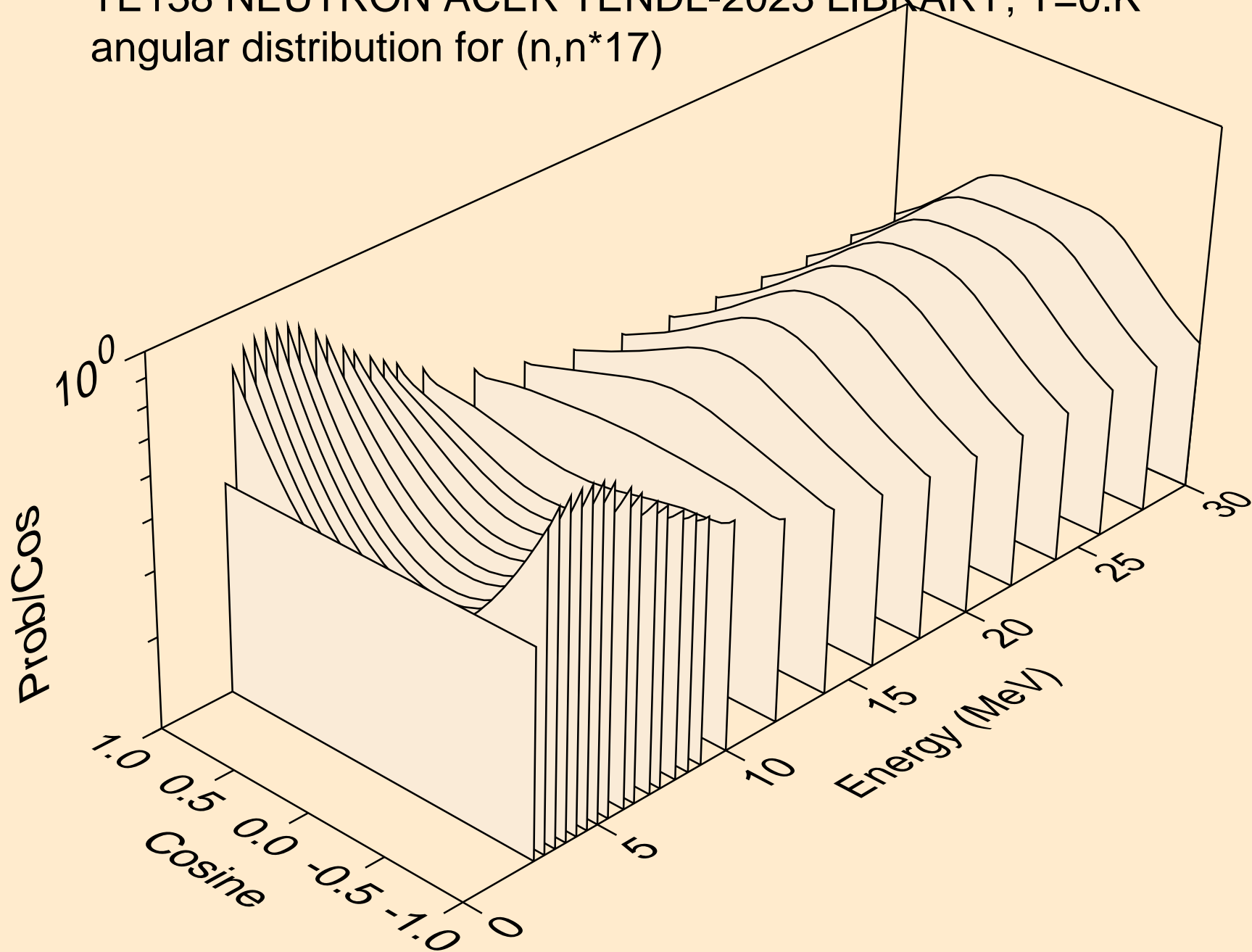

TE138 NEUTRON ACER TENDL-2023 LIBRARY; T=0.K  
angular distribution for (n,n\*18)

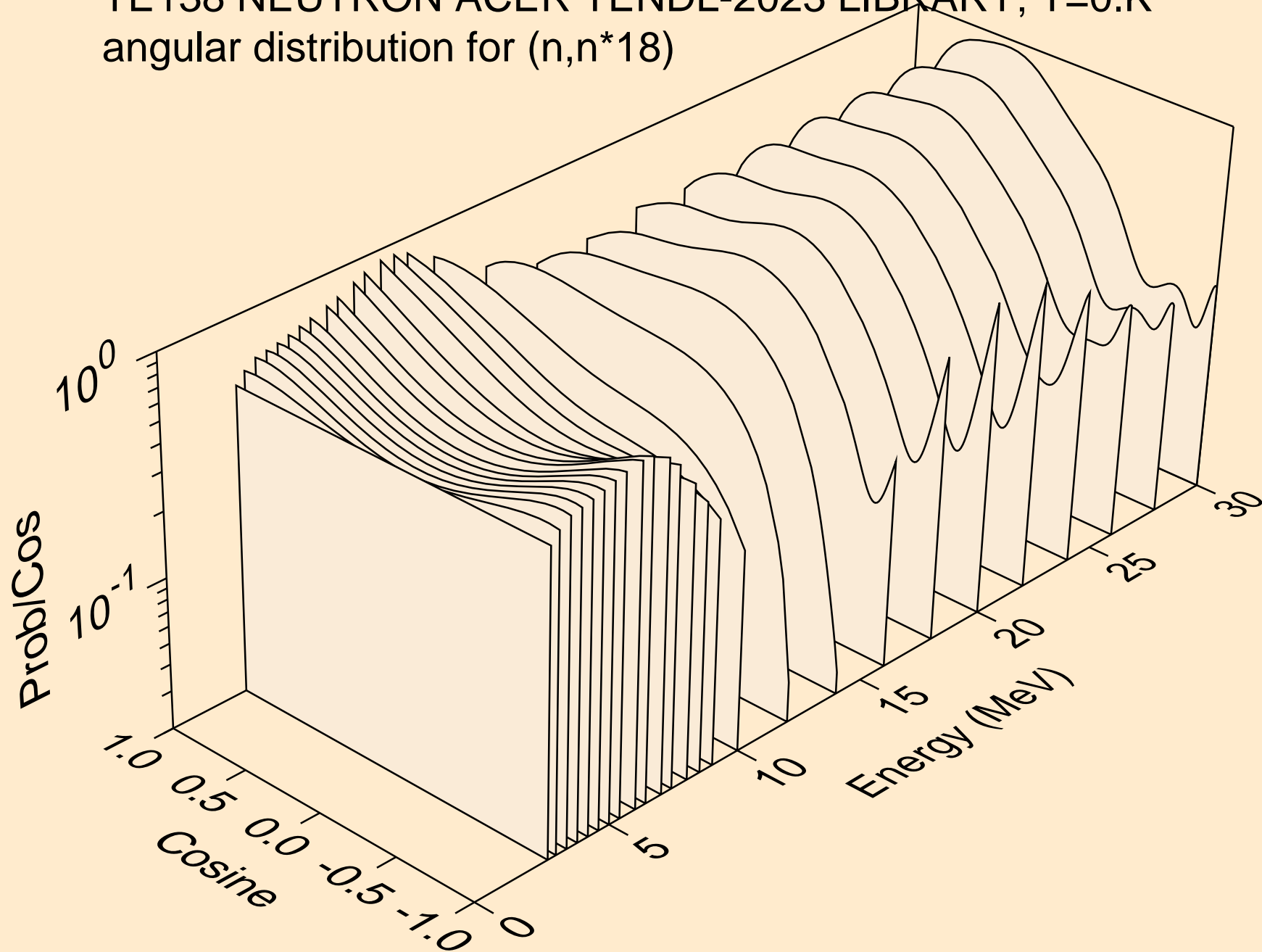

TE138 NEUTRON ACER TENDL-2023 LIBRARY; T=0.K  
angular distribution for (n,n\*19)

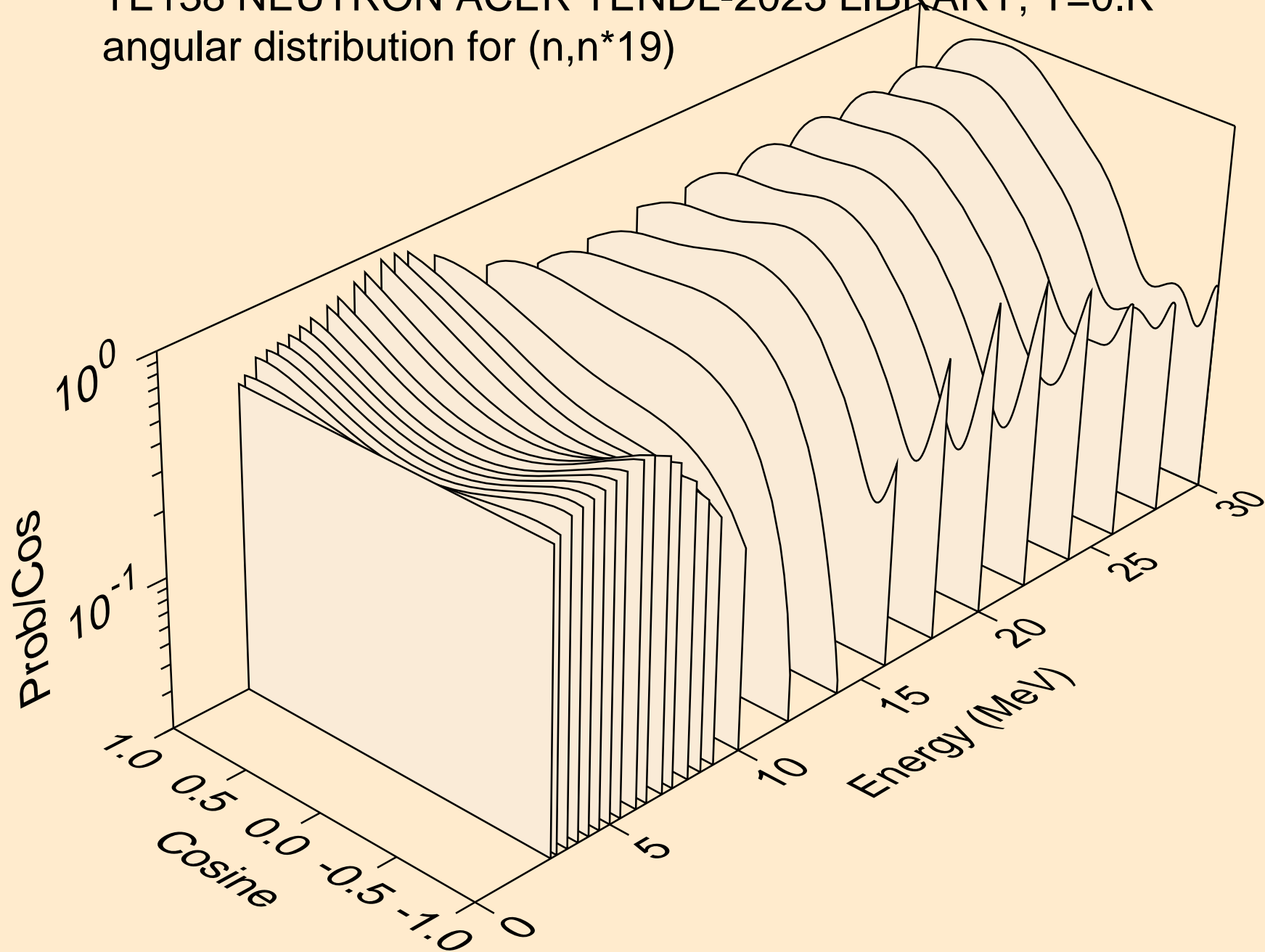

TE138 NEUTRON ACER TENDL-2023 LIBRARY; T=0.K  
angular distribution for (n,n\*20)

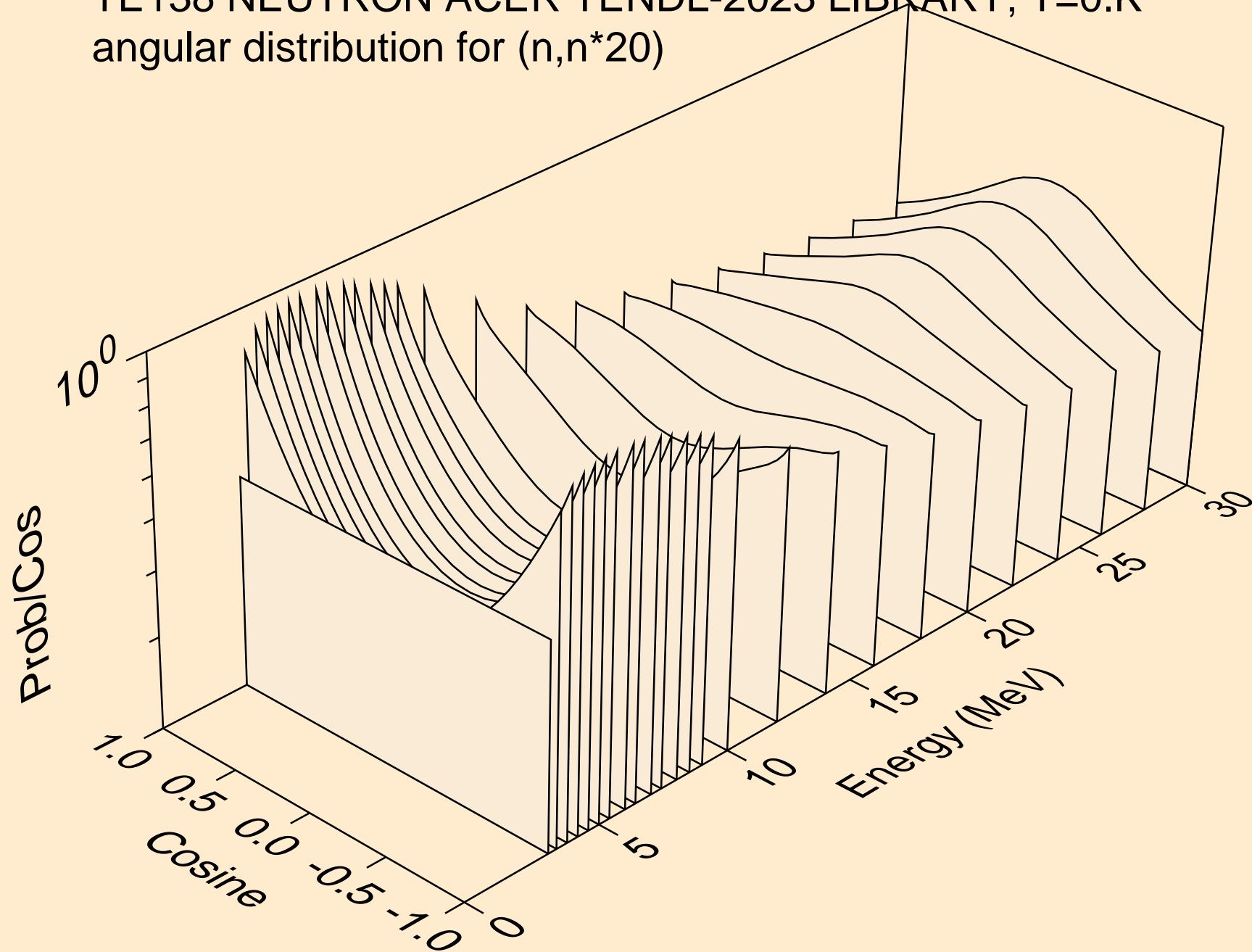



TE138 NEUTRON ACER TENDL-2023 LIBRARY; T=0.K  
angular distribution for (n,n\*21)

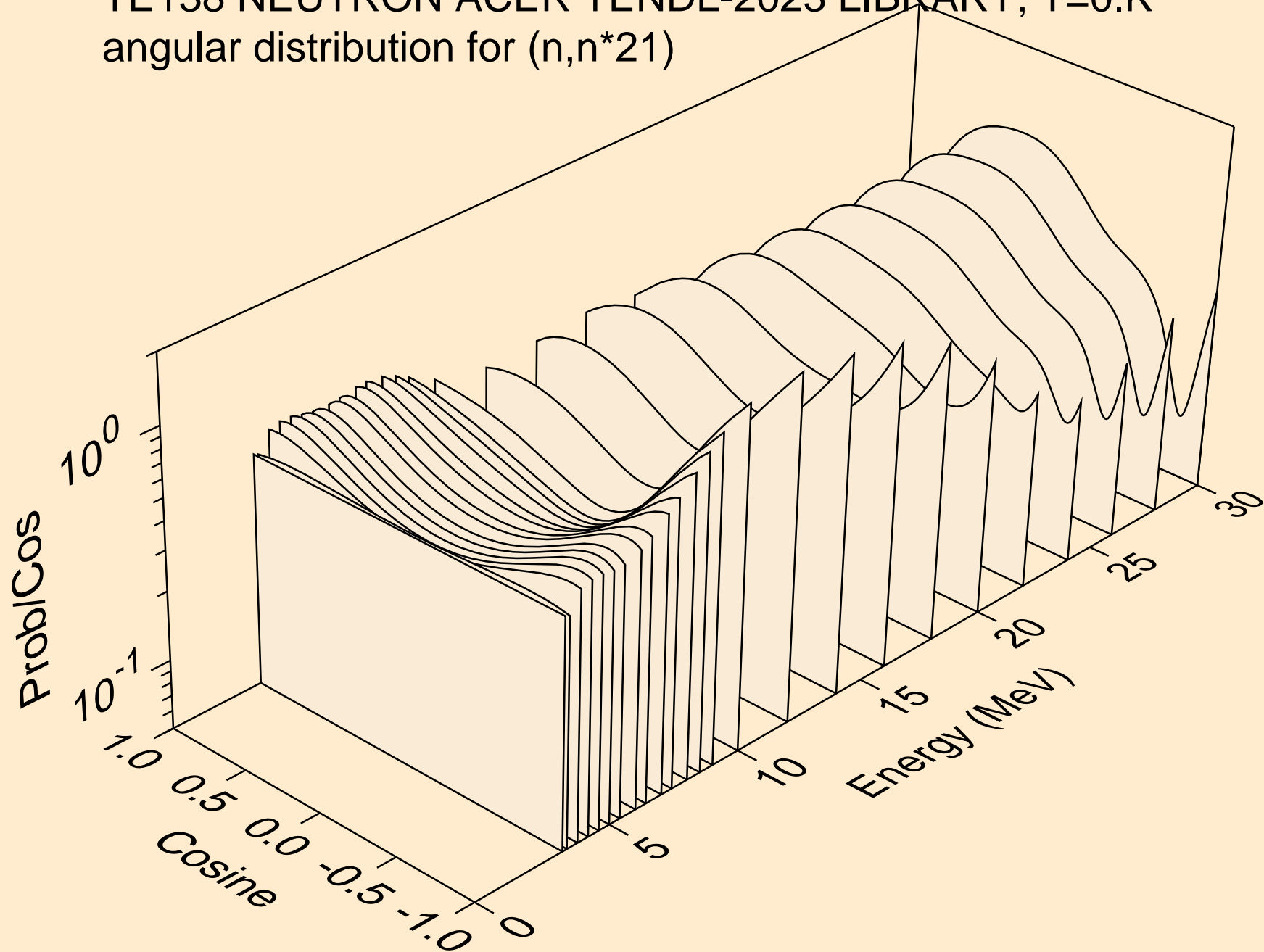

TE138 NEUTRON ACER TENDL-2023 LIBRARY; T=0.K  
angular distribution for (n,n\*22)

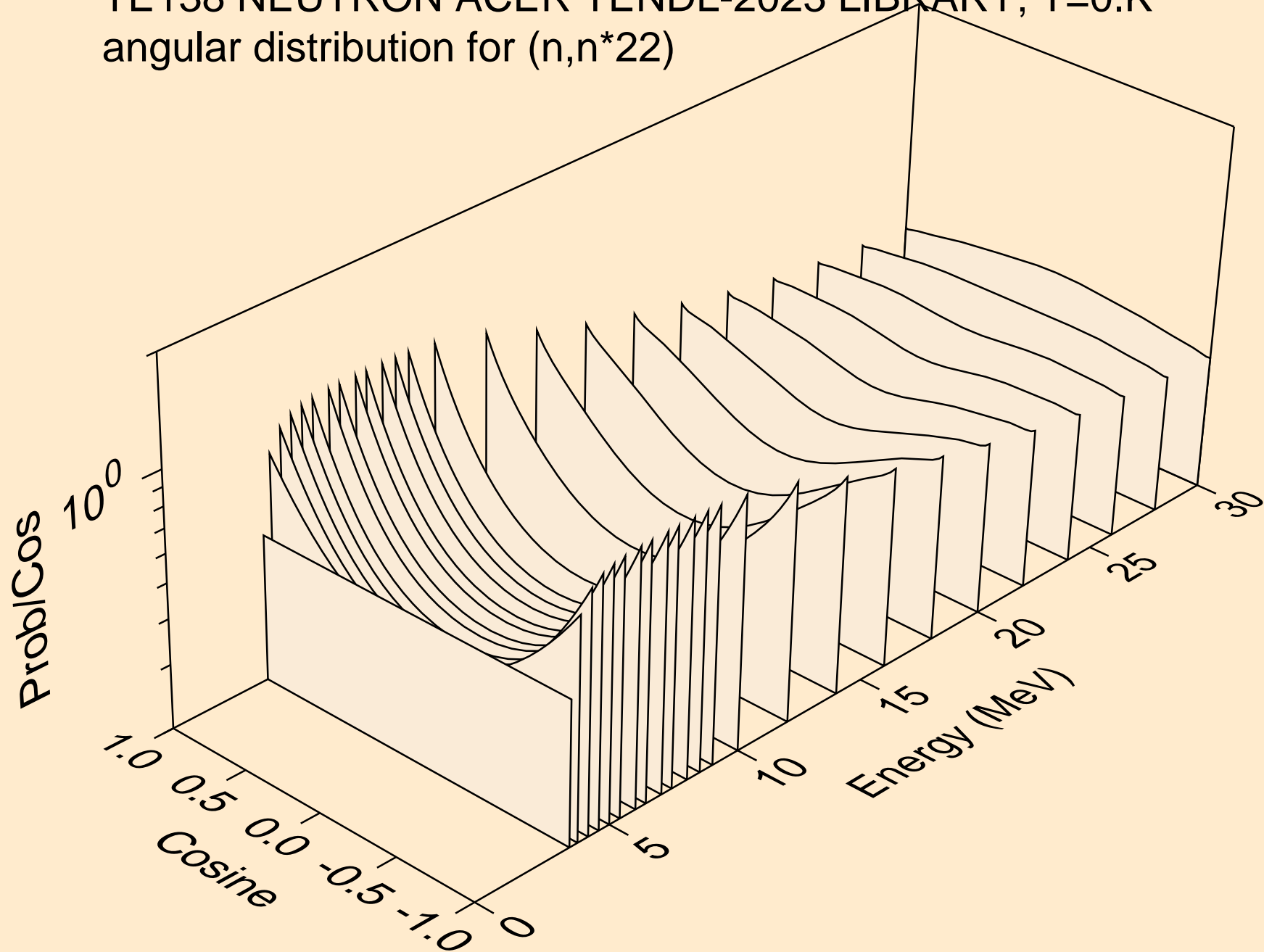

TE138 NEUTRON ACER TENDL-2023 LIBRARY; T=0.K  
angular distribution for (n,n\*23)

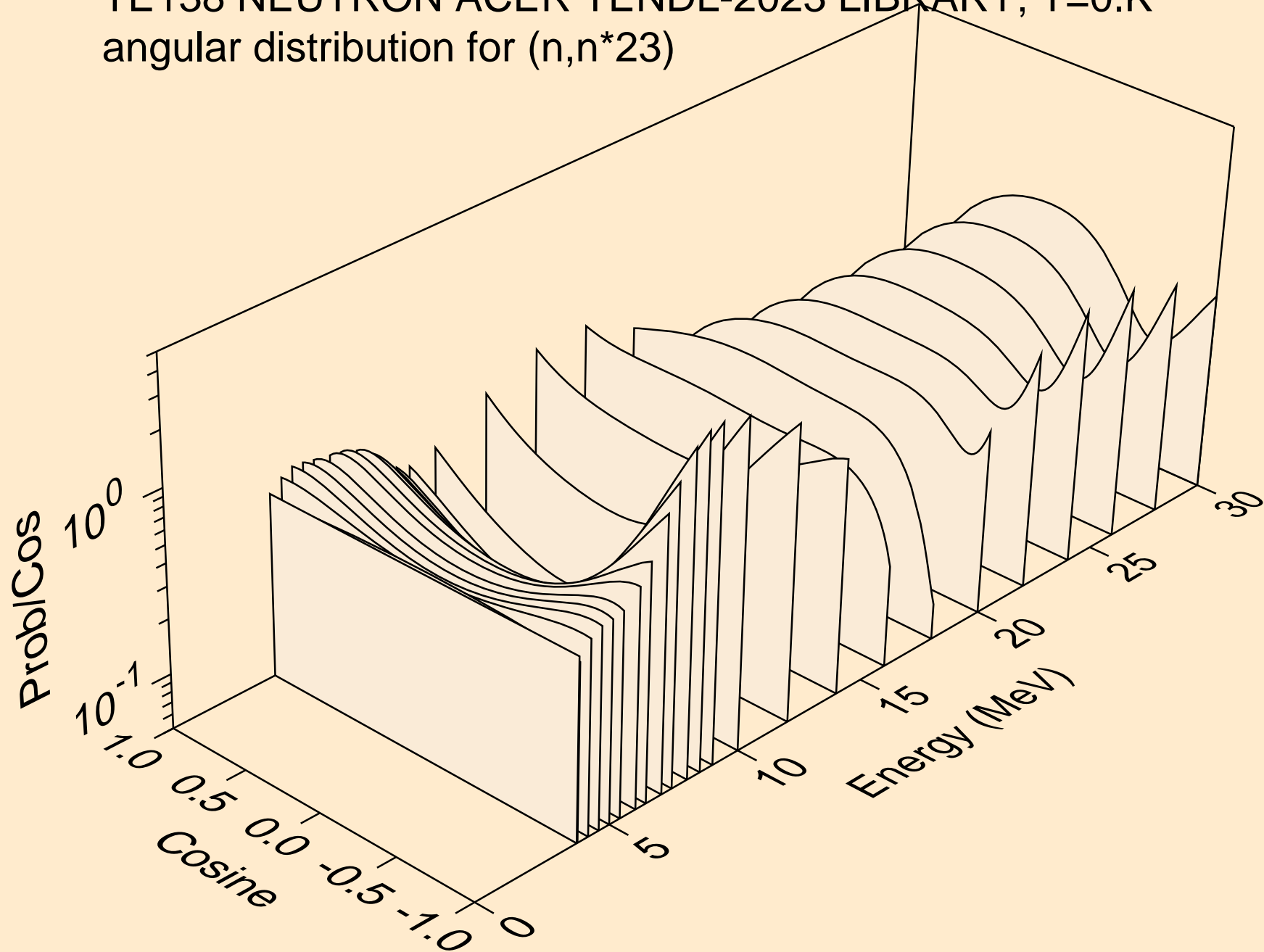

TE138 NEUTRON ACER TENDL-2023 LIBRARY; T=0.K  
angular distribution for (n,n\*24)

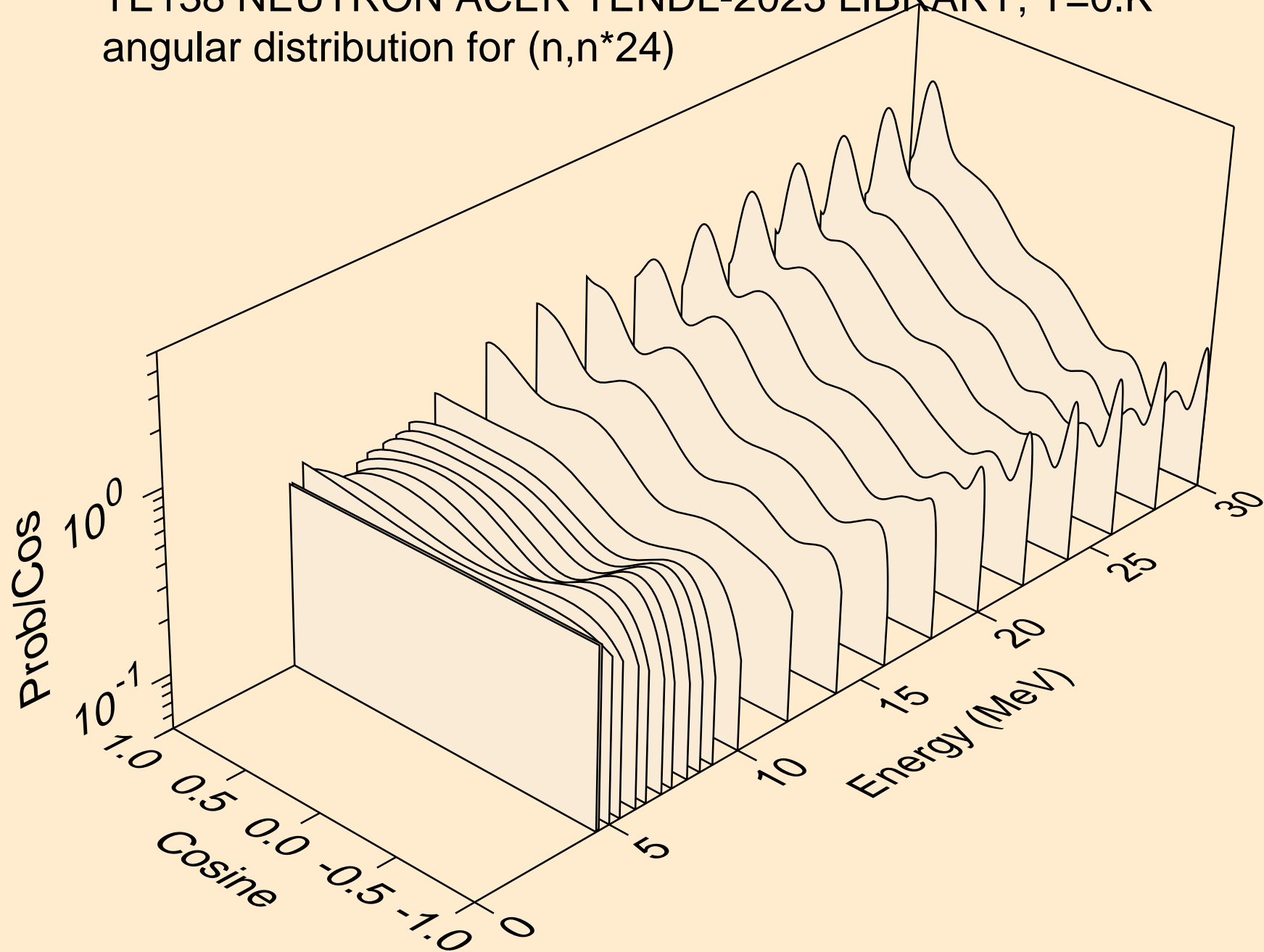

TE138 NEUTRON ACER TENDL-2023 LIBRARY; T=0.K  
Neutron emission for (n,x)

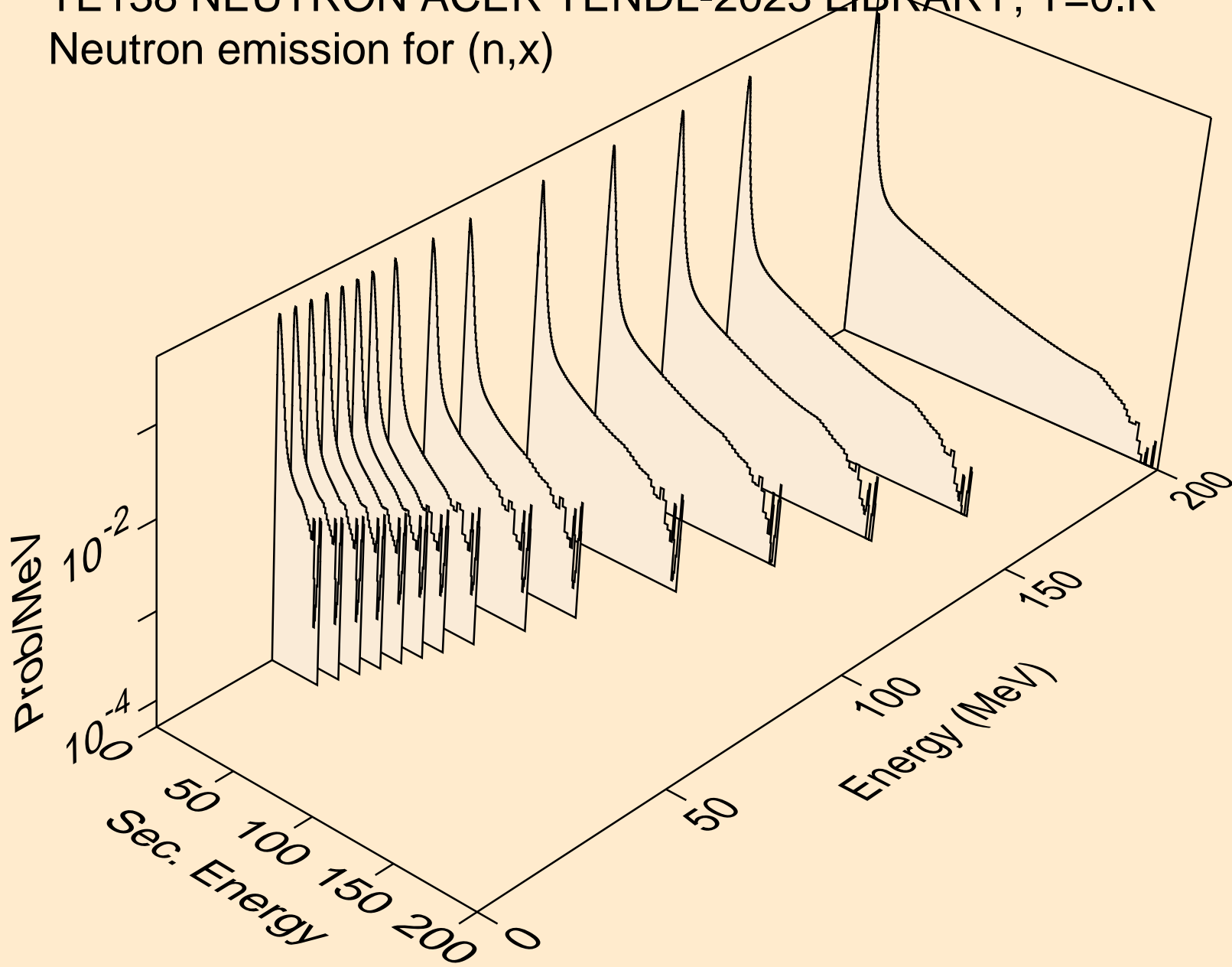

TE138 NEUTRON ACER TENDL-2023 LIBRARY; T=0.K  
Neutron emission for (n,2nd)

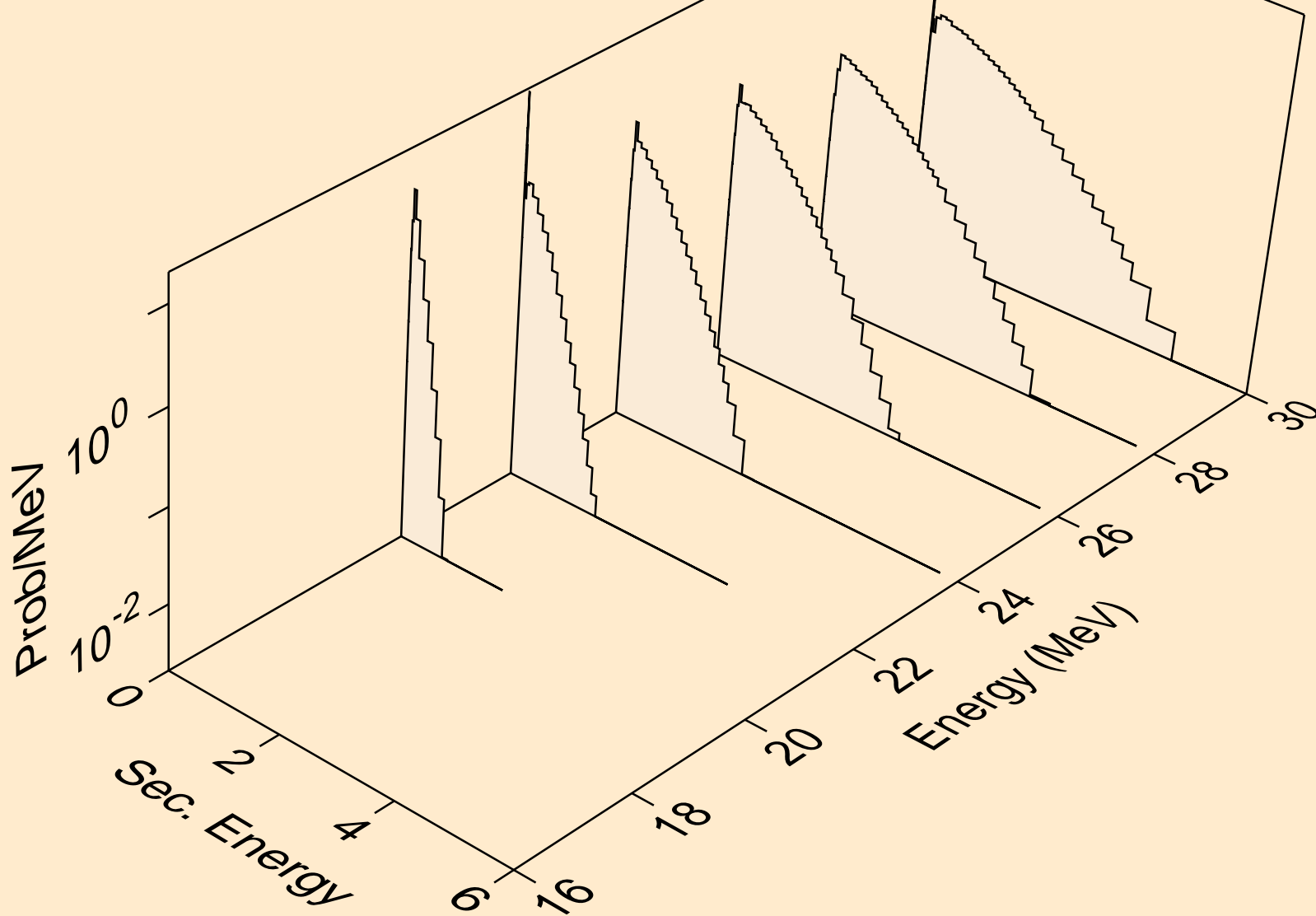

TE138 NEUTRON ACER TENDL-2023 LIBRARY; T=0.K  
Neutron emission for (n,2n)

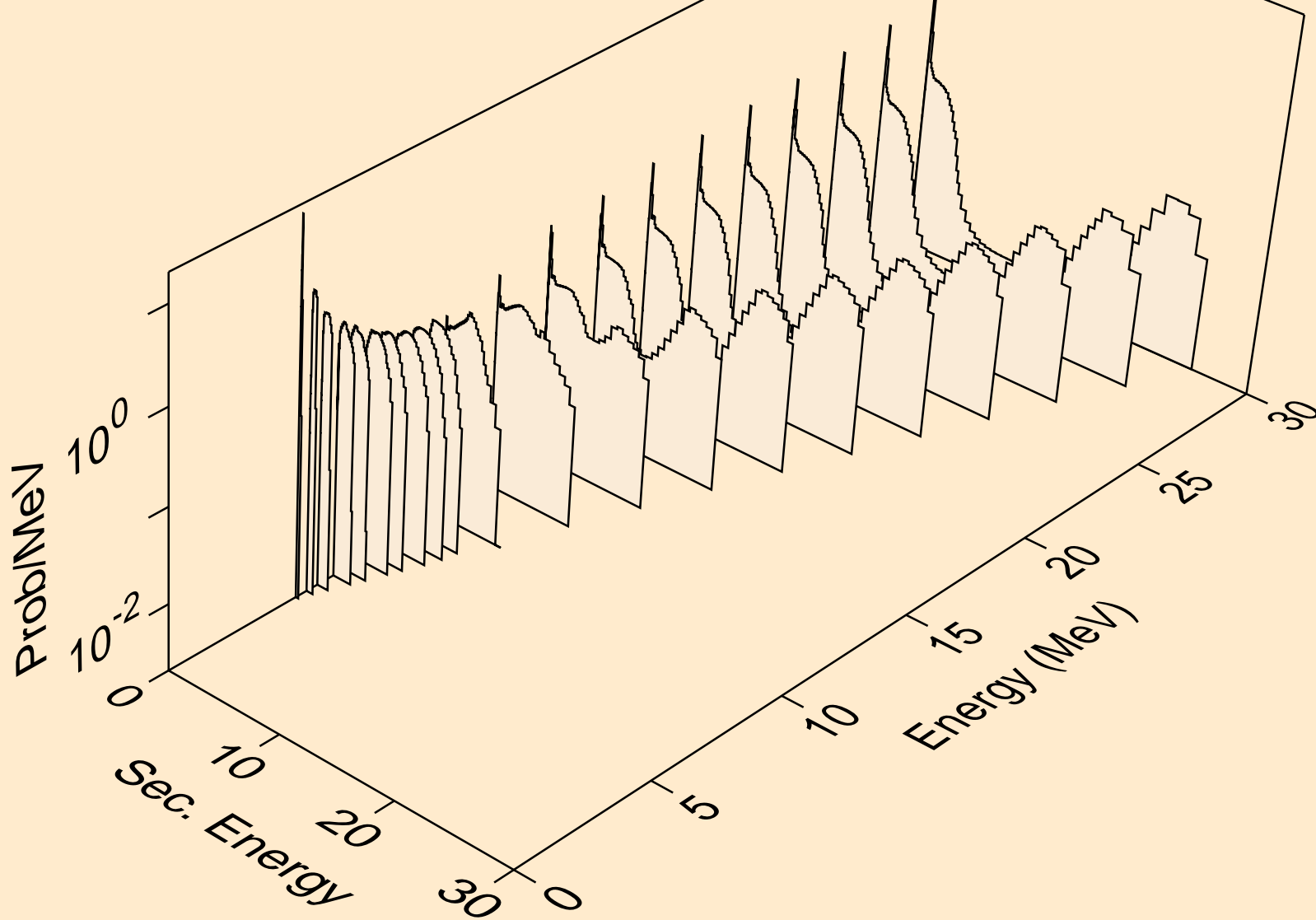

TE138 NEUTRON ACER TENDL-2023 LIBRARY; T=0.K  
Neutron emission for (n,3n)

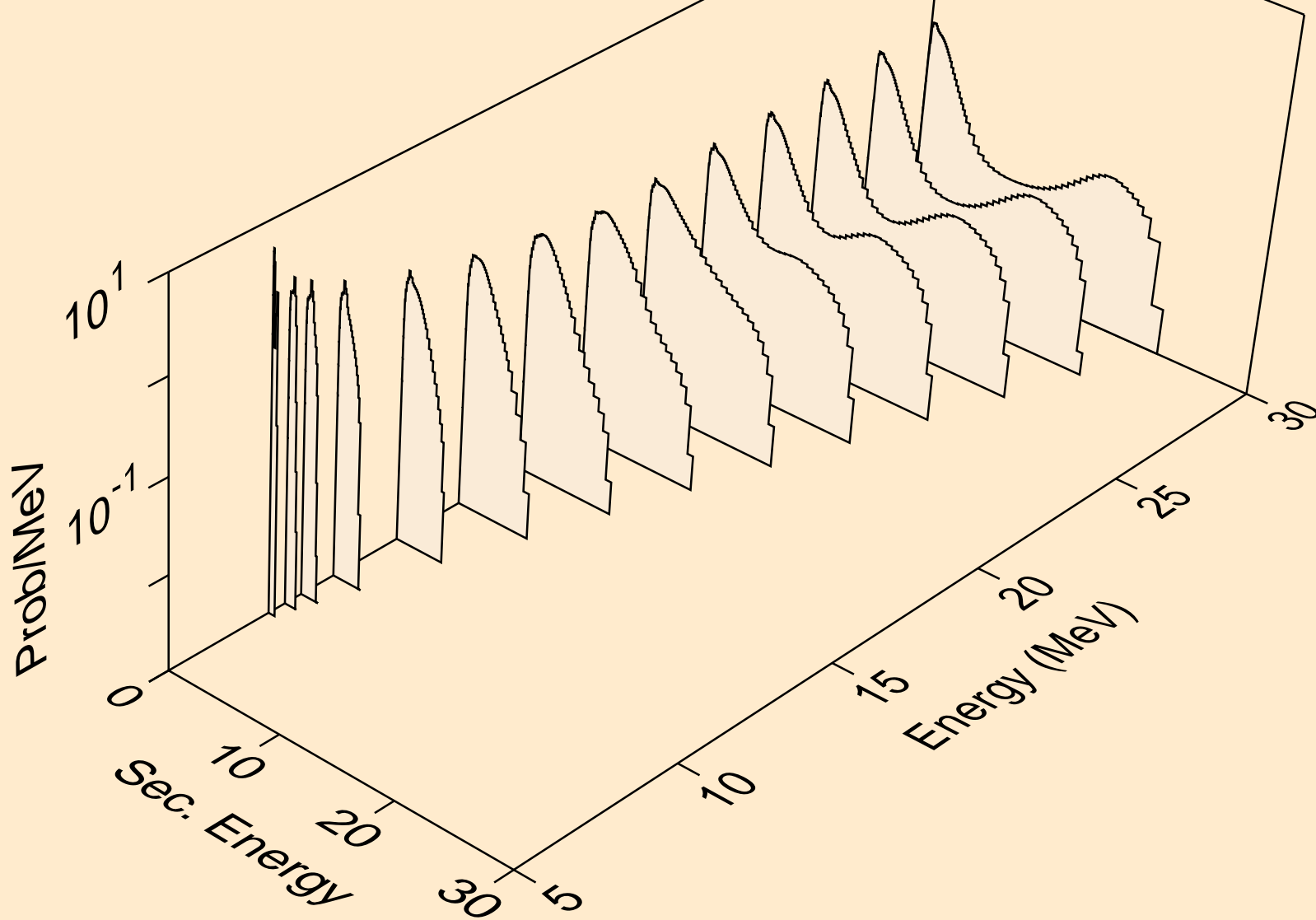



TE138 NEUTRON ACER TENDL-2023 LIBRARY; T=0.K  
Neutron emission for (n,n\*)a

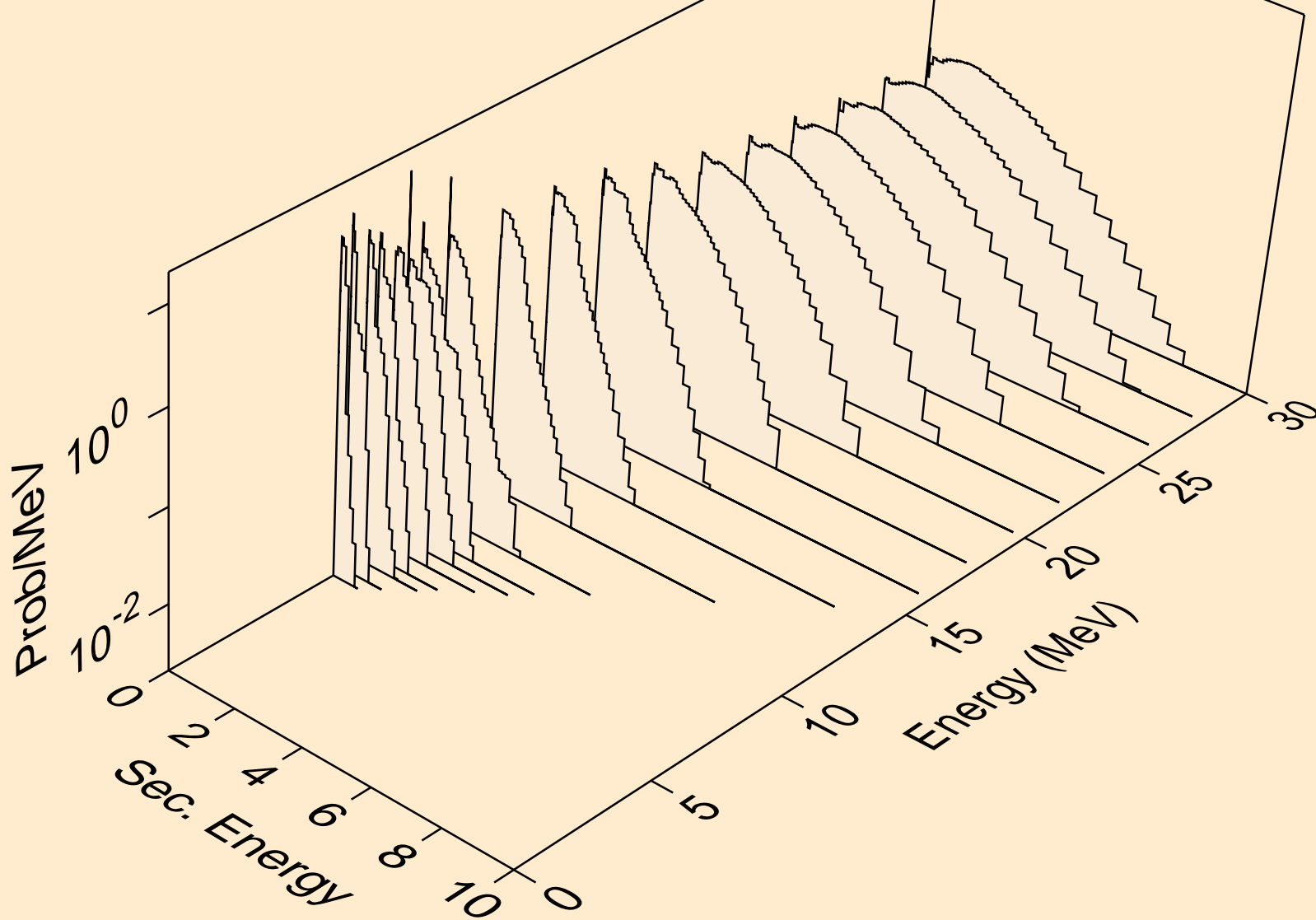

TE138 NEUTRON ACER TENDL-2023 LIBRARY; T=0.K  
Neutron emission for (n,2n)a

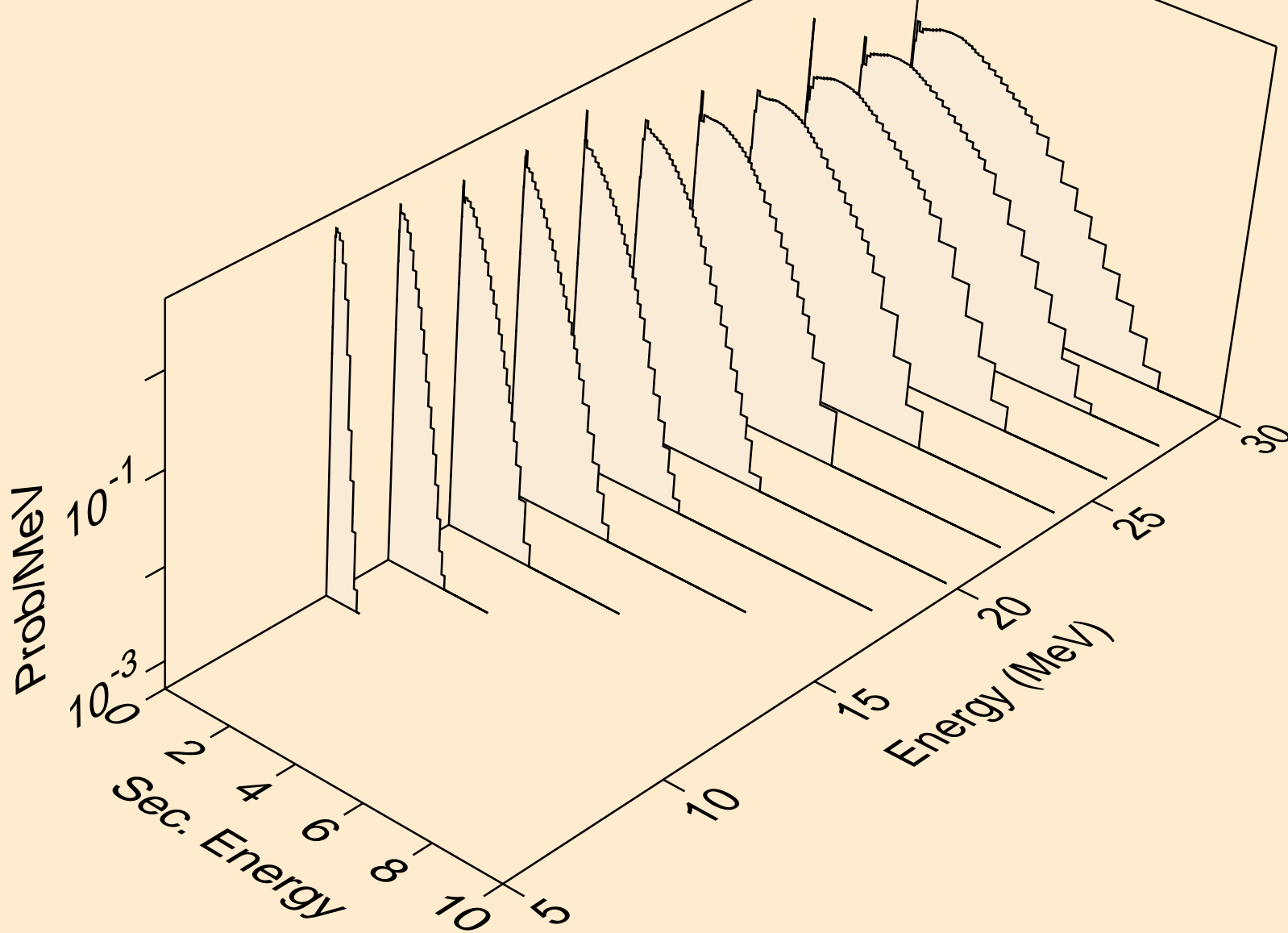

TE138 NEUTRON ACER TENDL-2023 LIBRARY; T=0.K  
Neutron emission for (n,3n)a

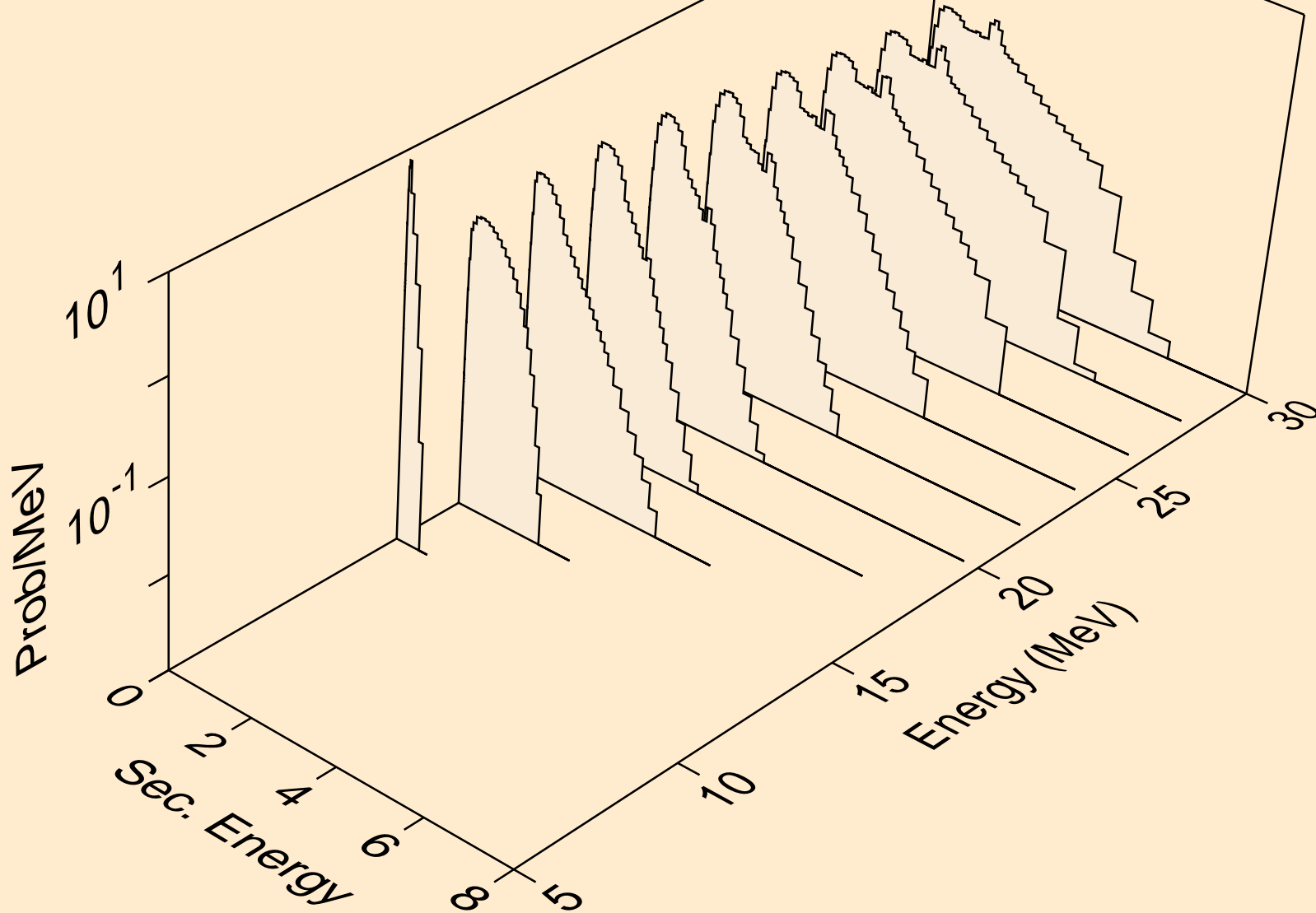

TE138 NEUTRON ACER TENDL-2023 LIBRARY; T=0.K  
Neutron emission for (n,n\*)p

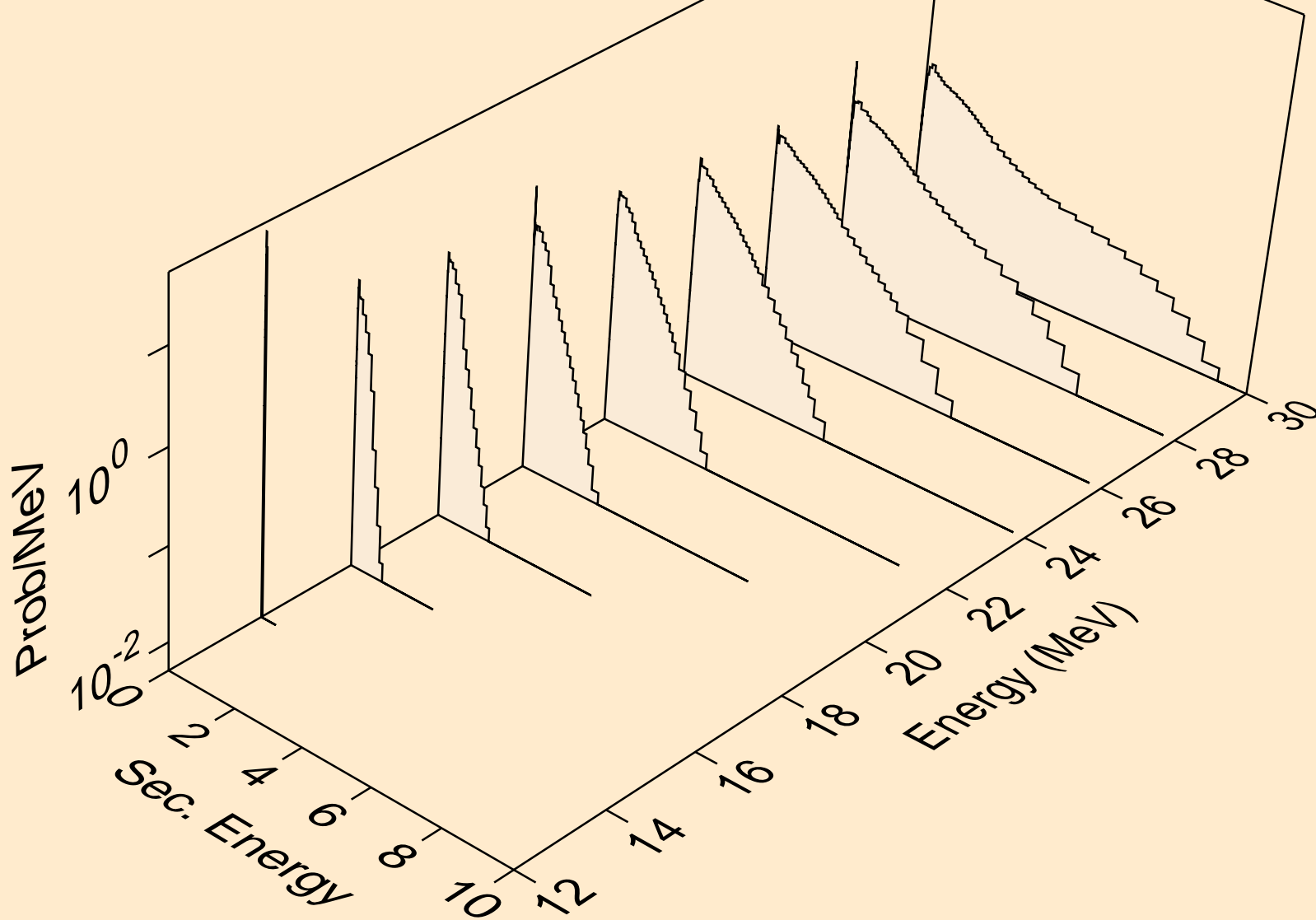

TE138 NEUTRON ACER TENDL-2023 LIBRARY; T=0.K  
Neutron emission for (n,n\*)d

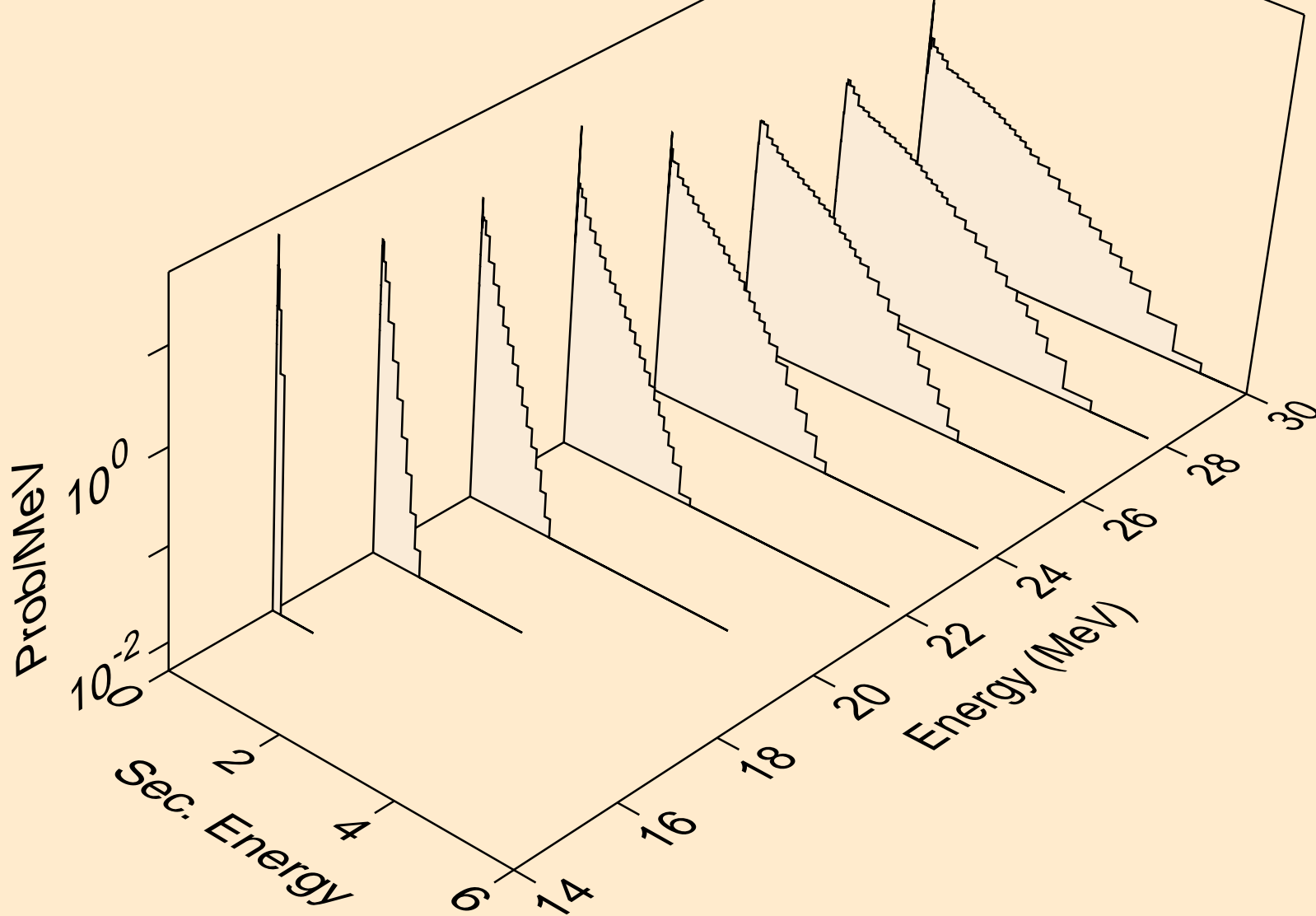

TE138 NEUTRON ACER TENDL-2023 LIBRARY; T=0.K  
Neutron emission for (n,n\*)t

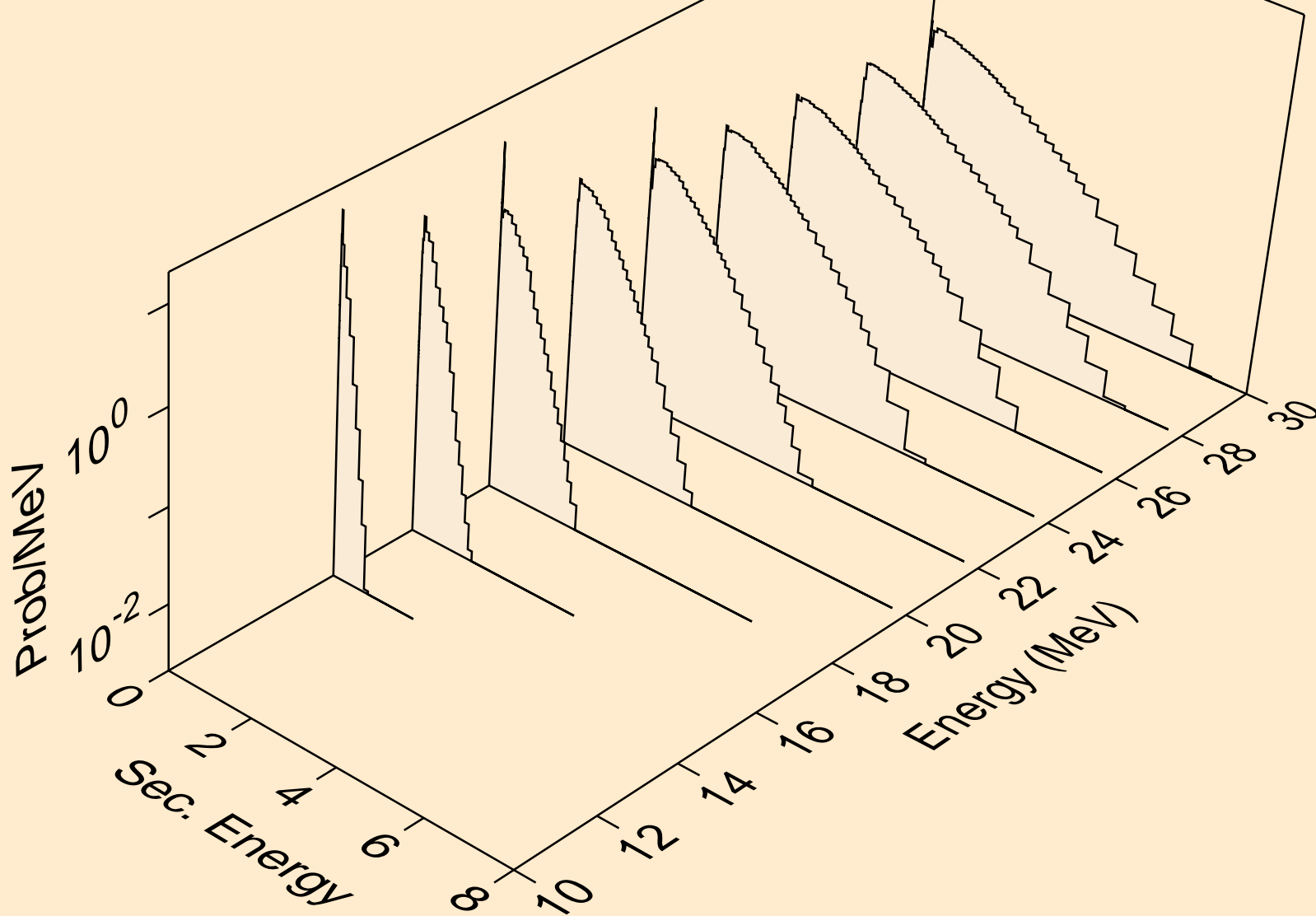

TE138 NEUTRON ACER TENDL-2023 LIBRARY; T=0.K  
Neutron emission for (n,n\*)he3

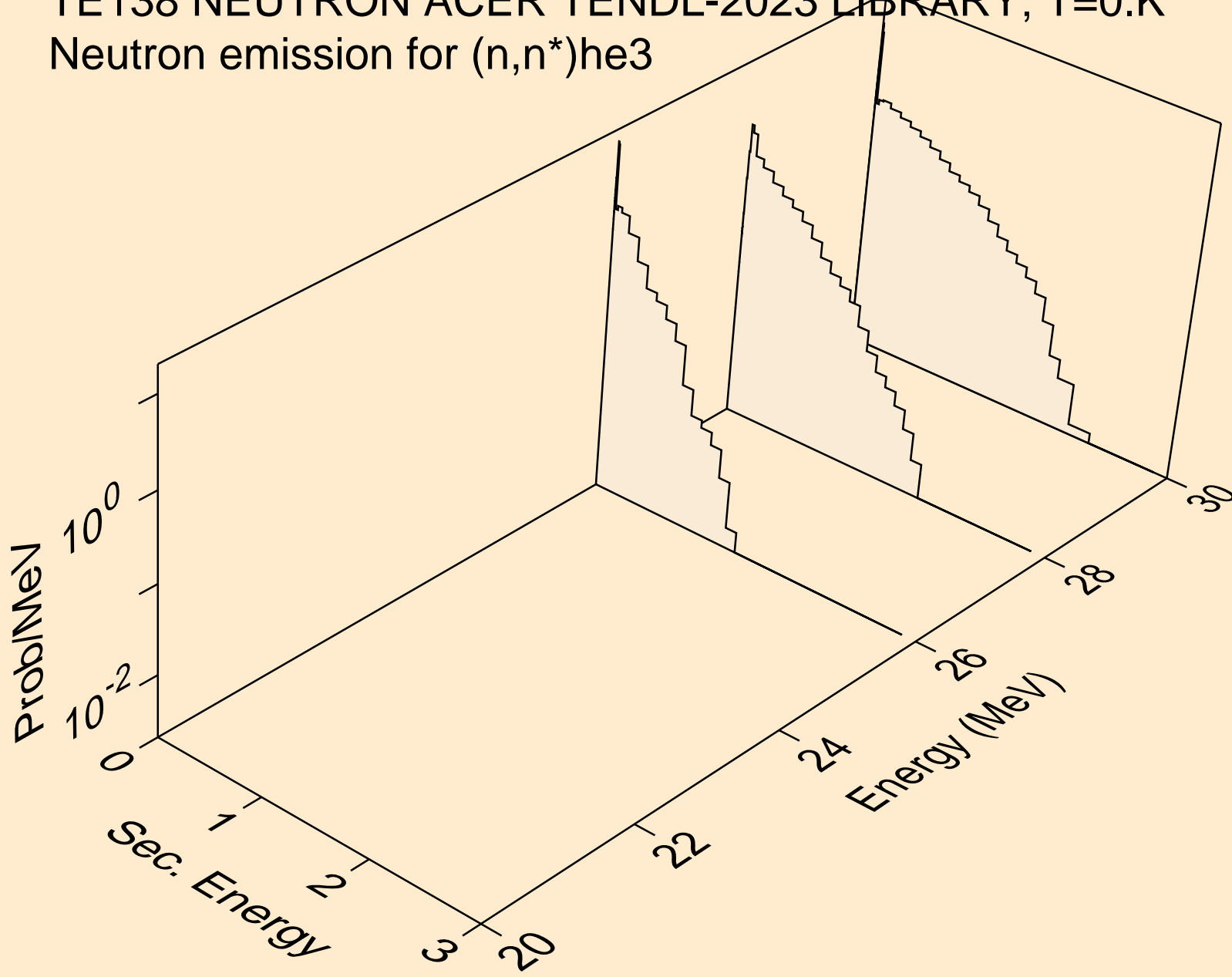

TE138 NEUTRON ACER TENDL-2023 LIBRARY; T=0.K  
Neutron emission for (n,4n)

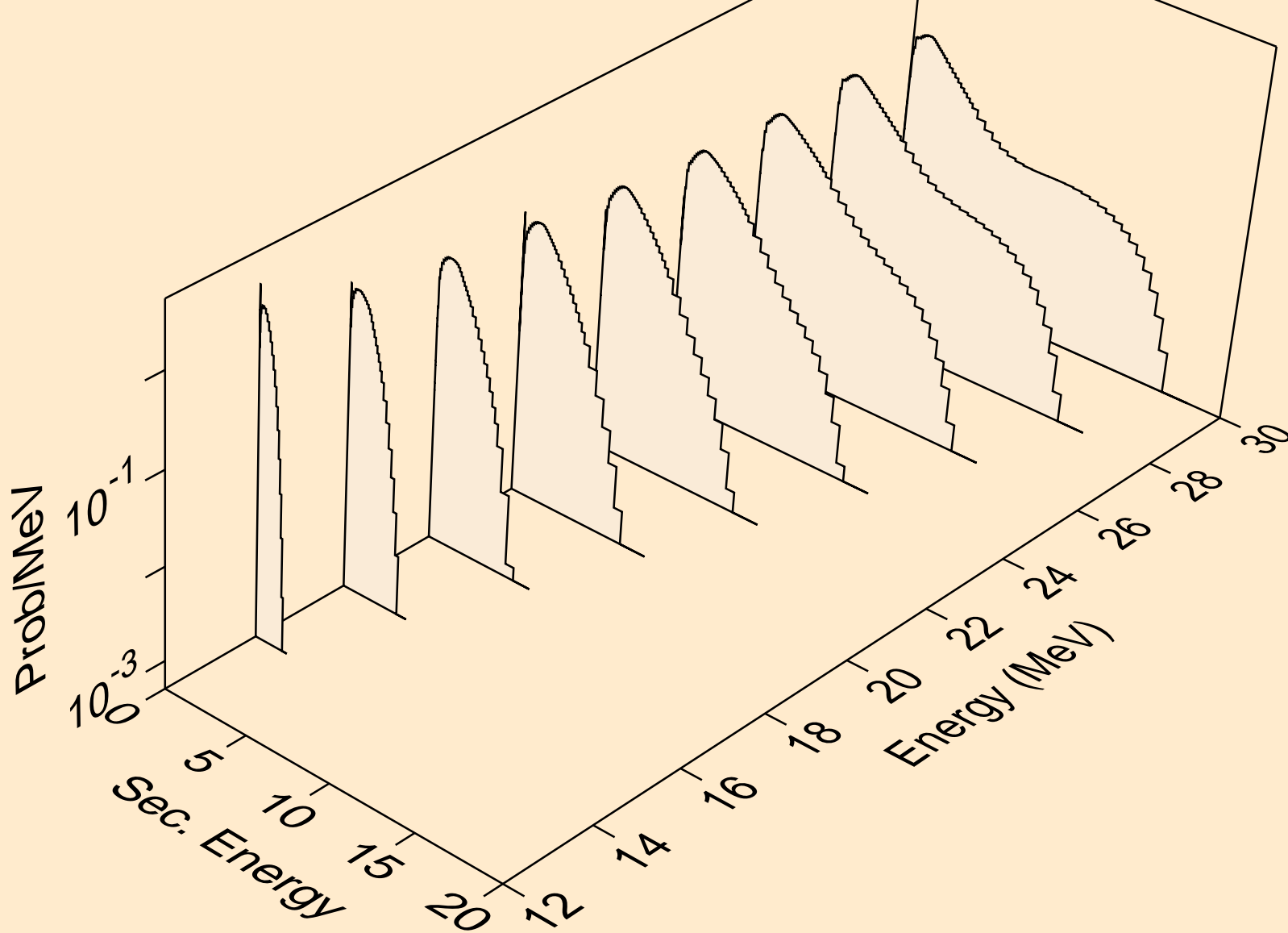



TE138 NEUTRON ACER TENDL-2023 LIBRARY; T=0.K  
Neutron emission for (n,2np)

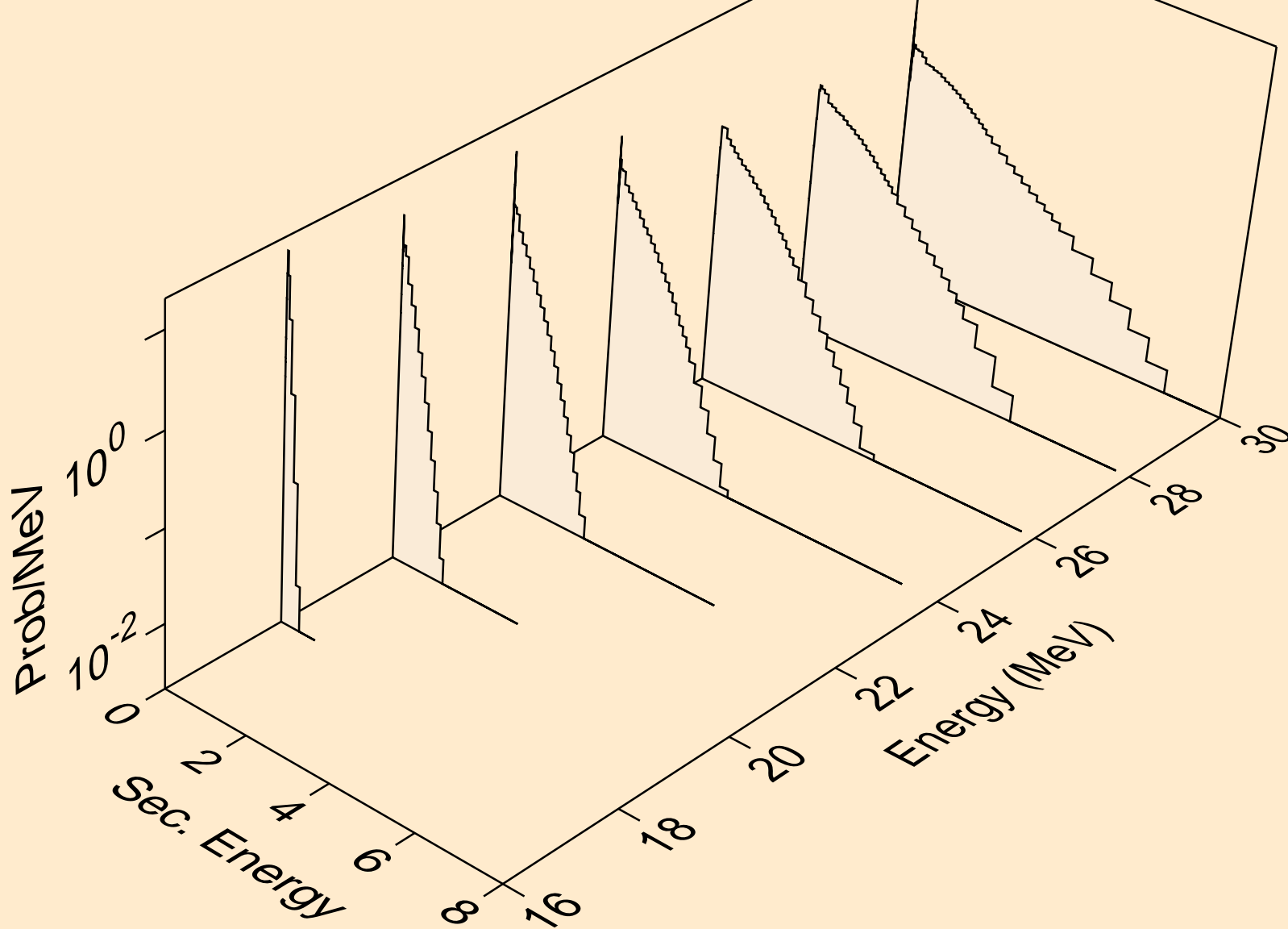

TE138 NEUTRON ACER TENDL-2023 LIBRARY; T=0.K  
Neutron emission for (n,3np)

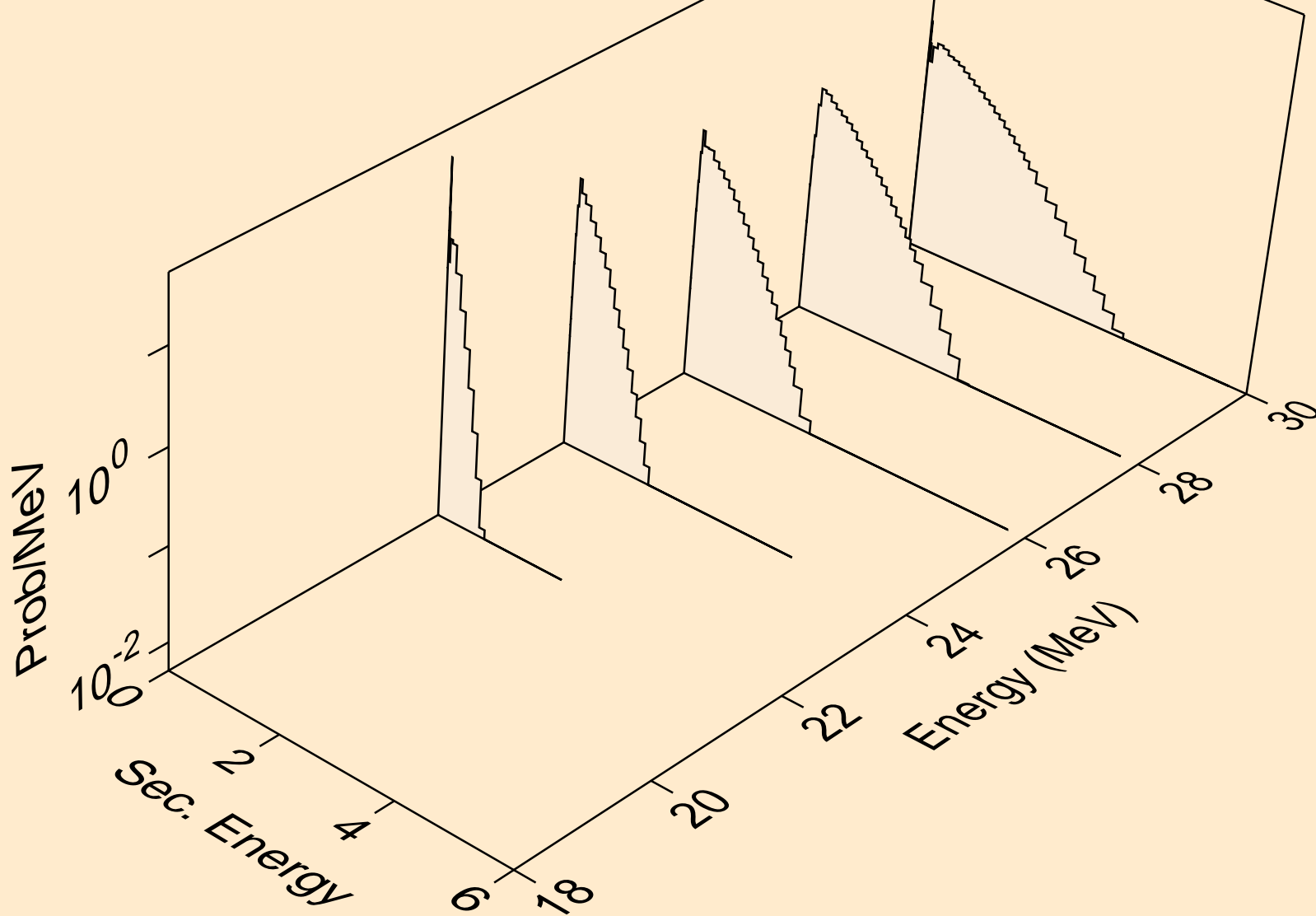

TE138 NEUTRON ACER TENDL-2023 LIBRARY; T=0.K  
Neutron emission for (n,n\*c)

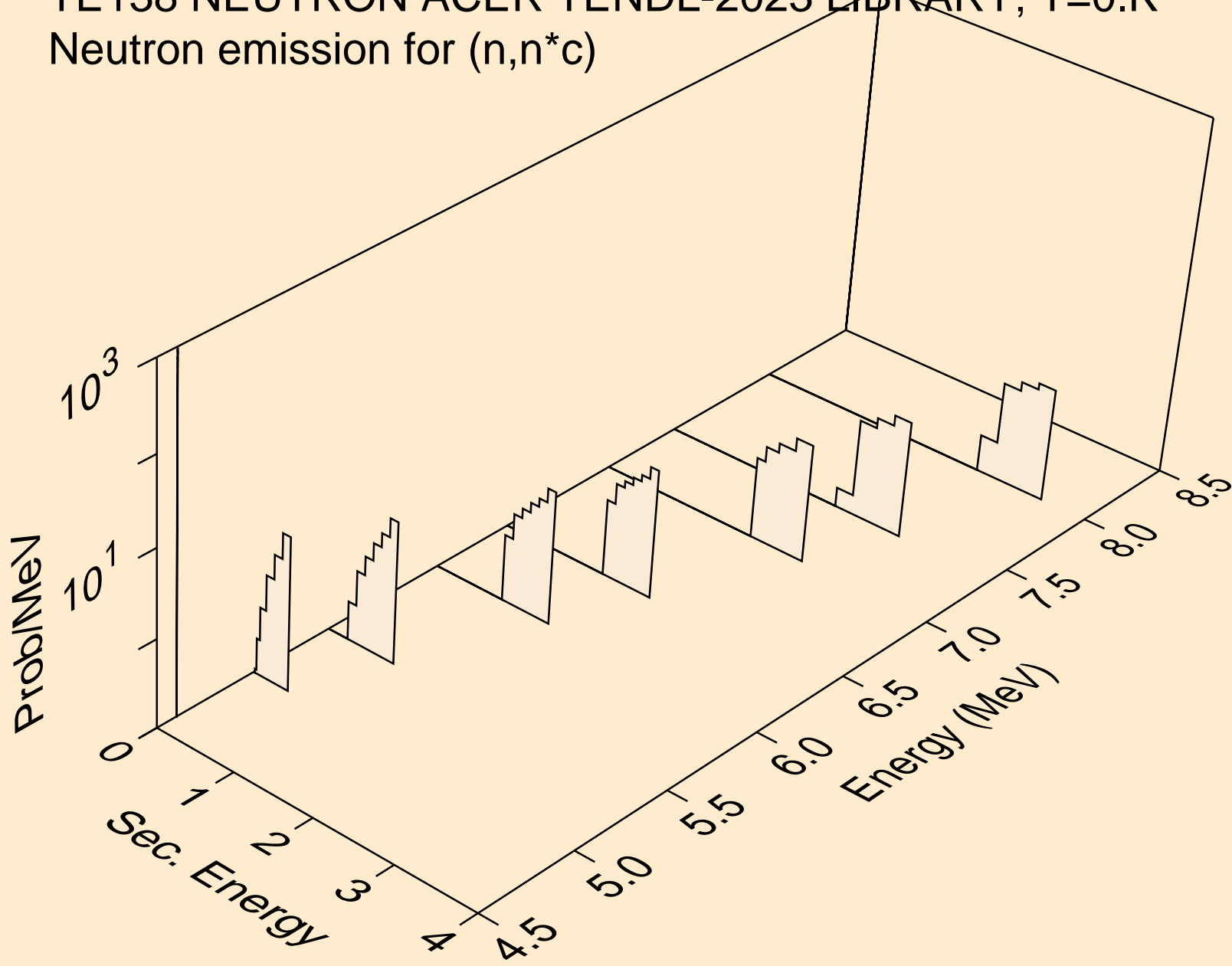

TE138 NEUTRON ACER TENDL-2023 LIBRARY; T=0.K  
Photon emission for (n,x)

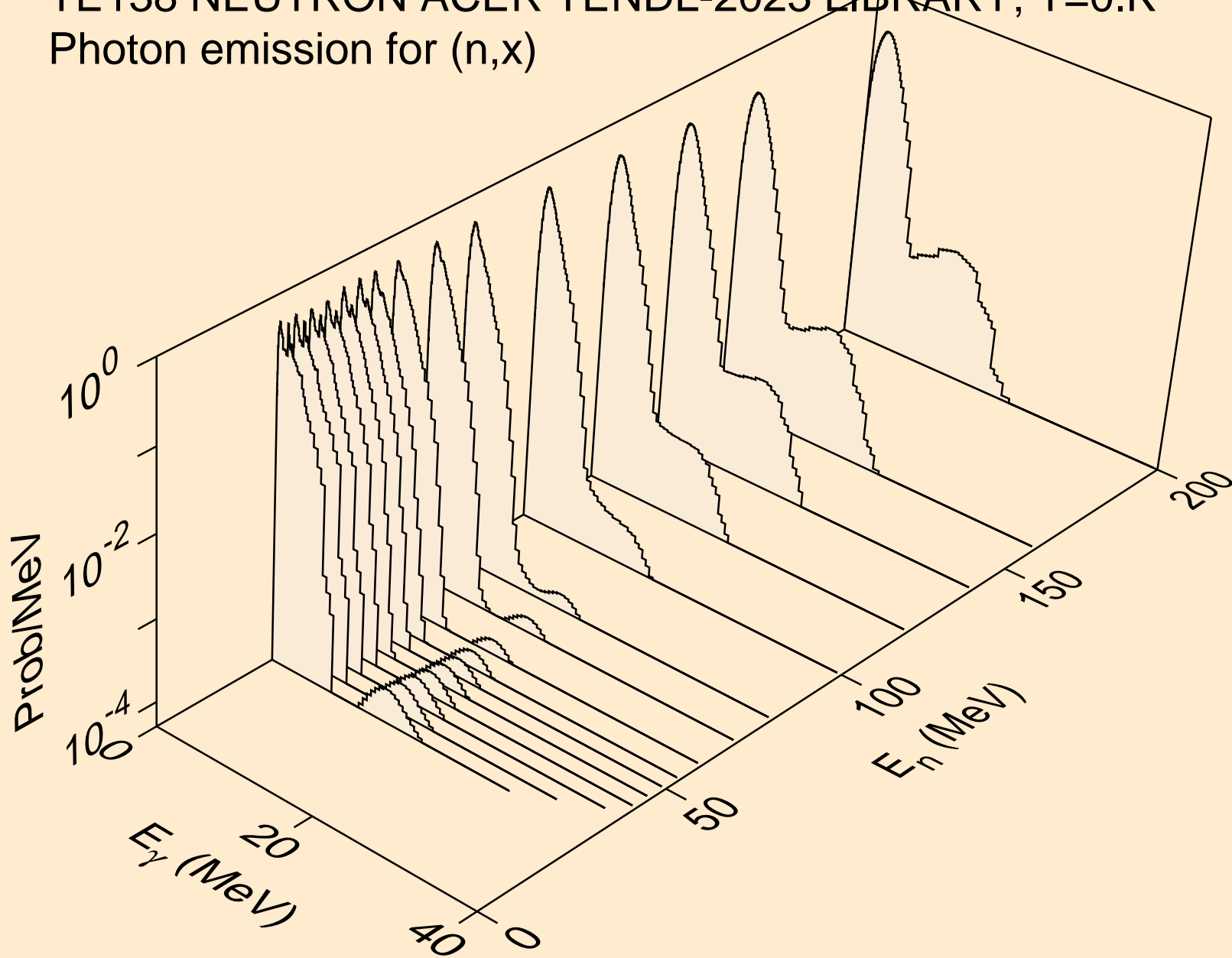

TE138 NEUTRON ACER TENDL-2023 LIBRARY; T=0.K  
Photon emission for (n,2nd)

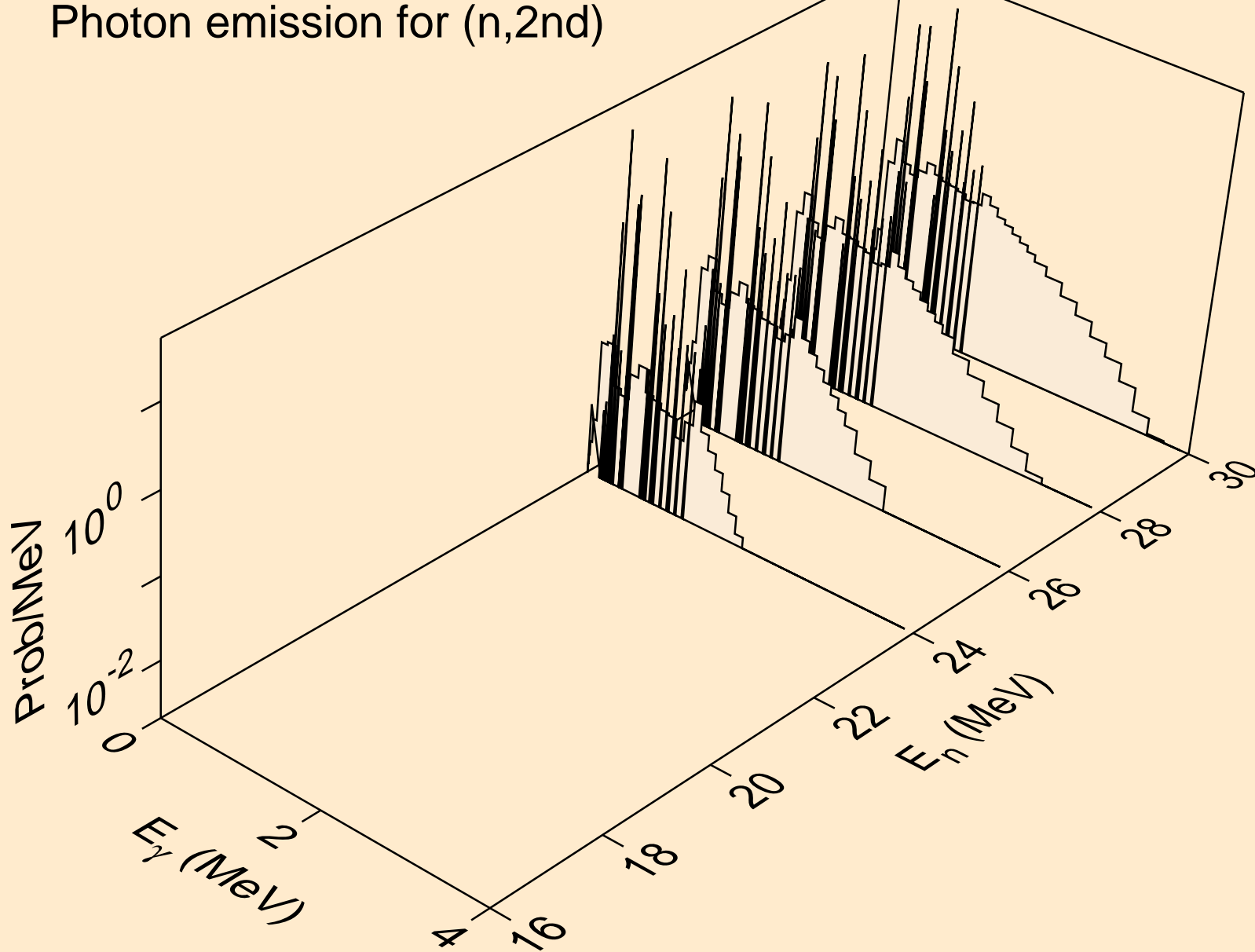

TE138 NEUTRON ACER TENDL-2023 LIBRARY; T=0.K  
Photon emission for (n,2n)

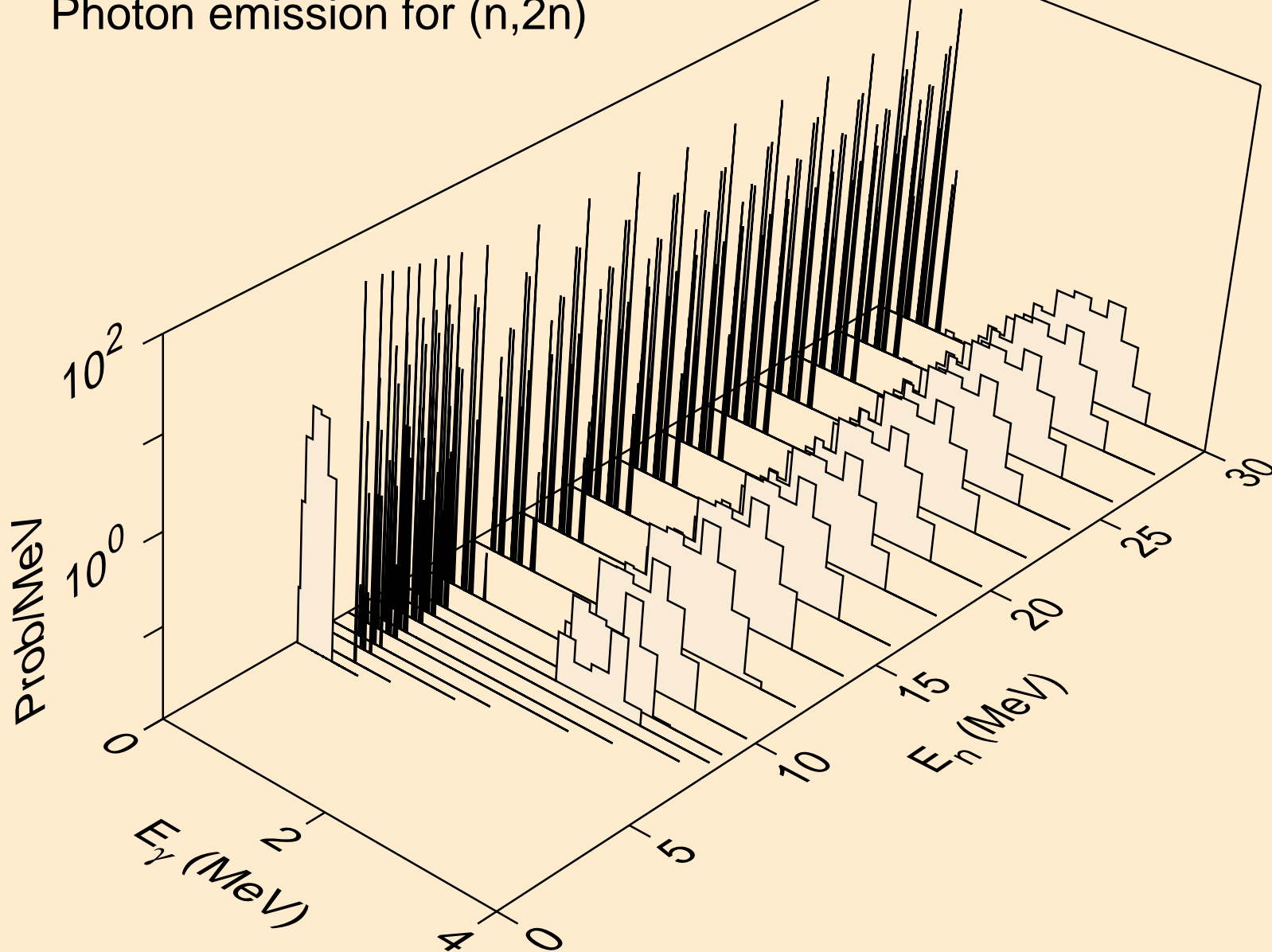

TE138 NEUTRON ACER TENDL-2023 LIBRARY; T=0.K  
Photon emission for (n,3n)

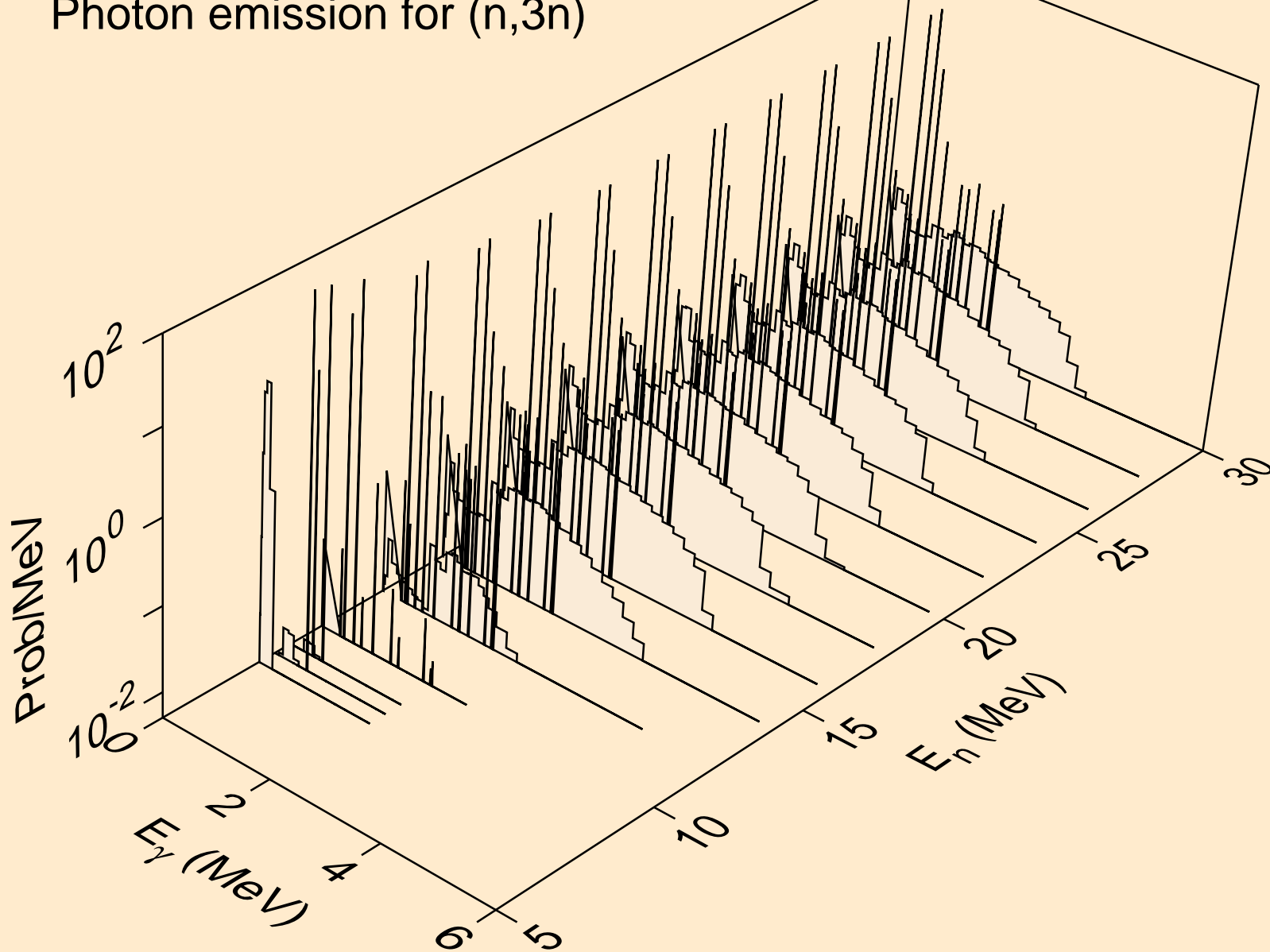

TE138 NEUTRON ACER TENDL-2023 LIBRARY; T=0.K  
Photon emission for (n,n\*)a

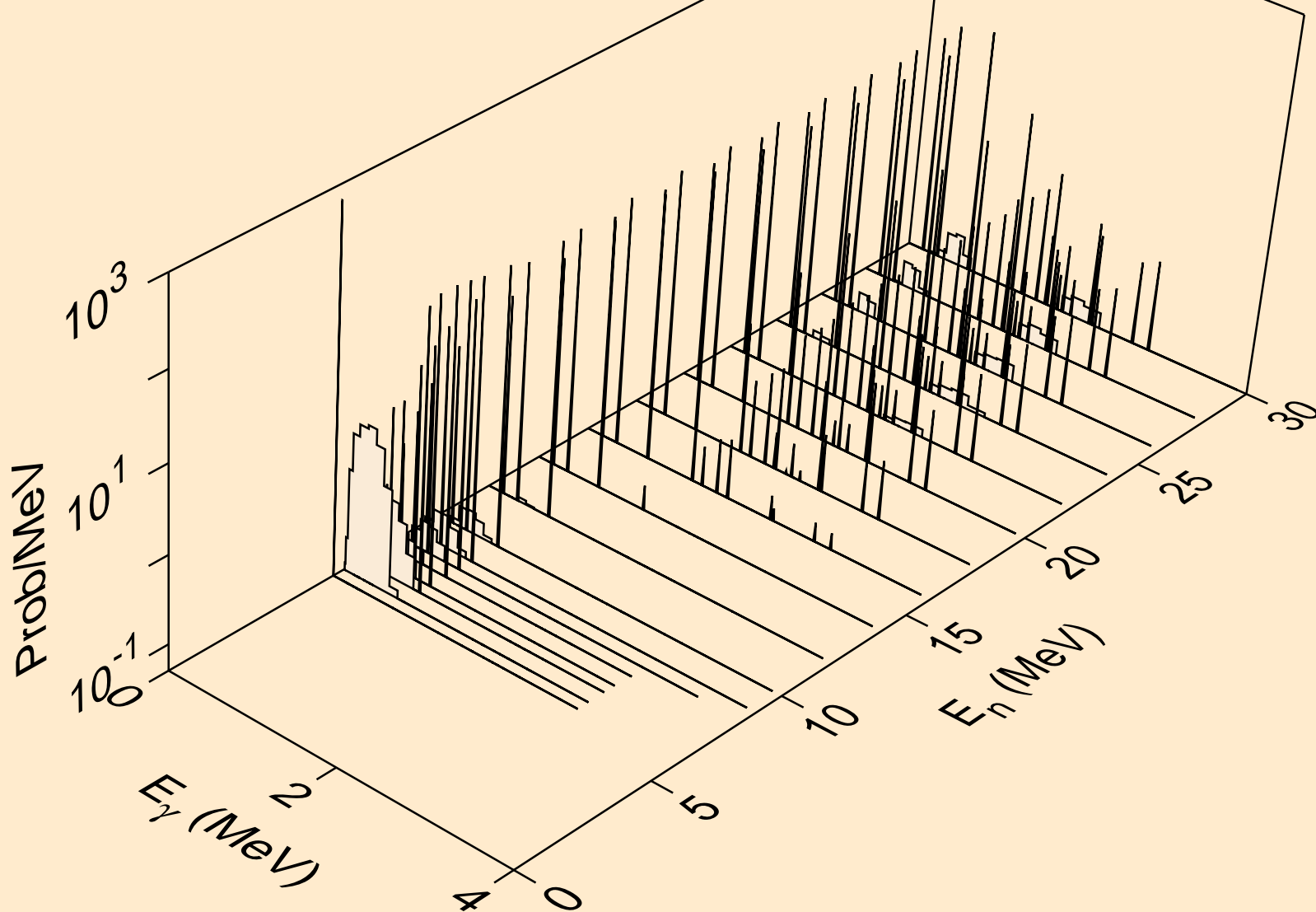



TE138 NEUTRON ACER TENDL-2023 LIBRARY; T=0.K  
Photon emission for (n,2n)a

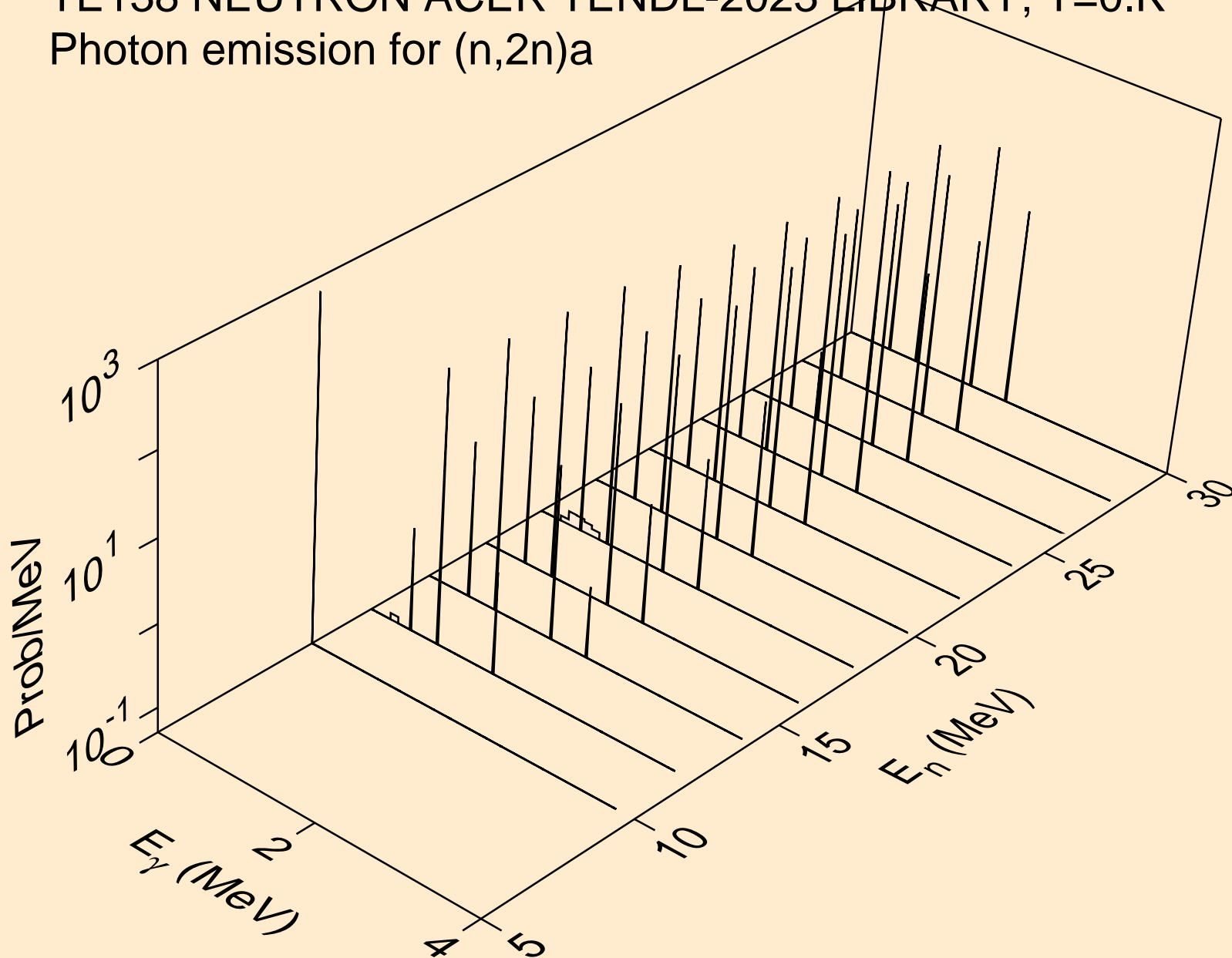

TE138 NEUTRON ACER TENDL-2023 LIBRARY; T=0.K  
Photon emission for (n,3n)a

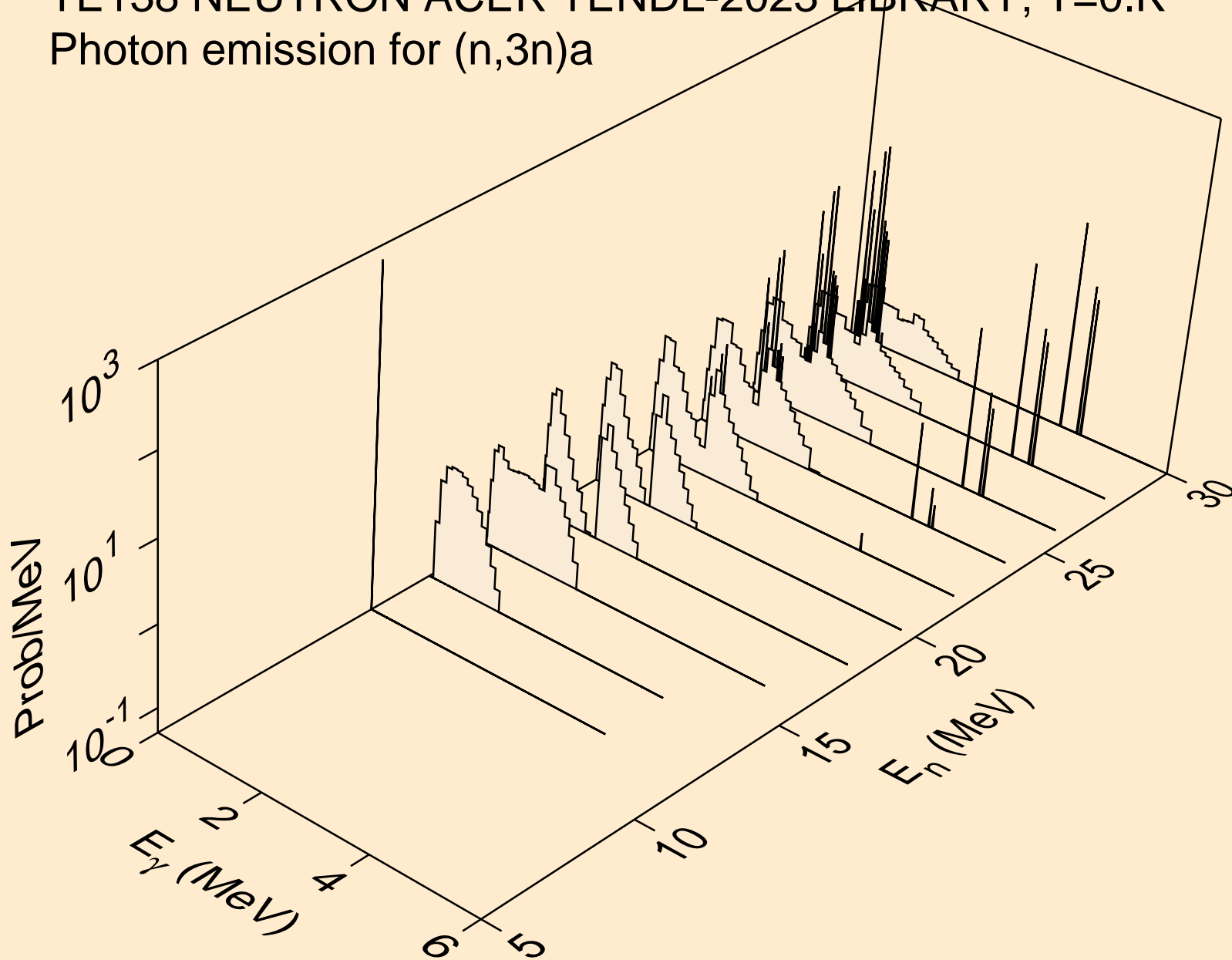

TE138 NEUTRON ACER TENDL-2023 LIBRARY; T=0.K  
Photon emission for (n,n\*)p

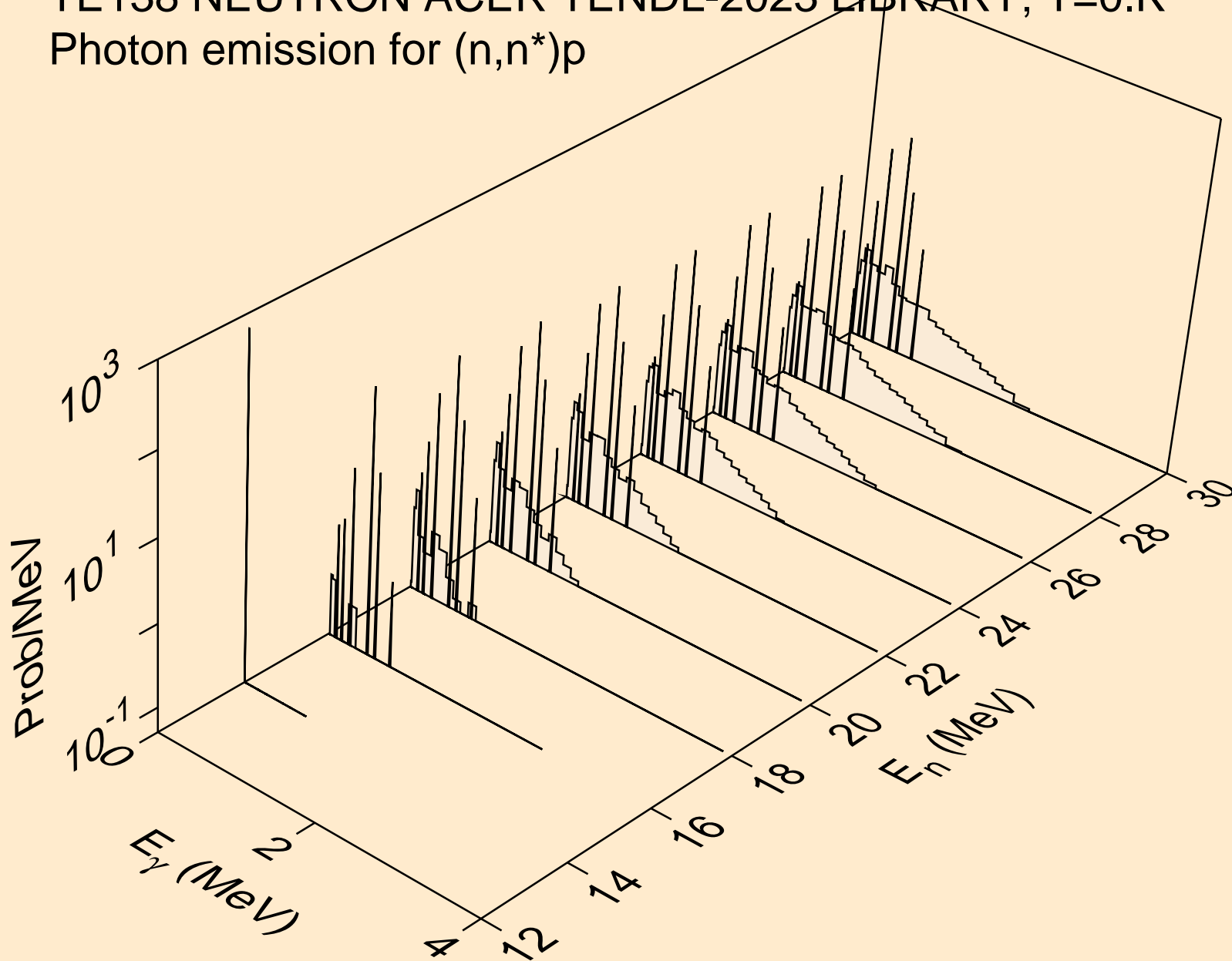

TE138 NEUTRON ACER TENDL-2023 LIBRARY; T=0.K  
Photon emission for (n,n\*)d

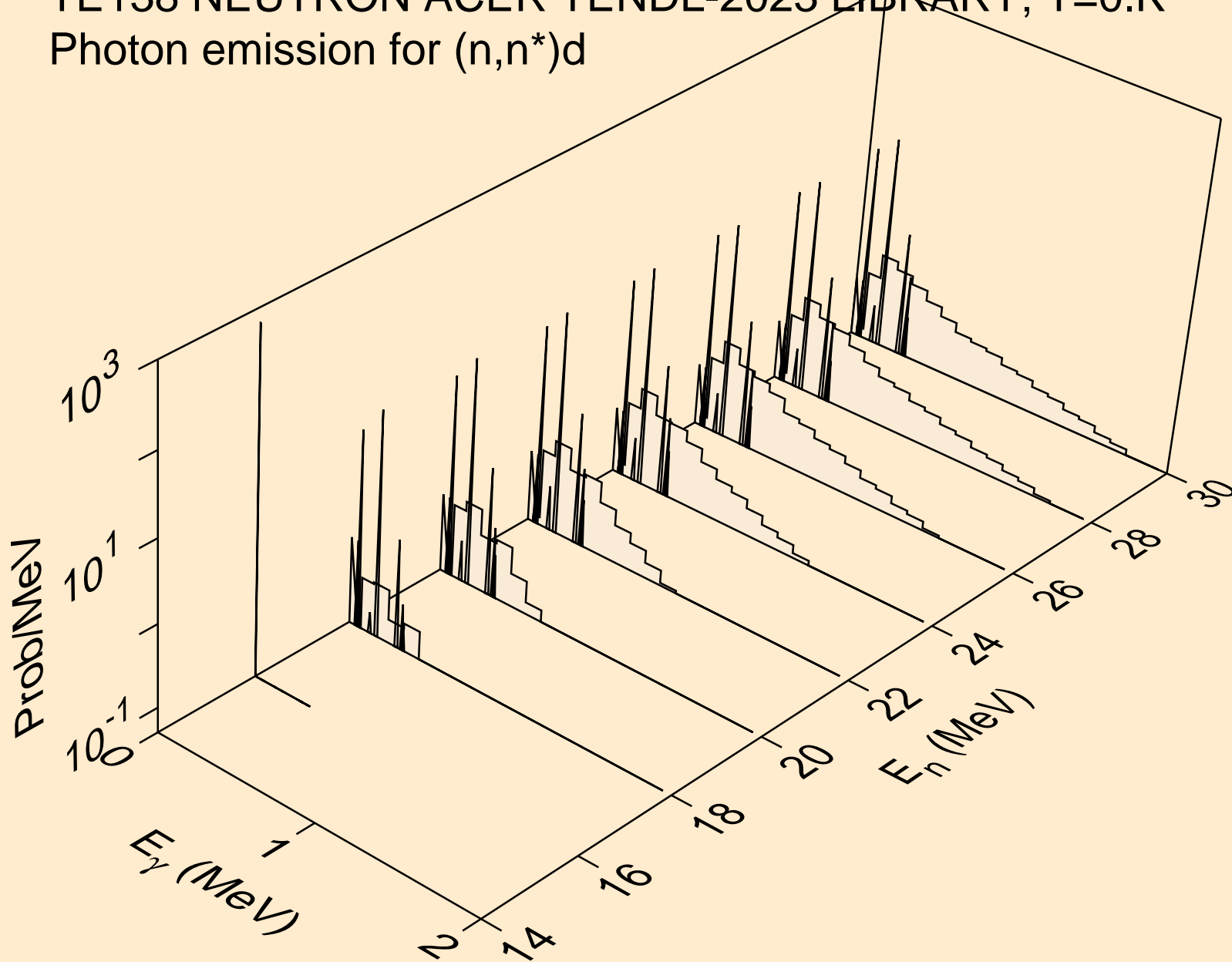

TE138 NEUTRON ACER TENDL-2023 LIBRARY; T=0.K  
Photon emission for (n,n\*)t

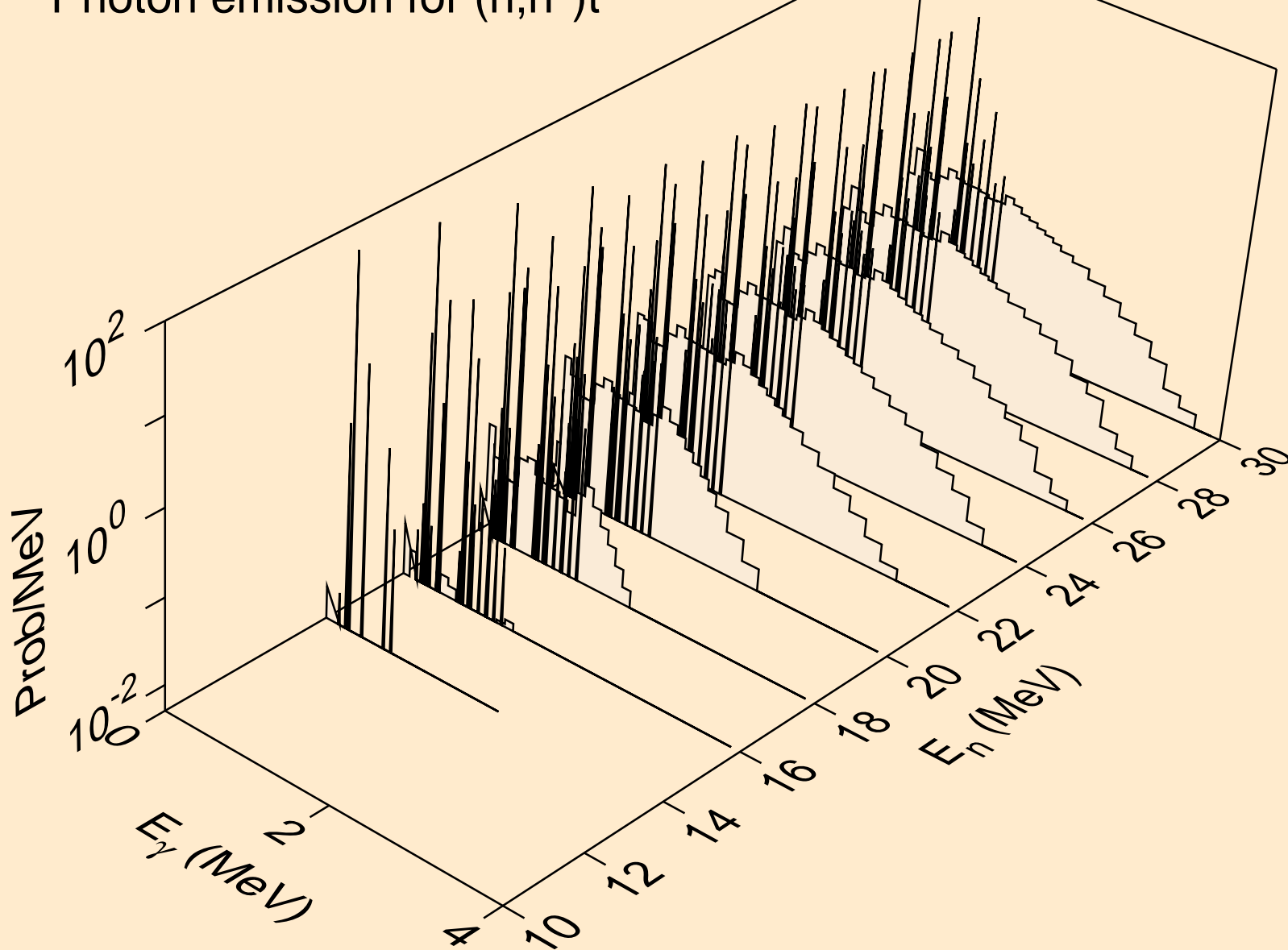

TE138 NEUTRON ACER TENDL-2023 LIBRARY; T=0.K  
Photon emission for (n,n\*)he3

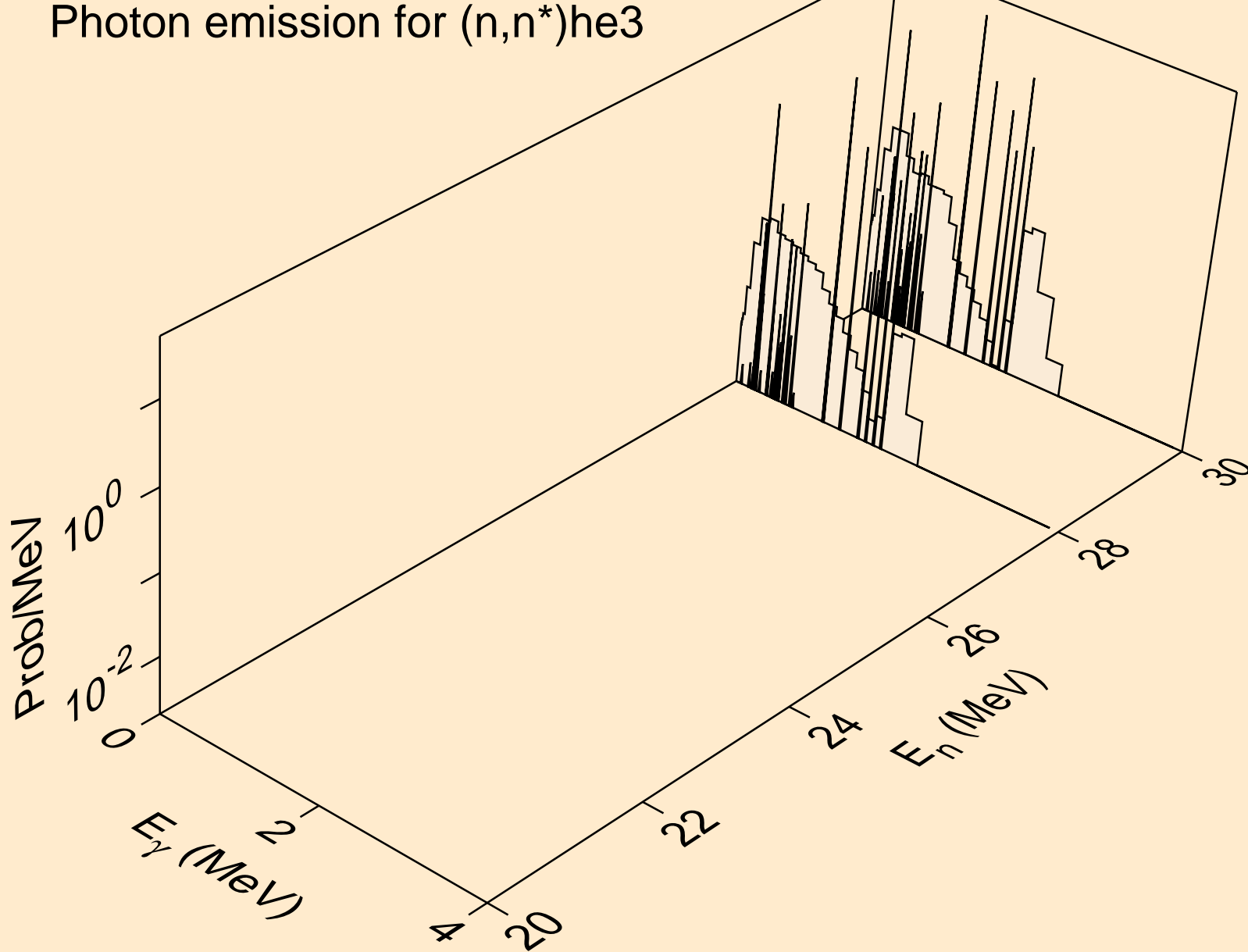

TE138 NEUTRON ACER TENDL-2023 LIBRARY; T=0.K  
Photon emission for (n,4n)

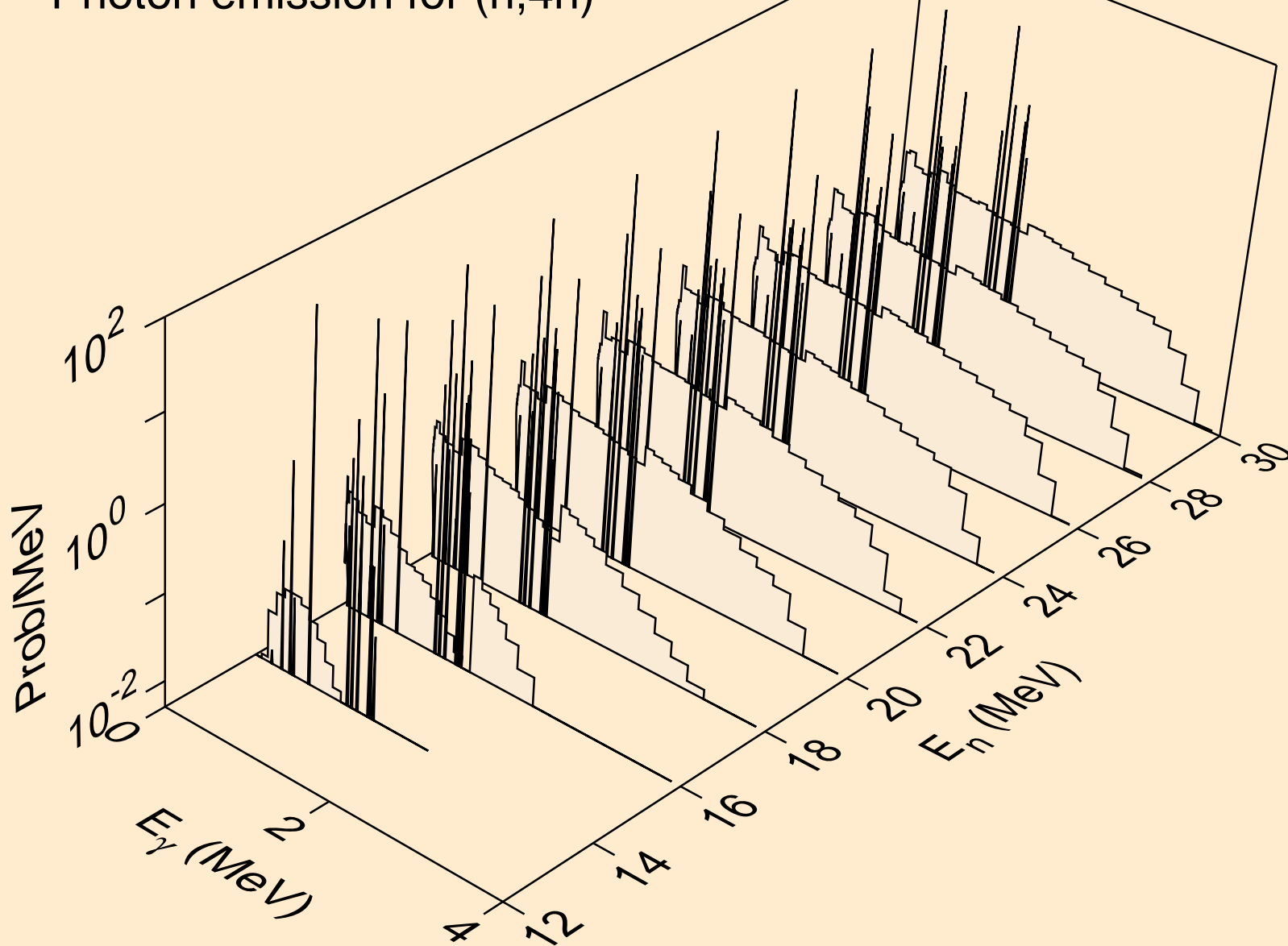

TE138 NEUTRON ACER TENDL-2023 LIBRARY; T=0.K  
Photon emission for (n,2np)

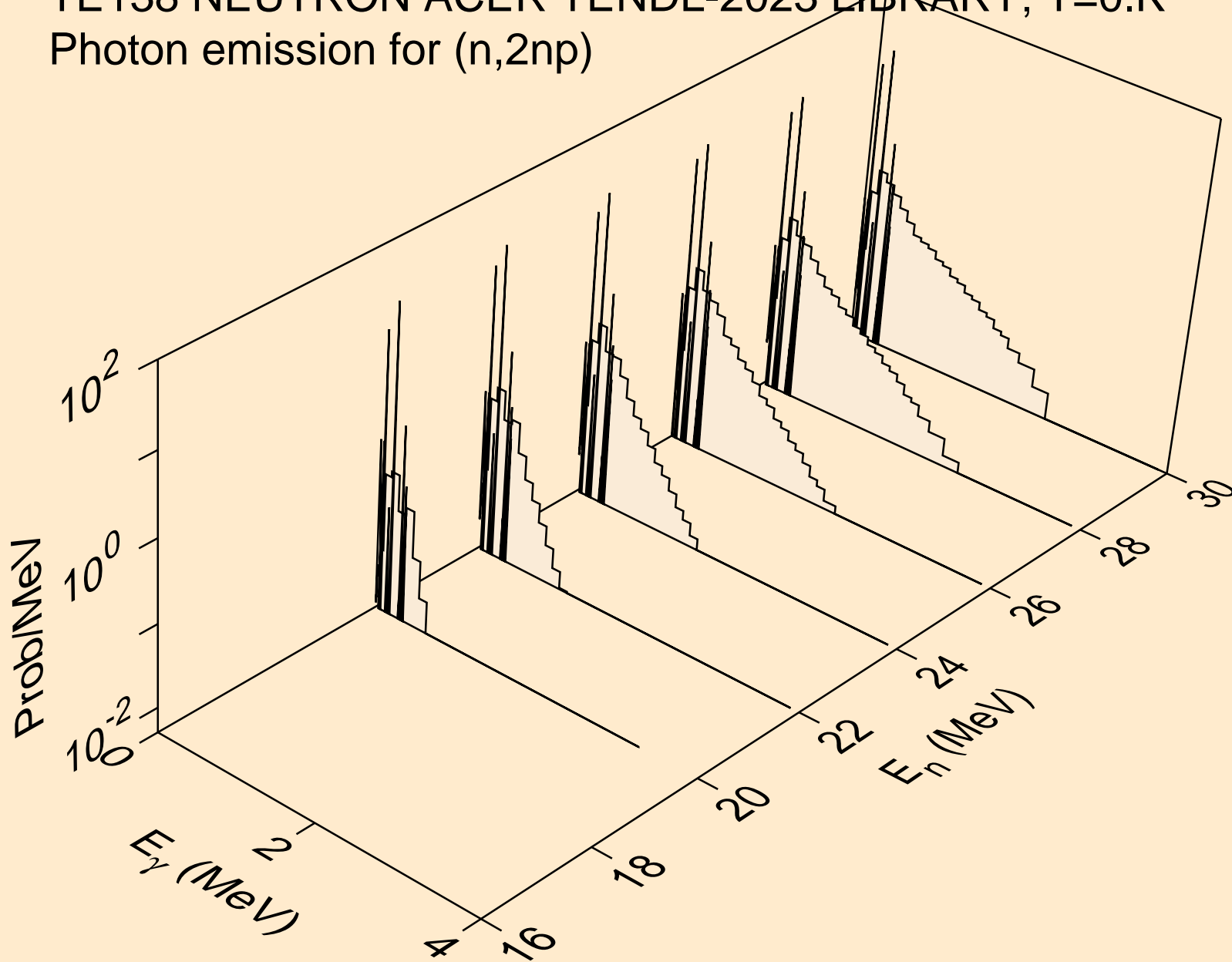



TE138 NEUTRON ACER TENDL-2023 LIBRARY; T=0.K  
Photon emission for (n,3np)

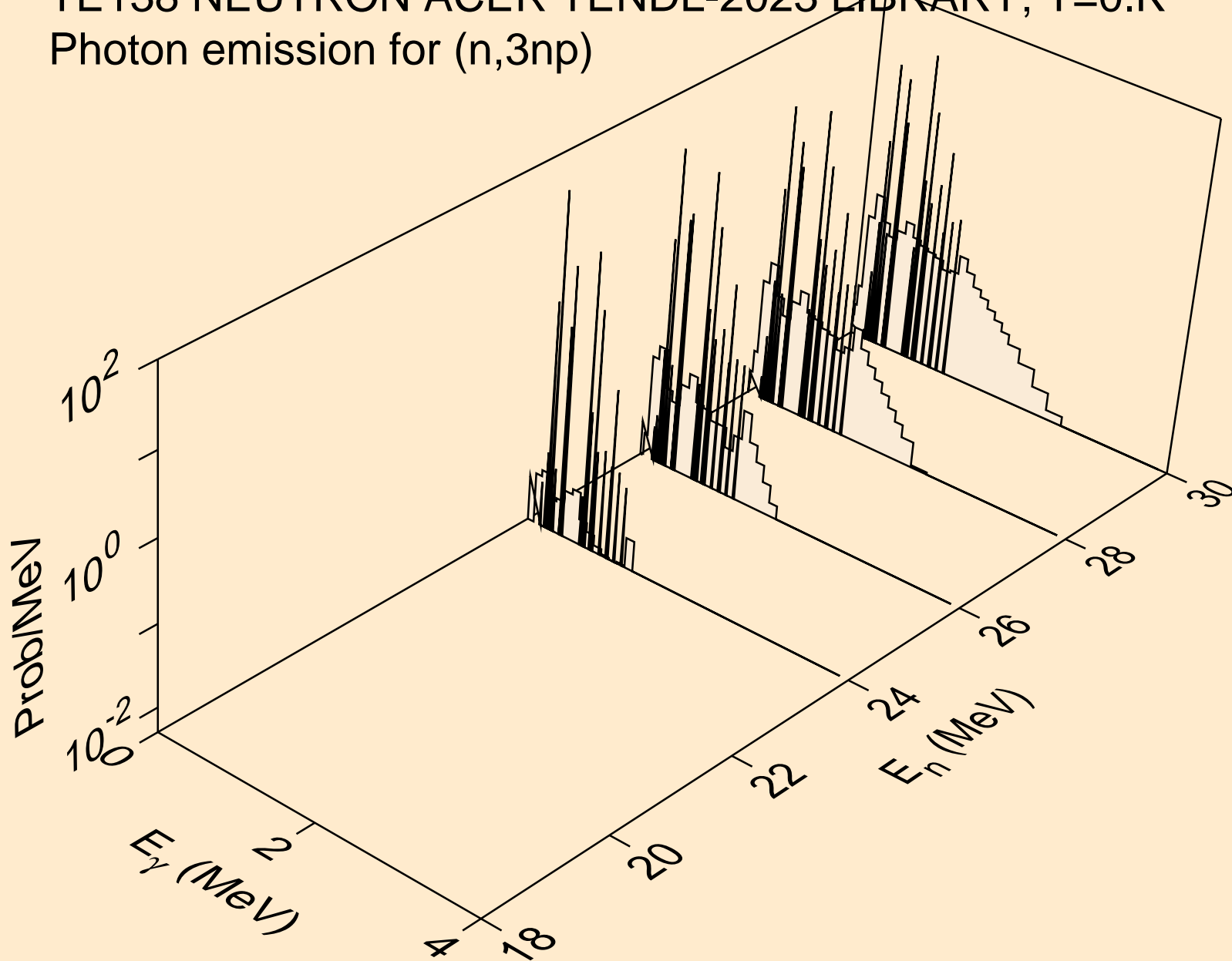

TE138 NEUTRON ACER TENDL-2023 LIBRARY; T=0.K  
Photon emission for (n,n\*c)

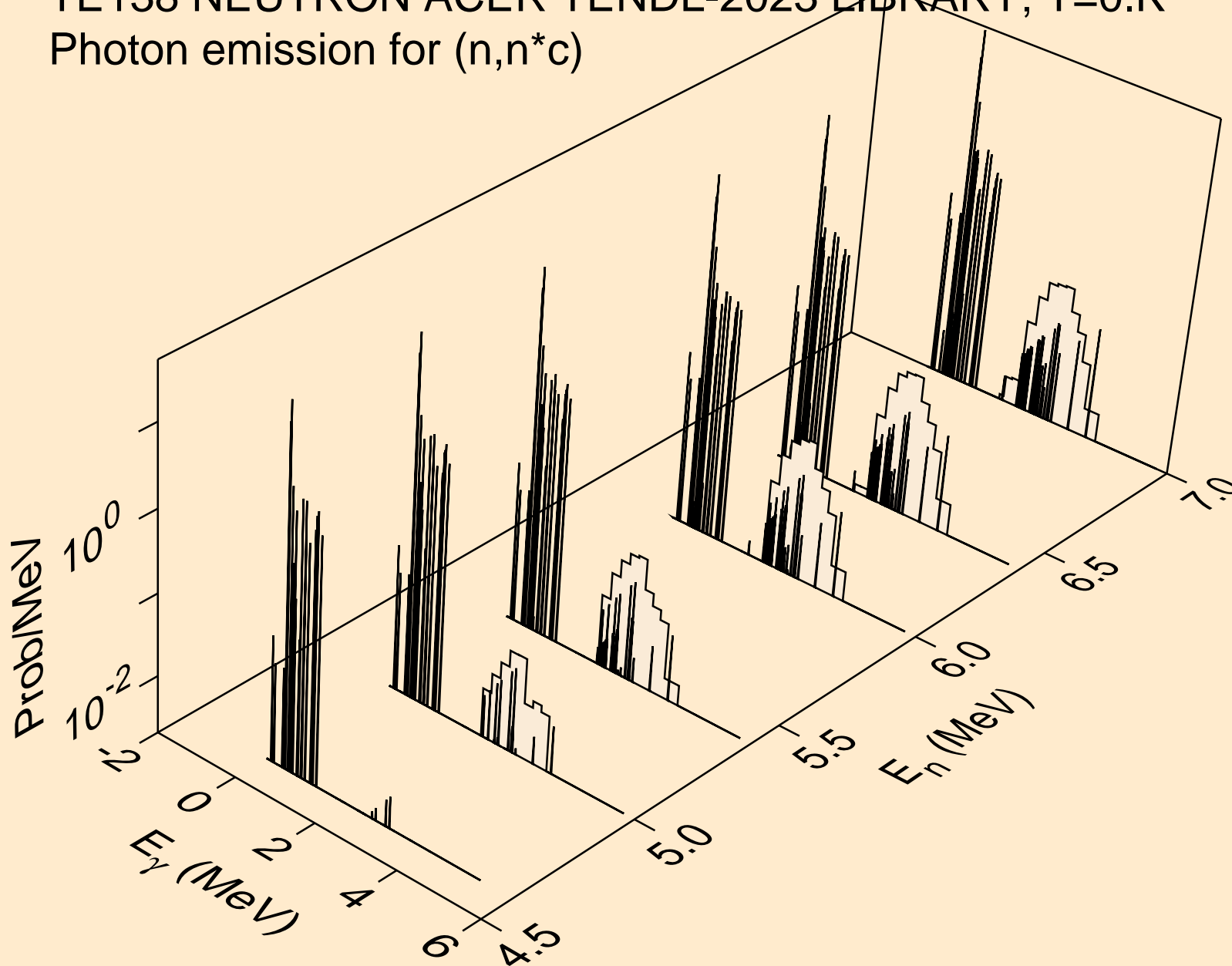

TE138 NEUTRON ACER TENDL-2023 LIBRARY; T=0.K  
Photon emission for (n,gma)

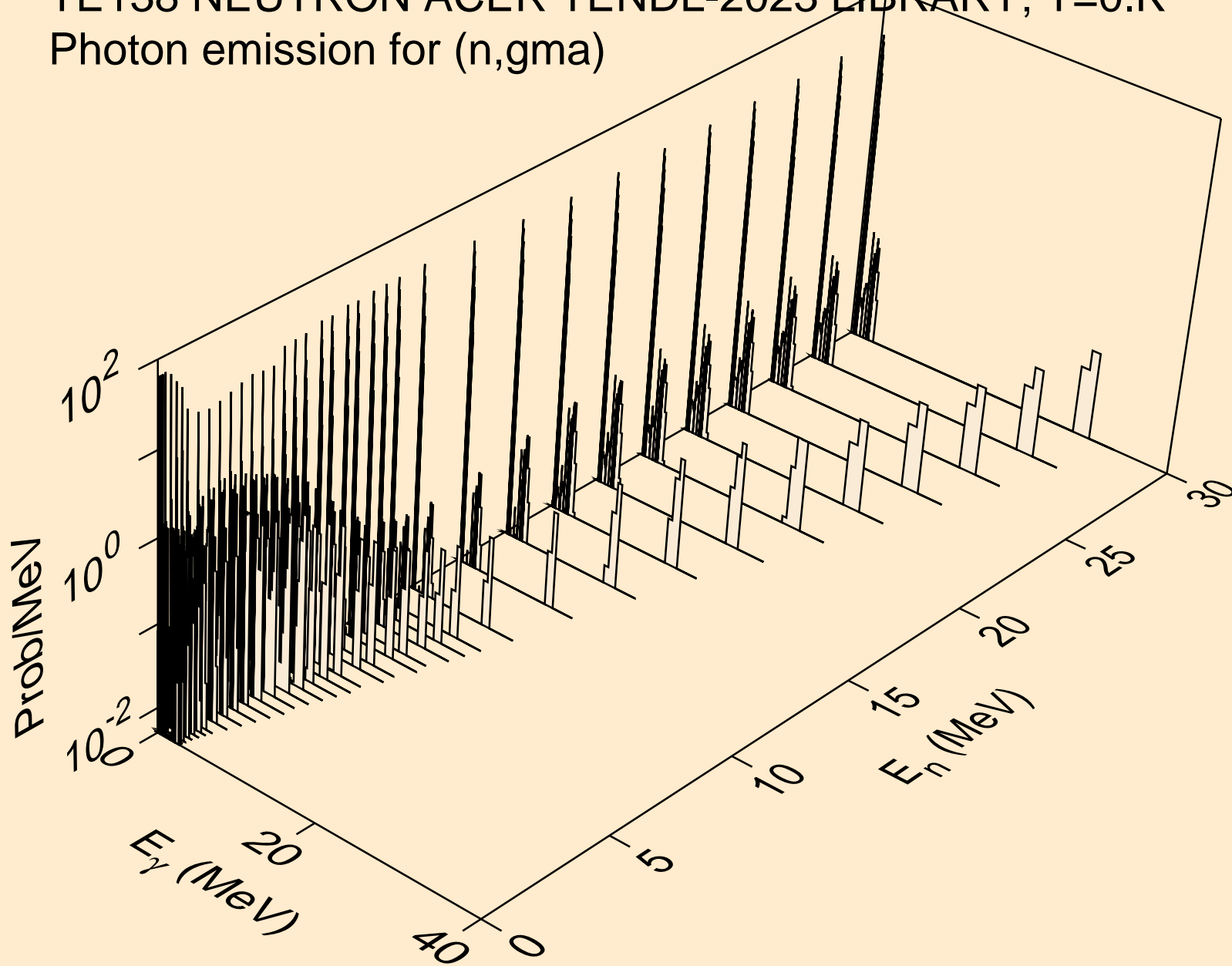

TE138 NEUTRON ACER TENDL-2023 LIBRARY; T=0.K  
Photon emission for (n,p)

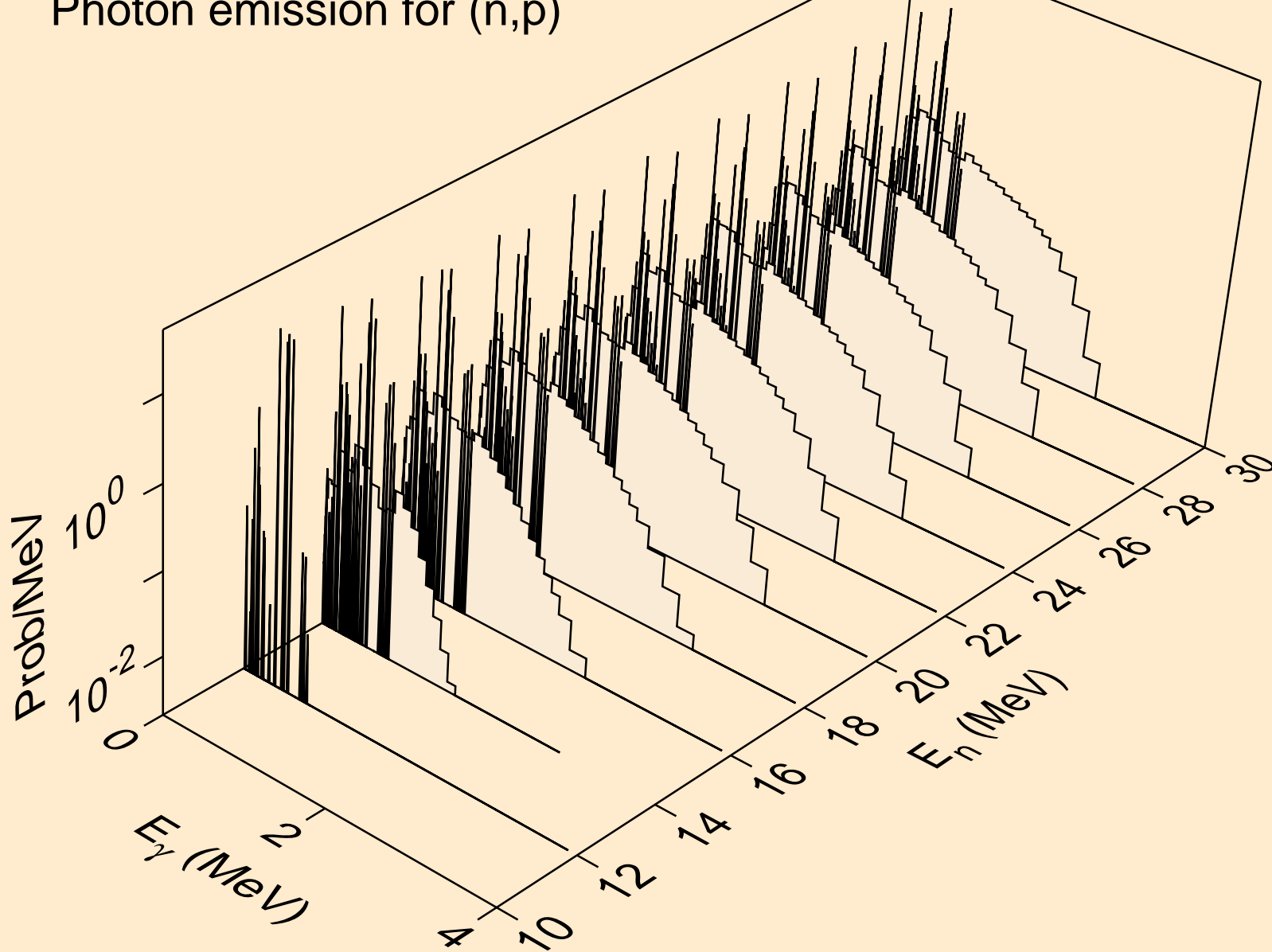

TE138 NEUTRON ACER TENDL-2023 LIBRARY; T=0.K  
Photon emission for (n,d)

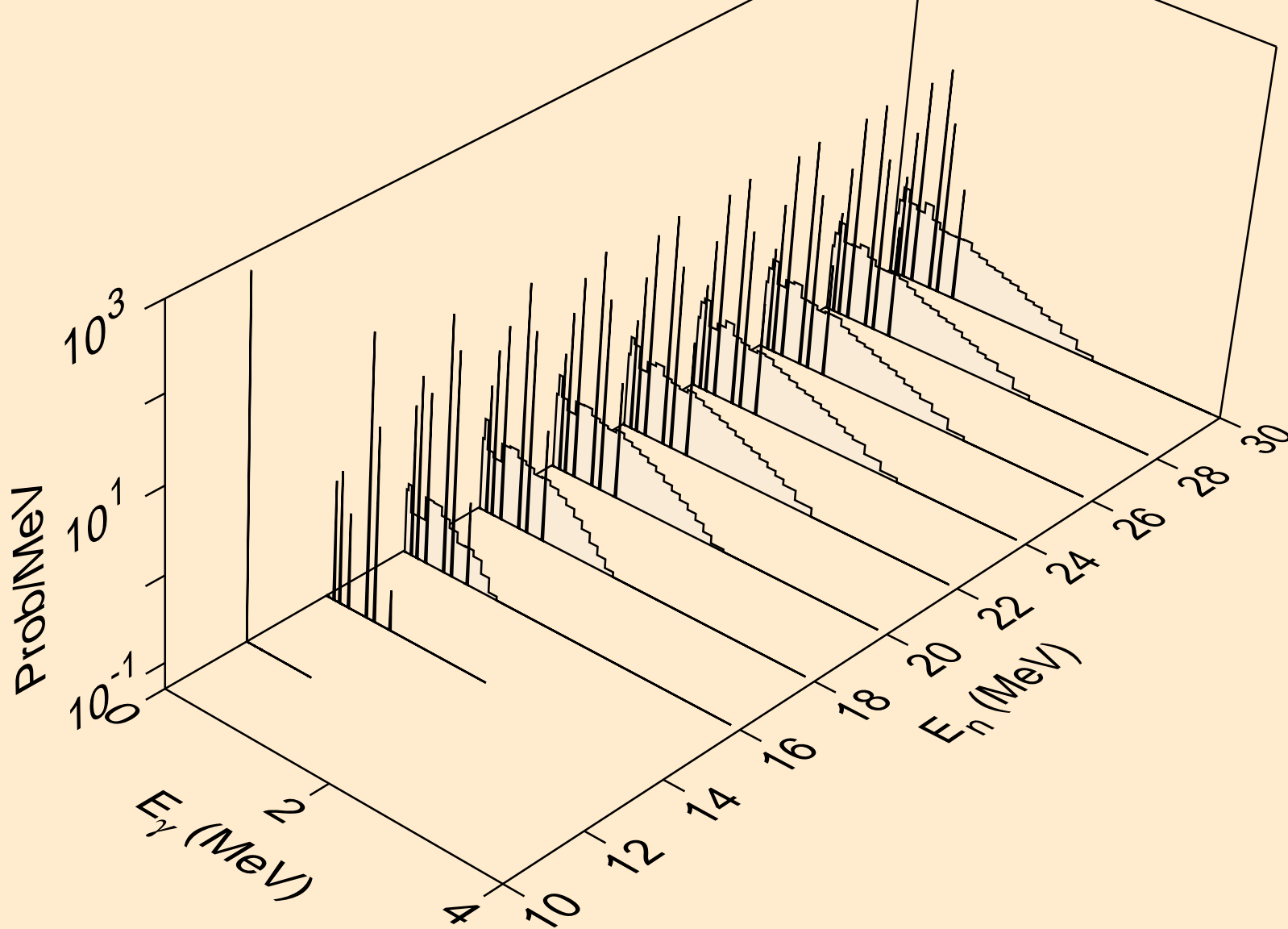

TE138 NEUTRON ACER TENDL-2023 LIBRARY; T=0.K  
Photon emission for (n,t)

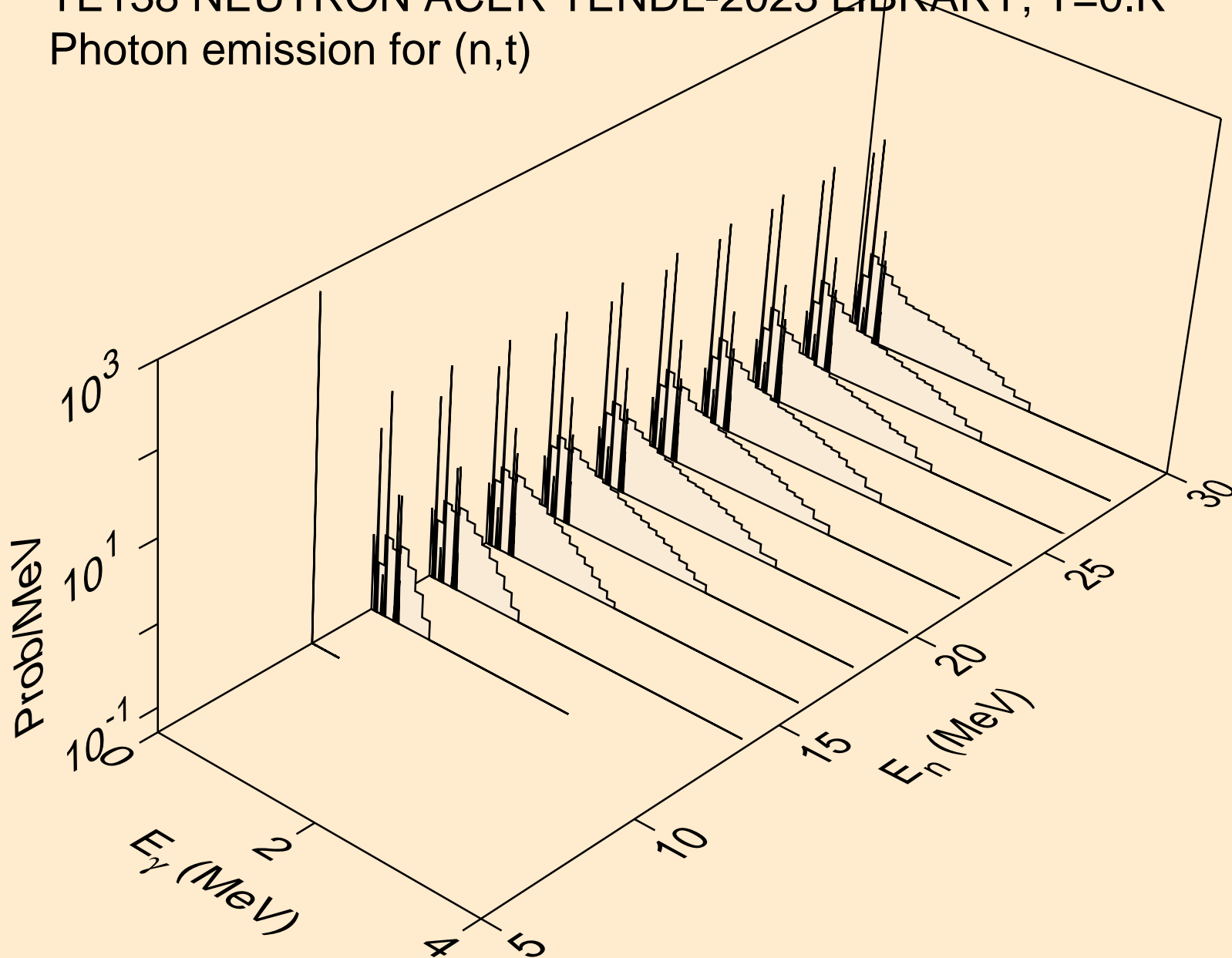

TE138 NEUTRON ACER TENDL-2023 LIBRARY; T=0.K  
Photon emission for (n,he3)

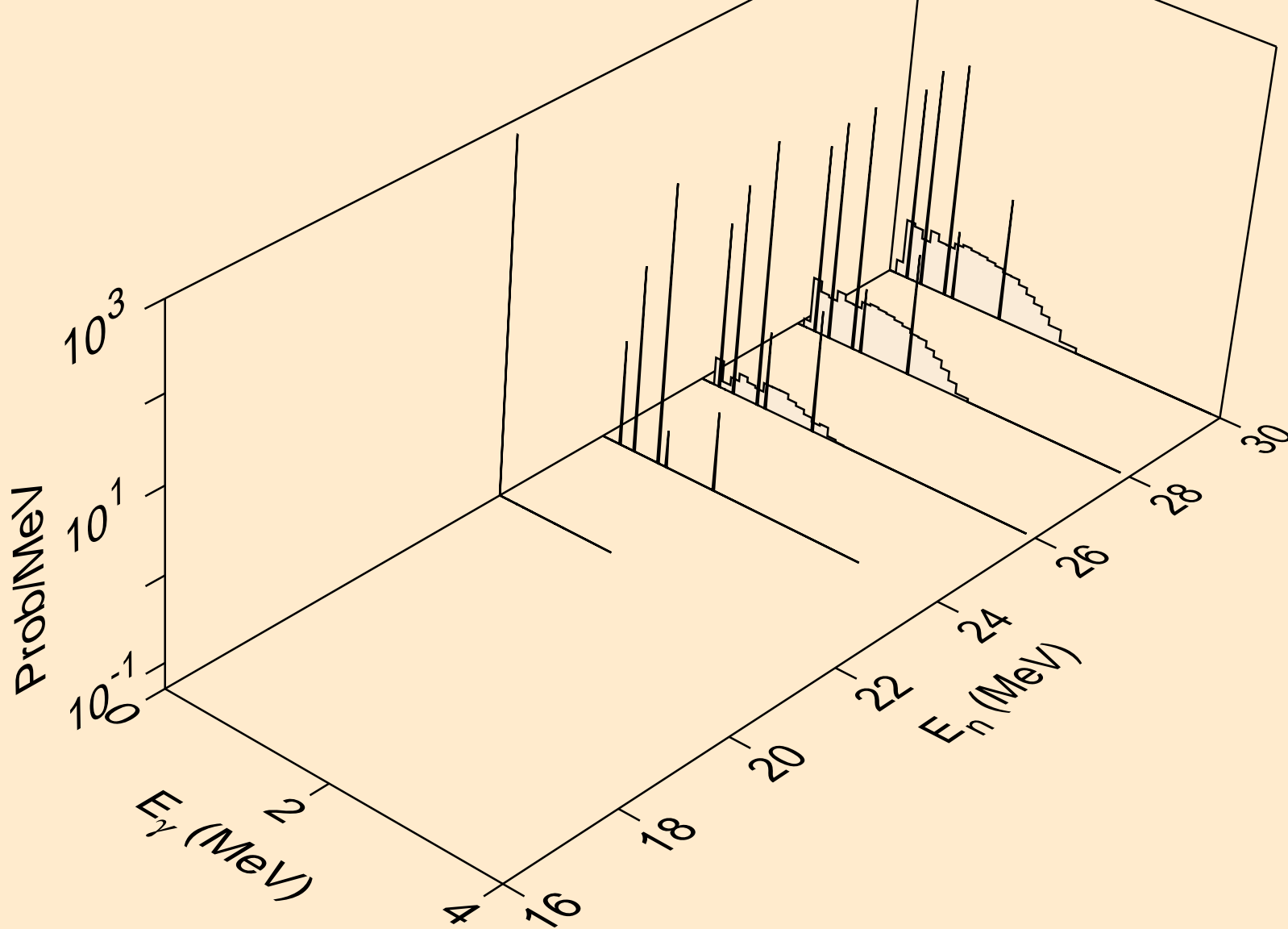

TE138 NEUTRON ACER TENDL-2023 LIBRARY; T=0.K  
Photon emission for (n,a)

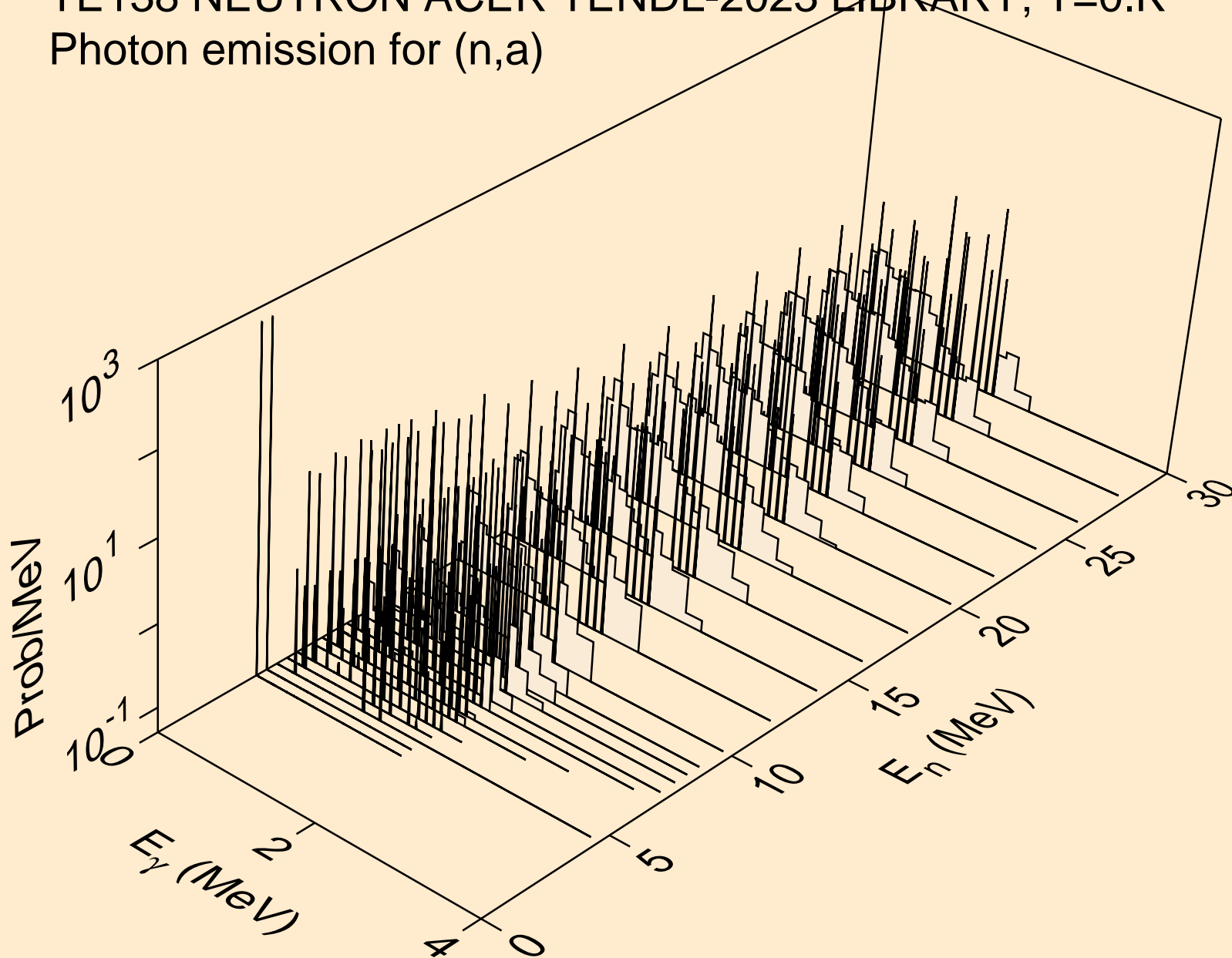



TE138 NEUTRON ACER TENDL-2023 LIBRARY; T=0.K  
thermal capture photon spectrum

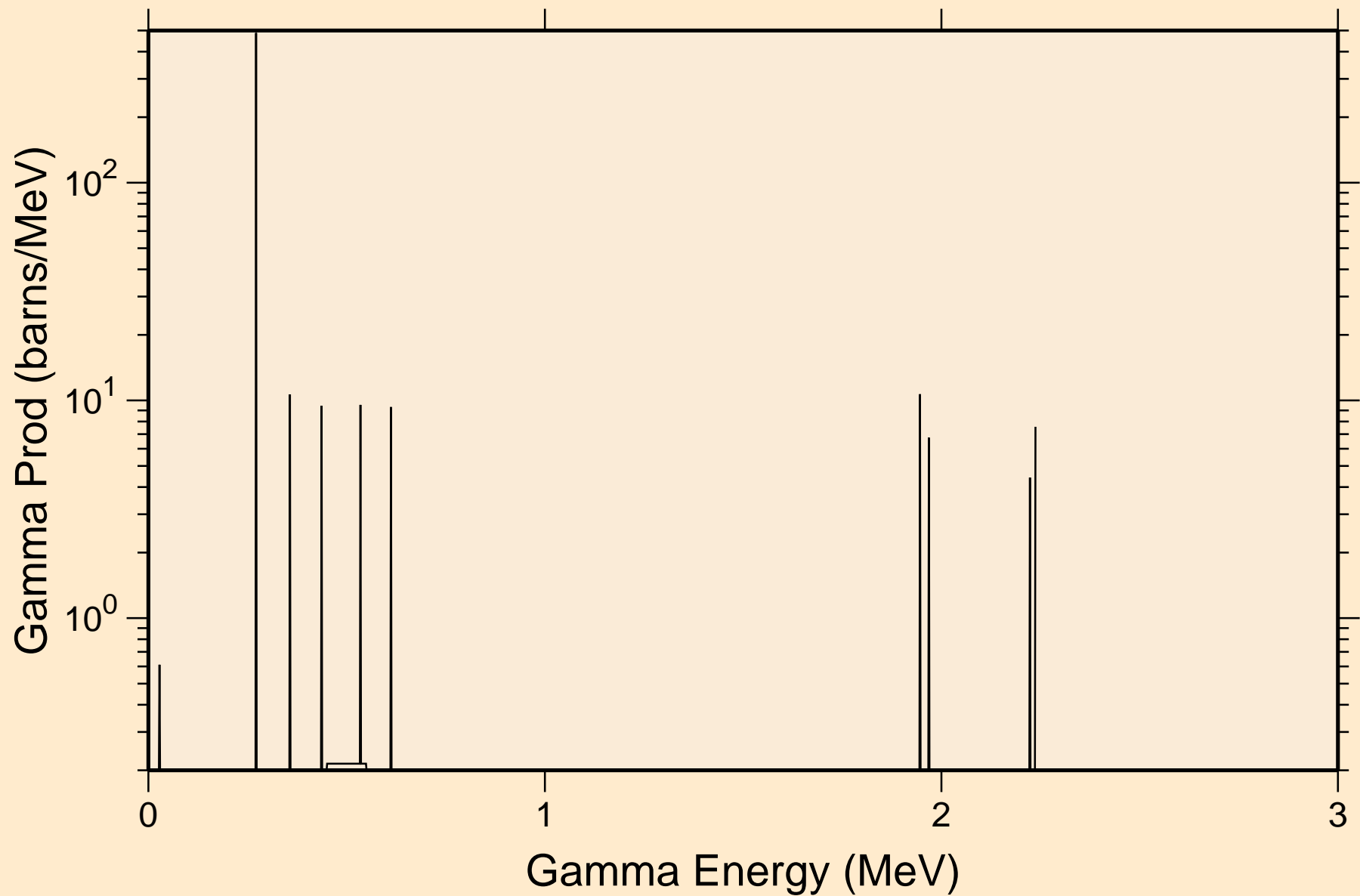

TE138 NEUTRON ACER TENDL-2023 LIBRARY; T=0.K  
14 MeV photon spectrum

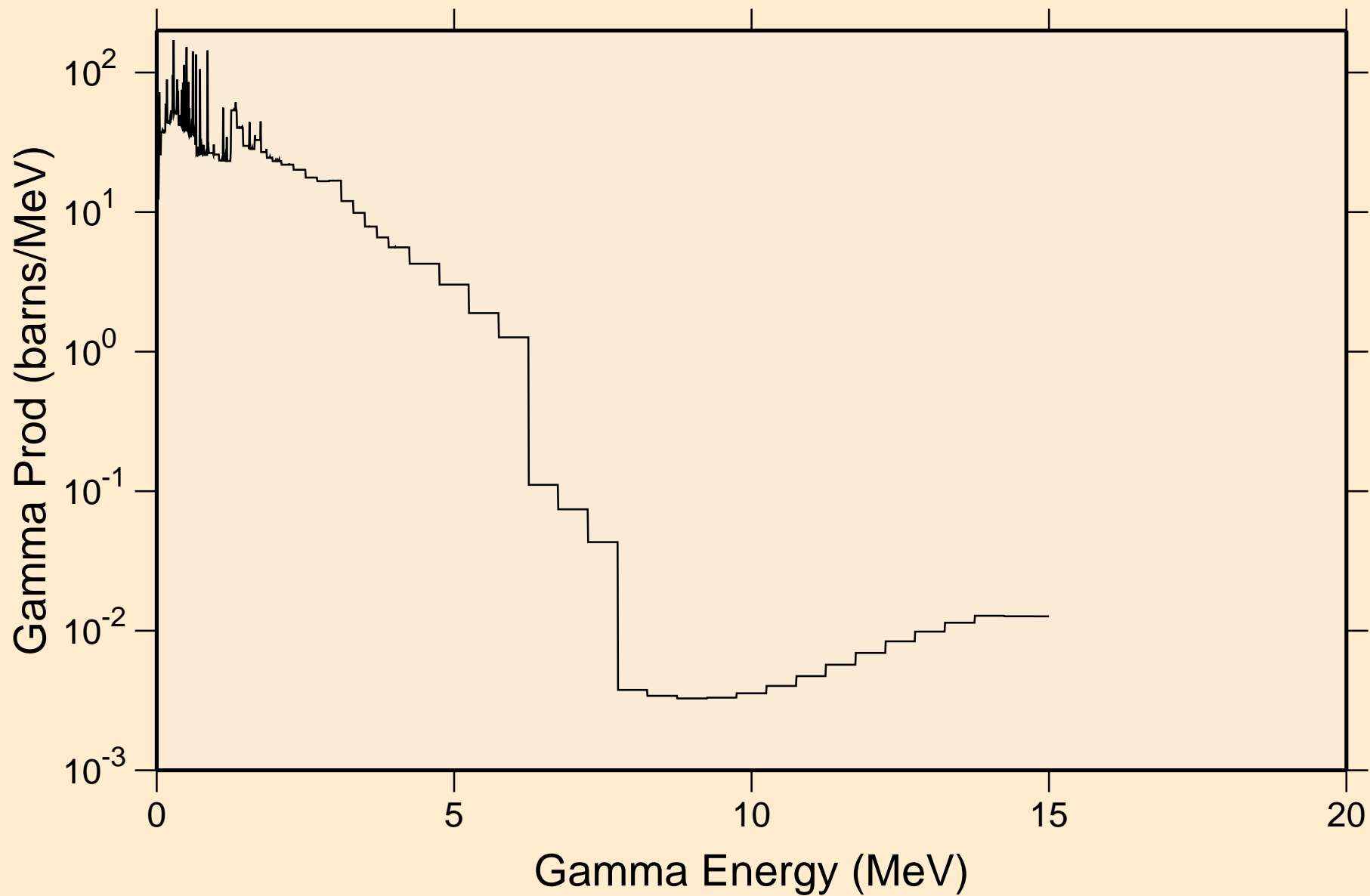

# TE138 NEUTRON ACER TENDL-2023 LIBRARY; T=0.K

## Particle heating contributions

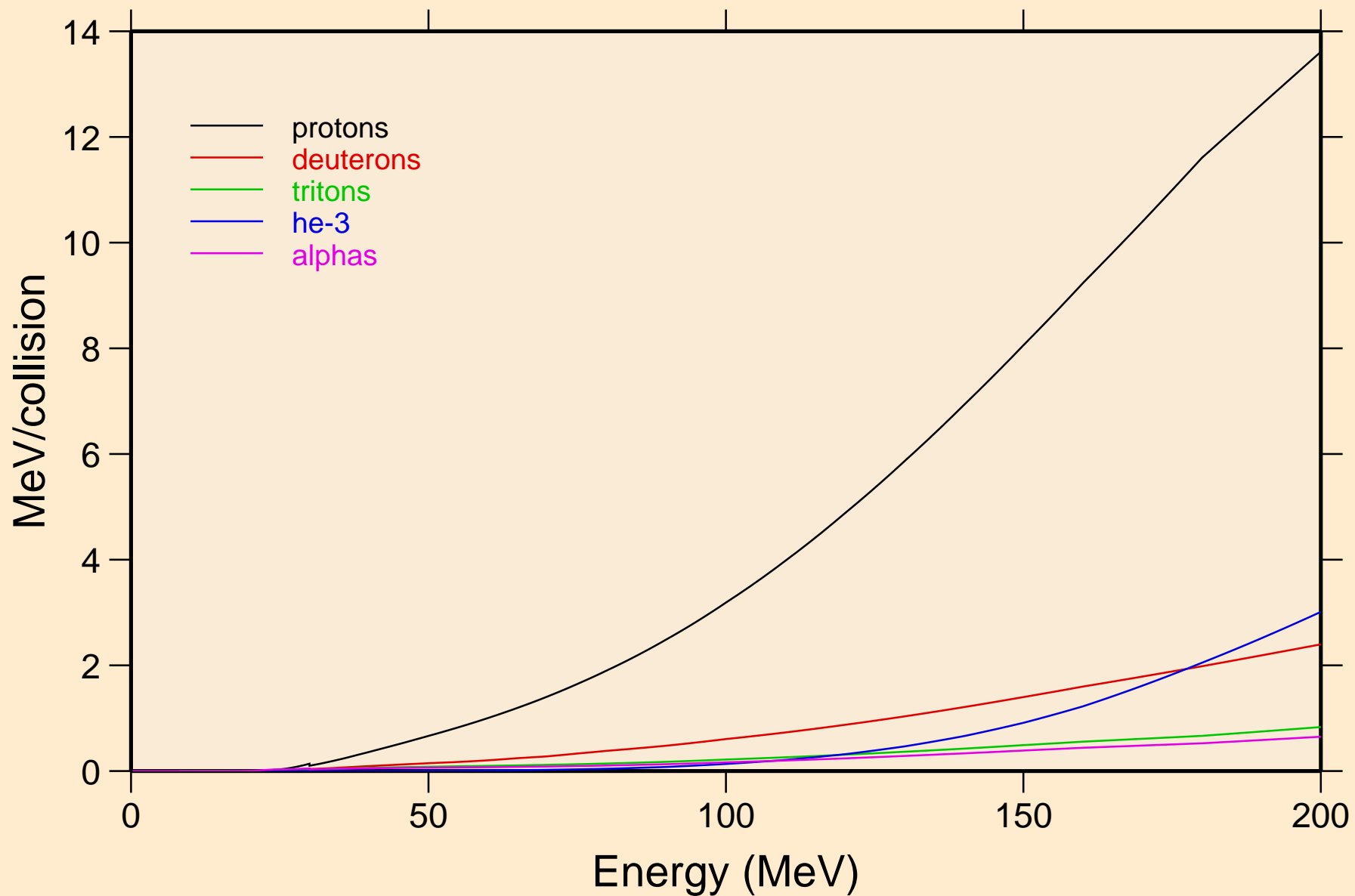

TE138 NEUTRON ACER TENDL-2023 LIBRARY; T=0.K  
Recoil Heating

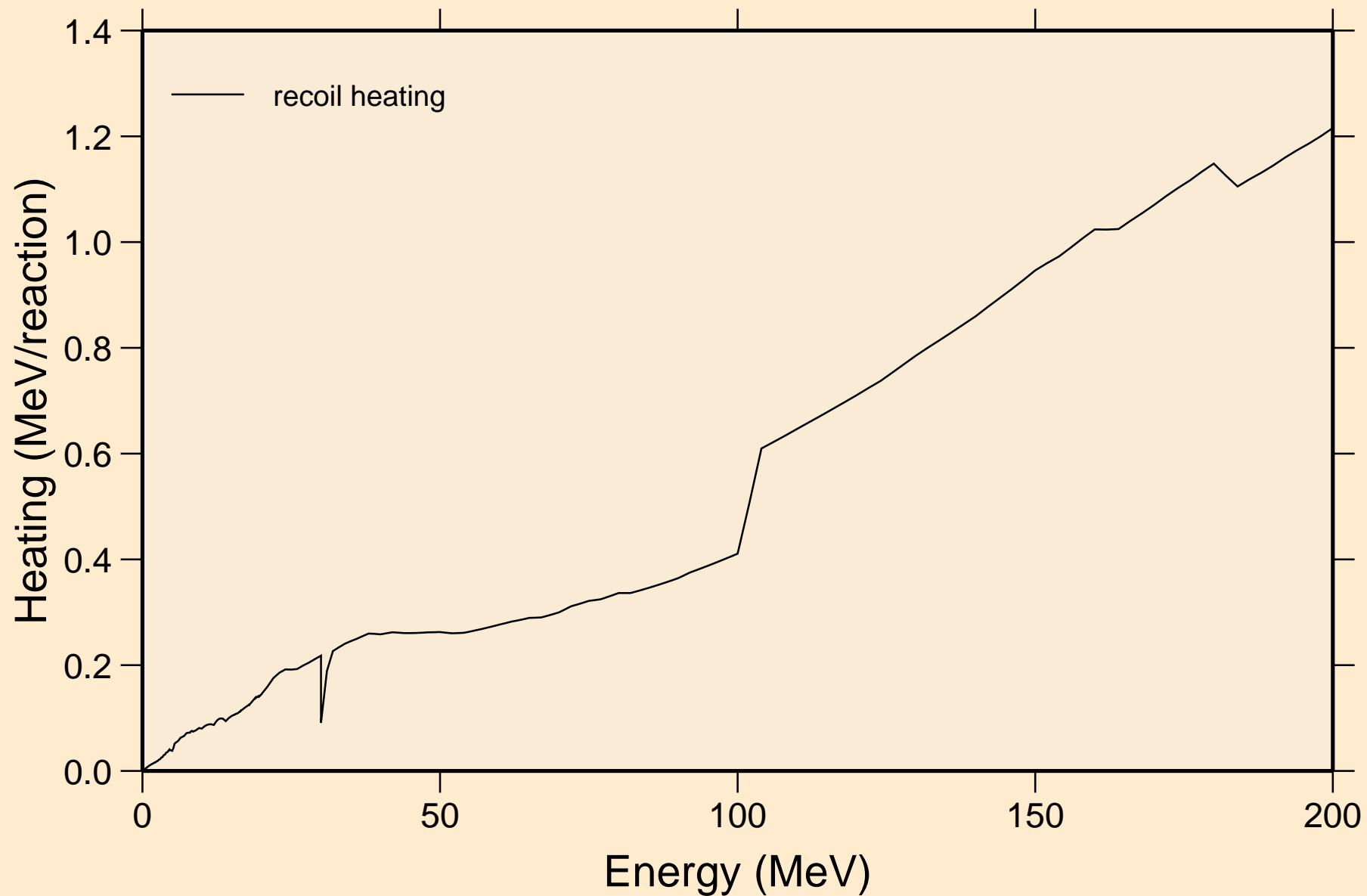

TE138 NEUTRON ACER TENDL-2023 LIBRARY; T=0.K  
Particle production cross sections

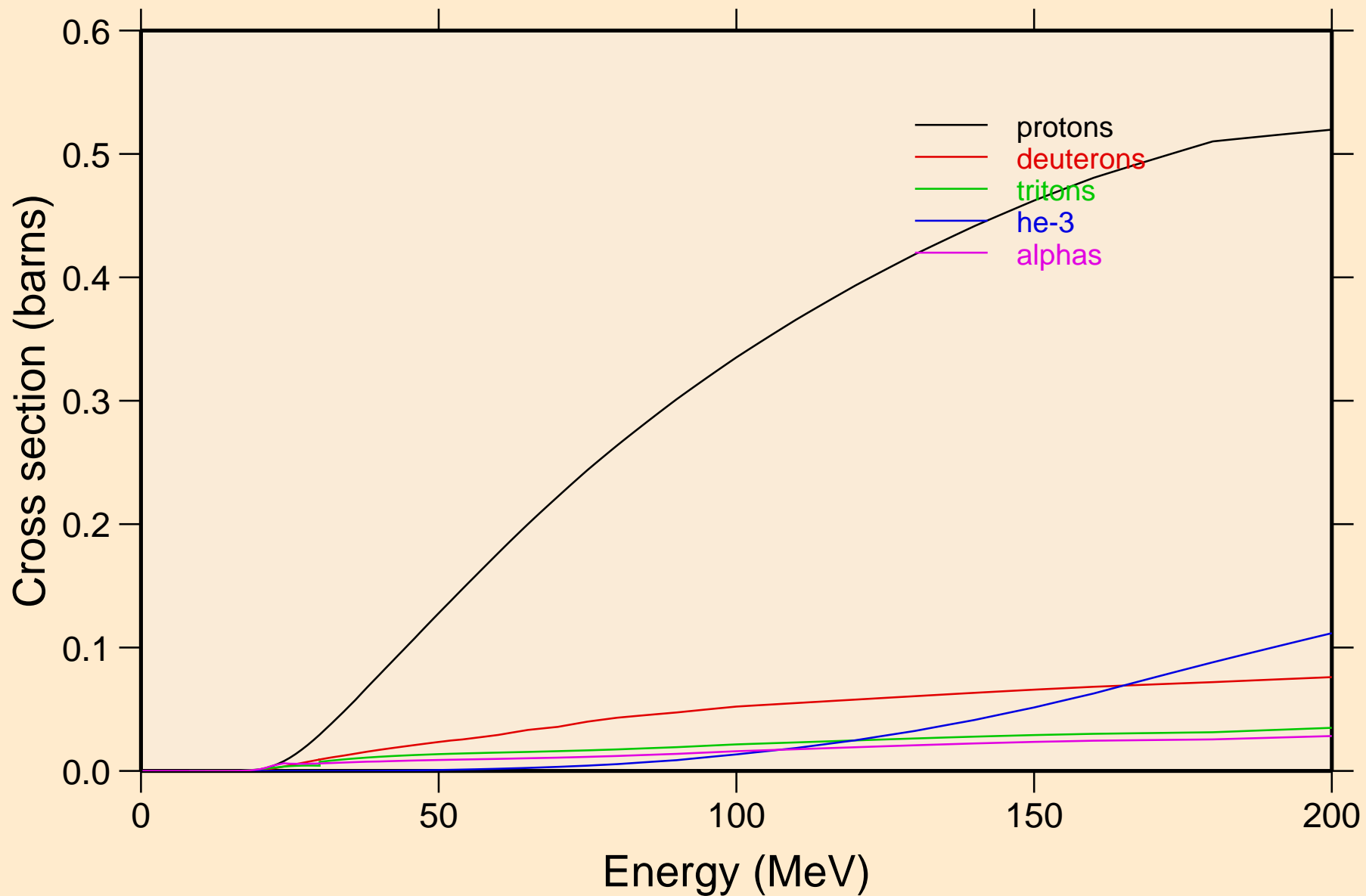

TE138 NEUTRON ACER TENDL-2023 LIBRARY; T=0.K  
protons from (n,x)

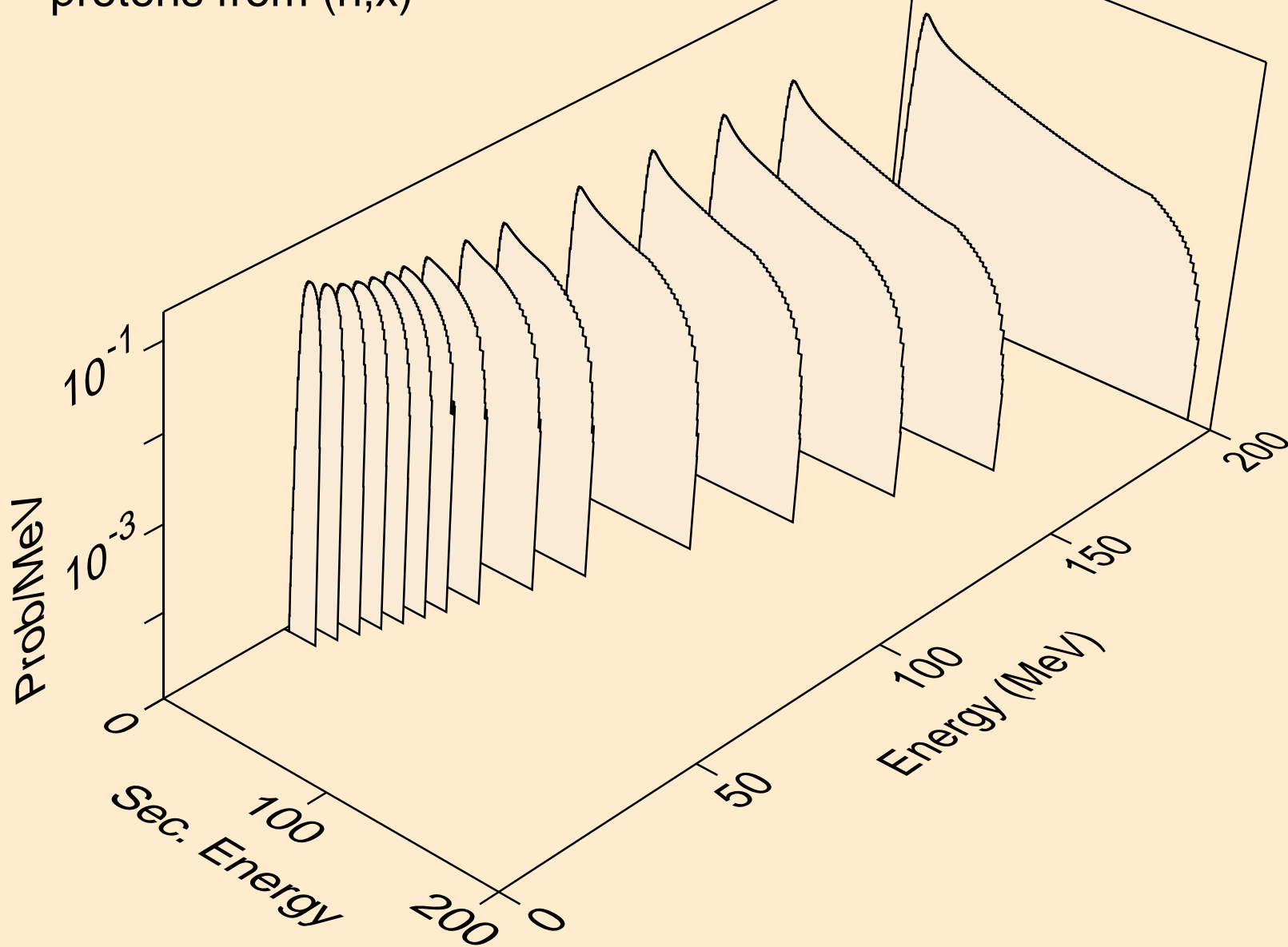

TE138 NEUTRON ACER TENDL-2023 LIBRARY; T=0.K  
protons from (n,n\*)p

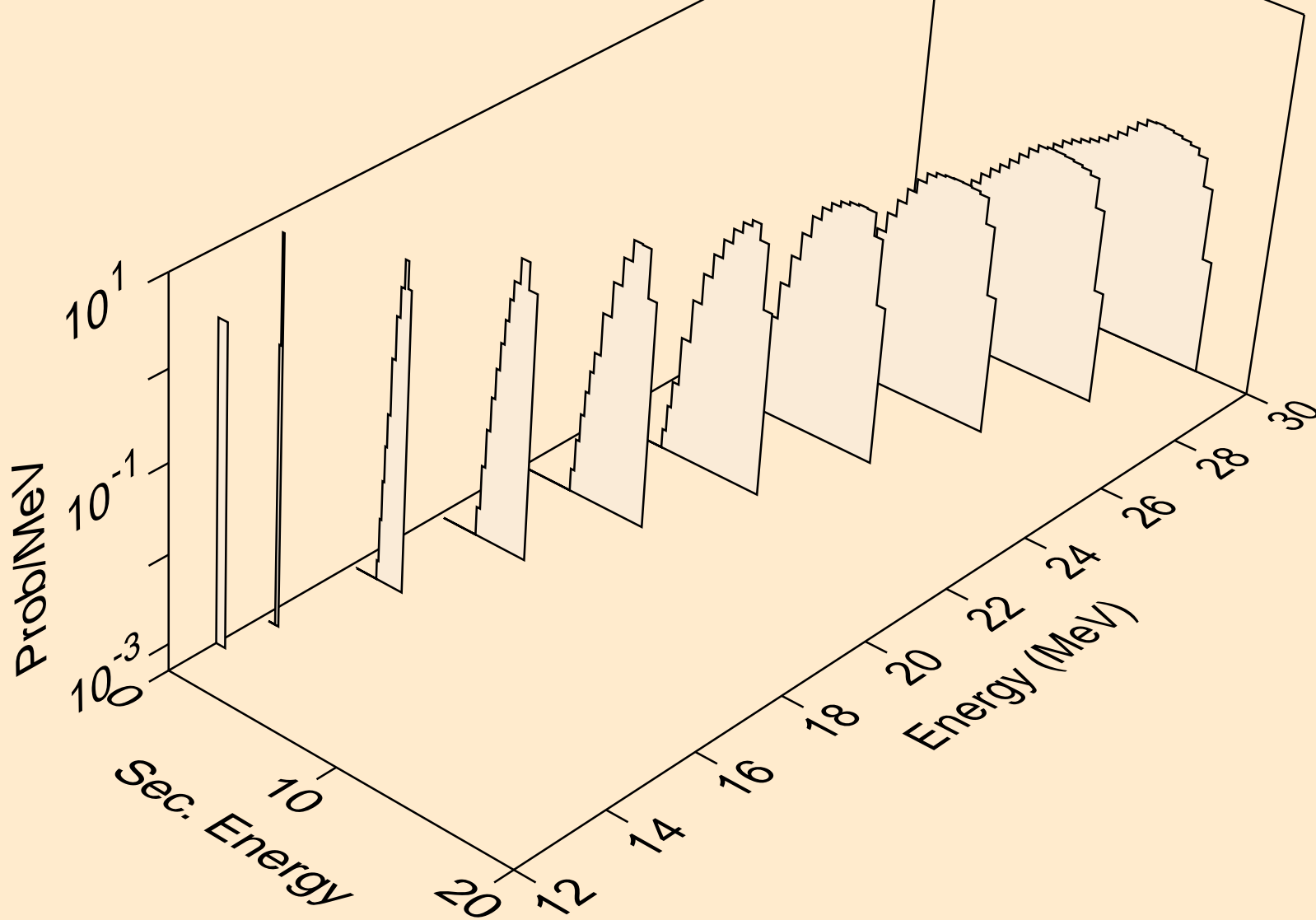

TE138 NEUTRON ACER TENDL-2023 LIBRARY; T=0.K  
protons from (n,2np)

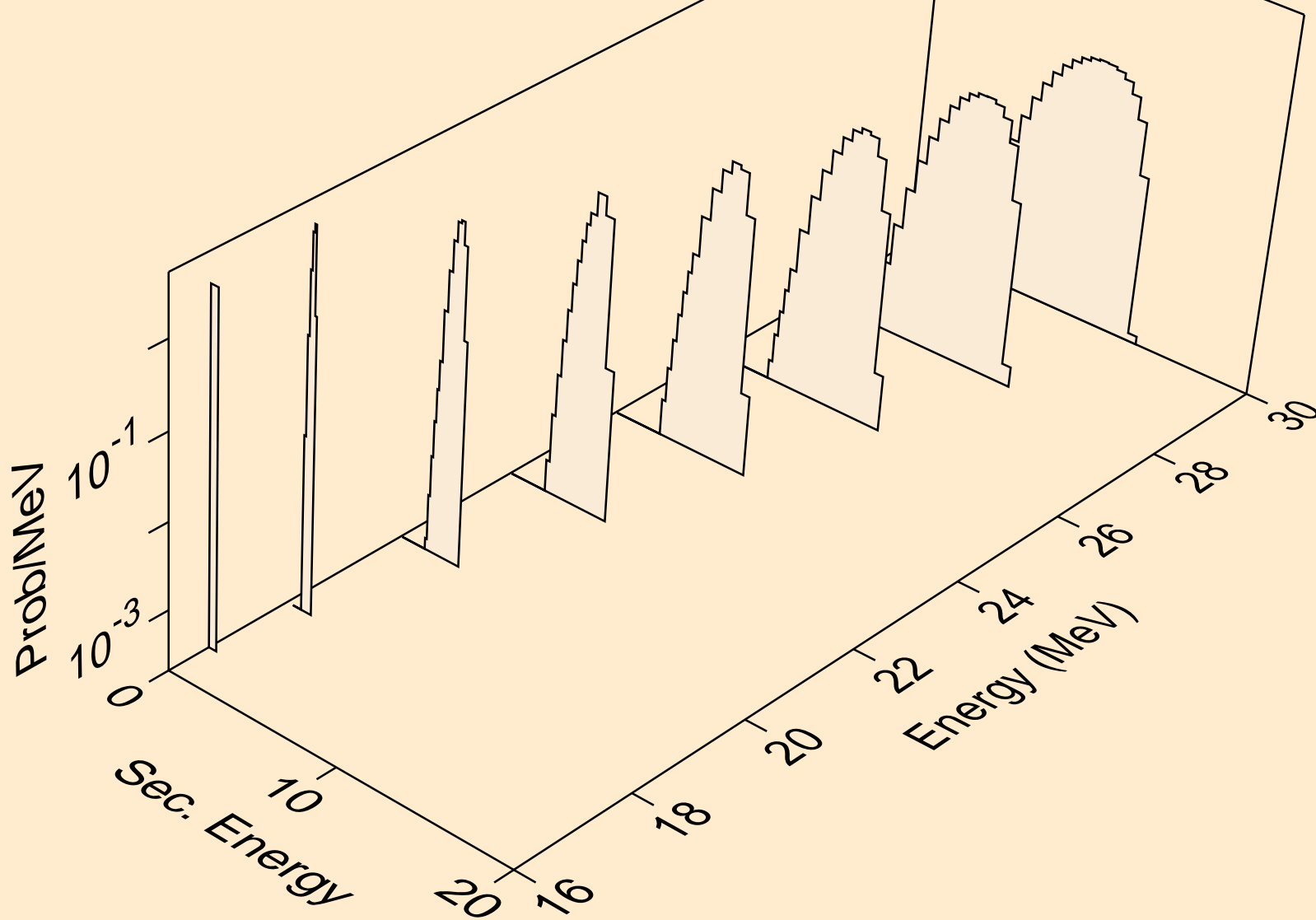



TE138 NEUTRON ACER TENDL-2023 LIBRARY; T=0.K  
protons from (n,3np)

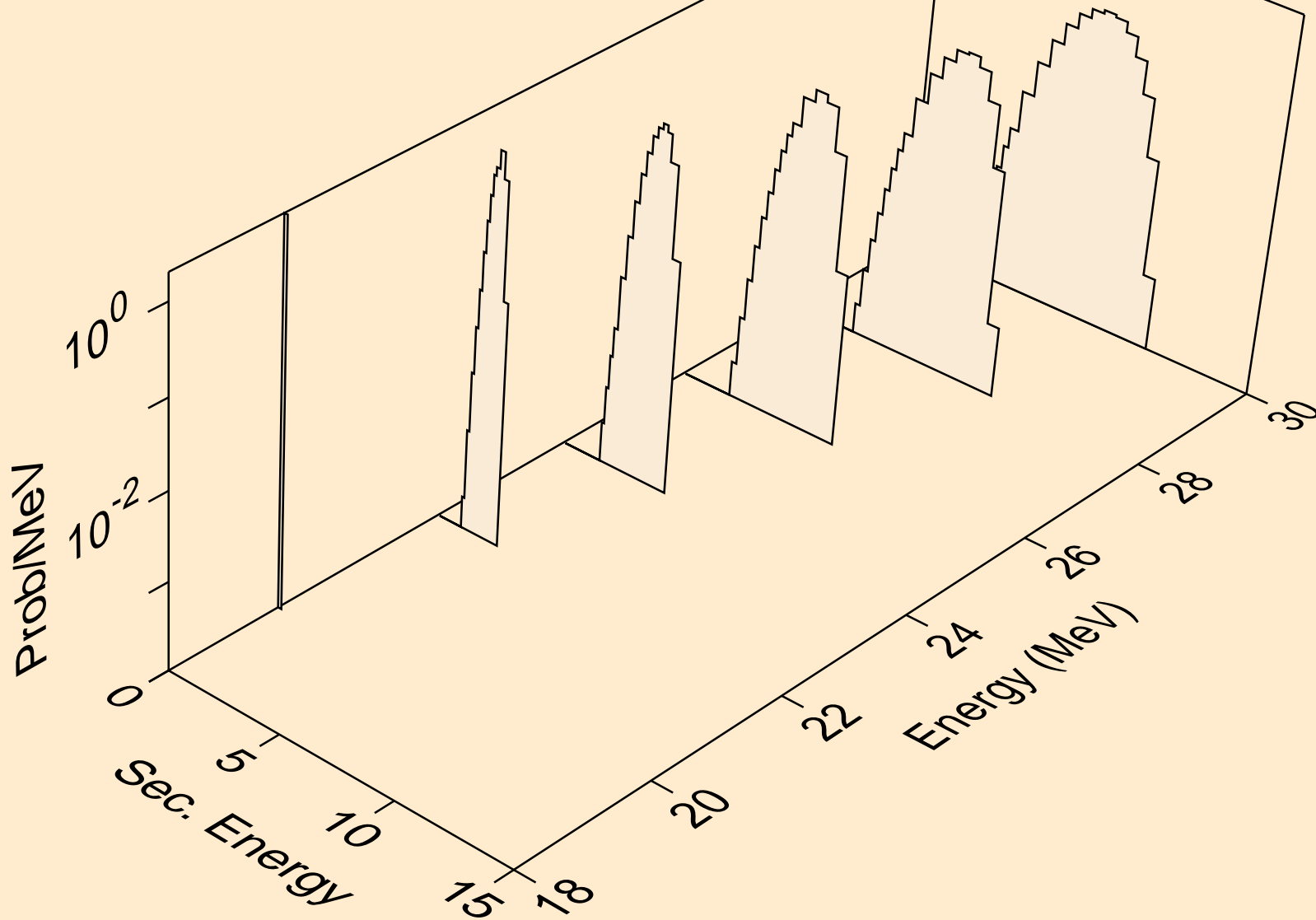

TE138 NEUTRON ACER TENDL-2023 LIBRARY; T=0.K  
protons from (n,p)

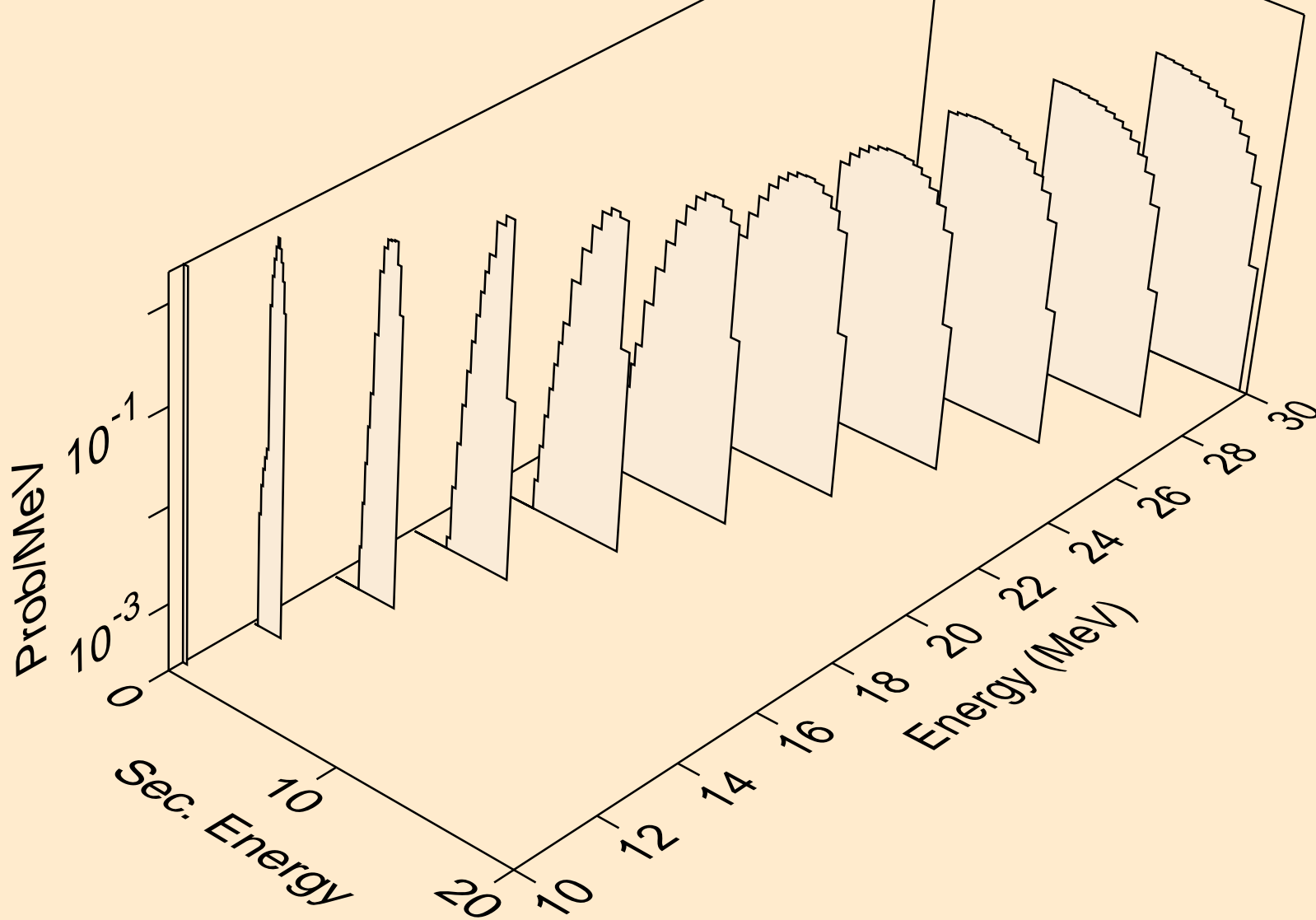

TE138 NEUTRON ACER TENDL-2023 LIBRARY; T=0.K  
deuterons from (n,x)

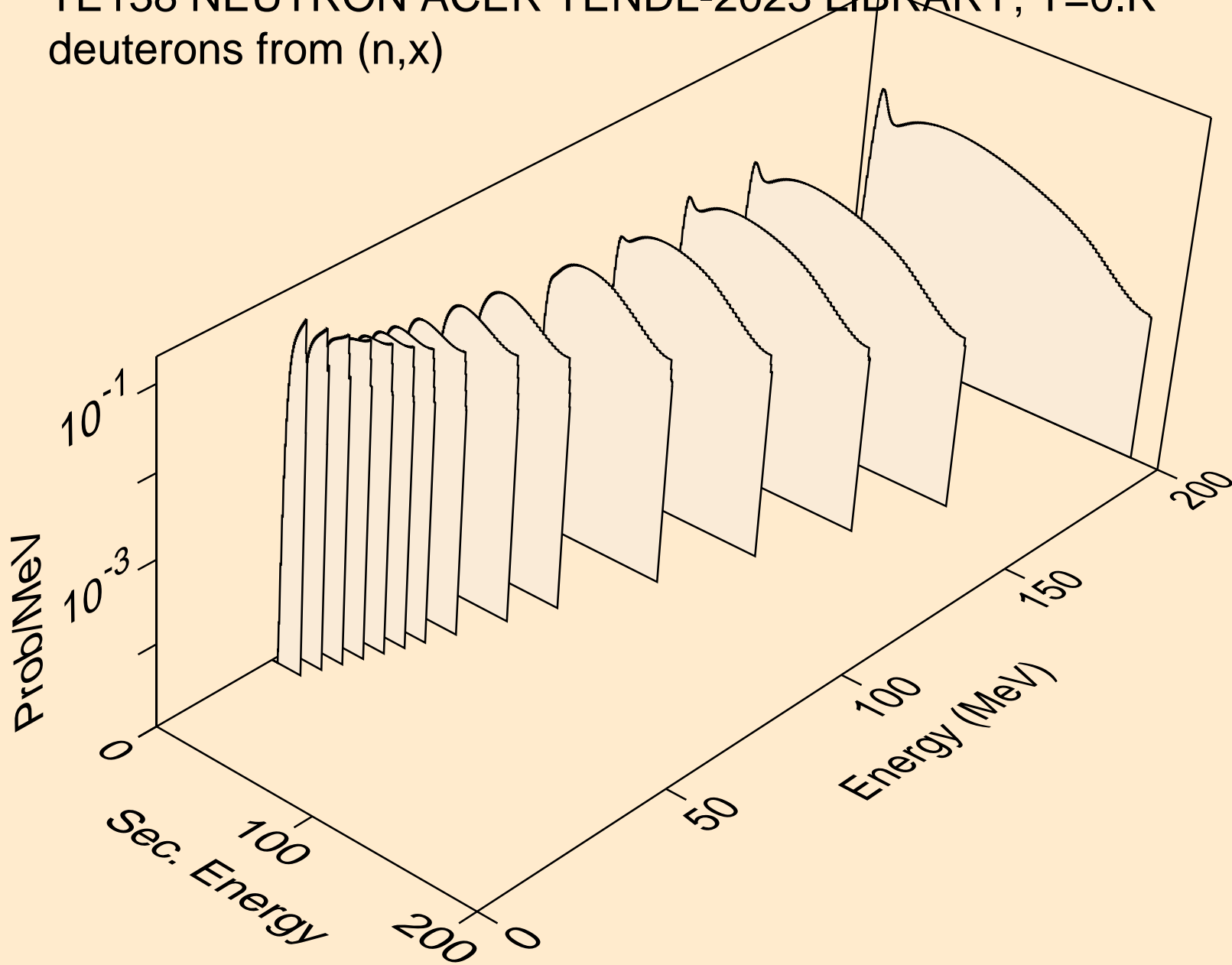

TE138 NEUTRON ACER TENDL-2023 LIBRARY; T=0.K  
deuterons from (n,2nd)

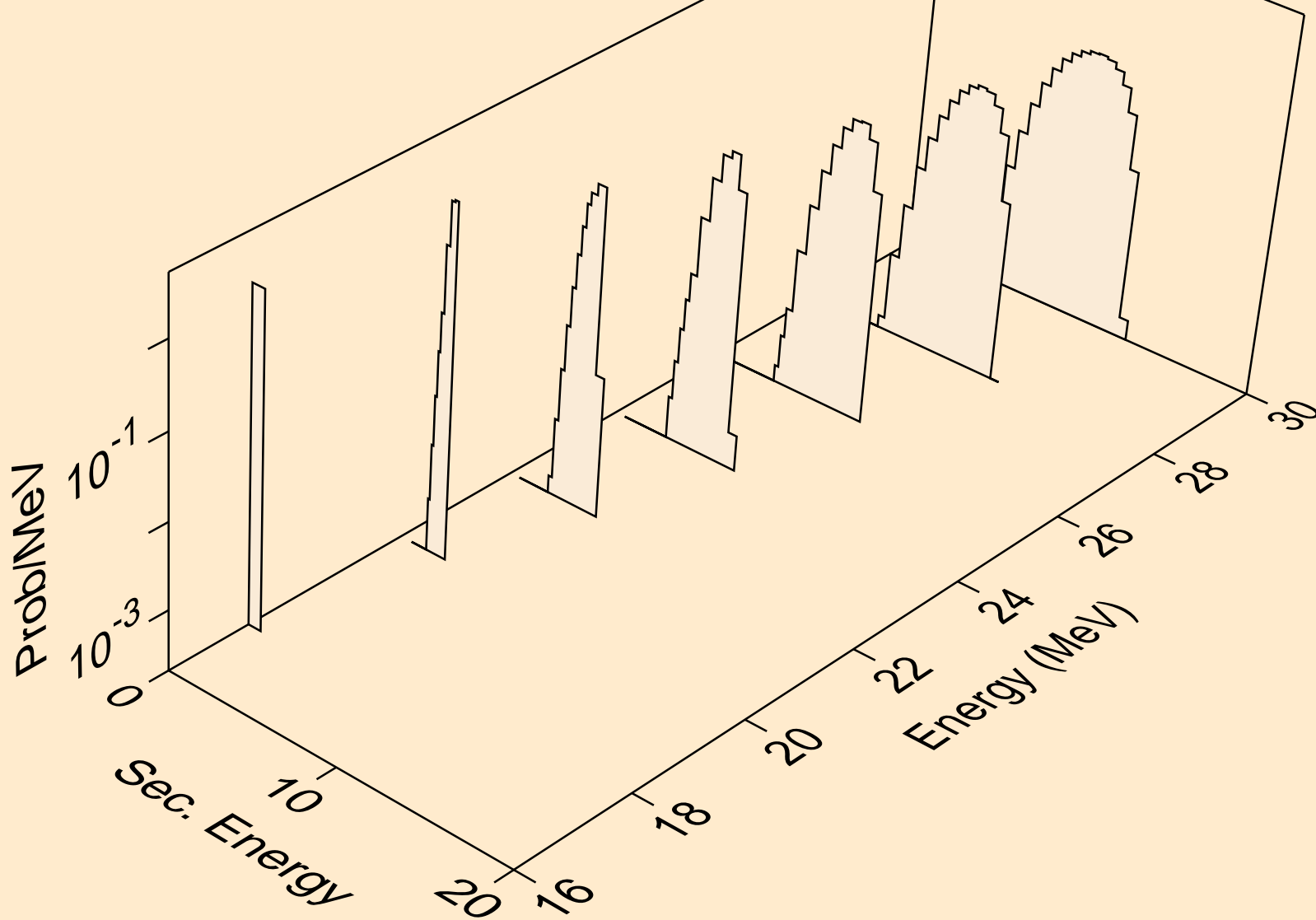

TE138 NEUTRON ACER TENDL-2023 LIBRARY; T=0.K  
deuterons from (n,n\*)d

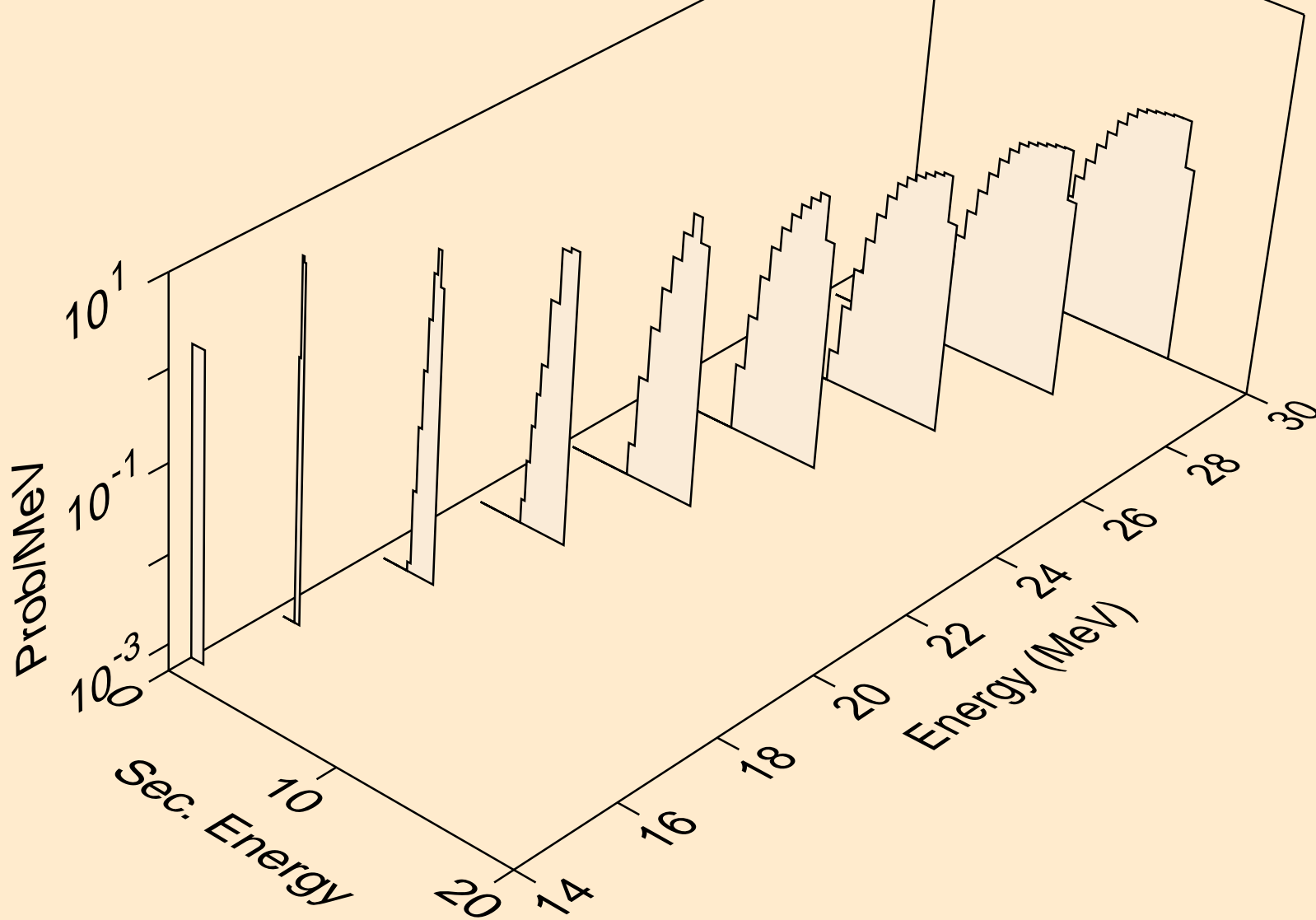

TE138 NEUTRON ACER TENDL-2023 LIBRARY; T=0.K  
deuterons from (n,d)

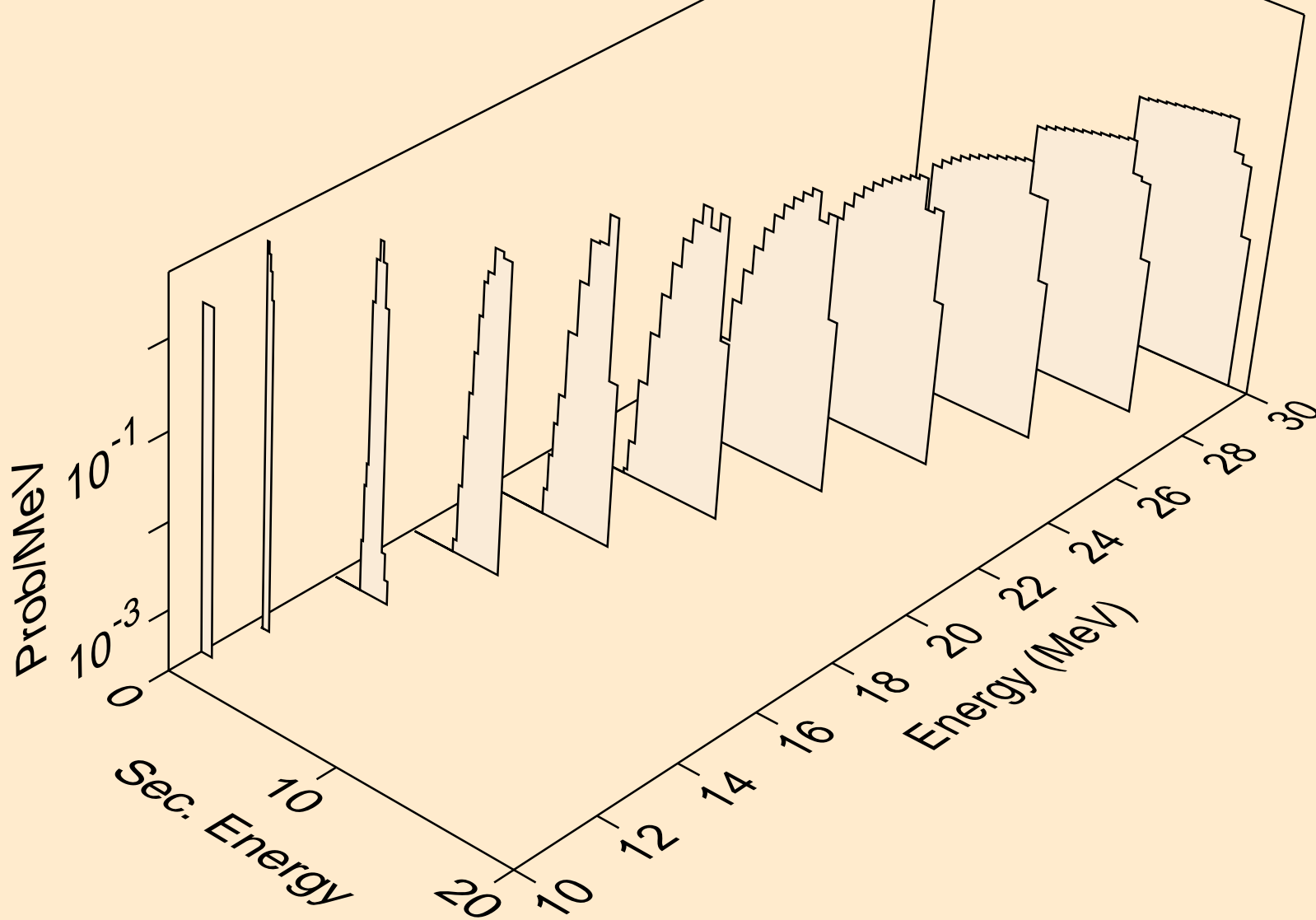

TE138 NEUTRON ACER TENDL-2023 LIBRARY; T=0.K  
tritons from (n,x)

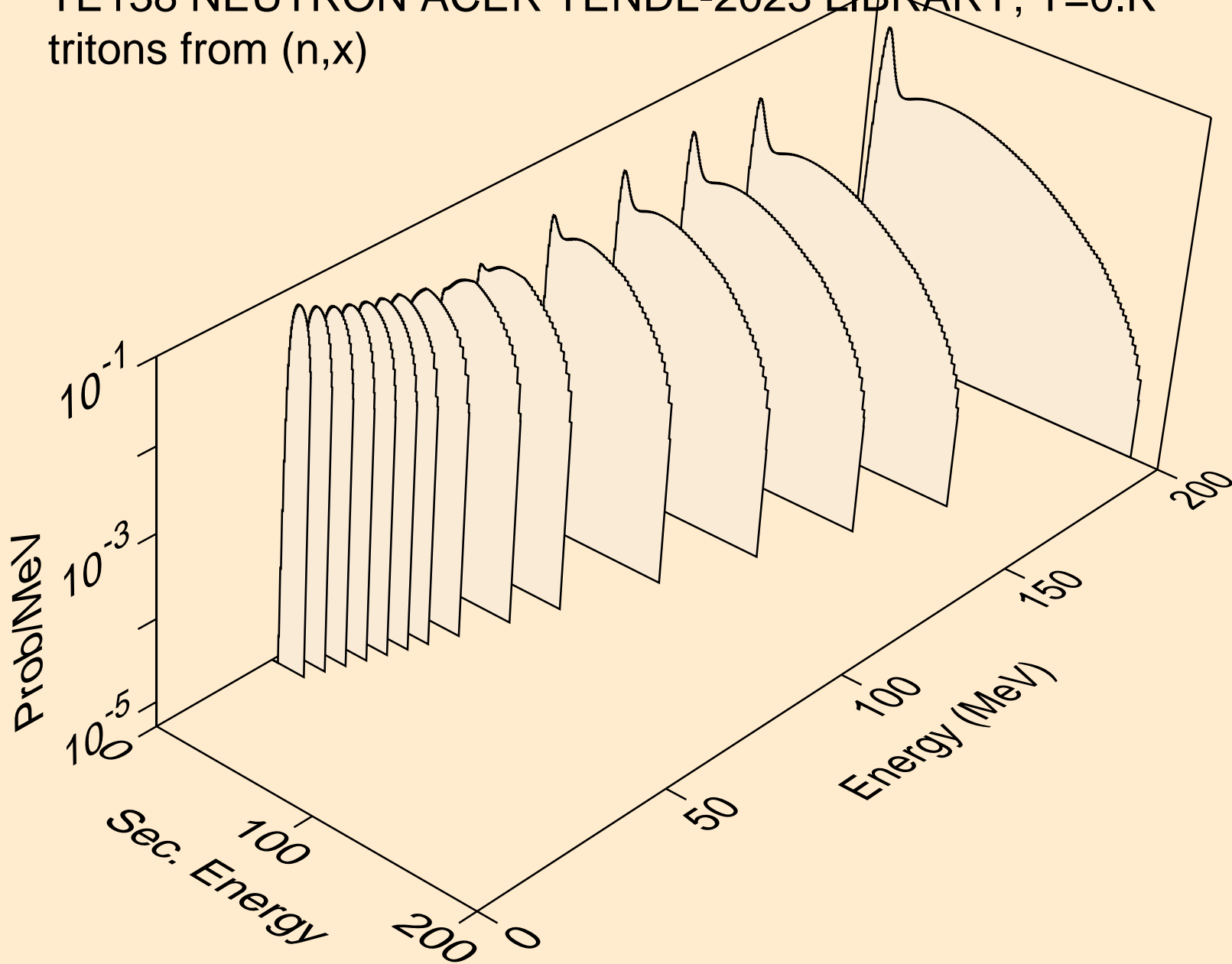

TE138 NEUTRON ACER TENDL-2023 LIBRARY; T=0.K  
tritons from (n,n\*)t

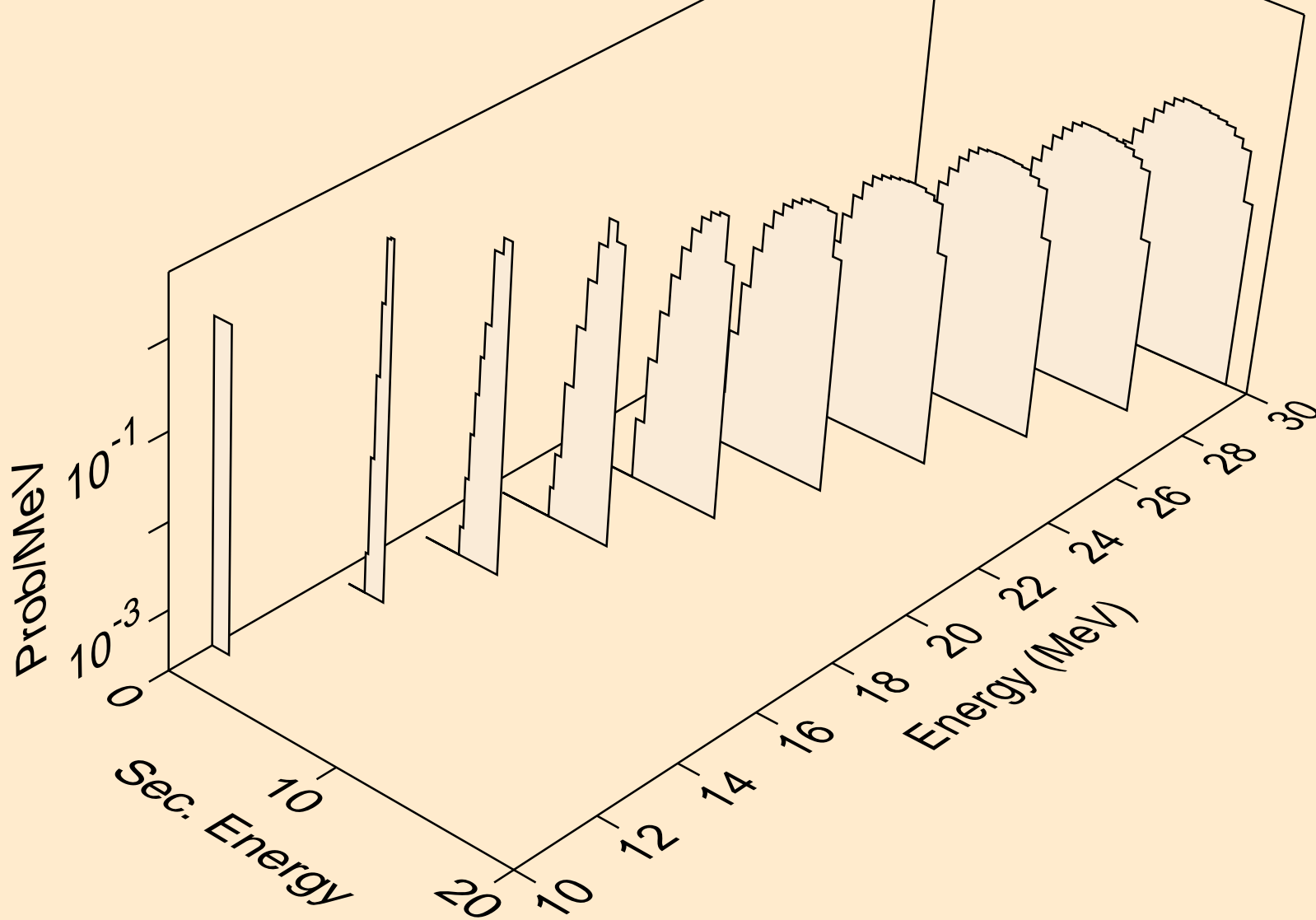



TE138 NEUTRON ACER TENDL-2023 LIBRARY; T=0.K  
tritons from (n,t)

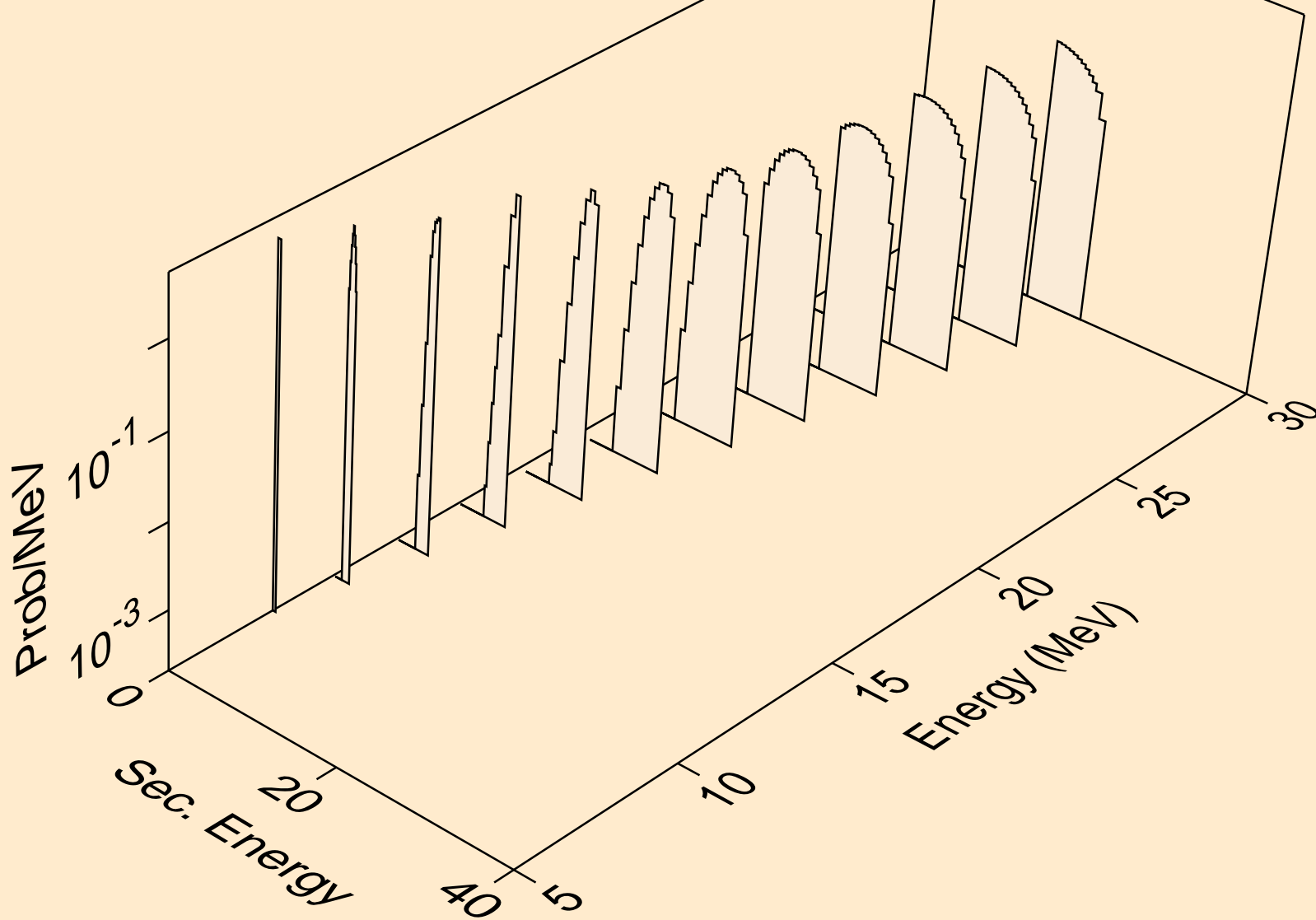

TE138 NEUTRON ACER TENDL-2023 LIBRARY; T=0.K  
he3s from (n,x)

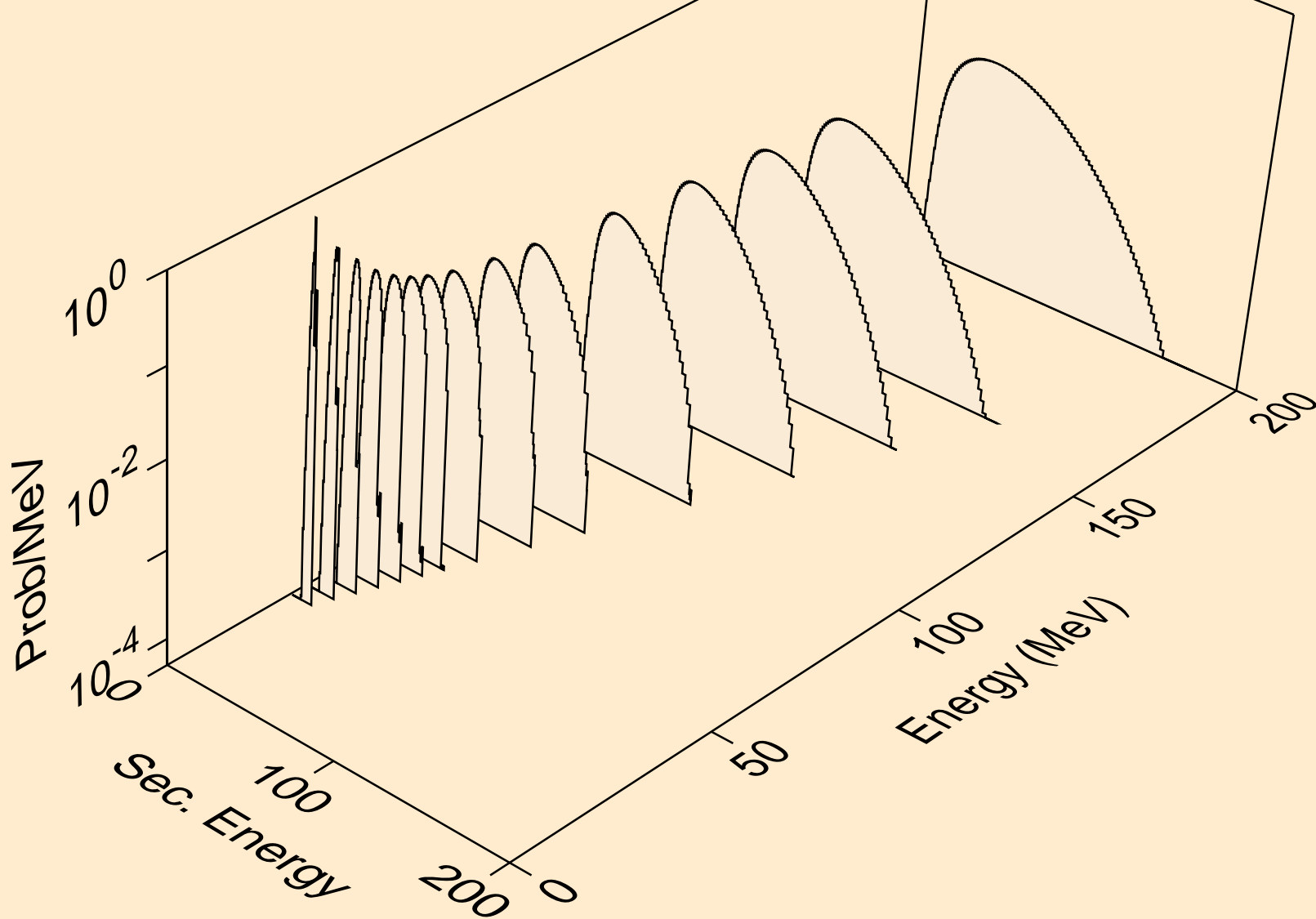

TE138 NEUTRON ACER TENDL-2023 LIBRARY; T=0.K  
he3s from (n,n\*)he3

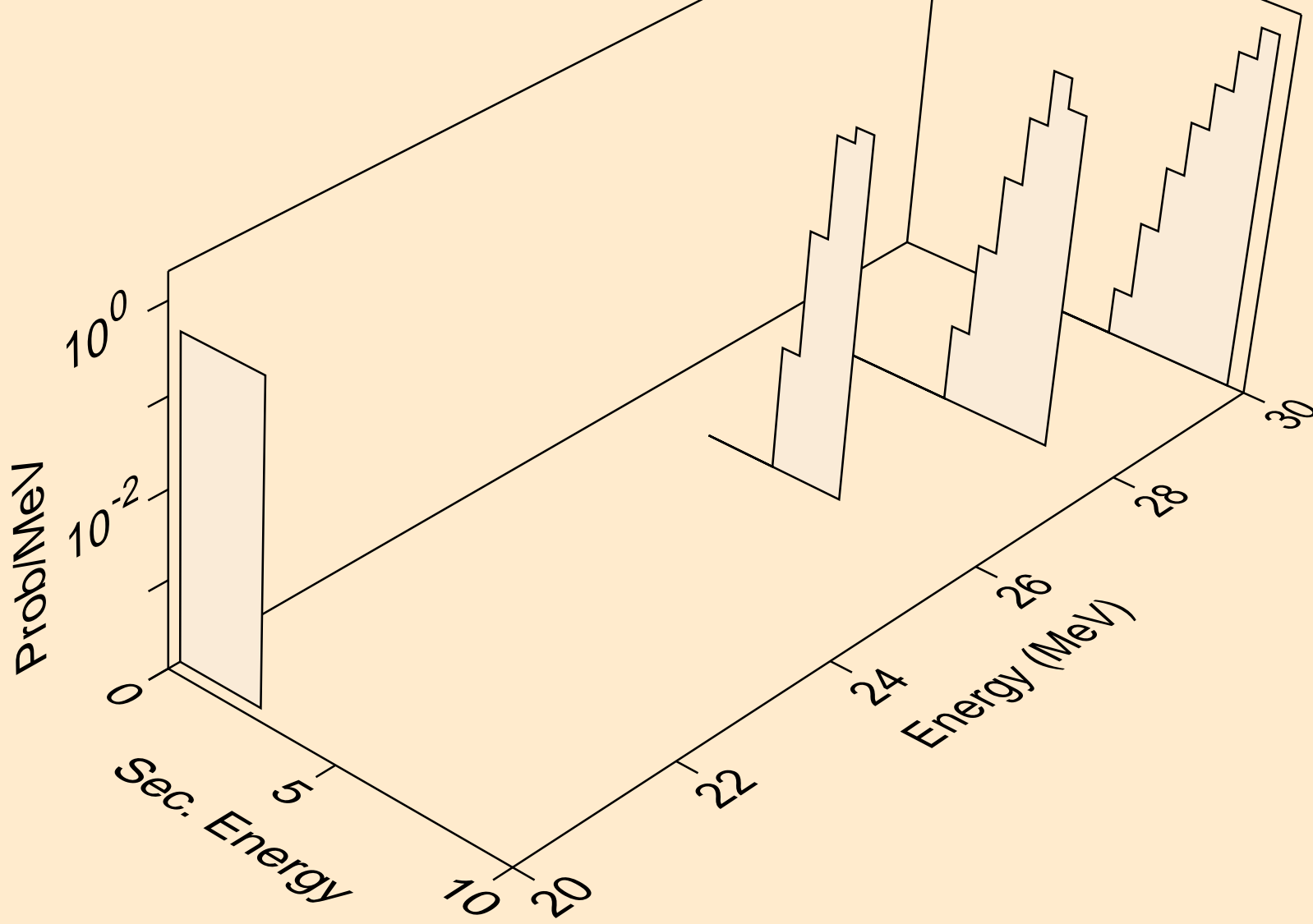

TE138 NEUTRON ACER TENDL-2023 LIBRARY; T=0.K  
he3s from (n,he3)

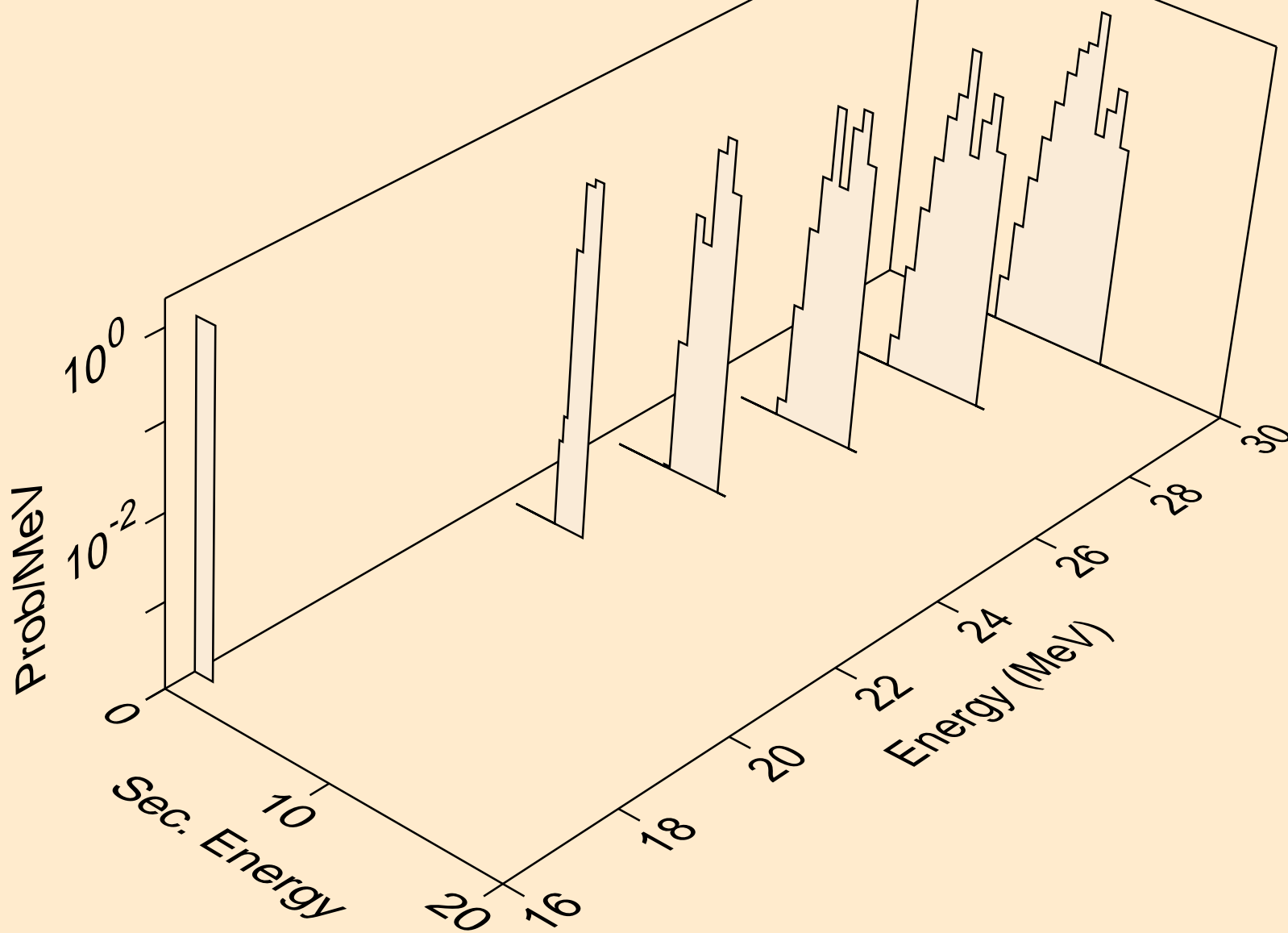

TE138 NEUTRON ACER TENDL-2023 LIBRARY; T=0.K  
alphas from (n,x)

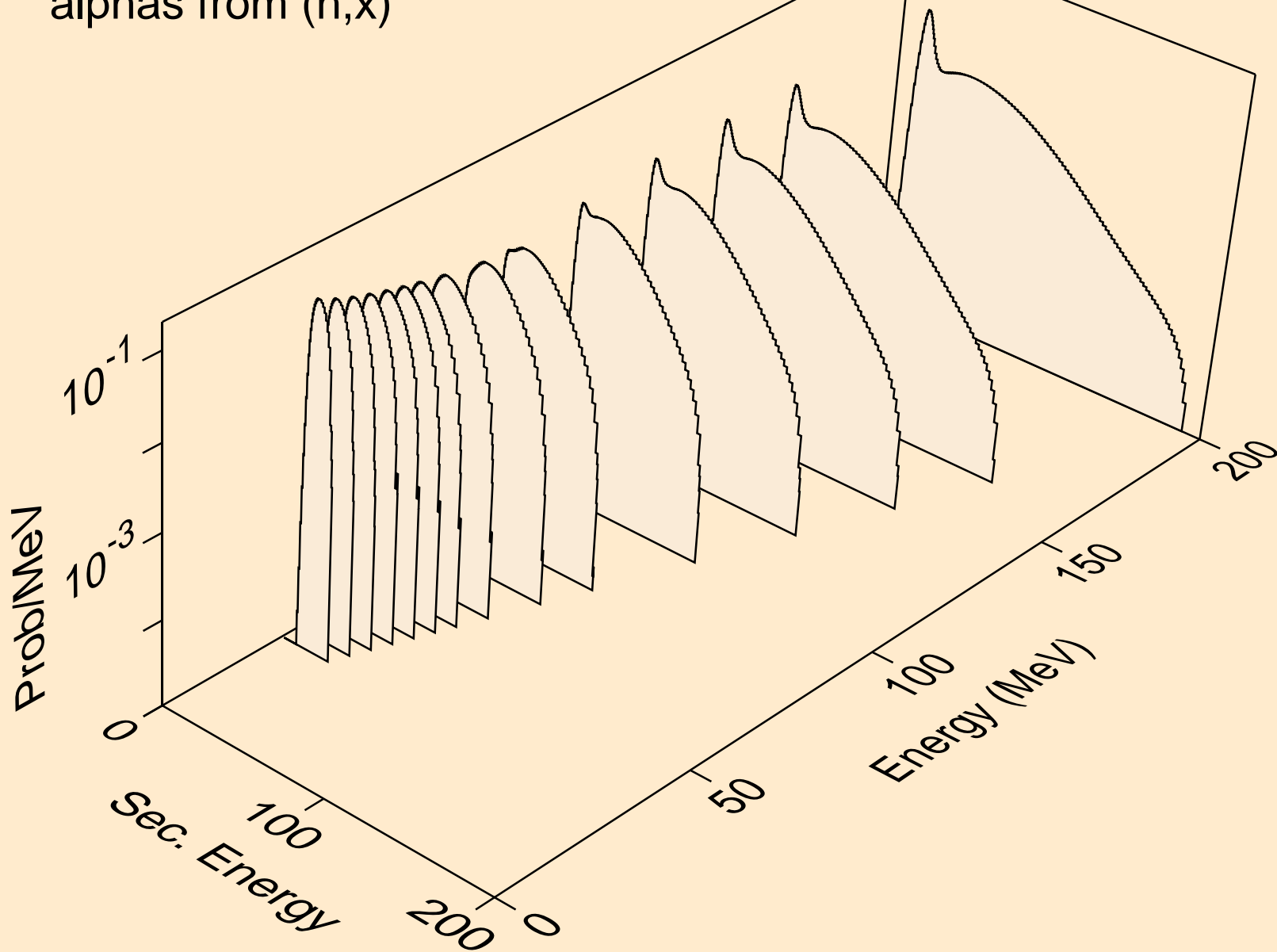

TE138 NEUTRON ACER TENDL-2023 LIBRARY; T=0.K  
alphas from (n,n\*)a

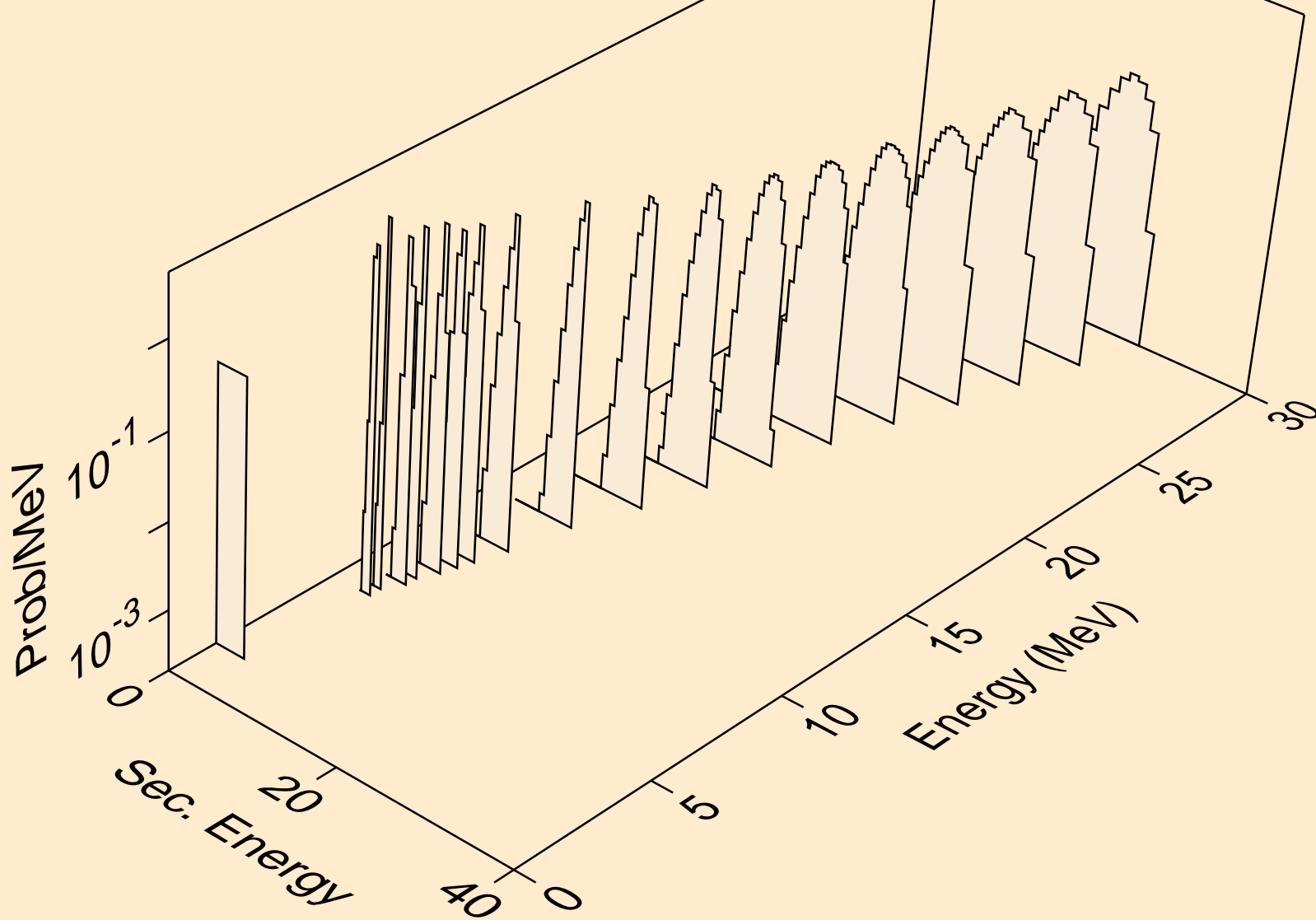

TE138 NEUTRON ACER TENDL-2023 LIBRARY; T=0.K  
alphas from (n,2n)a

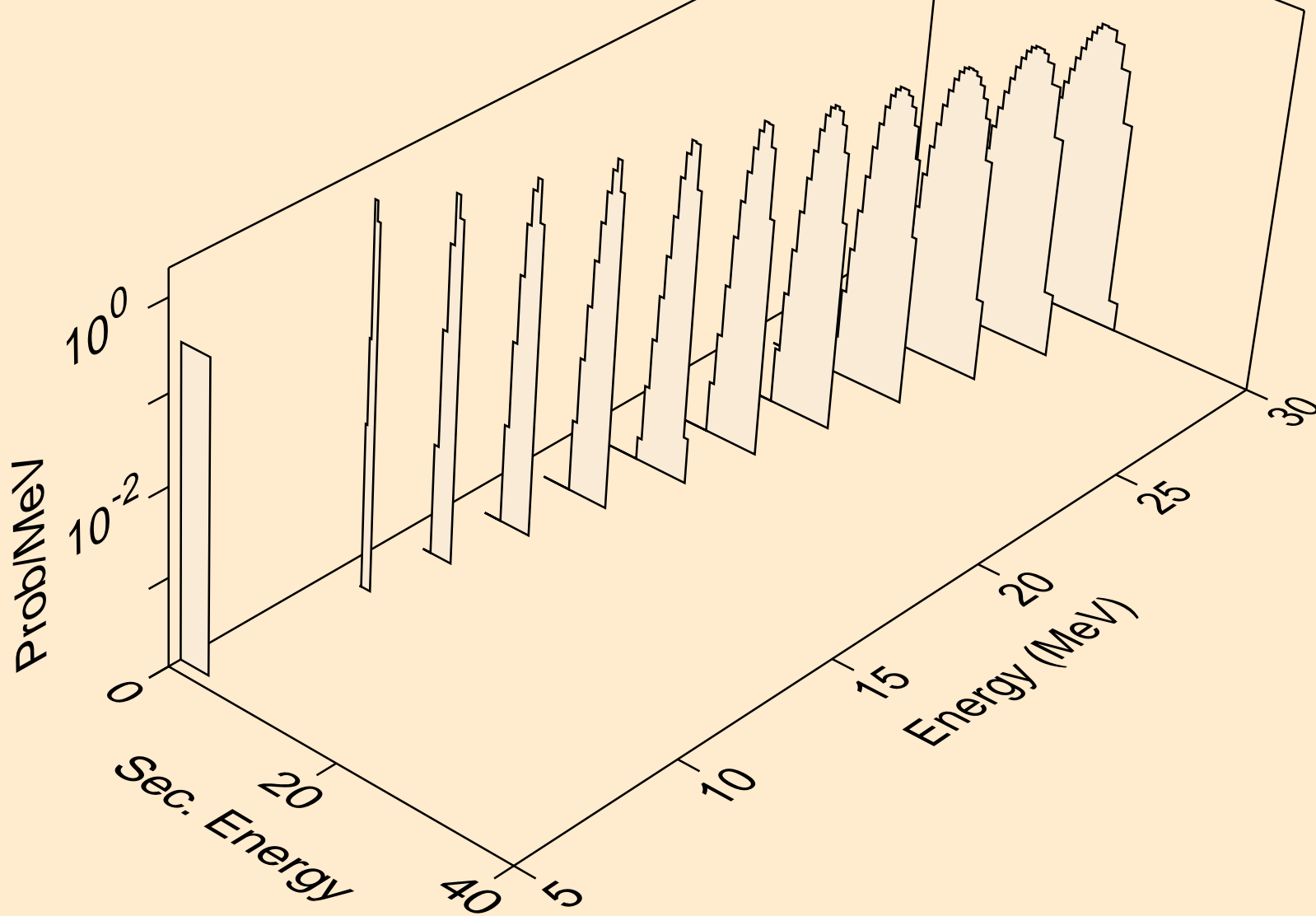

TE138 NEUTRON ACER TENDL-2023 LIBRARY; T=0.K  
alphas from (n,3n)a

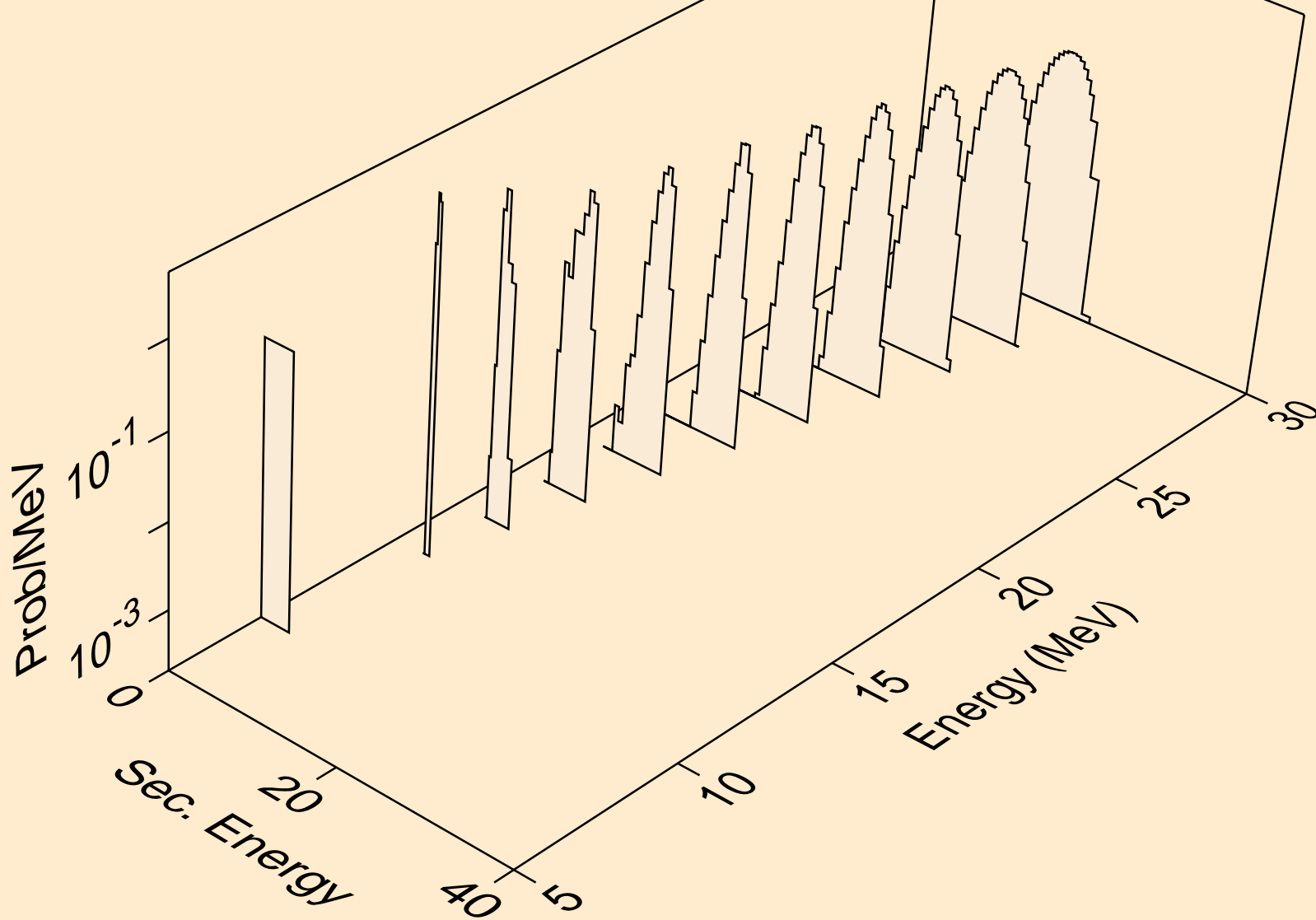



TE138 NEUTRON ACER TENDL-2023 LIBRARY; T=0.K  
alphas from (n,a)

