

TH227 NEUTRON ACER TENDL-2023 LIBRARY; T=0.K

Principal cross sections

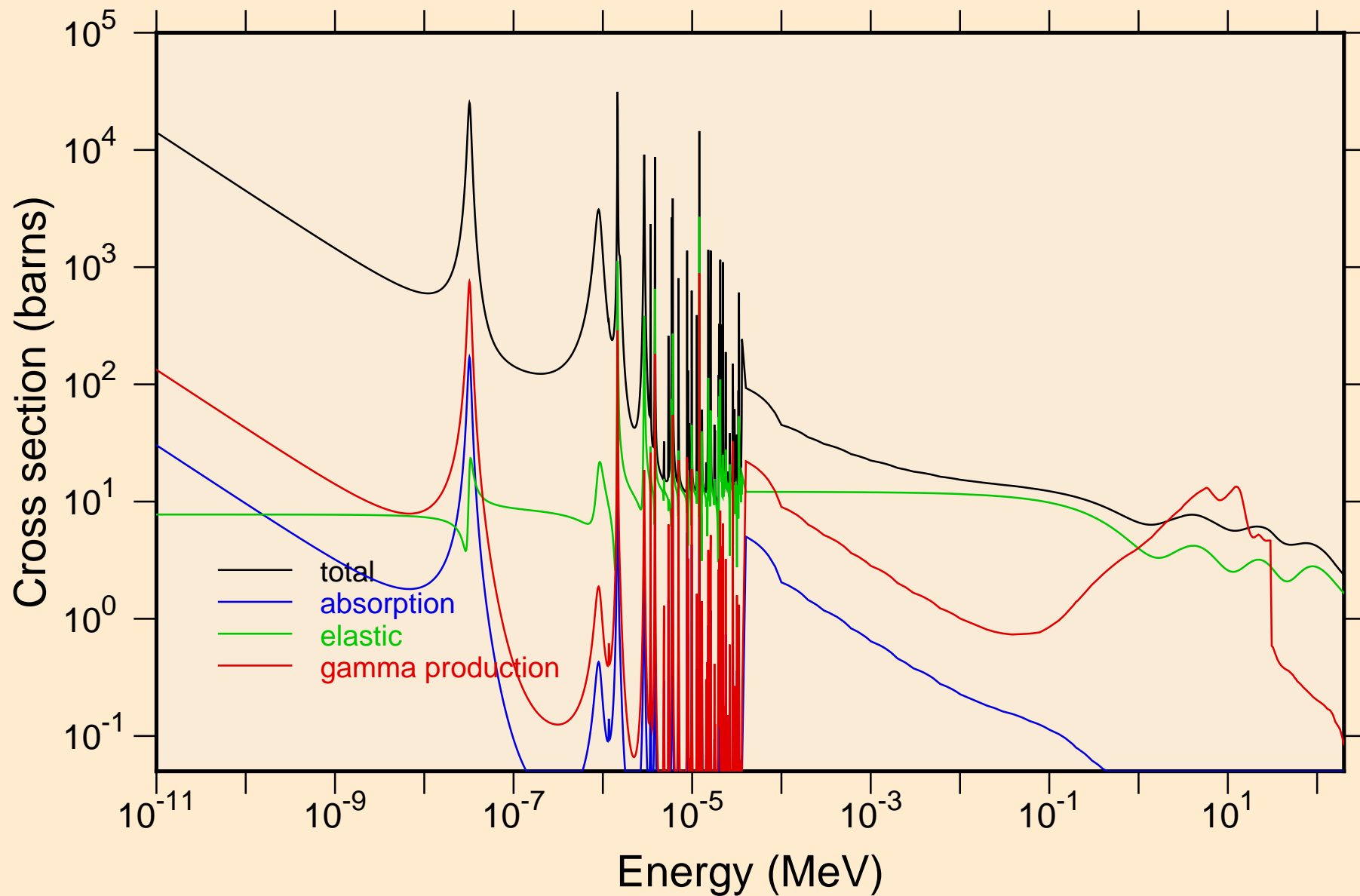

TH227 NEUTRON ACER TENDL-2023 LIBRARY; T=0.K
resonance total cross section

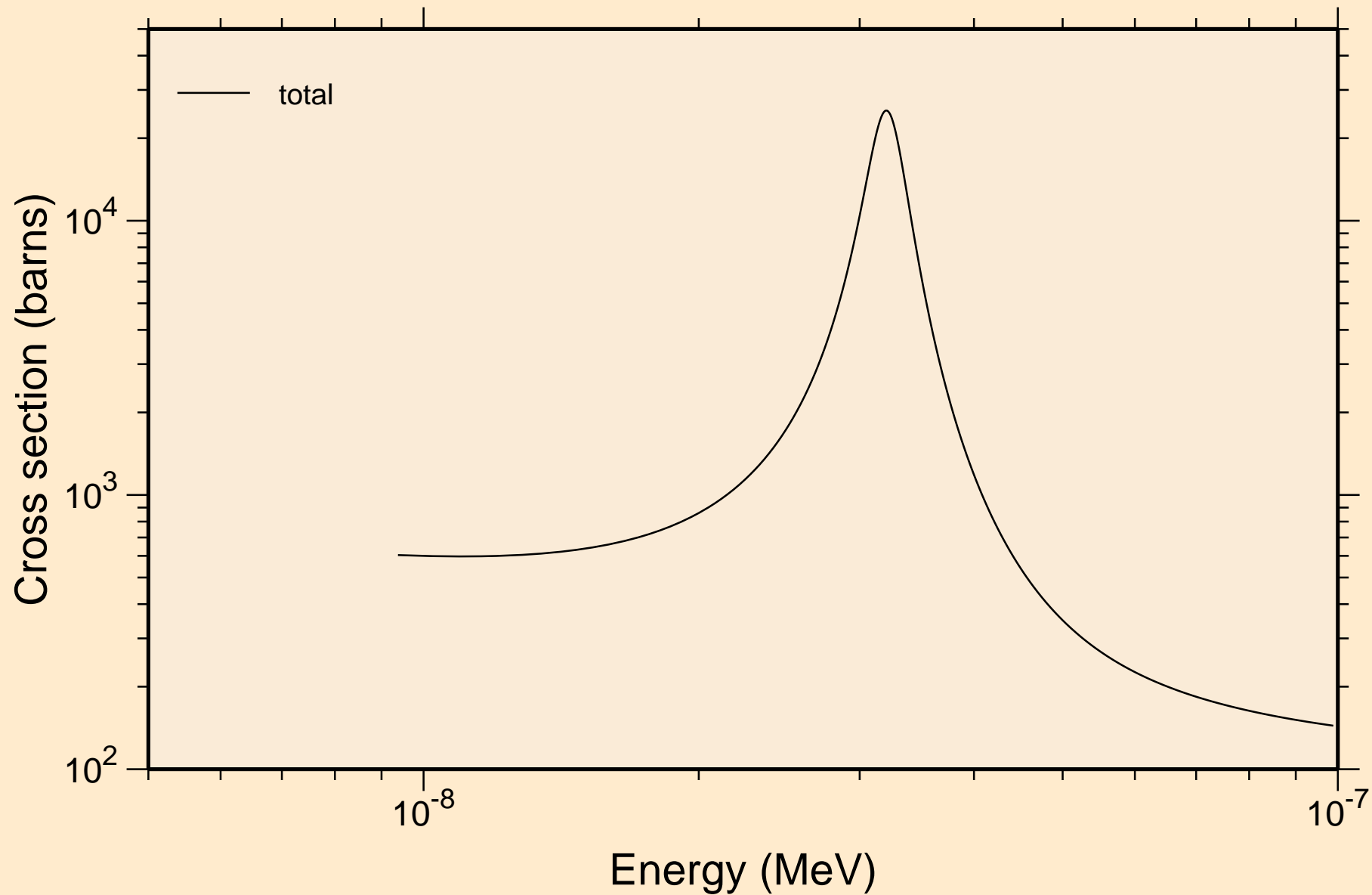

TH227 NEUTRON ACER TENDL-2023 LIBRARY; T=0.K
resonance total cross section

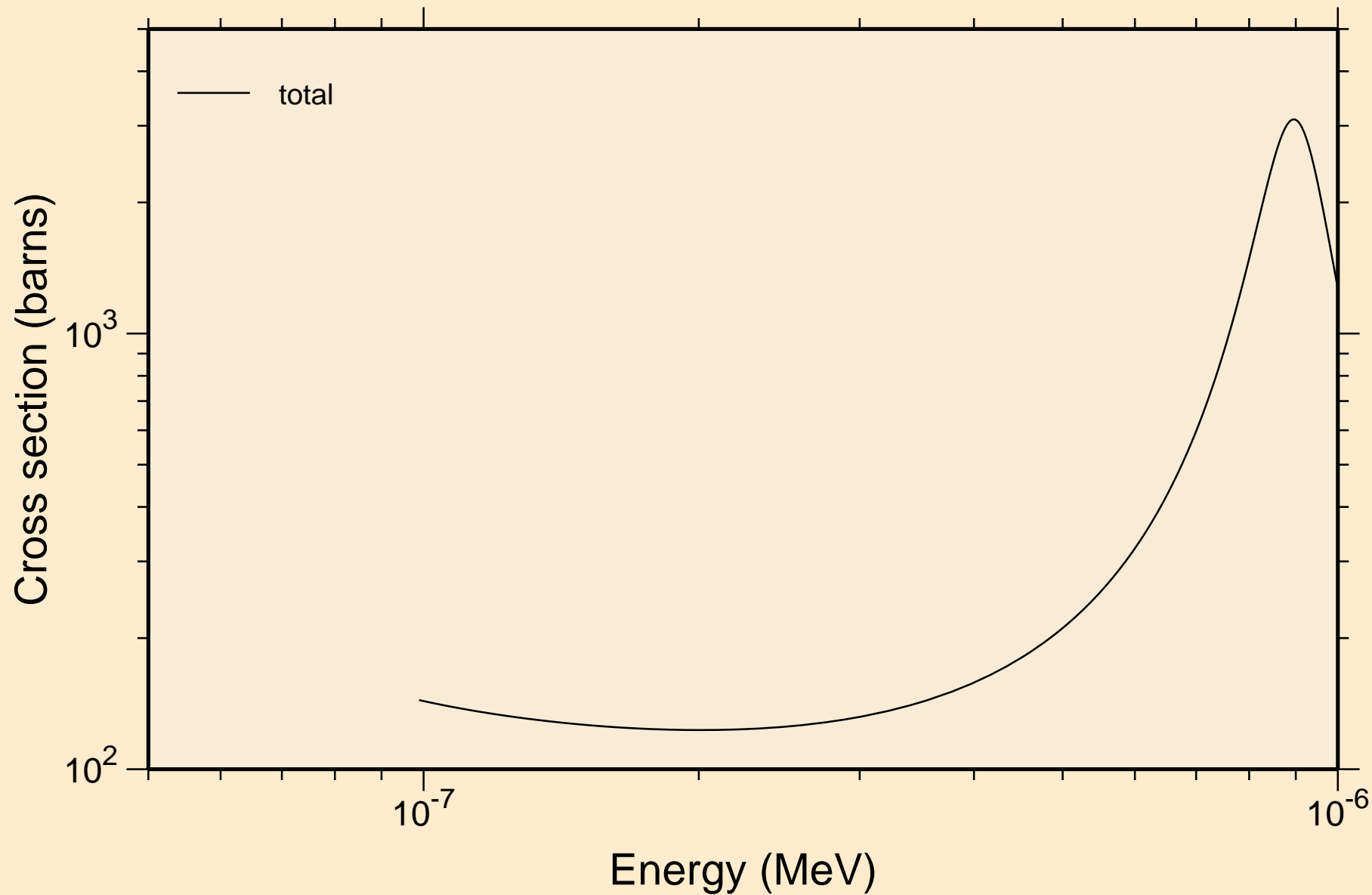

TH227 NEUTRON ACER TENDL-2023 LIBRARY; T=0.K
resonance total cross section

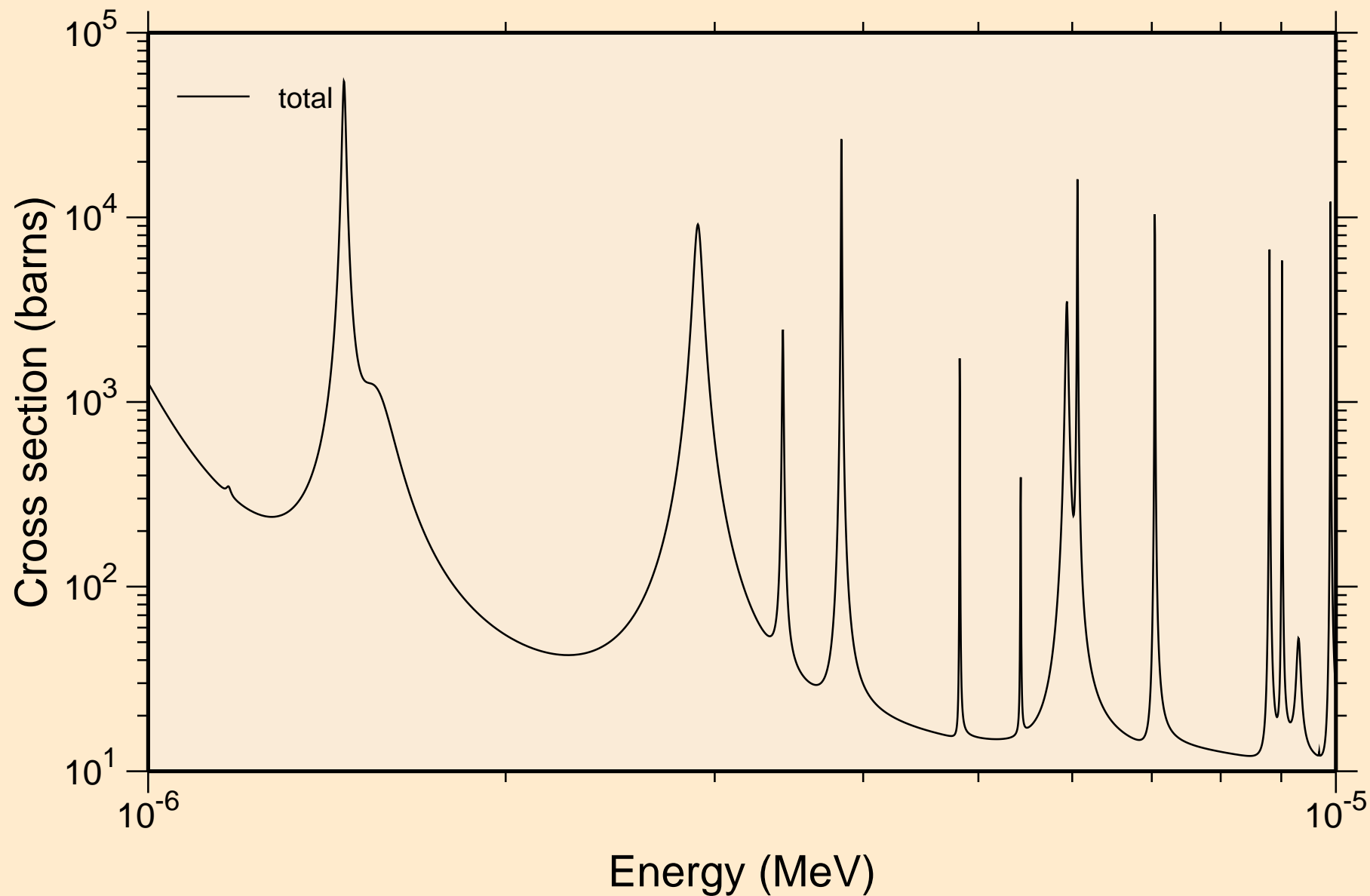

TH227 NEUTRON ACER TENDL-2023 LIBRARY; T=0.K
resonance total cross section

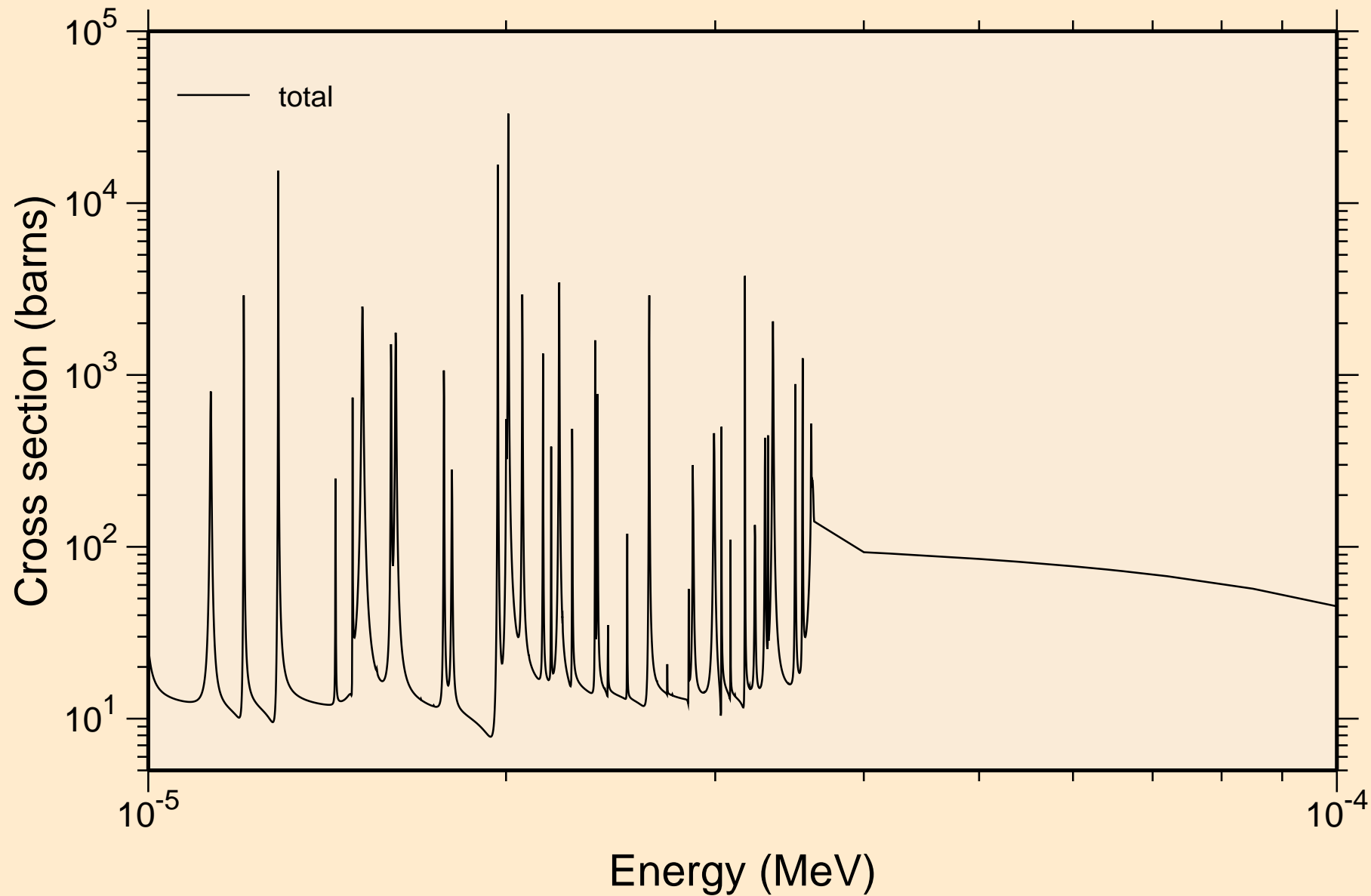

TH227 NEUTRON ACER TENDL-2023 LIBRARY; T=0.K
resonance total cross section

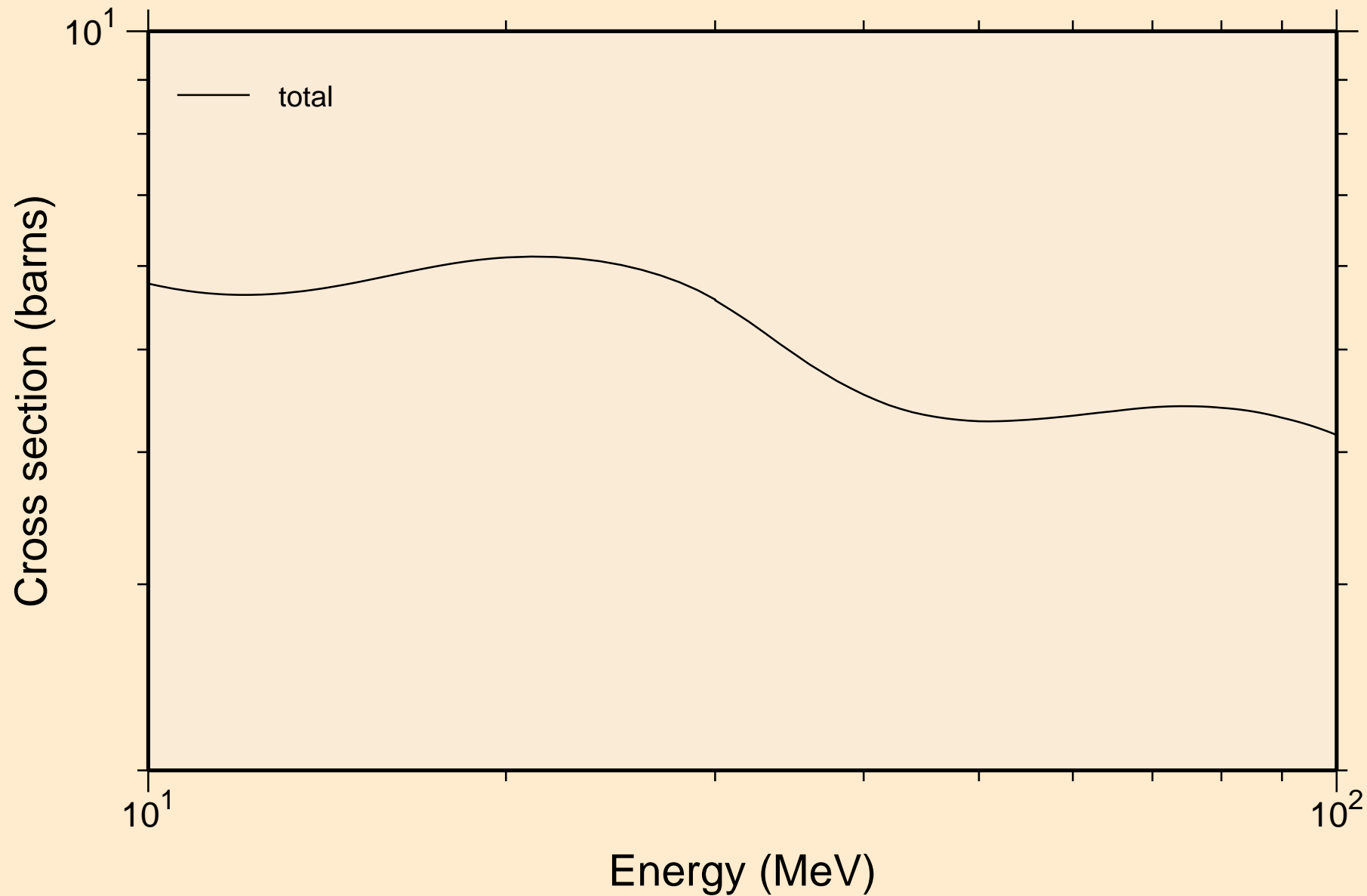

TH227 NEUTRON ACER TENDL-2023 LIBRARY; T=0.K
resonance absorption cross sections

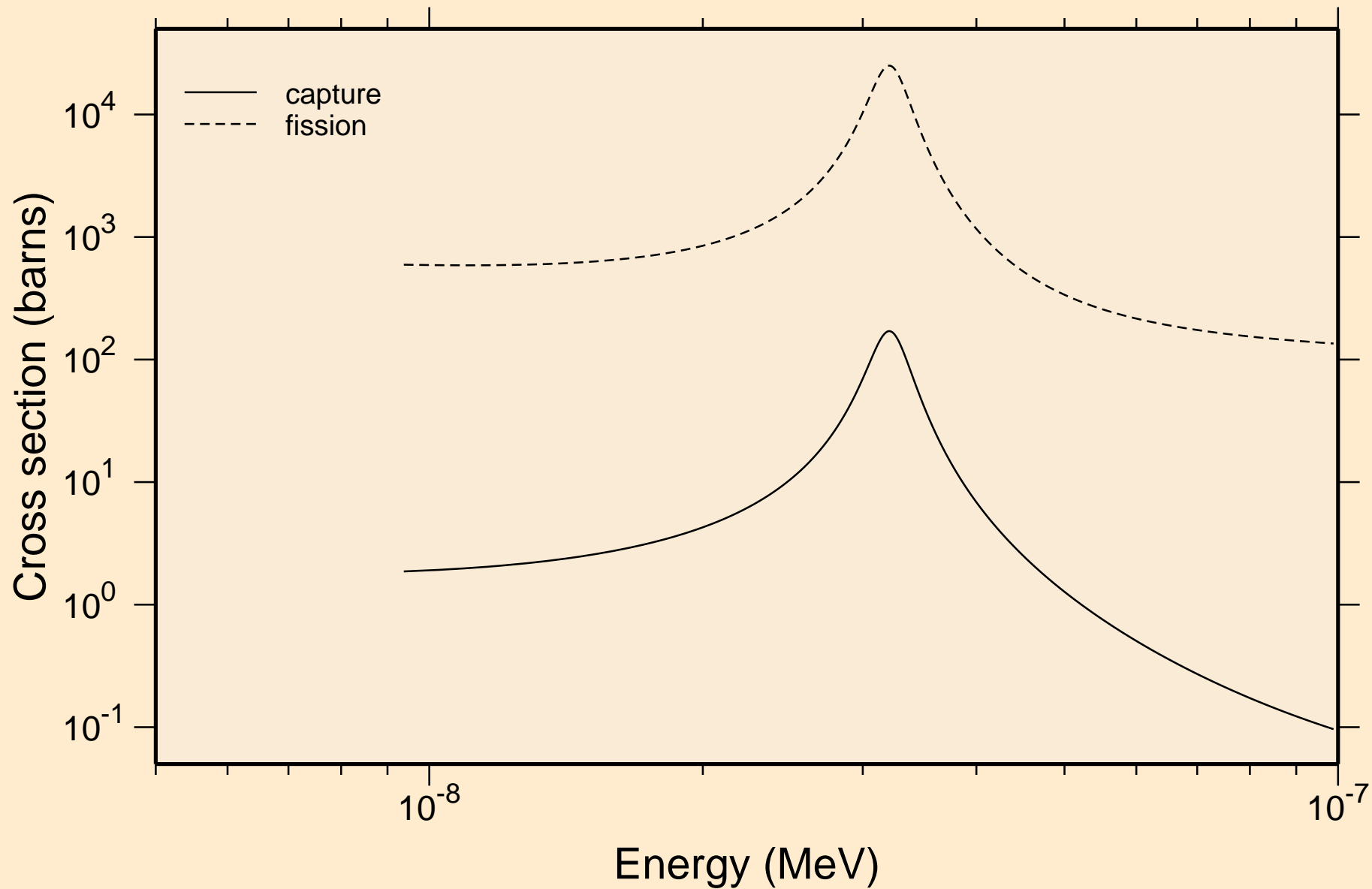

TH227 NEUTRON ACER TENDL-2023 LIBRARY; T=0.K
resonance absorption cross sections

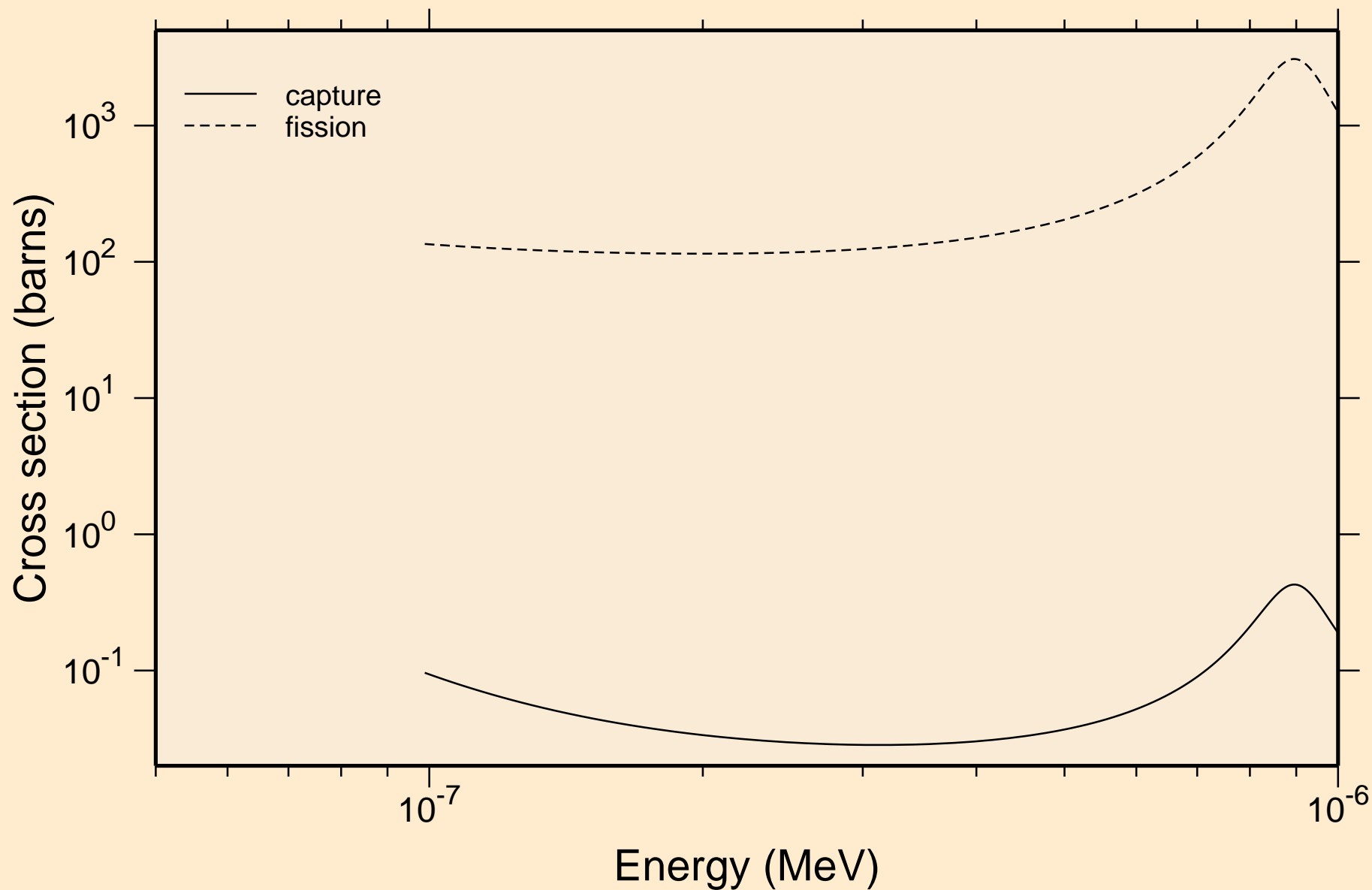

TH227 NEUTRON ACER TENDL-2023 LIBRARY; T=0.K
resonance absorption cross sections

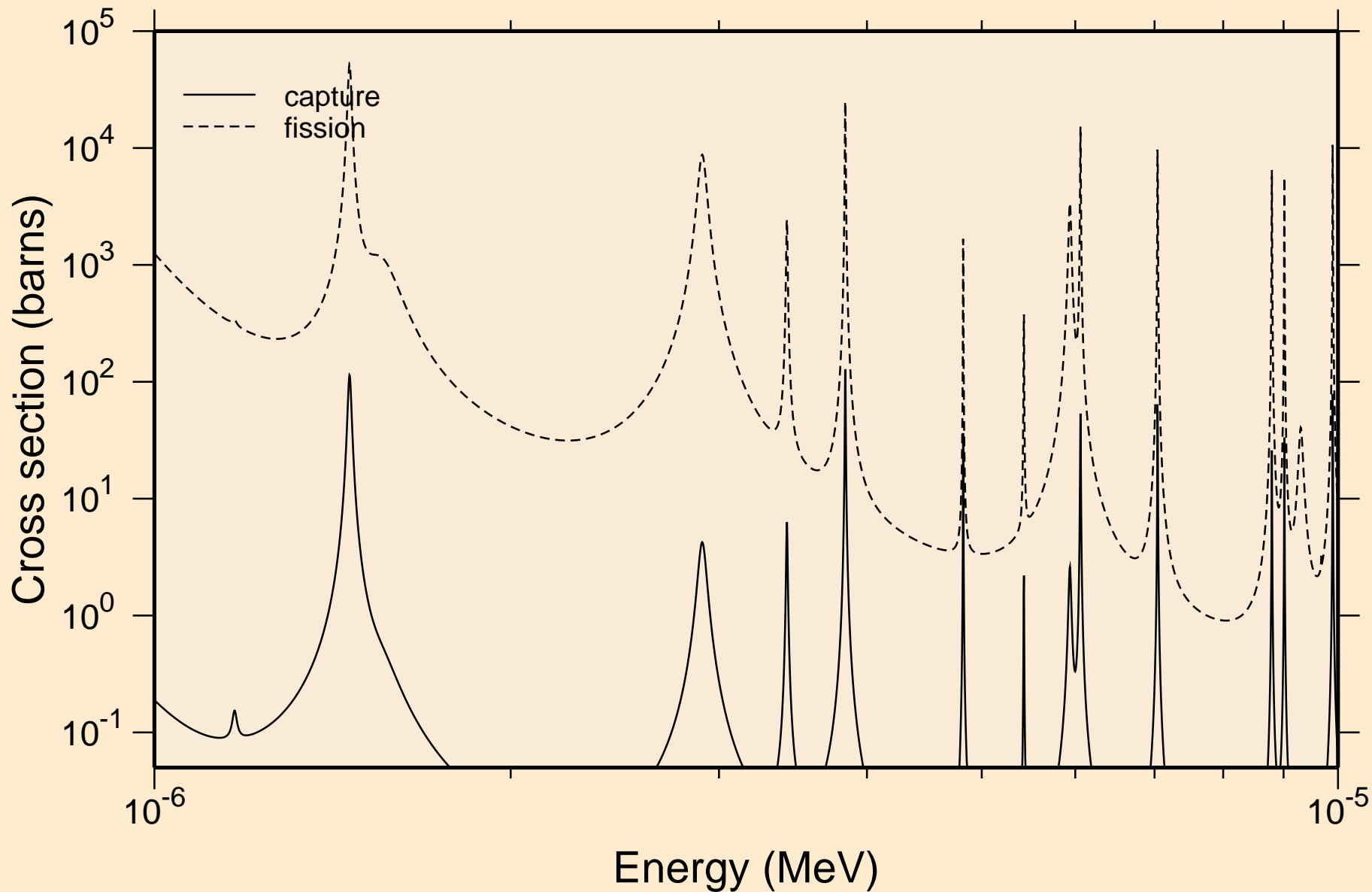

TH227 NEUTRON ACER TENDL-2023 LIBRARY; T=0.K
resonance absorption cross sections

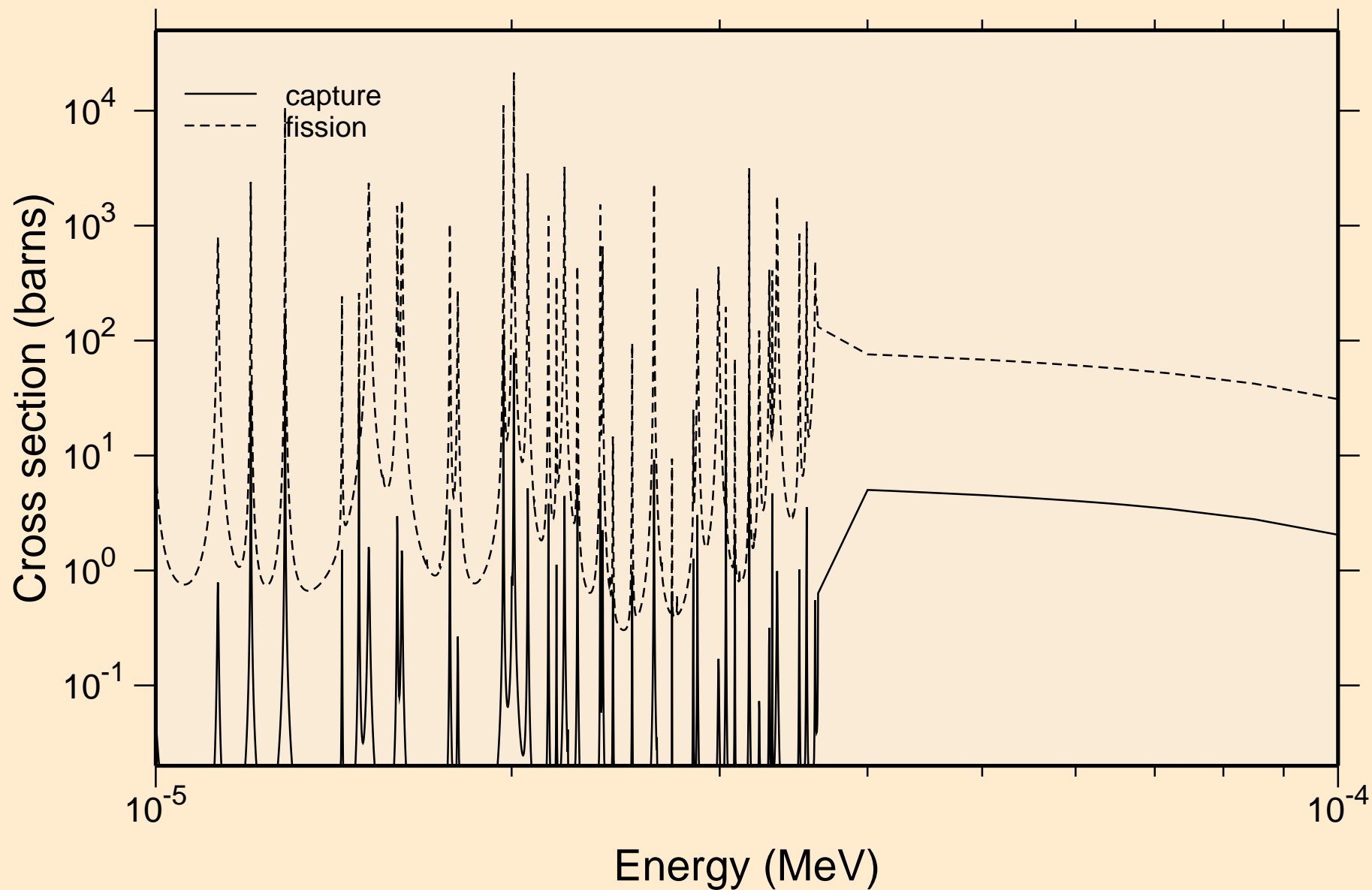

TH227 NEUTRON ACER TENDL-2023 LIBRARY; T=0.K
resonance absorption cross sections

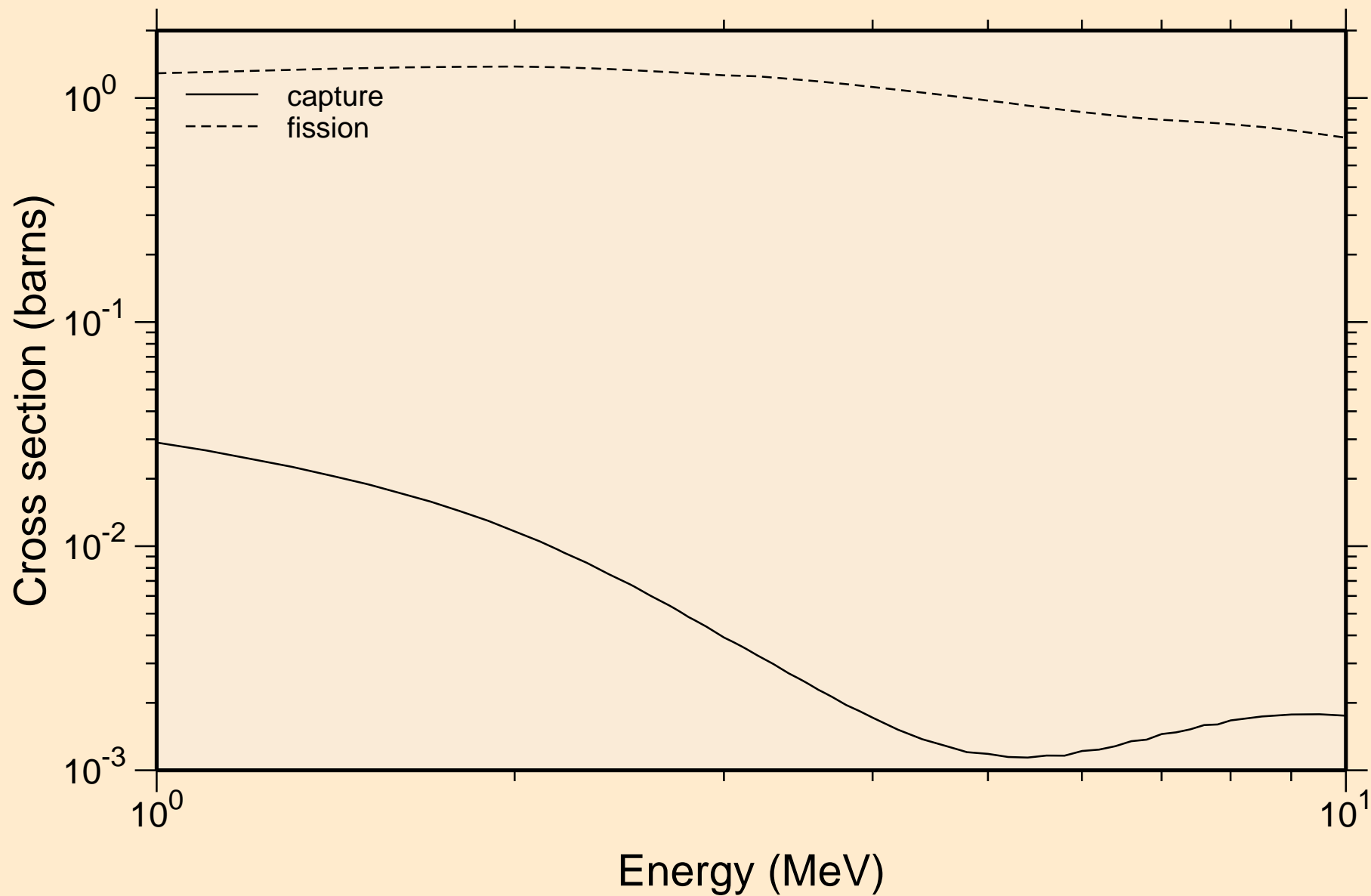

TH227 NEUTRON ACER TENDL-2023 LIBRARY; T=0.K
Heating

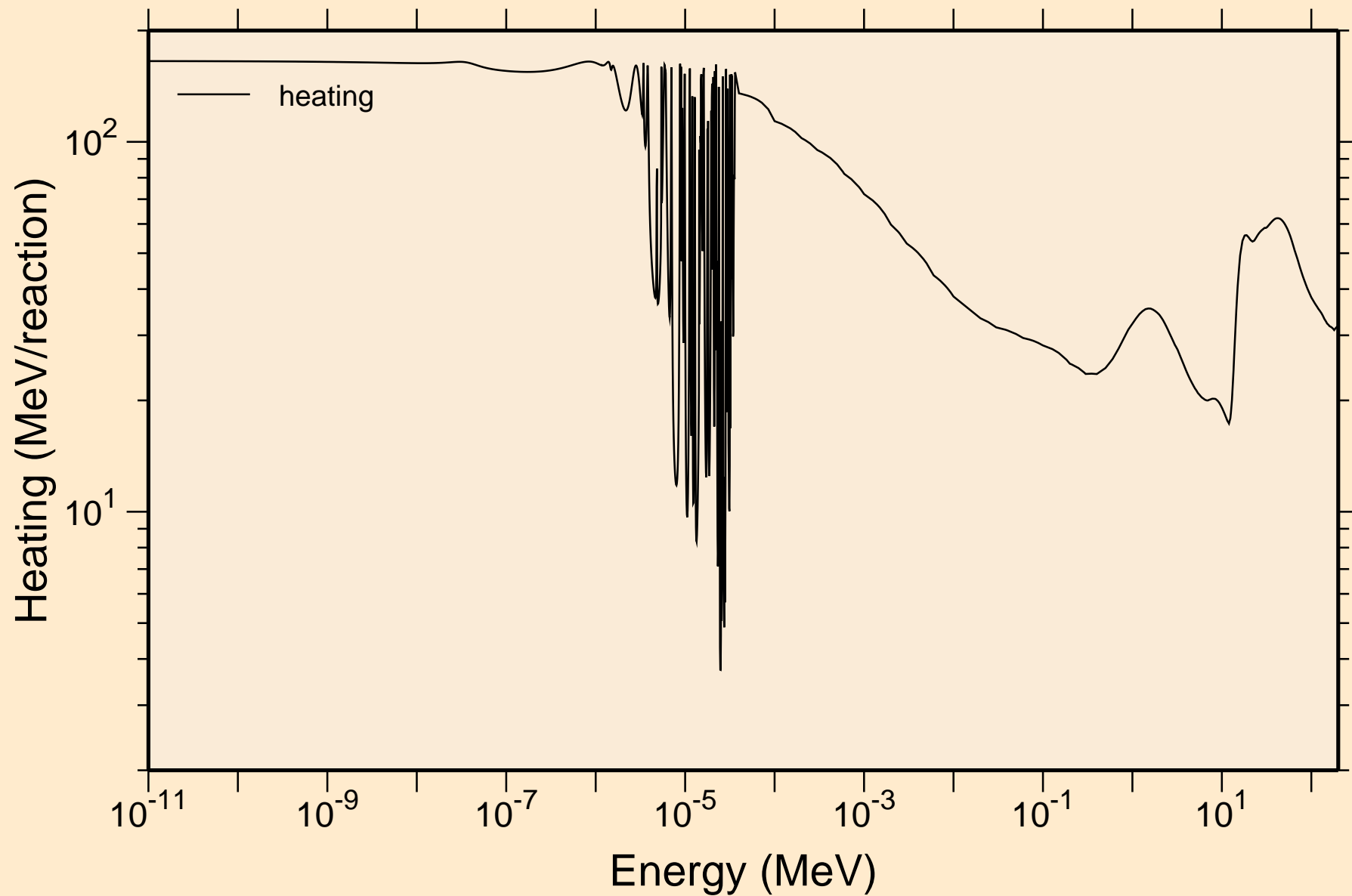

TH227 NEUTRON ACER TENDL-2023 LIBRARY; T=0.K
Damage

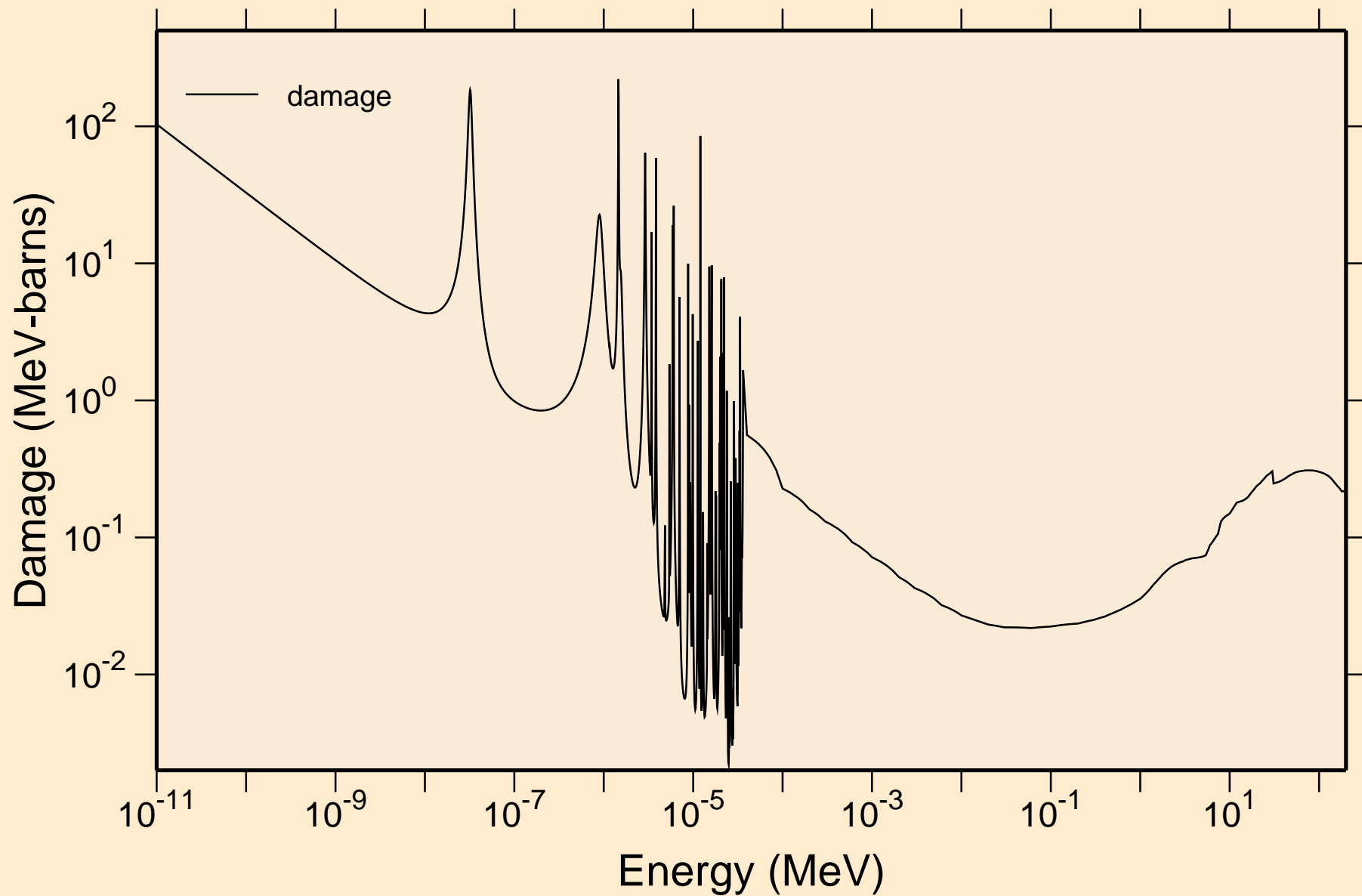

TH227 NEUTRON ACER TENDL-2023 LIBRARY; T=0.K

Non-threshold reactions

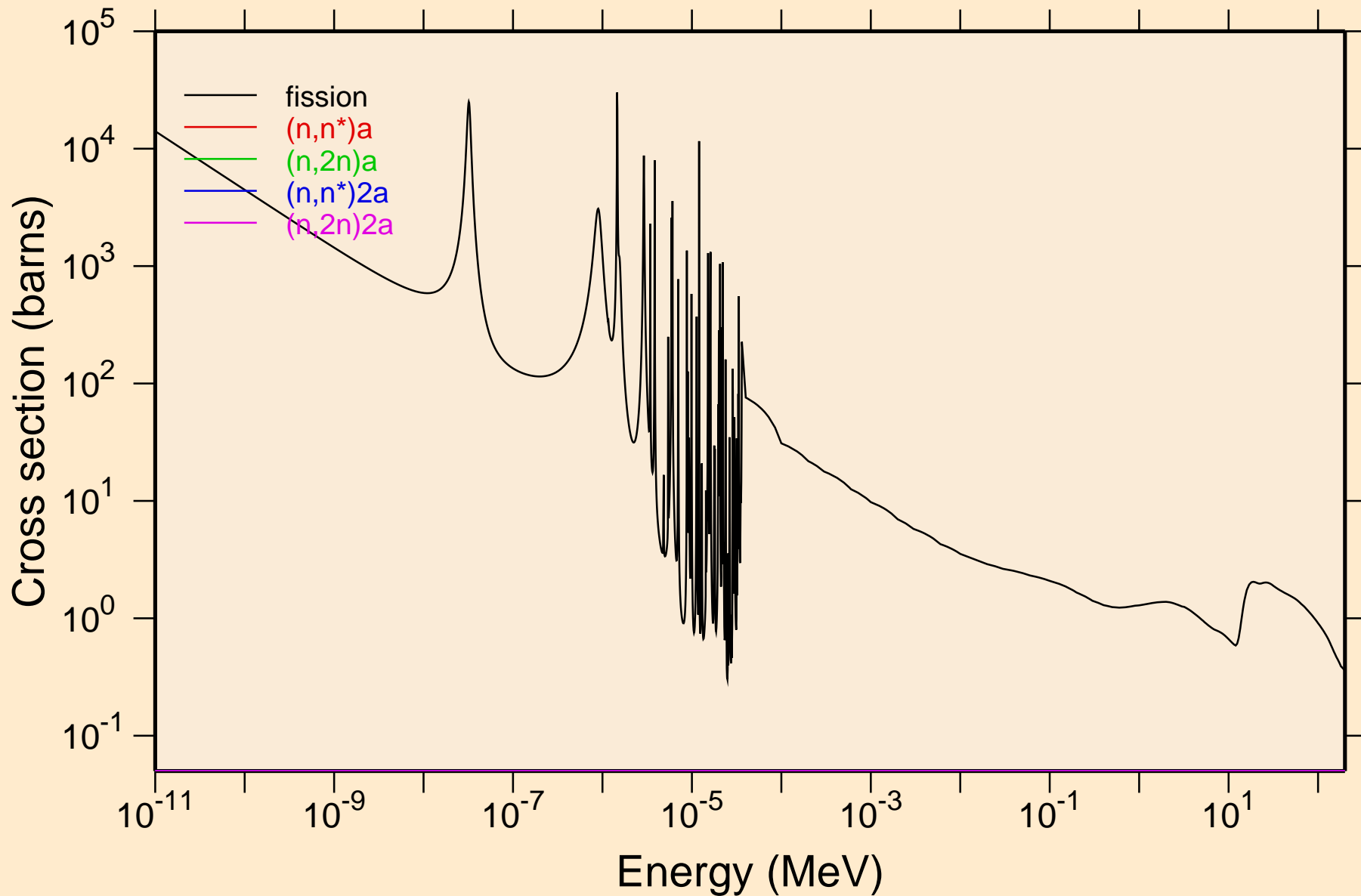

TH227 NEUTRON ACER TENDL-2023 LIBRARY; T=0.K
Non-threshold reactions

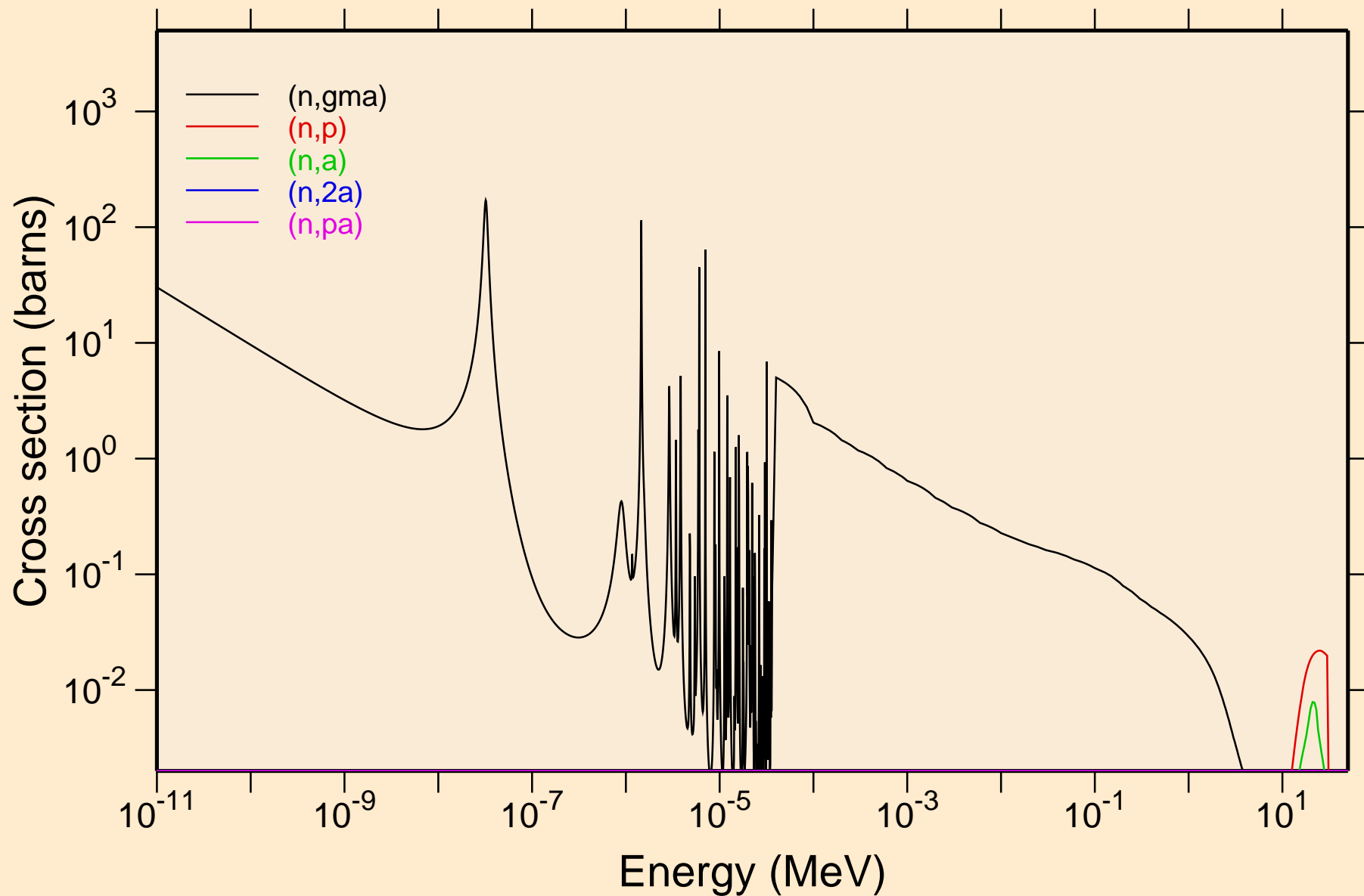

TH227 NEUTRON ACER TENDL-2023 LIBRARY; T=0.K
Non-threshold reactions

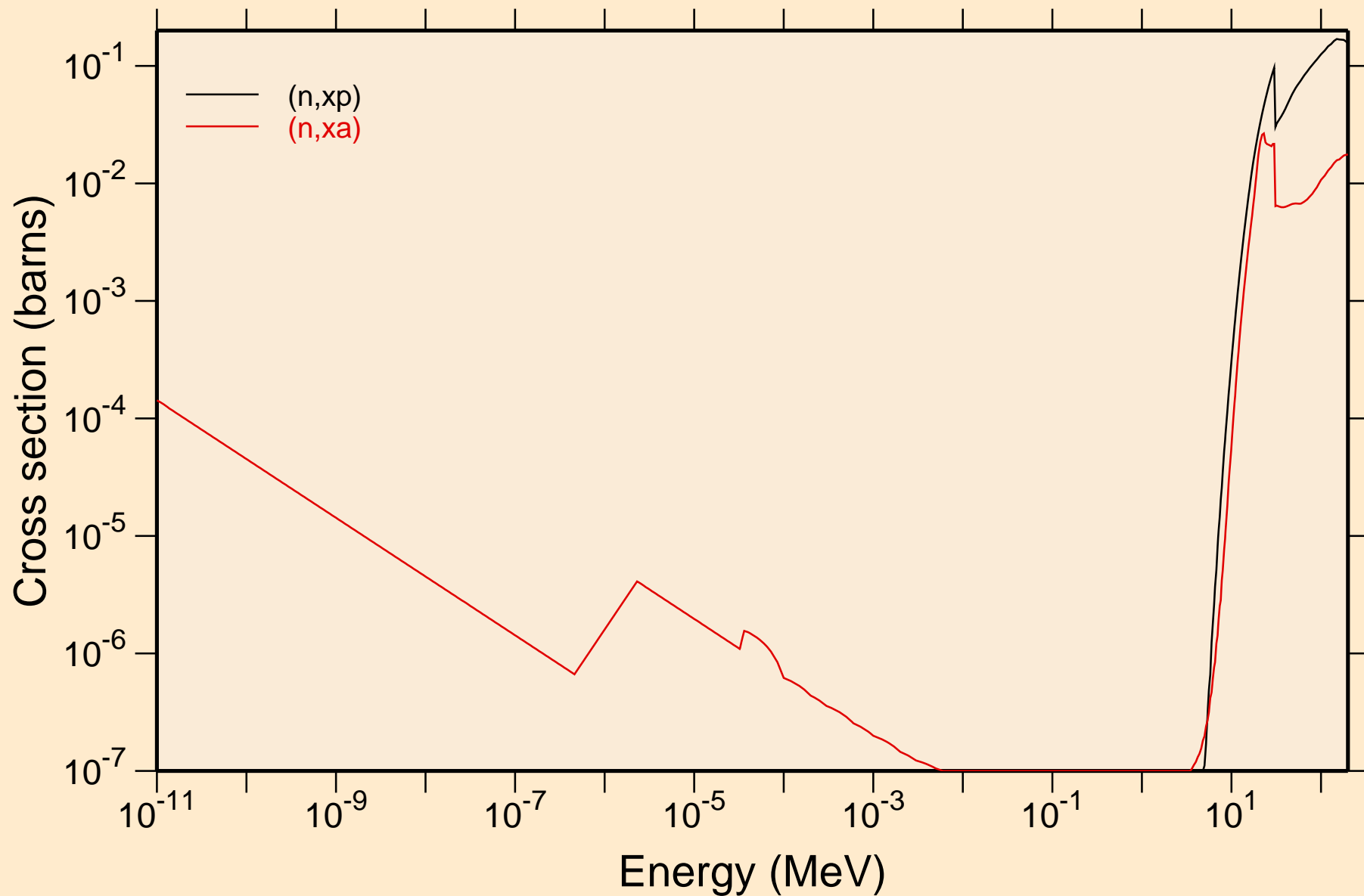

TH227 NEUTRON ACER TENDL-2023 LIBRARY; T=0.K

Principal cross sections

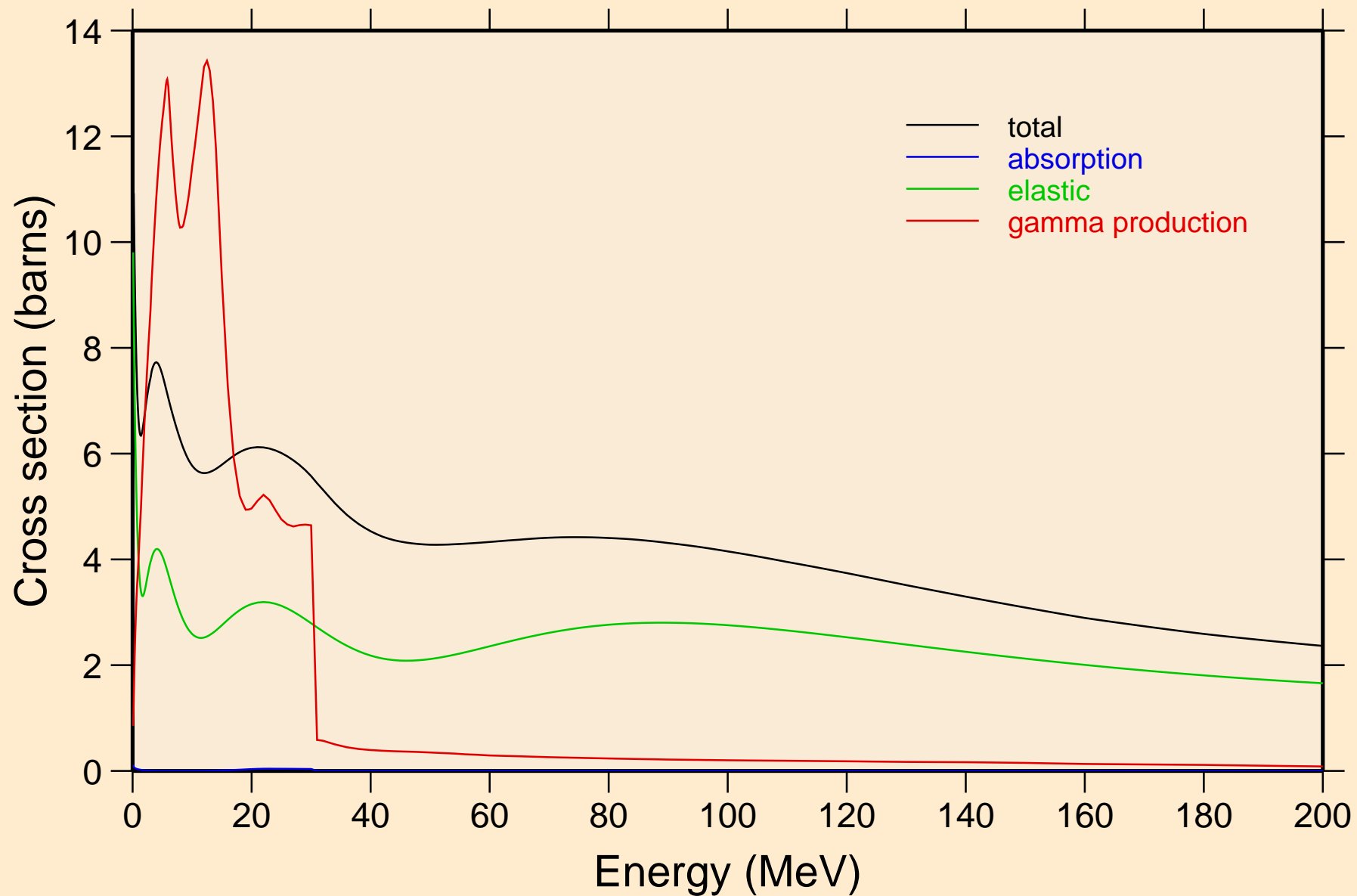

TH227 NEUTRON ACER TENDL-2023 LIBRARY; T=0.K
Heating

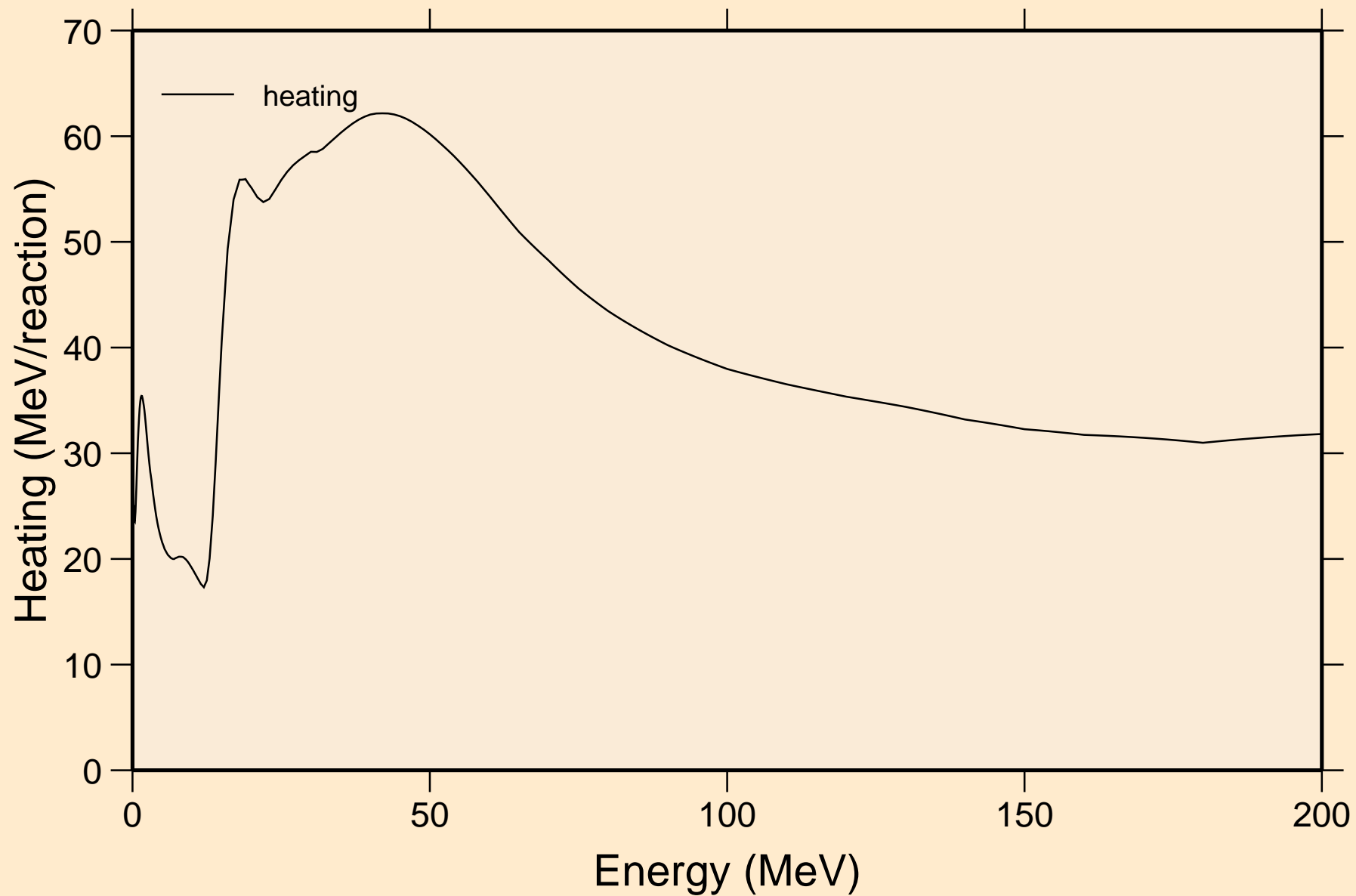

TH227 NEUTRON ACER TENDL-2023 LIBRARY; T=0.K
Damage

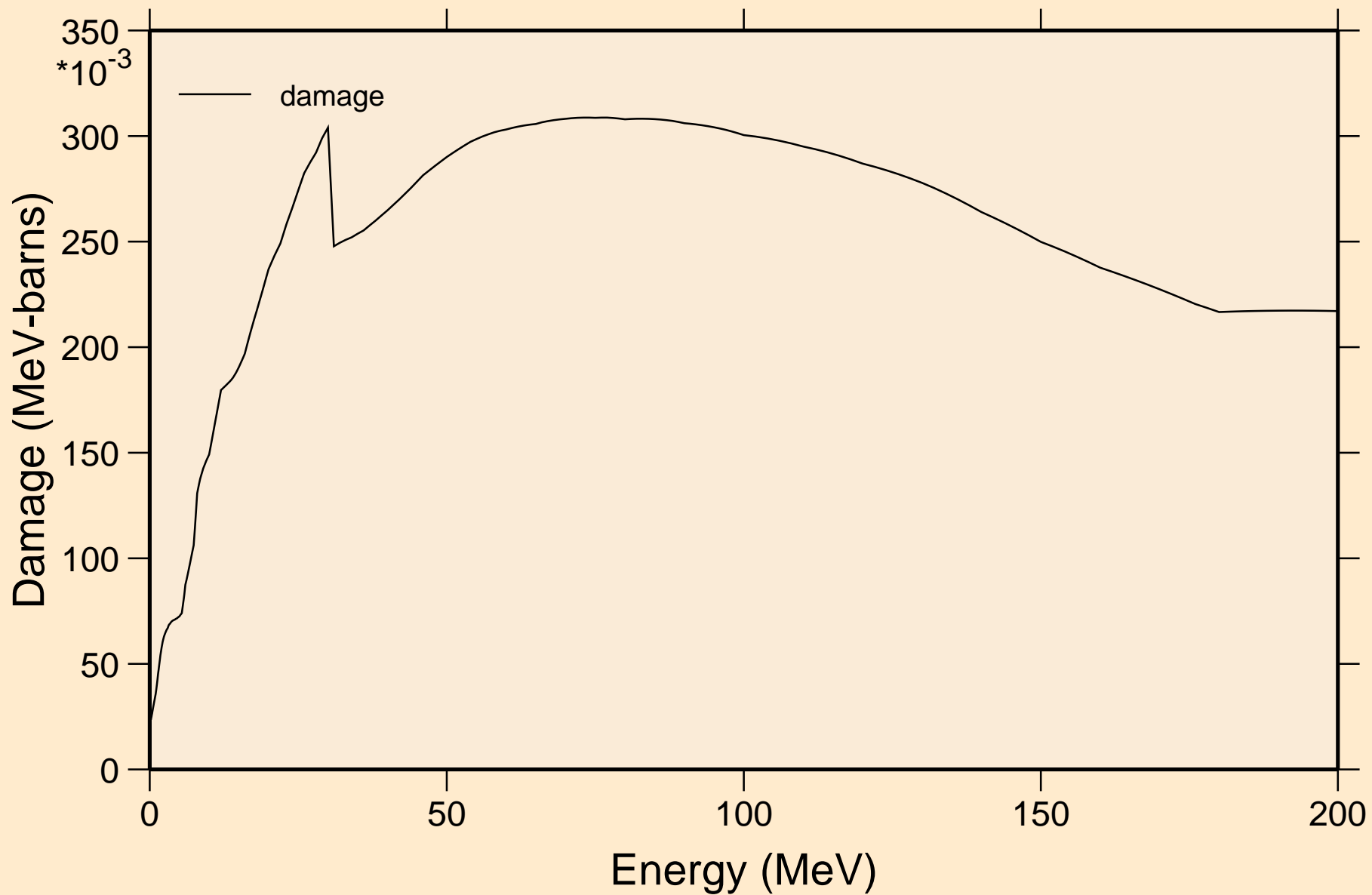

TH227 NEUTRON ACER TENDL-2023 LIBRARY; T=0.K

Non-threshold reactions

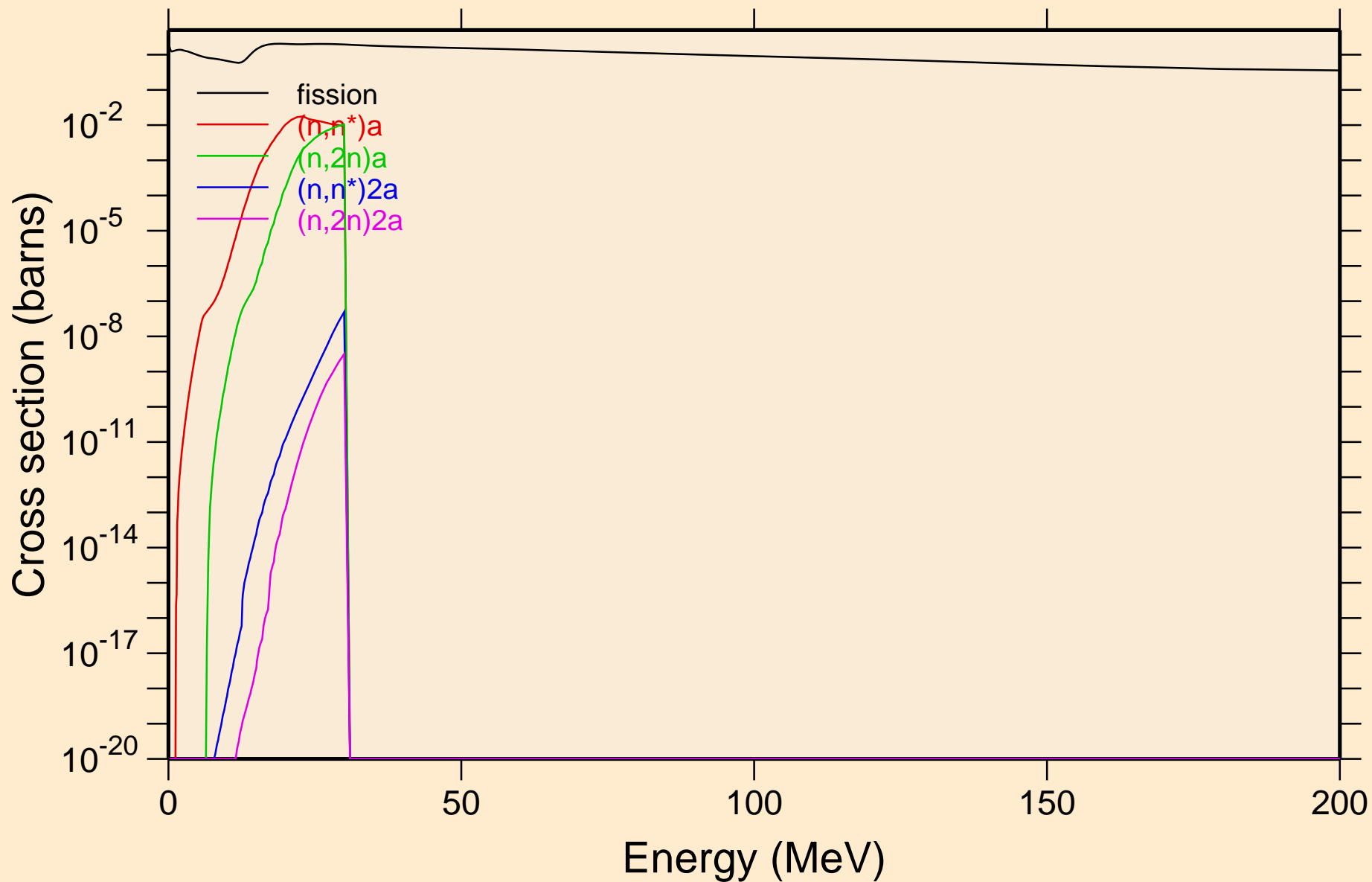

TH227 NEUTRON ACER TENDL-2023 LIBRARY; T=0.K
Non-threshold reactions

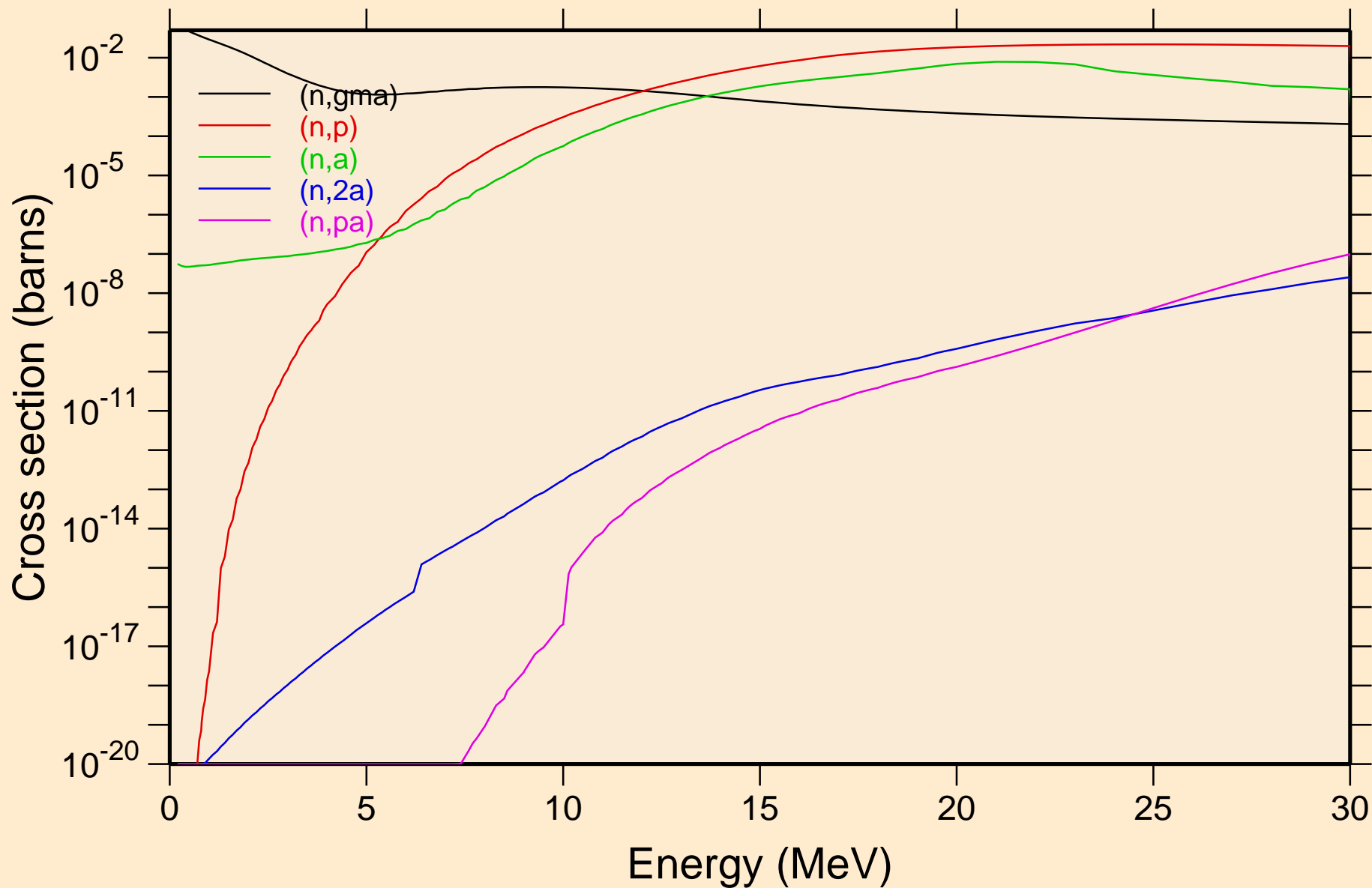

TH227 NEUTRON ACER TENDL-2023 LIBRARY; T=0.K
Non-threshold reactions

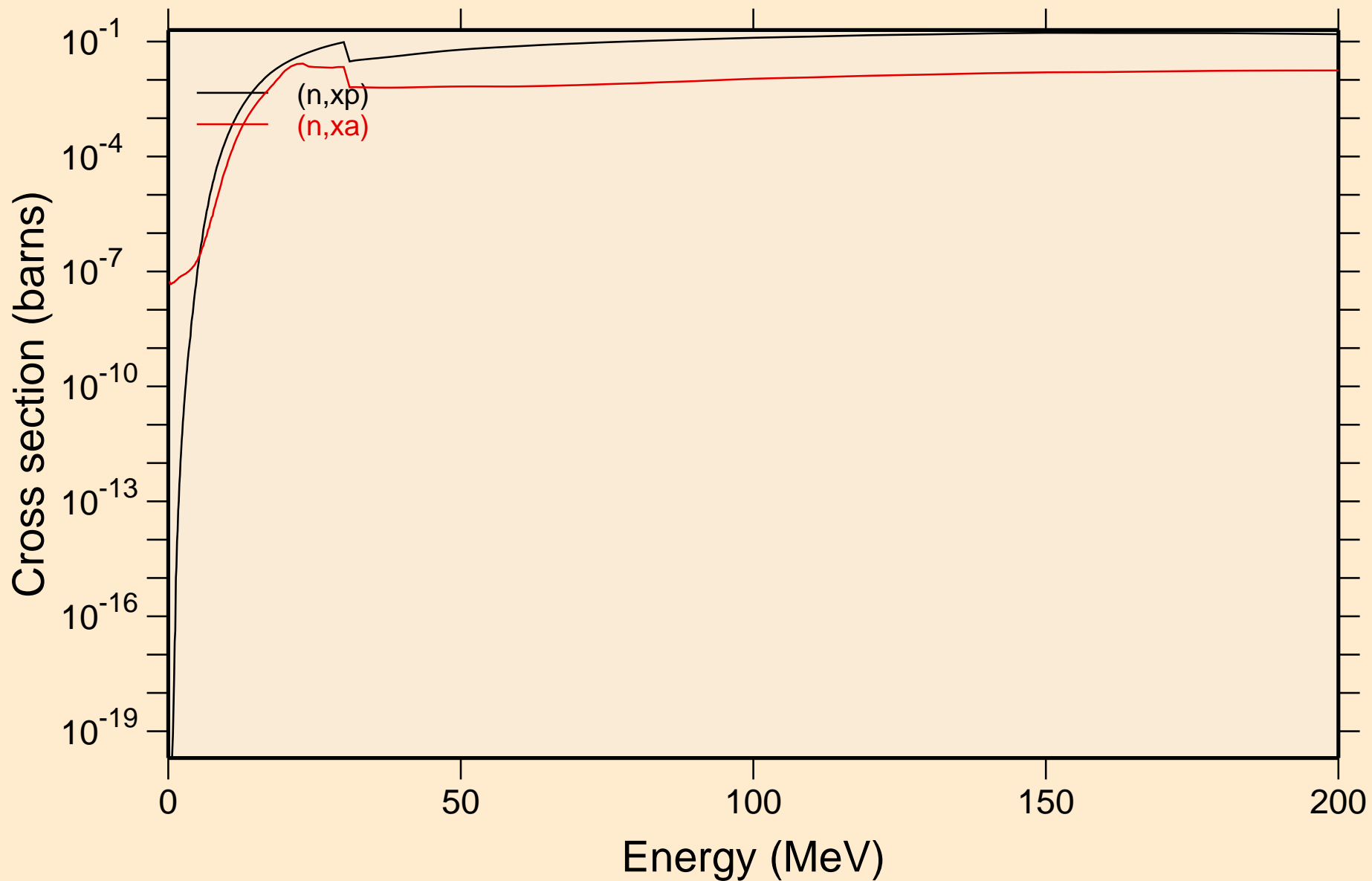

TH227 NEUTRON ACER TENDL-2023 LIBRARY; T=0.K
Inelastic levels

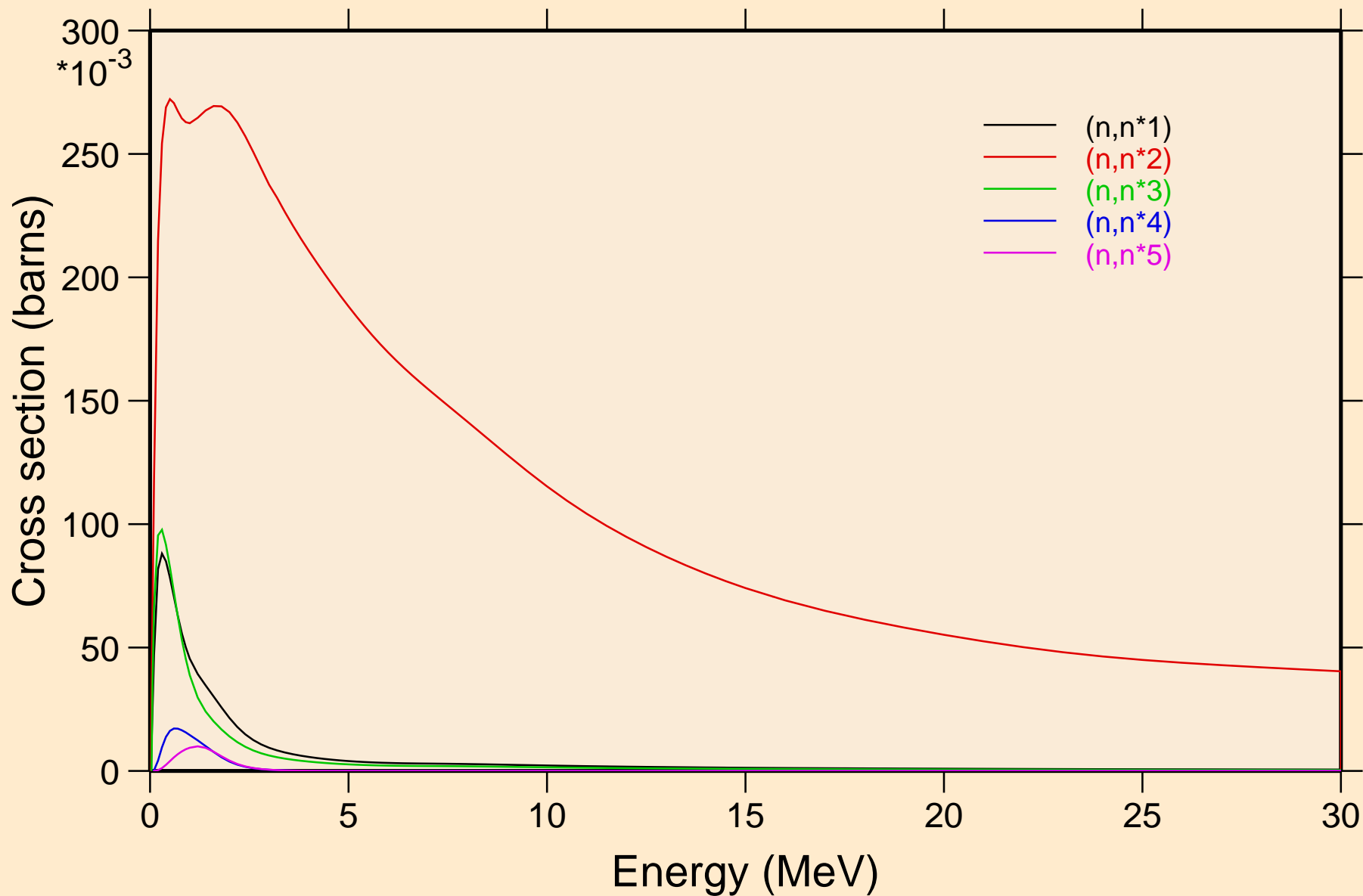

TH227 NEUTRON ACER TENDL-2023 LIBRARY; T=0.K
Inelastic levels

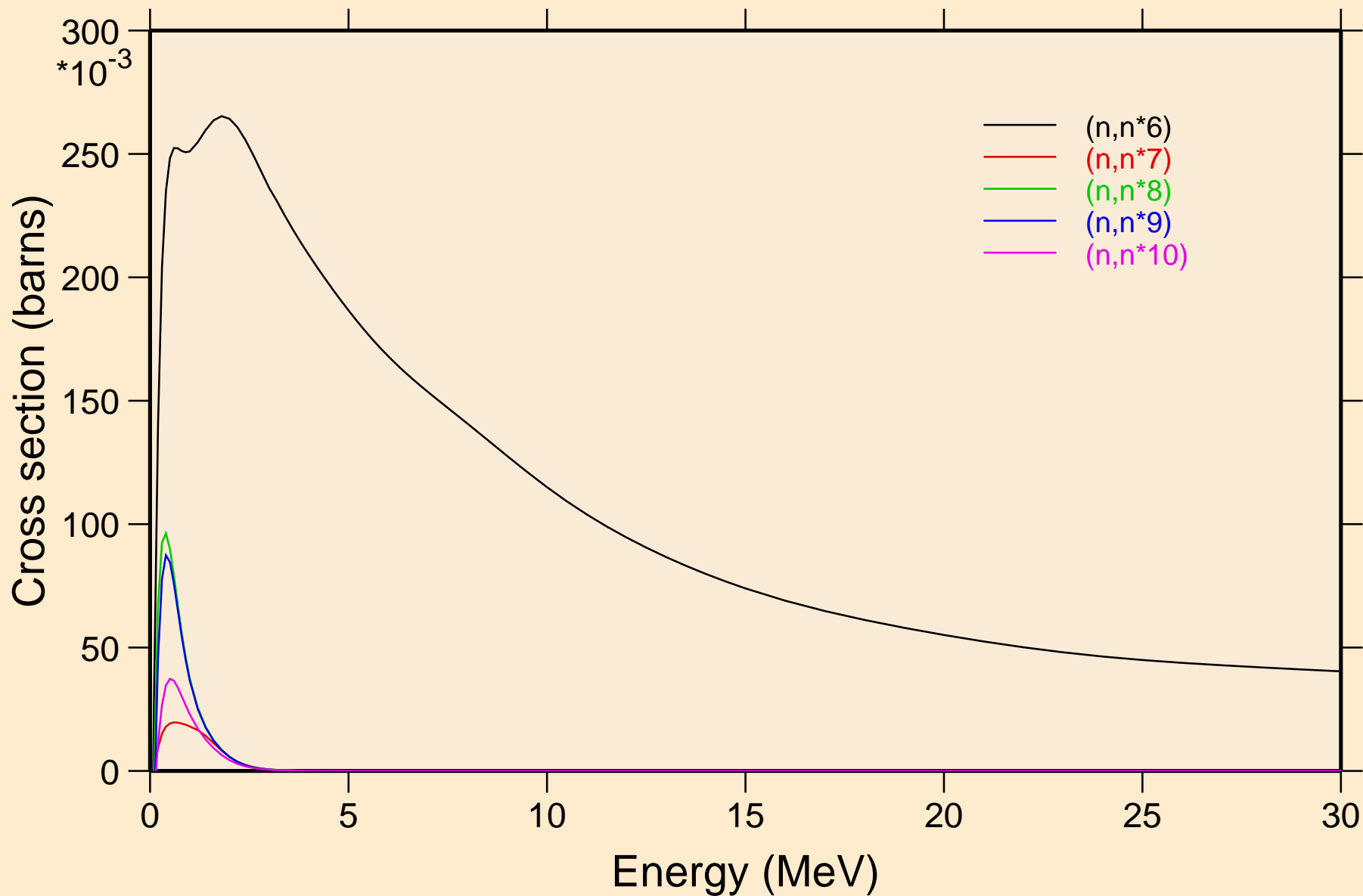

TH227 NEUTRON ACER TENDL-2023 LIBRARY; T=0.K

Inelastic levels

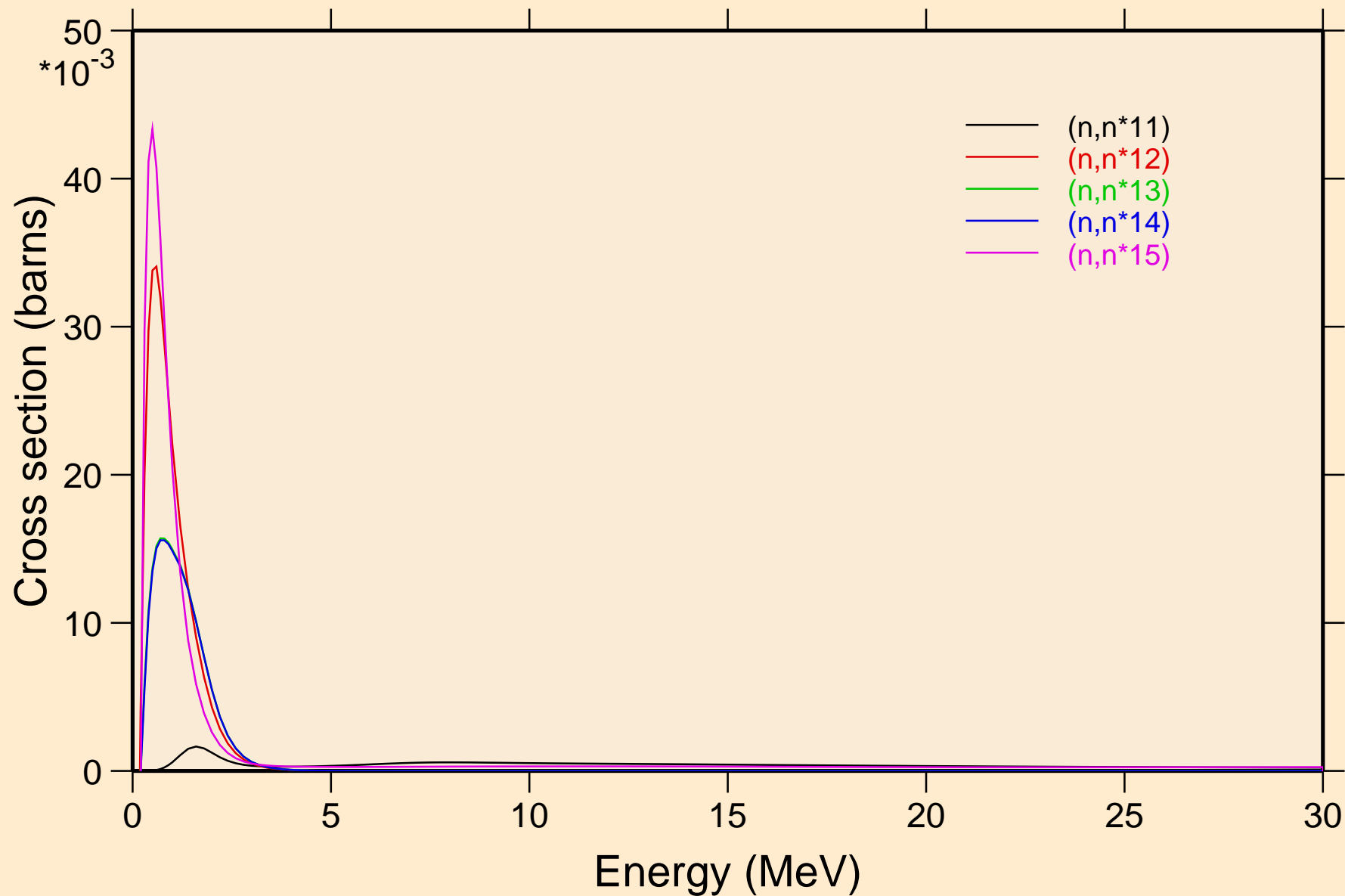

TH227 NEUTRON ACER TENDL-2023 LIBRARY; T=0.K
Threshold reactions

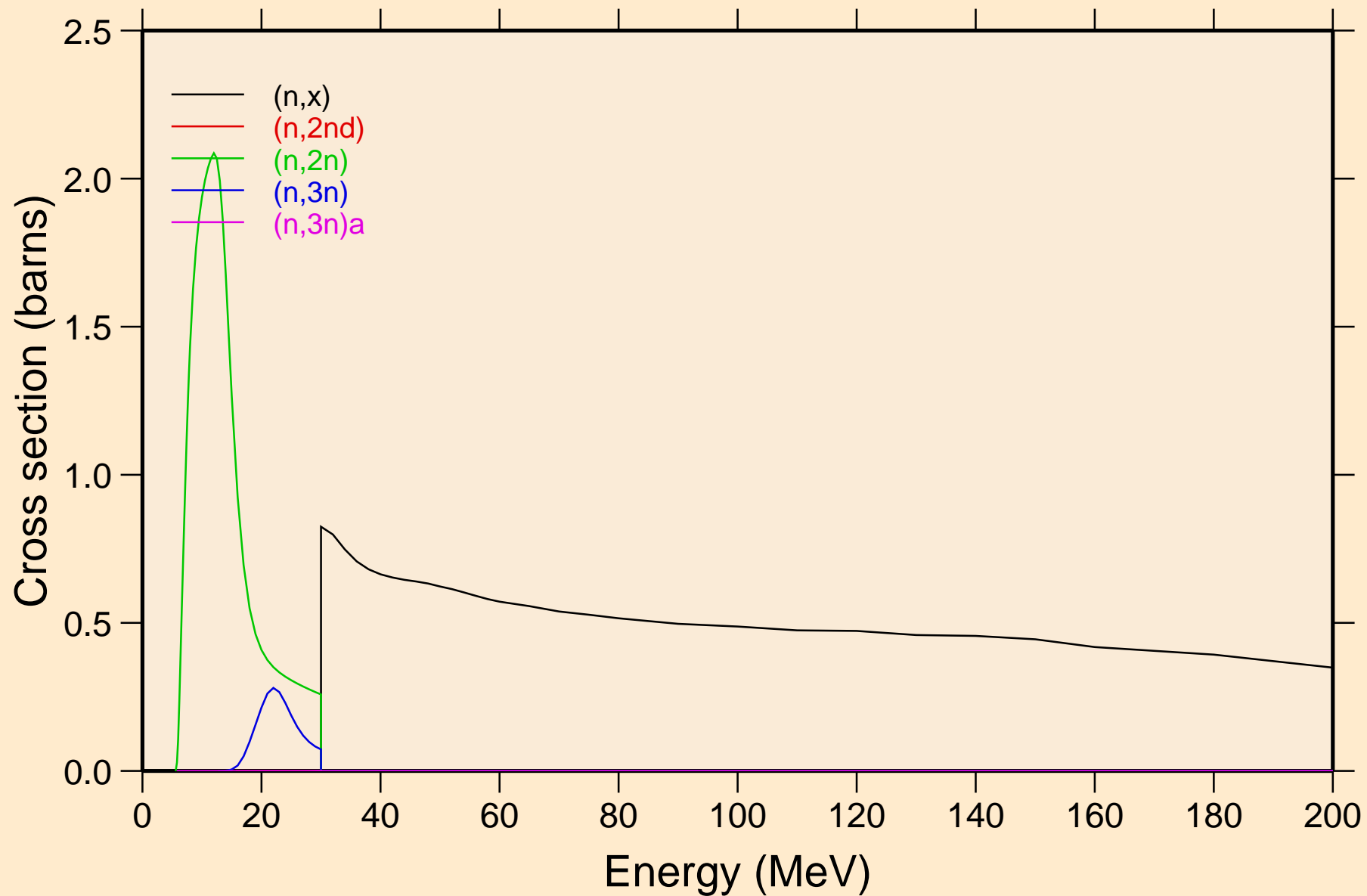

TH227 NEUTRON ACER TENDL-2023 LIBRARY; T=0.K

Threshold reactions

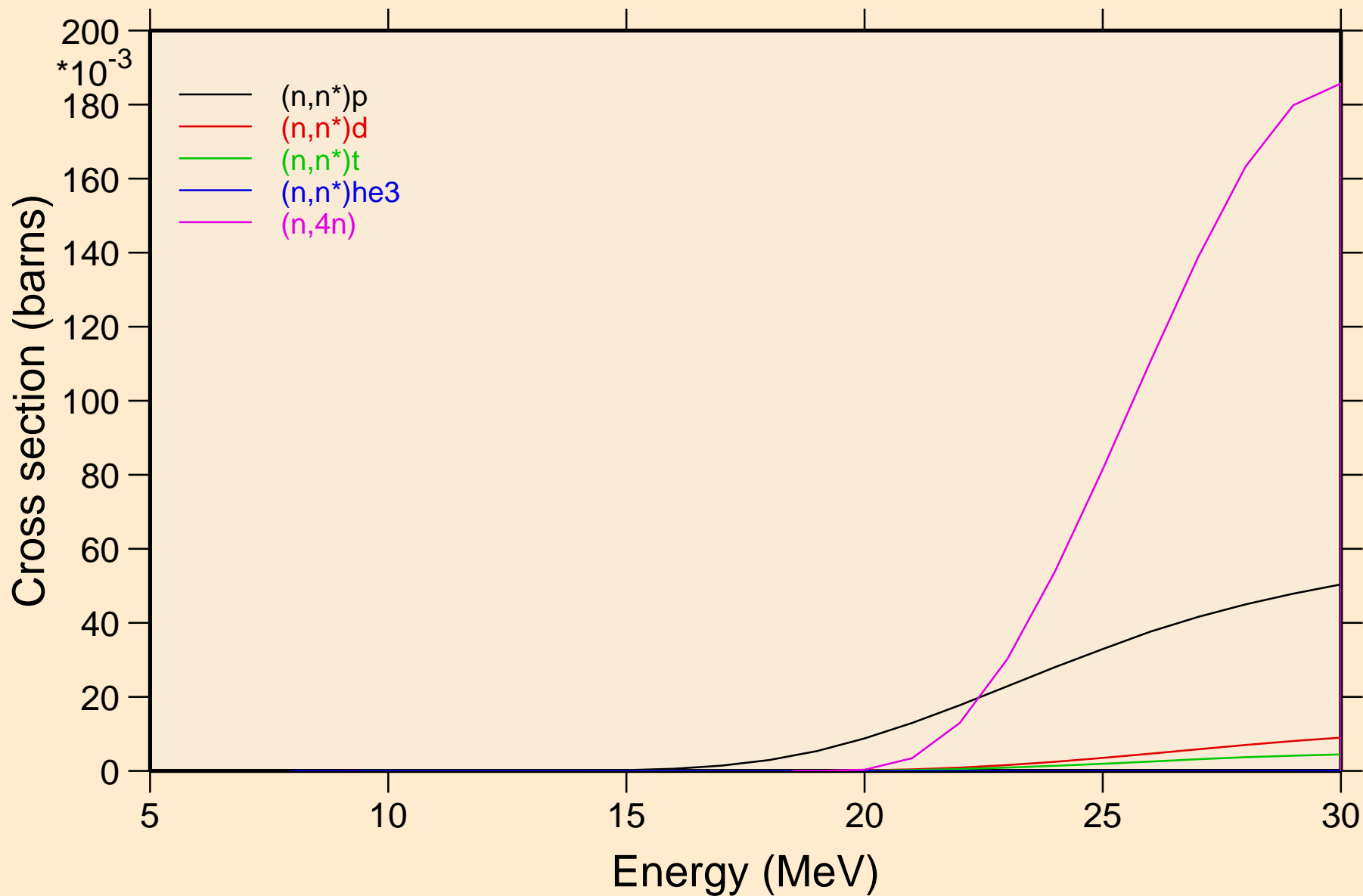

TH227 NEUTRON ACER TENDL-2023 LIBRARY; T=0.K
Threshold reactions

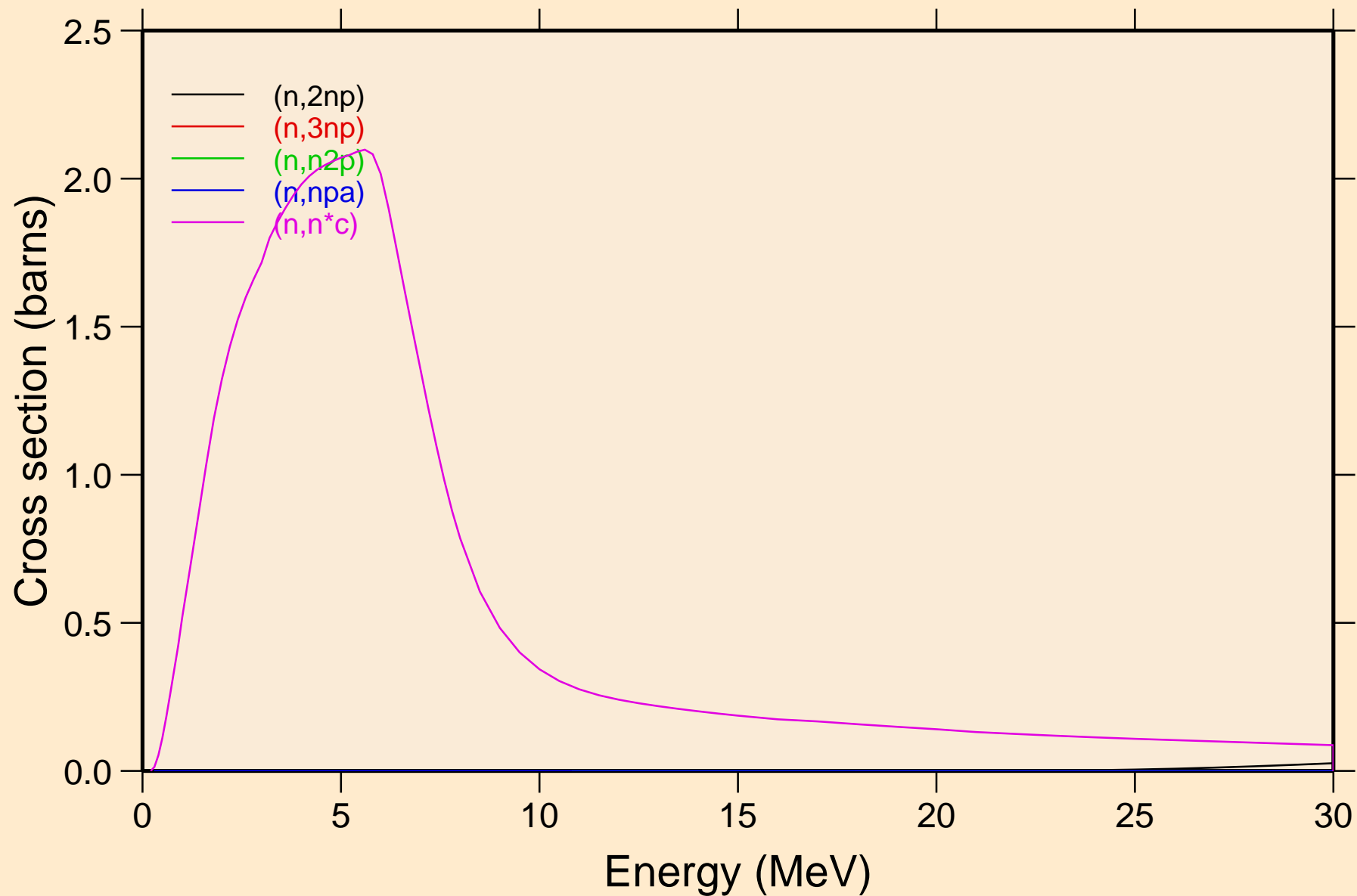

TH227 NEUTRON ACER TENDL-2023 LIBRARY; T=0.K
Threshold reactions

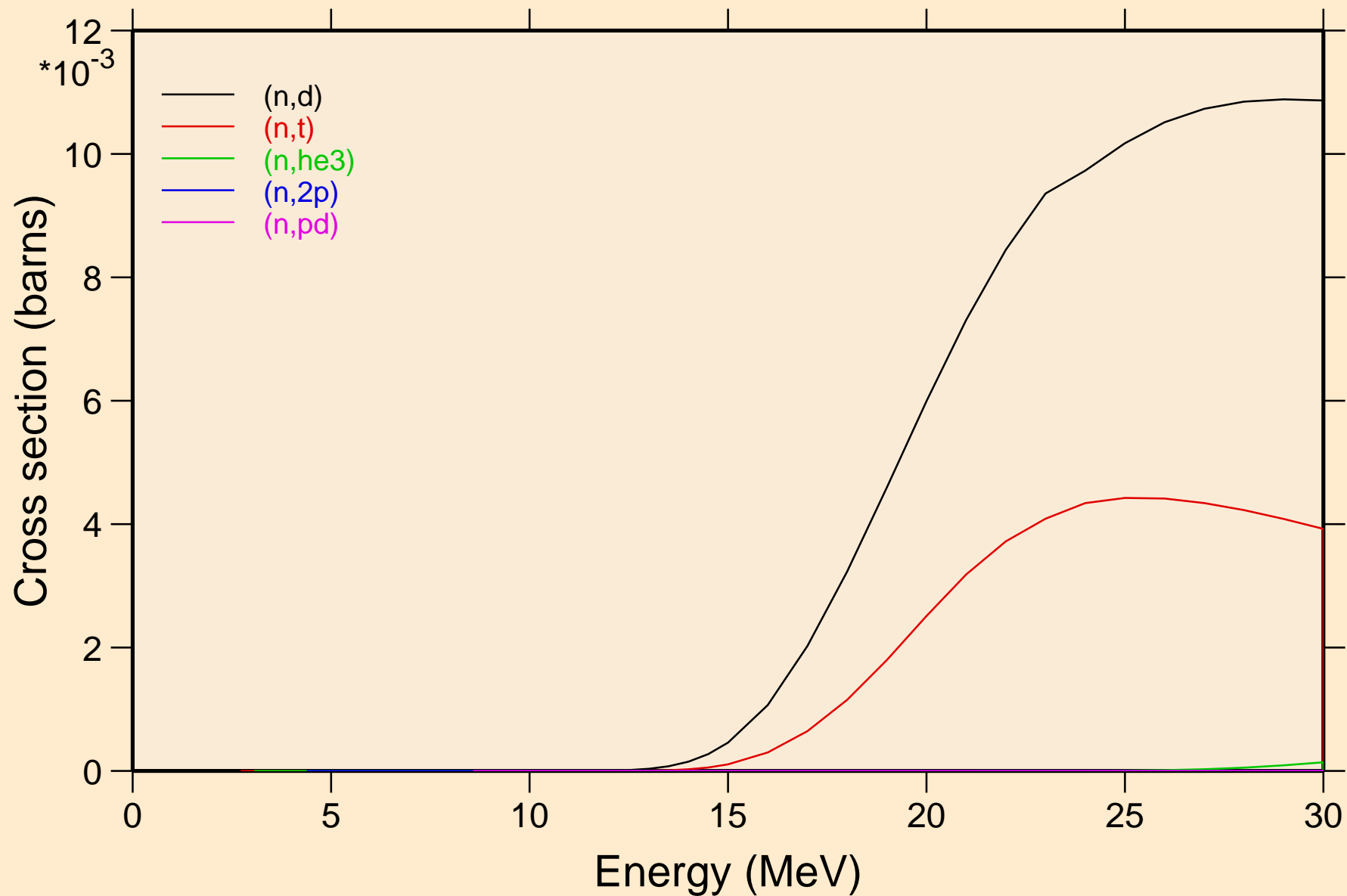

TH227 NEUTRON ACER TENDL-2023 LIBRARY; T=0.K
Threshold reactions

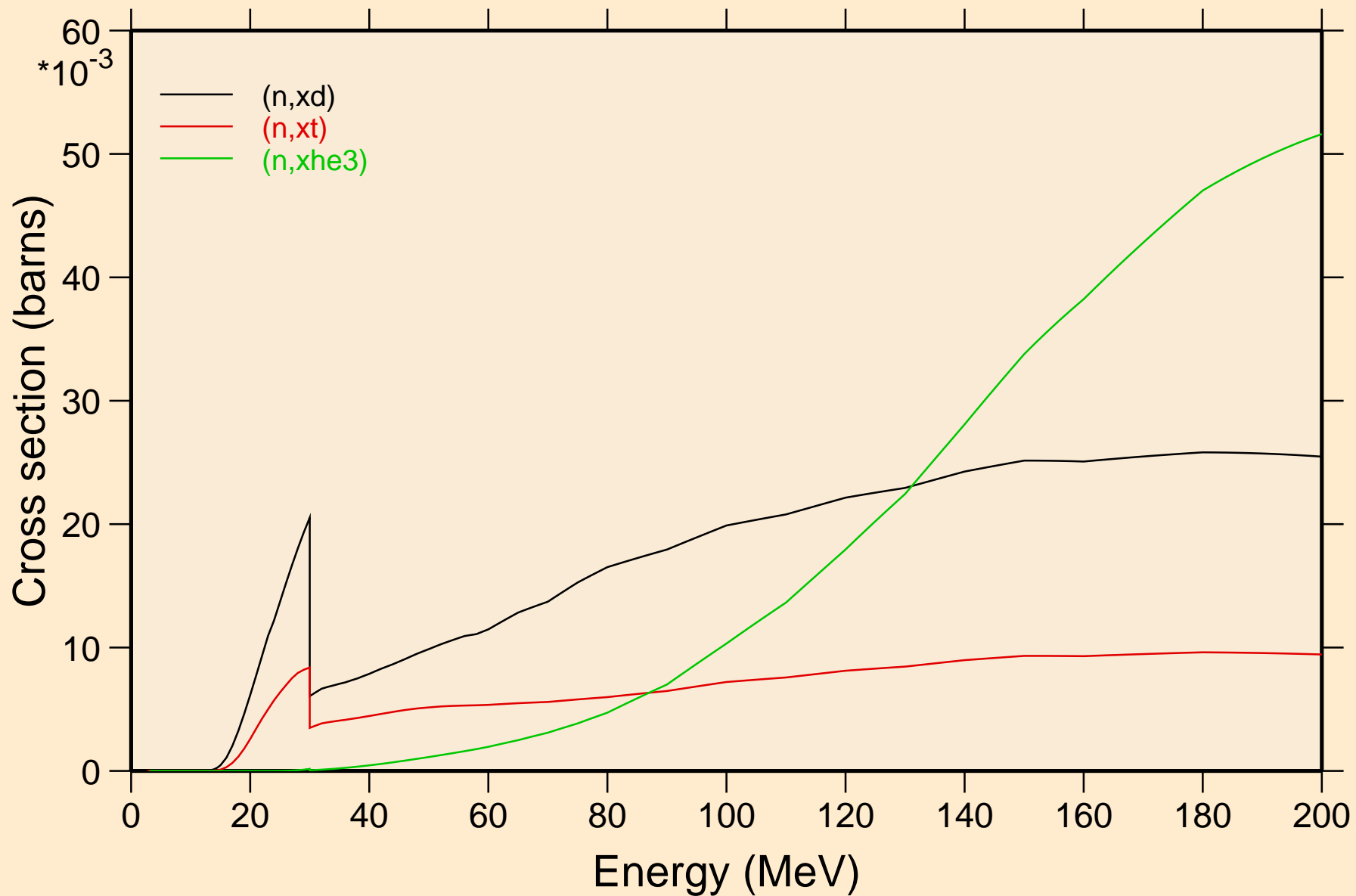

TH227 NEUTRON ACER TENDL-2023 LIBRARY; T=0.K
angular distribution for elastic

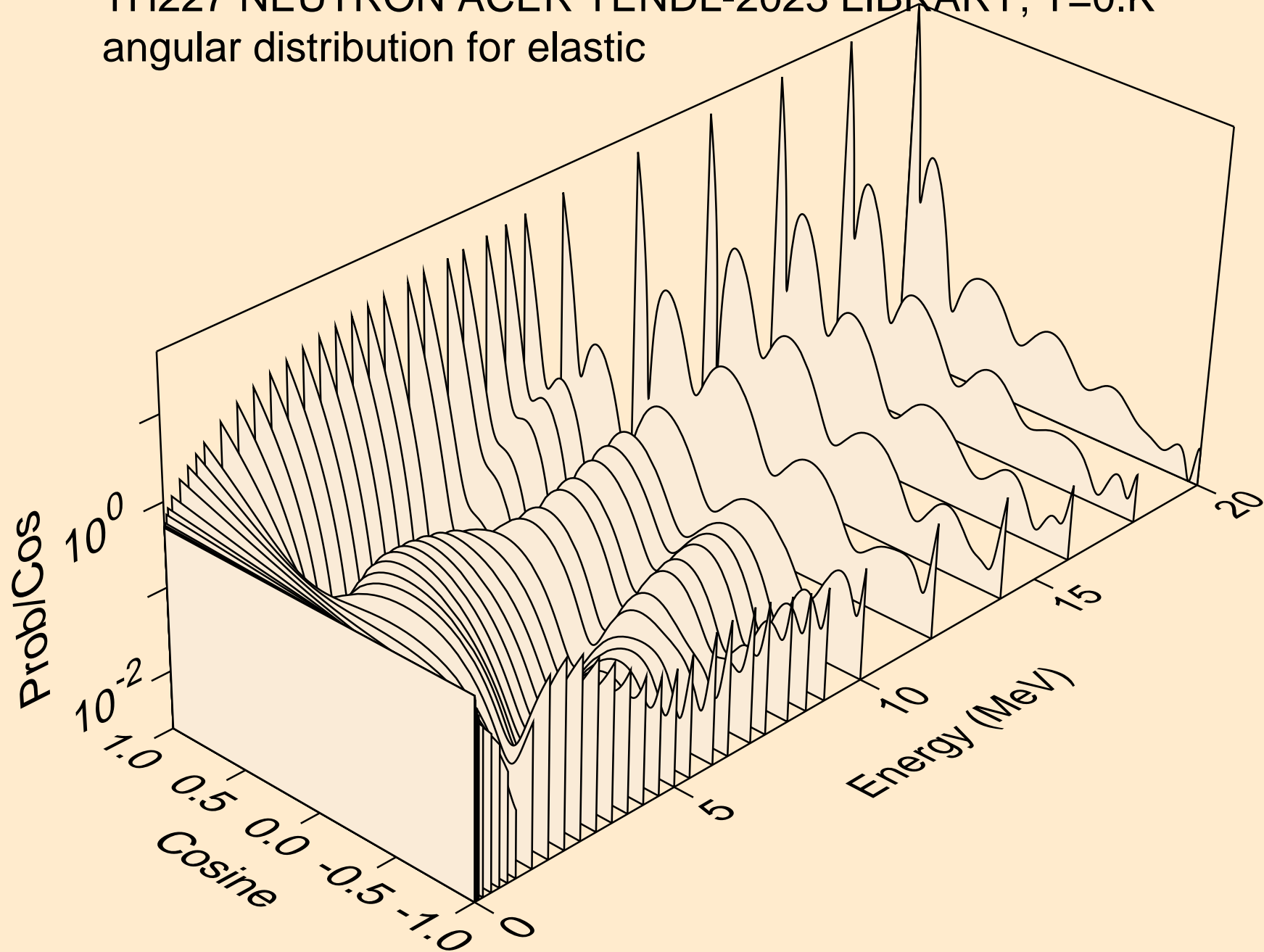

TH227 NEUTRON ACER TENDL-2023 LIBRARY; T=0.K
angular distribution for elastic

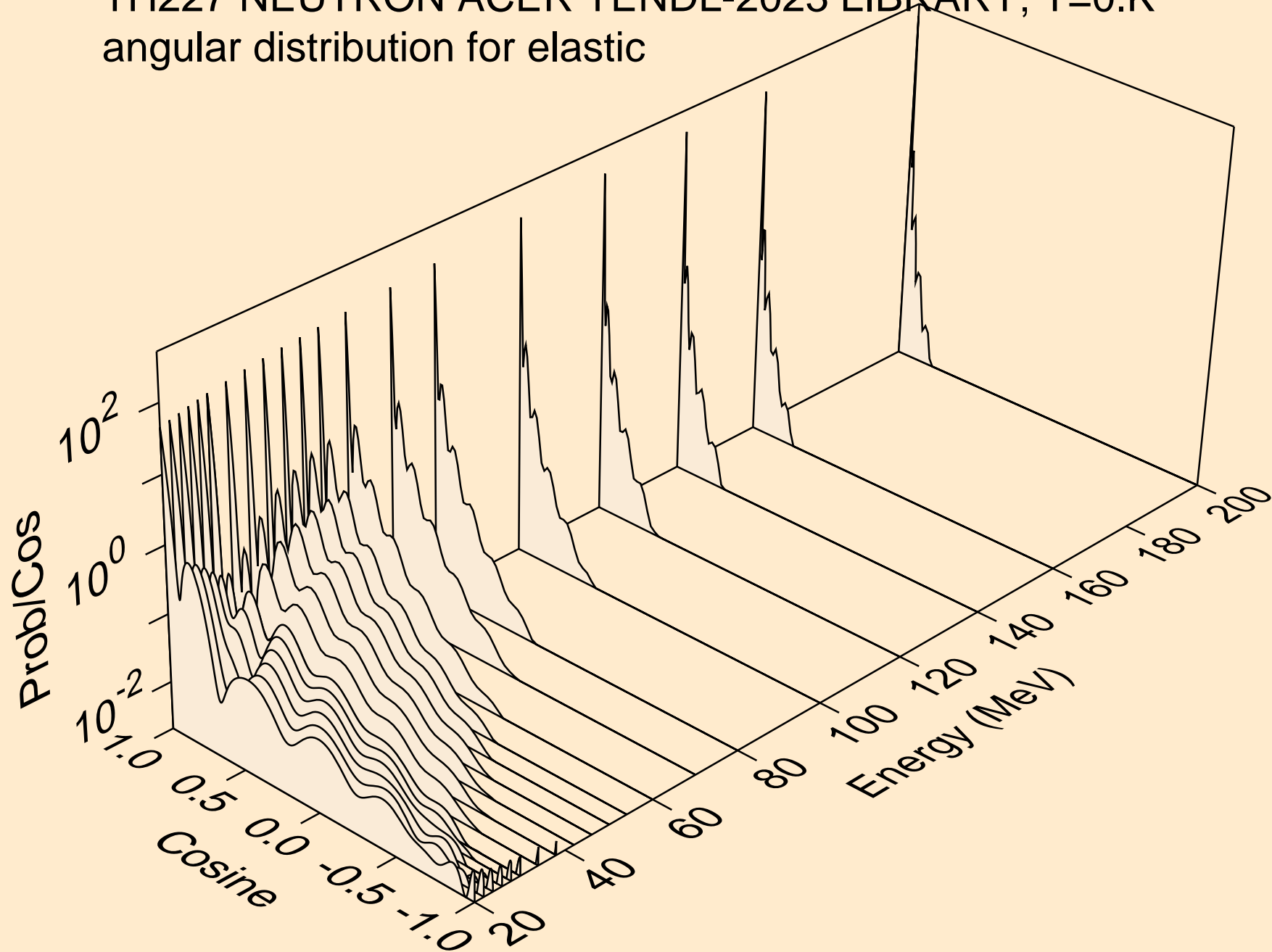

TH227 NEUTRON ACER TENDL-2023 LIBRARY; T=0.K
angular distribution for (n,n*1)

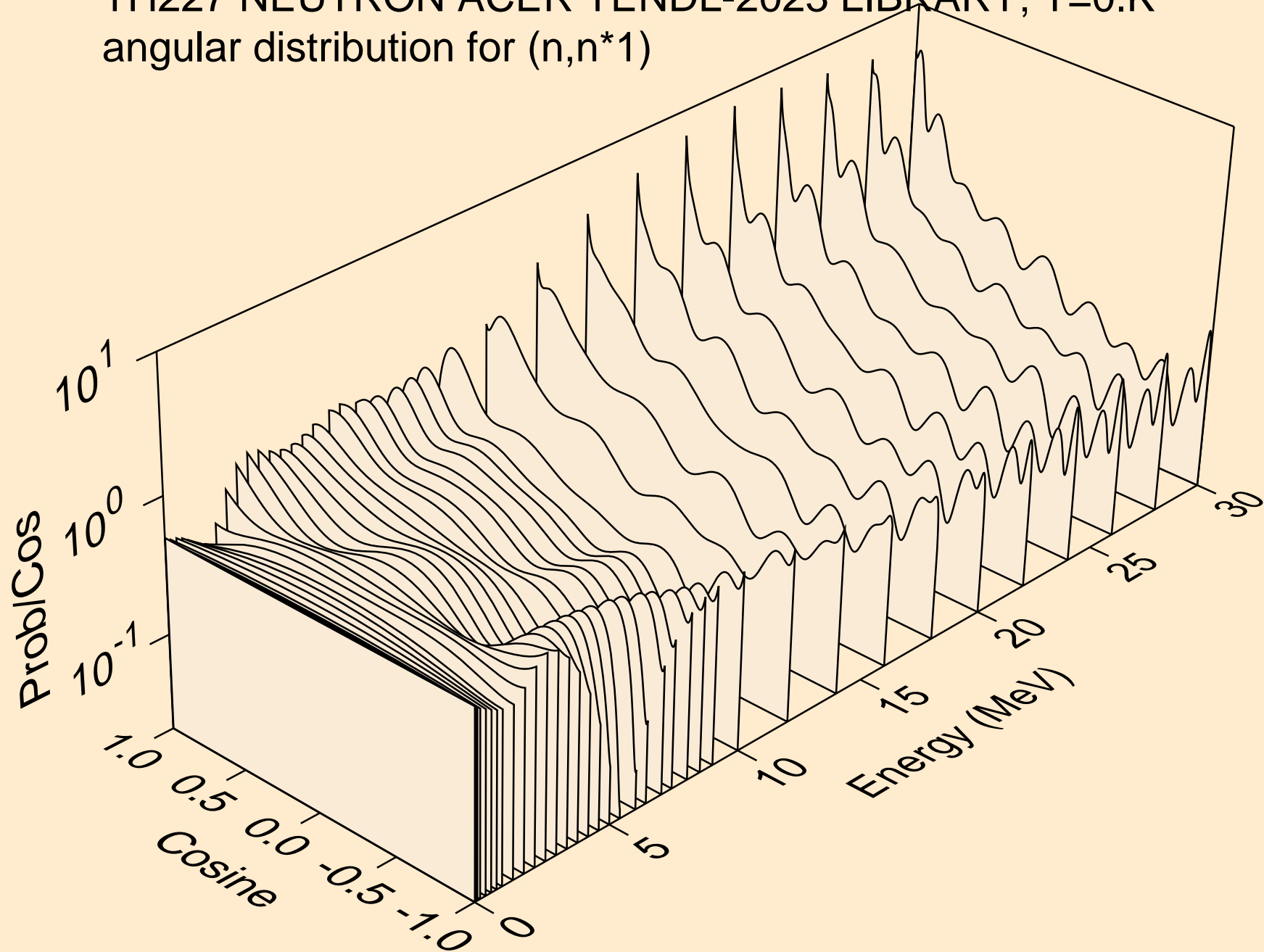

TH227 NEUTRON ACER TENDL-2023 LIBRARY; T=0.K
angular distribution for (n,n*2)

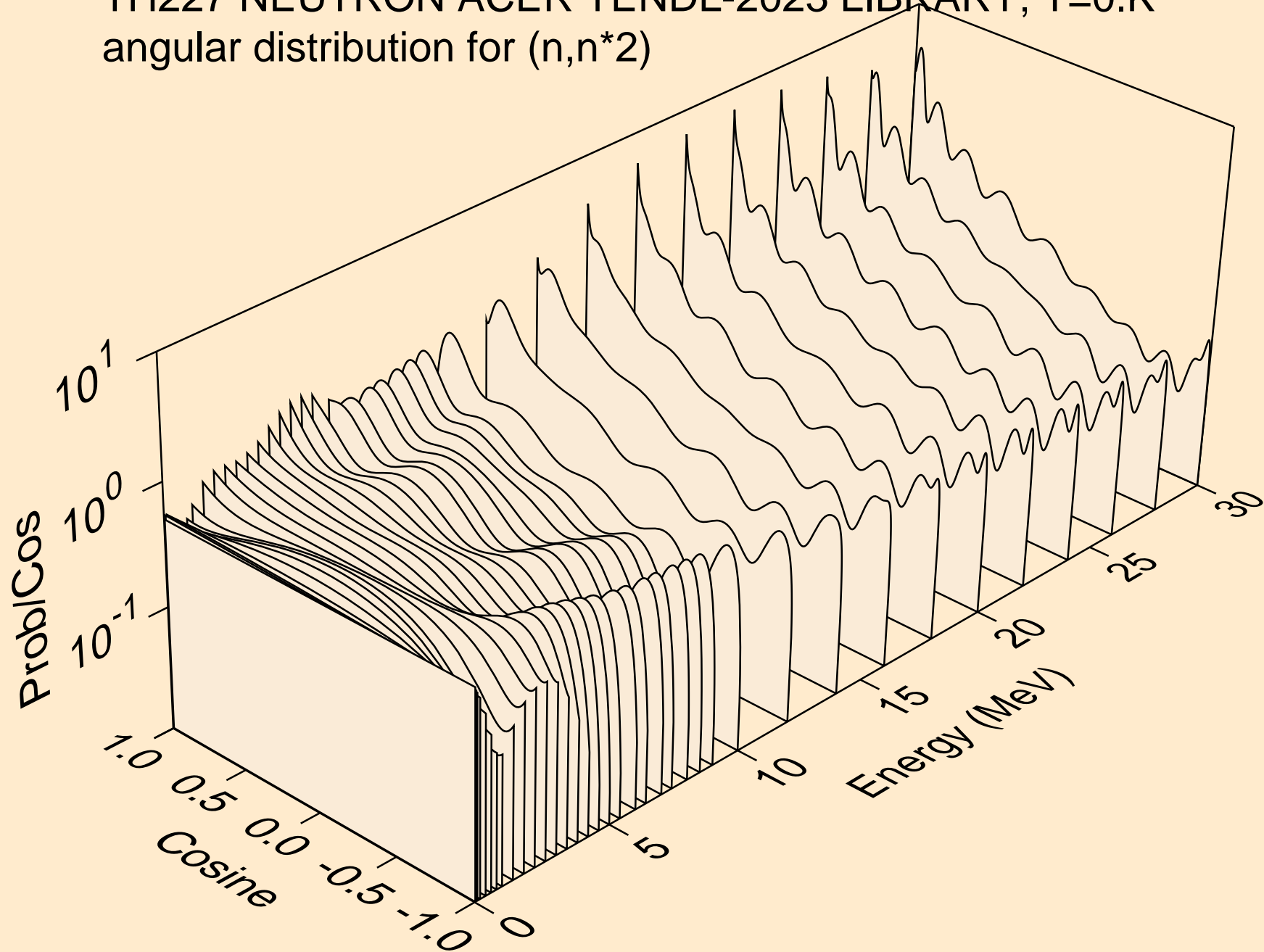

TH227 NEUTRON ACER TENDL-2023 LIBRARY; T=0.K
angular distribution for (n,n*3)

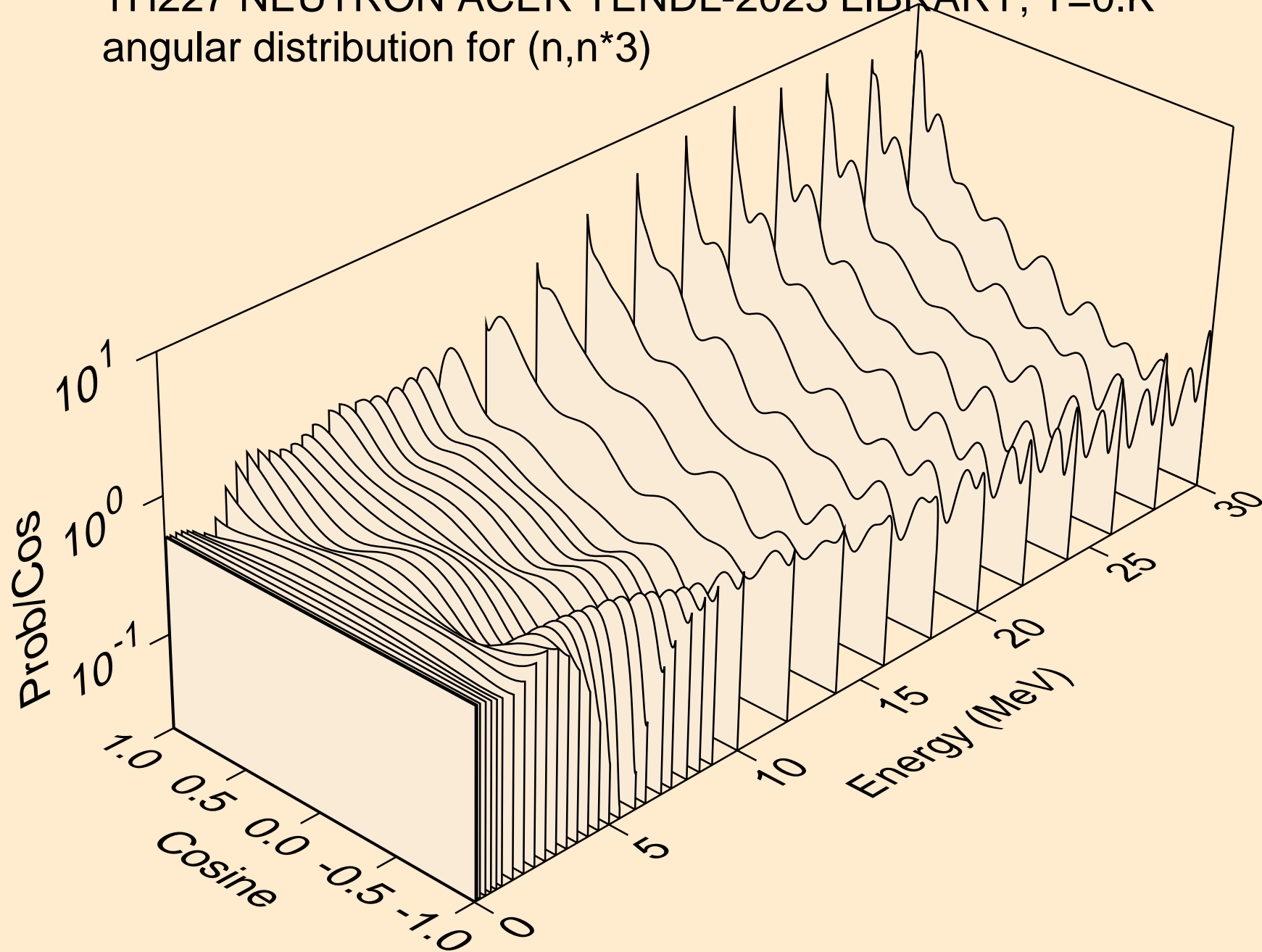

TH227 NEUTRON ACER TENDL-2023 LIBRARY; T=0.K
angular distribution for (n,n*4)

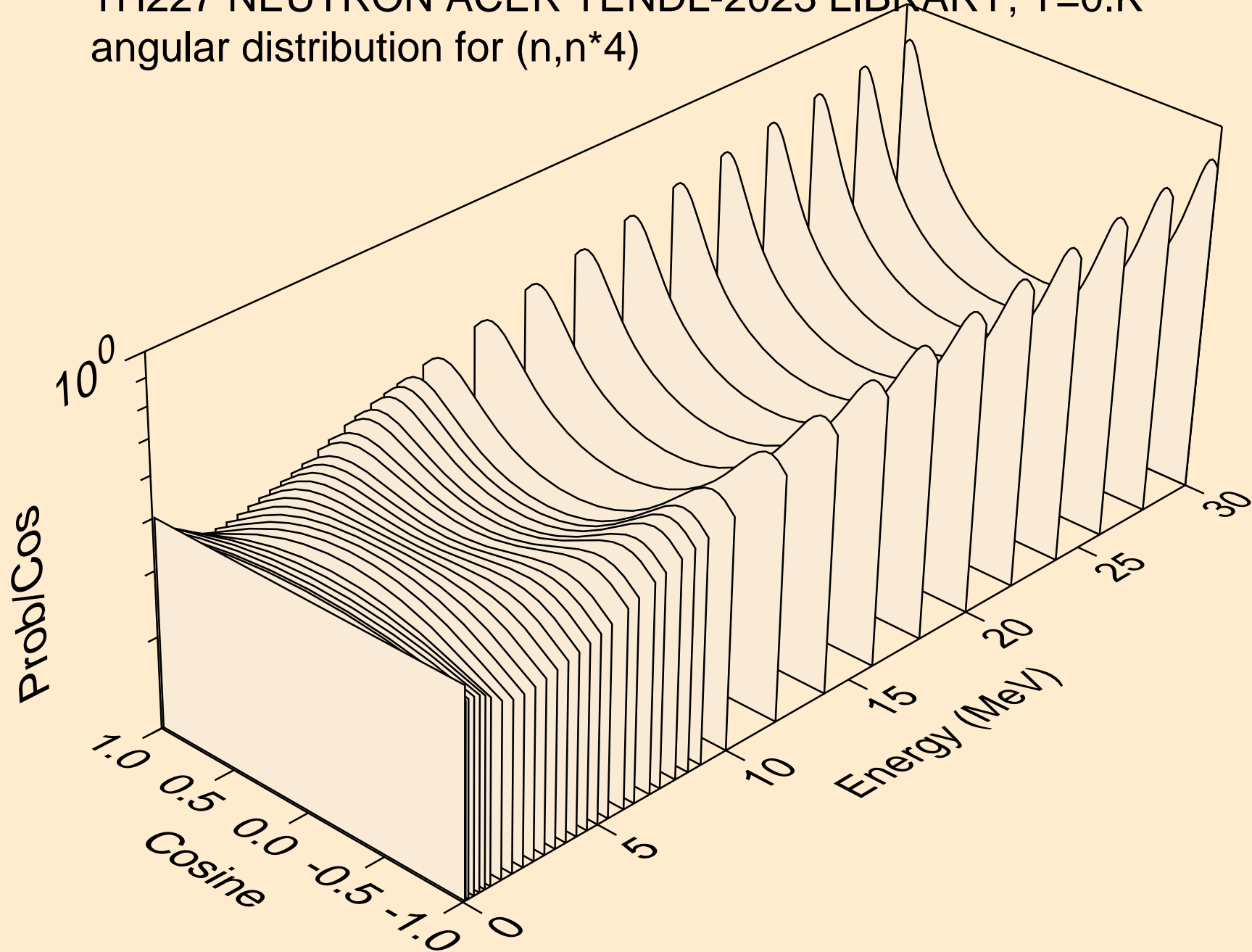

TH227 NEUTRON ACER TENDL-2023 LIBRARY; T=0.K
angular distribution for (n,n*5)

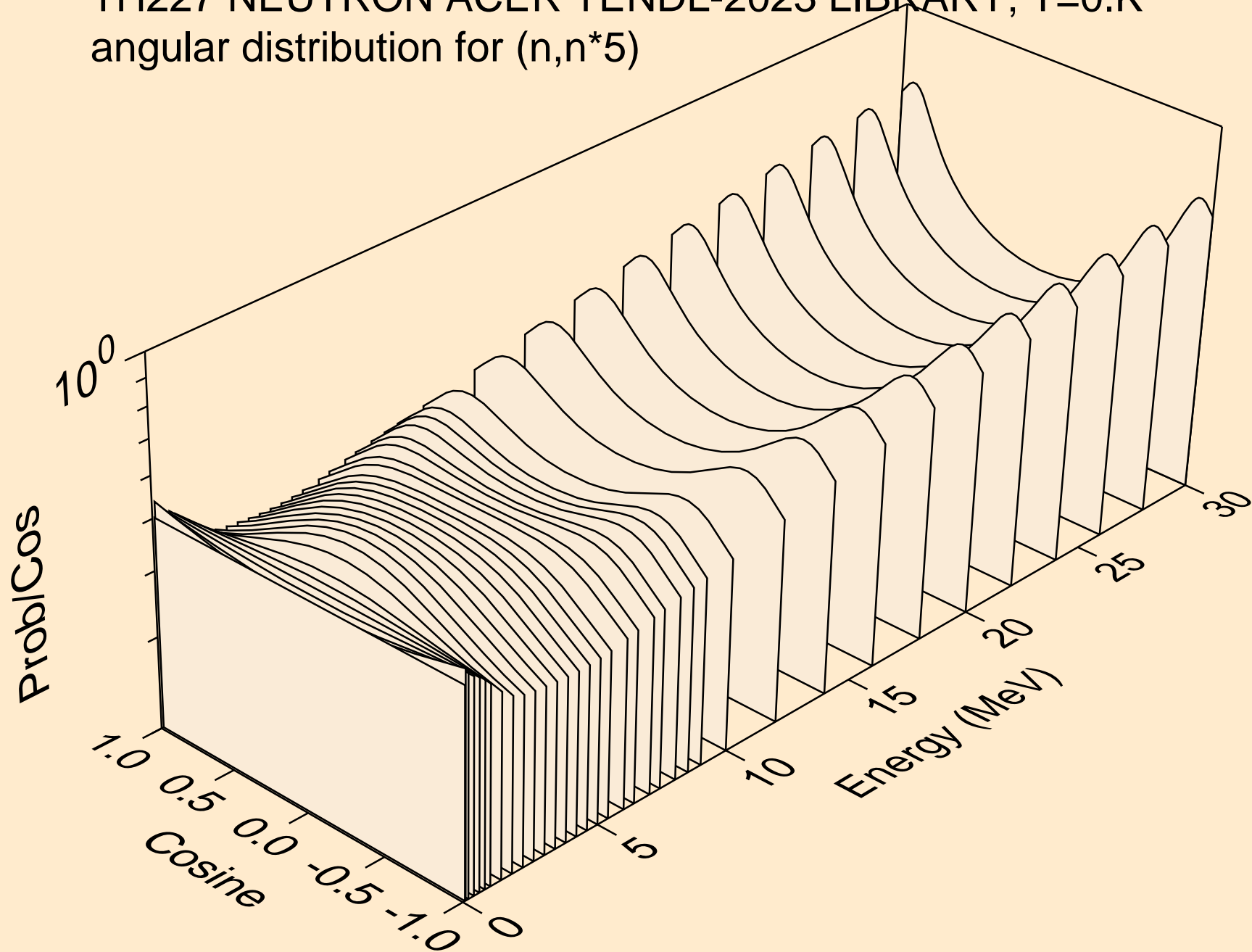

TH227 NEUTRON ACER TENDL-2023 LIBRARY; T=0.K
angular distribution for (n,n*6)

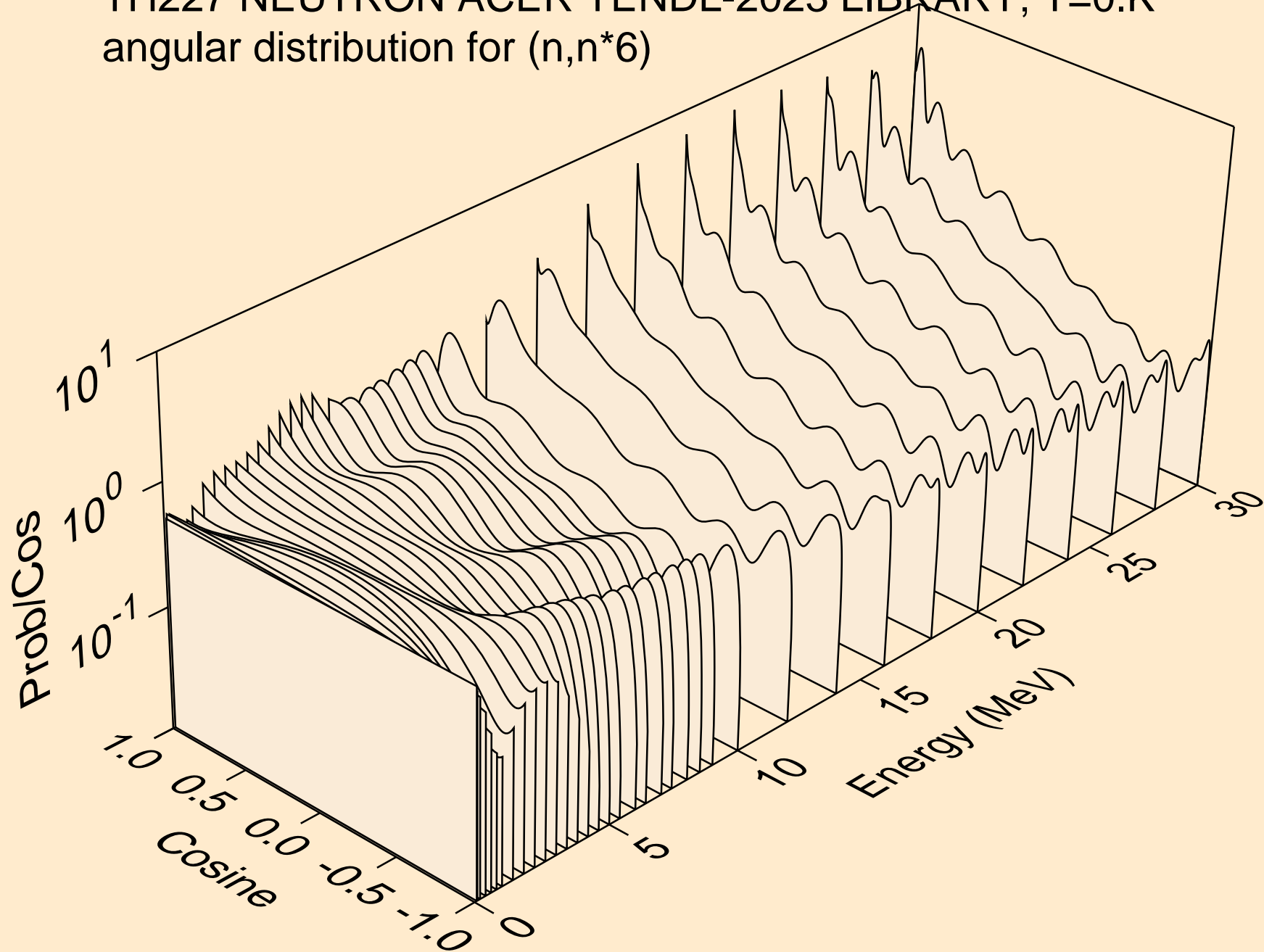

TH227 NEUTRON ACER TENDL-2023 LIBRARY; T=0.K
angular distribution for (n,n*7)

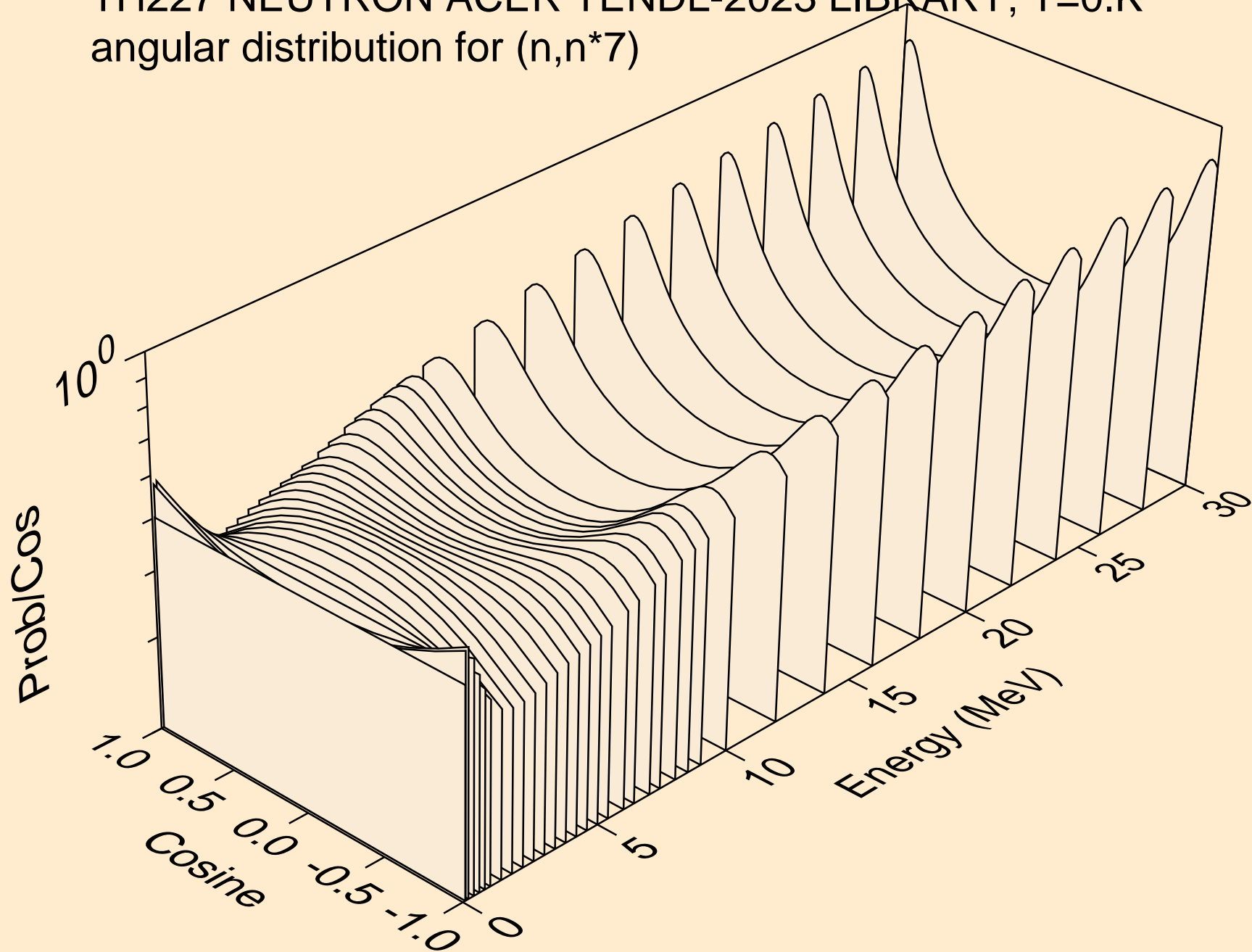

TH227 NEUTRON ACER TENDL-2023 LIBRARY; T=0.K
angular distribution for (n,n*8)

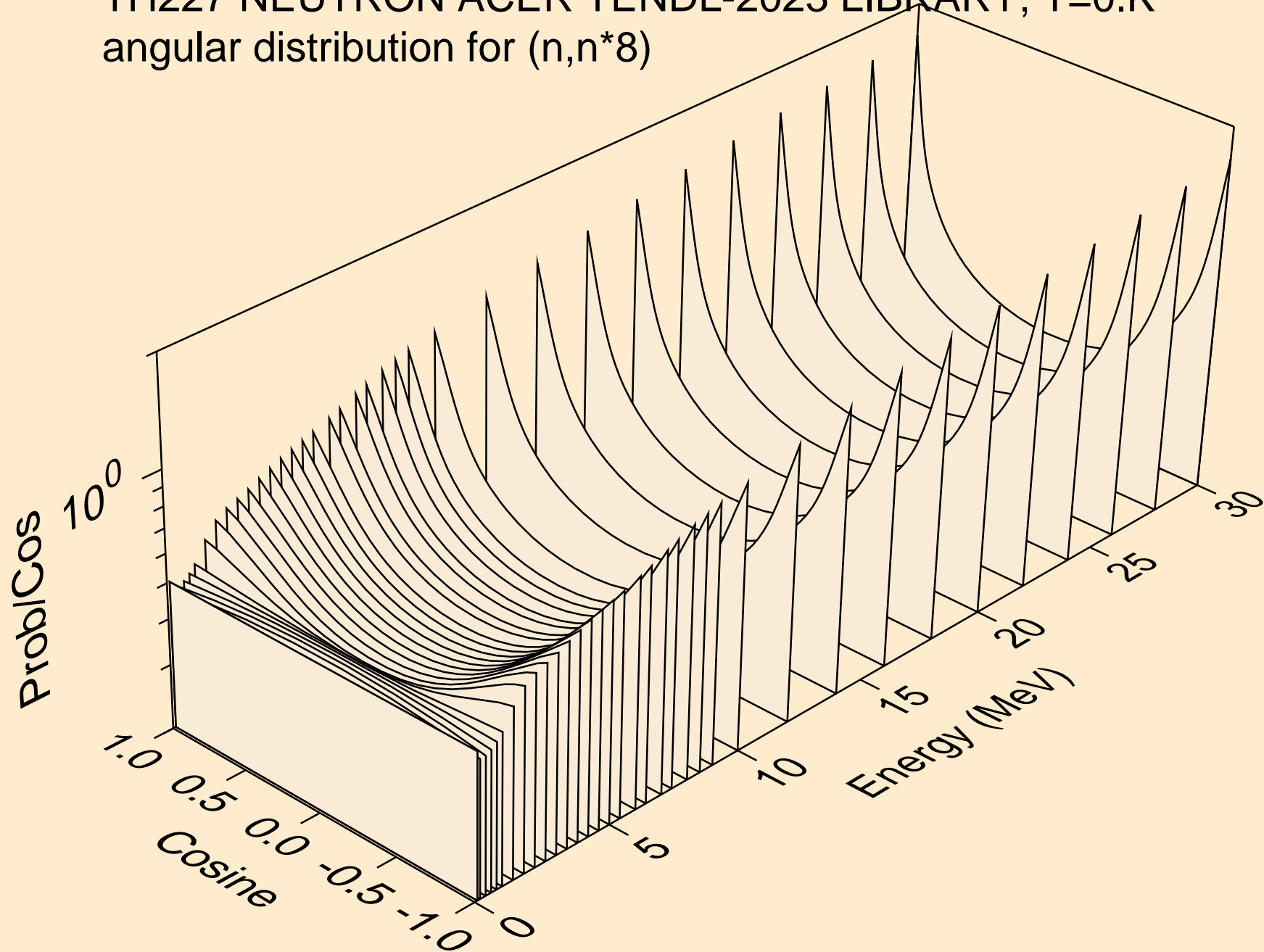

TH227 NEUTRON ACER TENDL-2023 LIBRARY; T=0.K
angular distribution for (n,n*9)

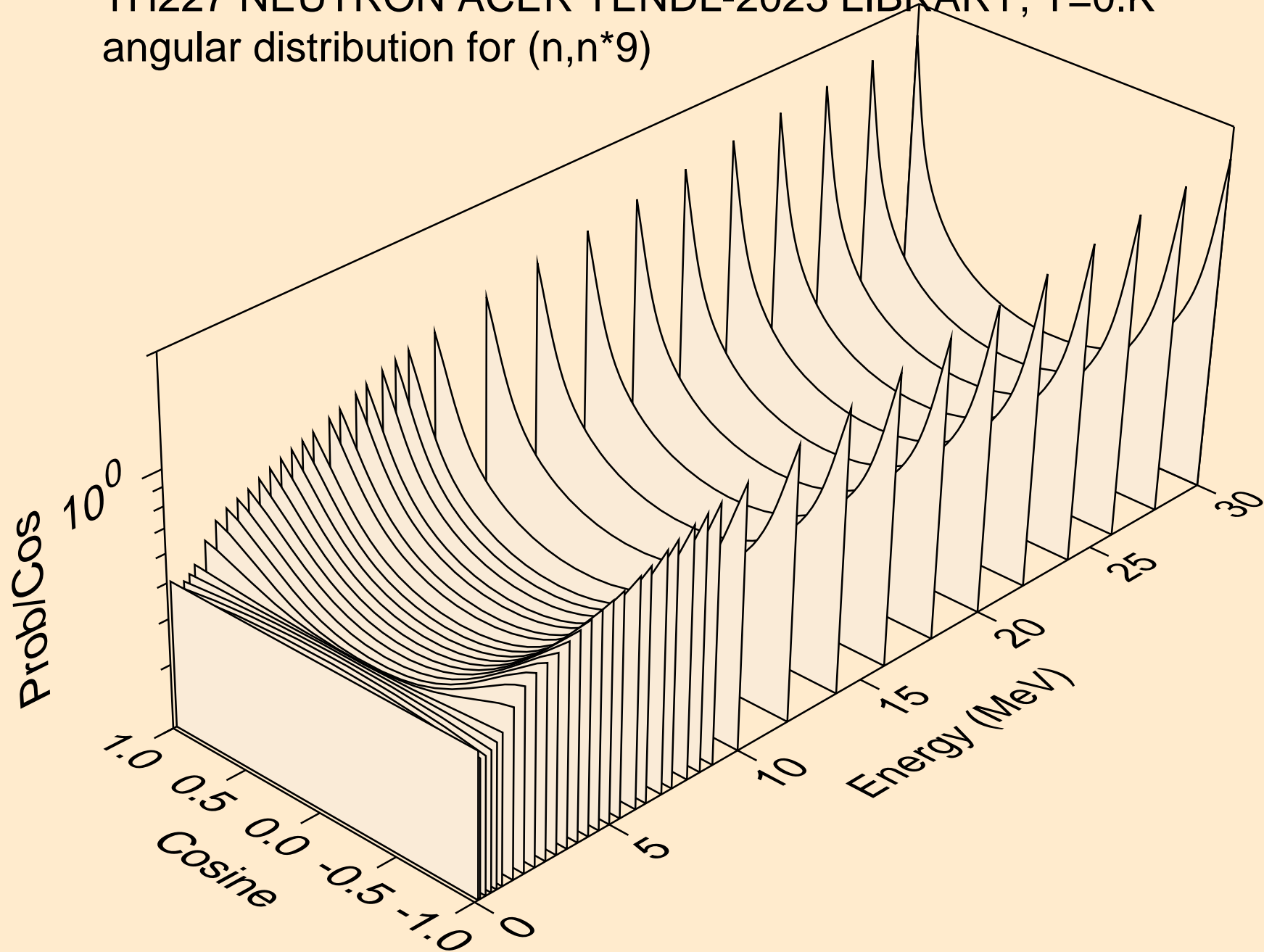

TH227 NEUTRON ACER TENDL-2023 LIBRARY; T=0.K
angular distribution for (n,n*10)

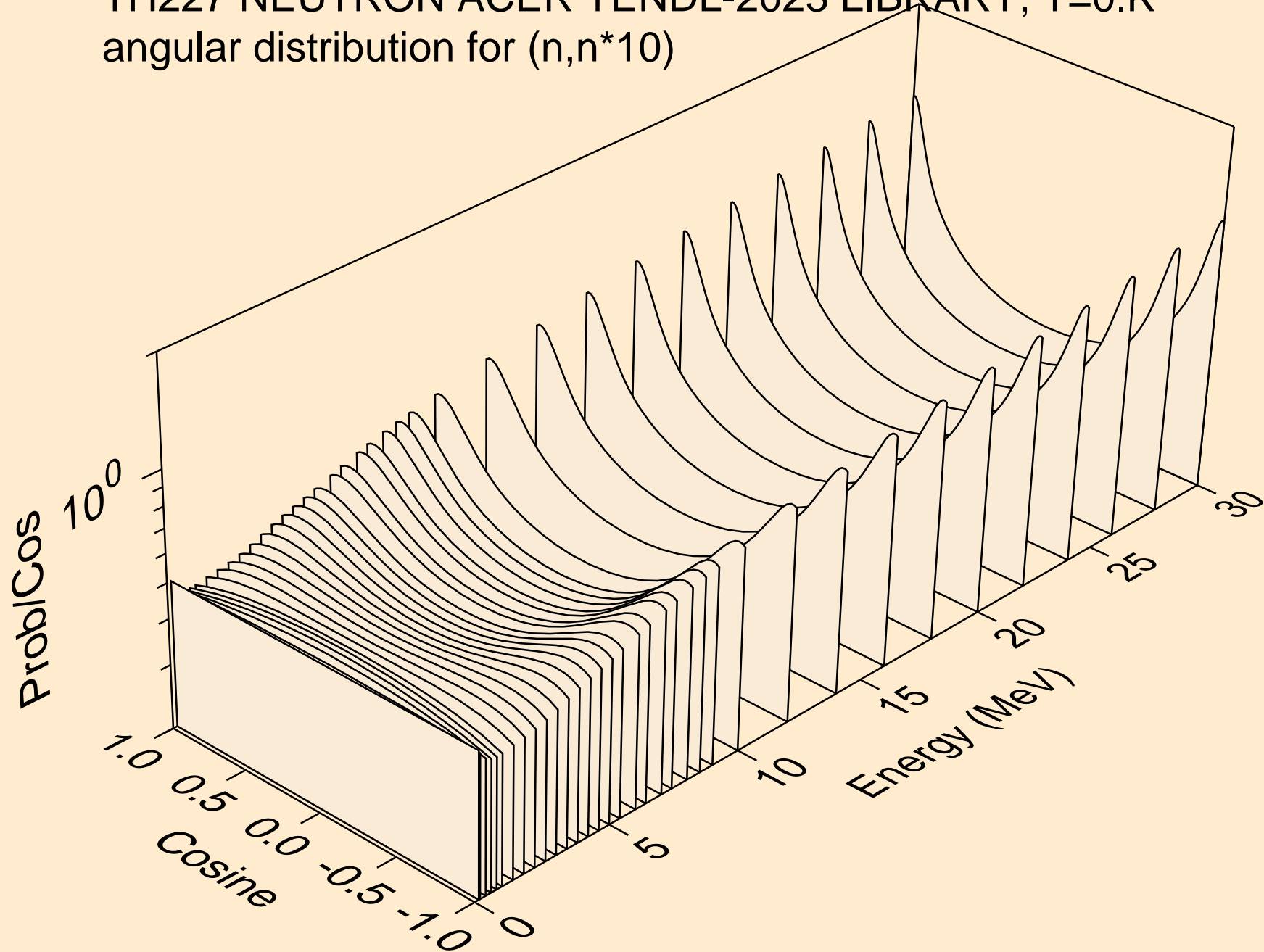

TH227 NEUTRON ACER TENDL-2023 LIBRARY; T=0.K
angular distribution for (n,n*11)

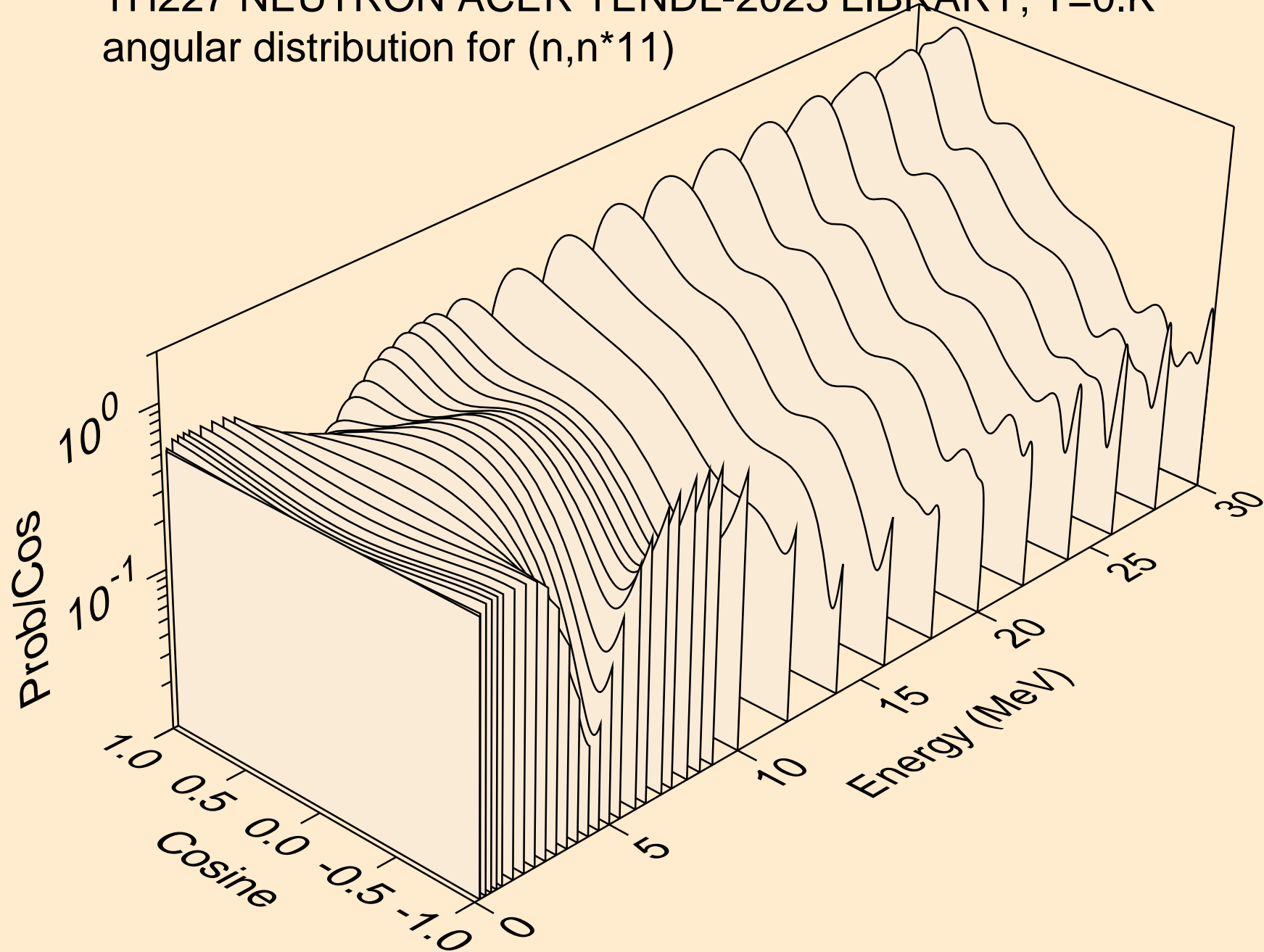

TH227 NEUTRON ACER TENDL-2023 LIBRARY; T=0.K
angular distribution for (n,n*12)

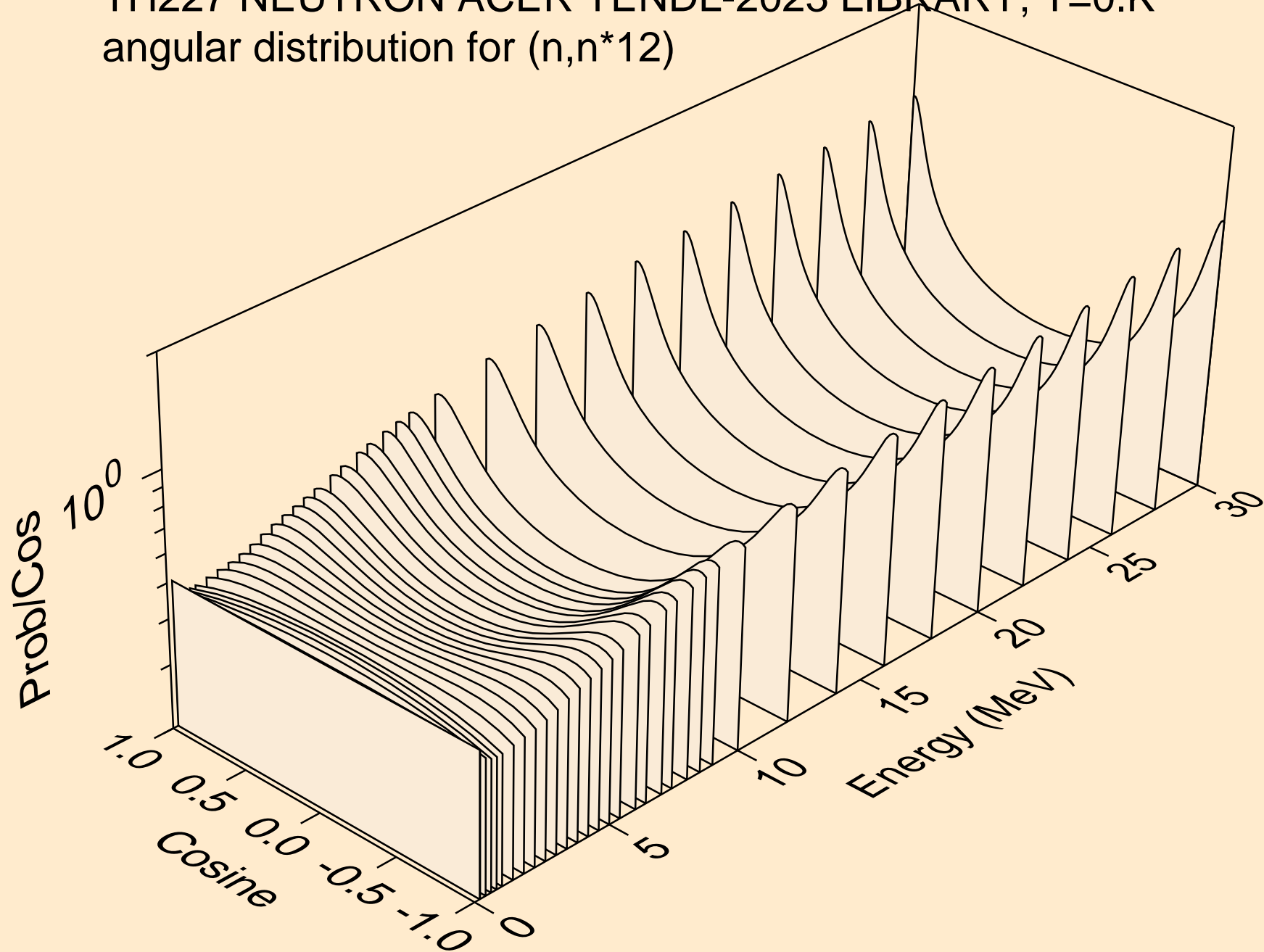

TH227 NEUTRON ACER TENDL-2023 LIBRARY; T=0.K
angular distribution for (n,n*13)

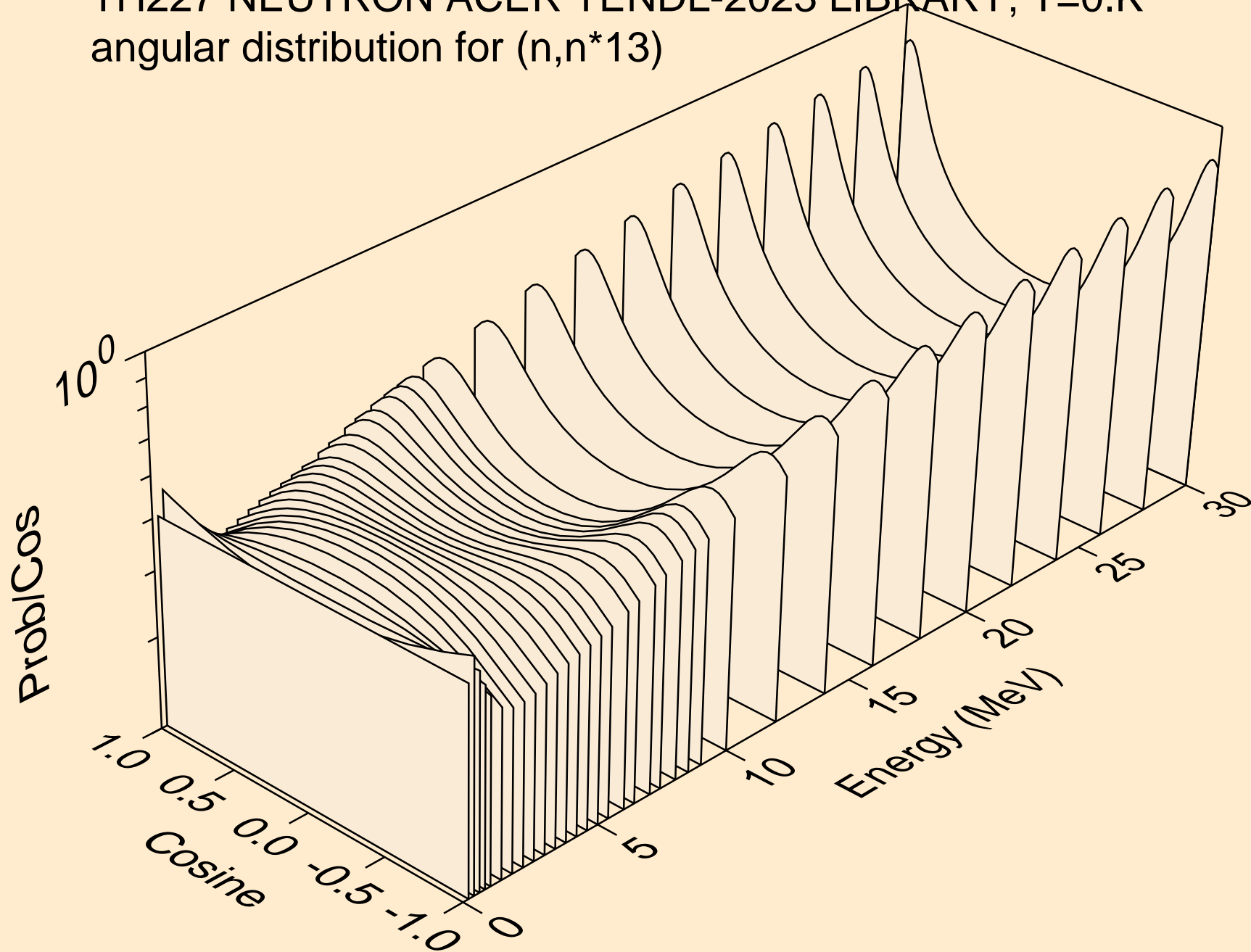

TH227 NEUTRON ACER TENDL-2023 LIBRARY; T=0.K
angular distribution for (n,n*14)

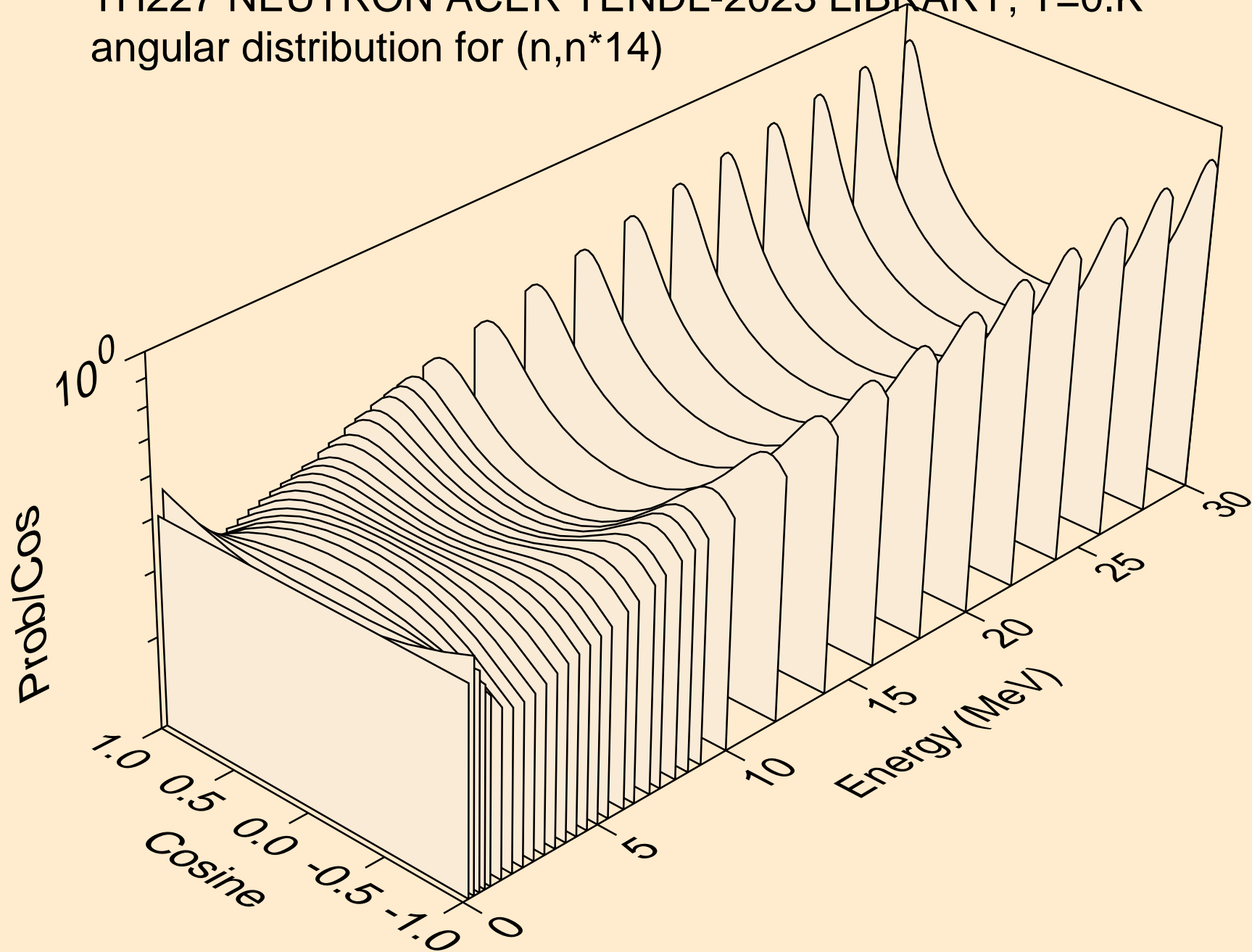

TH227 NEUTRON ACER TENDL-2023 LIBRARY; T=0.K
angular distribution for (n,n*15)

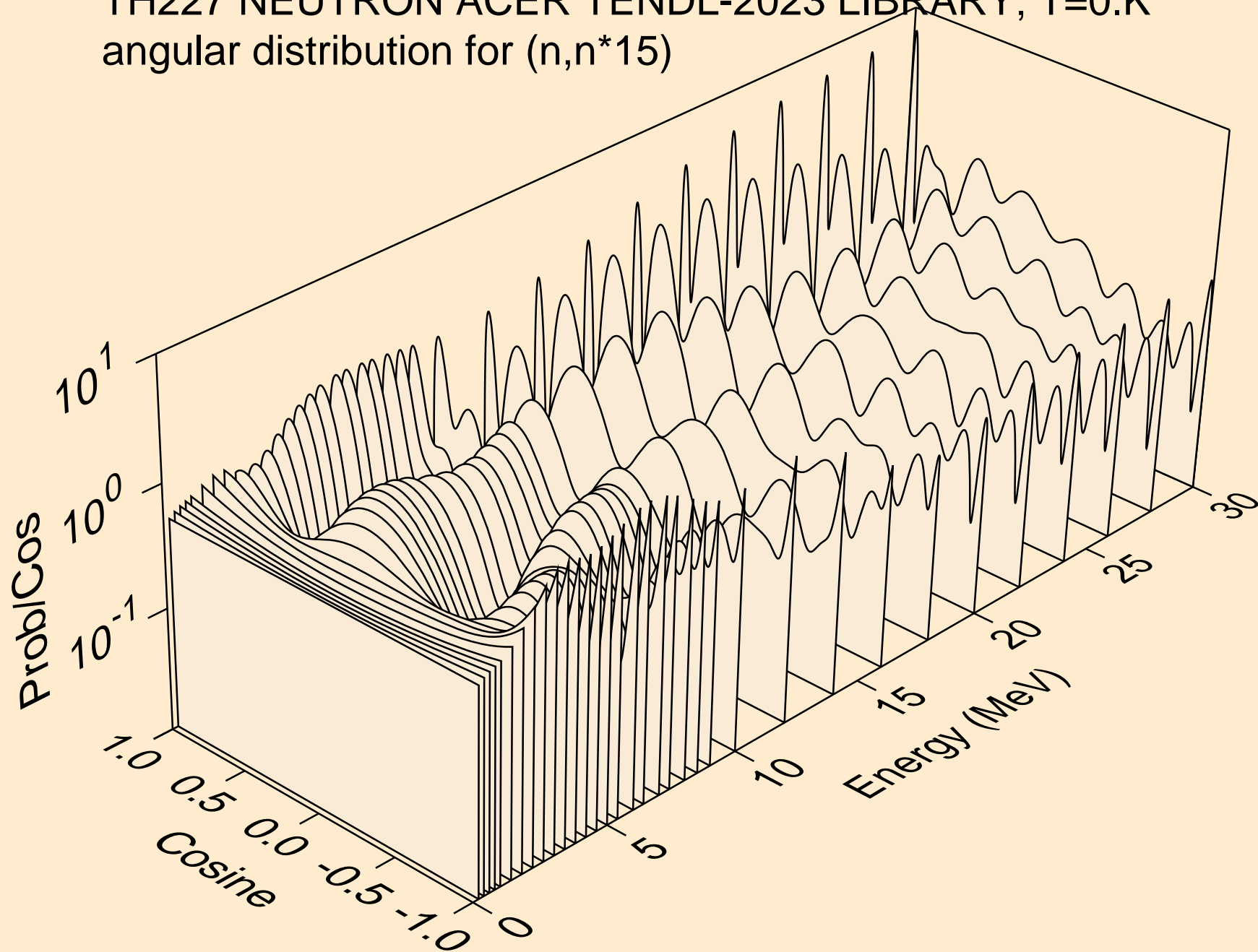

TH227 NEUTRON ACER TENDL-2023 LIBRARY; T=0.K
Total fission nubar

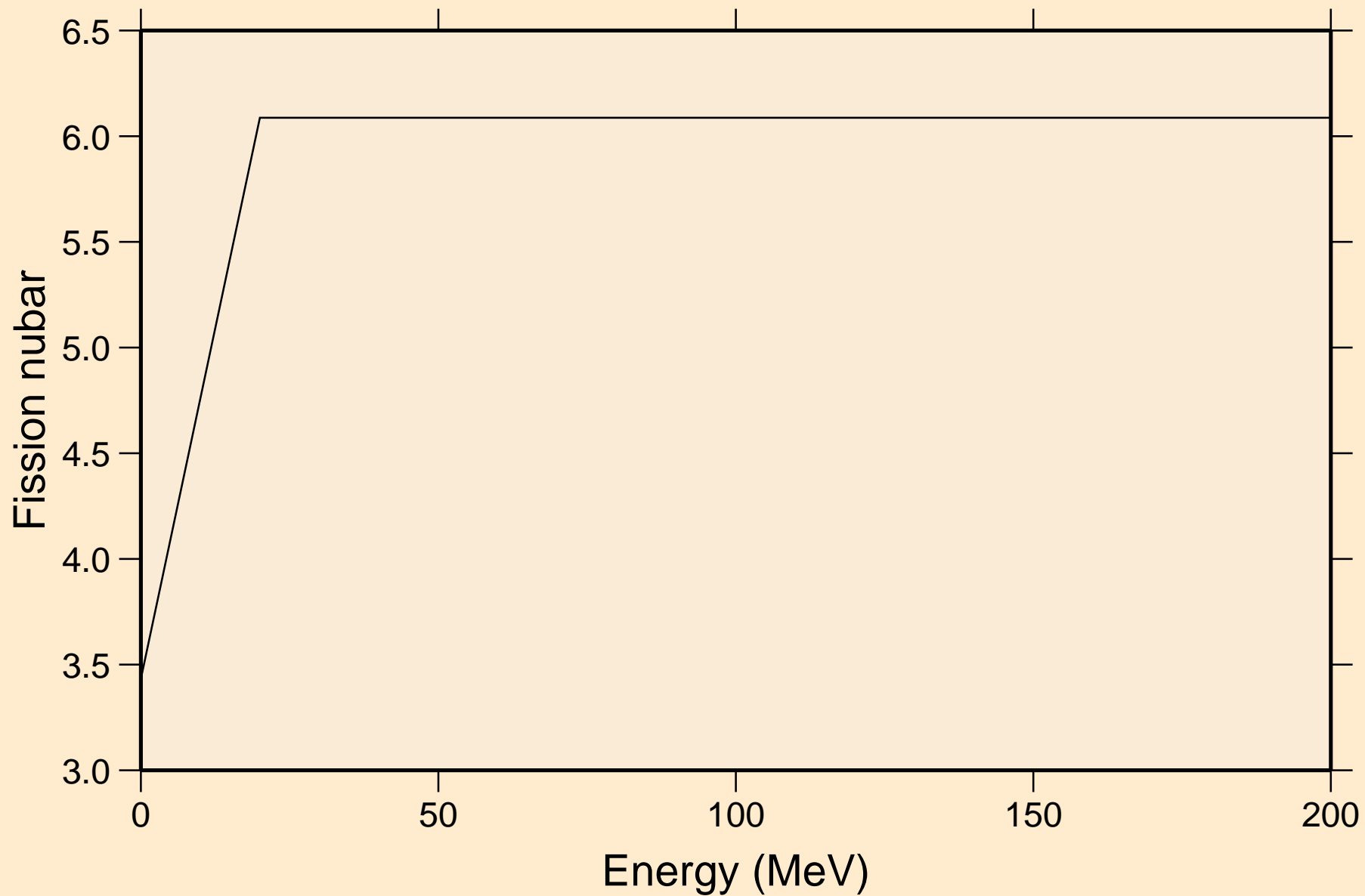

TH227 NEUTRON ACER TENDL-2023 LIBRARY; T=0.K
Neutron emission for (n,x)

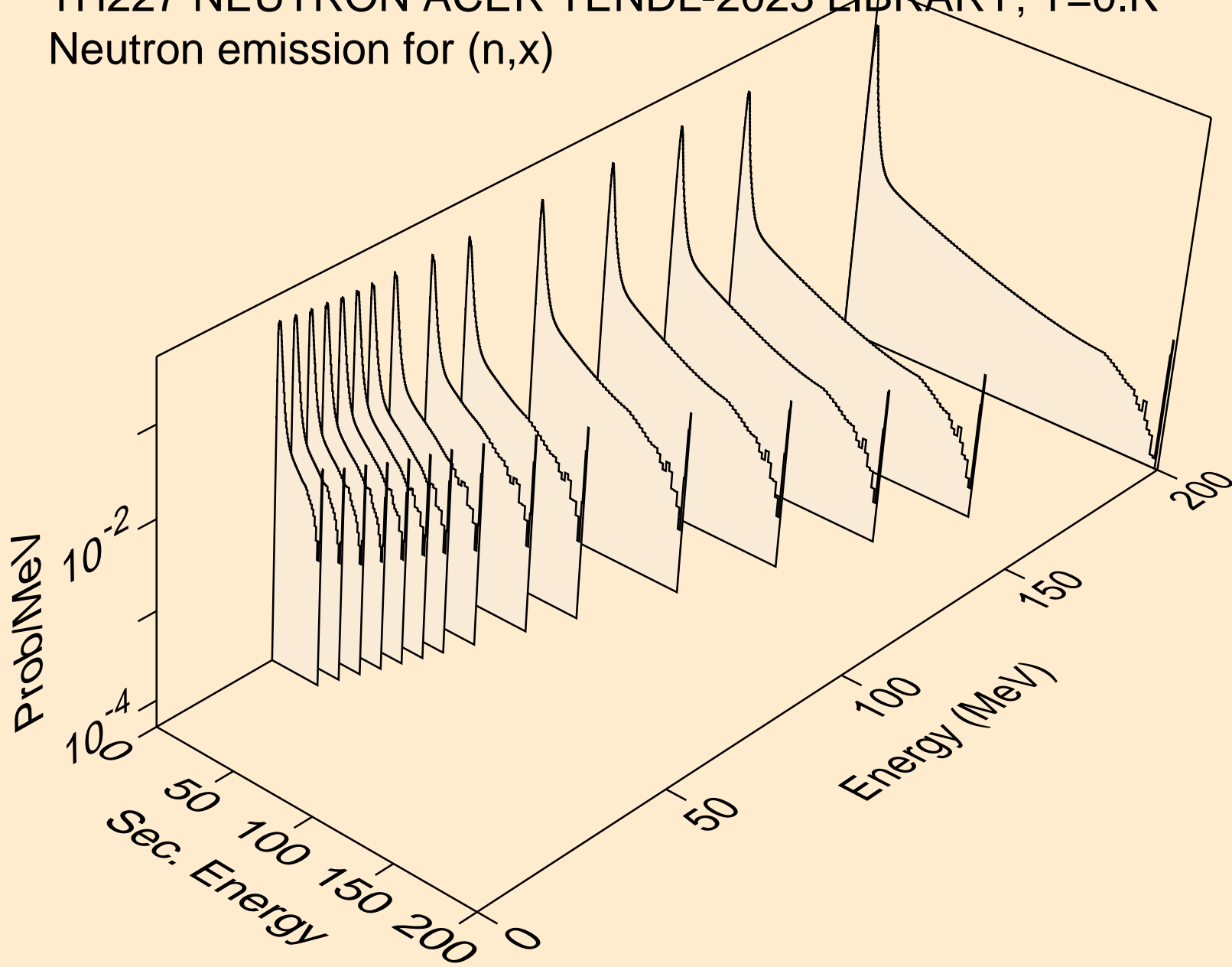

TH227 NEUTRON ACER TENDL-2023 LIBRARY; T=0.K
Neutron emission for (n,2nd)

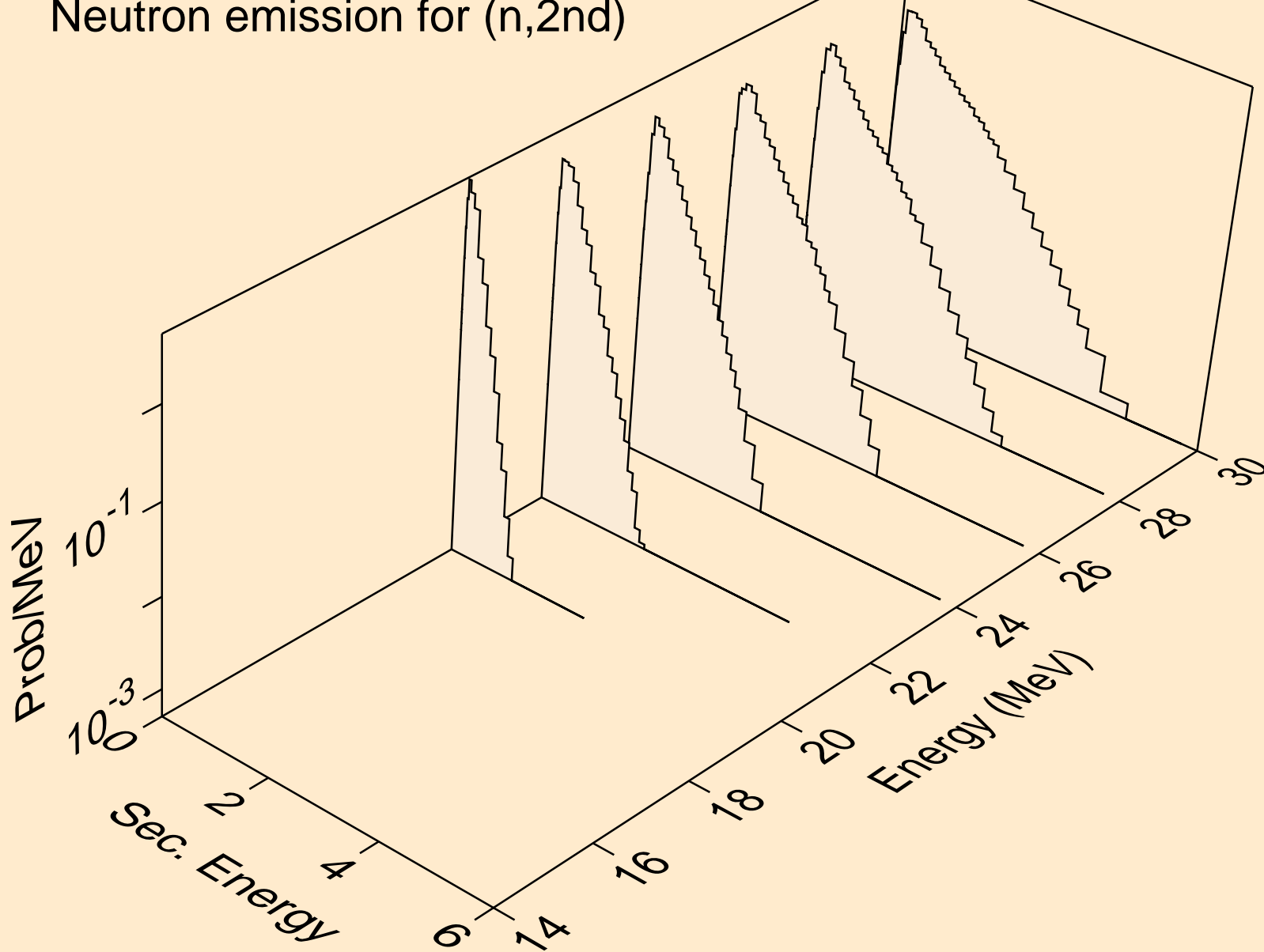

TH227 NEUTRON ACER TENDL-2023 LIBRARY; T=0.K
Neutron emission for (n,2n)

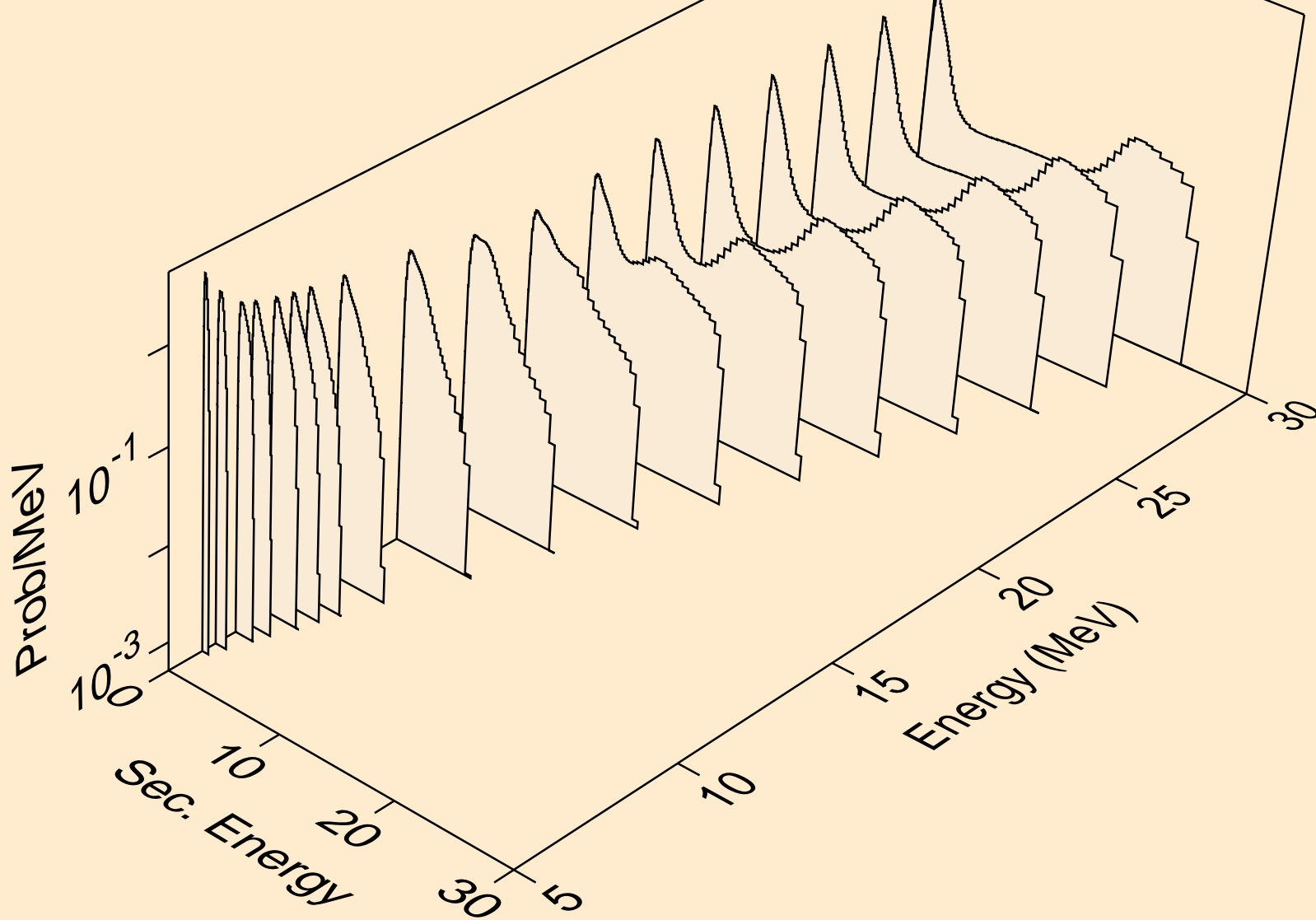

TH227 NEUTRON ACER TENDL-2023 LIBRARY; T=0.K
Neutron emission for (n,3n)

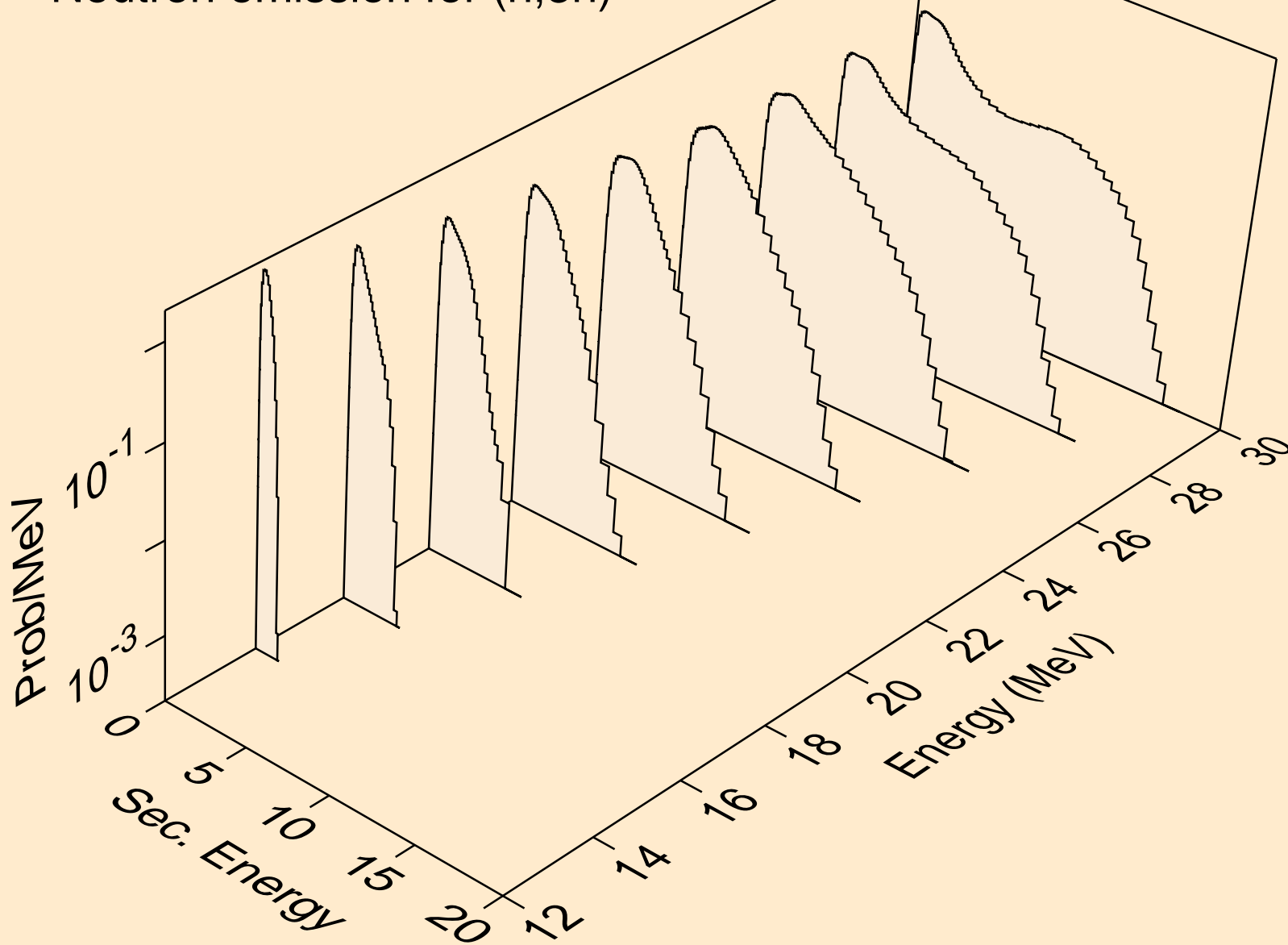

TH227 NEUTRON ACER TENDL-2023 LIBRARY; T=0.K
Neutron emission for fission

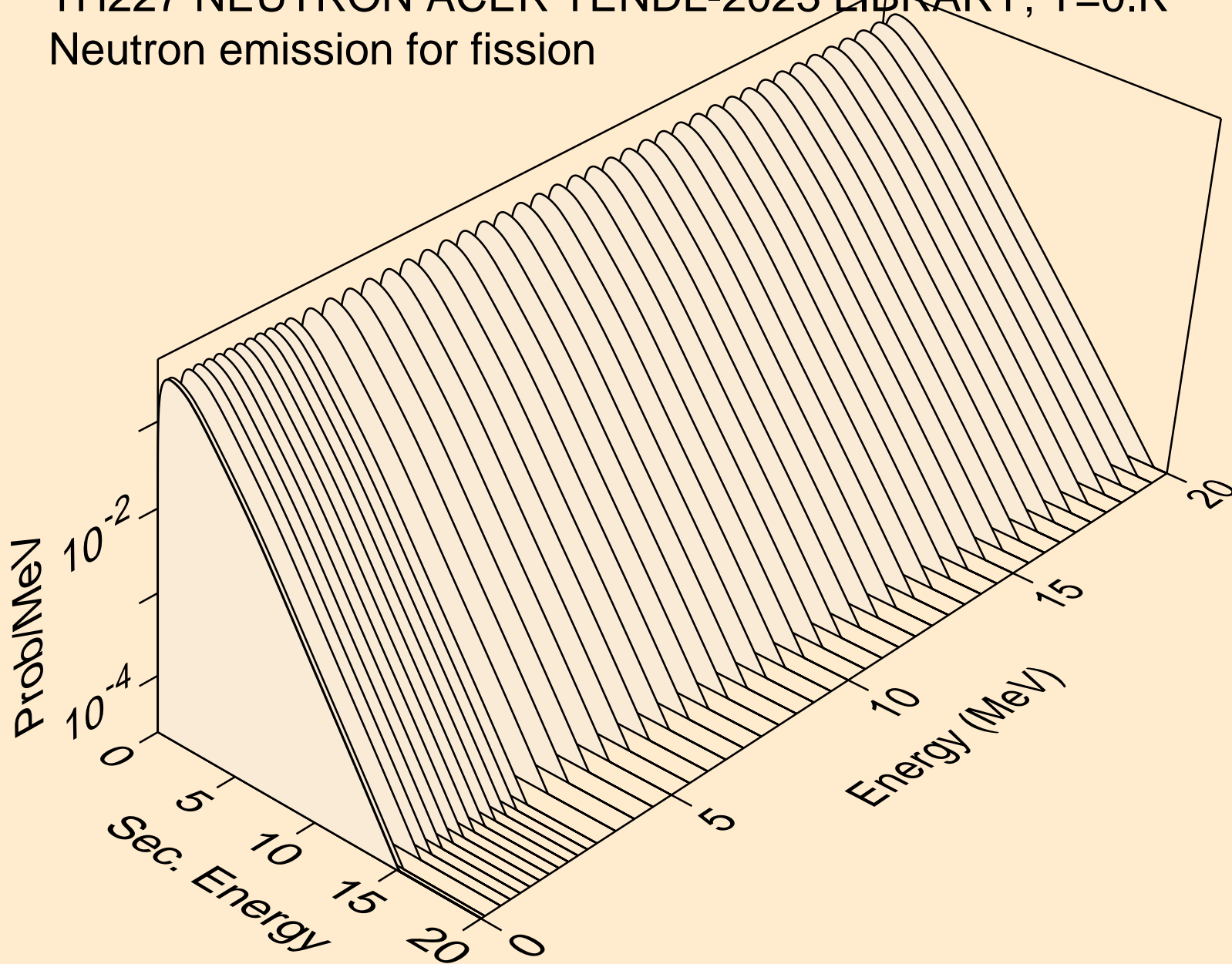

TH227 NEUTRON ACER TENDL-2023 LIBRARY; T=0.K
Neutron emission for (n,n*)a

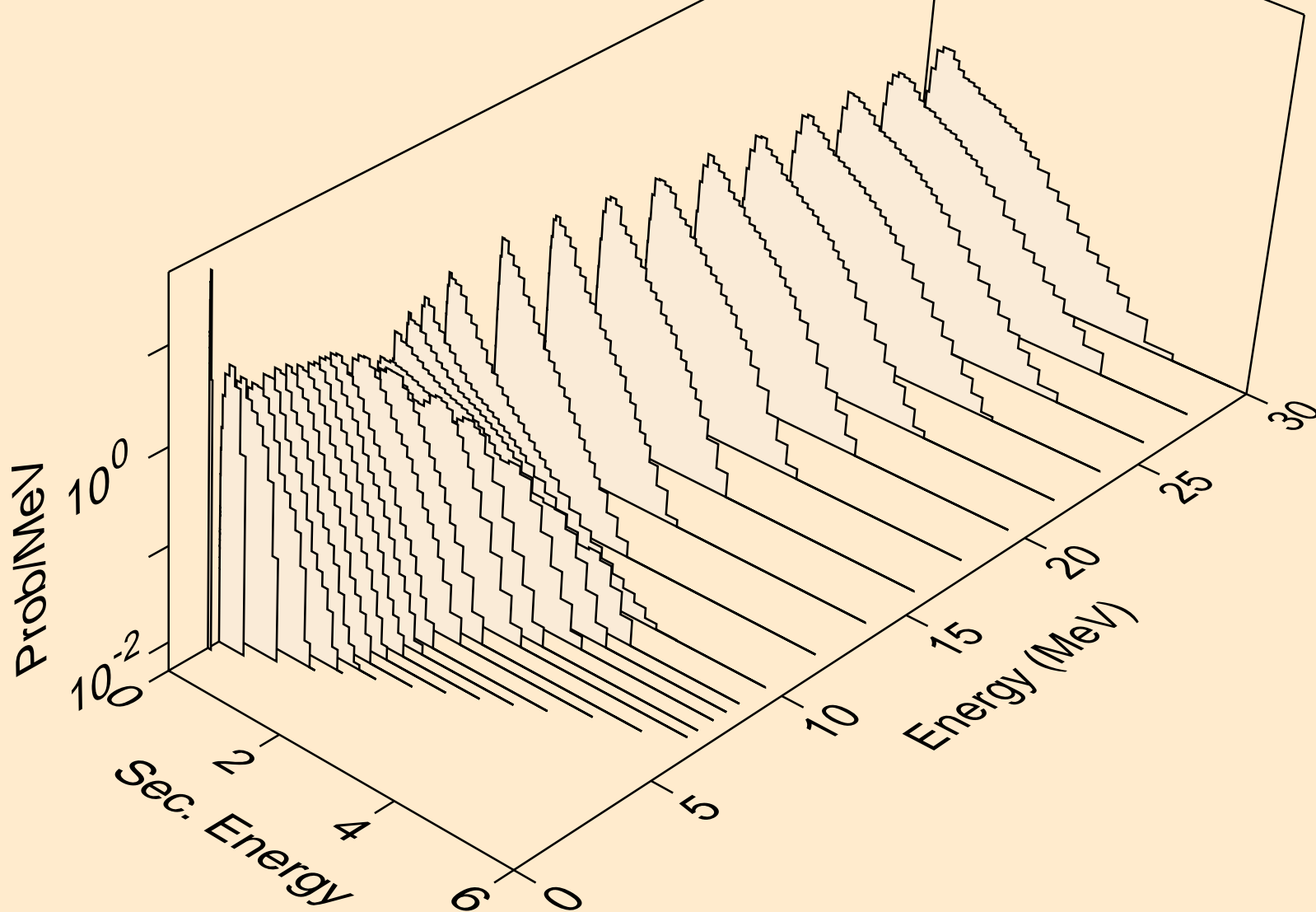

TH227 NEUTRON ACER TENDL-2023 LIBRARY; T=0.K
Neutron emission for (n,2n)a

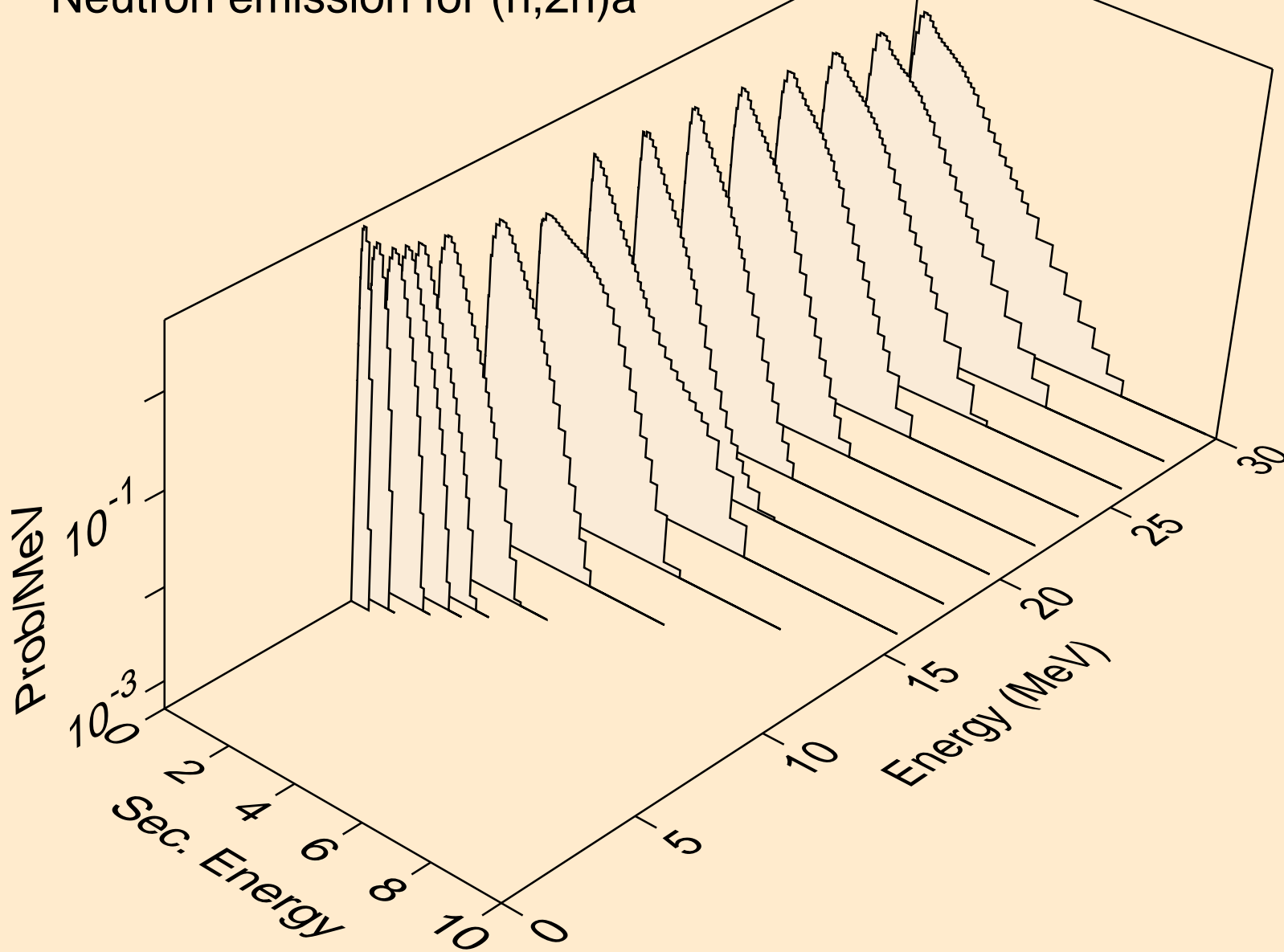

TH227 NEUTRON ACER TENDL-2023 LIBRARY; T=0.K
Neutron emission for (n,3n)a

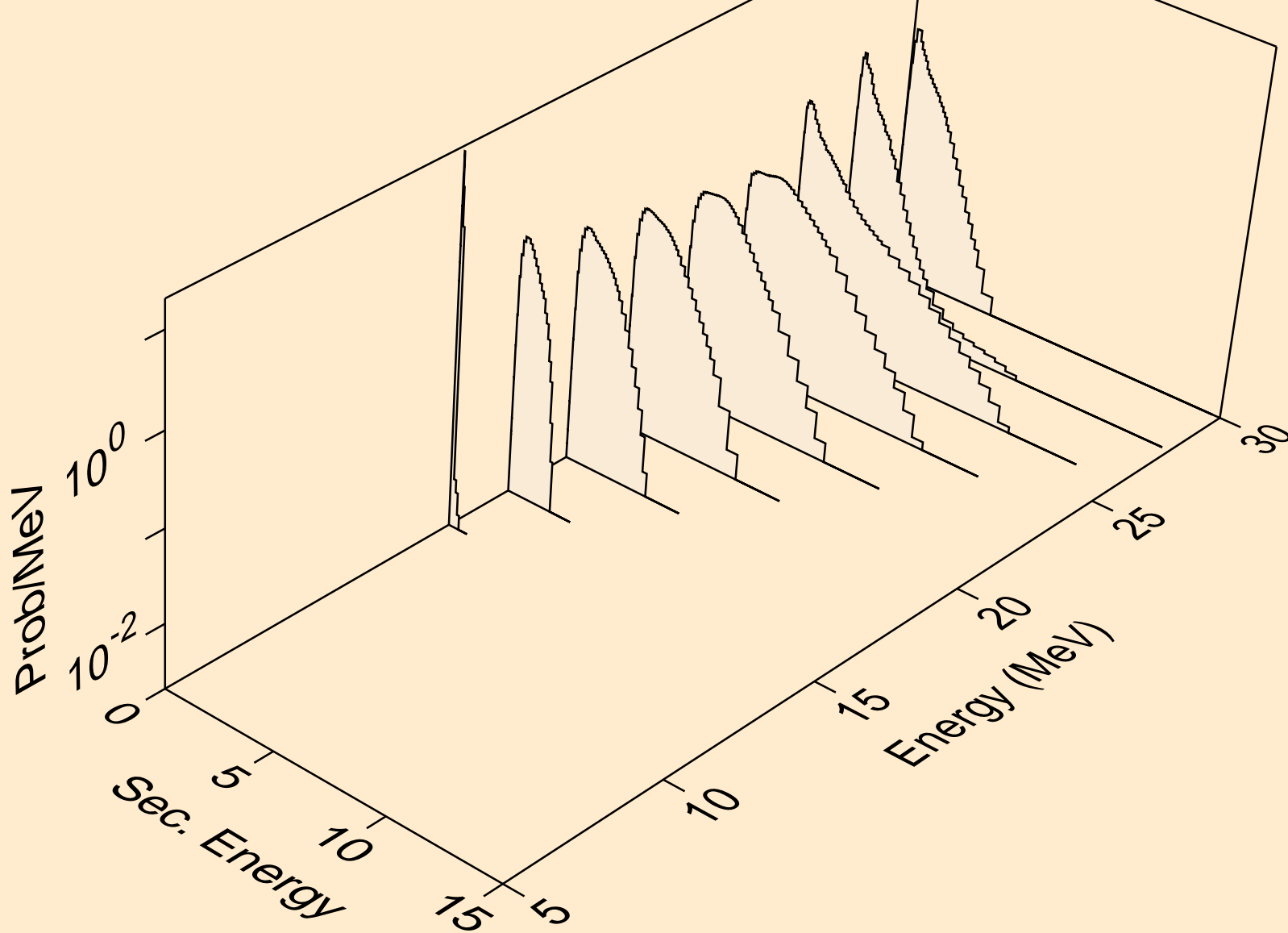

TH227 NEUTRON ACER TENDL-2023 LIBRARY; T=0.K
Neutron emission for (n,n*)p

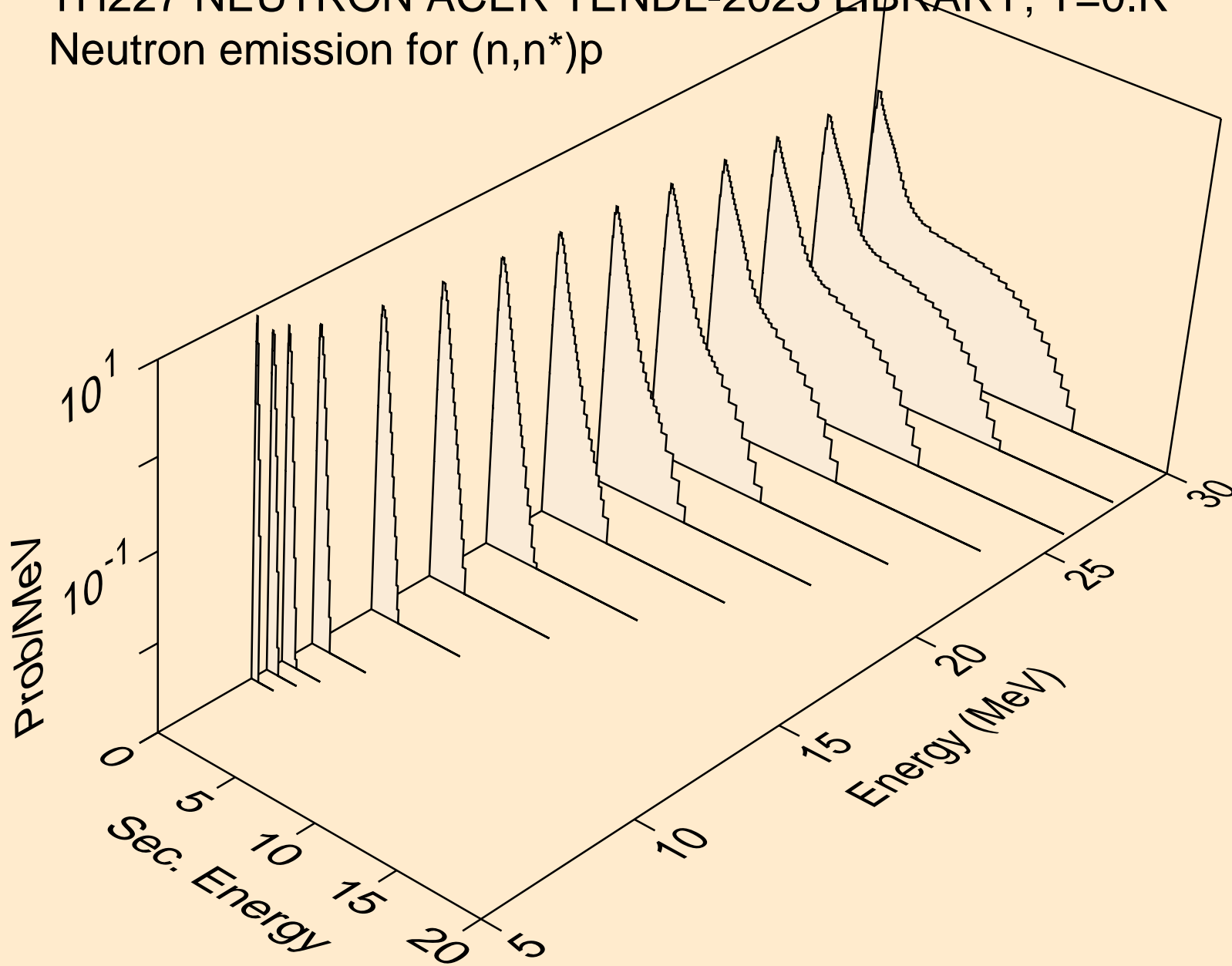

TH227 NEUTRON ACER TENDL-2023 LIBRARY; T=0.K
Neutron emission for (n,n*)2a

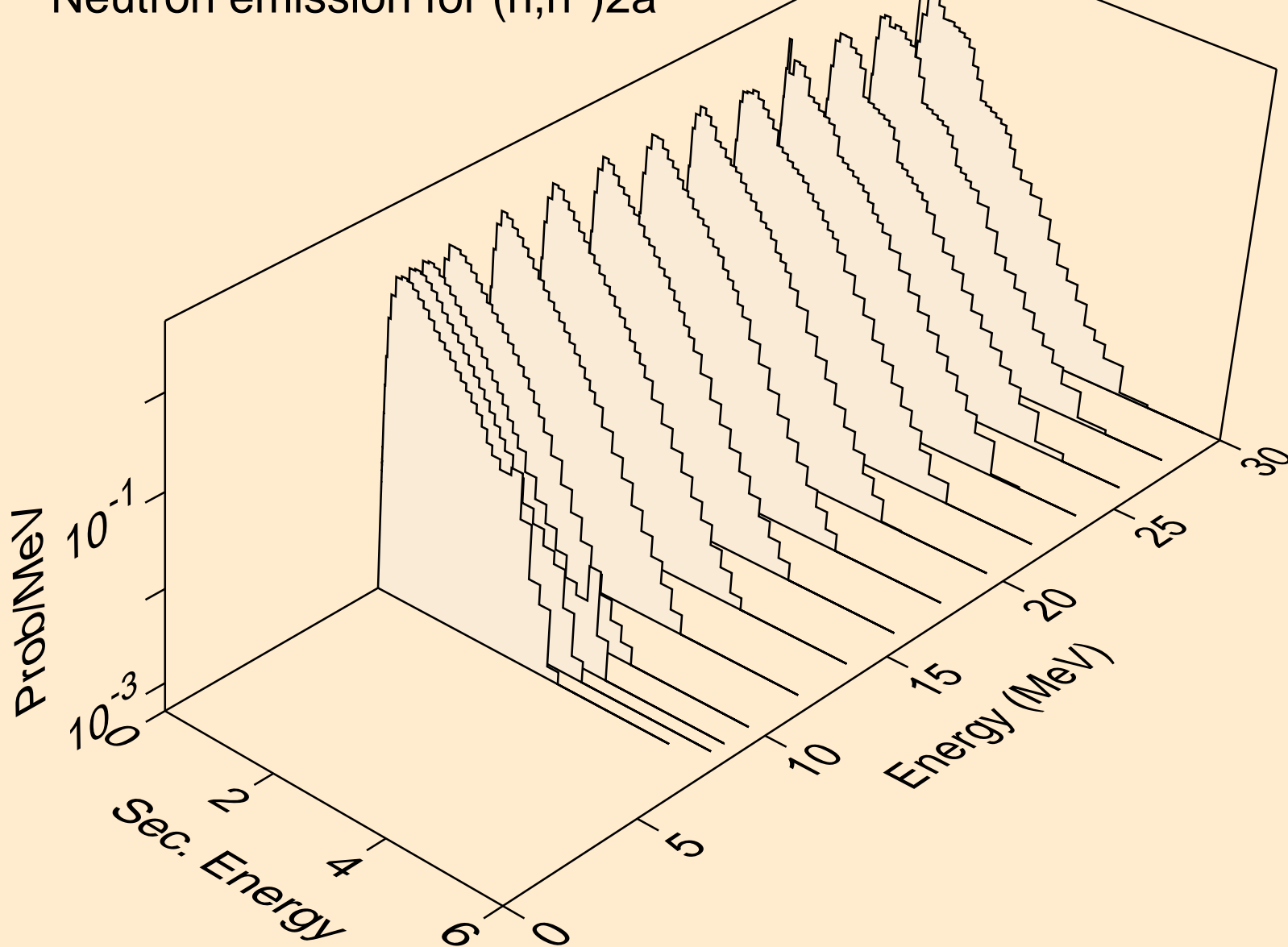

TH227 NEUTRON ACER TENDL-2023 LIBRARY; T=0.K
Neutron emission for (n,2n)2a

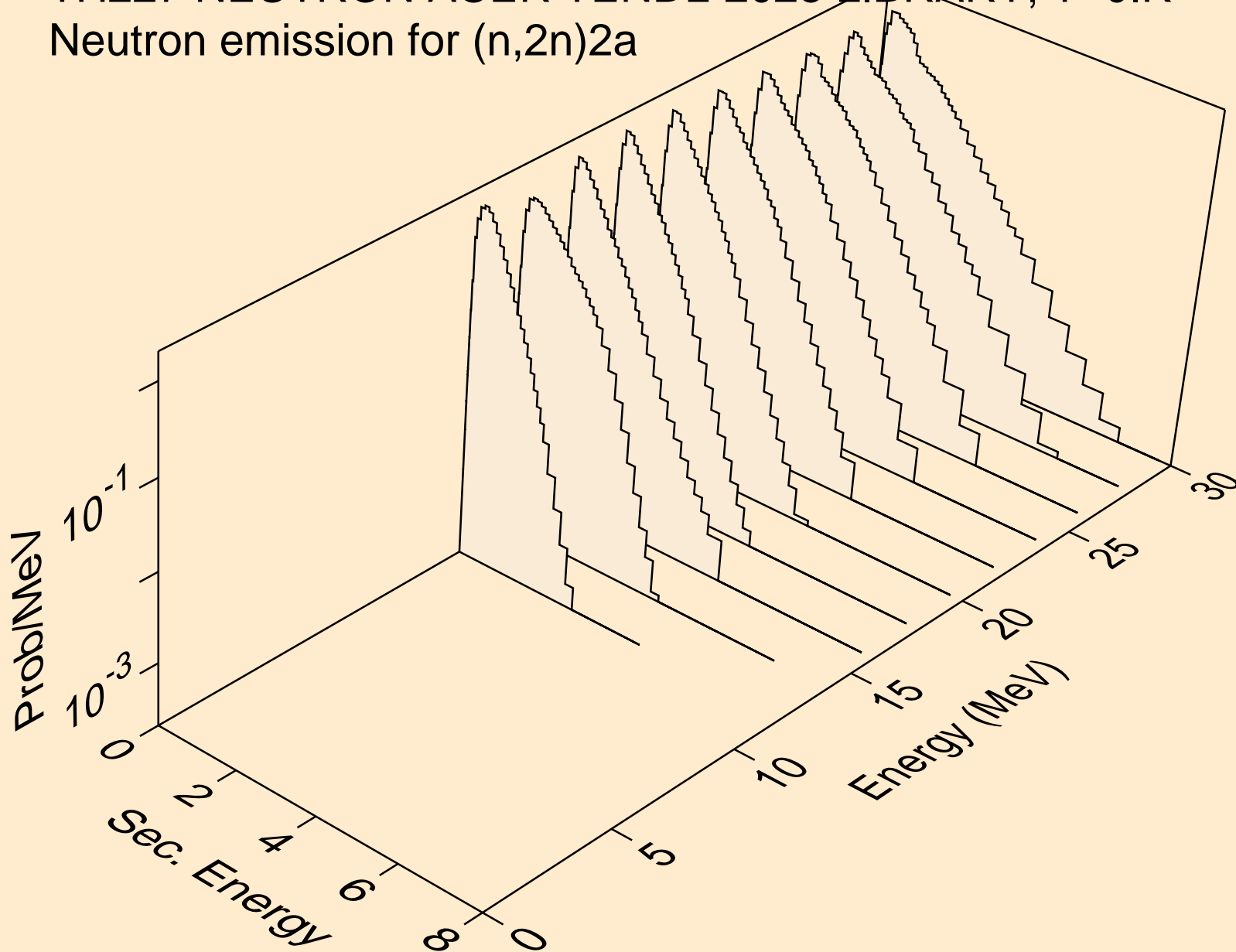

TH227 NEUTRON ACER TENDL-2023 LIBRARY; T=0.K
Neutron emission for (n,n*)d

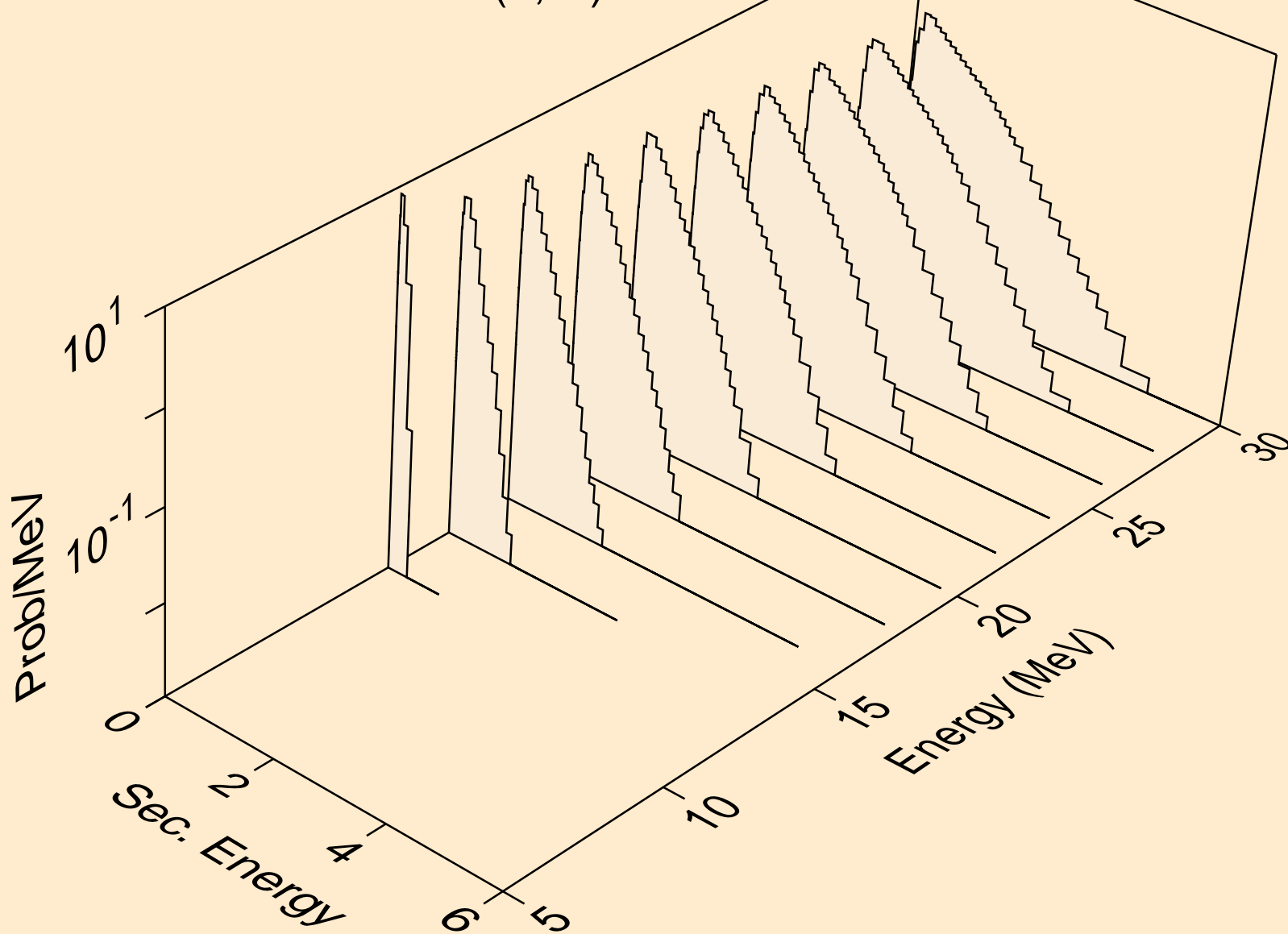

TH227 NEUTRON ACER TENDL-2023 LIBRARY; T=0.K
Neutron emission for (n,n*)t

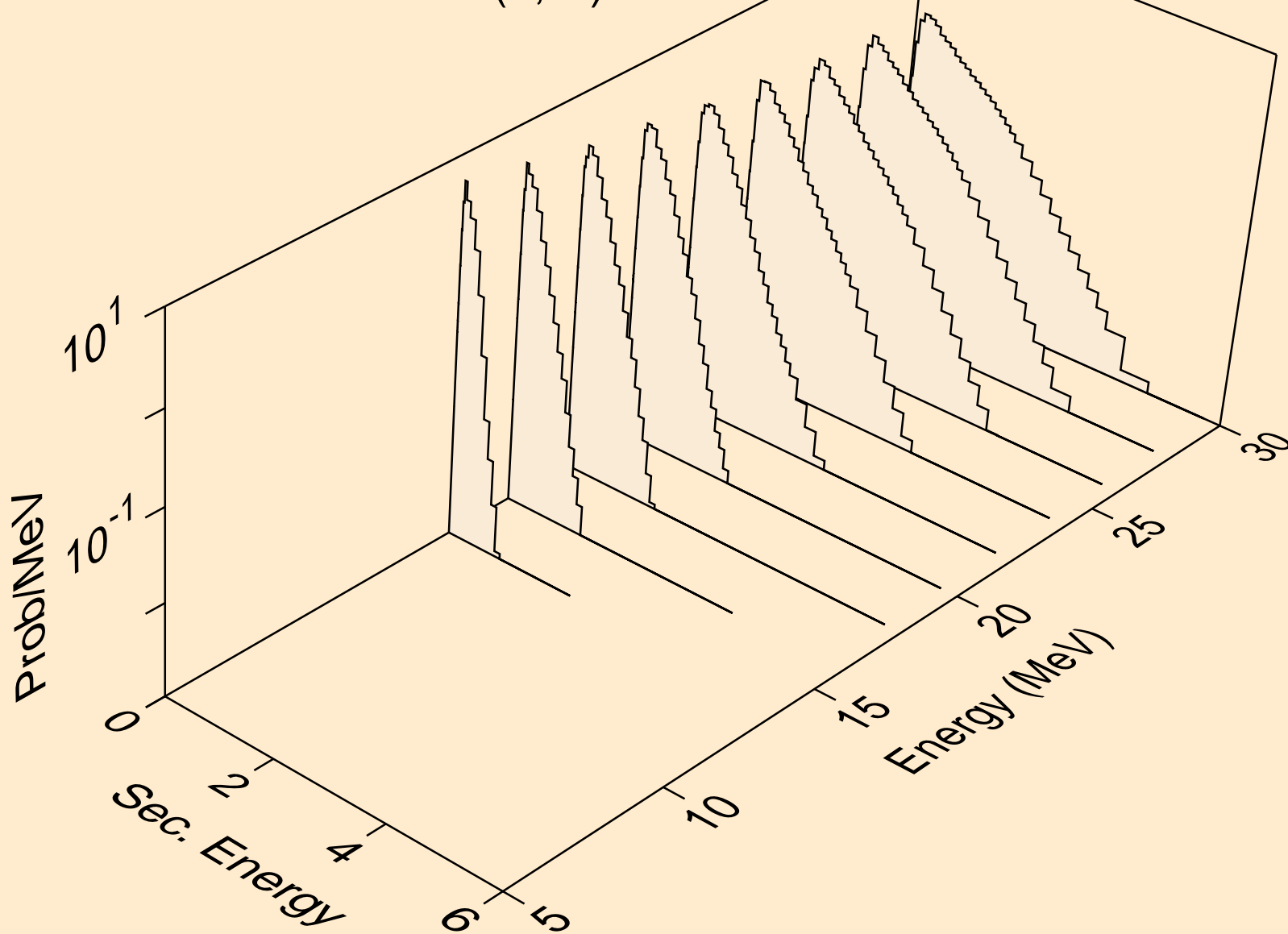

TH227 NEUTRON ACER TENDL-2023 LIBRARY; T=0.K
Neutron emission for (n,n*)he3

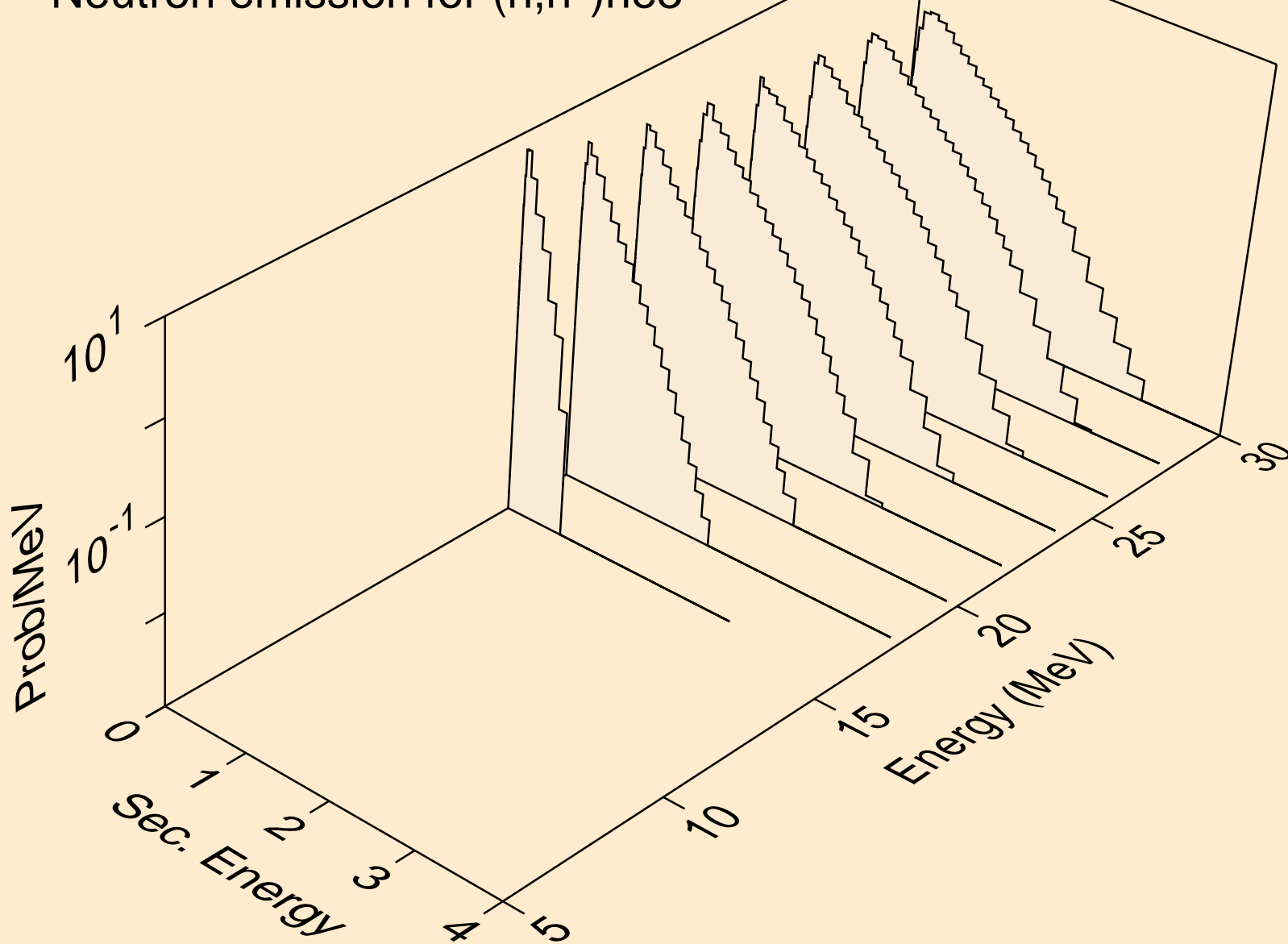

TH227 NEUTRON ACER TENDL-2023 LIBRARY; T=0.K
Neutron emission for (n,4n)

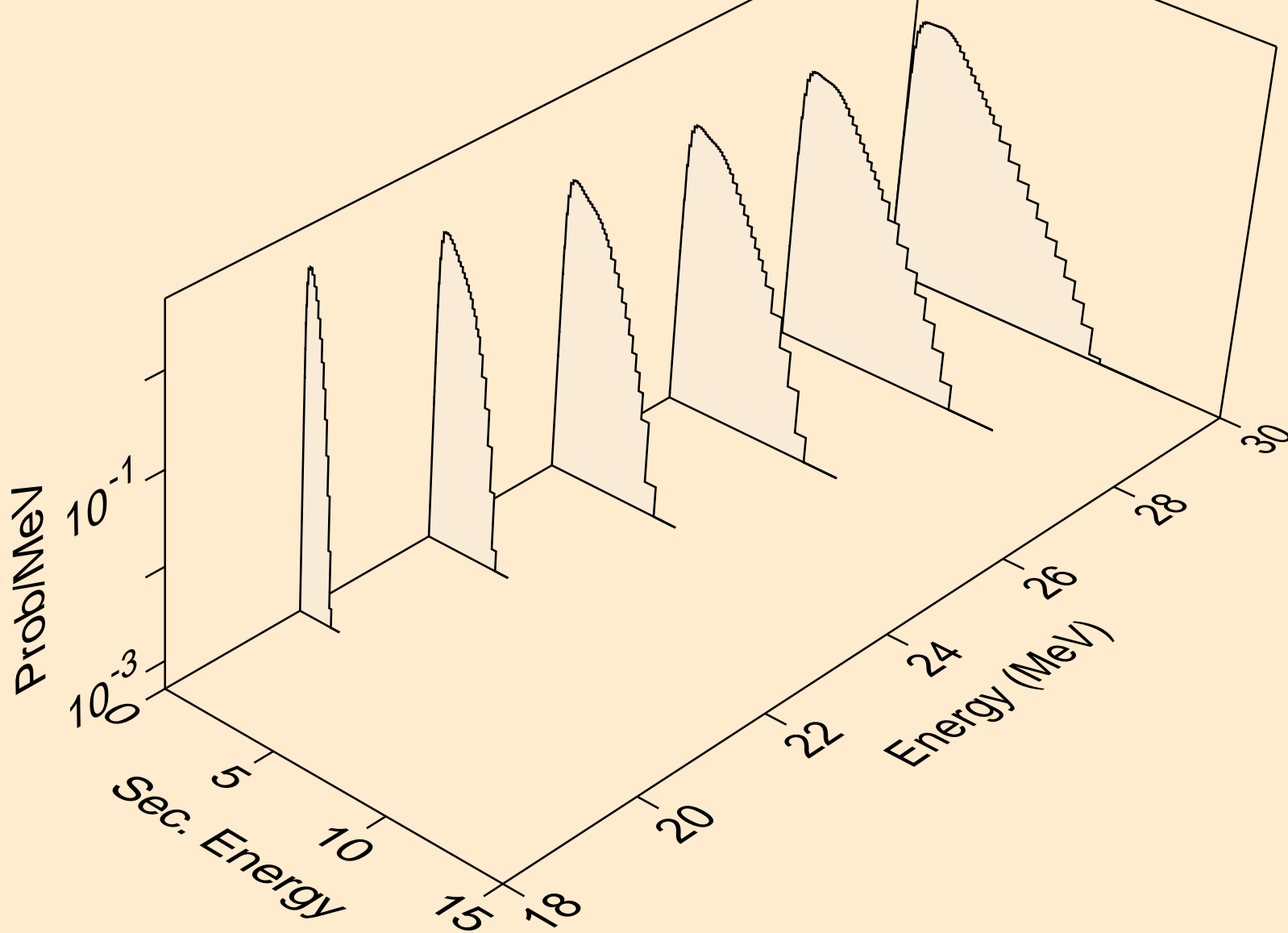

TH227 NEUTRON ACER TENDL-2023 LIBRARY; T=0.K
Neutron emission for (n,2np)

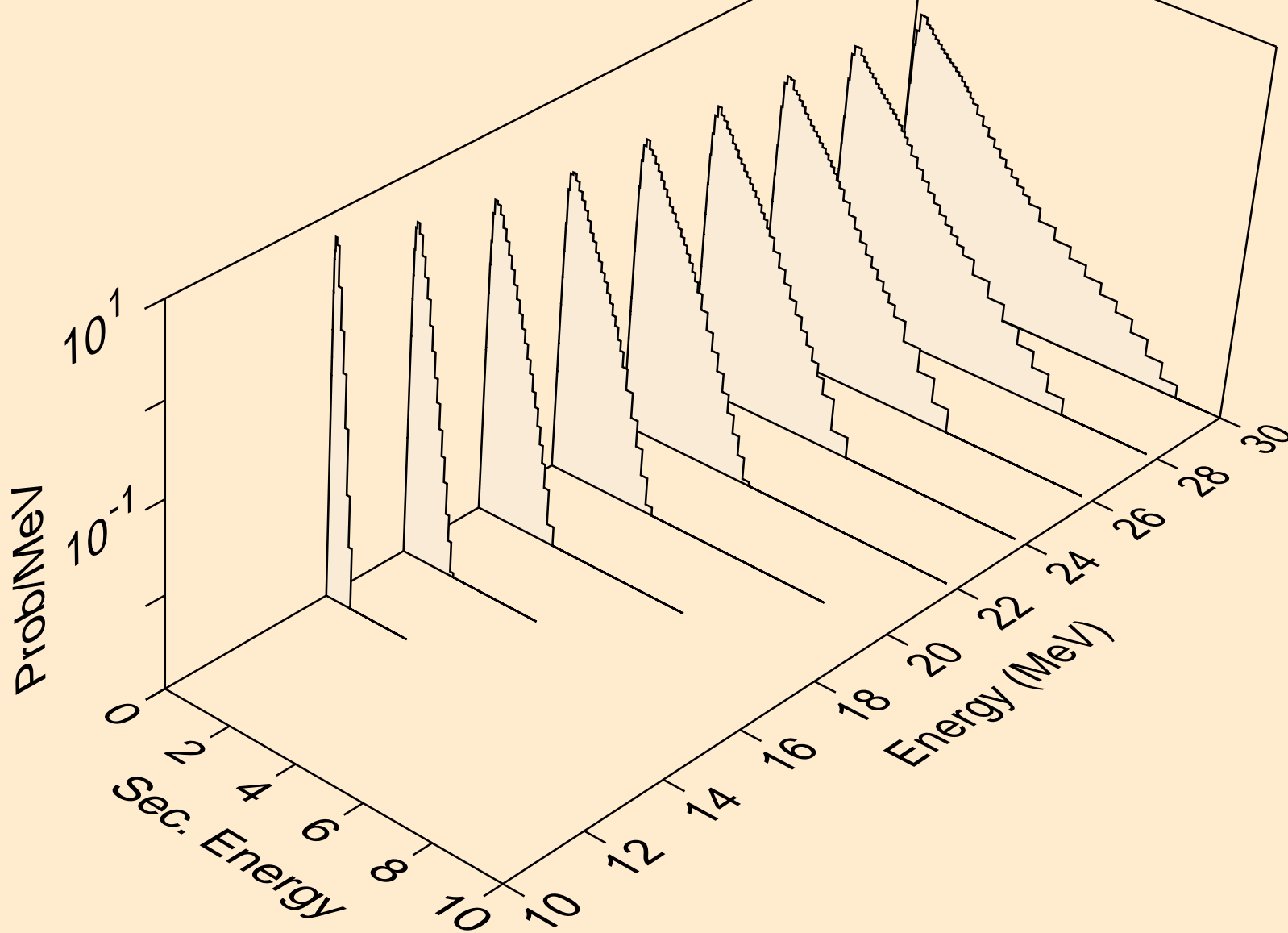

TH227 NEUTRON ACER TENDL-2023 LIBRARY; T=0.K
Neutron emission for (n,3np)

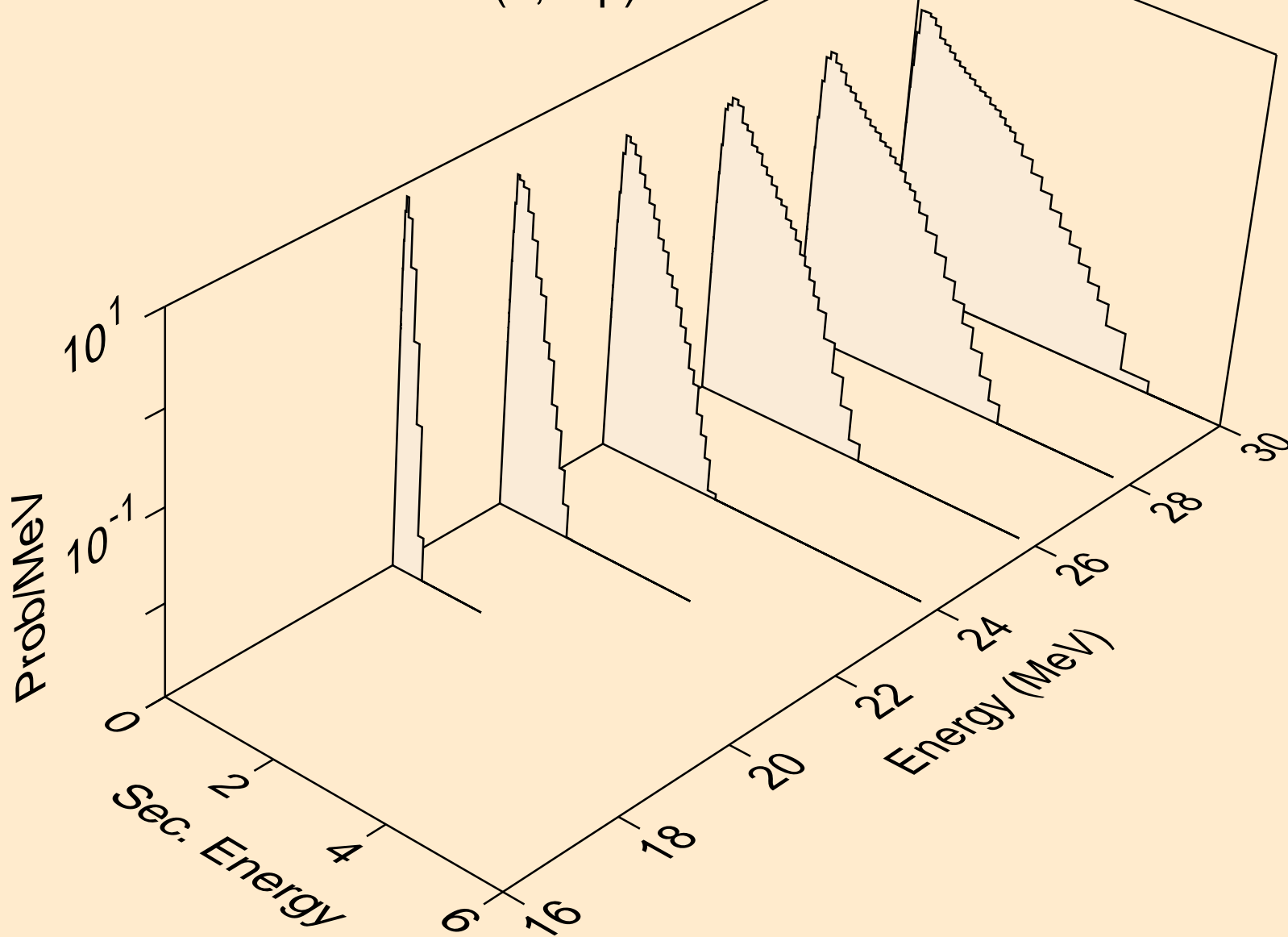

TH227 NEUTRON ACER TENDL-2023 LIBRARY; T=0.K
Neutron emission for (n,n2p)

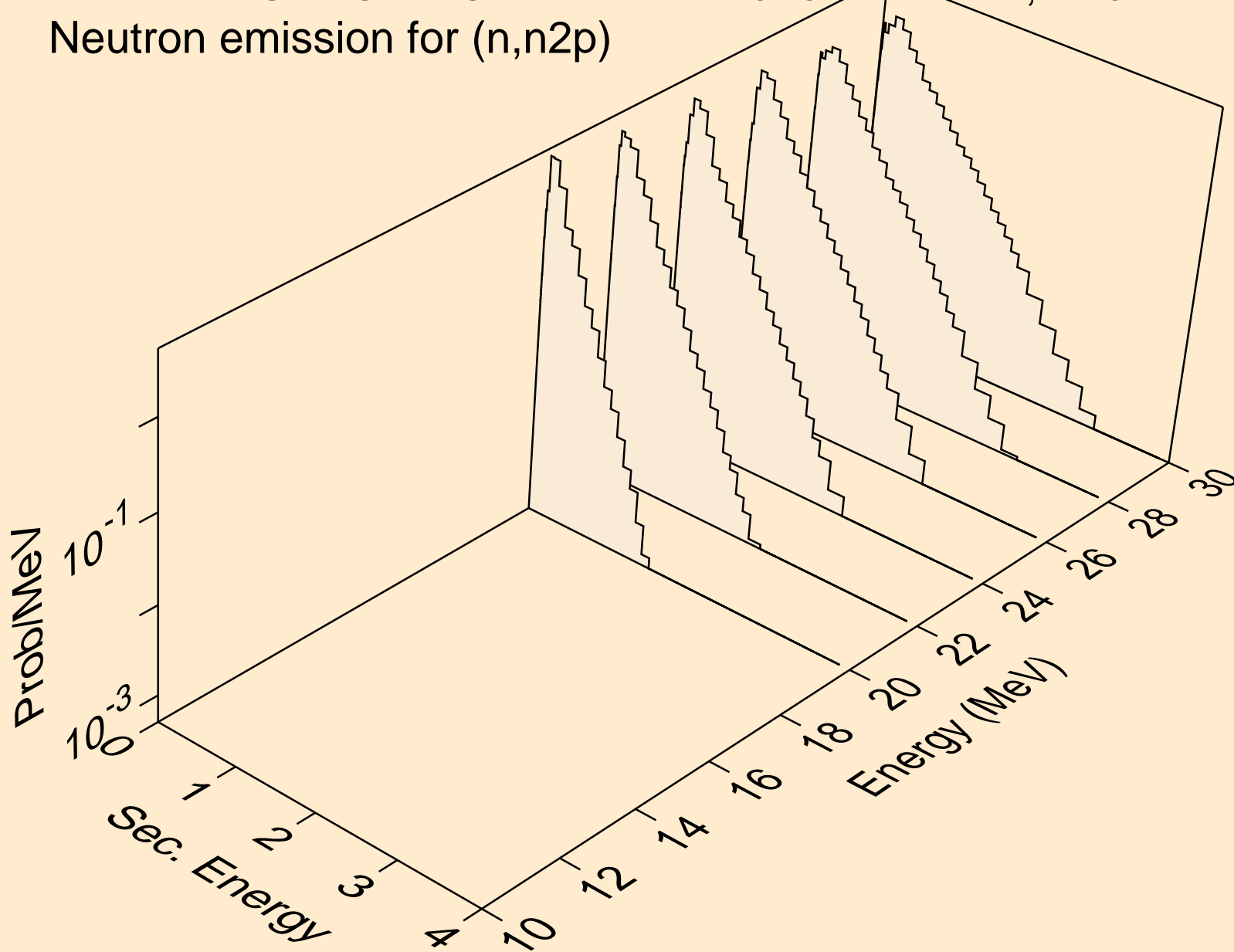

TH227 NEUTRON ACER TENDL-2023 LIBRARY; T=0.K
Neutron emission for (n,npa)

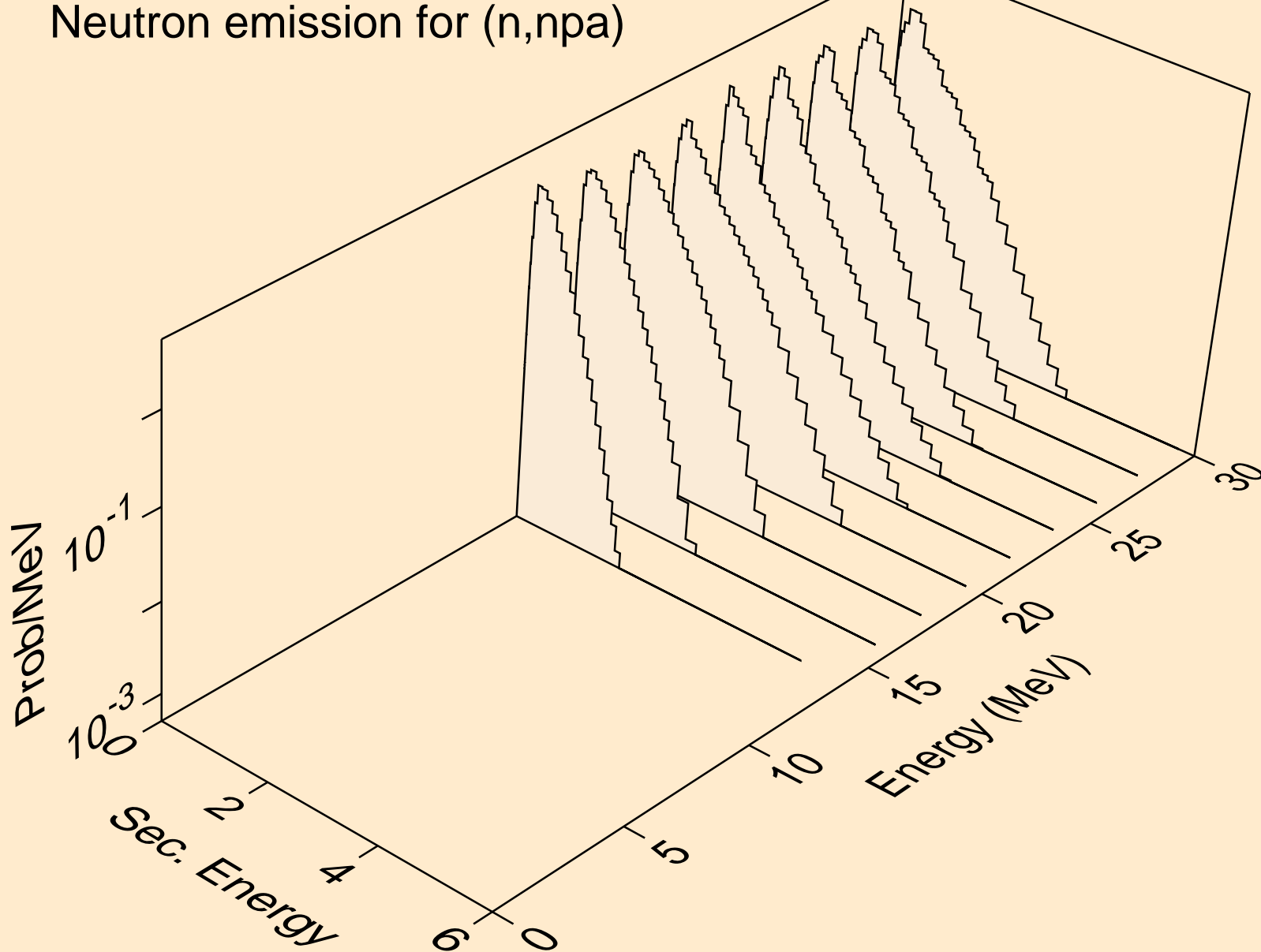

TH227 NEUTRON ACER TENDL-2023 LIBRARY; T=0.K
Neutron emission for (n,n*c)

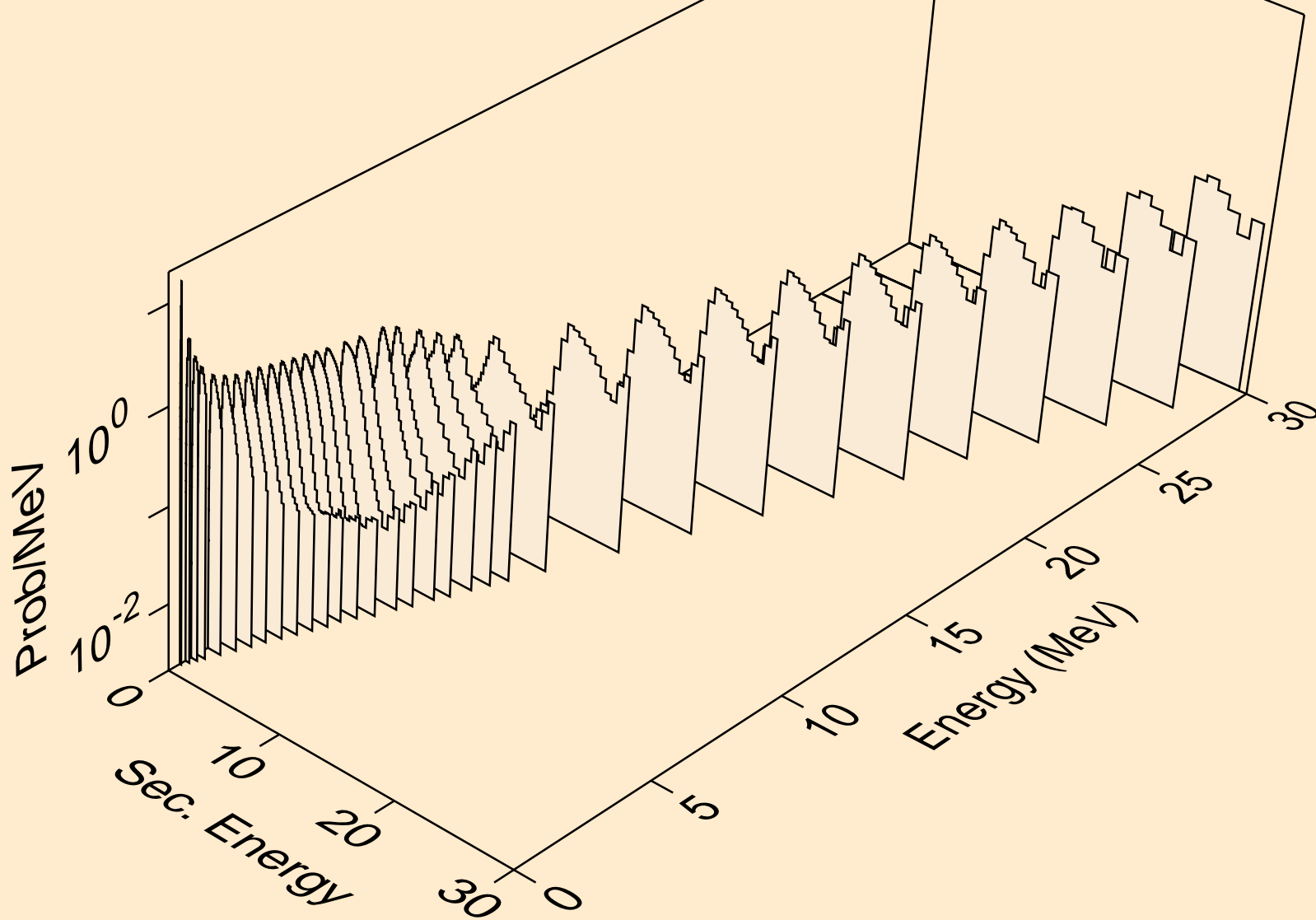

TH227 NEUTRON ACER TENDL-2023 LIBRARY; T=0.K

Delayed nubar

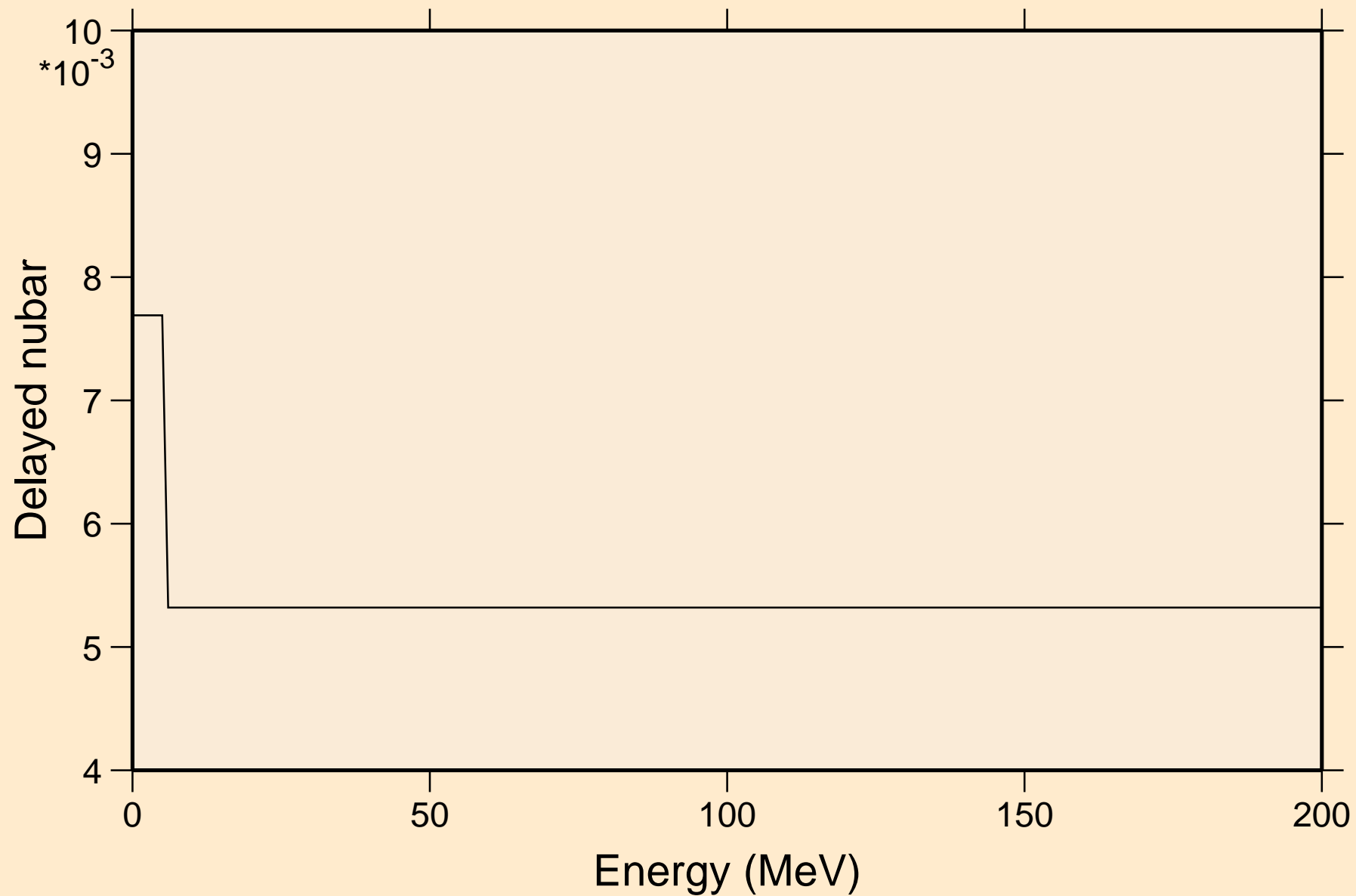

TH227 NEUTRON ACER TENDL-2023 LIBRARY; T=0.K

Delayed neutron spectra

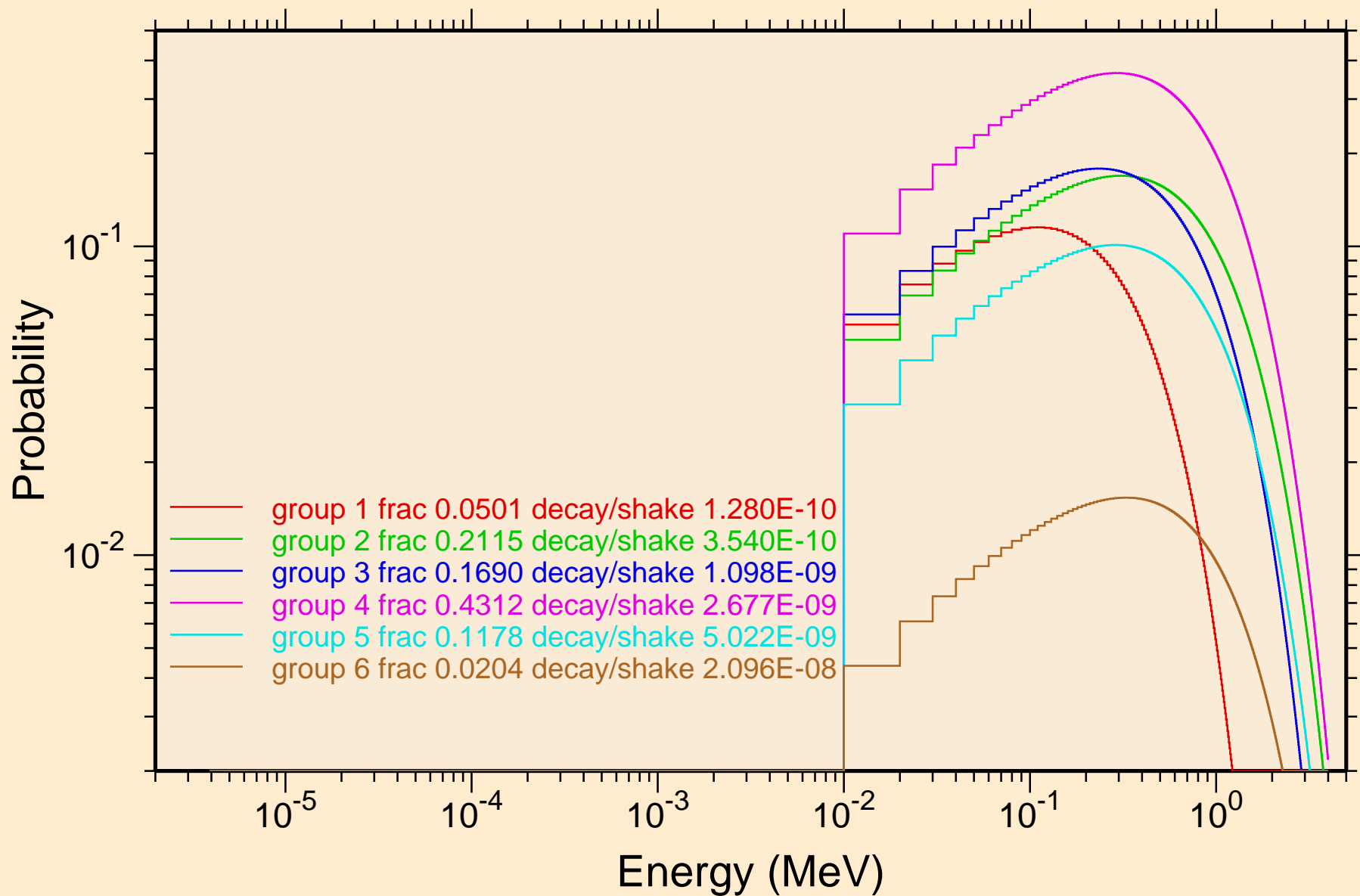

TH227 NEUTRON ACER TENDL-2023 LIBRARY; T=0.K
Photon emission for (n,x)

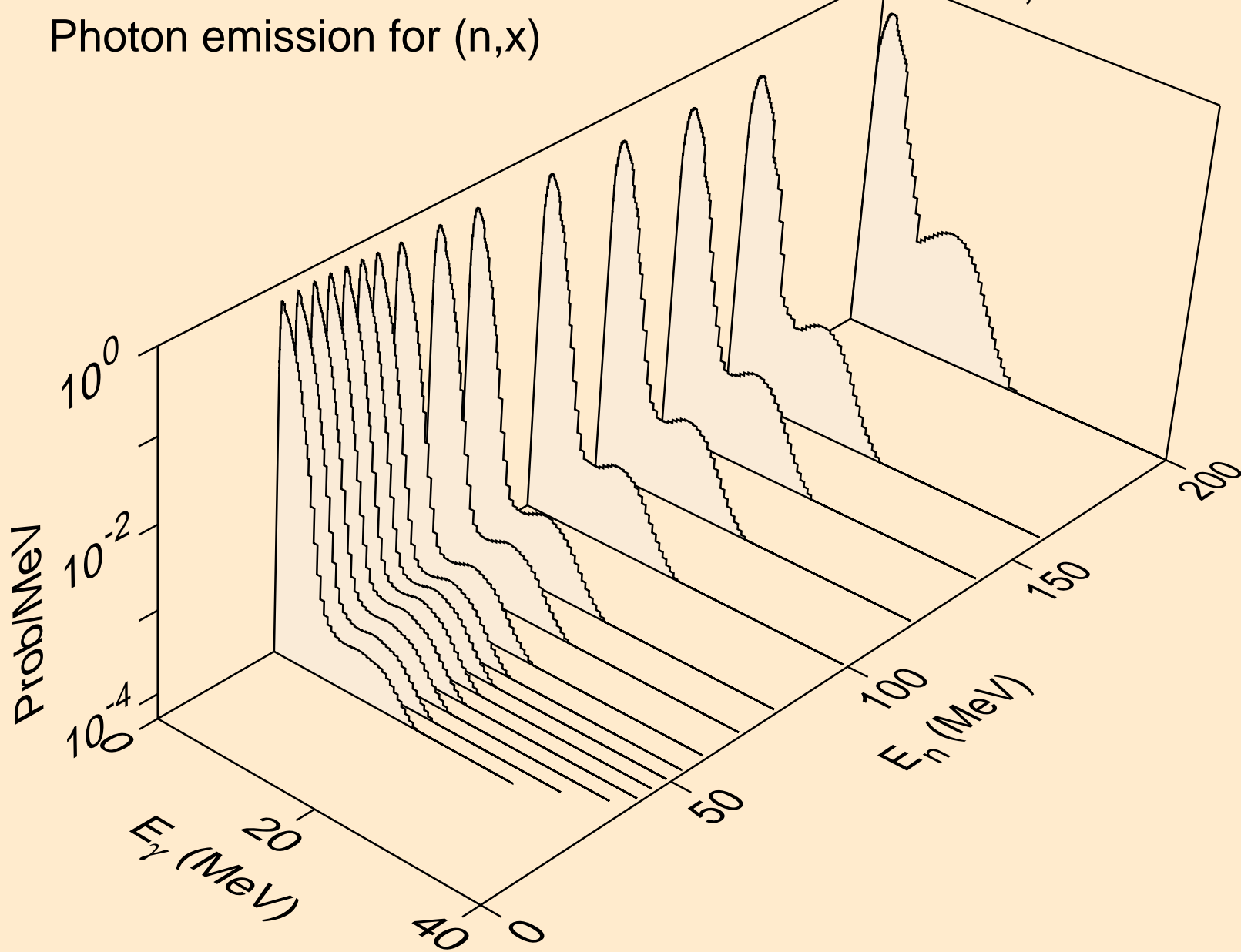

TH227 NEUTRON ACER TENDL-2023 LIBRARY; T=0.K
Photon emission for (n,2nd)

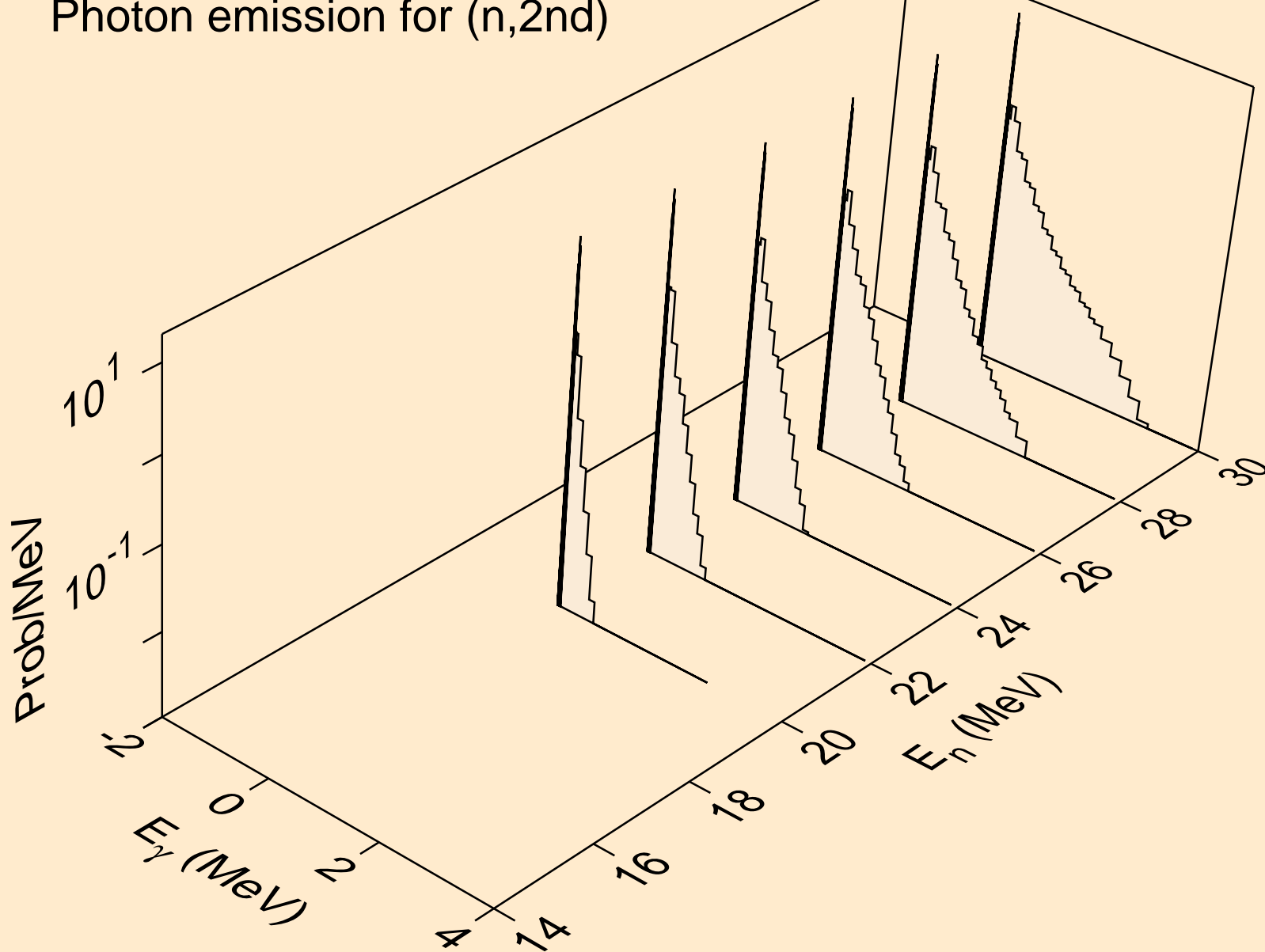

TH227 NEUTRON ACER TENDL-2023 LIBRARY; T=0.K
Photon emission for (n,2n)

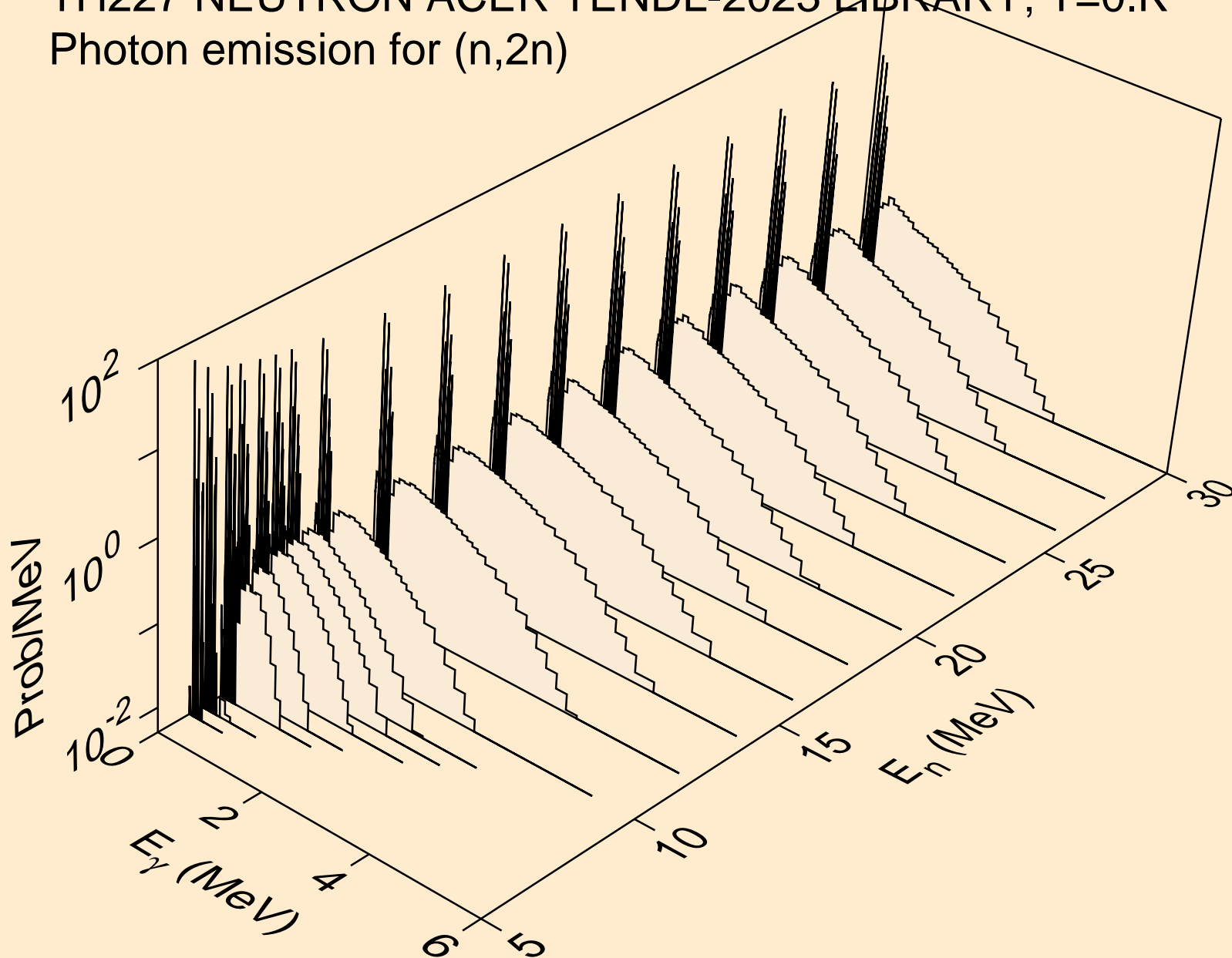

TH227 NEUTRON ACER TENDL-2023 LIBRARY; T=0.K
Photon emission for (n,3n)

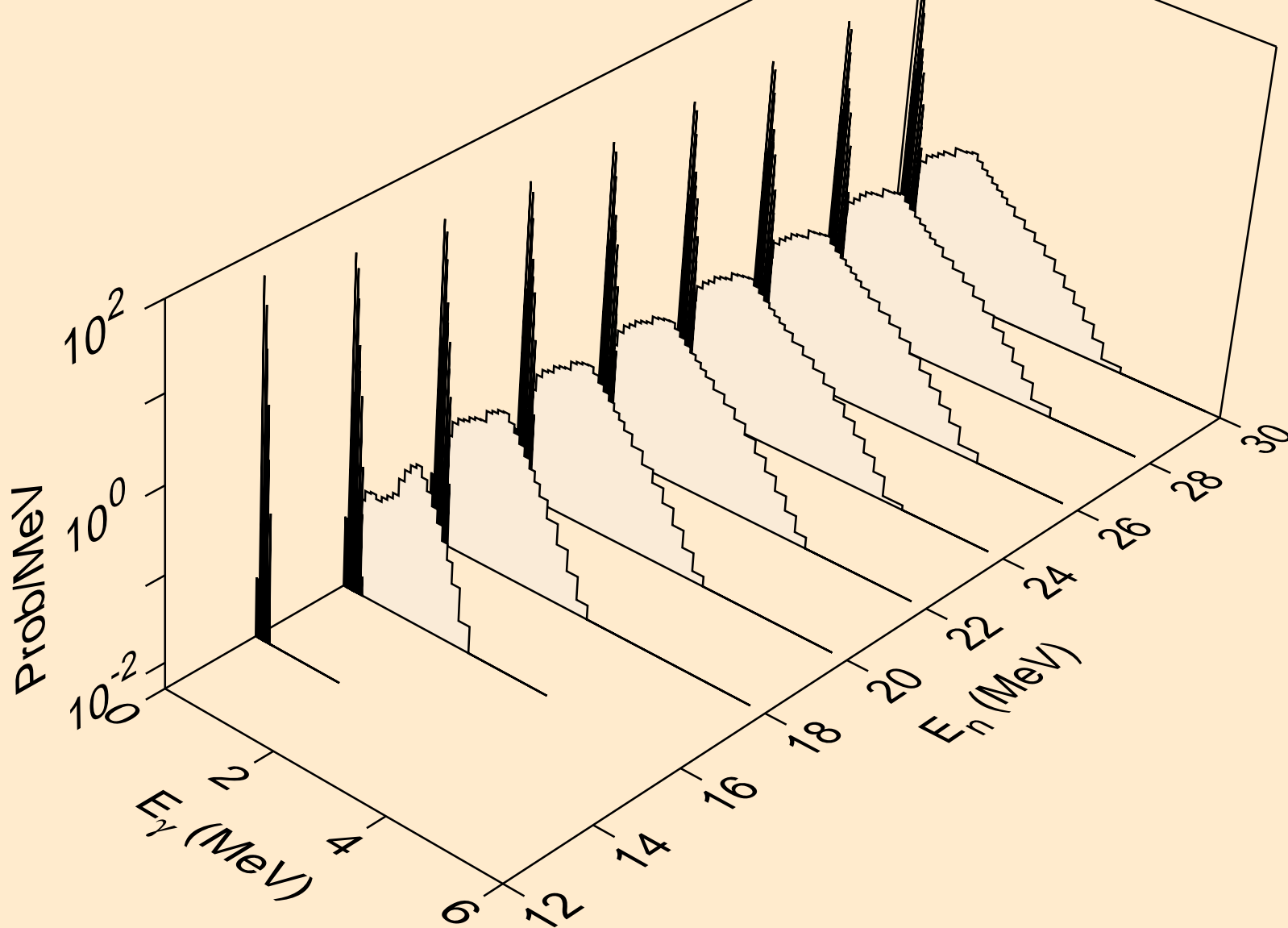

TH227 NEUTRON ACER TENDL-2023 LIBRARY; T=0.K
Photon emission for (n,n*)a

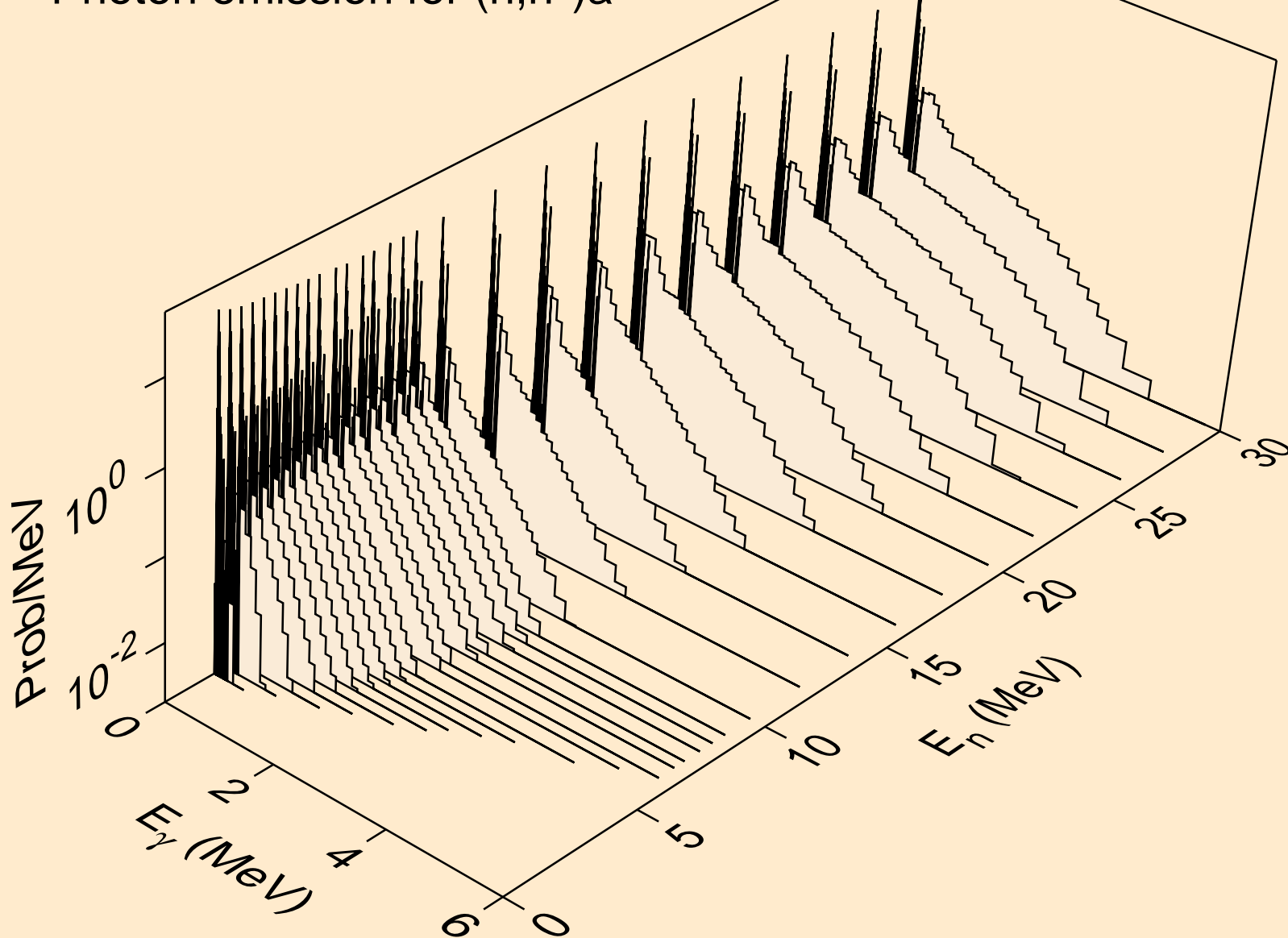

TH227 NEUTRON ACER TENDL-2023 LIBRARY; T=0.K
Photon emission for (n,2n)a

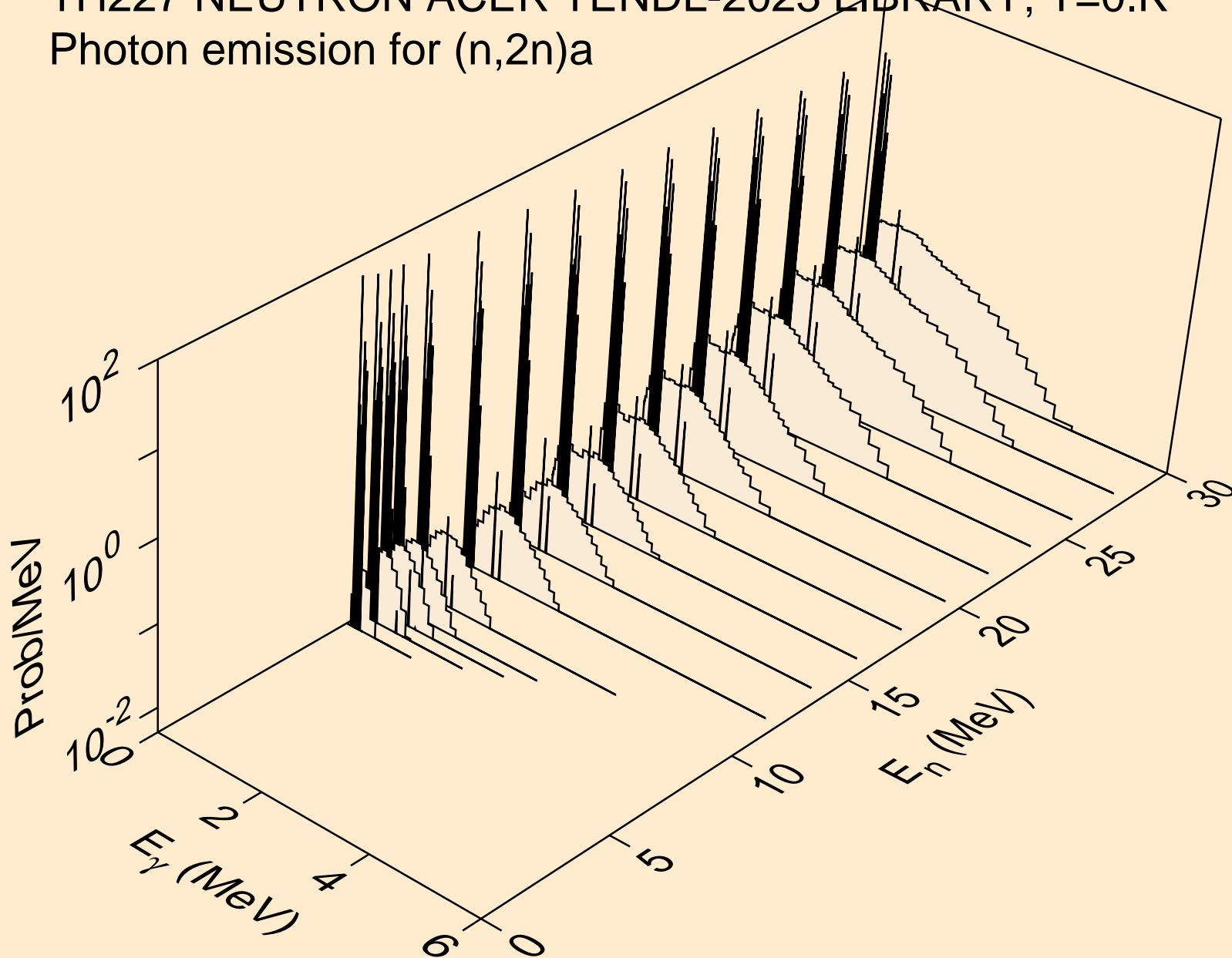

TH227 NEUTRON ACER TENDL-2023 LIBRARY; T=0.K
Photon emission for (n,3n)a

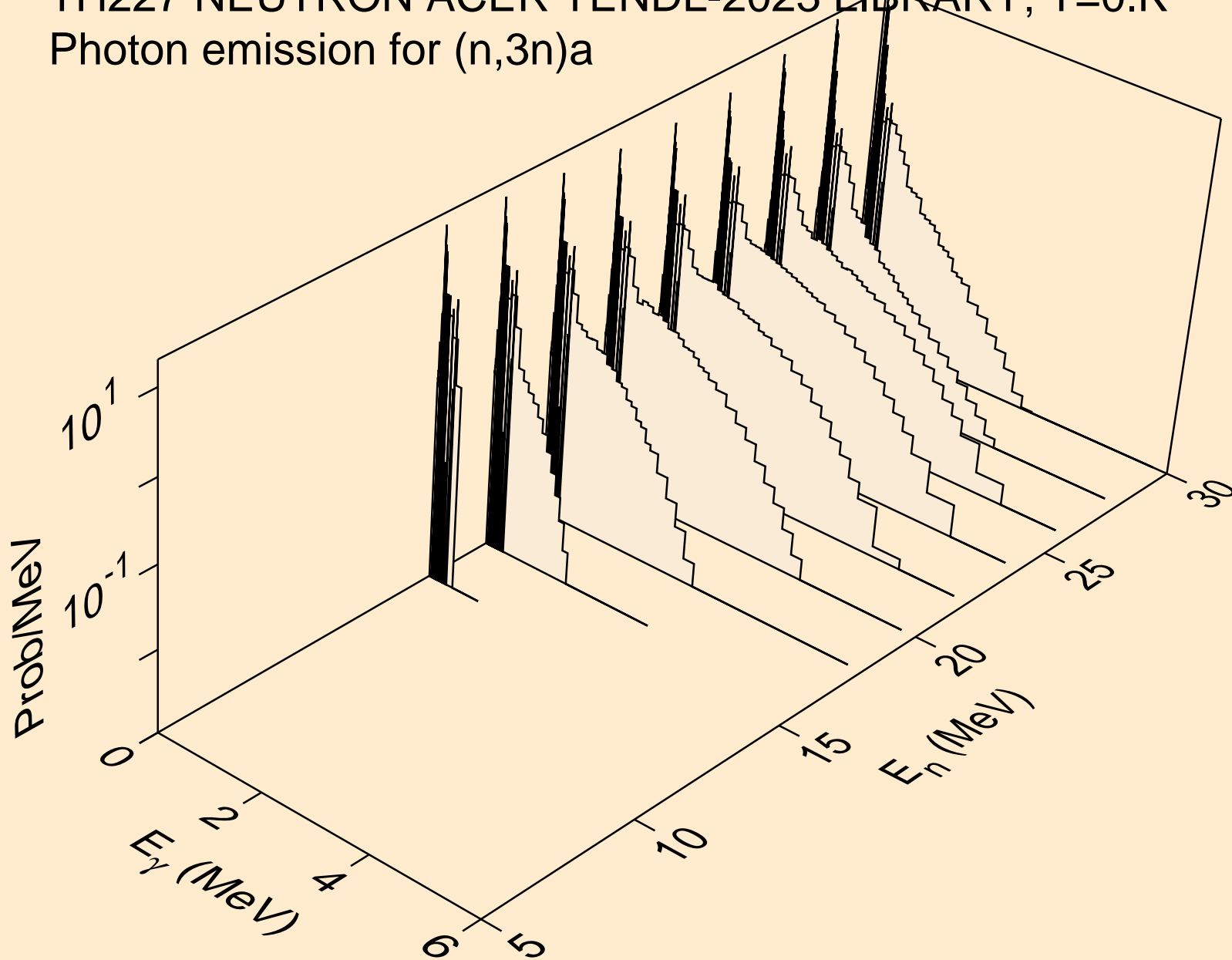

TH227 NEUTRON ACER TENDL-2023 LIBRARY; T=0.K
Photon emission for (n,n*)p

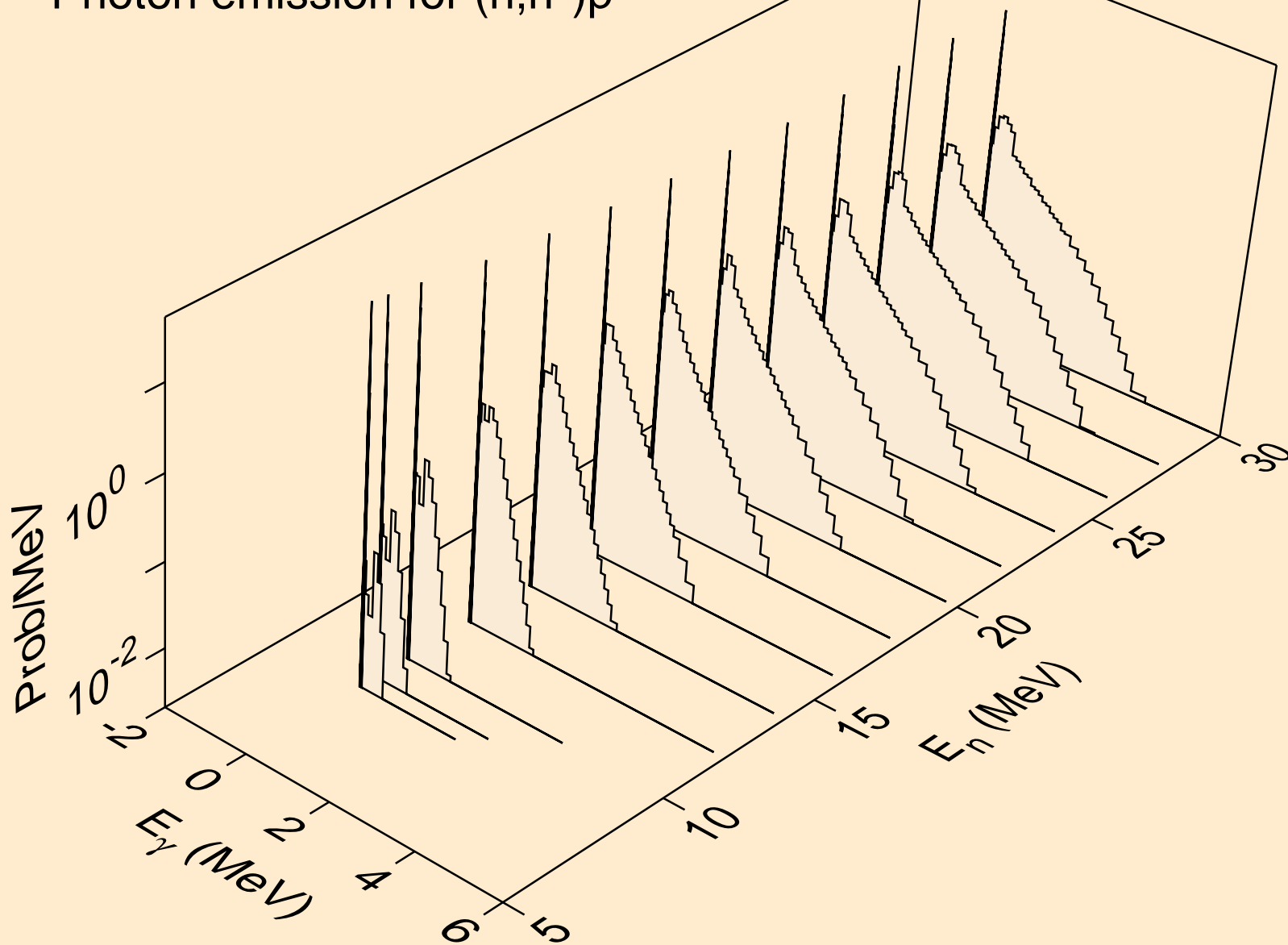

TH227 NEUTRON ACER TENDL-2023 LIBRARY; T=0.K
Photon emission for (n,n*)2a

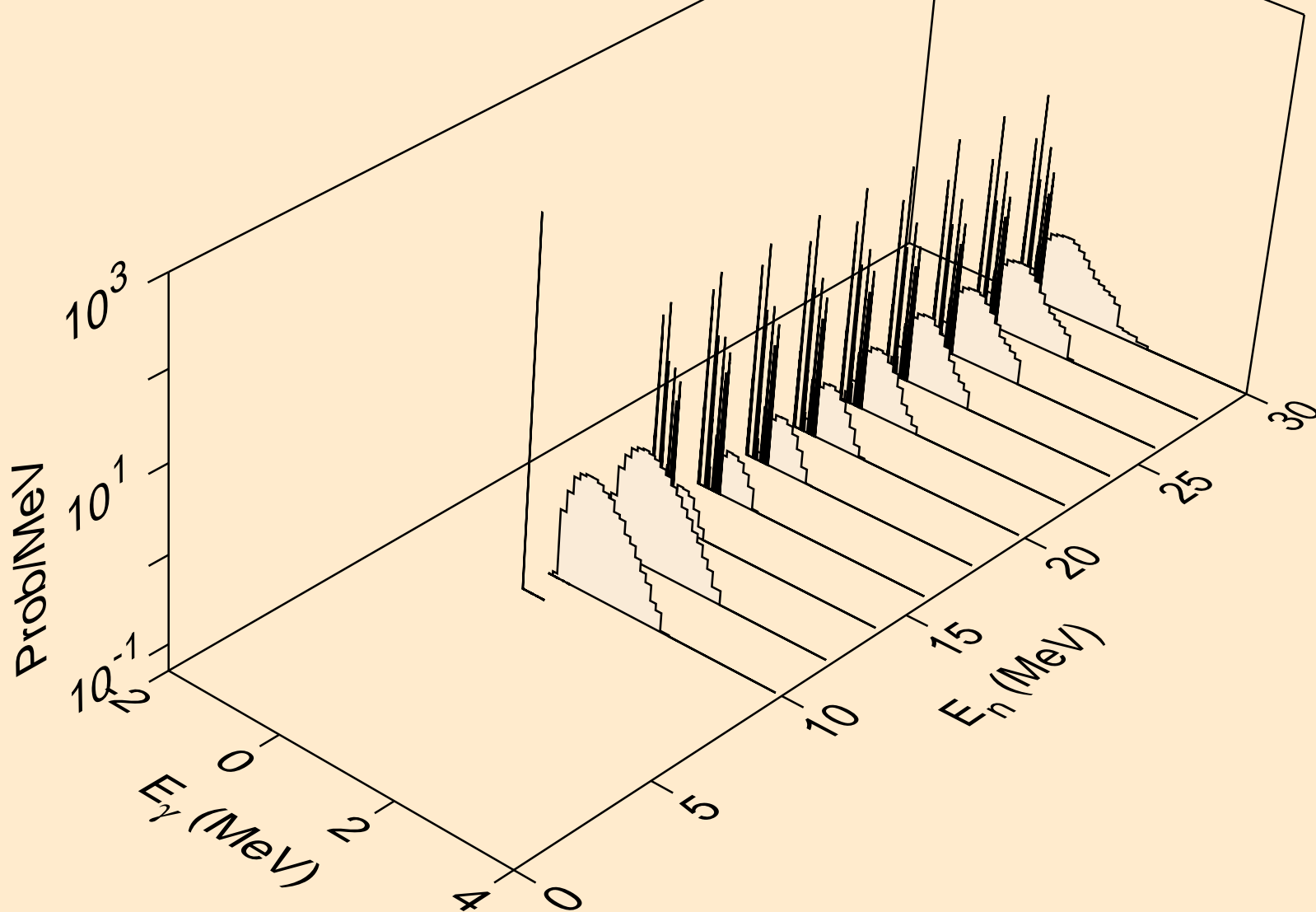

TH227 NEUTRON ACER TENDL-2023 LIBRARY; T=0.K
Photon emission for (n,2n)2a

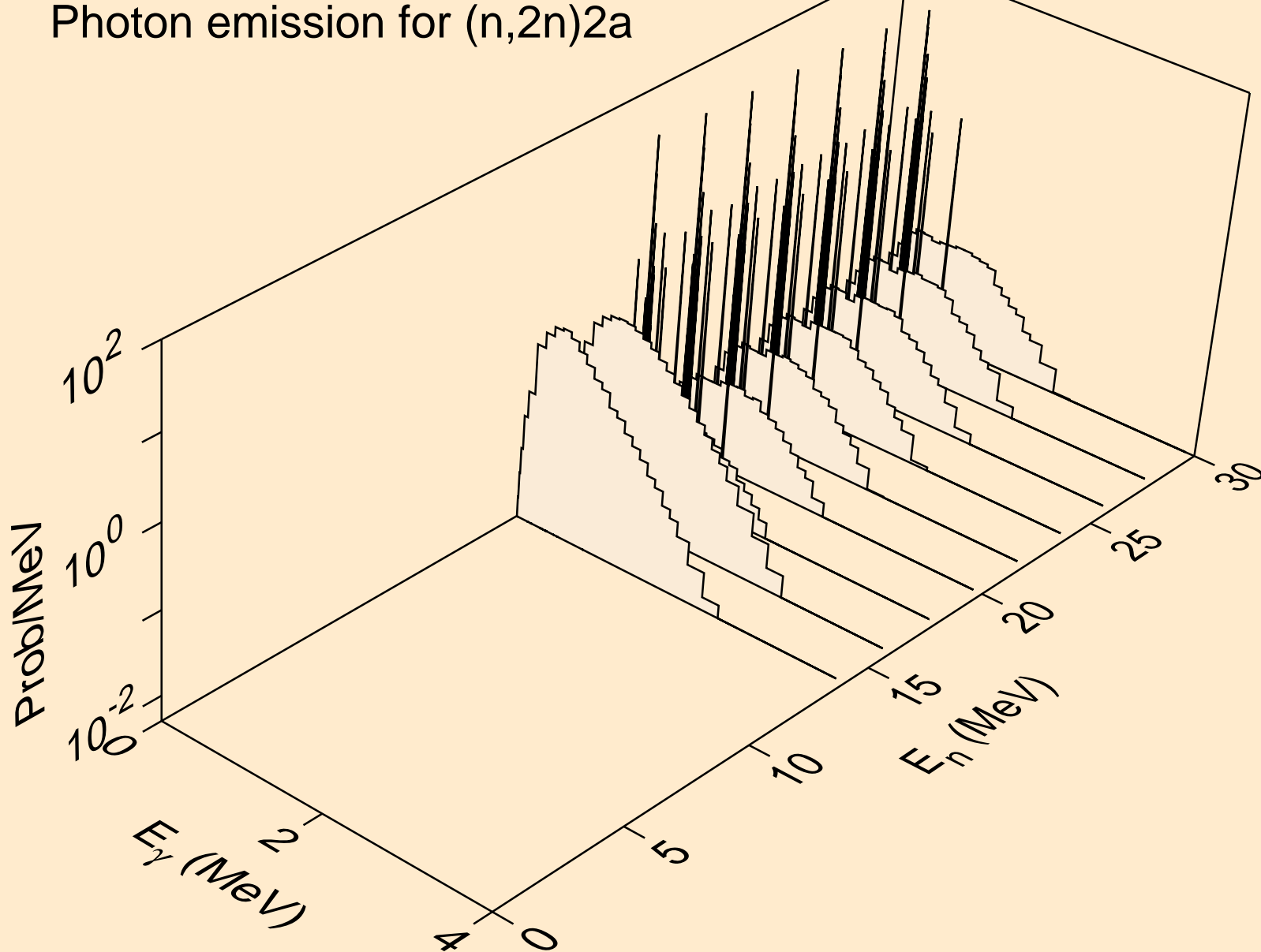

TH227 NEUTRON ACER TENDL-2023 LIBRARY; T=0.K
Photon emission for (n,n*)d

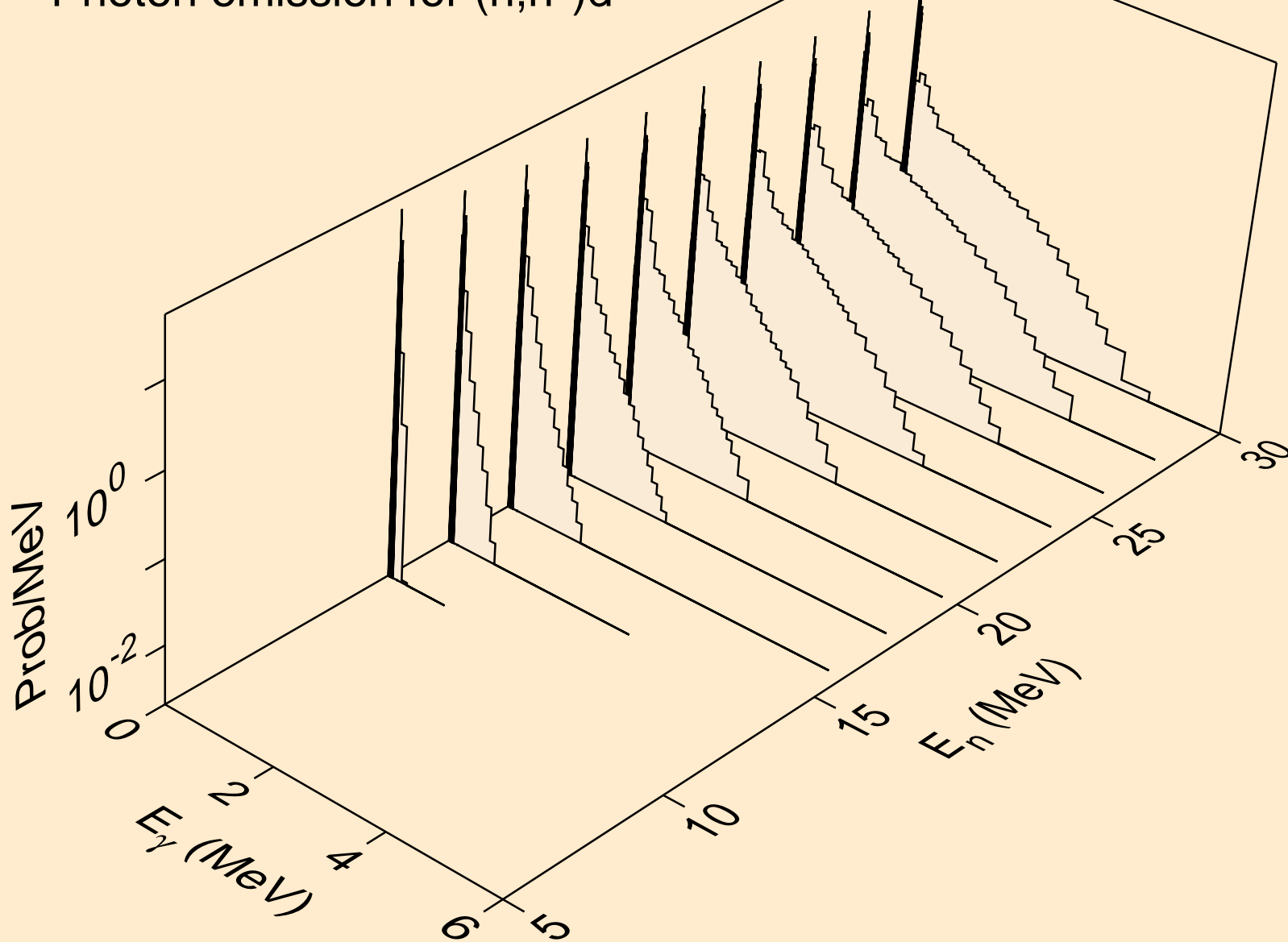

TH227 NEUTRON ACER TENDL-2023 LIBRARY; T=0.K
Photon emission for (n,n*)t

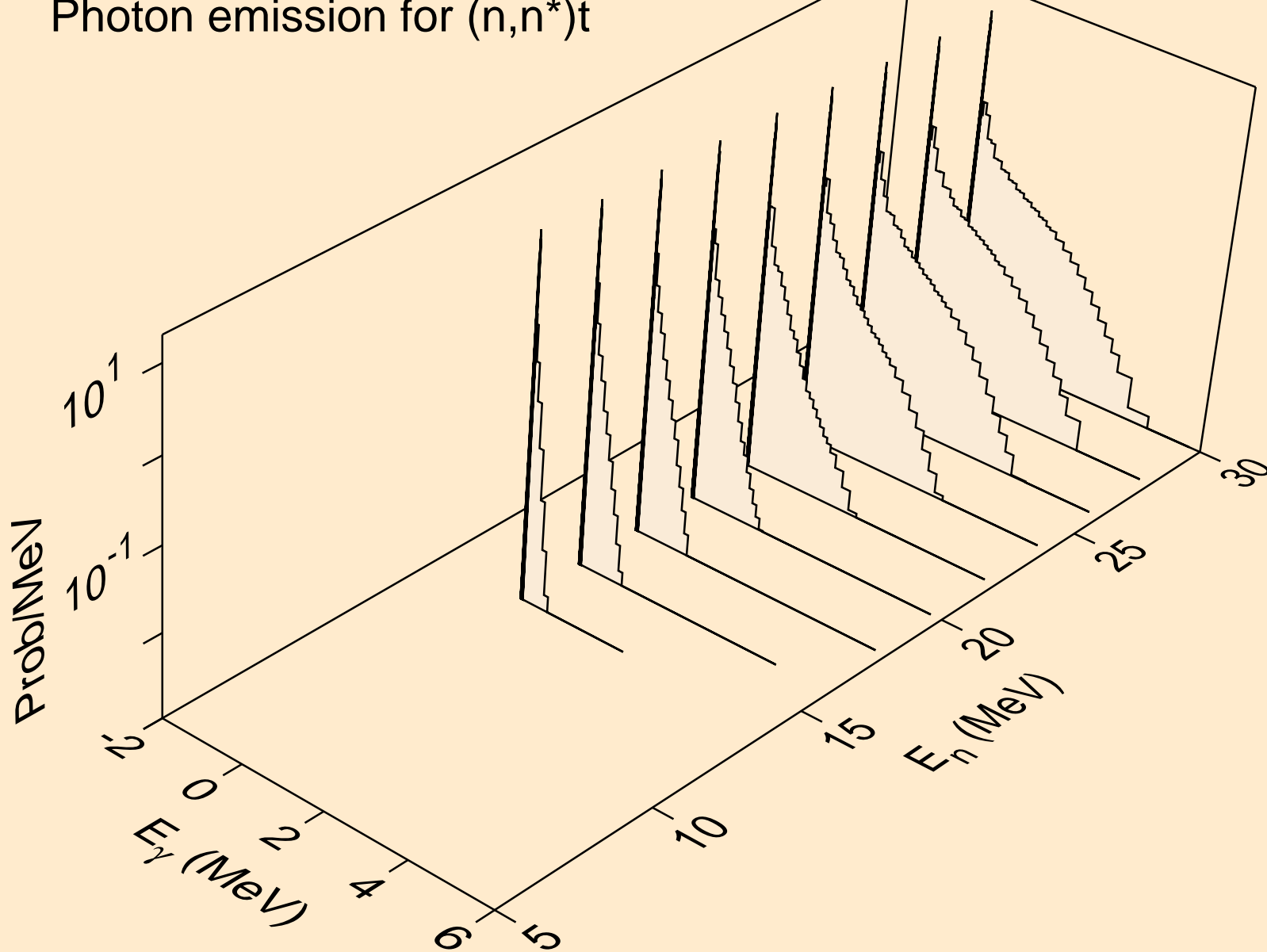

TH227 NEUTRON ACER TENDL-2023 LIBRARY; T=0.K
Photon emission for (n,n*)he3

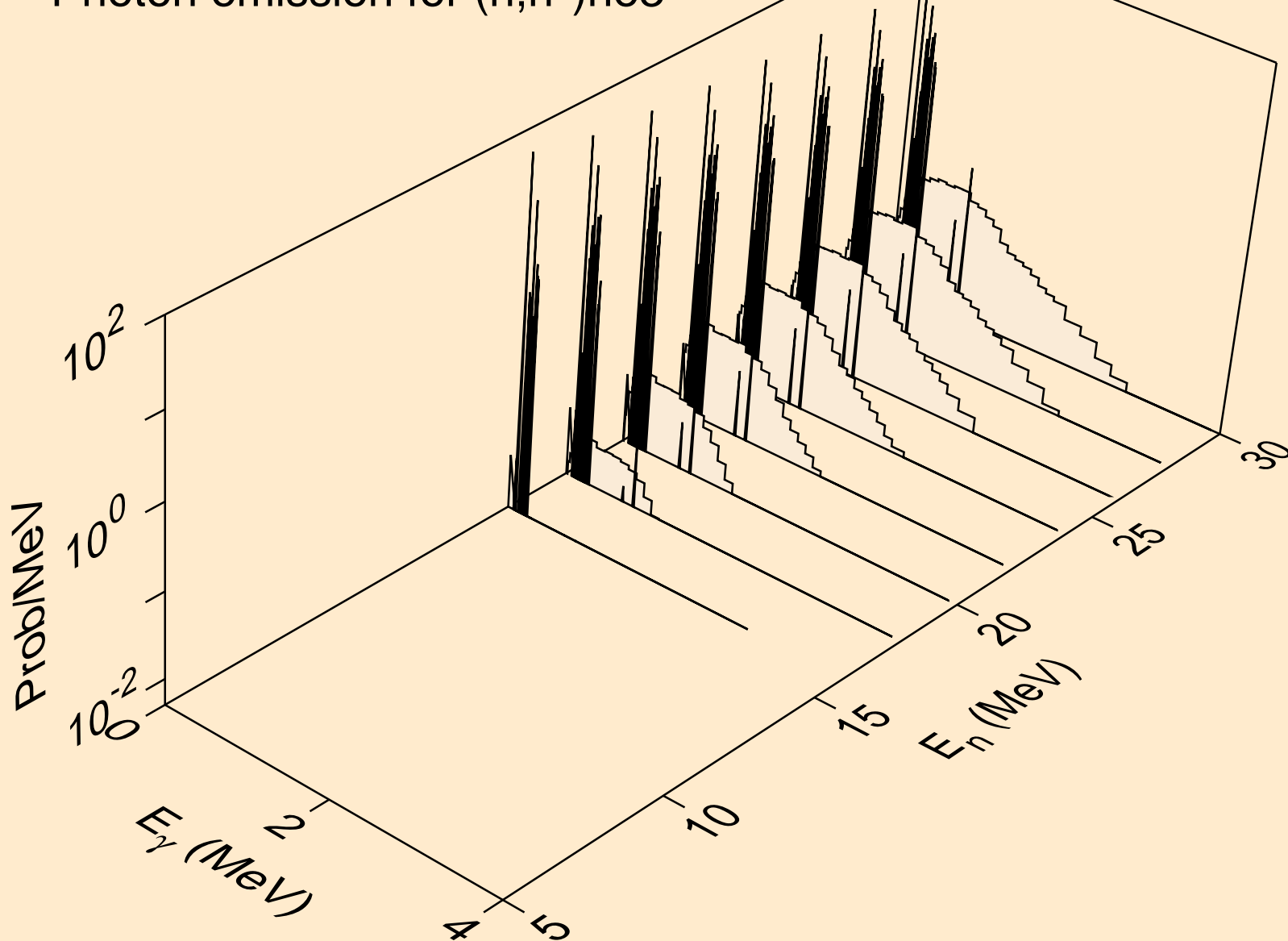

TH227 NEUTRON ACER TENDL-2023 LIBRARY; T=0.K
Photon emission for (n,4n)

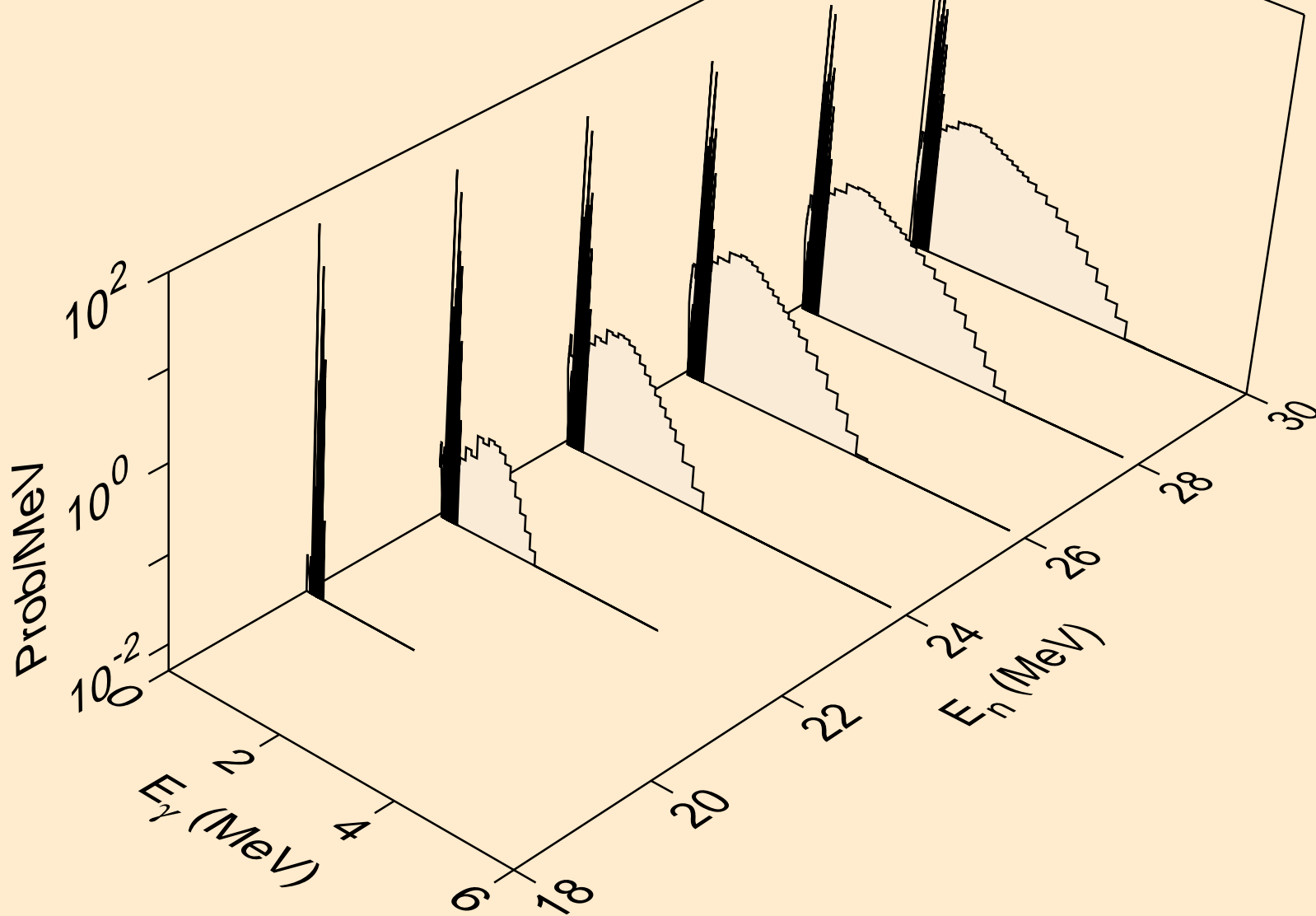

TH227 NEUTRON ACER TENDL-2023 LIBRARY; T=0.K
Photon emission for (n,2np)

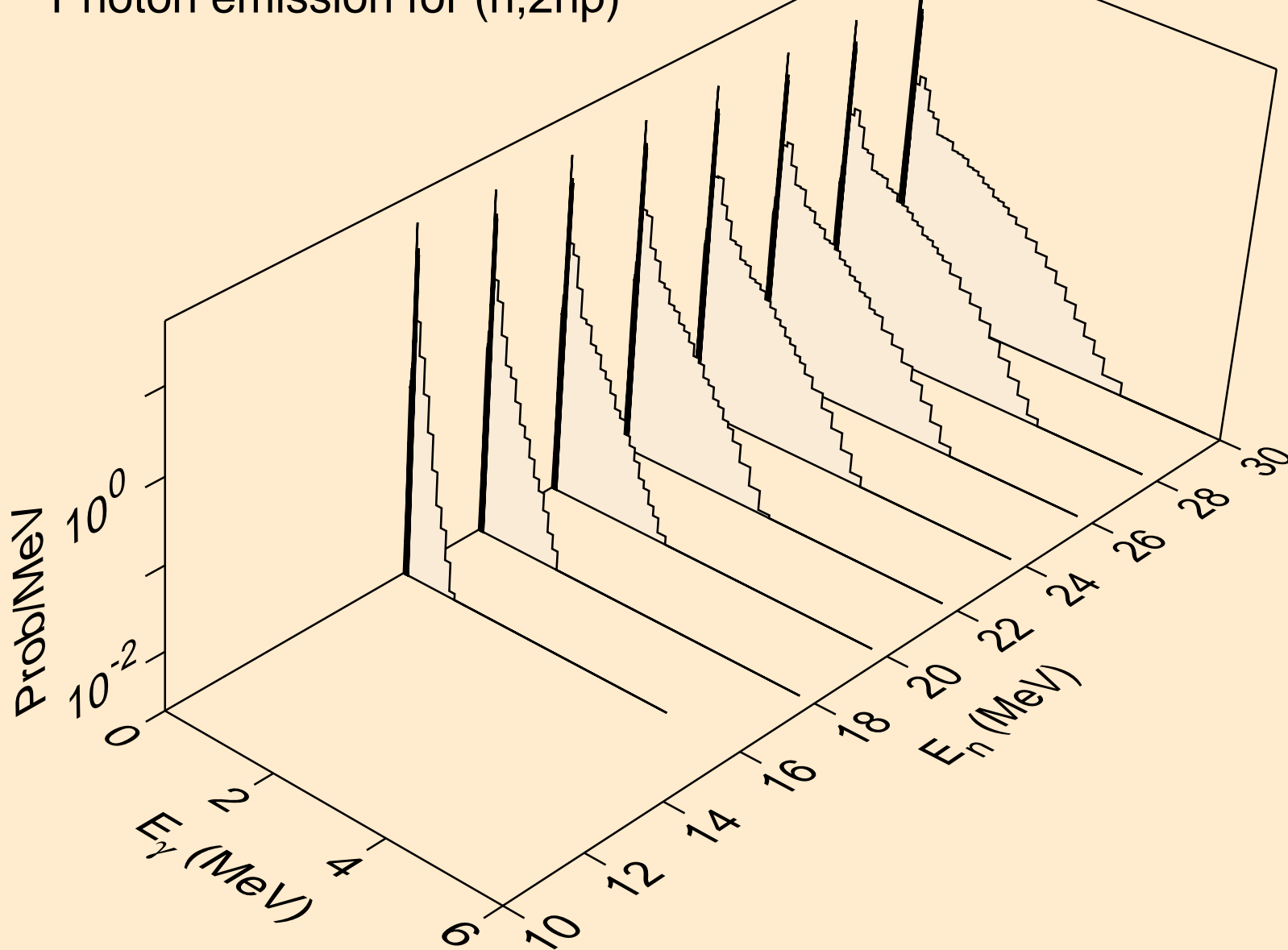

TH227 NEUTRON ACER TENDL-2023 LIBRARY; T=0.K
Photon emission for (n,3np)

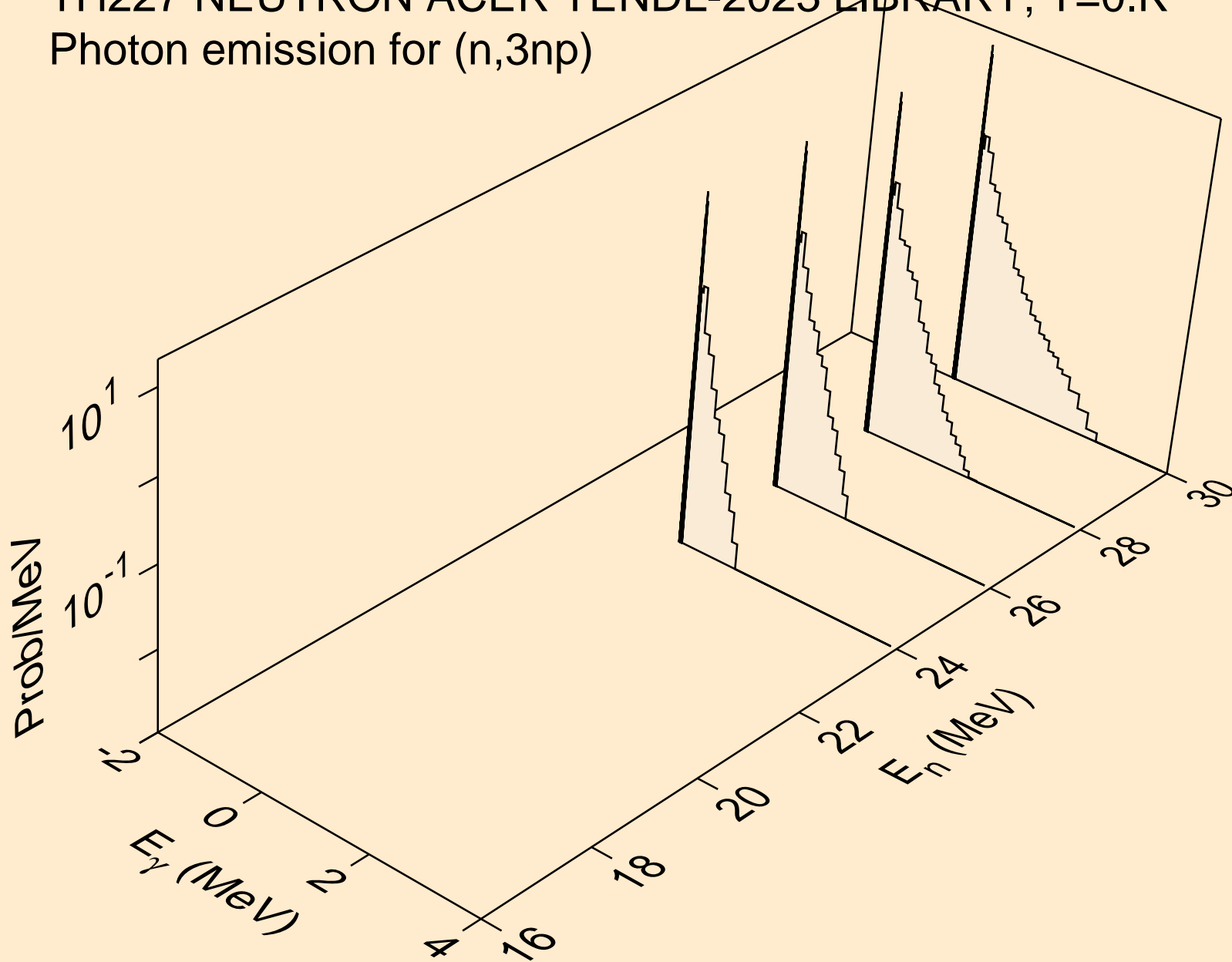

TH227 NEUTRON ACER TENDL-2023 LIBRARY; T=0.K
Photon emission for (n,n2p)

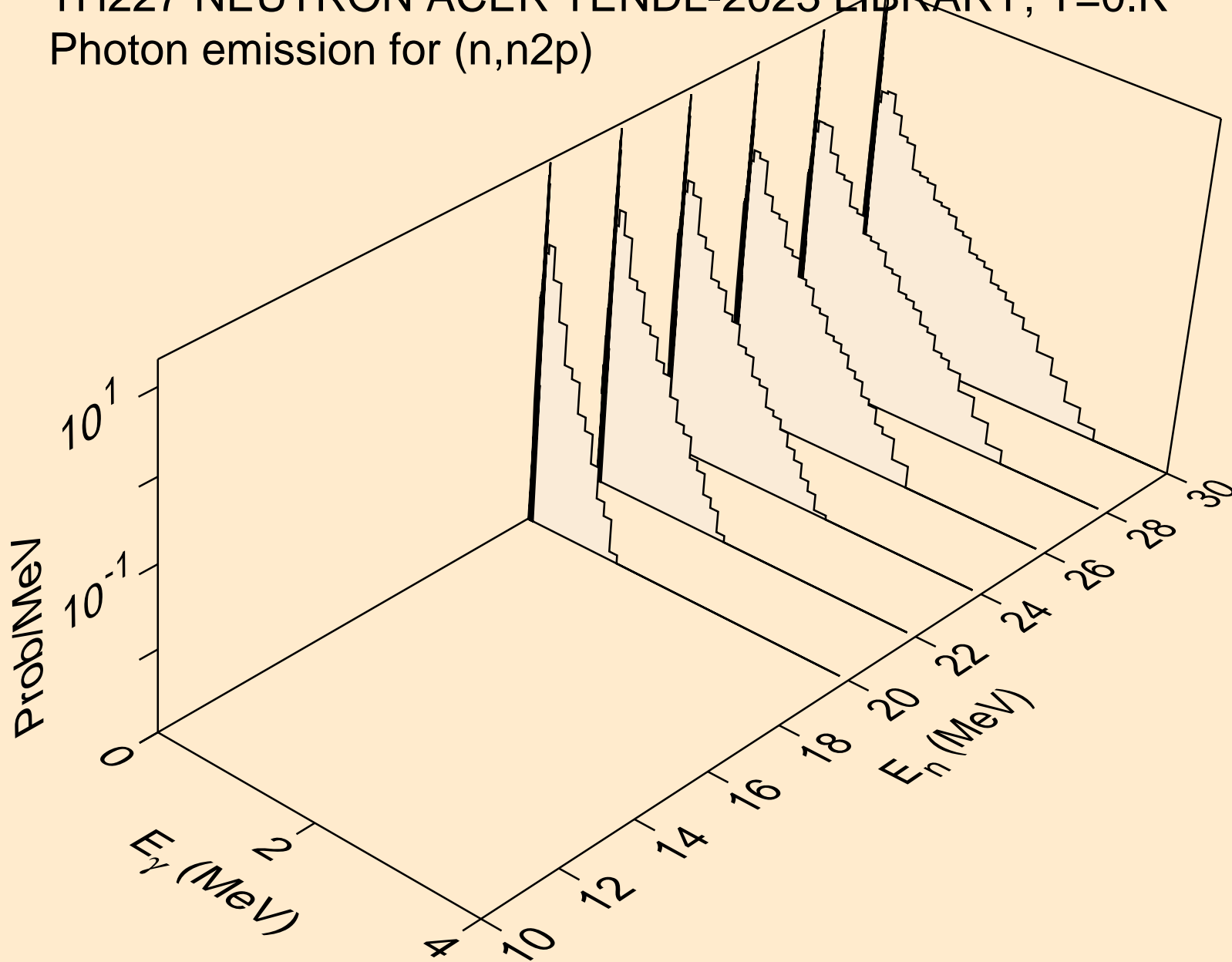

TH227 NEUTRON ACER TENDL-2023 LIBRARY; T=0.K
Photon emission for (n,npa)

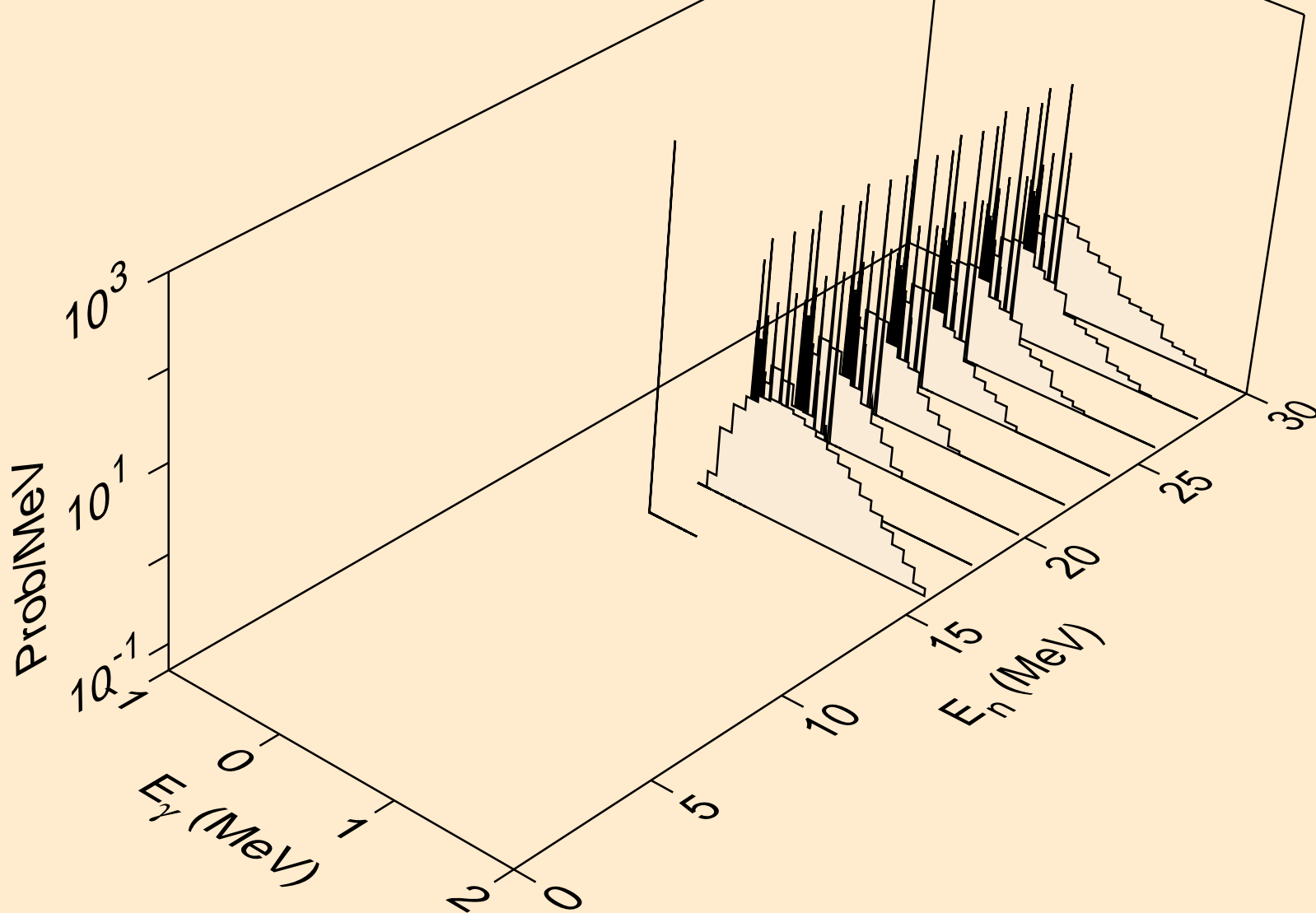

TH227 NEUTRON ACER TENDL-2023 LIBRARY; T=0.K
Photon emission for (n,n*c)

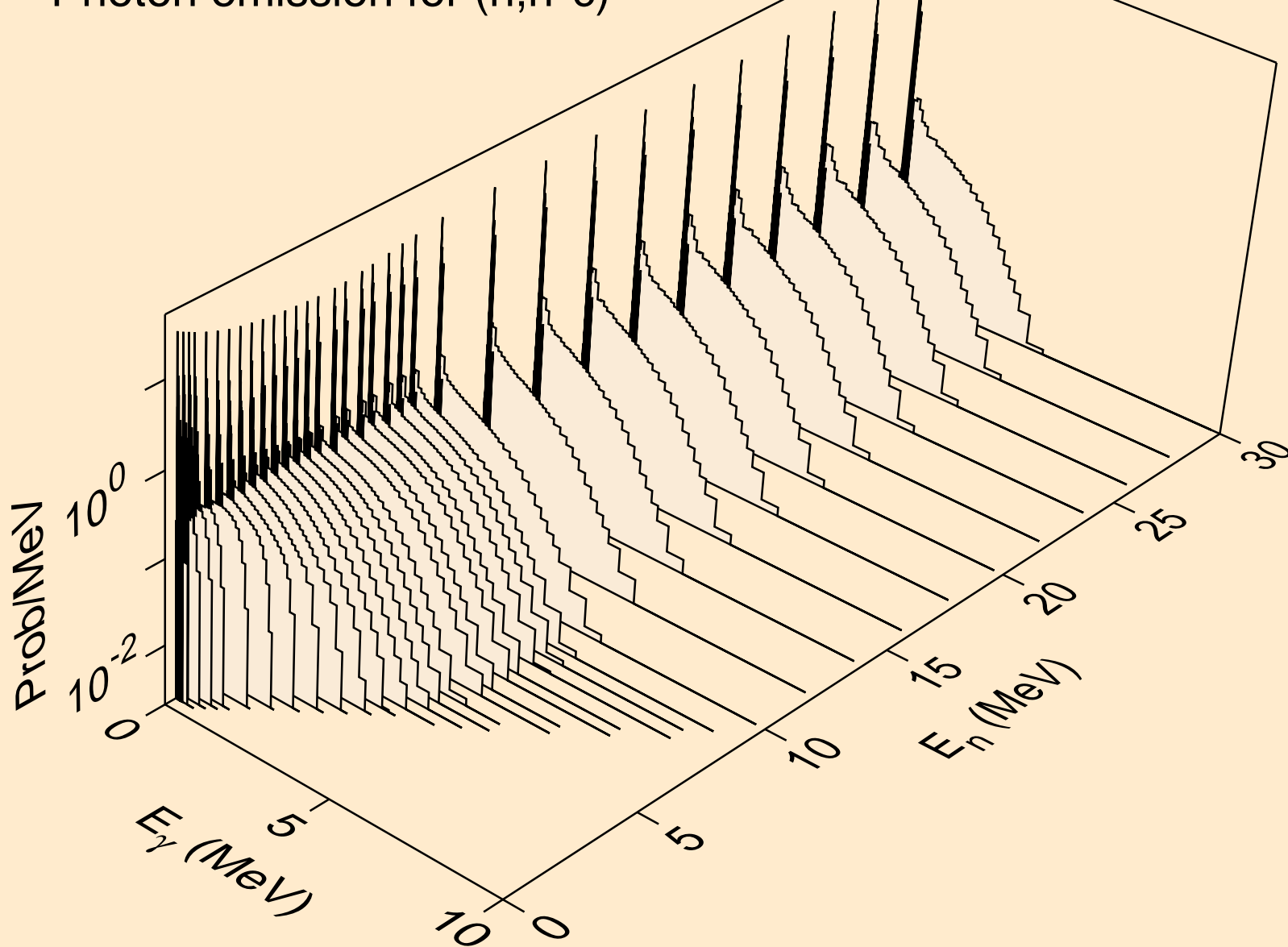

TH227 NEUTRON ACER TENDL-2023 LIBRARY; T=0.K
Photon emission for (n,gma)

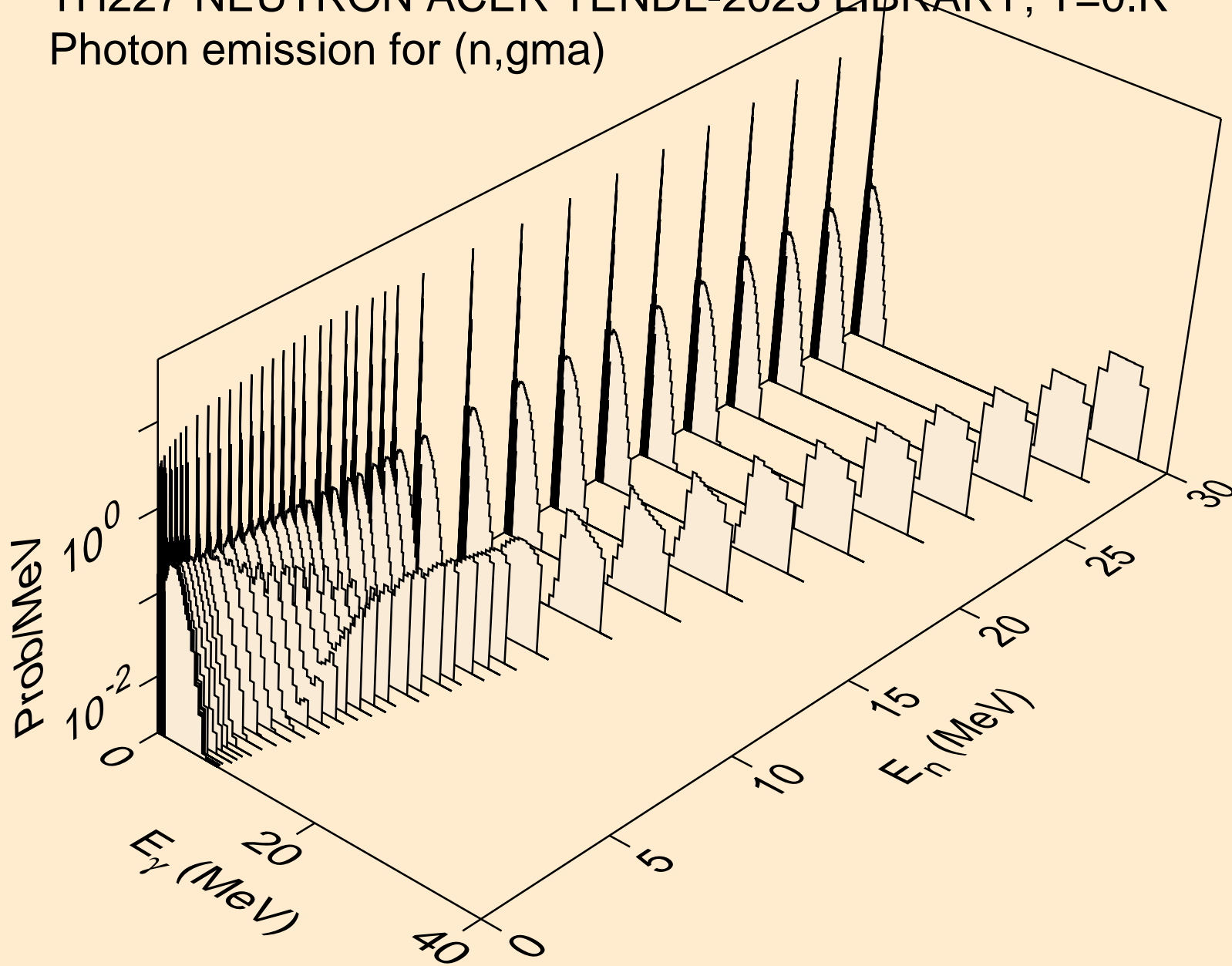

TH227 NEUTRON ACER TENDL-2023 LIBRARY; T=0.K
Photon emission for (n,p)

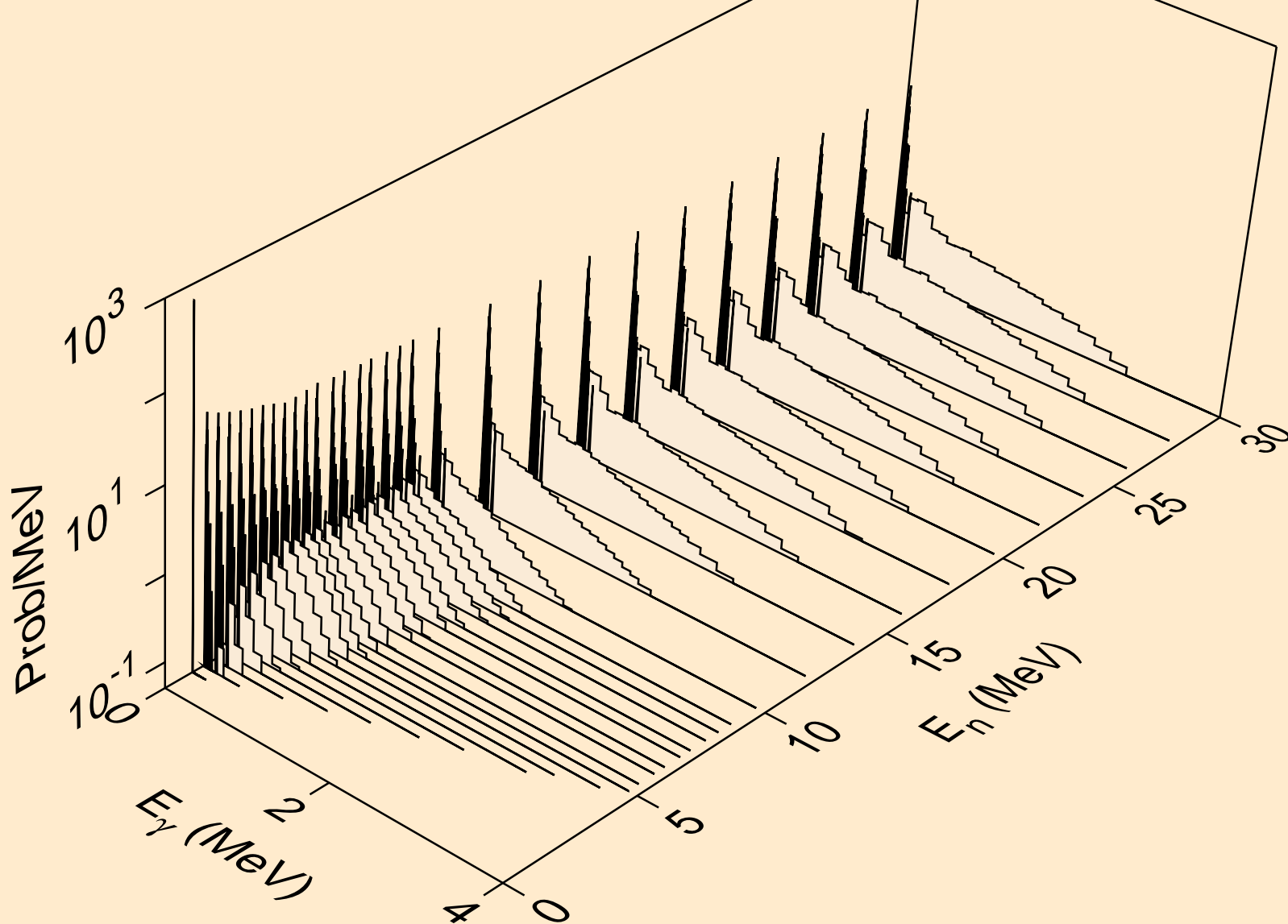

TH227 NEUTRON ACER TENDL-2023 LIBRARY; T=0.K
Photon emission for (n,d)

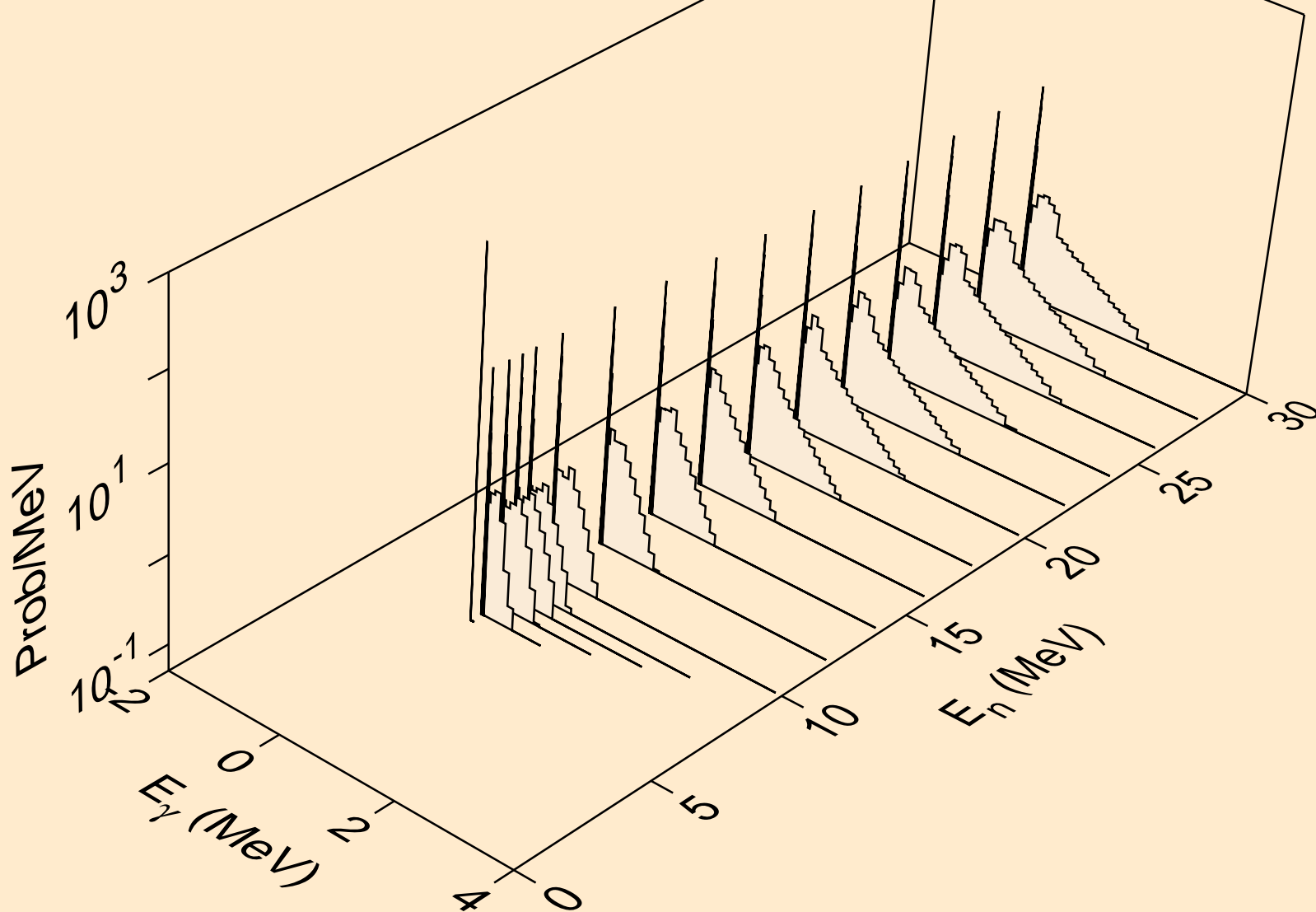

TH227 NEUTRON ACER TENDL-2023 LIBRARY; T=0.K
Photon emission for (n,t)

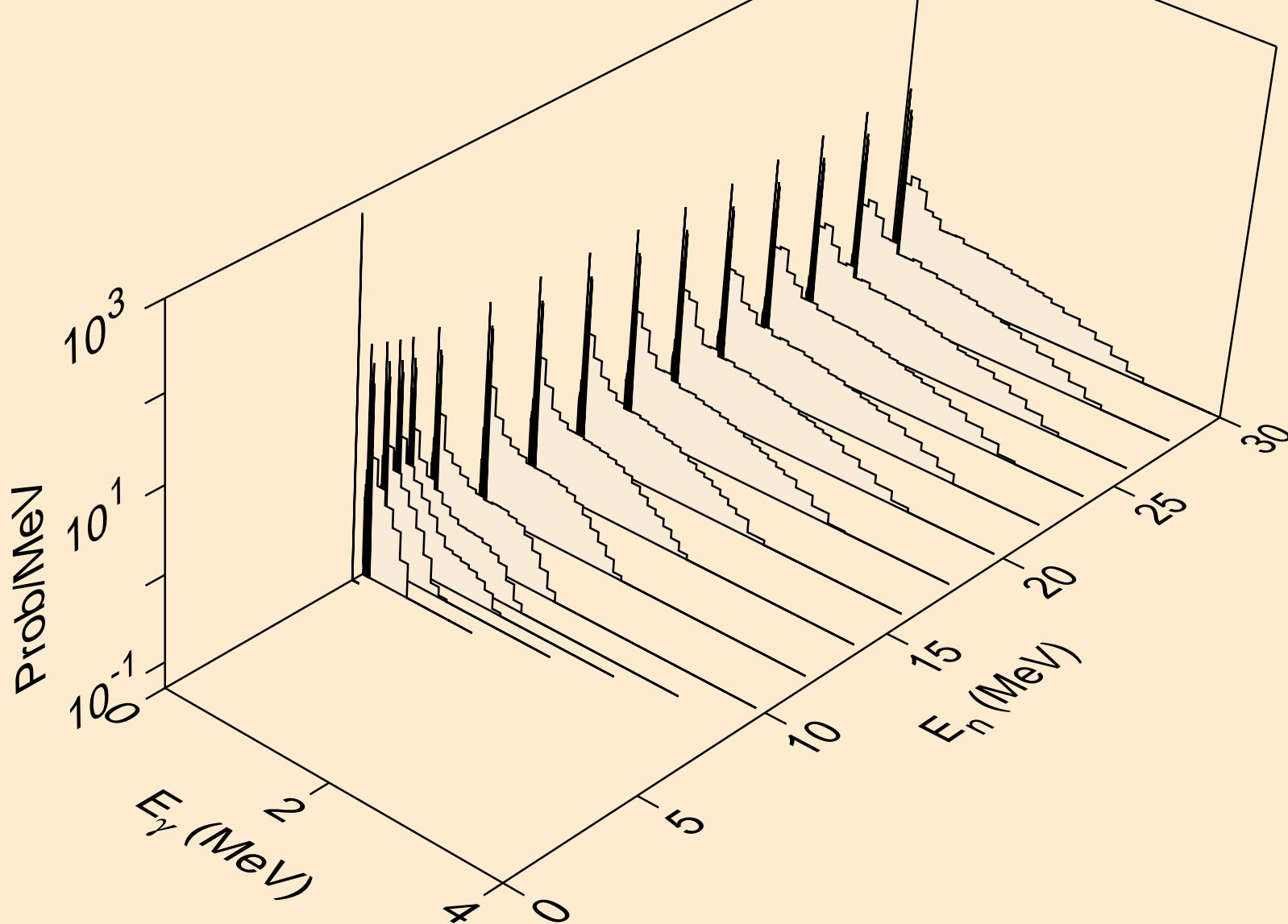

TH227 NEUTRON ACER TENDL-2023 LIBRARY; T=0.K
Photon emission for (n,he3)

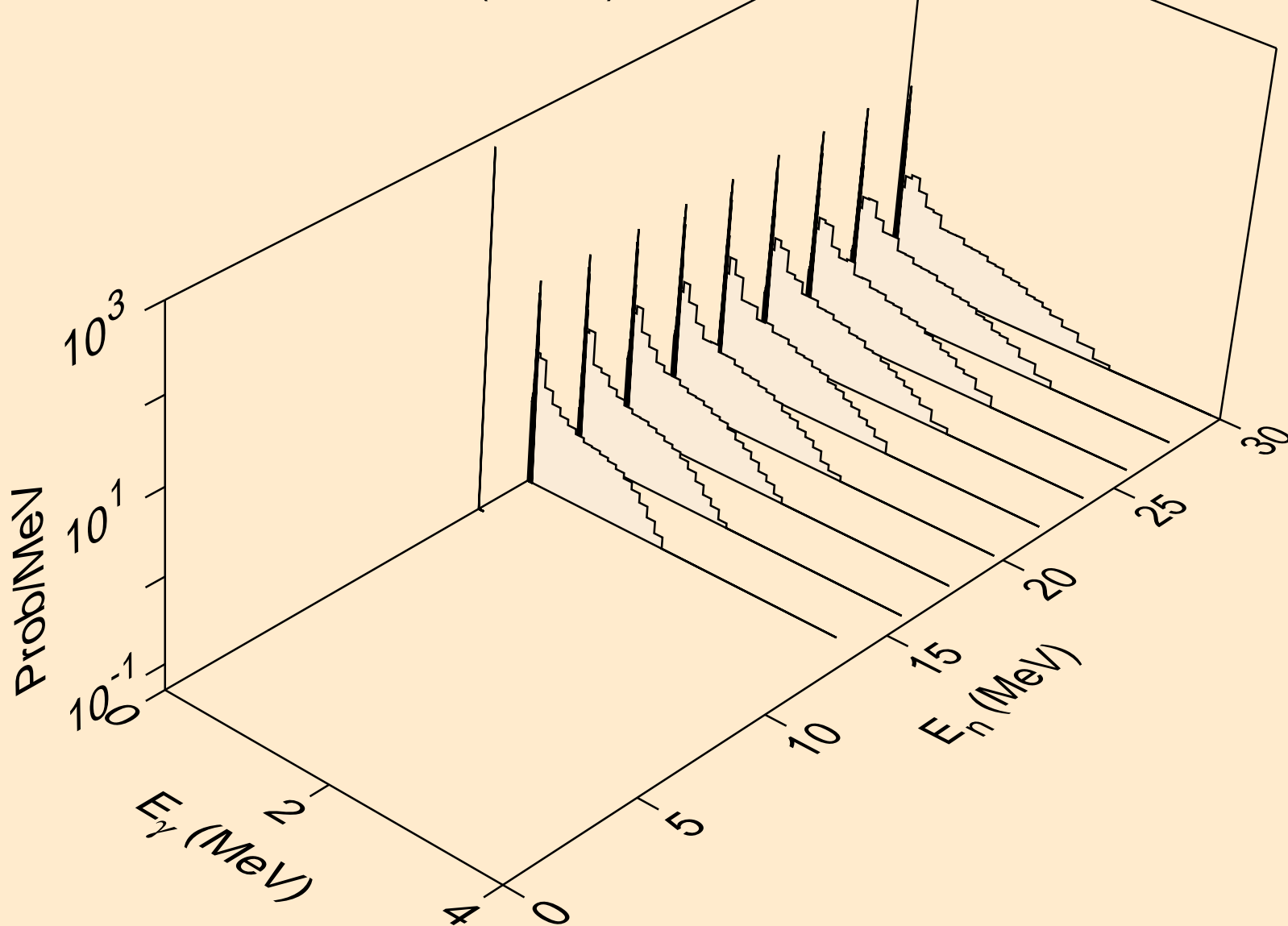

TH227 NEUTRON ACER TENDL-2023 LIBRARY; T=0.K
Photon emission for (n,a)

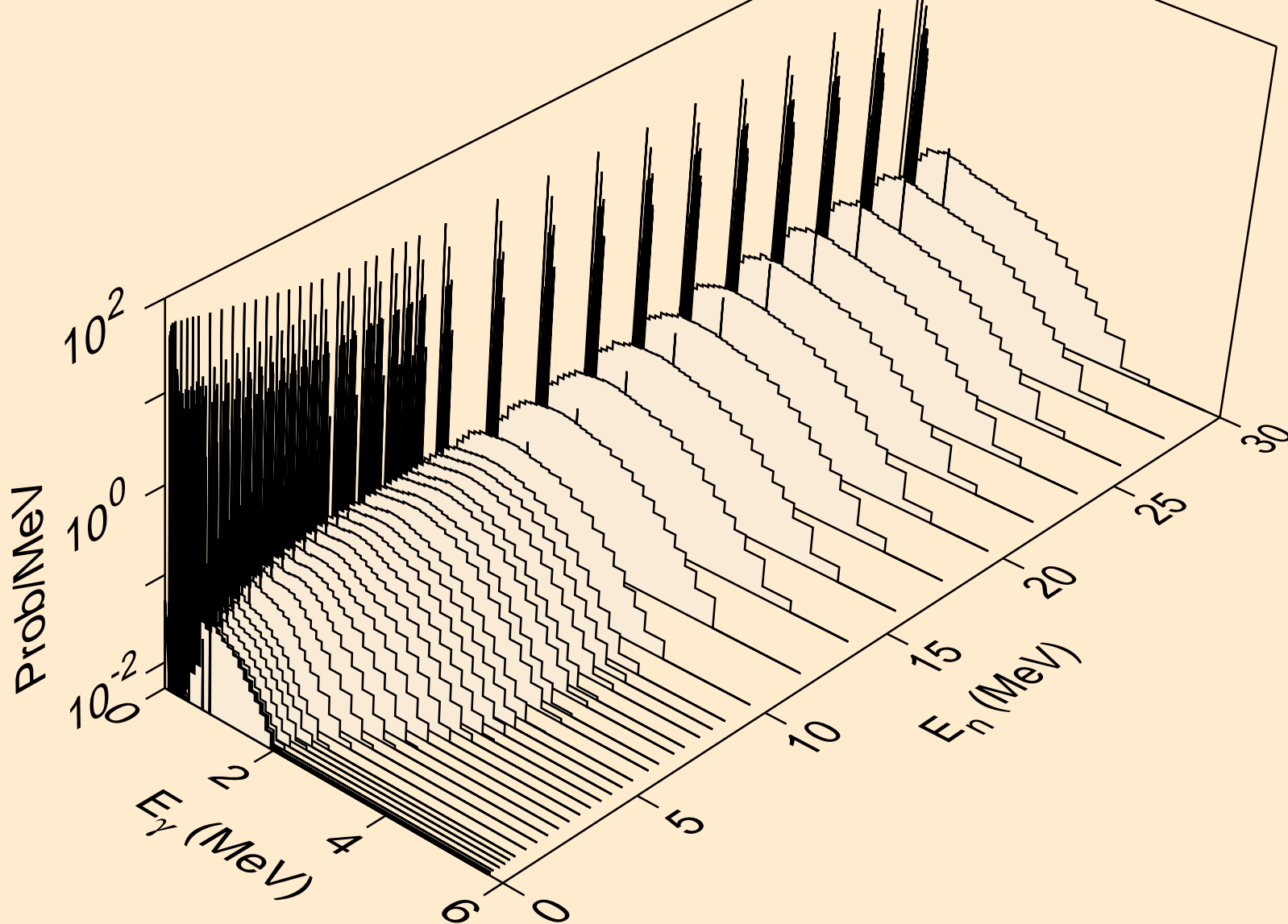

TH227 NEUTRON ACER TENDL-2023 LIBRARY; T=0.K
Photon emission for (n,2a)

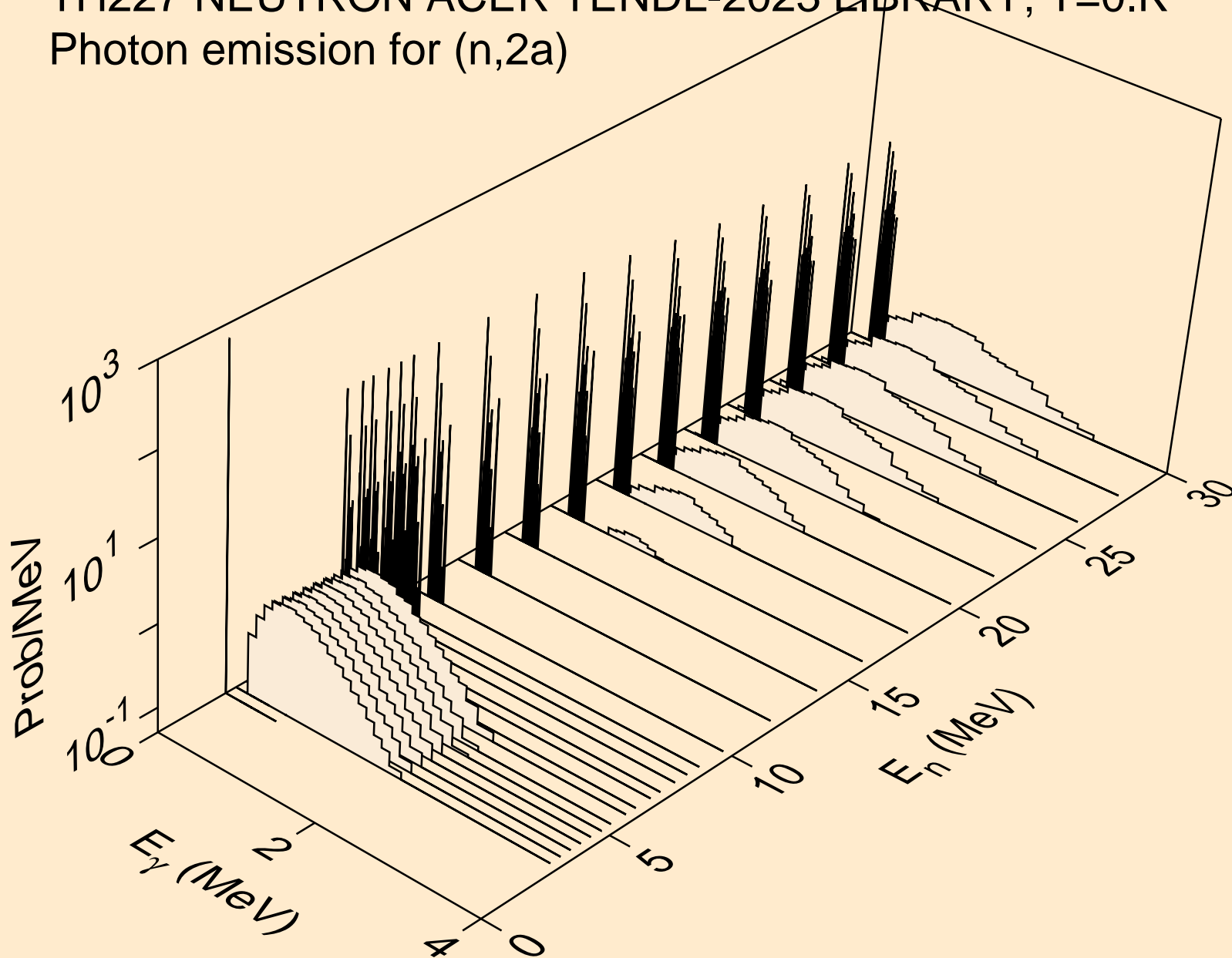

TH227 NEUTRON ACER TENDL-2023 LIBRARY; T=0.K
Photon emission for (n,2p)

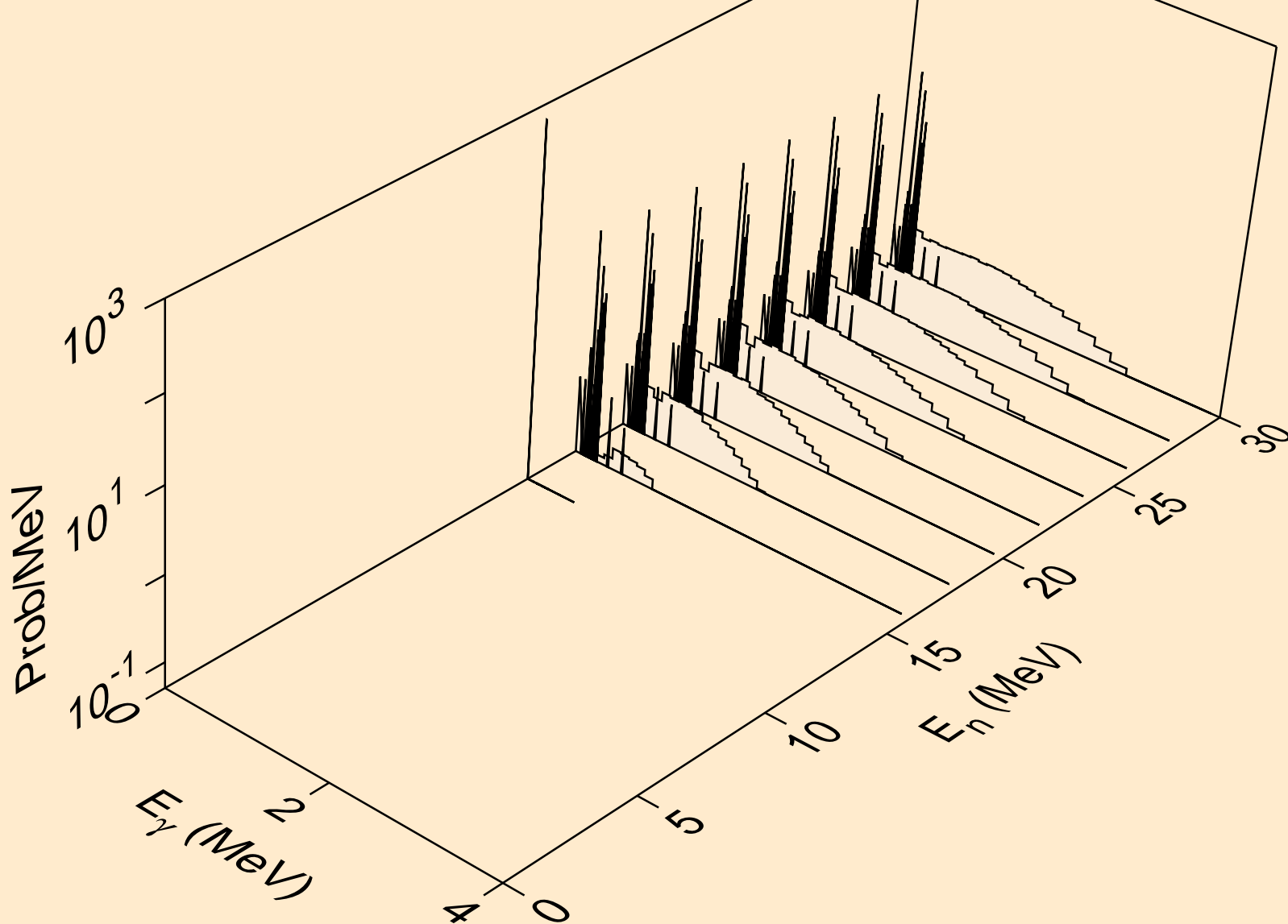

TH227 NEUTRON ACER TENDL-2023 LIBRARY; T=0.K
Photon emission for (n,p α)

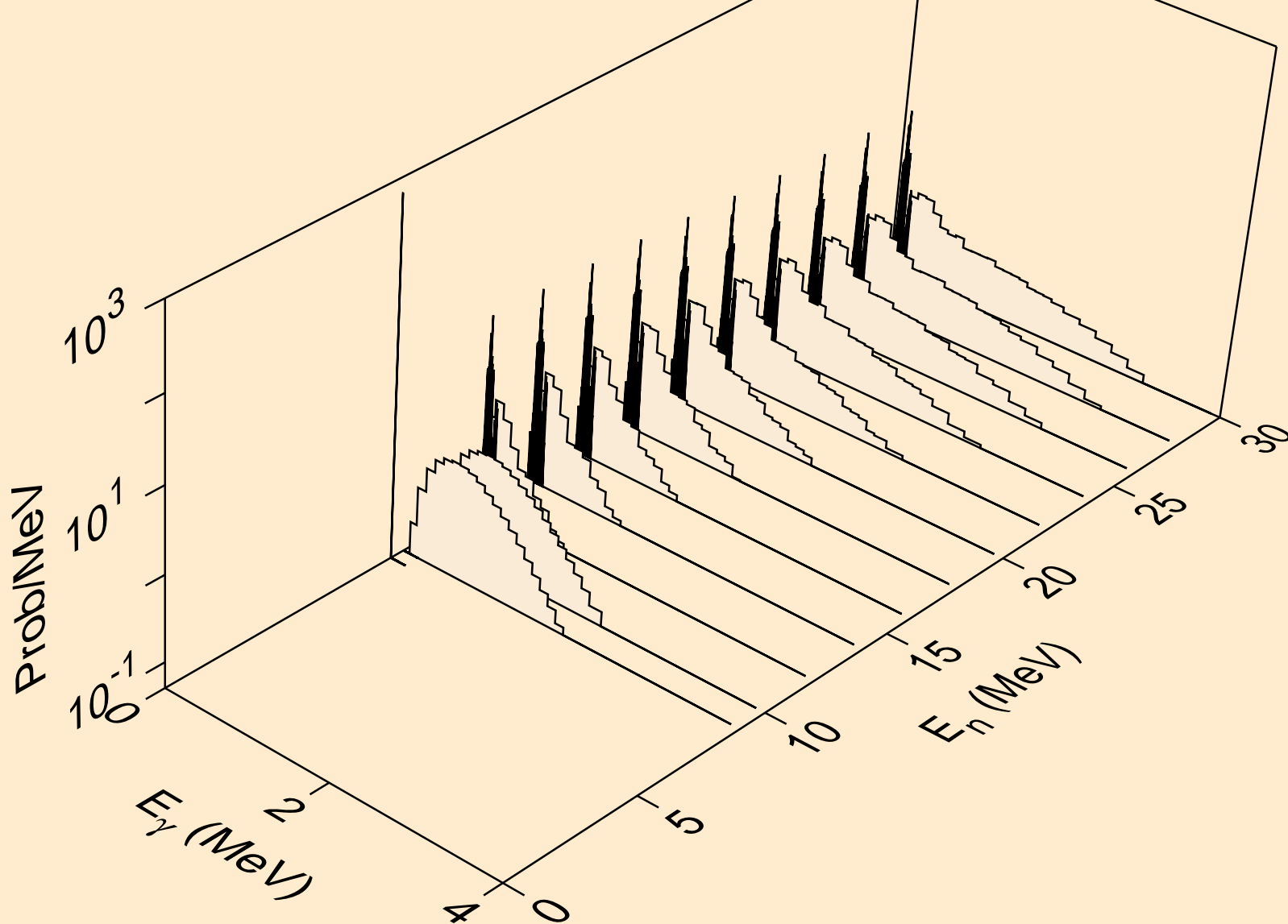

TH227 NEUTRON ACER TENDL-2023 LIBRARY; T=0.K
Photon emission for (n,pd)

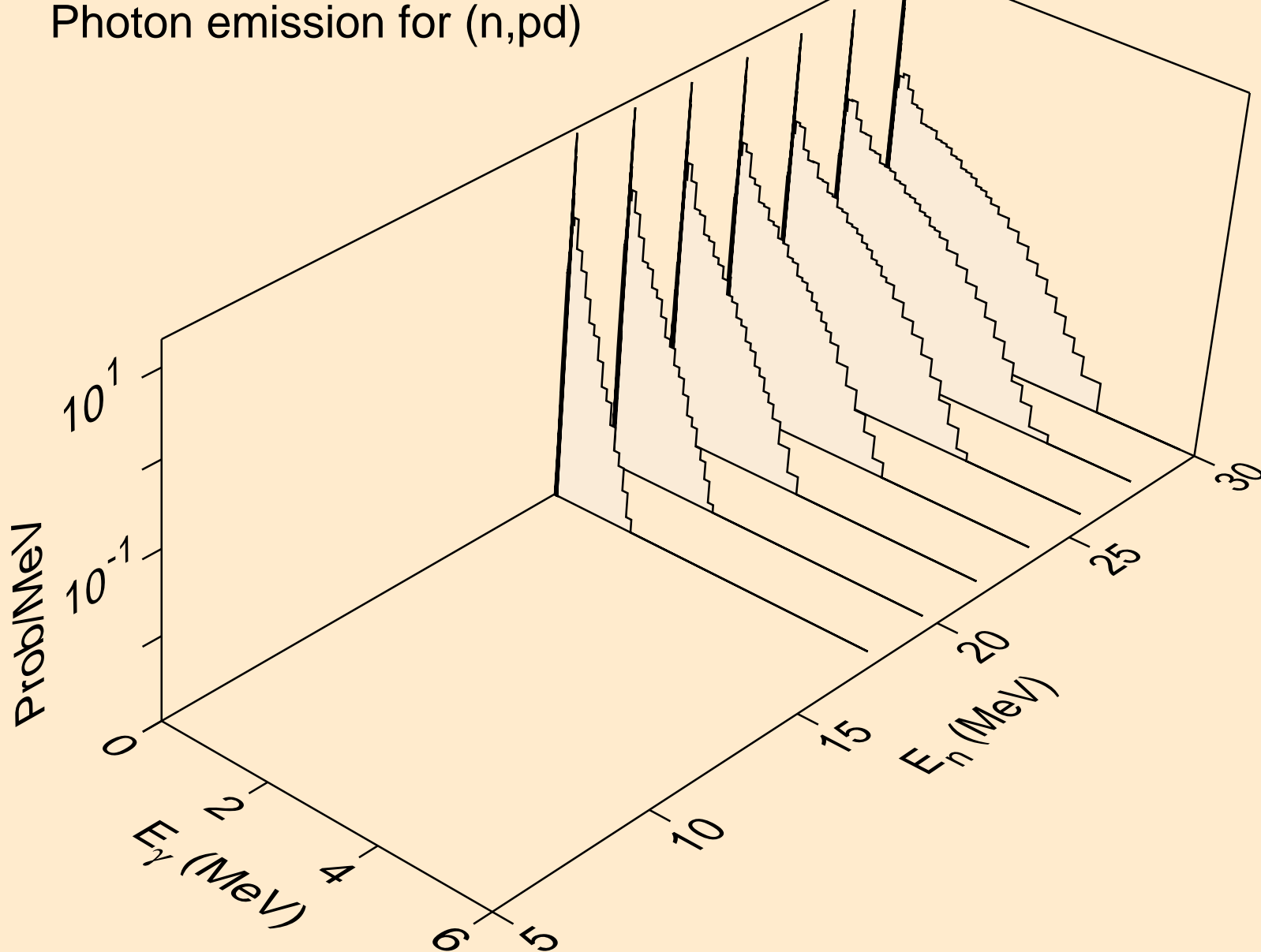

TH227 NEUTRON ACER TENDL-2023 LIBRARY; T=0.K
thermal capture photon spectrum

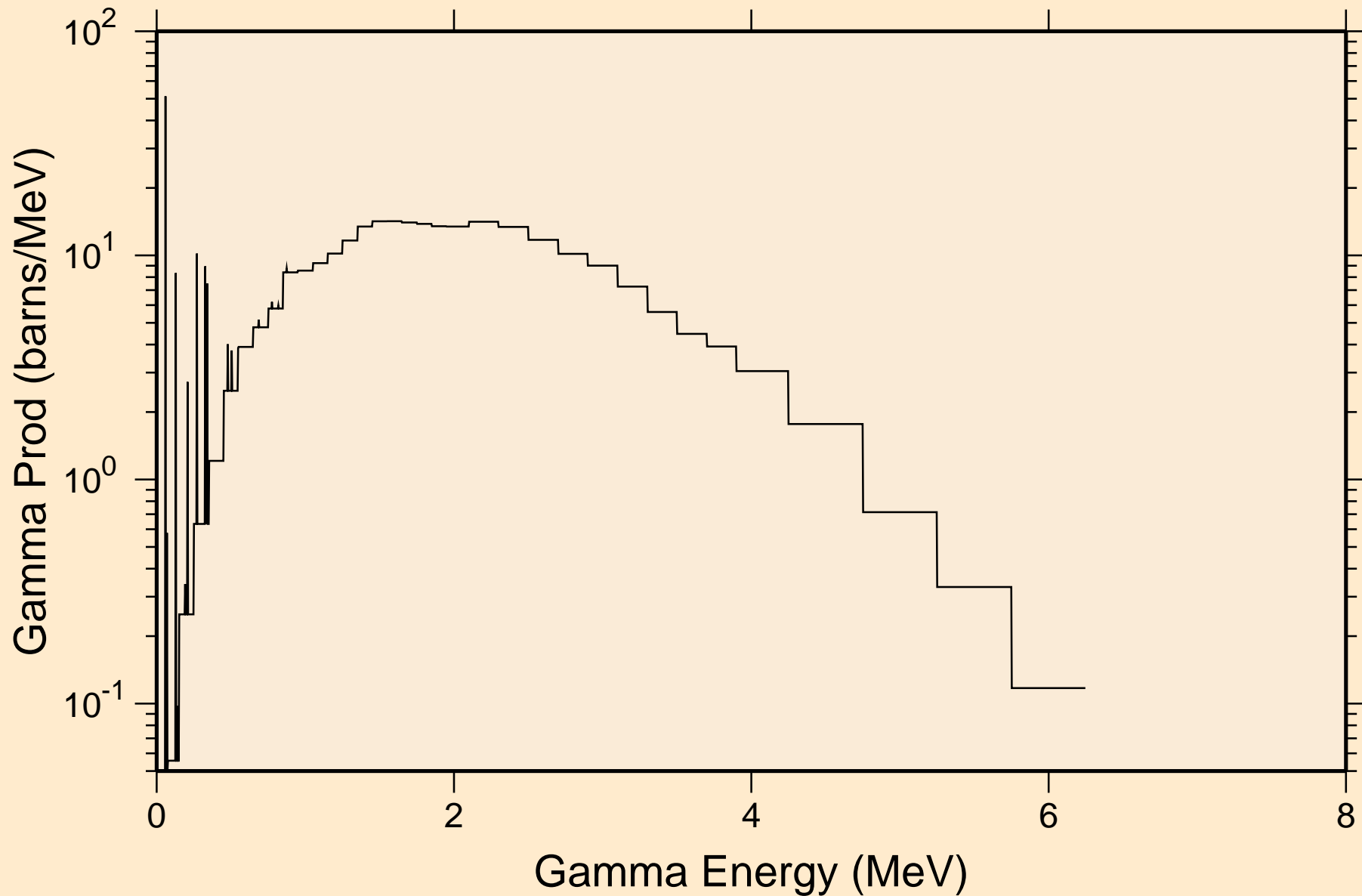

TH227 NEUTRON ACER TENDL-2023 LIBRARY; T=0.K
14 MeV photon spectrum

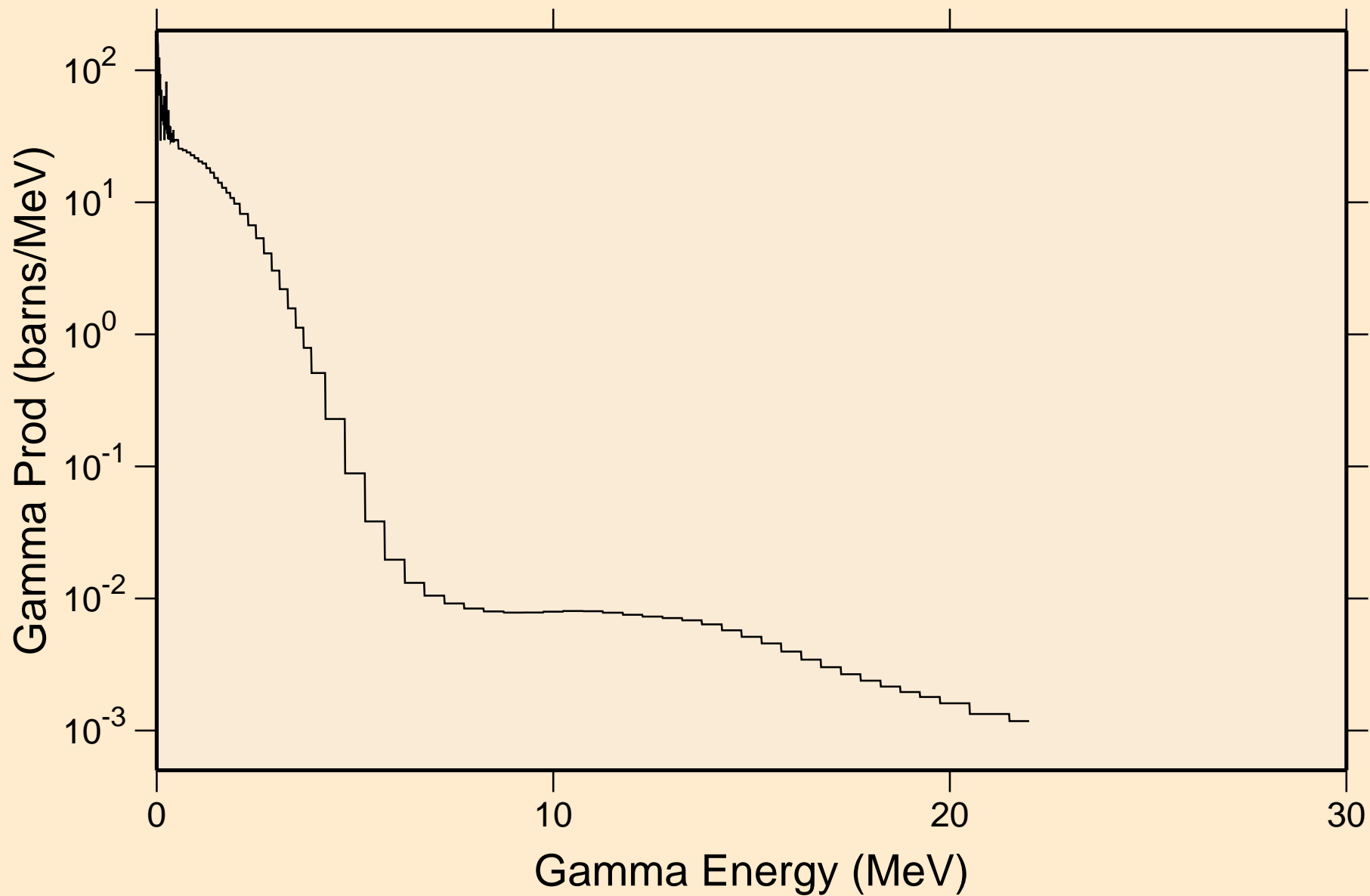

TH227 NEUTRON ACER TENDL-2023 LIBRARY; T=0.K

Particle heating contributions

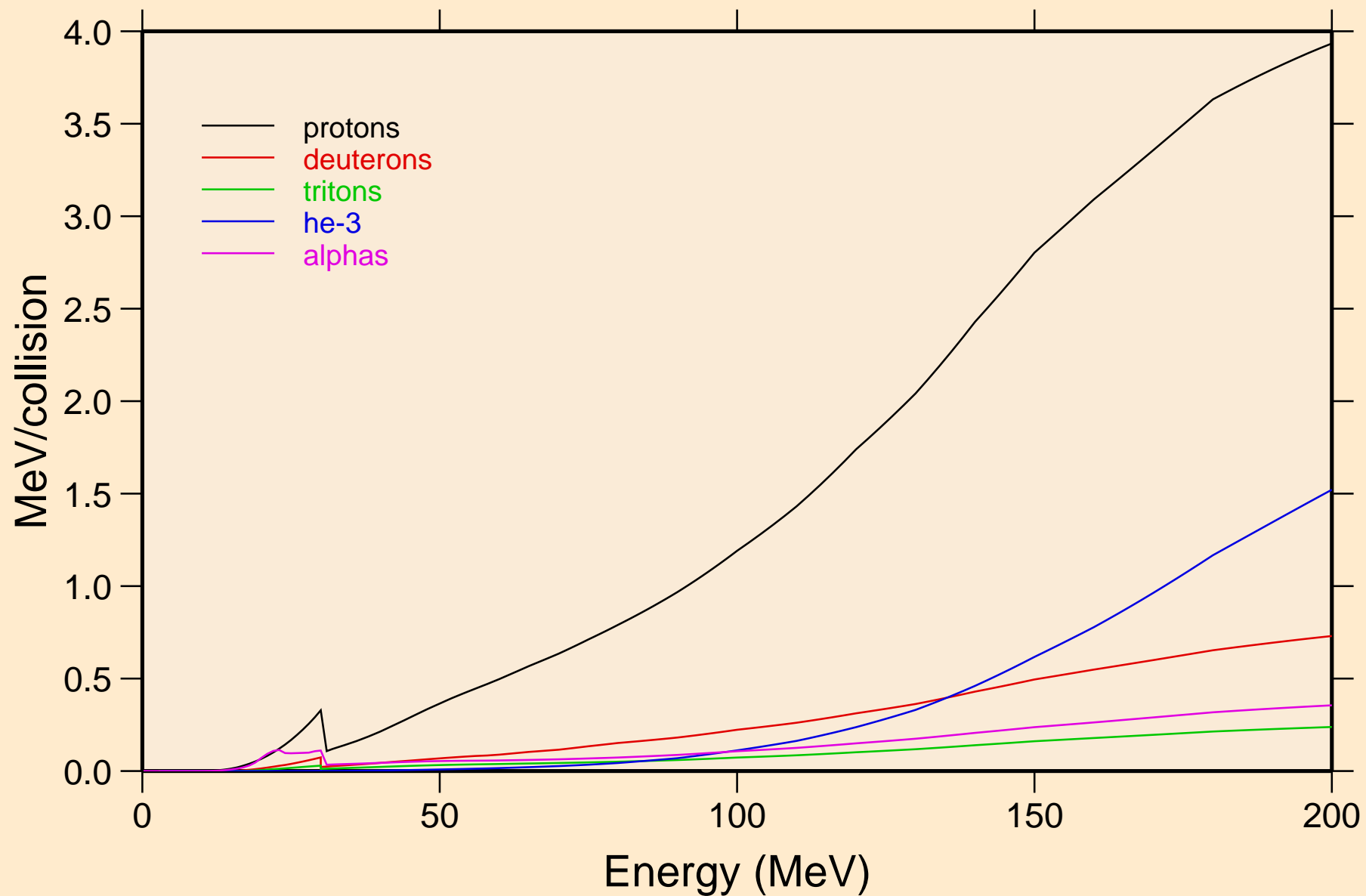

TH227 NEUTRON ACER TENDL-2023 LIBRARY; T=0.K
Recoil Heating

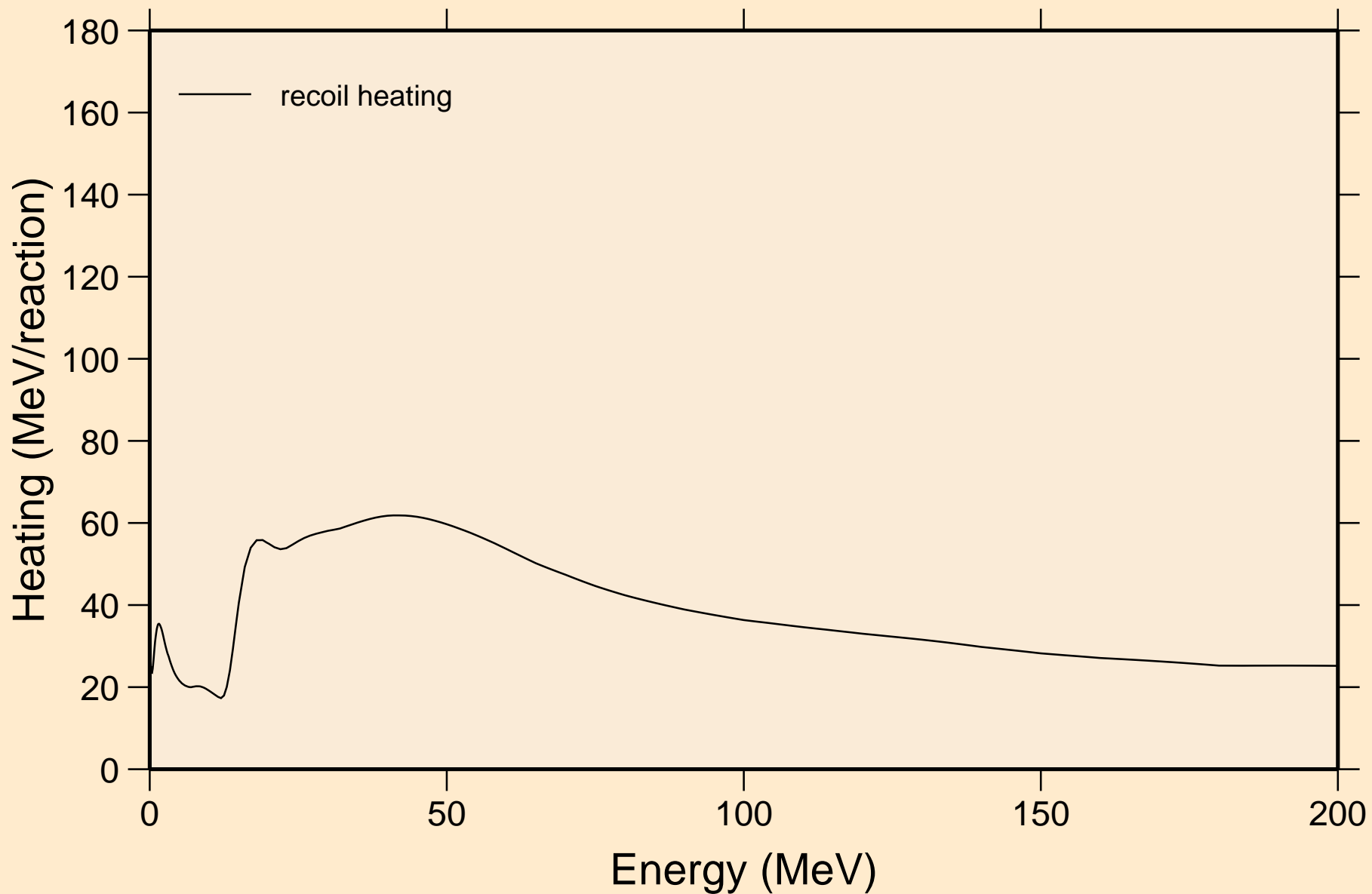

TH227 NEUTRON ACER TENDL-2023 LIBRARY; T=0.K

Particle production cross sections

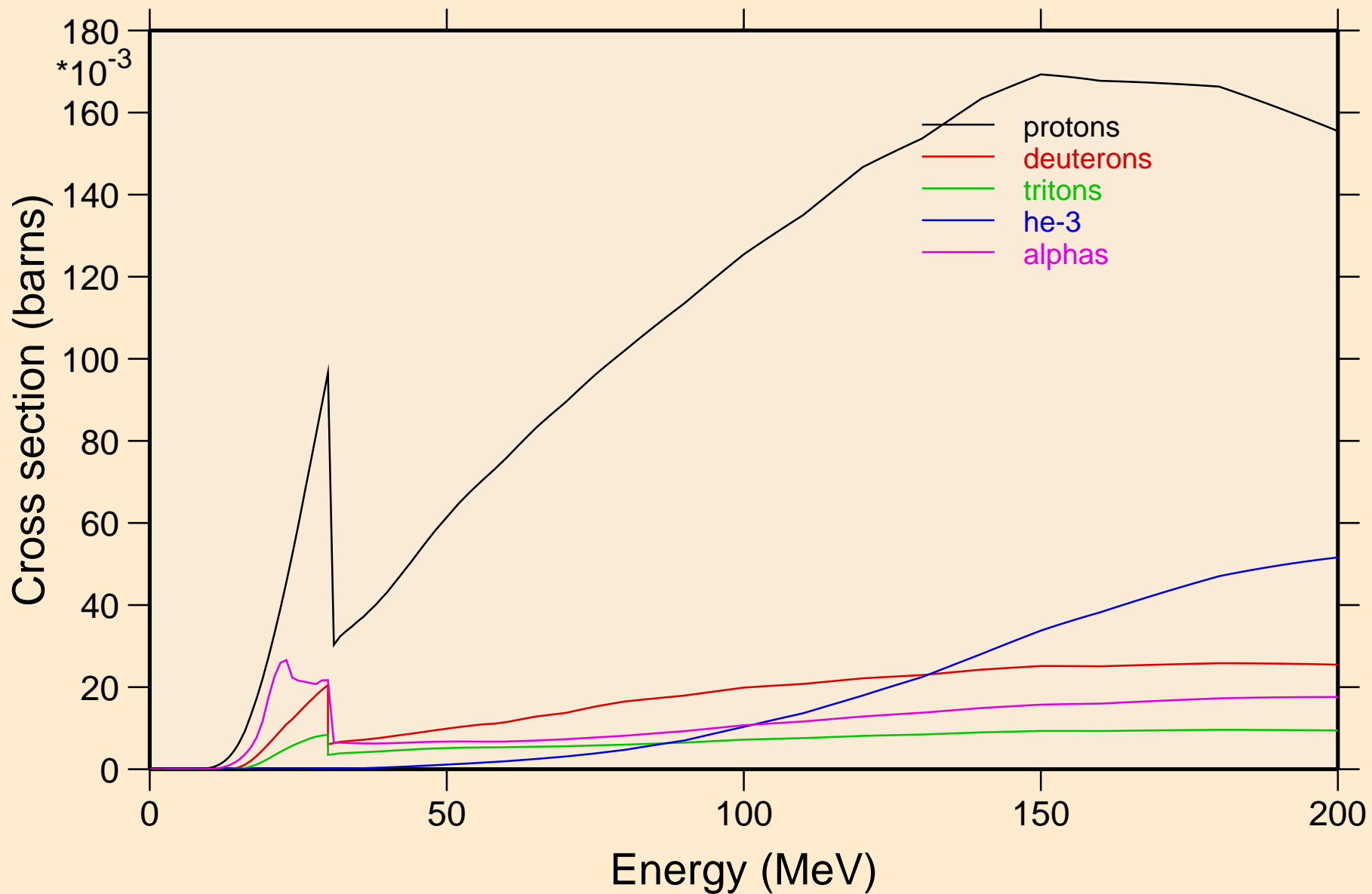

TH227 NEUTRON ACER TENDL-2023 LIBRARY; T=0.K
protons from (n,x)

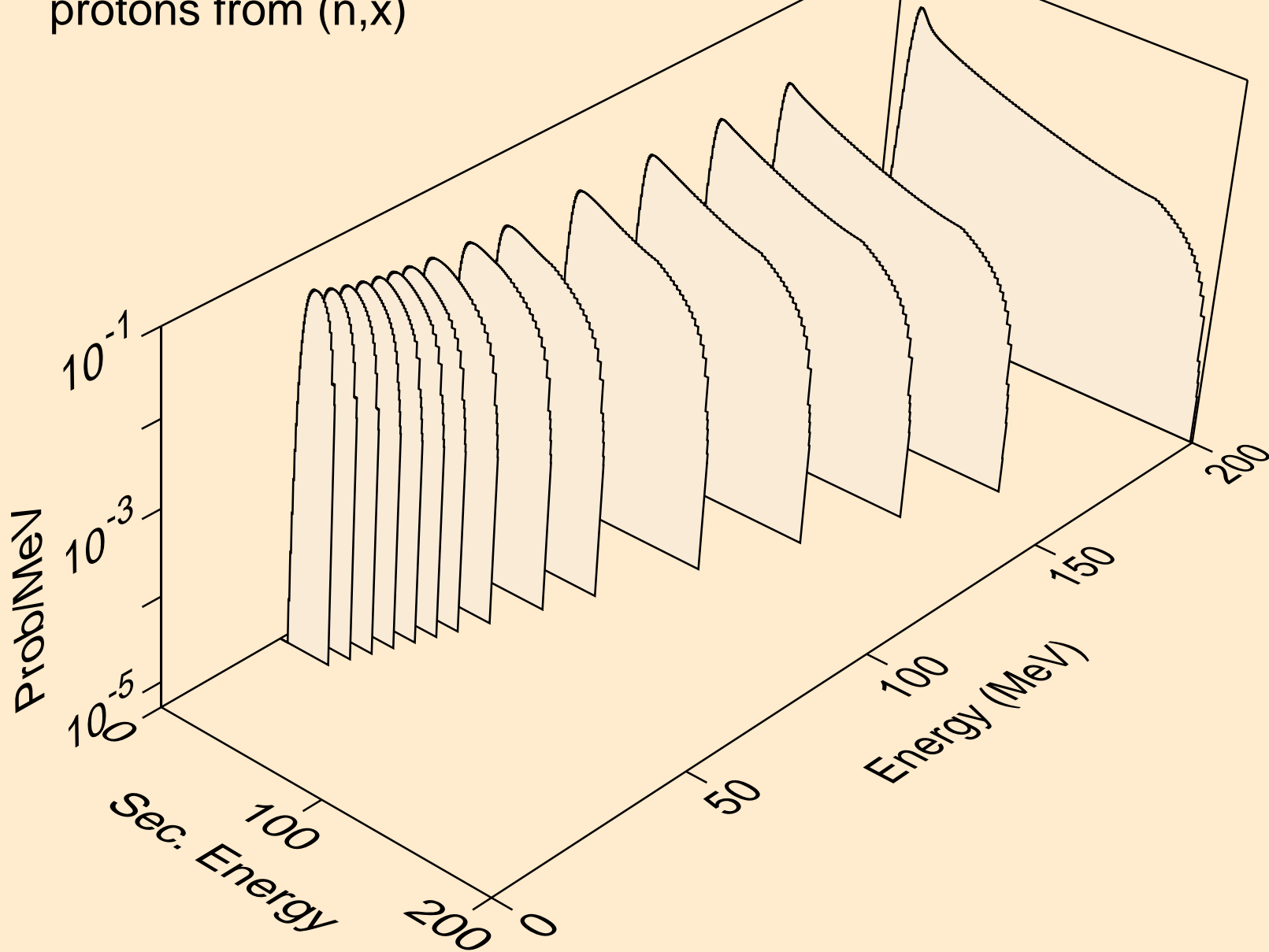

TH227 NEUTRON ACER TENDL-2023 LIBRARY; T=0.K
protons from (n,n*)p

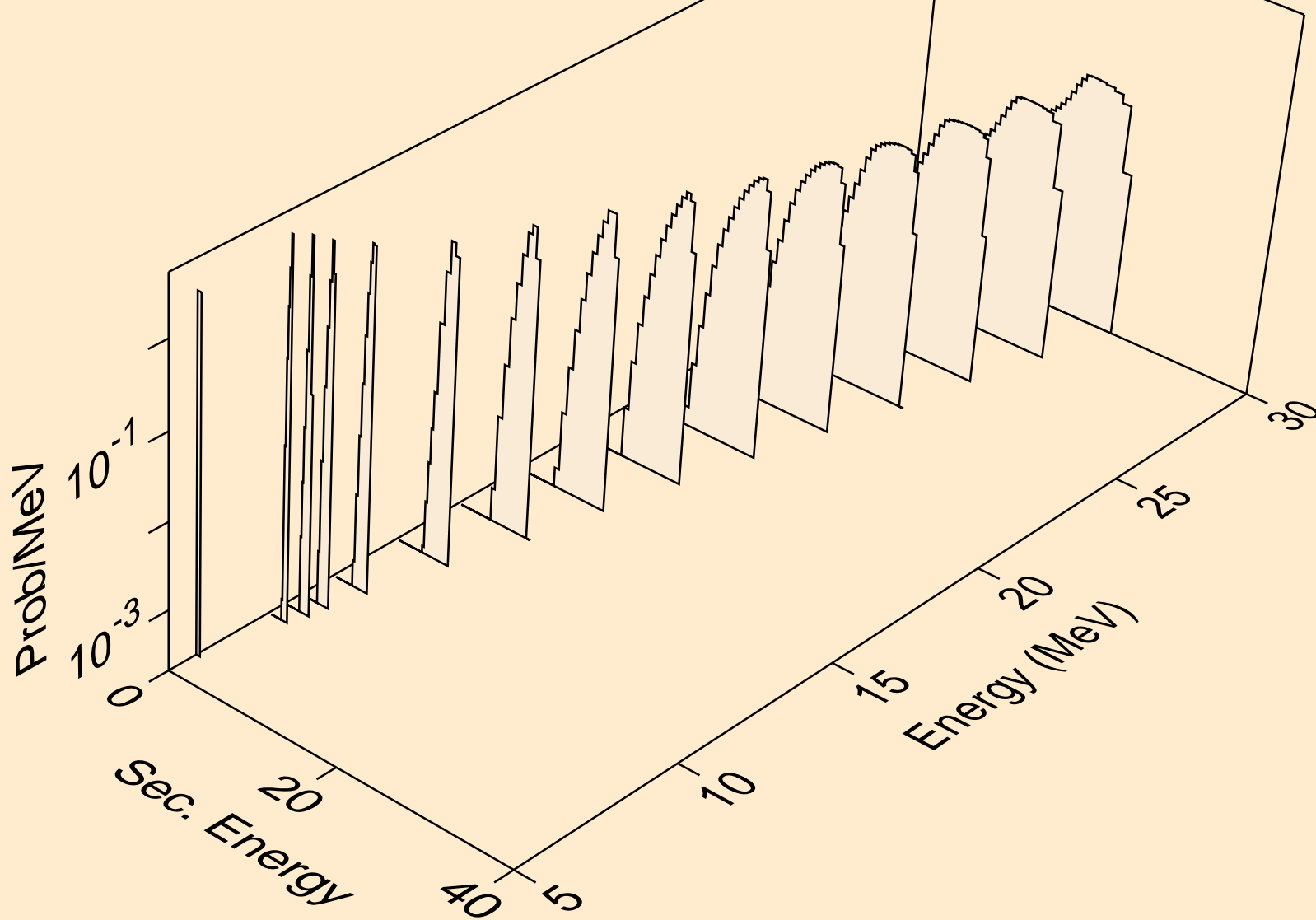

TH227 NEUTRON ACER TENDL-2023 LIBRARY; T=0.K
protons from (n,2np)

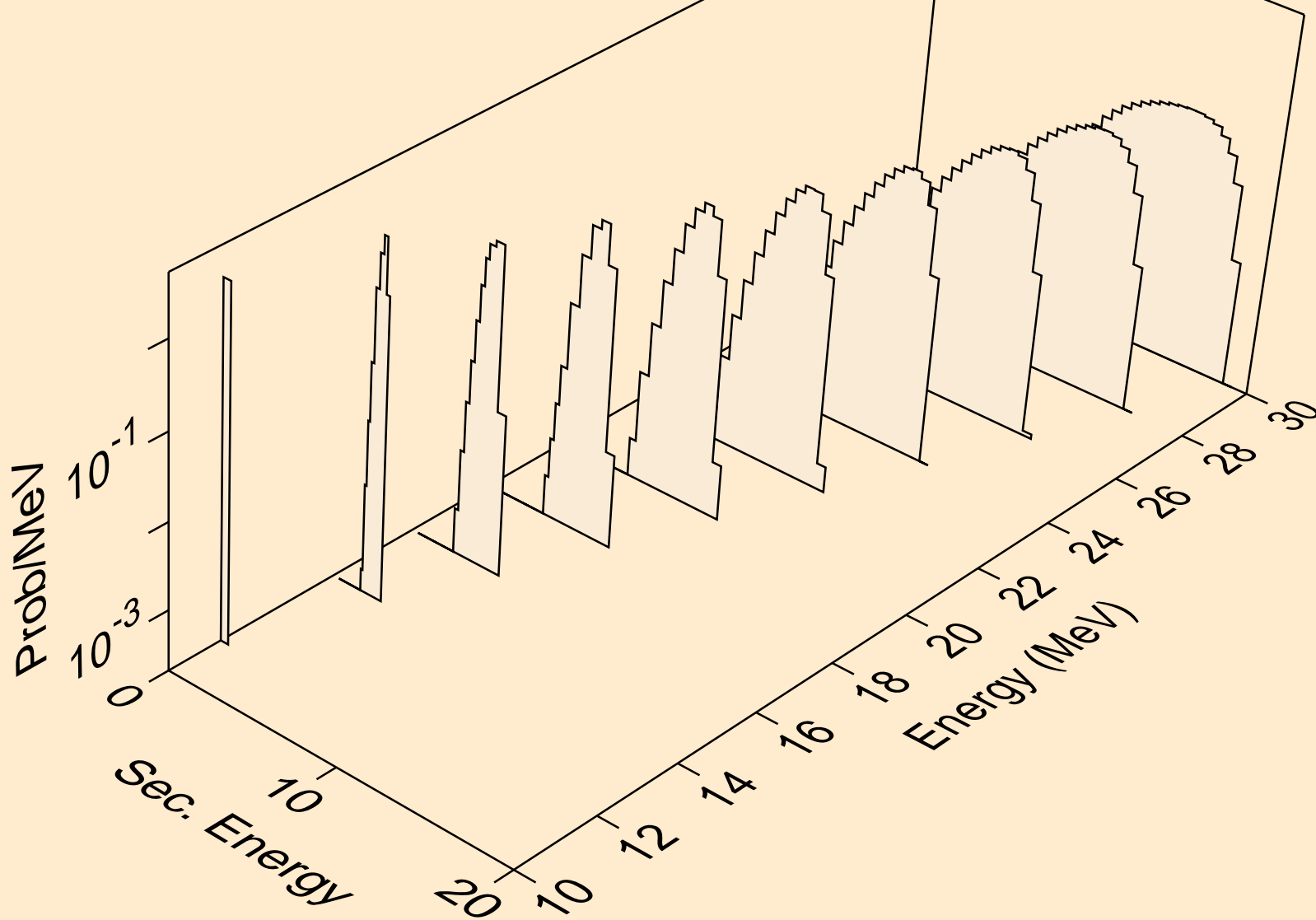

TH227 NEUTRON ACER TENDL-2023 LIBRARY; T=0.K
protons from (n,3np)

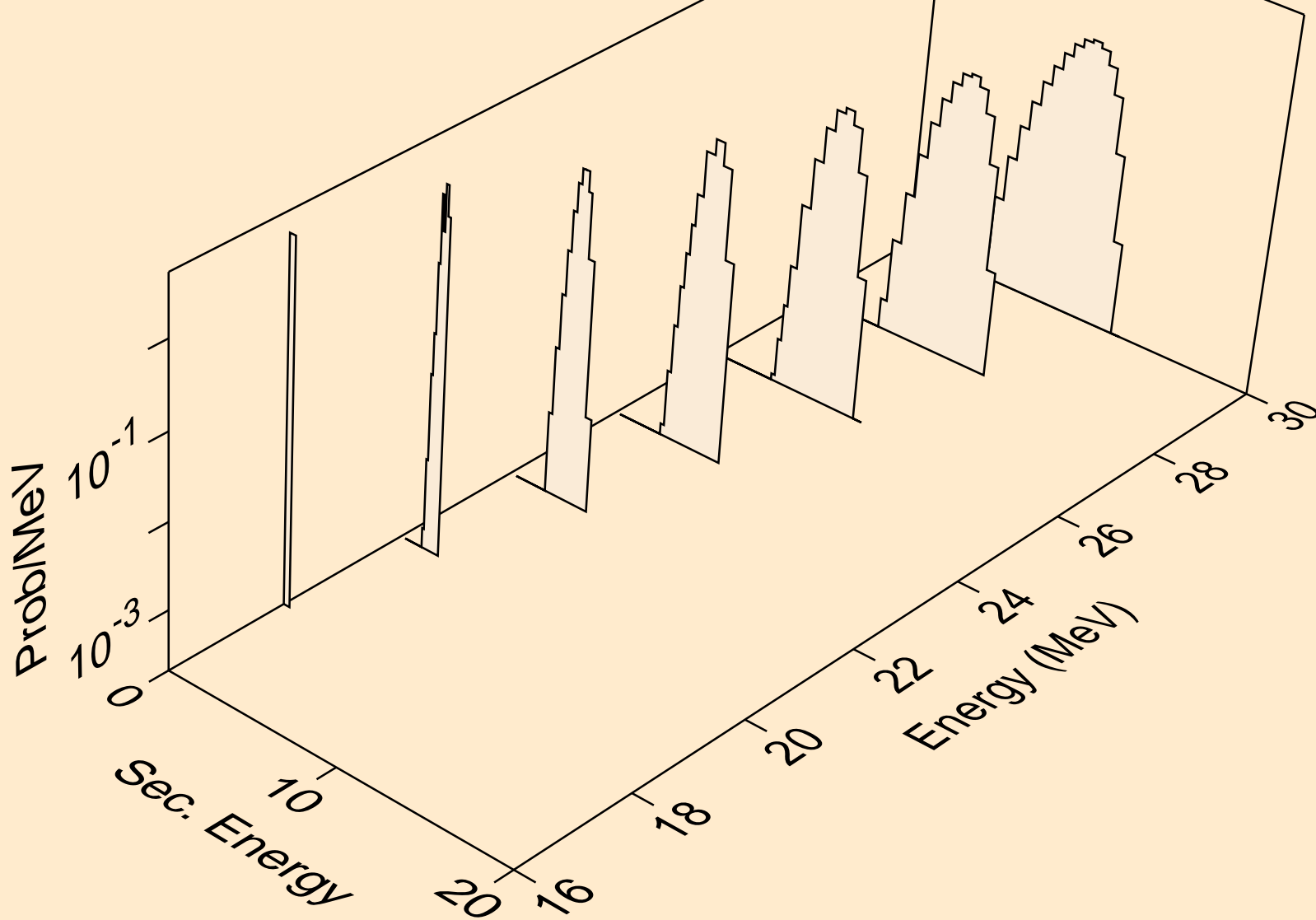

TH227 NEUTRON ACER TENDL-2023 LIBRARY; T=0.K
protons from (n,n2p)

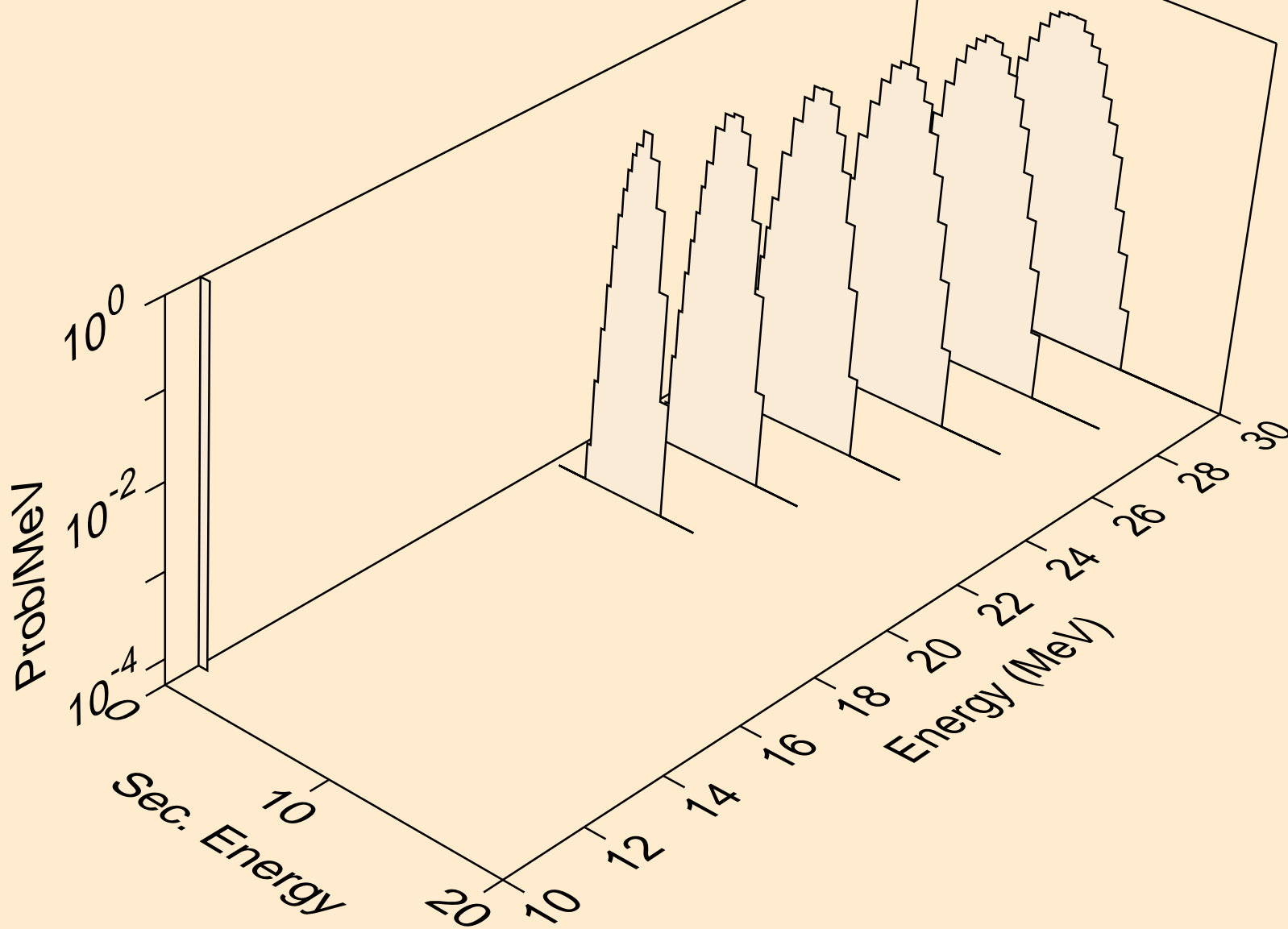

TH227 NEUTRON ACER TENDL-2023 LIBRARY; T=0.K
protons from (n,npa)

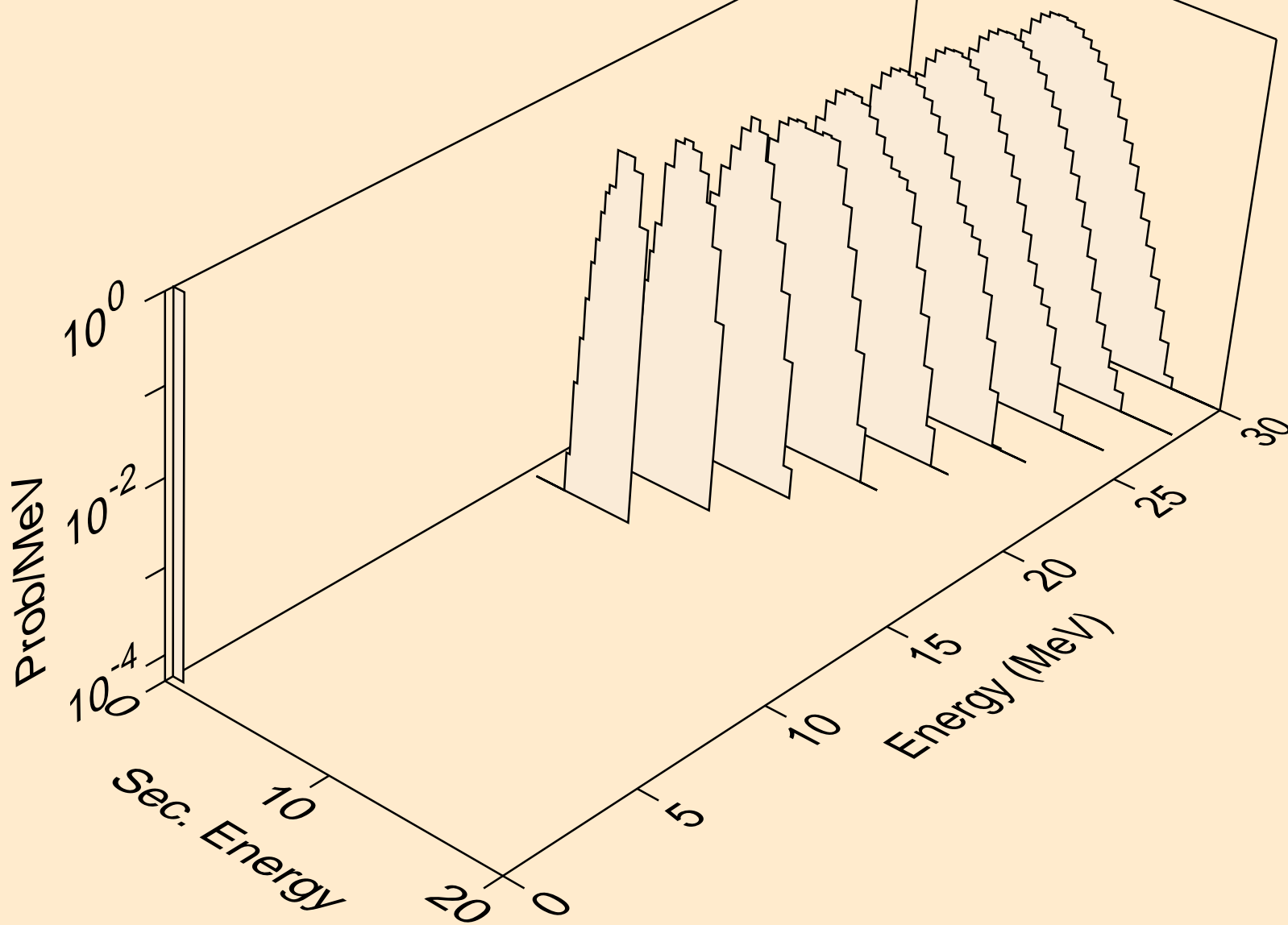

TH227 NEUTRON ACER TENDL-2023 LIBRARY; T=0.K
protons from (n,p)

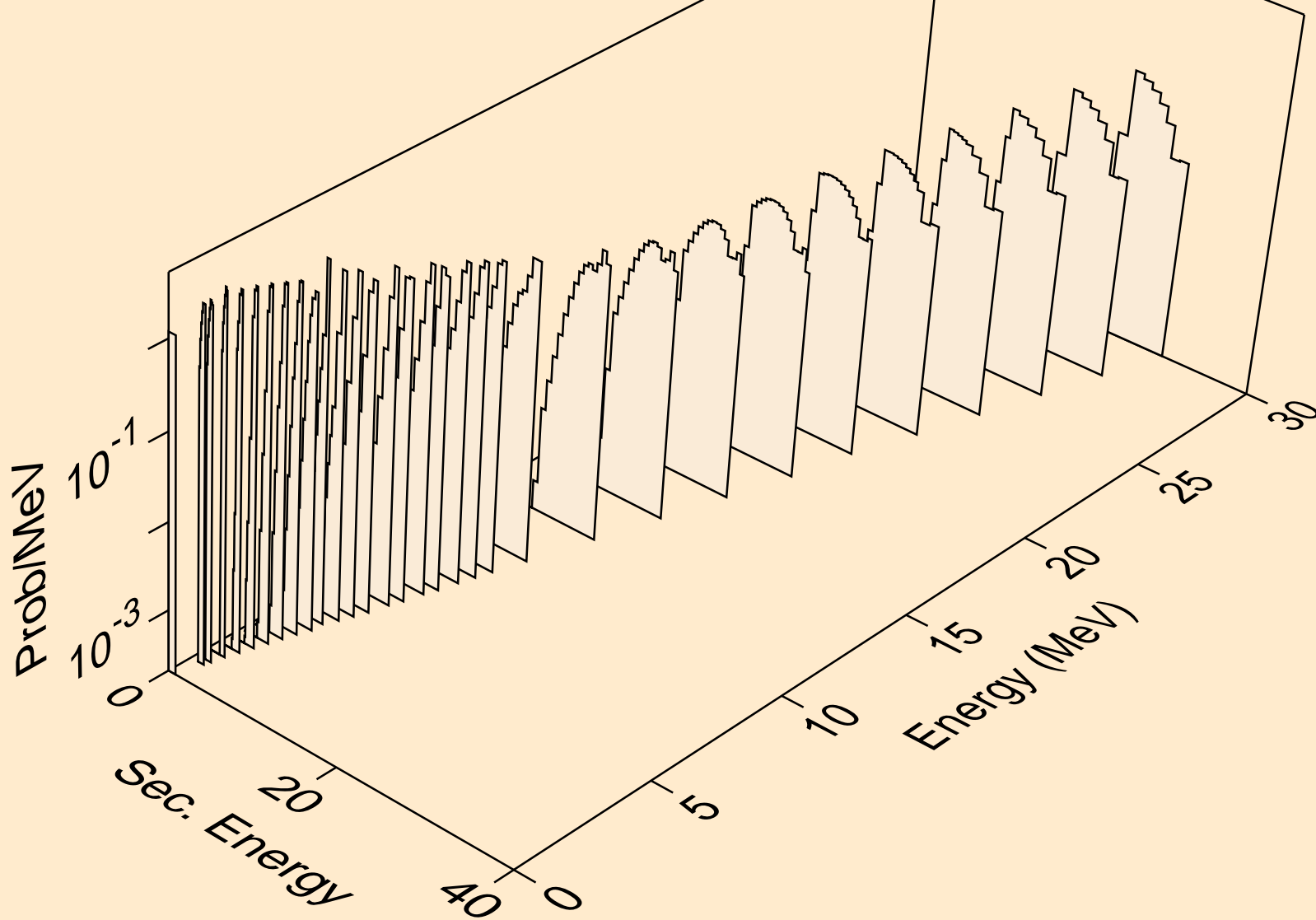

TH227 NEUTRON ACER TENDL-2023 LIBRARY; T=0.K
protons from (n,2p)

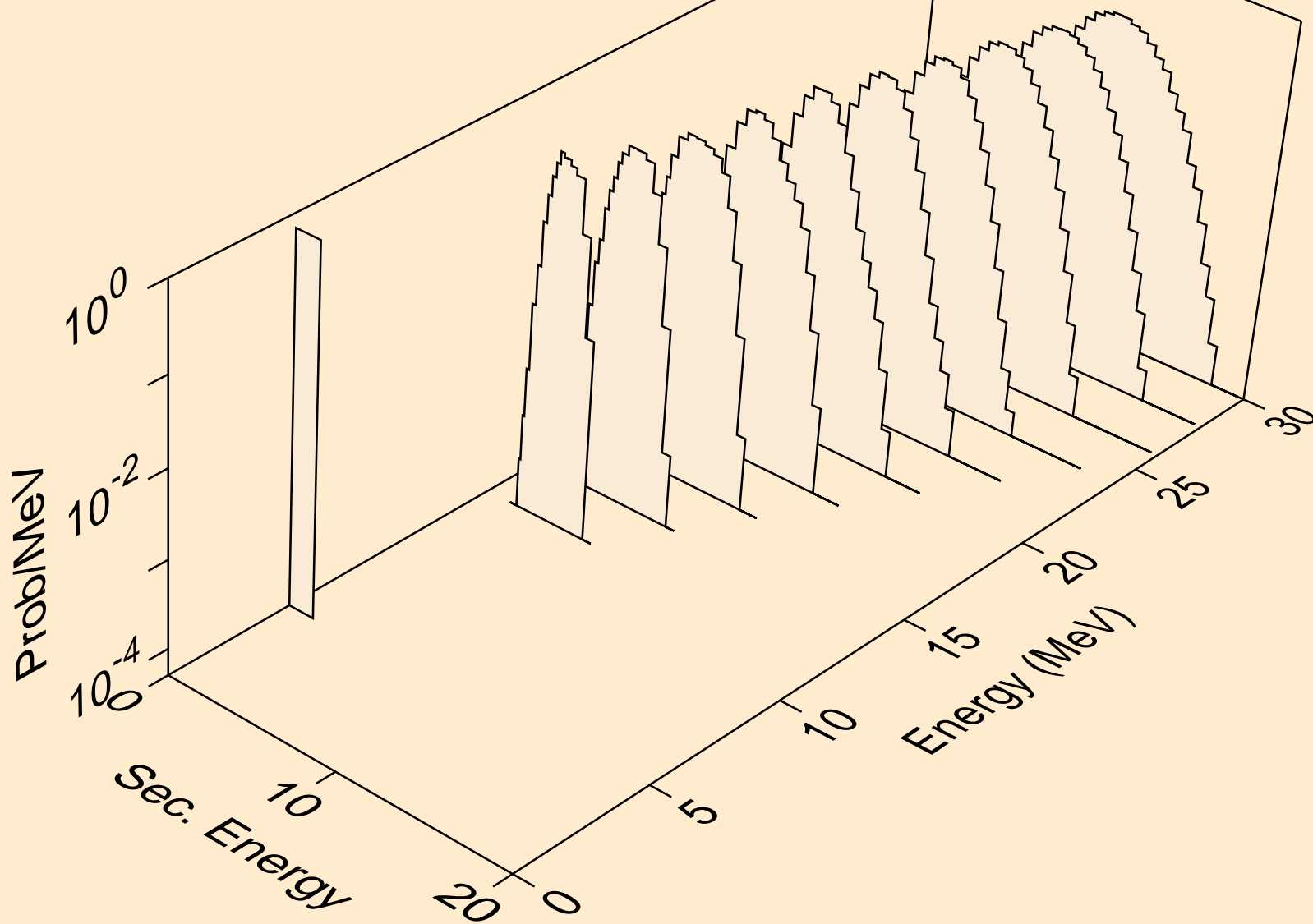

TH227 NEUTRON ACER TENDL-2023 LIBRARY; T=0.K
protons from (n,p)

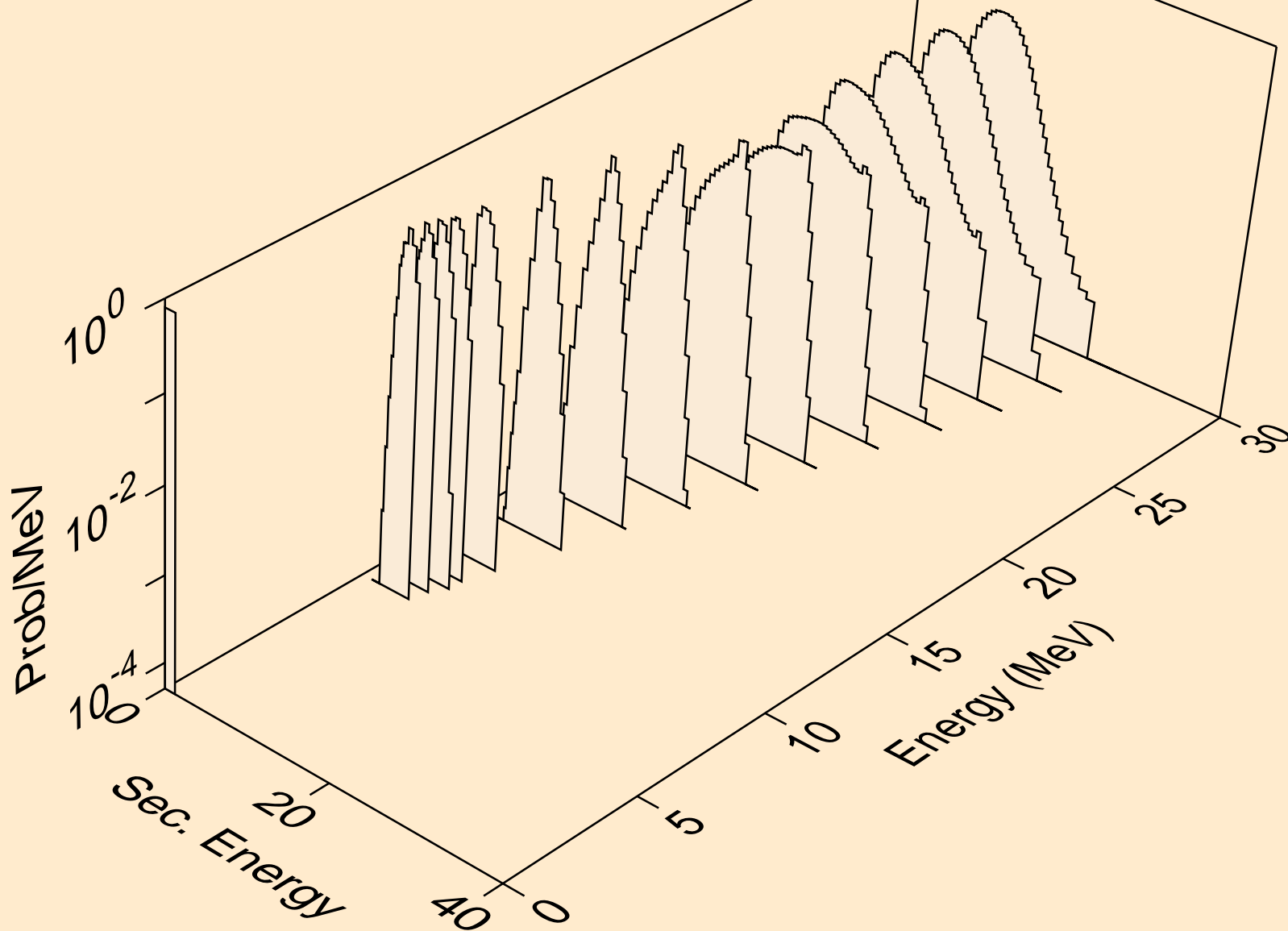

TH227 NEUTRON ACER TENDL-2023 LIBRARY; T=0.K
protons from (n,pd)

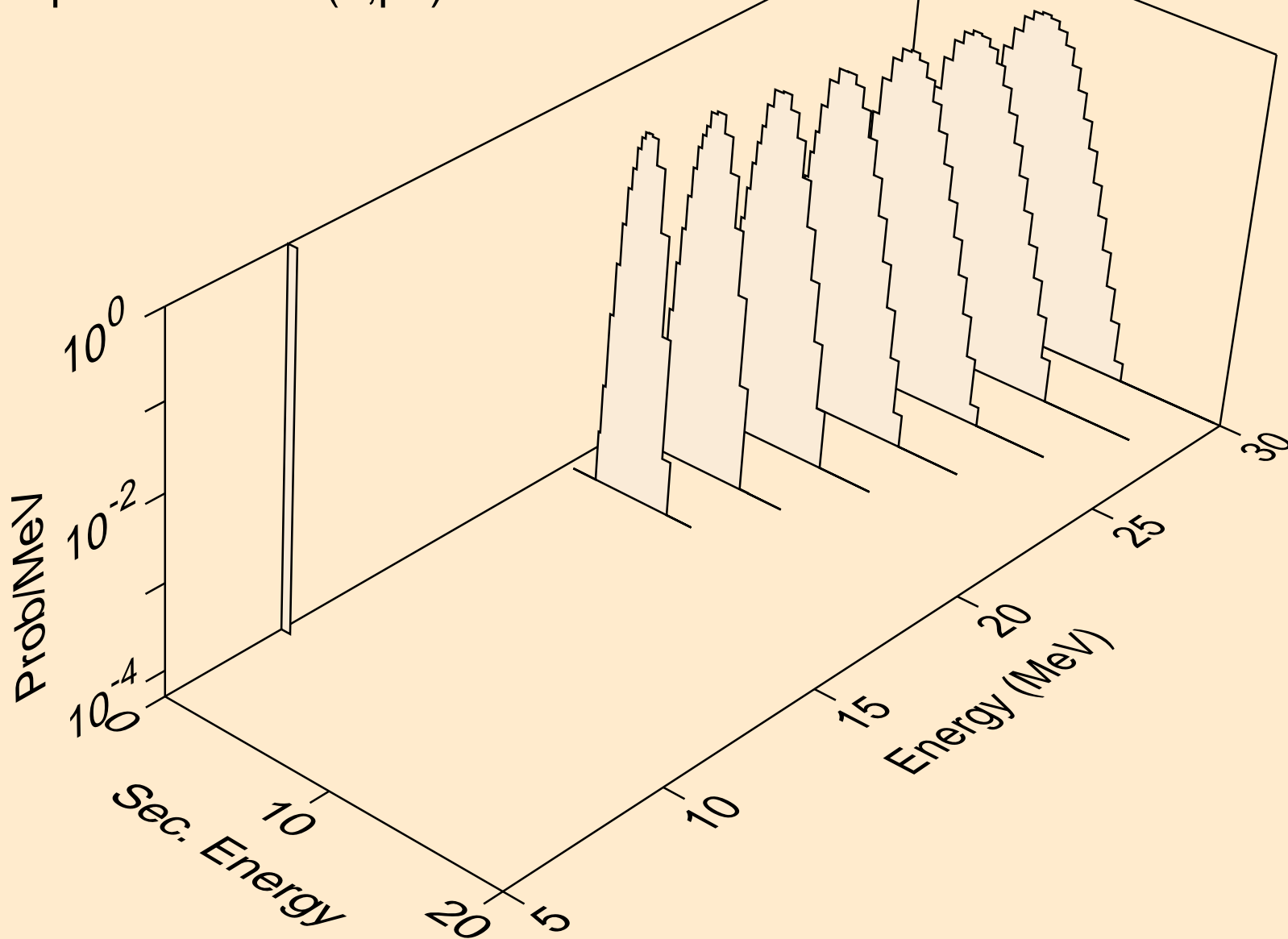

TH227 NEUTRON ACER TENDL-2023 LIBRARY; T=0.K
deuterons from (n,x)

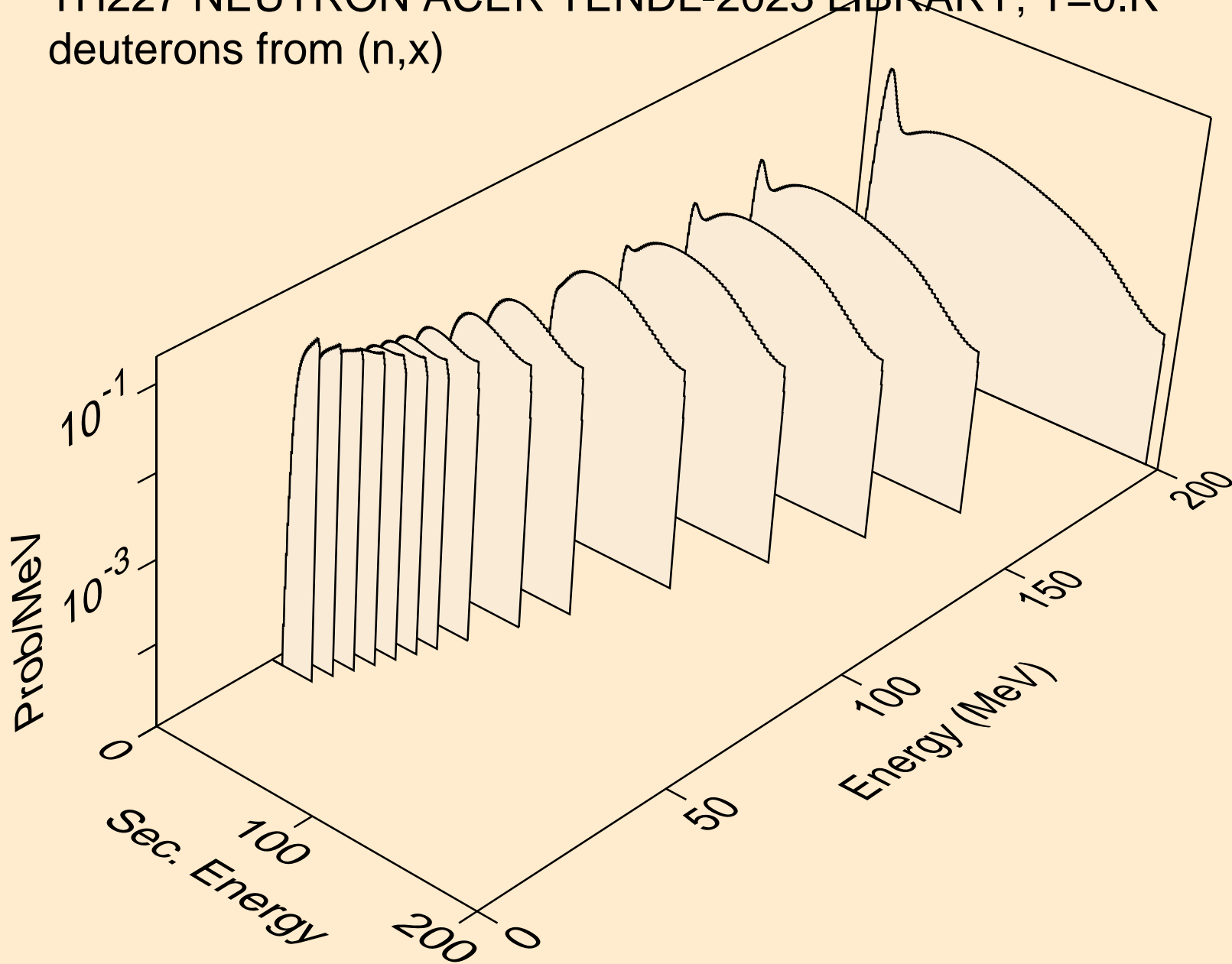

TH227 NEUTRON ACER TENDL-2023 LIBRARY; T=0.K
deuterons from (n,2nd)

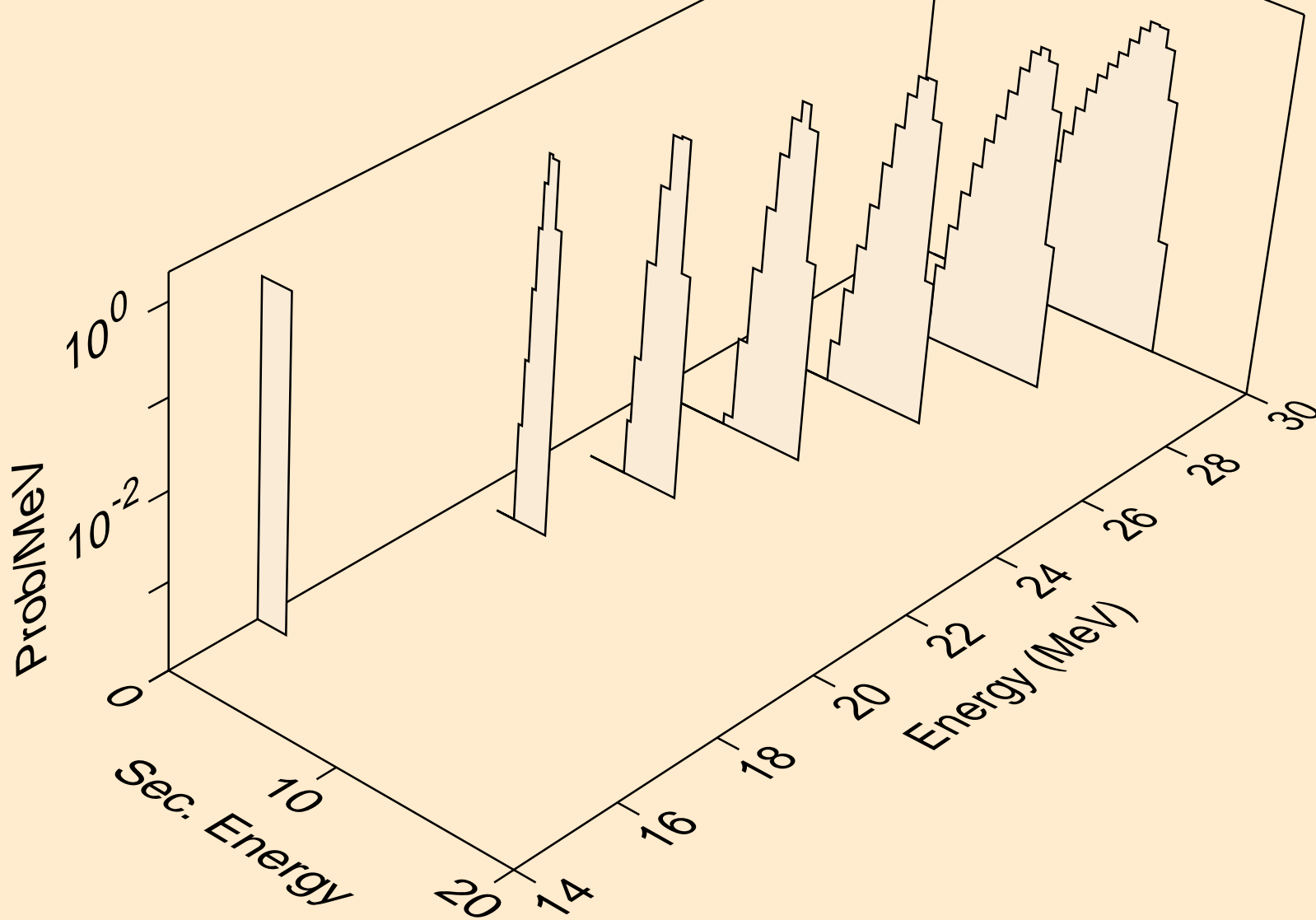

TH227 NEUTRON ACER TENDL-2023 LIBRARY; T=0.K
deuterons from (n,n*)d

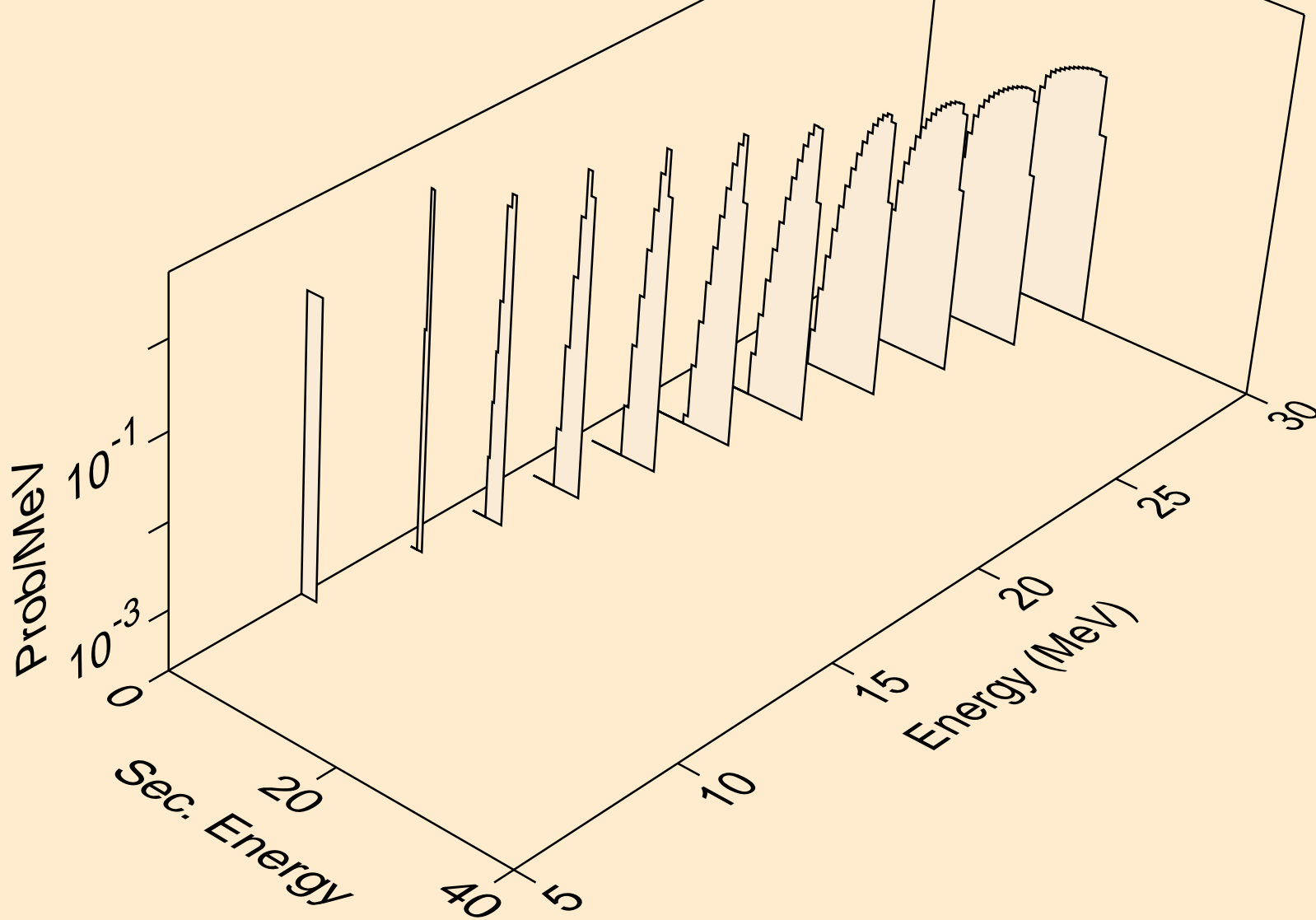

TH227 NEUTRON ACER TENDL-2023 LIBRARY; T=0.K
deuterons from (n,d)

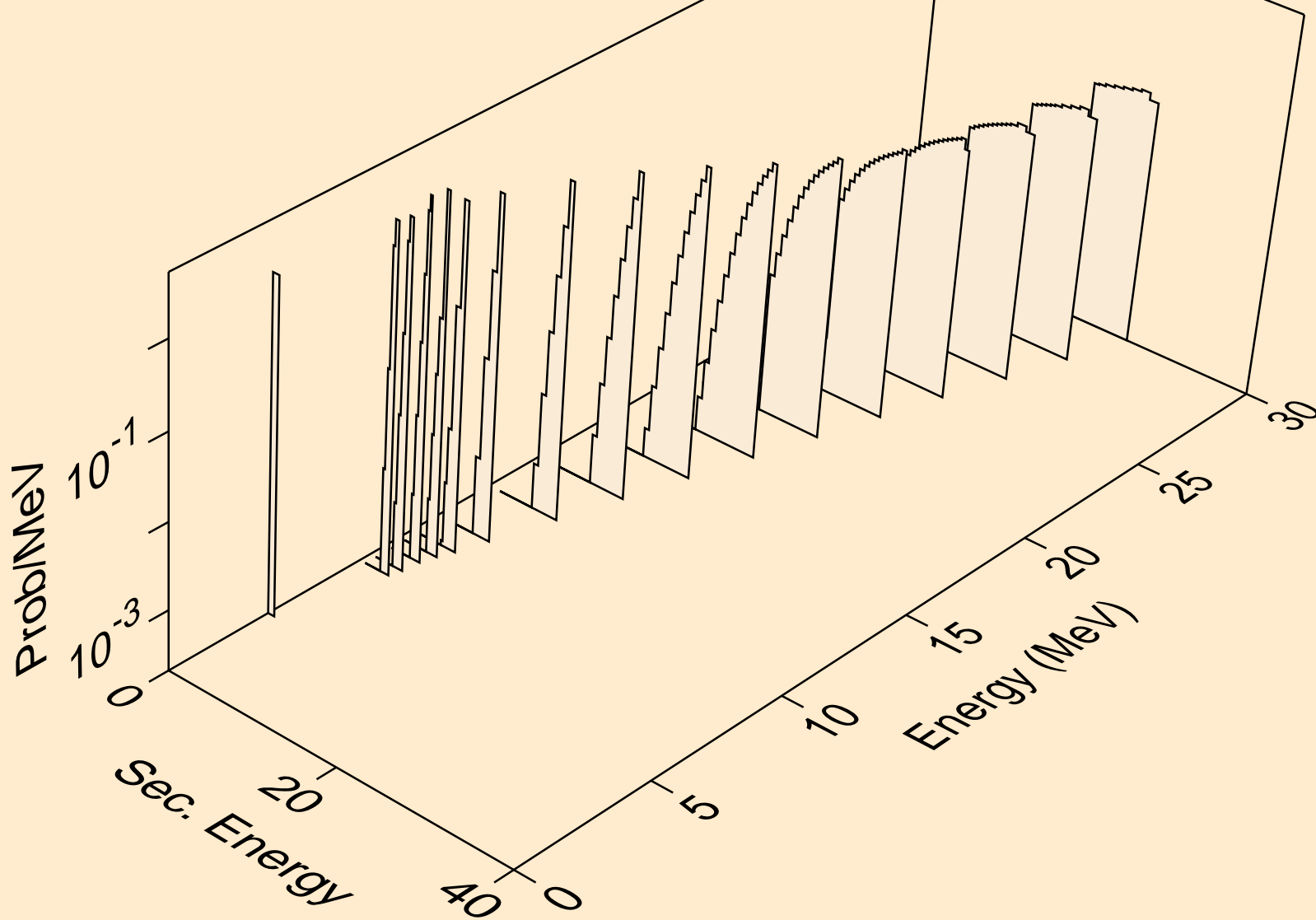

TH227 NEUTRON ACER TENDL-2023 LIBRARY; T=0.K
deuterons from (n,pd)

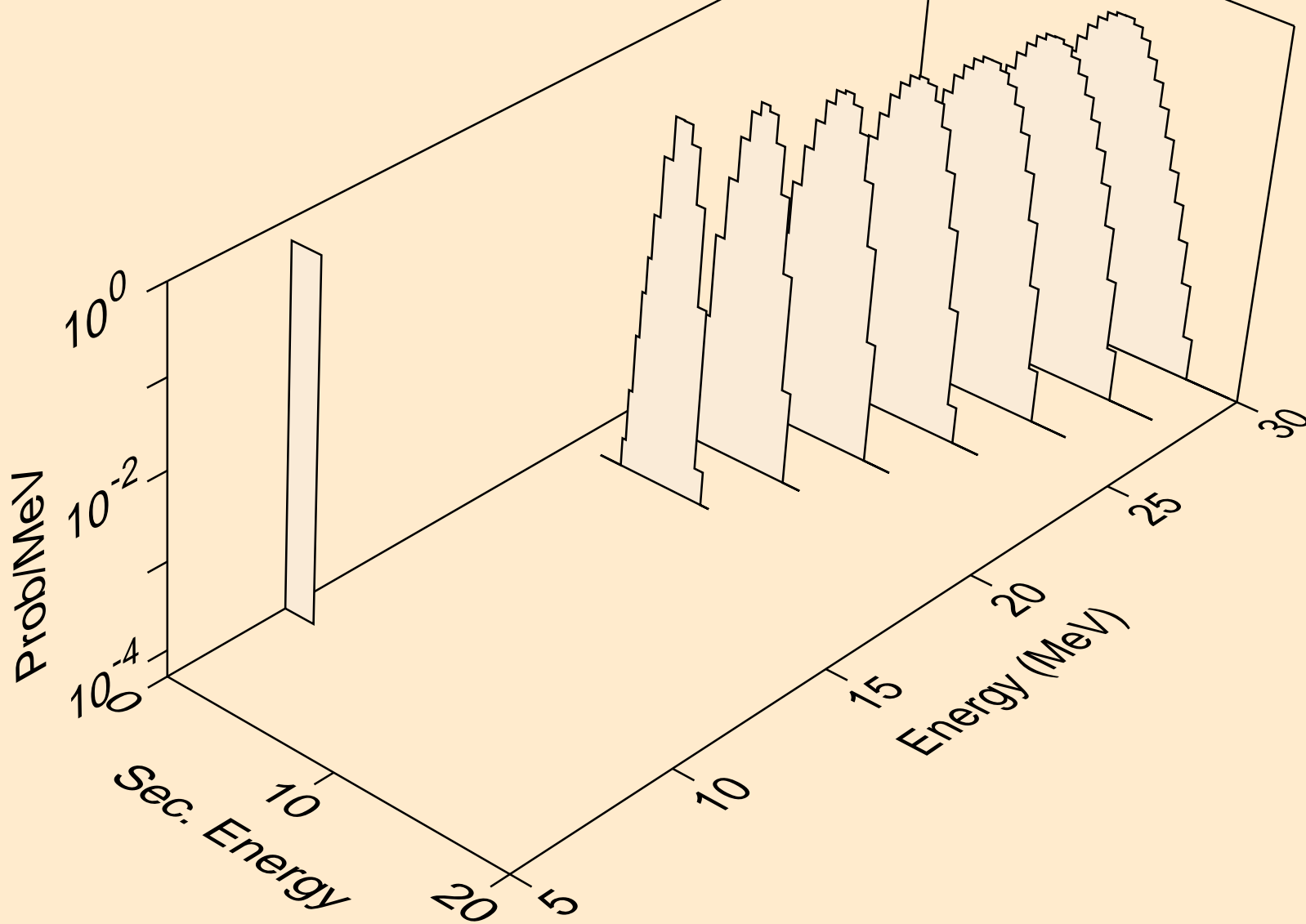

TH227 NEUTRON ACER TENDL-2023 LIBRARY; T=0.K
tritons from (n,x)

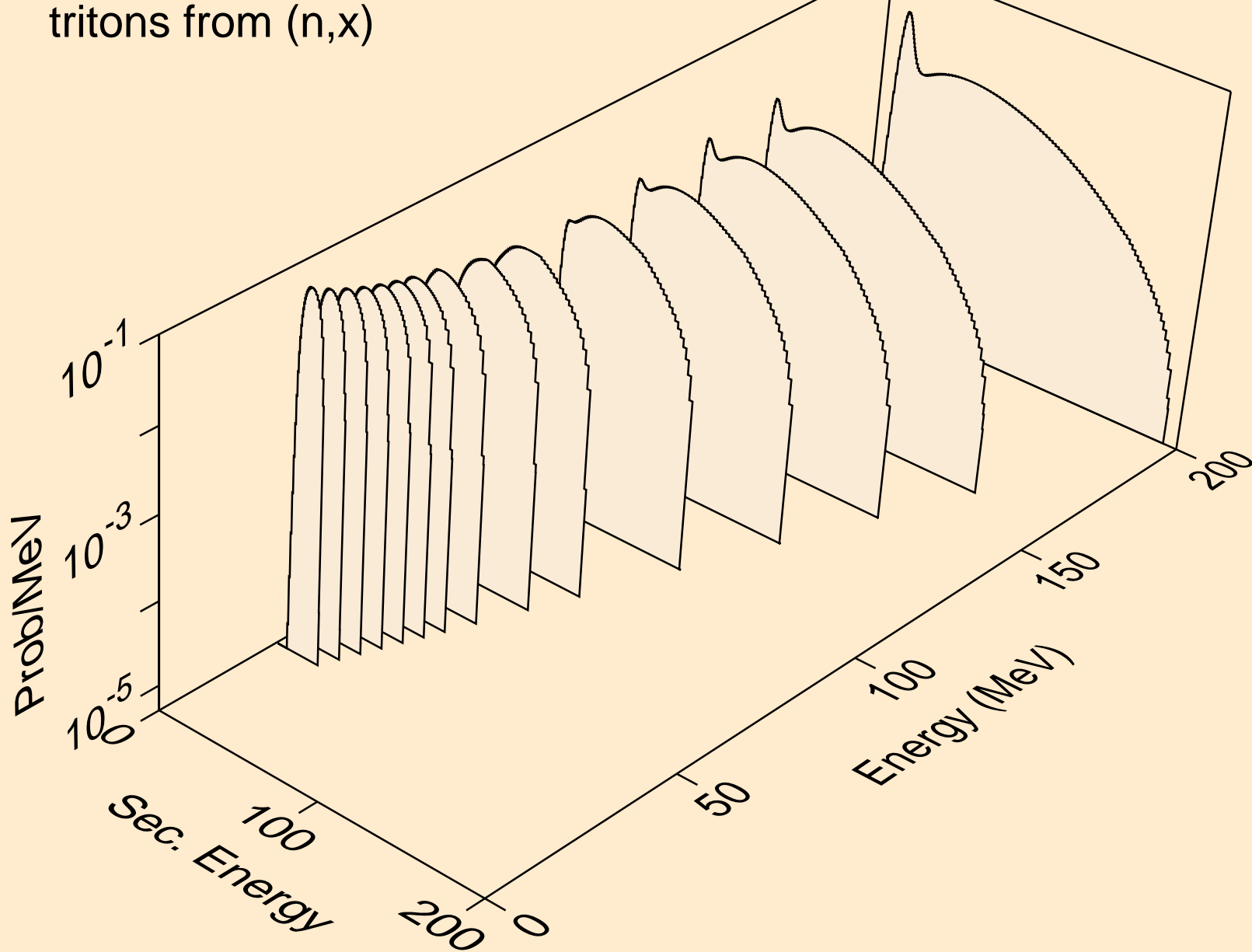

TH227 NEUTRON ACER TENDL-2023 LIBRARY; T=0.K
tritons from (n,n*)t

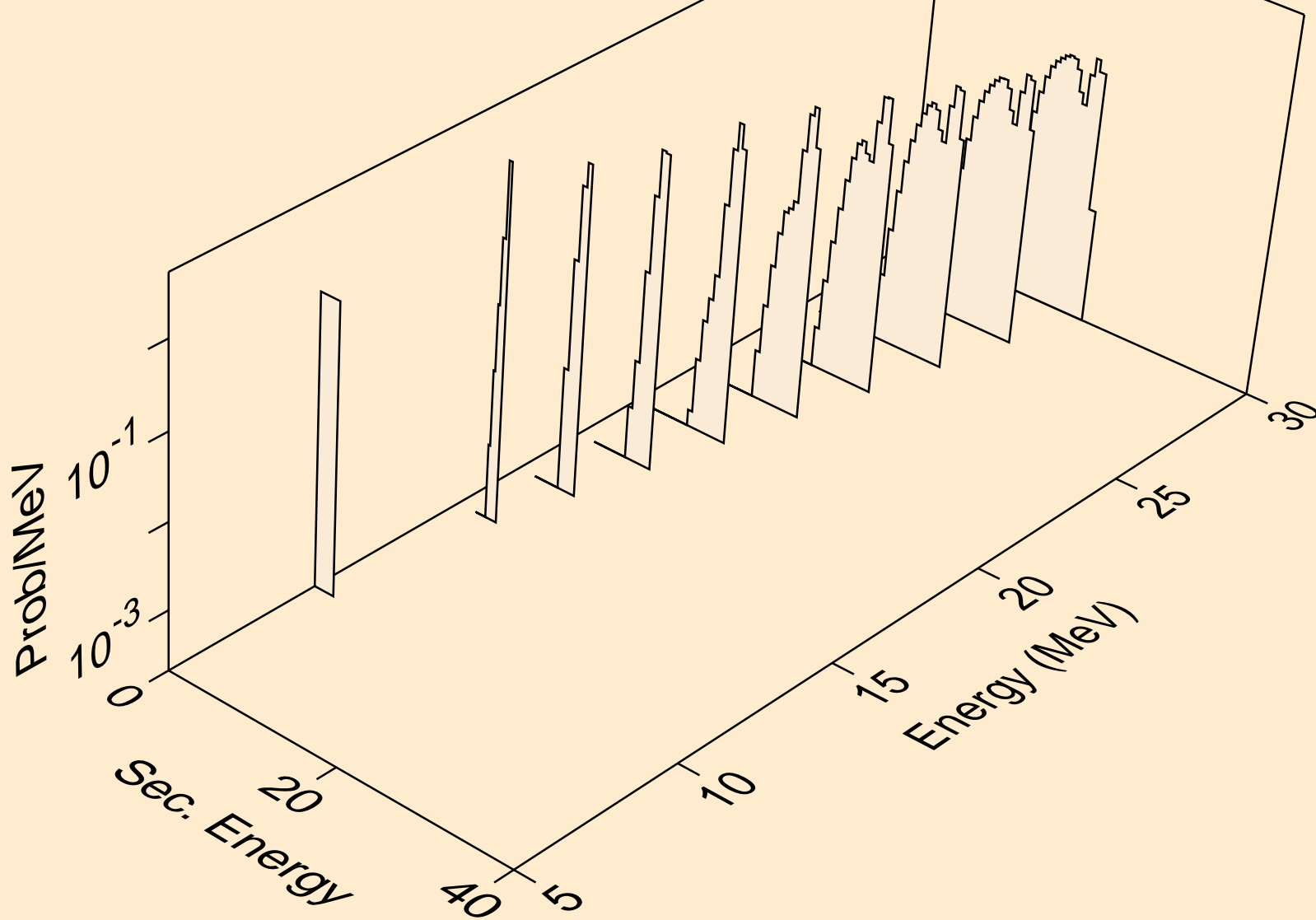

TH227 NEUTRON ACER TENDL-2023 LIBRARY; T=0.K
tritons from (n,t)

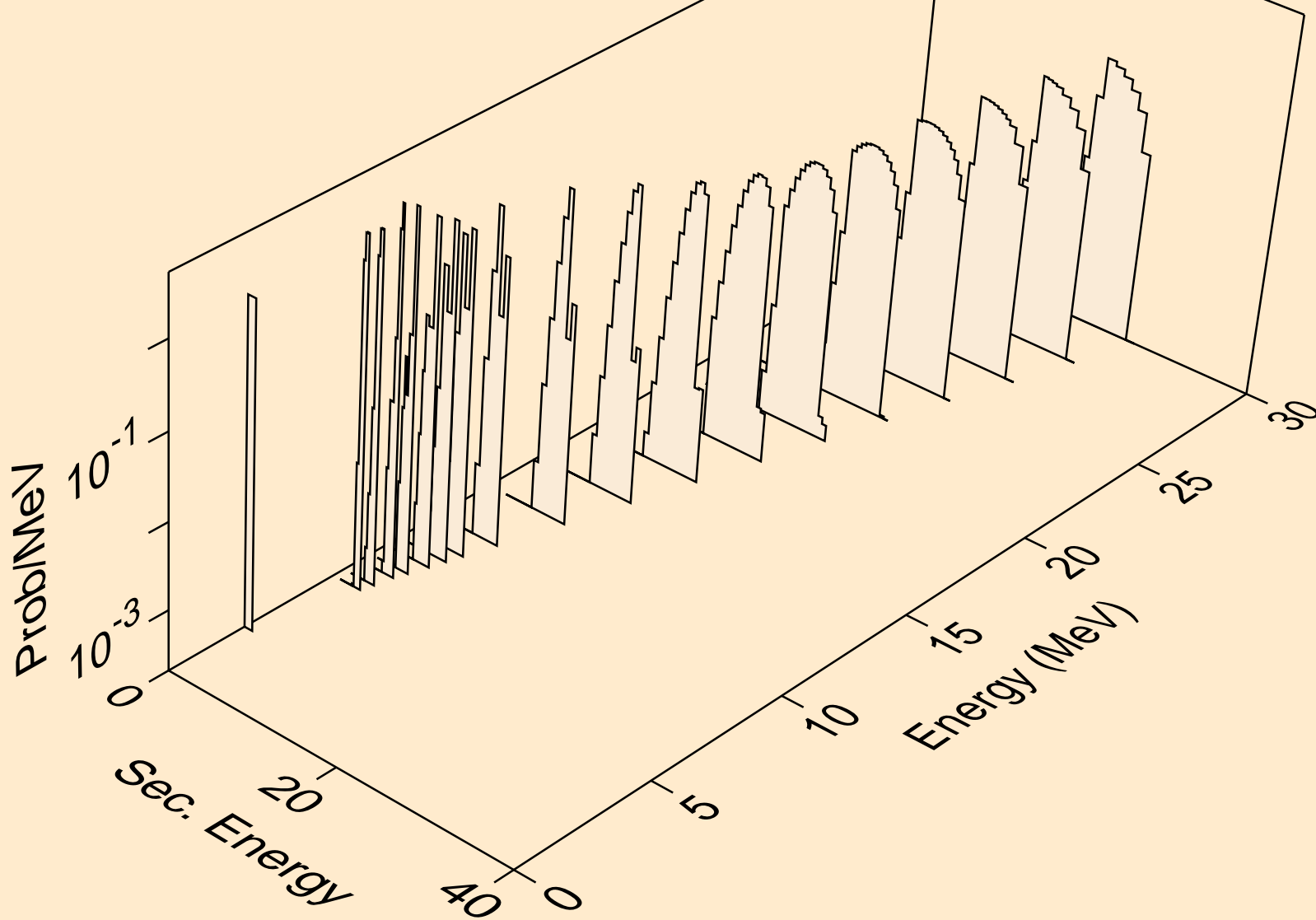

TH227 NEUTRON ACER TENDL-2023 LIBRARY; T=0.K
he3s from (n,x)

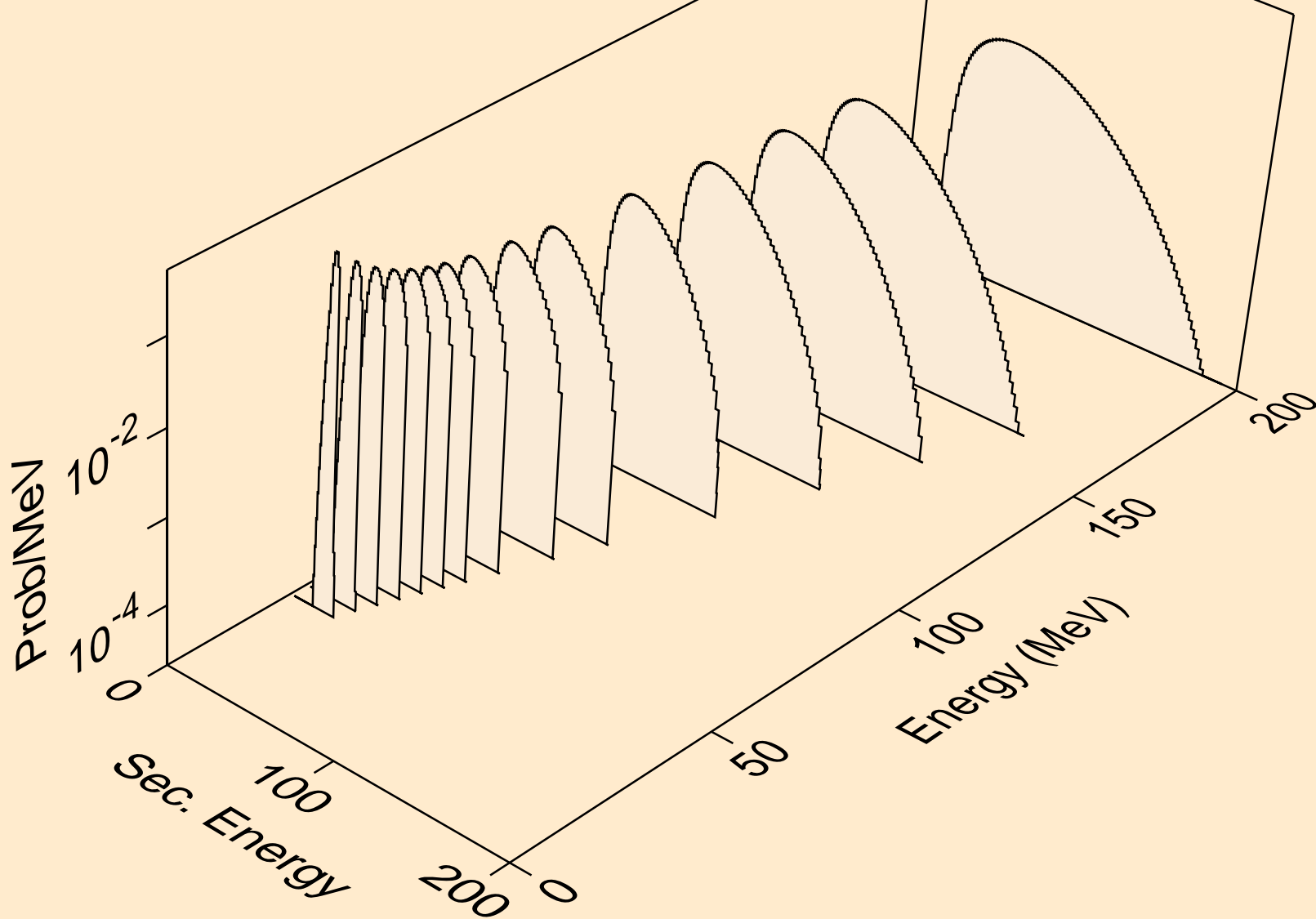

TH227 NEUTRON ACER TENDL-2023 LIBRARY; T=0.K
he3s from (n,n*)he3

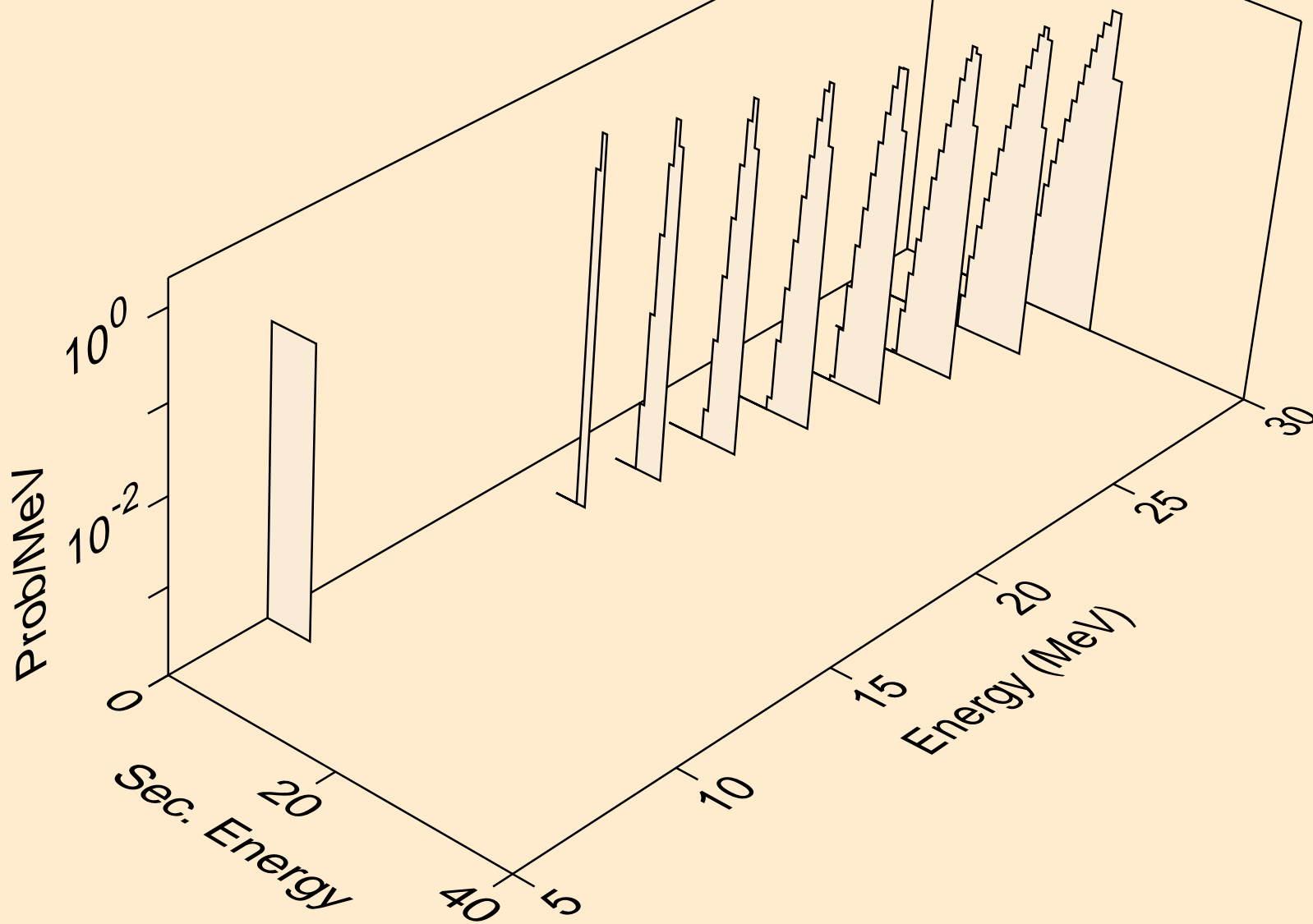

TH227 NEUTRON ACER TENDL-2023 LIBRARY; T=0.K
he3s from (n,he3)

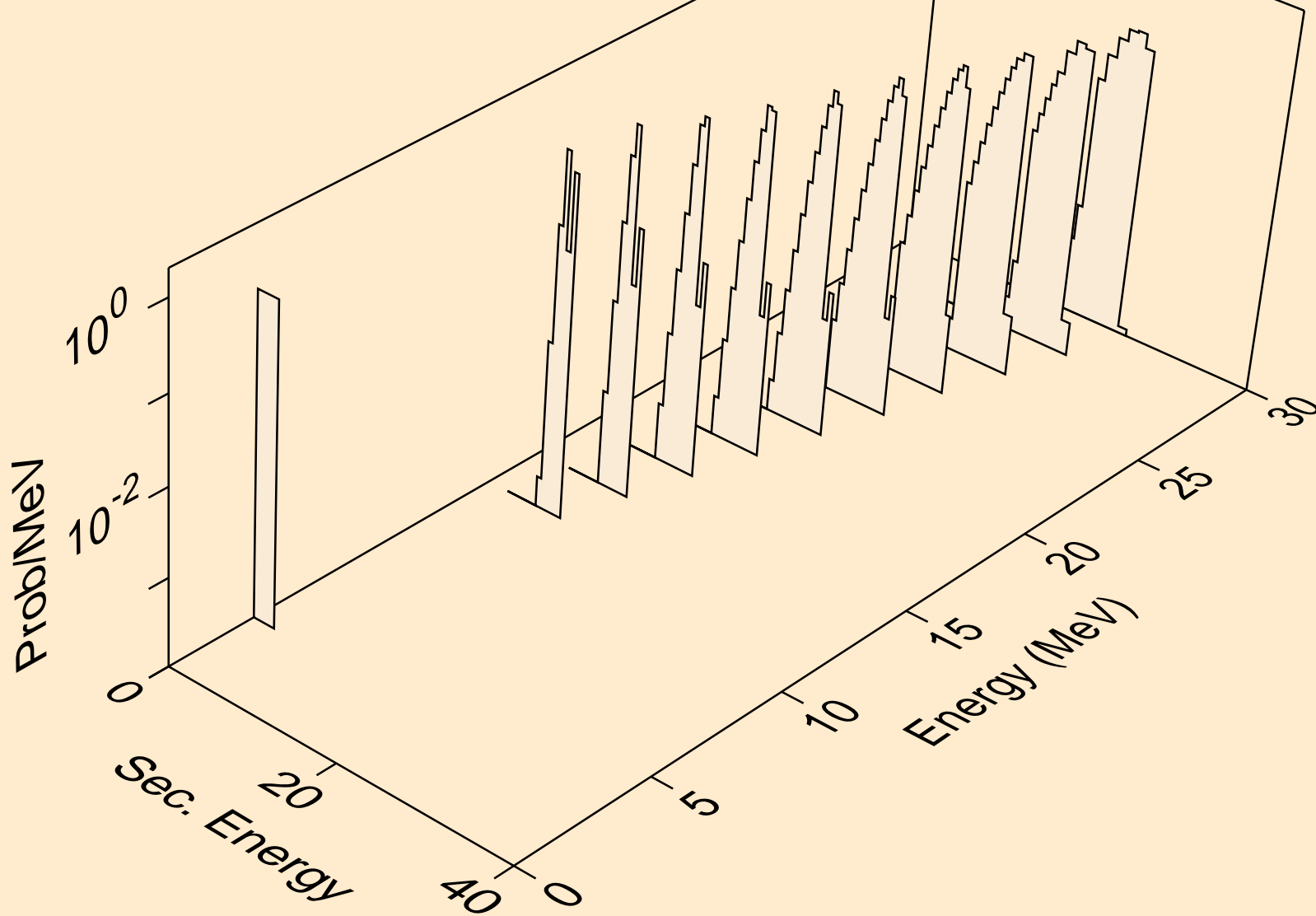

TH227 NEUTRON ACER TENDL-2023 LIBRARY; T=0.K
alphas from (n,x)

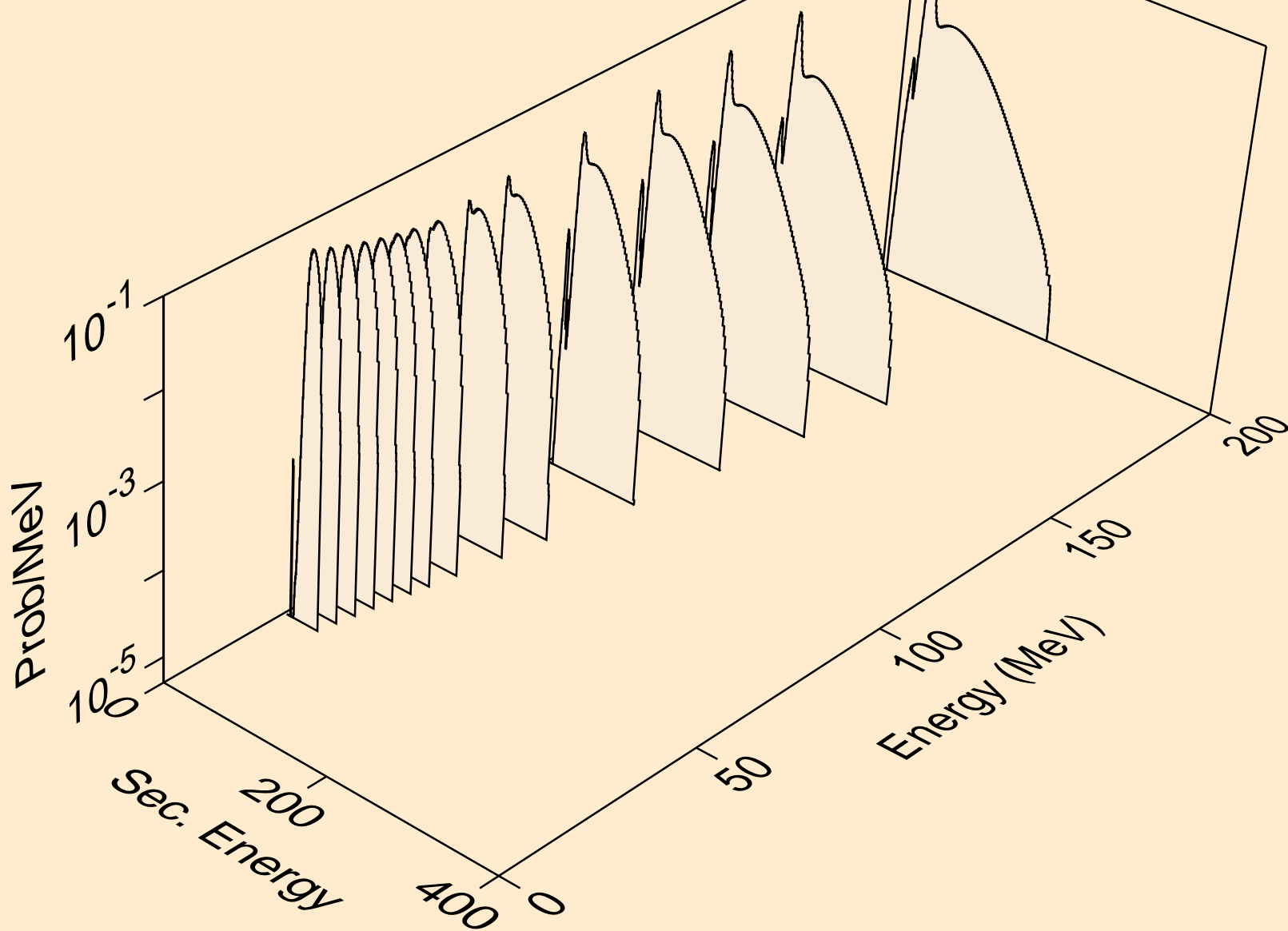

TH227 NEUTRON ACER TENDL-2023 LIBRARY; T=0.K
alphas from (n,n*)a

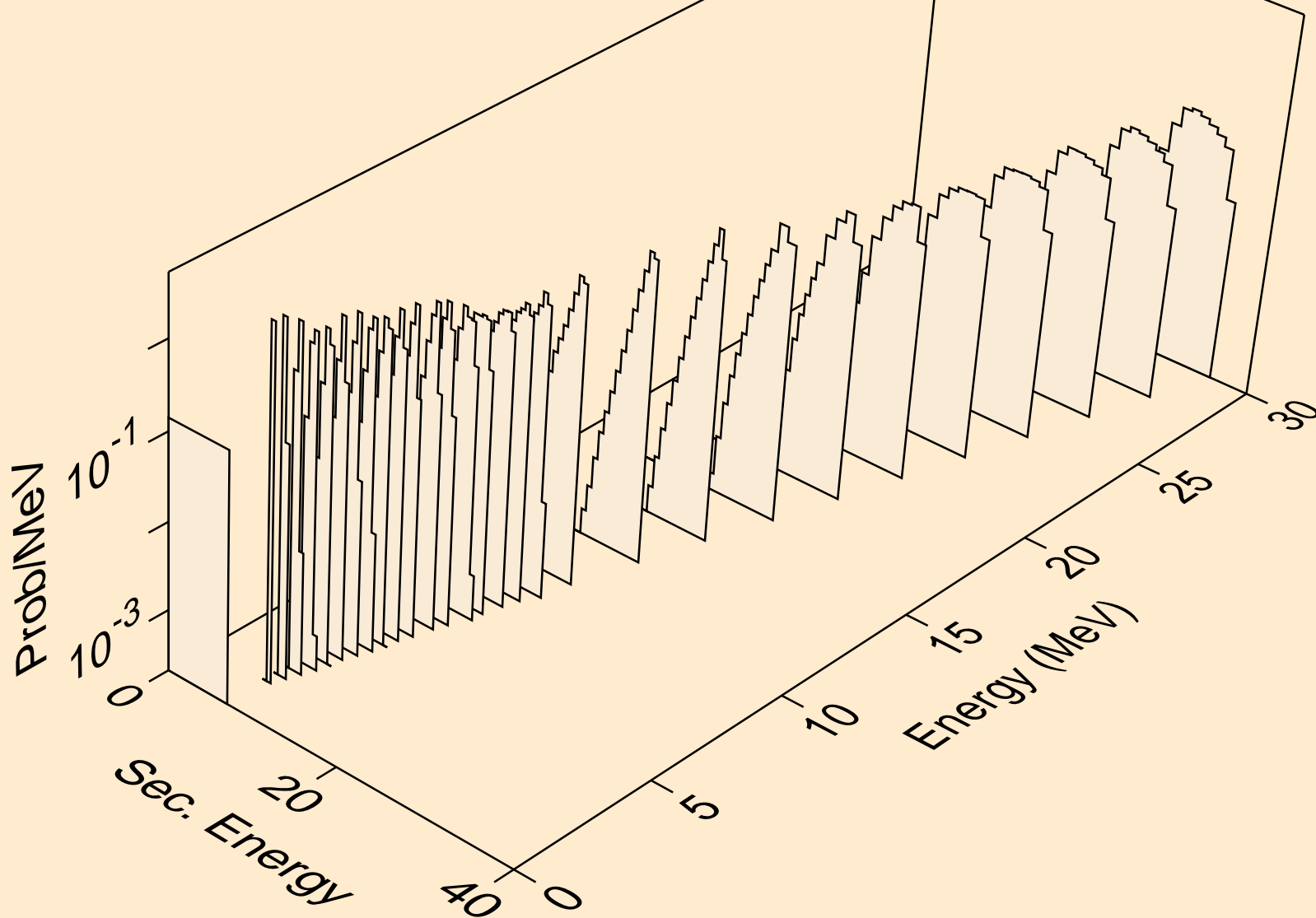

TH227 NEUTRON ACER TENDL-2023 LIBRARY; T=0.K
alphas from (n,2n)a

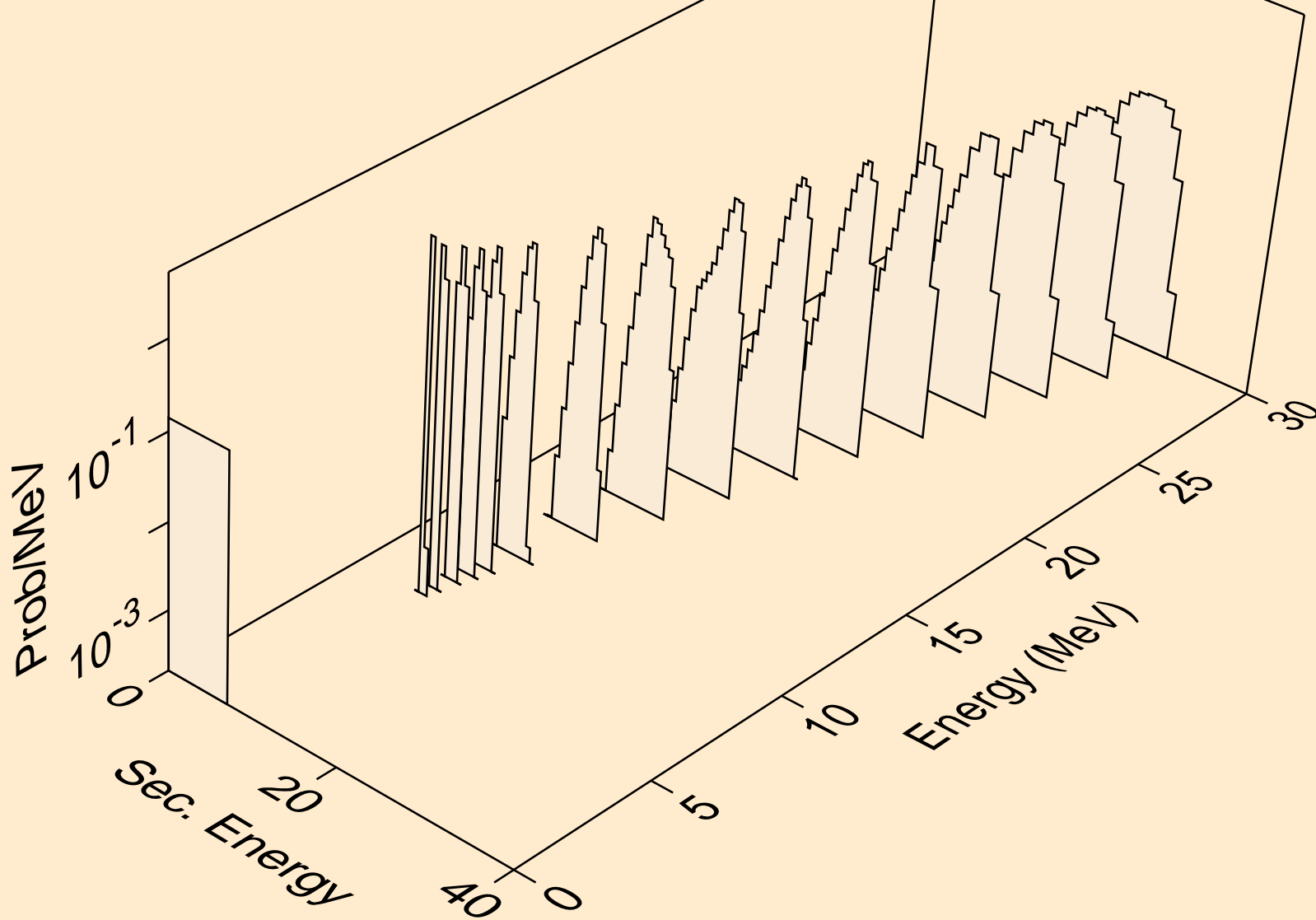

TH227 NEUTRON ACER TENDL-2023 LIBRARY; T=0.K
alphas from (n,3n)a

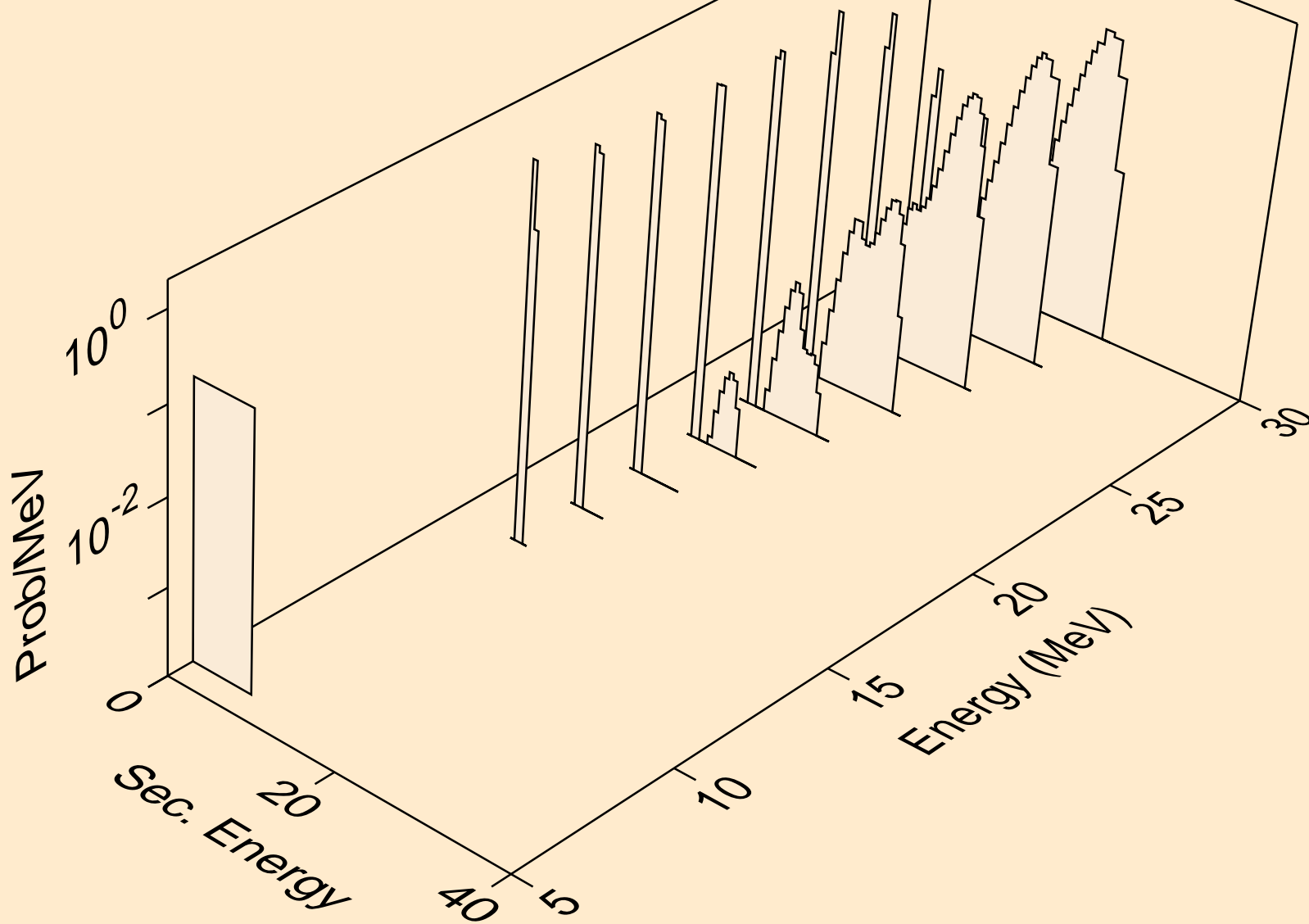

TH227 NEUTRON ACER TENDL-2023 LIBRARY; T=0.K
alphas from (n,n*)2a

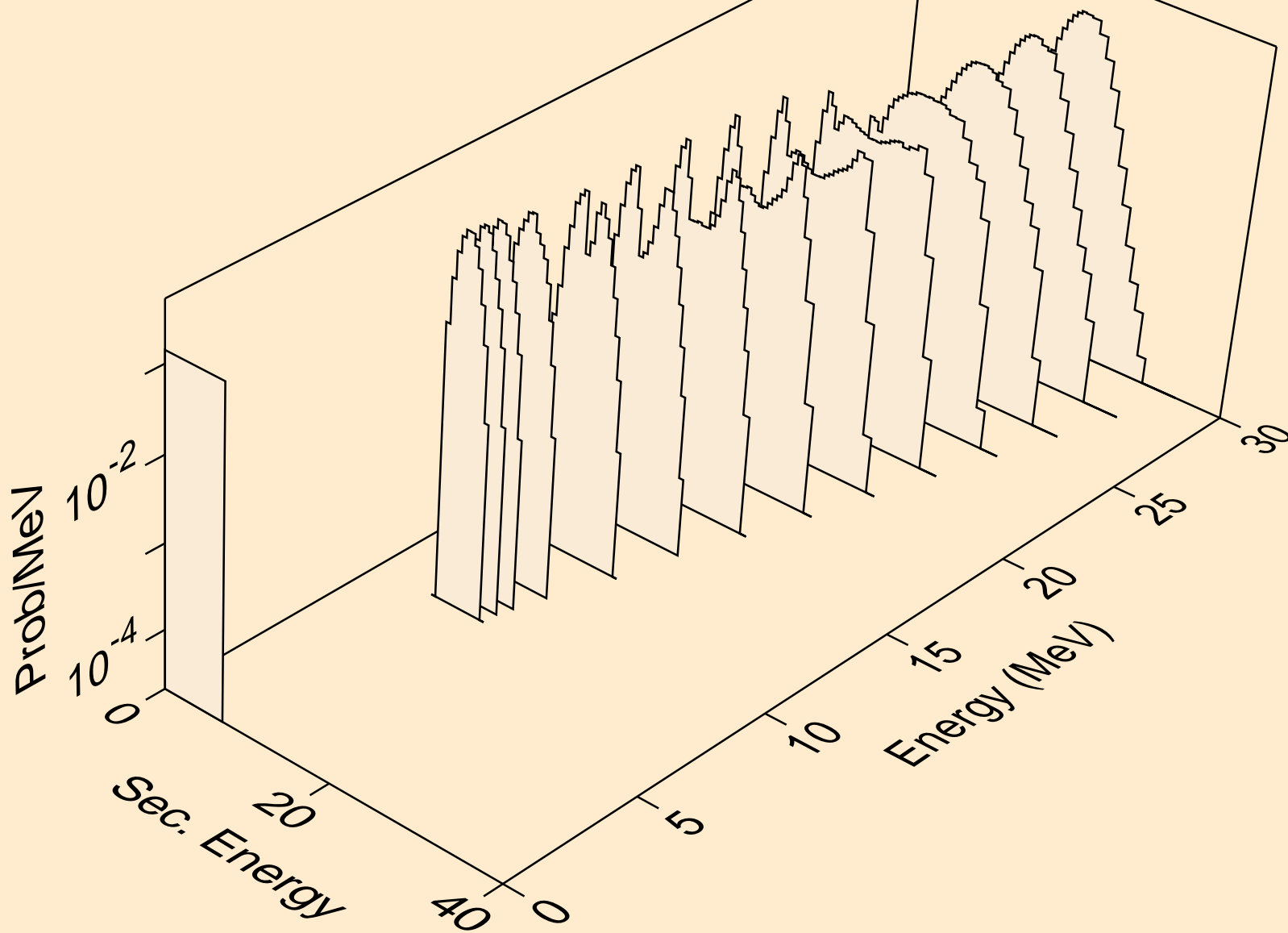

TH227 NEUTRON ACER TENDL-2023 LIBRARY; T=0.K
alphas from (n,2n)2a

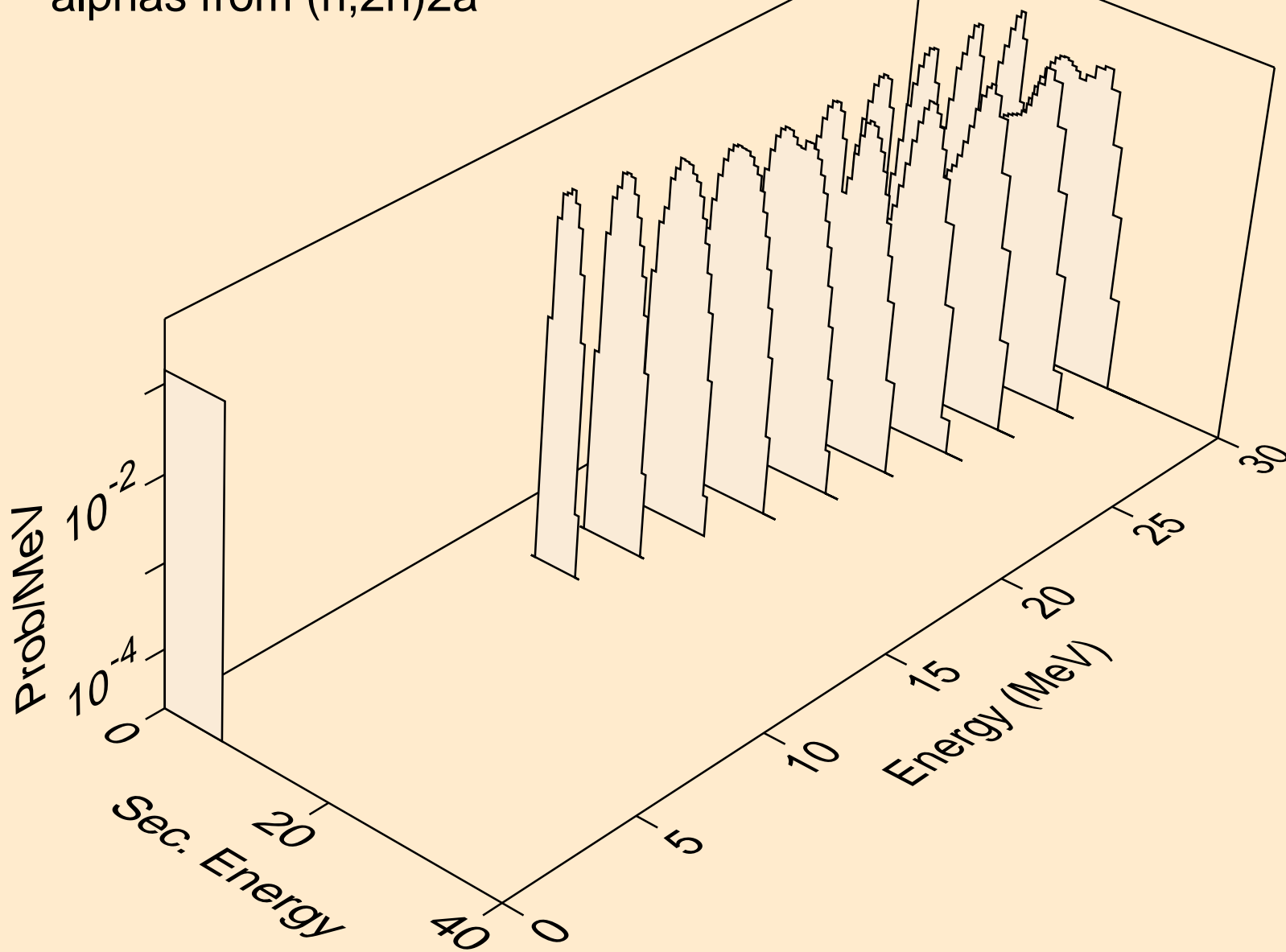

TH227 NEUTRON ACER TENDL-2023 LIBRARY; T=0.K
alphas from (n,npa)

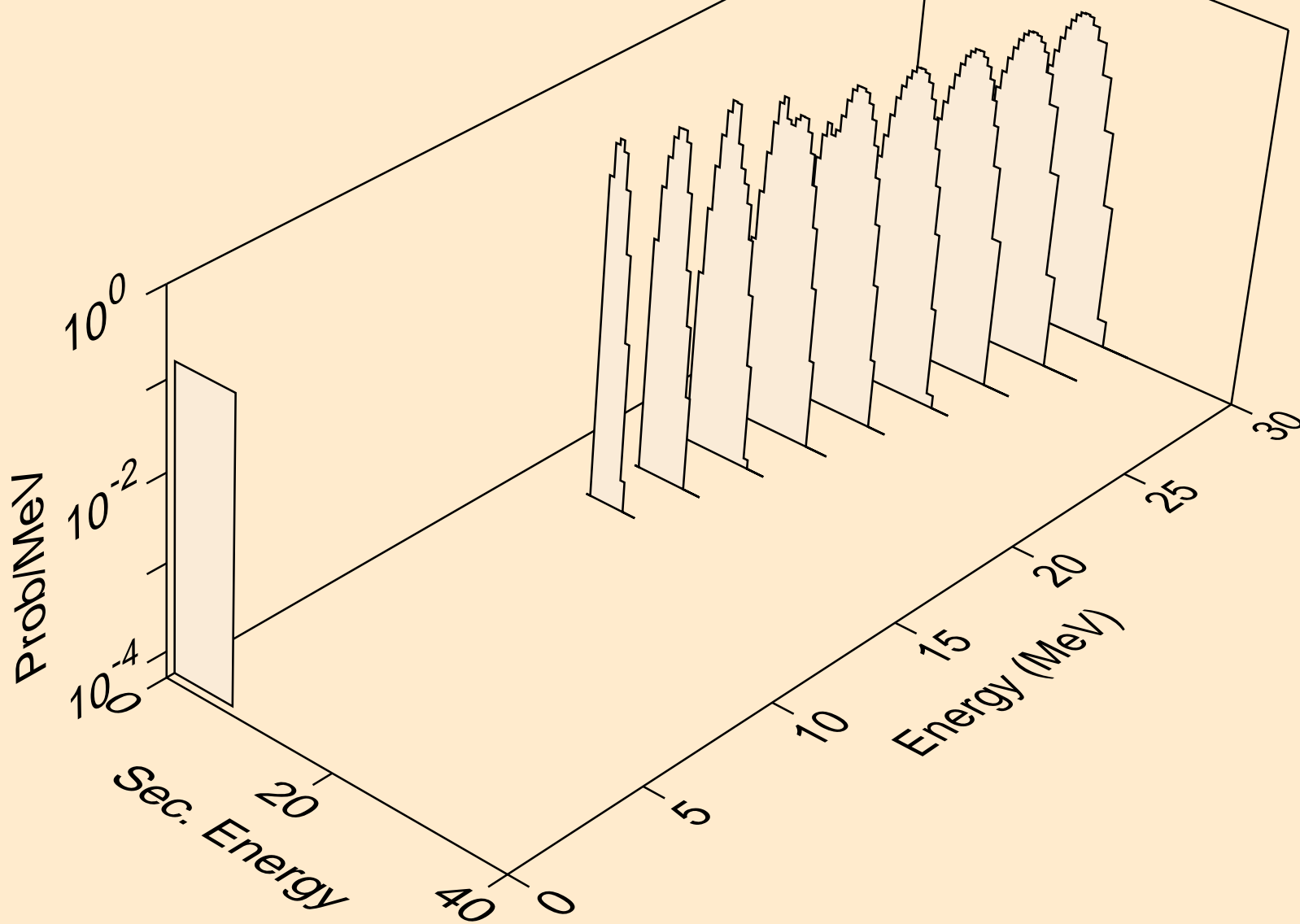

TH227 NEUTRON ACER TENDL-2023 LIBRARY; T=0.K
alphas from (n,a)

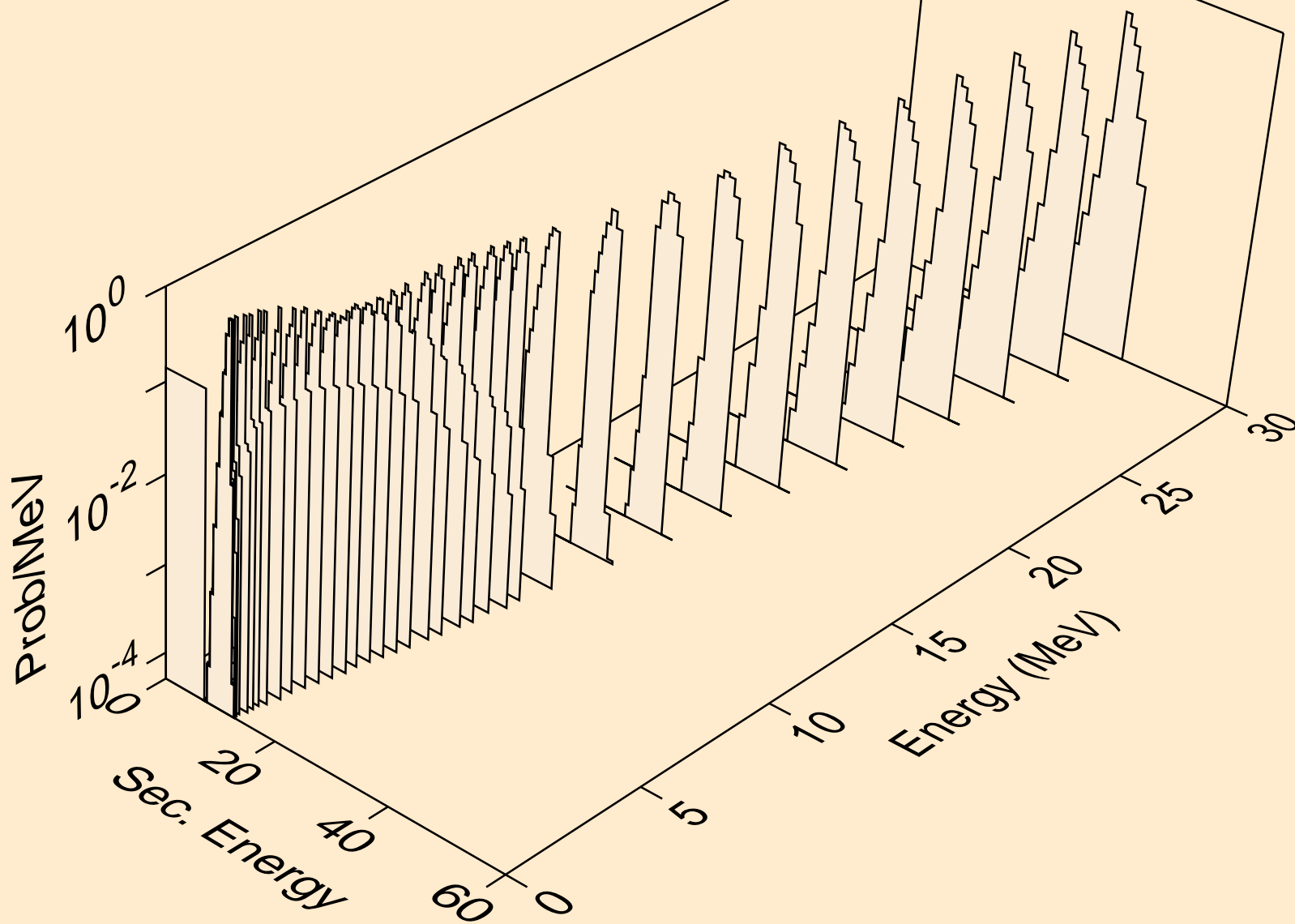

TH227 NEUTRON ACER TENDL-2023 LIBRARY; T=0.K
alphas from (n,2a)

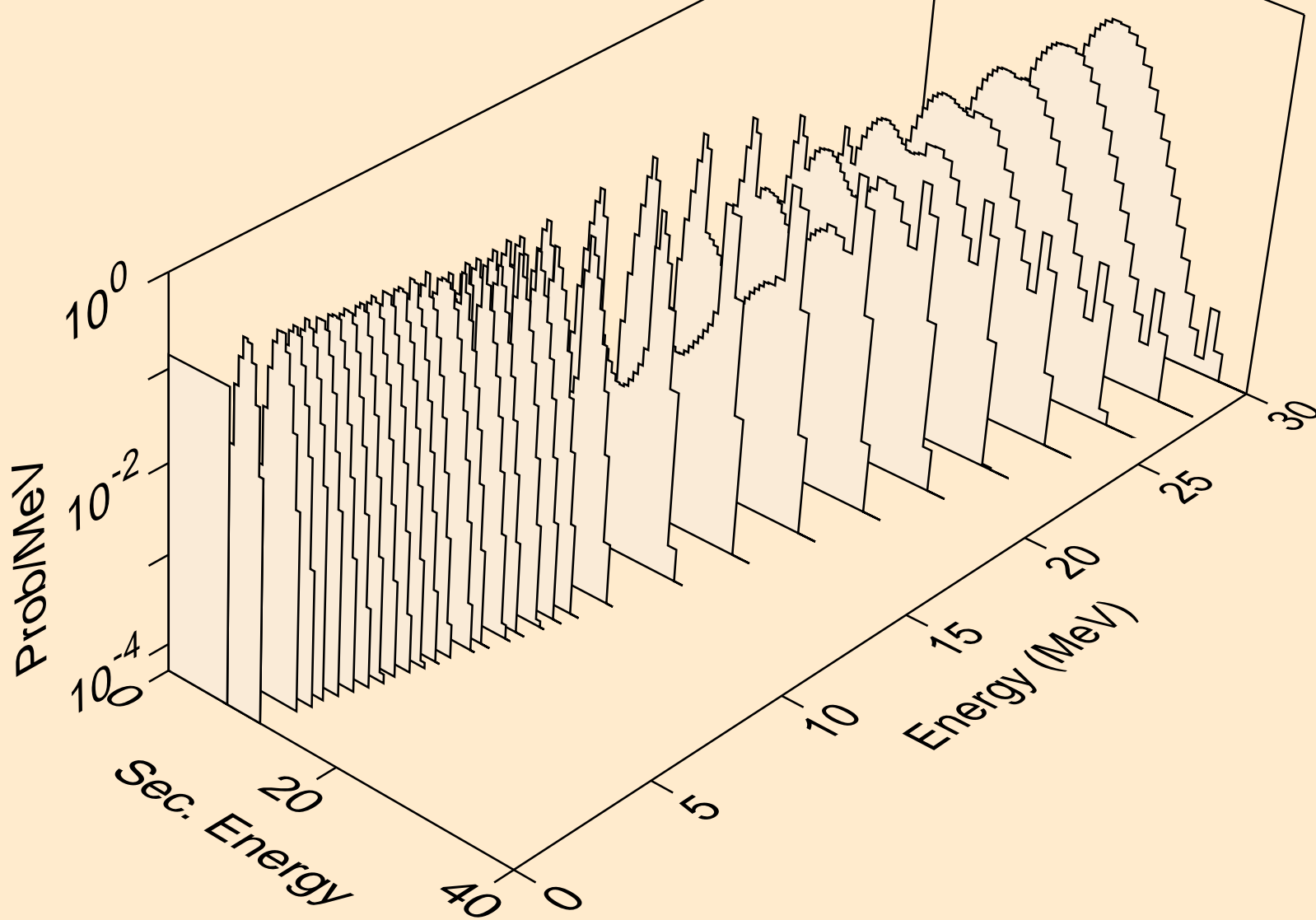

TH227 NEUTRON ACER TENDL-2023 LIBRARY; T=0.K
alphas from (n,pa)

