

# TH235 NEUTRON ACER TENDL-2023 LIBRARY; T=0.K

## Principal cross sections

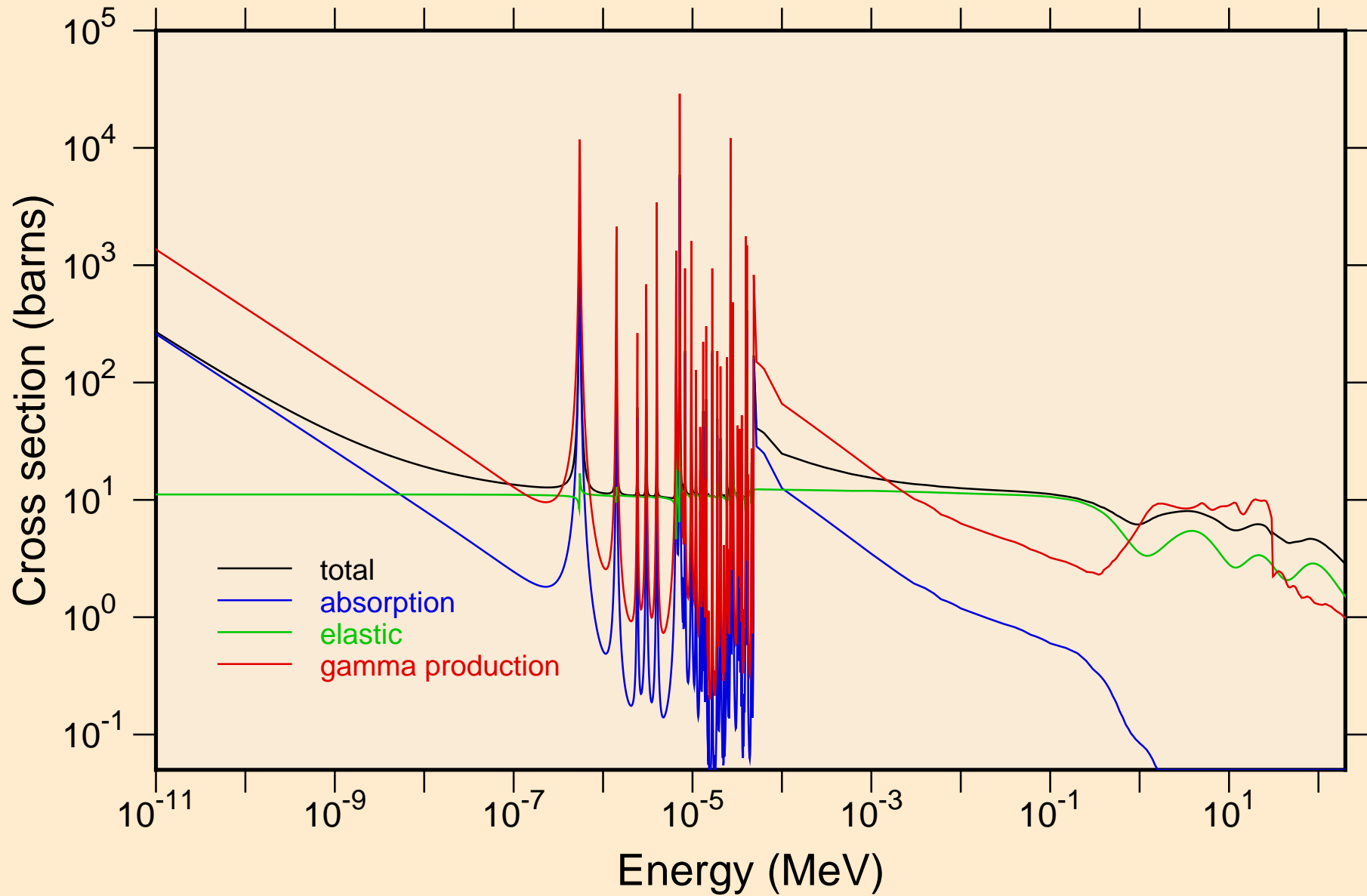

TH235 NEUTRON ACER TENDL-2023 LIBRARY; T=0.K  
resonance total cross section

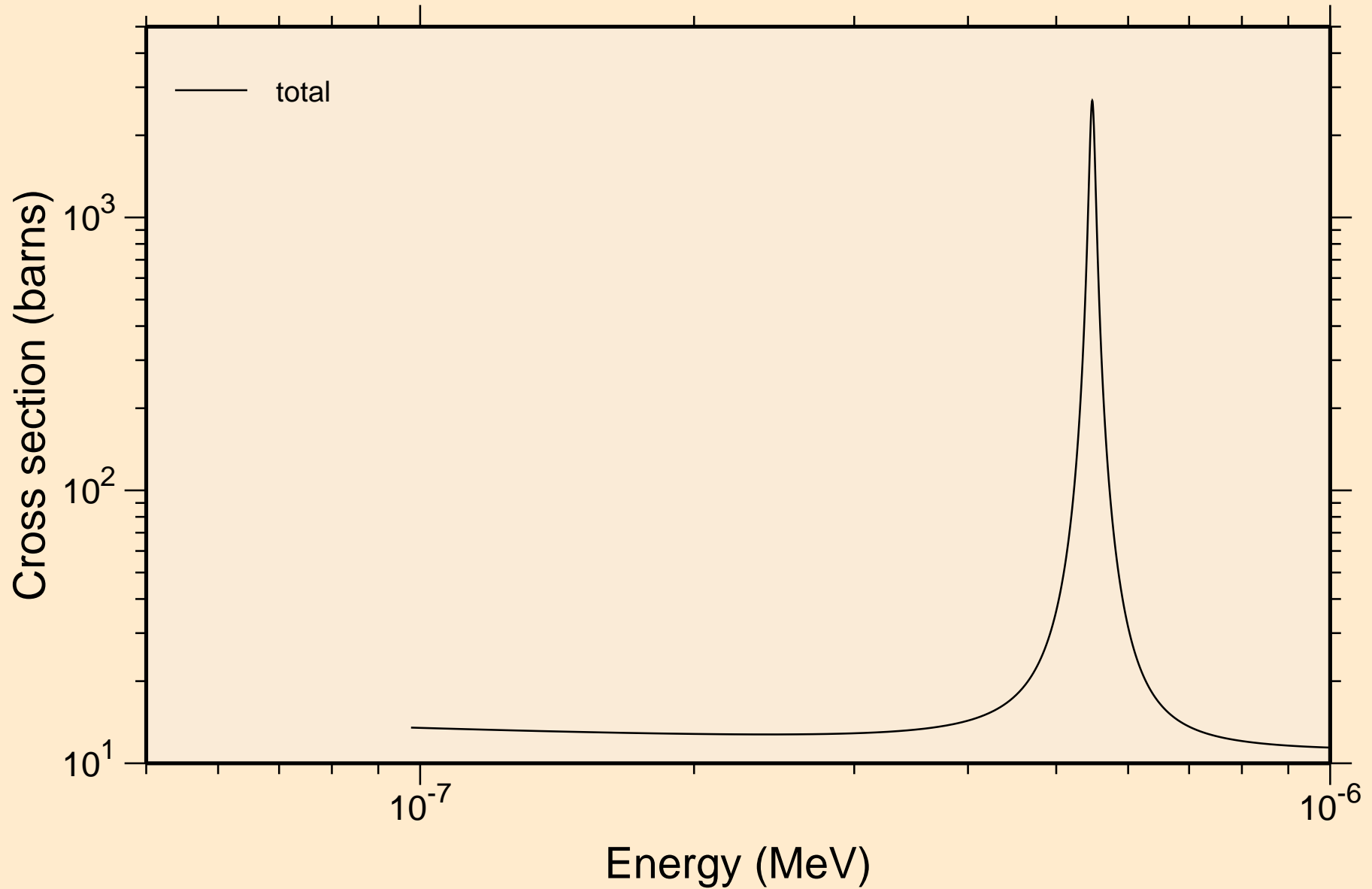

TH235 NEUTRON ACER TENDL-2023 LIBRARY; T=0.K  
resonance total cross section

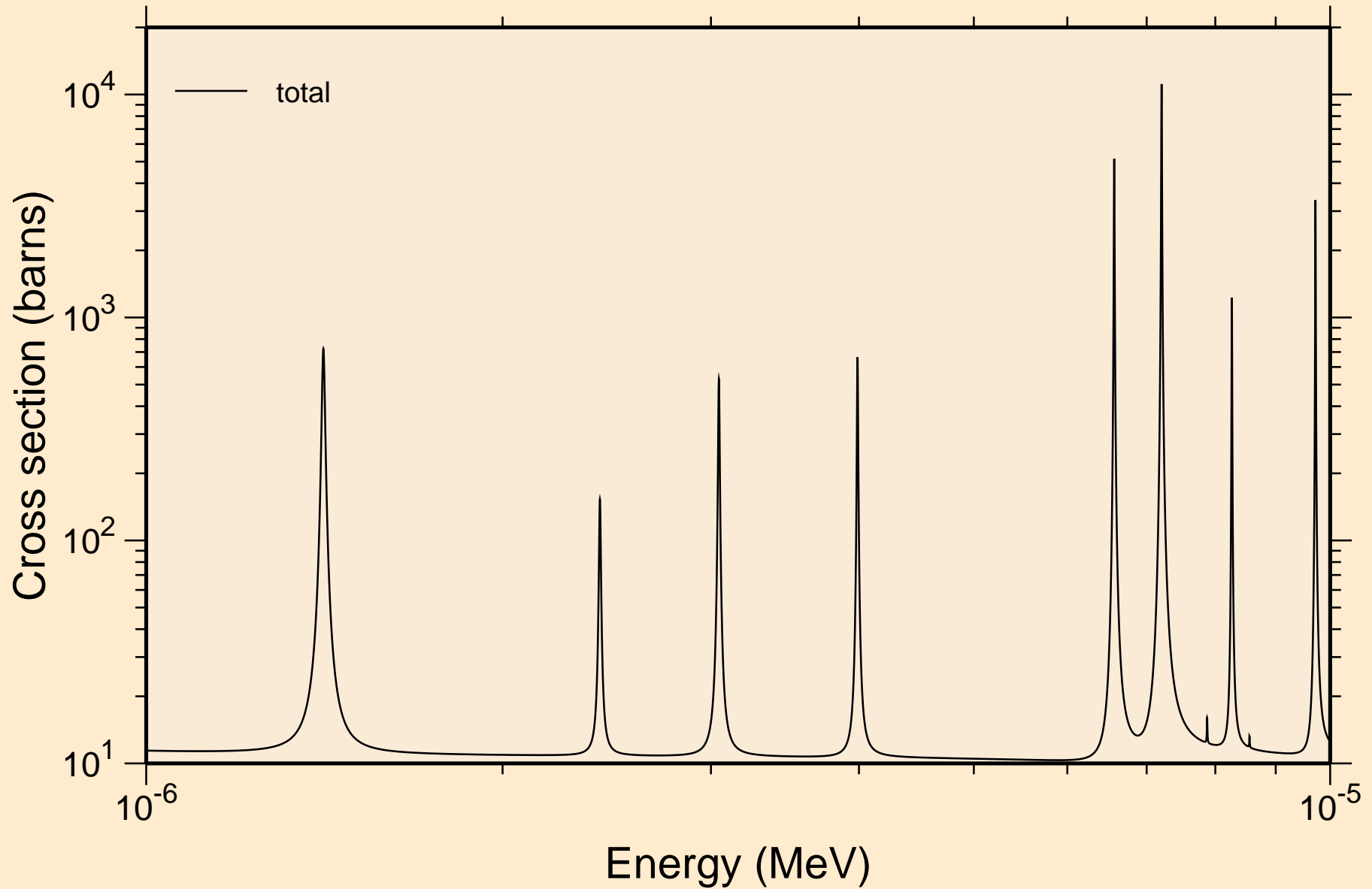

TH235 NEUTRON ACER TENDL-2023 LIBRARY; T=0.K  
resonance total cross section

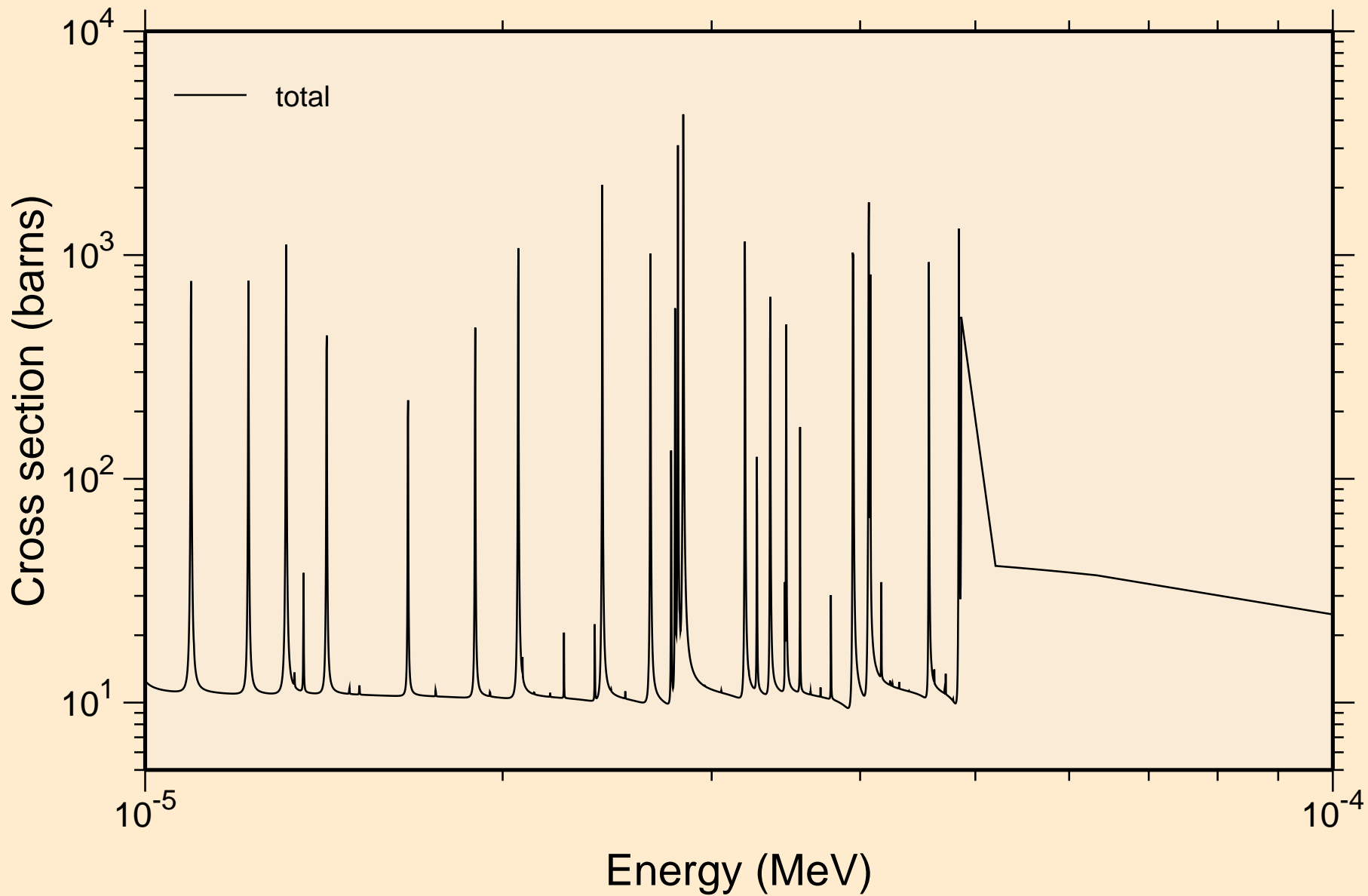

TH235 NEUTRON ACER TENDL-2023 LIBRARY; T=0.K  
resonance total cross section

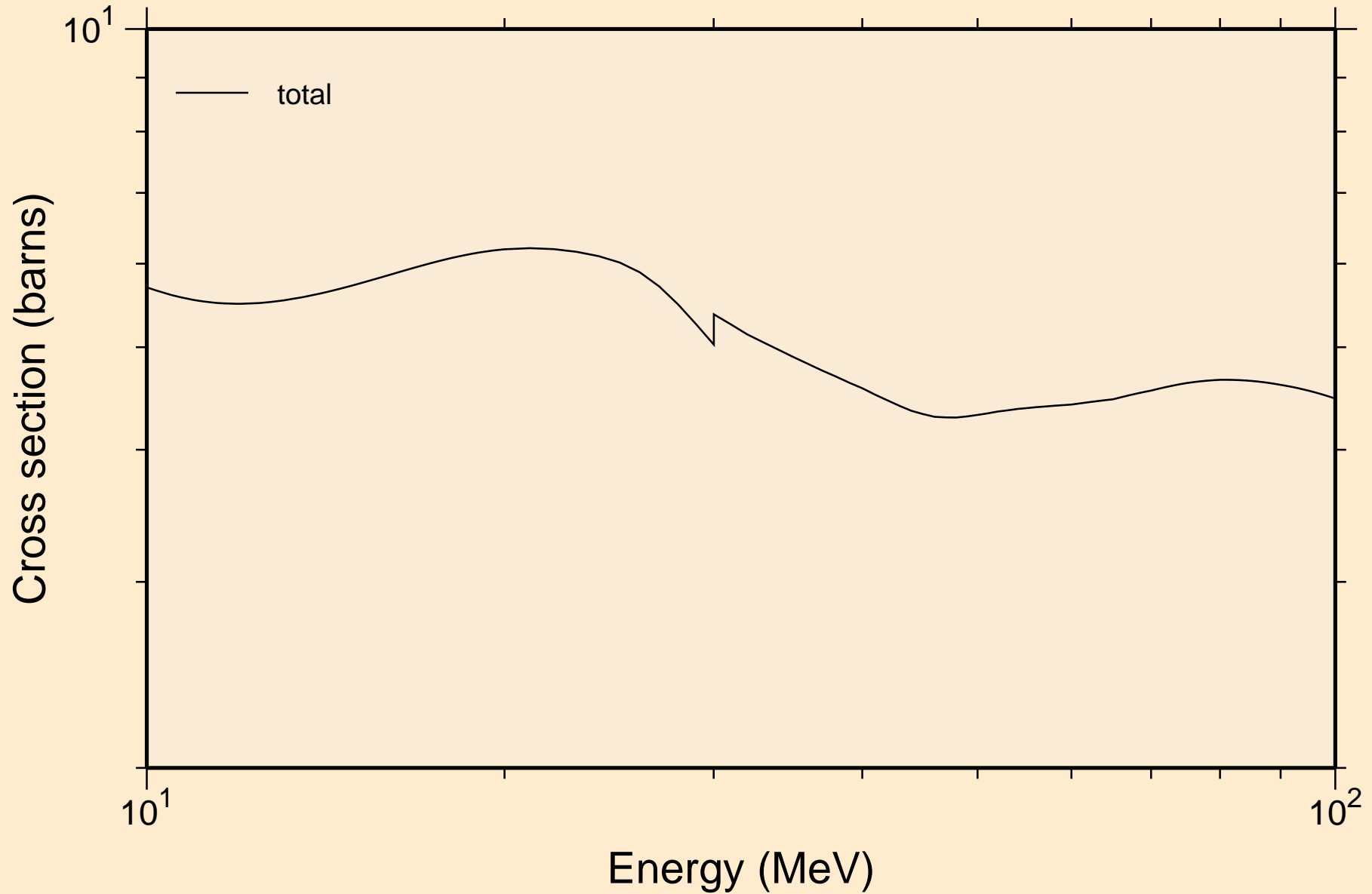

TH235 NEUTRON ACER TENDL-2023 LIBRARY; T=0.K  
resonance absorption cross sections

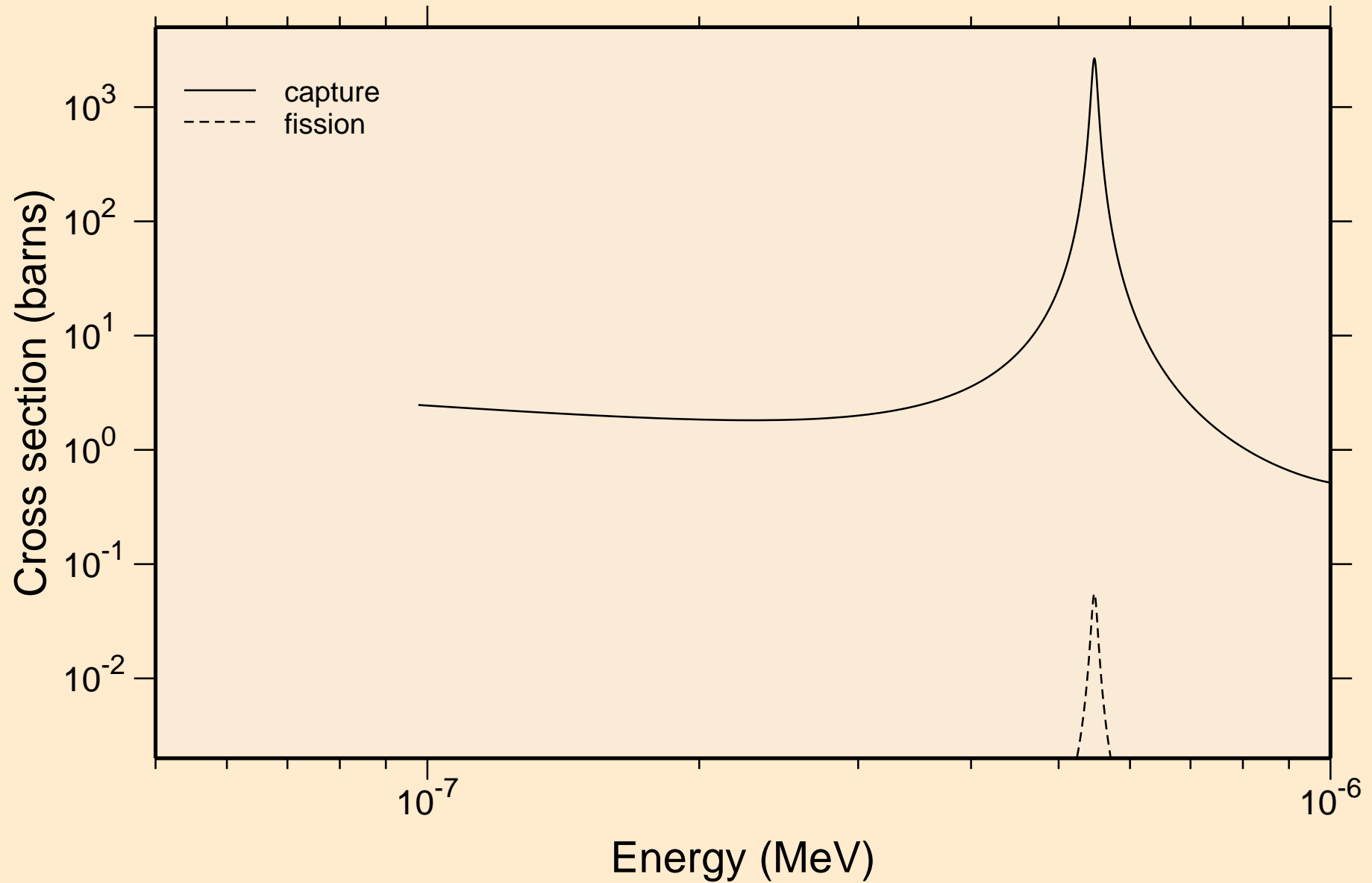

TH235 NEUTRON ACER TENDL-2023 LIBRARY; T=0.K  
resonance absorption cross sections

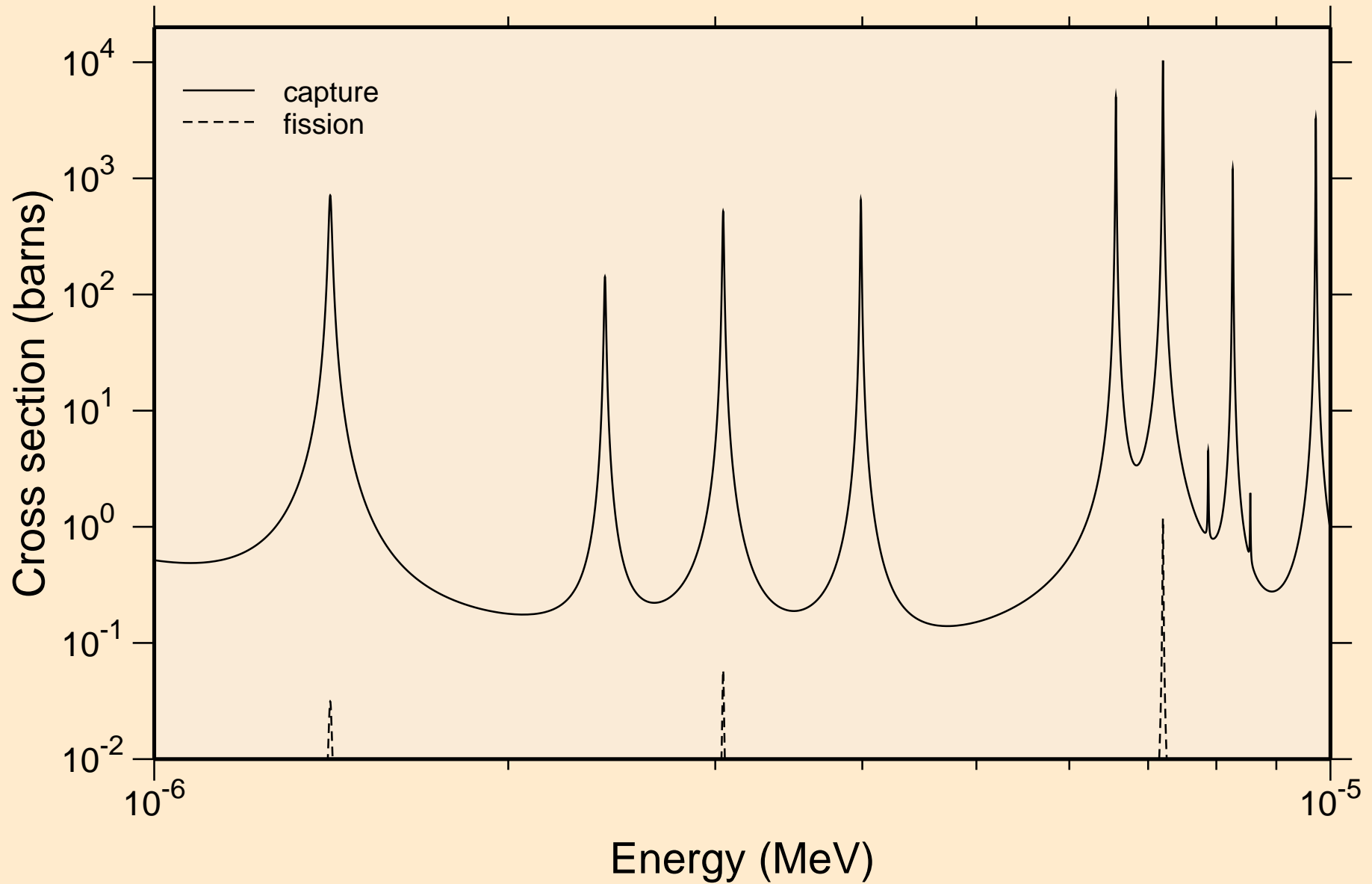

# TH235 NEUTRON ACER TENDL-2023 LIBRARY; T=0.K

## resonance absorption cross sections

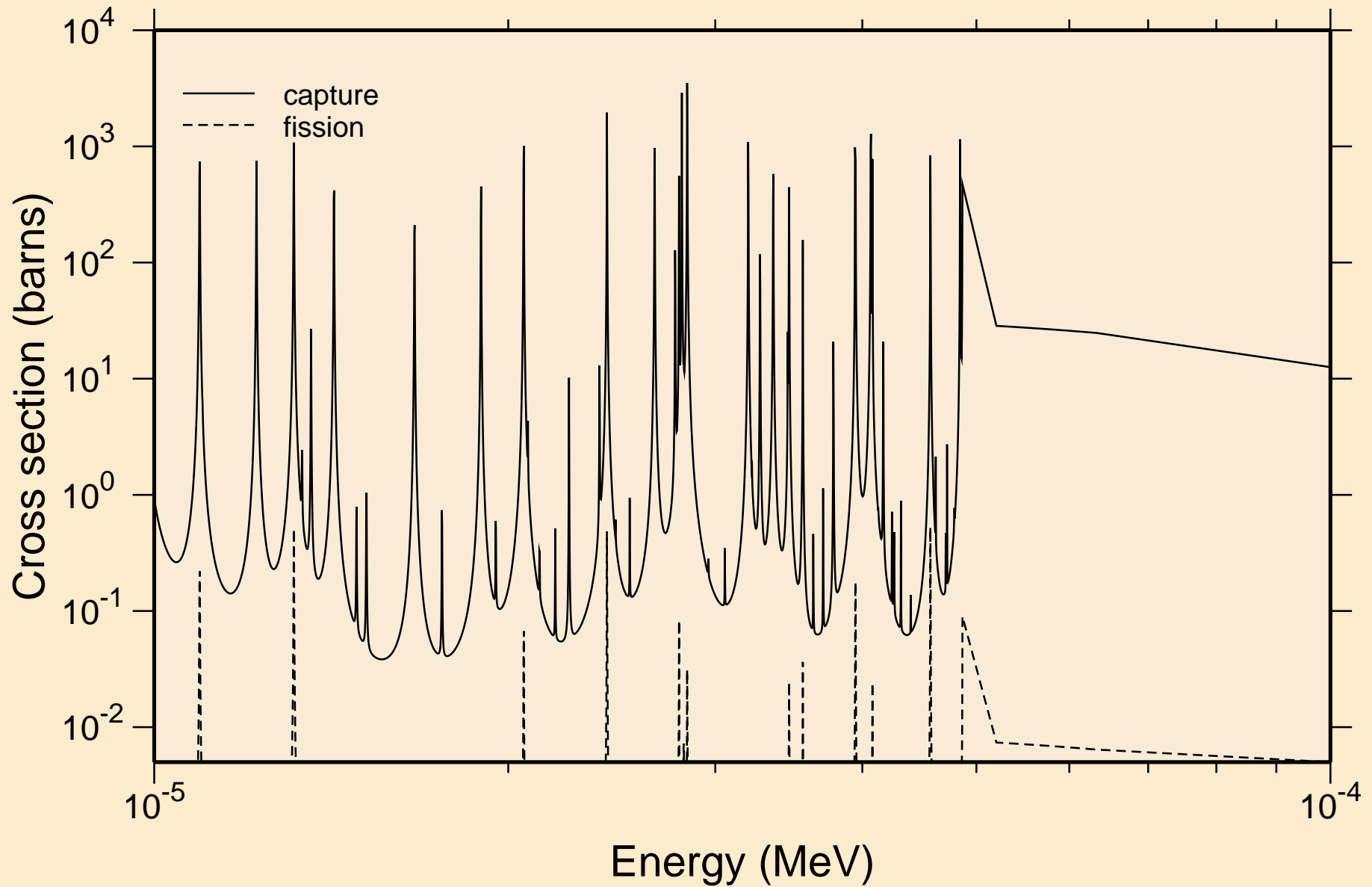



TH235 NEUTRON ACER TENDL-2023 LIBRARY; T=0.K  
resonance absorption cross sections

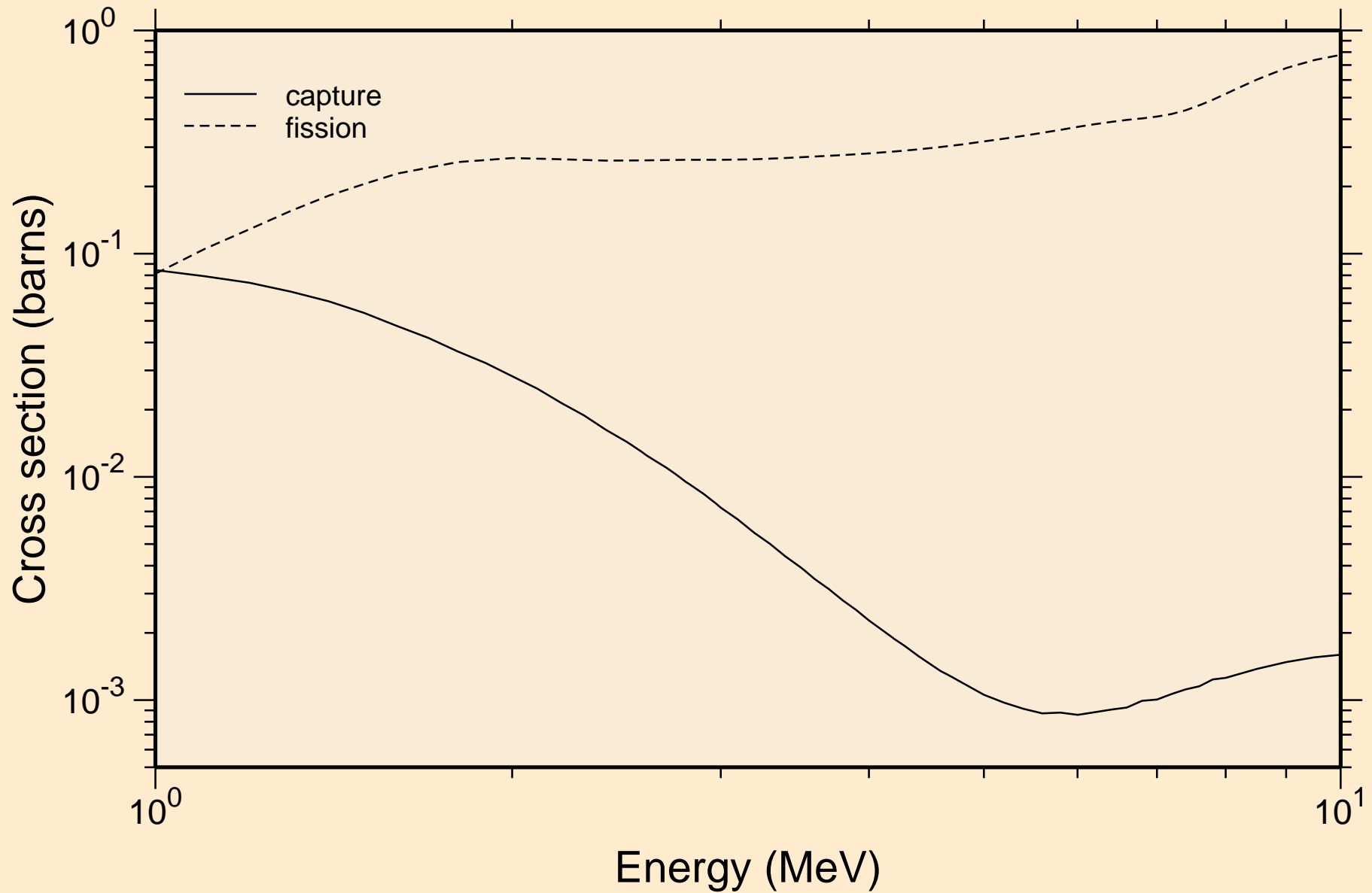

TH235 NEUTRON ACER TENDL-2023 LIBRARY; T=0.K  
Heating

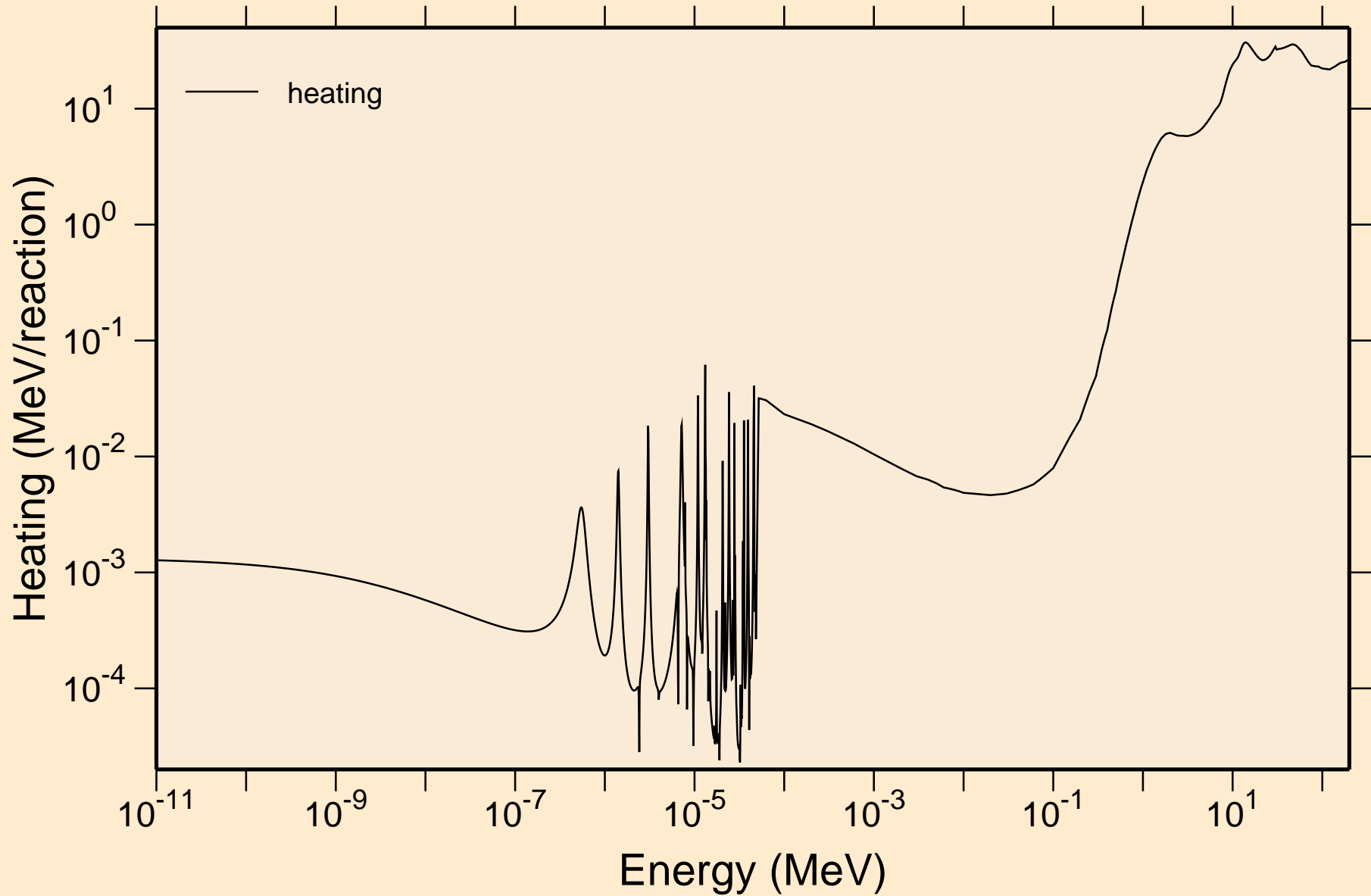

TH235 NEUTRON ACER TENDL-2023 LIBRARY; T=0.K  
Damage

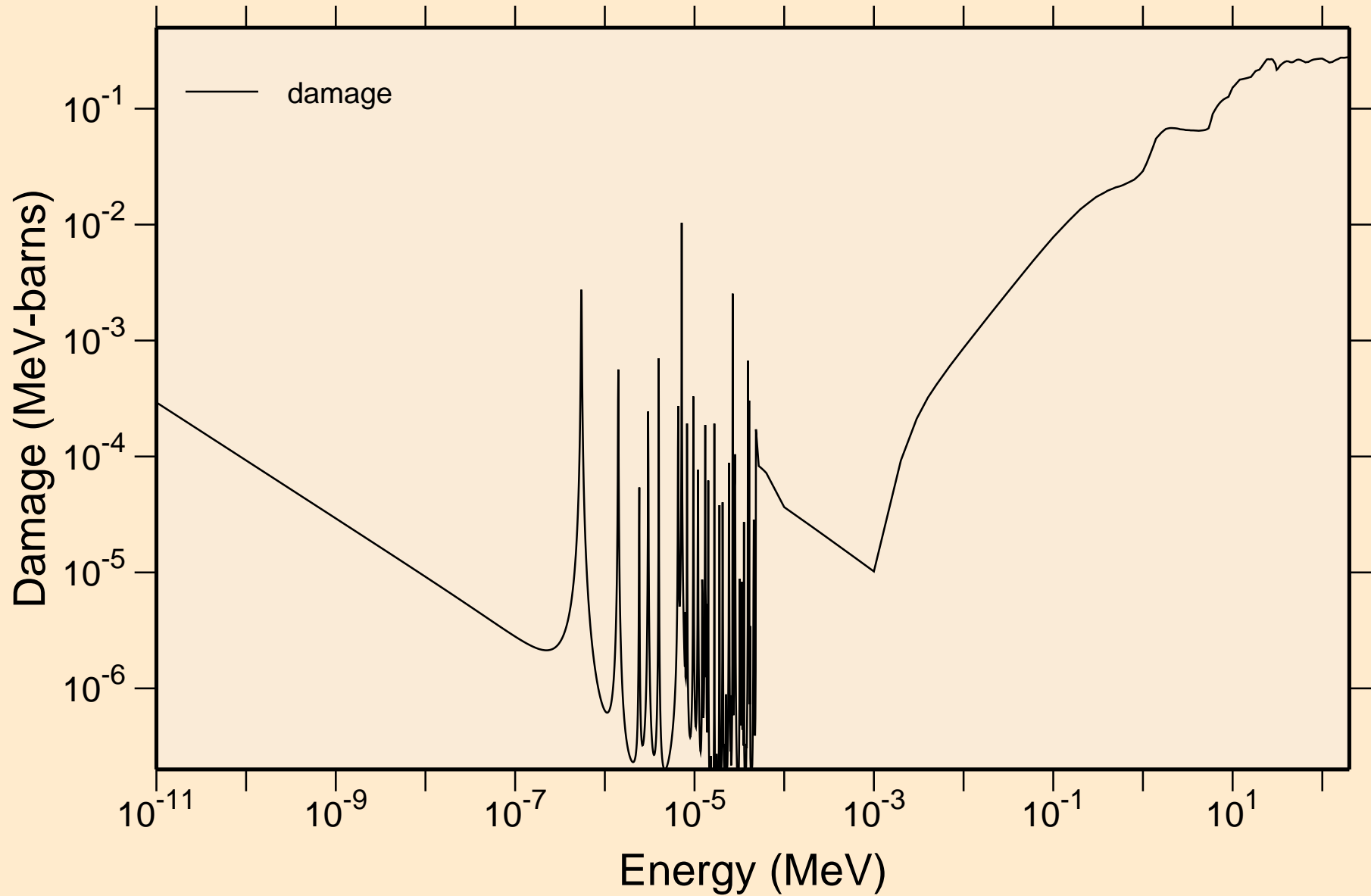

# TH235 NEUTRON ACER TENDL-2023 LIBRARY; T=0.K

## Non-threshold reactions

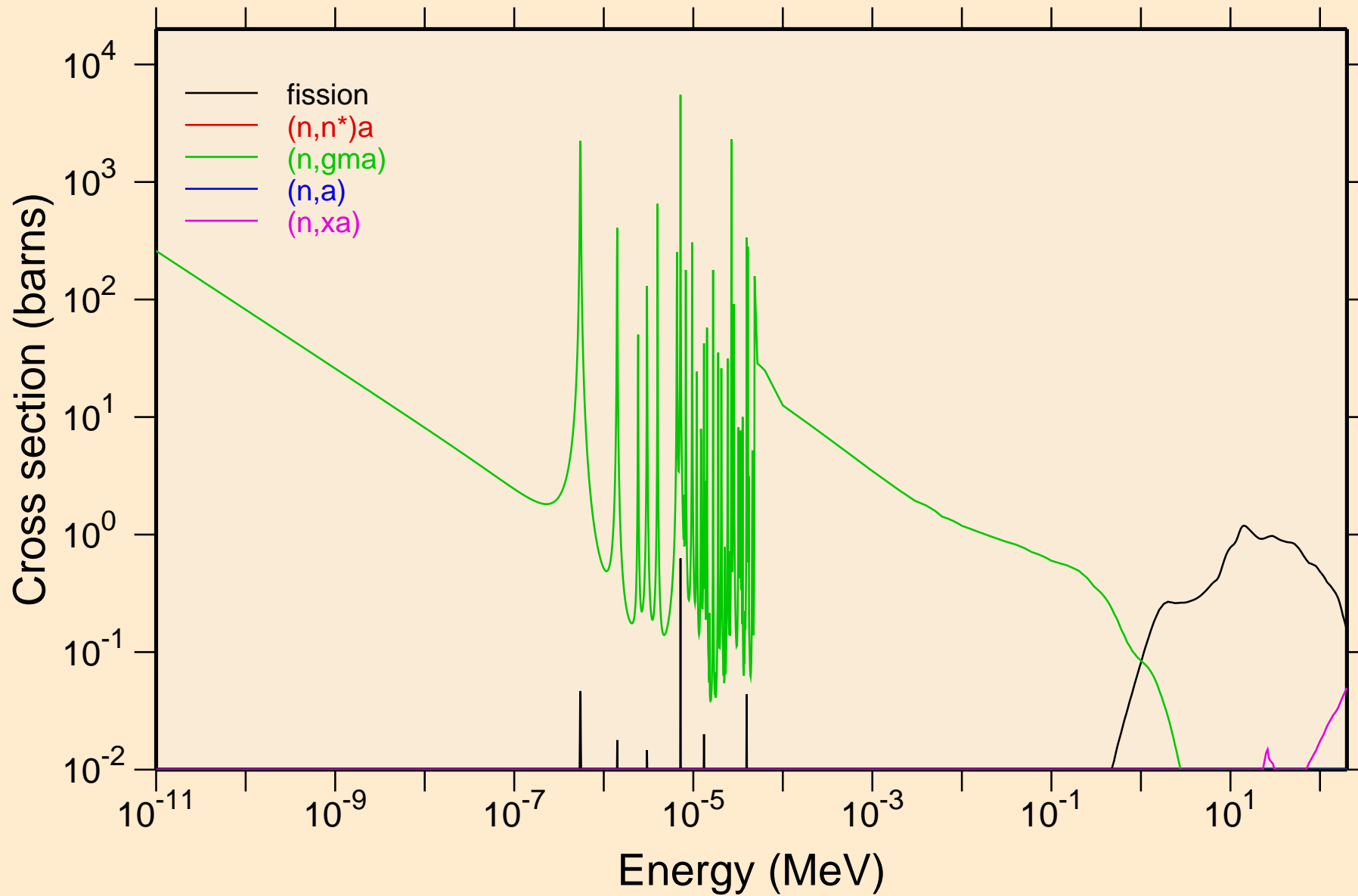

# TH235 NEUTRON ACER TENDL-2023 LIBRARY; T=0.K

## Principal cross sections

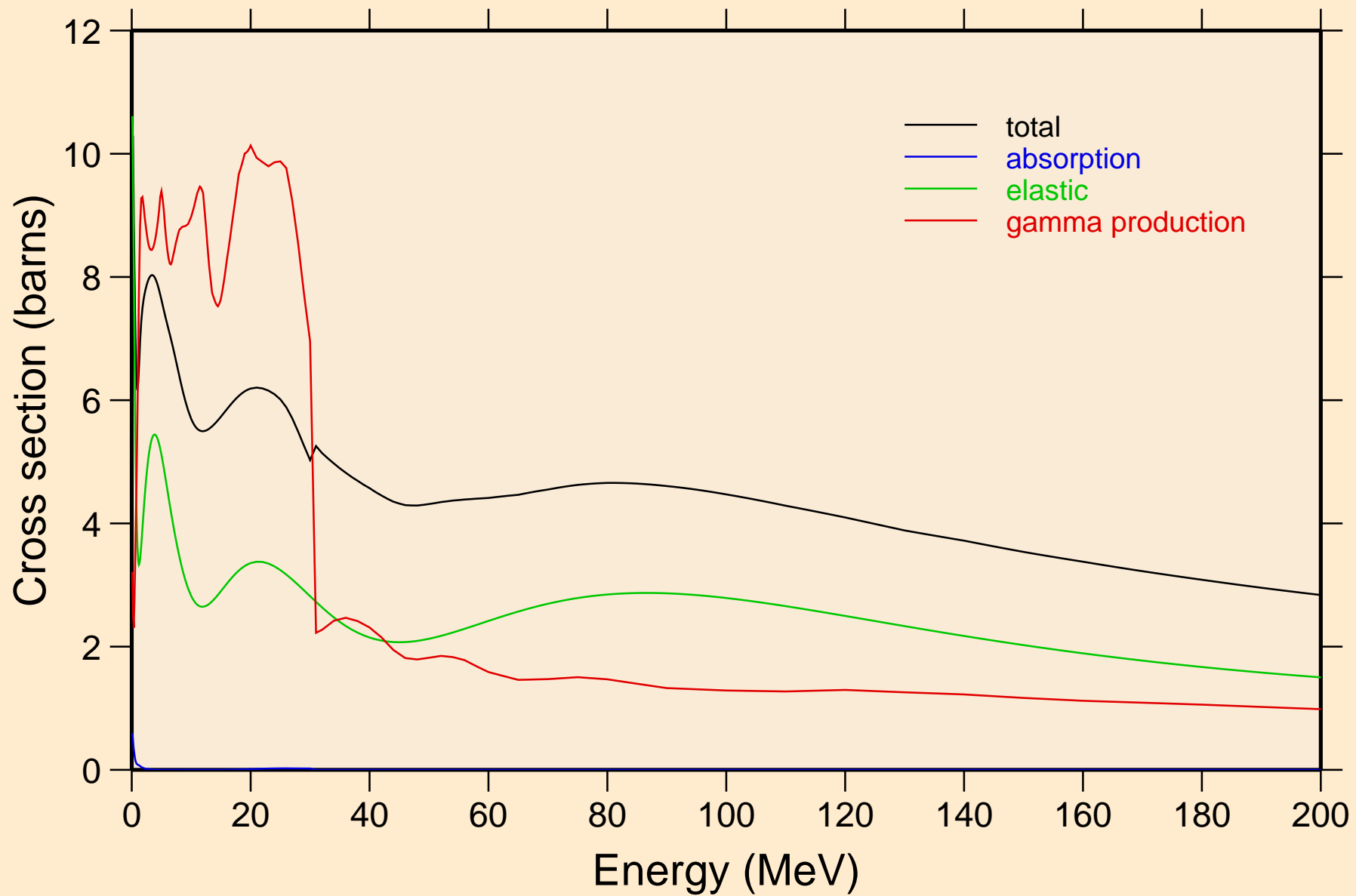

# TH235 NEUTRON ACER TENDL-2023 LIBRARY; T=0.K

## Heating

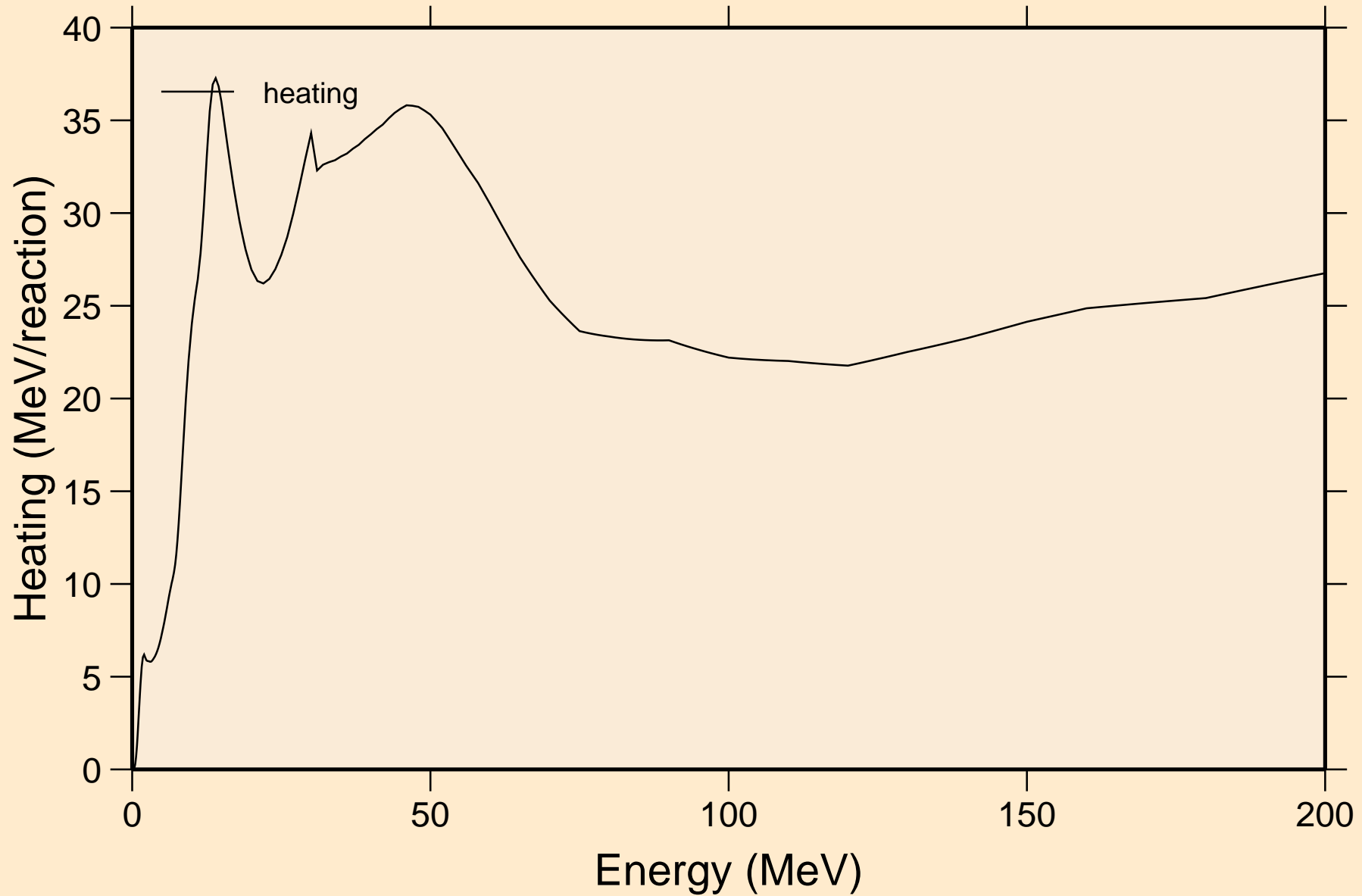

TH235 NEUTRON ACER TENDL-2023 LIBRARY; T=0.K  
Damage

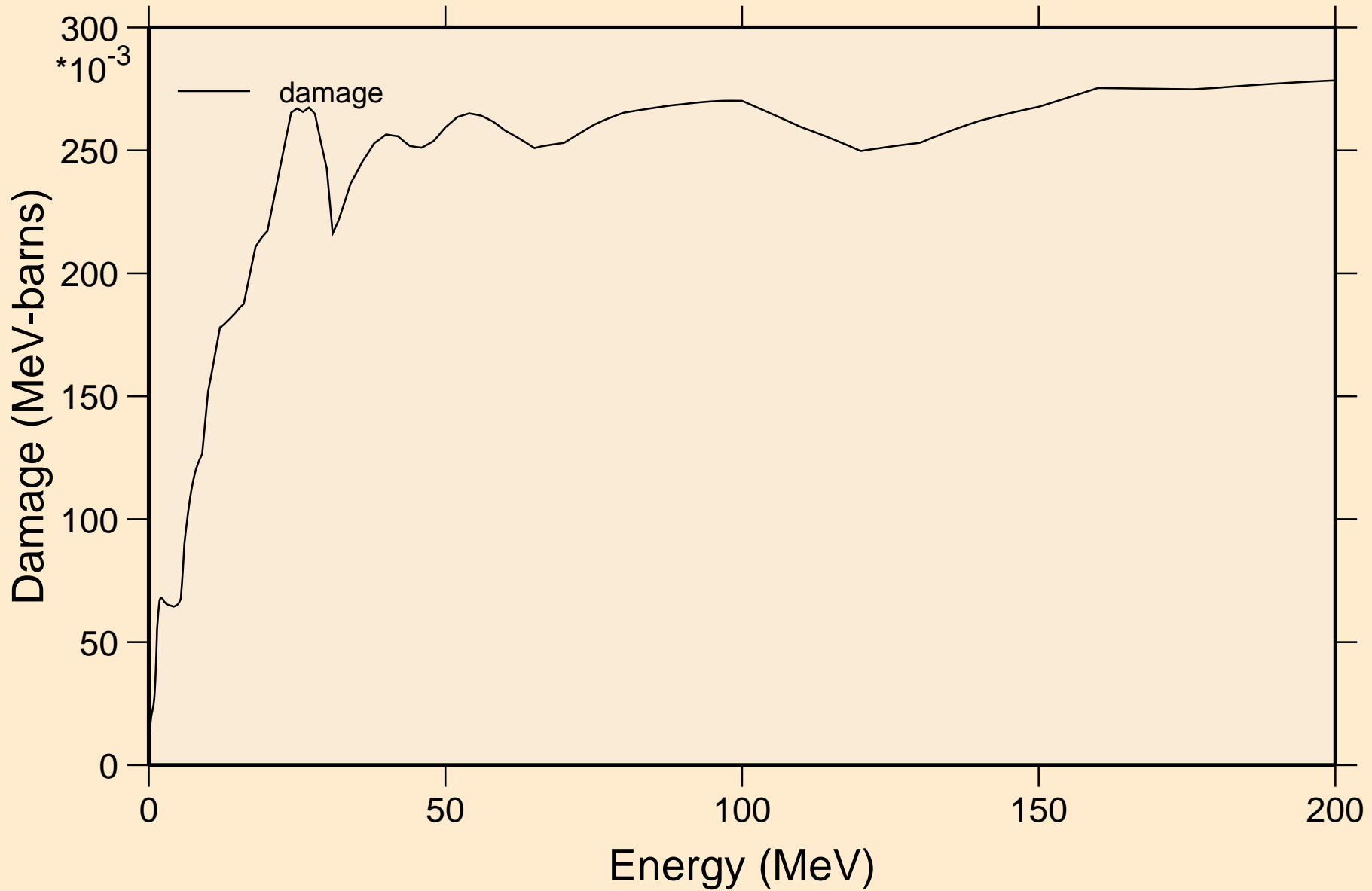

# TH235 NEUTRON ACER TENDL-2023 LIBRARY; T=0.K

## Non-threshold reactions

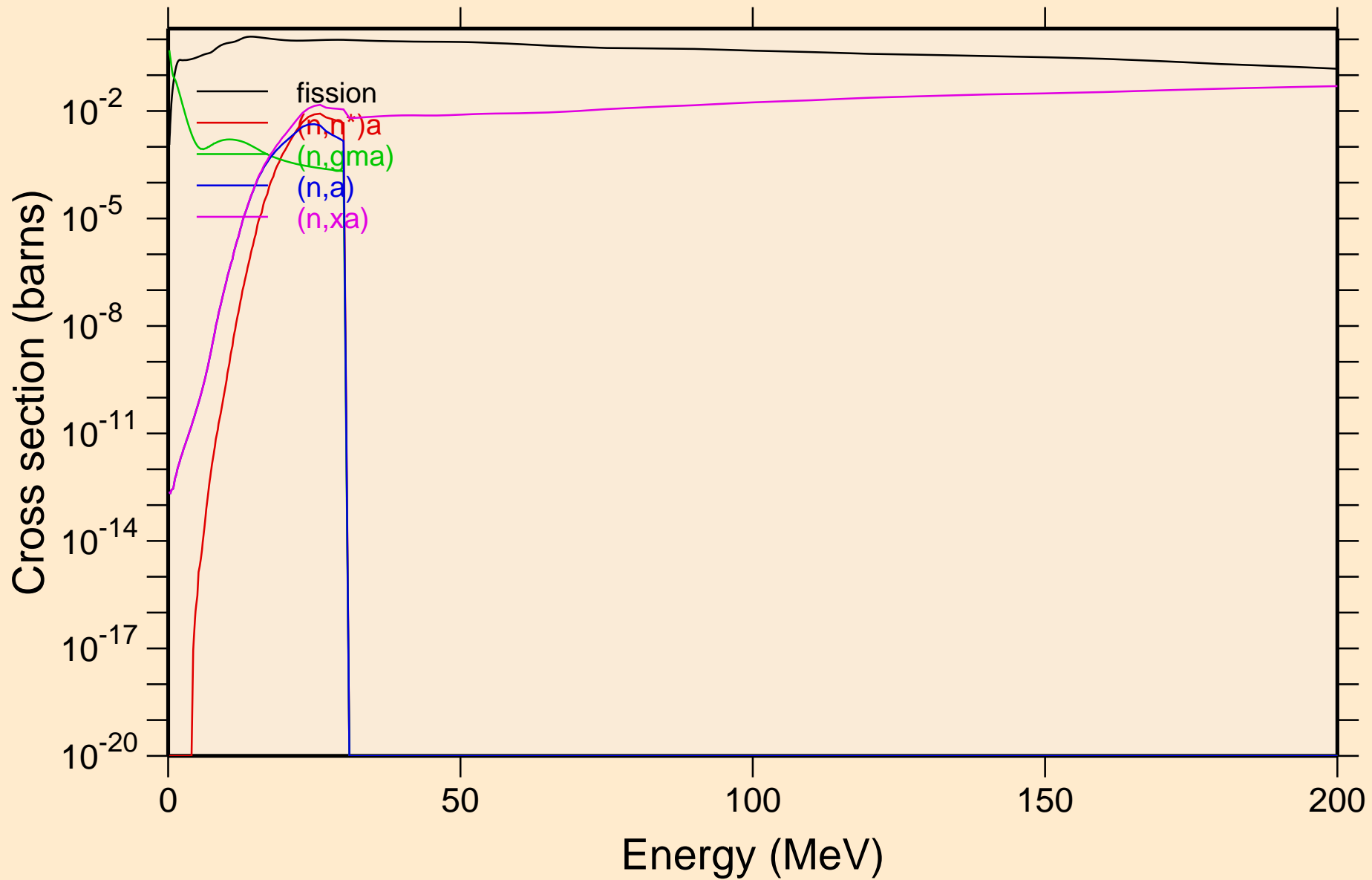



# TH235 NEUTRON ACER TENDL-2023 LIBRARY; T=0.K

## Inelastic levels

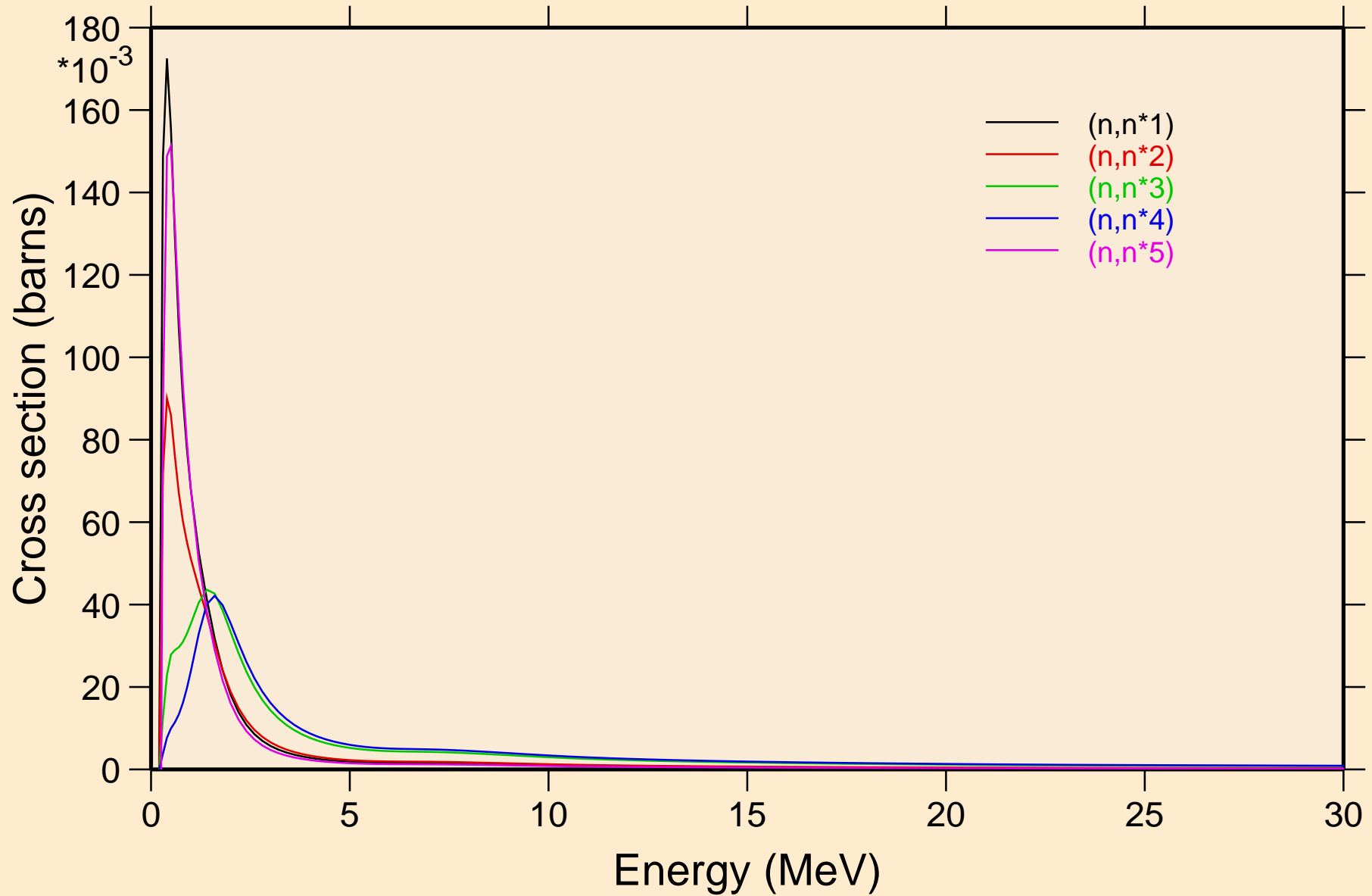

TH235 NEUTRON ACER TENDL-2023 LIBRARY; T=0.K  
Inelastic levels

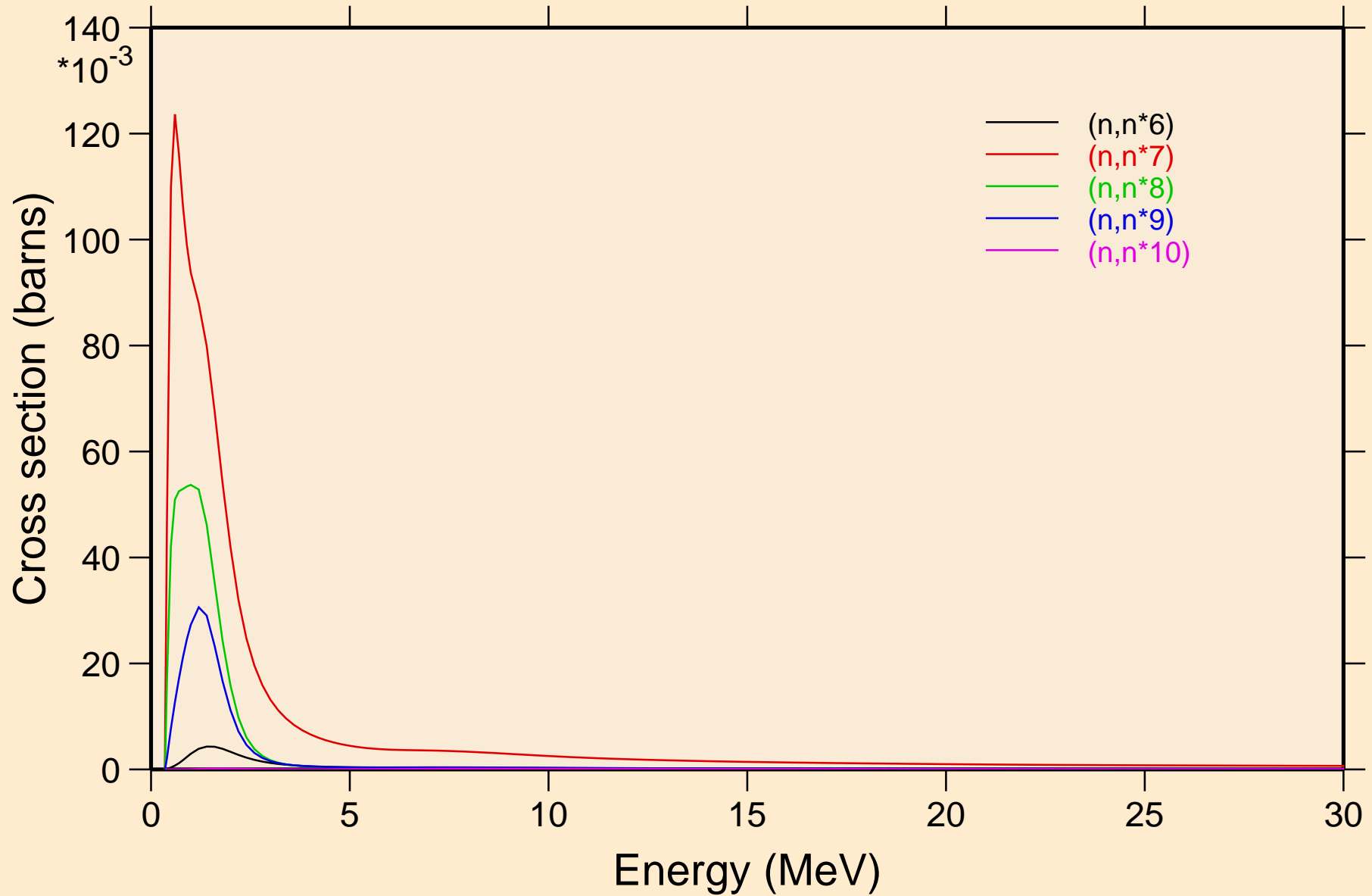

# TH235 NEUTRON ACER TENDL-2023 LIBRARY; T=0.K

## Inelastic levels

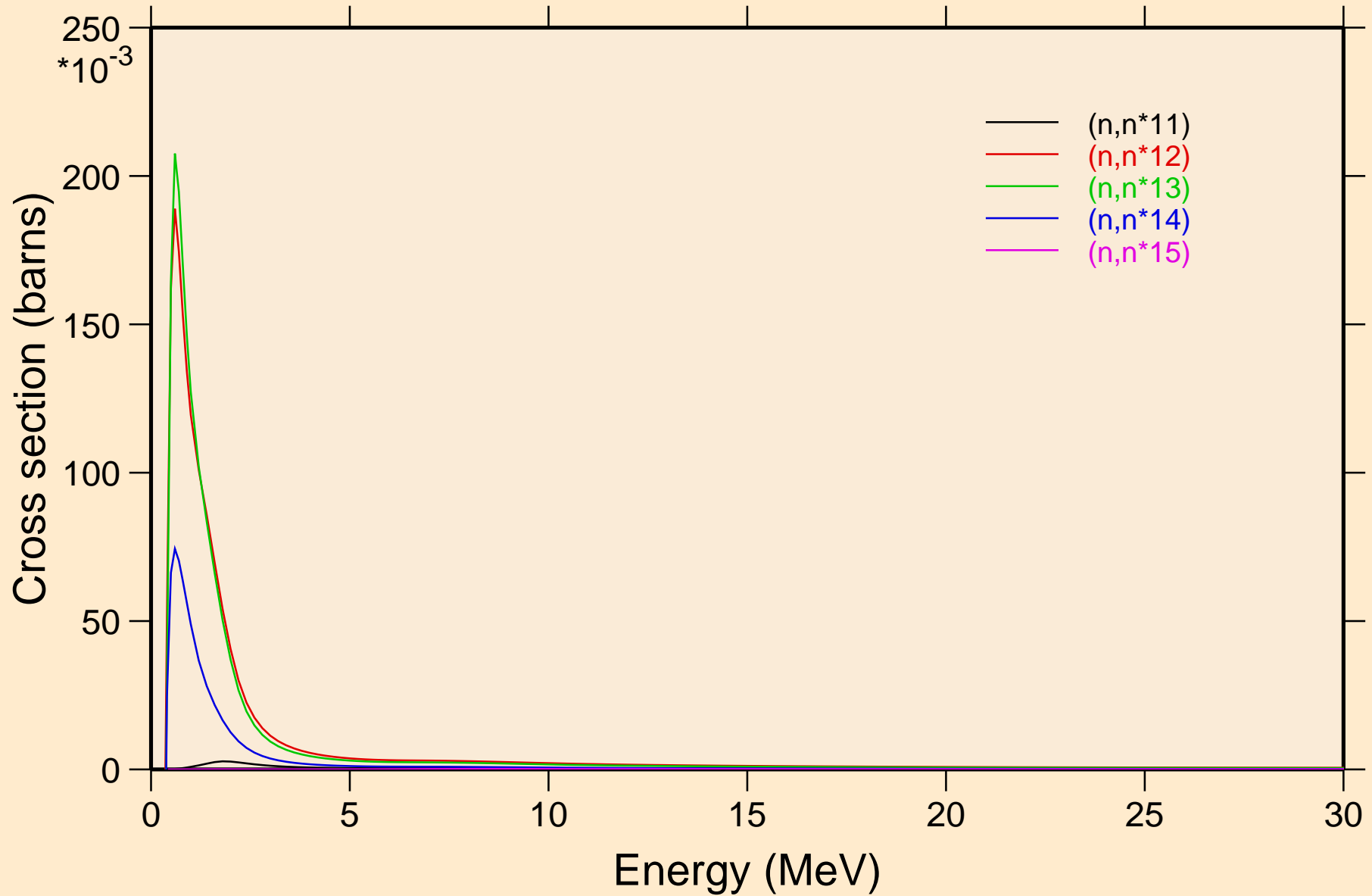

# TH235 NEUTRON ACER TENDL-2023 LIBRARY; T=0.K

## Inelastic levels

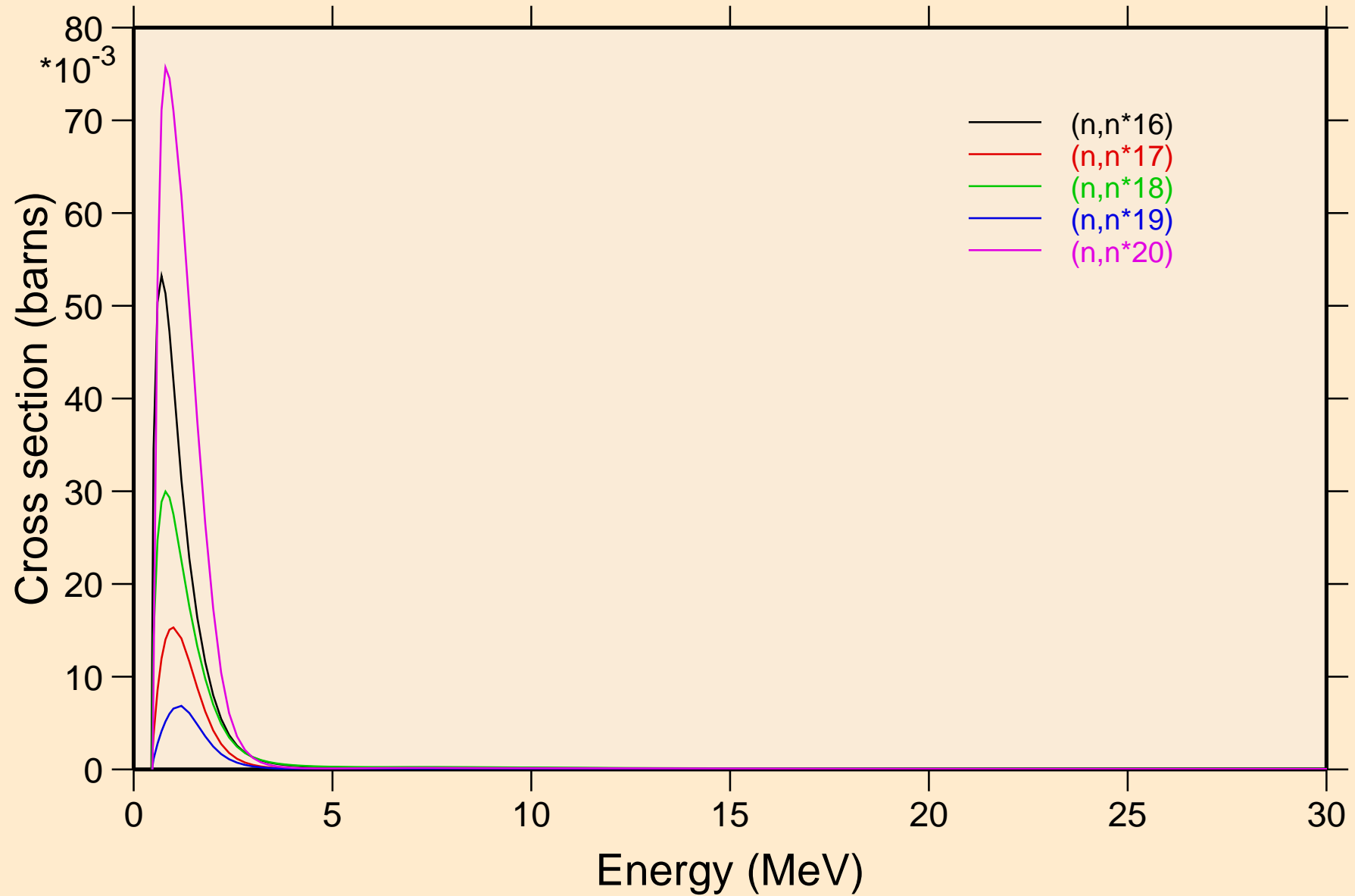

TH235 NEUTRON ACER TENDL-2023 LIBRARY; T=0.K  
Inelastic levels

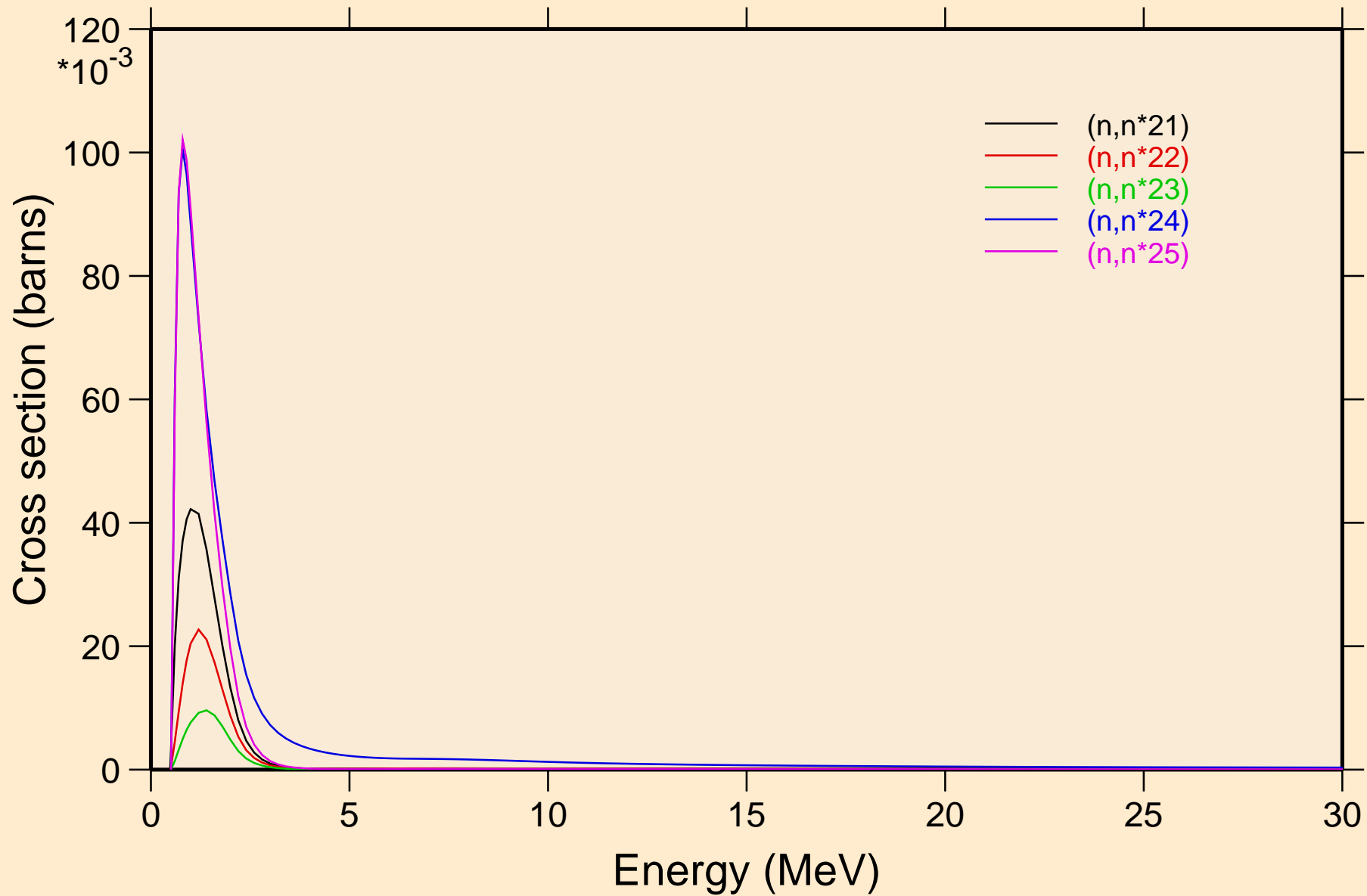

# TH235 NEUTRON ACER TENDL-2023 LIBRARY; T=0.K

## Inelastic levels

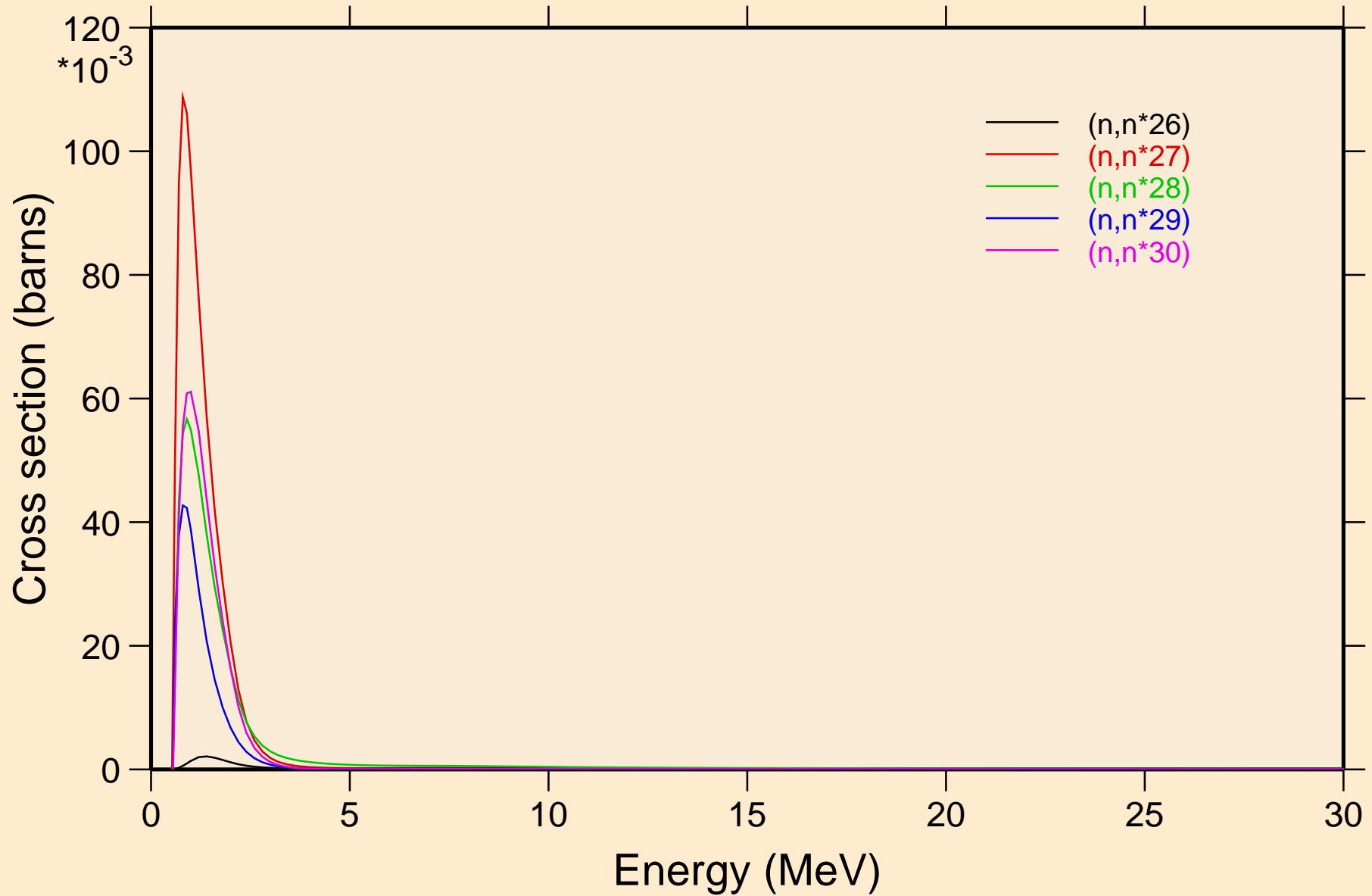

TH235 NEUTRON ACER TENDL-2023 LIBRARY; T=0.K  
Threshold reactions

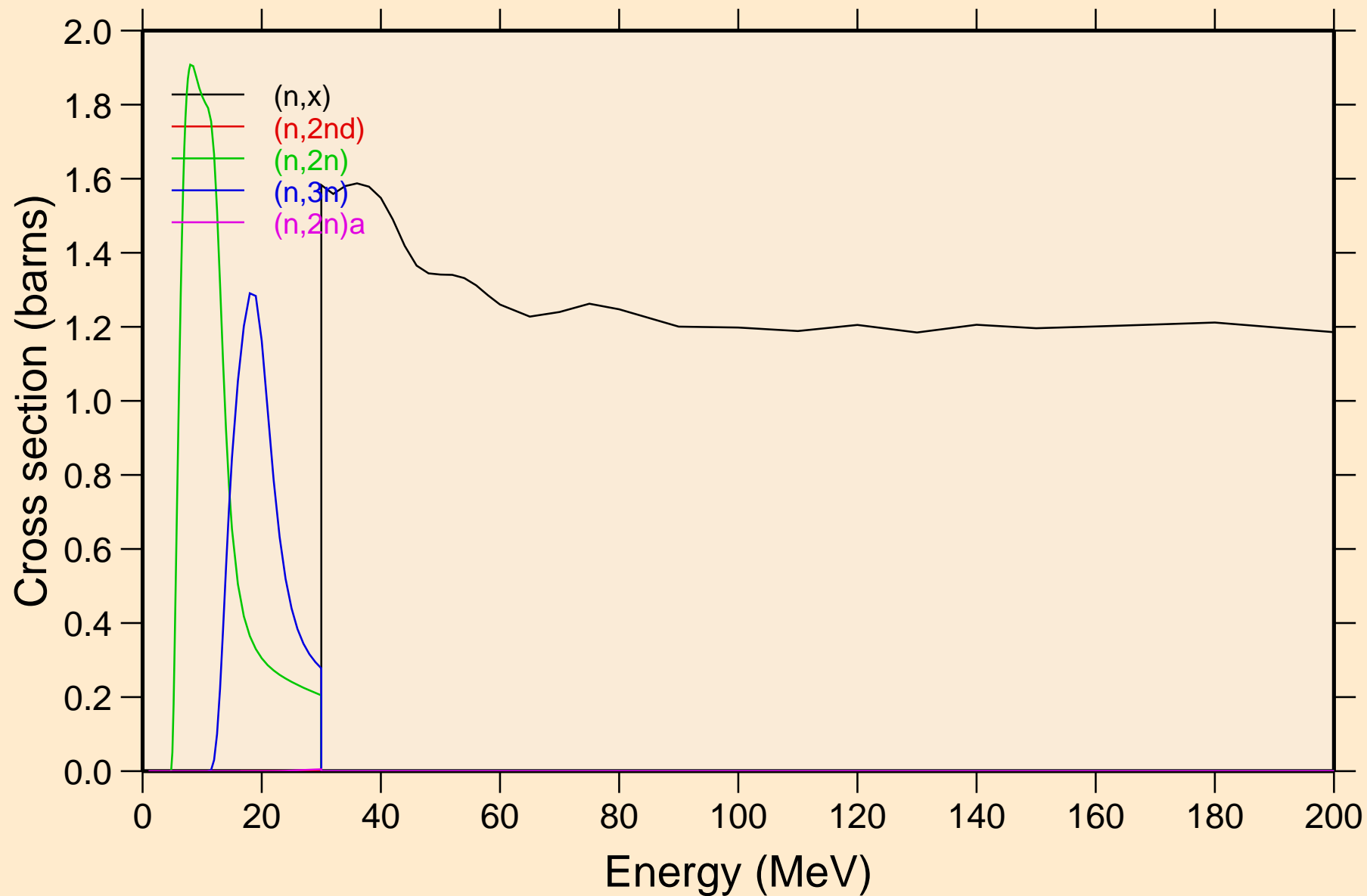

TH235 NEUTRON ACER TENDL-2023 LIBRARY; T=0.K  
Threshold reactions

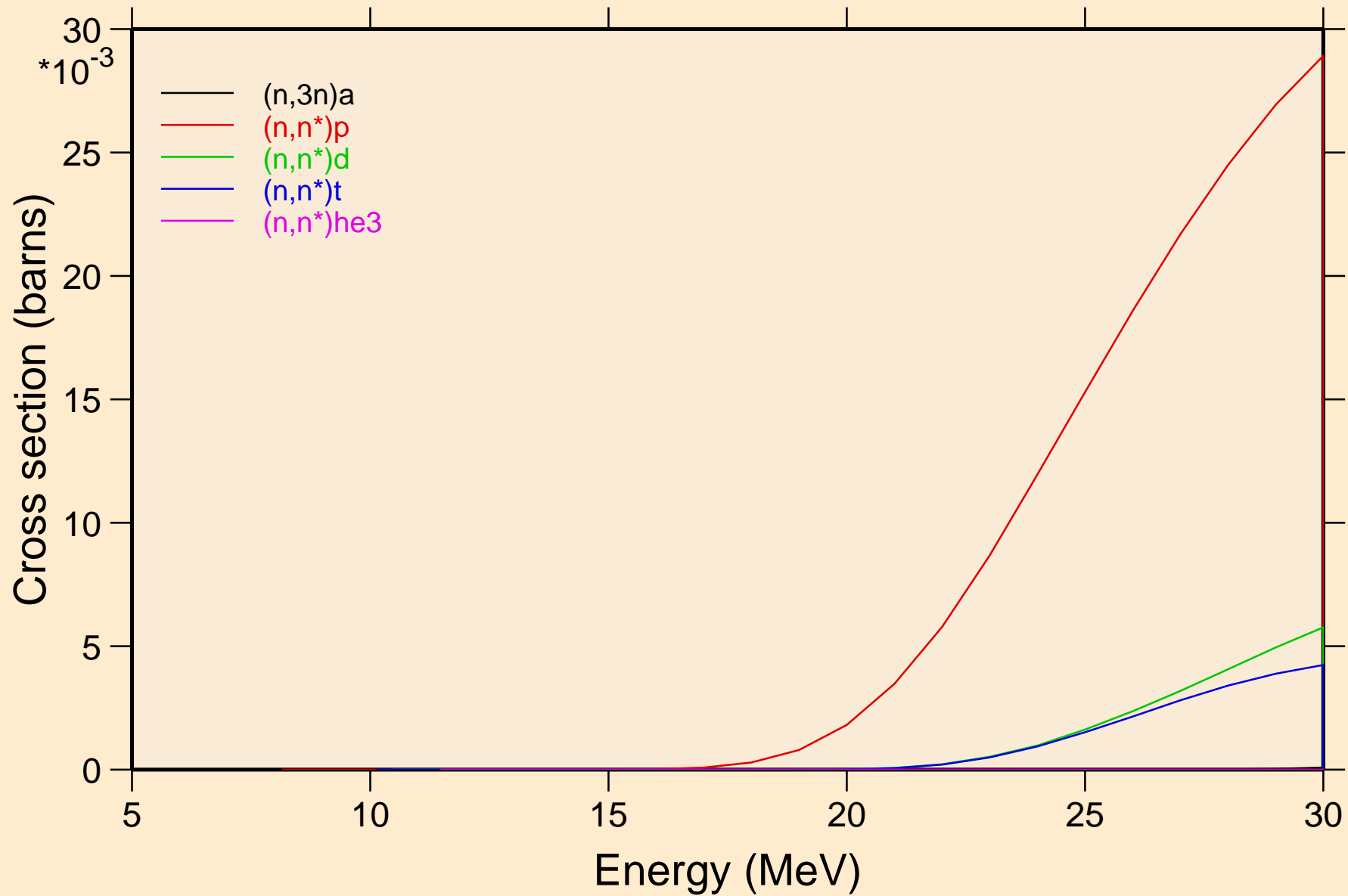



TH235 NEUTRON ACER TENDL-2023 LIBRARY; T=0.K  
Threshold reactions

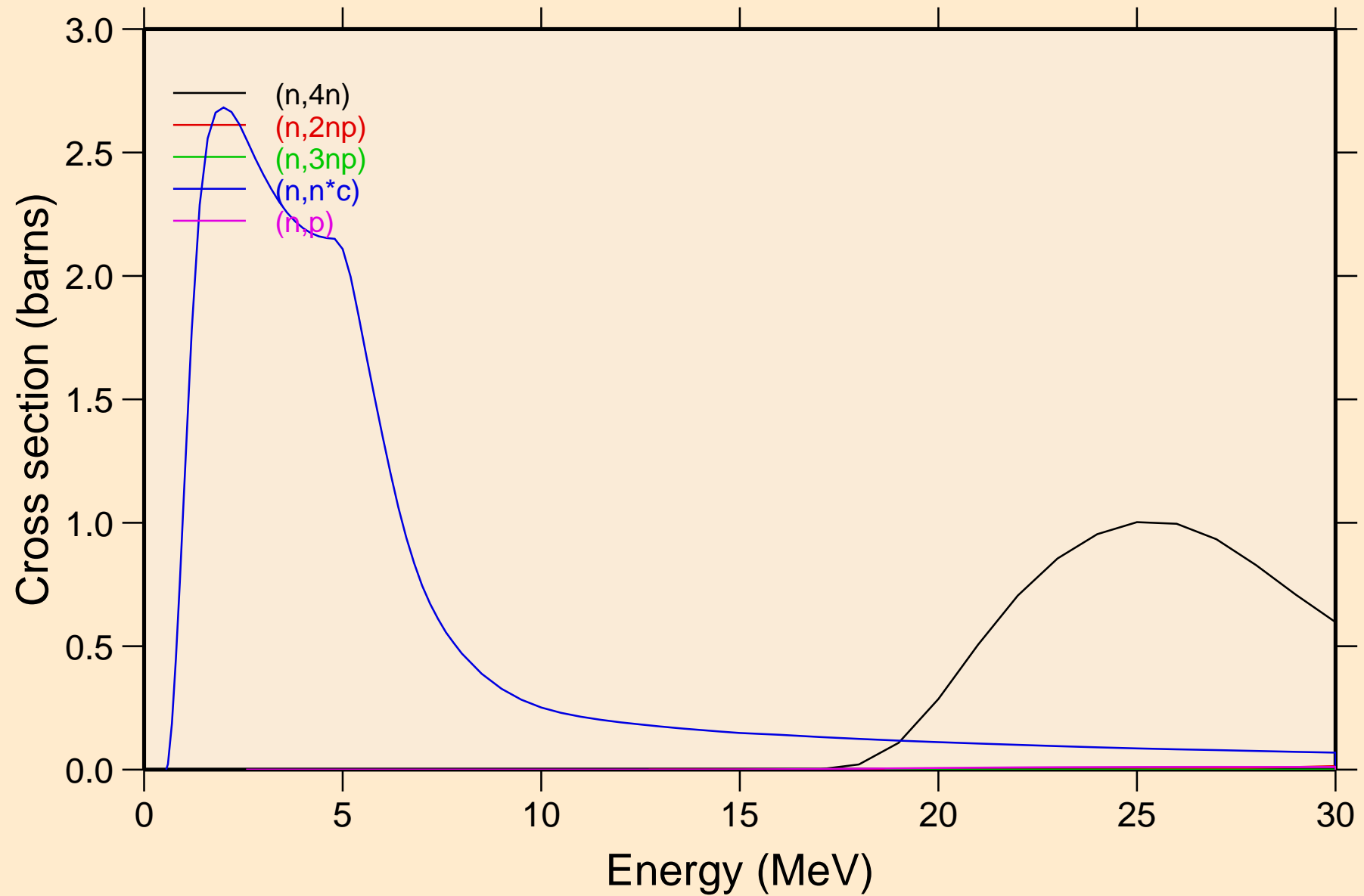

TH235 NEUTRON ACER TENDL-2023 LIBRARY; T=0.K  
Threshold reactions

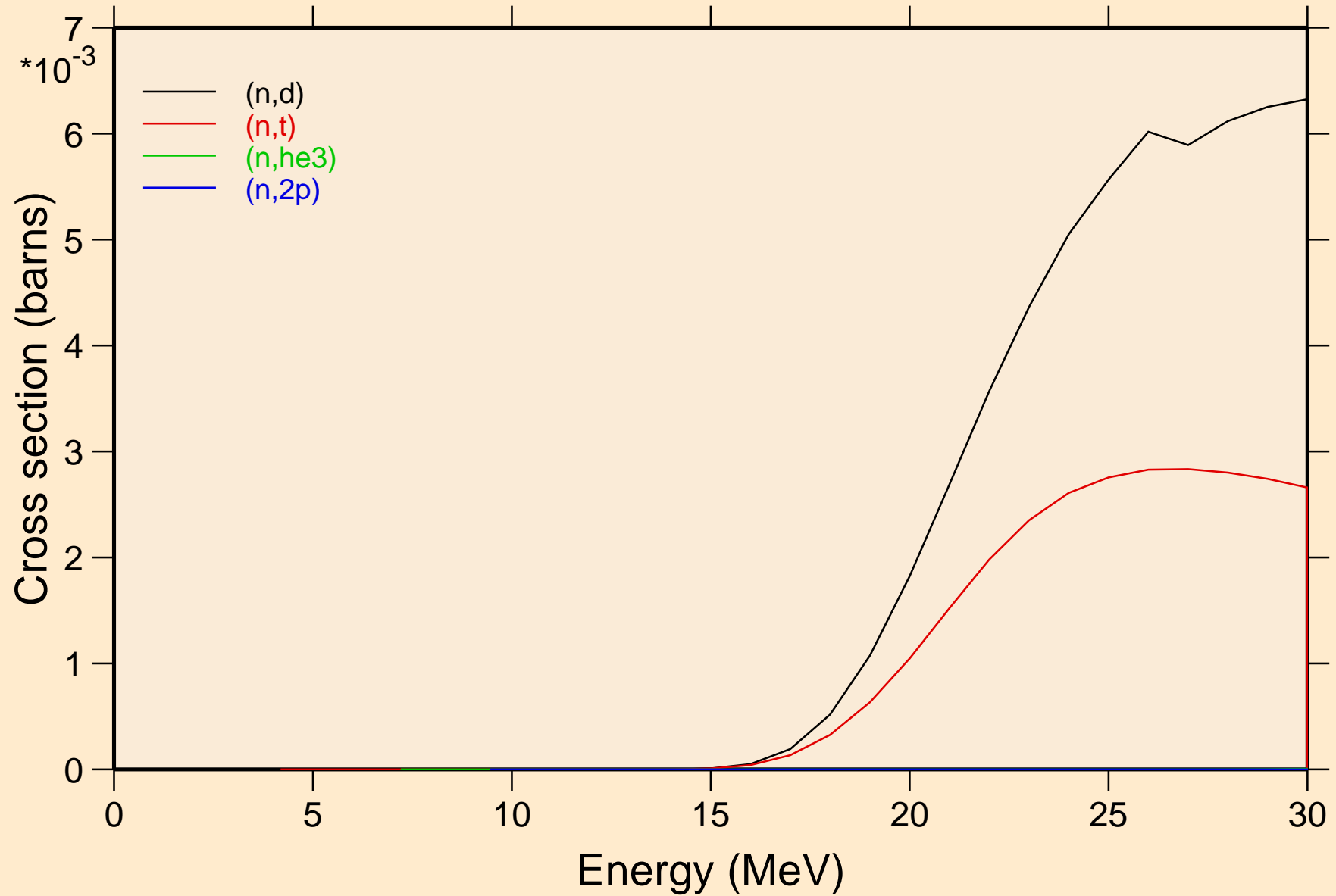

# TH235 NEUTRON ACER TENDL-2023 LIBRARY; T=0.K

## Threshold reactions

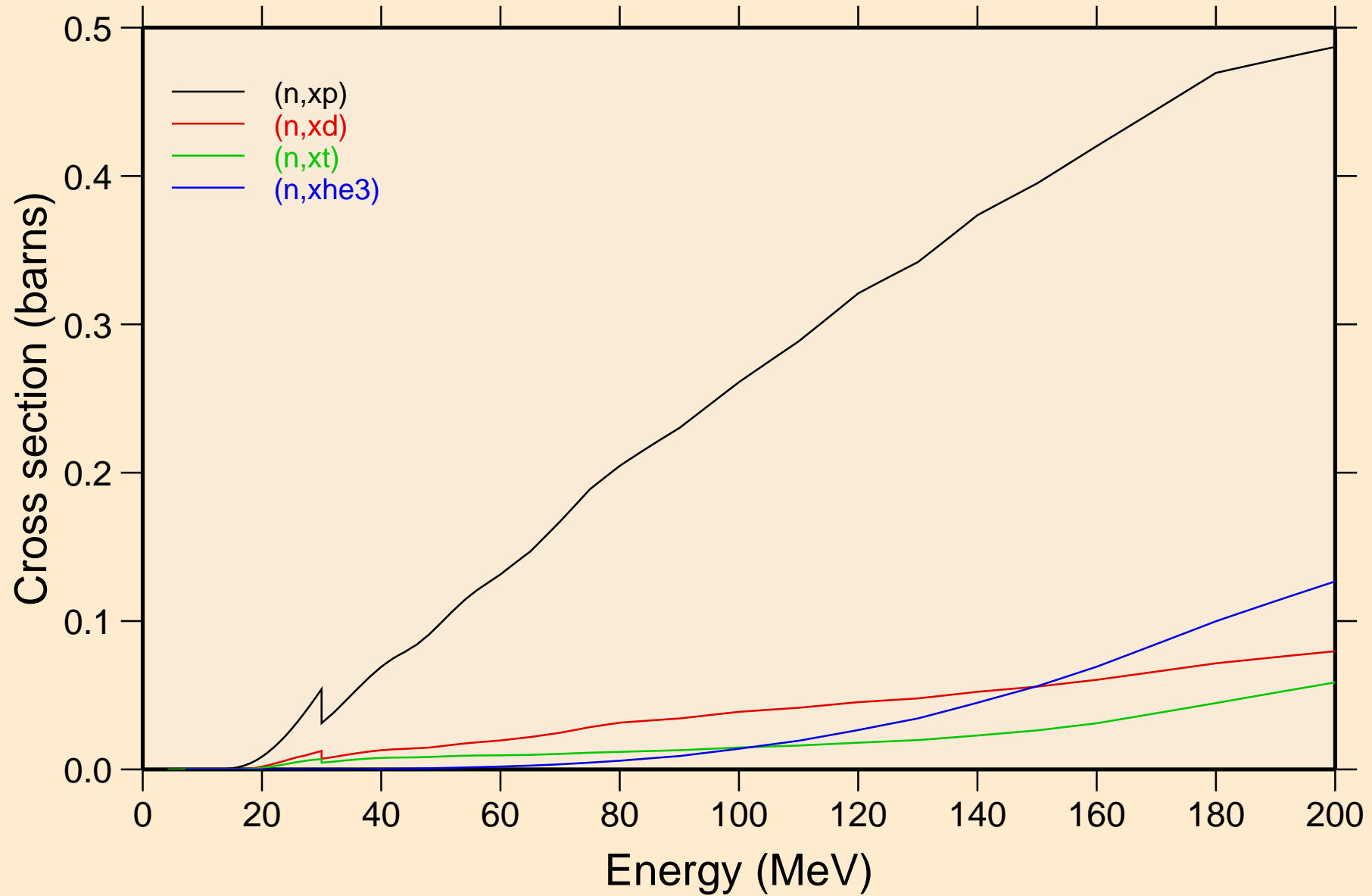

TH235 NEUTRON ACER TENDL-2023 LIBRARY; T=0.K  
angular distribution for elastic

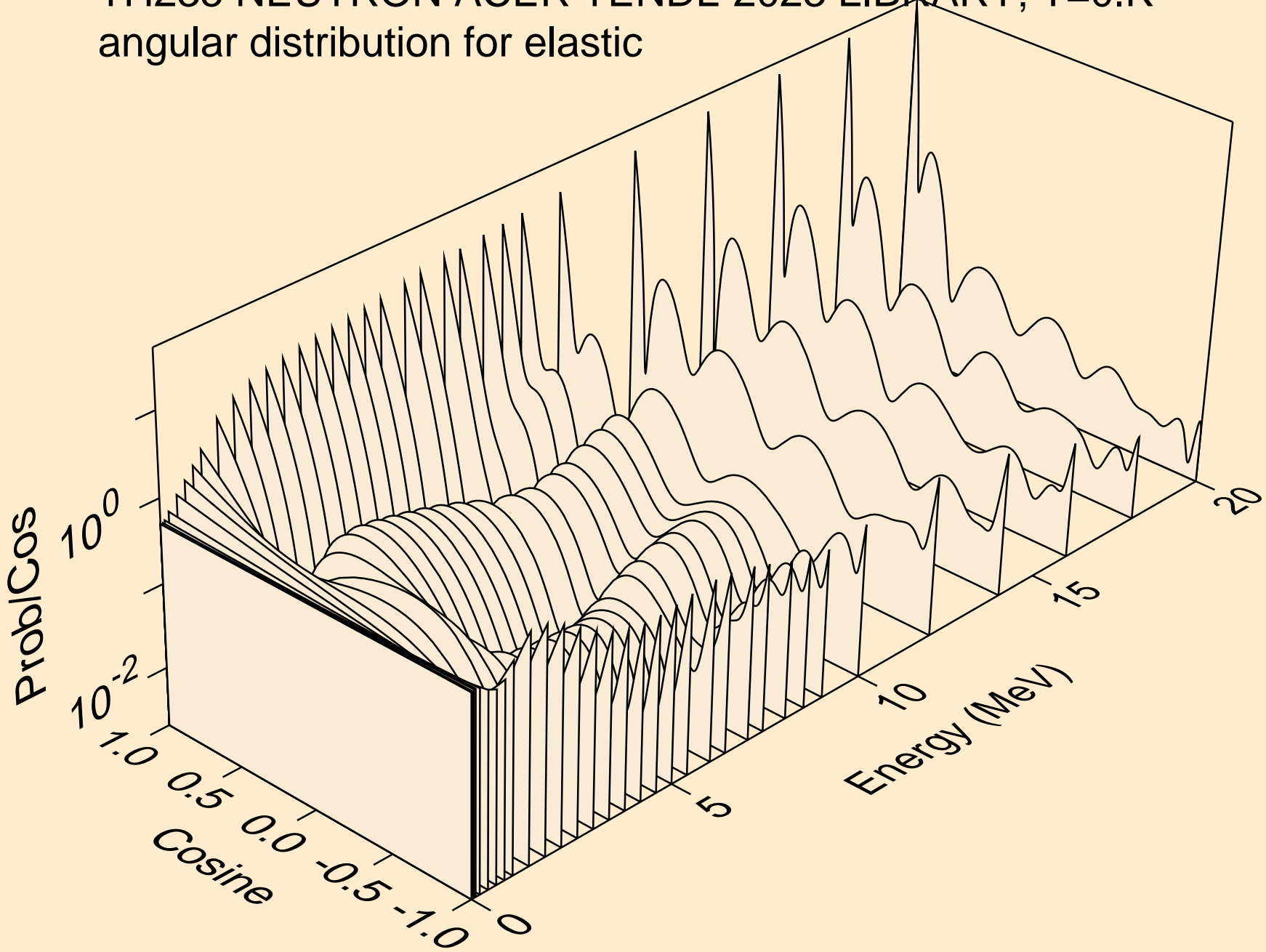

TH235 NEUTRON ACER TENDL-2023 LIBRARY; T=0.K  
angular distribution for elastic

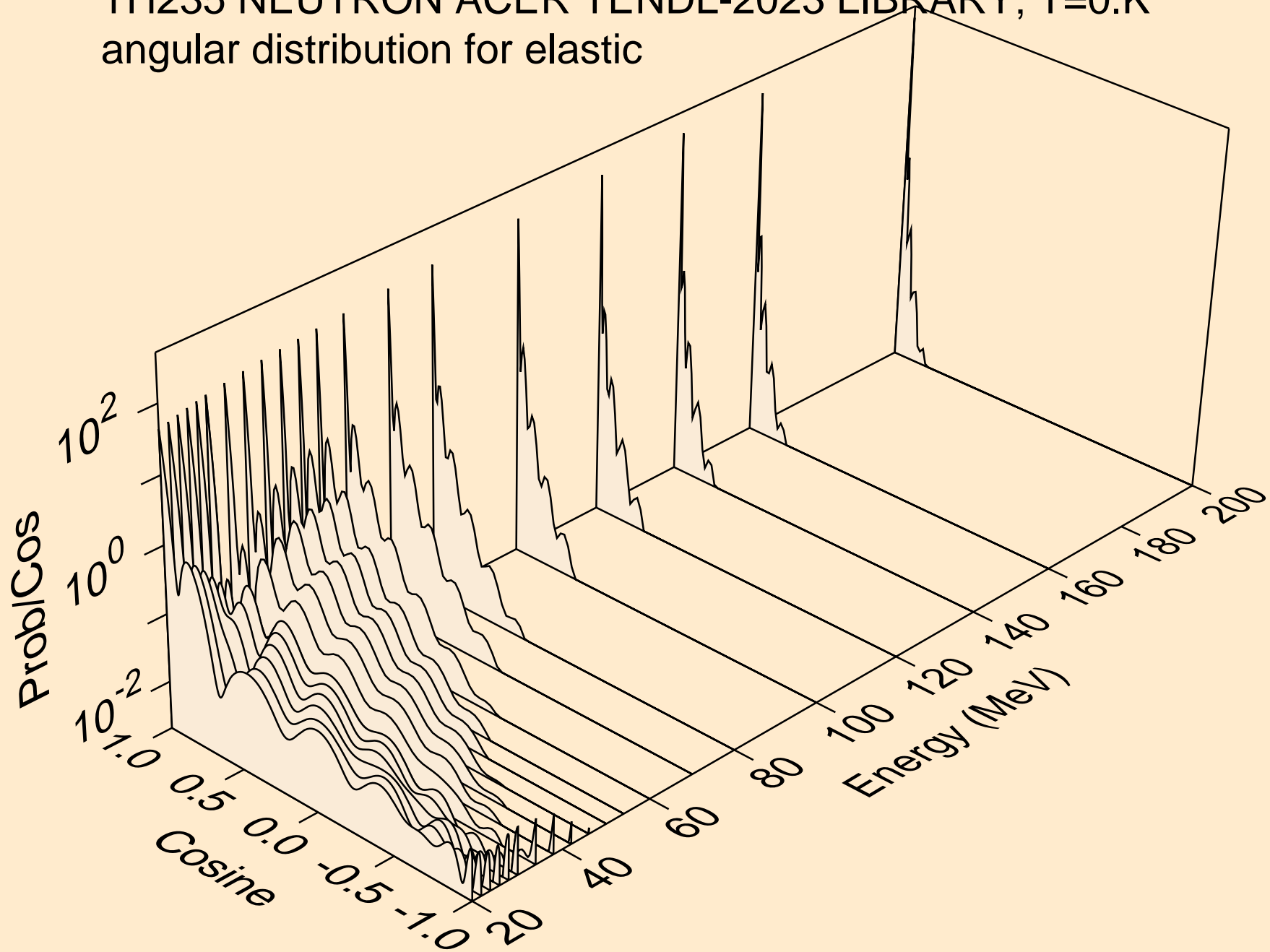

TH235 NEUTRON ACER TENDL-2023 LIBRARY; T=0.K  
angular distribution for (n,n\*1)

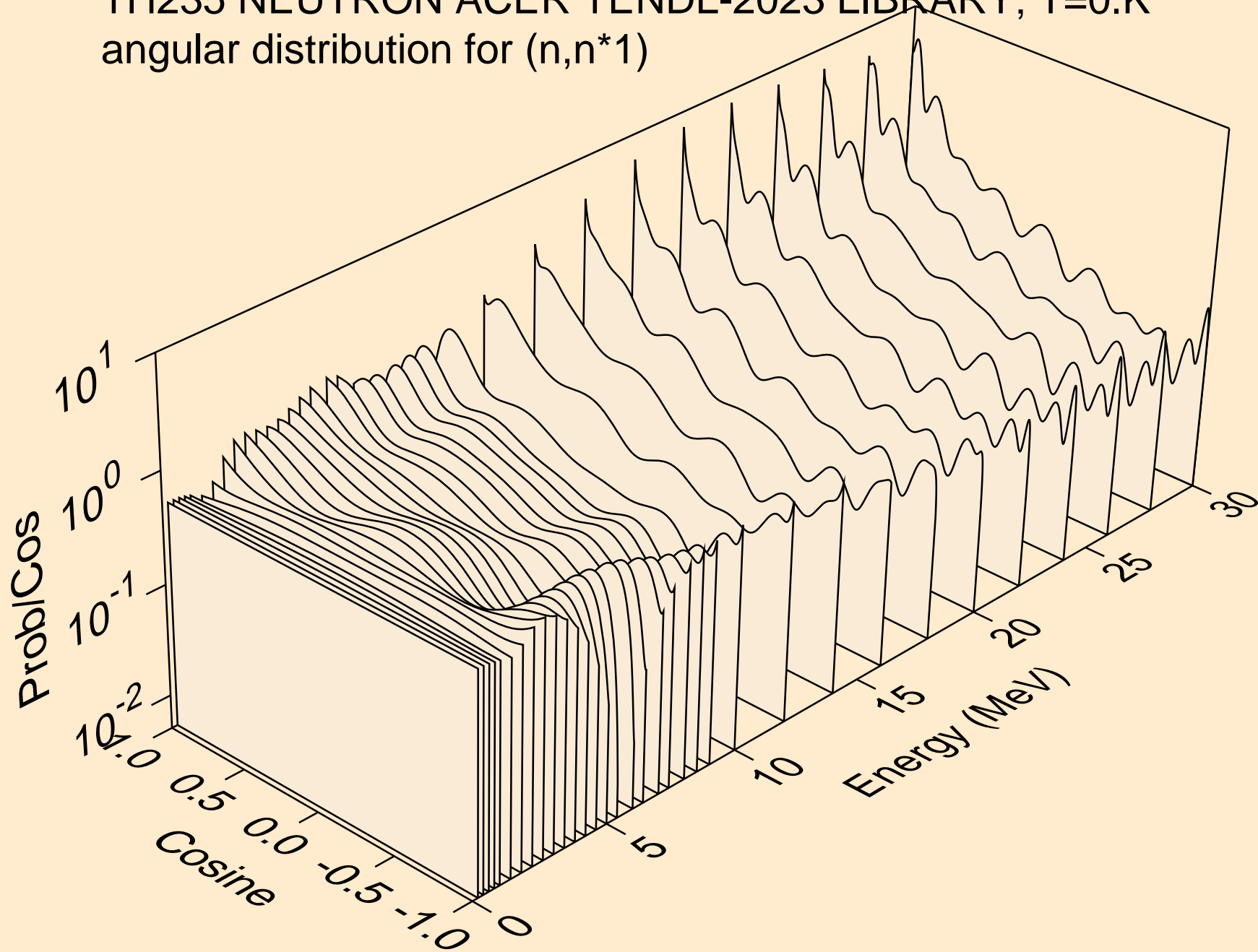

TH235 NEUTRON ACER TENDL-2023 LIBRARY; T=0.K  
angular distribution for (n,n\*2)

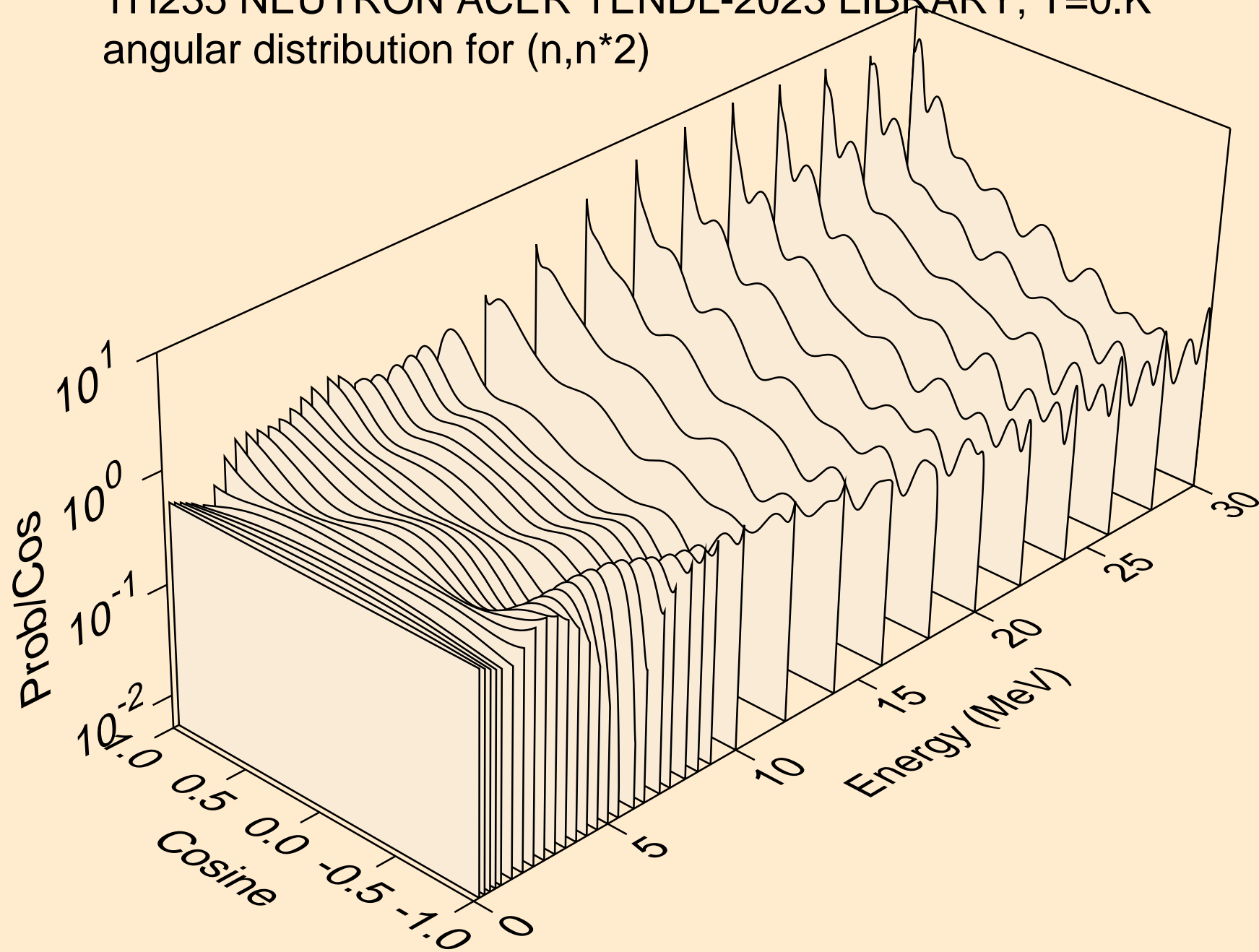

TH235 NEUTRON ACER TENDL-2023 LIBRARY; T=0.K  
angular distribution for (n,n\*3)

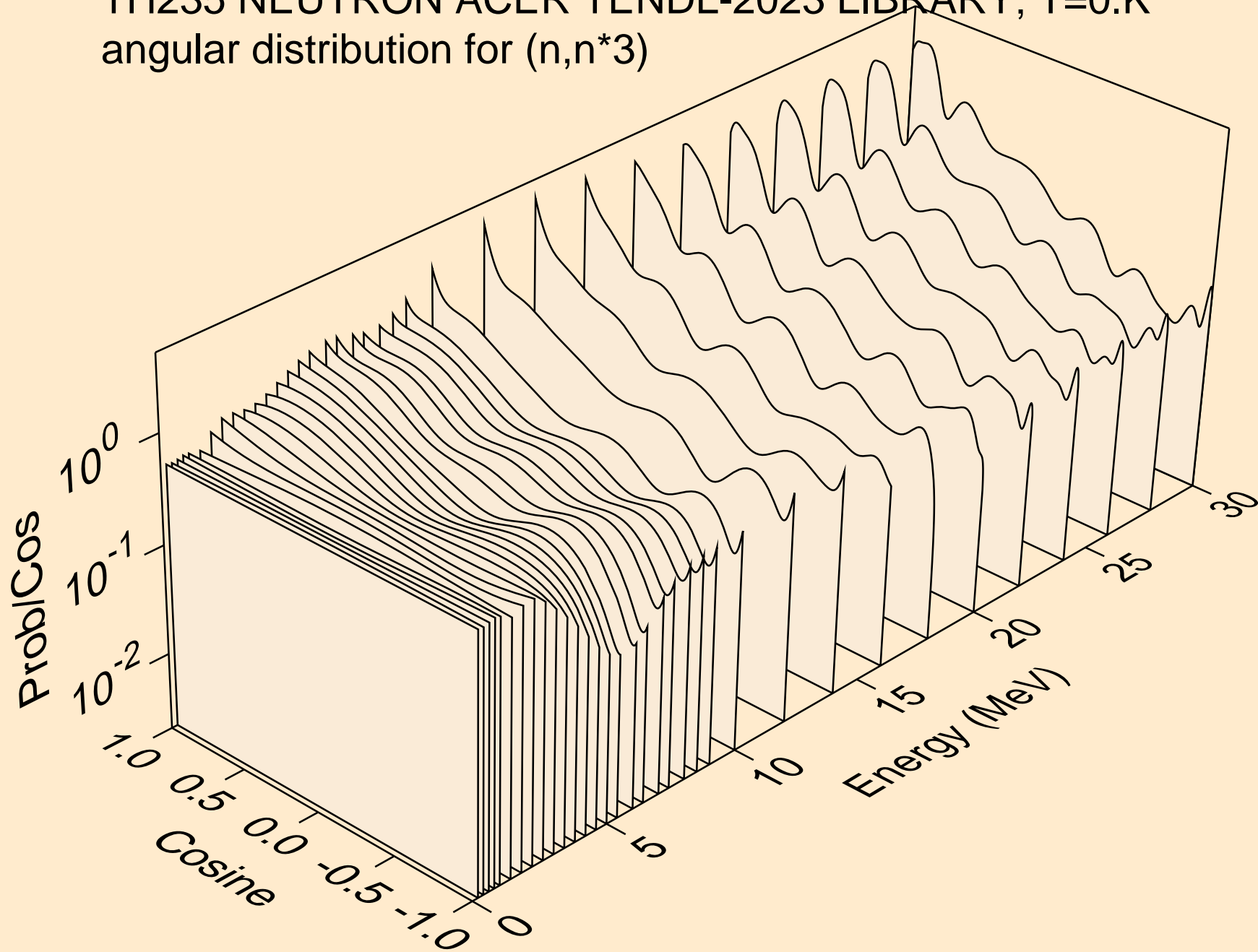



TH235 NEUTRON ACER TENDL-2023 LIBRARY; T=0.K  
angular distribution for (n,n\*4)

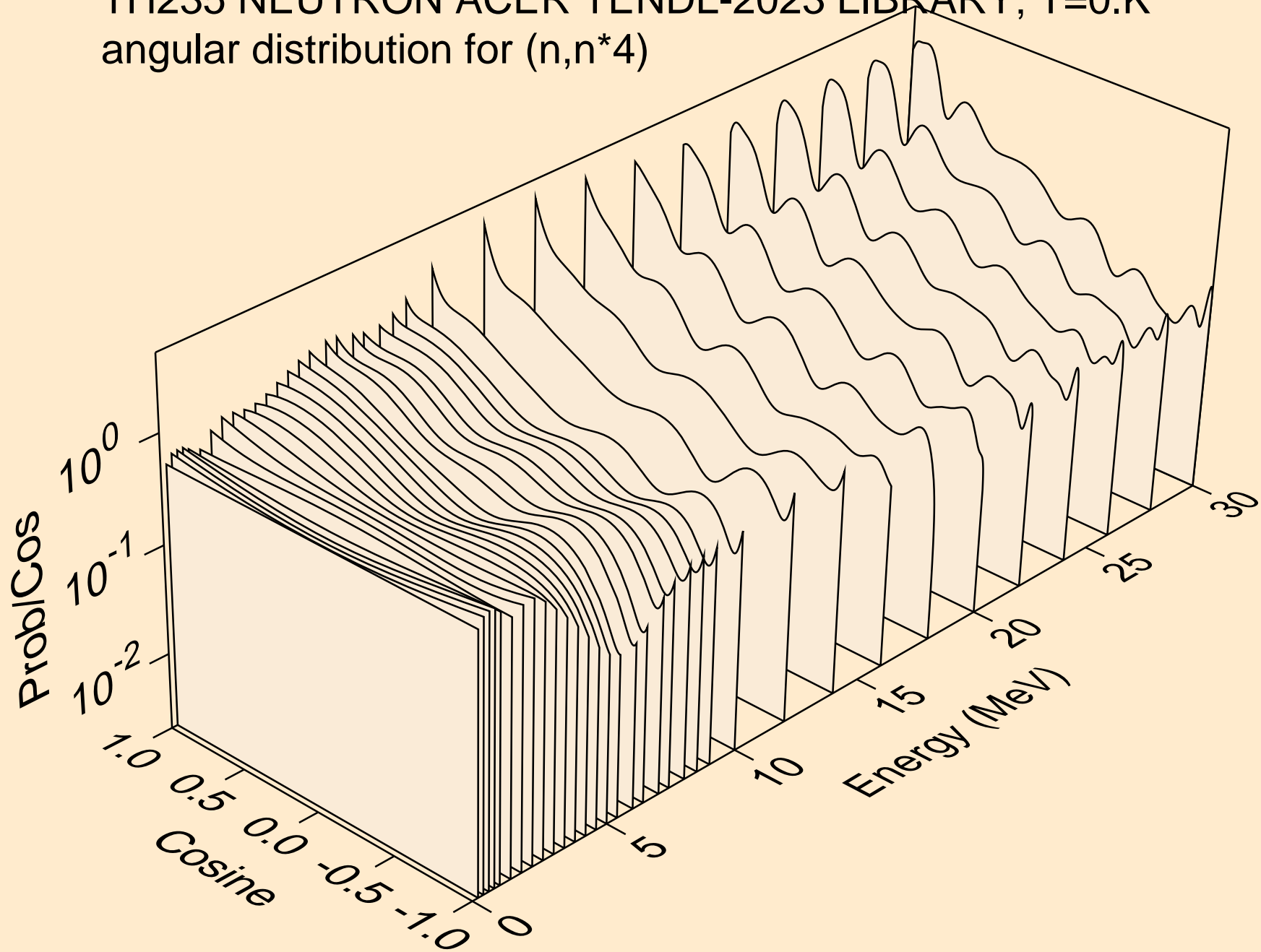

TH235 NEUTRON ACER TENDL-2023 LIBRARY; T=0.K  
angular distribution for (n,n\*5)

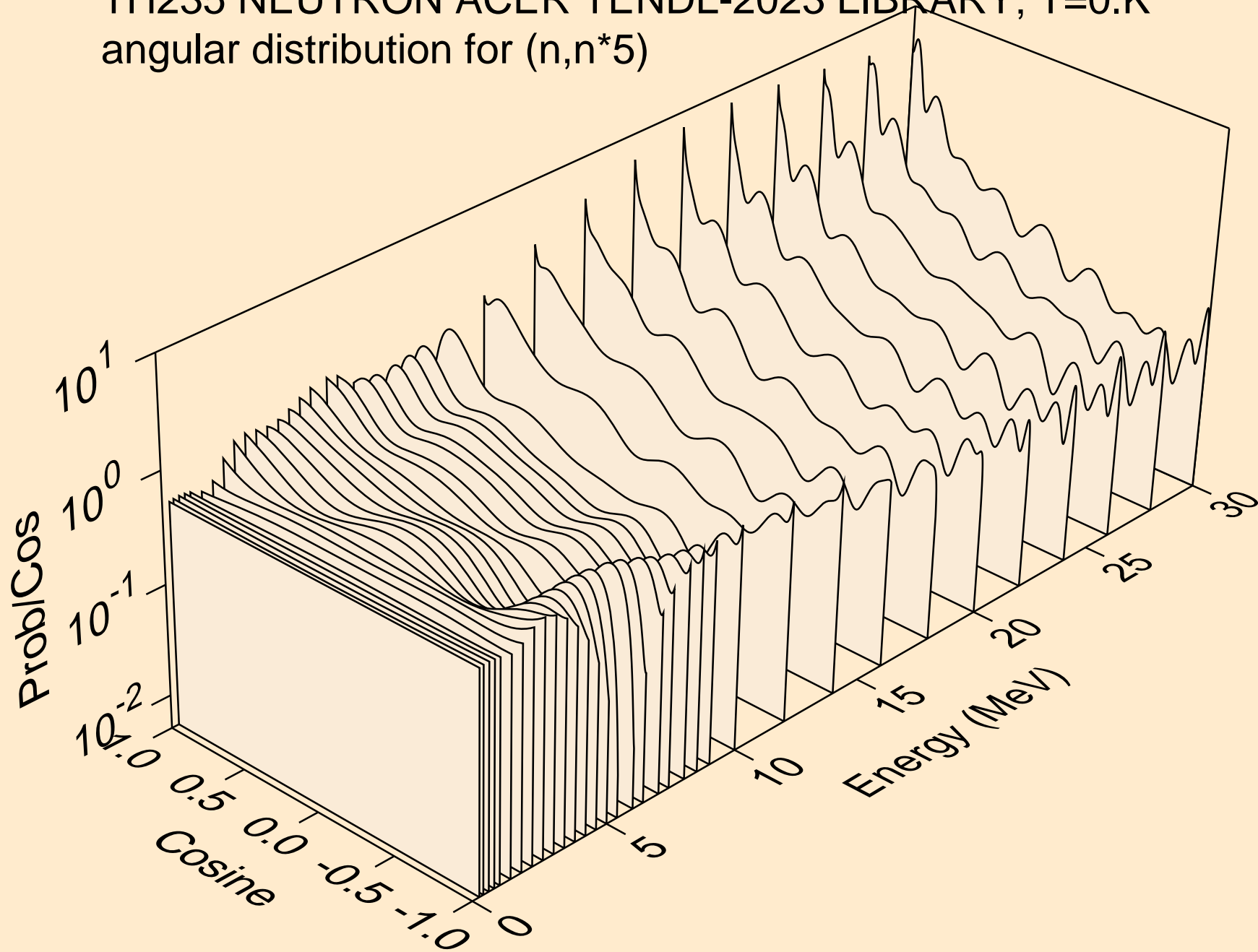

TH235 NEUTRON ACER TENDL-2023 LIBRARY; T=0.K  
angular distribution for (n,n\*6)

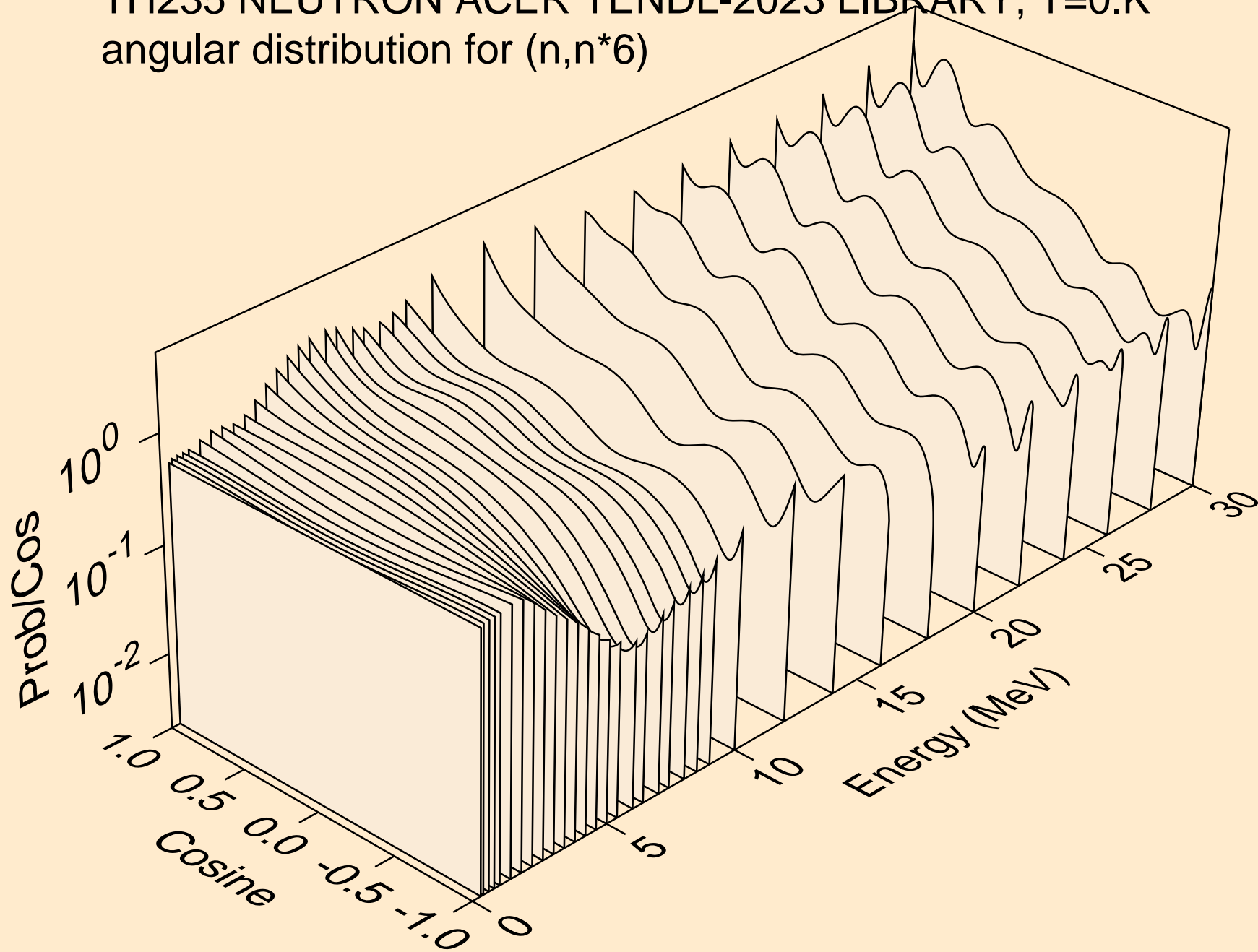

TH235 NEUTRON ACER TENDL-2023 LIBRARY; T=0.K  
angular distribution for (n,n\*7)

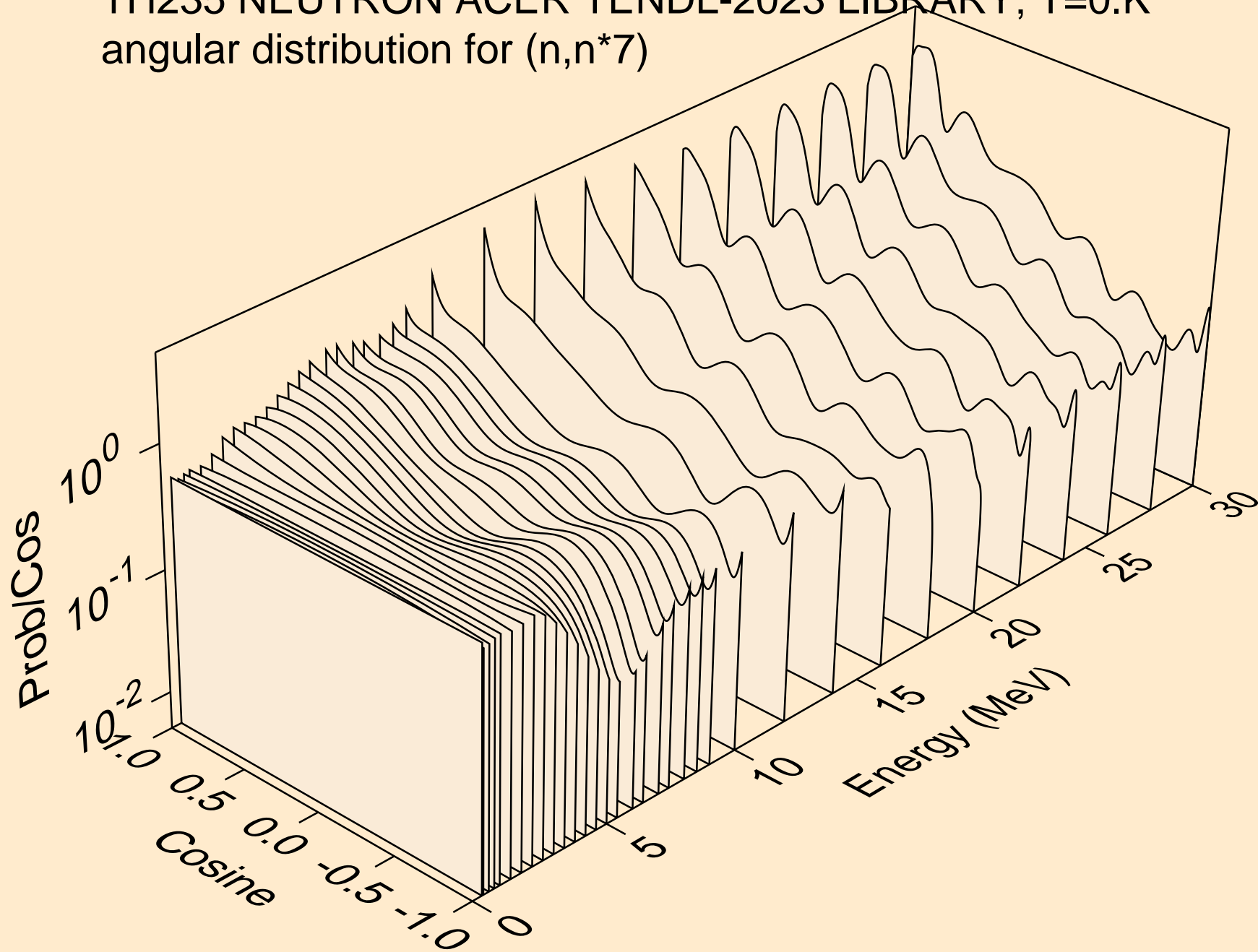

TH235 NEUTRON ACER TENDL-2023 LIBRARY; T=0.K  
angular distribution for (n,n\*8)

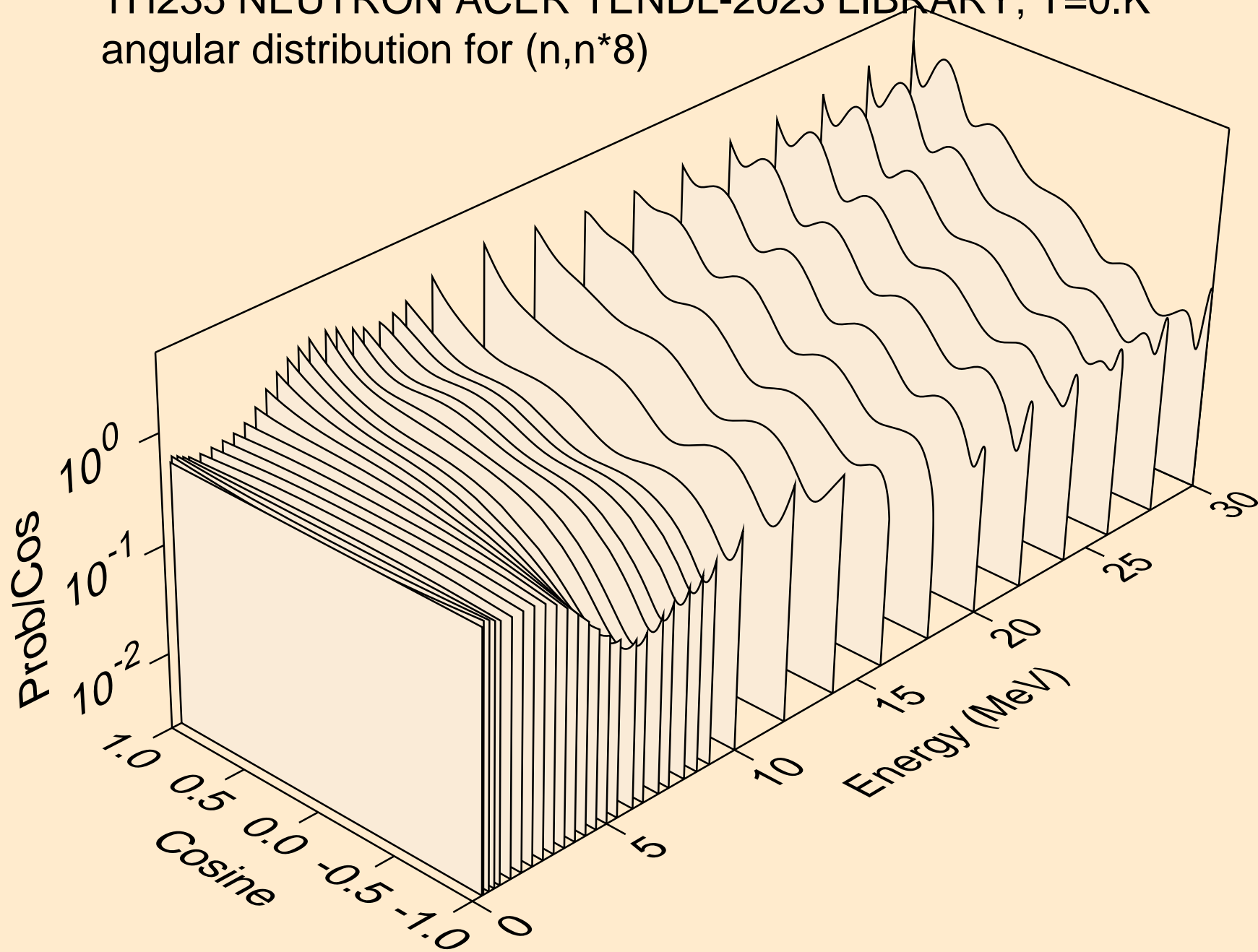

TH235 NEUTRON ACER TENDL-2023 LIBRARY; T=0.K  
angular distribution for (n,n\*9)

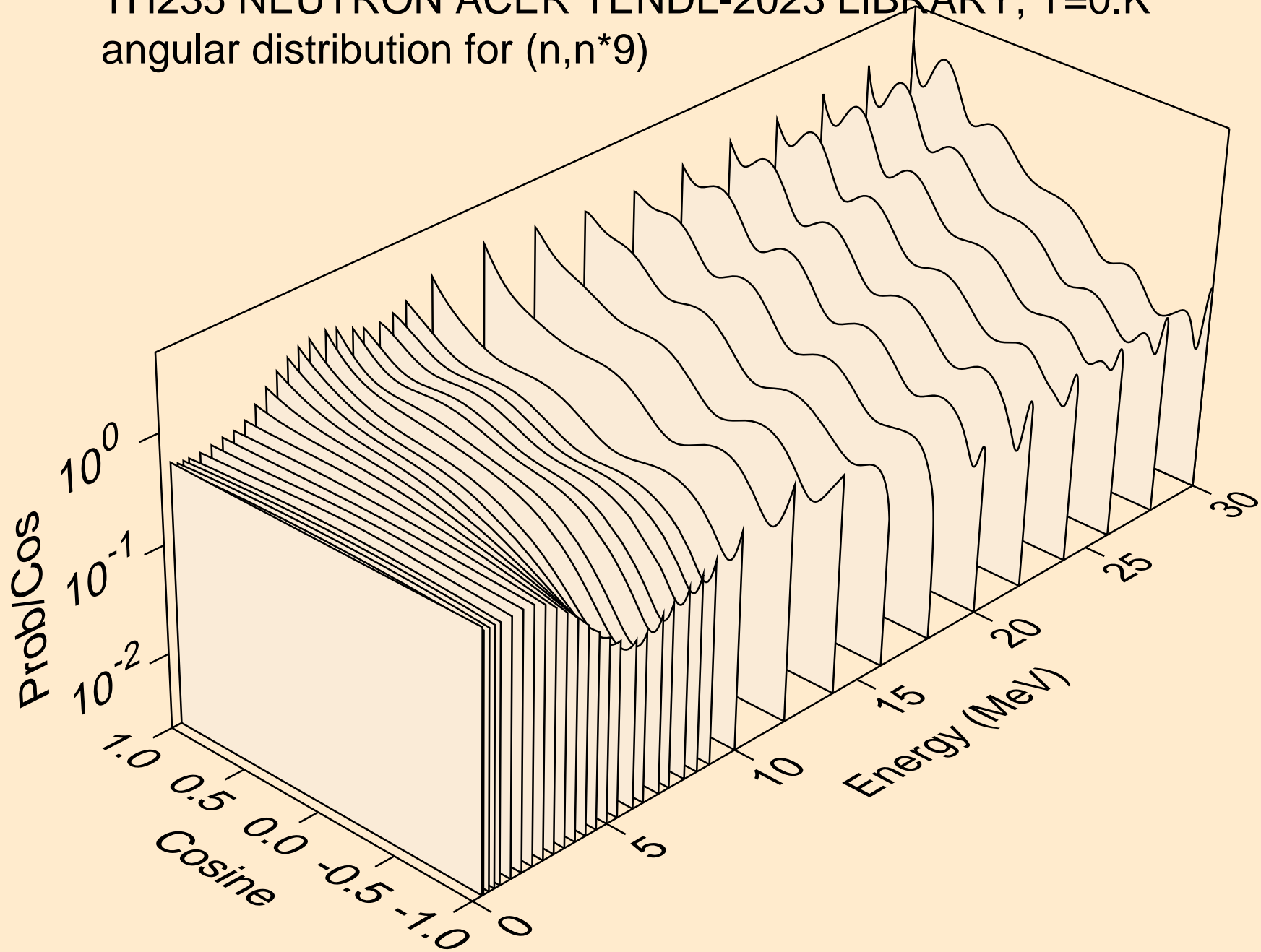

TH235 NEUTRON ACER TENDL-2023 LIBRARY; T=0.K  
angular distribution for (n,n\*10)

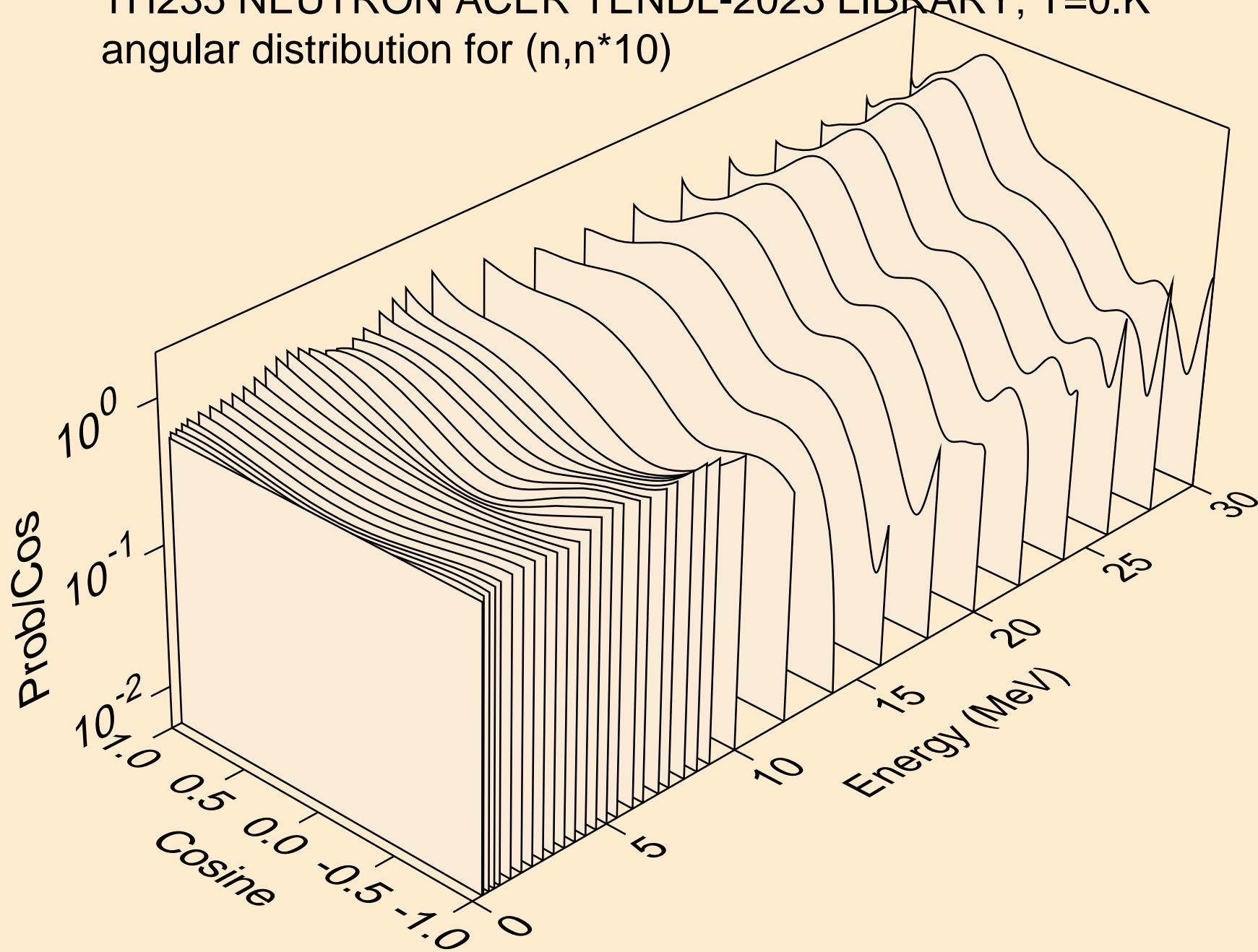



TH235 NEUTRON ACER TENDL-2023 LIBRARY; T=0.K  
angular distribution for (n,n\*11)

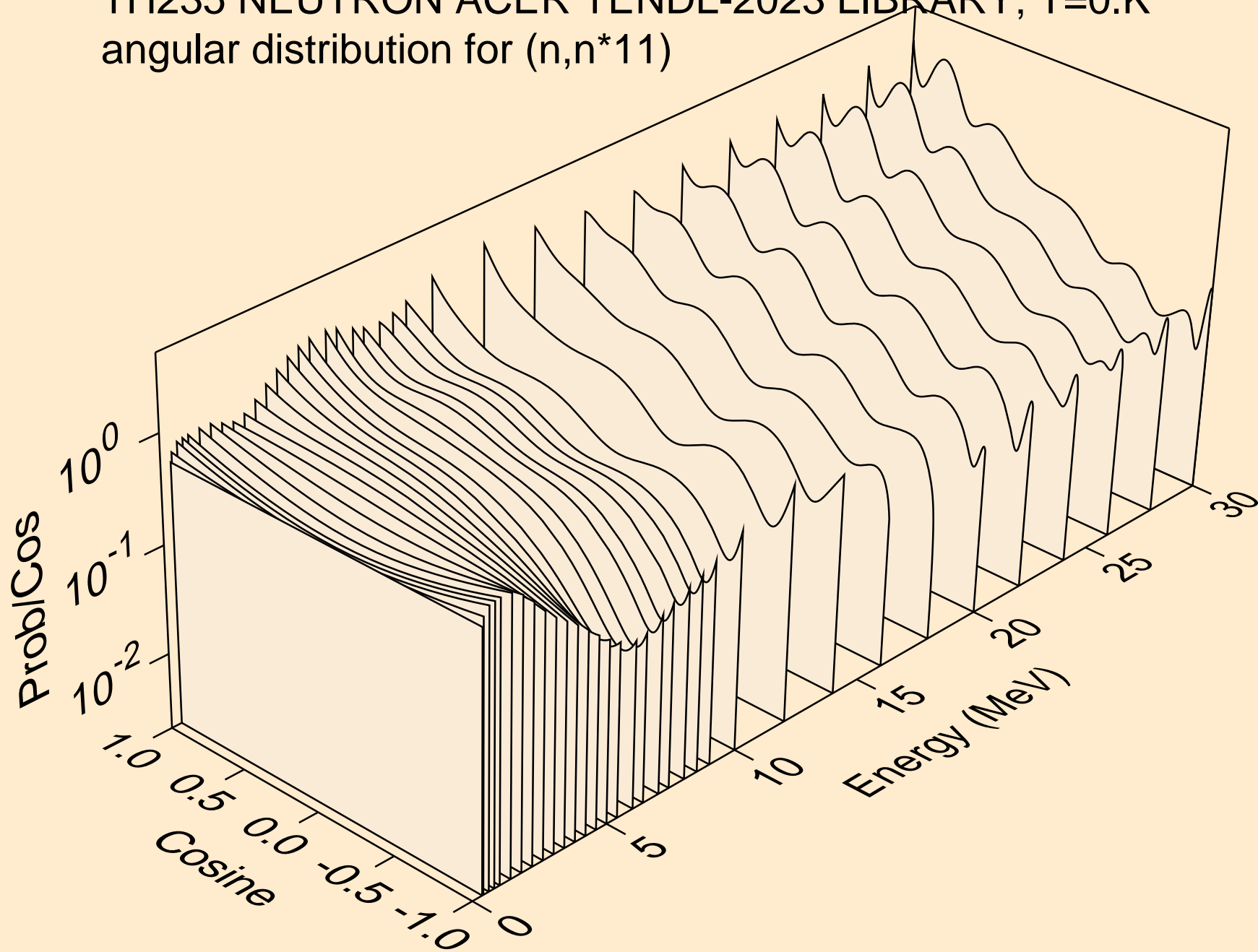



TH235 NEUTRON ACER TENDL-2023 LIBRARY; T=0.K  
angular distribution for (n,n\*12)

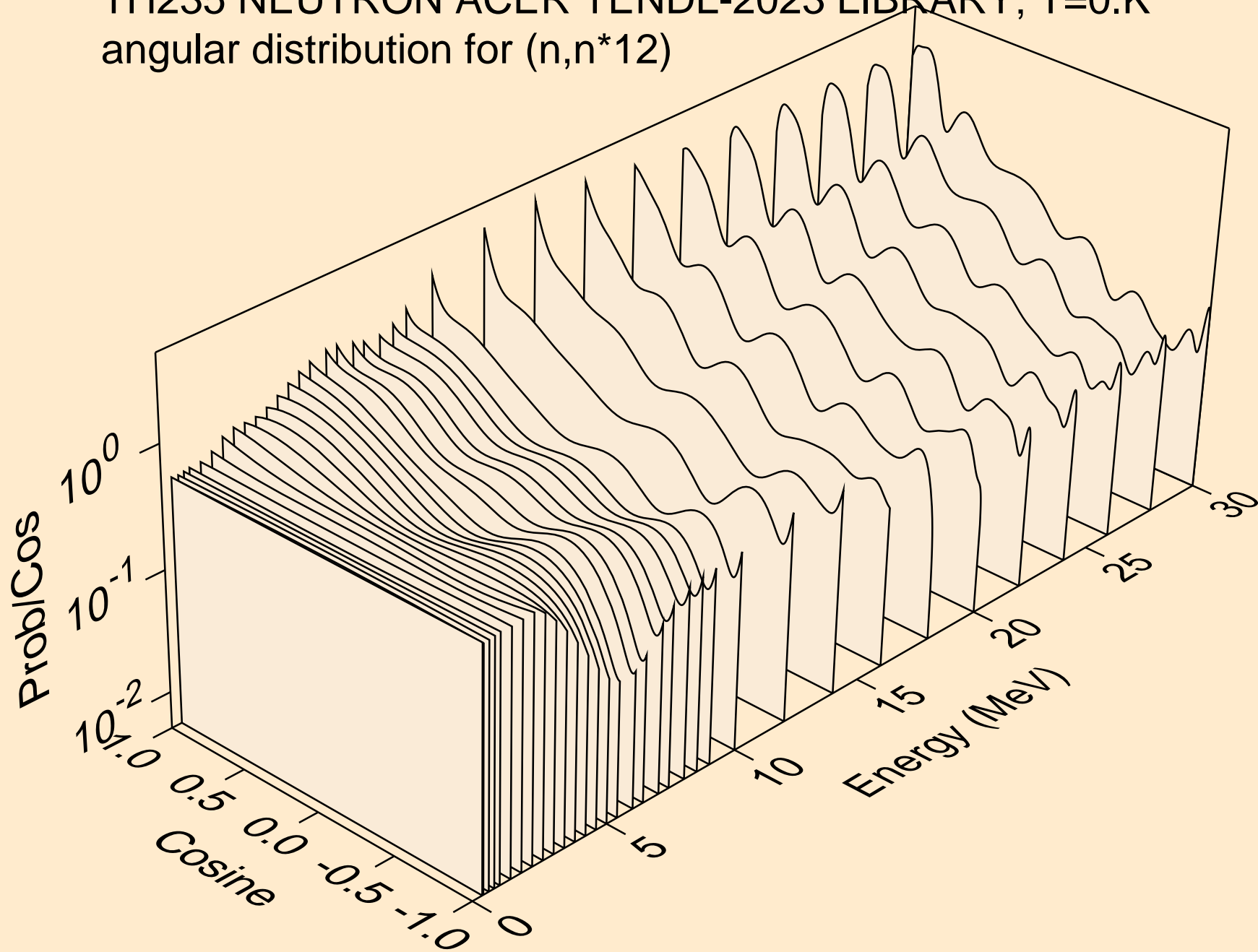

TH235 NEUTRON ACER TENDL-2023 LIBRARY; T=0.K  
angular distribution for (n,n\*13)

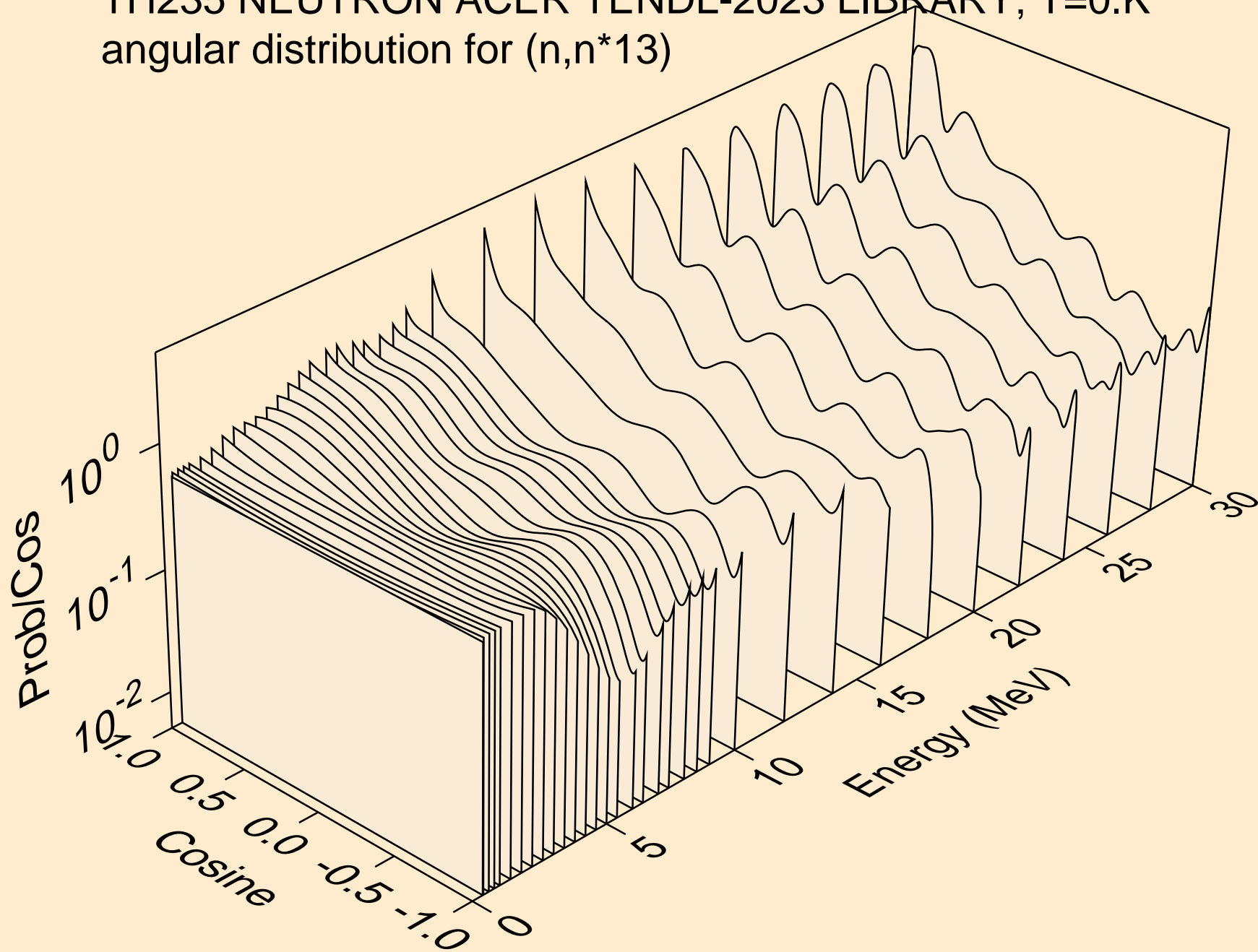

TH235 NEUTRON ACER TENDL-2023 LIBRARY; T=0.K  
angular distribution for (n,n\*14)

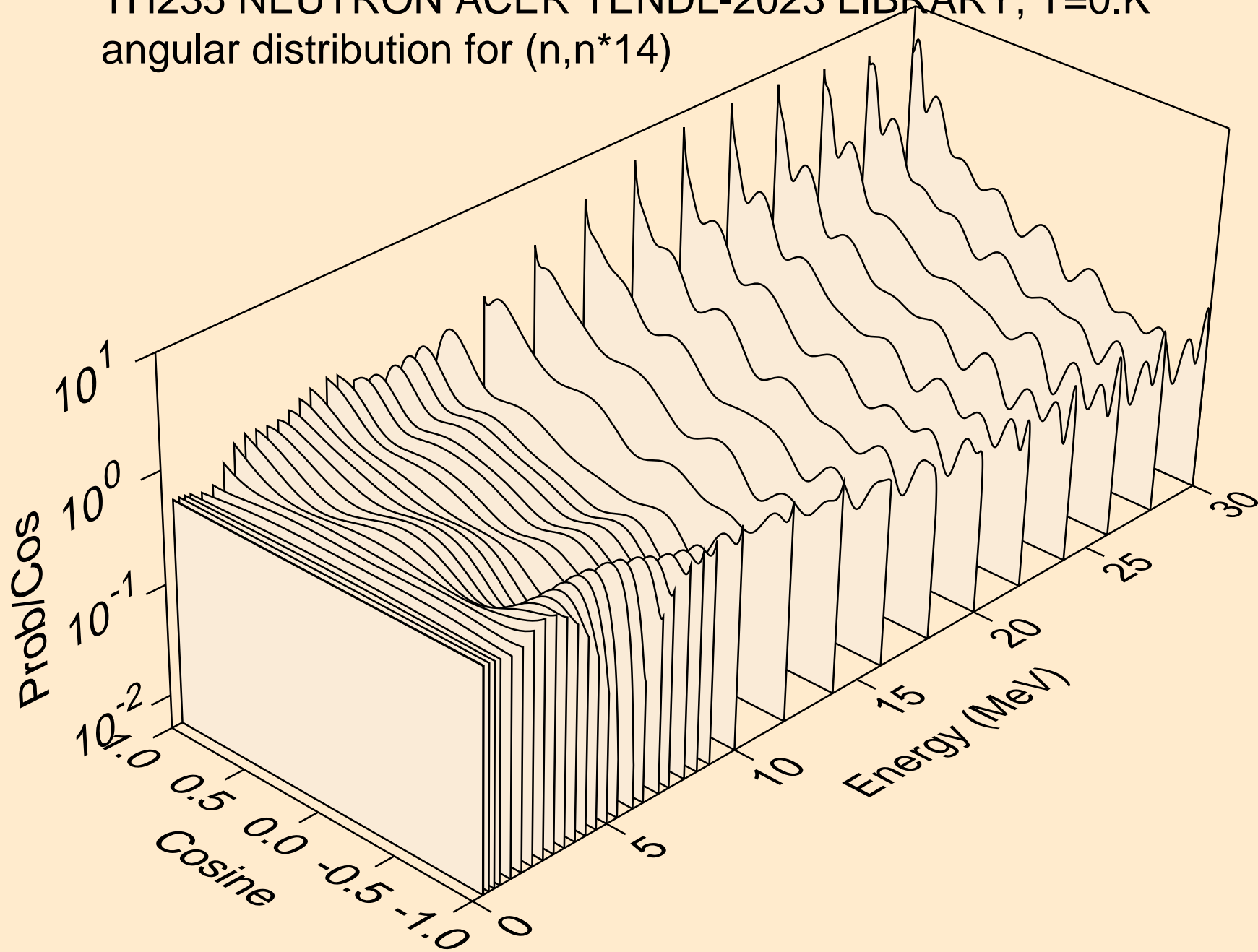

TH235 NEUTRON ACER TENDL-2023 LIBRARY; T=0.K  
angular distribution for (n,n\*15)

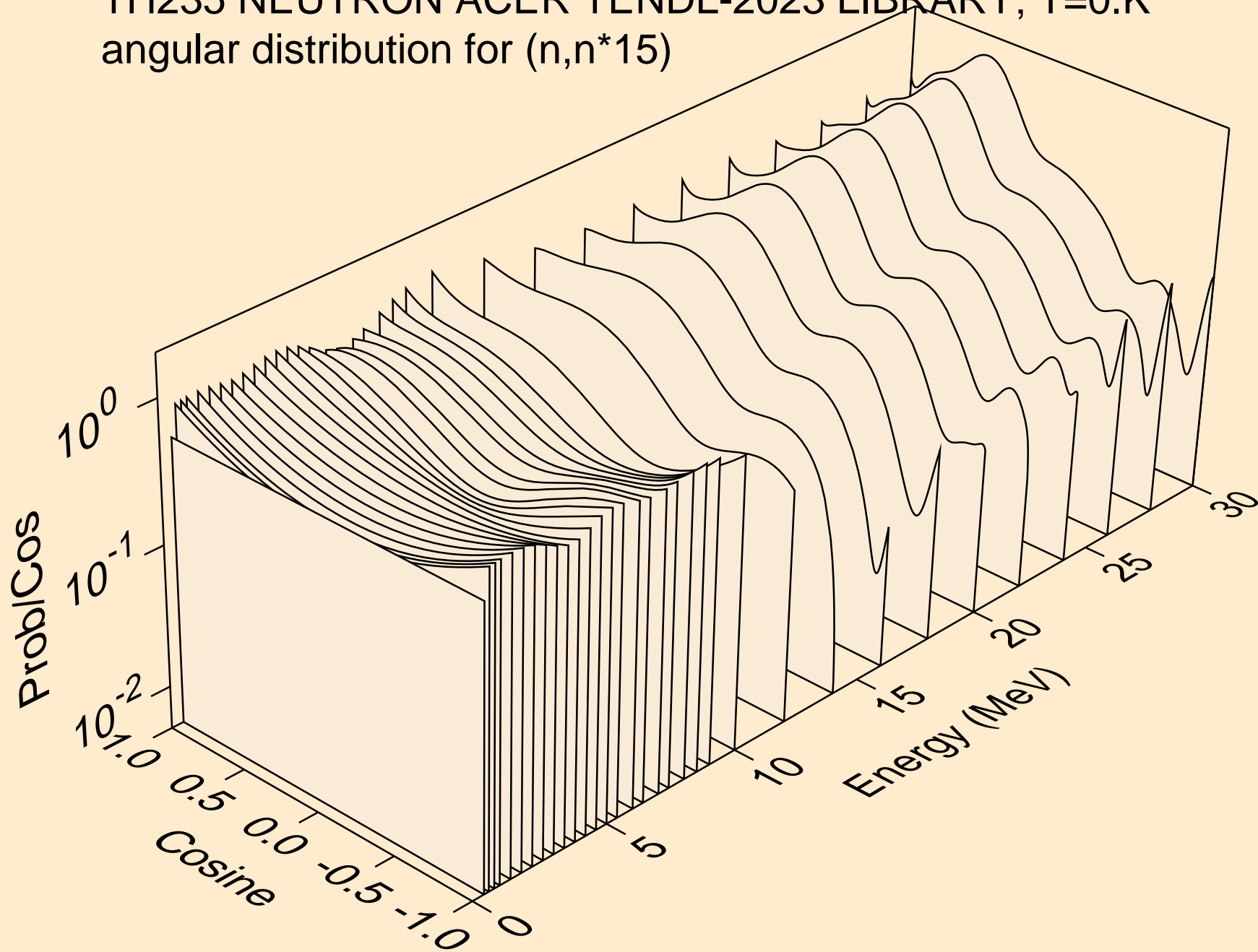

TH235 NEUTRON ACER TENDL-2023 LIBRARY; T=0.K  
angular distribution for (n,n\*16)

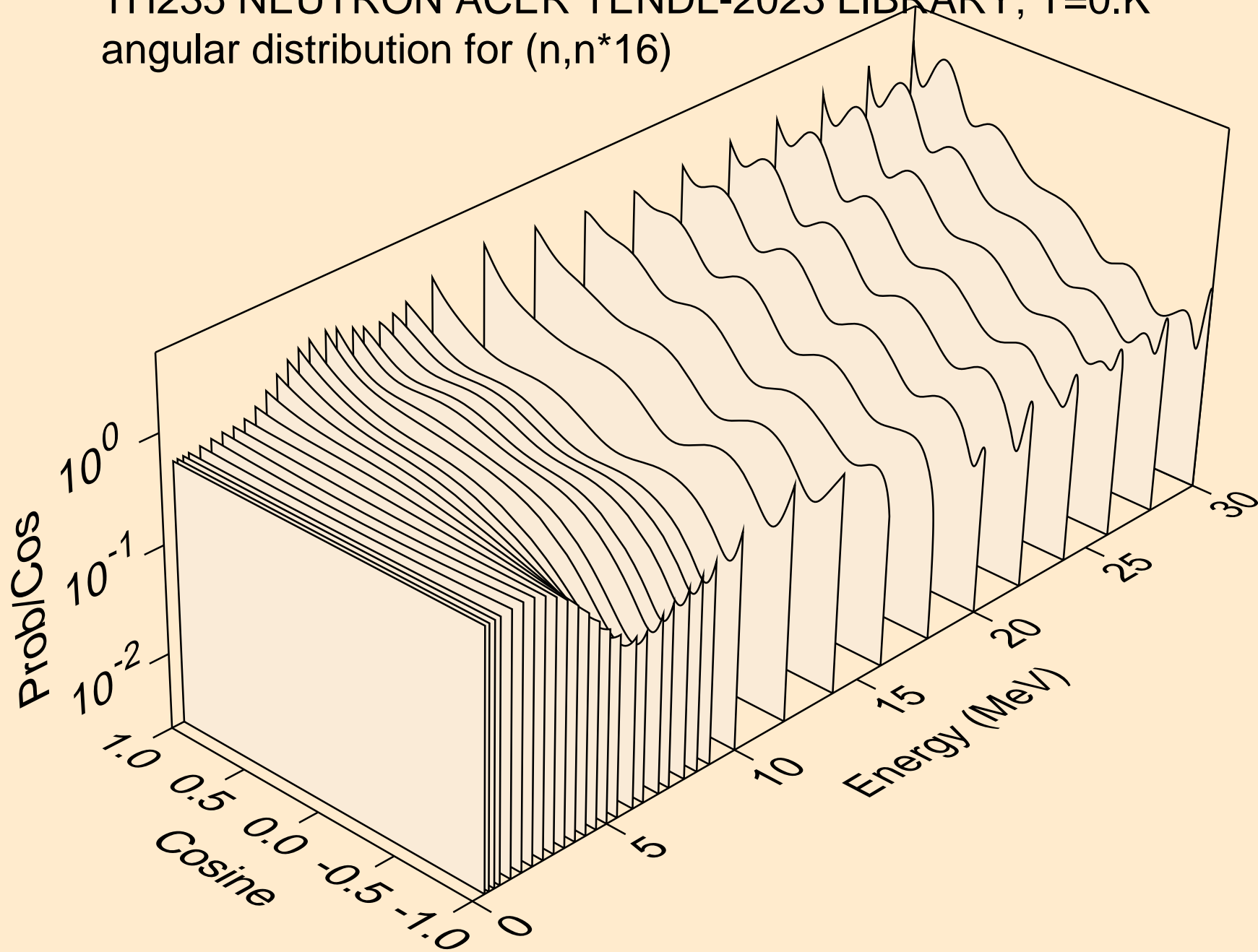

TH235 NEUTRON ACER TENDL-2023 LIBRARY; T=0.K  
angular distribution for (n,n\*17)

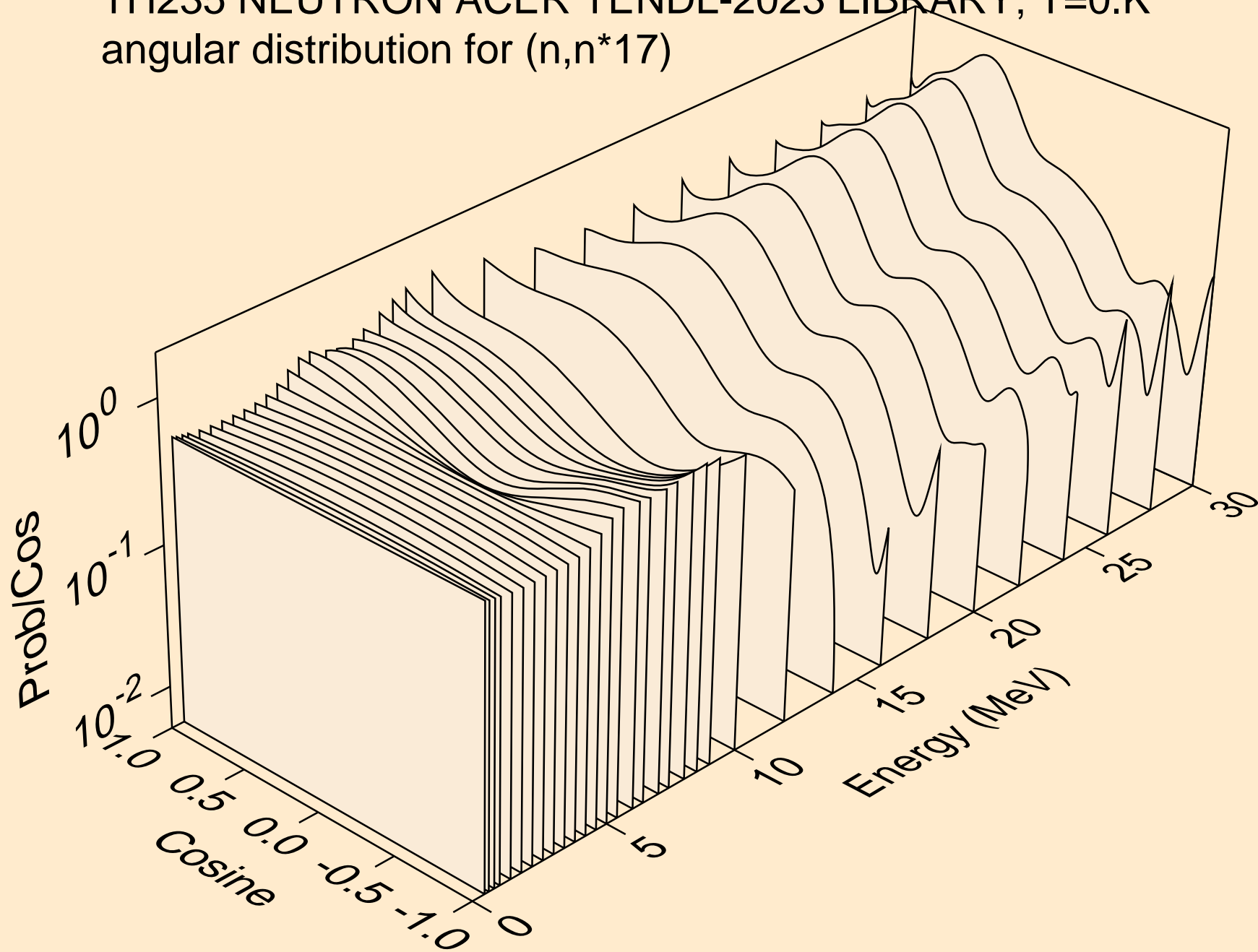

TH235 NEUTRON ACER TENDL-2023 LIBRARY; T=0.K  
angular distribution for (n,n\*18)

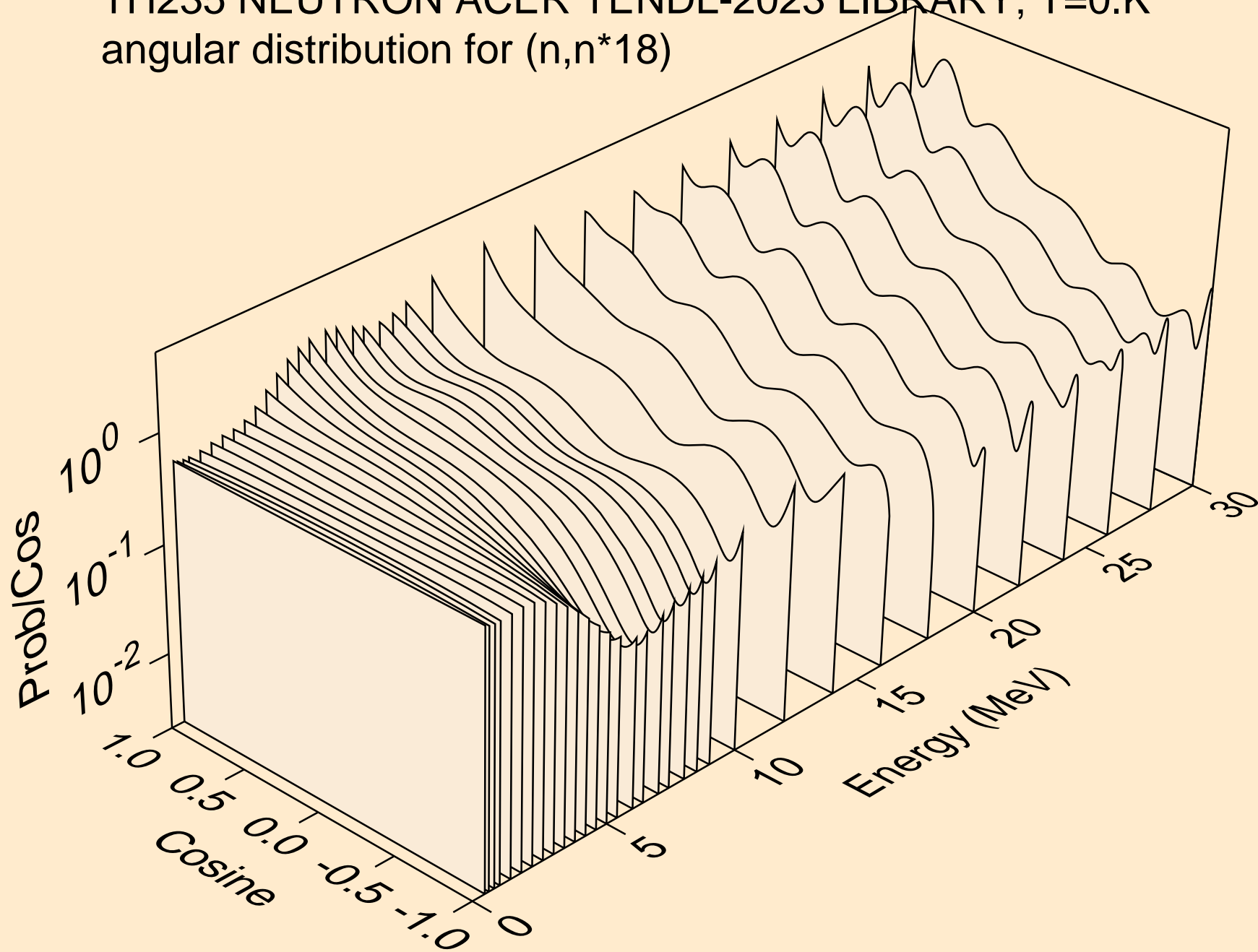



TH235 NEUTRON ACER TENDL-2023 LIBRARY; T=0.K  
angular distribution for (n,n\*19)

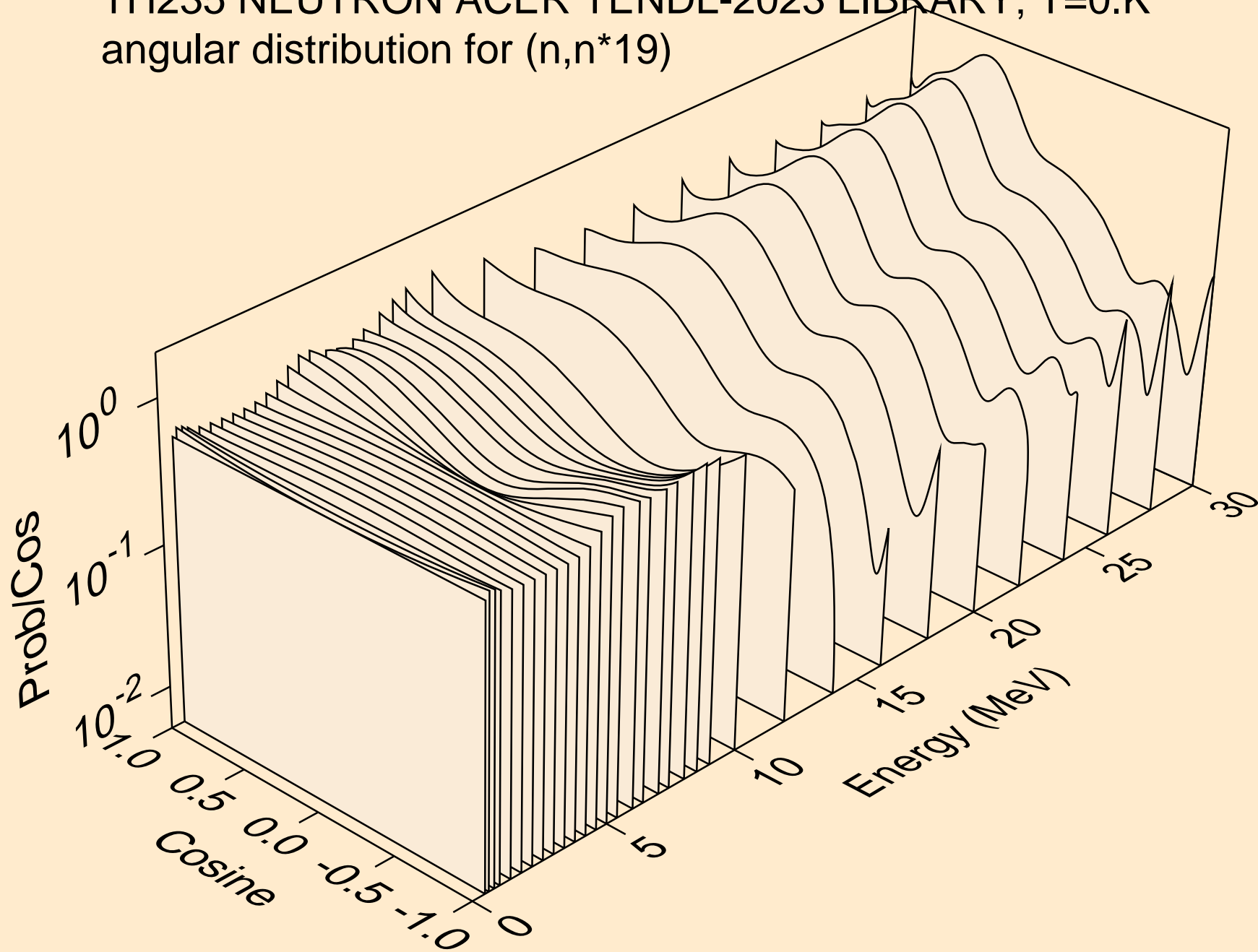



TH235 NEUTRON ACER TENDL-2023 LIBRARY; T=0.K  
angular distribution for (n,n\*20)

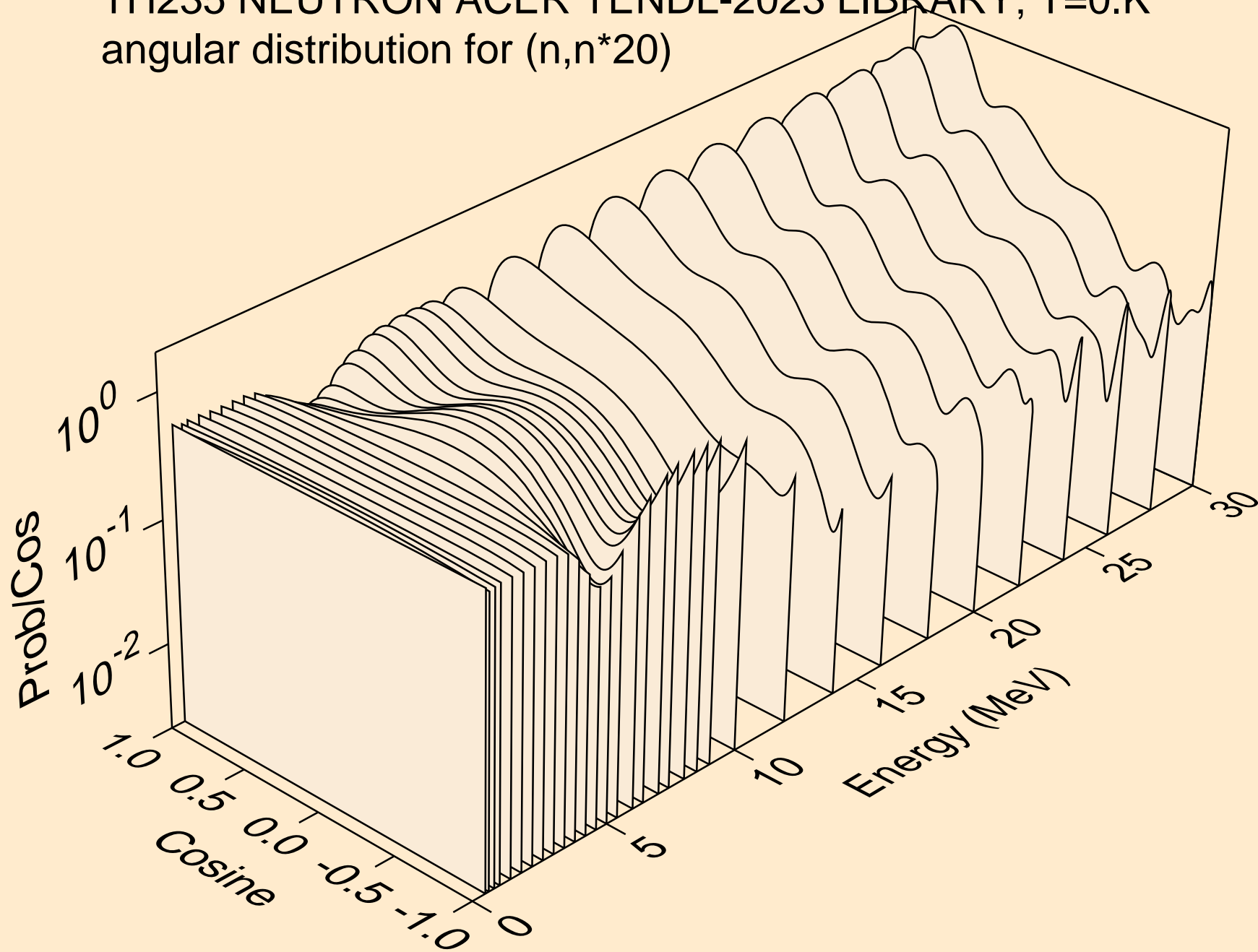

TH235 NEUTRON ACER TENDL-2023 LIBRARY; T=0.K  
angular distribution for (n,n\*21)

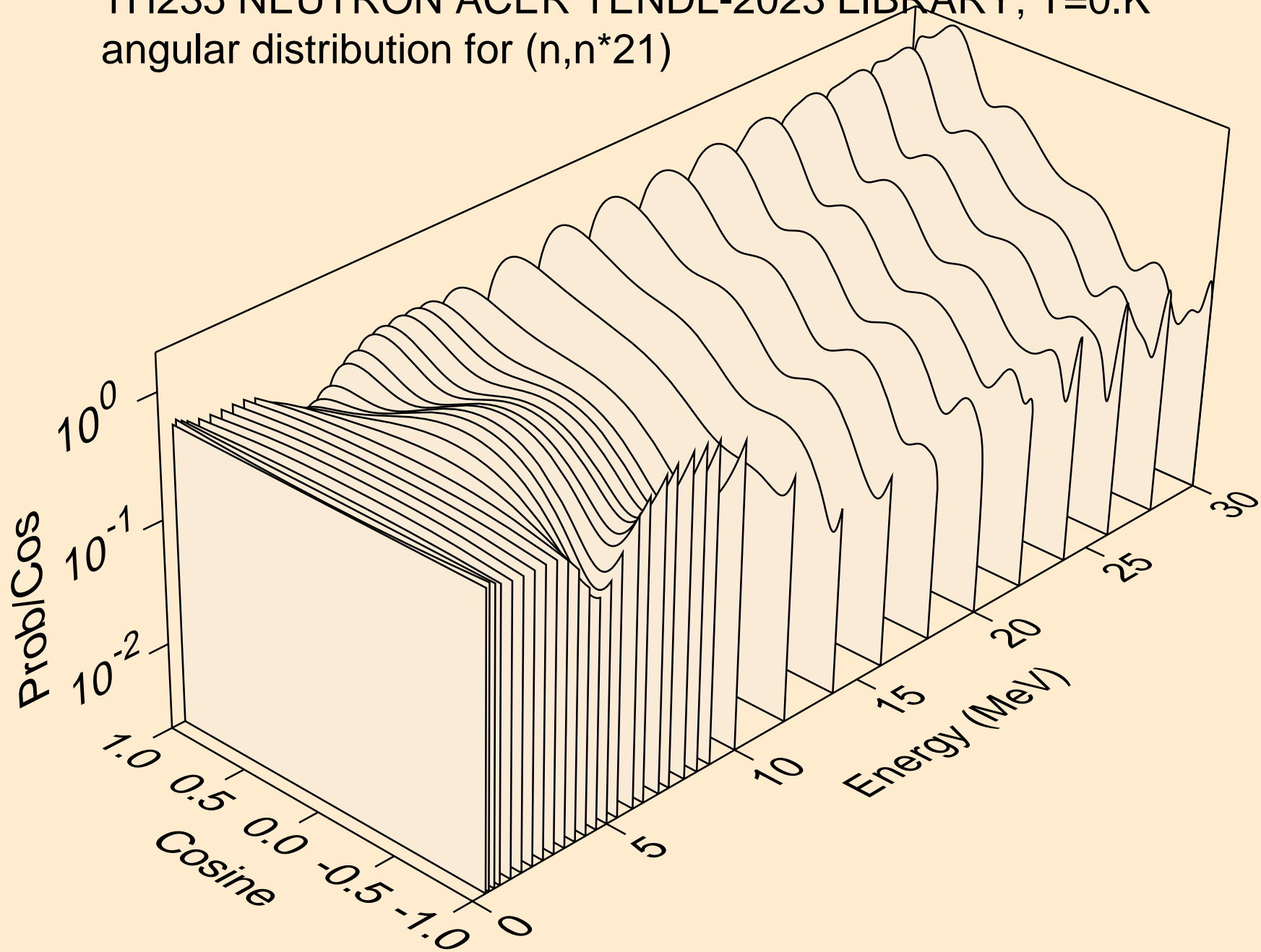

TH235 NEUTRON ACER TENDL-2023 LIBRARY; T=0.K  
angular distribution for (n,n\*22)

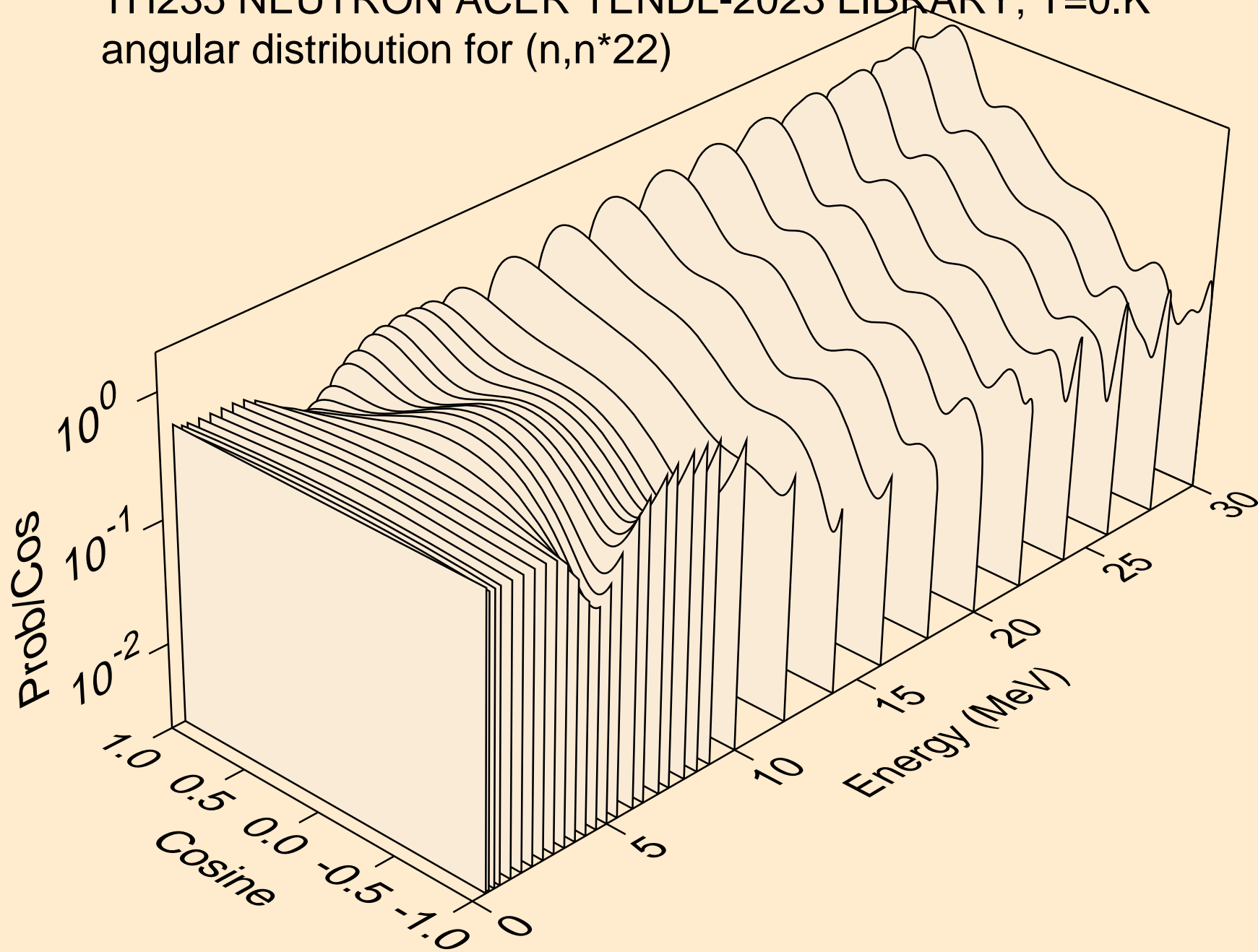

TH235 NEUTRON ACER TENDL-2023 LIBRARY; T=0.K  
angular distribution for (n,n\*23)

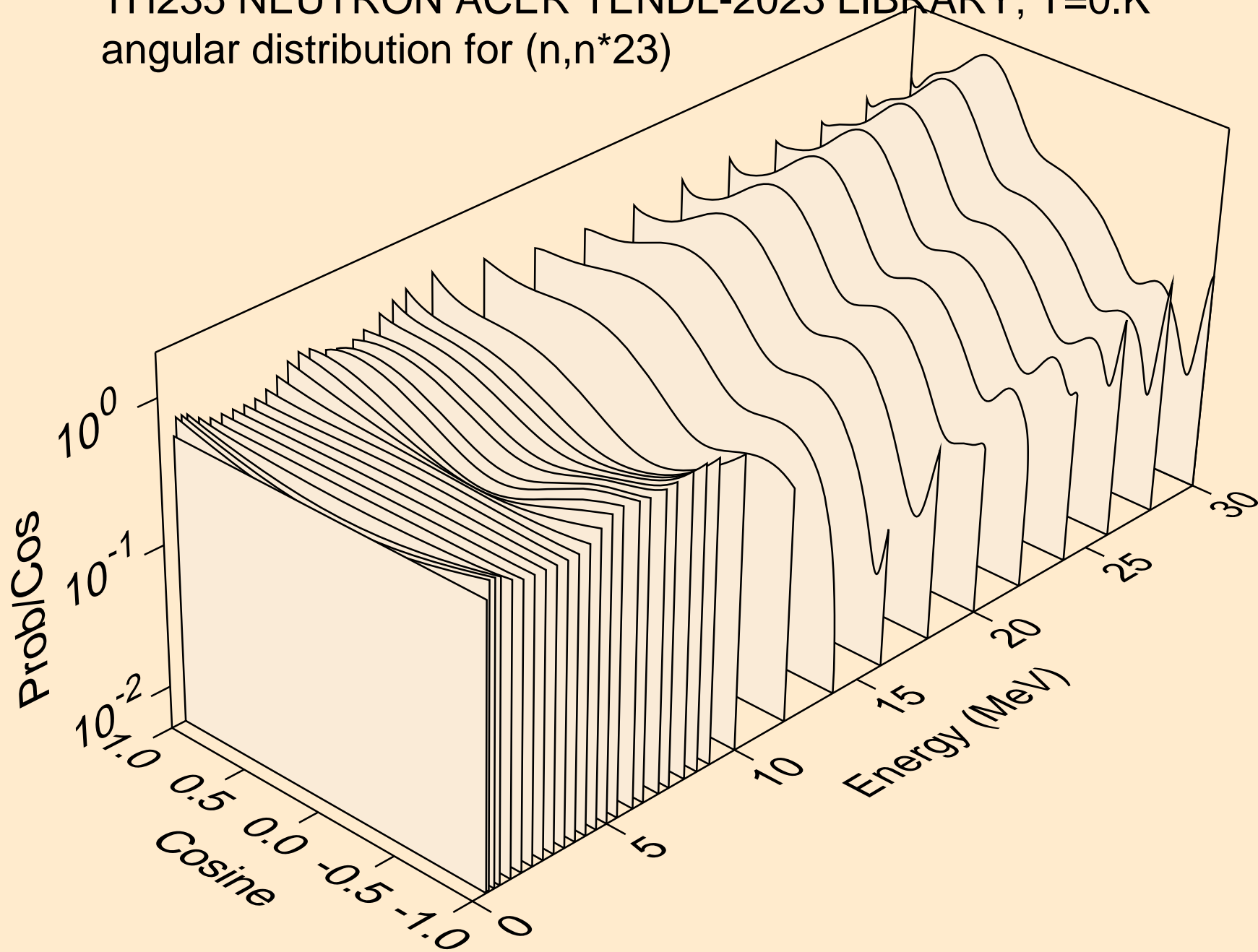

TH235 NEUTRON ACER TENDL-2023 LIBRARY; T=0.K  
angular distribution for (n,n\*24)

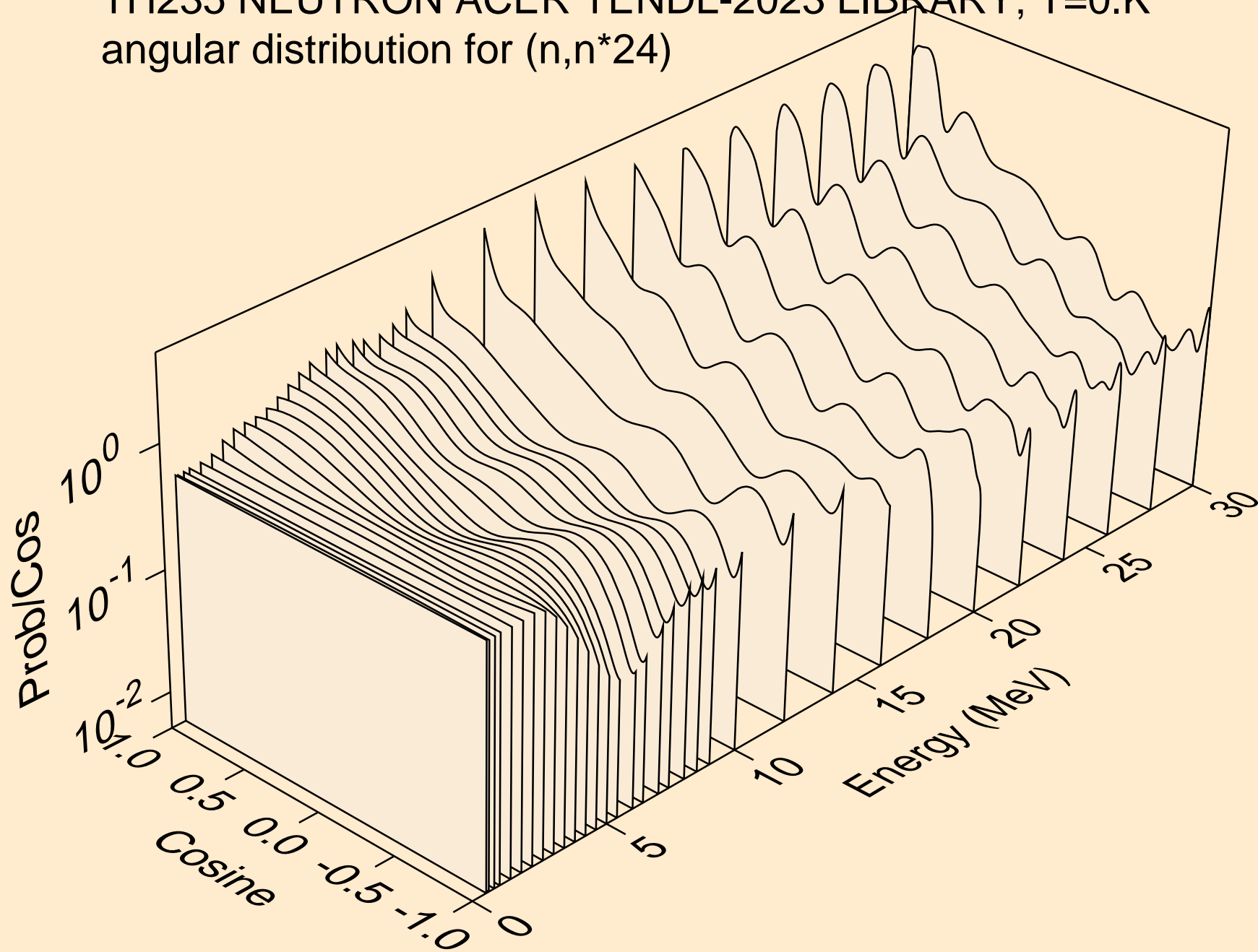

TH235 NEUTRON ACER TENDL-2023 LIBRARY; T=0.K  
angular distribution for (n,n\*25)

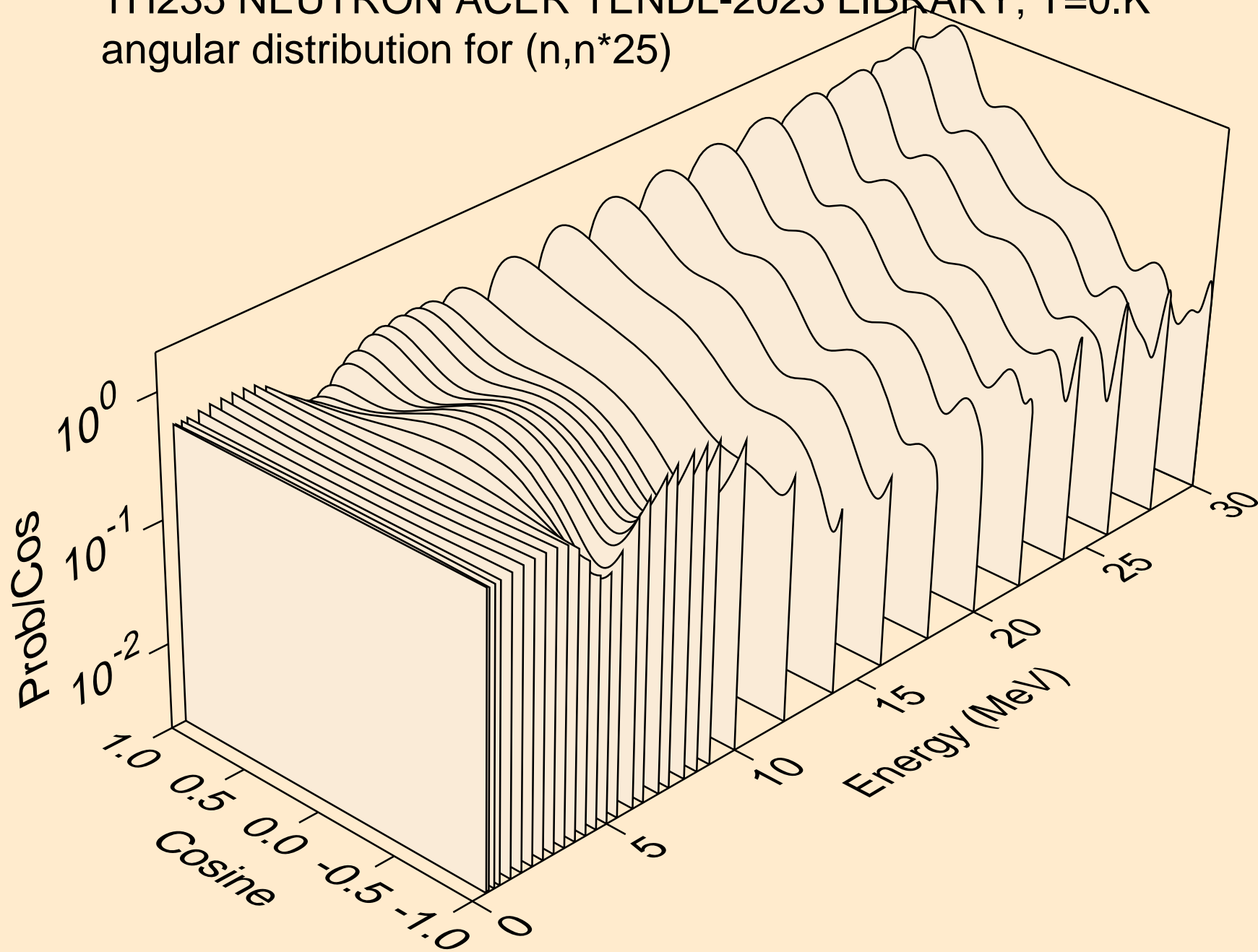

TH235 NEUTRON ACER TENDL-2023 LIBRARY; T=0.K  
angular distribution for (n,n\*26)

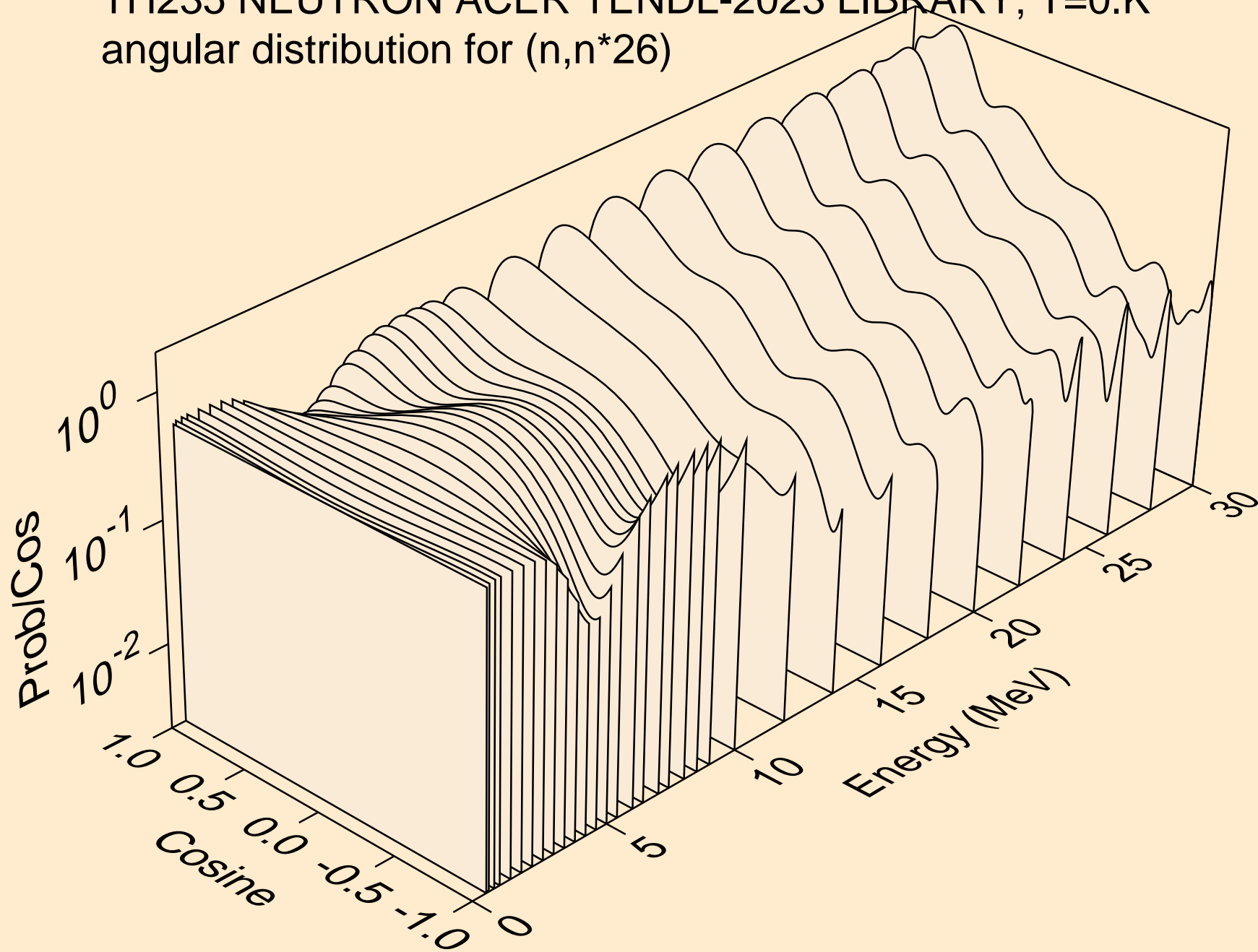

TH235 NEUTRON ACER TENDL-2023 LIBRARY; T=0.K  
angular distribution for (n,n\*27)

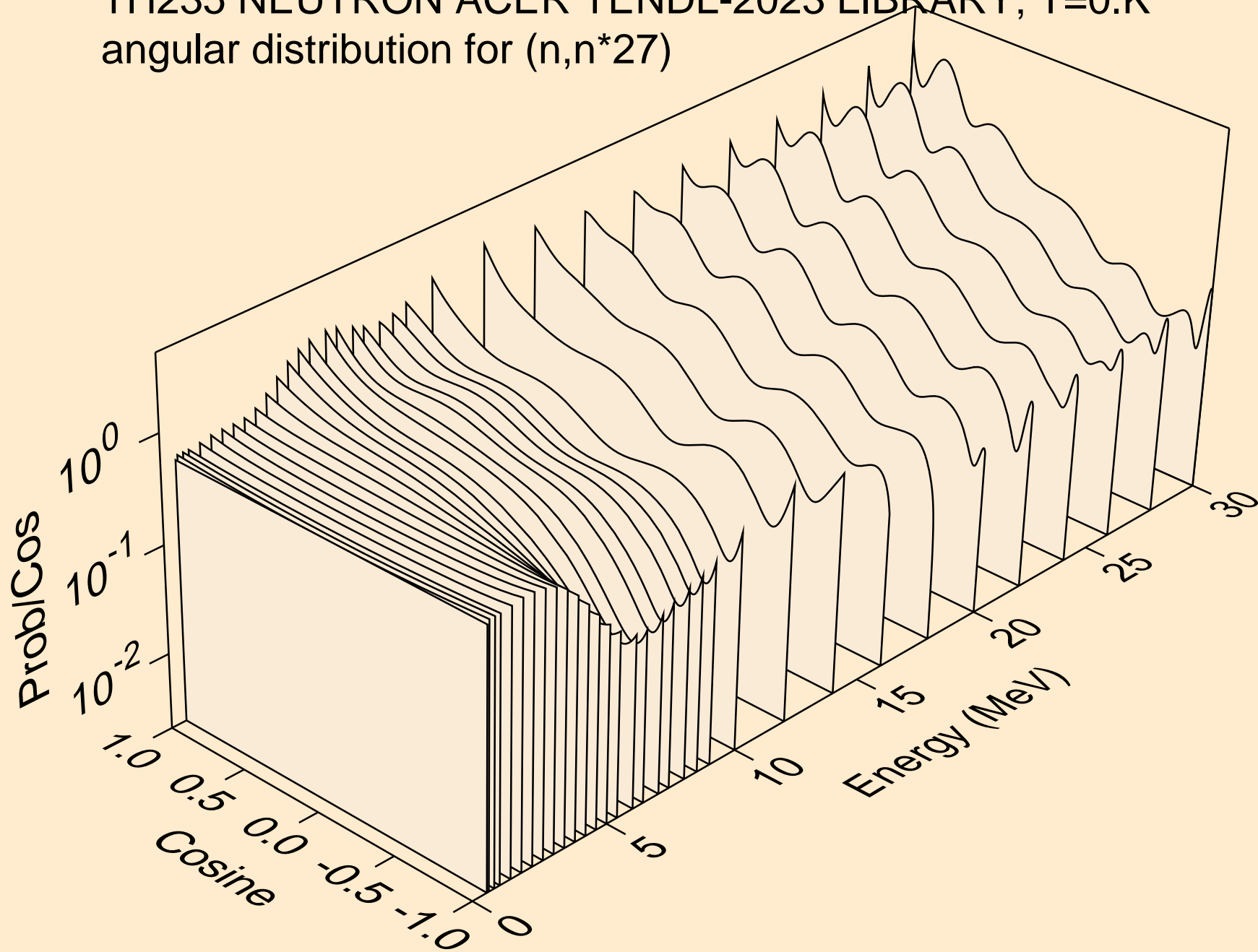



TH235 NEUTRON ACER TENDL-2023 LIBRARY; T=0.K  
angular distribution for (n,n\*28)

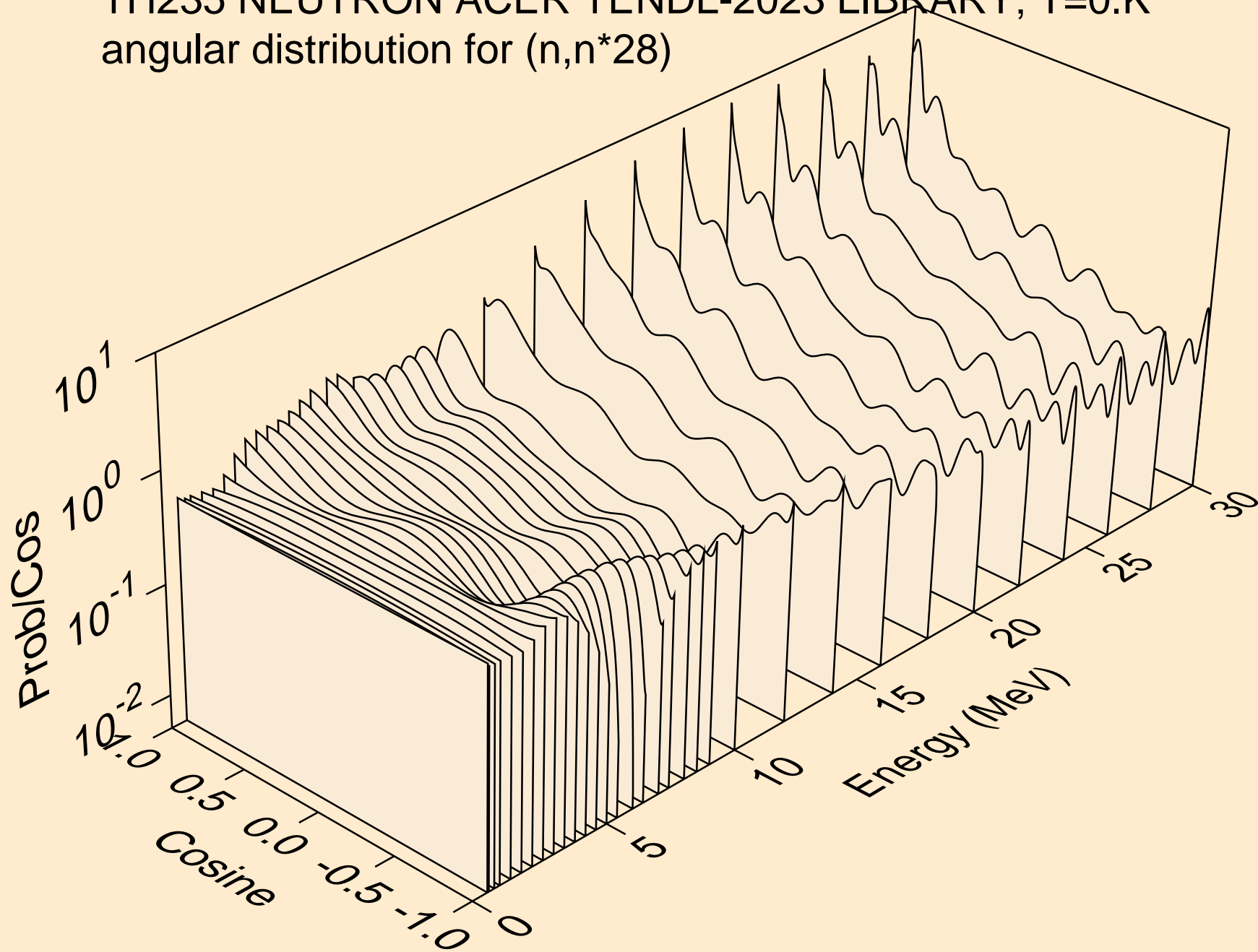

TH235 NEUTRON ACER TENDL-2023 LIBRARY; T=0.K  
angular distribution for (n,n\*29)

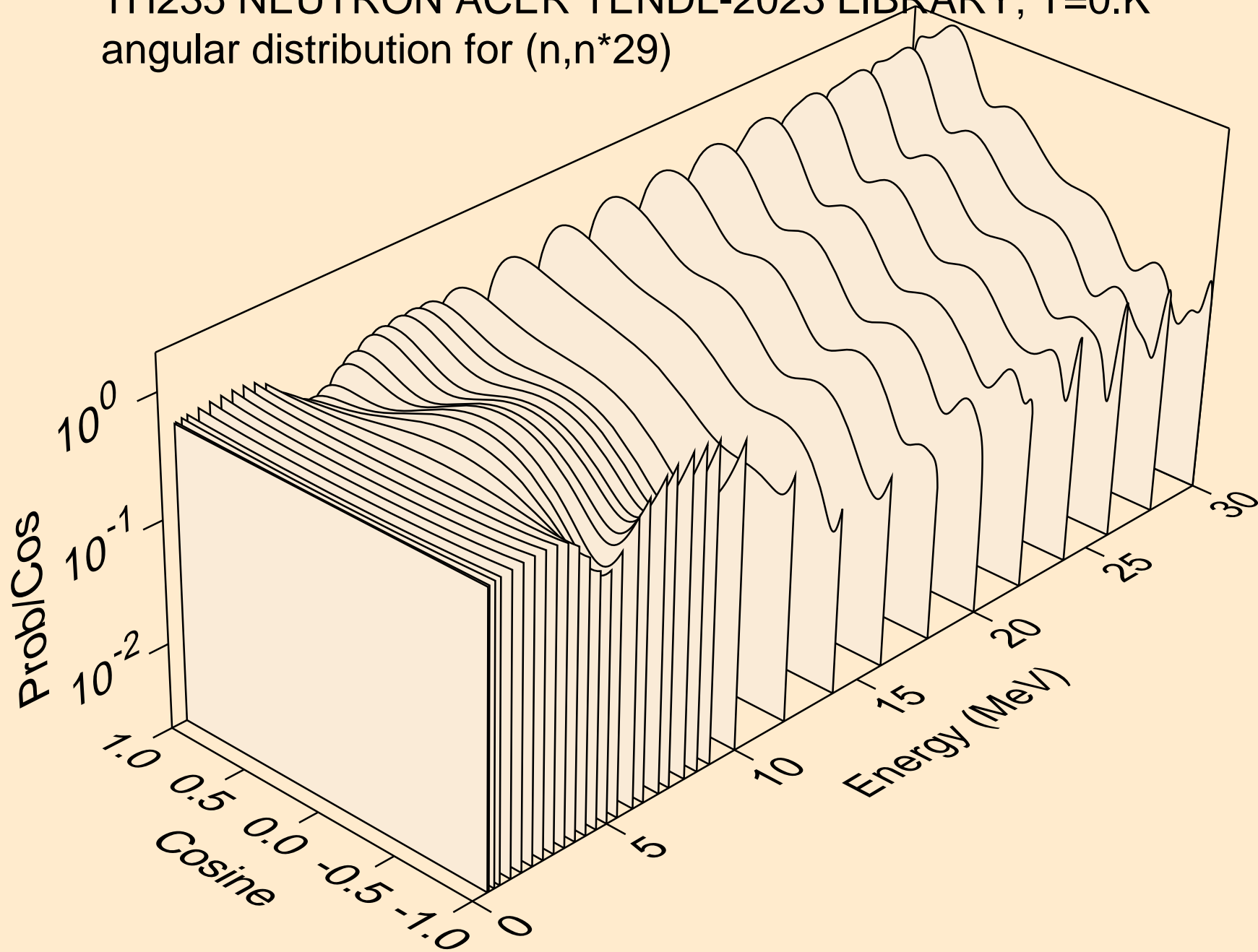

TH235 NEUTRON ACER TENDL-2023 LIBRARY; T=0.K  
angular distribution for (n,n\*30)

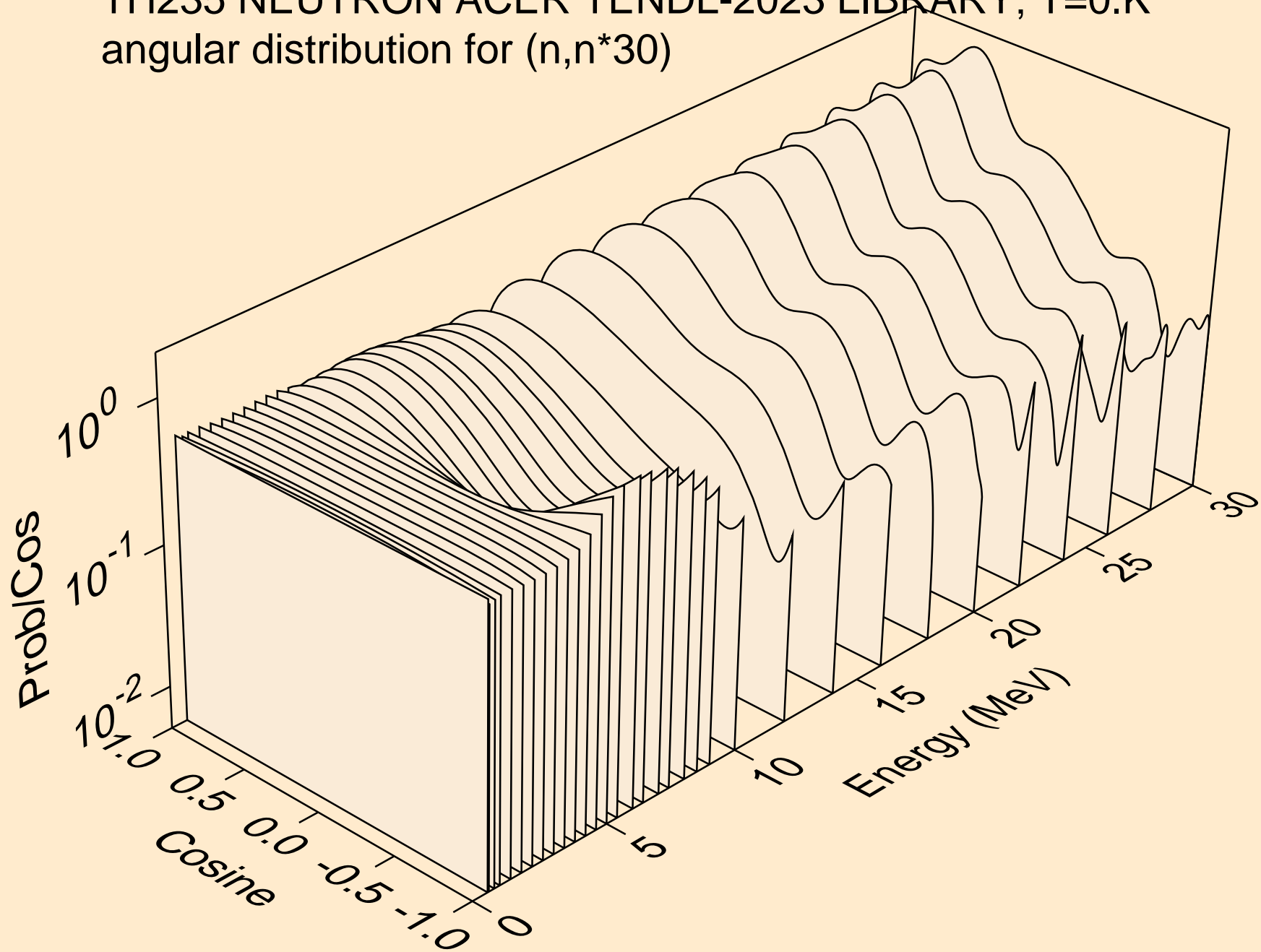

TH235 NEUTRON ACER TENDL-2023 LIBRARY; T=0.K  
Total fission nubar

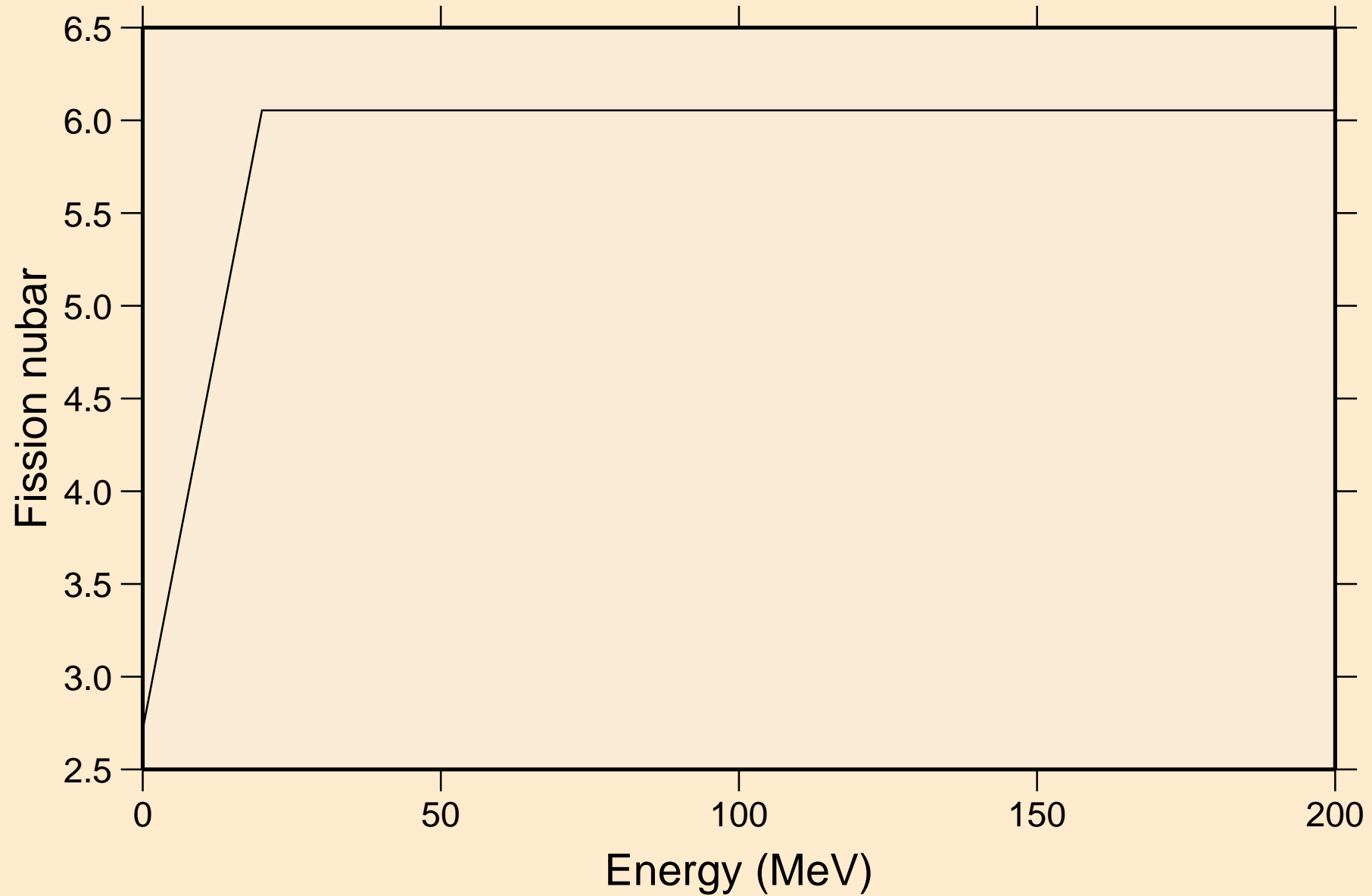

TH235 NEUTRON ACER TENDL-2023 LIBRARY; T=0.K  
Neutron emission for (n,x)

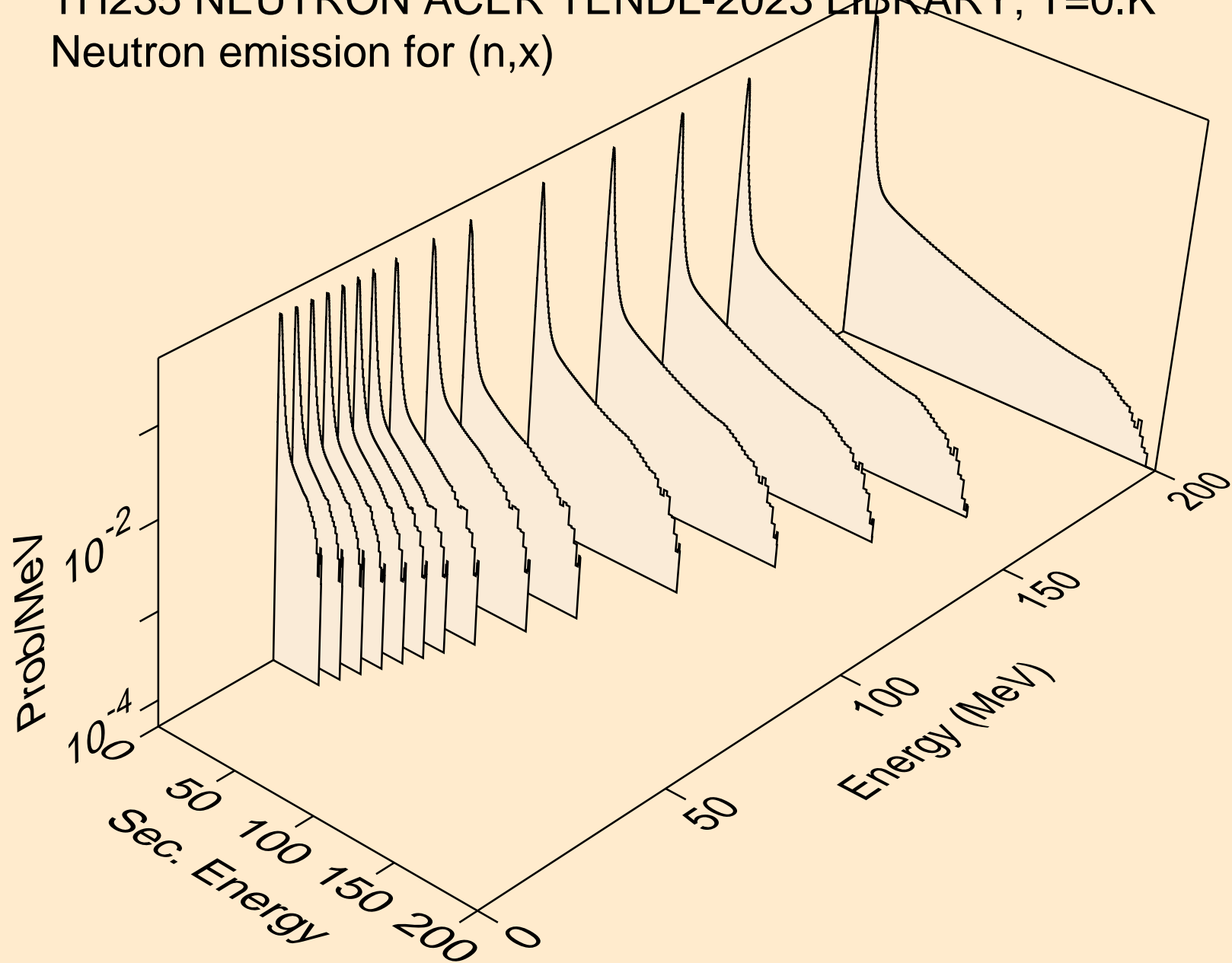

TH235 NEUTRON ACER TENDL-2023 LIBRARY; T=0.K  
Neutron emission for (n,2nd)

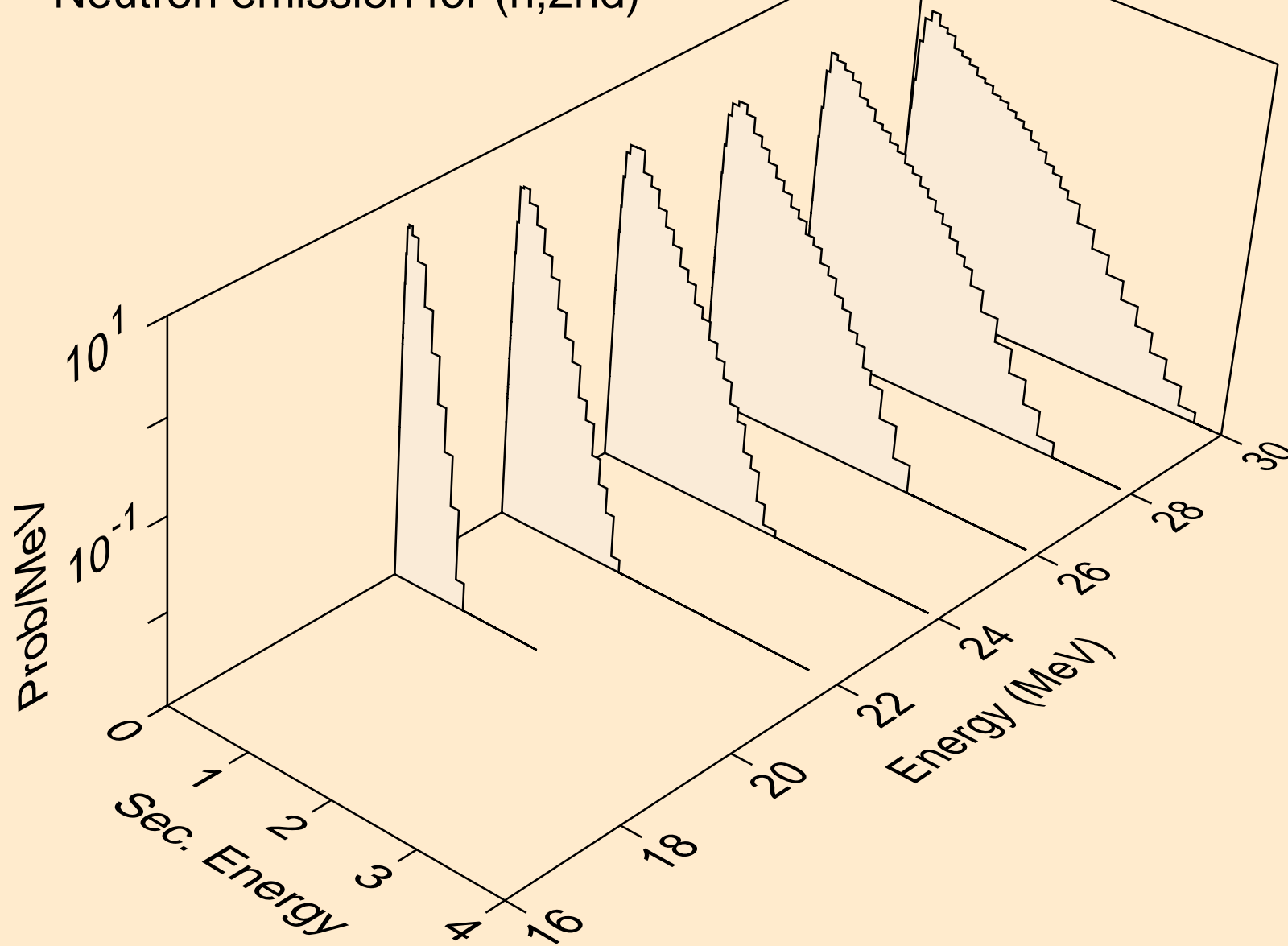

TH235 NEUTRON ACER TENDL-2023 LIBRARY; T=0.K  
Neutron emission for (n,2n)

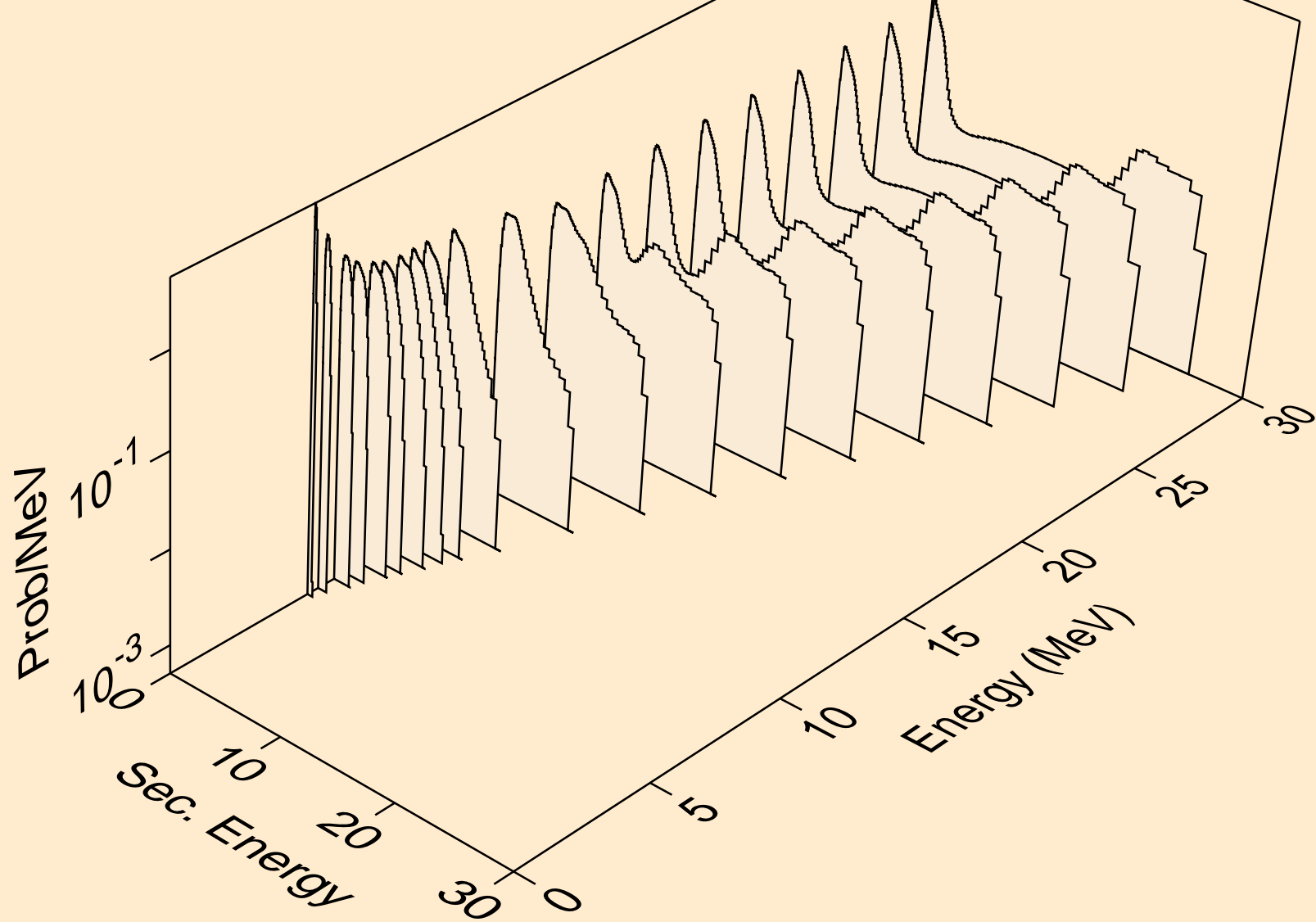

TH235 NEUTRON ACER TENDL-2023 LIBRARY; T=0.K  
Neutron emission for (n,3n)

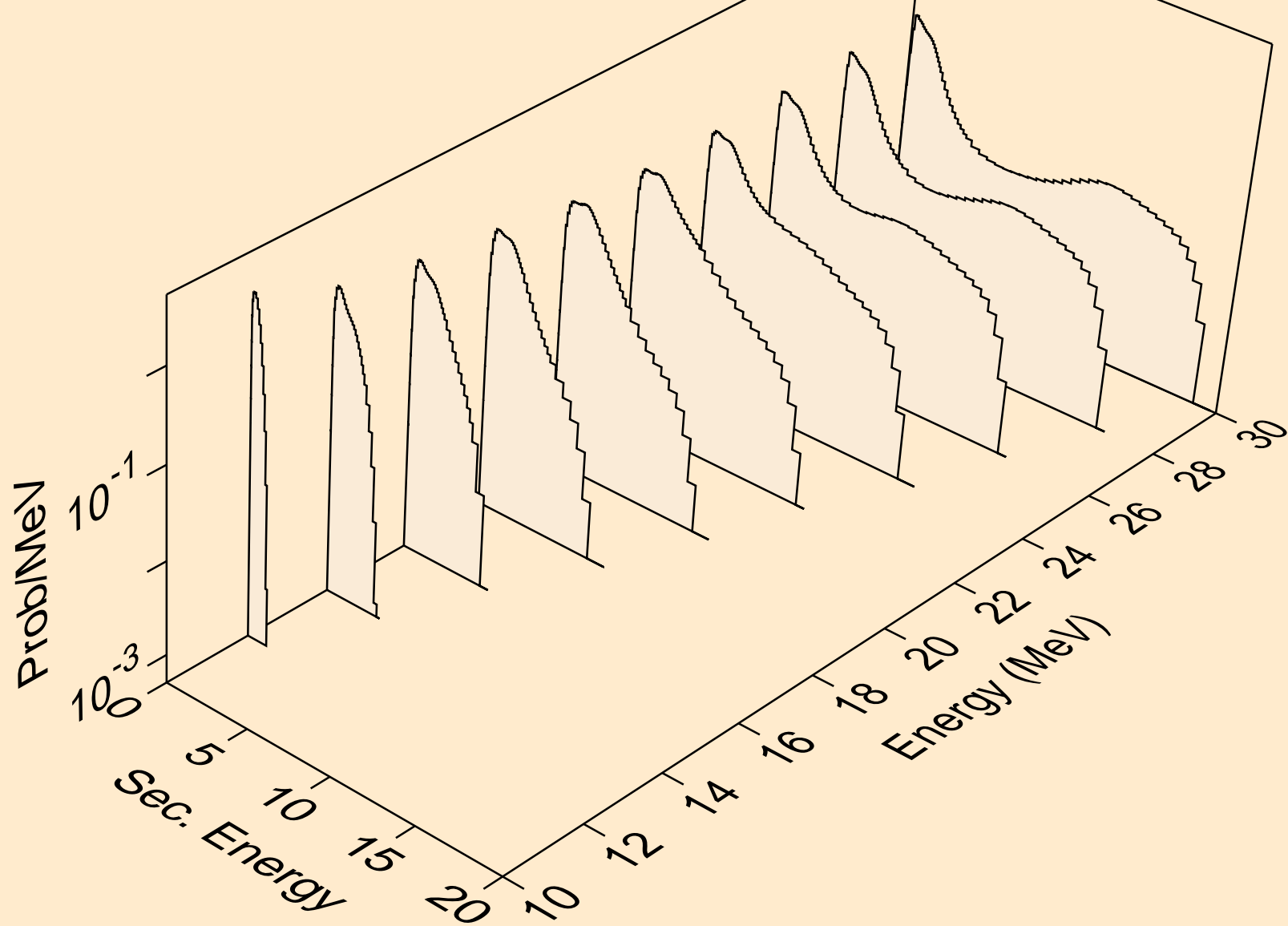



TH235 NEUTRON ACER TENDL-2023 LIBRARY; T=0.K  
Neutron emission for fission

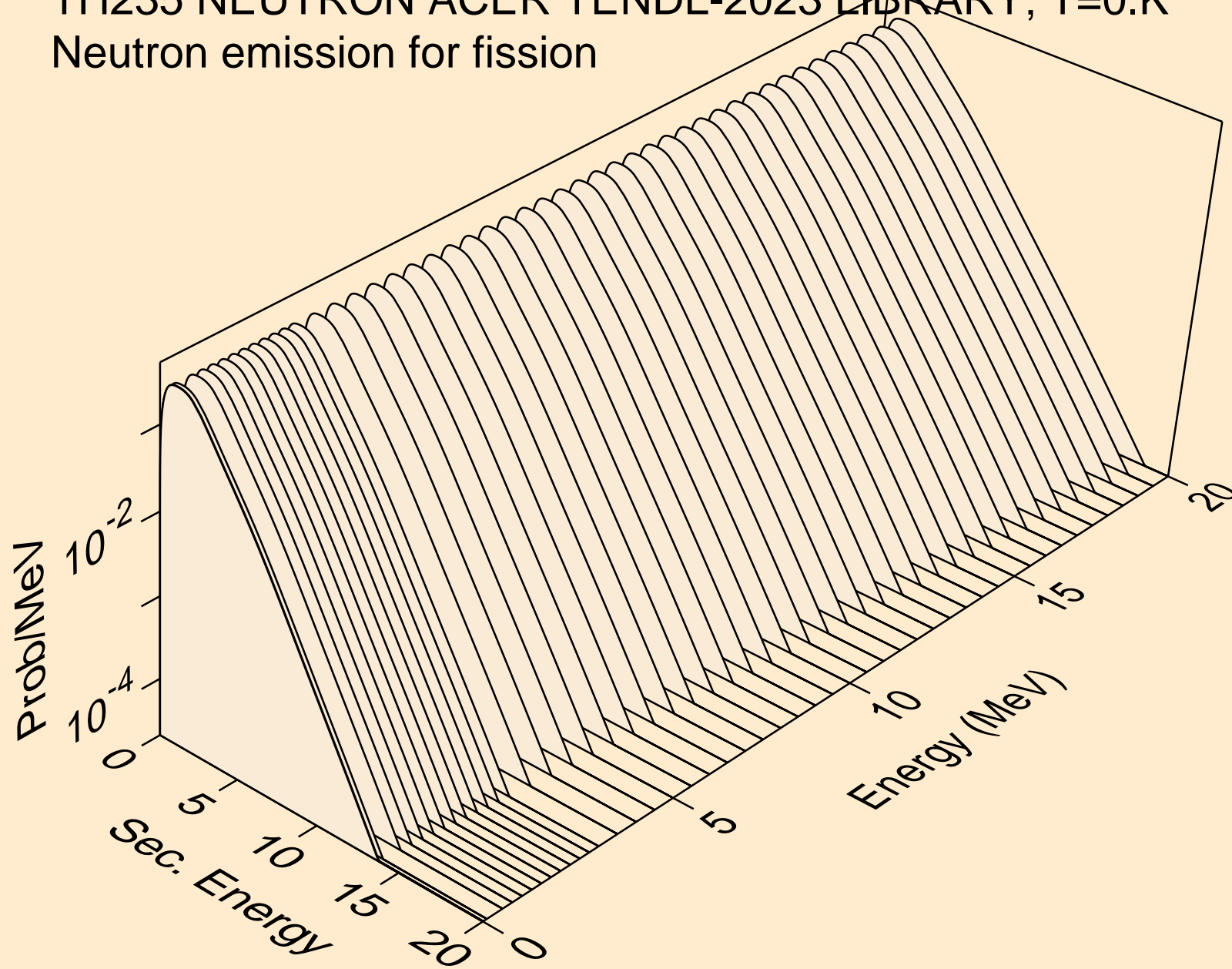

TH235 NEUTRON ACER TENDL-2023 LIBRARY; T=0.K  
Neutron emission for (n,n\*)a

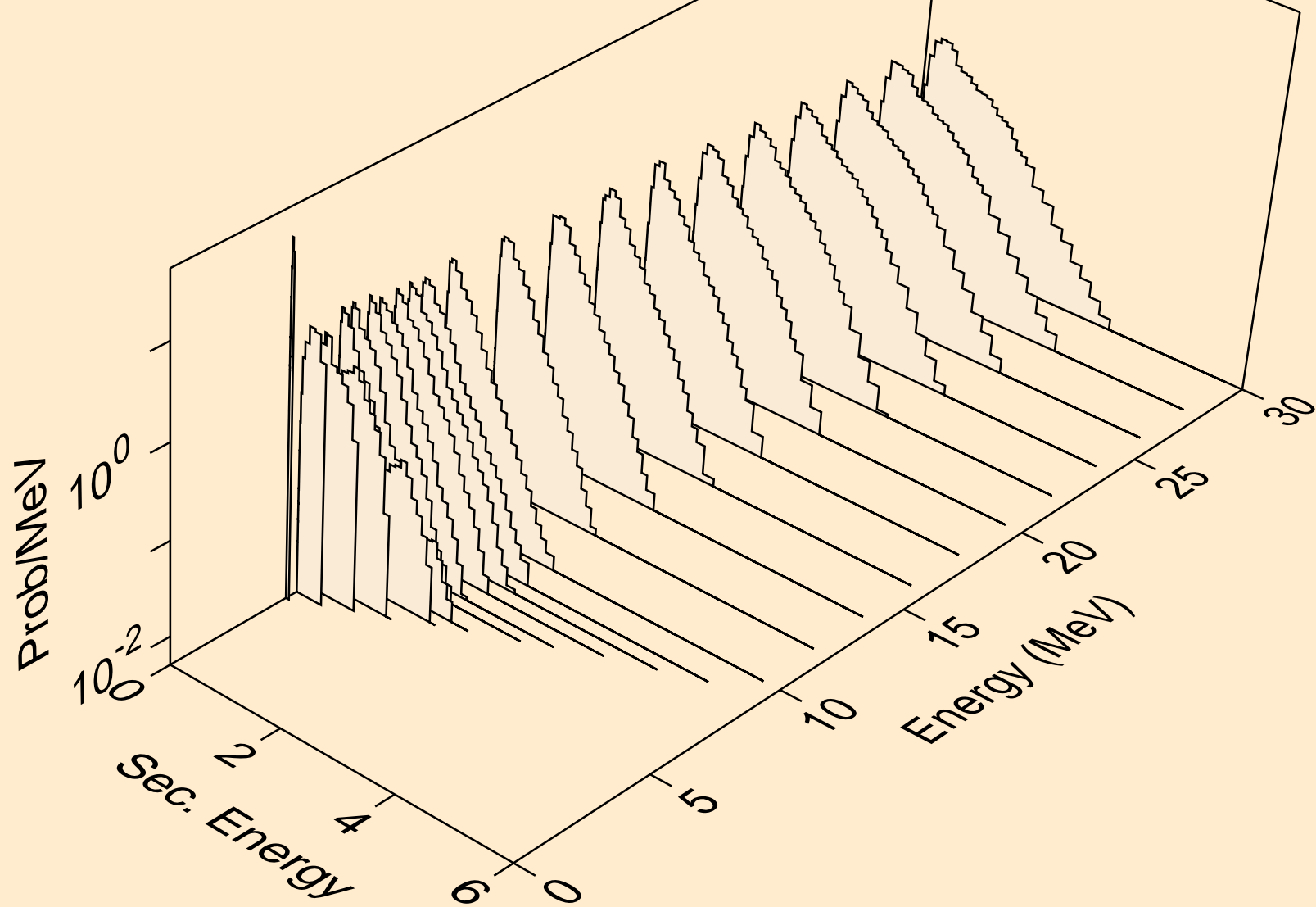

TH235 NEUTRON ACER TENDL-2023 LIBRARY; T=0.K  
Neutron emission for (n,2n)a

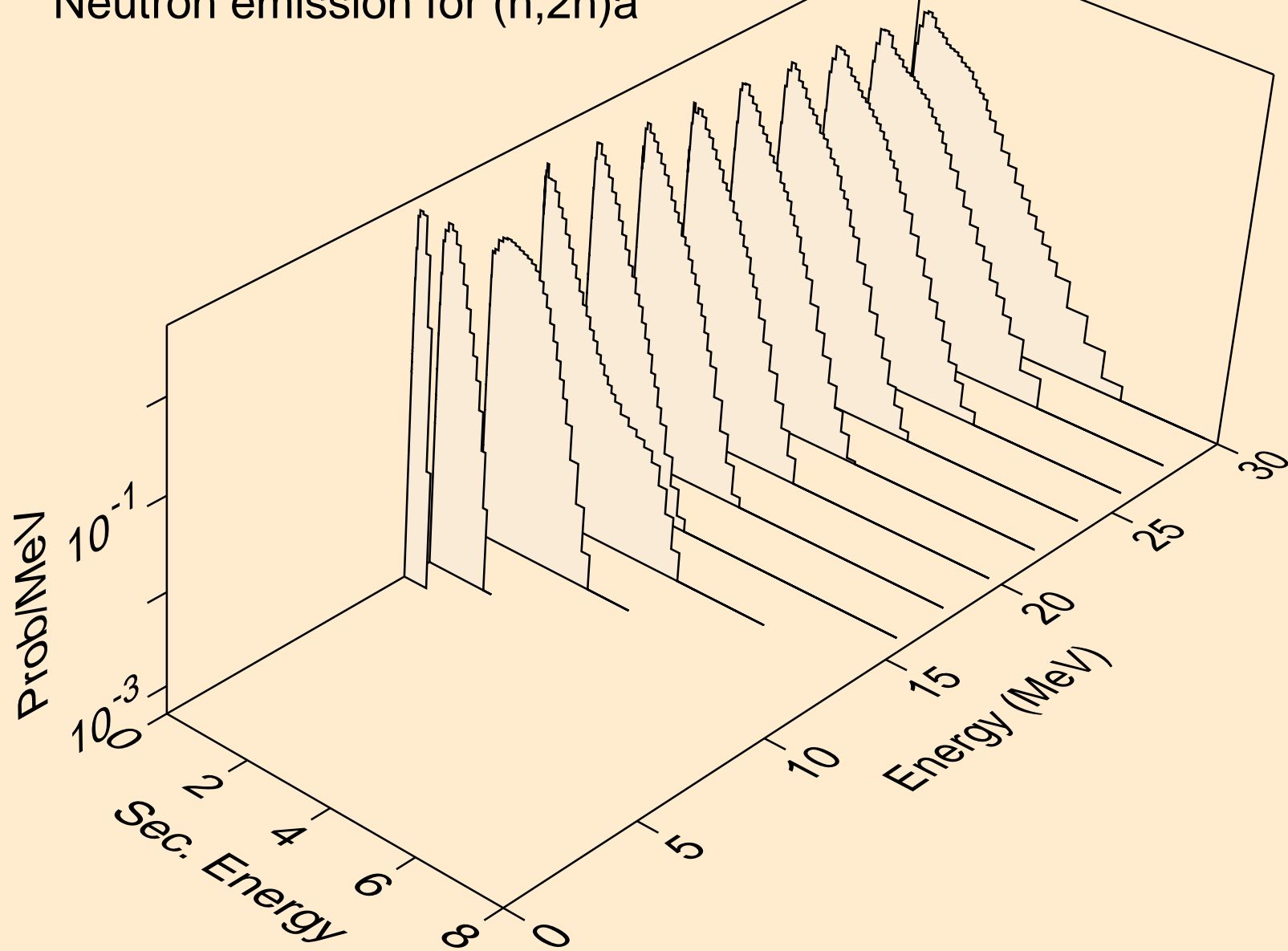

TH235 NEUTRON ACER TENDL-2023 LIBRARY; T=0.K  
Neutron emission for (n,3n)a

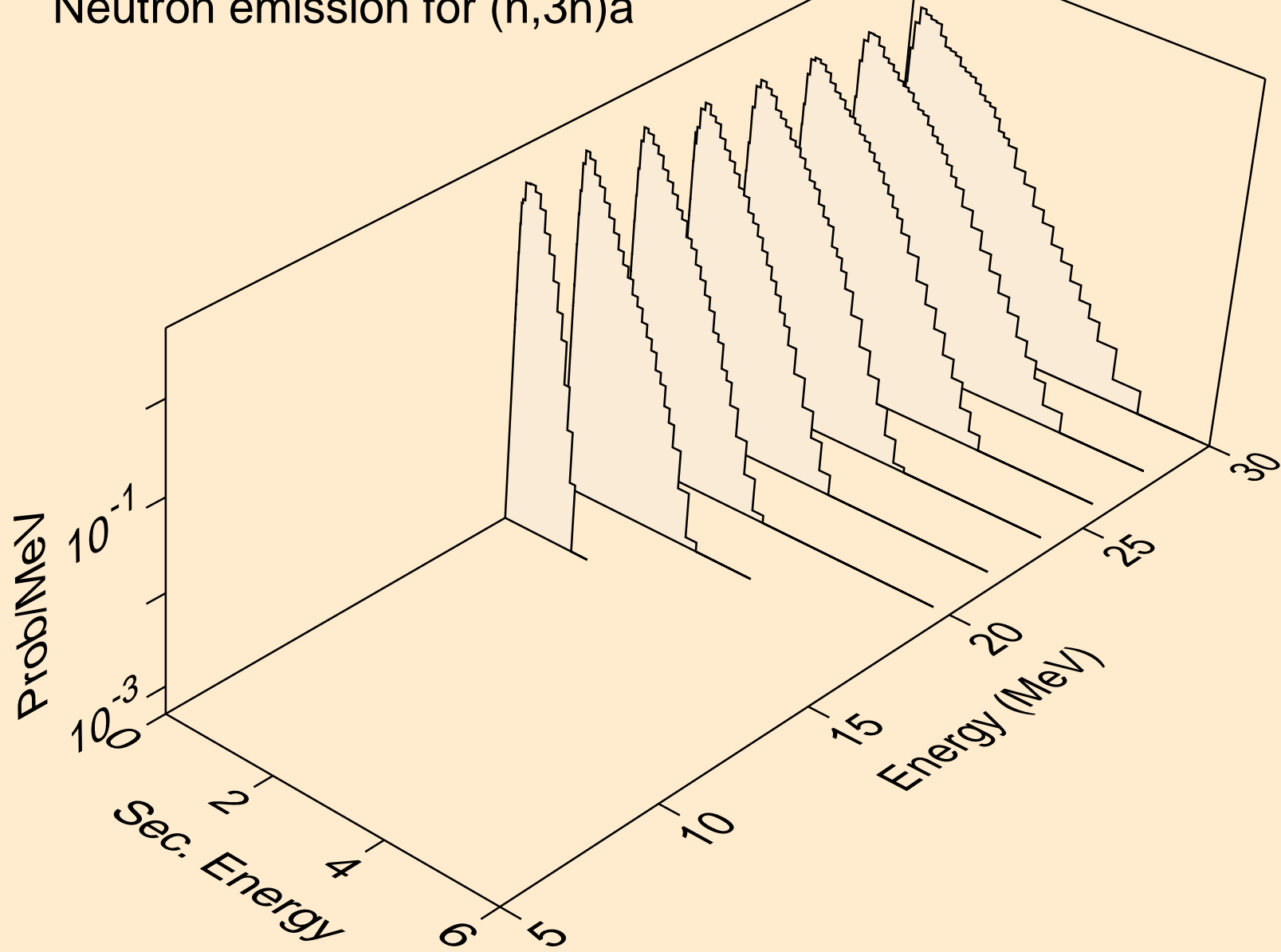

TH235 NEUTRON ACER TENDL-2023 LIBRARY; T=0.K  
Neutron emission for (n,n\*)p

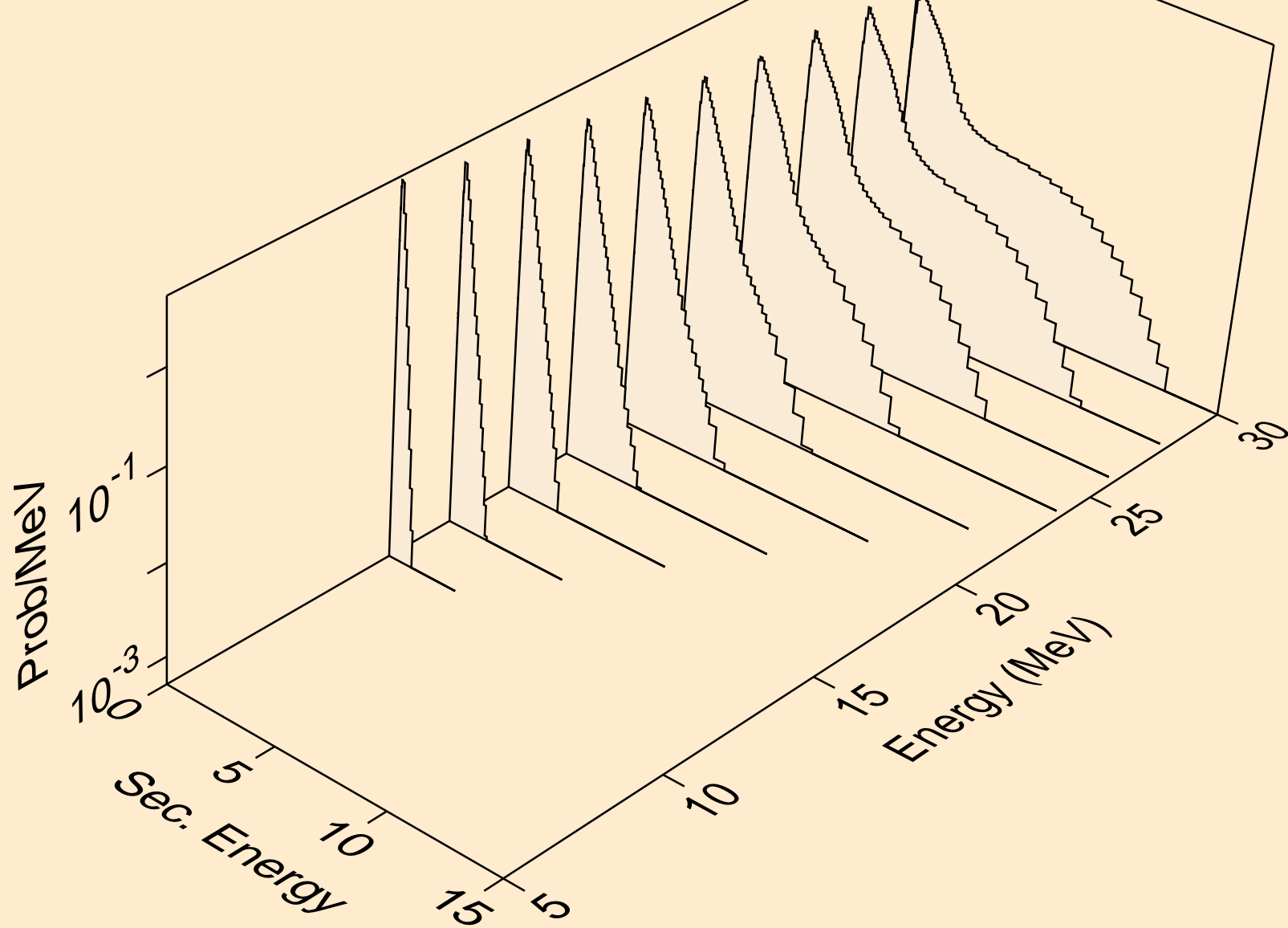

TH235 NEUTRON ACER TENDL-2023 LIBRARY; T=0.K  
Neutron emission for (n,n\*)d

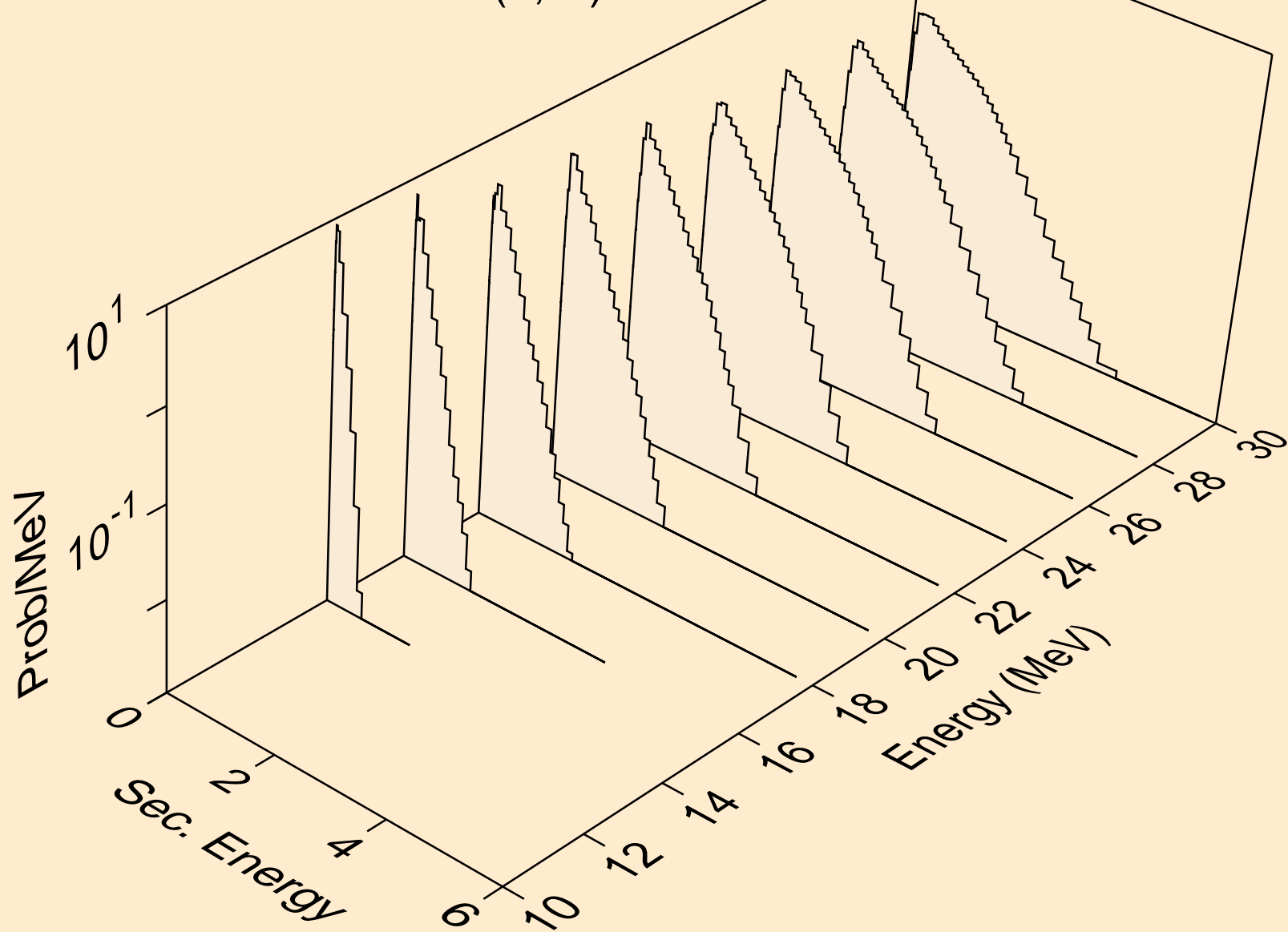

TH235 NEUTRON ACER TENDL-2023 LIBRARY; T=0.K  
Neutron emission for (n,n\*)t

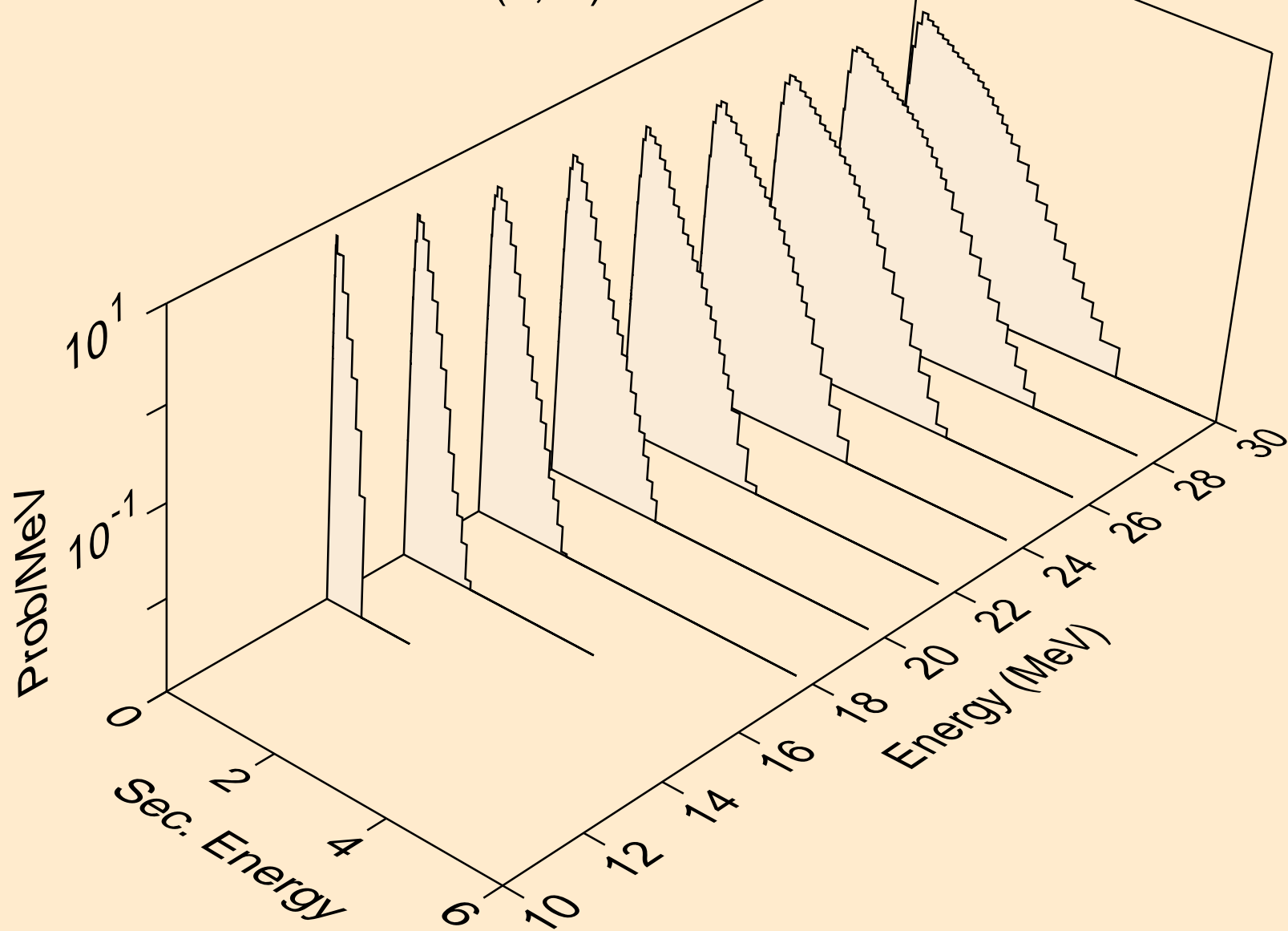

TH235 NEUTRON ACER TENDL-2023 LIBRARY; T=0.K  
Neutron emission for (n,n\*)he3

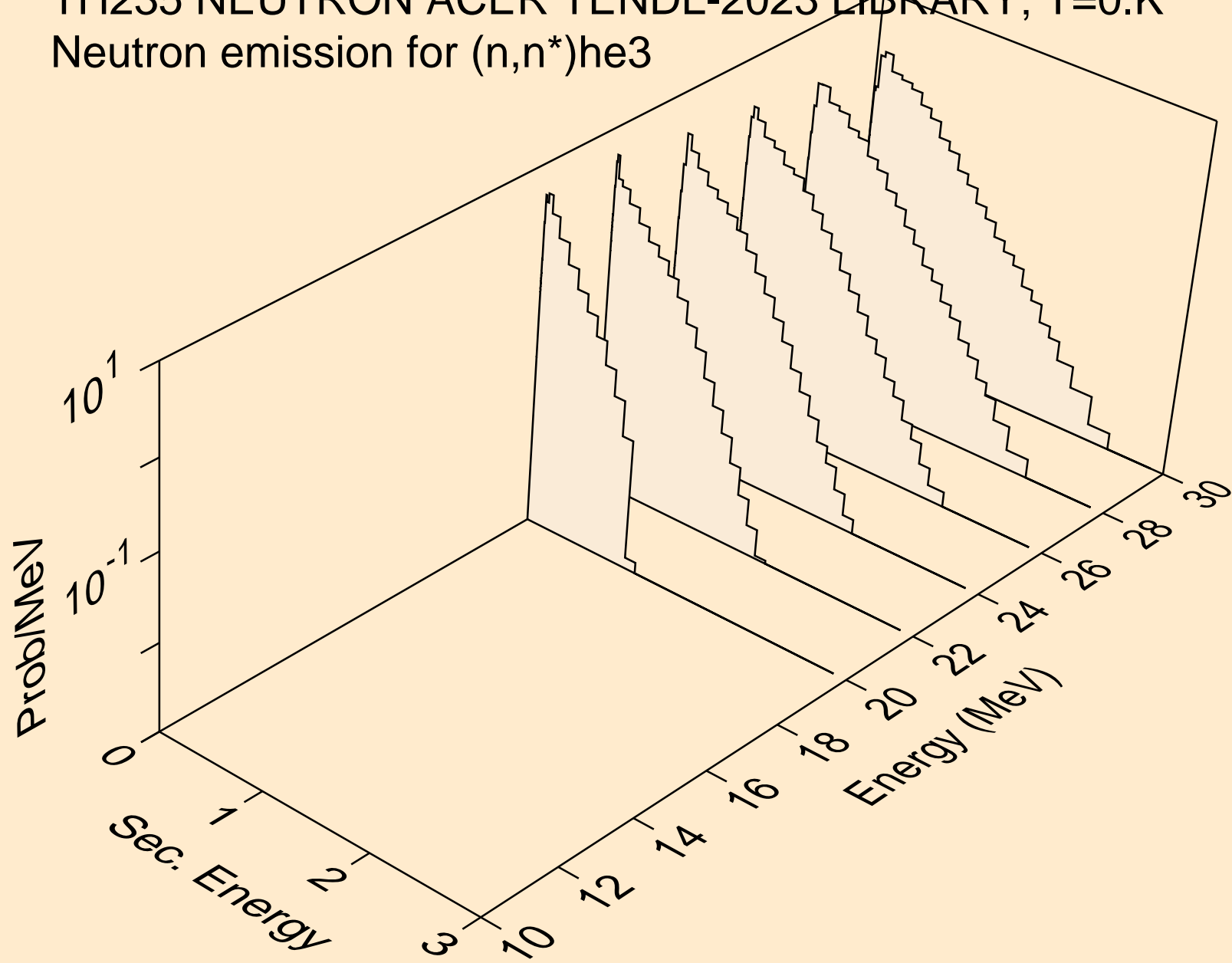



TH235 NEUTRON ACER TENDL-2023 LIBRARY; T=0.K  
Neutron emission for (n,4n)

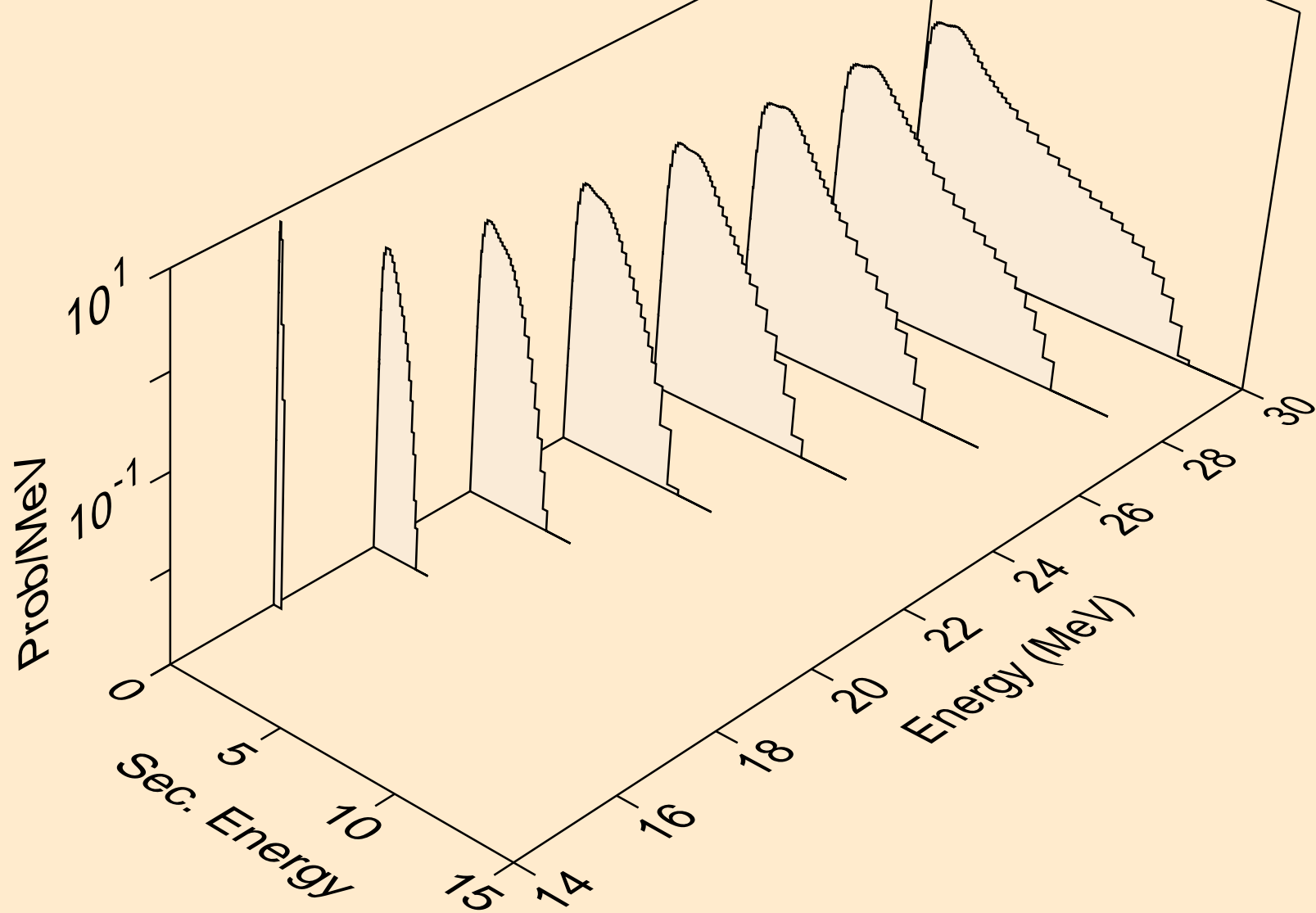

TH235 NEUTRON ACER TENDL-2023 LIBRARY; T=0.K  
Neutron emission for (n,2np)

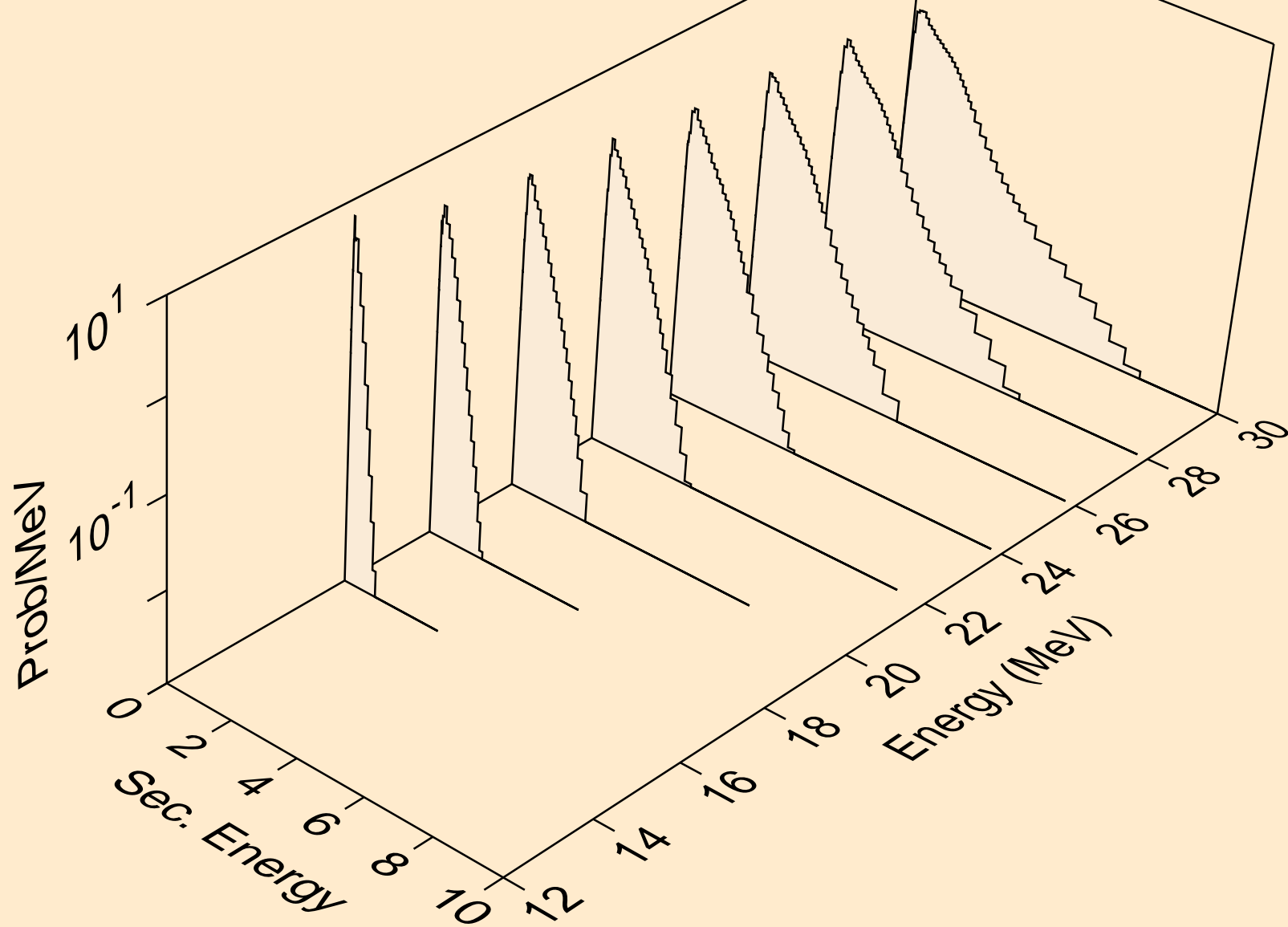

TH235 NEUTRON ACER TENDL-2023 LIBRARY; T=0.K  
Neutron emission for (n,3np)

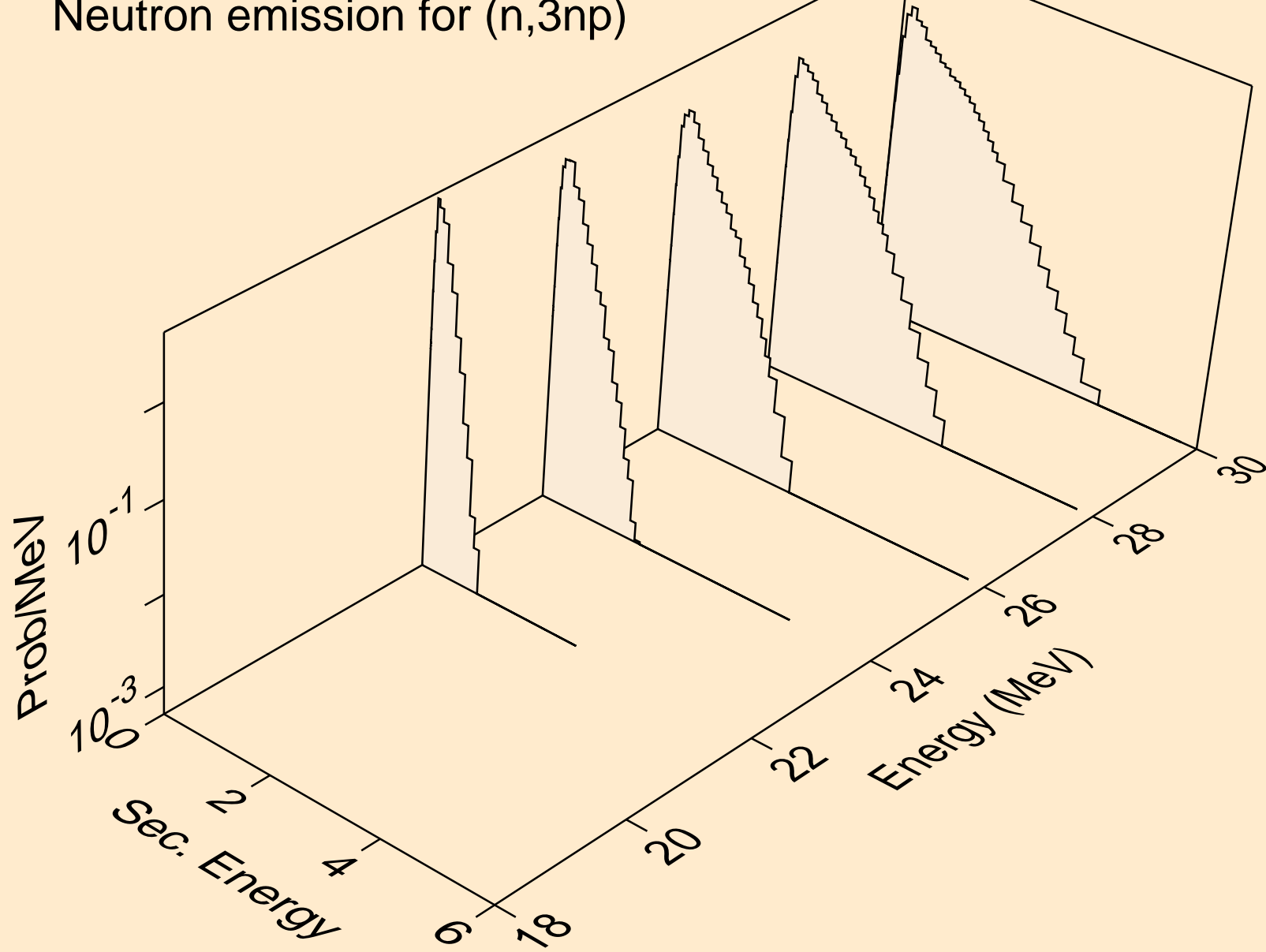

TH235 NEUTRON ACER TENDL-2023 LIBRARY; T=0.K  
Neutron emission for (n,n\*c)

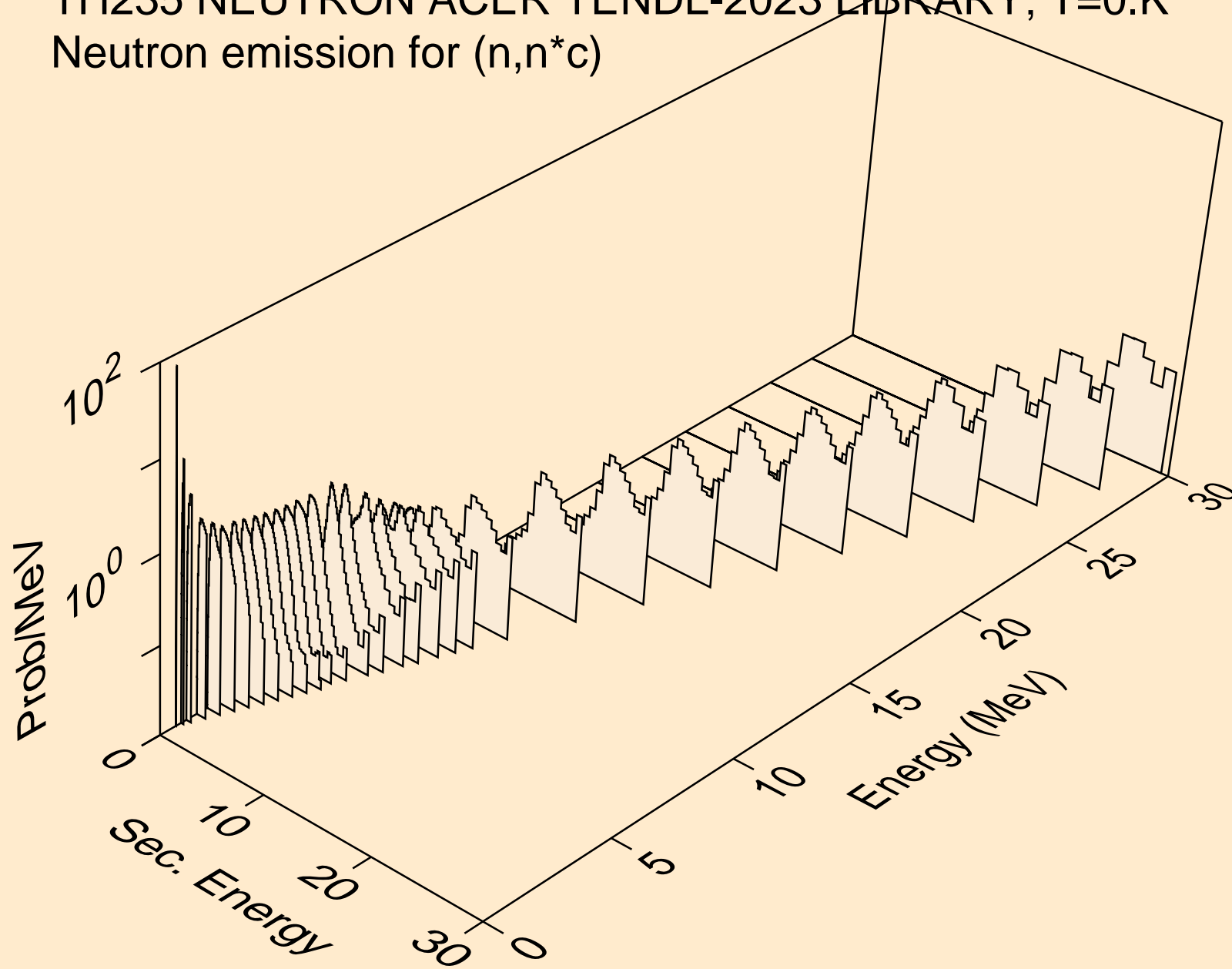

# TH235 NEUTRON ACER TENDL-2023 LIBRARY; T=0.K

## Delayed nubar

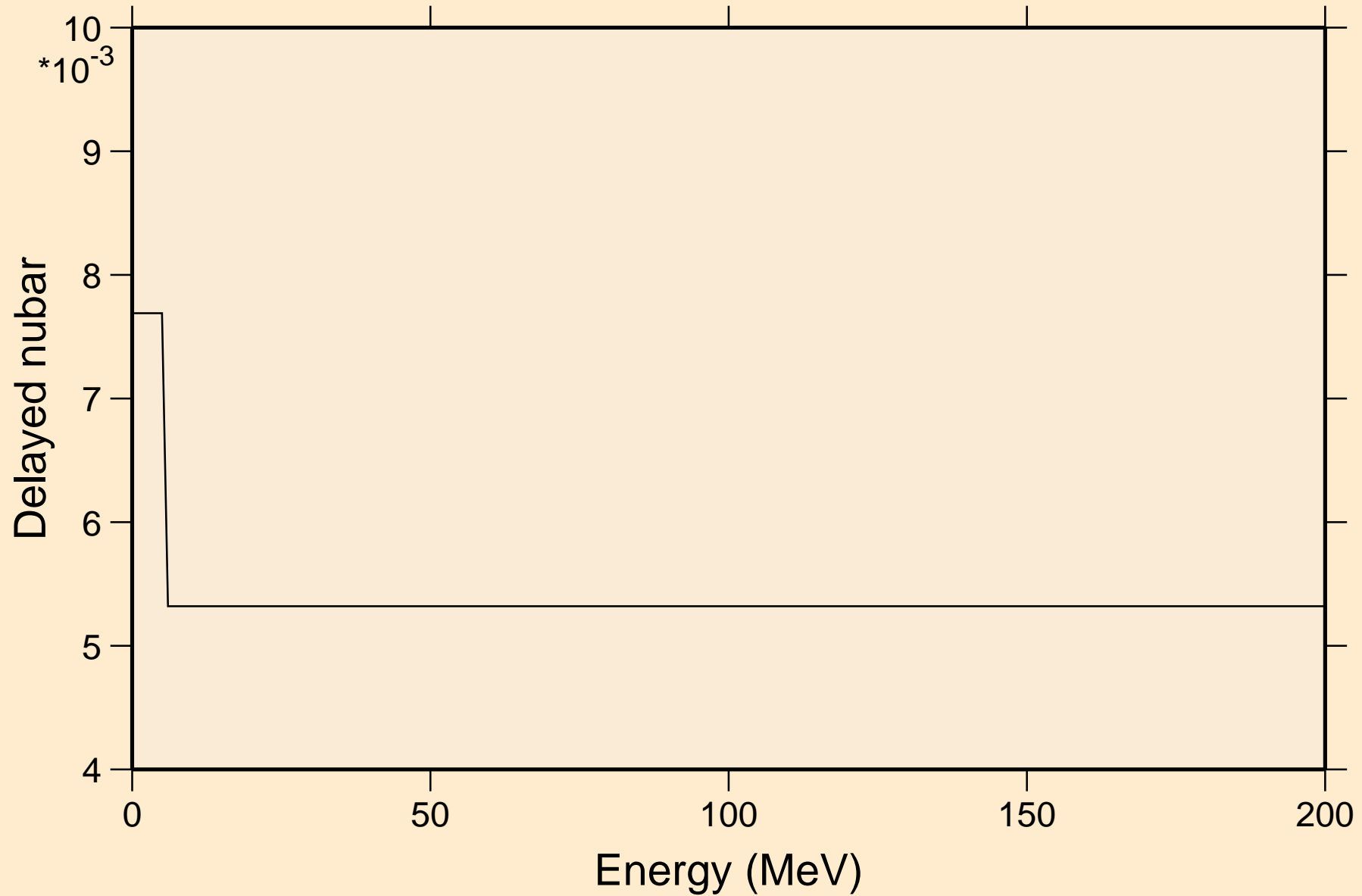

# TH235 NEUTRON ACER TENDL-2023 LIBRARY; T=0.K

## Delayed neutron spectra

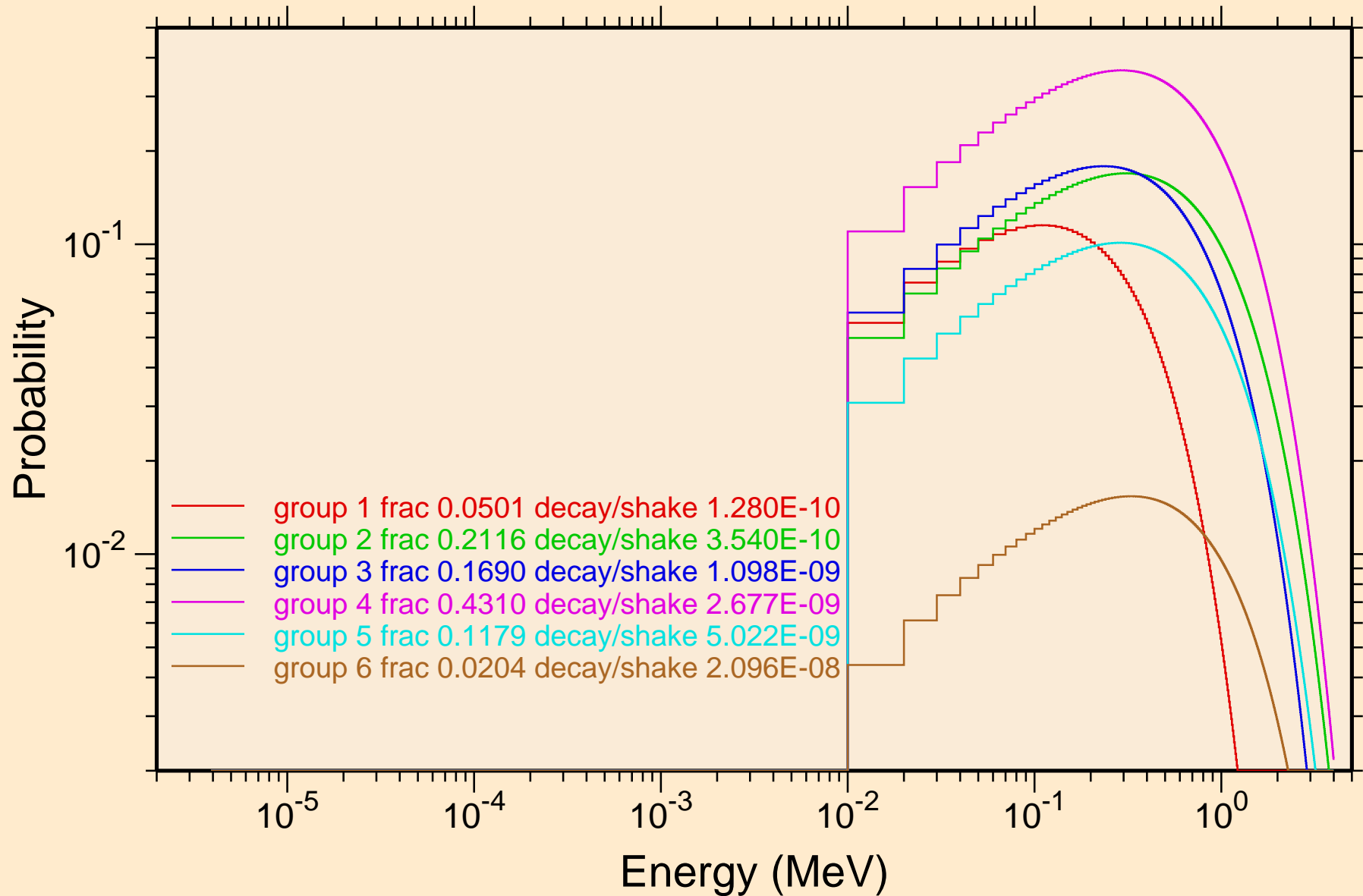

TH235 NEUTRON ACER TENDL-2023 LIBRARY; T=0.K  
Photon emission for (n,x)

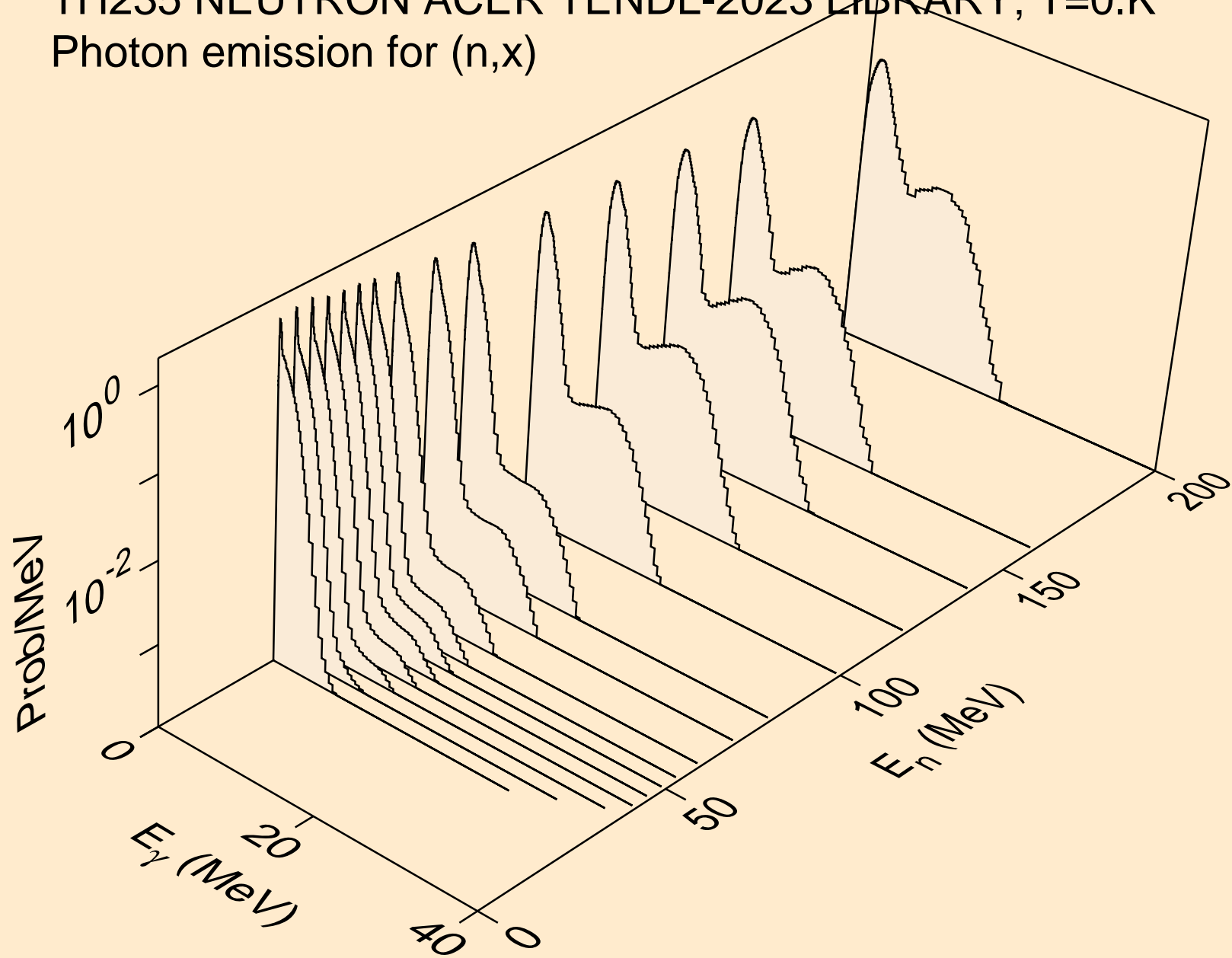

TH235 NEUTRON ACER TENDL-2023 LIBRARY; T=0.K  
Photon emission for (n,2nd)

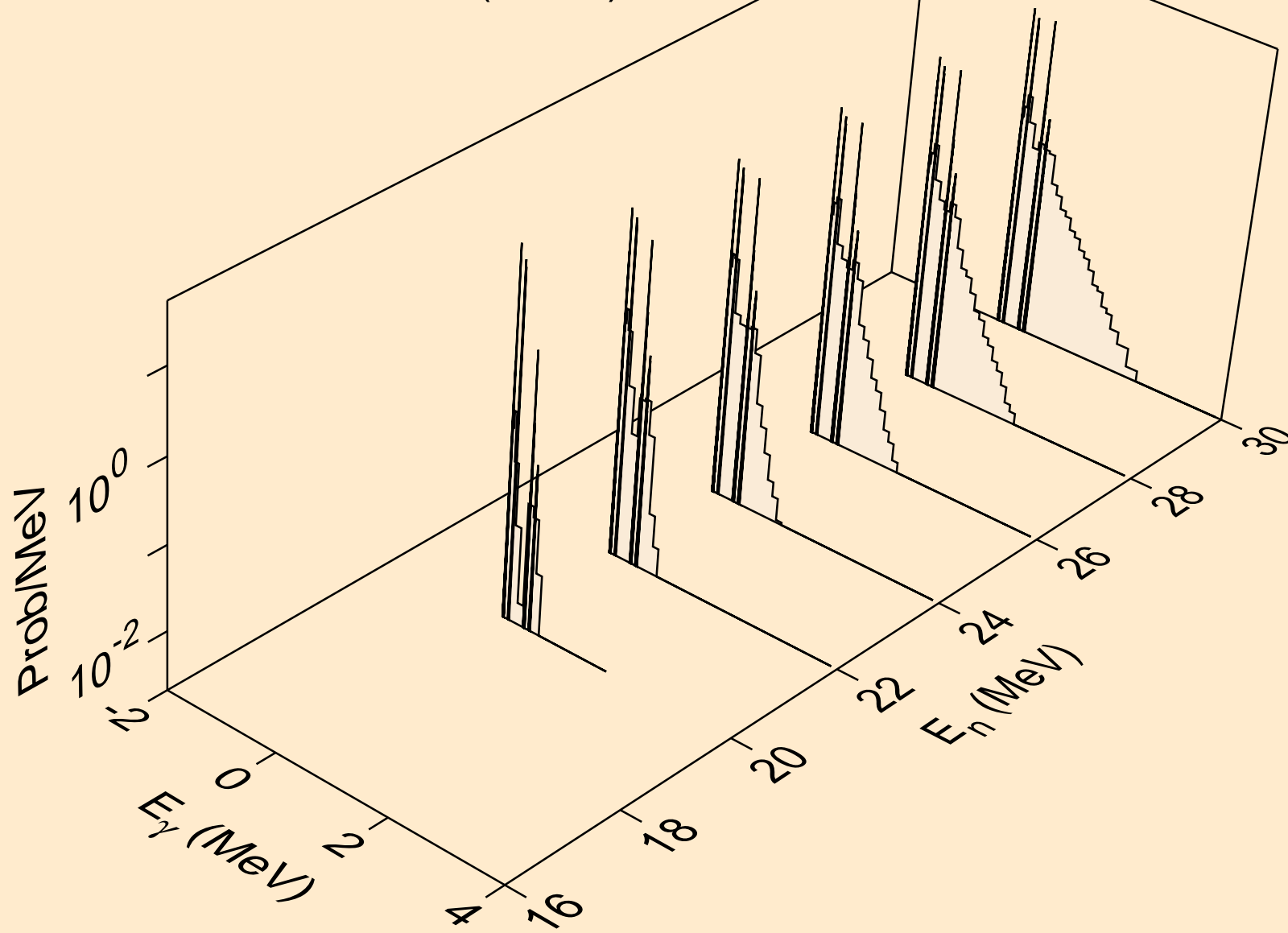



TH235 NEUTRON ACER TENDL-2023 LIBRARY; T=0.K  
Photon emission for (n,2n)

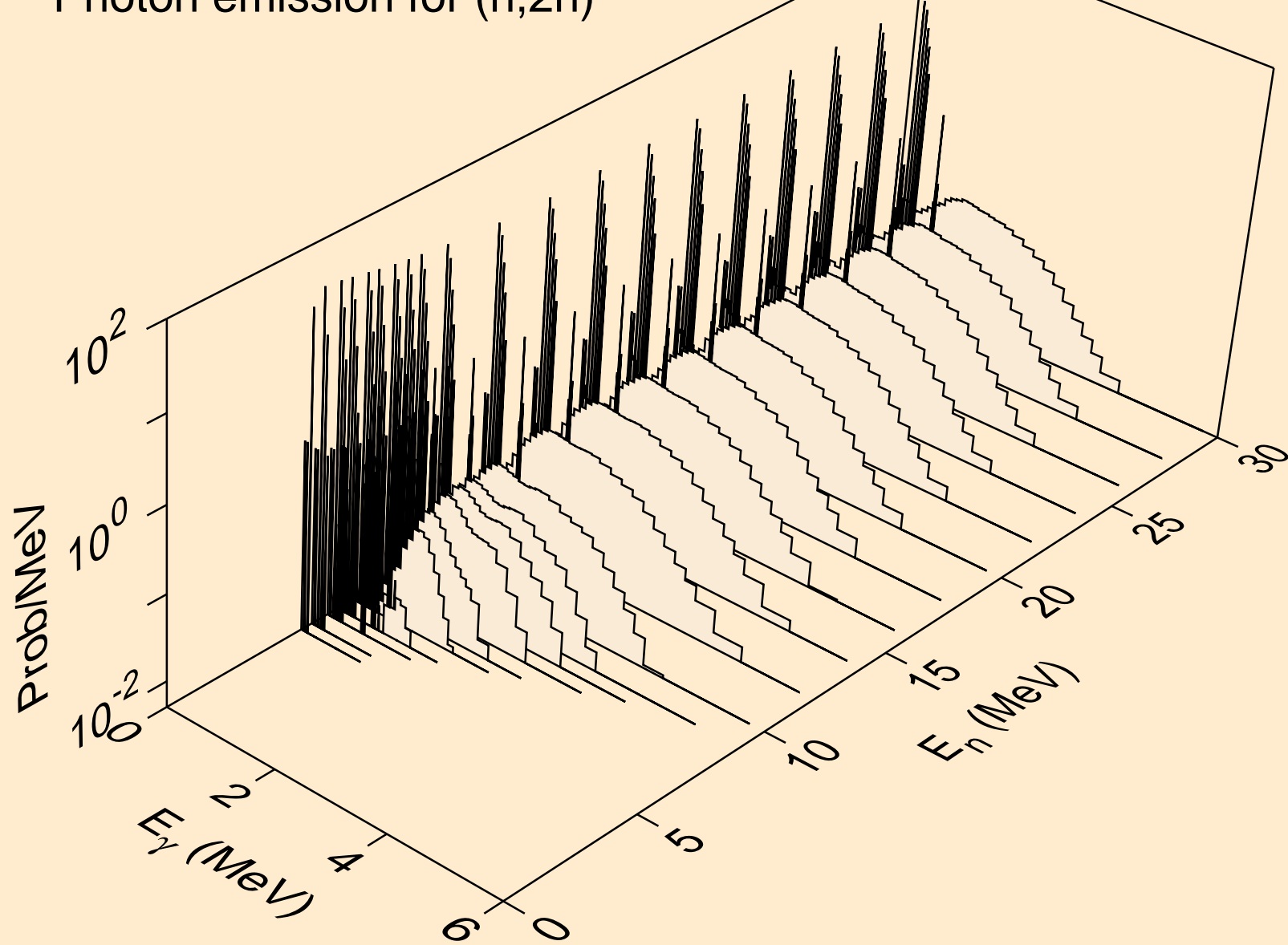

TH235 NEUTRON ACER TENDL-2023 LIBRARY; T=0.K  
Photon emission for (n,3n)

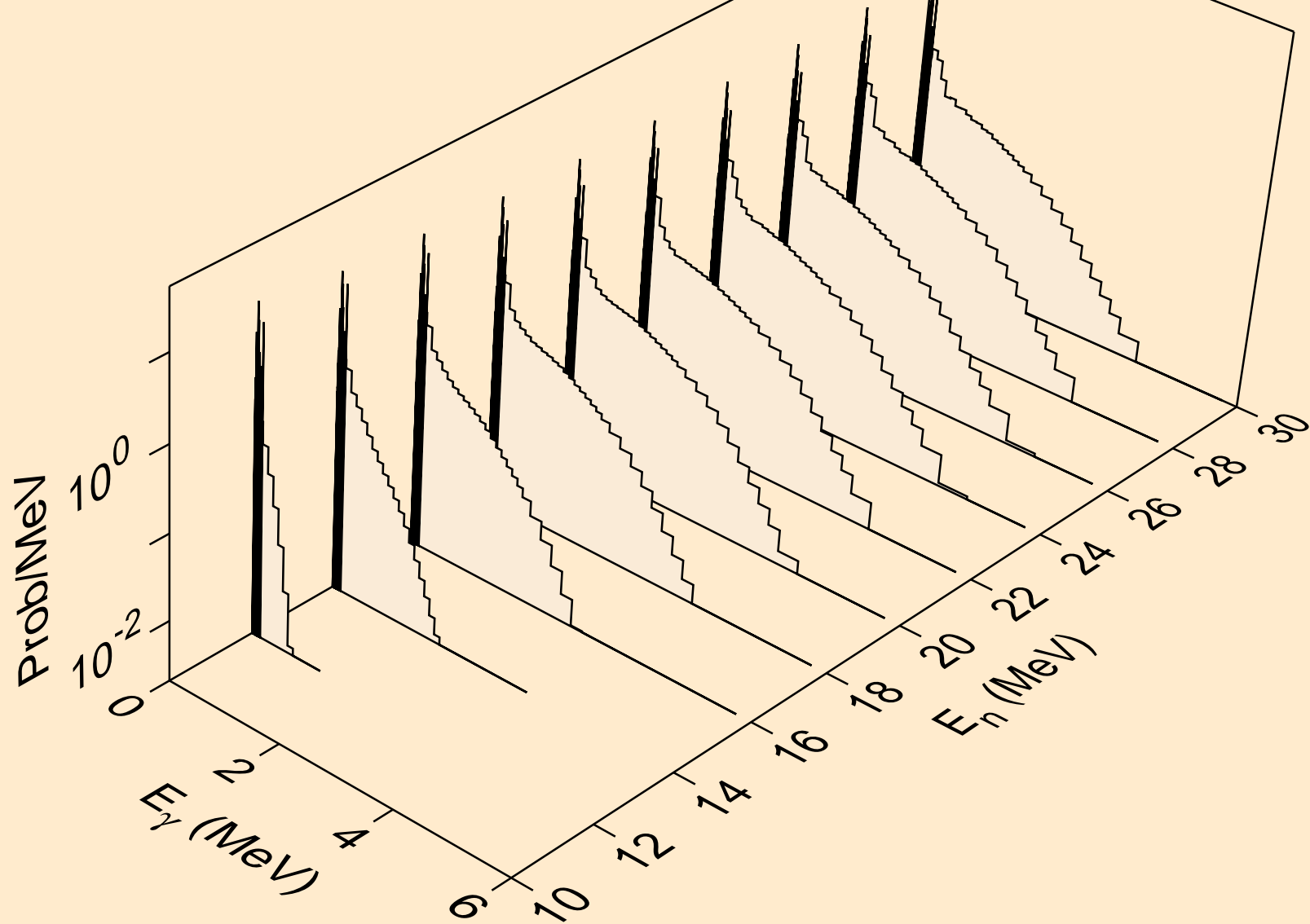

TH235 NEUTRON ACER TENDL-2023 LIBRARY; T=0.K  
Photon emission for (n,n\*)a

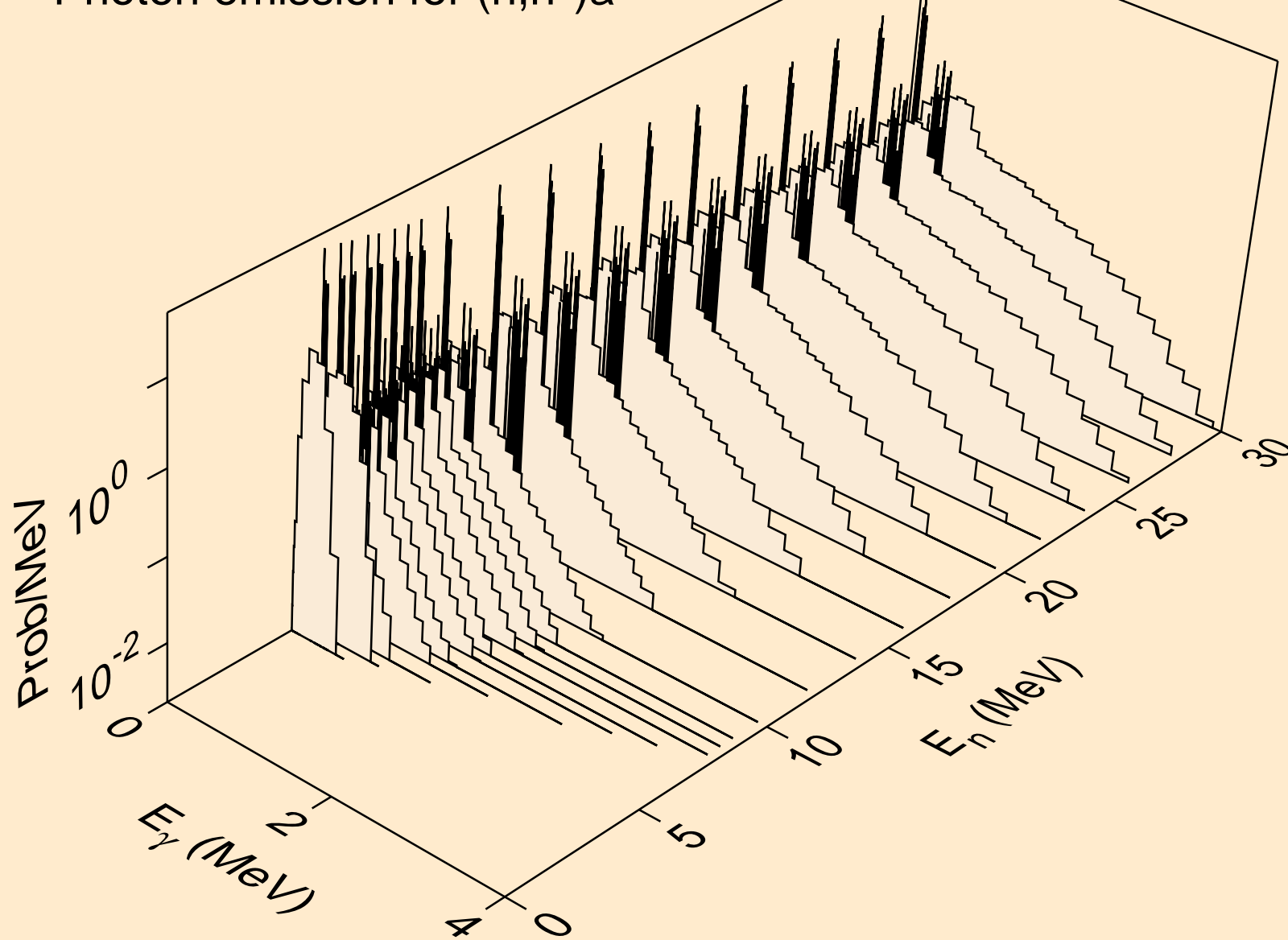

TH235 NEUTRON ACER TENDL-2023 LIBRARY; T=0.K  
Photon emission for (n,2n)a

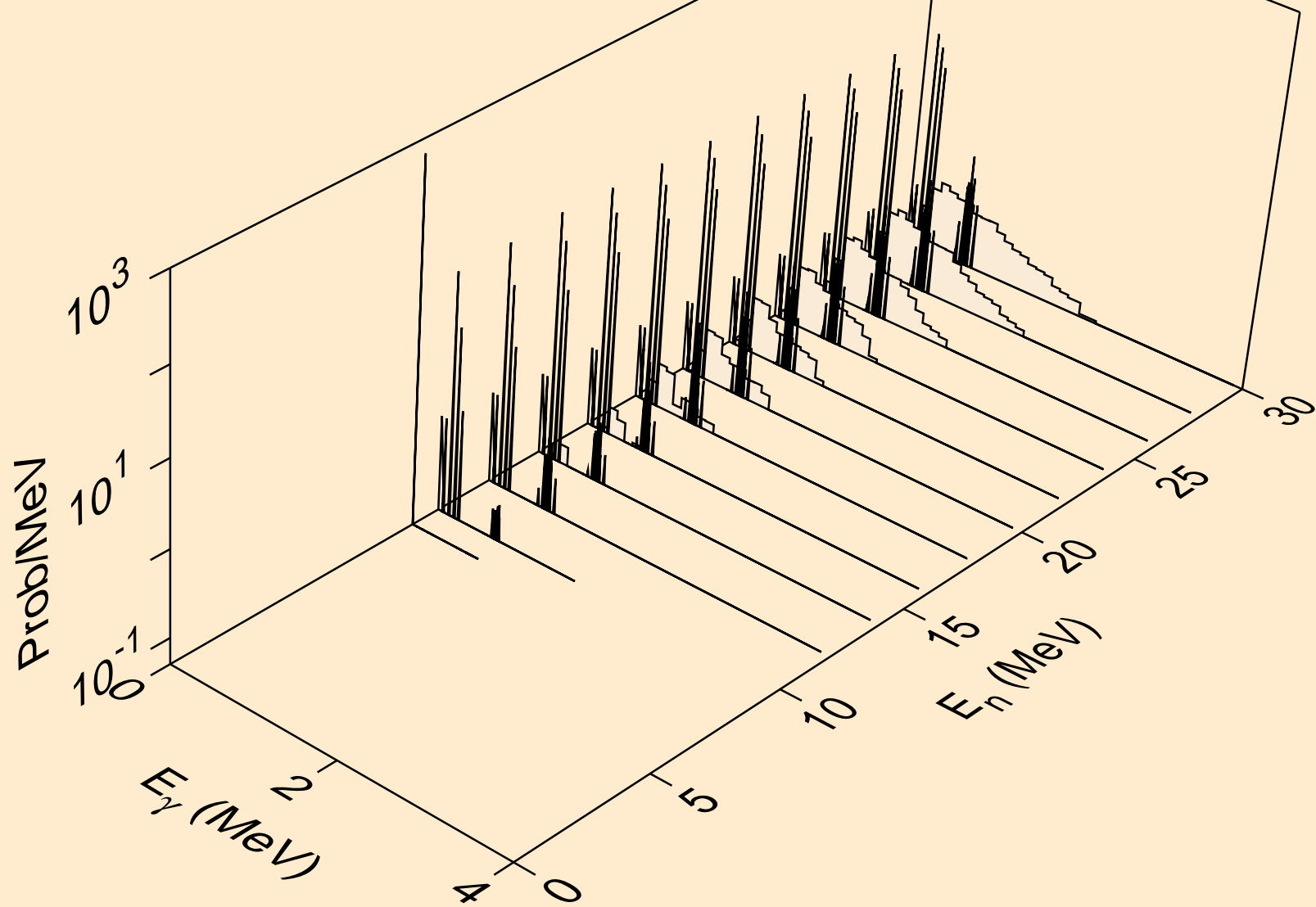

TH235 NEUTRON ACER TENDL-2023 LIBRARY; T=0.K  
Photon emission for (n,3n)a

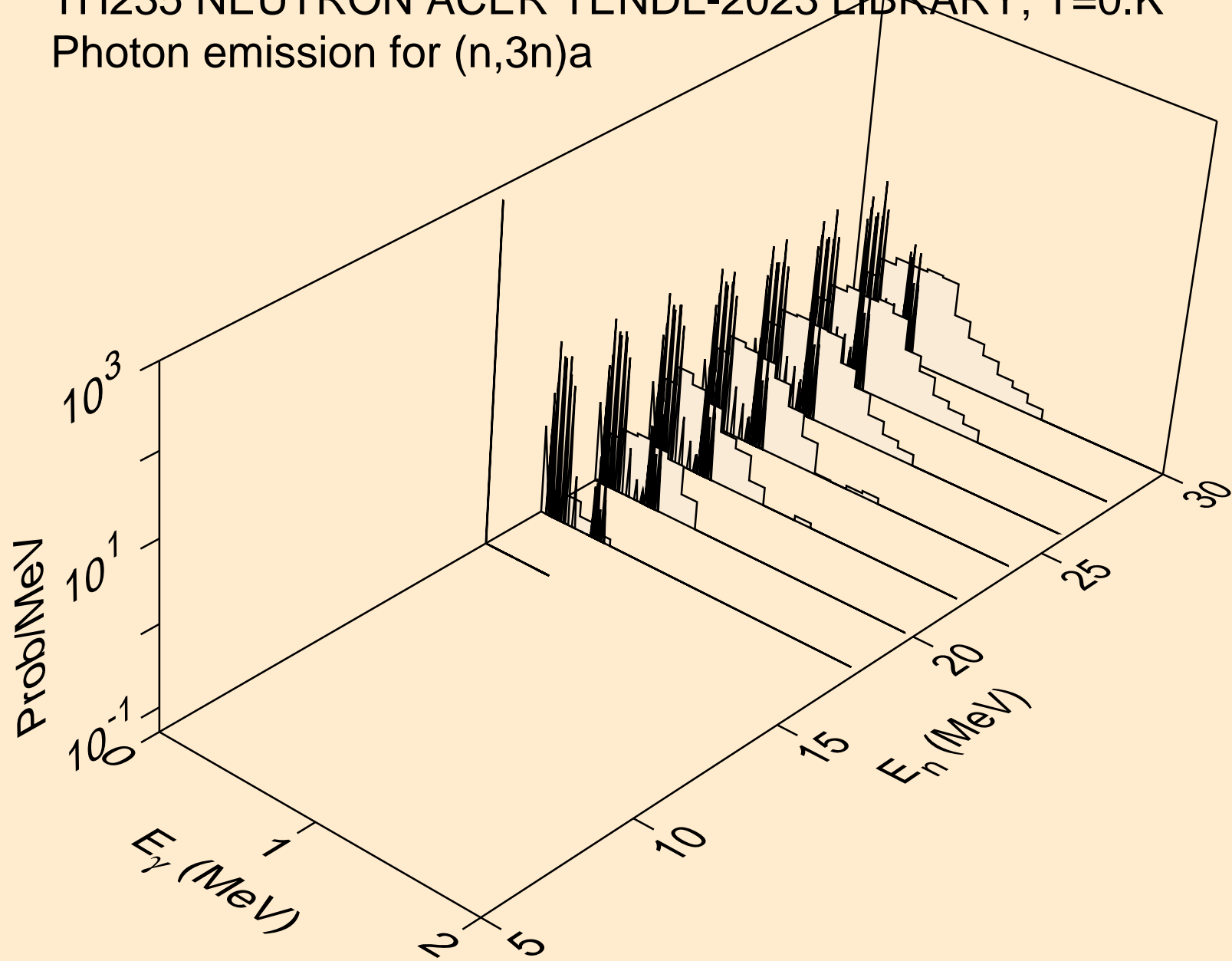

TH235 NEUTRON ACER TENDL-2023 LIBRARY; T=0.K  
Photon emission for (n,n\*)p

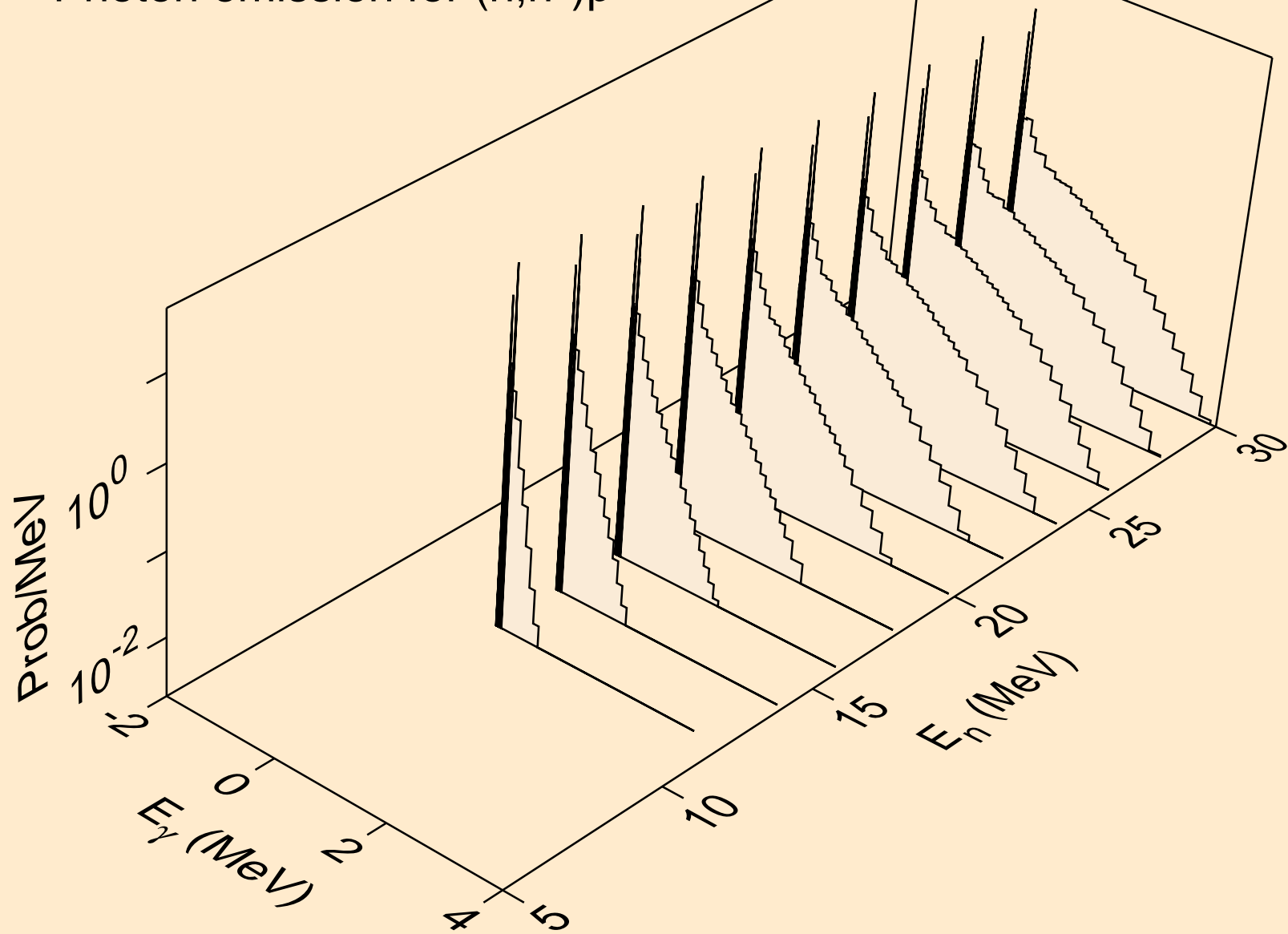

TH235 NEUTRON ACER TENDL-2023 LIBRARY; T=0.K  
Photon emission for (n,n\*)d

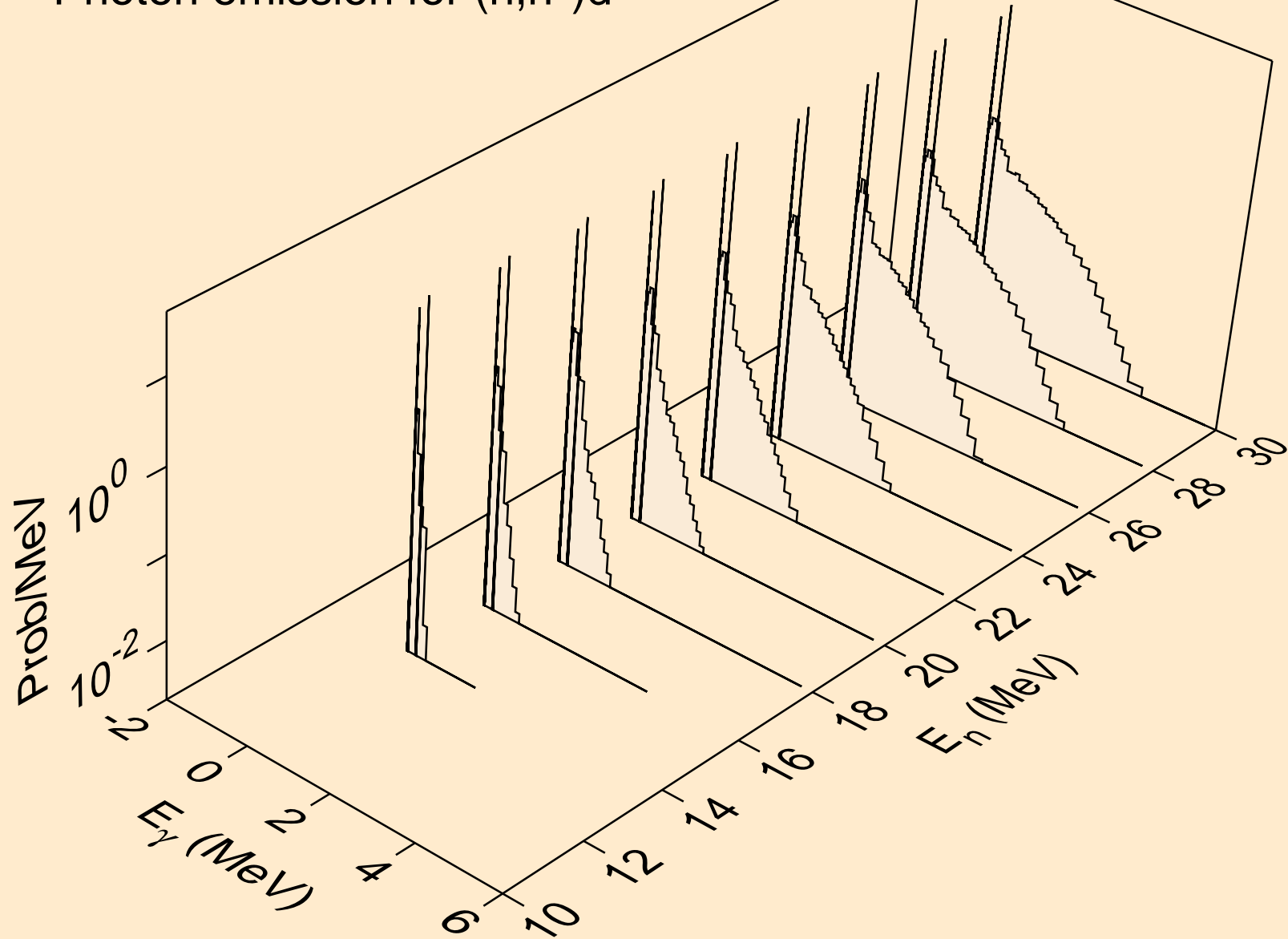

TH235 NEUTRON ACER TENDL-2023 LIBRARY; T=0.K  
Photon emission for (n,n\*)t

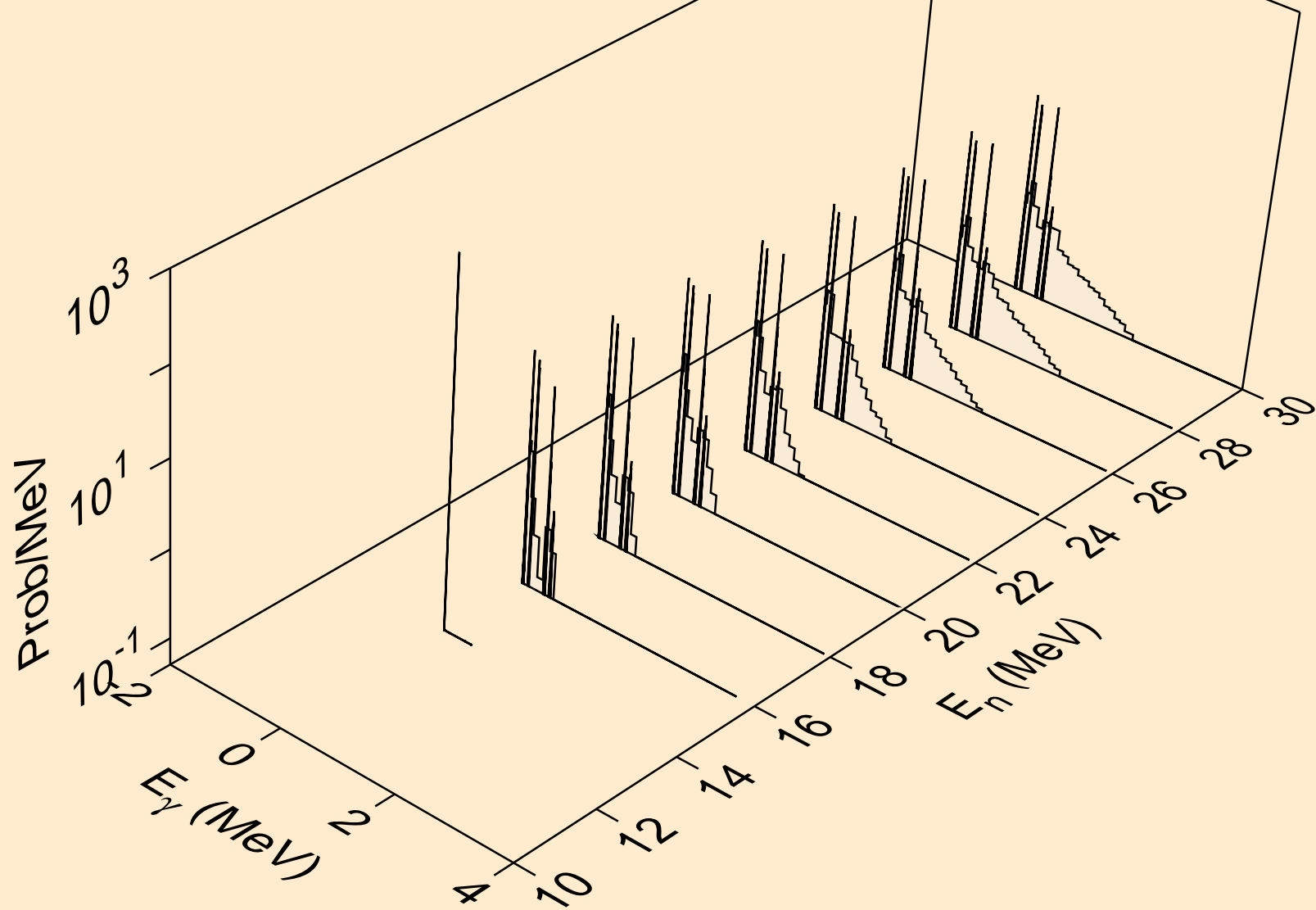



TH235 NEUTRON ACER TENDL-2023 LIBRARY; T=0.K  
Photon emission for (n,n\*)he3

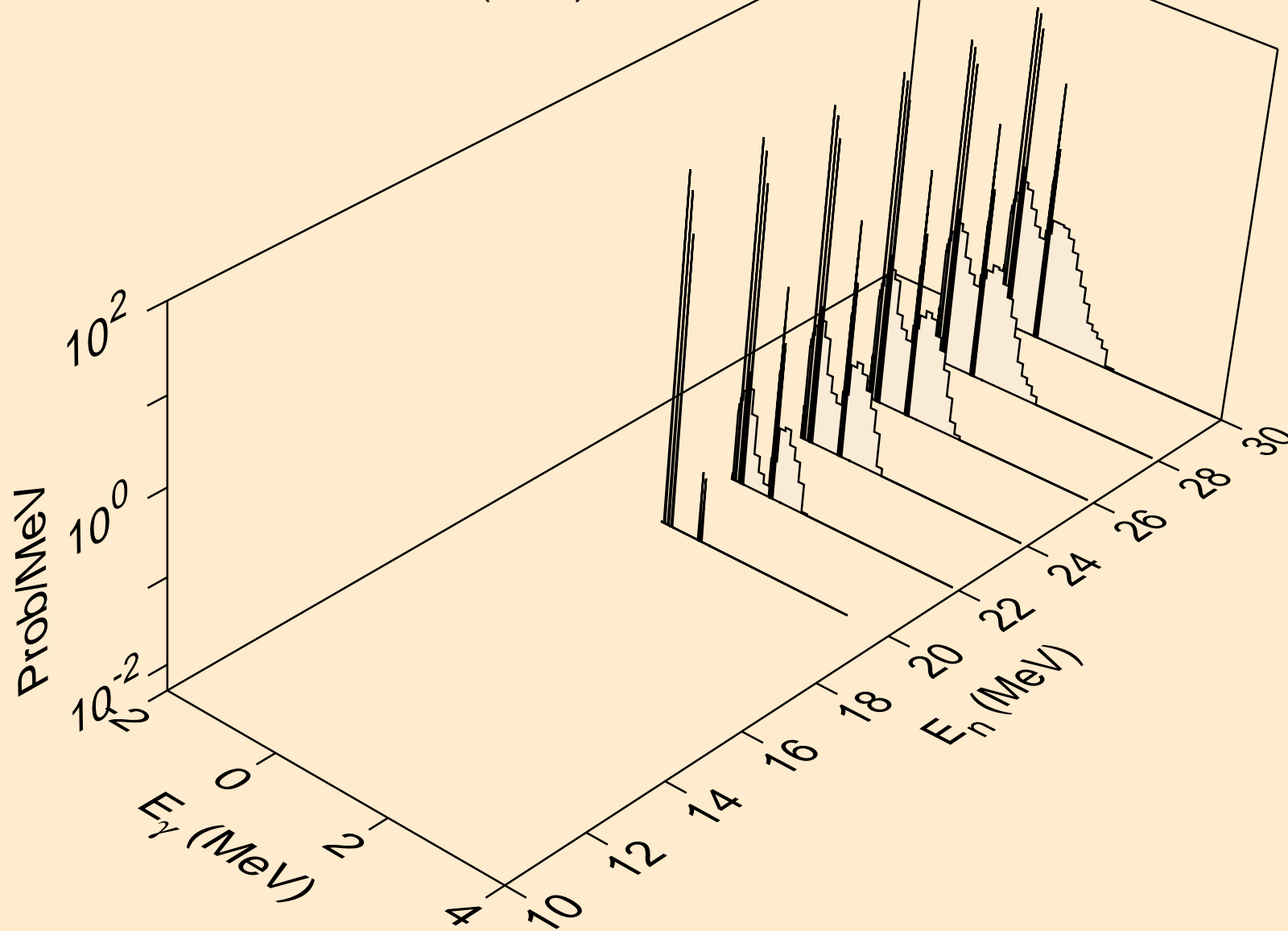

TH235 NEUTRON ACER TENDL-2023 LIBRARY; T=0.K  
Photon emission for (n,4n)

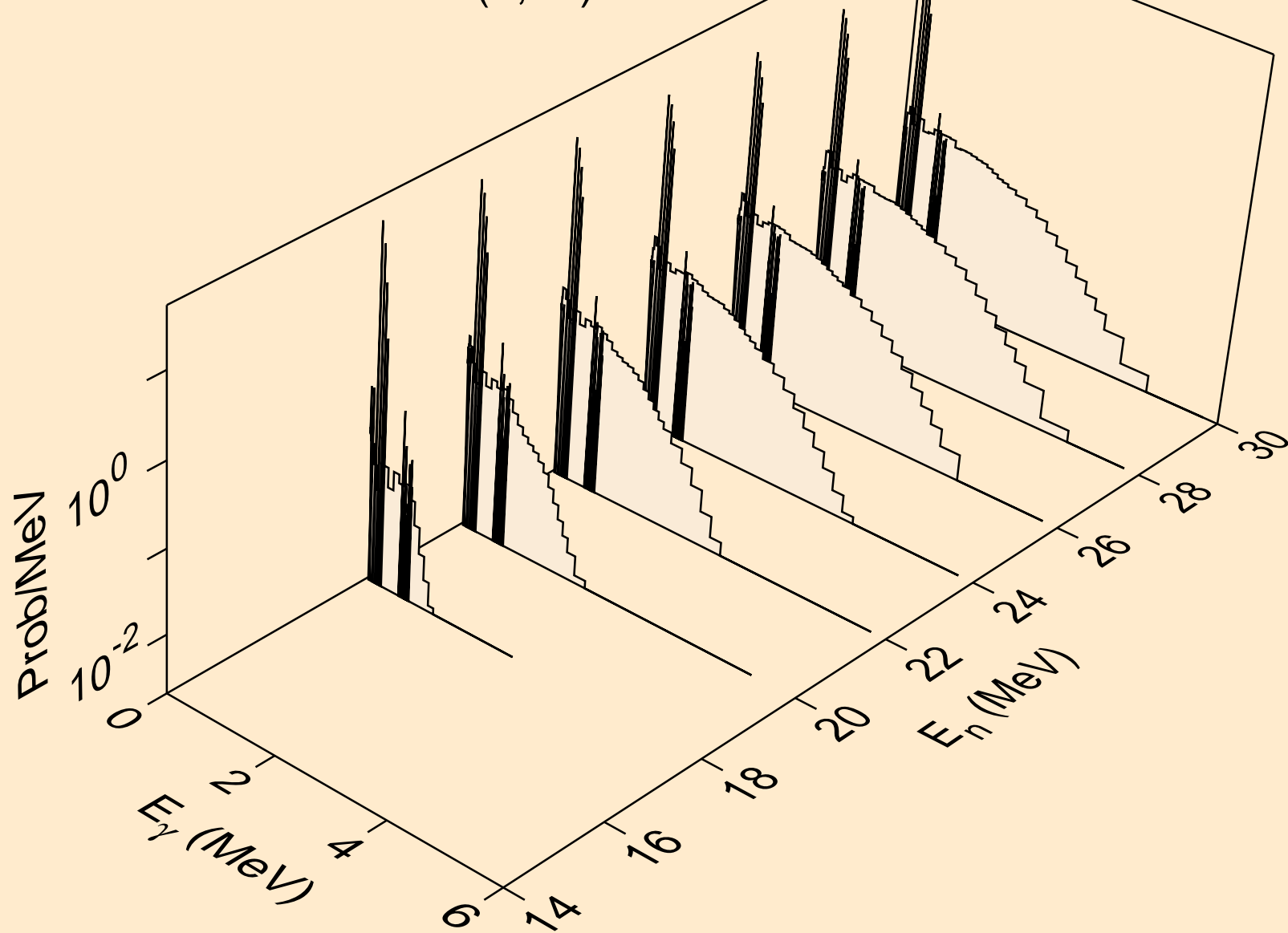

TH235 NEUTRON ACER TENDL-2023 LIBRARY; T=0.K  
Photon emission for (n,2np)

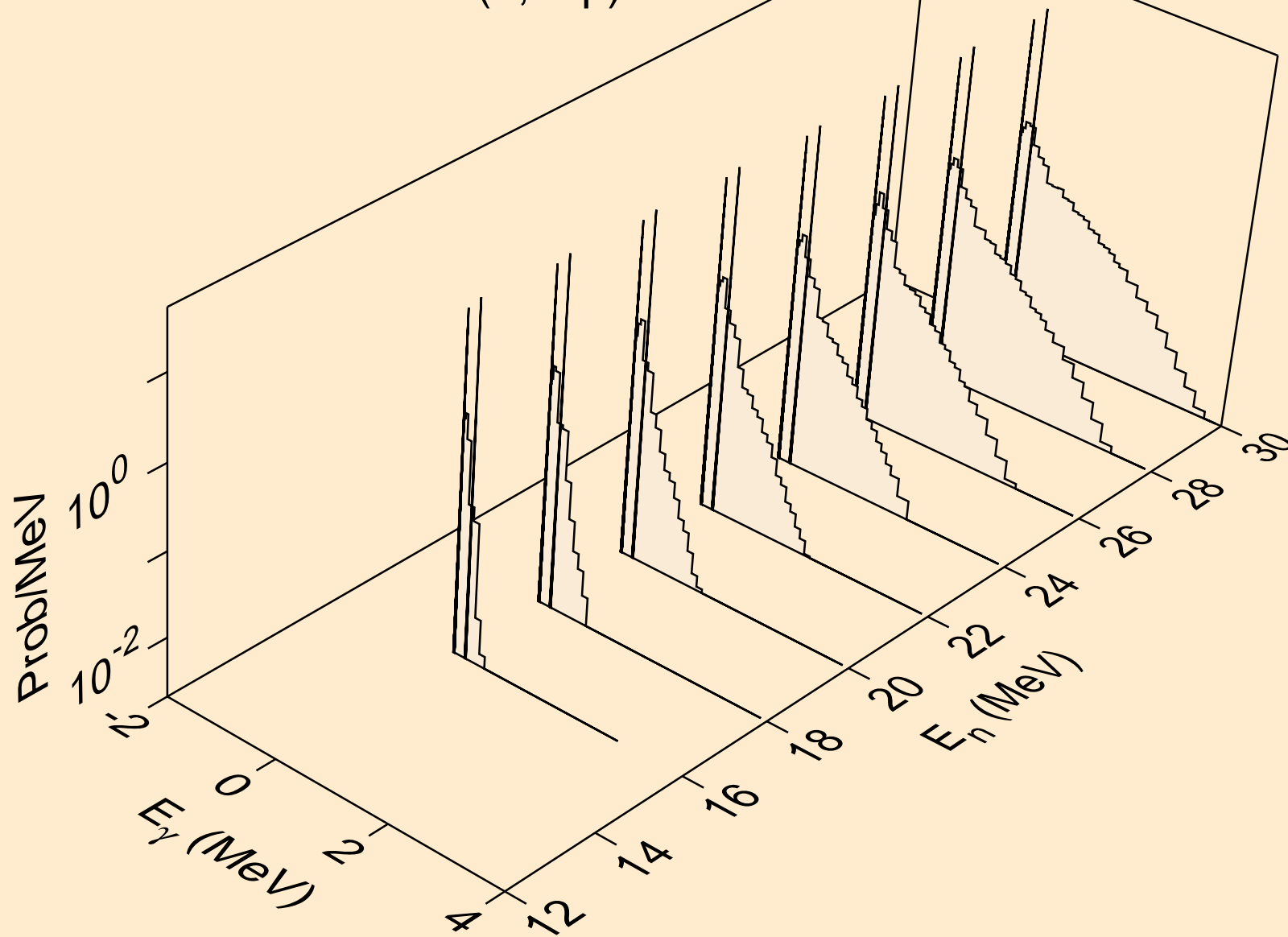

TH235 NEUTRON ACER TENDL-2023 LIBRARY; T=0.K  
Photon emission for (n,3np)

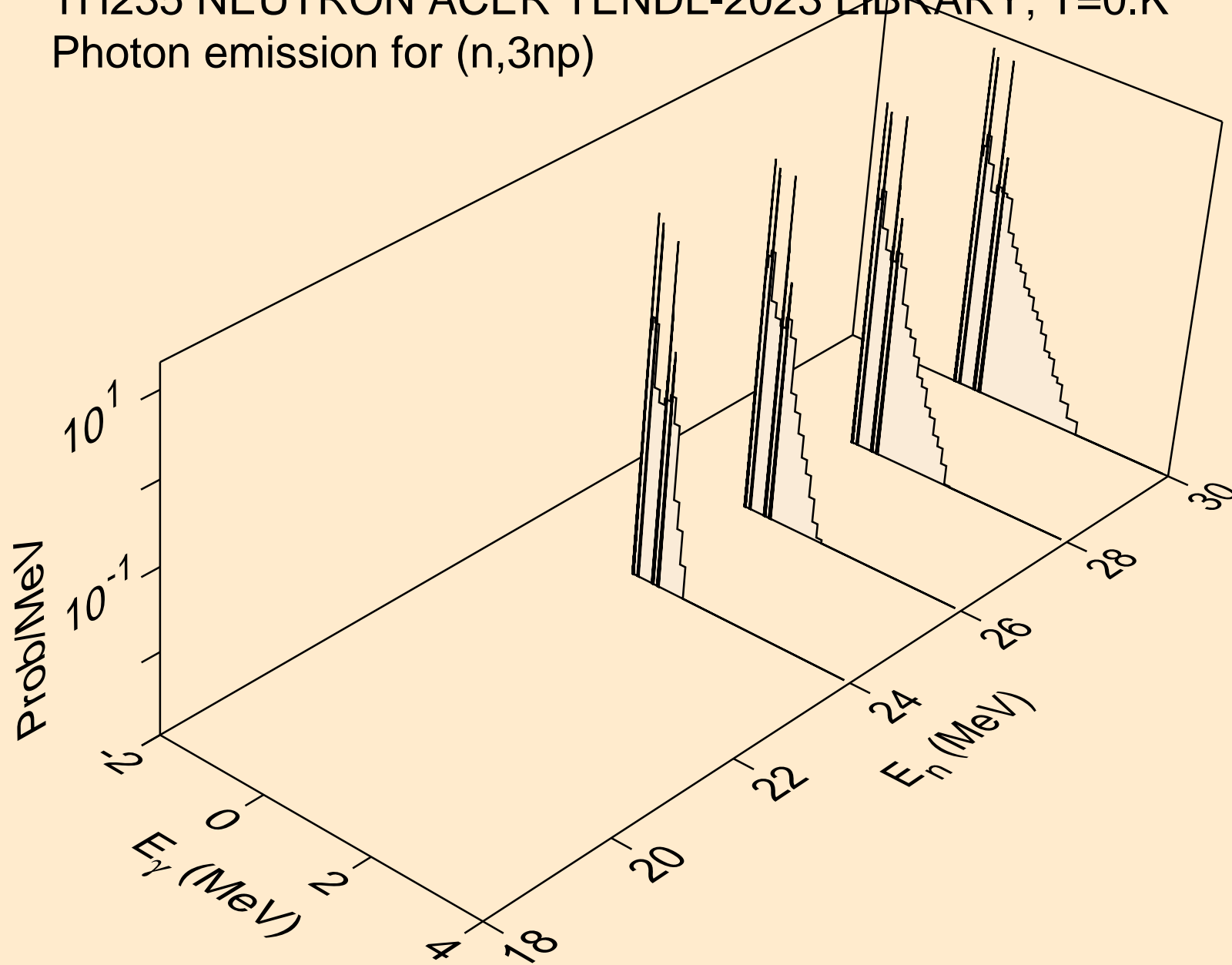

TH235 NEUTRON ACER TENDL-2023 LIBRARY; T=0.K  
Photon emission for (n,n\*c)

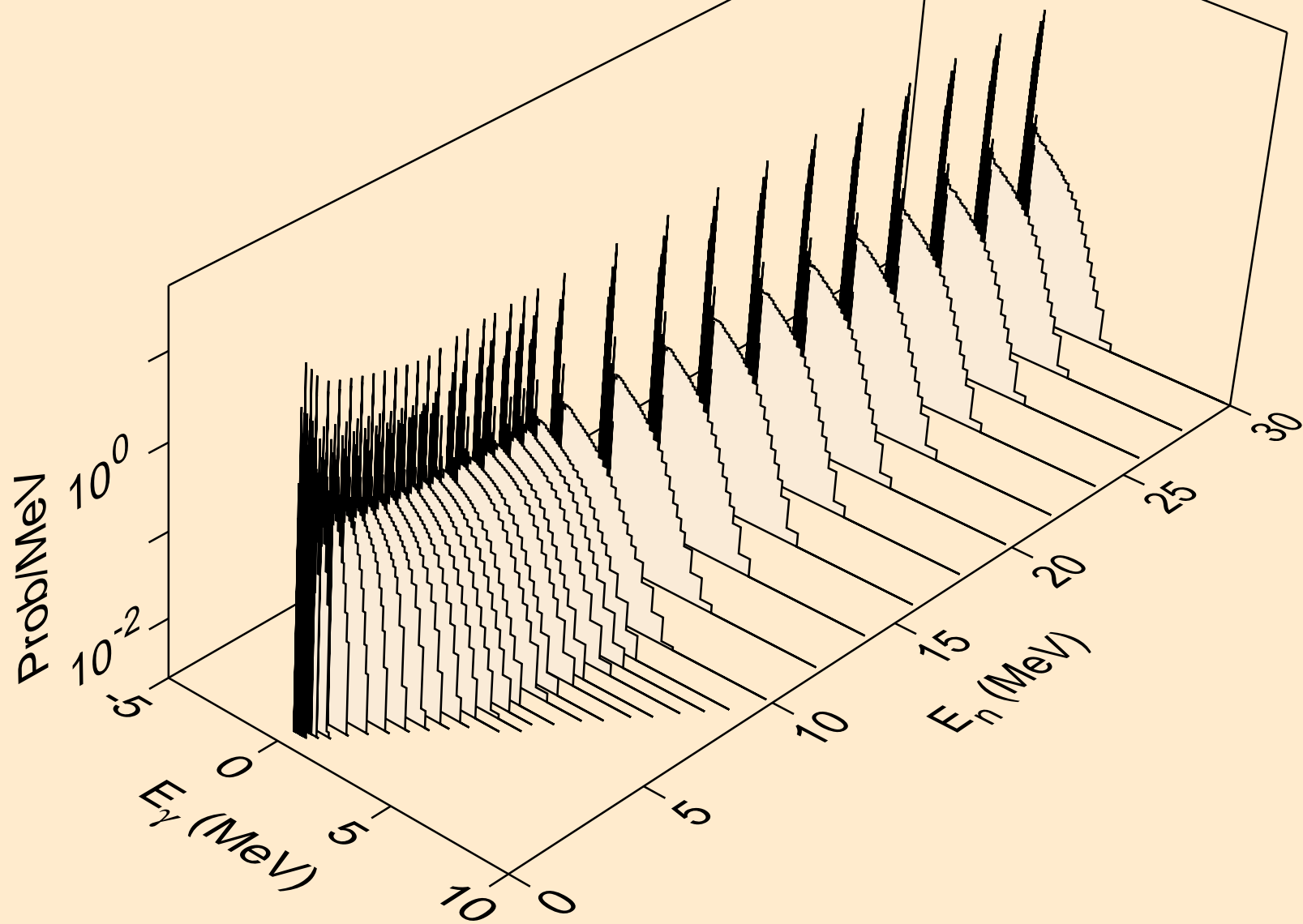

TH235 NEUTRON ACER TENDL-2023 LIBRARY; T=0.K  
Photon emission for (n,gma)

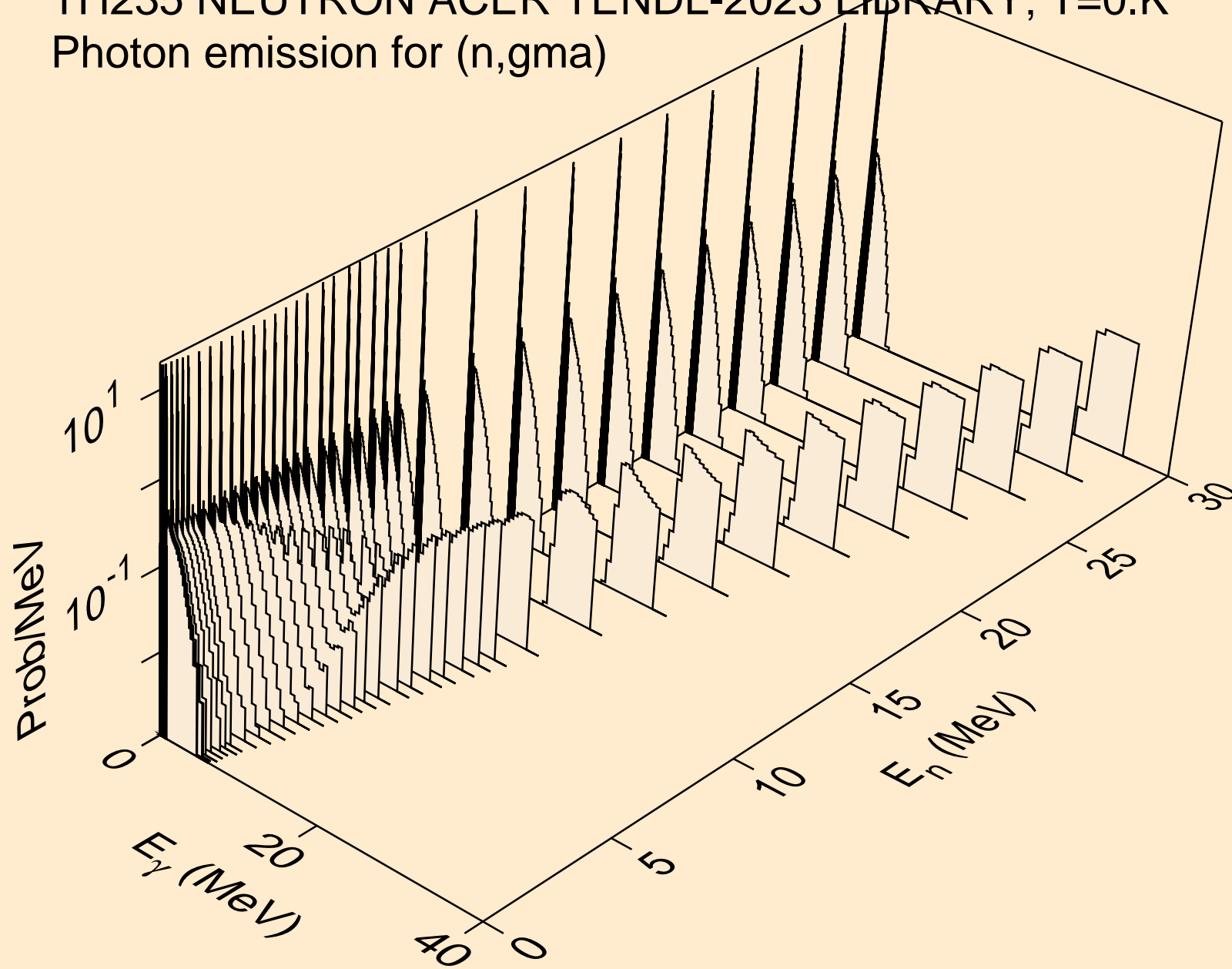

TH235 NEUTRON ACER TENDL-2023 LIBRARY; T=0.K  
Photon emission for (n,p)

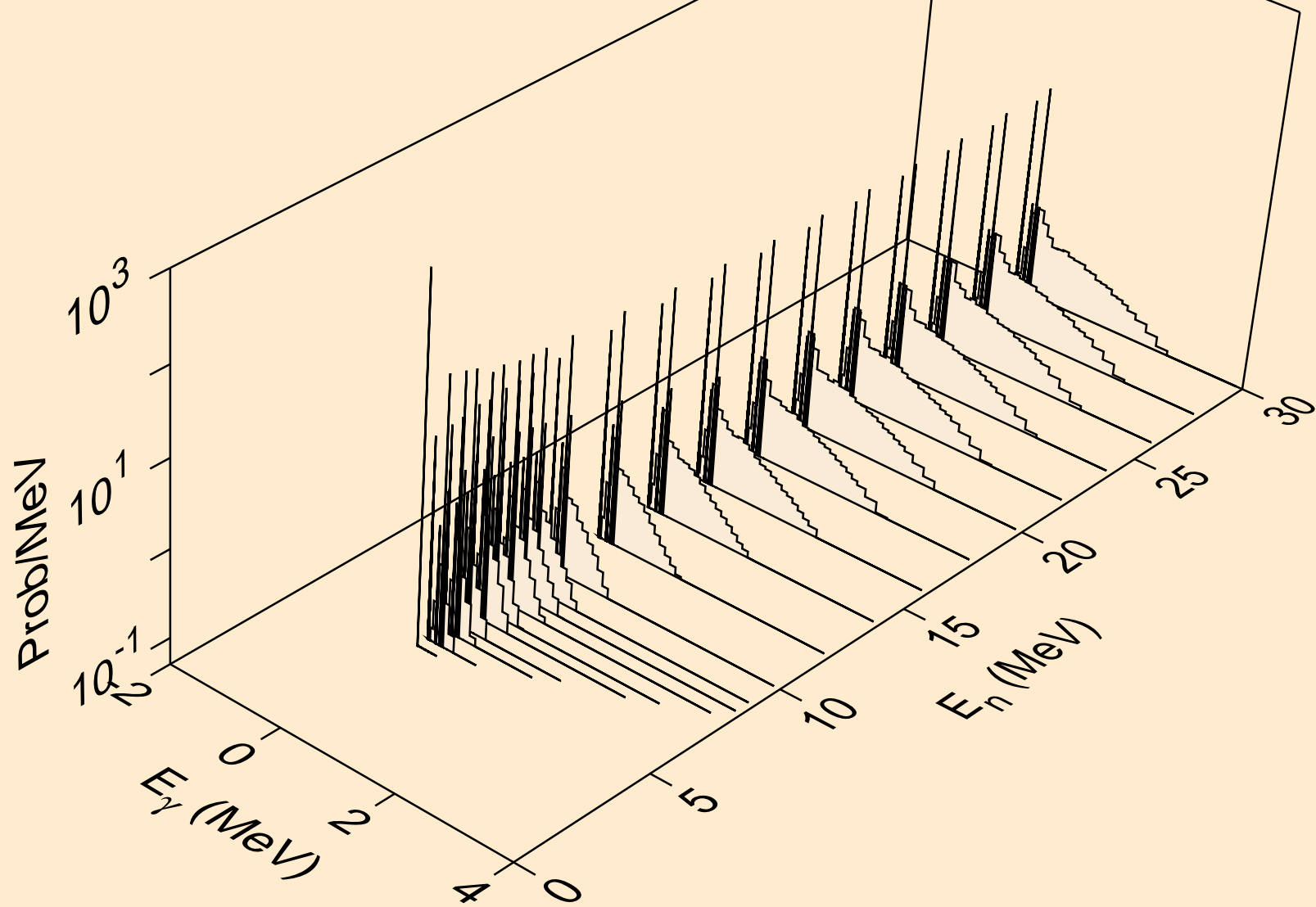

TH235 NEUTRON ACER TENDL-2023 LIBRARY; T=0.K  
Photon emission for (n,d)

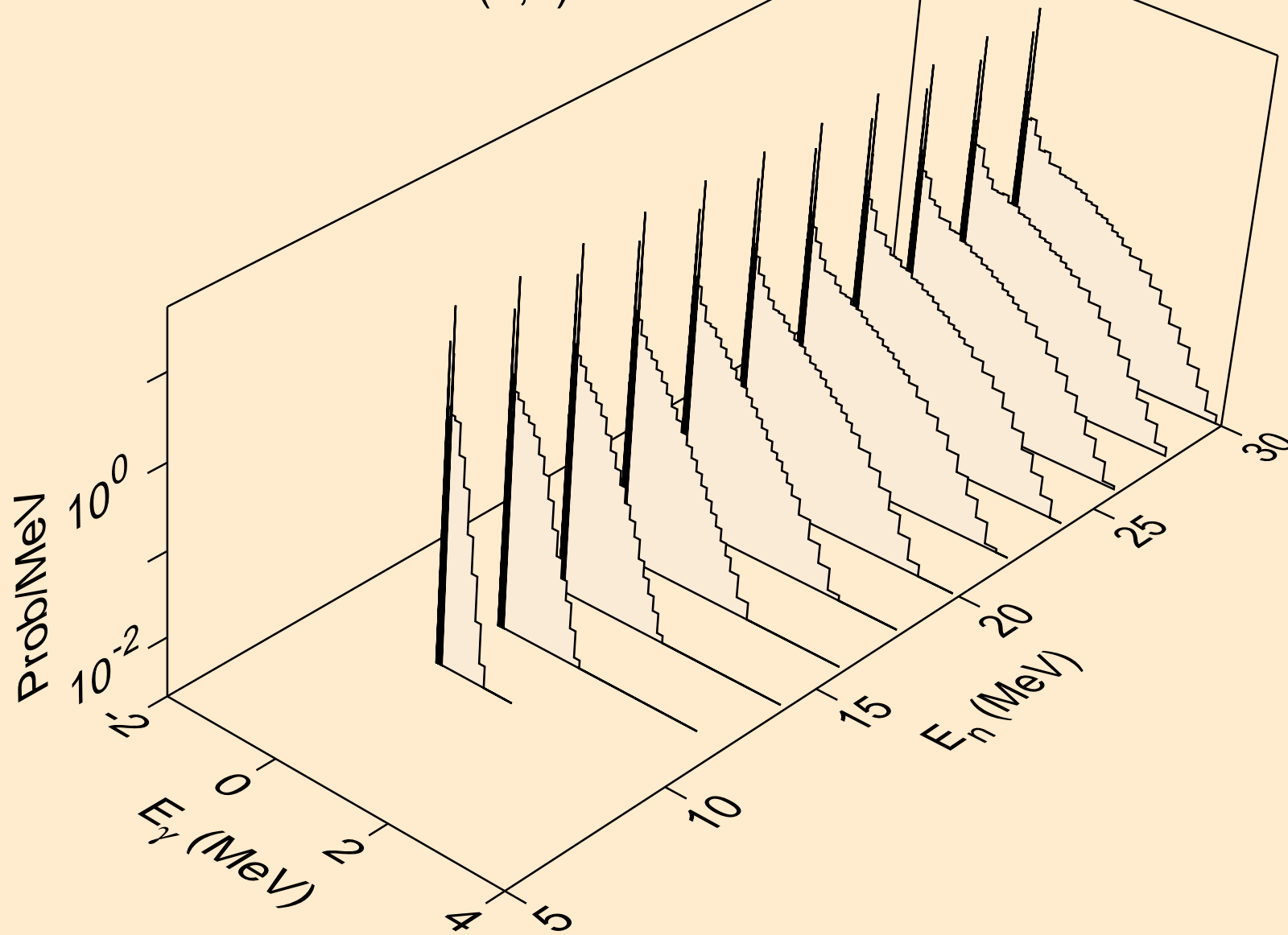



TH235 NEUTRON ACER TENDL-2023 LIBRARY; T=0.K  
Photon emission for (n,t)

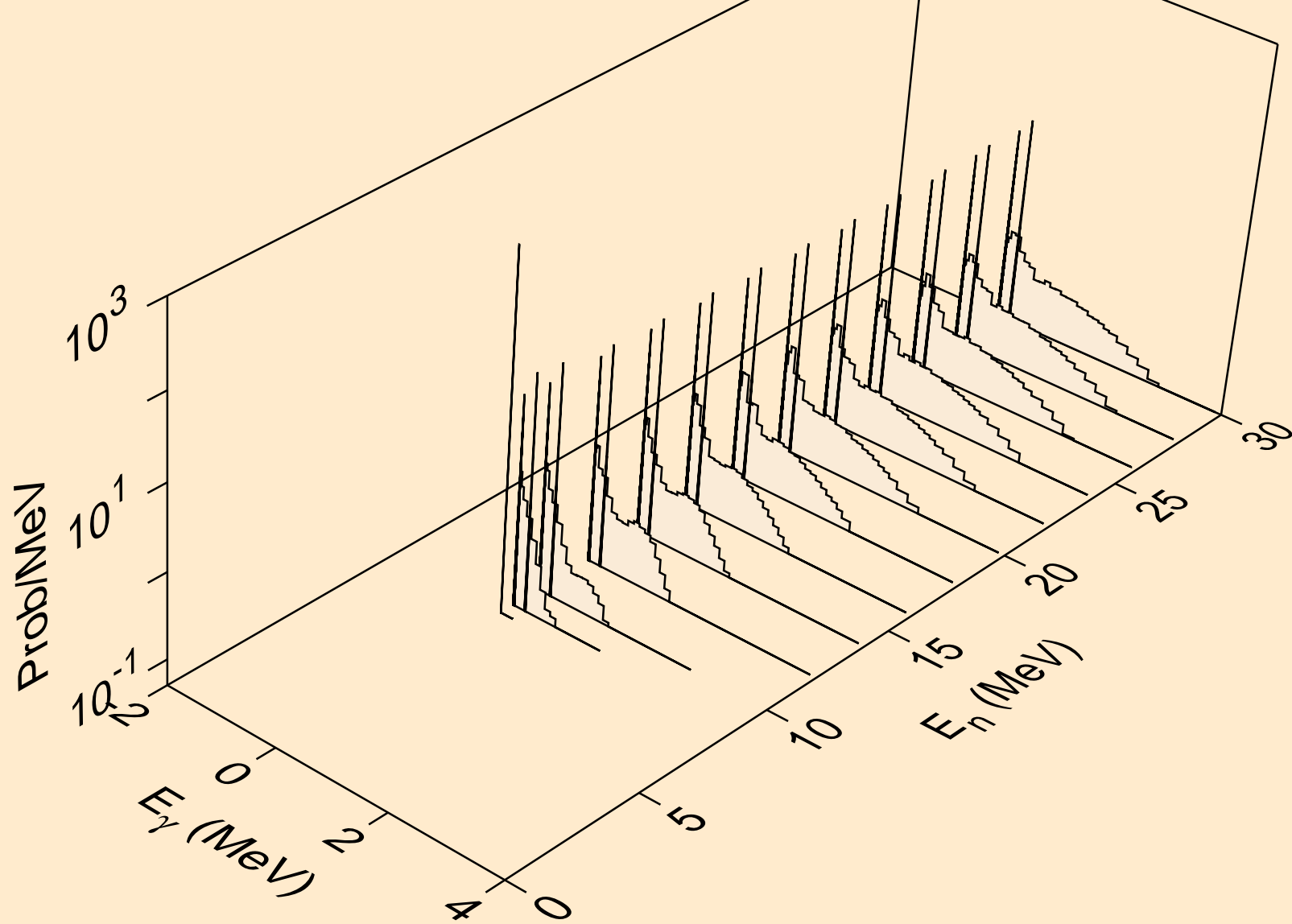

TH235 NEUTRON ACER TENDL-2023 LIBRARY; T=0.K  
Photon emission for (n,he3)

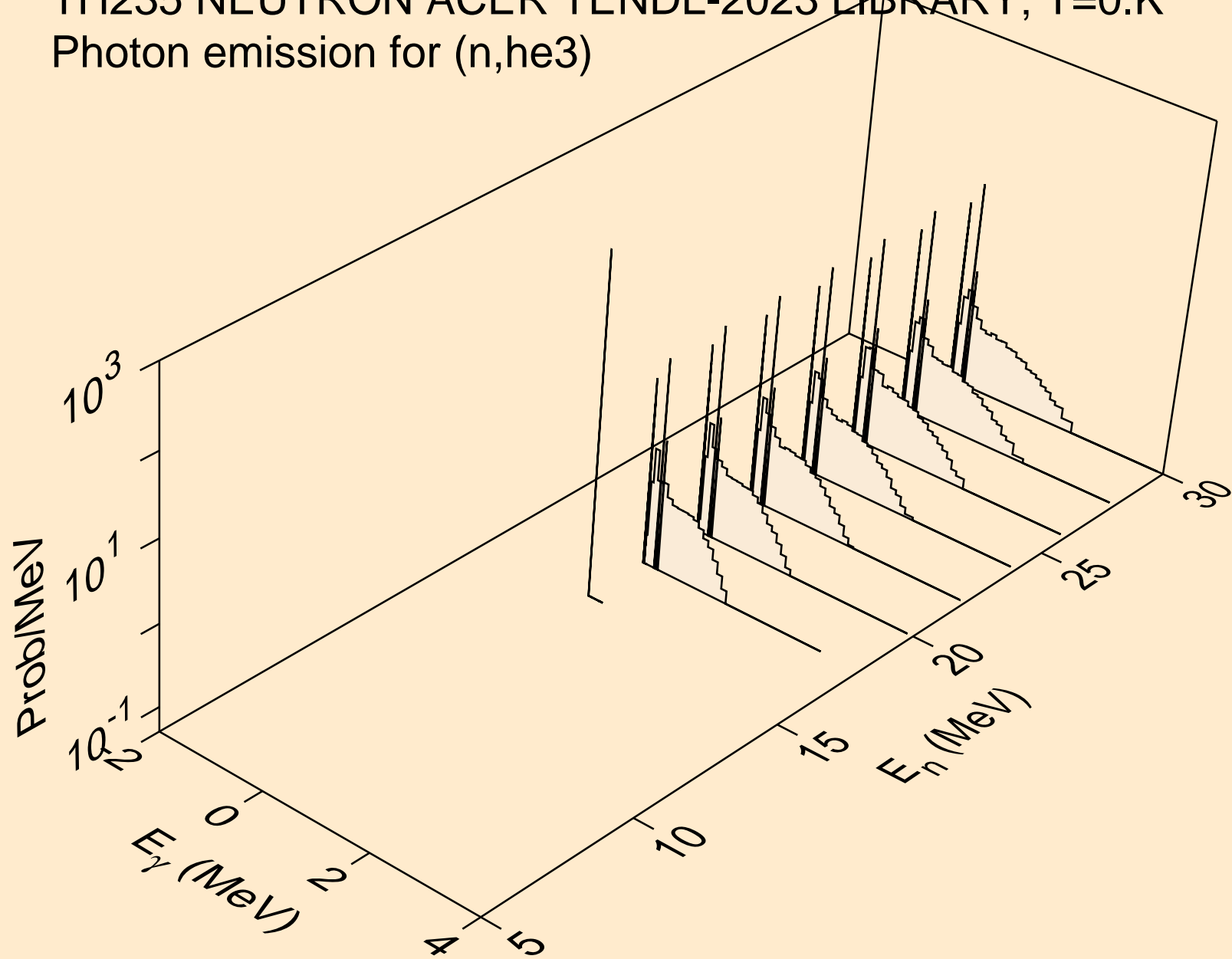

TH235 NEUTRON ACER TENDL-2023 LIBRARY; T=0.K  
Photon emission for (n,a)

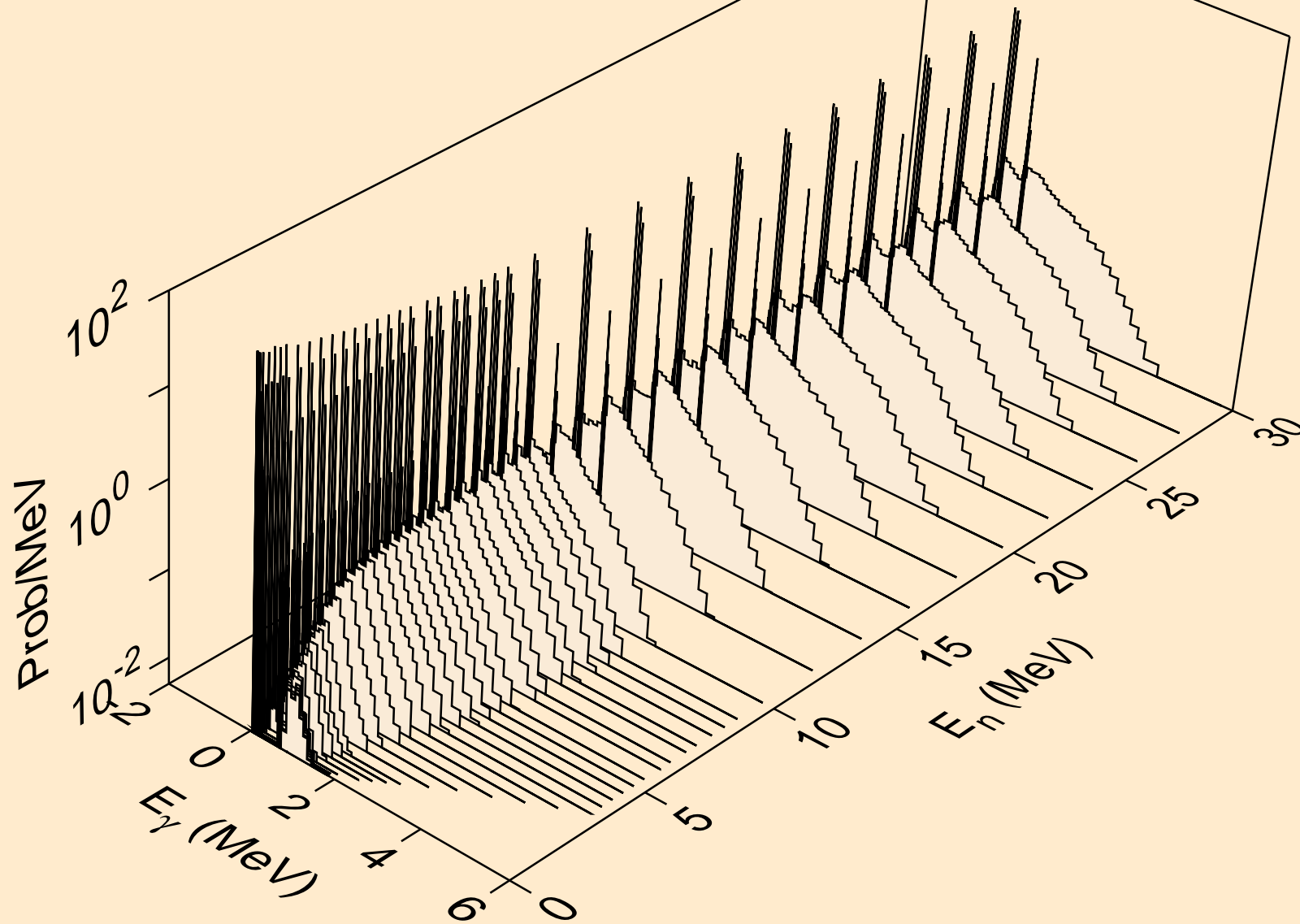

TH235 NEUTRON ACER TENDL-2023 LIBRARY; T=0.K  
Photon emission for (n,2p)

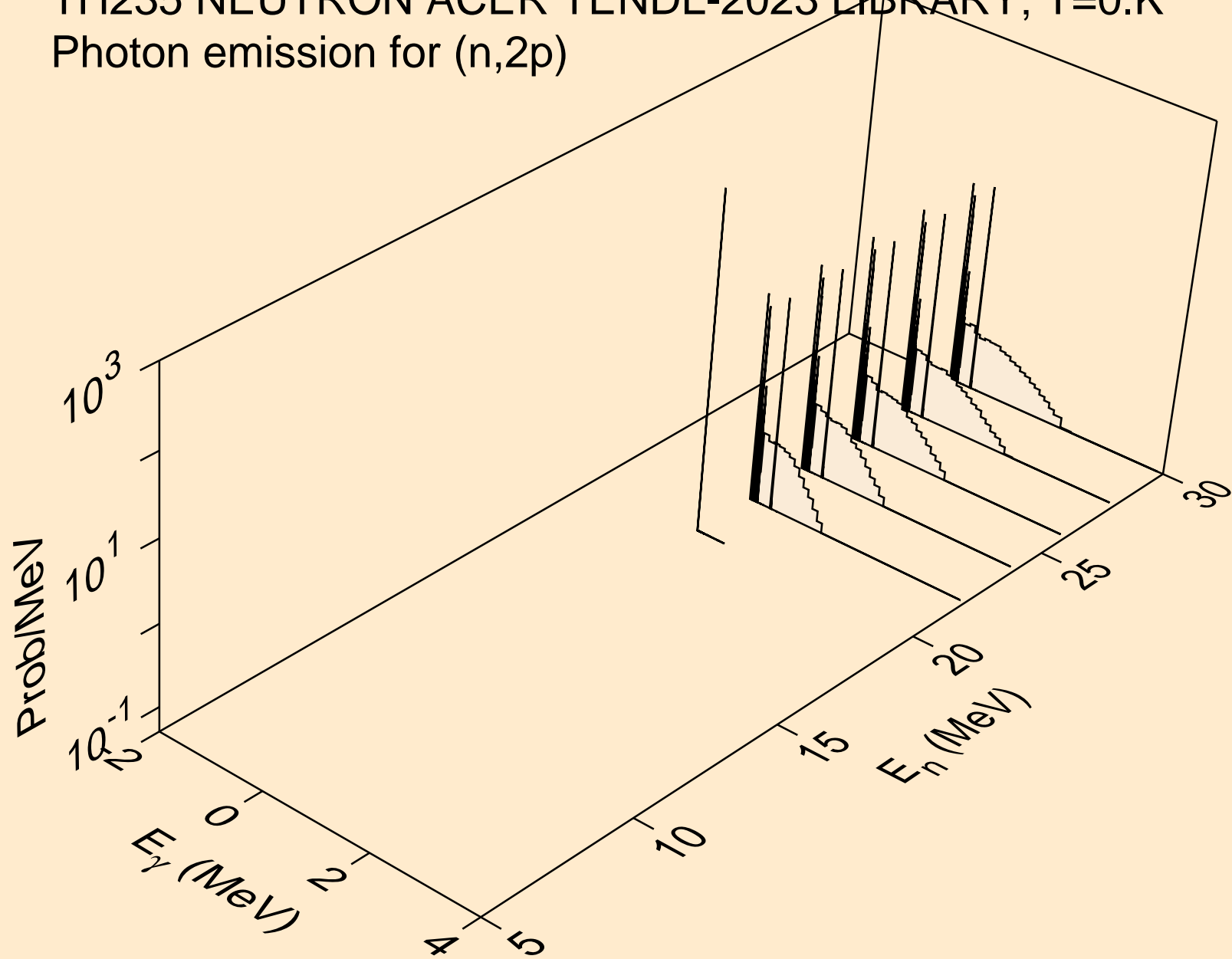

TH235 NEUTRON ACER TENDL-2023 LIBRARY; T=0.K  
thermal capture photon spectrum

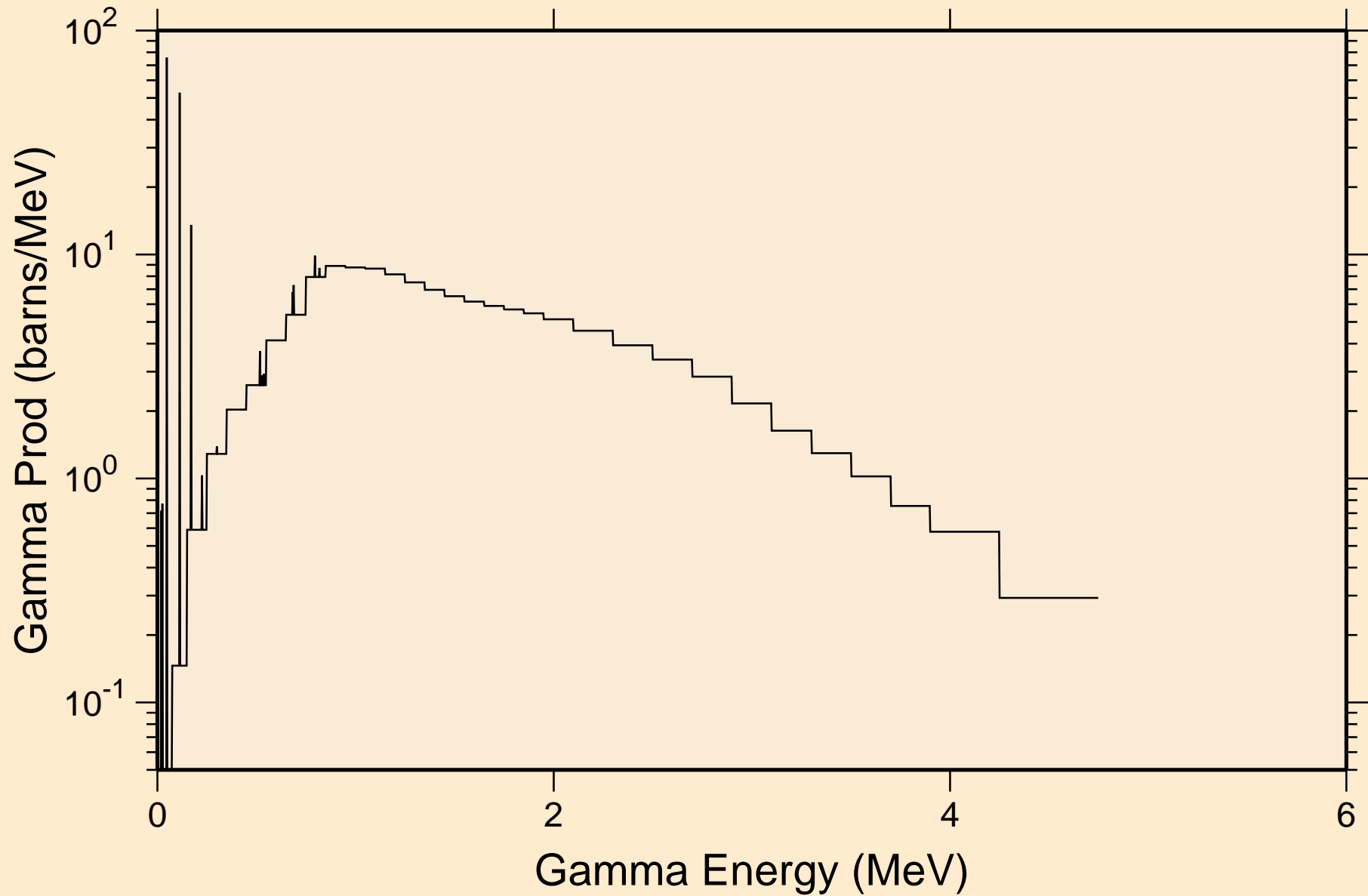

TH235 NEUTRON ACER TENDL-2023 LIBRARY; T=0.K  
14 MeV photon spectrum

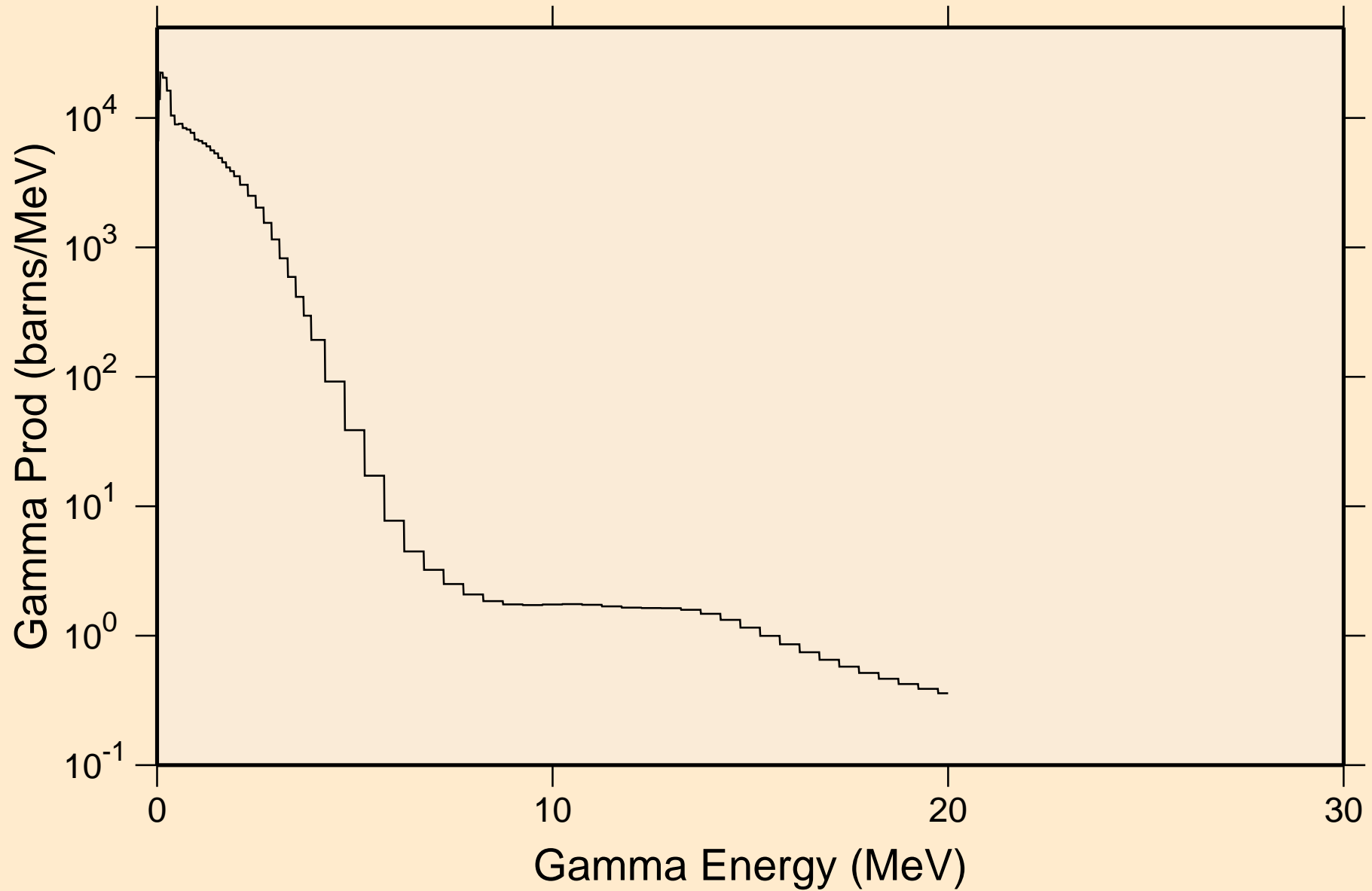

# TH235 NEUTRON ACER TENDL-2023 LIBRARY; T=0.K

## Particle heating contributions

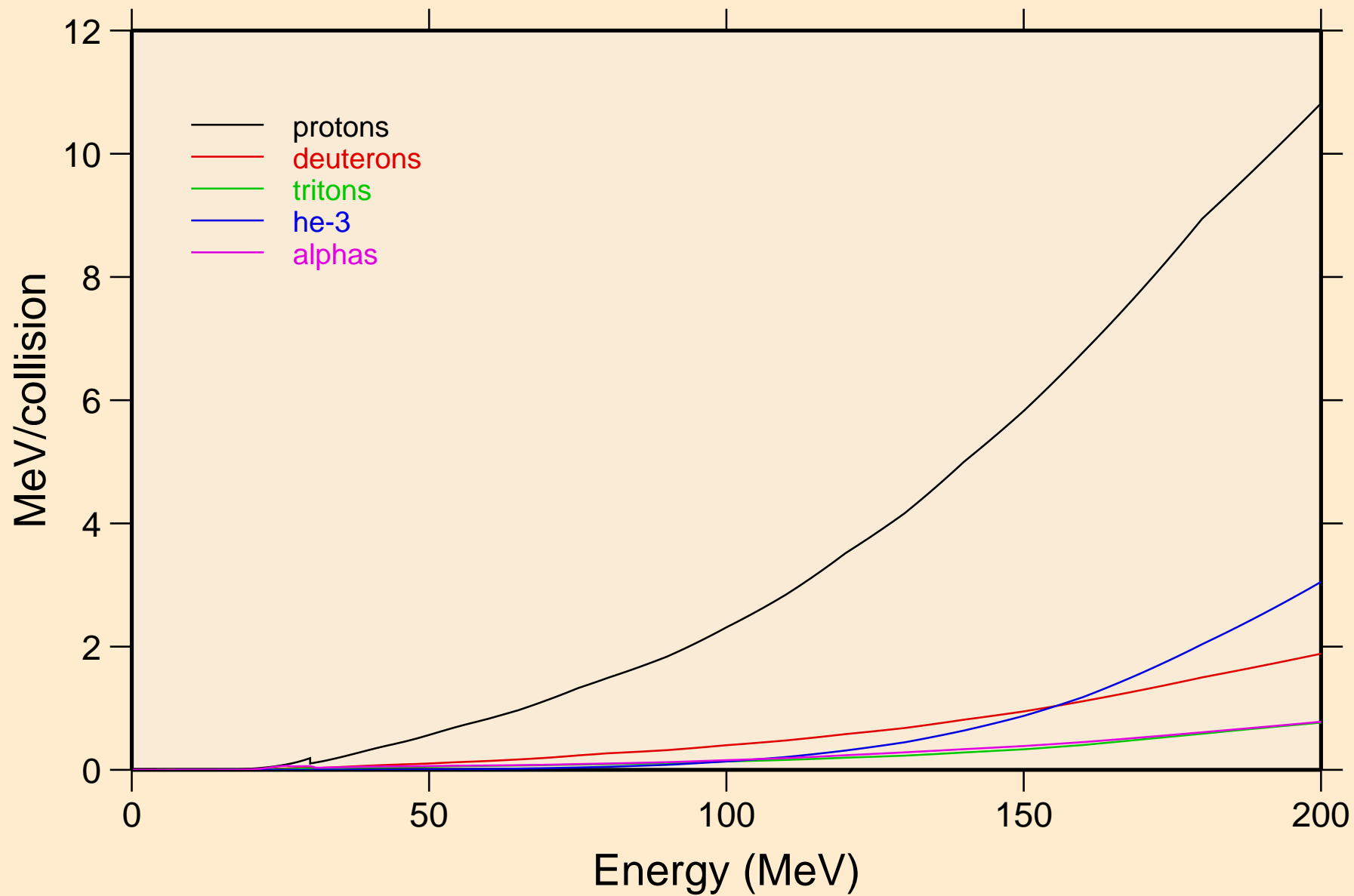

TH235 NEUTRON ACER TENDL-2023 LIBRARY; T=0.K  
Recoil Heating

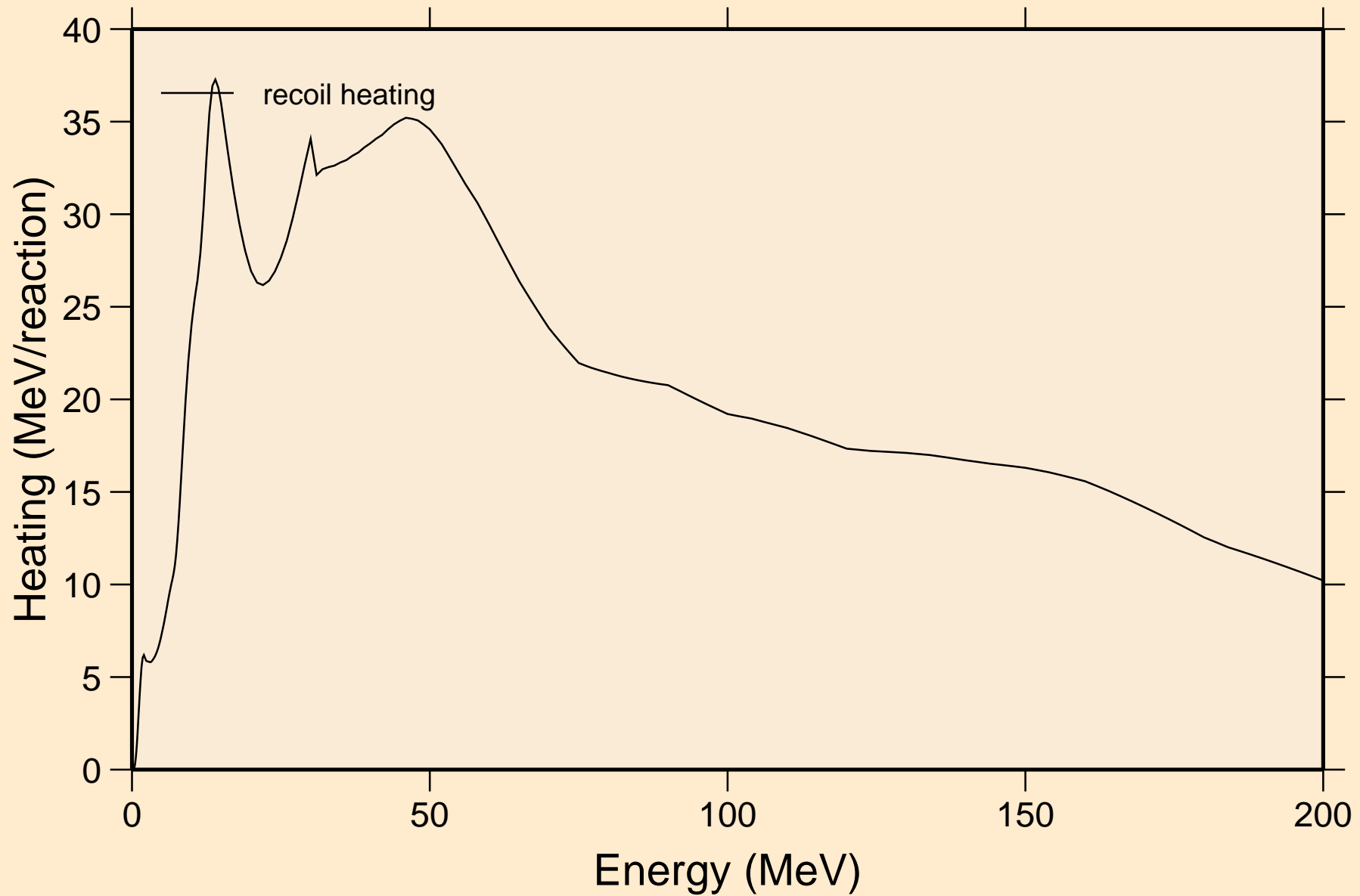



# TH235 NEUTRON ACER TENDL-2023 LIBRARY; T=0.K

## Particle production cross sections

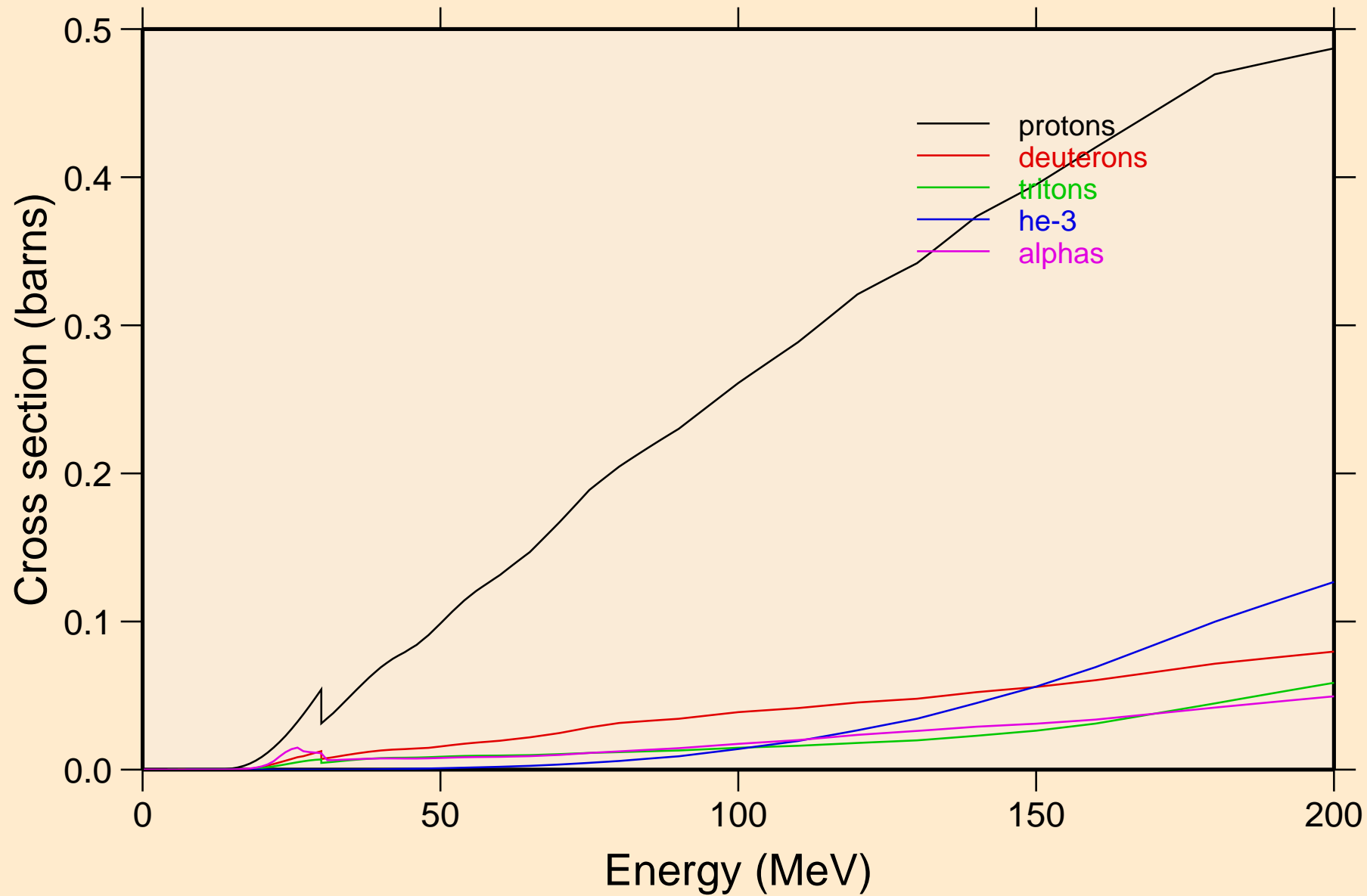

TH235 NEUTRON ACER TENDL-2023 LIBRARY; T=0.K  
protons from (n,x)

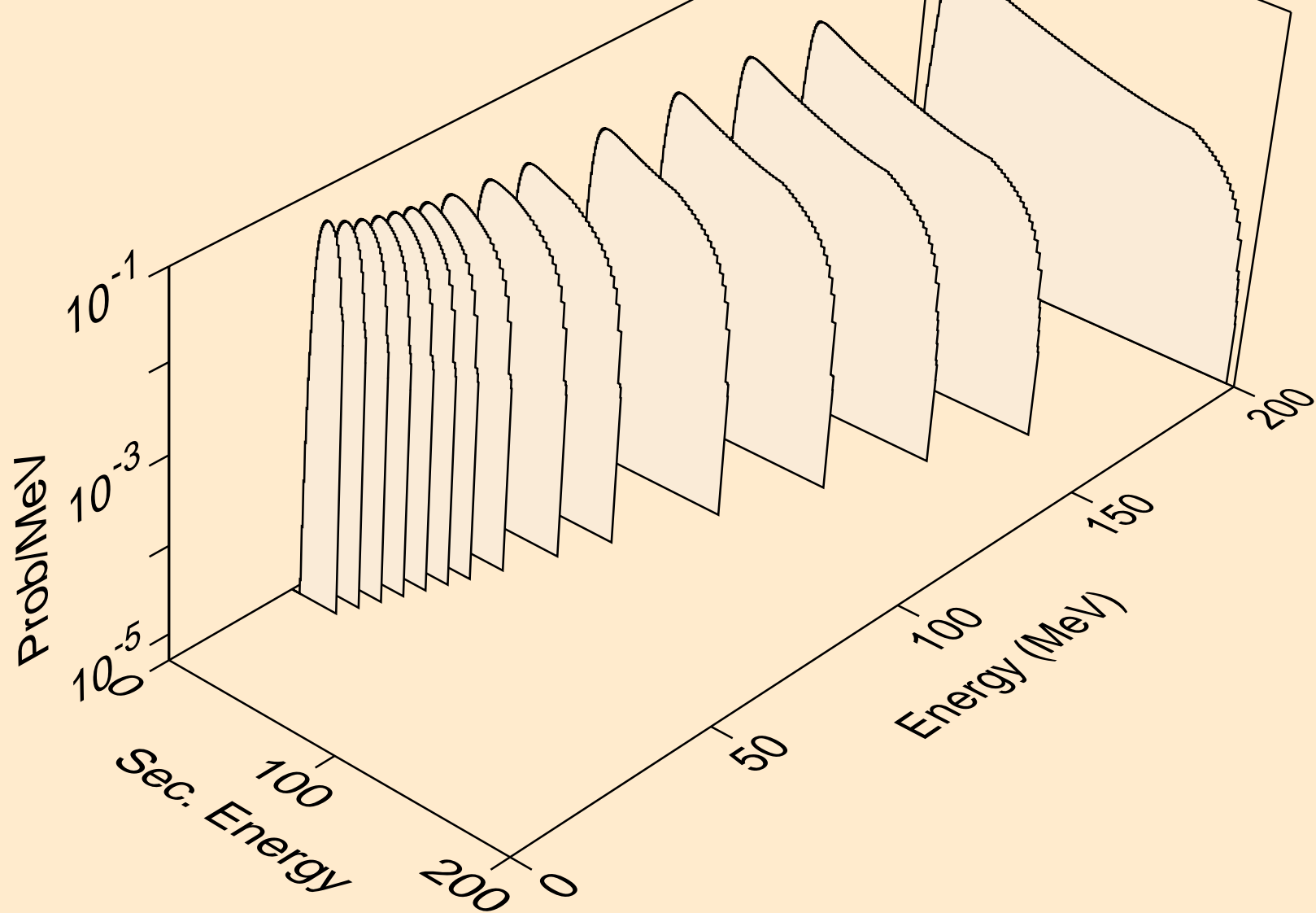

TH235 NEUTRON ACER TENDL-2023 LIBRARY; T=0.K  
protons from (n,n\*)p

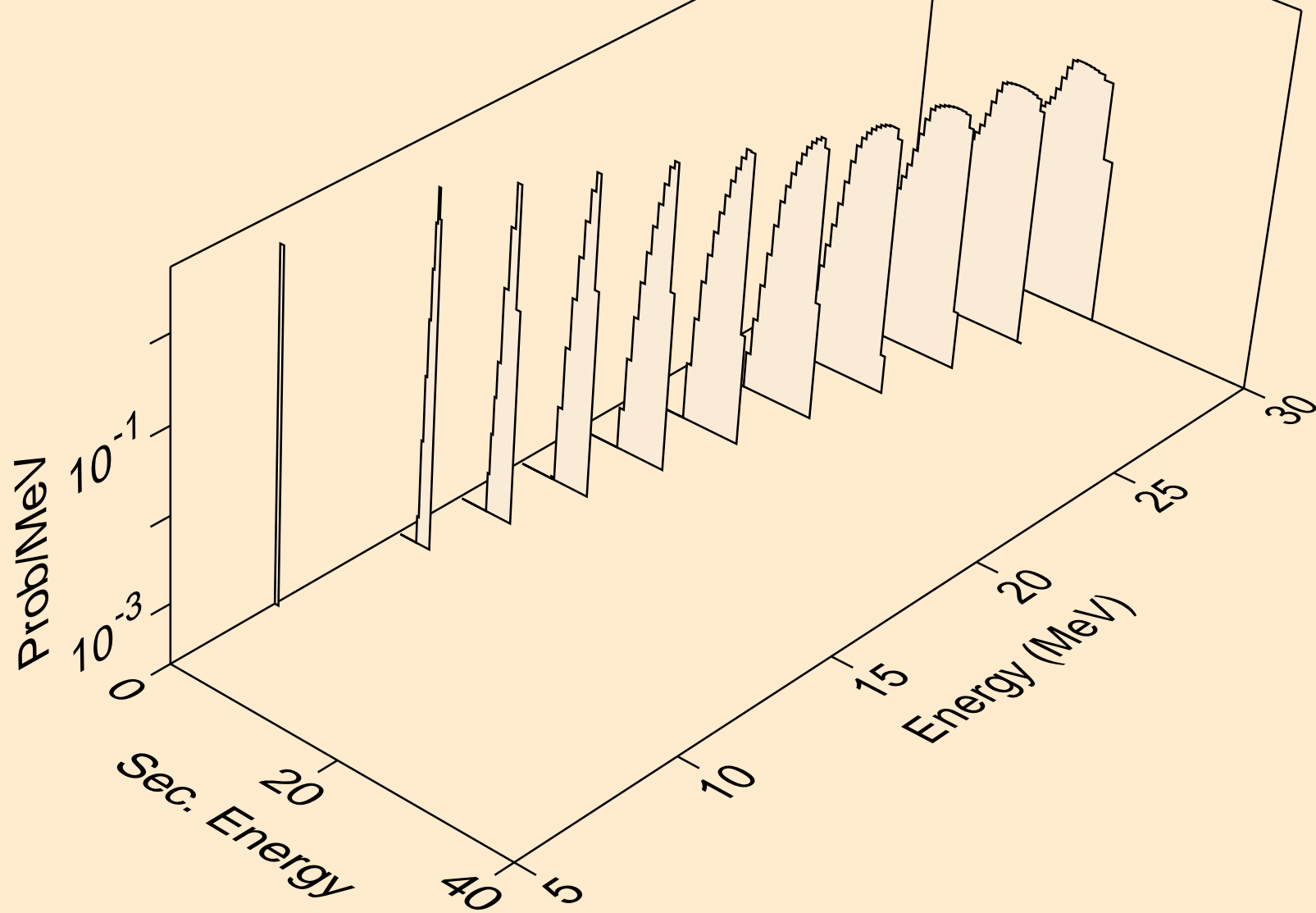

TH235 NEUTRON ACER TENDL-2023 LIBRARY; T=0.K  
protons from (n,2np)

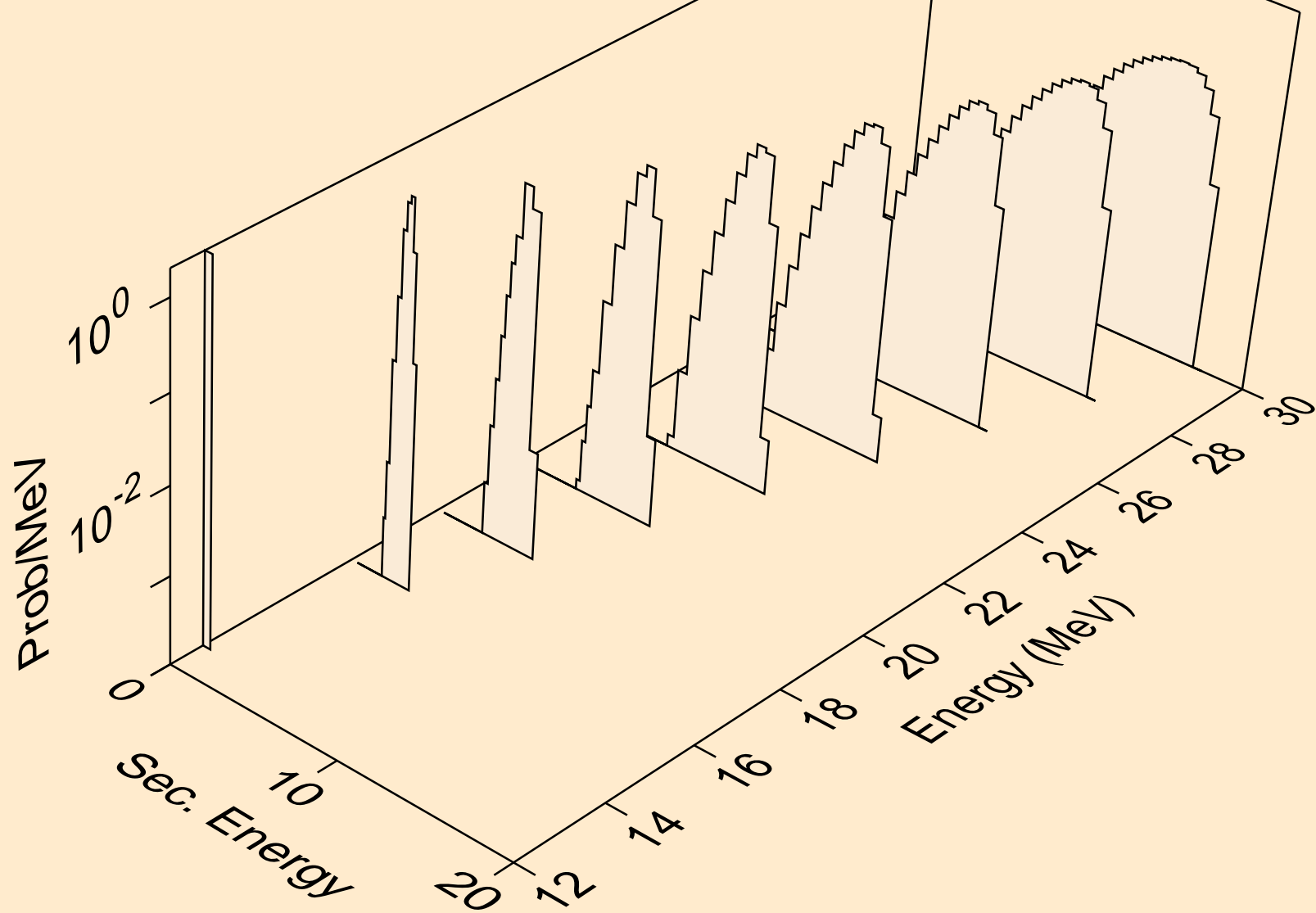

TH235 NEUTRON ACER TENDL-2023 LIBRARY; T=0.K  
protons from (n,3np)

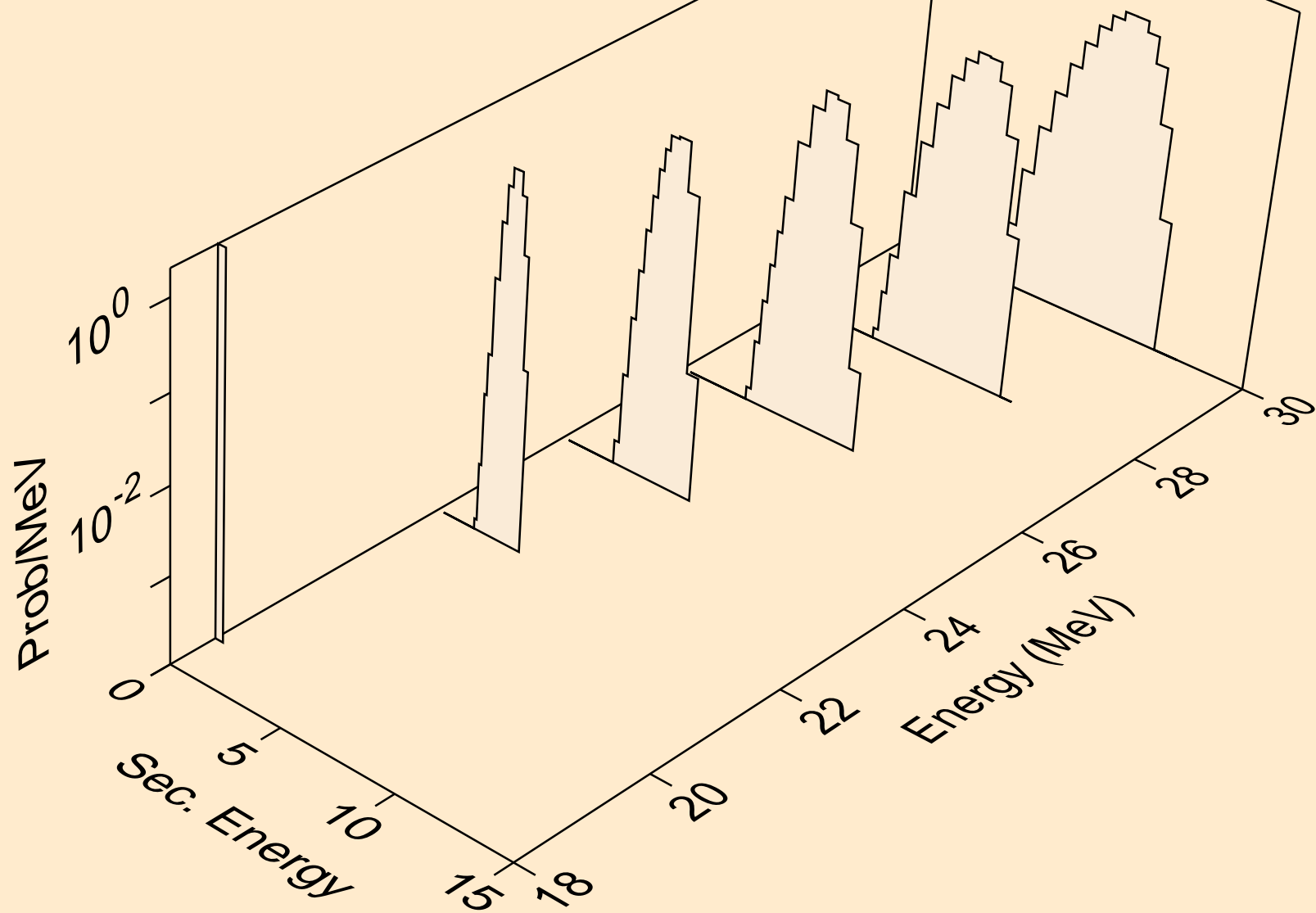

TH235 NEUTRON ACER TENDL-2023 LIBRARY; T=0.K  
protons from (n,p)

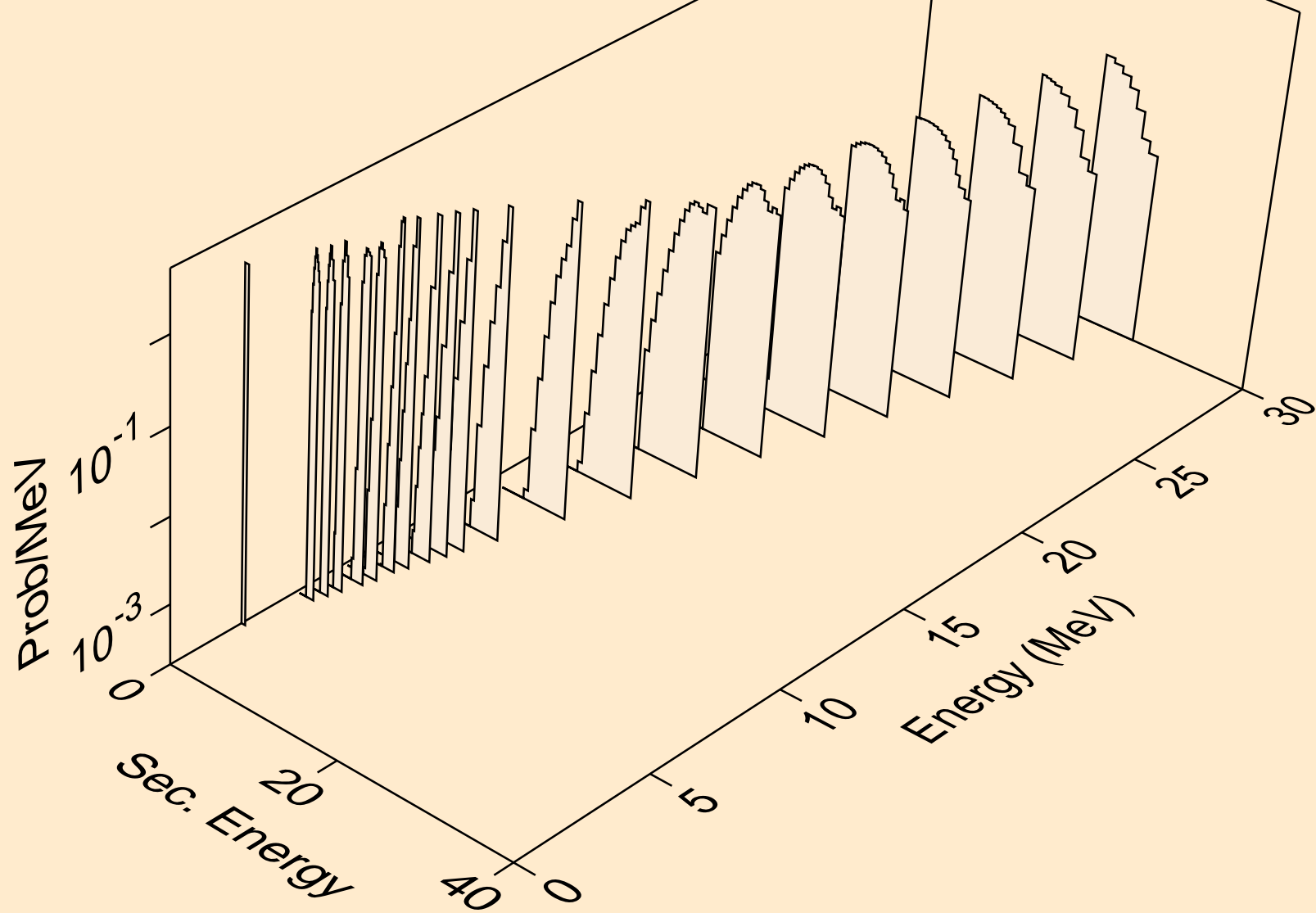

TH235 NEUTRON ACER TENDL-2023 LIBRARY; T=0.K  
protons from (n,2p)

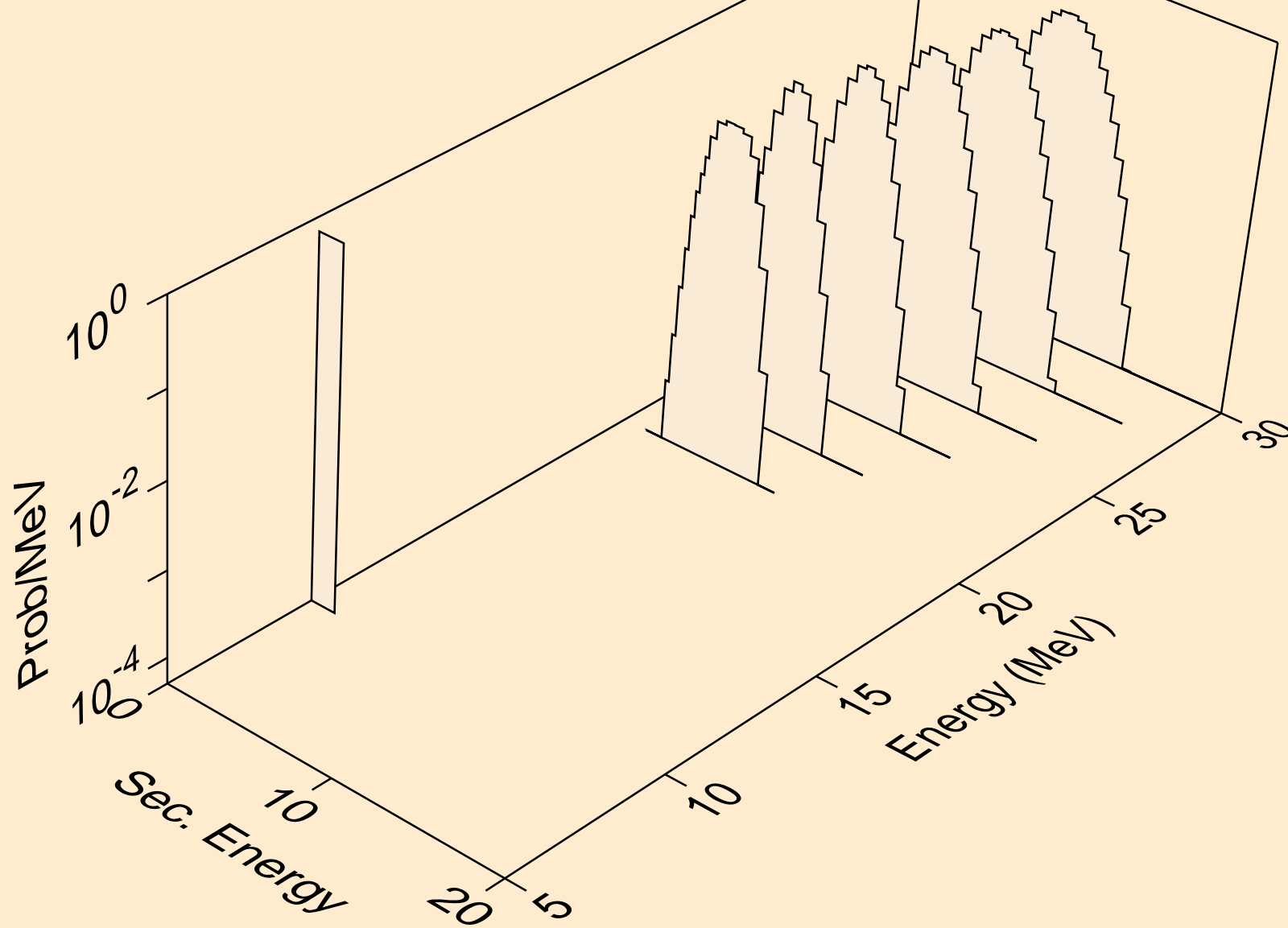

TH235 NEUTRON ACER TENDL-2023 LIBRARY; T=0.K  
deuterons from (n,x)

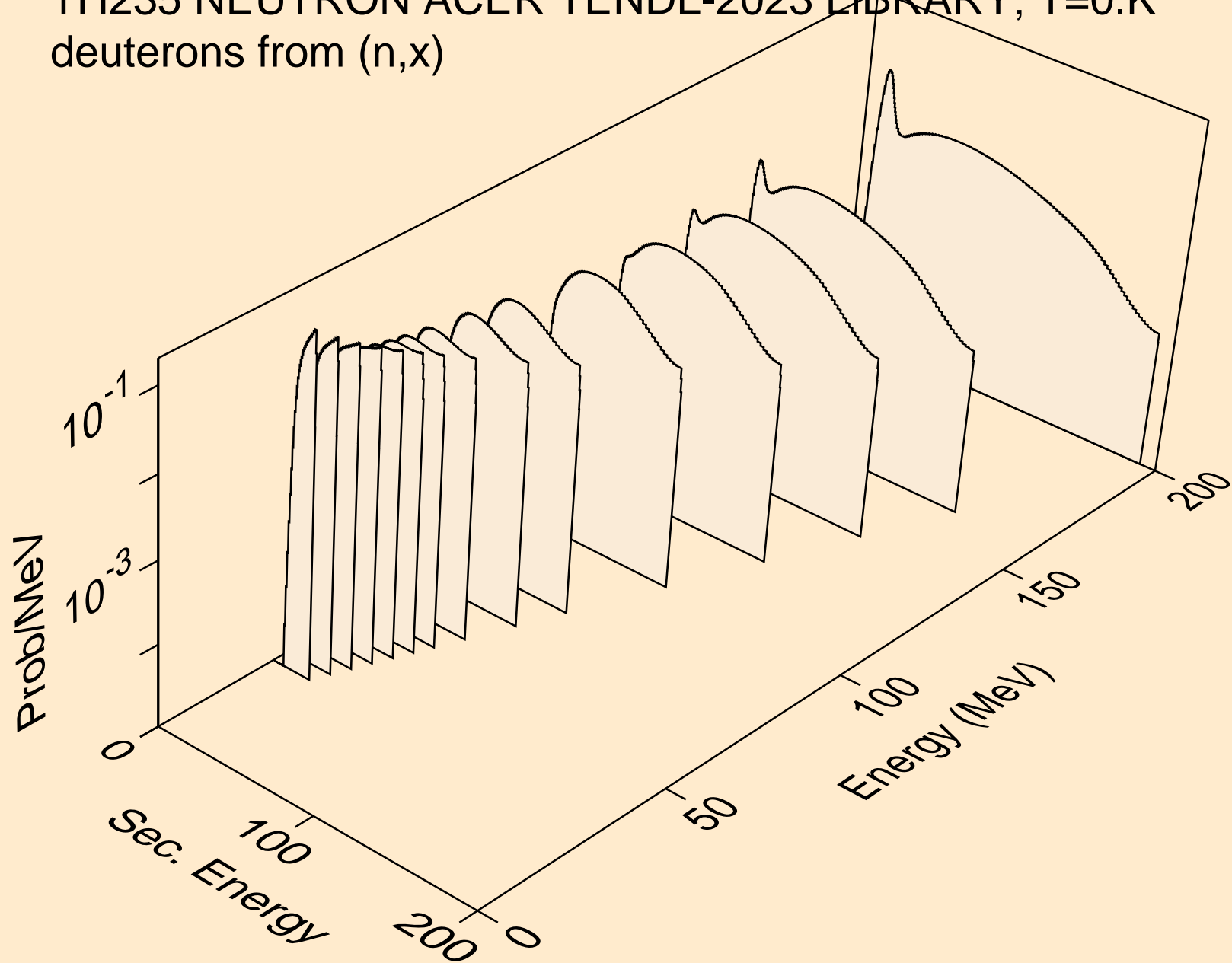



TH235 NEUTRON ACER TENDL-2023 LIBRARY; T=0.K  
deuterons from (n,2nd)

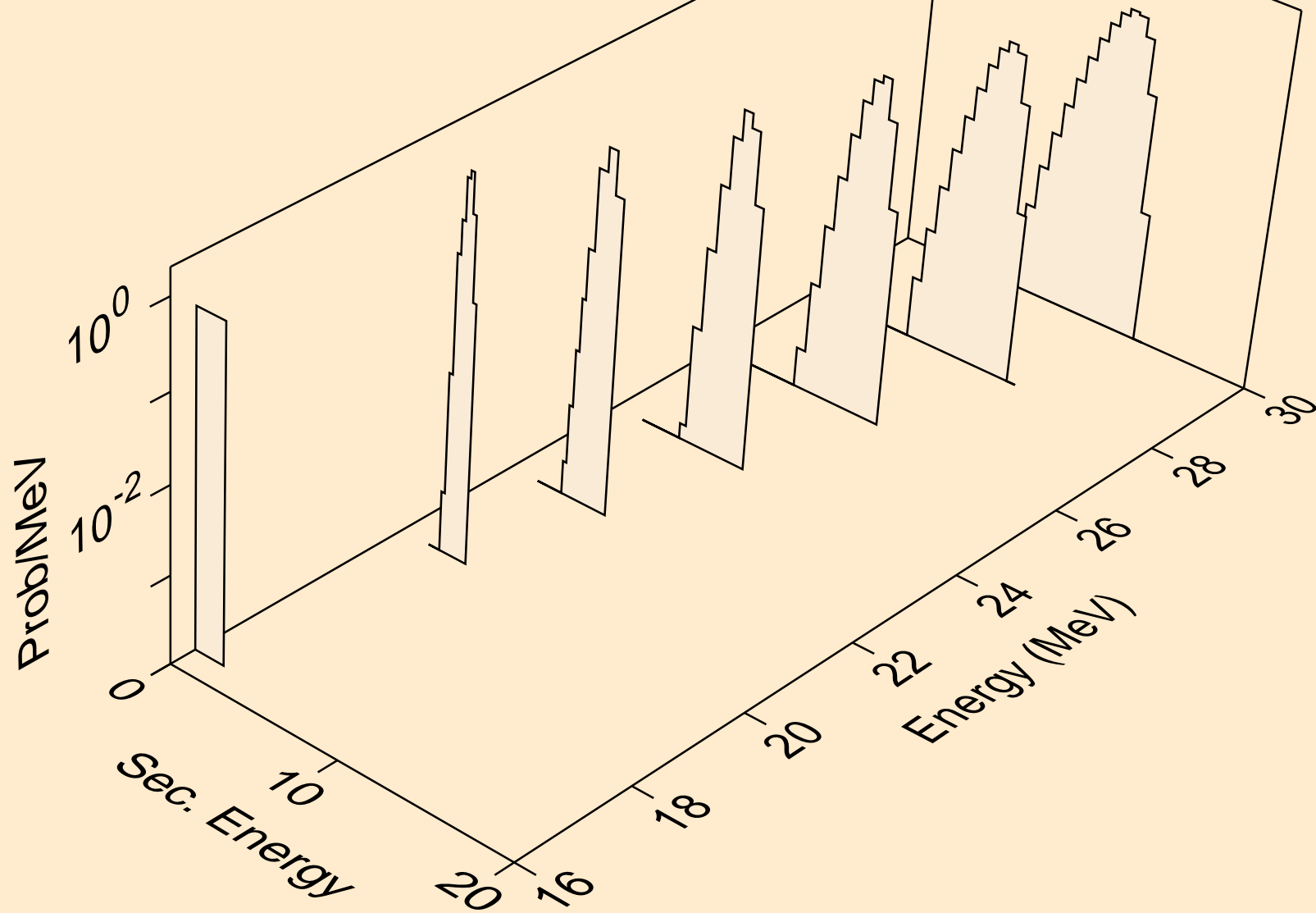

TH235 NEUTRON ACER TENDL-2023 LIBRARY; T=0.K  
deuterons from (n,n\*)d

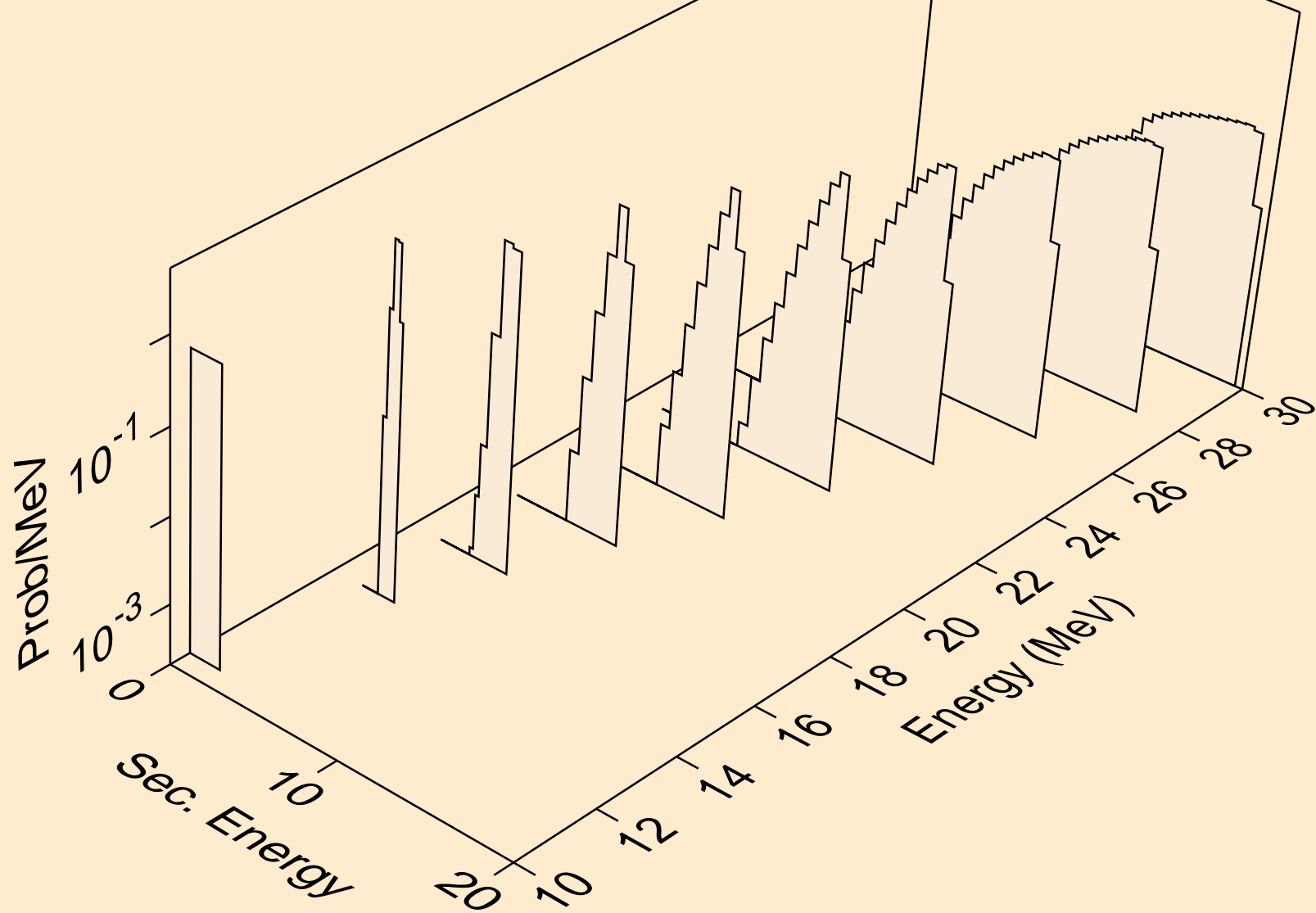

TH235 NEUTRON ACER TENDL-2023 LIBRARY; T=0.K  
deuterons from (n,d)

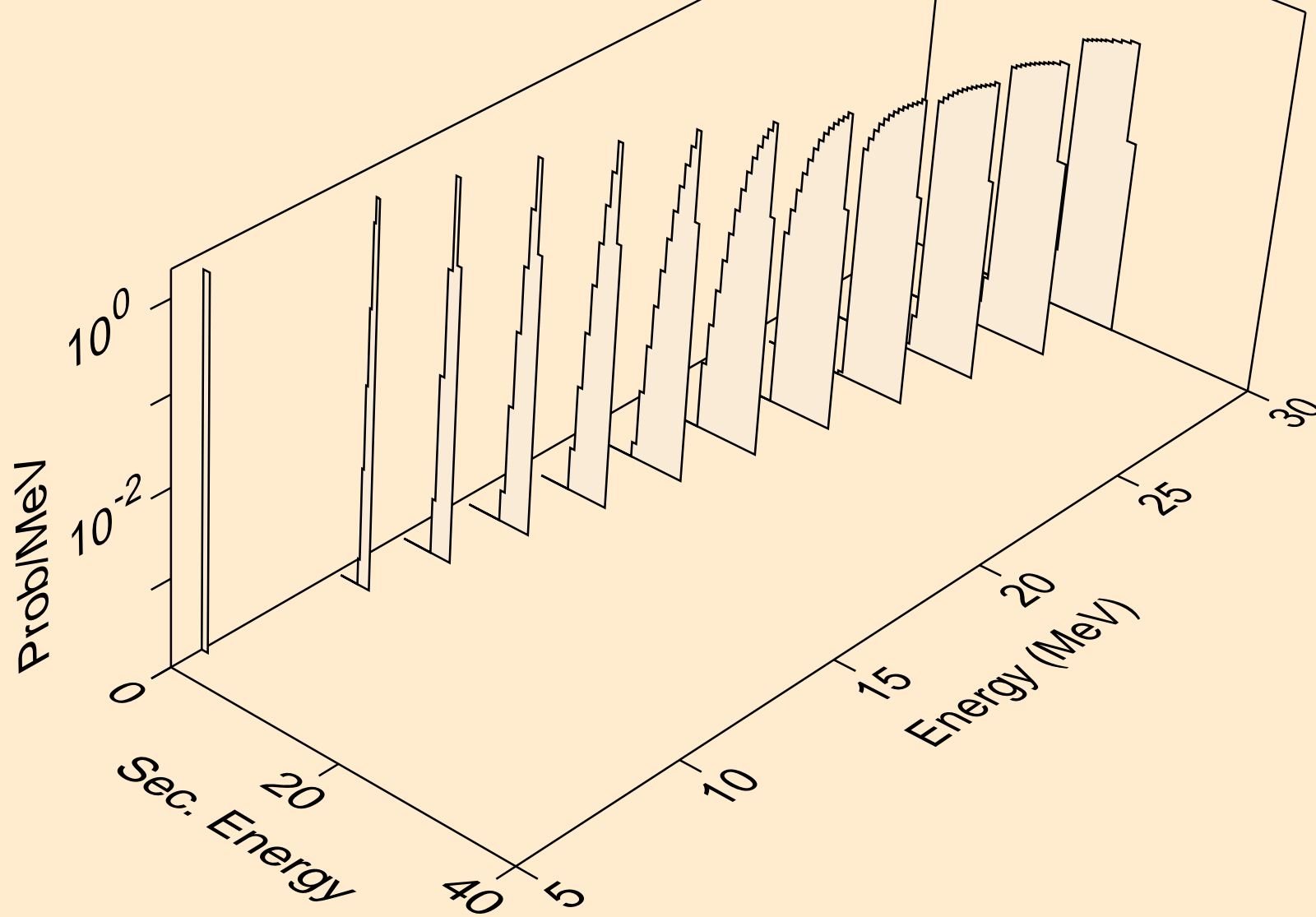

TH235 NEUTRON ACER TENDL-2023 LIBRARY; T=0.K  
tritons from (n,x)

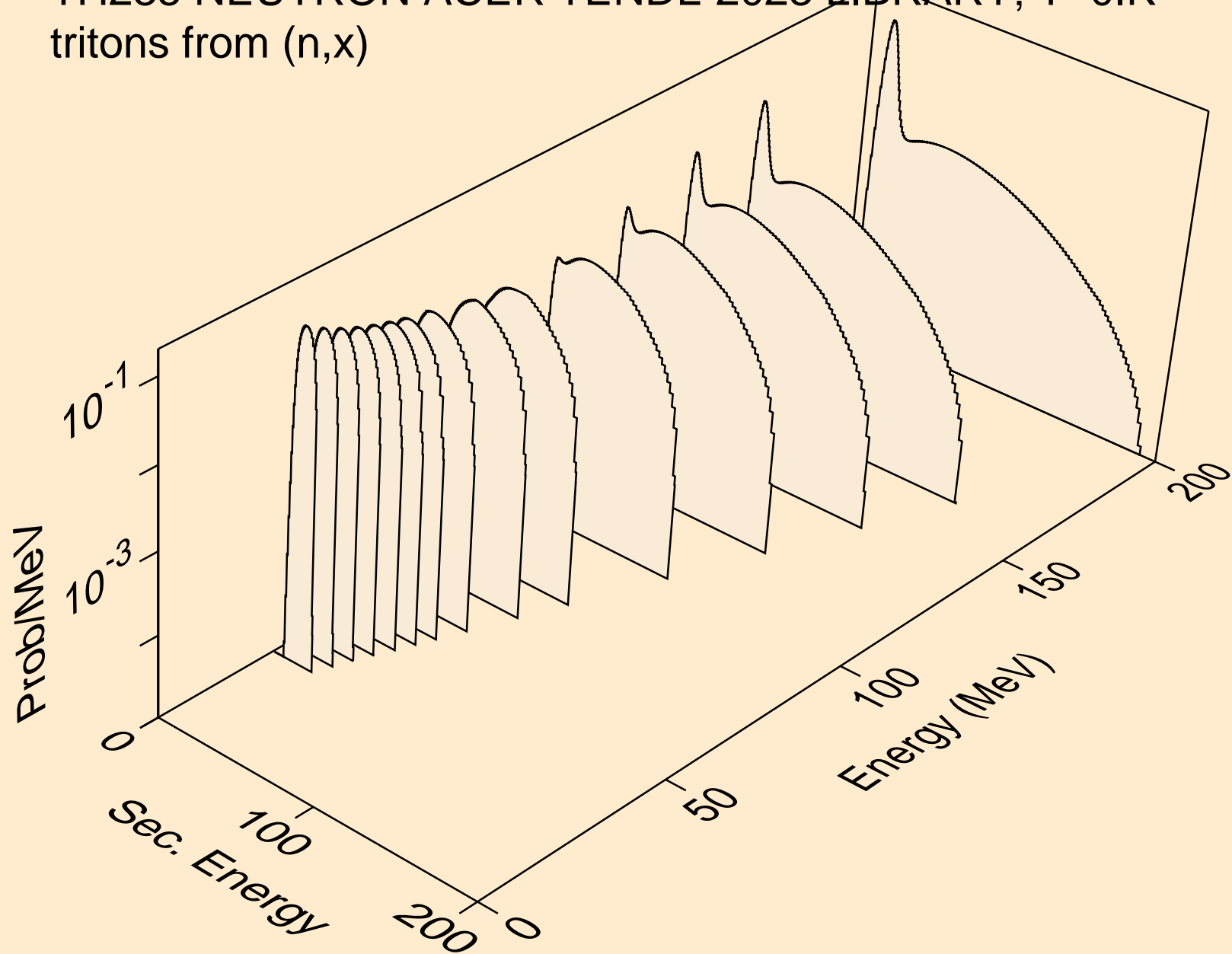

TH235 NEUTRON ACER TENDL-2023 LIBRARY; T=0.K  
tritons from (n,n\*)t

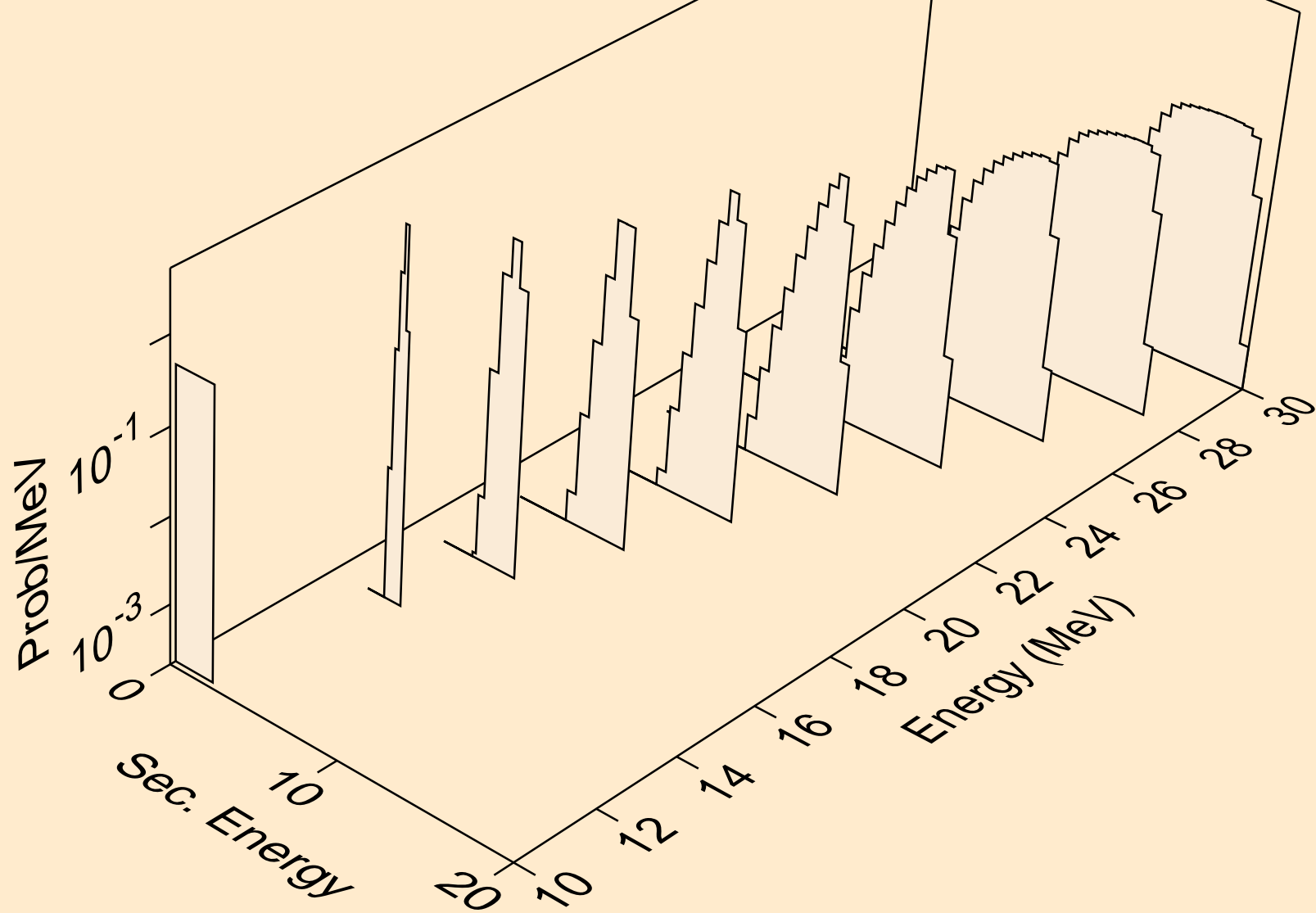

TH235 NEUTRON ACER TENDL-2023 LIBRARY; T=0.K  
tritons from (n,t)

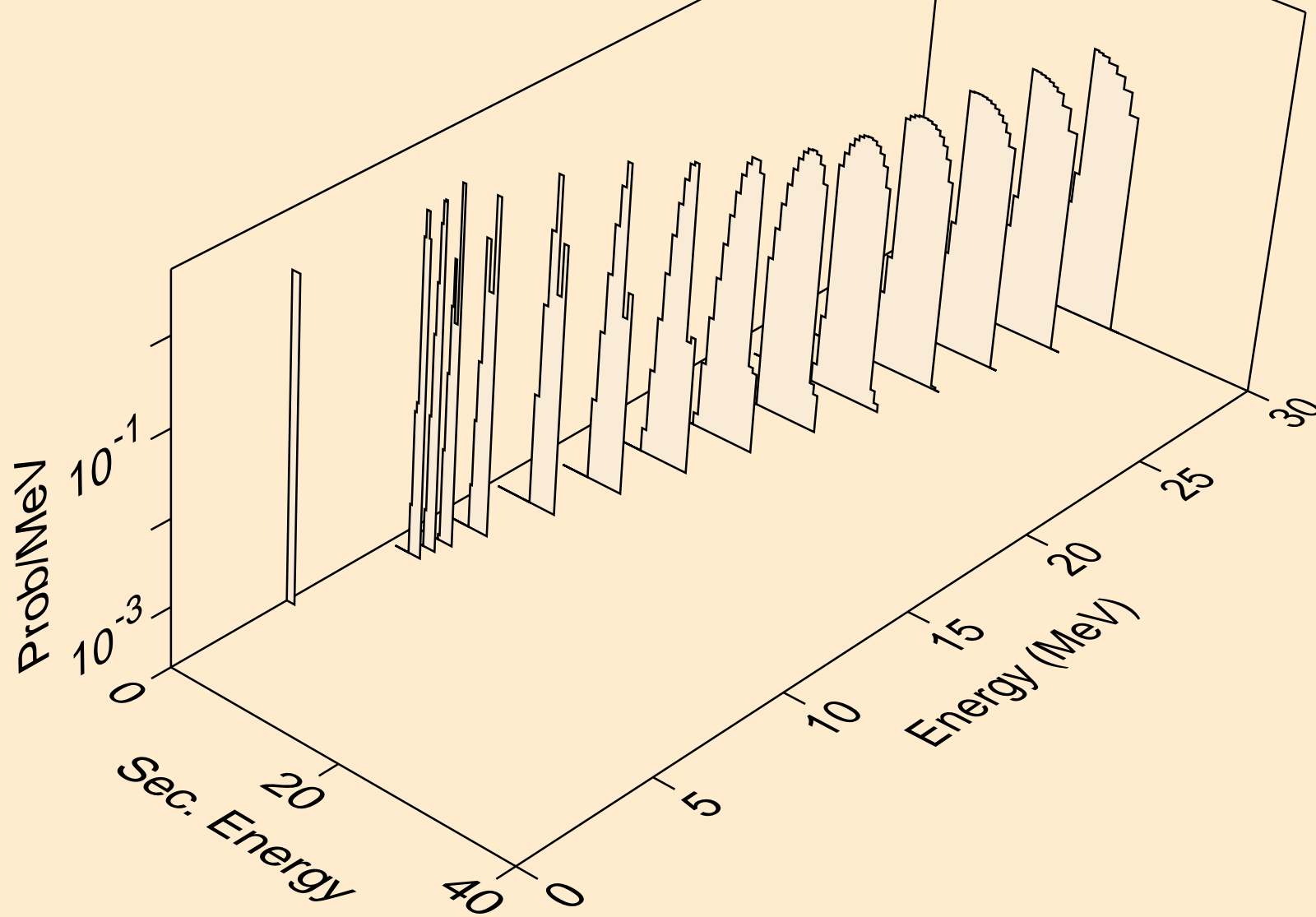

TH235 NEUTRON ACER TENDL-2023 LIBRARY; T=0.K  
he3s from (n,x)

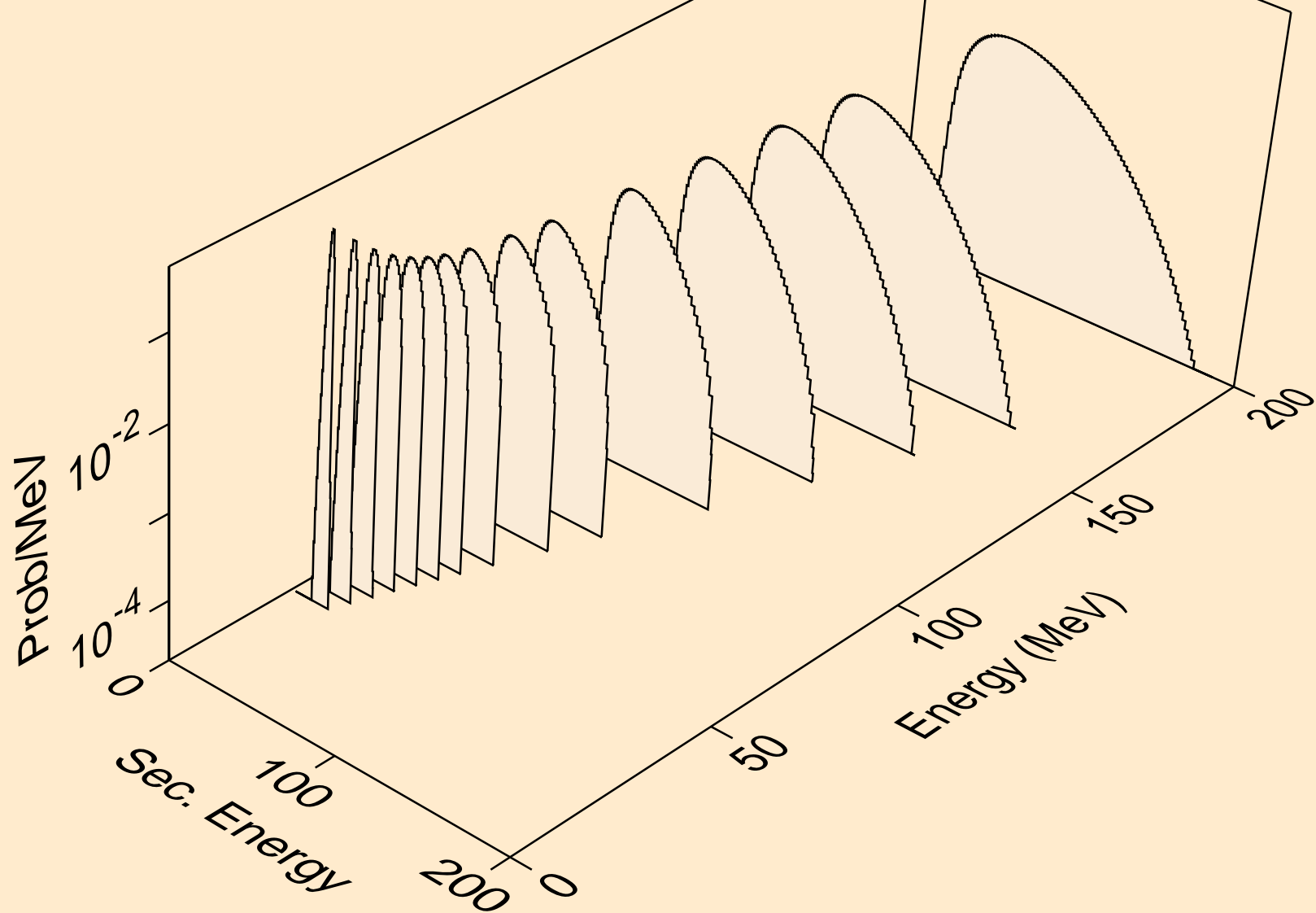

TH235 NEUTRON ACER TENDL-2023 LIBRARY; T=0.K  
he3s from (n,n\*)he3

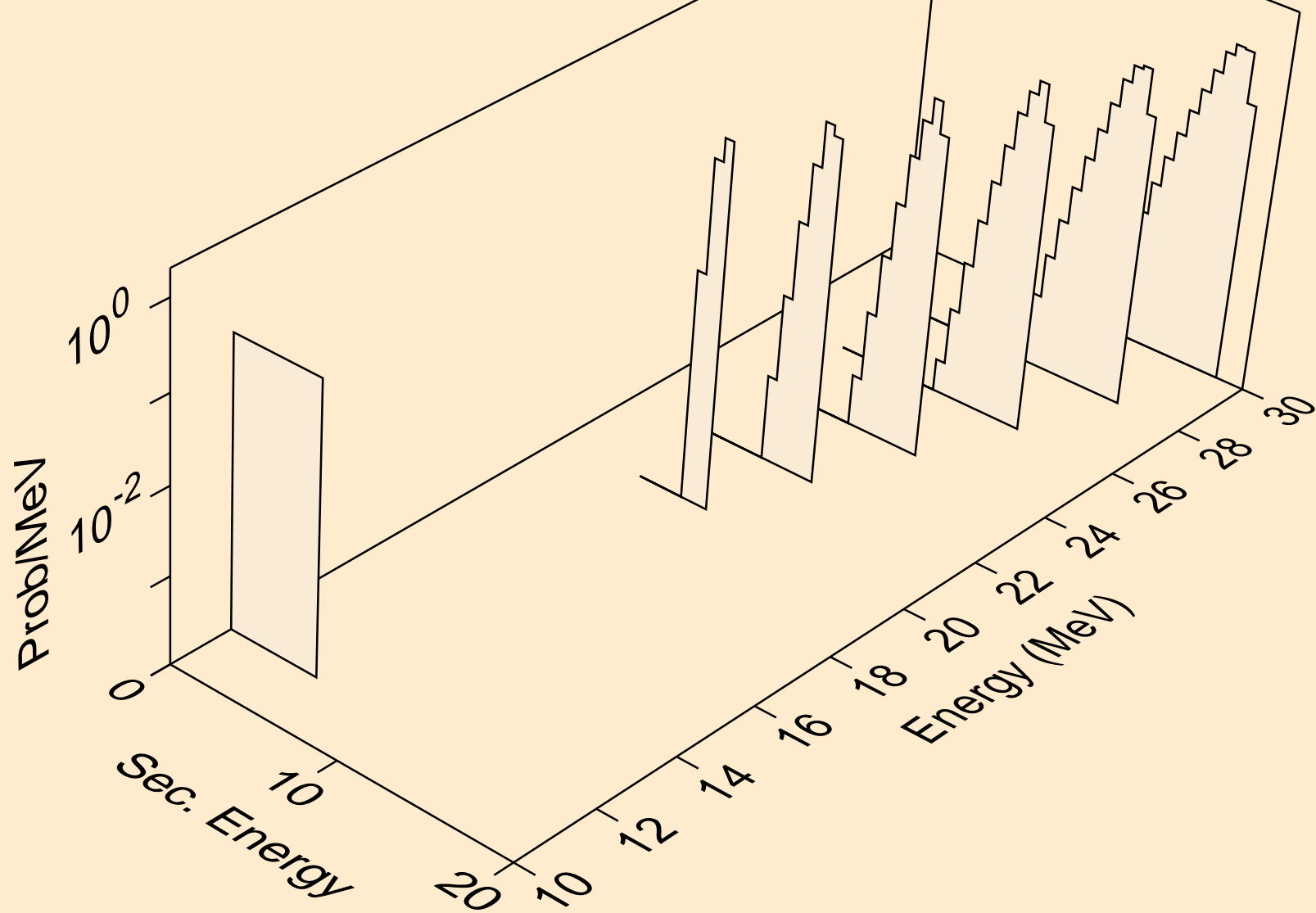



TH235 NEUTRON ACER TENDL-2023 LIBRARY; T=0.K  
he3s from (n,he3)

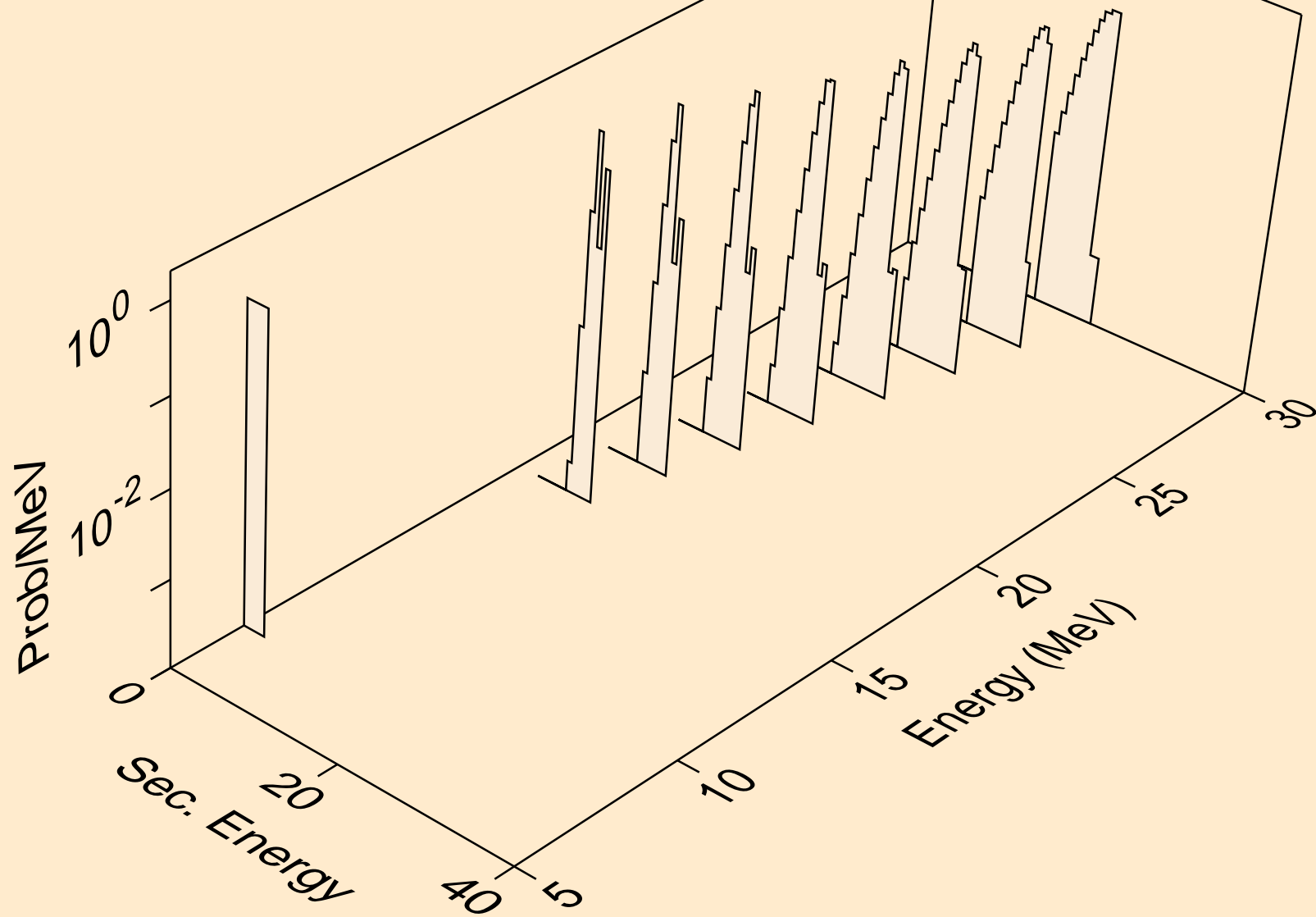

TH235 NEUTRON ACER TENDL-2023 LIBRARY; T=0.K  
alphas from (n,x)

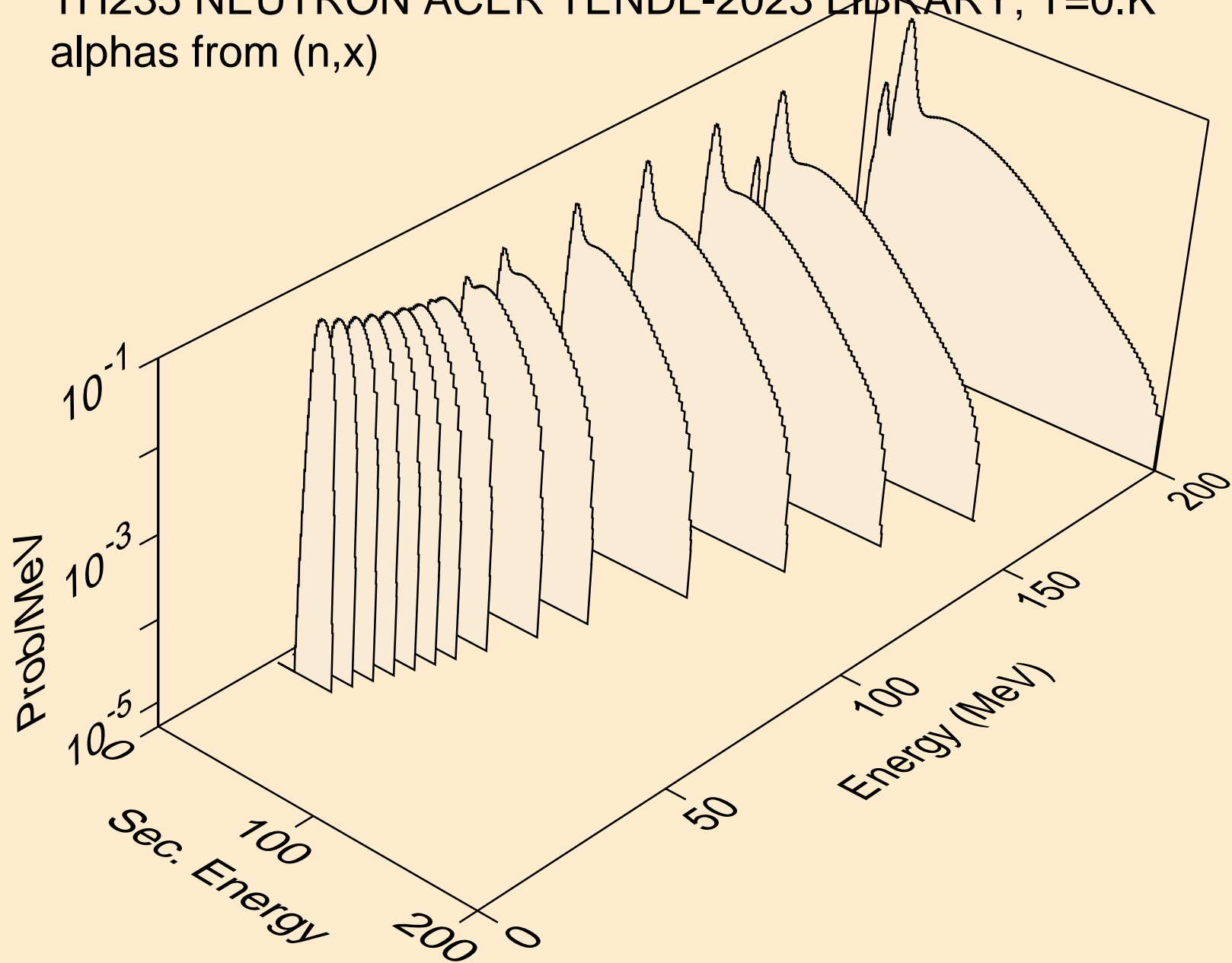

TH235 NEUTRON ACER TENDL-2023 LIBRARY; T=0.K  
alphas from (n,n\*)a

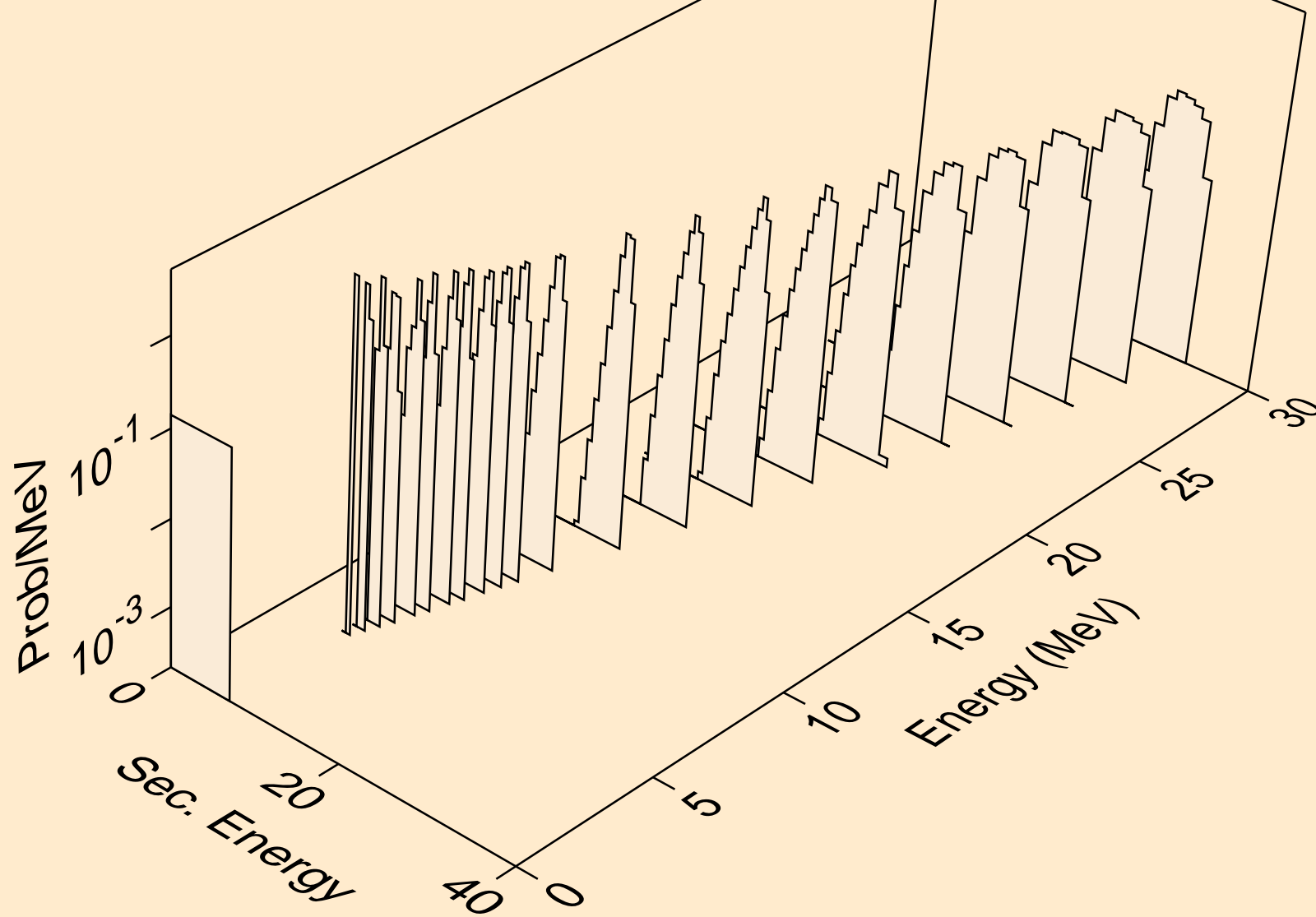

TH235 NEUTRON ACER TENDL-2023 LIBRARY; T=0.K  
alphas from (n,2n)a

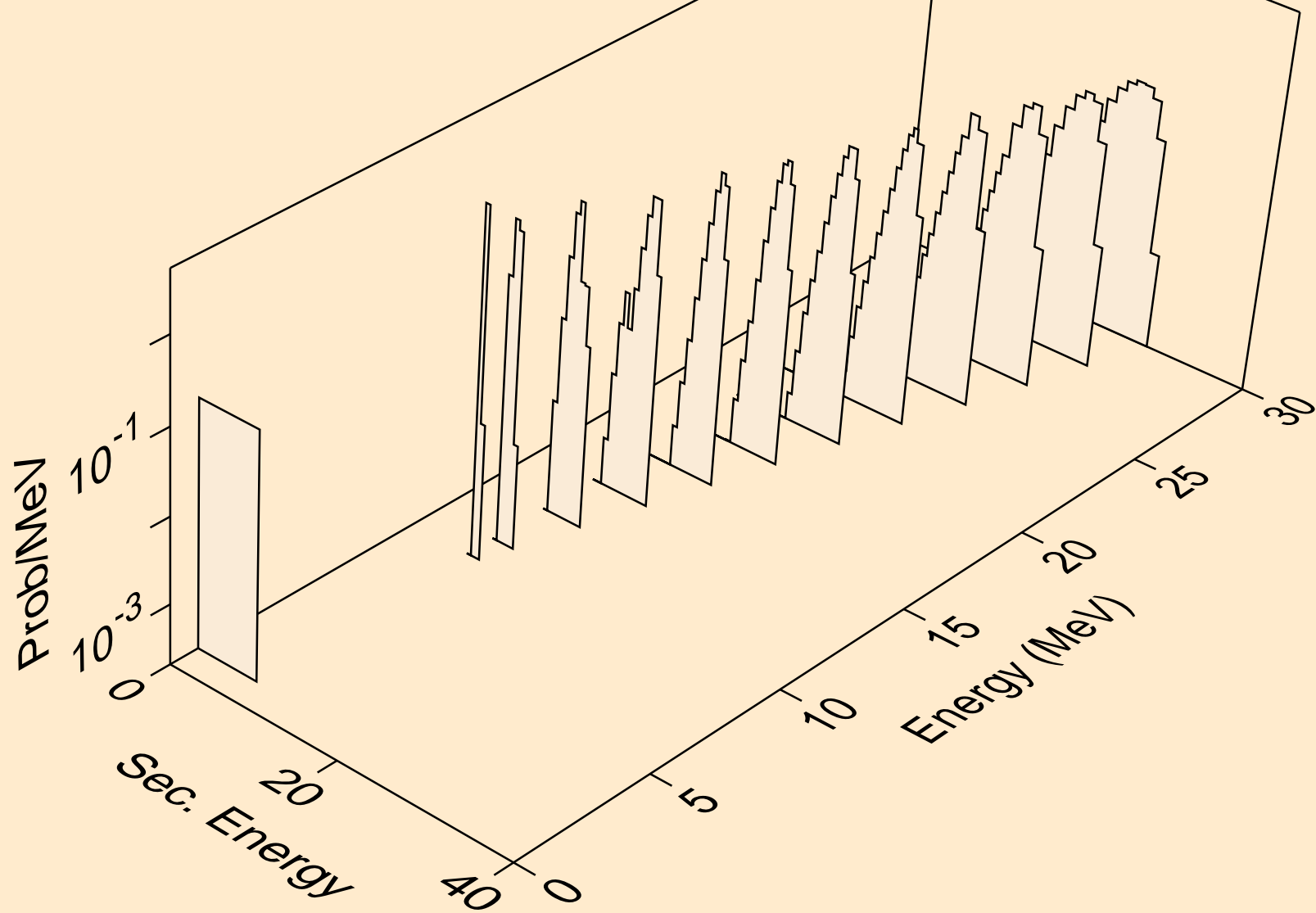

TH235 NEUTRON ACER TENDL-2023 LIBRARY; T=0.K  
alphas from (n,3n)a

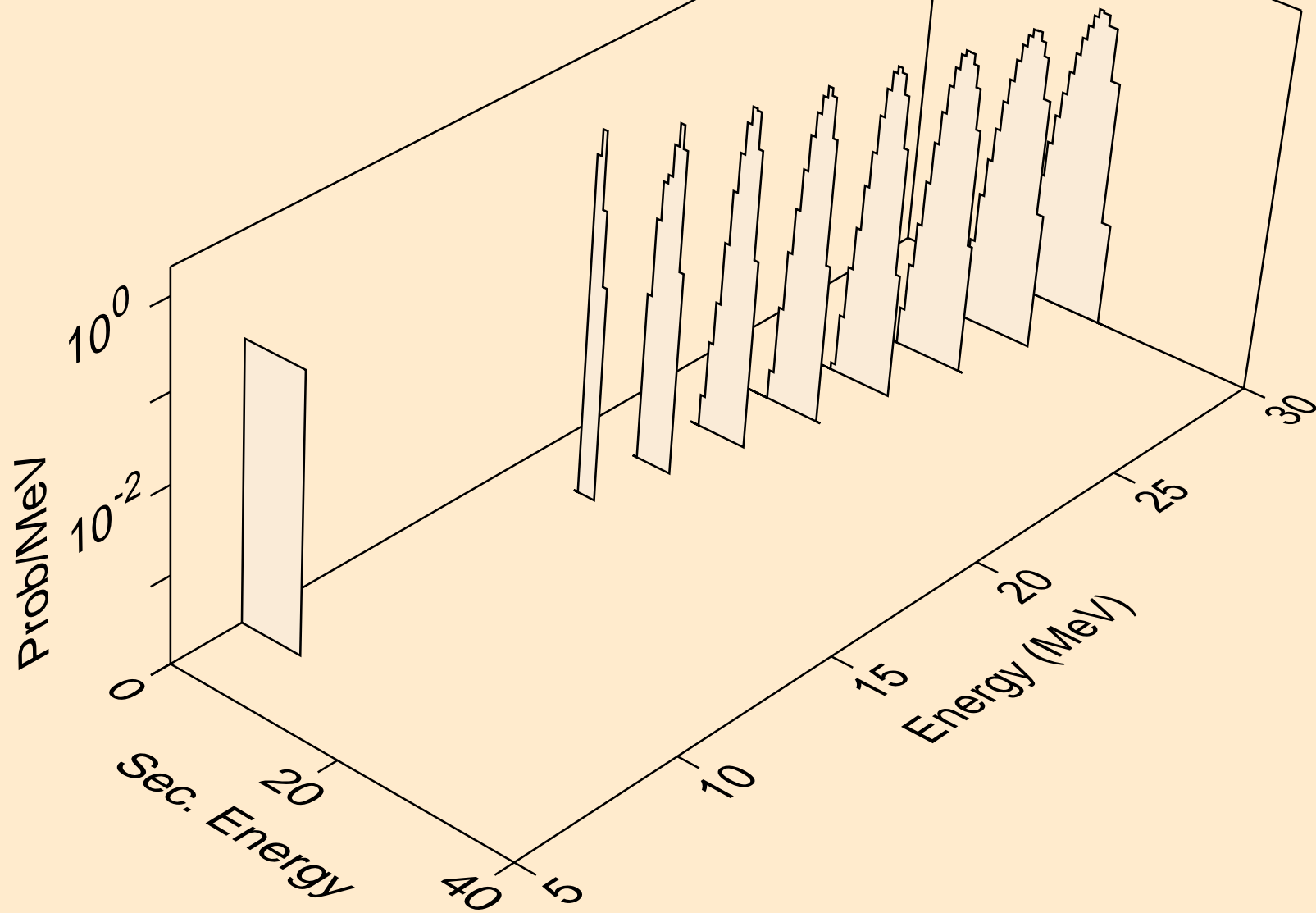

TH235 NEUTRON ACER TENDL-2023 LIBRARY; T=0.K  
alphas from (n,a)

