

TL198M NEUTRON ACER TENDL-2023 LIBRARY; T=0.K  
Principal cross sections

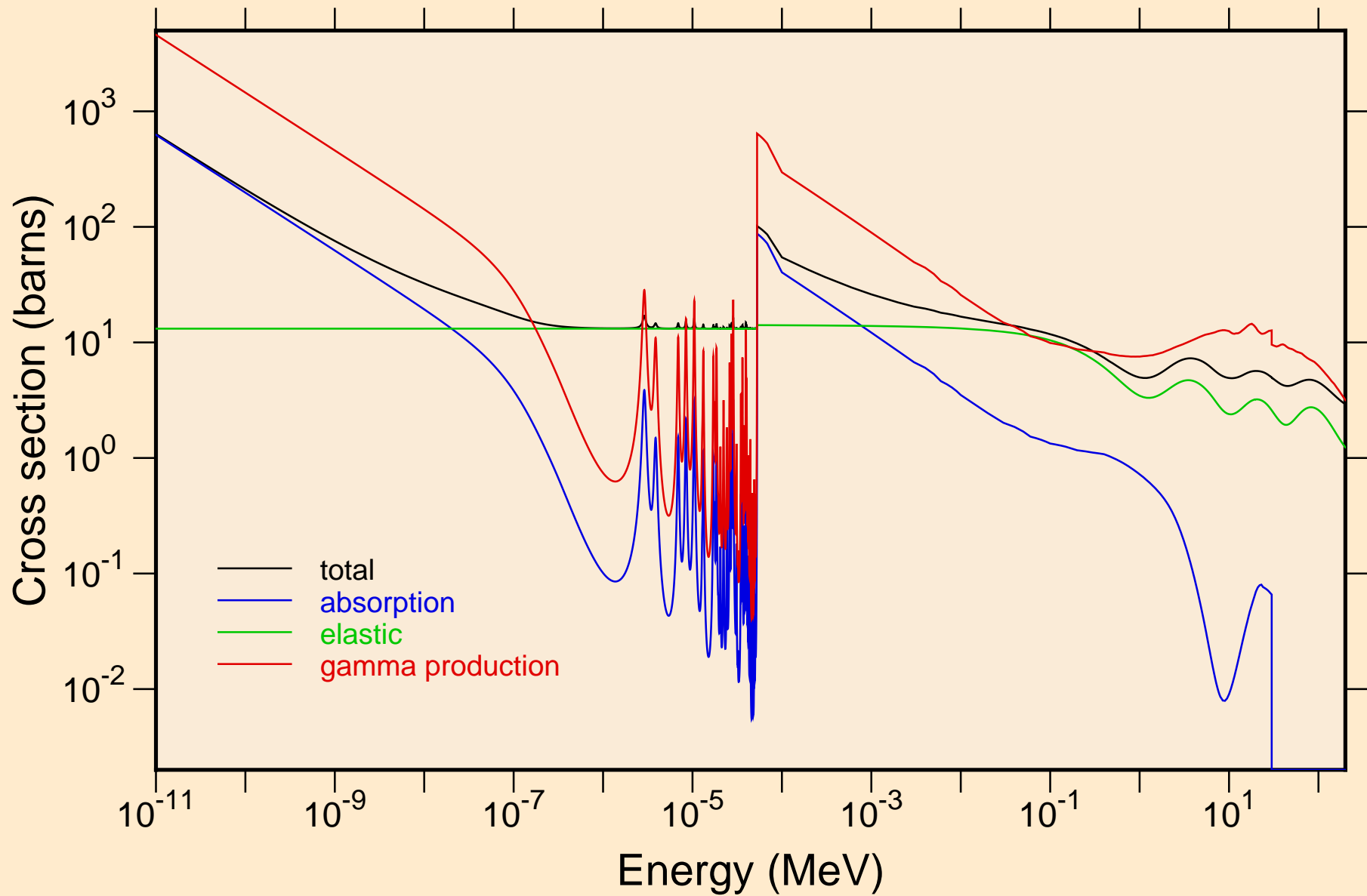

TL198M NEUTRON ACER TENDL-2023 LIBRARY; T=0.K  
resonance total cross section

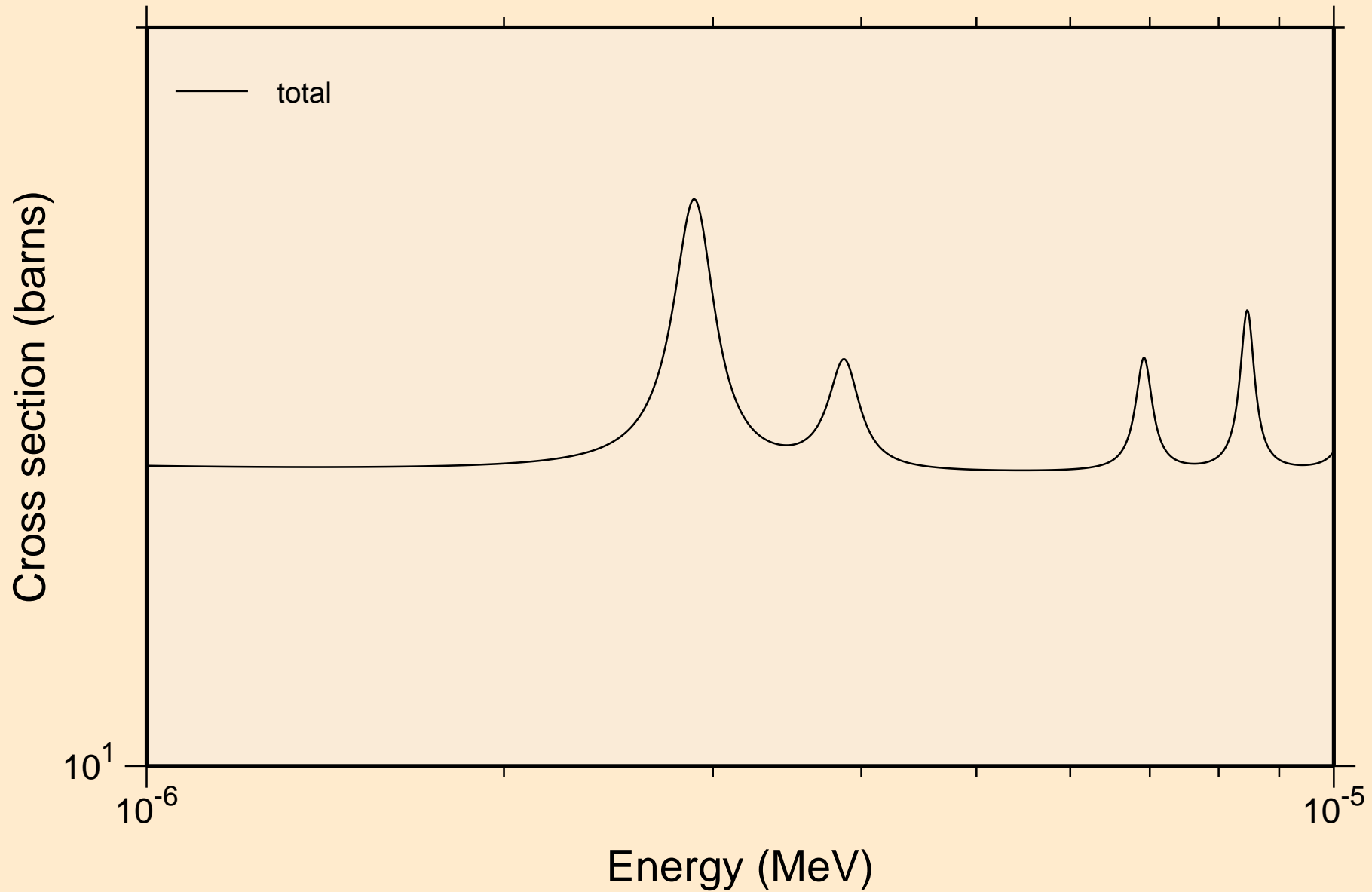

TL198M NEUTRON ACER TENDL-2023 LIBRARY; T=0.K  
resonance total cross section

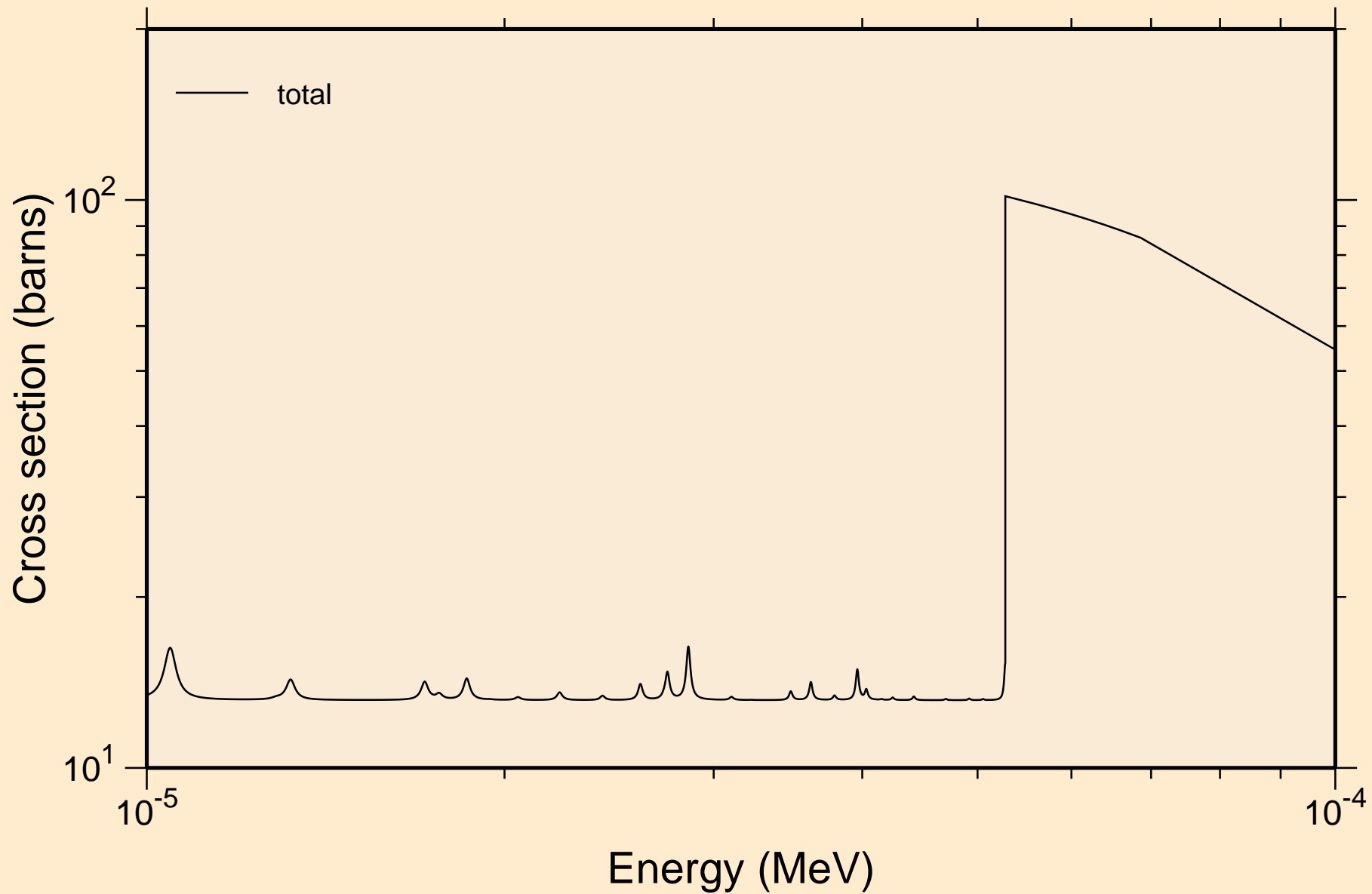

TL198M NEUTRON ACER TENDL-2023 LIBRARY; T=0.K  
resonance total cross section

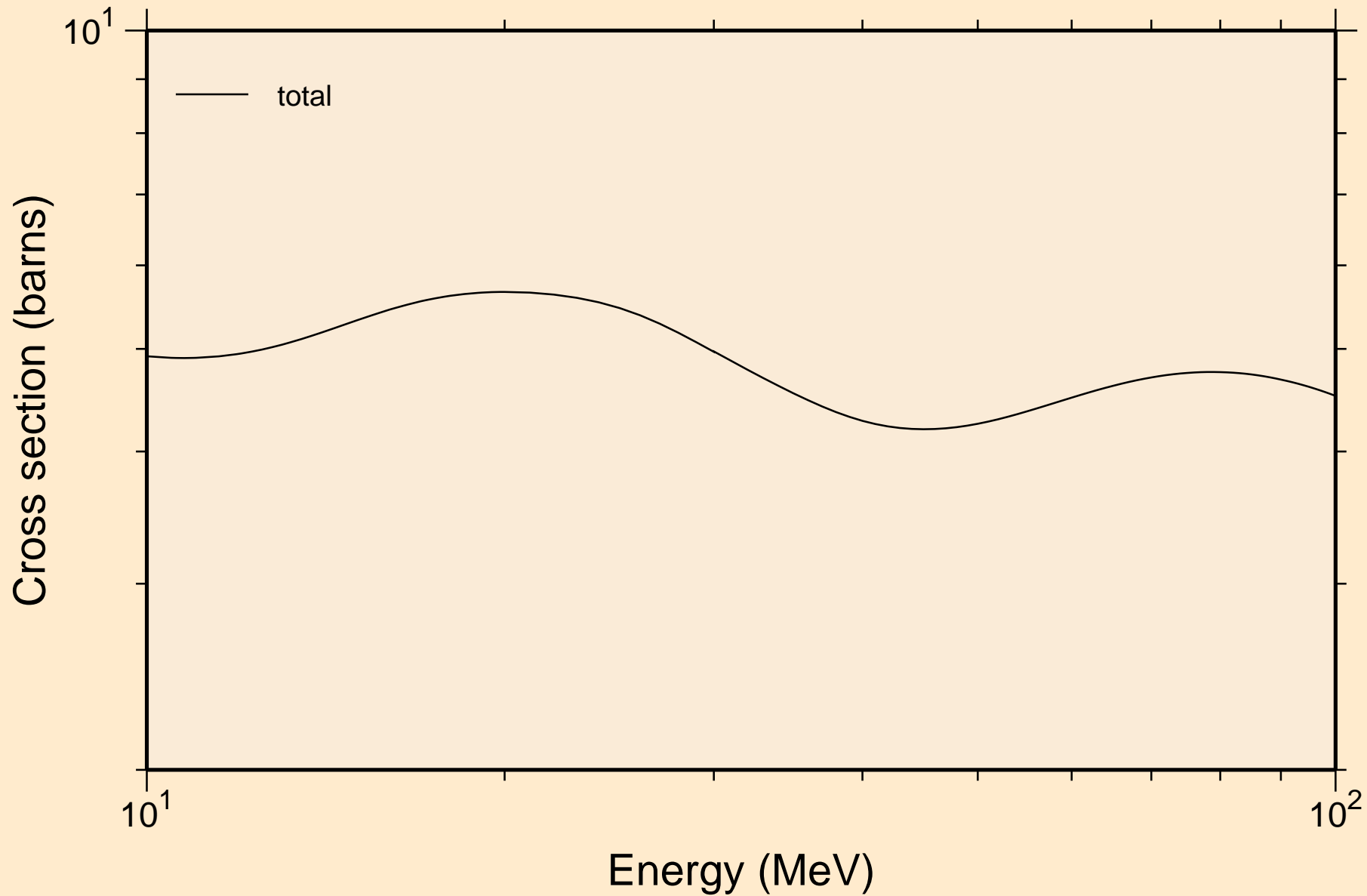

TL198M NEUTRON ACER TENDL-2023 LIBRARY; T=0.K  
resonance absorption cross sections

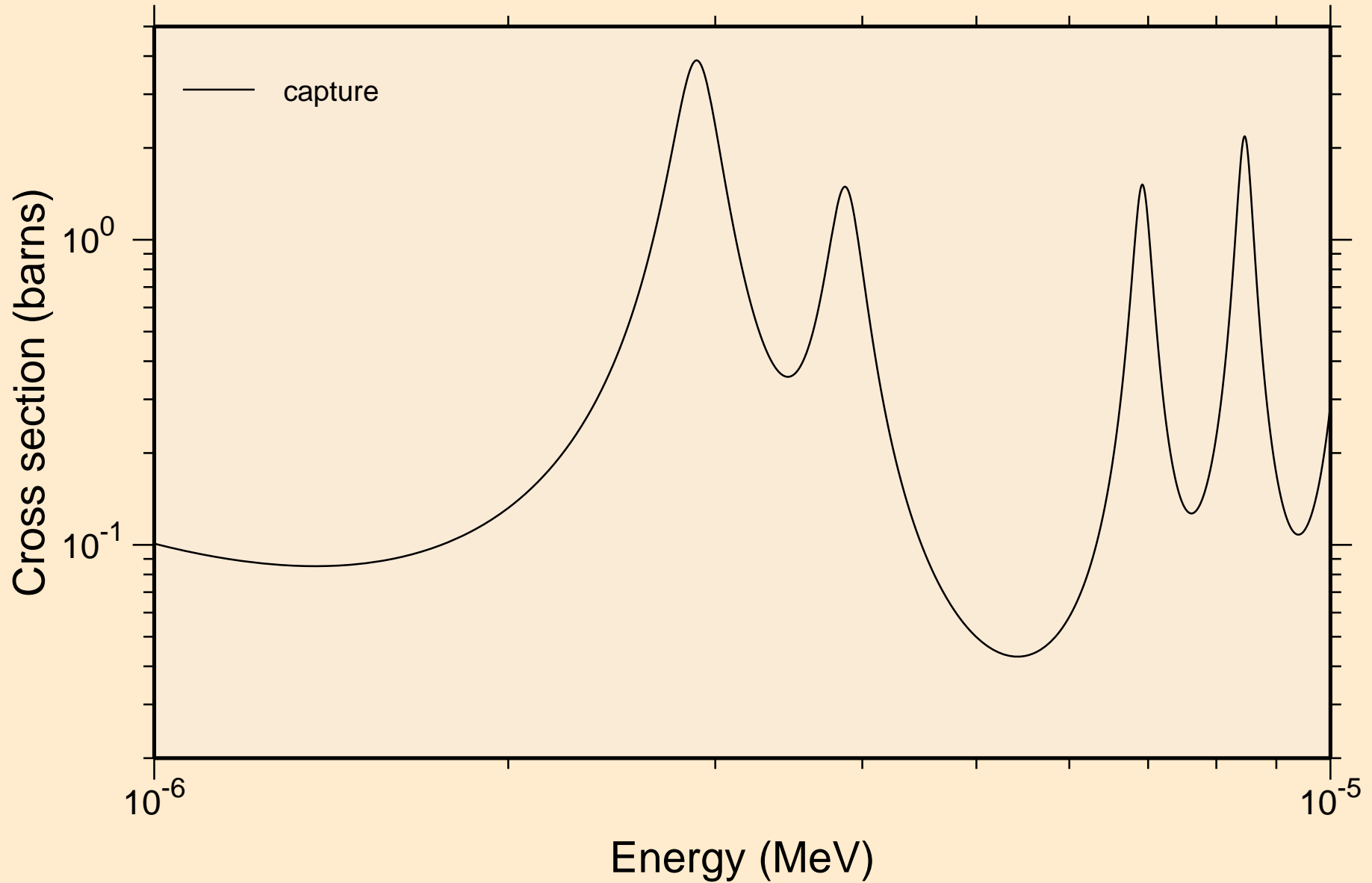

TL198M NEUTRON ACER TENDL-2023 LIBRARY; T=0.K  
resonance absorption cross sections

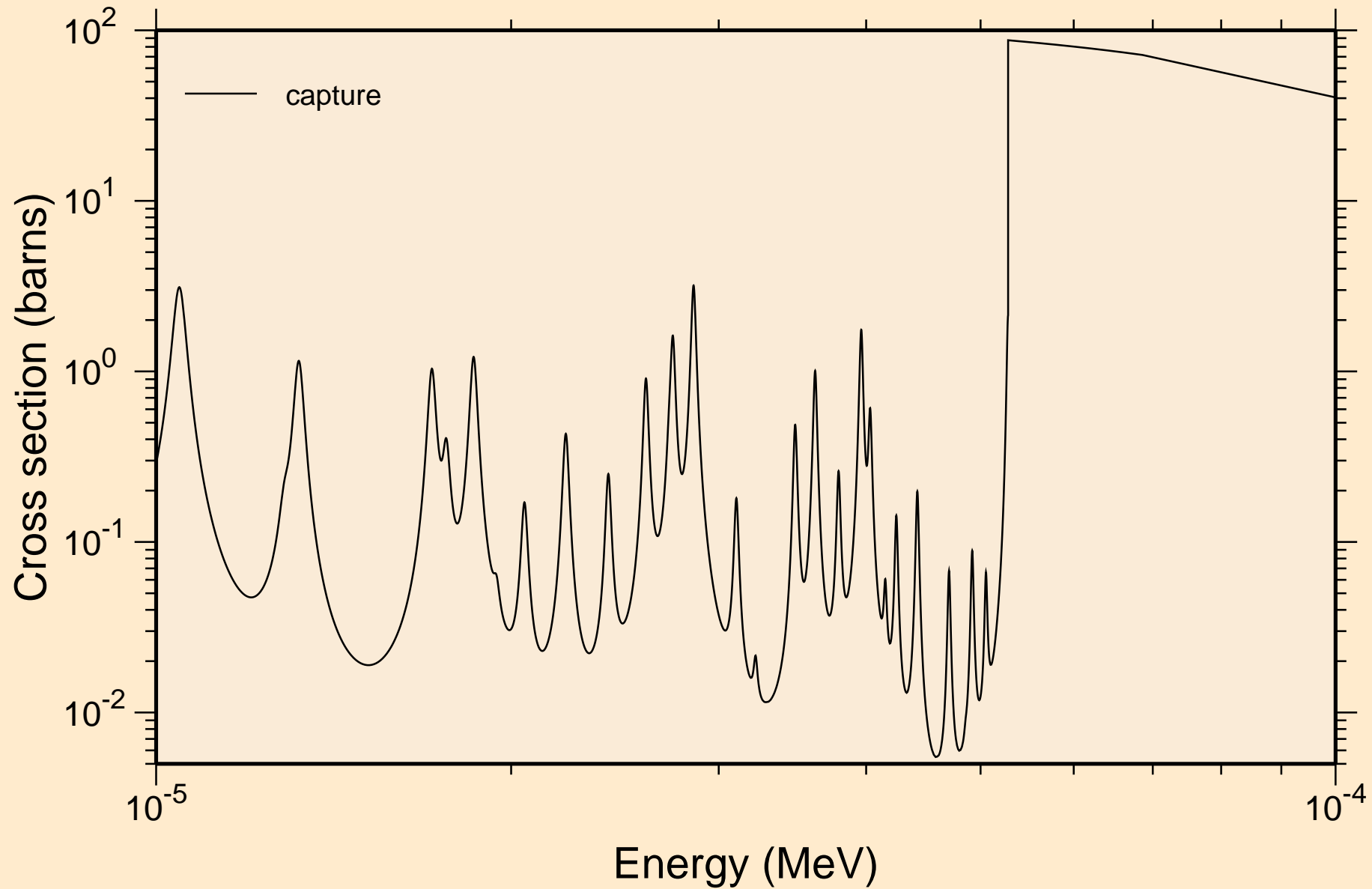

TL198M NEUTRON ACER TENDL-2023 LIBRARY; T=0.K  
resonance absorption cross sections

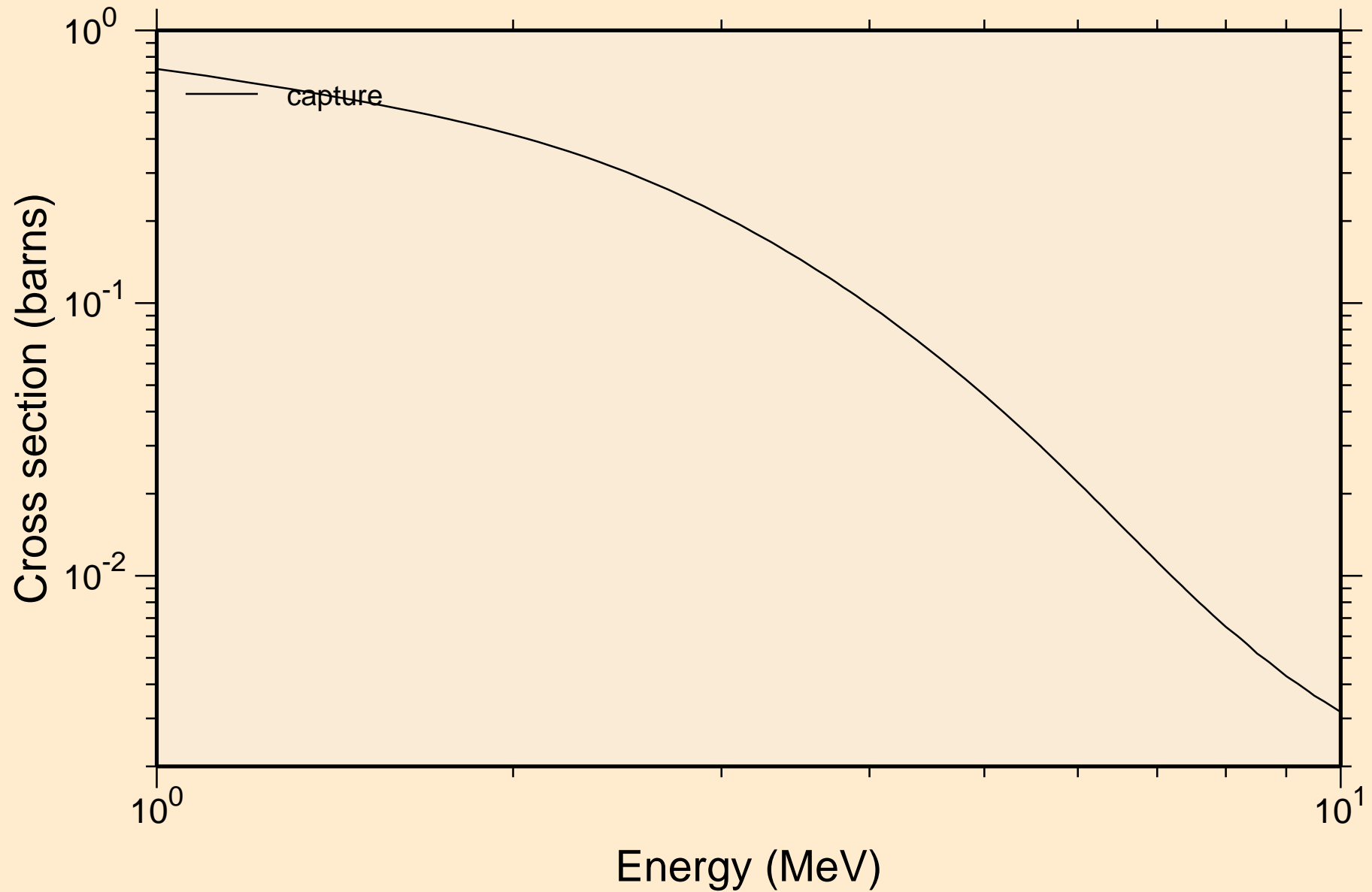

TL198M NEUTRON ACER TENDL-2023 LIBRARY; T=0.K  
Heating

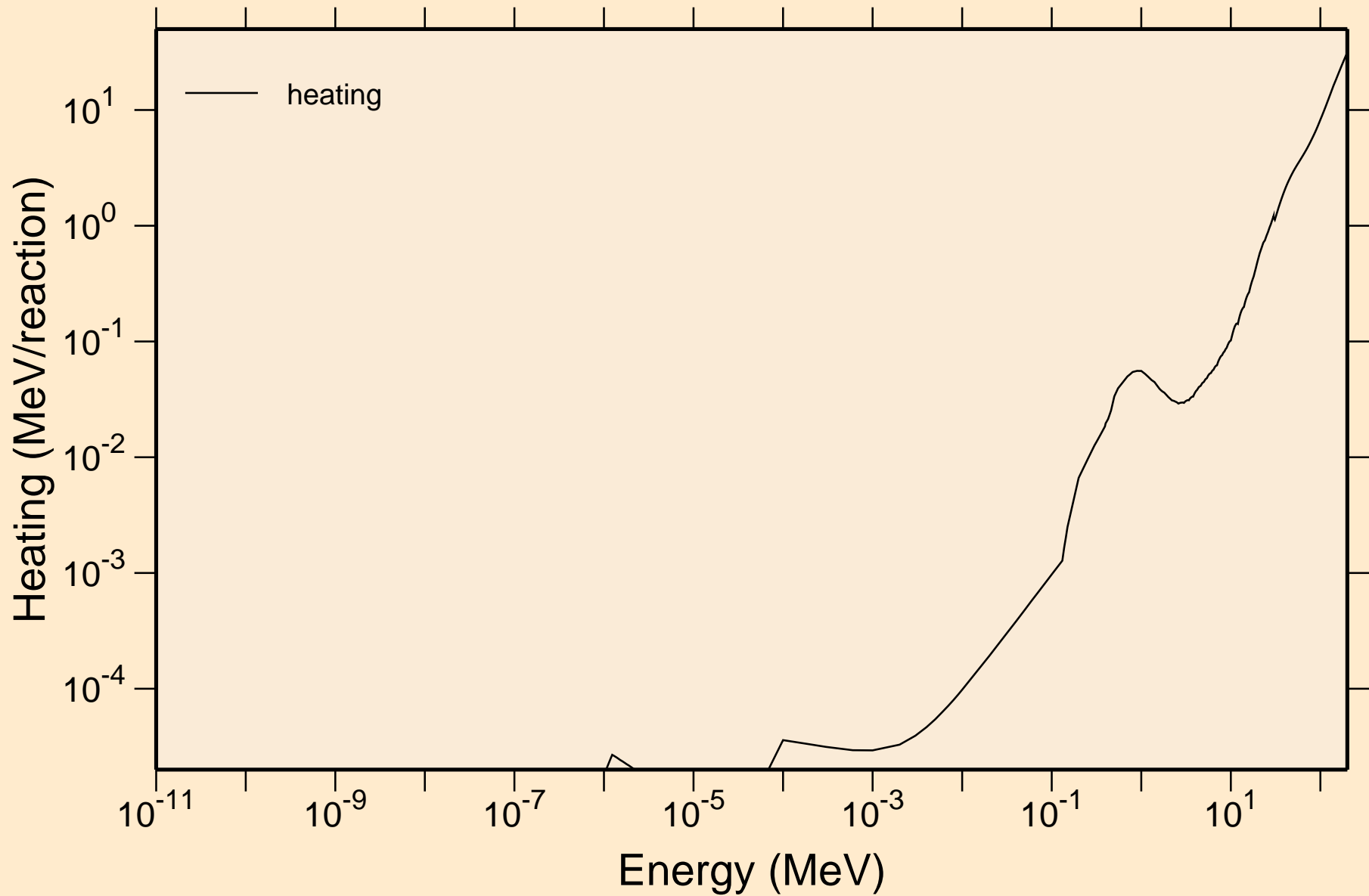



TL198M NEUTRON ACER TENDL-2023 LIBRARY; T=0.K  
Damage

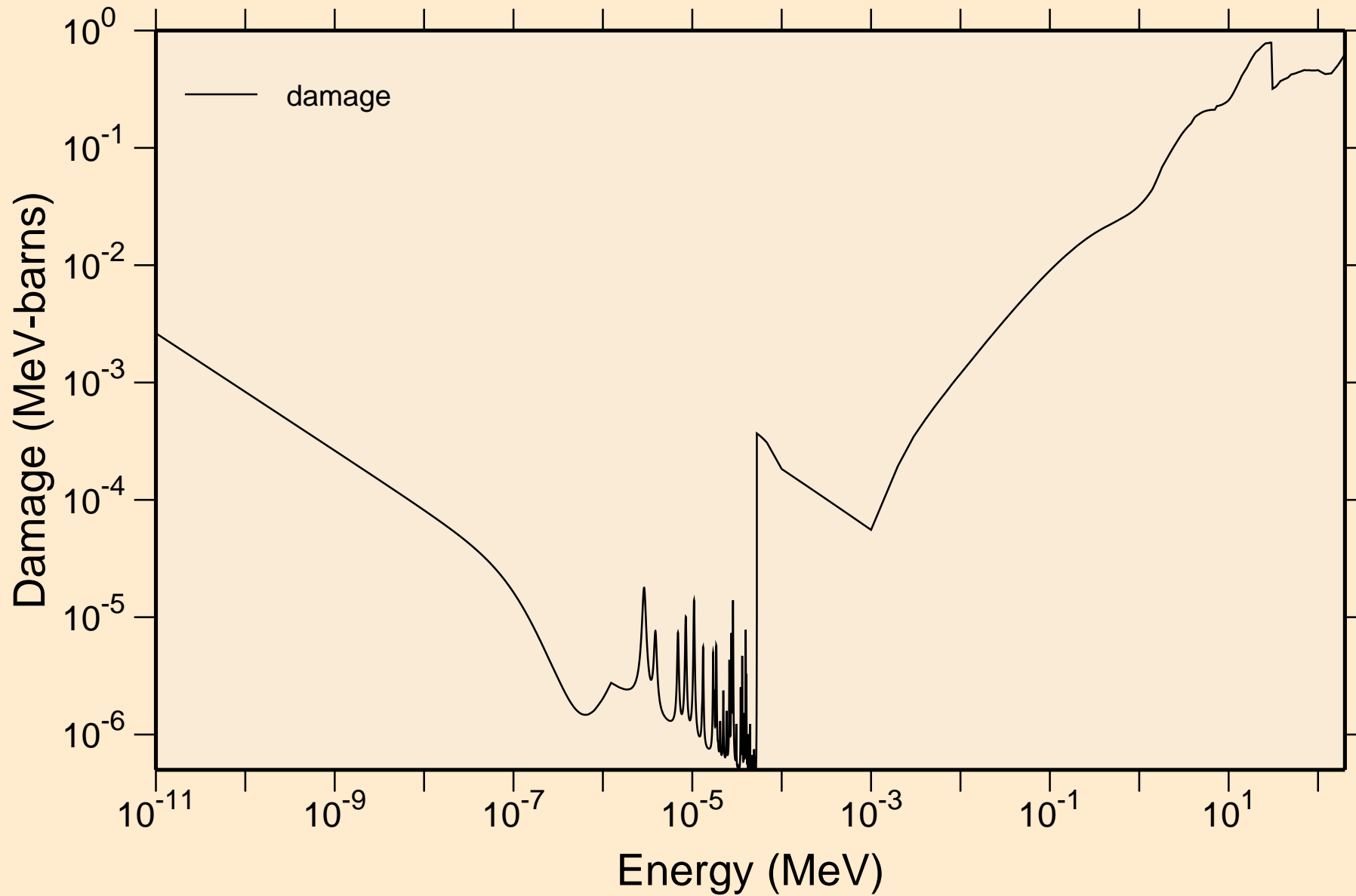

TL198M NEUTRON ACER TENDL-2023 LIBRARY; T=0.K  
Non-threshold reactions

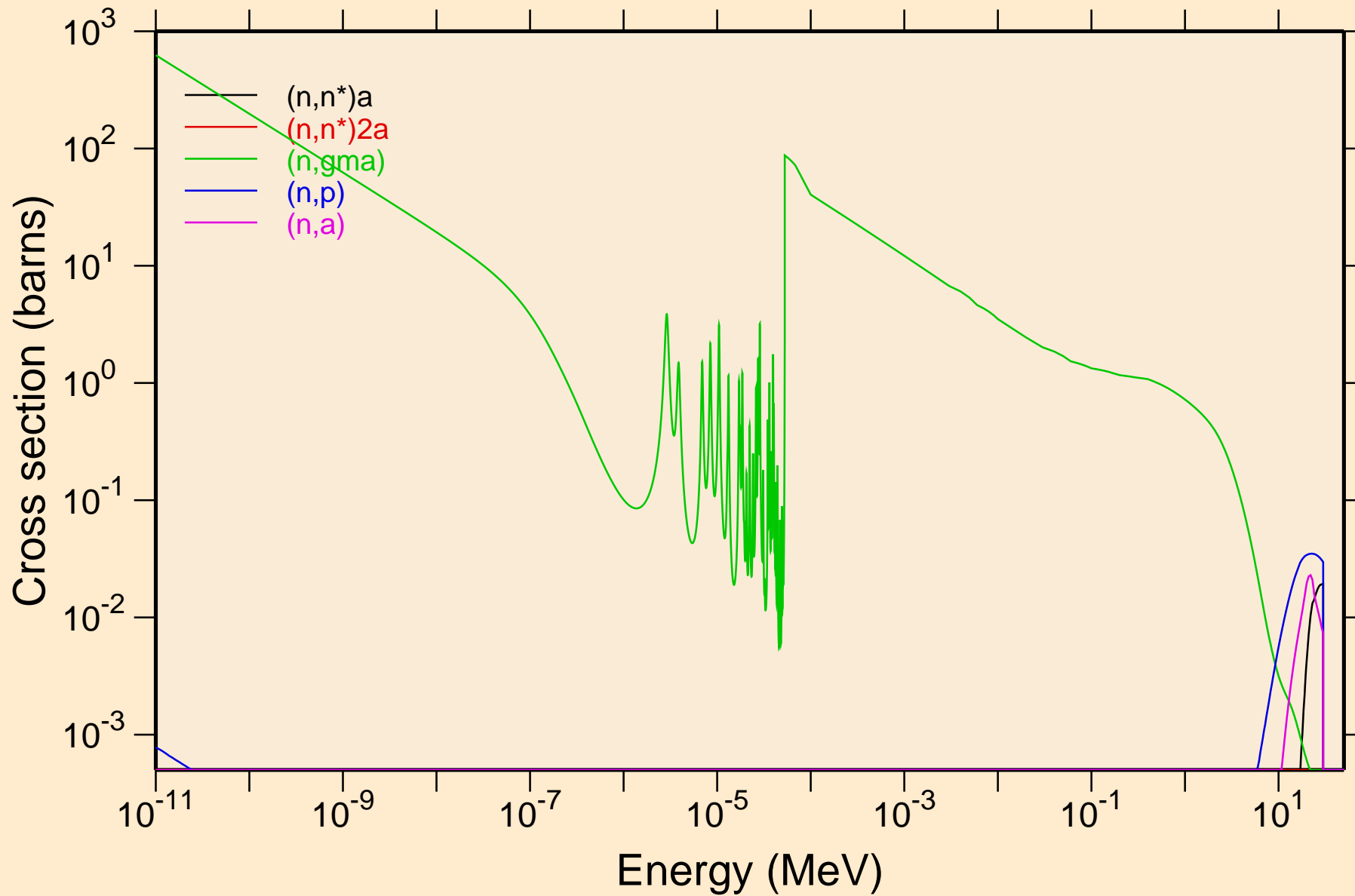

TL198M NEUTRON ACER TENDL-2023 LIBRARY; T=0.K  
Non-threshold reactions

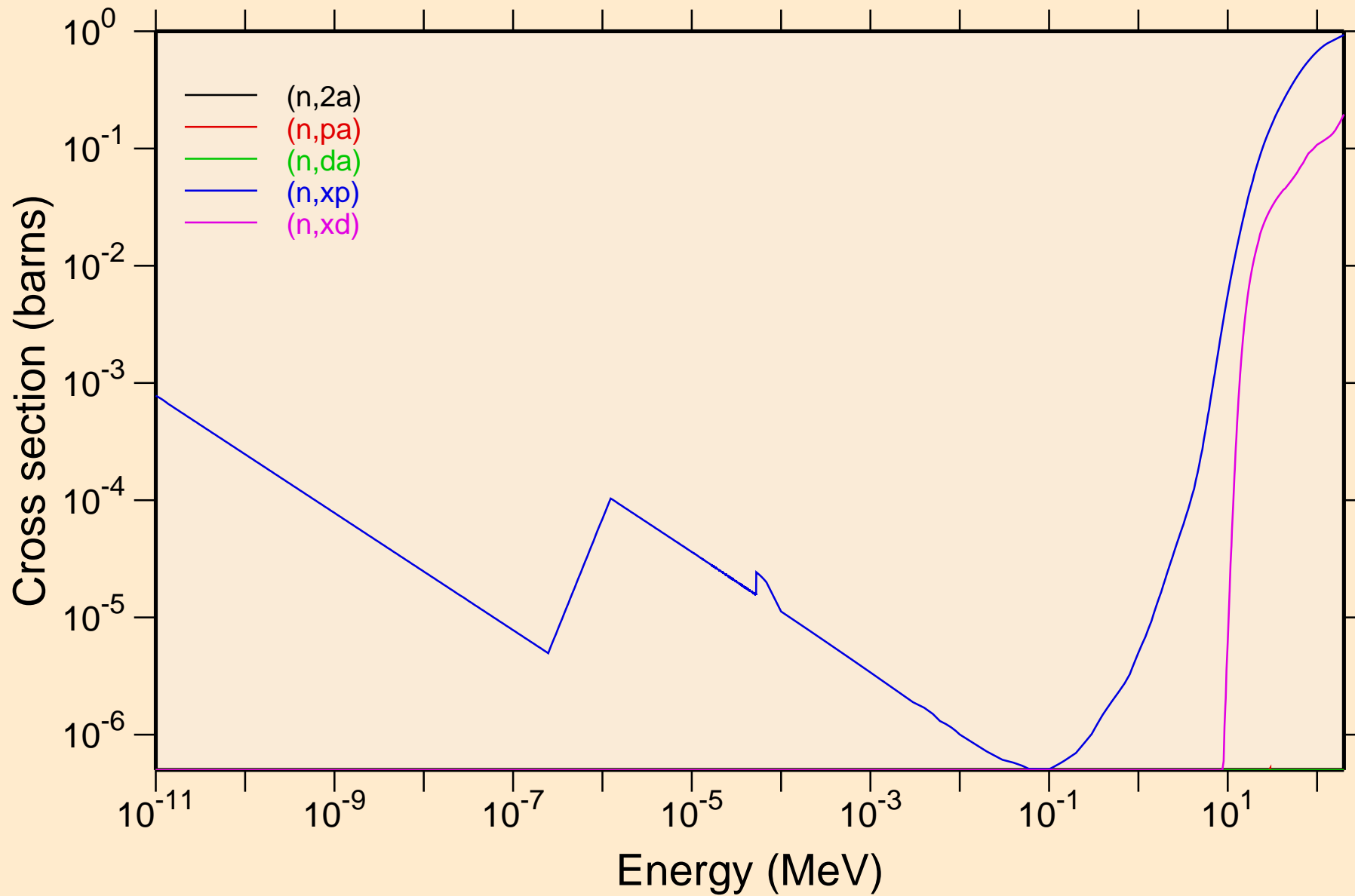

TL198M NEUTRON ACER TENDL-2023 LIBRARY; T=0.K  
Non-threshold reactions

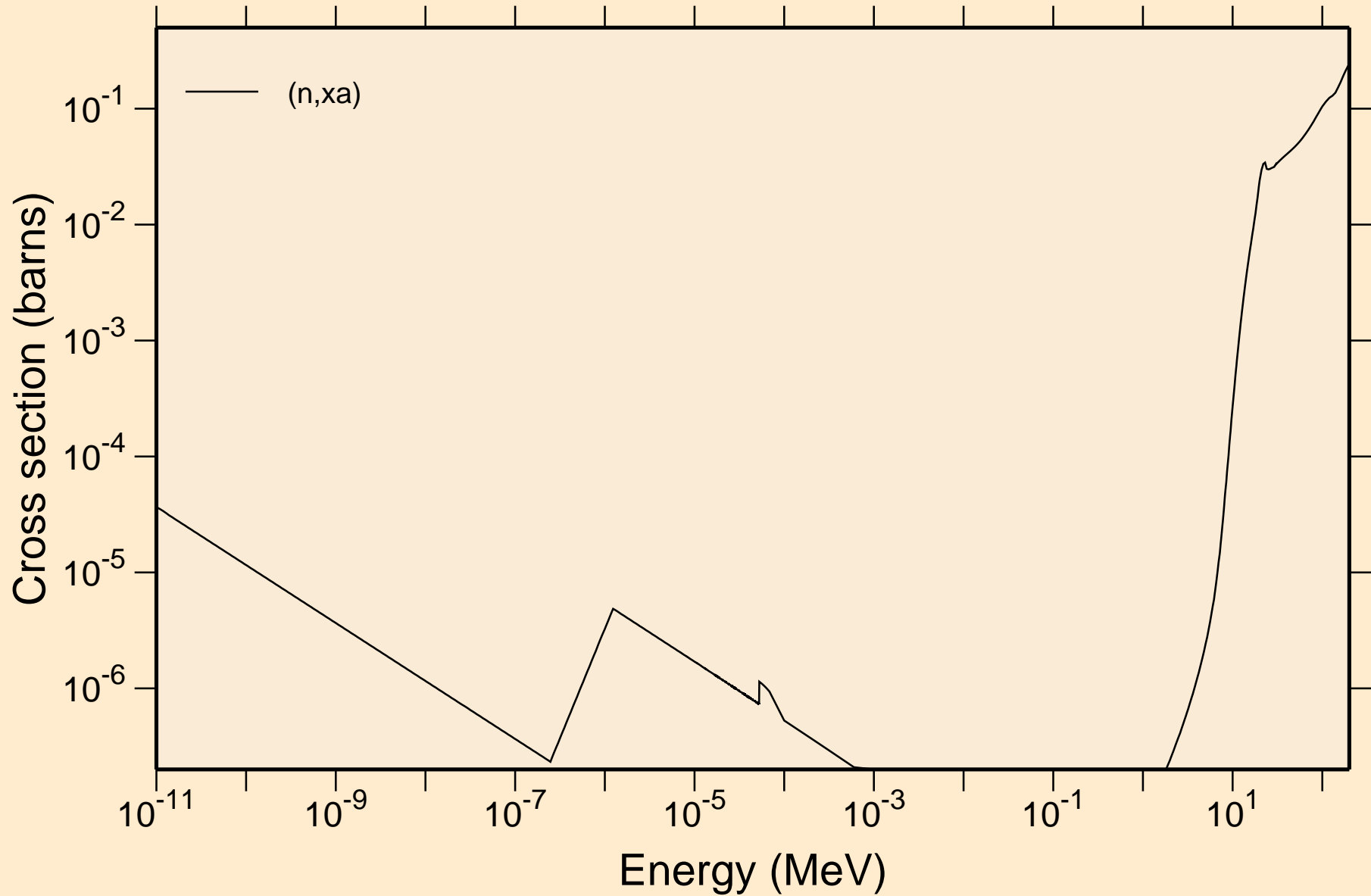

TL198M NEUTRON ACER TENDL-2023 LIBRARY; T=0.K  
Principal cross sections

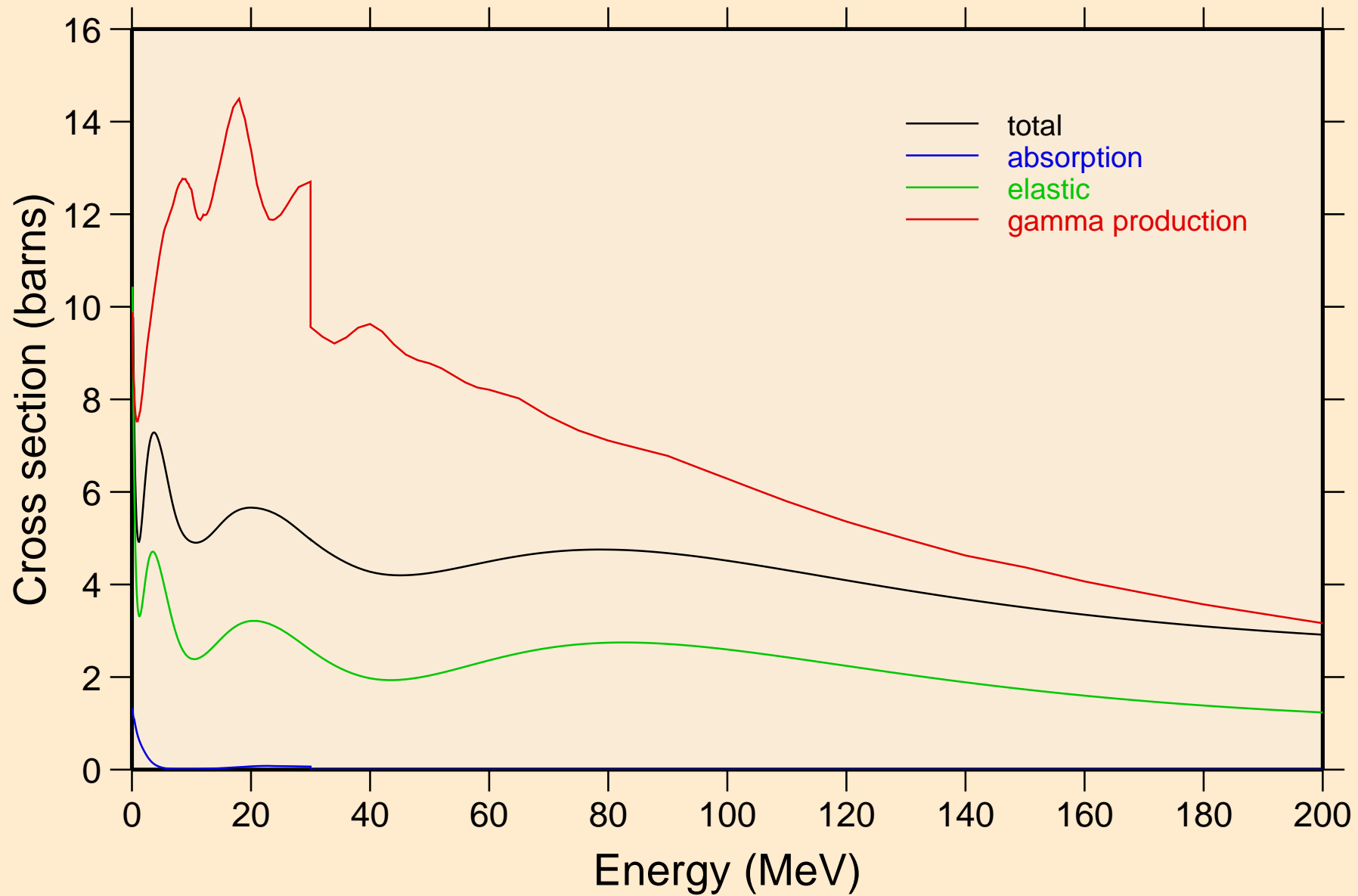

TL198M NEUTRON ACER TENDL-2023 LIBRARY; T=0.K  
Heating

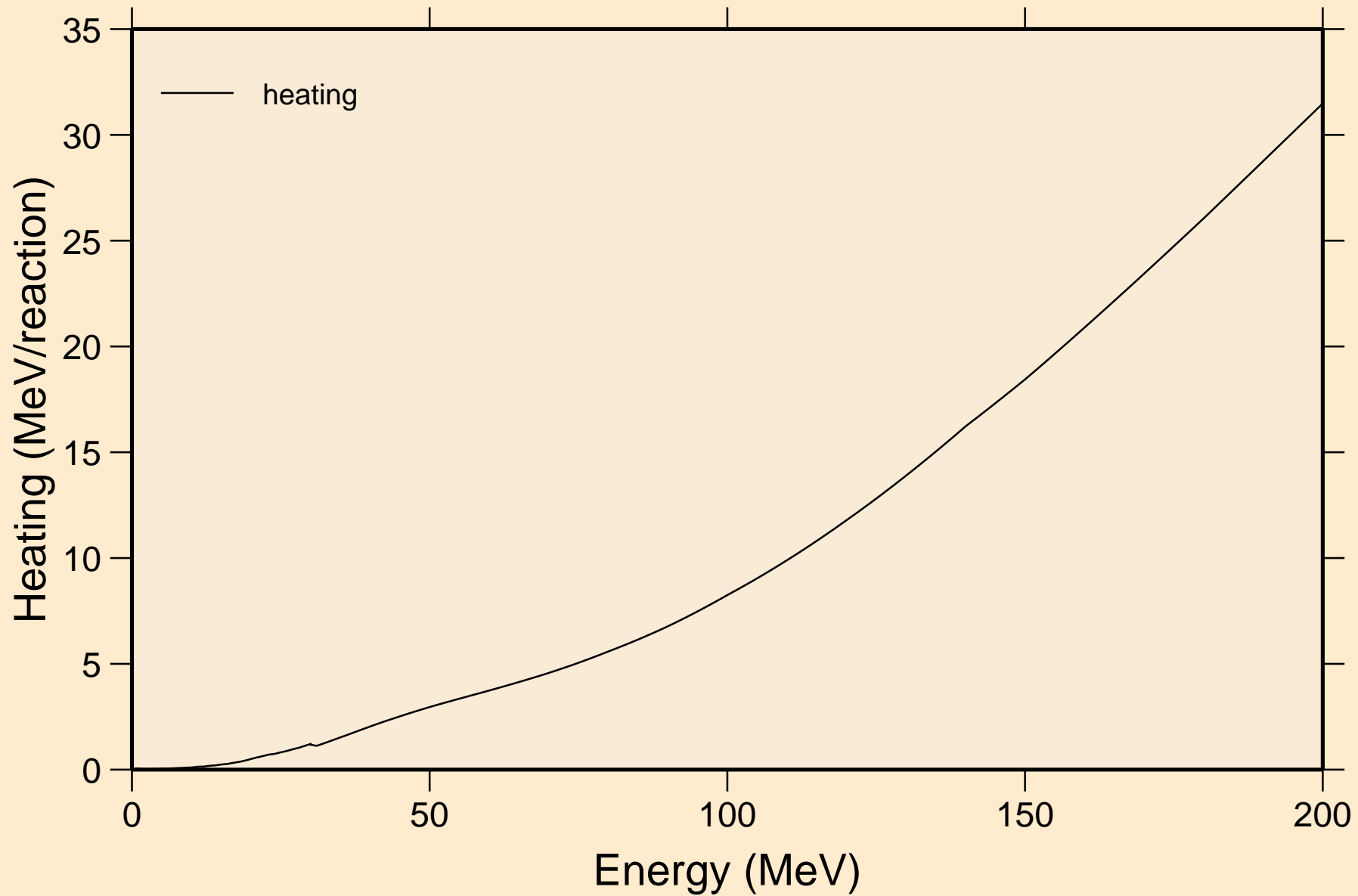

TL198M NEUTRON ACER TENDL-2023 LIBRARY; T=0.K  
Damage

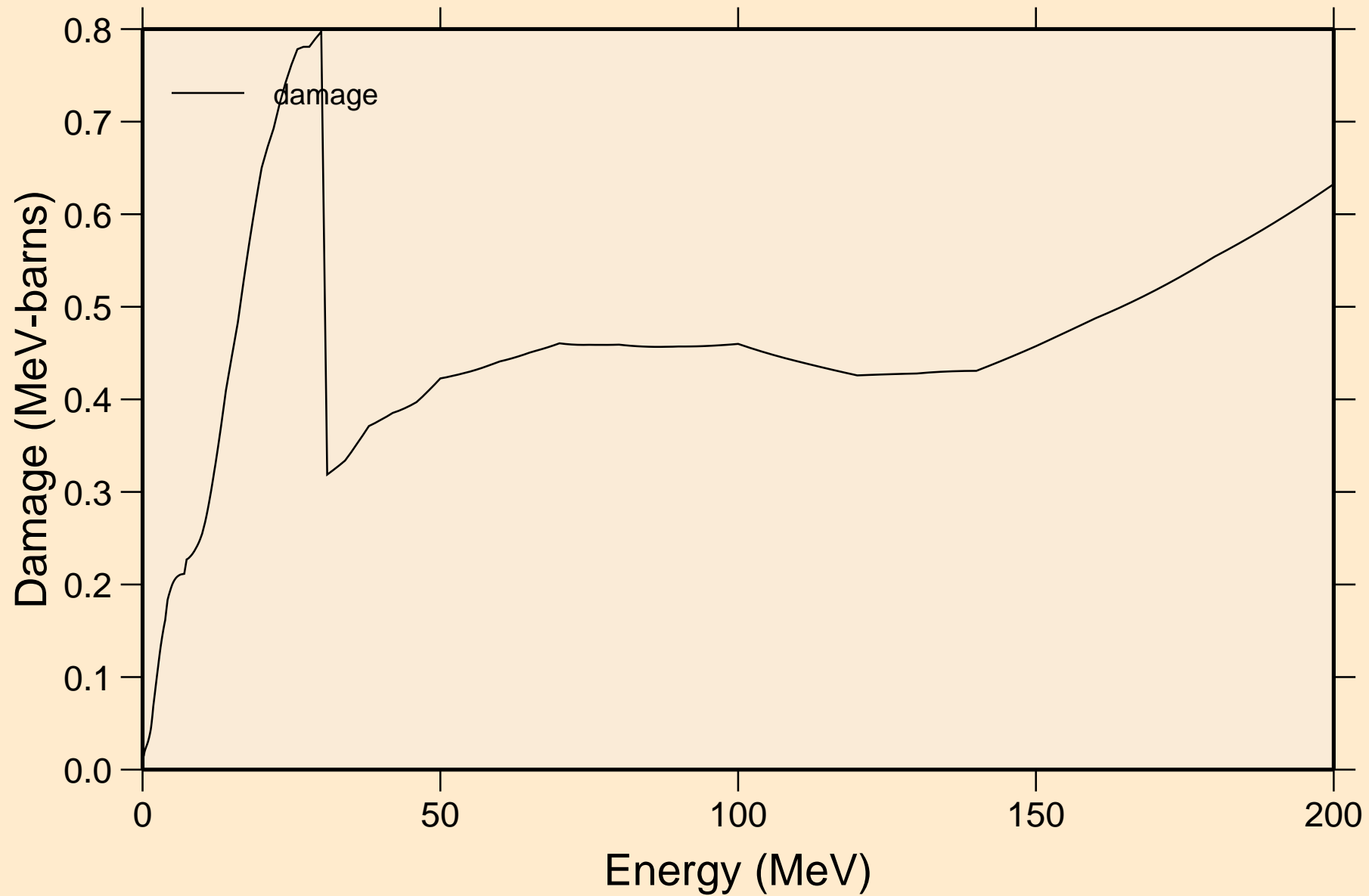

TL198M NEUTRON ACER TENDL-2023 LIBRARY; T=0.K  
Non-threshold reactions

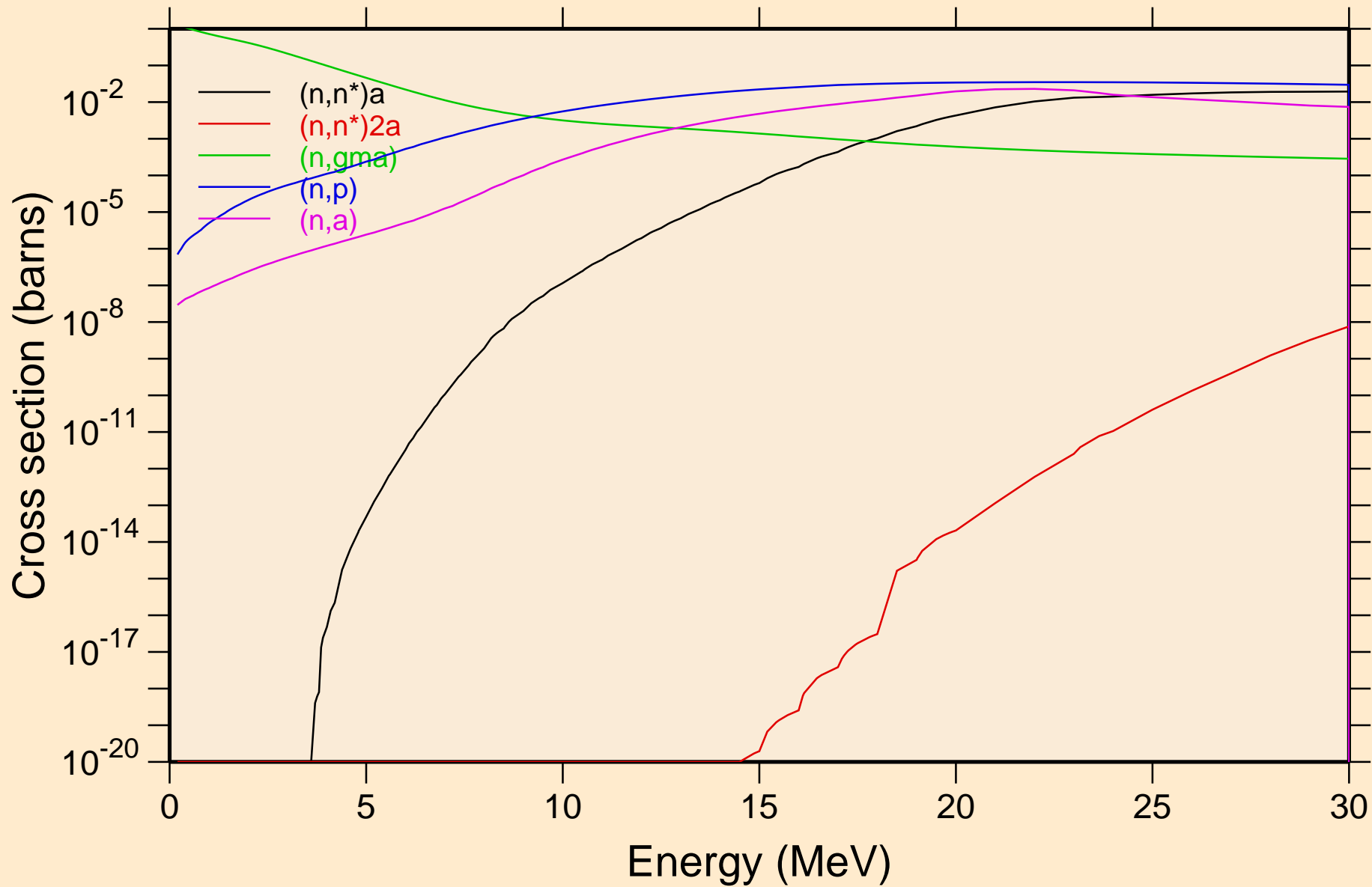



TL198M NEUTRON ACER TENDL-2023 LIBRARY; T=0.K  
Non-threshold reactions

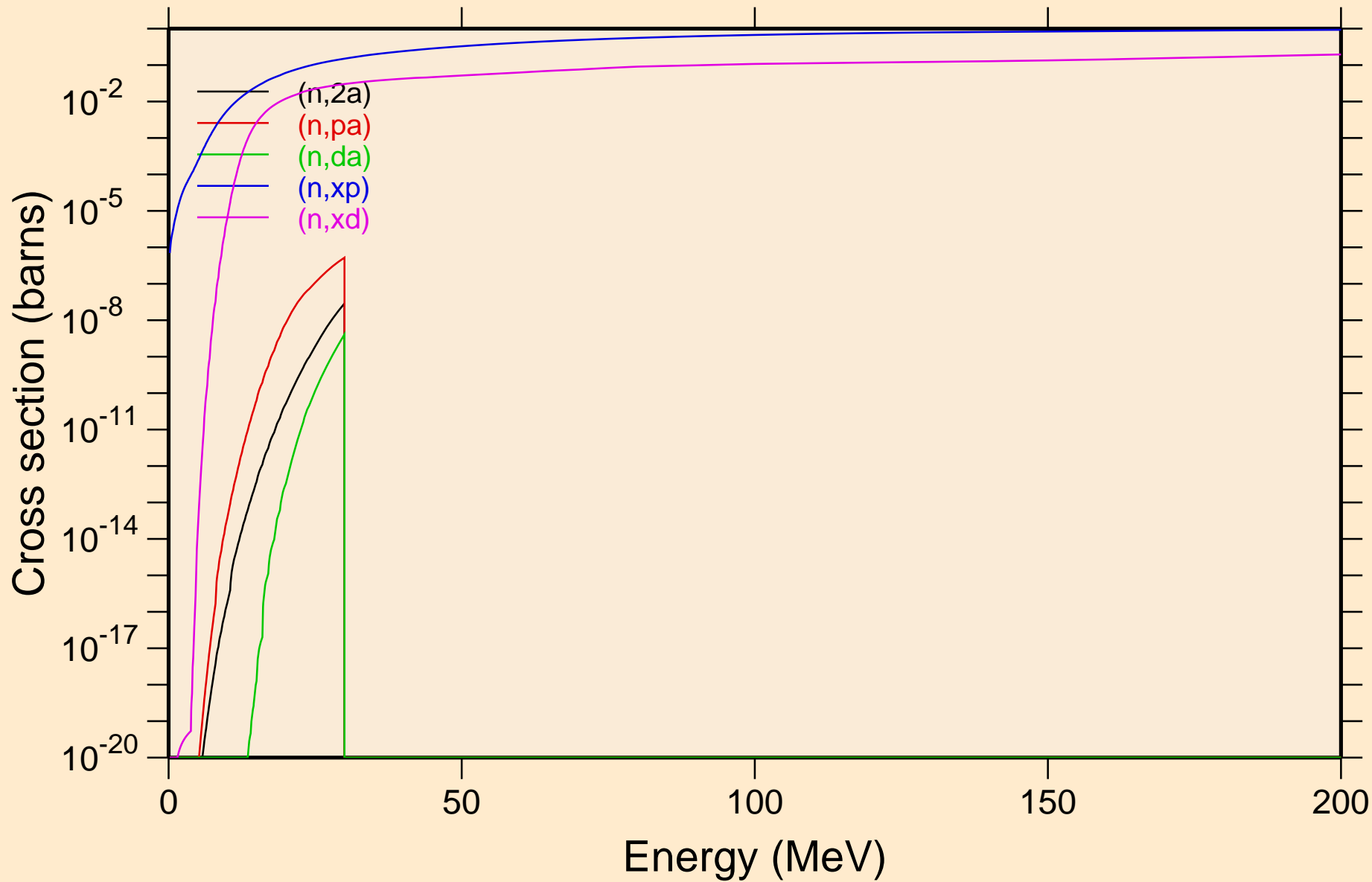

TL198M NEUTRON ACER TENDL-2023 LIBRARY; T=0.K  
Non-threshold reactions

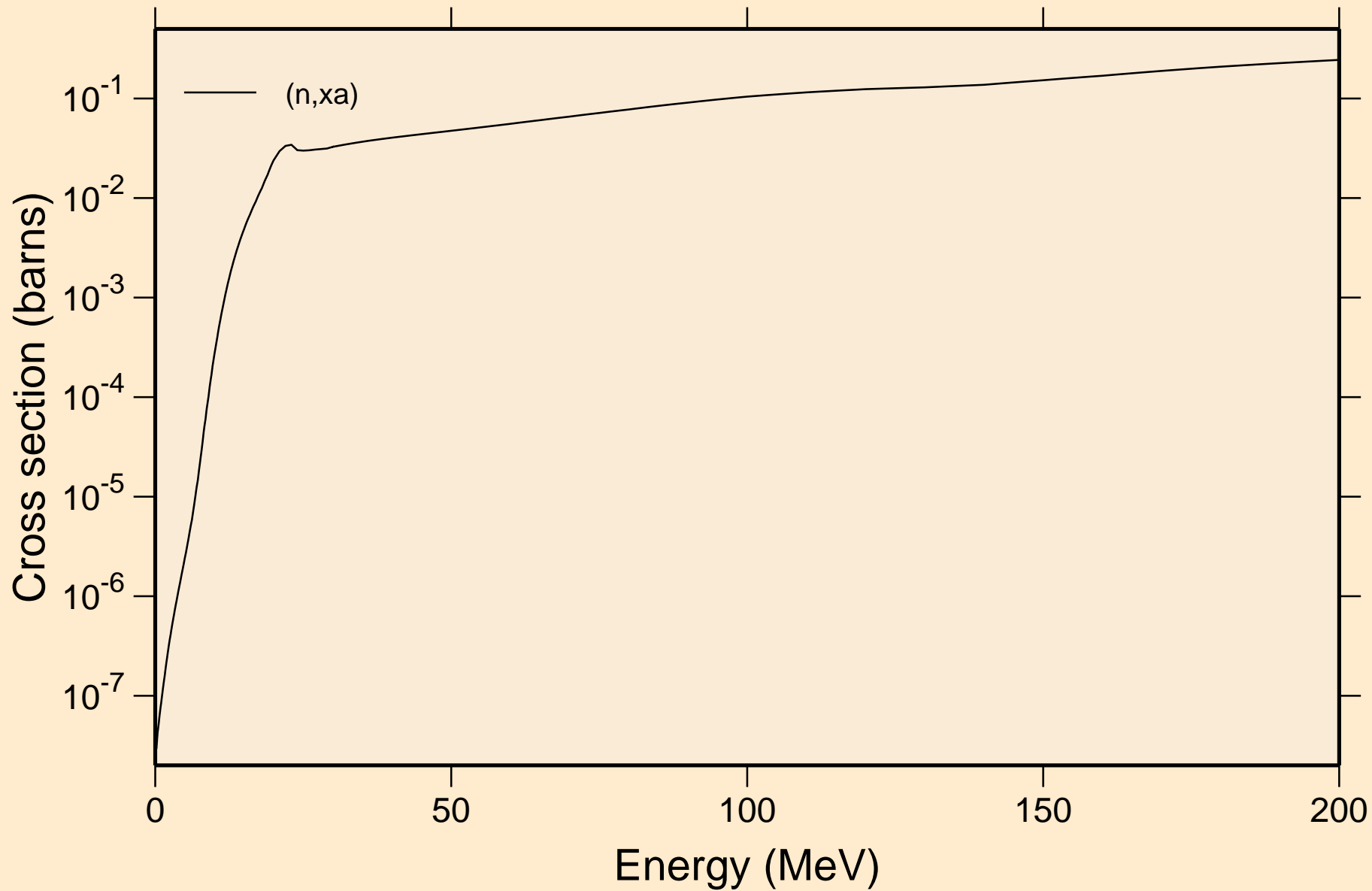

TL198M NEUTRON ACER TENDL-2023 LIBRARY; T=0.K  
Inelastic levels

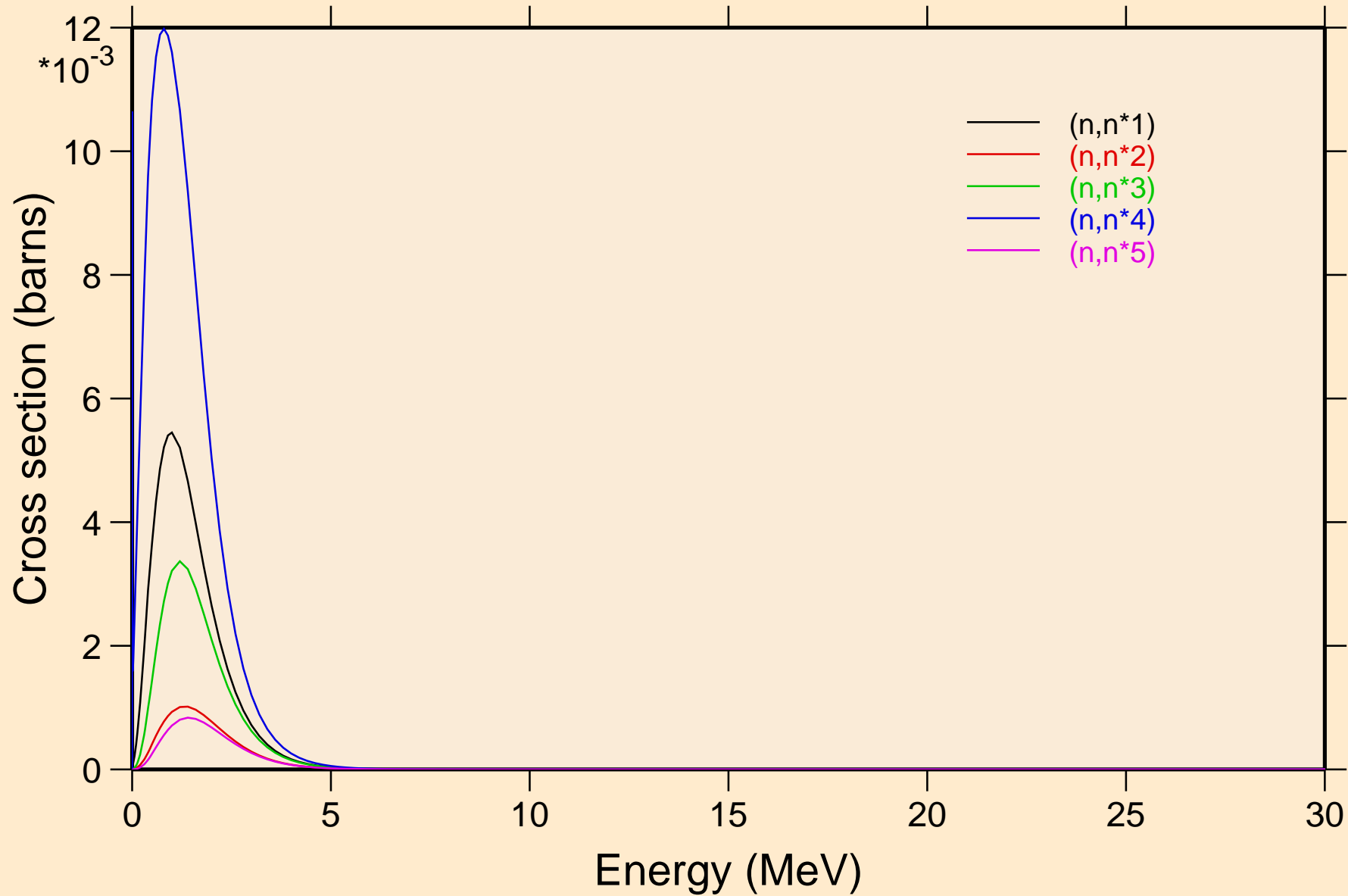

TL198M NEUTRON ACER TENDL-2023 LIBRARY; T=0.K  
Inelastic levels

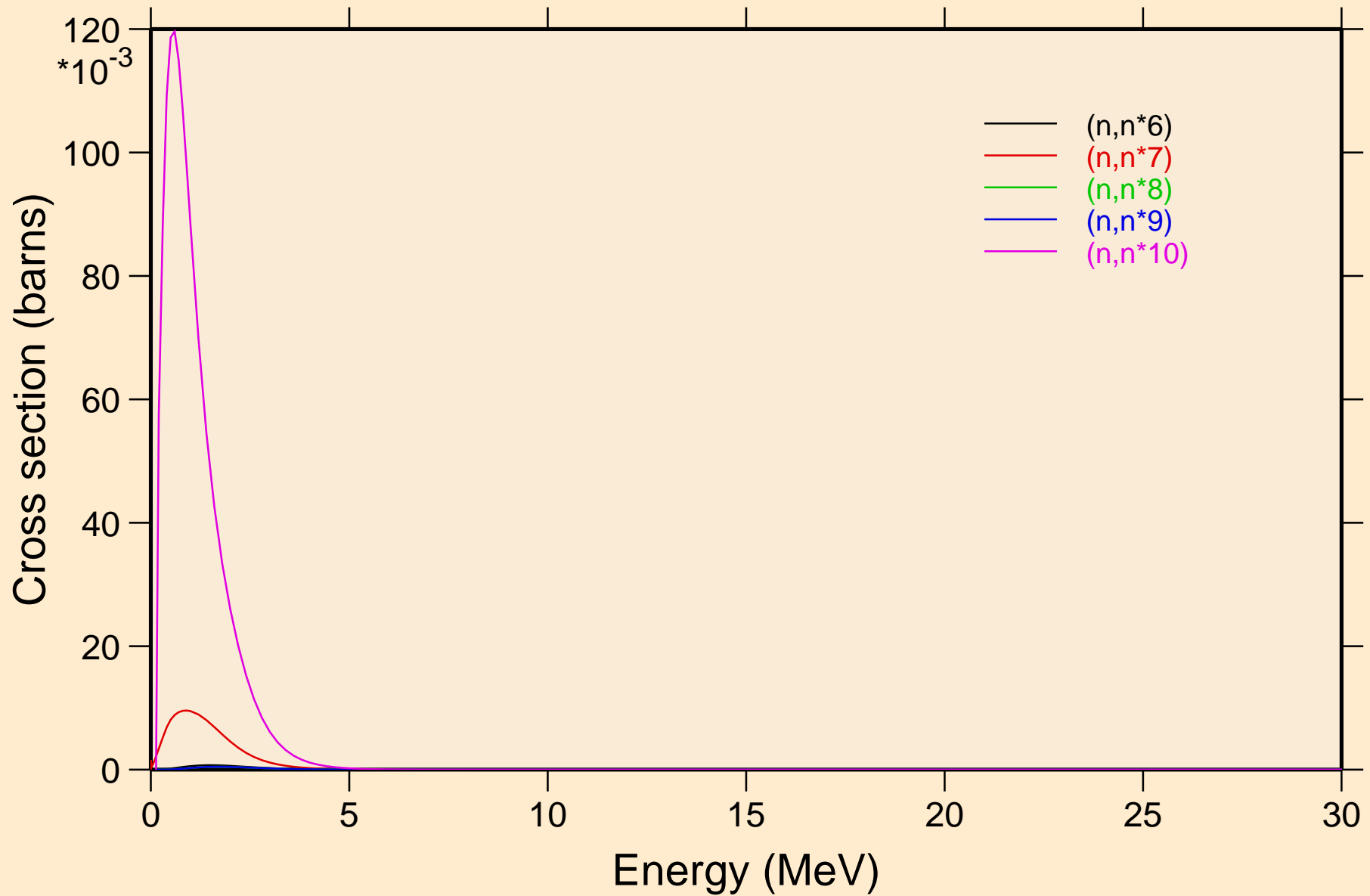

TL198M NEUTRON ACER TENDL-2023 LIBRARY; T=0.K  
Inelastic levels

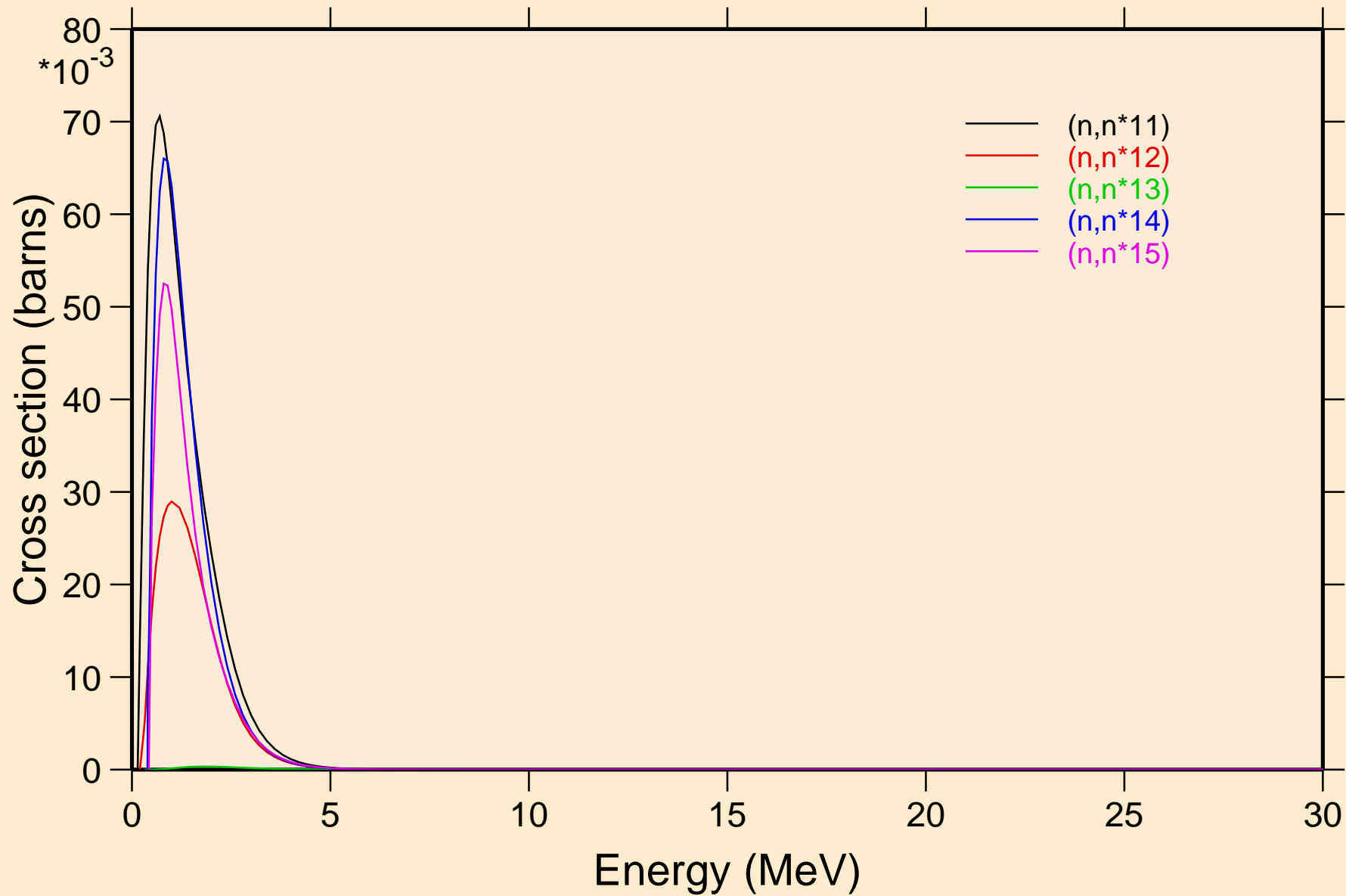

TL198M NEUTRON ACER TENDL-2023 LIBRARY; T=0.K  
Inelastic levels

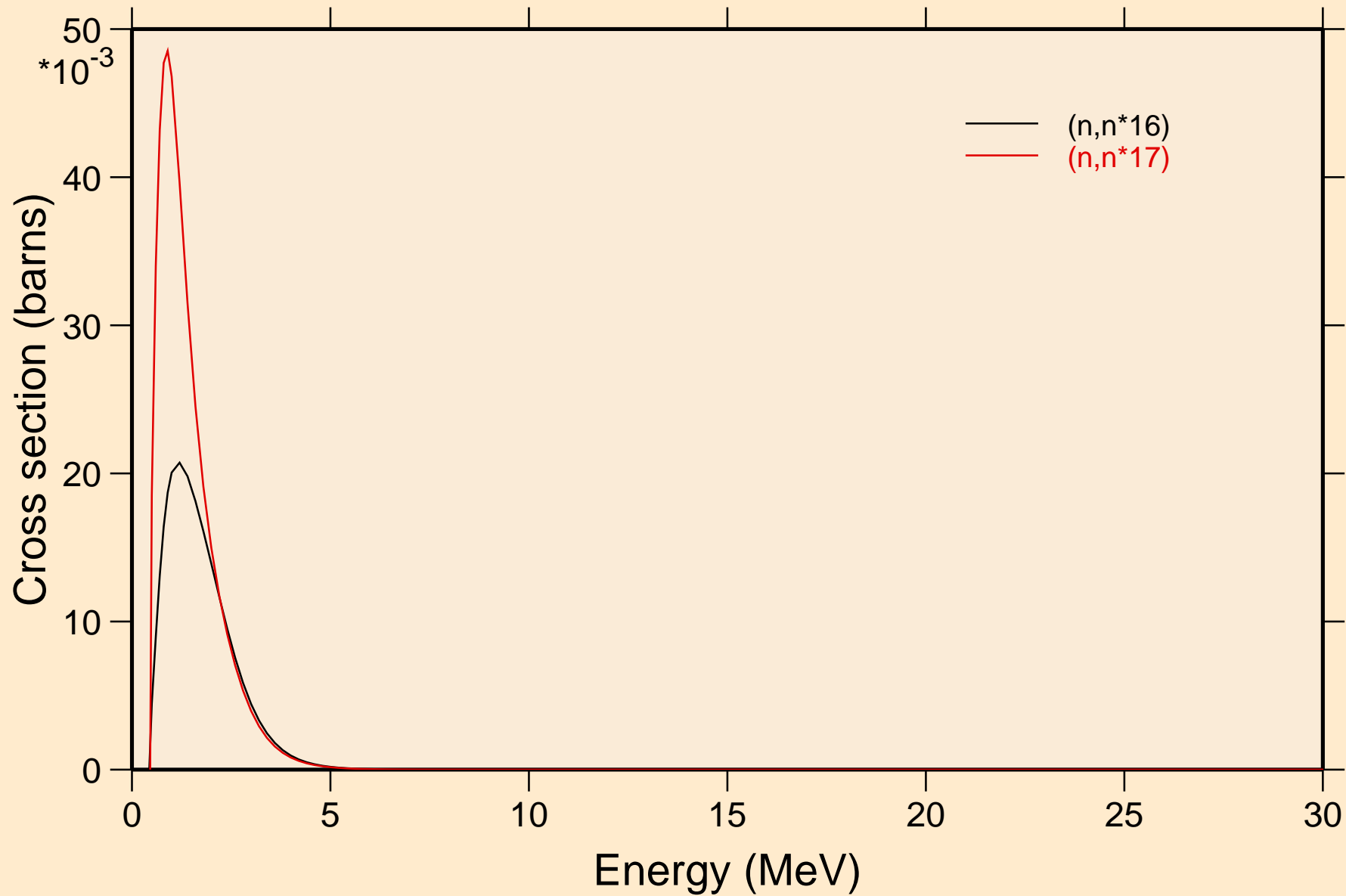

TL198M NEUTRON ACER TENDL-2023 LIBRARY; T=0.K  
Threshold reactions

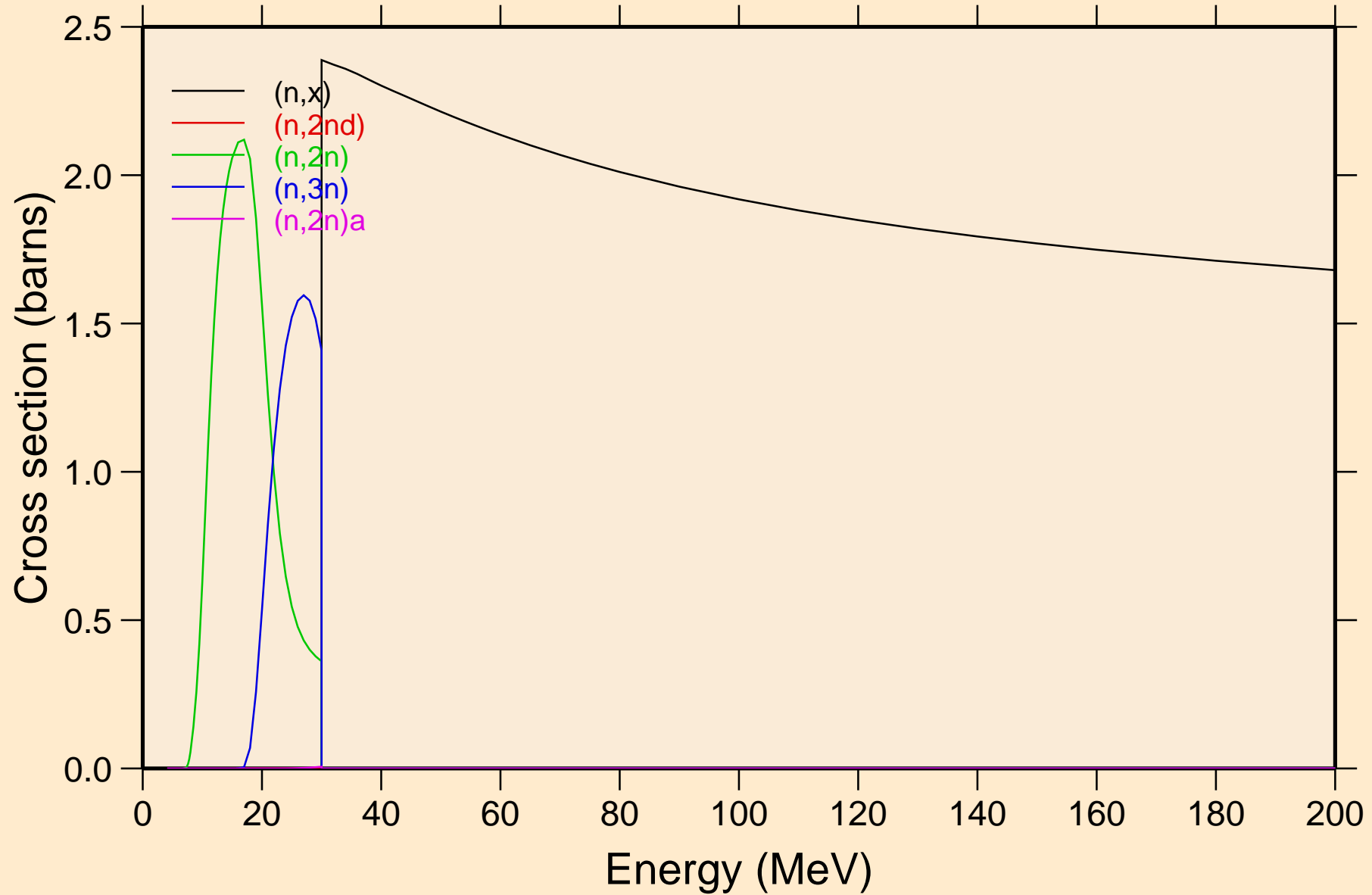

TL198M NEUTRON ACER TENDL-2023 LIBRARY; T=0.K  
Threshold reactions

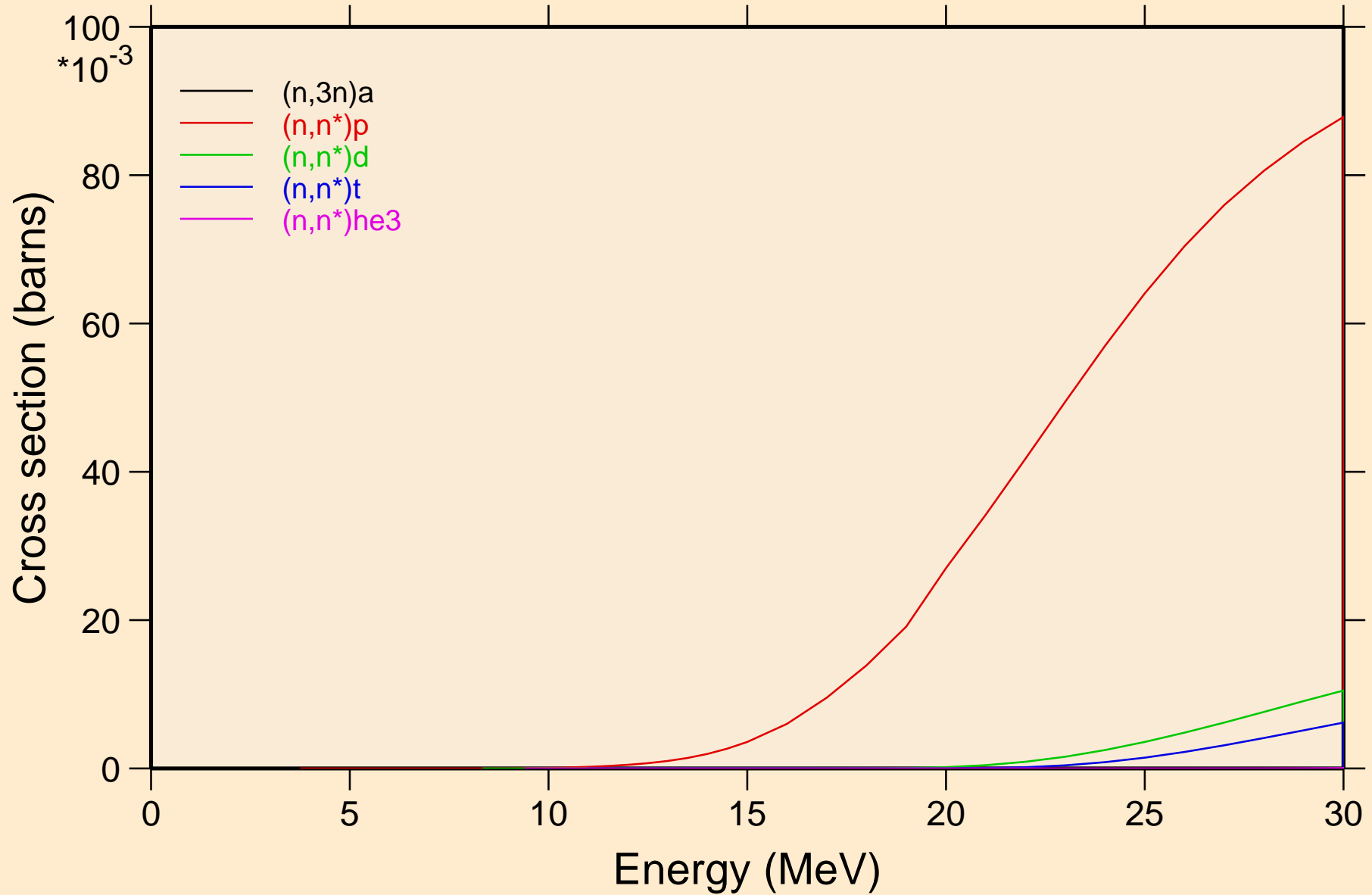



TL198M NEUTRON ACER TENDL-2023 LIBRARY; T=0.K  
Threshold reactions

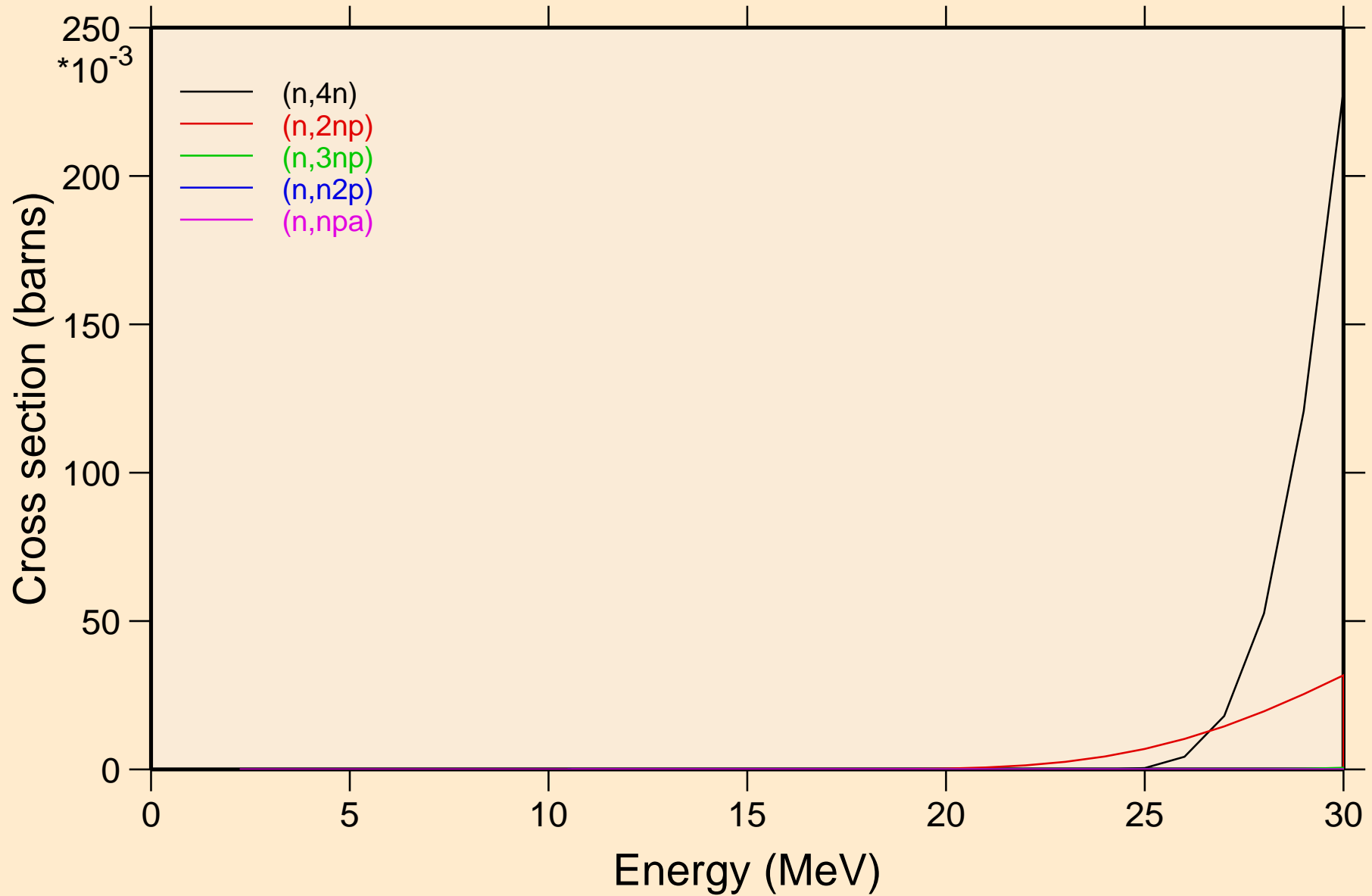

TL198M NEUTRON ACER TENDL-2023 LIBRARY; T=0.K  
Threshold reactions

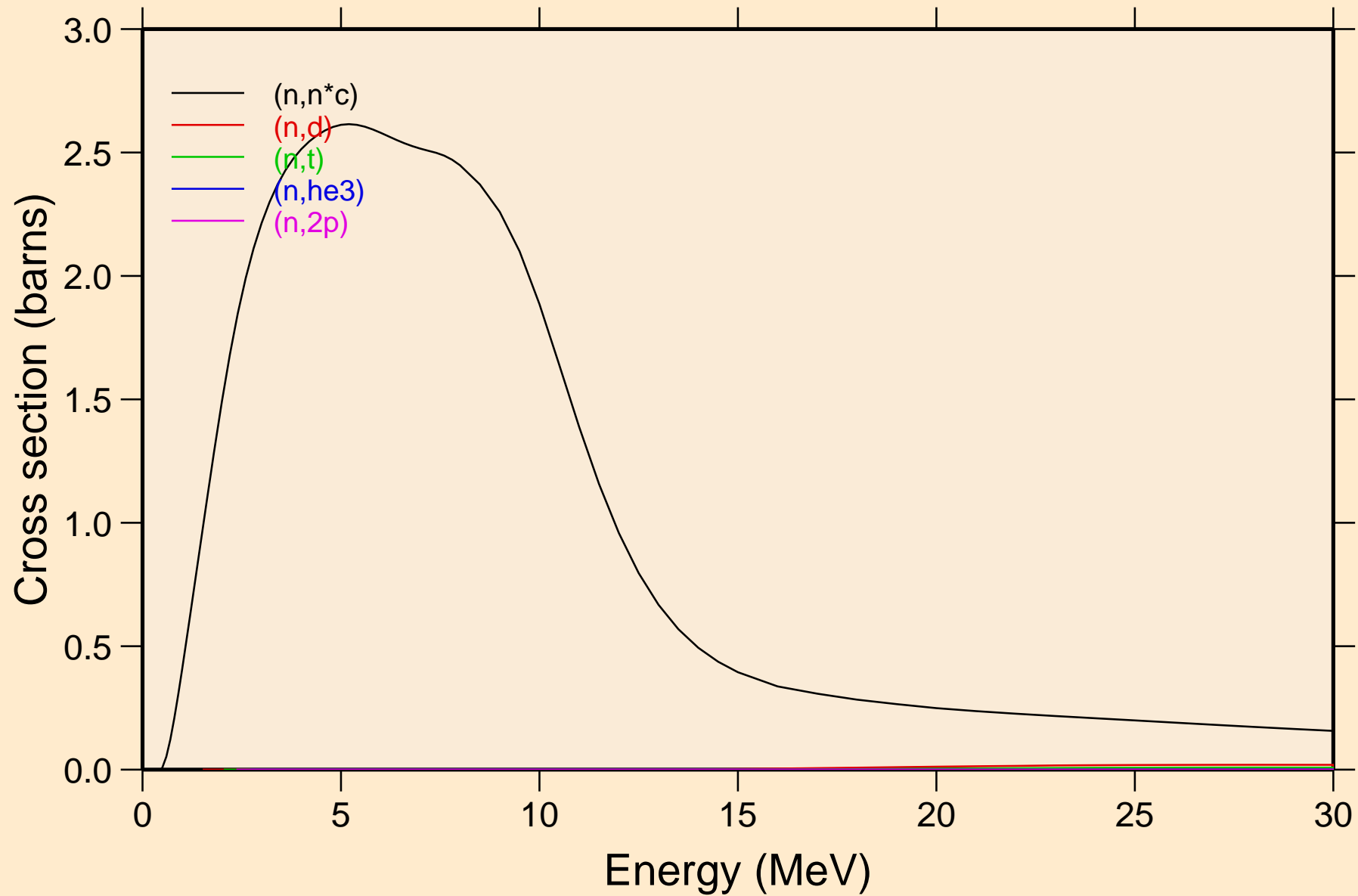

TL198M NEUTRON ACER TENDL-2023 LIBRARY; T=0.K  
Threshold reactions

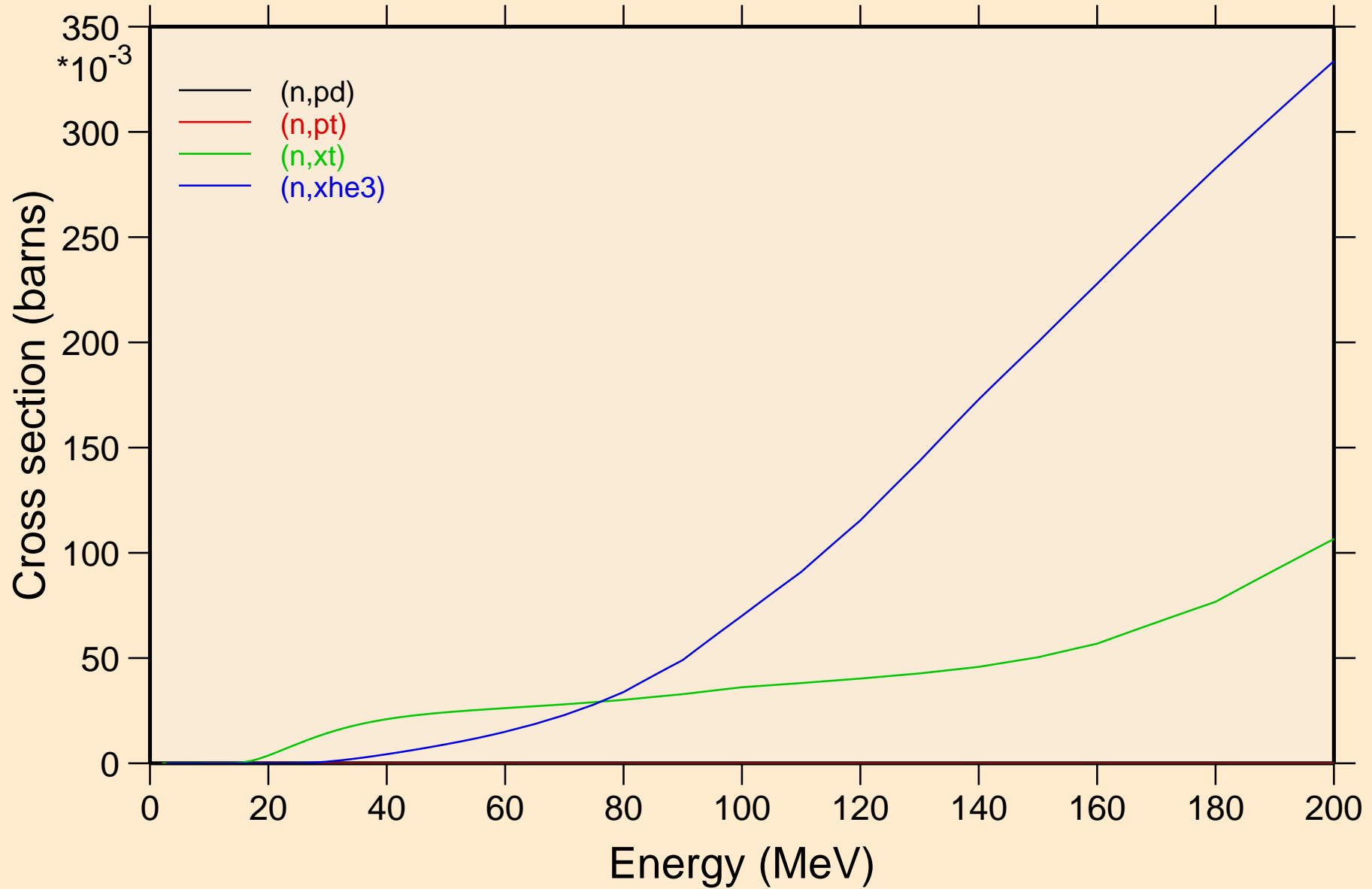

TL198M NEUTRON ACER TENDL-2023 LIBRARY; T=0.K  
angular distribution for elastic

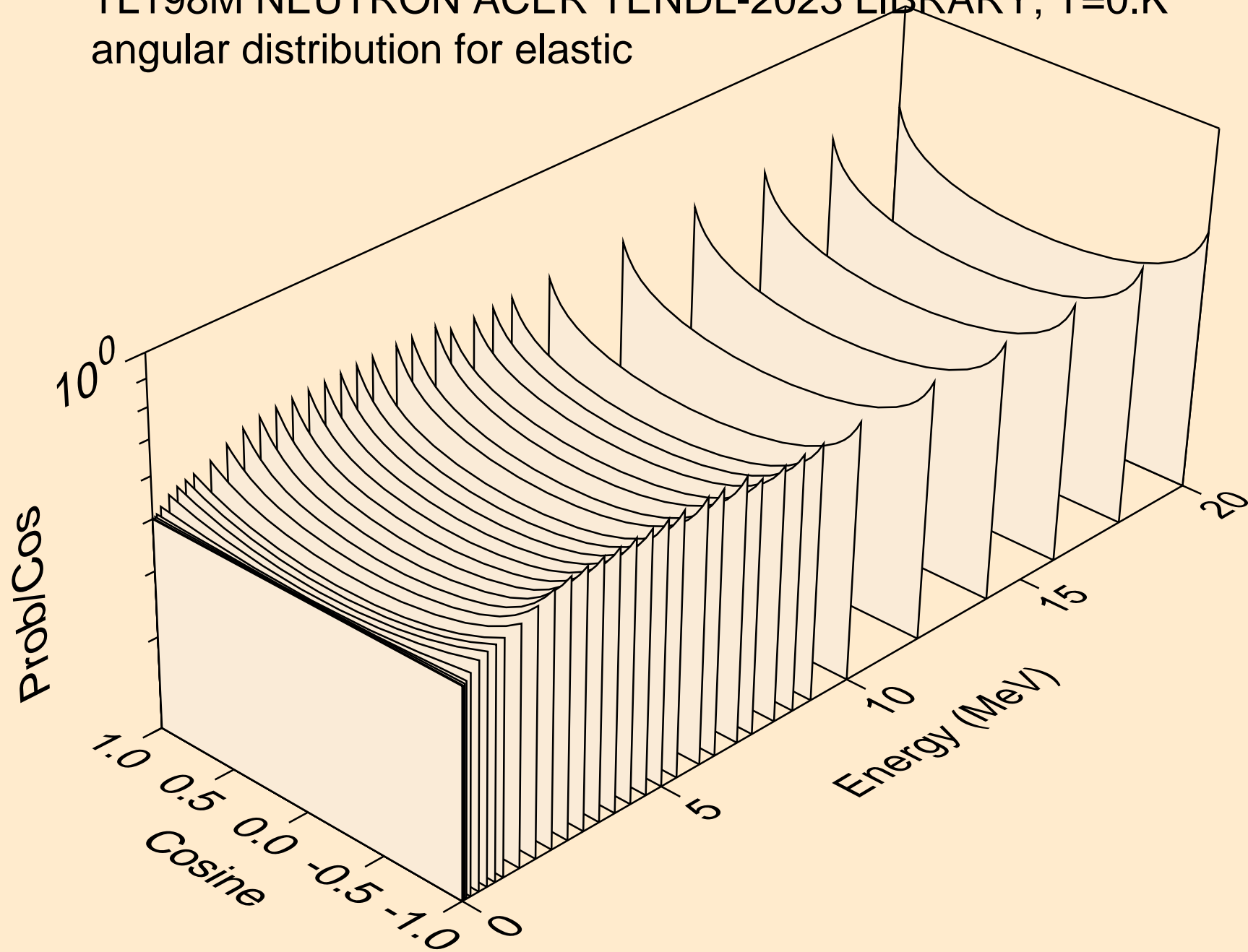

TL198M NEUTRON ACER TENDL-2023 LIBRARY; T=0.K  
angular distribution for elastic

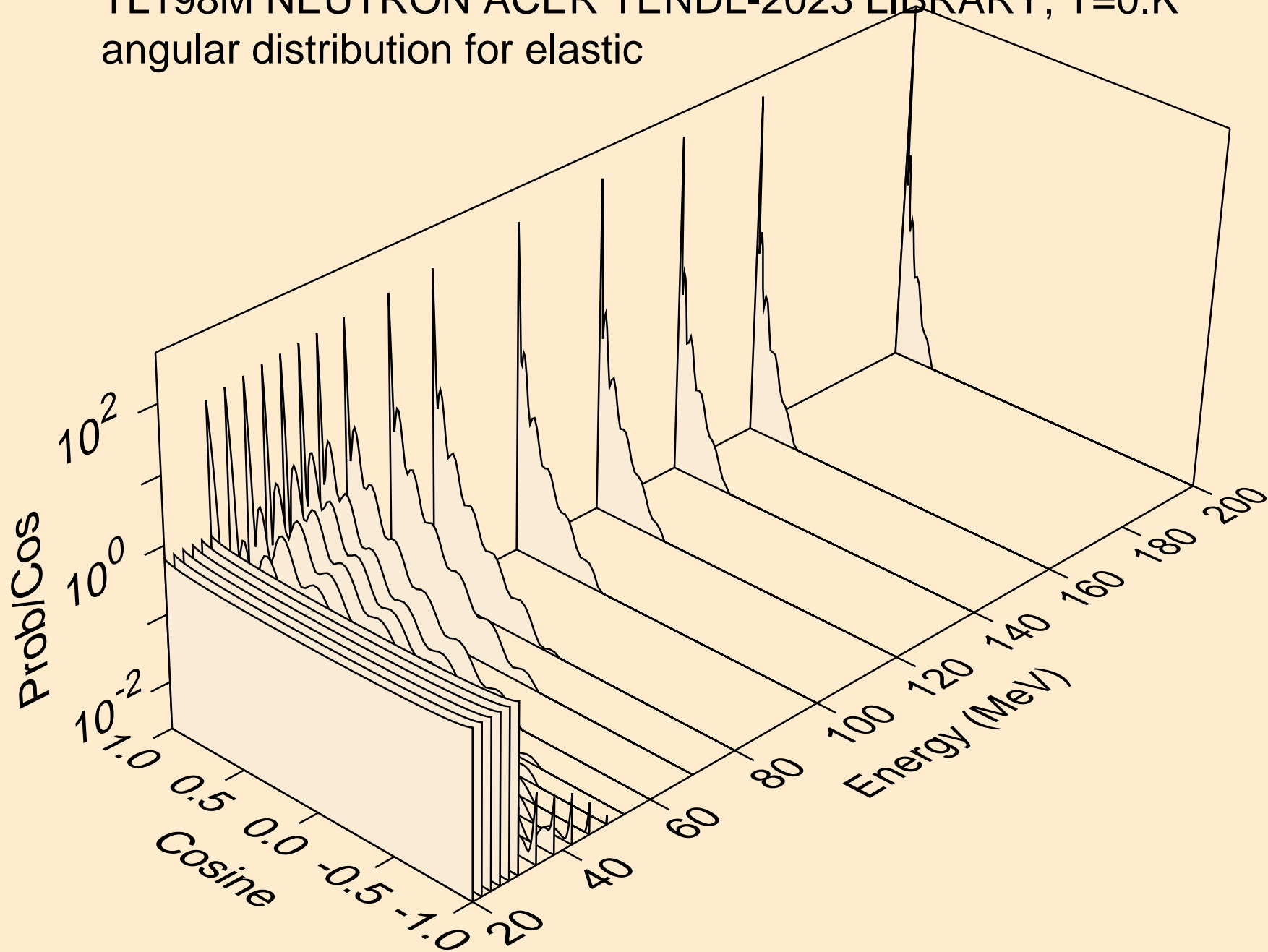

TL198M NEUTRON ACER TENDL-2023 LIBRARY; T=0.K  
angular distribution for (n,n\*1)

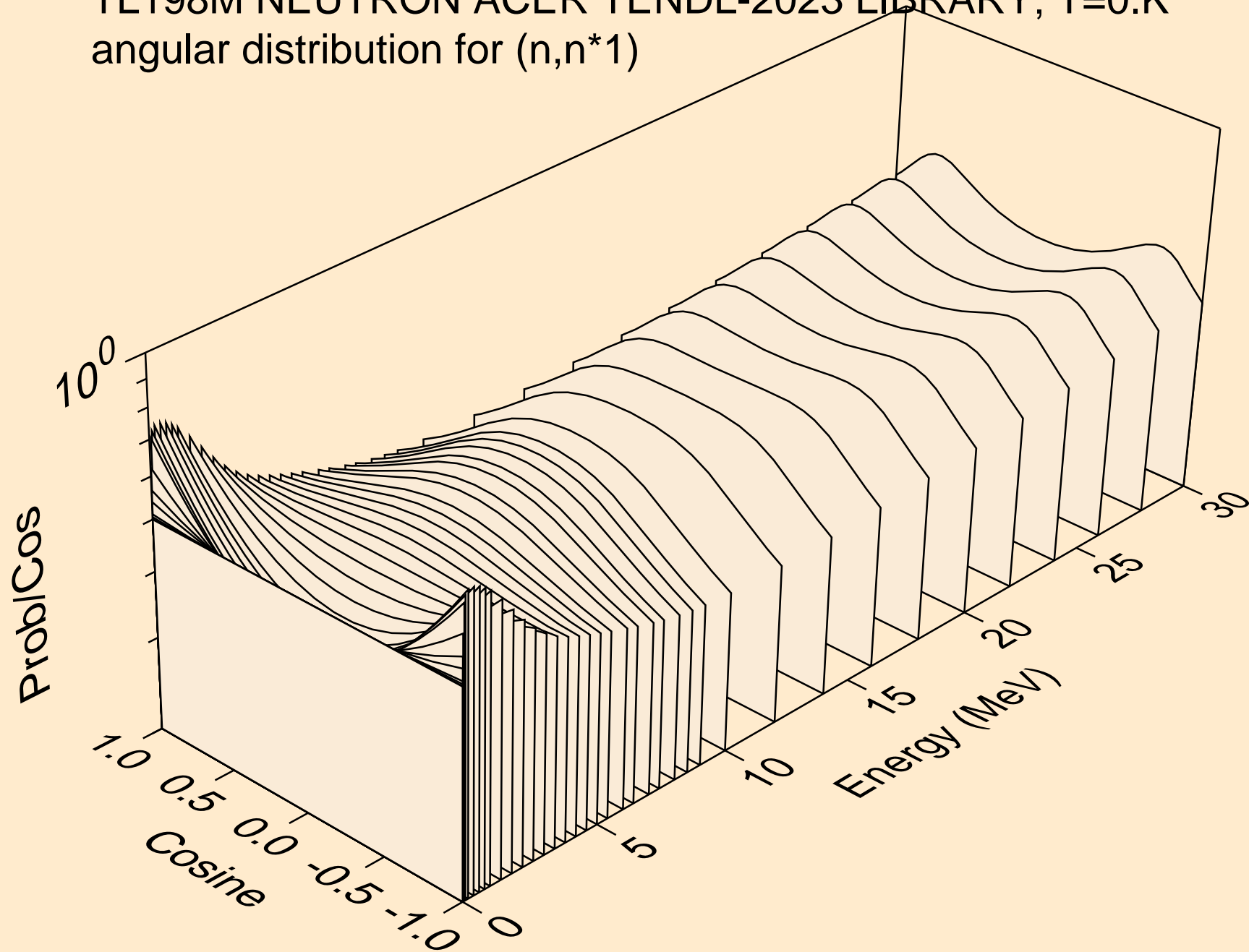

TL198M NEUTRON ACER TENDL-2023 LIBRARY; T=0.K  
angular distribution for (n,n\*2)

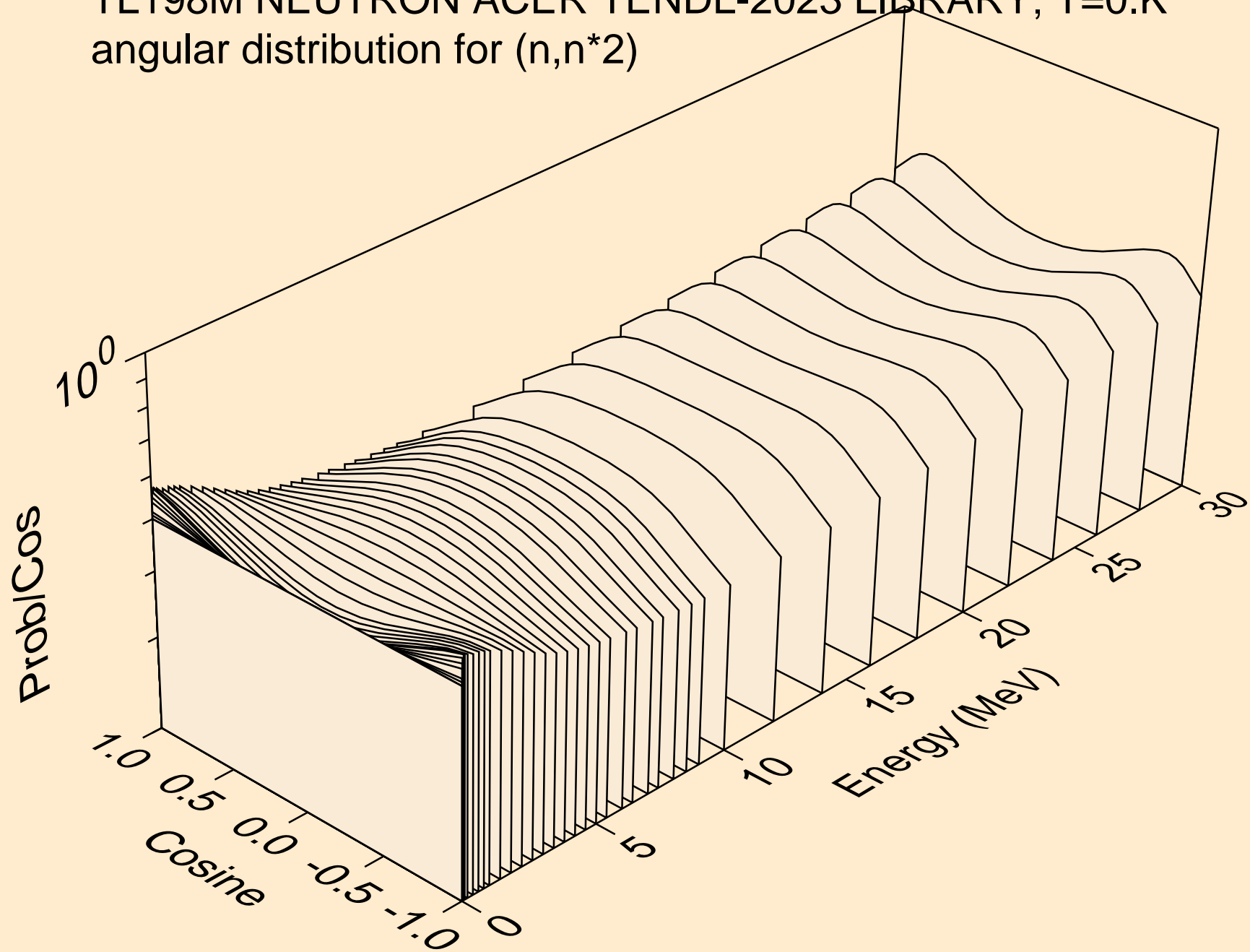

TL198M NEUTRON ACER TENDL-2023 LIBRARY; T=0.K  
angular distribution for (n,n\*3)

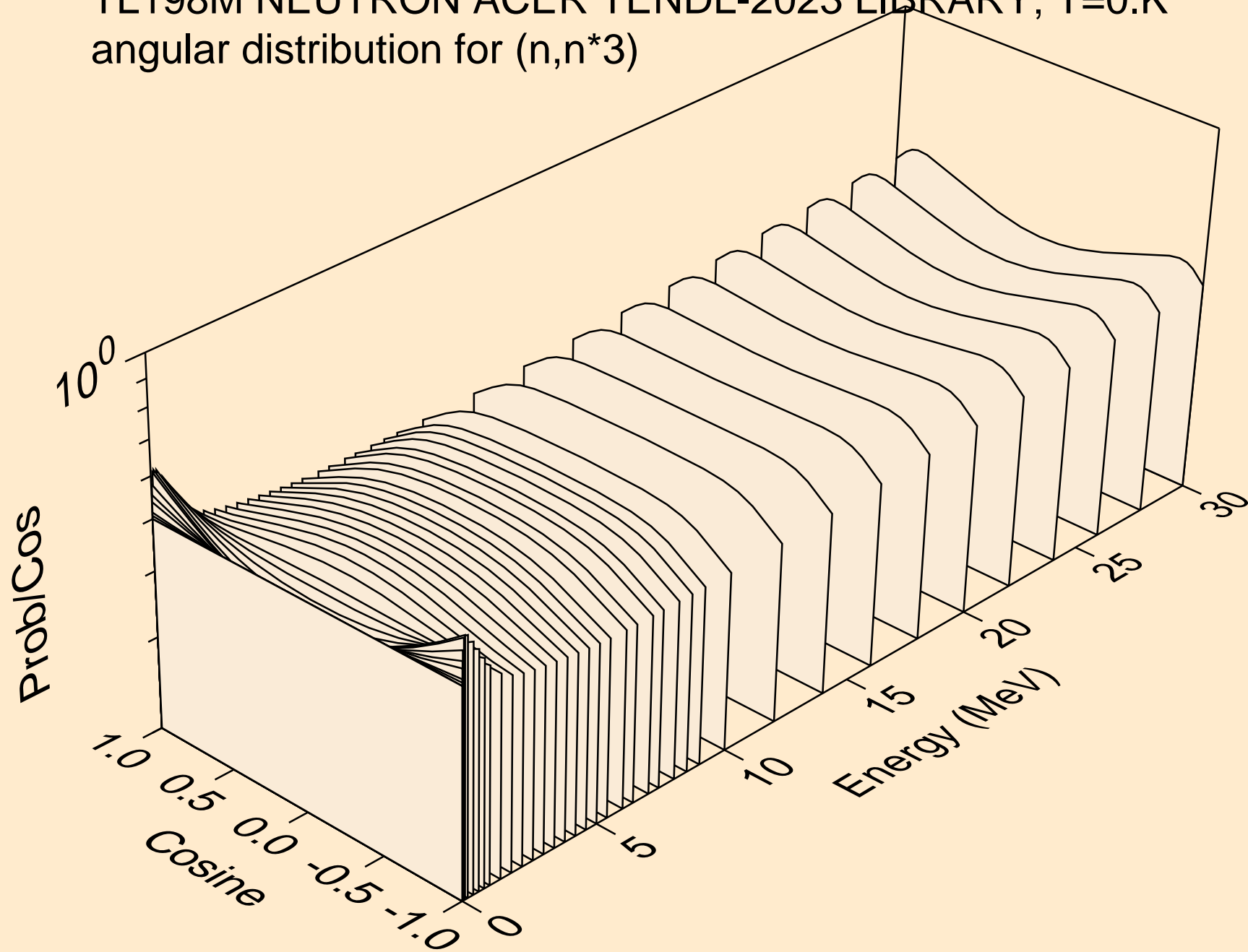



TL198M NEUTRON ACER TENDL-2023 LIBRARY; T=0.K  
angular distribution for (n,n\*4)

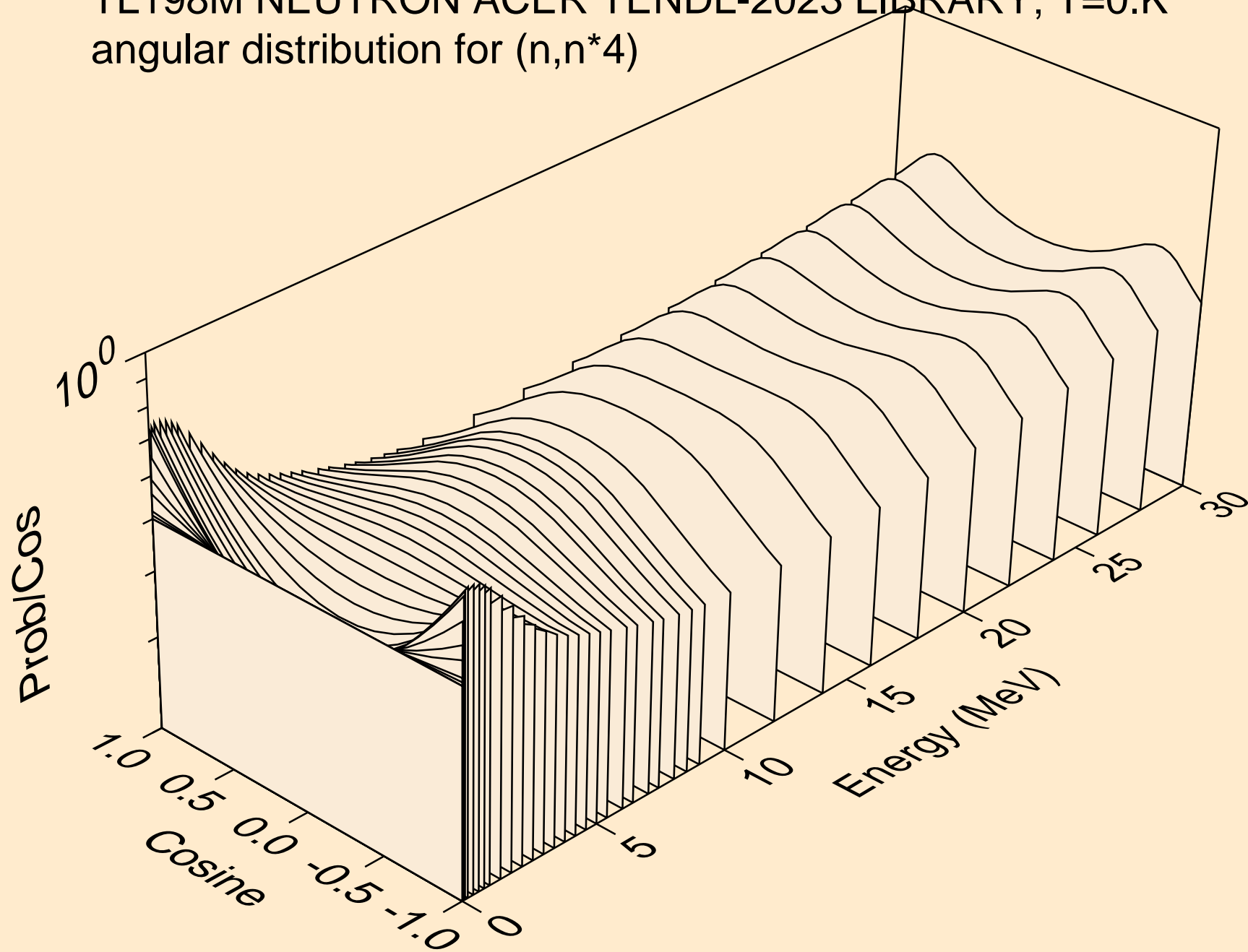

TL198M NEUTRON ACER TENDL-2023 LIBRARY; T=0.K  
angular distribution for (n,n\*5)

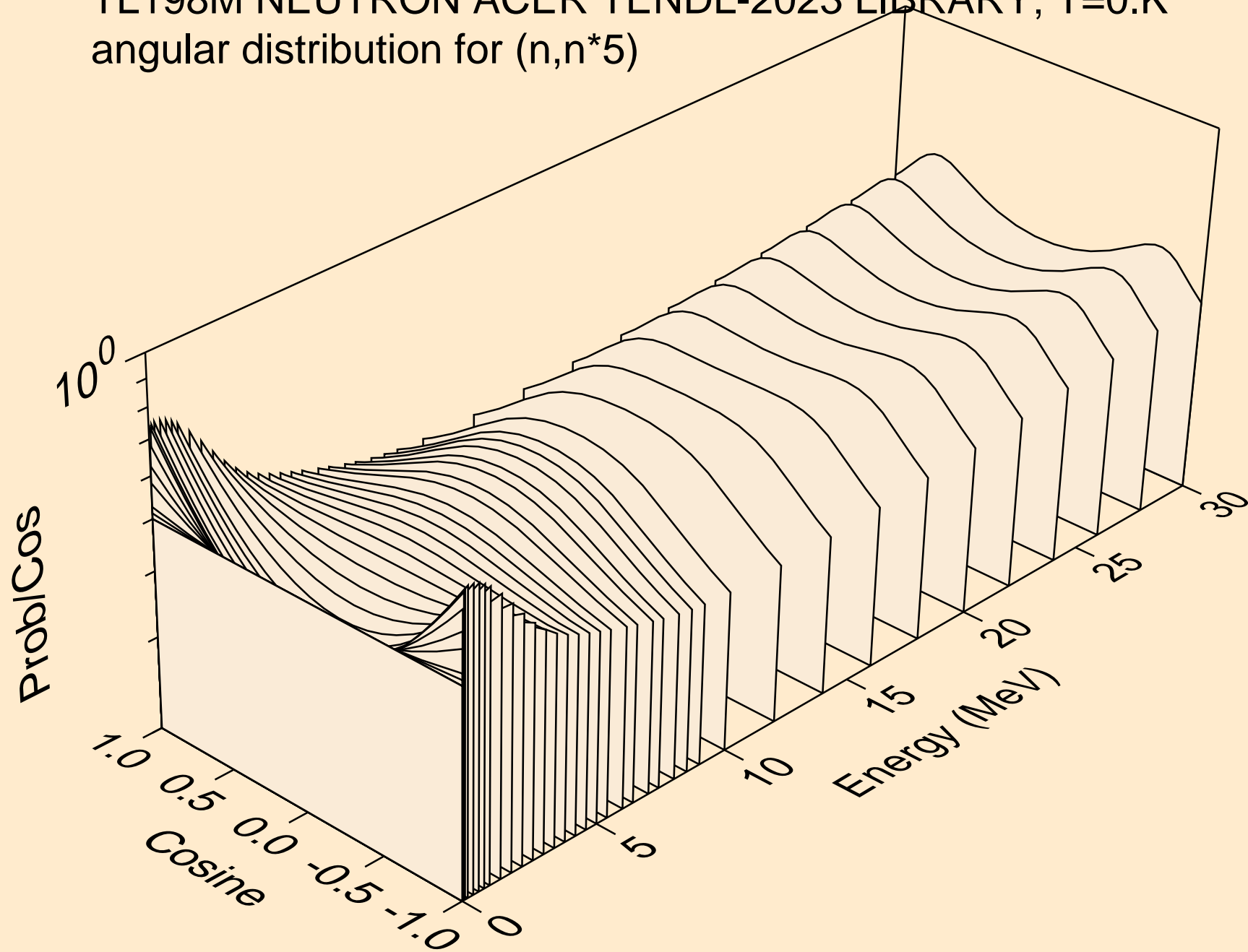

TL198M NEUTRON ACER TENDL-2023 LIBRARY; T=0.K  
angular distribution for (n,n\*6)

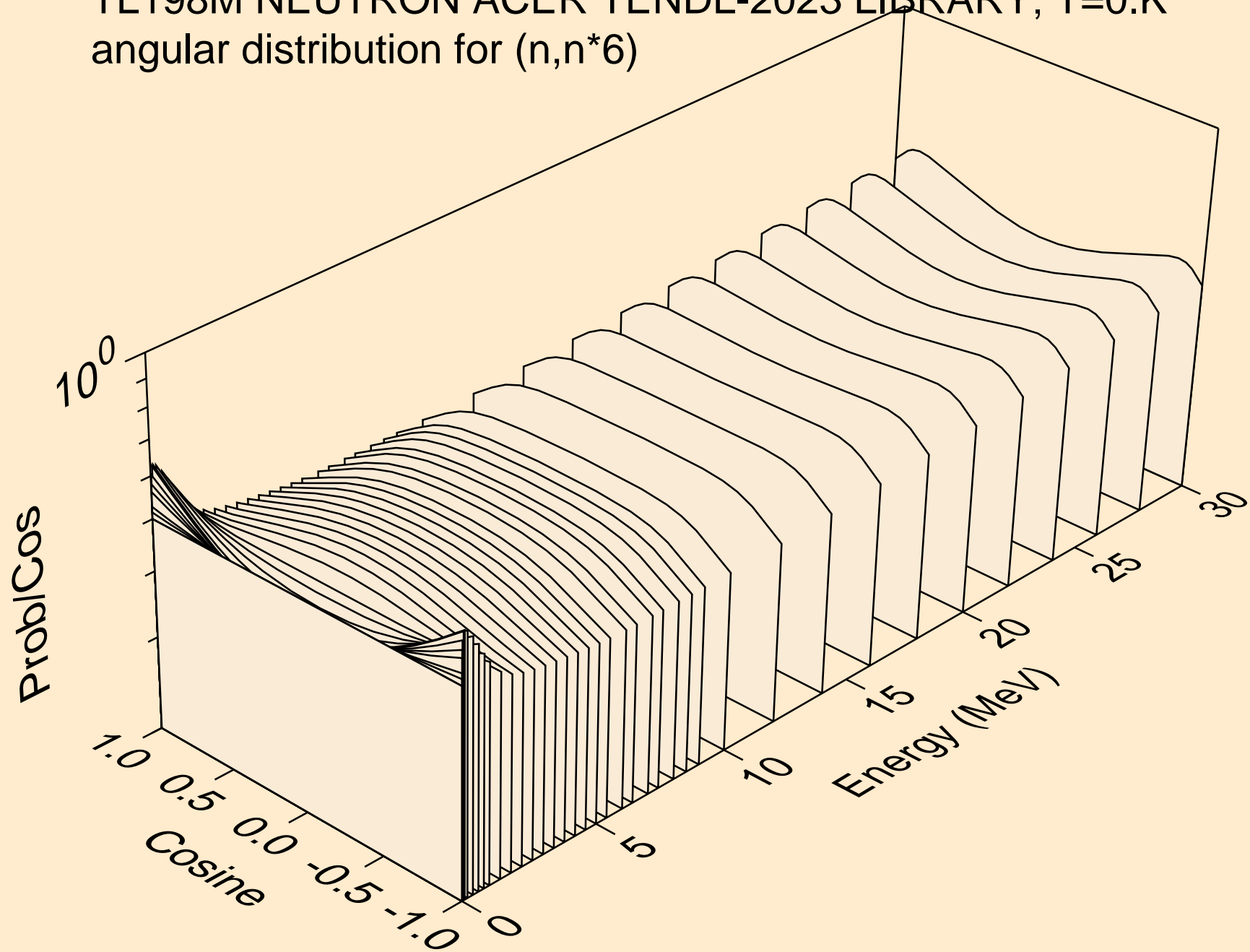

TL198M NEUTRON ACER TENDL-2023 LIBRARY; T=0.K  
angular distribution for (n,n\*7)

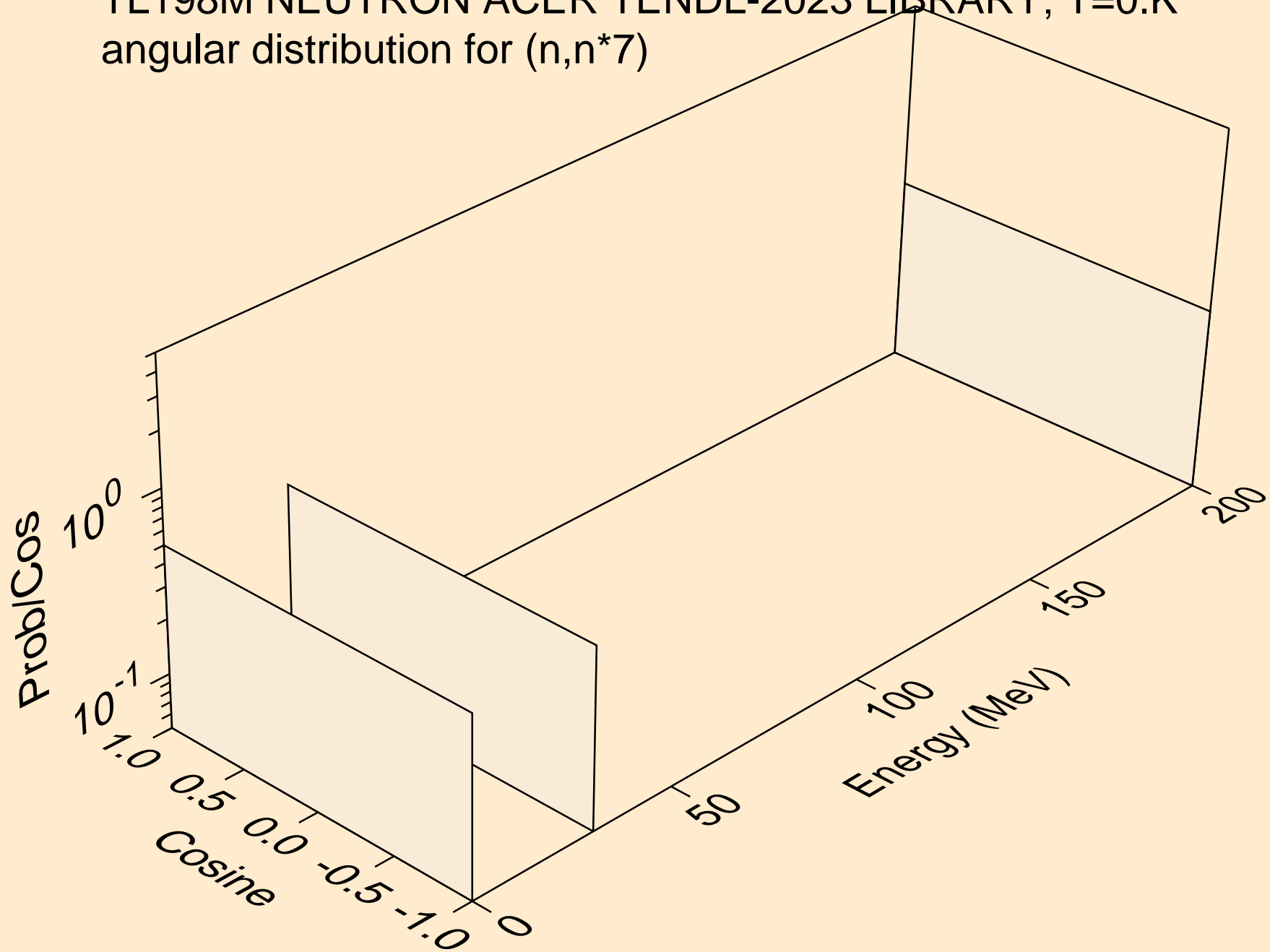

TL198M NEUTRON ACER TENDL-2023 LIBRARY; T=0.K  
angular distribution for (n,n\*8)

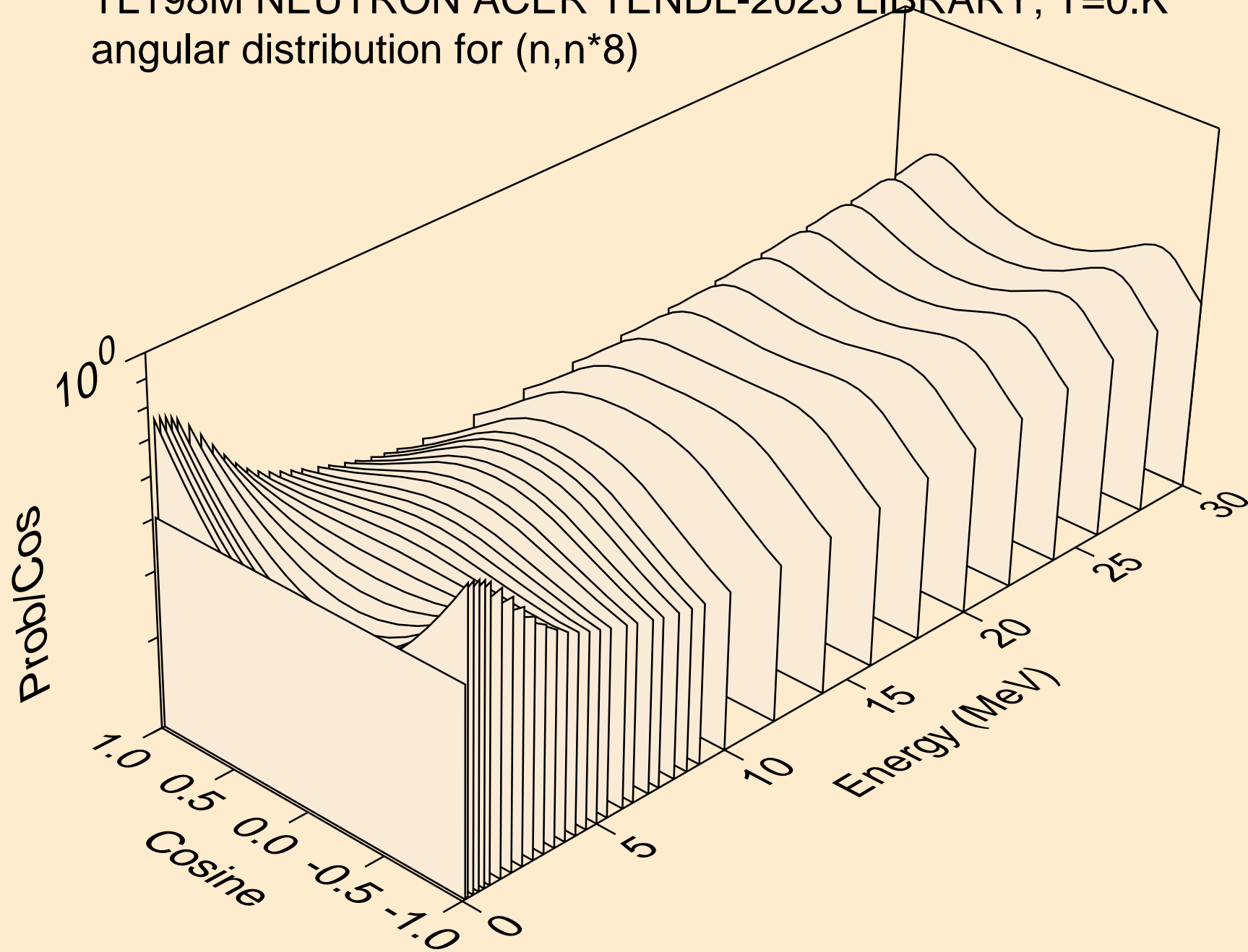

TL198M NEUTRON ACER TENDL-2023 LIBRARY; T=0.K  
angular distribution for (n,n\*9)

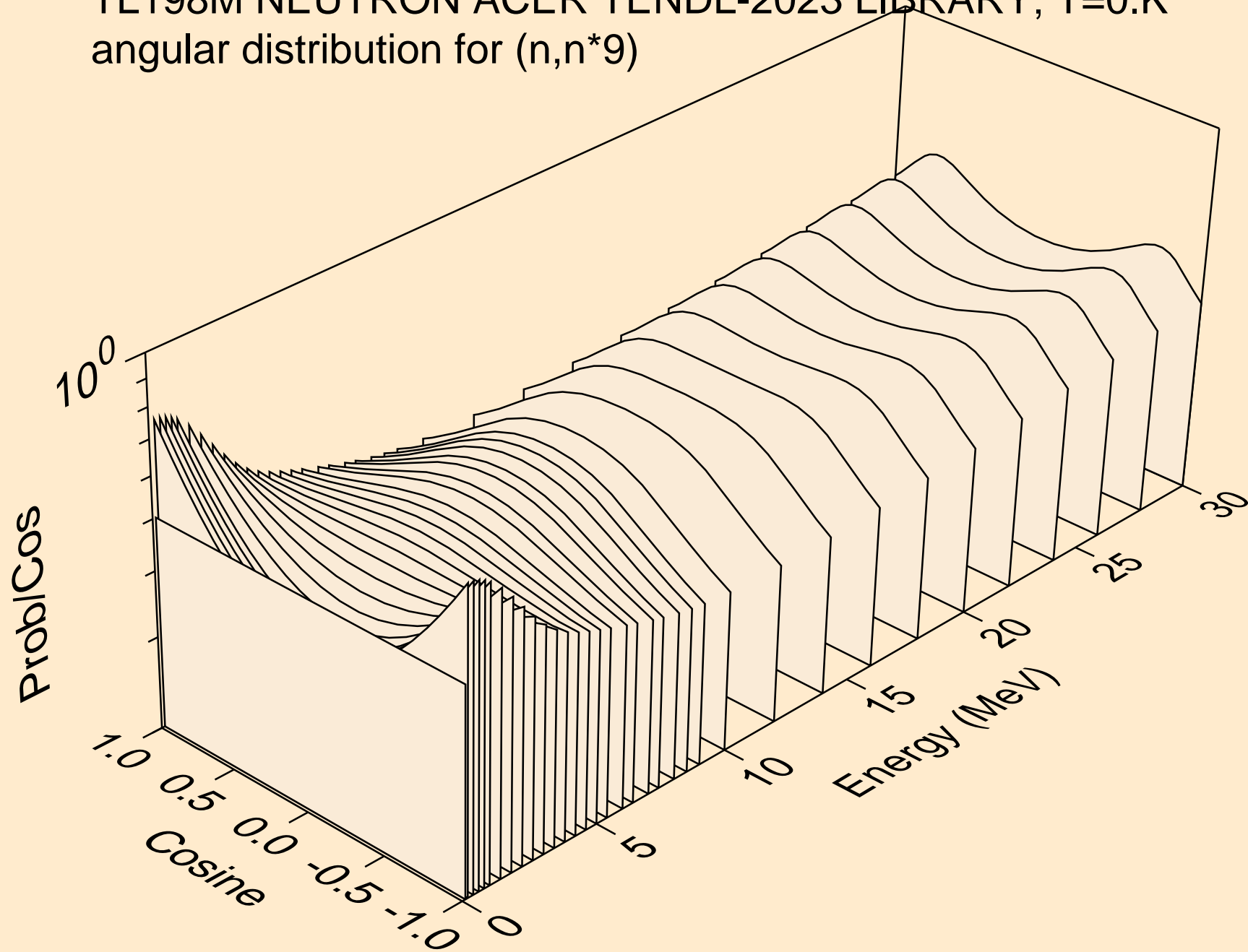

TL198M NEUTRON ACER TENDL-2023 LIBRARY; T=0.K  
angular distribution for (n,n\*10)

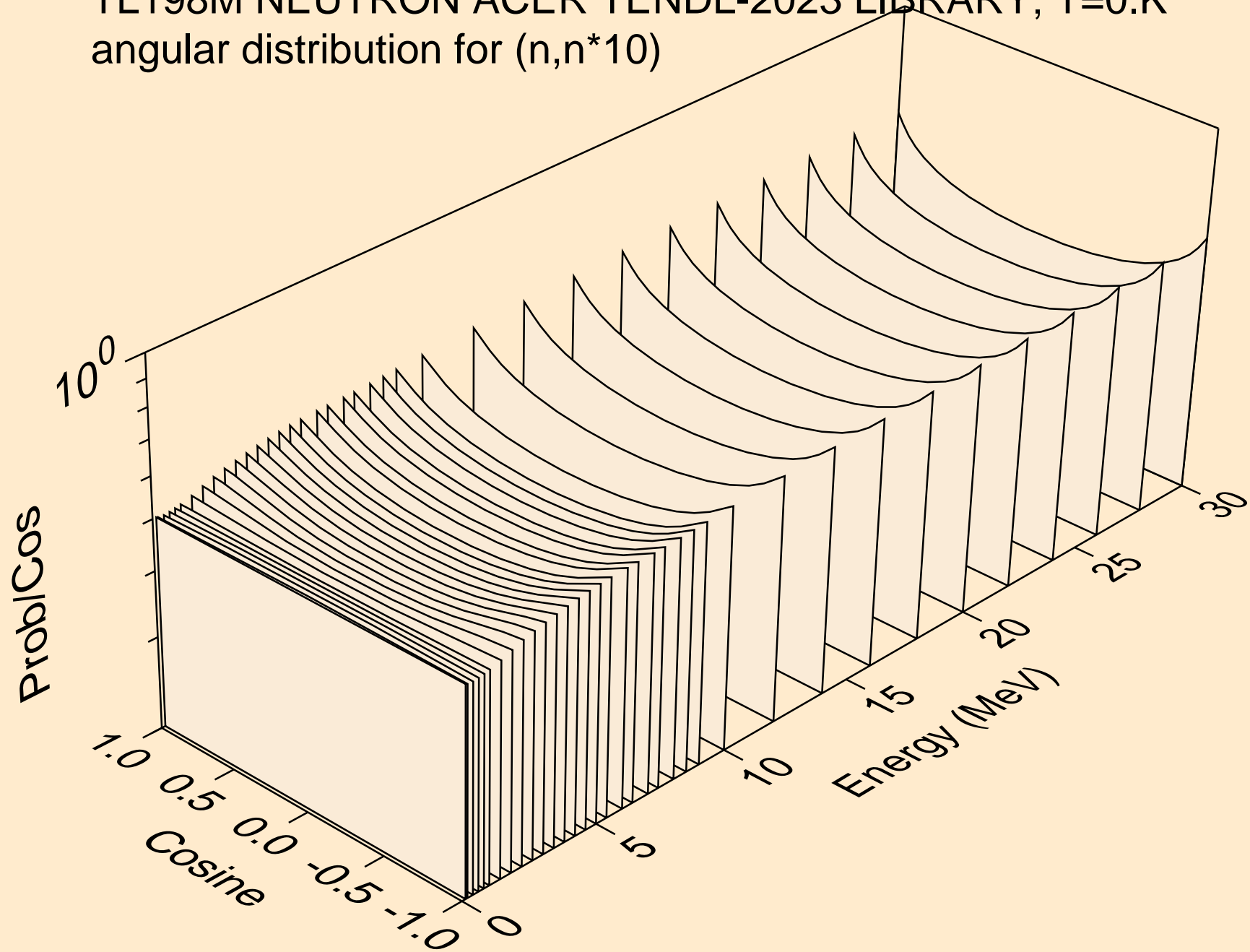

TL198M NEUTRON ACER TENDL-2023 LIBRARY; T=0.K  
angular distribution for (n,n\*11)

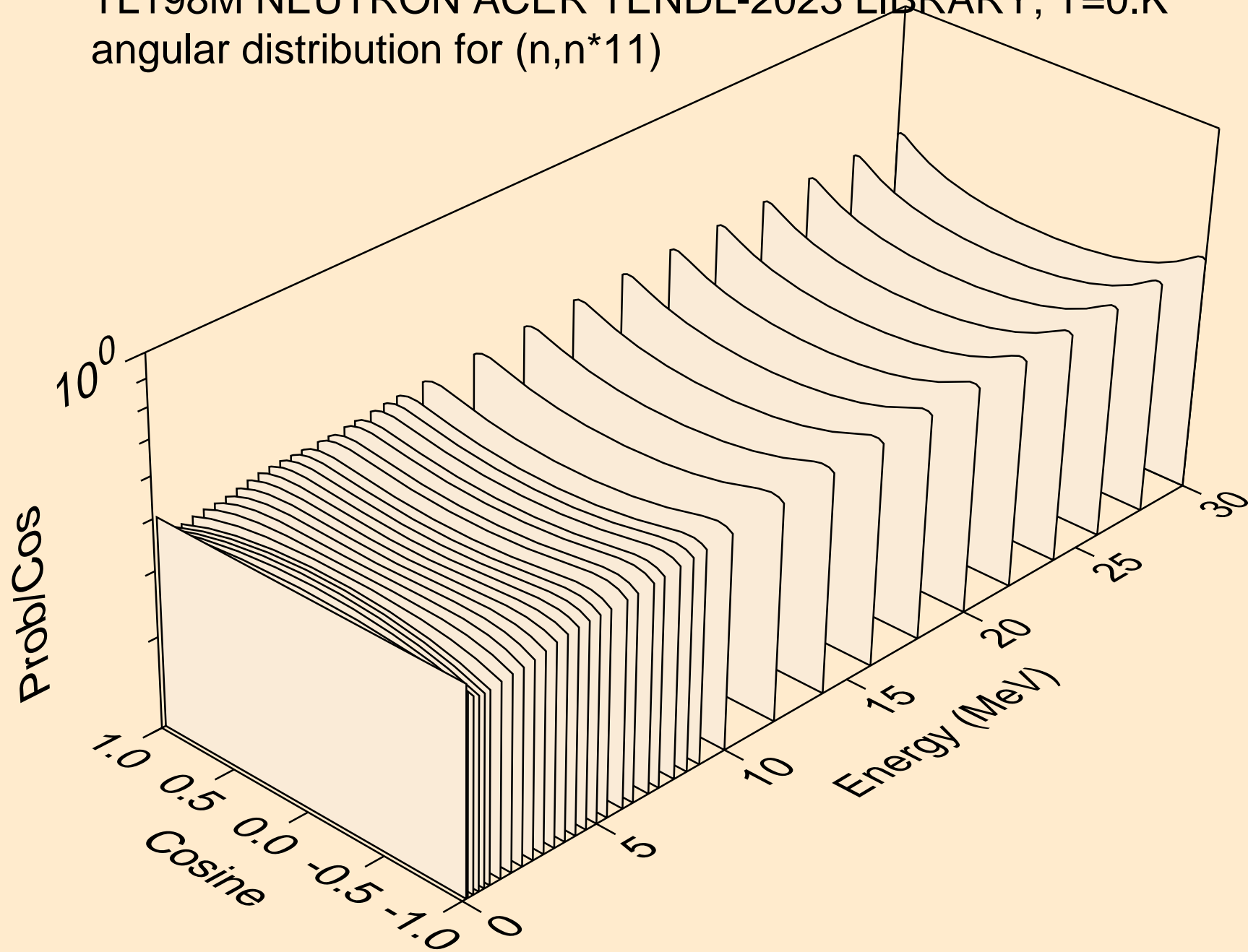



TL198M NEUTRON ACER TENDL-2023 LIBRARY; T=0.K  
angular distribution for (n,n\*12)

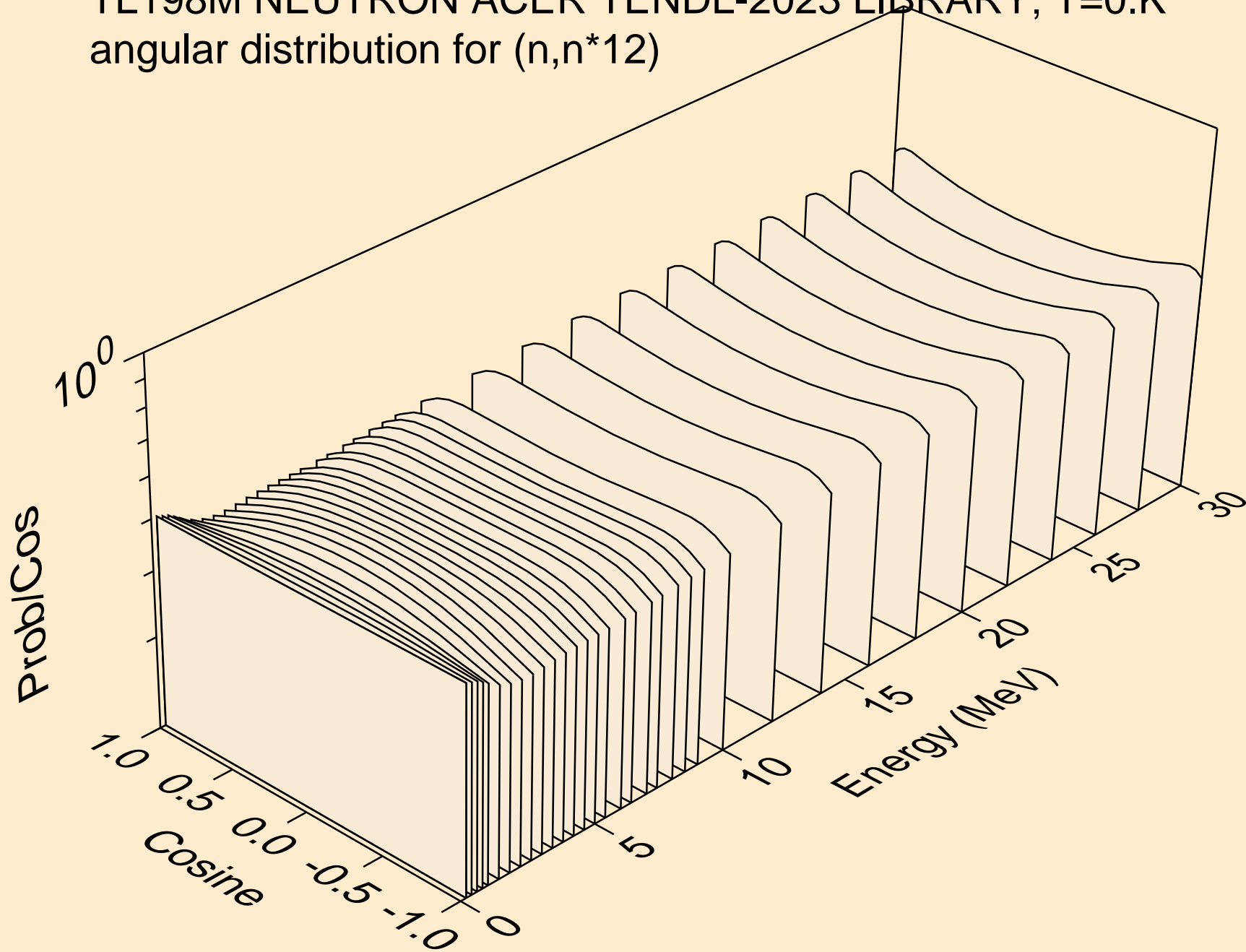

TL198M NEUTRON ACER TENDL-2023 LIBRARY; T=0.K  
angular distribution for (n,n\*13)

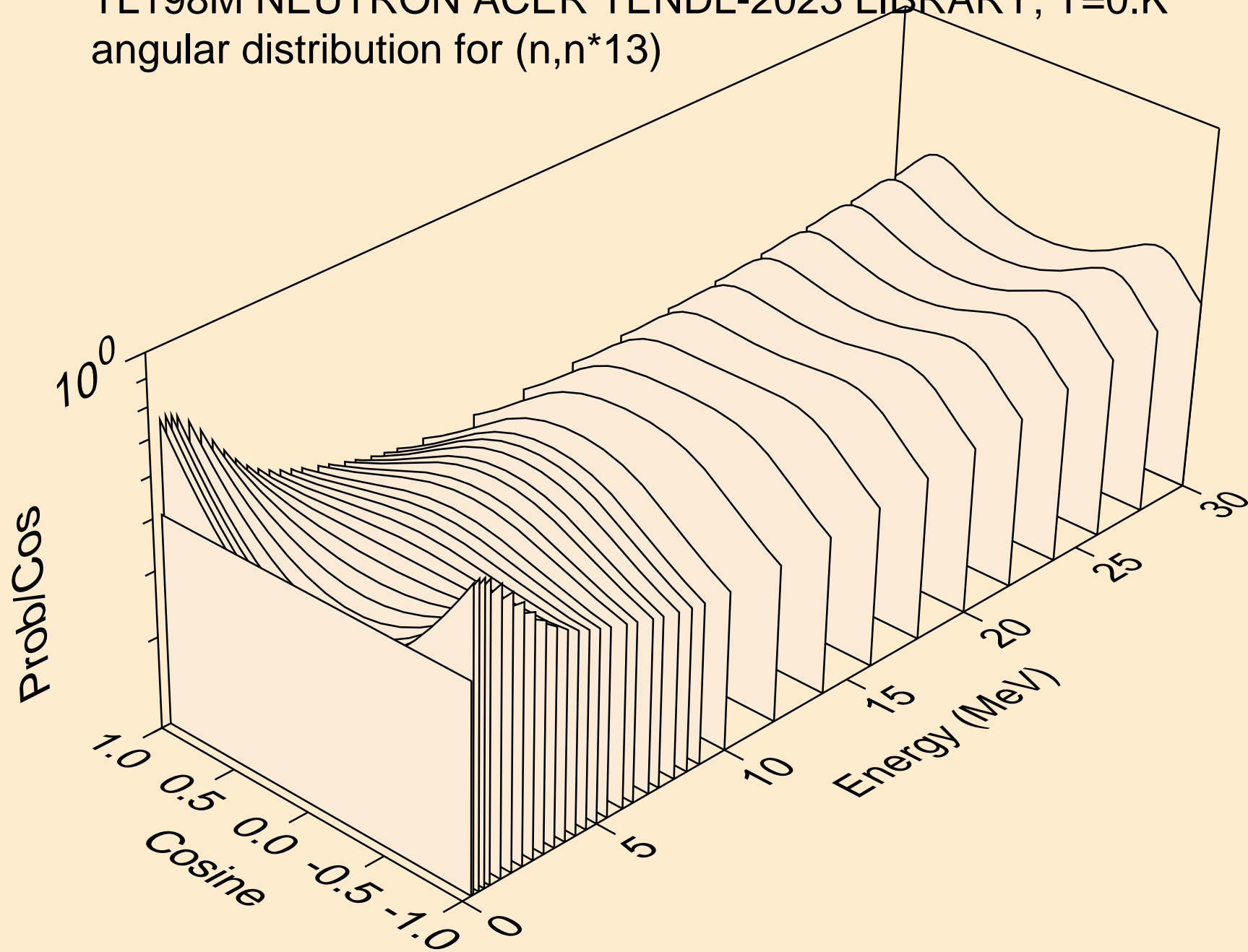

TL198M NEUTRON ACER TENDL-2023 LIBRARY; T=0.K  
angular distribution for (n,n\*14)

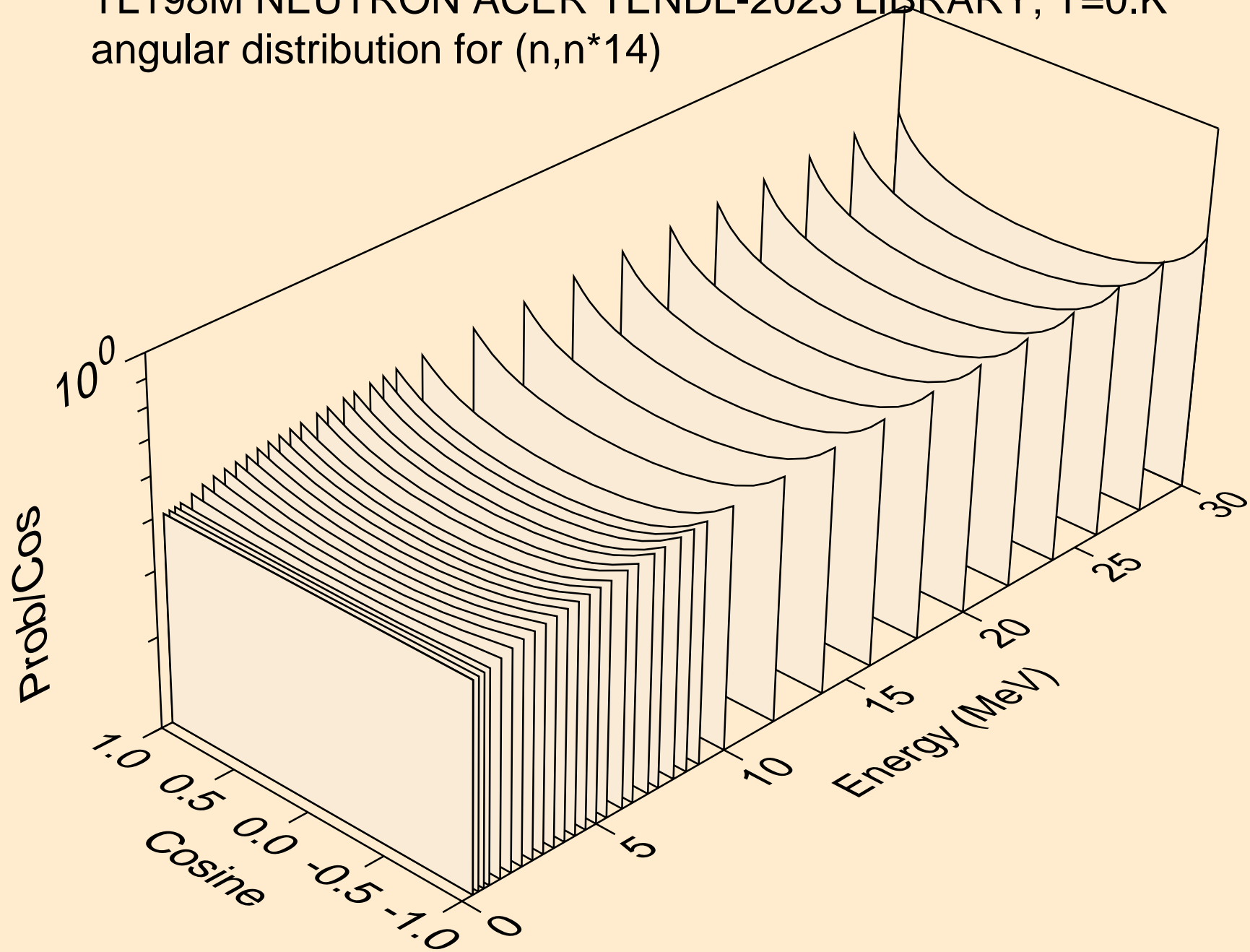

TL198M NEUTRON ACER TENDL-2023 LIBRARY; T=0.K  
angular distribution for (n,n\*15)

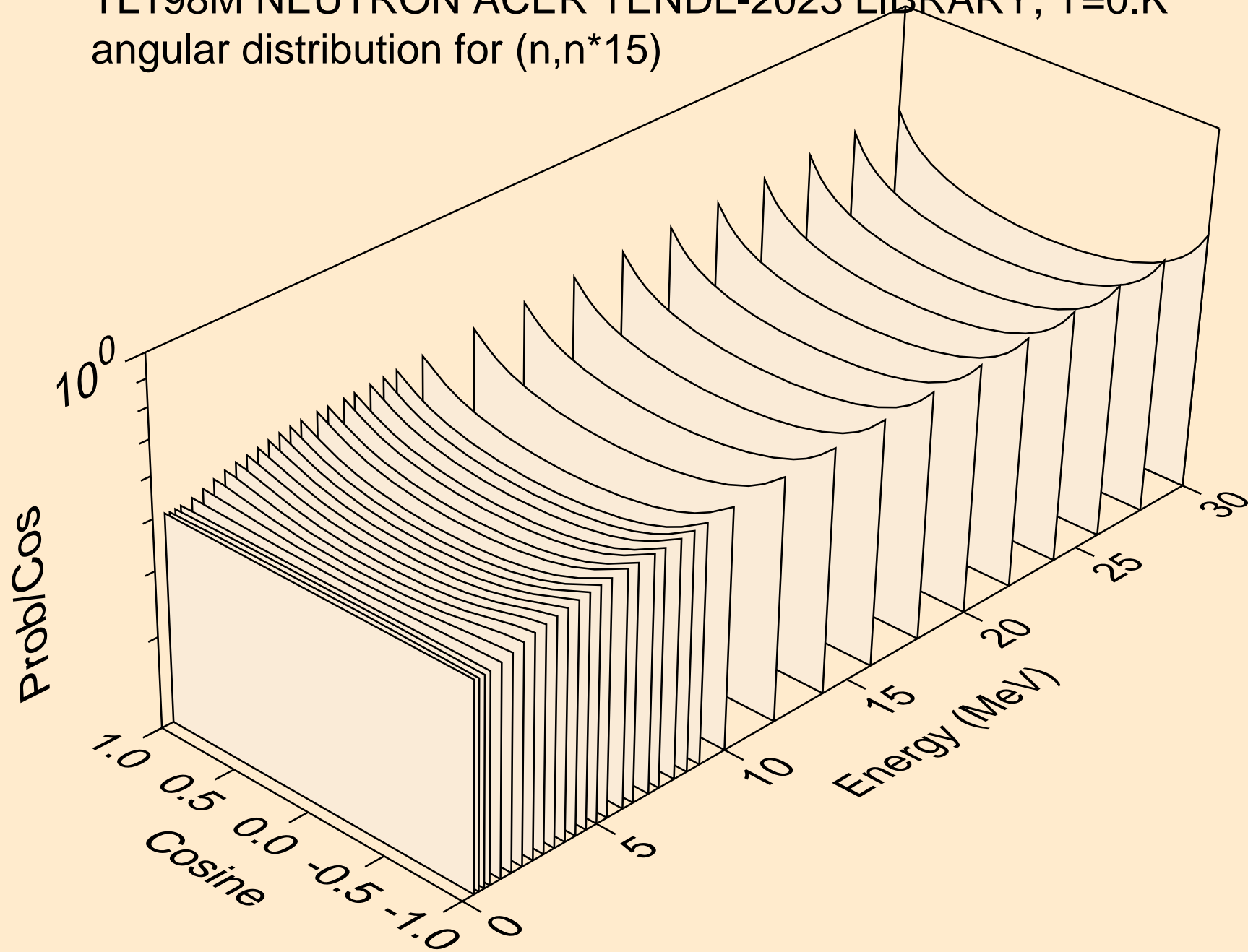

TL198M NEUTRON ACER TENDL-2023 LIBRARY; T=0.K  
angular distribution for (n,n\*16)

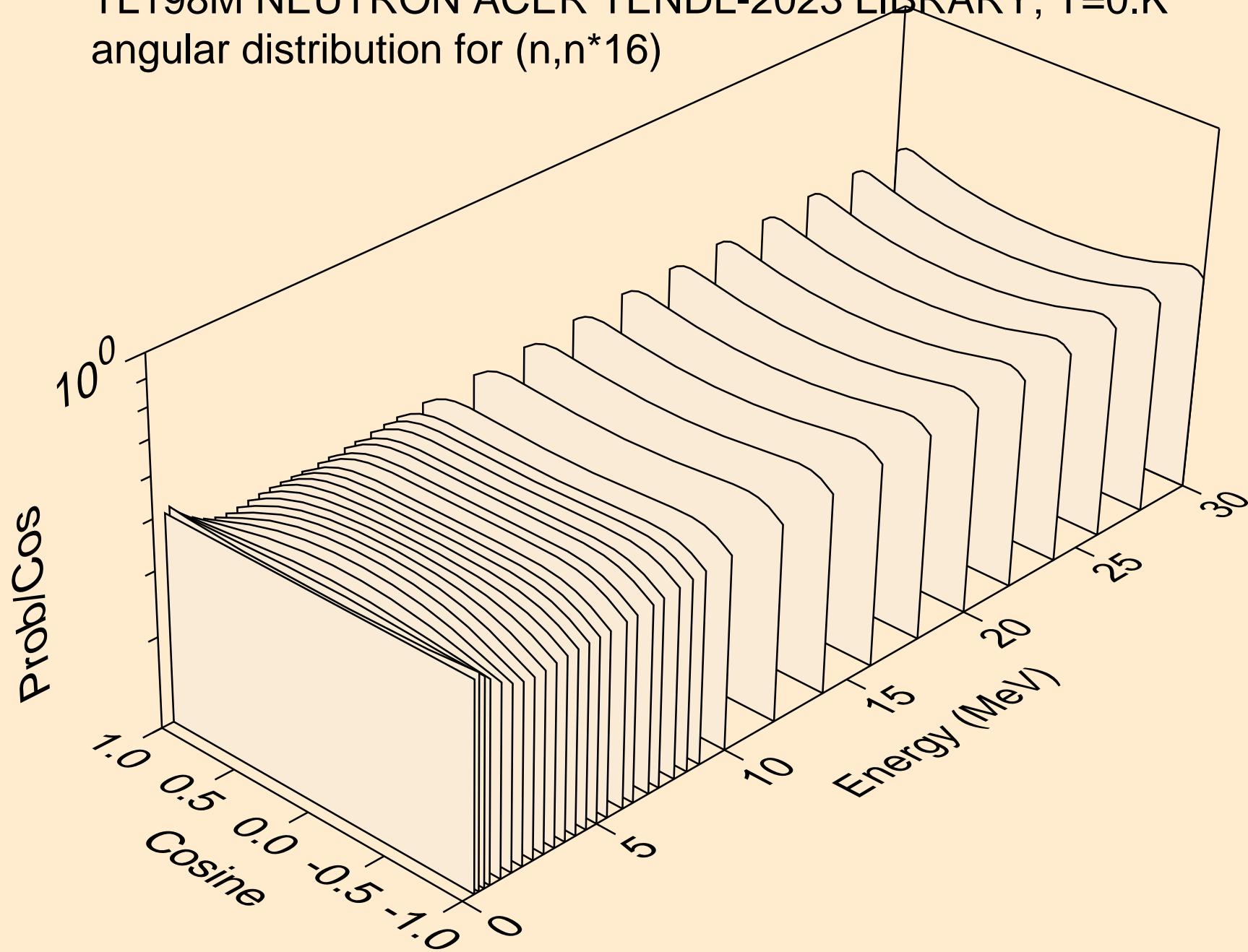

TL198M NEUTRON ACER TENDL-2023 LIBRARY; T=0.K  
angular distribution for (n,n\*17)

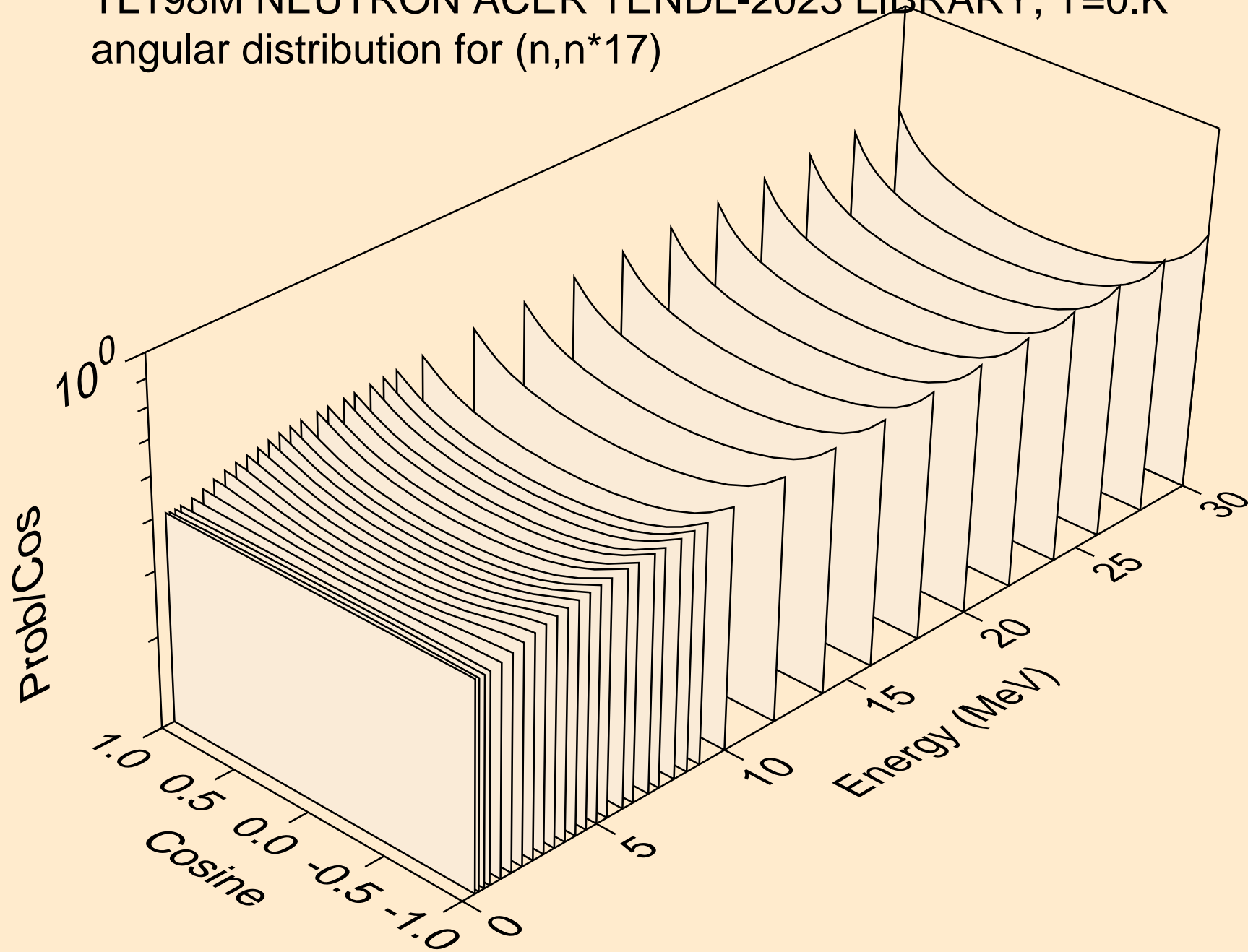

TL198M NEUTRON ACER TENDL-2023 LIBRARY; T=0.K  
Neutron emission for (n,x)

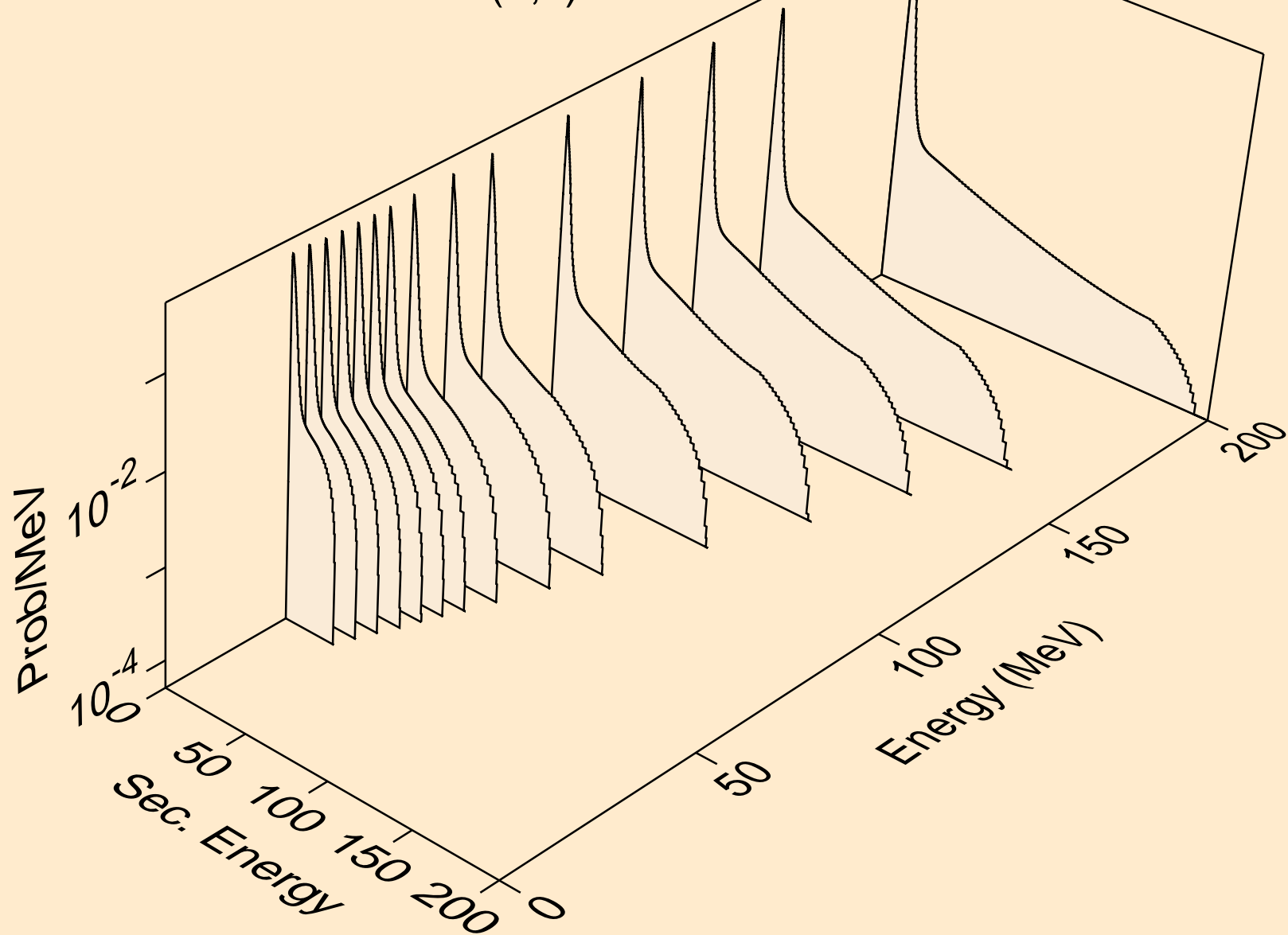

TL198M NEUTRON ACER TENDL-2023 LIBRARY; T=0.K  
Neutron emission for (n,2nd)

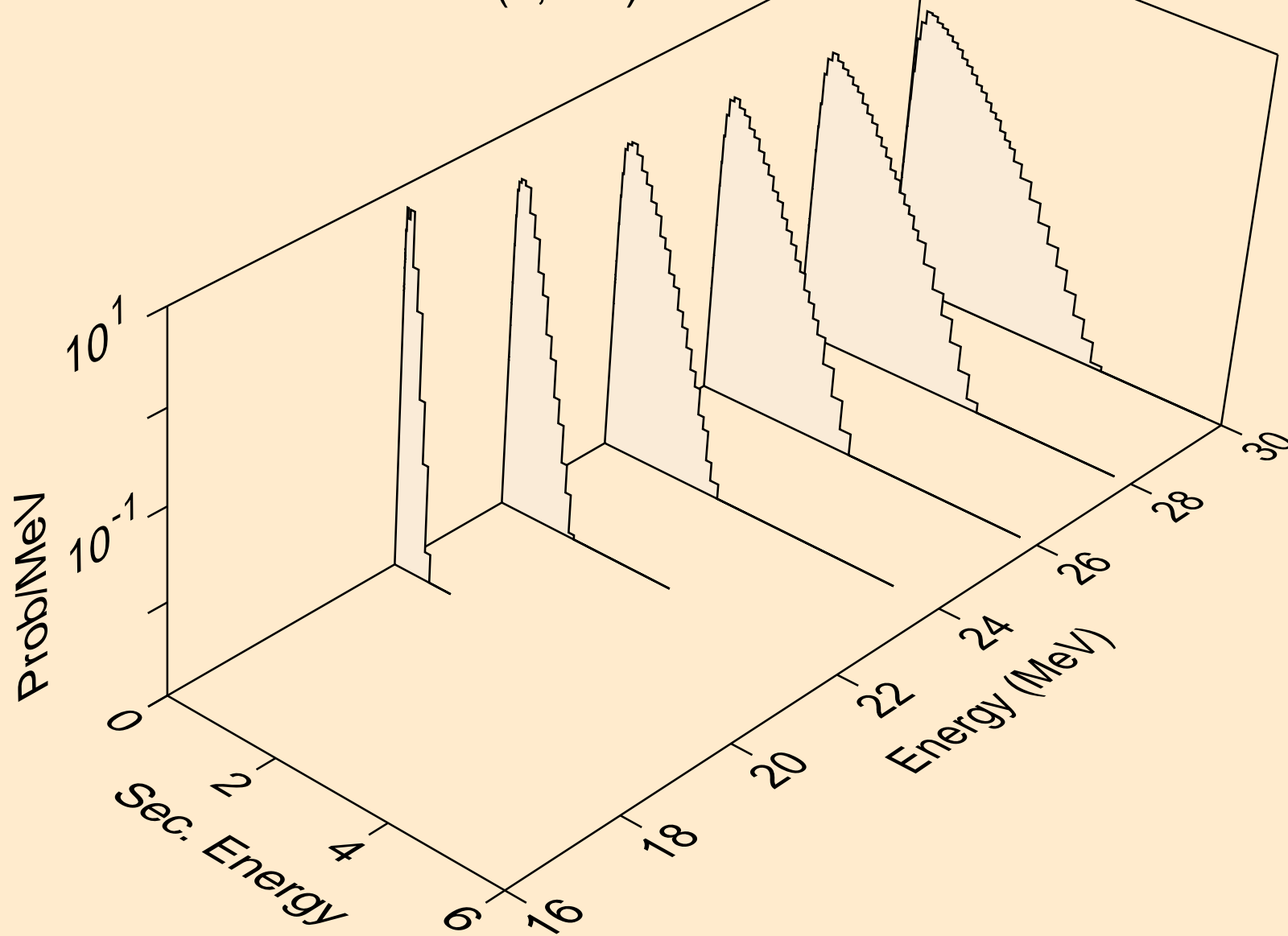



TL198M NEUTRON ACER TENDL-2023 LIBRARY; T=0.K  
Neutron emission for (n,2n)

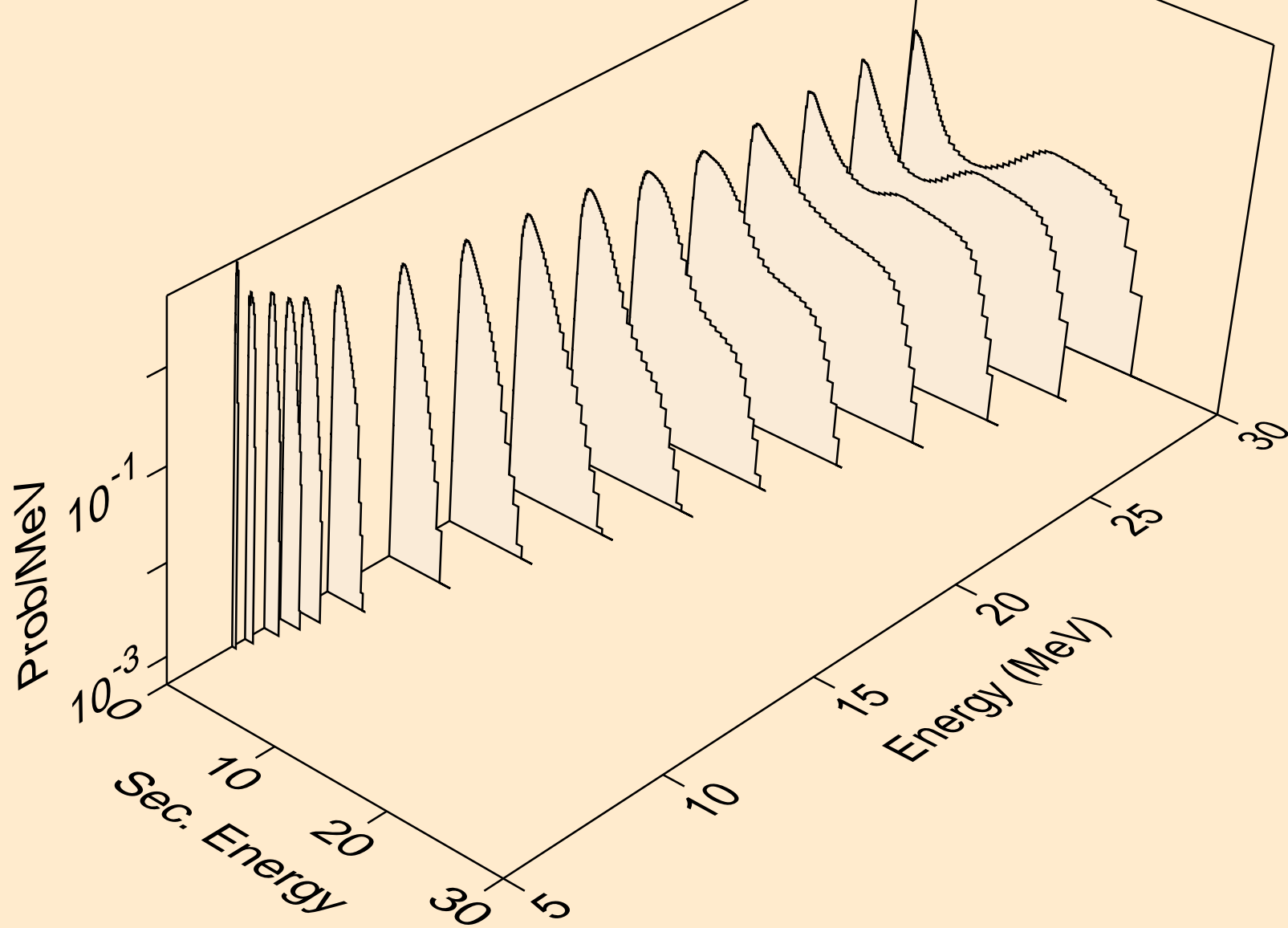

TL198M NEUTRON ACER TENDL-2023 LIBRARY; T=0.K  
Neutron emission for (n,3n)

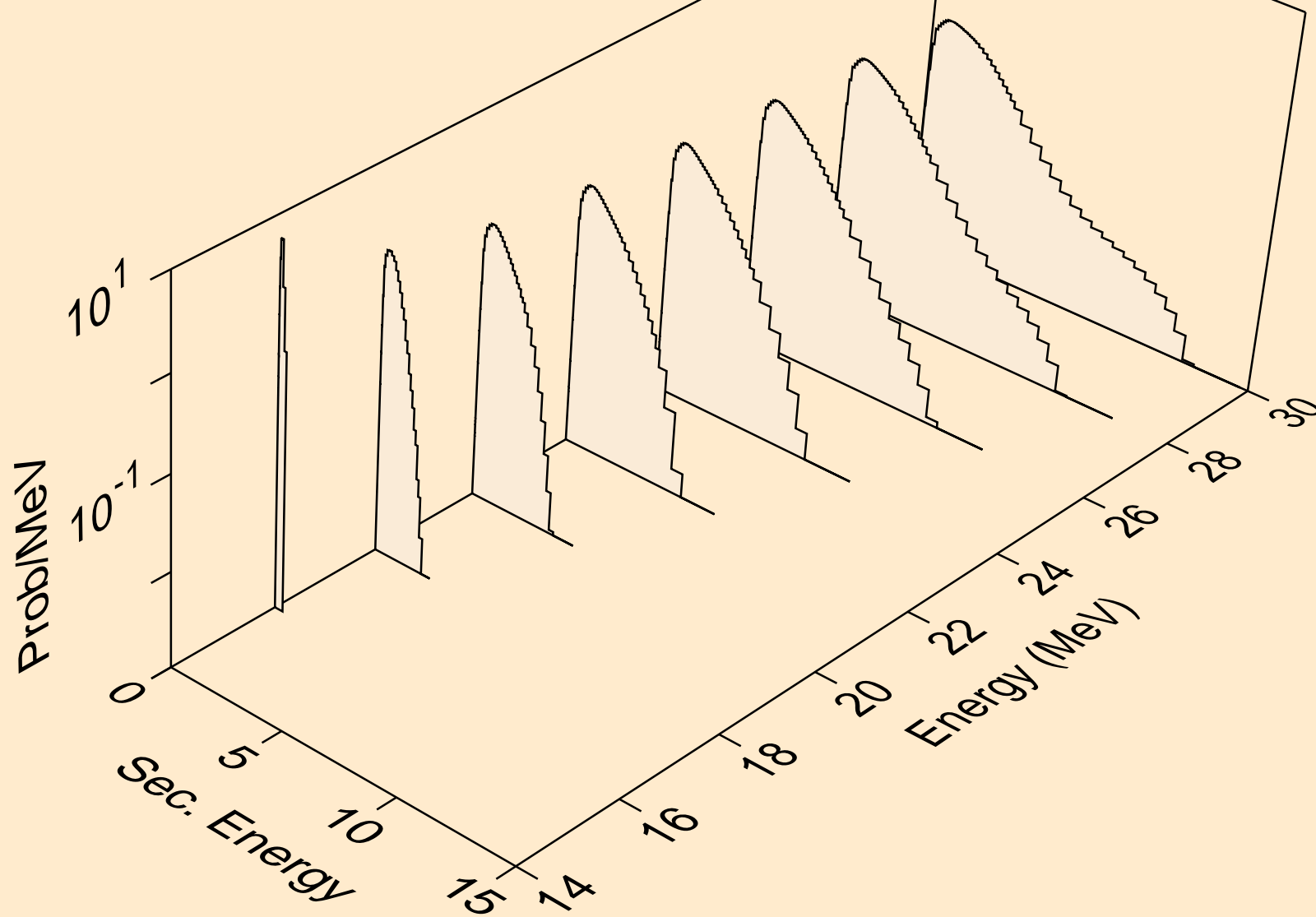

TL198M NEUTRON ACER TENDL-2023 LIBRARY; T=0.K  
Neutron emission for (n,n\*)a

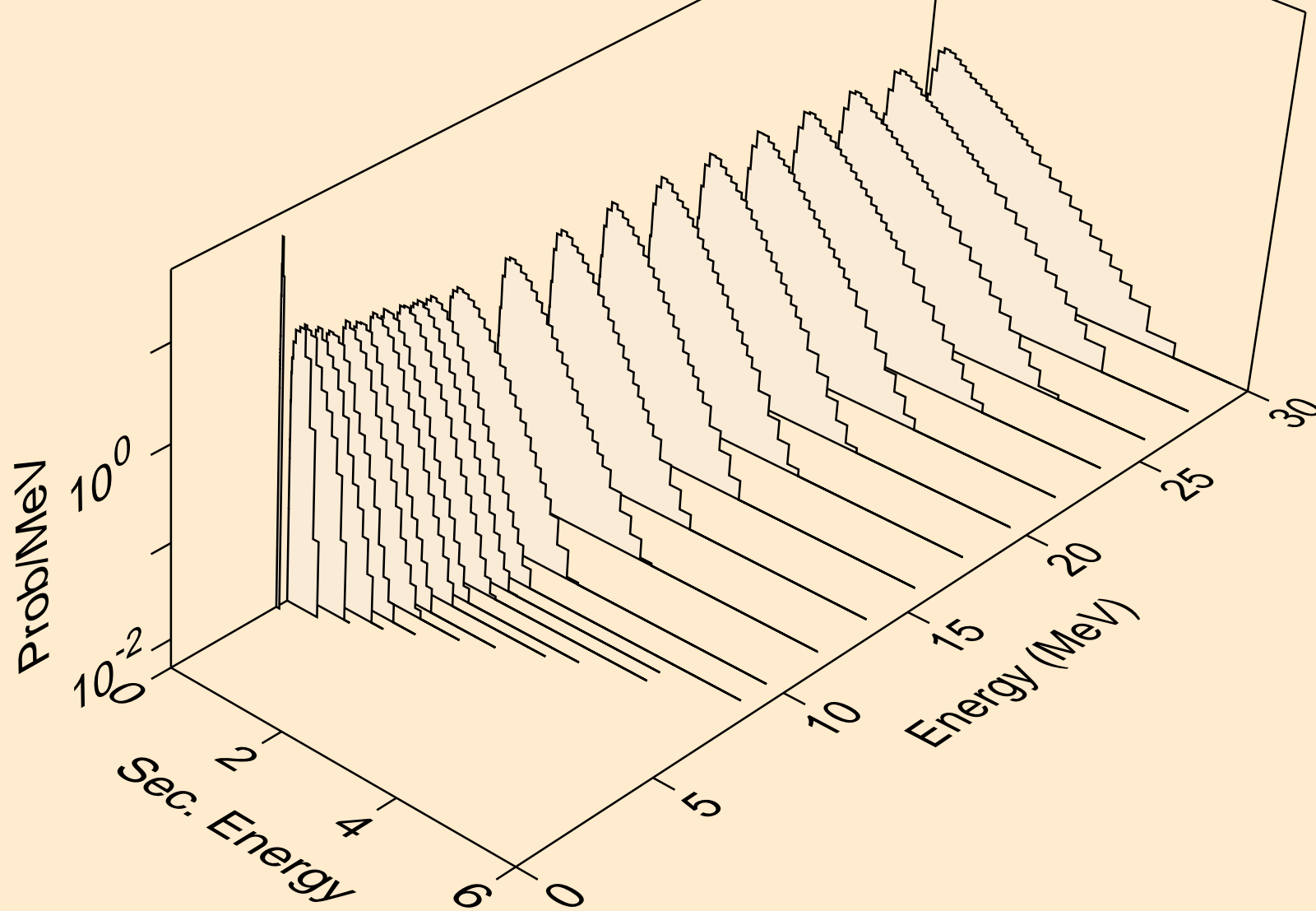

TL198M NEUTRON ACER TENDL-2023 LIBRARY; T=0.K  
Neutron emission for (n,2n)a

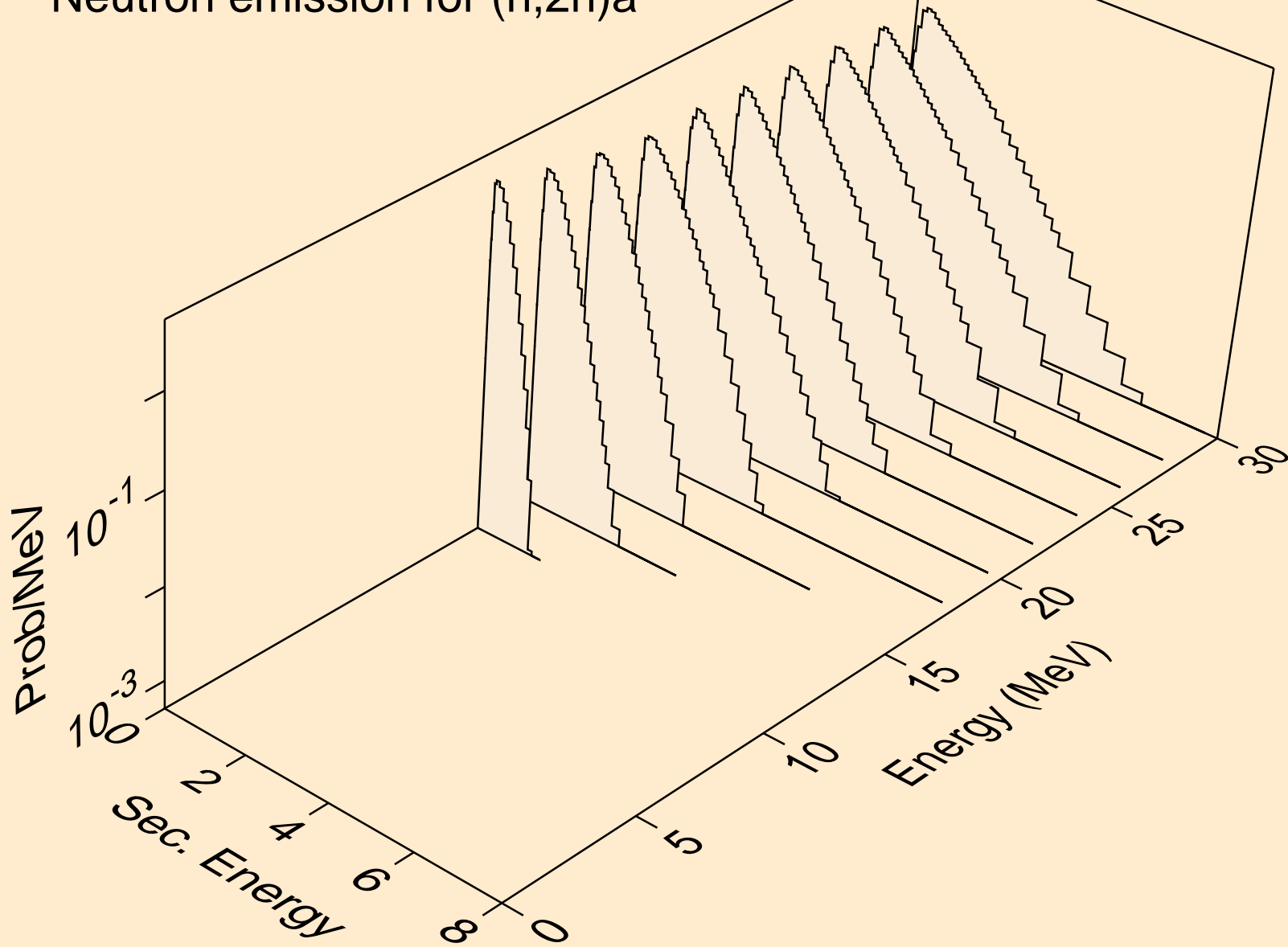

TL198M NEUTRON ACER TENDL-2023 LIBRARY; T=0.K  
Neutron emission for (n,3n)a

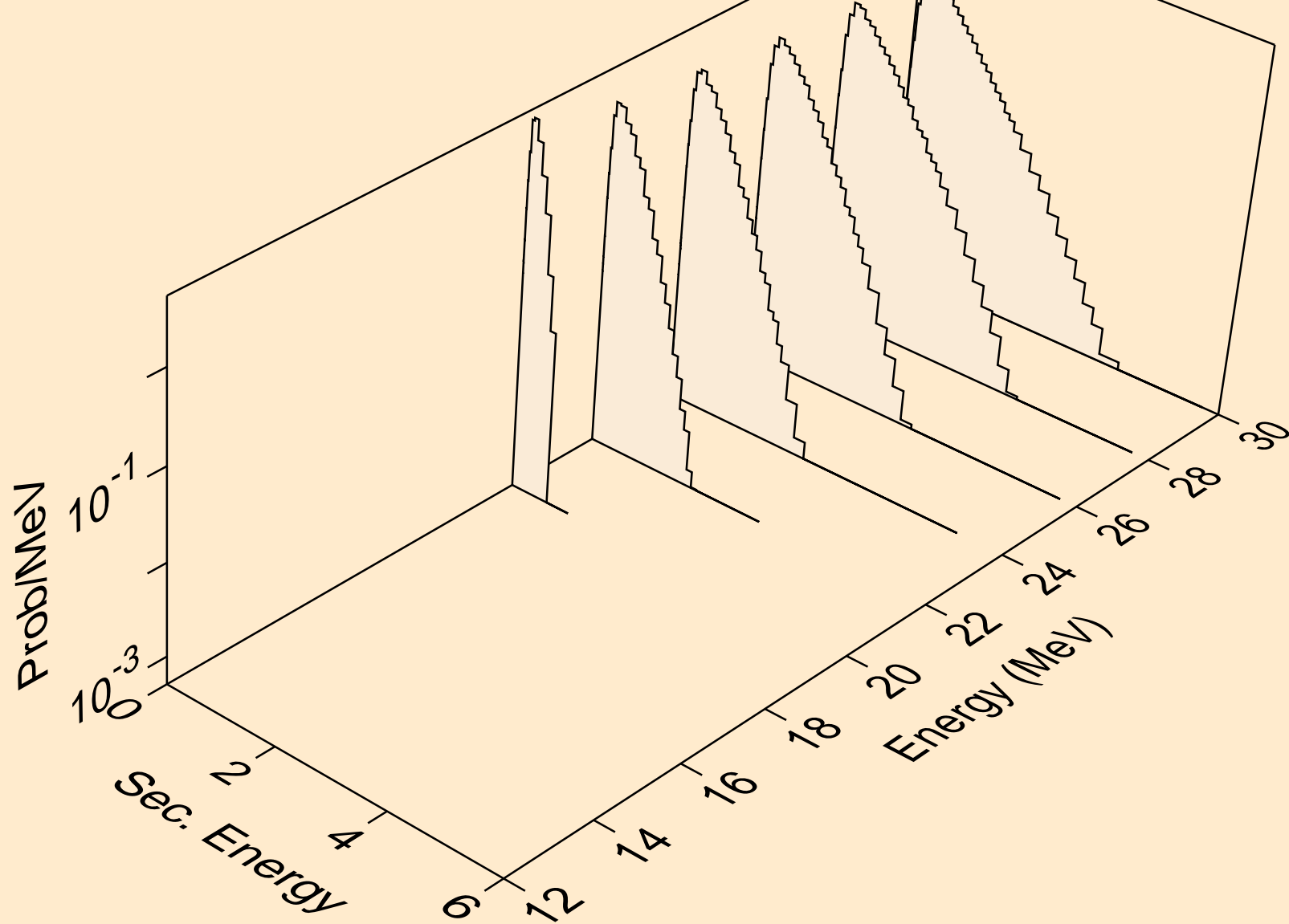

TL198M NEUTRON ACER TENDL-2023 LIBRARY; T=0.K  
Neutron emission for (n,n\*)p

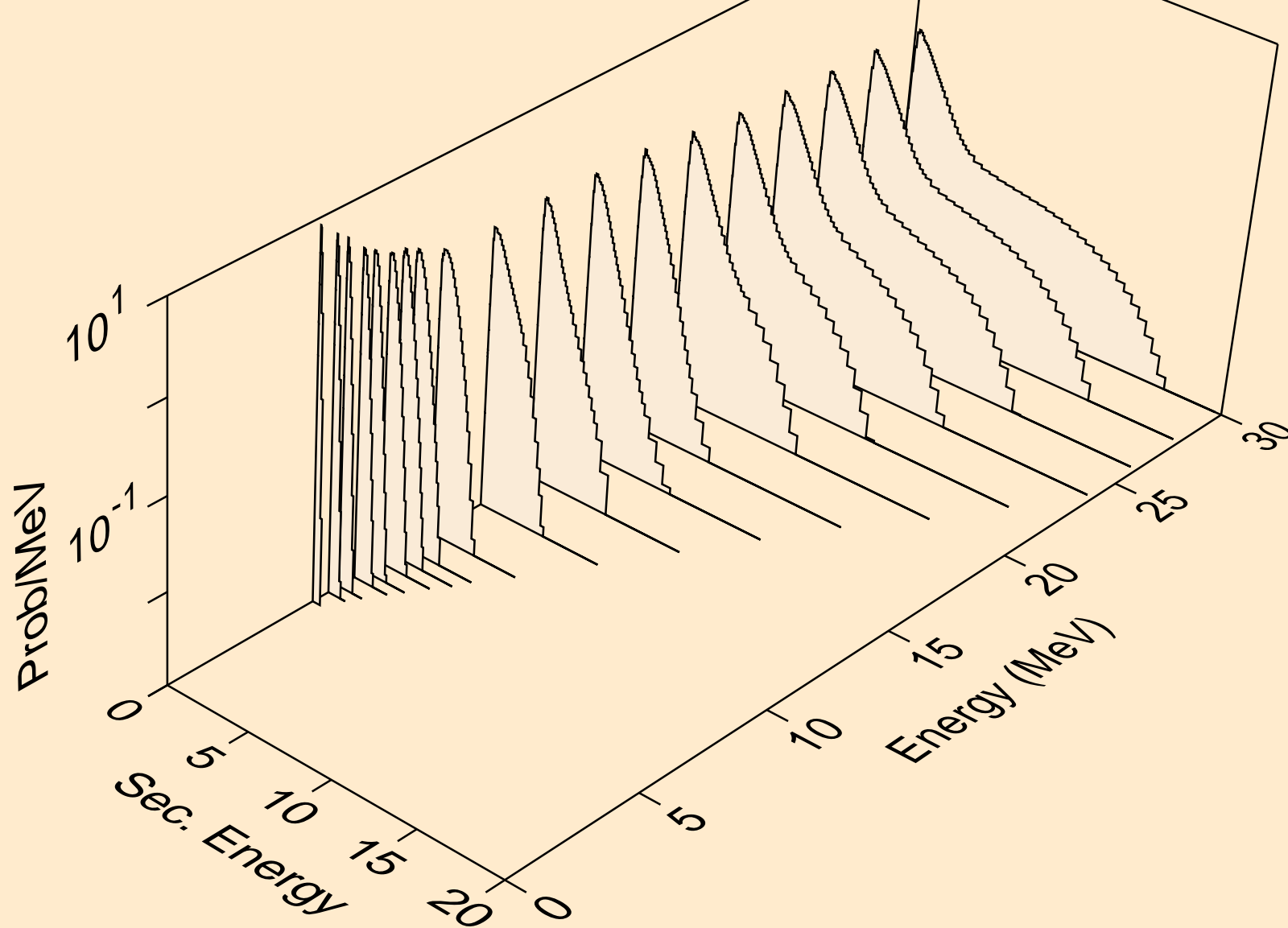

TL198M NEUTRON ACER TENDL-2023 LIBRARY; T=0.K  
Neutron emission for (n,n\*)2a

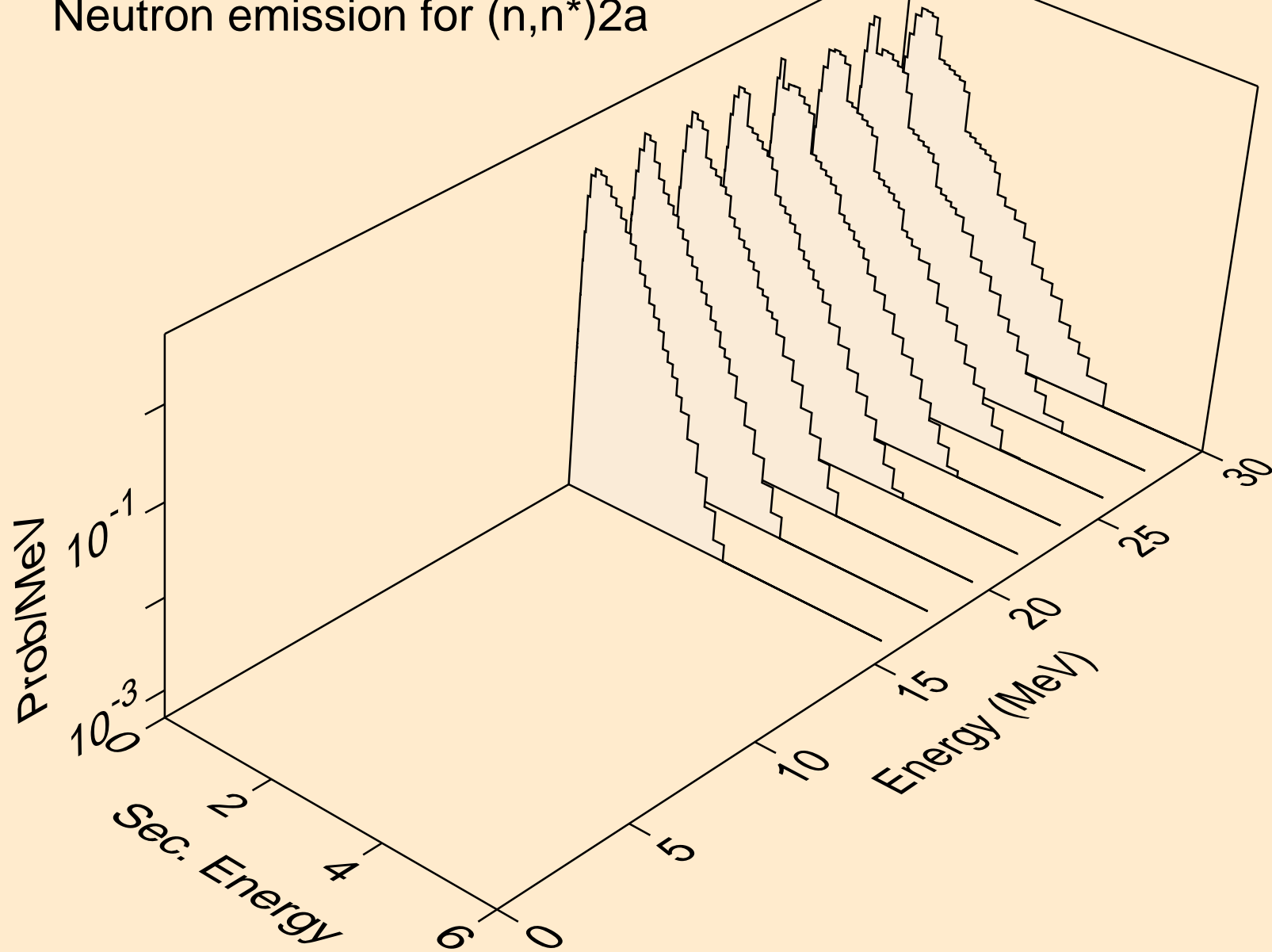

TL198M NEUTRON ACER TENDL-2023 LIBRARY; T=0.K  
Neutron emission for (n,n\*)d

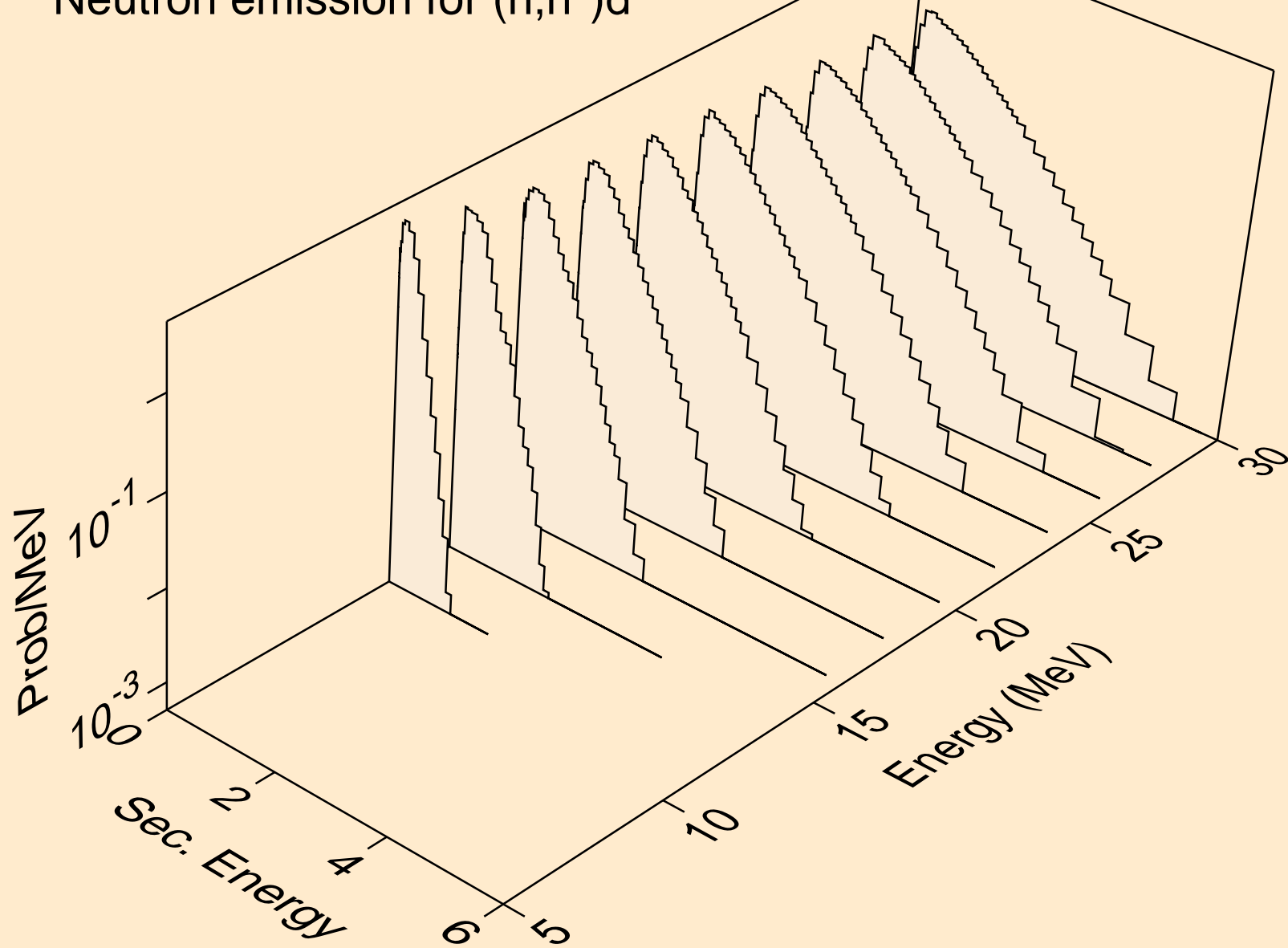



TL198M NEUTRON ACER TENDL-2023 LIBRARY; T=0.K  
Neutron emission for (n,n\*)t

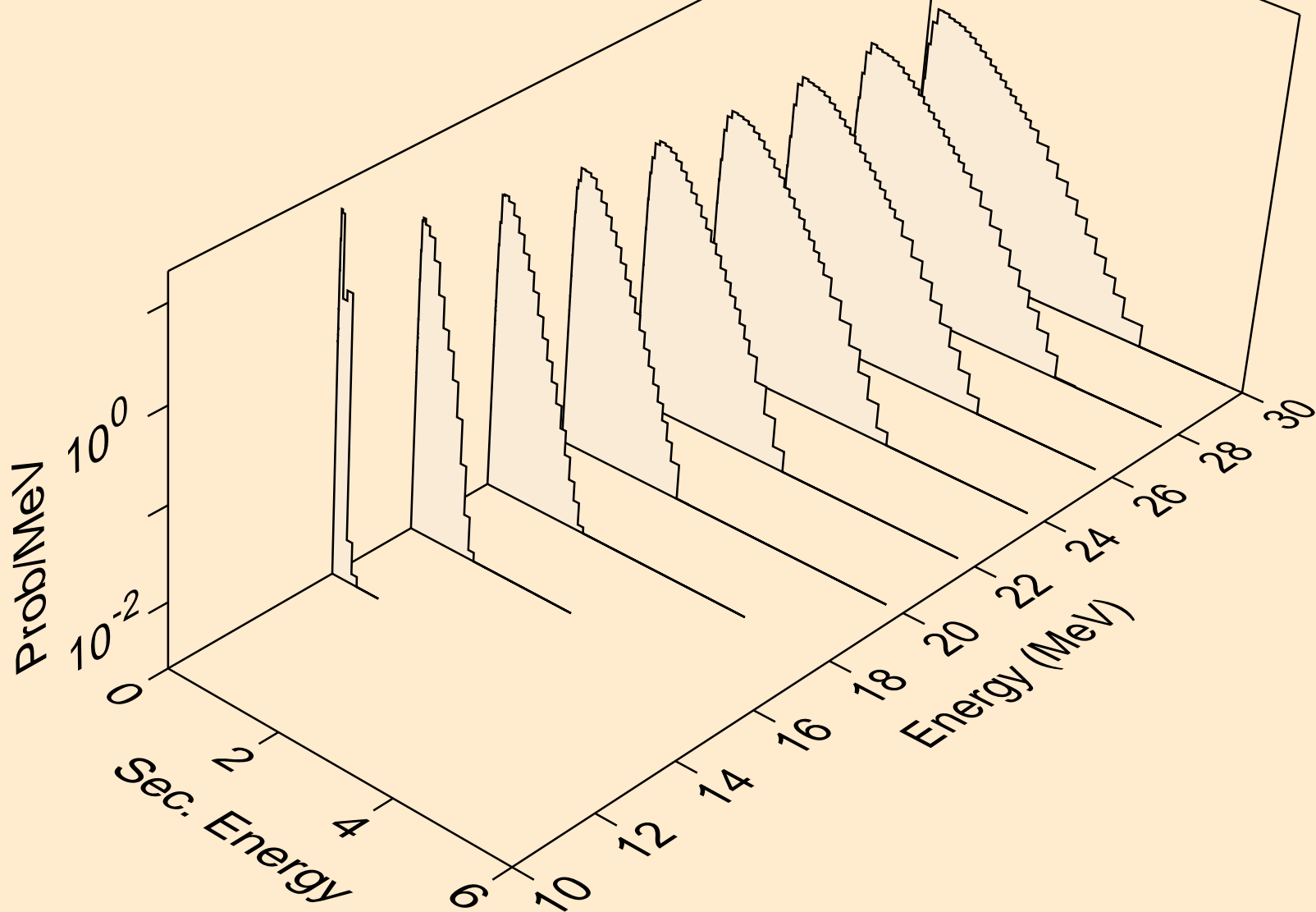

TL198M NEUTRON ACER TENDL-2023 LIBRARY; T=0.K  
Neutron emission for (n,n\*)he3

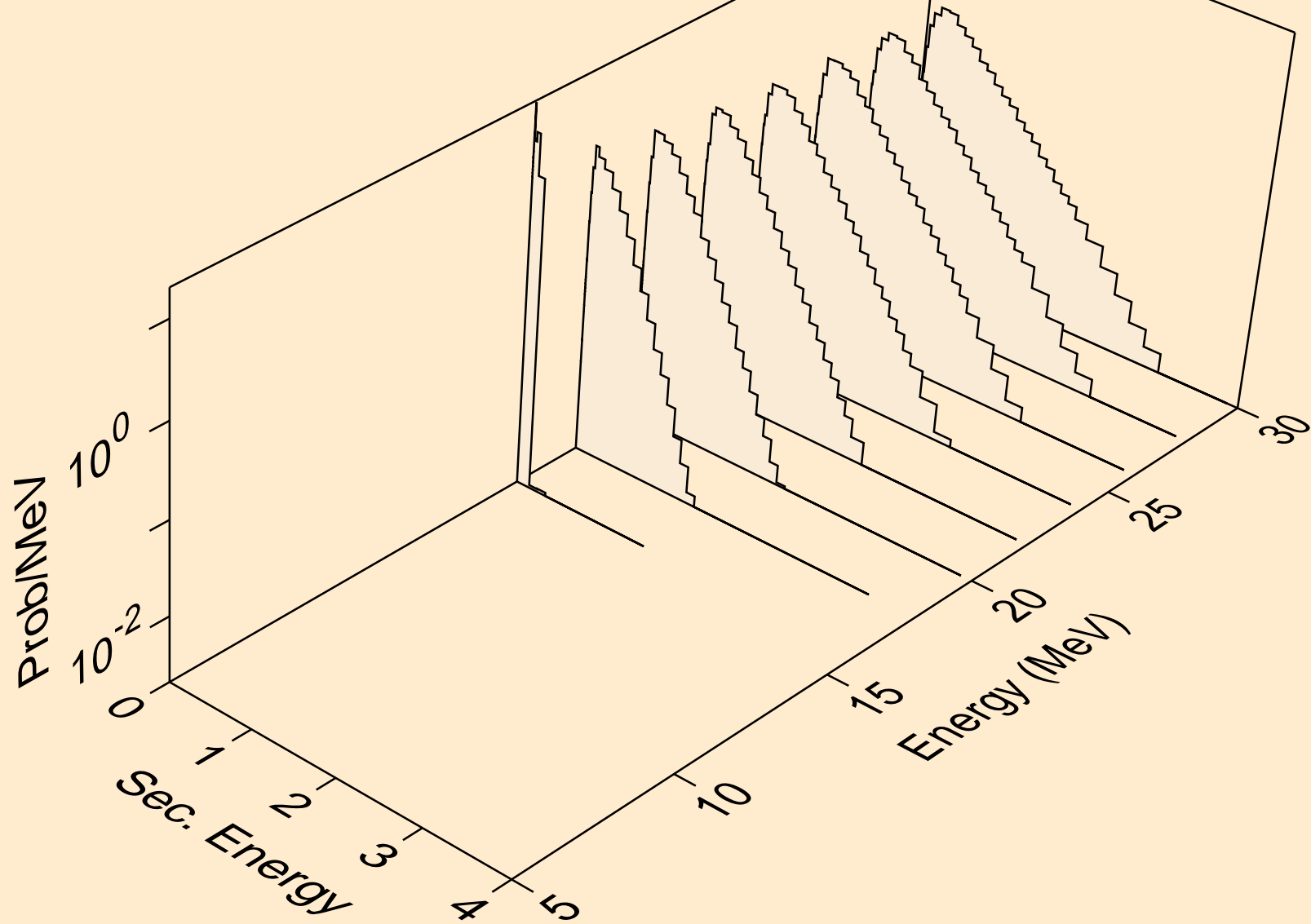

TL198M NEUTRON ACER TENDL-2023 LIBRARY; T=0.K  
Neutron emission for (n,4n)

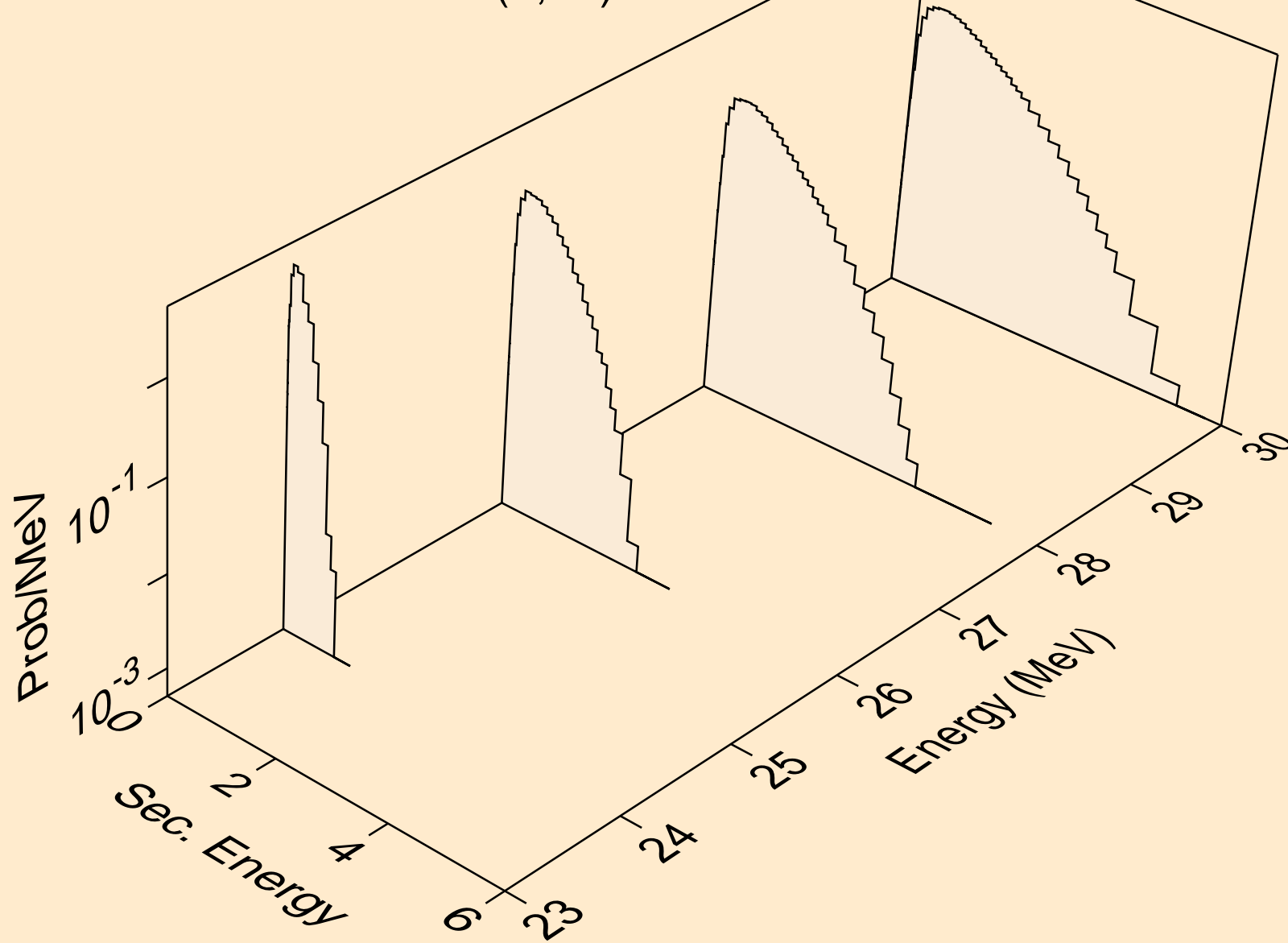

TL198M NEUTRON ACER TENDL-2023 LIBRARY; T=0.K  
Neutron emission for (n,2np)

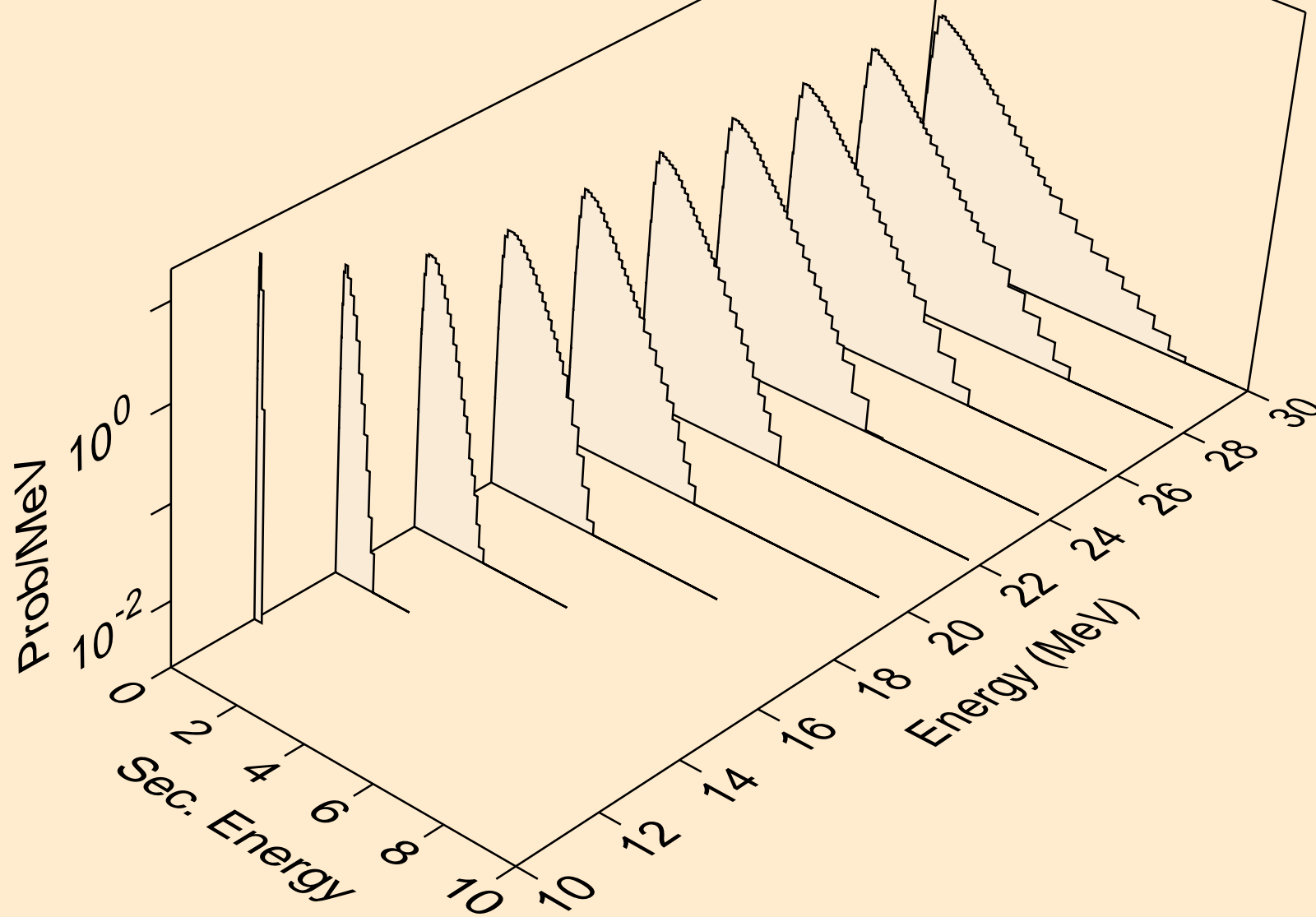

TL198M NEUTRON ACER TENDL-2023 LIBRARY; T=0.K  
Neutron emission for (n,3np)

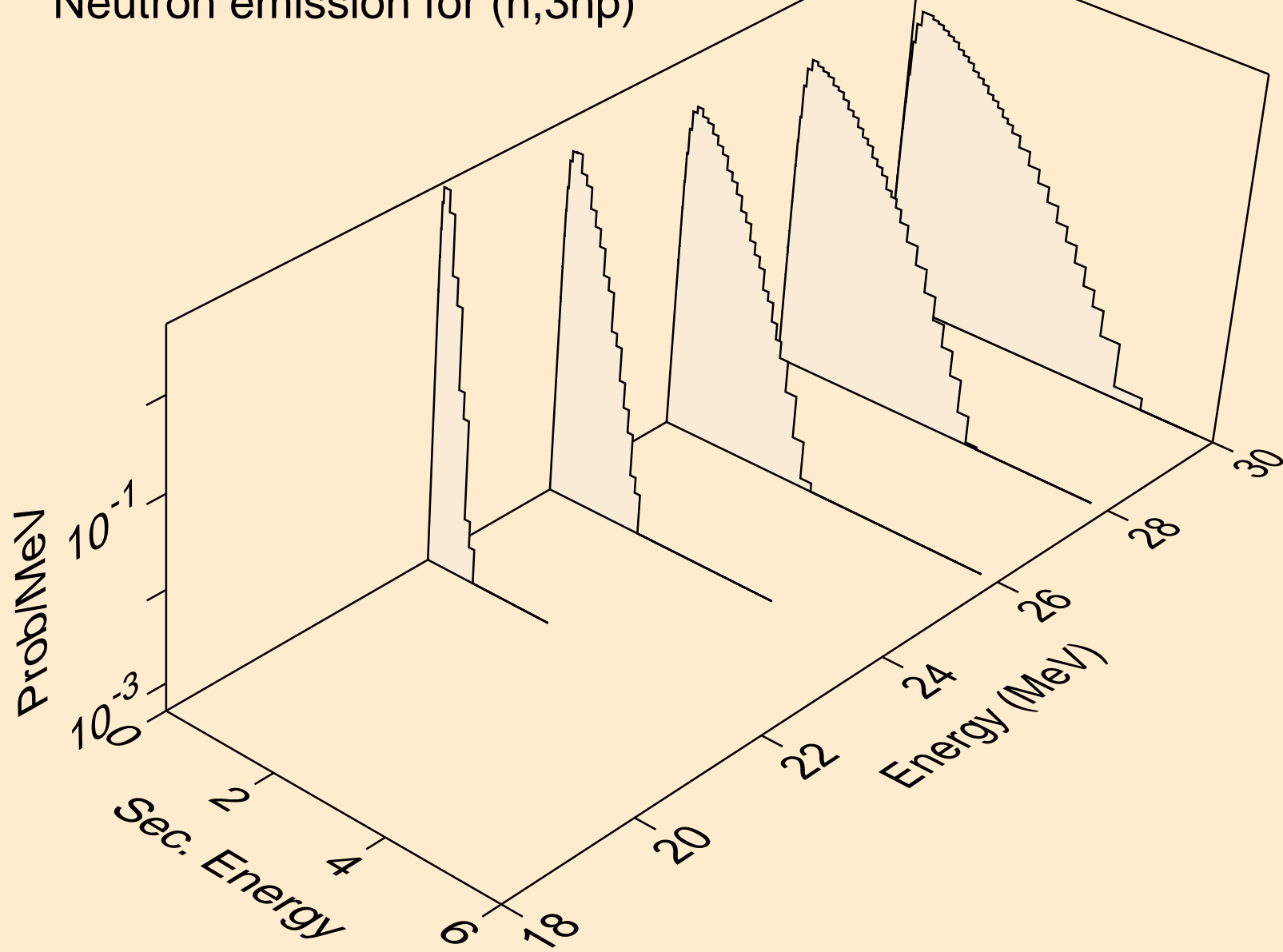

TL198M NEUTRON ACER TENDL-2023 LIBRARY; T=0.K  
Neutron emission for (n,n2p)

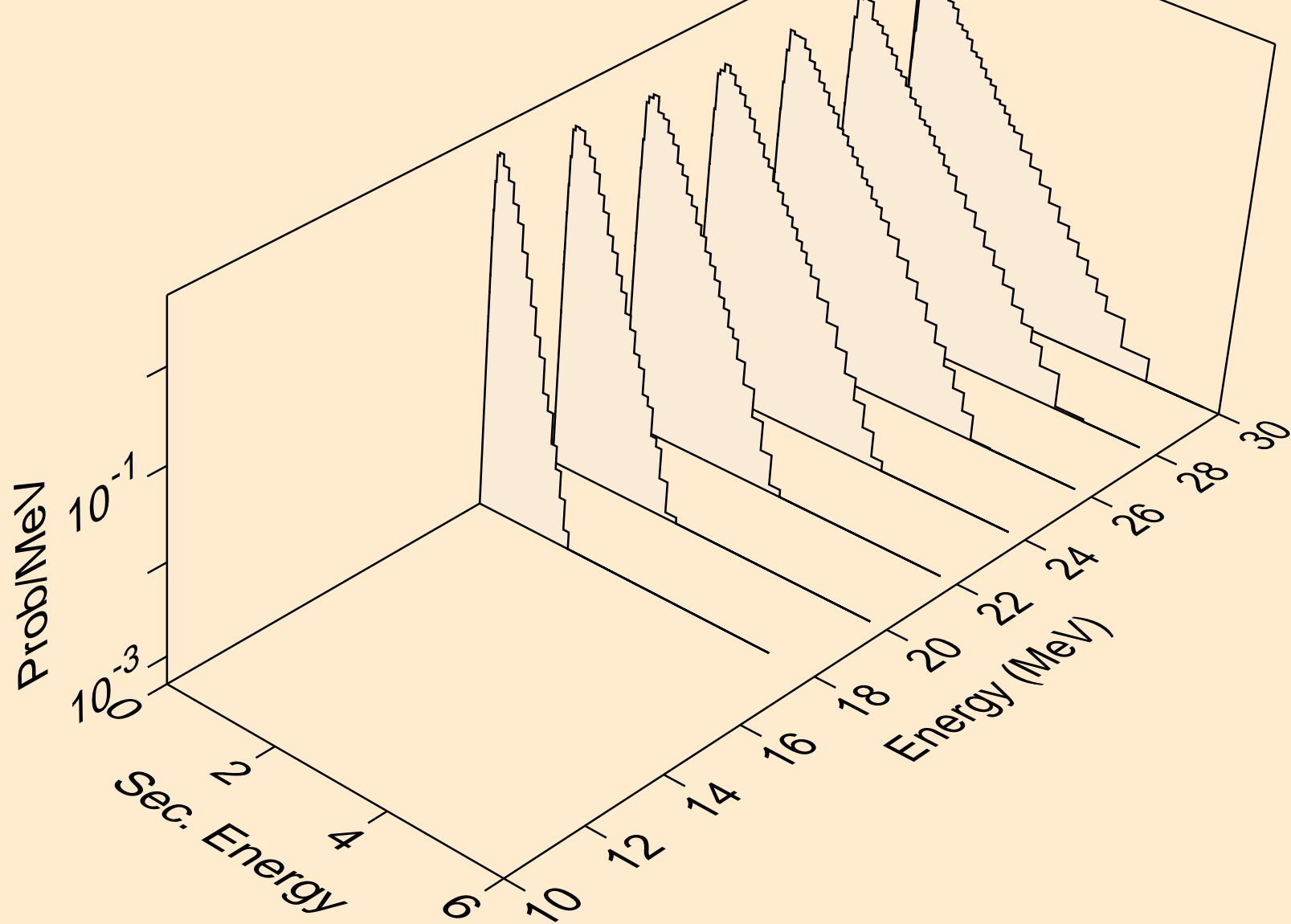

TL198M NEUTRON ACER TENDL-2023 LIBRARY; T=0.K  
Neutron emission for (n,npa)

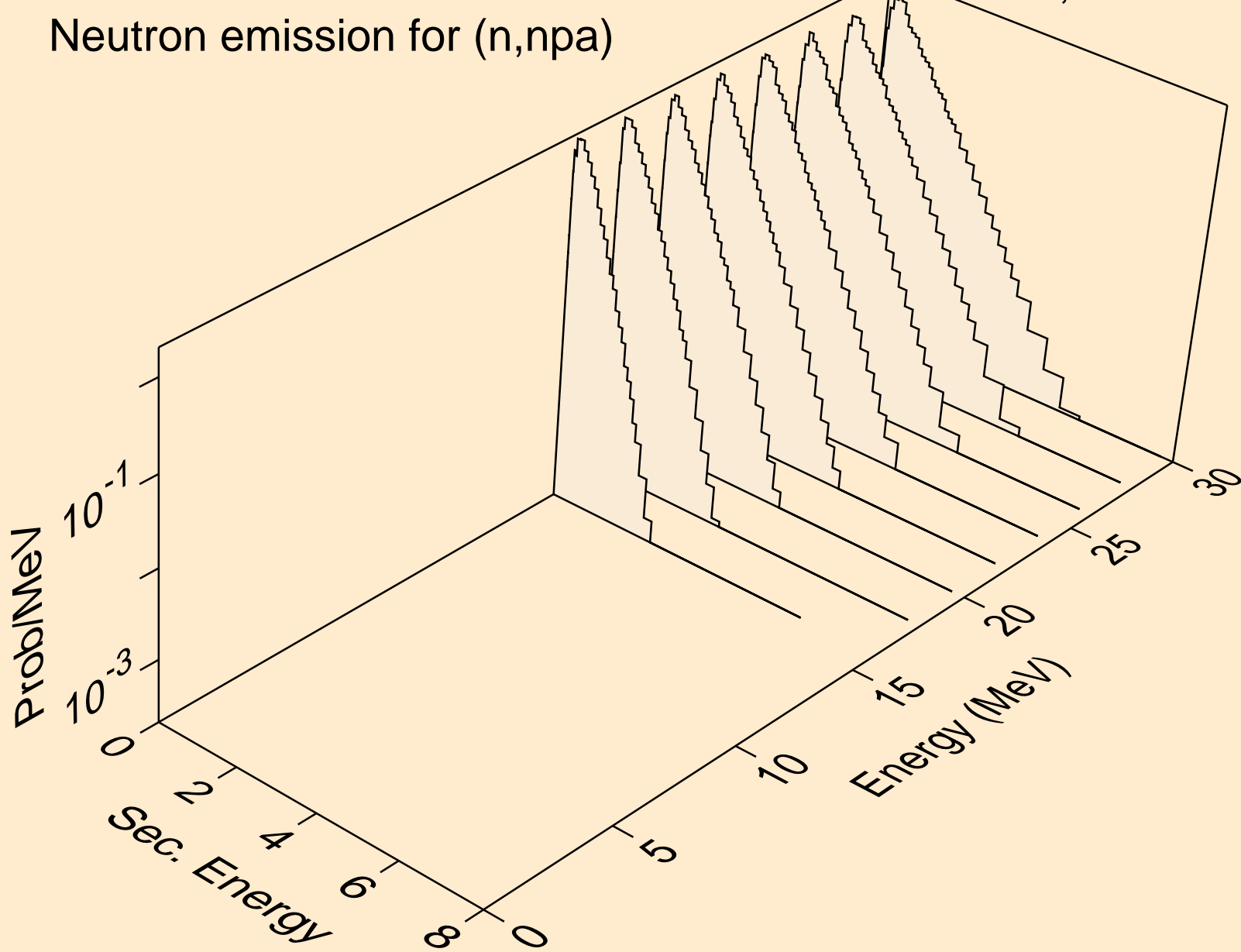

TL198M NEUTRON ACER TENDL-2023 LIBRARY; T=0.K  
Neutron emission for (n,n\*c)

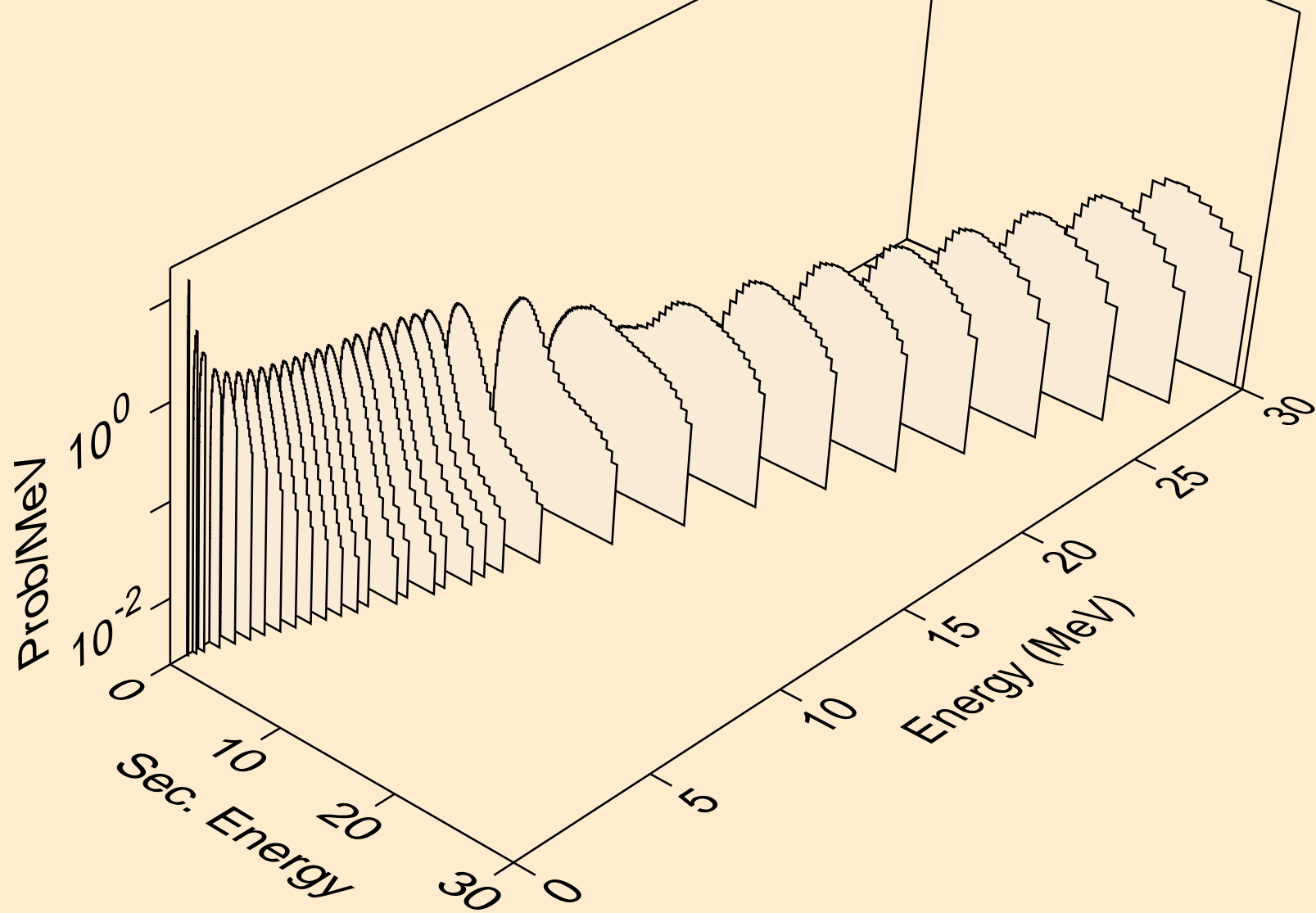



TL198M NEUTRON ACER TENDL-2023 LIBRARY; T=0.K  
Photon emission for (n,x)

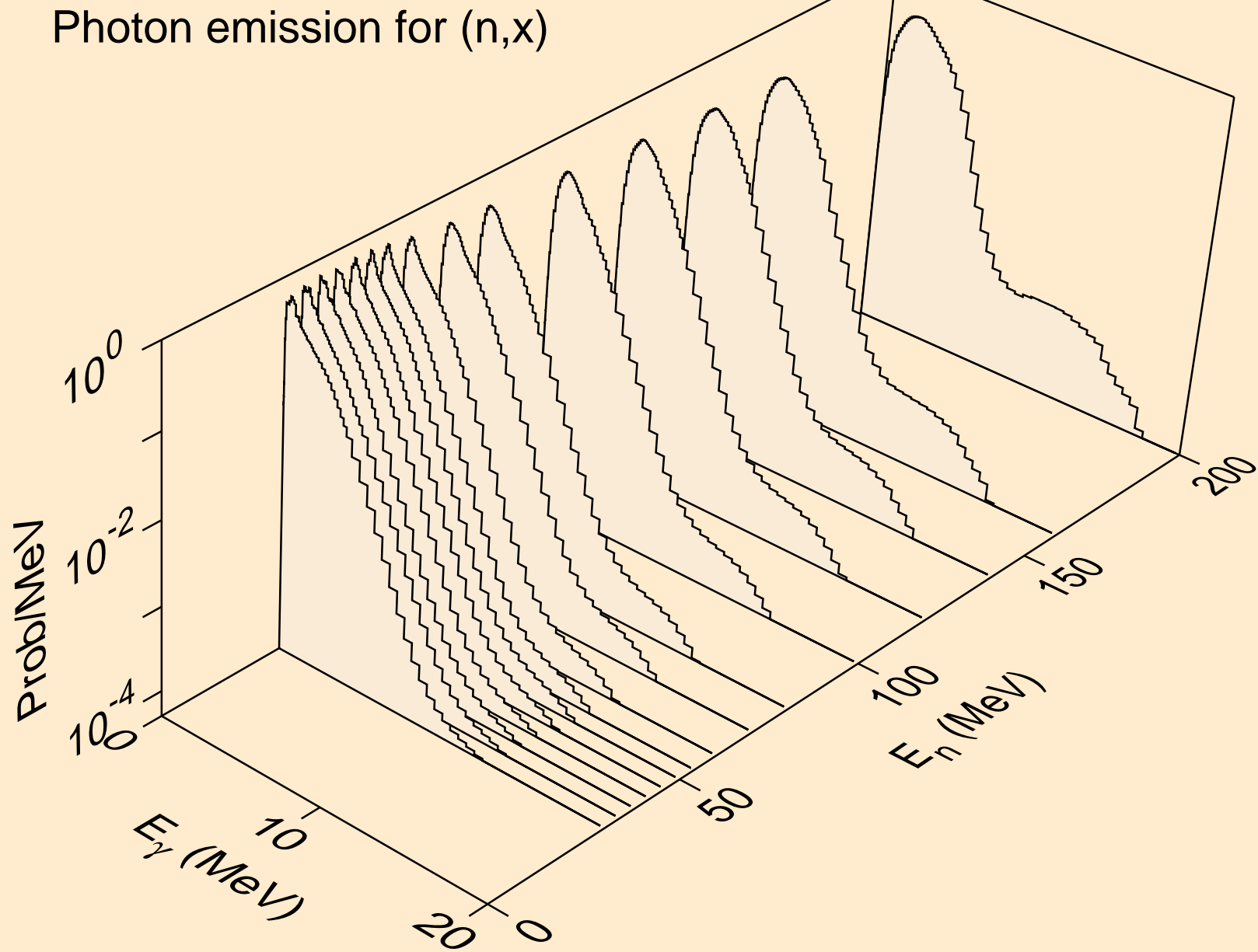

TL198M NEUTRON ACER TENDL-2023 LIBRARY; T=0.K  
Photon emission for (n,2nd)

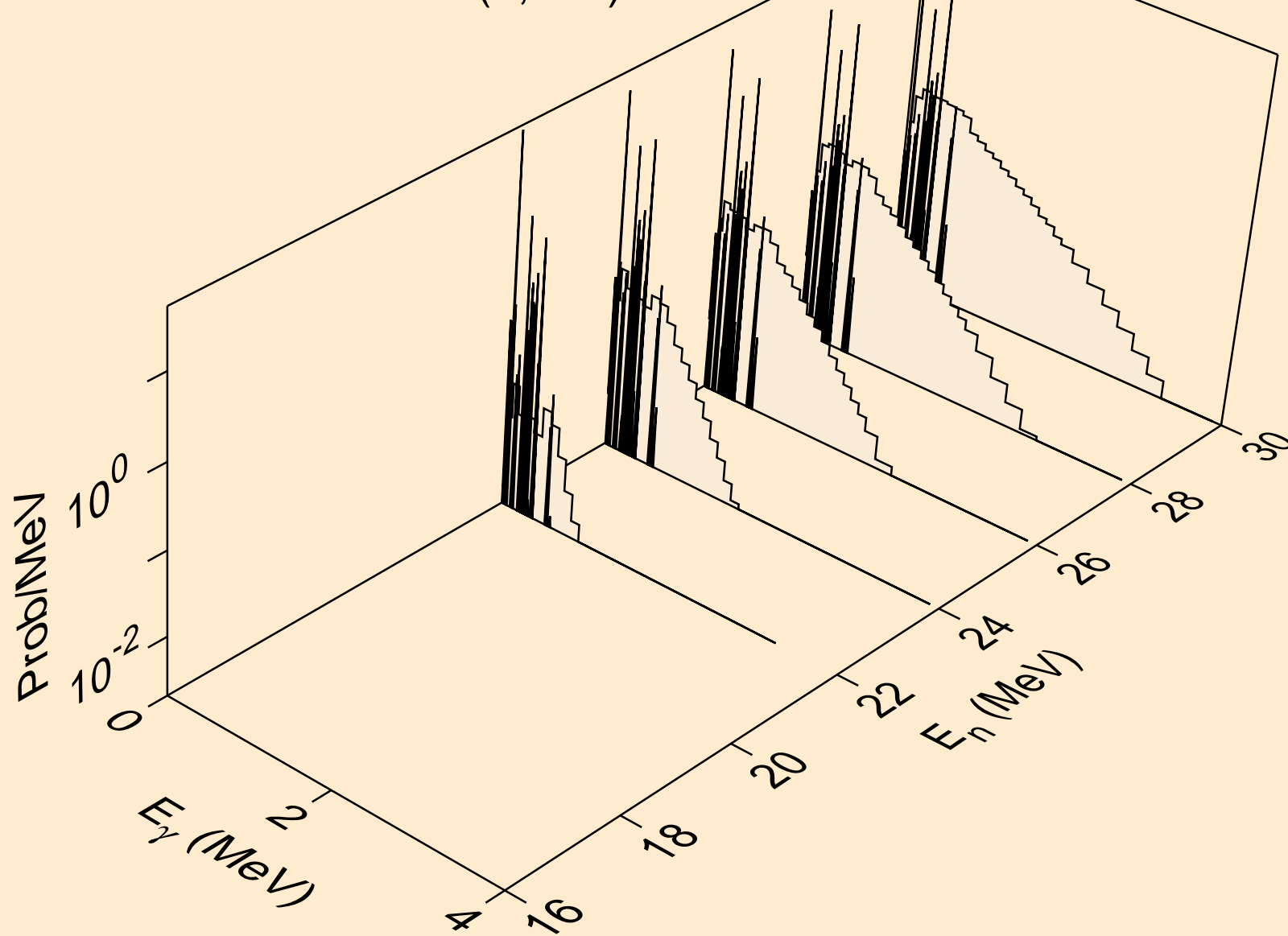

TL198M NEUTRON ACER TENDL-2023 LIBRARY; T=0.K  
Photon emission for (n,2n)

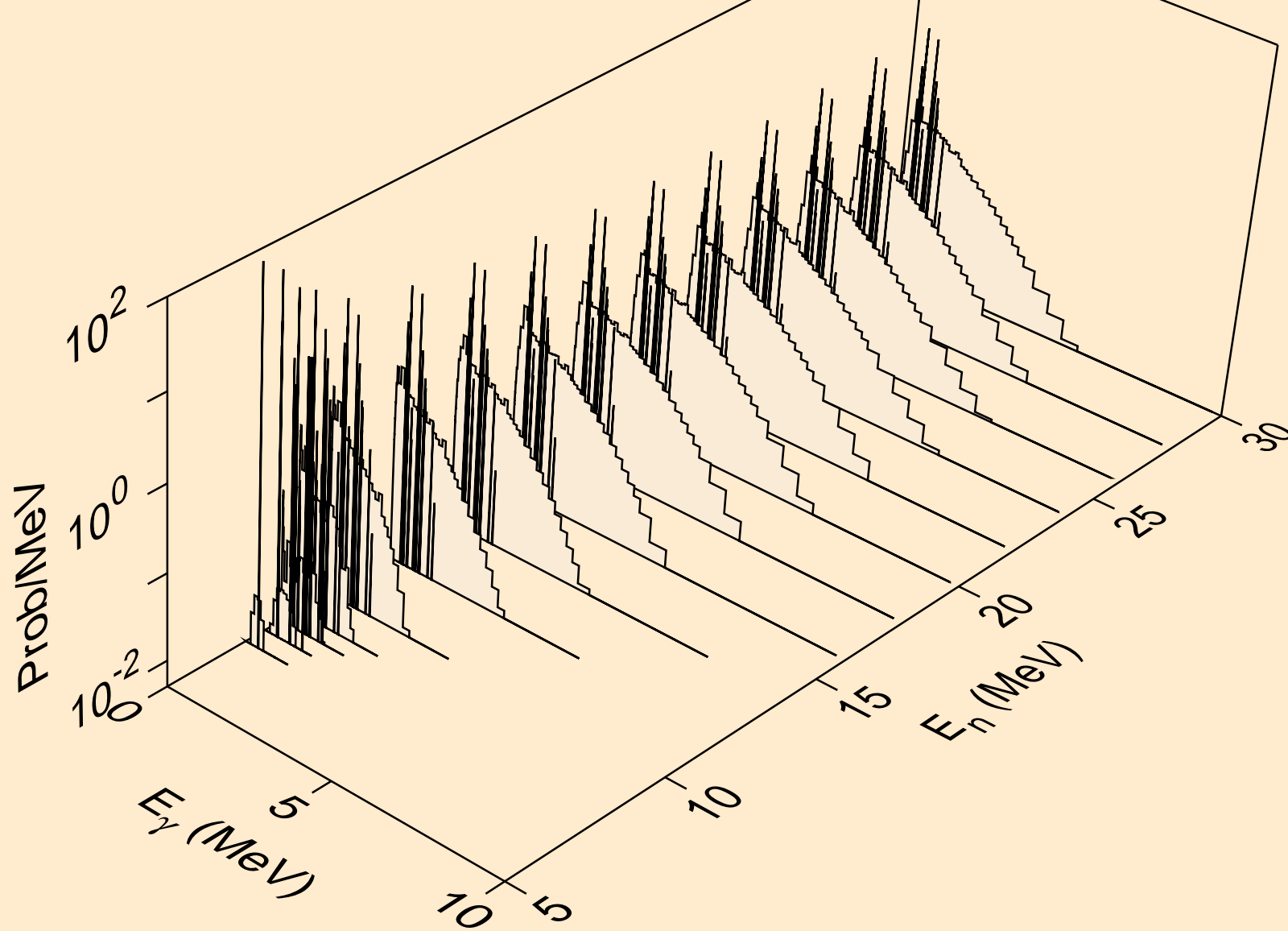

TL198M NEUTRON ACER TENDL-2023 LIBRARY; T=0.K  
Photon emission for (n,3n)

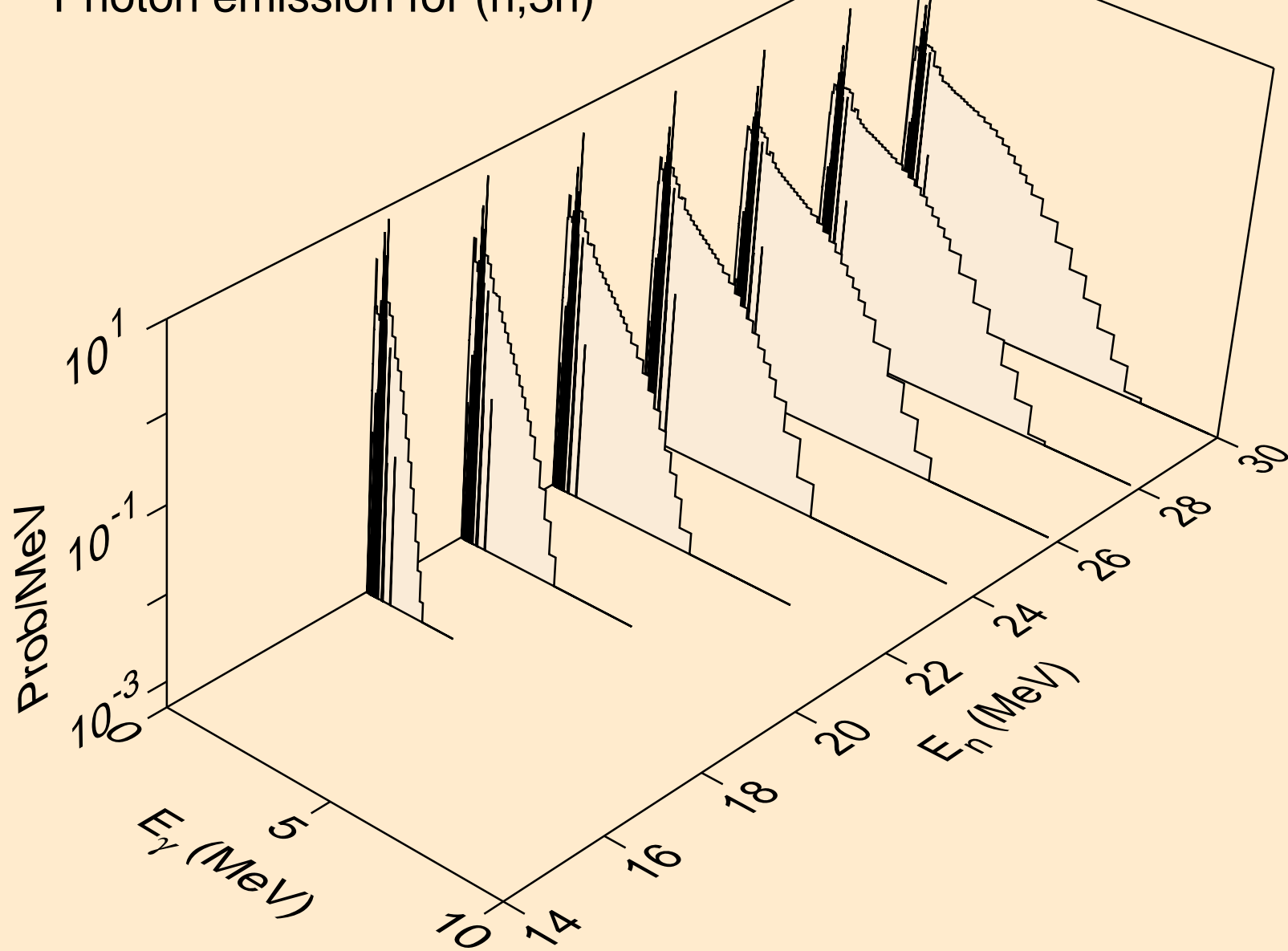

TL198M NEUTRON ACER TENDL-2023 LIBRARY; T=0.K  
Photon emission for (n,n\*)a

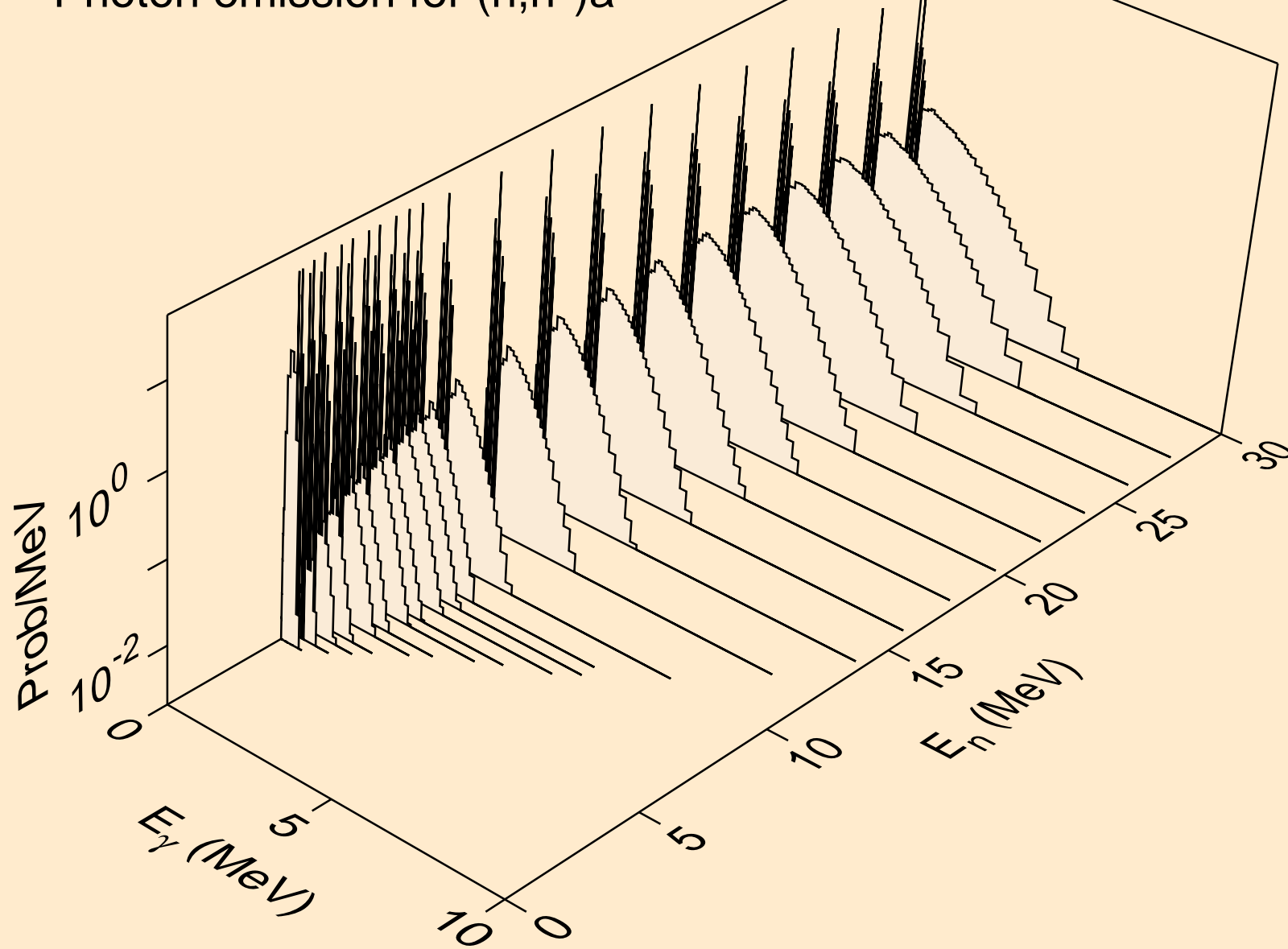

TL198M NEUTRON ACER TENDL-2023 LIBRARY; T=0.K  
Photon emission for (n,2n)a

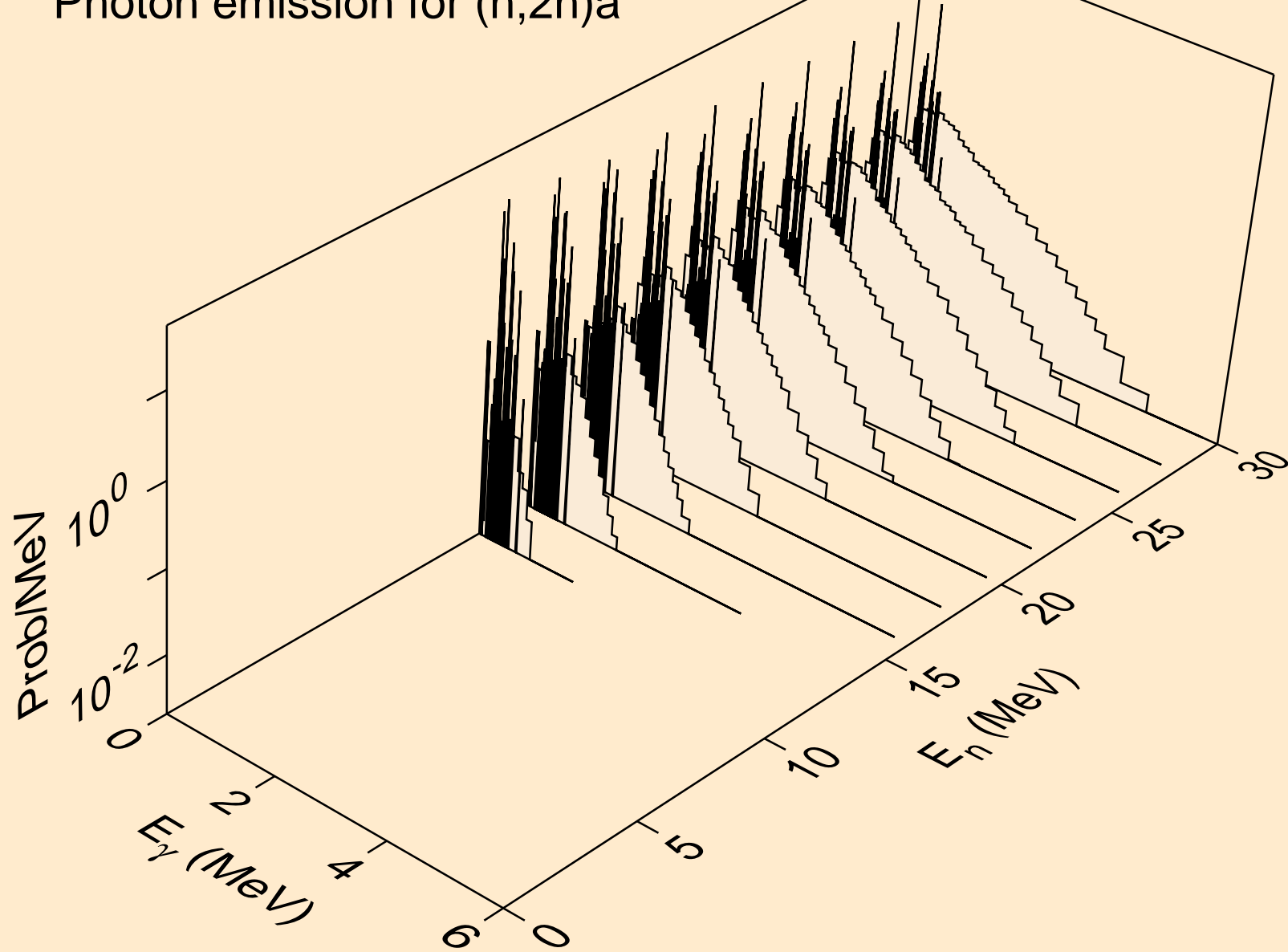

TL198M NEUTRON ACER TENDL-2023 LIBRARY; T=0.K  
Photon emission for (n,3n)a

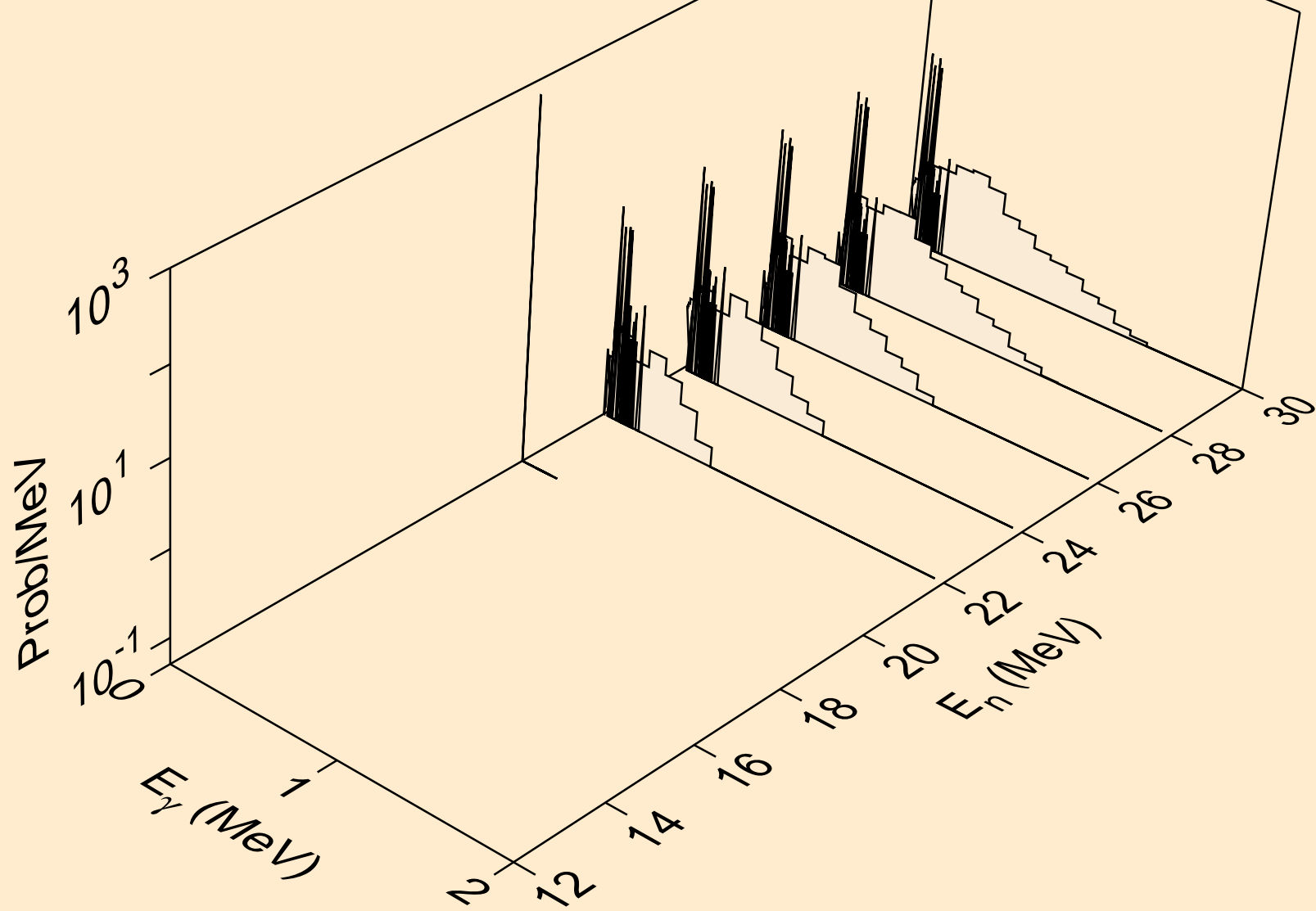

TL198M NEUTRON ACER TENDL-2023 LIBRARY; T=0.K  
Photon emission for (n,n\*)p

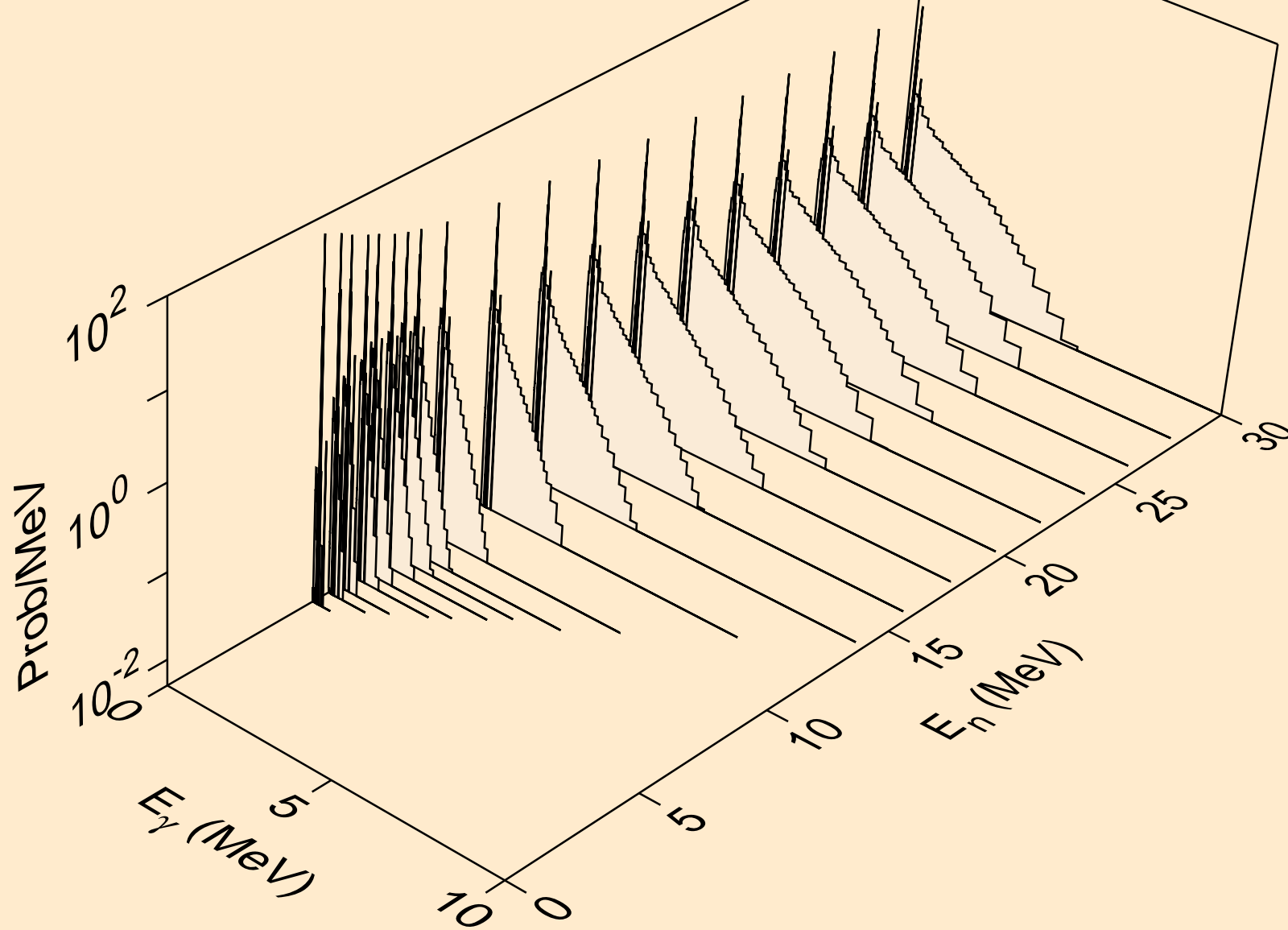



TL198M NEUTRON ACER TENDL-2023 LIBRARY; T=0.K  
Photon emission for (n,n\*)2a

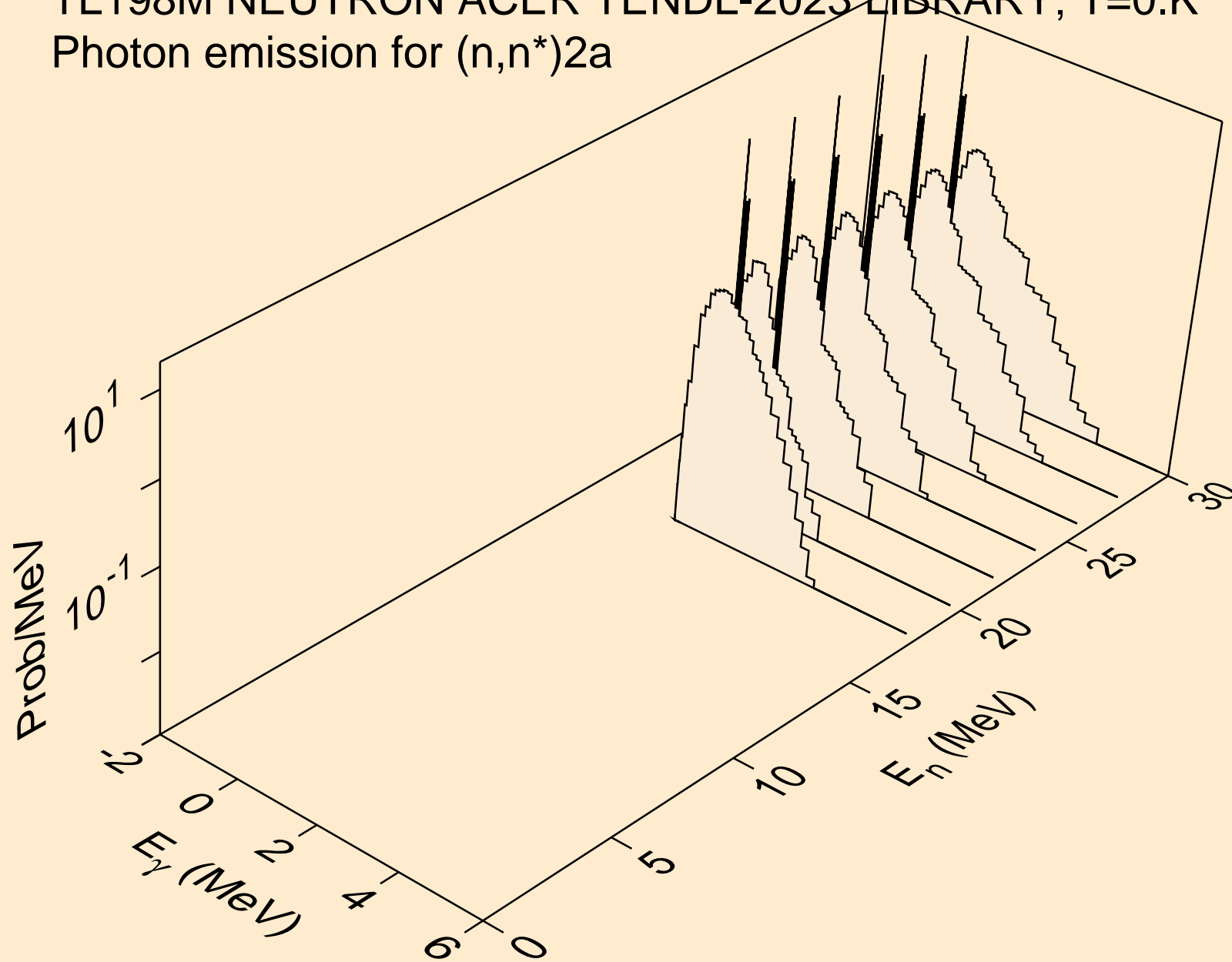

TL198M NEUTRON ACER TENDL-2023 LIBRARY; T=0.K  
Photon emission for (n,n\*)d

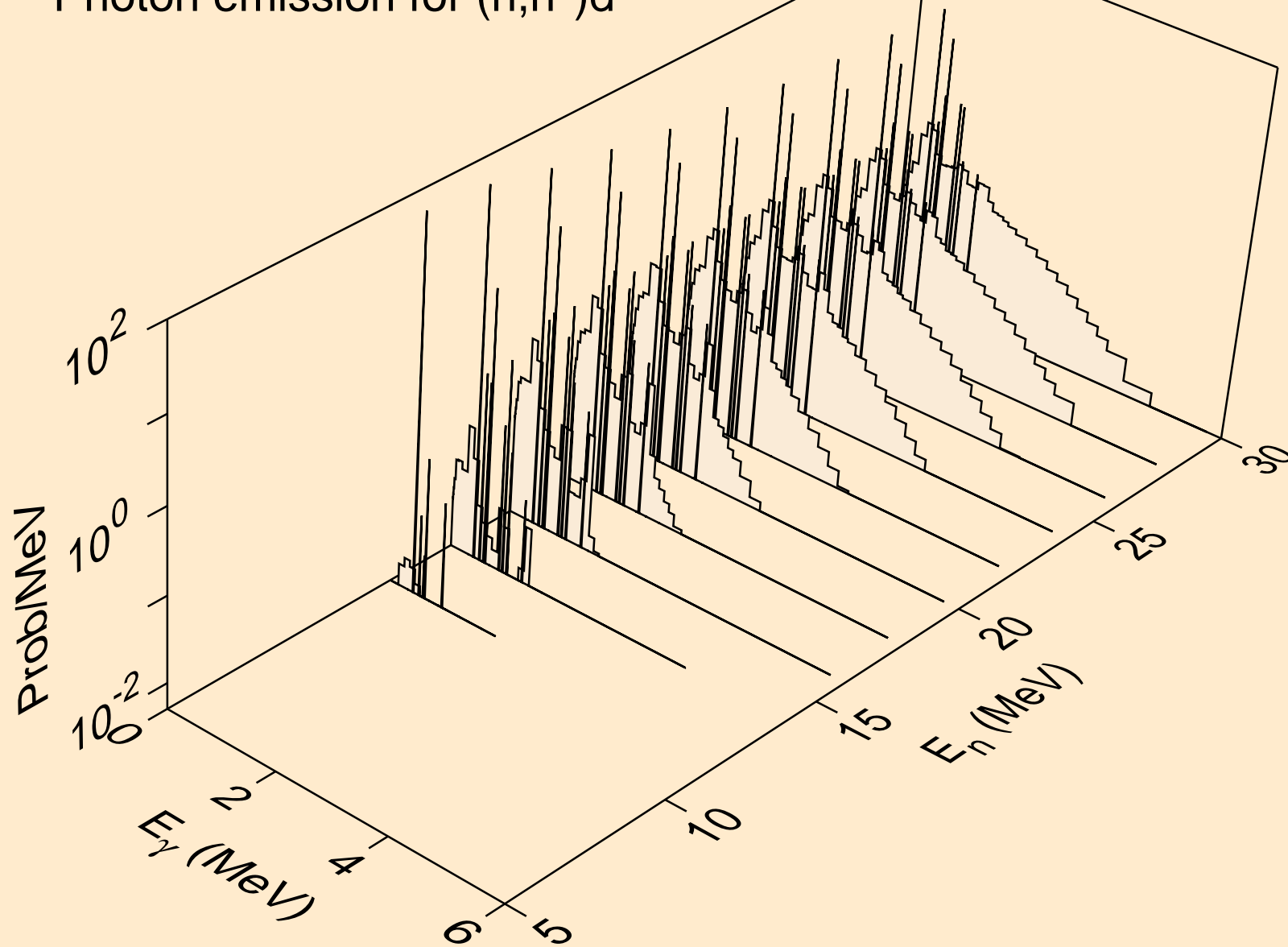

TL198M NEUTRON ACER TENDL-2023 LIBRARY; T=0.K  
Photon emission for (n,n\*)t

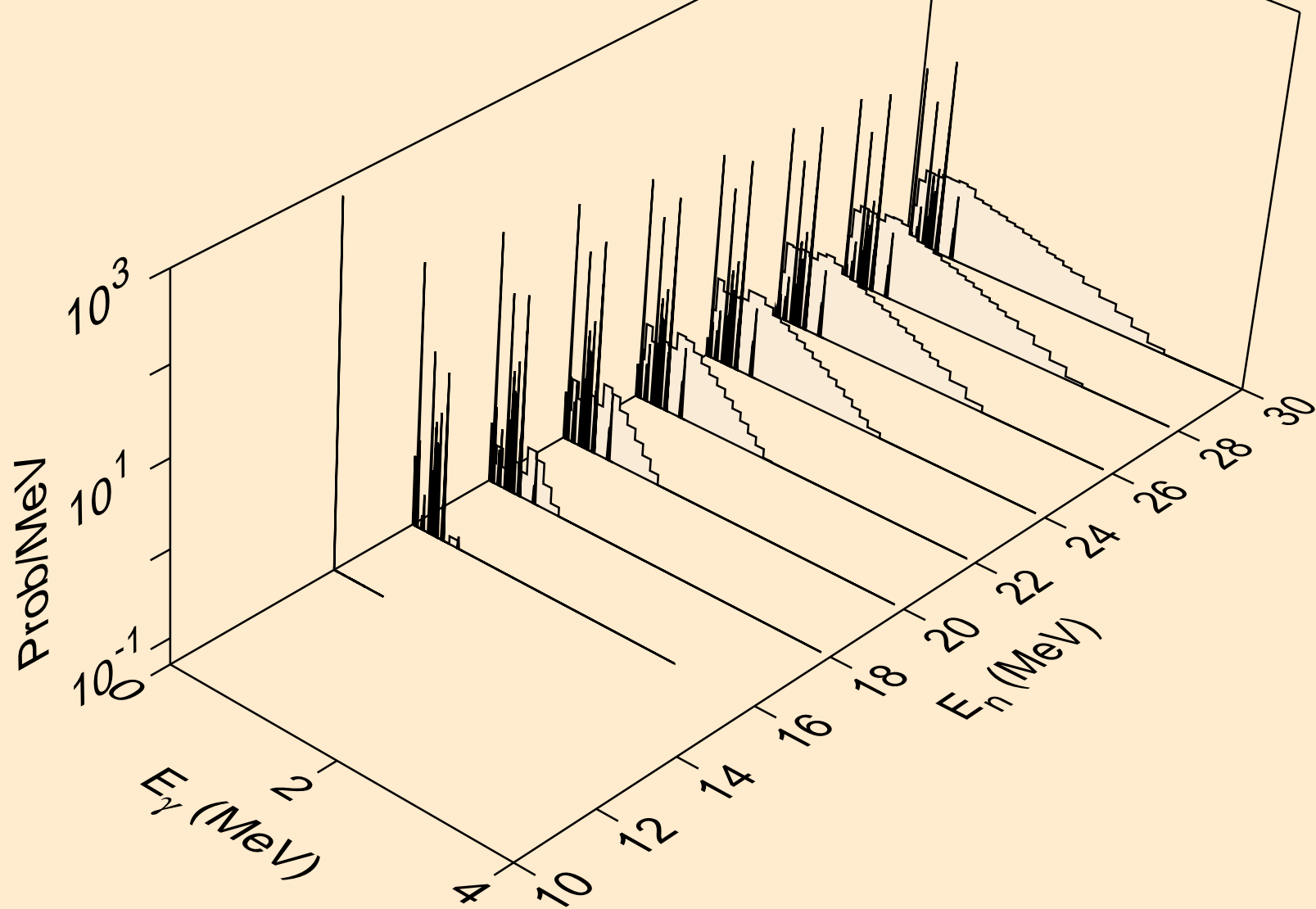

TL198M NEUTRON ACER TENDL-2023 LIBRARY; T=0.K  
Photon emission for (n,n\*)he3

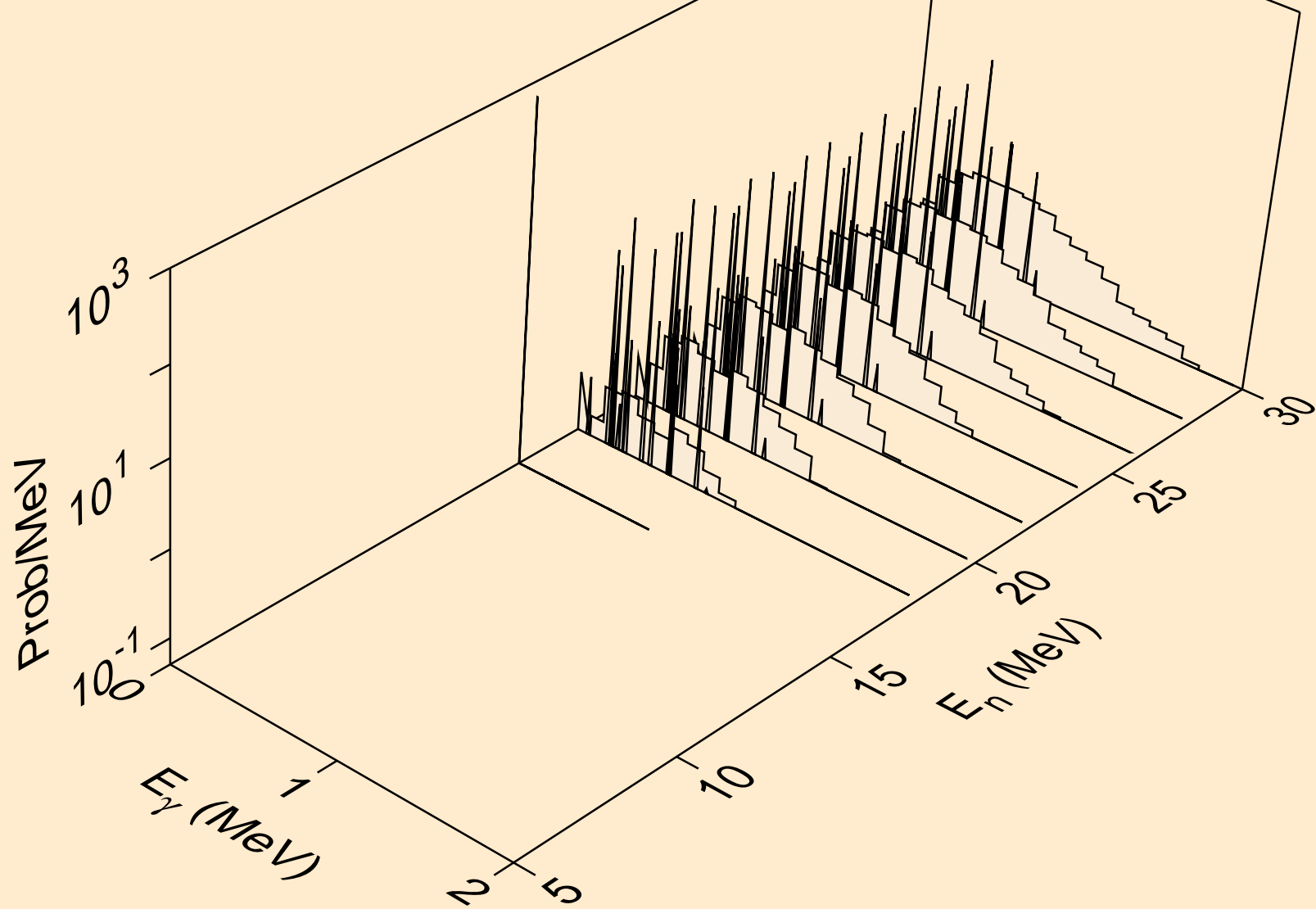

TL198M NEUTRON ACER TENDL-2023 LIBRARY; T=0.K  
Photon emission for (n,4n)

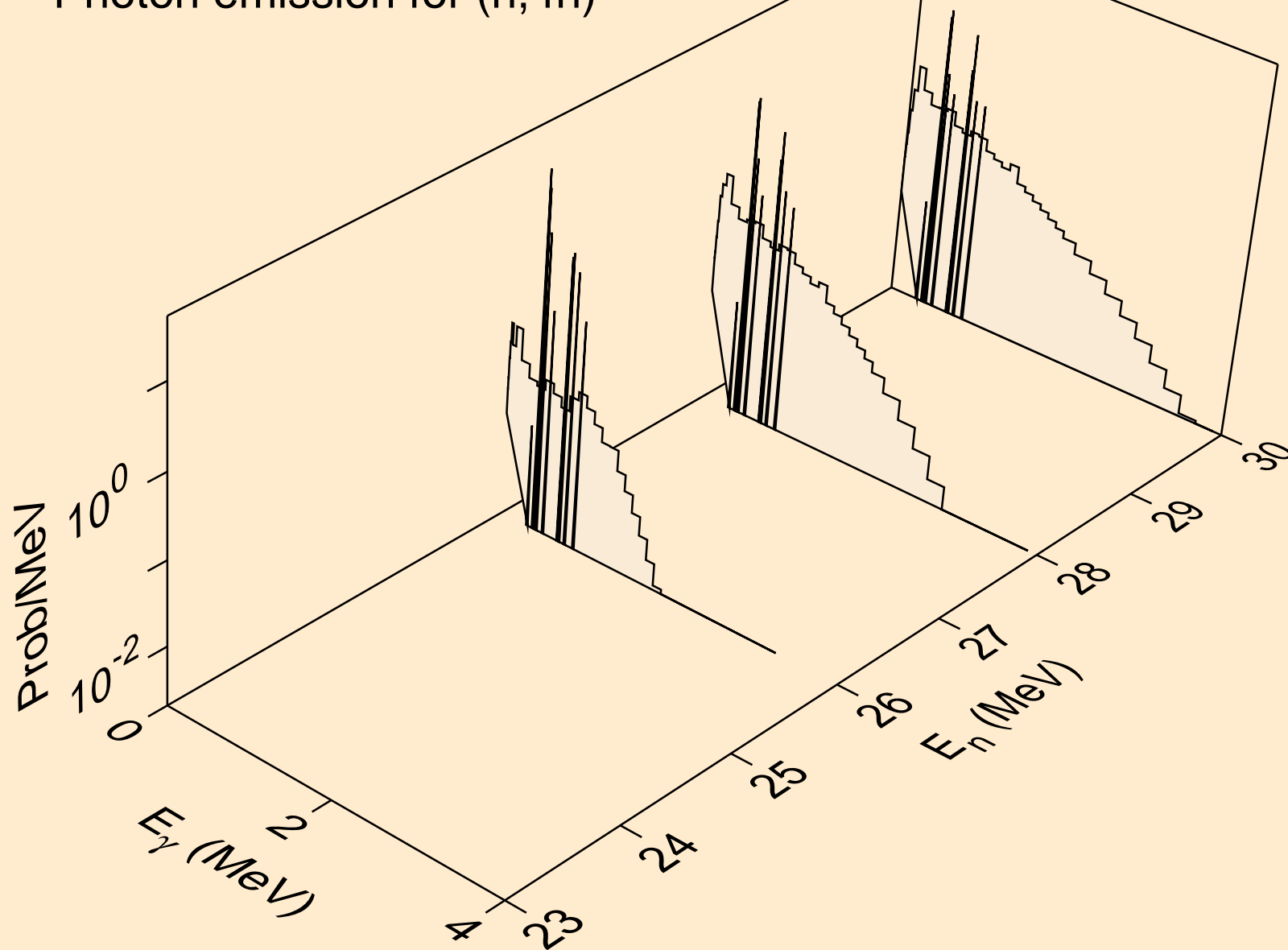

TL198M NEUTRON ACER TENDL-2023 LIBRARY; T=0.K  
Photon emission for (n,2np)

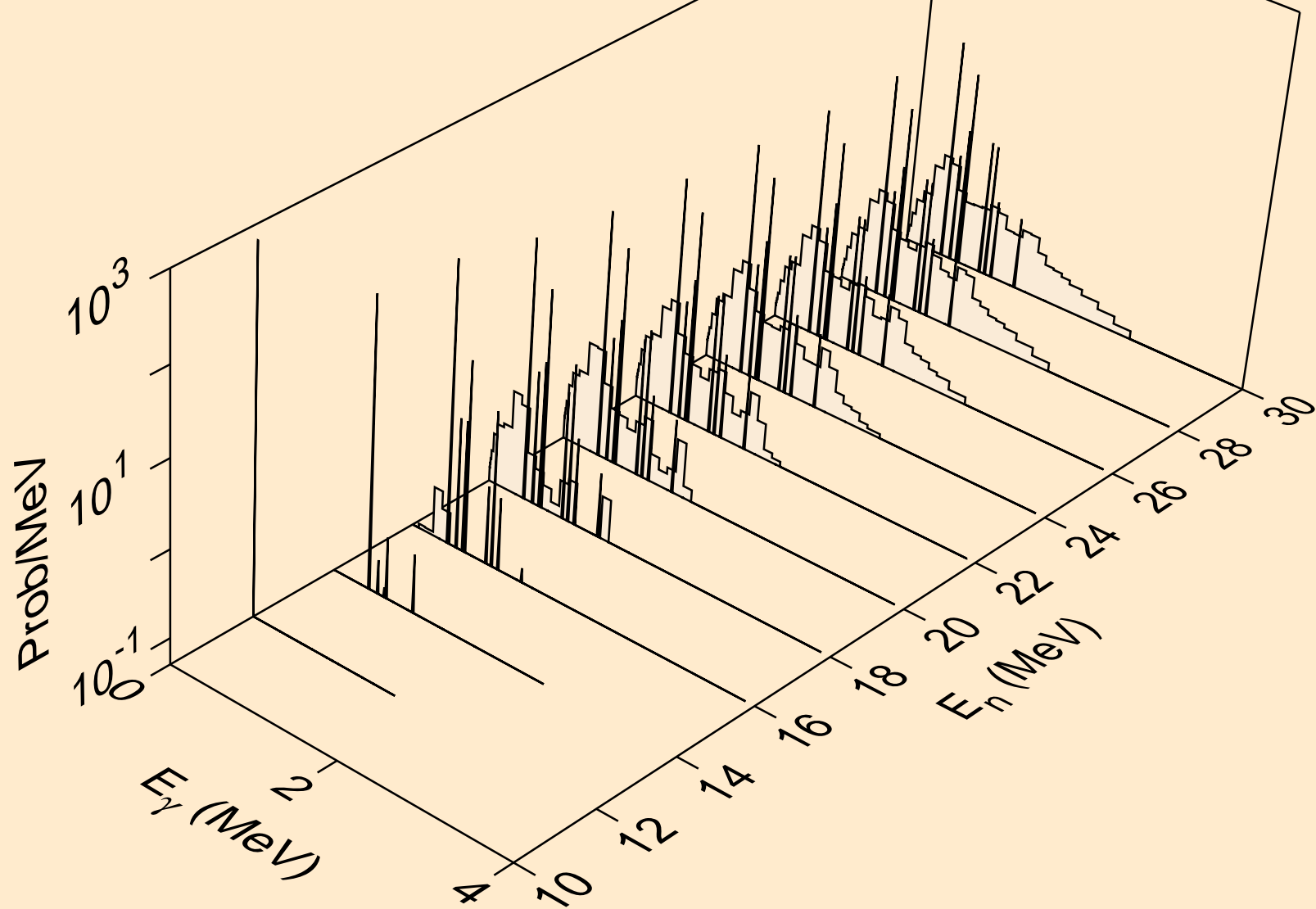

TL198M NEUTRON ACER TENDL-2023 LIBRARY; T=0.K  
Photon emission for (n,3np)

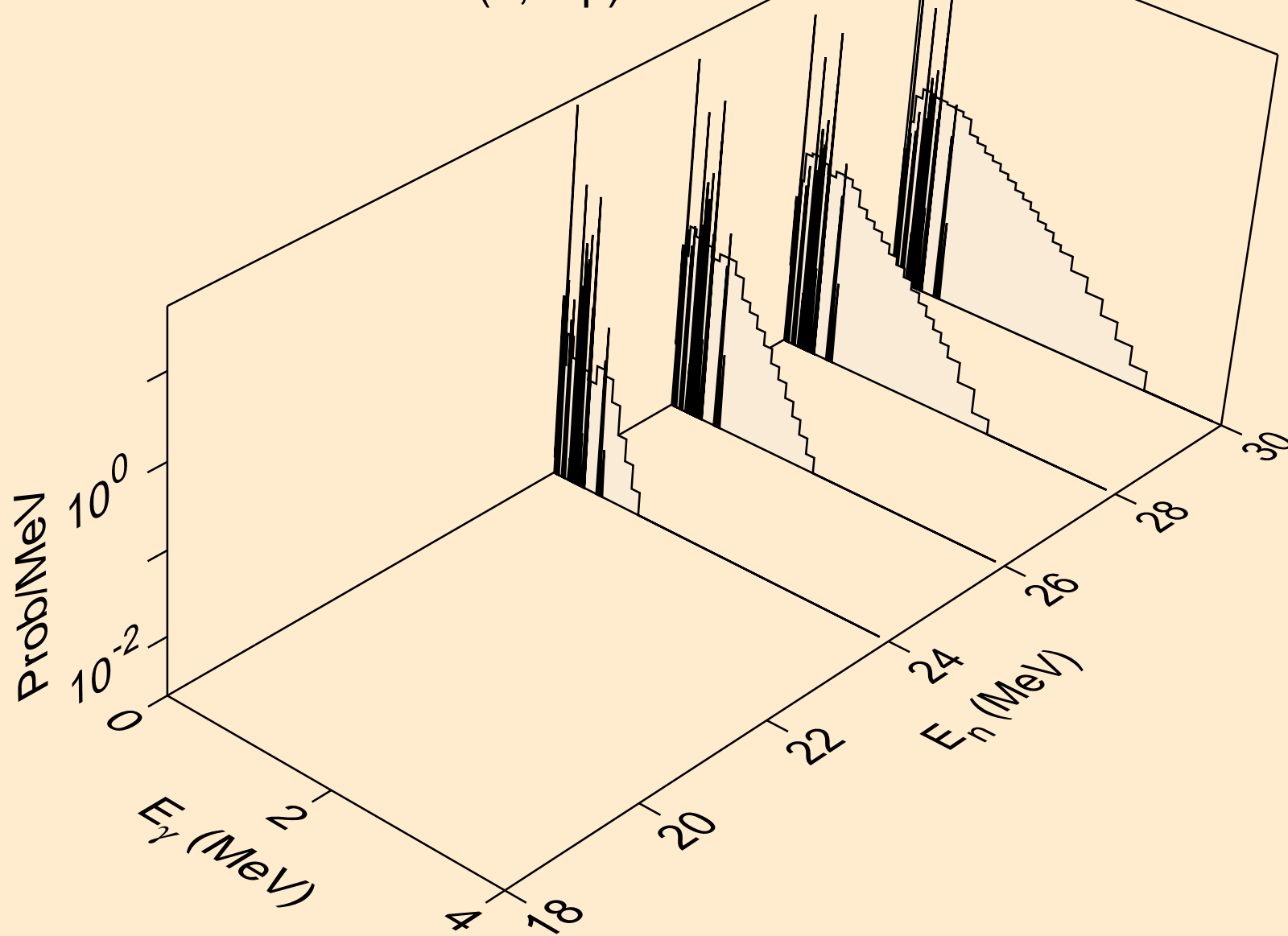

TL198M NEUTRON ACER TENDL-2023 LIBRARY; T=0.K  
Photon emission for (n,n2p)

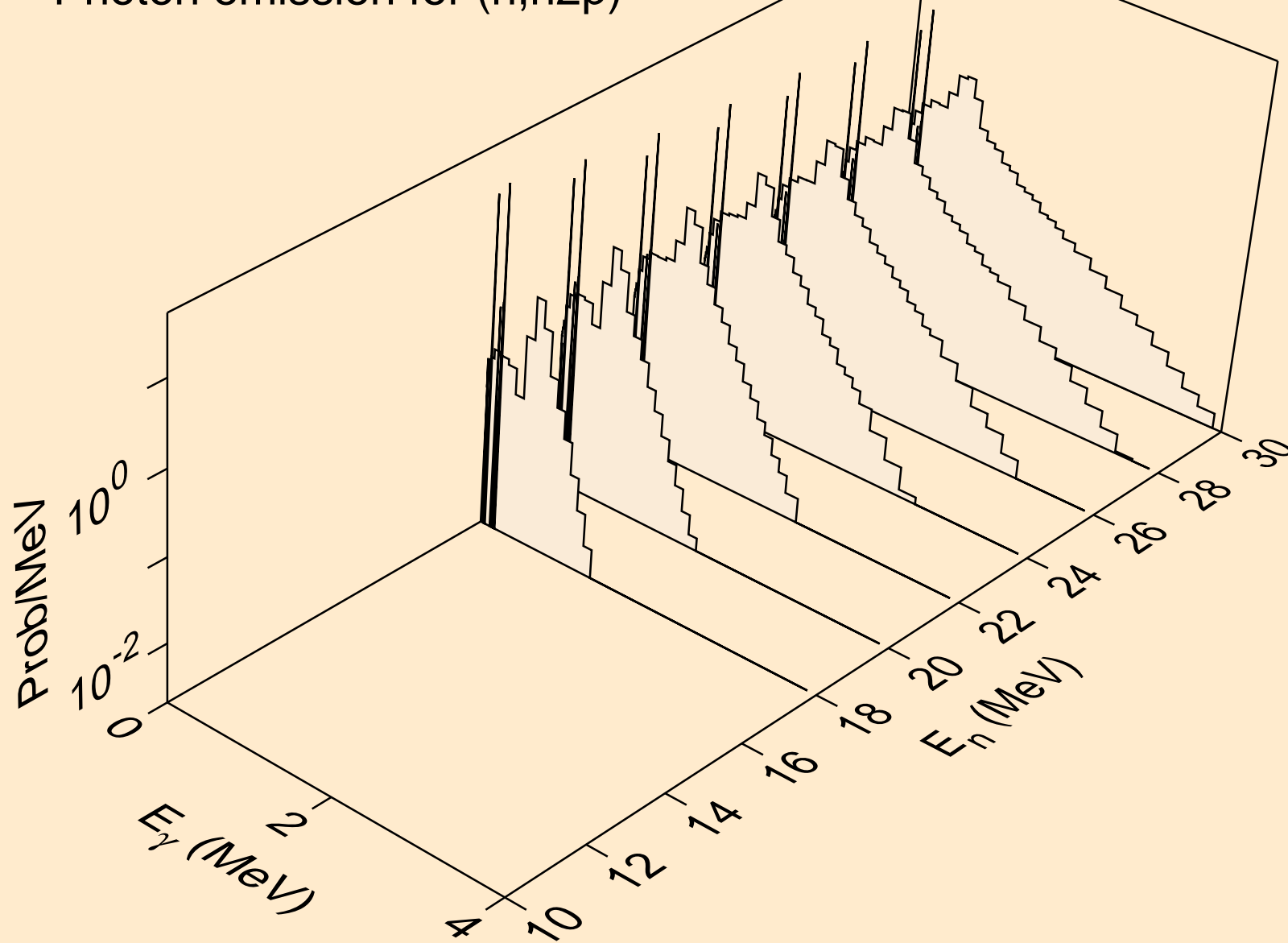



TL198M NEUTRON ACER TENDL-2023 LIBRARY; T=0.K  
Photon emission for (n,npa)

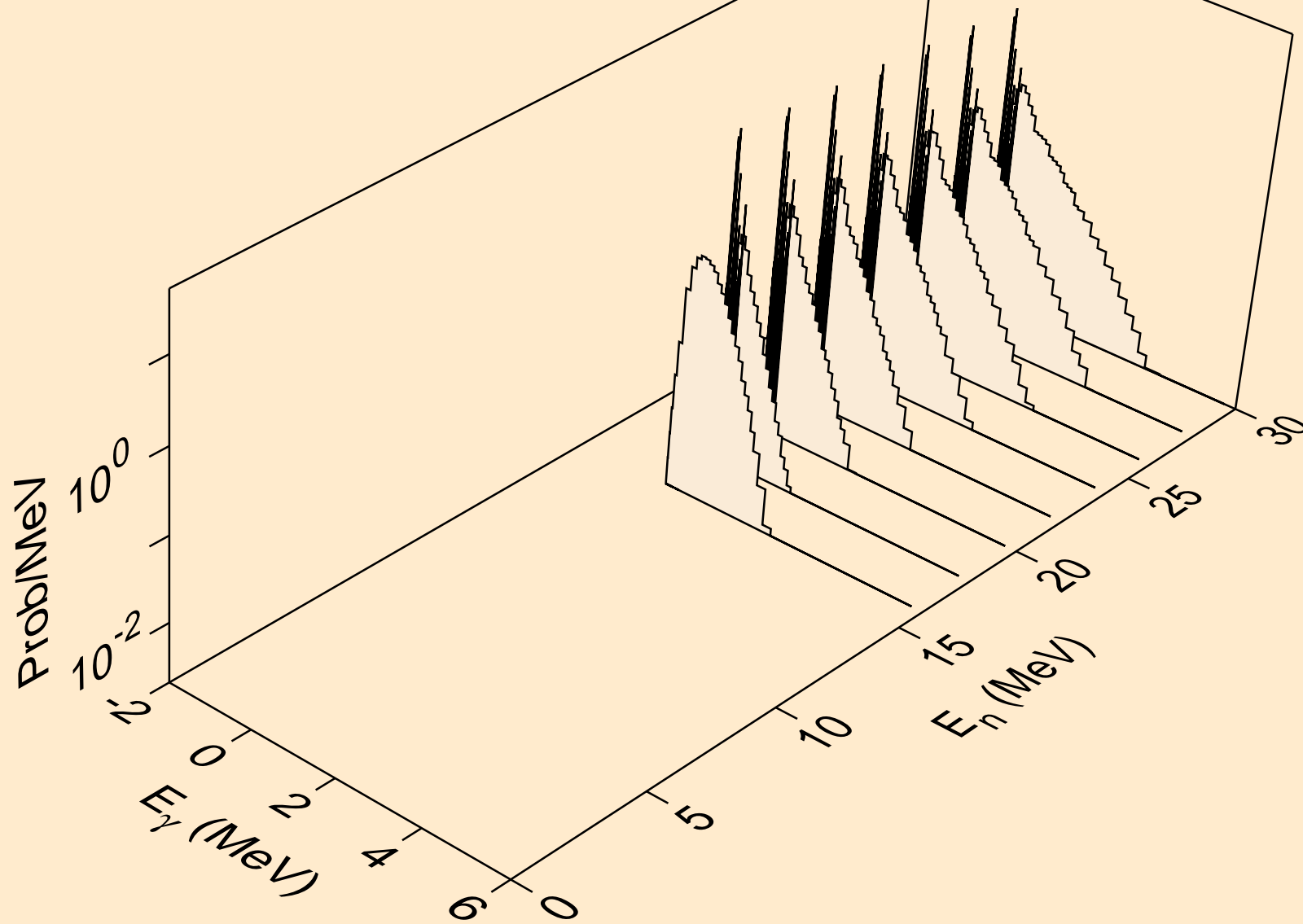

TL198M NEUTRON ACER TENDL-2023 LIBRARY; T=0.K  
Photon emission for (n,n\*1)

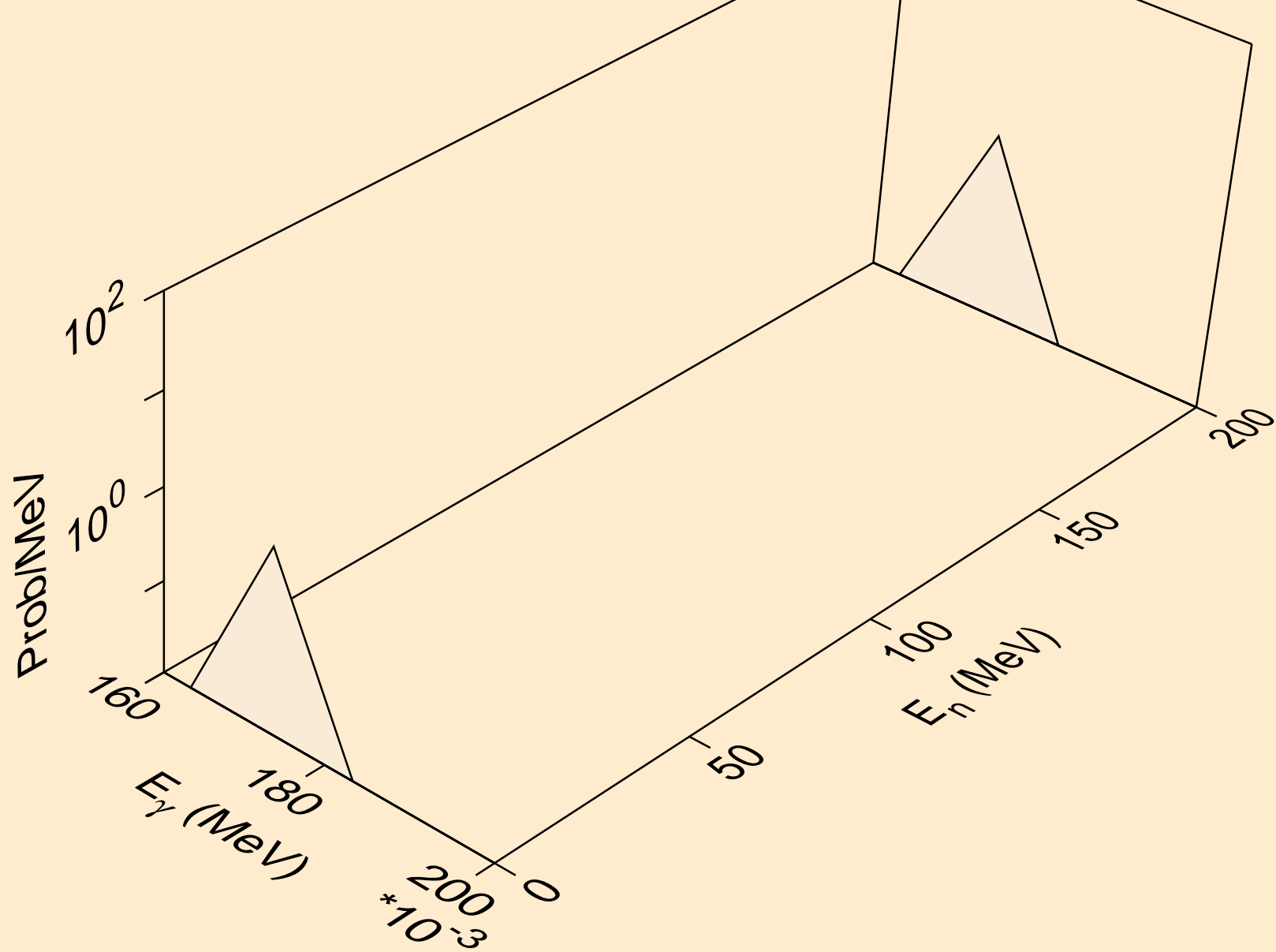

TL198M NEUTRON ACER TENDL-2023 LIBRARY; T=0.K  
Photon emission for (n,n\*2)

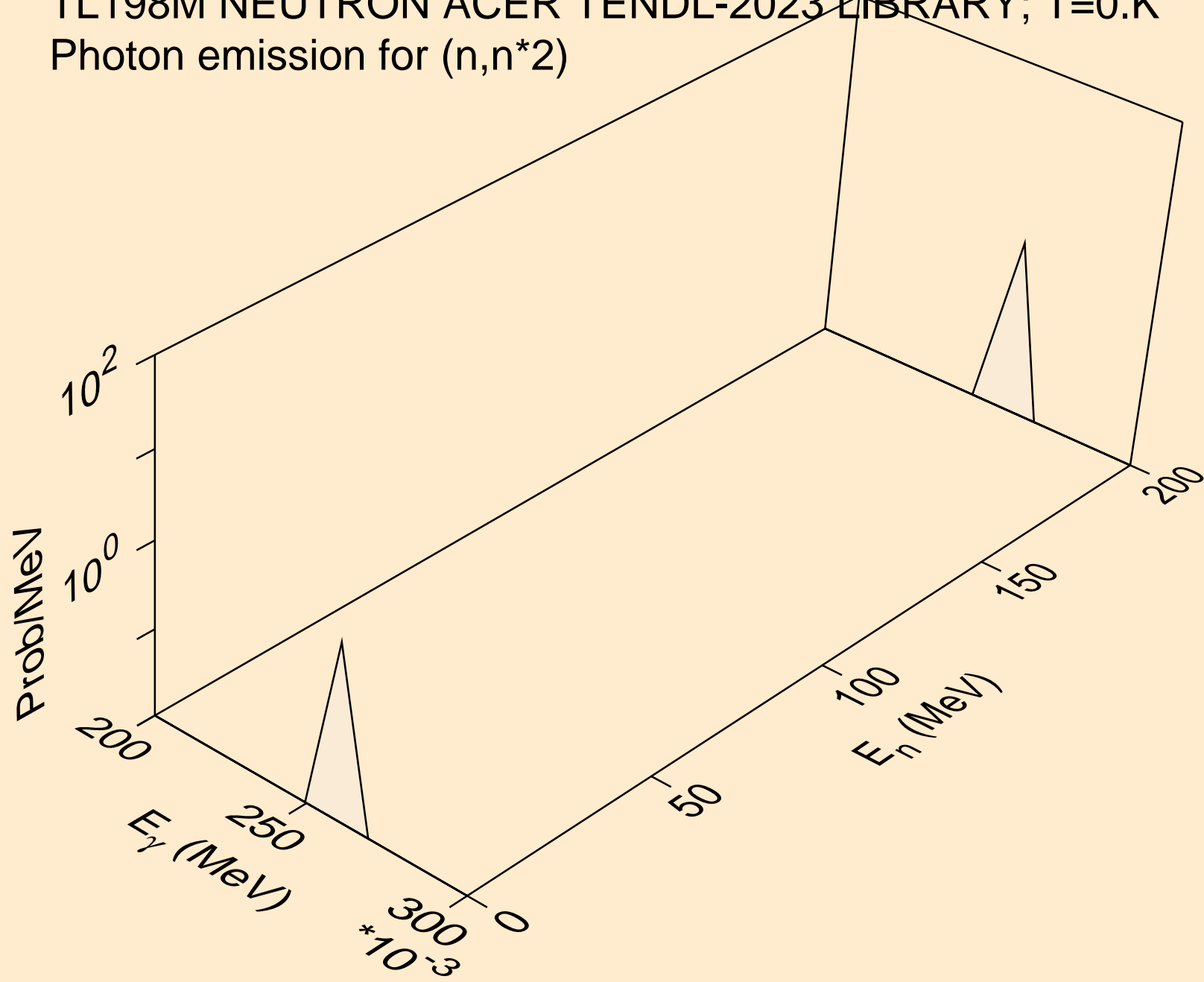

TL198M NEUTRON ACER TENDL-2023 LIBRARY; T=0.K  
Photon emission for (n,n\*3)

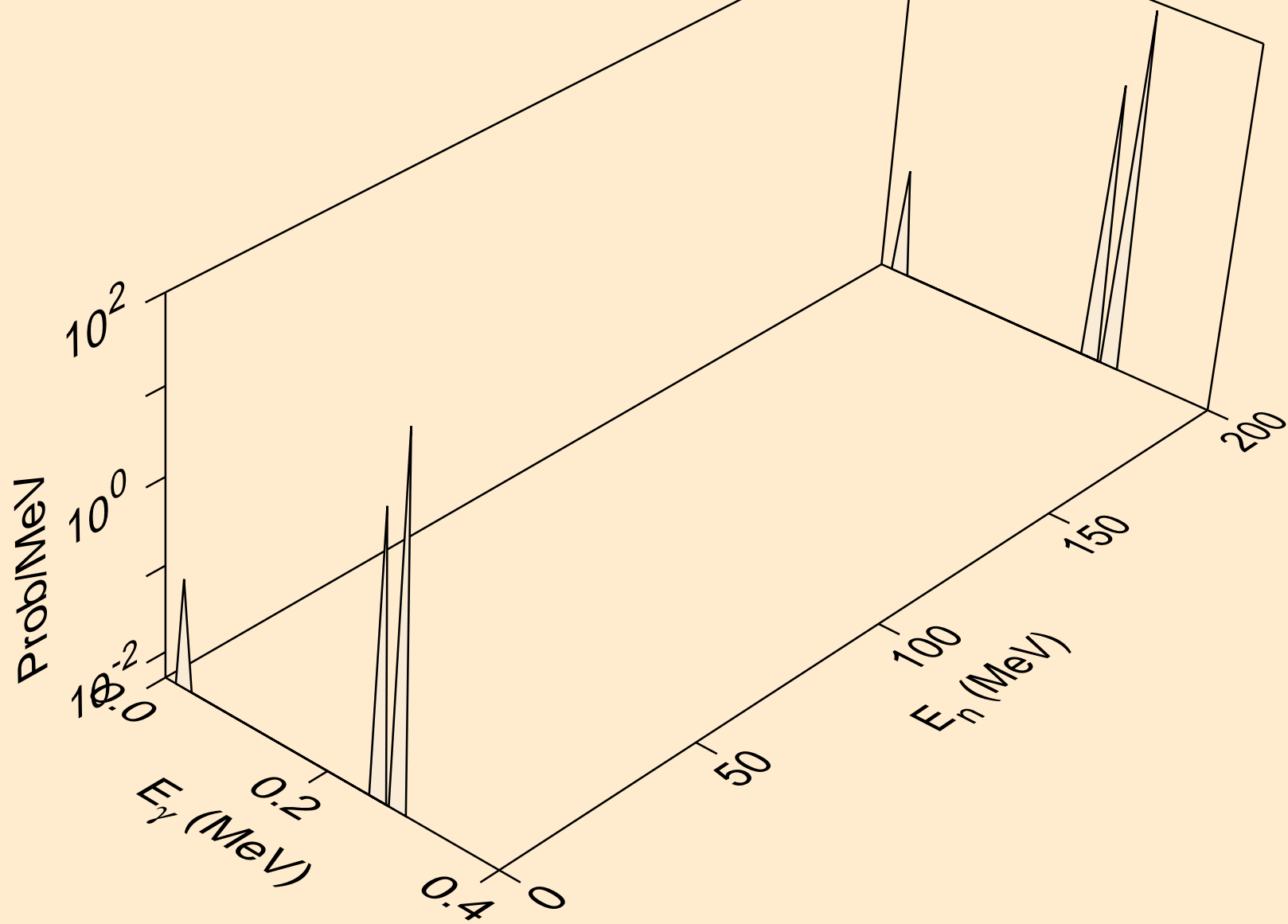

TL198M NEUTRON ACER TENDL-2023 LIBRARY; T=0.K  
Photon emission for (n,n\*4)

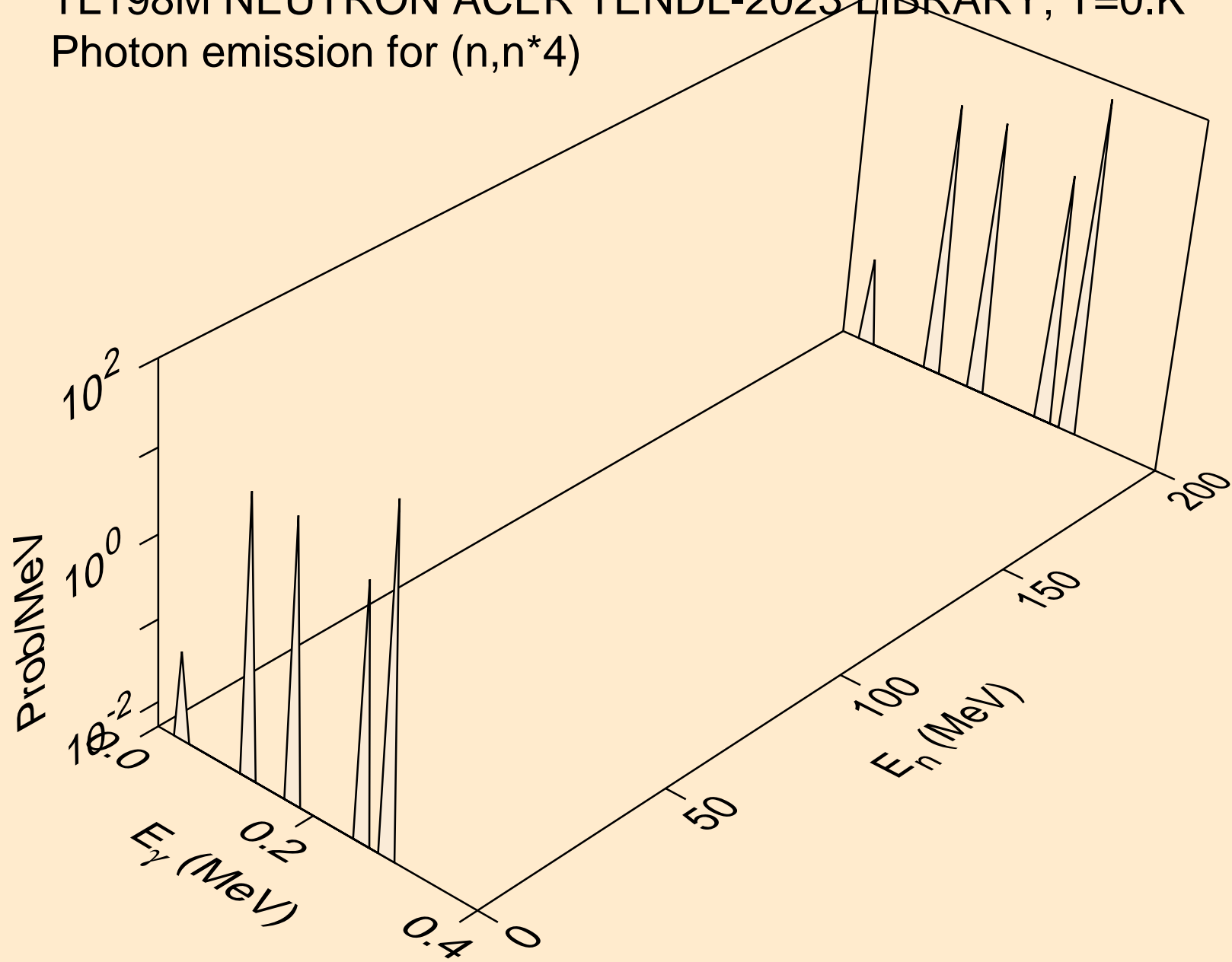

TL198M NEUTRON ACER TENDL-2023 LIBRARY; T=0.K  
Photon emission for (n,n\*5)

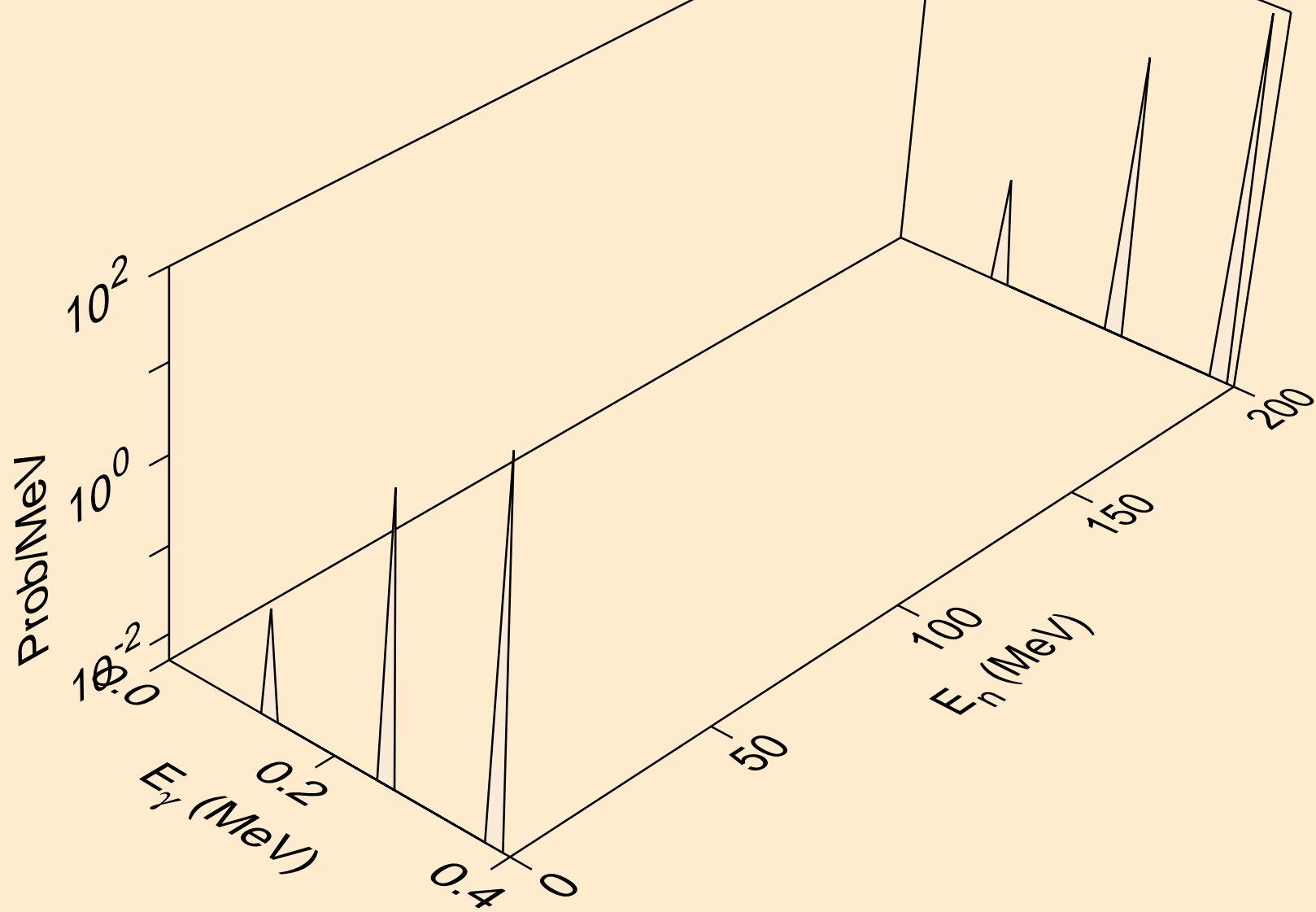

TL198M NEUTRON ACER TENDL-2023 LIBRARY; T=0.K  
Photon emission for (n,n\*6)

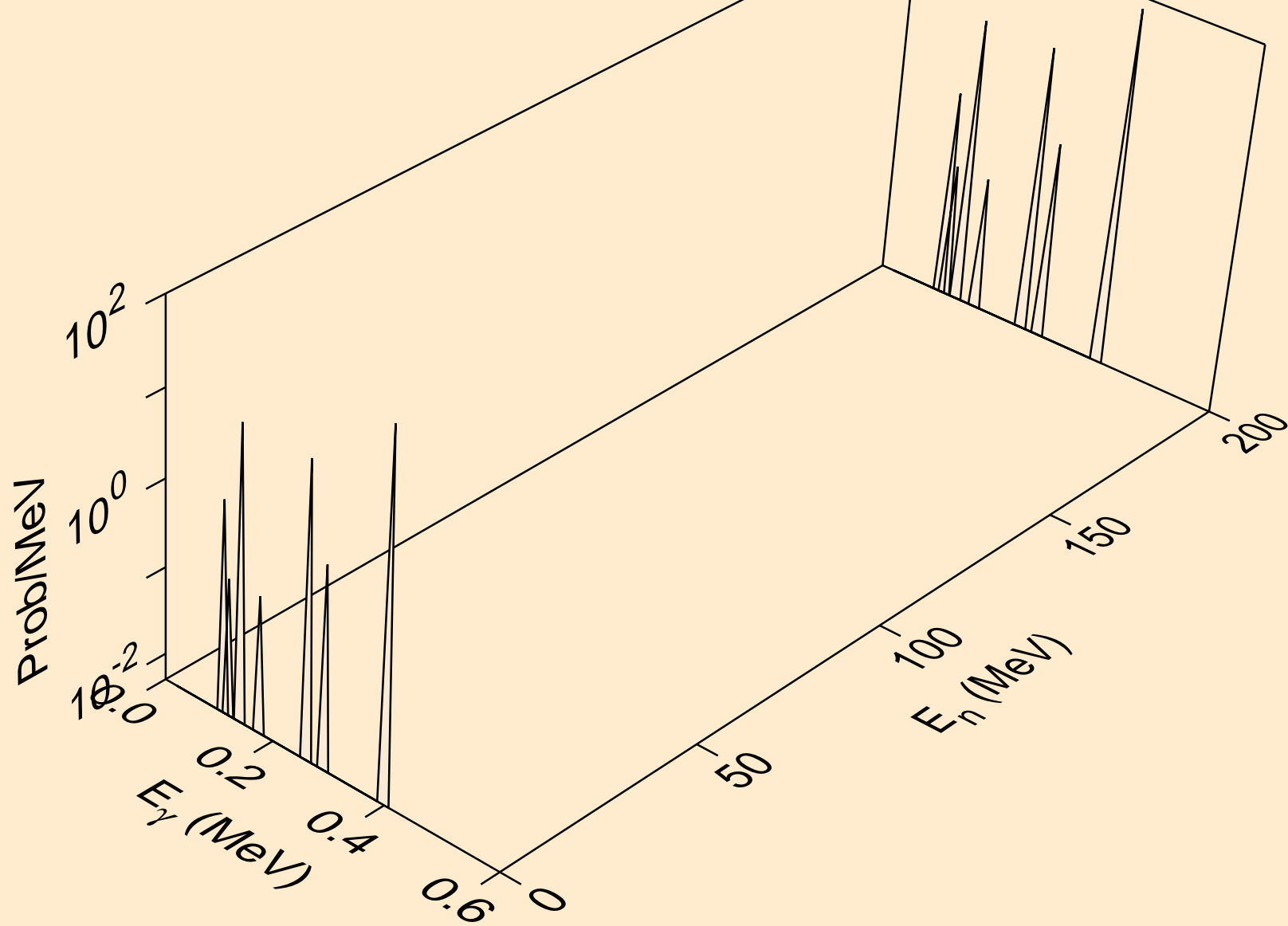

TL198M NEUTRON ACER TENDL-2023 LIBRARY; T=0.K  
Photon emission for (n,n\*8)

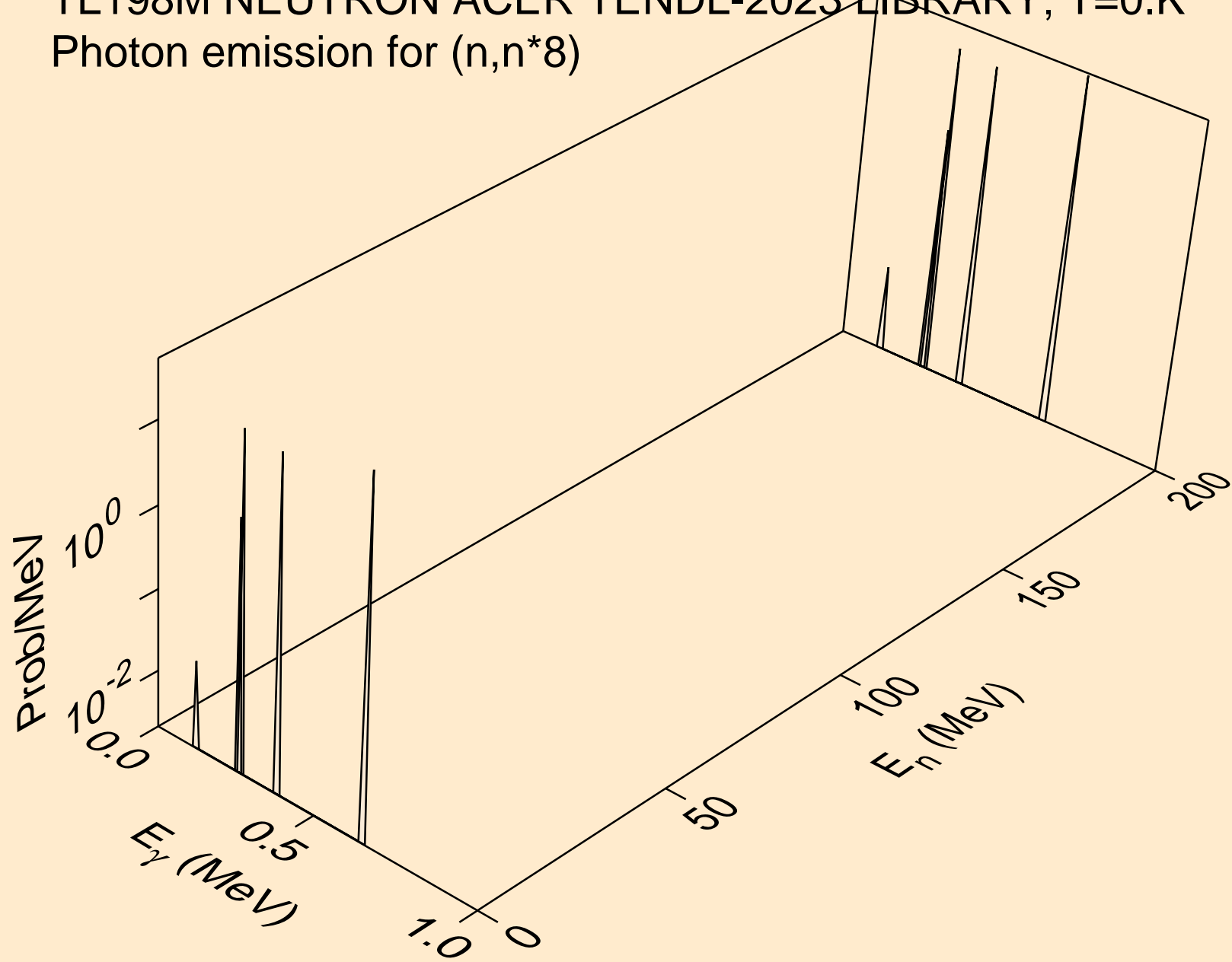



TL198M NEUTRON ACER TENDL-2023 LIBRARY; T=0.K  
Photon emission for (n,n\*9)

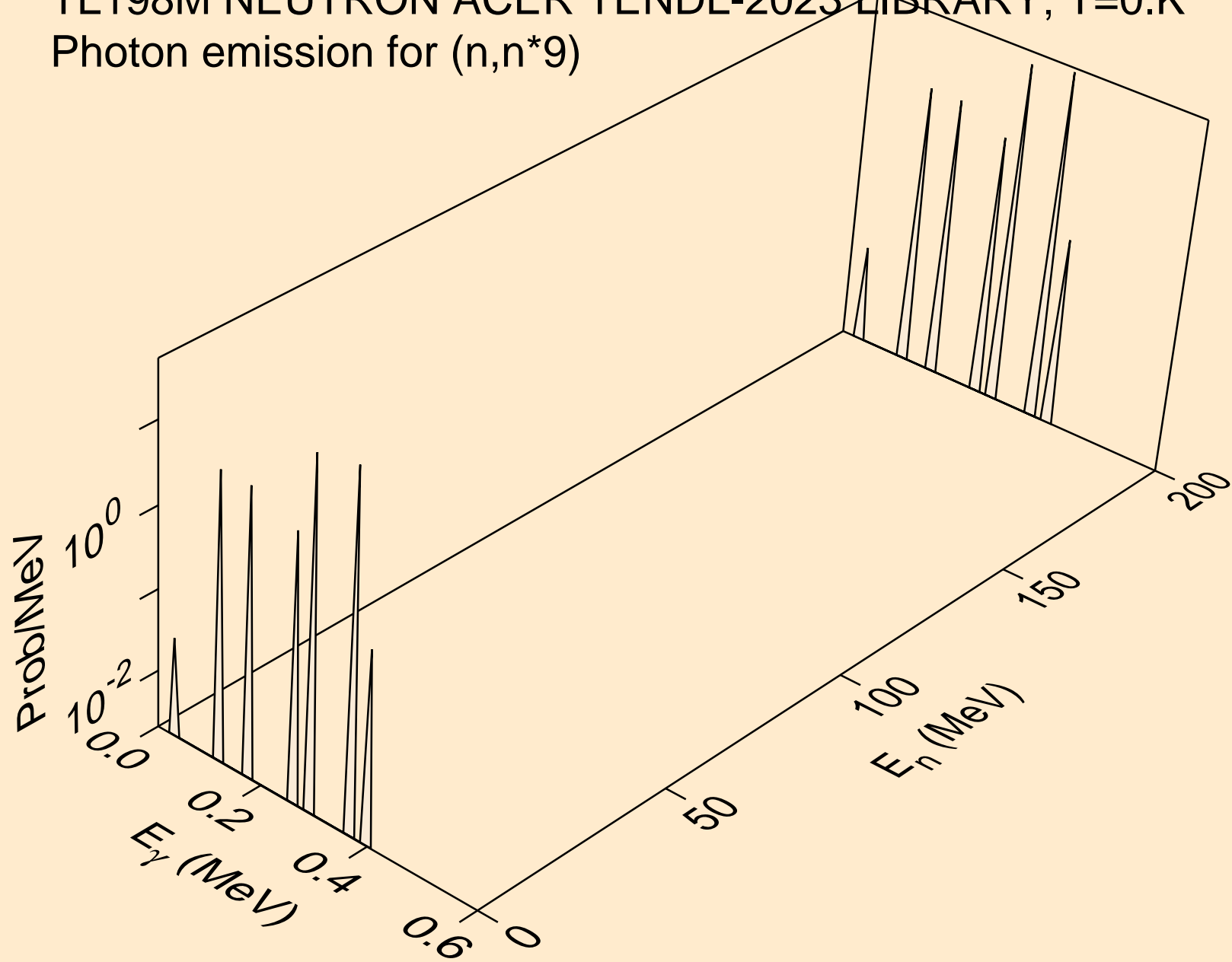

TL198M NEUTRON ACER TENDL-2023 LIBRARY; T=0.K  
Photon emission for (n,n\*10)

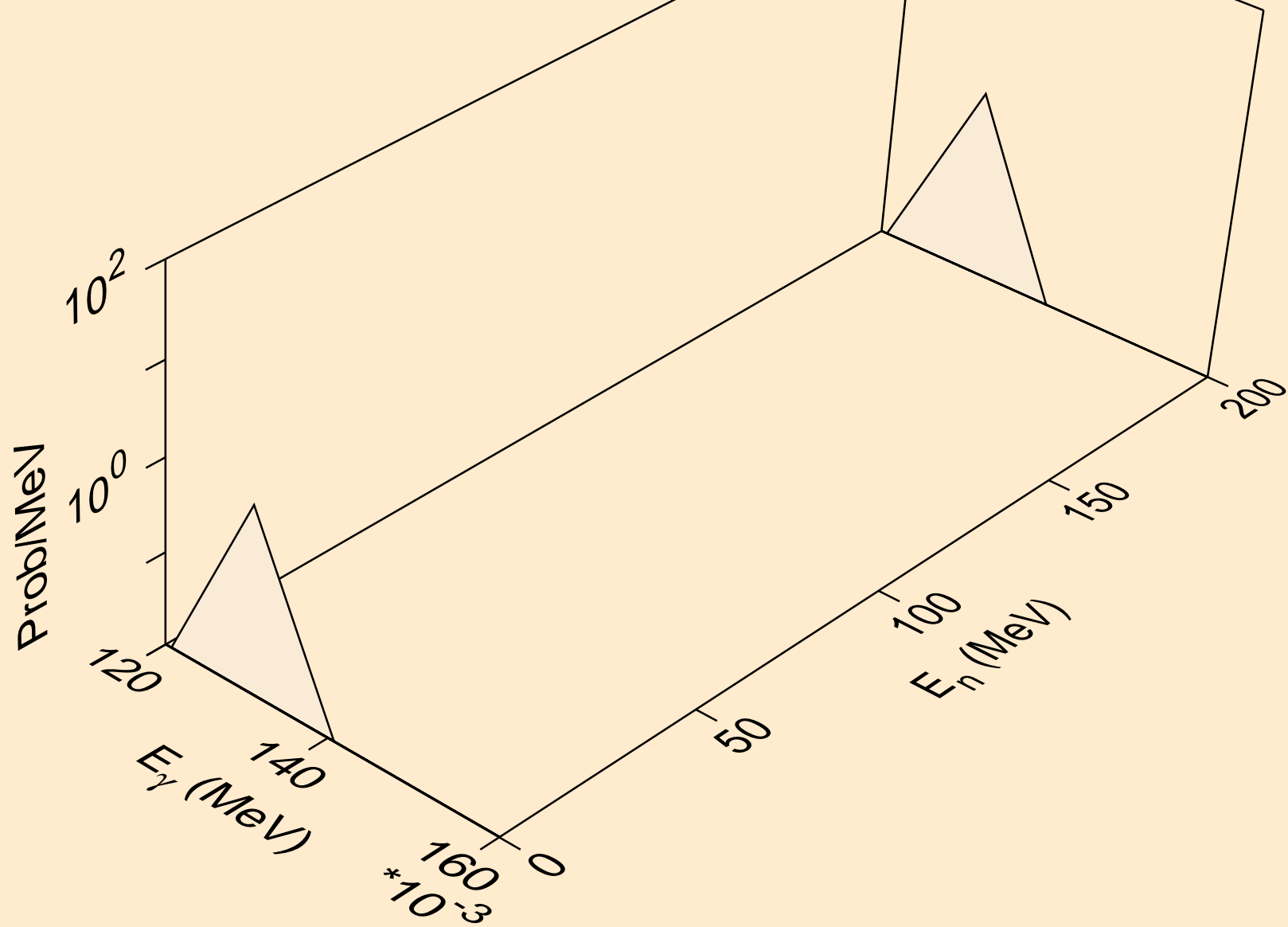

TL198M NEUTRON ACER TENDL-2023 LIBRARY; T=0.K  
Photon emission for (n,n\*11)

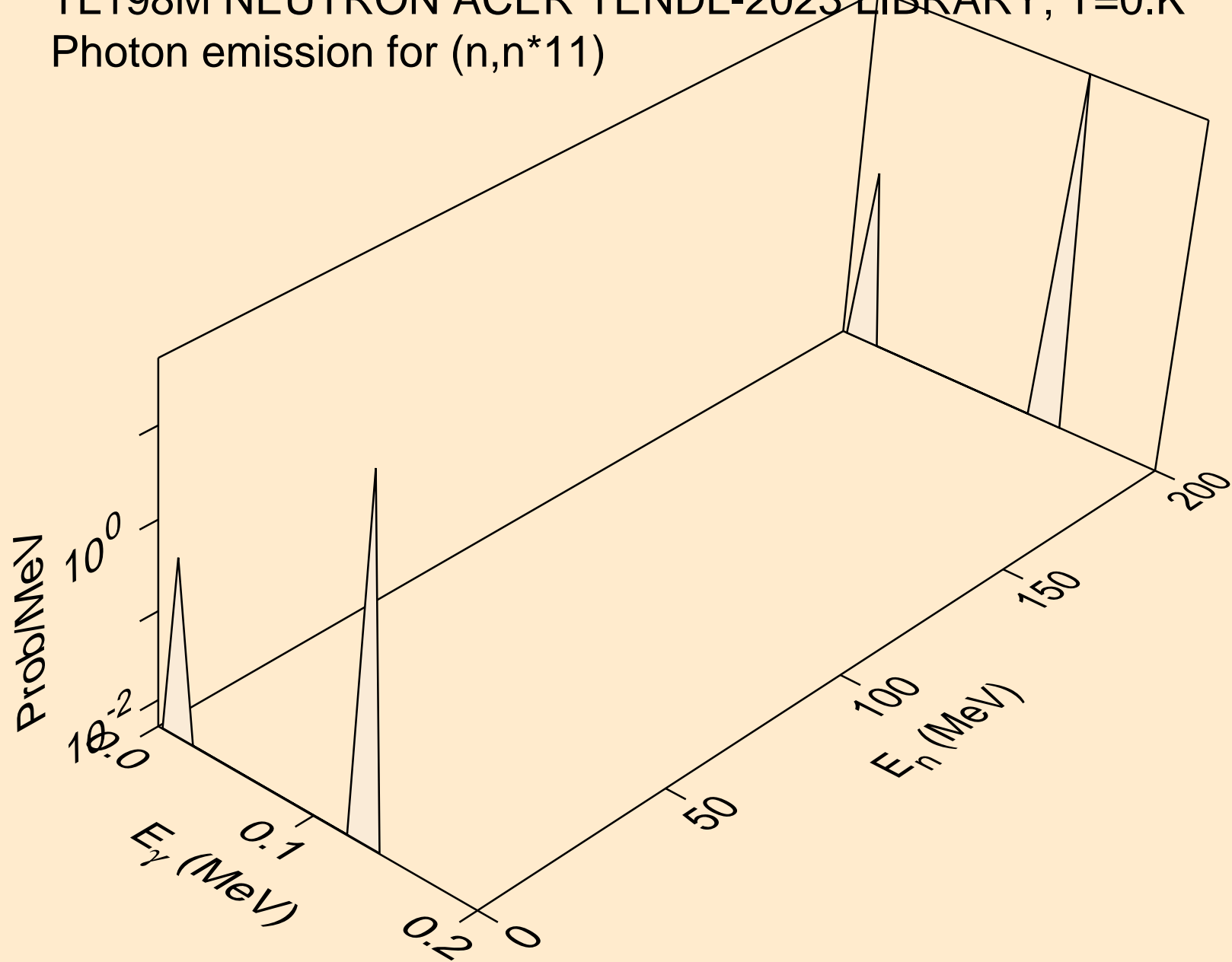

TL198M NEUTRON ACER TENDL-2023 LIBRARY; T=0.K  
Photon emission for (n,n\*12)

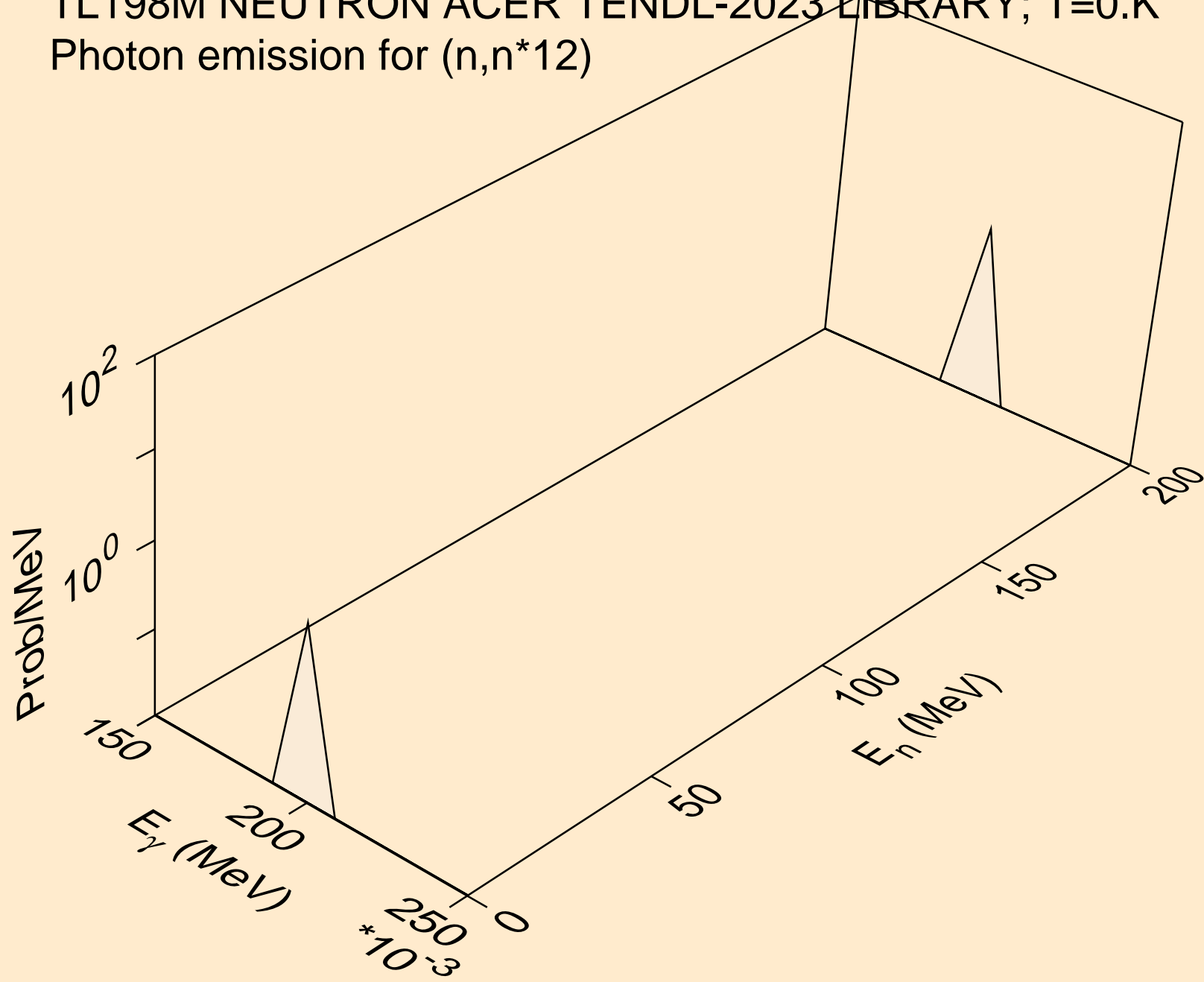

TL198M NEUTRON ACER TENDL-2023 LIBRARY; T=0.K  
Photon emission for (n,n\*13)

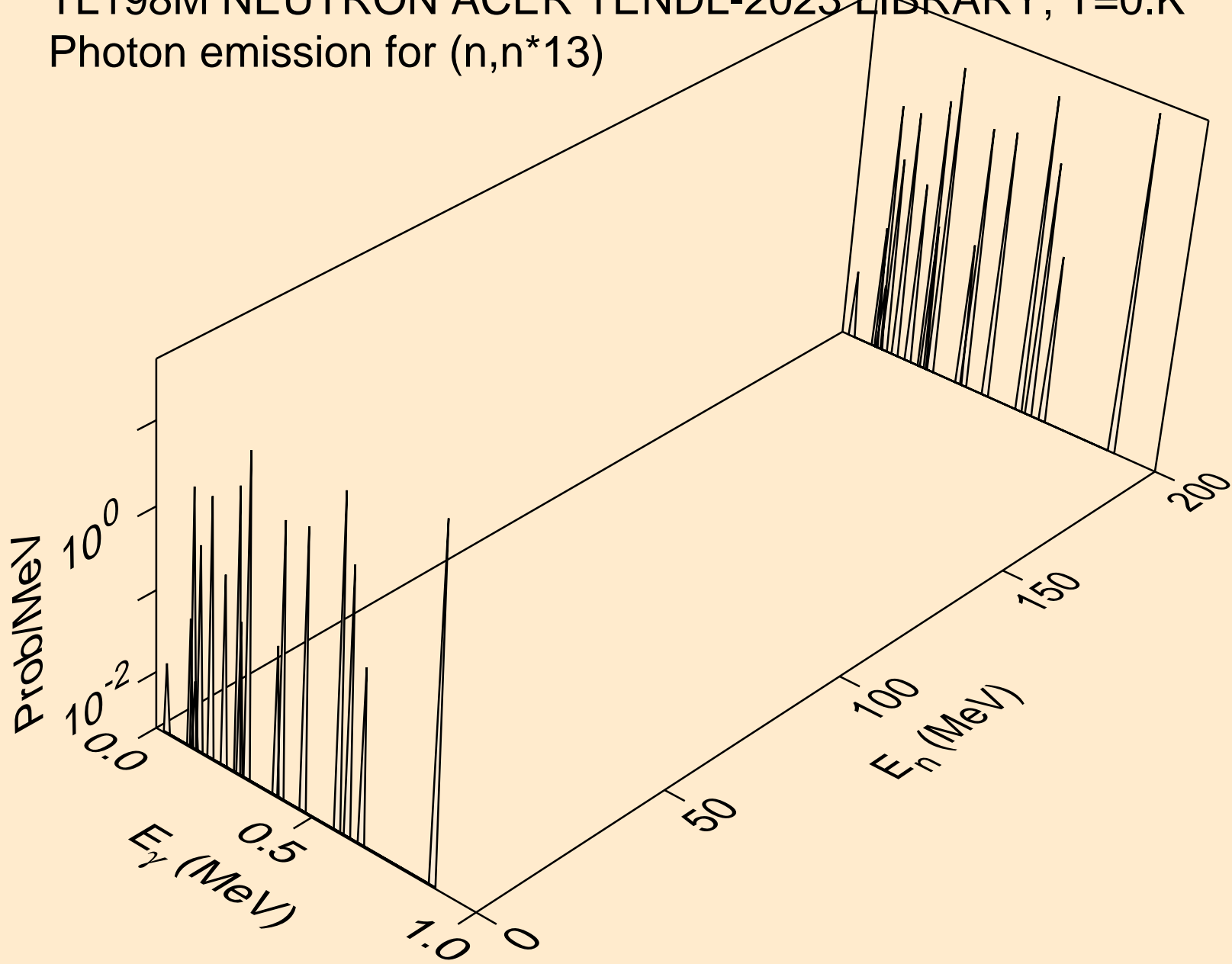

TL198M NEUTRON ACER TENDL-2023 LIBRARY; T=0.K  
Photon emission for (n,n\*14)

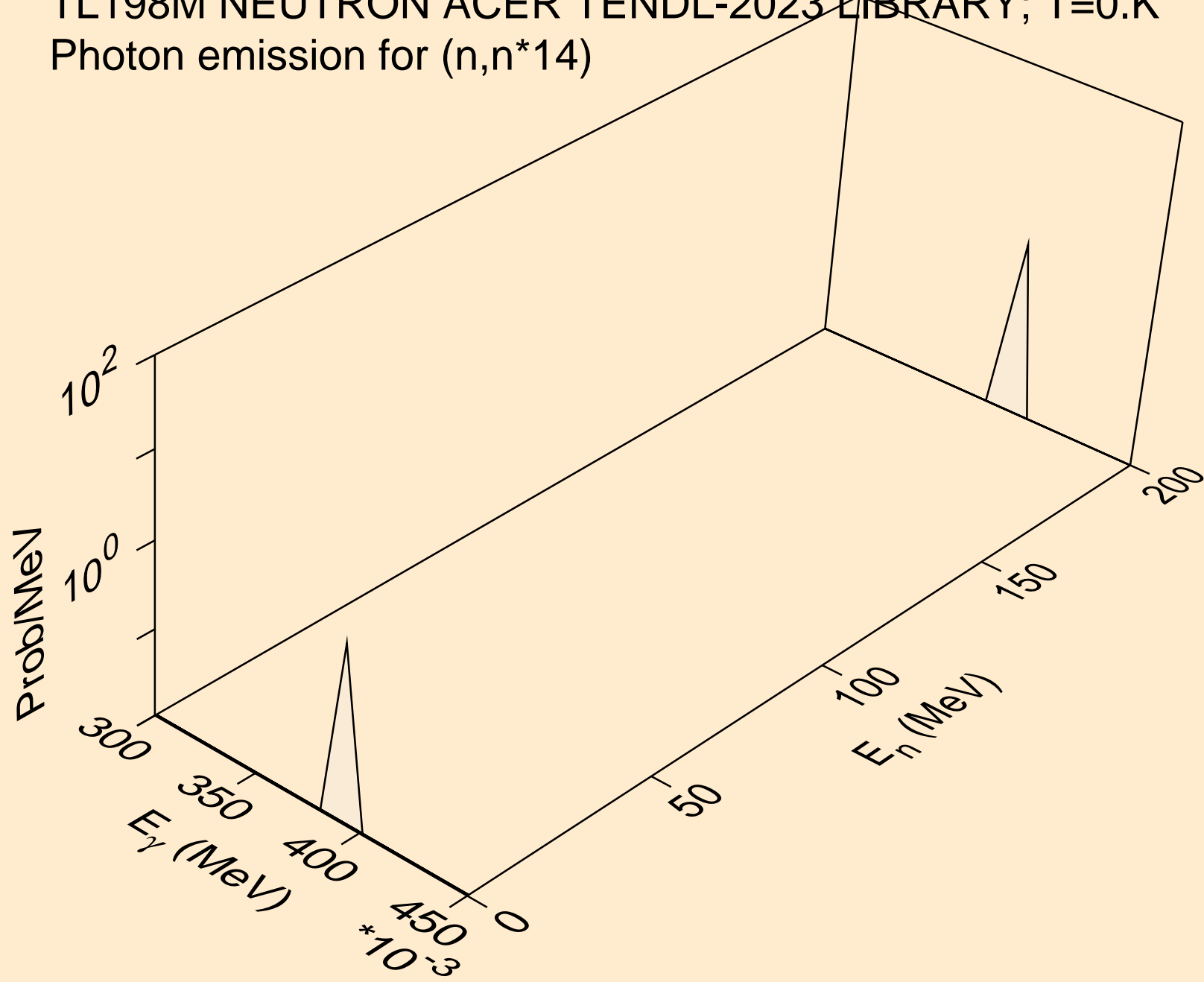

TL198M NEUTRON ACER TENDL-2023 LIBRARY; T=0.K  
Photon emission for (n,n\*15)

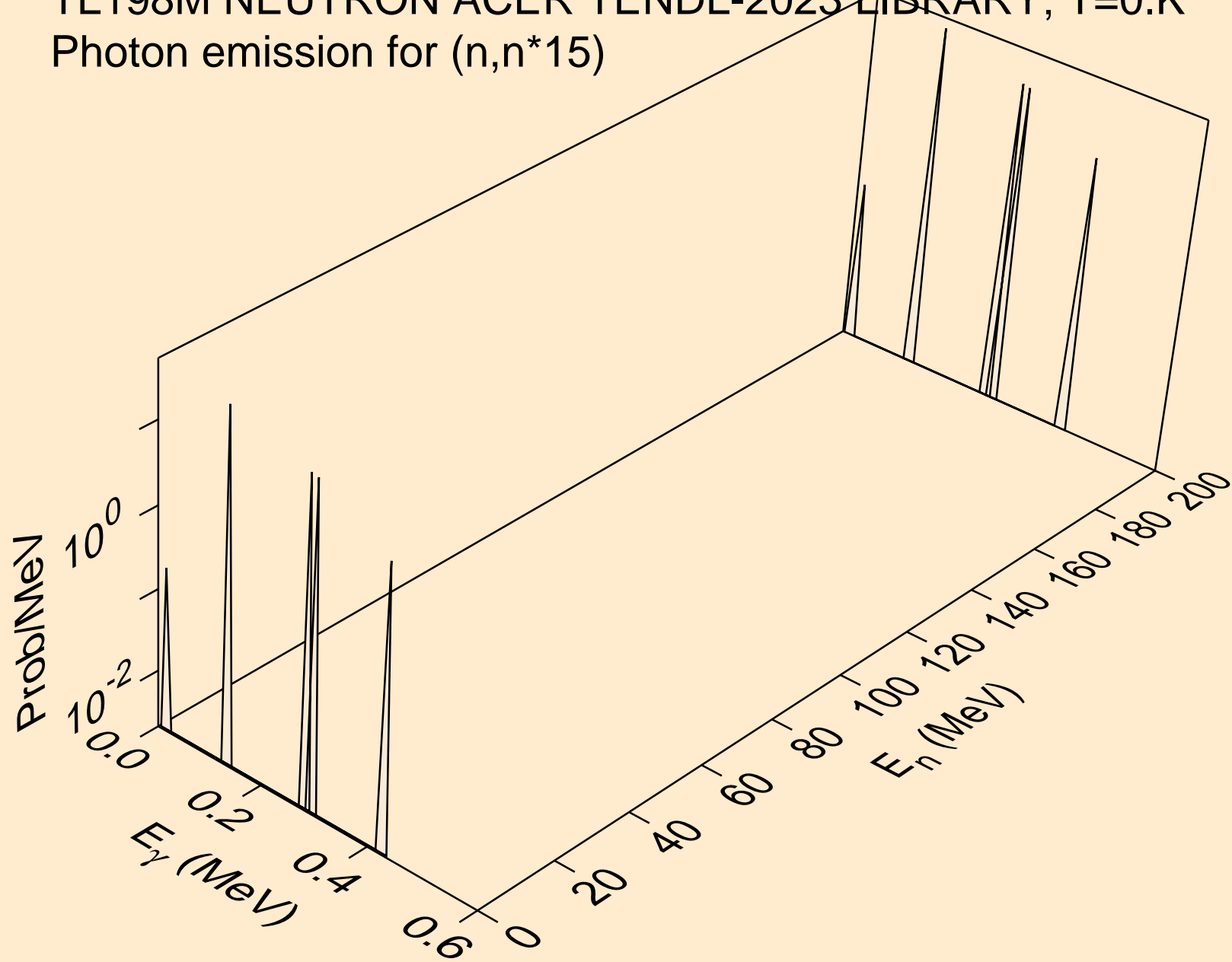

TL198M NEUTRON ACER TENDL-2023 LIBRARY; T=0.K  
Photon emission for (n,n\*16)

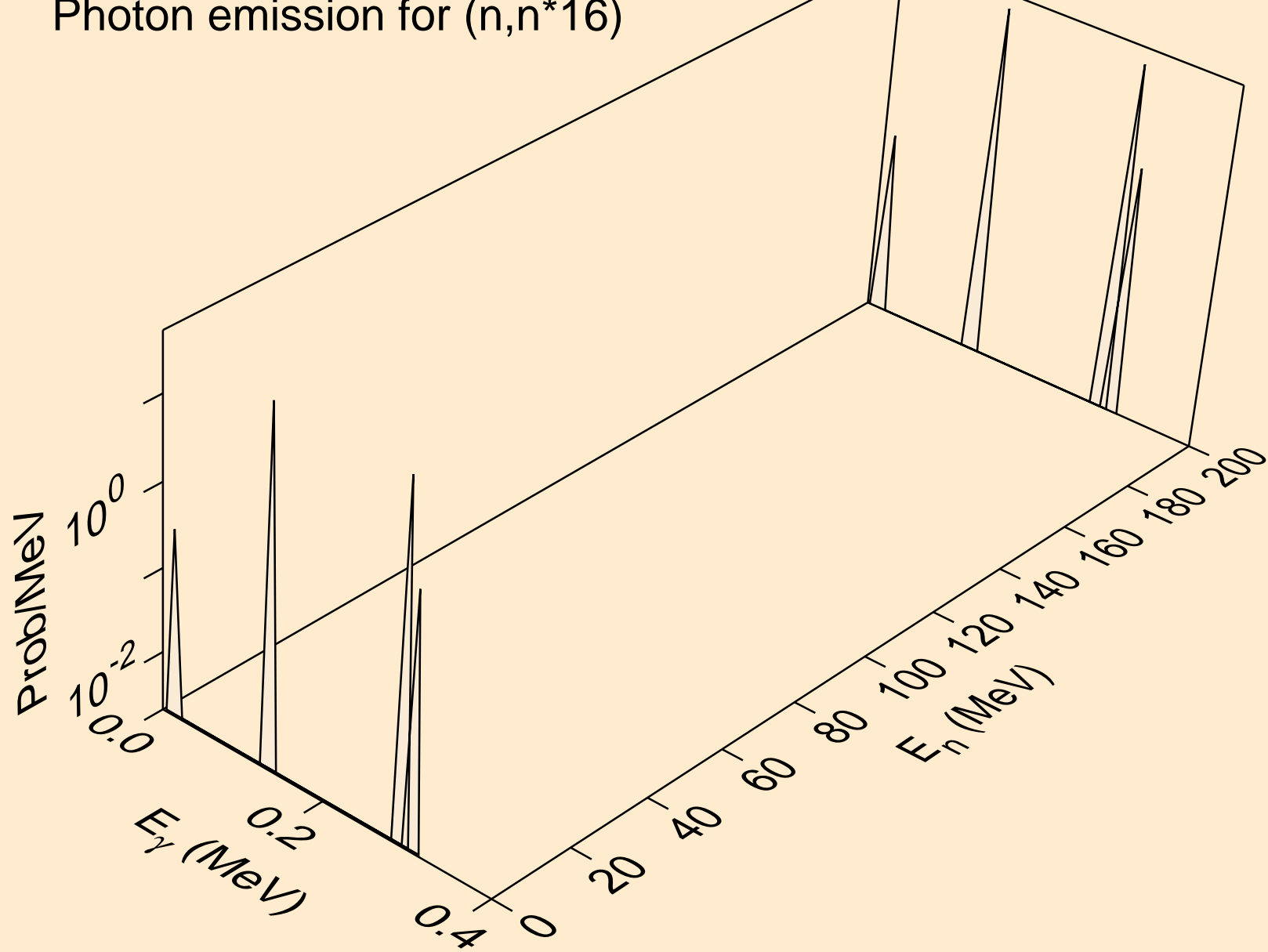



TL198M NEUTRON ACER TENDL-2023 LIBRARY; T=0.K  
Photon emission for (n,n\*17)

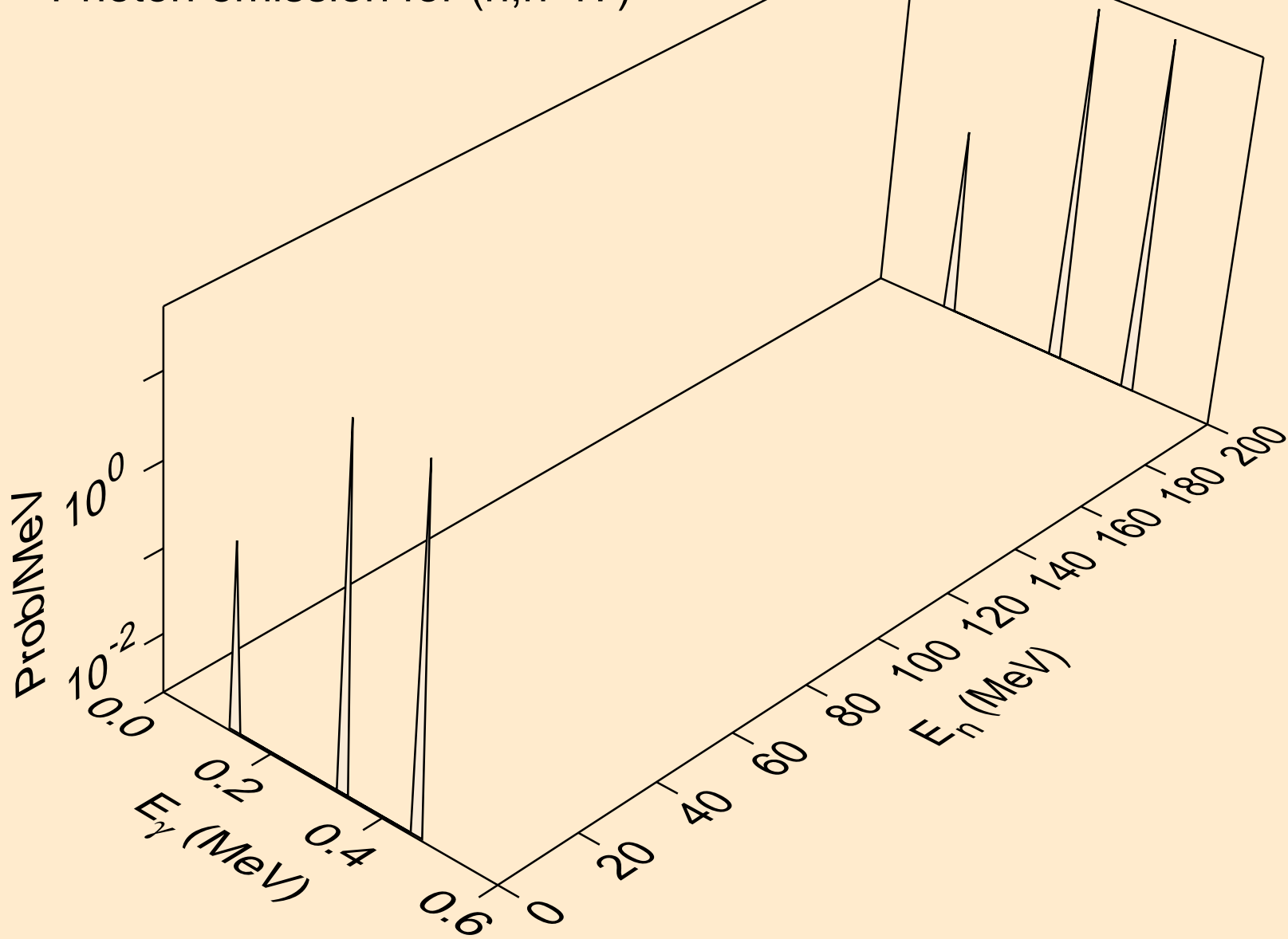

TL198M NEUTRON ACER TENDL-2023 LIBRARY; T=0.K  
Photon emission for (n,n\*c)

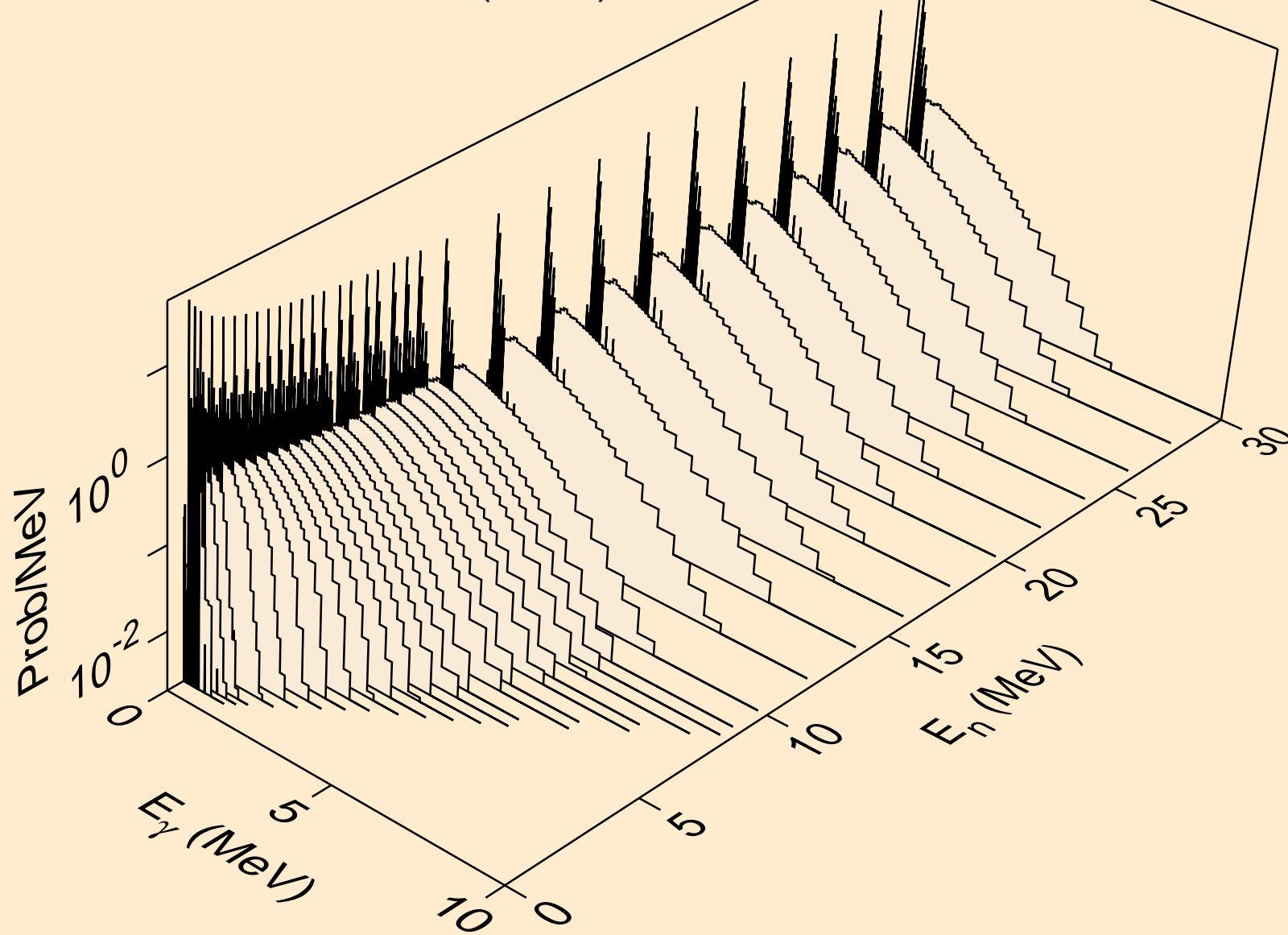

TL198M NEUTRON ACER TENDL-2023 LIBRARY; T=0.K  
Photon emission for (n,gma)

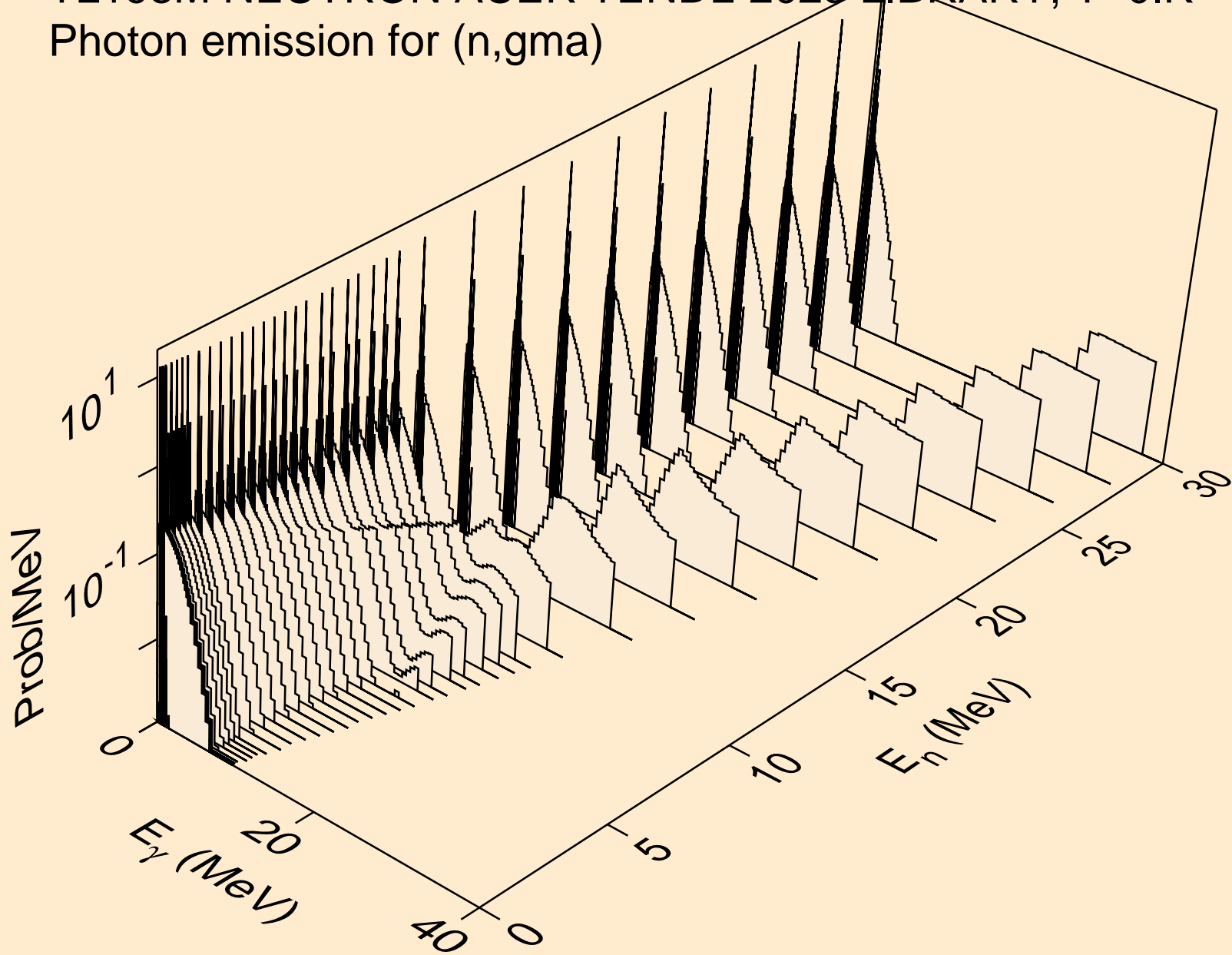

TL198M NEUTRON ACER TENDL-2023 LIBRARY; T=0.K  
Photon emission for (n,p)

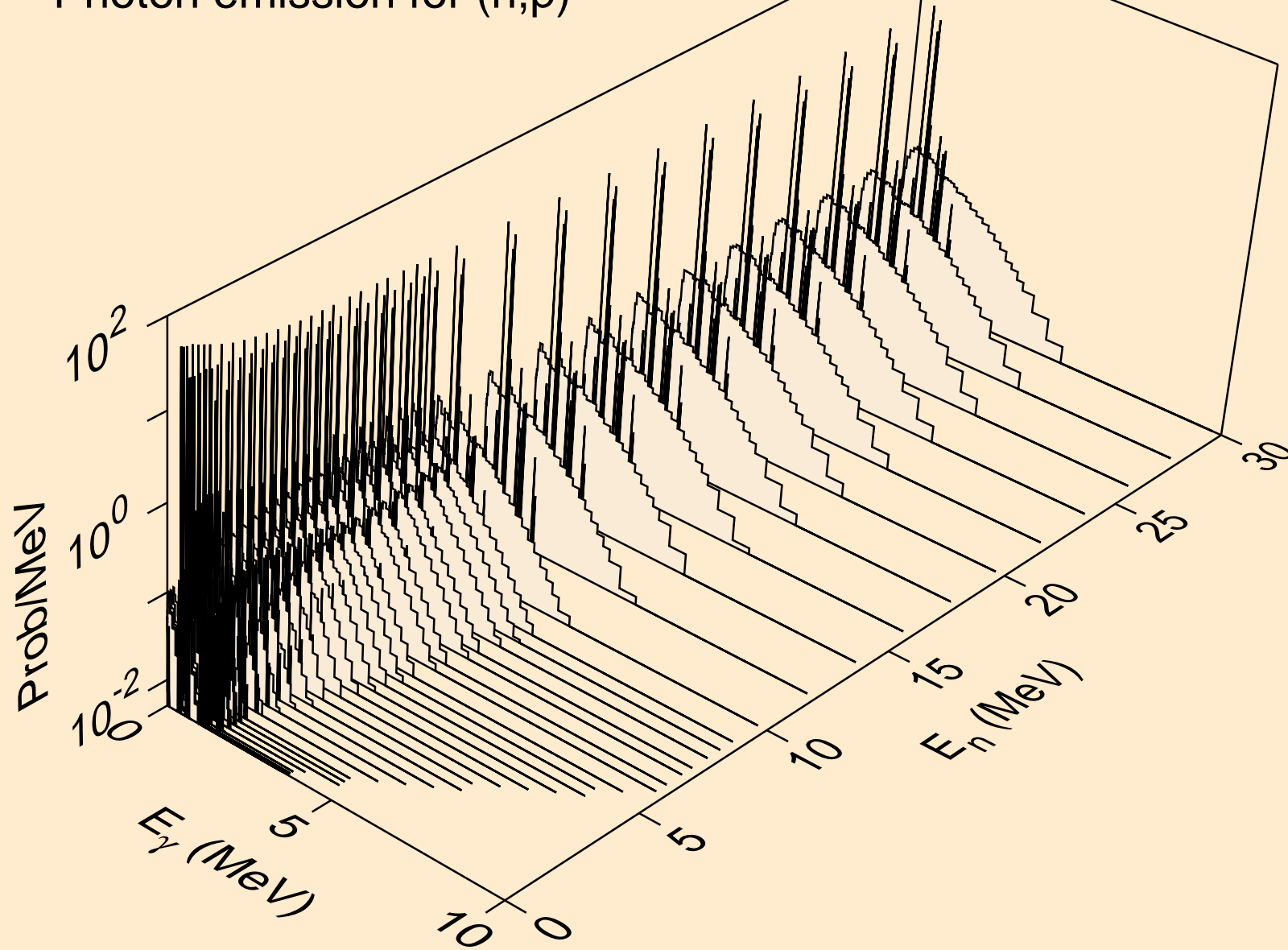

TL198M NEUTRON ACER TENDL-2023 LIBRARY; T=0.K  
Photon emission for (n,d)

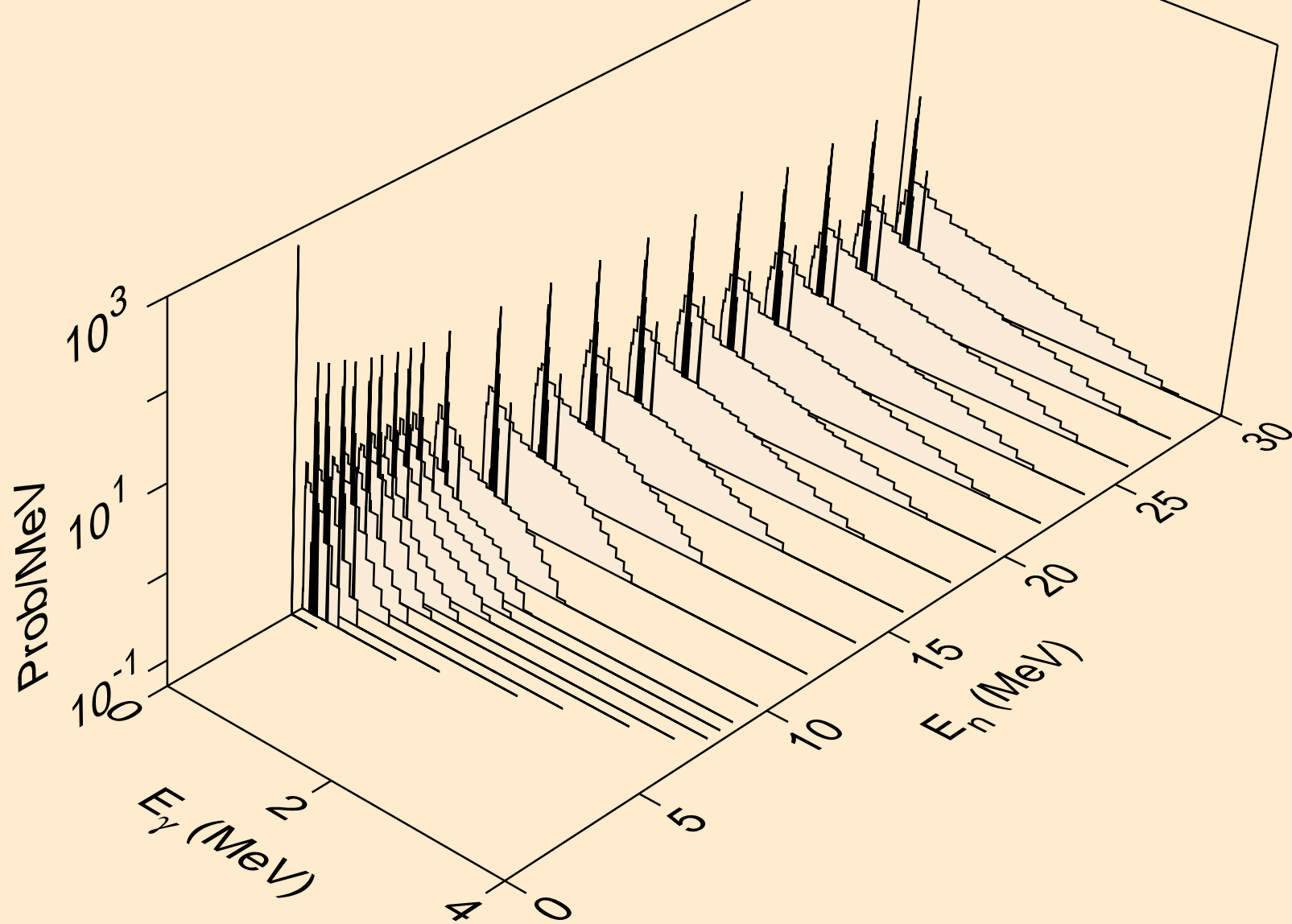

TL198M NEUTRON ACER TENDL-2023 LIBRARY; T=0.K  
Photon emission for (n,t)

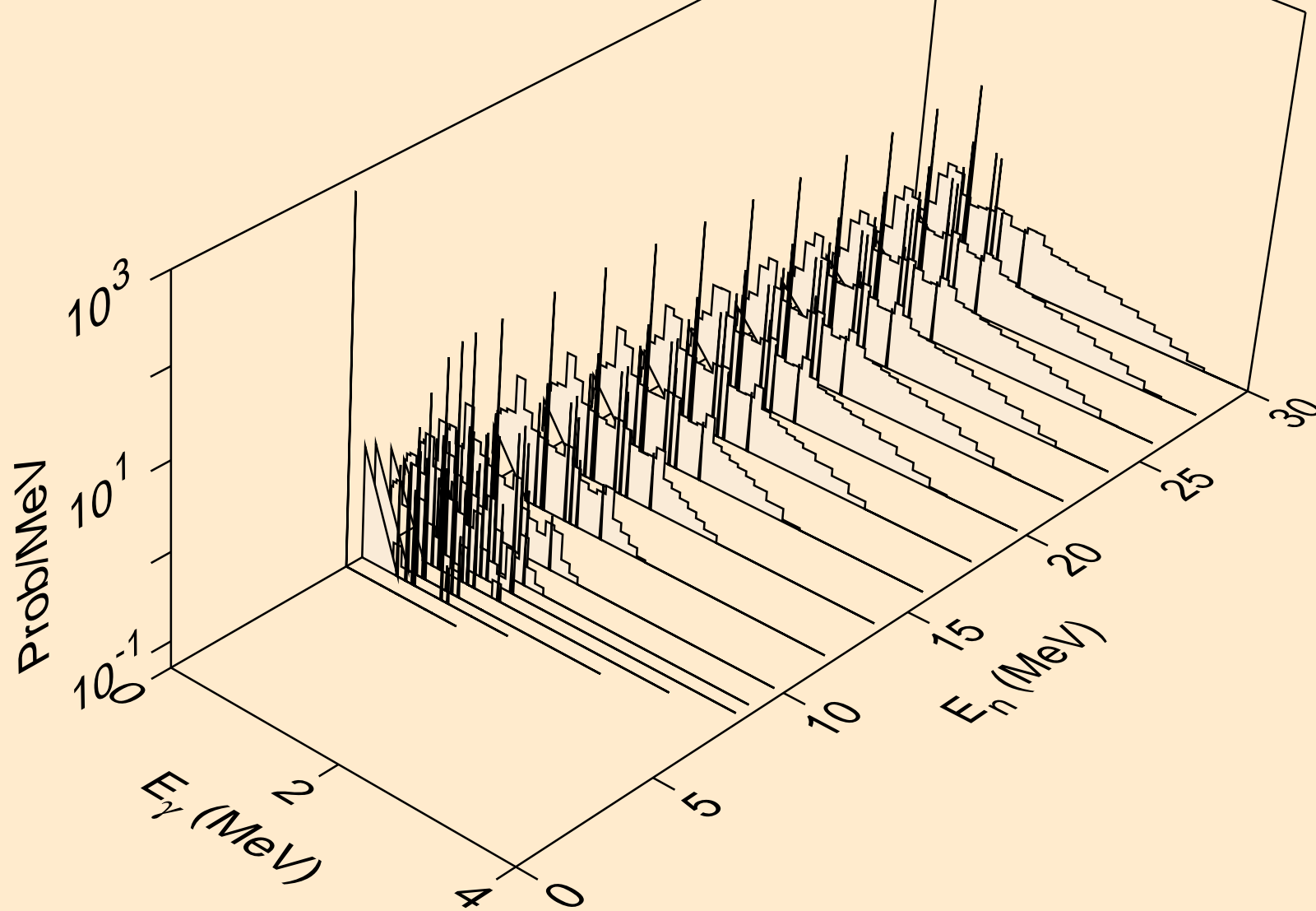

TL198M NEUTRON ACER TENDL-2023 LIBRARY; T=0.K  
Photon emission for (n,he3)

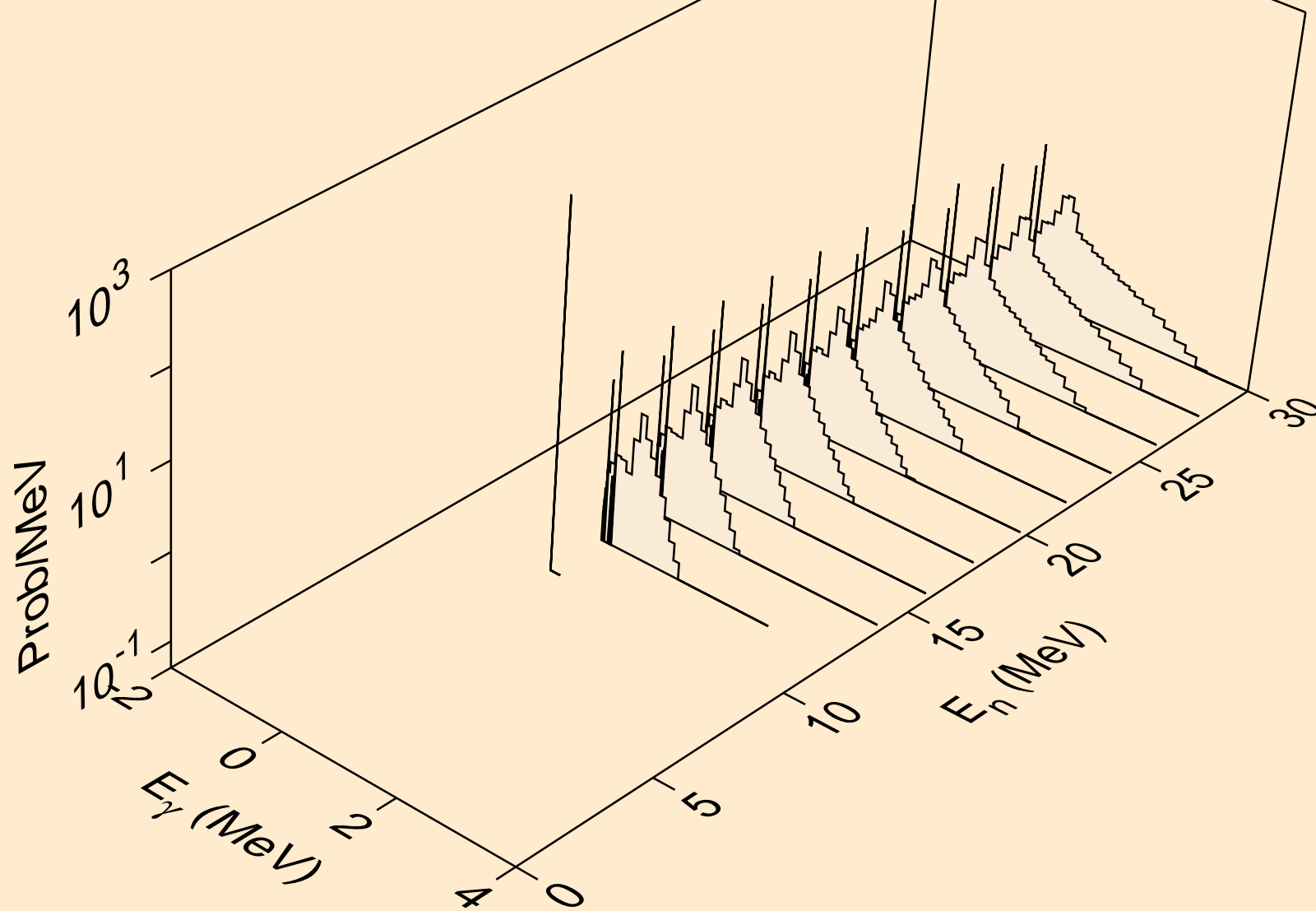

TL198M NEUTRON ACER TENDL-2023 LIBRARY; T=0.K  
Photon emission for (n,a)

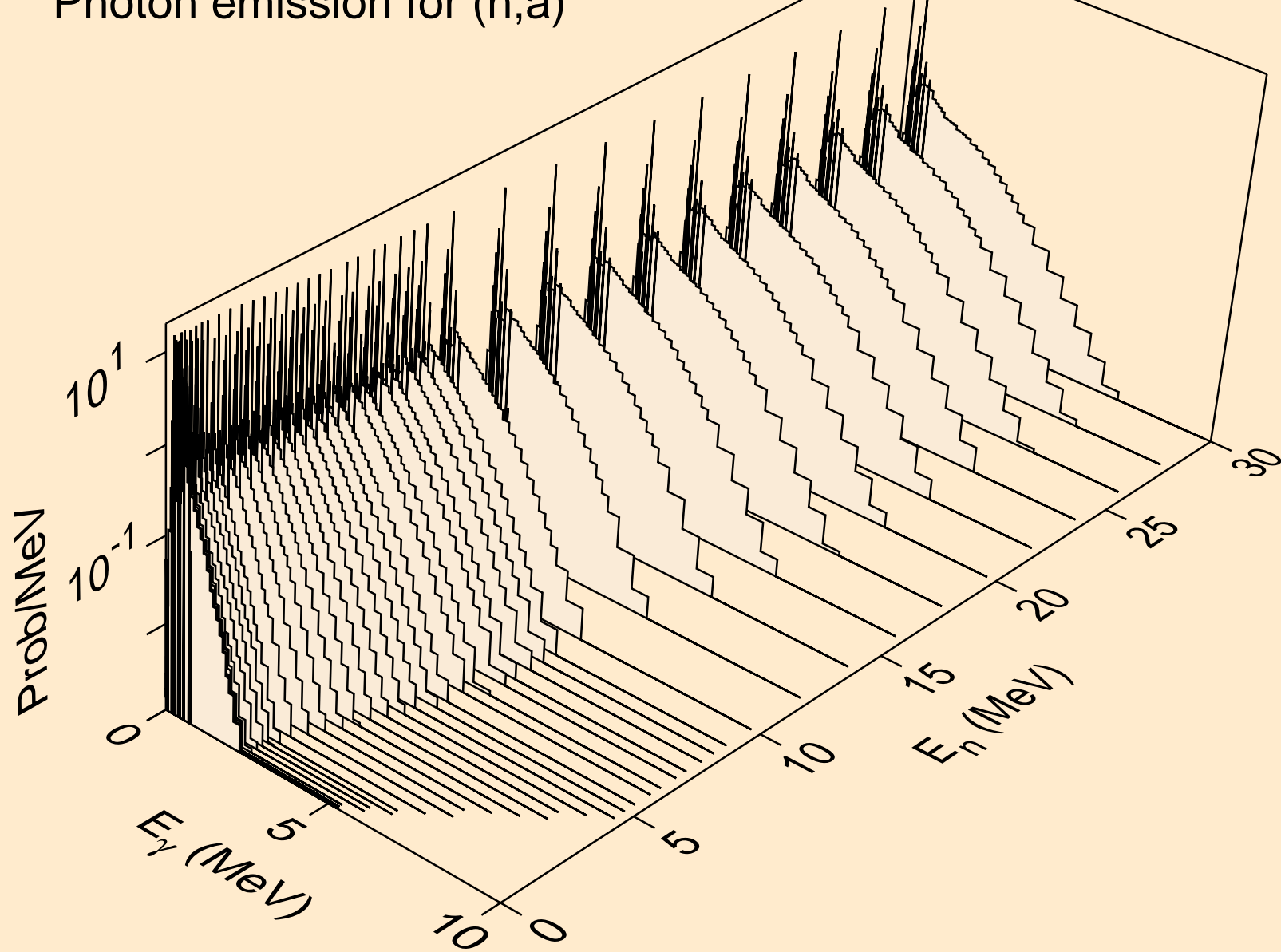



TL198M NEUTRON ACER TENDL-2023 LIBRARY; T=0.K  
Photon emission for (n,2a)

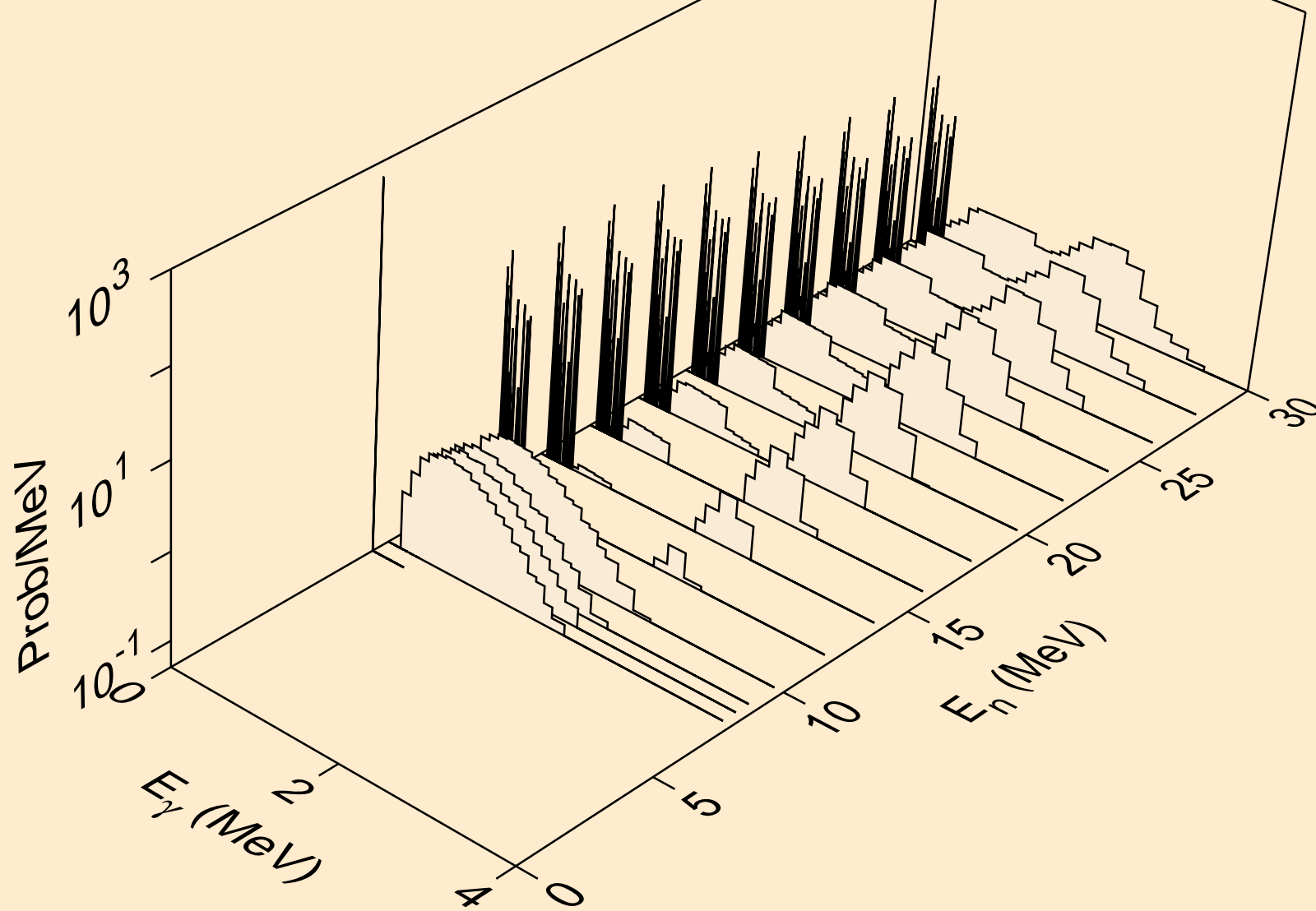

TL198M NEUTRON ACER TENDL-2023 LIBRARY; T=0.K  
Photon emission for (n,2p)

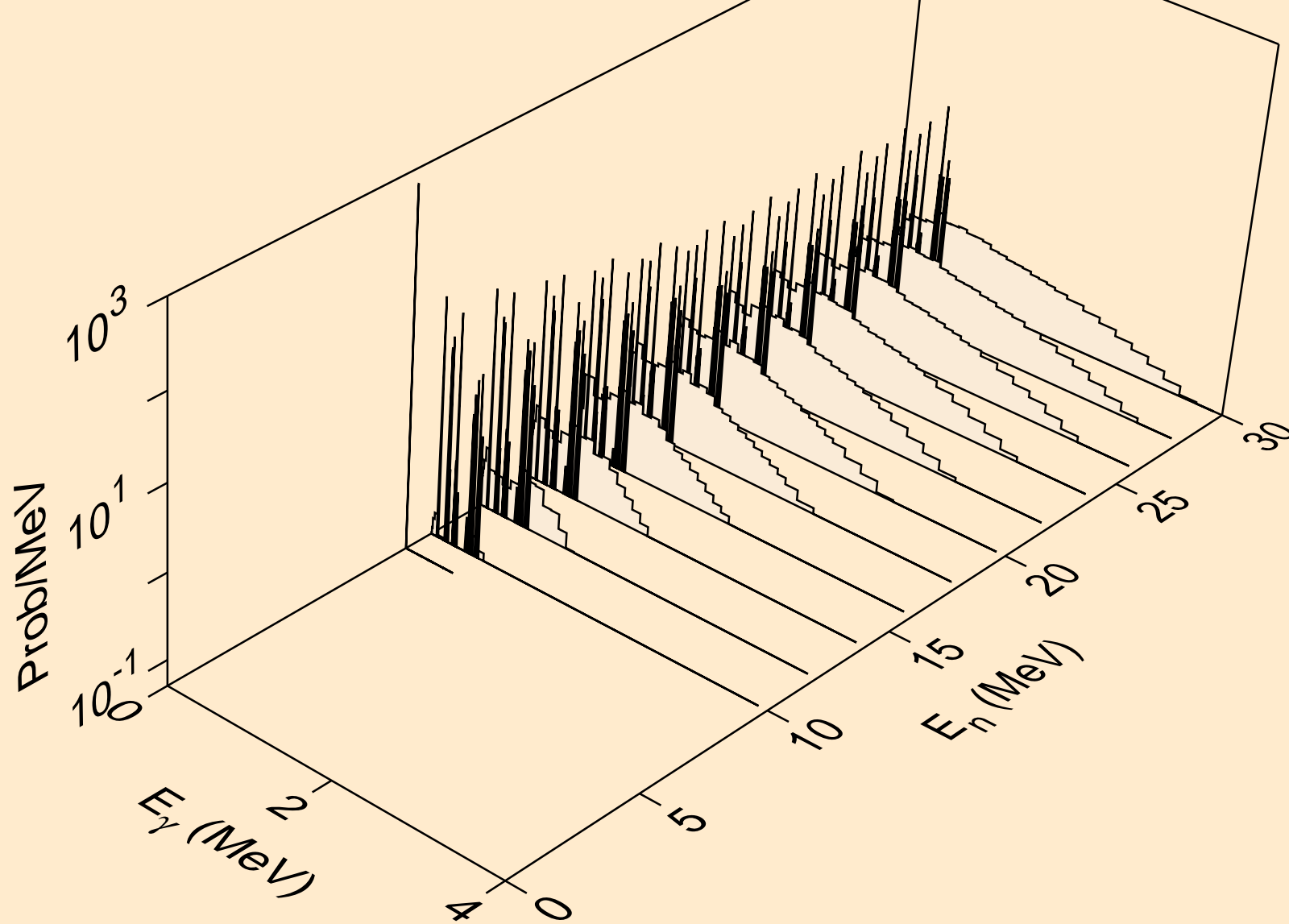

TL198M NEUTRON ACER TENDL-2023 LIBRARY; T=0.K  
Photon emission for (n,p $\alpha$ )

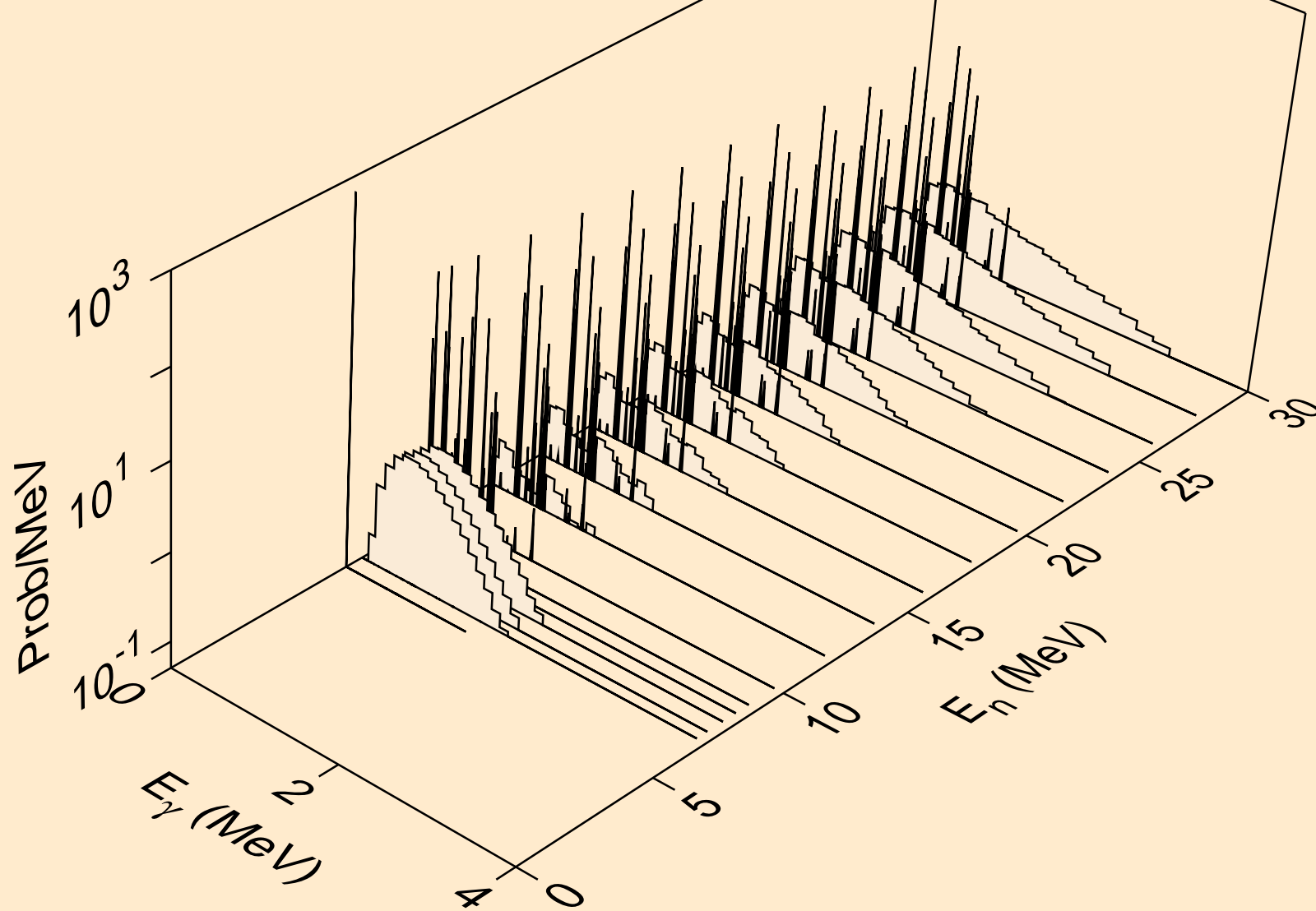

TL198M NEUTRON ACER TENDL-2023 LIBRARY; T=0.K  
Photon emission for (n,pd)

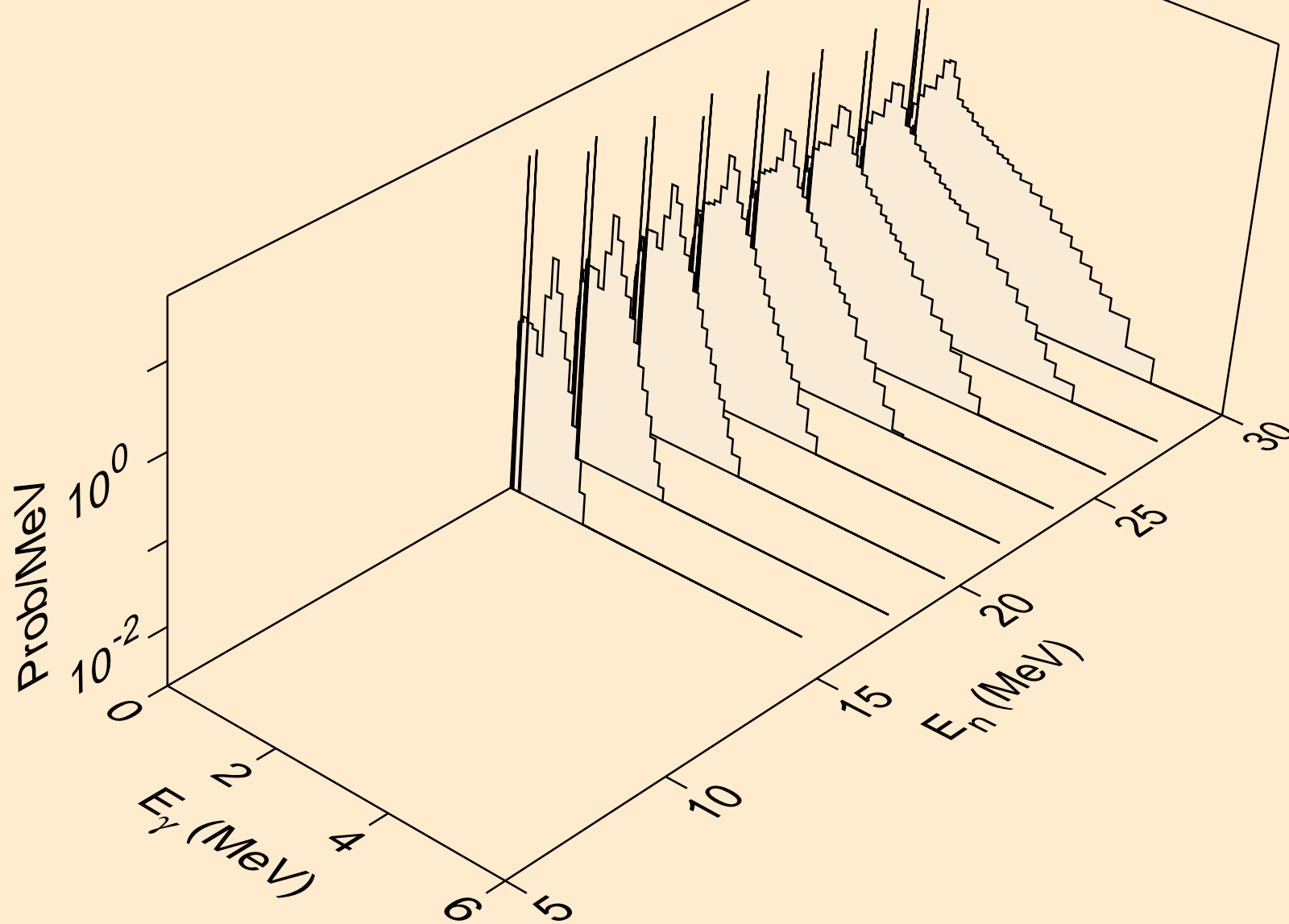

TL198M NEUTRON ACER TENDL-2023 LIBRARY; T=0.K  
Photon emission for (n,pt)

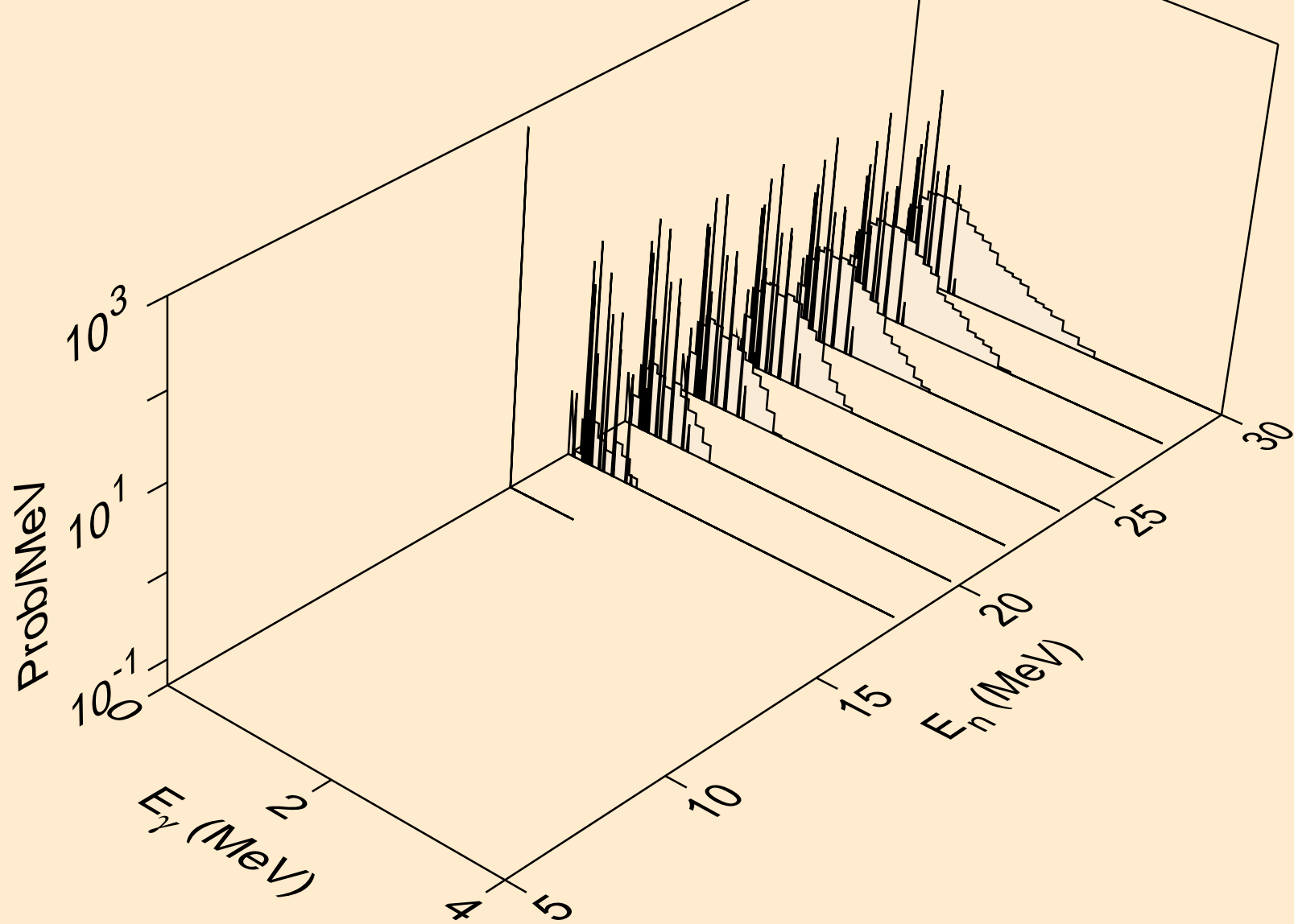

TL198M NEUTRON ACER TENDL-2023 LIBRARY; T=0.K  
Photon emission for (n,da)

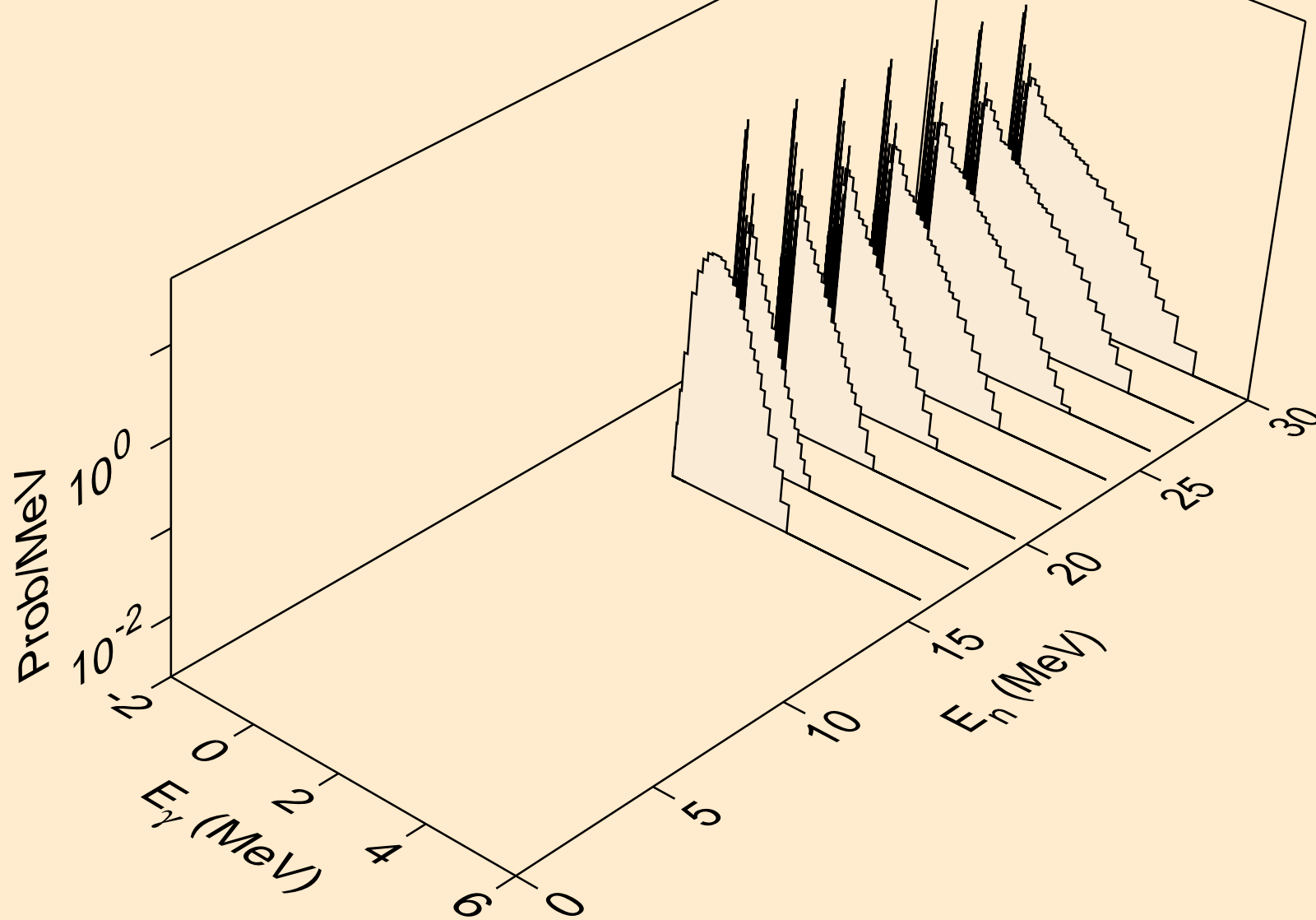

TL198M NEUTRON ACER TENDL-2023 LIBRARY; T=0.K  
thermal capture photon spectrum

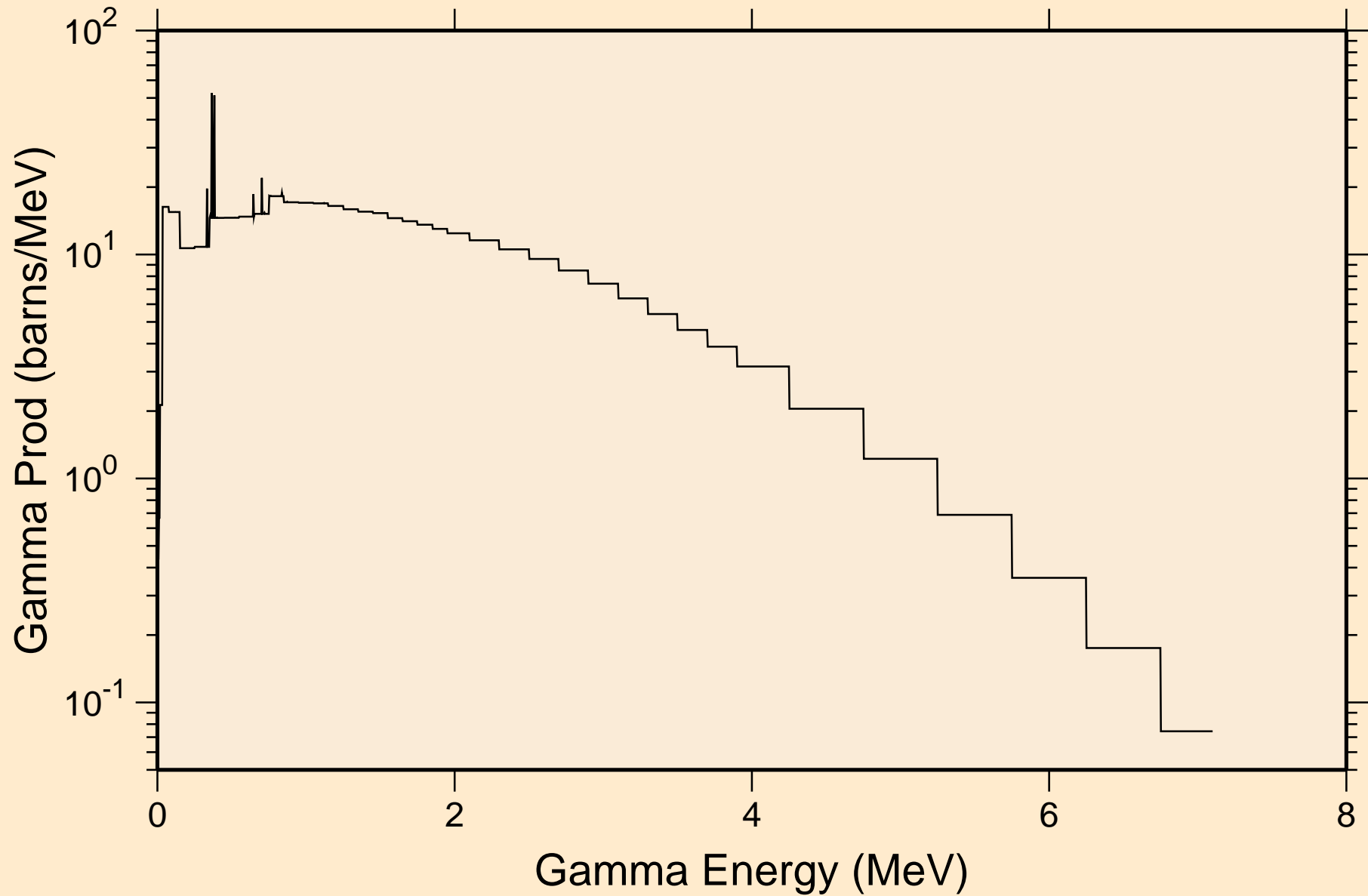

TL198M NEUTRON ACER TENDL-2023 LIBRARY; T=0.K  
14 MeV photon spectrum

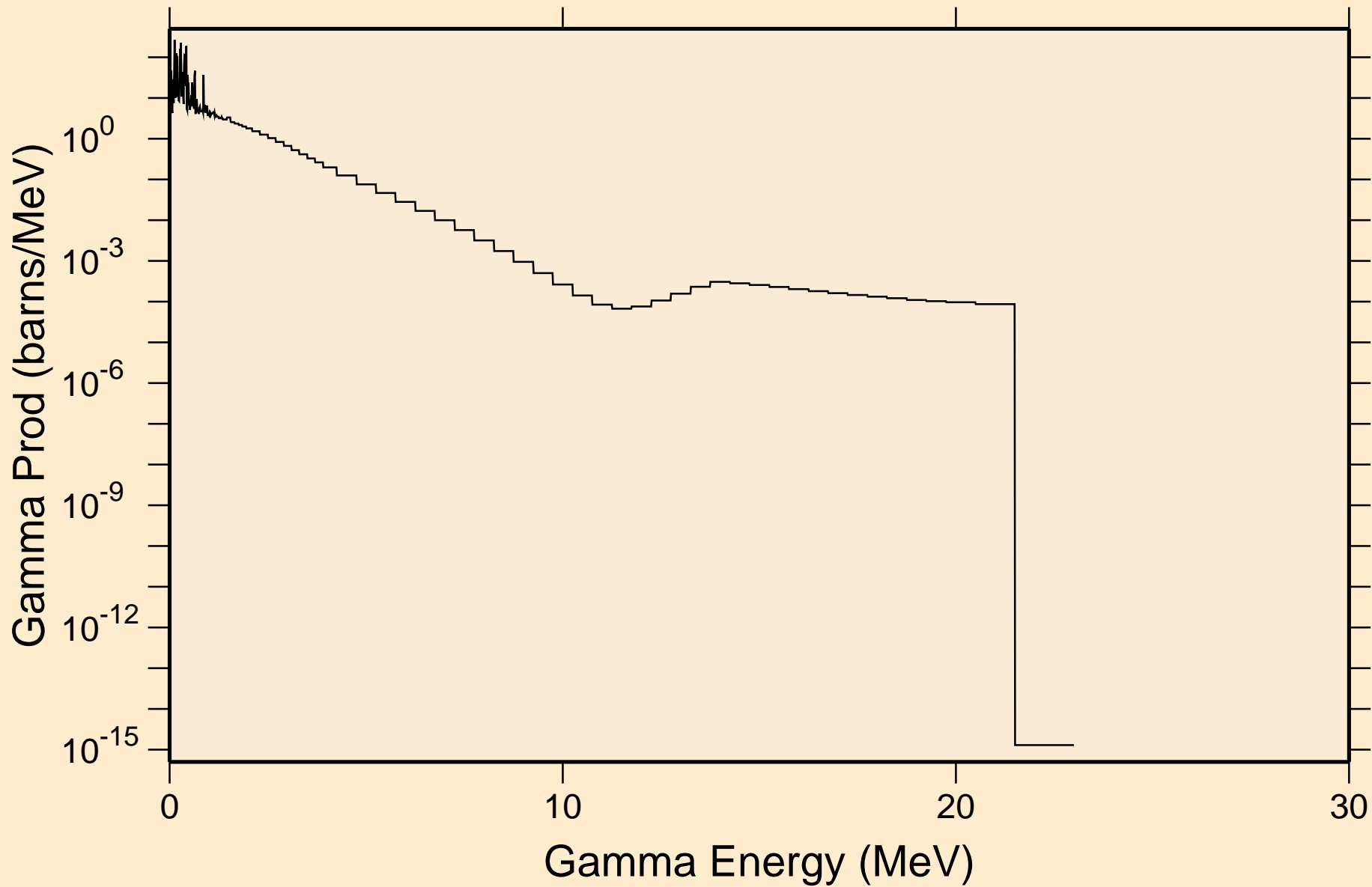



TL198M NEUTRON ACER TENDL-2023 LIBRARY; T=0.K  
Particle heating contributions

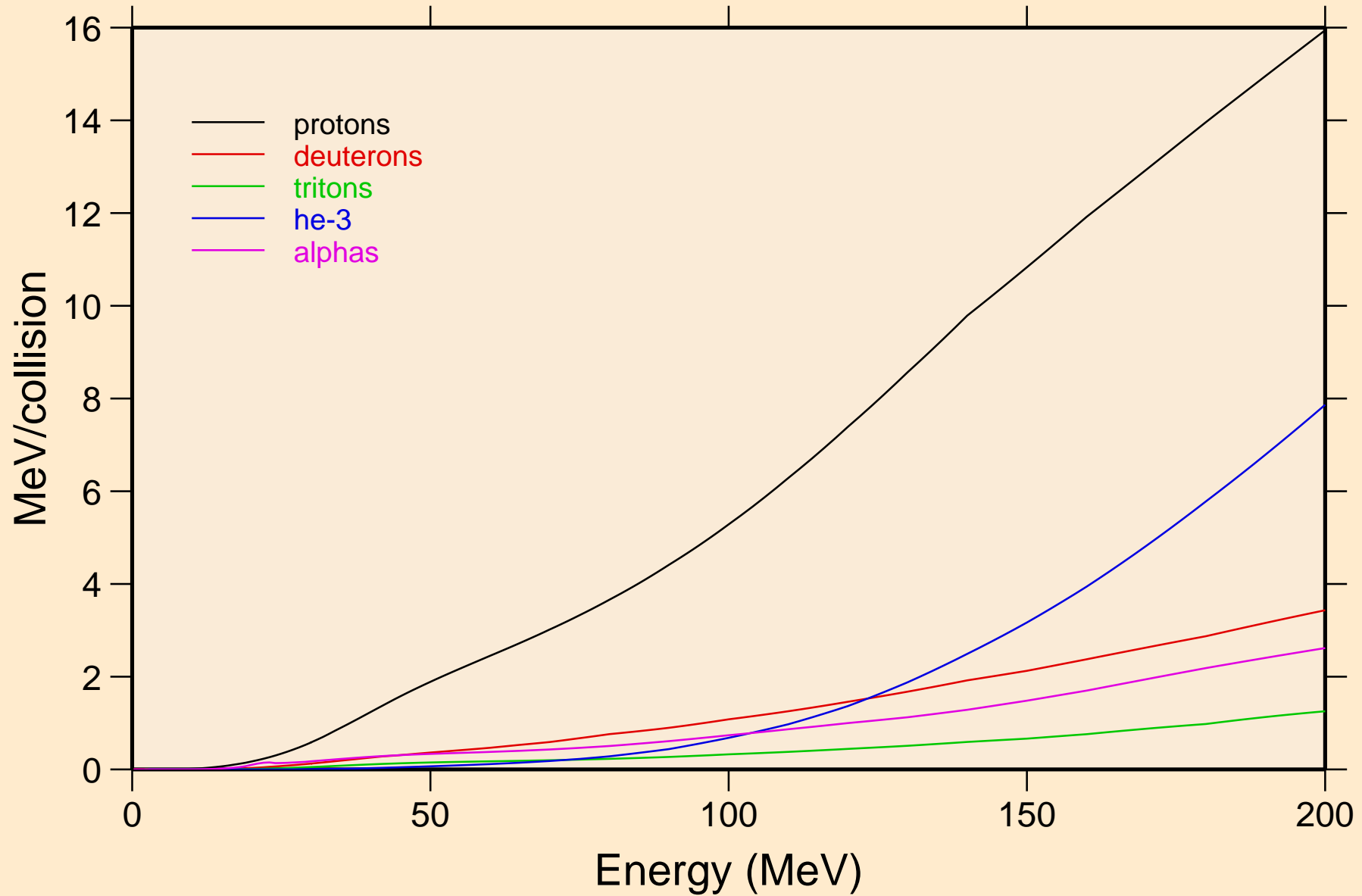

TL198M NEUTRON ACER TENDL-2023 LIBRARY; T=0.K  
Recoil Heating

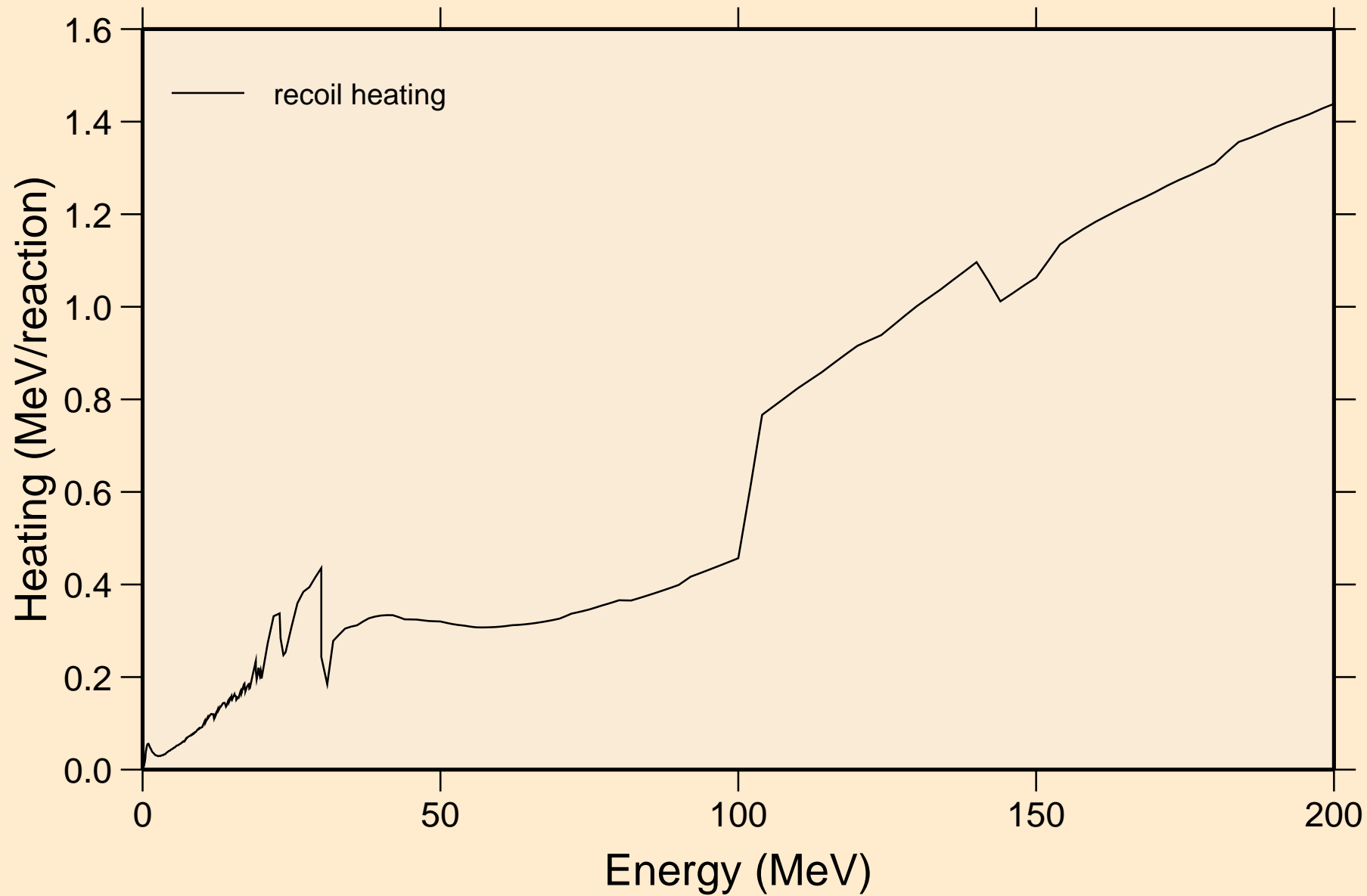

TL198M NEUTRON ACER TENDL-2023 LIBRARY; T=0.K  
Particle production cross sections

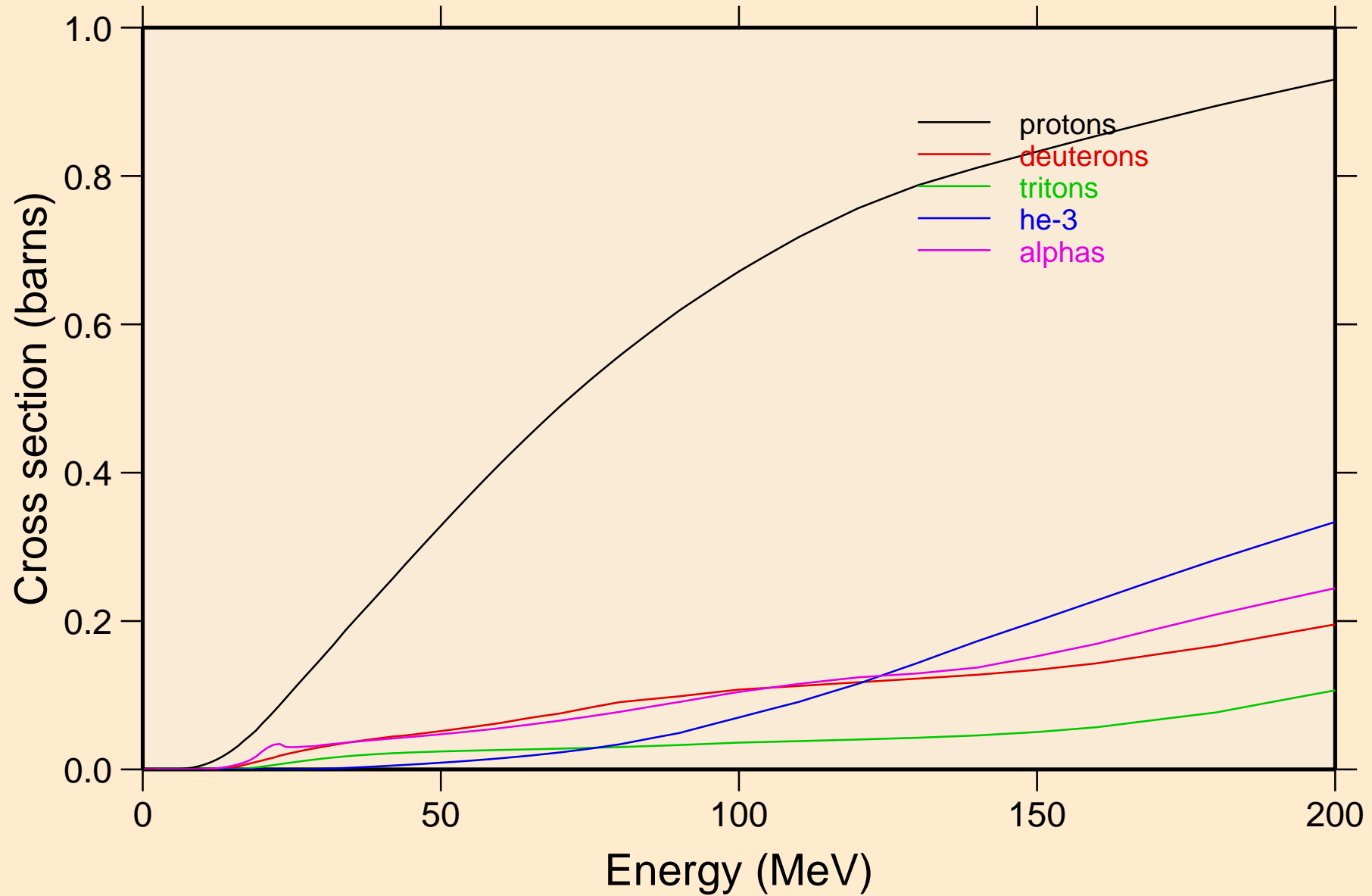

TL198M NEUTRON ACER TENDL-2023 LIBRARY; T=0.K  
protons from (n,x)

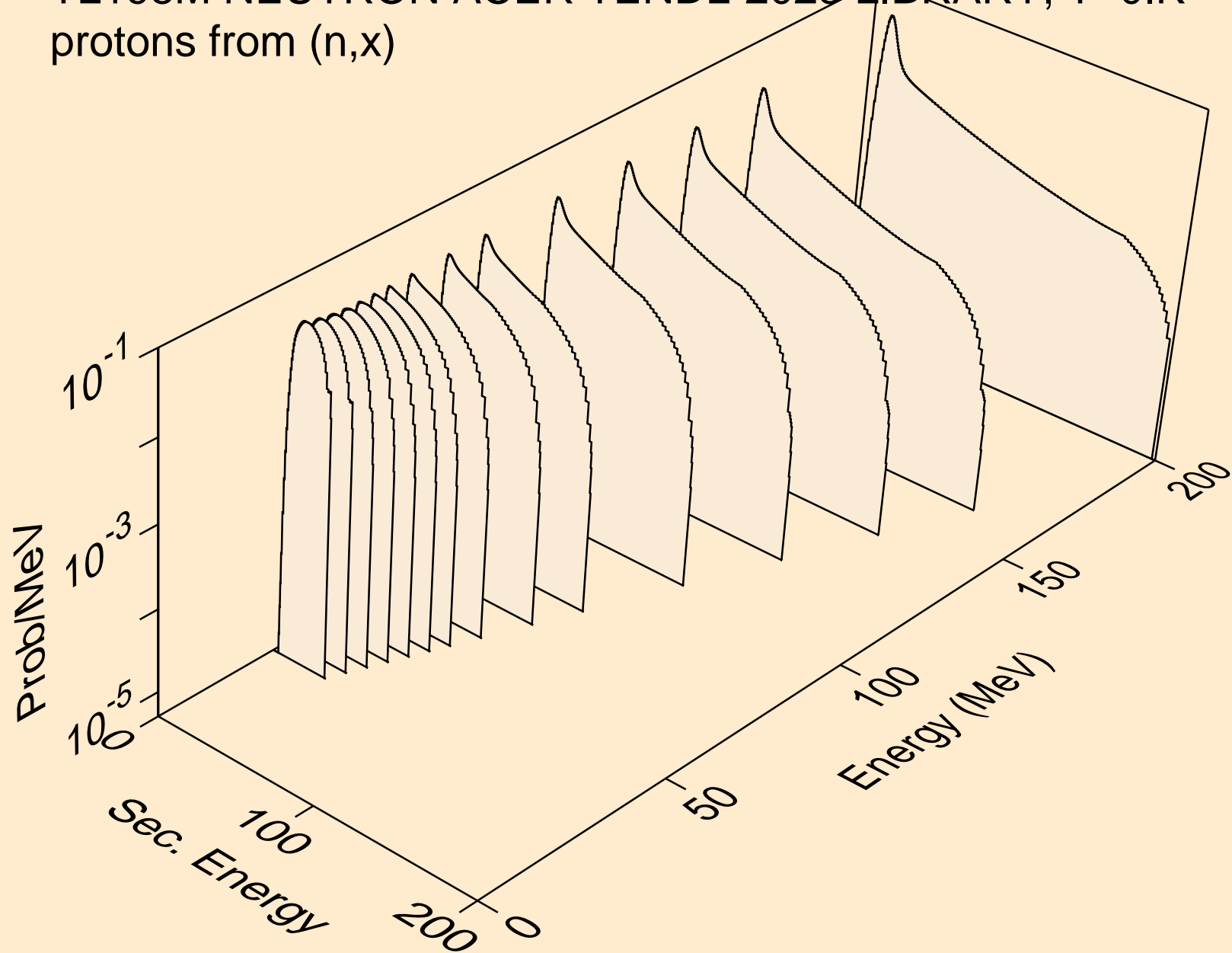

TL198M NEUTRON ACER TENDL-2023 LIBRARY; T=0.K  
protons from (n,n\*)p

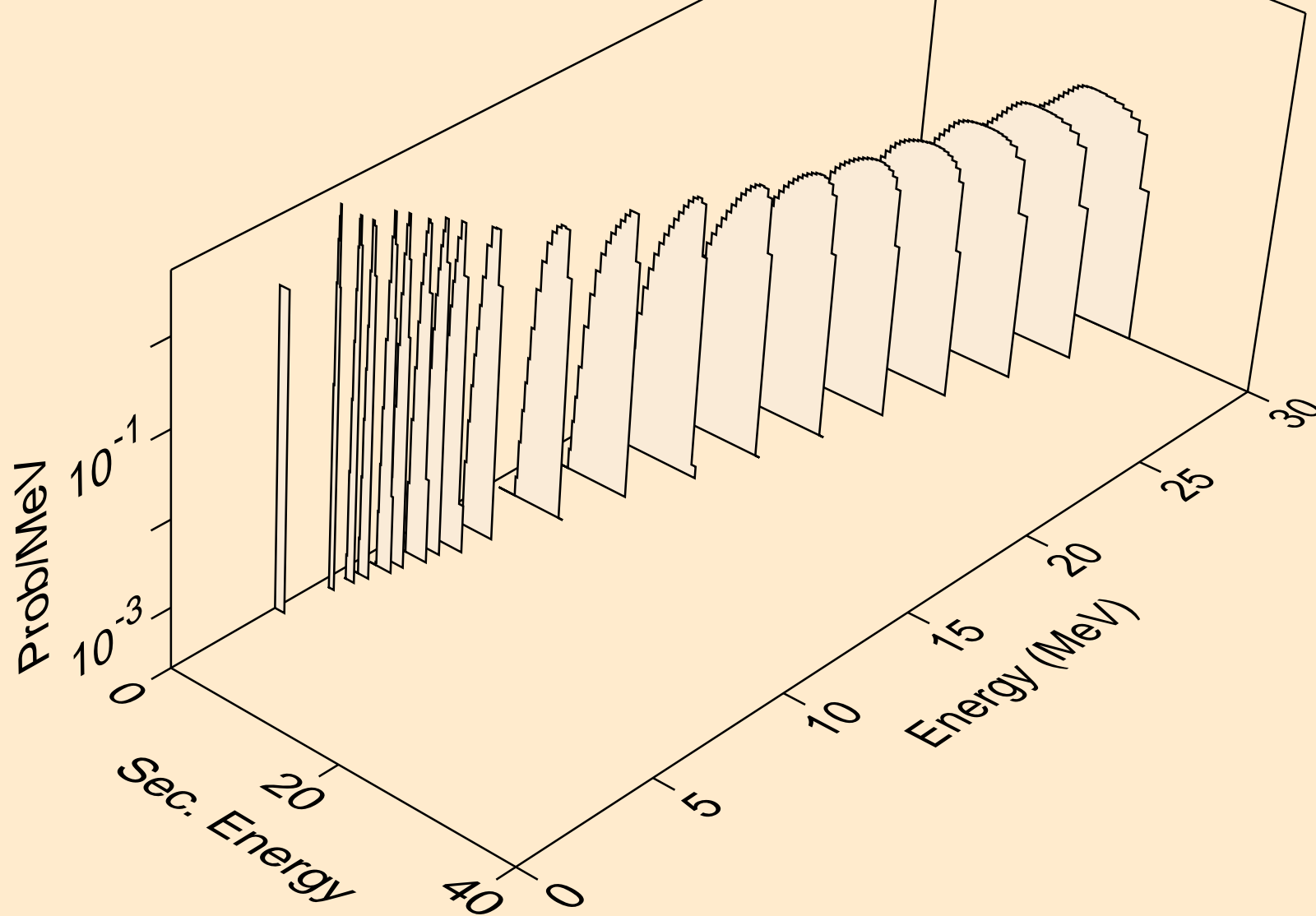

TL198M NEUTRON ACER TENDL-2023 LIBRARY; T=0.K  
protons from (n,2np)

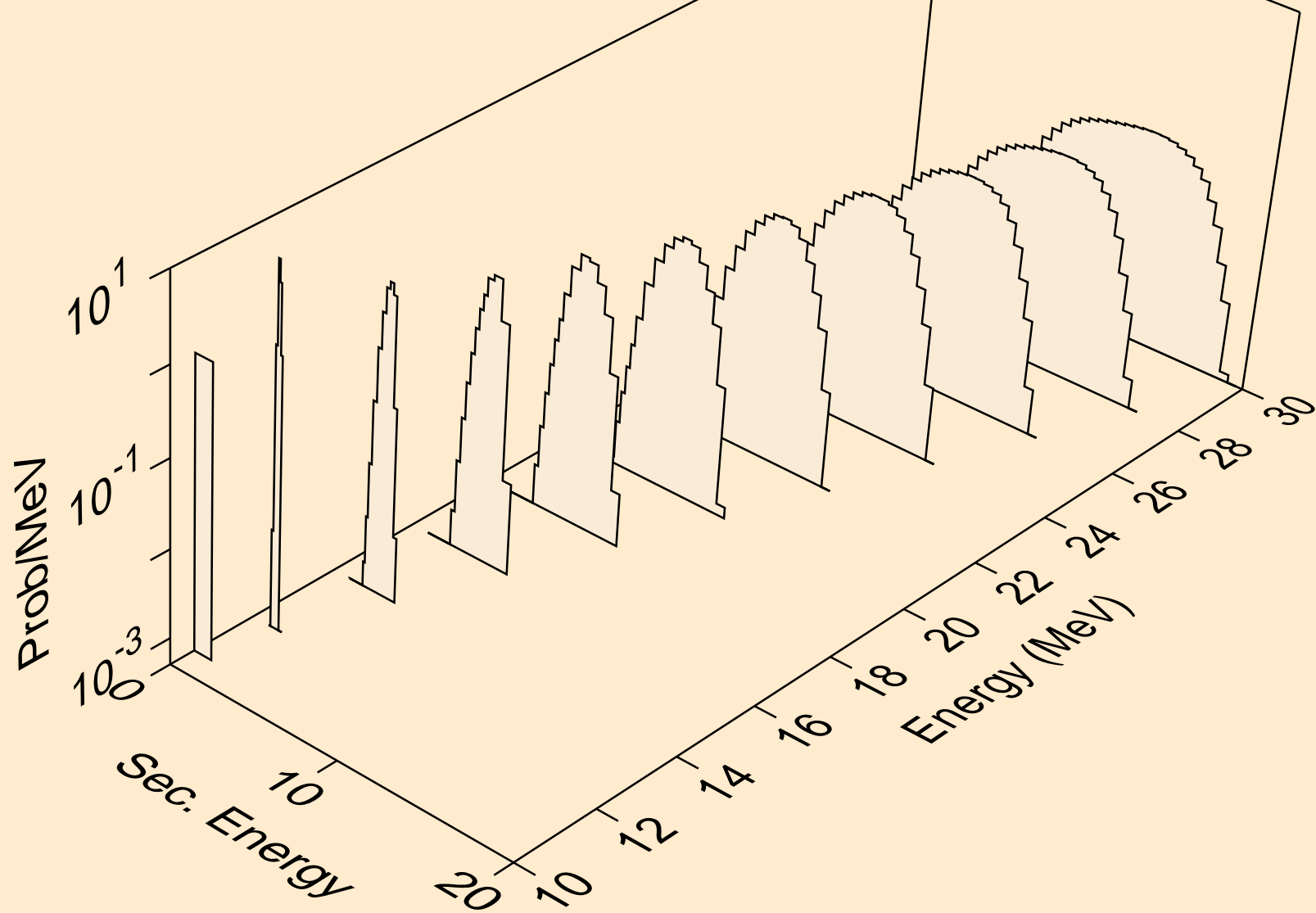

TL198M NEUTRON ACER TENDL-2023 LIBRARY; T=0.K  
protons from (n,3np)

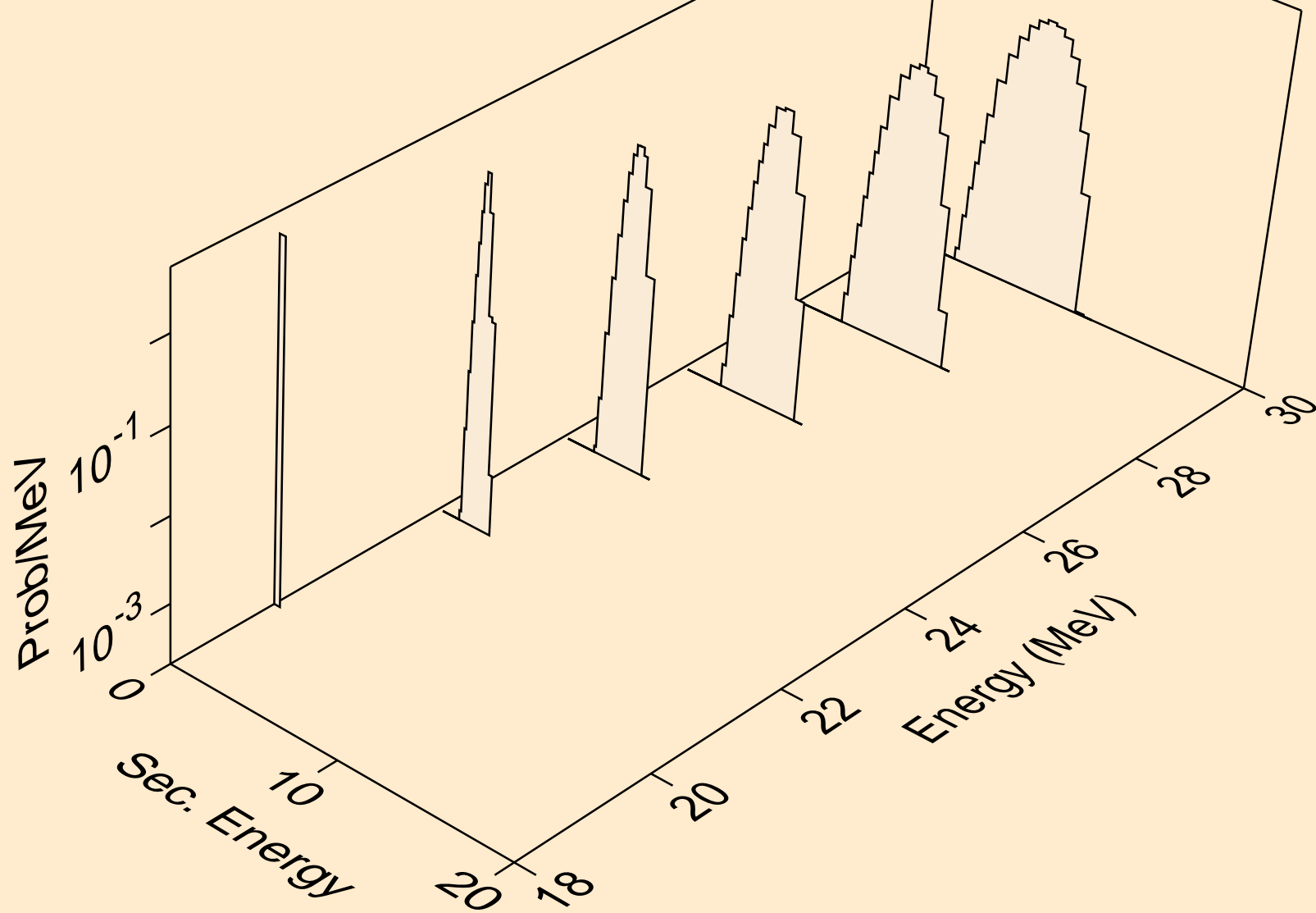

TL198M NEUTRON ACER TENDL-2023 LIBRARY; T=0.K  
protons from (n,n2p)

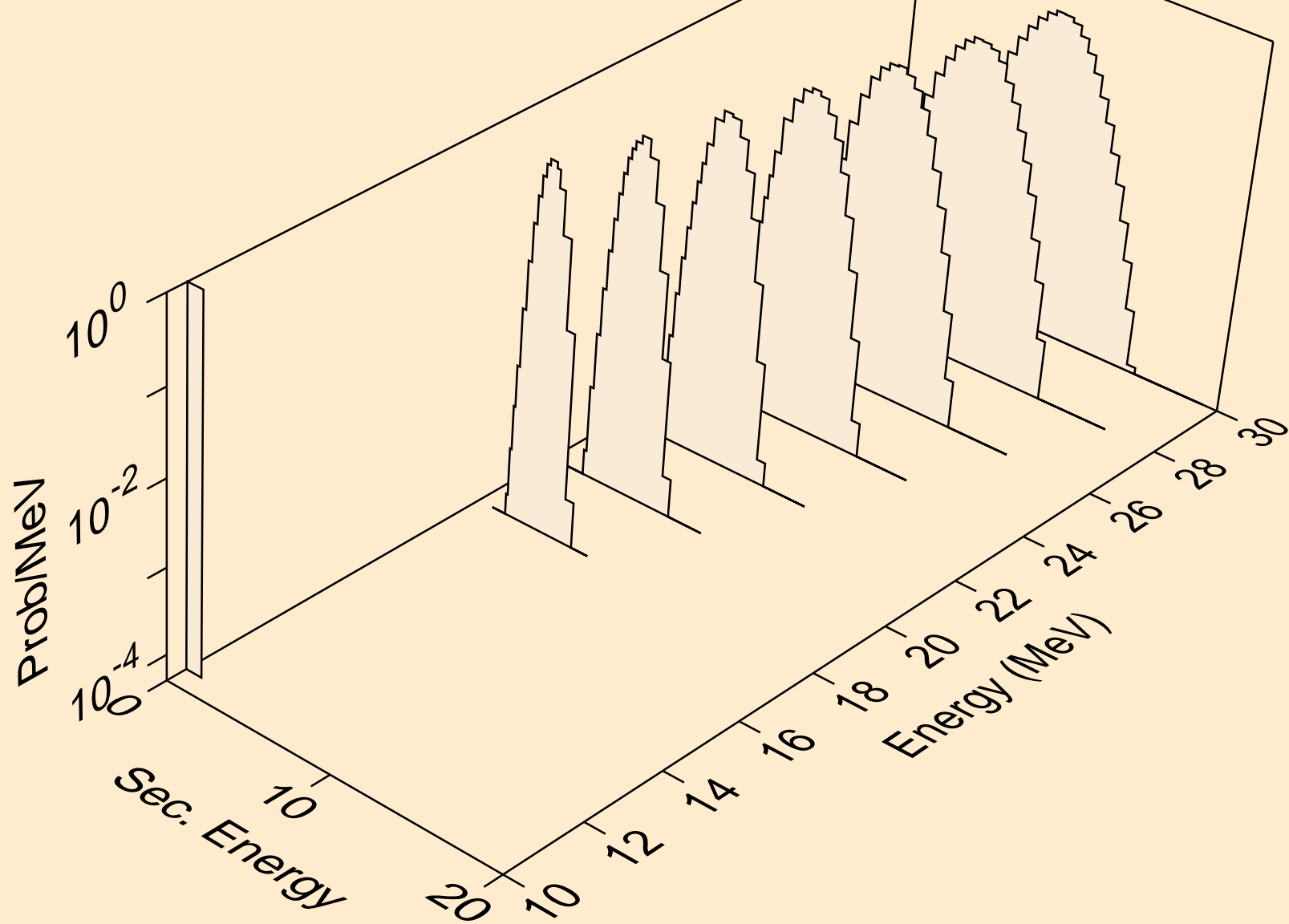



TL198M NEUTRON ACER TENDL-2023 LIBRARY; T=0.K  
protons from (n,npa)

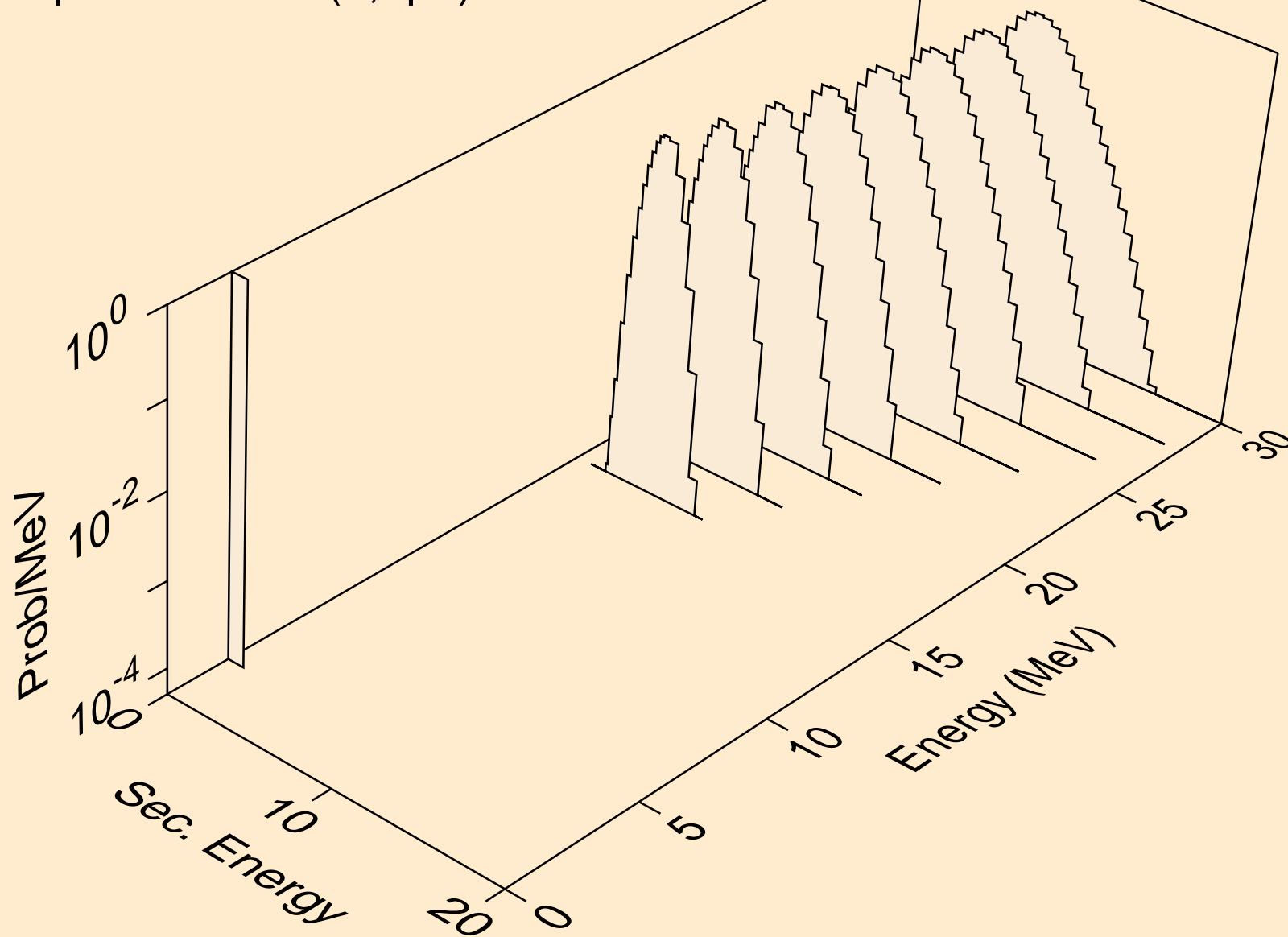

TL198M NEUTRON ACER TENDL-2023 LIBRARY; T=0.K  
protons from (n,p)

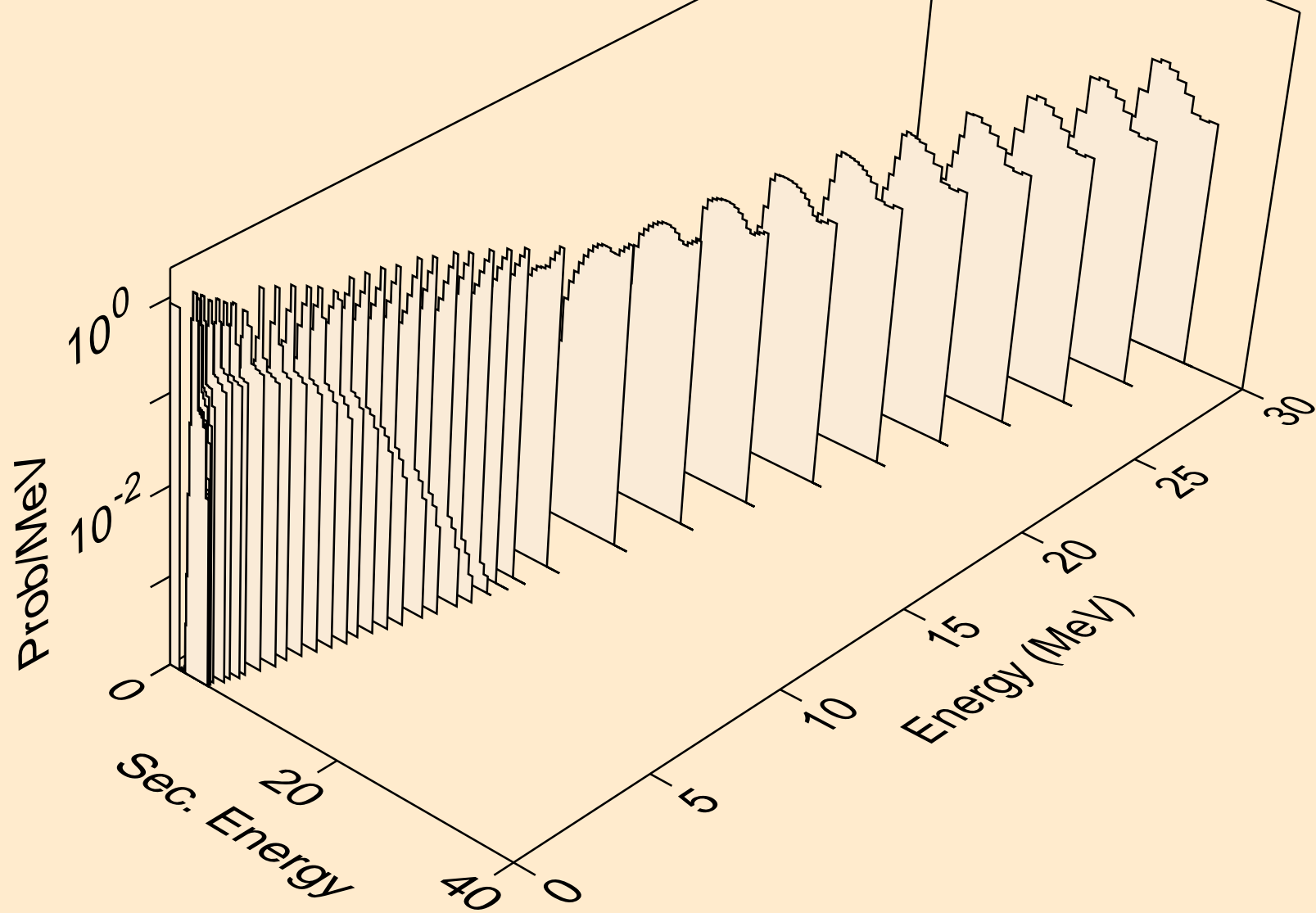

TL198M NEUTRON ACER TENDL-2023 LIBRARY; T=0.K  
protons from (n,2p)

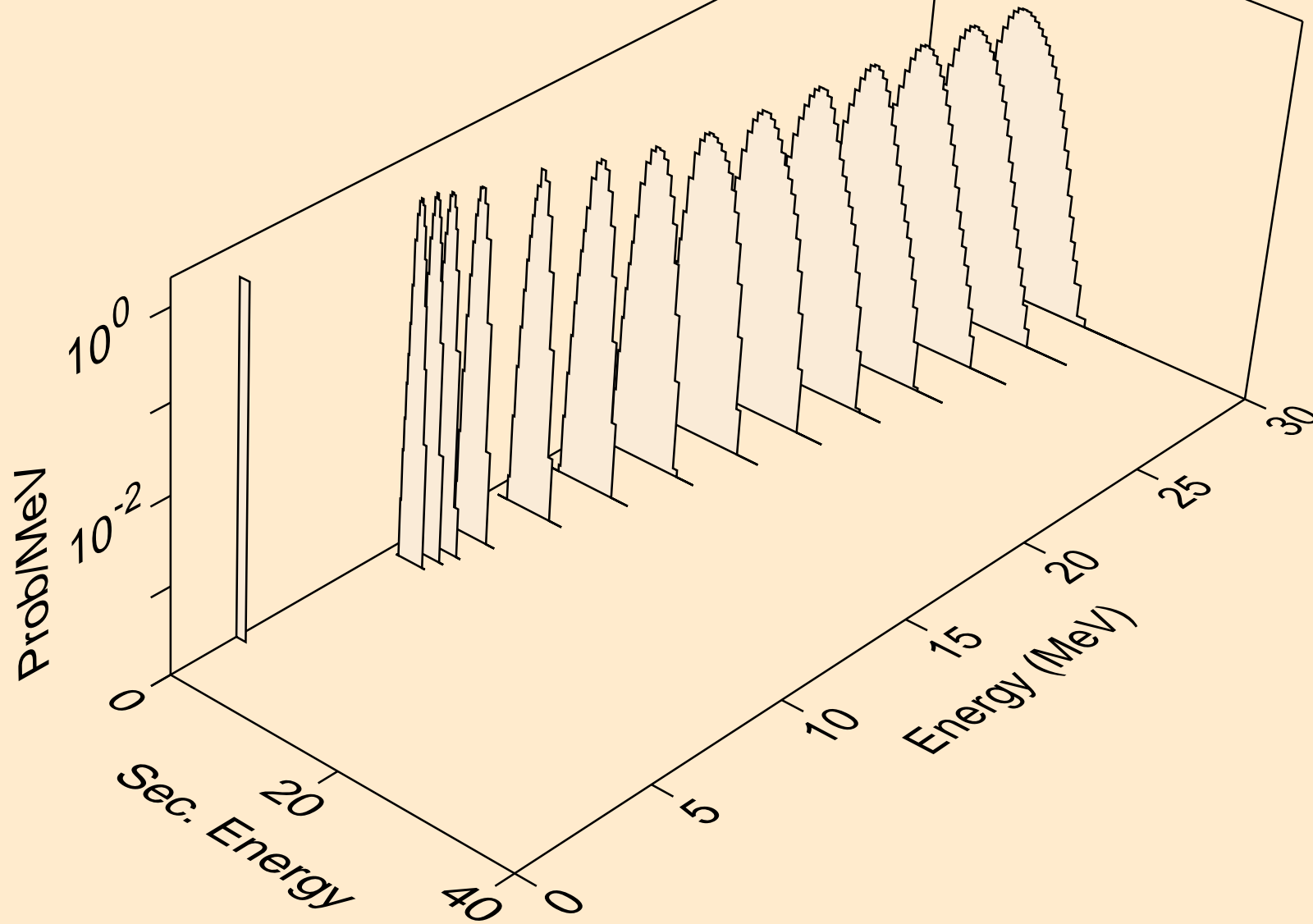

TL198M NEUTRON ACER TENDL-2023 LIBRARY; T=0.K  
protons from (n,p)

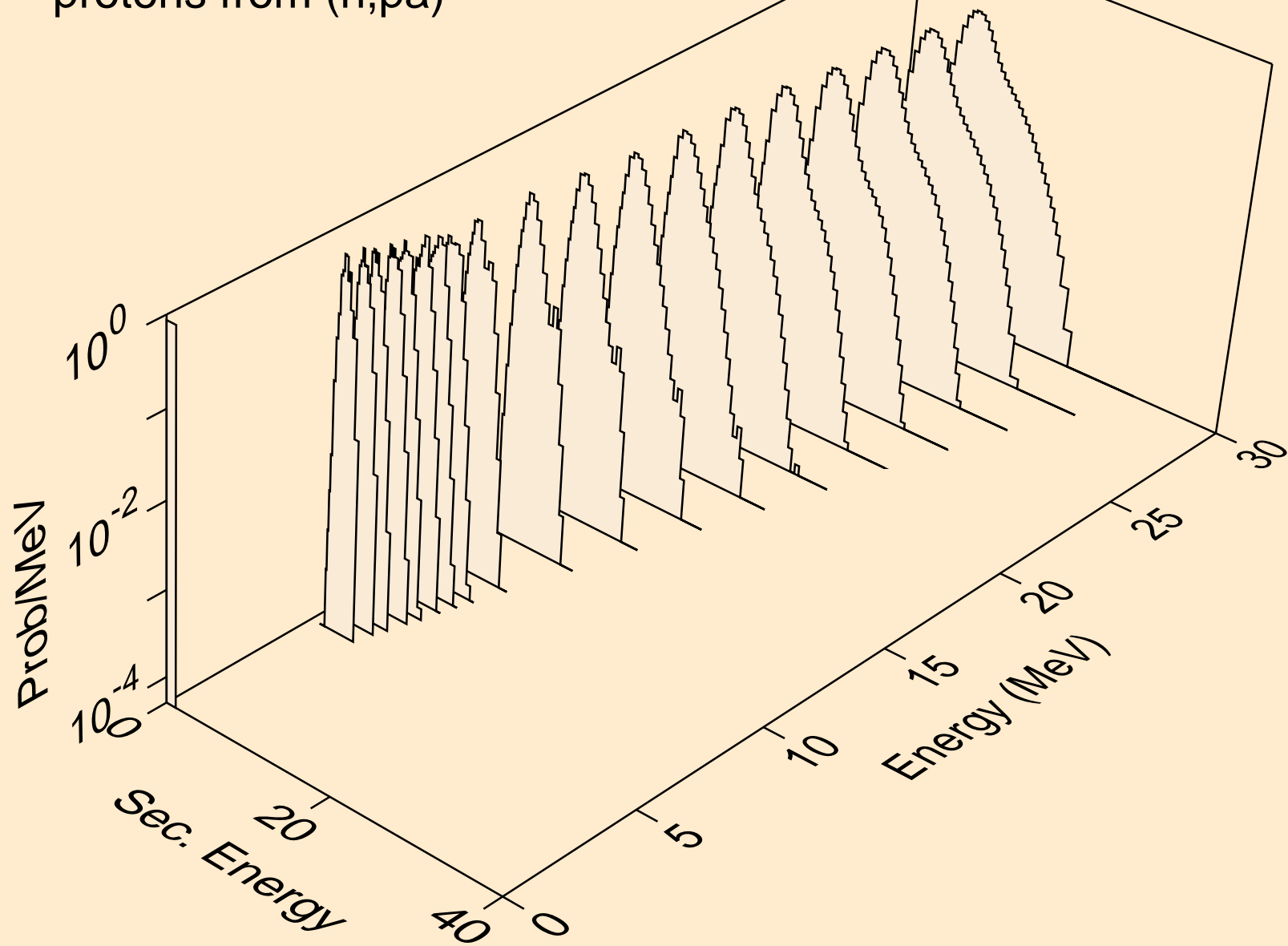

TL198M NEUTRON ACER TENDL-2023 LIBRARY; T=0.K  
protons from (n,pd)

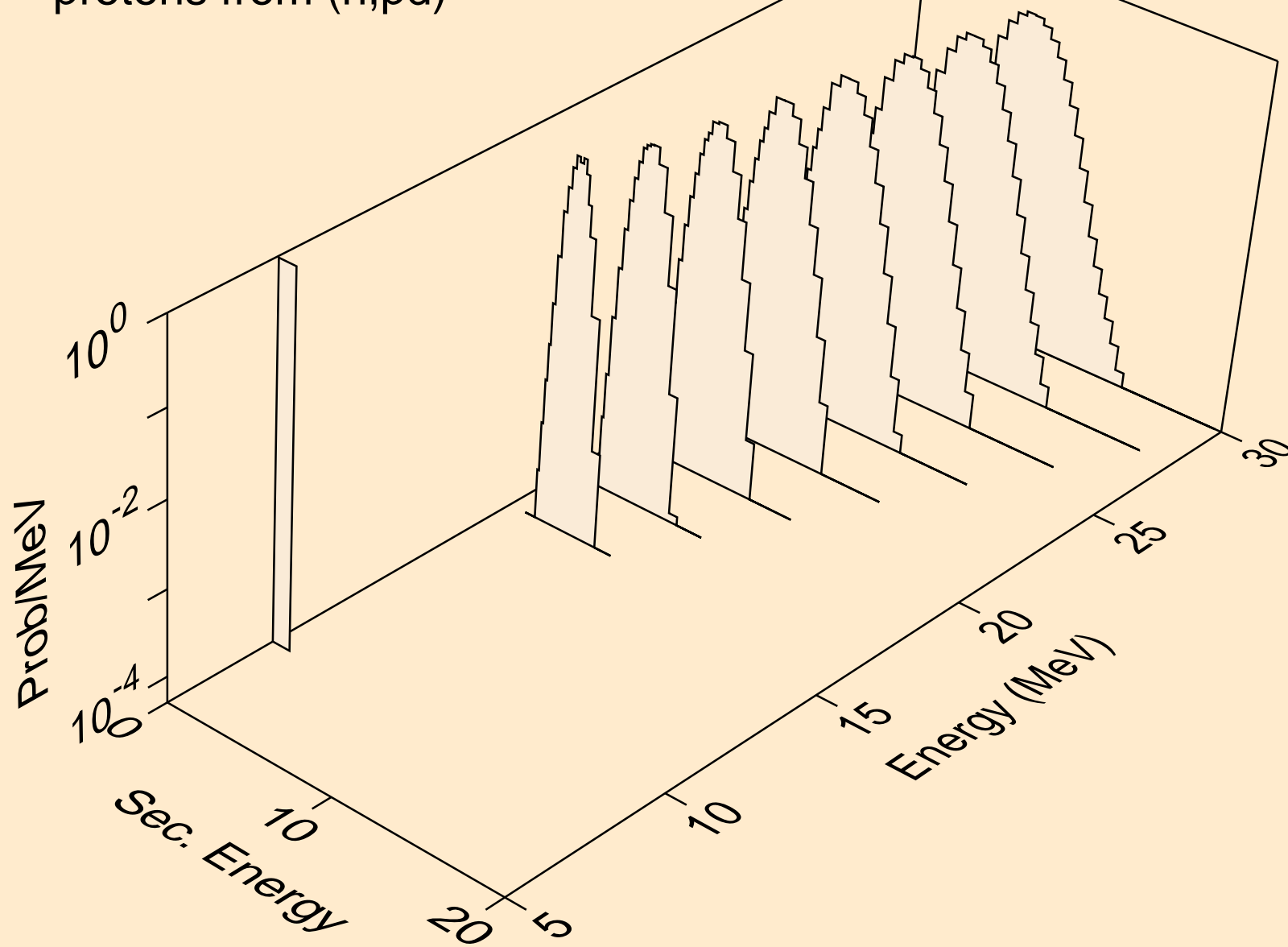

TL198M NEUTRON ACER TENDL-2023 LIBRARY; T=0.K  
protons from (n,pt)

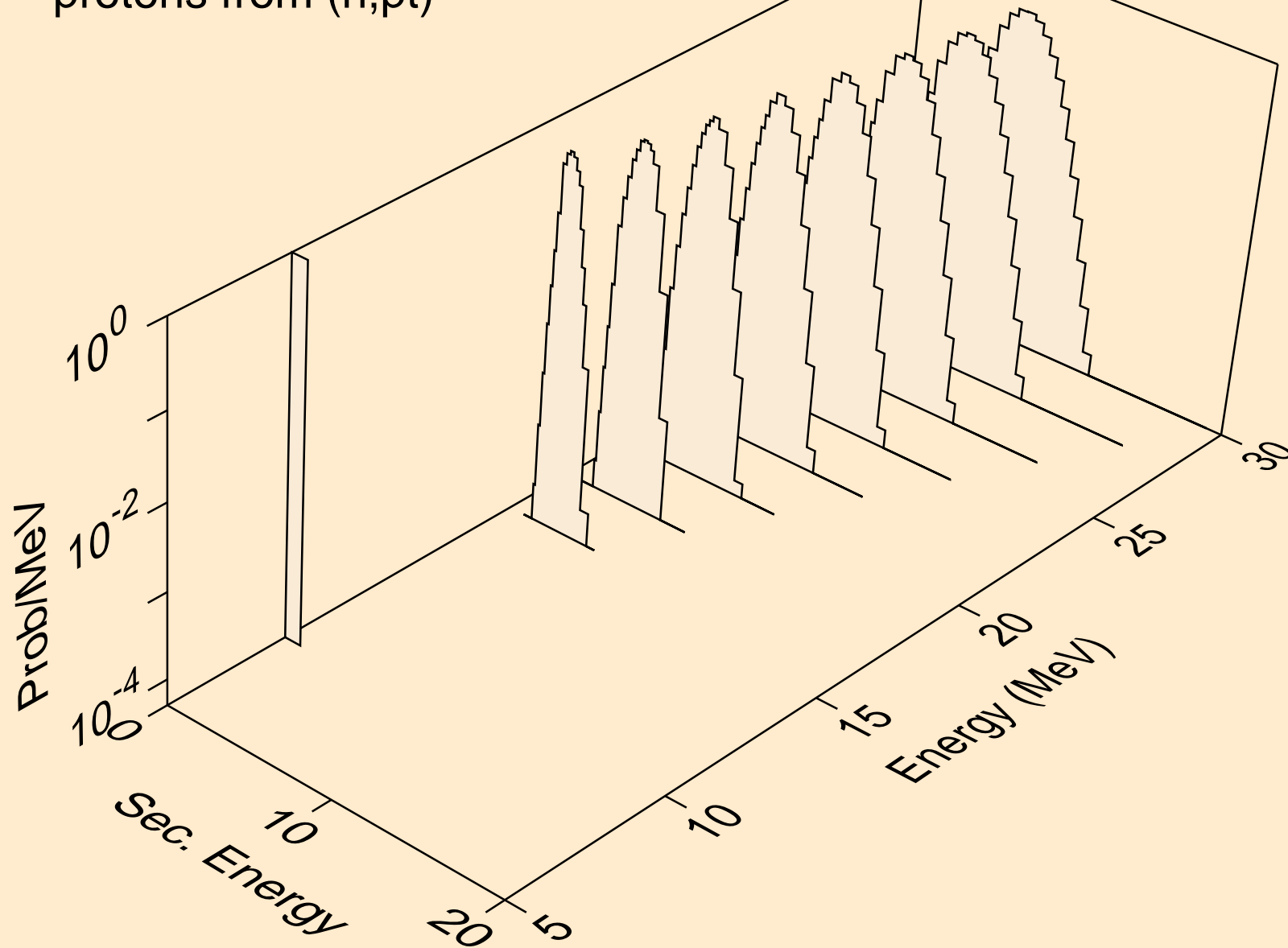

TL198M NEUTRON ACER TENDL-2023 LIBRARY; T=0.K  
deuterons from (n,x)

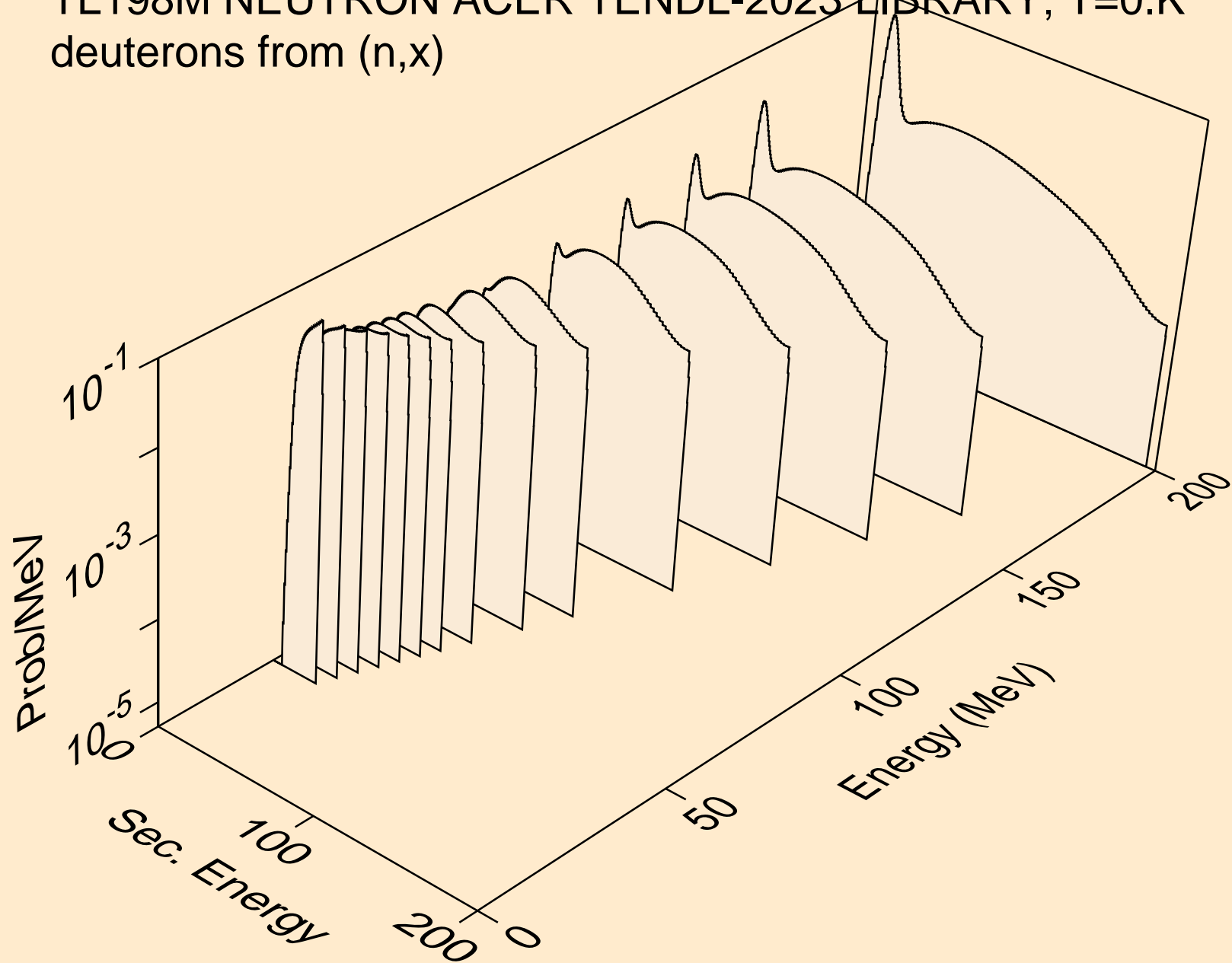

TL198M NEUTRON ACER TENDL-2023 LIBRARY; T=0.K  
deuterons from (n,2nd)

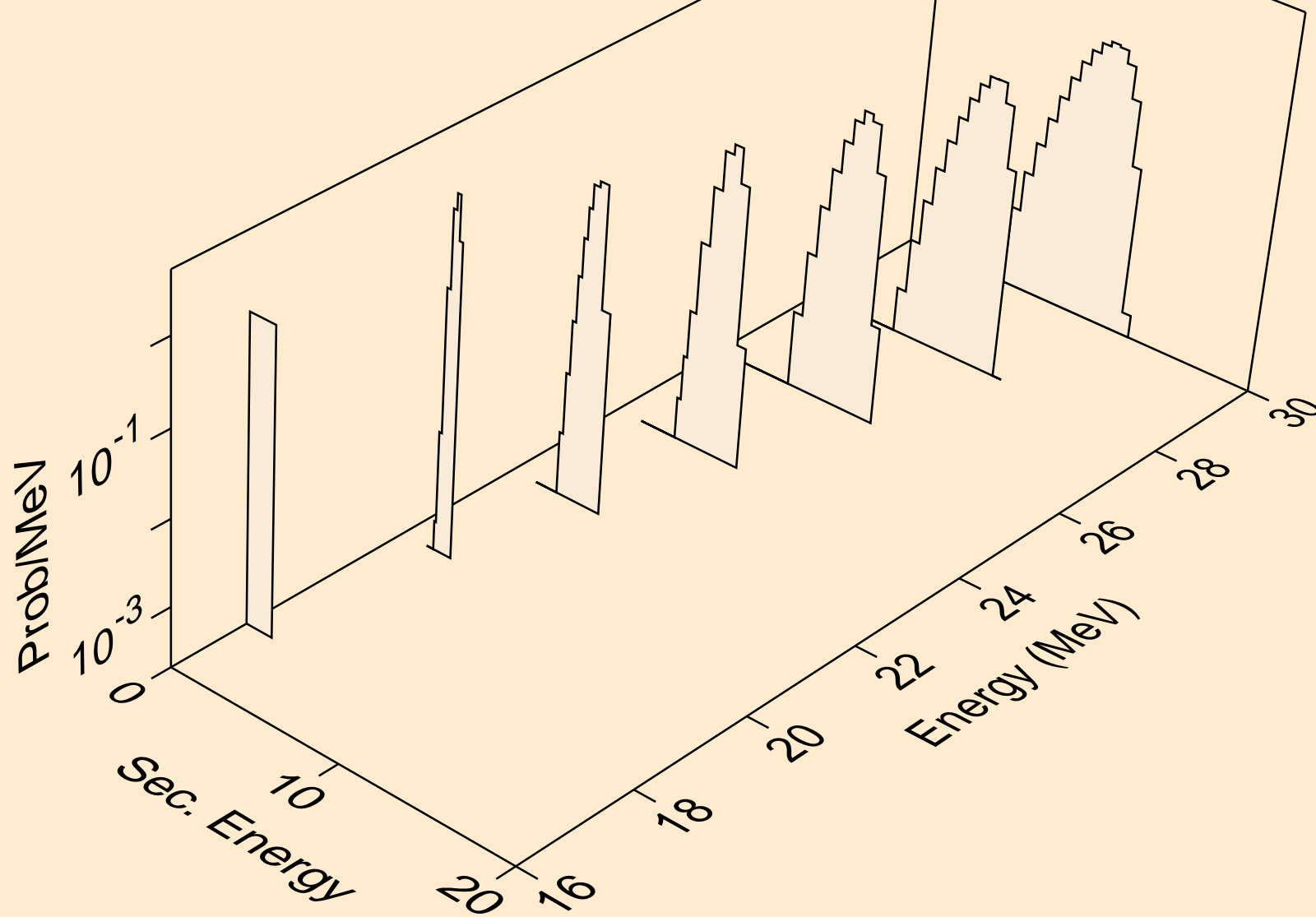



TL198M NEUTRON ACER TENDL-2023 LIBRARY; T=0.K  
deuterons from (n,n\*)d

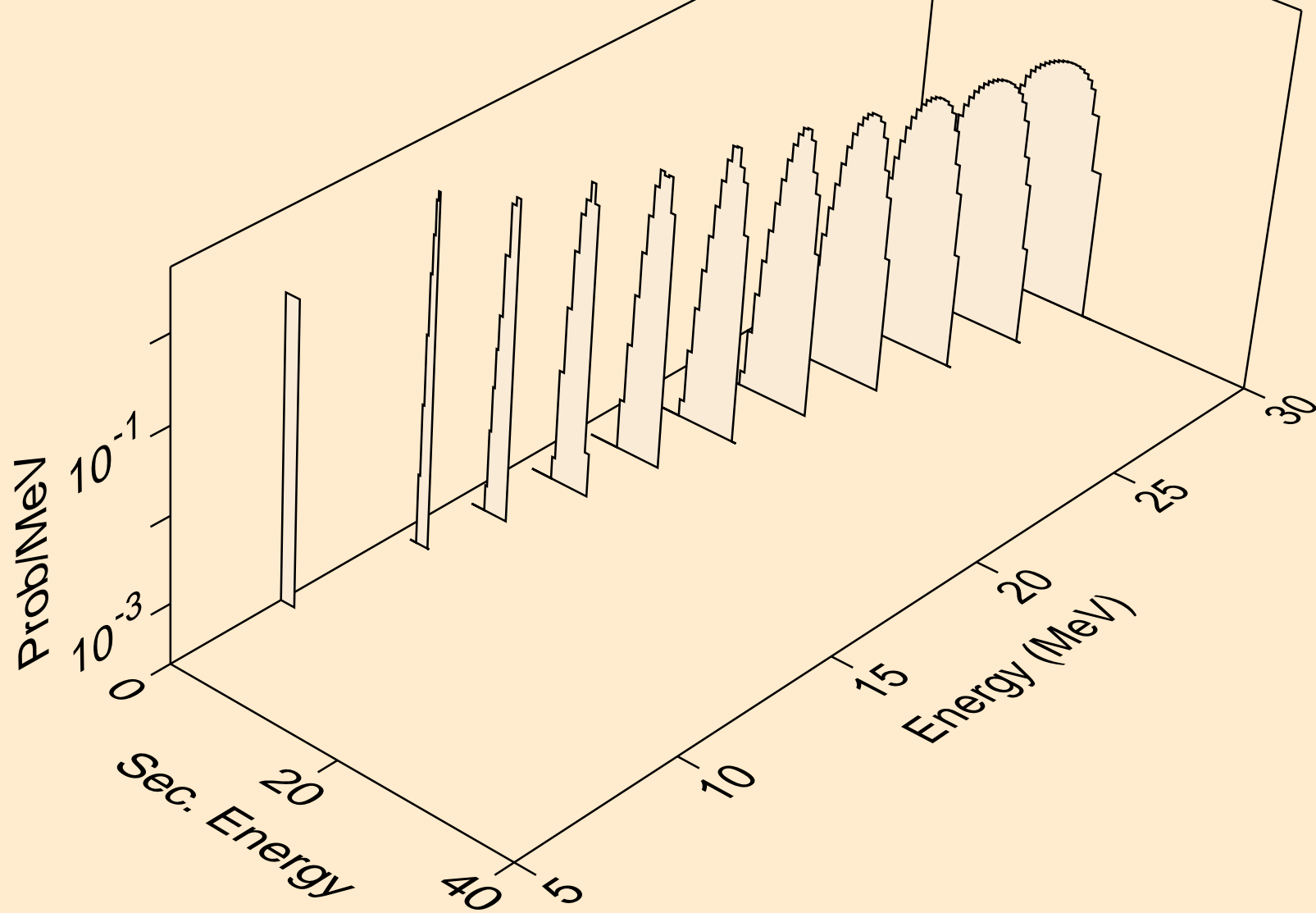

TL198M NEUTRON ACER TENDL-2023 LIBRARY; T=0.K  
deuterons from (n,d)

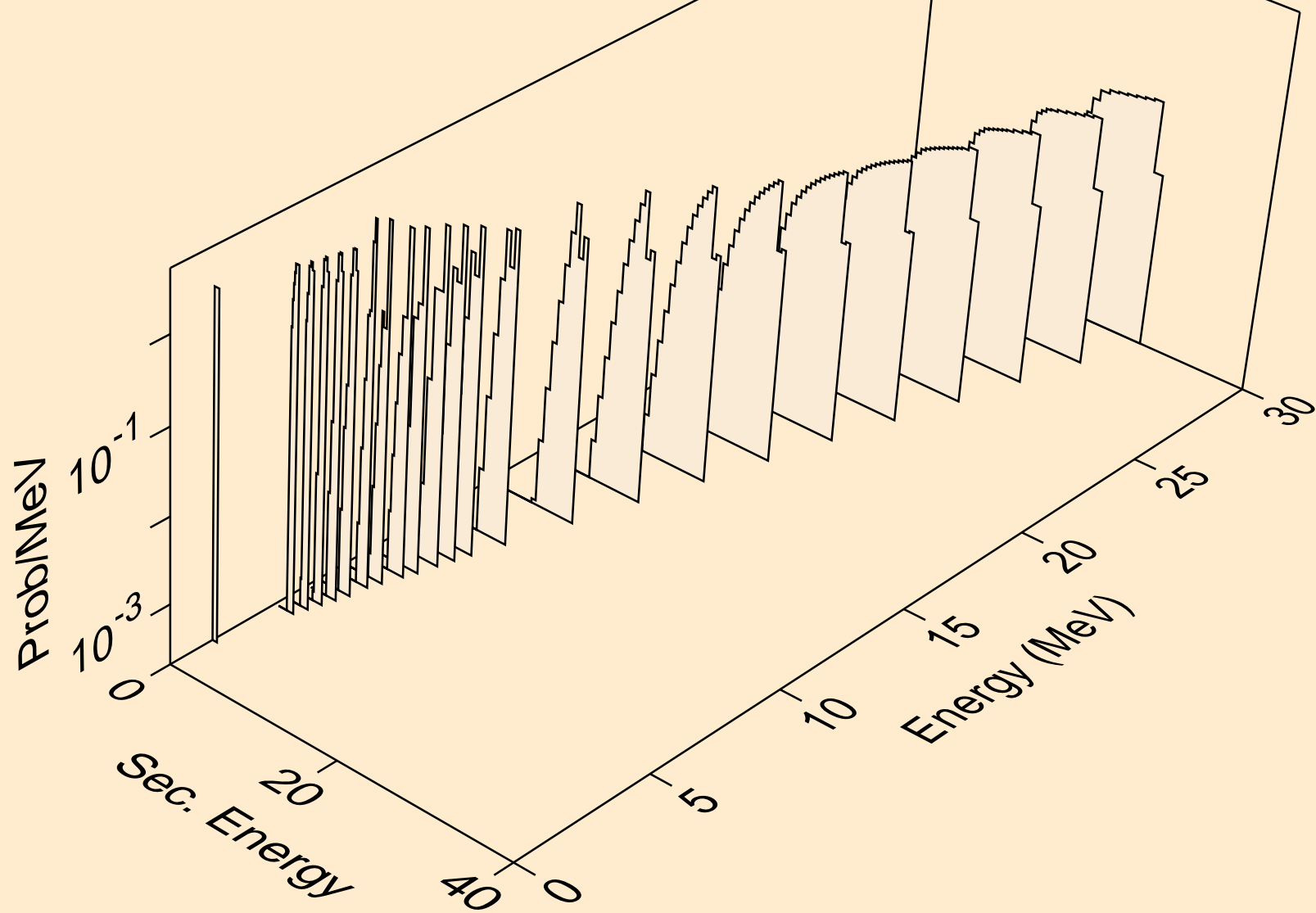

TL198M NEUTRON ACER TENDL-2023 LIBRARY; T=0.K  
deuterons from (n,pd)

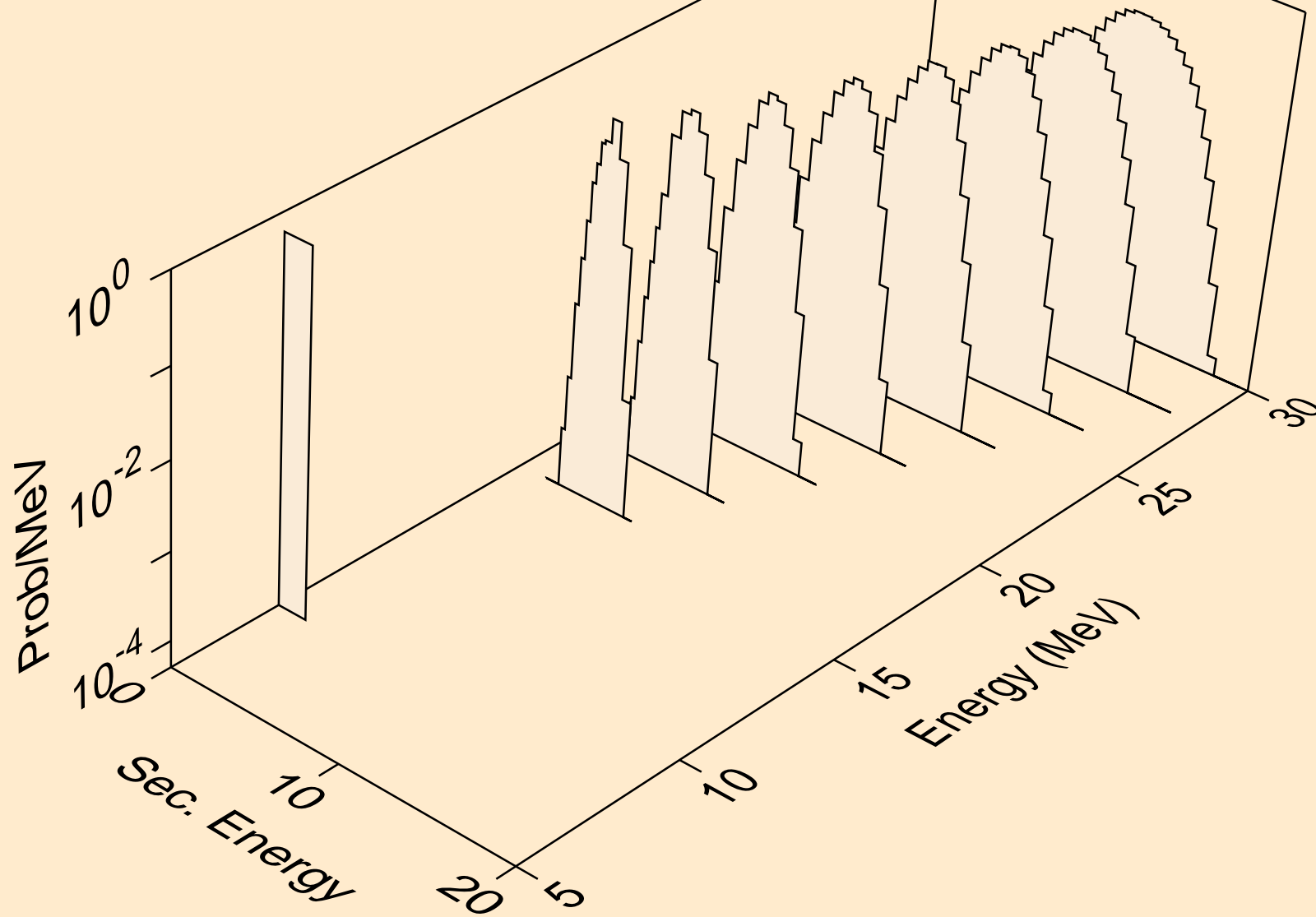

TL198M NEUTRON ACER TENDL-2023 LIBRARY; T=0.K  
deuterons from (n,da)

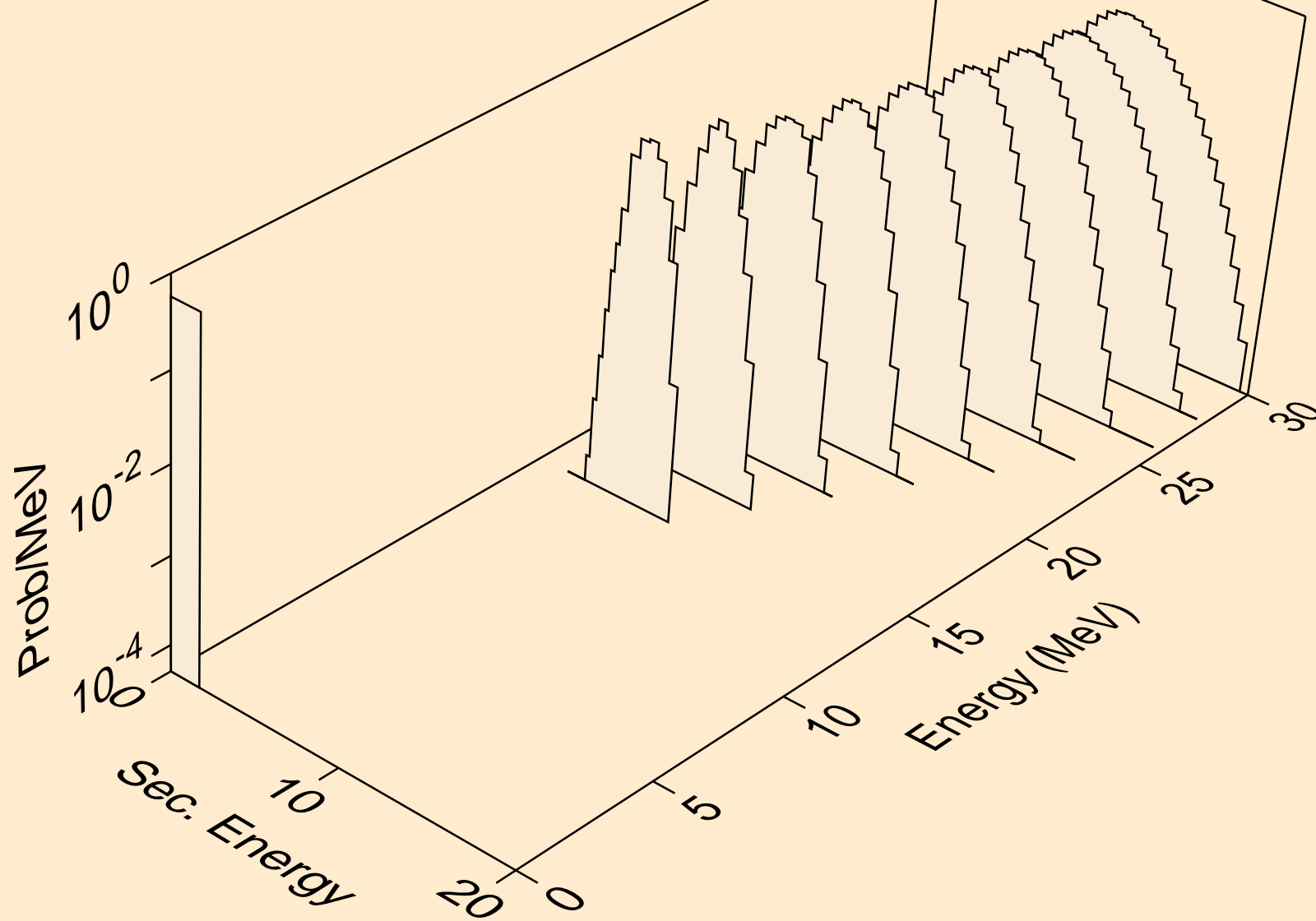

TL198M NEUTRON ACER TENDL-2023 LIBRARY; T=0.K  
tritons from (n,x)

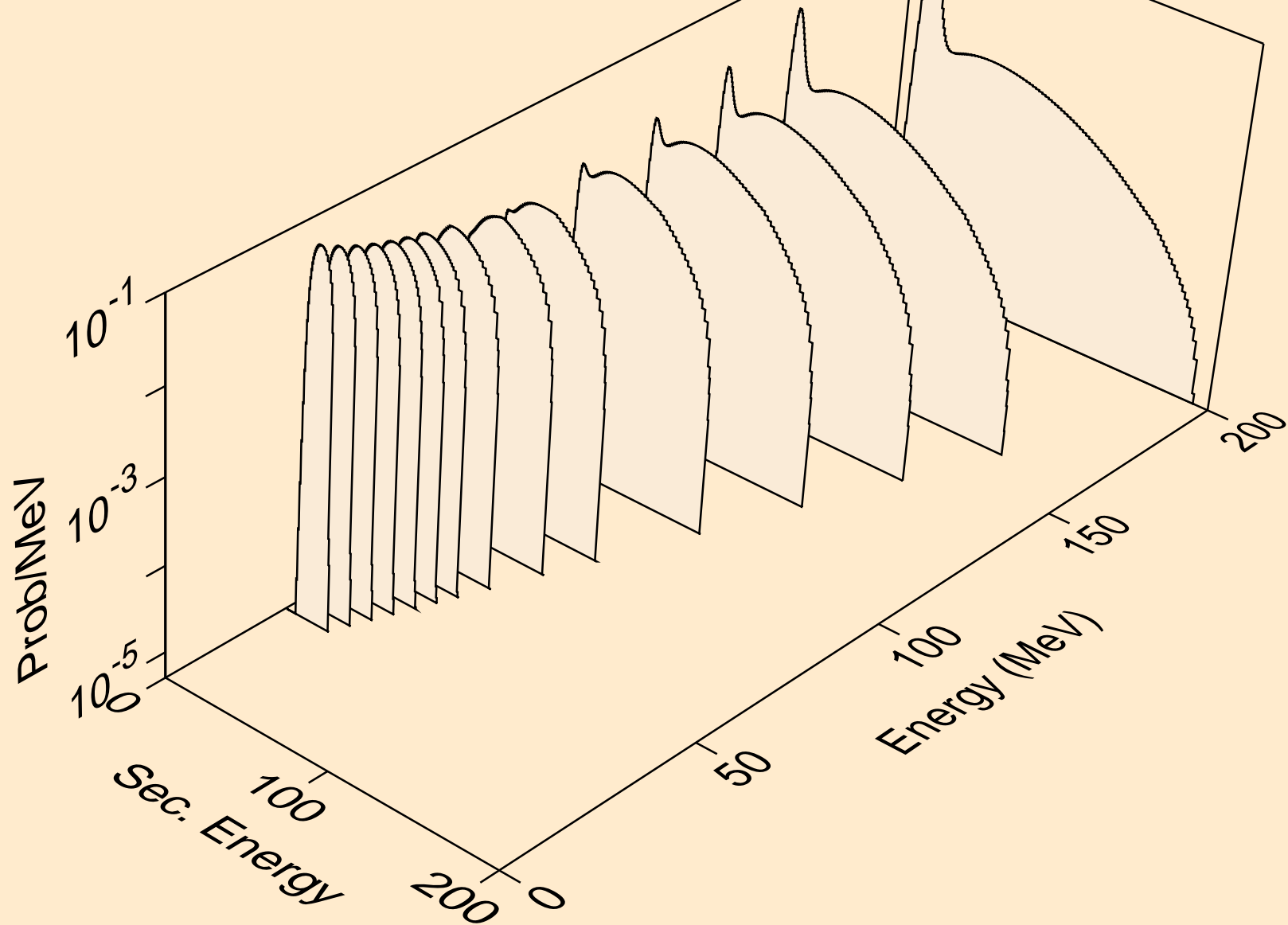

TL198M NEUTRON ACER TENDL-2023 LIBRARY; T=0.K  
tritons from (n,n\*)t

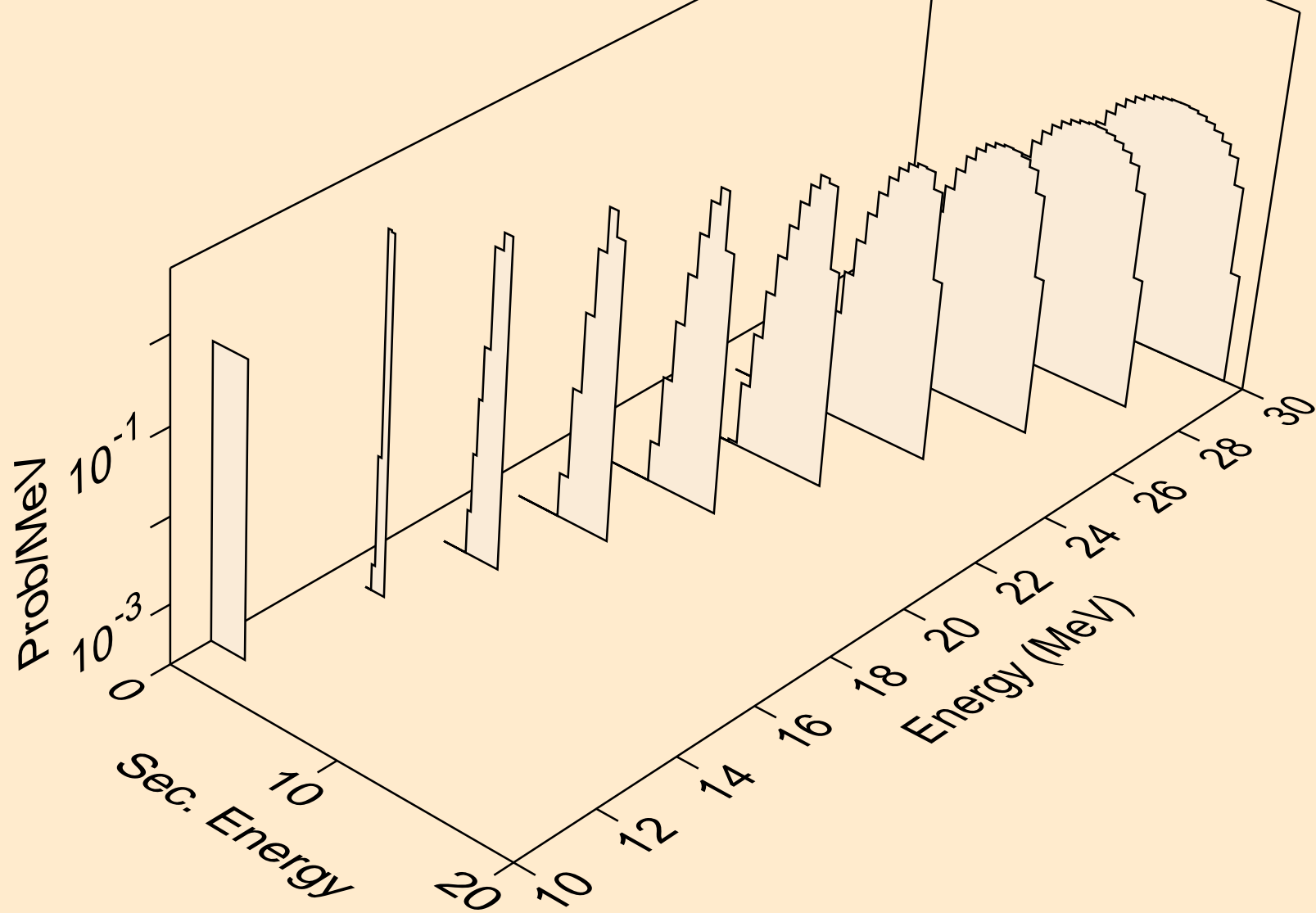

TL198M NEUTRON ACER TENDL-2023 LIBRARY; T=0.K  
tritons from (n,t)

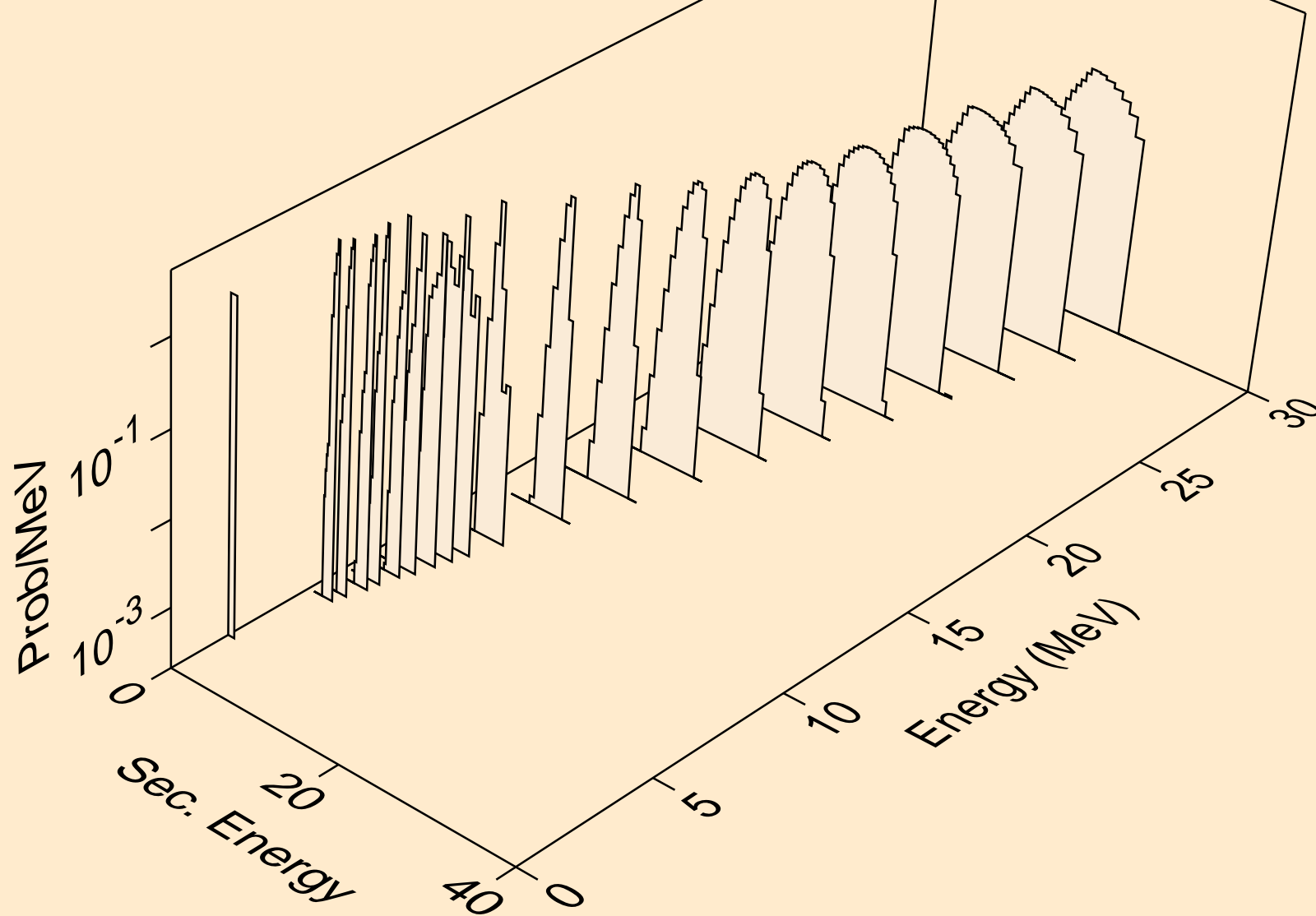

TL198M NEUTRON ACER TENDL-2023 LIBRARY; T=0.K  
tritons from (n,pt)

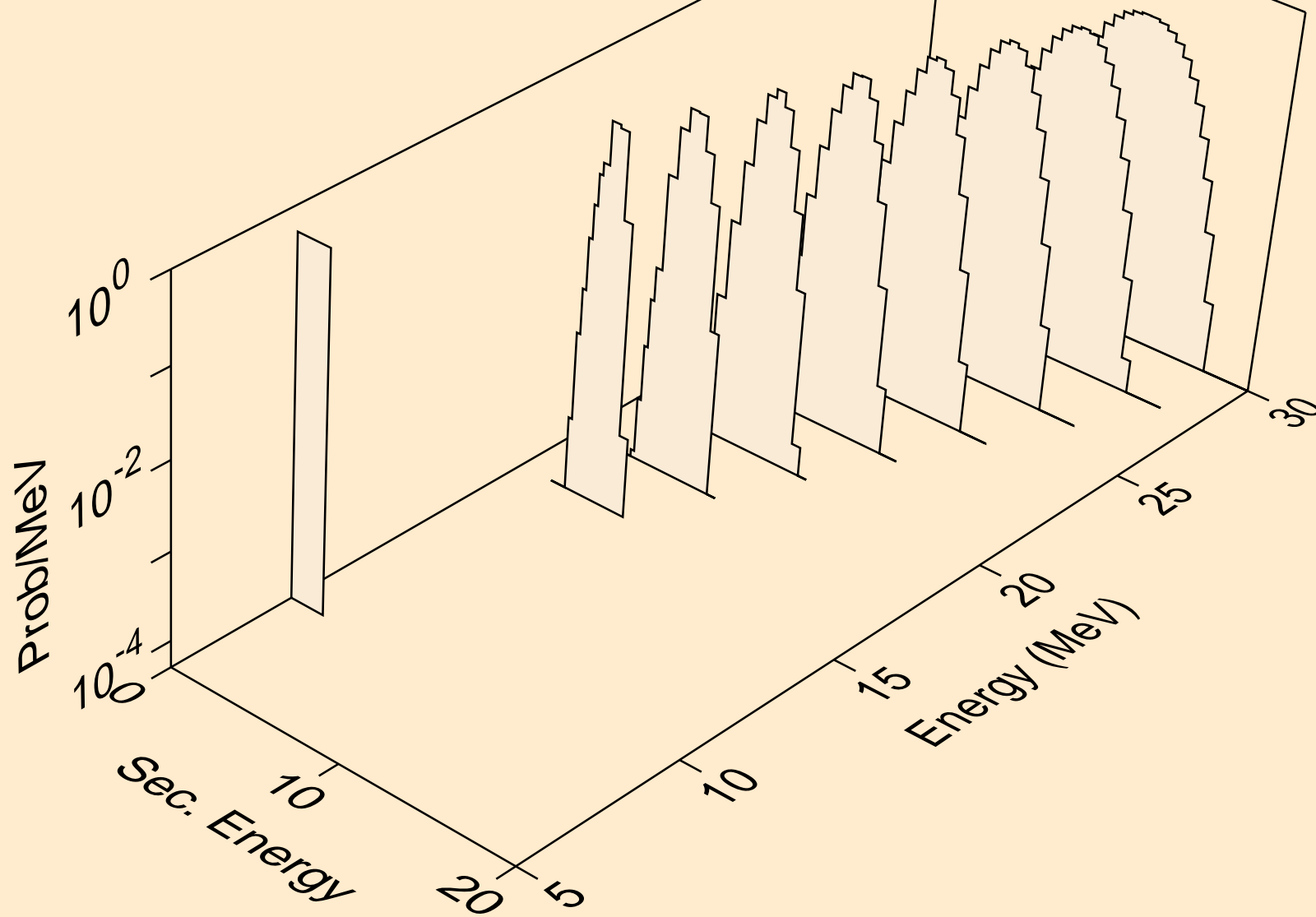



TL198M NEUTRON ACER TENDL-2023 LIBRARY; T=0.K  
he3s from (n,x)

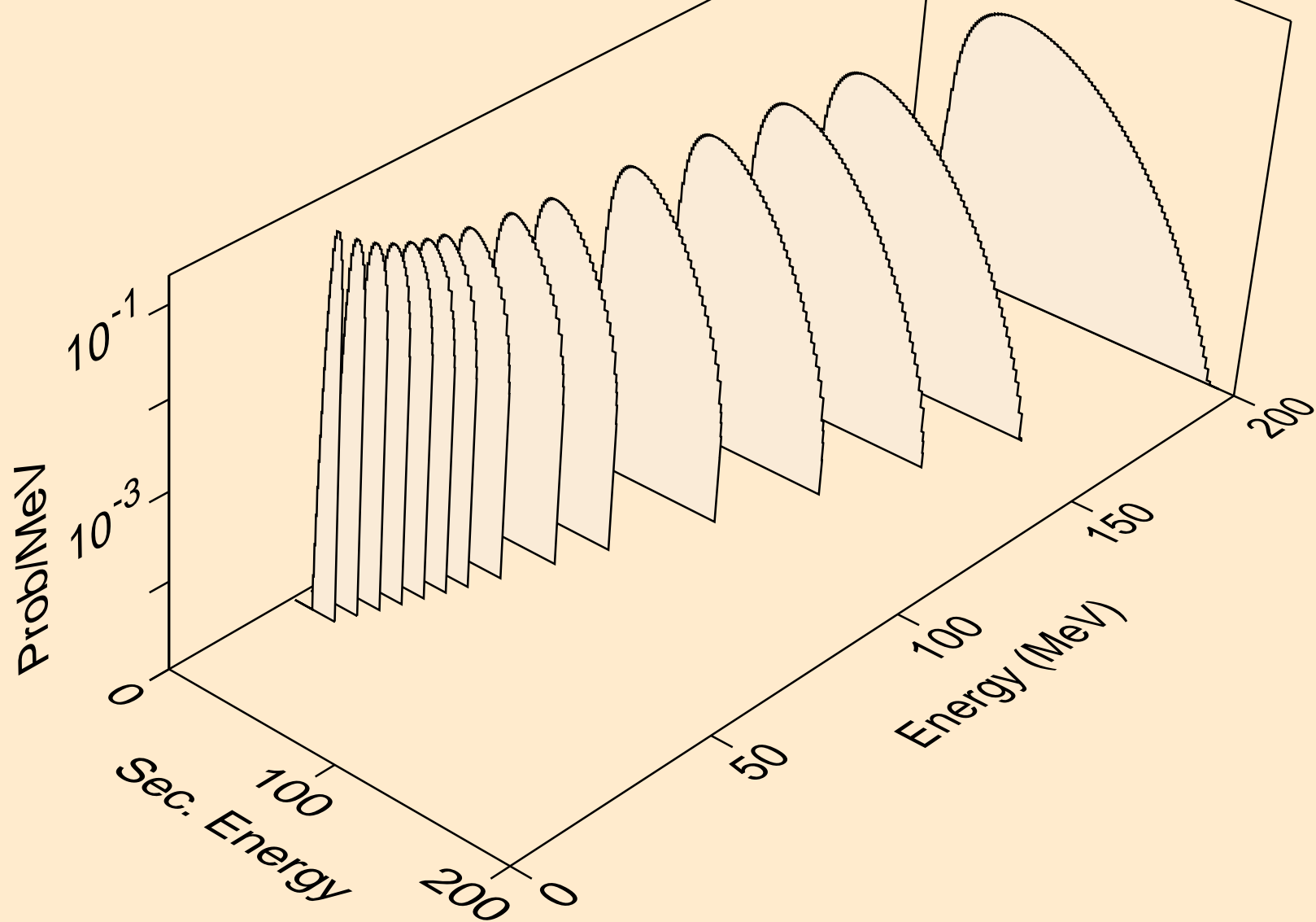

TL198M NEUTRON ACER TENDL-2023 LIBRARY; T=0.K  
he3s from (n,n\*)he3

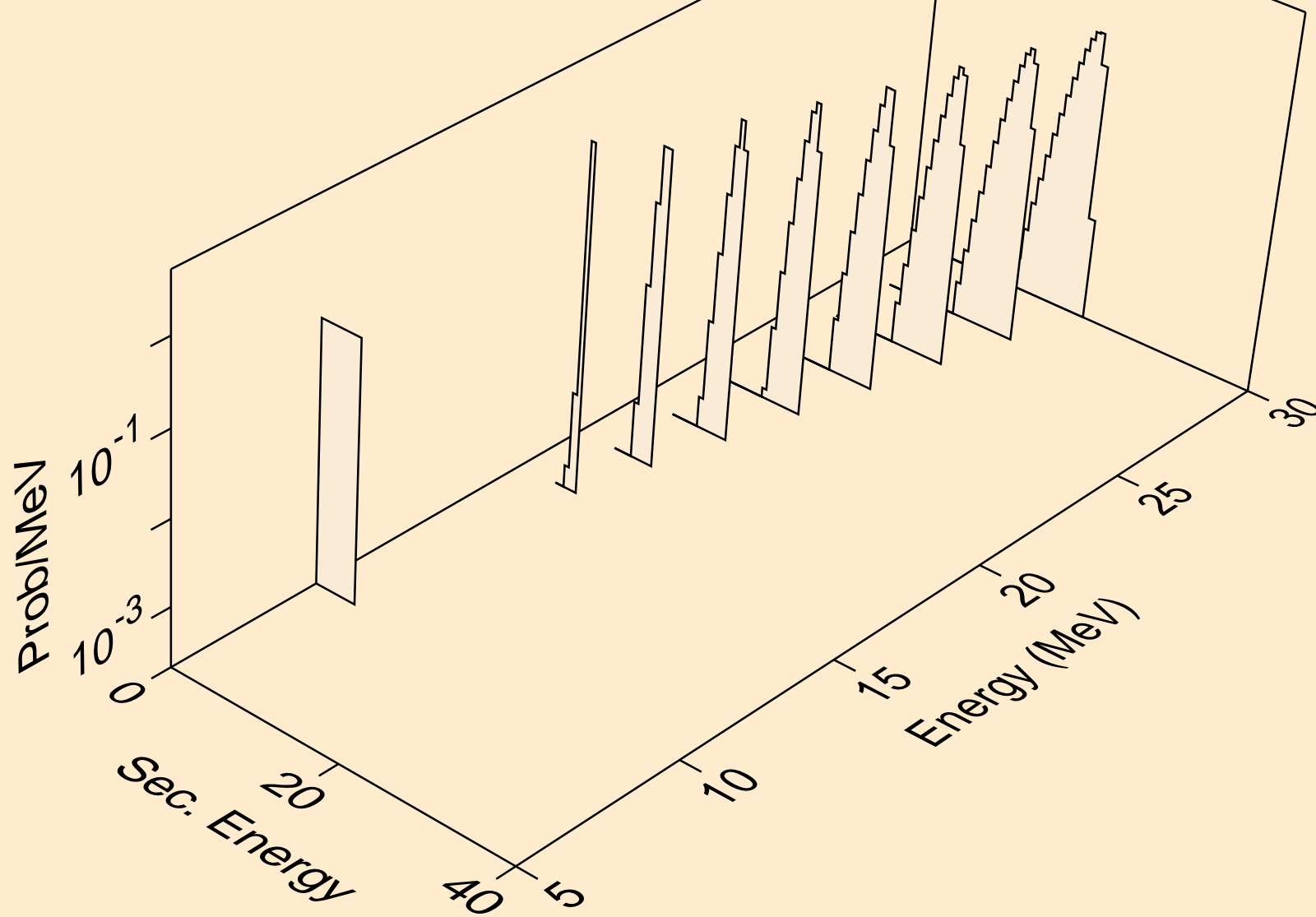

TL198M NEUTRON ACER TENDL-2023 LIBRARY; T=0.K  
he3s from (n,he3)

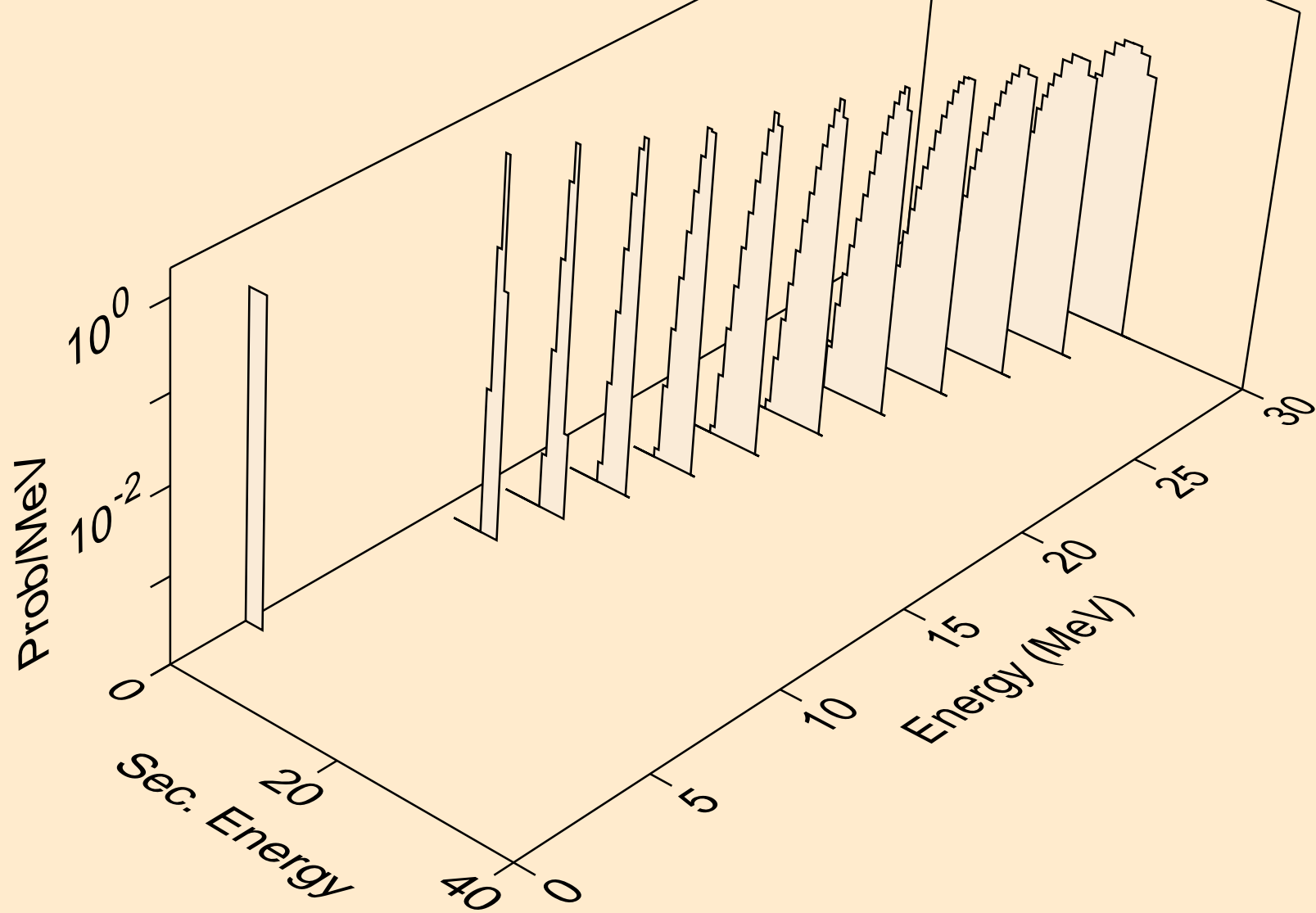

TL198M NEUTRON ACER TENDL-2023 LIBRARY; T=0.K  
alphas from (n,x)

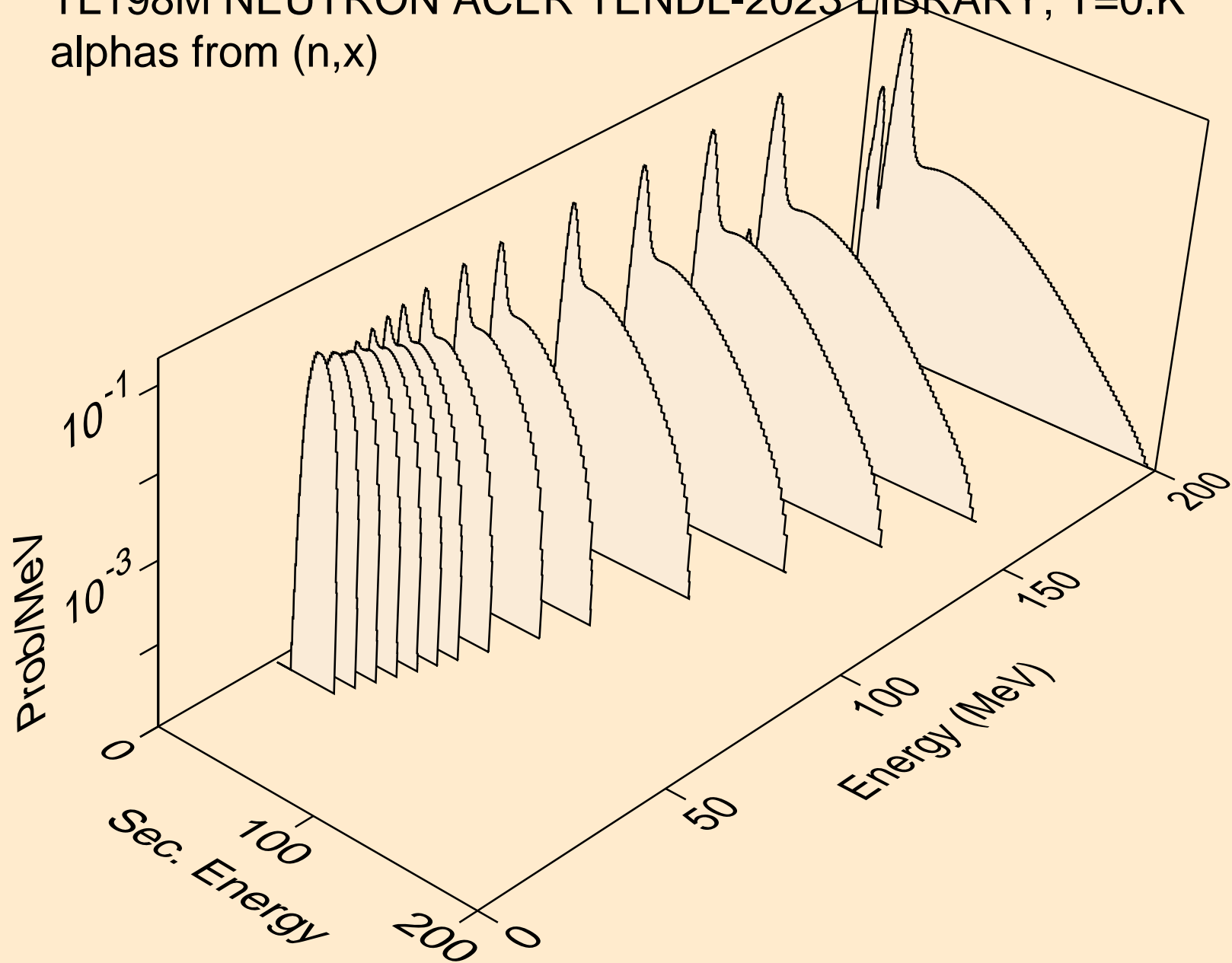

TL198M NEUTRON ACER TENDL-2023 LIBRARY; T=0.K  
alphas from (n,n\*)a

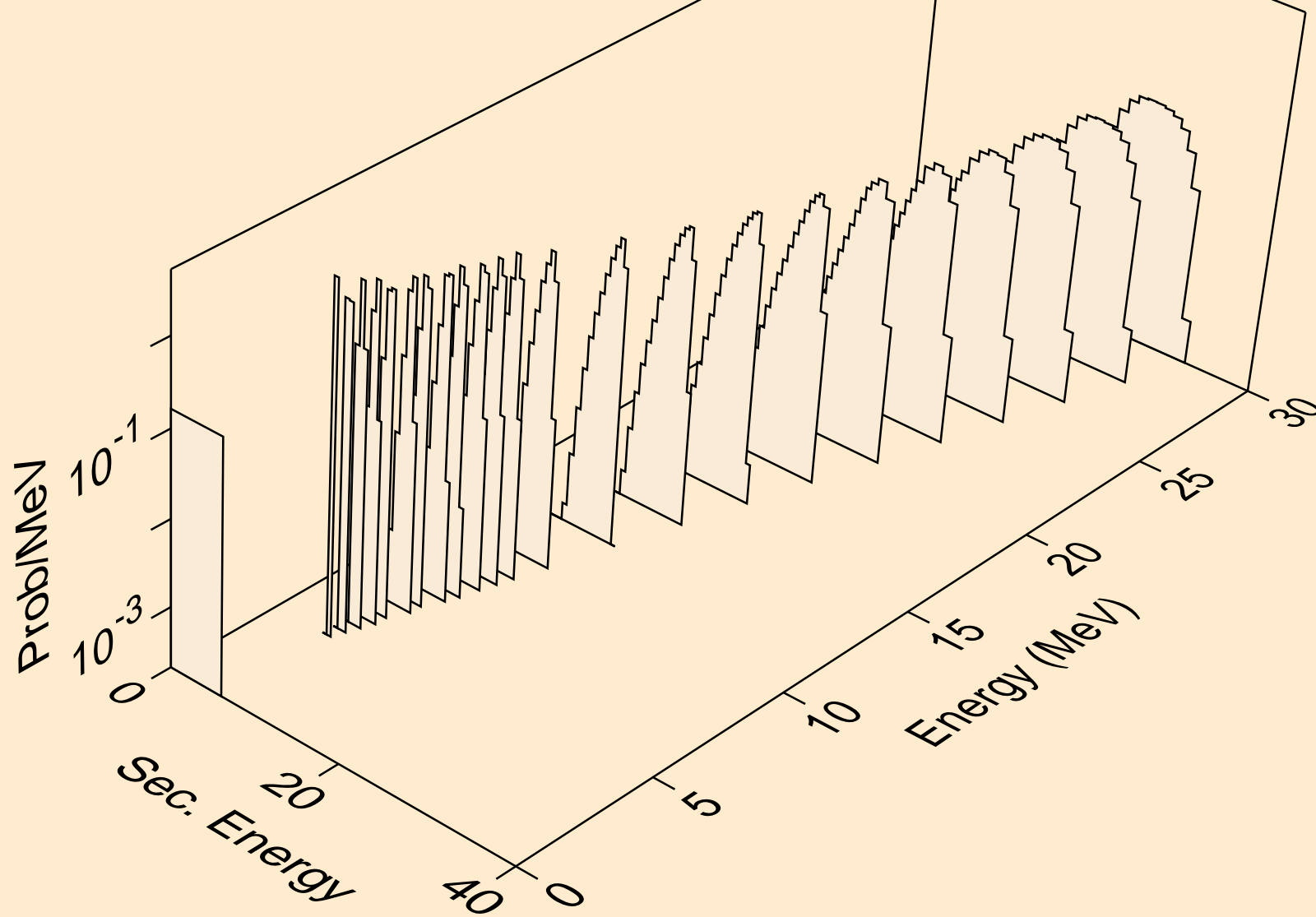

TL198M NEUTRON ACER TENDL-2023 LIBRARY; T=0.K  
alphas from (n,2n)a

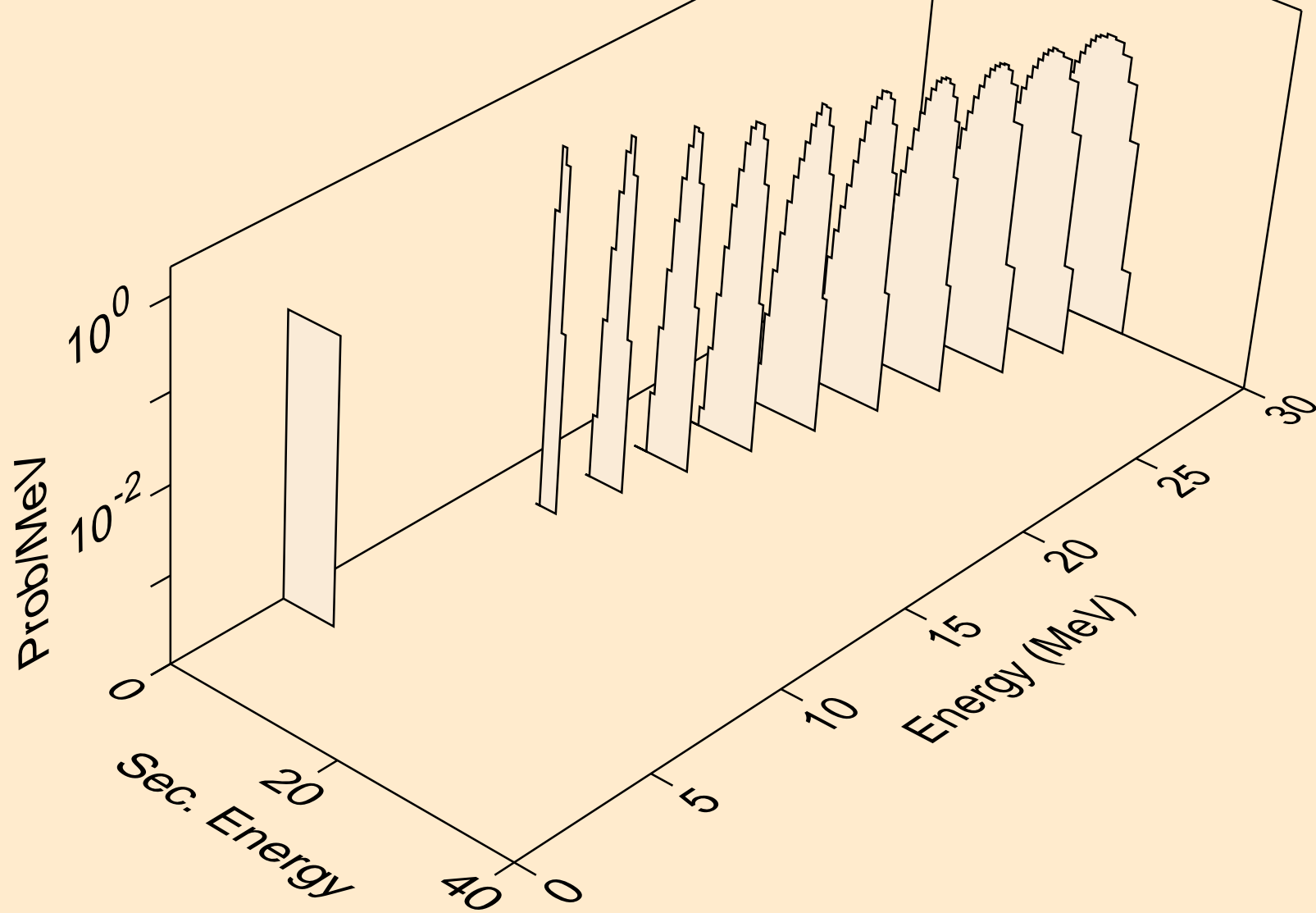

TL198M NEUTRON ACER TENDL-2023 LIBRARY; T=0.K  
alphas from (n,3n)a

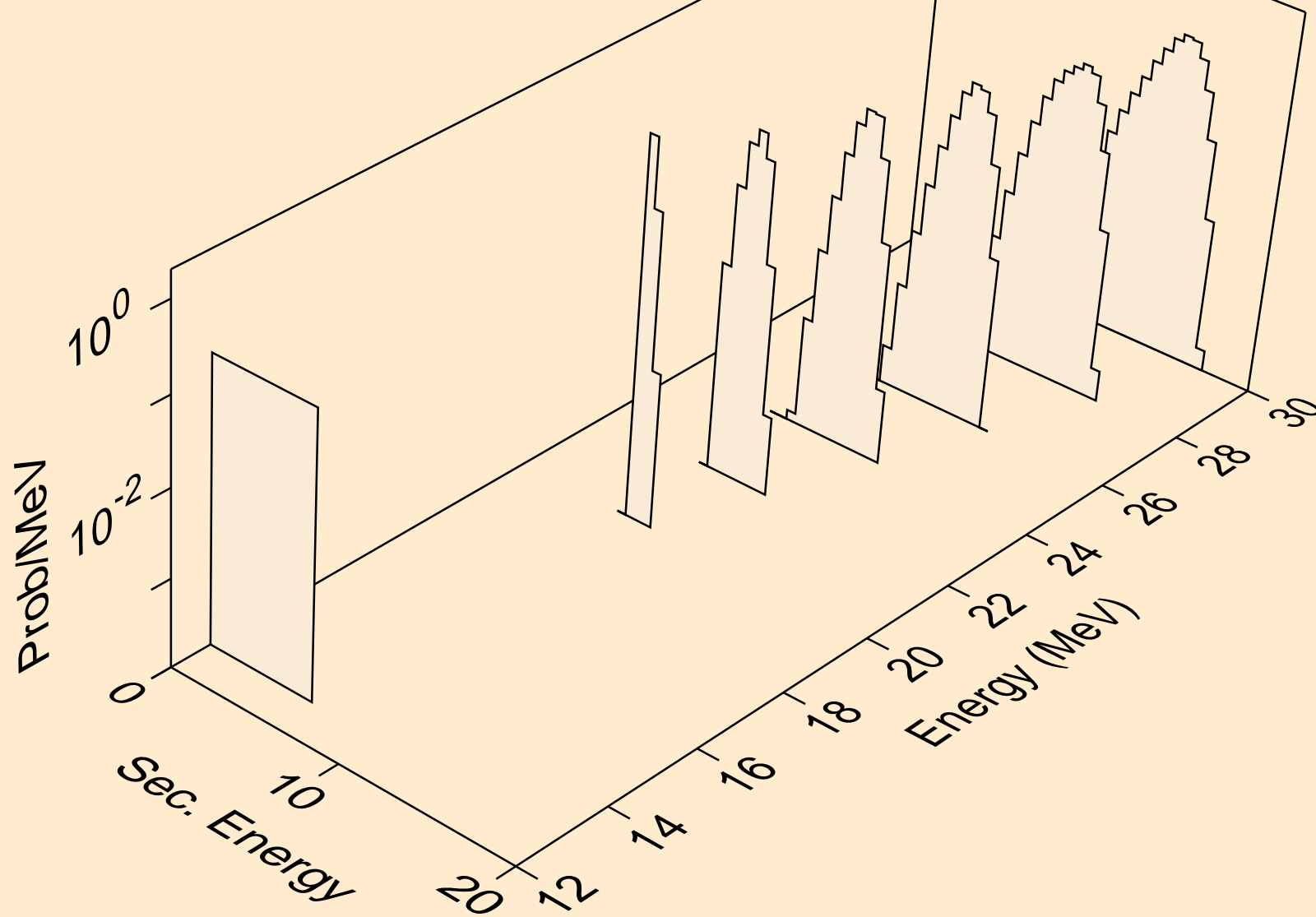

TL198M NEUTRON ACER TENDL-2023 LIBRARY; T=0.K  
alphas from (n,n\*)2a

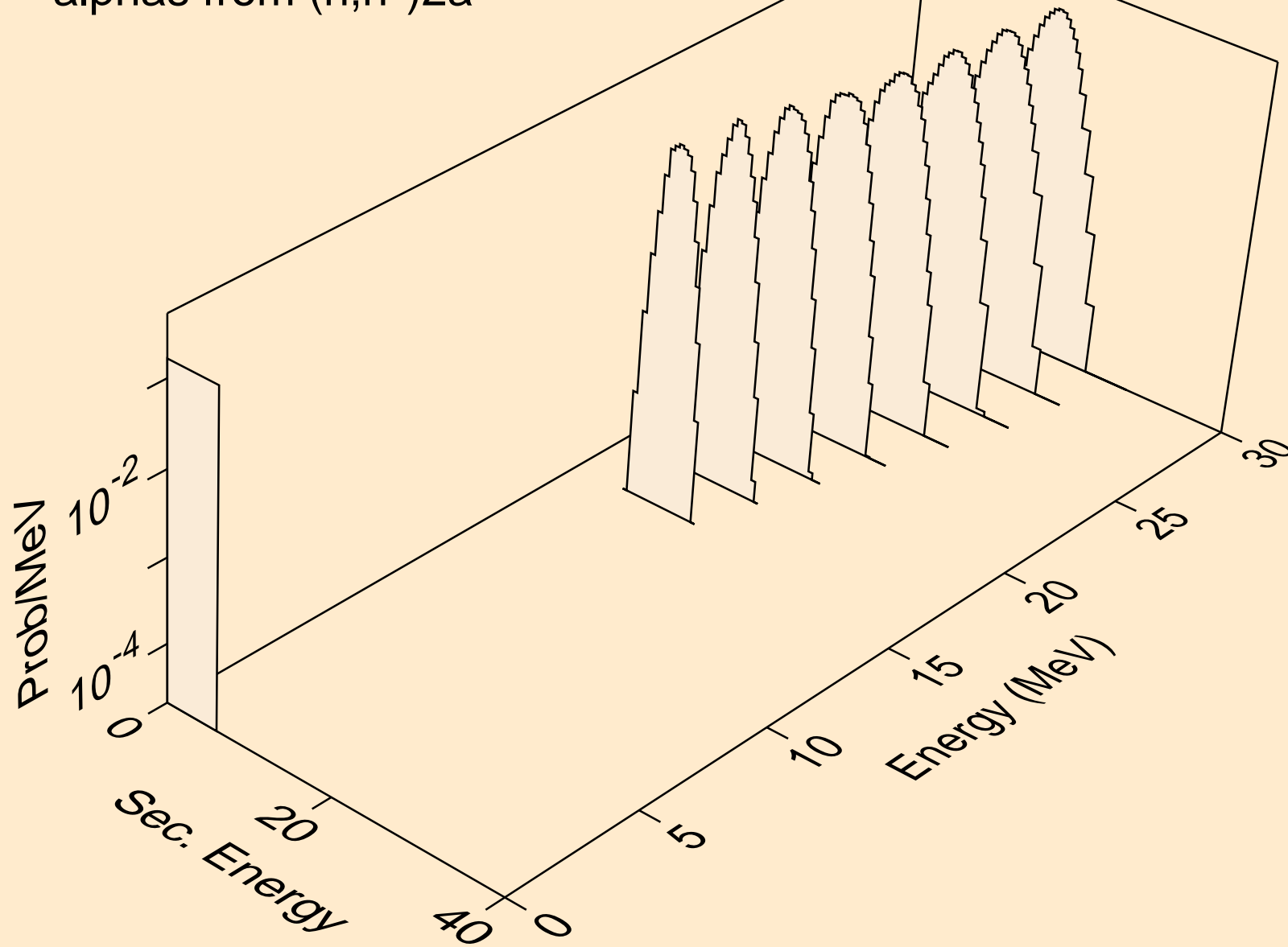



TL198M NEUTRON ACER TENDL-2023 LIBRARY; T=0.K  
alphas from (n,npa)

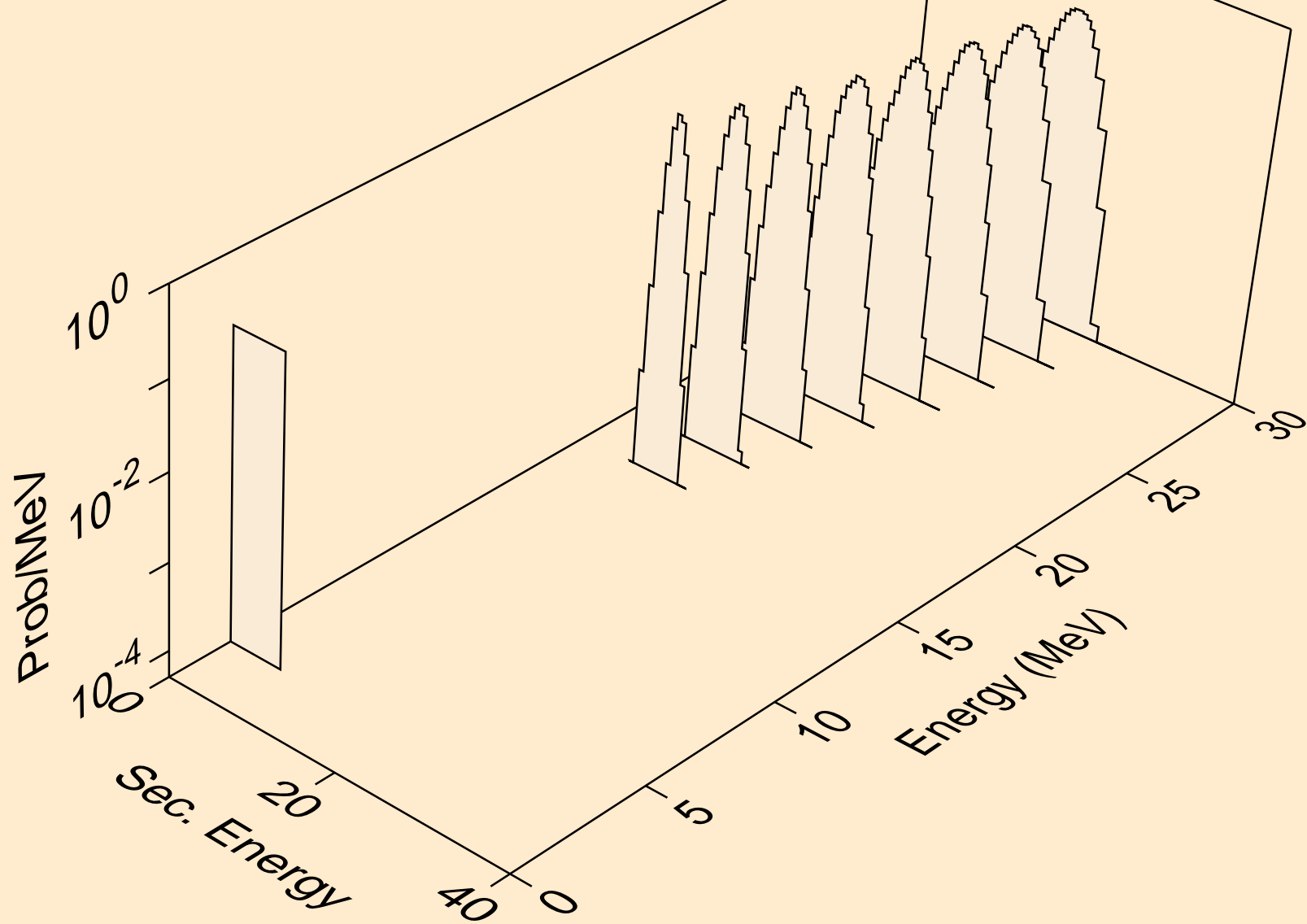

TL198M NEUTRON ACER TENDL-2023 LIBRARY; T=0.K  
alphas from (n,a)

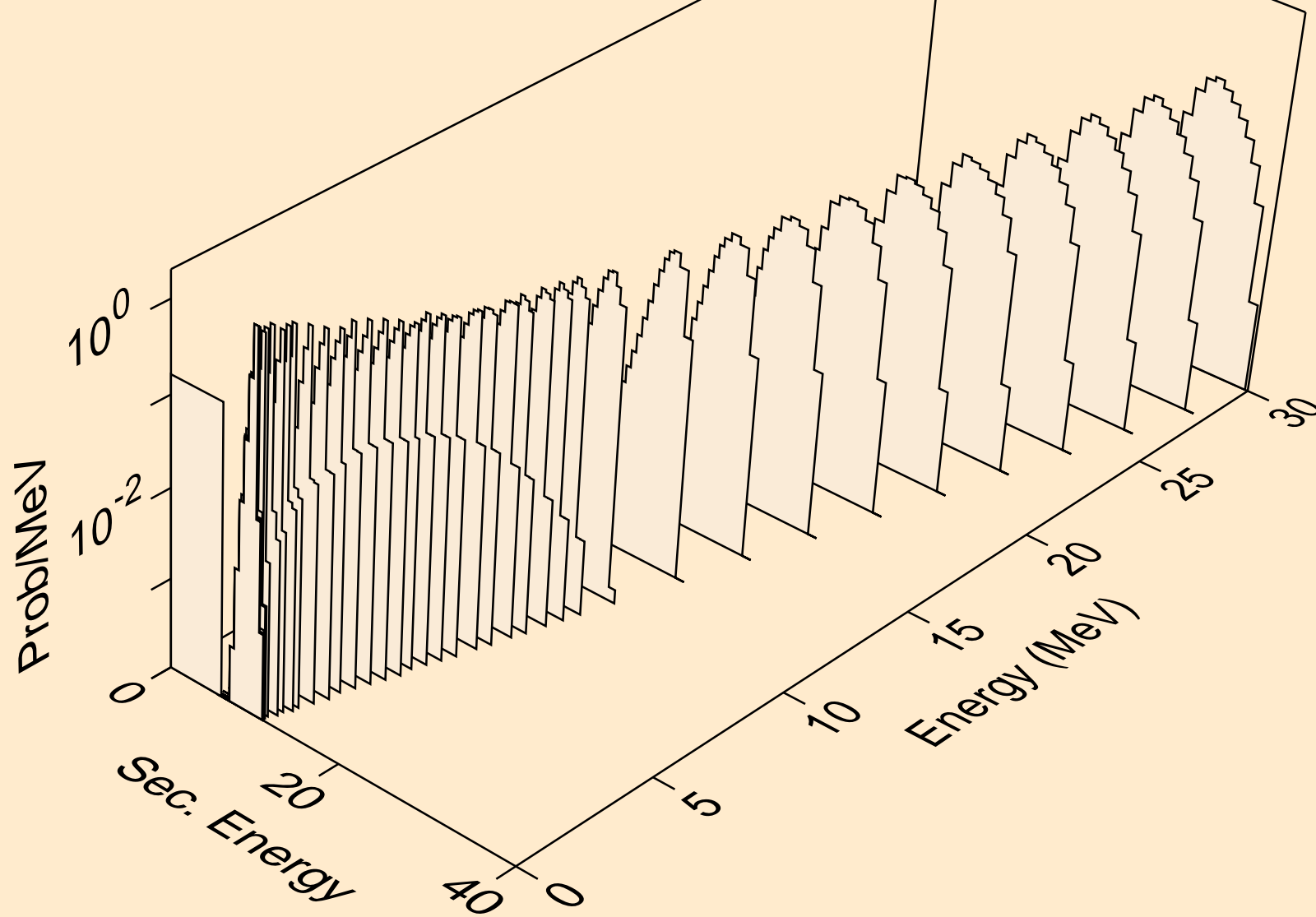

TL198M NEUTRON ACER TENDL-2023 LIBRARY; T=0.K  
alphas from (n,2a)

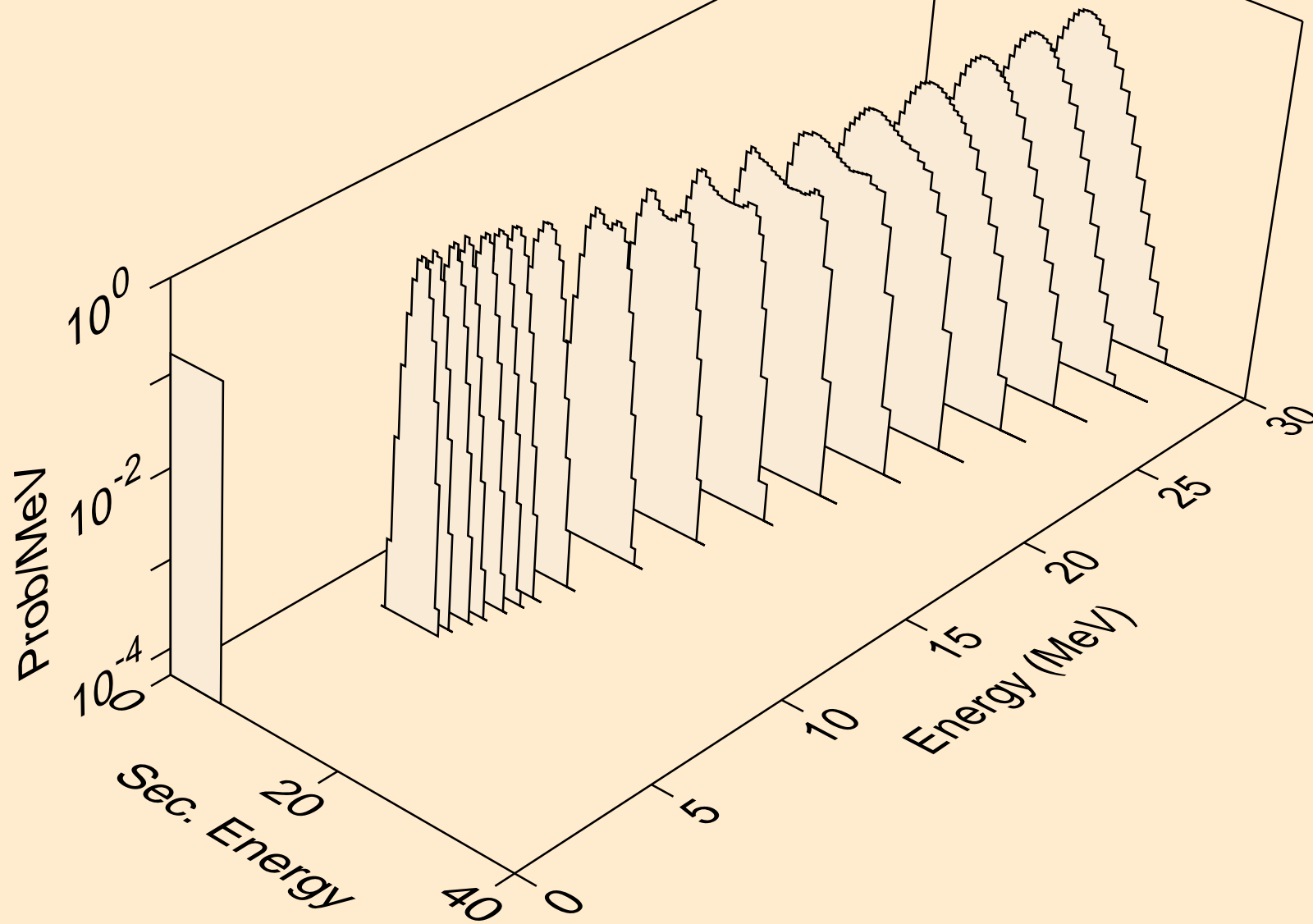

TL198M NEUTRON ACER TENDL-2023 LIBRARY; T=0.K  
alphas from (n,pa)

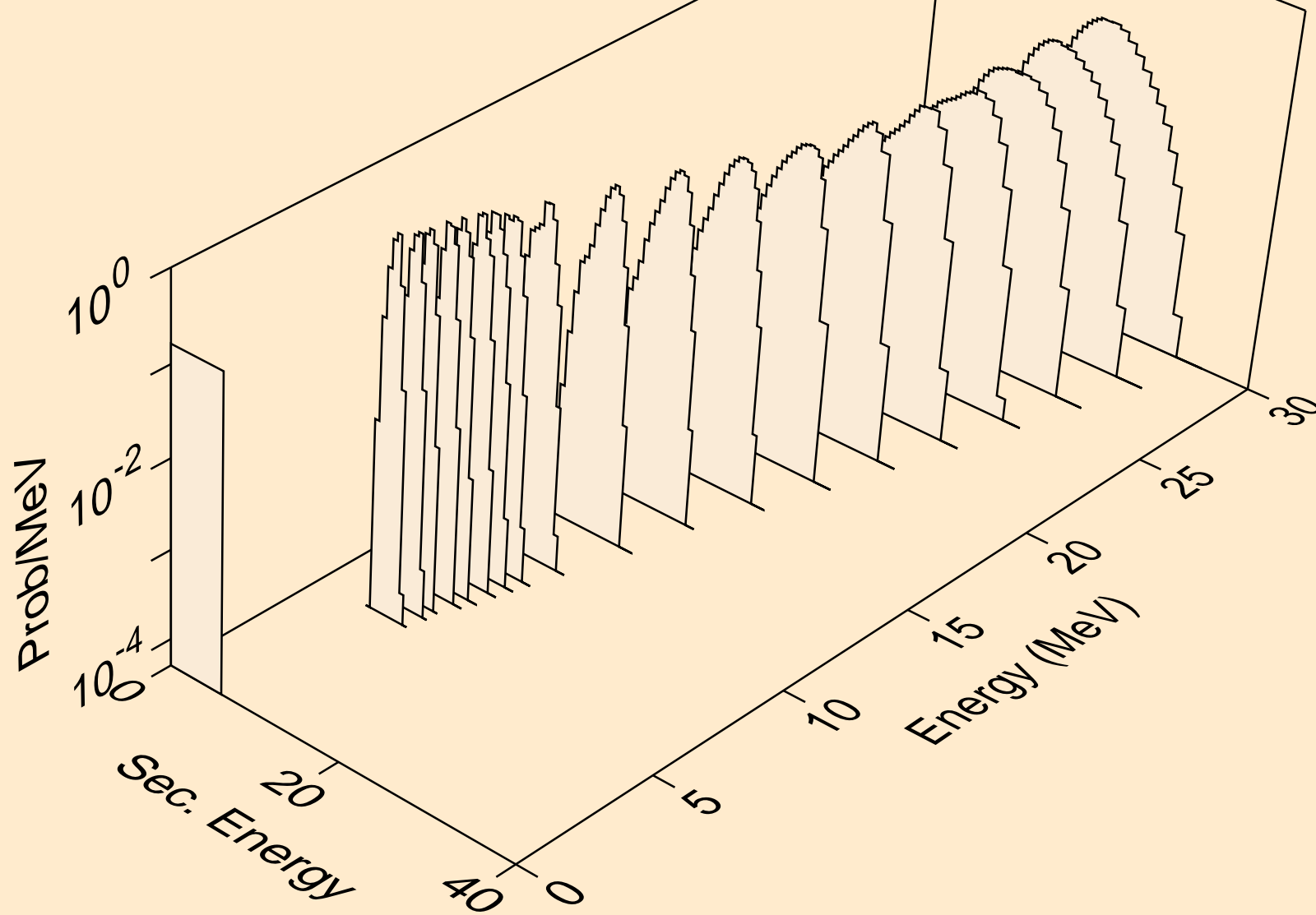

TL198M NEUTRON ACER TENDL-2023 LIBRARY; T=0.K  
alphas from (n,da)

