

W183 NEUTRON ACER TENDL-2023 LIBRARY; T=0.K

Principal cross sections

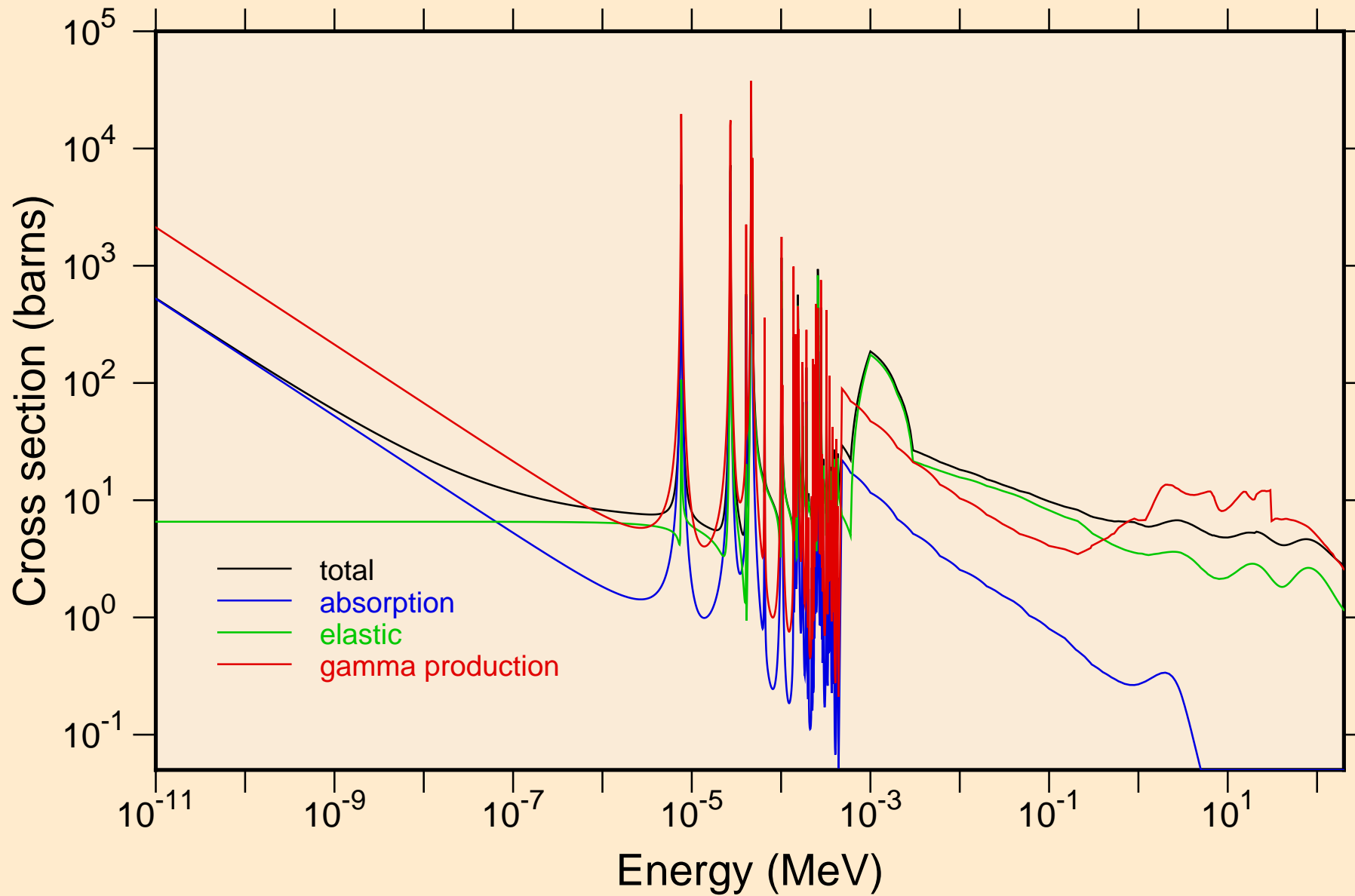

W183 NEUTRON ACER TENDL-2023 LIBRARY; T=0.K
resonance total cross section

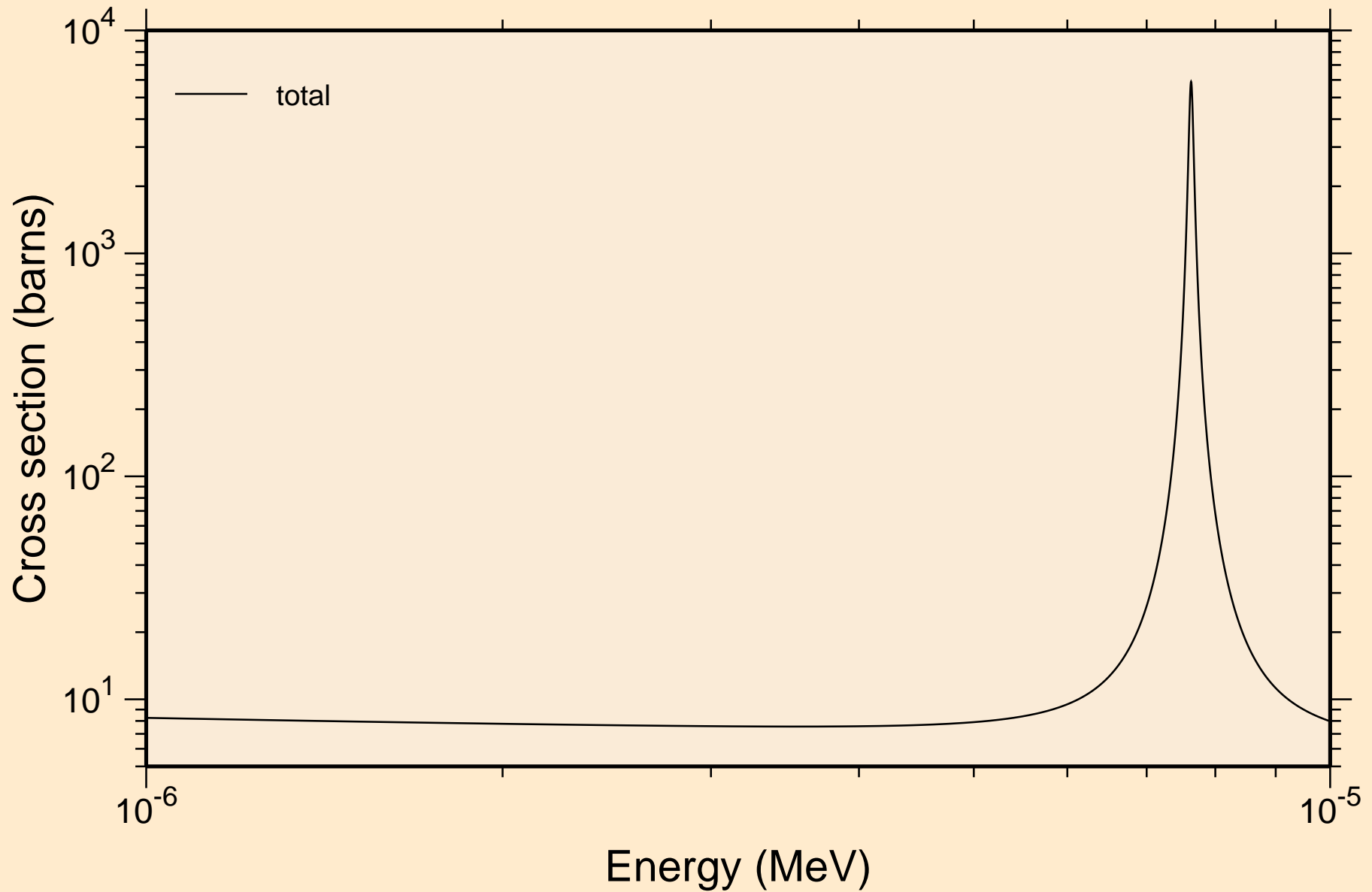

W183 NEUTRON ACER TENDL-2023 LIBRARY; T=0.K
resonance total cross section

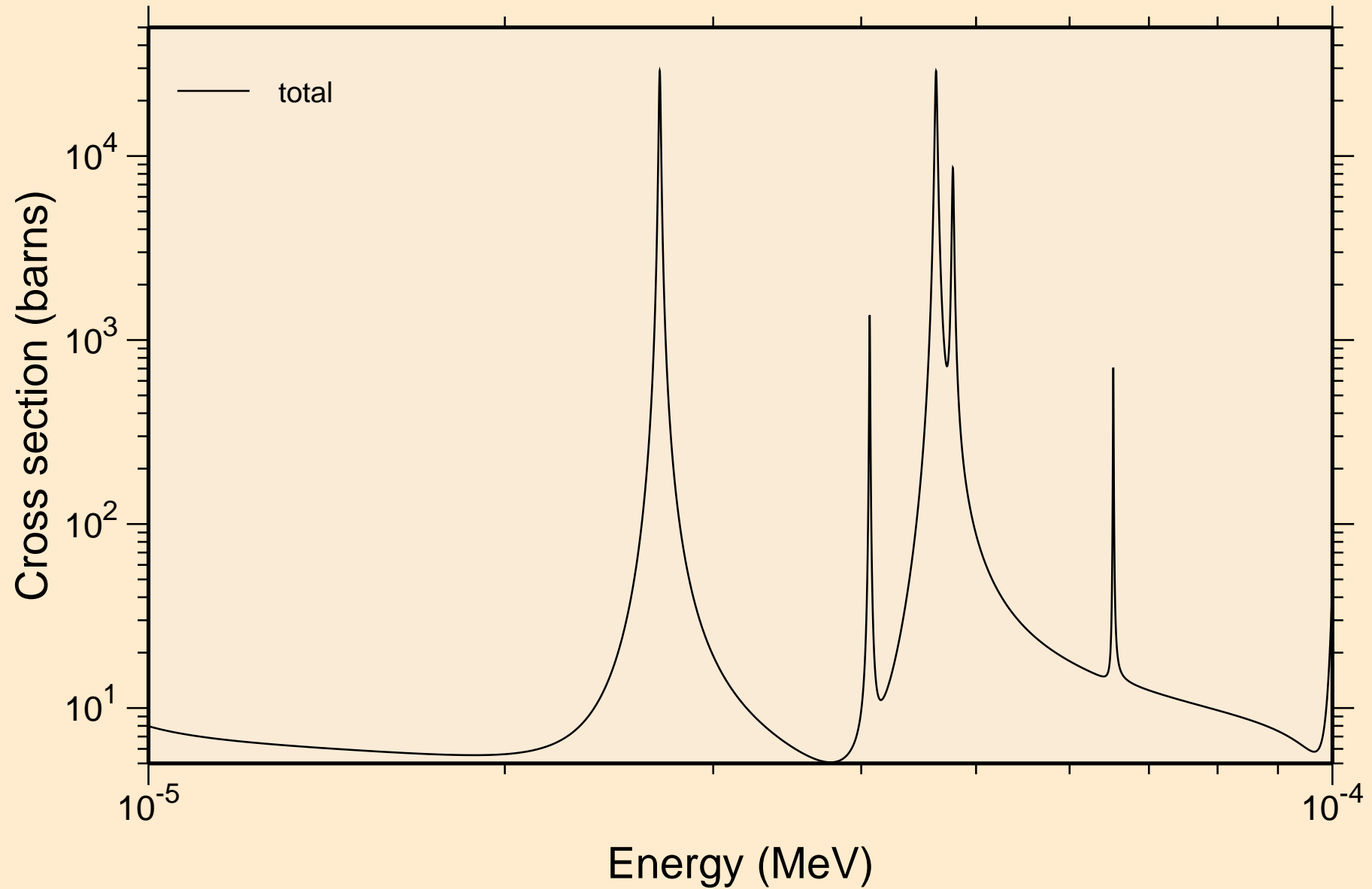

W183 NEUTRON ACER TENDL-2023 LIBRARY; T=0.K
resonance total cross section

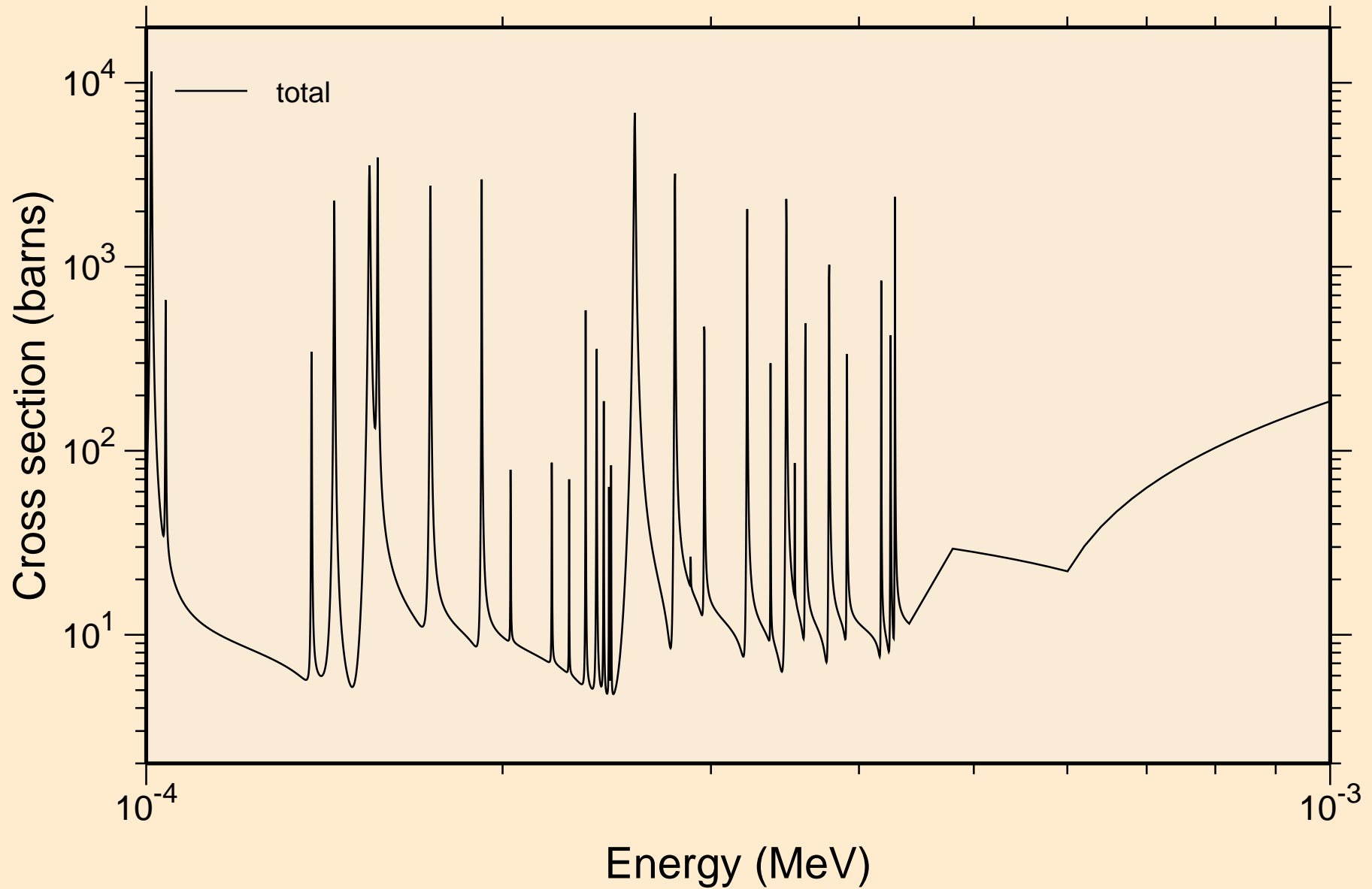

W183 NEUTRON ACER TENDL-2023 LIBRARY; T=0.K
resonance total cross section

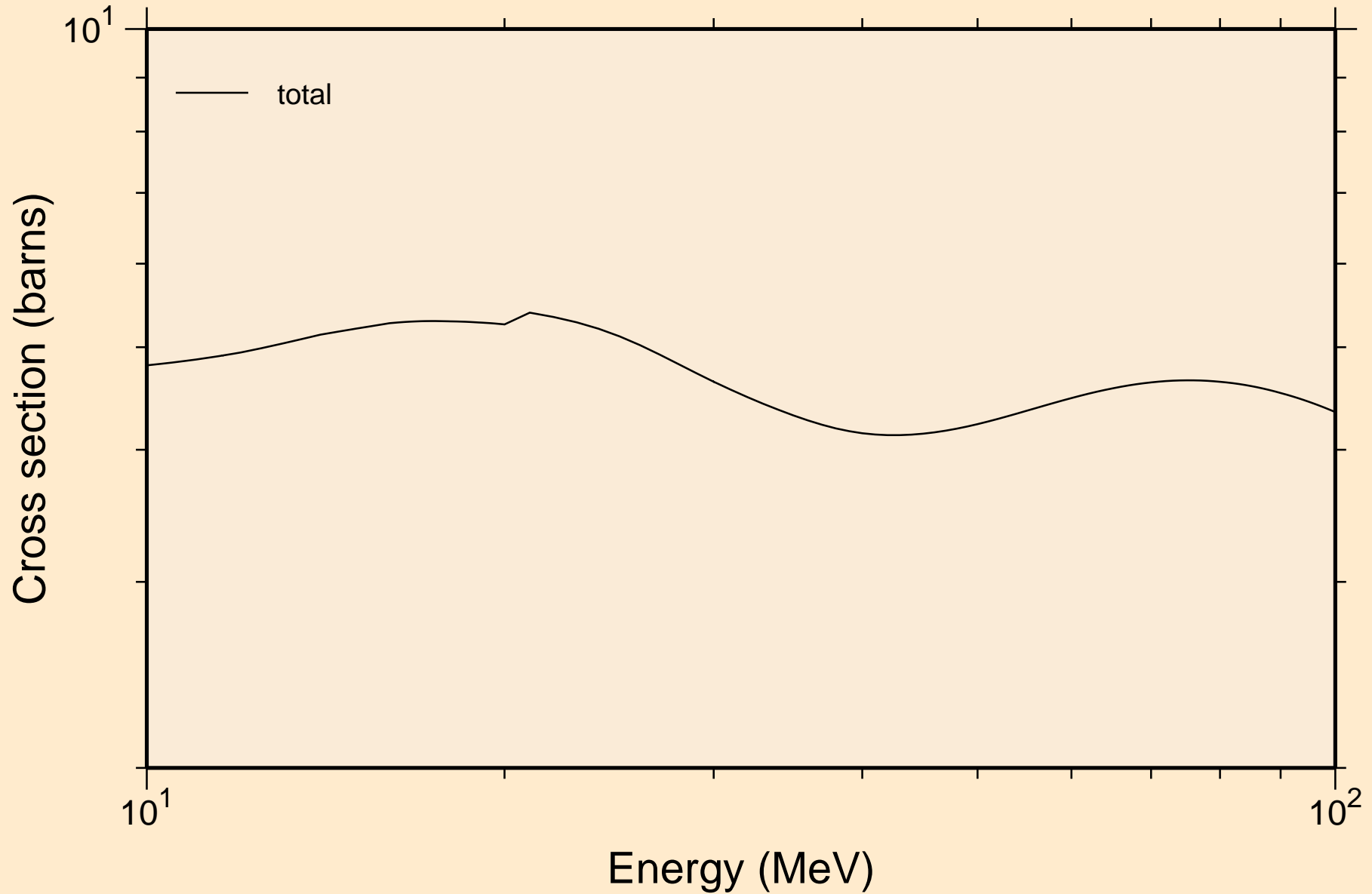

W183 NEUTRON ACER TENDL-2023 LIBRARY; T=0.K
resonance absorption cross sections

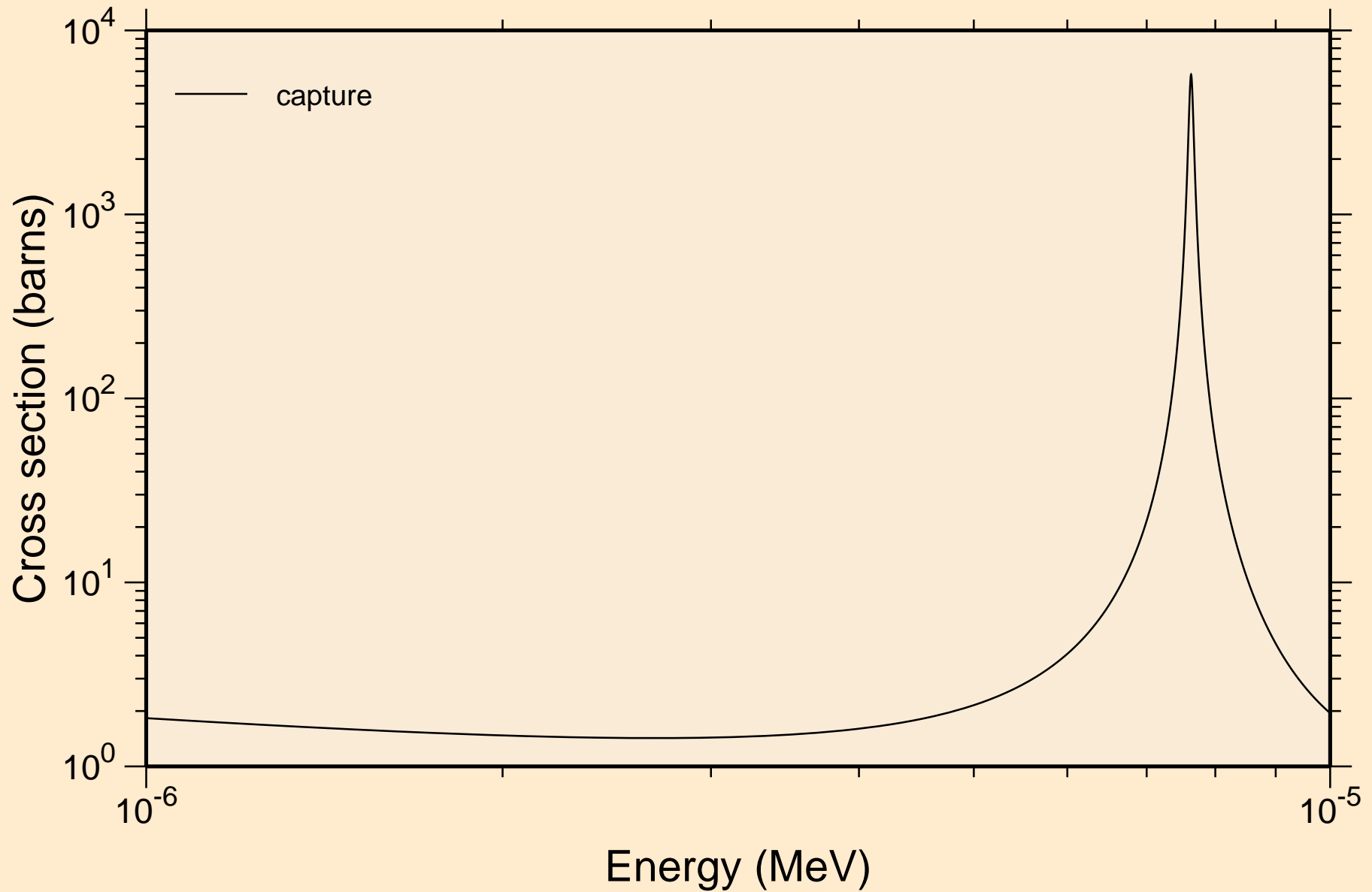

W183 NEUTRON ACER TENDL-2023 LIBRARY; T=0.K
resonance absorption cross sections

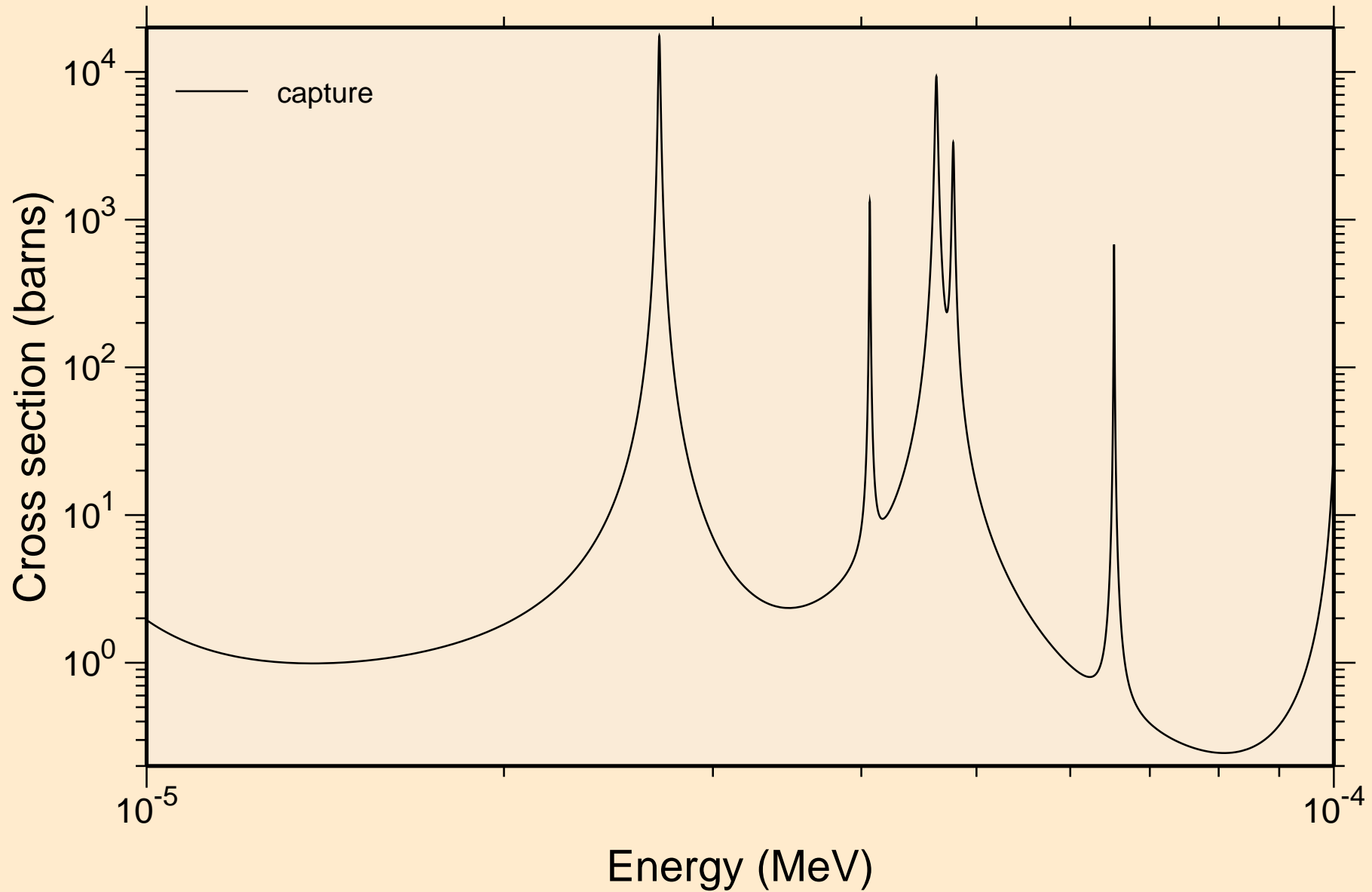

W183 NEUTRON ACER TENDL-2023 LIBRARY; T=0.K
resonance absorption cross sections

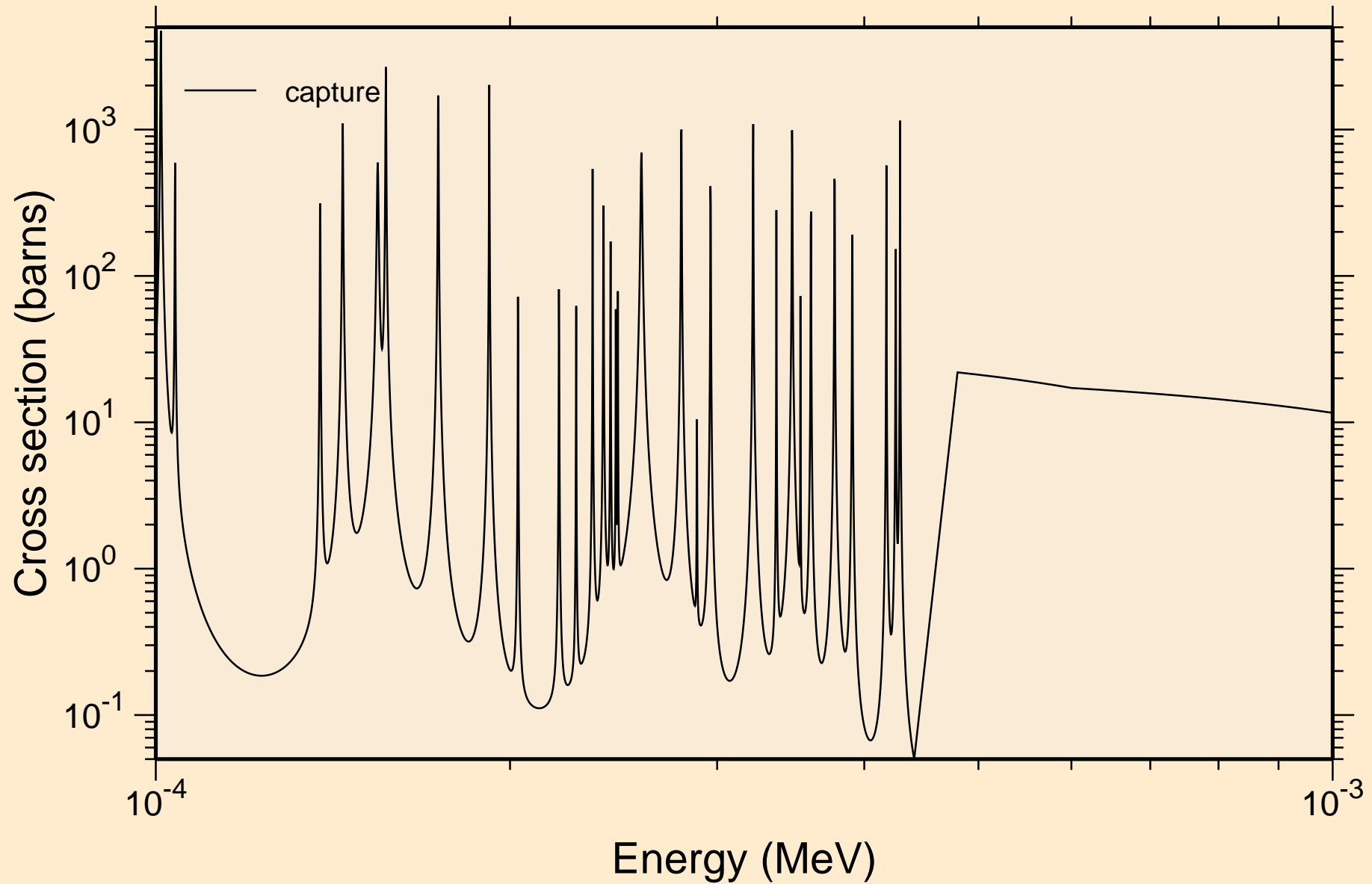

W183 NEUTRON ACER TENDL-2023 LIBRARY; T=0.K
resonance absorption cross sections

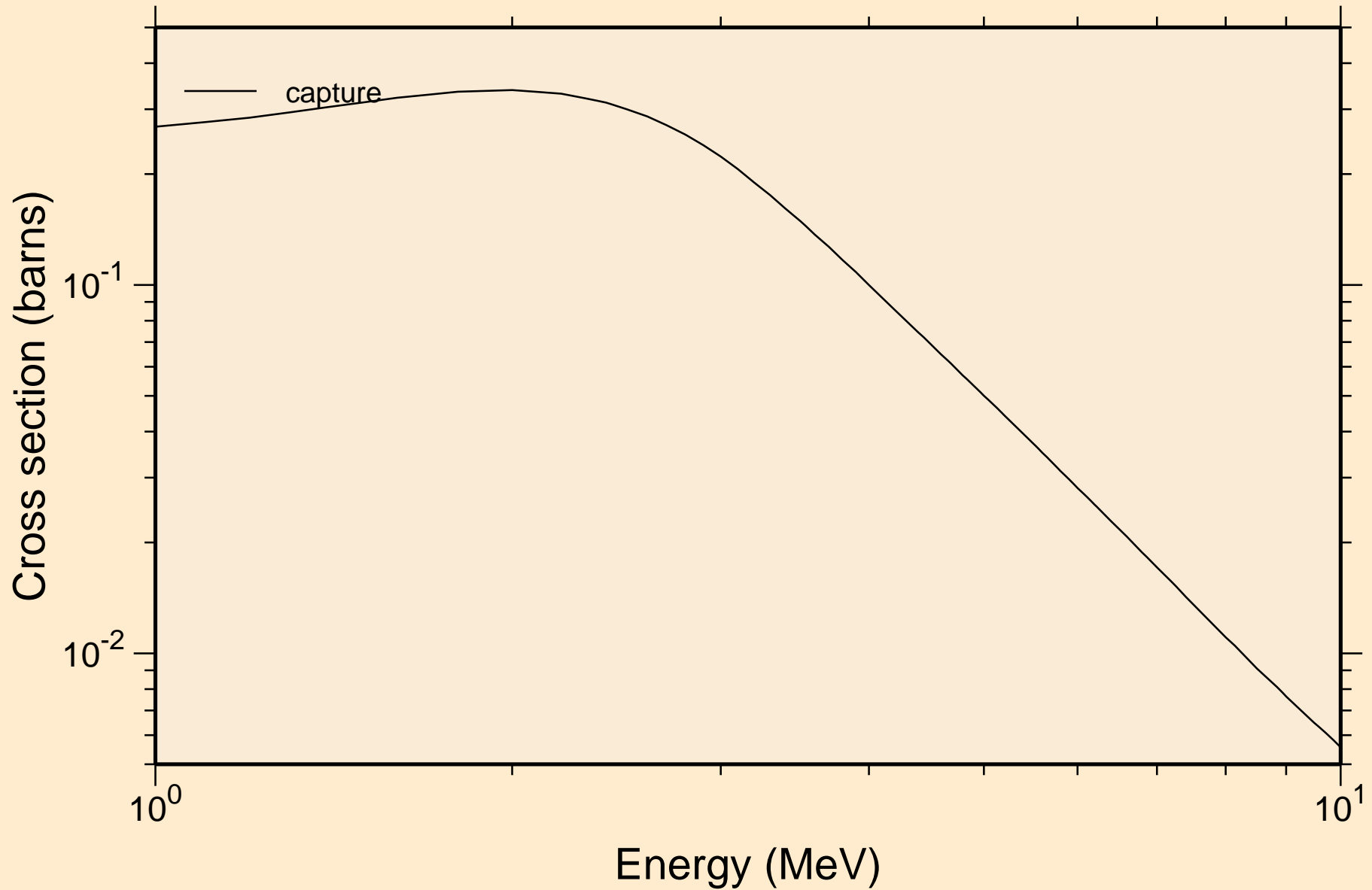

W183 NEUTRON ACER TENDL-2023 LIBRARY; T=0.K

Heating

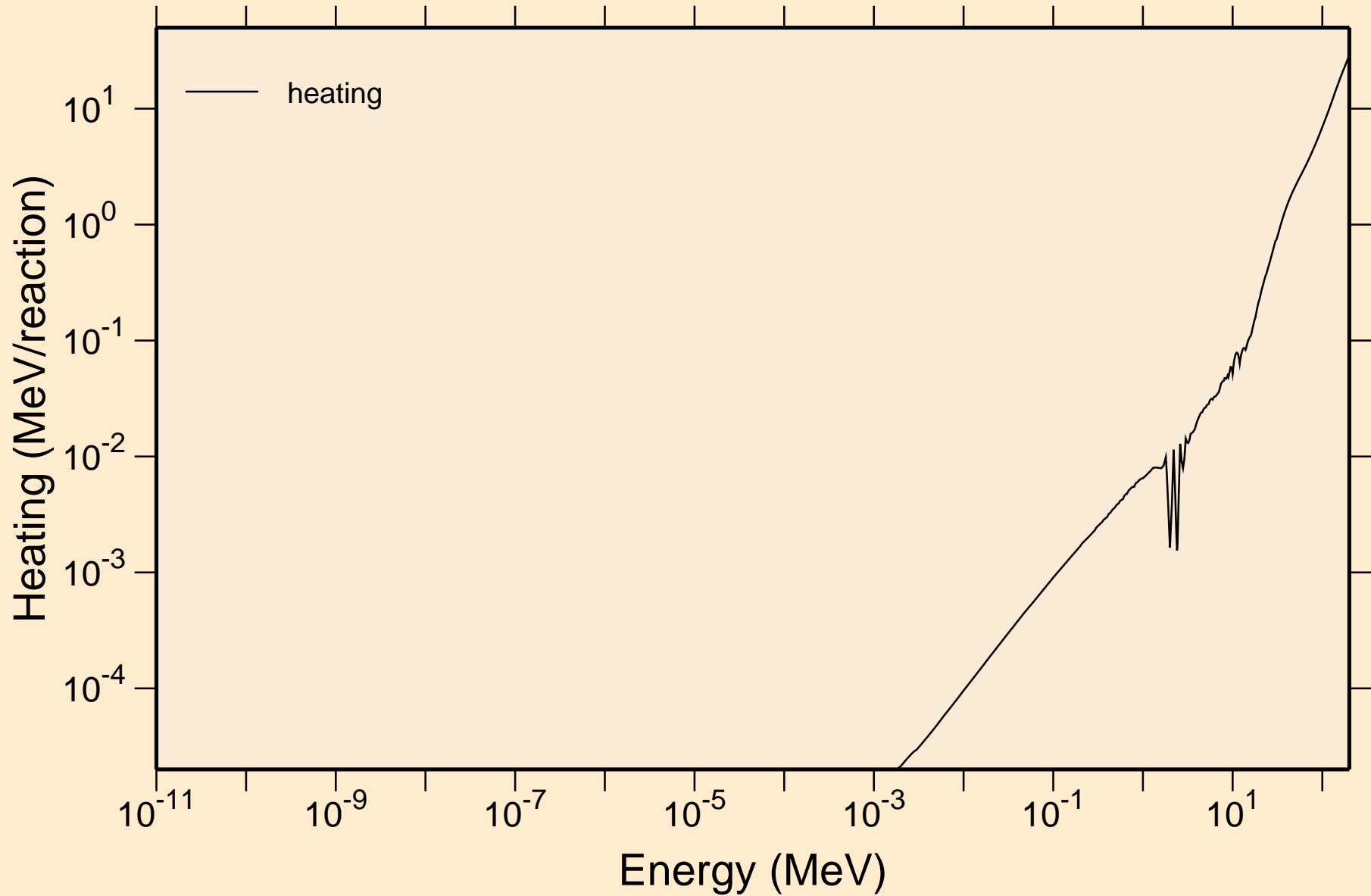

W183 NEUTRON ACER TENDL-2023 LIBRARY; T=0.K

Damage

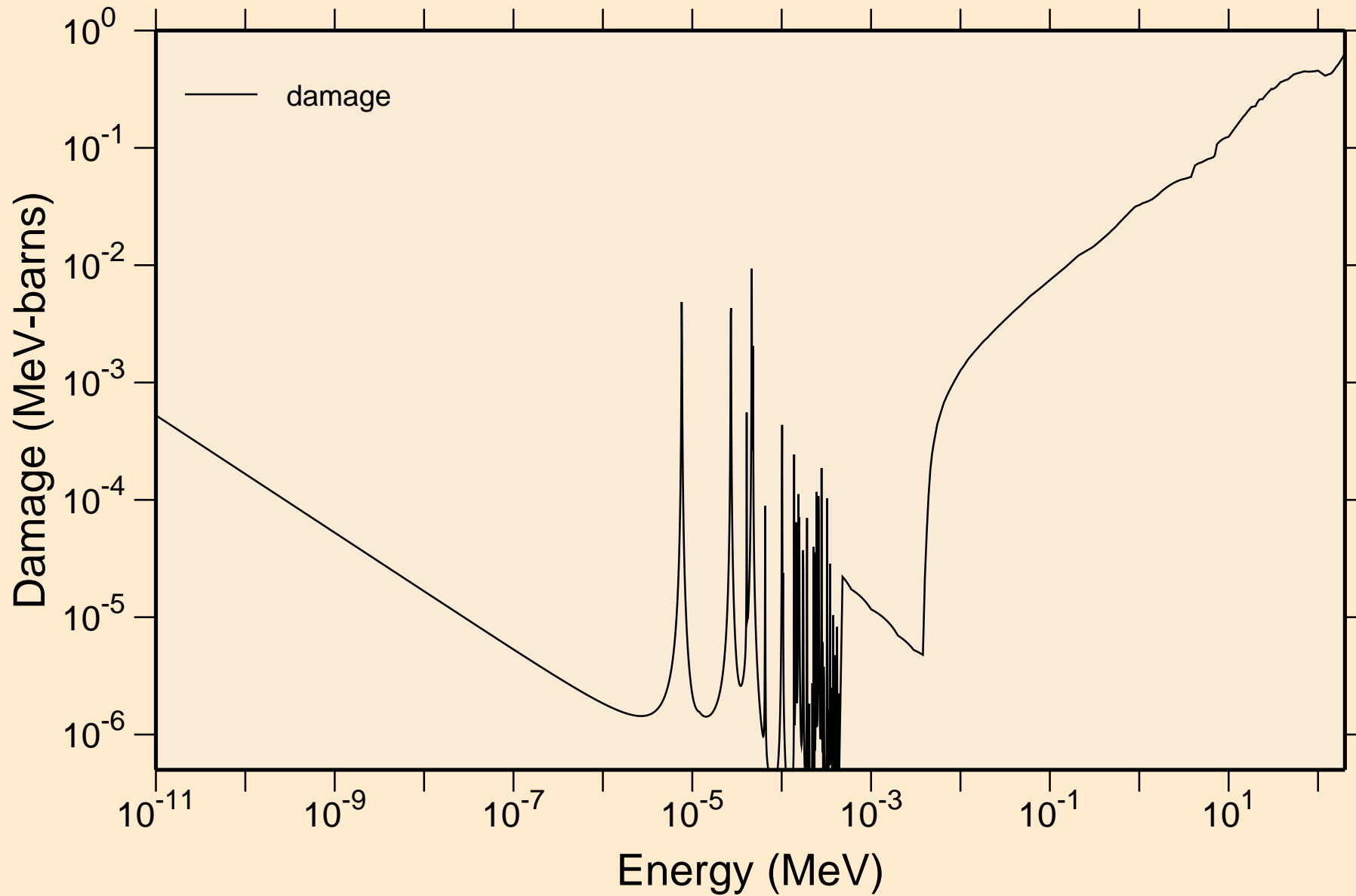

W183 NEUTRON ACER TENDL-2023 LIBRARY; T=0.K
Non-threshold reactions

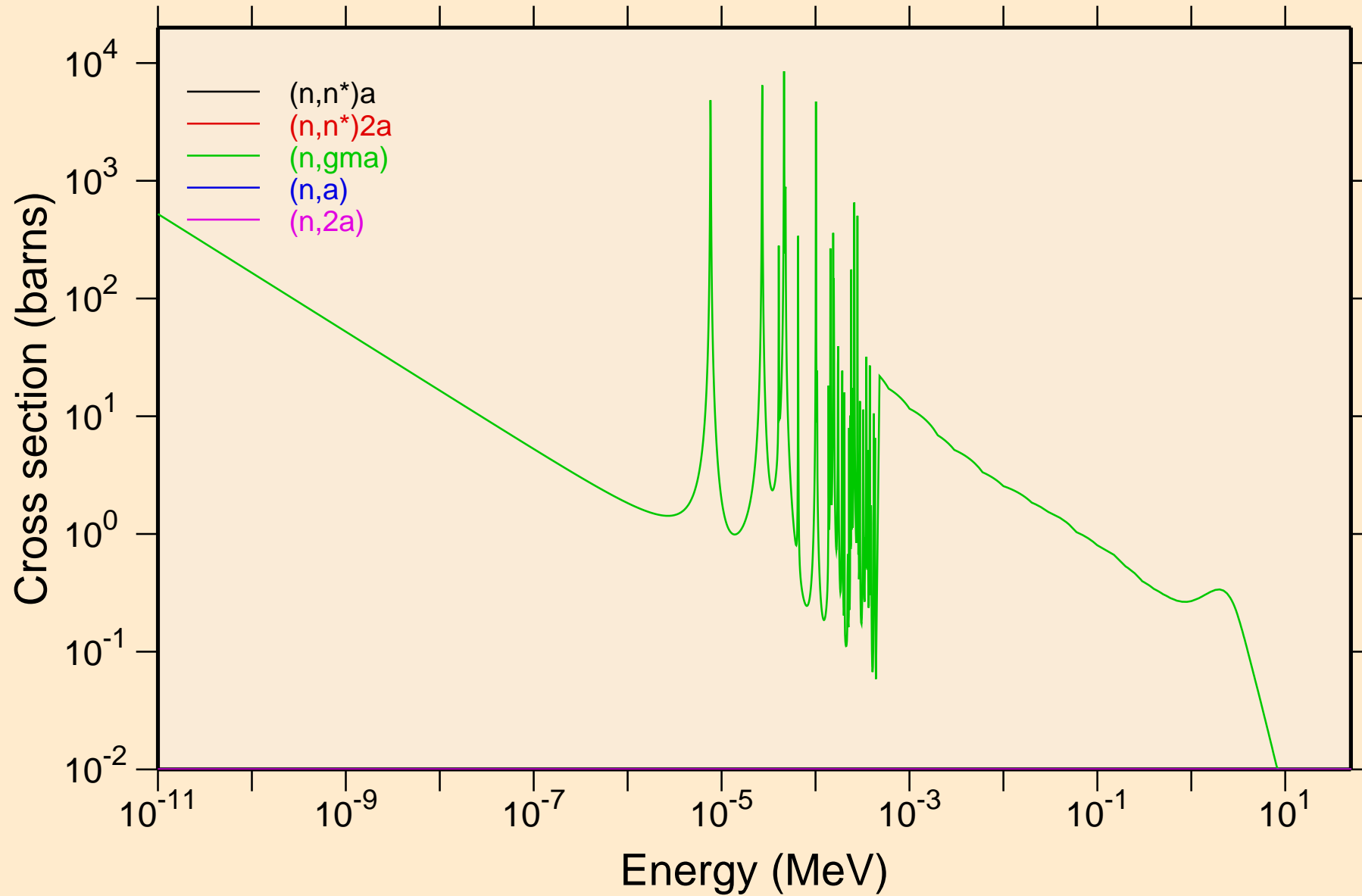

W183 NEUTRON ACER TENDL-2023 LIBRARY; T=0.K
Non-threshold reactions

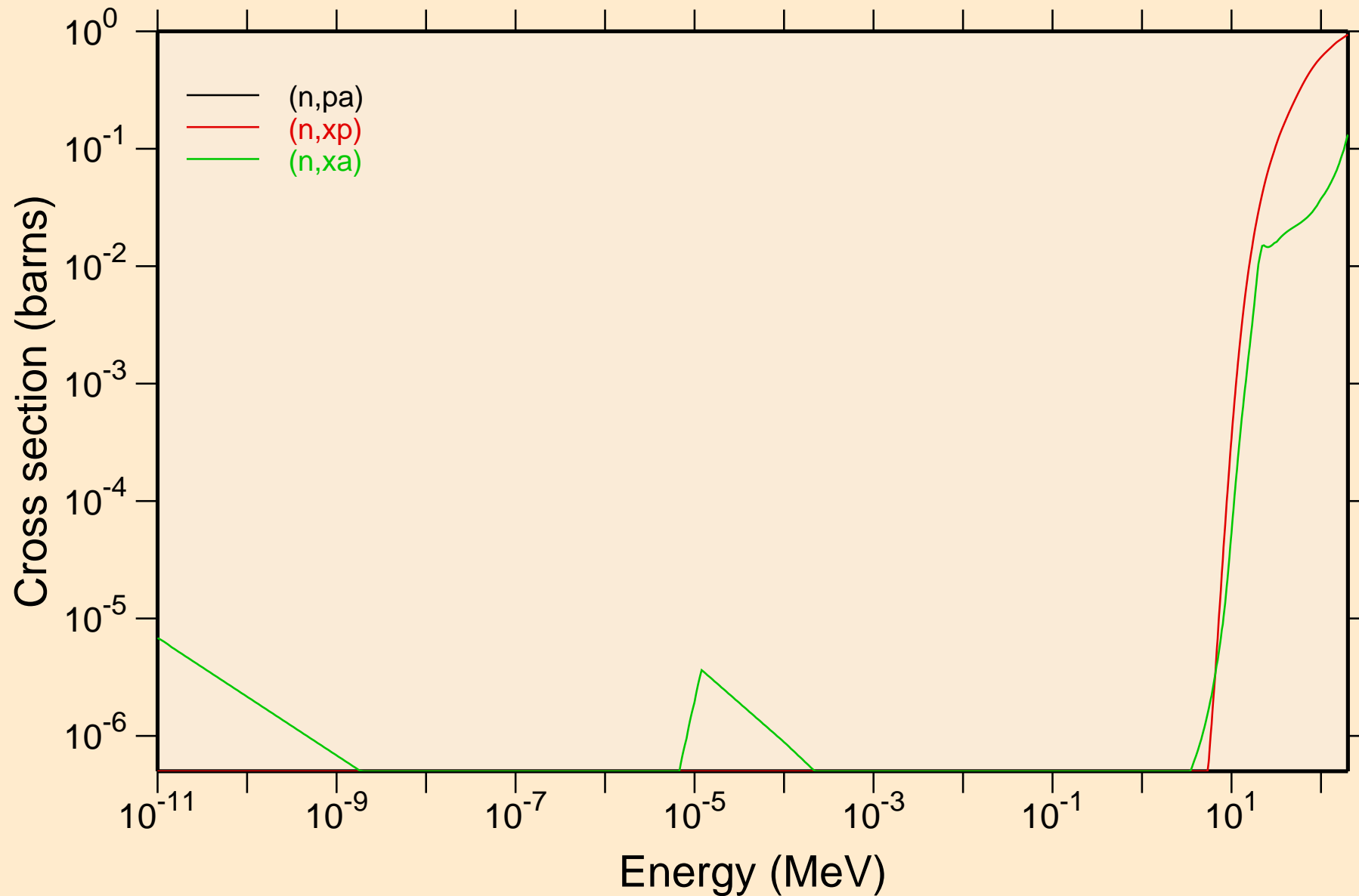

W183 NEUTRON ACER TENDL-2023 LIBRARY; T=0.K

Principal cross sections

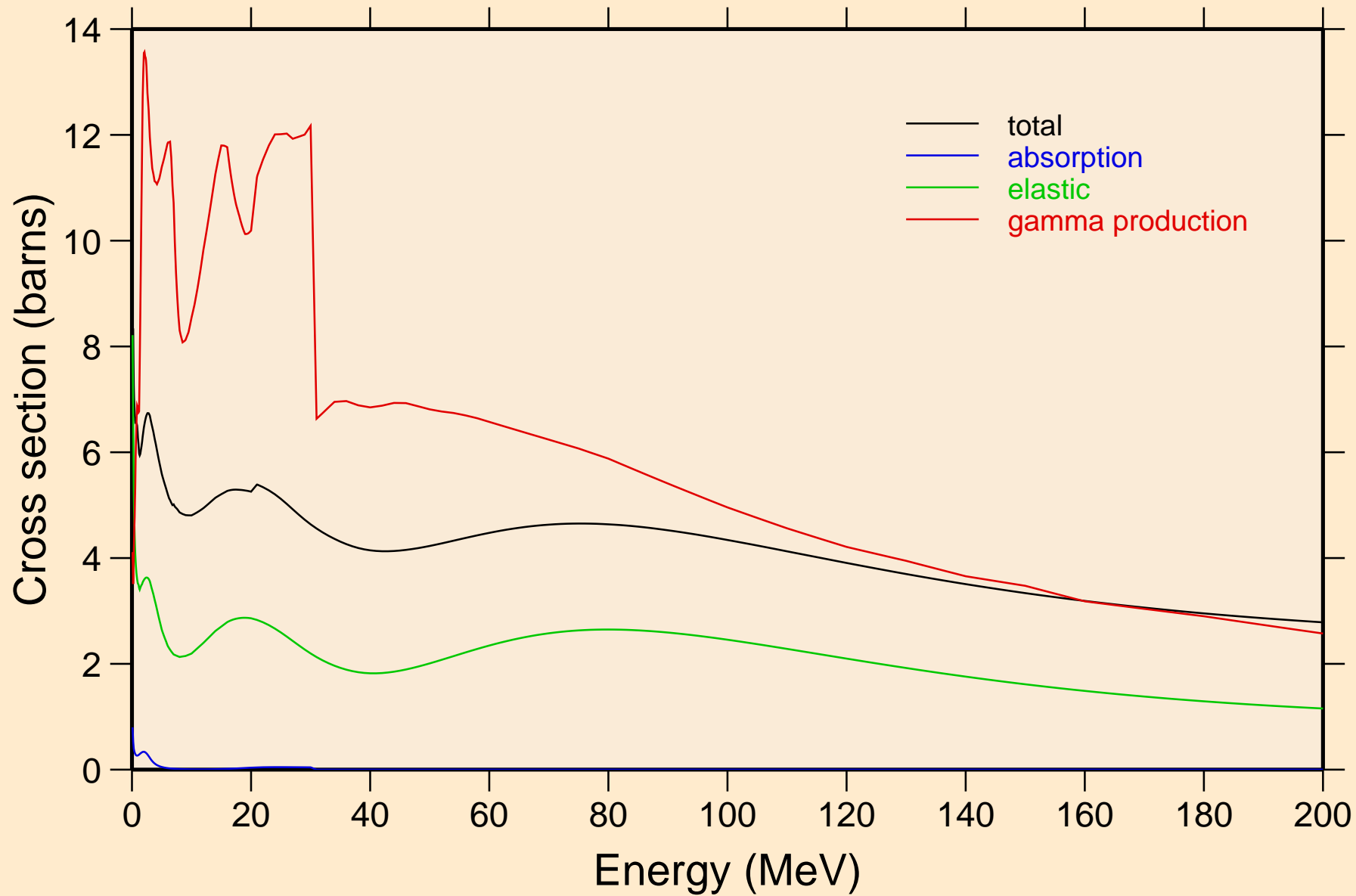

W183 NEUTRON ACER TENDL-2023 LIBRARY; T=0.K

Heating

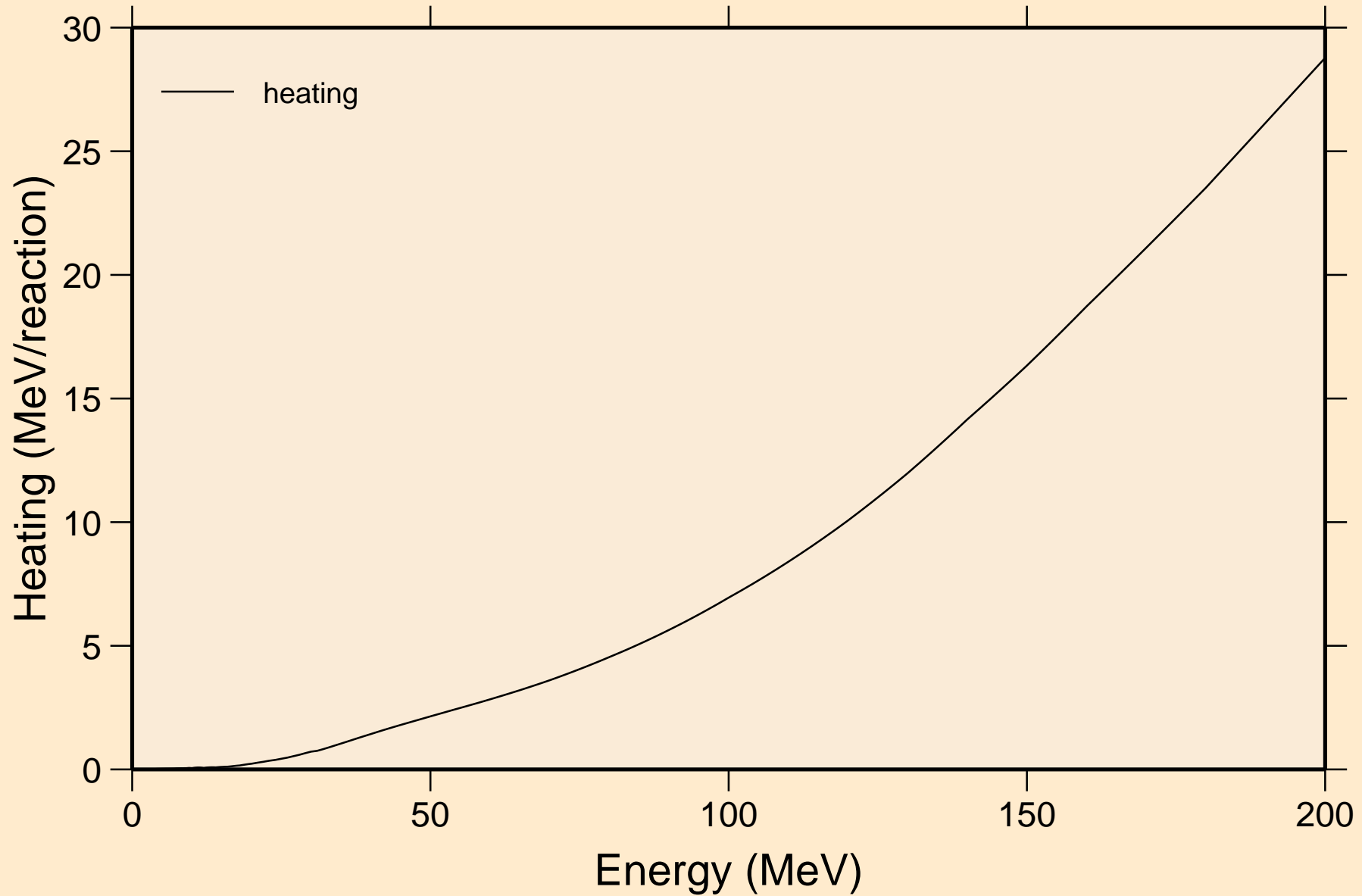

W183 NEUTRON ACER TENDL-2023 LIBRARY; T=0.K

Damage

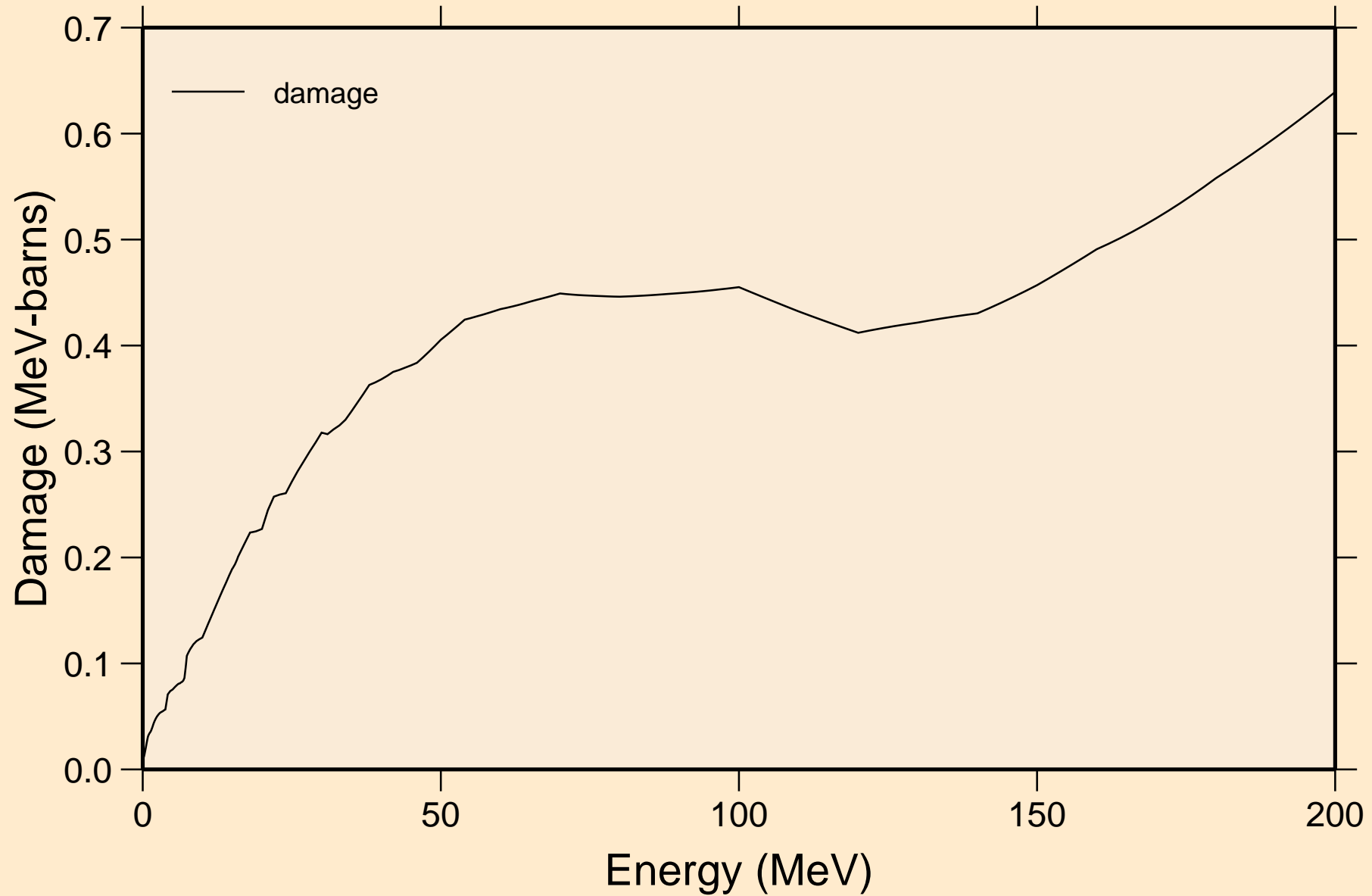

W183 NEUTRON ACER TENDL-2023 LIBRARY; T=0.K

Non-threshold reactions

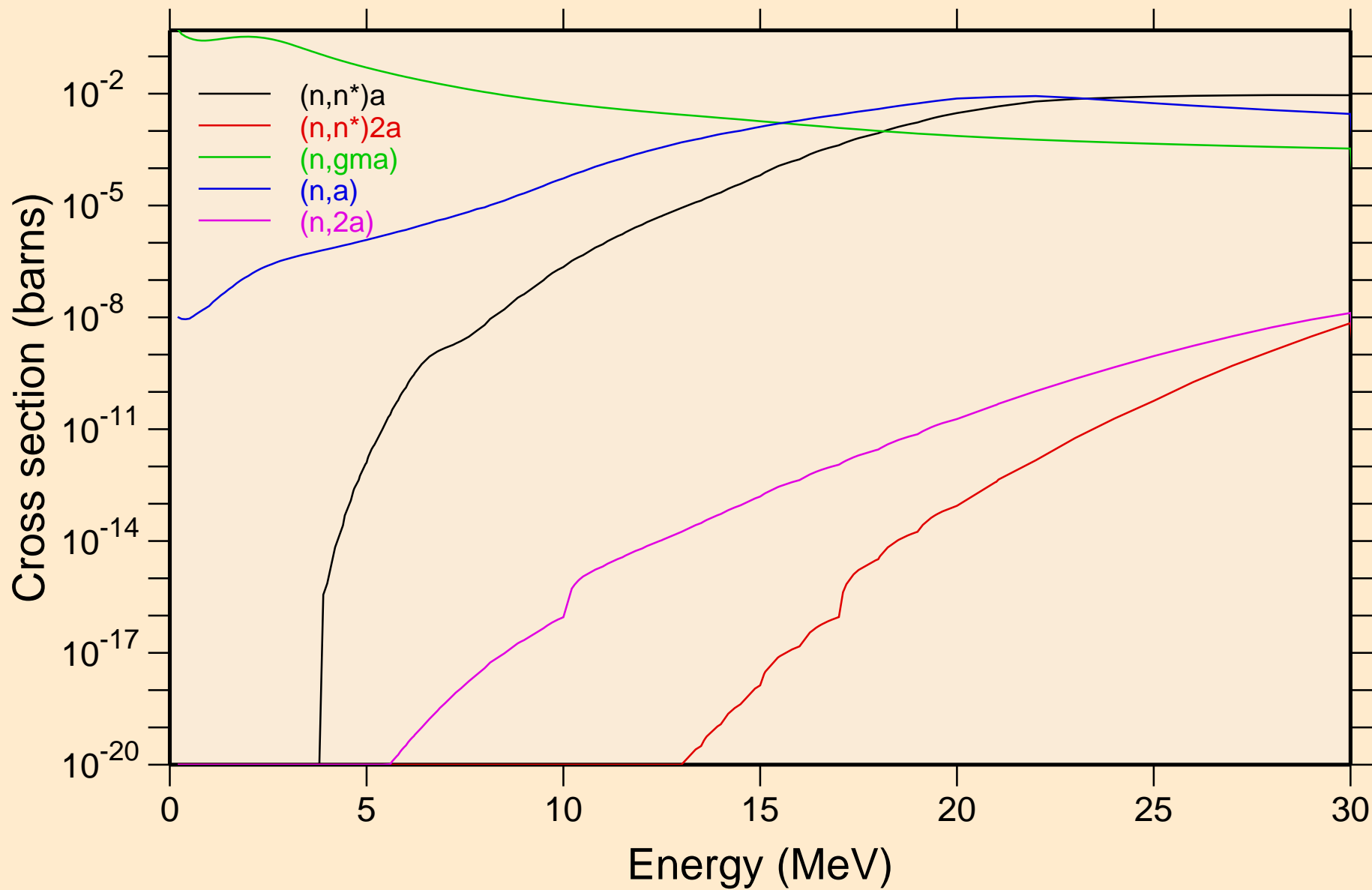

W183 NEUTRON ACER TENDL-2023 LIBRARY; T=0.K
Non-threshold reactions

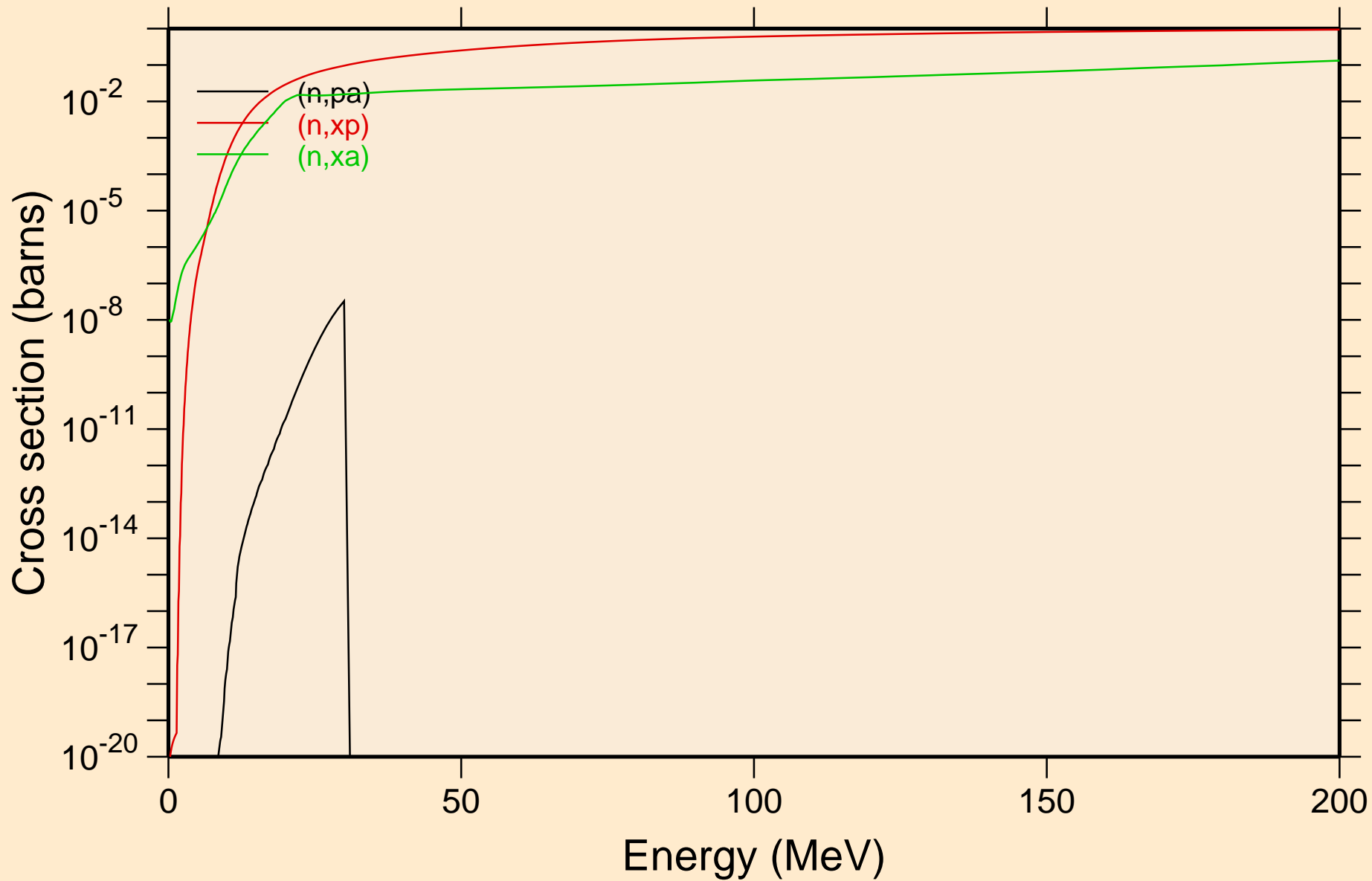

W183 NEUTRON ACER TENDL-2023 LIBRARY; T=0.K
Inelastic levels

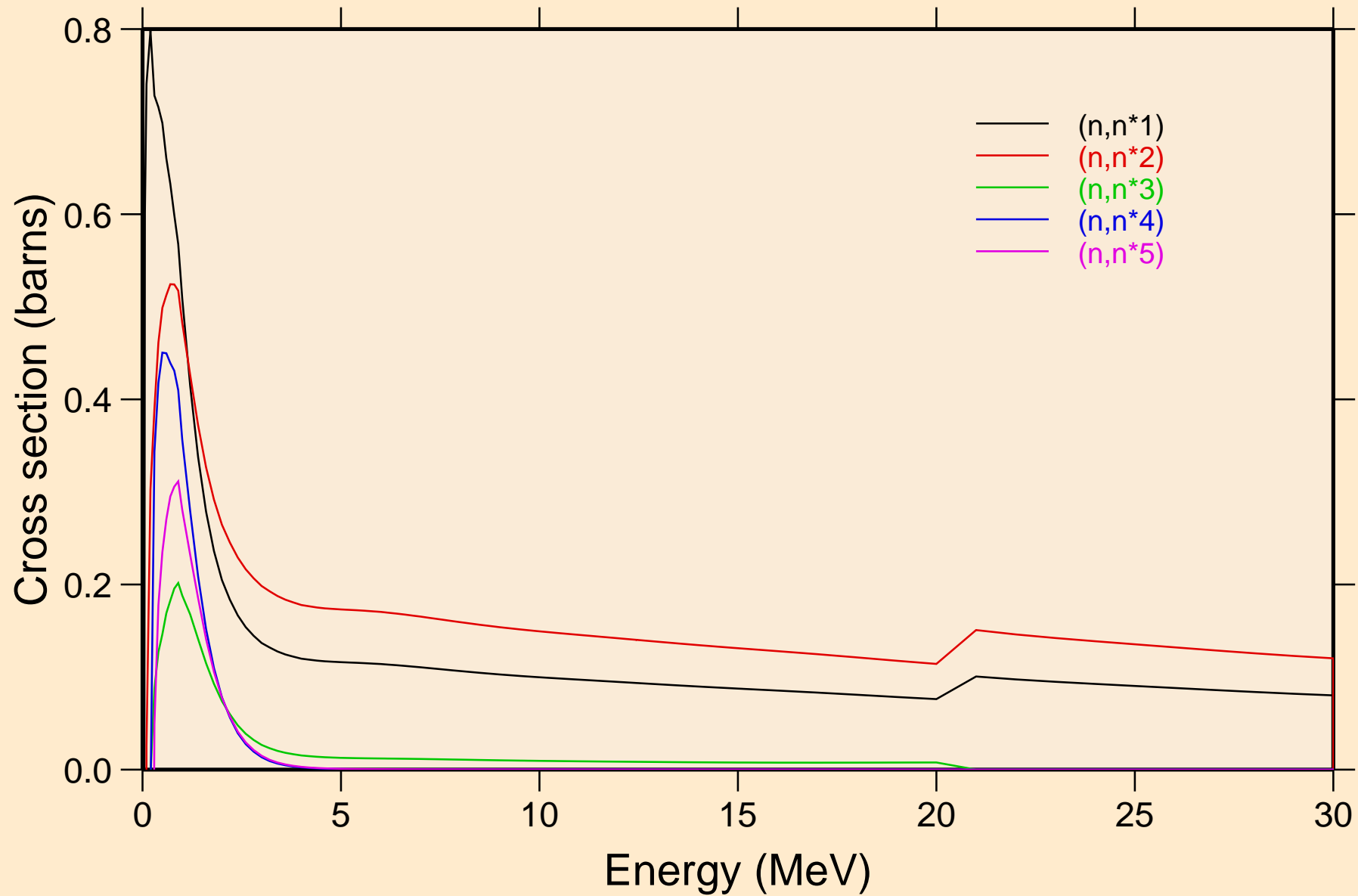

W183 NEUTRON ACER TENDL-2023 LIBRARY; T=0.K
Inelastic levels

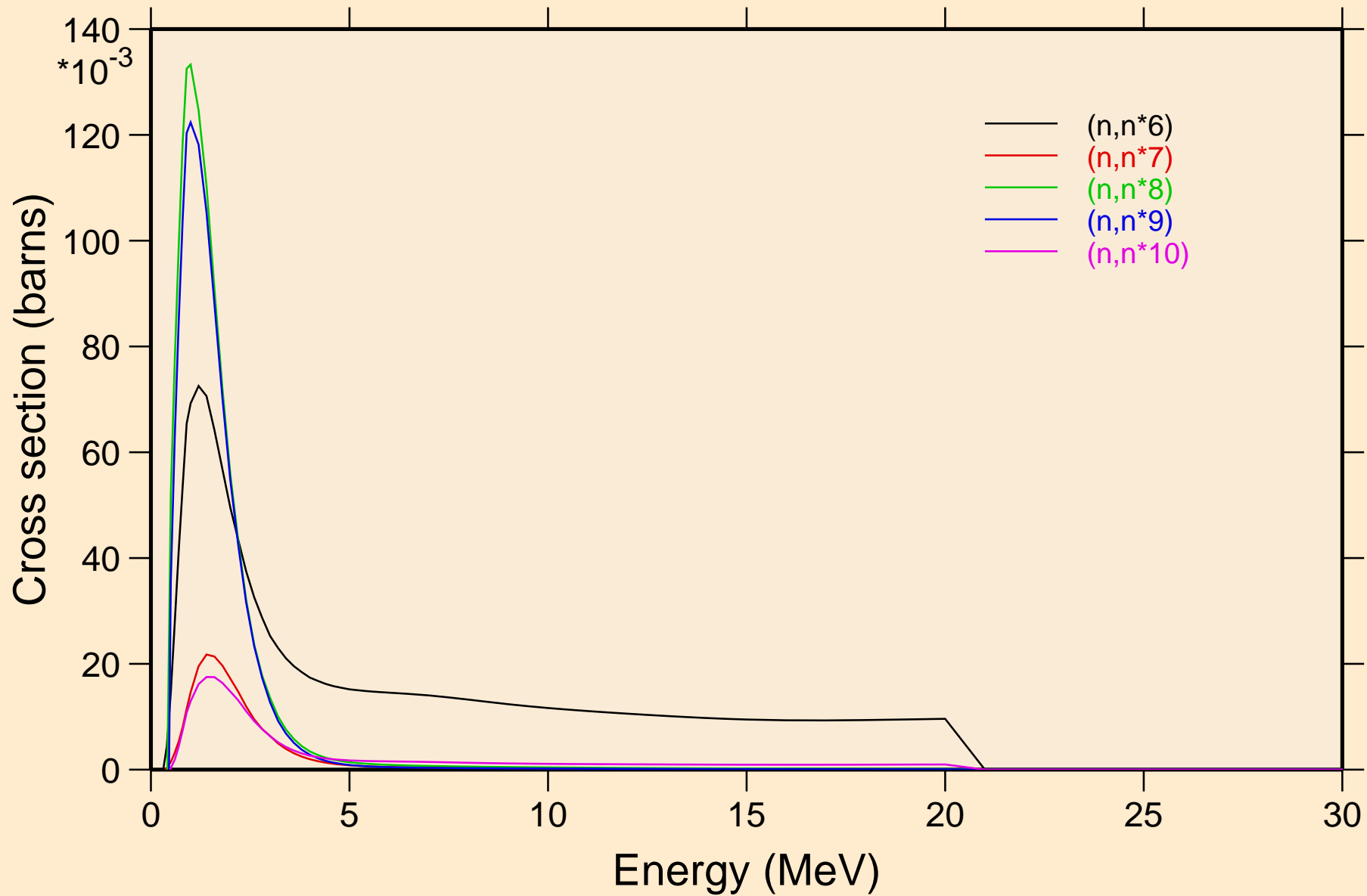

W183 NEUTRON ACER TENDL-2023 LIBRARY; T=0.K
Inelastic levels

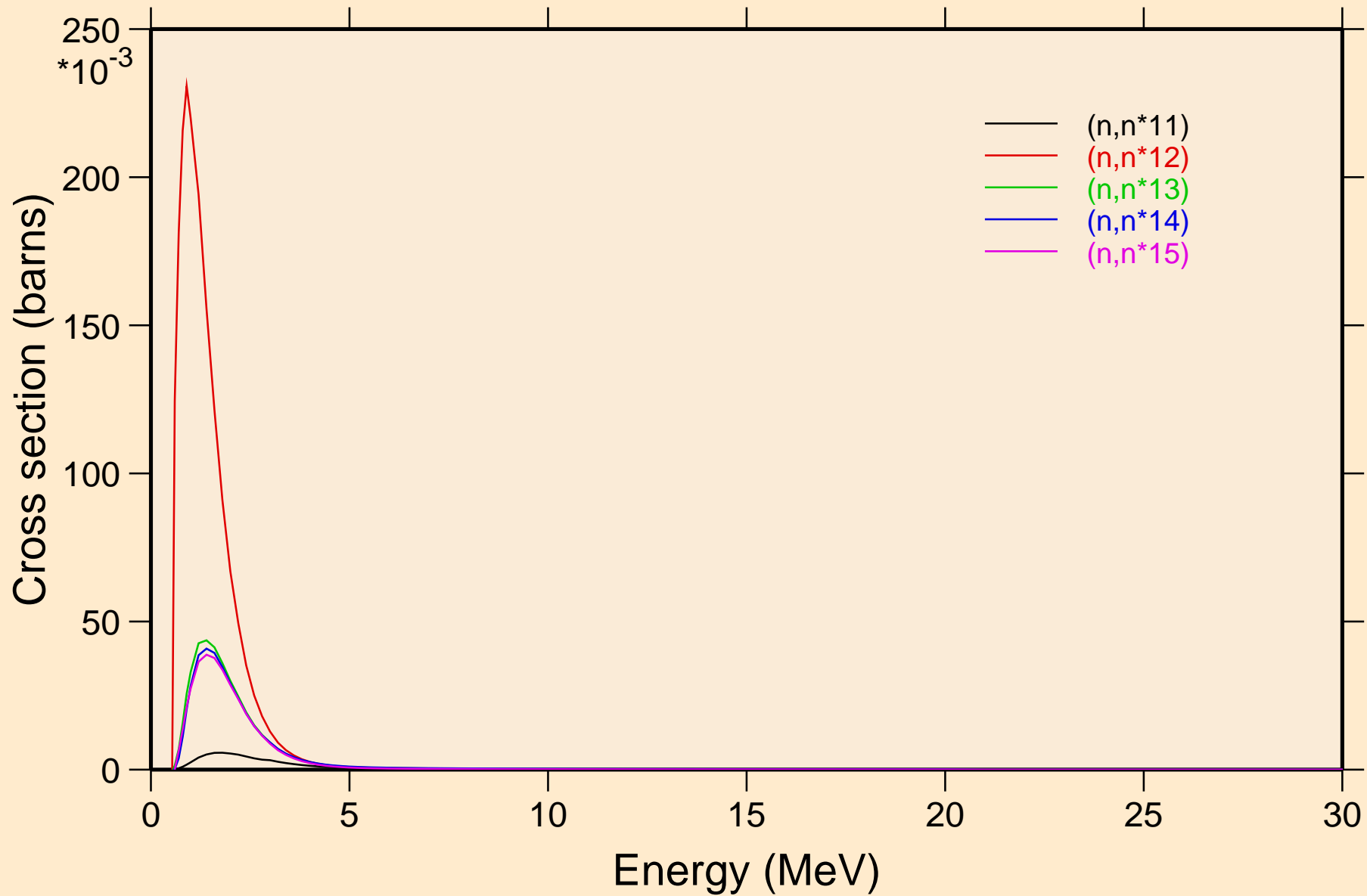

W183 NEUTRON ACER TENDL-2023 LIBRARY; T=0.K

Threshold reactions

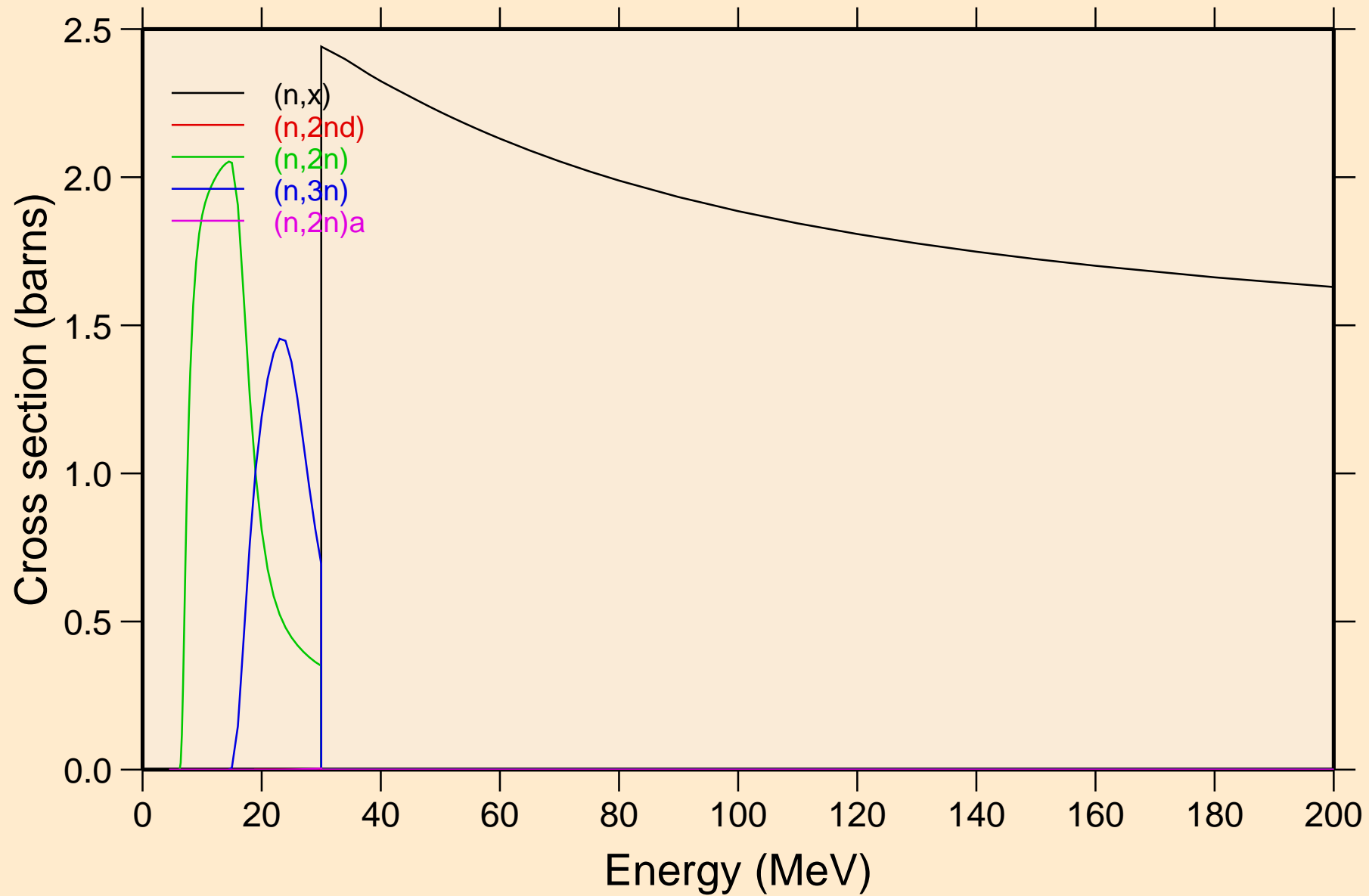

W183 NEUTRON ACER TENDL-2023 LIBRARY; T=0.K

Threshold reactions

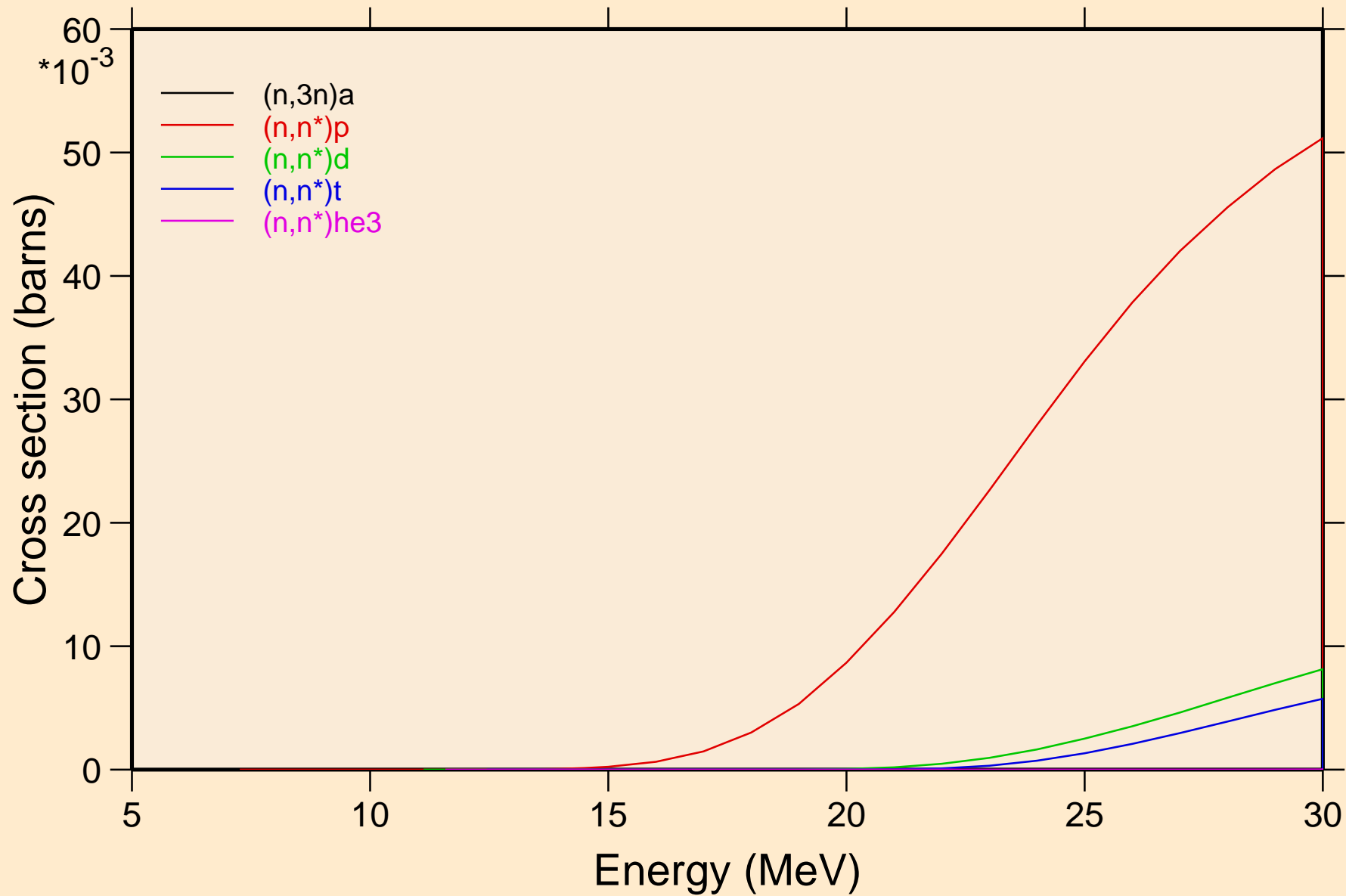

W183 NEUTRON ACER TENDL-2023 LIBRARY; T=0.K
Threshold reactions

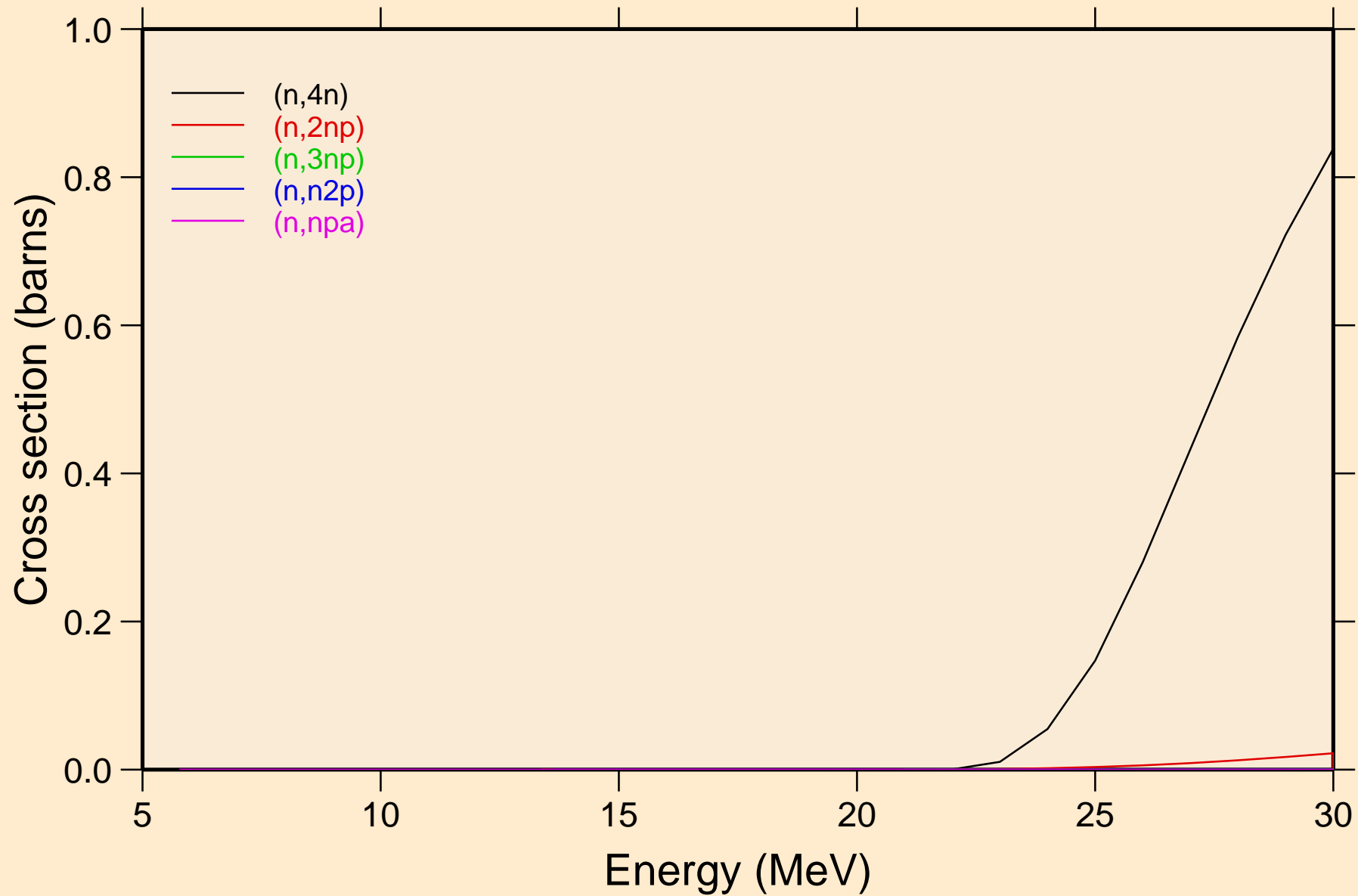

W183 NEUTRON ACER TENDL-2023 LIBRARY; T=0.K
Threshold reactions

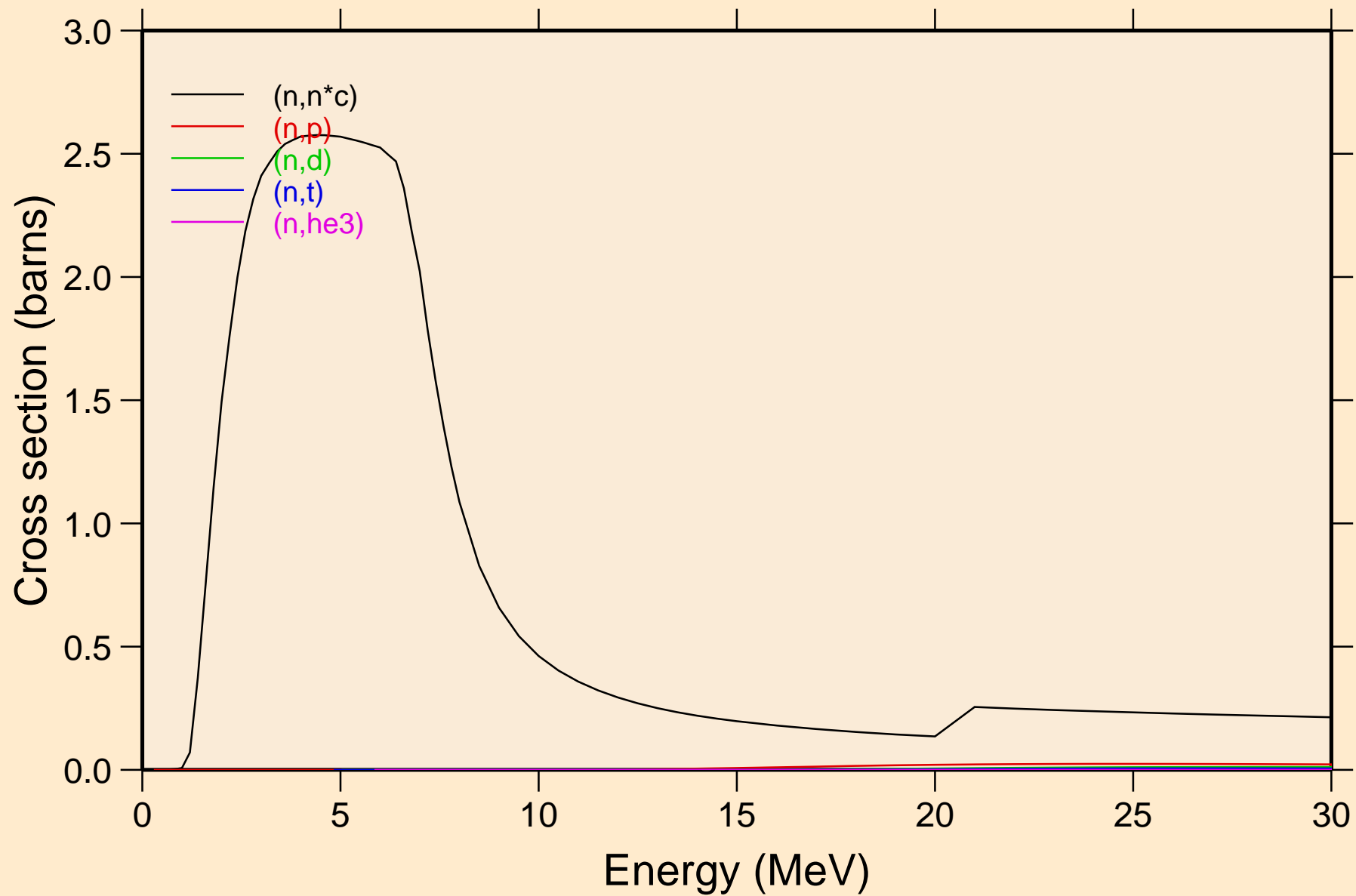

W183 NEUTRON ACER TENDL-2023 LIBRARY; T=0.K
Threshold reactions

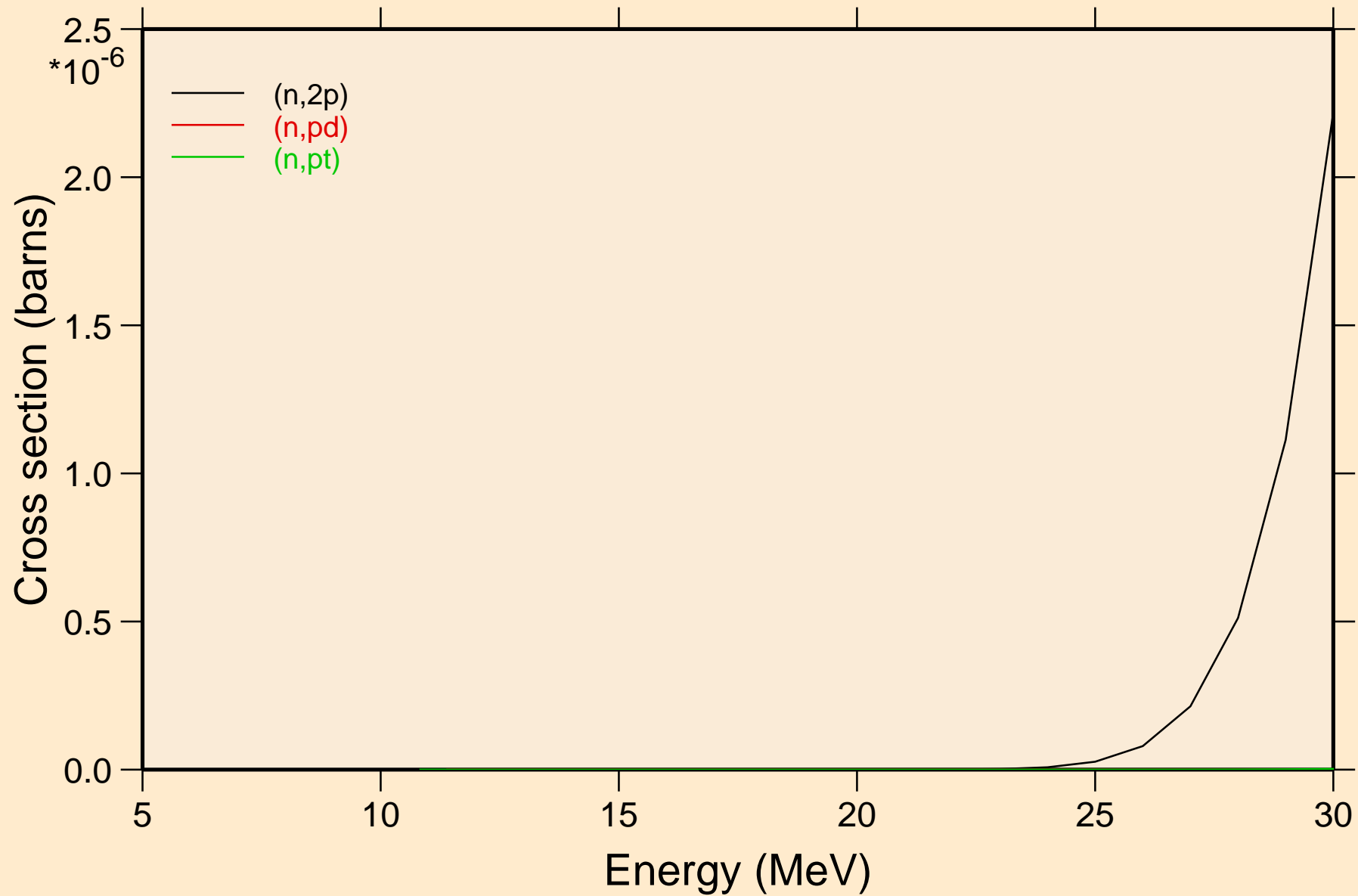

W183 NEUTRON ACER TENDL-2023 LIBRARY; T=0.K
Threshold reactions

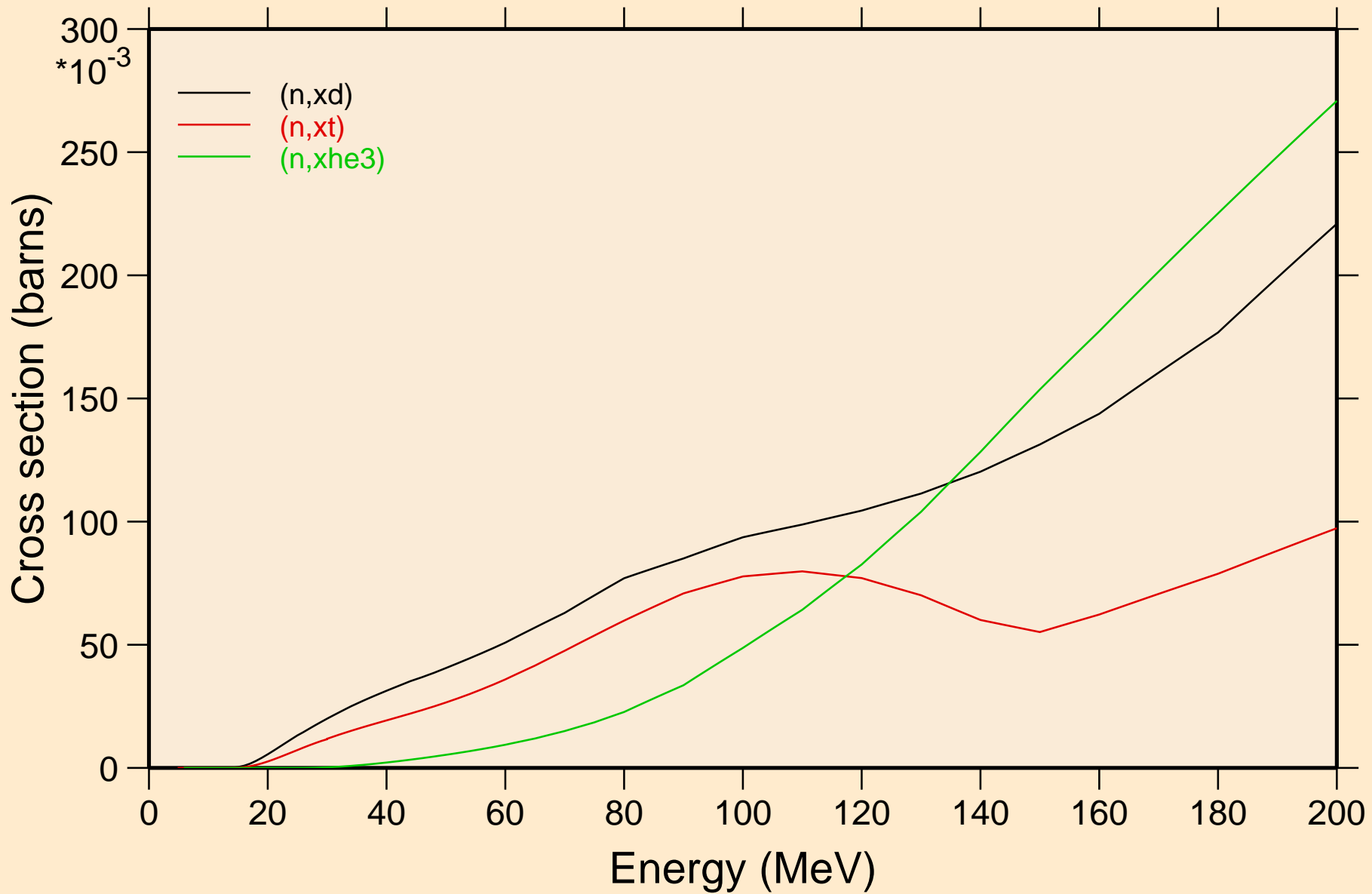

W183 NEUTRON ACER TENDL-2023 LIBRARY; T=0.K
angular distribution for elastic

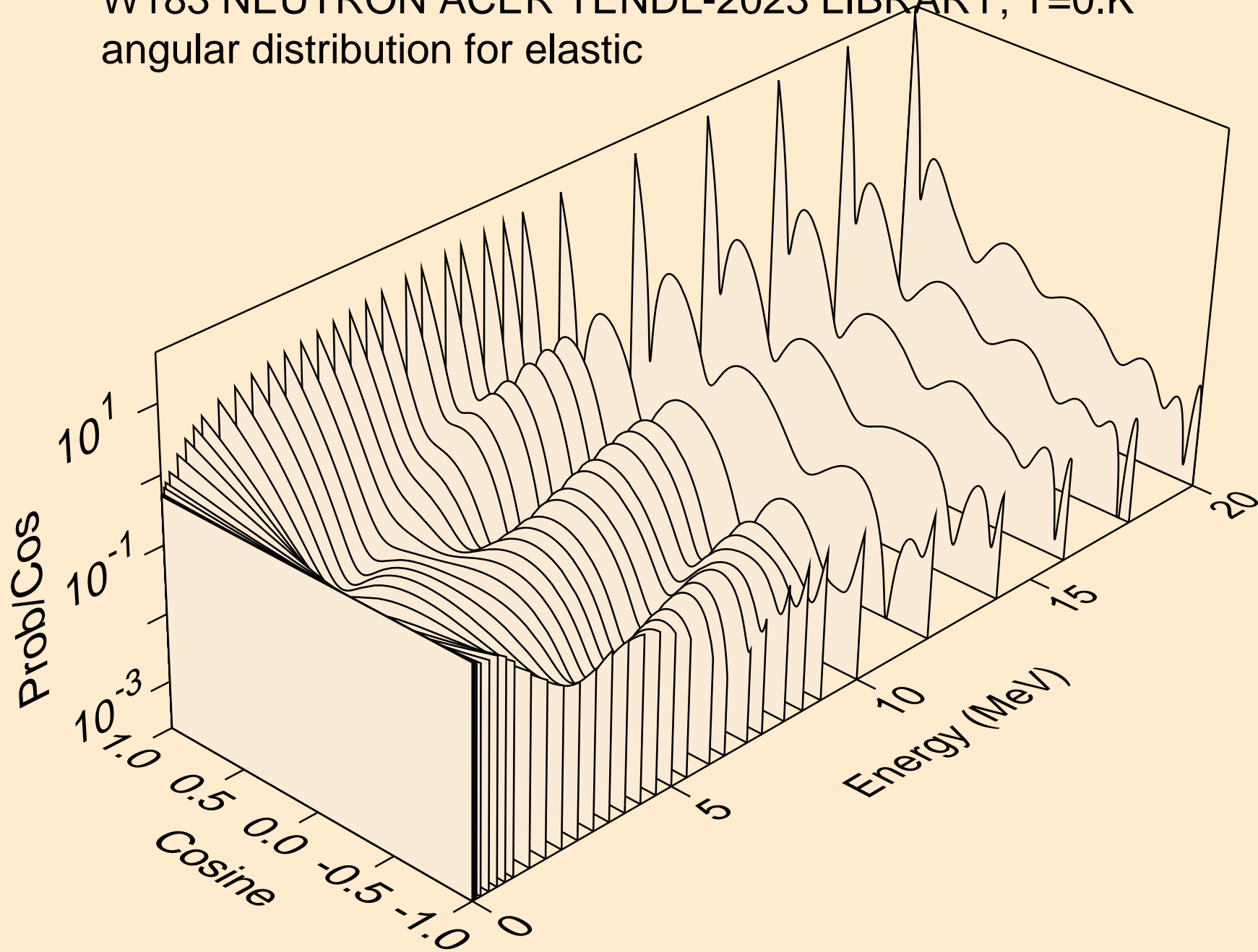

W183 NEUTRON ACER TENDL-2023 LIBRARY; T=0.K
angular distribution for elastic

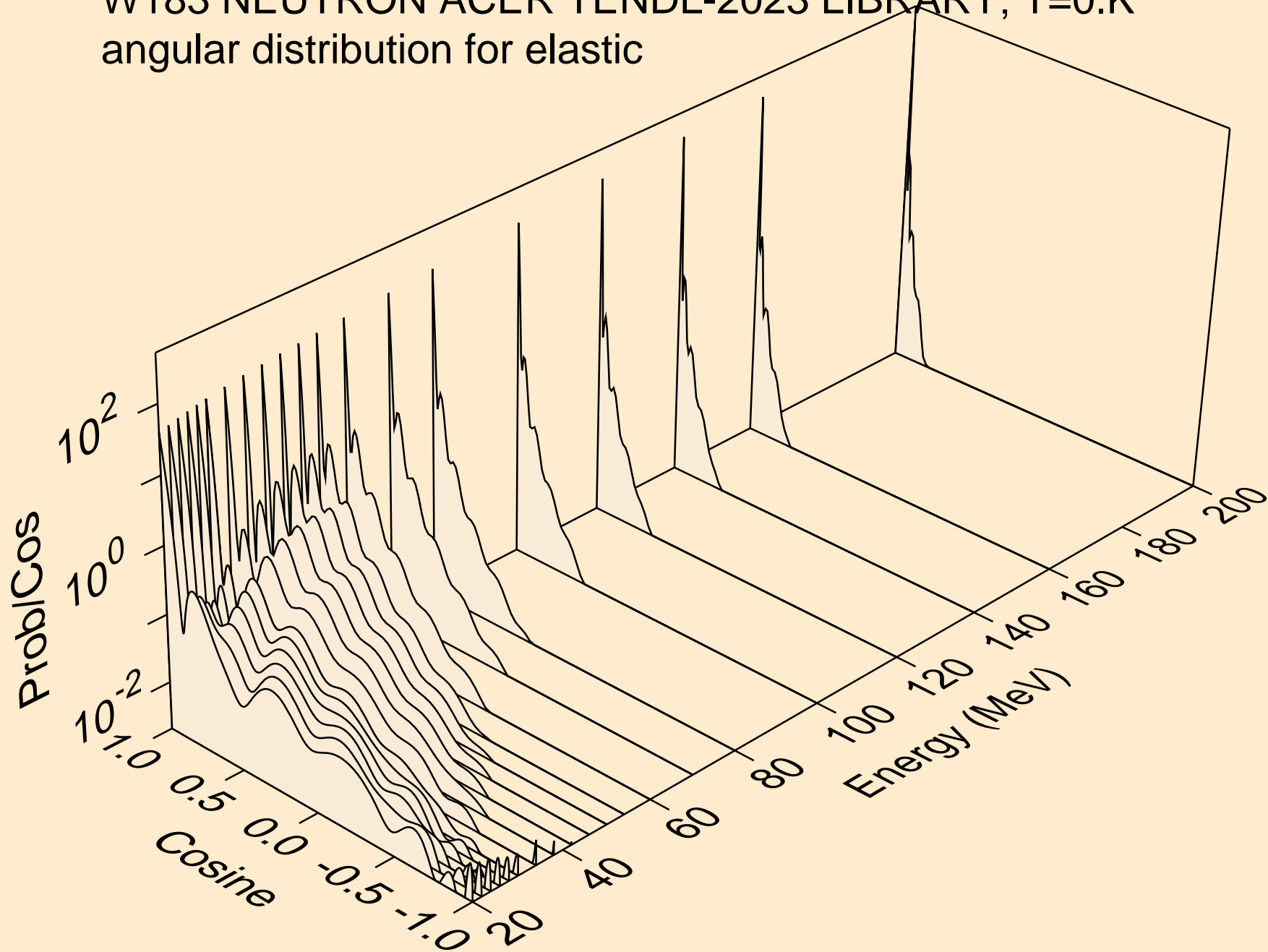

W183 NEUTRON ACER TENDL-2023 LIBRARY; T=0.K
angular distribution for (n,n*1)

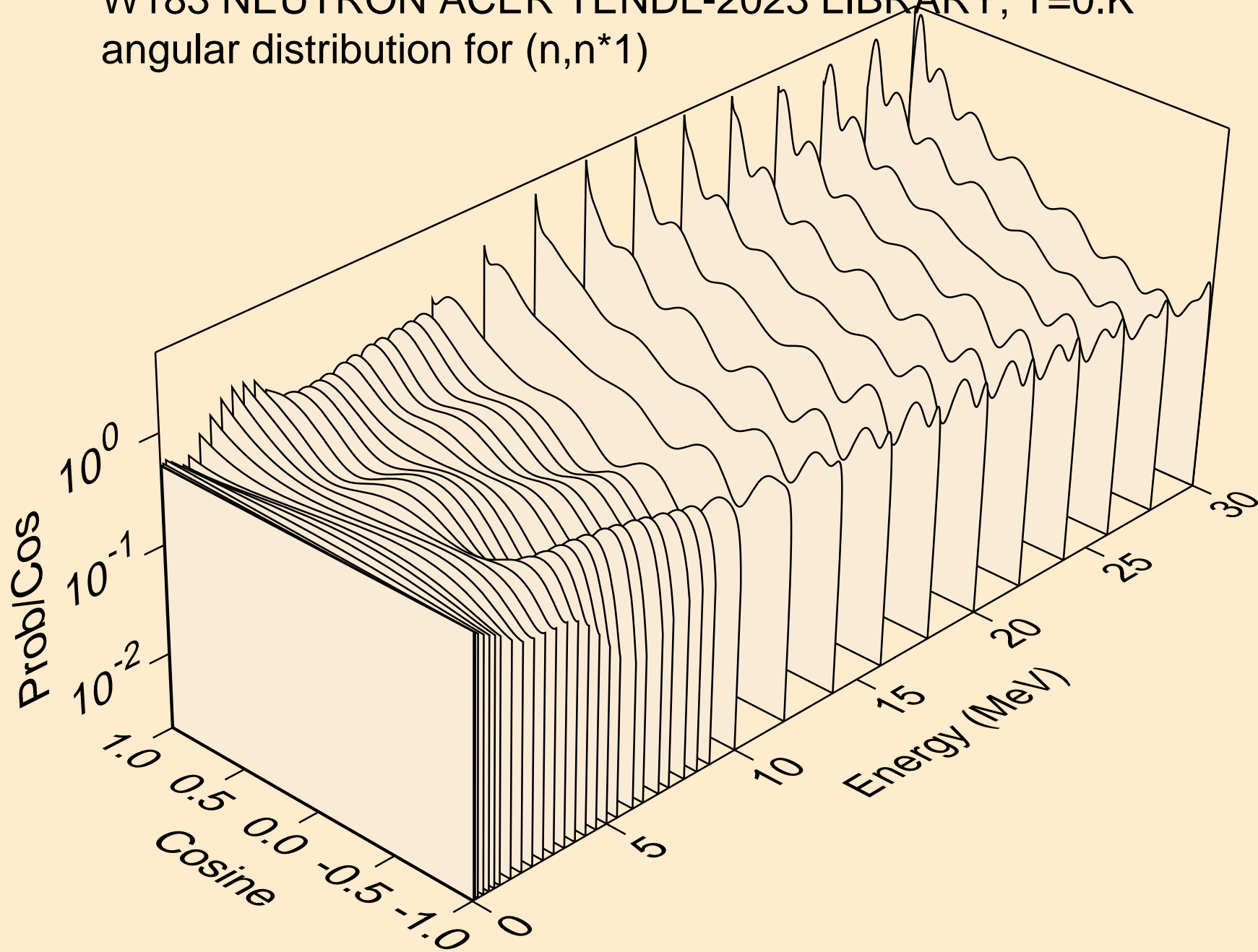

W183 NEUTRON ACER TENDL-2023 LIBRARY; T=0.K
angular distribution for (n,n*2)

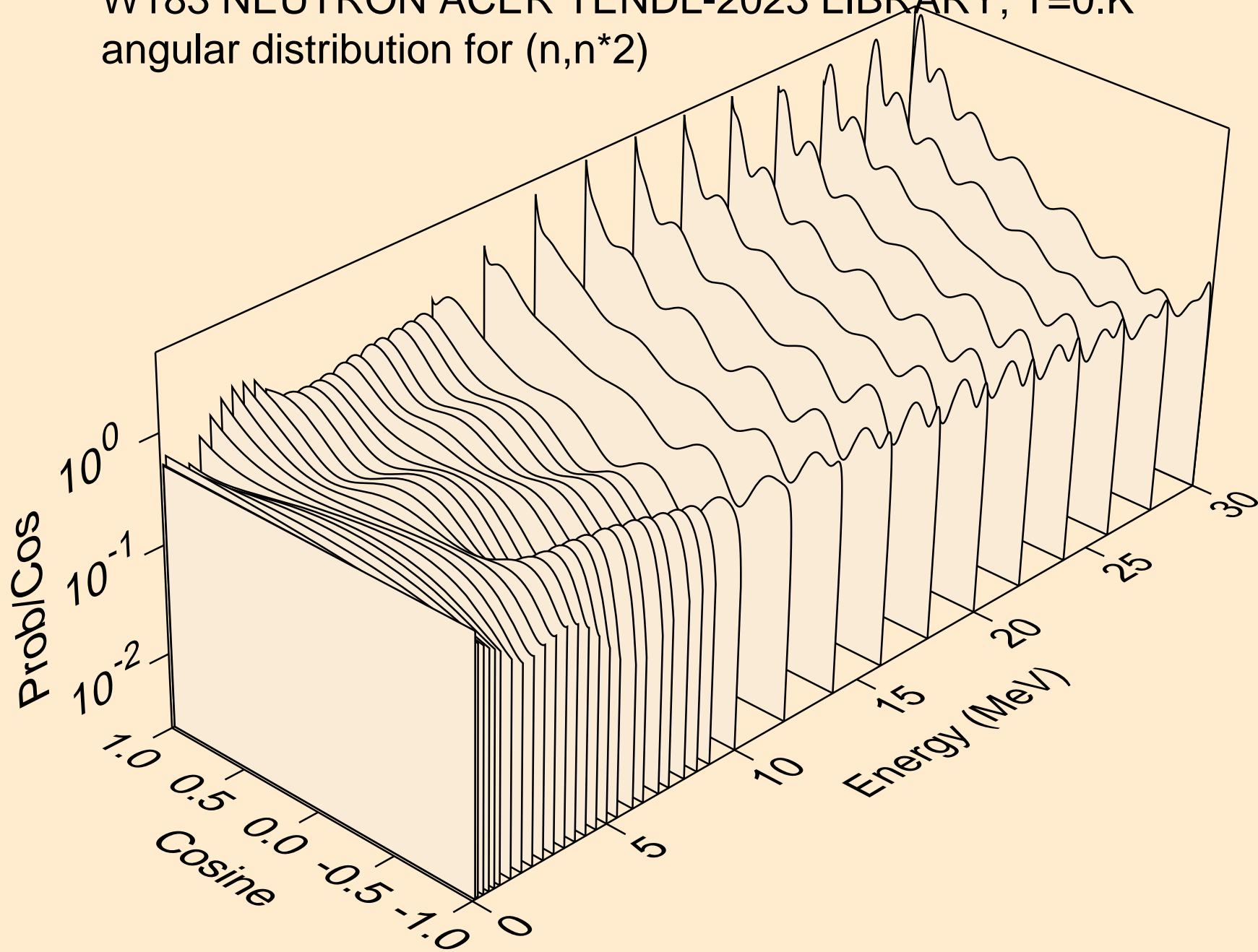

W183 NEUTRON ACER TENDL-2023 LIBRARY; T=0.K
angular distribution for (n,n*3)

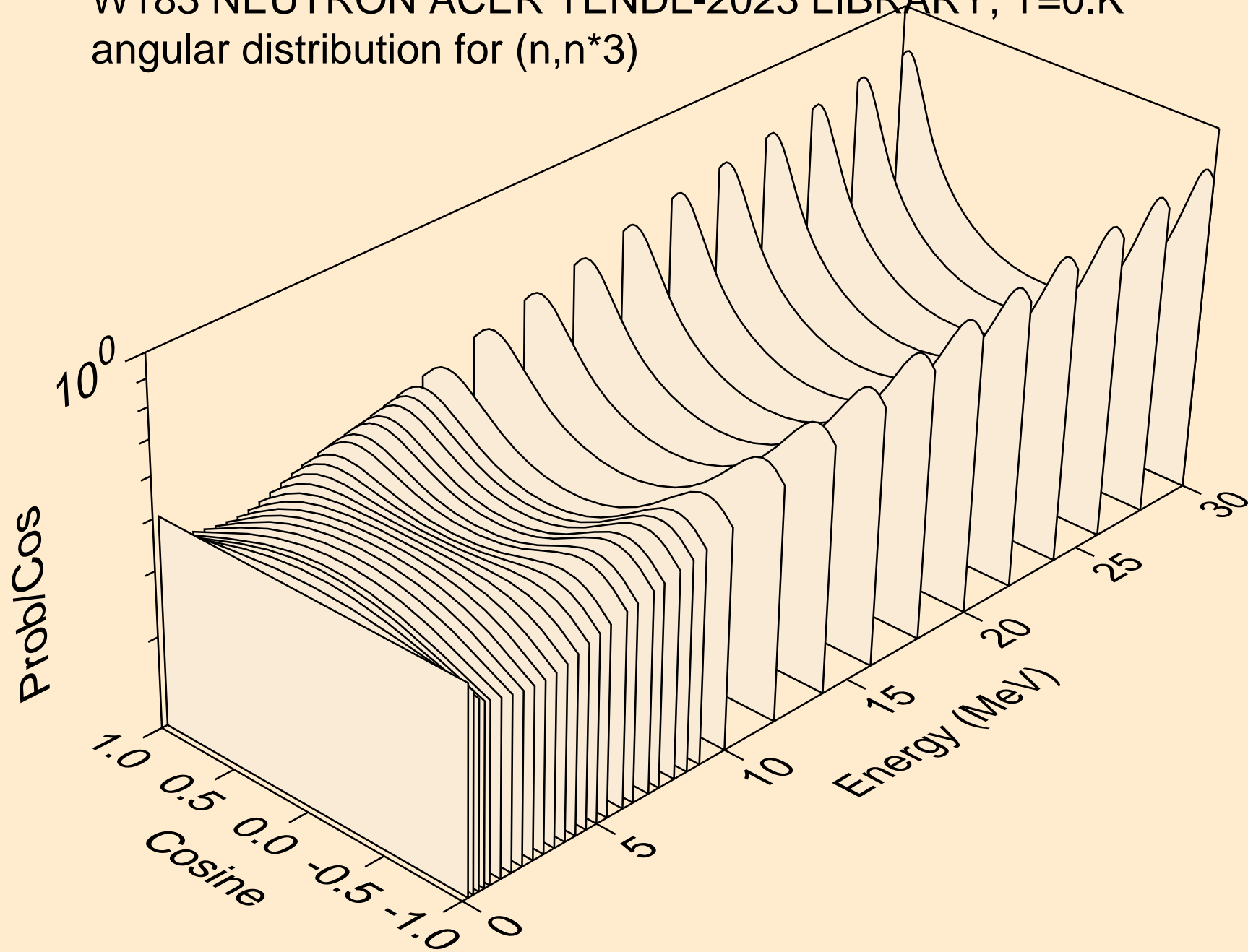

W183 NEUTRON ACER TENDL-2023 LIBRARY; T=0.K
angular distribution for (n,n*4)

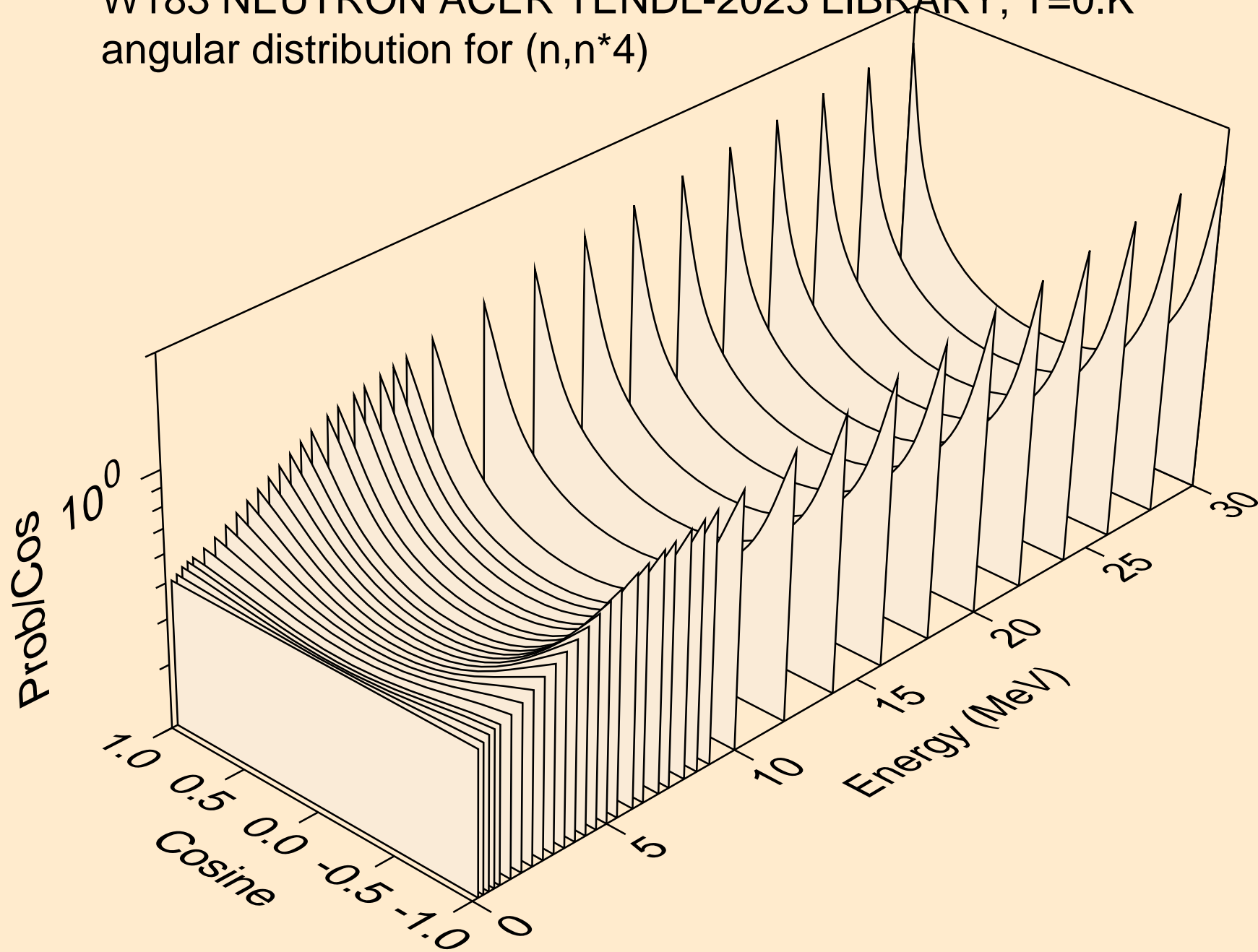

W183 NEUTRON ACER TENDL-2023 LIBRARY; T=0.K
angular distribution for (n,n*5)

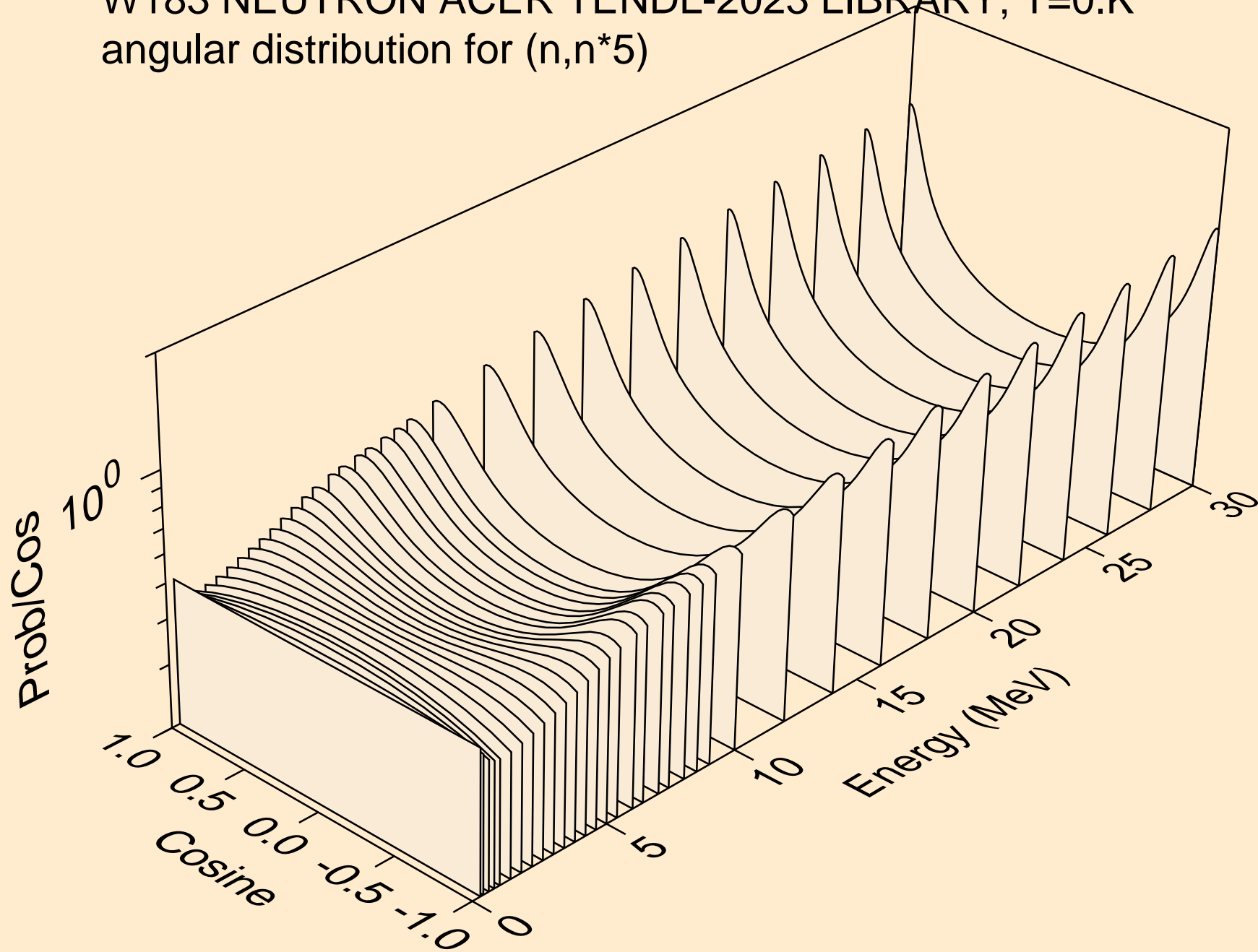

W183 NEUTRON ACER TENDL-2023 LIBRARY; T=0.K
angular distribution for (n,n*6)

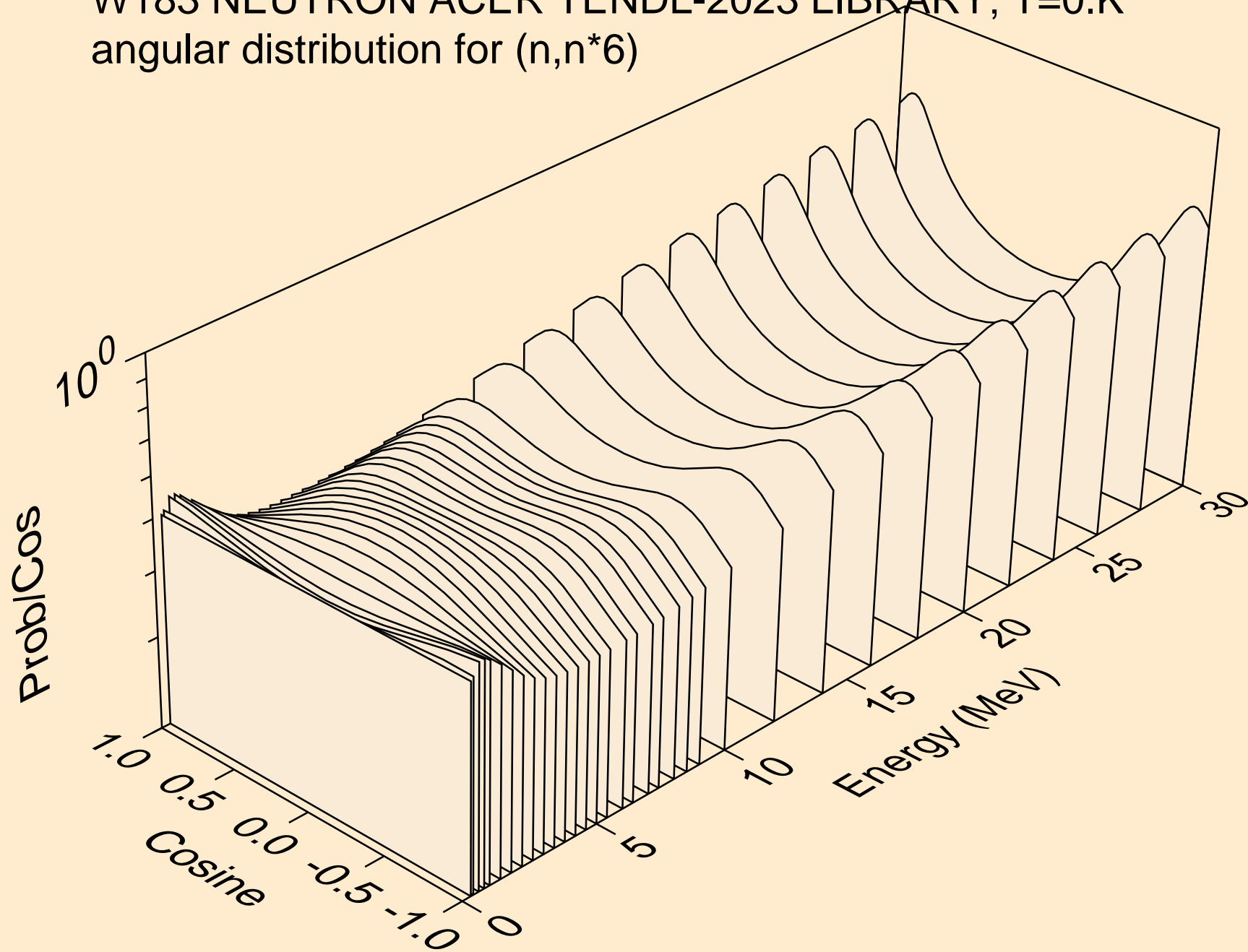

W183 NEUTRON ACER TENDL-2023 LIBRARY; T=0.K
angular distribution for (n,n*7)

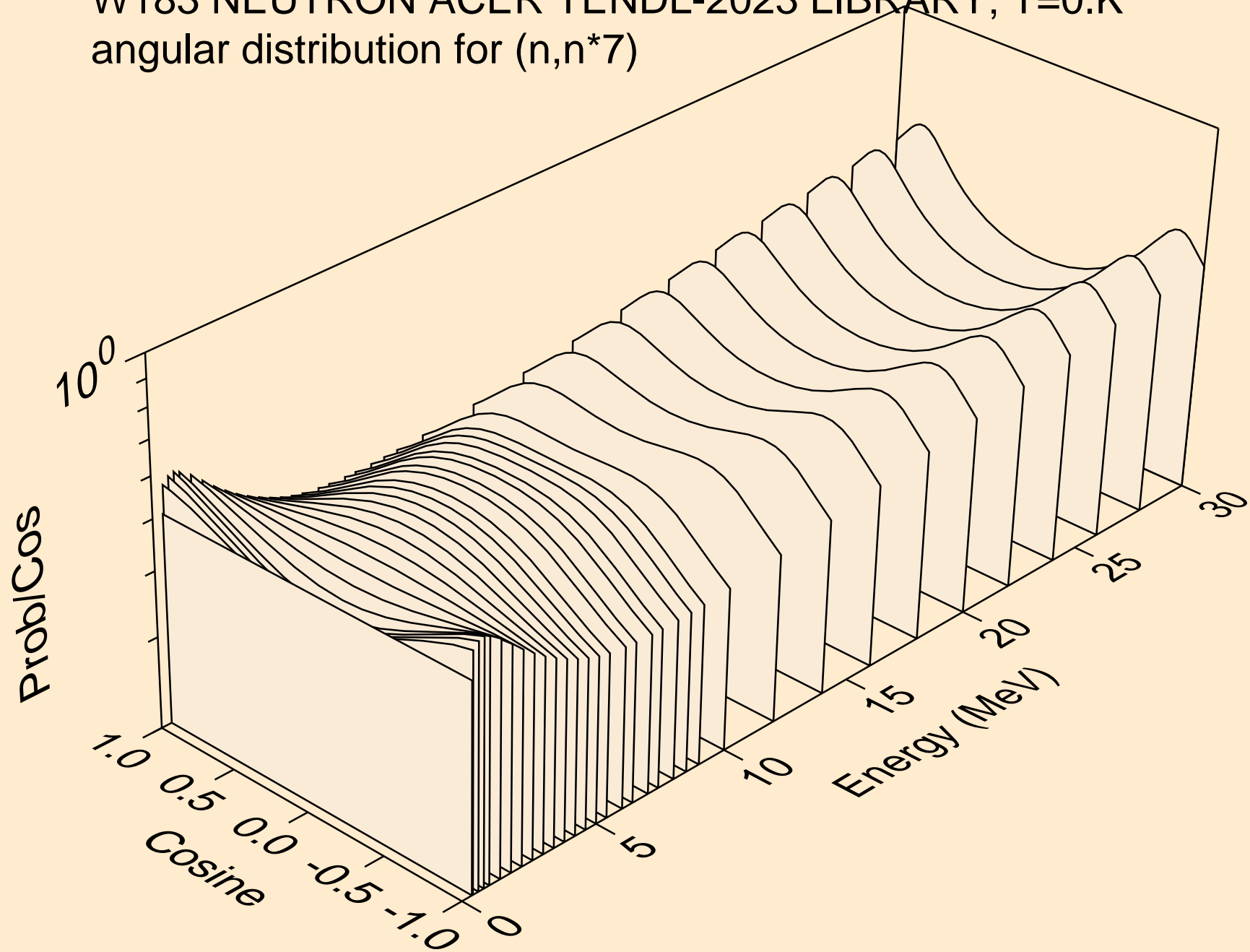

W183 NEUTRON ACER TENDL-2023 LIBRARY; T=0.K
angular distribution for (n,n*8)

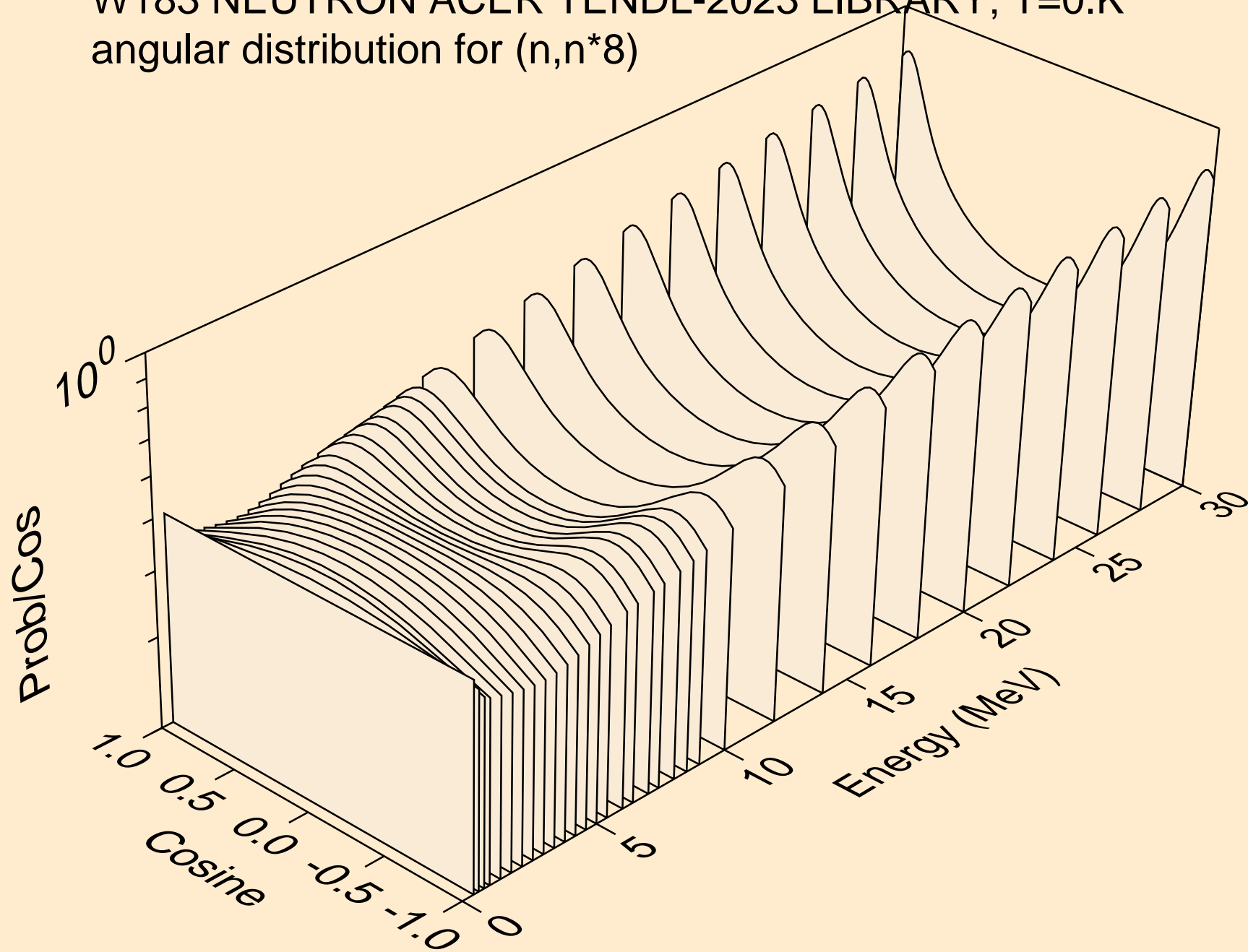

W183 NEUTRON ACER TENDL-2023 LIBRARY; T=0.K
angular distribution for (n,n*9)

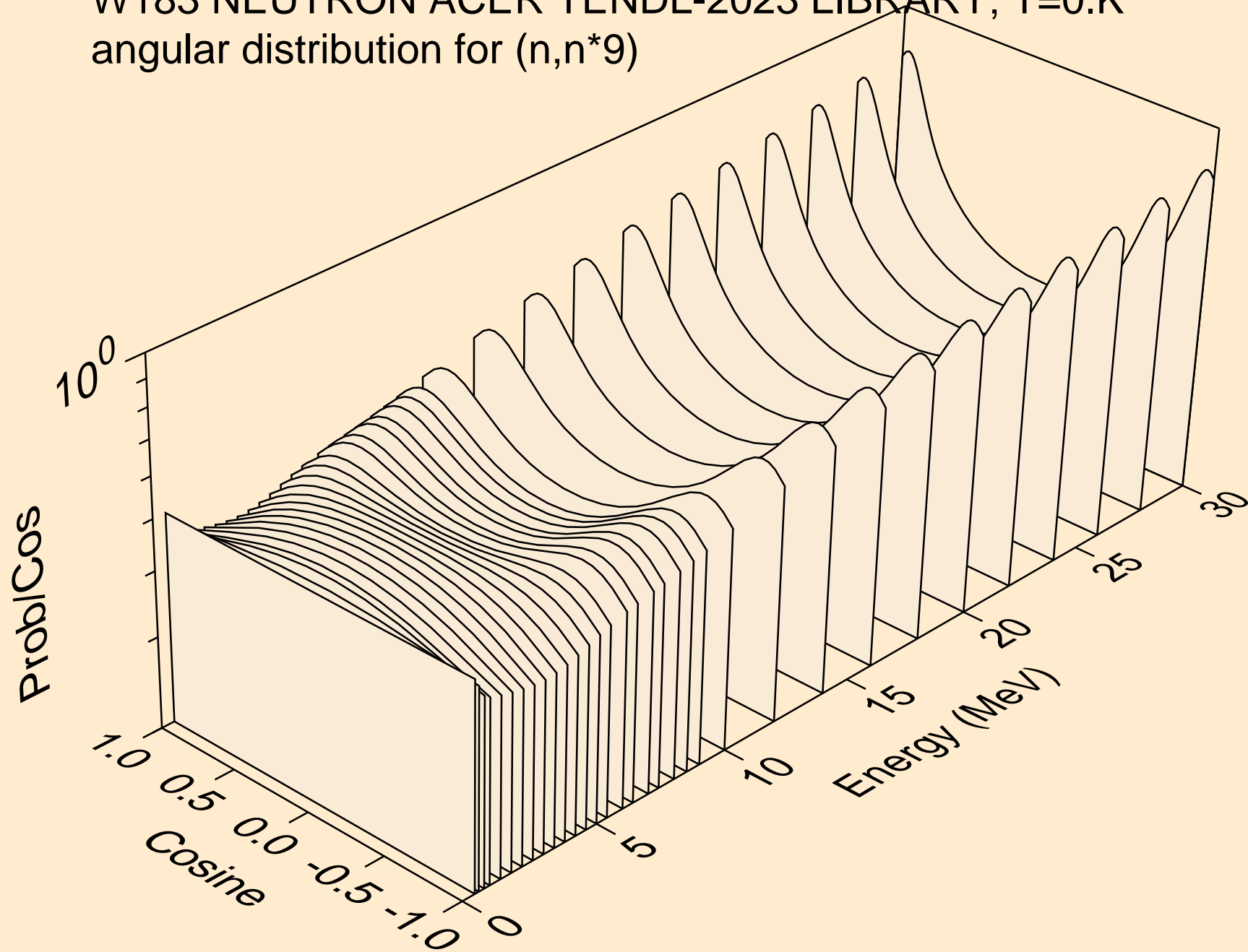

W183 NEUTRON ACER TENDL-2023 LIBRARY; T=0.K
angular distribution for (n,n*10)

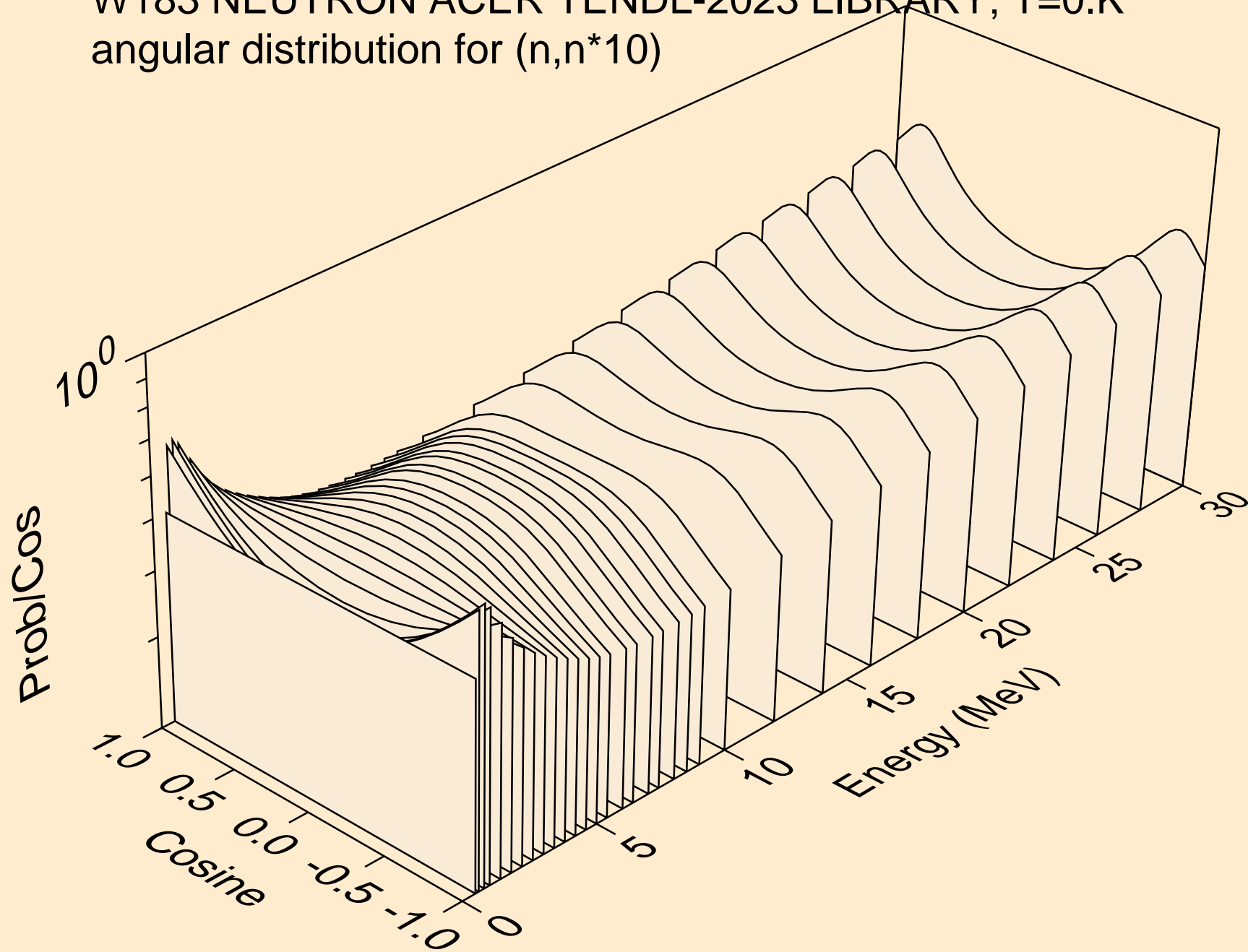

W183 NEUTRON ACER TENDL-2023 LIBRARY; T=0.K
angular distribution for (n,n*11)

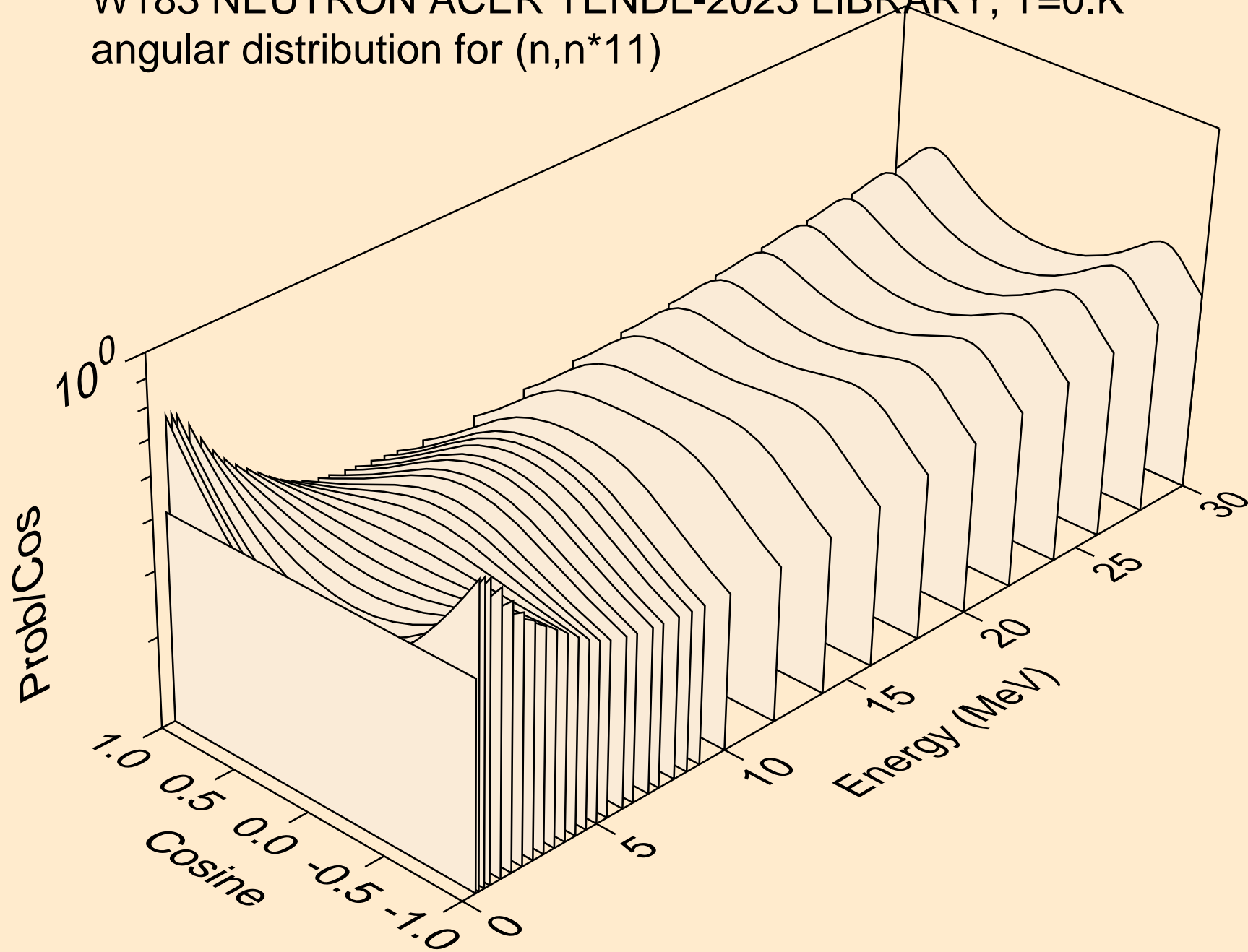

W183 NEUTRON ACER TENDL-2023 LIBRARY; T=0.K
angular distribution for (n,n*12)

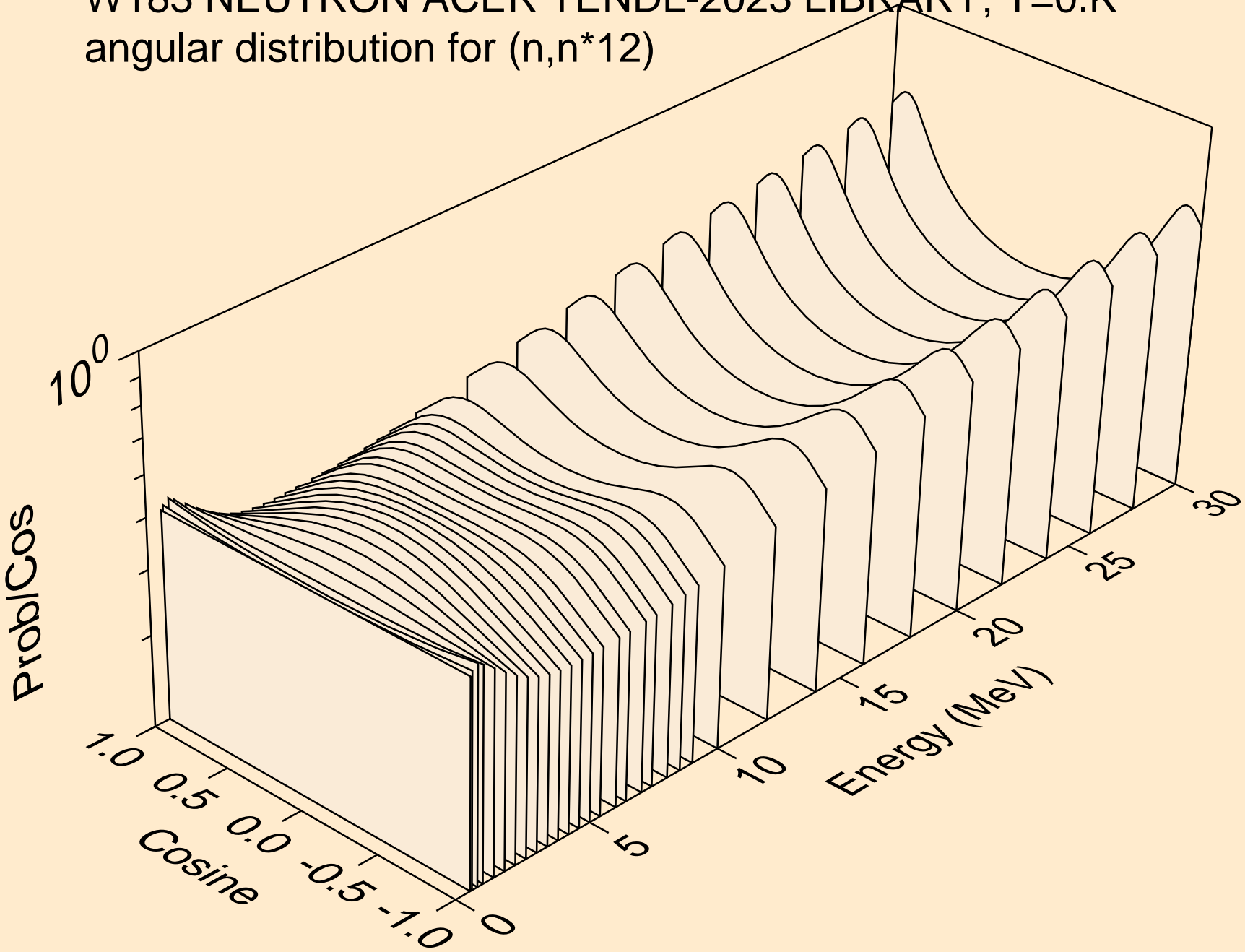

W183 NEUTRON ACER TENDL-2023 LIBRARY; T=0.K
angular distribution for (n,n*13)

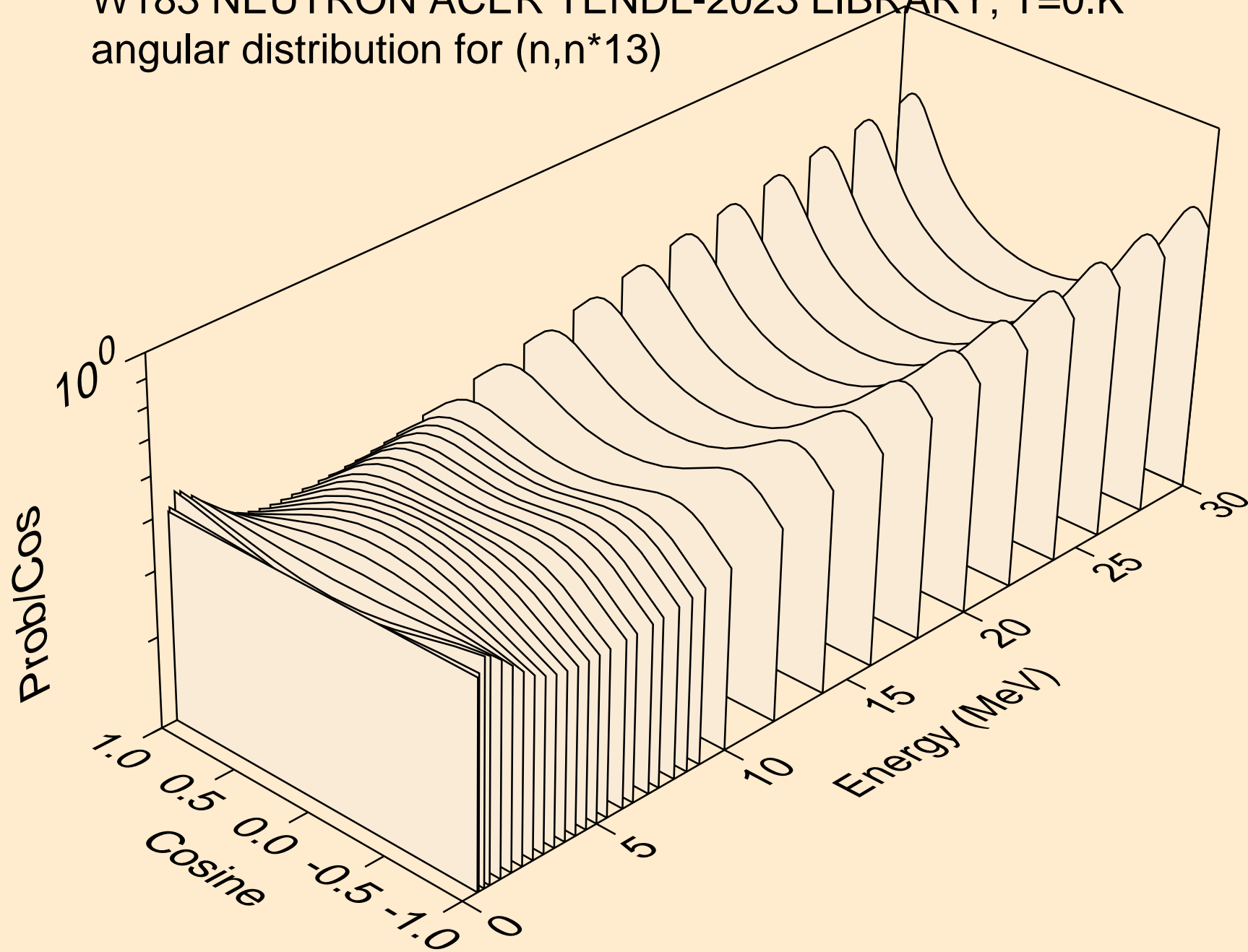

W183 NEUTRON ACER TENDL-2023 LIBRARY; T=0.K
angular distribution for (n,n*14)

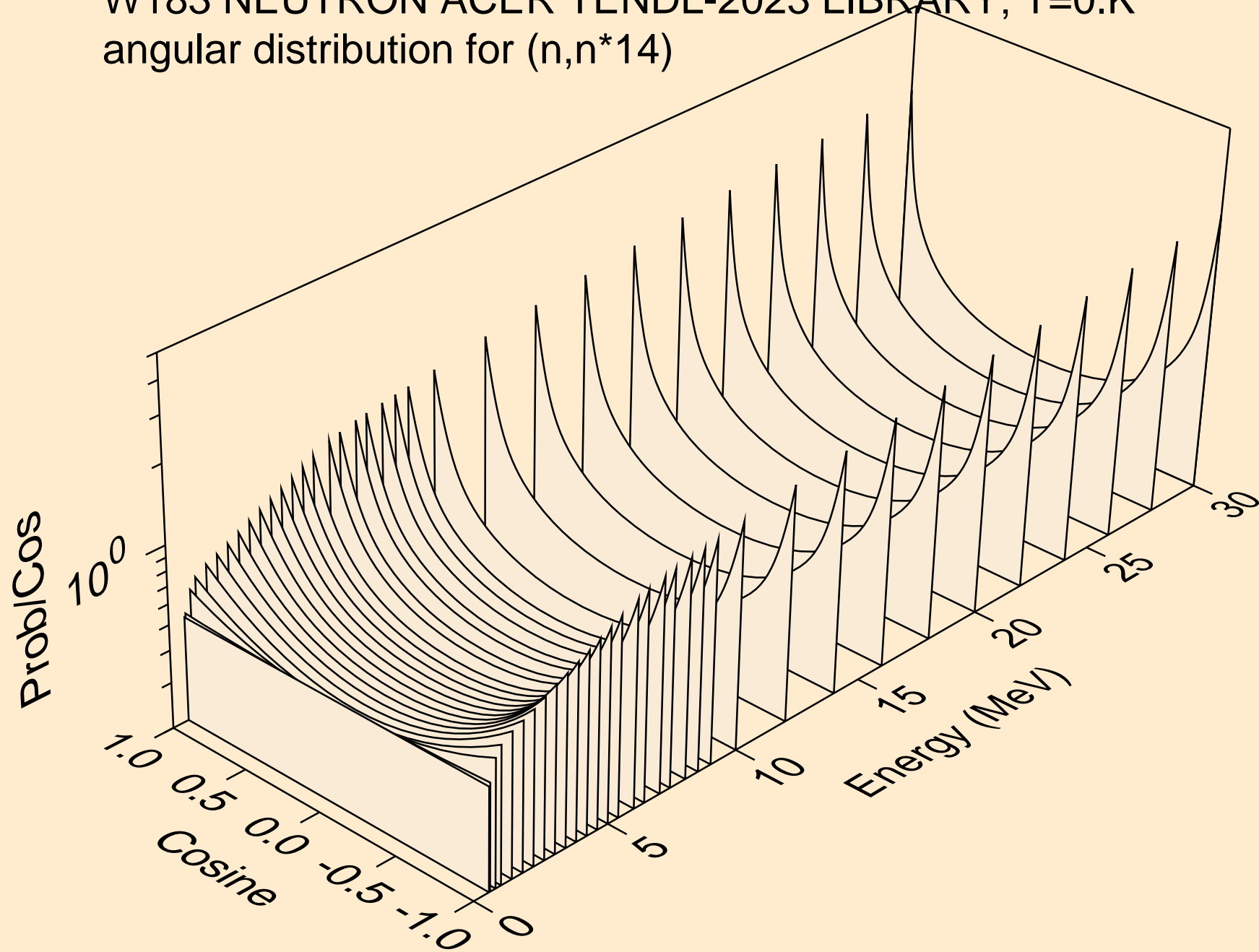

W183 NEUTRON ACER TENDL-2023 LIBRARY; T=0.K
angular distribution for (n,n*15)

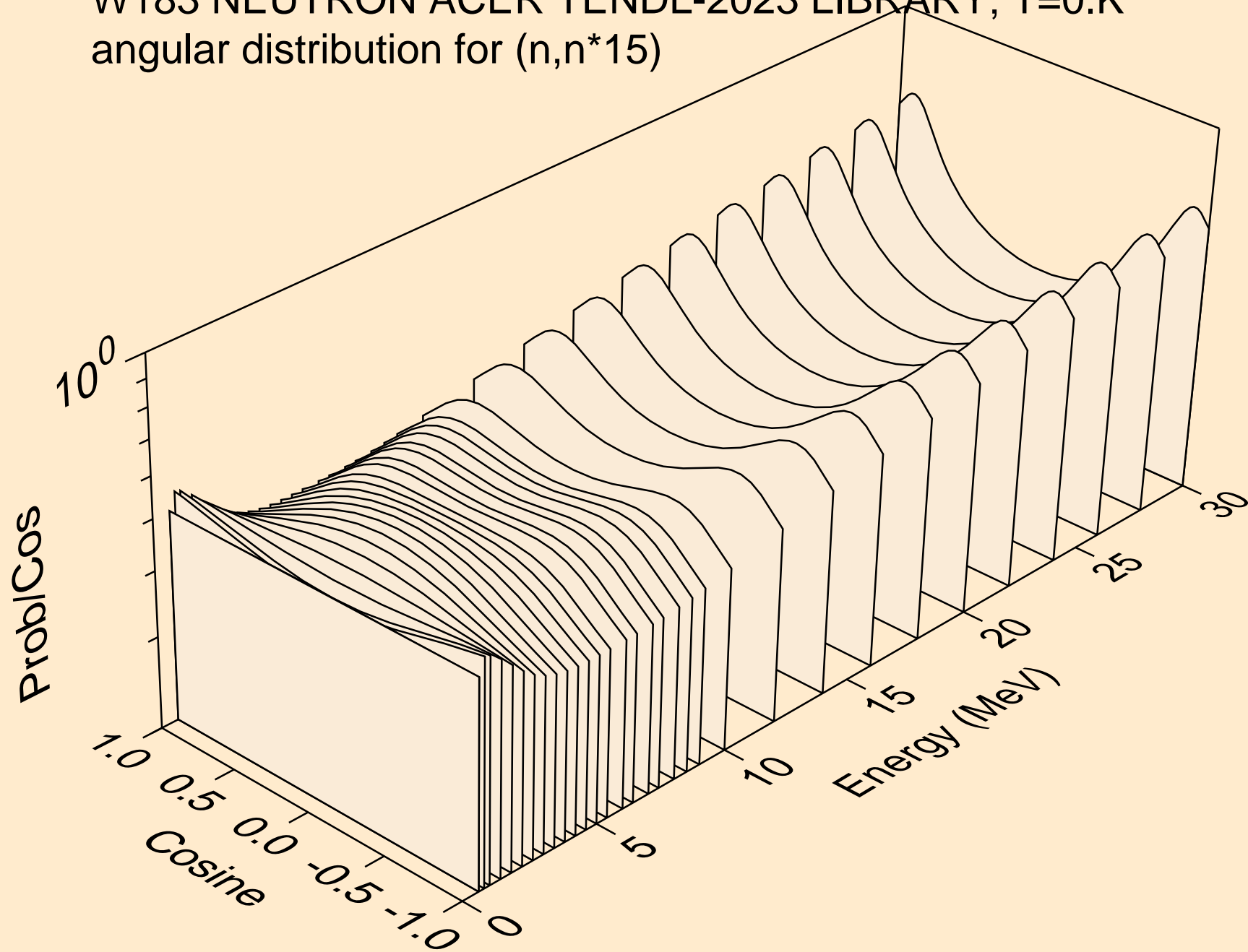

W183 NEUTRON ACER TENDL-2023 LIBRARY; T=0.K
Neutron emission for (n,x)

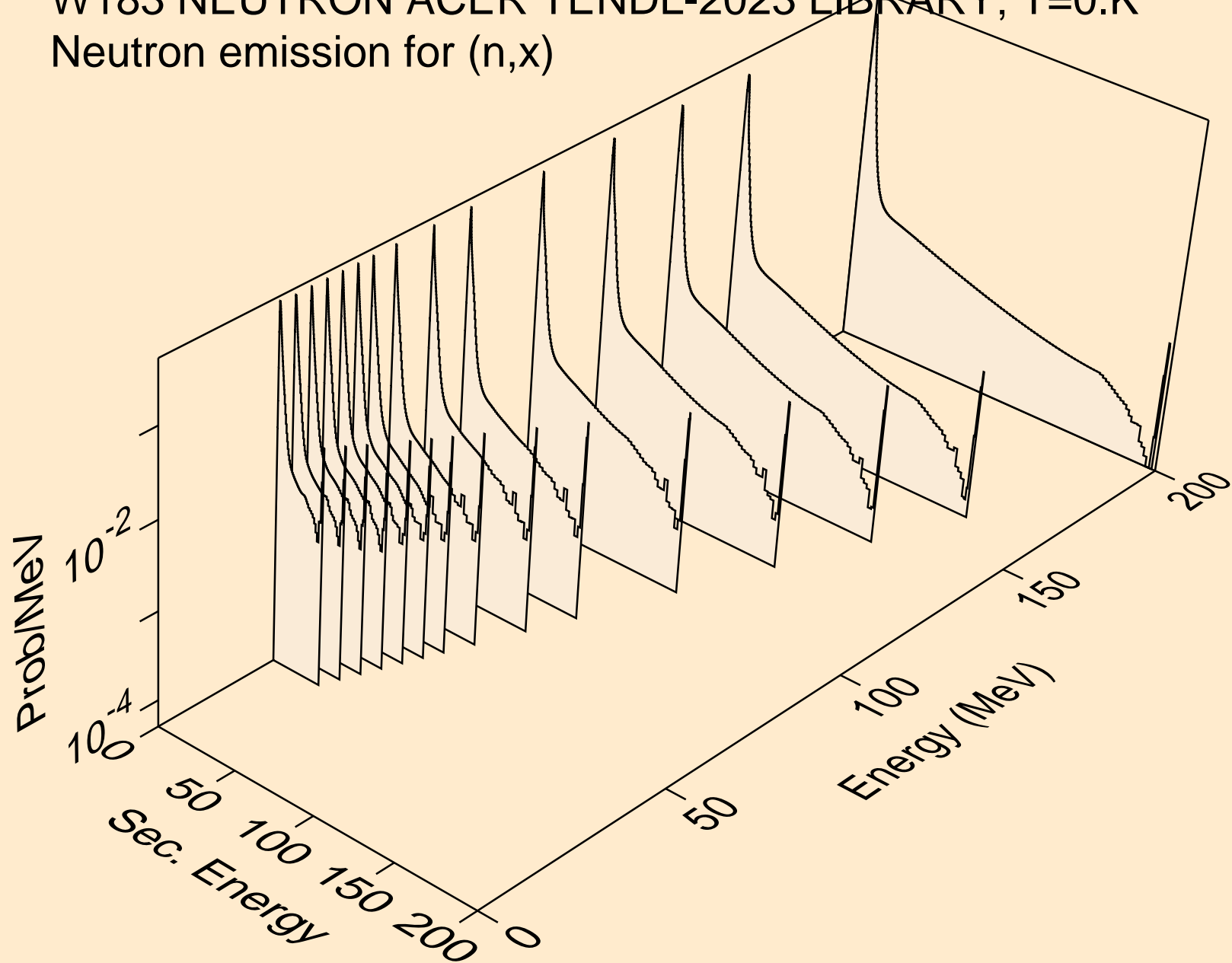

W183 NEUTRON ACER TENDL-2023 LIBRARY; T=0.K
Neutron emission for (n,2nd)

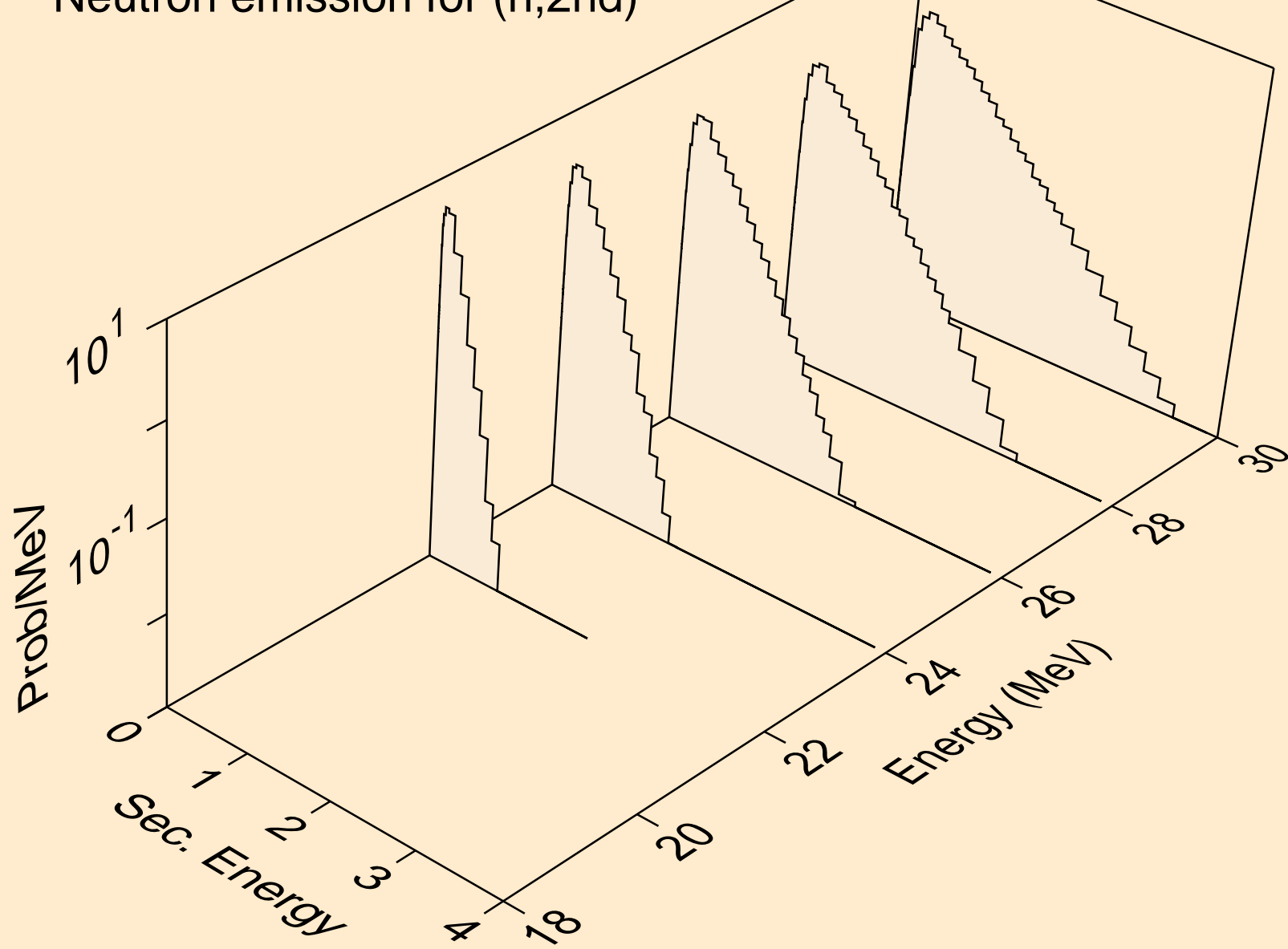

W183 NEUTRON ACER TENDL-2023 LIBRARY; T=0.K
Neutron emission for (n,2n)

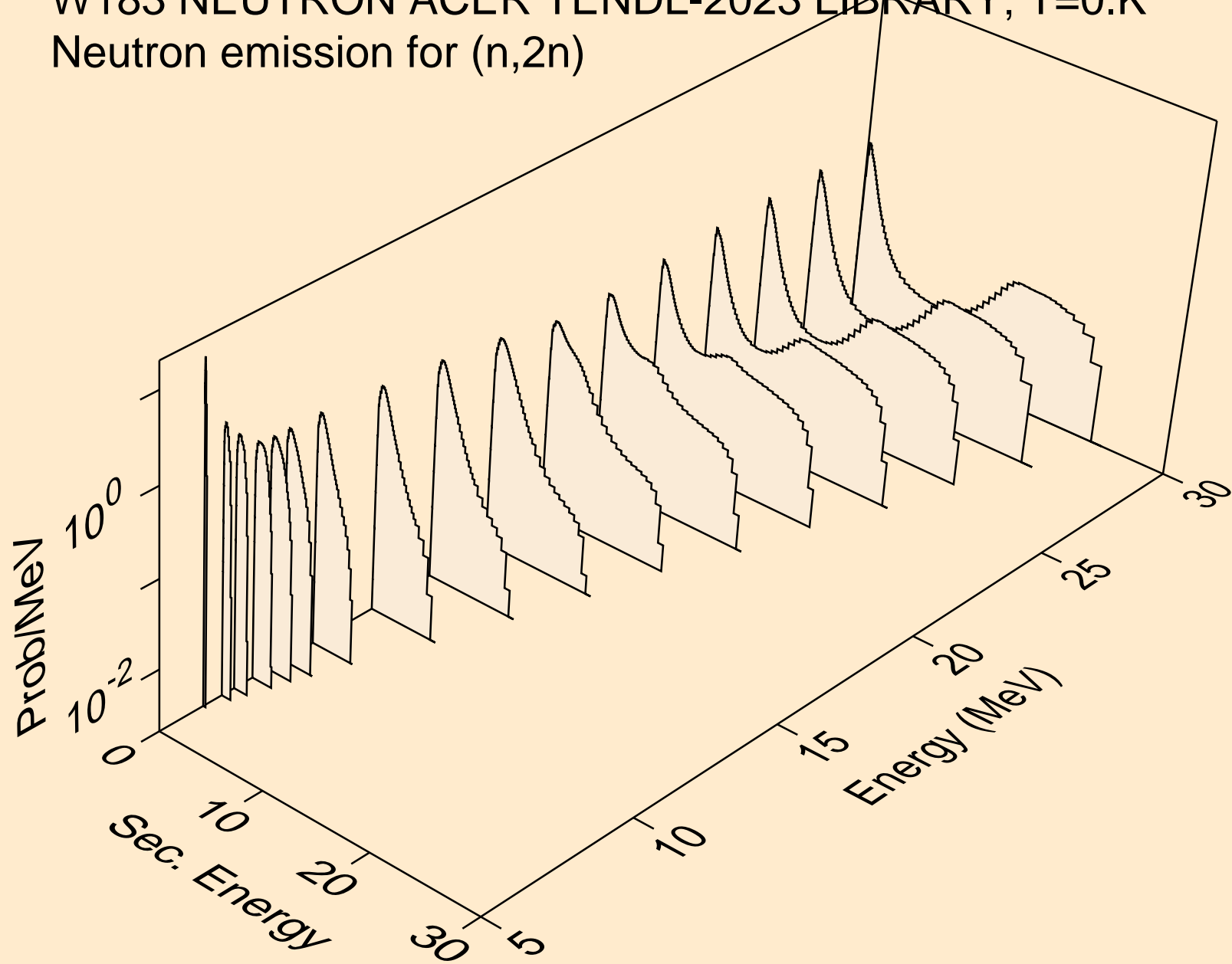

W183 NEUTRON ACER TENDL-2023 LIBRARY; T=0.K
Neutron emission for (n,3n)

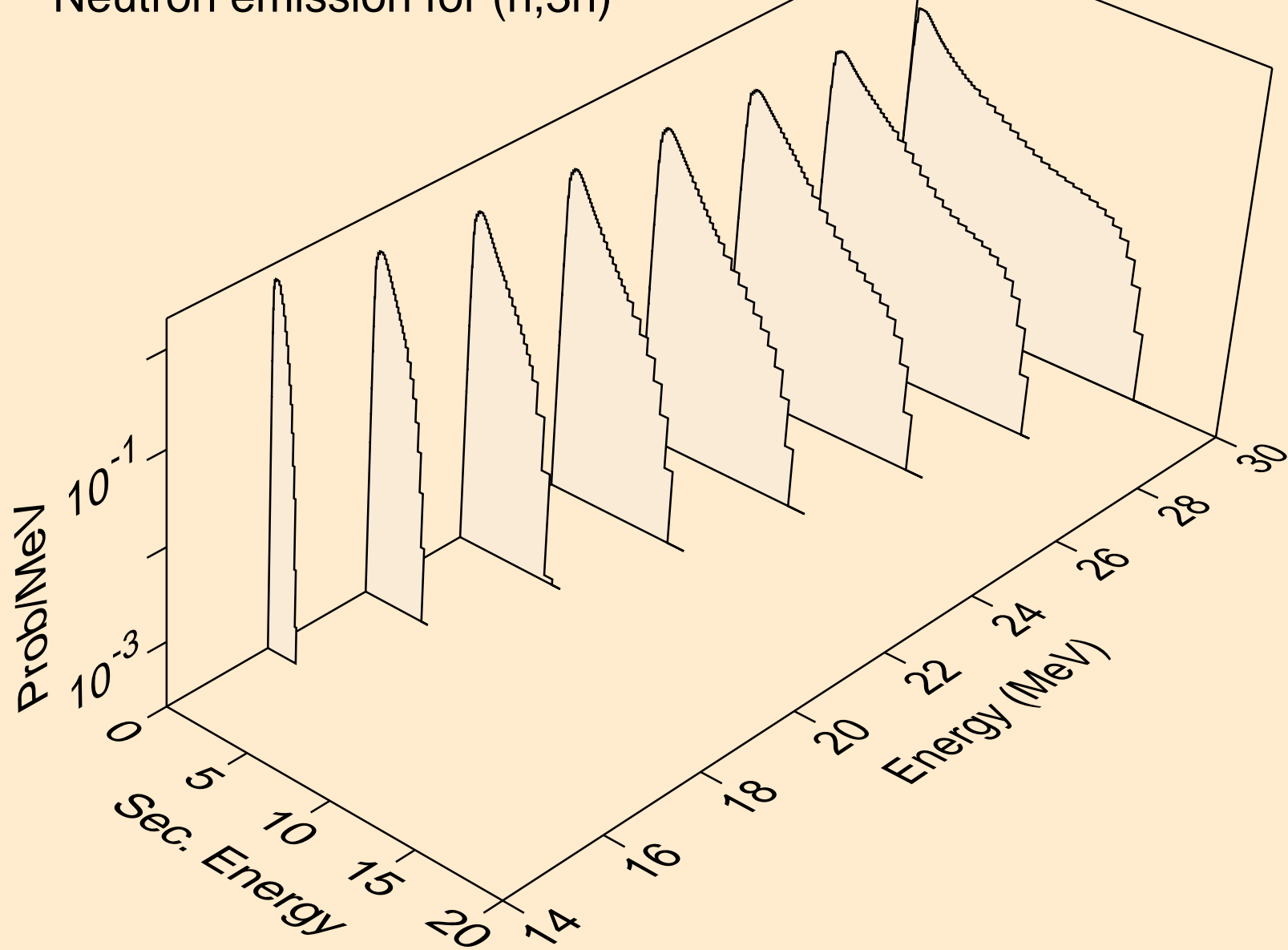

W183 NEUTRON ACER TENDL-2023 LIBRARY; T=0.K
Neutron emission for (n,n*)a

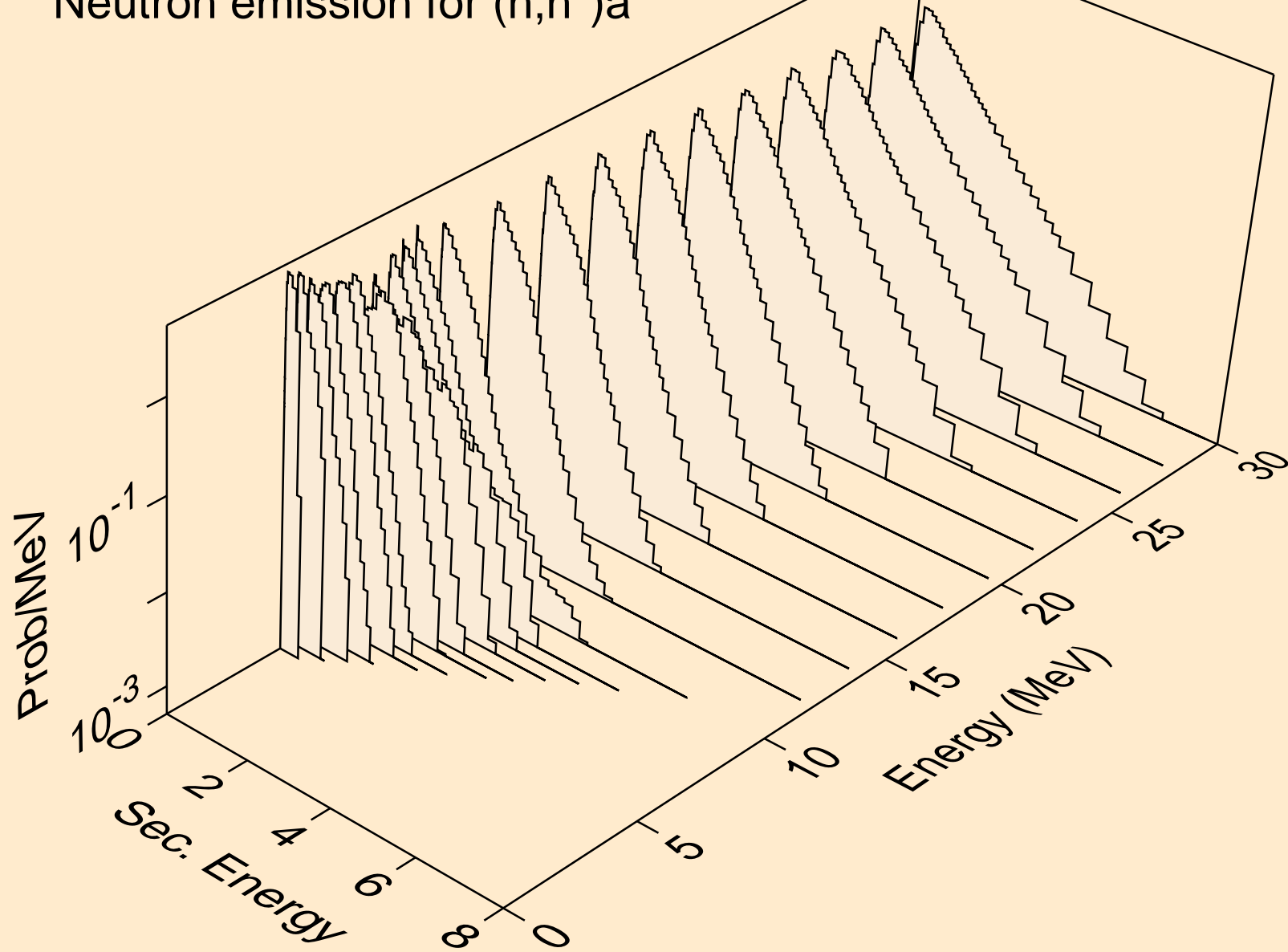

W183 NEUTRON ACER TENDL-2023 LIBRARY; T=0.K
Neutron emission for (n,2n)a

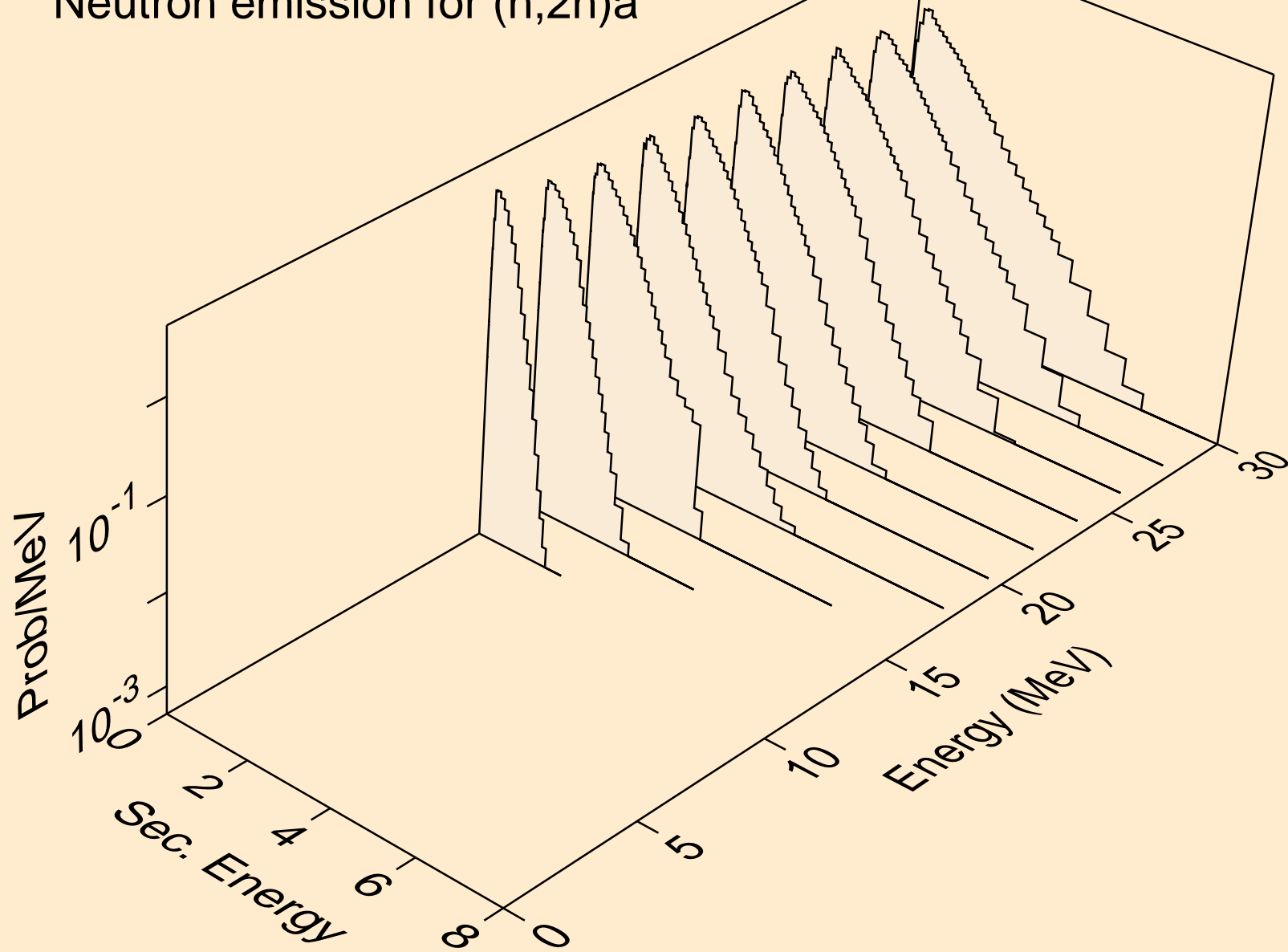

W183 NEUTRON ACER TENDL-2023 LIBRARY; T=0.K
Neutron emission for (n,3n)a

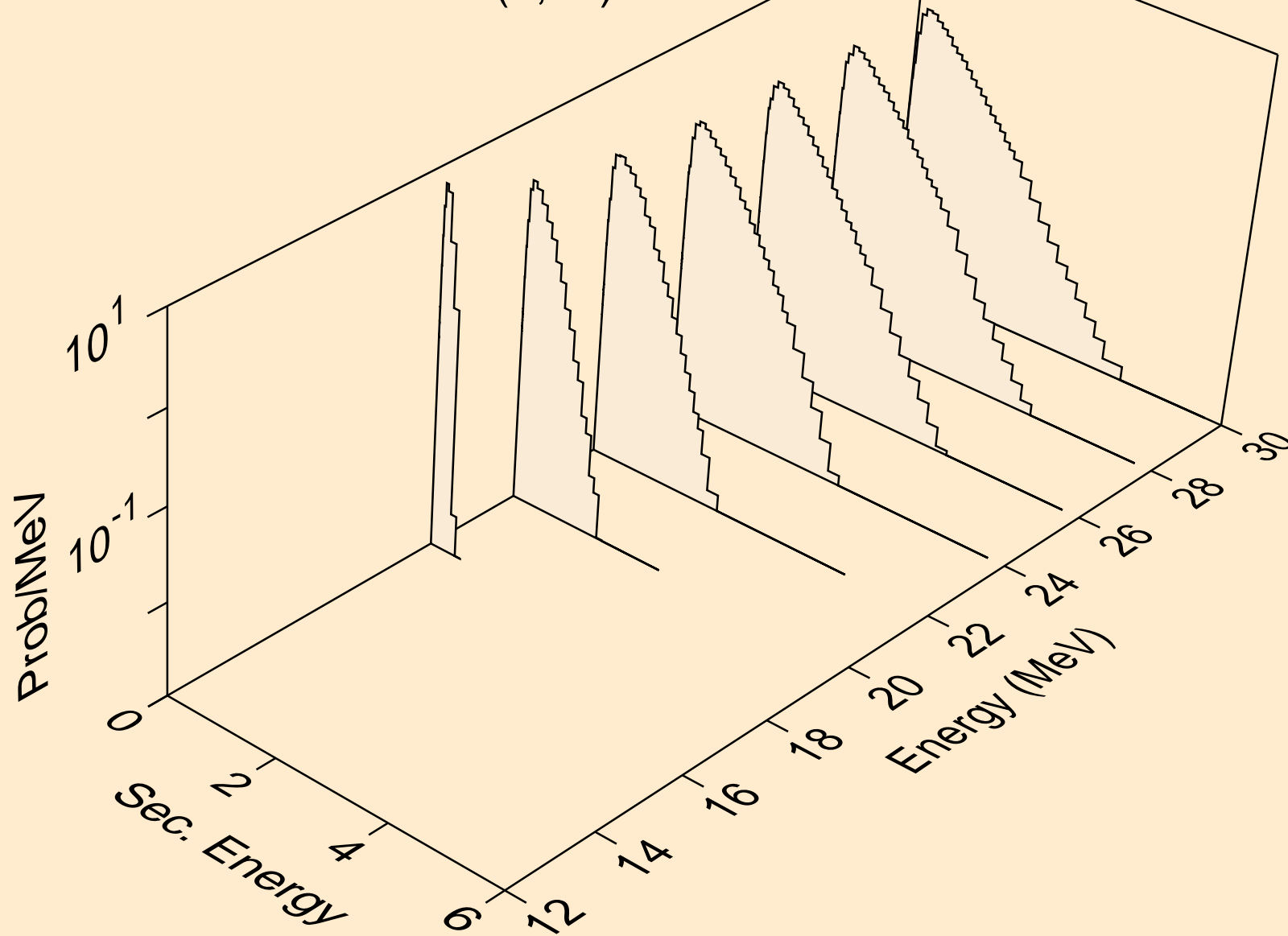

W183 NEUTRON ACER TENDL-2023 LIBRARY; T=0.K
Neutron emission for (n,n*)p

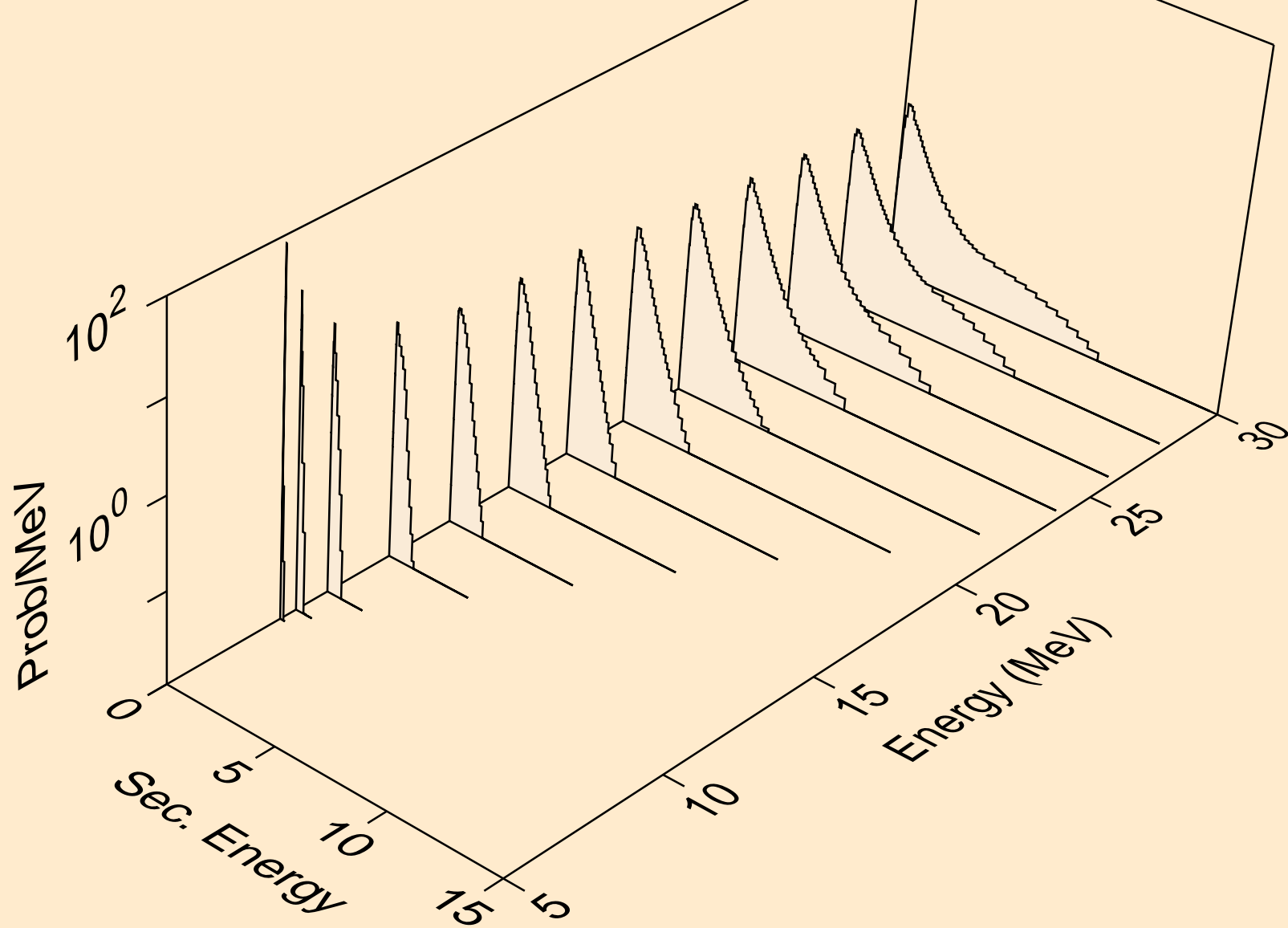

W183 NEUTRON ACER TENDL-2023 LIBRARY; T=0.K
Neutron emission for (n,n*)2a

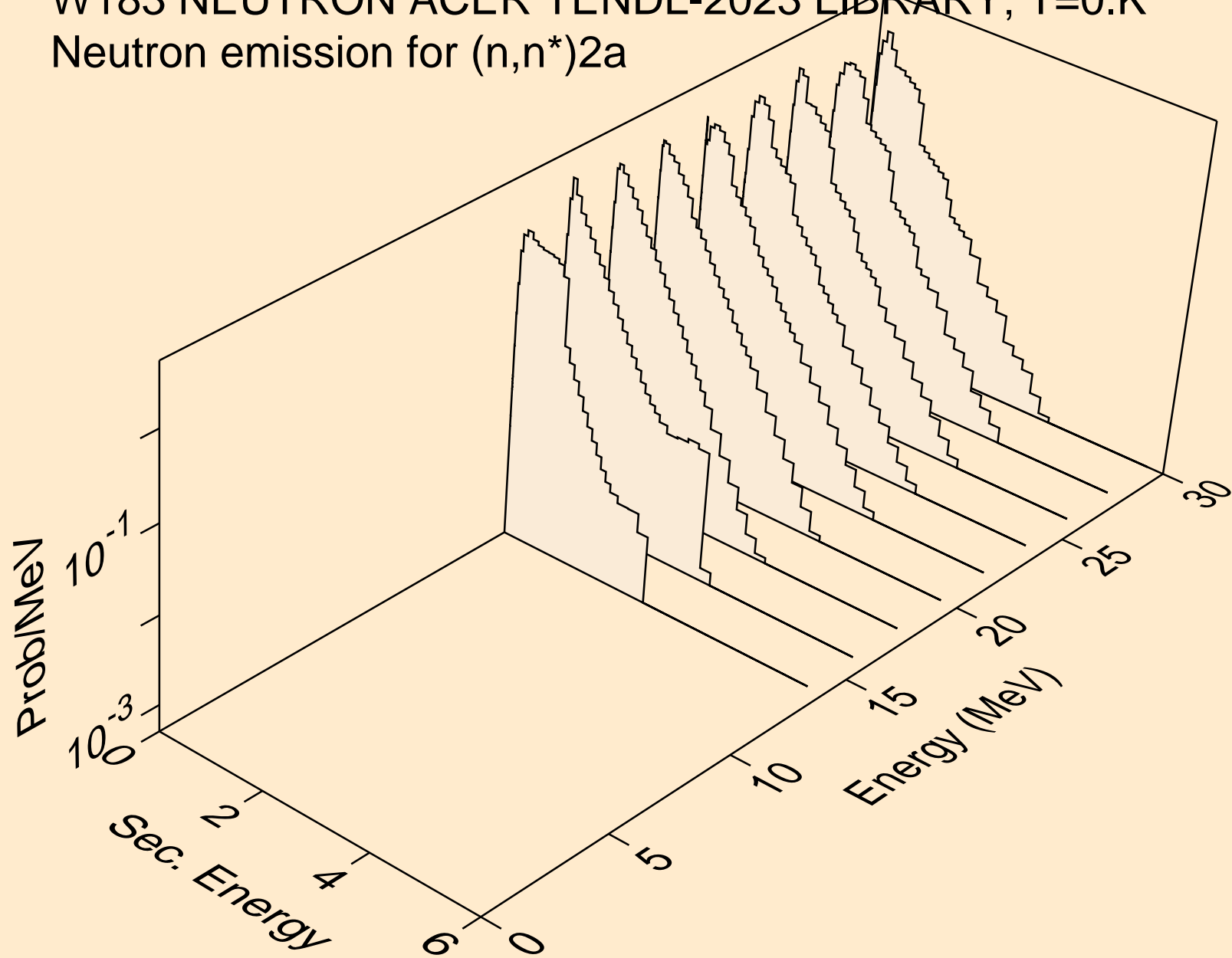

W183 NEUTRON ACER TENDL-2023 LIBRARY; T=0.K
Neutron emission for (n,n*)d

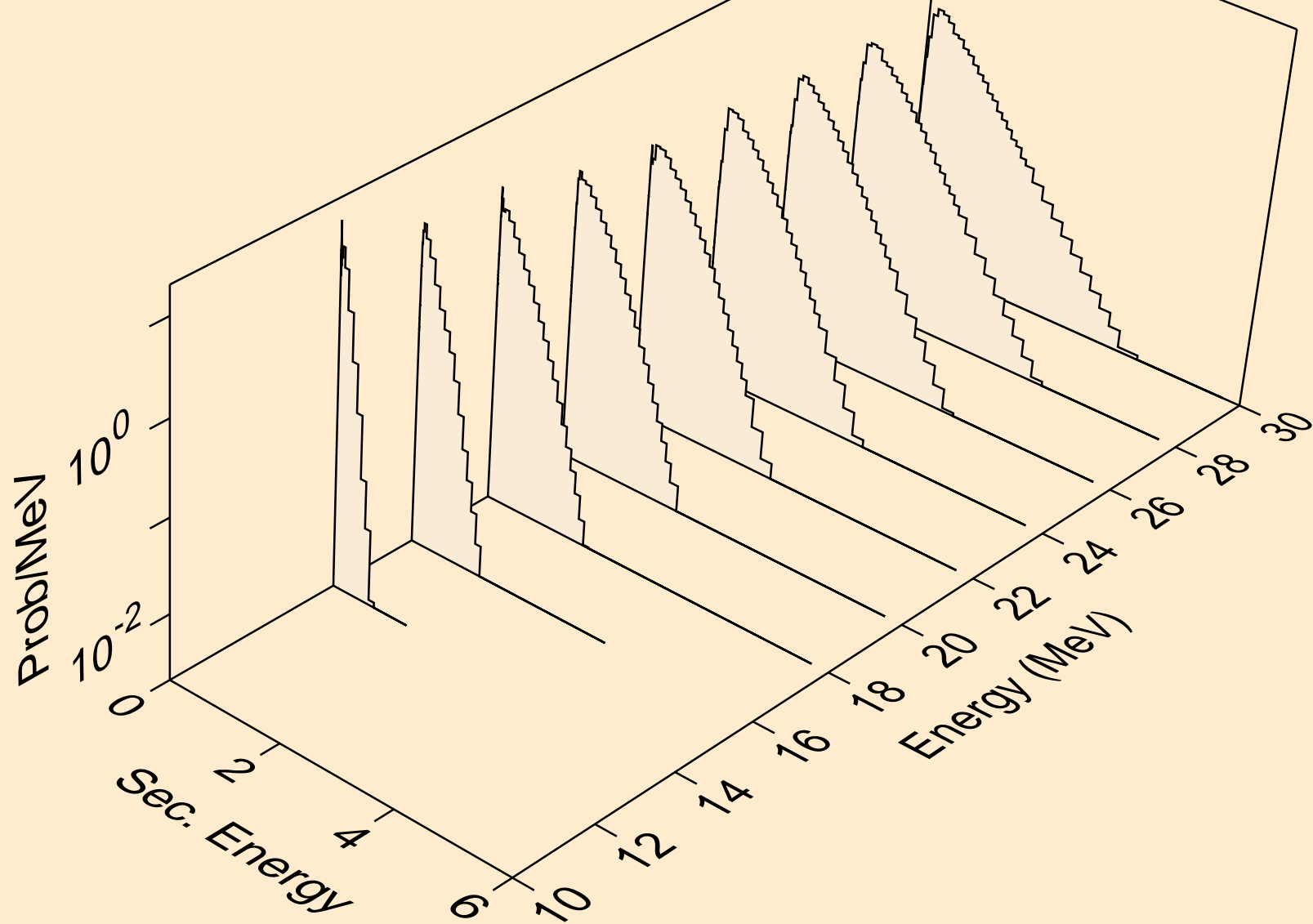

W183 NEUTRON ACER TENDL-2023 LIBRARY; T=0.K
Neutron emission for (n,n*)t

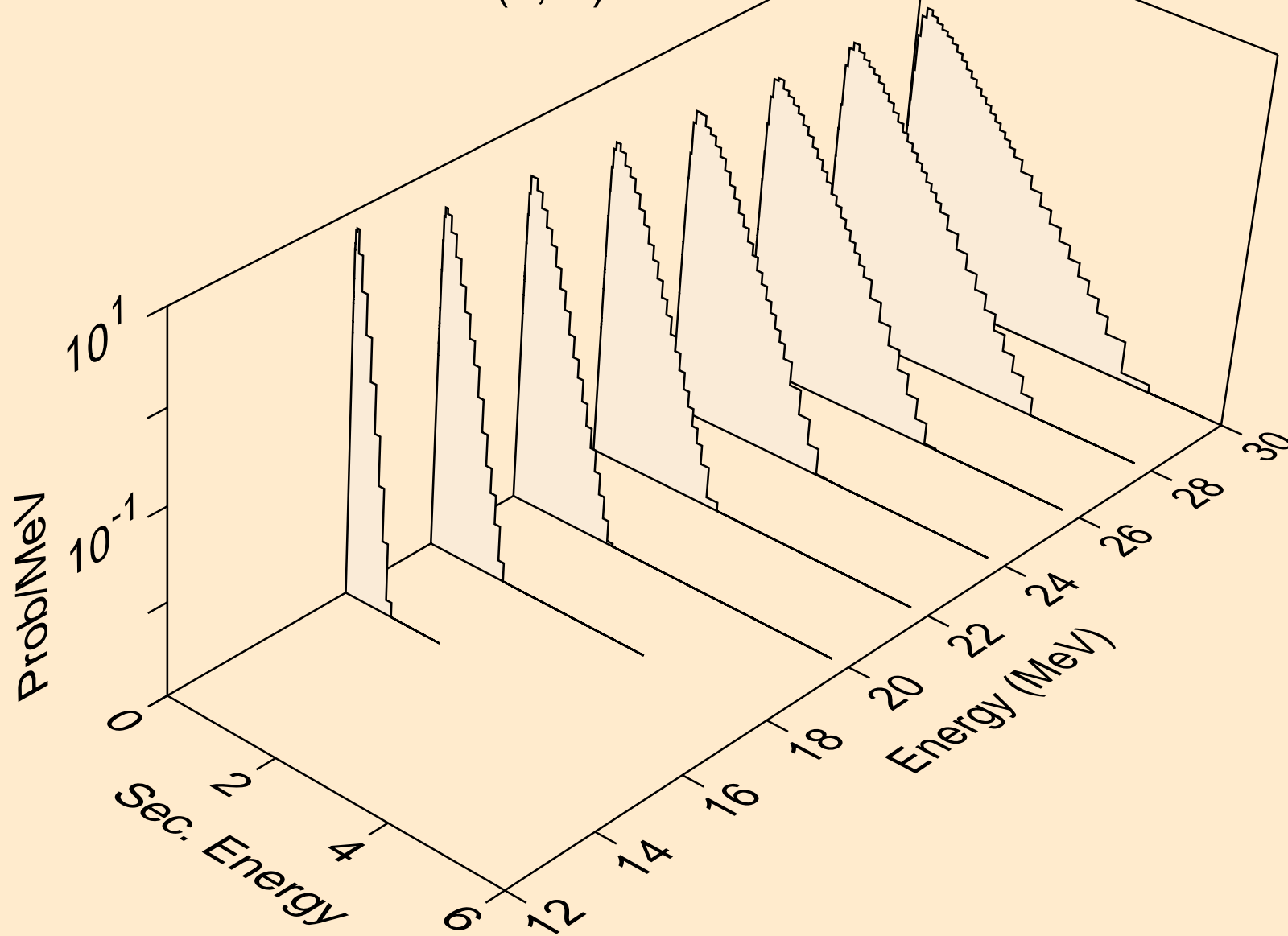

W183 NEUTRON ACER TENDL-2023 LIBRARY; T=0.K
Neutron emission for (n,n*)he3

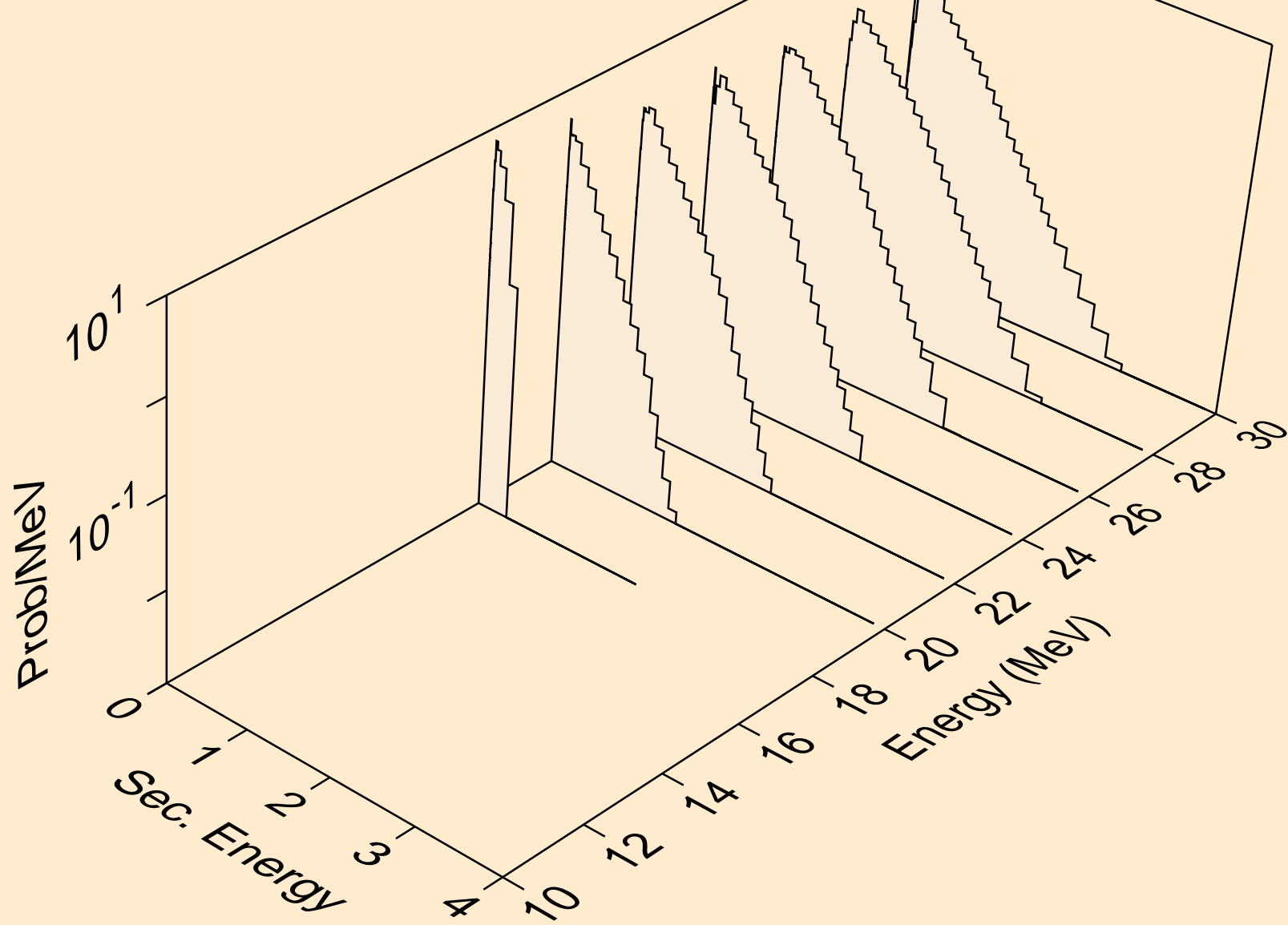

W183 NEUTRON ACER TENDL-2023 LIBRARY; T=0.K
Neutron emission for (n,4n)

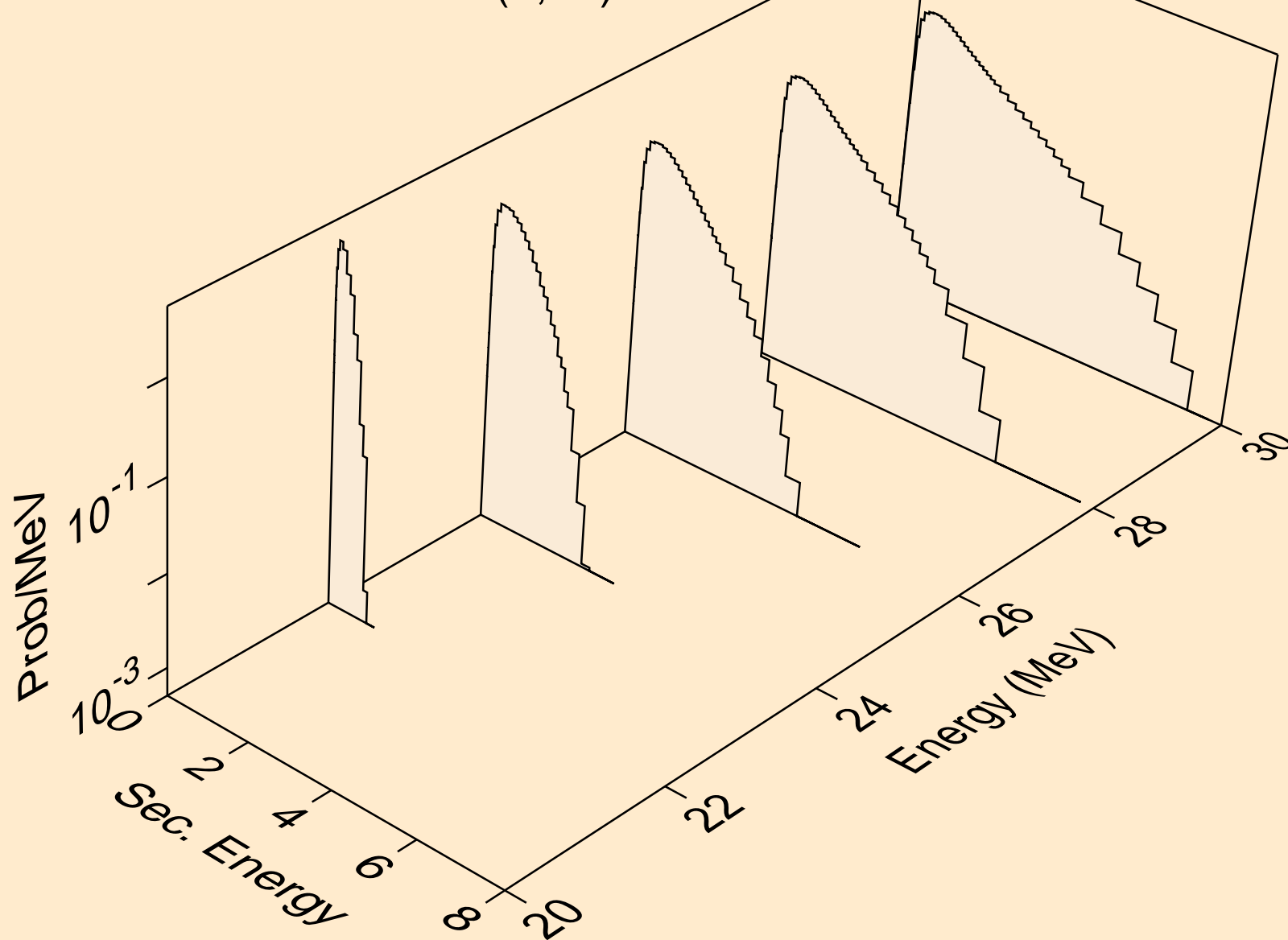

W183 NEUTRON ACER TENDL-2023 LIBRARY; T=0.K
Neutron emission for (n,2np)

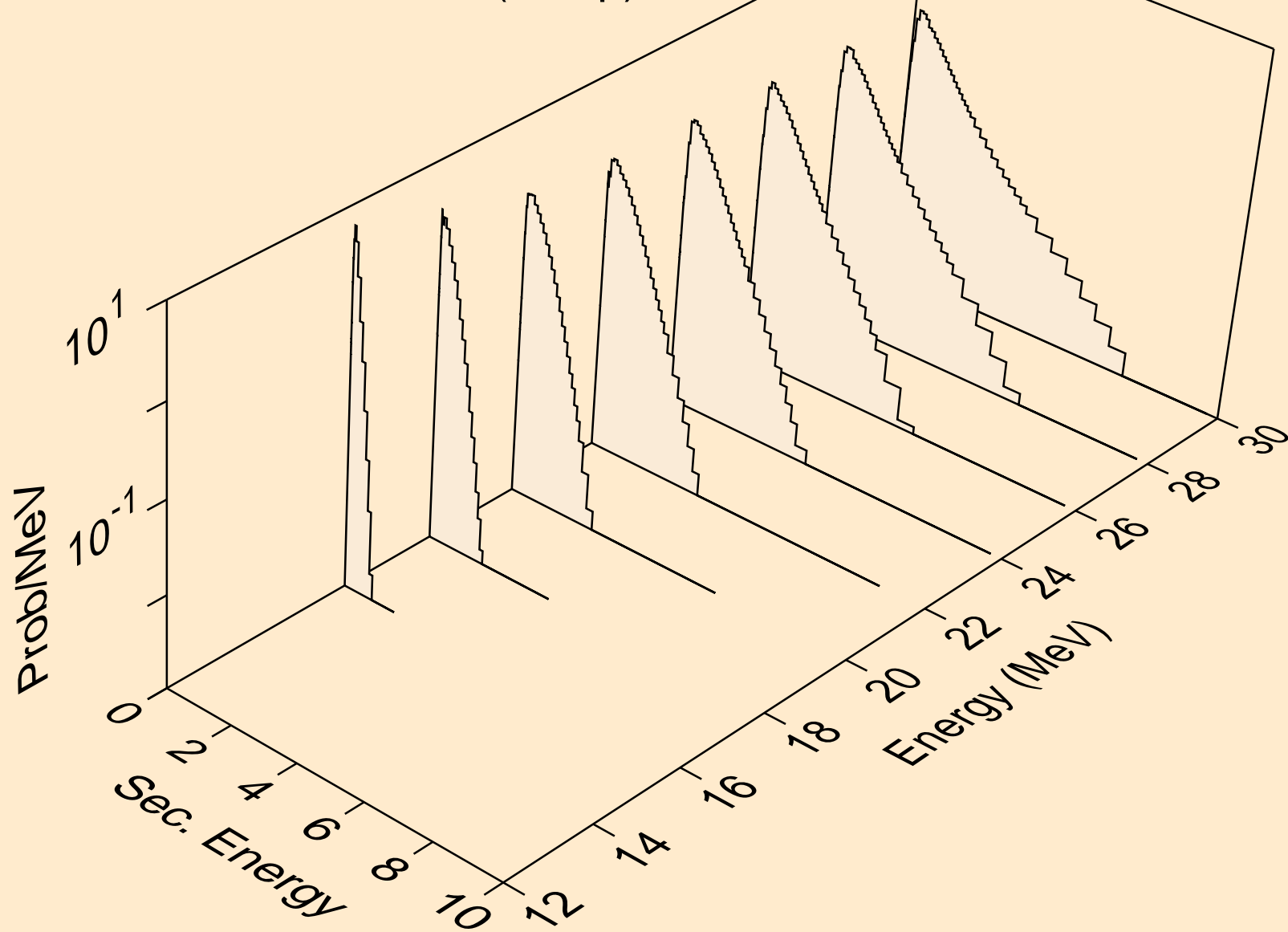

W183 NEUTRON ACER TENDL-2023 LIBRARY; T=0.K
Neutron emission for (n,3np)

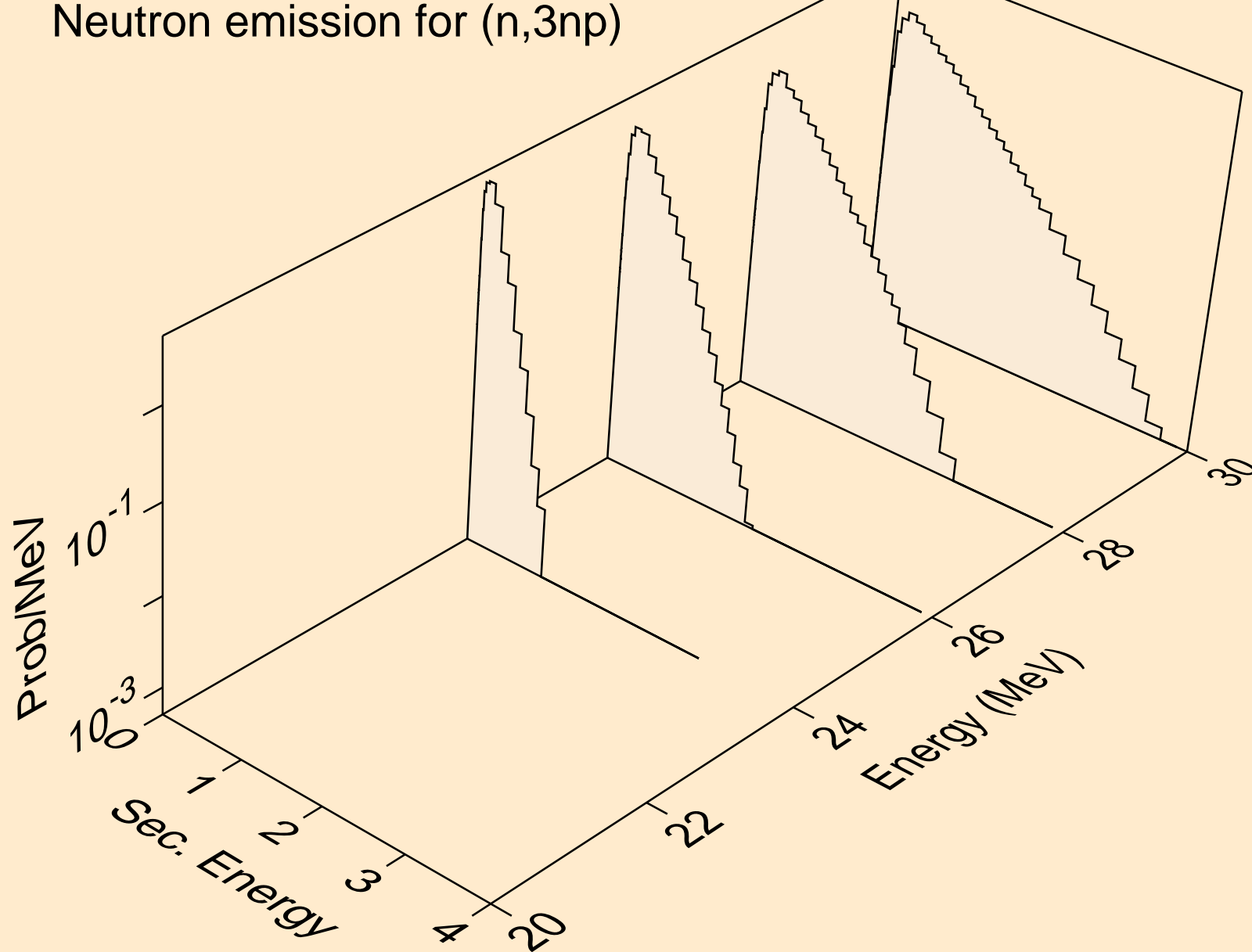

W183 NEUTRON ACER TENDL-2023 LIBRARY; T=0.K
Neutron emission for (n,n2p)

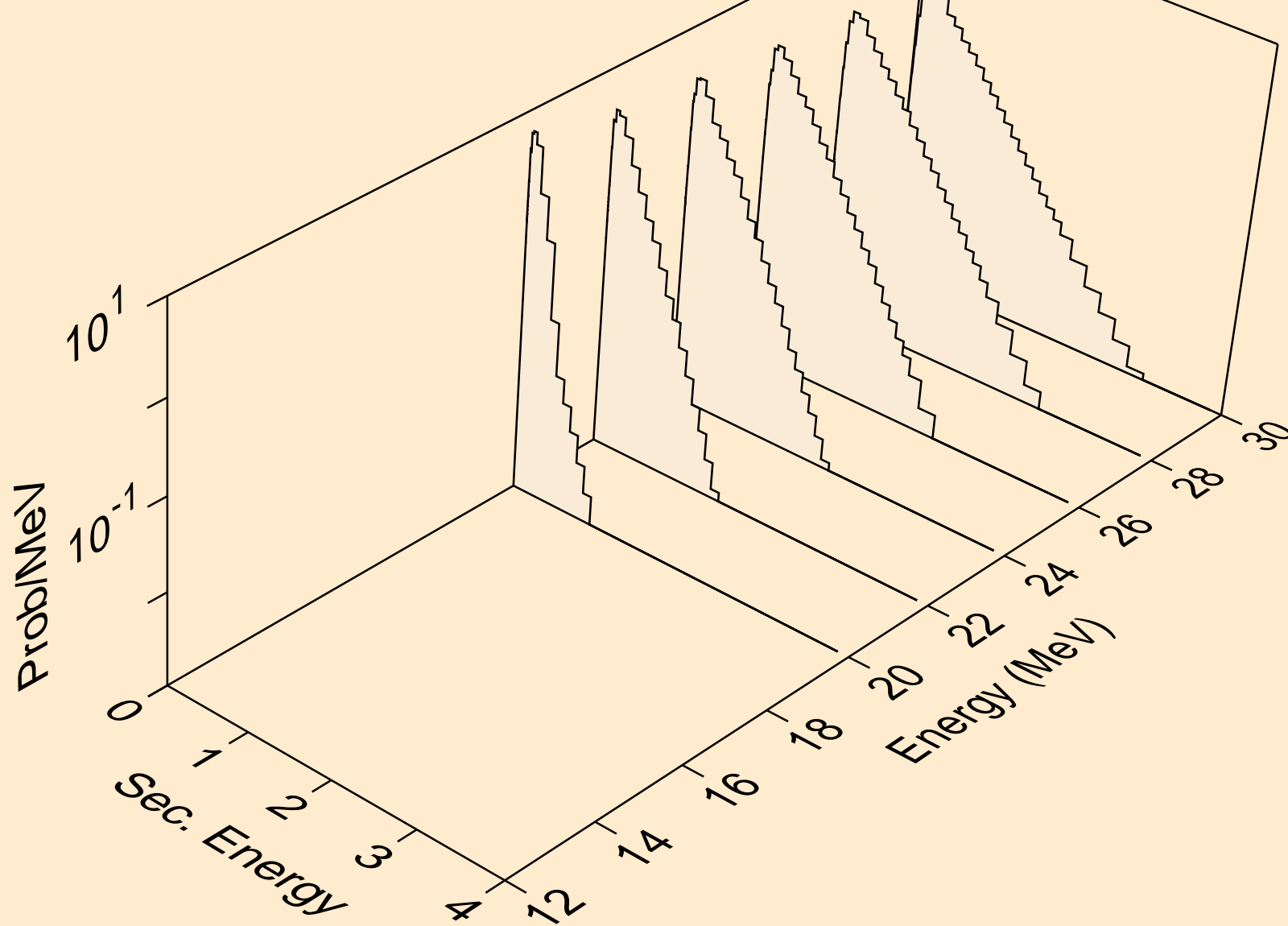

W183 NEUTRON ACER TENDL-2023 LIBRARY; T=0.K
Neutron emission for (n,npa)

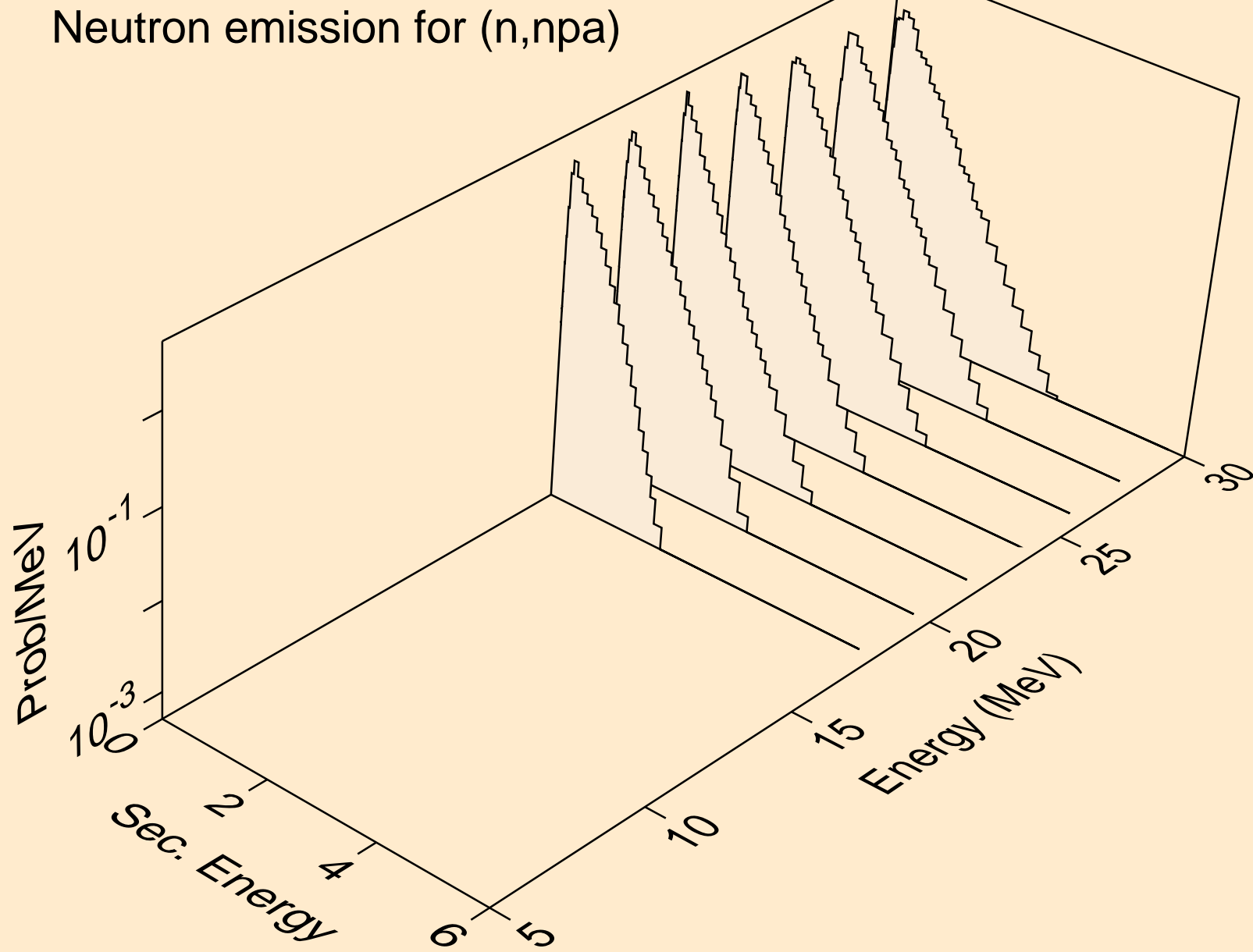

W183 NEUTRON ACER TENDL-2023 LIBRARY; T=0.K
Neutron emission for (n,n*c)

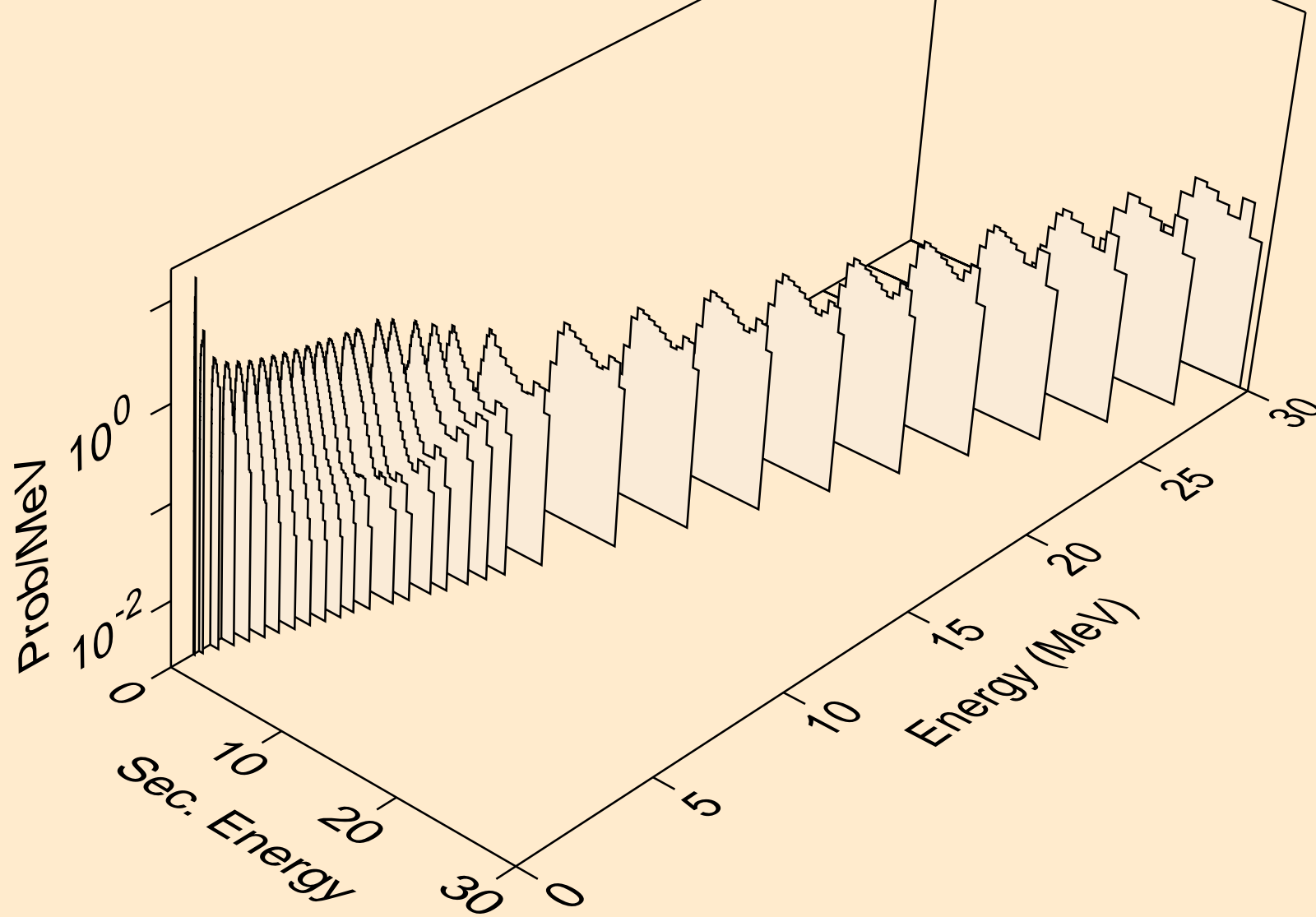

W183 NEUTRON ACER TENDL-2023 LIBRARY; T=0.K
Photon emission for (n,x)

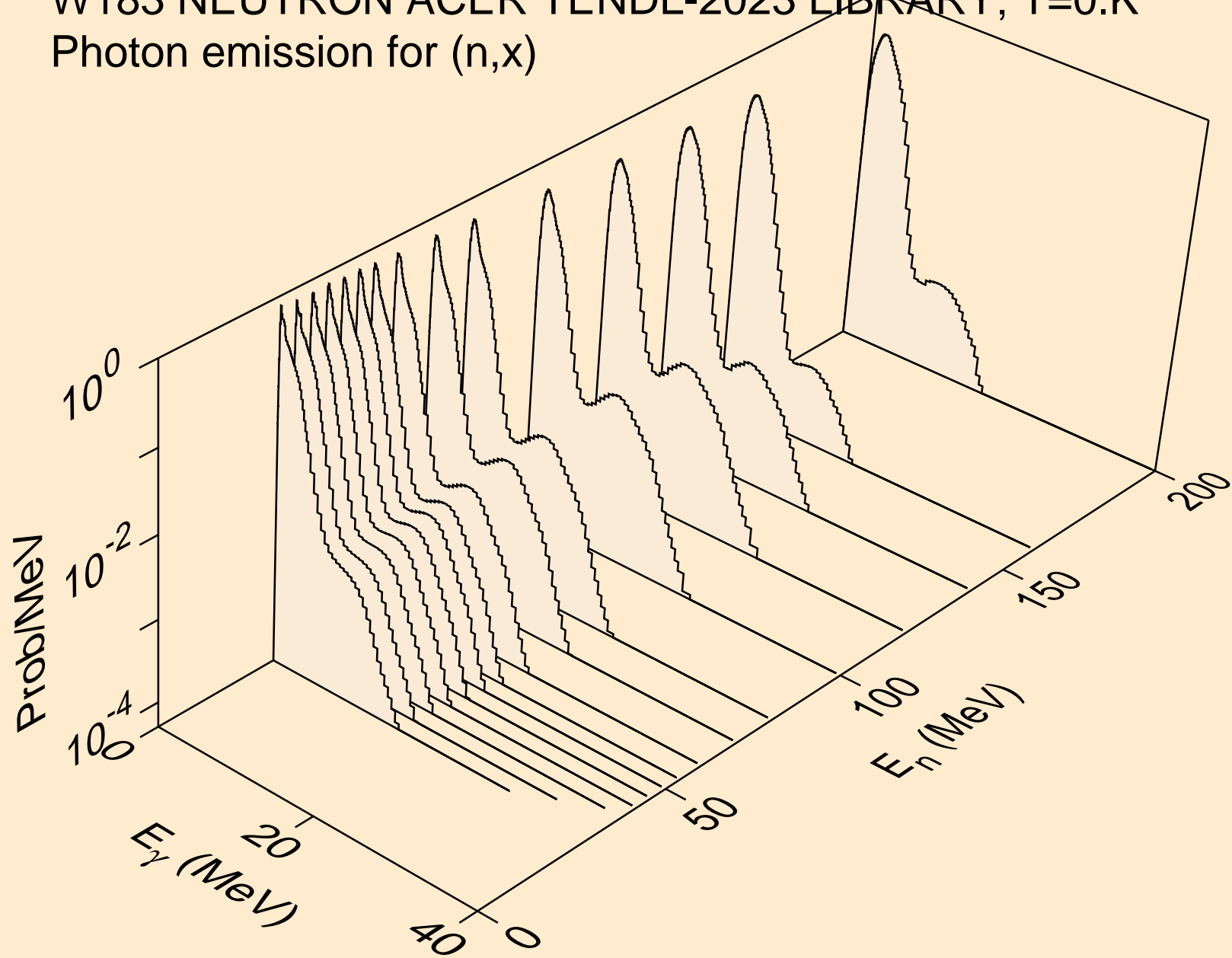

W183 NEUTRON ACER TENDL-2023 LIBRARY; T=0.K
Photon emission for (n,2nd)

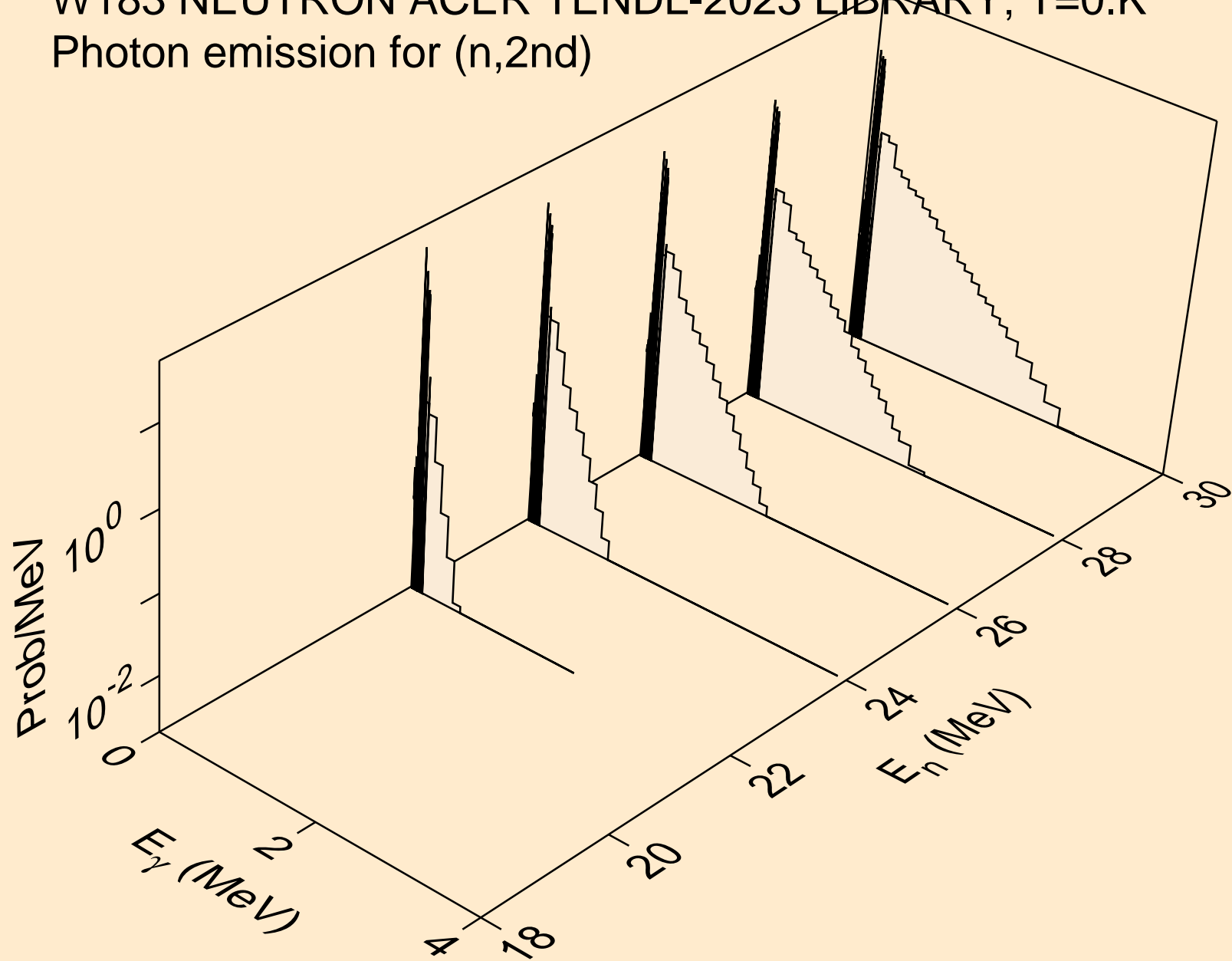

W183 NEUTRON ACER TENDL-2023 LIBRARY; T=0.K
Photon emission for (n,2n)

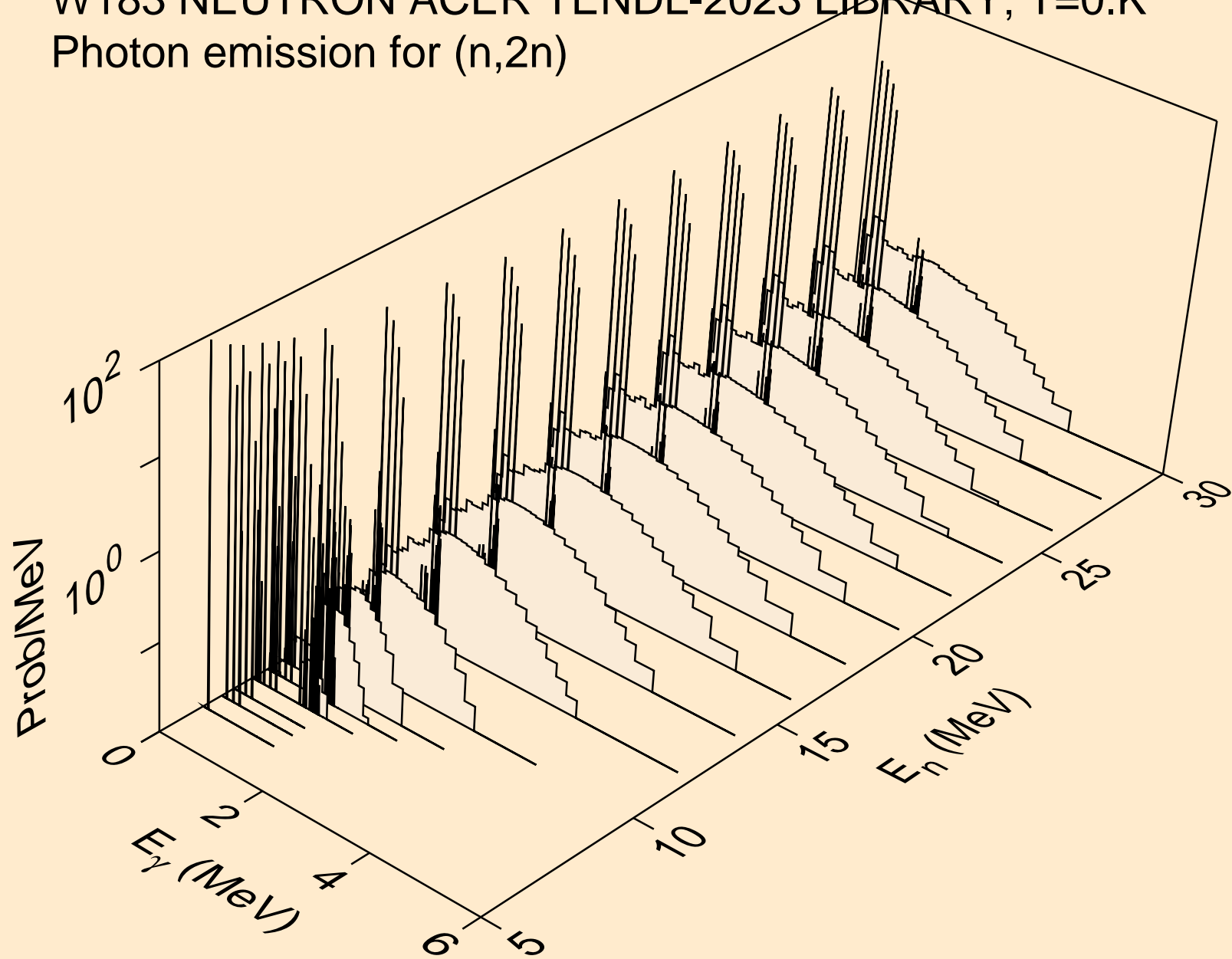

W183 NEUTRON ACER TENDL-2023 LIBRARY; T=0.K
Photon emission for (n,3n)

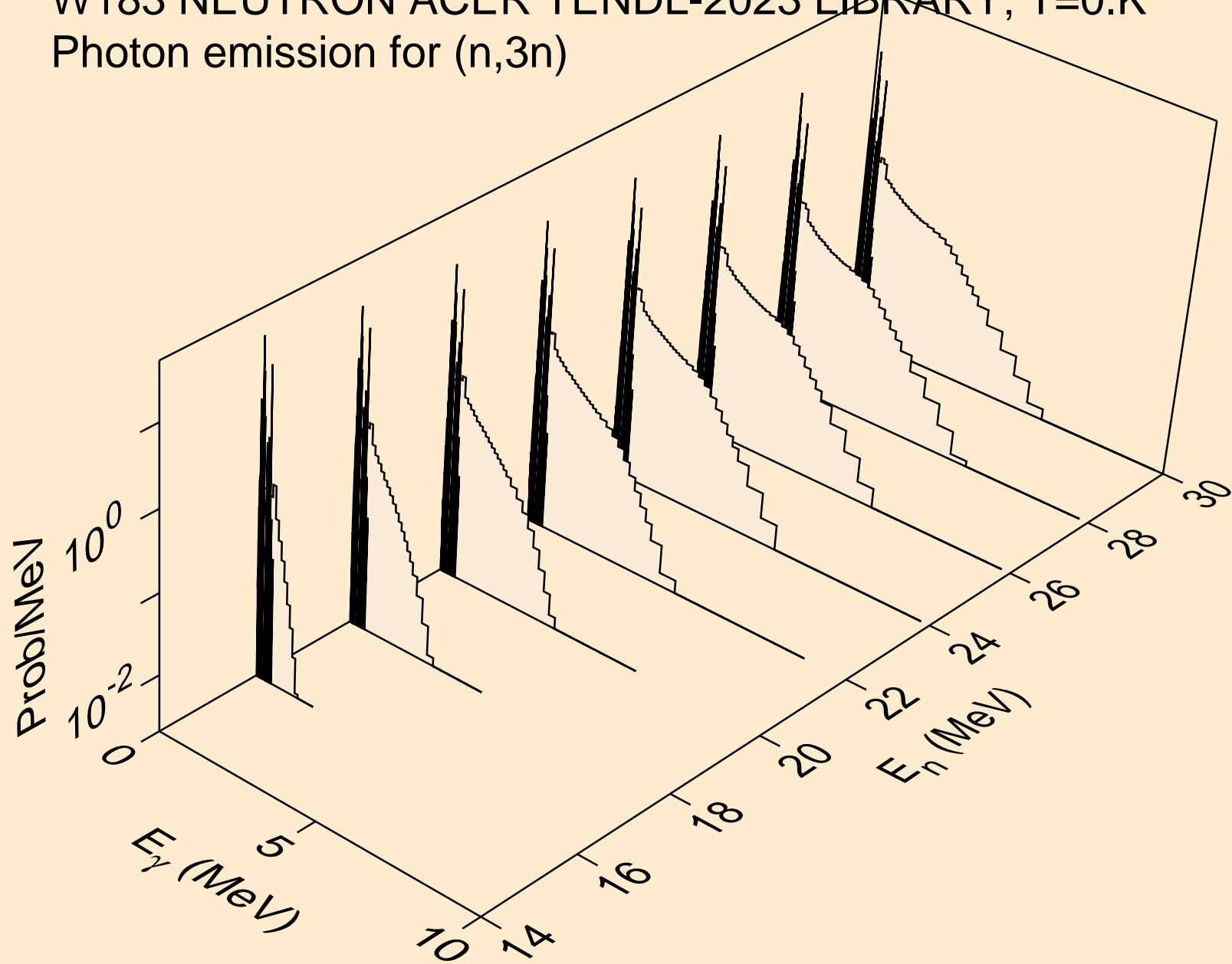

W183 NEUTRON ACER TENDL-2023 LIBRARY; T=0.K
Photon emission for (n,n*)a

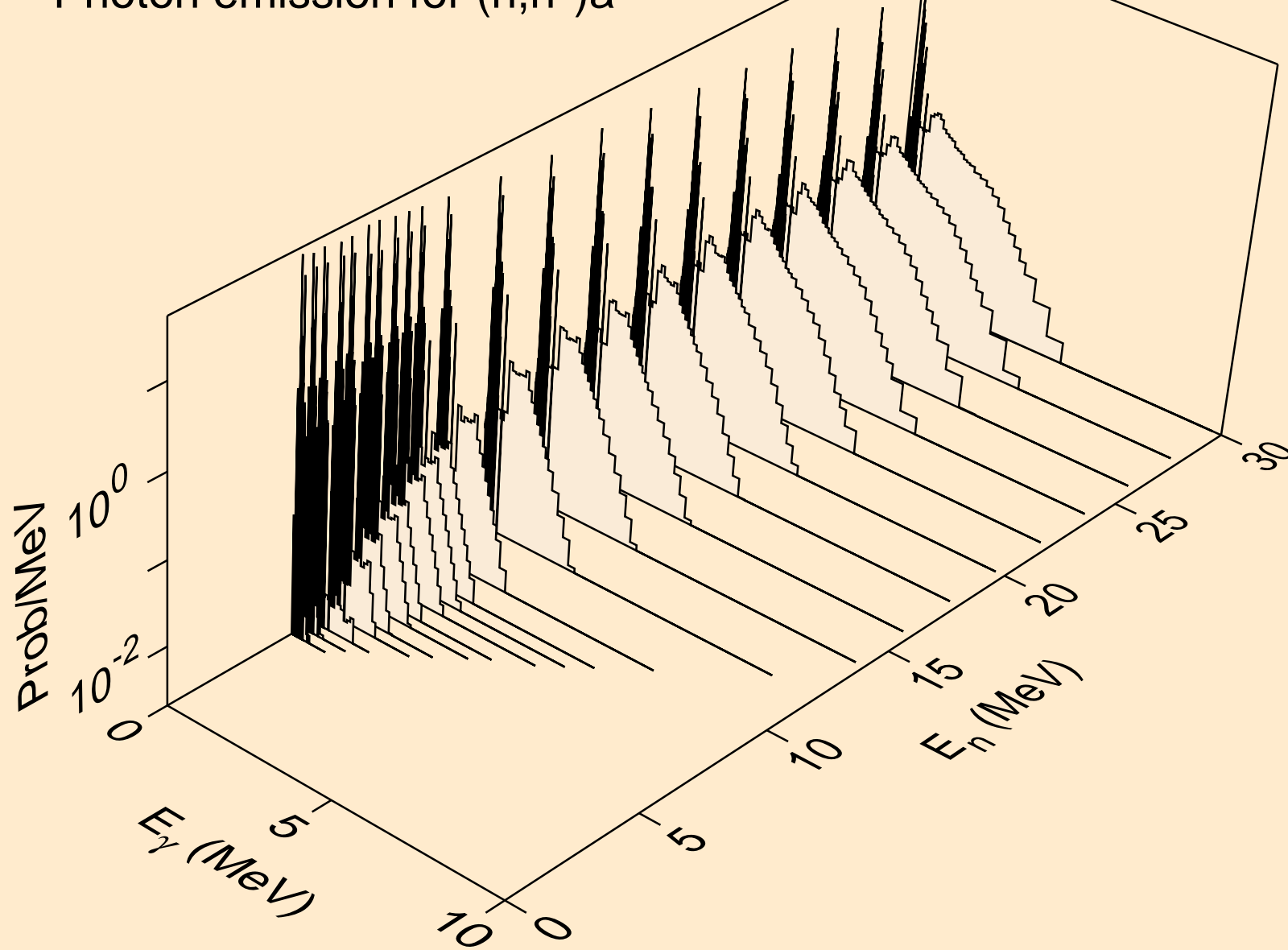

W183 NEUTRON ACER TENDL-2023 LIBRARY; T=0.K
Photon emission for (n,2n)a

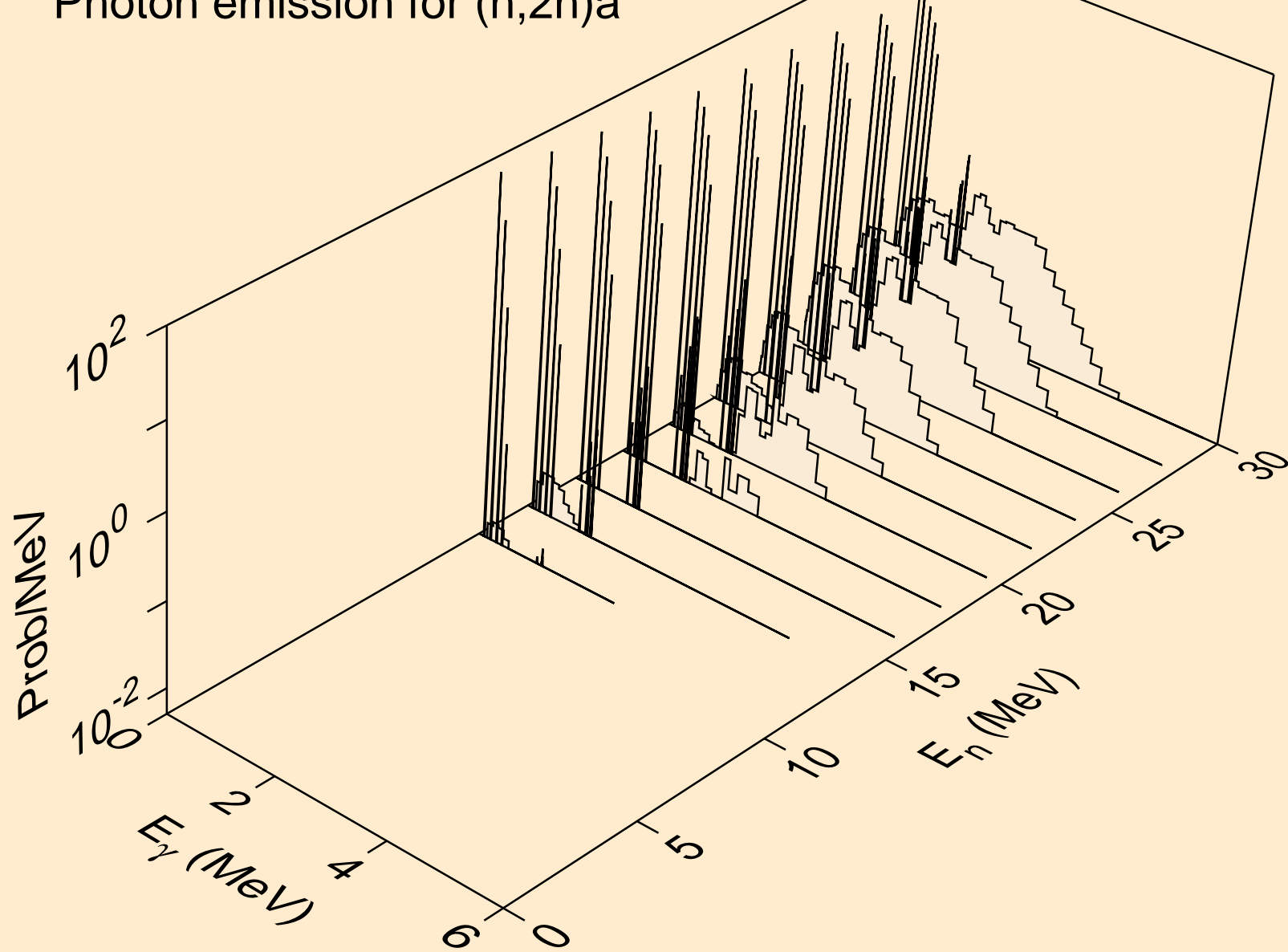

W183 NEUTRON ACER TENDL-2023 LIBRARY; T=0.K
Photon emission for (n,3n)a

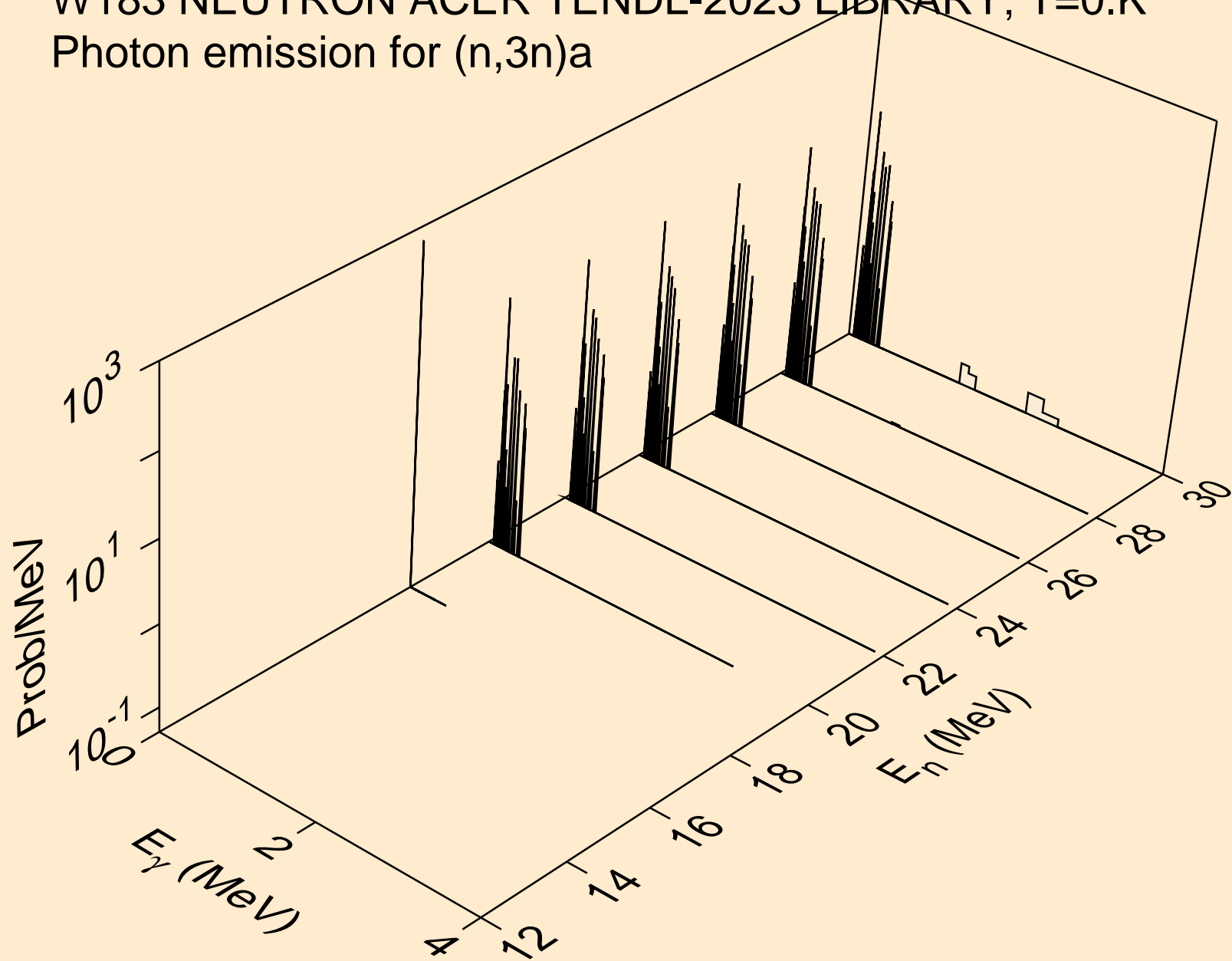

W183 NEUTRON ACER TENDL-2023 LIBRARY; T=0.K
Photon emission for (n,n*)p

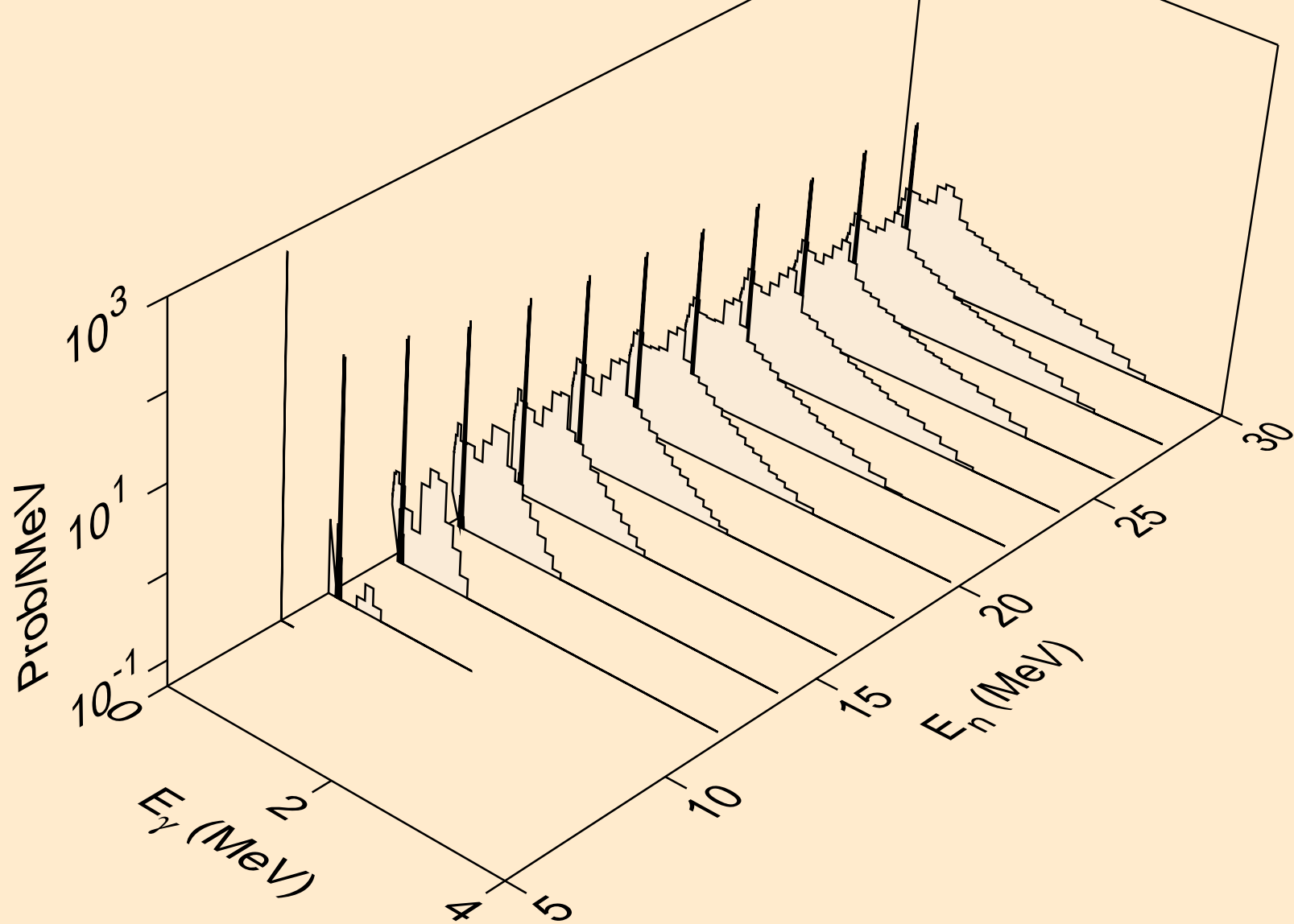

W183 NEUTRON ACER TENDL-2023 LIBRARY; T=0.K
Photon emission for (n,n*)2a

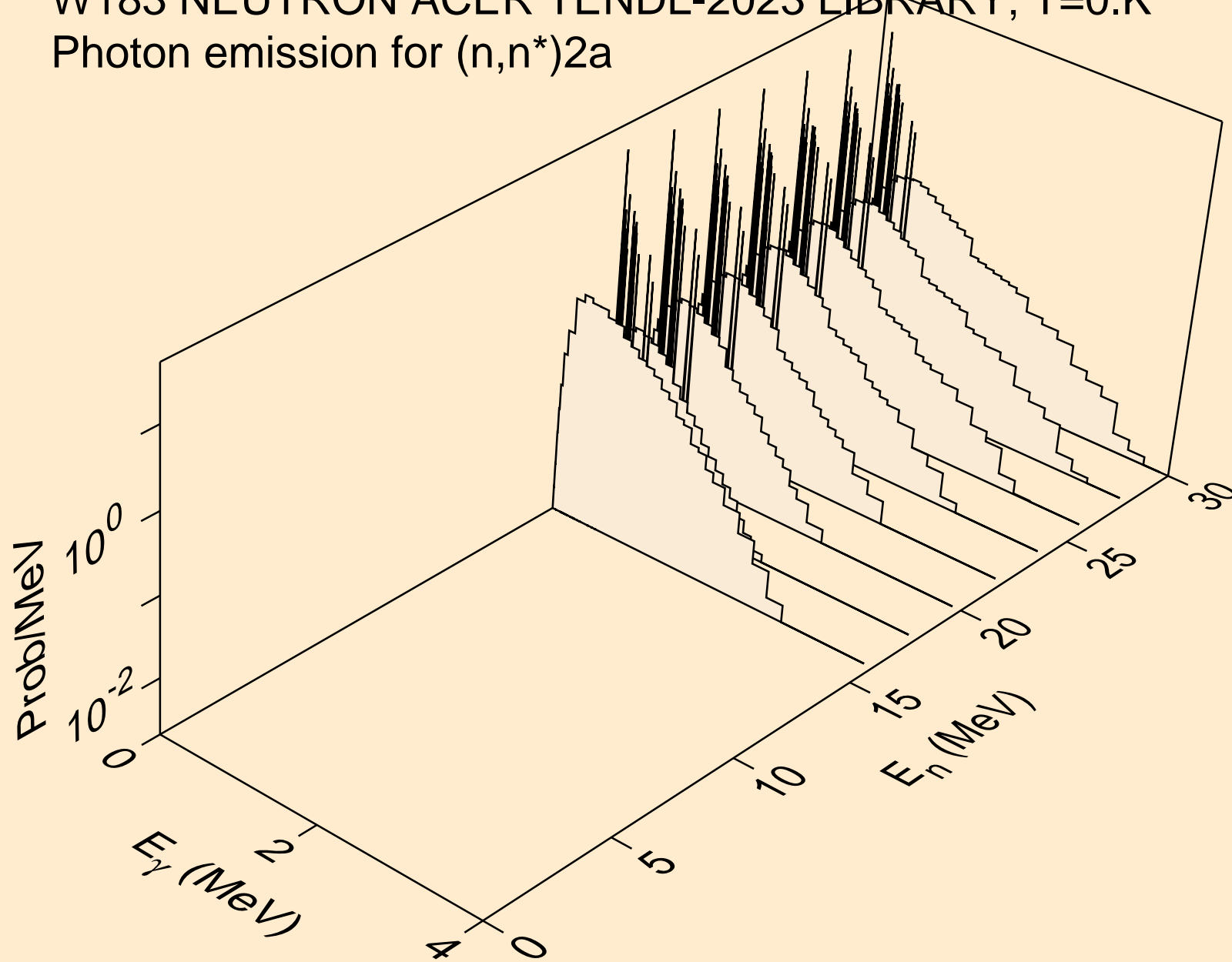

W183 NEUTRON ACER TENDL-2023 LIBRARY; T=0.K
Photon emission for (n,n*)d

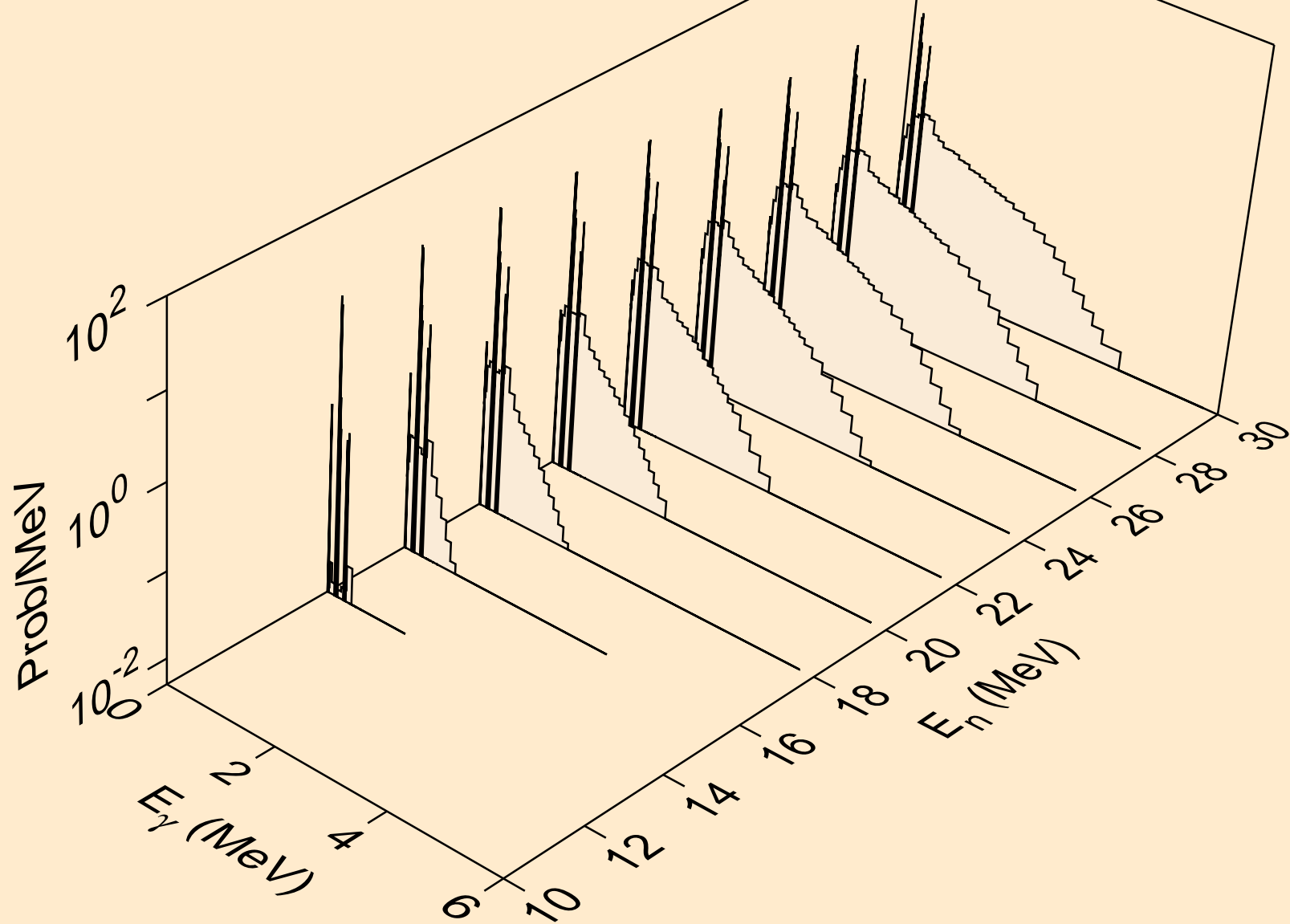

W183 NEUTRON ACER TENDL-2023 LIBRARY; T=0.K
Photon emission for (n,n*)t

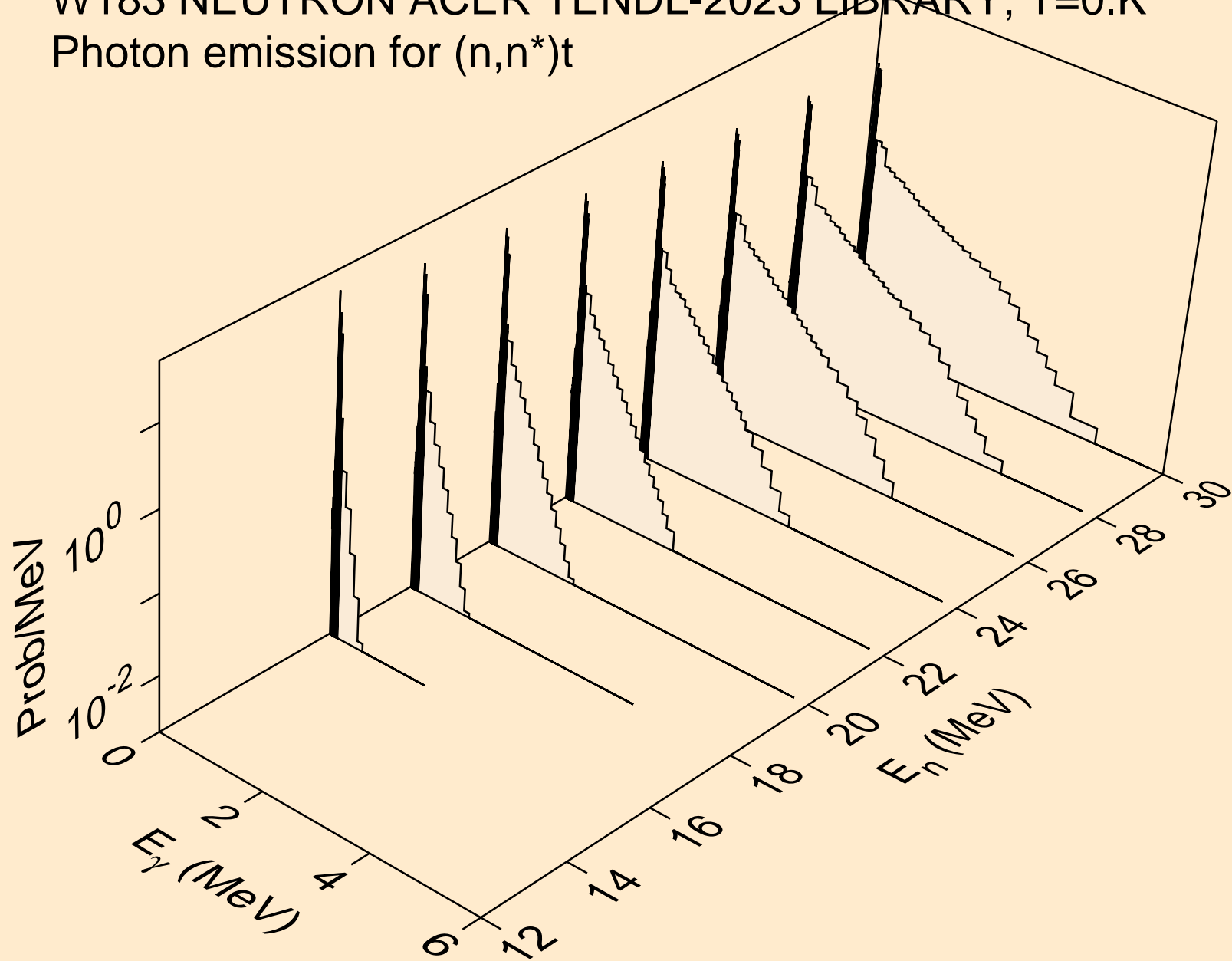

W183 NEUTRON ACER TENDL-2023 LIBRARY; T=0.K
Photon emission for (n,n*)he3

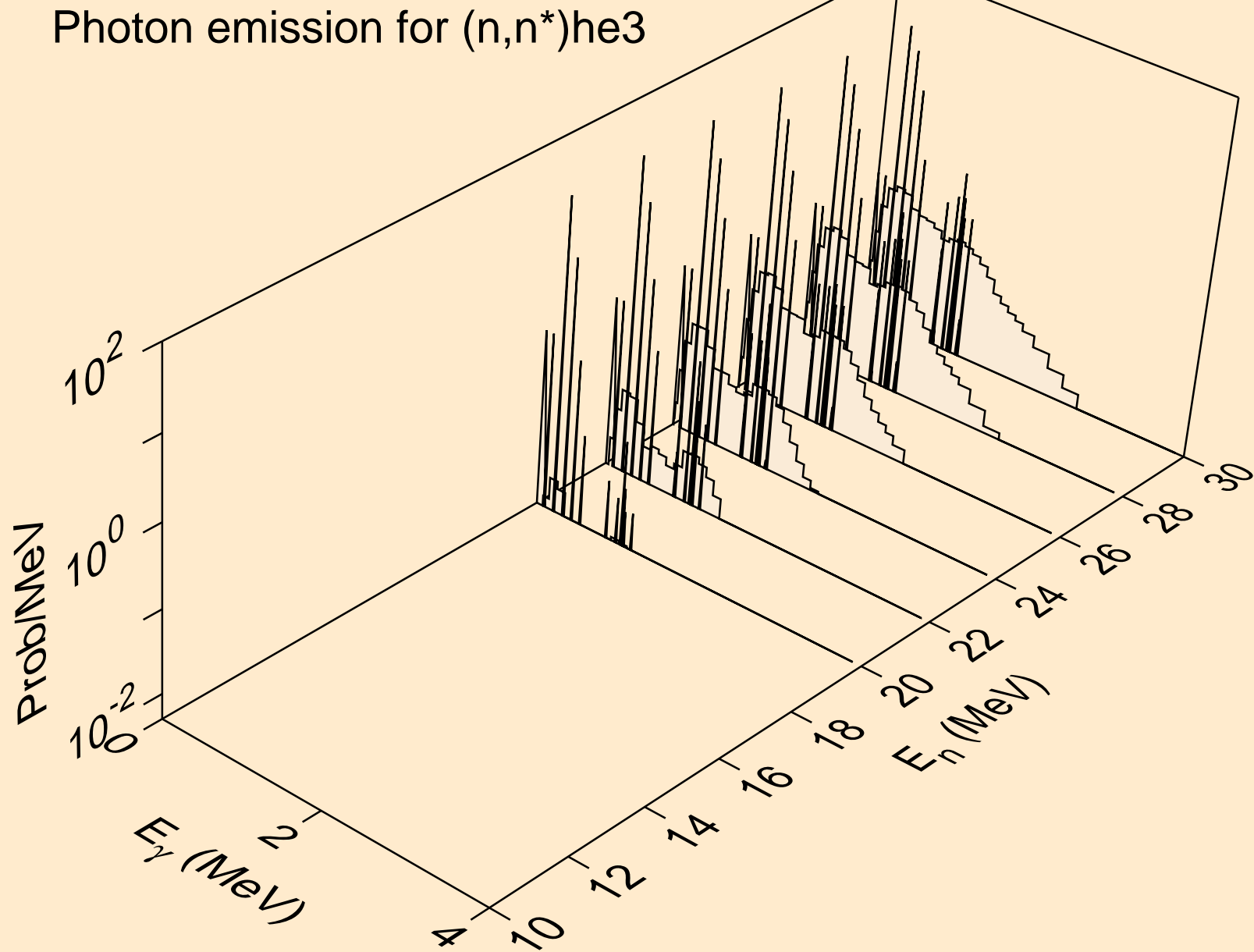

W183 NEUTRON ACER TENDL-2023 LIBRARY; T=0.K
Photon emission for (n,4n)

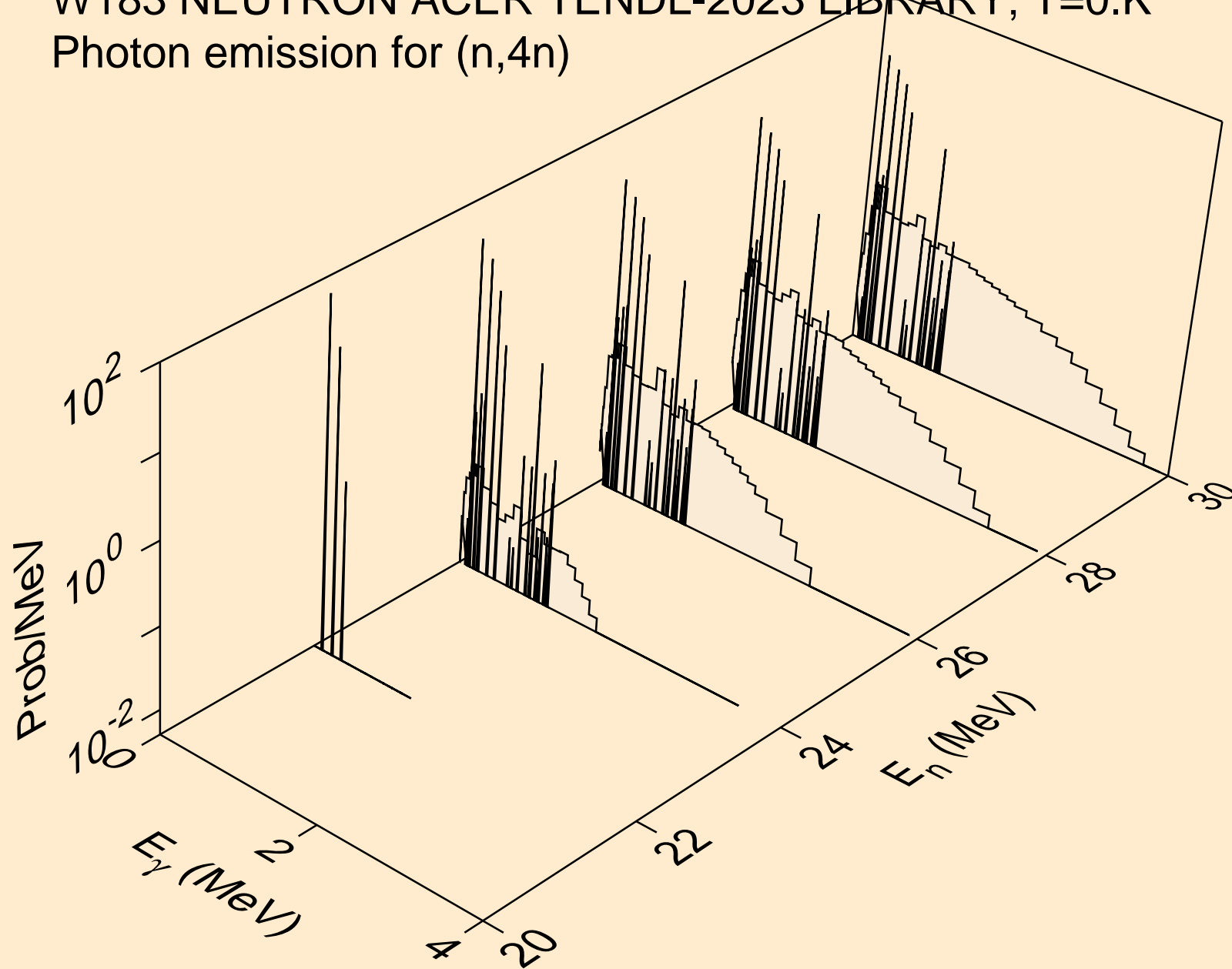

W183 NEUTRON ACER TENDL-2023 LIBRARY; T=0.K
Photon emission for (n,2np)

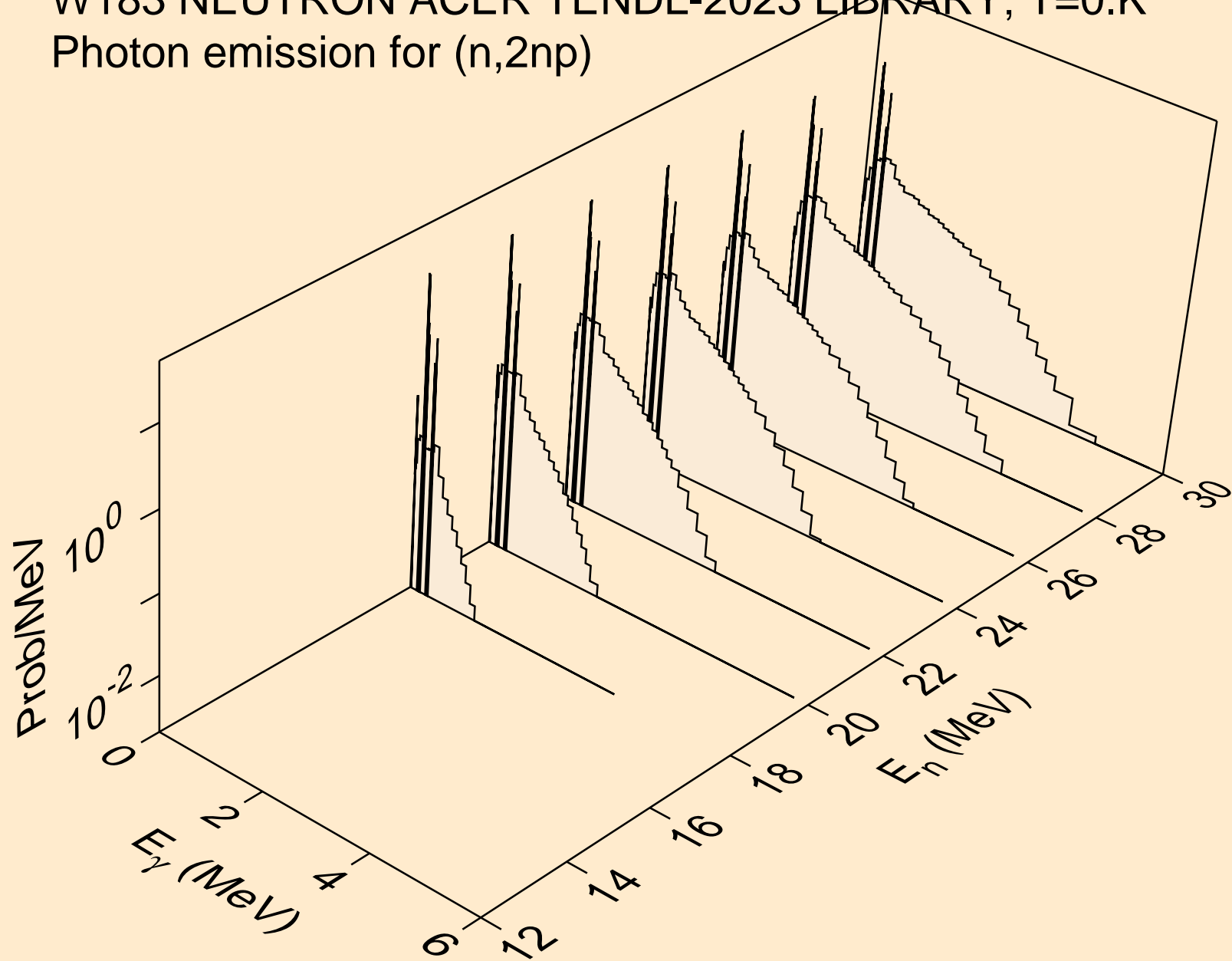

W183 NEUTRON ACER TENDL-2023 LIBRARY; T=0.K
Photon emission for (n,3np)

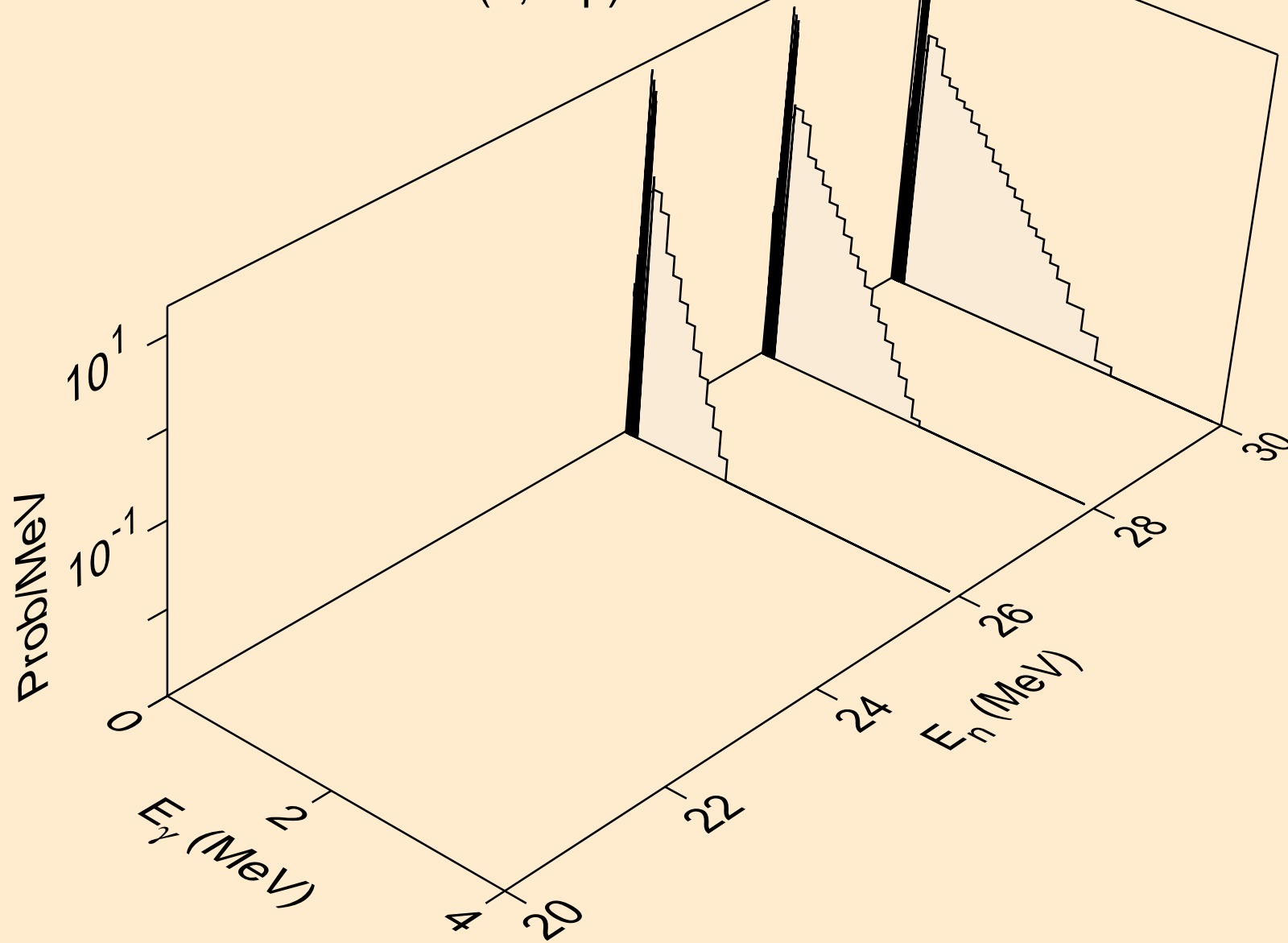

W183 NEUTRON ACER TENDL-2023 LIBRARY; T=0.K
Photon emission for (n,n2p)

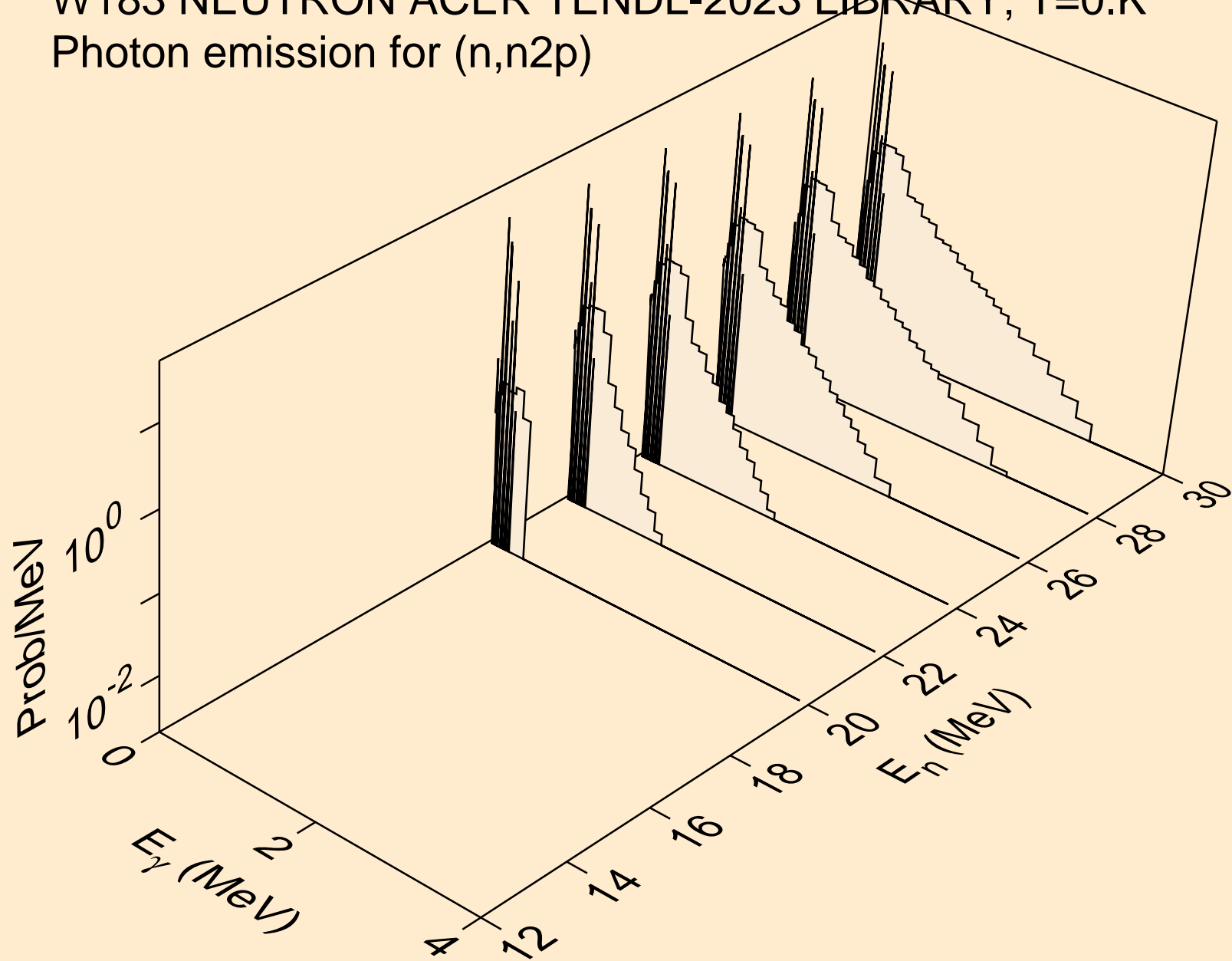

W183 NEUTRON ACER TENDL-2023 LIBRARY; T=0.K
Photon emission for (n,npa)

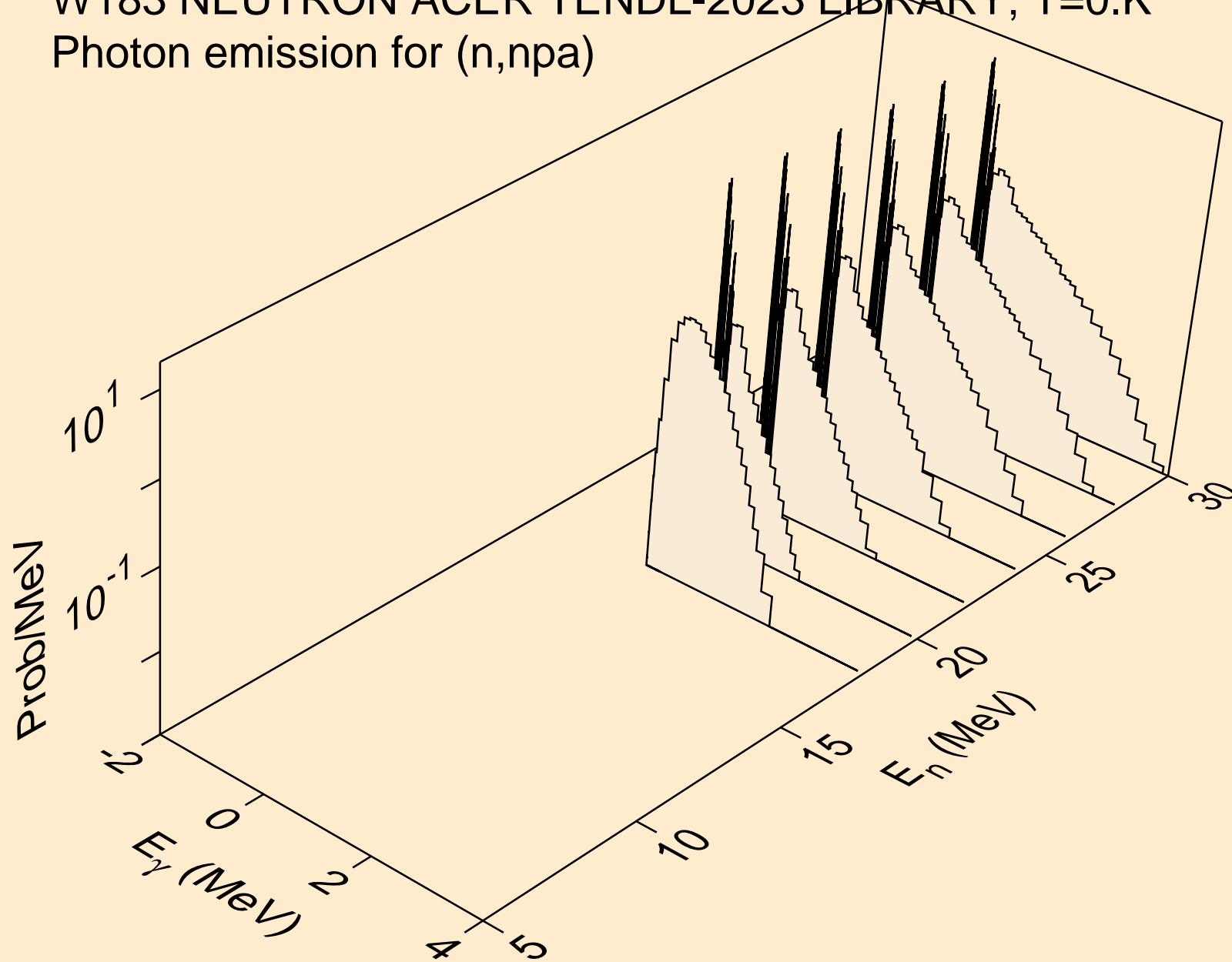

W183 NEUTRON ACER TENDL-2023 LIBRARY; T=0.K
Photon emission for (n,n*c)

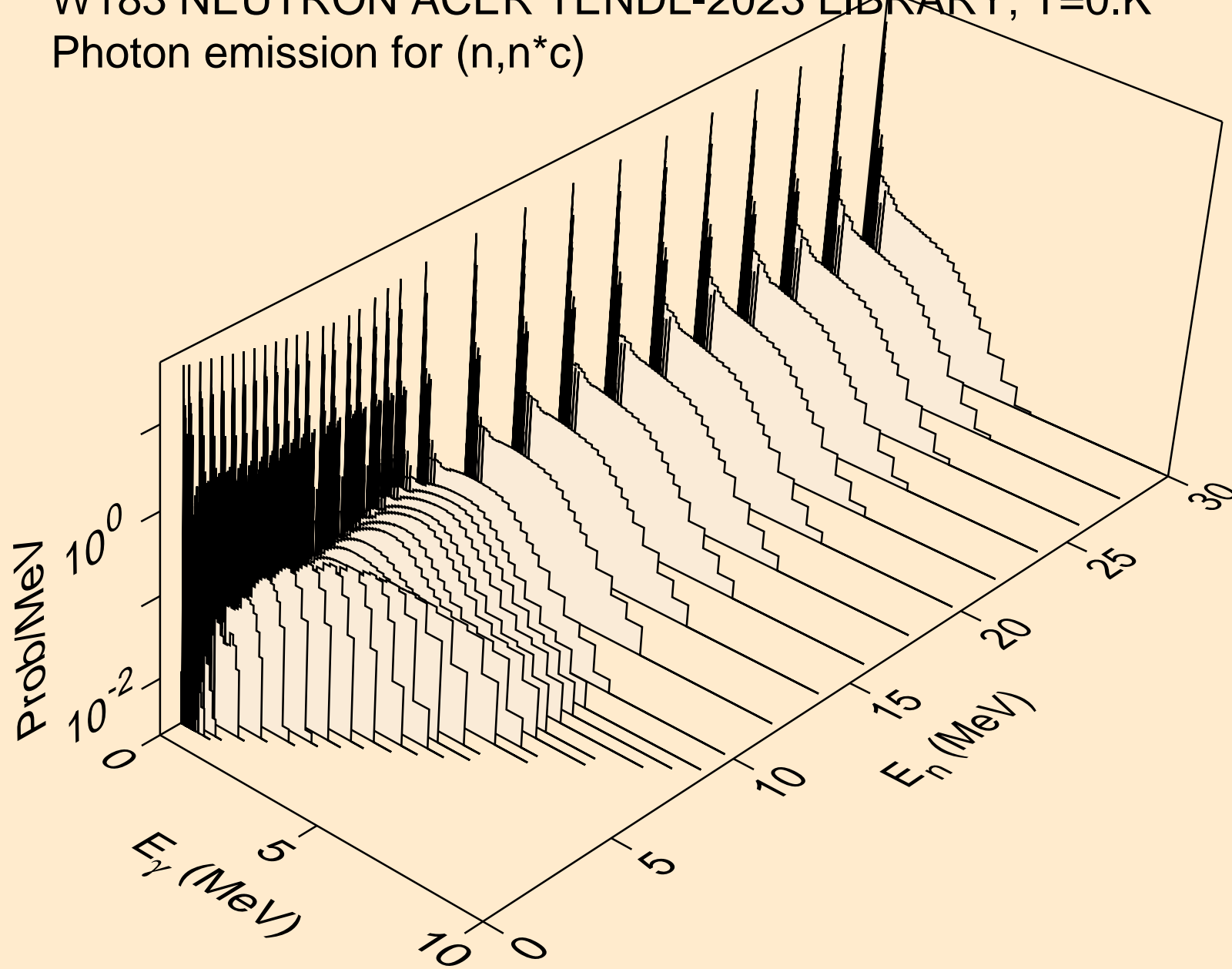

W183 NEUTRON ACER TENDL-2023 LIBRARY; T=0.K
Photon emission for (n,gma)

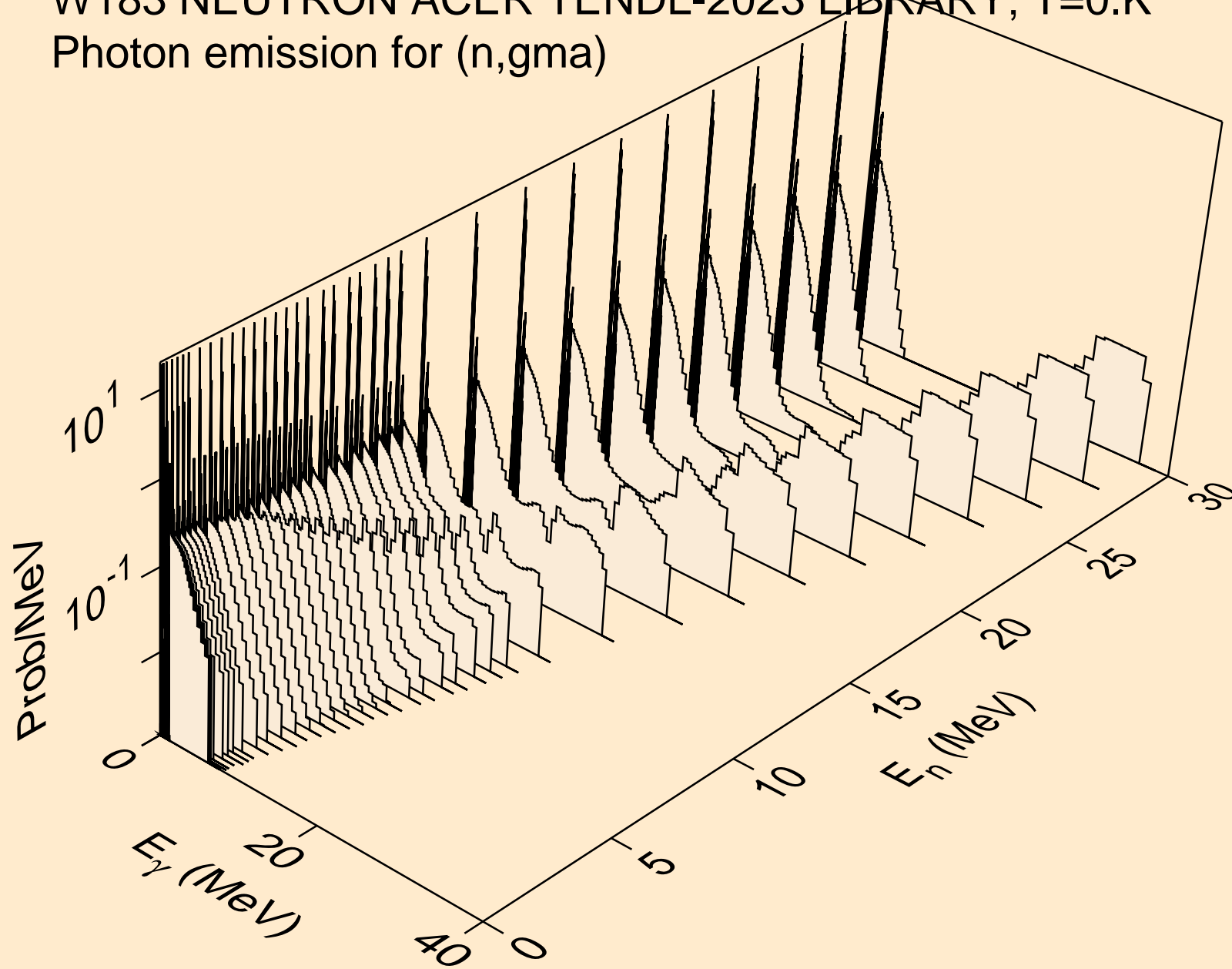

W183 NEUTRON ACER TENDL-2023 LIBRARY; T=0.K
Photon emission for (n,p)

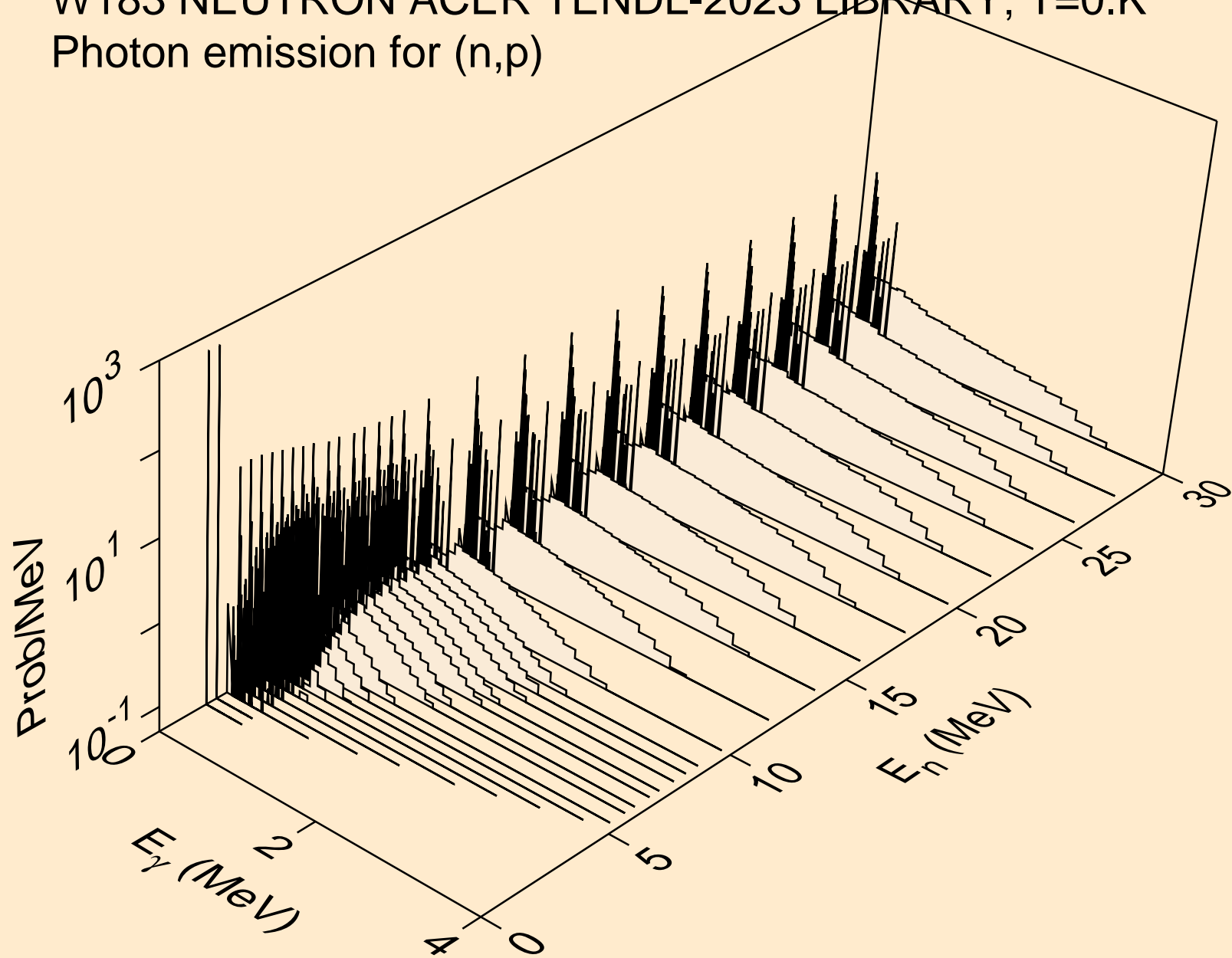

W183 NEUTRON ACER TENDL-2023 LIBRARY; T=0.K
Photon emission for (n,d)

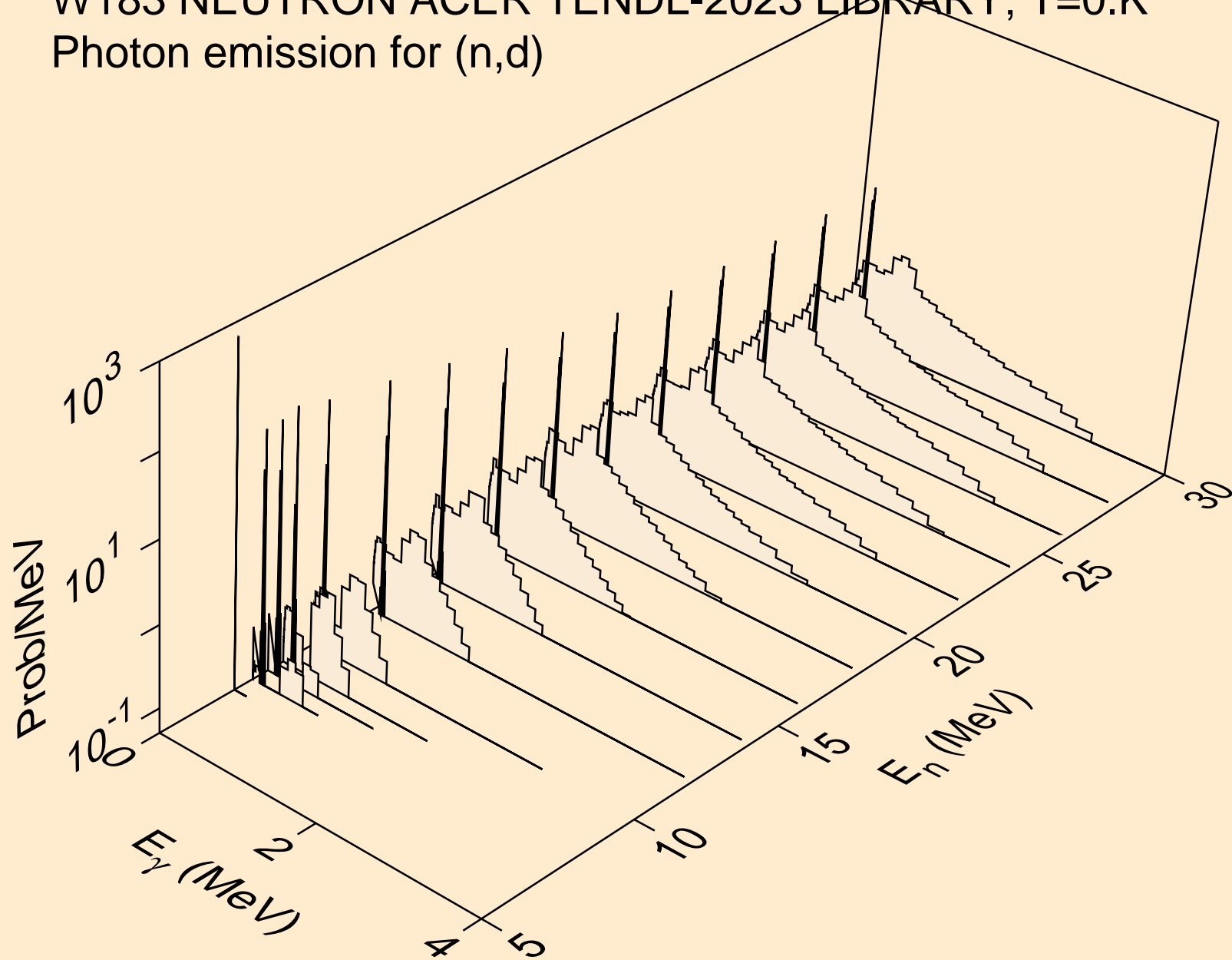

W183 NEUTRON ACER TENDL-2023 LIBRARY; T=0.K
Photon emission for (n,t)

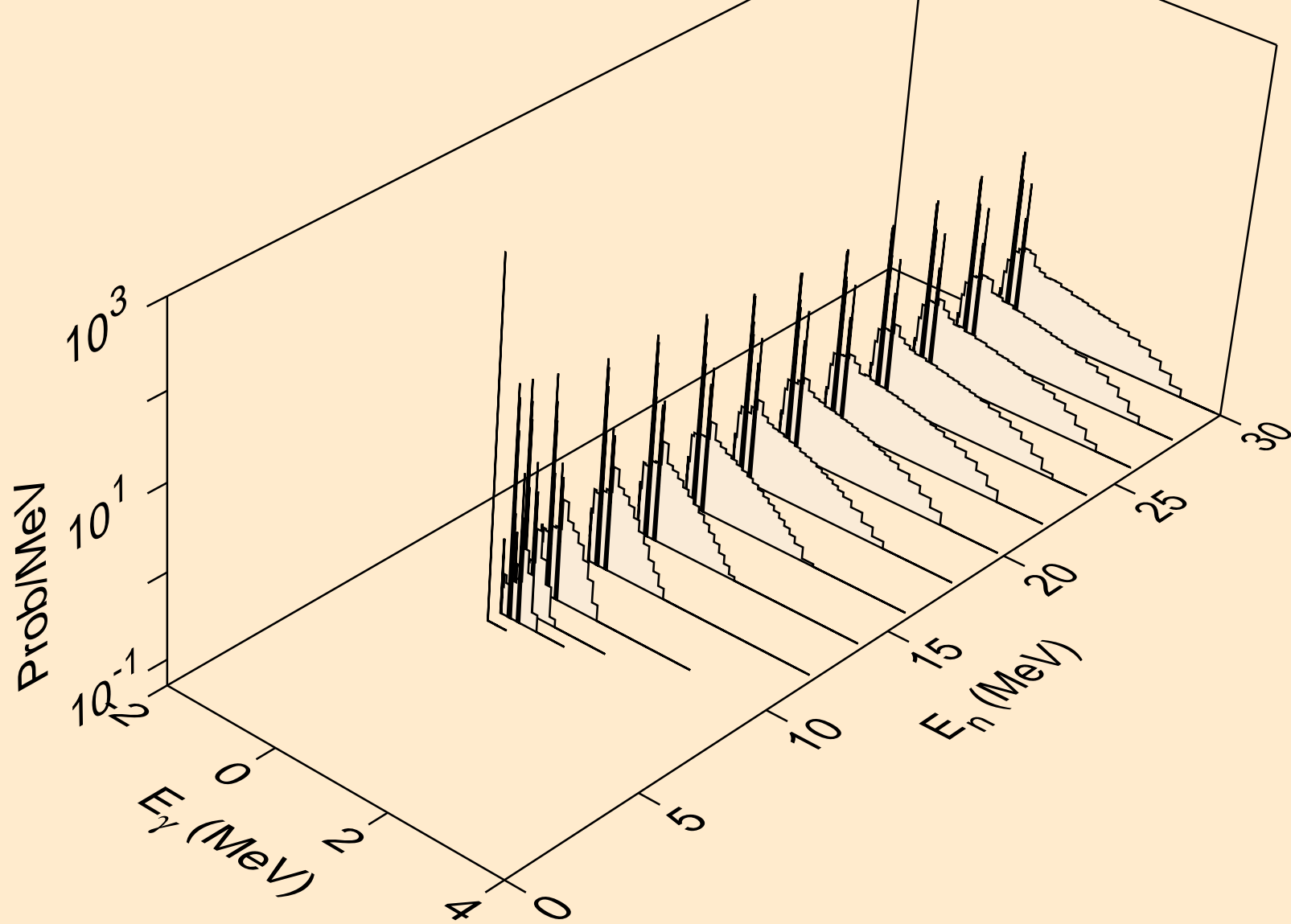

W183 NEUTRON ACER TENDL-2023 LIBRARY; T=0.K
Photon emission for (n,he3)

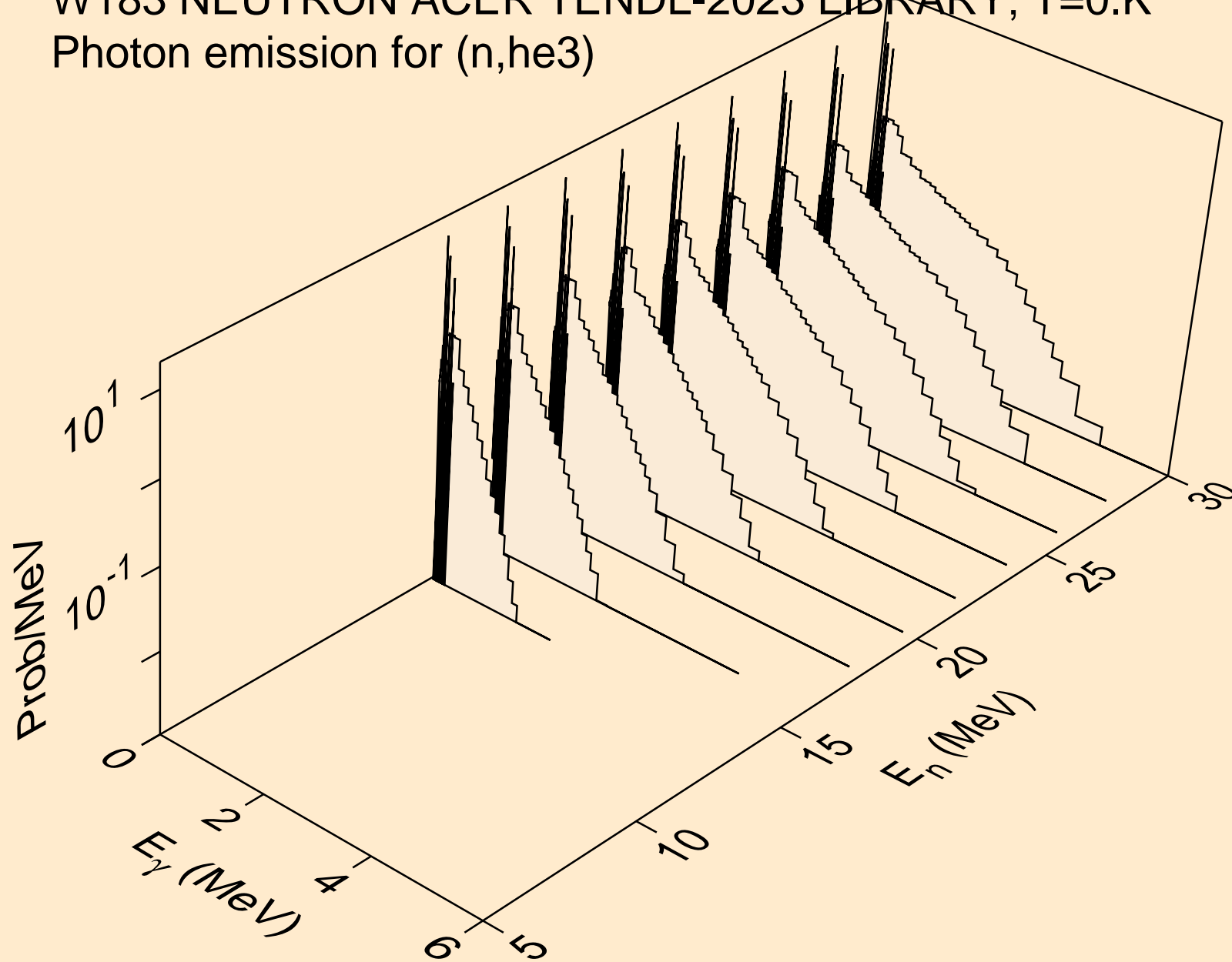

W183 NEUTRON ACER TENDL-2023 LIBRARY; T=0.K
Photon emission for (n,a)

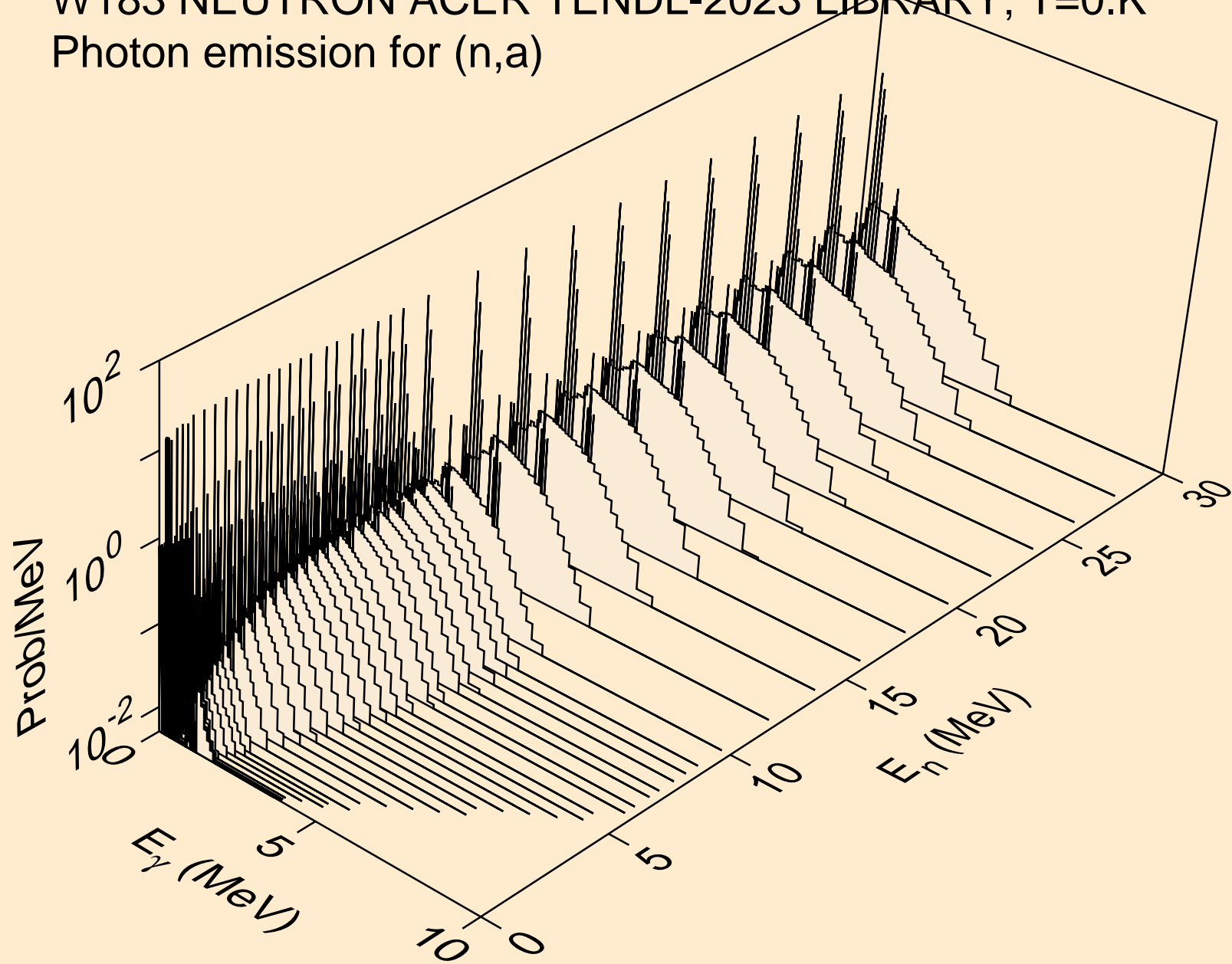

W183 NEUTRON ACER TENDL-2023 LIBRARY; T=0.K
Photon emission for (n,2a)

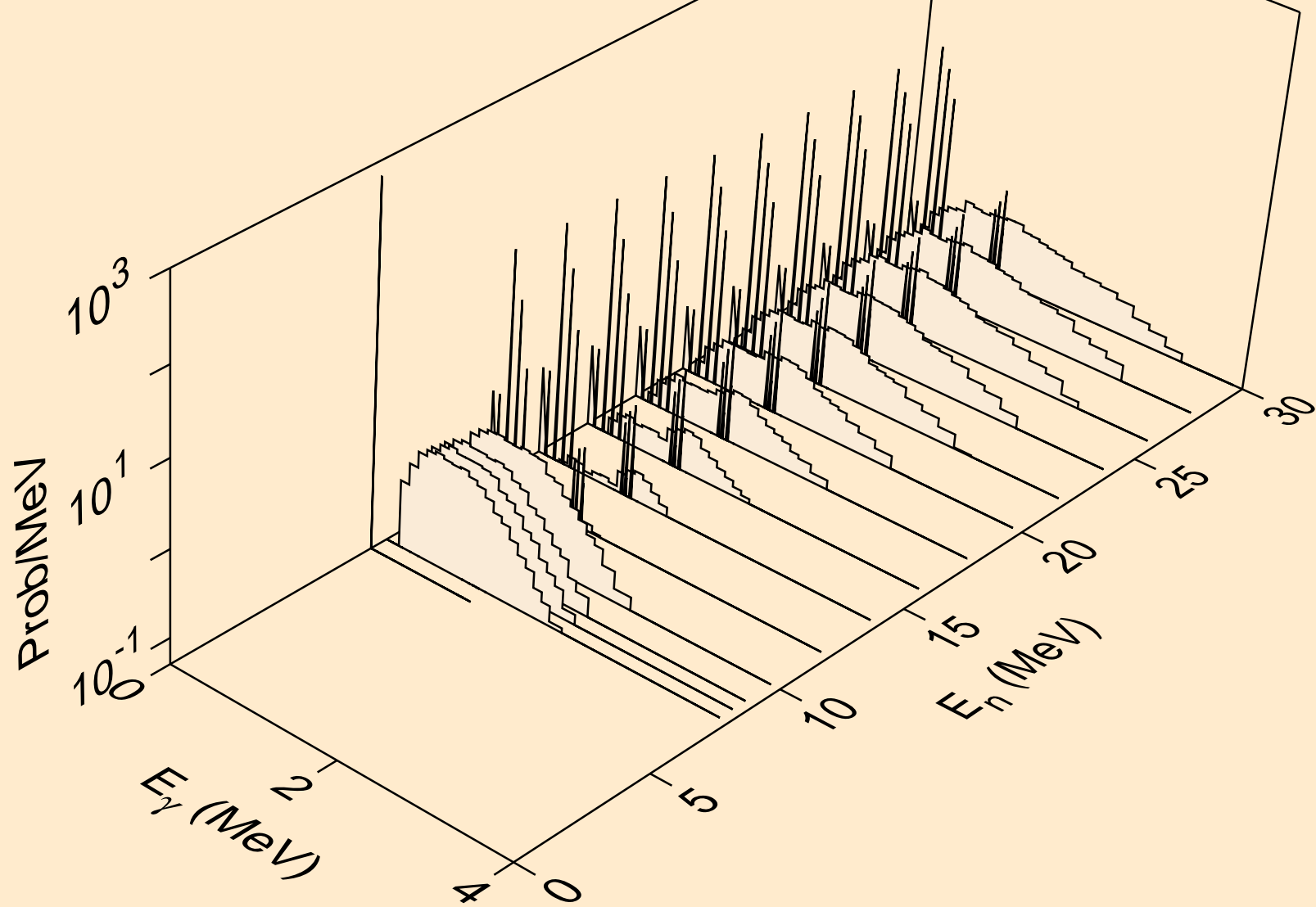

W183 NEUTRON ACER TENDL-2023 LIBRARY; T=0.K
Photon emission for (n,2p)

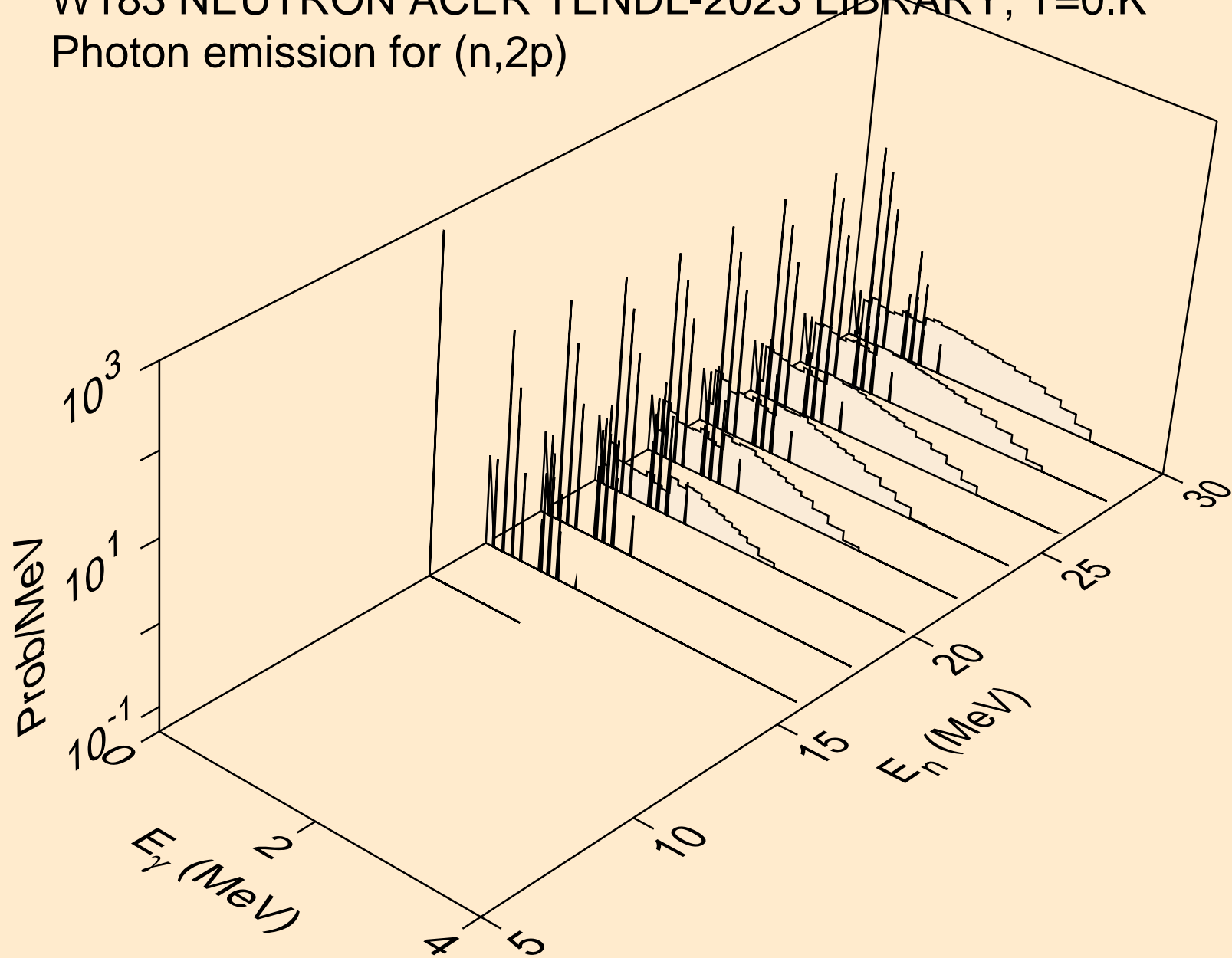

W183 NEUTRON ACER TENDL-2023 LIBRARY; T=0.K
Photon emission for (n,p)

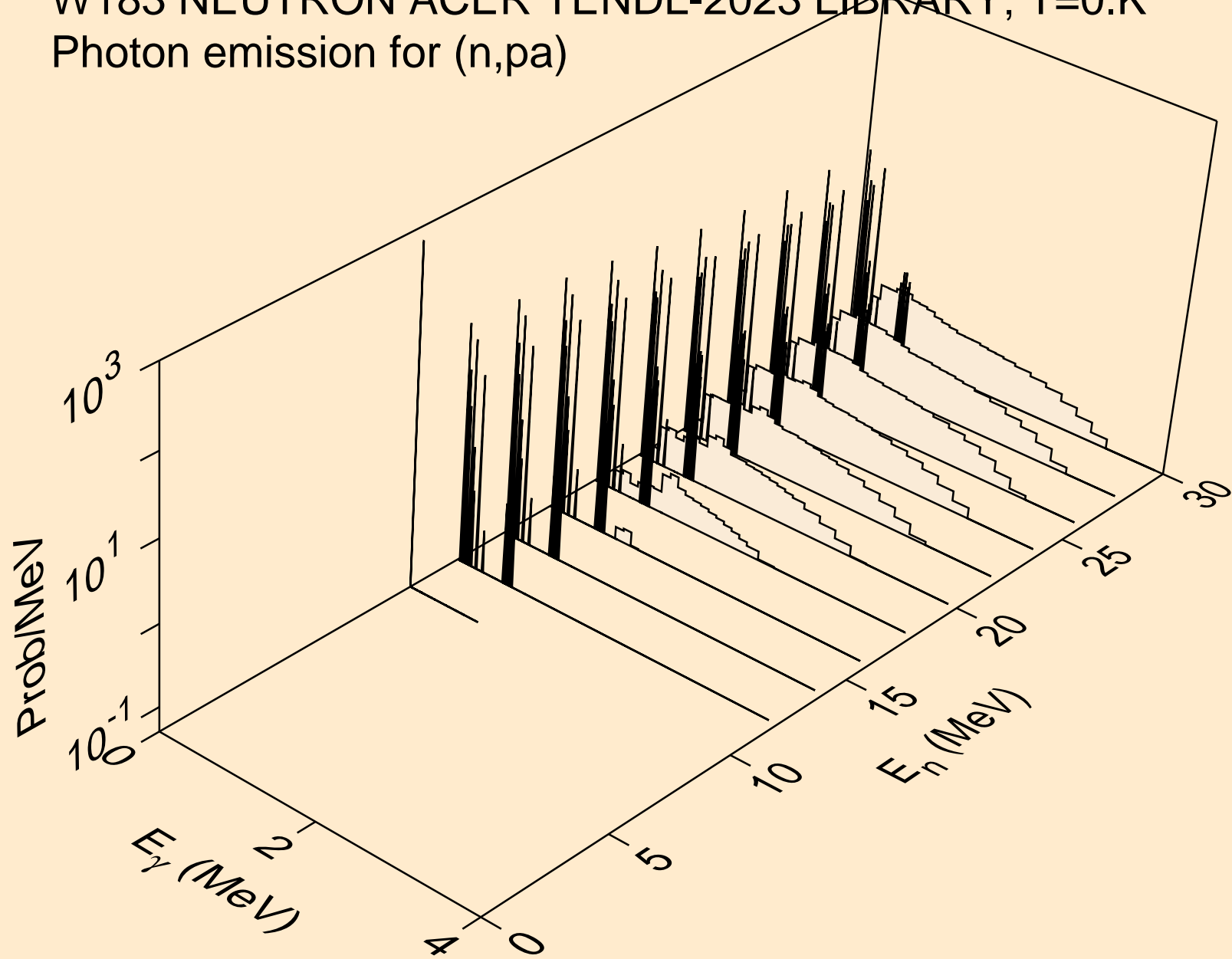

W183 NEUTRON ACER TENDL-2023 LIBRARY; T=0.K
Photon emission for (n,pd)

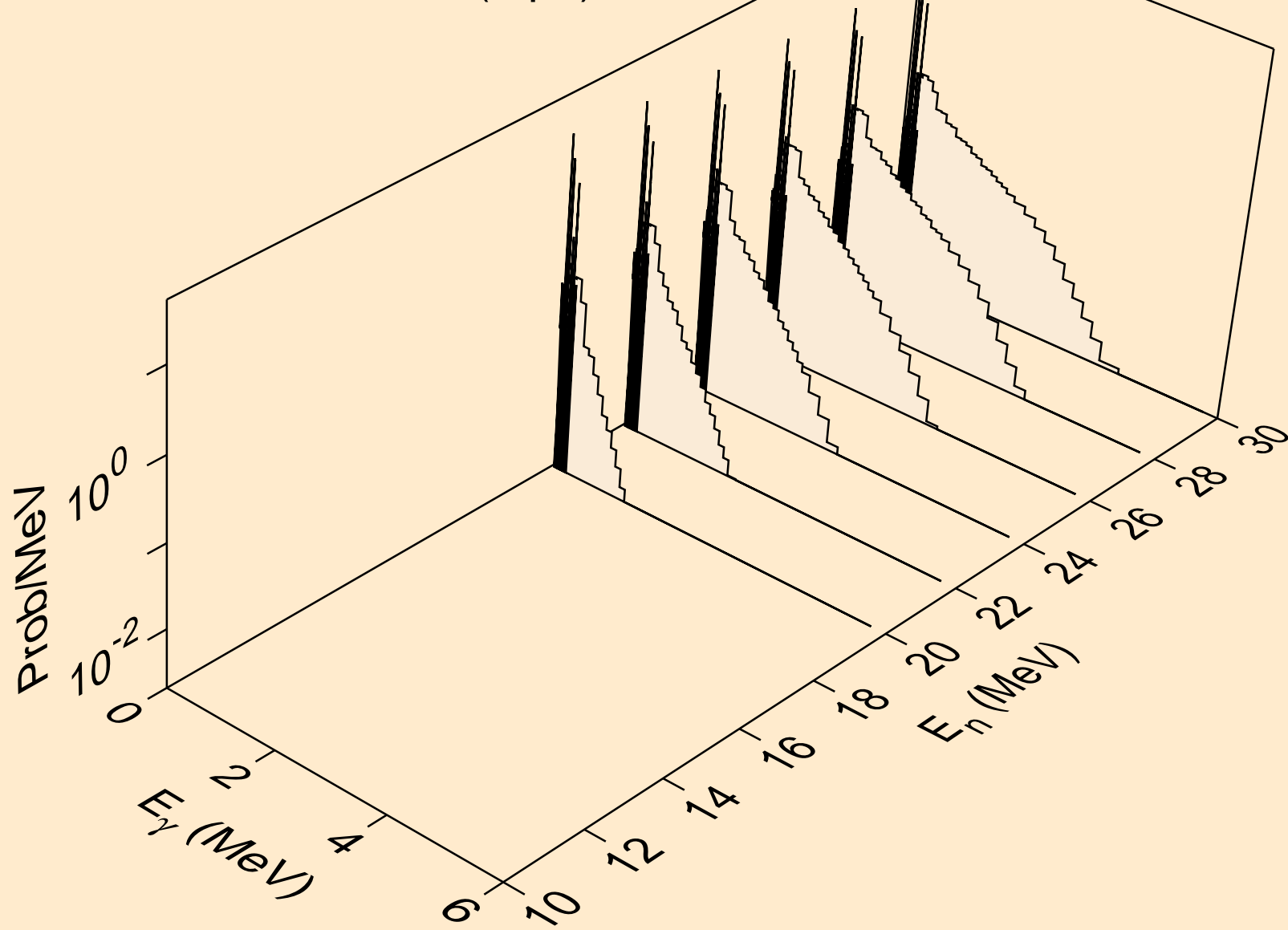

W183 NEUTRON ACER TENDL-2023 LIBRARY; T=0.K
Photon emission for (n,pt)

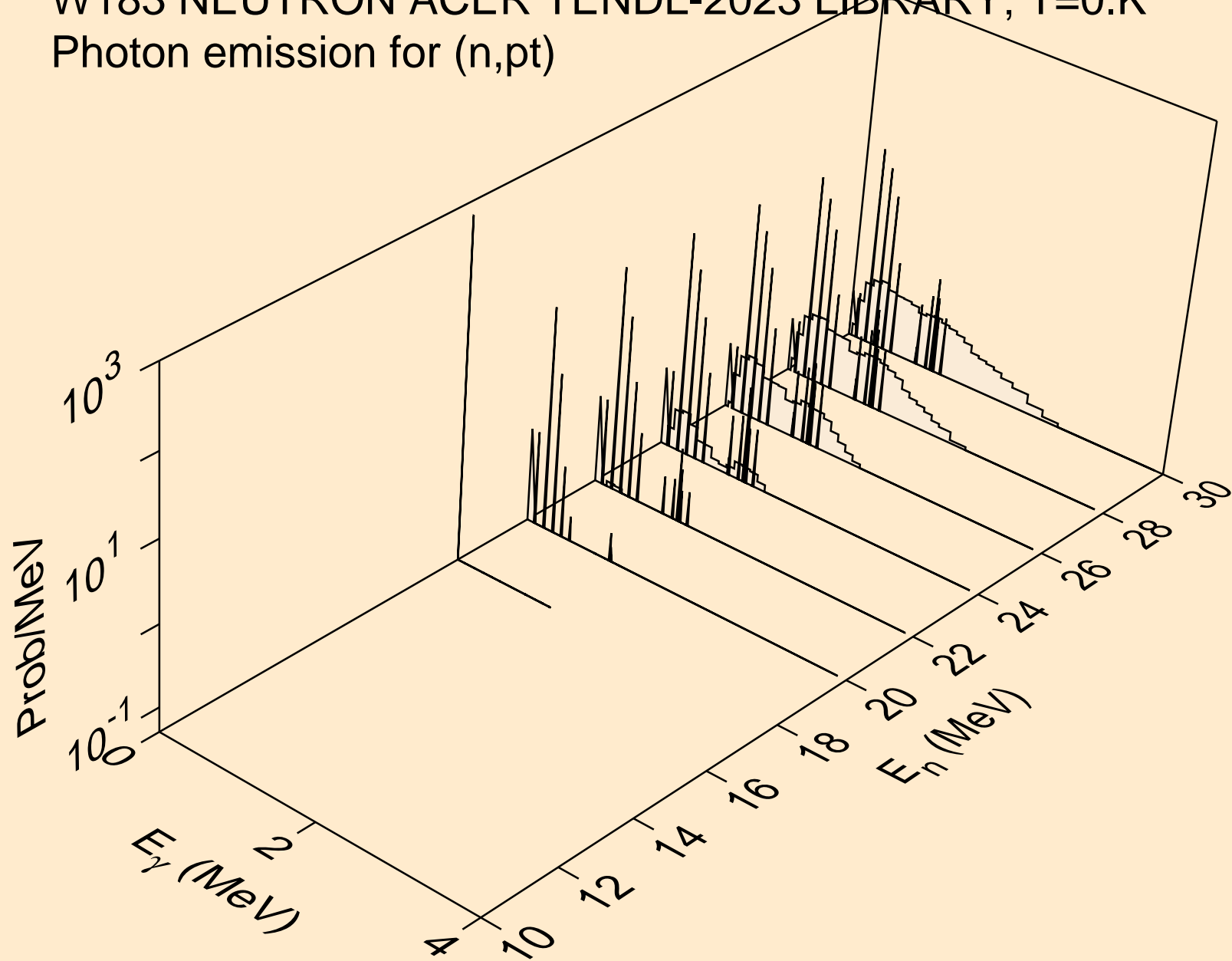

W183 NEUTRON ACER TENDL-2023 LIBRARY; T=0.K
thermal capture photon spectrum

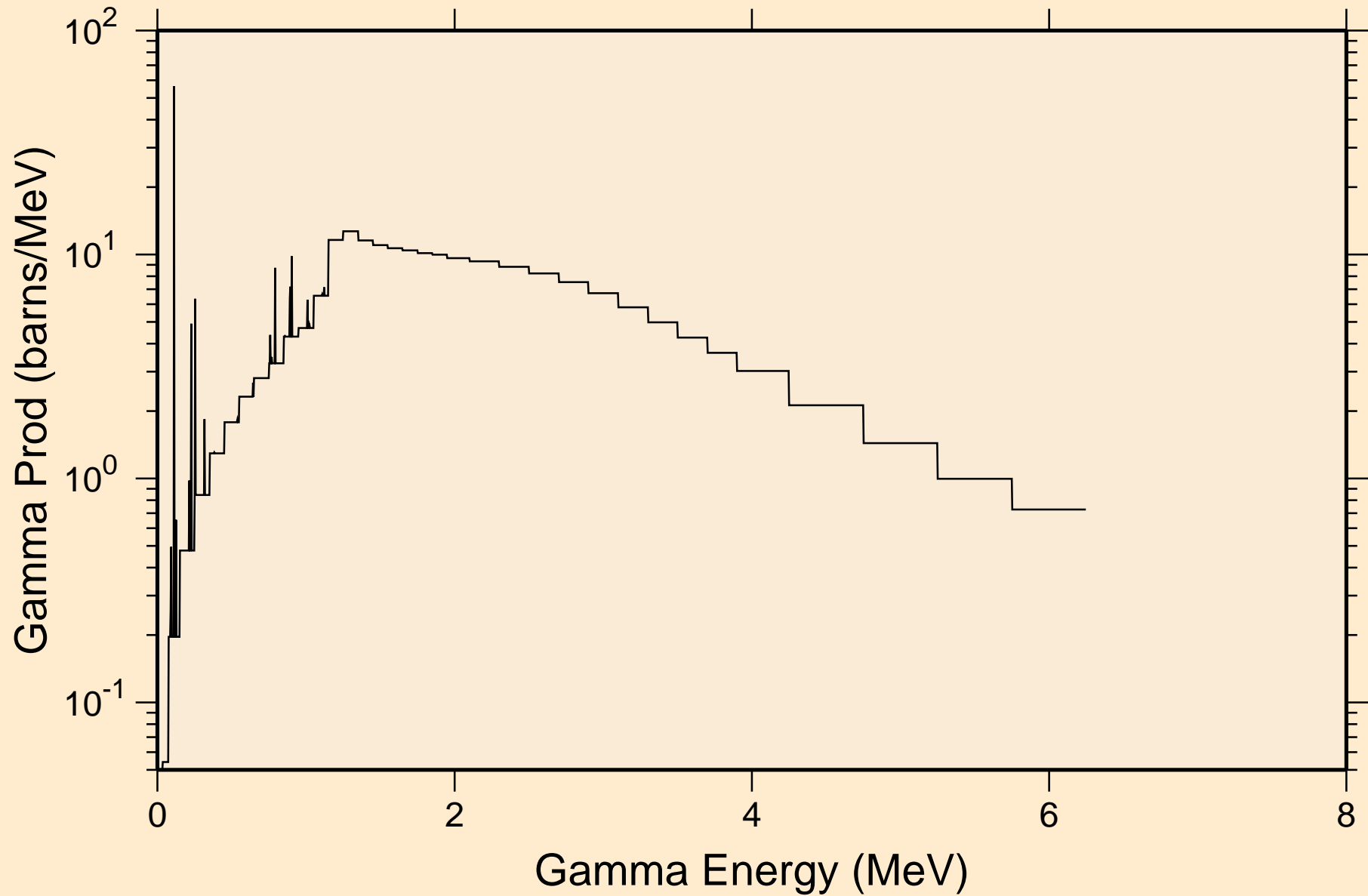

W183 NEUTRON ACER TENDL-2023 LIBRARY; T=0.K
14 MeV photon spectrum

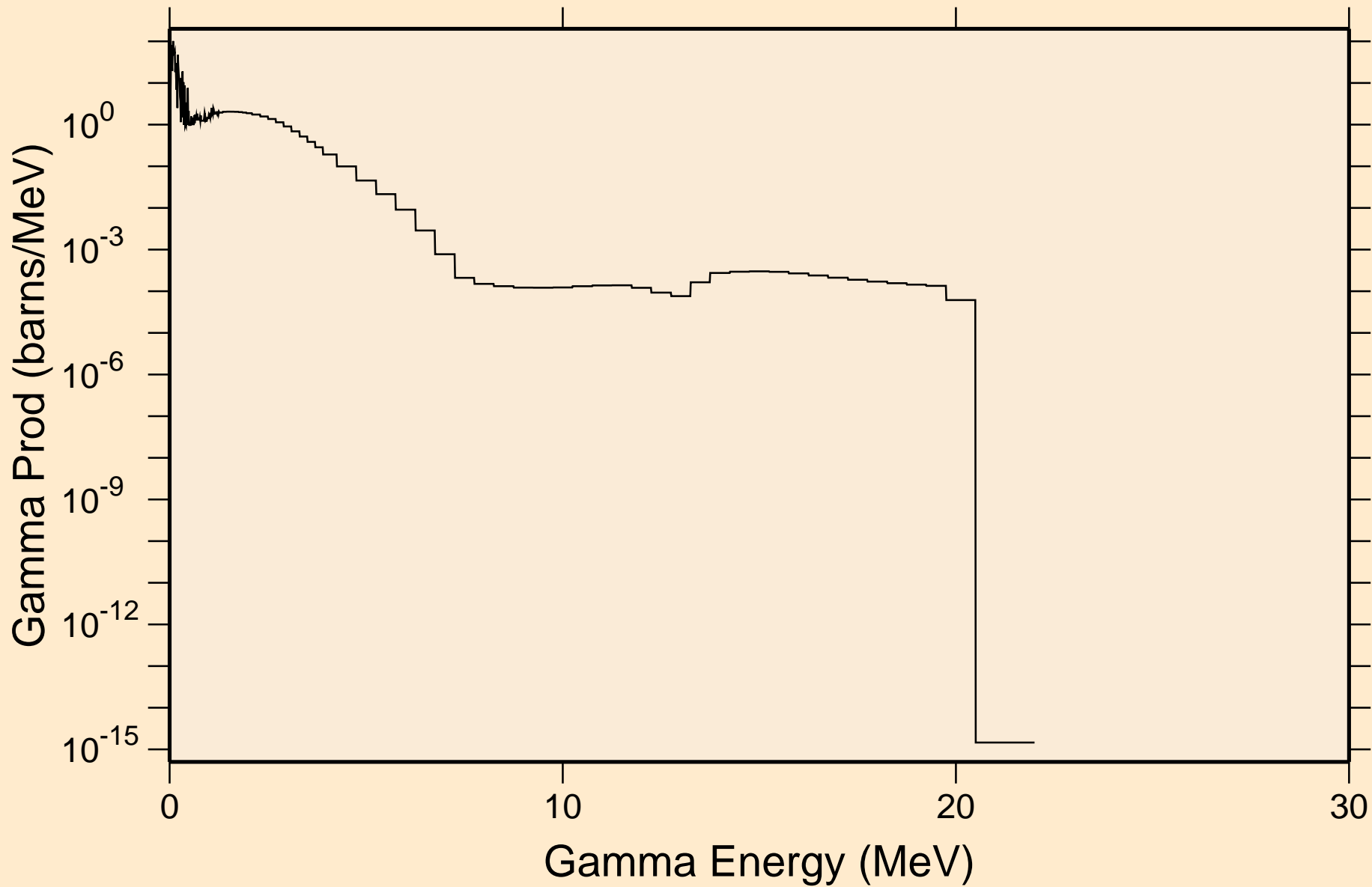

W183 NEUTRON ACER TENDL-2023 LIBRARY; T=0.K

Particle heating contributions

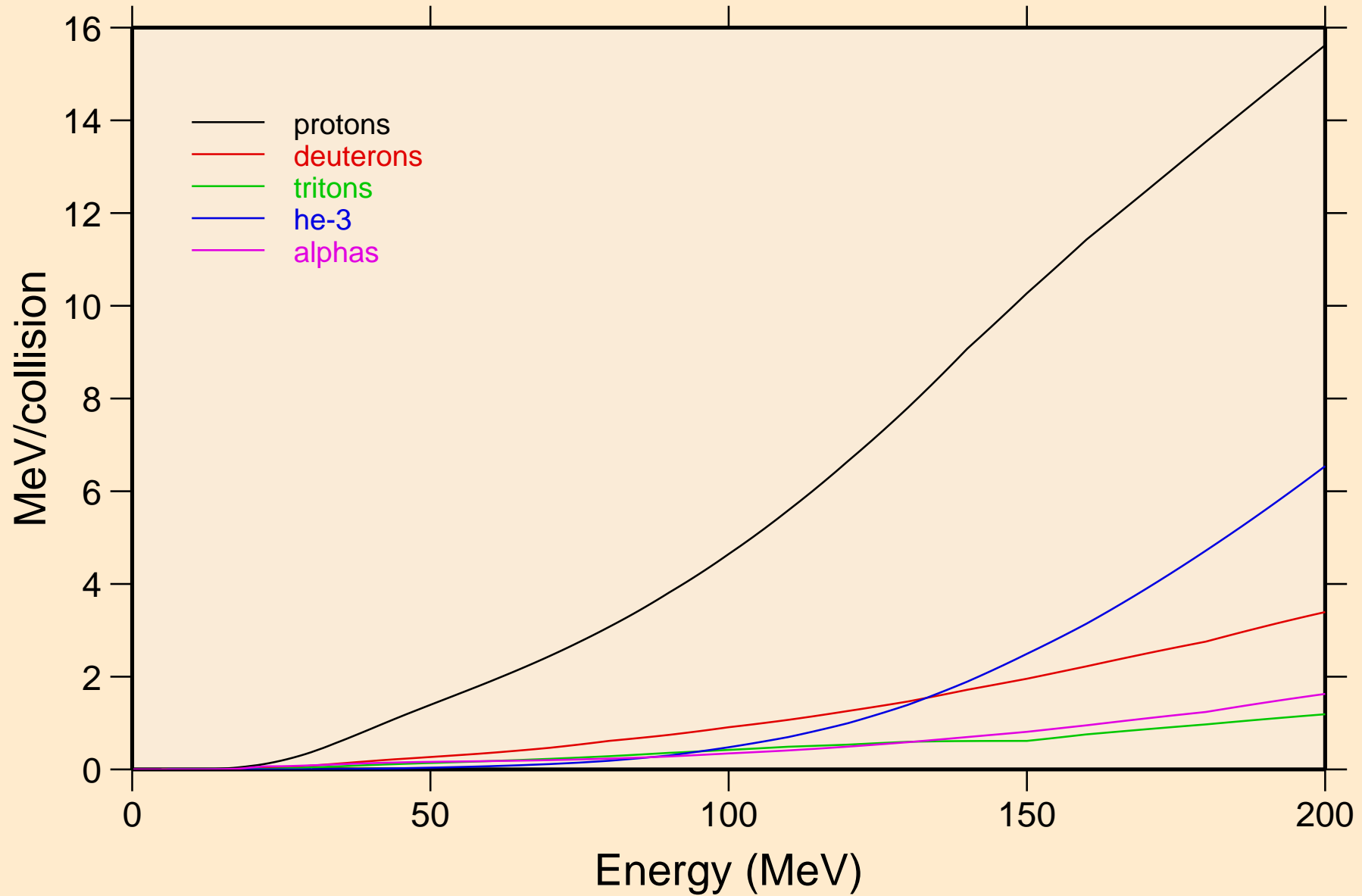

W183 NEUTRON ACER TENDL-2023 LIBRARY; T=0.K
Recoil Heating

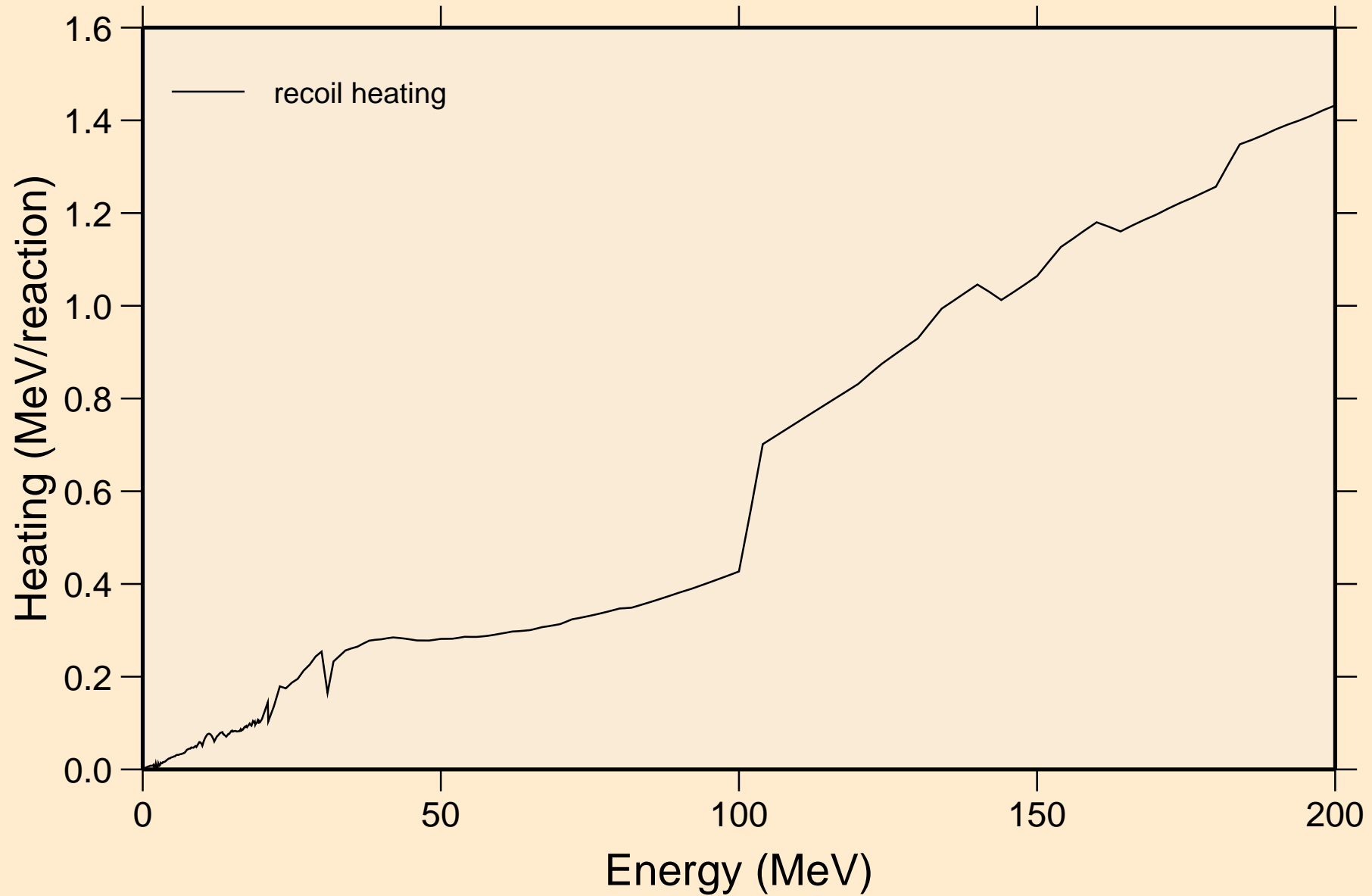

W183 NEUTRON ACER TENDL-2023 LIBRARY; T=0.K
Particle production cross sections

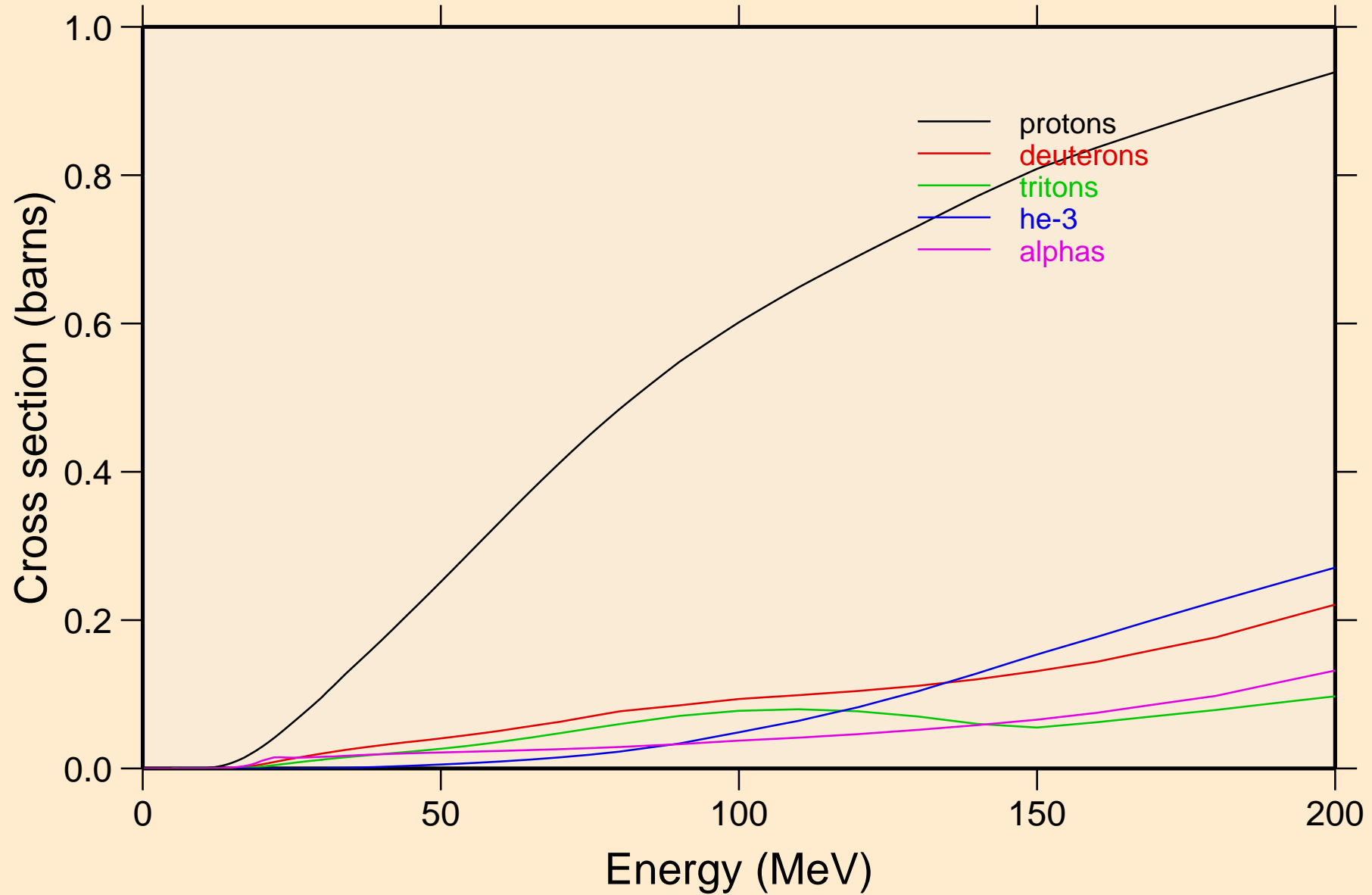

W183 NEUTRON ACER TENDL-2023 LIBRARY; T=0.K
protons from (n,x)

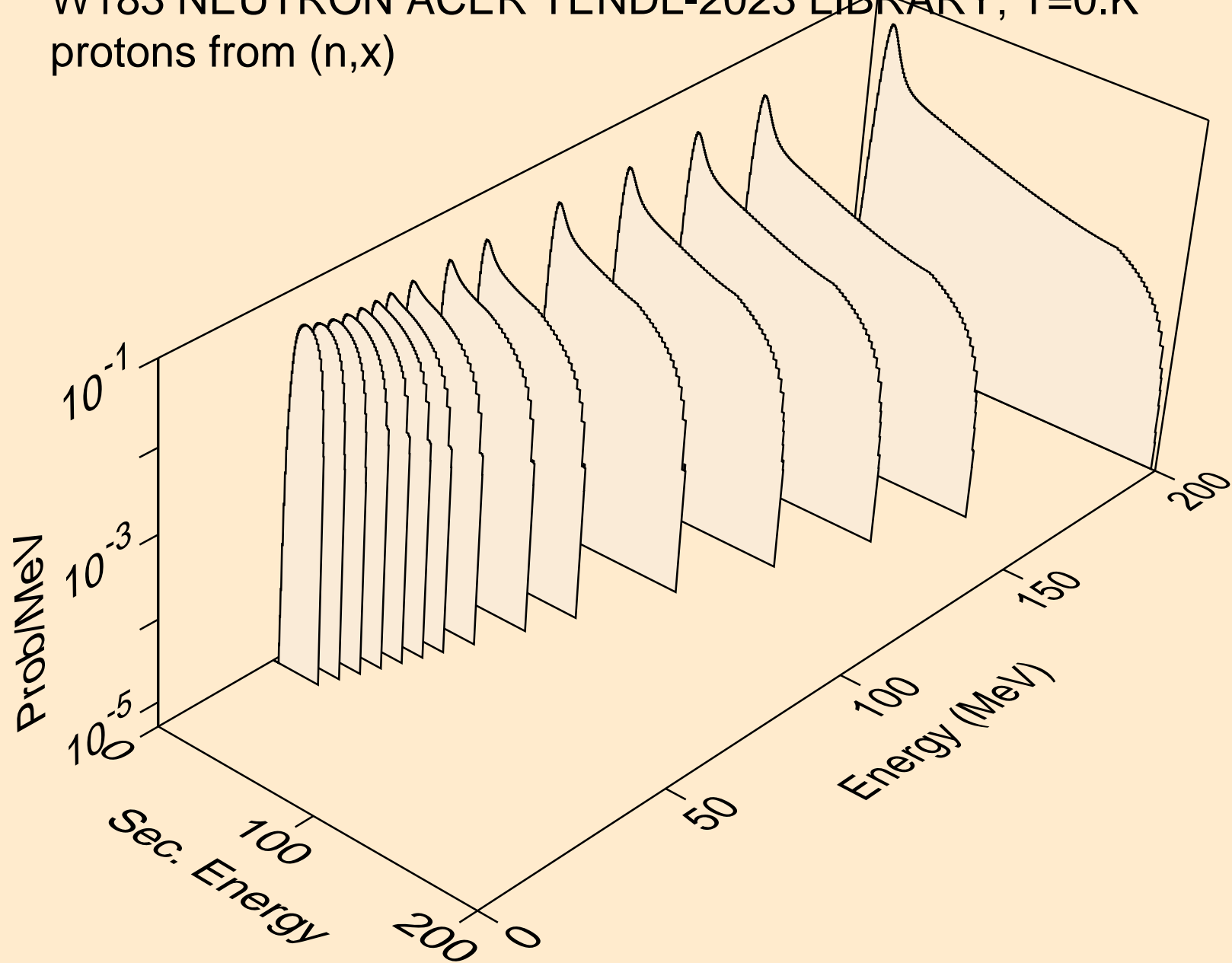

W183 NEUTRON ACER TENDL-2023 LIBRARY; T=0.K
protons from (n,n*)p

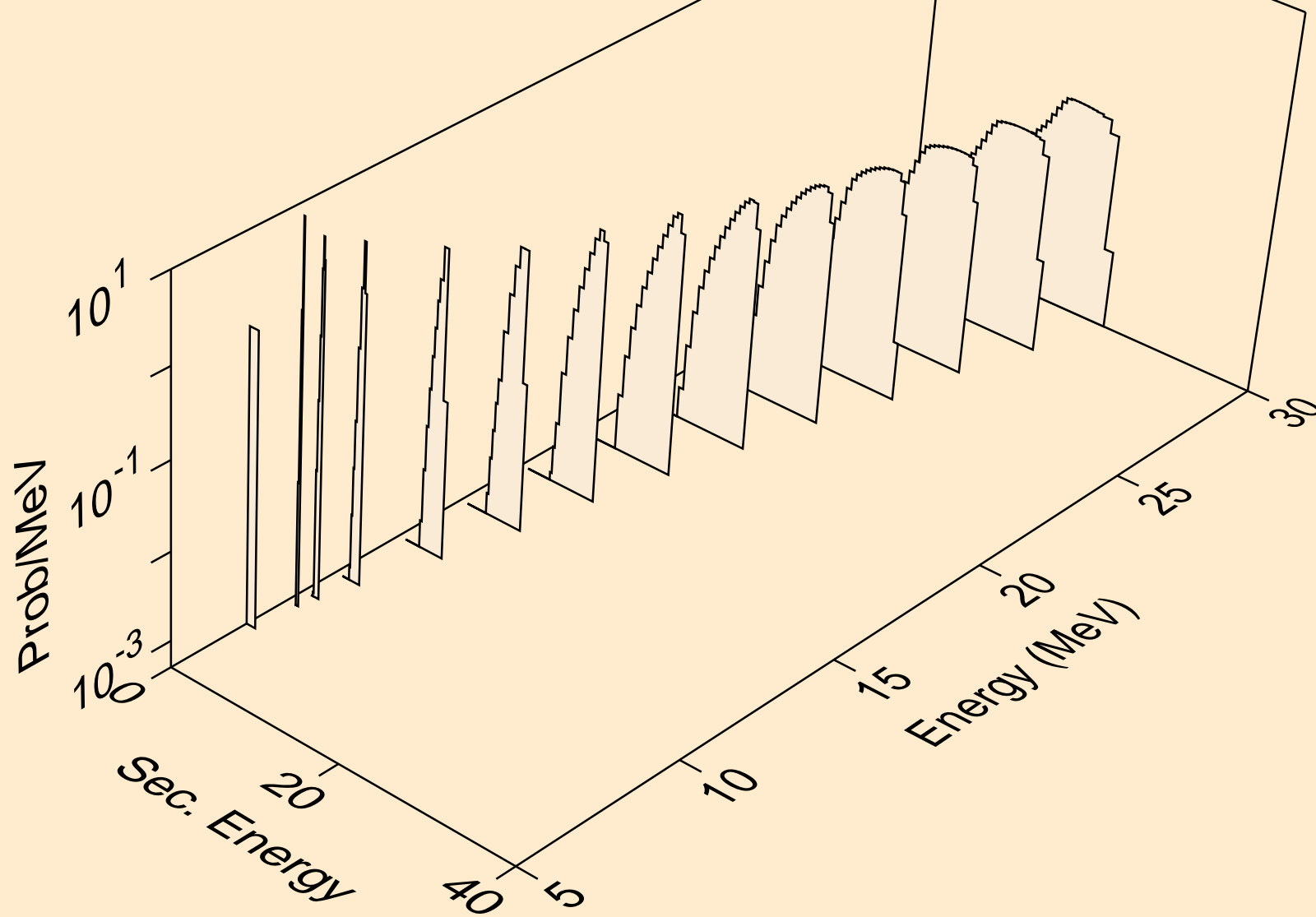

W183 NEUTRON ACER TENDL-2023 LIBRARY; T=0.K
protons from (n,2np)

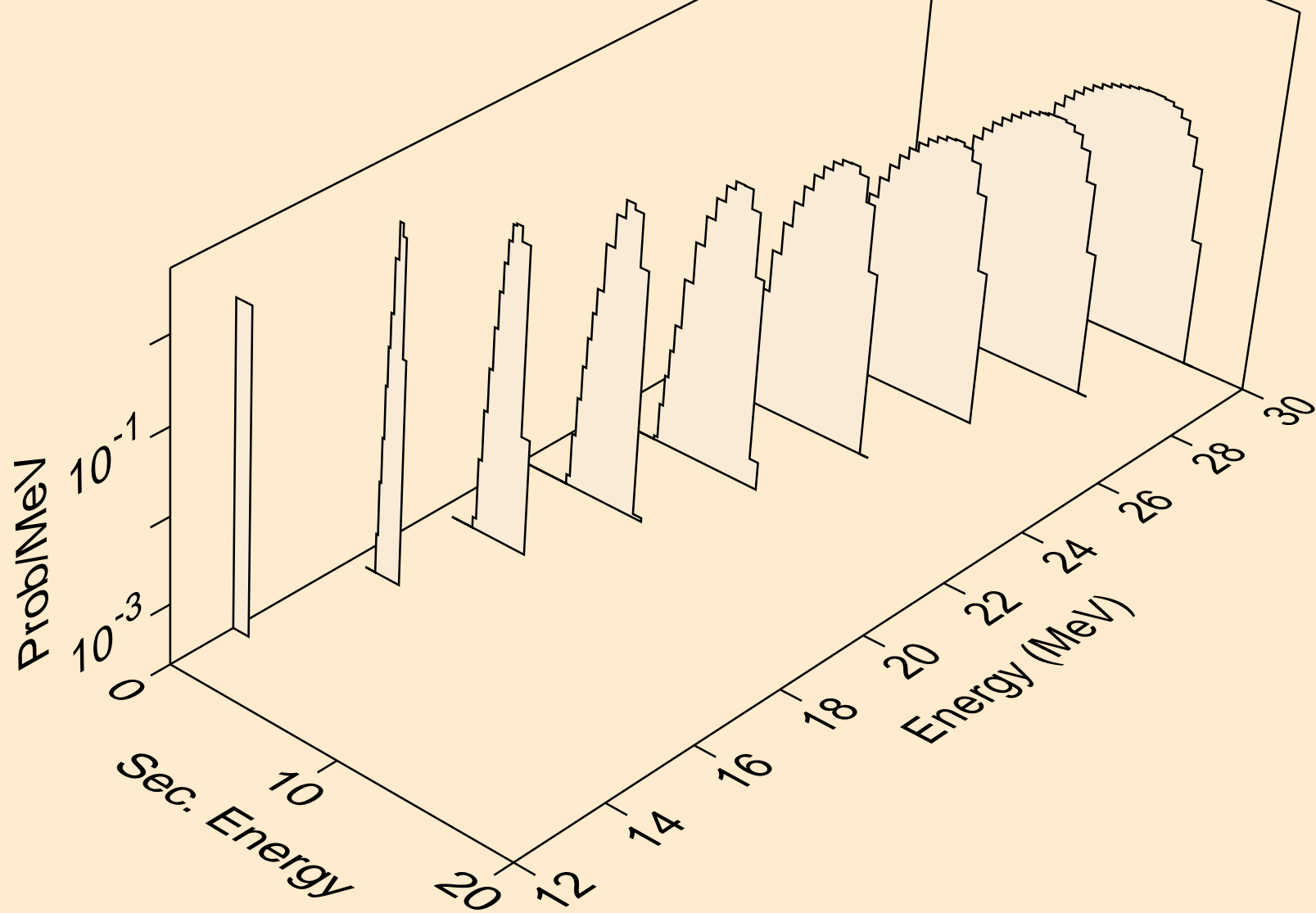

W183 NEUTRON ACER TENDL-2023 LIBRARY; T=0.K
protons from (n,3np)

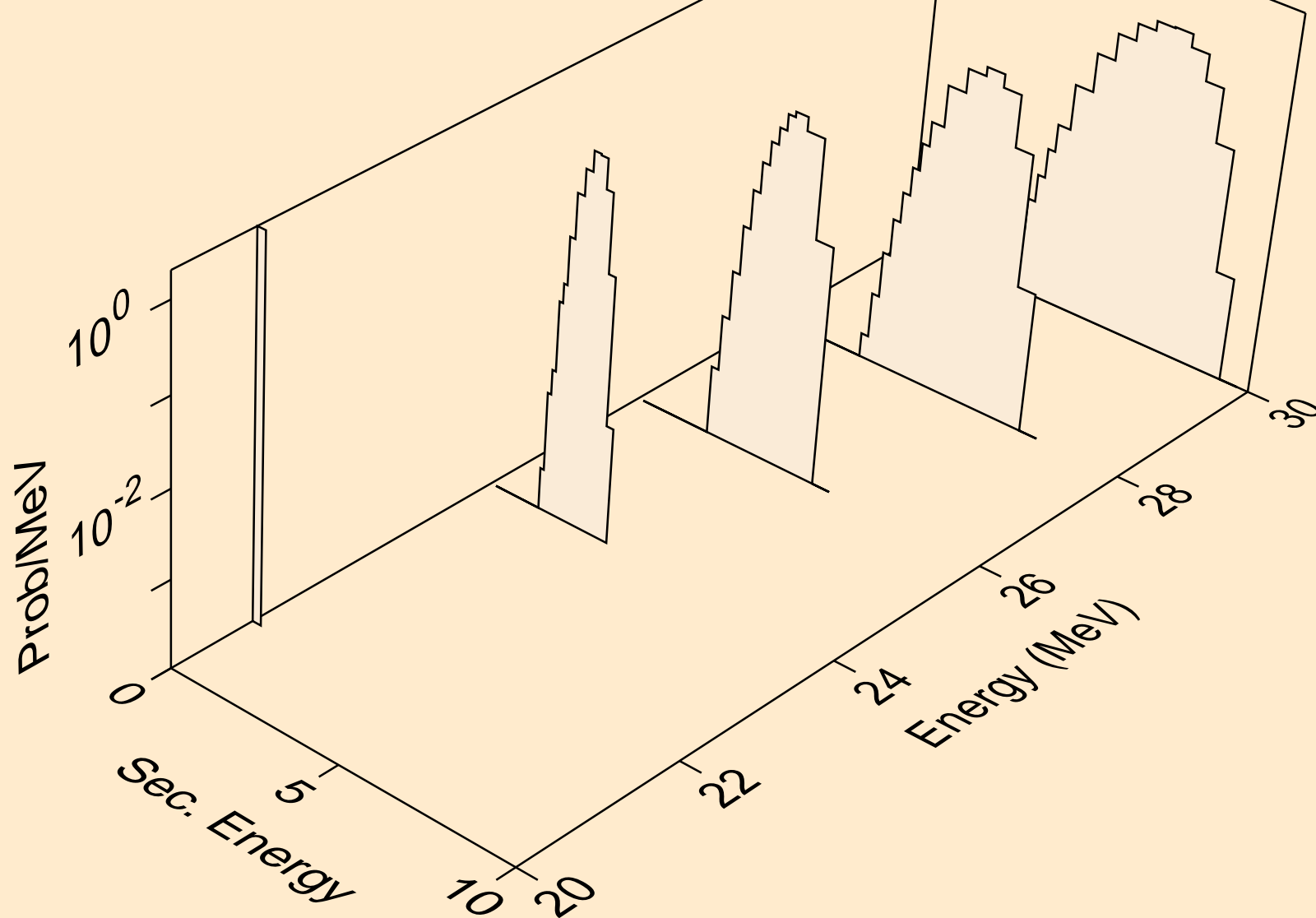

W183 NEUTRON ACER TENDL-2023 LIBRARY; T=0.K
protons from (n,n2p)

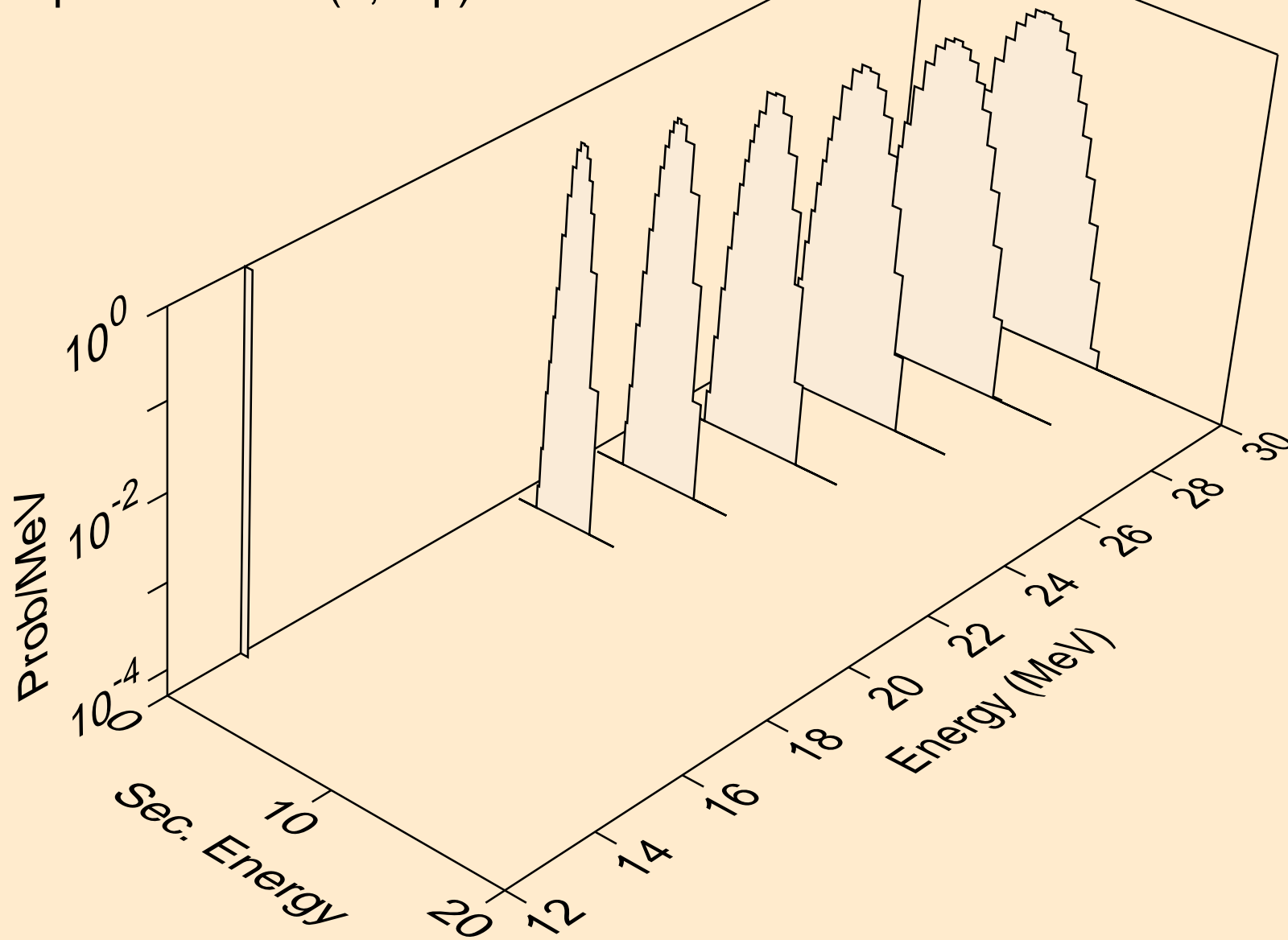

W183 NEUTRON ACER TENDL-2023 LIBRARY; T=0.K
protons from (n,npa)

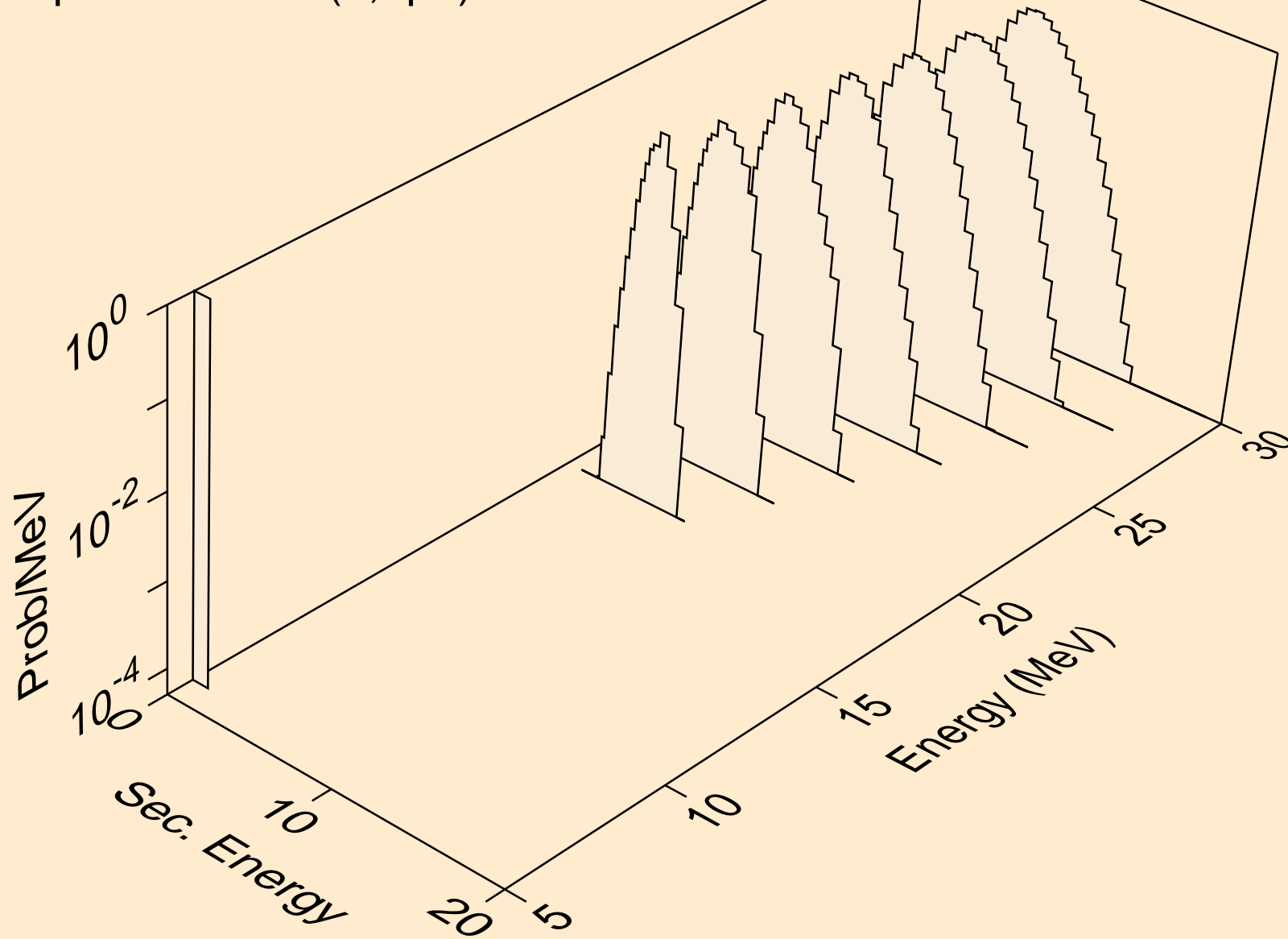

W183 NEUTRON ACER TENDL-2023 LIBRARY; T=0.K
protons from (n,p)

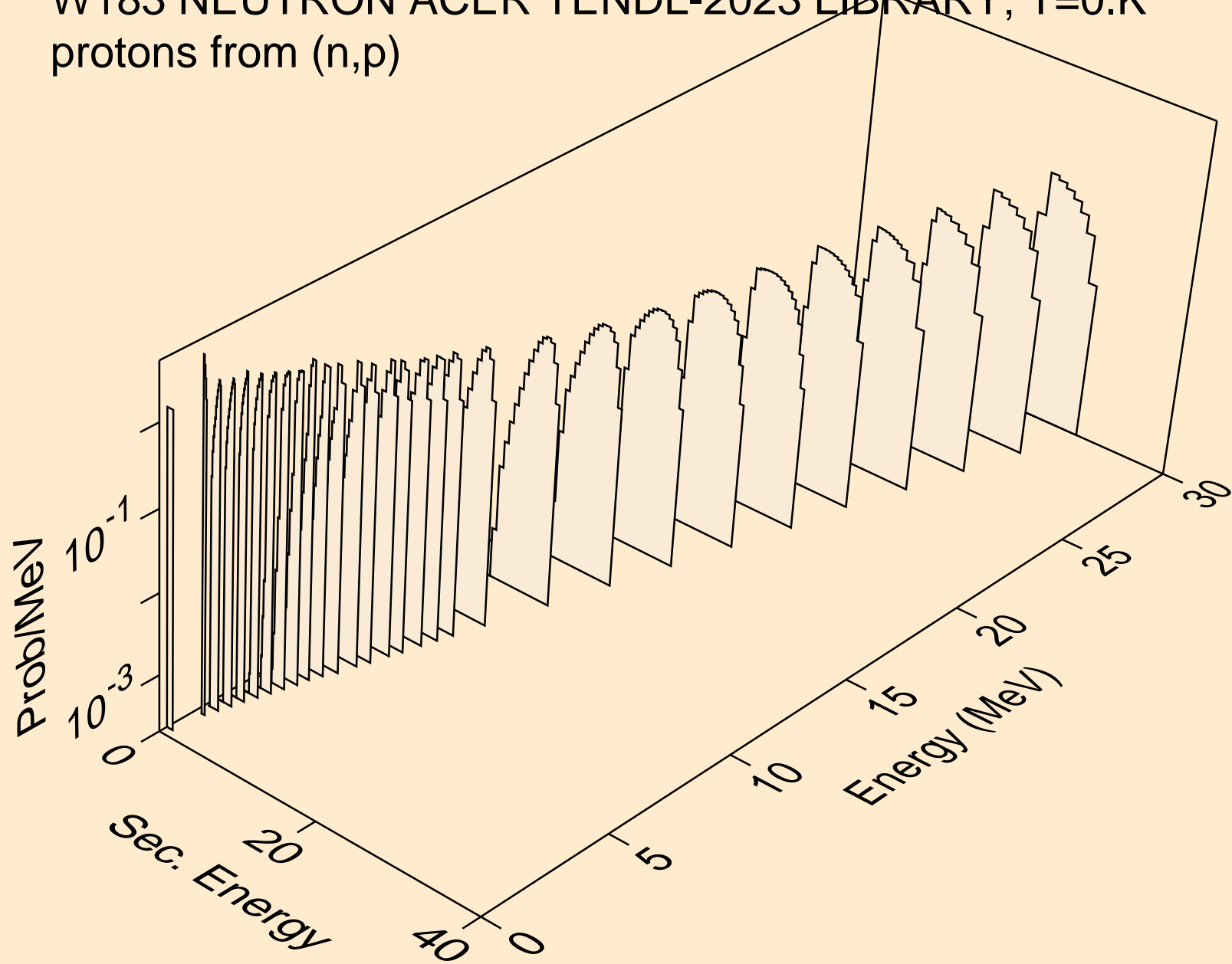

W183 NEUTRON ACER TENDL-2023 LIBRARY; T=0.K
protons from (n,2p)

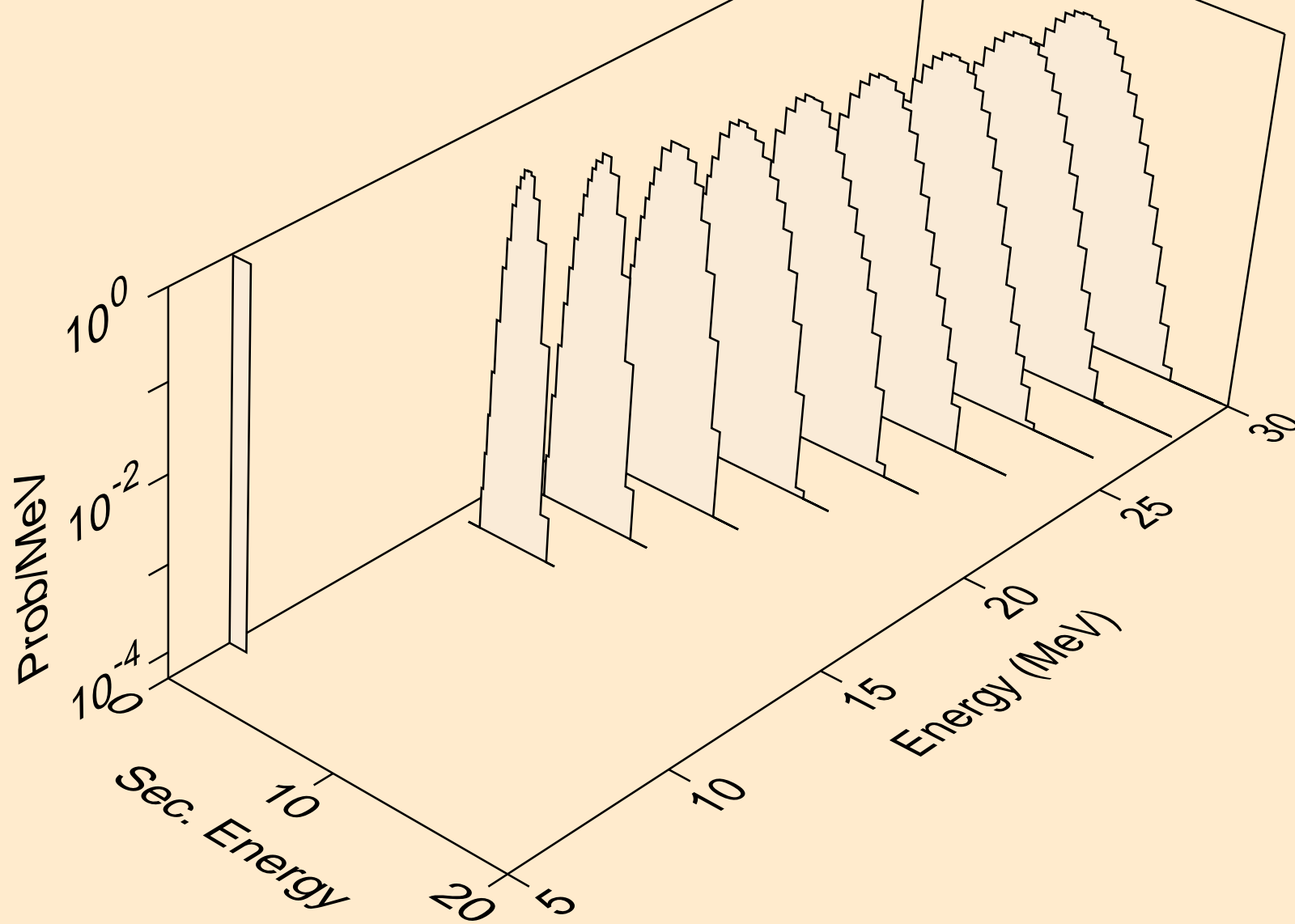

W183 NEUTRON ACER TENDL-2023 LIBRARY; T=0.K
protons from (n,p)

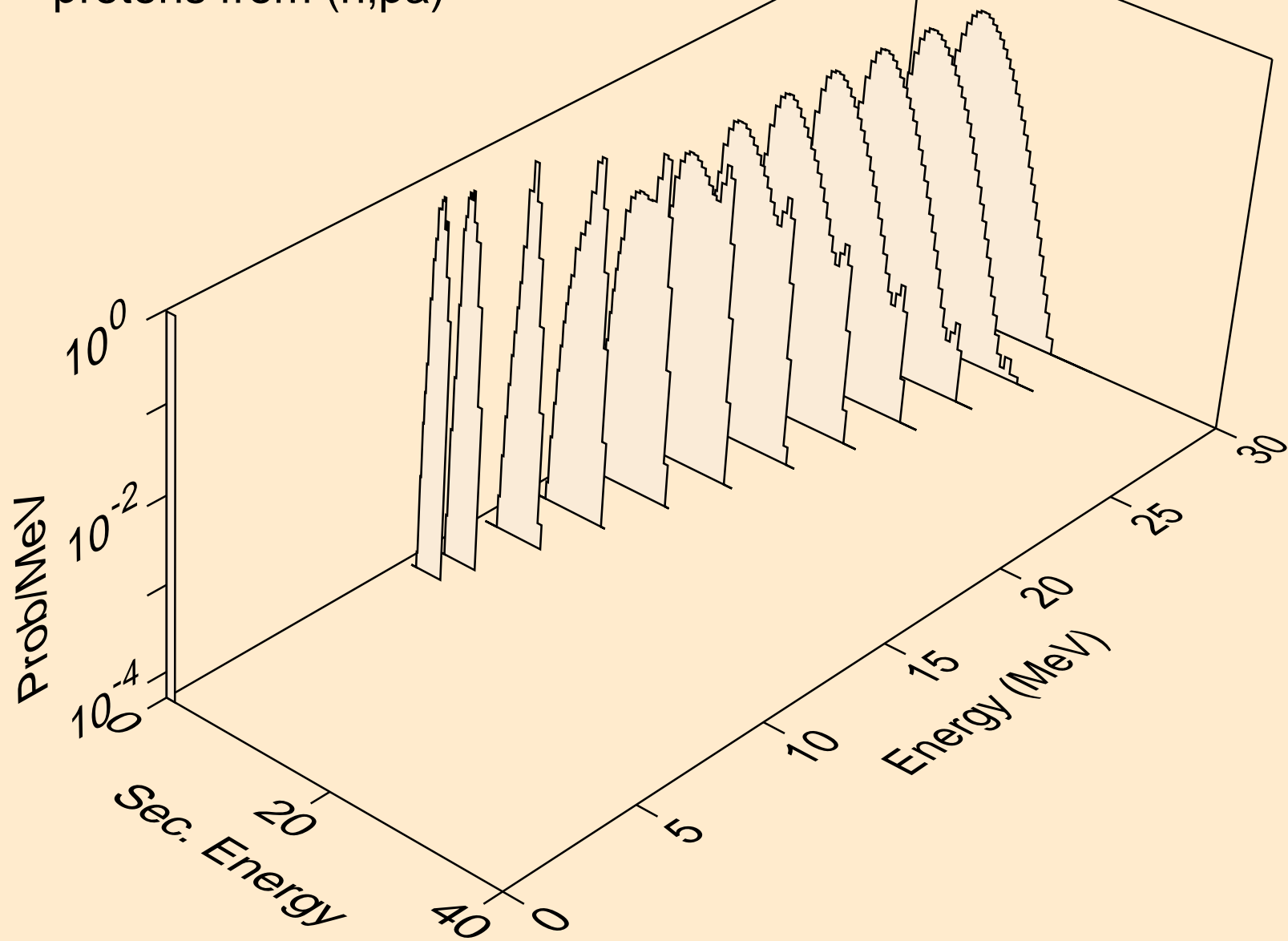

W183 NEUTRON ACER TENDL-2023 LIBRARY; T=0.K
protons from (n,pd)

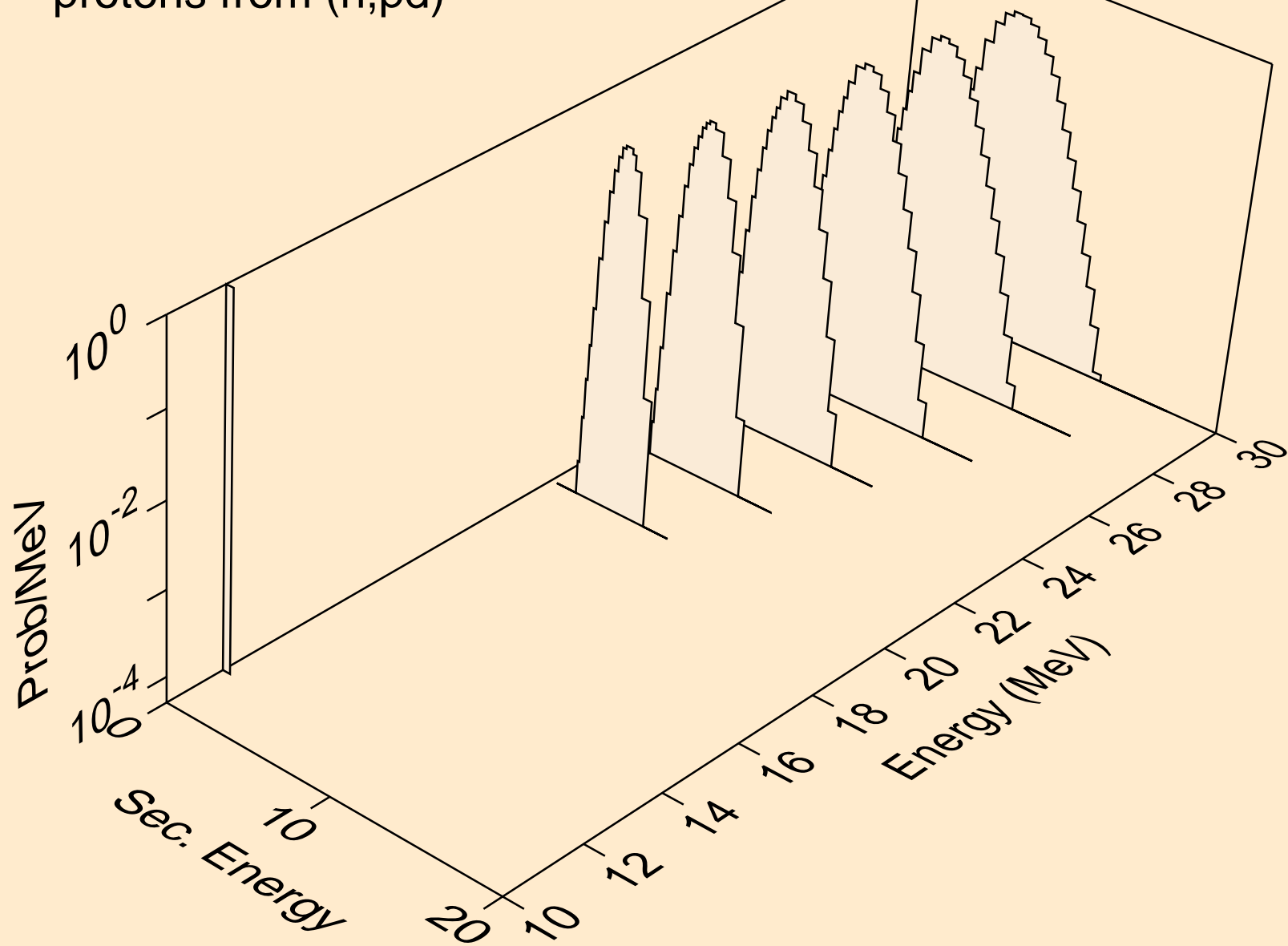

W183 NEUTRON ACER TENDL-2023 LIBRARY; T=0.K
protons from (n,pt)

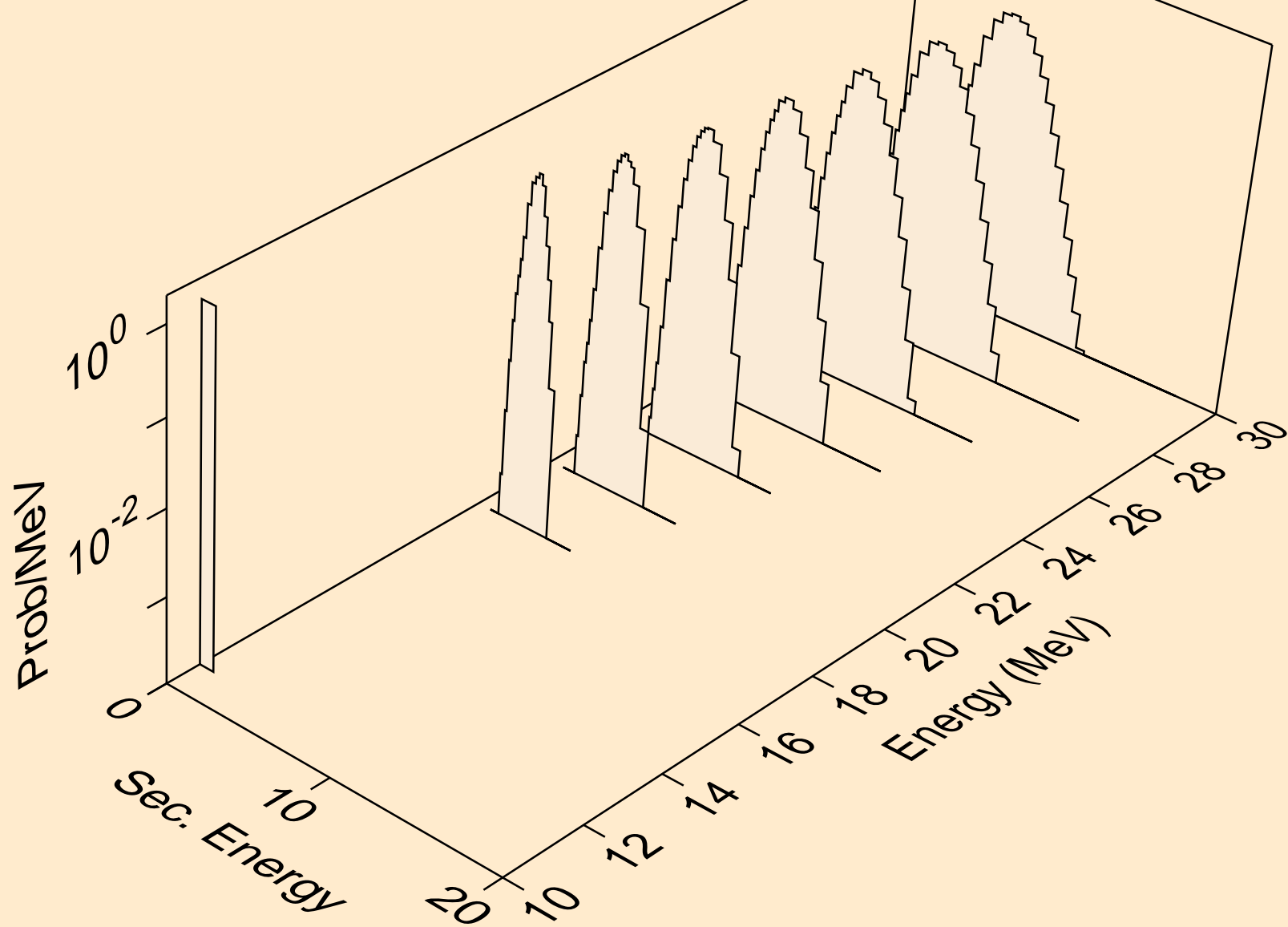

W183 NEUTRON ACER TENDL-2023 LIBRARY; T=0.K
deuterons from (n,x)

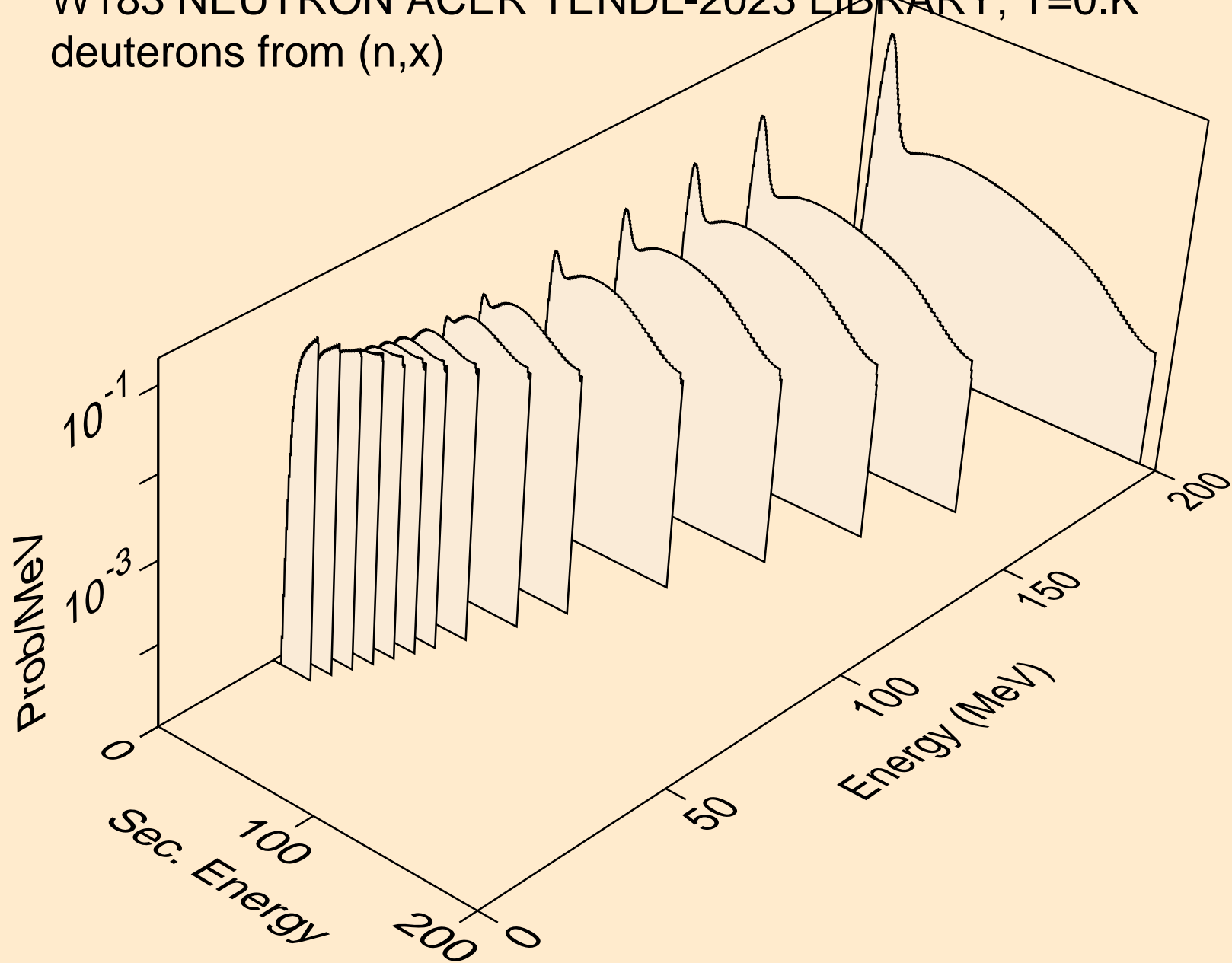

W183 NEUTRON ACER TENDL-2023 LIBRARY; T=0.K
deuterons from (n,2nd)

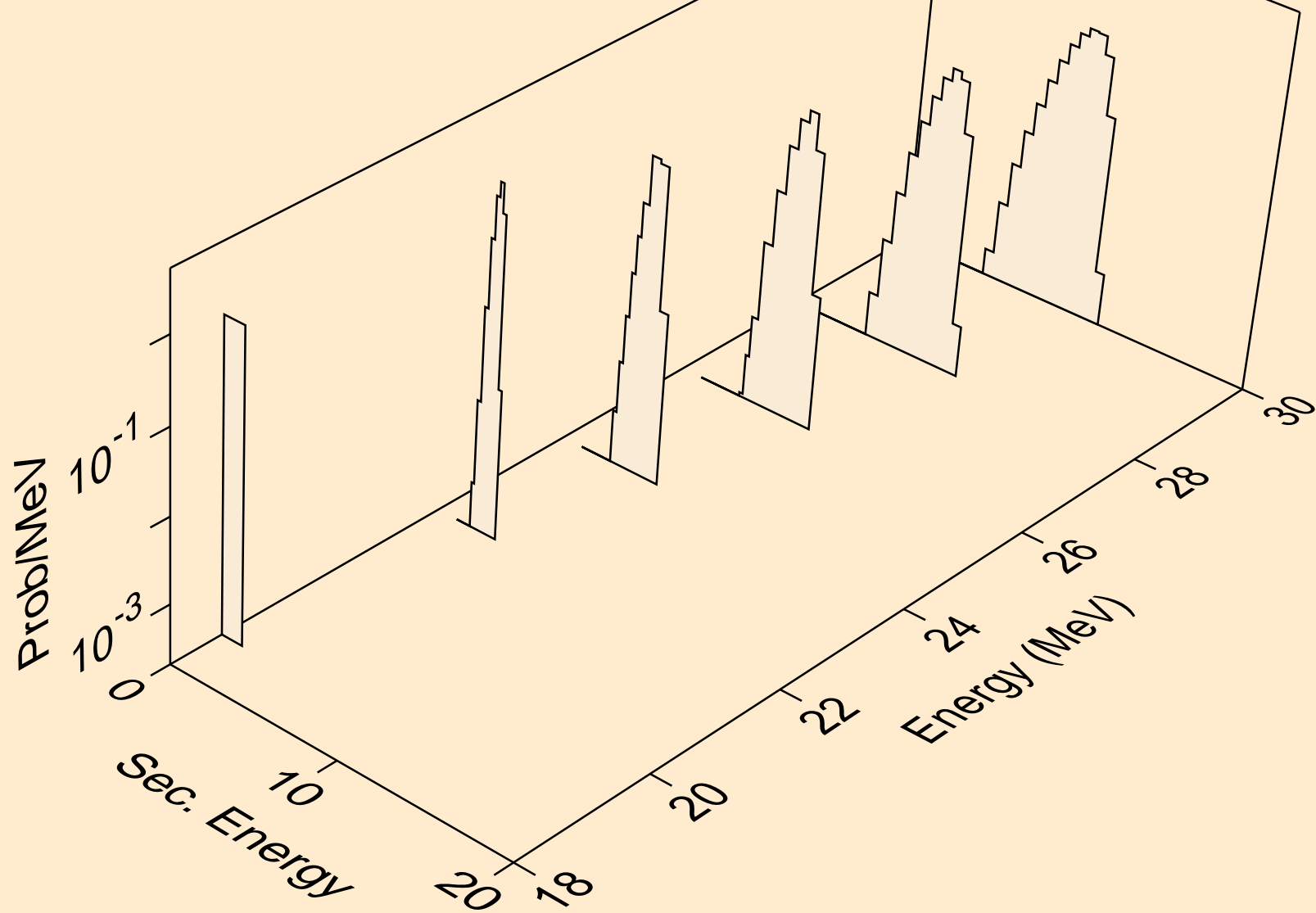

W183 NEUTRON ACER TENDL-2023 LIBRARY; T=0.K
deuterons from (n,n*)d

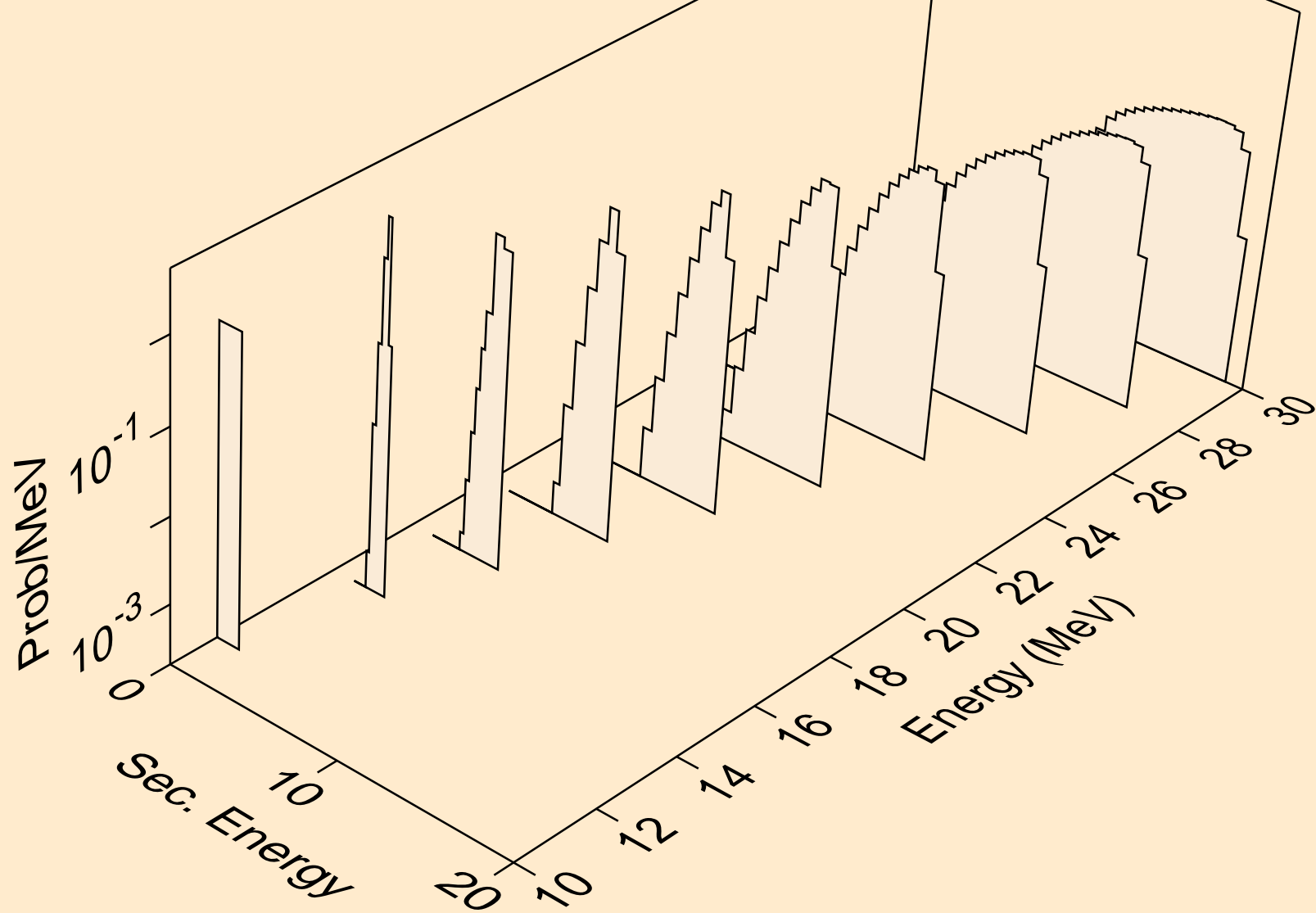

W183 NEUTRON ACER TENDL-2023 LIBRARY; T=0.K
deuterons from (n,d)

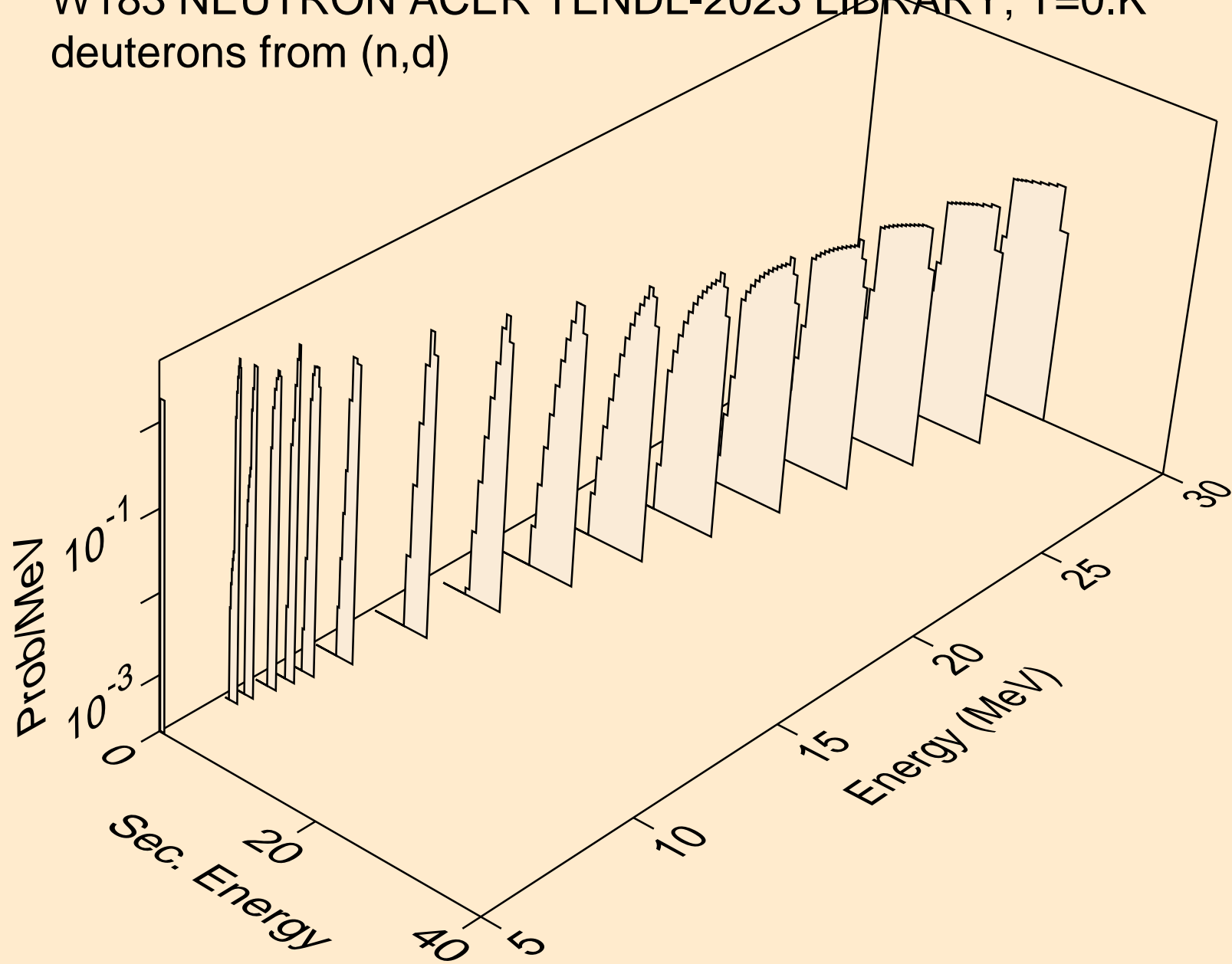

W183 NEUTRON ACER TENDL-2023 LIBRARY; T=0.K
deuterons from (n,pd)

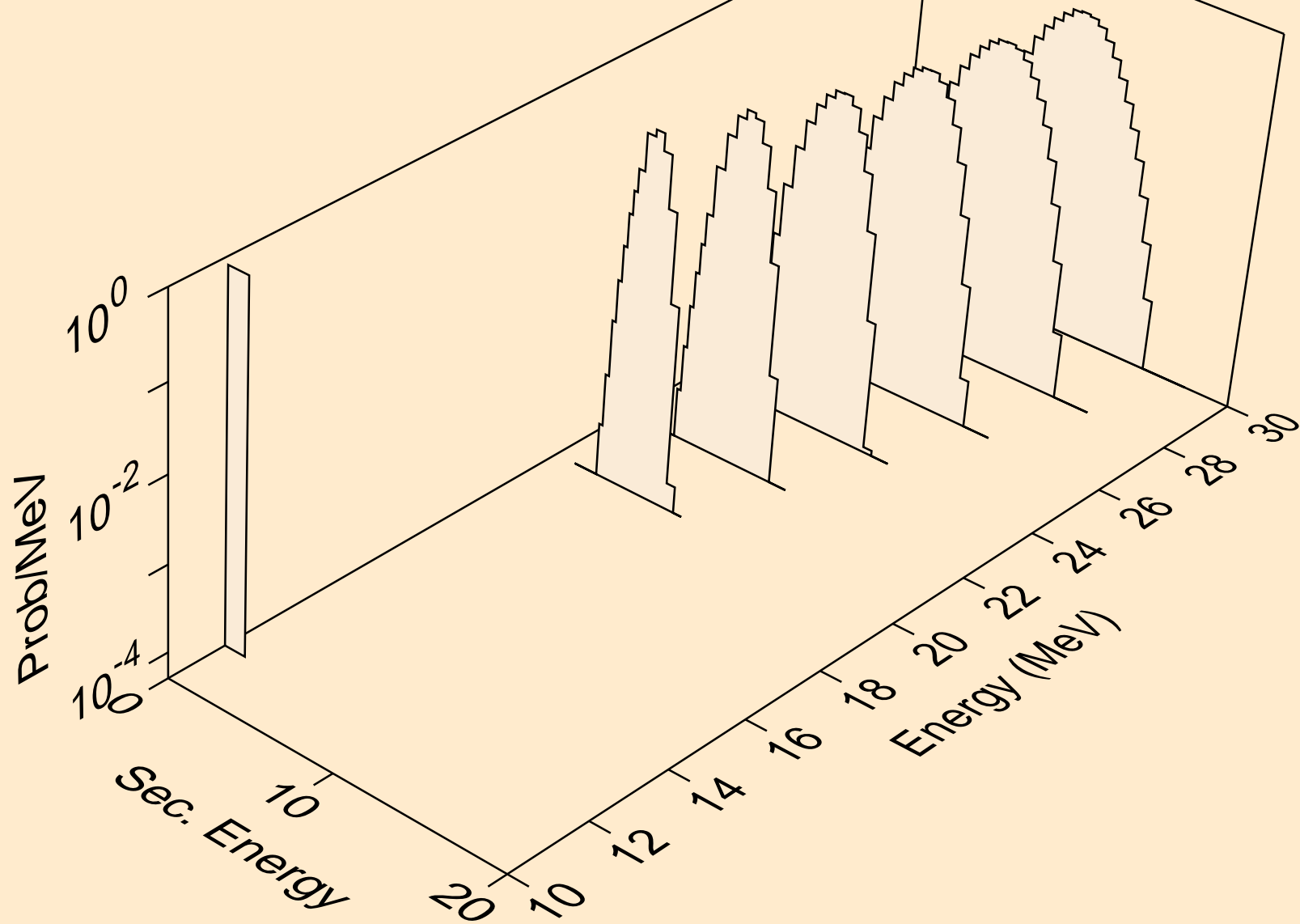

W183 NEUTRON ACER TENDL-2023 LIBRARY; T=0.K
tritons from (n,x)

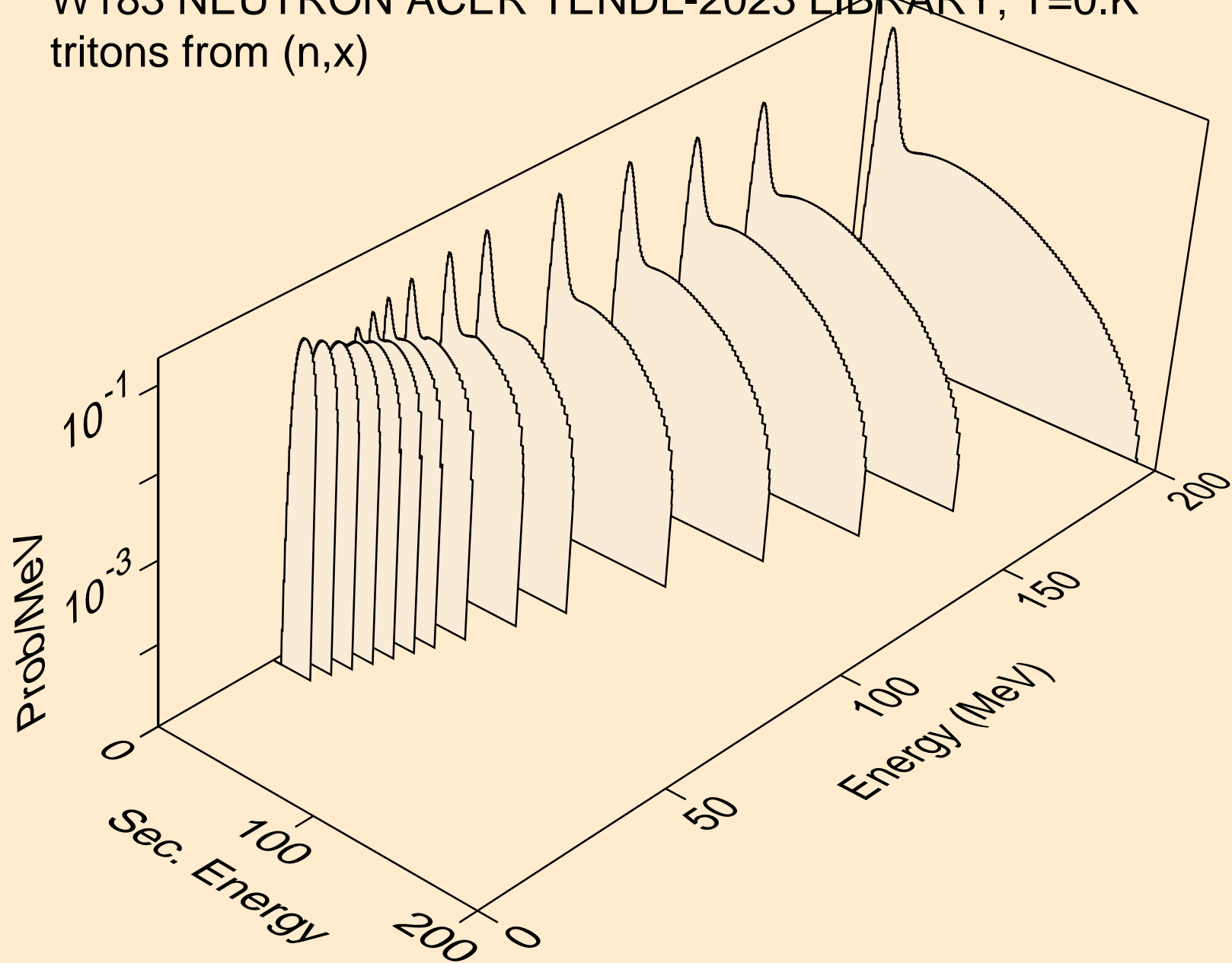

W183 NEUTRON ACER TENDL-2023 LIBRARY; T=0.K
tritons from (n,n*)t

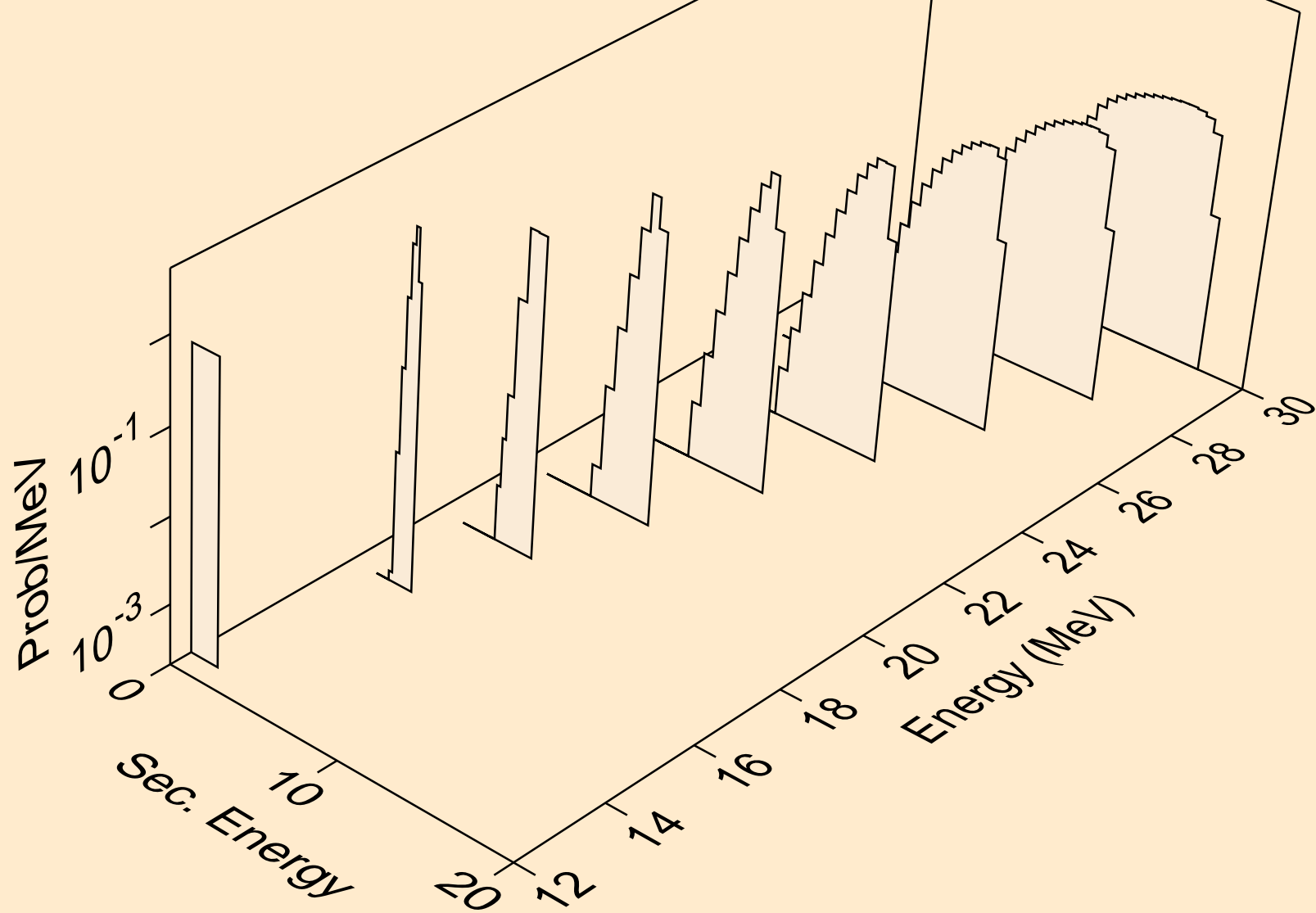

W183 NEUTRON ACER TENDL-2023 LIBRARY; T=0.K
tritons from (n,t)

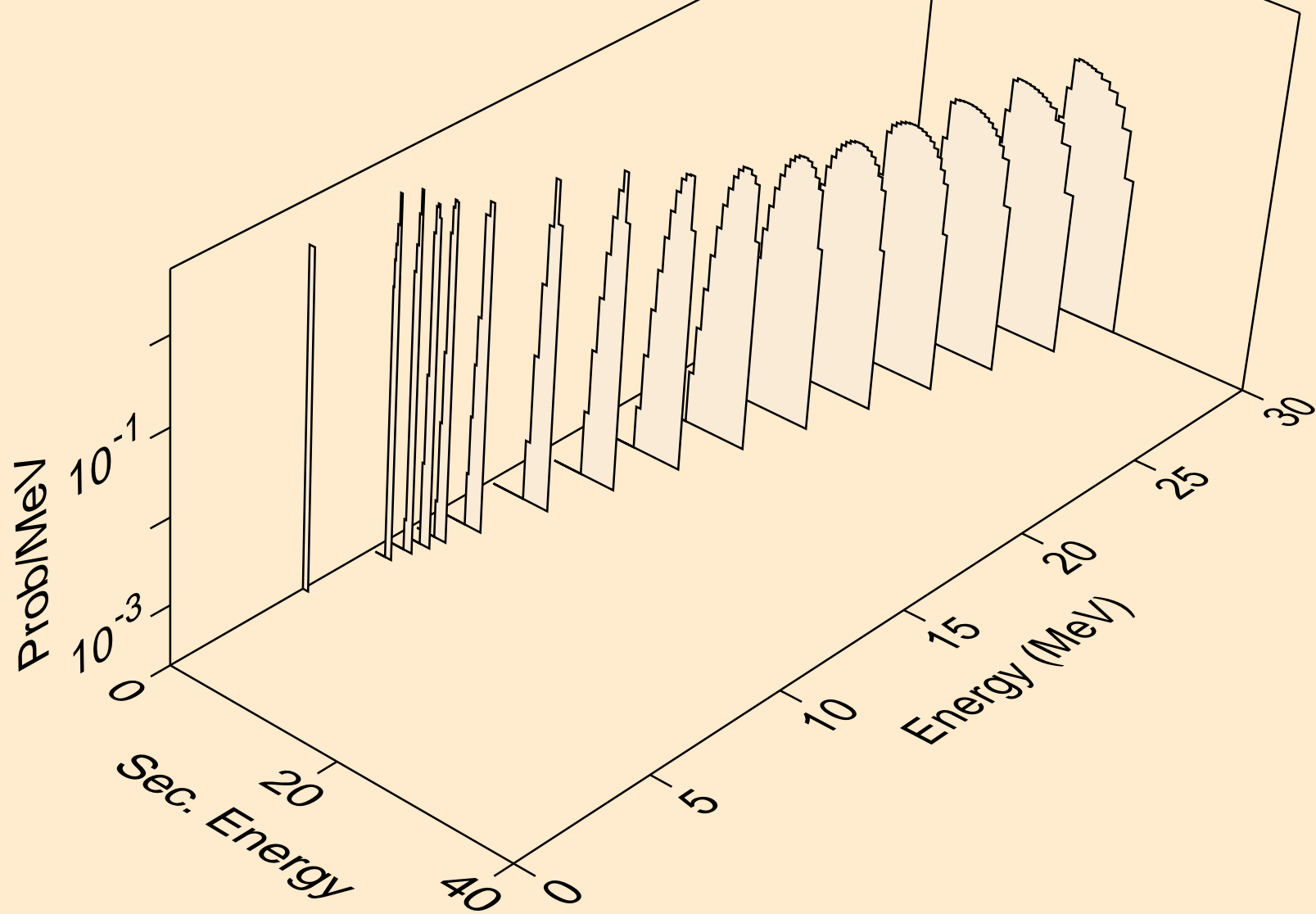

W183 NEUTRON ACER TENDL-2023 LIBRARY; T=0.K
tritons from (n,pt)

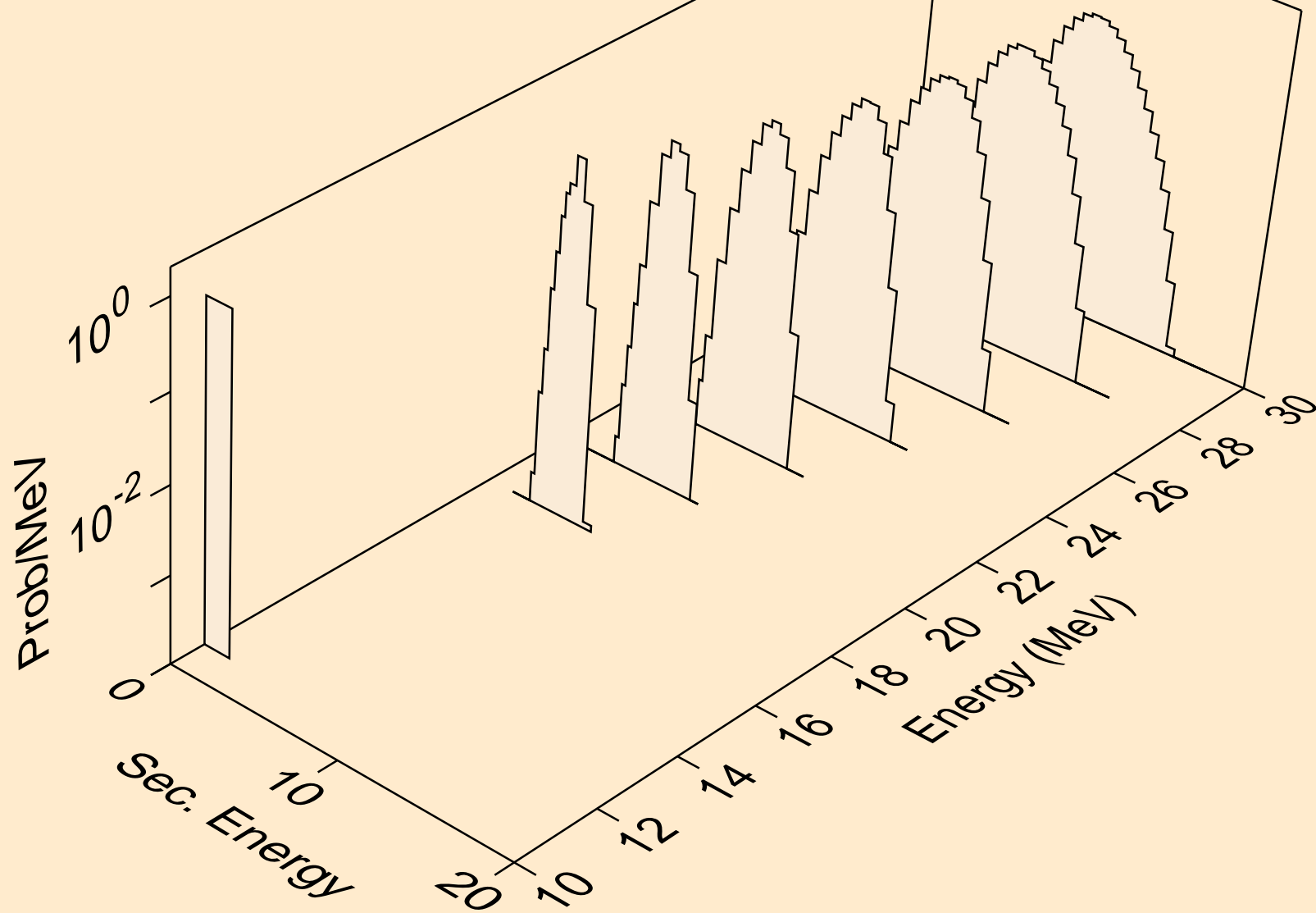

W183 NEUTRON ACER TENDL-2023 LIBRARY; T=0.K
he3s from (n,x)

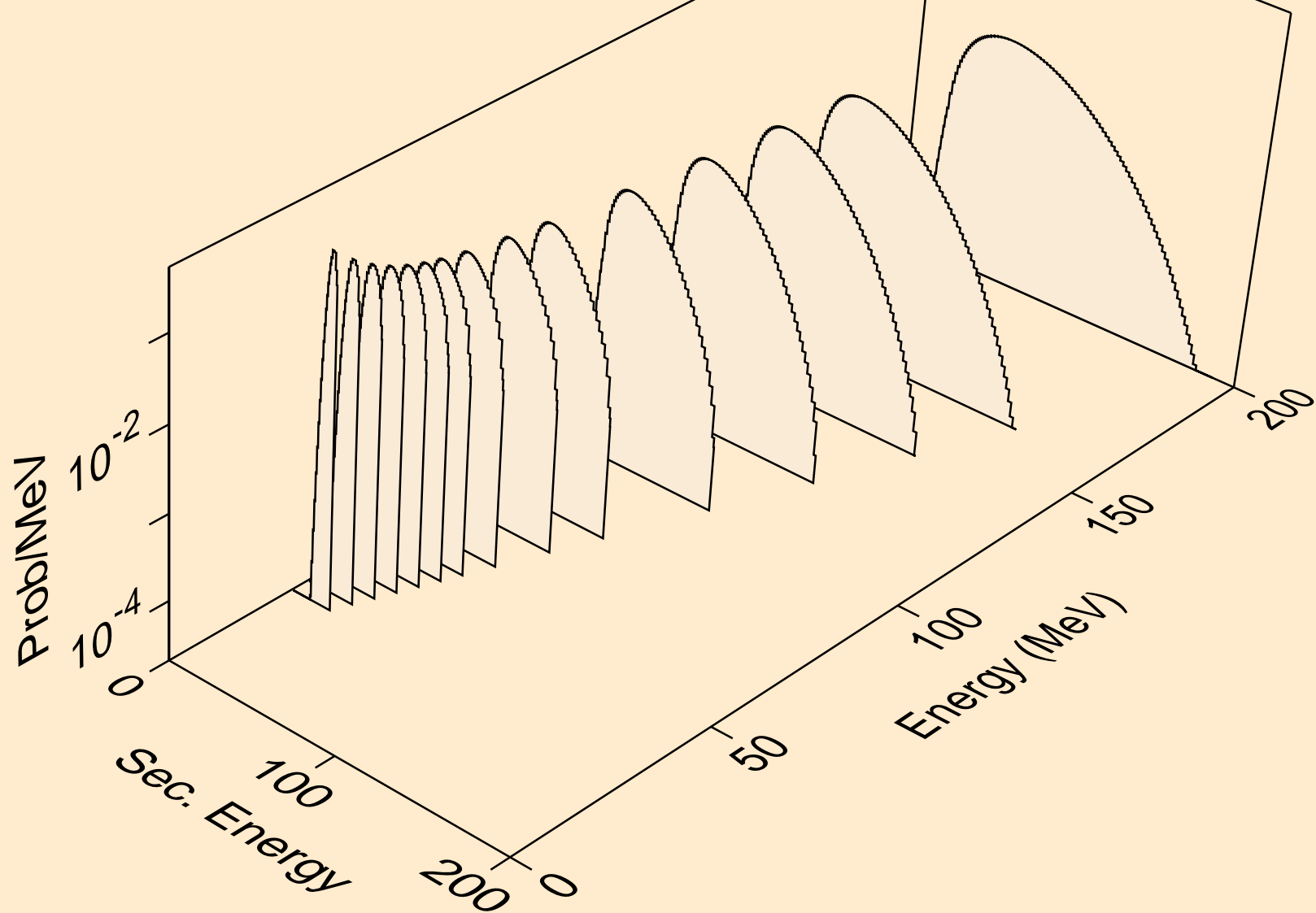

W183 NEUTRON ACER TENDL-2023 LIBRARY; T=0.K
he3s from (n,n*)he3

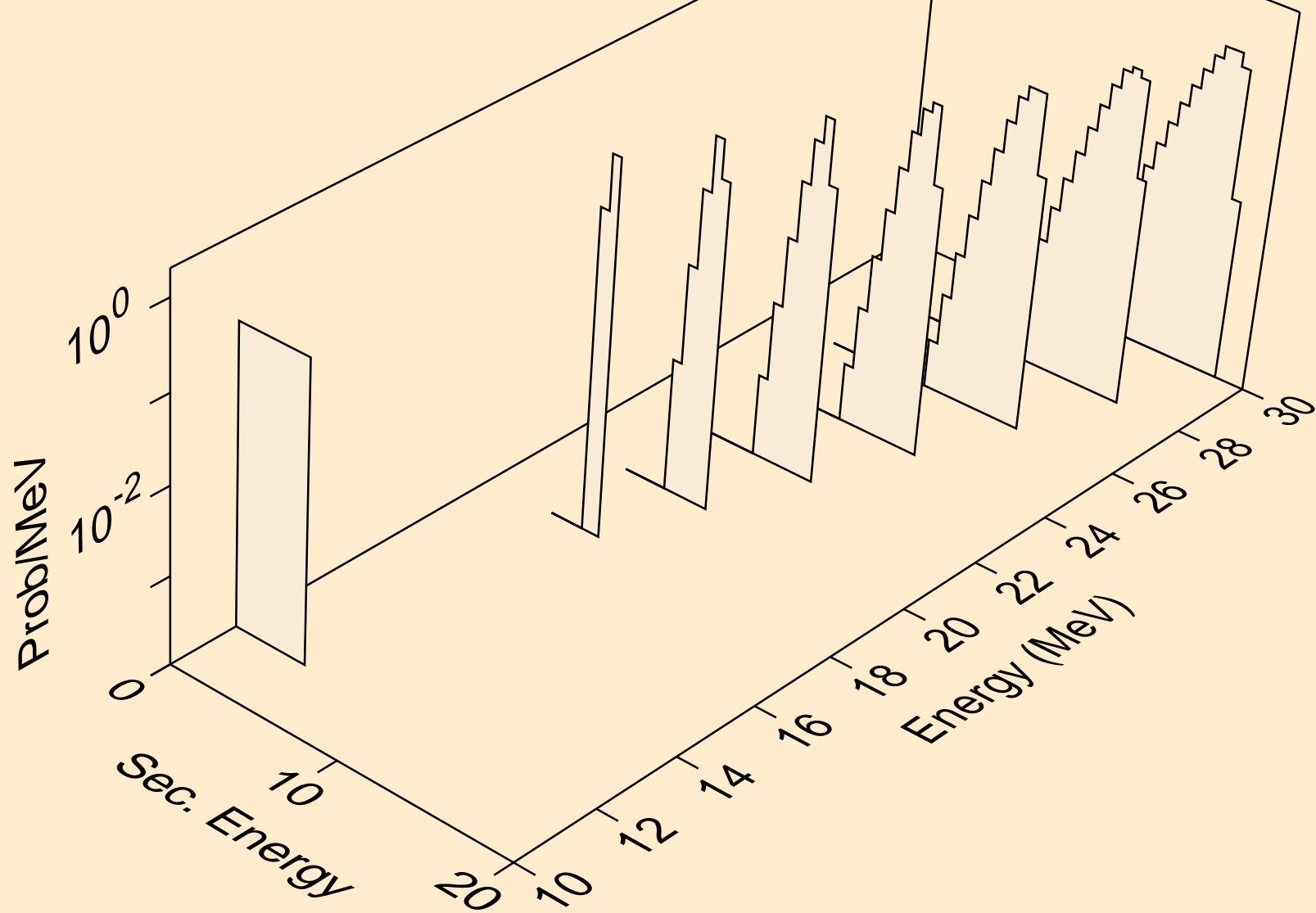

W183 NEUTRON ACER TENDL-2023 LIBRARY; T=0.K
he3s from (n,he3)

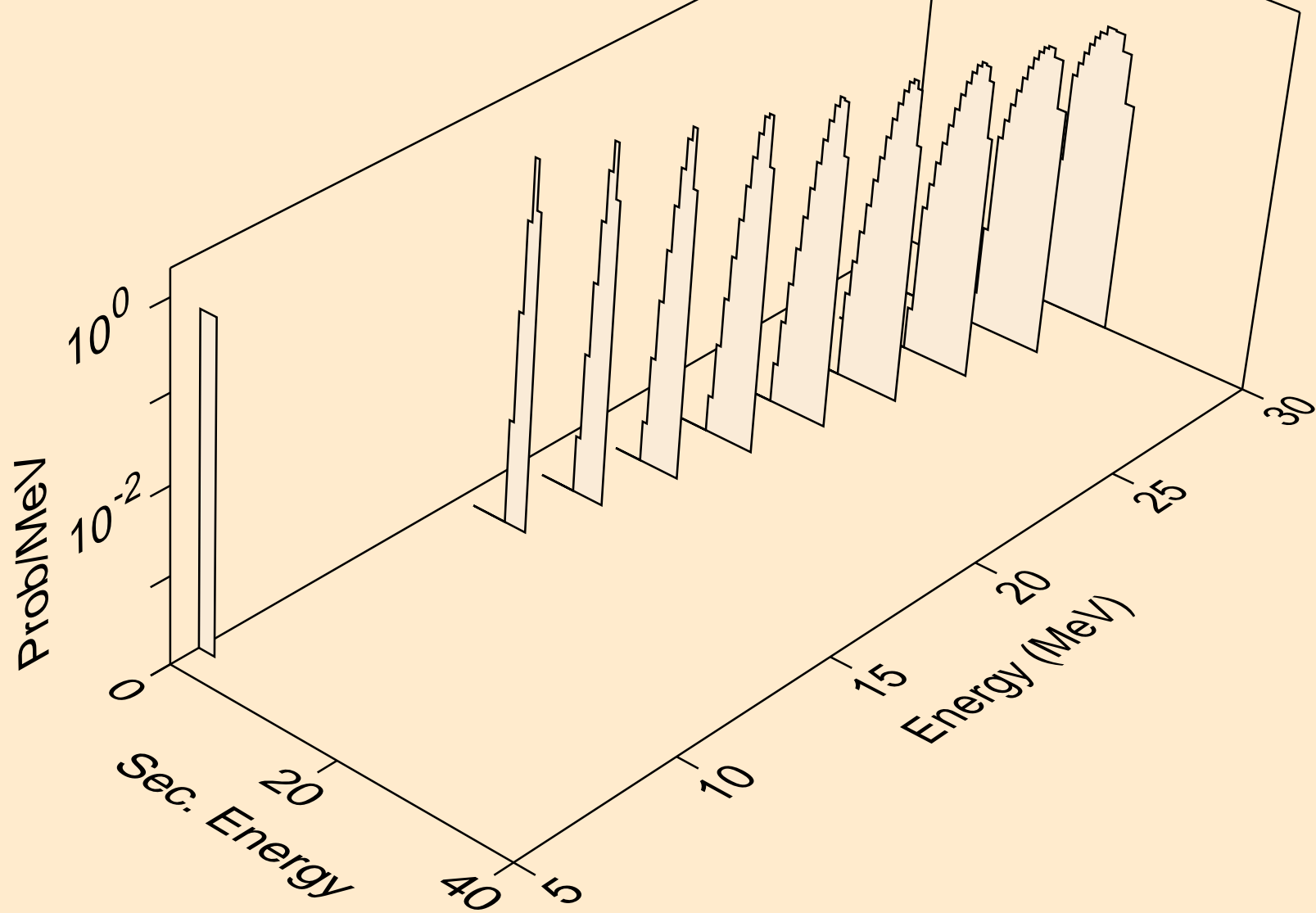

W183 NEUTRON ACER TENDL-2023 LIBRARY; T=0.K
alphas from (n,x)

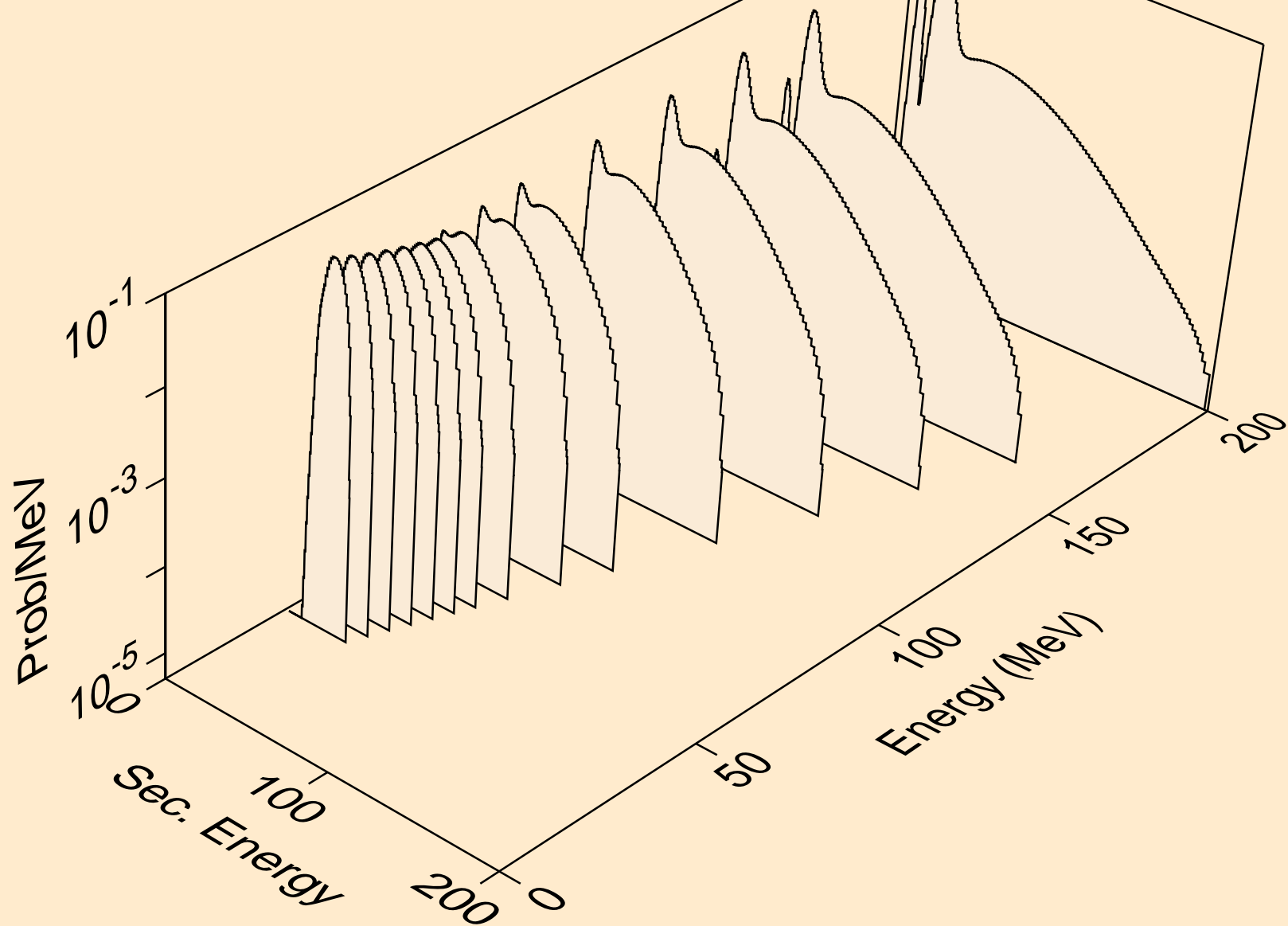

W183 NEUTRON ACER TENDL-2023 LIBRARY; T=0.K
alphas from (n,n*)a

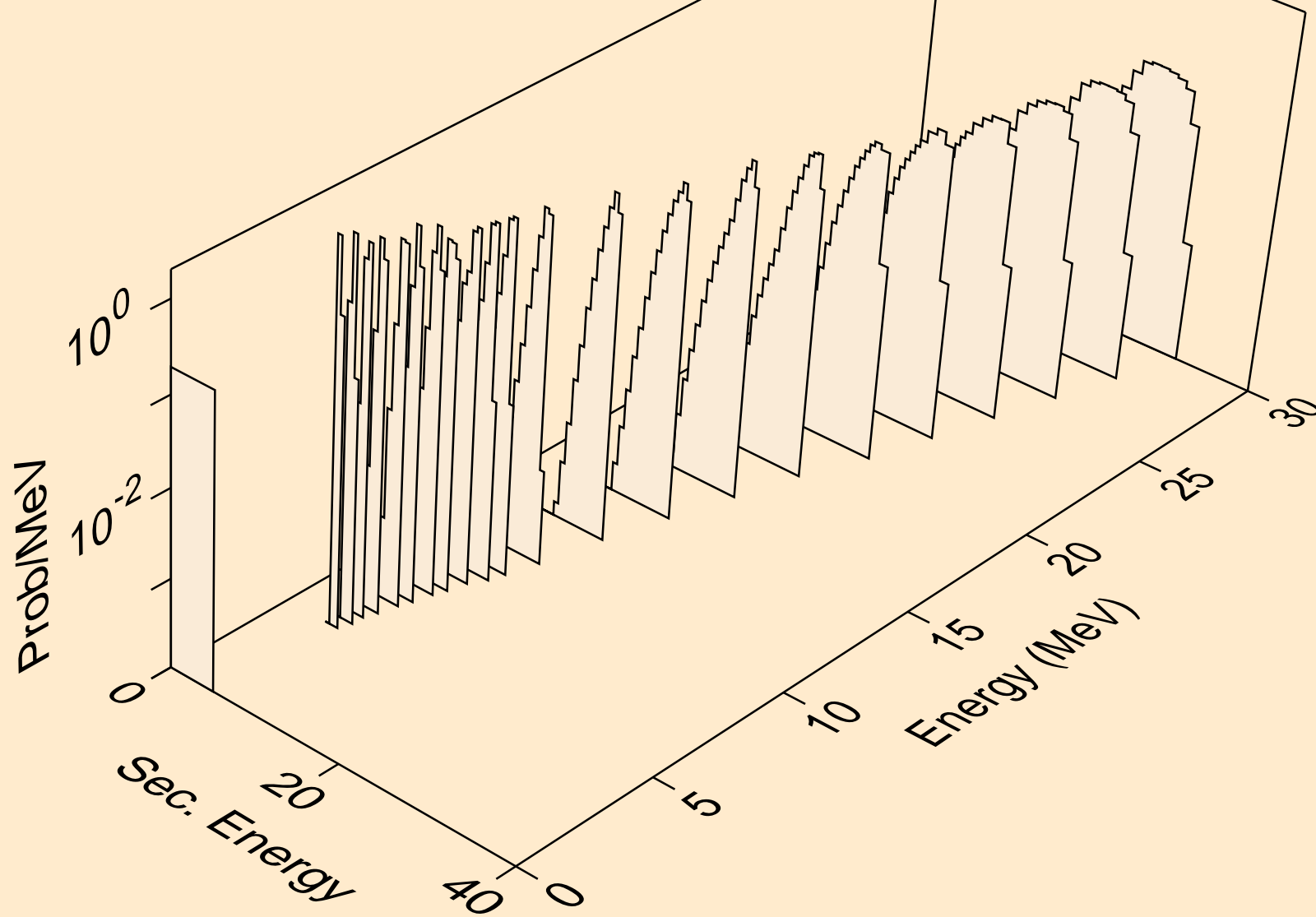

W183 NEUTRON ACER TENDL-2023 LIBRARY; T=0.K
alphas from (n,2n)a

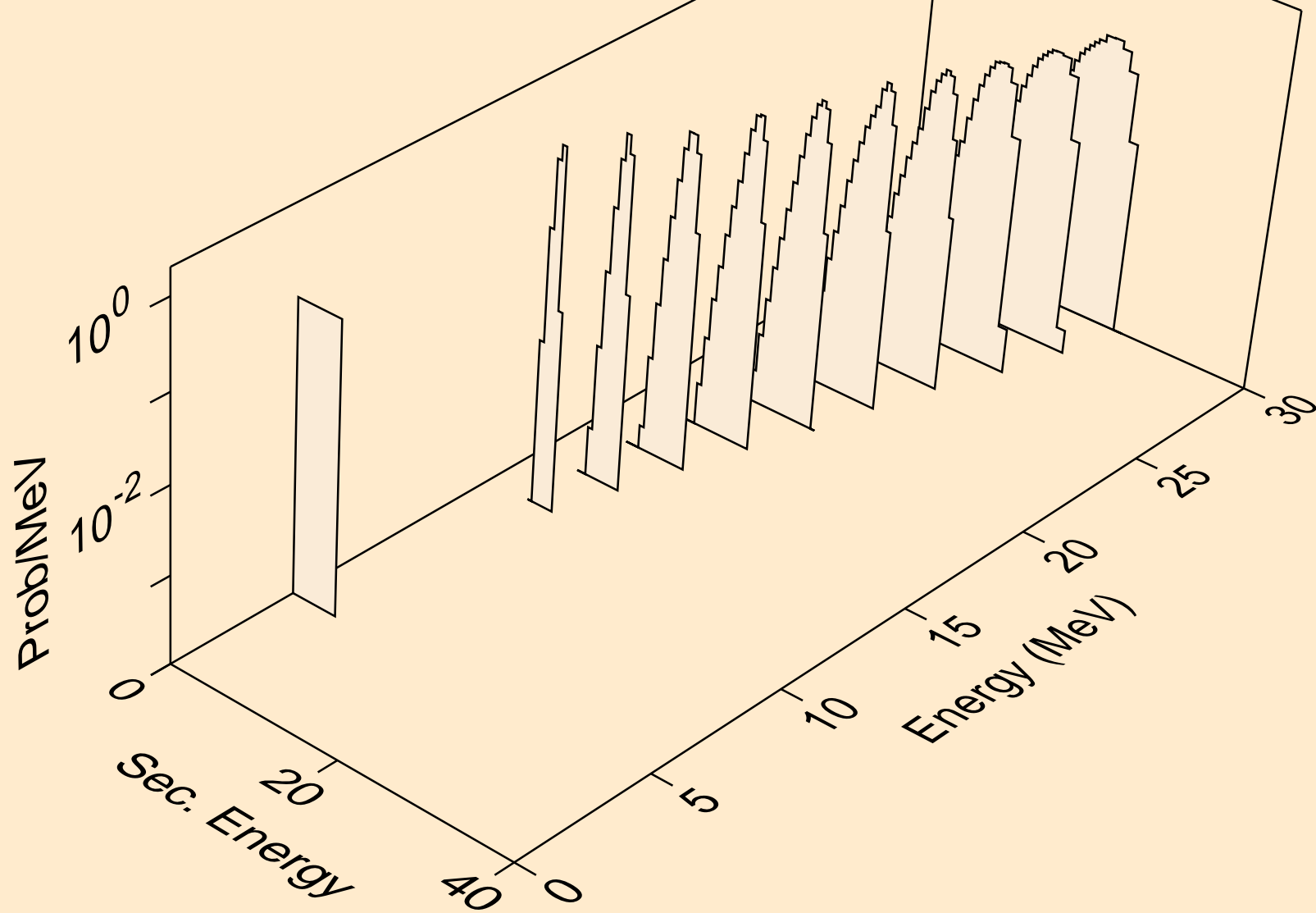

W183 NEUTRON ACER TENDL-2023 LIBRARY; T=0.K
alphas from (n,3n)a

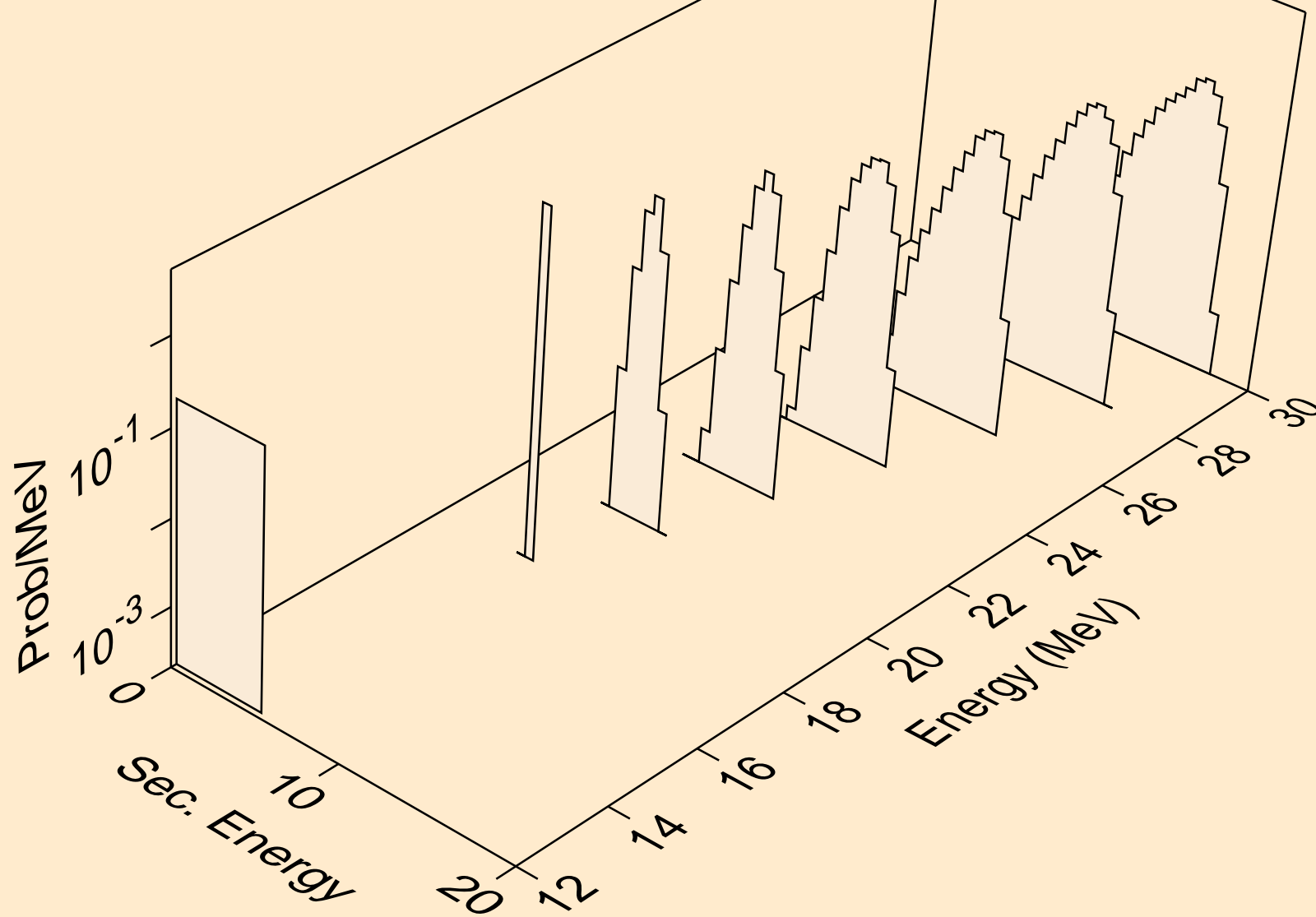

W183 NEUTRON ACER TENDL-2023 LIBRARY; T=0.K
alphas from (n,n*)2a

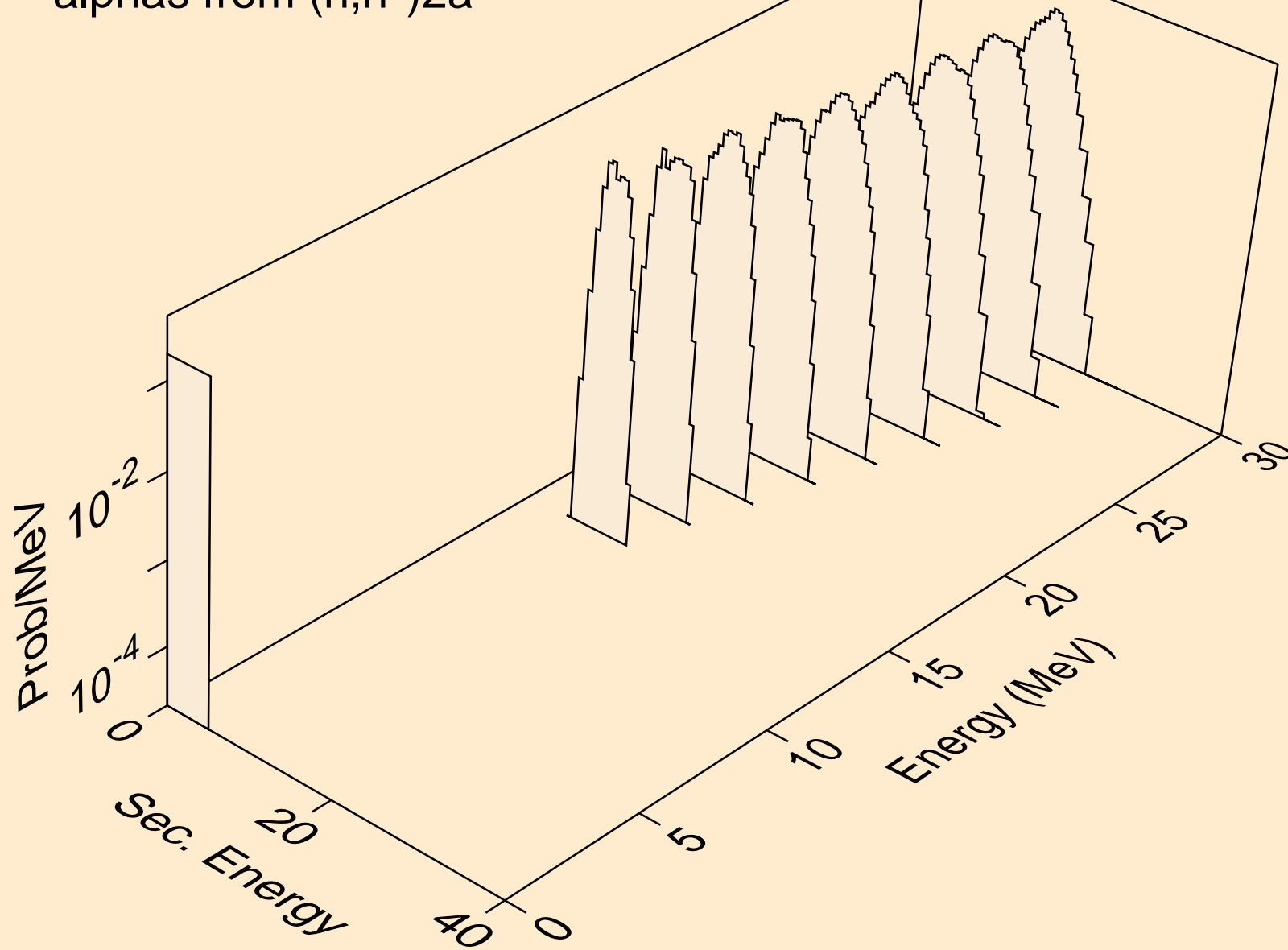

W183 NEUTRON ACER TENDL-2023 LIBRARY; T=0.K
alphas from (n,npa)

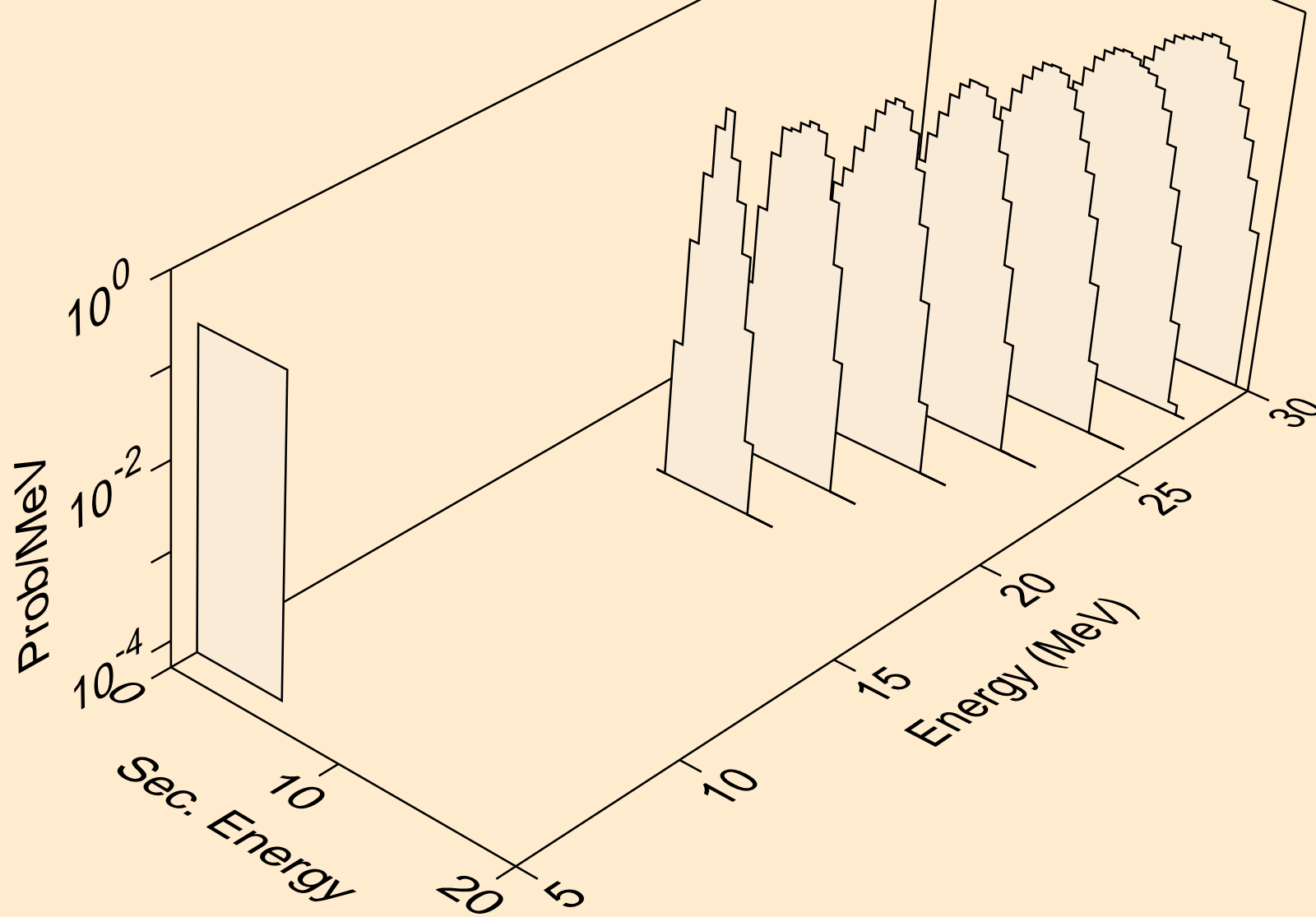

W183 NEUTRON ACER TENDL-2023 LIBRARY; T=0.K
alphas from (n,a)

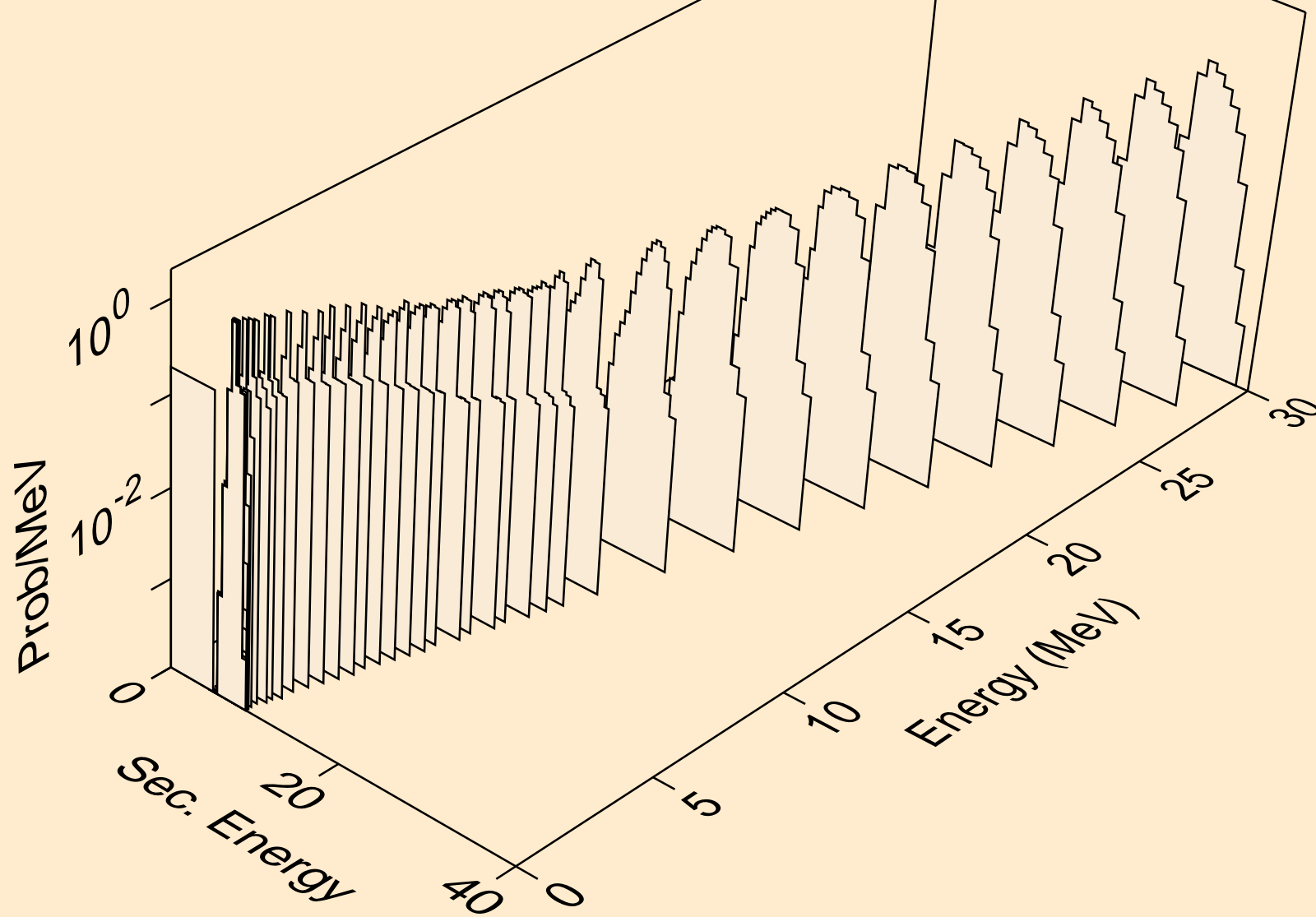

W183 NEUTRON ACER TENDL-2023 LIBRARY; T=0.K
alphas from (n,2a)

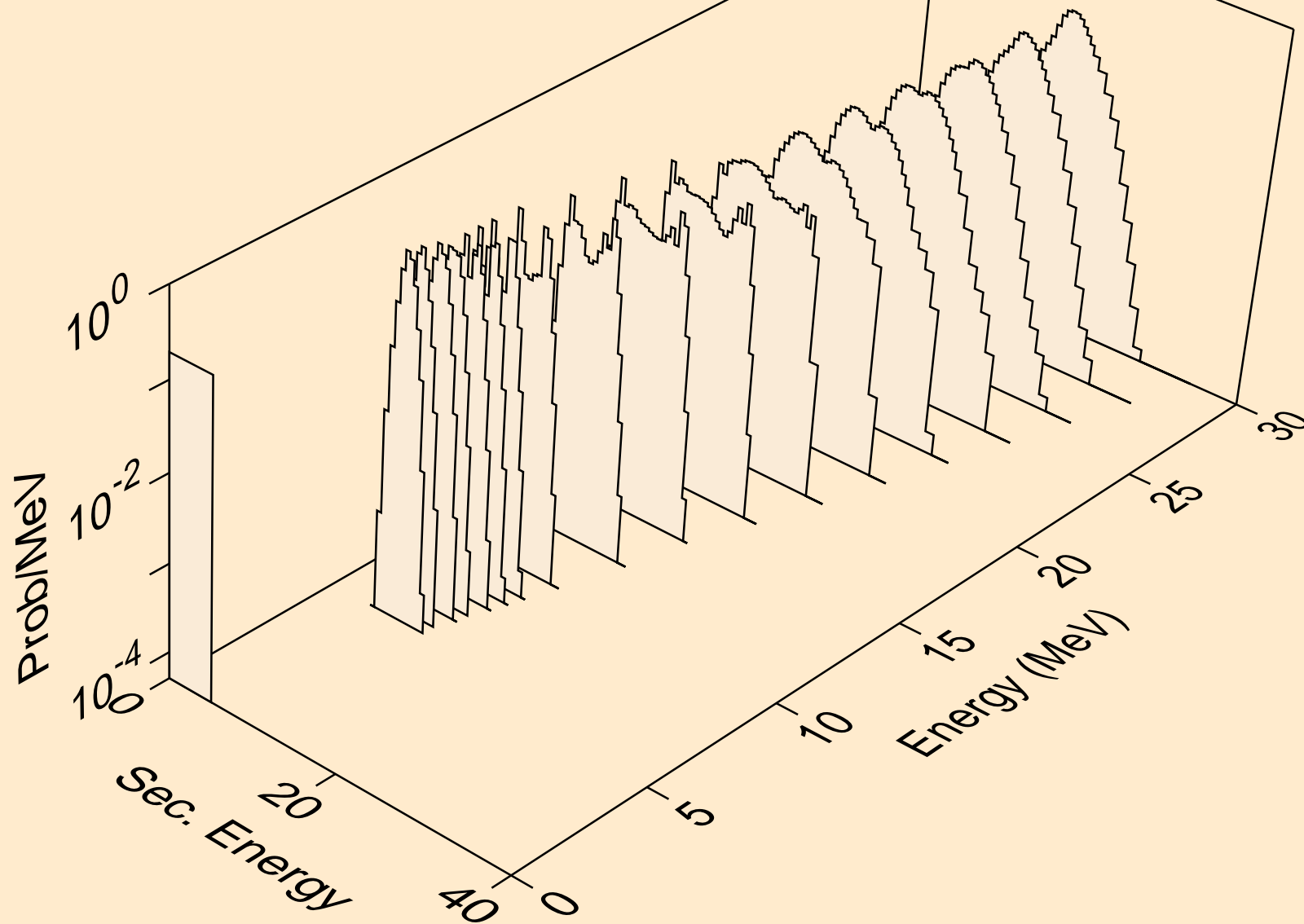

W183 NEUTRON ACER TENDL-2023 LIBRARY; T=0.K
alphas from (n,pa)

