

# YB163 NEUTRON ACER TENDL-2023 LIBRARY; T=0.K

## Principal cross sections

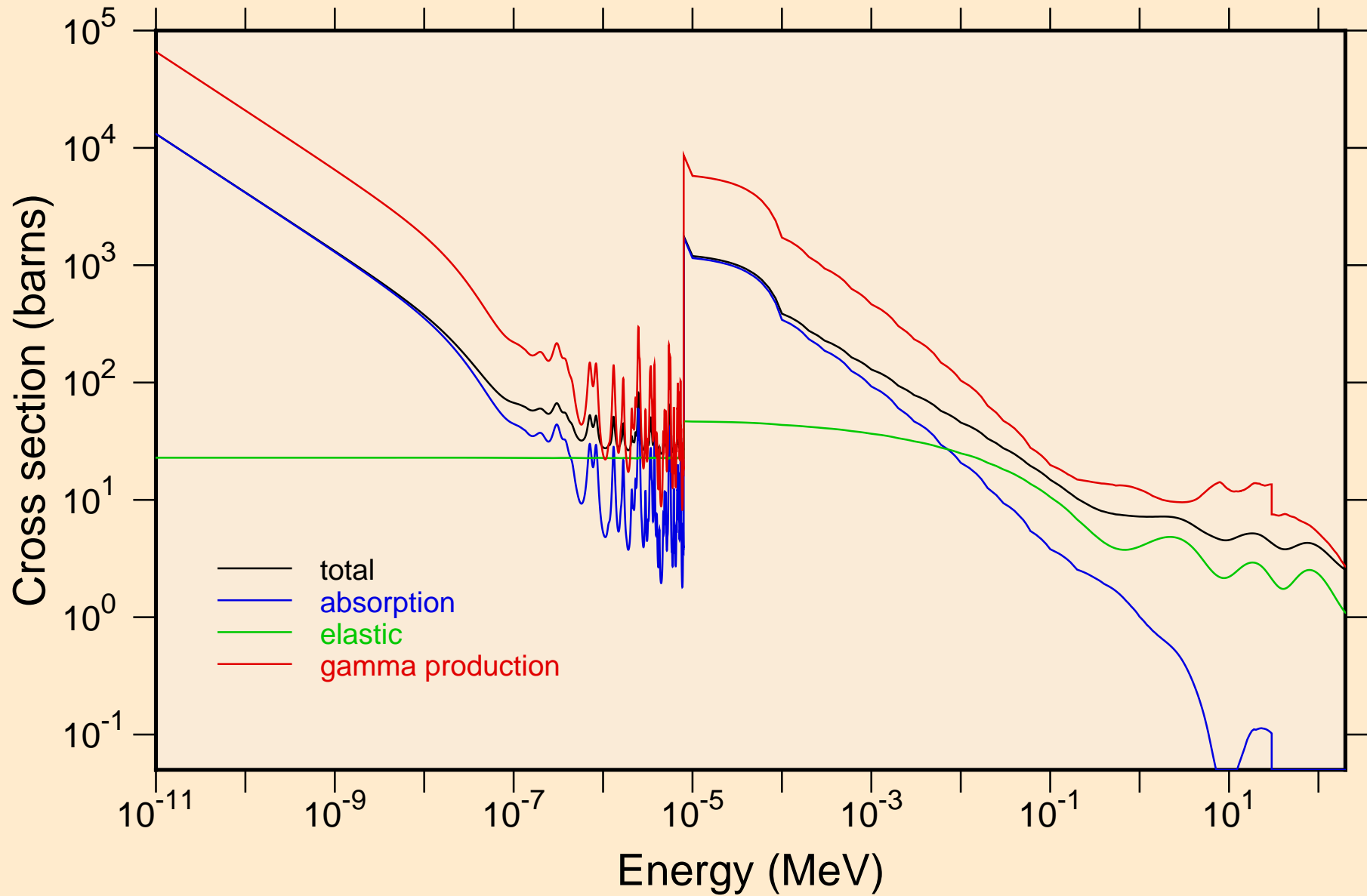

YB163 NEUTRON ACER TENDL-2023 LIBRARY; T=0.K  
resonance total cross section

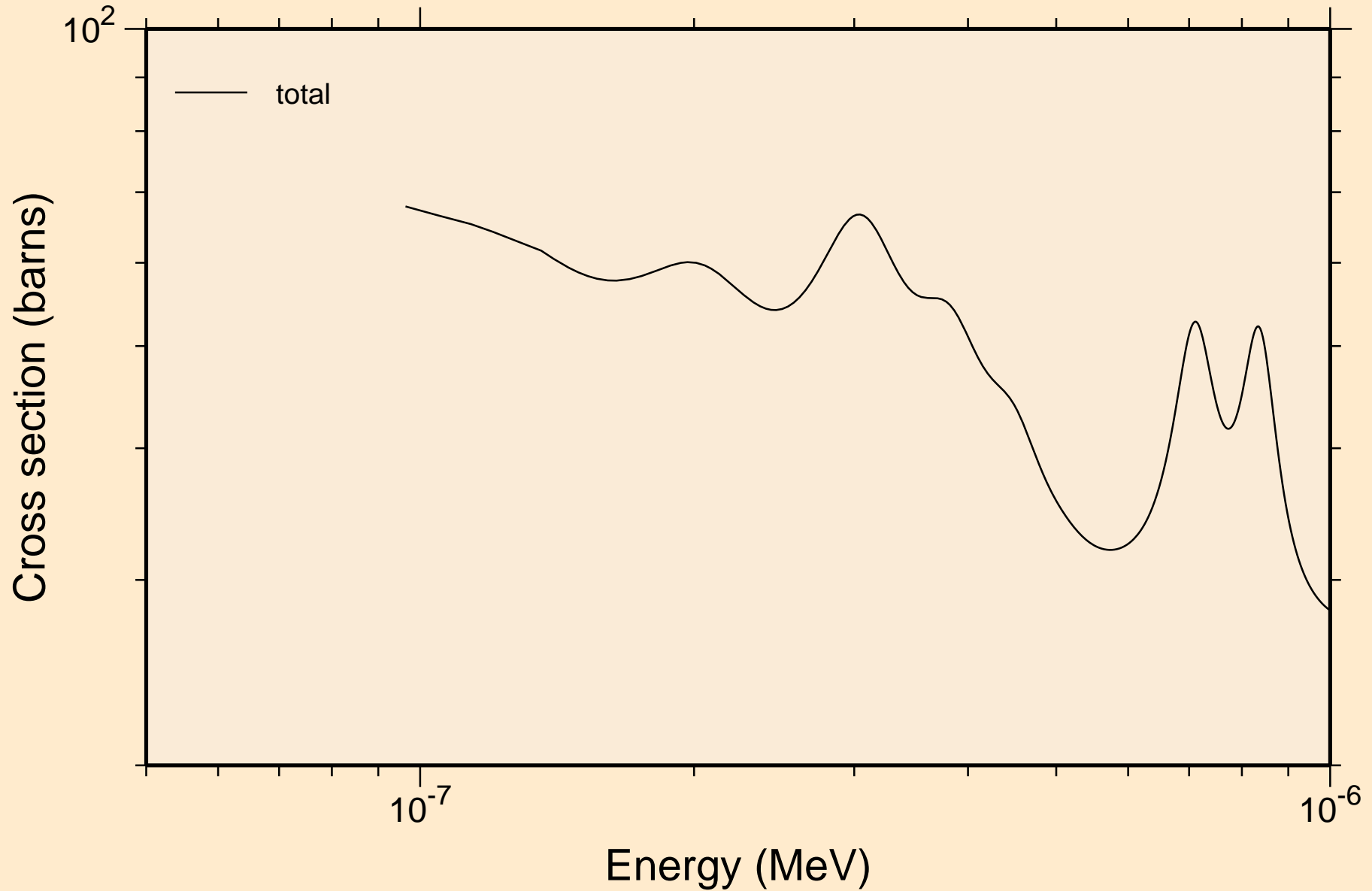

YB163 NEUTRON ACER TENDL-2023 LIBRARY; T=0.K  
resonance total cross section

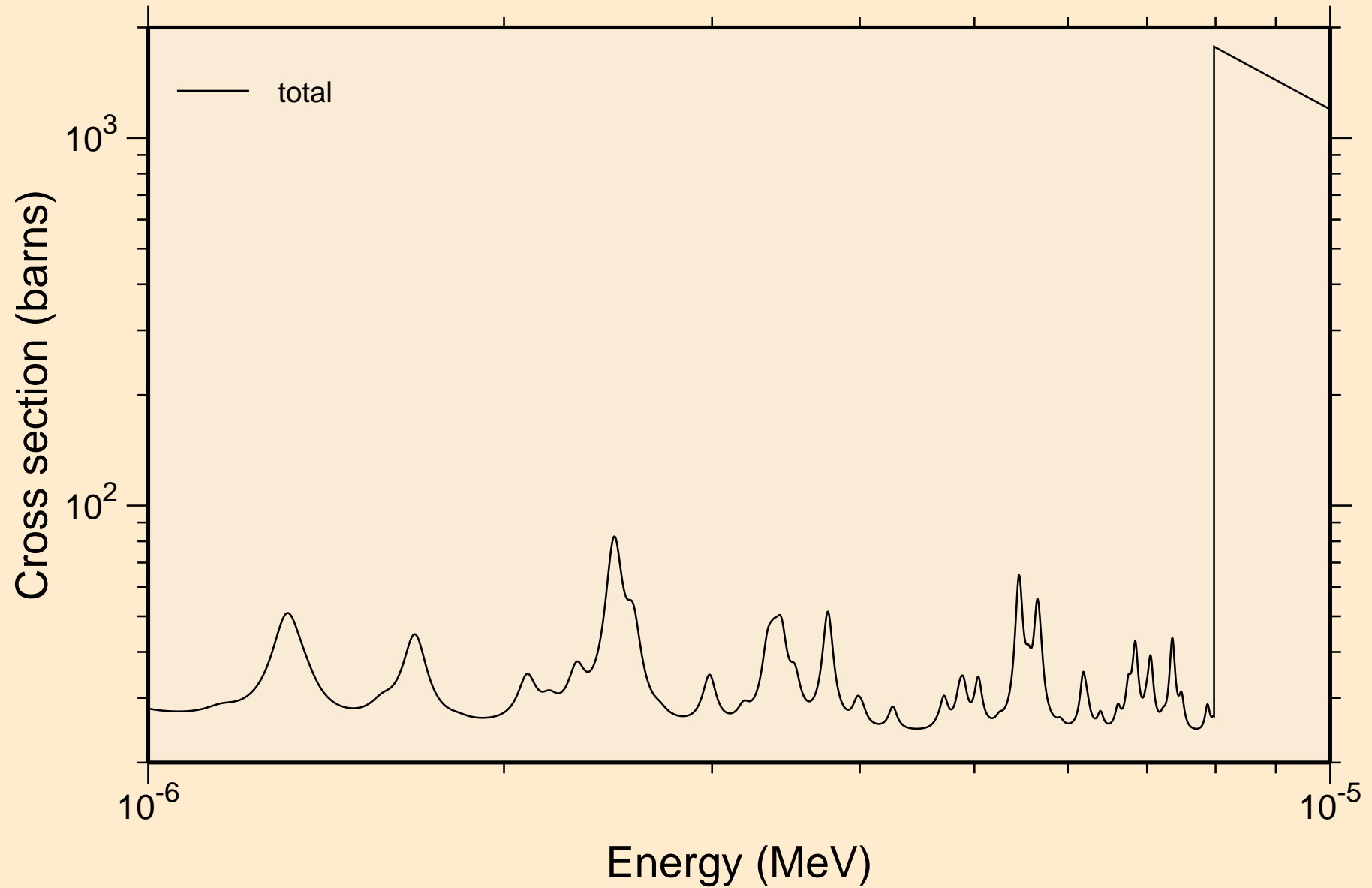

YB163 NEUTRON ACER TENDL-2023 LIBRARY; T=0.K  
resonance total cross section

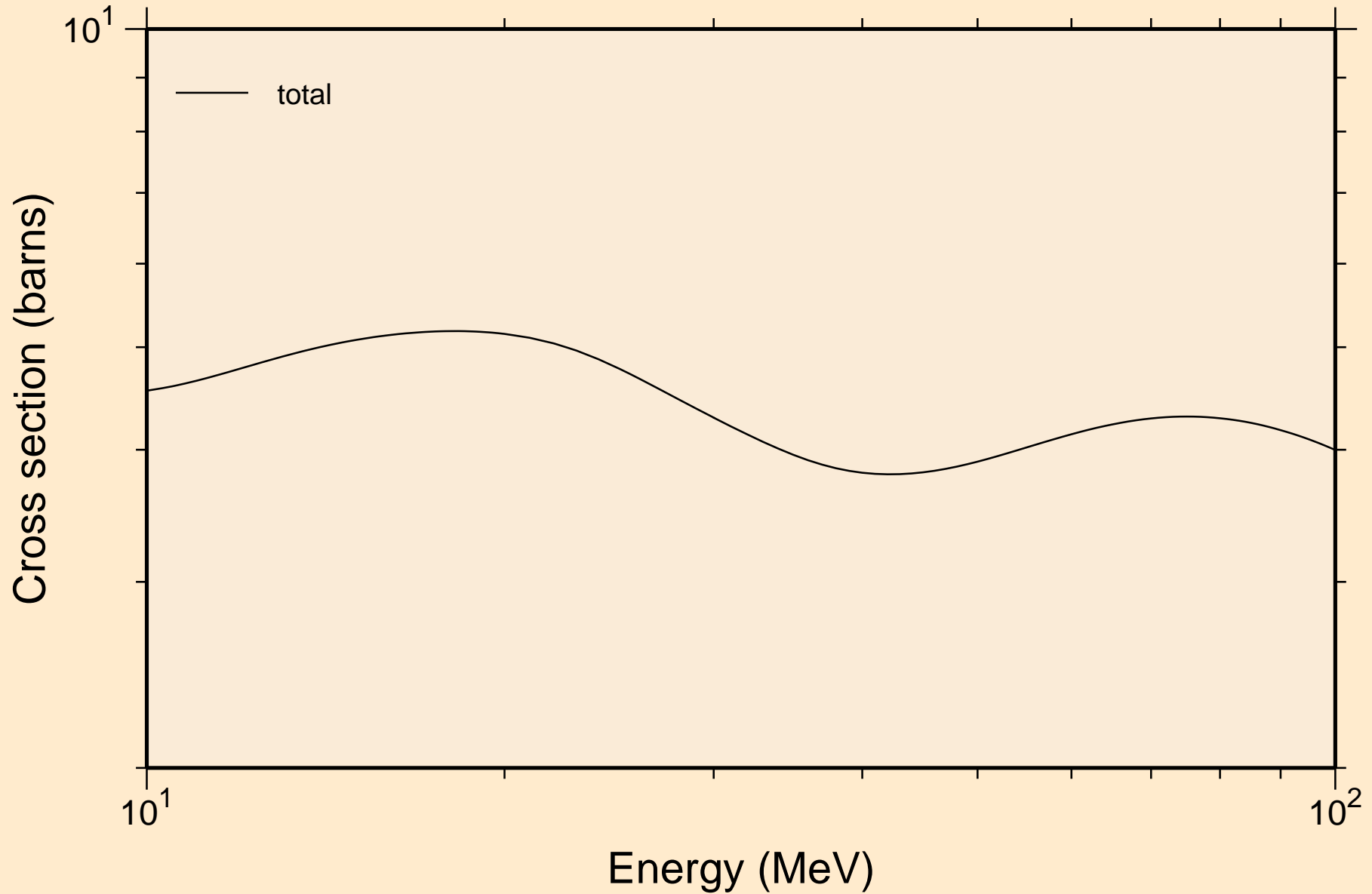

YB163 NEUTRON ACER TENDL-2023 LIBRARY; T=0.K  
resonance absorption cross sections

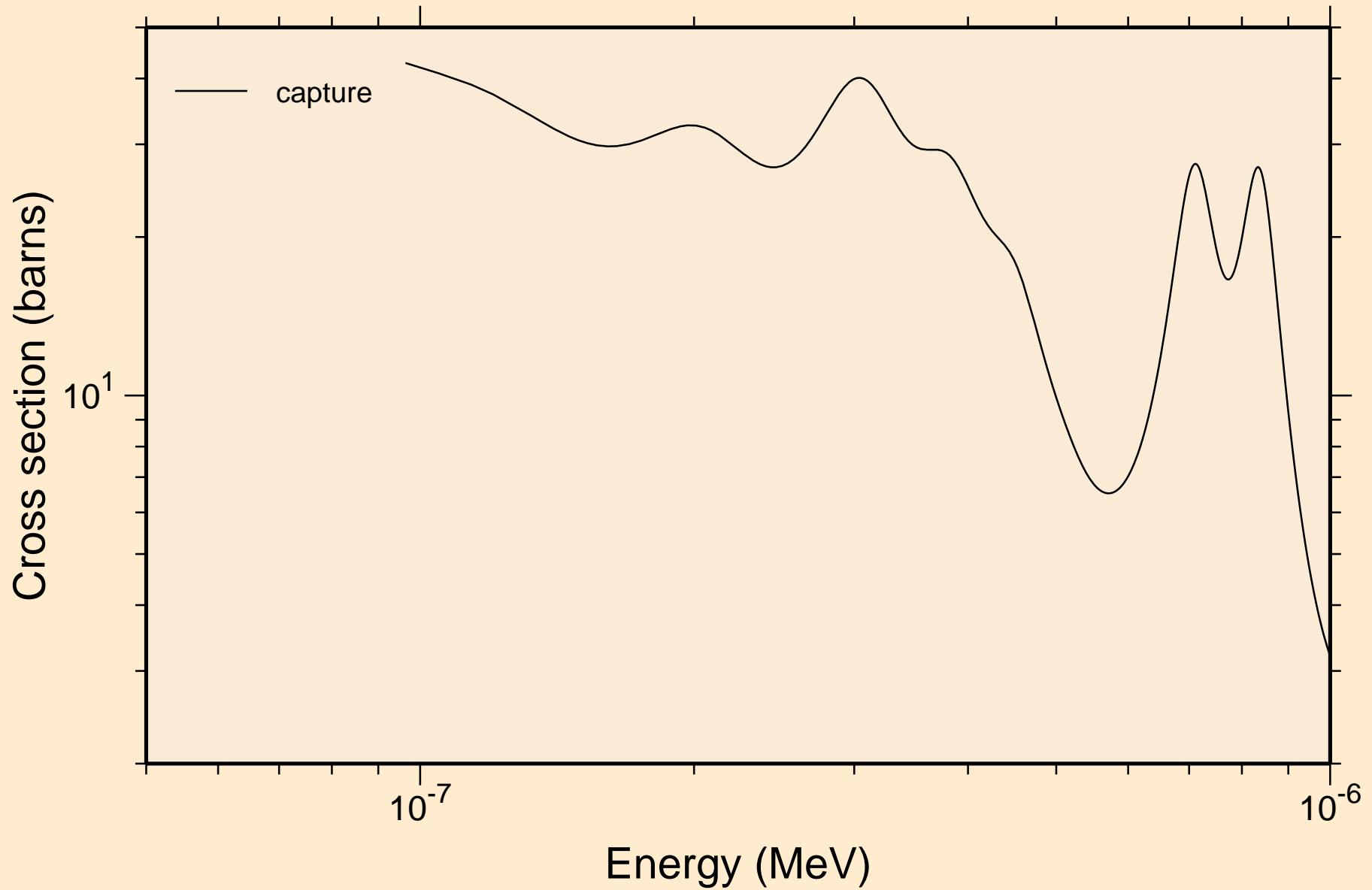

YB163 NEUTRON ACER TENDL-2023 LIBRARY; T=0.K  
resonance absorption cross sections

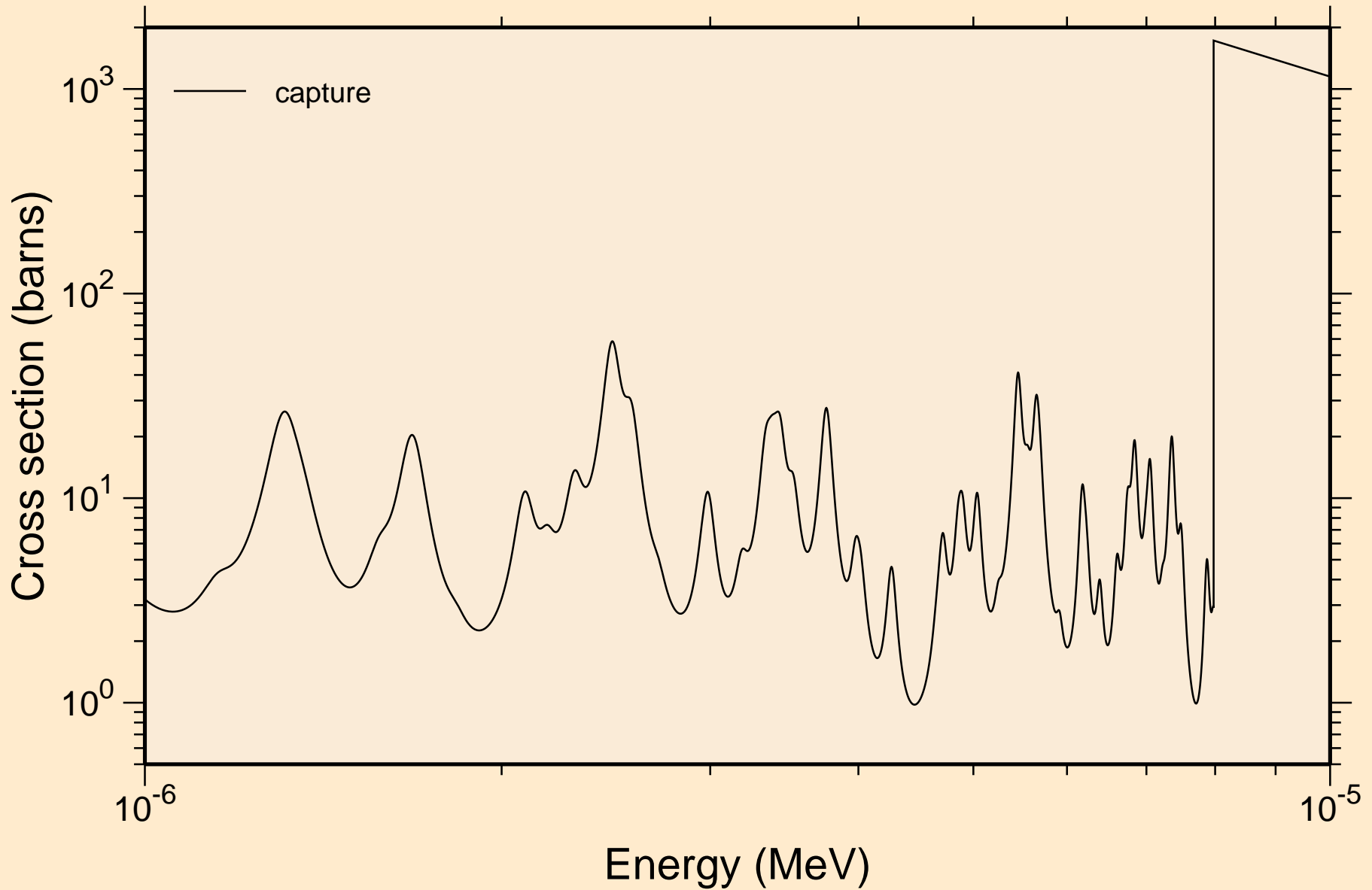

YB163 NEUTRON ACER TENDL-2023 LIBRARY; T=0.K  
resonance absorption cross sections

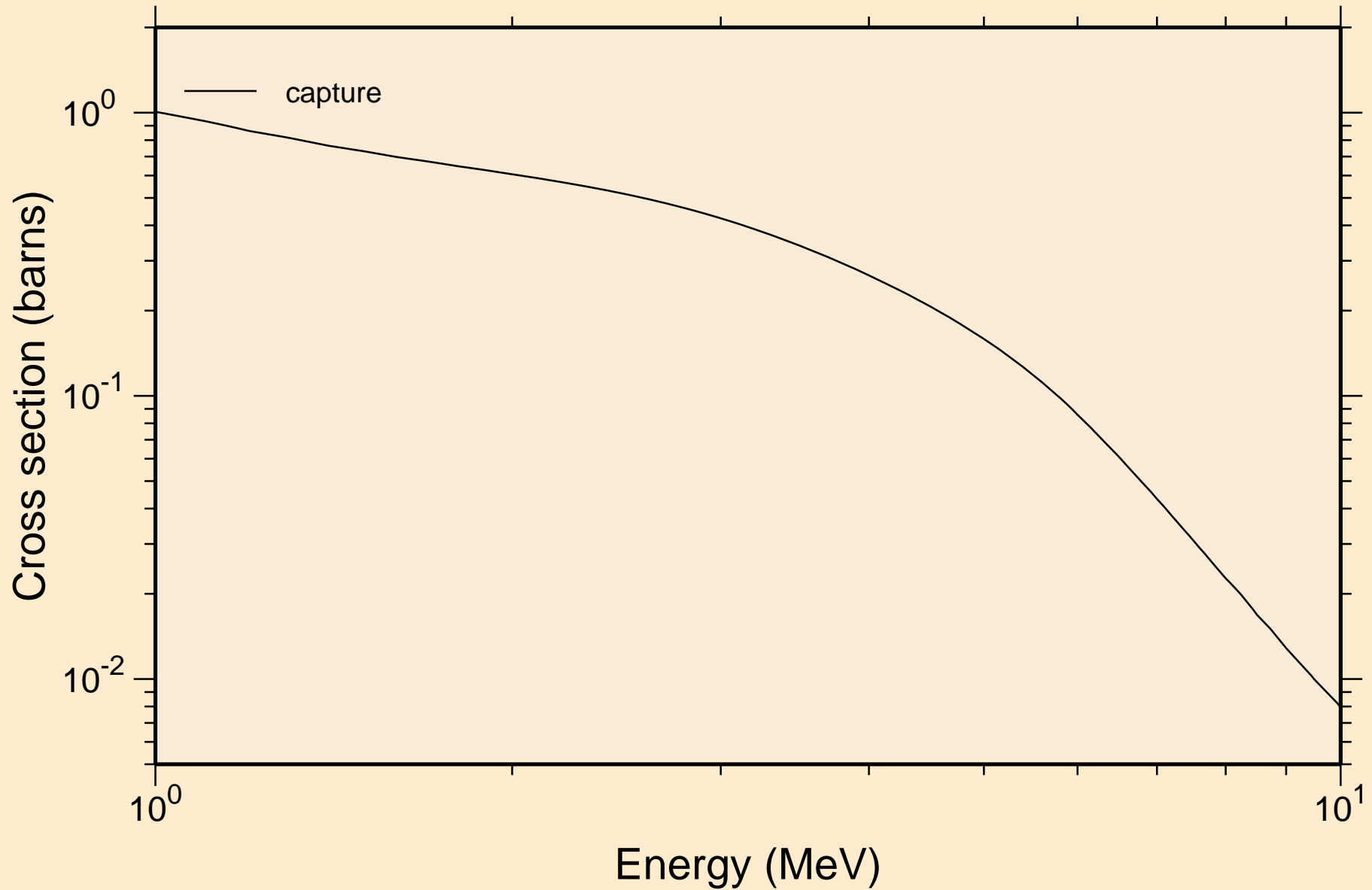

# YB163 NEUTRON ACER TENDL-2023 LIBRARY; T=0.K

## Heating

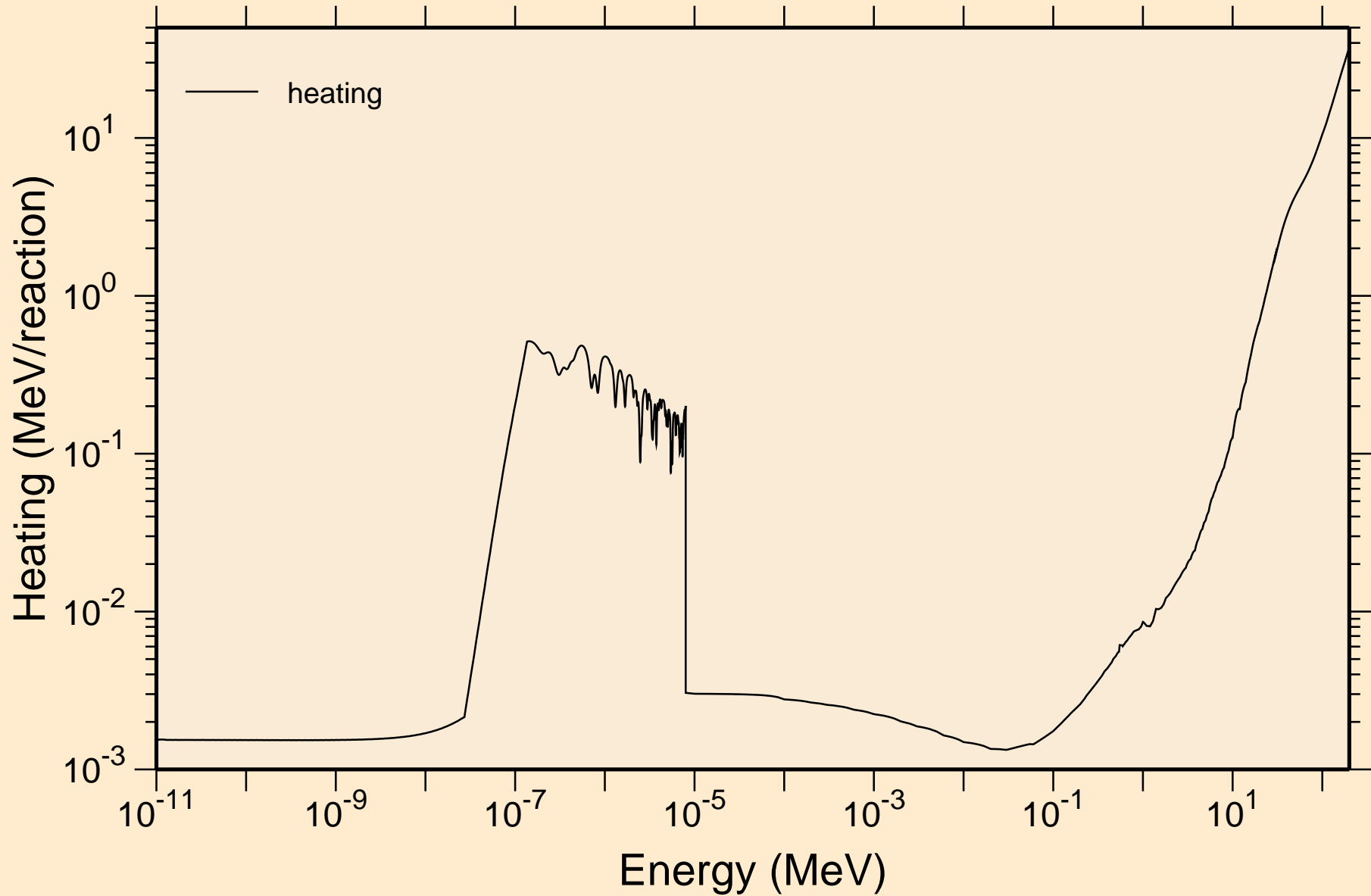



YB163 NEUTRON ACER TENDL-2023 LIBRARY; T=0.K  
Damage

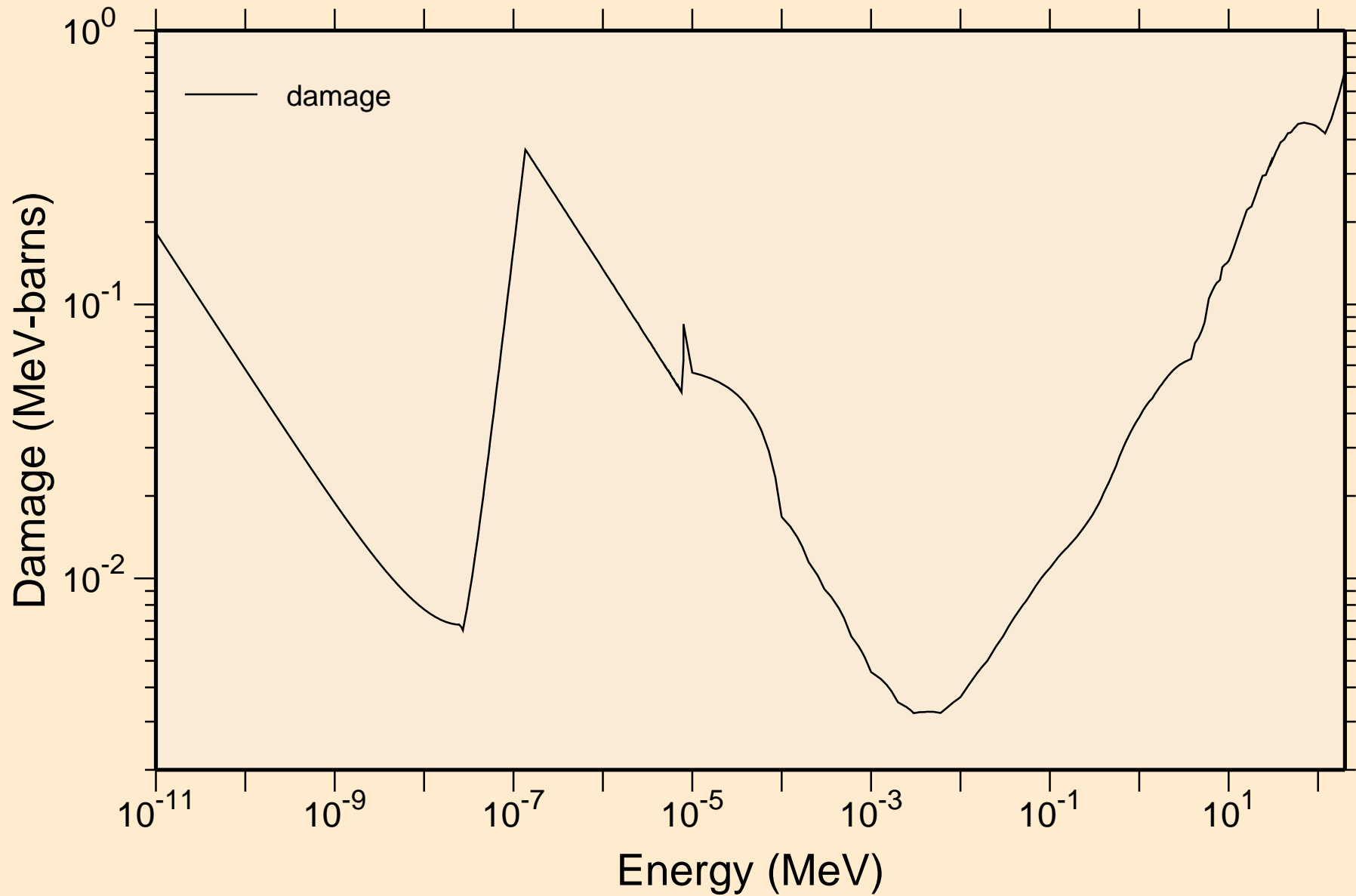

YB163 NEUTRON ACER TENDL-2023 LIBRARY; T=0.K  
Non-threshold reactions

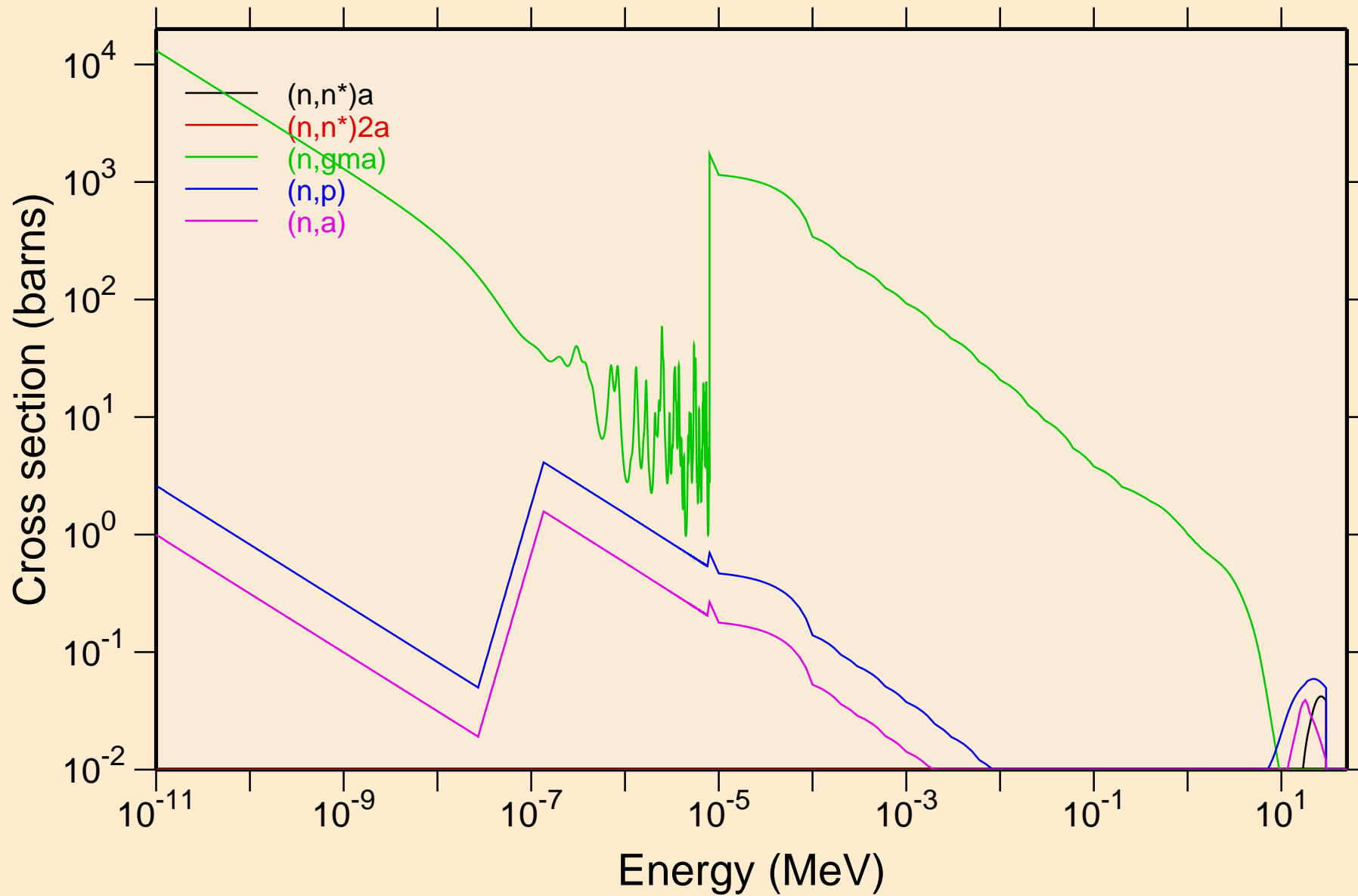

YB163 NEUTRON ACER TENDL-2023 LIBRARY; T=0.K  
Non-threshold reactions

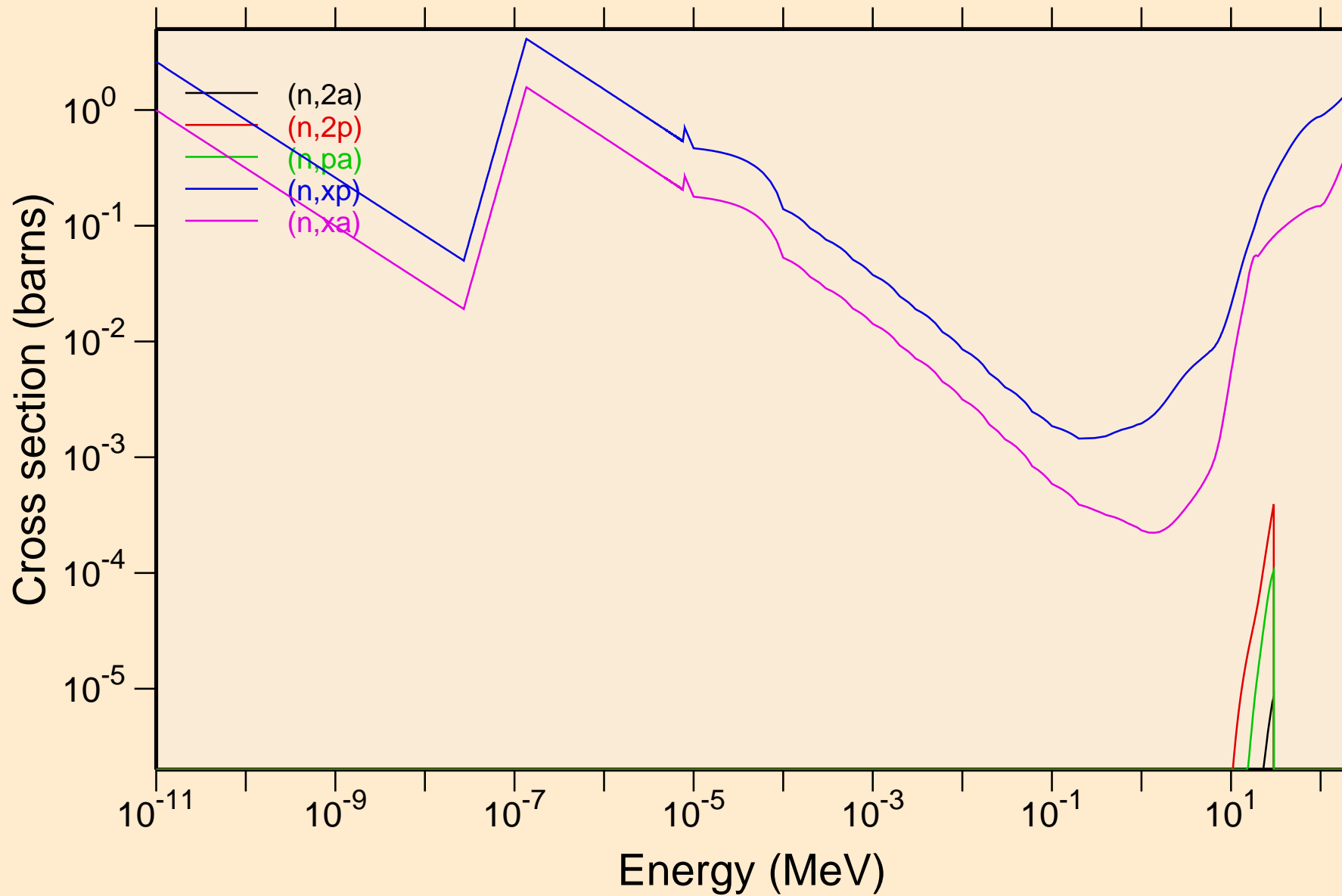

# YB163 NEUTRON ACER TENDL-2023 LIBRARY; T=0.K

## Principal cross sections

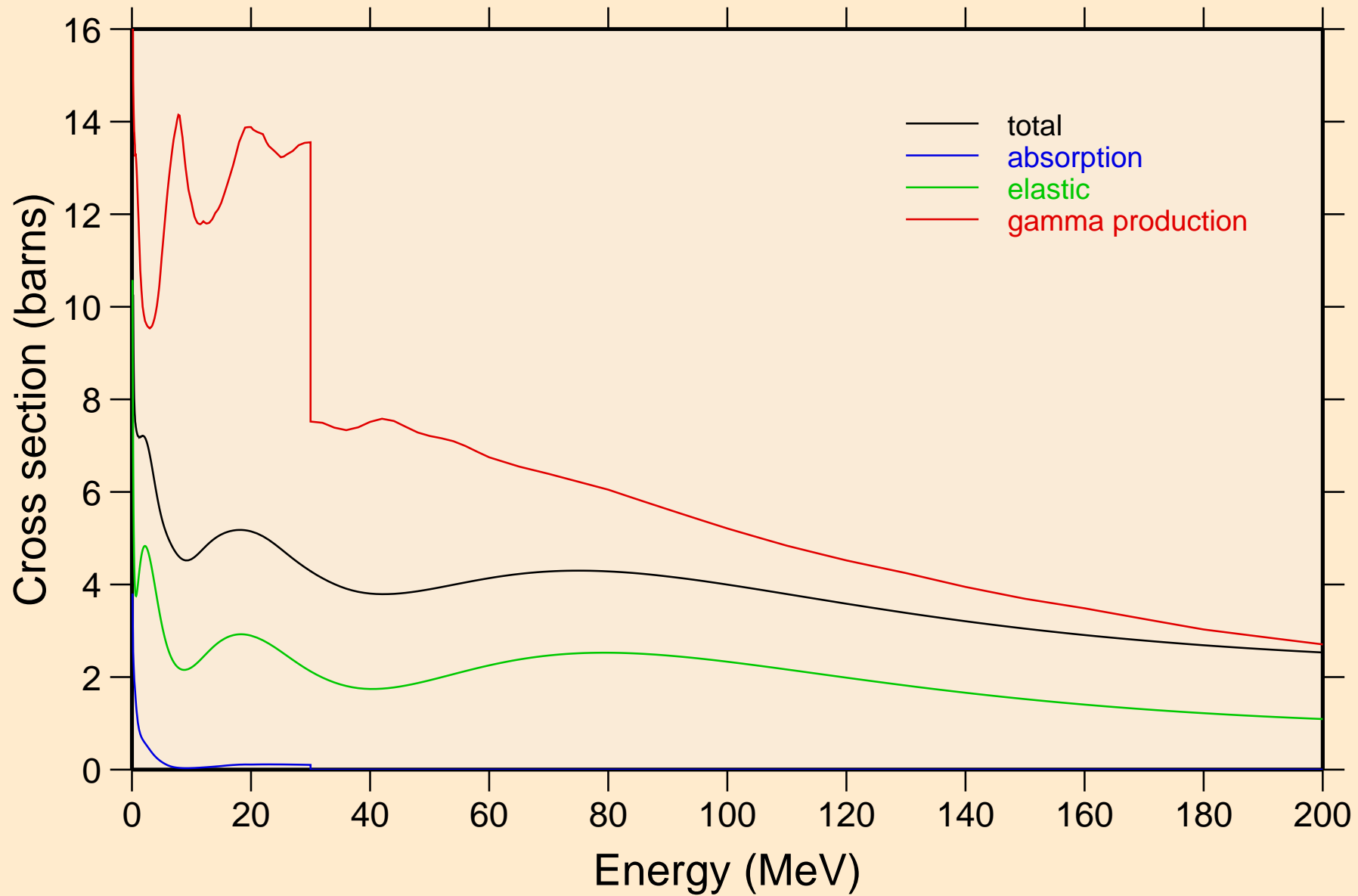

# YB163 NEUTRON ACER TENDL-2023 LIBRARY; T=0.K

## Heating

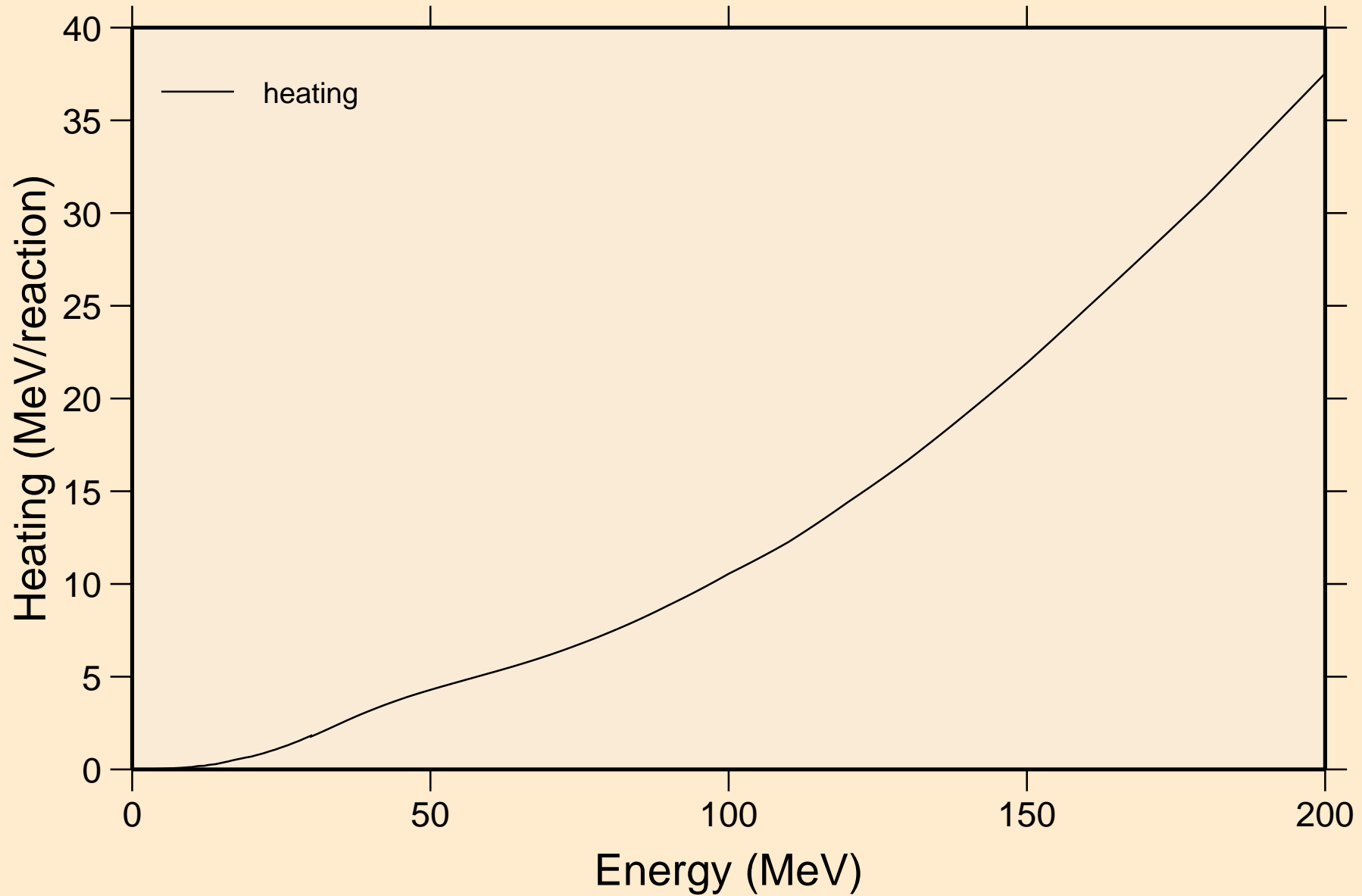

# YB163 NEUTRON ACER TENDL-2023 LIBRARY; T=0.K

## Damage

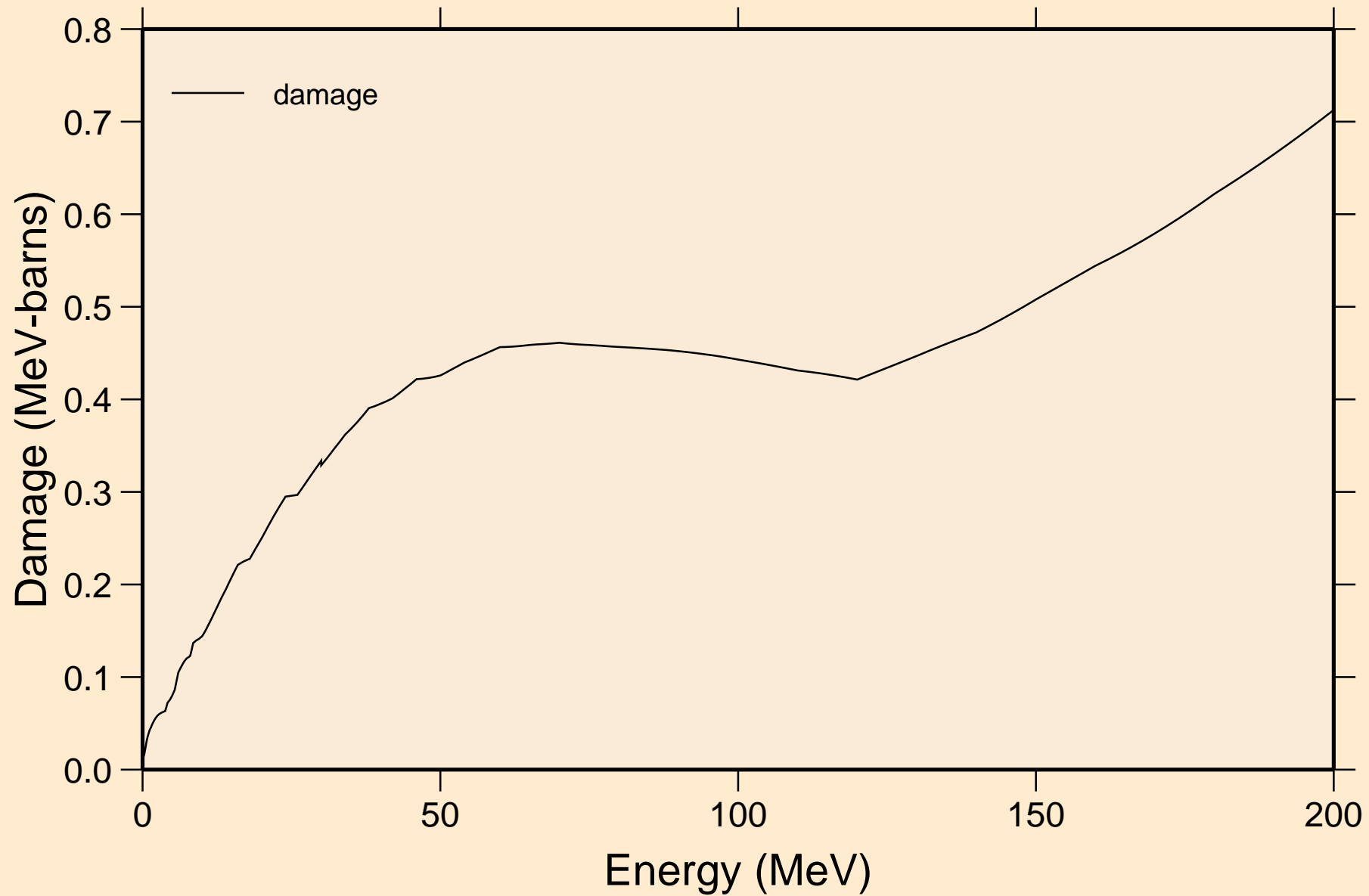

YB163 NEUTRON ACER TENDL-2023 LIBRARY; T=0.K  
Non-threshold reactions

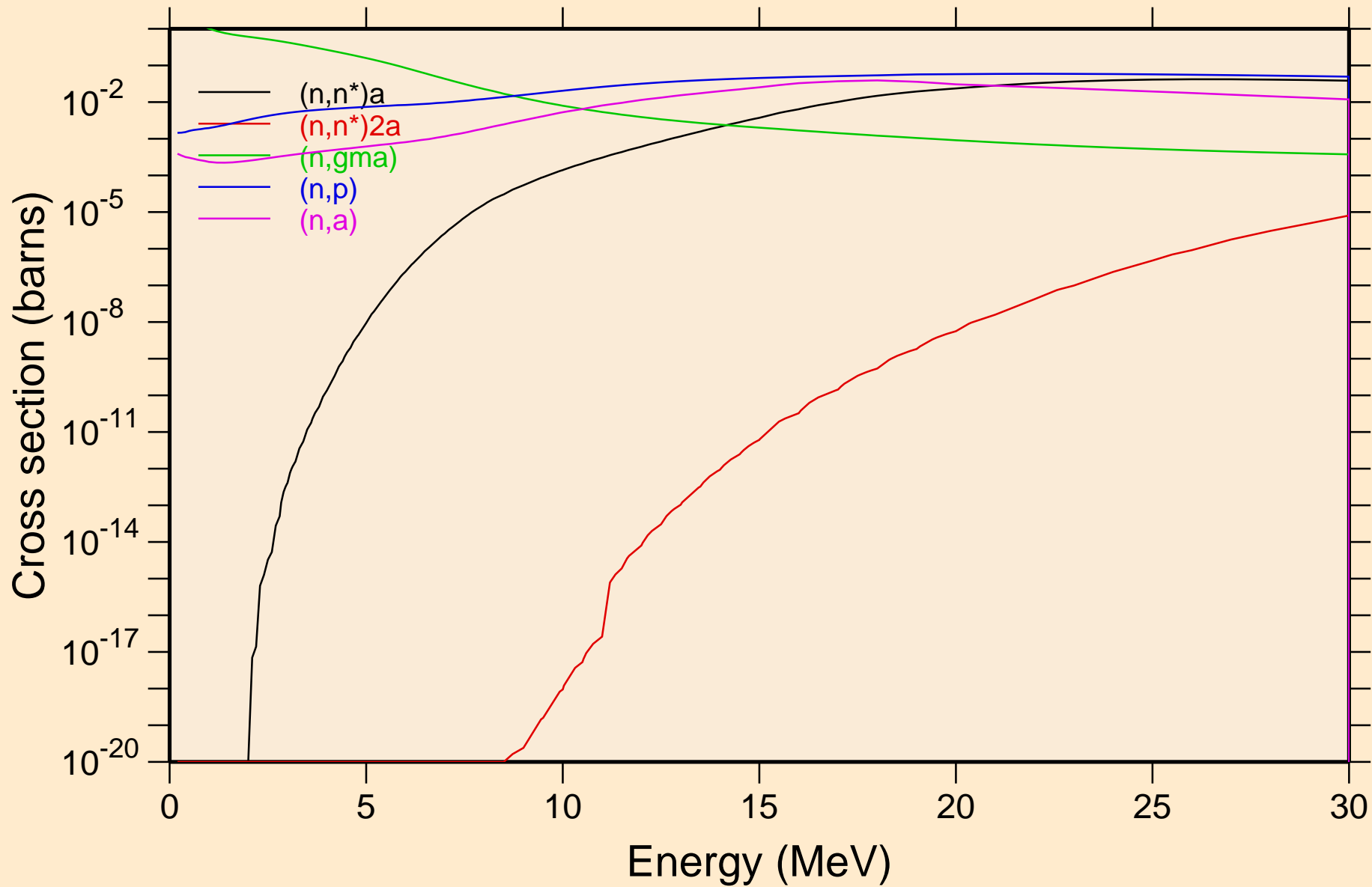

YB163 NEUTRON ACER TENDL-2023 LIBRARY; T=0.K  
Non-threshold reactions

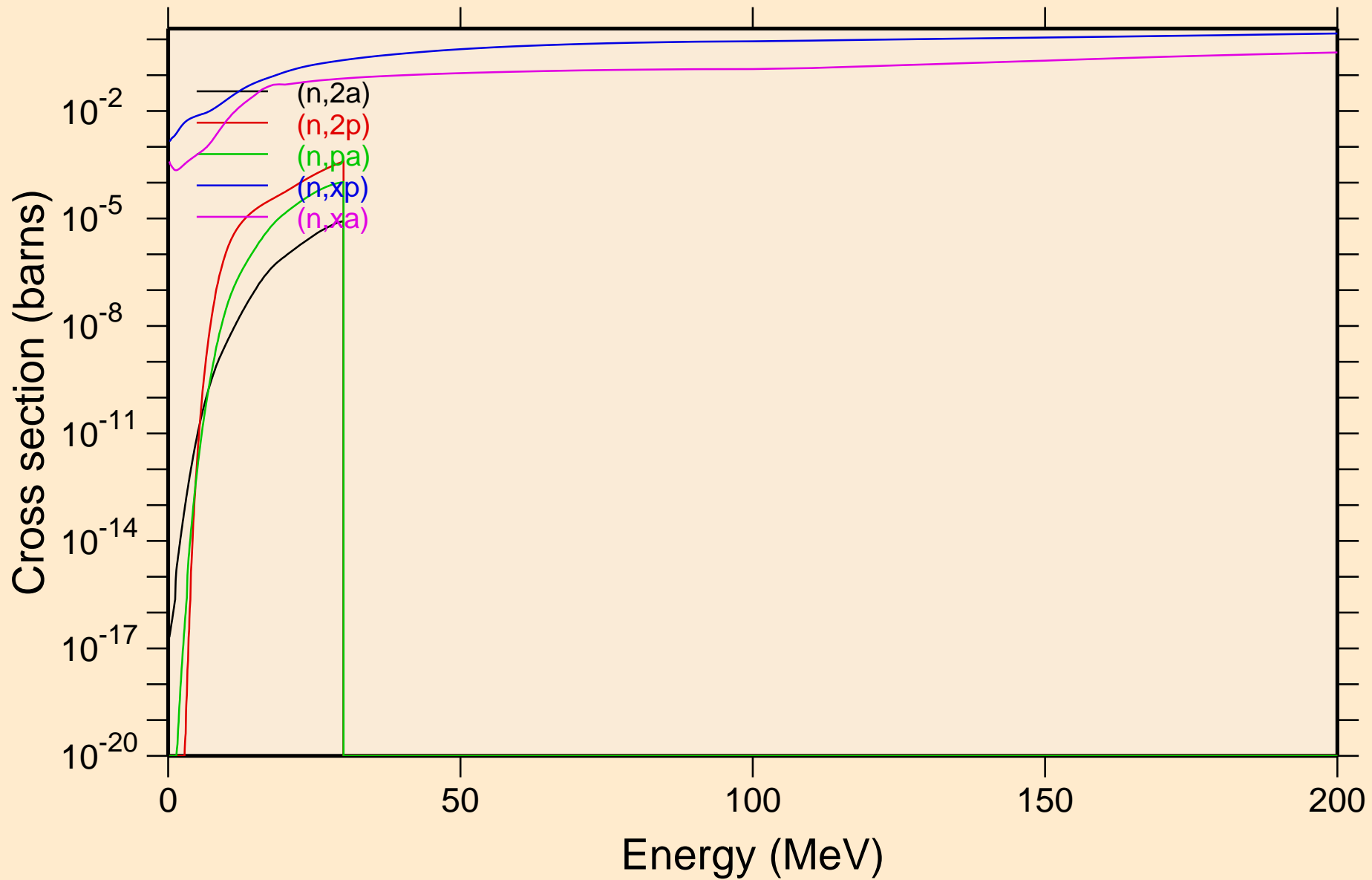



YB163 NEUTRON ACER TENDL-2023 LIBRARY; T=0.K  
Inelastic levels

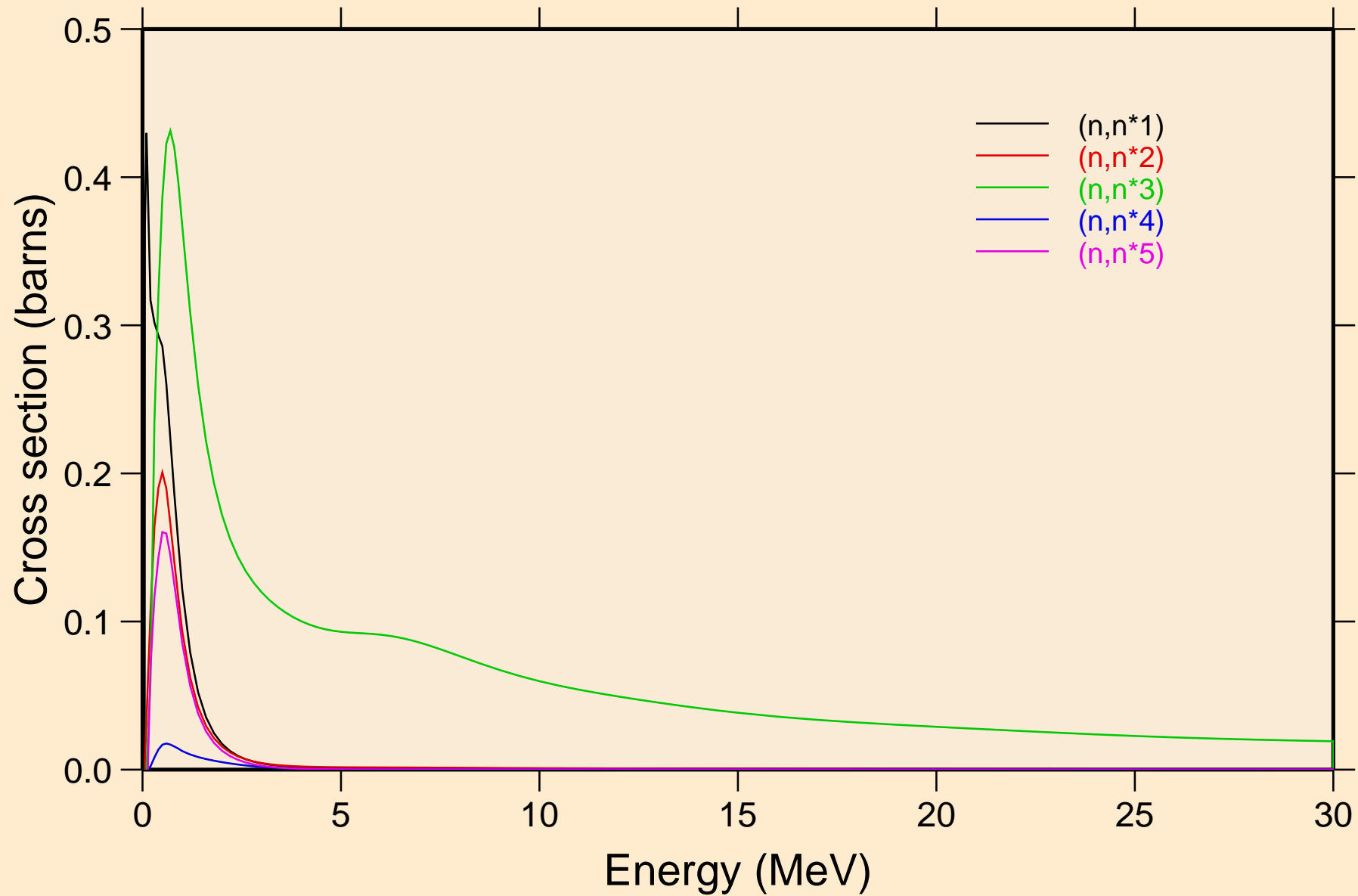

YB163 NEUTRON ACER TENDL-2023 LIBRARY; T=0.K  
Inelastic levels

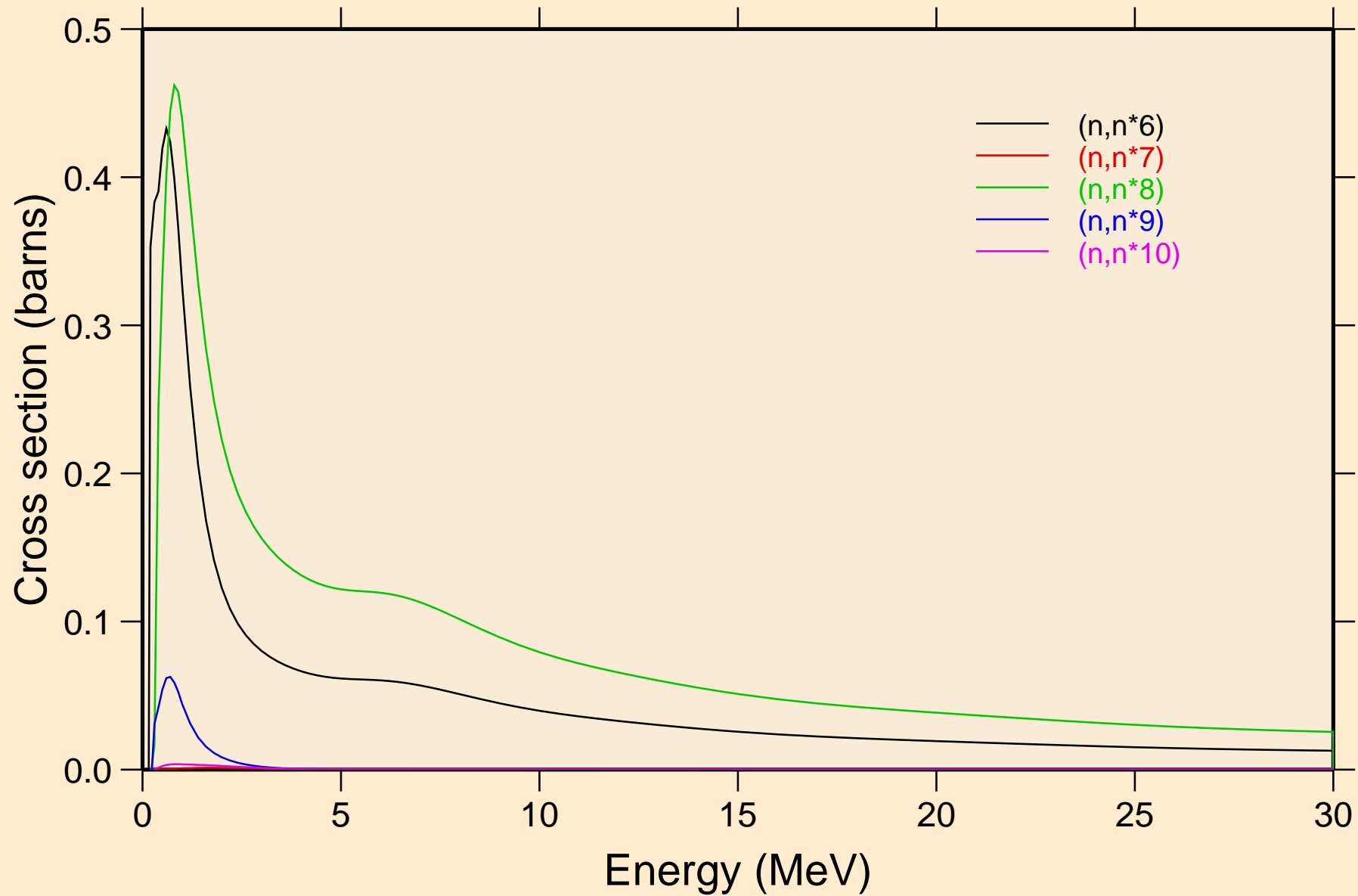

YB163 NEUTRON ACER TENDL-2023 LIBRARY; T=0.K  
Inelastic levels

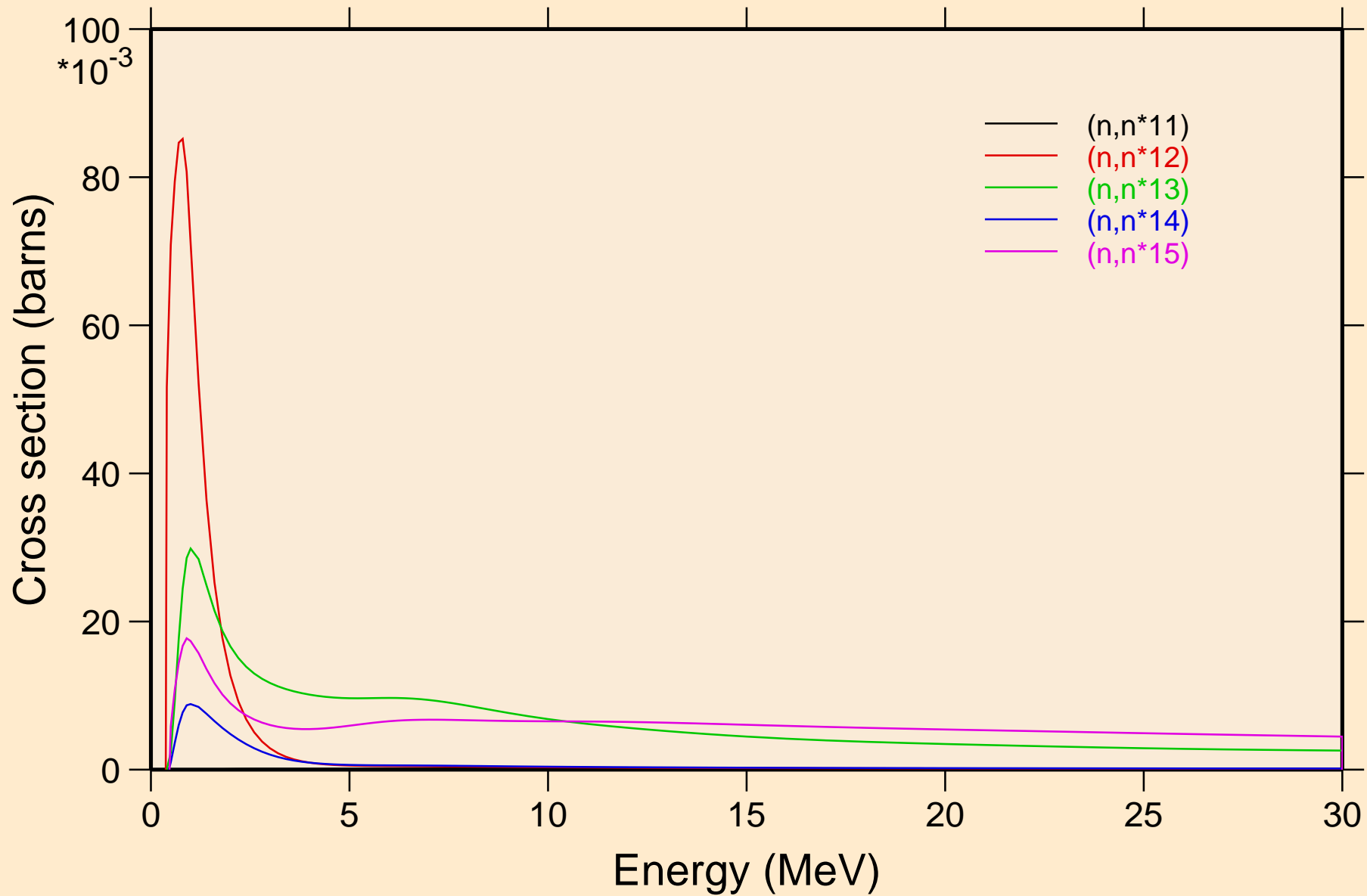

YB163 NEUTRON ACER TENDL-2023 LIBRARY; T=0.K  
Inelastic levels

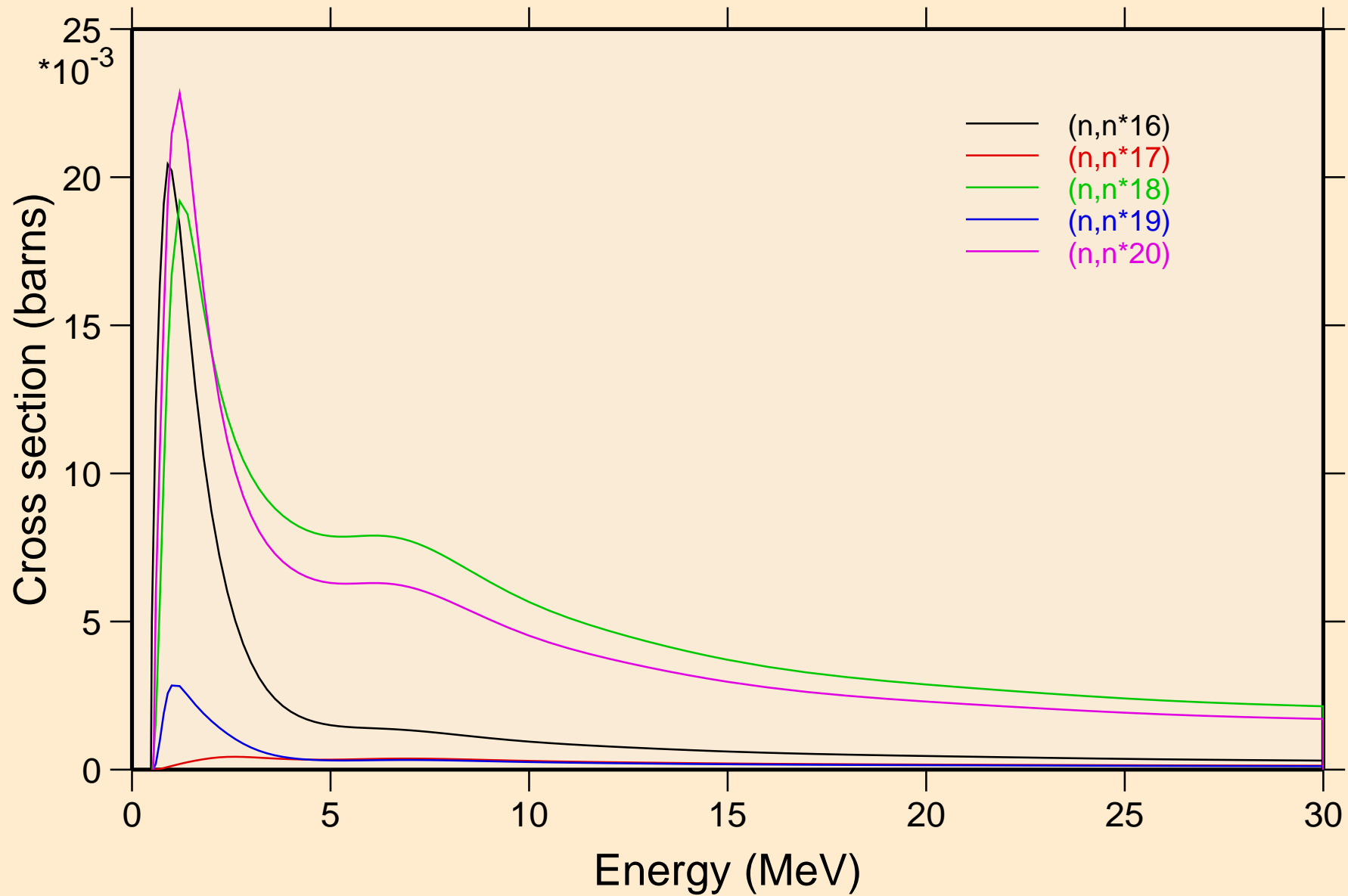

YB163 NEUTRON ACER TENDL-2023 LIBRARY; T=0.K  
Threshold reactions

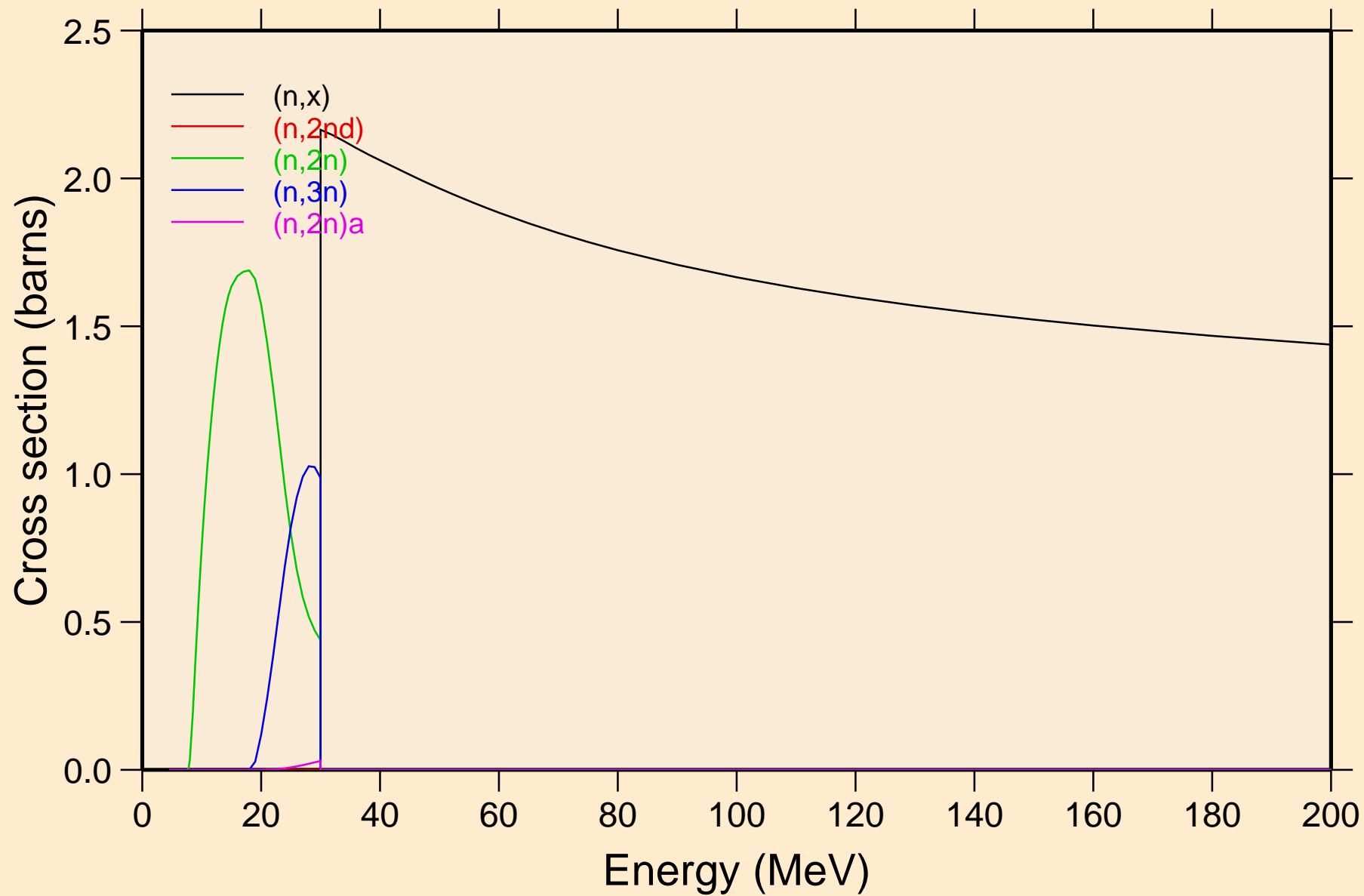

# YB163 NEUTRON ACER TENDL-2023 LIBRARY; T=0.K

## Threshold reactions

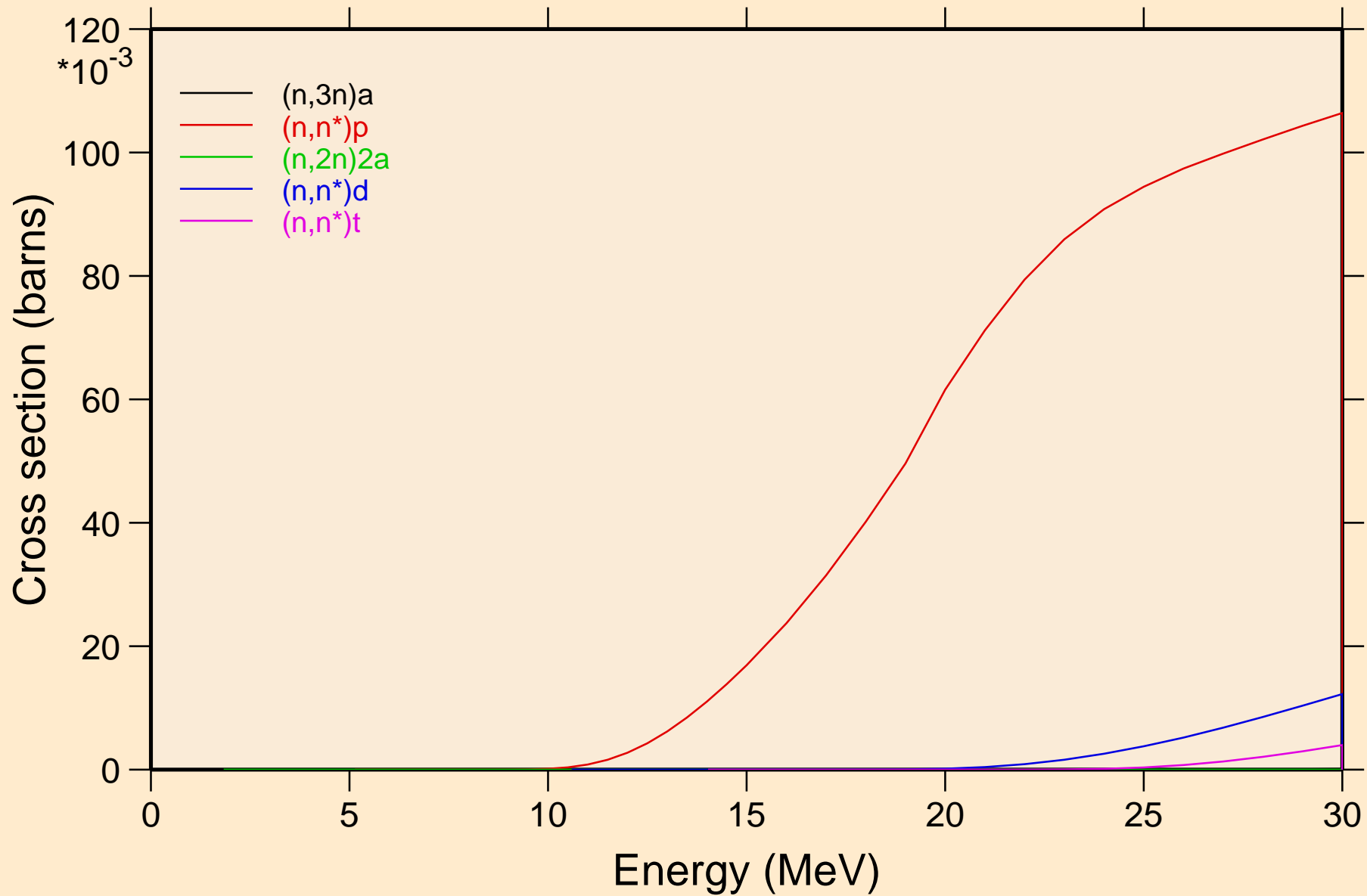

YB163 NEUTRON ACER TENDL-2023 LIBRARY; T=0.K  
Threshold reactions

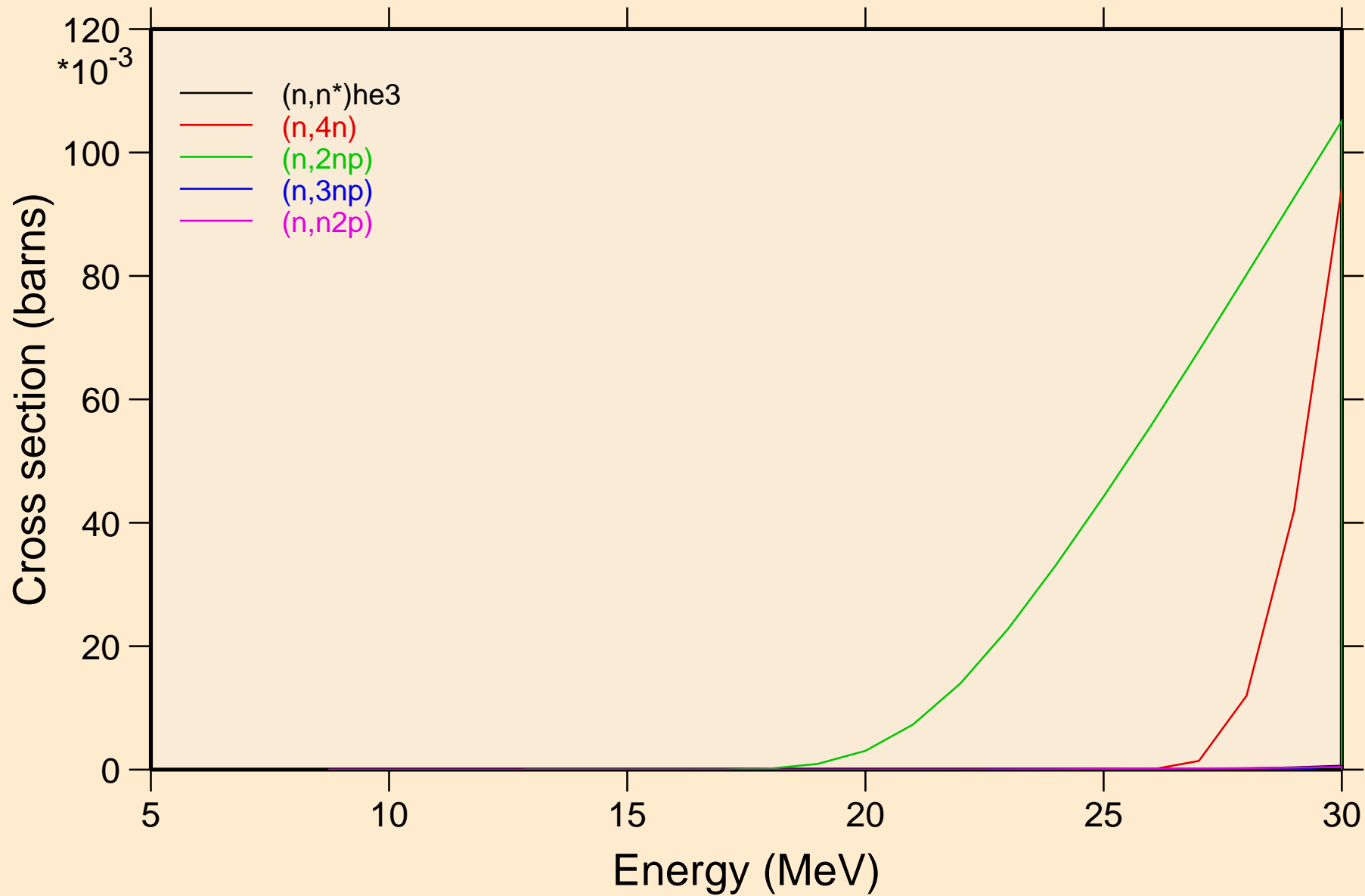

YB163 NEUTRON ACER TENDL-2023 LIBRARY; T=0.K  
Threshold reactions

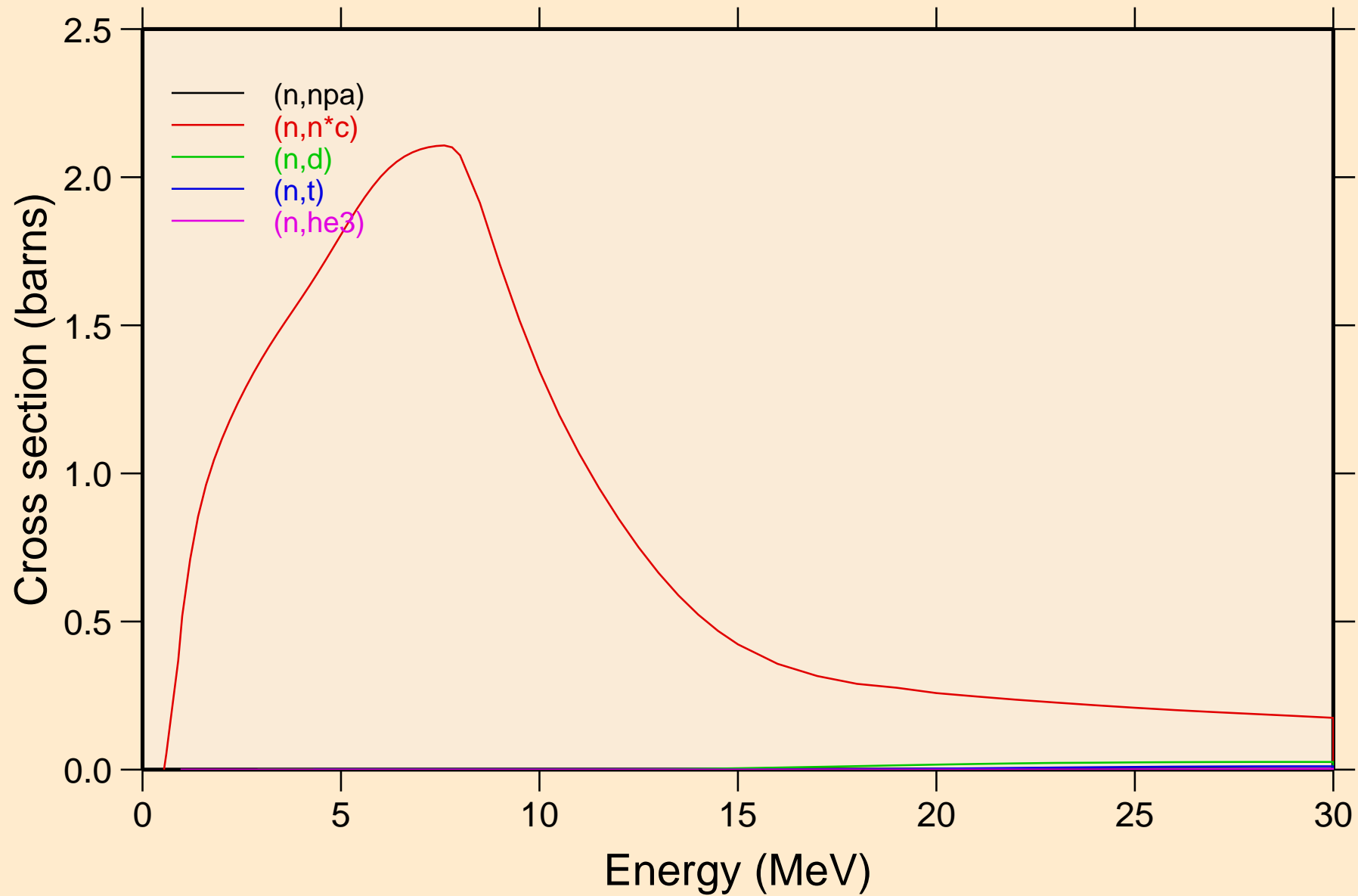



YB163 NEUTRON ACER TENDL-2023 LIBRARY; T=0.K  
Threshold reactions

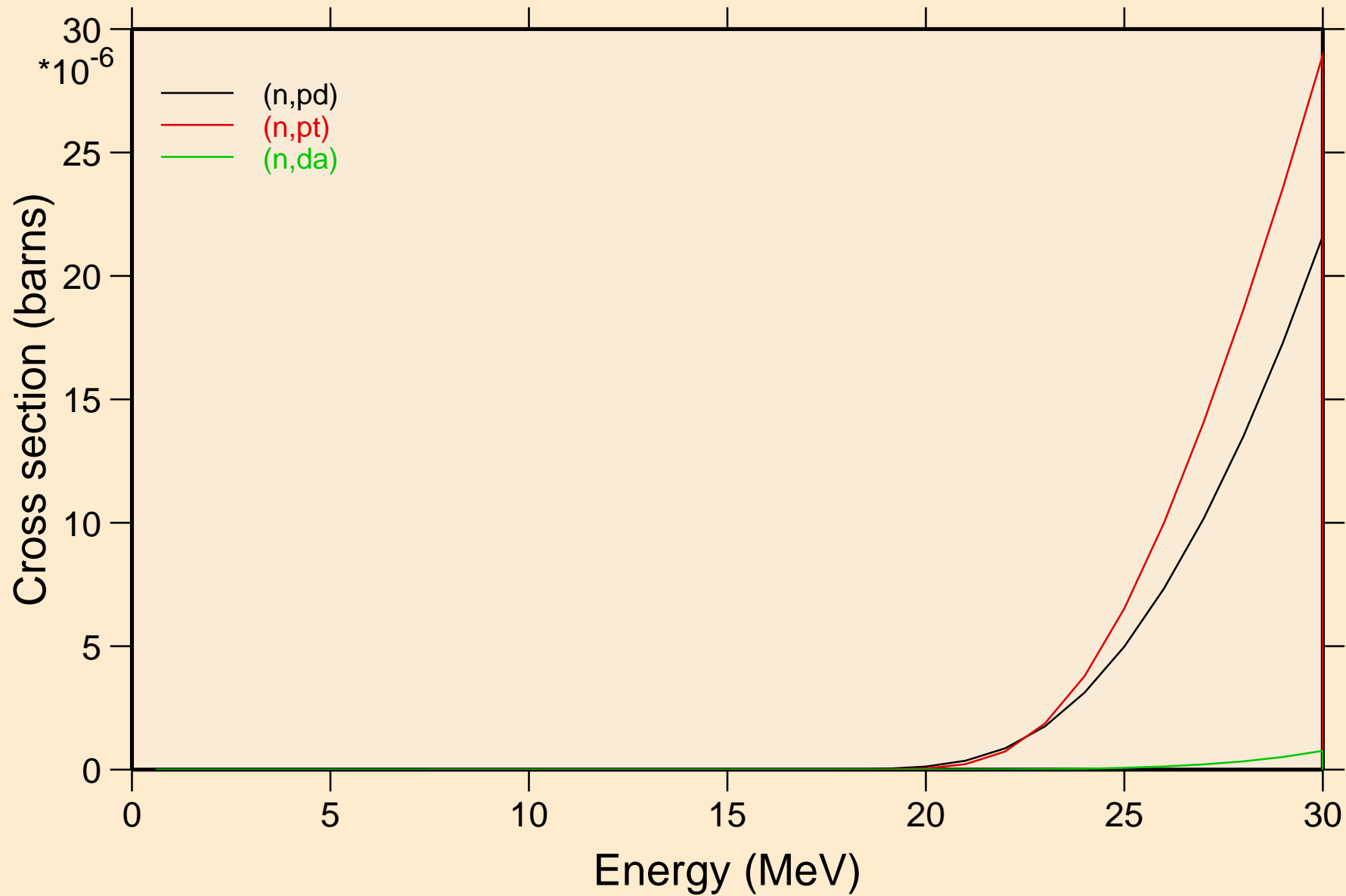

YB163 NEUTRON ACER TENDL-2023 LIBRARY; T=0.K  
Threshold reactions

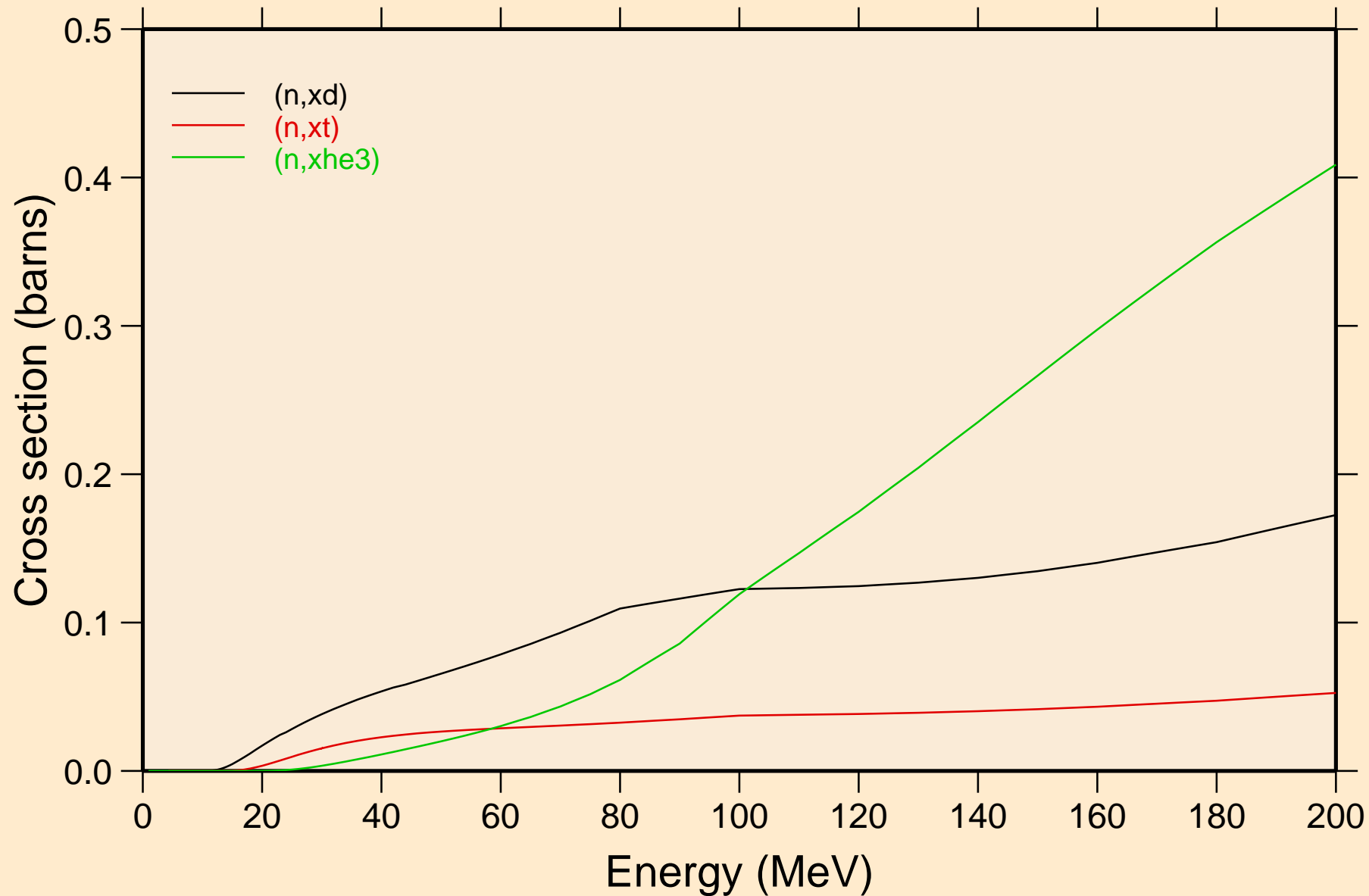

YB163 NEUTRON ACER TENDL-2023 LIBRARY; T=0.K  
angular distribution for elastic

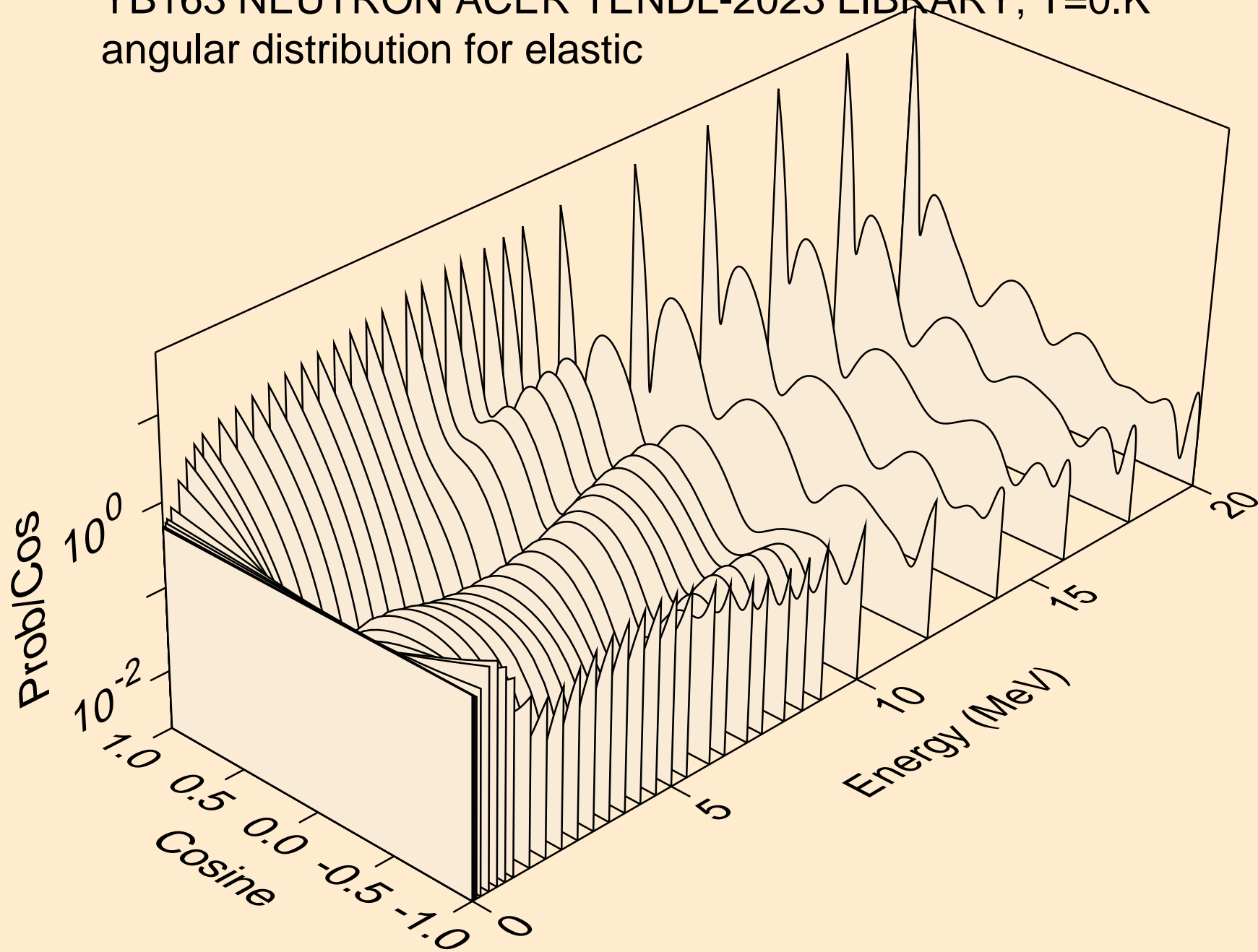

YB163 NEUTRON ACER TENDL-2023 LIBRARY; T=0.K  
angular distribution for elastic

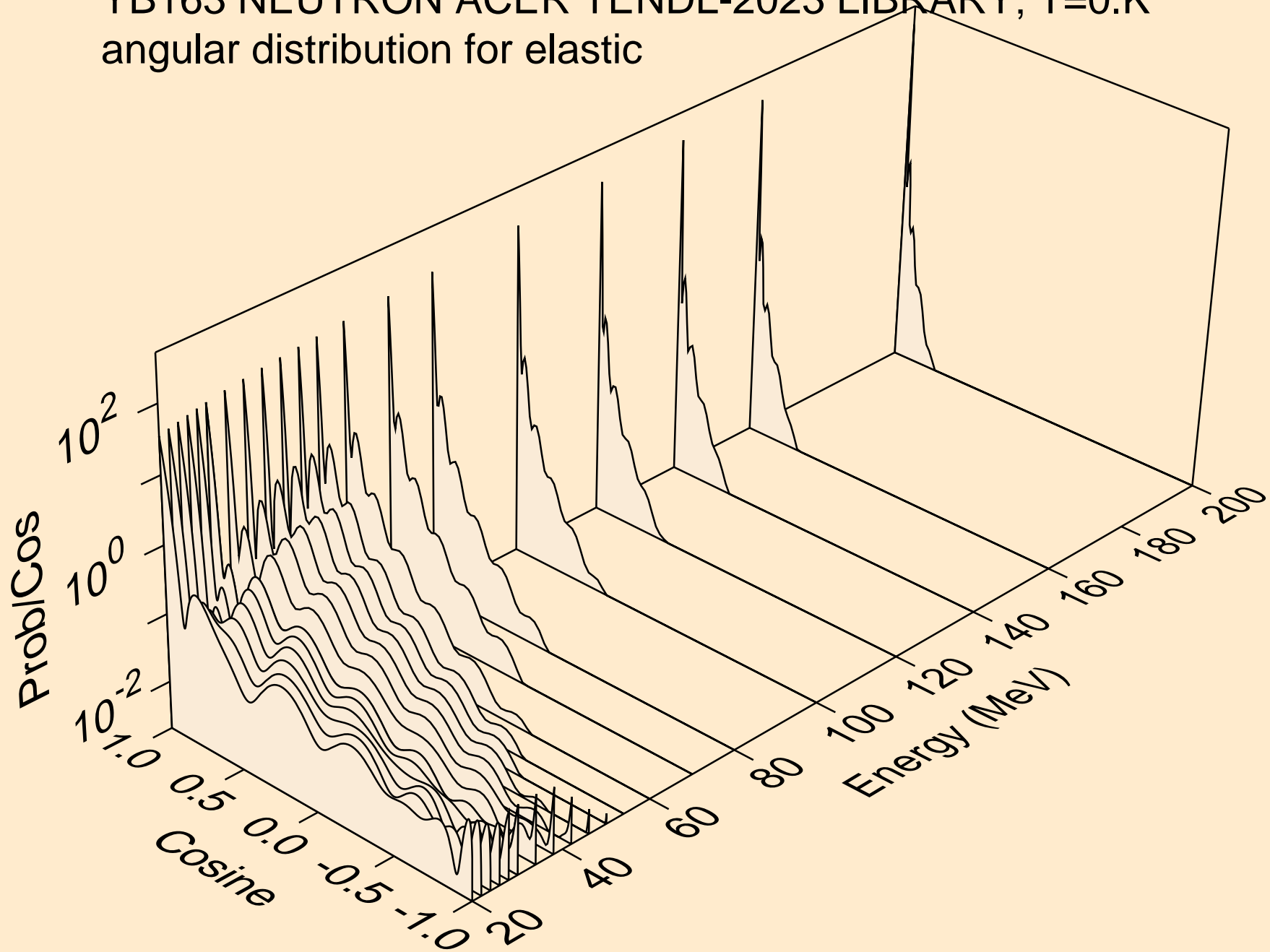

YB163 NEUTRON ACER TENDL-2023 LIBRARY; T=0.K  
angular distribution for (n,n\*1)

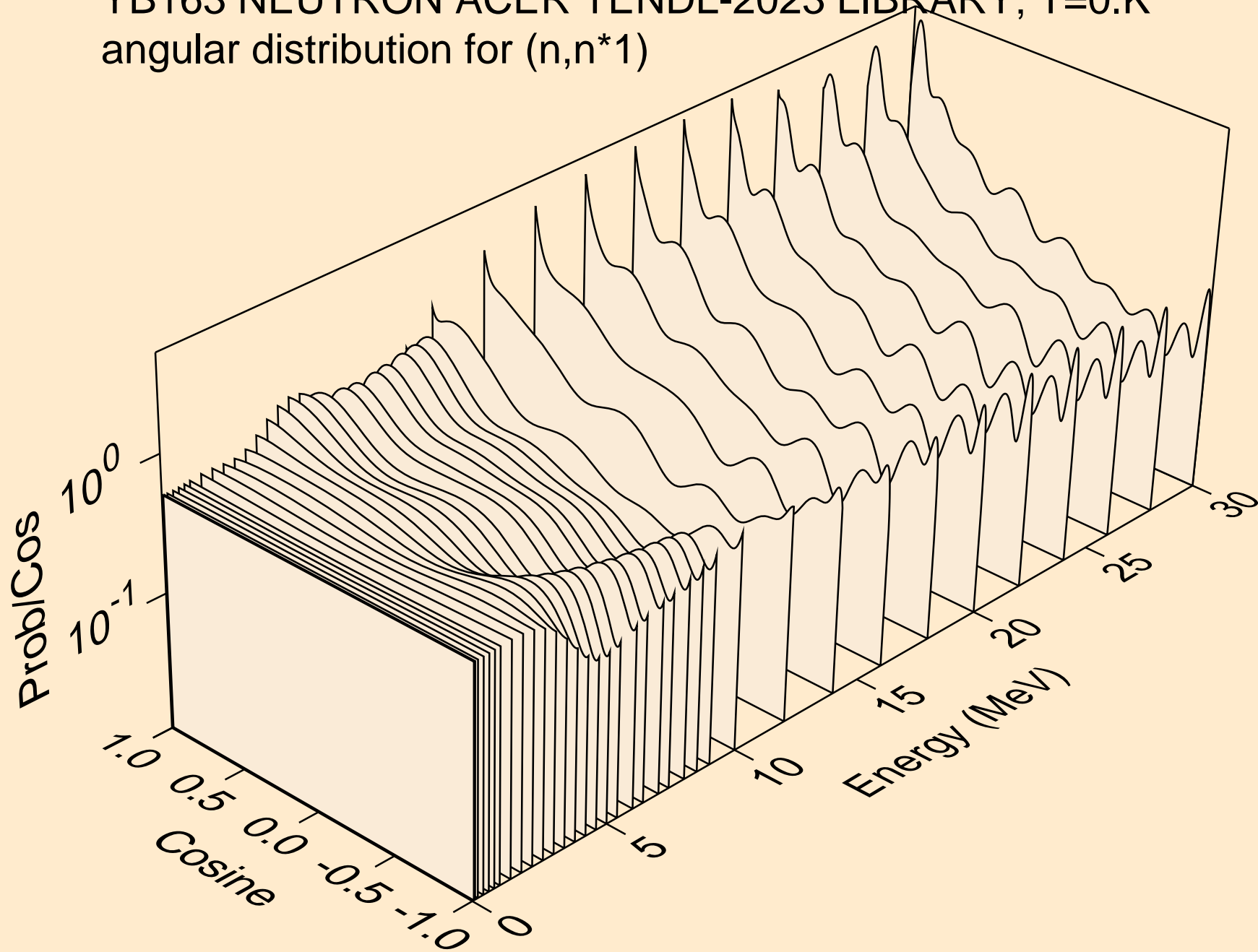

YB163 NEUTRON ACER TENDL-2023 LIBRARY; T=0.K  
angular distribution for (n,n\*2)

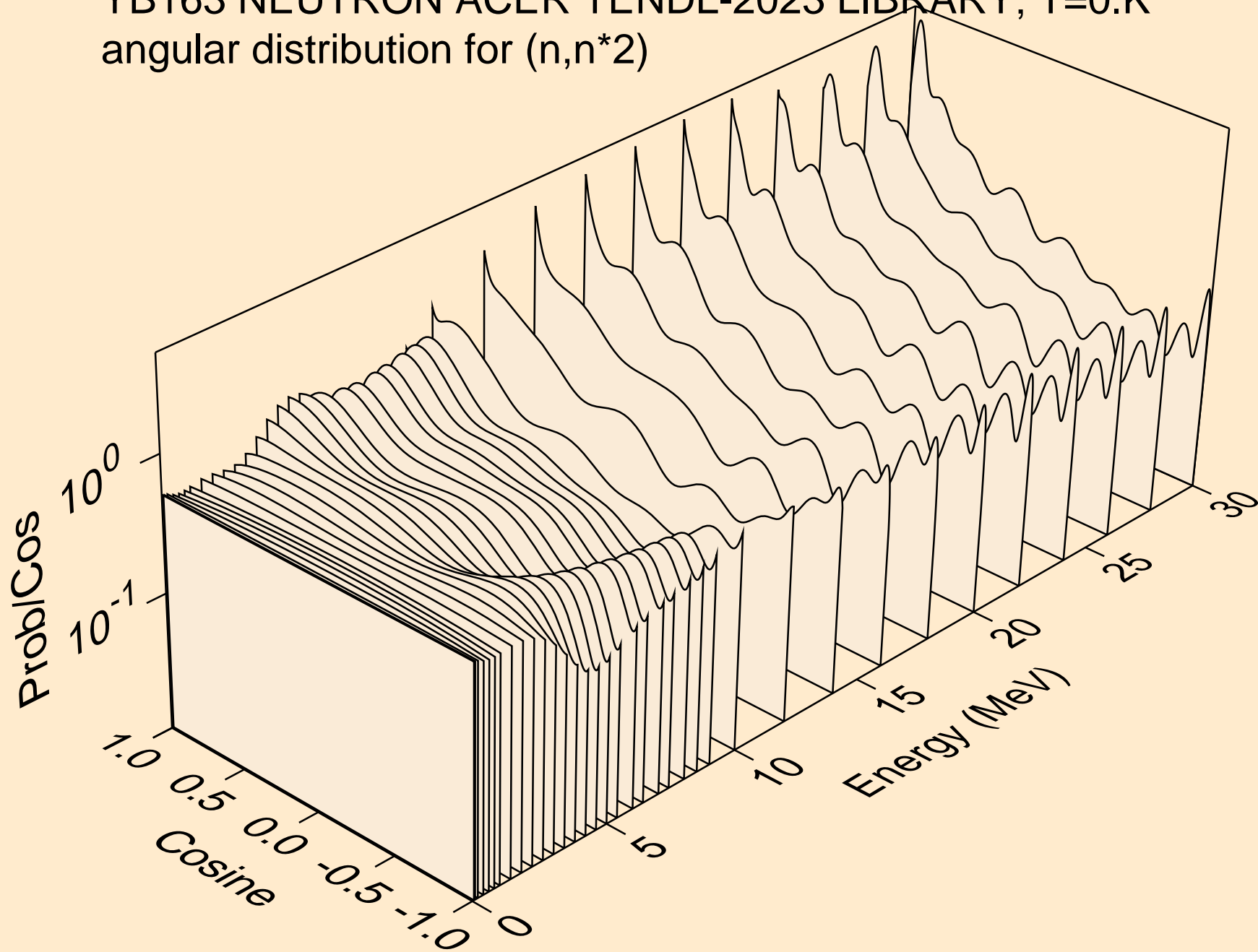

YB163 NEUTRON ACER TENDL-2023 LIBRARY; T=0.K  
angular distribution for (n,n\*3)

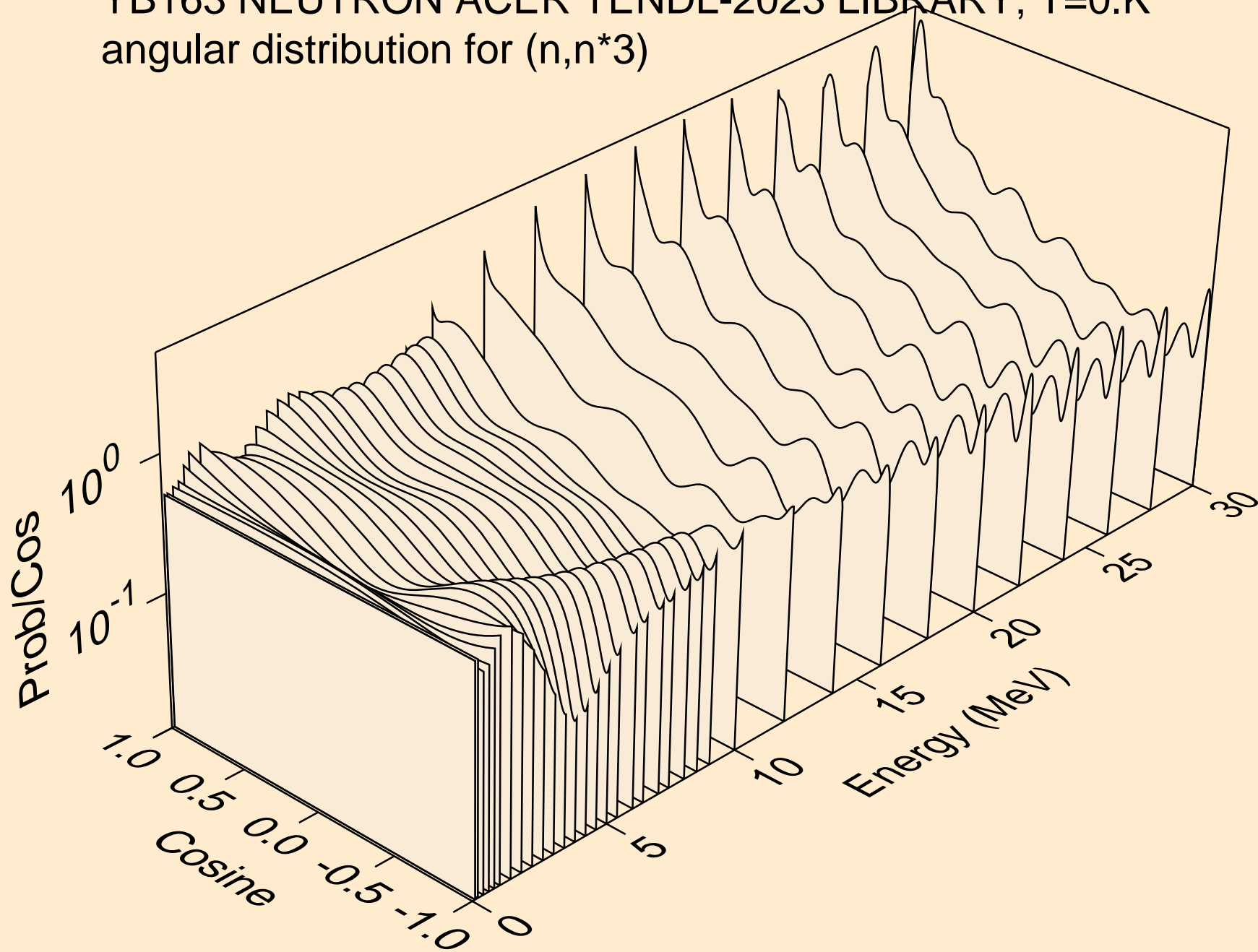

YB163 NEUTRON ACER TENDL-2023 LIBRARY; T=0.K  
angular distribution for (n,n\*4)

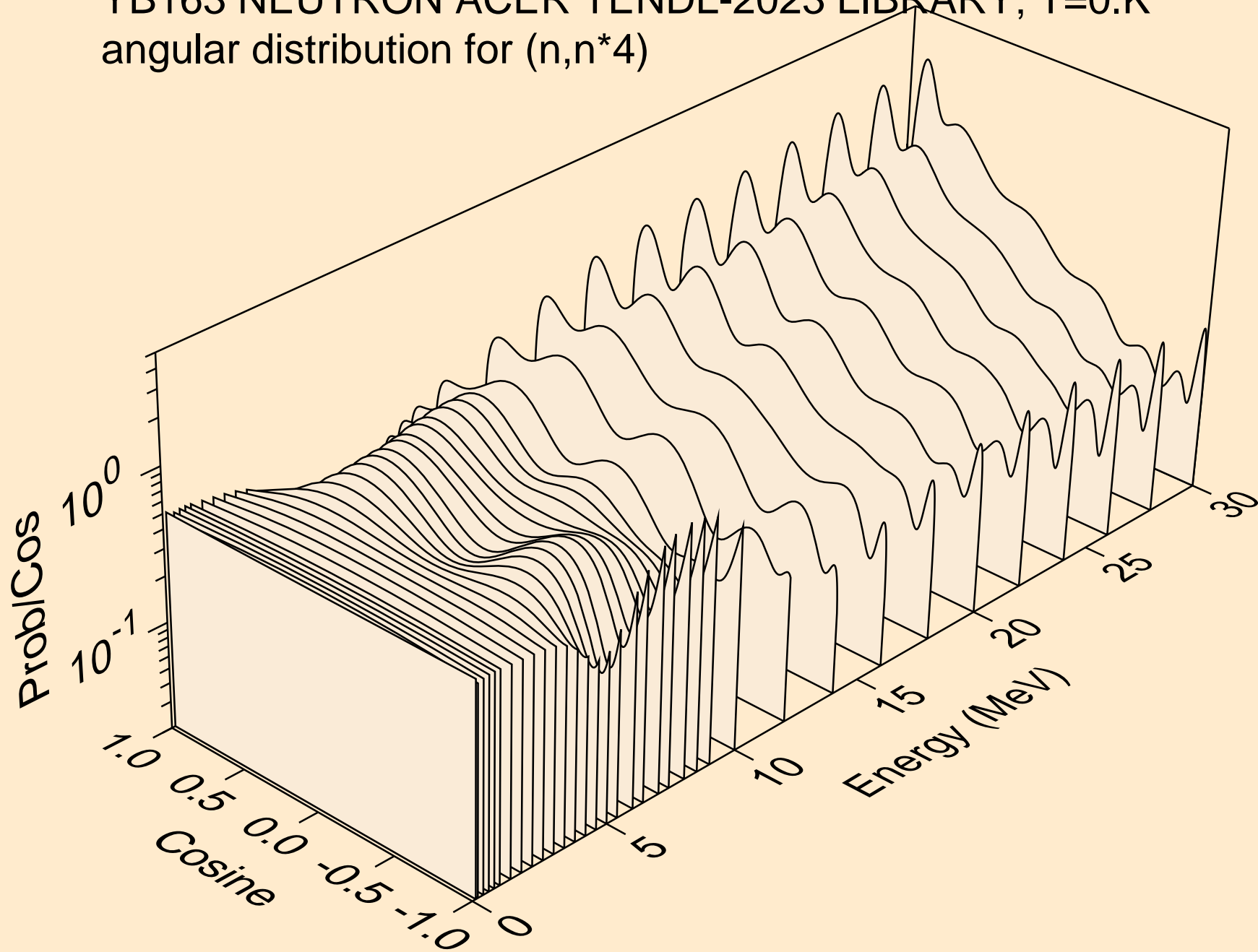



YB163 NEUTRON ACER TENDL-2023 LIBRARY; T=0.K  
angular distribution for (n,n\*5)

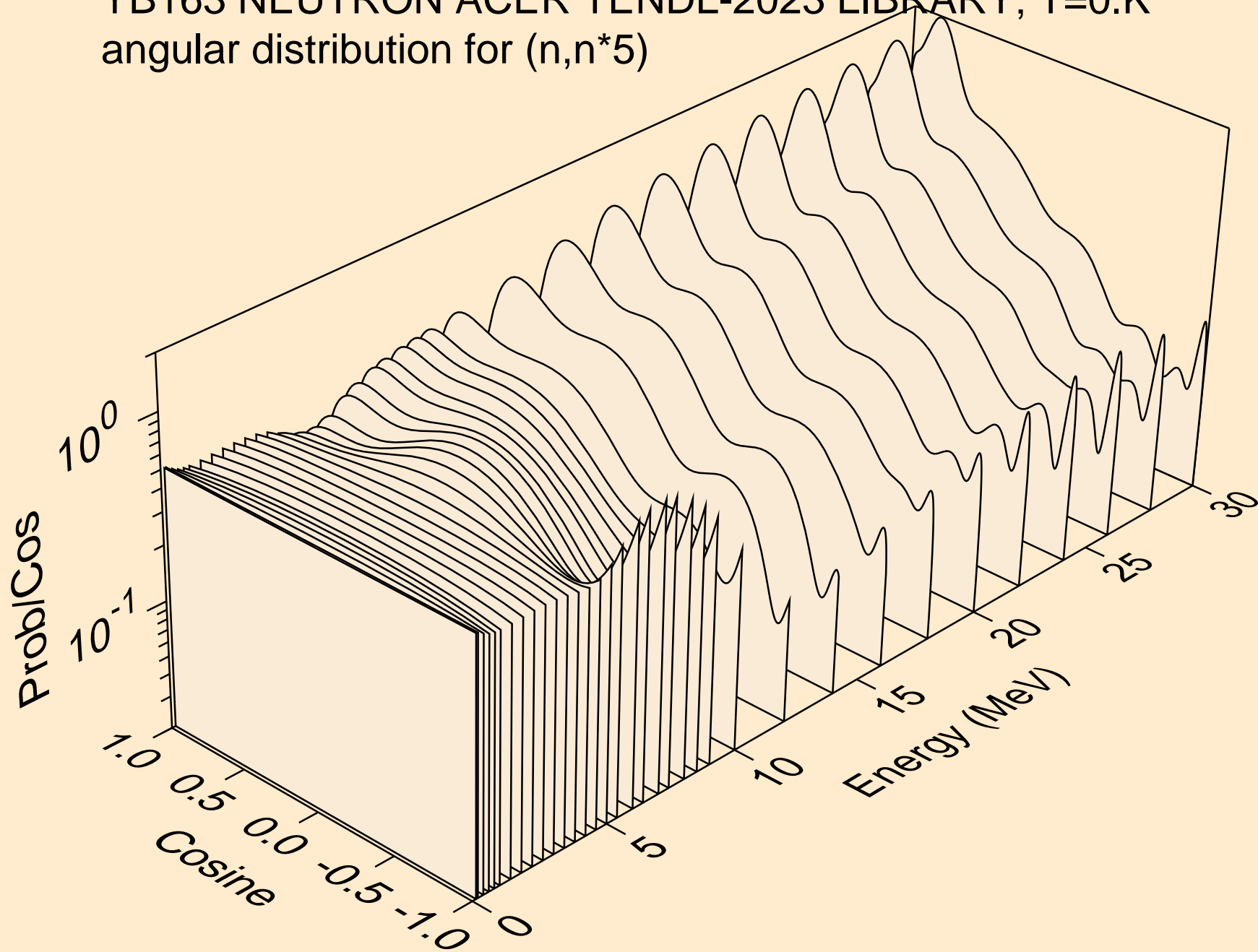

YB163 NEUTRON ACER TENDL-2023 LIBRARY; T=0.K  
angular distribution for (n,n\*6)

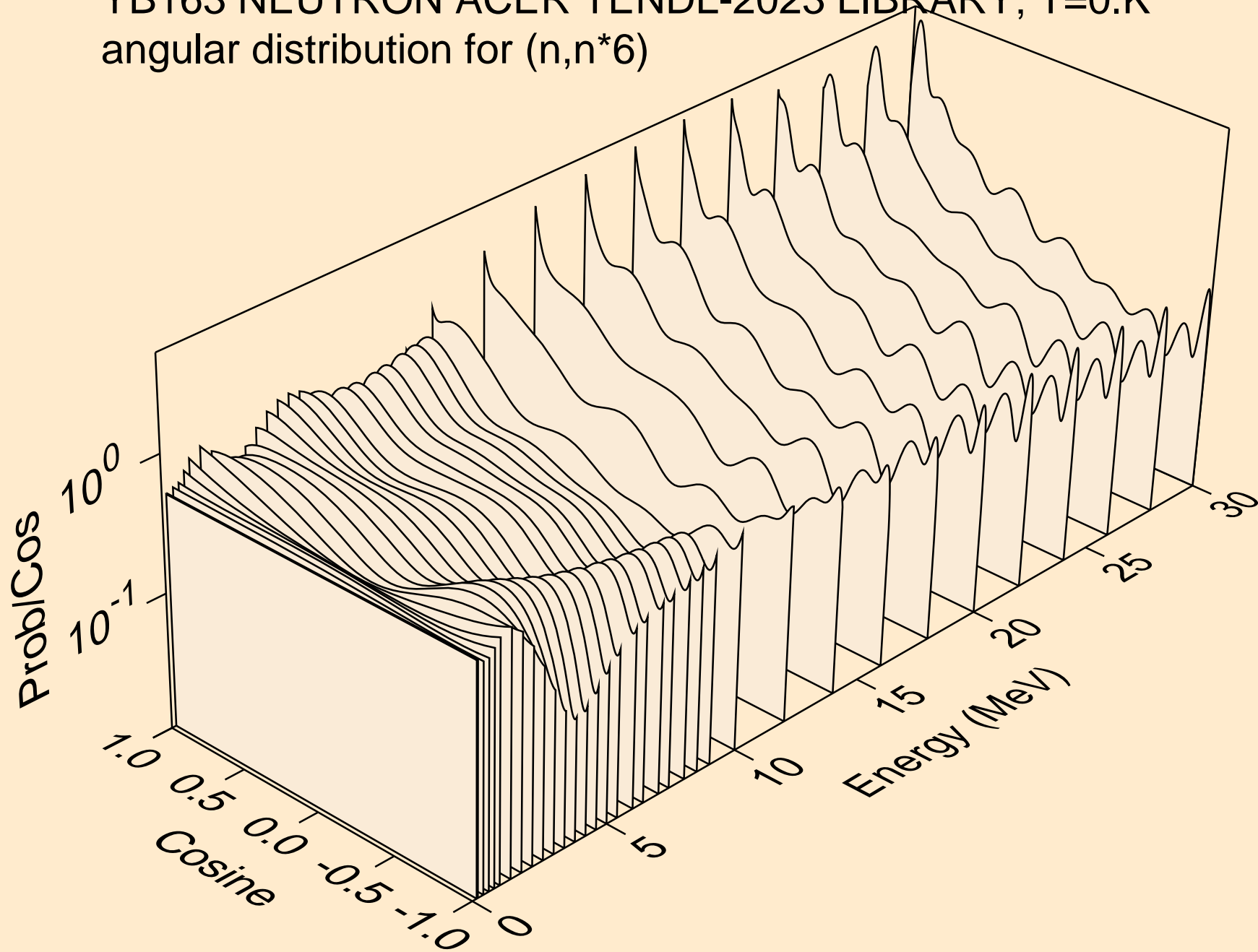

YB163 NEUTRON ACER TENDL-2023 LIBRARY; T=0.K  
angular distribution for (n,n\*7)

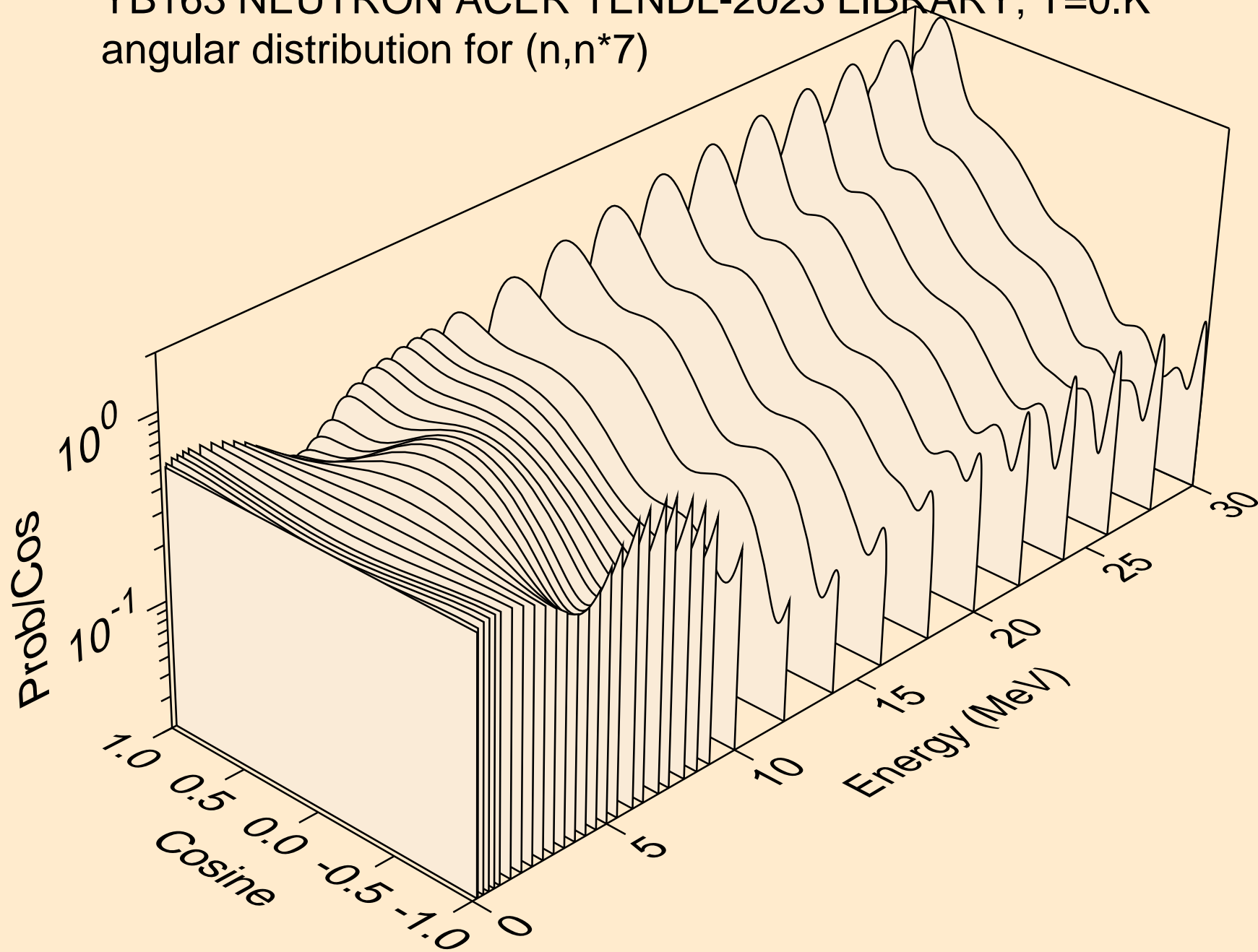

YB163 NEUTRON ACER TENDL-2023 LIBRARY; T=0.K  
angular distribution for (n,n\*8)

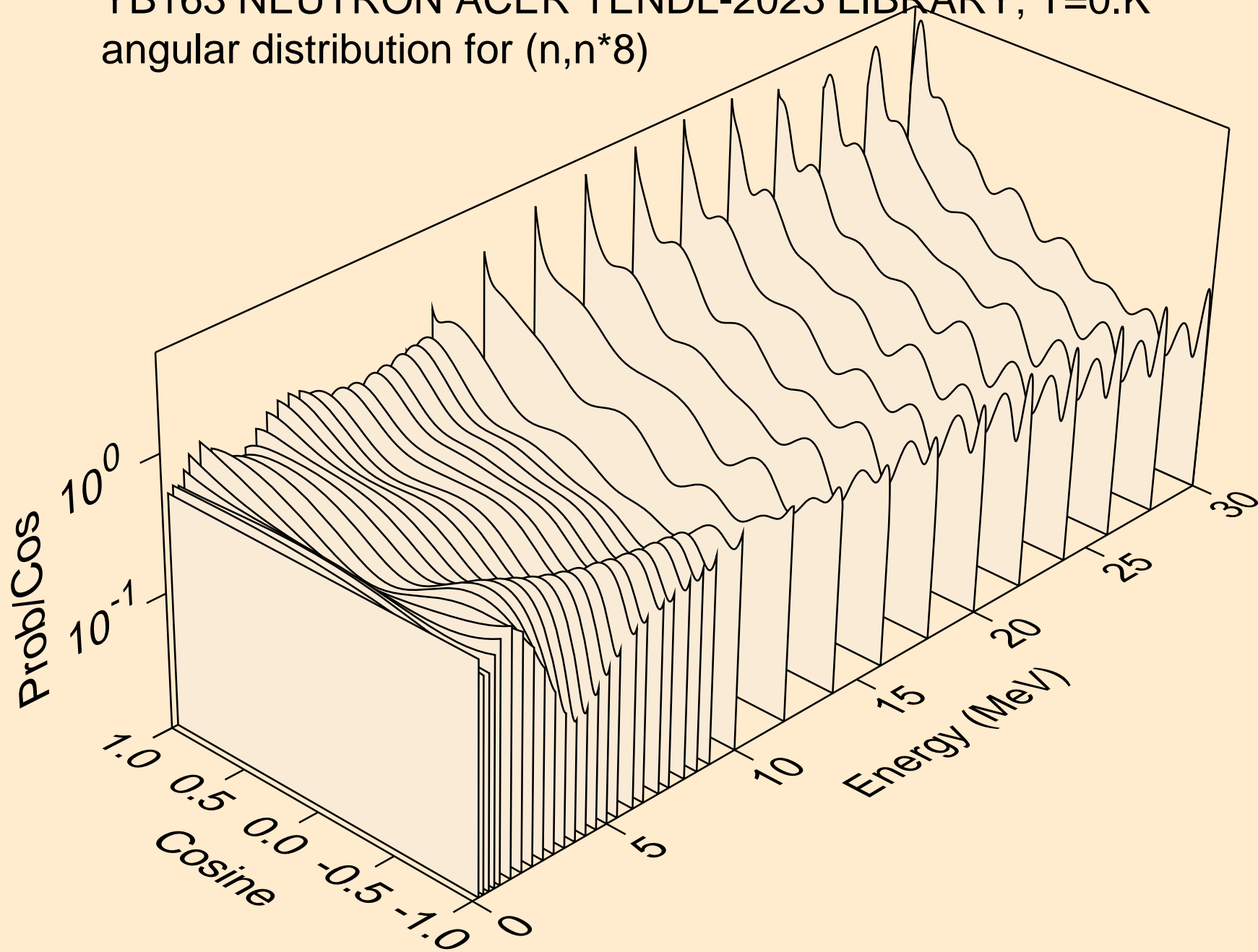

YB163 NEUTRON ACER TENDL-2023 LIBRARY; T=0.K  
angular distribution for (n,n\*9)

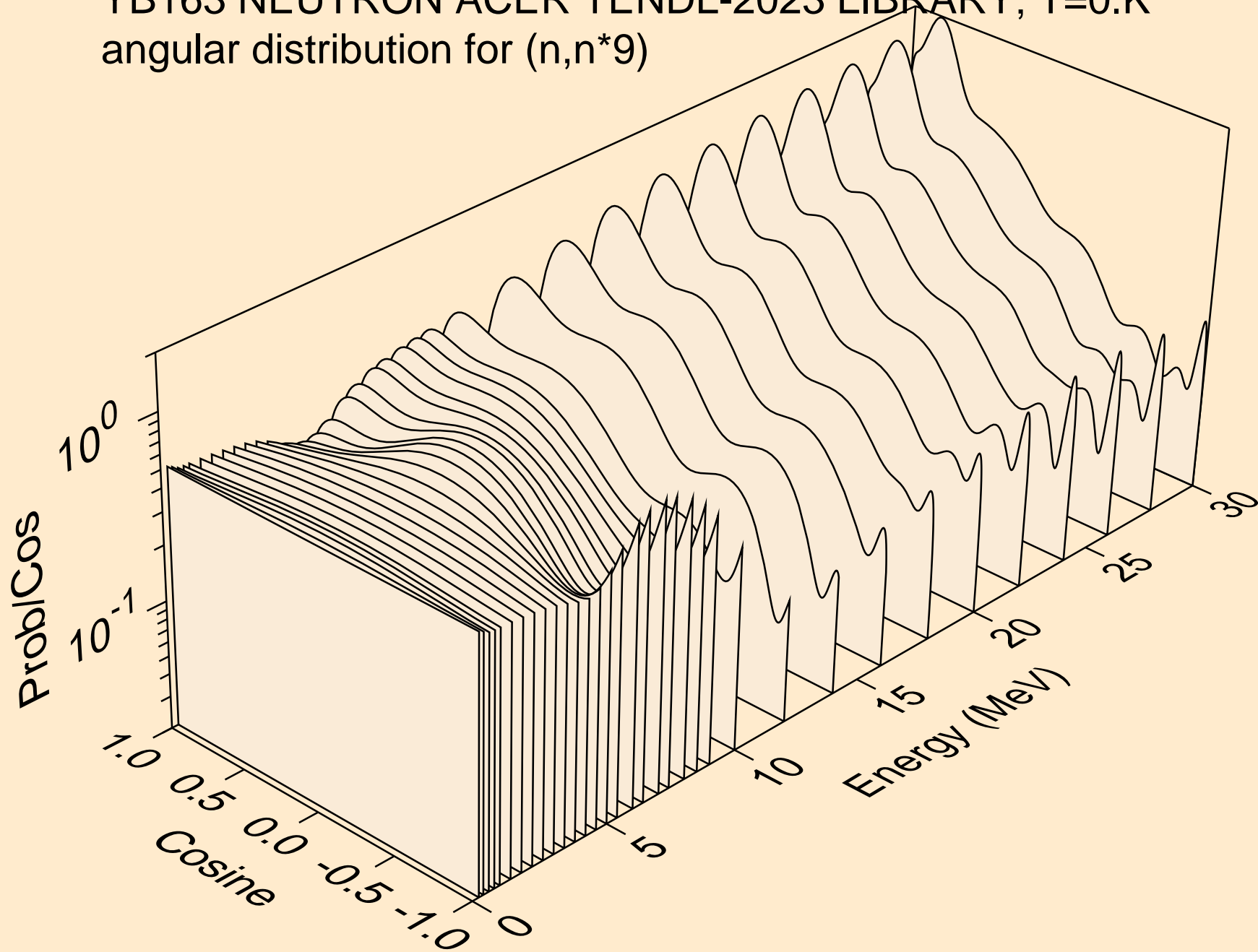

YB163 NEUTRON ACER TENDL-2023 LIBRARY; T=0.K  
angular distribution for (n,n\*10)

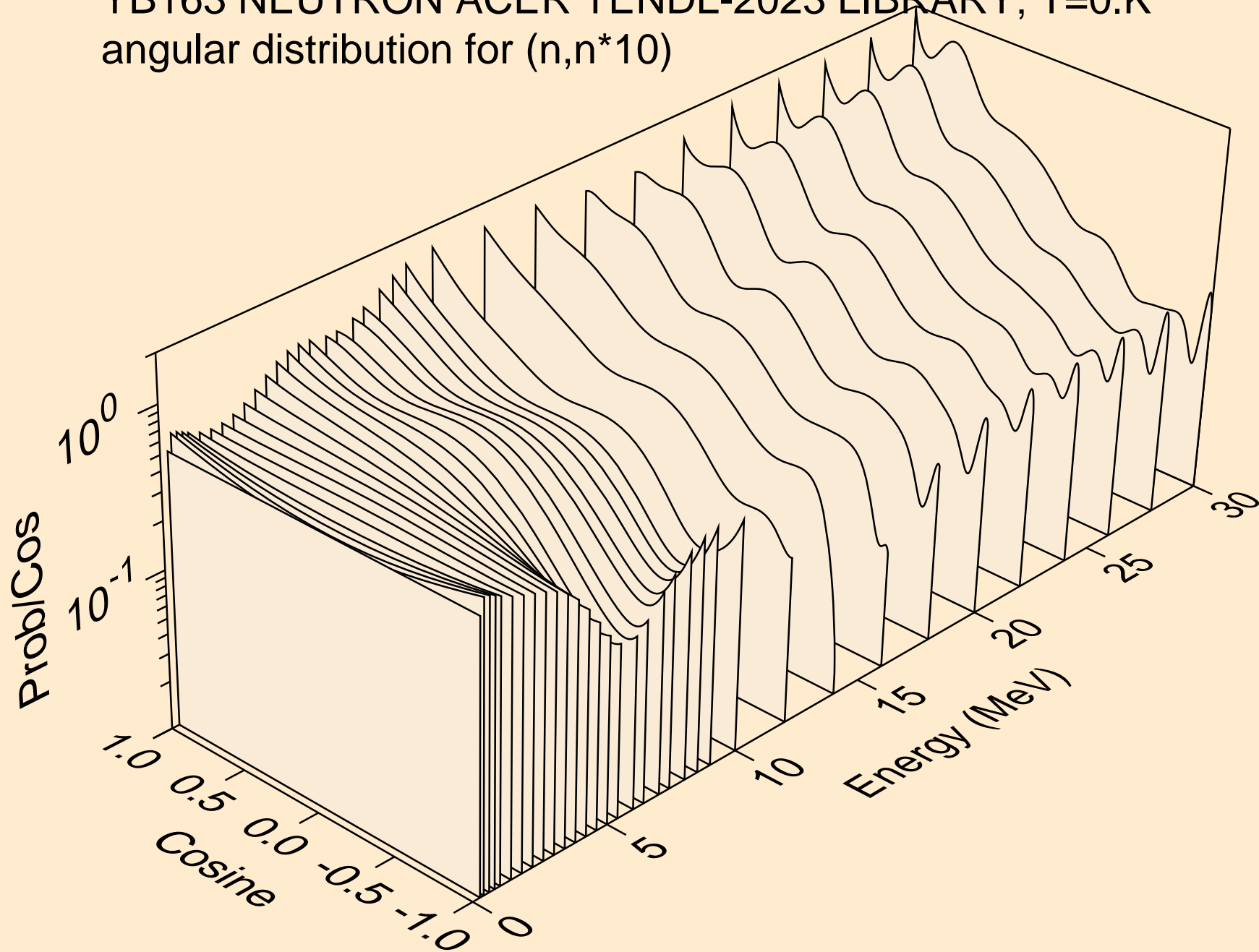

YB163 NEUTRON ACER TENDL-2023 LIBRARY; T=0.K  
angular distribution for (n,n\*11)

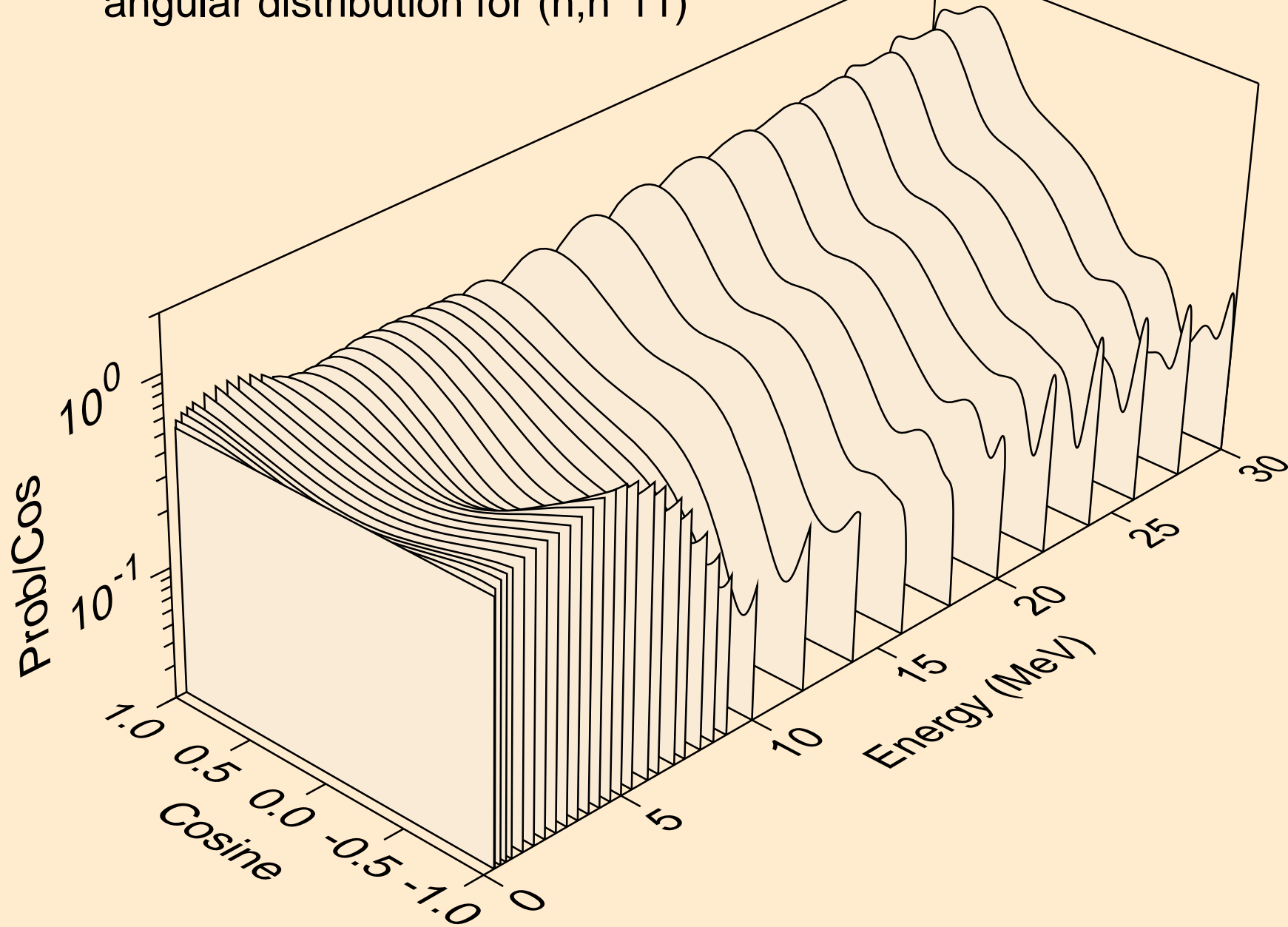

YB163 NEUTRON ACER TENDL-2023 LIBRARY; T=0.K  
angular distribution for (n,n\*12)

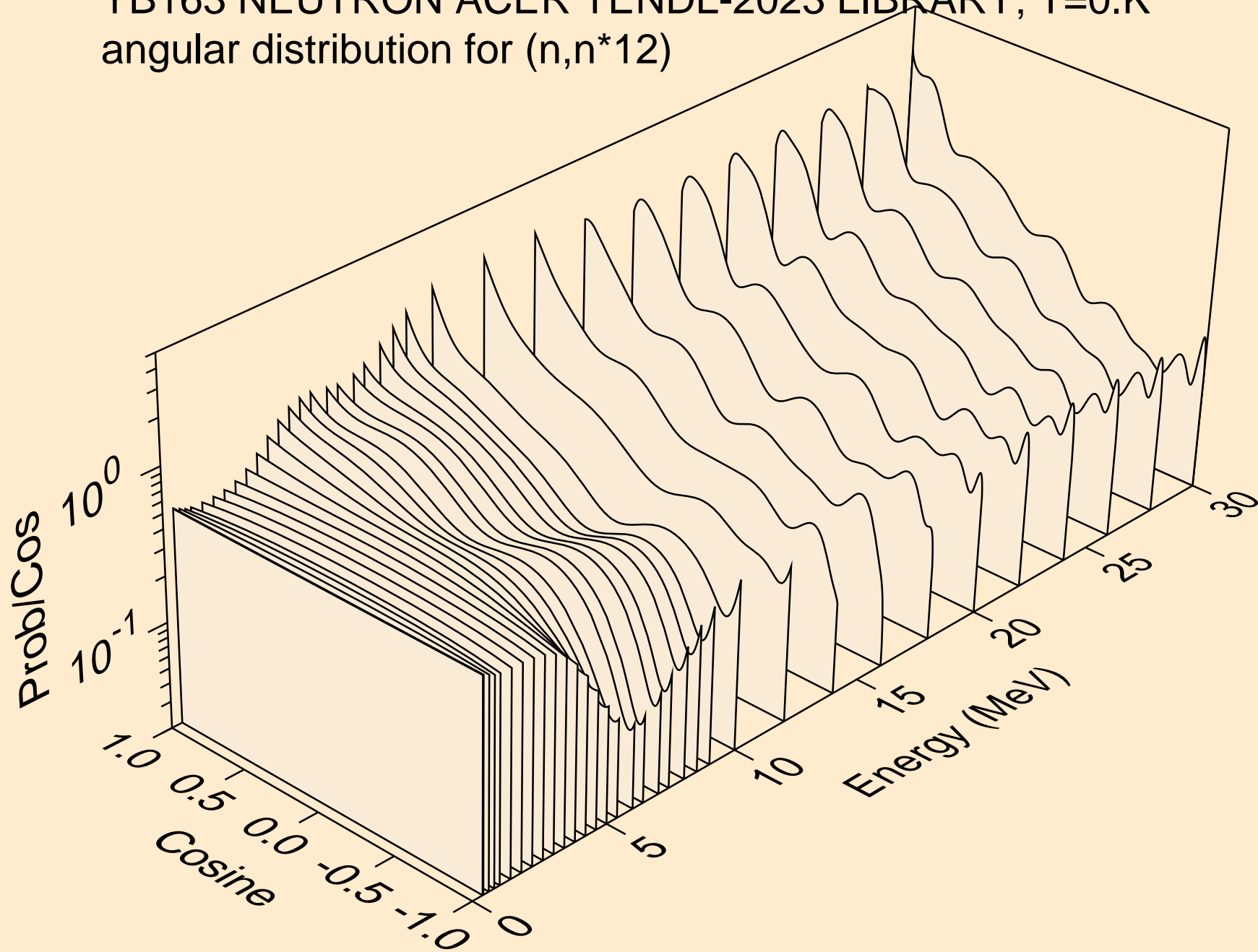



YB163 NEUTRON ACER TENDL-2023 LIBRARY; T=0.K  
angular distribution for (n,n\*13)

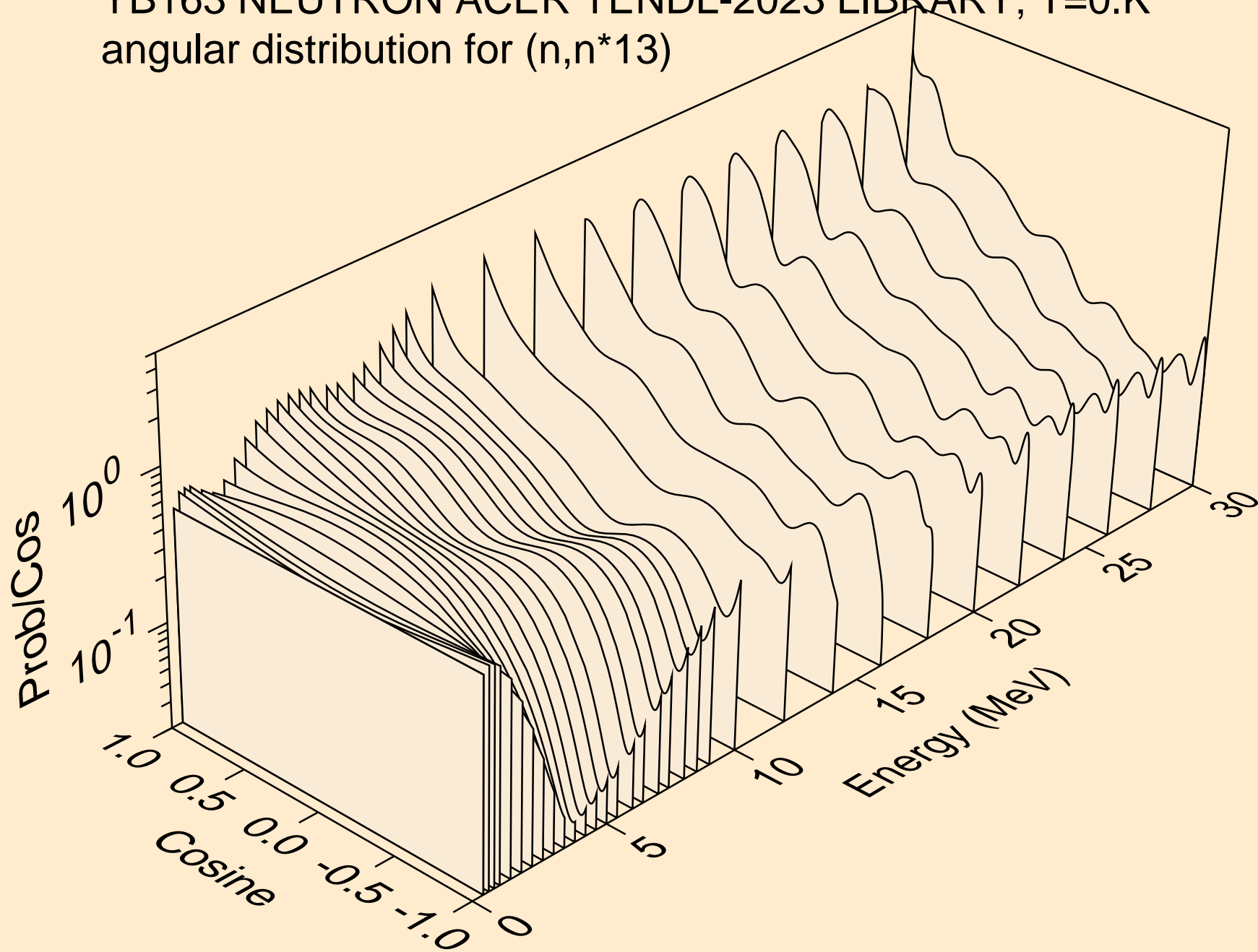

YB163 NEUTRON ACER TENDL-2023 LIBRARY; T=0.K  
angular distribution for (n,n\*14)

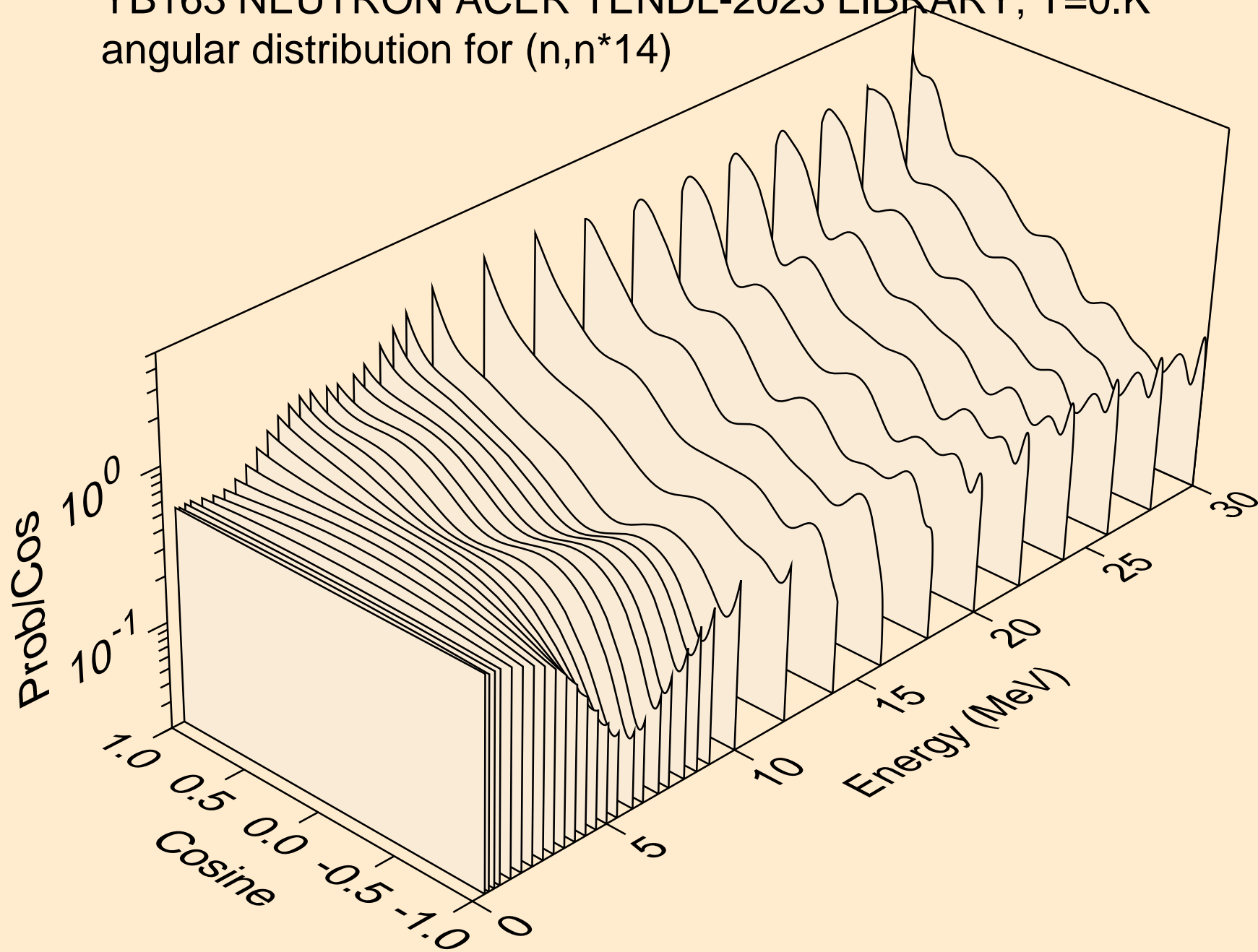

YB163 NEUTRON ACER TENDL-2023 LIBRARY; T=0.K  
angular distribution for (n,n\*15)

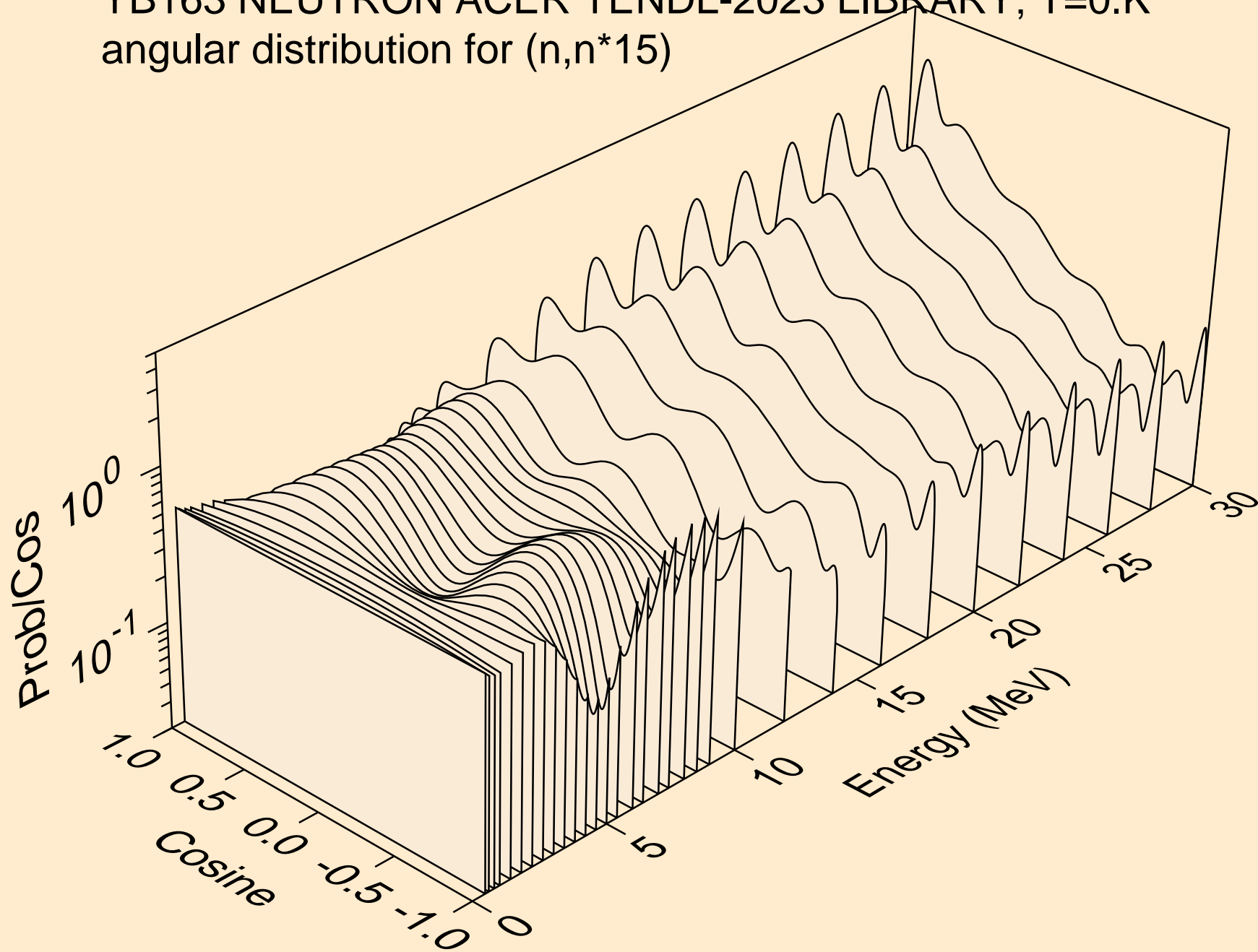

YB163 NEUTRON ACER TENDL-2023 LIBRARY; T=0.K  
angular distribution for (n,n\*16)

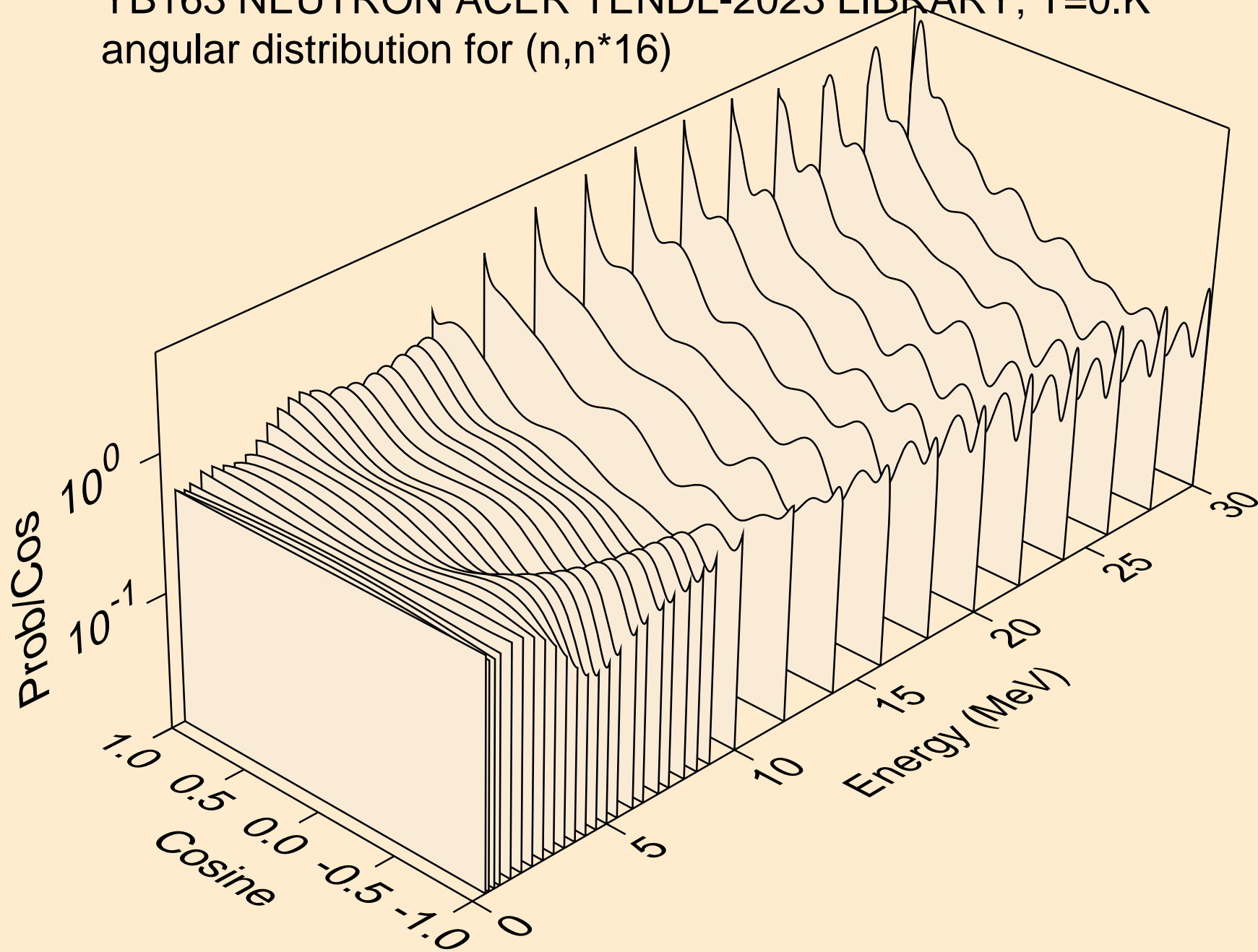

YB163 NEUTRON ACER TENDL-2023 LIBRARY; T=0.K  
angular distribution for (n,n\*17)

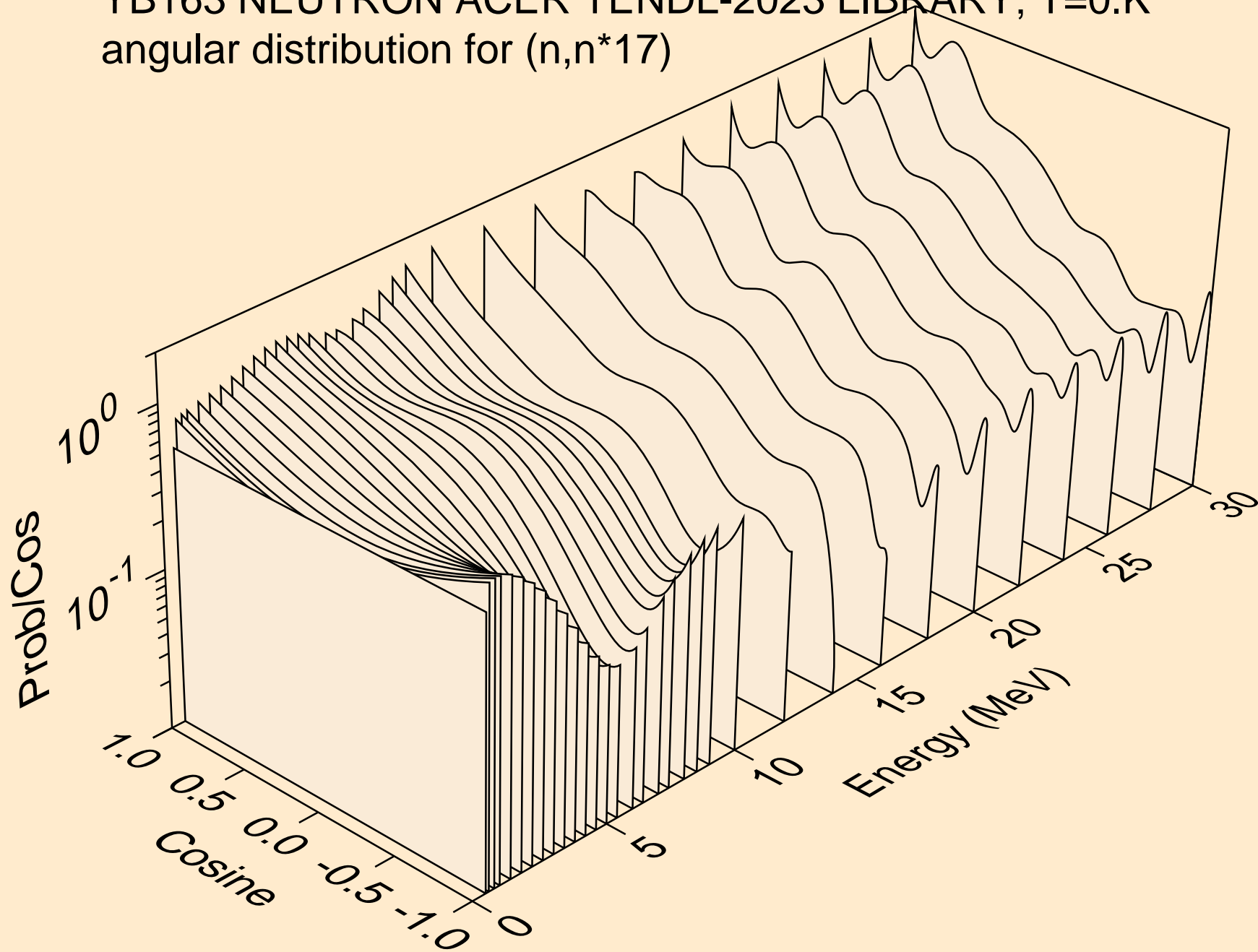

YB163 NEUTRON ACER TENDL-2023 LIBRARY; T=0.K  
angular distribution for (n,n\*18)

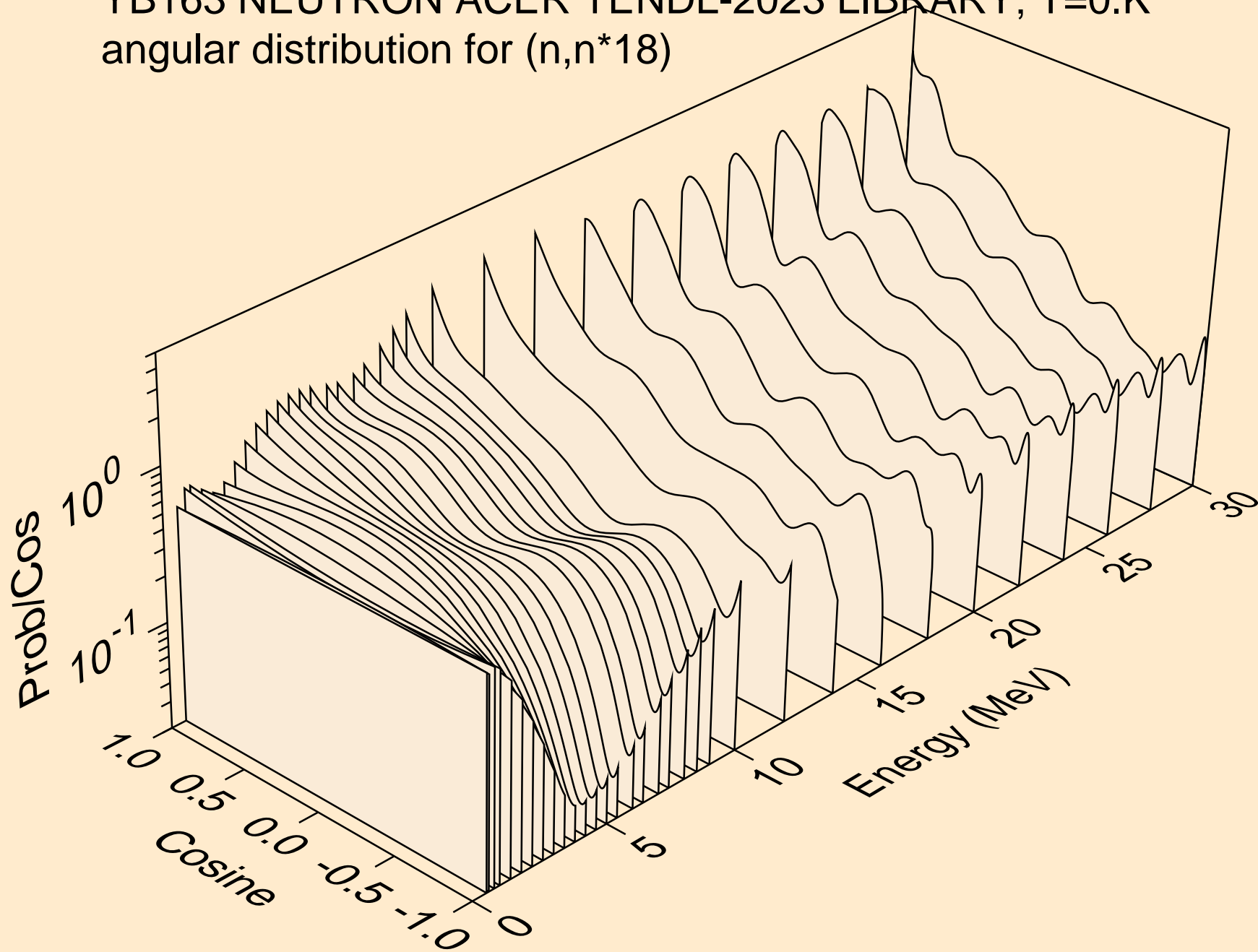

YB163 NEUTRON ACER TENDL-2023 LIBRARY; T=0.K  
angular distribution for (n,n\*19)

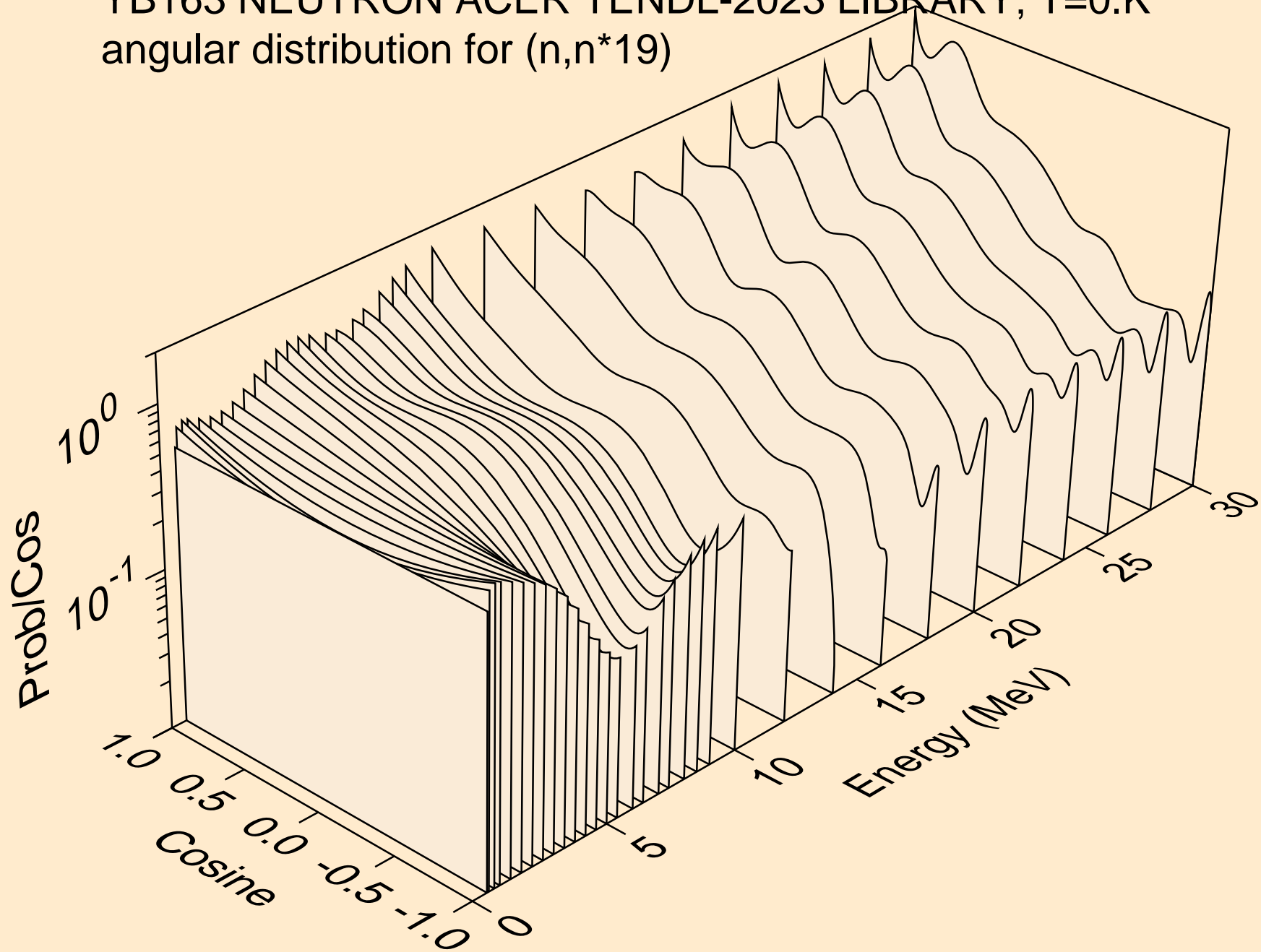

YB163 NEUTRON ACER TENDL-2023 LIBRARY; T=0.K  
angular distribution for (n,n\*20)

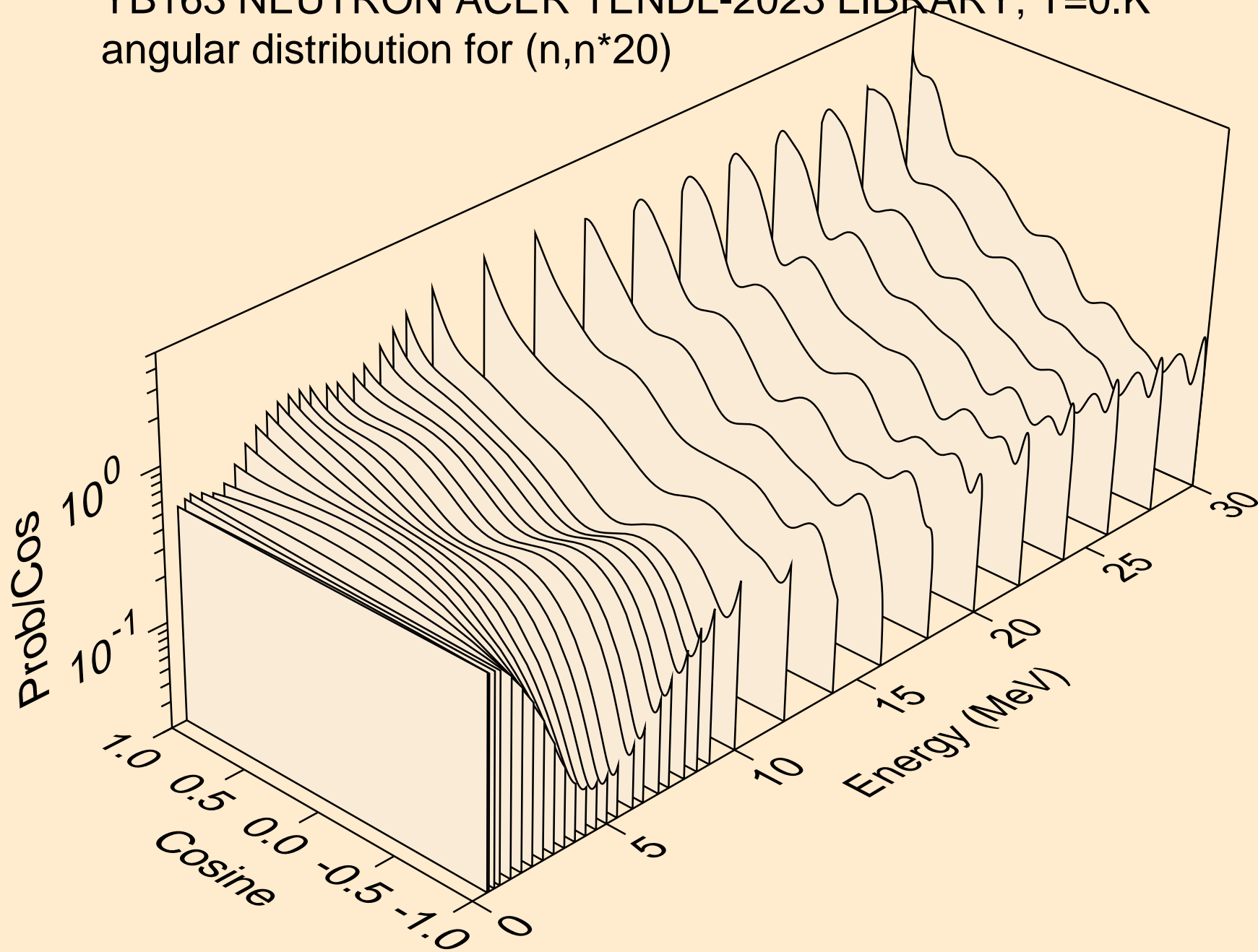



YB163 NEUTRON ACER TENDL-2023 LIBRARY; T=0.K  
Neutron emission for (n,x)

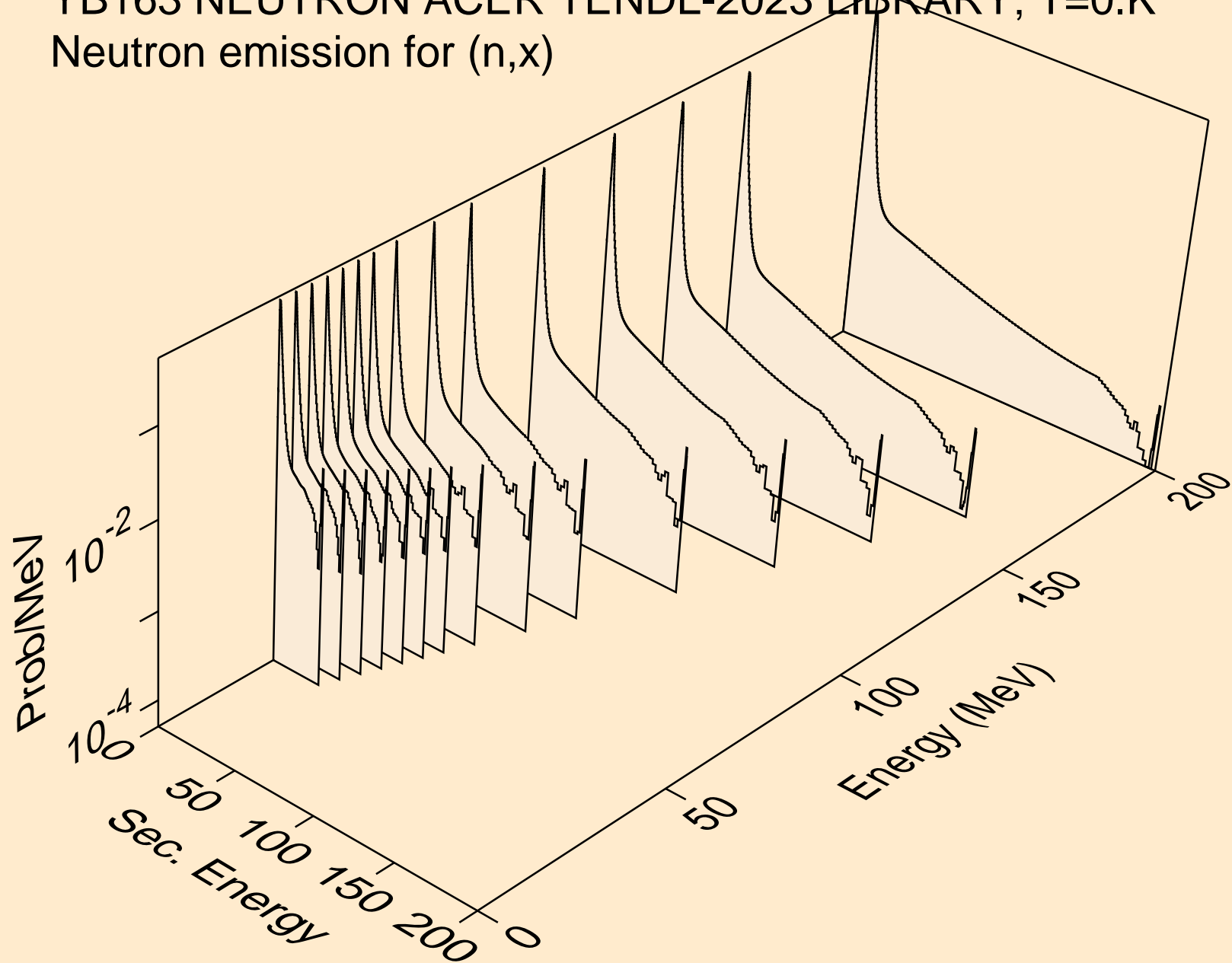

YB163 NEUTRON ACER TENDL-2023 LIBRARY; T=0.K  
Neutron emission for (n,2nd)

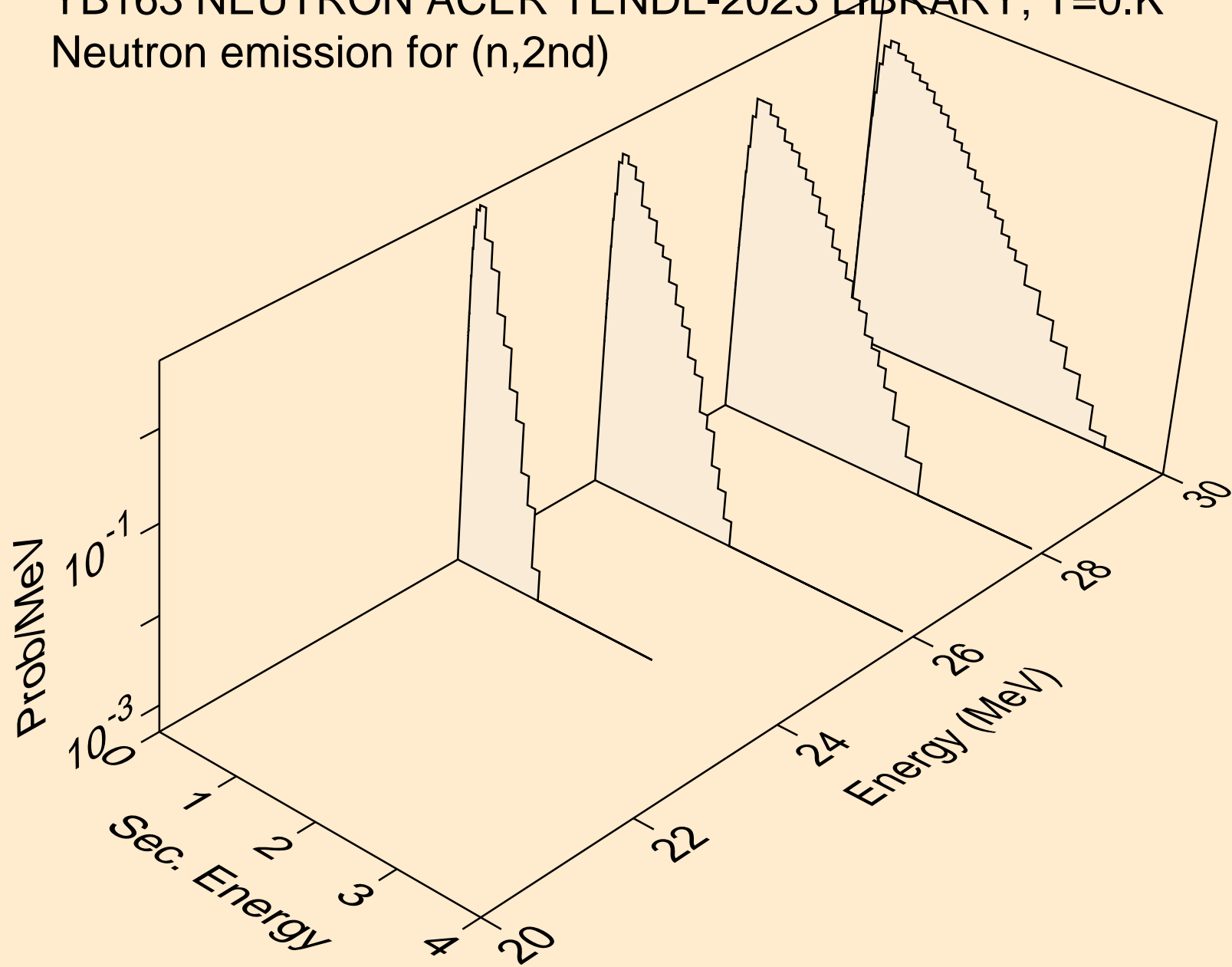

YB163 NEUTRON ACER TENDL-2023 LIBRARY; T=0.K  
Neutron emission for (n,2n)

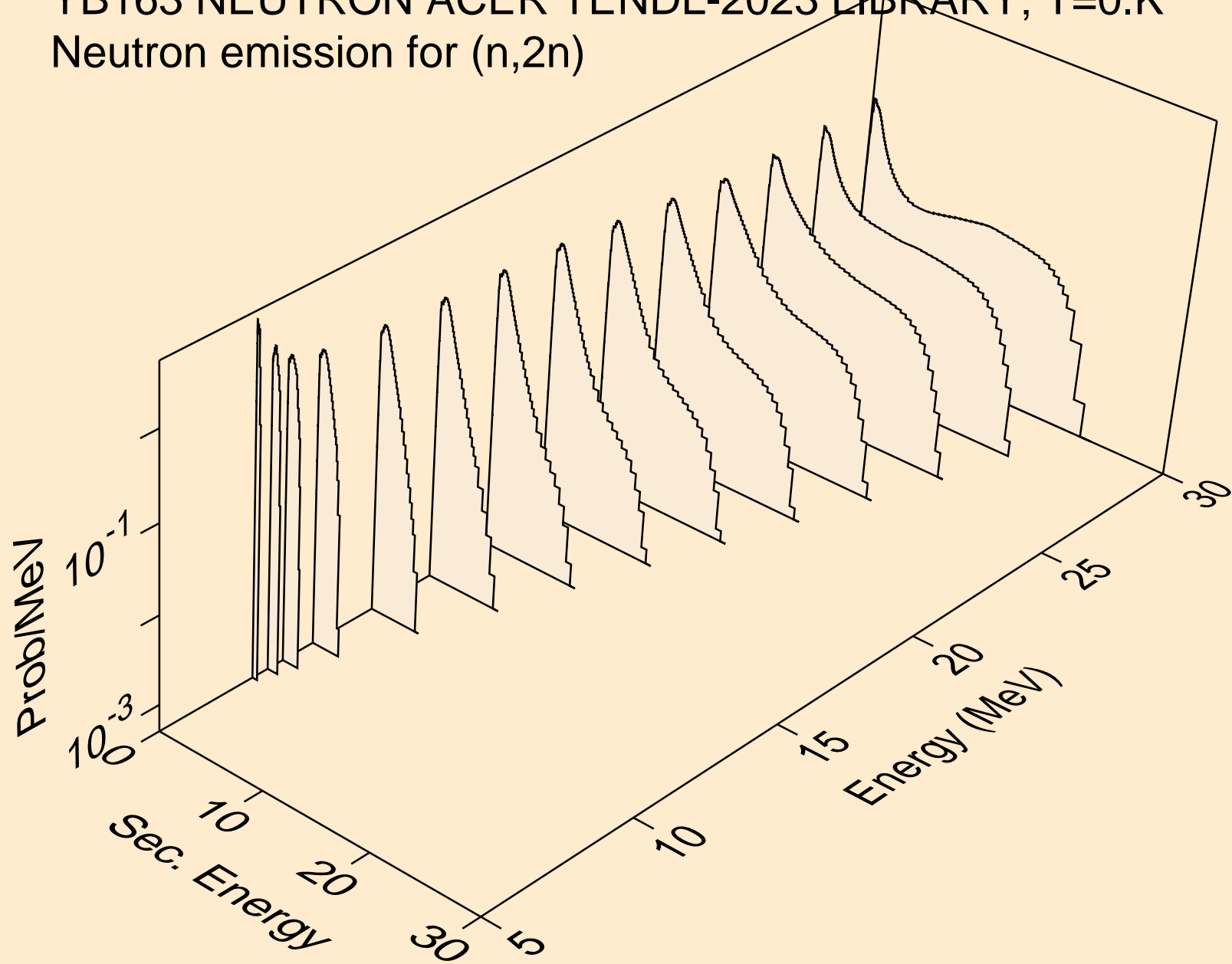

YB163 NEUTRON ACER TENDL-2023 LIBRARY; T=0.K  
Neutron emission for (n,3n)

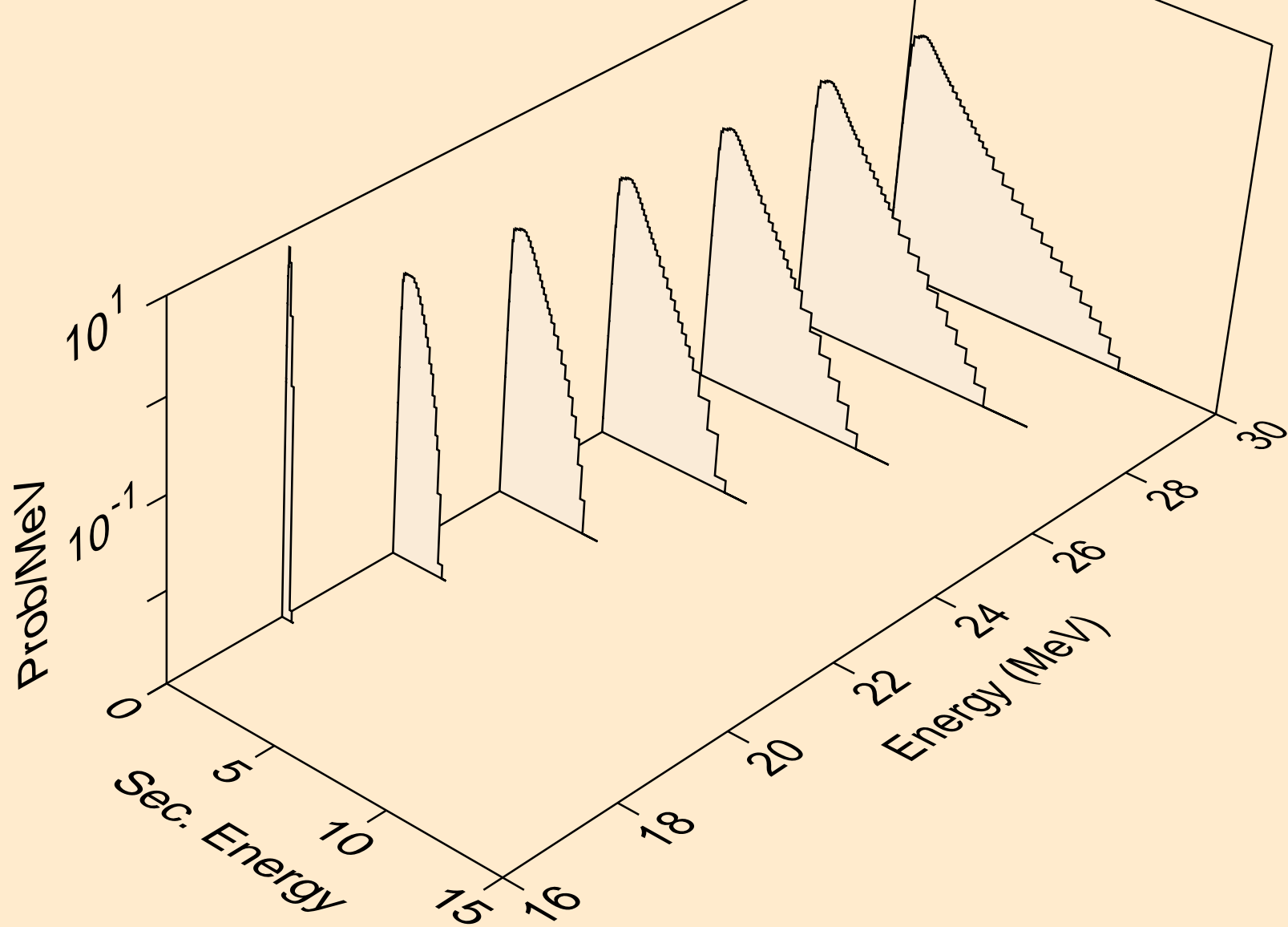

YB163 NEUTRON ACER TENDL-2023 LIBRARY; T=0.K  
Neutron emission for (n,n\*)a

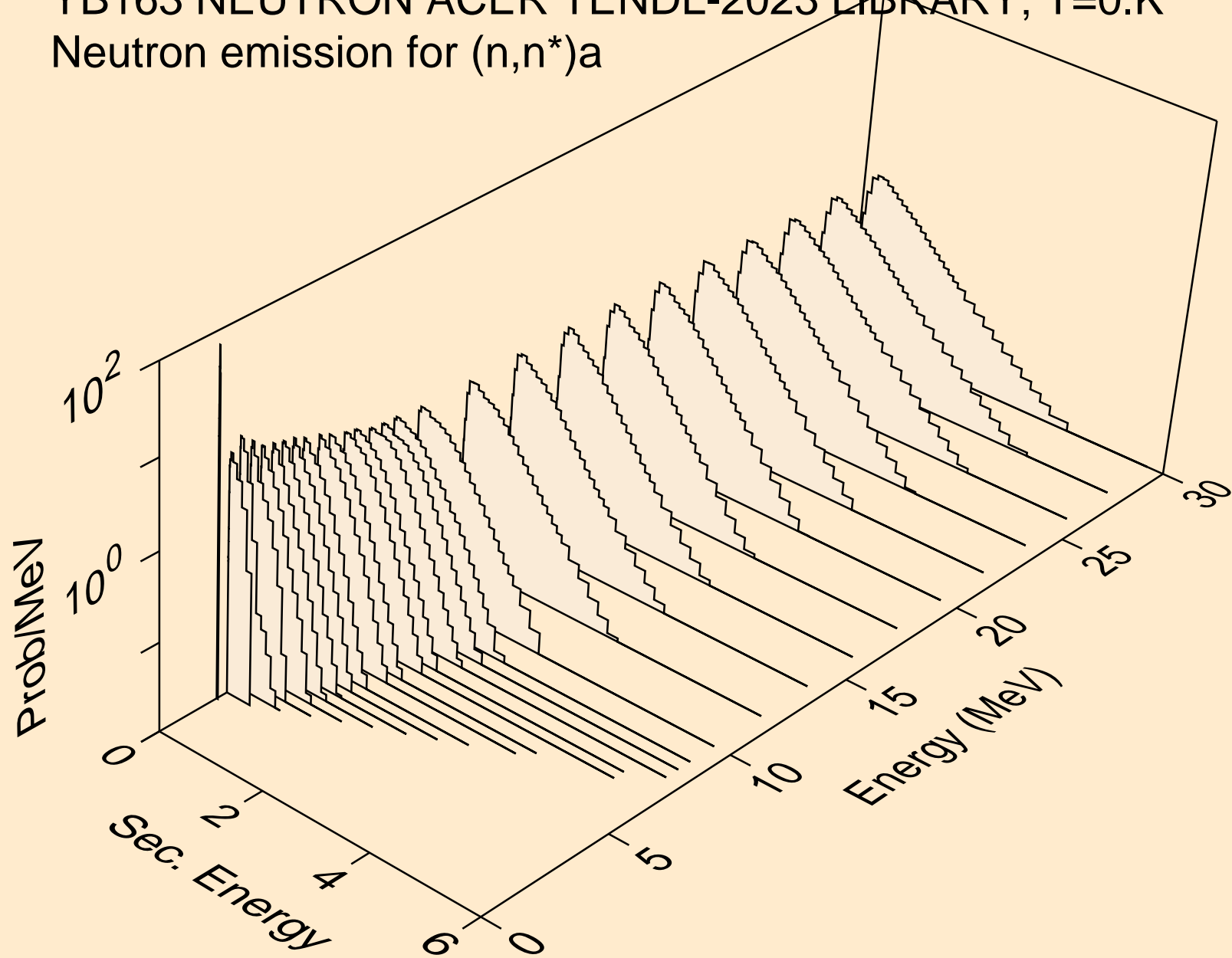

YB163 NEUTRON ACER TENDL-2023 LIBRARY; T=0.K  
Neutron emission for (n,2n)a

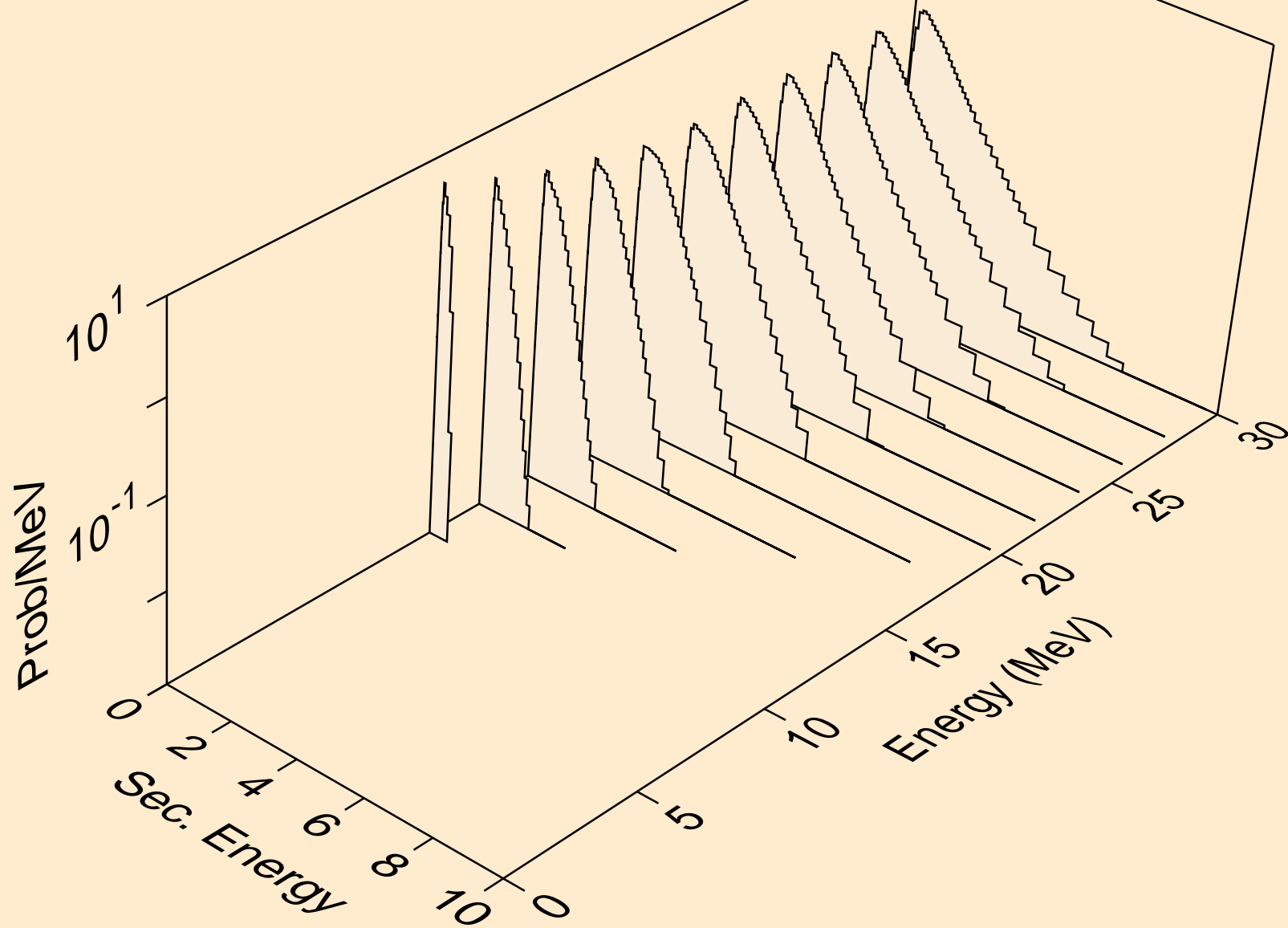

YB163 NEUTRON ACER TENDL-2023 LIBRARY; T=0.K  
Neutron emission for (n,3n)a

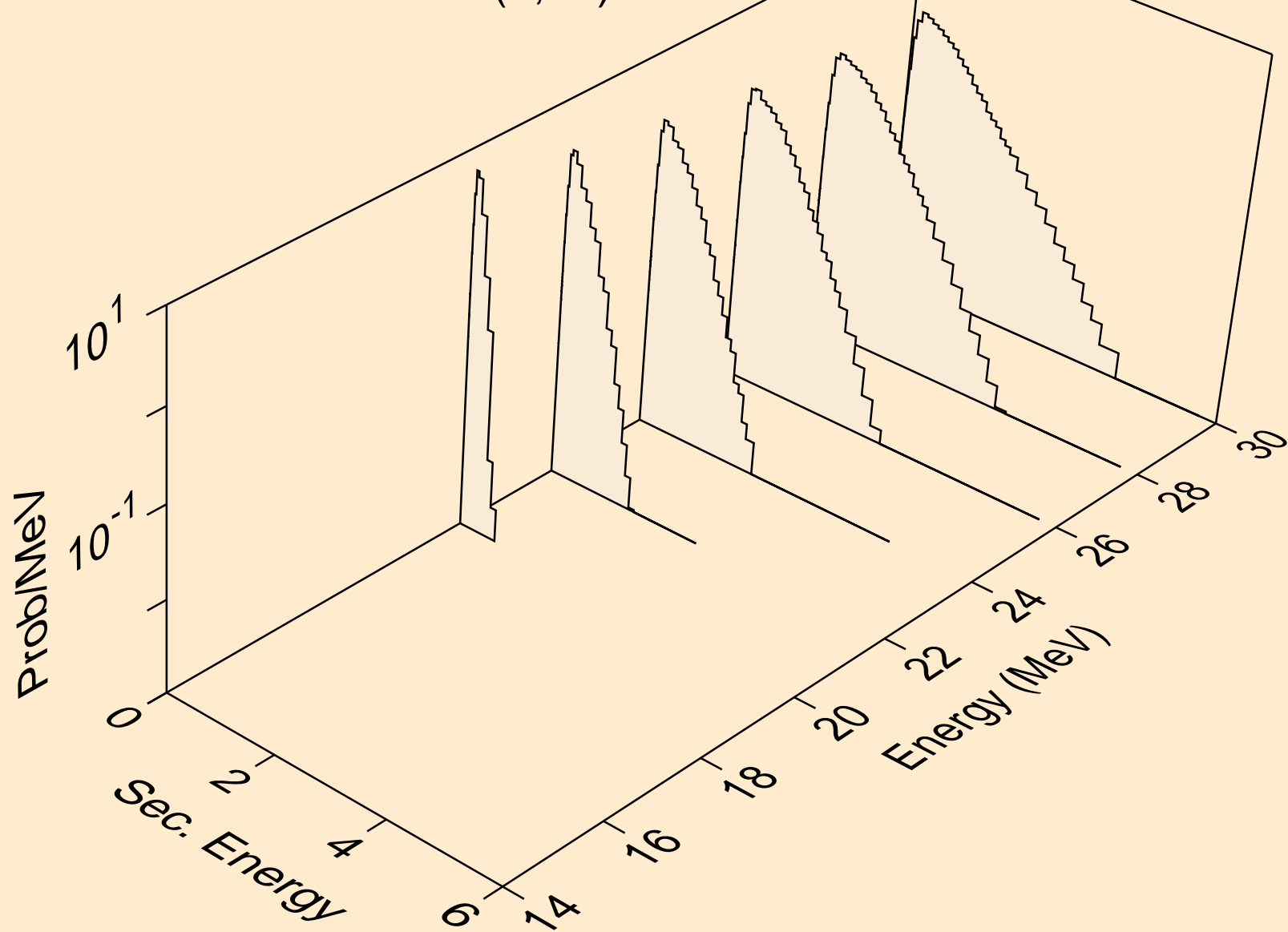

YB163 NEUTRON ACER TENDL-2023 LIBRARY; T=0.K  
Neutron emission for (n,n\*)p

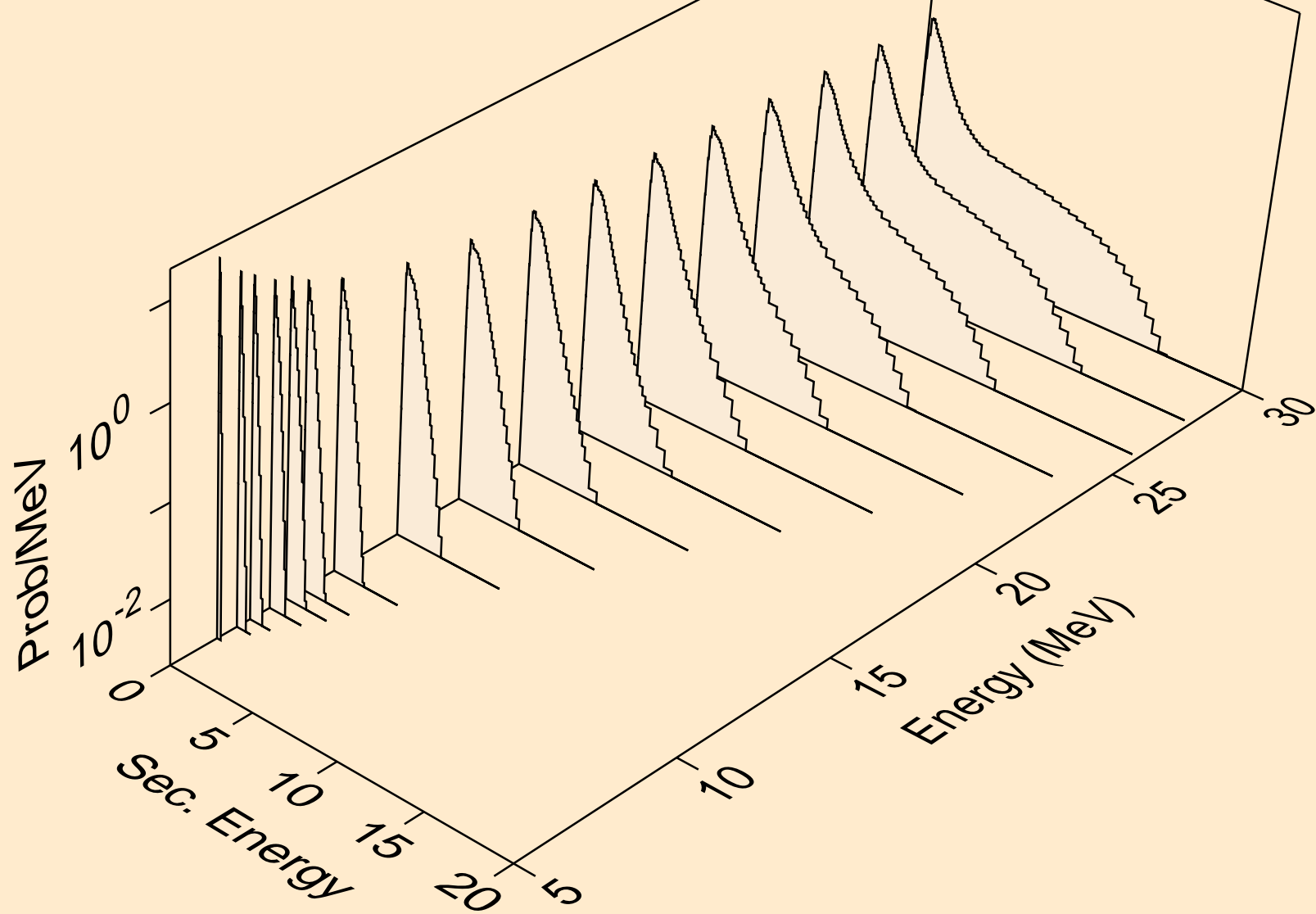



YB163 NEUTRON ACER TENDL-2023 LIBRARY; T=0.K  
Neutron emission for (n,n\*)2a

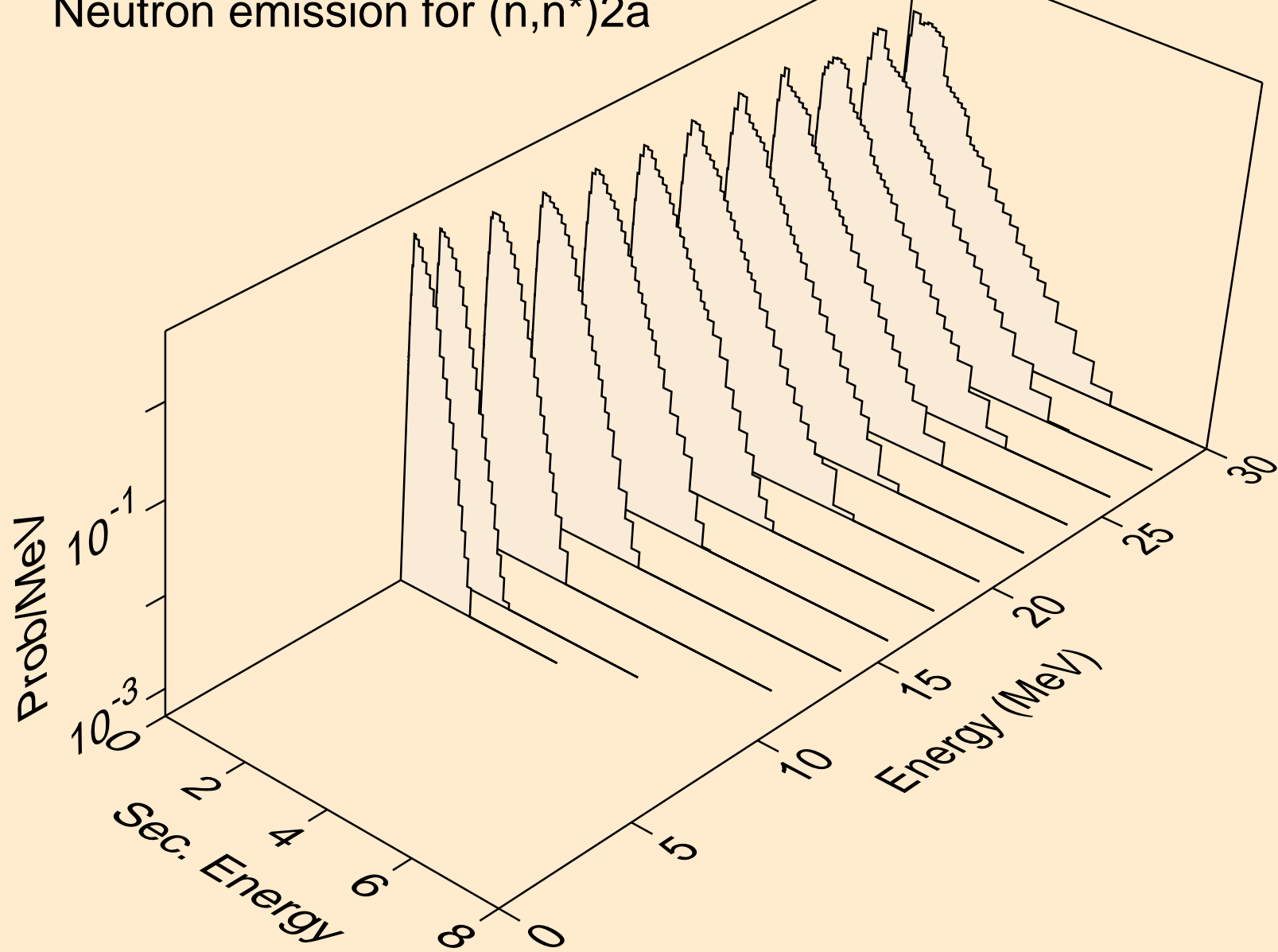

YB163 NEUTRON ACER TENDL-2023 LIBRARY; T=0.K  
Neutron emission for (n,2n)2a

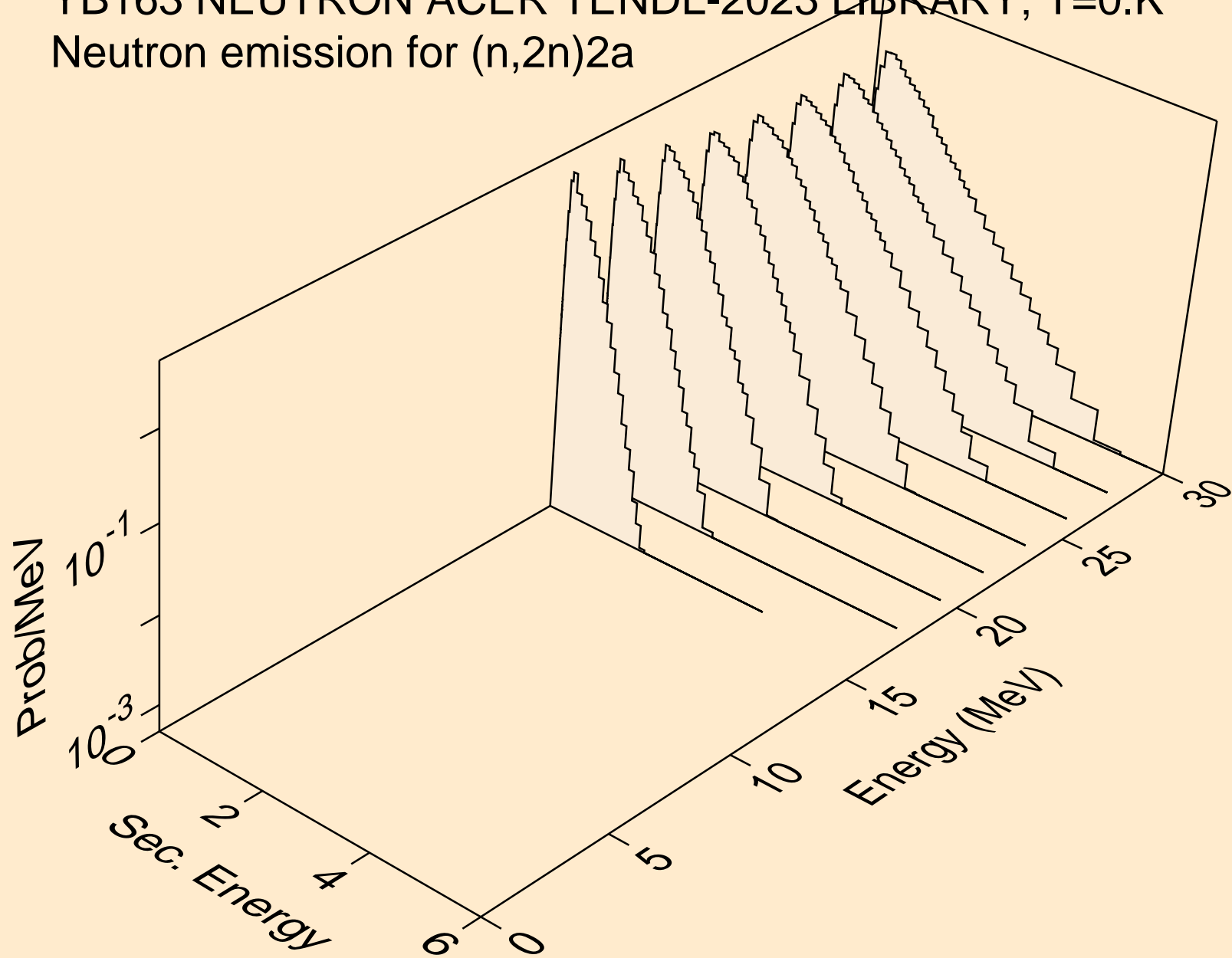

YB163 NEUTRON ACER TENDL-2023 LIBRARY; T=0.K  
Neutron emission for (n,n\*)d

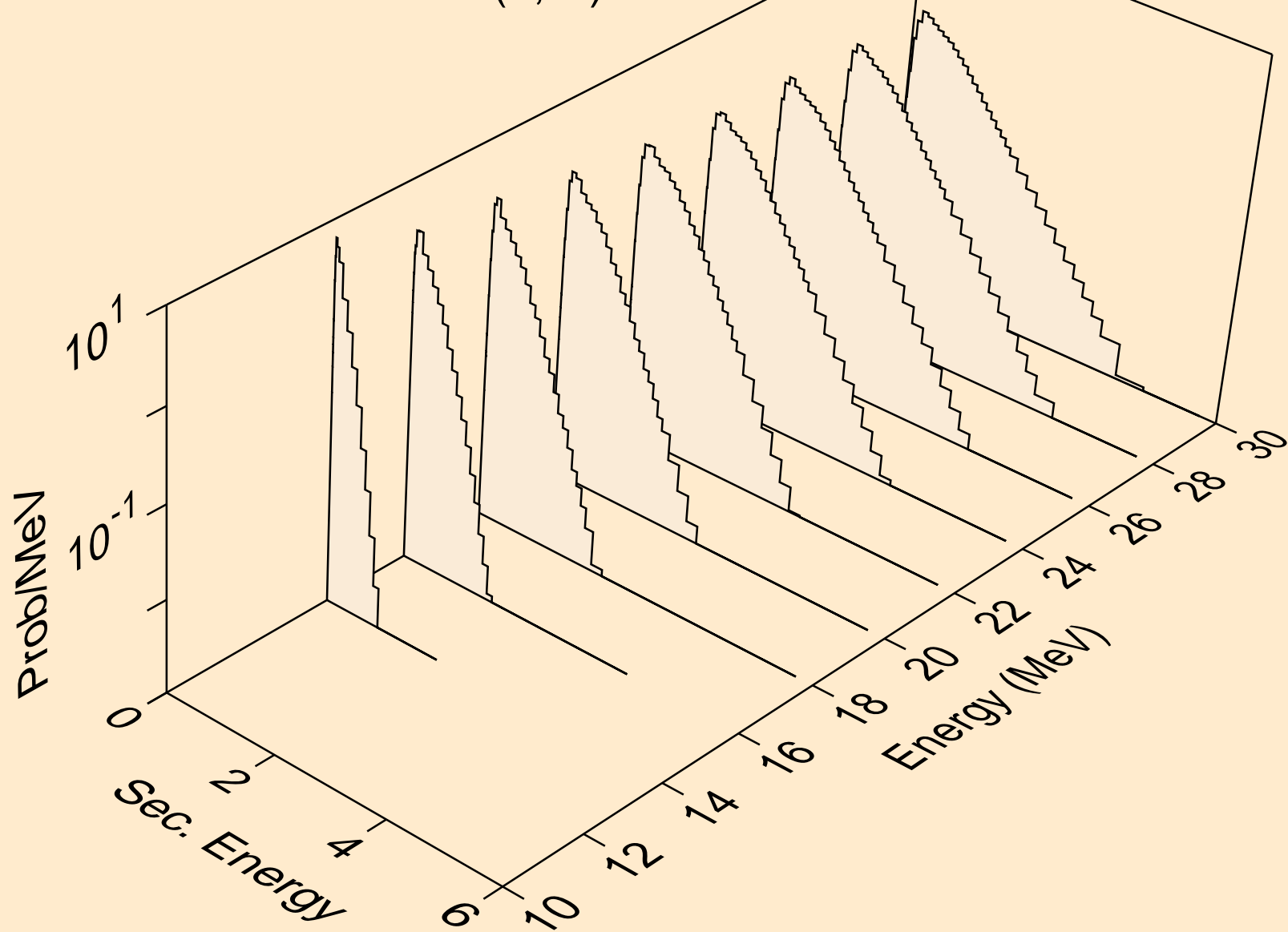

YB163 NEUTRON ACER TENDL-2023 LIBRARY; T=0.K  
Neutron emission for (n,n\*)t

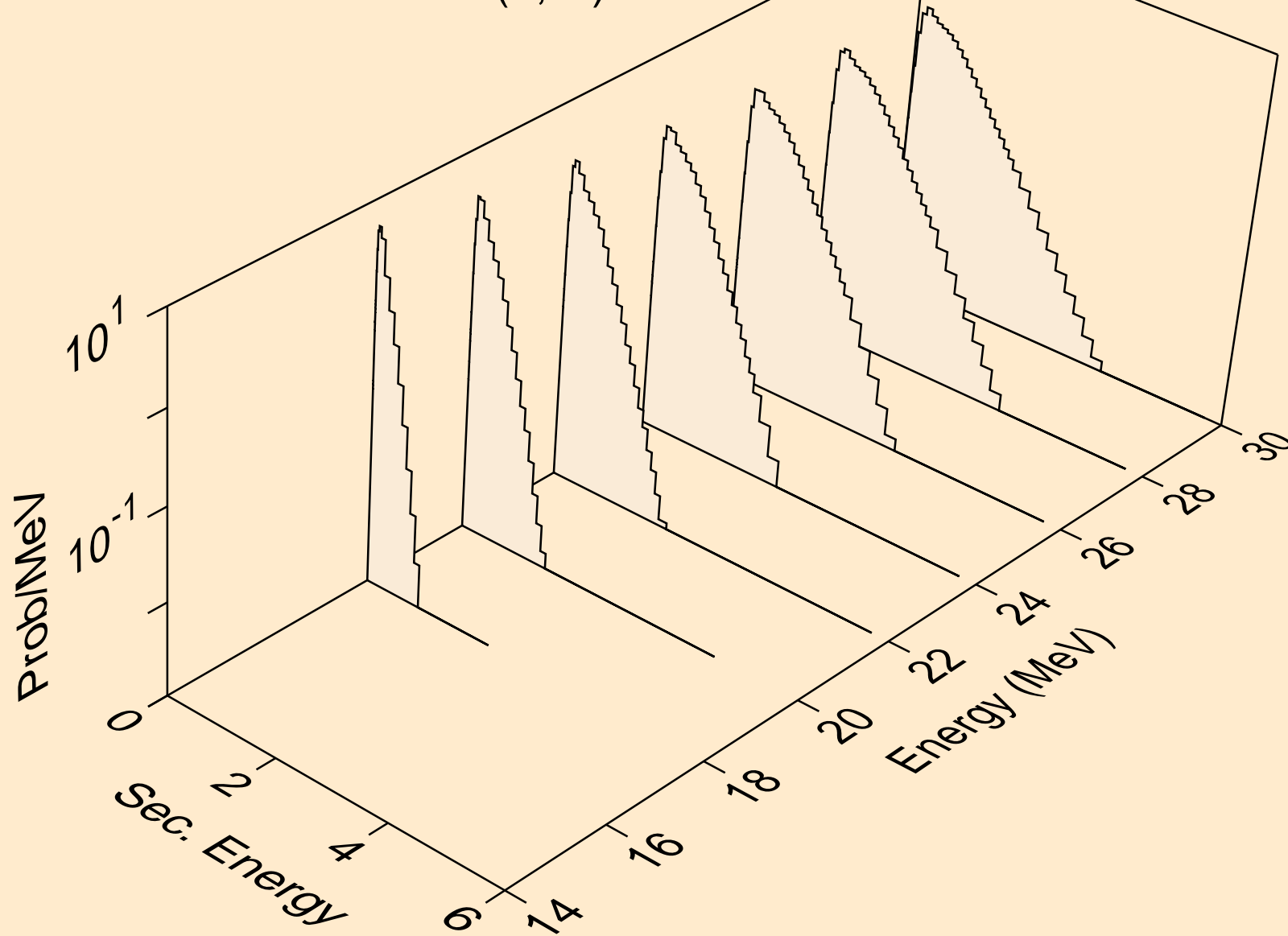

YB163 NEUTRON ACER TENDL-2023 LIBRARY; T=0.K  
Neutron emission for (n,n\*)he3

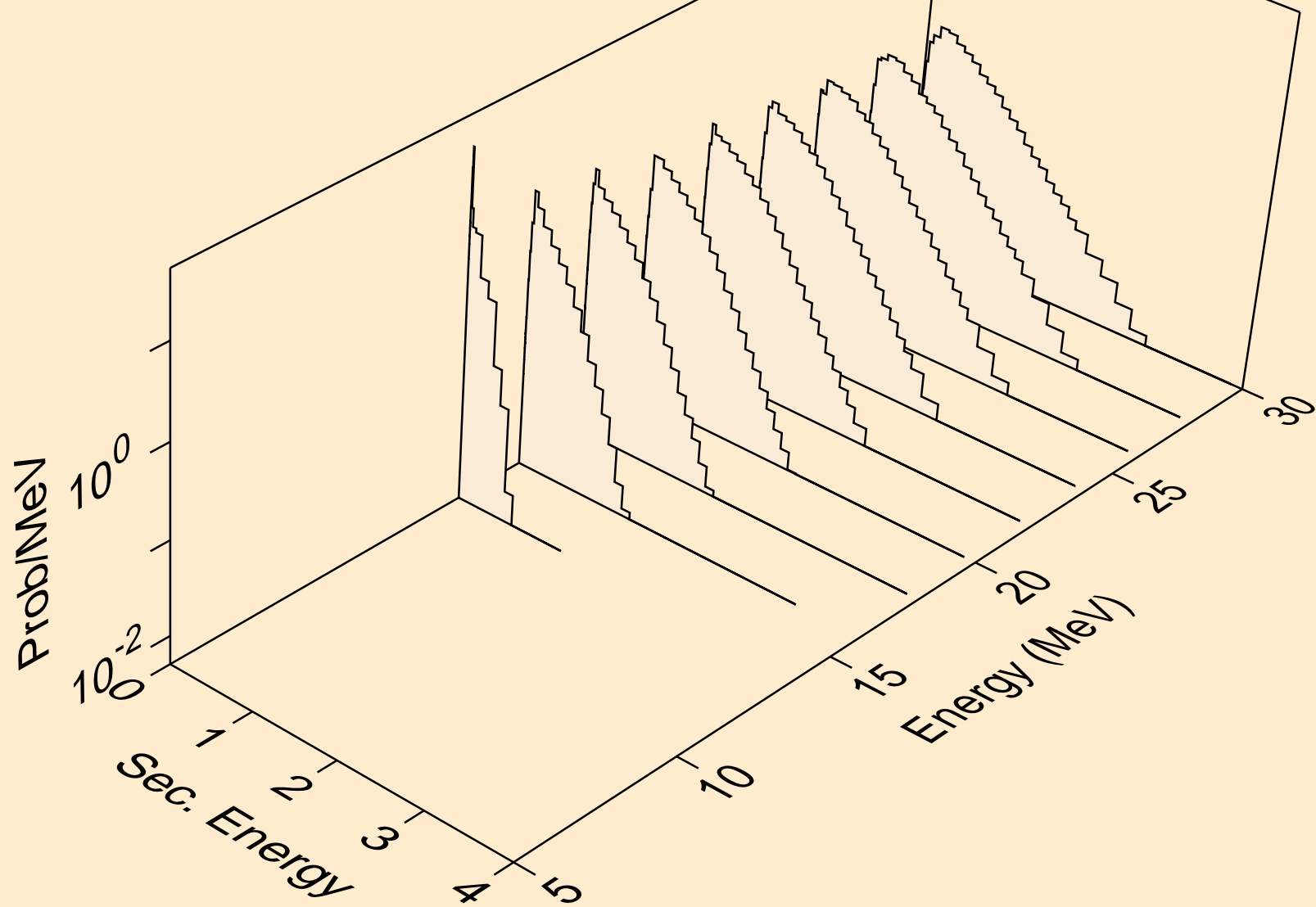

YB163 NEUTRON ACER TENDL-2023 LIBRARY; T=0.K  
Neutron emission for (n,4n)

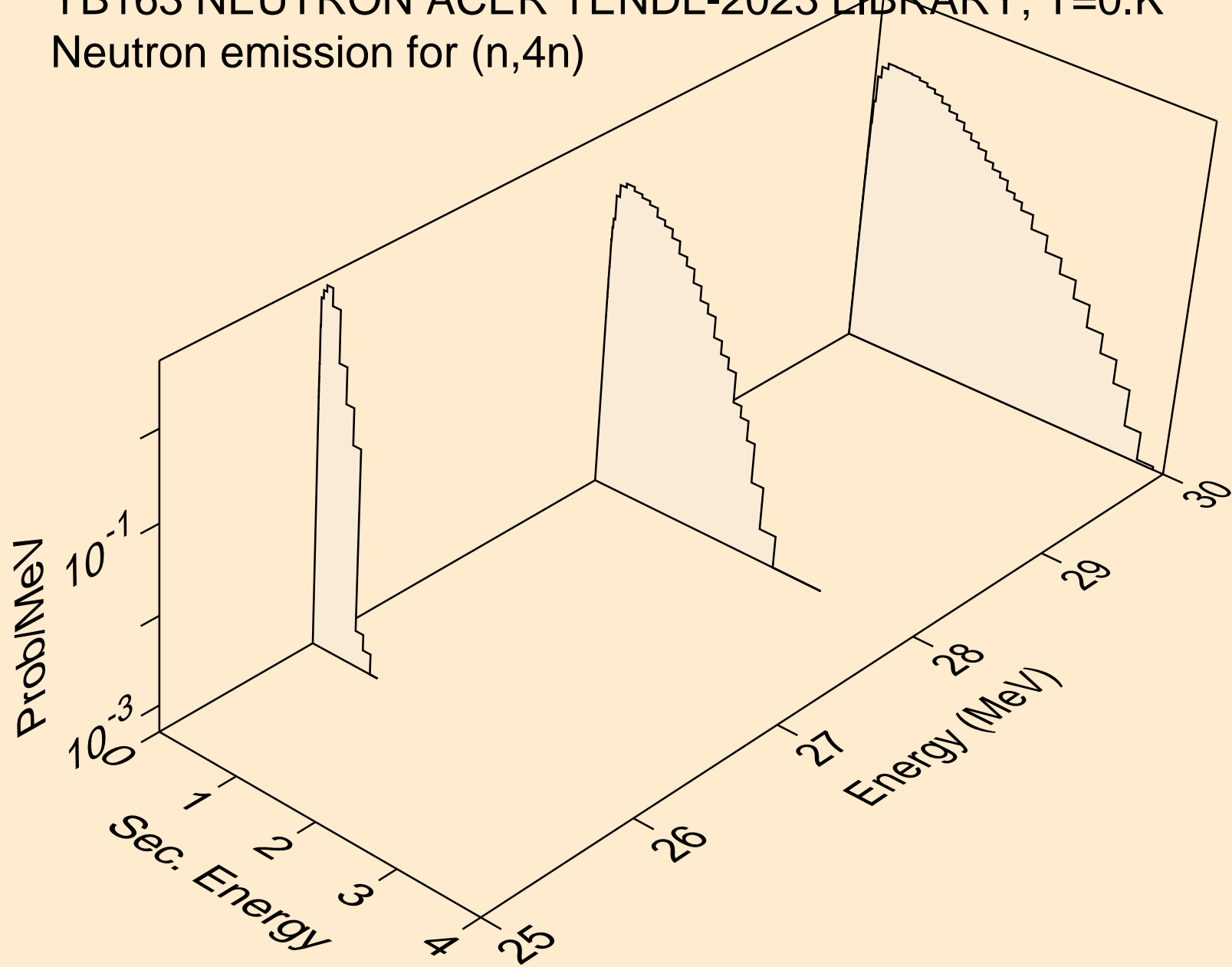

YB163 NEUTRON ACER TENDL-2023 LIBRARY; T=0.K  
Neutron emission for (n,2np)

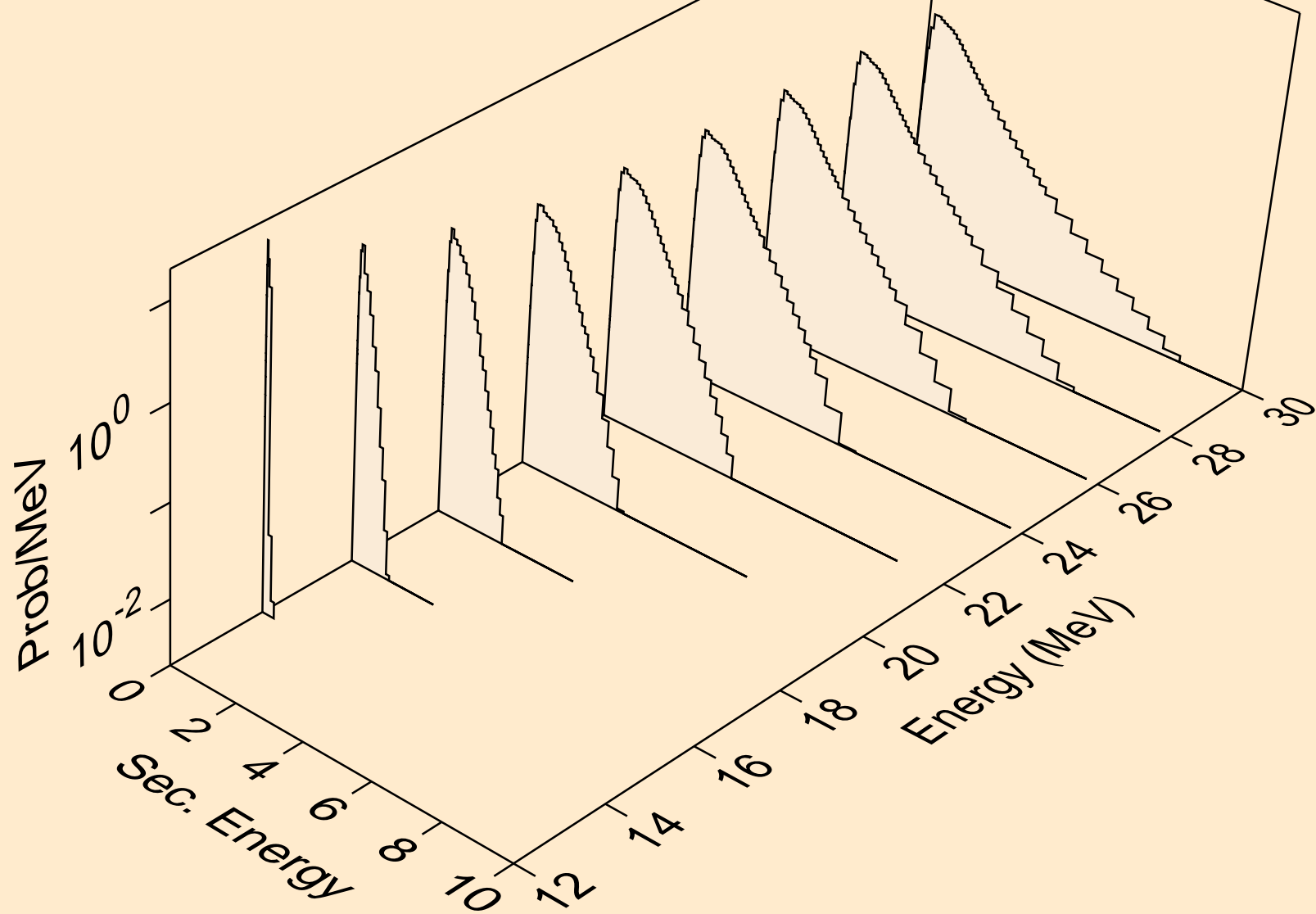

YB163 NEUTRON ACER TENDL-2023 LIBRARY; T=0.K  
Neutron emission for (n,3np)

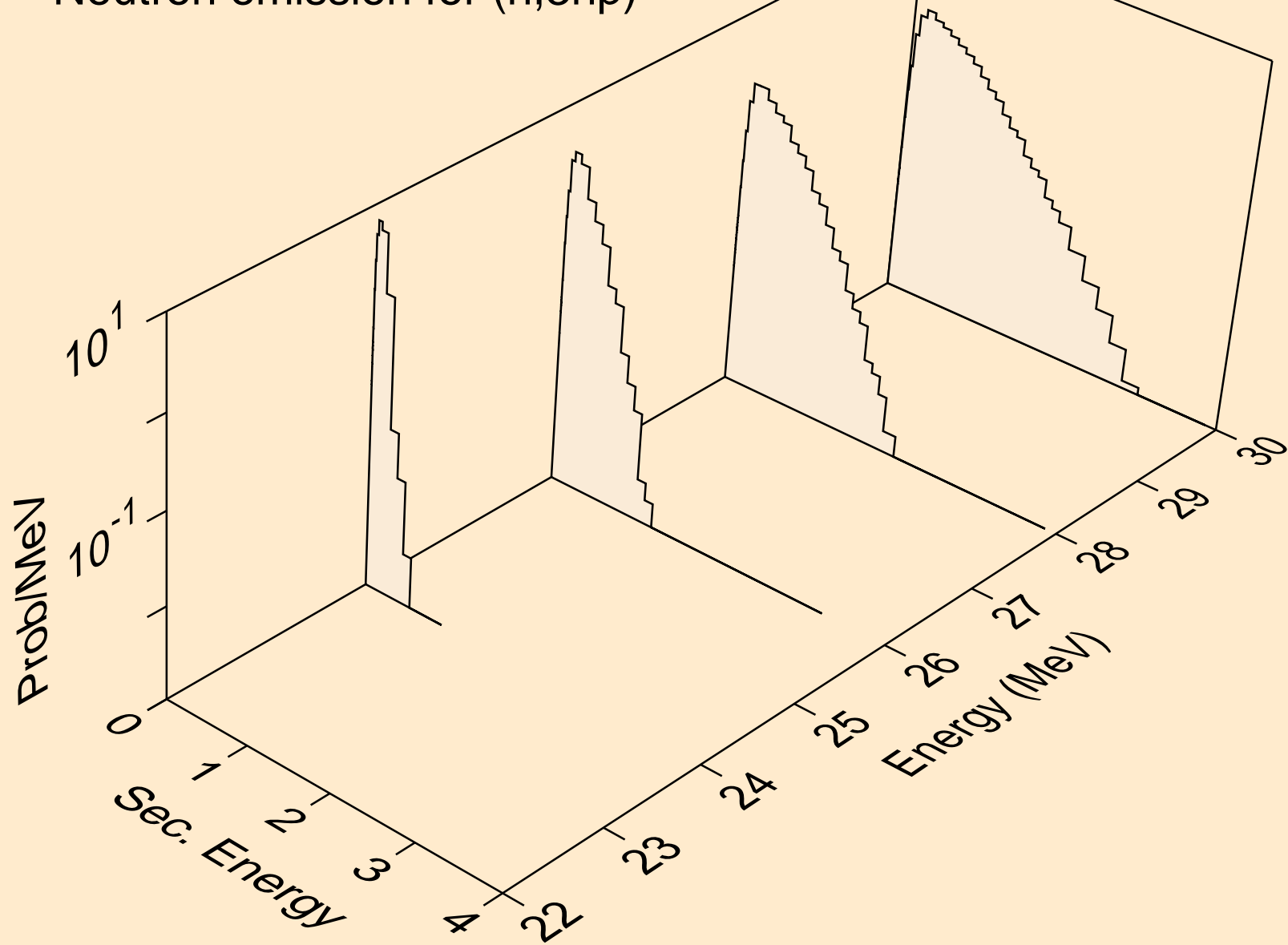



YB163 NEUTRON ACER TENDL-2023 LIBRARY; T=0.K  
Neutron emission for (n,n2p)

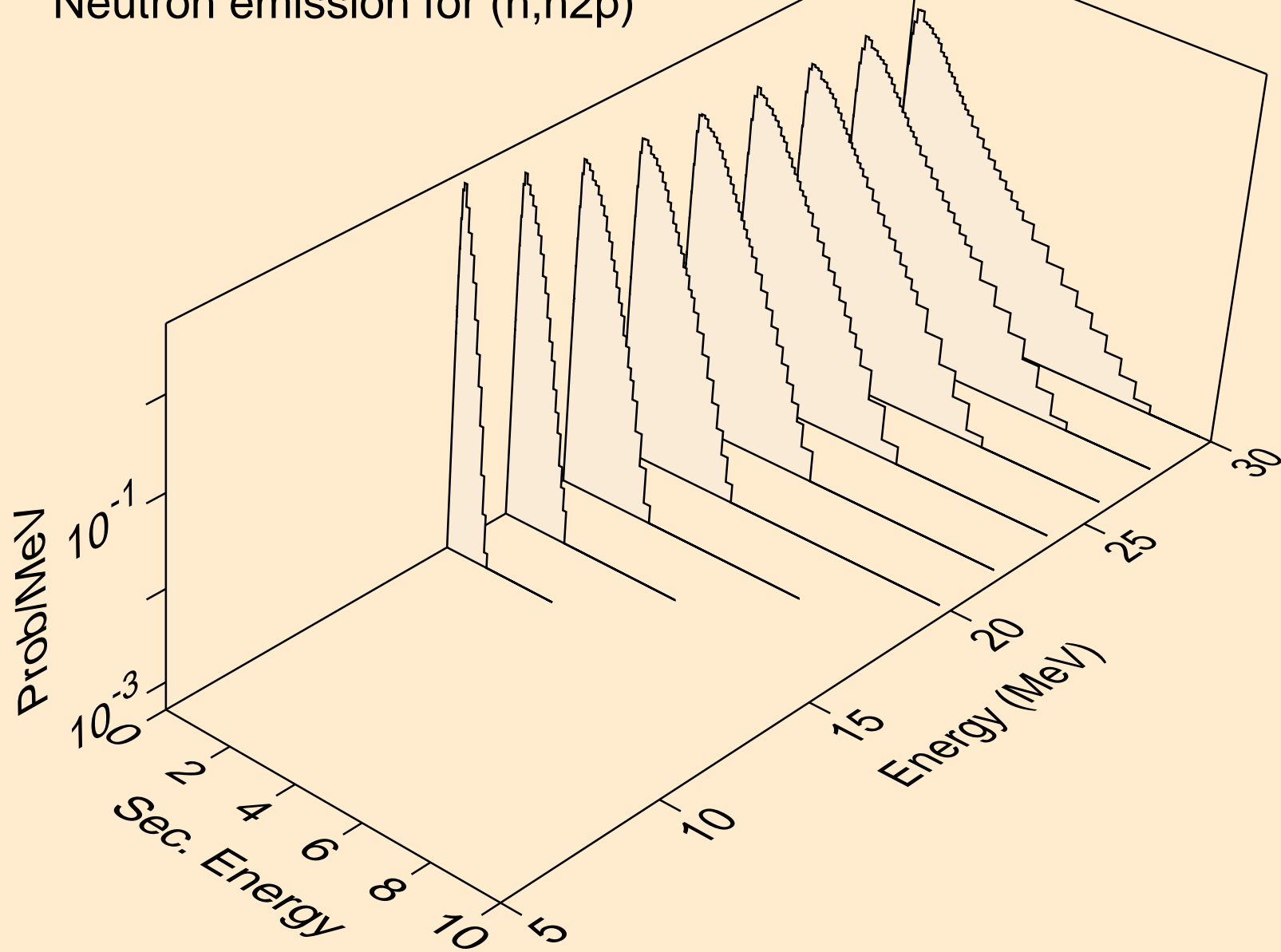

YB163 NEUTRON ACER TENDL-2023 LIBRARY; T=0.K  
Neutron emission for (n,npa)

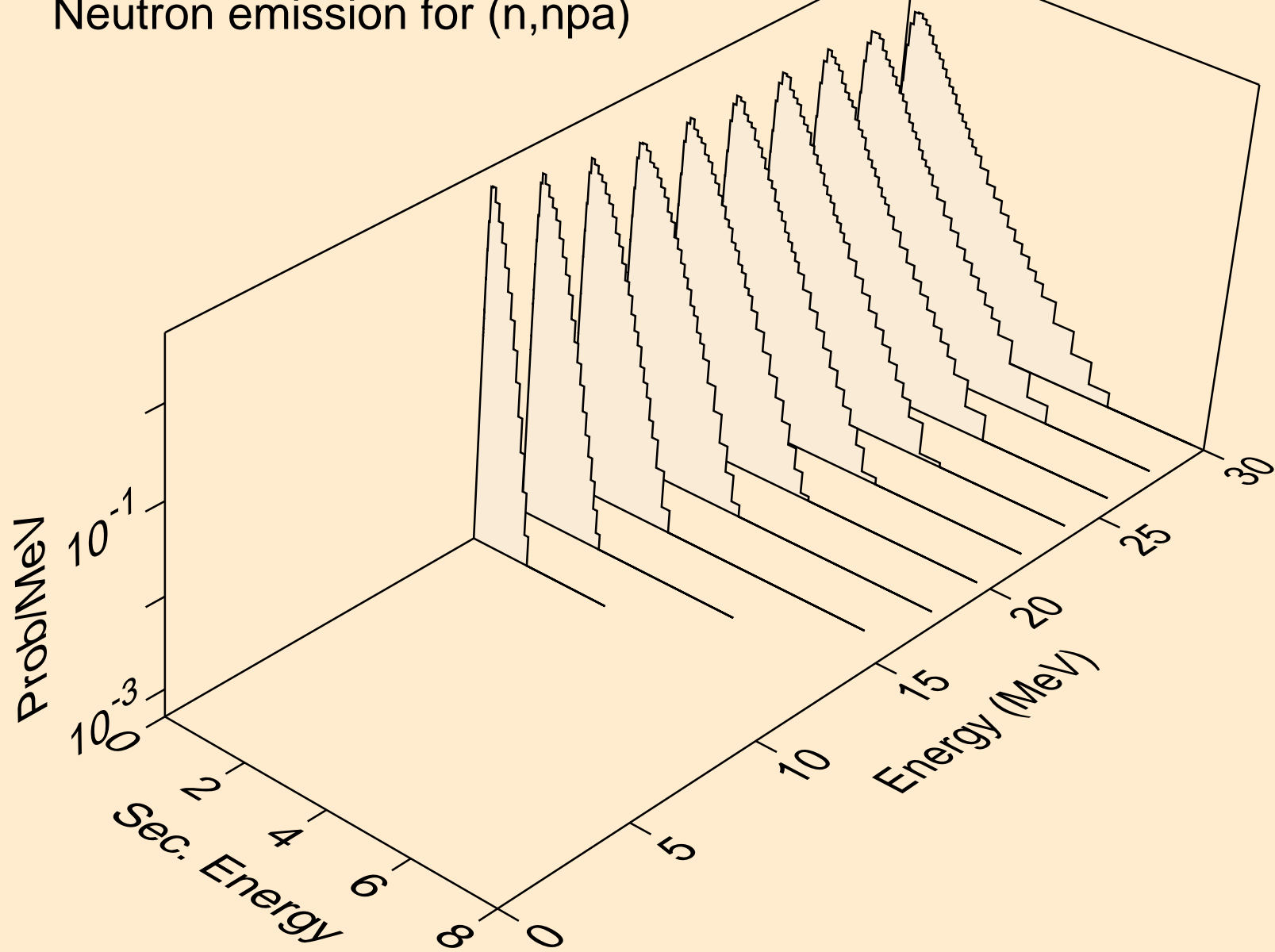

YB163 NEUTRON ACER TENDL-2023 LIBRARY; T=0.K  
Neutron emission for (n,n\*c)

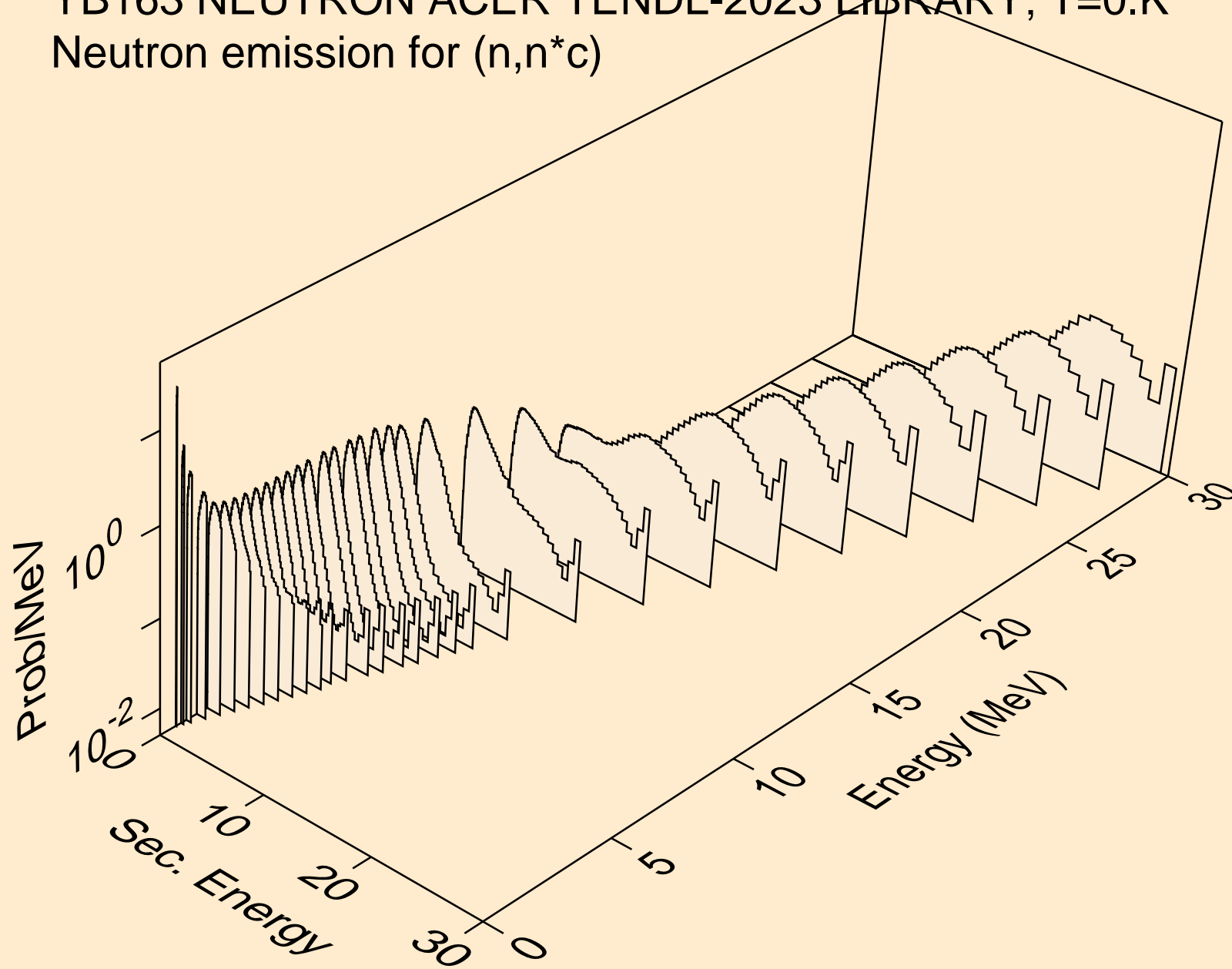

YB163 NEUTRON ACER TENDL-2023 LIBRARY; T=0.K  
Photon emission for (n,x)

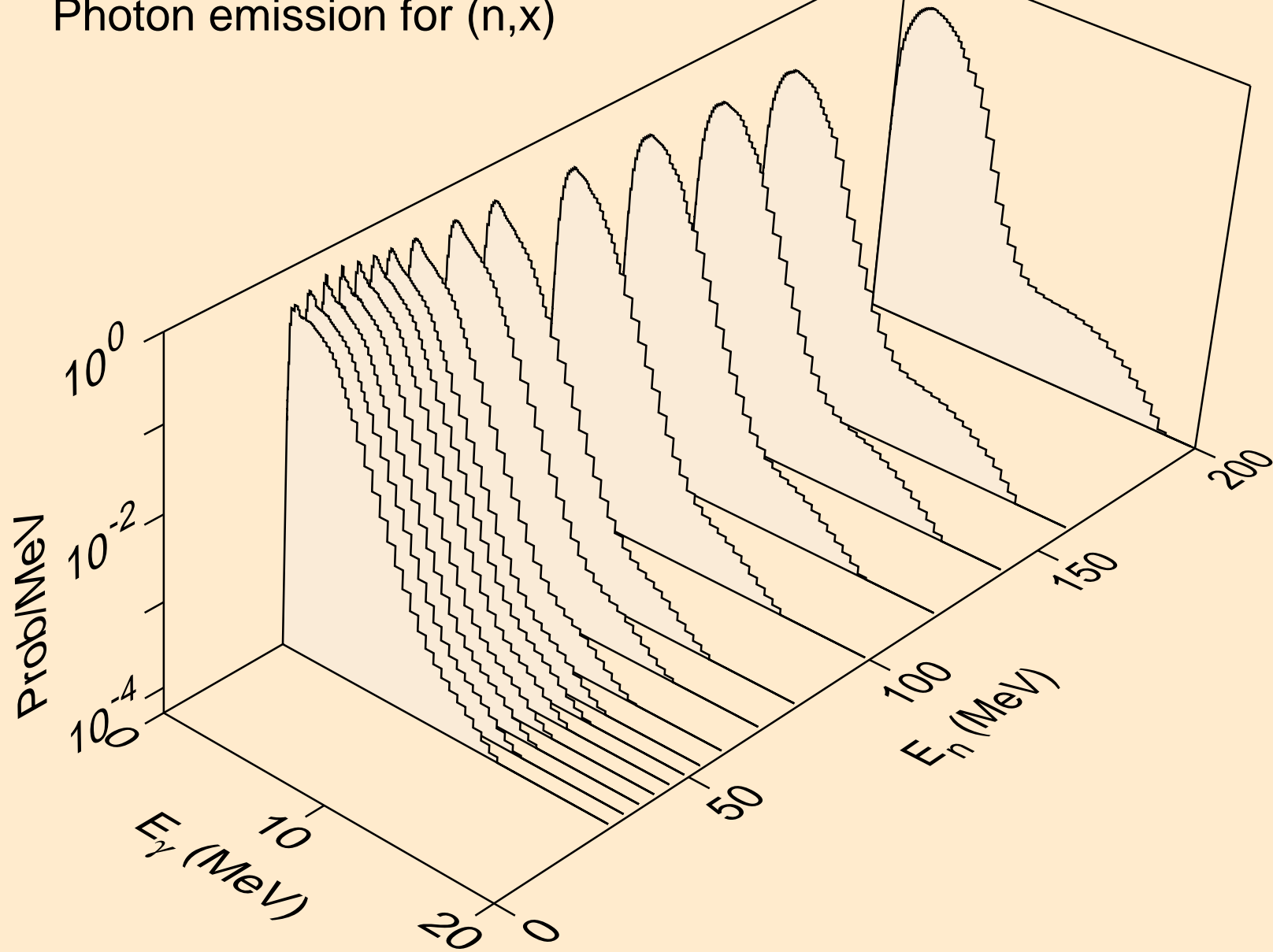

YB163 NEUTRON ACER TENDL-2023 LIBRARY; T=0.K  
Photon emission for (n,2nd)

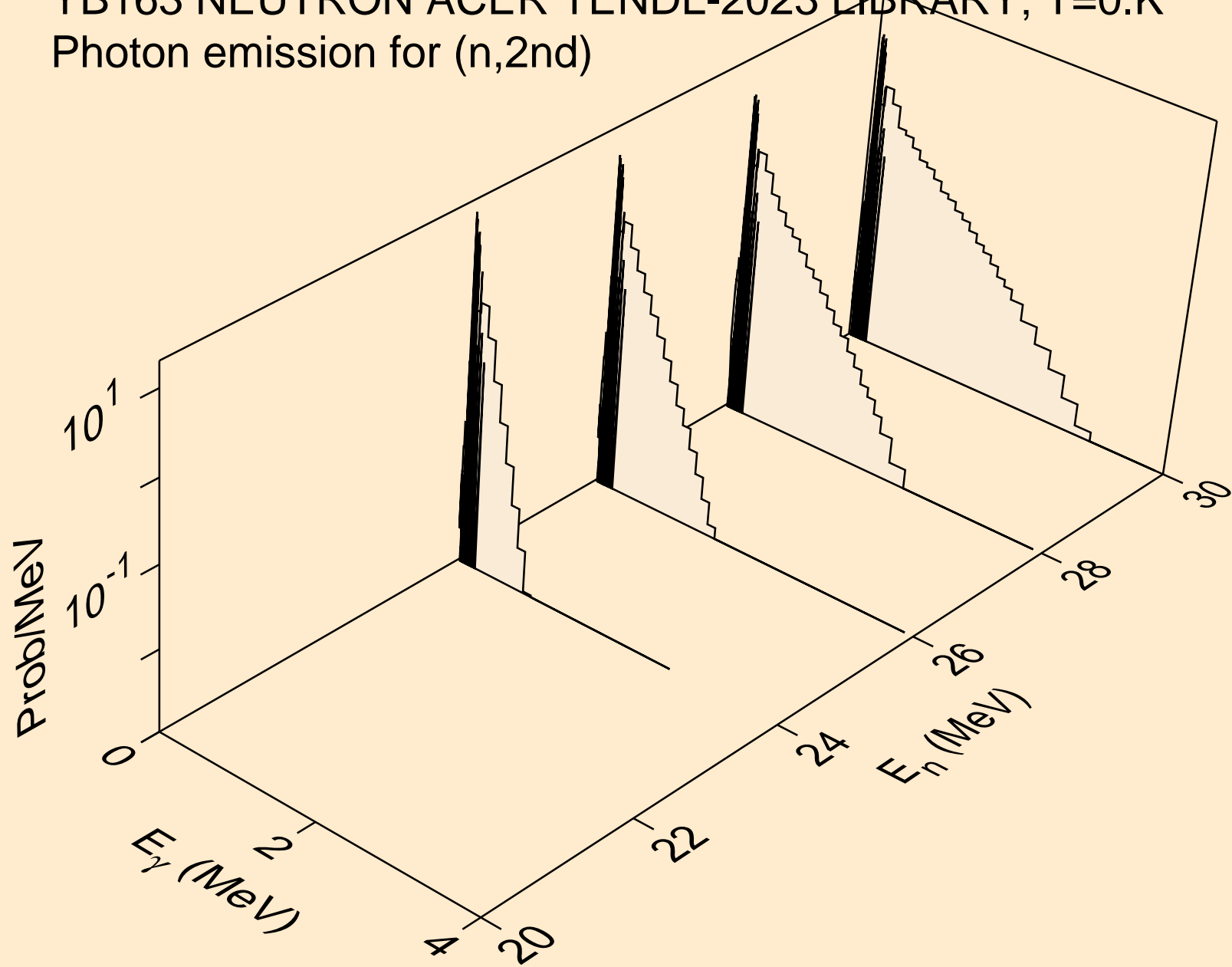

YB163 NEUTRON ACER TENDL-2023 LIBRARY; T=0.K  
Photon emission for (n,2n)

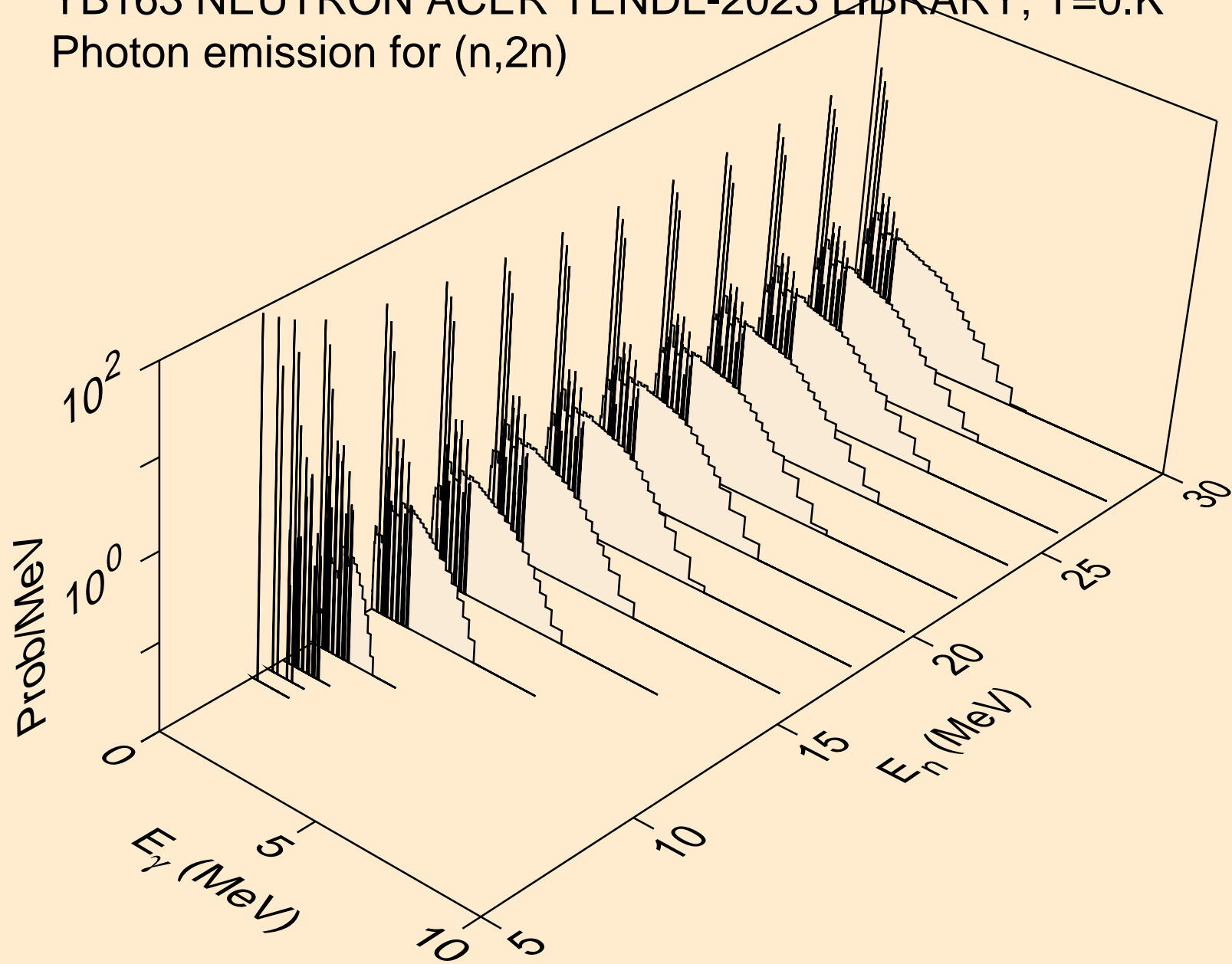

YB163 NEUTRON ACER TENDL-2023 LIBRARY; T=0.K  
Photon emission for (n,3n)

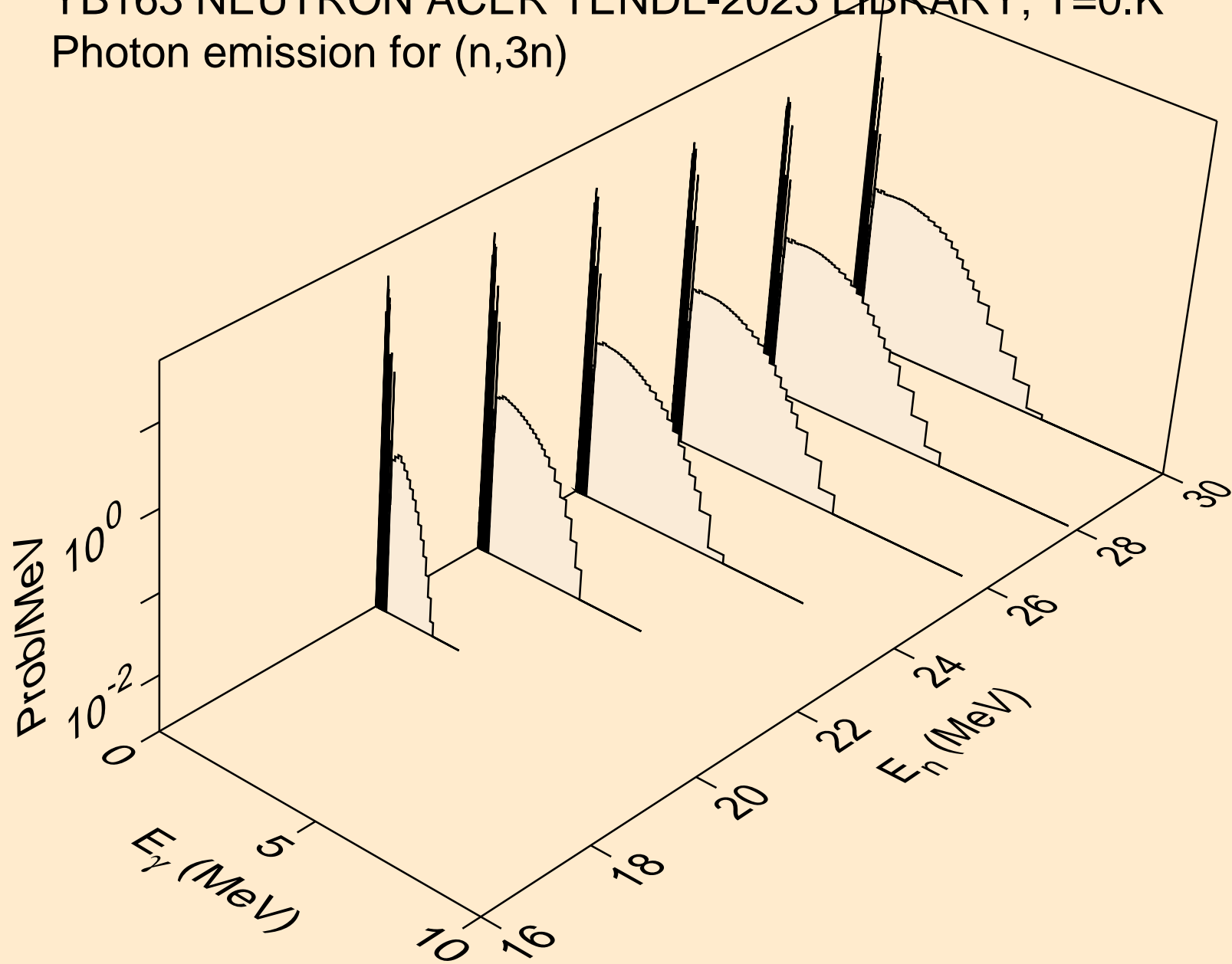

YB163 NEUTRON ACER TENDL-2023 LIBRARY; T=0.K  
Photon emission for (n,n\*)a

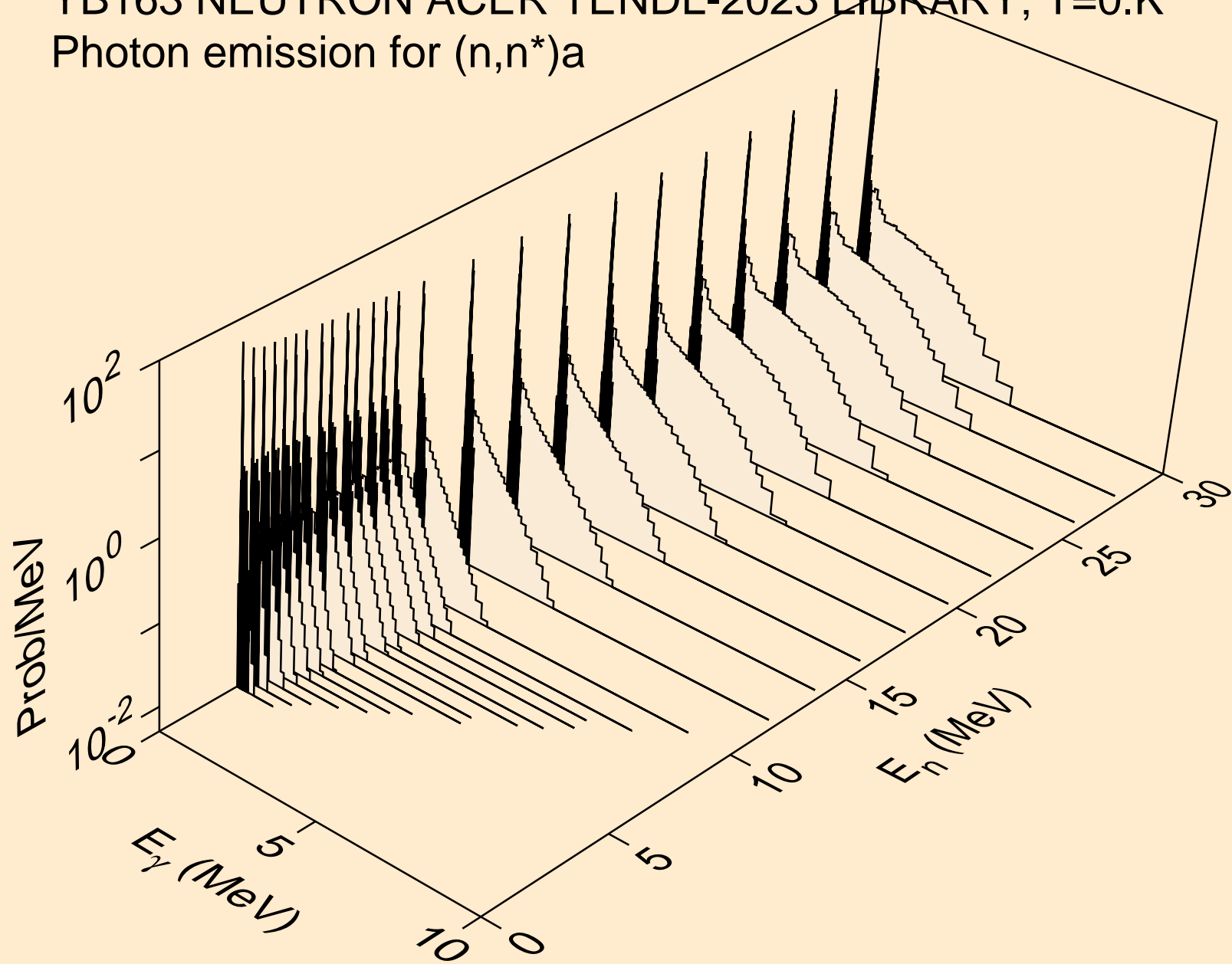



YB163 NEUTRON ACER TENDL-2023 LIBRARY; T=0.K  
Photon emission for (n,2n)a

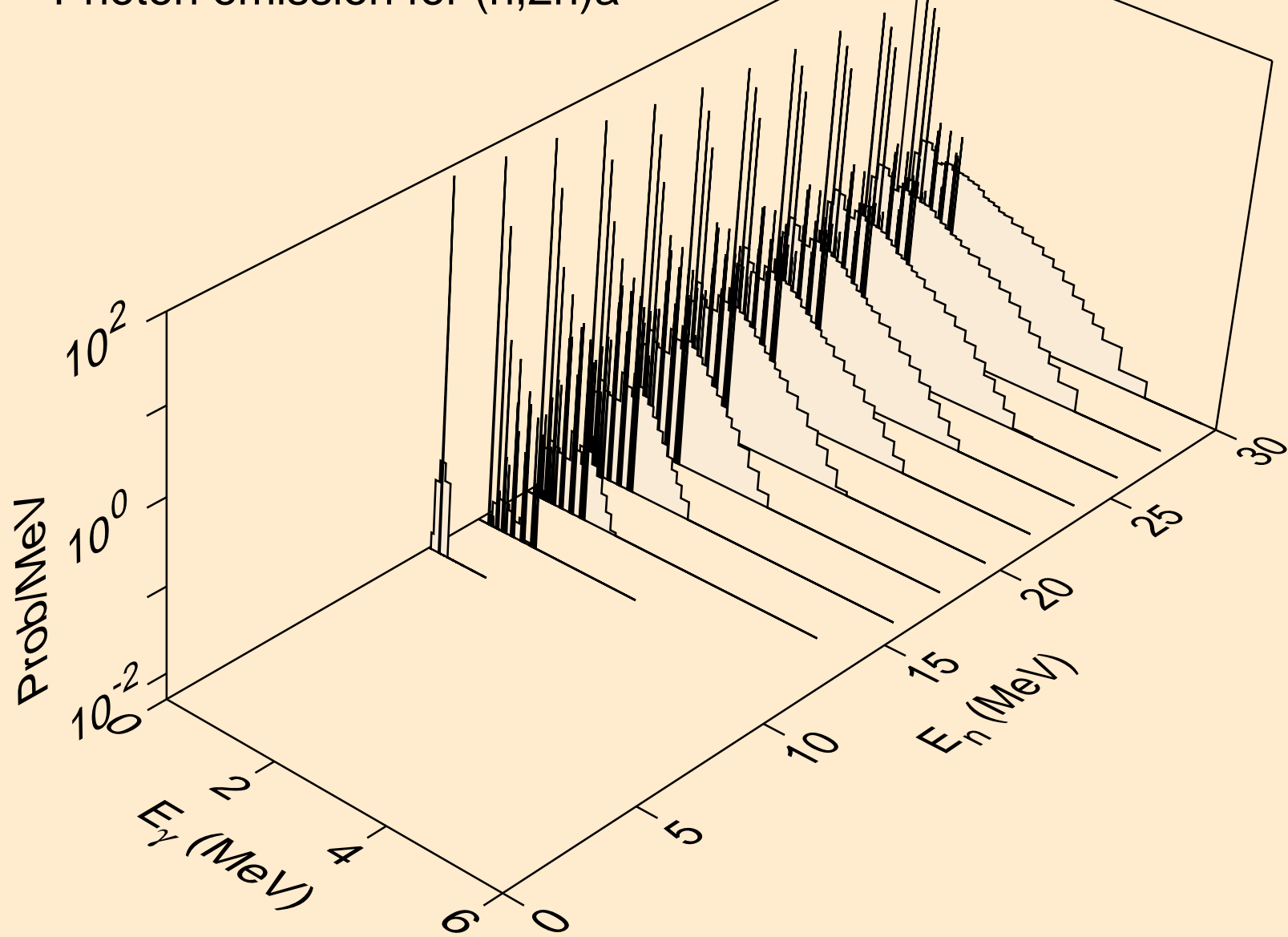

YB163 NEUTRON ACER TENDL-2023 LIBRARY; T=0.K  
Photon emission for (n,3n)a

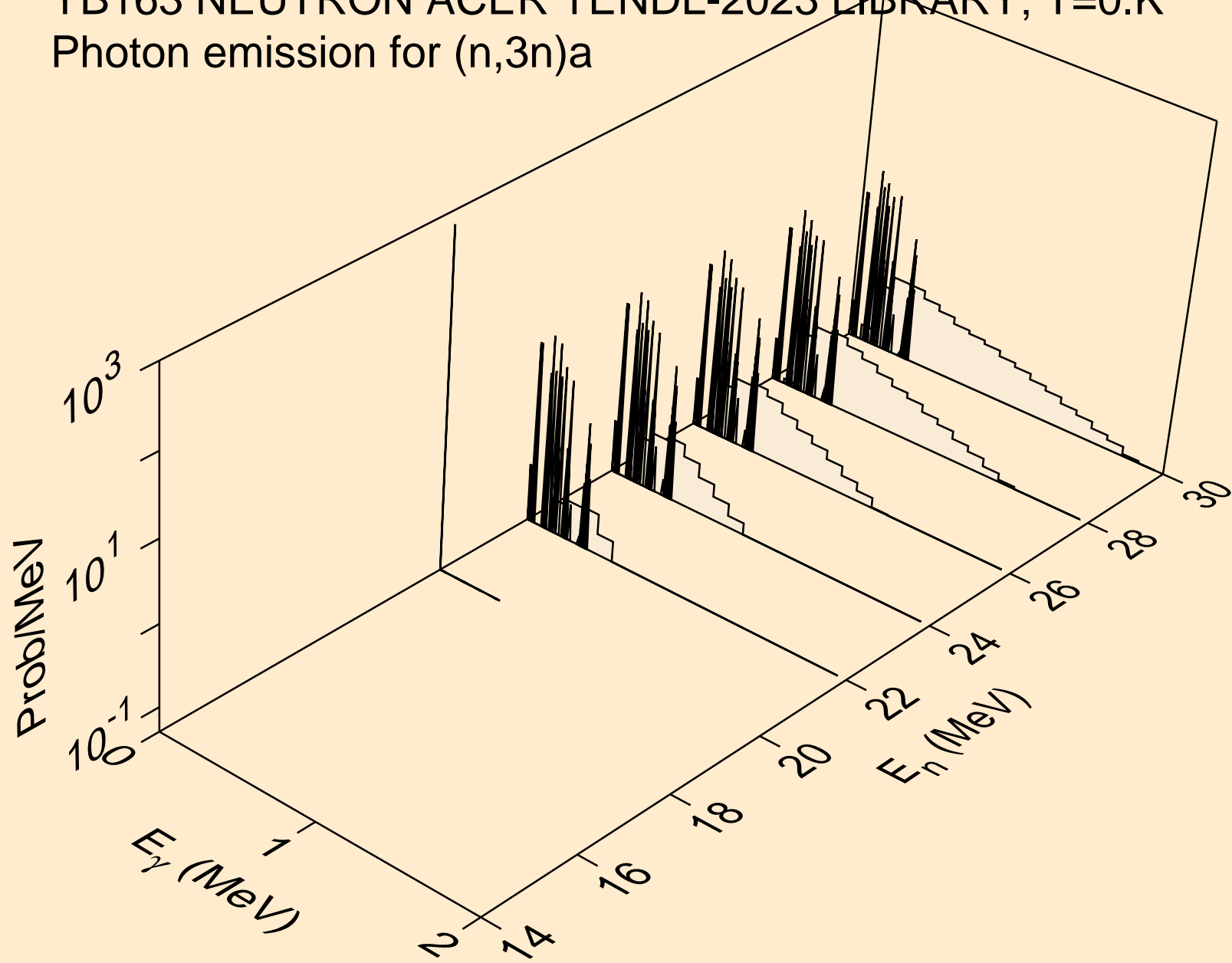

YB163 NEUTRON ACER TENDL-2023 LIBRARY; T=0.K  
Photon emission for (n,n\*)p

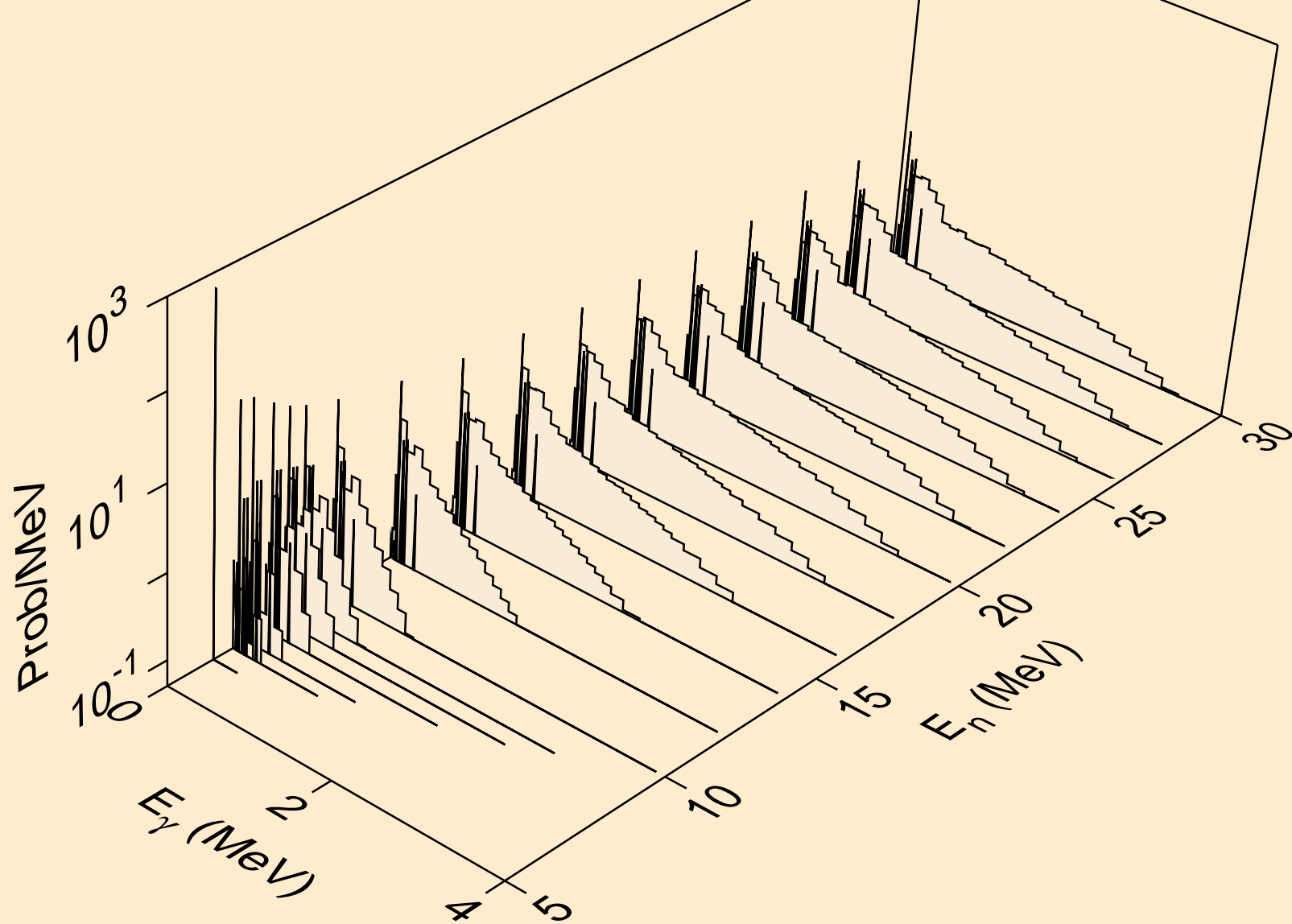

YB163 NEUTRON ACER TENDL-2023 LIBRARY; T=0.K  
Photon emission for (n,n\*)2a

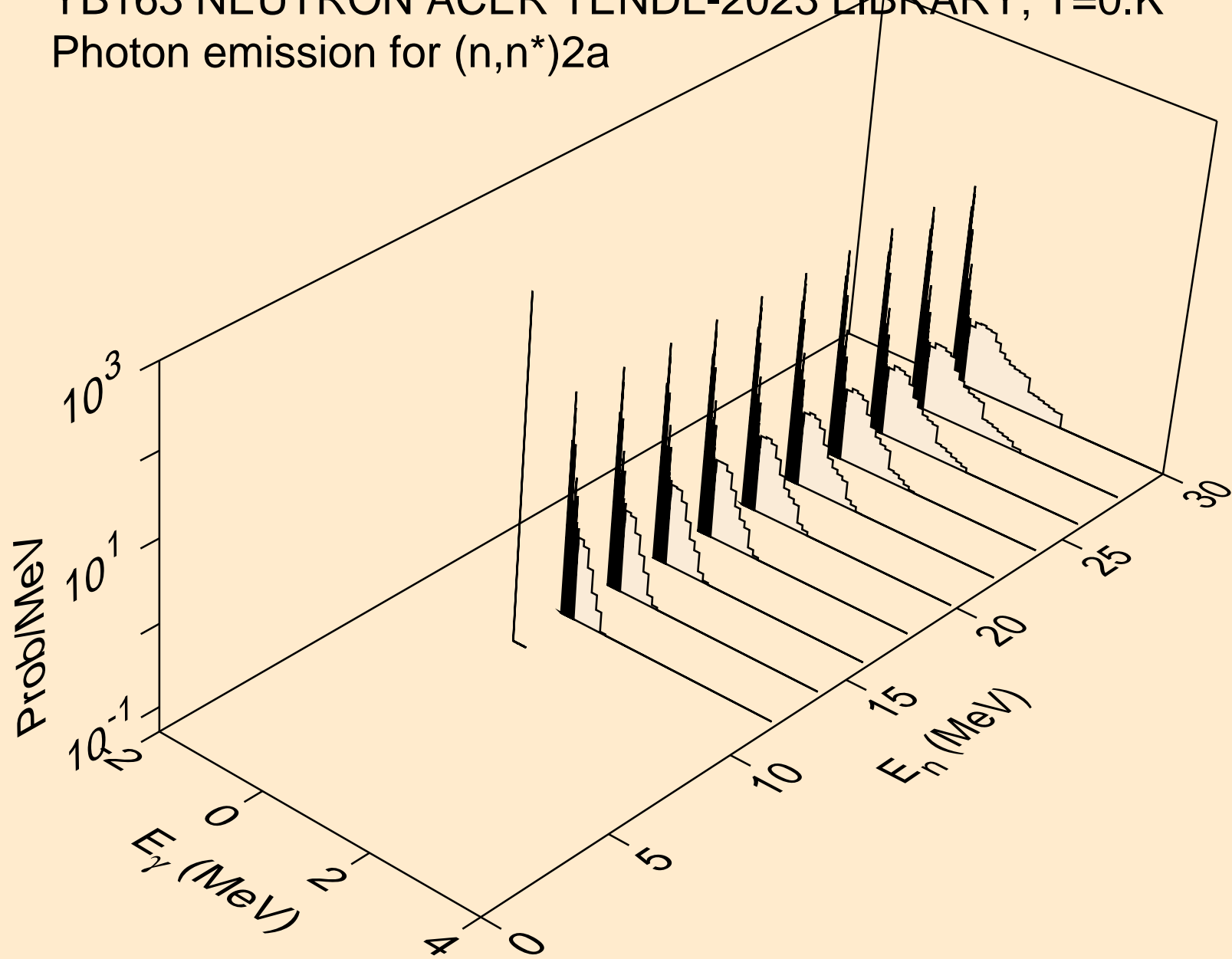

YB163 NEUTRON ACER TENDL-2023 LIBRARY; T=0.K  
Photon emission for (n,2n)2a

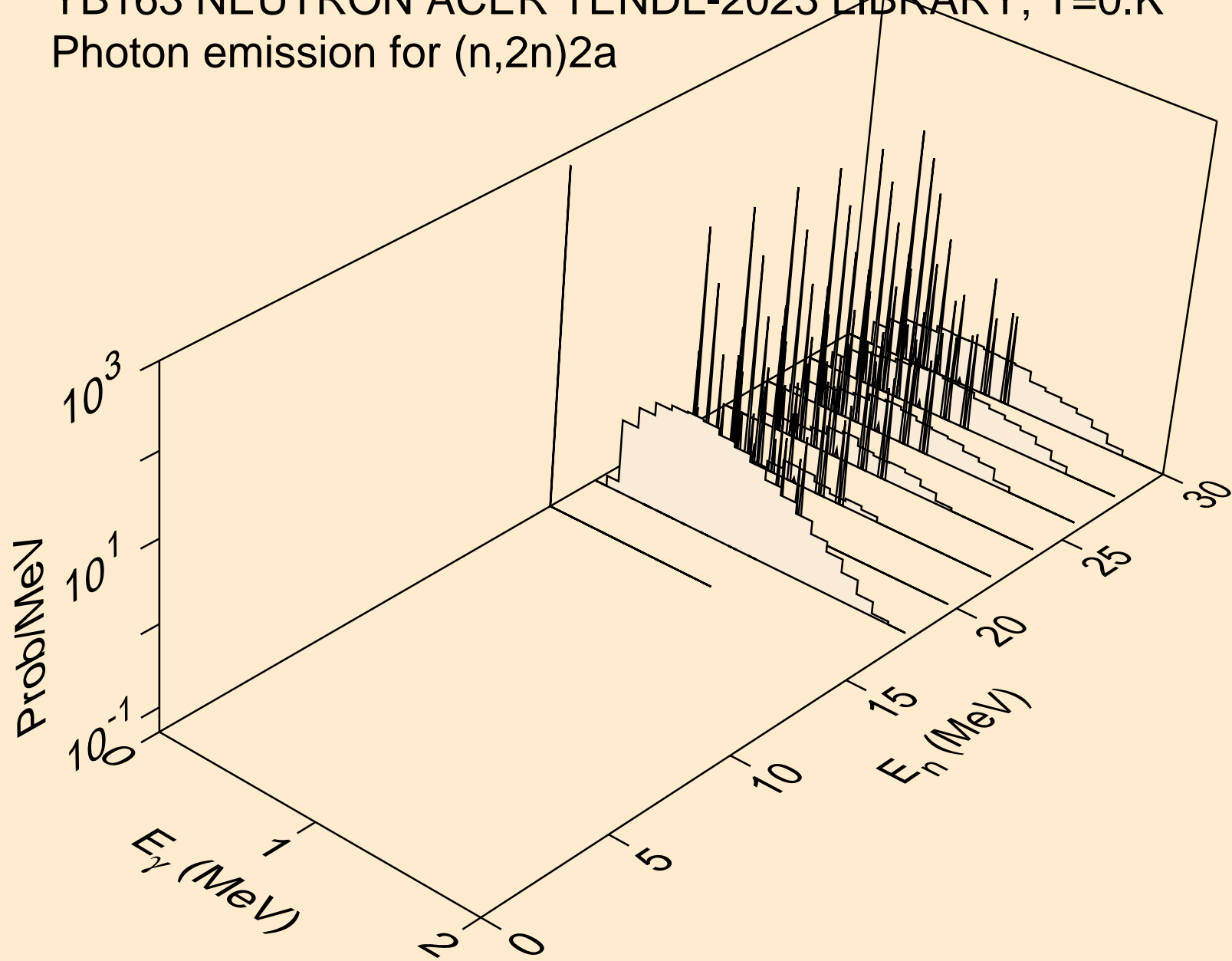

YB163 NEUTRON ACER TENDL-2023 LIBRARY; T=0.K  
Photon emission for (n,n\*)d

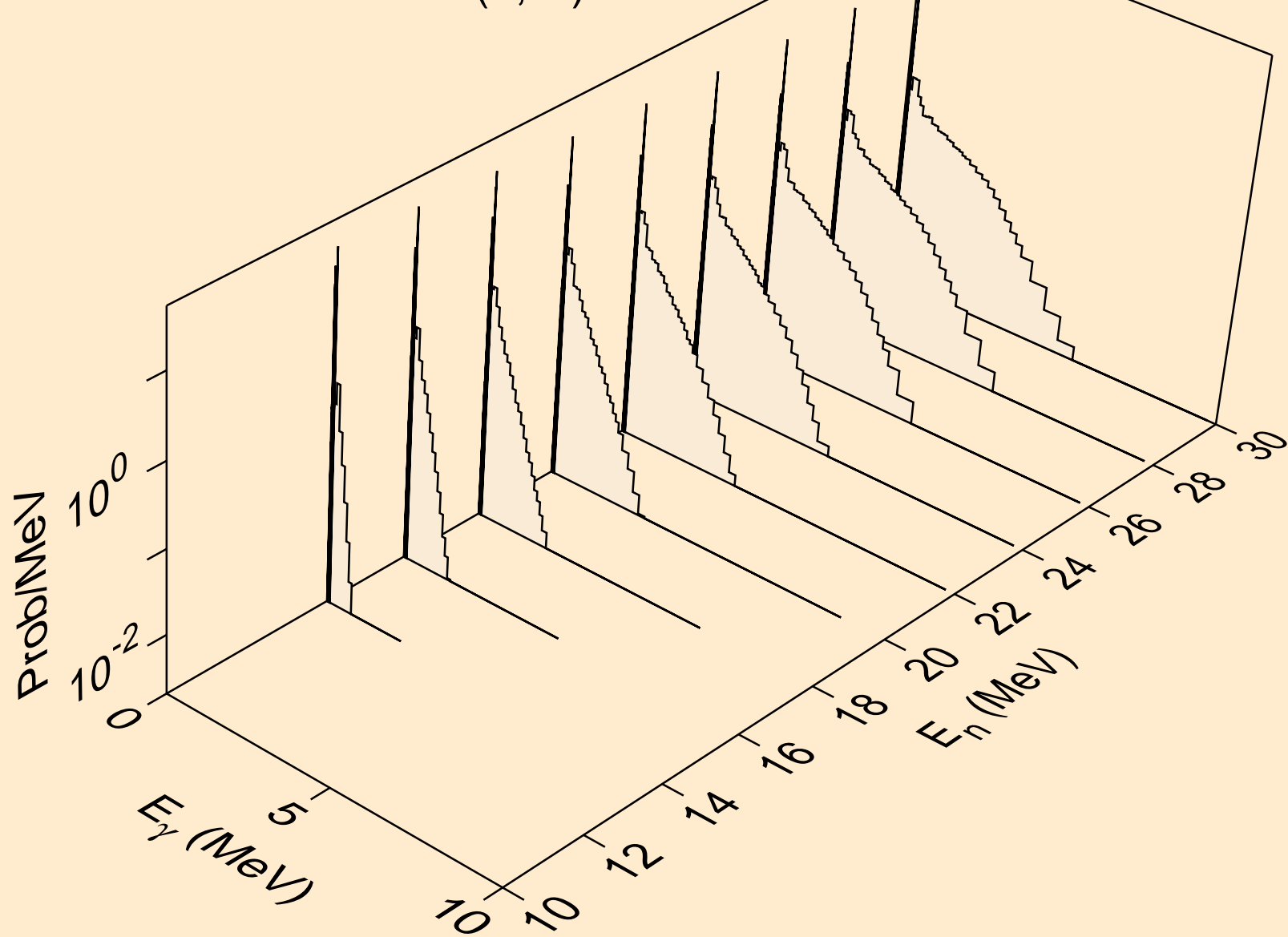

YB163 NEUTRON ACER TENDL-2023 LIBRARY; T=0.K  
Photon emission for (n,n\*)t

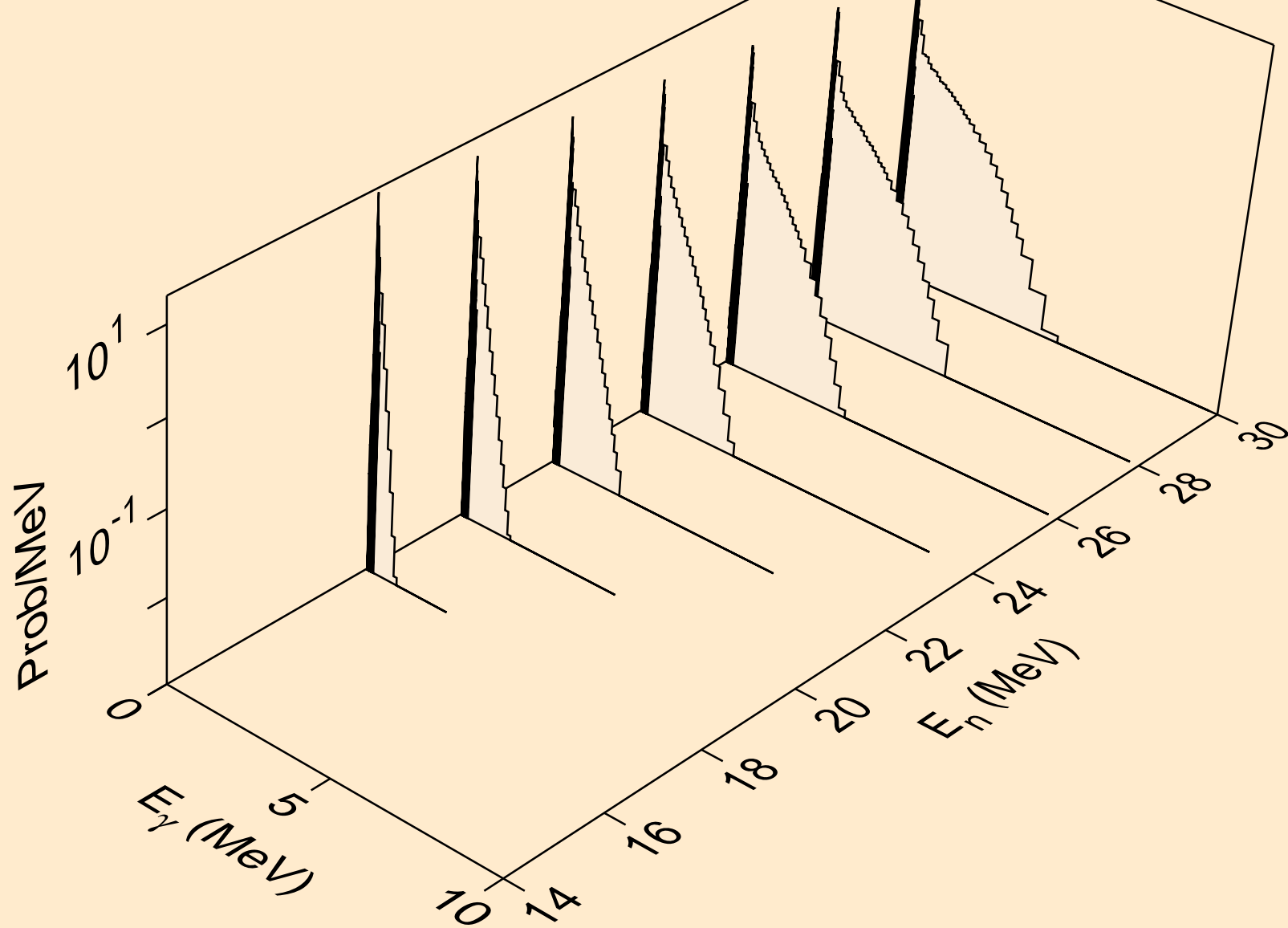

YB163 NEUTRON ACER TENDL-2023 LIBRARY; T=0.K  
Photon emission for (n,n\*)he3

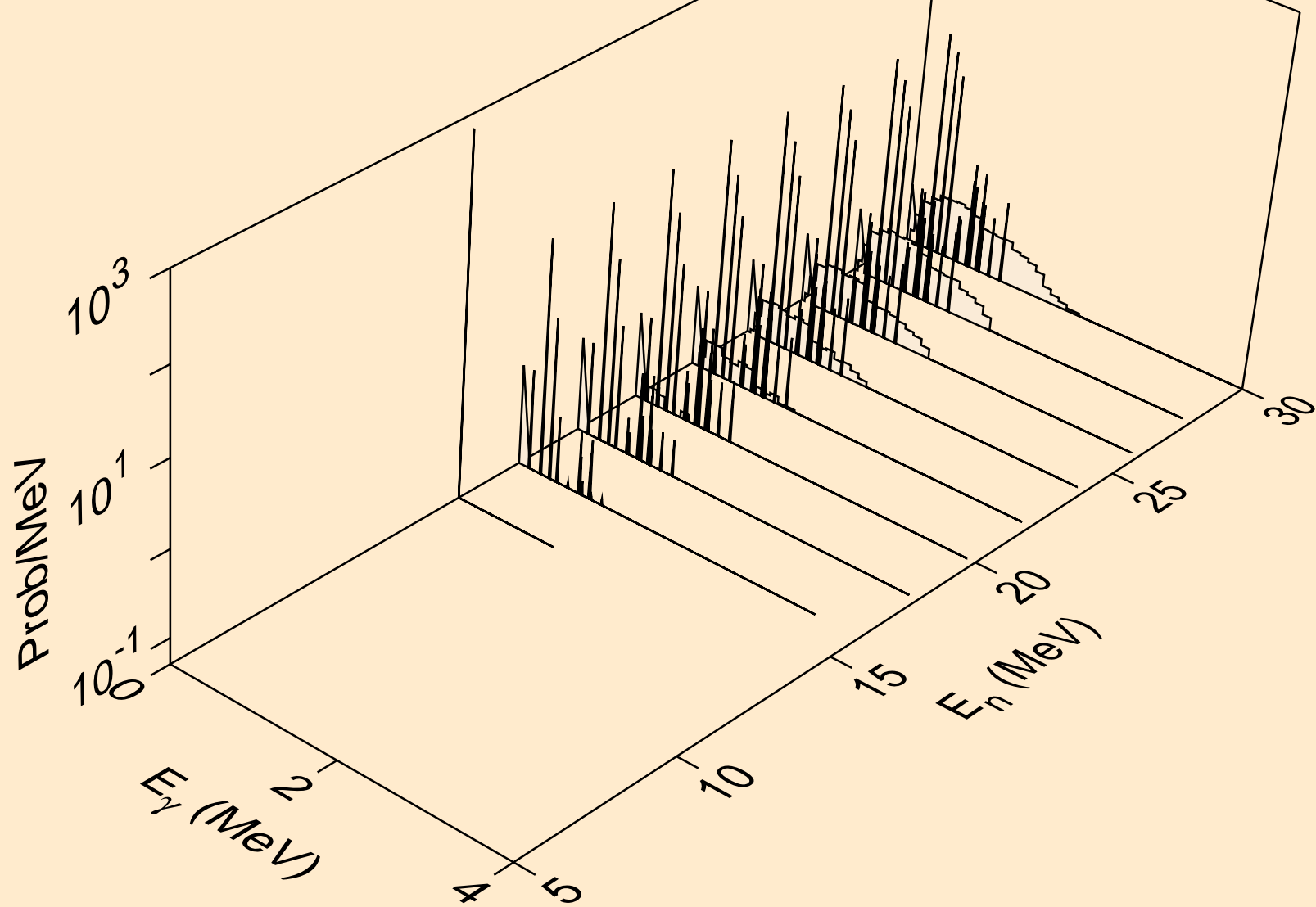



YB163 NEUTRON ACER TENDL-2023 LIBRARY; T=0.K  
Photon emission for (n,4n)

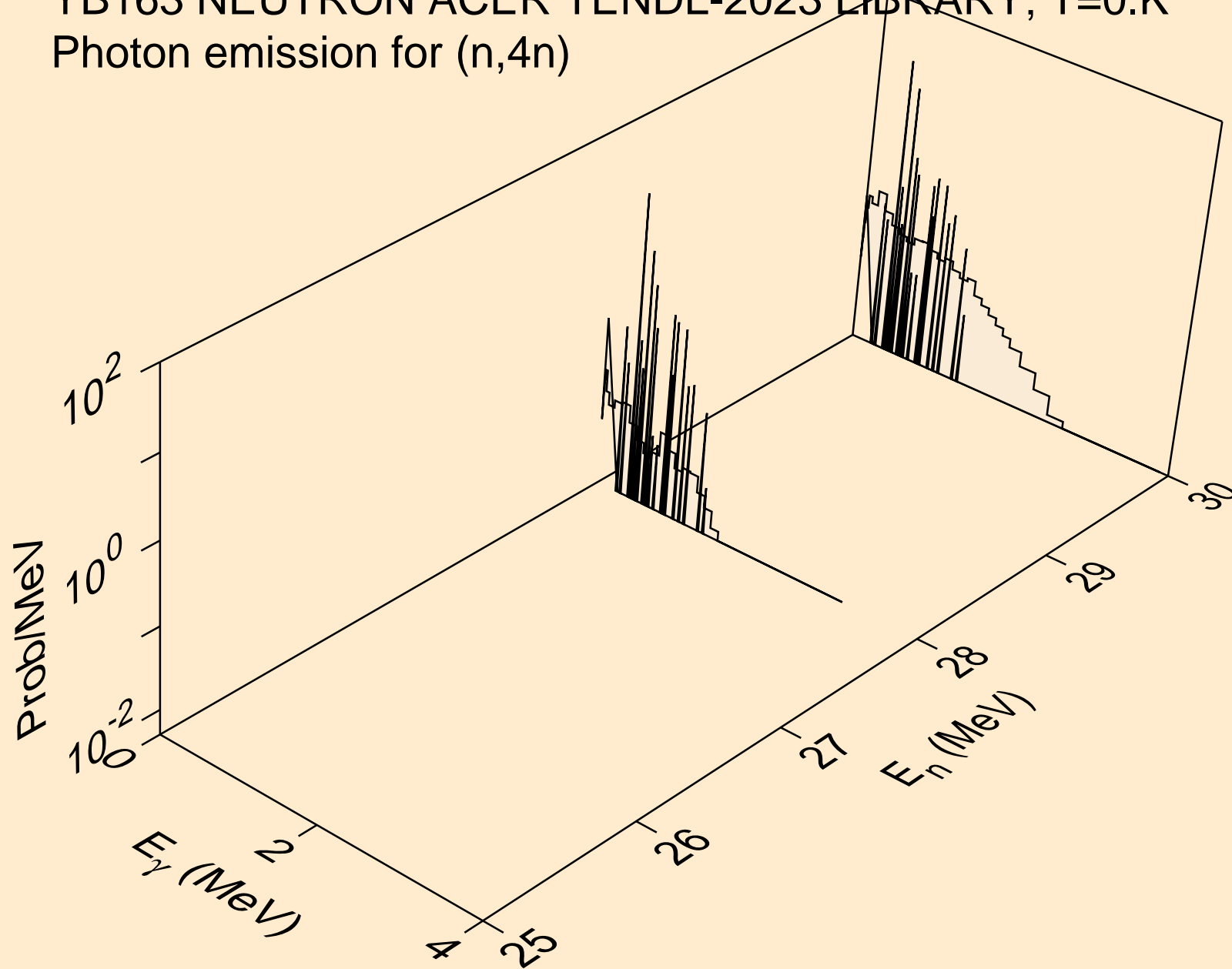

YB163 NEUTRON ACER TENDL-2023 LIBRARY; T=0.K  
Photon emission for (n,2np)

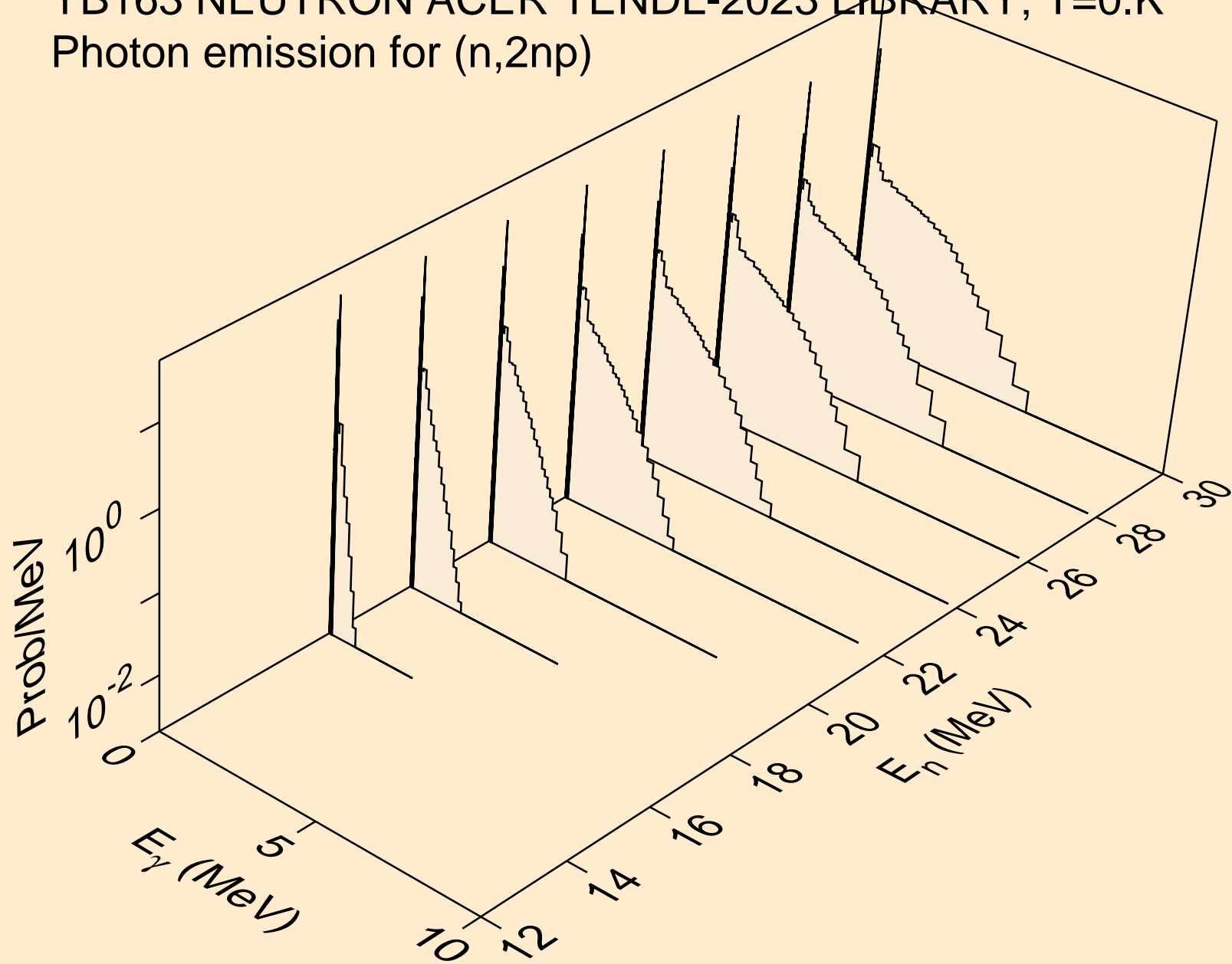

YB163 NEUTRON ACER TENDL-2023 LIBRARY; T=0.K  
Photon emission for (n,3np)

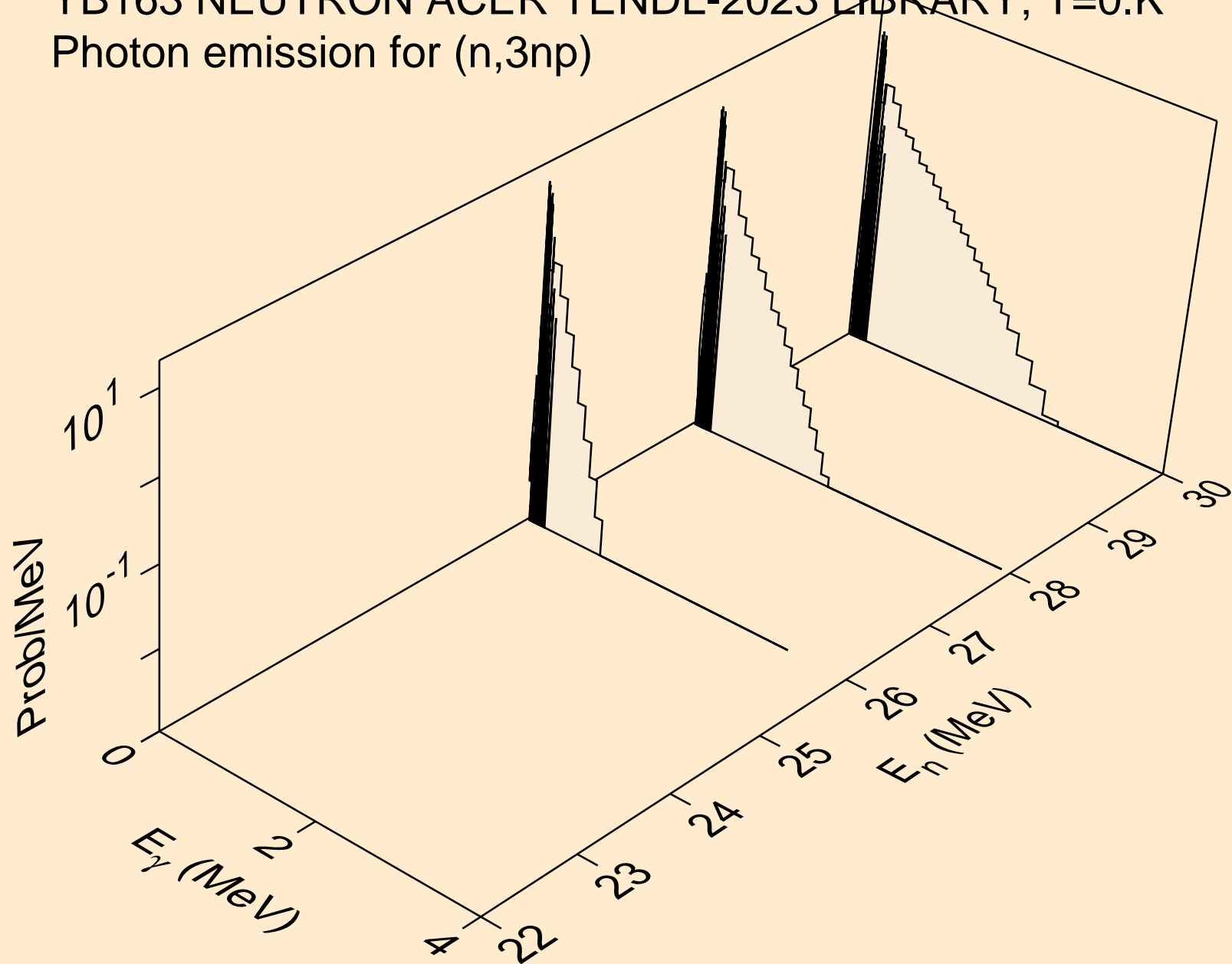

YB163 NEUTRON ACER TENDL-2023 LIBRARY; T=0.K  
Photon emission for (n,n2p)

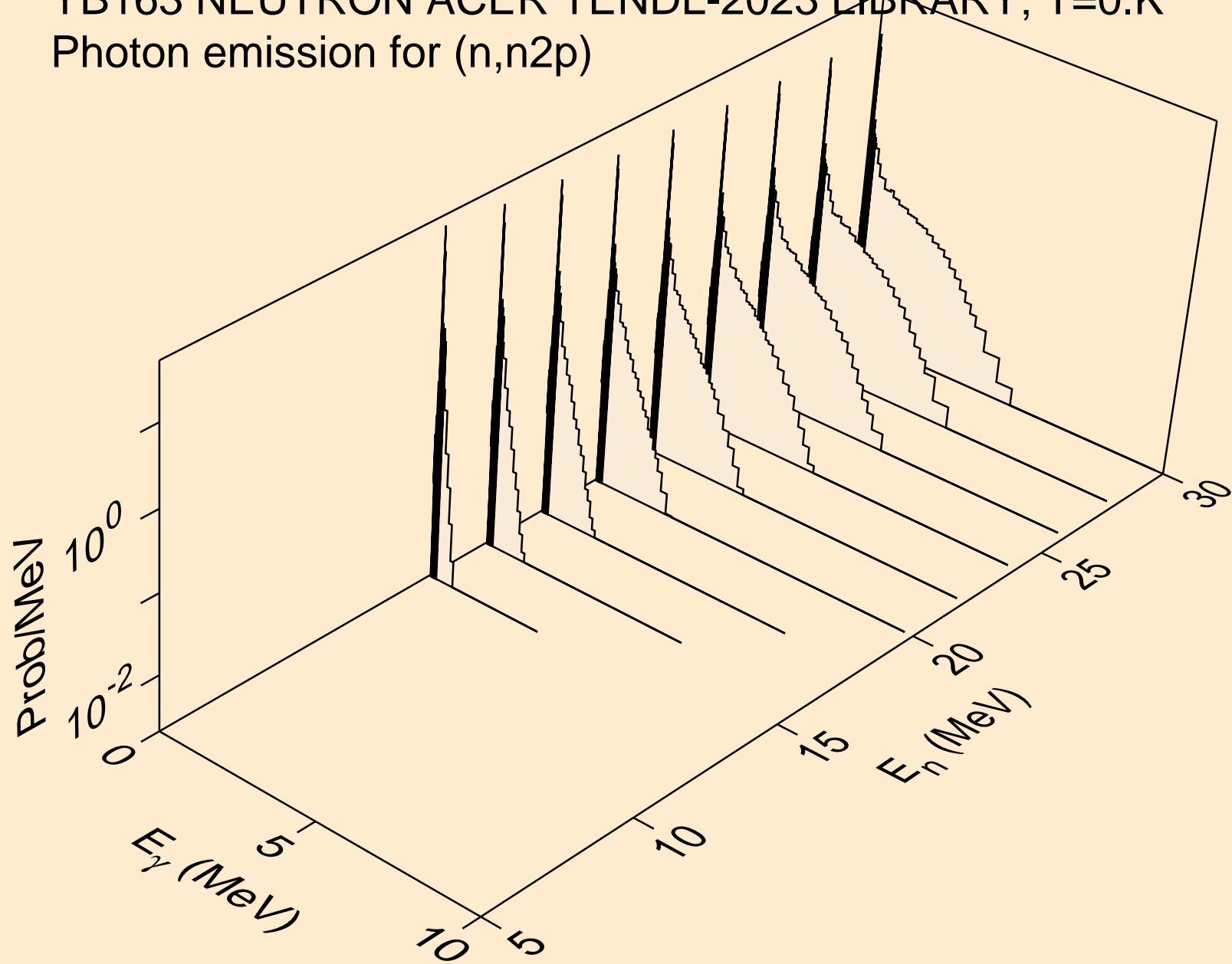

YB163 NEUTRON ACER TENDL-2023 LIBRARY; T=0.K  
Photon emission for (n,npa)

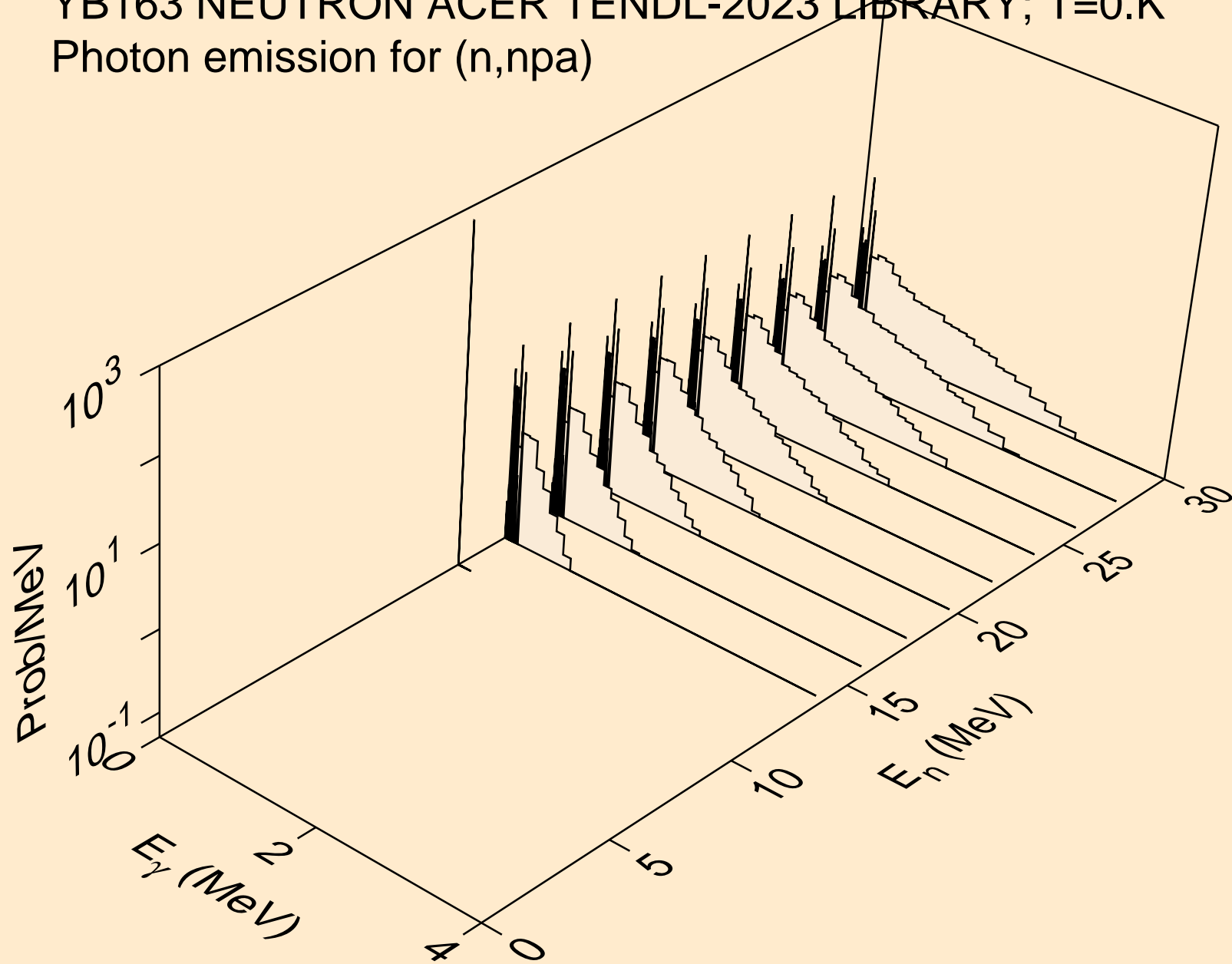

YB163 NEUTRON ACER TENDL-2023 LIBRARY; T=0.K  
Photon emission for (n,n\*c)

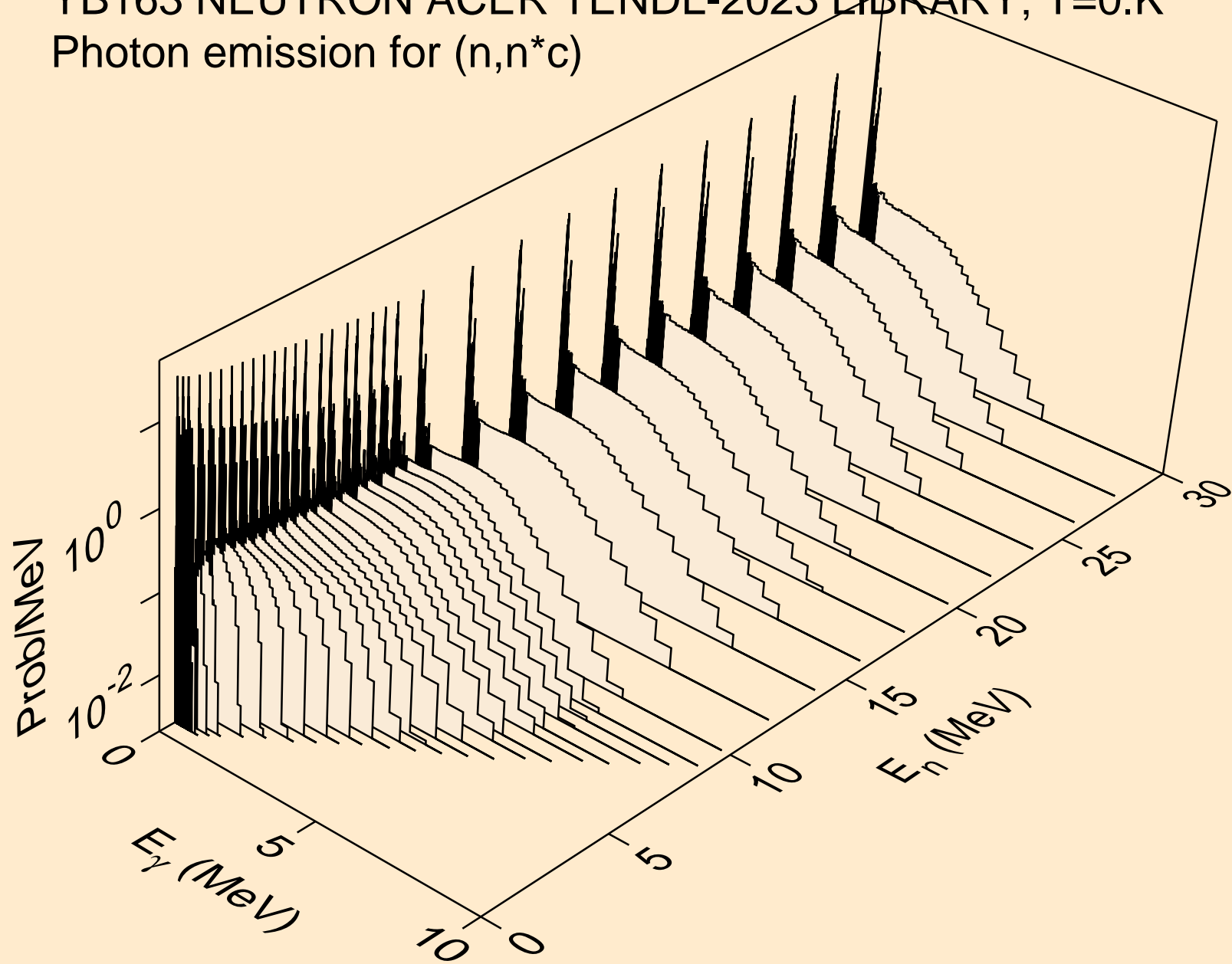

YB163 NEUTRON ACER TENDL-2023 LIBRARY; T=0.K  
Photon emission for (n,gma)

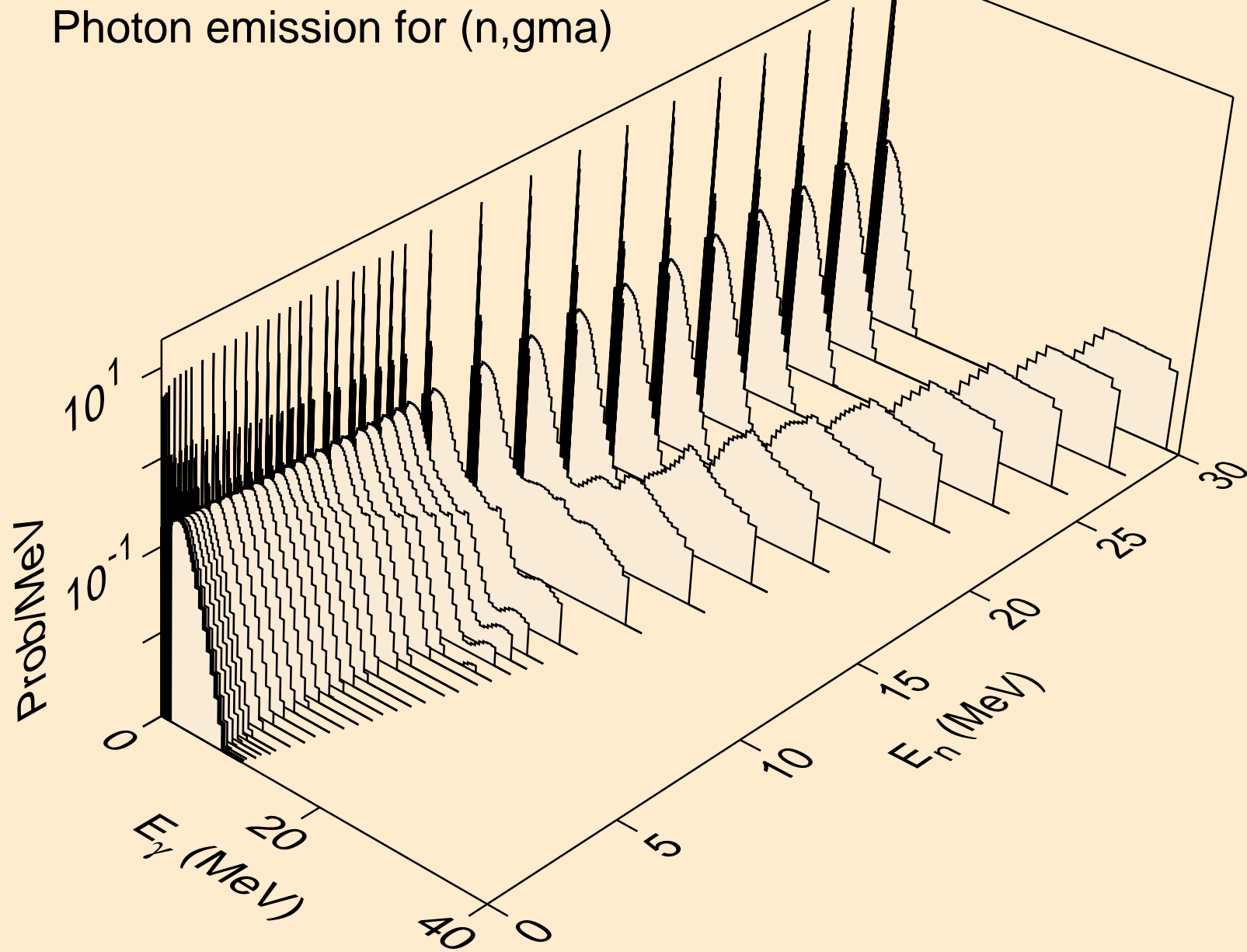

YB163 NEUTRON ACER TENDL-2023 LIBRARY; T=0.K  
Photon emission for (n,p)

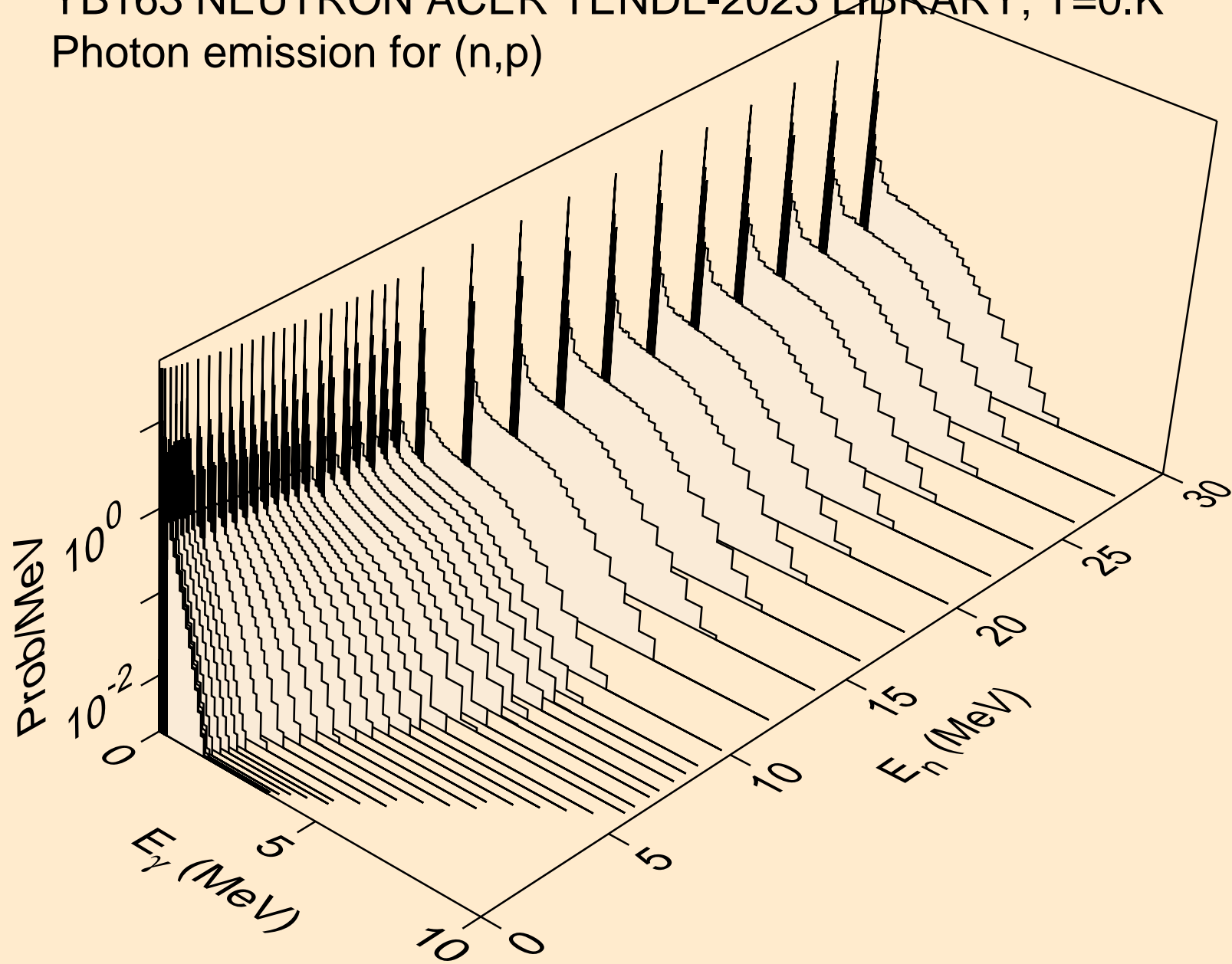



YB163 NEUTRON ACER TENDL-2023 LIBRARY; T=0.K  
Photon emission for (n,d)

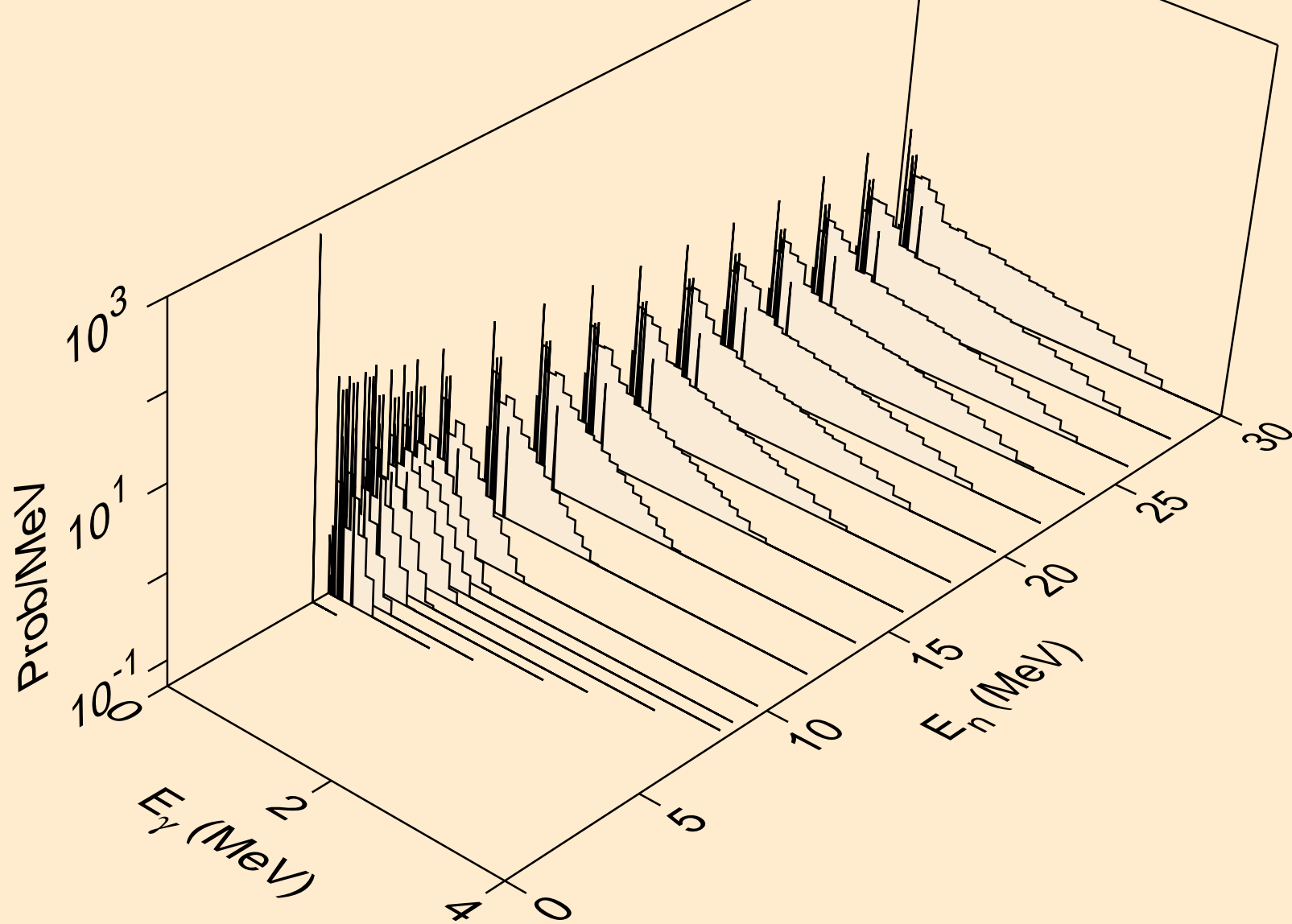

YB163 NEUTRON ACER TENDL-2023 LIBRARY; T=0.K  
Photon emission for (n,t)

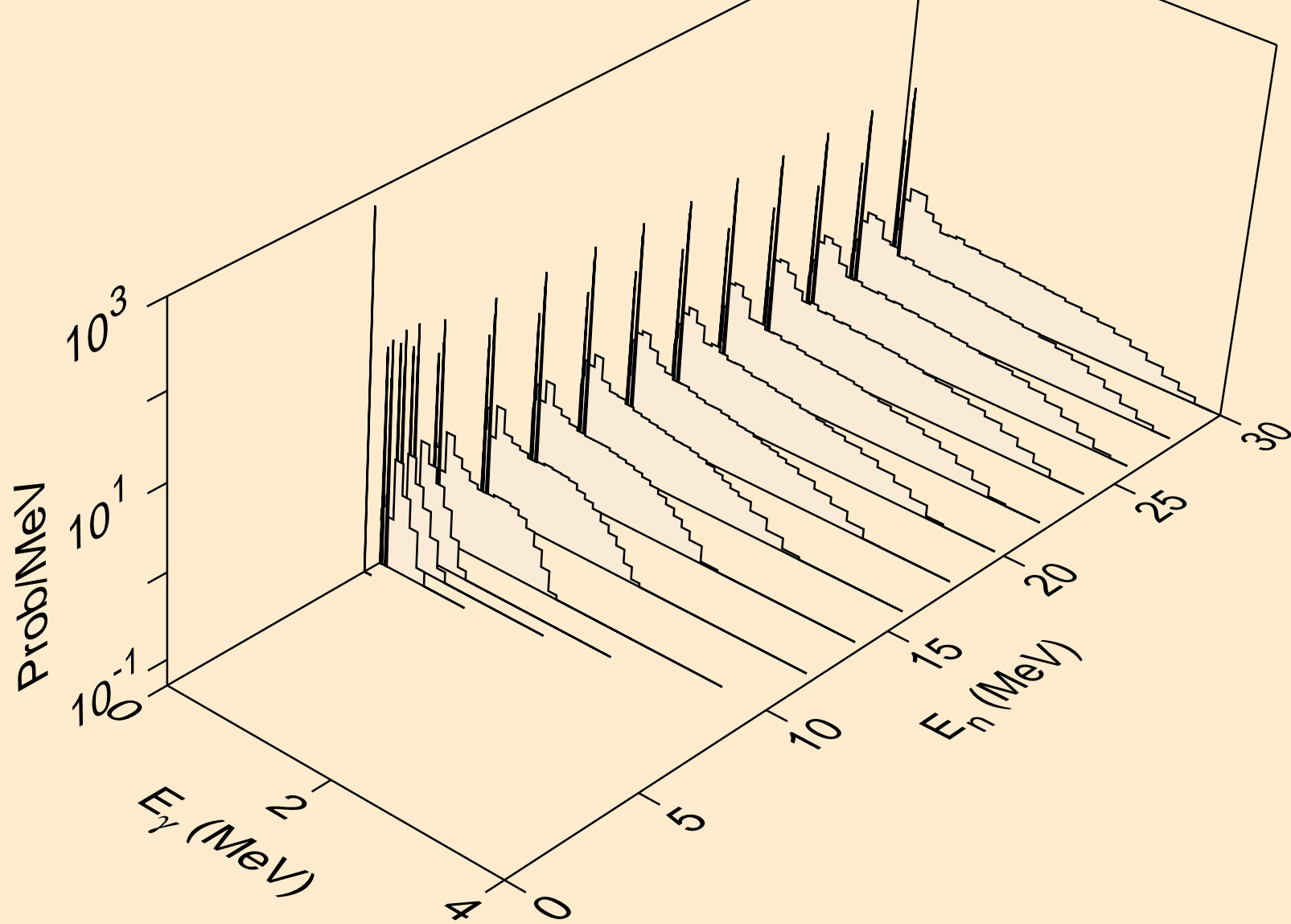

YB163 NEUTRON ACER TENDL-2023 LIBRARY; T=0.K  
Photon emission for (n,he3)

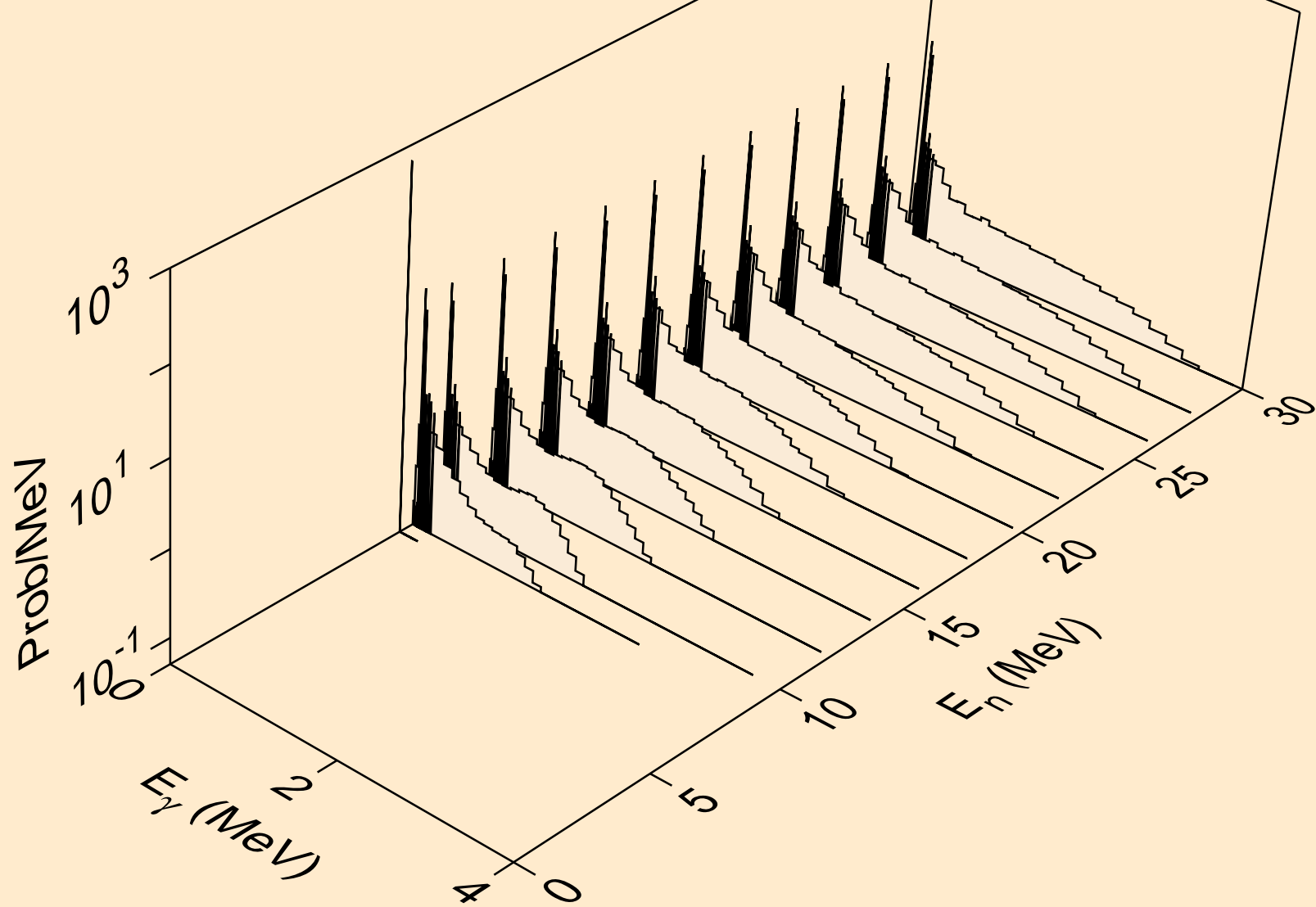

YB163 NEUTRON ACER TENDL-2023 LIBRARY; T=0.K  
Photon emission for (n,a)

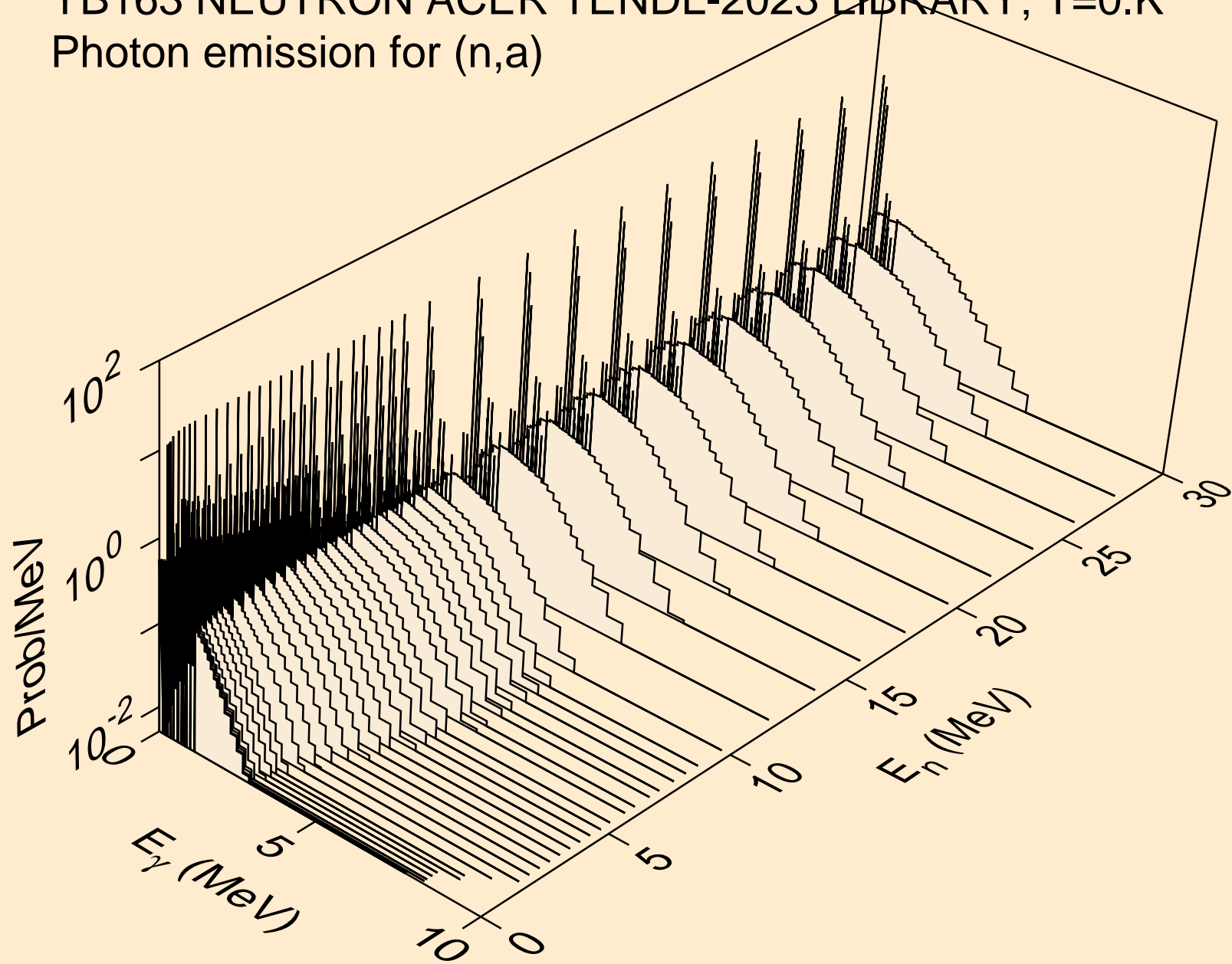

YB163 NEUTRON ACER TENDL-2023 LIBRARY; T=0.K  
Photon emission for (n,2a)

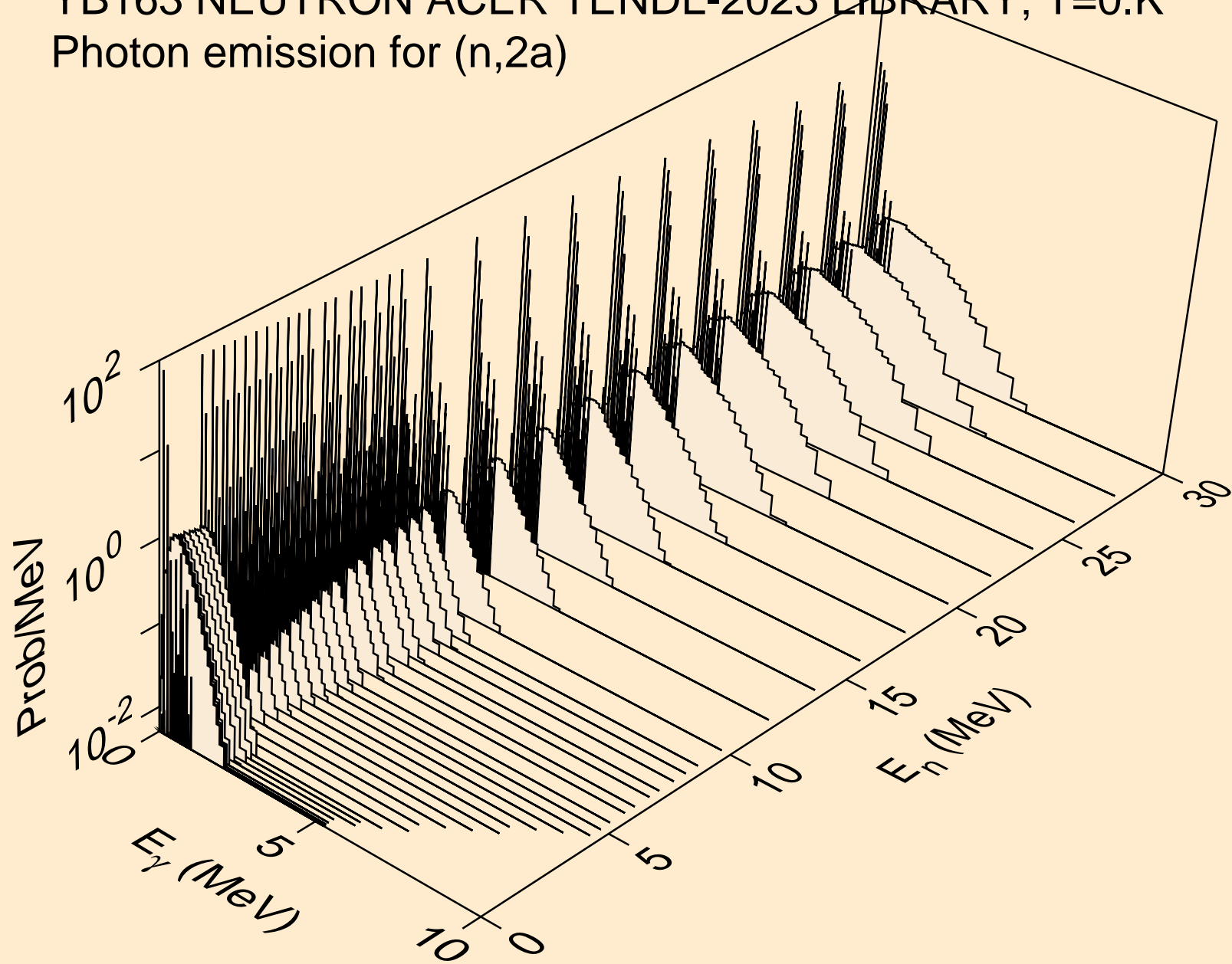

YB163 NEUTRON ACER TENDL-2023 LIBRARY; T=0.K  
Photon emission for (n,2p)

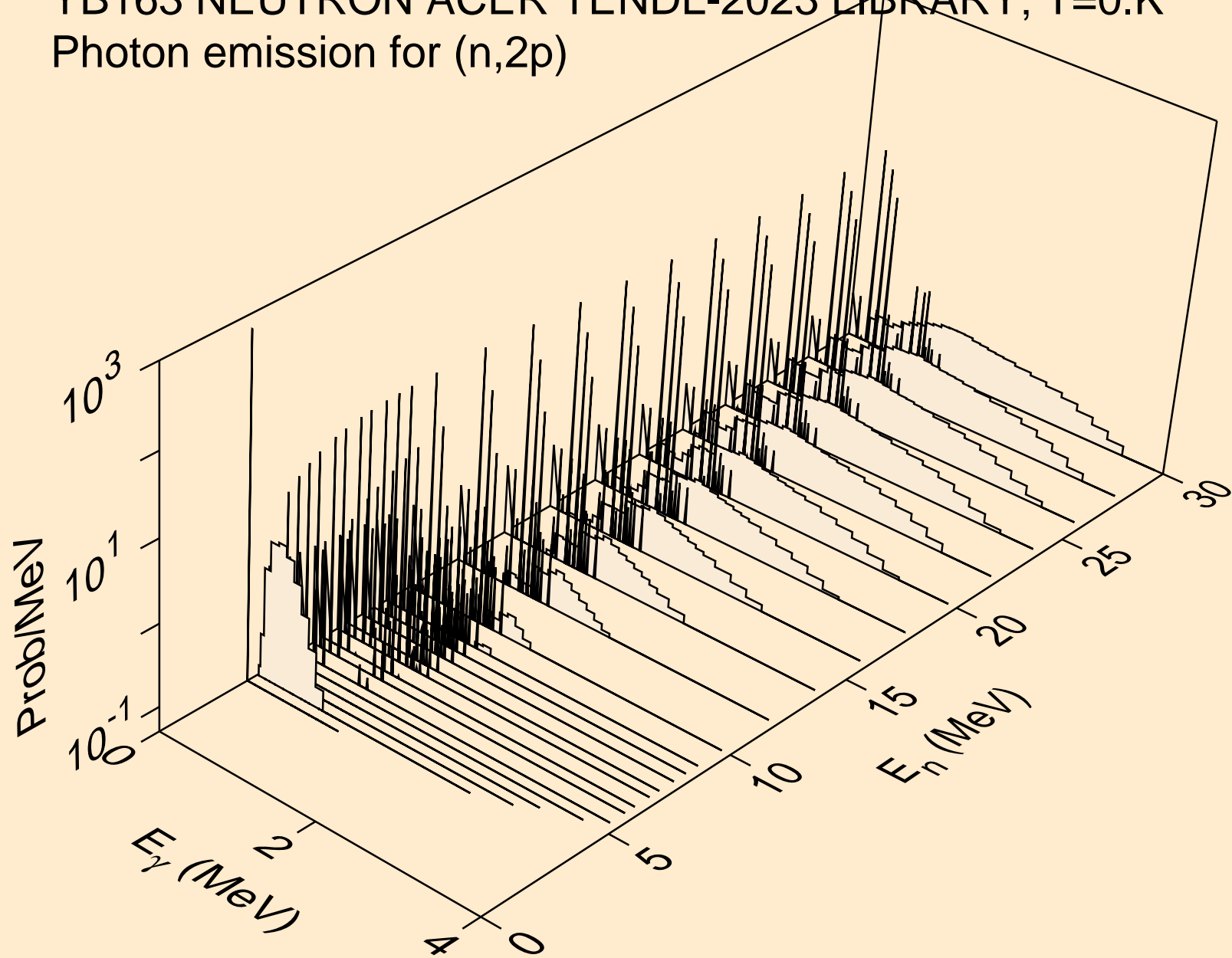

YB163 NEUTRON ACER TENDL-2023 LIBRARY; T=0.K  
Photon emission for (n,p $\alpha$ )

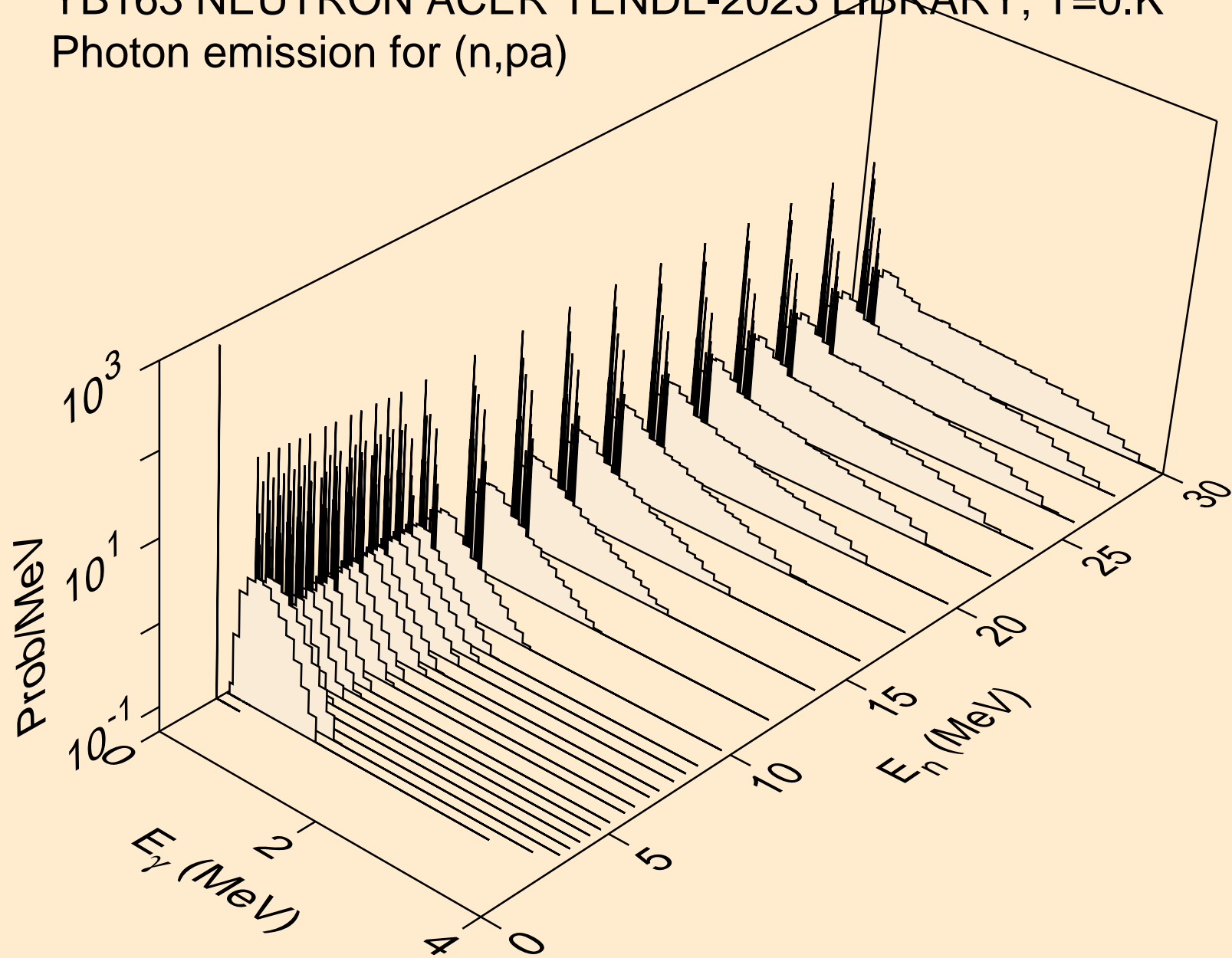

YB163 NEUTRON ACER TENDL-2023 LIBRARY; T=0.K  
Photon emission for (n,pd)

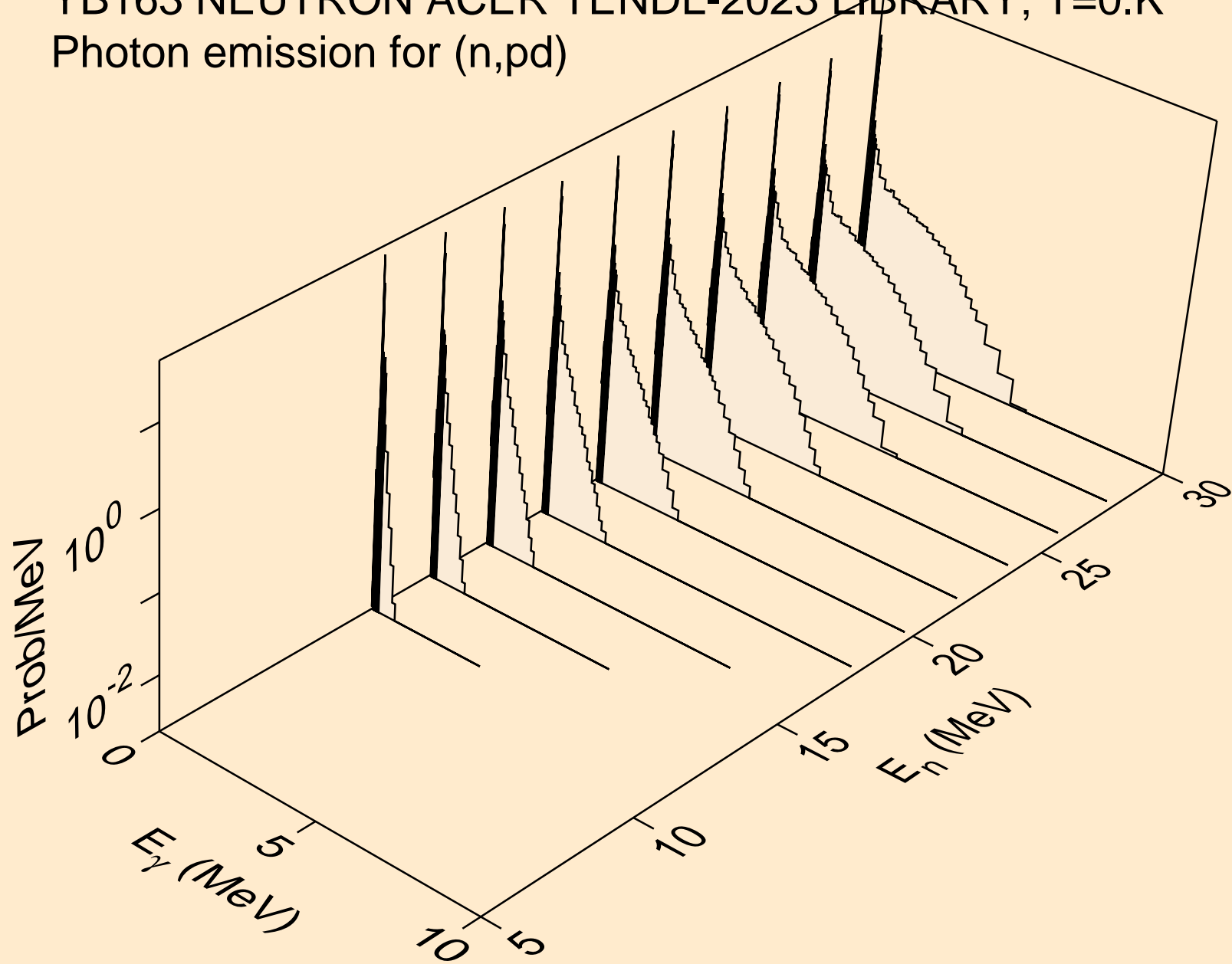



YB163 NEUTRON ACER TENDL-2023 LIBRARY; T=0.K  
Photon emission for (n,pt)

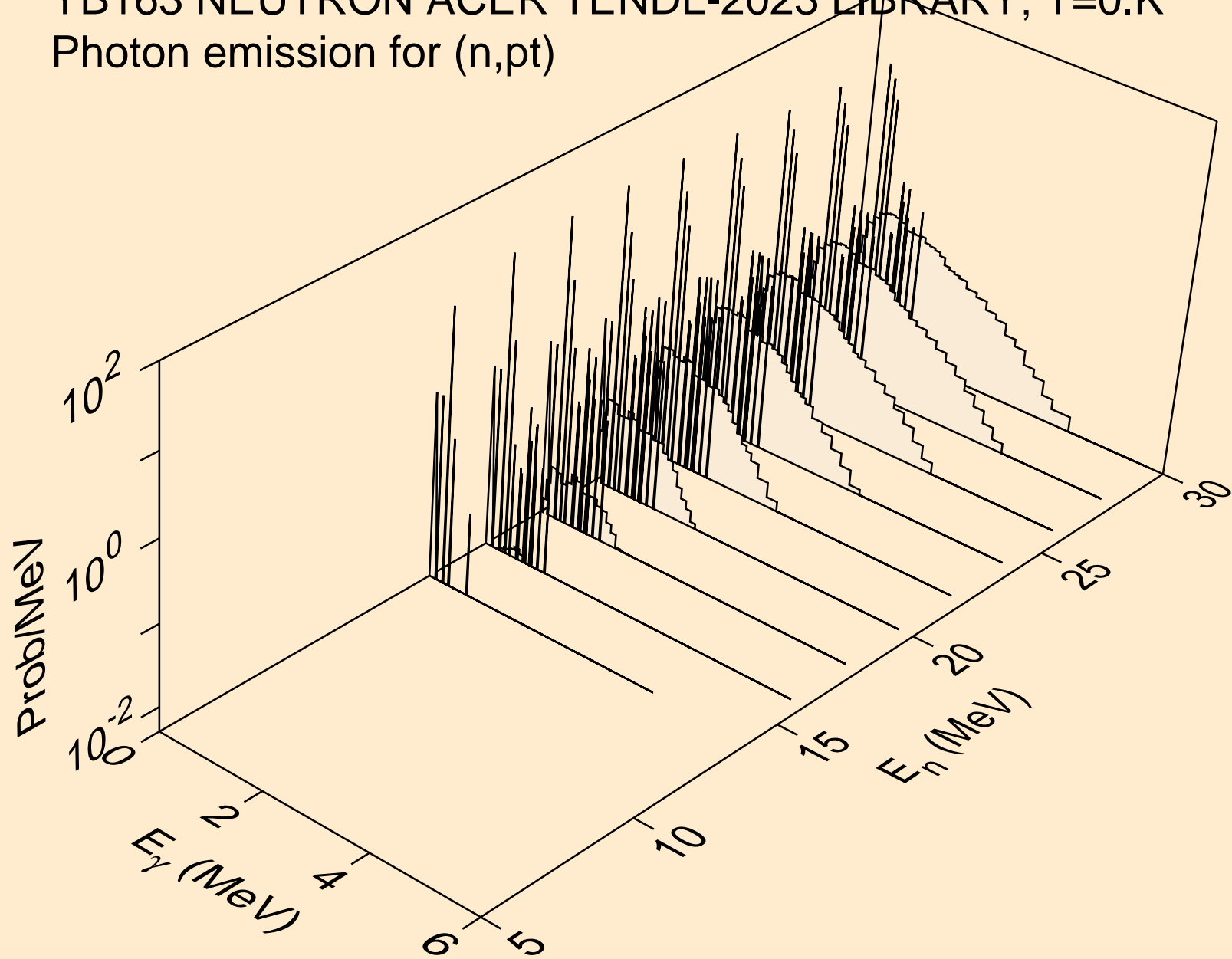

YB163 NEUTRON ACER TENDL-2023 LIBRARY; T=0.K  
Photon emission for (n,da)

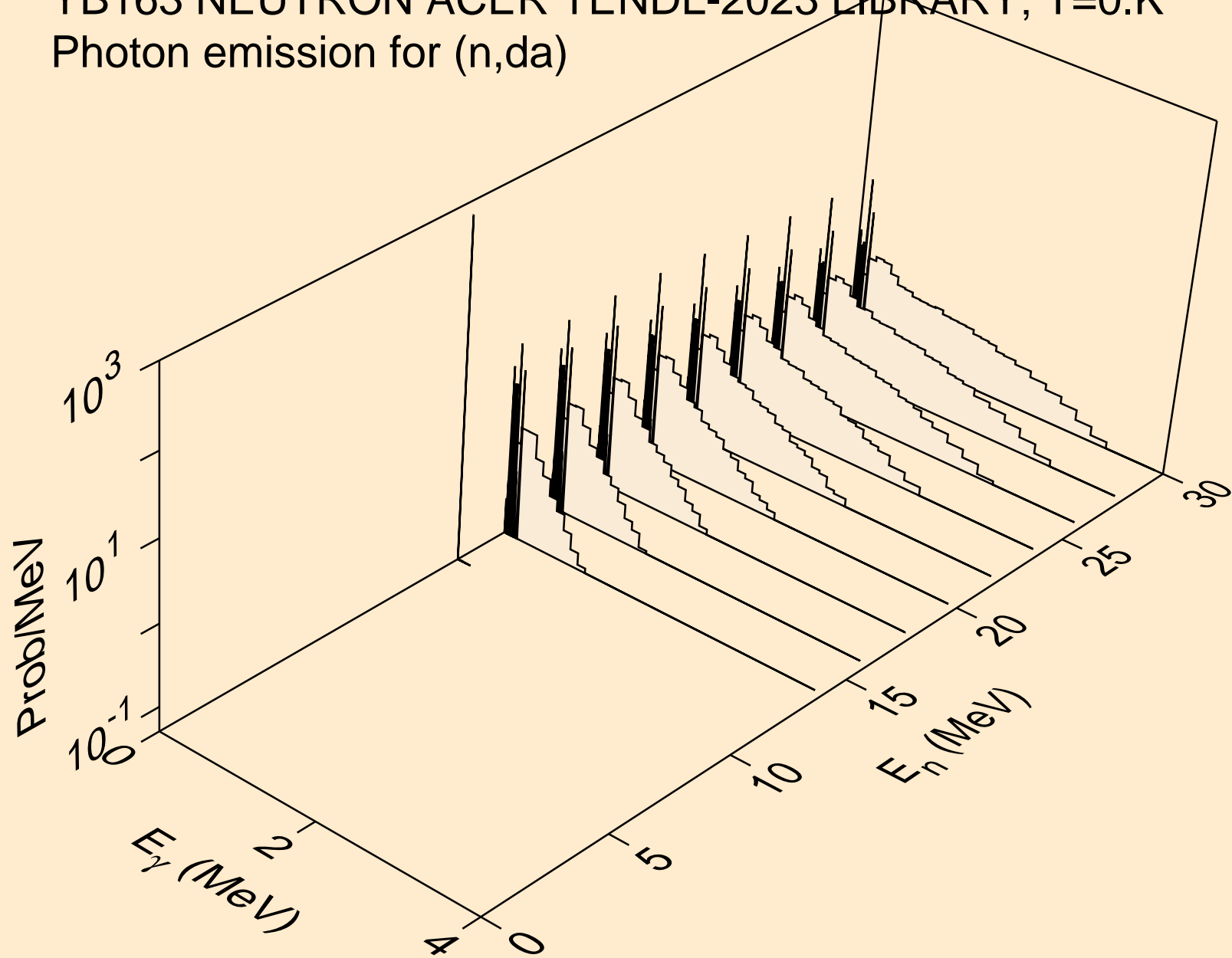

YB163 NEUTRON ACER TENDL-2023 LIBRARY; T=0.K  
thermal capture photon spectrum

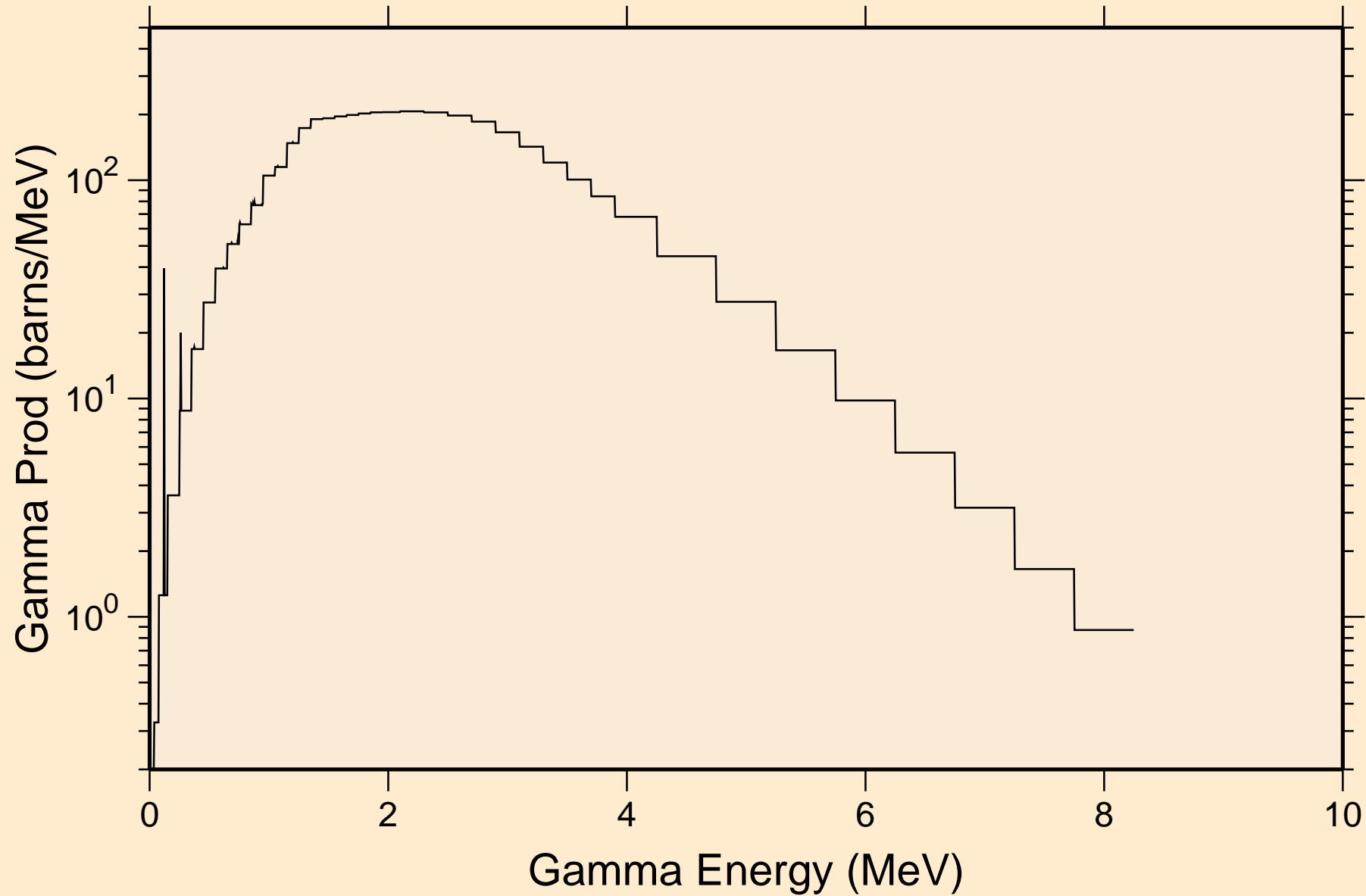

YB163 NEUTRON ACER TENDL-2023 LIBRARY; T=0.K  
14 MeV photon spectrum

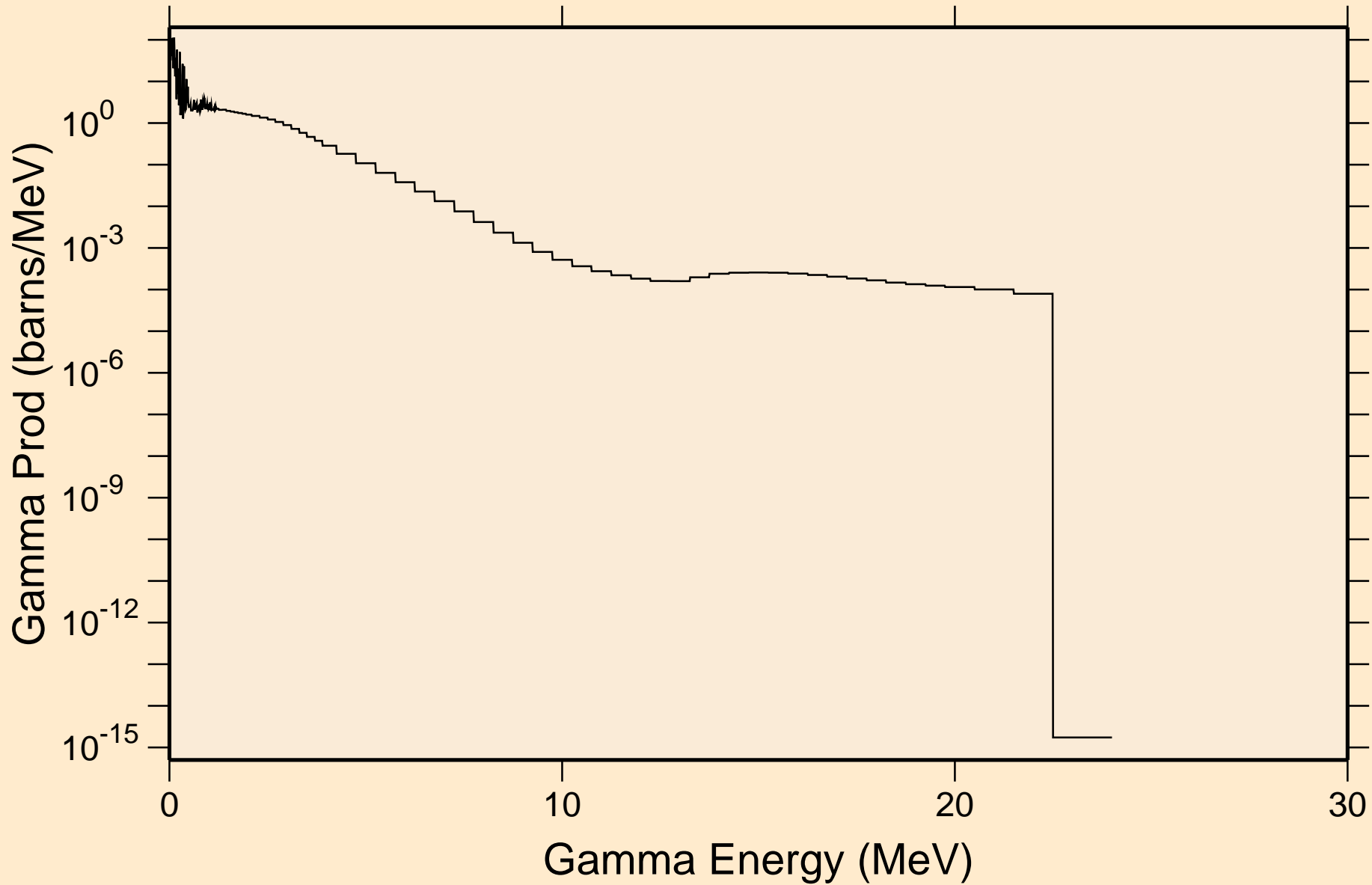

# YB163 NEUTRON ACER TENDL-2023 LIBRARY; T=0.K

## Particle heating contributions

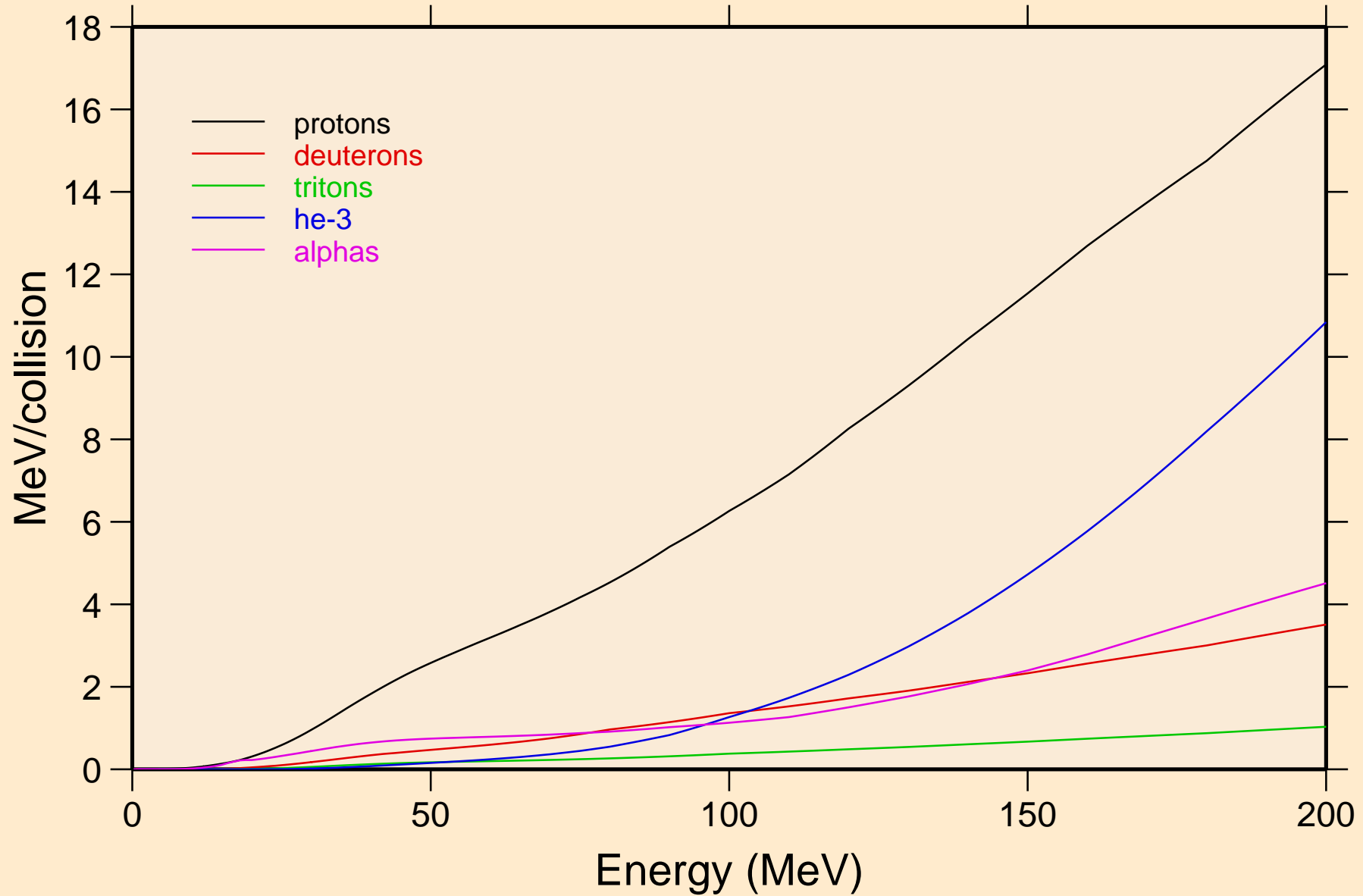

YB163 NEUTRON ACER TENDL-2023 LIBRARY; T=0.K  
Recoil Heating

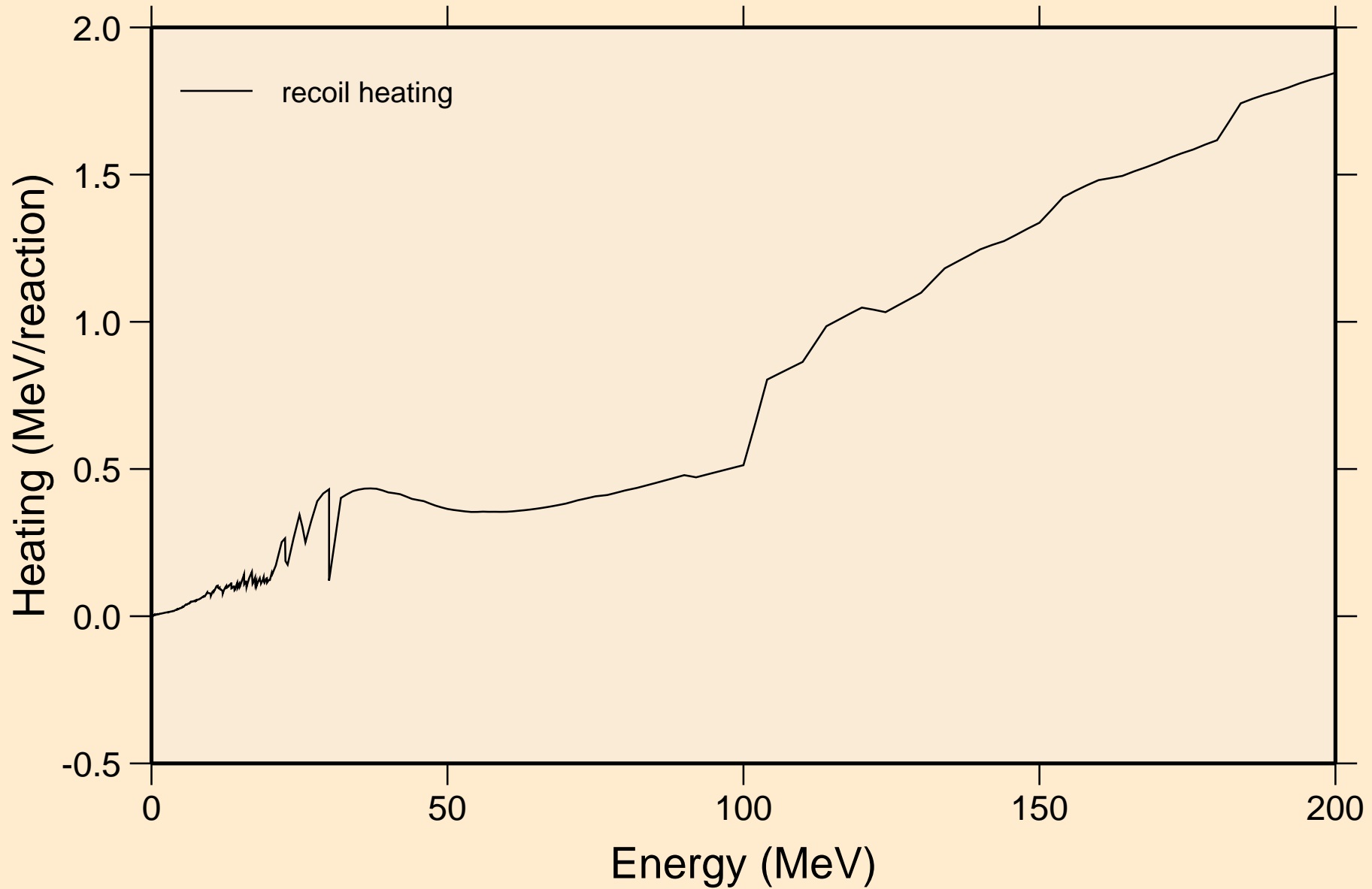

YB163 NEUTRON ACER TENDL-2023 LIBRARY; T=0.K  
Particle production cross sections

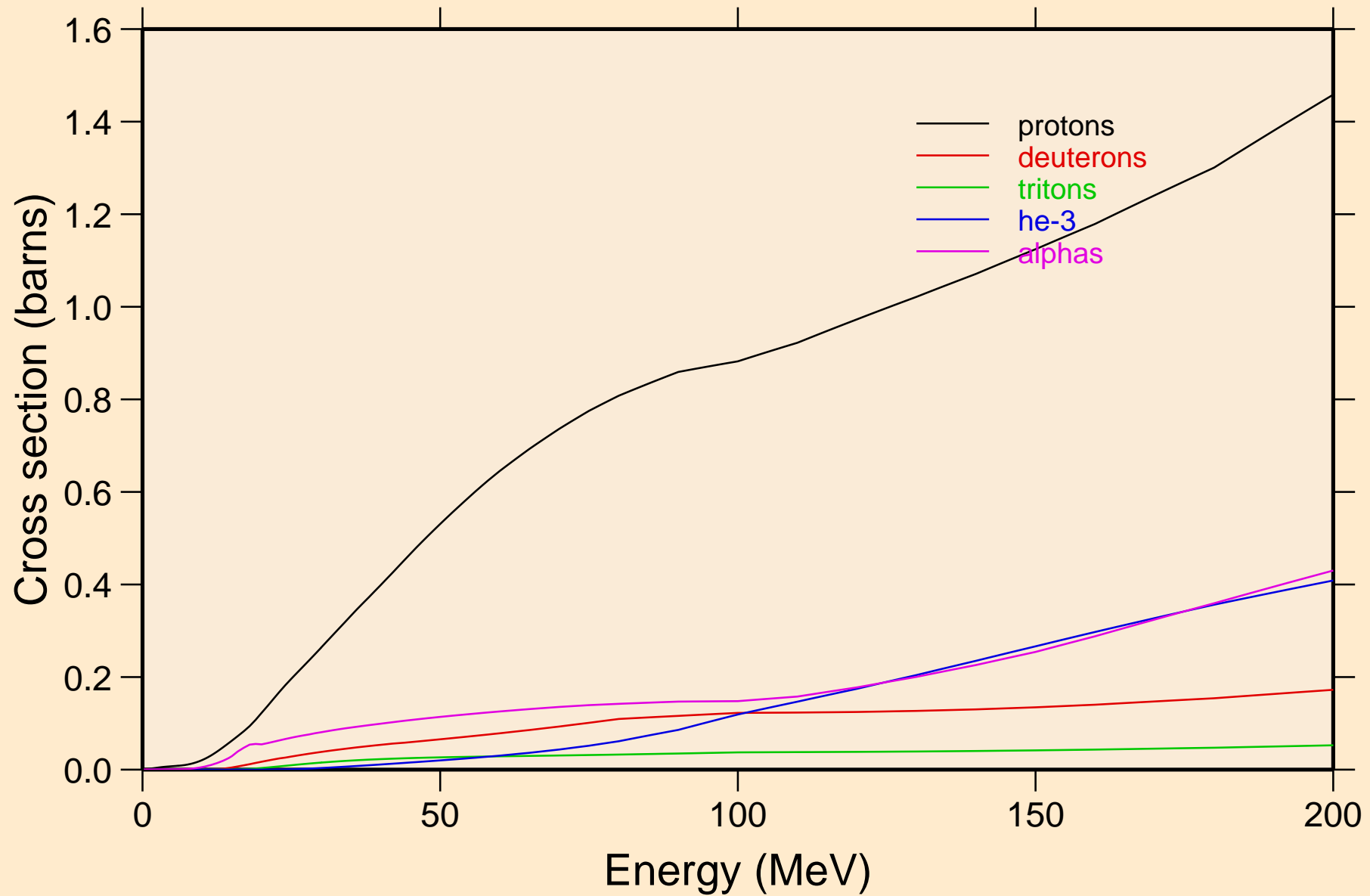

YB163 NEUTRON ACER TENDL-2023 LIBRARY; T=0.K  
protons from (n,x)

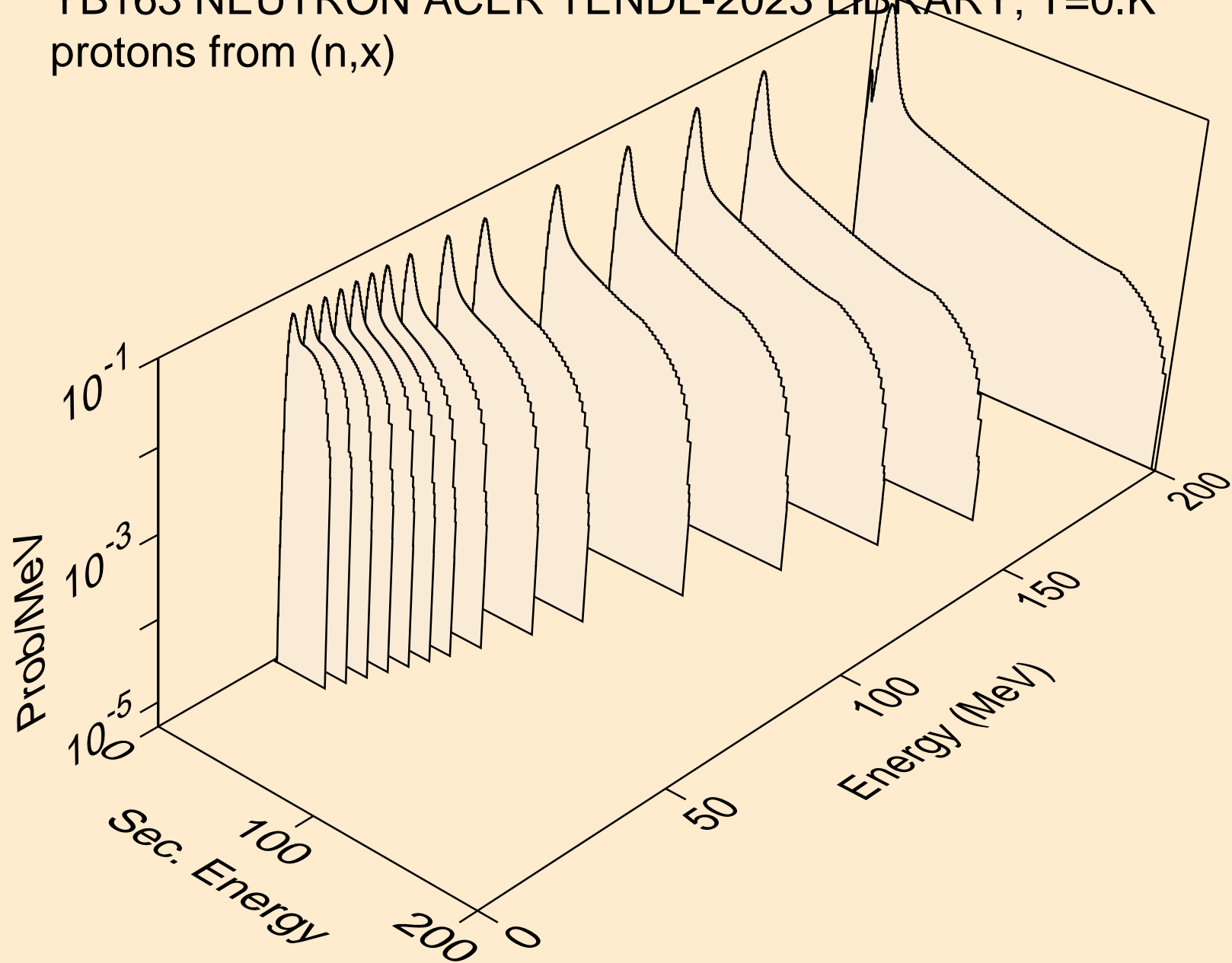



YB163 NEUTRON ACER TENDL-2023 LIBRARY; T=0.K  
protons from (n,n\*)p

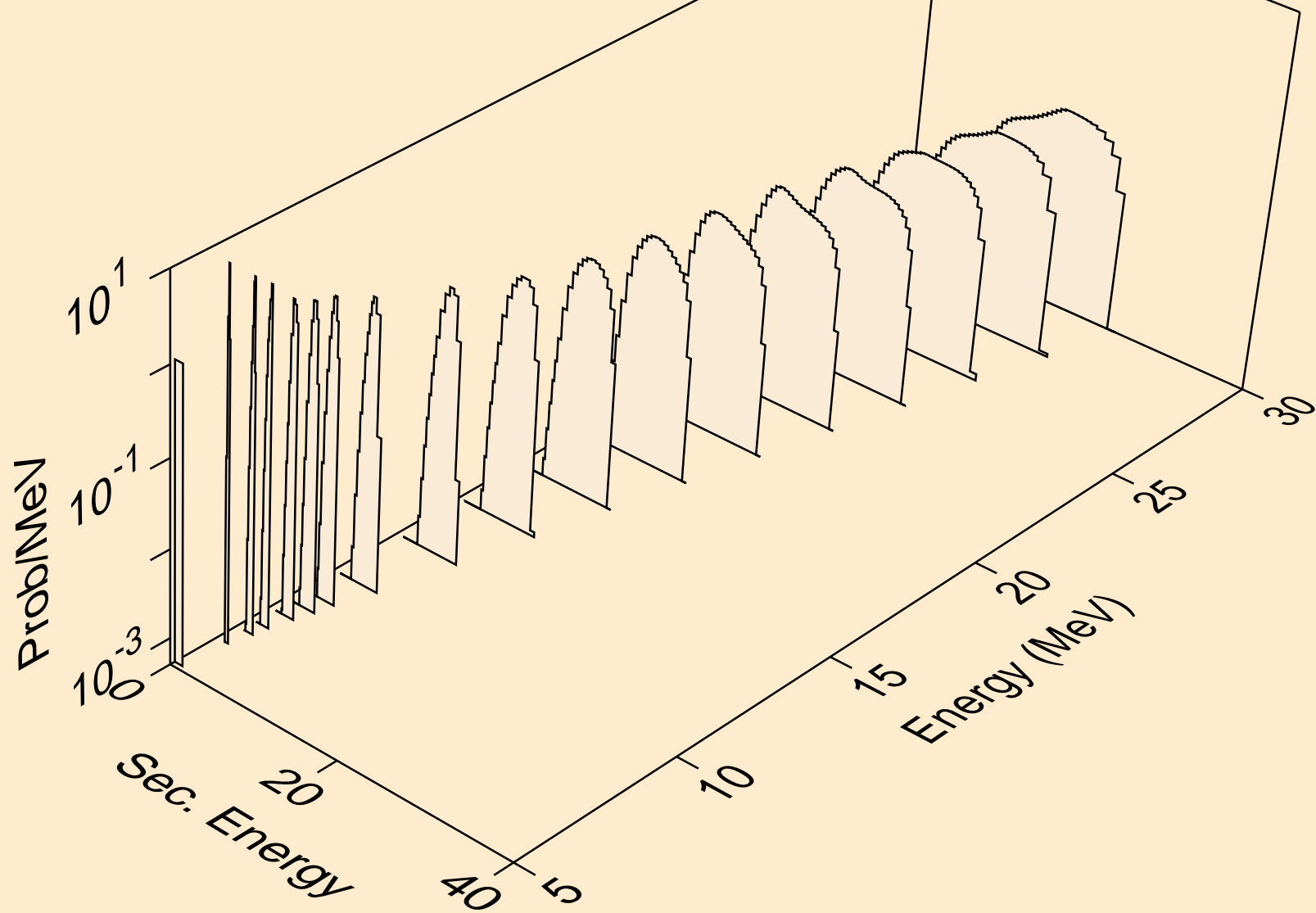

YB163 NEUTRON ACER TENDL-2023 LIBRARY; T=0.K  
protons from (n,2np)

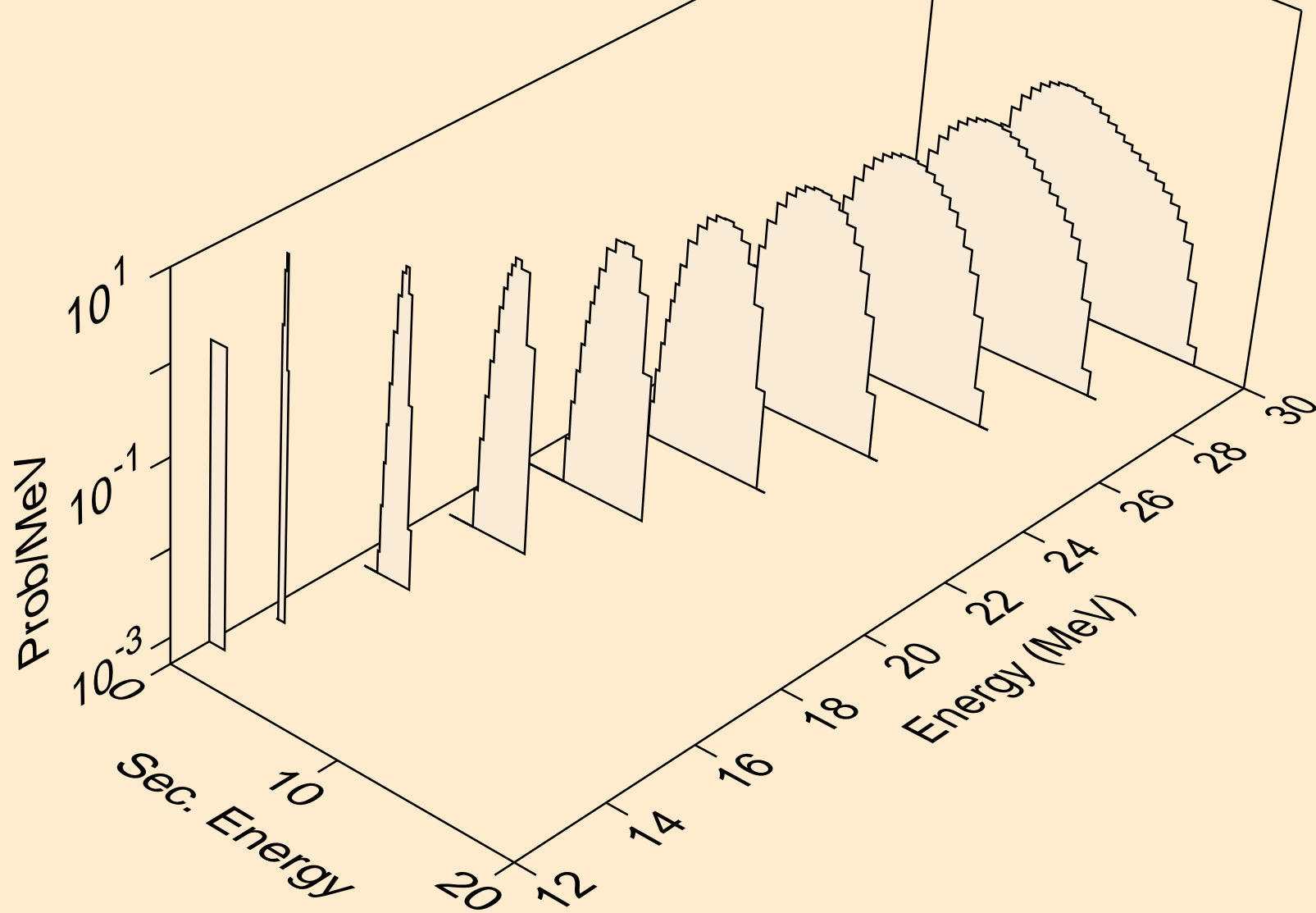

YB163 NEUTRON ACER TENDL-2023 LIBRARY; T=0.K  
protons from (n,3np)

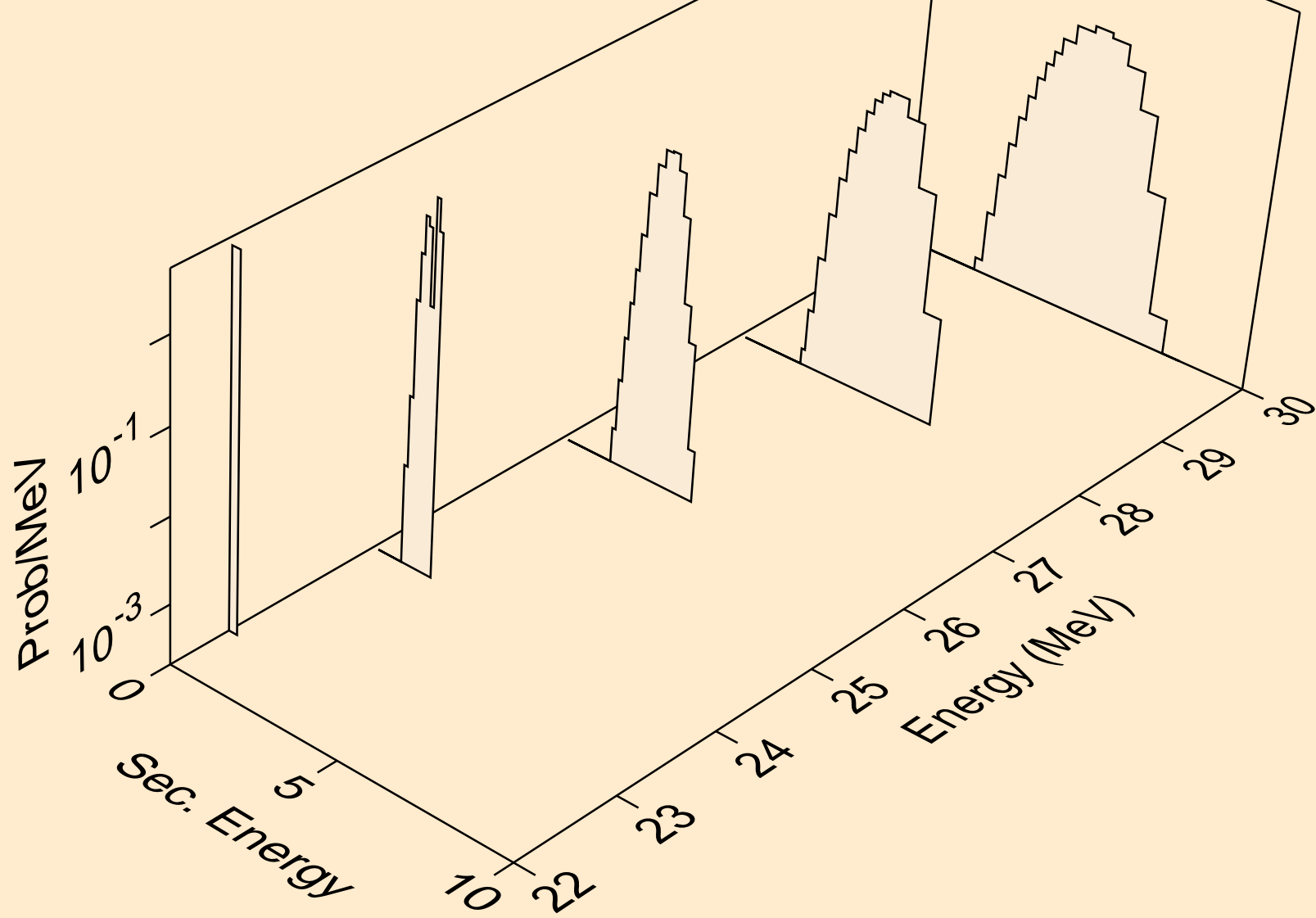

YB163 NEUTRON ACER TENDL-2023 LIBRARY; T=0.K  
protons from (n,n2p)

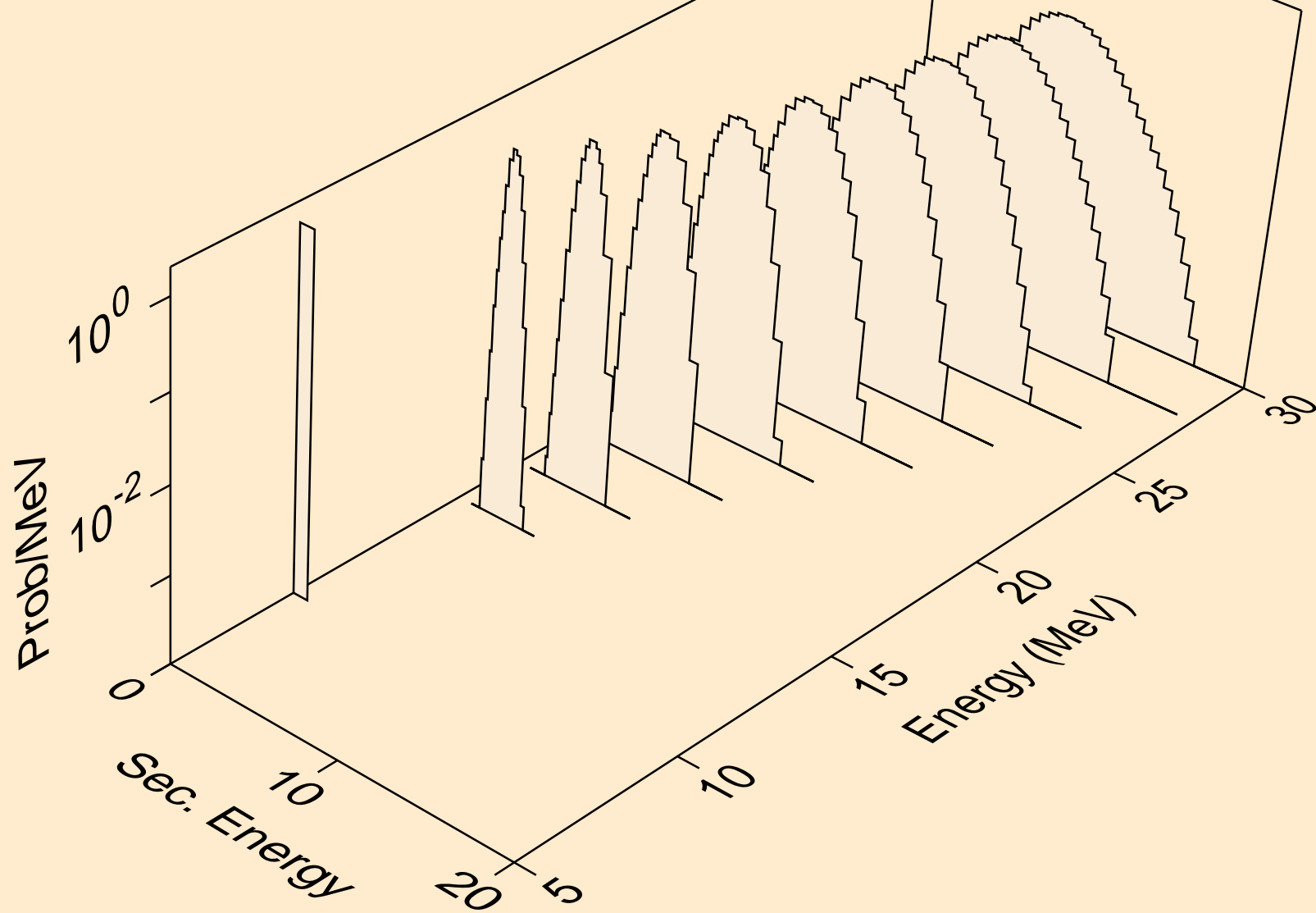

YB163 NEUTRON ACER TENDL-2023 LIBRARY; T=0.K  
protons from (n,npa)

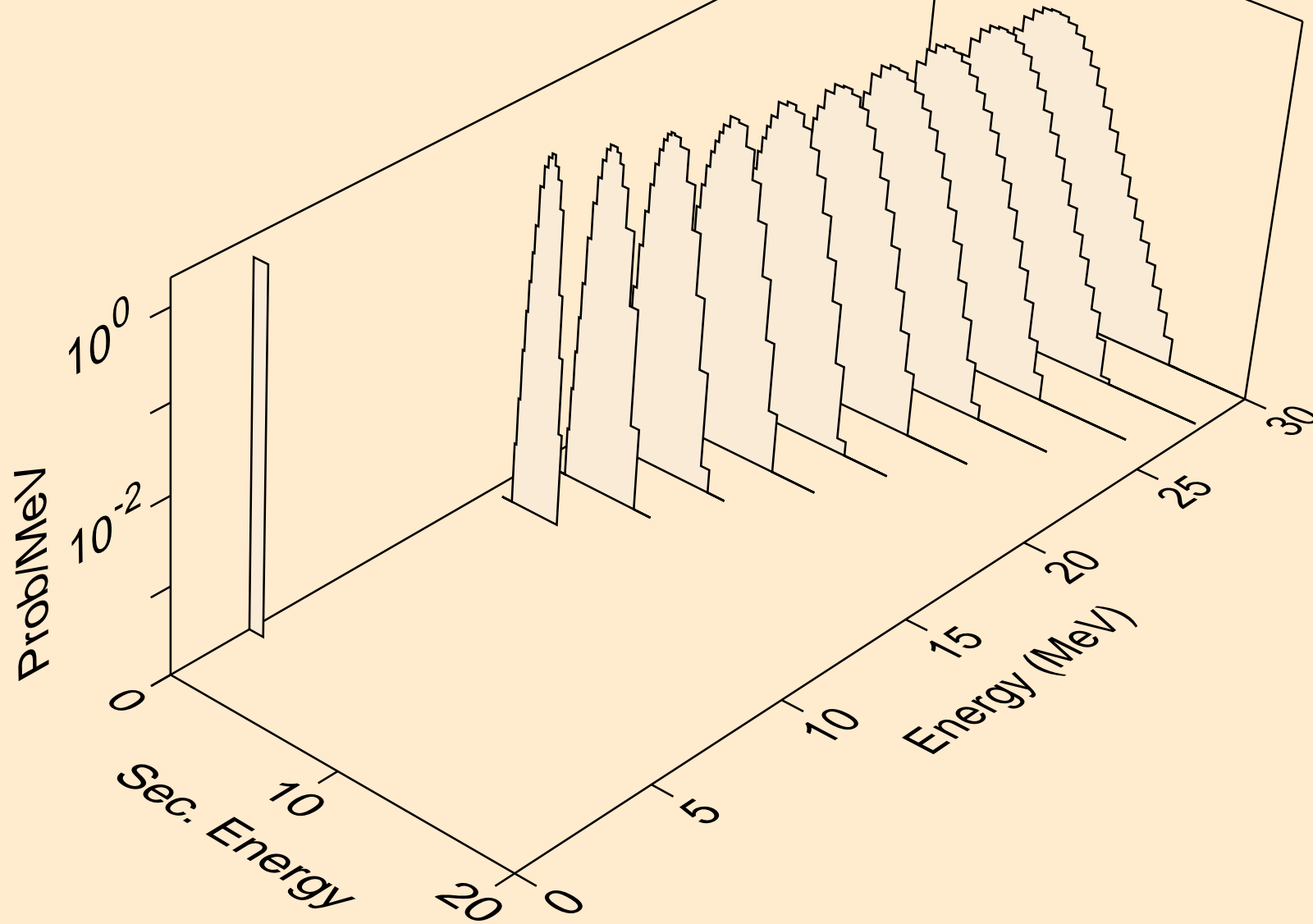

YB163 NEUTRON ACER TENDL-2023 LIBRARY; T=0.K  
protons from (n,p)

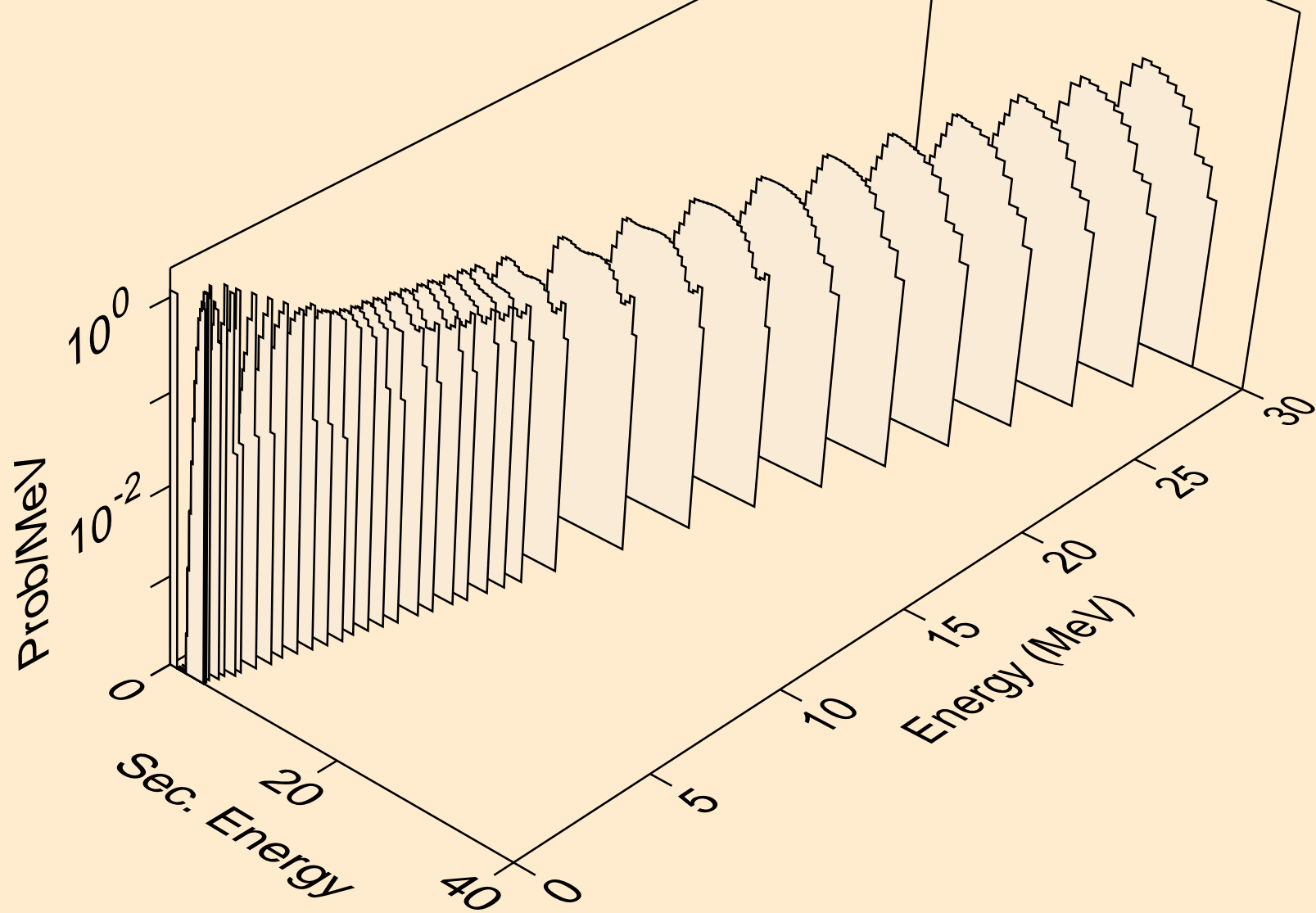

YB163 NEUTRON ACER TENDL-2023 LIBRARY; T=0.K  
protons from (n,2p)

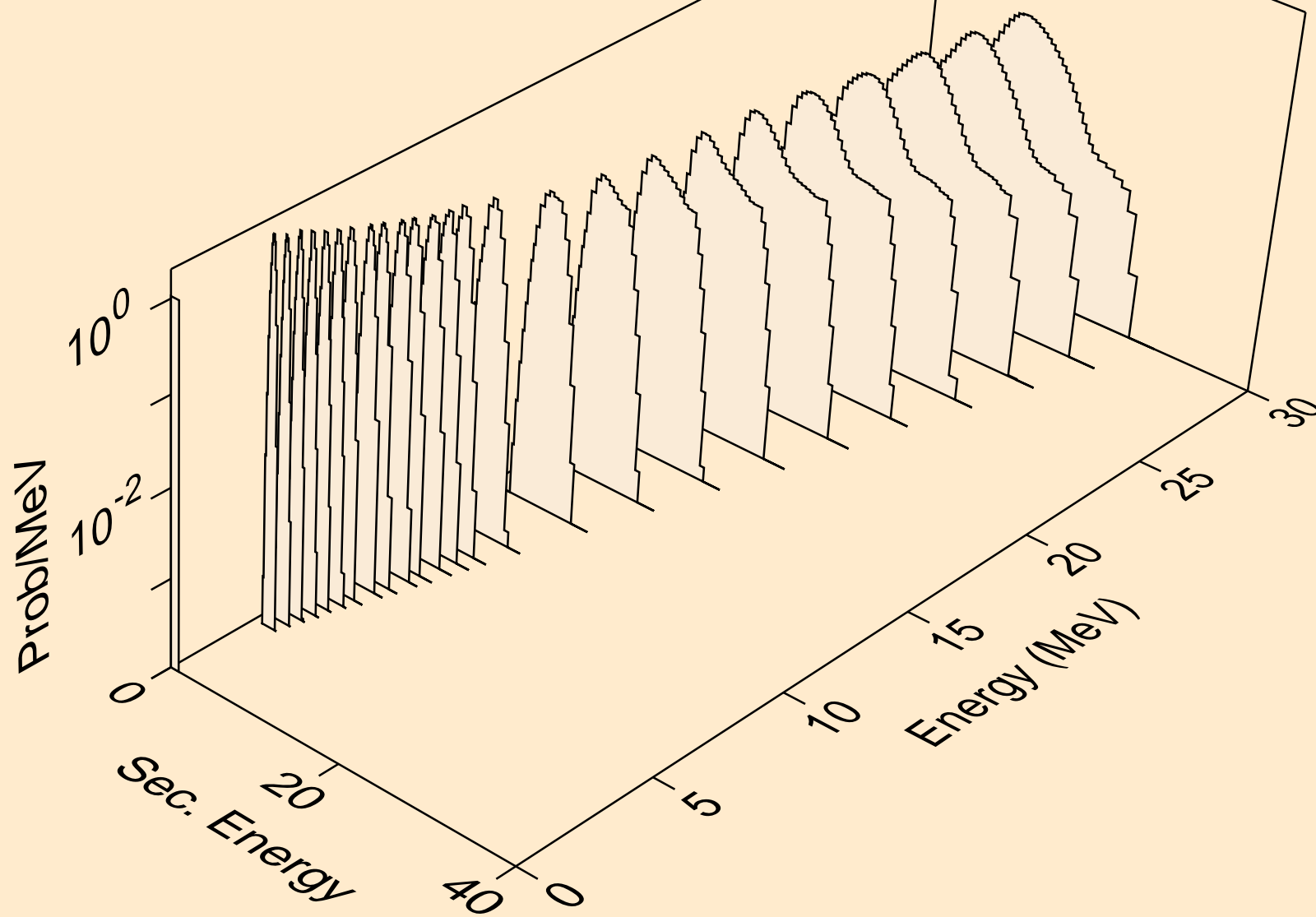

YB163 NEUTRON ACER TENDL-2023 LIBRARY; T=0.K  
protons from (n,p)

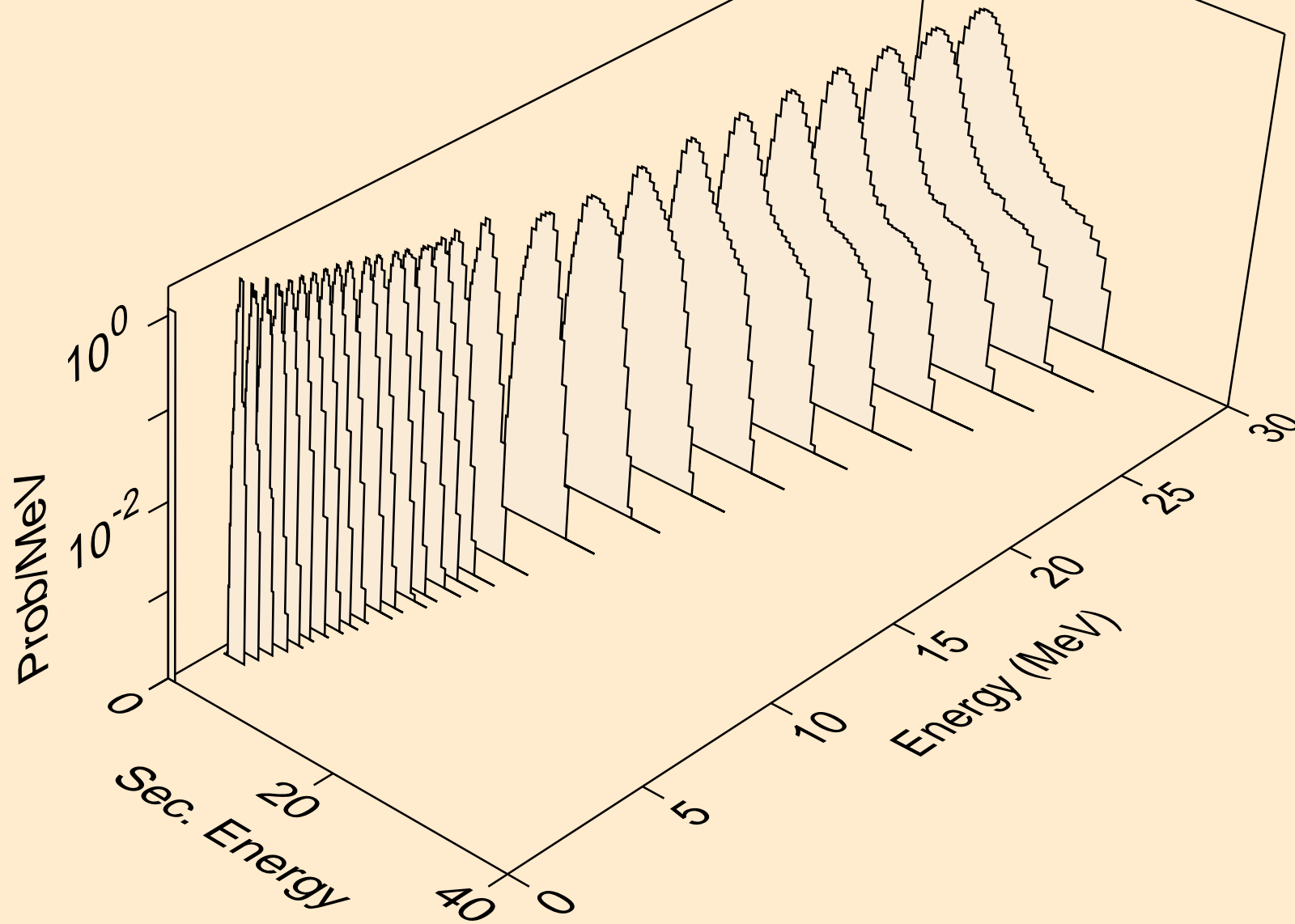



YB163 NEUTRON ACER TENDL-2023 LIBRARY; T=0.K  
protons from (n,pd)

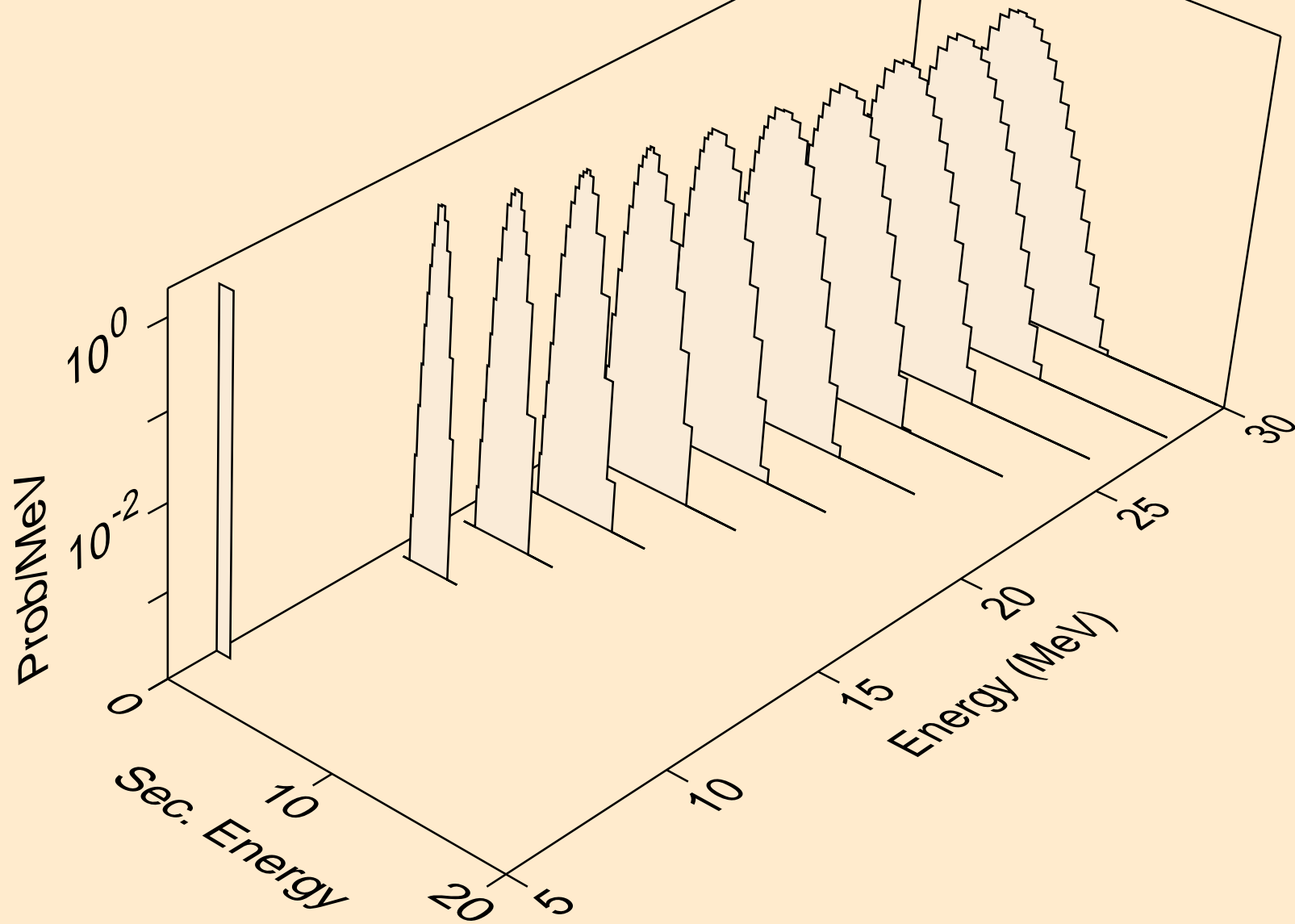

YB163 NEUTRON ACER TENDL-2023 LIBRARY; T=0.K  
protons from (n,pt)

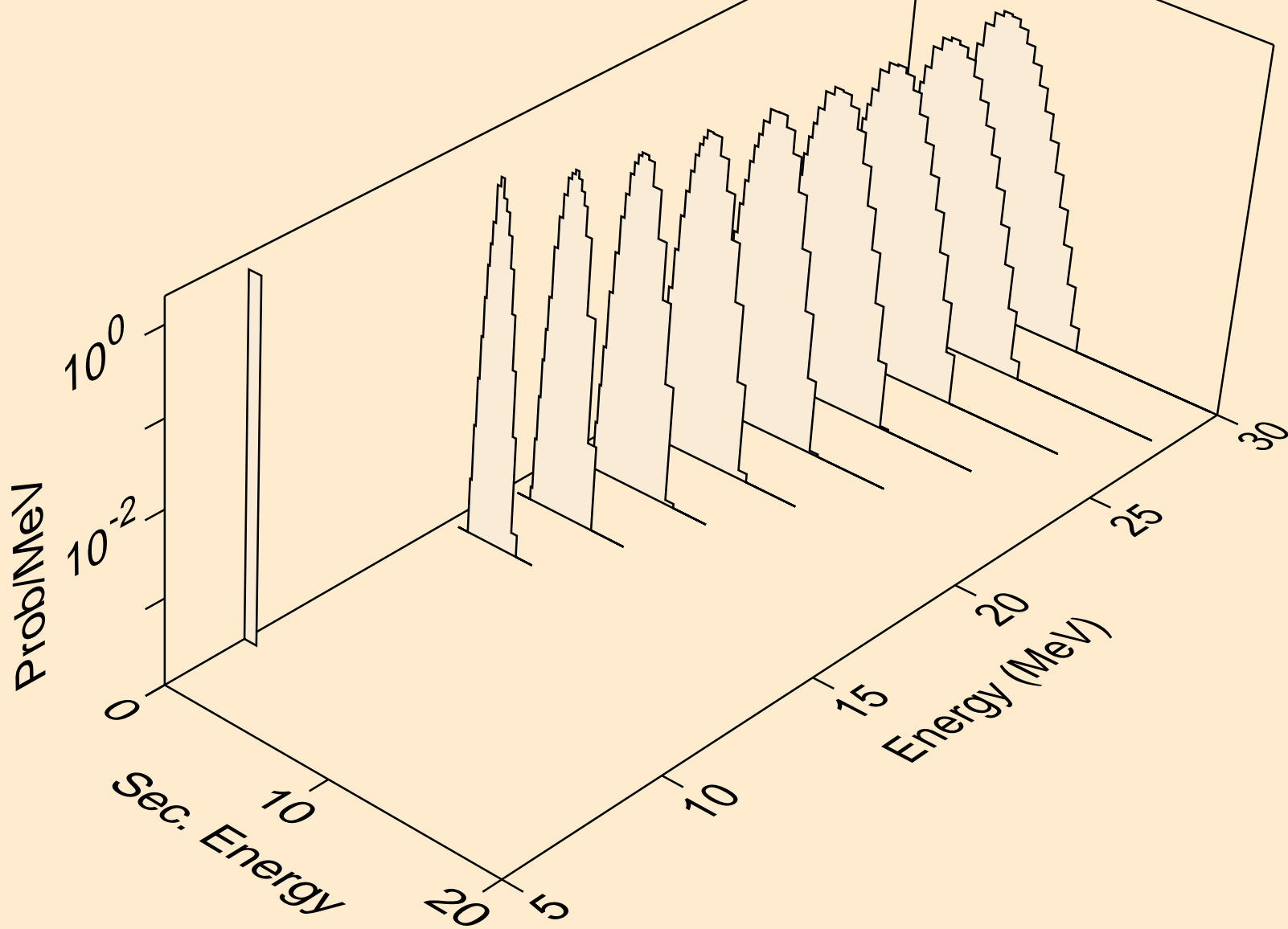

YB163 NEUTRON ACER TENDL-2023 LIBRARY; T=0.K  
deuterons from (n,x)

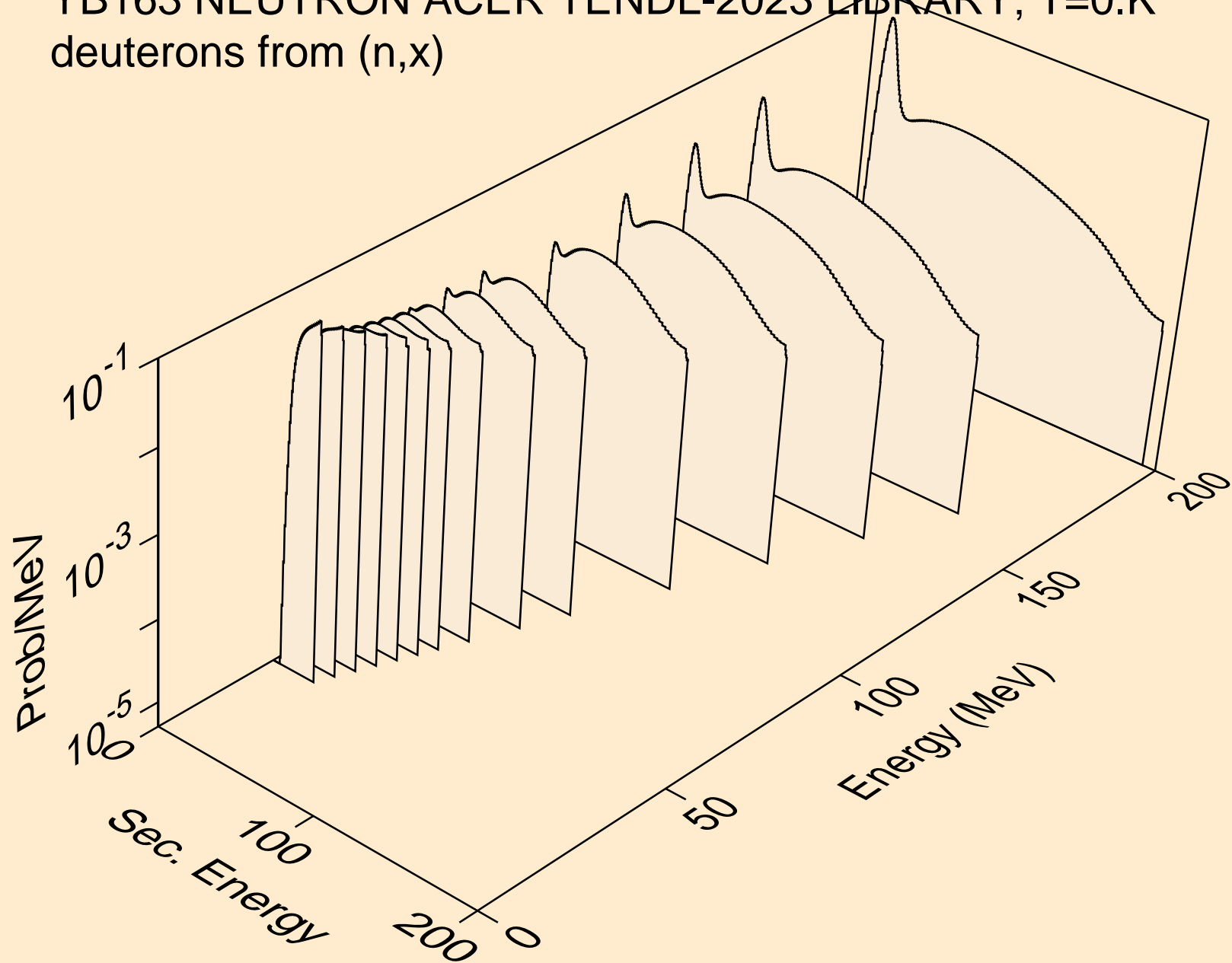

YB163 NEUTRON ACER TENDL-2023 LIBRARY; T=0.K  
deuterons from (n,2nd)

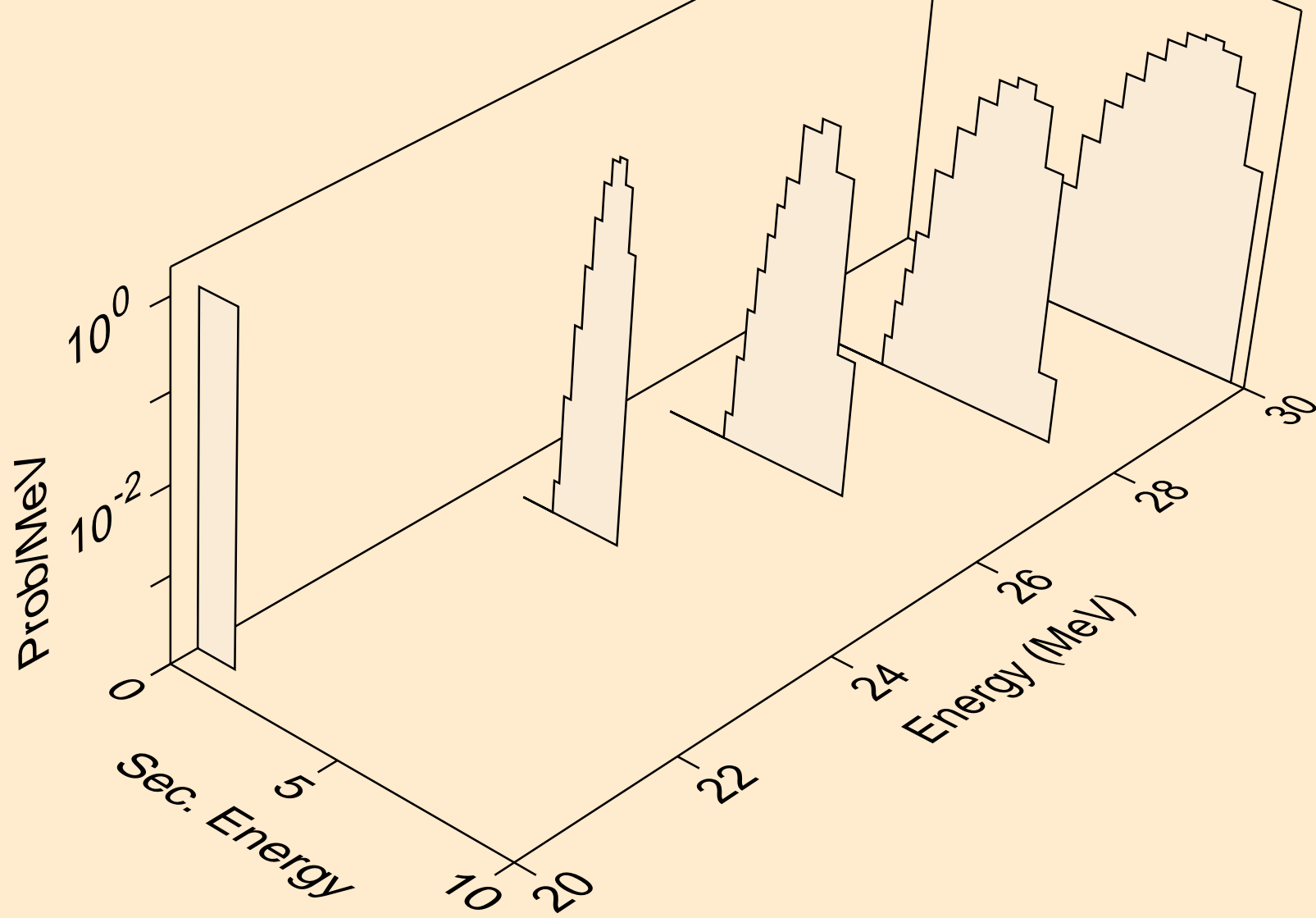

YB163 NEUTRON ACER TENDL-2023 LIBRARY; T=0.K  
deuterons from (n,n\*)d

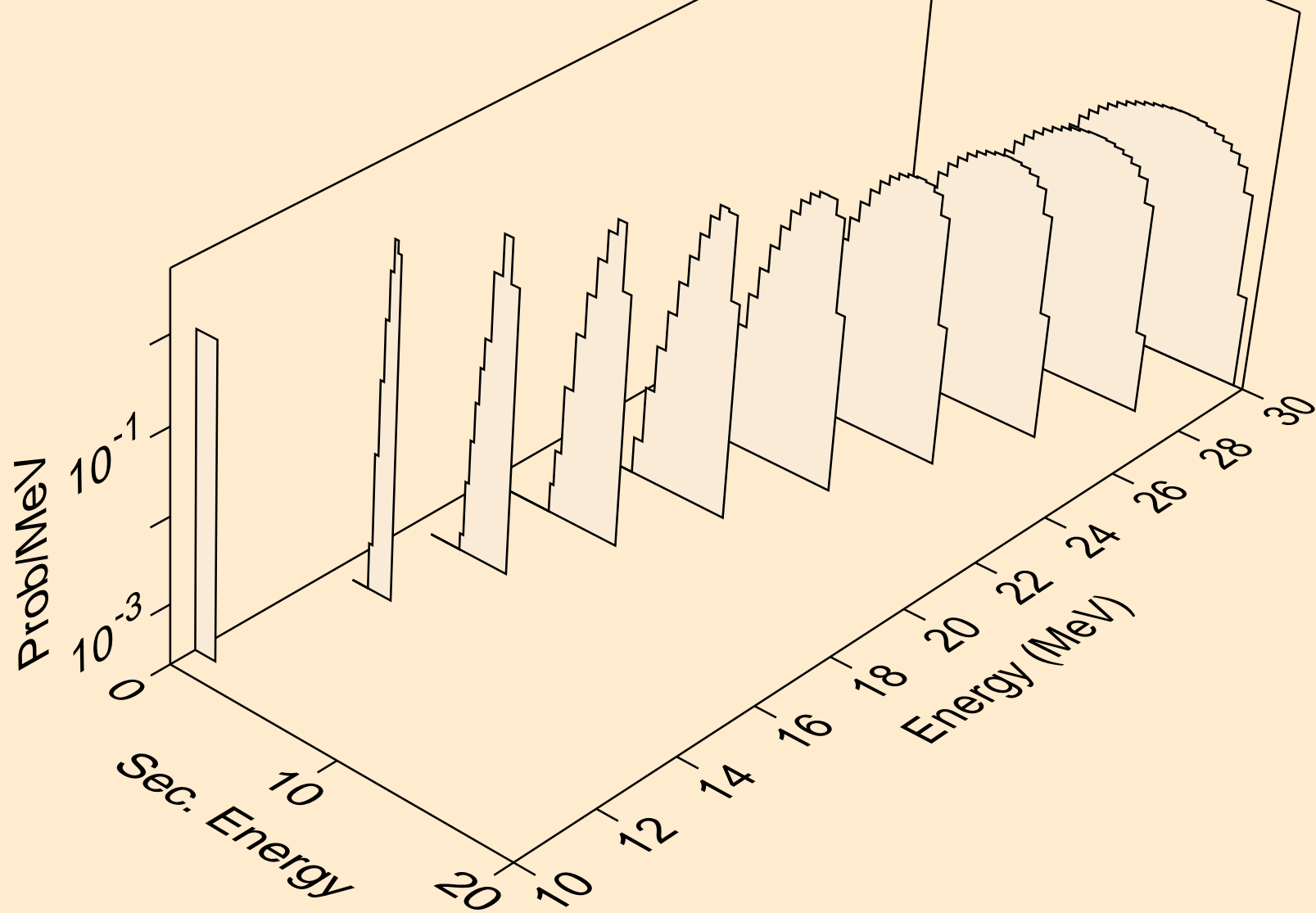

YB163 NEUTRON ACER TENDL-2023 LIBRARY; T=0.K  
deuterons from (n,d)

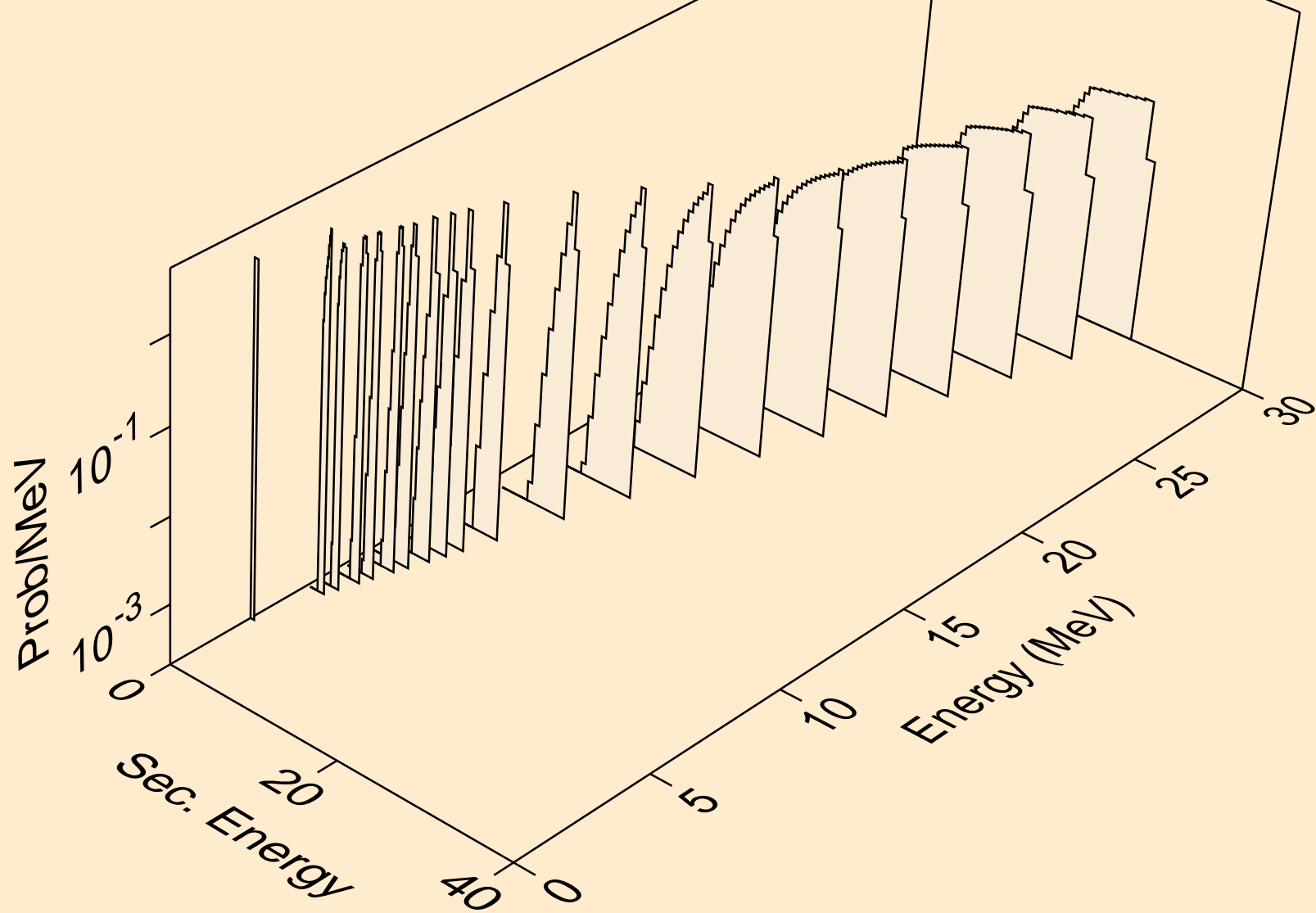

YB163 NEUTRON ACER TENDL-2023 LIBRARY; T=0.K  
deuterons from (n,pd)

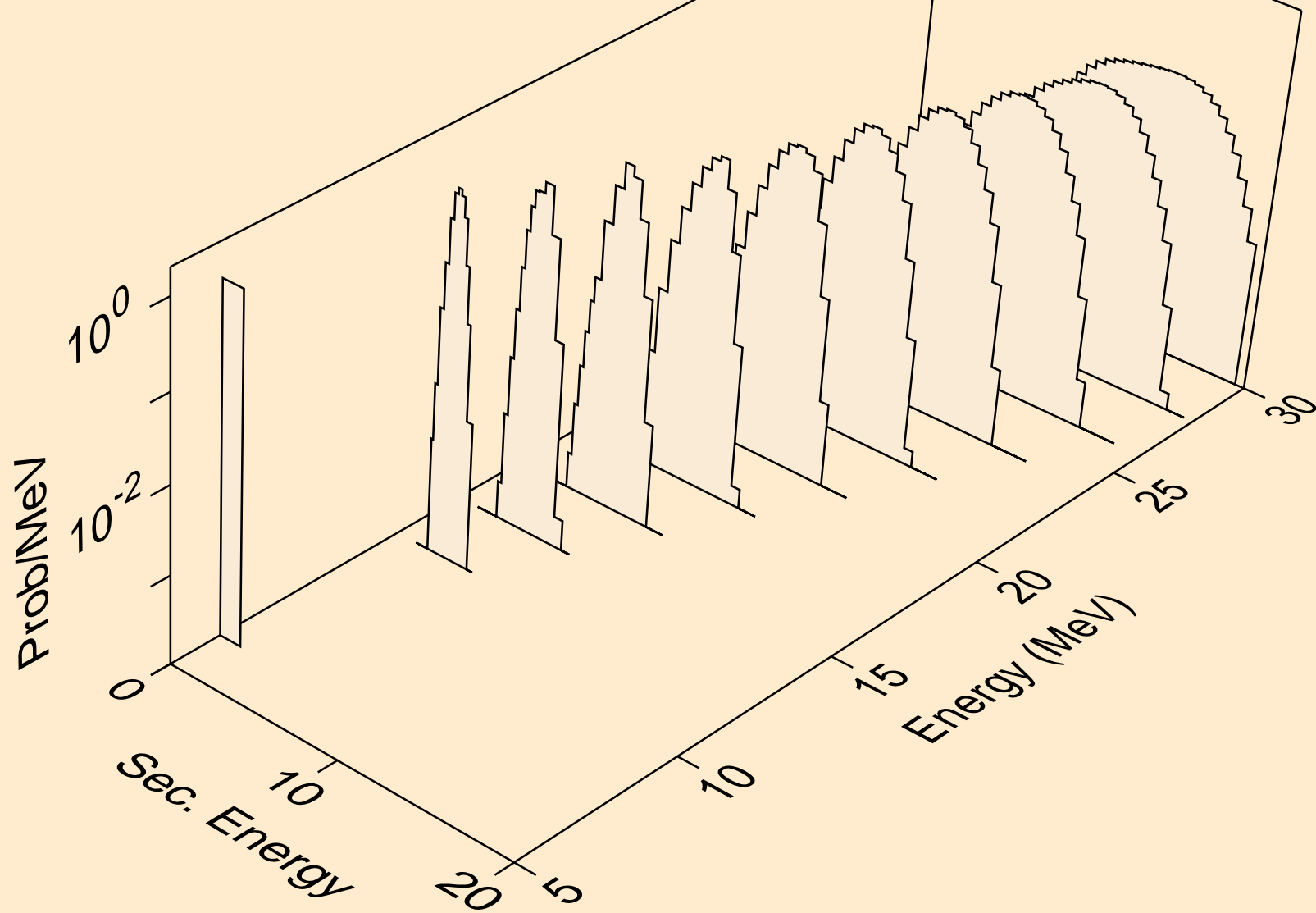

YB163 NEUTRON ACER TENDL-2023 LIBRARY; T=0.K  
deuterons from (n,da)

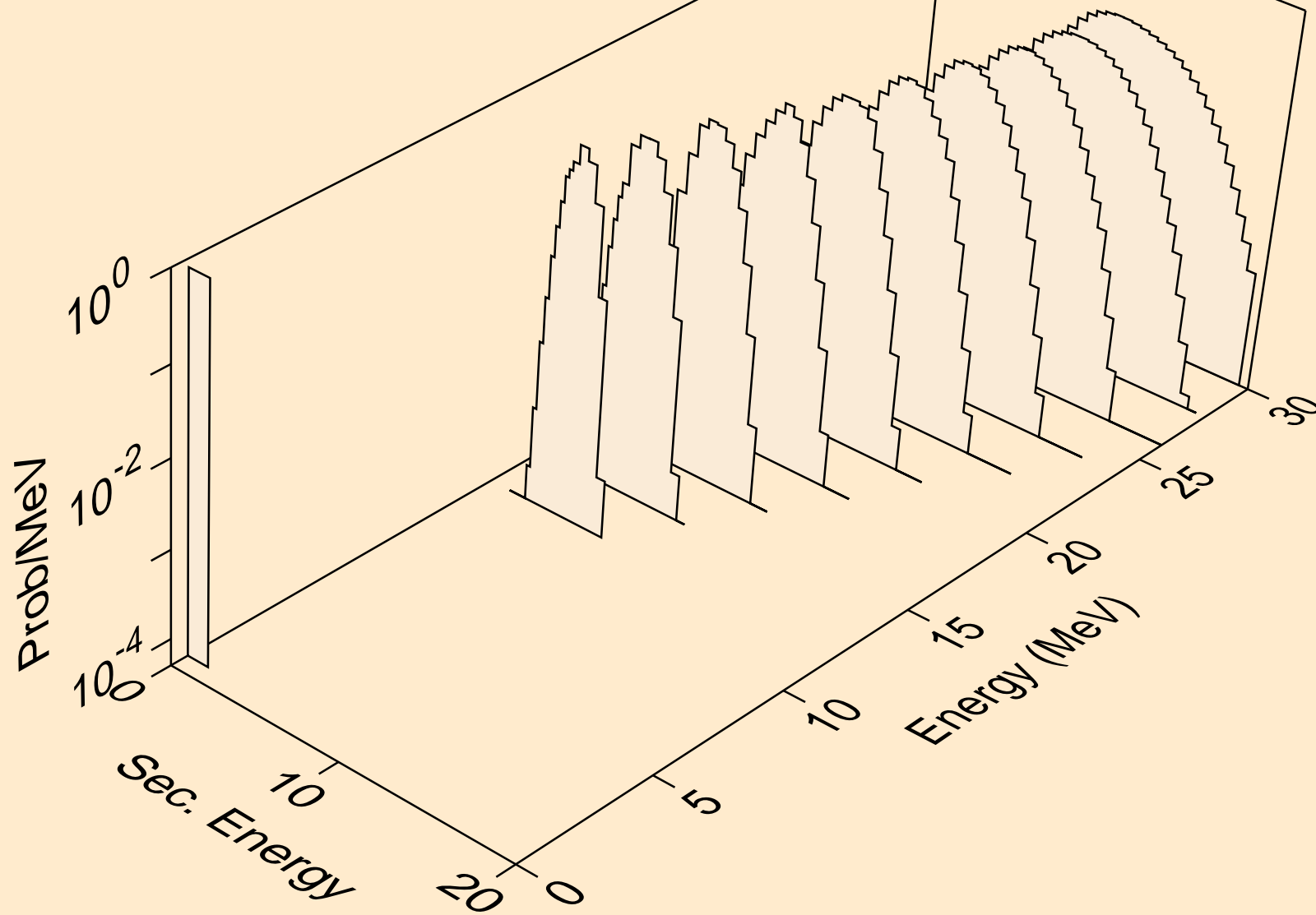



YB163 NEUTRON ACER TENDL-2023 LIBRARY; T=0.K  
tritons from (n,x)

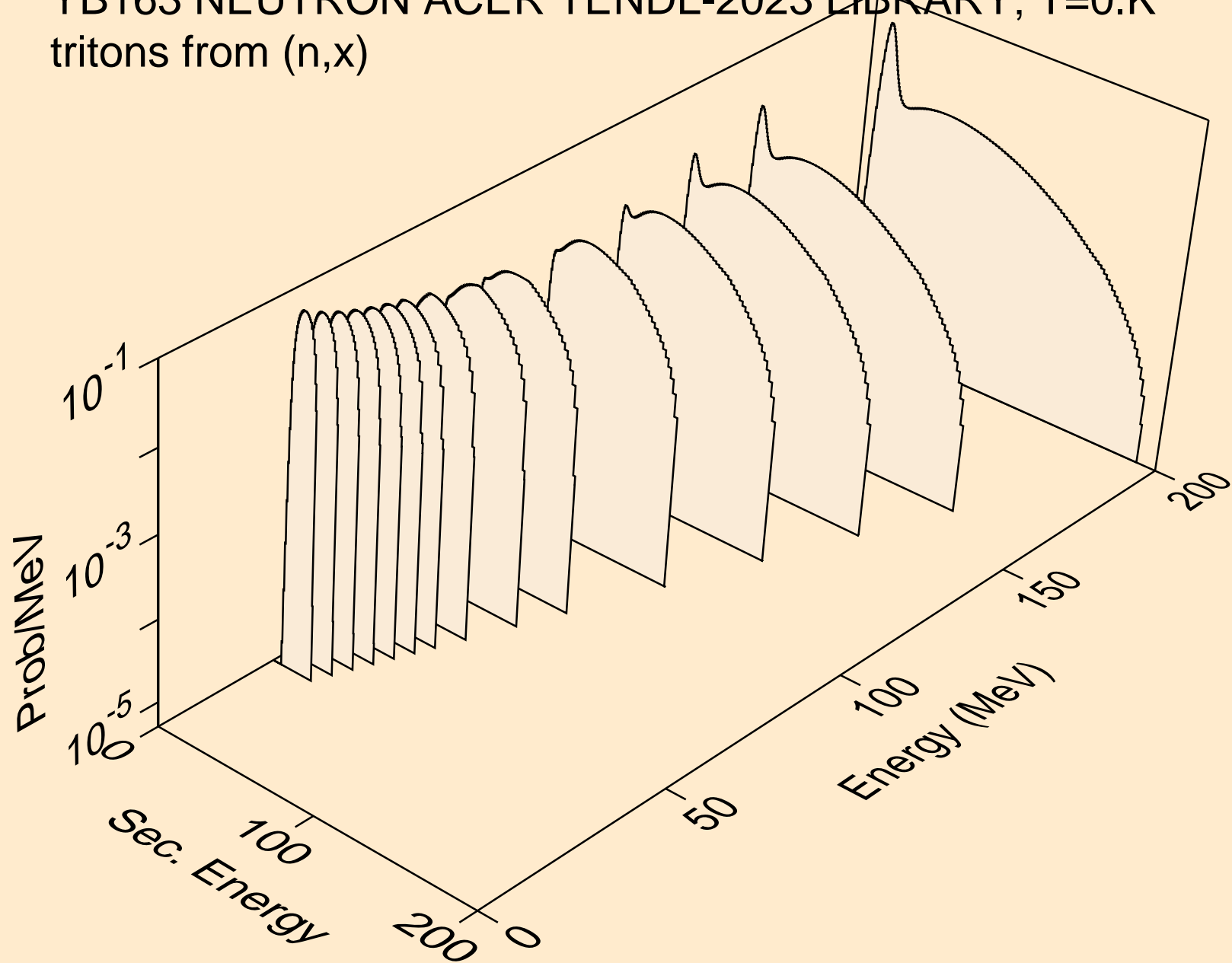

YB163 NEUTRON ACER TENDL-2023 LIBRARY; T=0.K  
tritons from (n,n\*)t

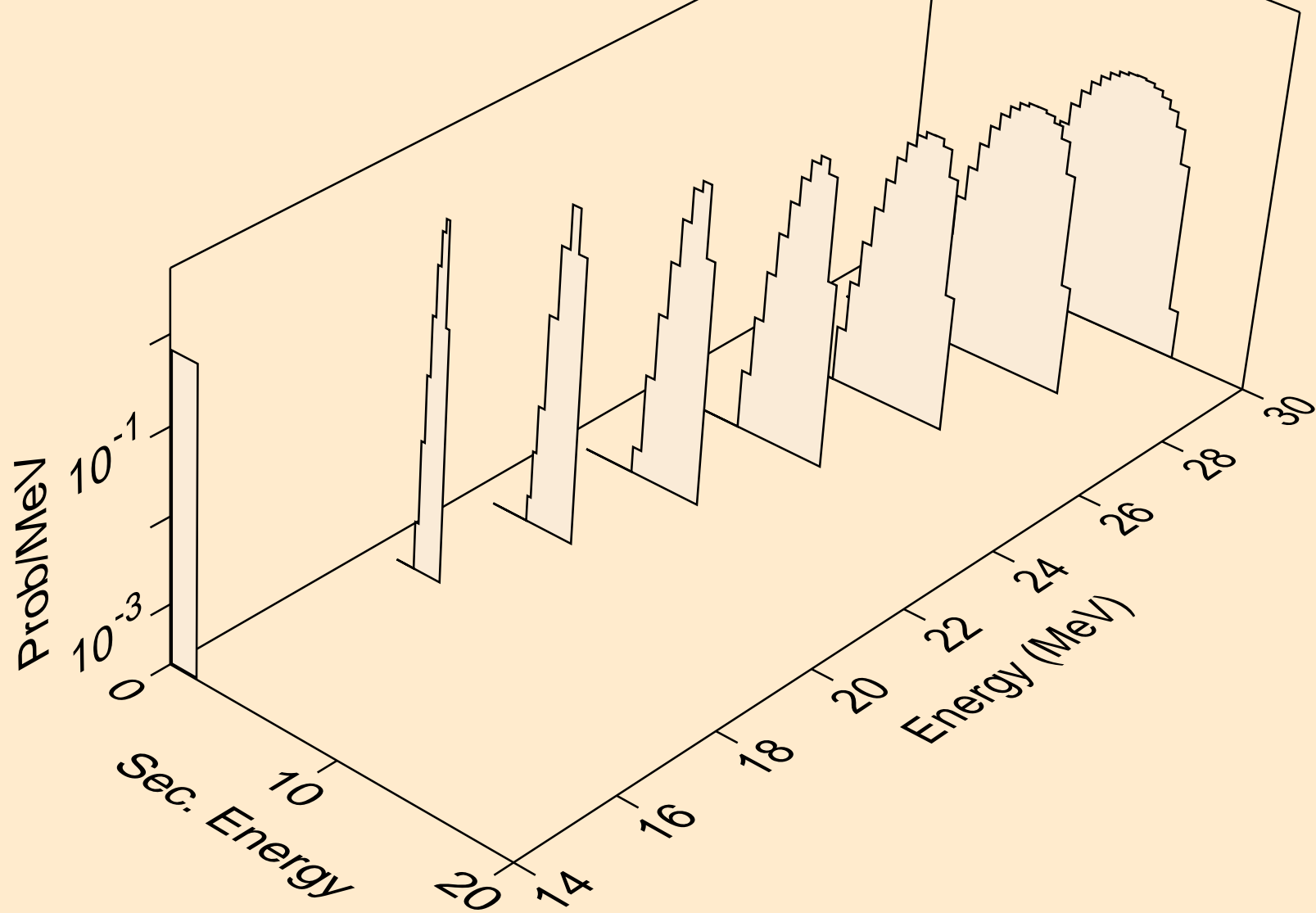

YB163 NEUTRON ACER TENDL-2023 LIBRARY; T=0.K  
tritons from (n,t)

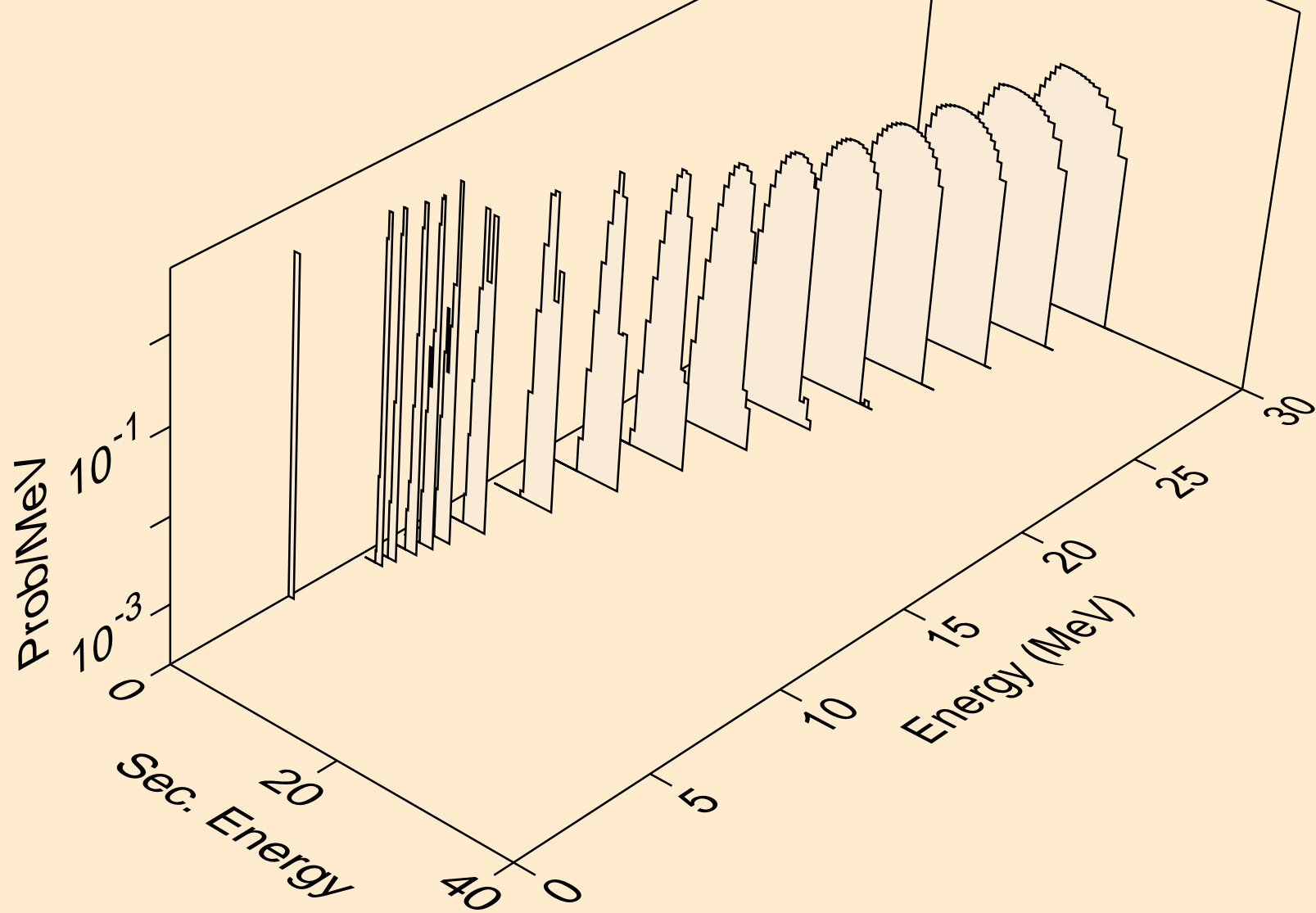

YB163 NEUTRON ACER TENDL-2023 LIBRARY; T=0.K  
tritons from (n,pt)

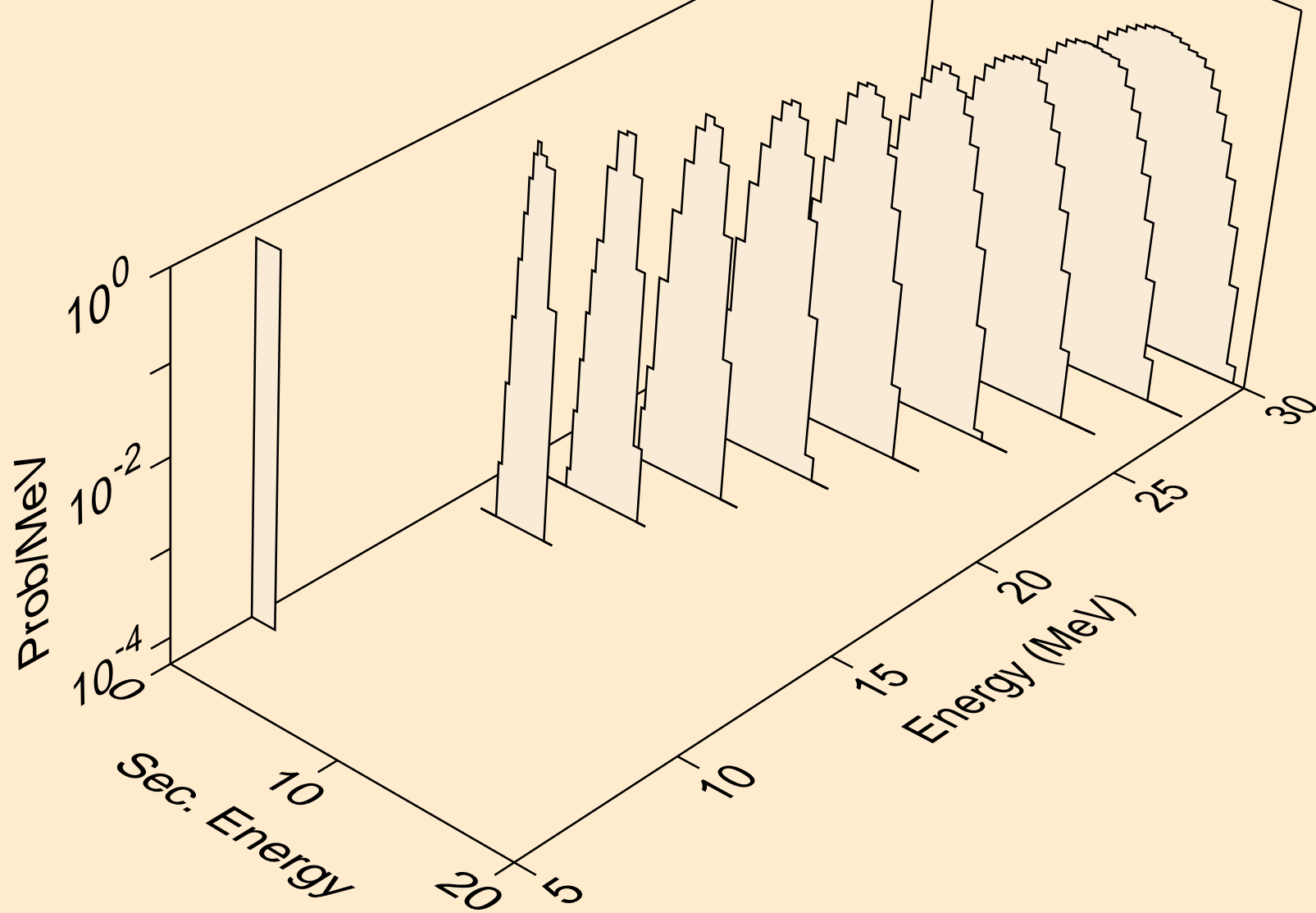

YB163 NEUTRON ACER TENDL-2023 LIBRARY; T=0.K  
he3s from (n,x)

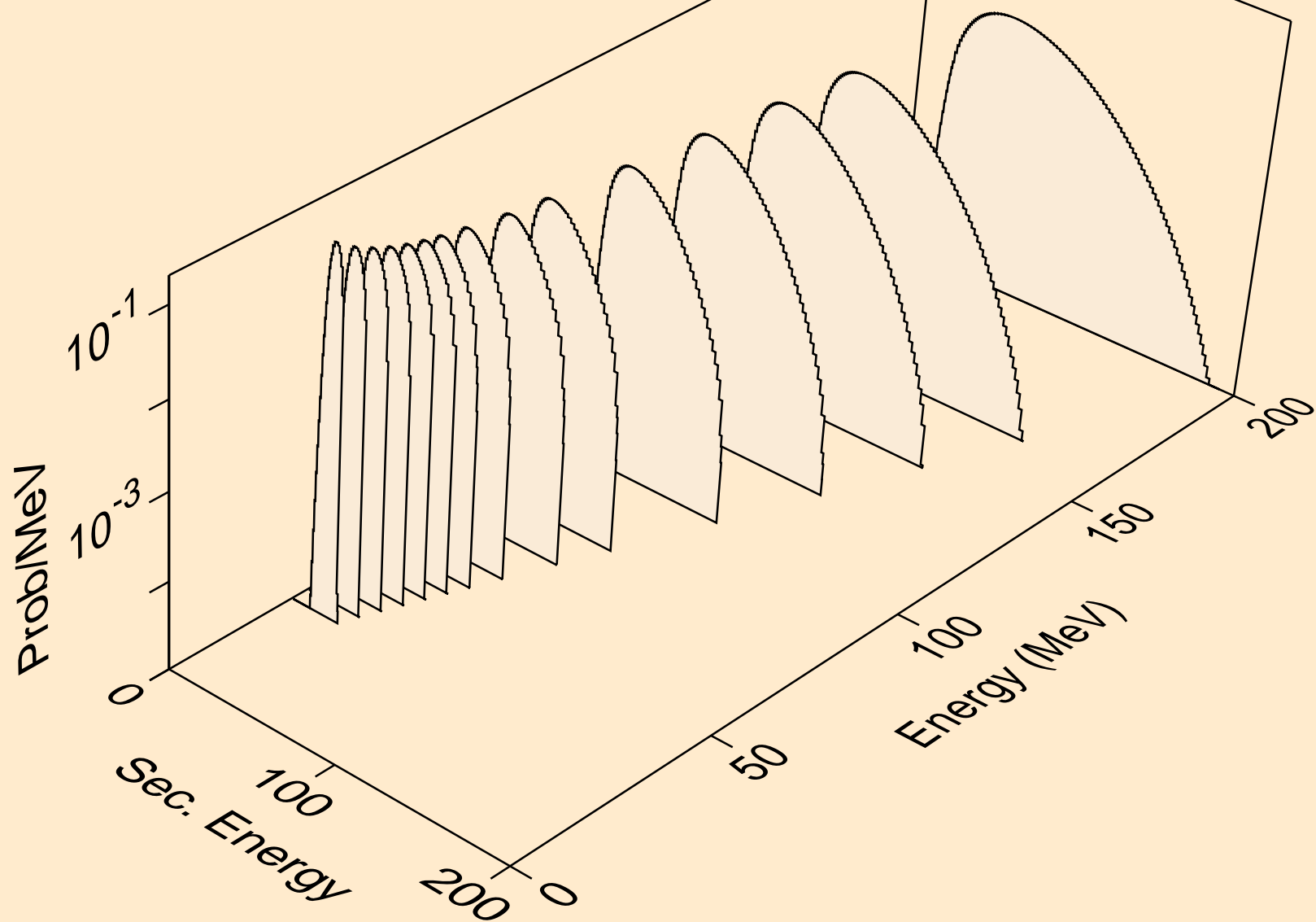

YB163 NEUTRON ACER TENDL-2023 LIBRARY; T=0.K  
he3s from (n,n\*)he3

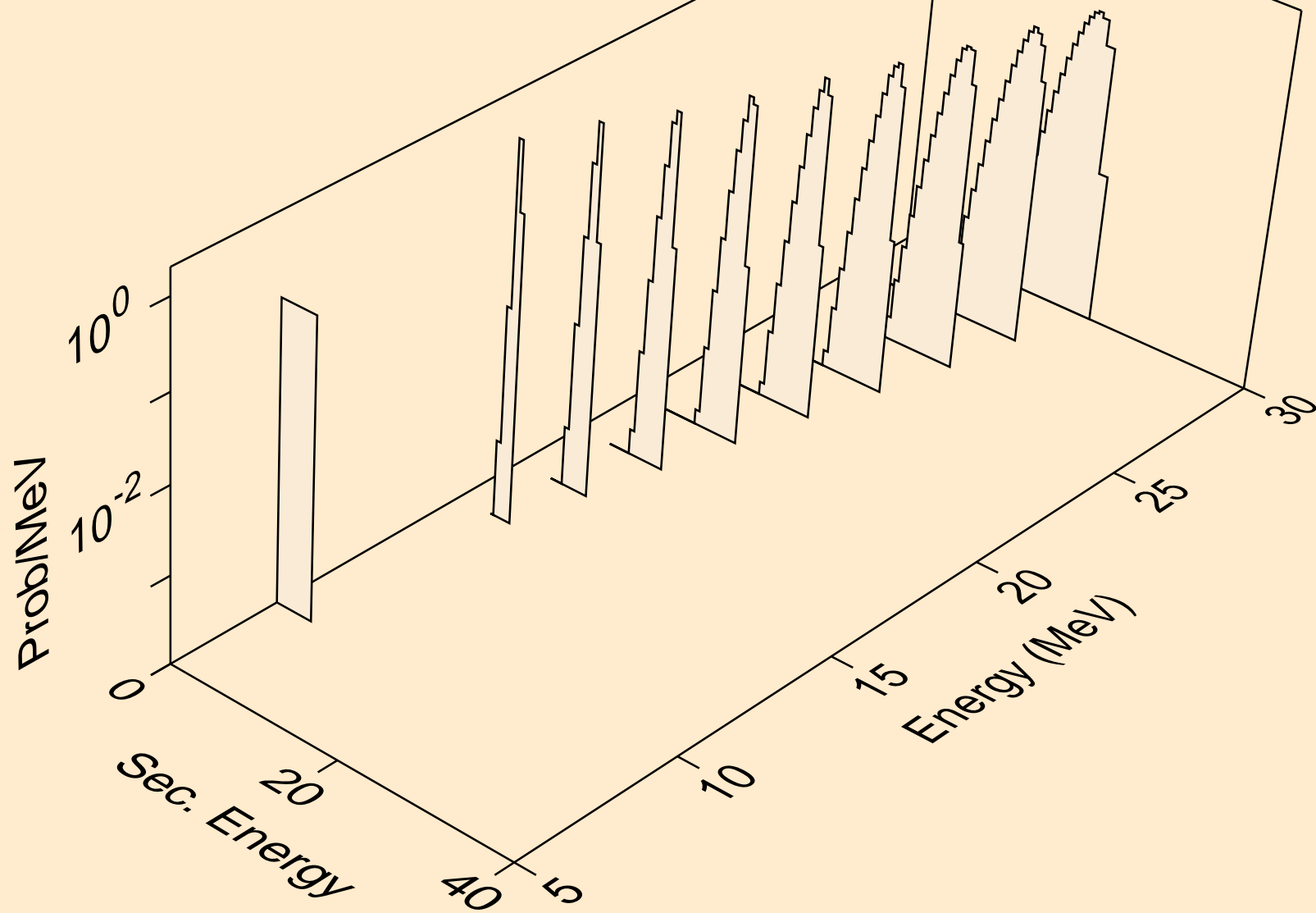

YB163 NEUTRON ACER TENDL-2023 LIBRARY; T=0.K  
he3s from (n,he3)

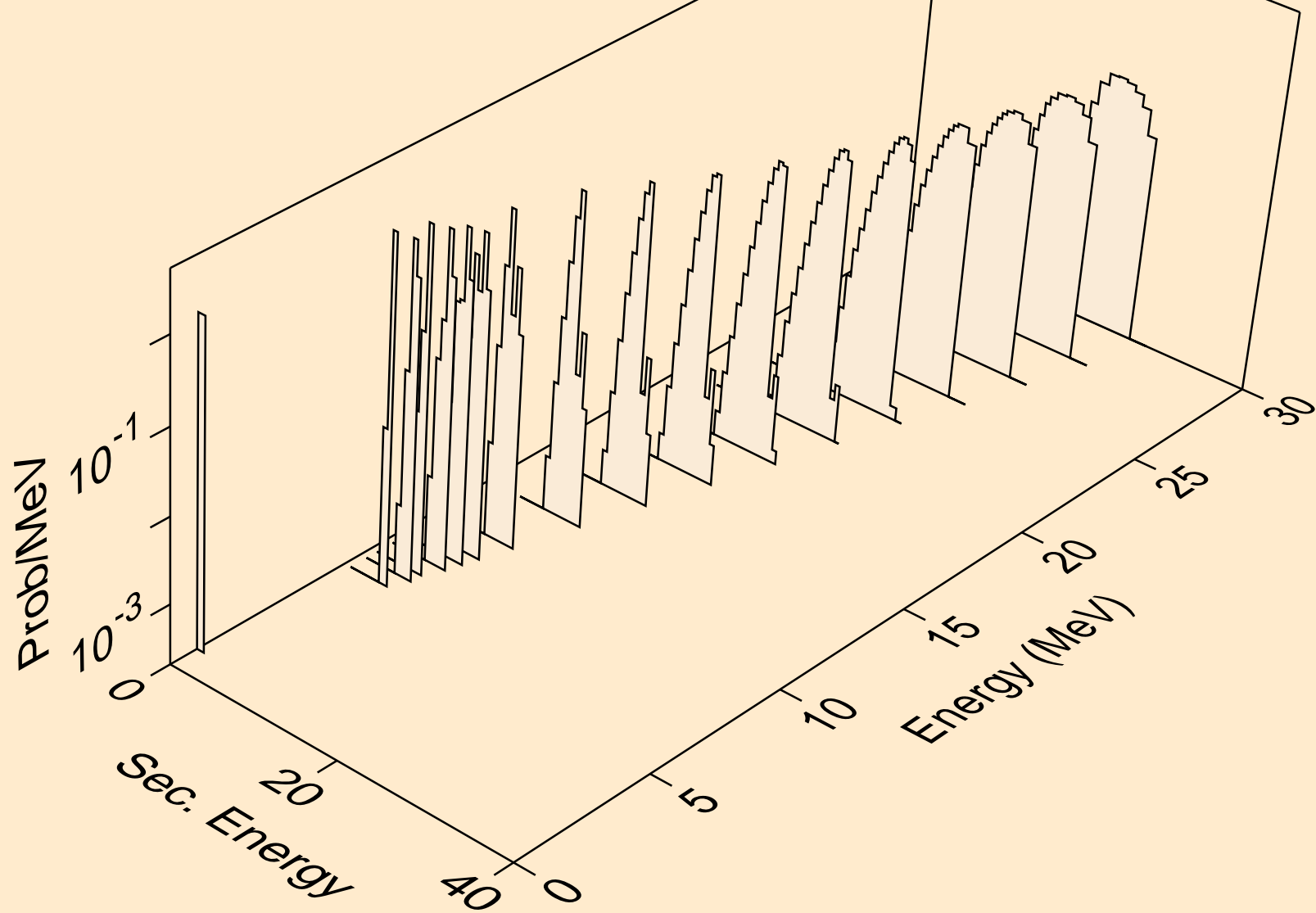

YB163 NEUTRON ACER TENDL-2023 LIBRARY; T=0.K  
alphas from (n,x)

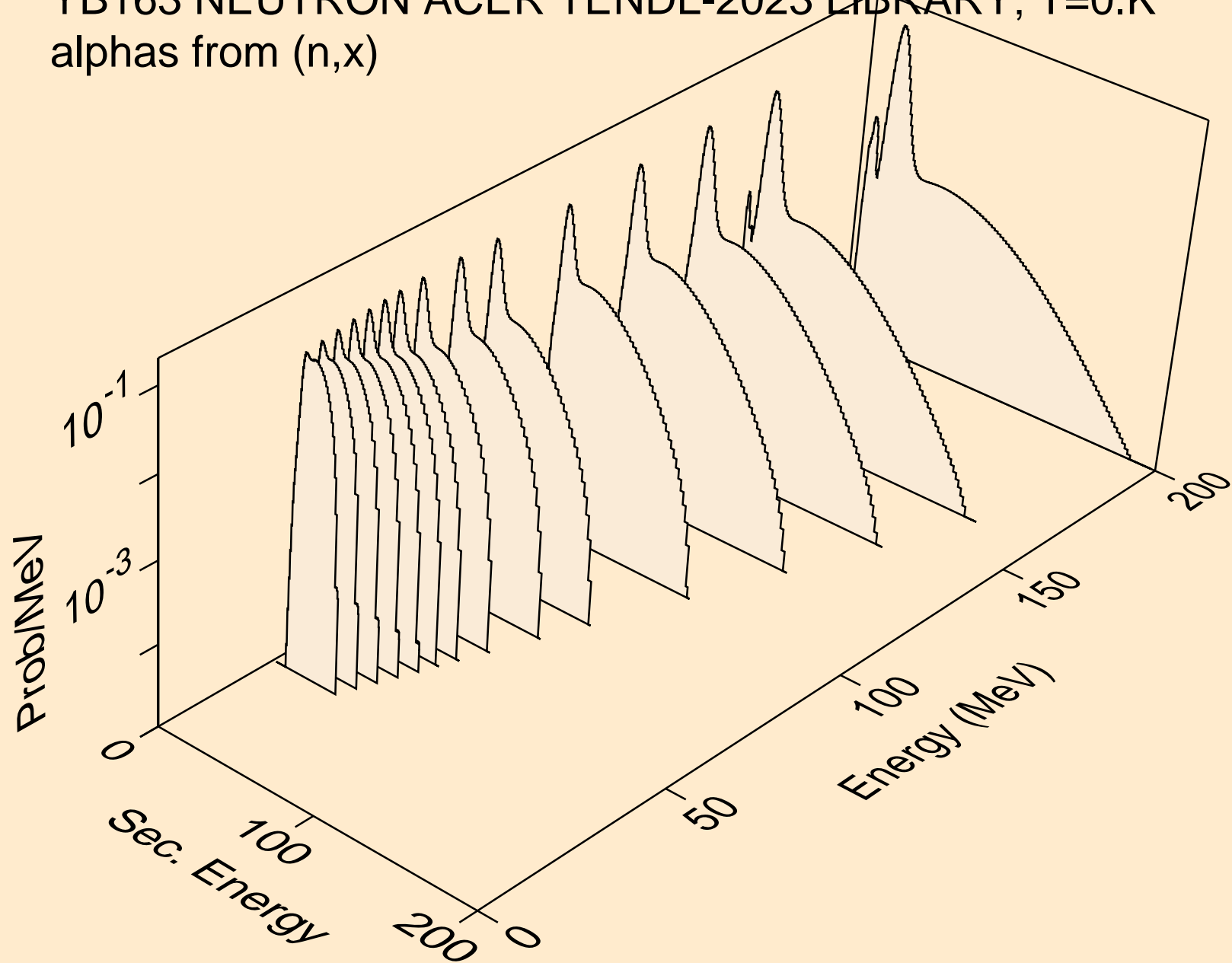



YB163 NEUTRON ACER TENDL-2023 LIBRARY; T=0.K  
alphas from (n,n\*)a

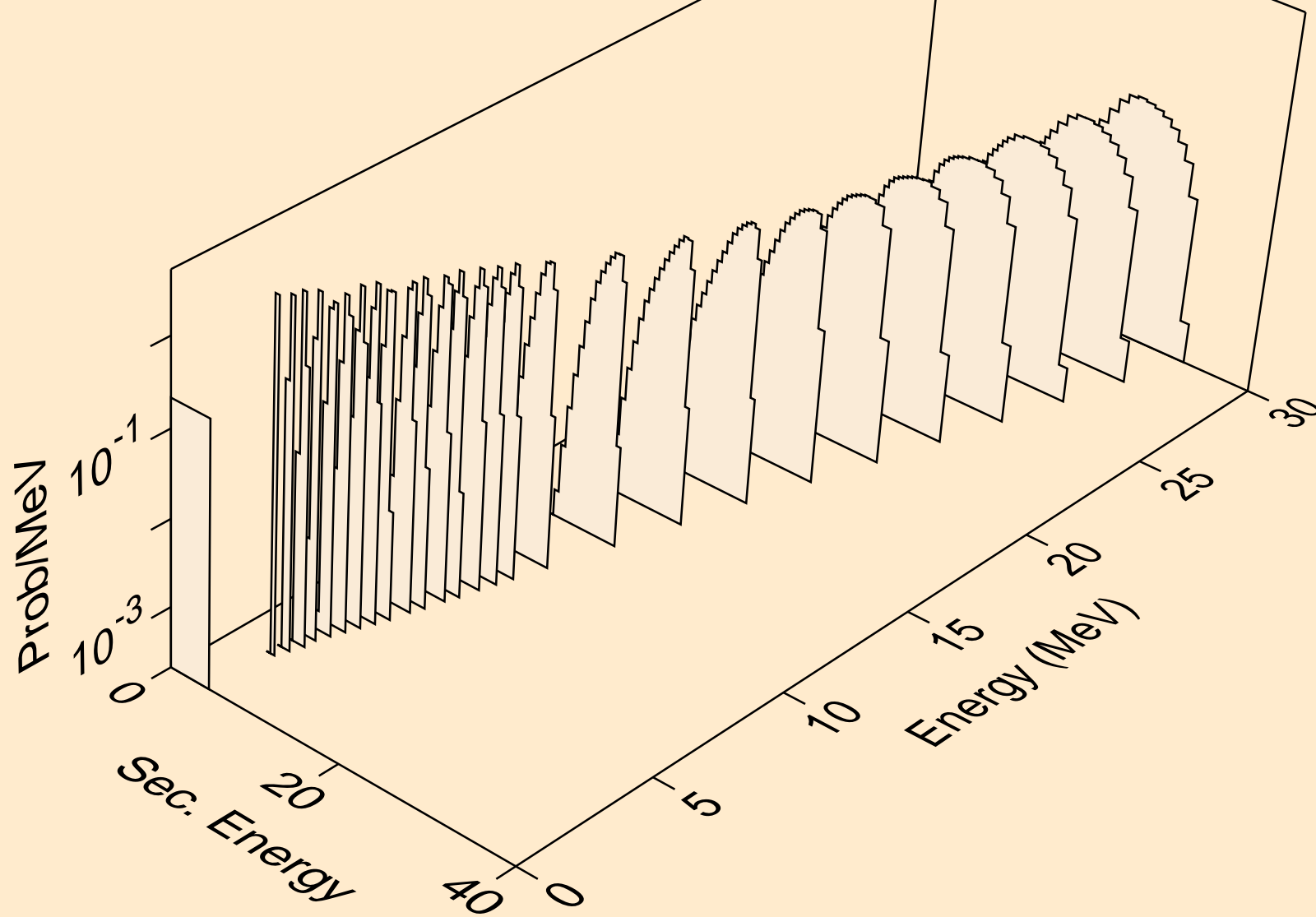

YB163 NEUTRON ACER TENDL-2023 LIBRARY; T=0.K  
alphas from (n,2n)a

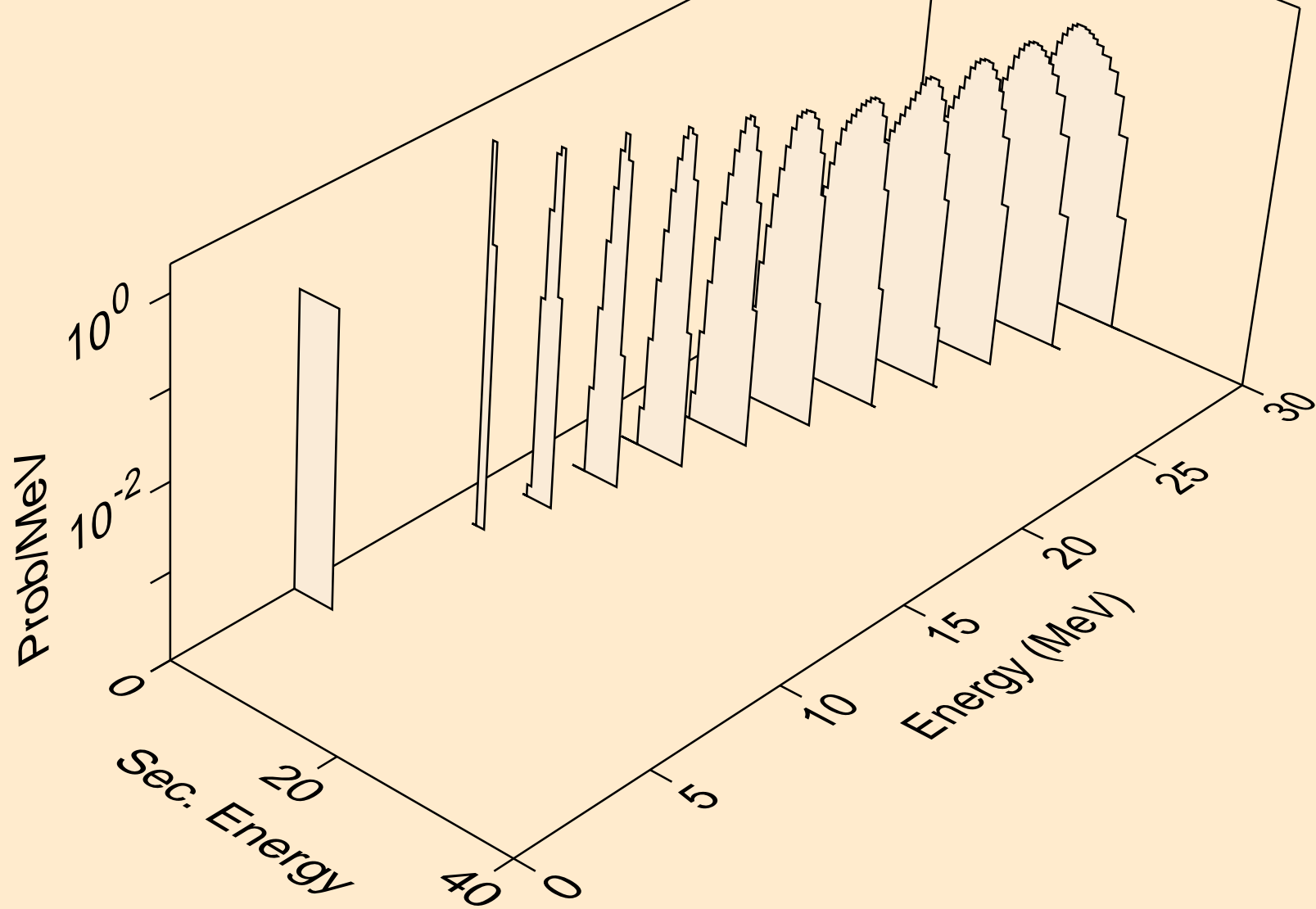

YB163 NEUTRON ACER TENDL-2023 LIBRARY; T=0.K  
alphas from (n,3n)a

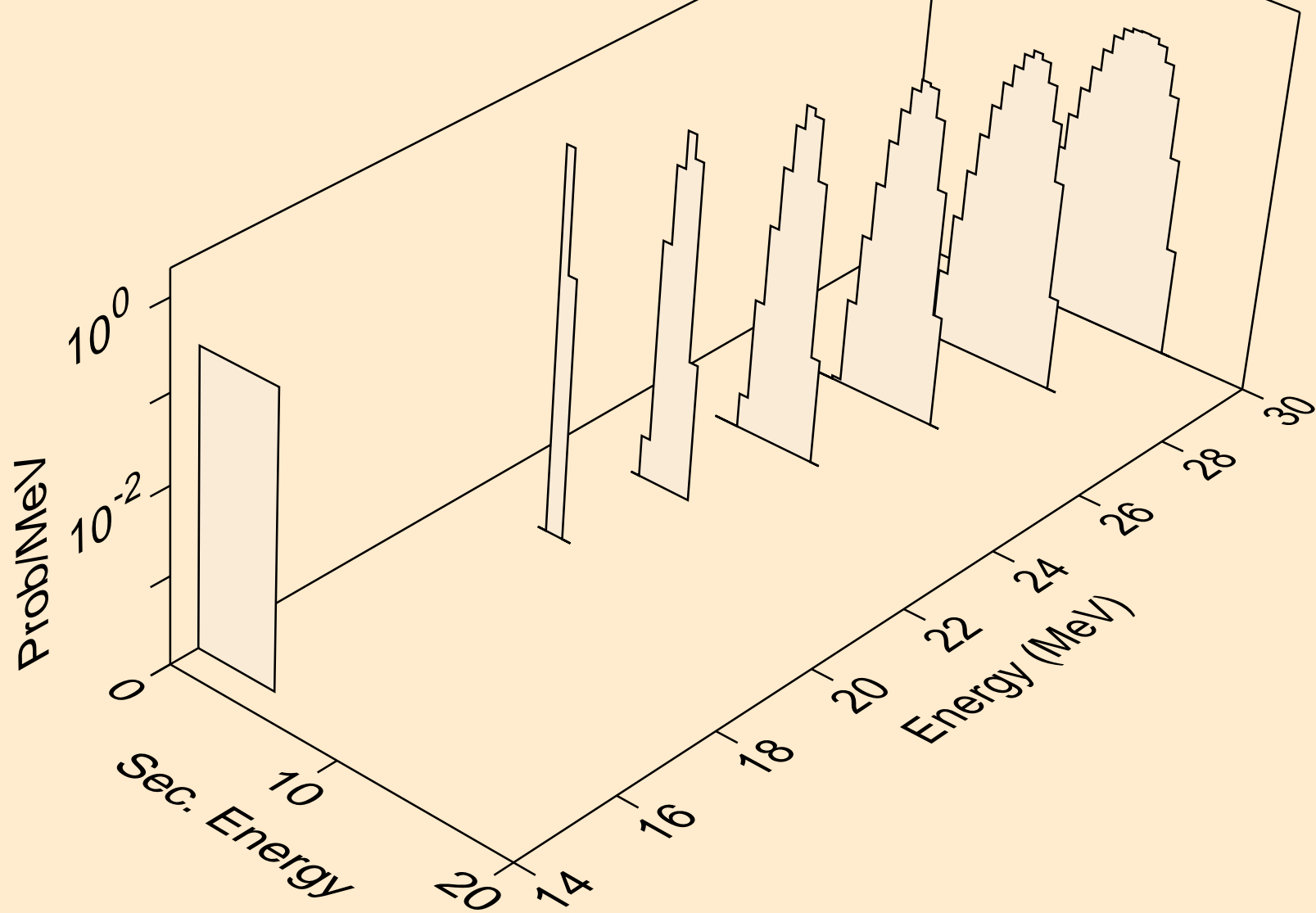

YB163 NEUTRON ACER TENDL-2023 LIBRARY; T=0.K  
alphas from (n,n\*)2a

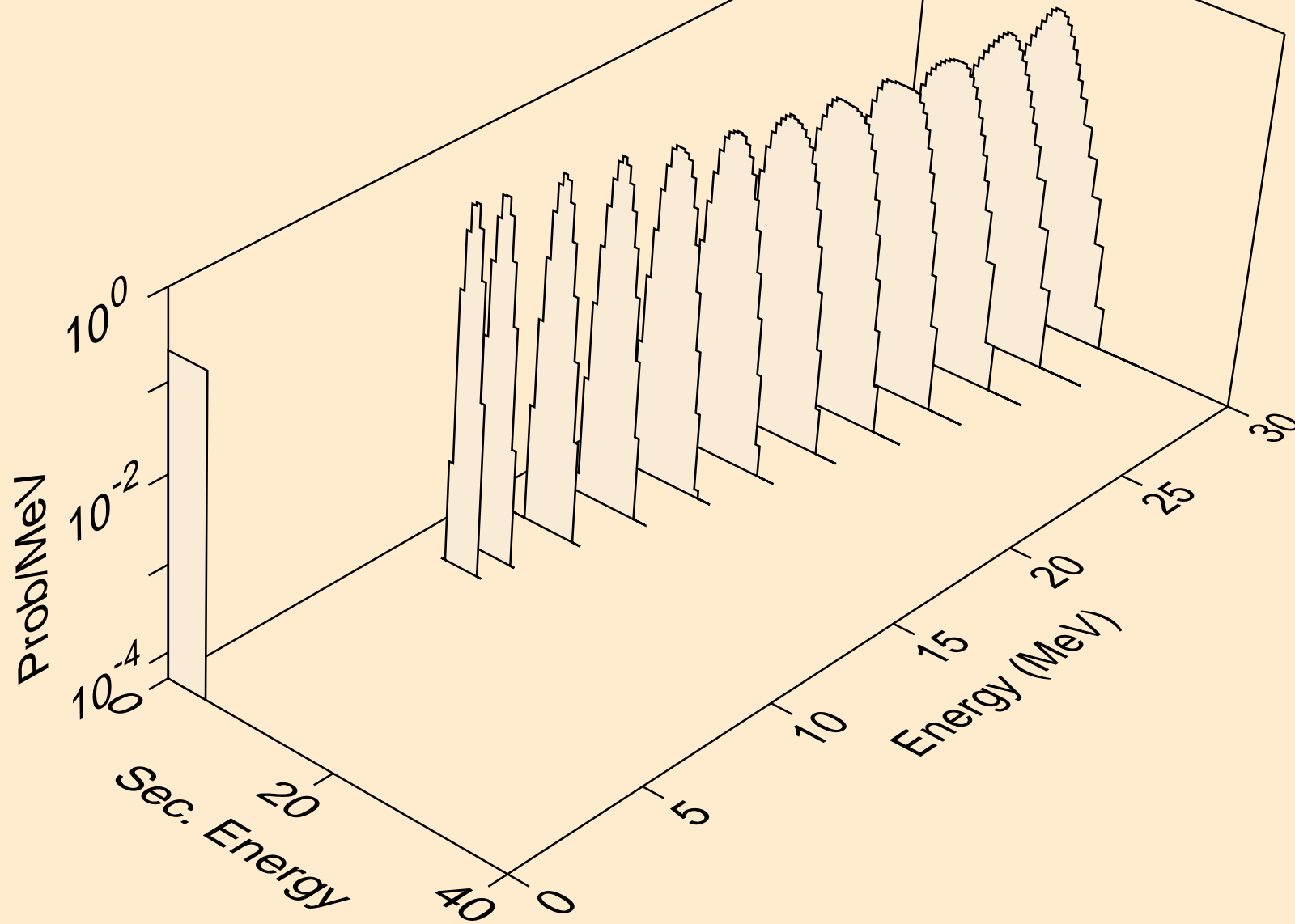

YB163 NEUTRON ACER TENDL-2023 LIBRARY; T=0.K  
alphas from (n,2n)2a

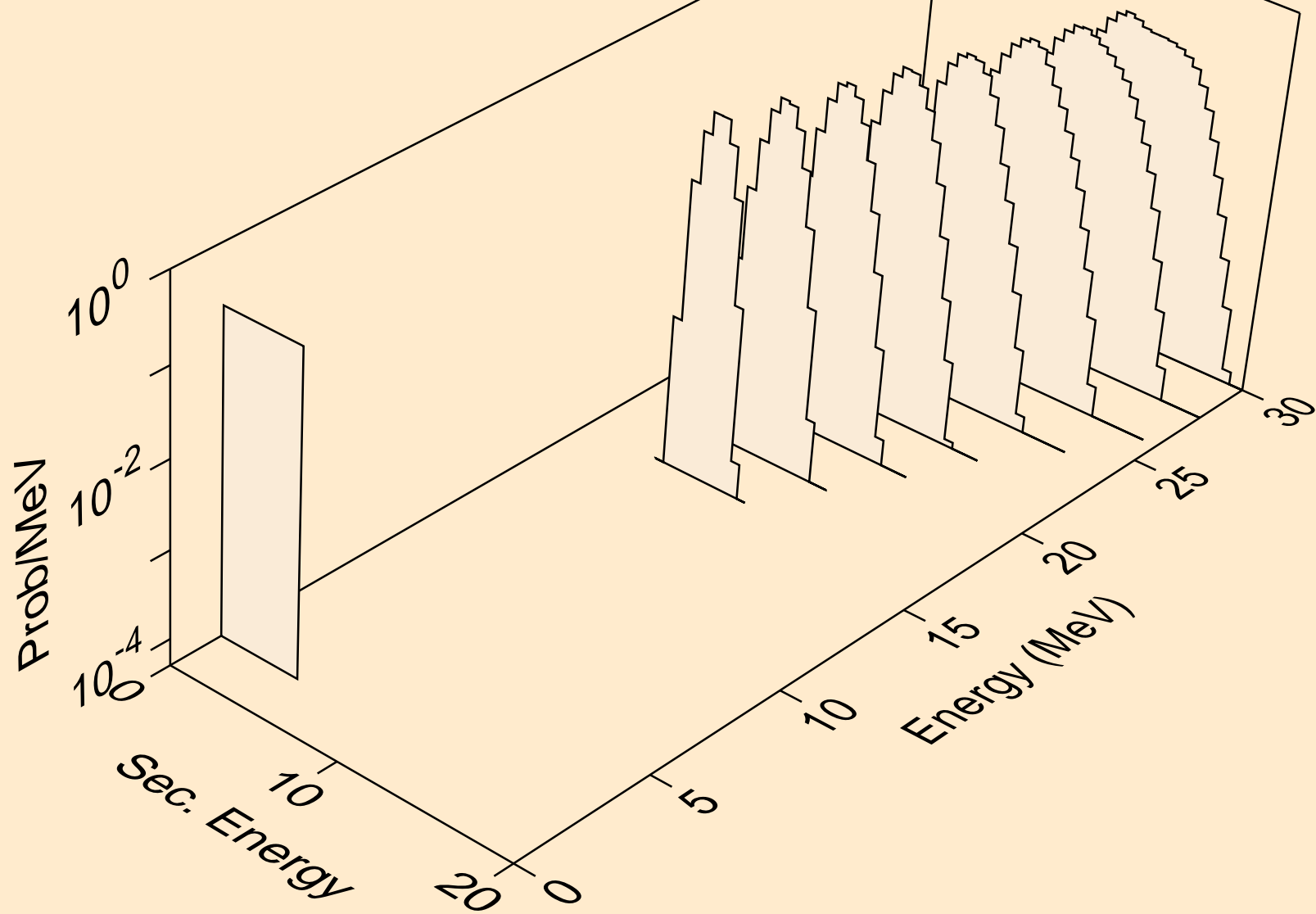

YB163 NEUTRON ACER TENDL-2023 LIBRARY; T=0.K  
alphas from (n,npa)

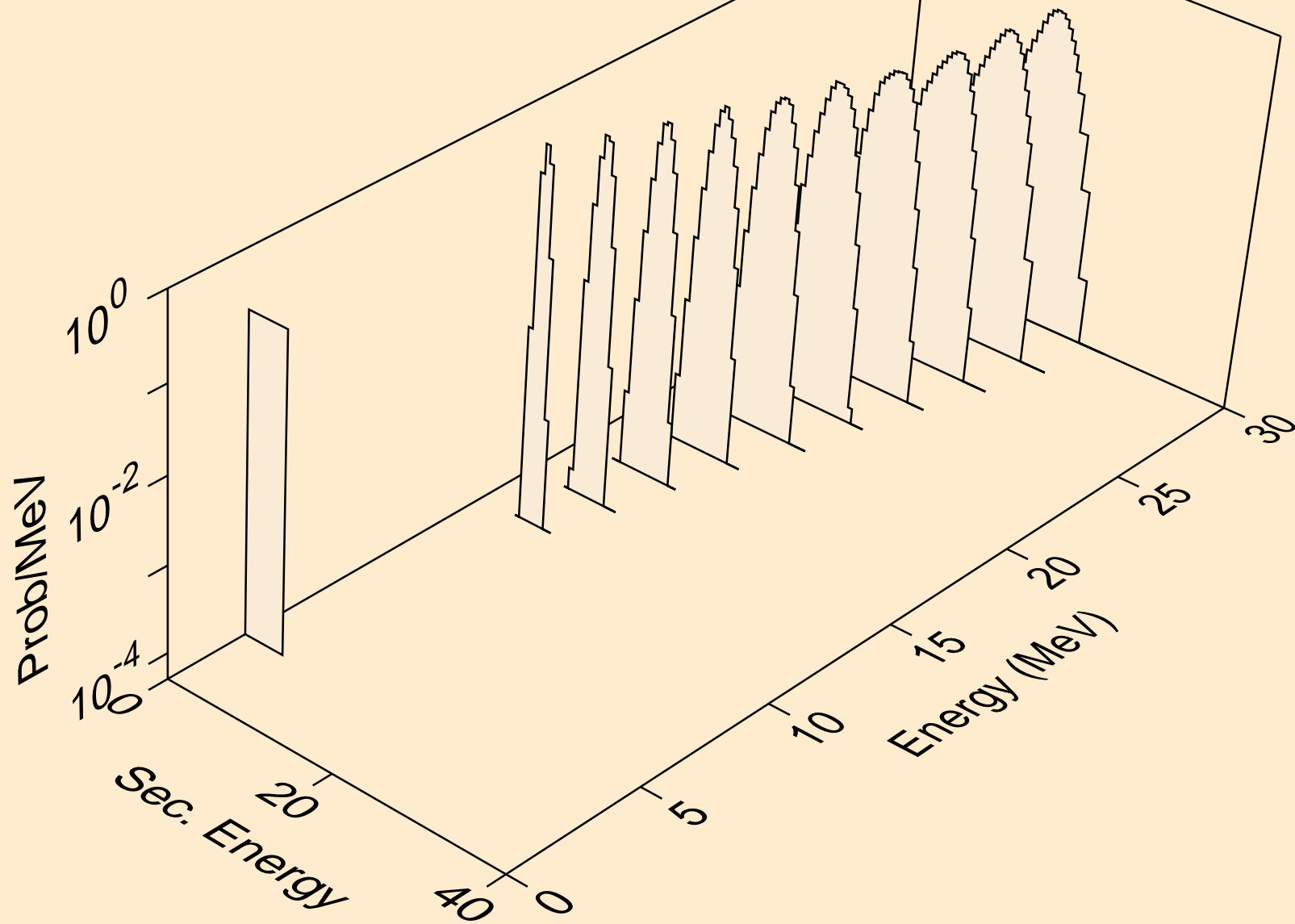

YB163 NEUTRON ACER TENDL-2023 LIBRARY; T=0.K  
alphas from (n,a)

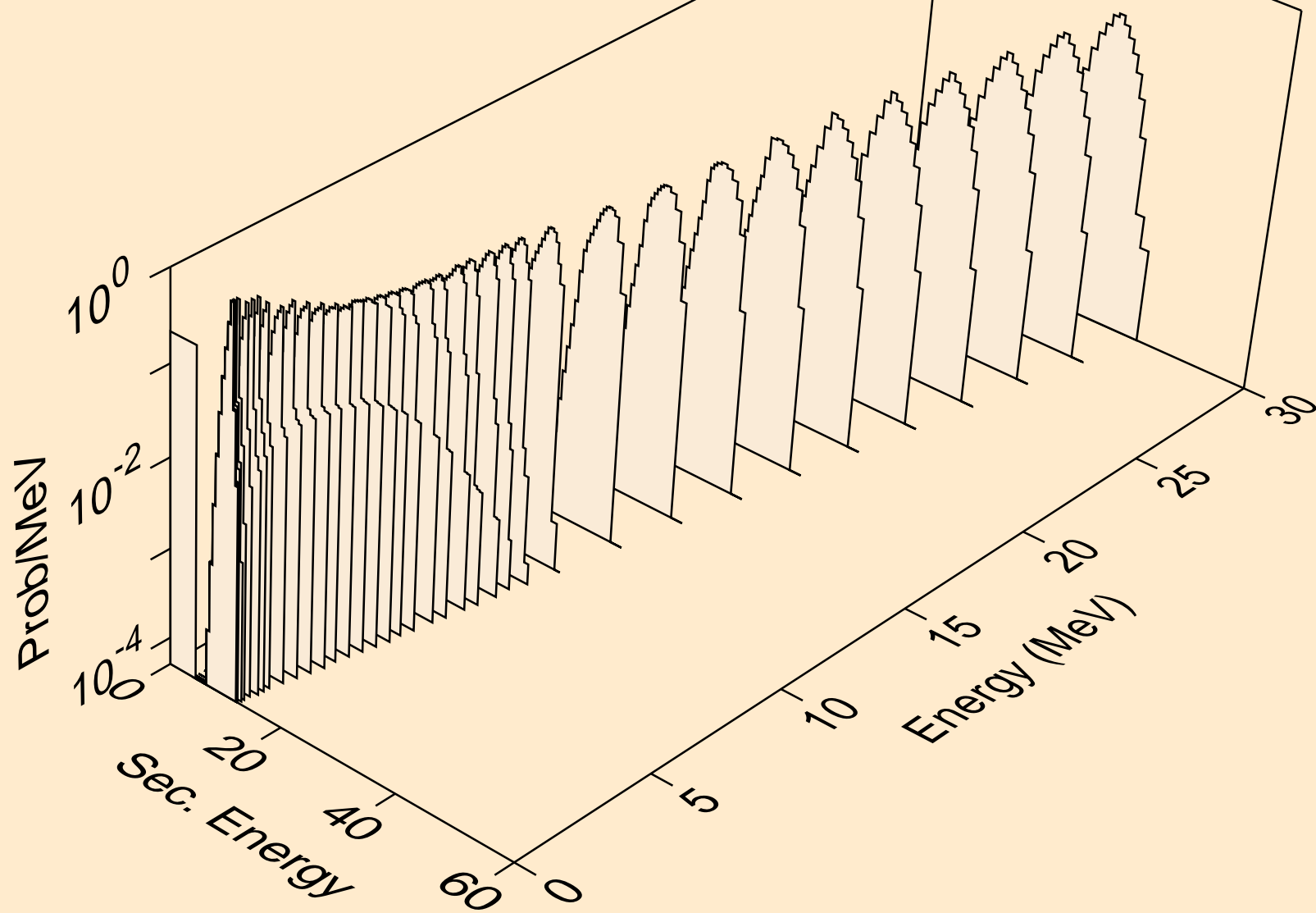

YB163 NEUTRON ACER TENDL-2023 LIBRARY; T=0.K  
alphas from (n,2a)

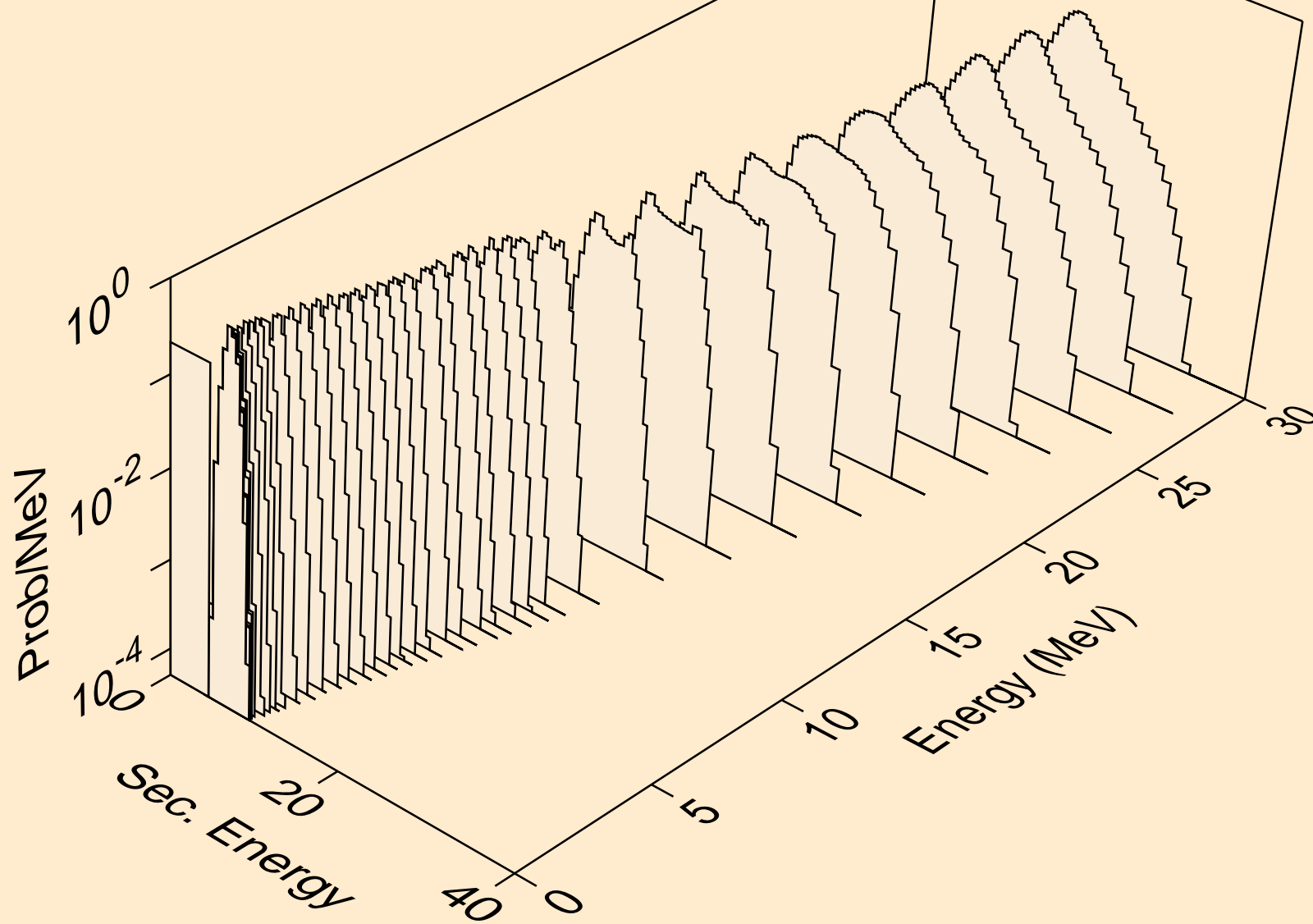



YB163 NEUTRON ACER TENDL-2023 LIBRARY; T=0.K  
alphas from (n,pa)

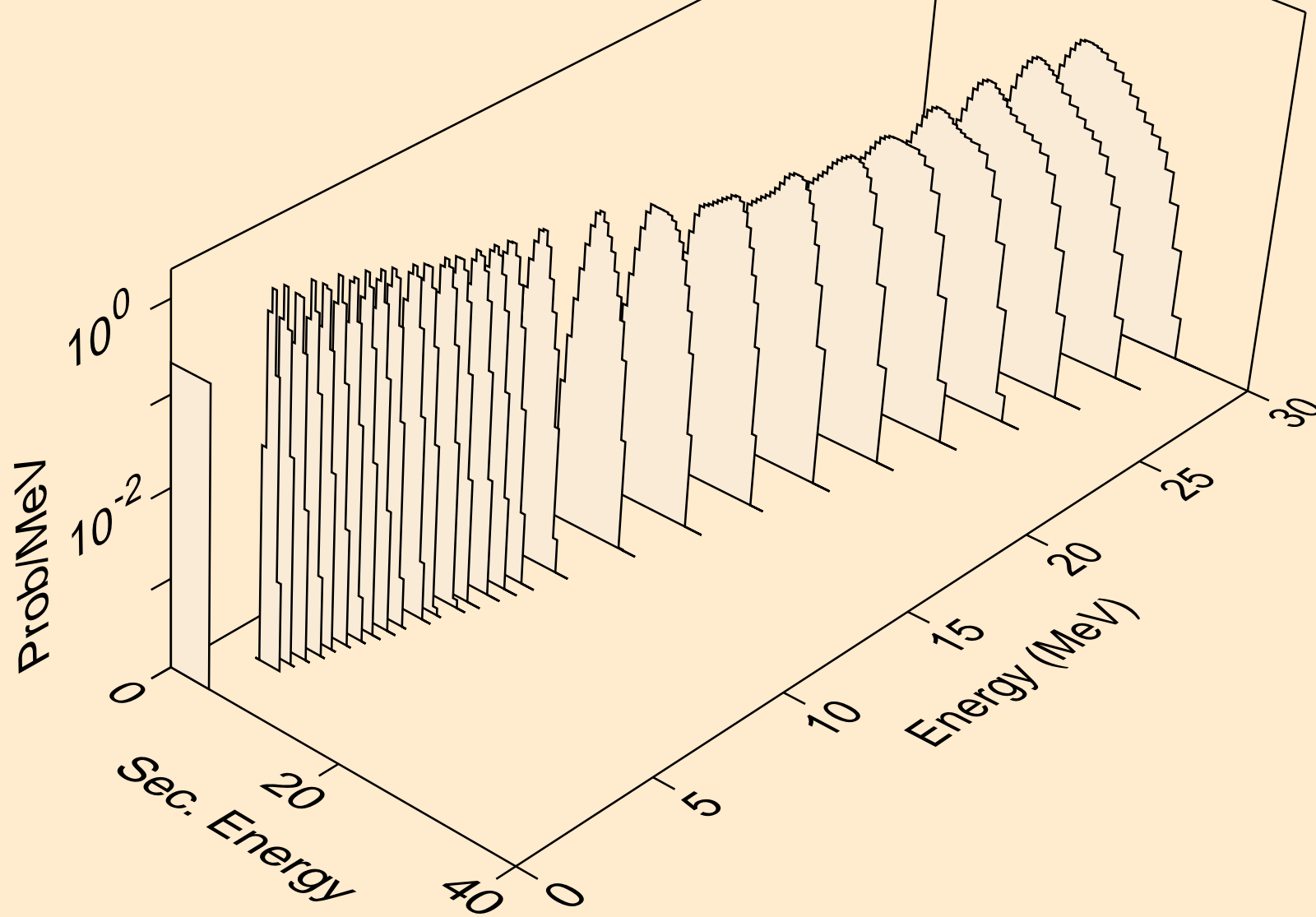

YB163 NEUTRON ACER TENDL-2023 LIBRARY; T=0.K  
alphas from (n,da)

