

ZN061 NEUTRON ACER TENDL-2023 LIBRARY; T=0.K

Principal cross sections

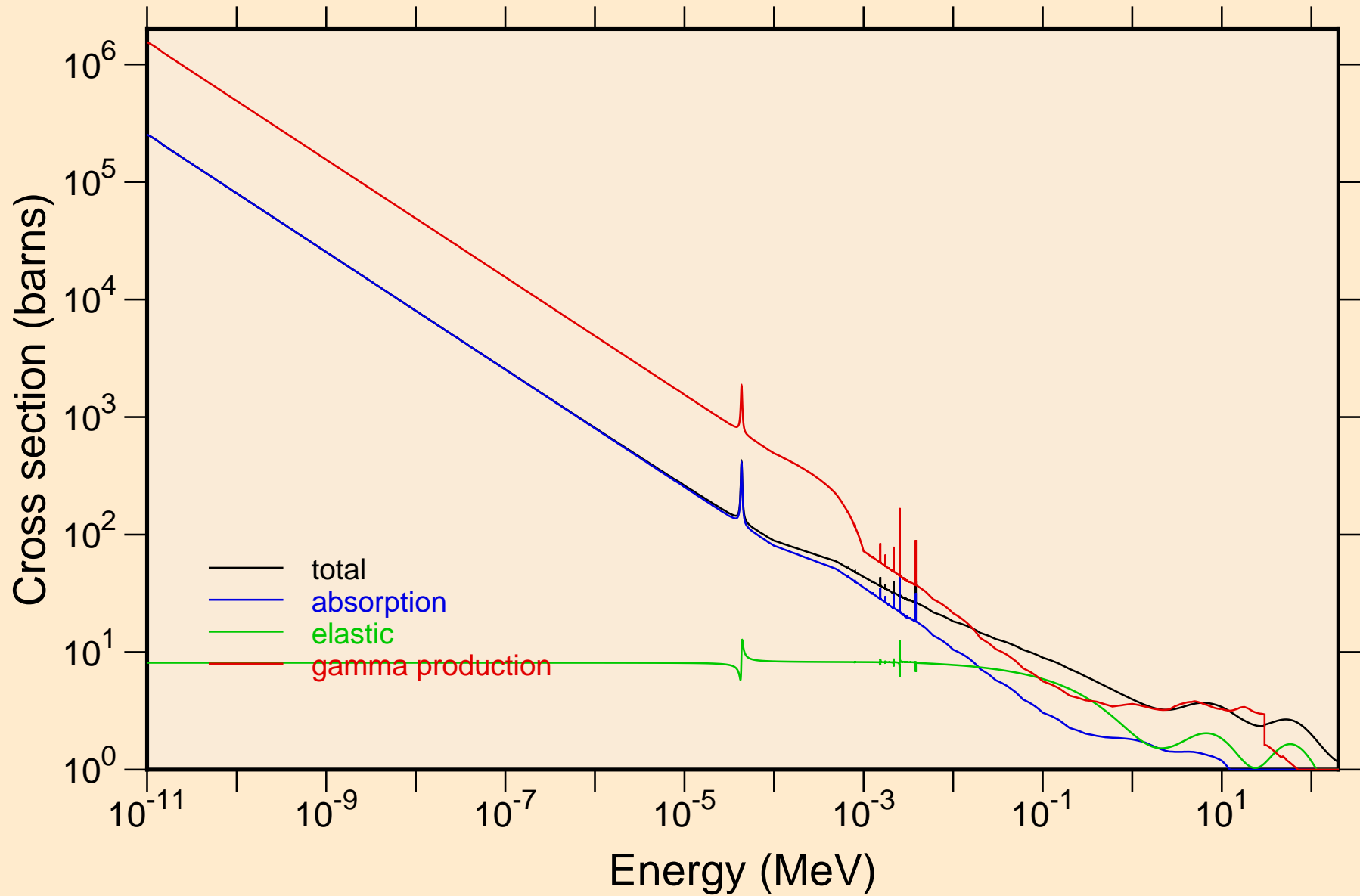

ZN061 NEUTRON ACER TENDL-2023 LIBRARY; T=0.K
resonance total cross section

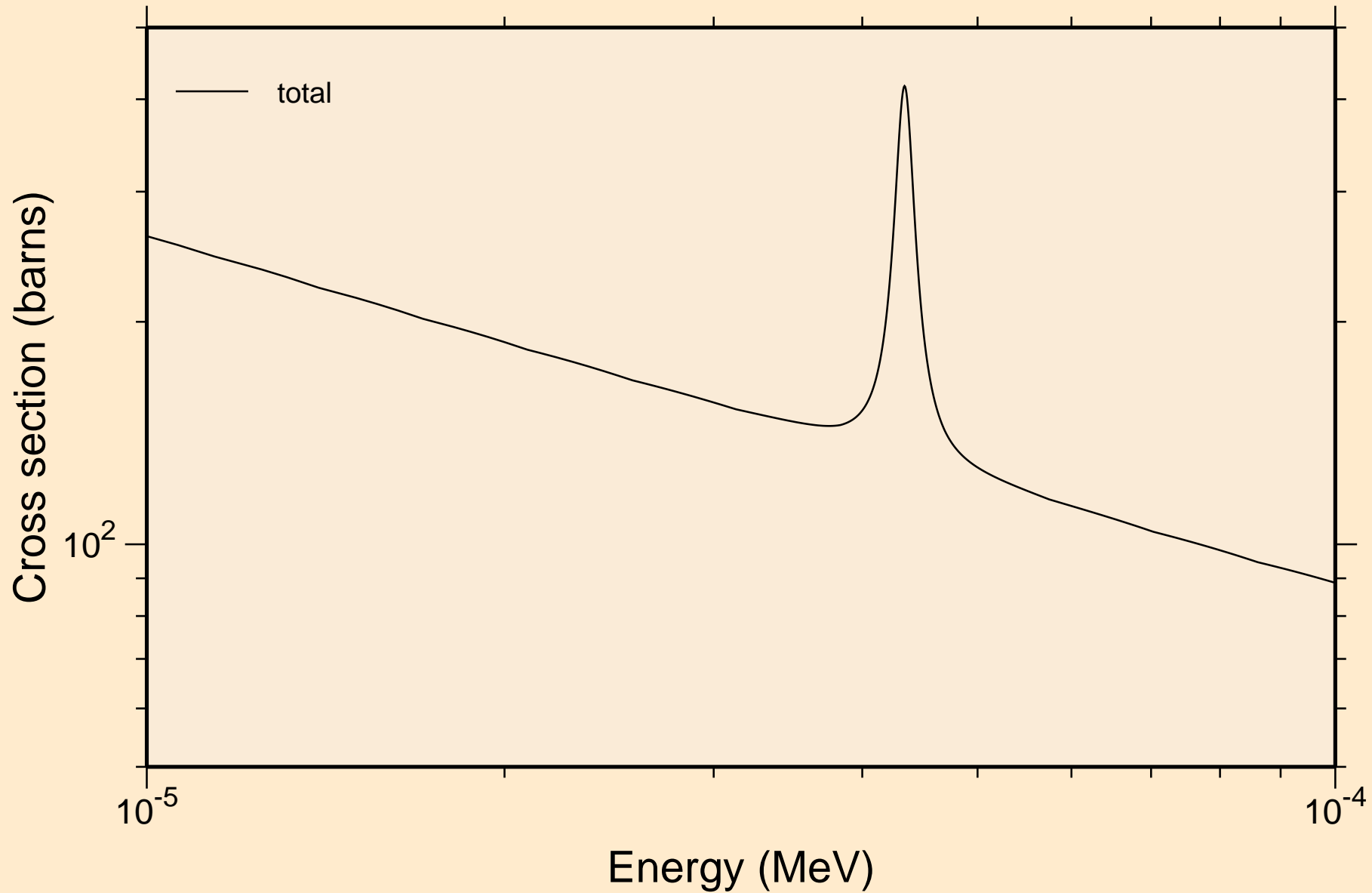

ZN061 NEUTRON ACER TENDL-2023 LIBRARY; T=0.K
resonance total cross section

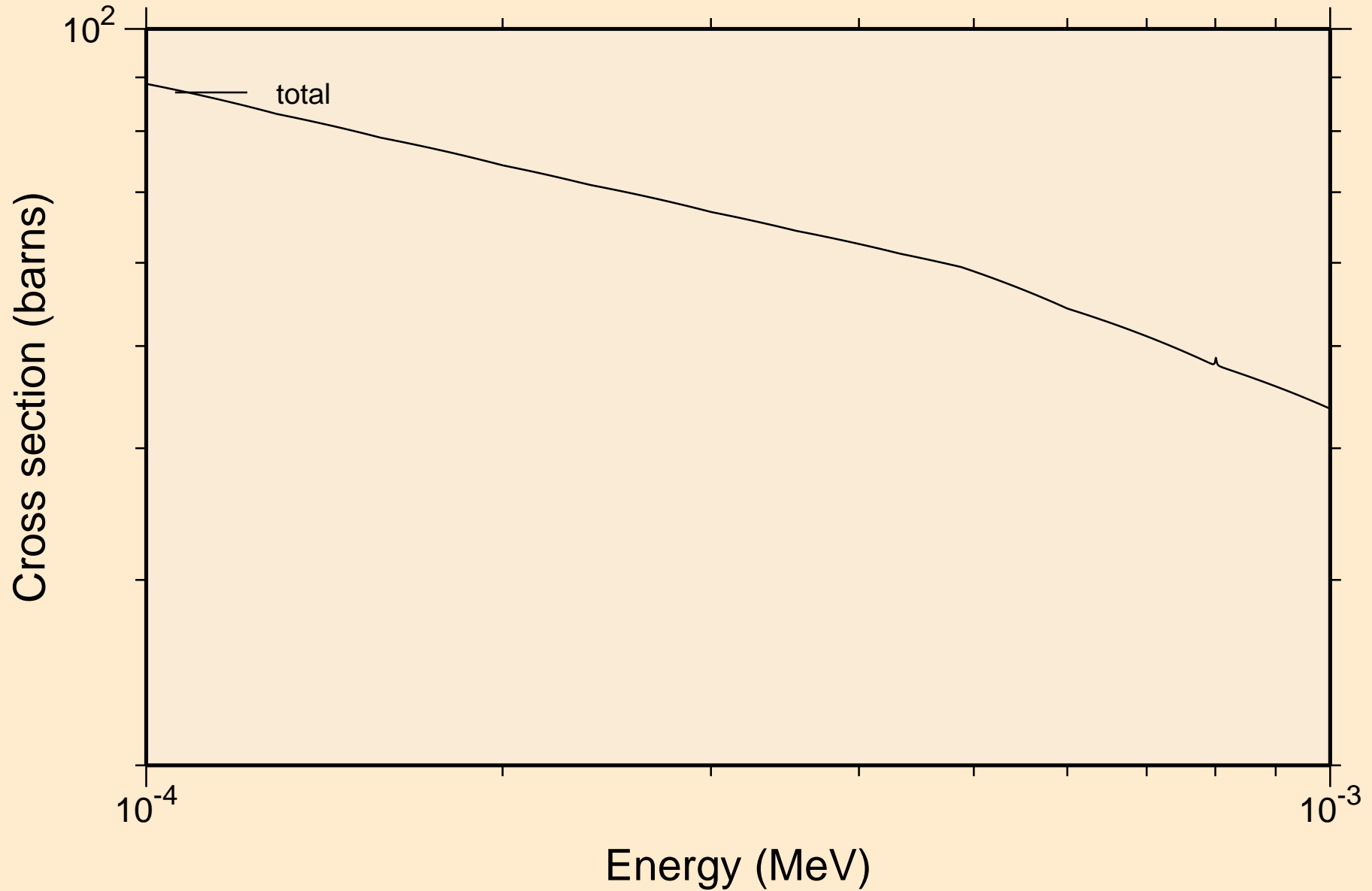

ZN061 NEUTRON ACER TENDL-2023 LIBRARY; T=0.K
resonance total cross section

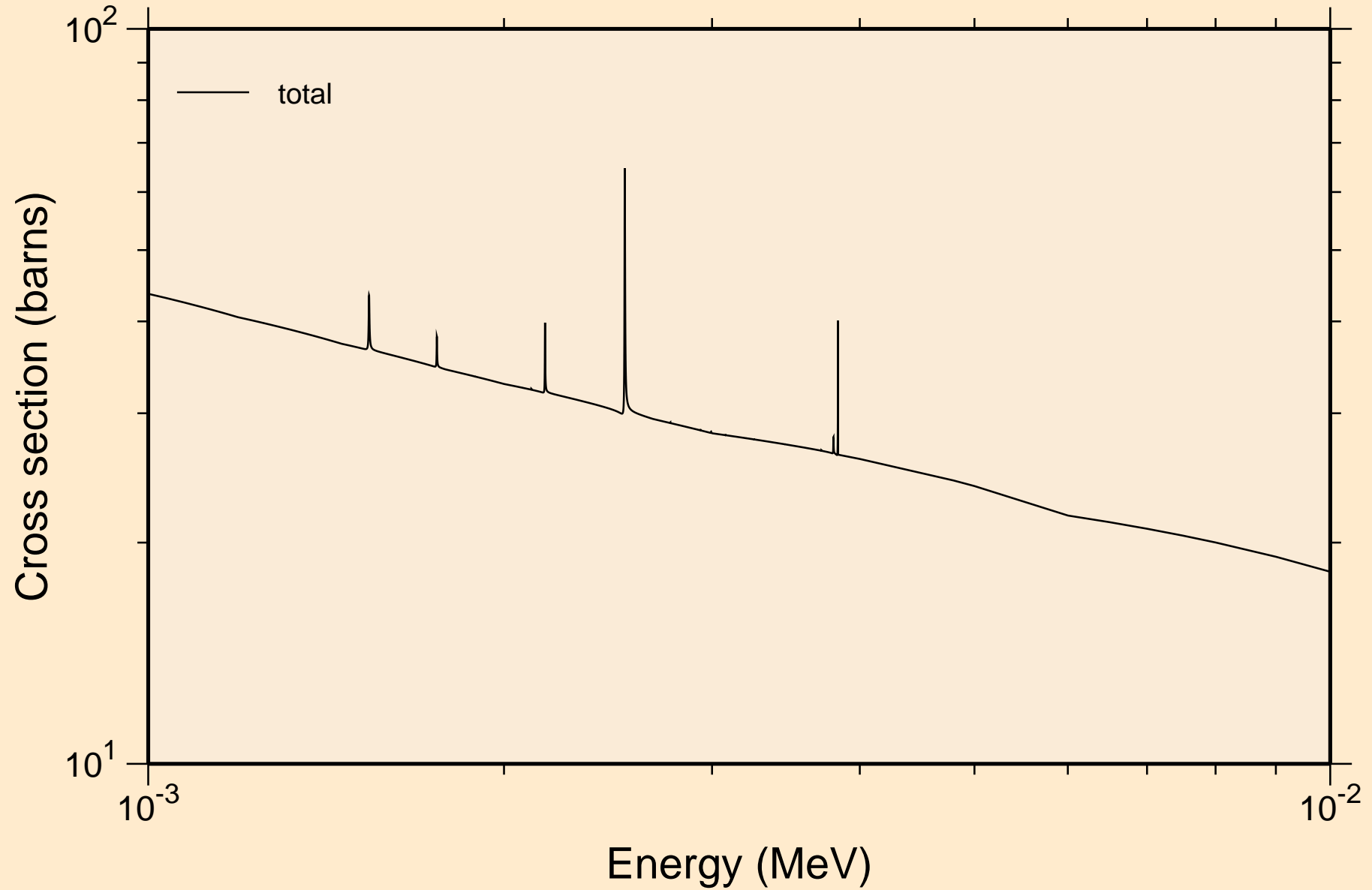

ZN061 NEUTRON ACER TENDL-2023 LIBRARY; T=0.K
resonance total cross section

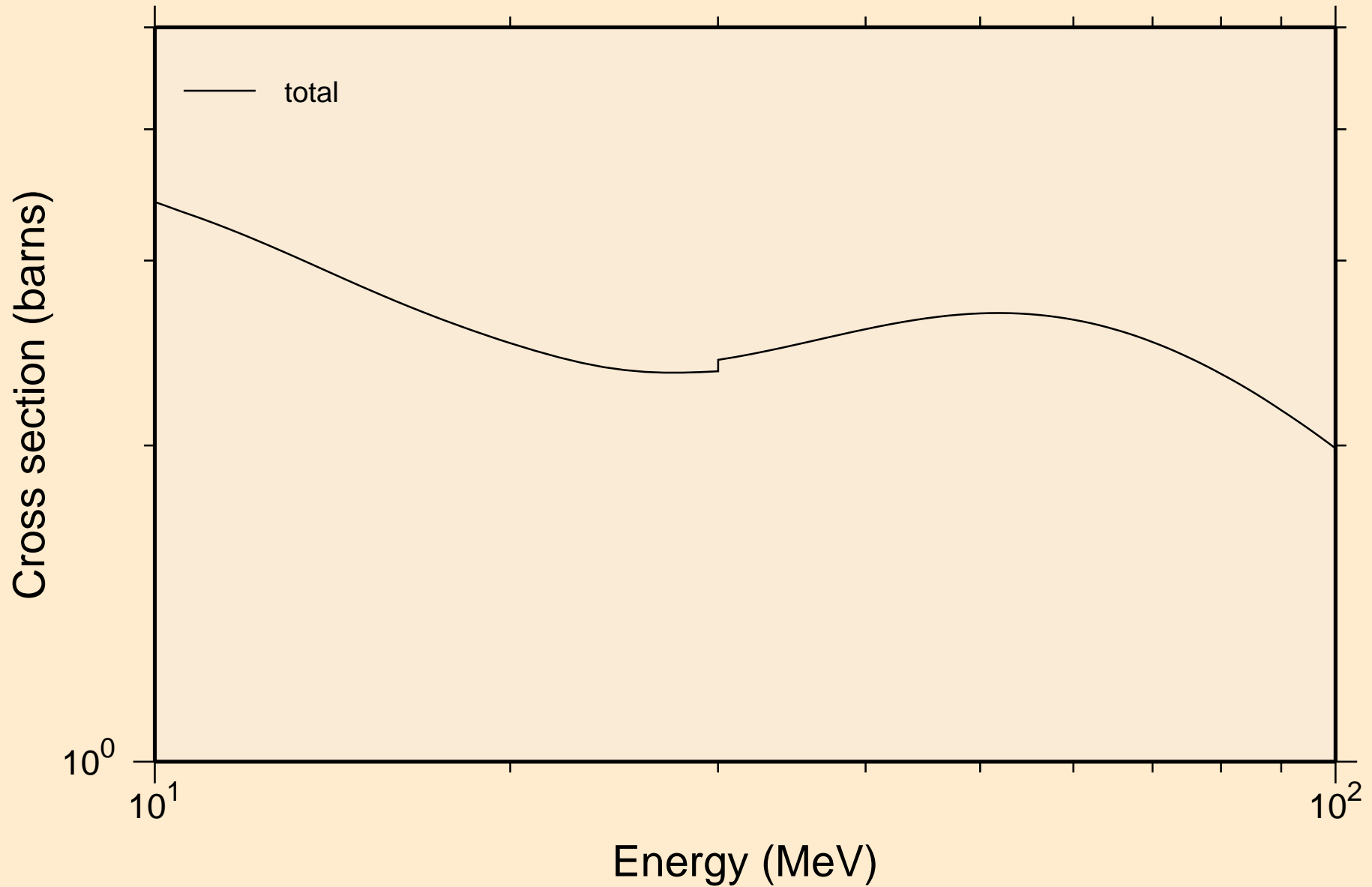

ZN061 NEUTRON ACER TENDL-2023 LIBRARY; T=0.K
resonance absorption cross sections

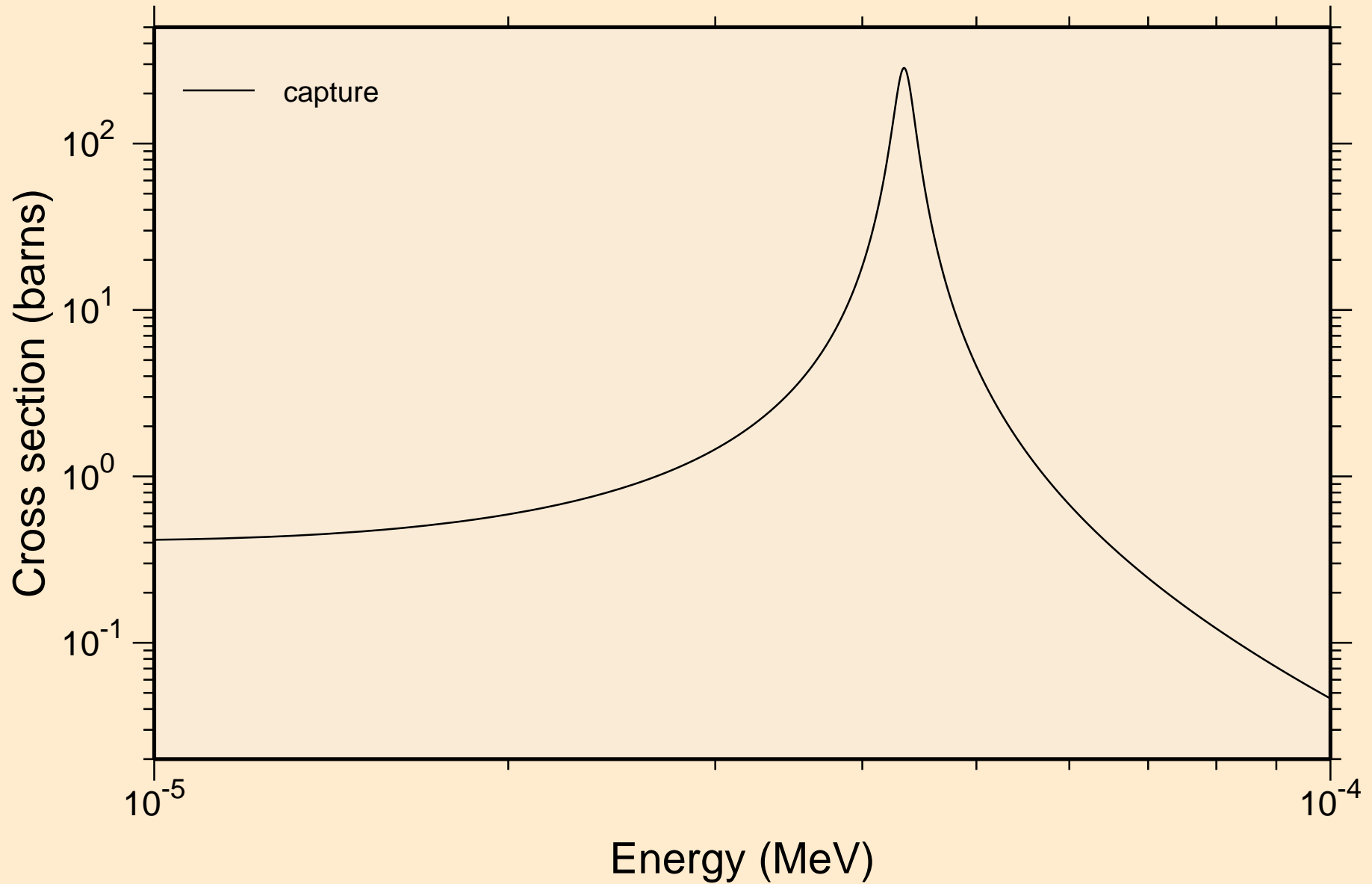

ZN061 NEUTRON ACER TENDL-2023 LIBRARY; T=0.K
resonance absorption cross sections

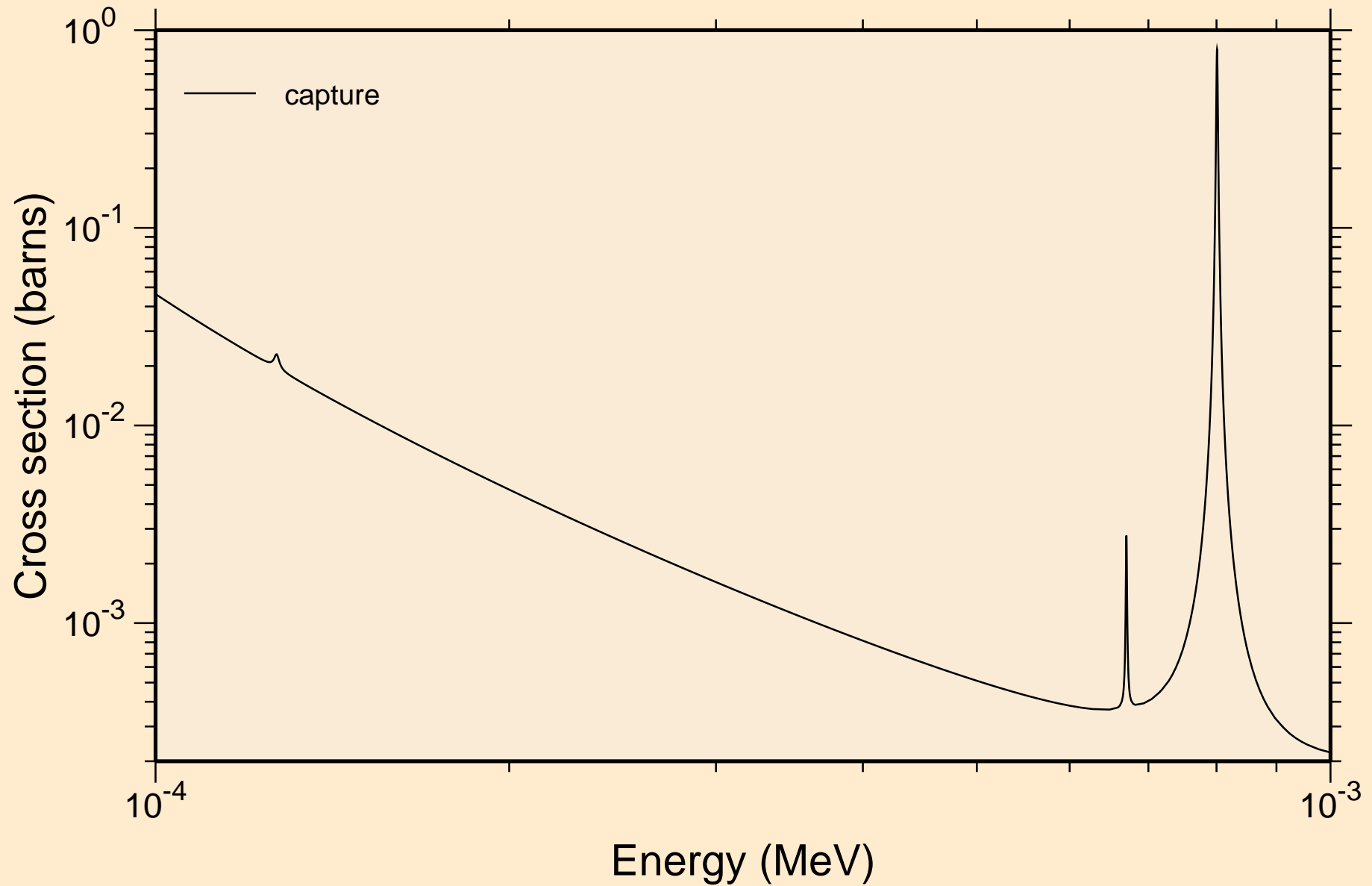

ZN061 NEUTRON ACER TENDL-2023 LIBRARY; T=0.K
resonance absorption cross sections

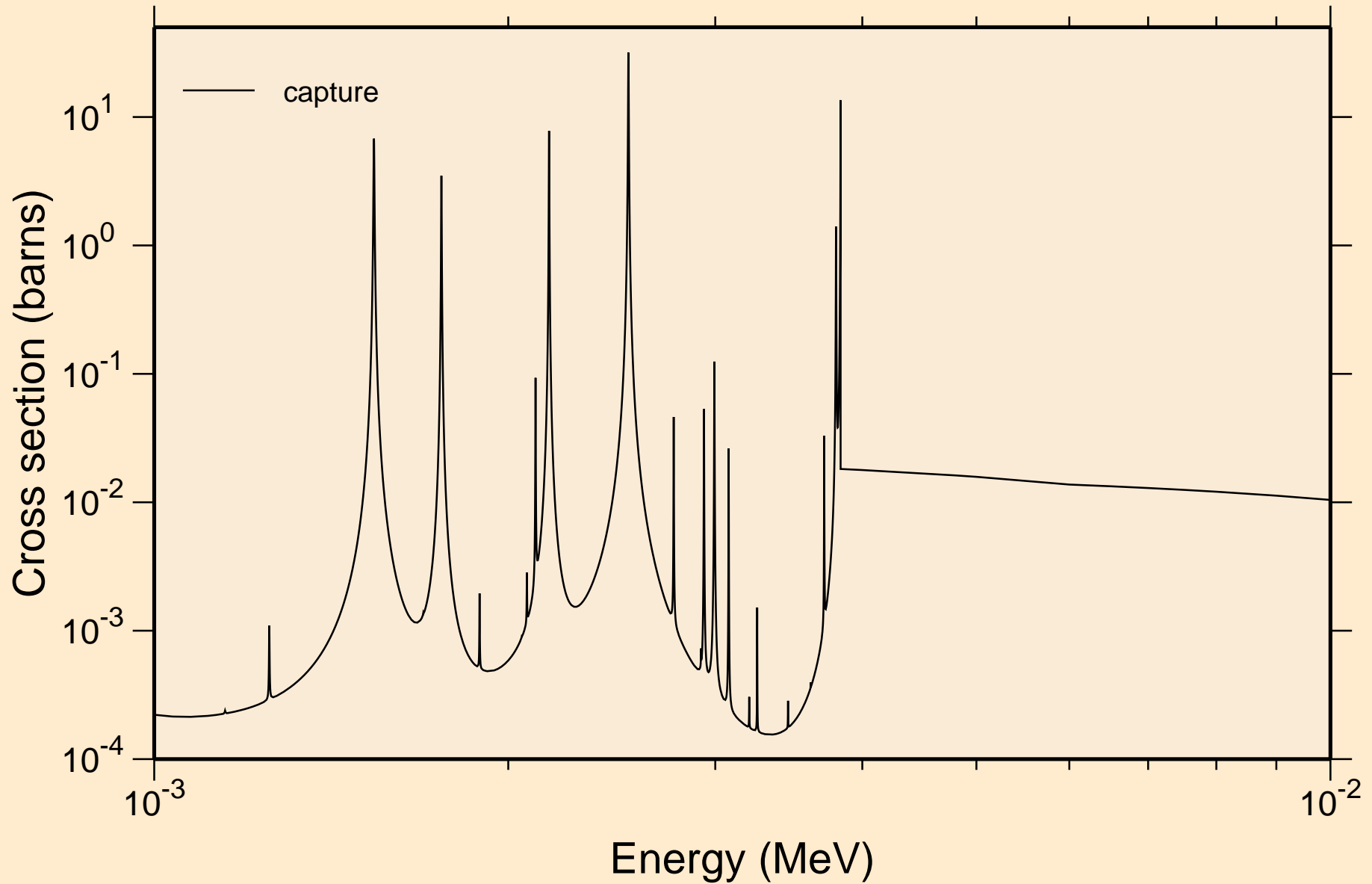

ZN061 NEUTRON ACER TENDL-2023 LIBRARY; T=0.K
resonance absorption cross sections

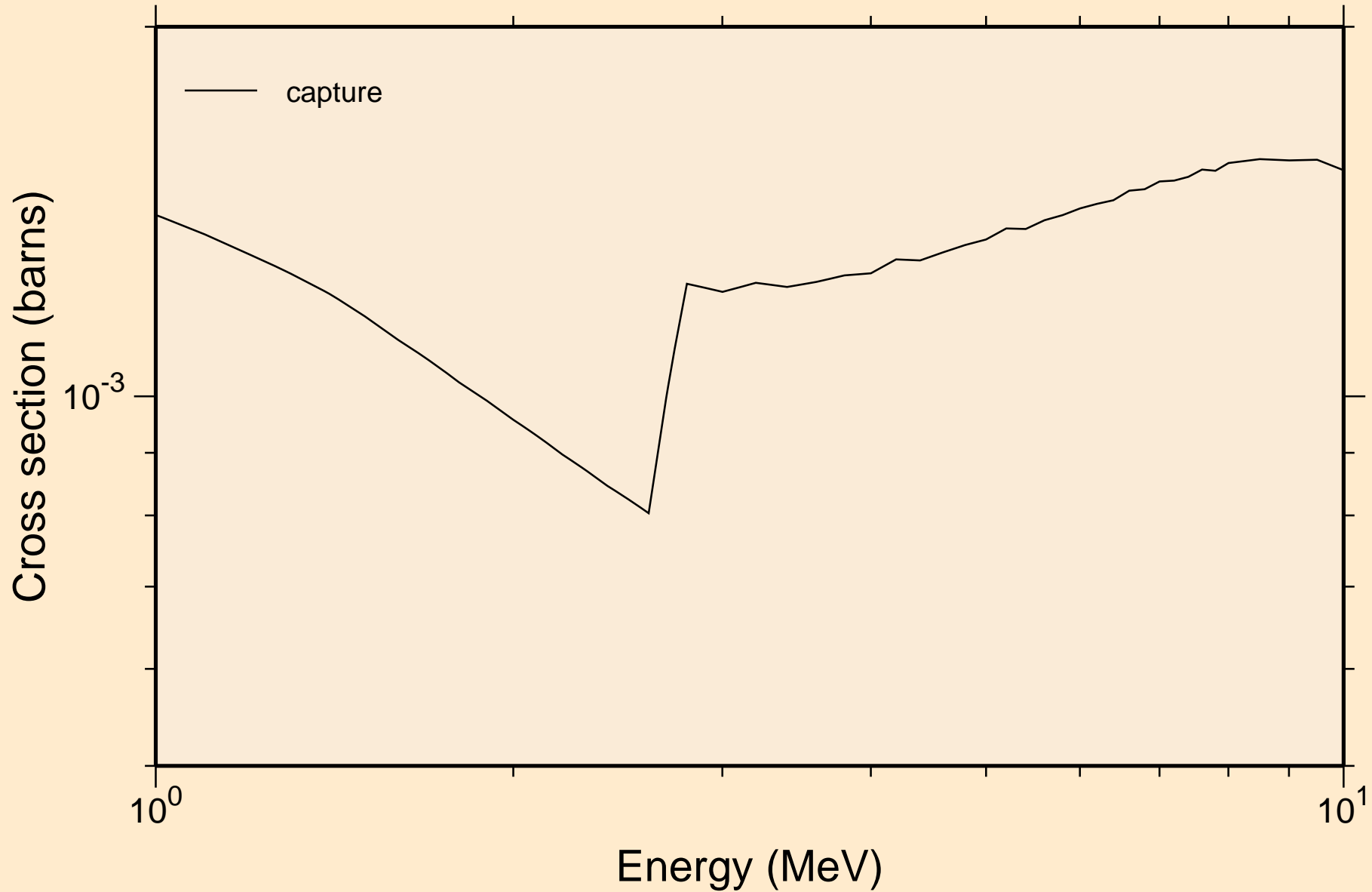

ZN061 NEUTRON ACER TENDL-2023 LIBRARY; T=0.K

Heating

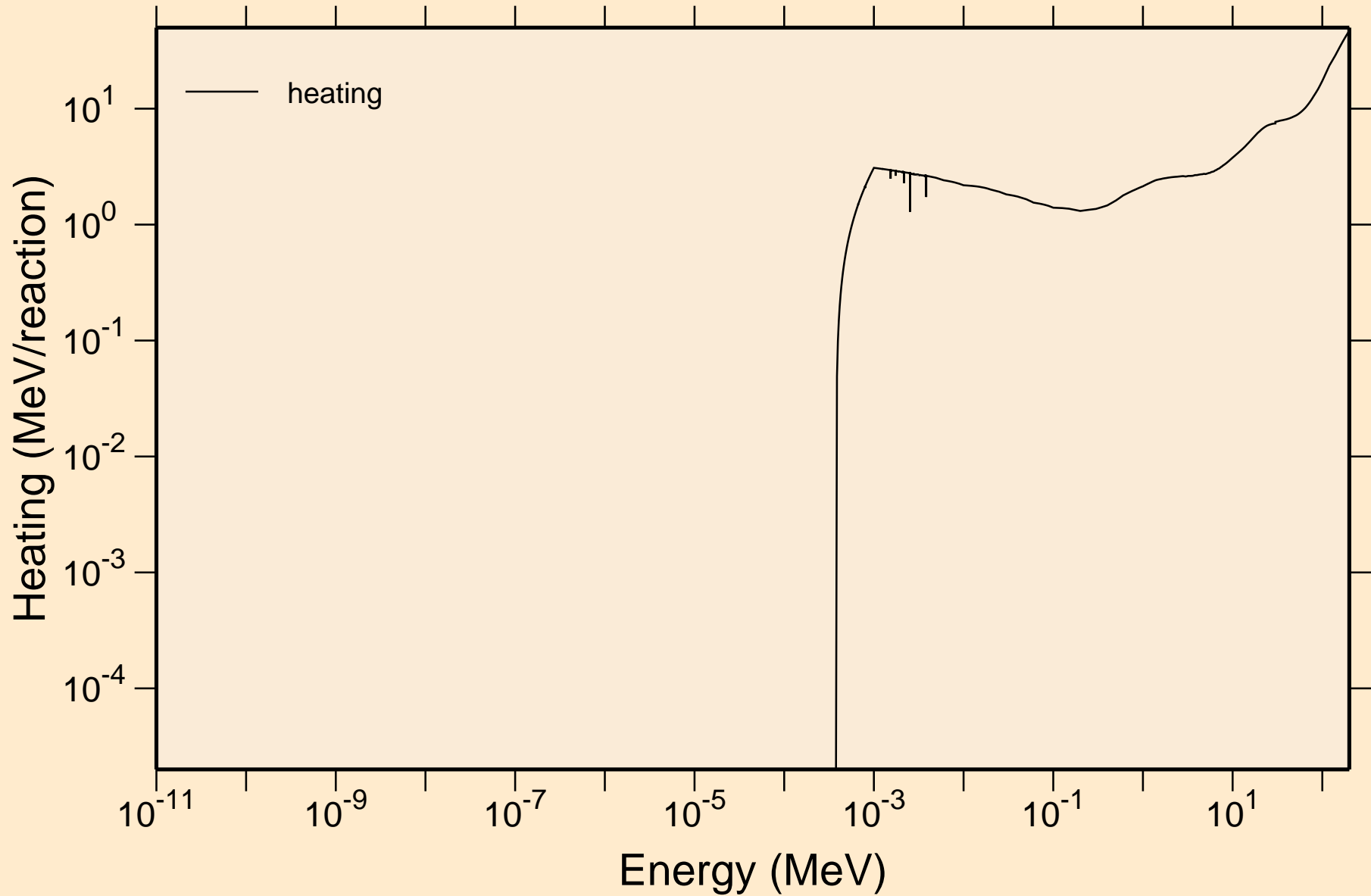

ZN061 NEUTRON ACER TENDL-2023 LIBRARY; T=0.K
Damage

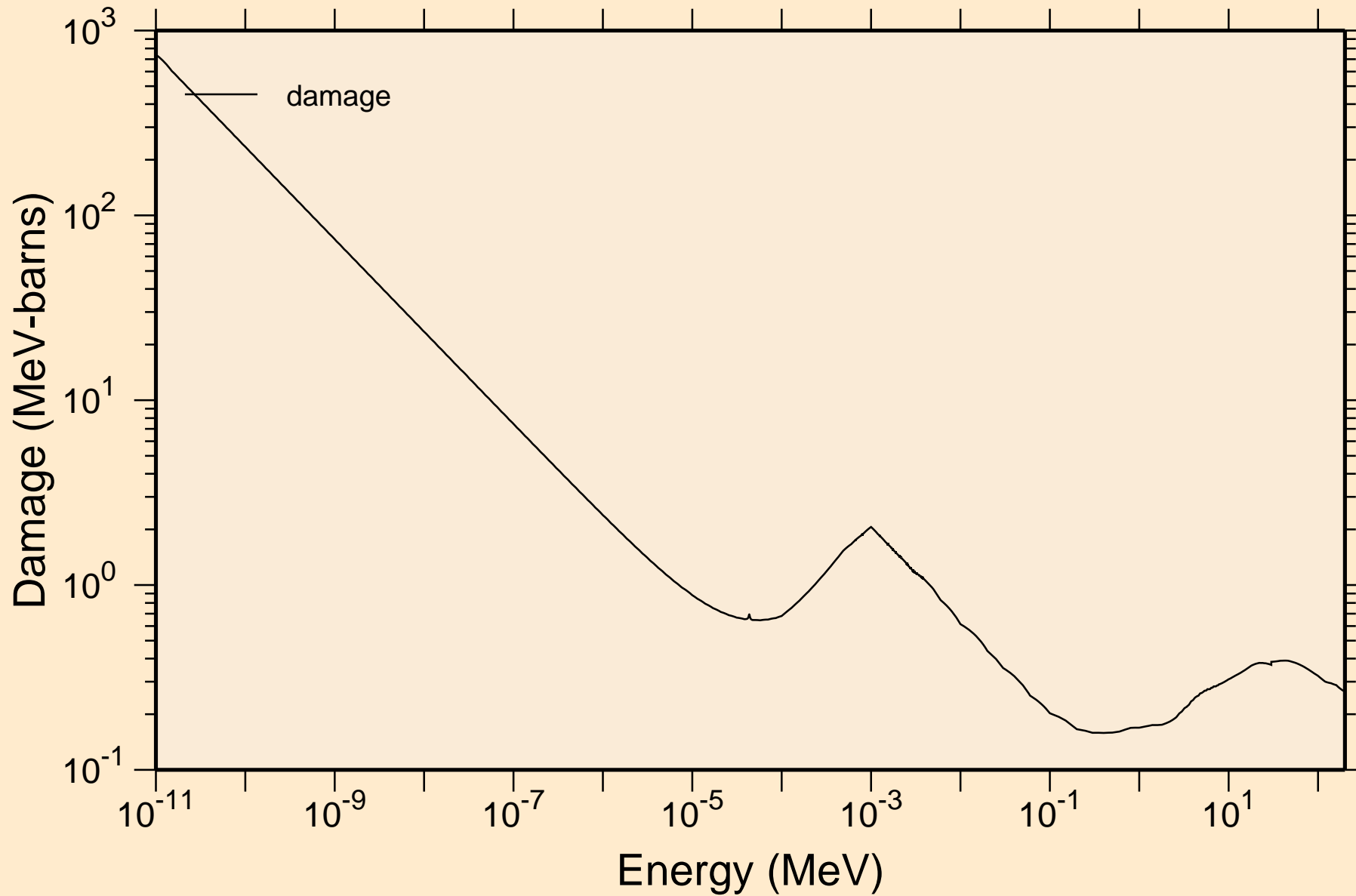

ZN061 NEUTRON ACER TENDL-2023 LIBRARY; T=0.K

Non-threshold reactions

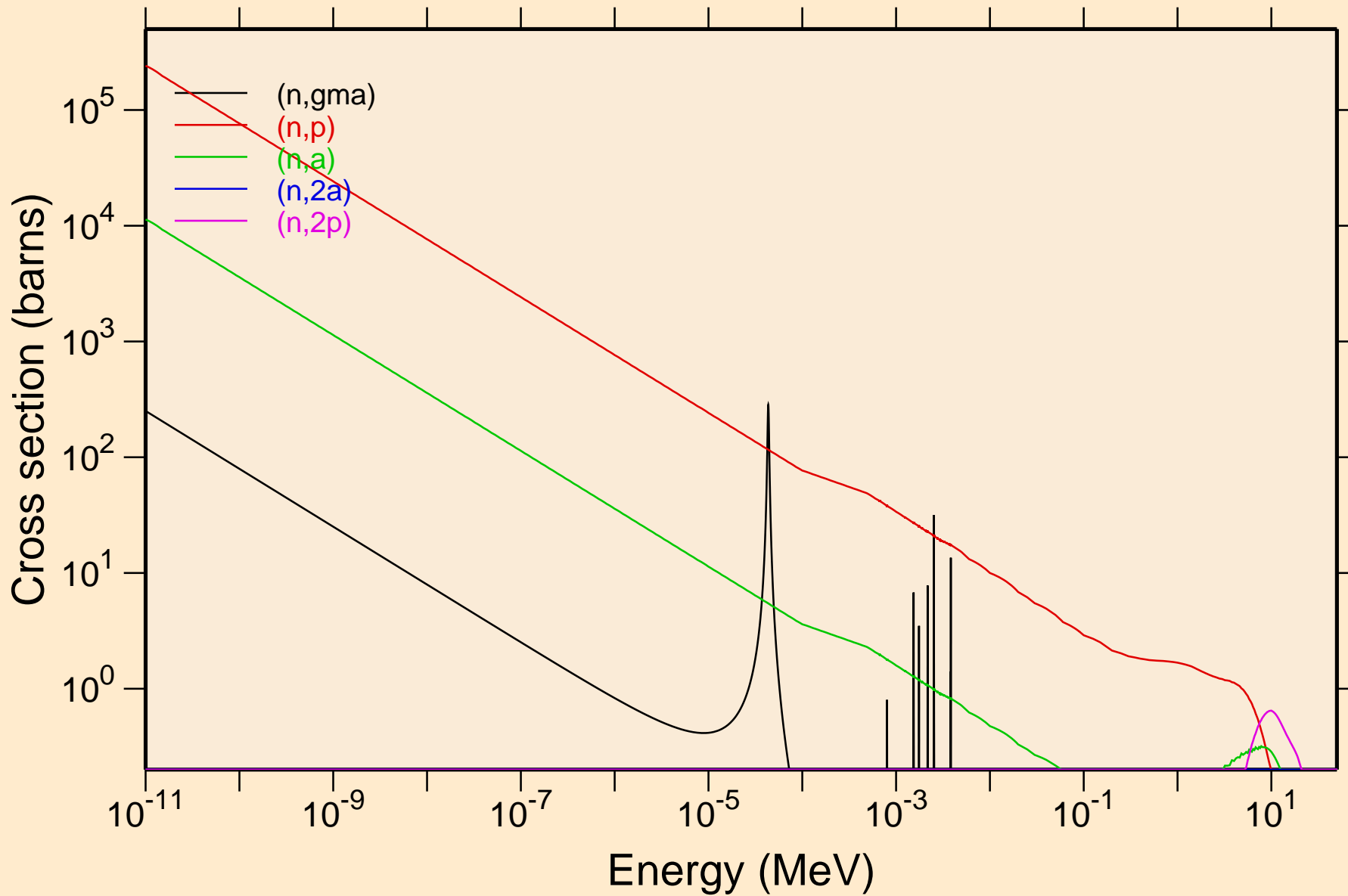

ZN061 NEUTRON ACER TENDL-2023 LIBRARY; T=0.K
Non-threshold reactions

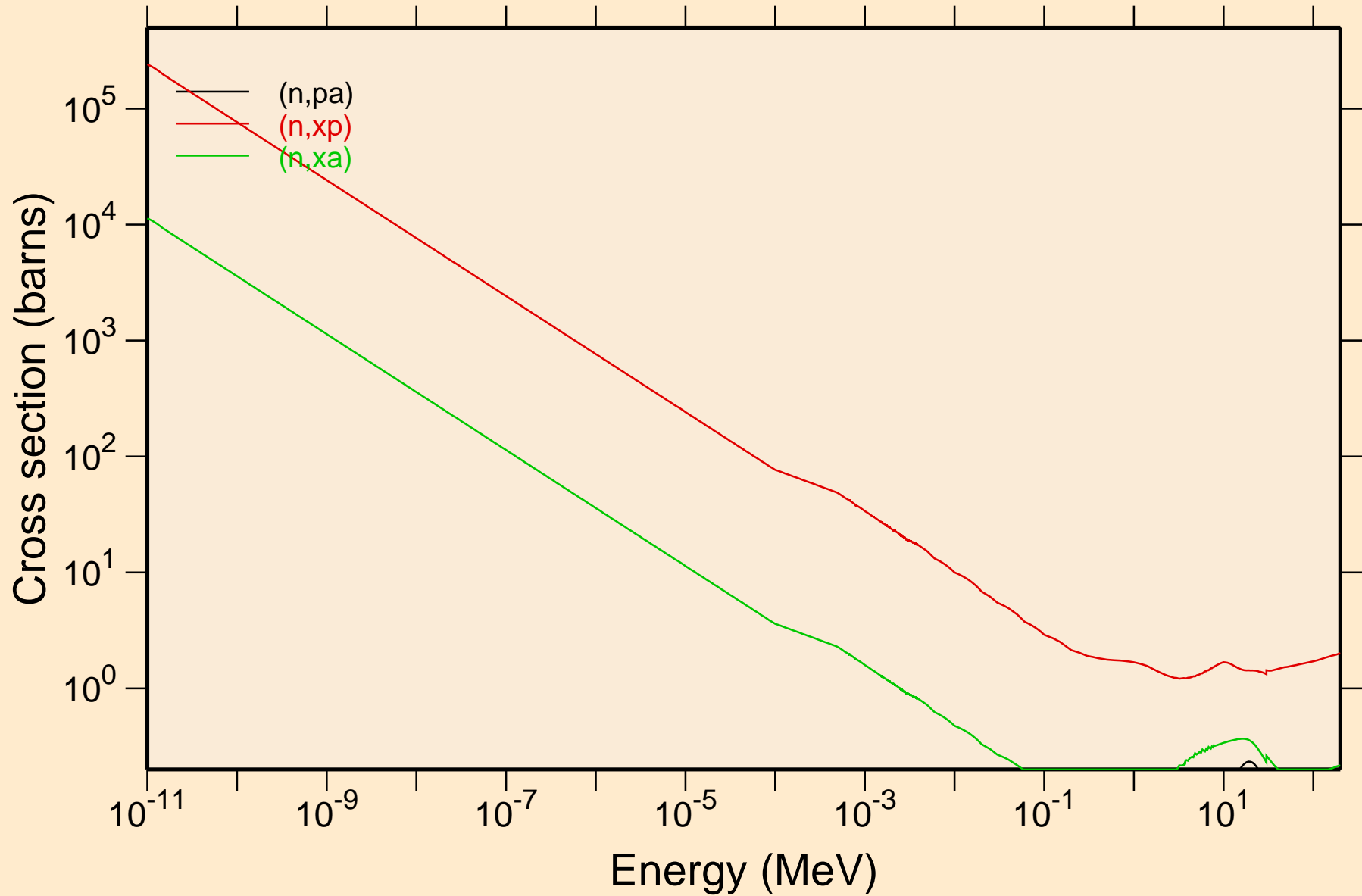

ZN061 NEUTRON ACER TENDL-2023 LIBRARY; T=0.K

Principal cross sections

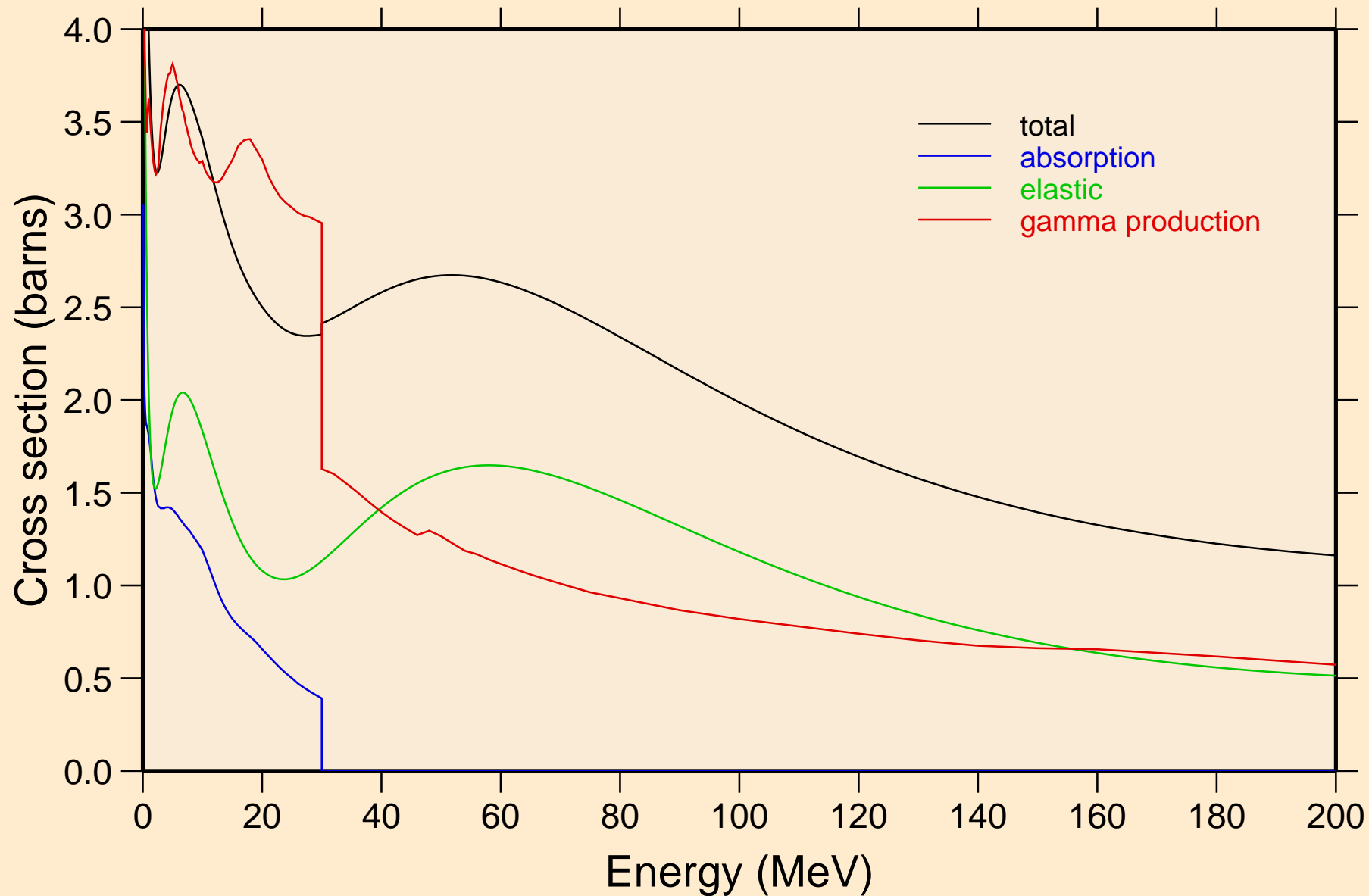

ZN061 NEUTRON ACER TENDL-2023 LIBRARY; T=0.K

Heating

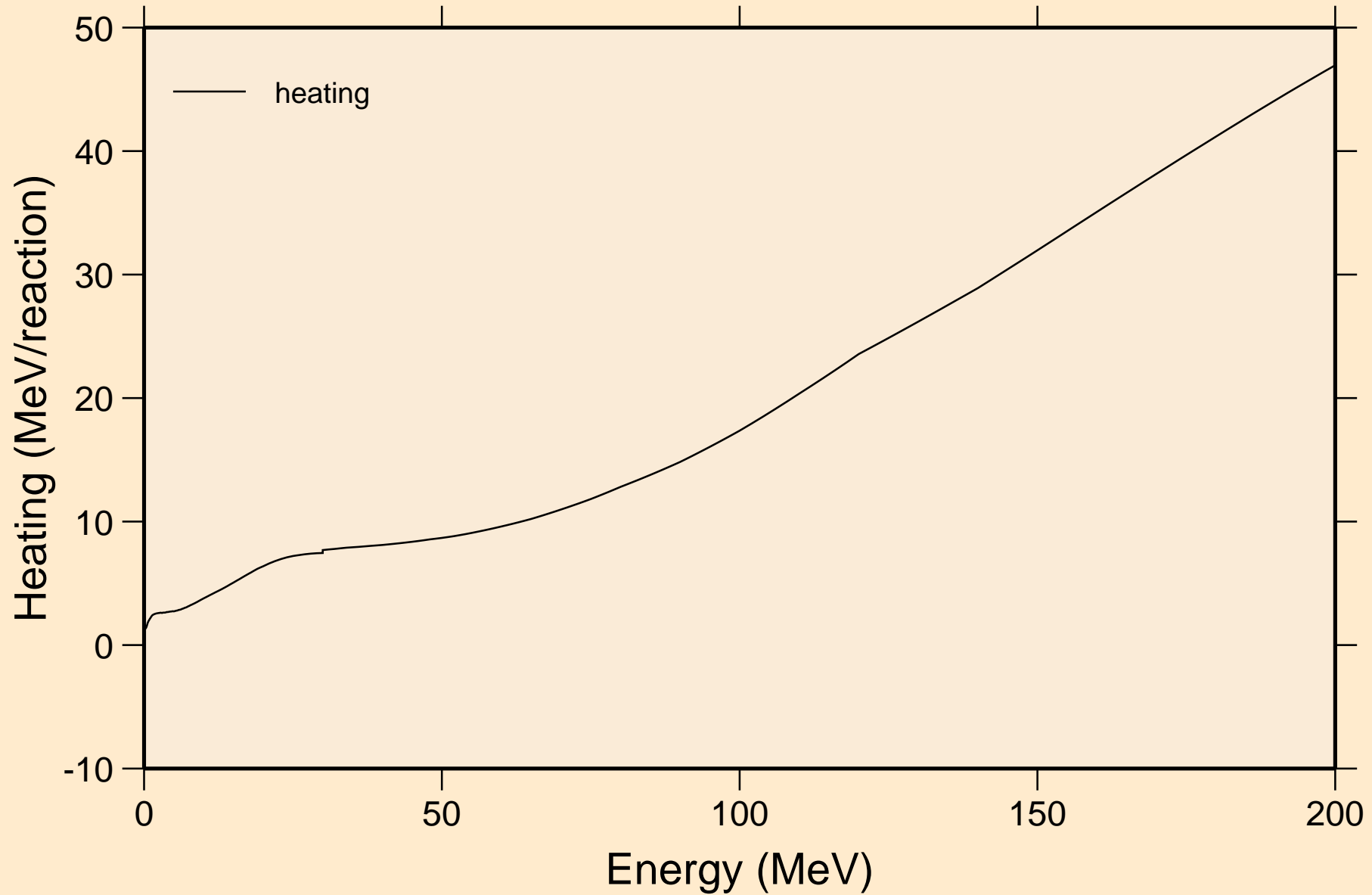

ZN061 NEUTRON ACER TENDL-2023 LIBRARY; T=0.K

Damage

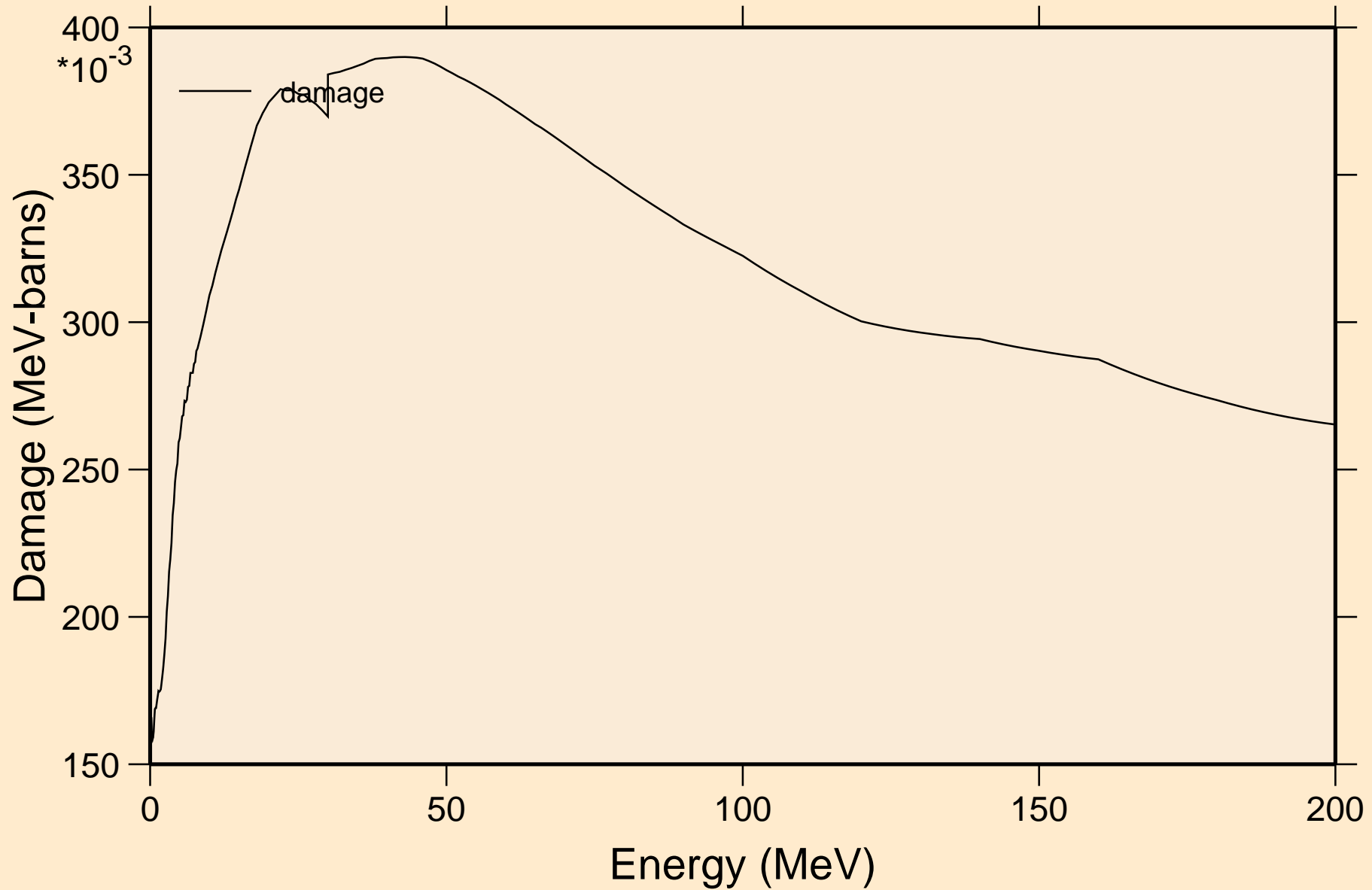

ZN061 NEUTRON ACER TENDL-2023 LIBRARY; T=0.K

Non-threshold reactions

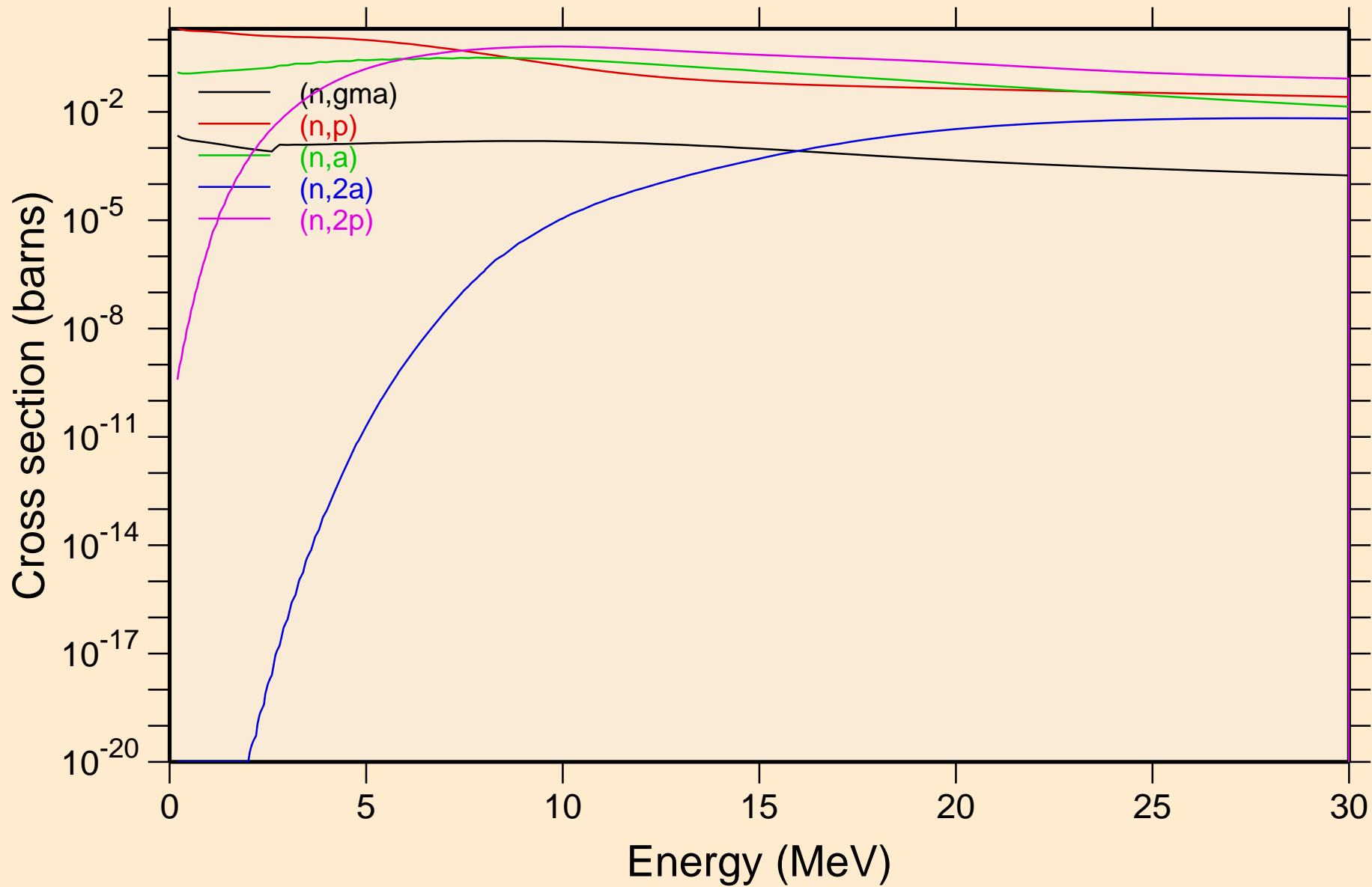

ZN061 NEUTRON ACER TENDL-2023 LIBRARY; T=0.K
Non-threshold reactions

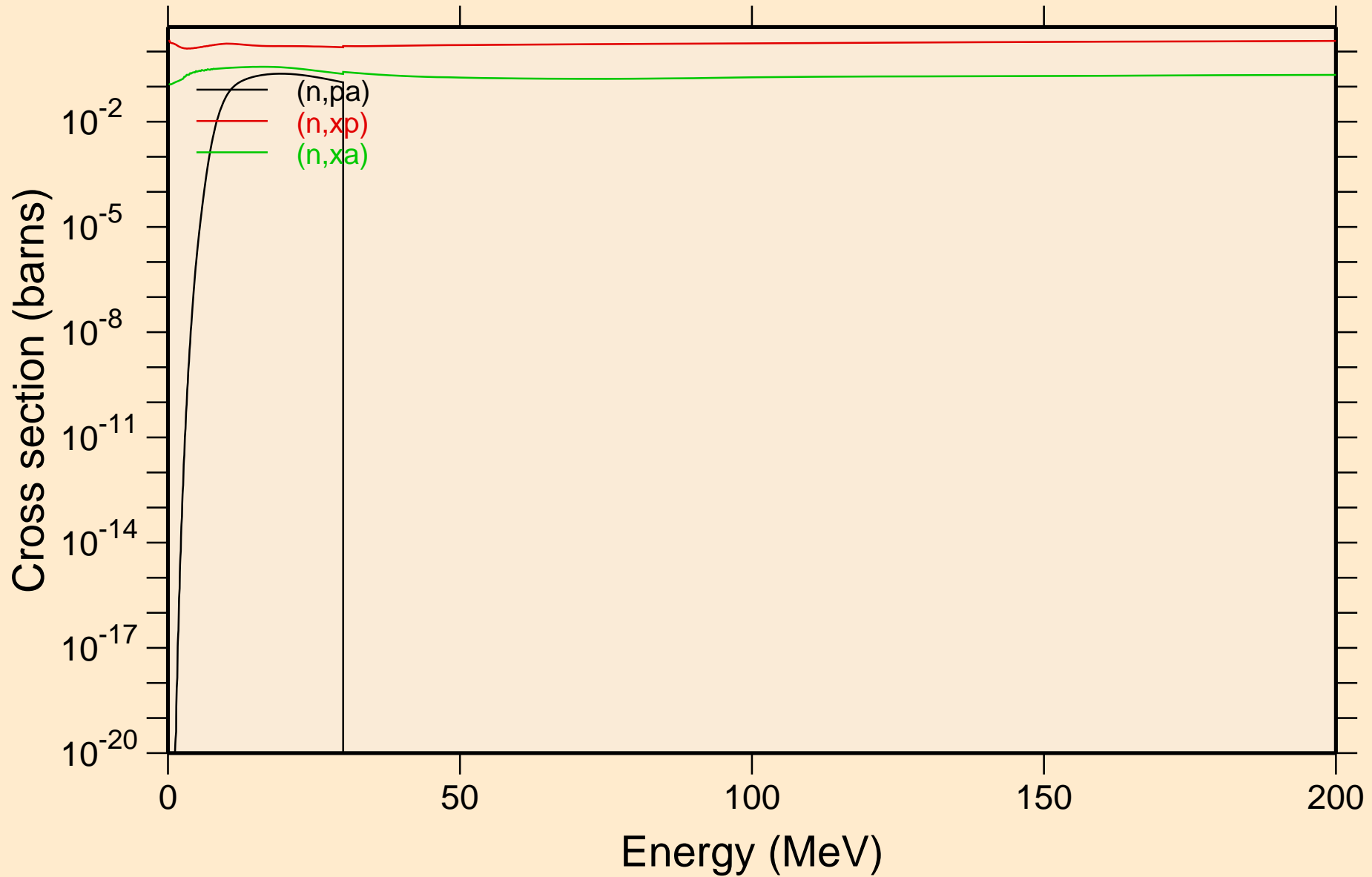

ZN061 NEUTRON ACER TENDL-2023 LIBRARY; T=0.K
Inelastic levels

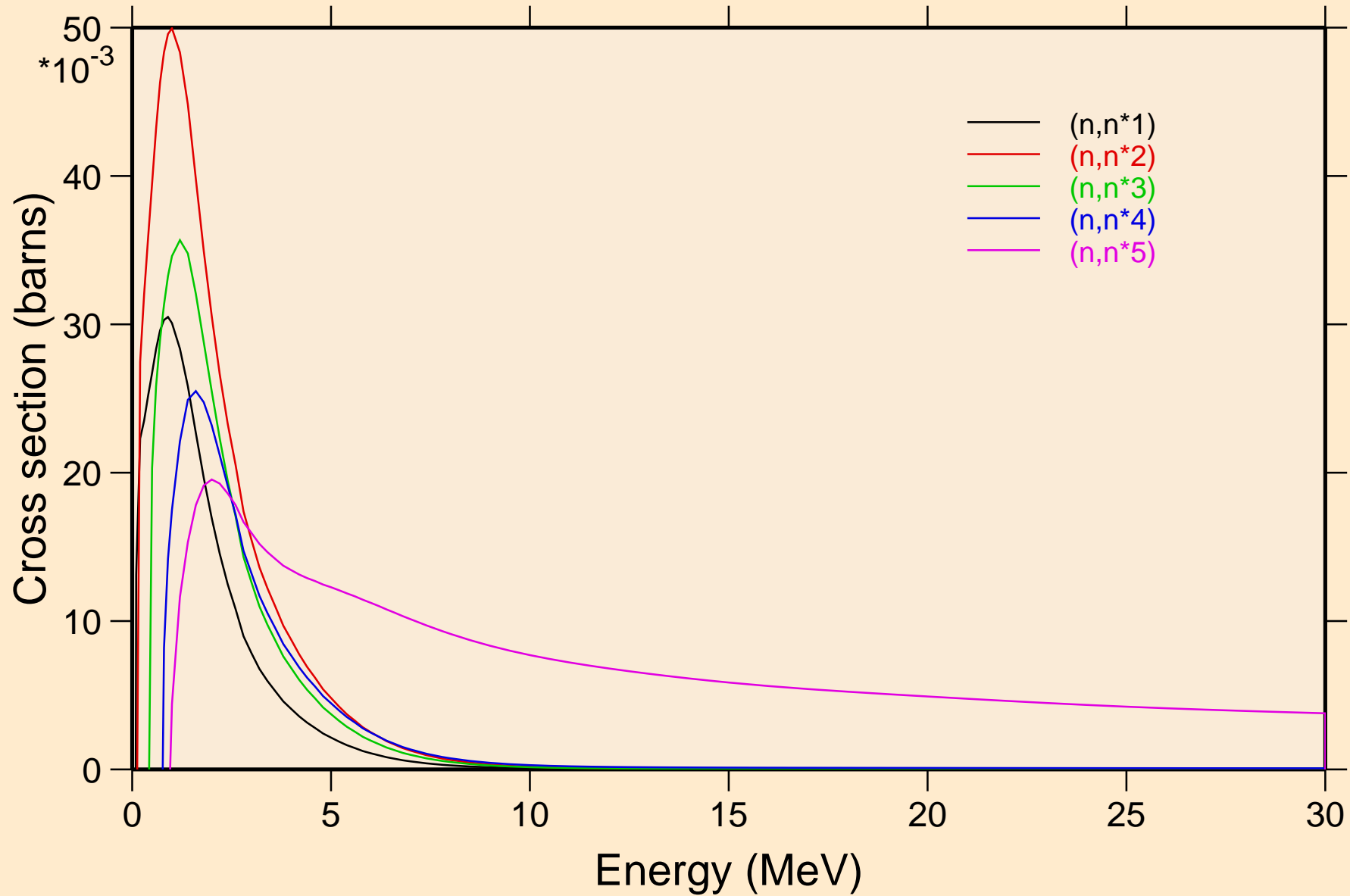

ZN061 NEUTRON ACER TENDL-2023 LIBRARY; T=0.K
Inelastic levels

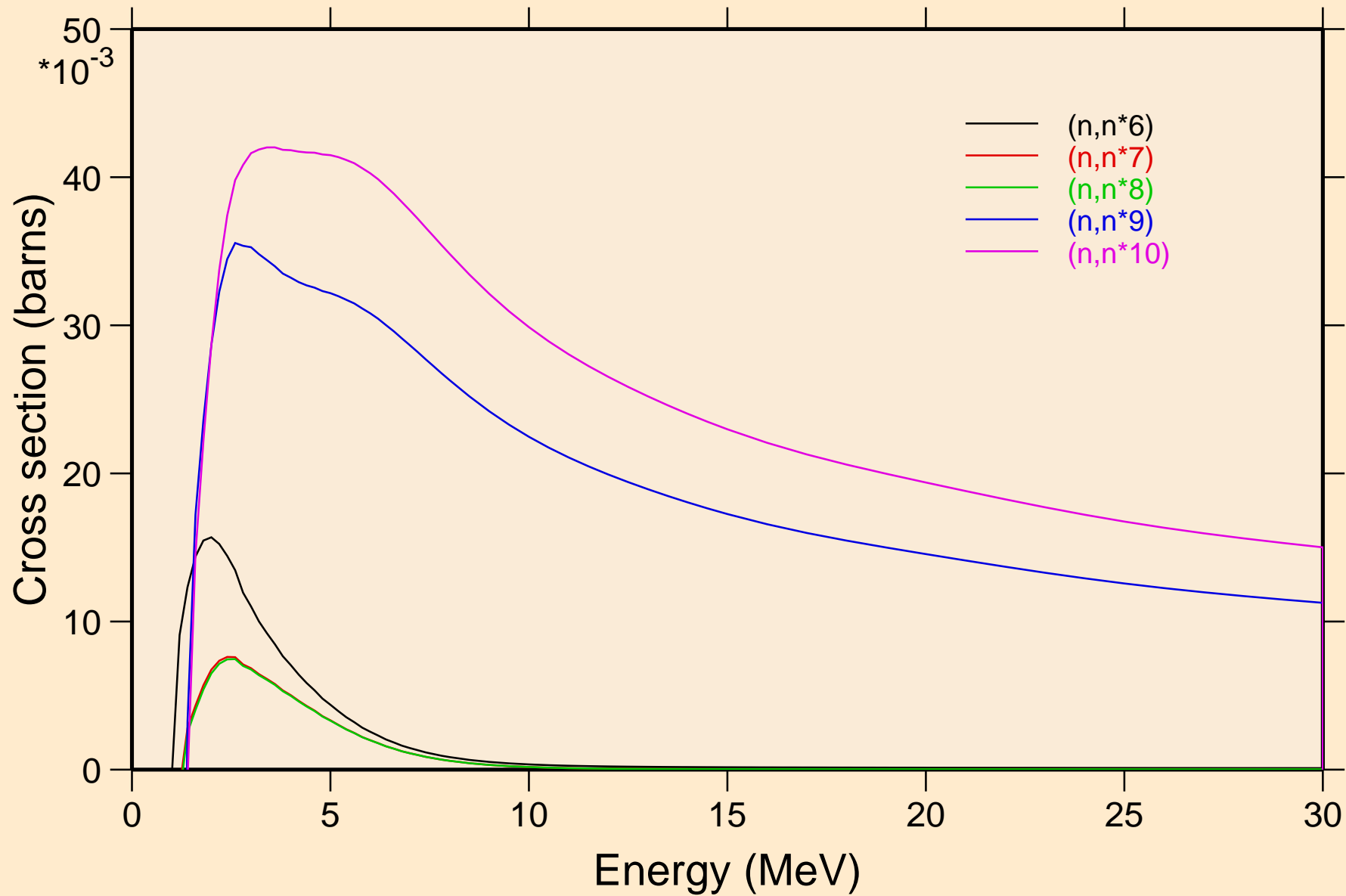

ZN061 NEUTRON ACER TENDL-2023 LIBRARY; T=0.K
Inelastic levels

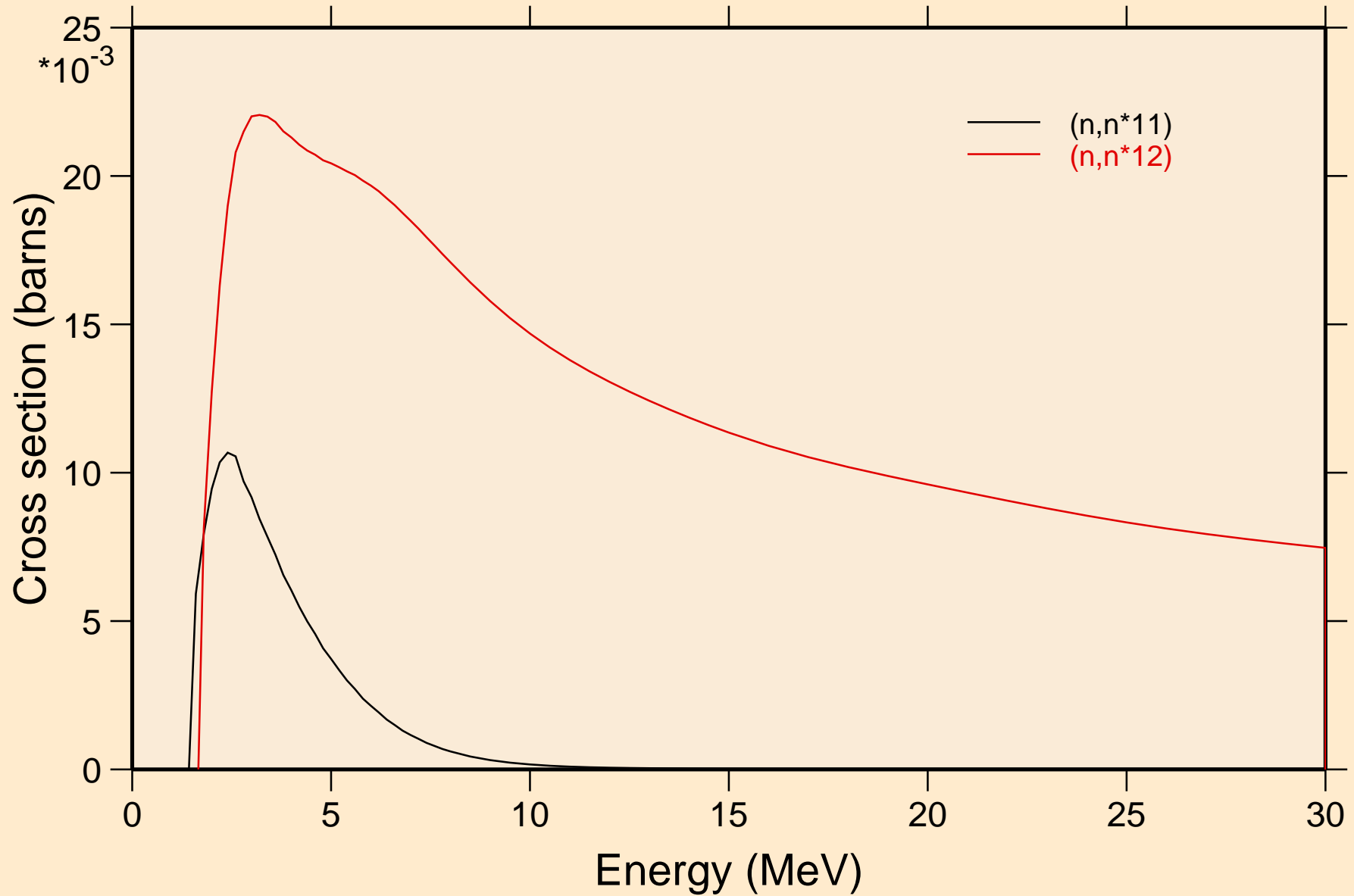

ZN061 NEUTRON ACER TENDL-2023 LIBRARY; T=0.K
Threshold reactions

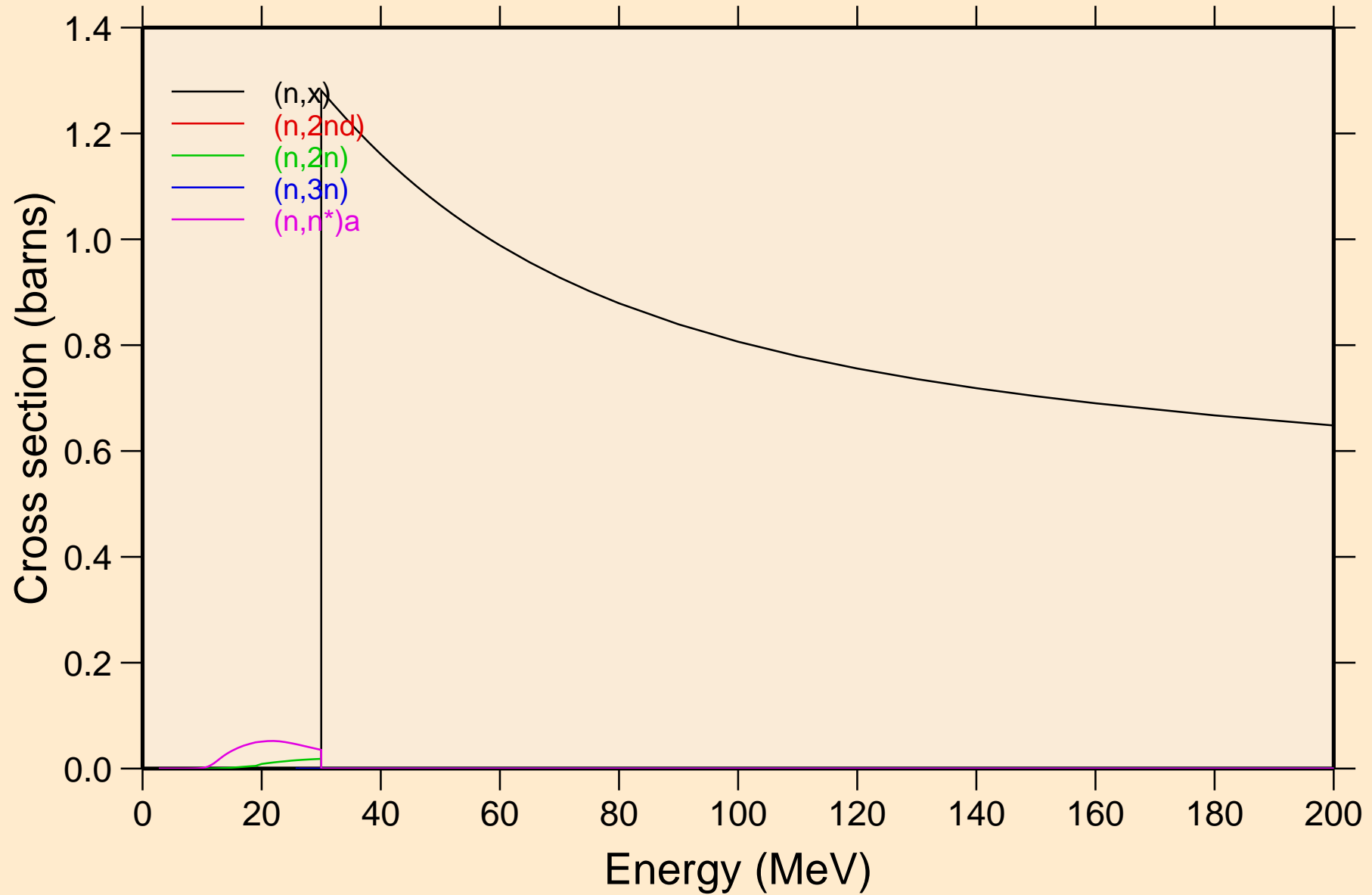

ZN061 NEUTRON ACER TENDL-2023 LIBRARY; T=0.K

Threshold reactions

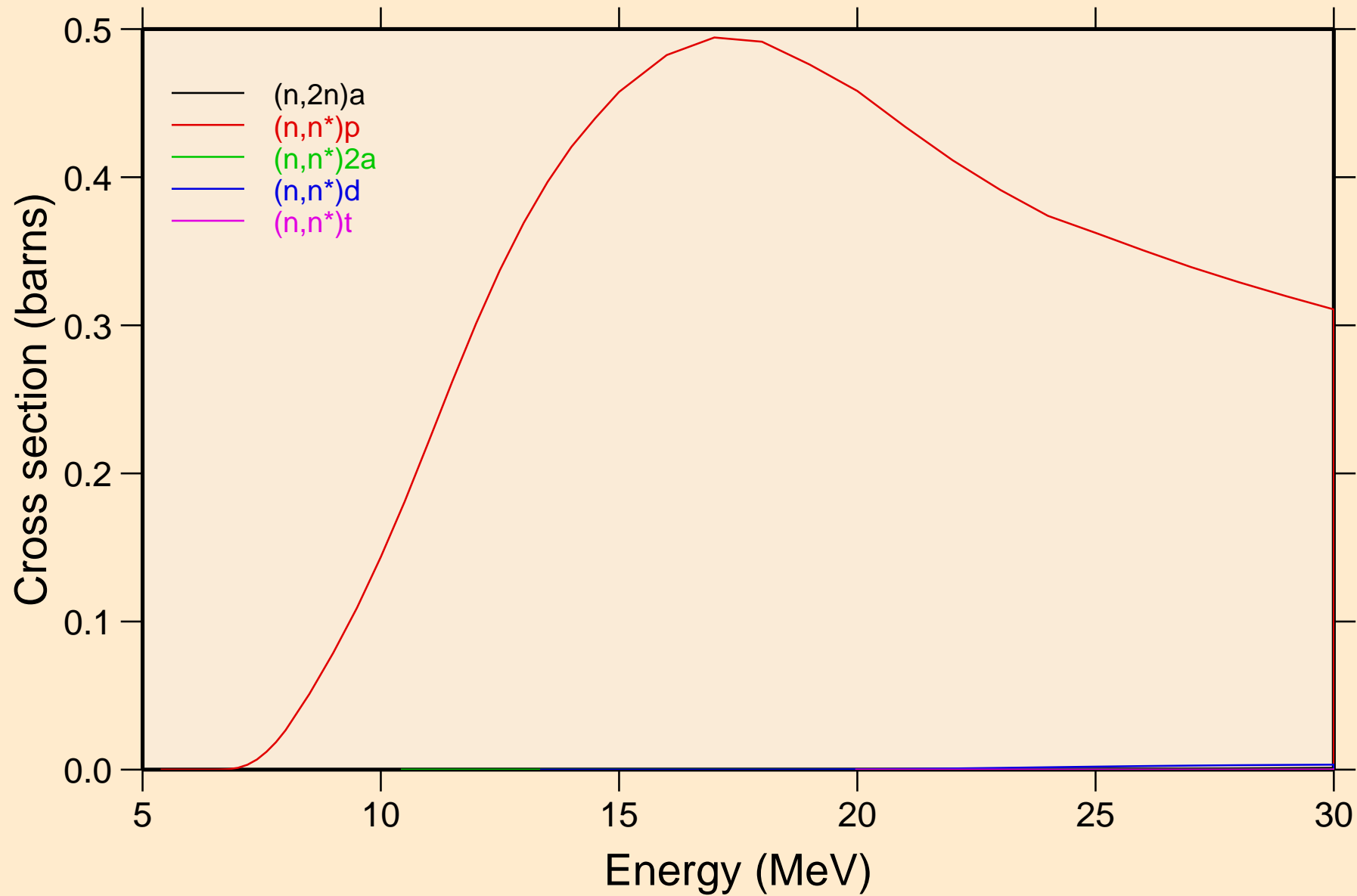

ZN061 NEUTRON ACER TENDL-2023 LIBRARY; T=0.K

Threshold reactions

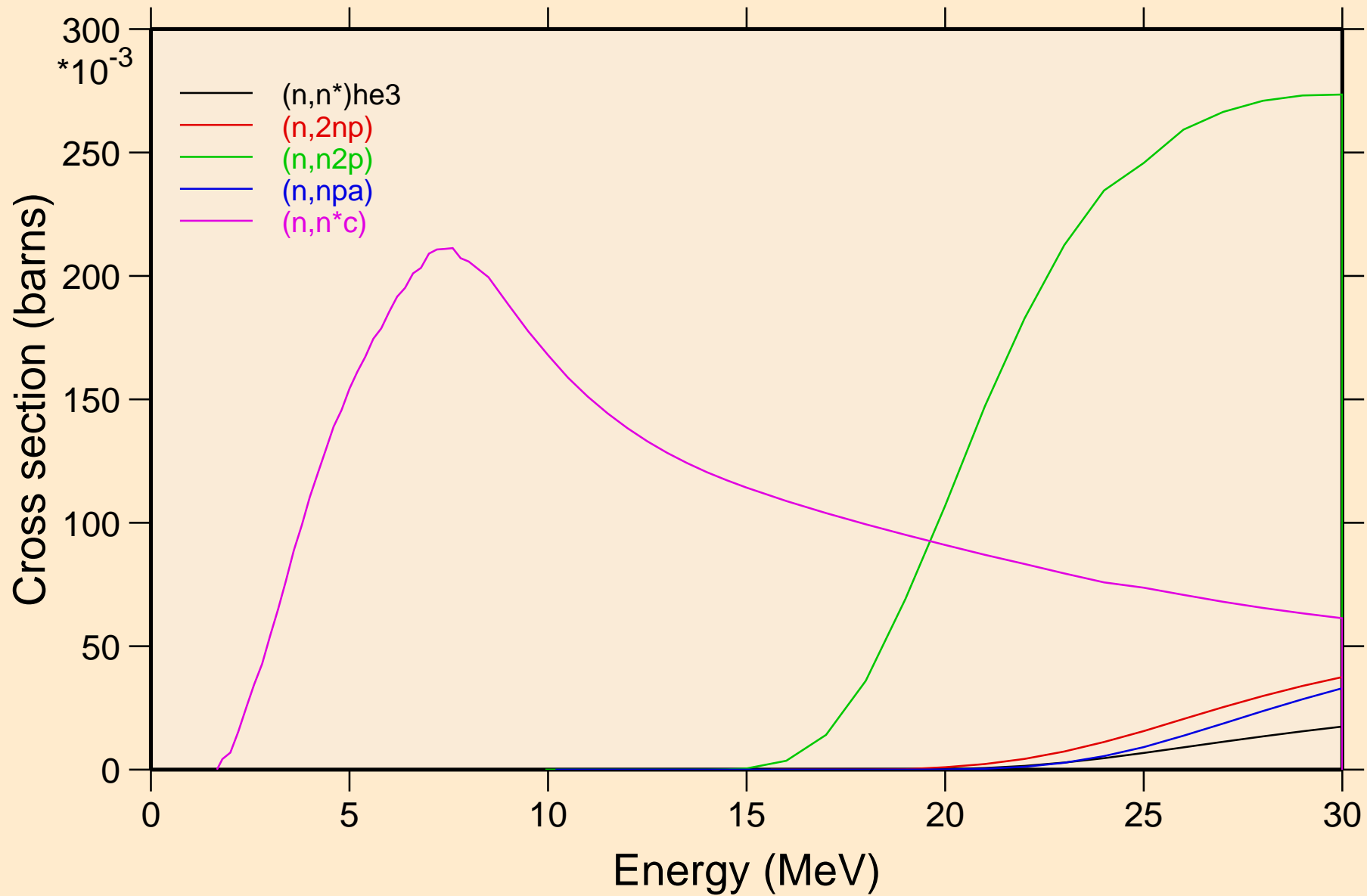

ZN061 NEUTRON ACER TENDL-2023 LIBRARY; T=0.K
Threshold reactions

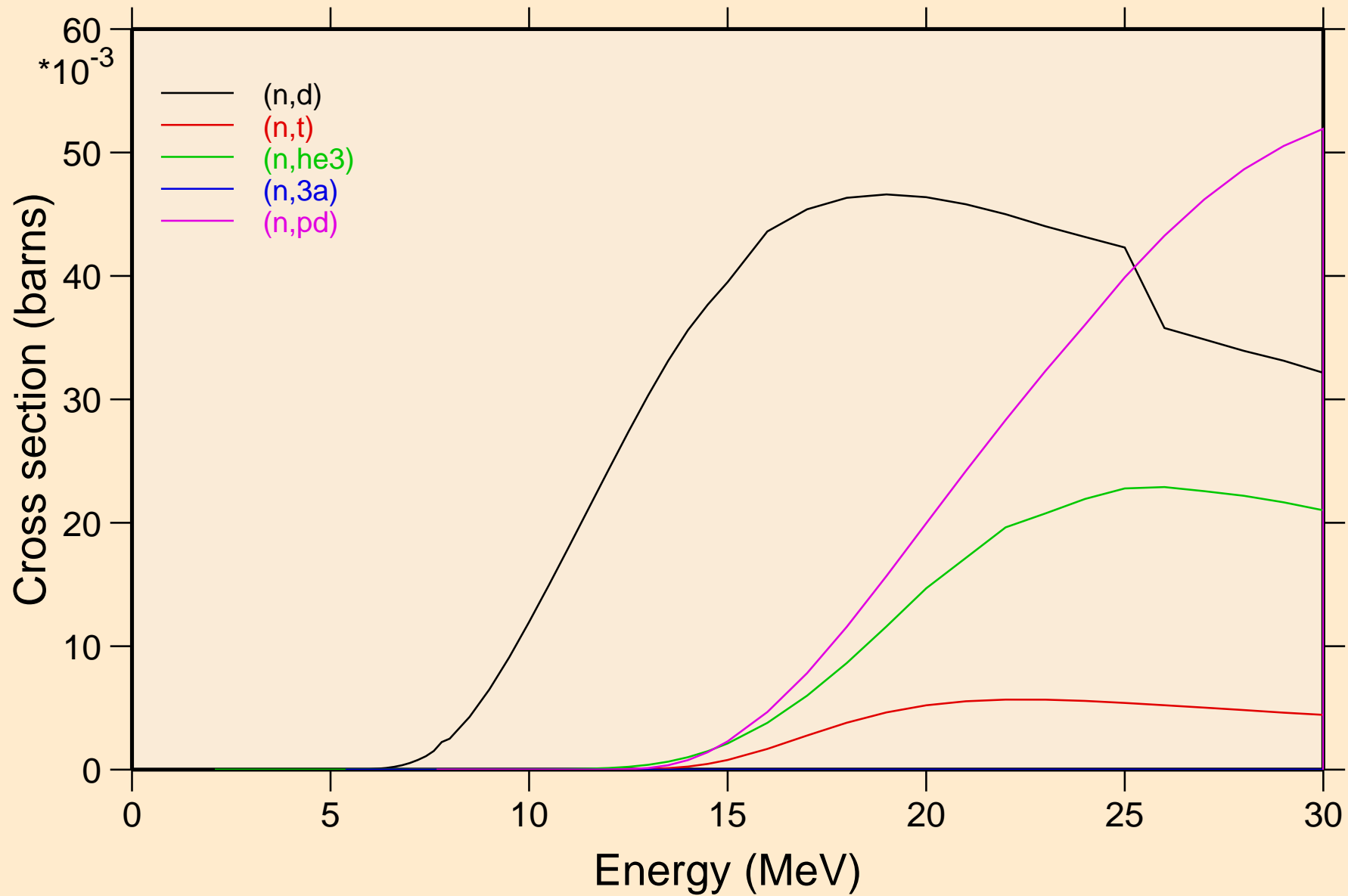

ZN061 NEUTRON ACER TENDL-2023 LIBRARY; T=0.K
Threshold reactions

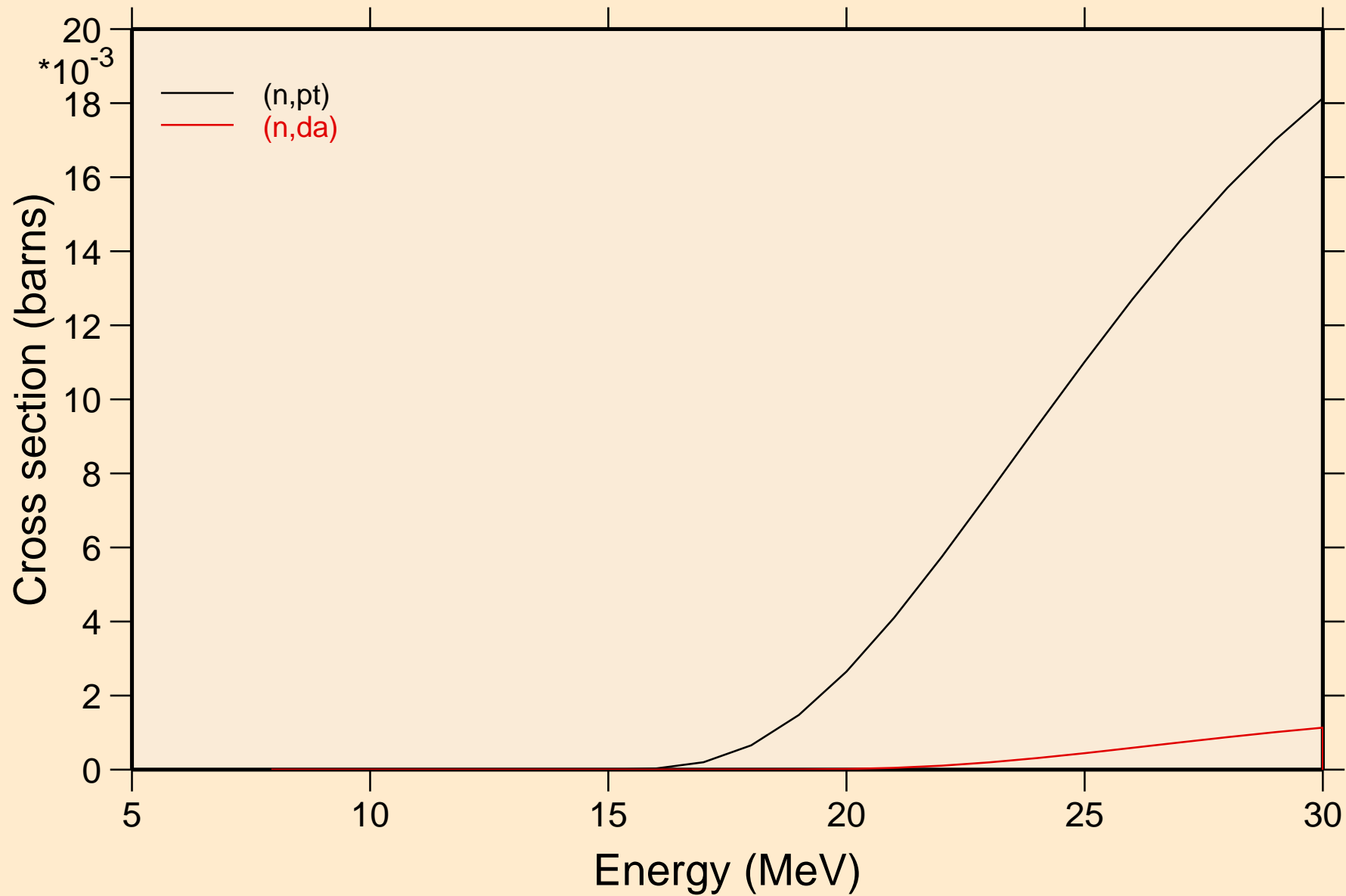

ZN061 NEUTRON ACER TENDL-2023 LIBRARY; T=0.K

Threshold reactions

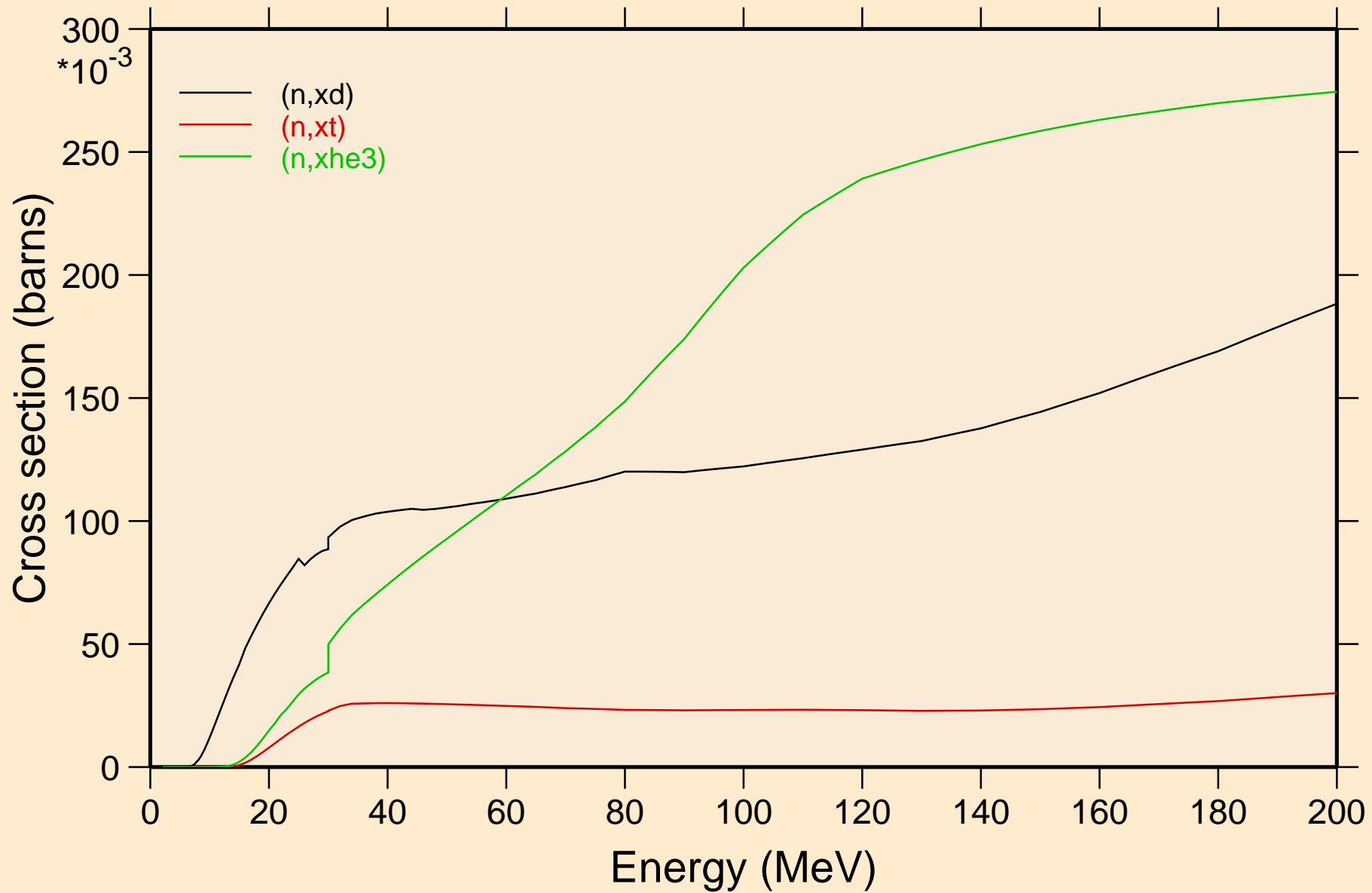

ZN061 NEUTRON ACER TENDL-2023 LIBRARY; T=0.K
angular distribution for elastic

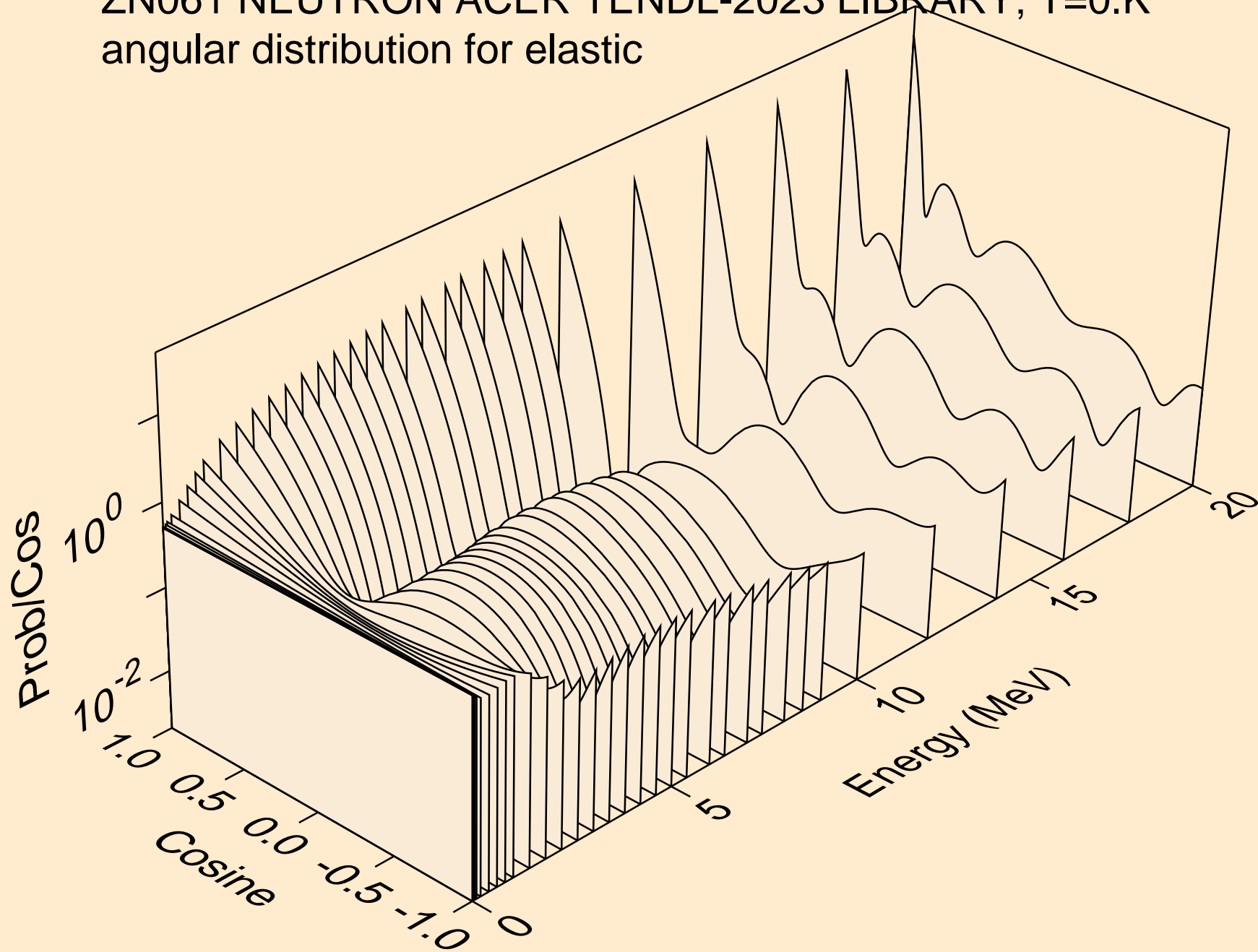

ZN061 NEUTRON ACER TENDL-2023 LIBRARY; T=0.K
angular distribution for elastic

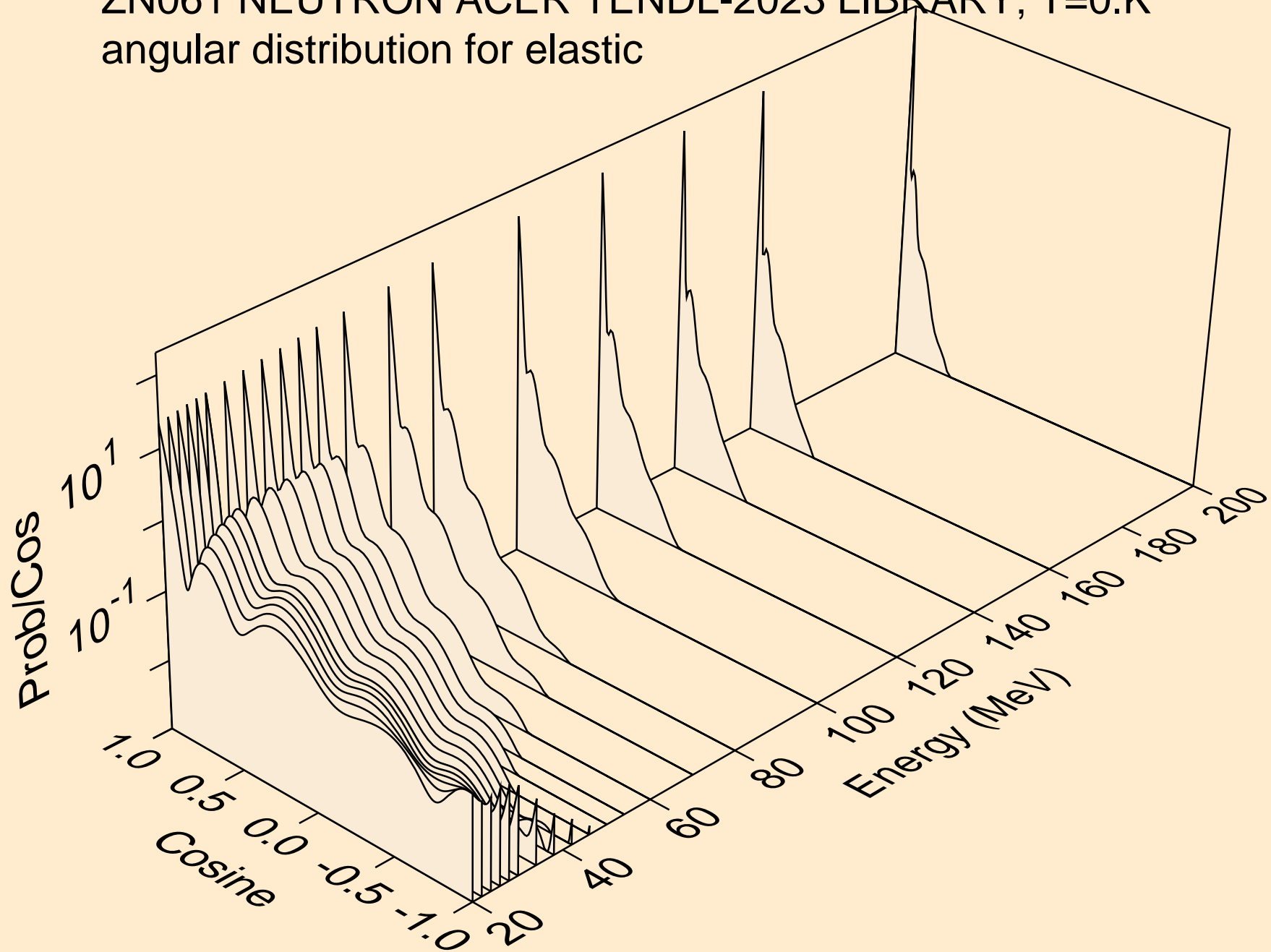

ZN061 NEUTRON ACER TENDL-2023 LIBRARY; T=0.K
angular distribution for (n,n*1)

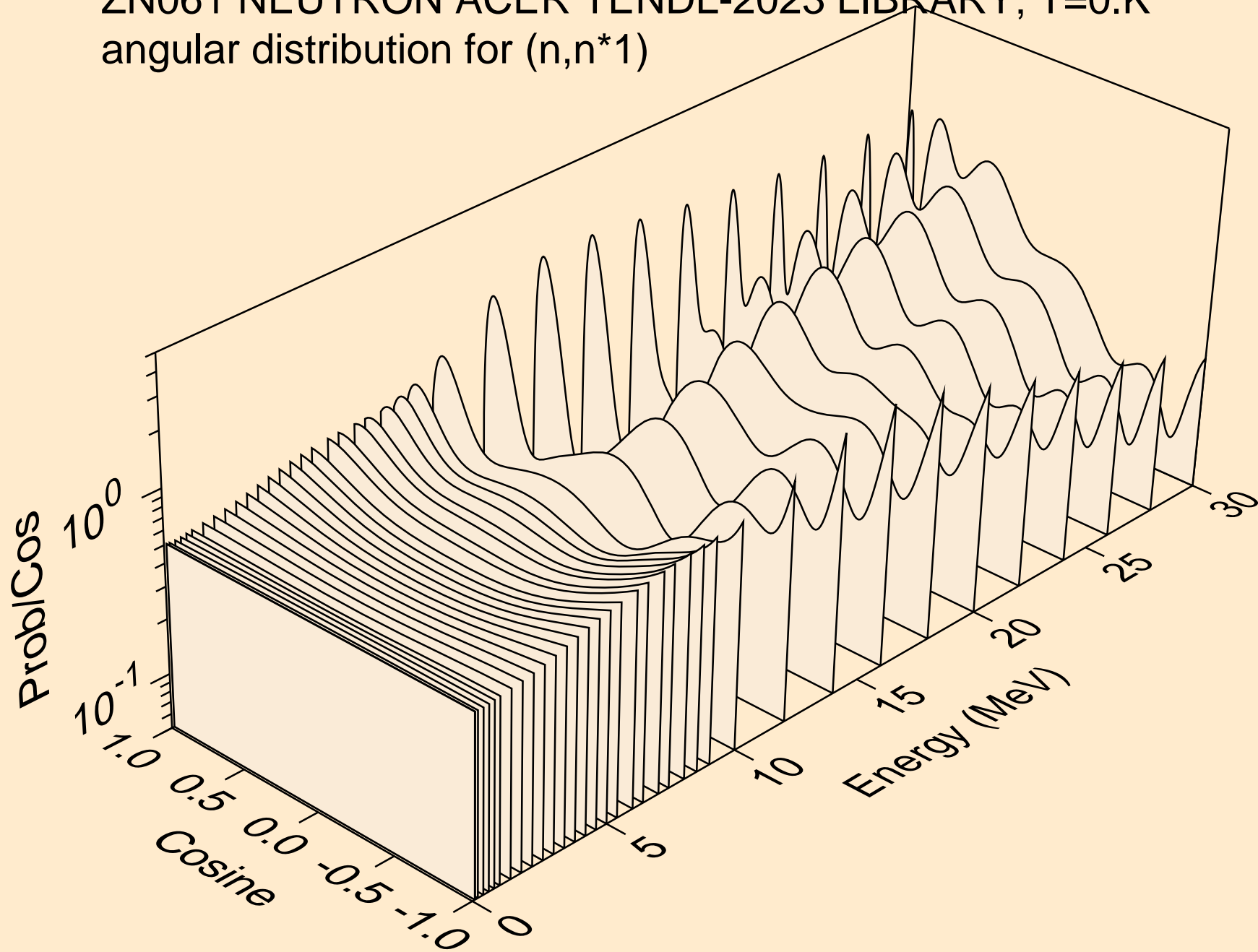

ZN061 NEUTRON ACER TENDL-2023 LIBRARY; T=0.K
angular distribution for (n,n*2)

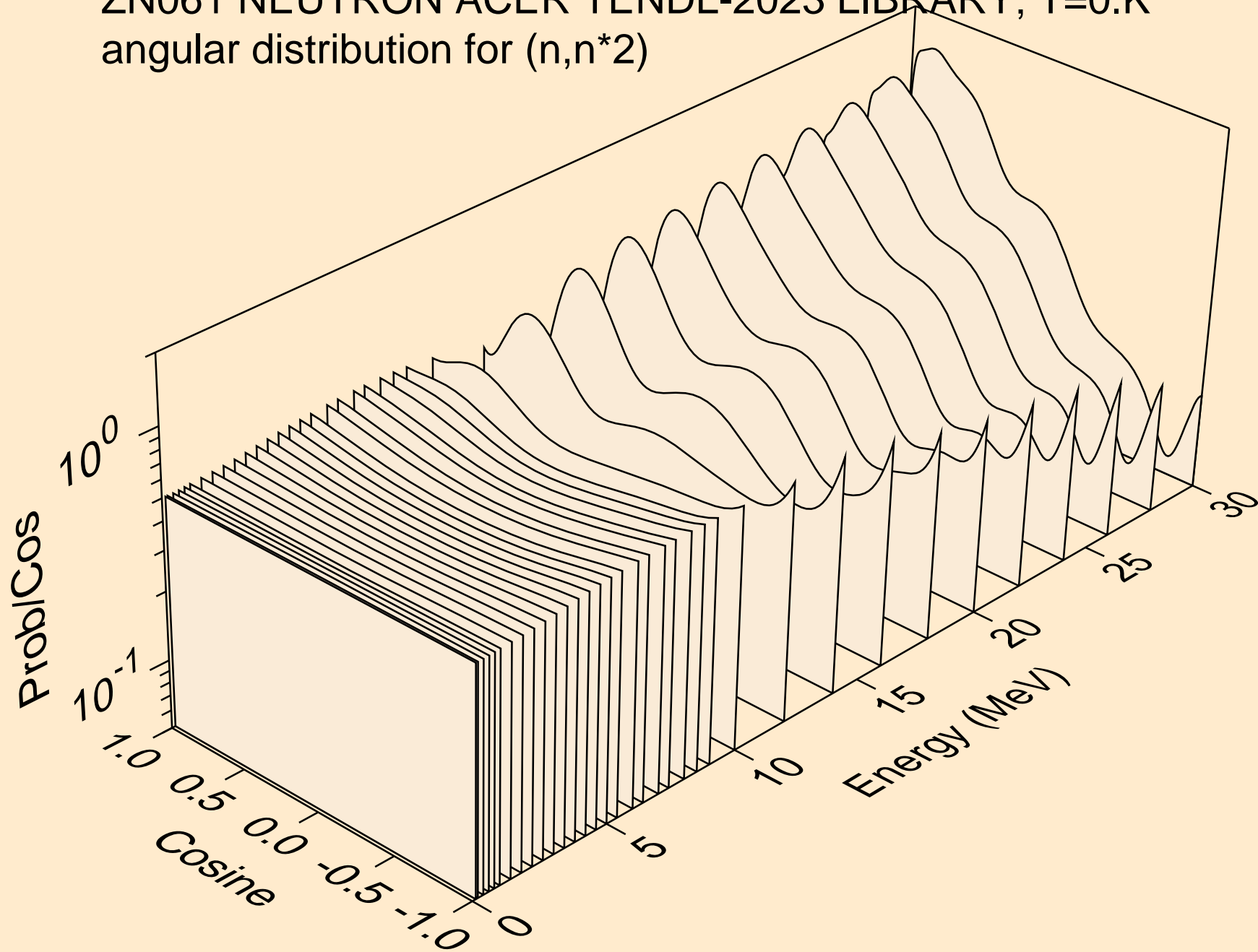

ZN061 NEUTRON ACER TENDL-2023 LIBRARY; T=0.K
angular distribution for (n,n*3)

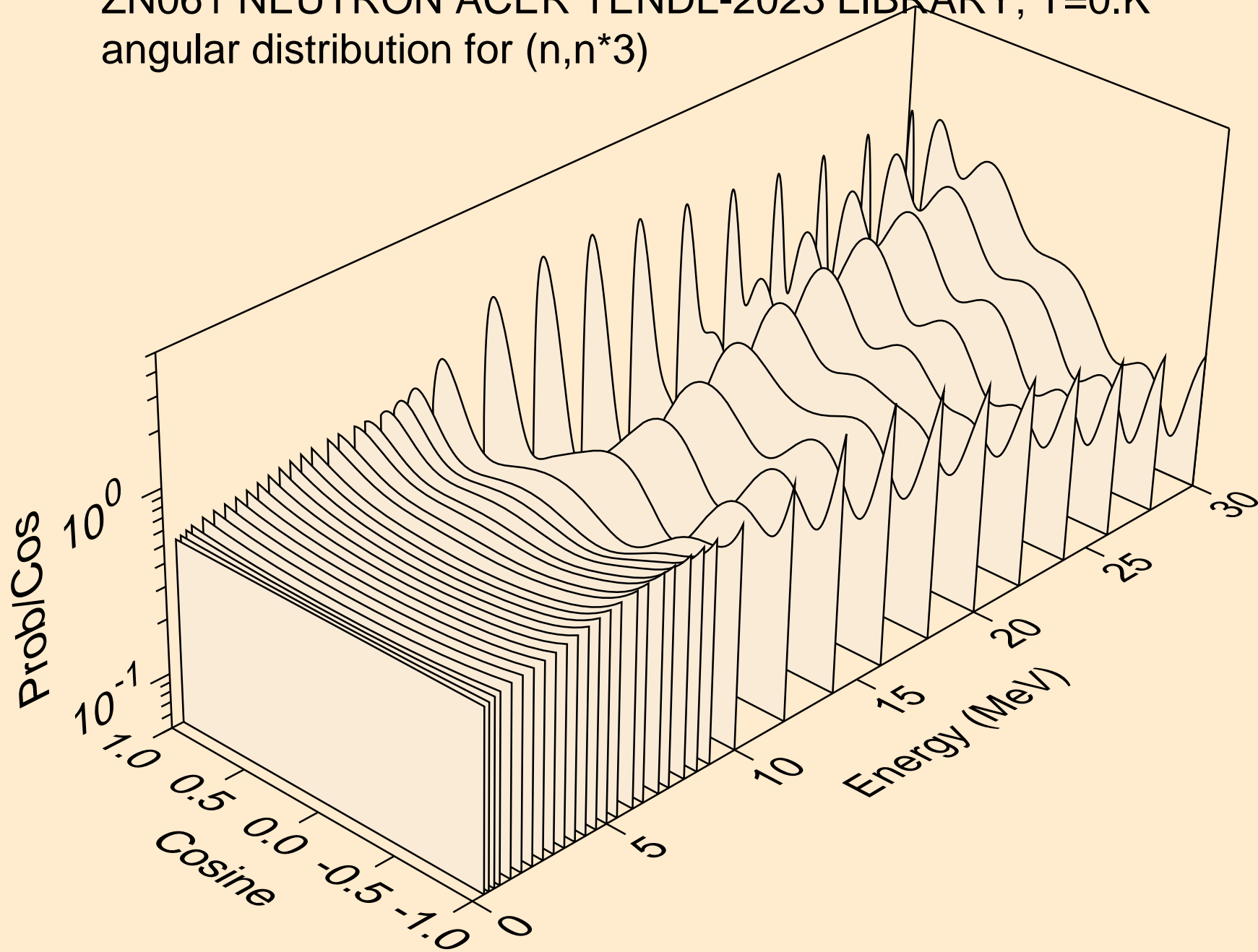

ZN061 NEUTRON ACER TENDL-2023 LIBRARY; T=0.K
angular distribution for (n,n*4)

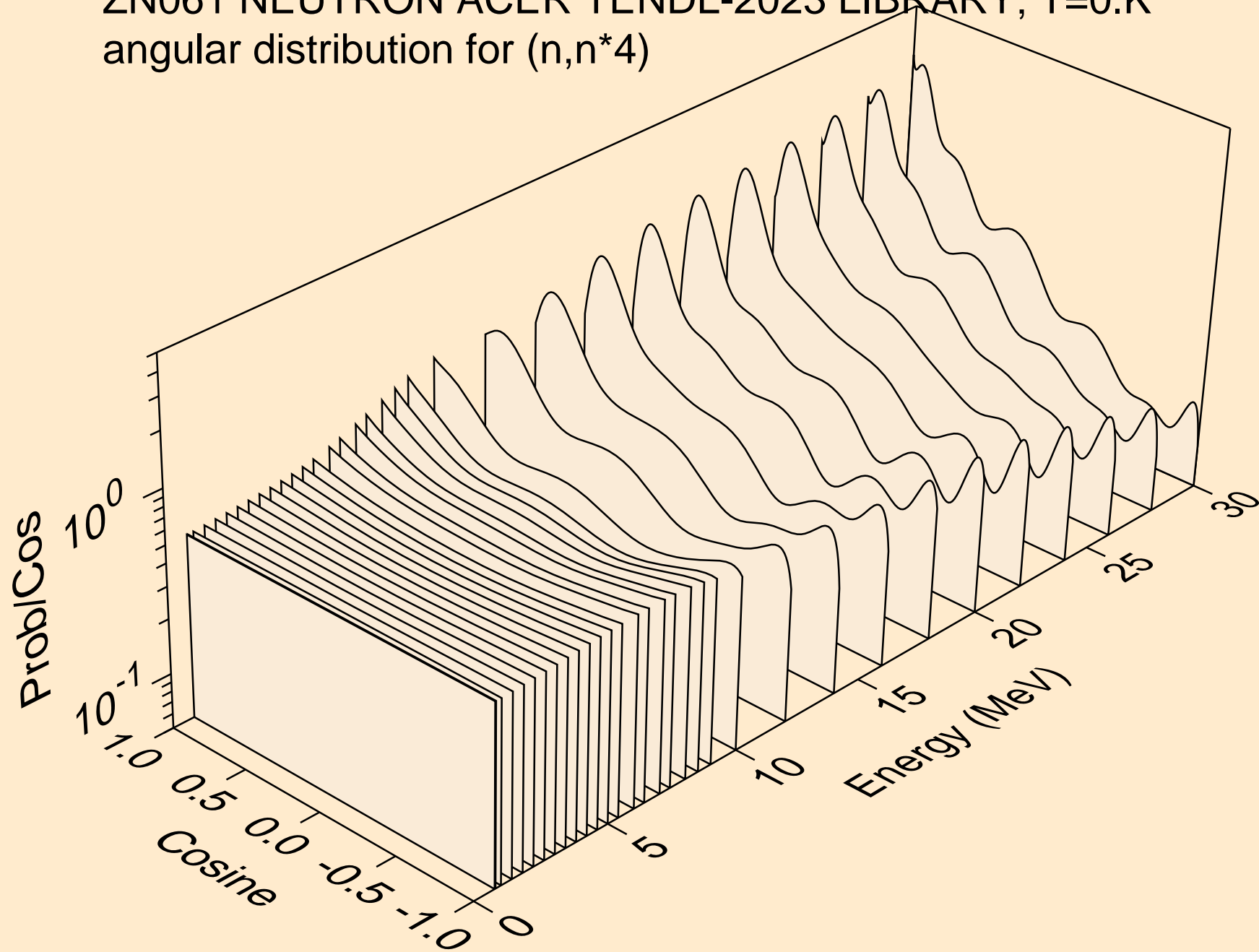

ZN061 NEUTRON ACER TENDL-2023 LIBRARY; T=0.K
angular distribution for (n,n*5)

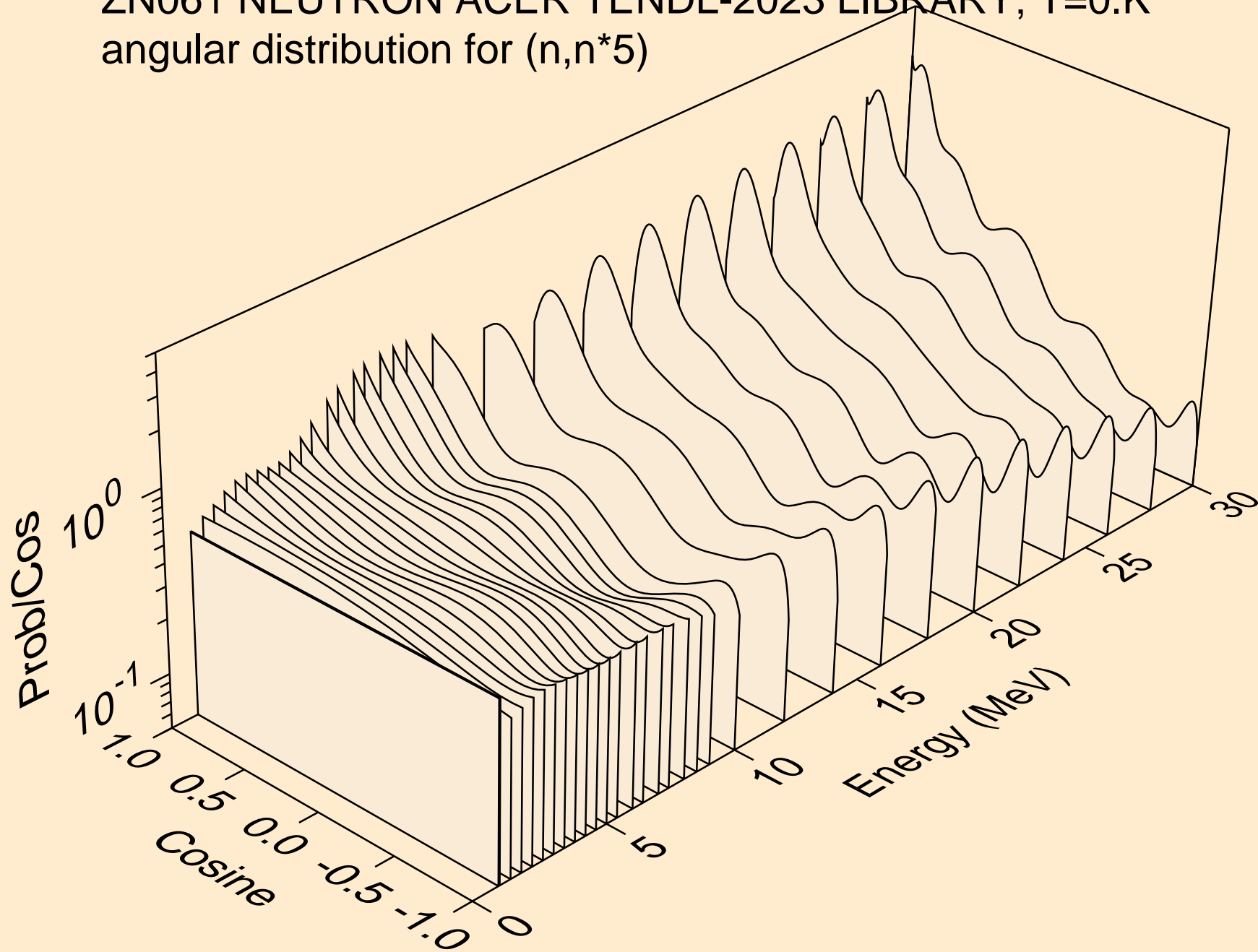

ZN061 NEUTRON ACER TENDL-2023 LIBRARY; T=0.K
angular distribution for (n,n*6)

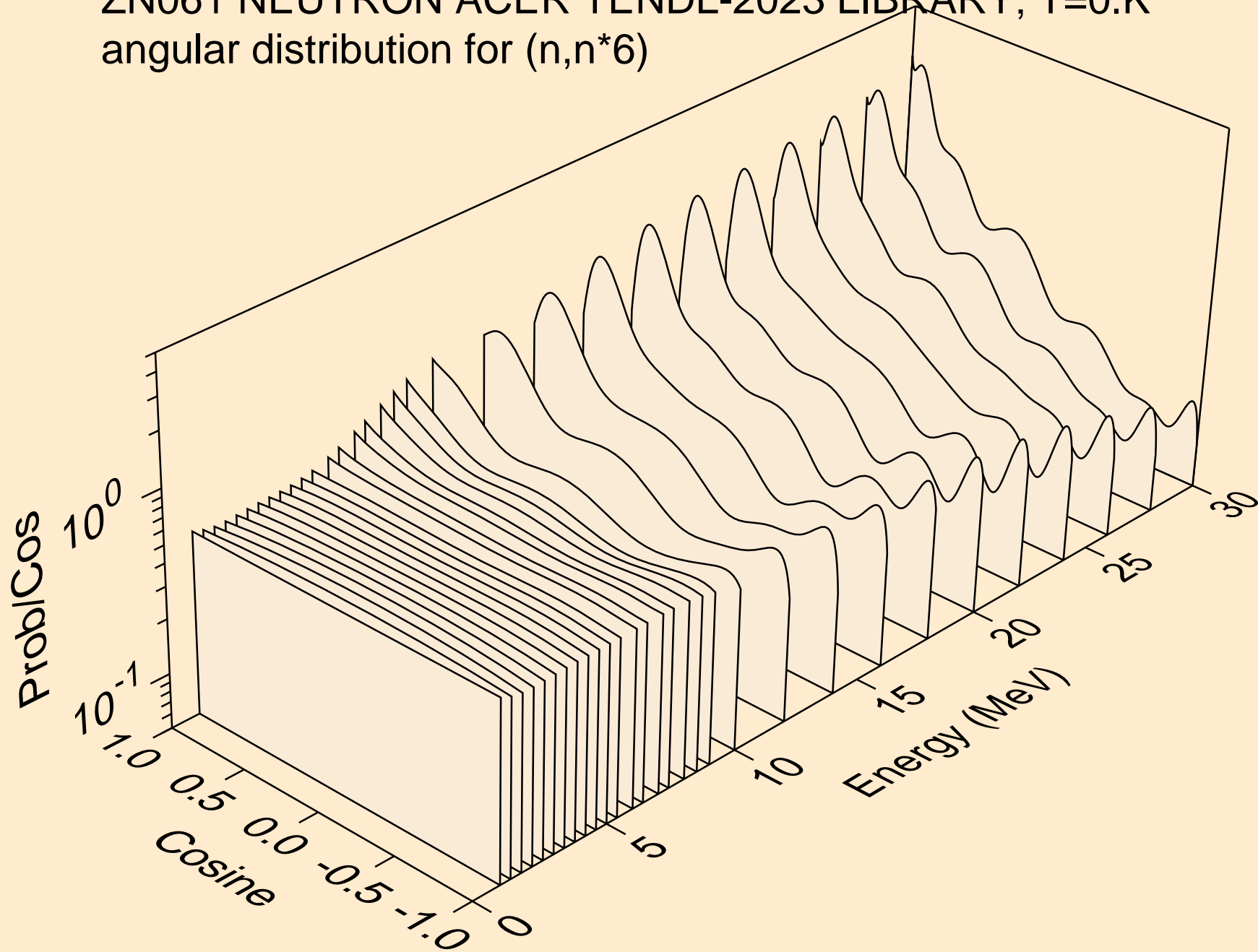

ZN061 NEUTRON ACER TENDL-2023 LIBRARY; T=0.K
angular distribution for (n,n*7)

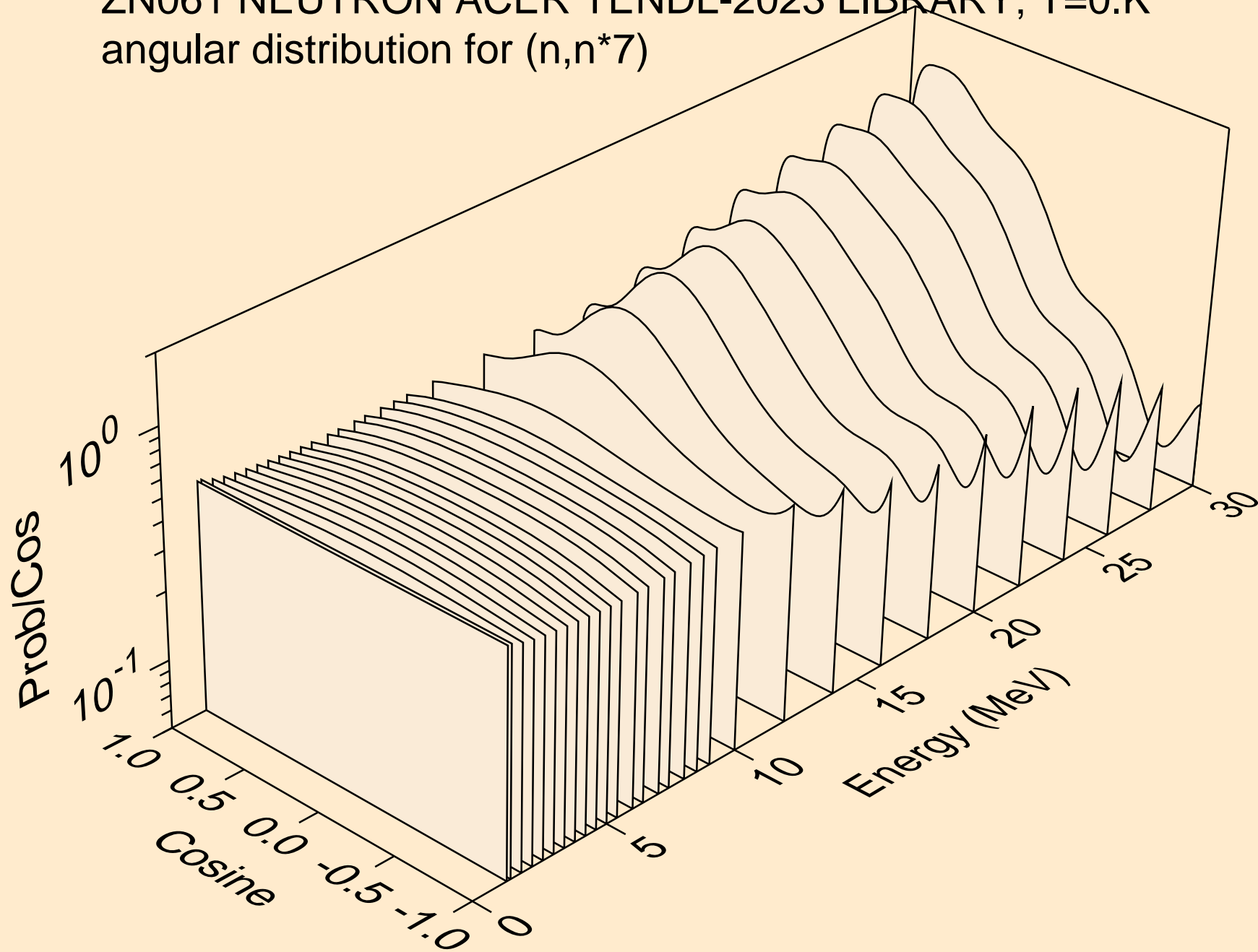

ZN061 NEUTRON ACER TENDL-2023 LIBRARY; T=0.K
angular distribution for (n,n*8)

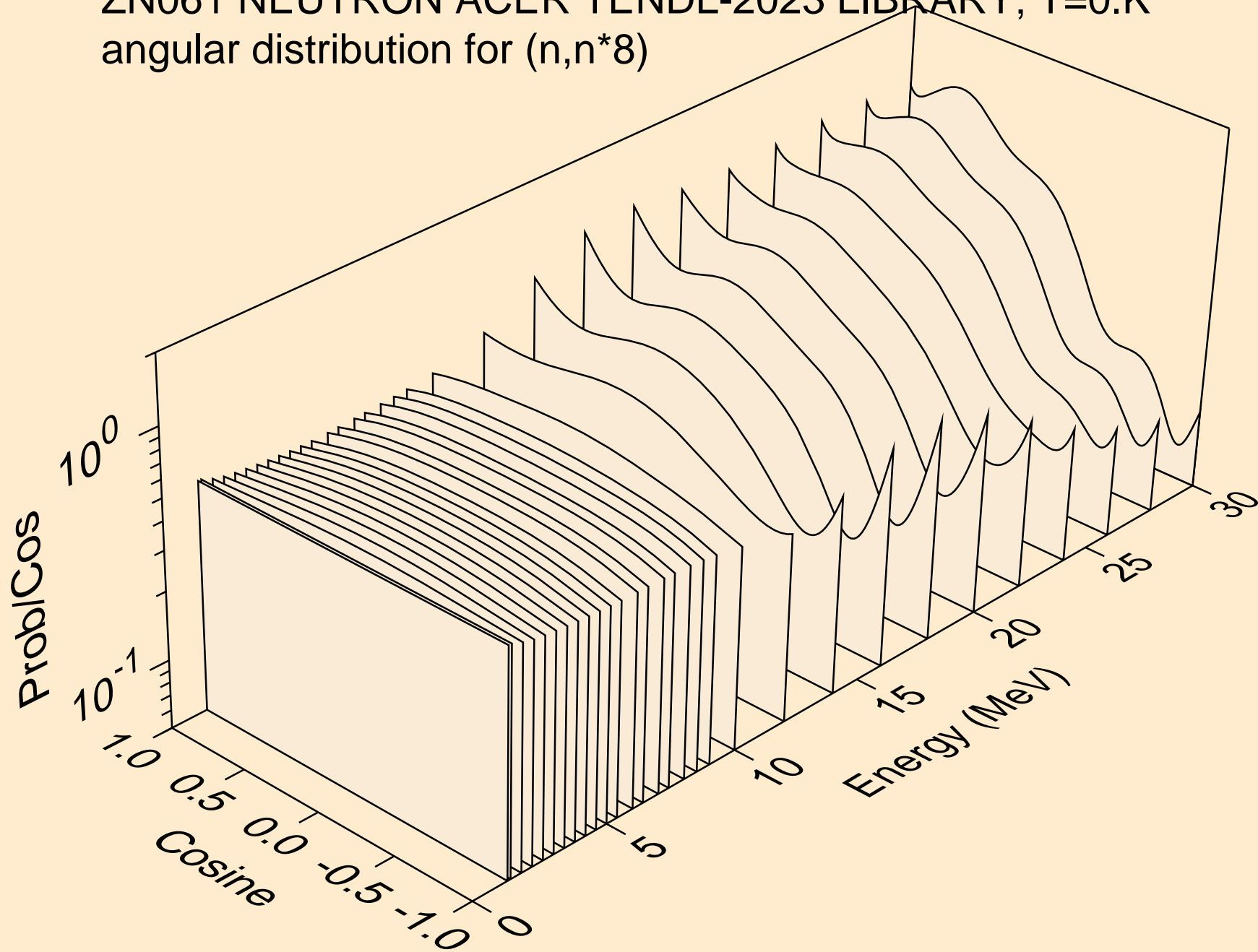

ZN061 NEUTRON ACER TENDL-2023 LIBRARY; T=0.K
angular distribution for (n,n*9)

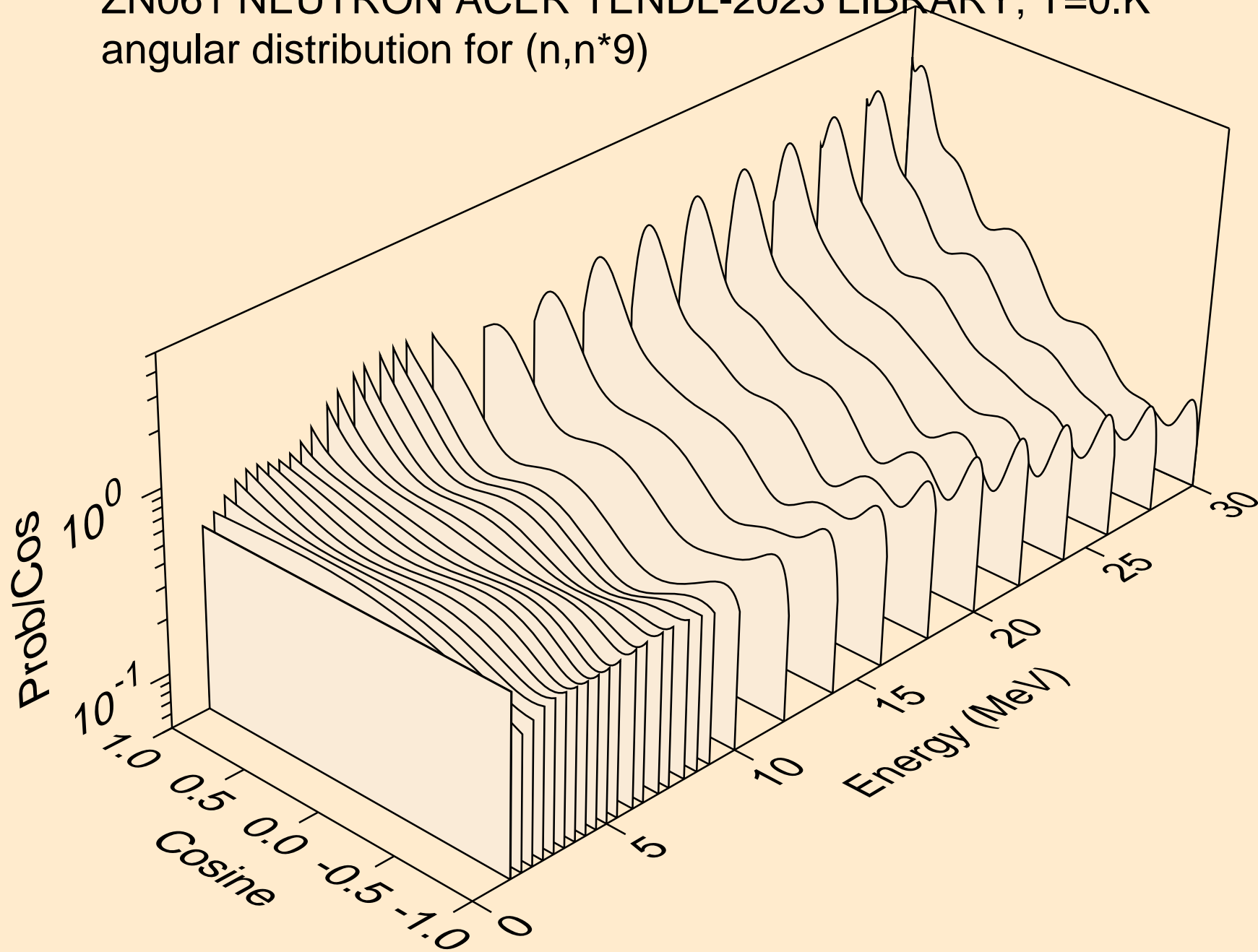

ZN061 NEUTRON ACER TENDL-2023 LIBRARY; T=0.K
angular distribution for (n,n*10)

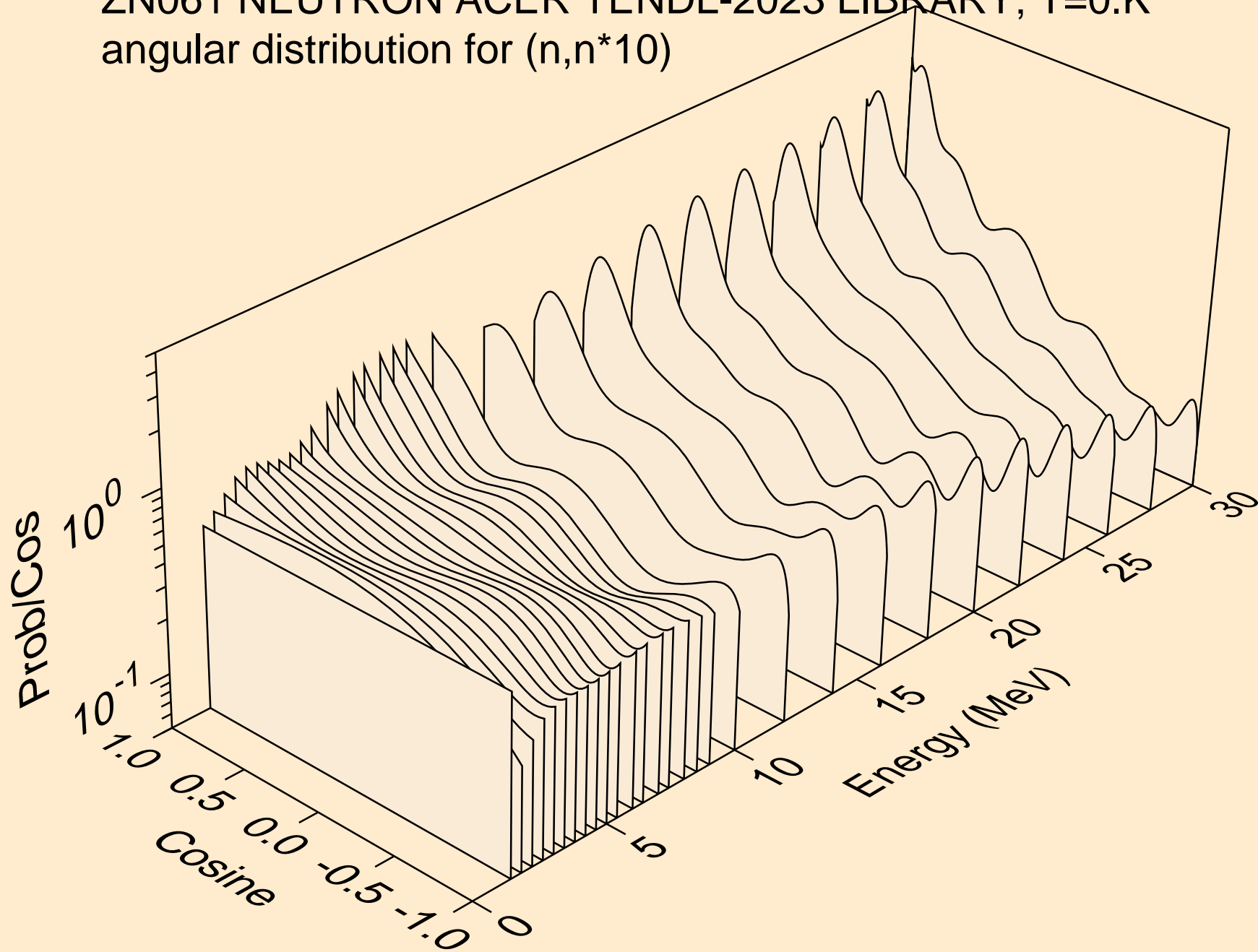

ZN061 NEUTRON ACER TENDL-2023 LIBRARY; T=0.K
angular distribution for (n,n*11)

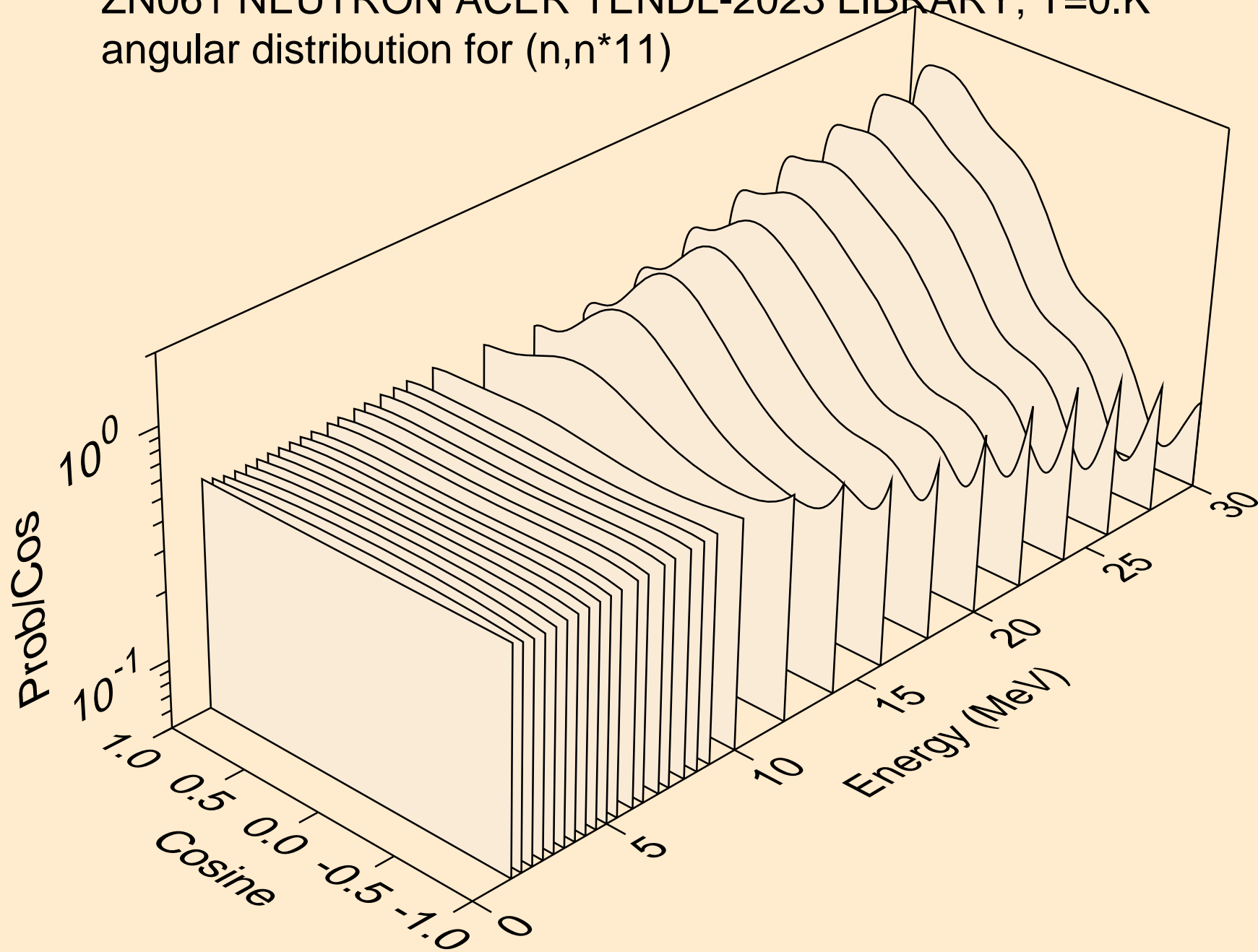

ZN061 NEUTRON ACER TENDL-2023 LIBRARY; T=0.K
angular distribution for (n,n*12)

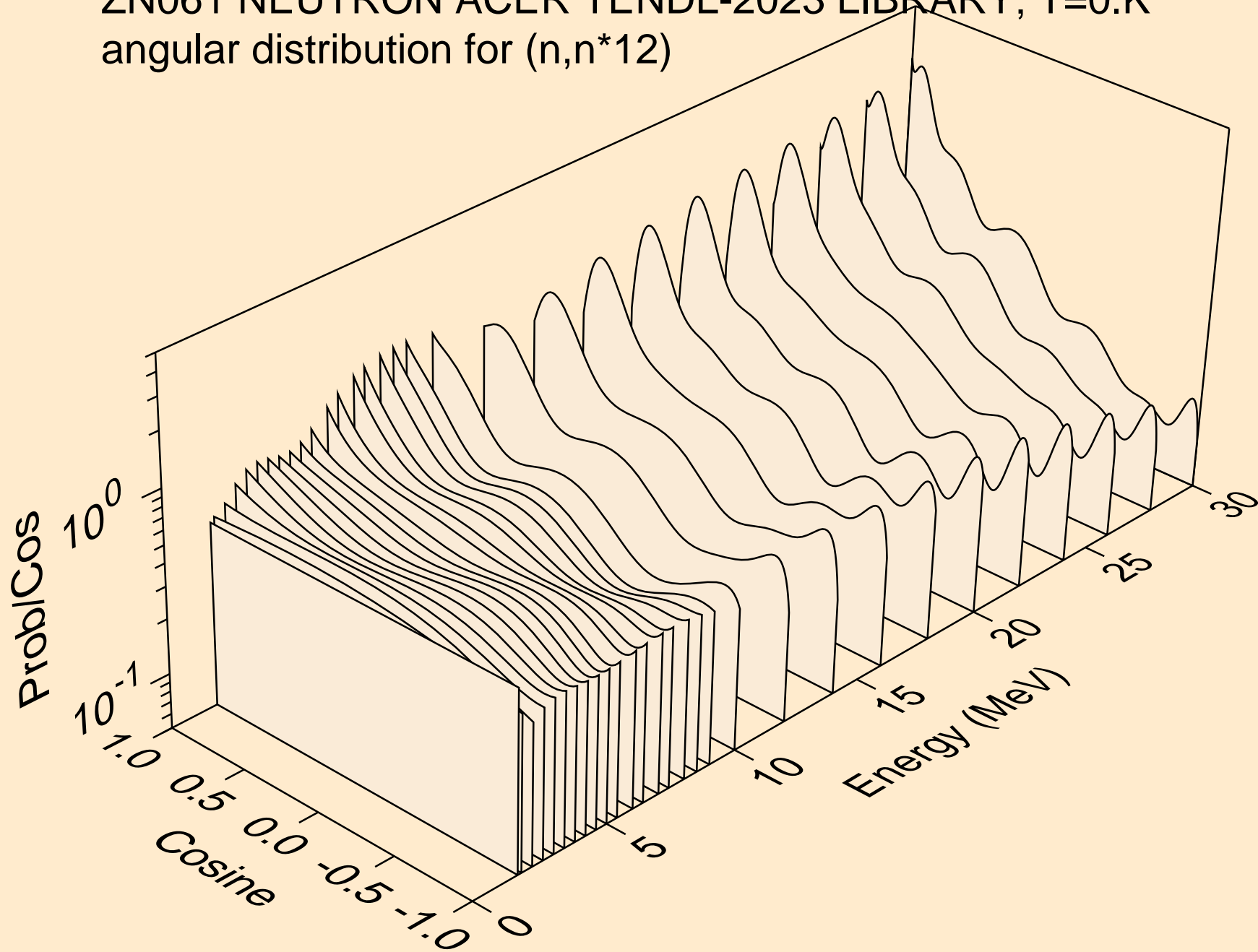

ZN061 NEUTRON ACER TENDL-2023 LIBRARY; T=0.K
Neutron emission for (n,x)

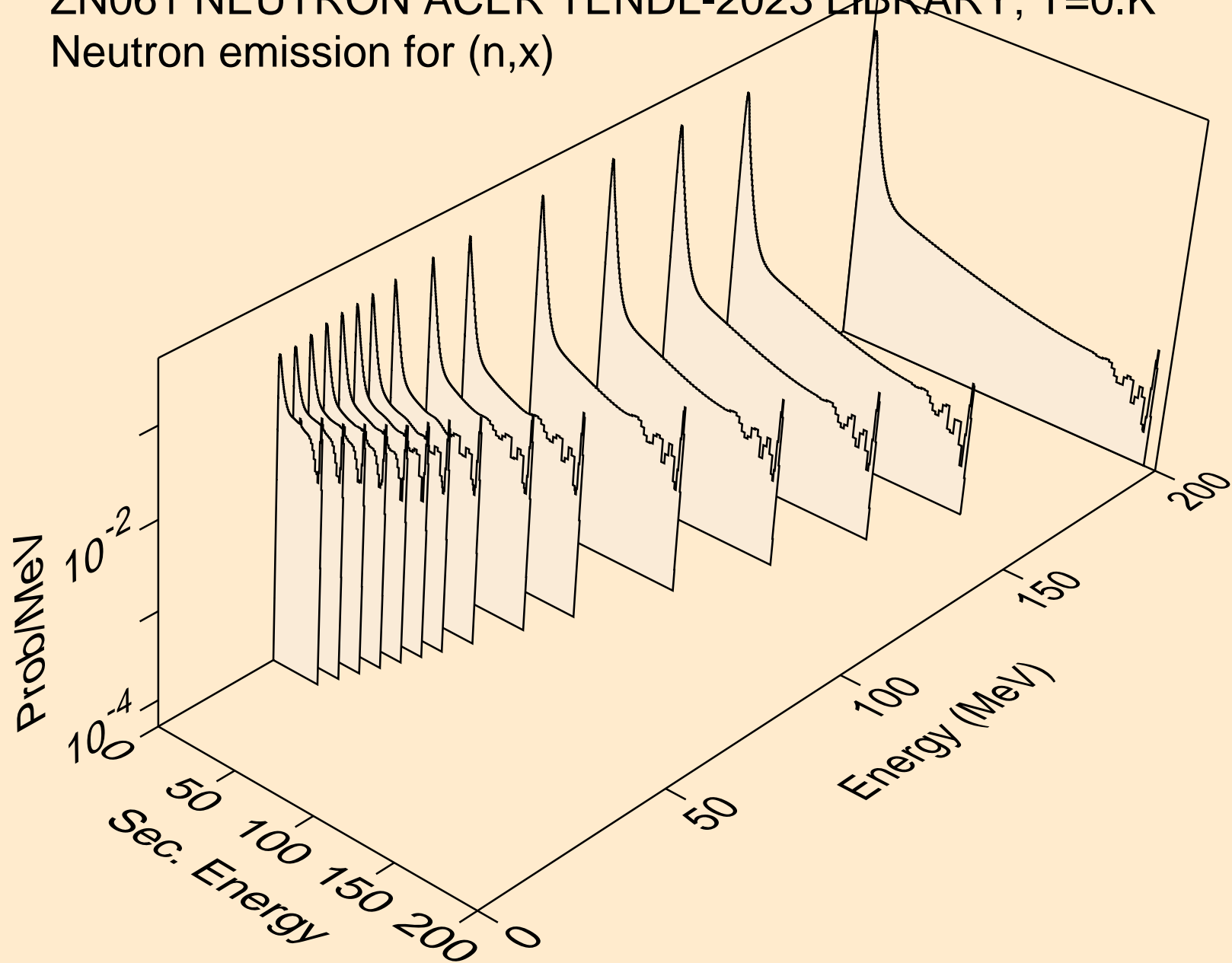

ZN061 NEUTRON ACER TENDL-2023 LIBRARY; T=0.K
Neutron emission for (n,2nd)

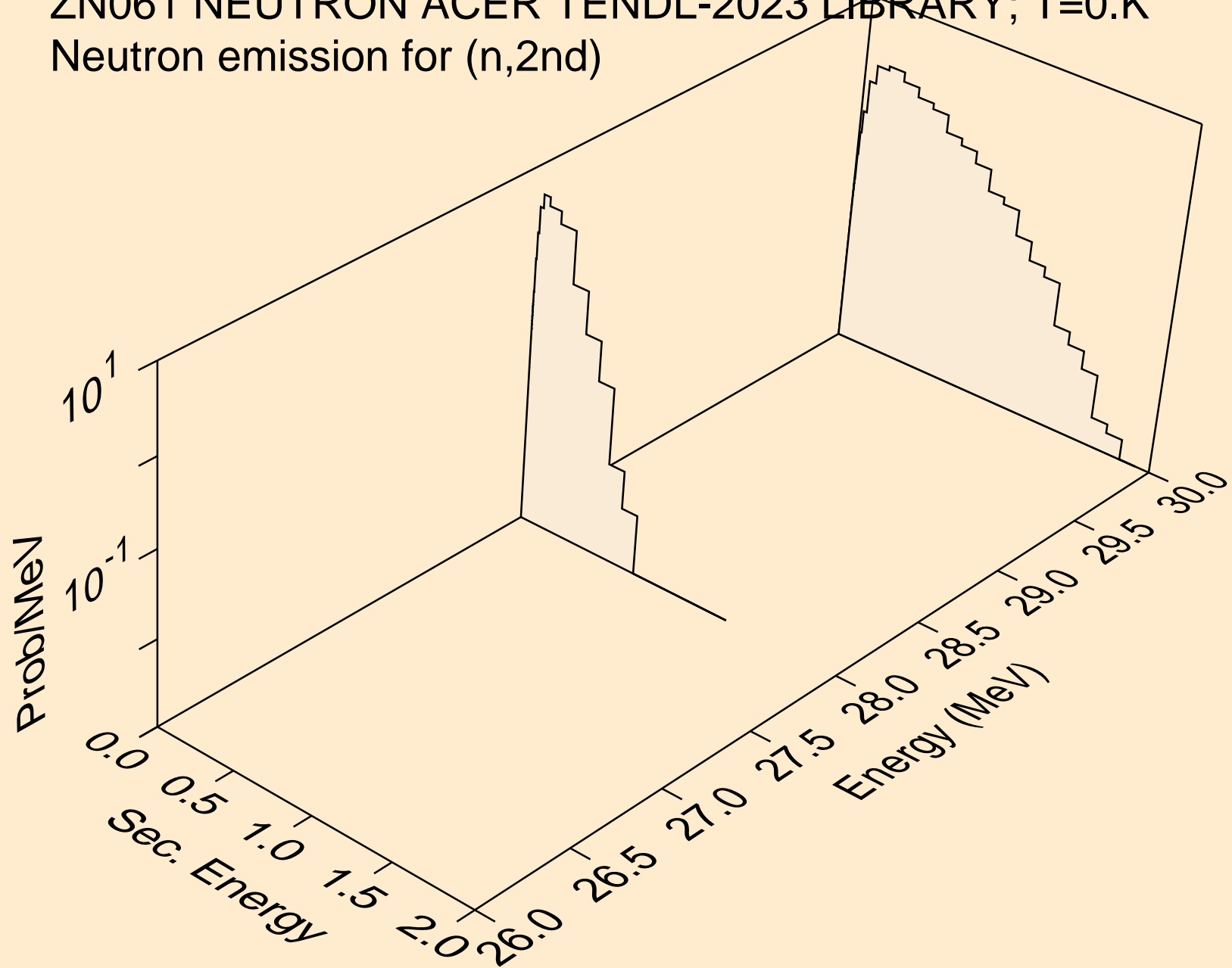

ZN061 NEUTRON ACER TENDL-2023 LIBRARY; T=0.K
Neutron emission for (n,2n)

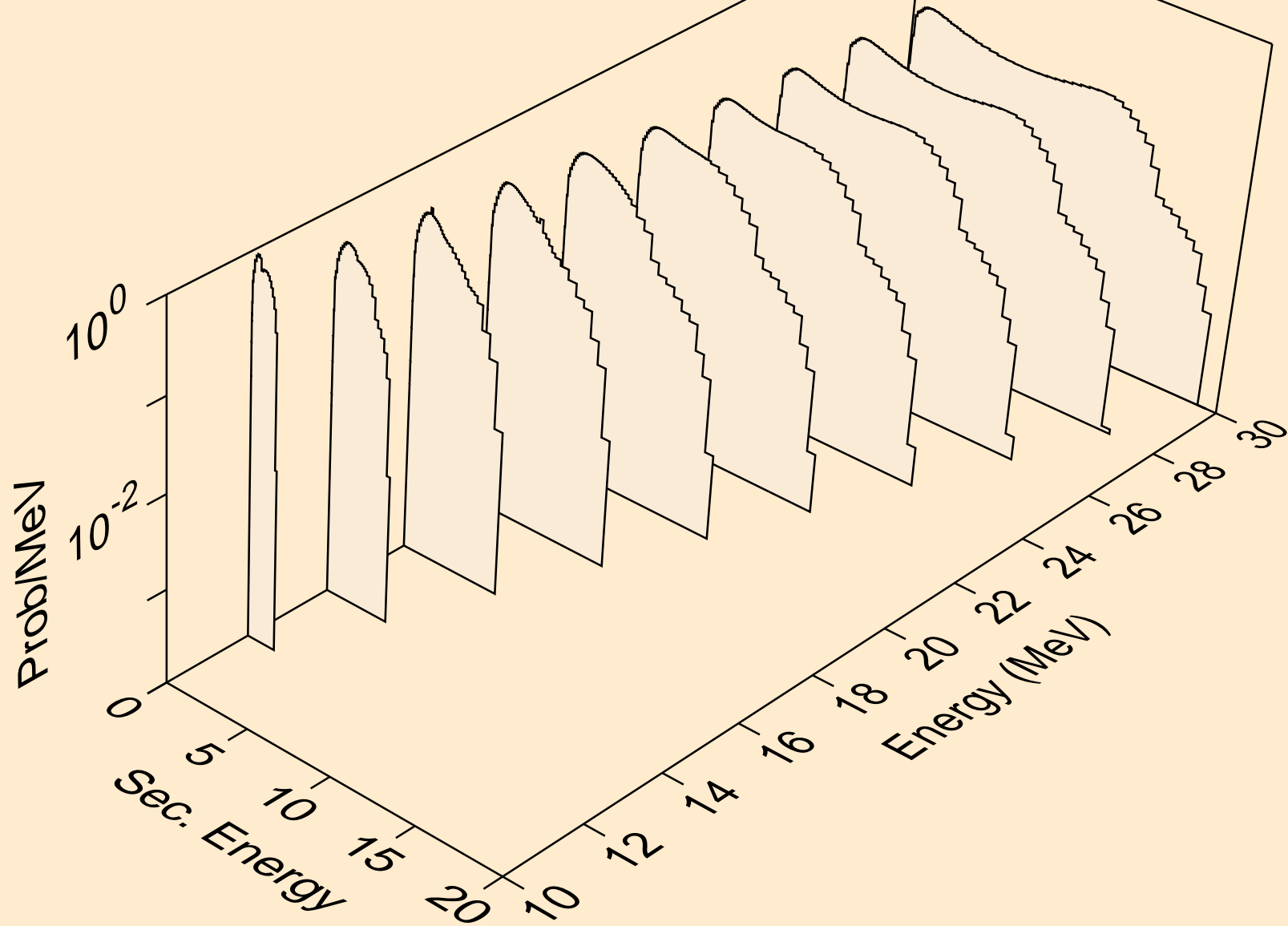

ZN061 NEUTRON ACER TENDL-2023 LIBRARY; T=0.K
Neutron emission for (n,3n)

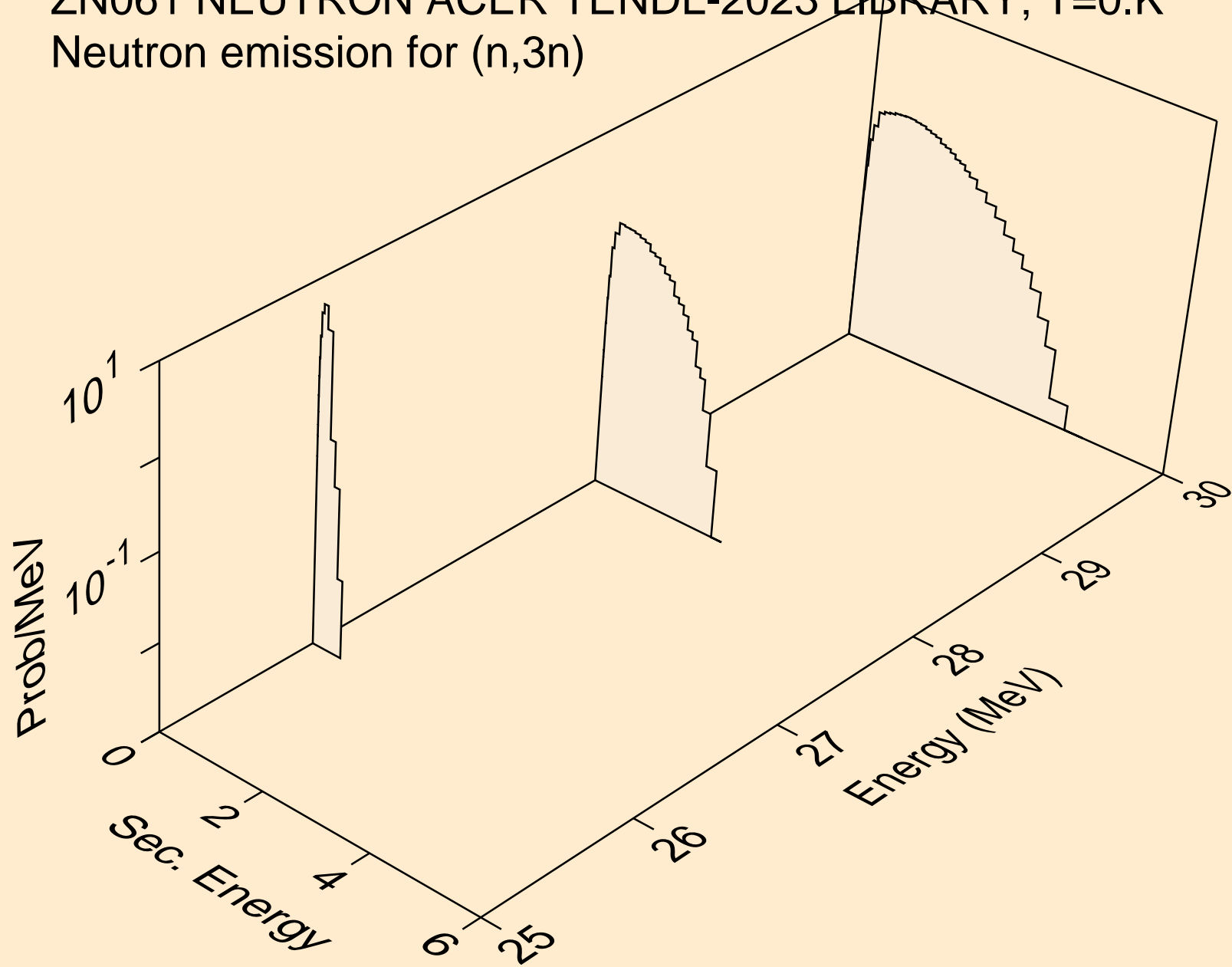

ZN061 NEUTRON ACER TENDL-2023 LIBRARY; T=0.K
Neutron emission for (n,n*)a

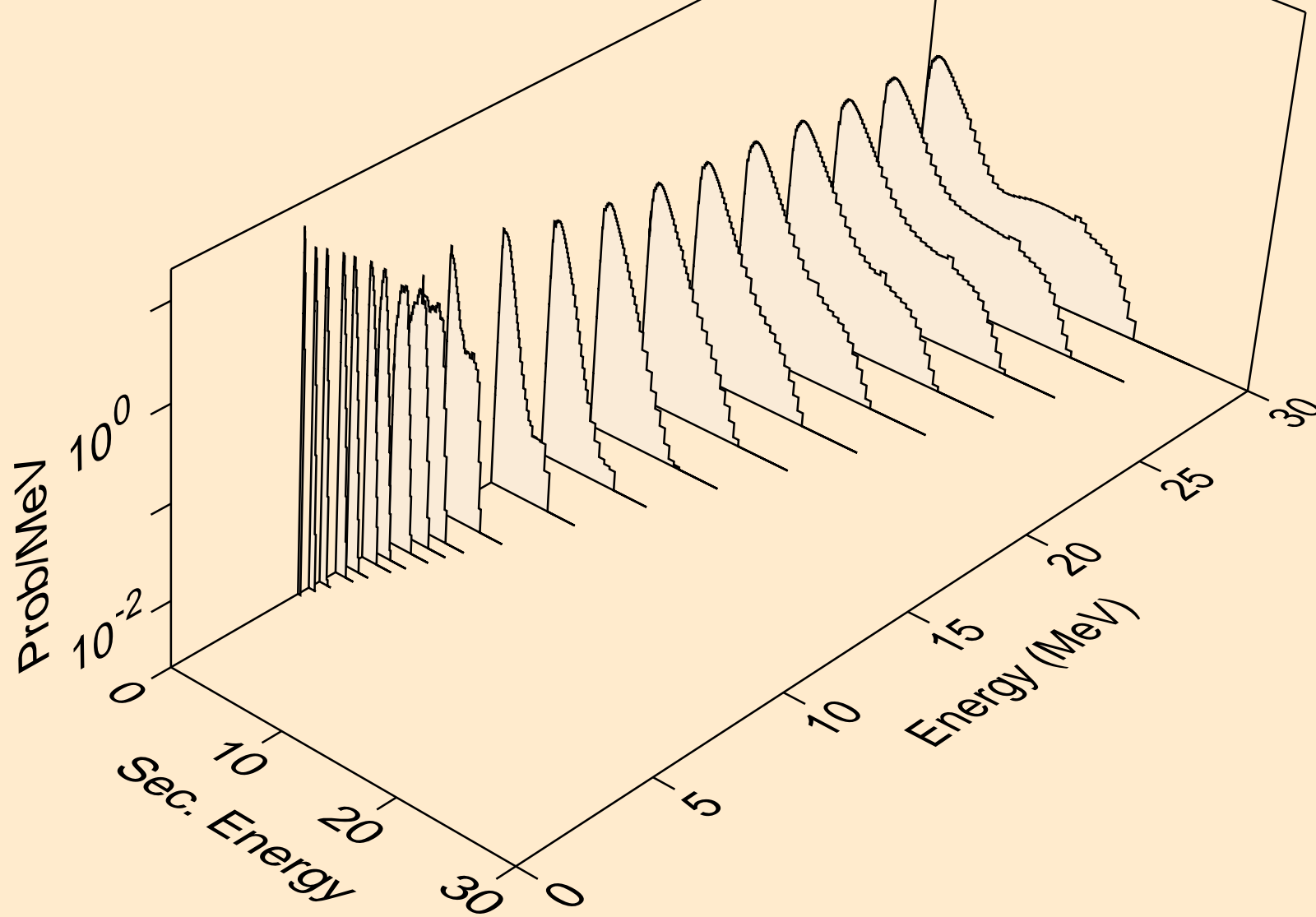

ZN061 NEUTRON ACER TENDL-2023 LIBRARY; T=0.K
Neutron emission for (n,2n)a

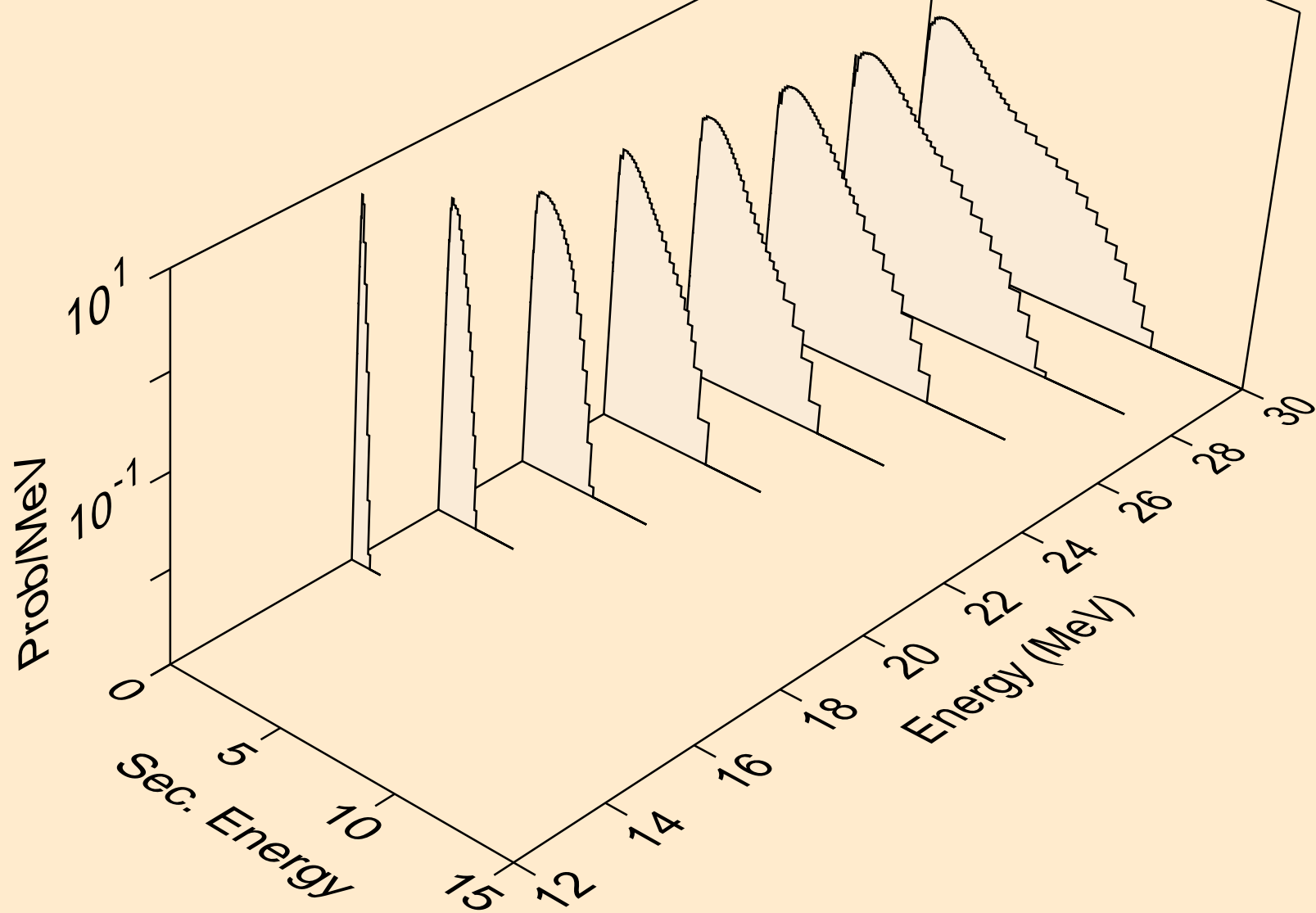

ZN061 NEUTRON ACER TENDL-2023 LIBRARY; T=0.K
Neutron emission for (n,n*)p

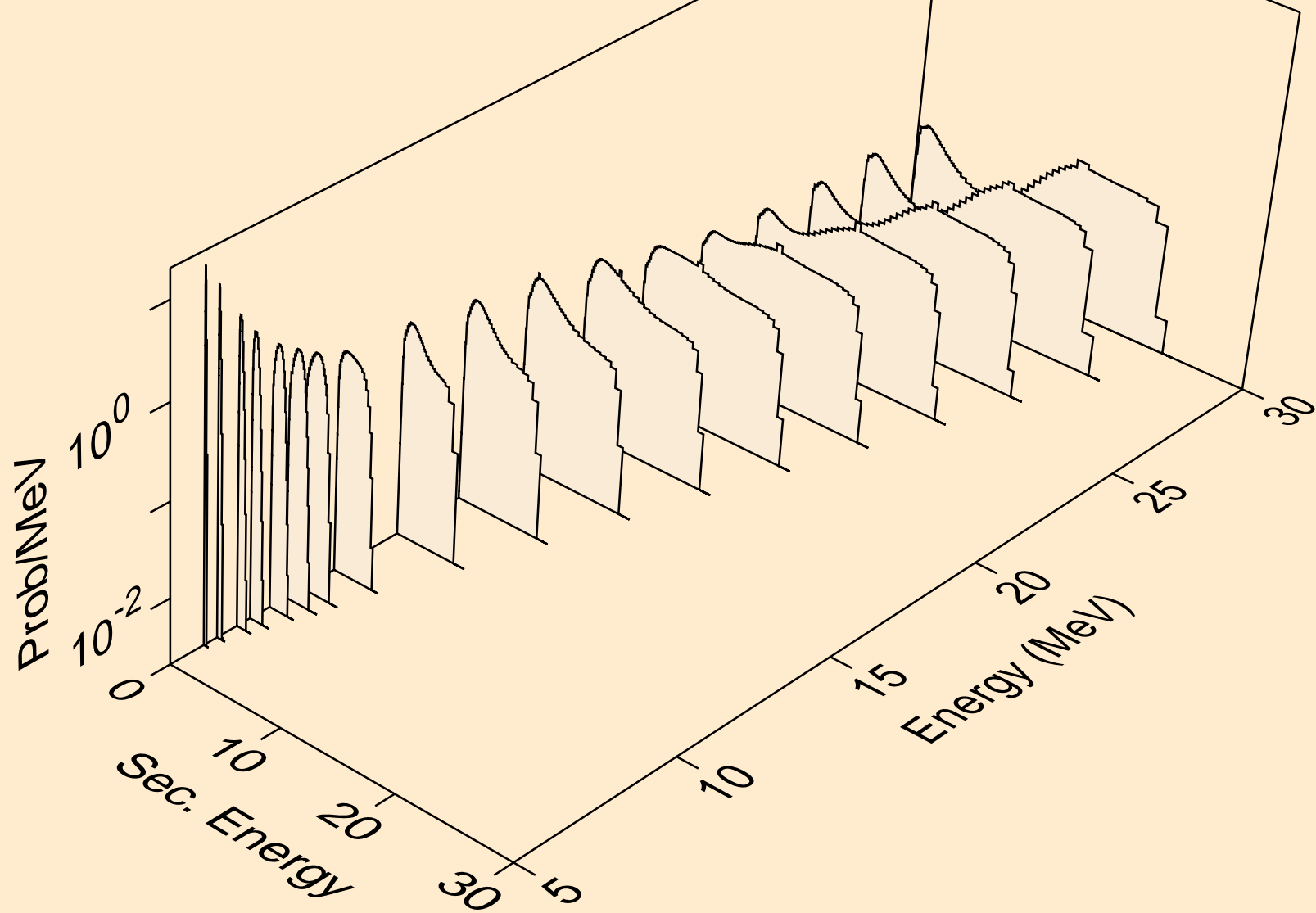

ZN061 NEUTRON ACER TENDL-2023 LIBRARY; T=0.K
Neutron emission for (n,n*)2a

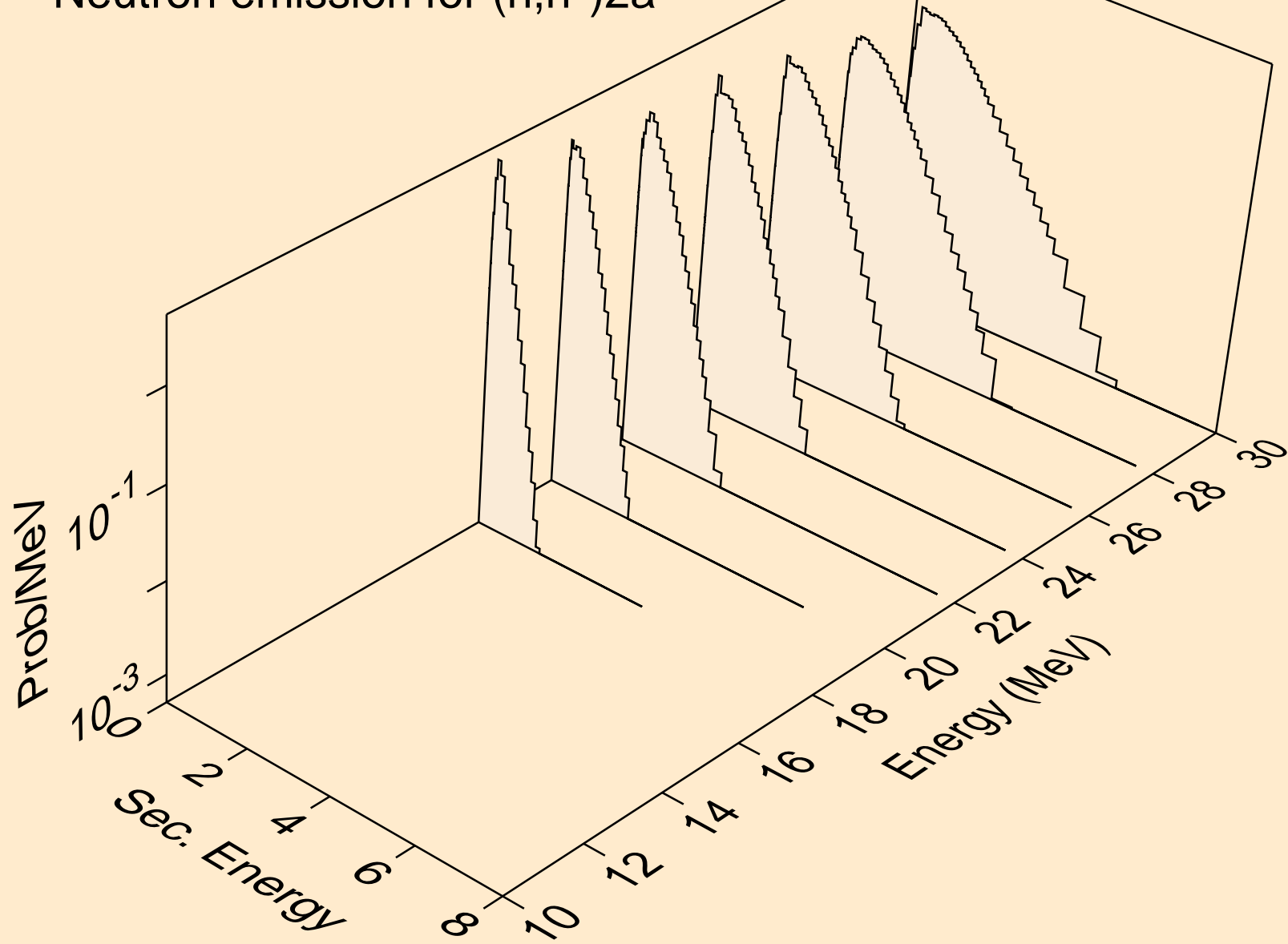

ZN061 NEUTRON ACER TENDL-2023 LIBRARY; T=0.K
Neutron emission for (n,n*)d

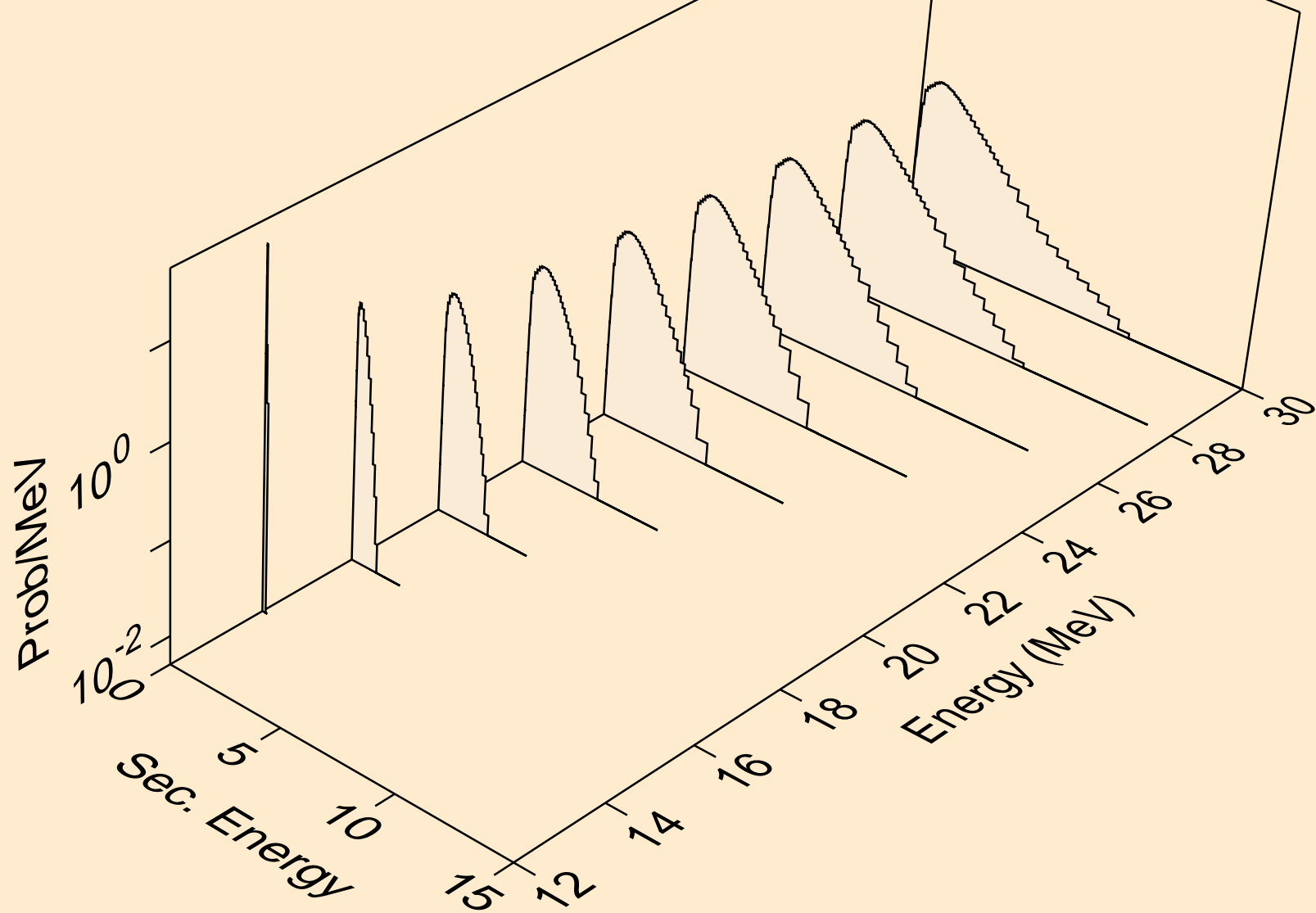

ZN061 NEUTRON ACER TENDL-2023 LIBRARY; T=0.K
Neutron emission for (n,n*)t

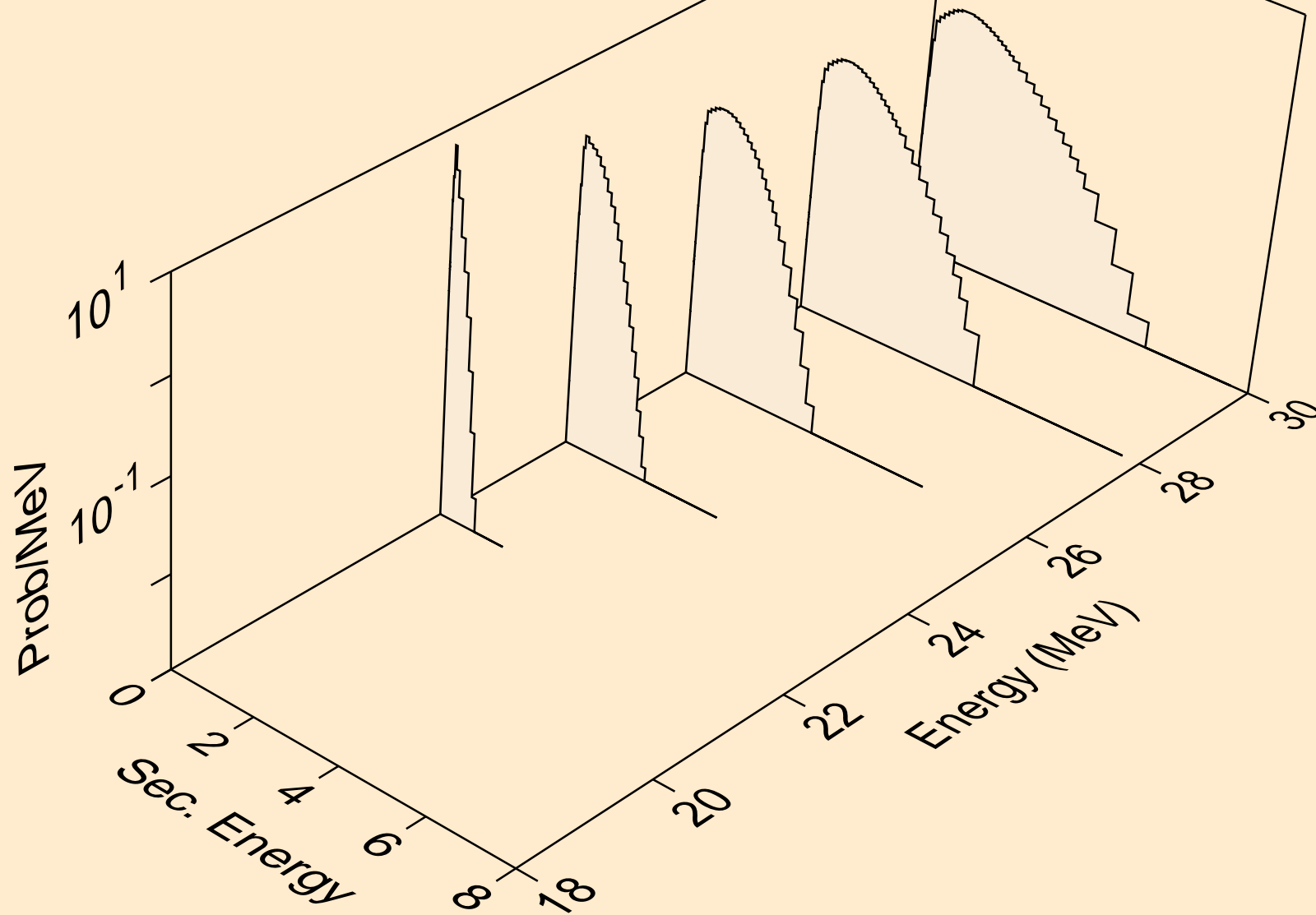

ZN061 NEUTRON ACER TENDL-2023 LIBRARY; T=0.K
Neutron emission for (n,n*)he3

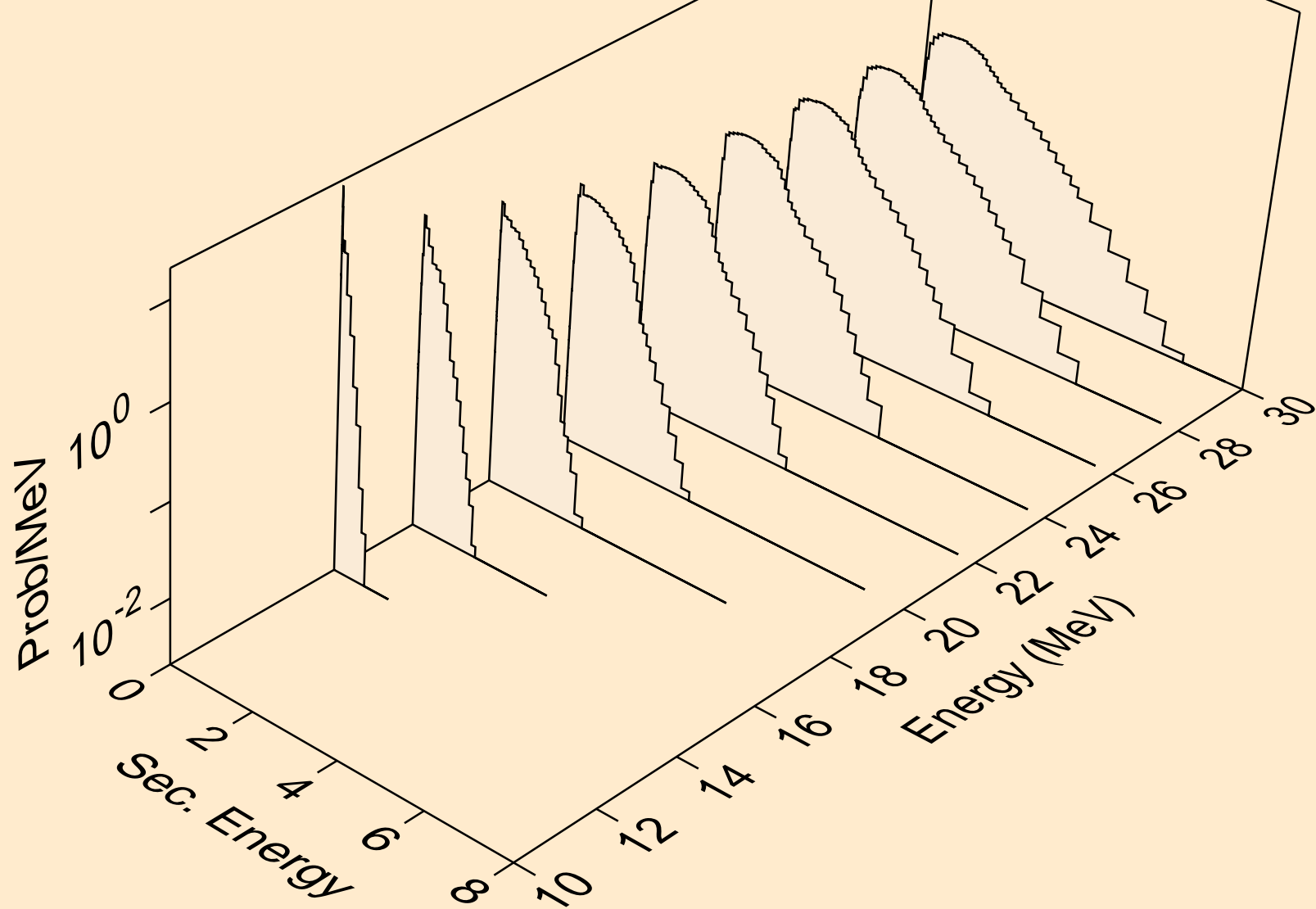

ZN061 NEUTRON ACER TENDL-2023 LIBRARY; T=0.K
Neutron emission for (n,2np)

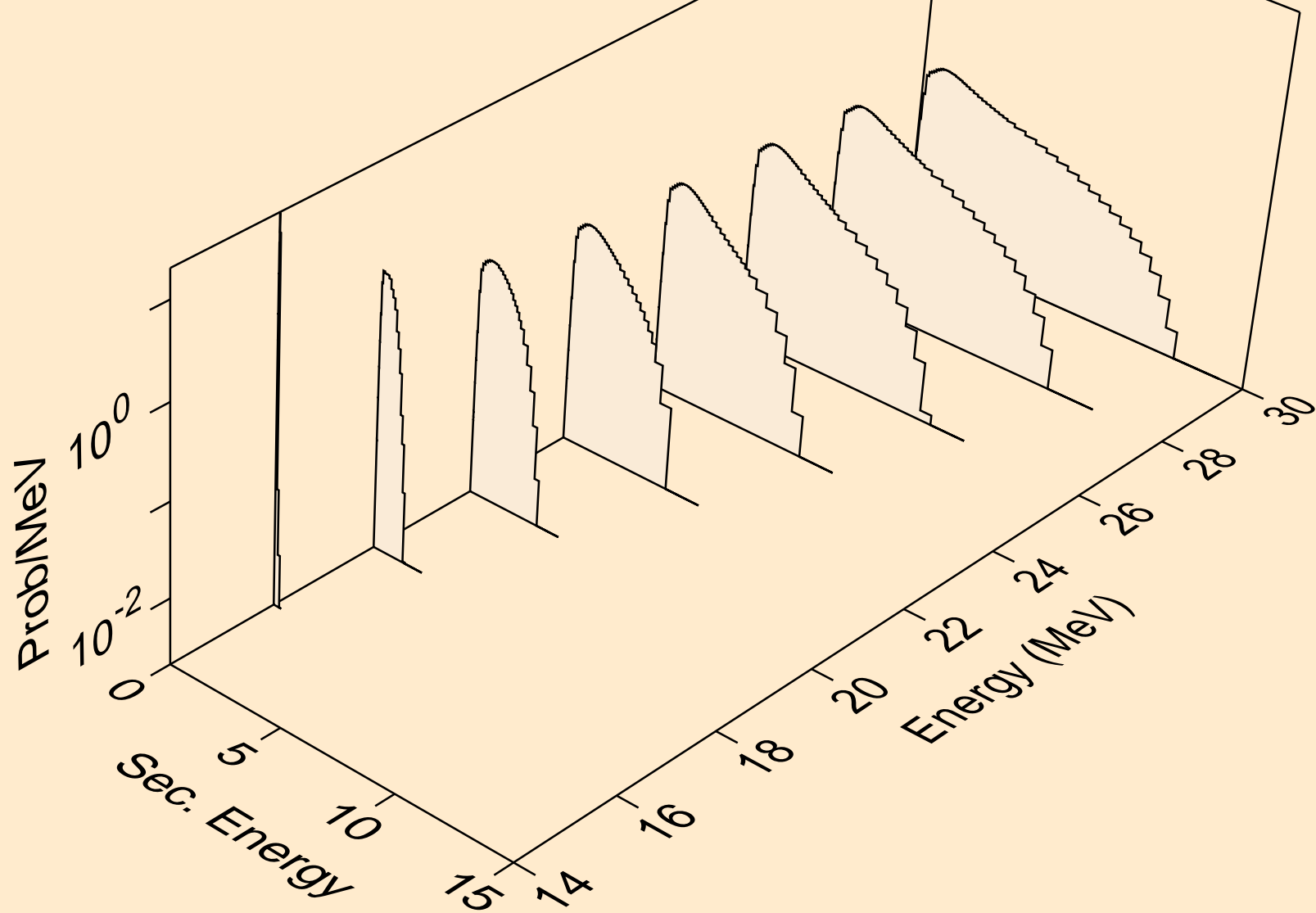

ZN061 NEUTRON ACER TENDL-2023 LIBRARY; T=0.K
Neutron emission for (n,n2p)

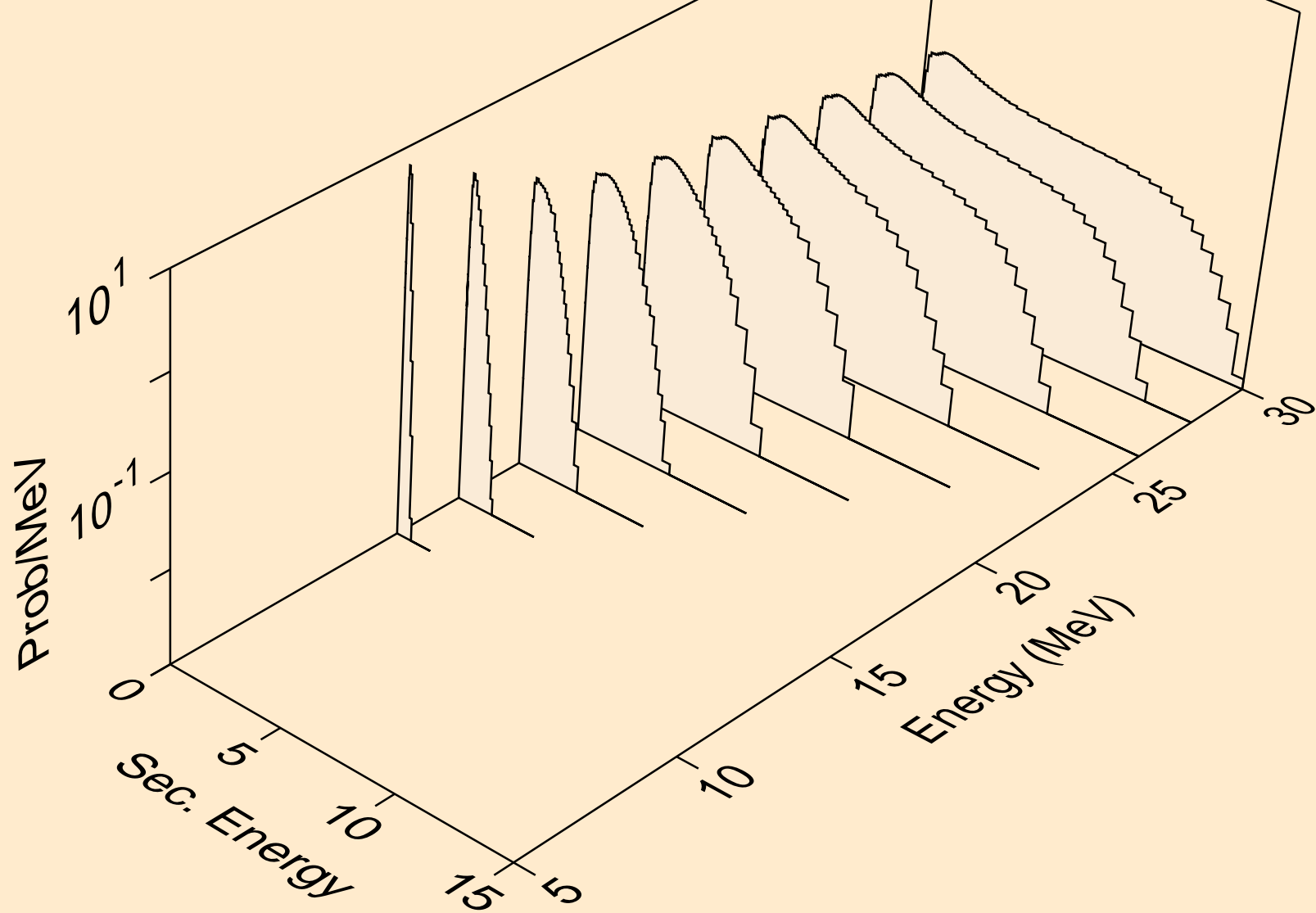

ZN061 NEUTRON ACER TENDL-2023 LIBRARY; T=0.K
Neutron emission for (n,npa)

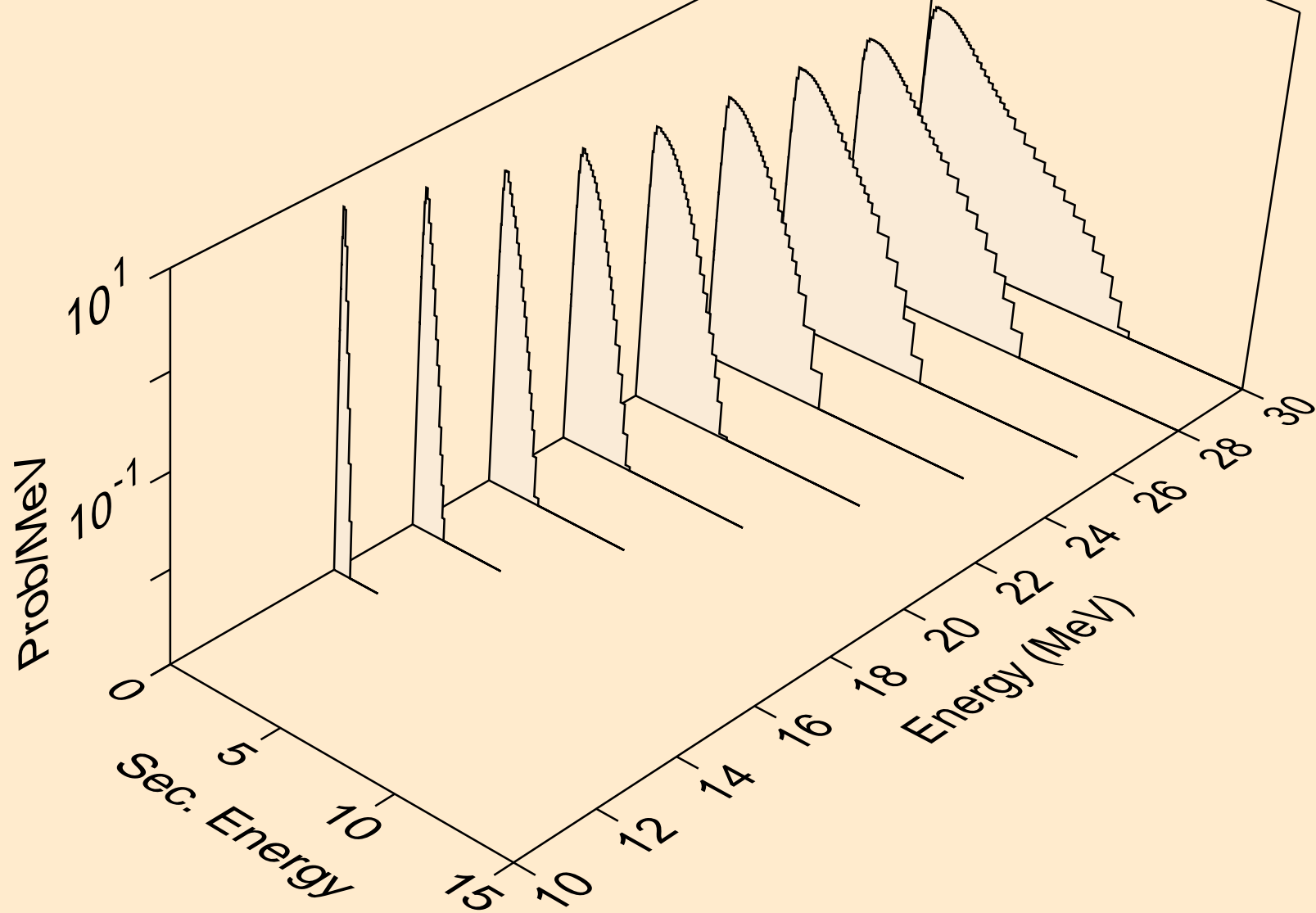

ZN061 NEUTRON ACER TENDL-2023 LIBRARY; T=0.K
Neutron emission for (n,n*c)

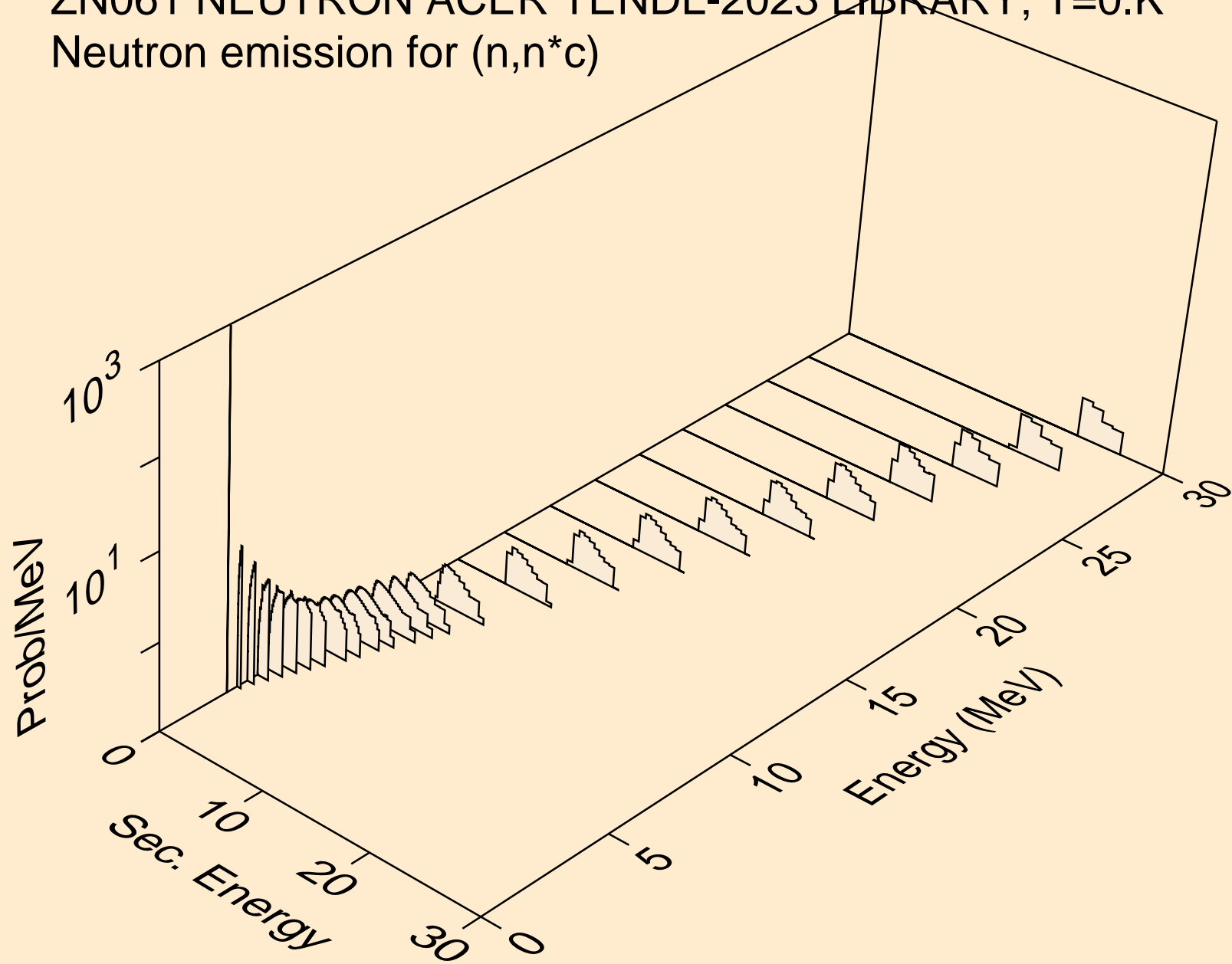

ZN061 NEUTRON ACER TENDL-2023 LIBRARY; T=0.K
Photon emission for (n,x)

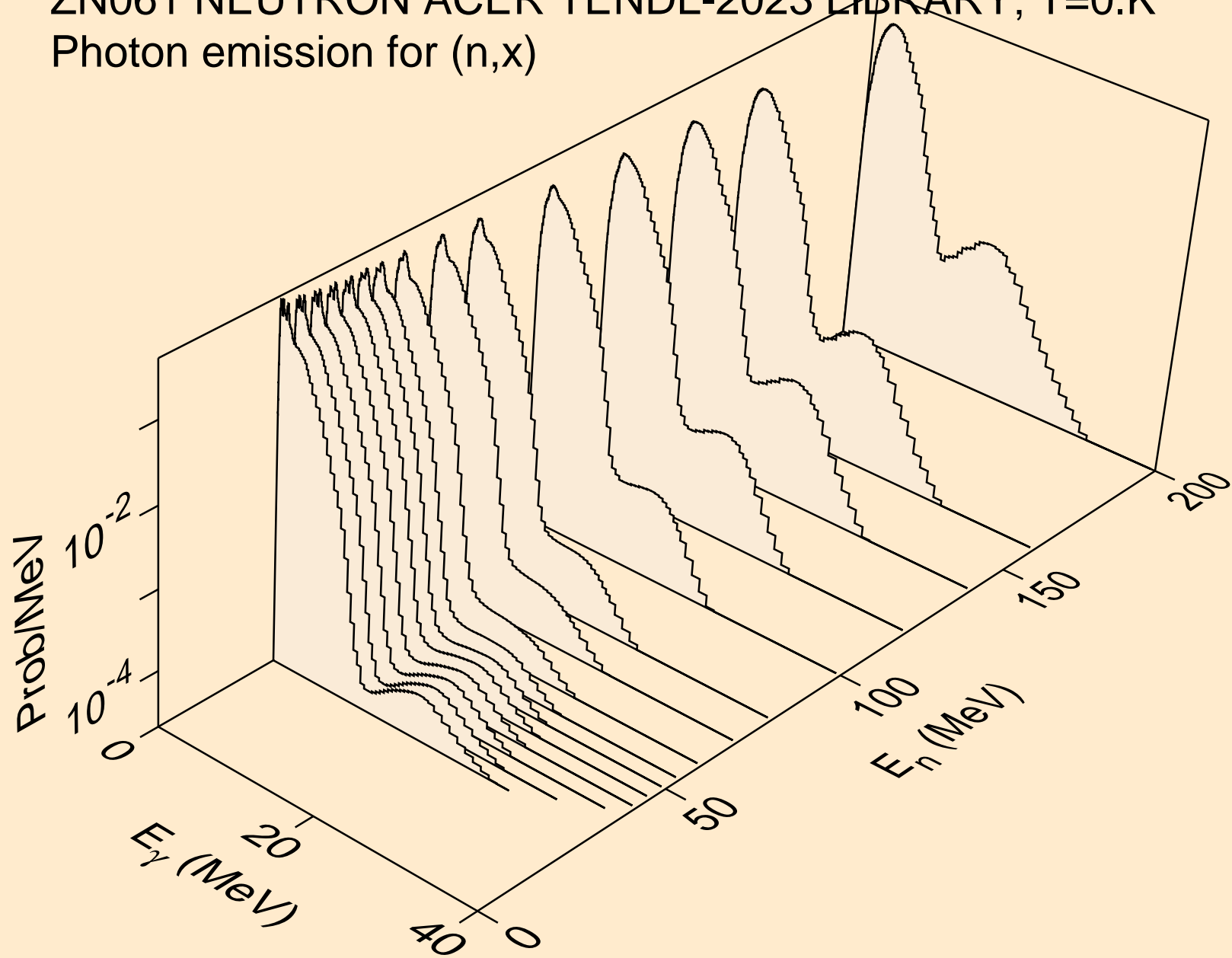

ZN061 NEUTRON ACER TENDL-2023 LIBRARY; T=0.K
Photon emission for (n,2nd)

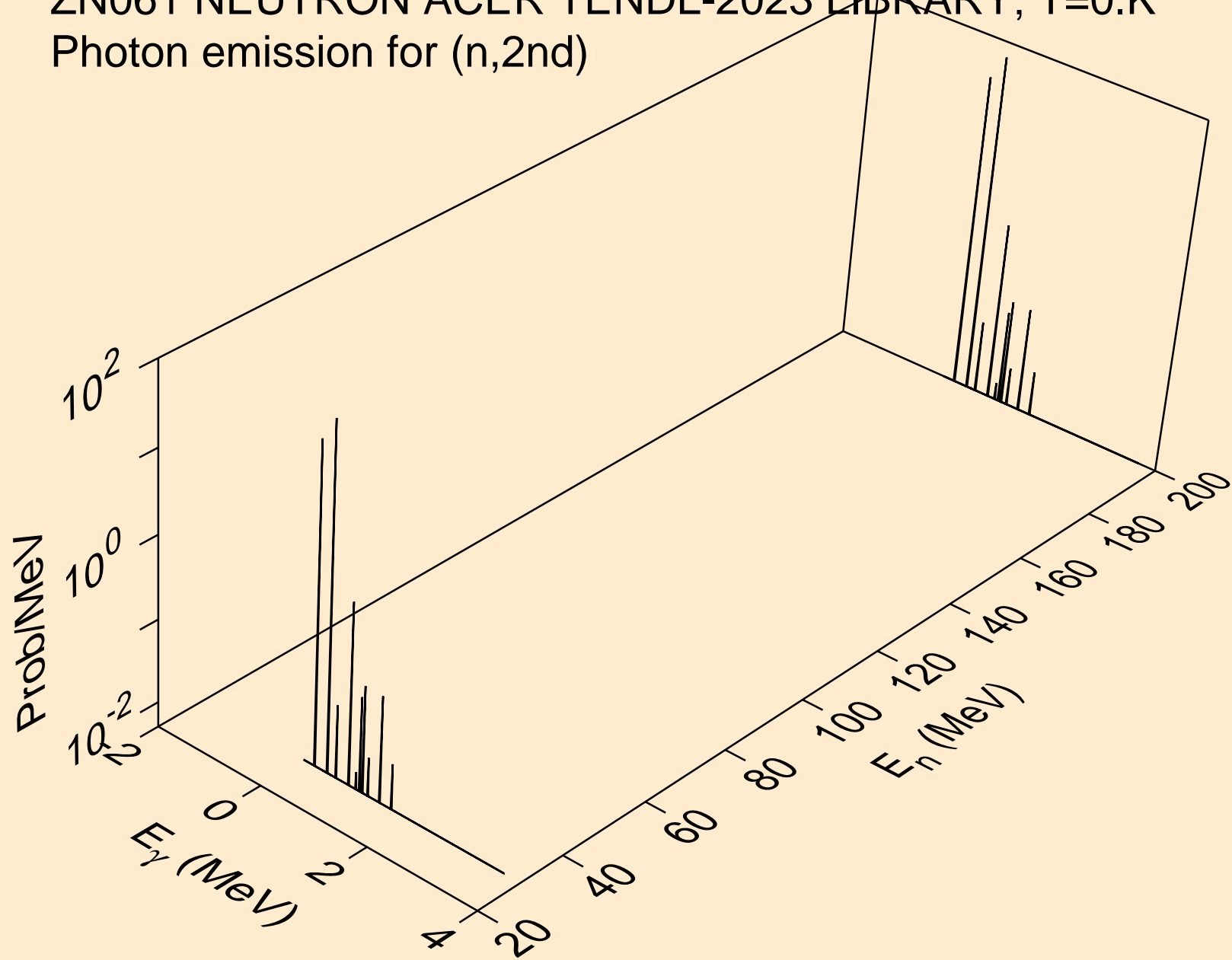

ZN061 NEUTRON ACER TENDL-2023 LIBRARY; T=0.K
Photon emission for (n,2n)

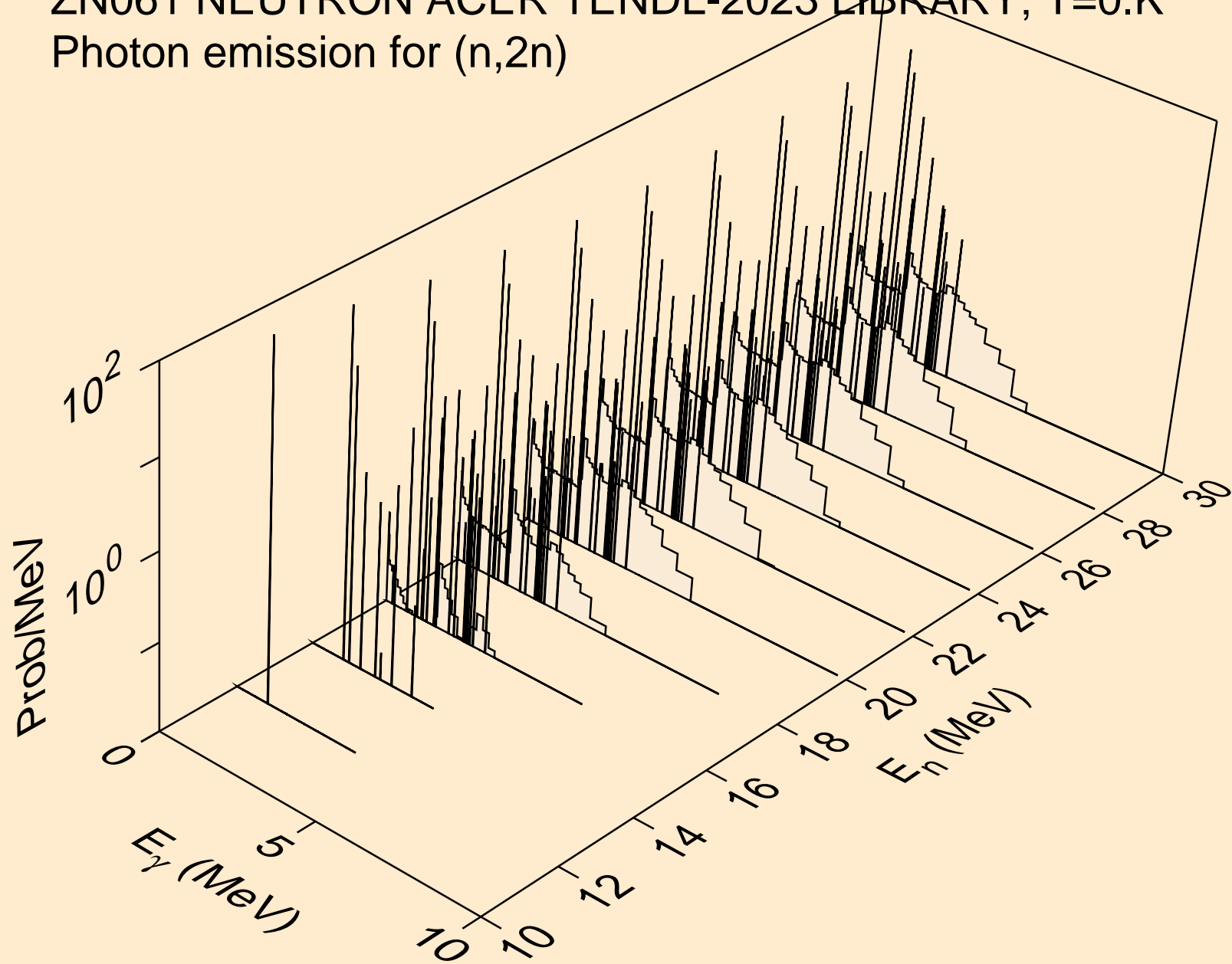

ZN061 NEUTRON ACER TENDL-2023 LIBRARY; T=0.K
Photon emission for (n,3n)

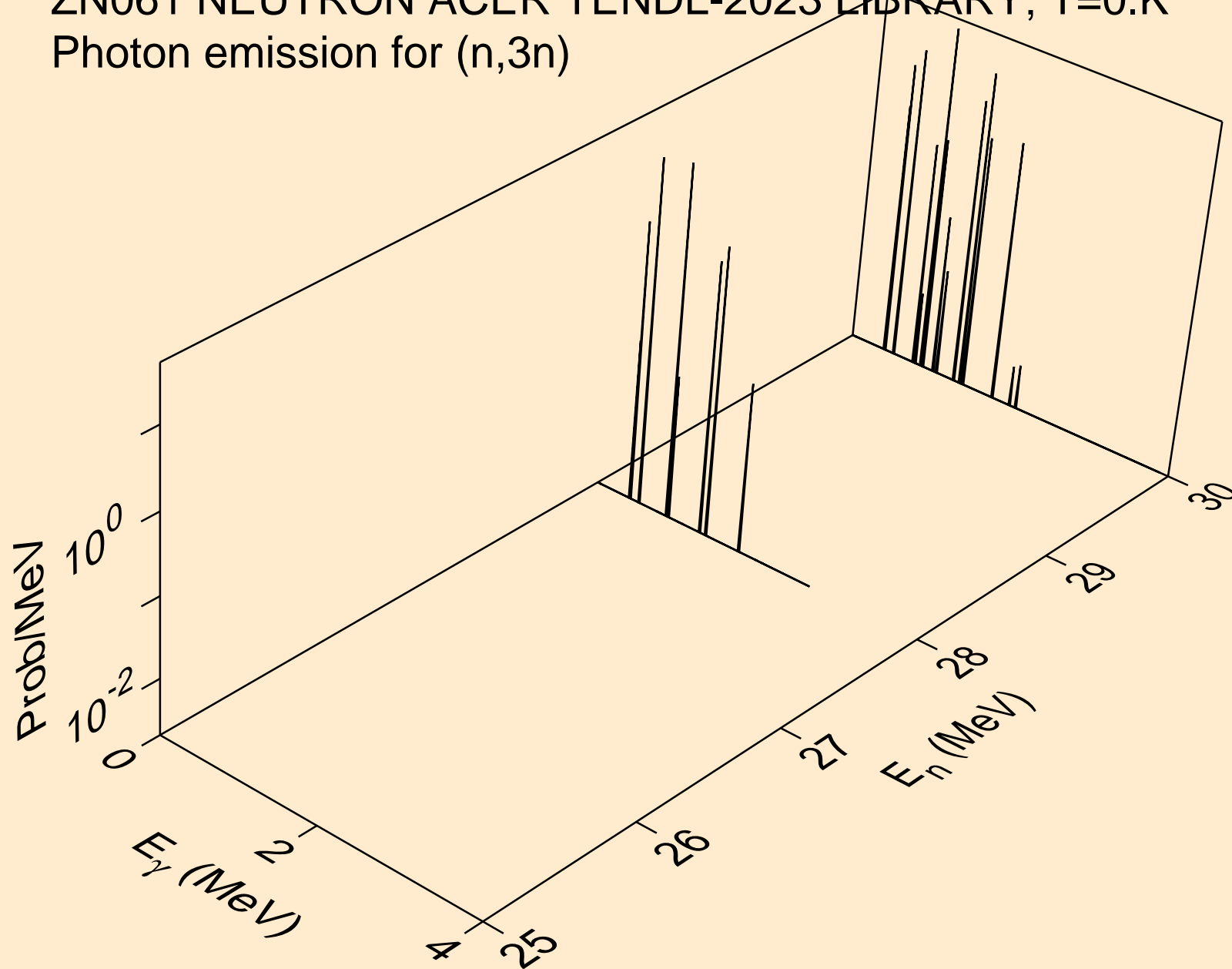

ZN061 NEUTRON ACER TENDL-2023 LIBRARY; T=0.K
Photon emission for (n,n*)a

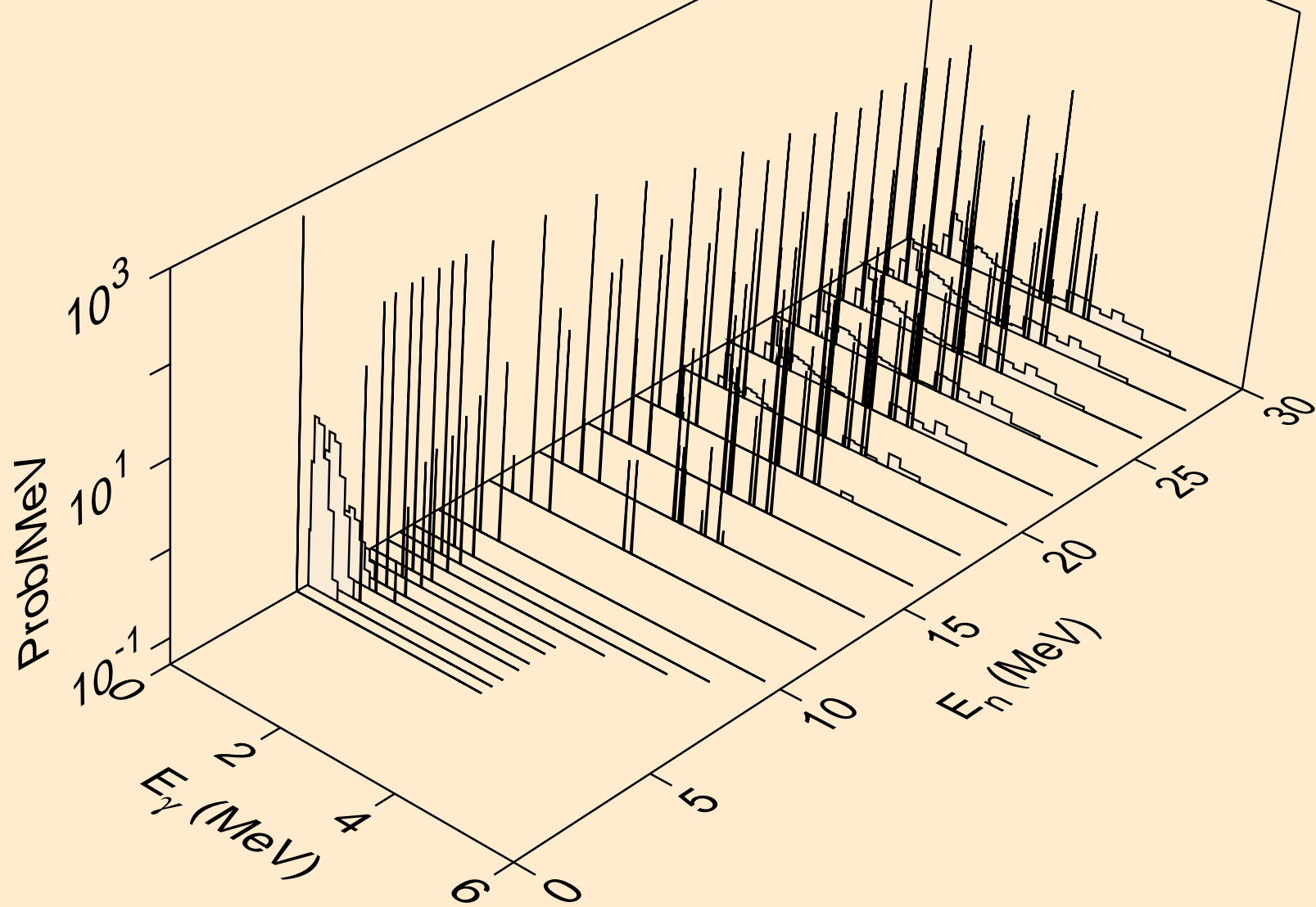

ZN061 NEUTRON ACER TENDL-2023 LIBRARY; T=0.K
Photon emission for (n,2n)a

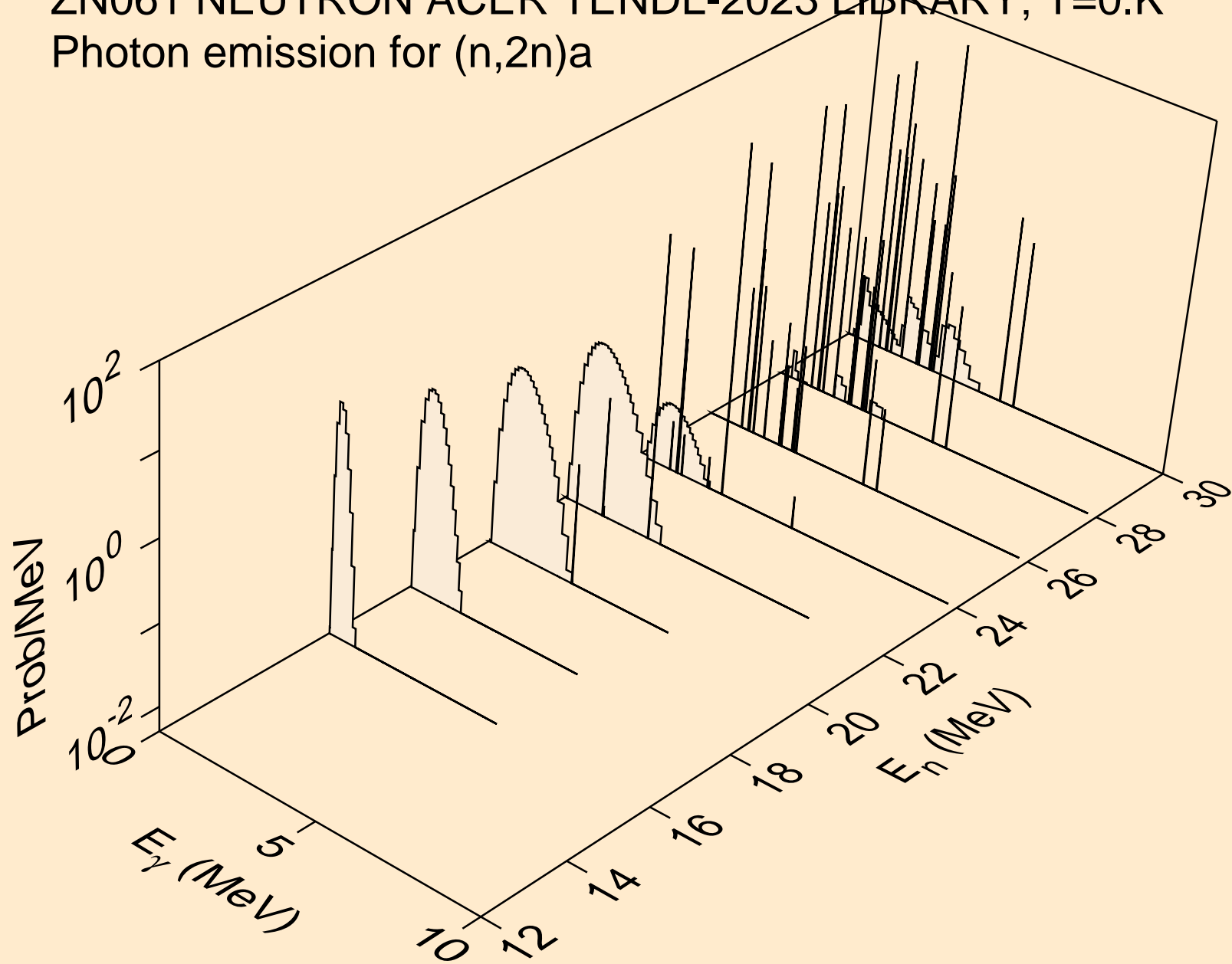

ZN061 NEUTRON ACER TENDL-2023 LIBRARY; T=0.K
Photon emission for (n,n*)p

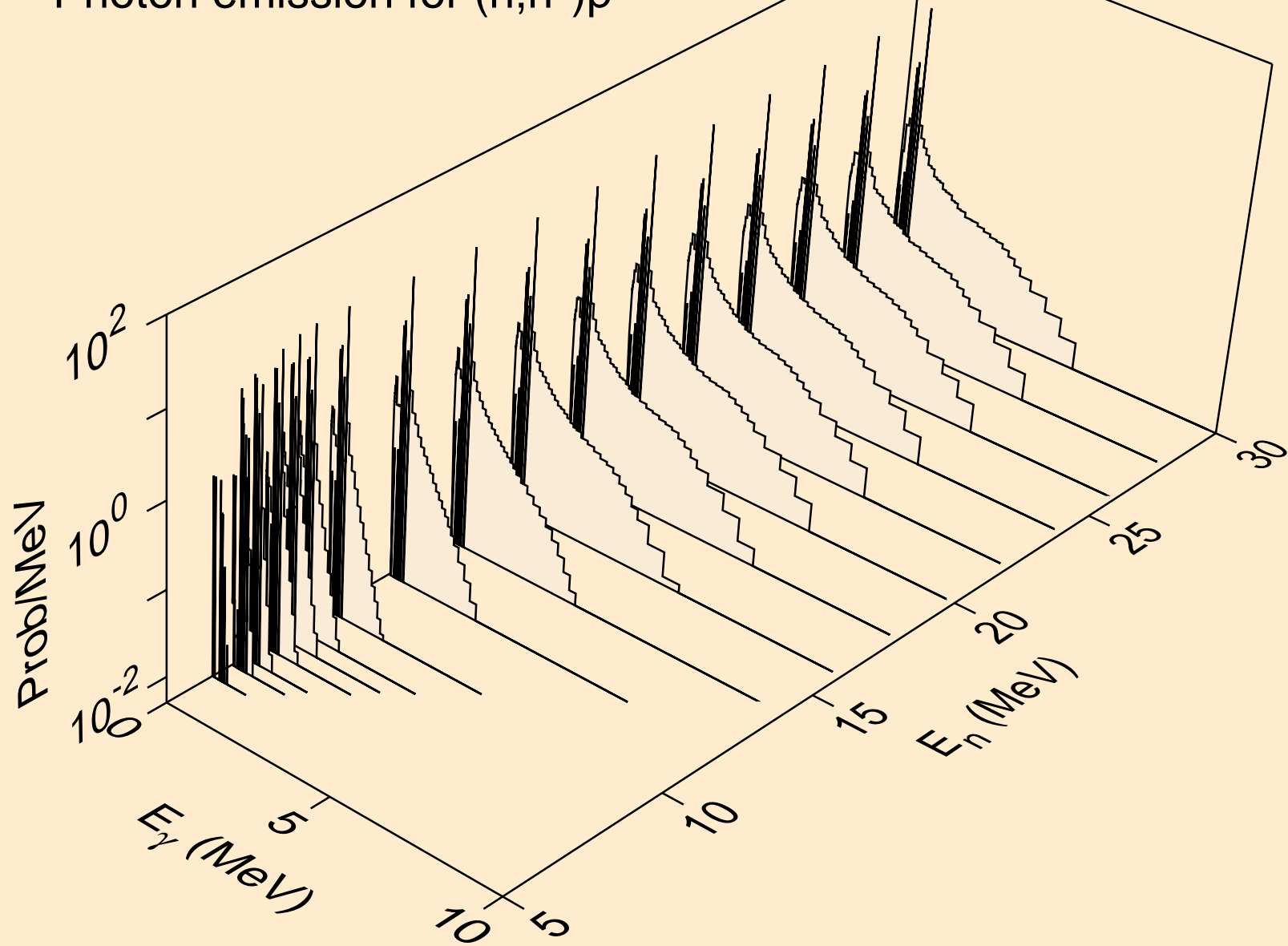

ZN061 NEUTRON ACER TENDL-2023 LIBRARY; T=0.K
Photon emission for (n,n*)2a

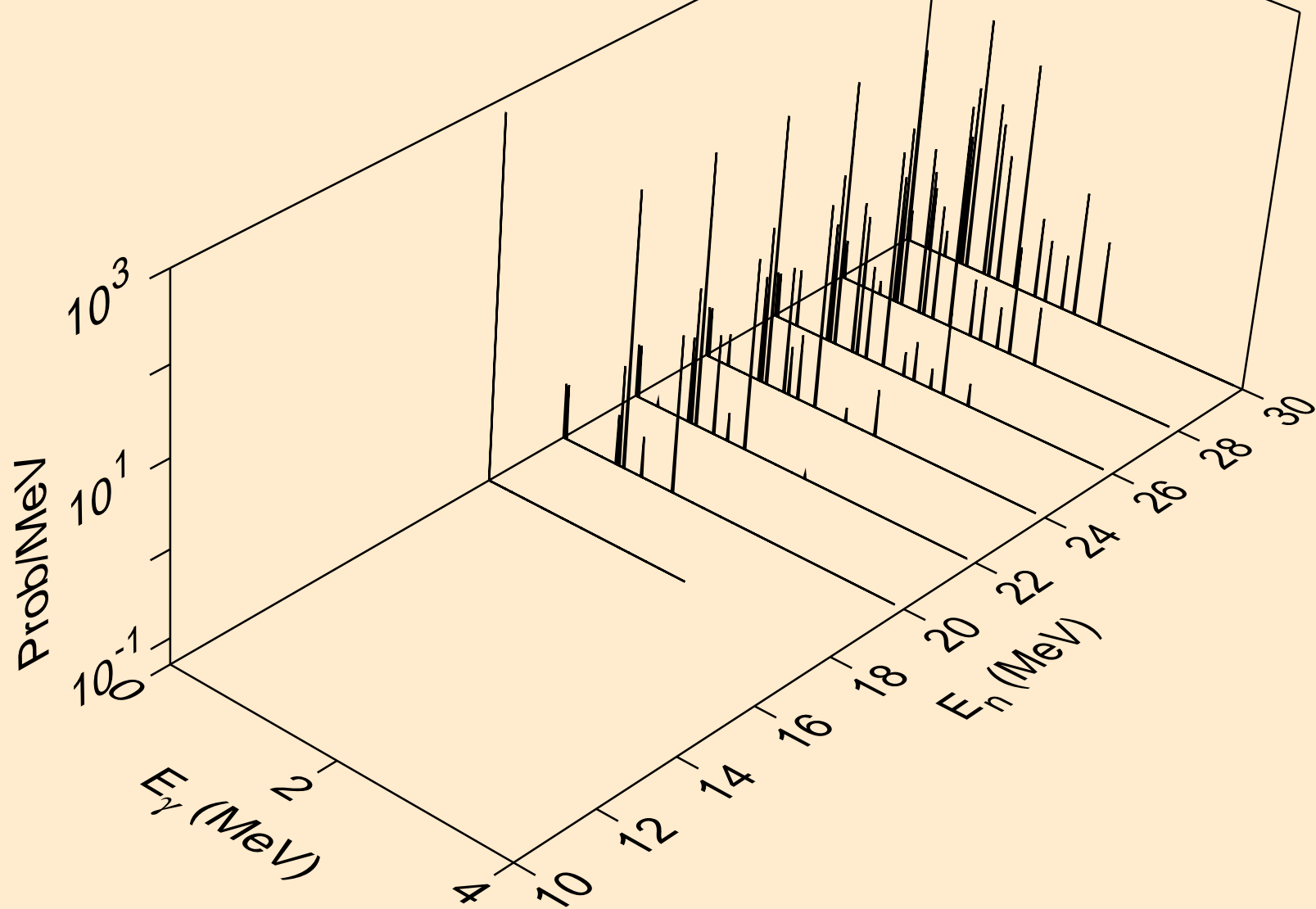

ZN061 NEUTRON ACER TENDL-2023 LIBRARY; T=0.K
Photon emission for (n,n*)d

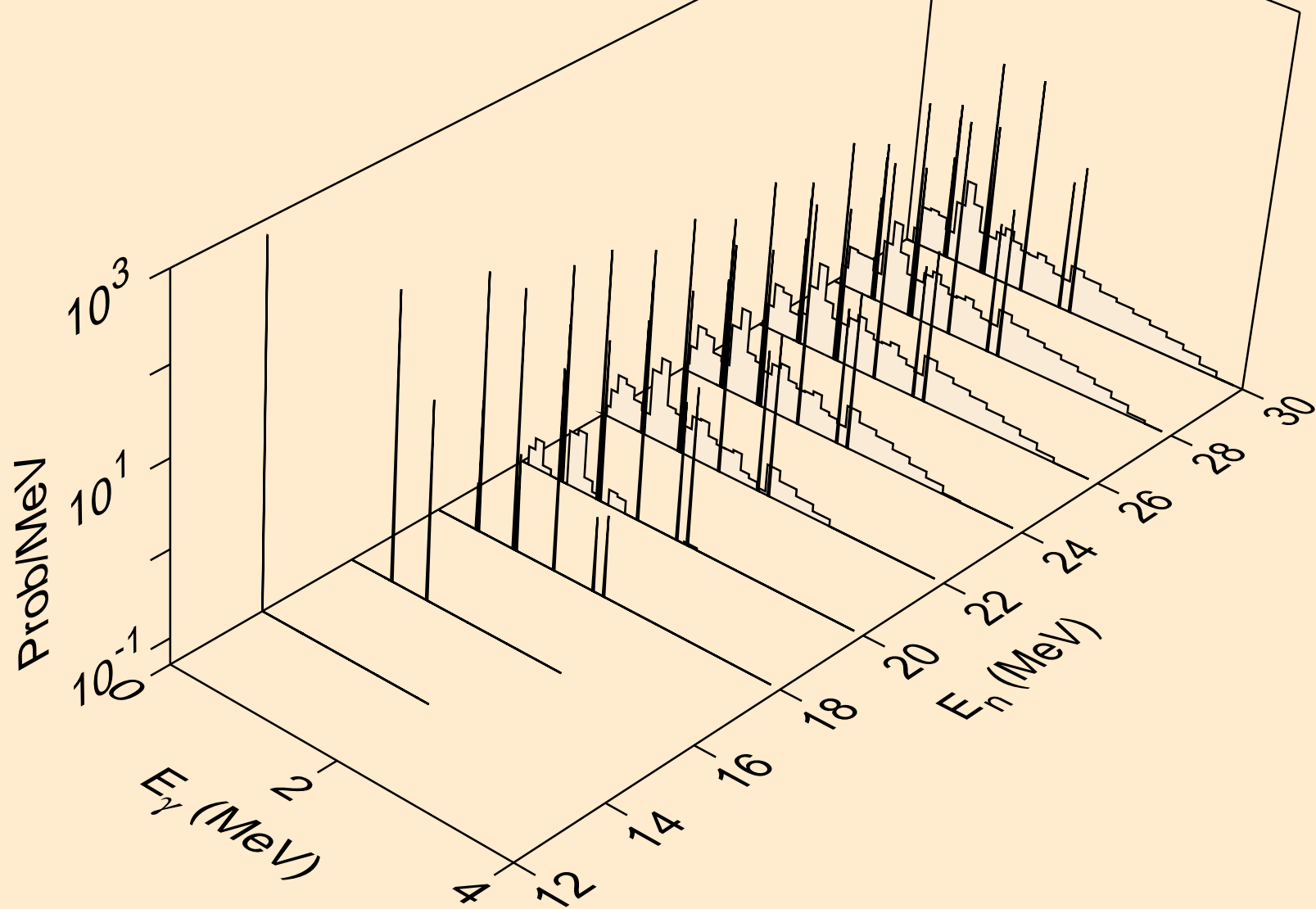

ZN061 NEUTRON ACER TENDL-2023 LIBRARY; T=0.K
Photon emission for (n,n*)t

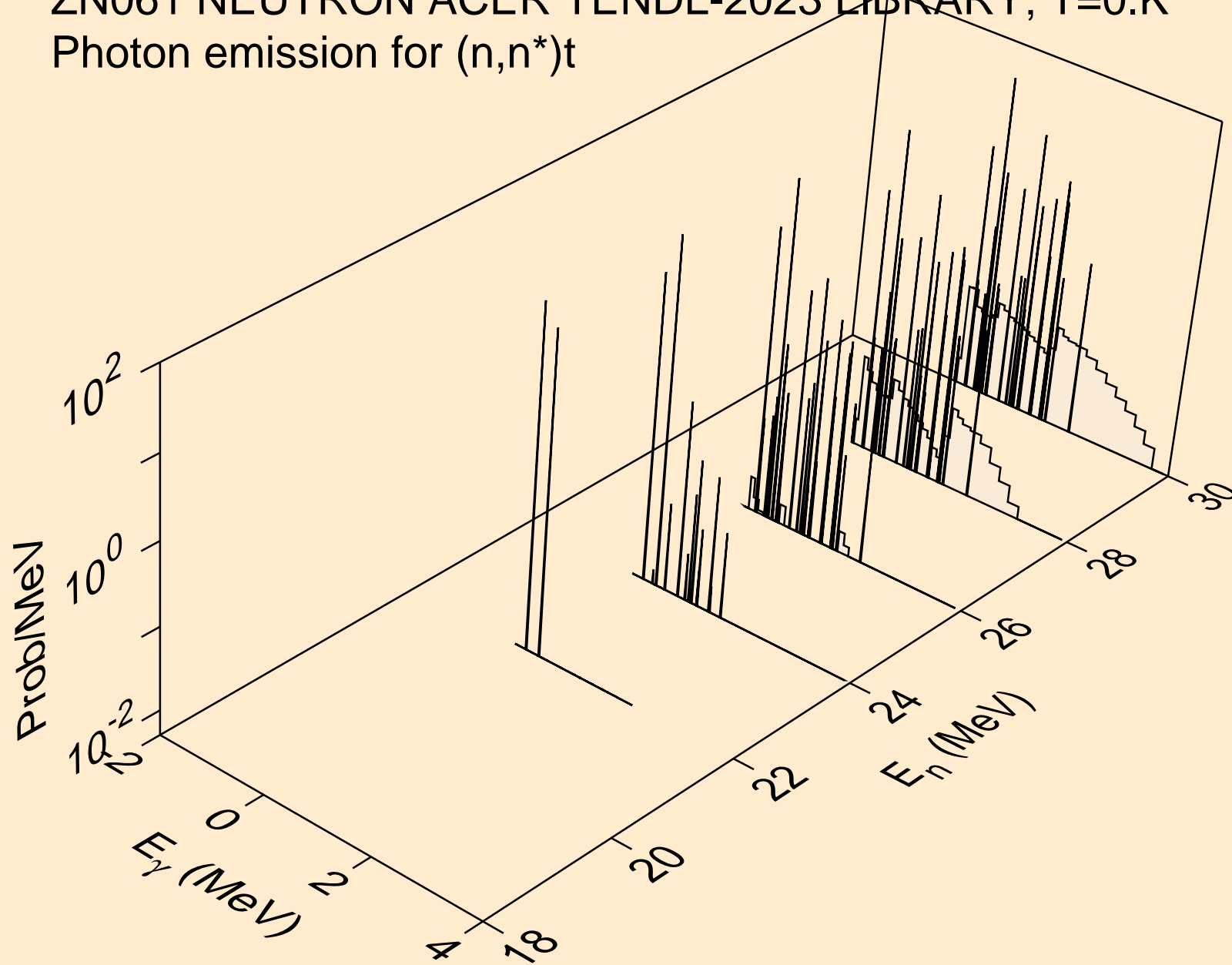

ZN061 NEUTRON ACER TENDL-2023 LIBRARY; T=0.K
Photon emission for (n,n*)he3

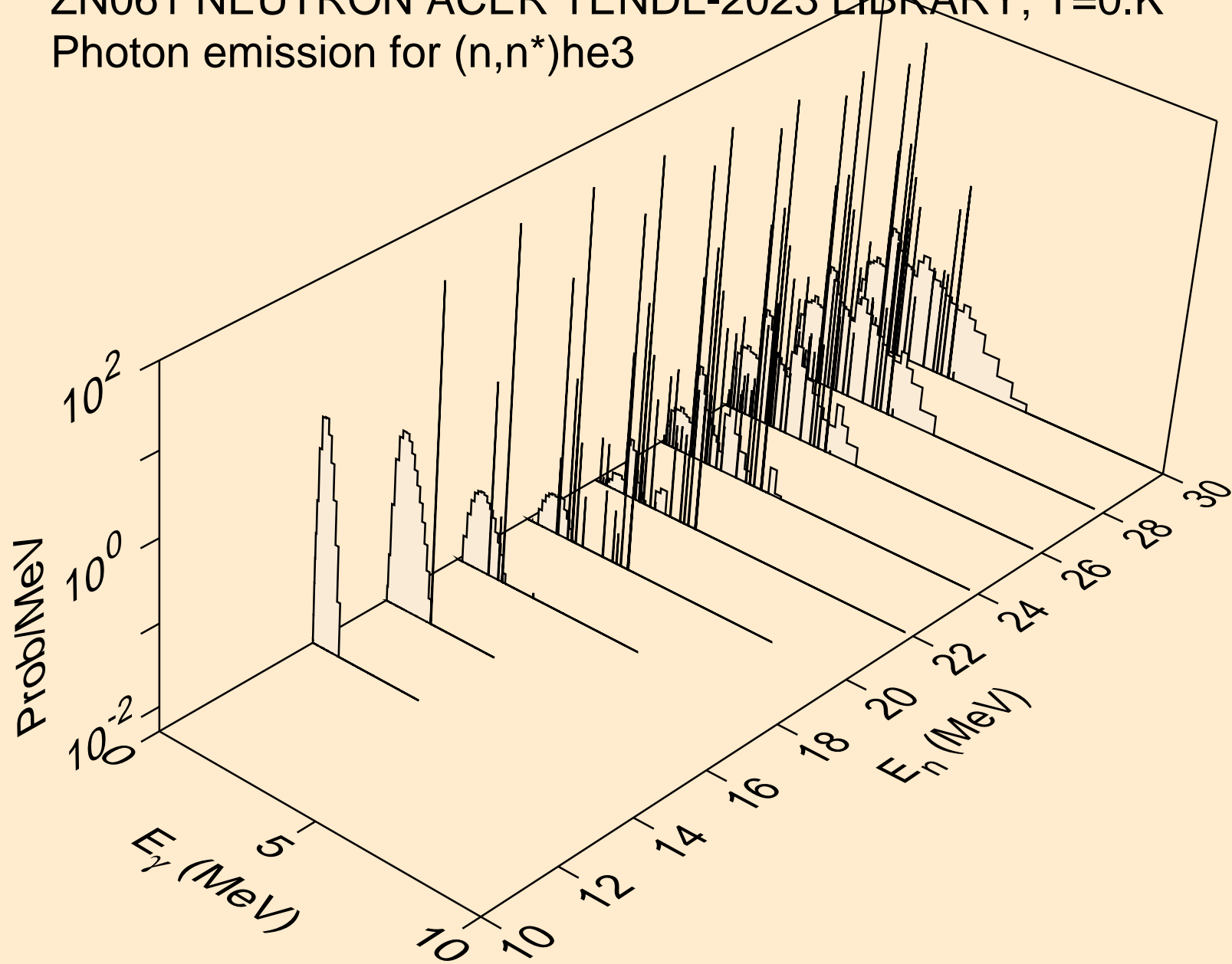

ZN061 NEUTRON ACER TENDL-2023 LIBRARY; T=0.K
Photon emission for (n,2np)

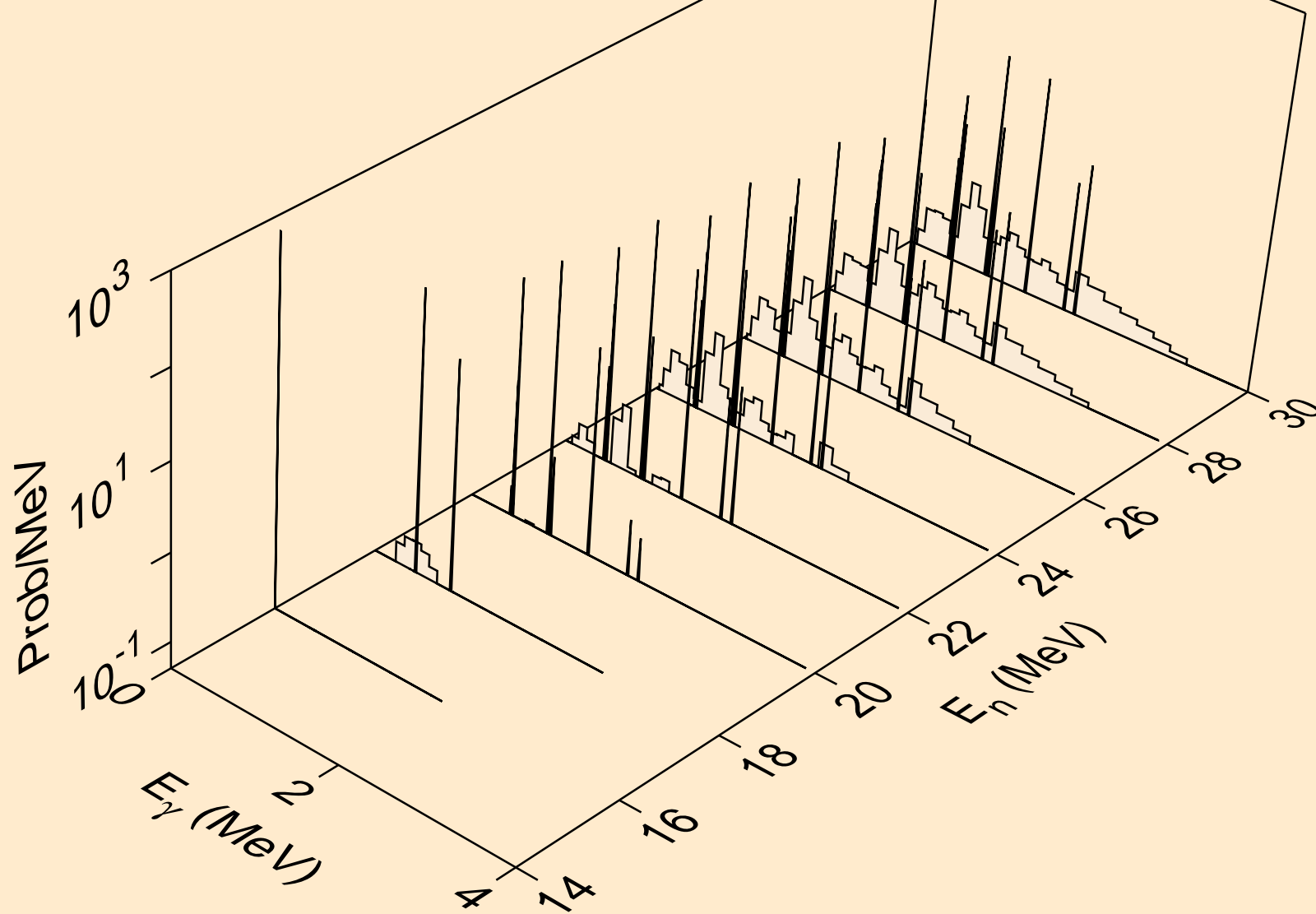

ZN061 NEUTRON ACER TENDL-2023 LIBRARY; T=0.K
Photon emission for (n,n2p)

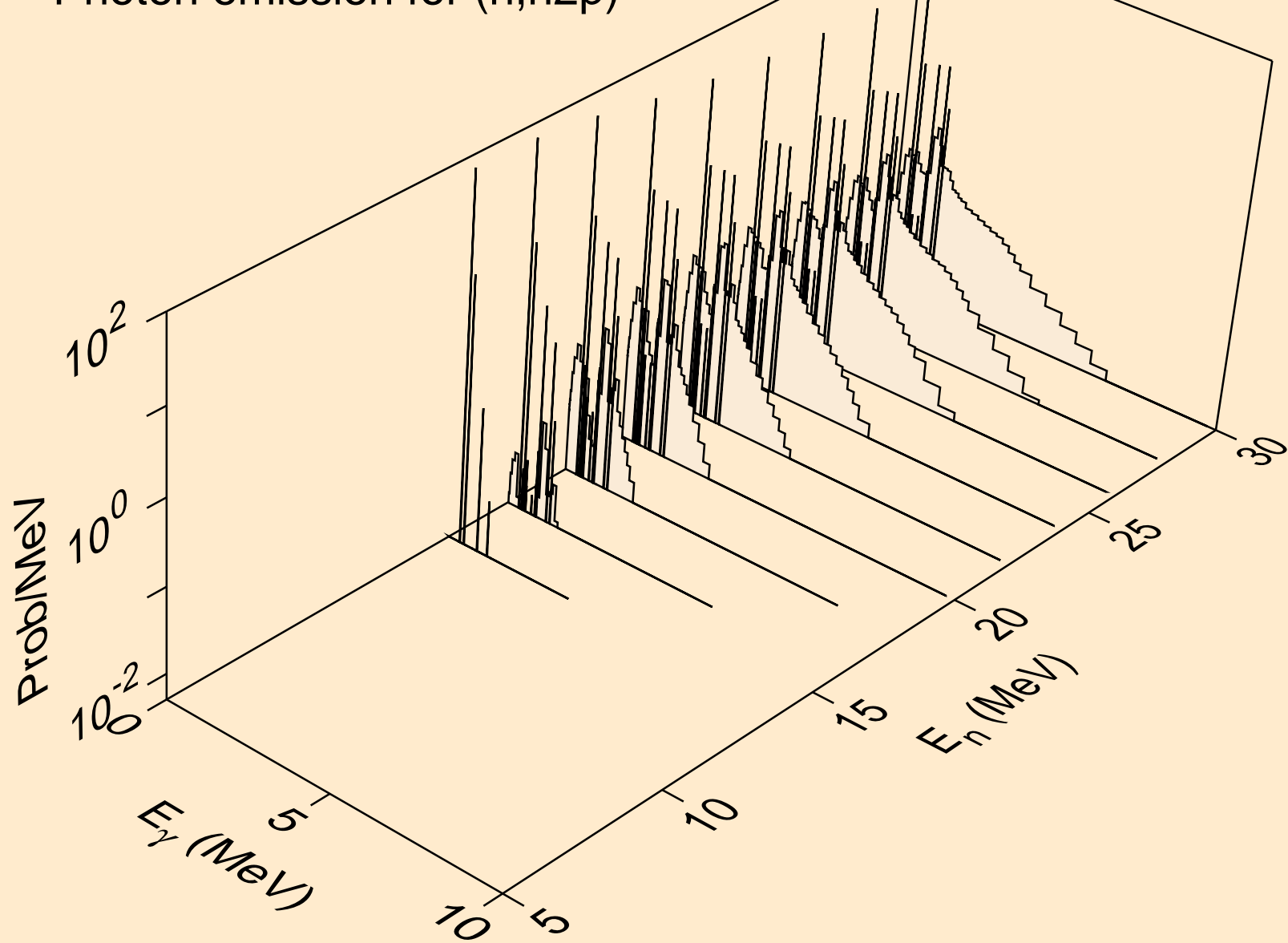

ZN061 NEUTRON ACER TENDL-2023 LIBRARY; T=0.K
Photon emission for (n,npa)

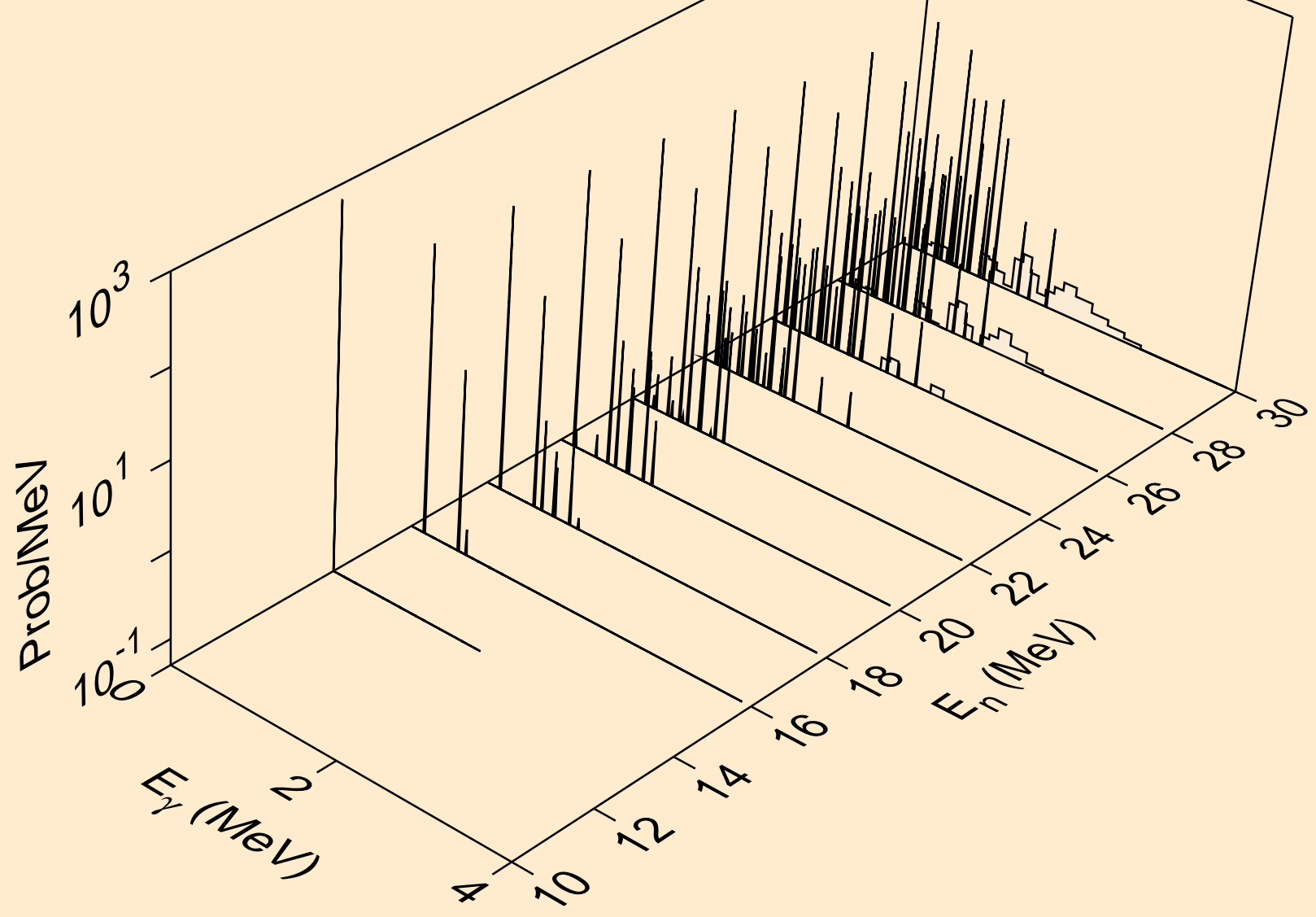

ZN061 NEUTRON ACER TENDL-2023 LIBRARY; T=0.K
Photon emission for (n,n*c)

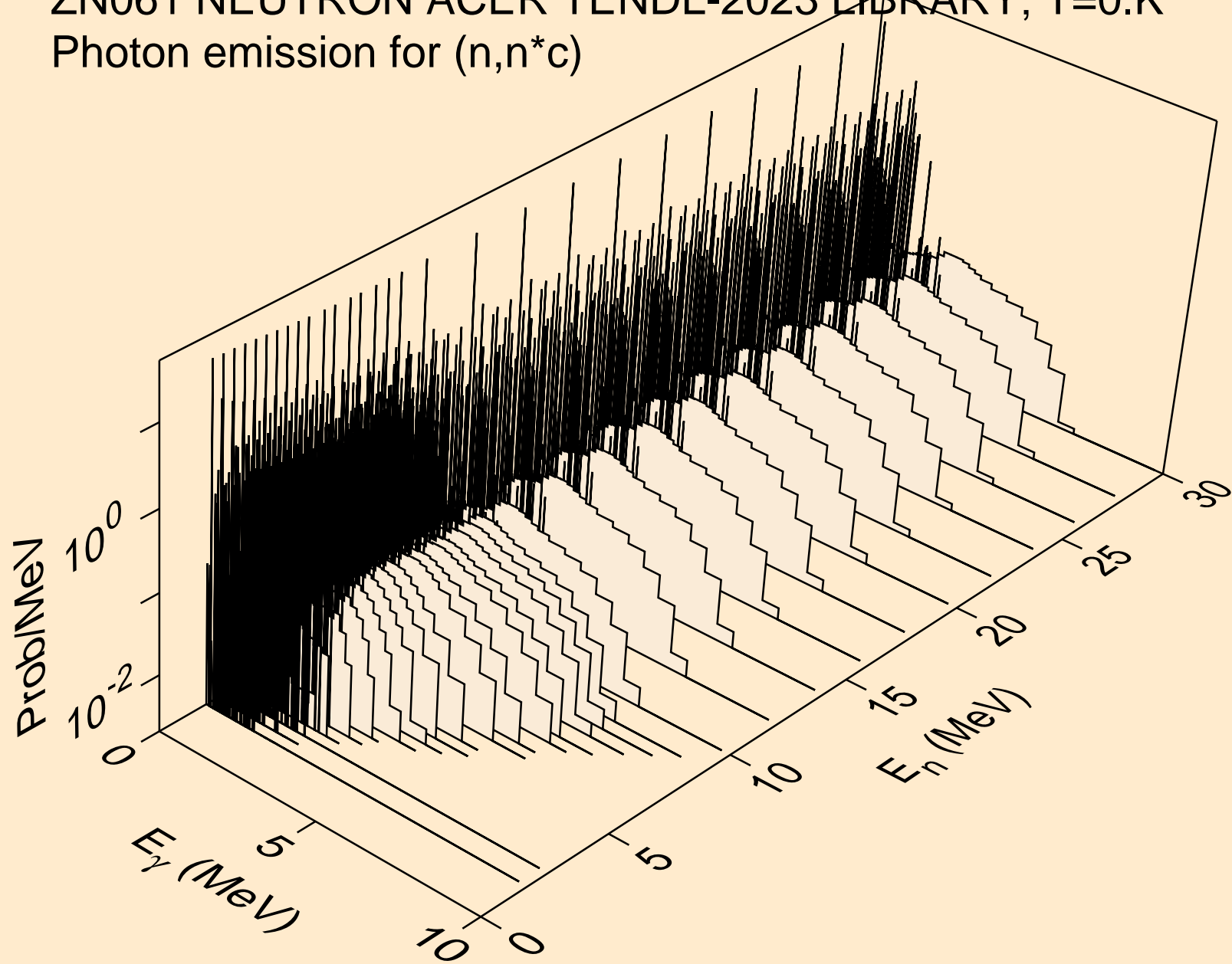

ZN061 NEUTRON ACER TENDL-2023 LIBRARY; T=0.K
Photon emission for (n,gma)

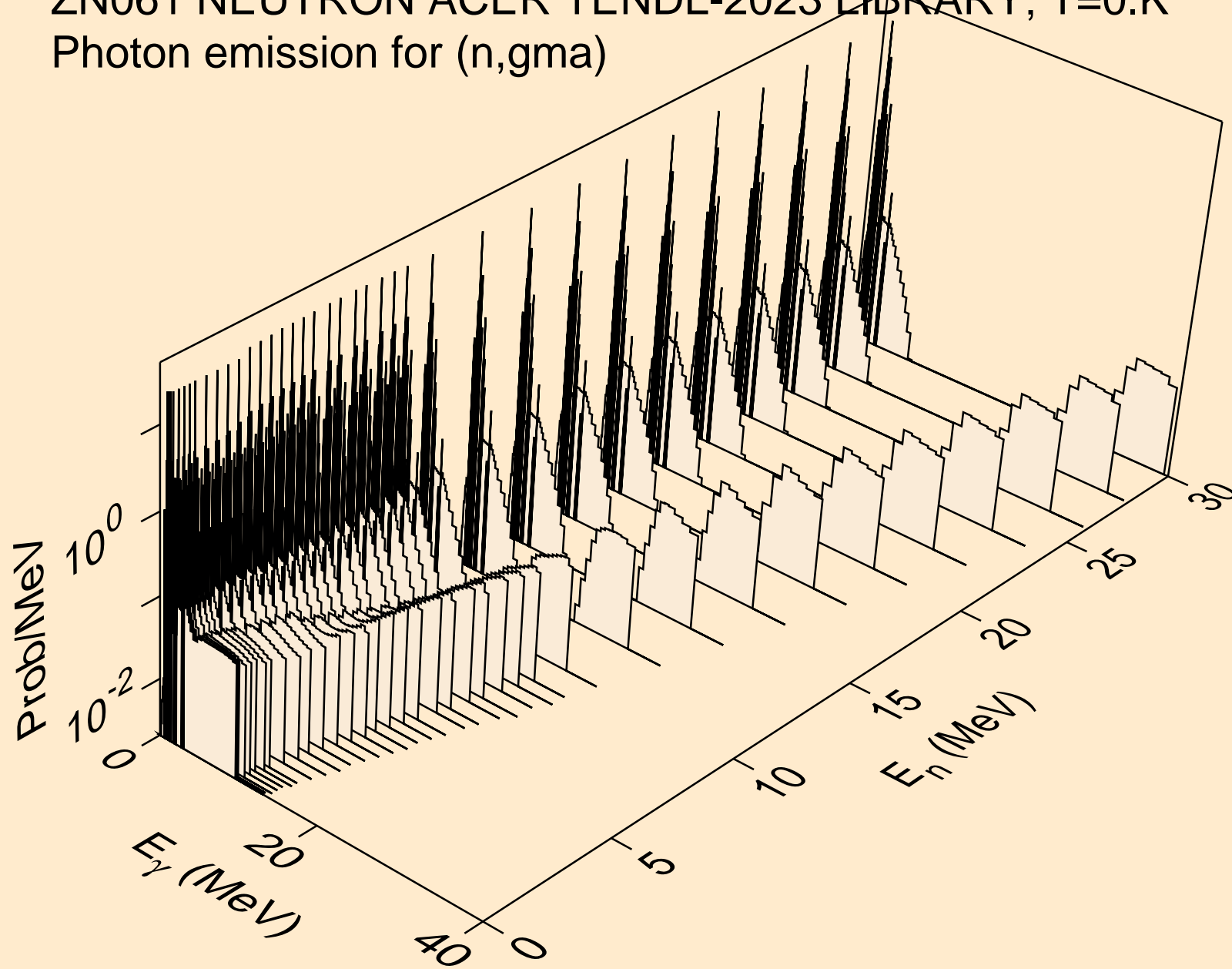

ZN061 NEUTRON ACER TENDL-2023 LIBRARY; T=0.K
Photon emission for (n,p)

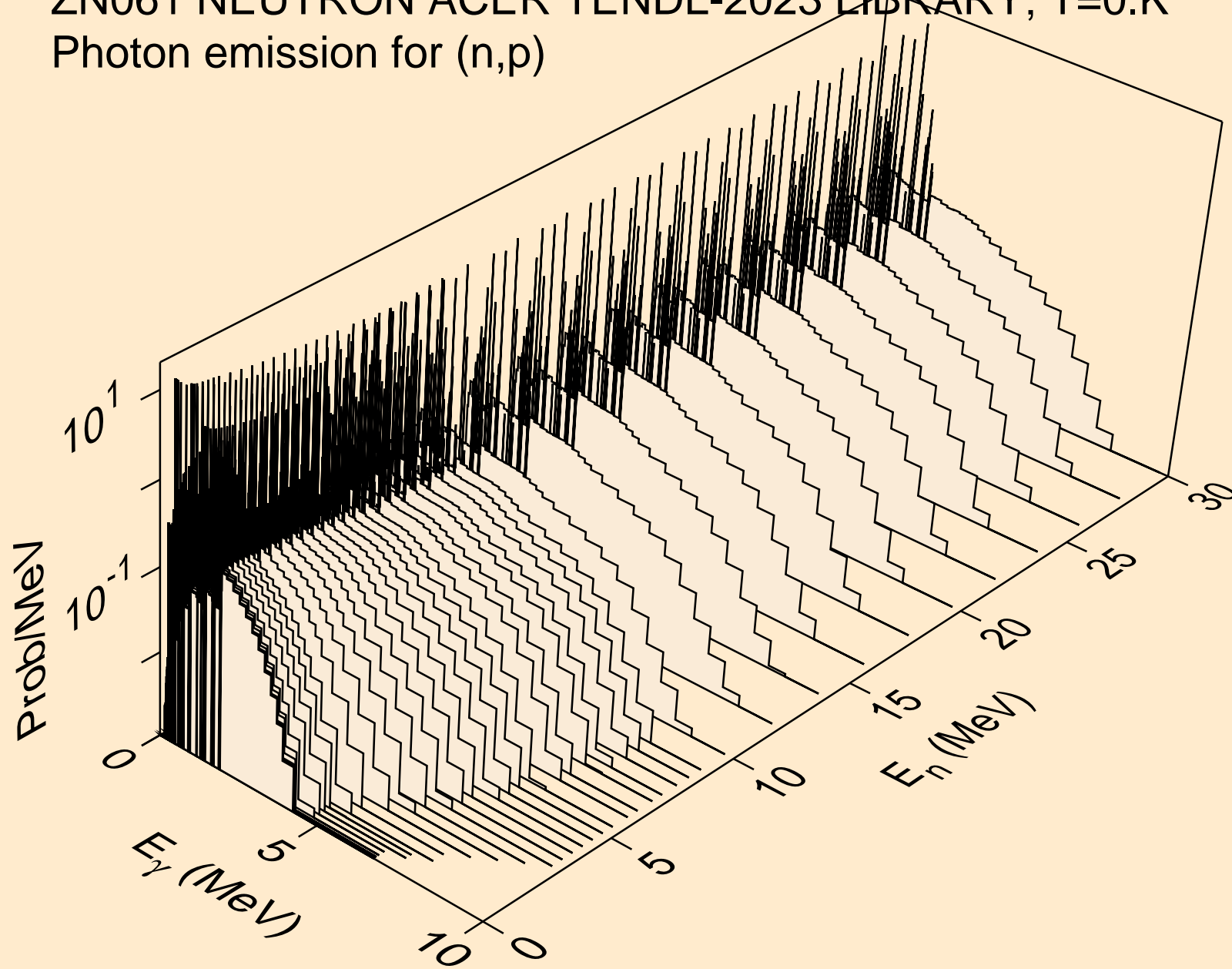

ZN061 NEUTRON ACER TENDL-2023 LIBRARY; T=0.K
Photon emission for (n,d)

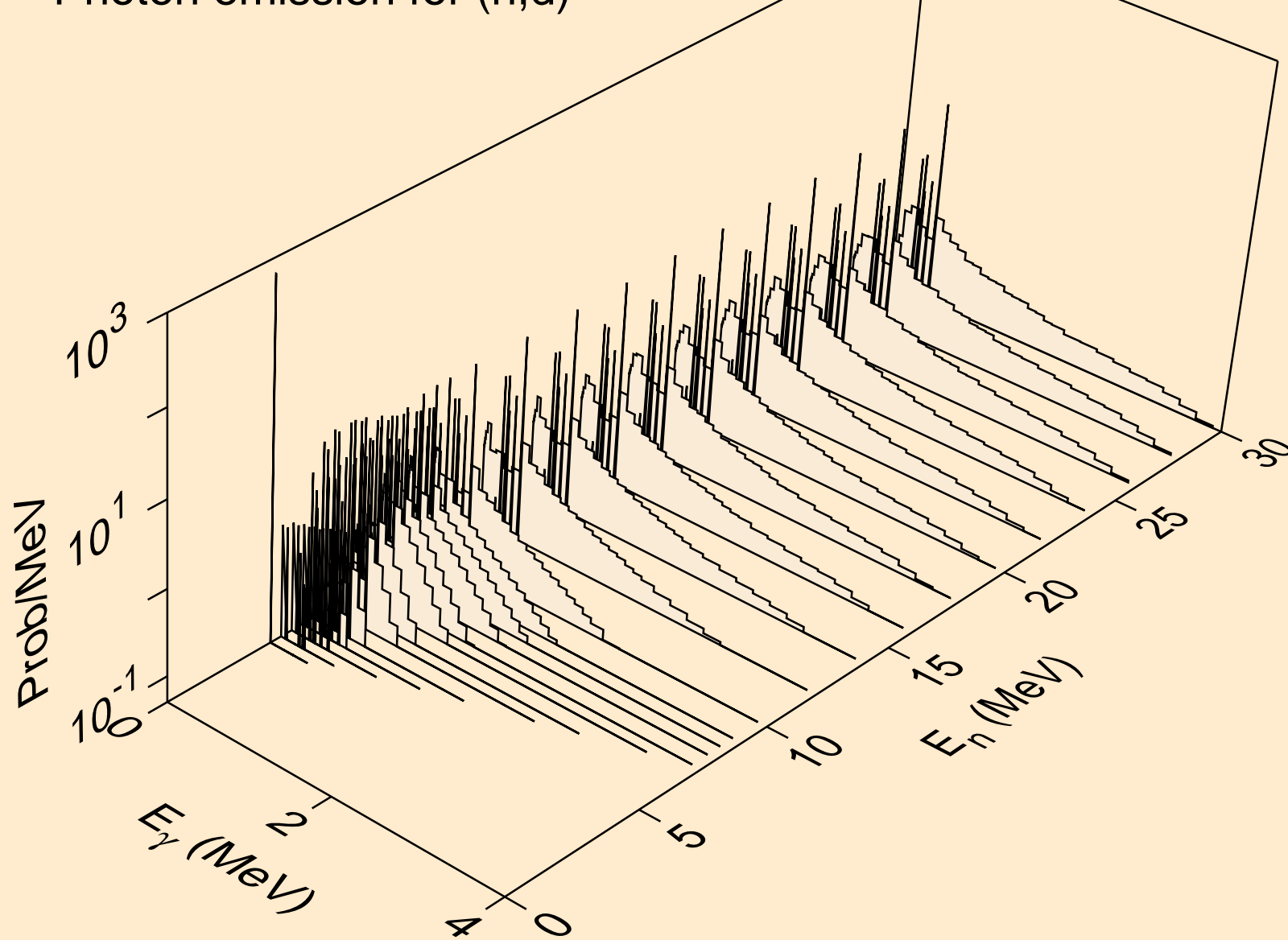

ZN061 NEUTRON ACER TENDL-2023 LIBRARY; T=0.K
Photon emission for (n,t)

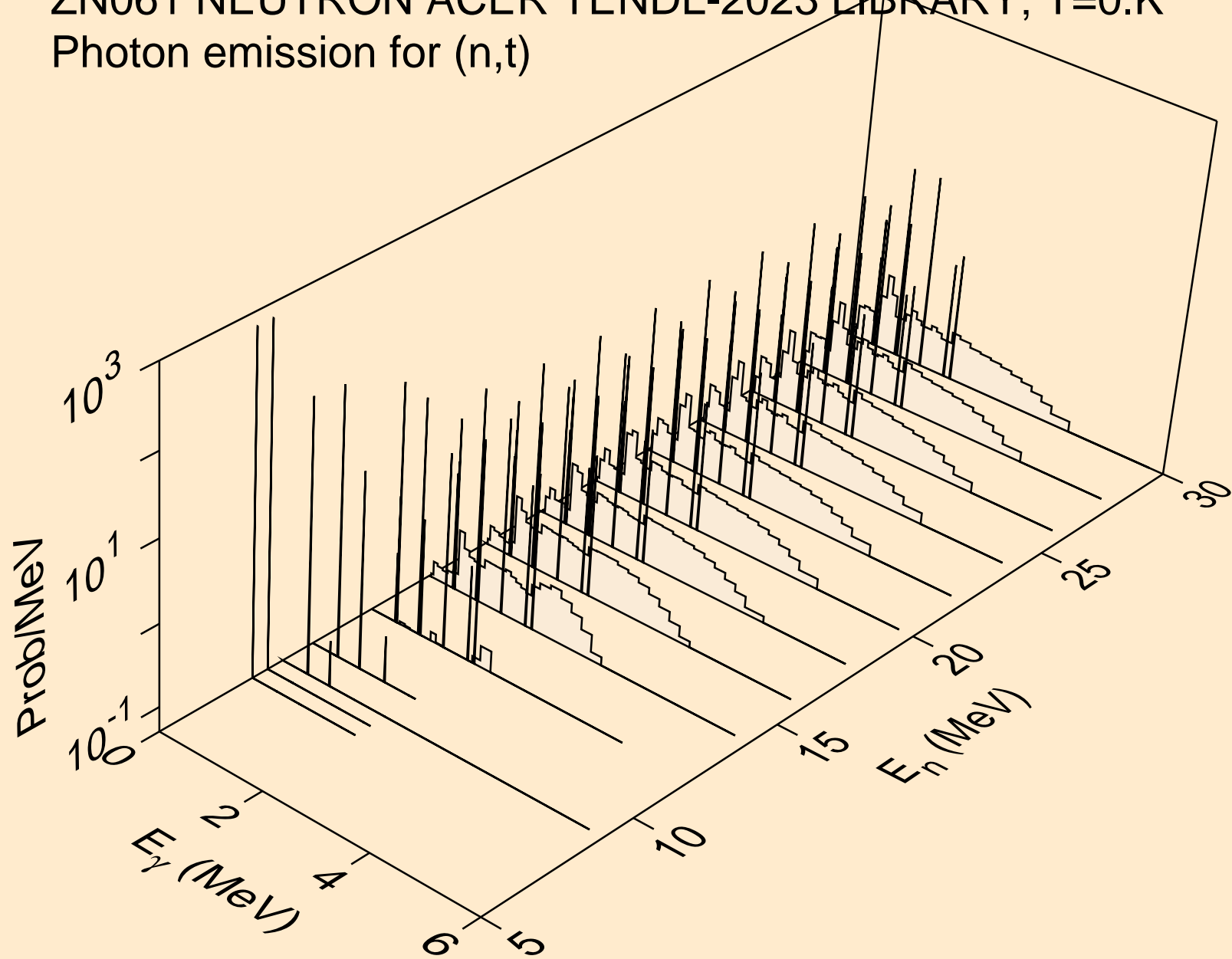

ZN061 NEUTRON ACER TENDL-2023 LIBRARY; T=0.K
Photon emission for (n,he3)

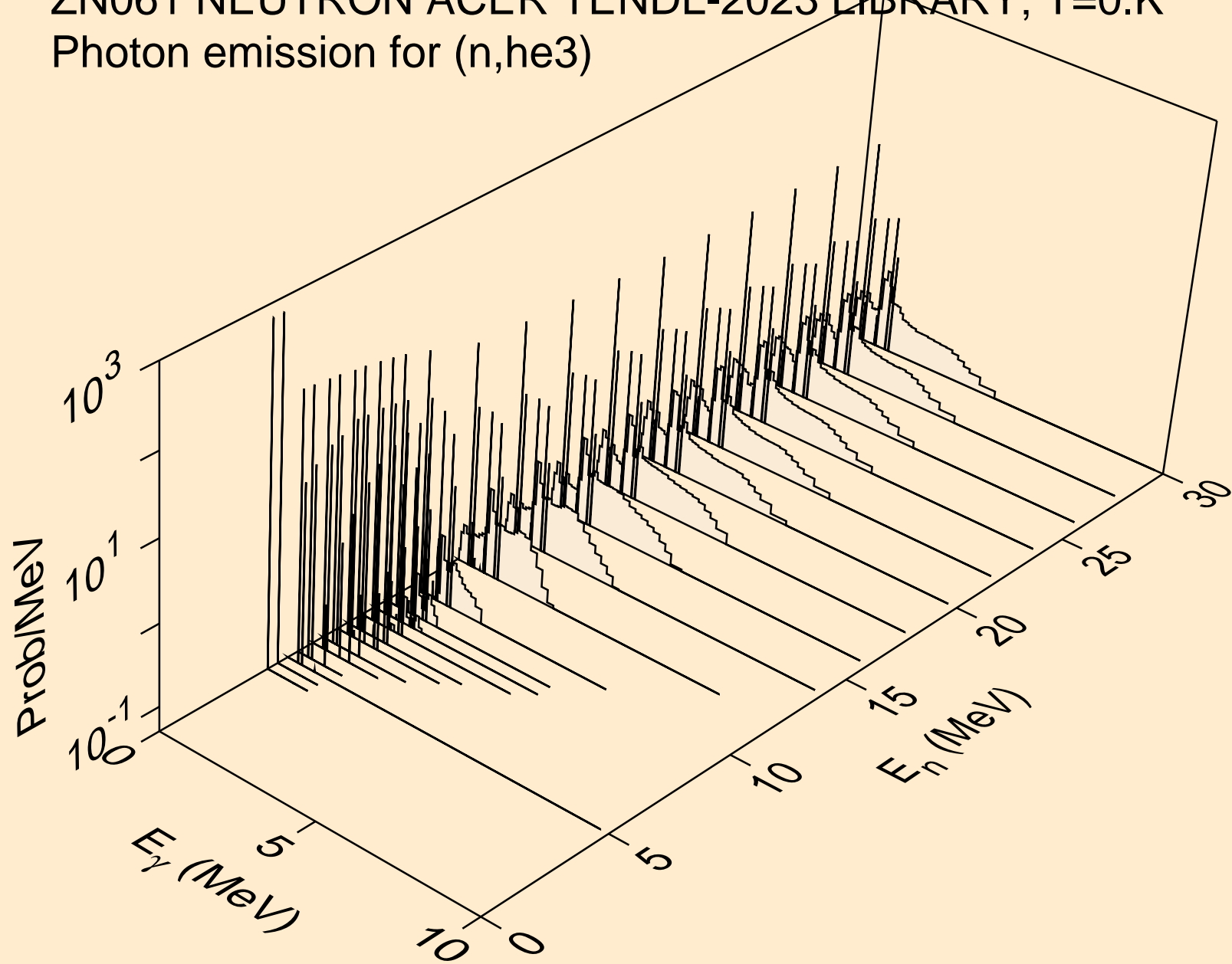

ZN061 NEUTRON ACER TENDL-2023 LIBRARY; T=0.K
Photon emission for (n,a)

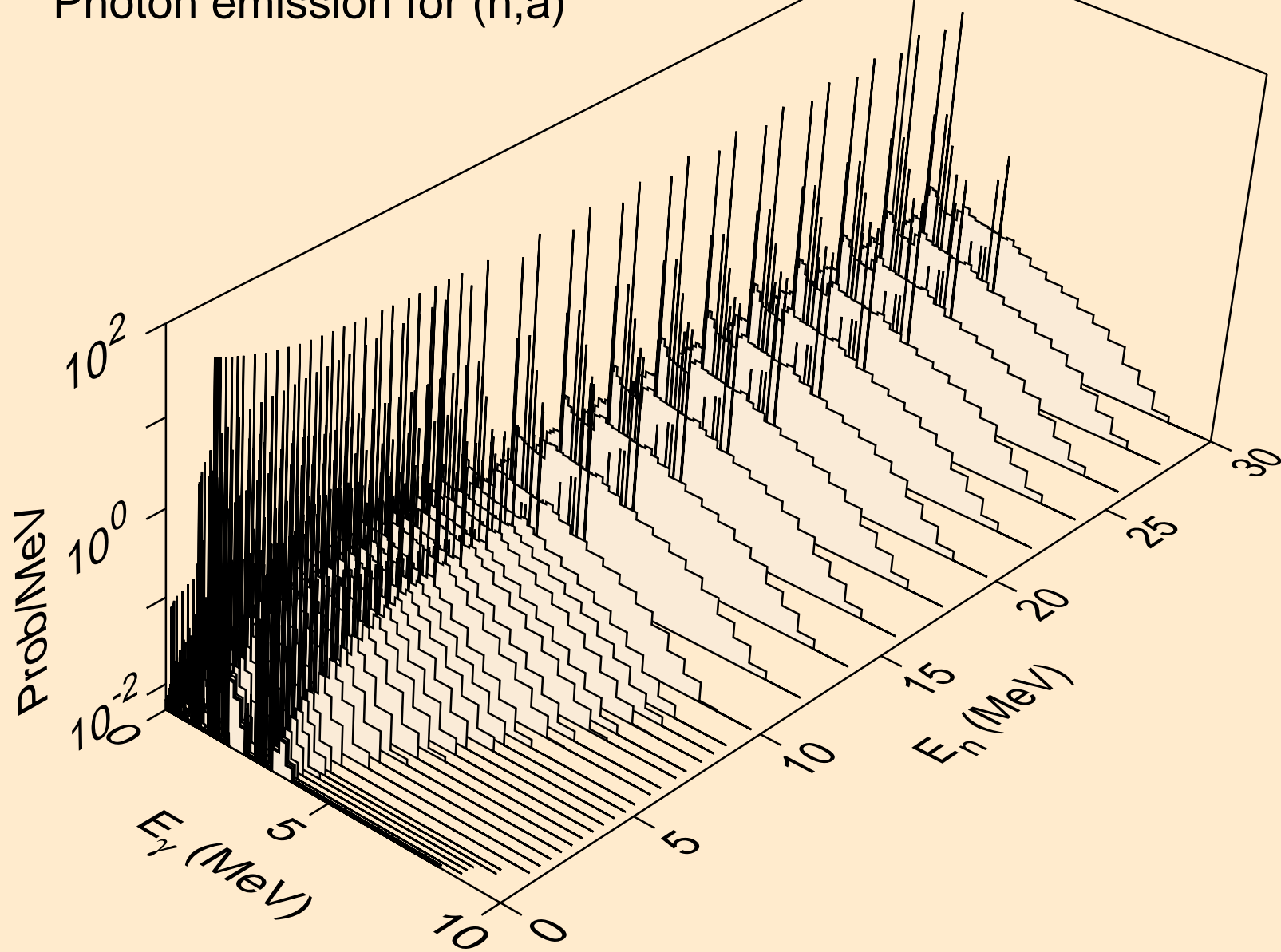

ZN061 NEUTRON ACER TENDL-2023 LIBRARY; T=0.K
Photon emission for (n,2a)

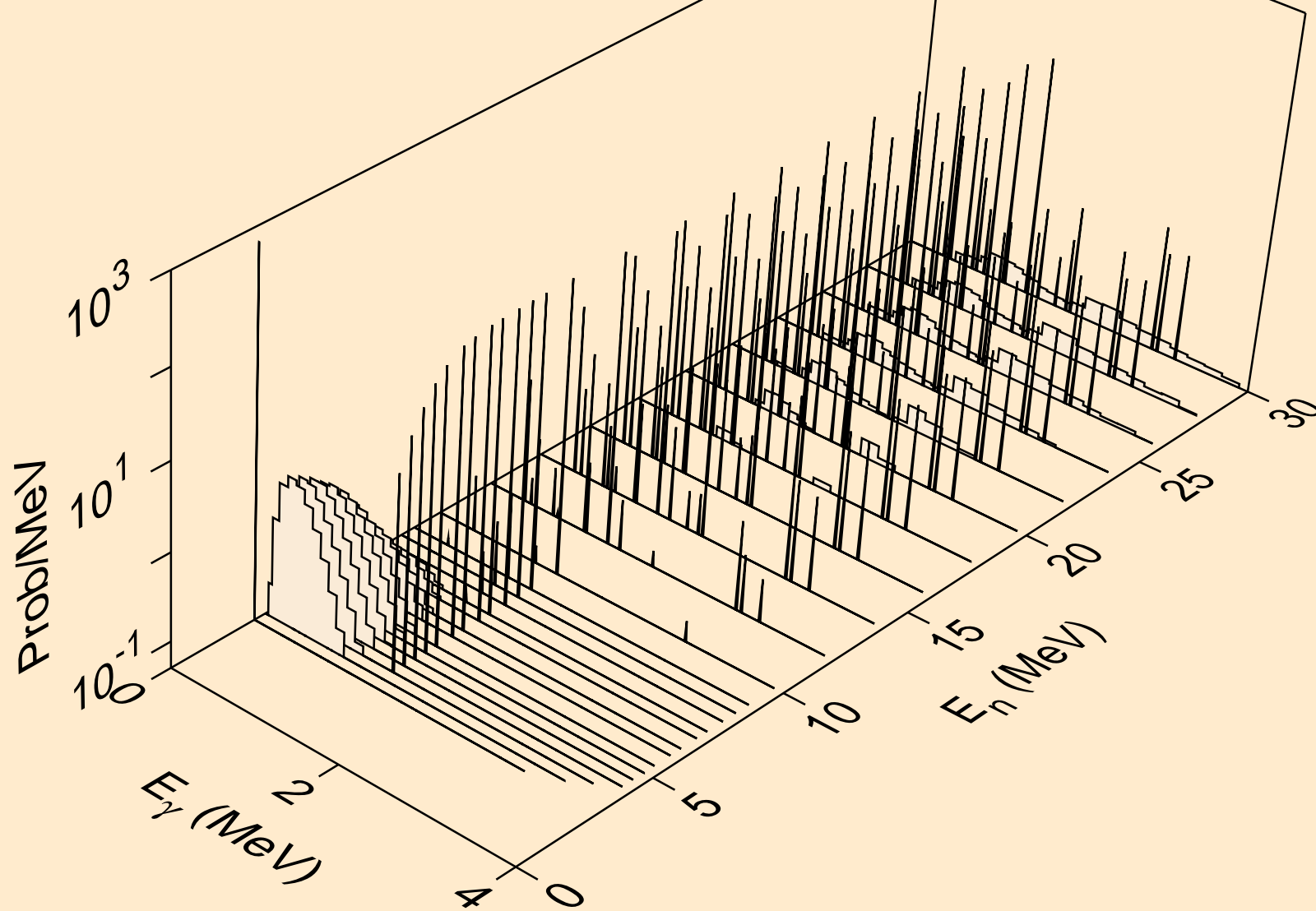

ZN061 NEUTRON ACER TENDL-2023 LIBRARY; T=0.K
Photon emission for (n,3a)

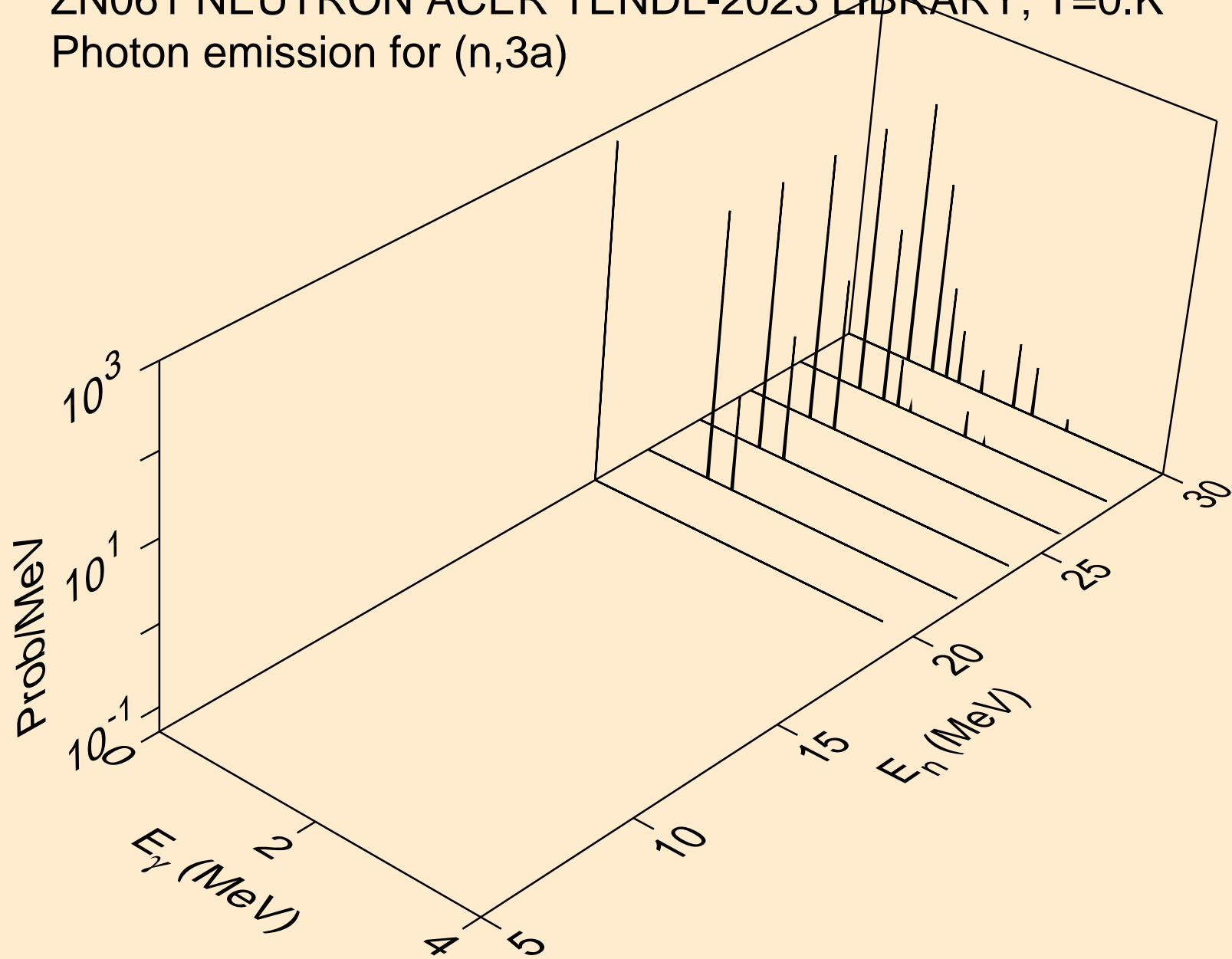

ZN061 NEUTRON ACER TENDL-2023 LIBRARY; T=0.K
Photon emission for (n,2p)

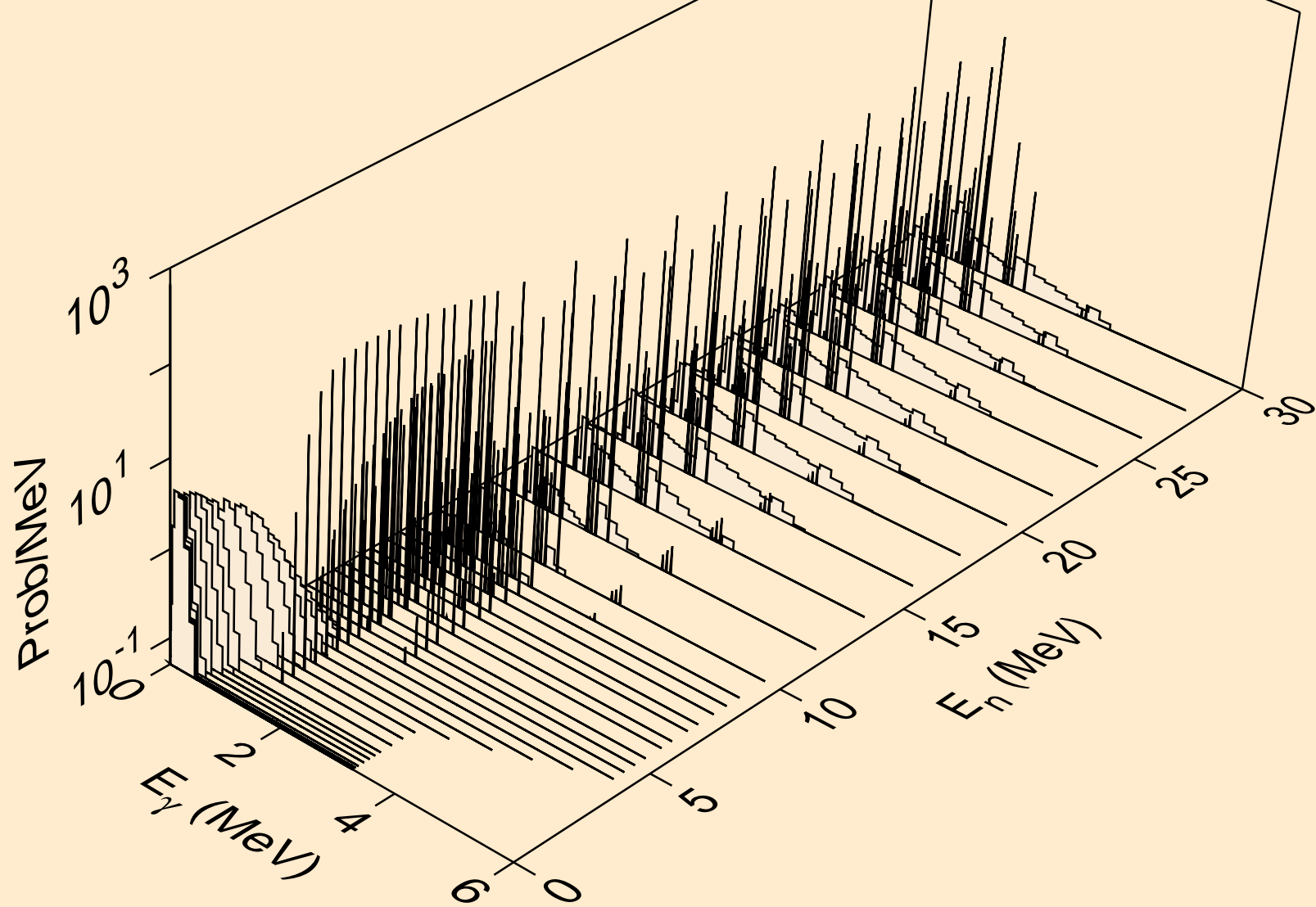

ZN061 NEUTRON ACER TENDL-2023 LIBRARY; T=0.K
Photon emission for (n,p α)

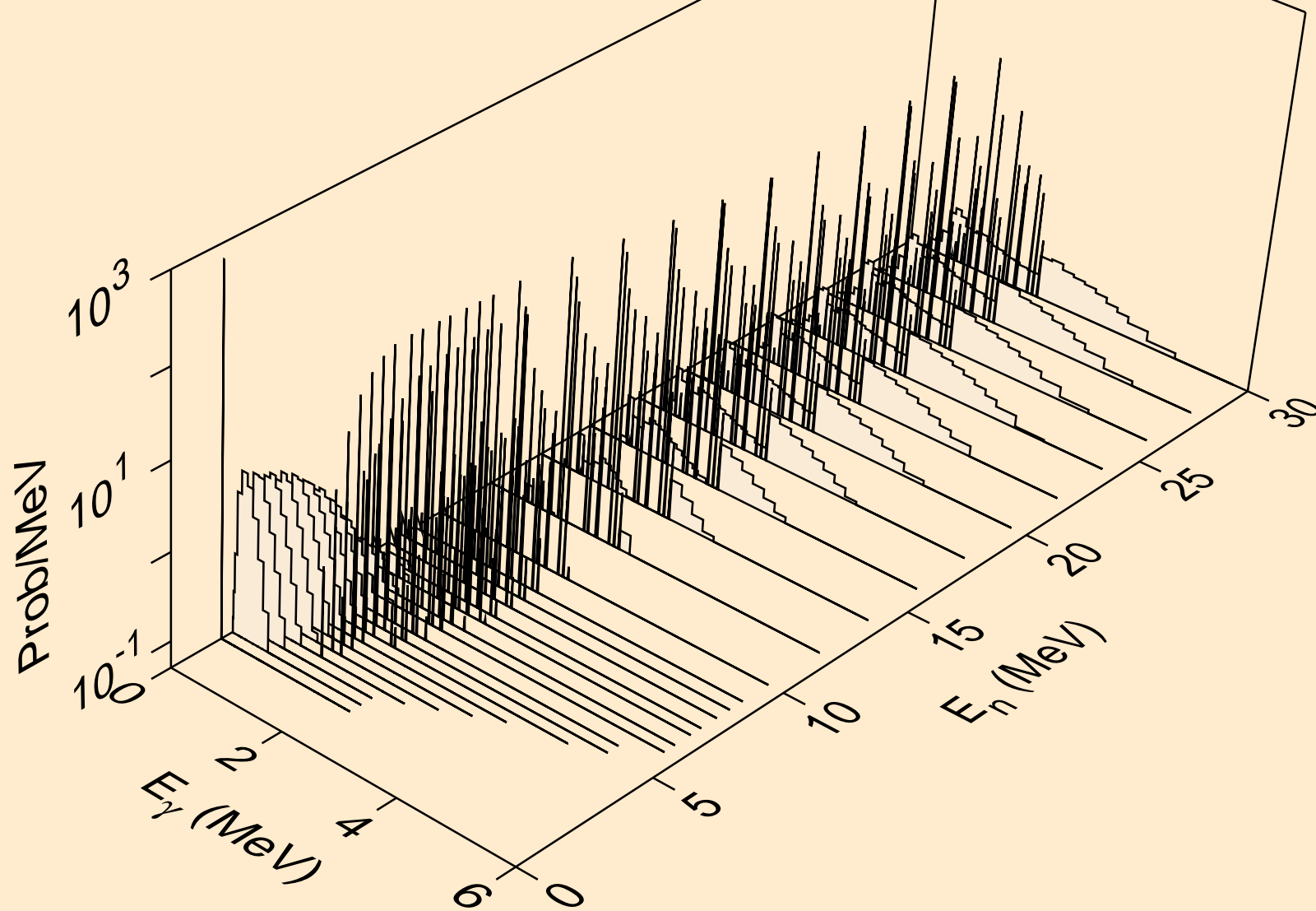

ZN061 NEUTRON ACER TENDL-2023 LIBRARY; T=0.K
Photon emission for (n,pd)

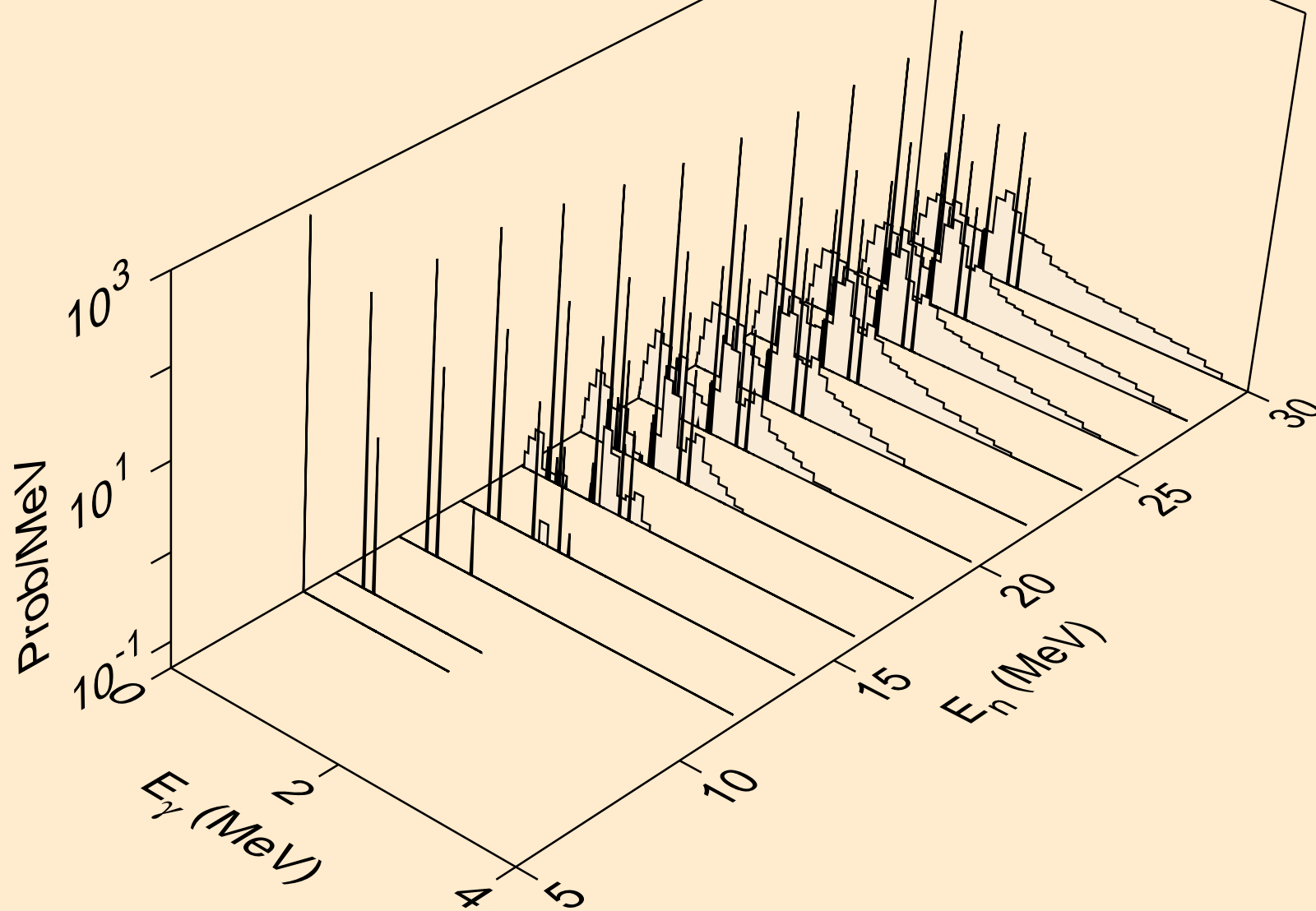

ZN061 NEUTRON ACER TENDL-2023 LIBRARY; T=0.K
Photon emission for (n,pt)

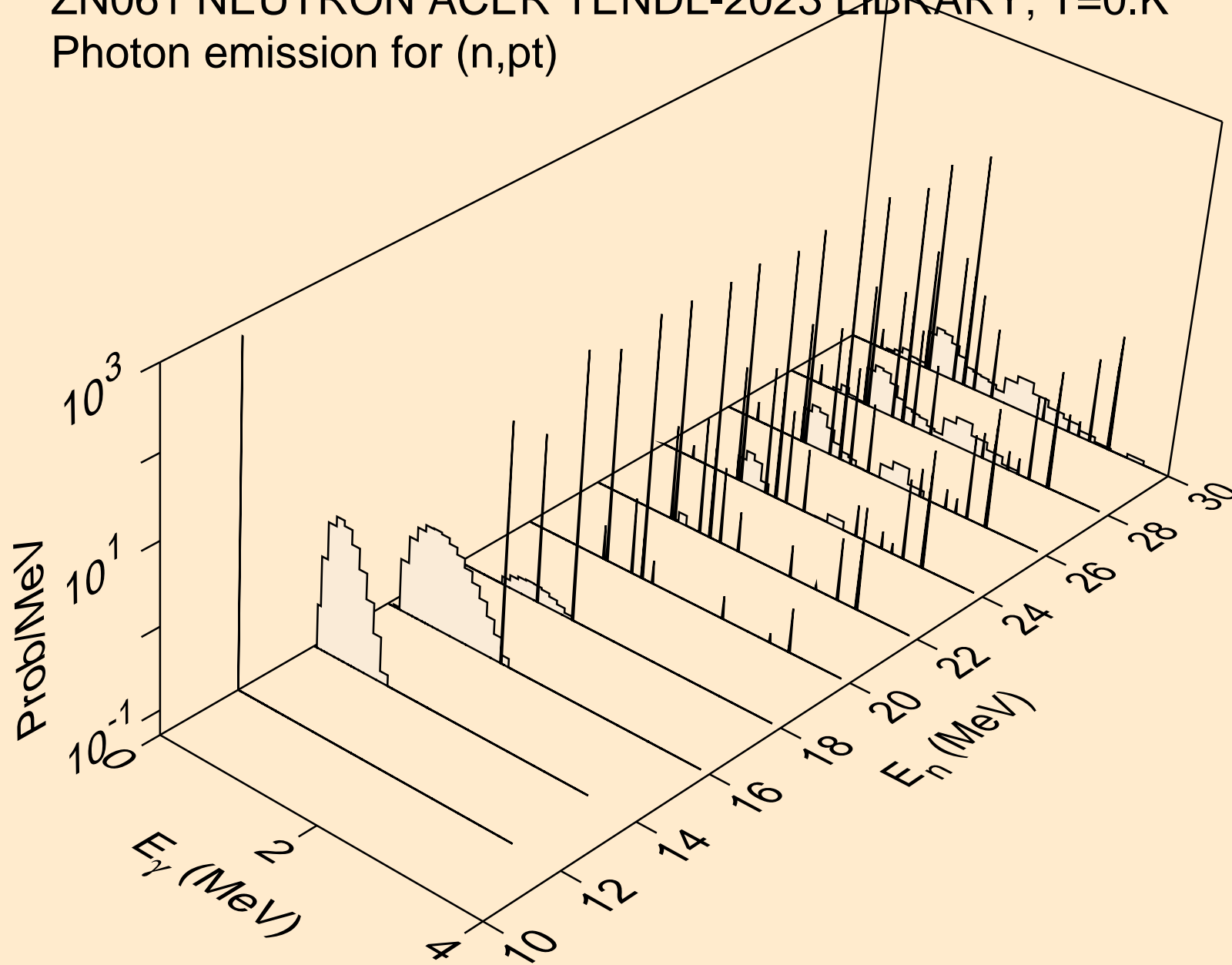

ZN061 NEUTRON ACER TENDL-2023 LIBRARY; T=0.K
Photon emission for (n,da)

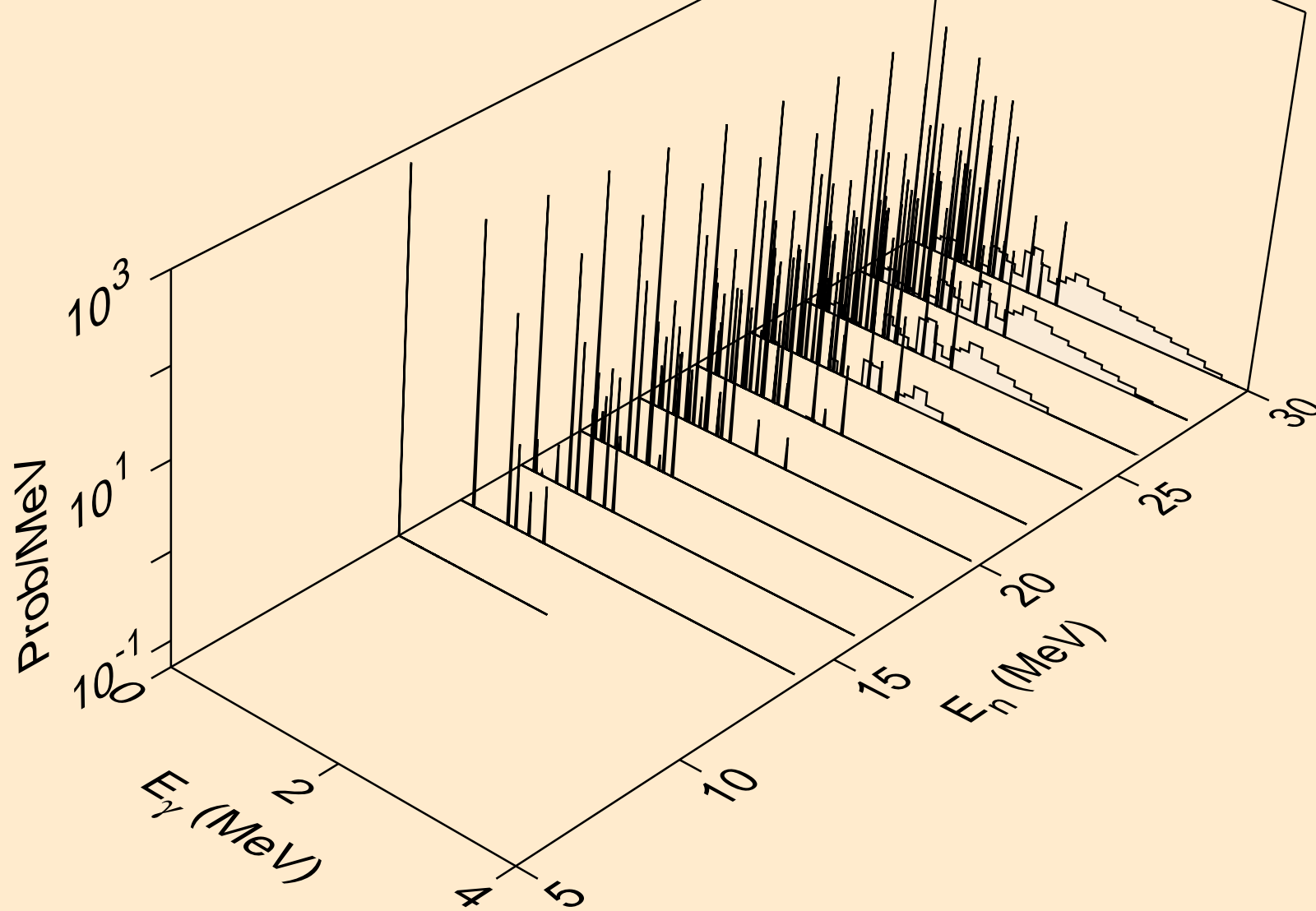

ZN061 NEUTRON ACER TENDL-2023 LIBRARY; T=0.K
thermal capture photon spectrum

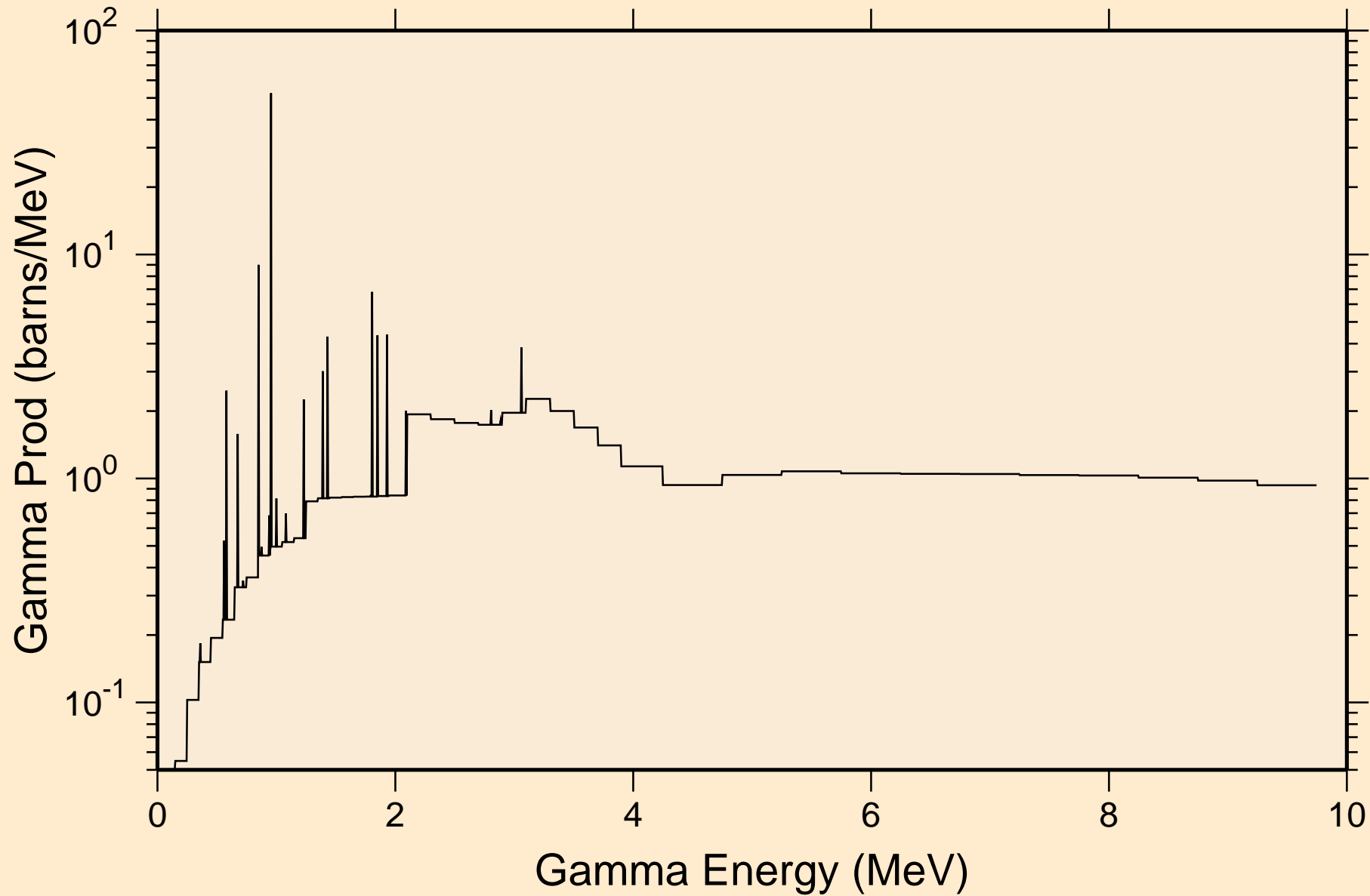

ZN061 NEUTRON ACER TENDL-2023 LIBRARY; T=0.K
14 MeV photon spectrum

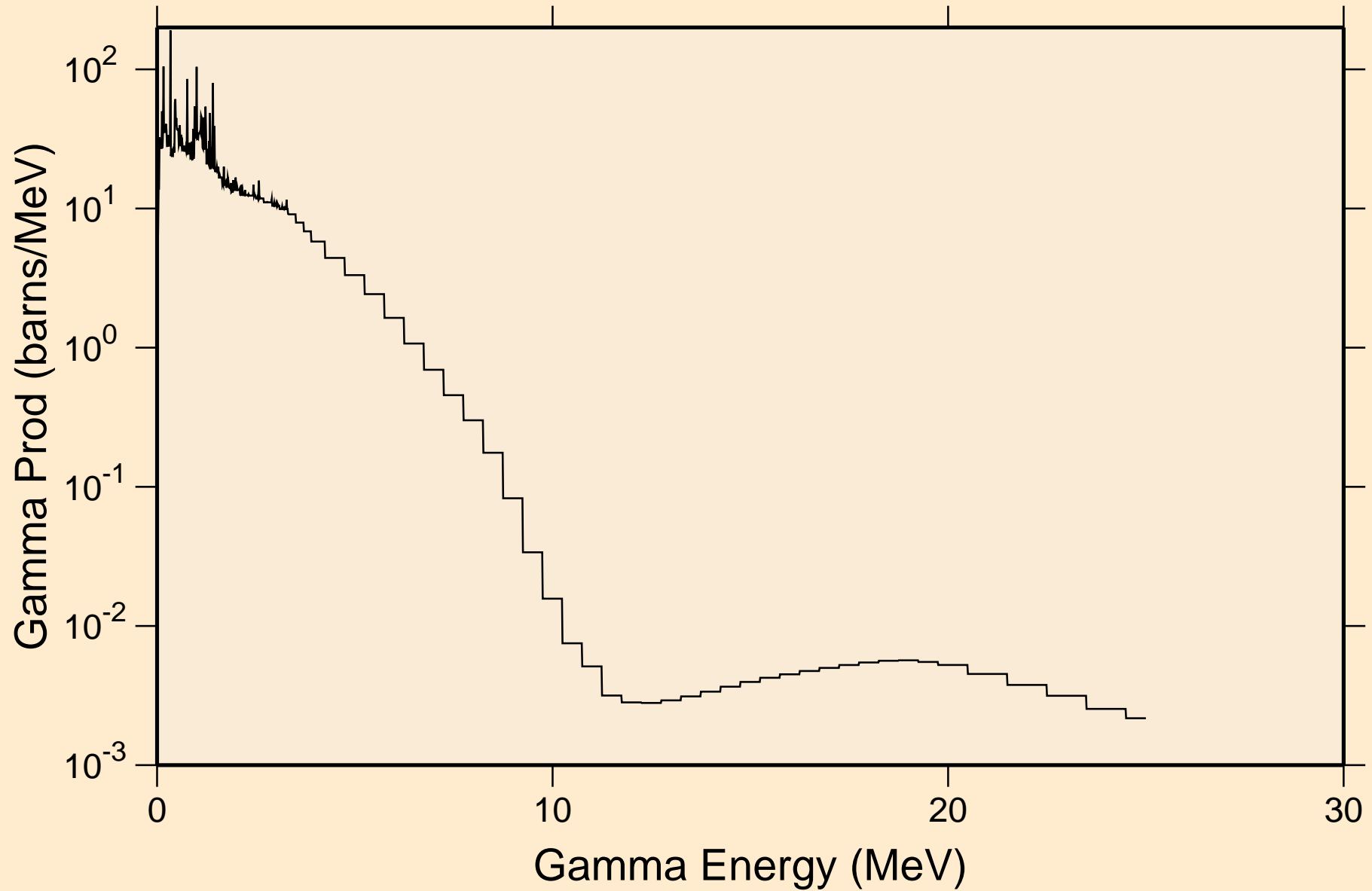

ZN061 NEUTRON ACER TENDL-2023 LIBRARY; T=0.K

Particle heating contributions

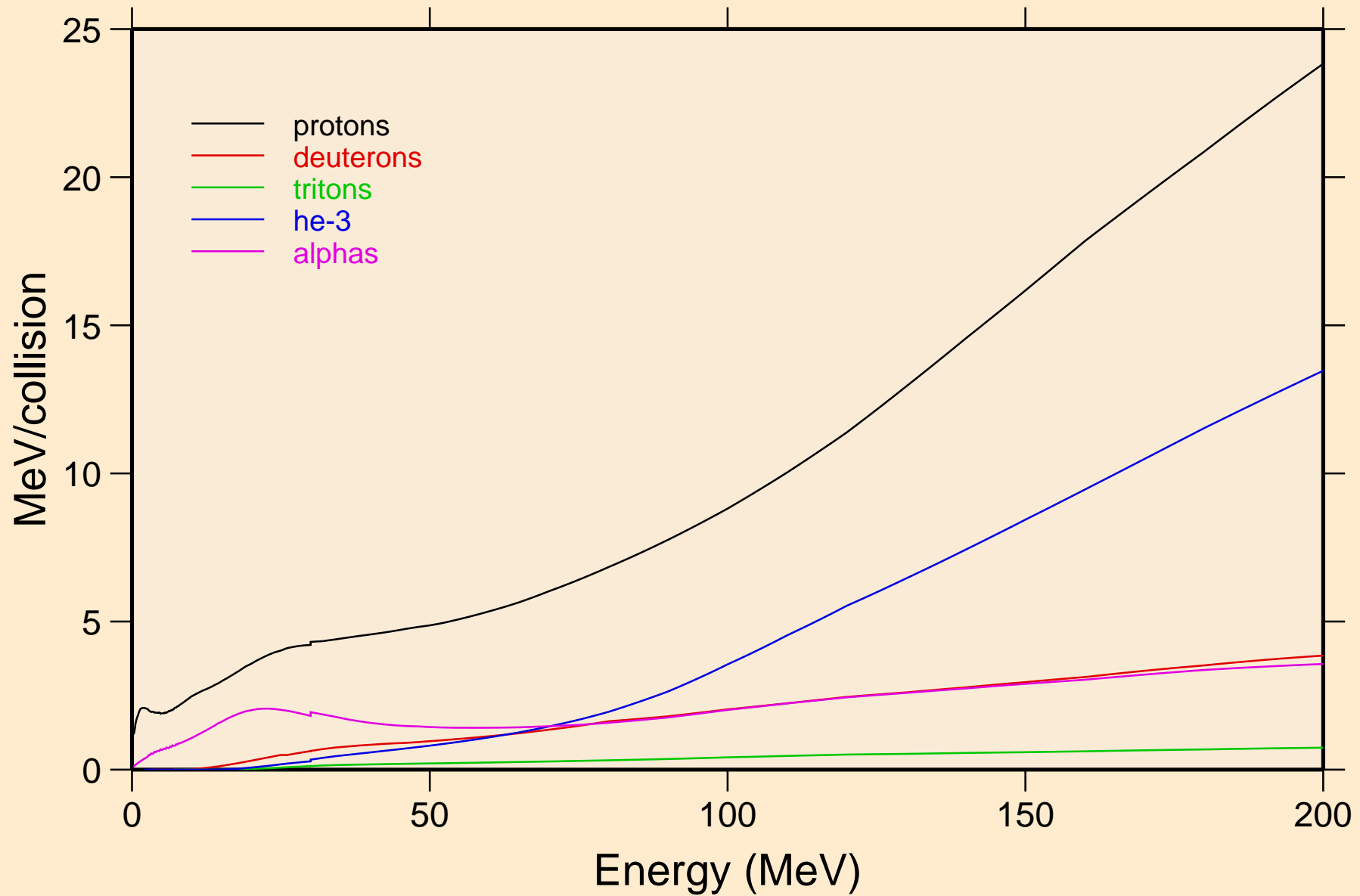

ZN061 NEUTRON ACER TENDL-2023 LIBRARY; T=0.K
Recoil Heating

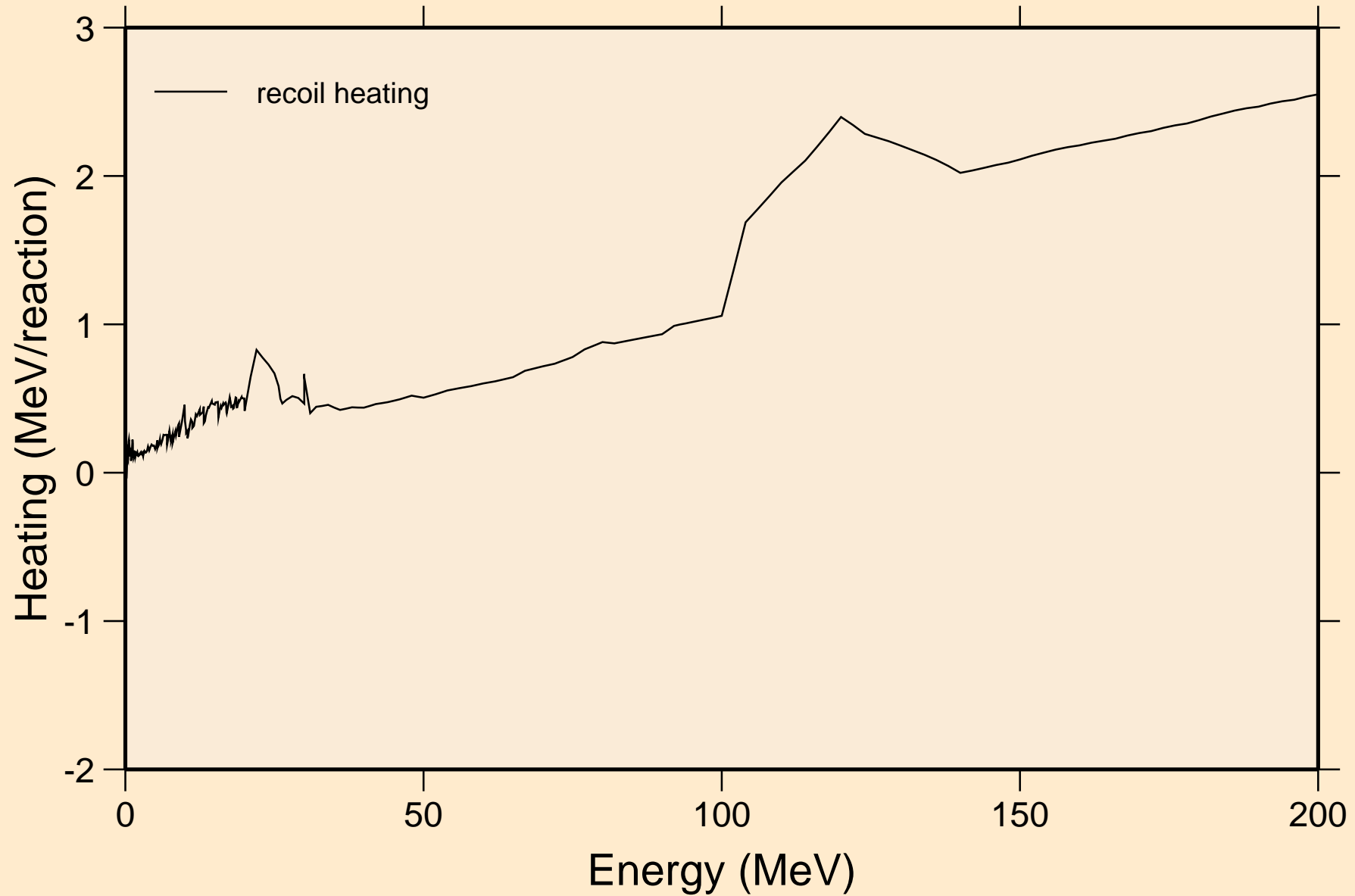

ZN061 NEUTRON ACER TENDL-2023 LIBRARY; T=0.K

Particle production cross sections

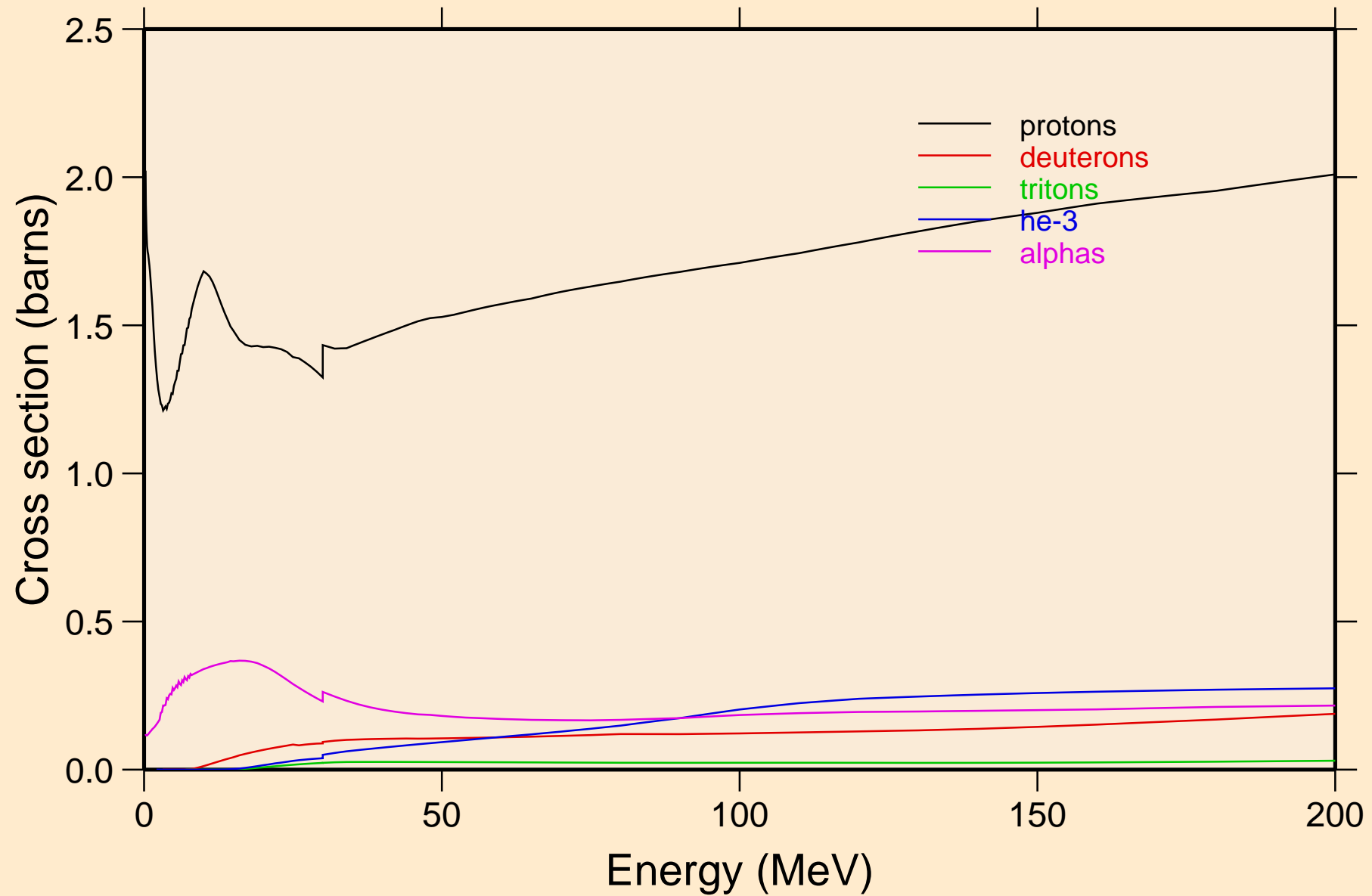

ZN061 NEUTRON ACER TENDL-2023 LIBRARY; T=0.K
protons from (n,x)

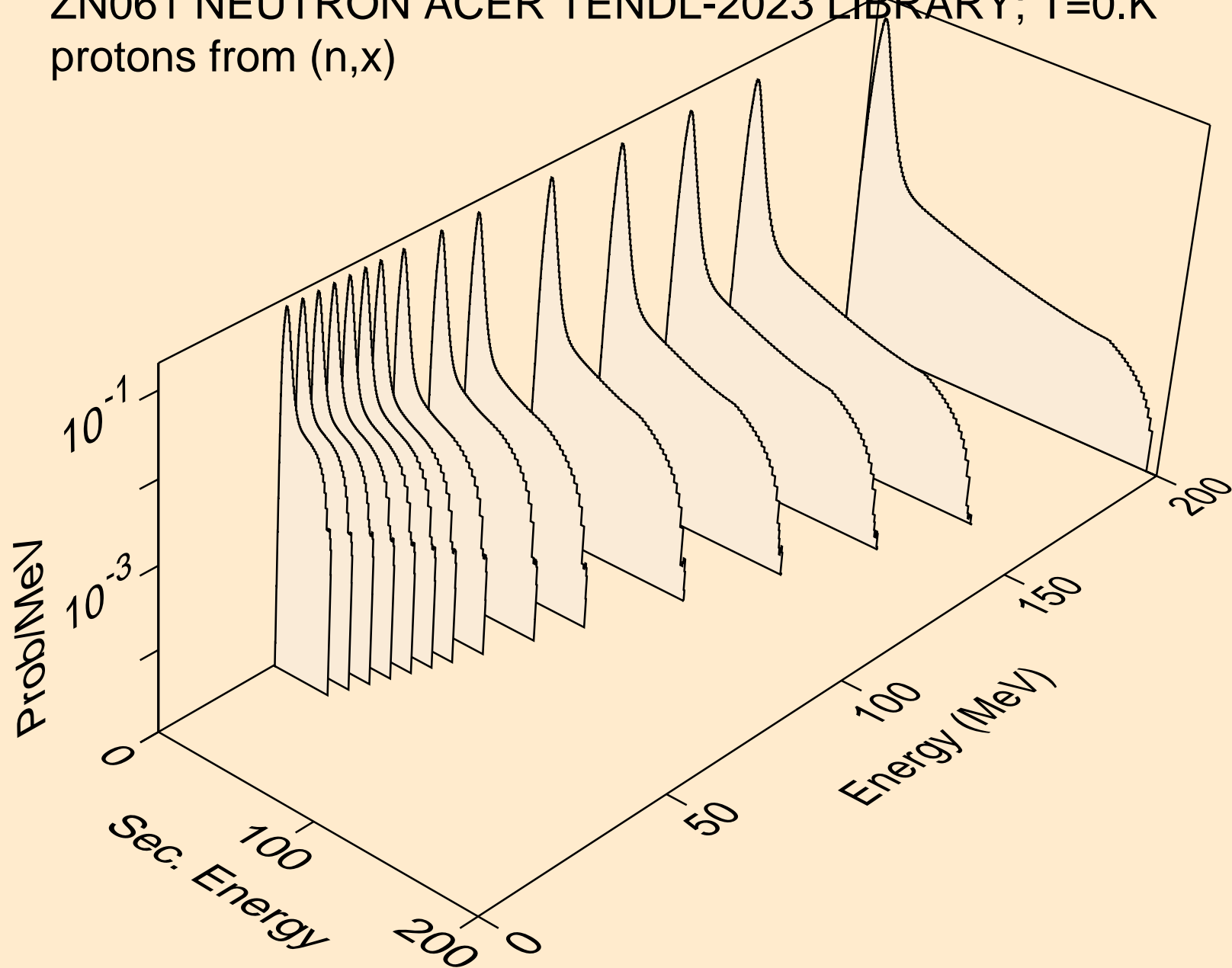

ZN061 NEUTRON ACER TENDL-2023 LIBRARY; T=0.K
protons from (n,n*)p

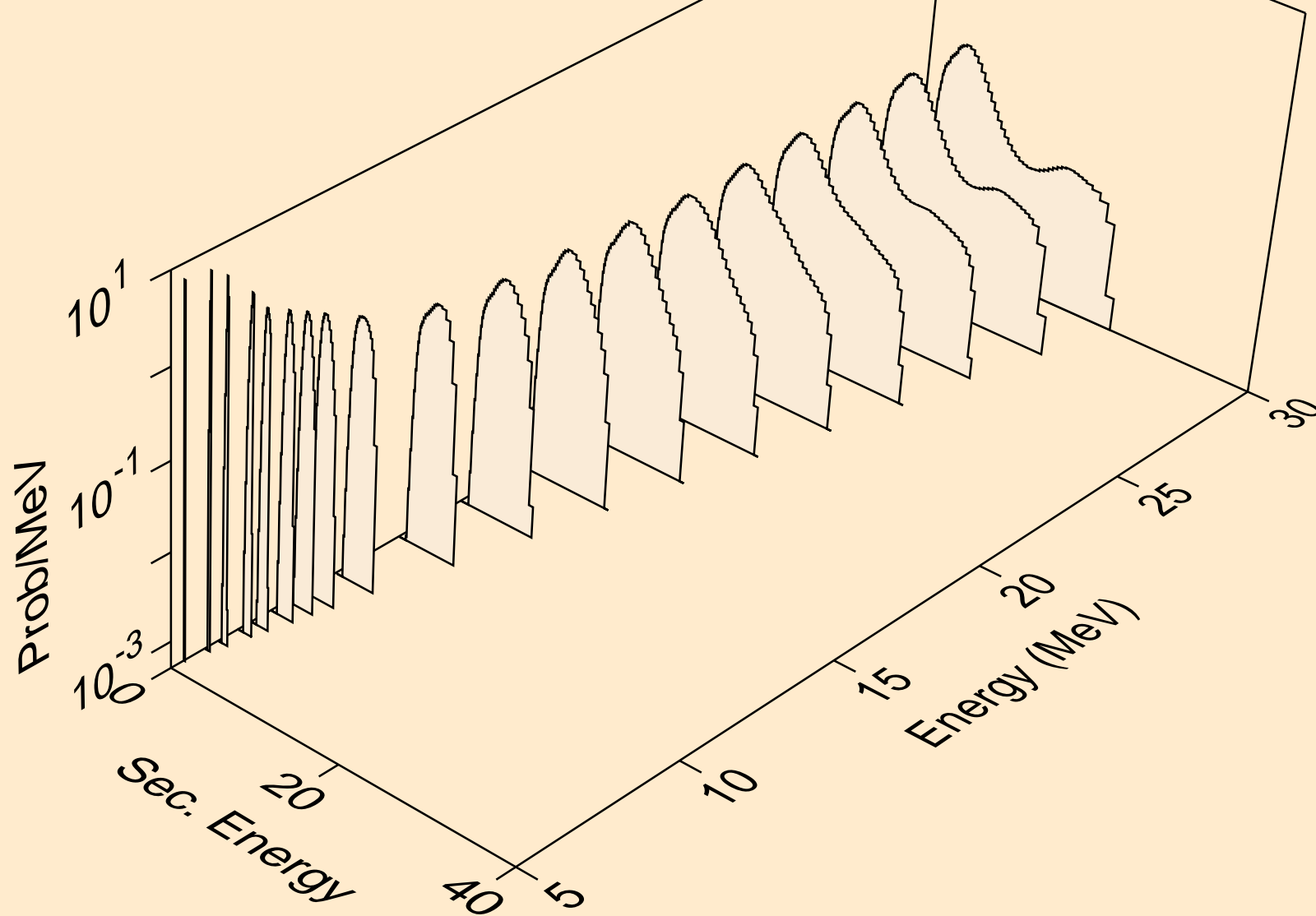

ZN061 NEUTRON ACER TENDL-2023 LIBRARY; T=0.K
protons from (n,2np)

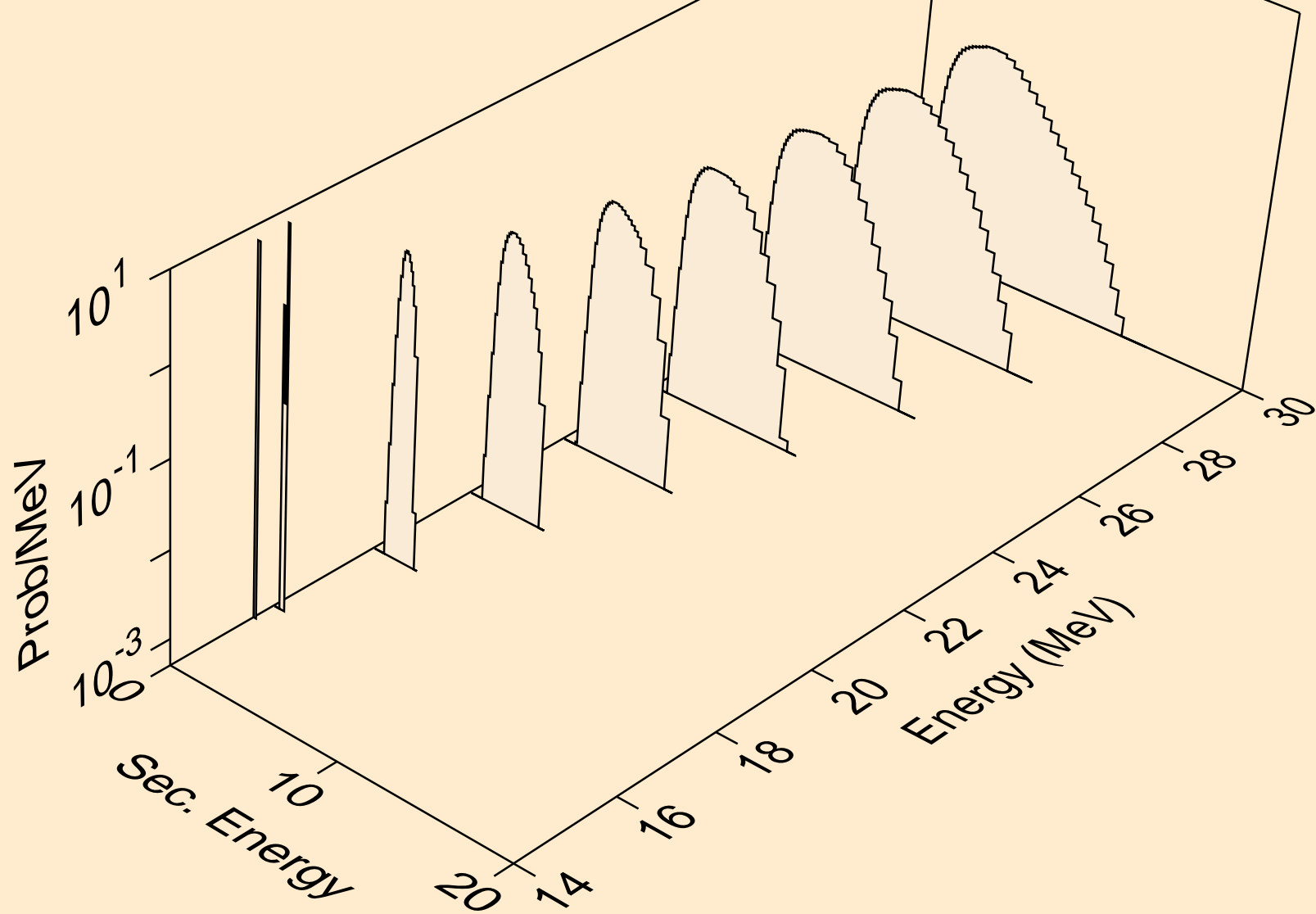

ZN061 NEUTRON ACER TENDL-2023 LIBRARY; T=0.K
protons from (n,n2p)

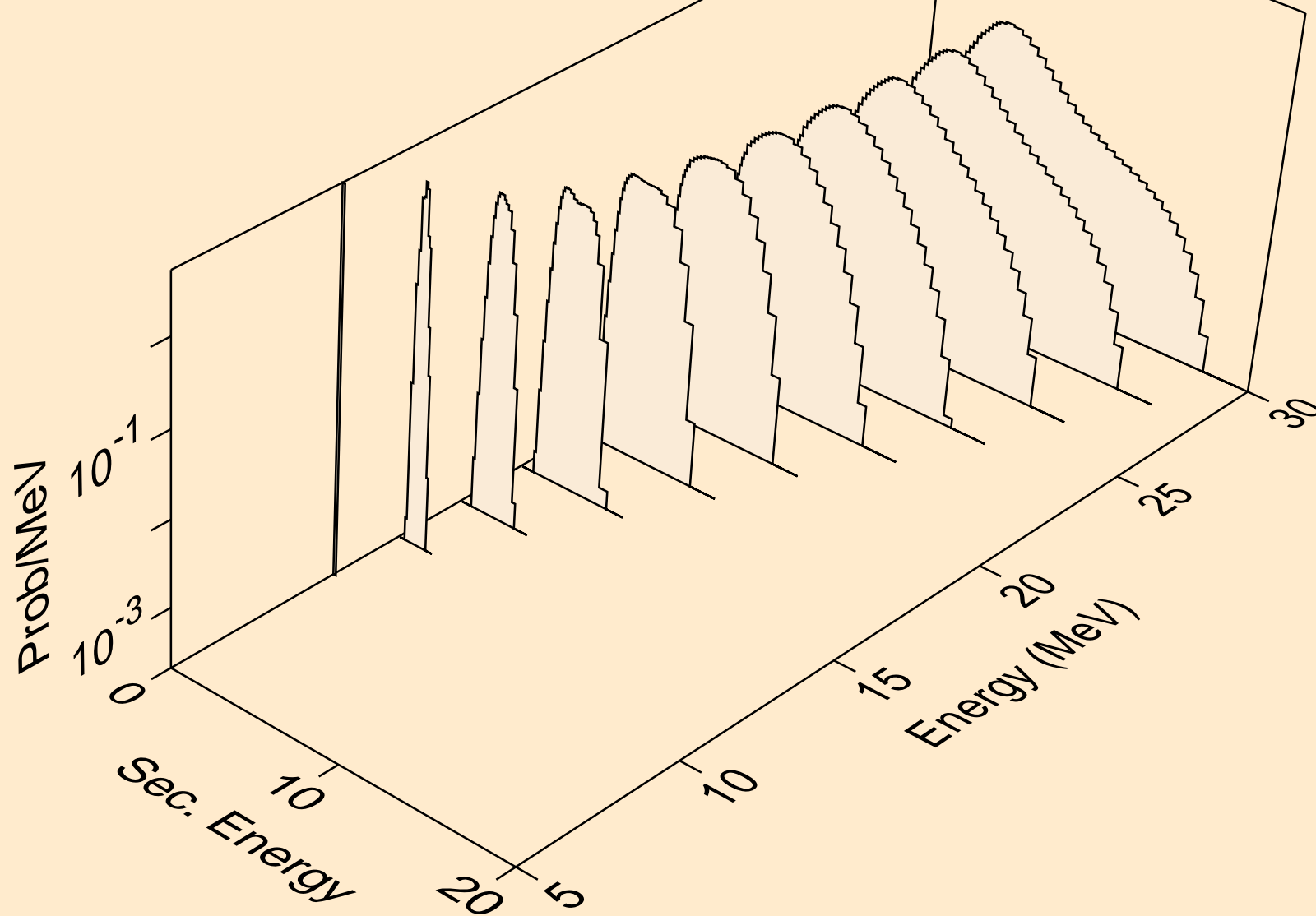

ZN061 NEUTRON ACER TENDL-2023 LIBRARY; T=0.K
protons from (n,npa)

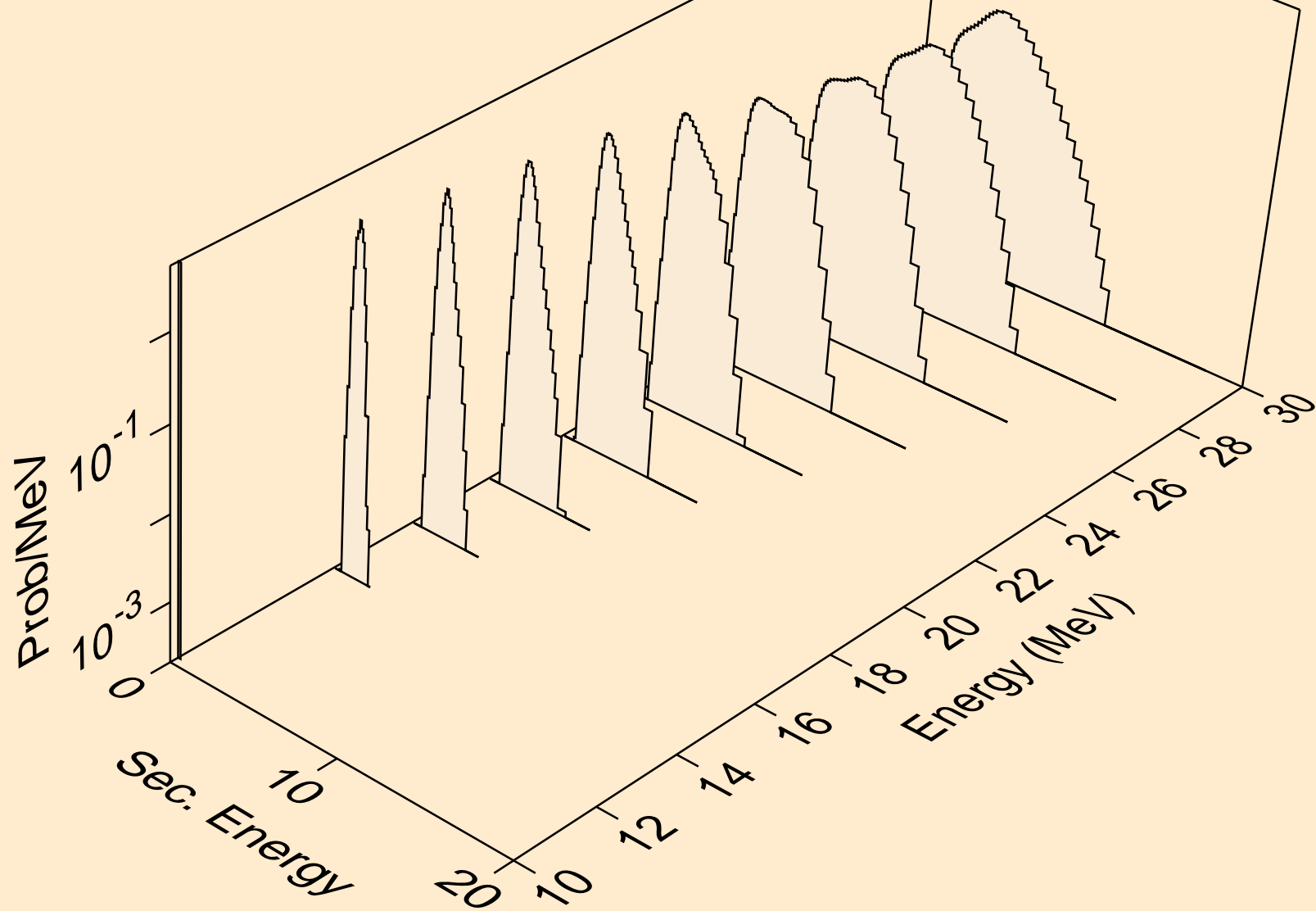

ZN061 NEUTRON ACER TENDL-2023 LIBRARY; T=0.K
protons from (n,p)

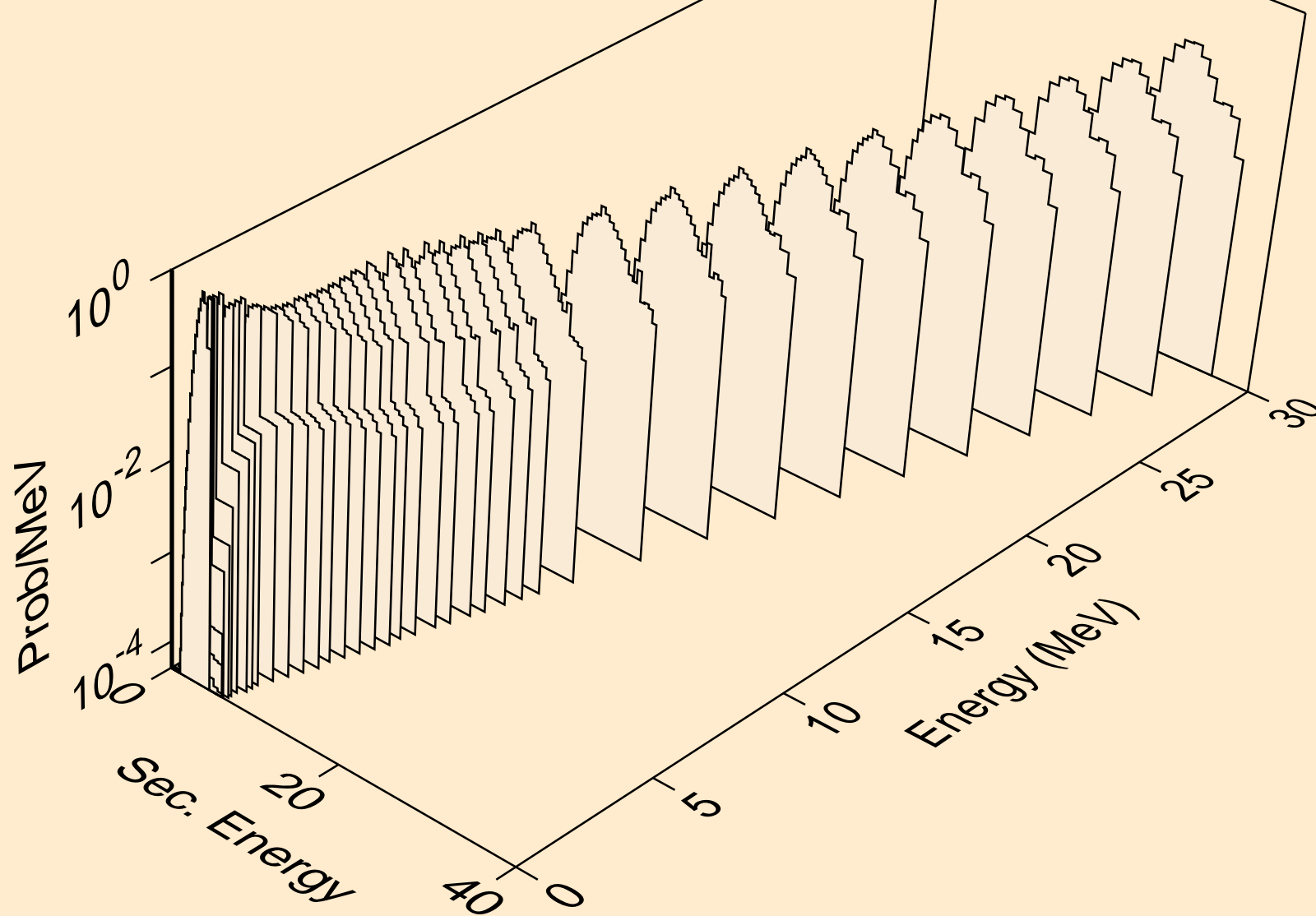

ZN061 NEUTRON ACER TENDL-2023 LIBRARY; T=0.K
protons from (n,2p)

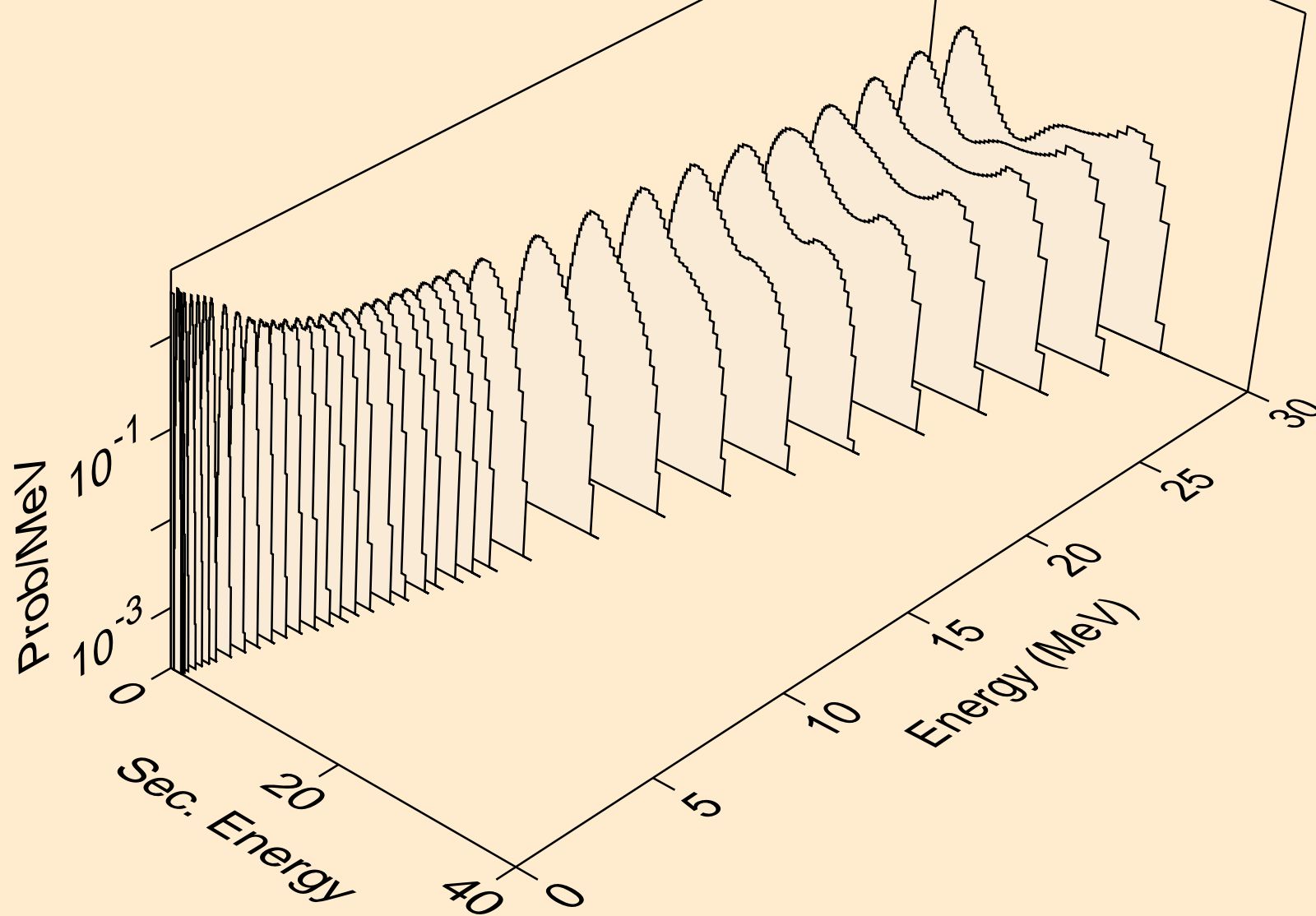

ZN061 NEUTRON ACER TENDL-2023 LIBRARY; T=0.K
protons from (n,p)

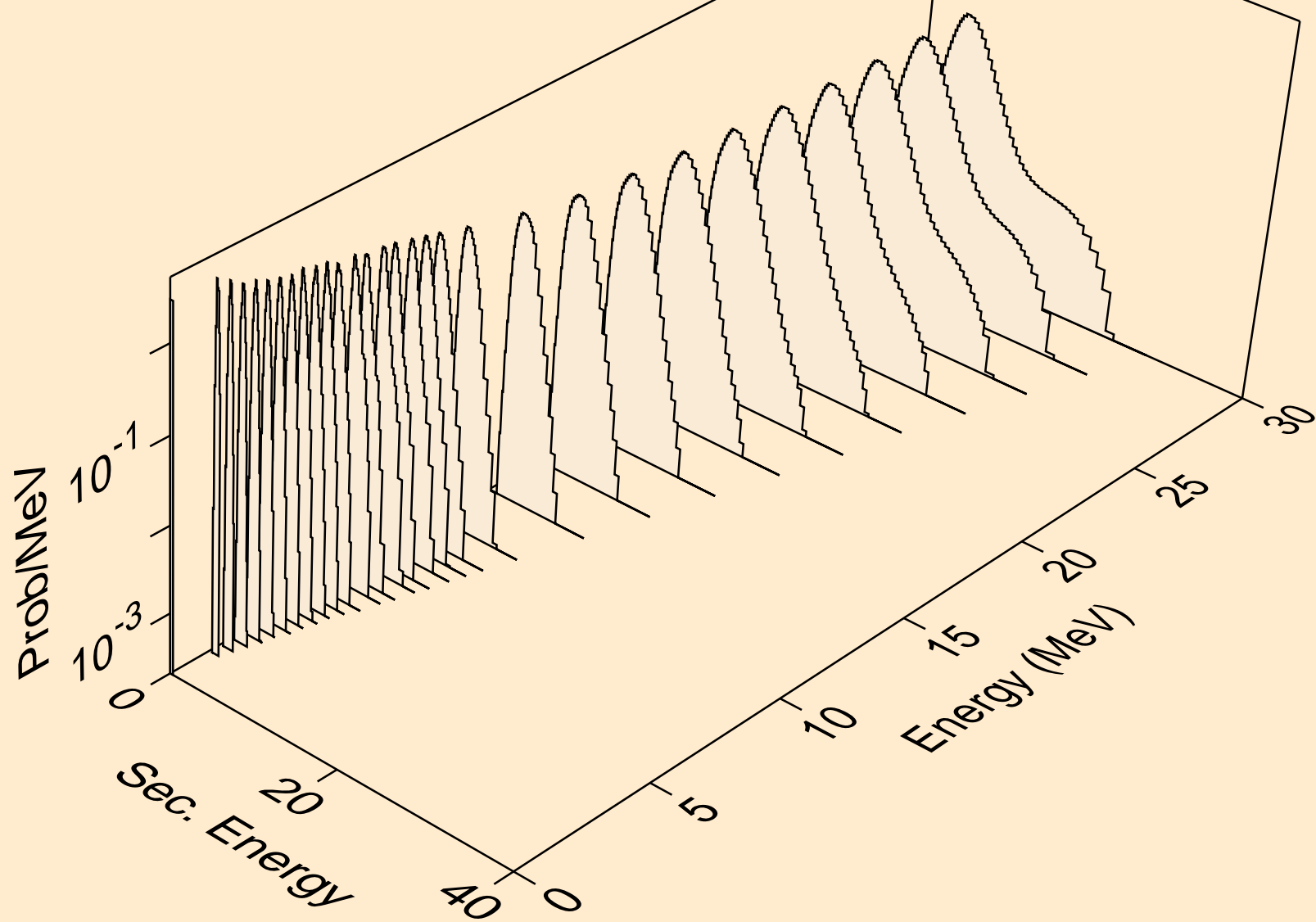

ZN061 NEUTRON ACER TENDL-2023 LIBRARY; T=0.K
protons from (n,pd)

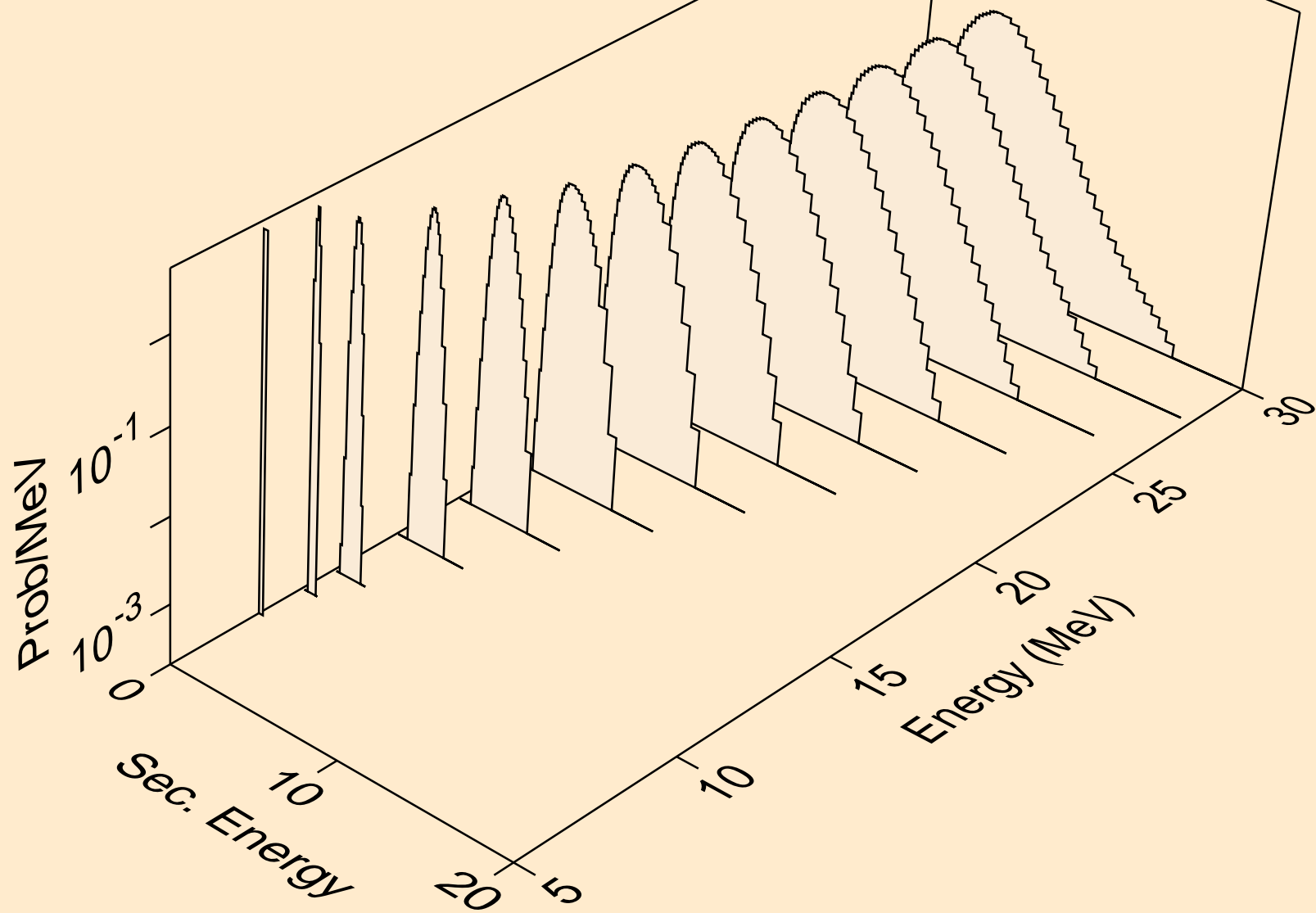

ZN061 NEUTRON ACER TENDL-2023 LIBRARY; T=0.K
protons from (n,pt)

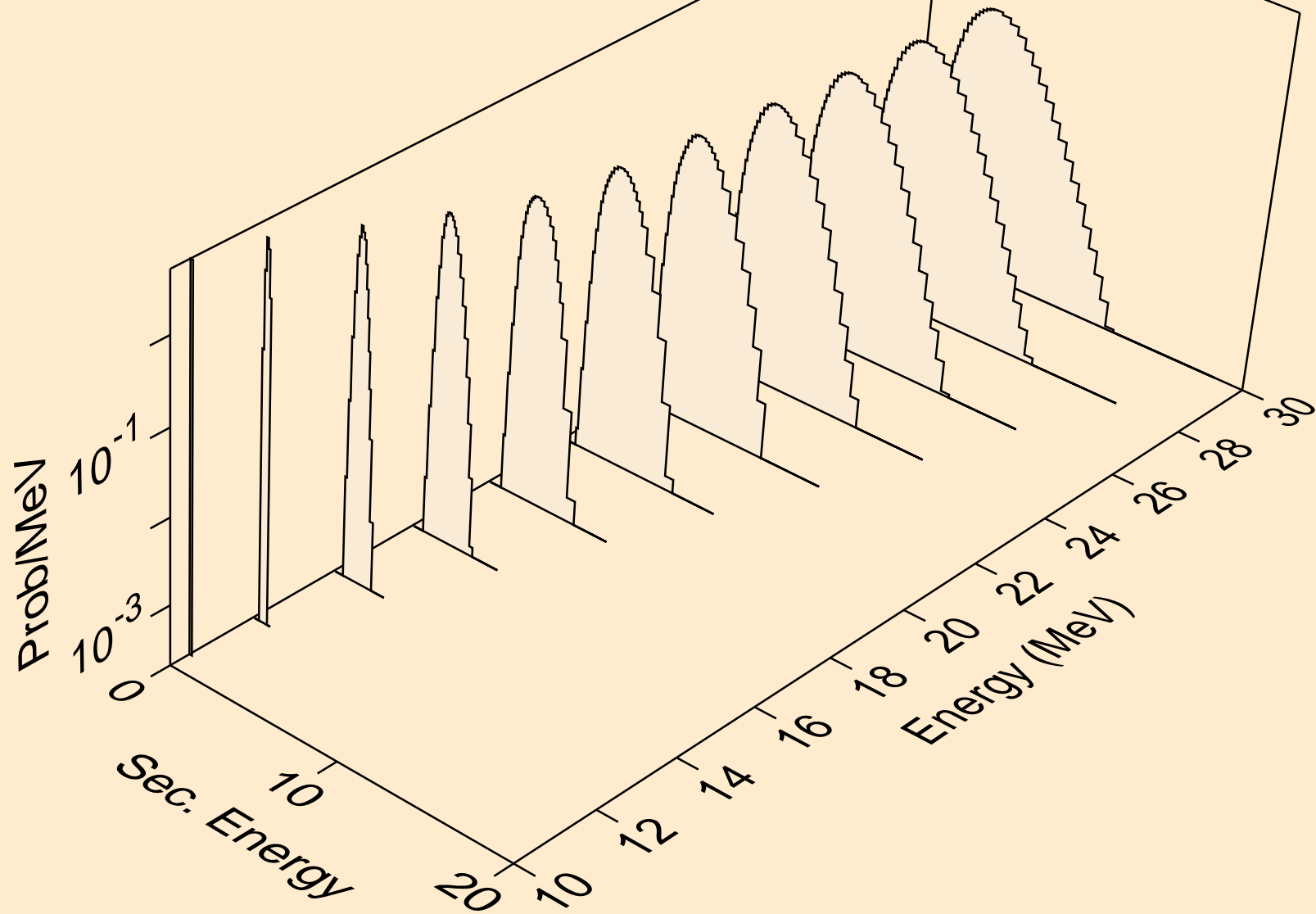

ZN061 NEUTRON ACER TENDL-2023 LIBRARY; T=0.K
deuterons from (n,x)

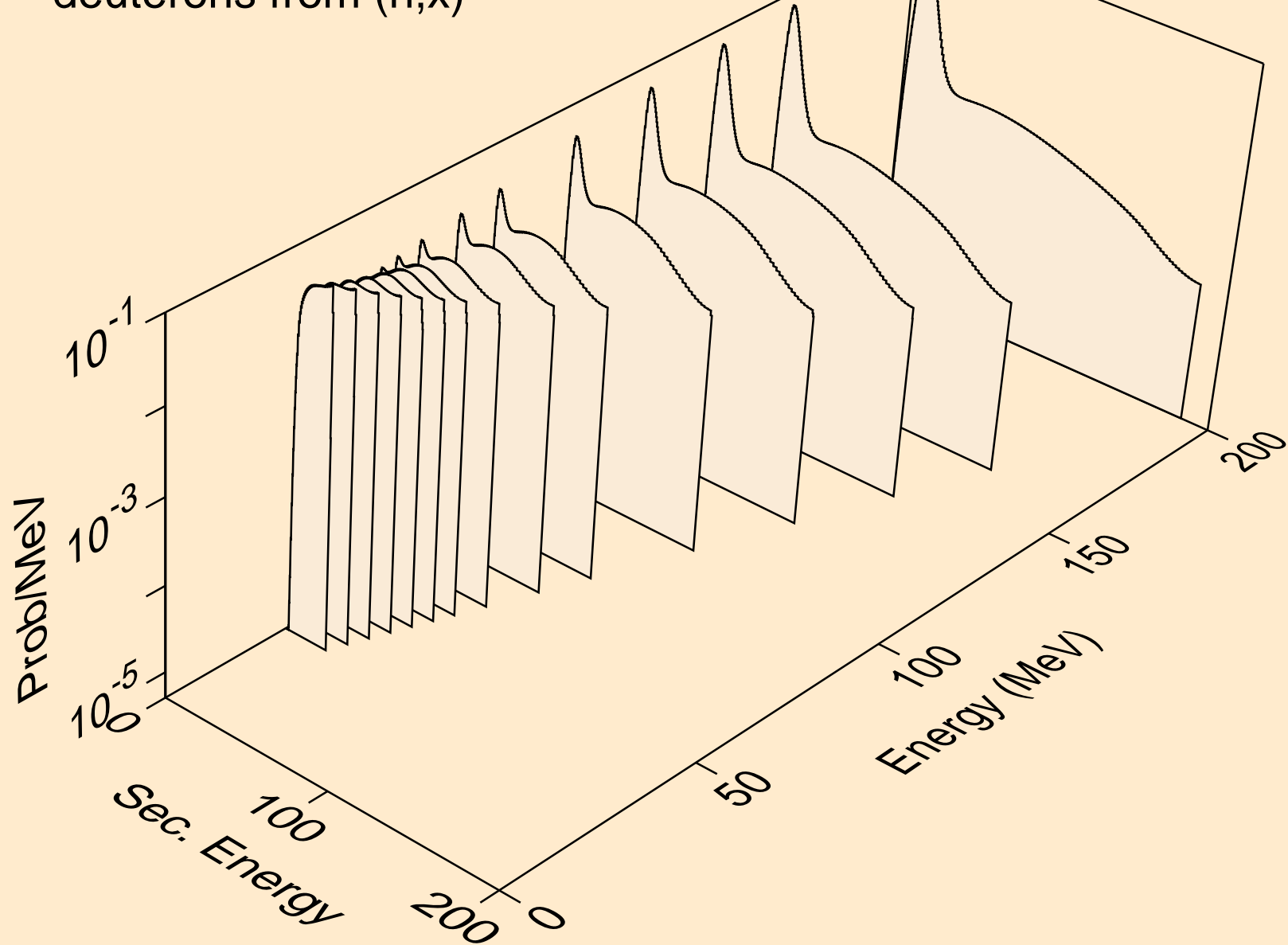

ZN061 NEUTRON ACER TENDL-2023 LIBRARY; T=0.K
deuterons from (n,2nd)

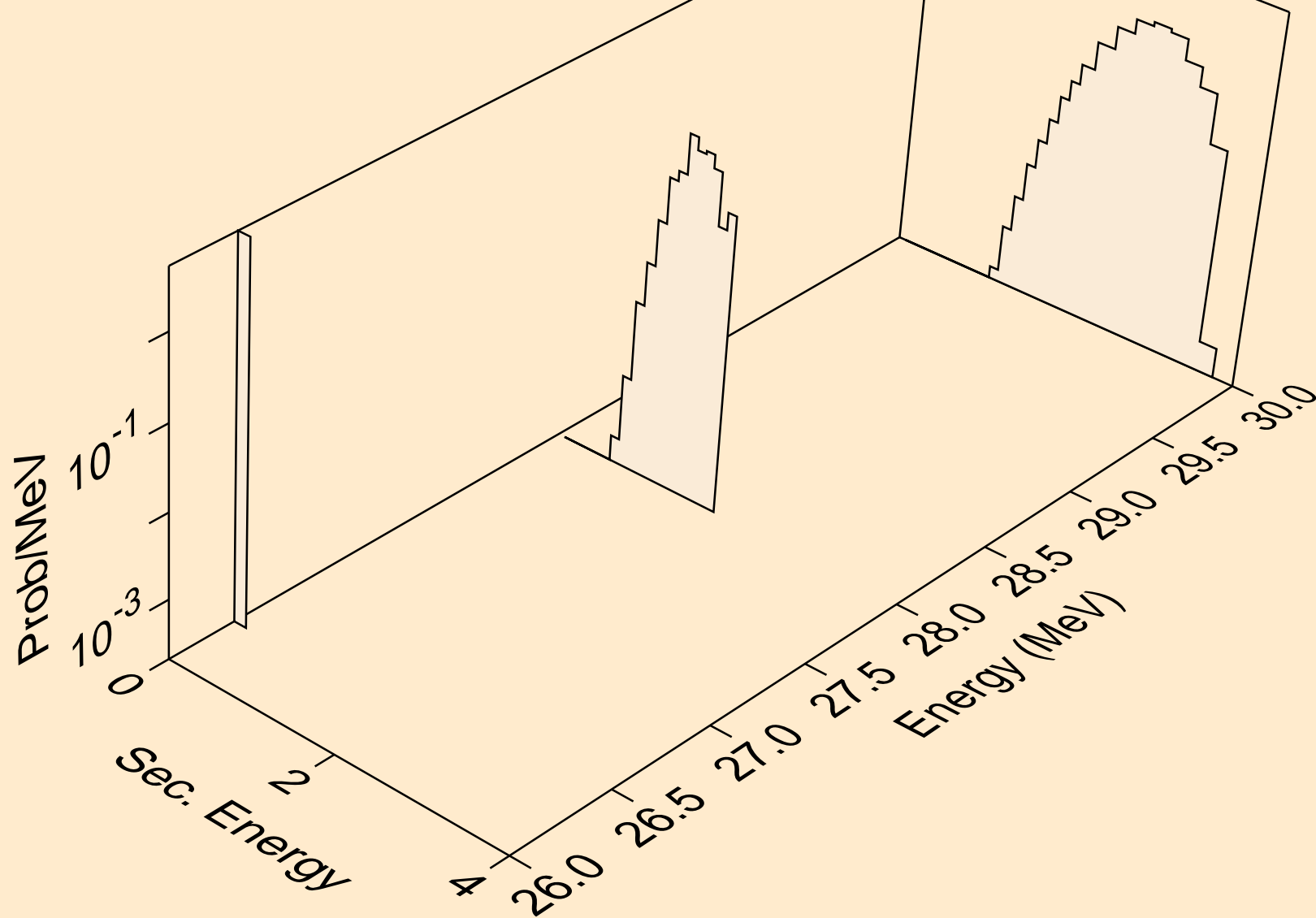

ZN061 NEUTRON ACER TENDL-2023 LIBRARY; T=0.K
deuterons from (n,n*)d

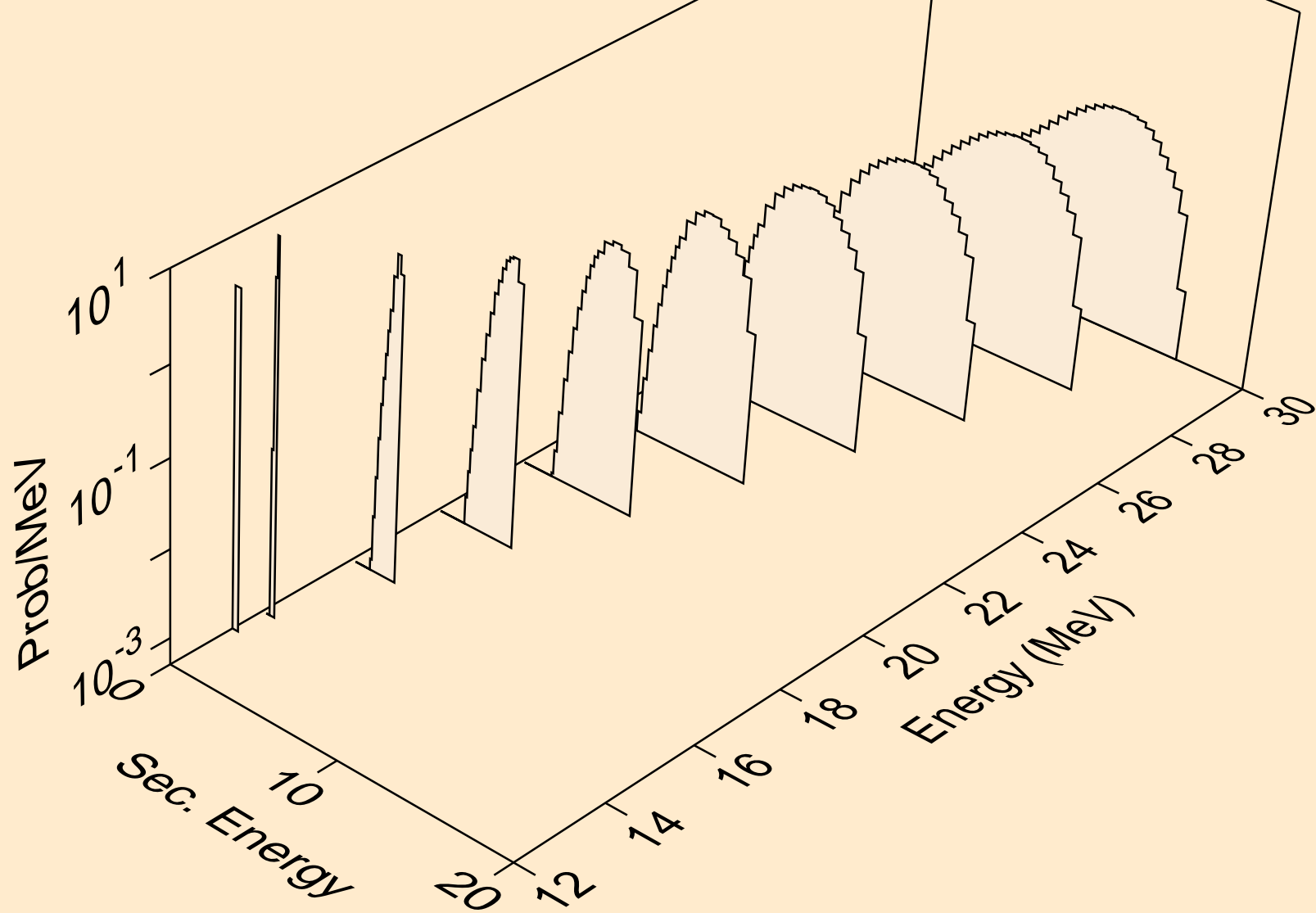

ZN061 NEUTRON ACER TENDL-2023 LIBRARY; T=0.K
deuterons from (n,d)

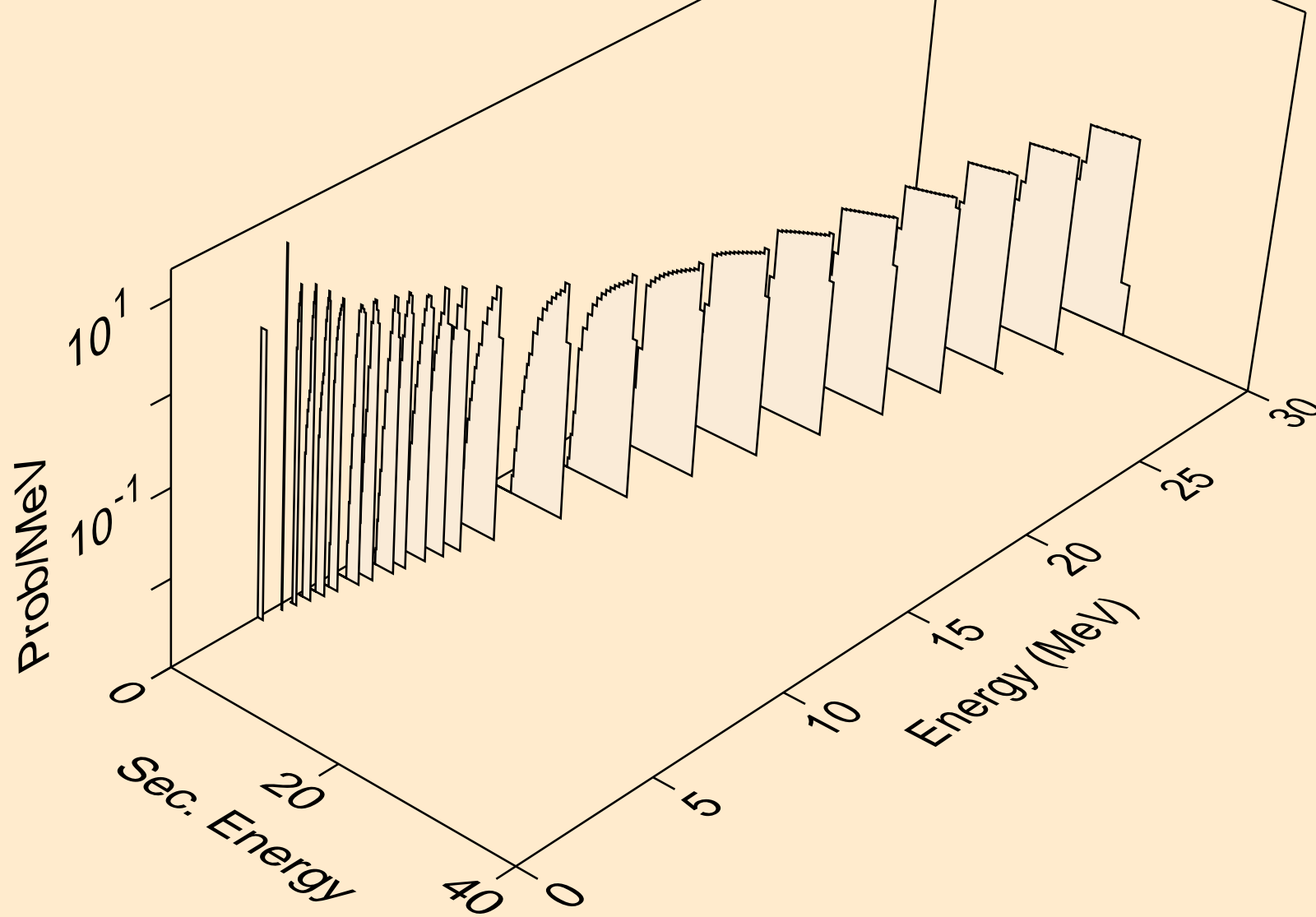

ZN061 NEUTRON ACER TENDL-2023 LIBRARY; T=0.K
deuterons from (n,pd)

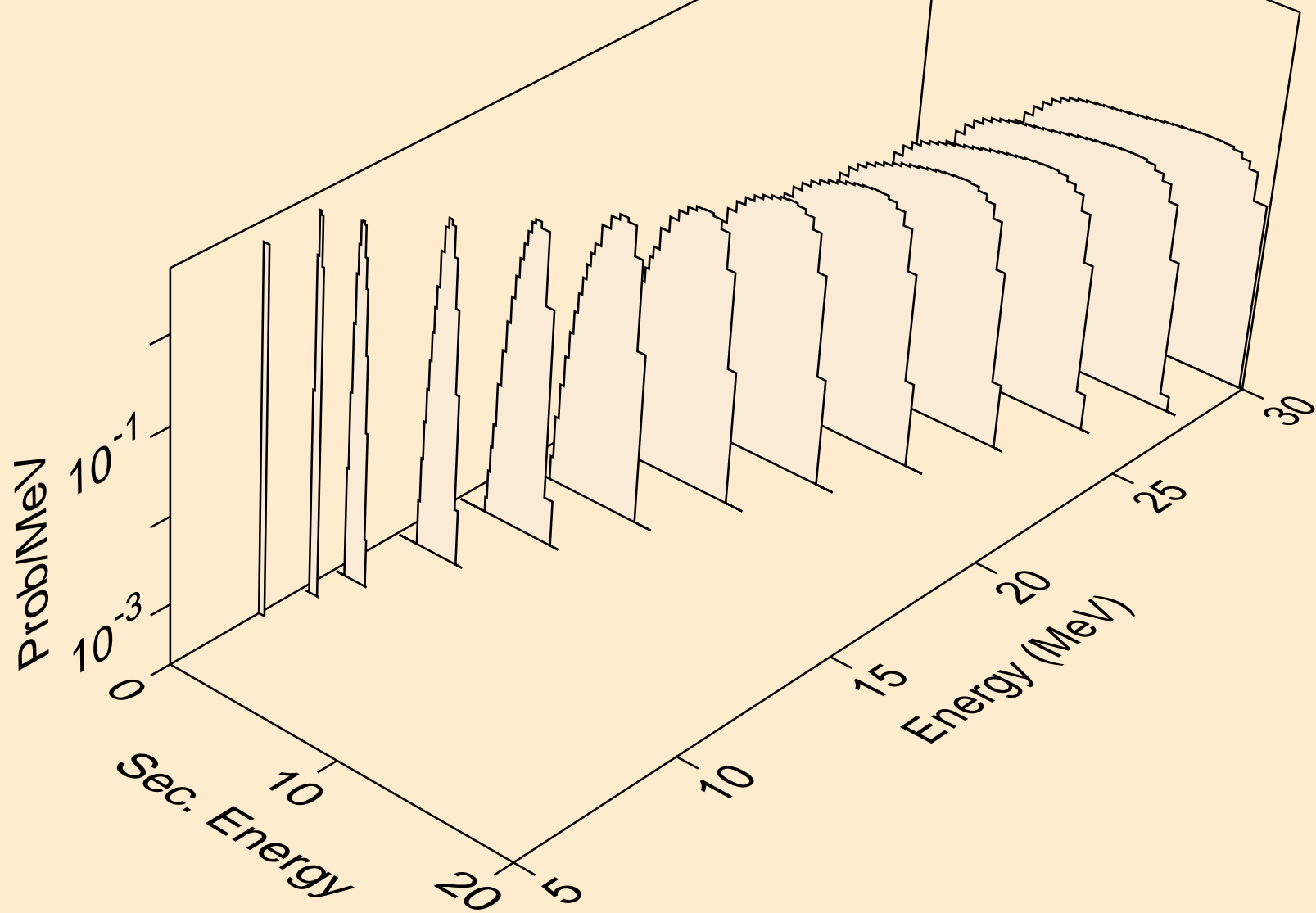

ZN061 NEUTRON ACER TENDL-2023 LIBRARY; T=0.K
deuterons from (n,da)

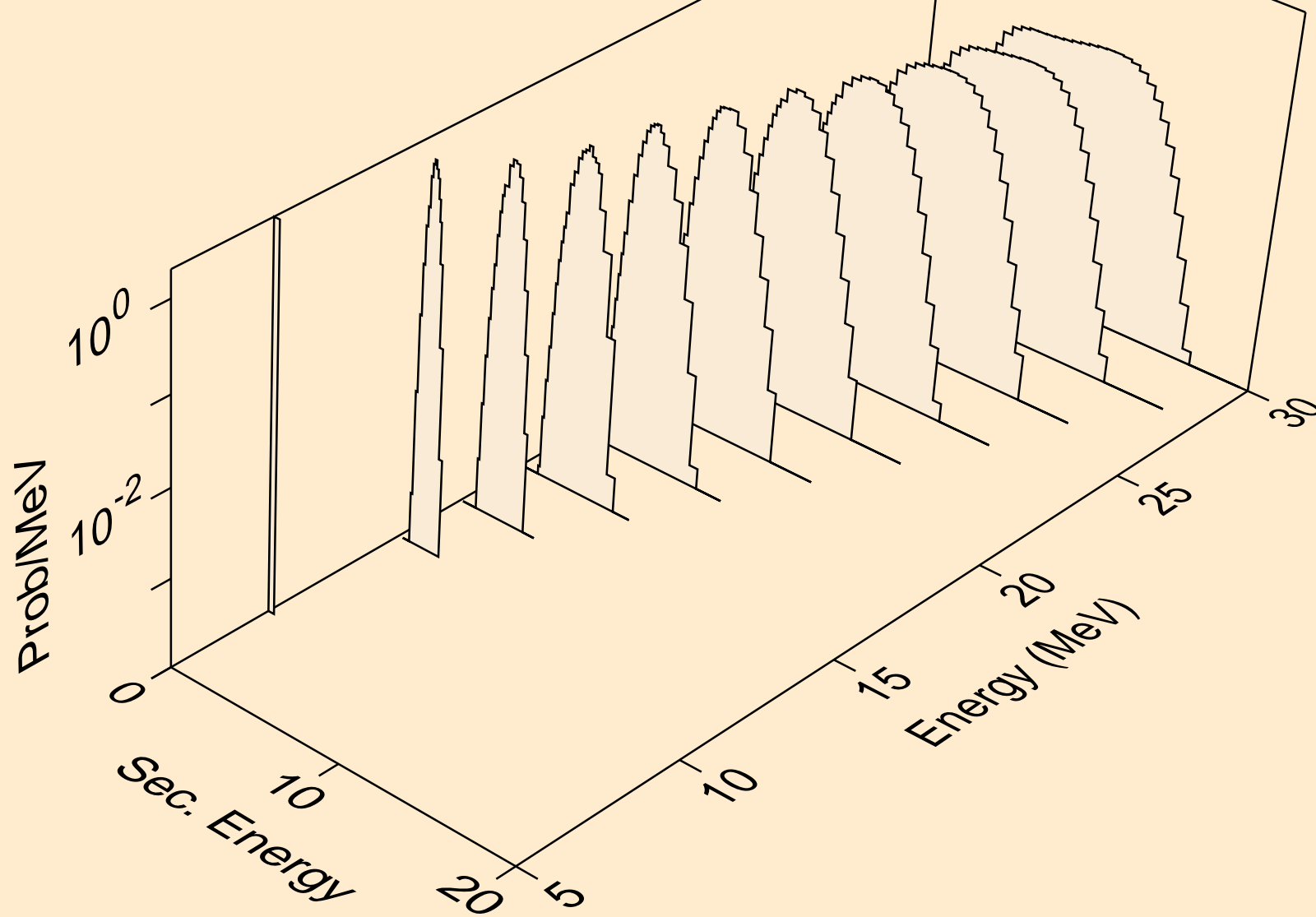

ZN061 NEUTRON ACER TENDL-2023 LIBRARY; T=0.K
tritons from (n,x)

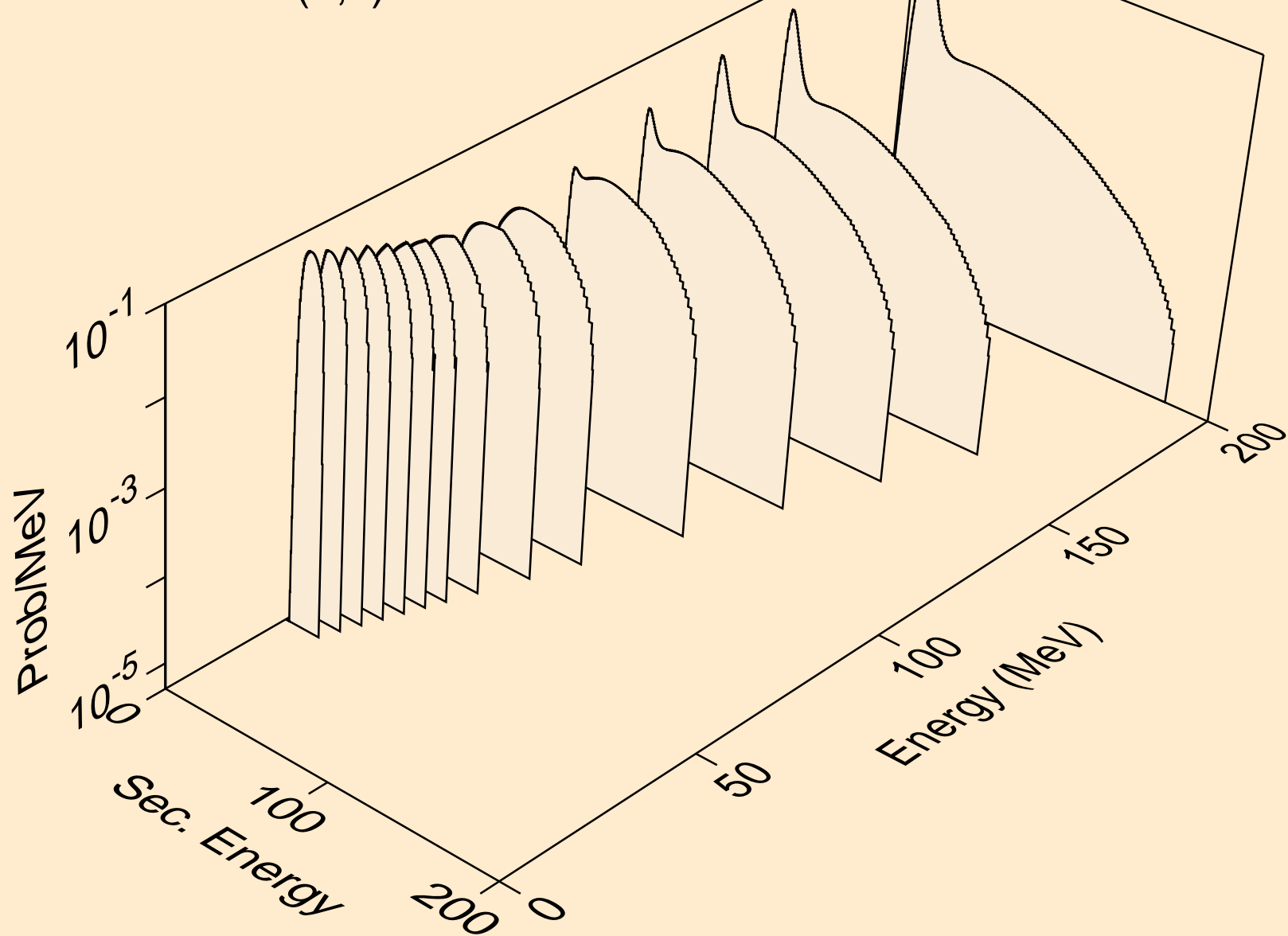

ZN061 NEUTRON ACER TENDL-2023 LIBRARY; T=0.K
tritons from (n,n*)t

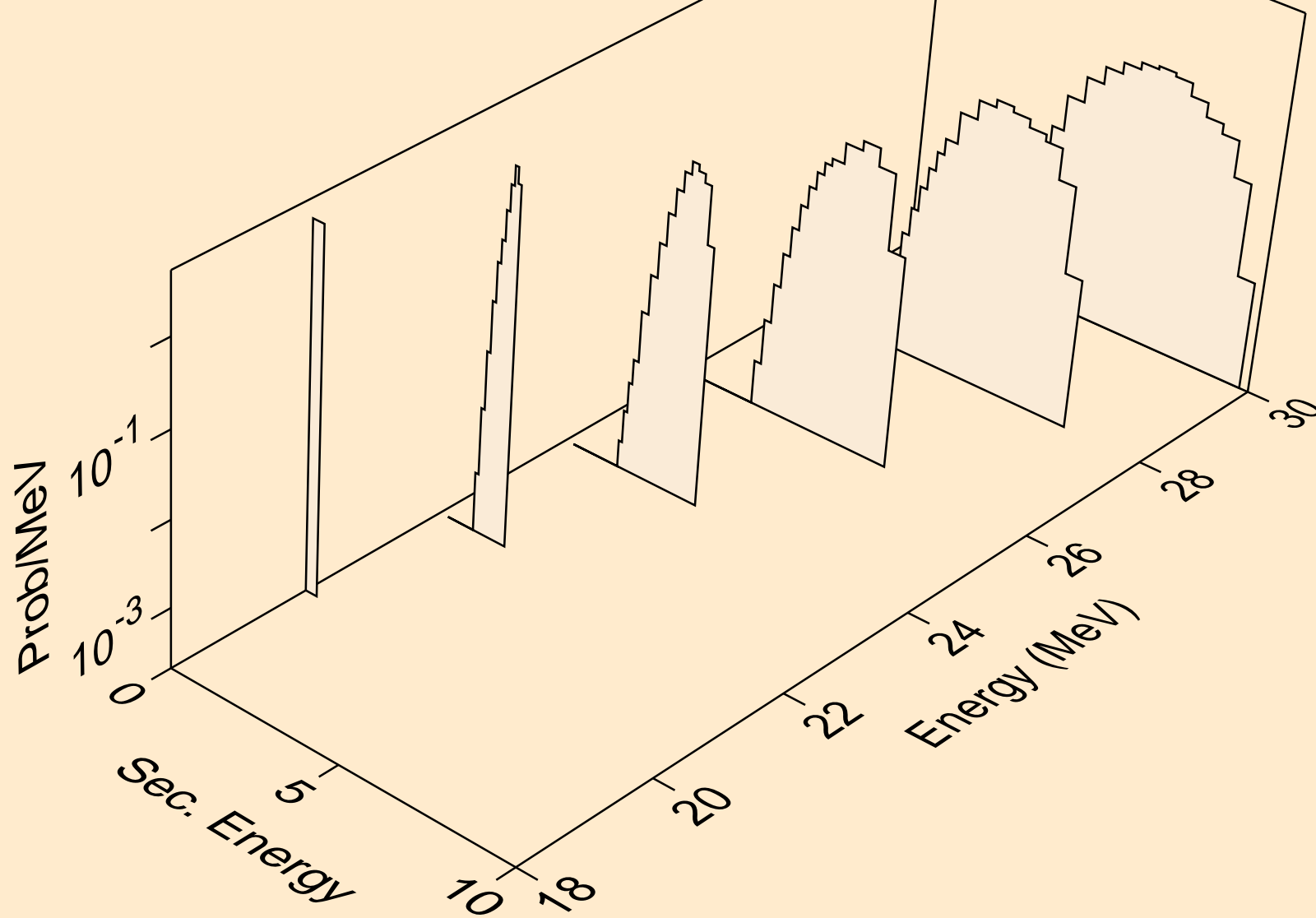

ZN061 NEUTRON ACER TENDL-2023 LIBRARY; T=0.K
tritons from (n,t)

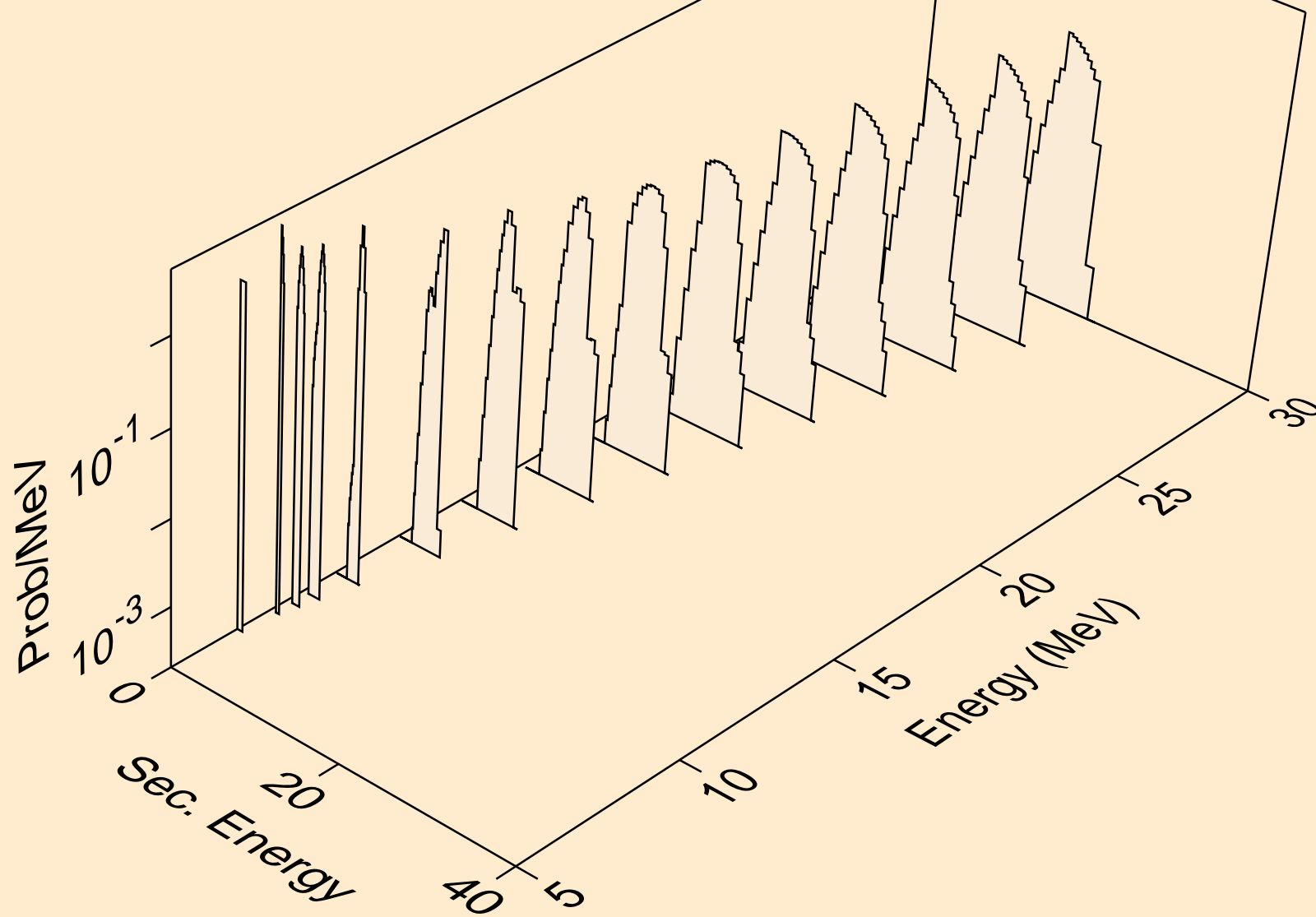

ZN061 NEUTRON ACER TENDL-2023 LIBRARY; T=0.K
tritons from (n,pt)

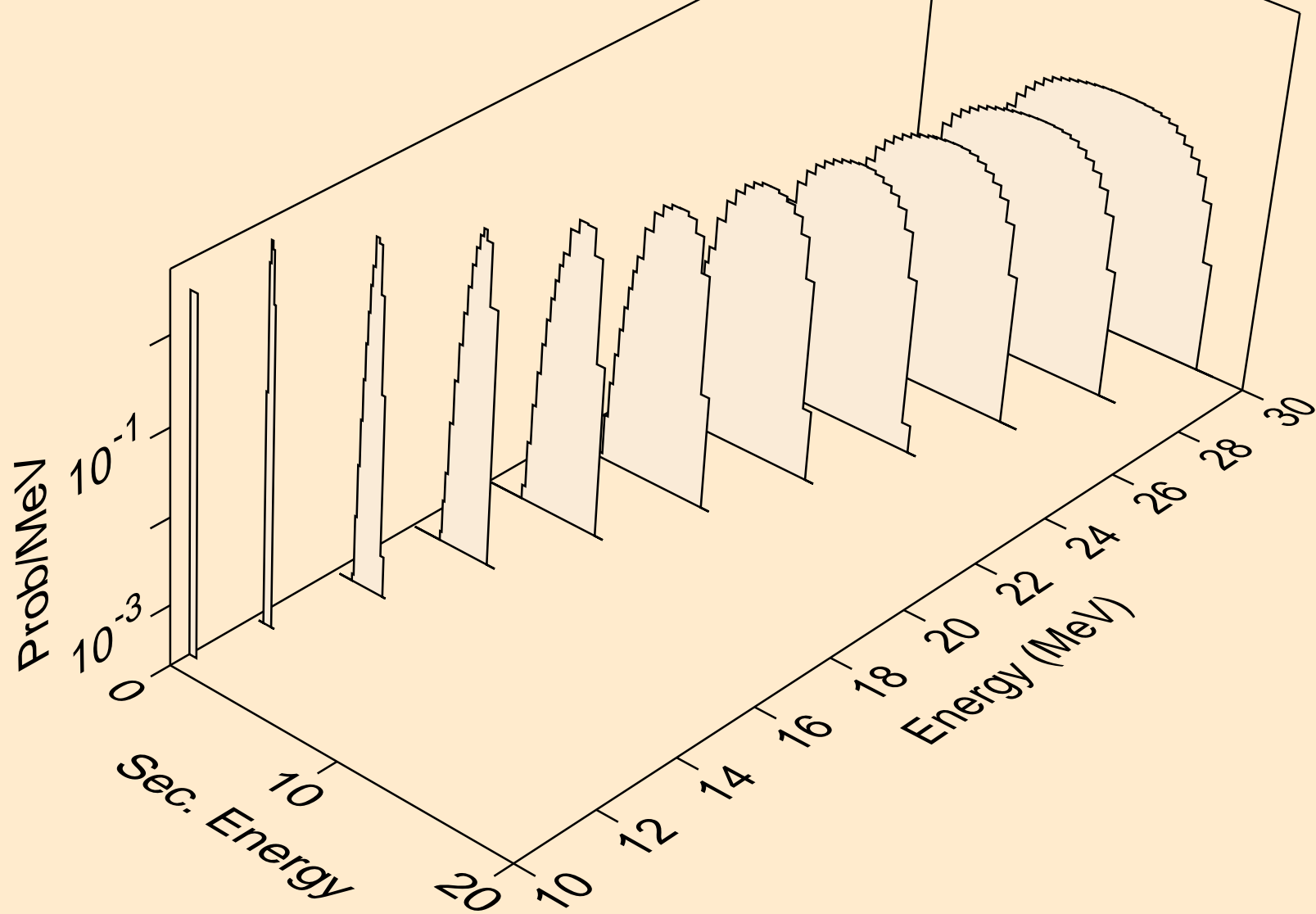

ZN061 NEUTRON ACER TENDL-2023 LIBRARY; T=0.K
he3s from (n,x)

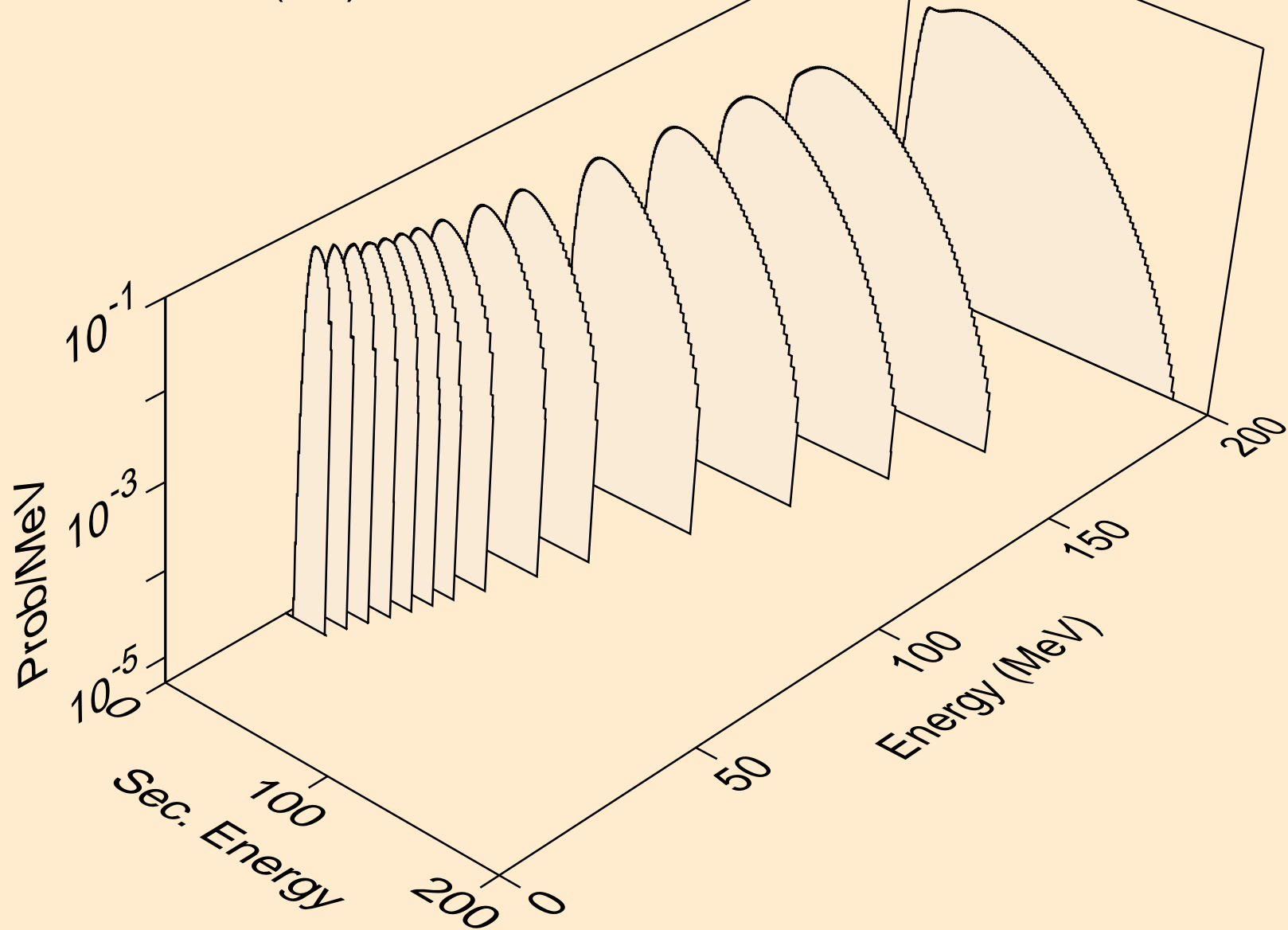

ZN061 NEUTRON ACER TENDL-2023 LIBRARY; T=0.K
he3s from (n,n*)he3

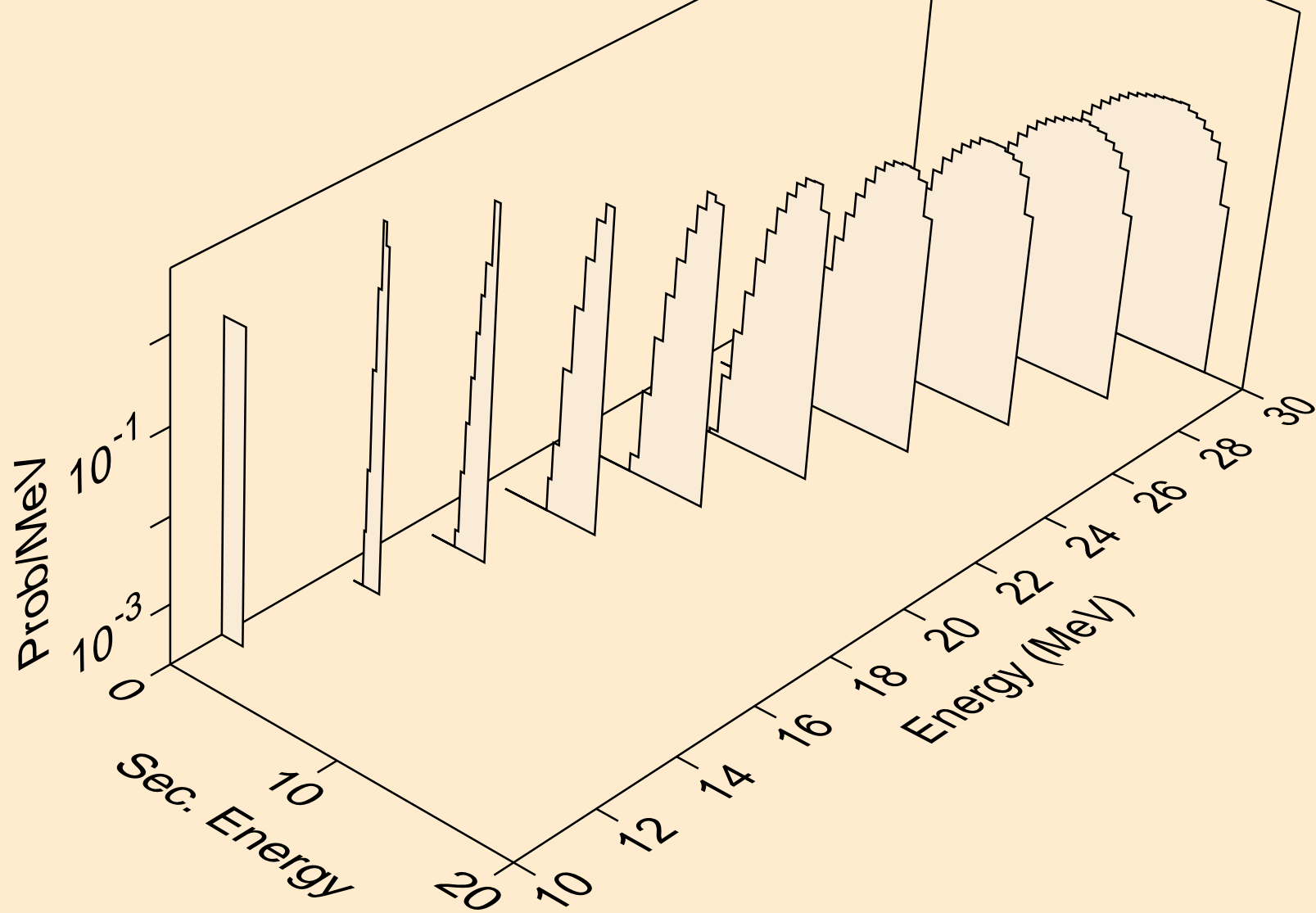

ZN061 NEUTRON ACER TENDL-2023 LIBRARY; T=0.K
he3s from (n,he3)

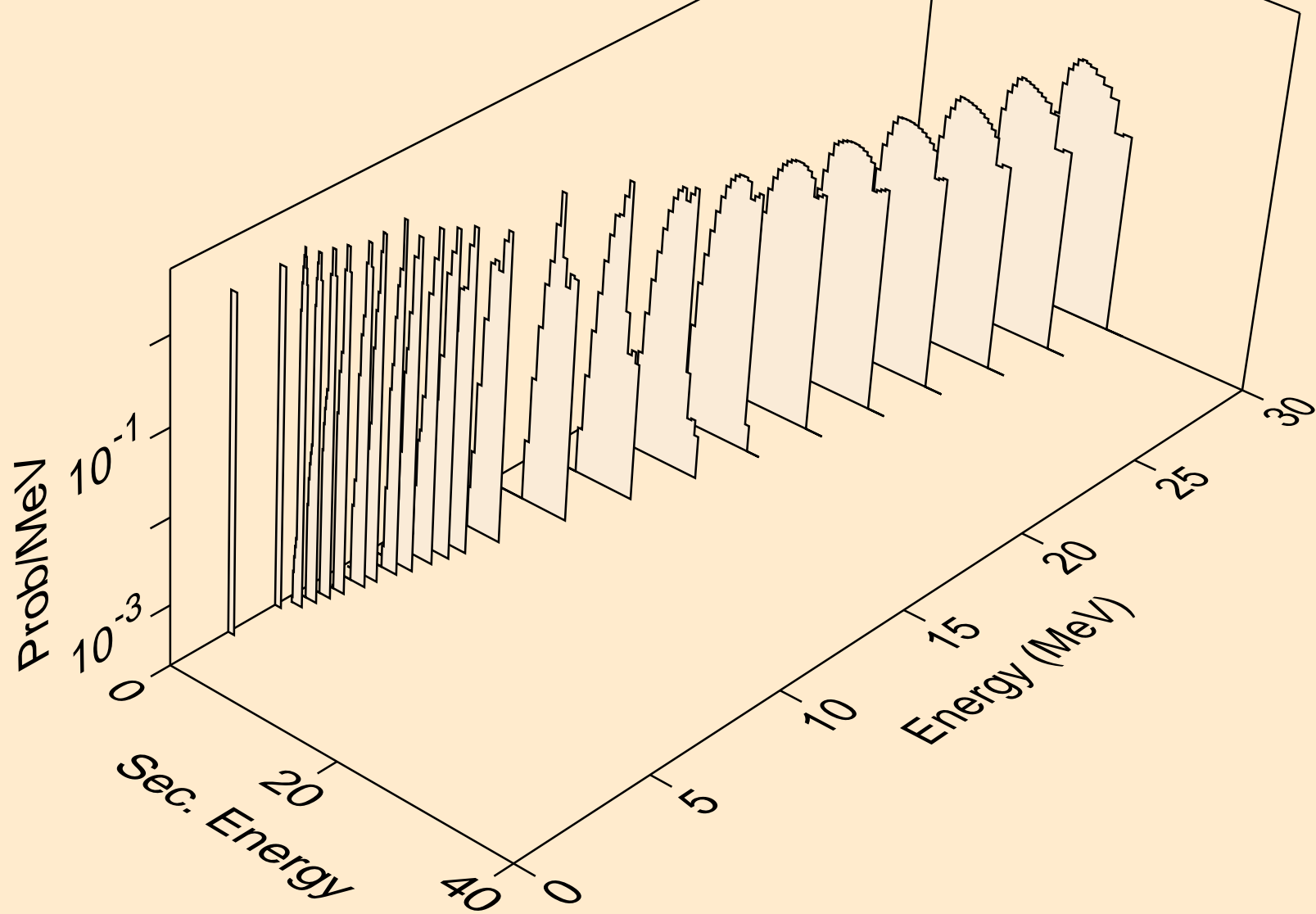

ZN061 NEUTRON ACER TENDL-2023 LIBRARY; T=0.K
alphas from (n,x)

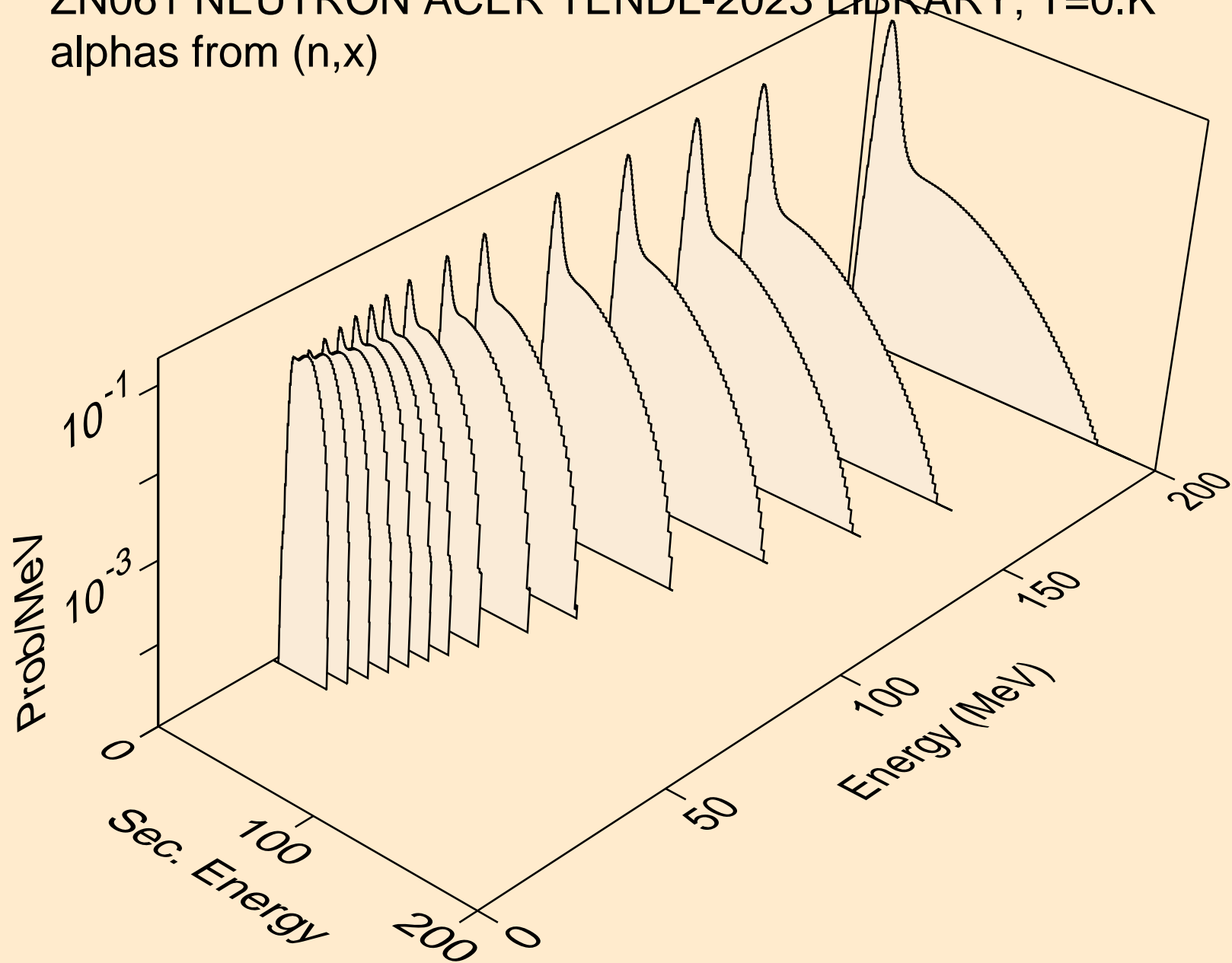

ZN061 NEUTRON ACER TENDL-2023 LIBRARY; T=0.K
alphas from (n,n*)a

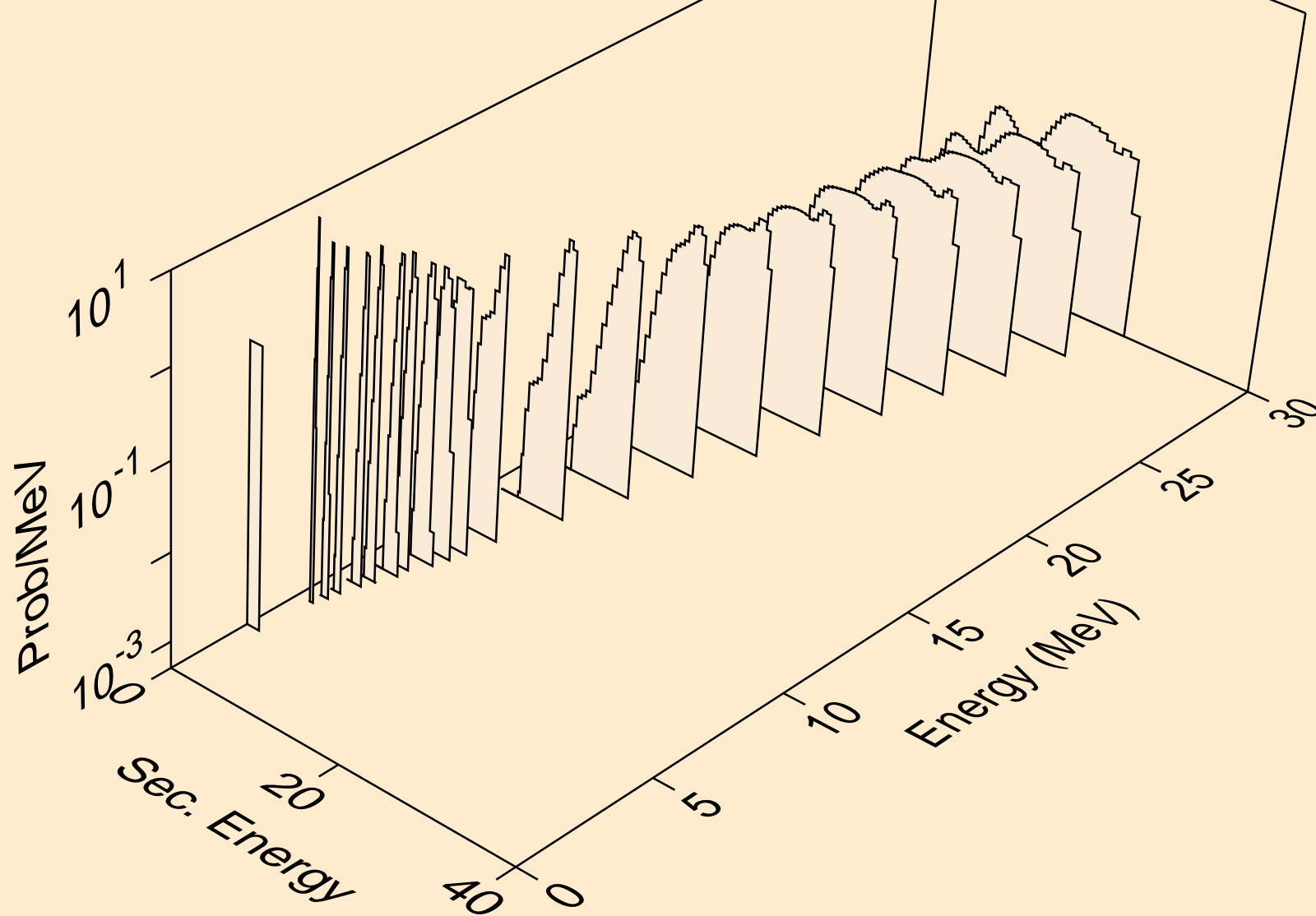

ZN061 NEUTRON ACER TENDL-2023 LIBRARY; T=0.K
alphas from (n,2n)a

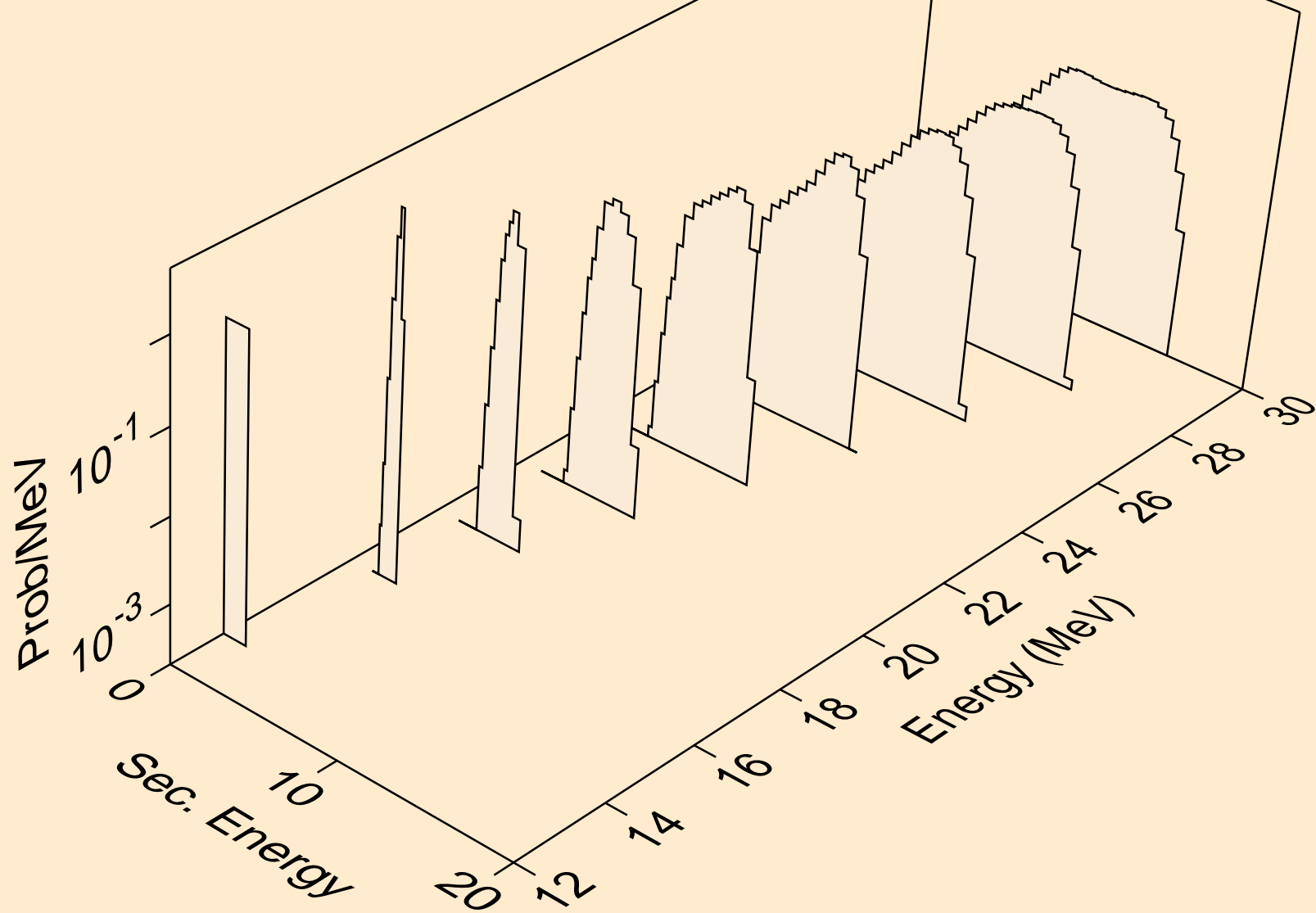

ZN061 NEUTRON ACER TENDL-2023 LIBRARY; T=0.K
alphas from (n,n*)2a

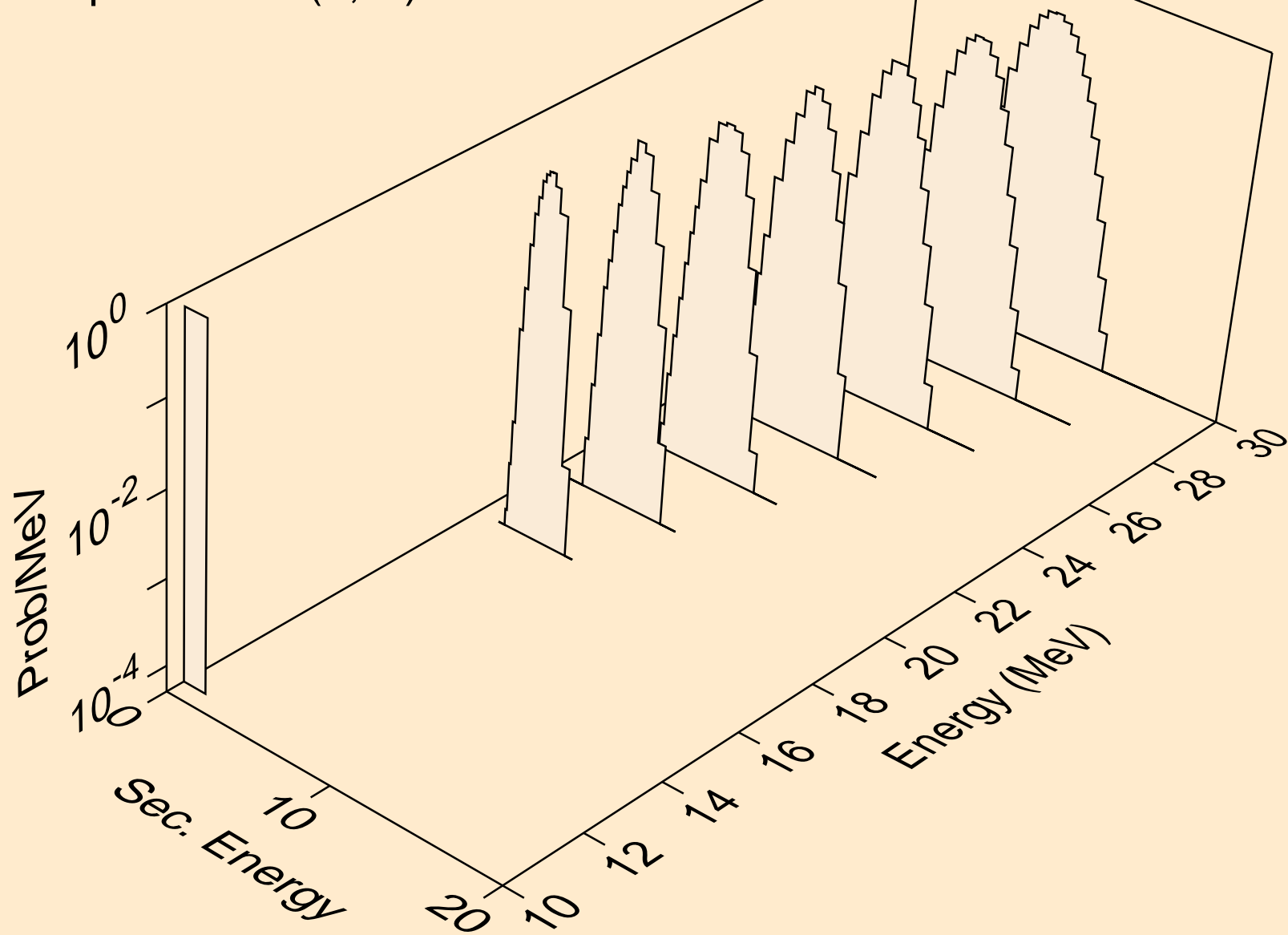

ZN061 NEUTRON ACER TENDL-2023 LIBRARY; T=0.K
alphas from (n,npa)

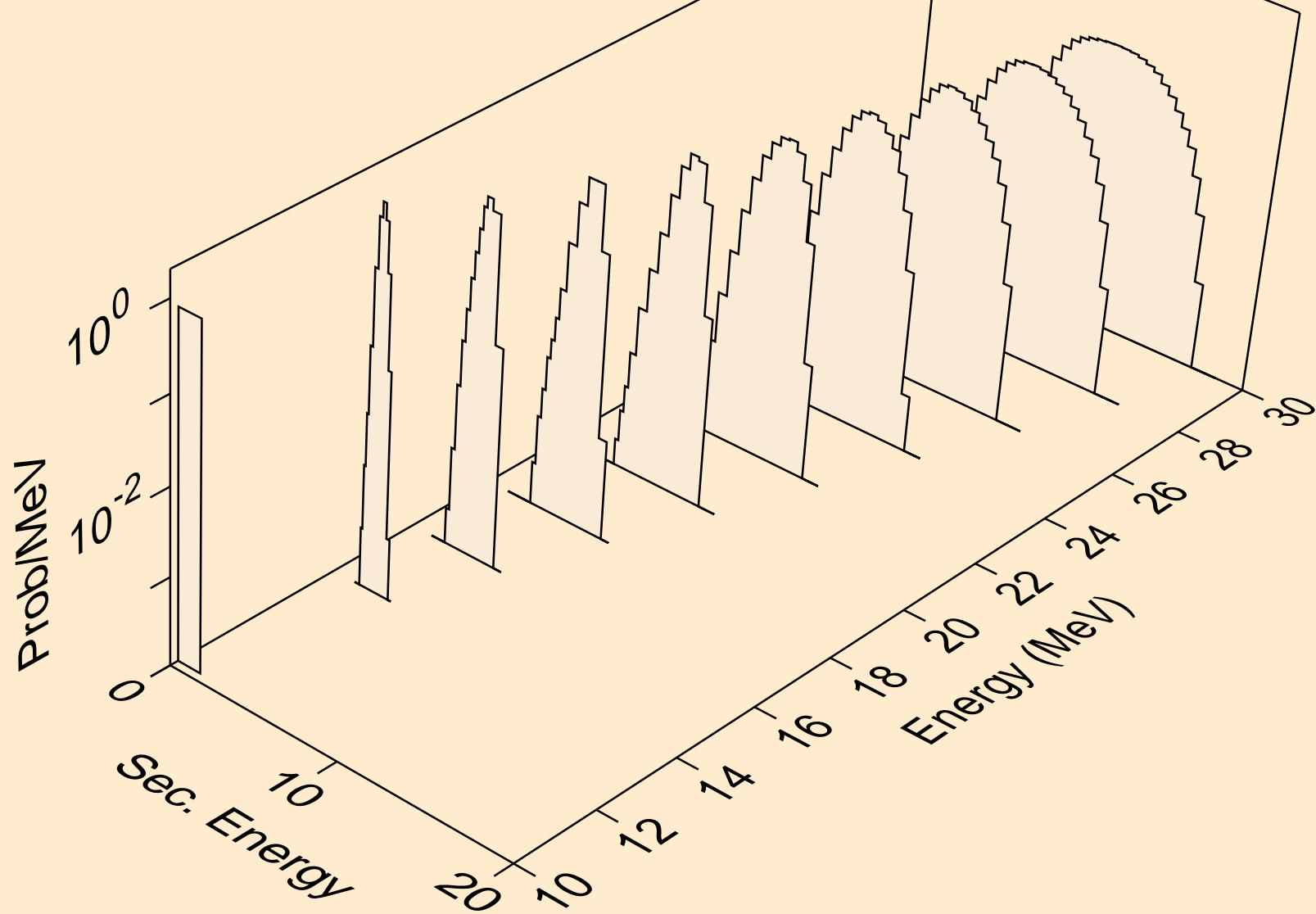

ZN061 NEUTRON ACER TENDL-2023 LIBRARY; T=0.K
alphas from (n,a)

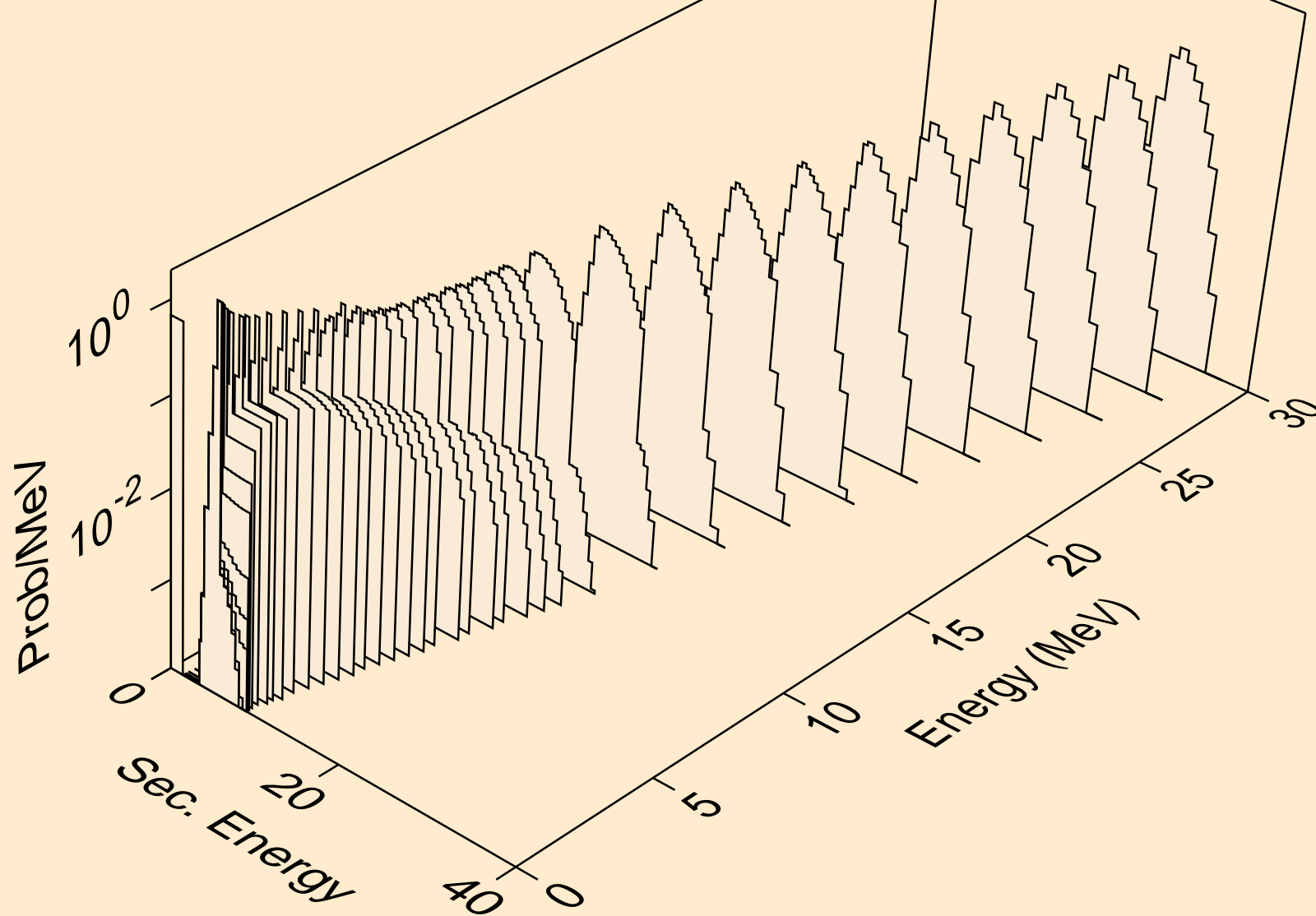

ZN061 NEUTRON ACER TENDL-2023 LIBRARY; T=0.K
alphas from (n,2a)

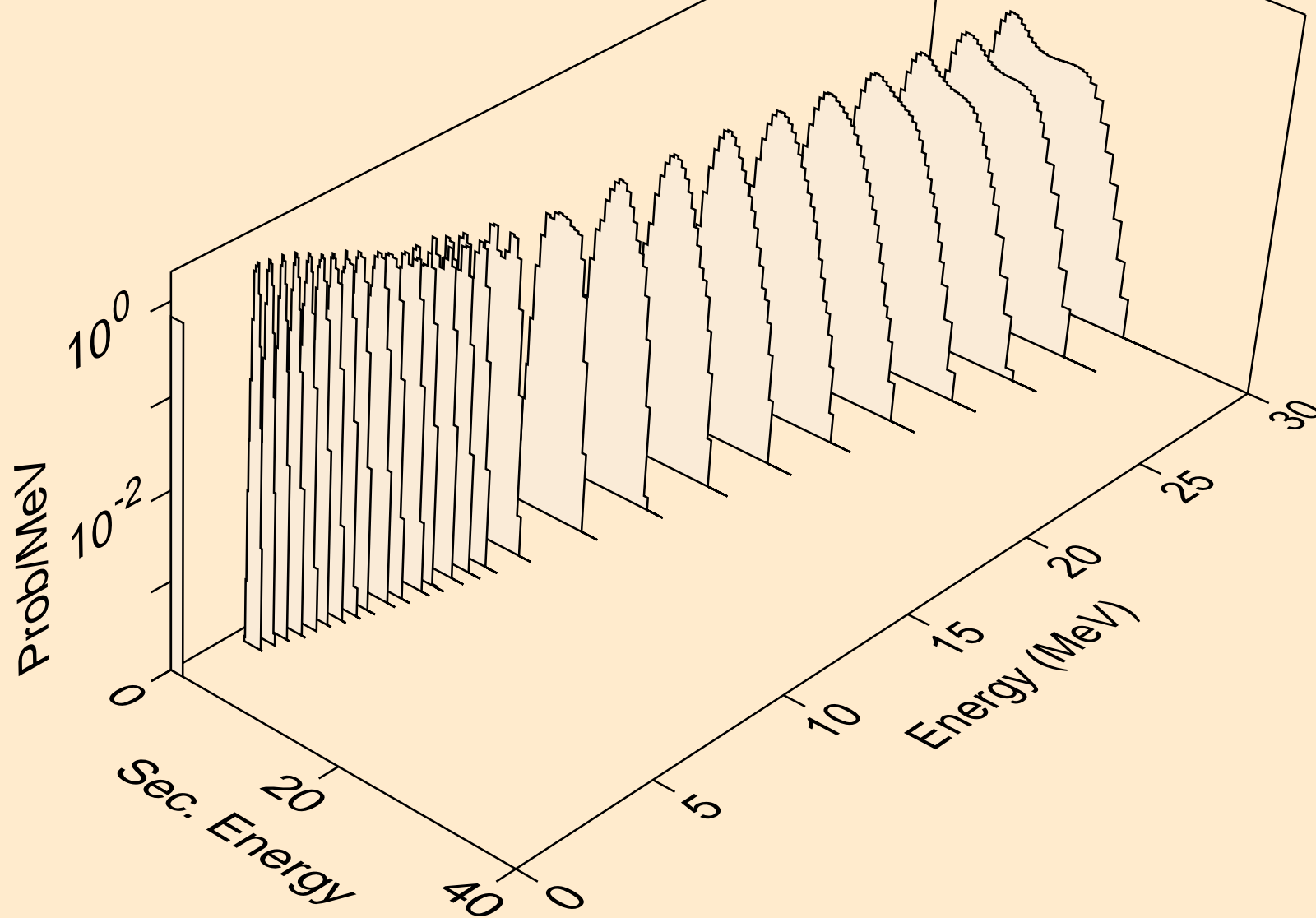

ZN061 NEUTRON ACER TENDL-2023 LIBRARY; T=0.K
alphas from (n,3a)

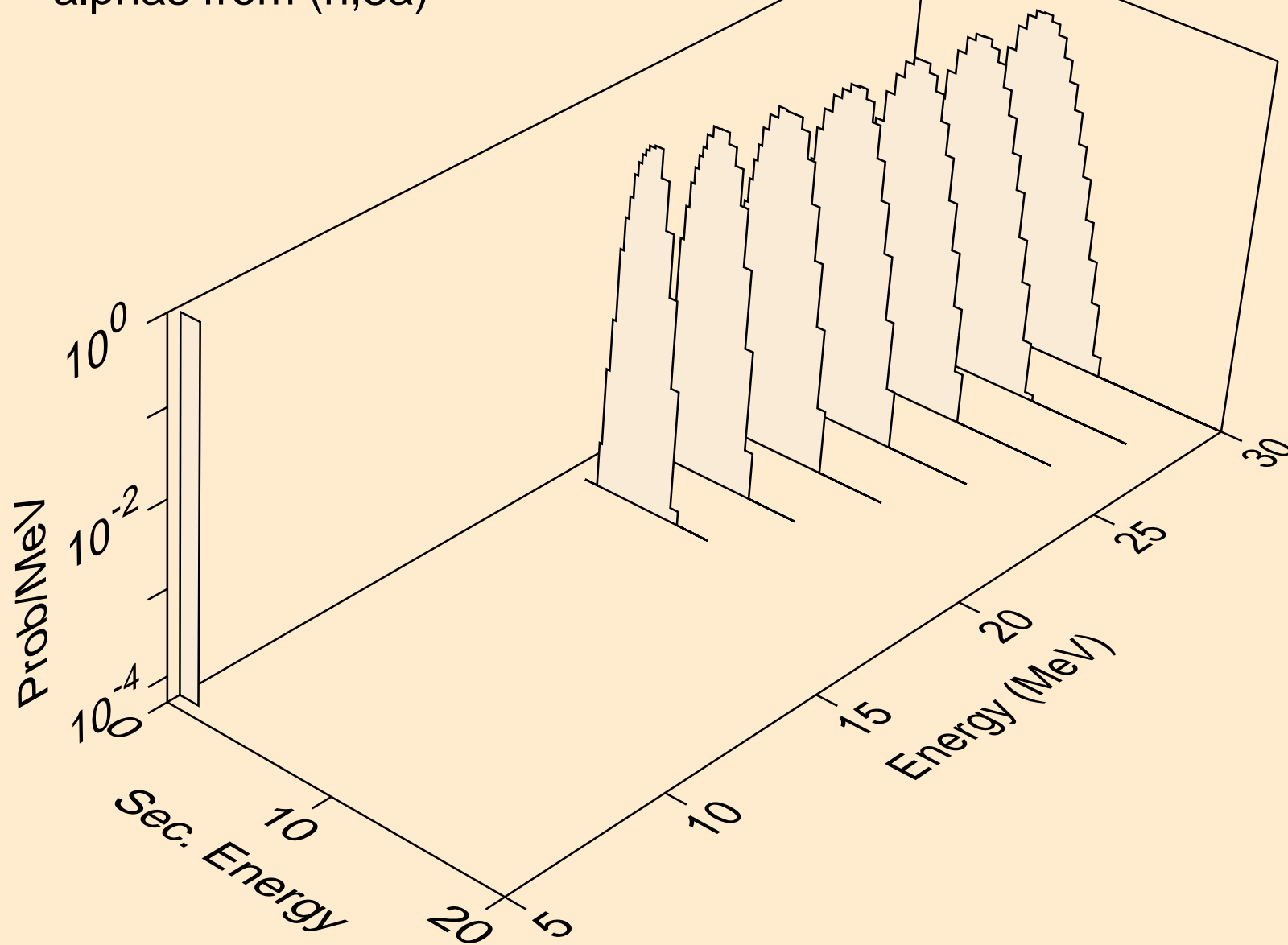

ZN061 NEUTRON ACER TENDL-2023 LIBRARY; T=0.K
alphas from (n,pa)

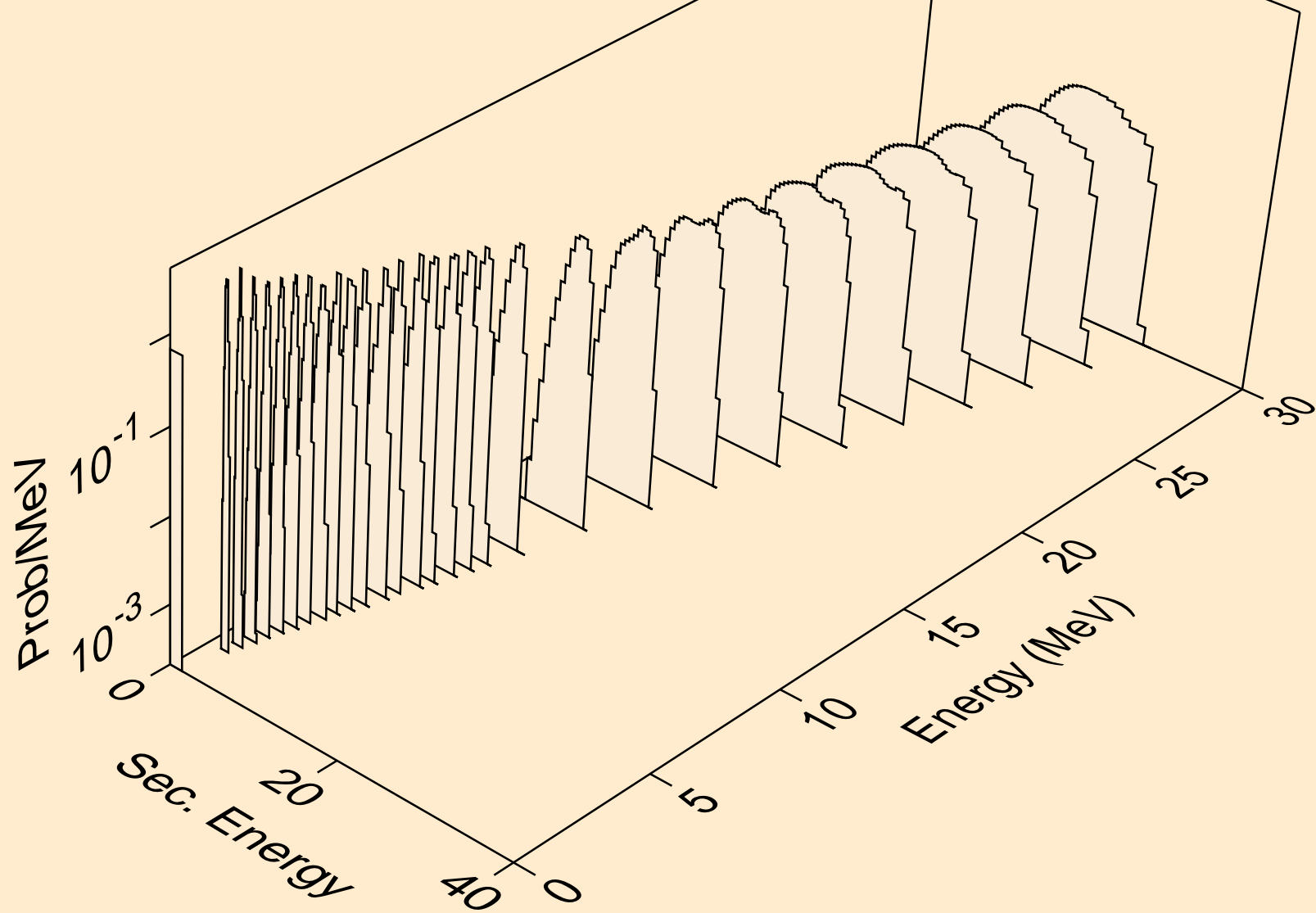

ZN061 NEUTRON ACER TENDL-2023 LIBRARY; T=0.K
alphas from (n,da)

