

AG095 NEUTRON ACER TENDL-2024 LIBRARY; T=0.K

Principal cross sections

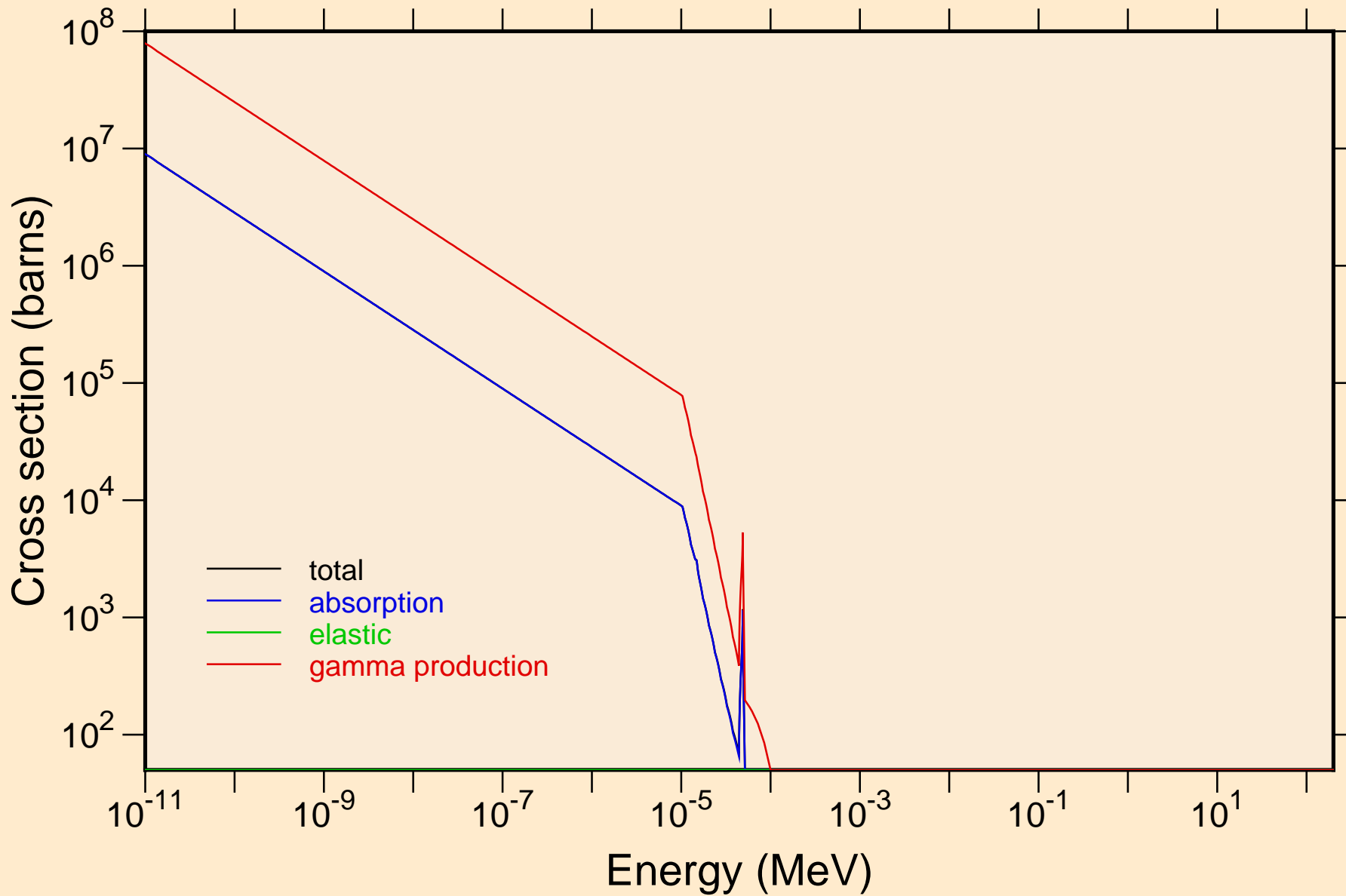

AG095 NEUTRON ACER TENDL-2024 LIBRARY; T=0.K

Heating

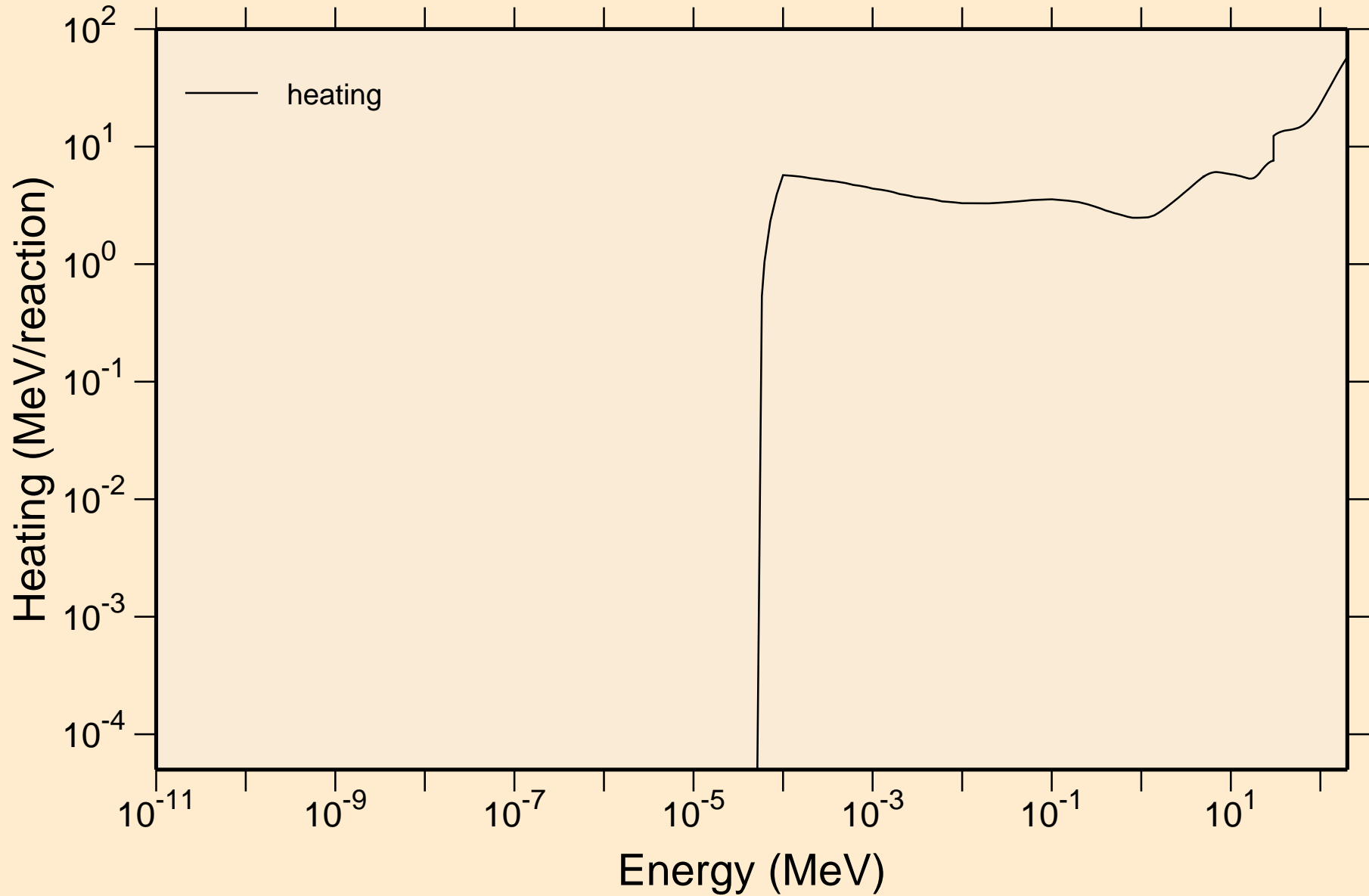

AG095 NEUTRON ACER TENDL-2024 LIBRARY; T=0.K
Damage

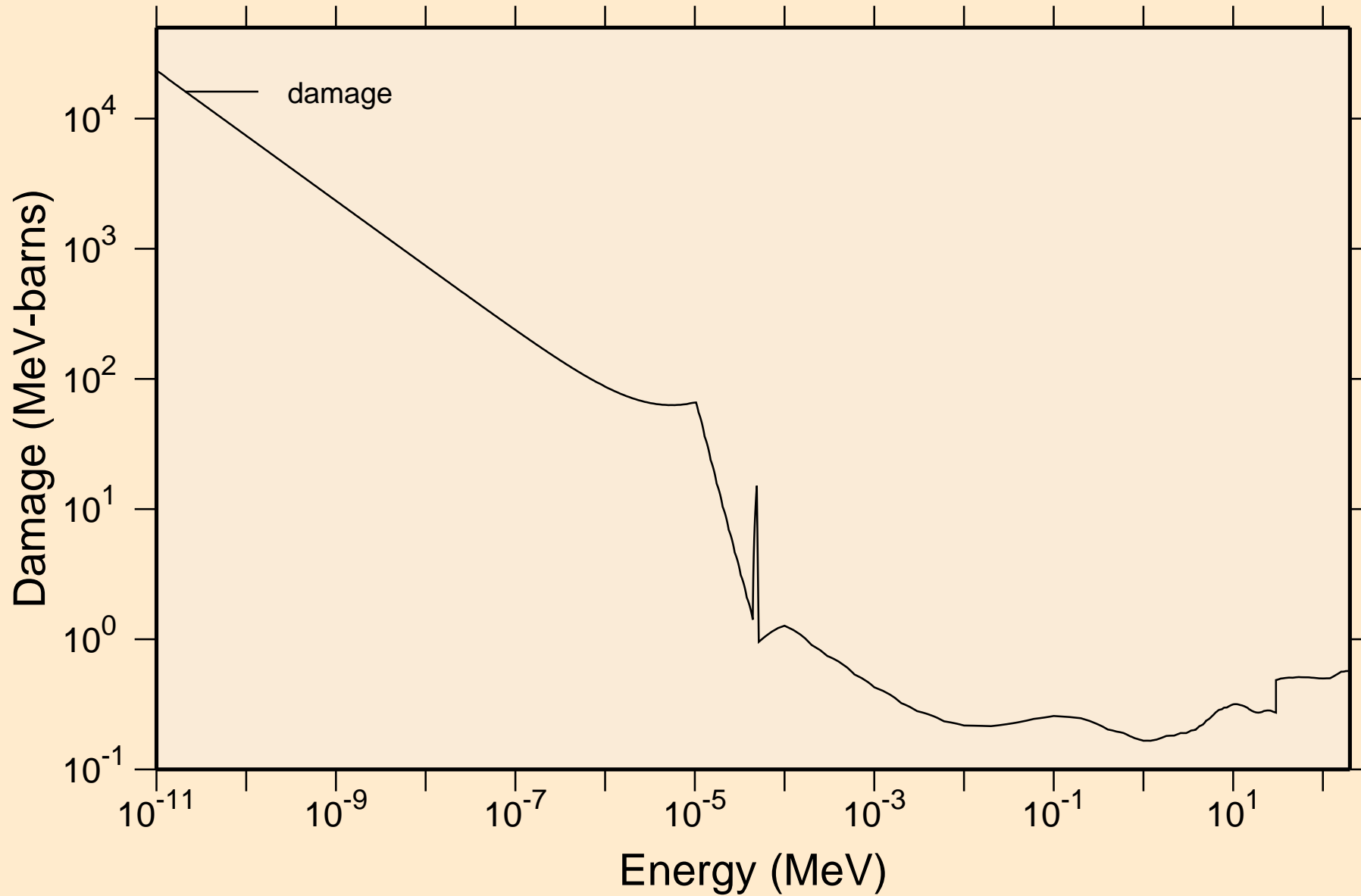

AG095 NEUTRON ACER TENDL-2024 LIBRARY; T=0.K
Non-threshold reactions

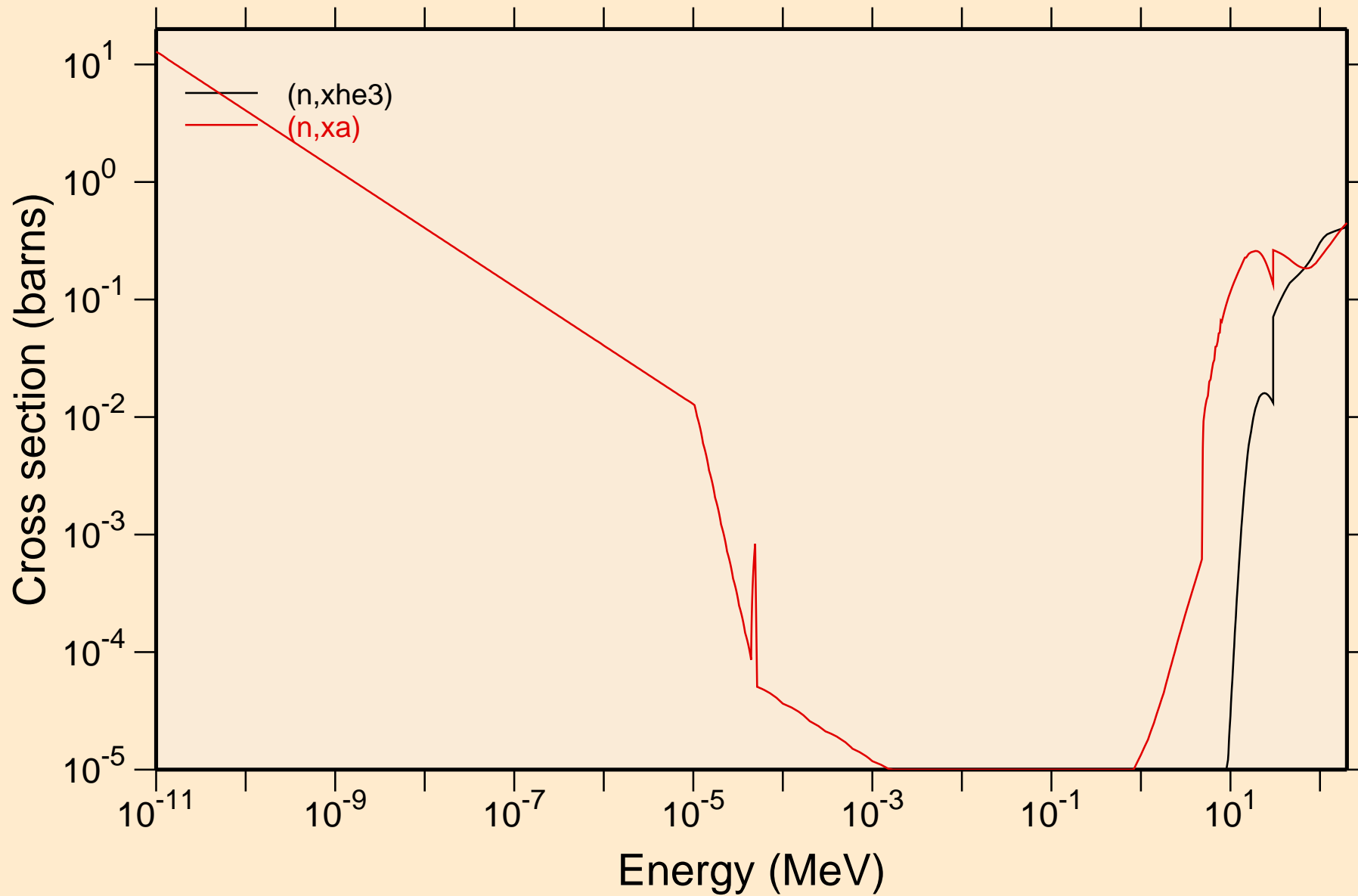

AG095 NEUTRON ACER TENDL-2024 LIBRARY; T=0.K

Principal cross sections

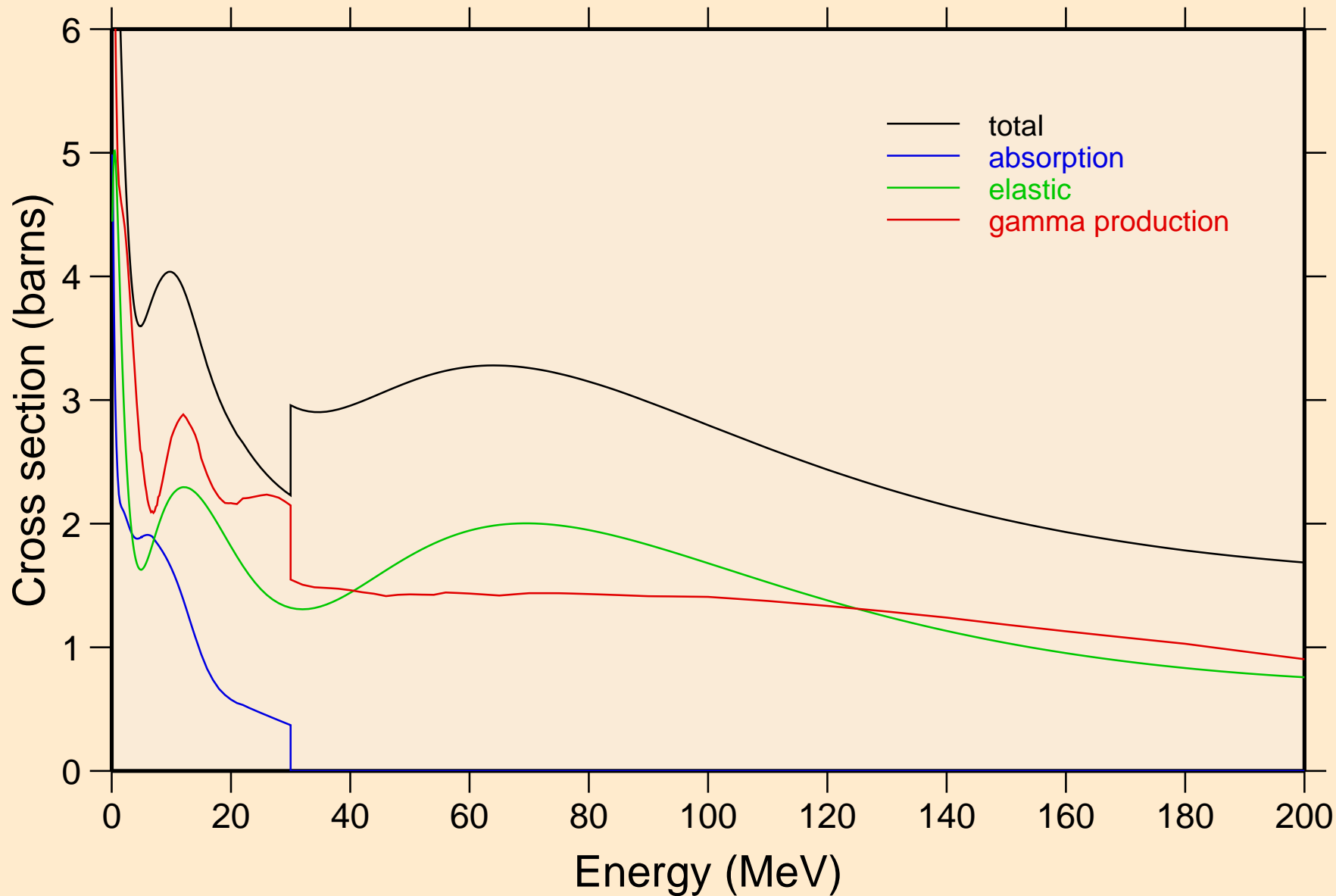

AG095 NEUTRON ACER TENDL-2024 LIBRARY; T=0.K

Heating

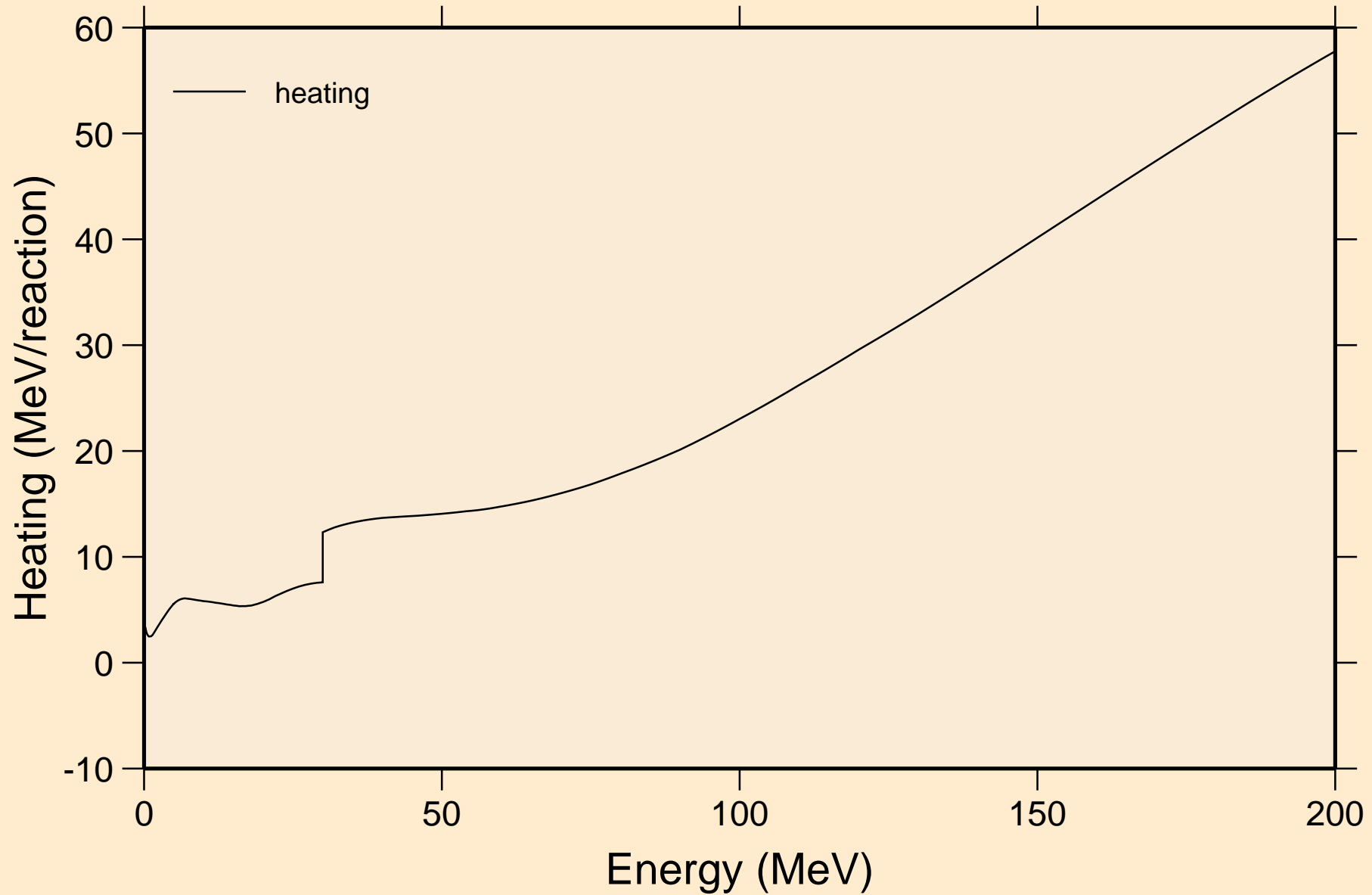

AG095 NEUTRON ACER TENDL-2024 LIBRARY; T=0.K

Damage

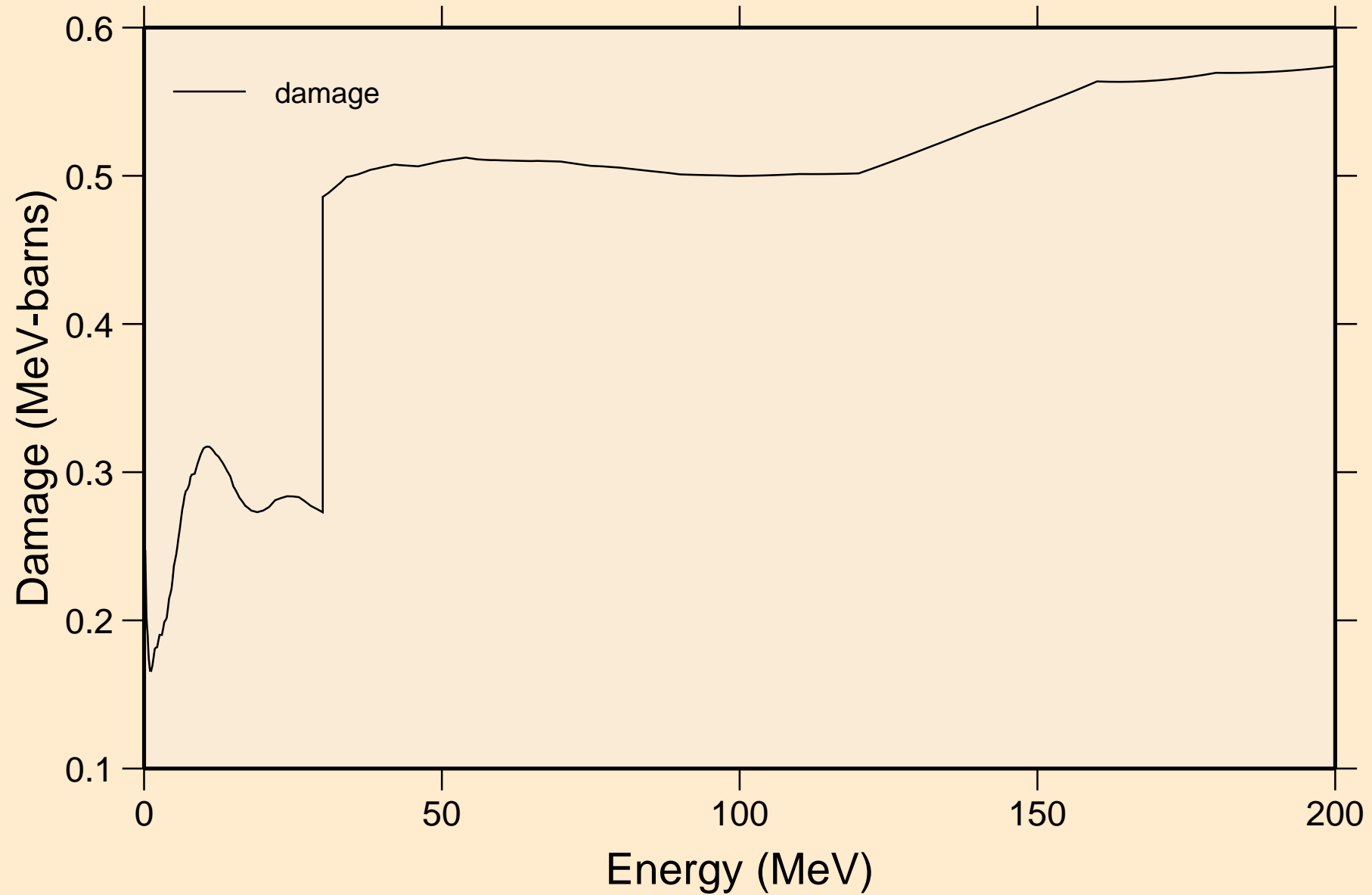

AG095 NEUTRON ACER TENDL-2024 LIBRARY; T=0.K
Non-threshold reactions

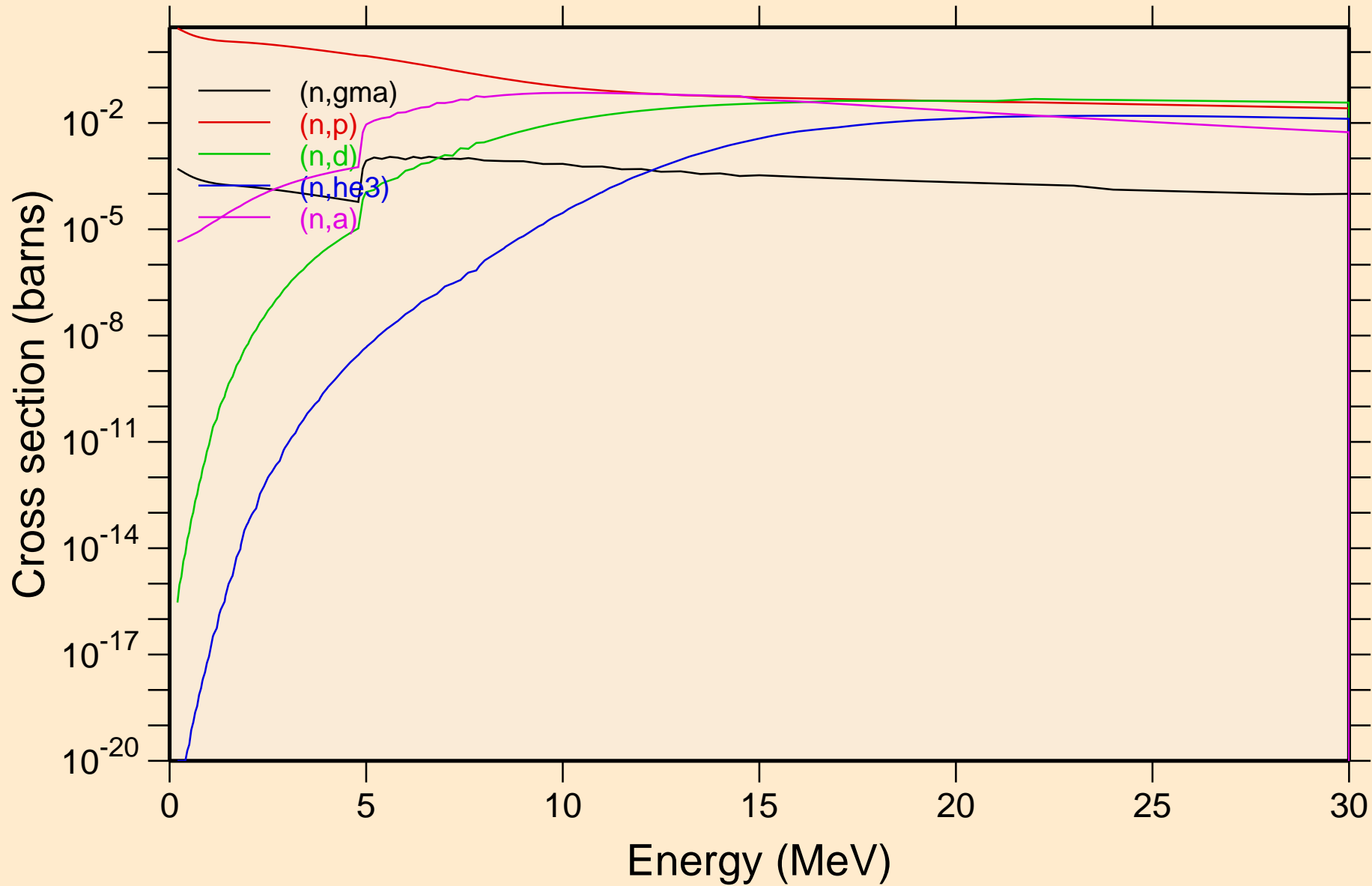

AG095 NEUTRON ACER TENDL-2024 LIBRARY; T=0.K
Non-threshold reactions

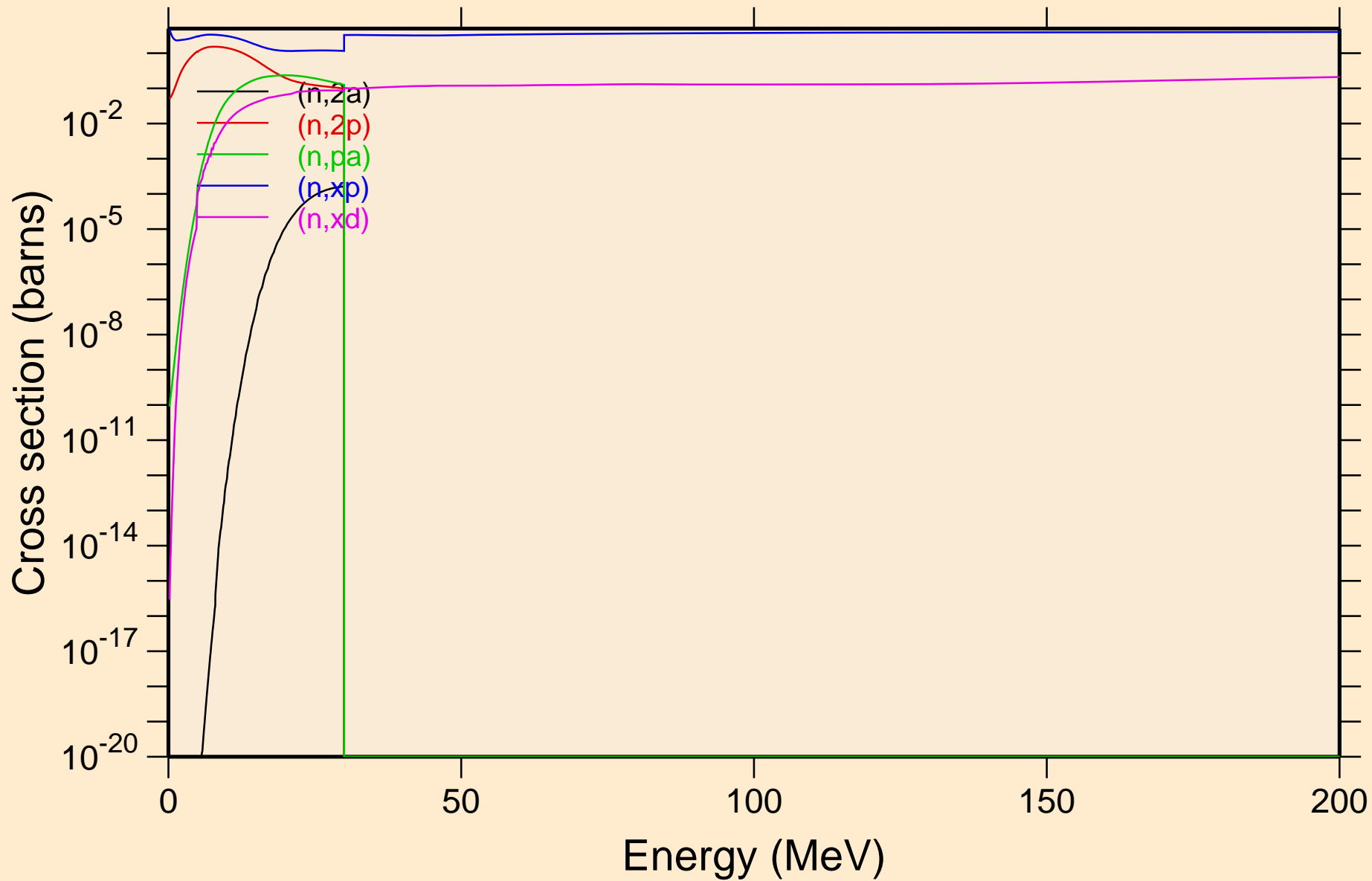

AG095 NEUTRON ACER TENDL-2024 LIBRARY; T=0.K
Non-threshold reactions

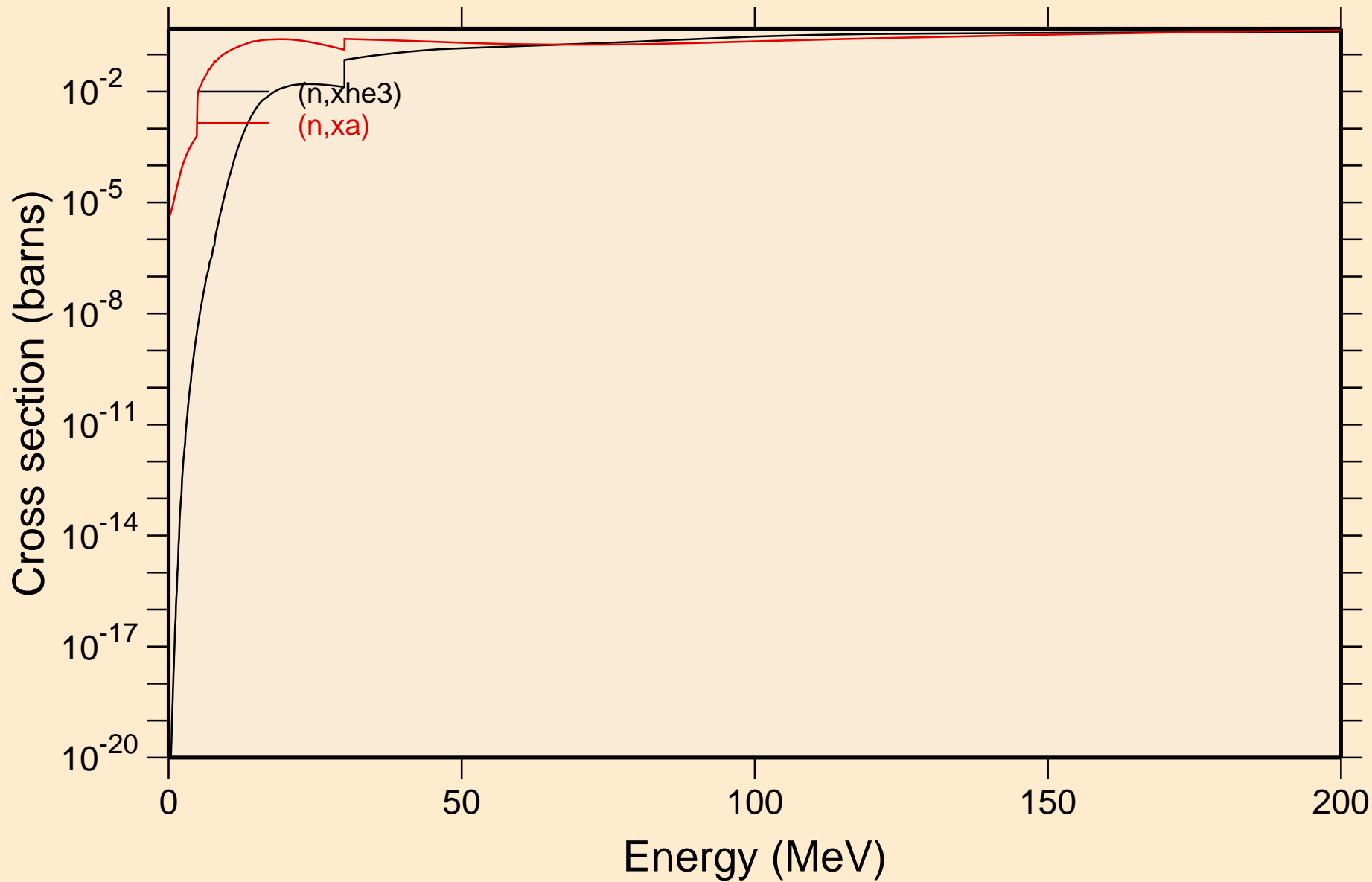

AG095 NEUTRON ACER TENDL-2024 LIBRARY; T=0.K
Inelastic levels

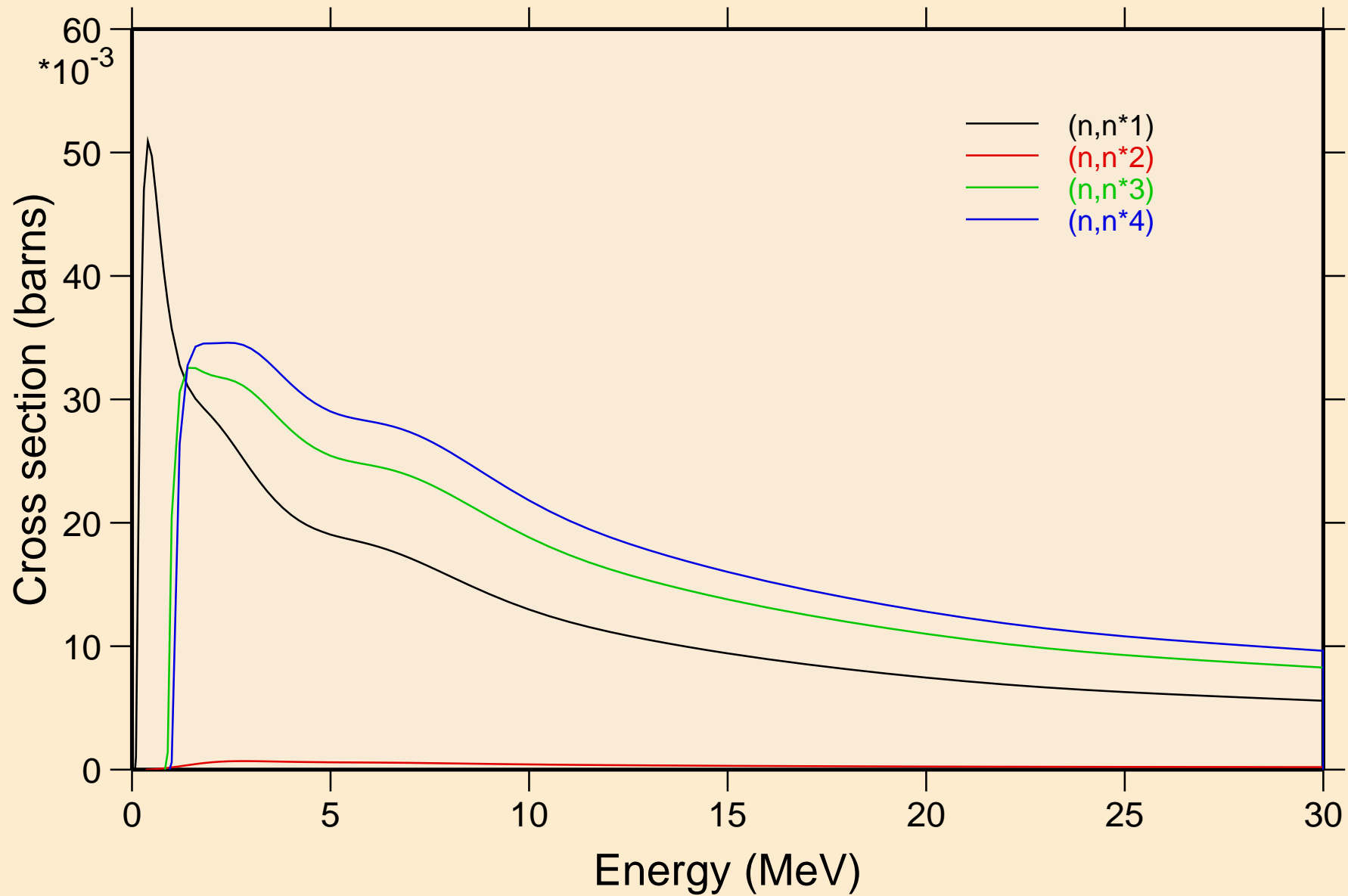

AG095 NEUTRON ACER TENDL-2024 LIBRARY; T=0.K
Threshold reactions

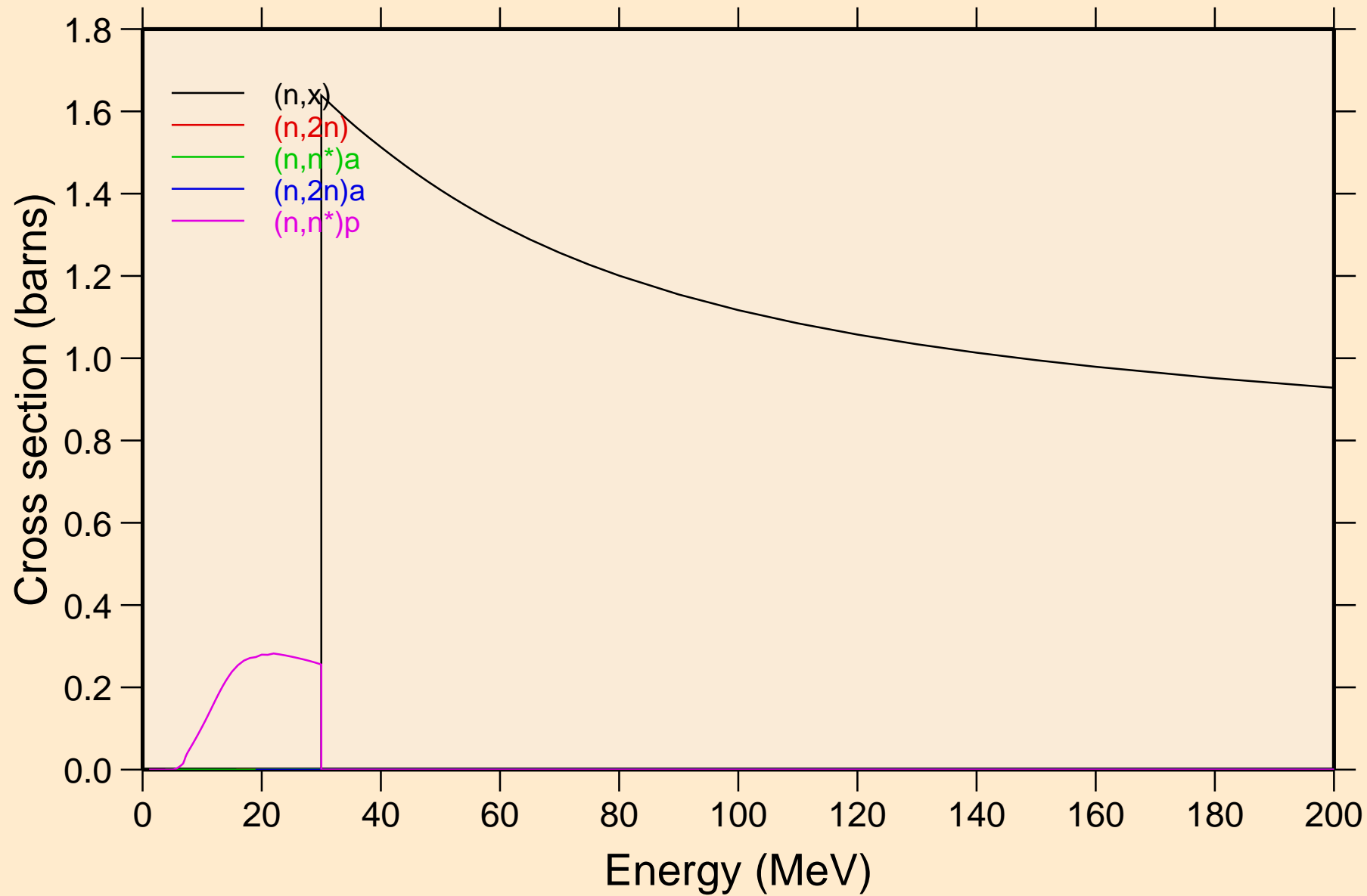

AG095 NEUTRON ACER TENDL-2024 LIBRARY; T=0.K
Threshold reactions

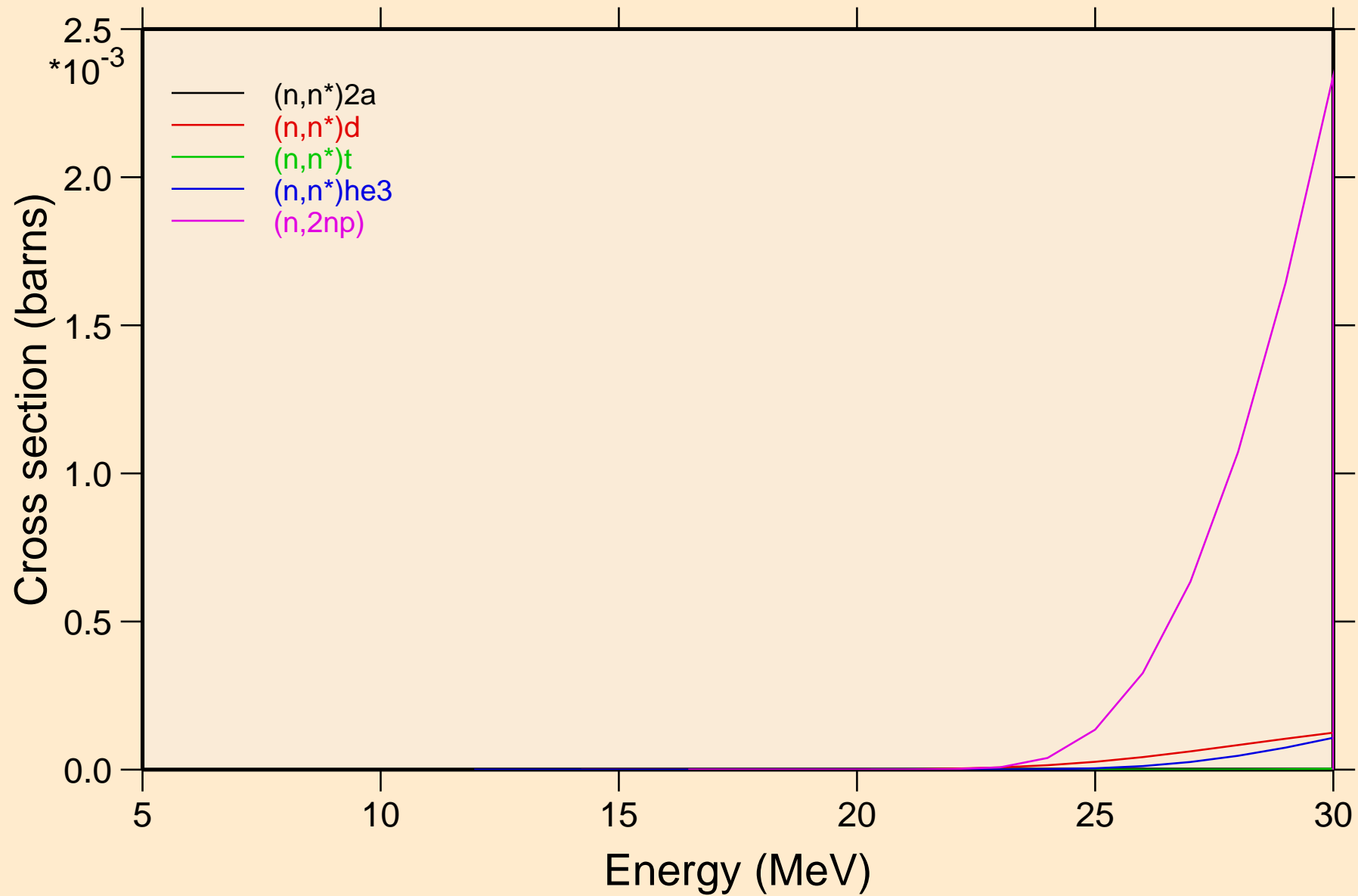

AG095 NEUTRON ACER TENDL-2024 LIBRARY; T=0.K

Threshold reactions

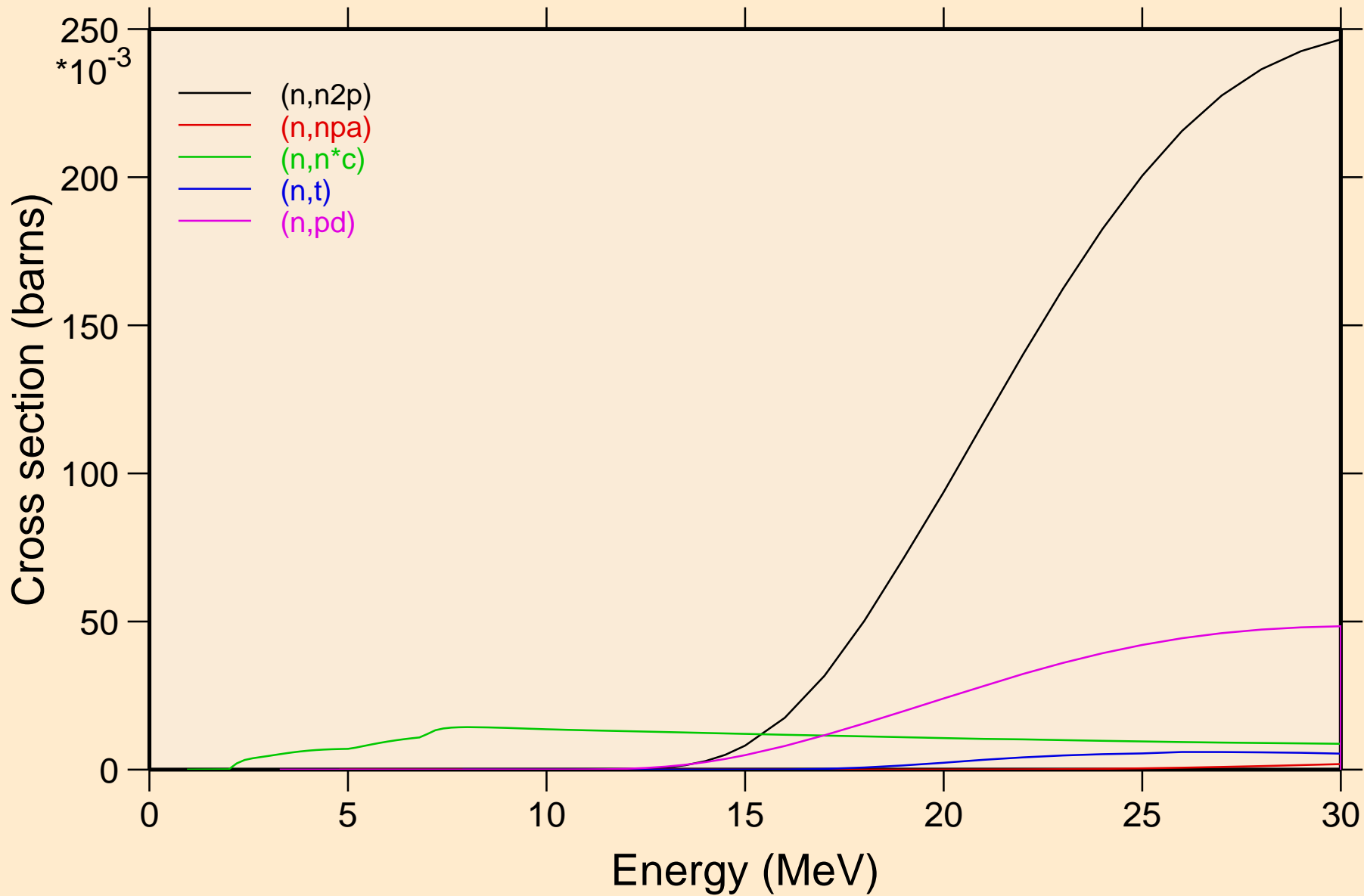

AG095 NEUTRON ACER TENDL-2024 LIBRARY; T=0.K
Threshold reactions

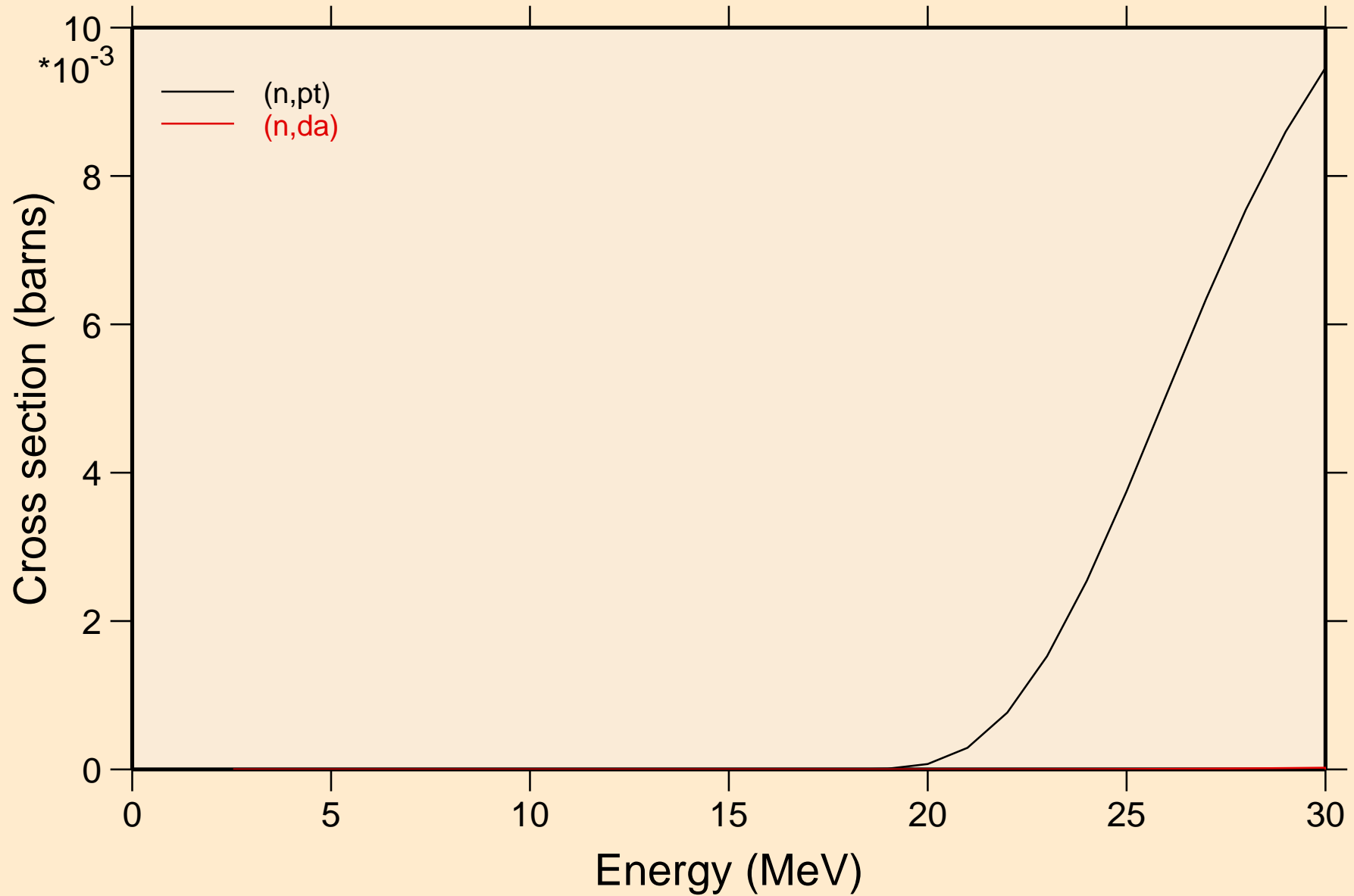

AG095 NEUTRON ACER TENDL-2024 LIBRARY; T=0.K
Threshold reactions

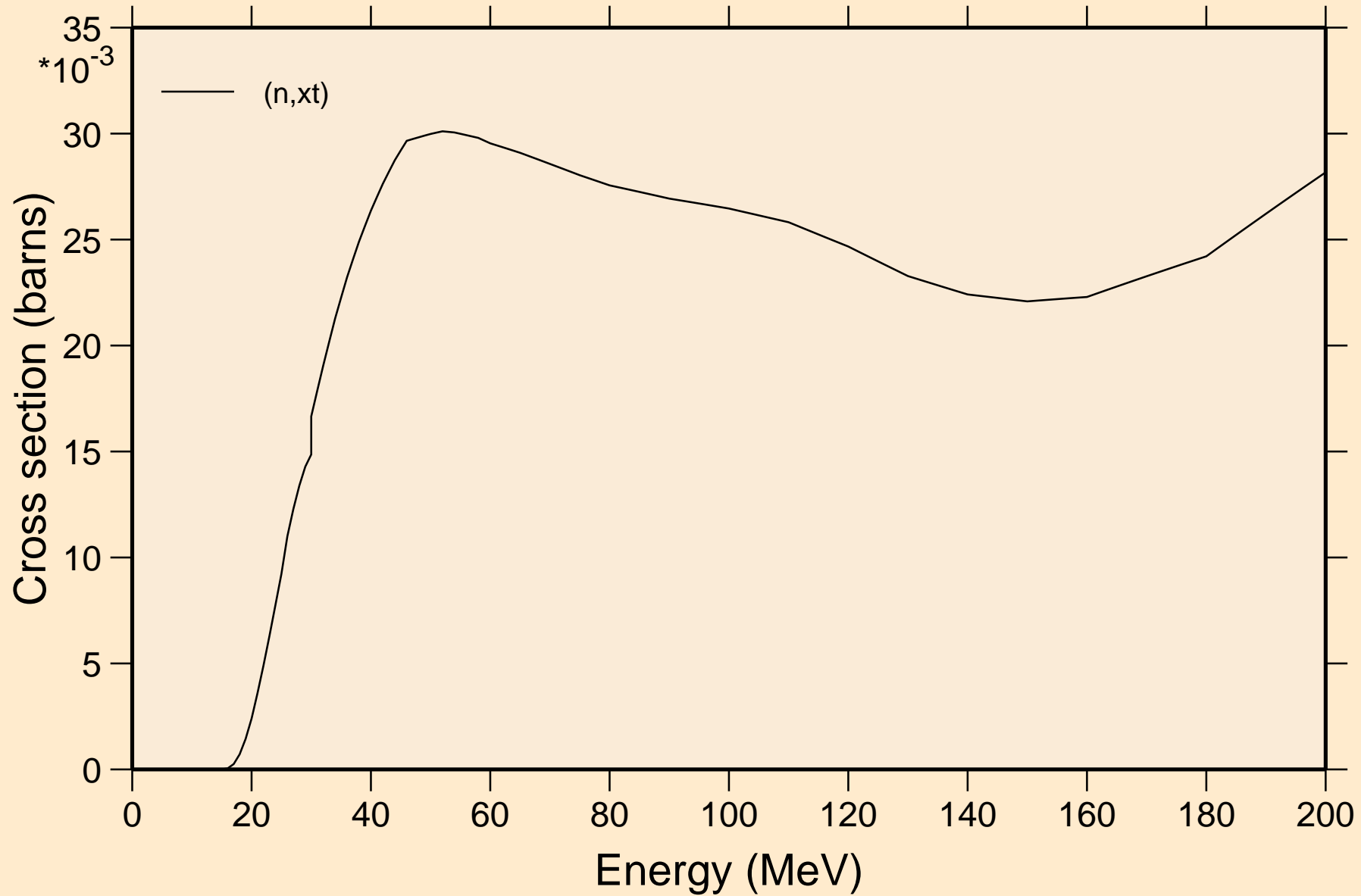

AG095 NEUTRON ACER TENDL-2024 LIBRARY; T=0.K
angular distribution for elastic

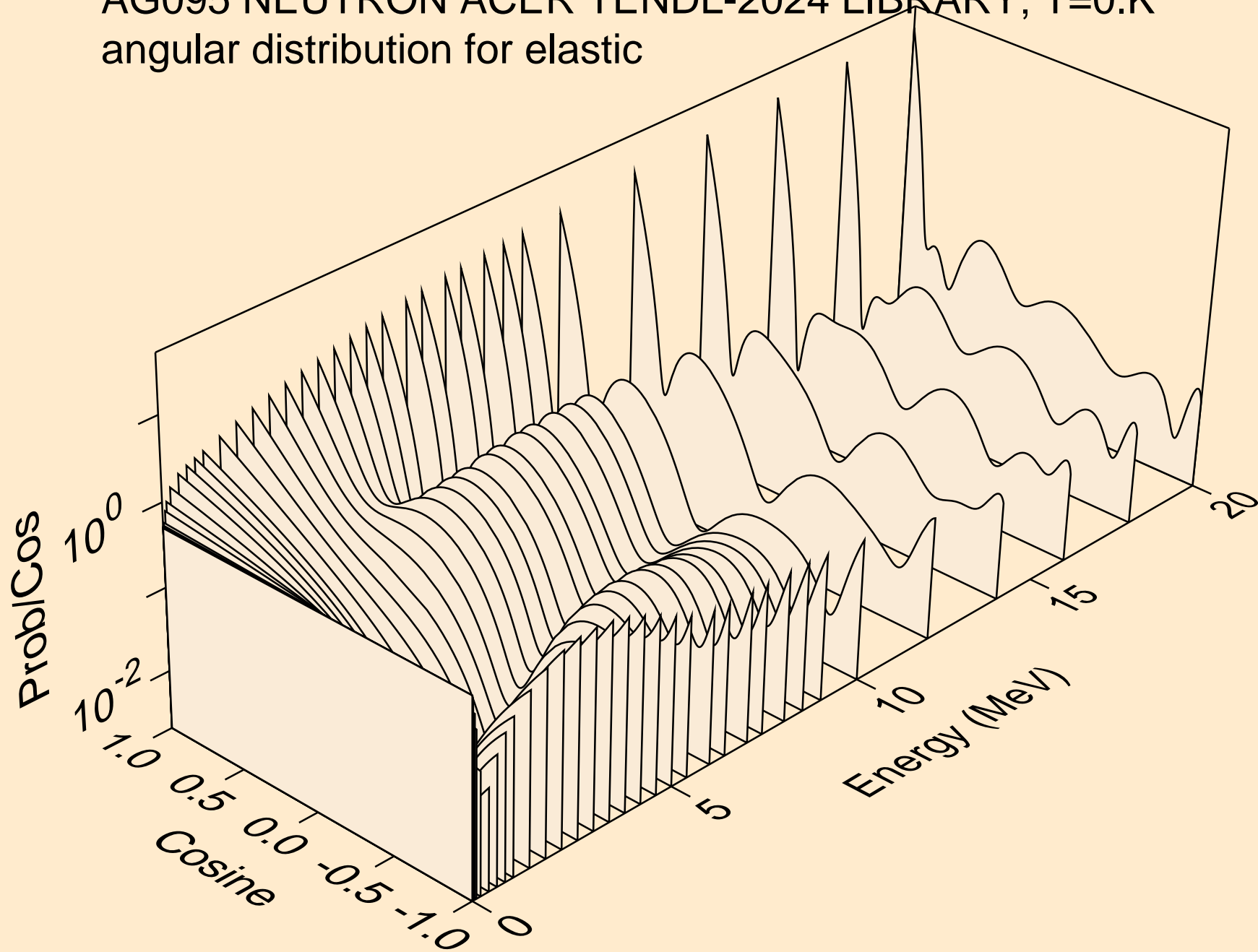

AG095 NEUTRON ACER TENDL-2024 LIBRARY; T=0.K
angular distribution for elastic

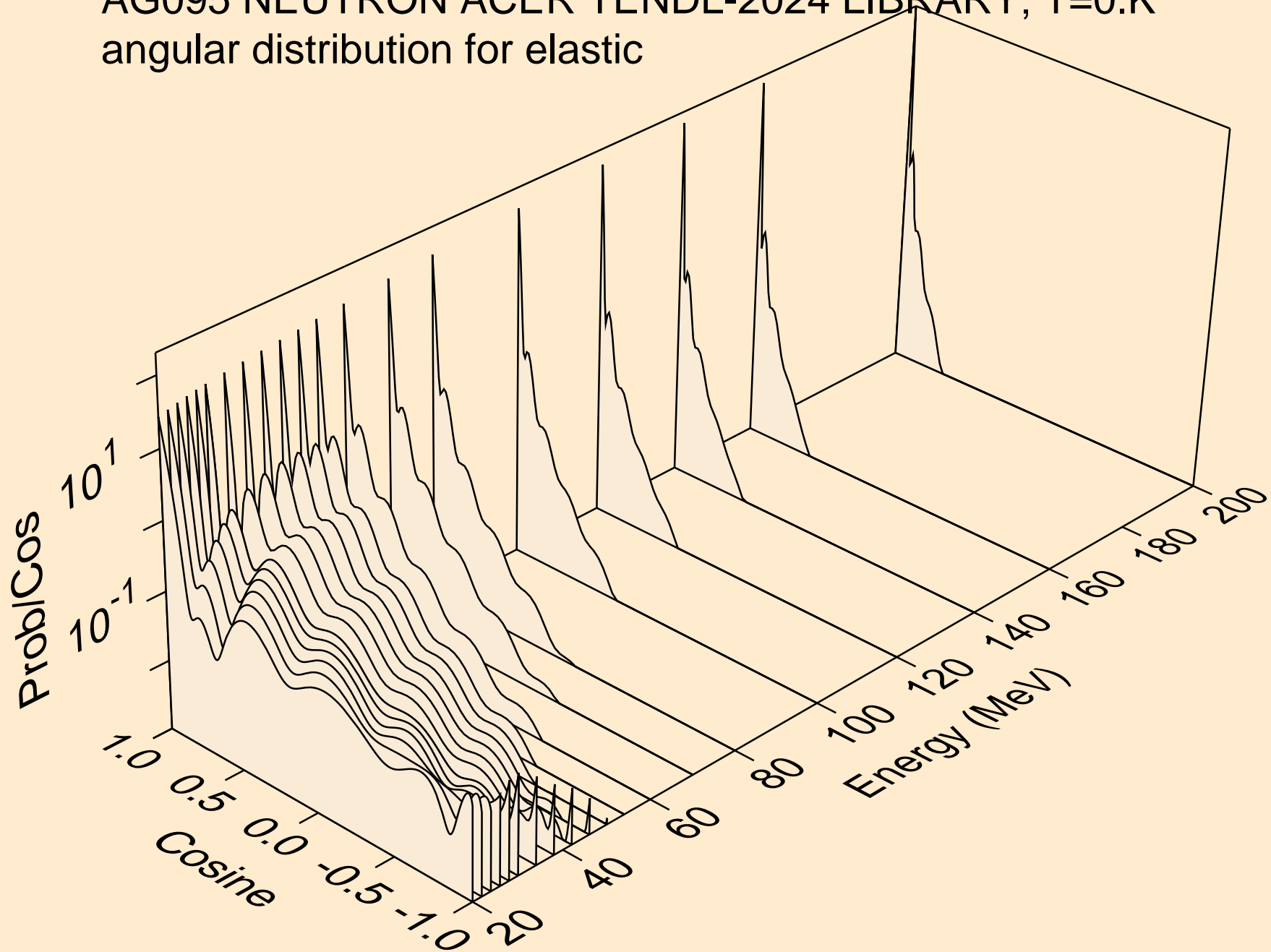

AG095 NEUTRON ACER TENDL-2024 LIBRARY; T=0.K
angular distribution for (n,n*1)

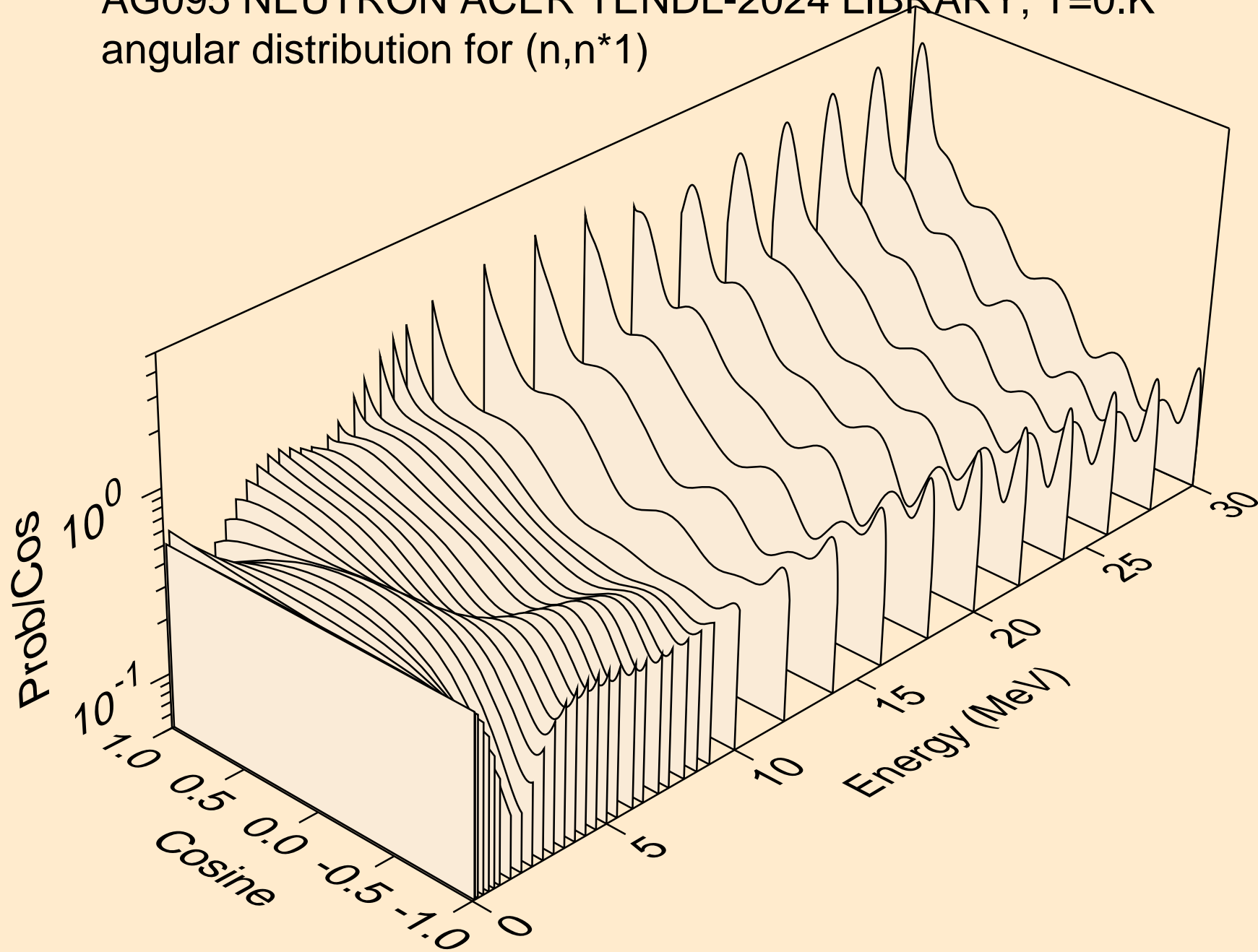

AG095 NEUTRON ACER TENDL-2024 LIBRARY; T=0.K
angular distribution for (n,n*2)

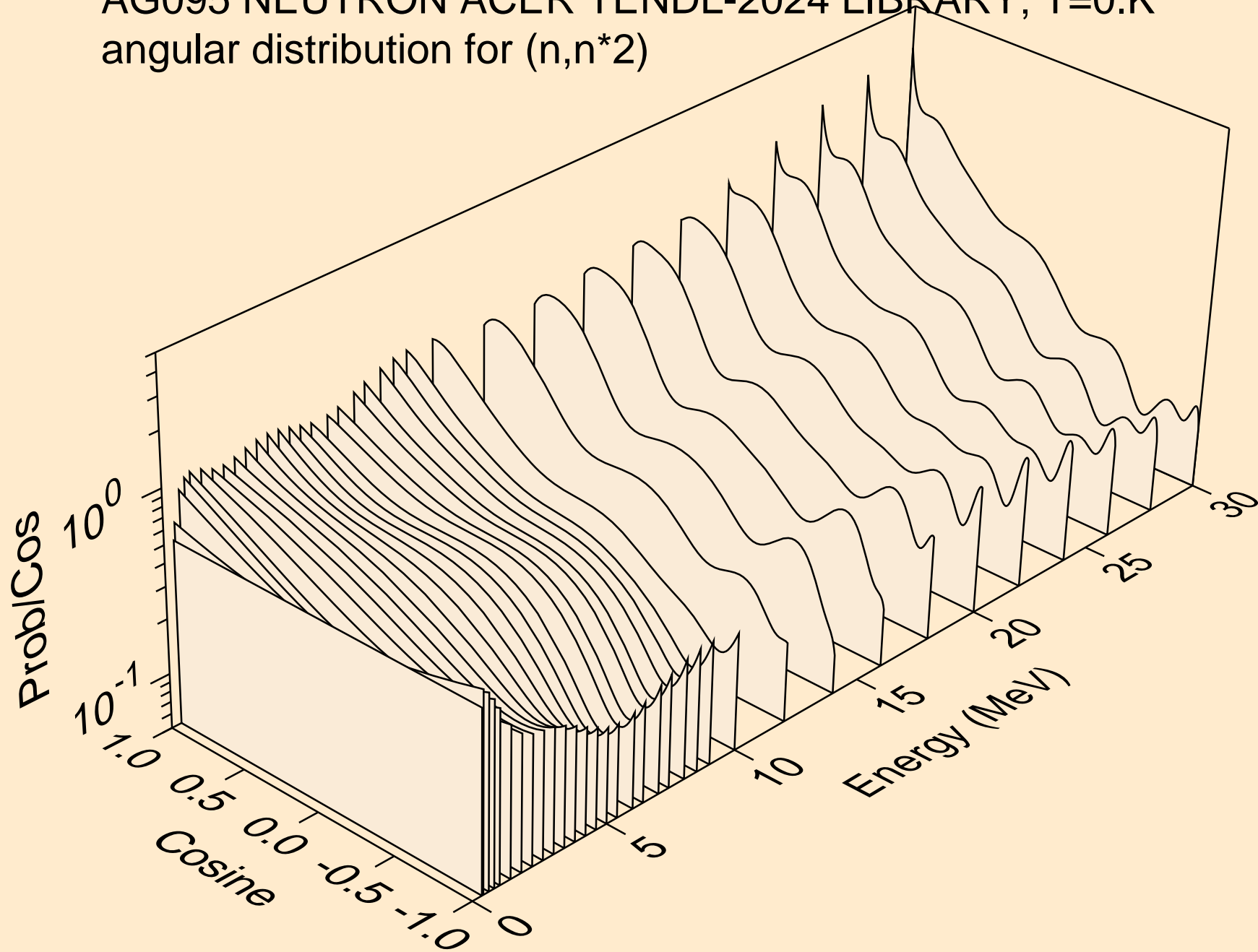

AG095 NEUTRON ACER TENDL-2024 LIBRARY; T=0.K
angular distribution for (n,n*3)

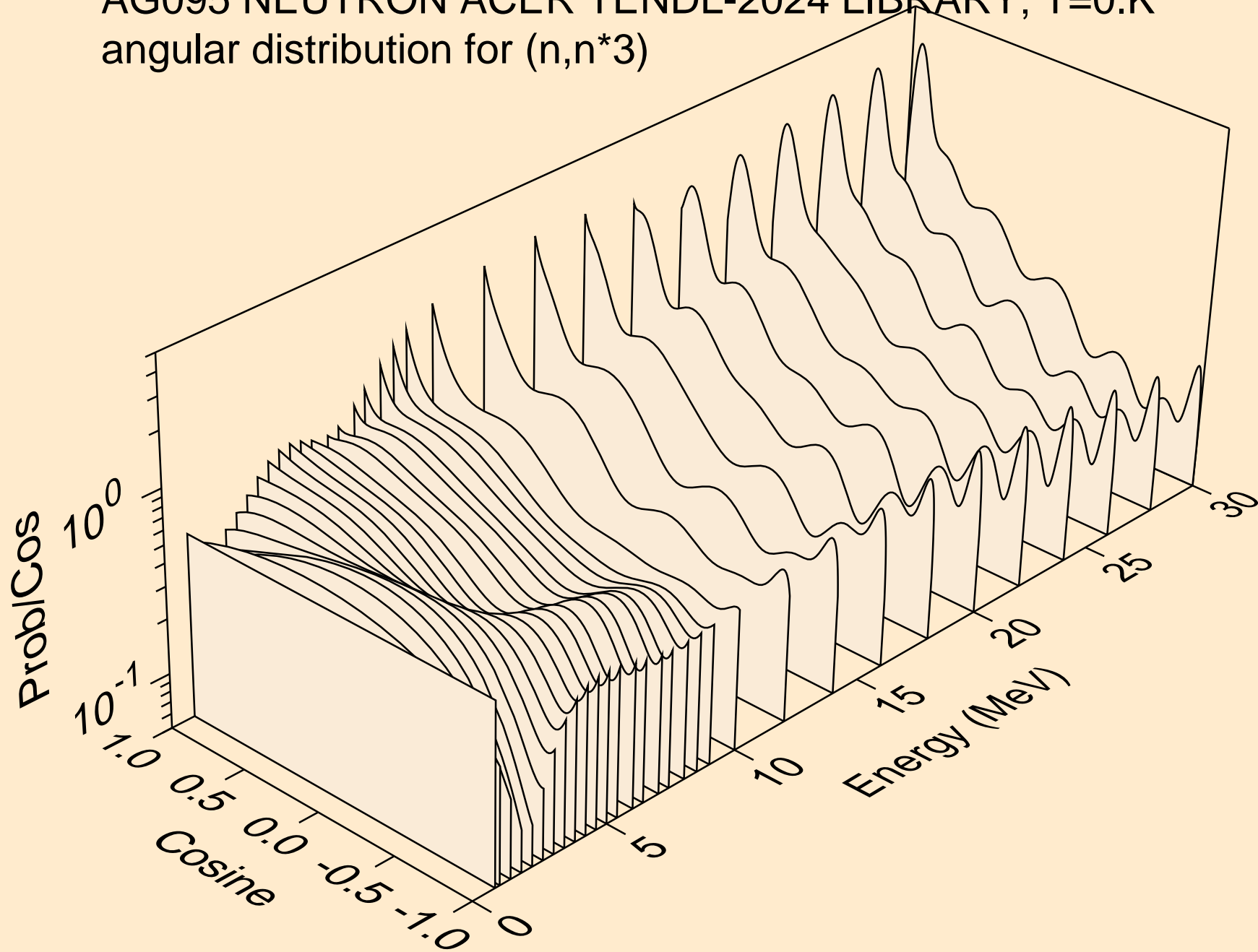

AG095 NEUTRON ACER TENDL-2024 LIBRARY; T=0.K
angular distribution for (n,n*4)

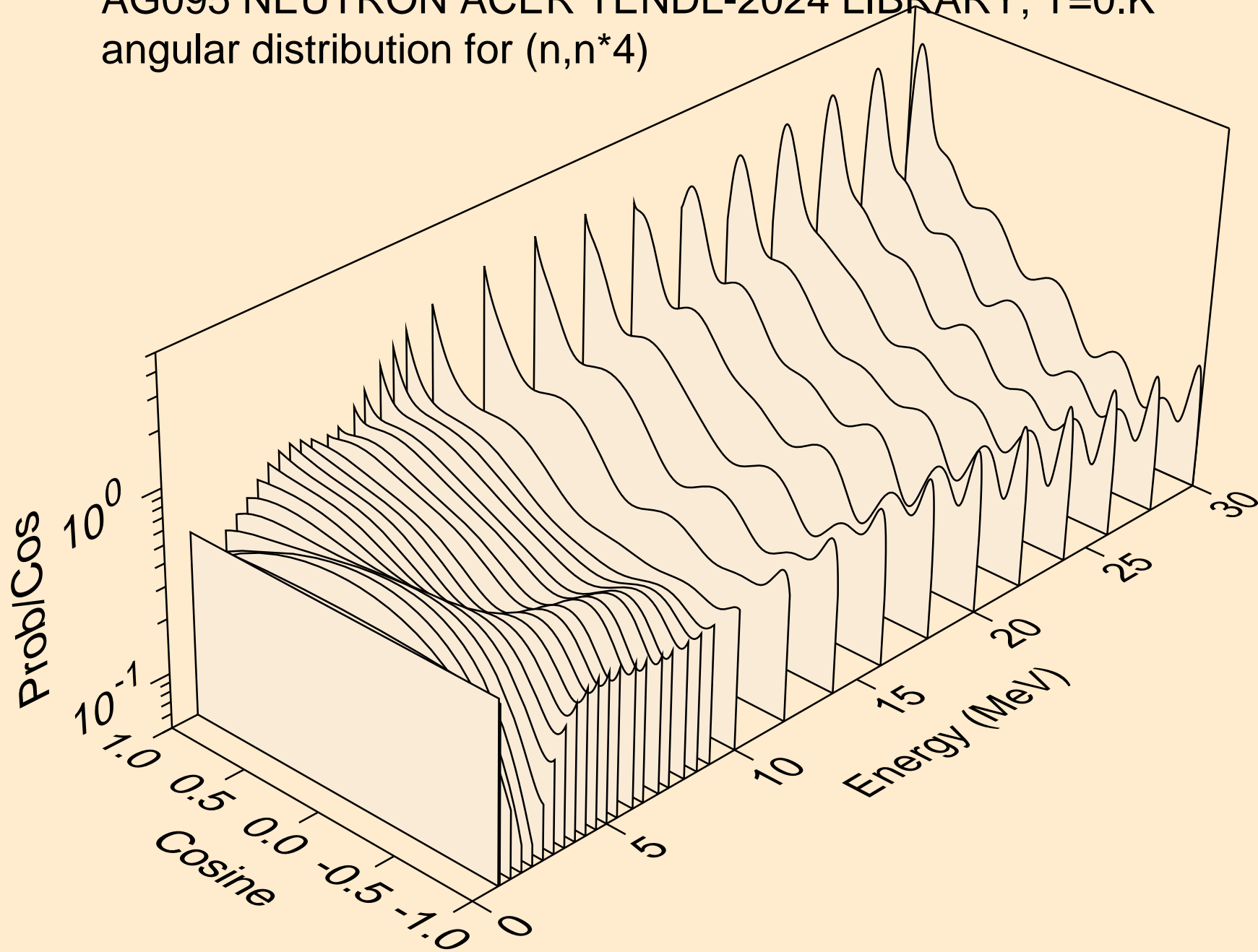

AG095 NEUTRON ACER TENDL-2024 LIBRARY; T=0.K
Neutron emission for (n,x)

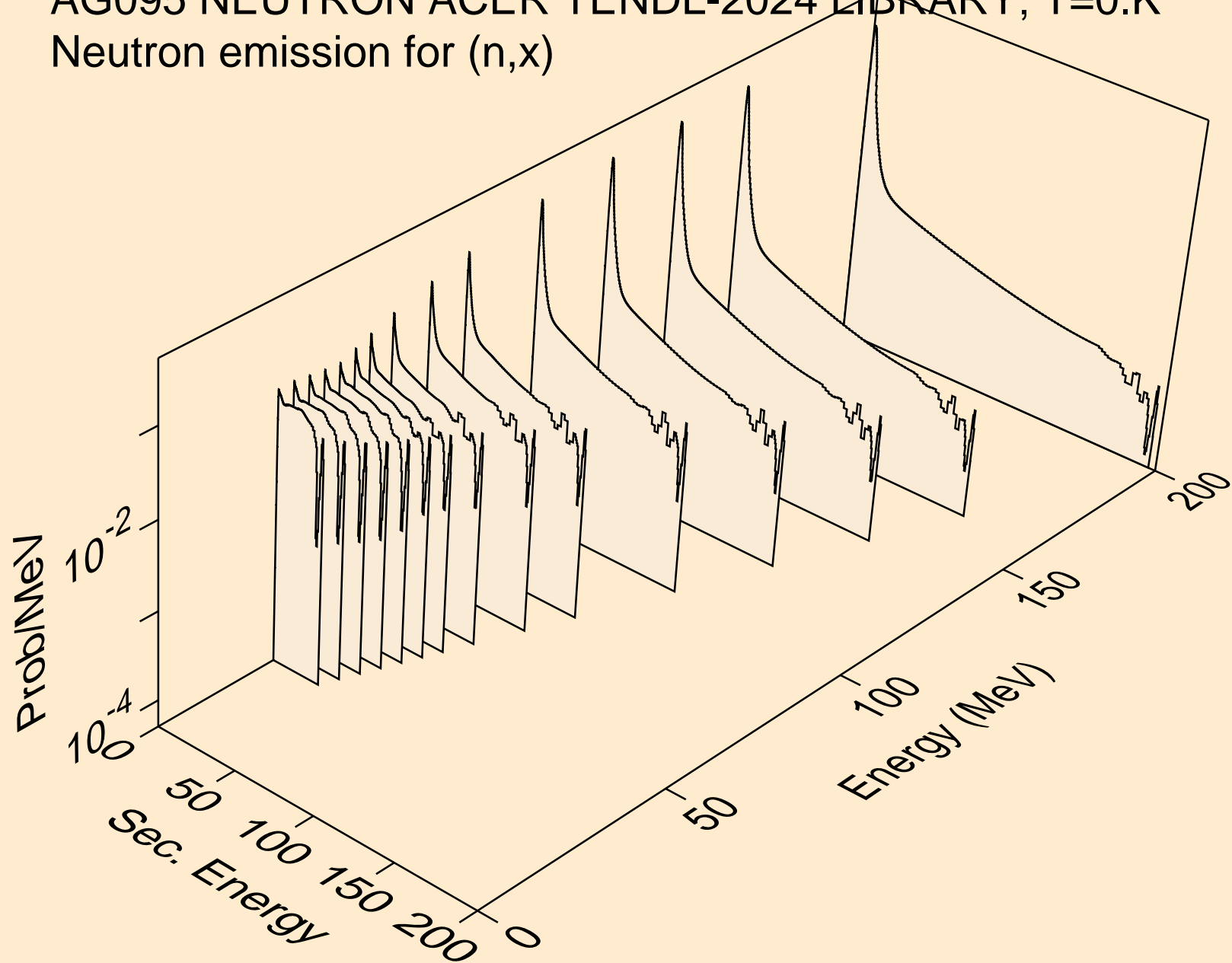

AG095 NEUTRON ACER TENDL-2024 LIBRARY; T=0.K
Neutron emission for (n,2n)

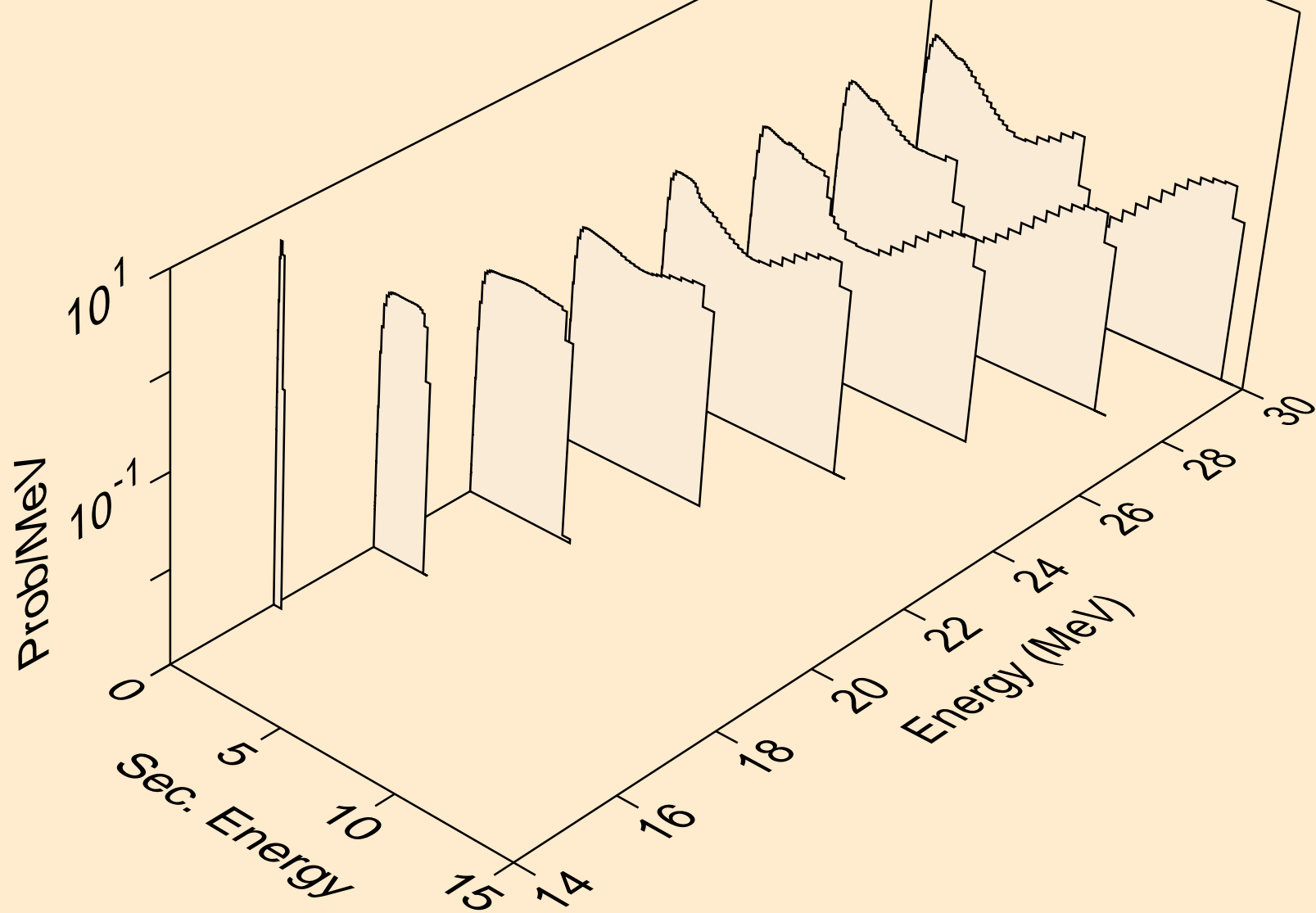

AG095 NEUTRON ACER TENDL-2024 LIBRARY; T=0.K
Neutron emission for (n,n*)a

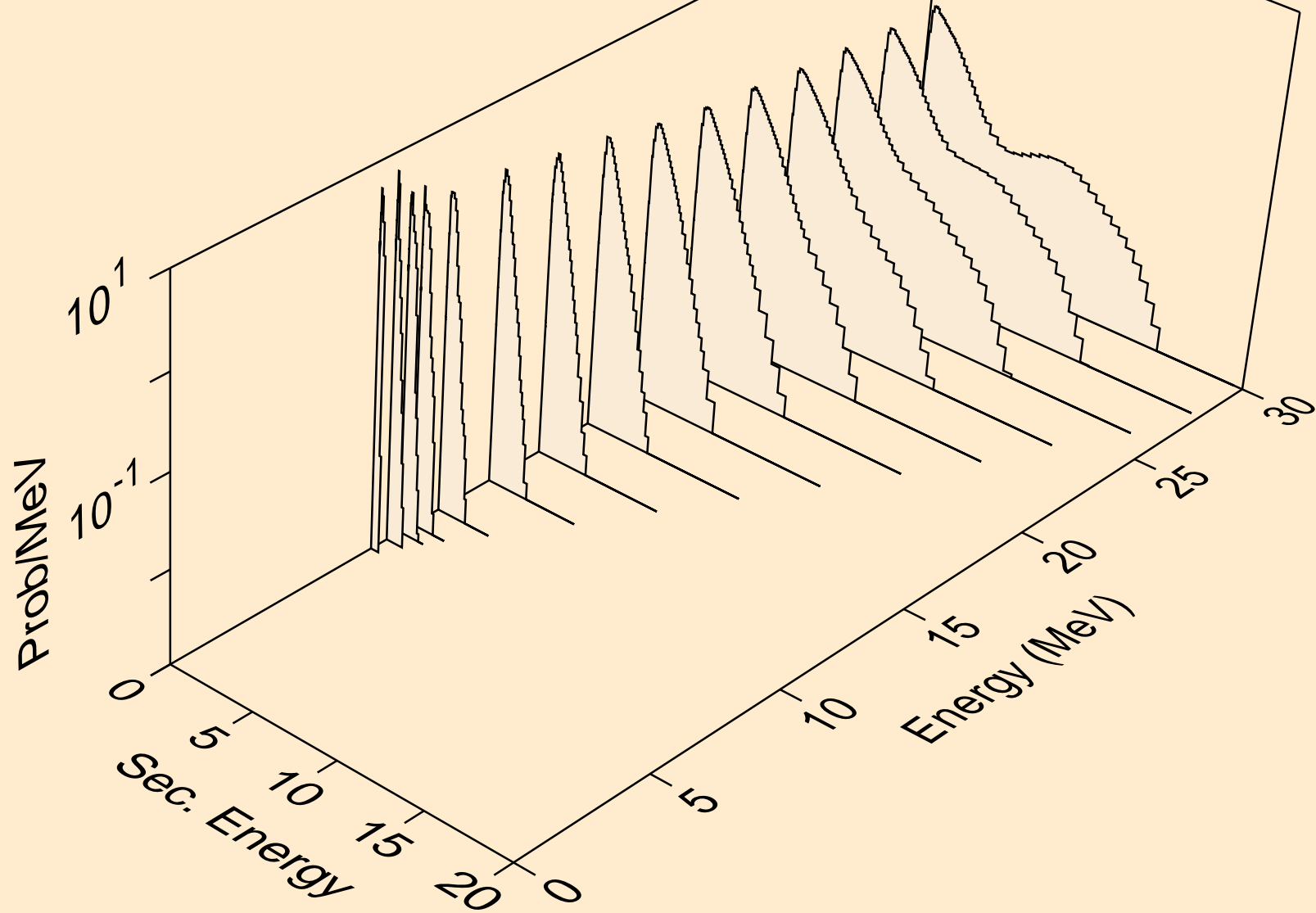

AG095 NEUTRON ACER TENDL-2024 LIBRARY; T=0.K
Neutron emission for (n,2n)a

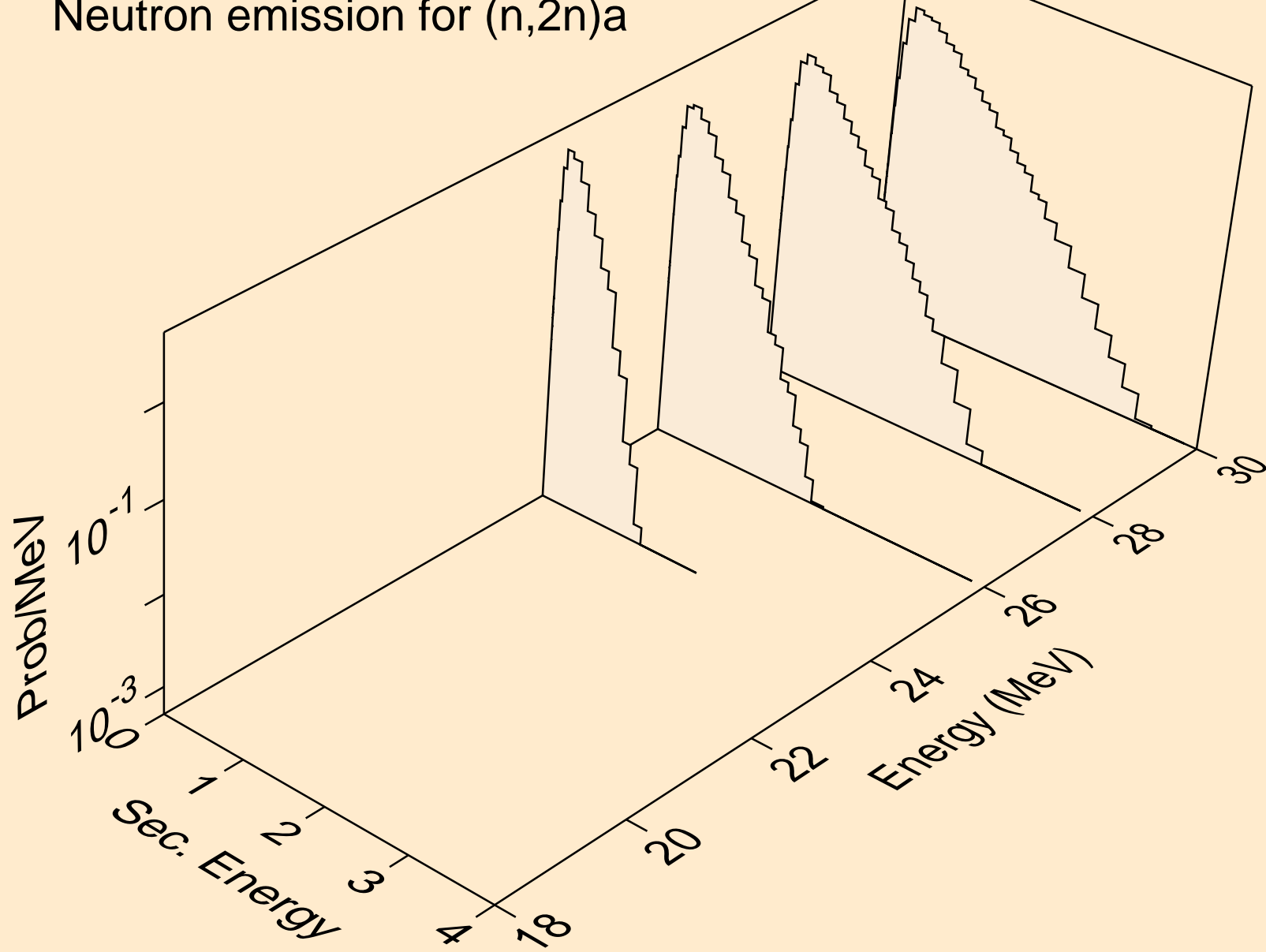

AG095 NEUTRON ACER TENDL-2024 LIBRARY; T=0.K
Neutron emission for (n,n*)p

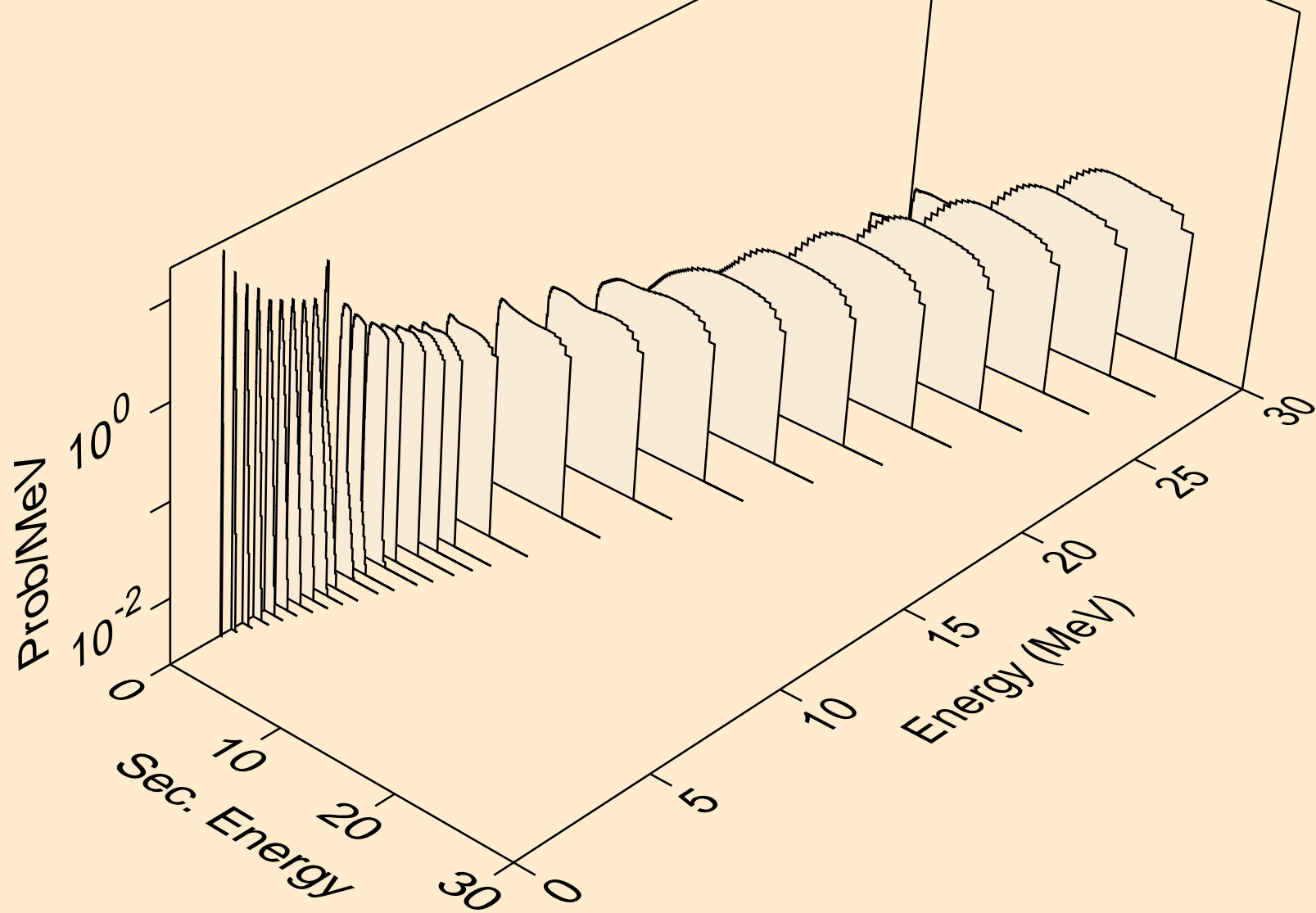

AG095 NEUTRON ACER TENDL-2024 LIBRARY; T=0.K
Neutron emission for (n,n*)2a

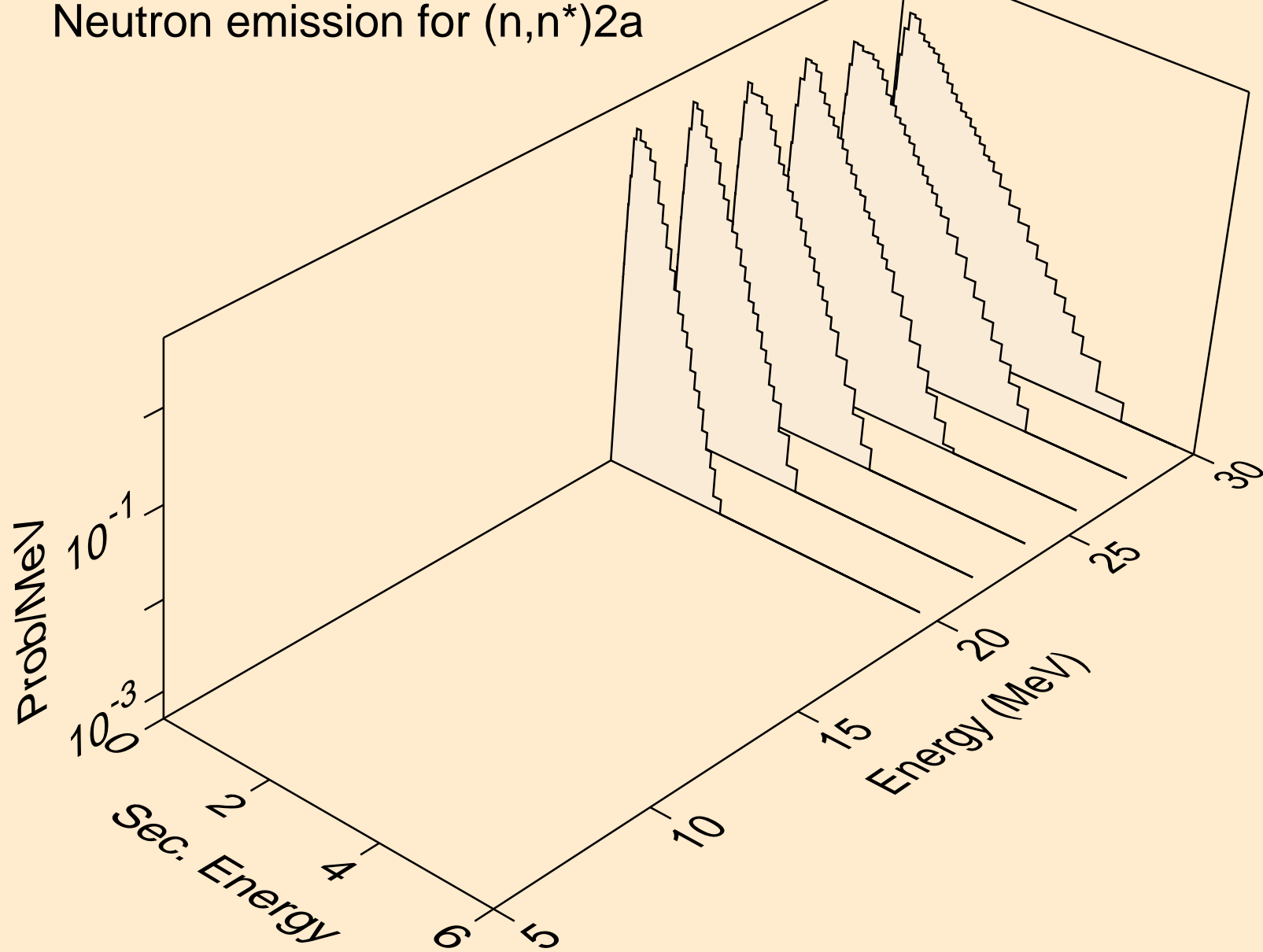

AG095 NEUTRON ACER TENDL-2024 LIBRARY; T=0.K
Neutron emission for (n,n*)d

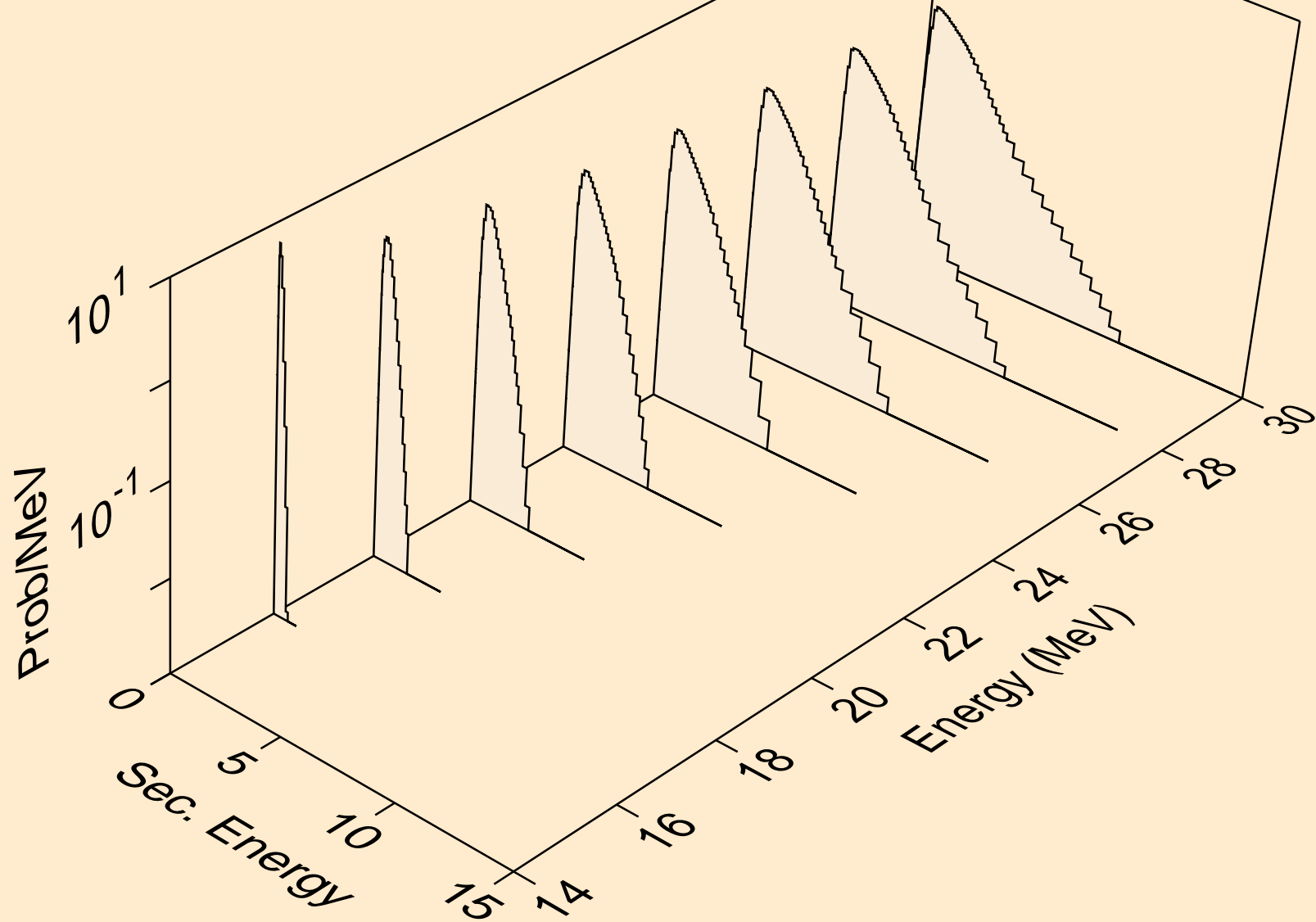

AG095 NEUTRON ACER TENDL-2024 LIBRARY; T=0.K
Neutron emission for (n,n*)t

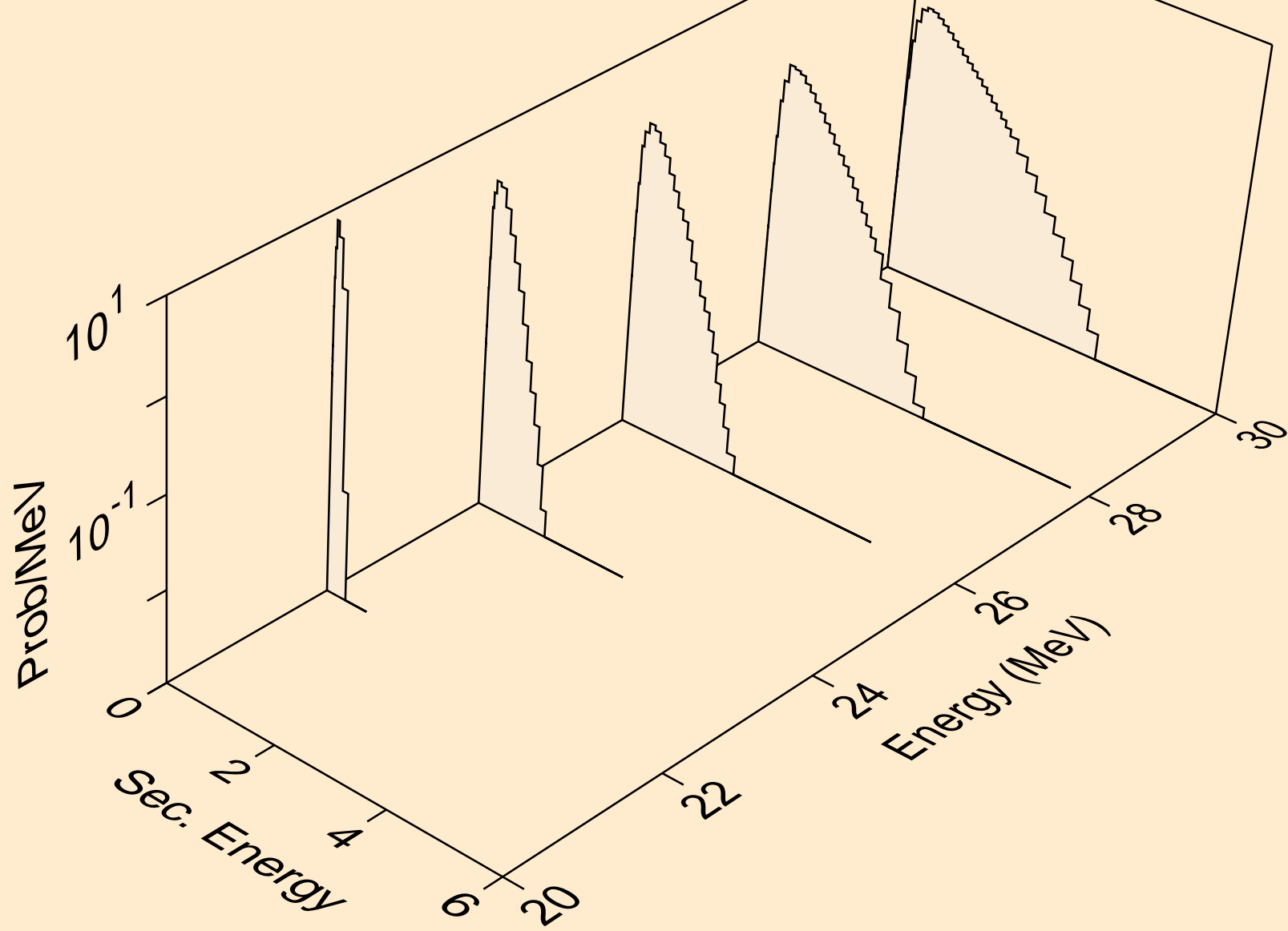

AG095 NEUTRON ACER TENDL-2024 LIBRARY; T=0.K
Neutron emission for (n,n*)he3

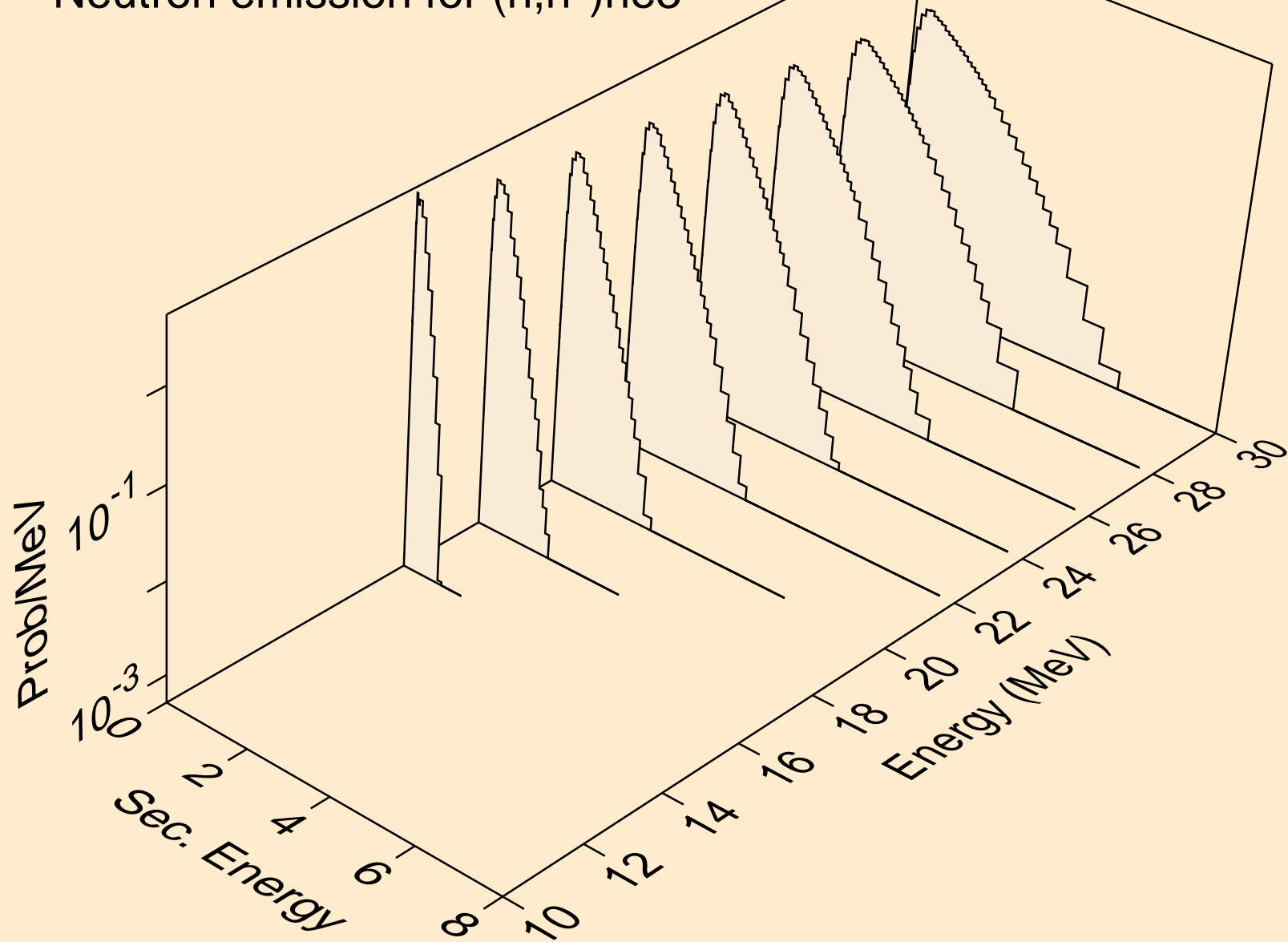

AG095 NEUTRON ACER TENDL-2024 LIBRARY; T=0.K
Neutron emission for (n,2np)

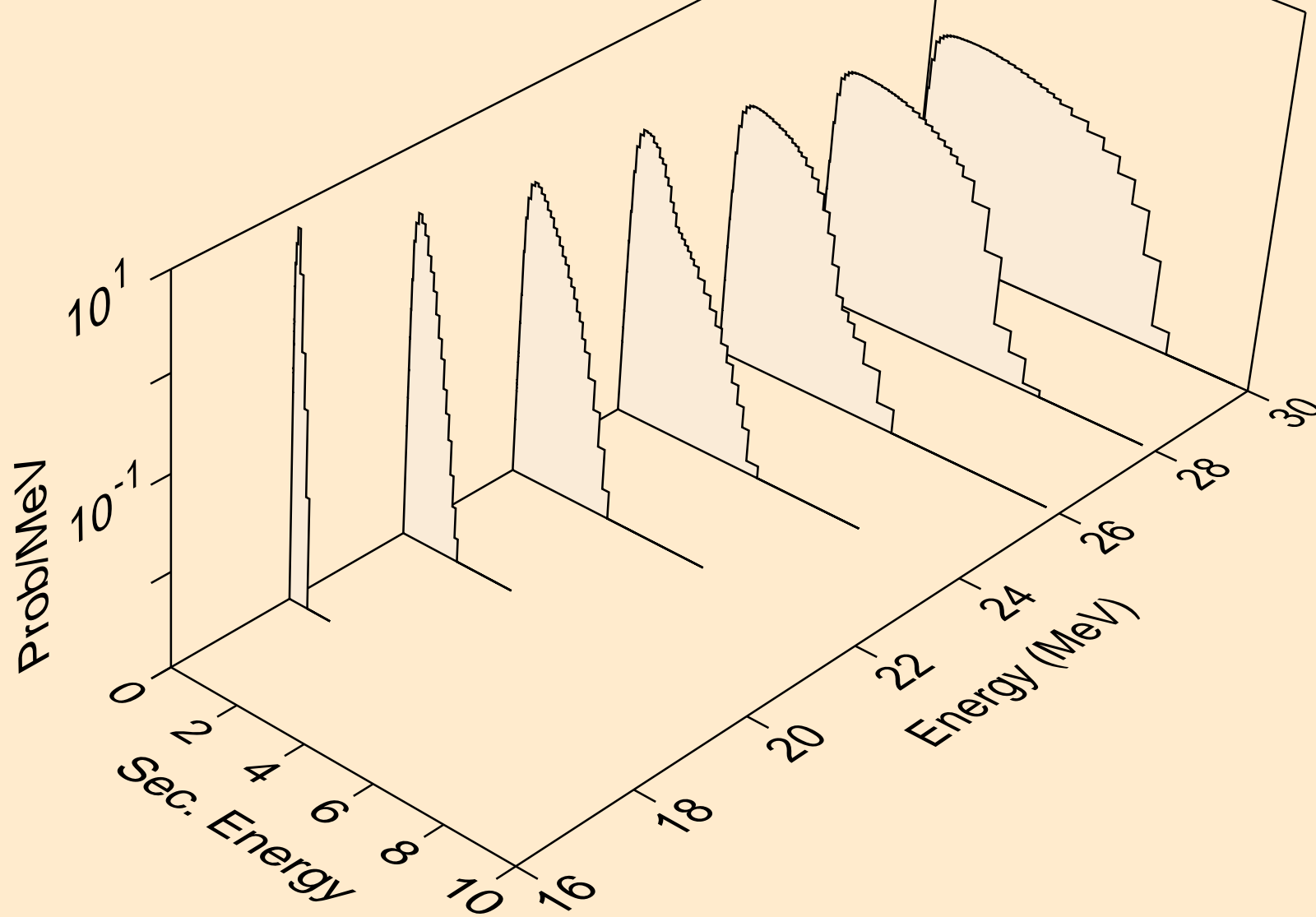

AG095 NEUTRON ACER TENDL-2024 LIBRARY; T=0.K
Neutron emission for (n,n2p)

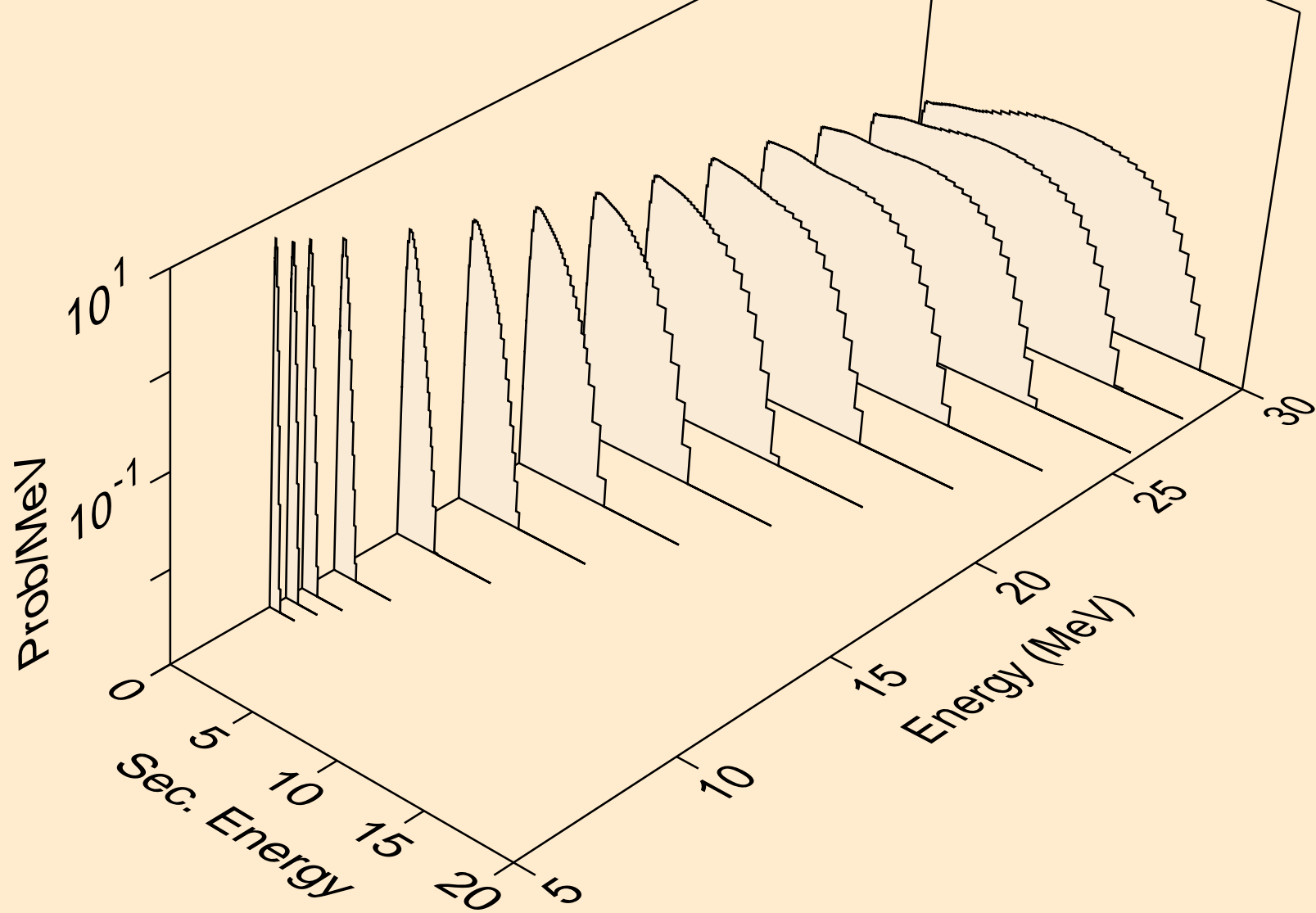

AG095 NEUTRON ACER TENDL-2024 LIBRARY; T=0.K
Neutron emission for (n,npa)

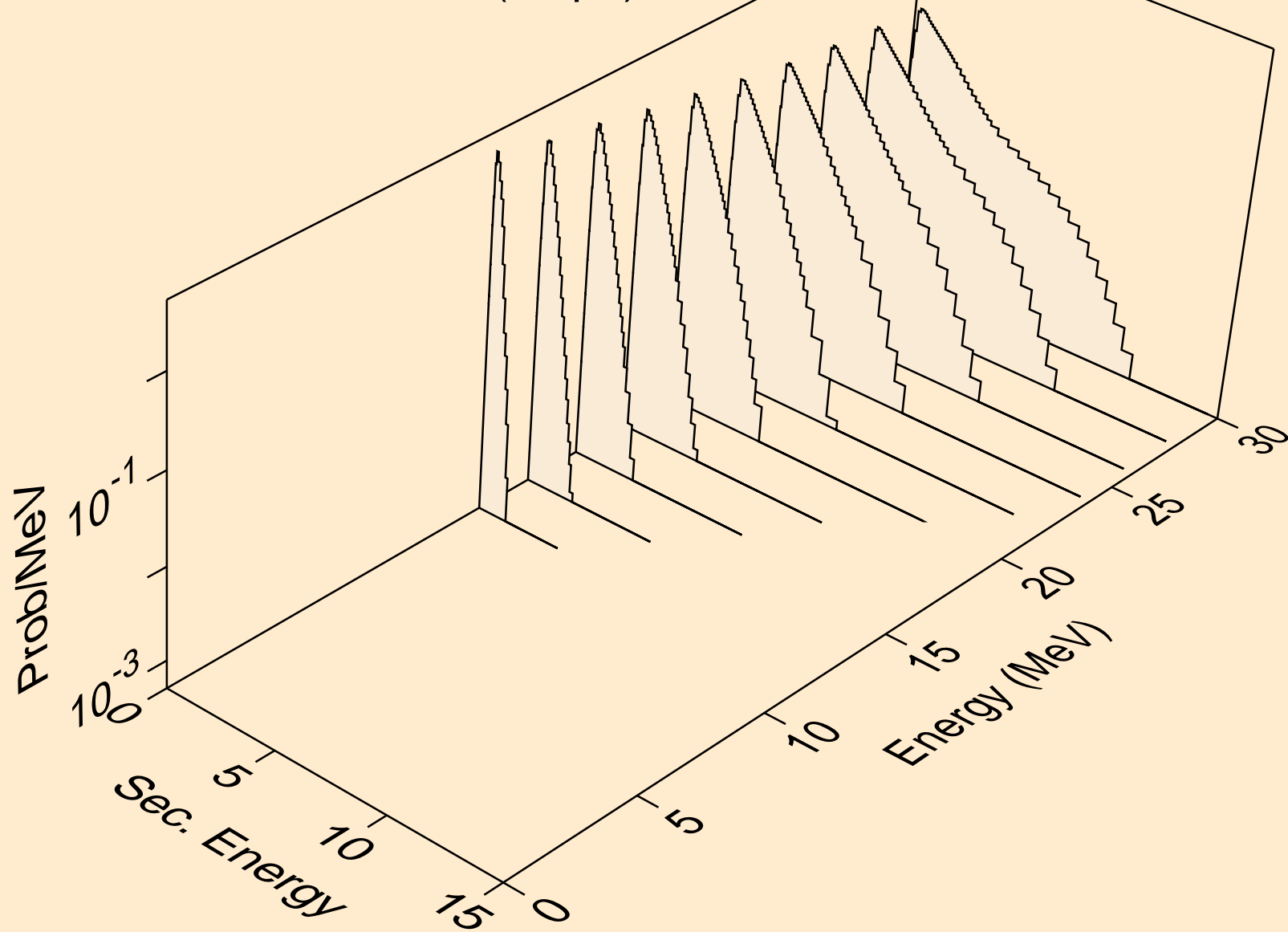

AG095 NEUTRON ACER TENDL-2024 LIBRARY; T=0.K
Neutron emission for (n,n*c)

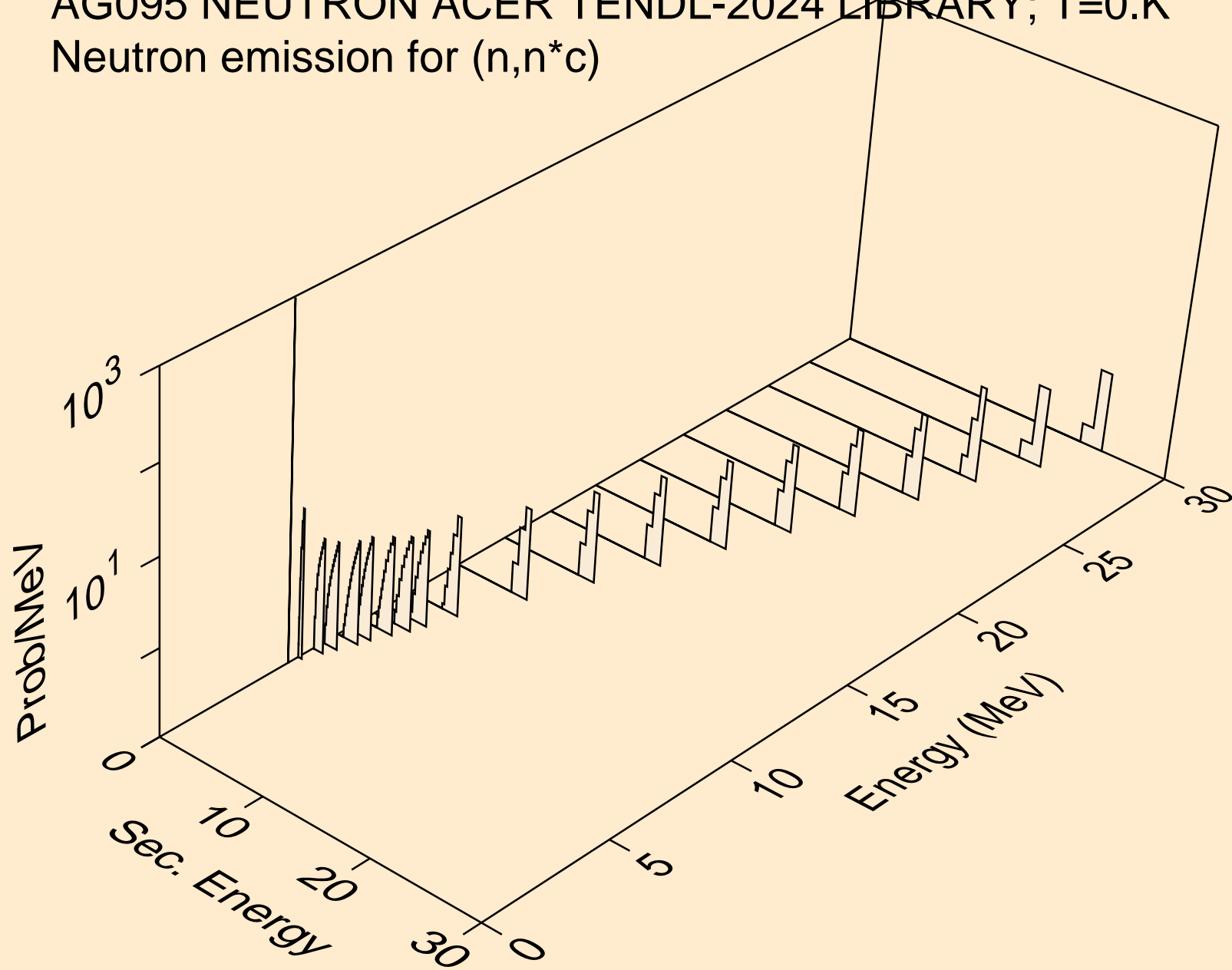

AG095 NEUTRON ACER TENDL-2024 LIBRARY; T=0.K
Photon emission for (n,x)

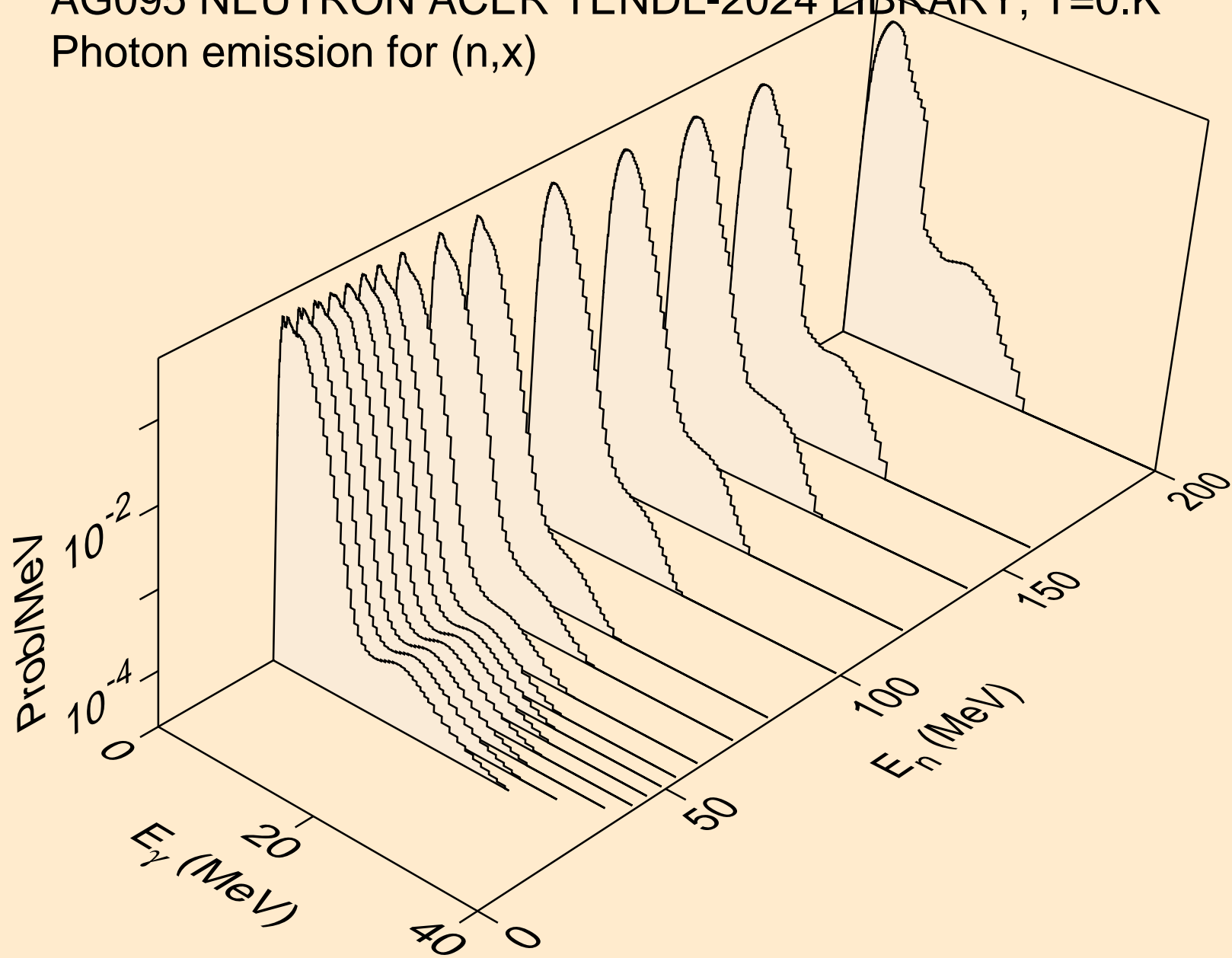

AG095 NEUTRON ACER TENDL-2024 LIBRARY; T=0.K
Photon emission for (n,2n)

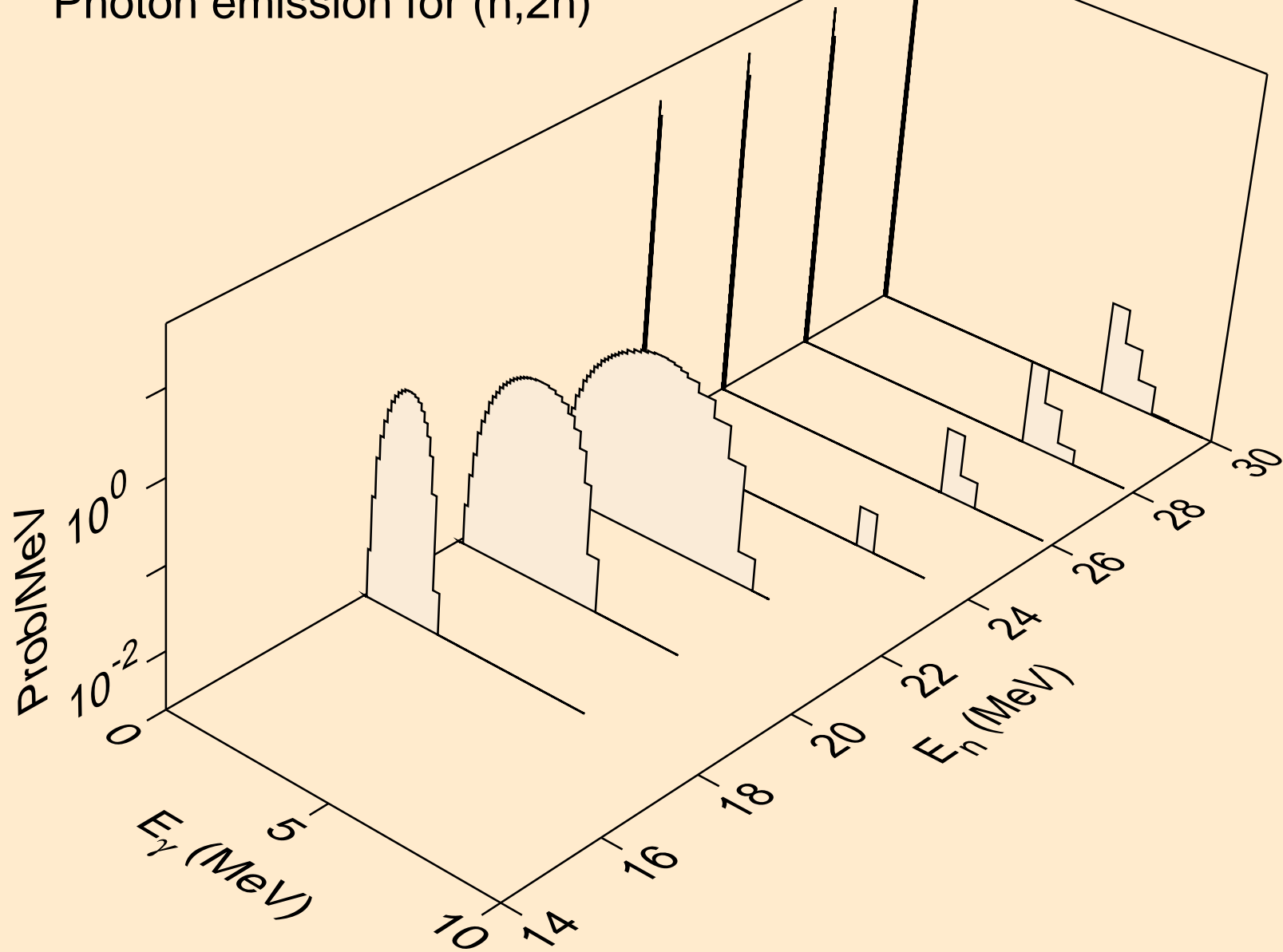

AG095 NEUTRON ACER TENDL-2024 LIBRARY; T=0.K
Photon emission for (n,n*)a

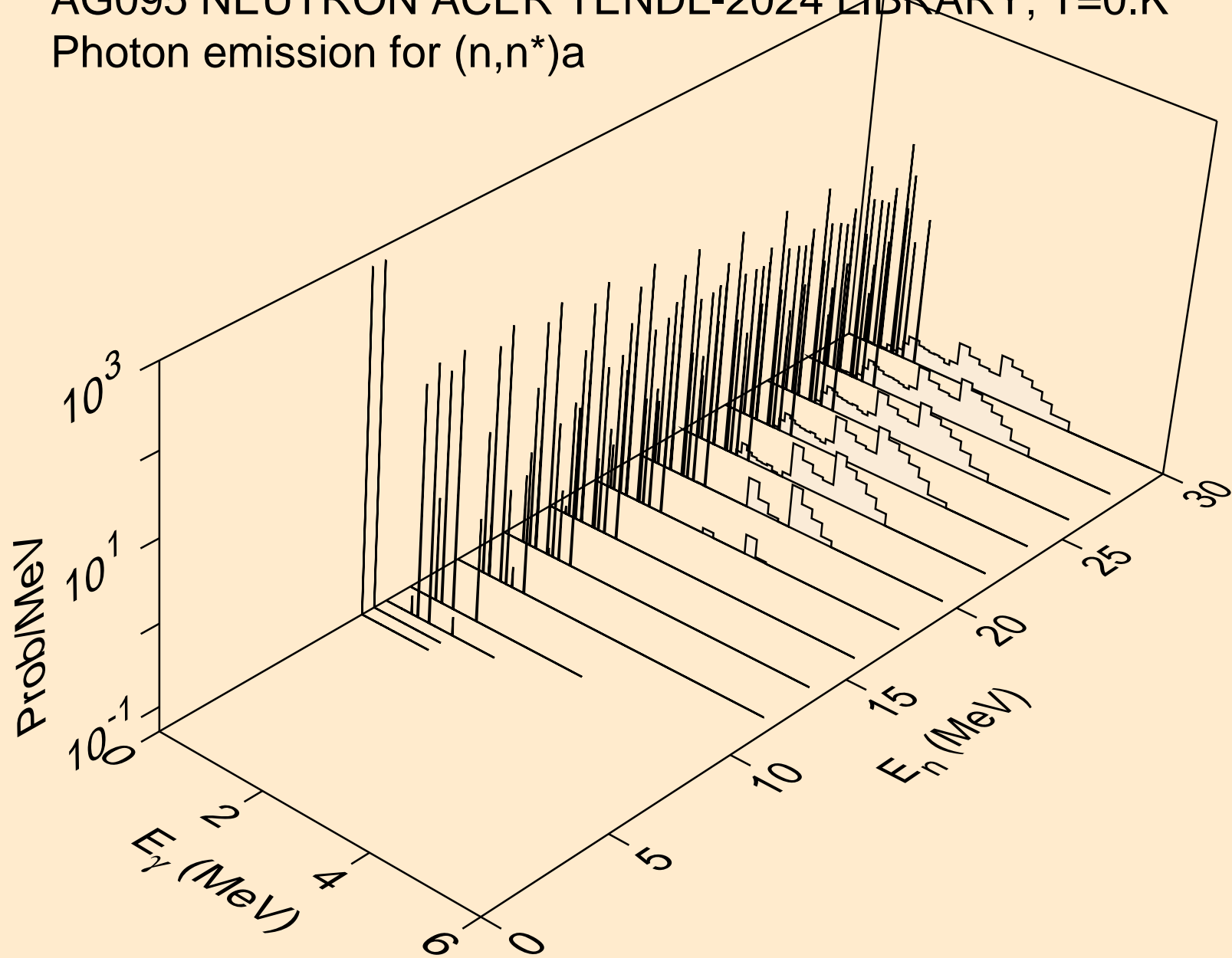

AG095 NEUTRON ACER TENDL-2024 LIBRARY; T=0.K
Photon emission for (n,2n)a

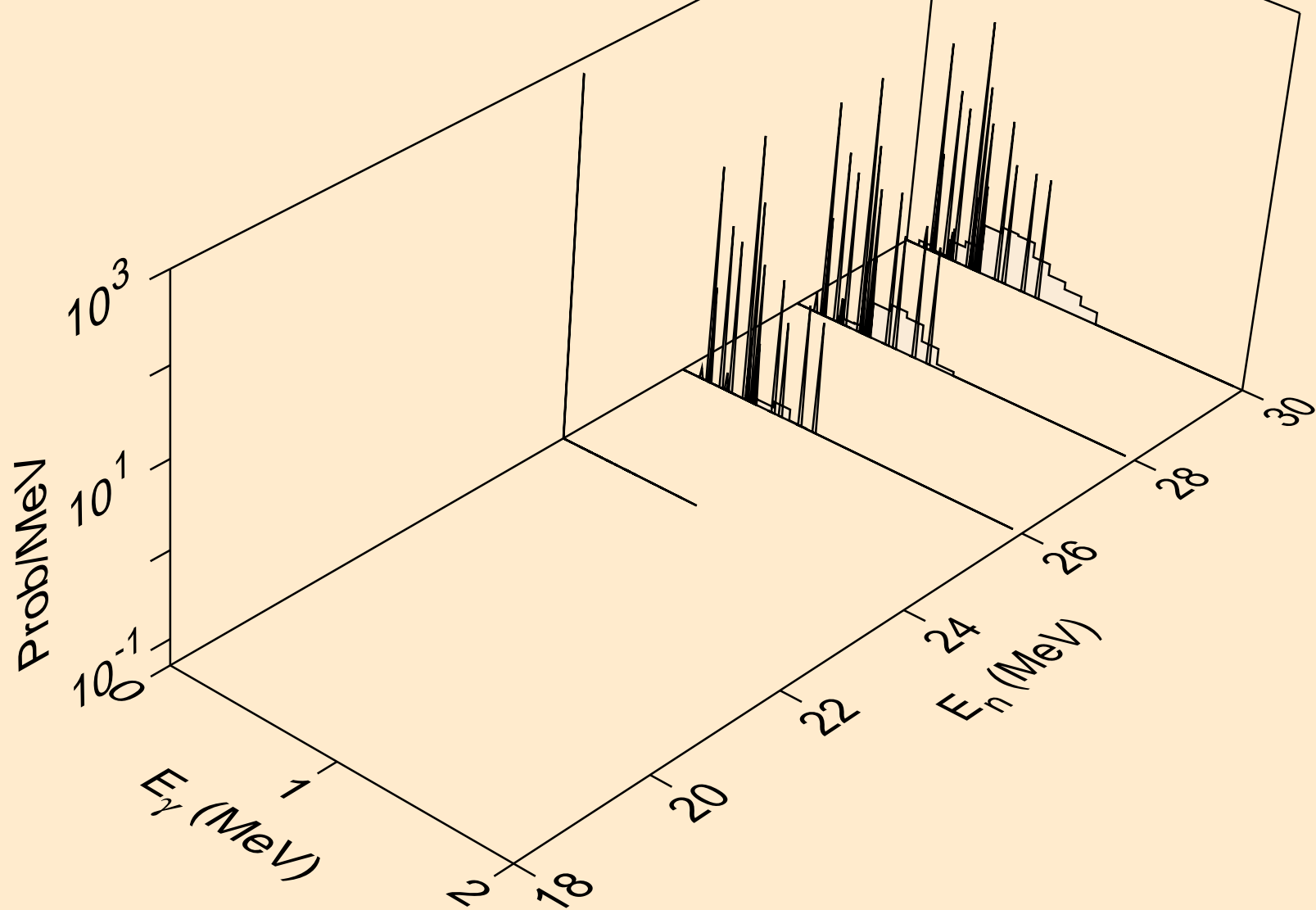

AG095 NEUTRON ACER TENDL-2024 LIBRARY; T=0.K
Photon emission for (n,n*)p

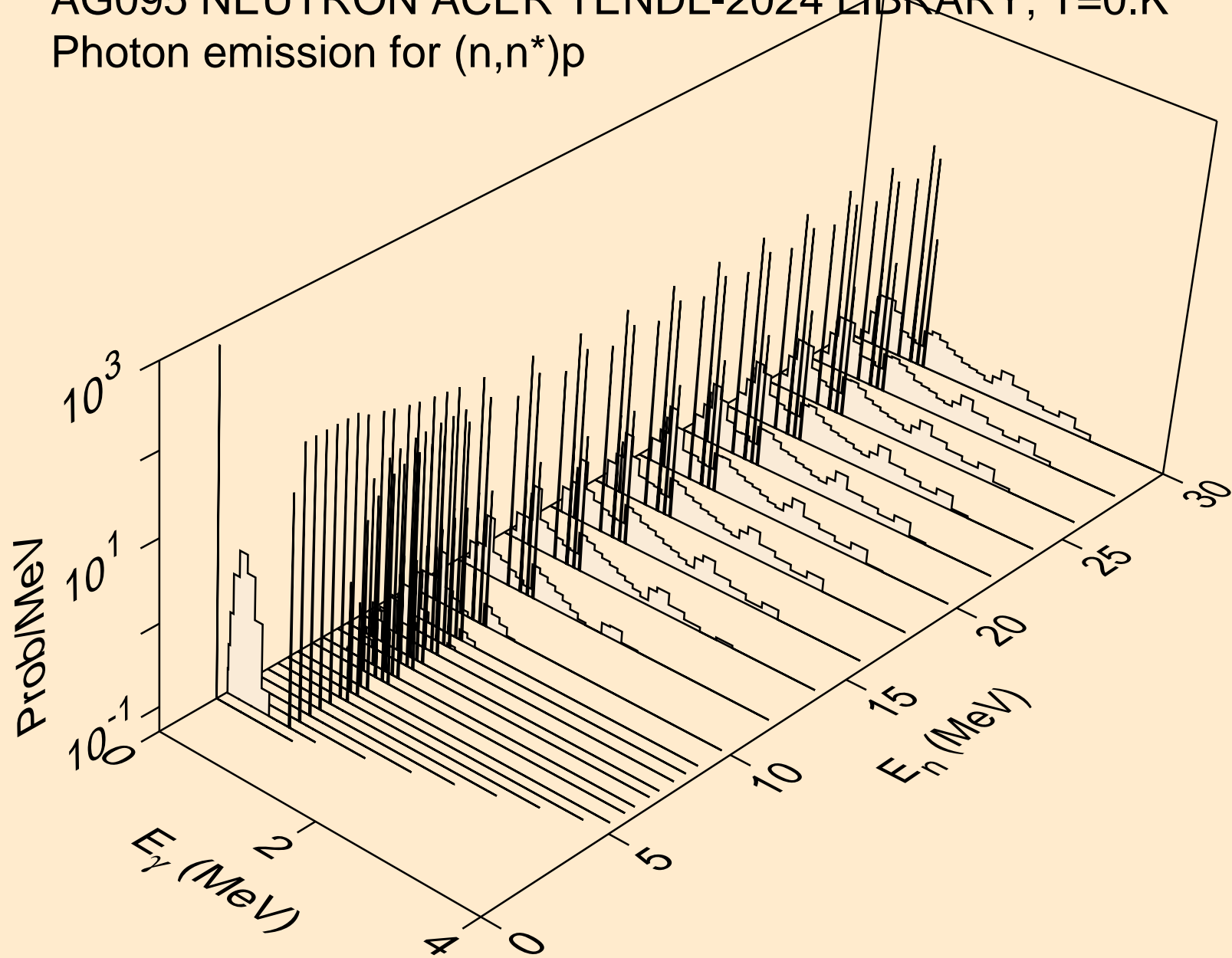

AG095 NEUTRON ACER TENDL-2024 LIBRARY; T=0.K
Photon emission for (n,n*)2a

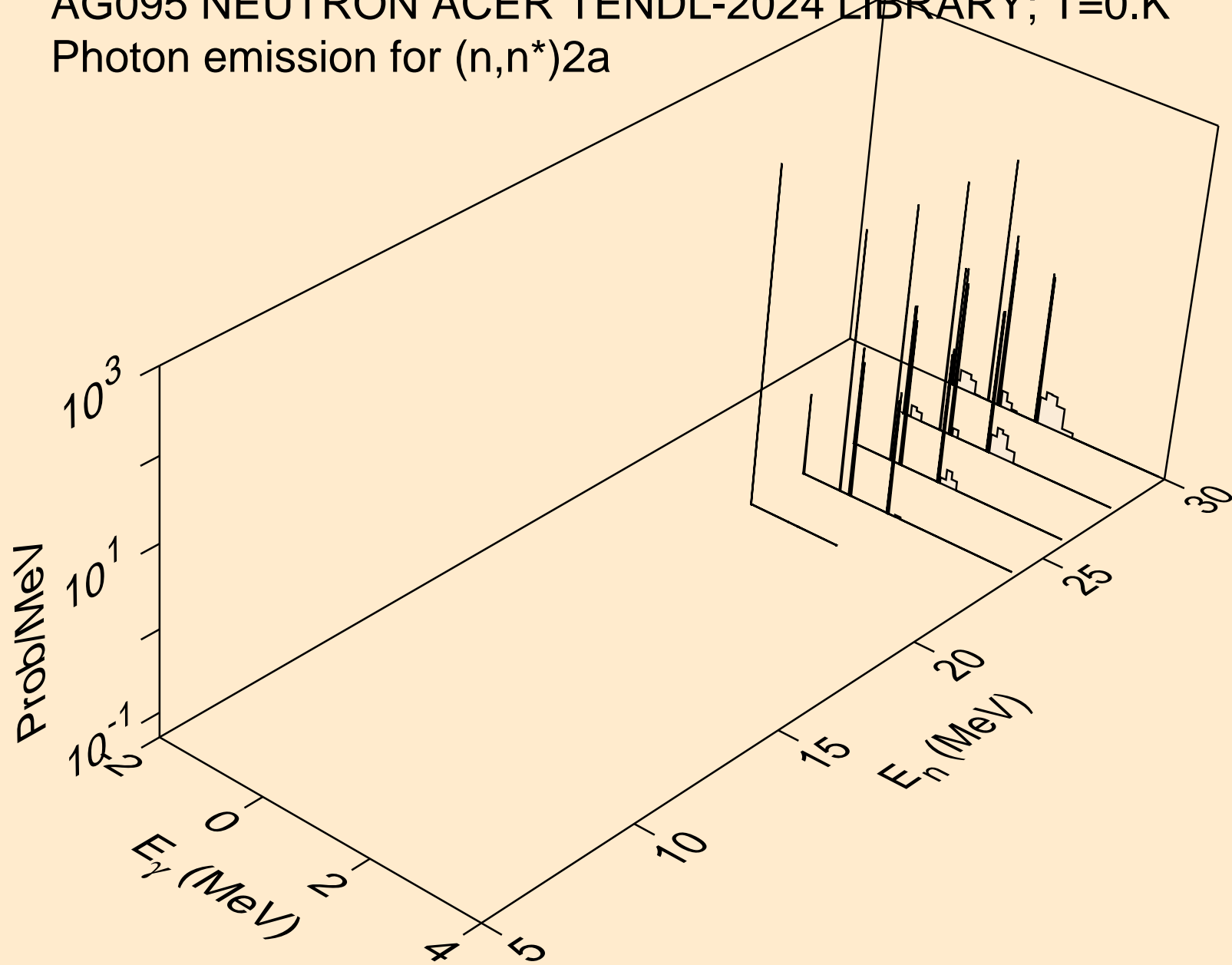

AG095 NEUTRON ACER TENDL-2024 LIBRARY; T=0.K
Photon emission for (n,n*)d

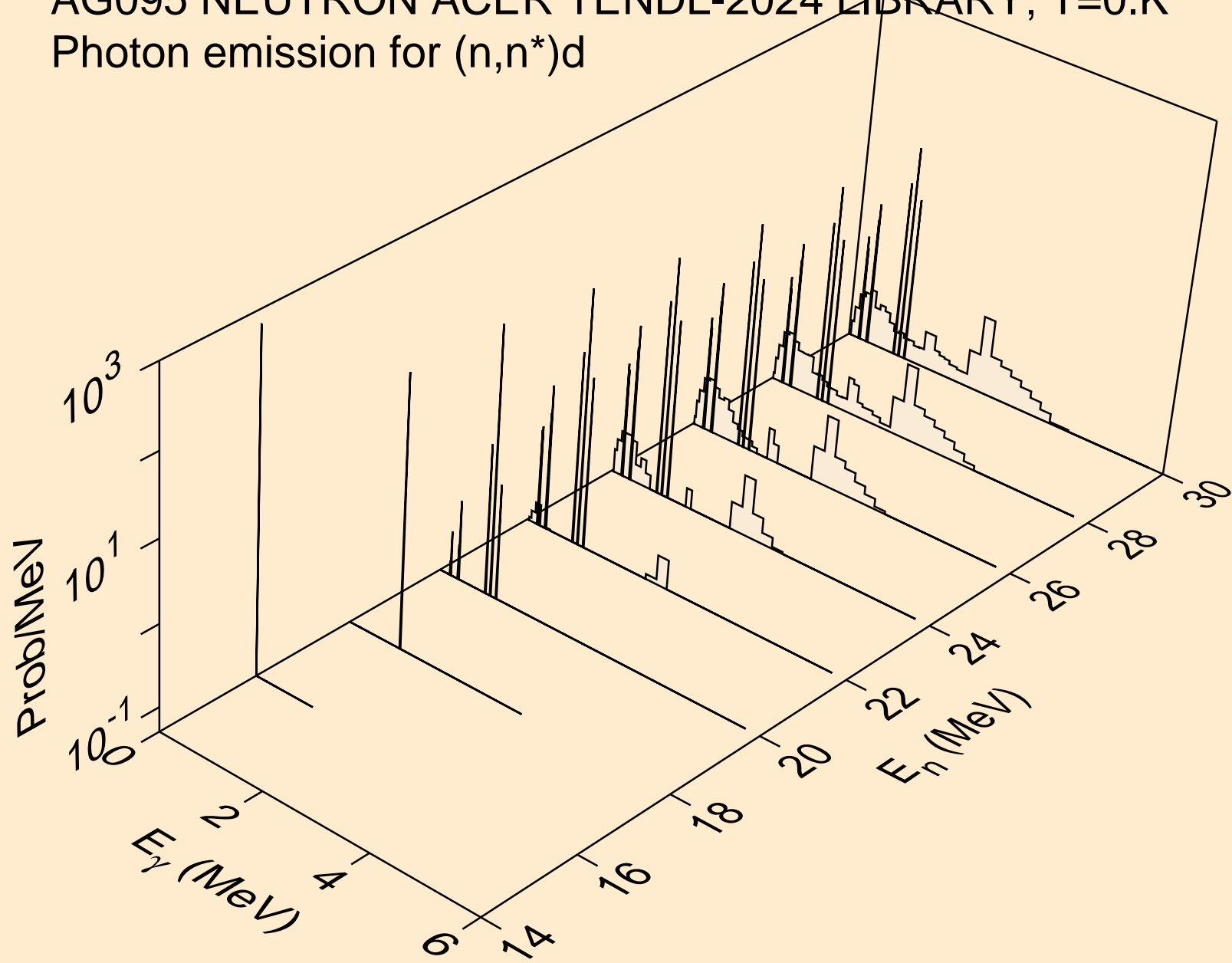

AG095 NEUTRON ACER TENDL-2024 LIBRARY; T=0.K
Photon emission for (n,n*)t

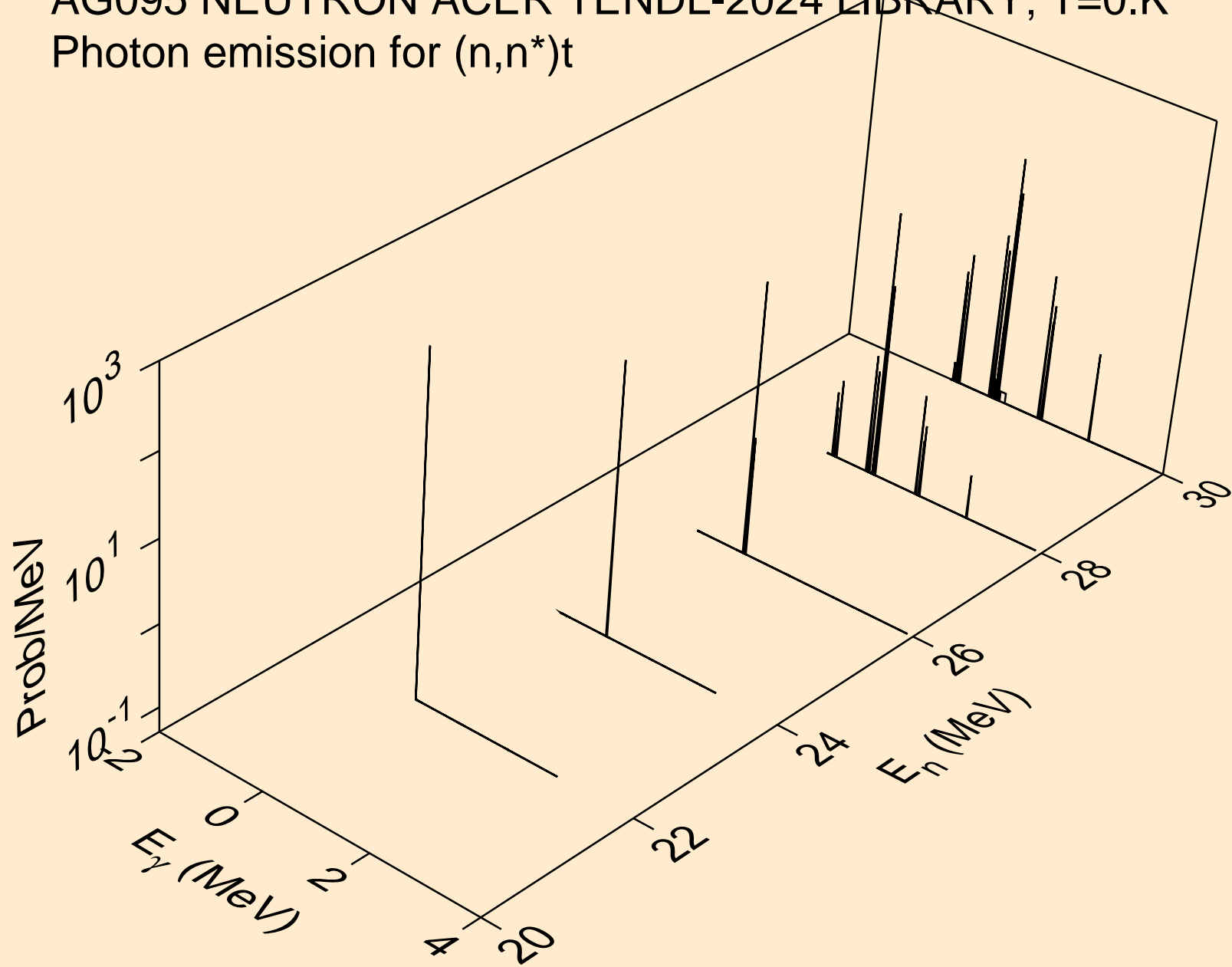

AG095 NEUTRON ACER TENDL-2024 LIBRARY; T=0.K
Photon emission for (n,n*)he3

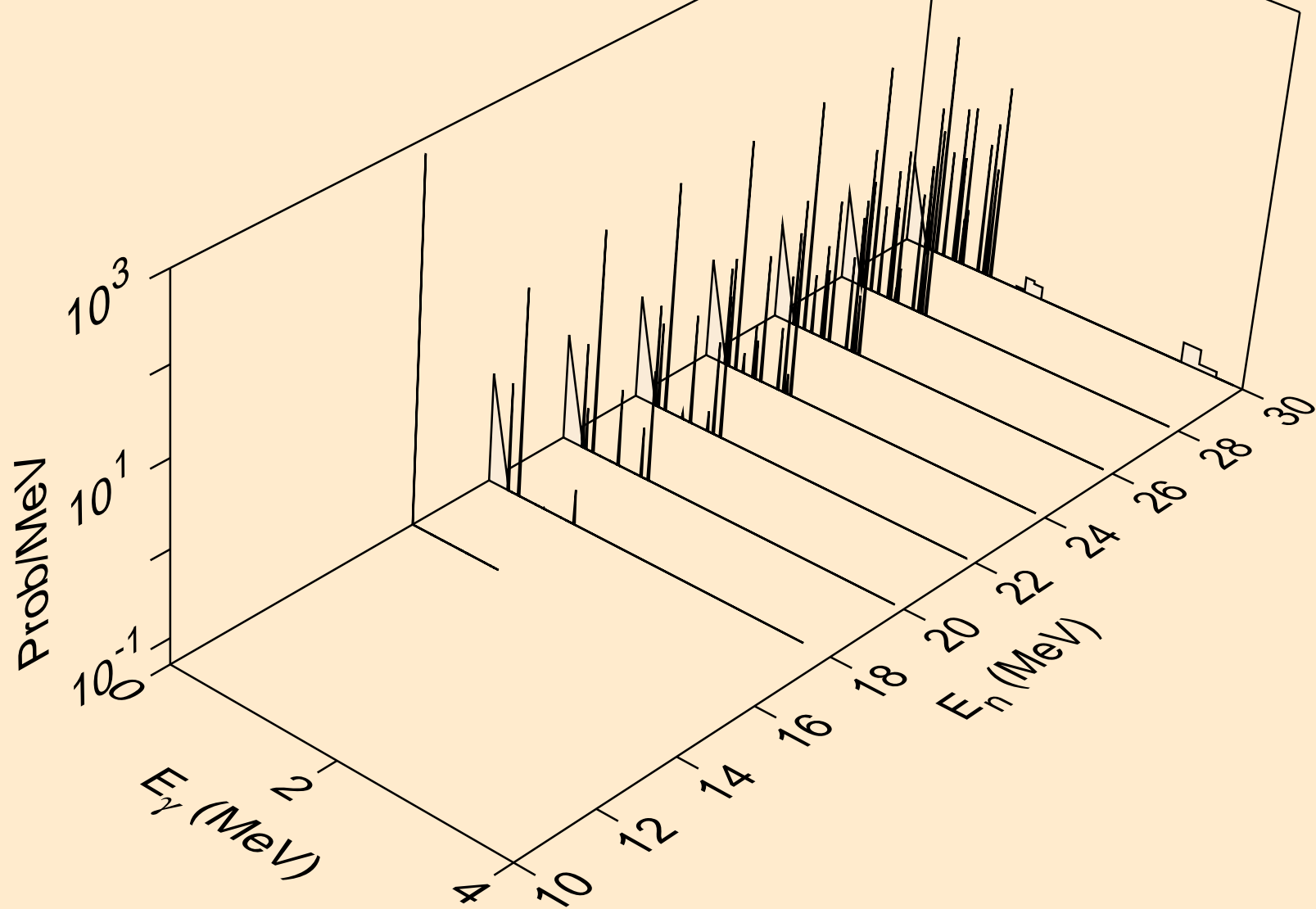

AG095 NEUTRON ACER TENDL-2024 LIBRARY; T=0.K
Photon emission for (n,2np)

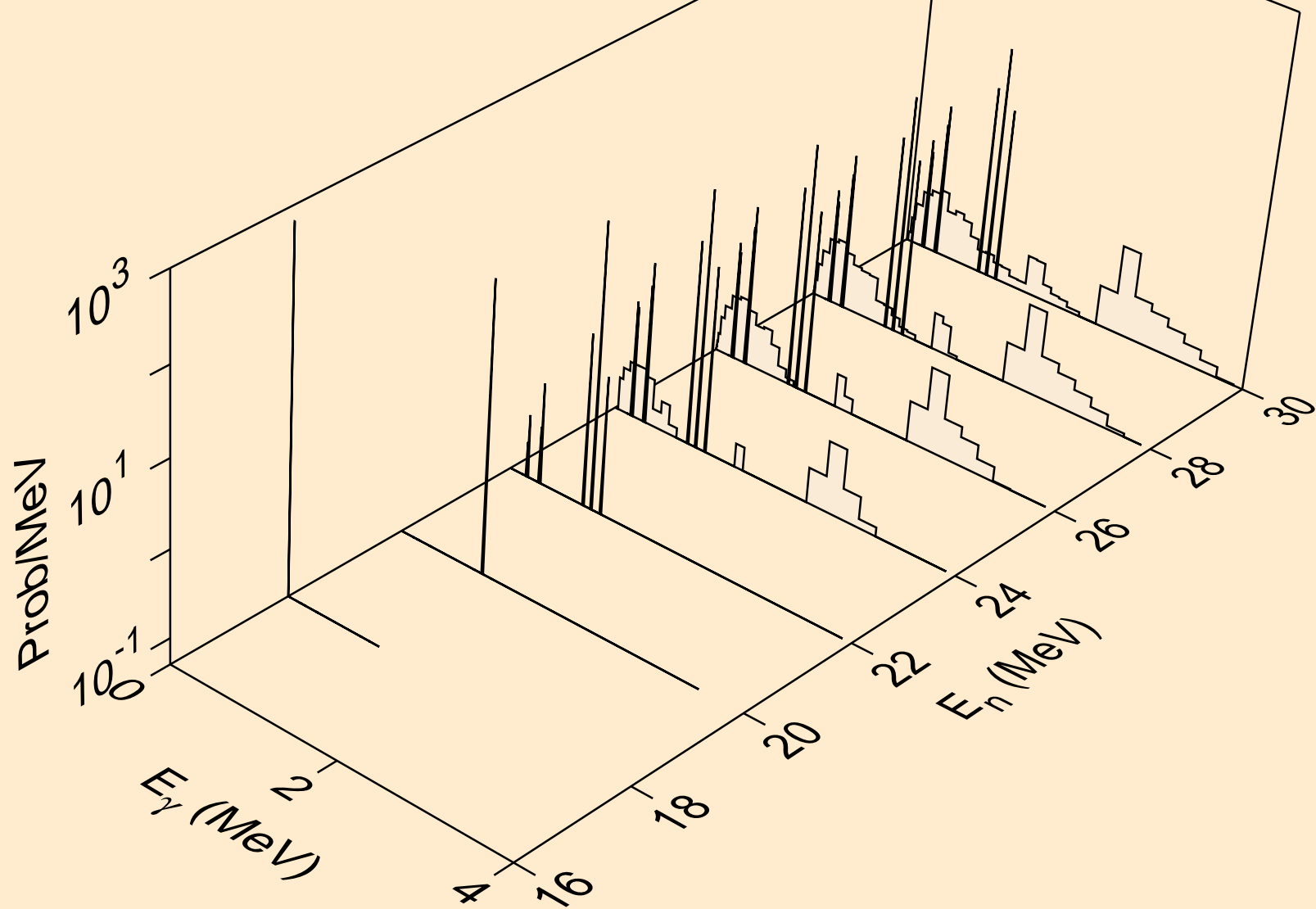

AG095 NEUTRON ACER TENDL-2024 LIBRARY; T=0.K
Photon emission for (n,n2p)

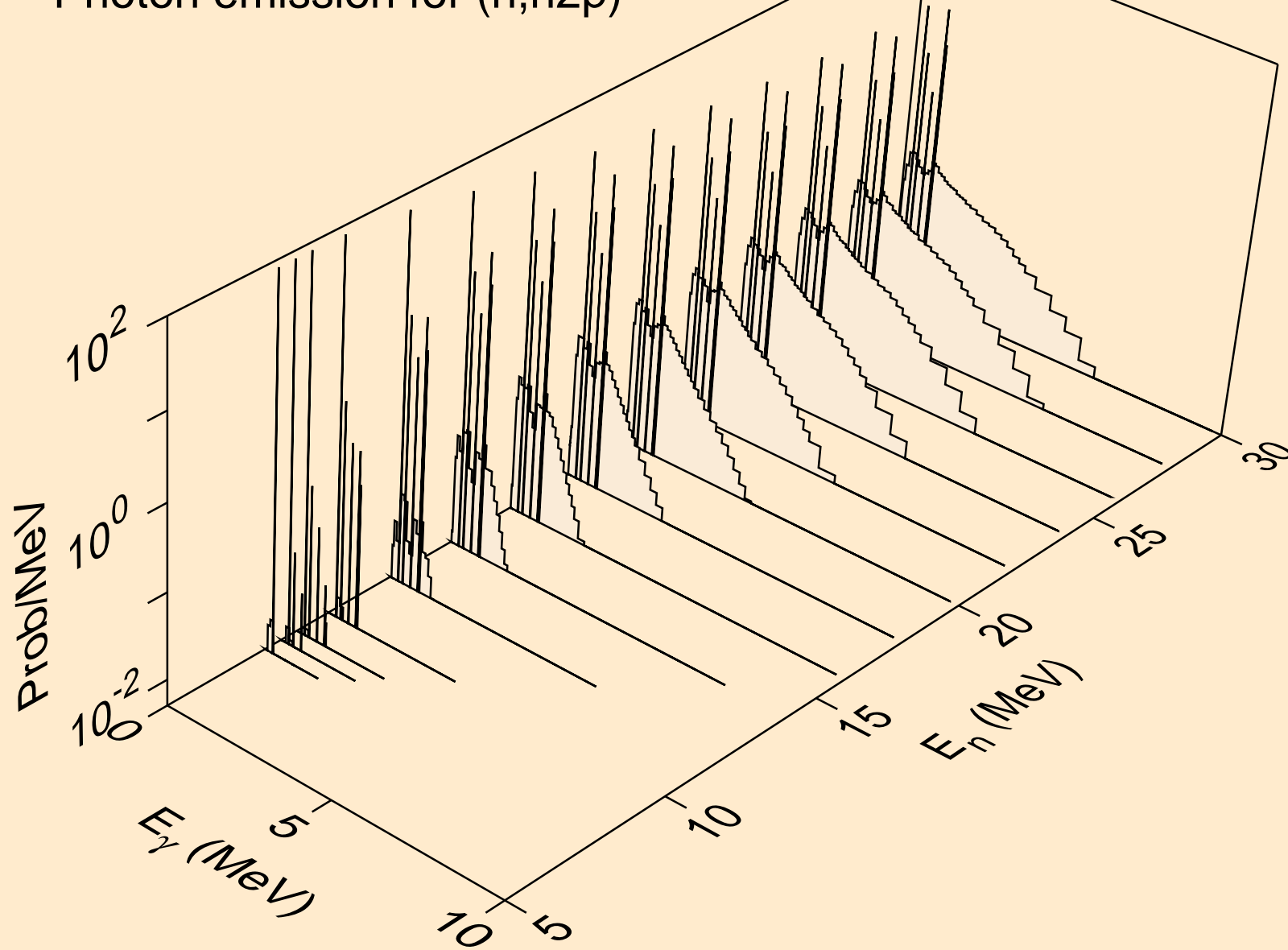

AG095 NEUTRON ACER TENDL-2024 LIBRARY; T=0.K
Photon emission for (n,npa)

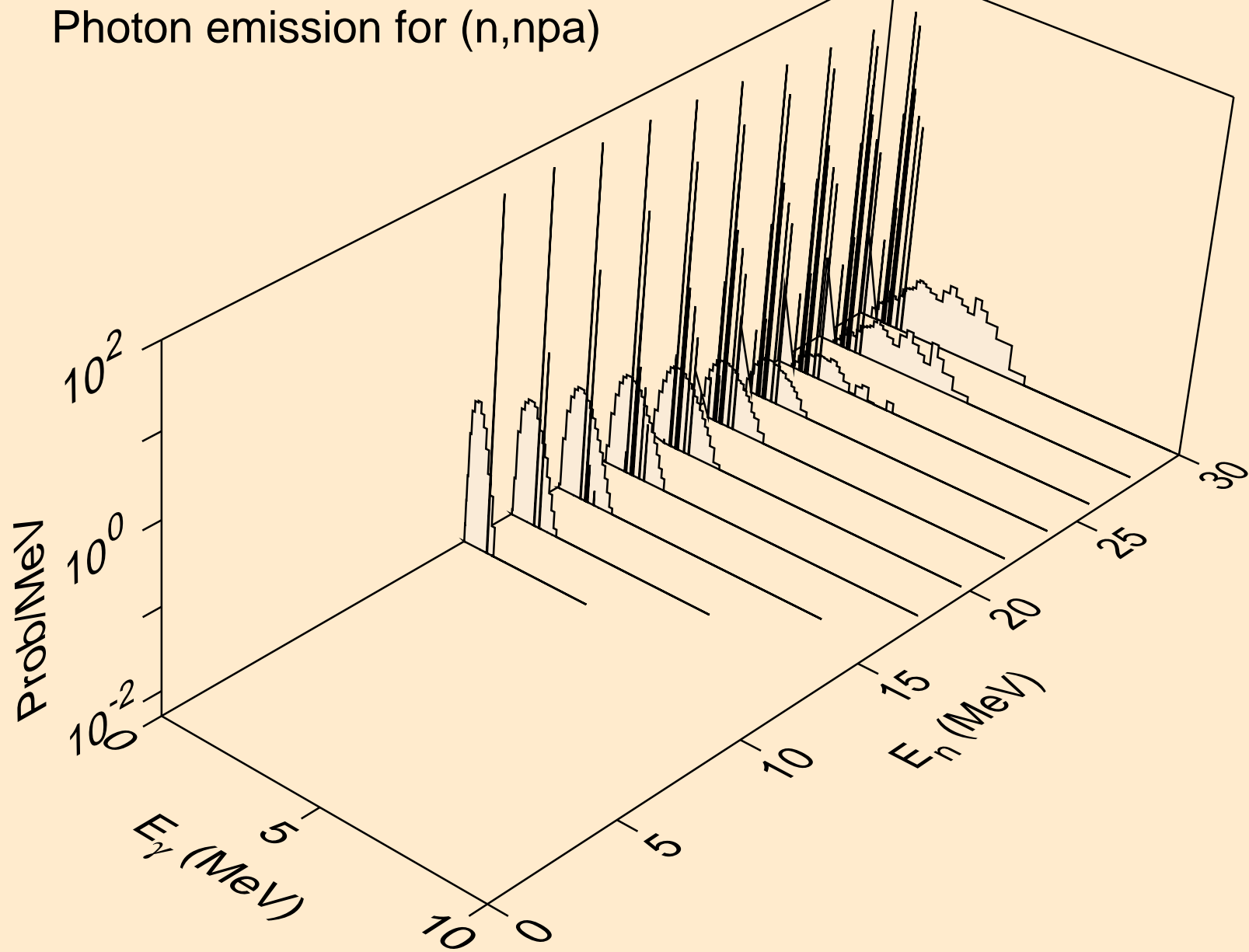

AG095 NEUTRON ACER TENDL-2024 LIBRARY; T=0.K
Photon emission for (n,n*c)

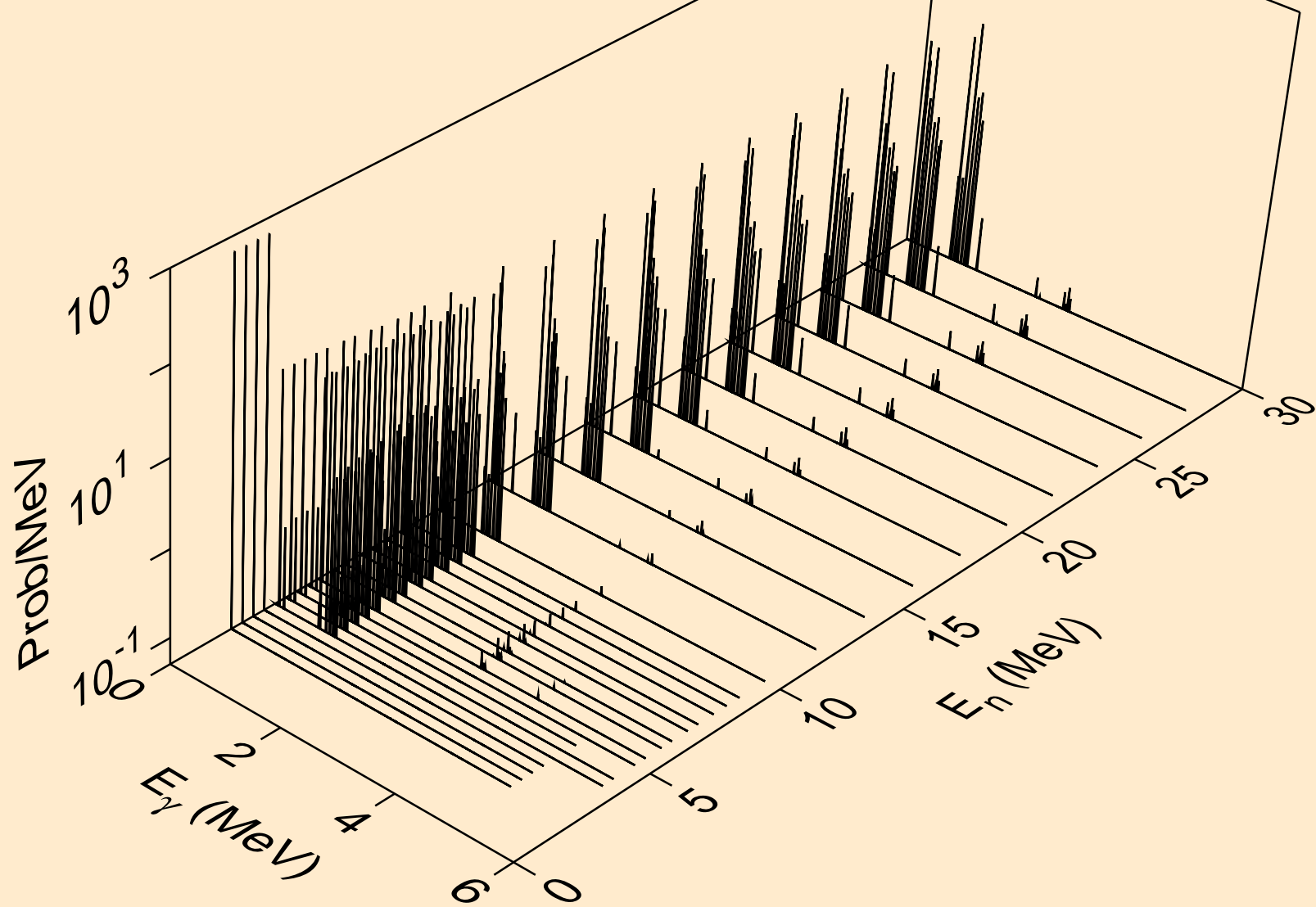

AG095 NEUTRON ACER TENDL-2024 LIBRARY; T=0.K
Photon emission for (n,gma)

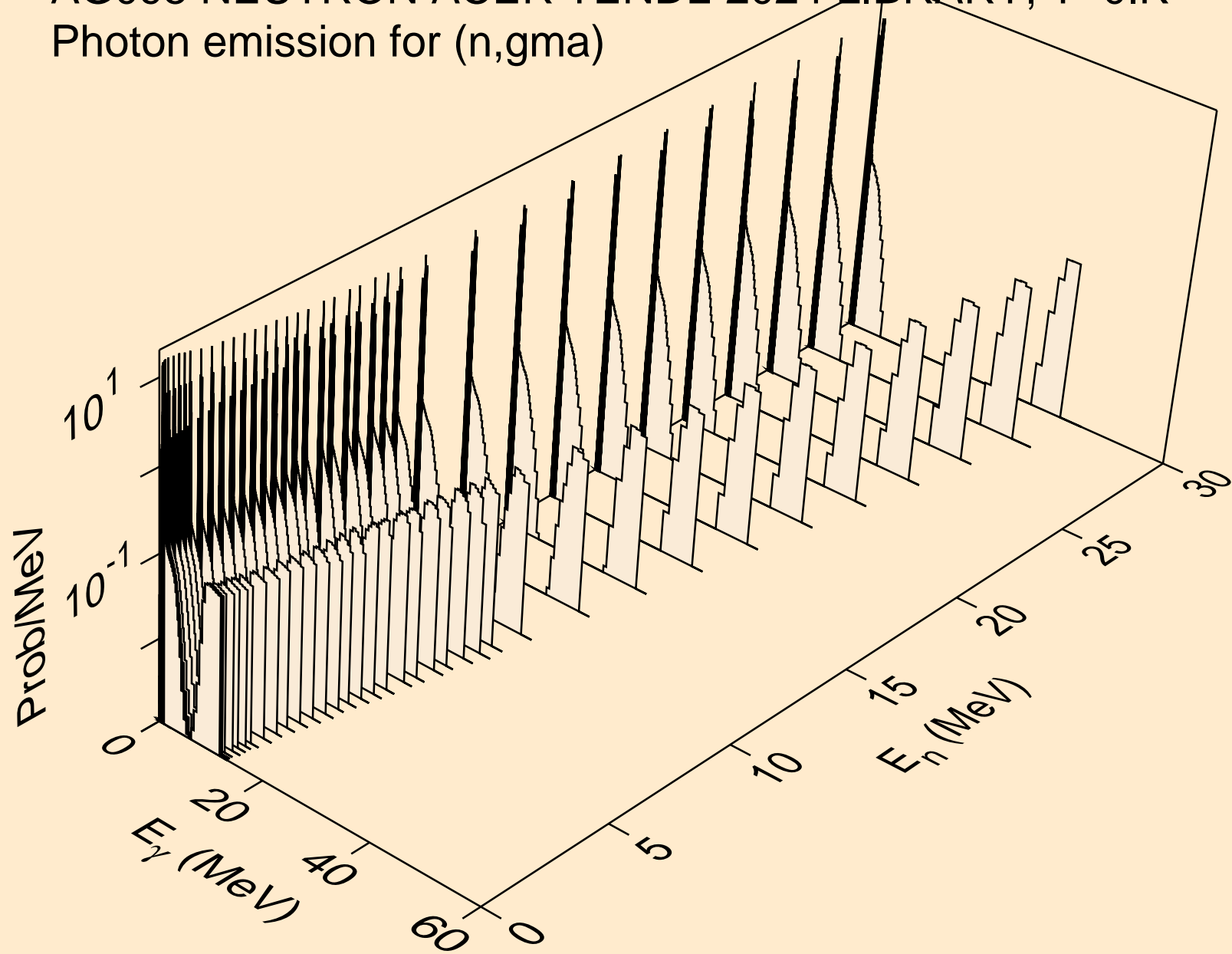

AG095 NEUTRON ACER TENDL-2024 LIBRARY; T=0.K
Photon emission for (n,p)

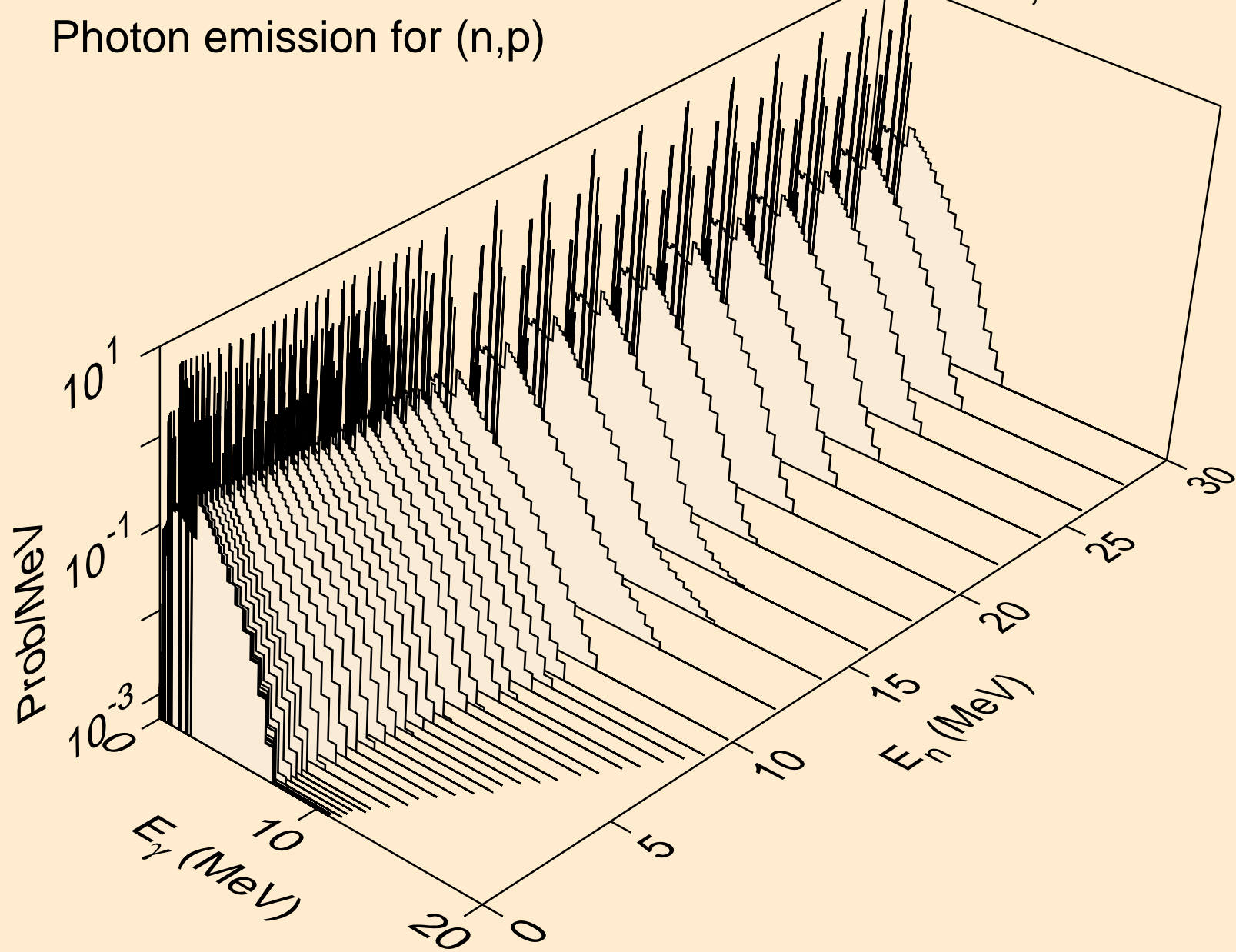

AG095 NEUTRON ACER TENDL-2024 LIBRARY; T=0.K
Photon emission for (n,d)

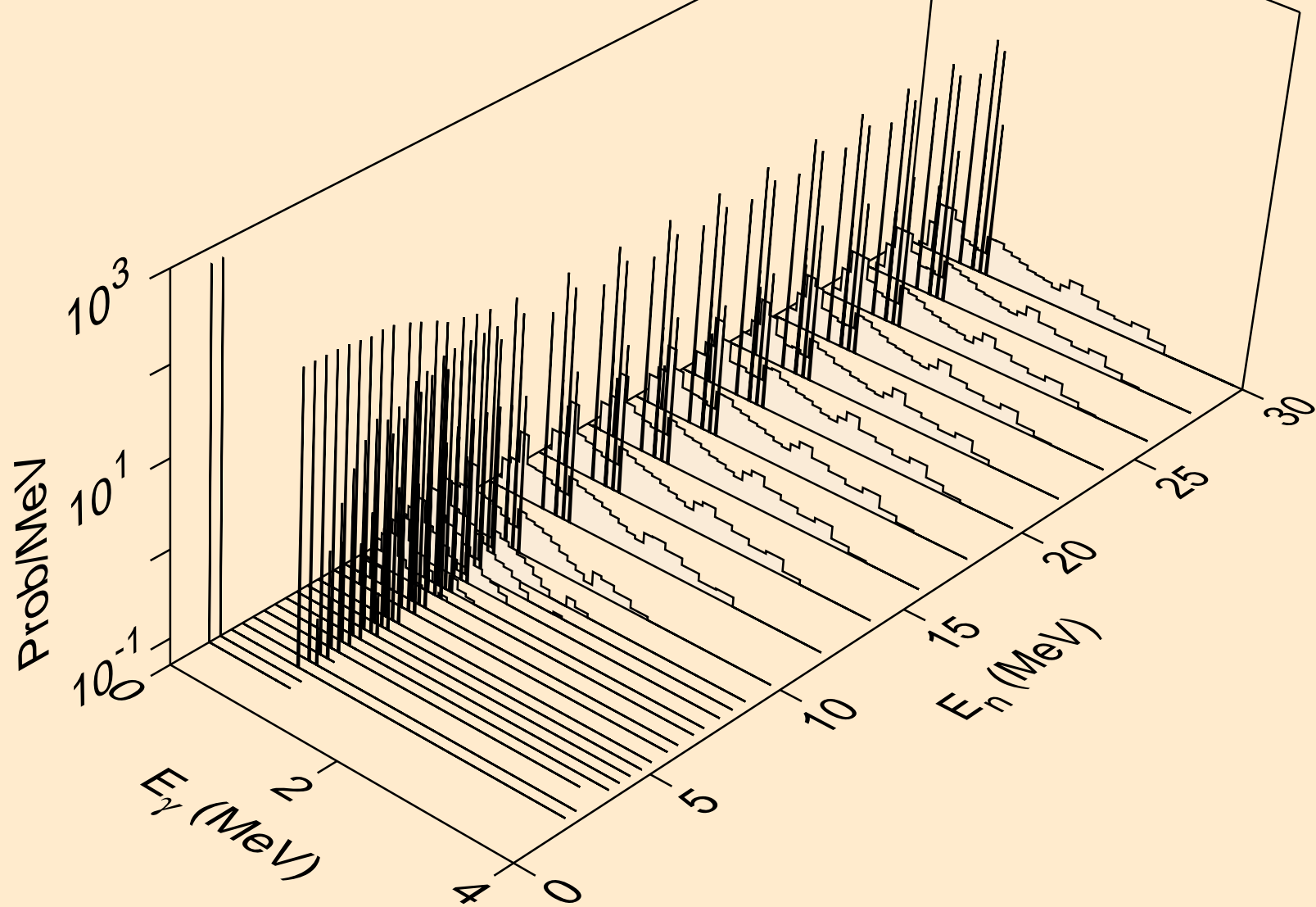

AG095 NEUTRON ACER TENDL-2024 LIBRARY; T=0.K
Photon emission for (n,t)

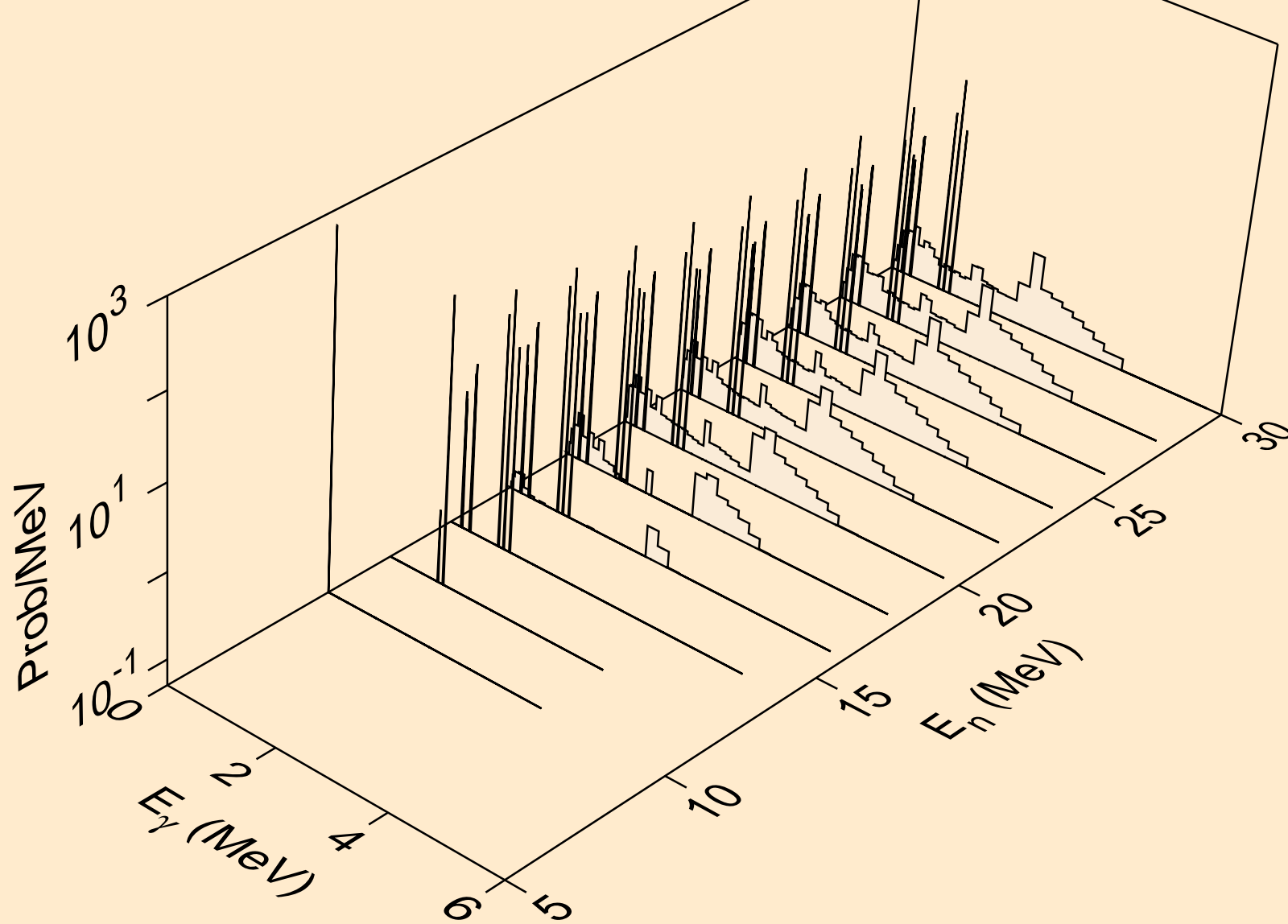

AG095 NEUTRON ACER TENDL-2024 LIBRARY; T=0.K
Photon emission for (n,he3)

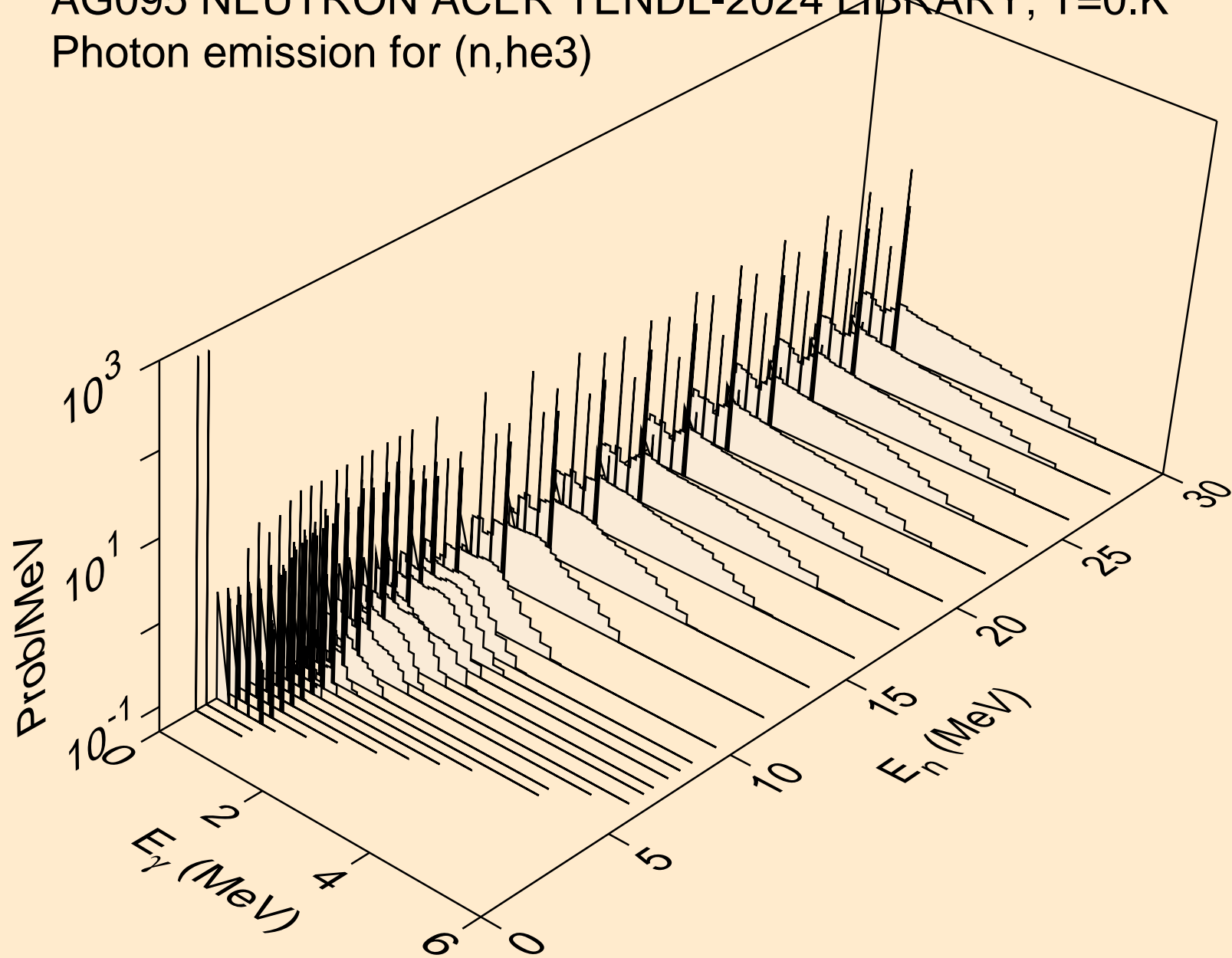

AG095 NEUTRON ACER TENDL-2024 LIBRARY; T=0.K
Photon emission for (n,a)

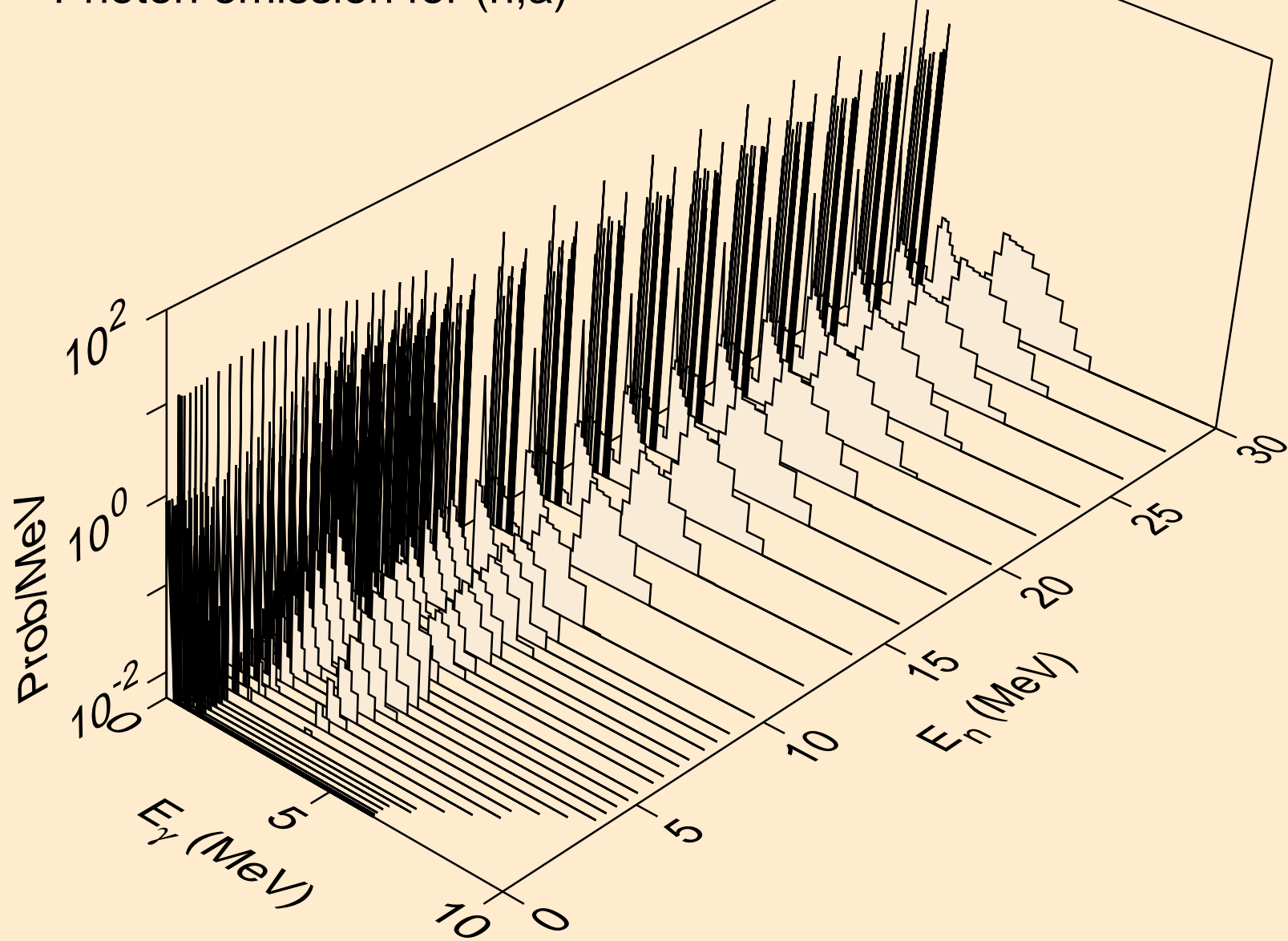

AG095 NEUTRON ACER TENDL-2024 LIBRARY; T=0.K
Photon emission for (n,2a)

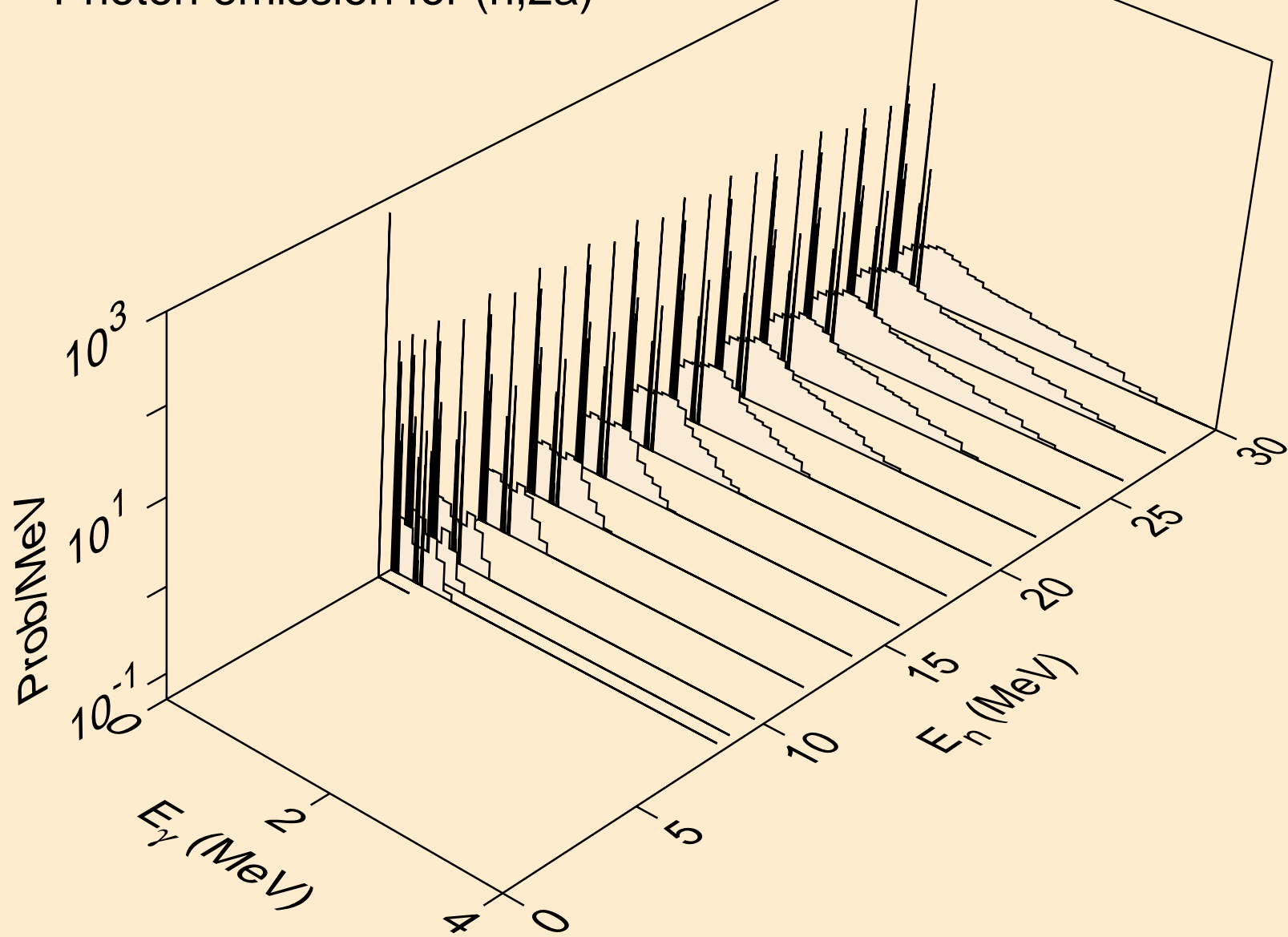

AG095 NEUTRON ACER TENDL-2024 LIBRARY; T=0.K
Photon emission for (n,2p)

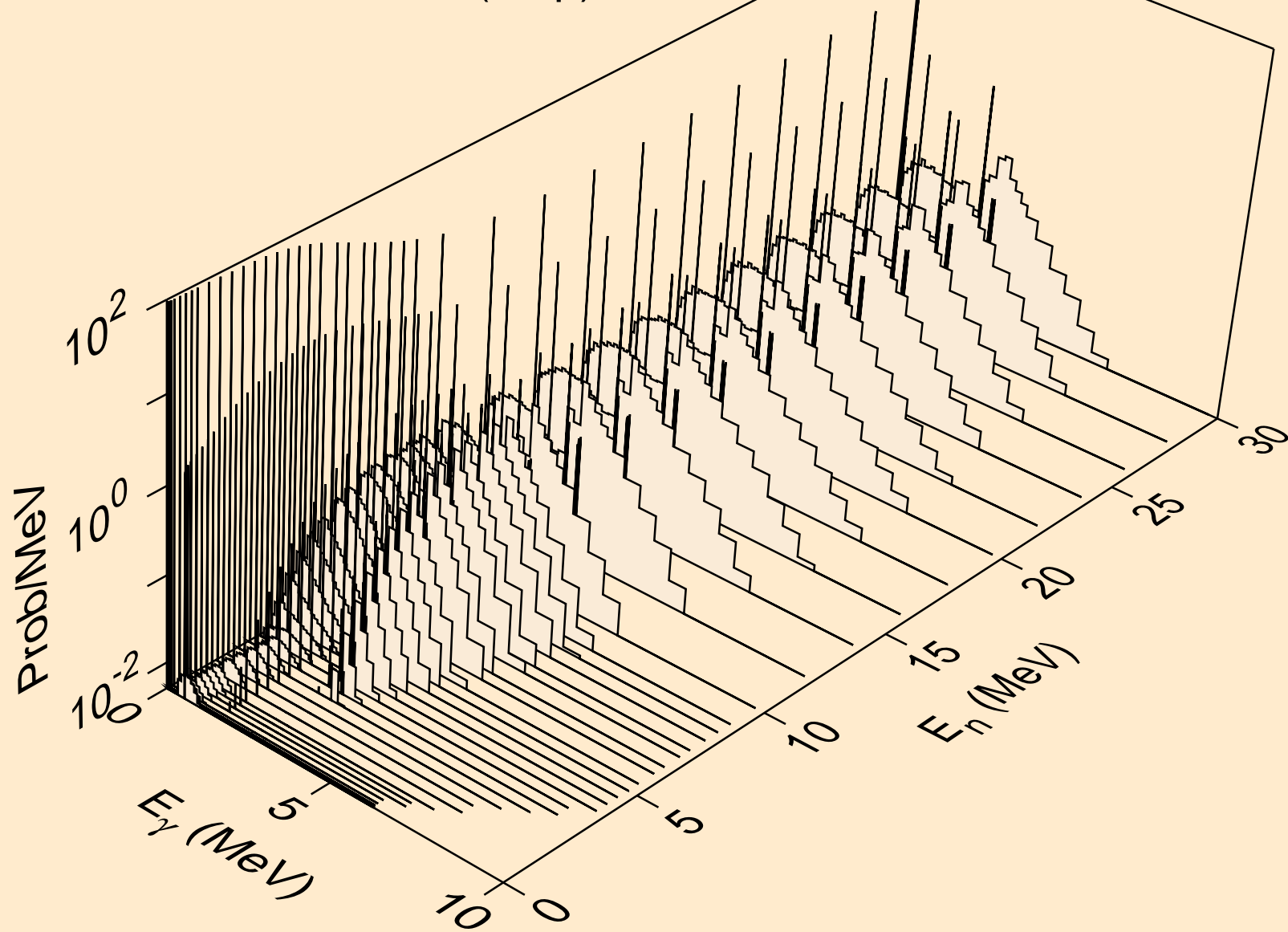

AG095 NEUTRON ACER TENDL-2024 LIBRARY; T=0.K
Photon emission for (n,p α)

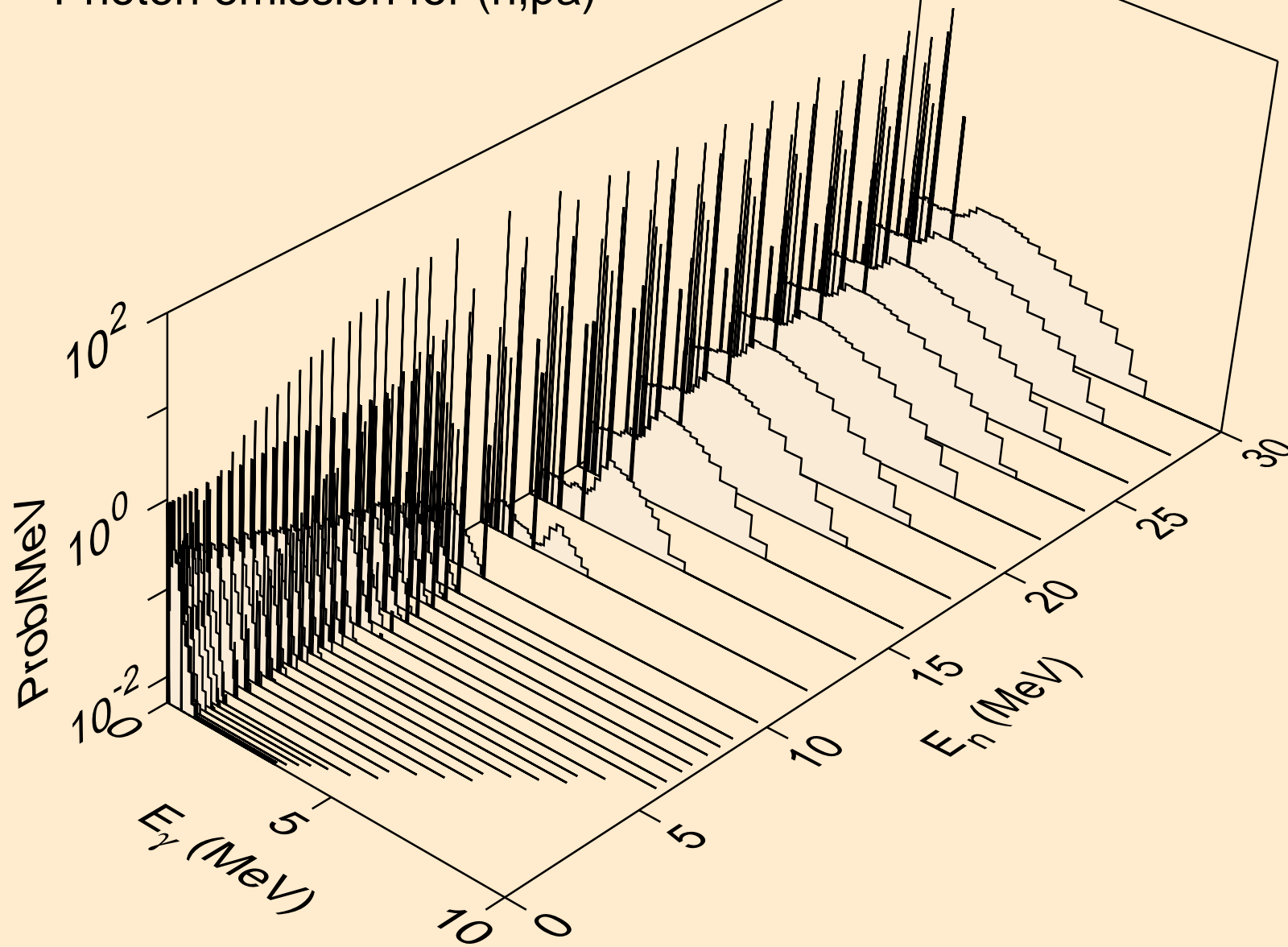

AG095 NEUTRON ACER TENDL-2024 LIBRARY; T=0.K
Photon emission for (n,pd)

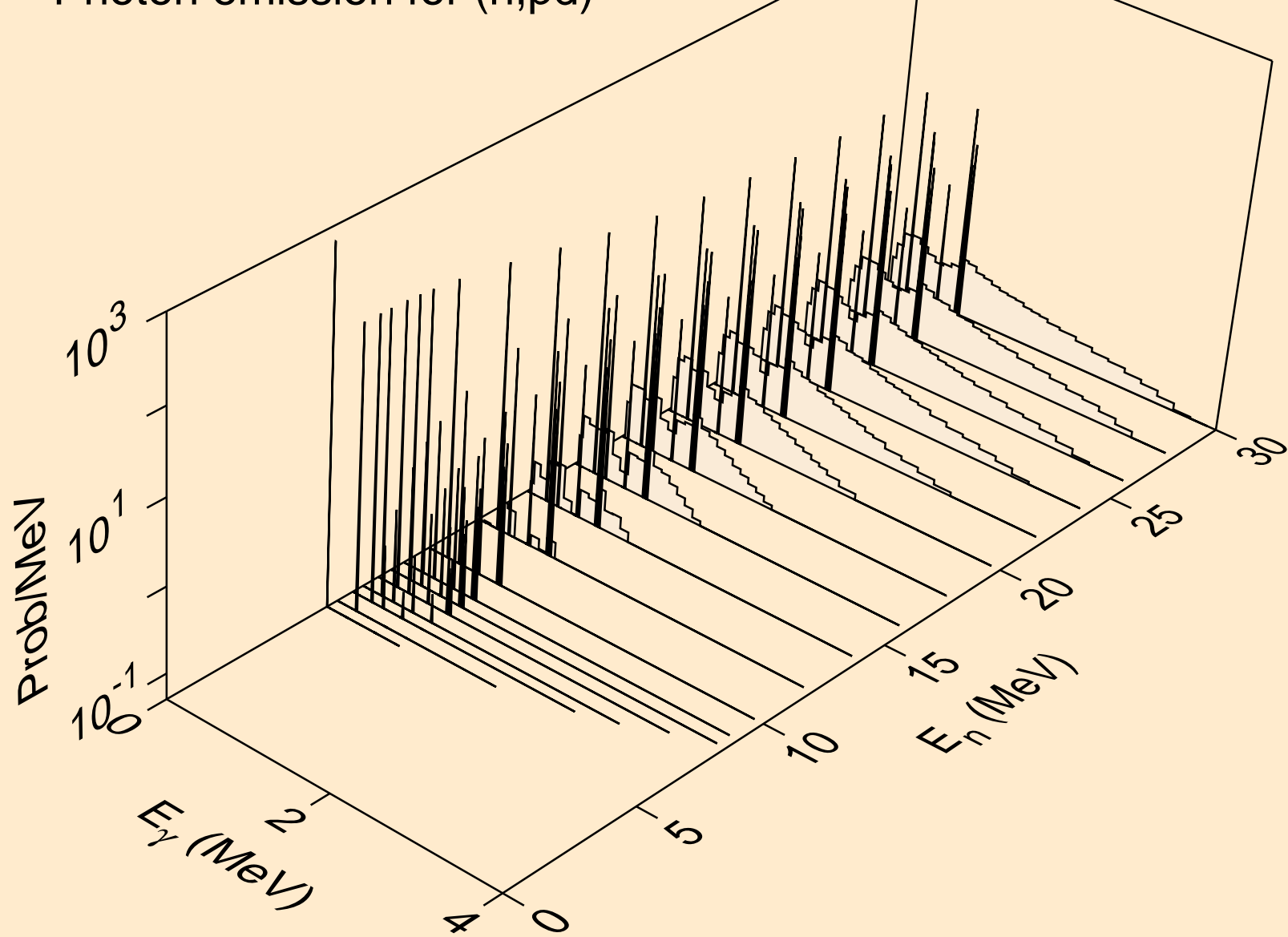

AG095 NEUTRON ACER TENDL-2024 LIBRARY; T=0.K
Photon emission for (n,pt)

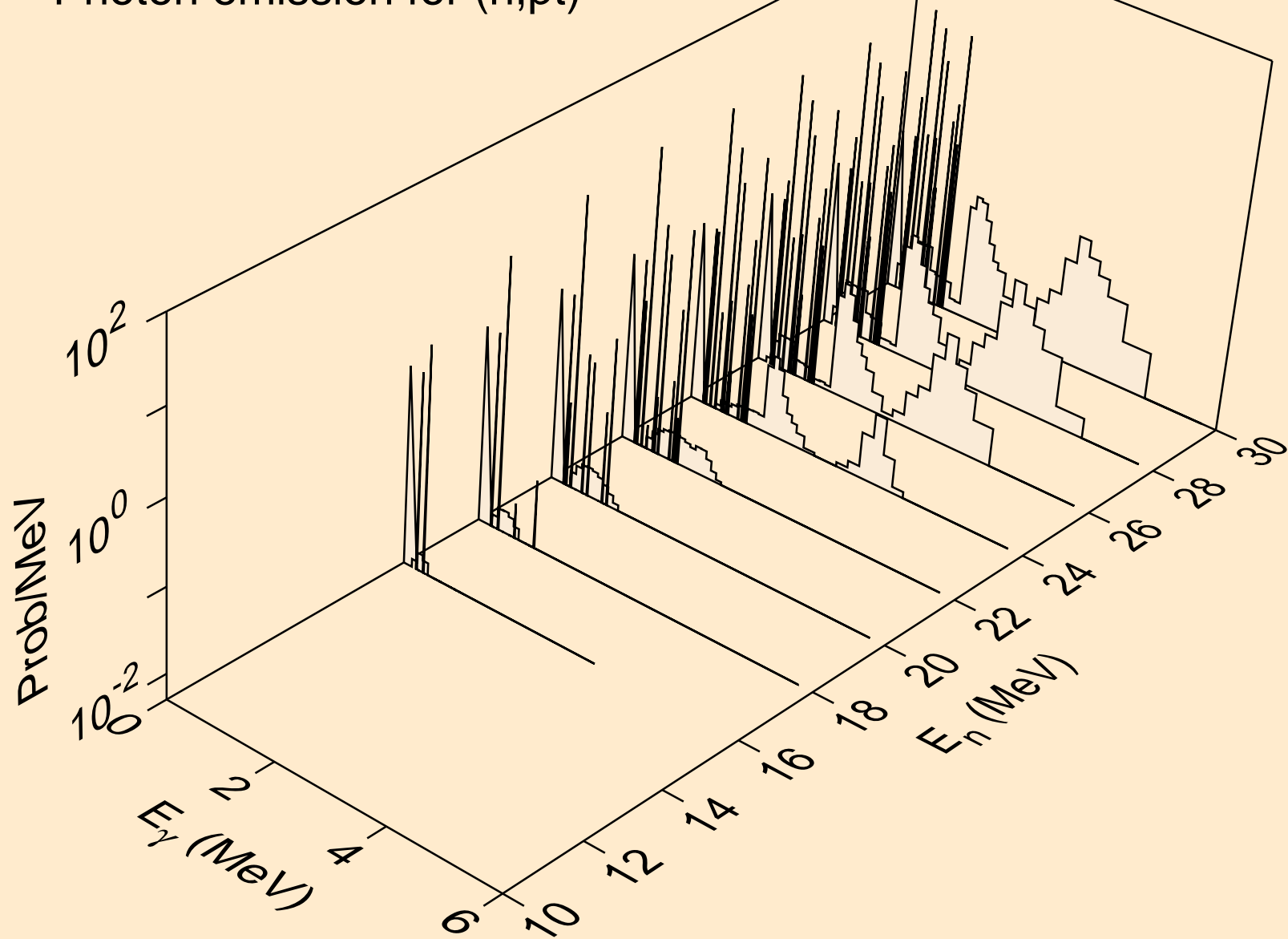

AG095 NEUTRON ACER TENDL-2024 LIBRARY; T=0.K
Photon emission for (n,da)

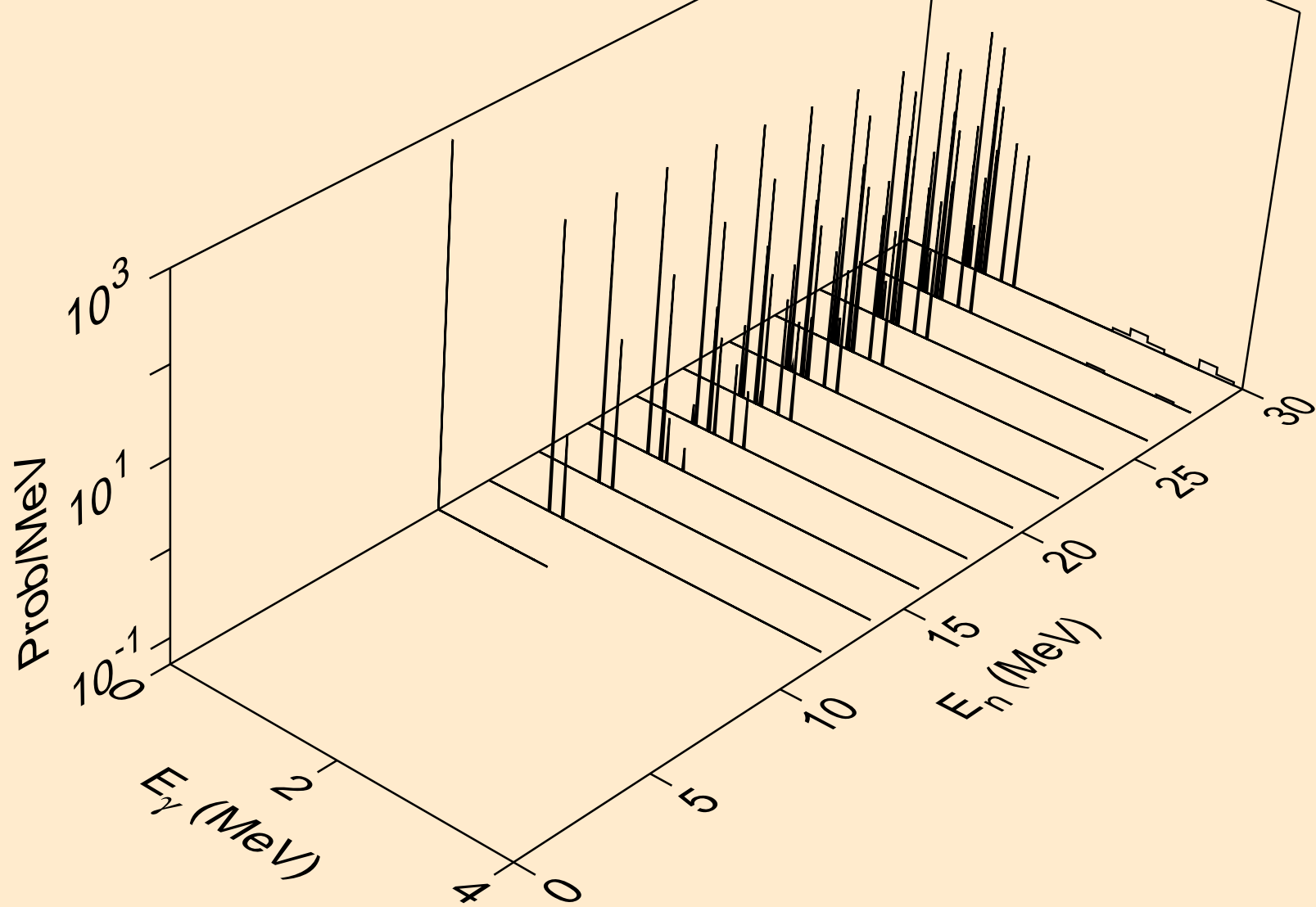

AG095 NEUTRON ACER TENDL-2024 LIBRARY; T=0.K
thermal capture photon spectrum

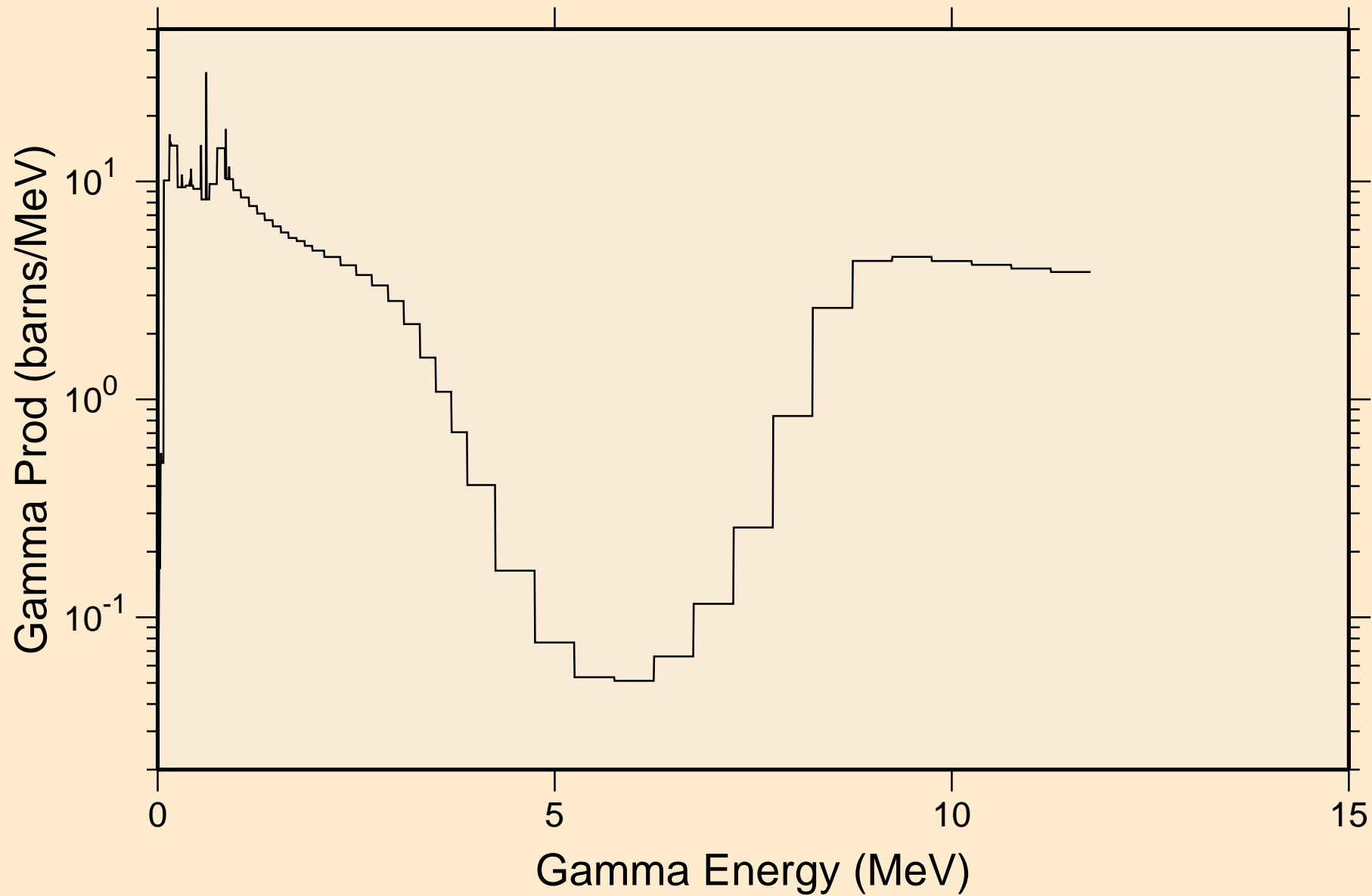

AG095 NEUTRON ACER TENDL-2024 LIBRARY; T=0.K
14 MeV photon spectrum

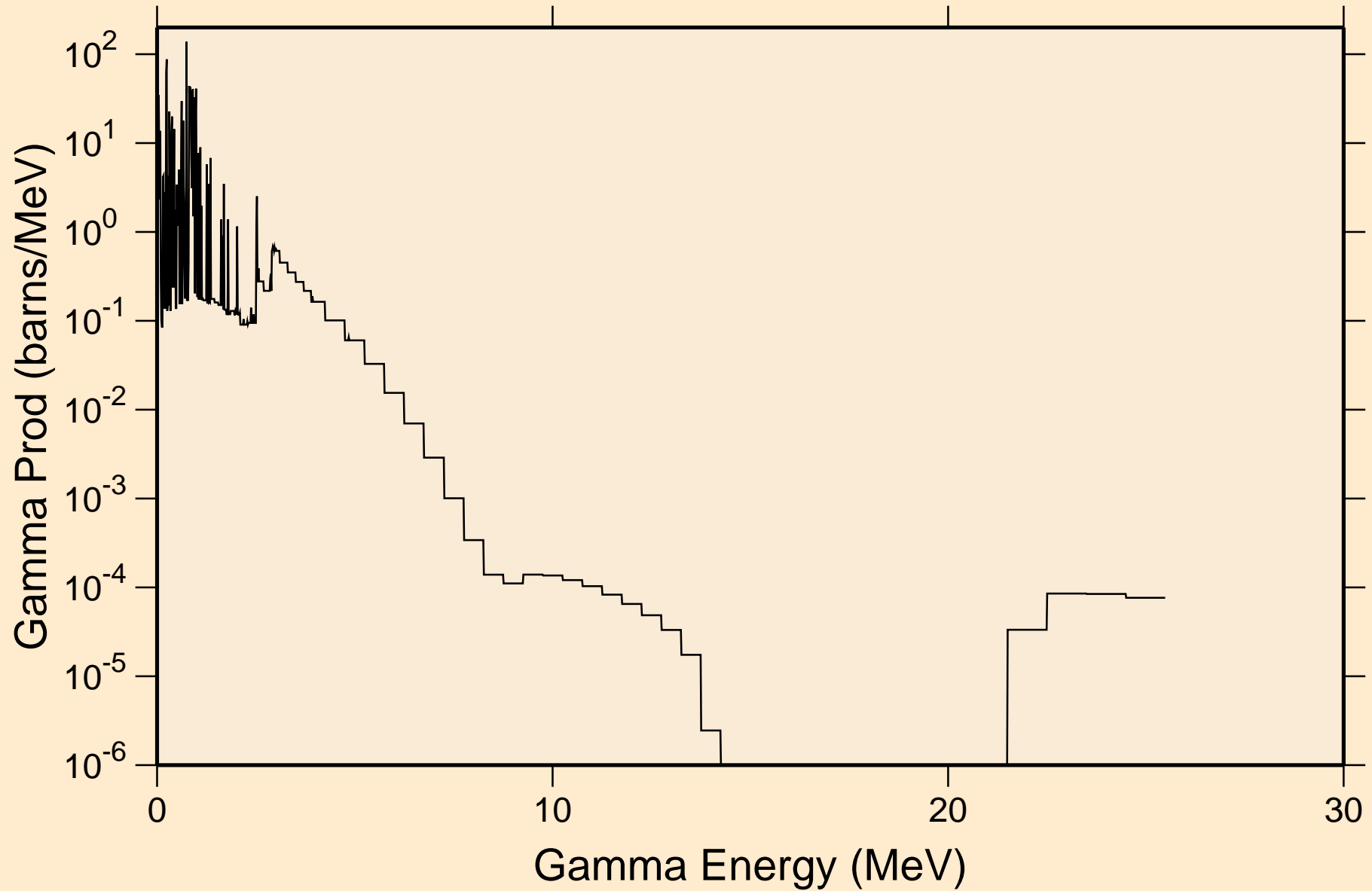

AG095 NEUTRON ACER TENDL-2024 LIBRARY; T=0.K

Particle heating contributions

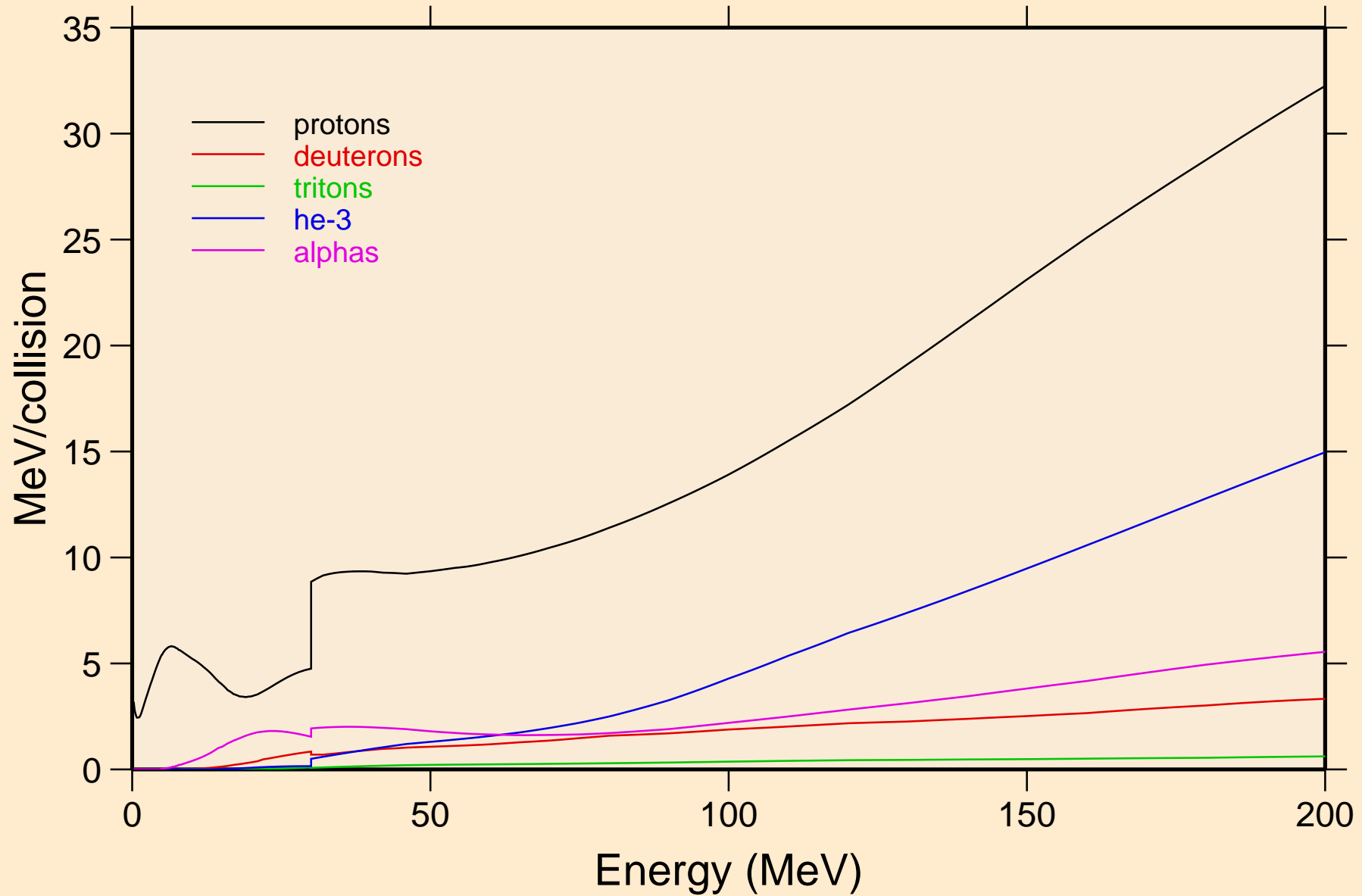

AG095 NEUTRON ACER TENDL-2024 LIBRARY; T=0.K
Recoil Heating

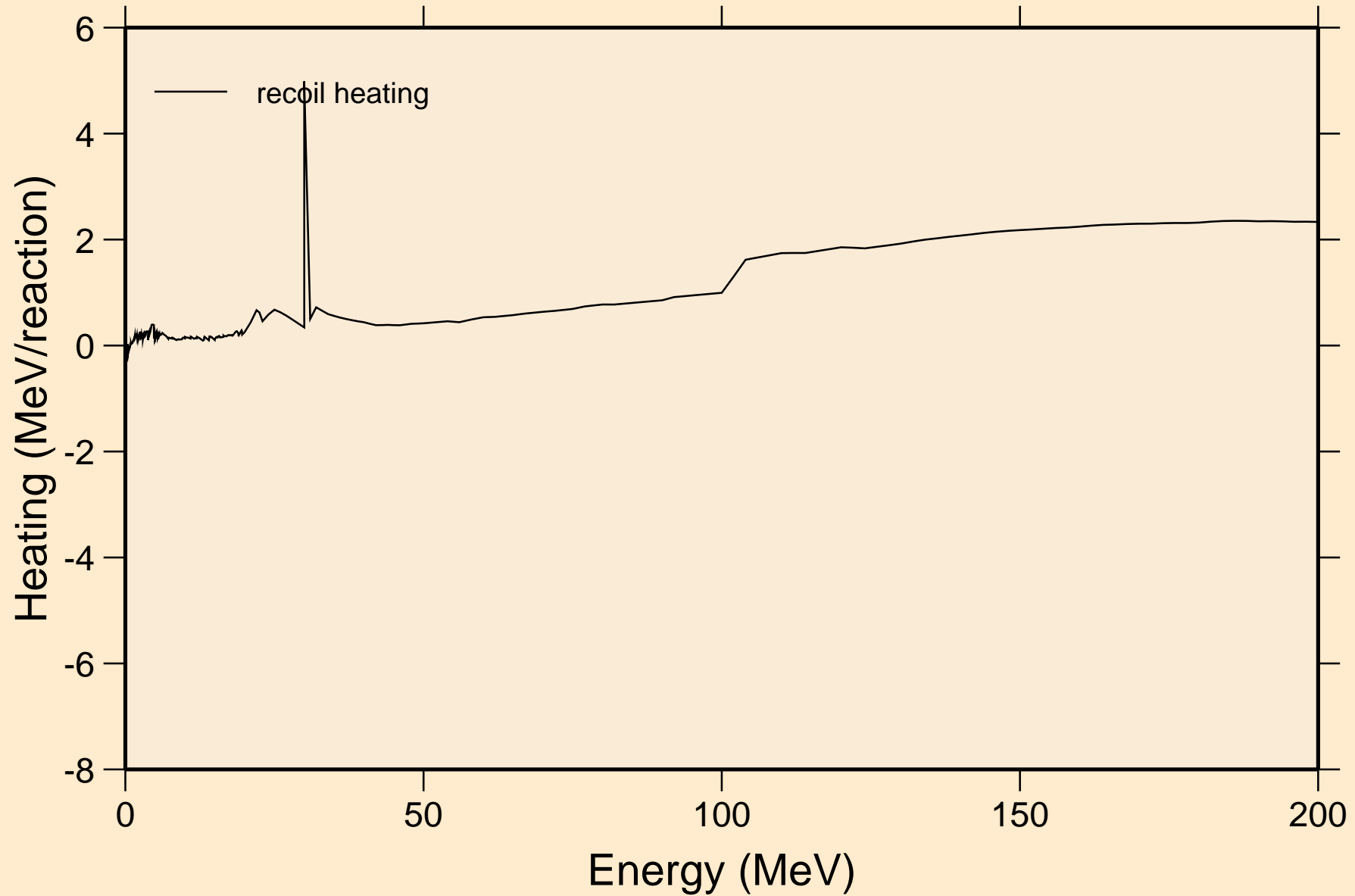

AG095 NEUTRON ACER TENDL-2024 LIBRARY; T=0.K
Particle production cross sections

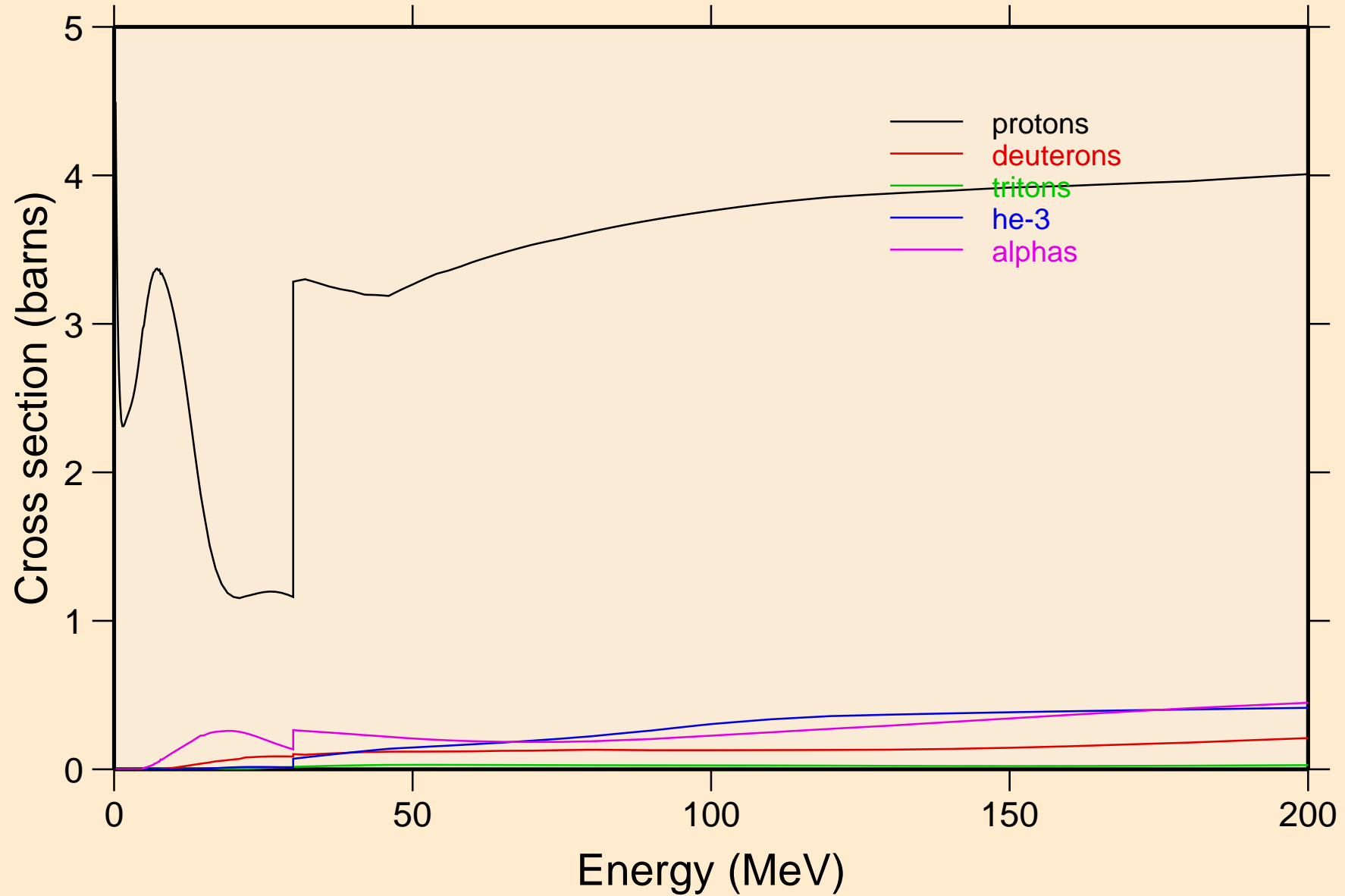

AG095 NEUTRON ACER TENDL-2024 LIBRARY; T=0.K
protons from (n,x)

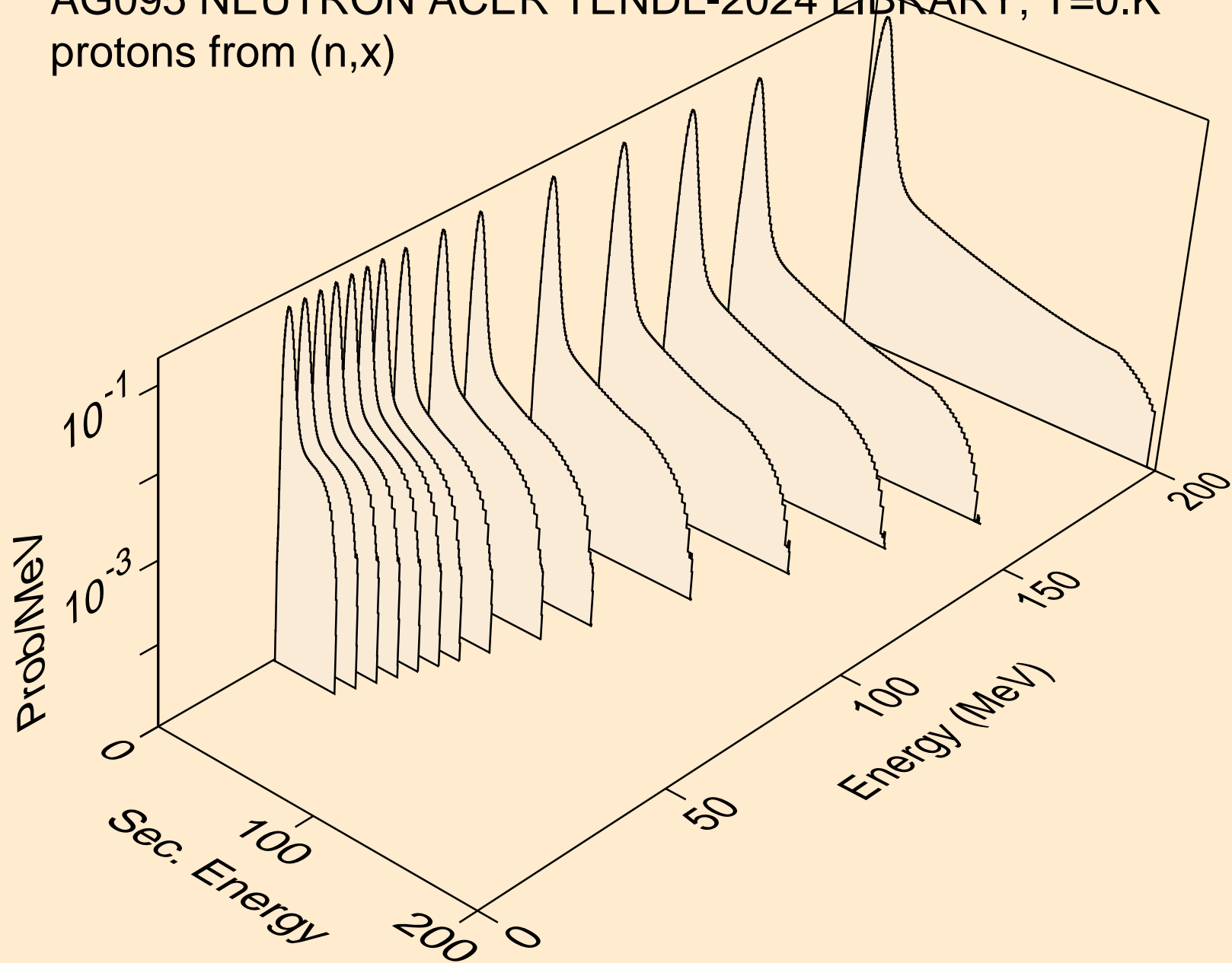

AG095 NEUTRON ACER TENDL-2024 LIBRARY; T=0.K
protons from (n,n*)p

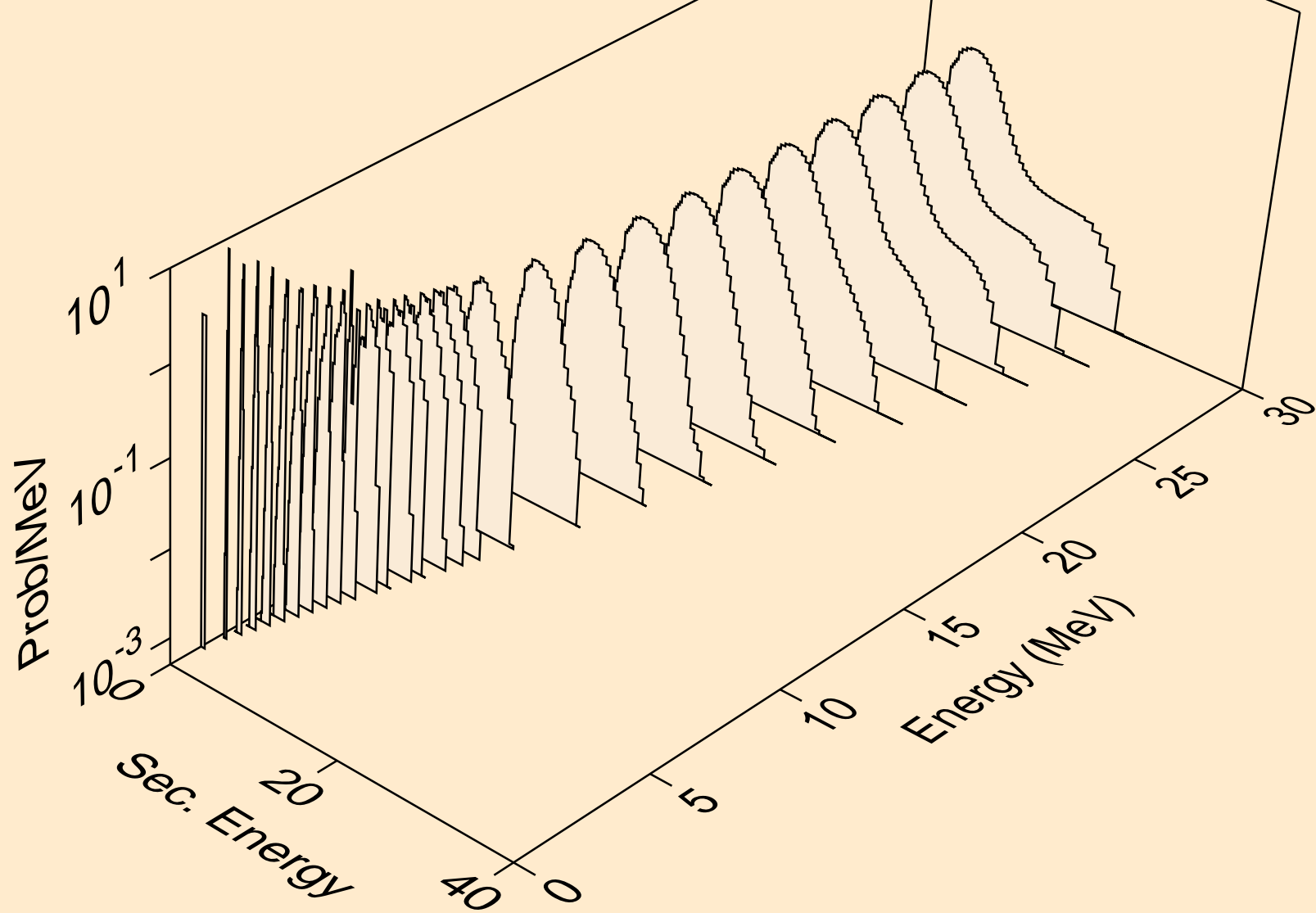

AG095 NEUTRON ACER TENDL-2024 LIBRARY; T=0.K
protons from (n,2np)

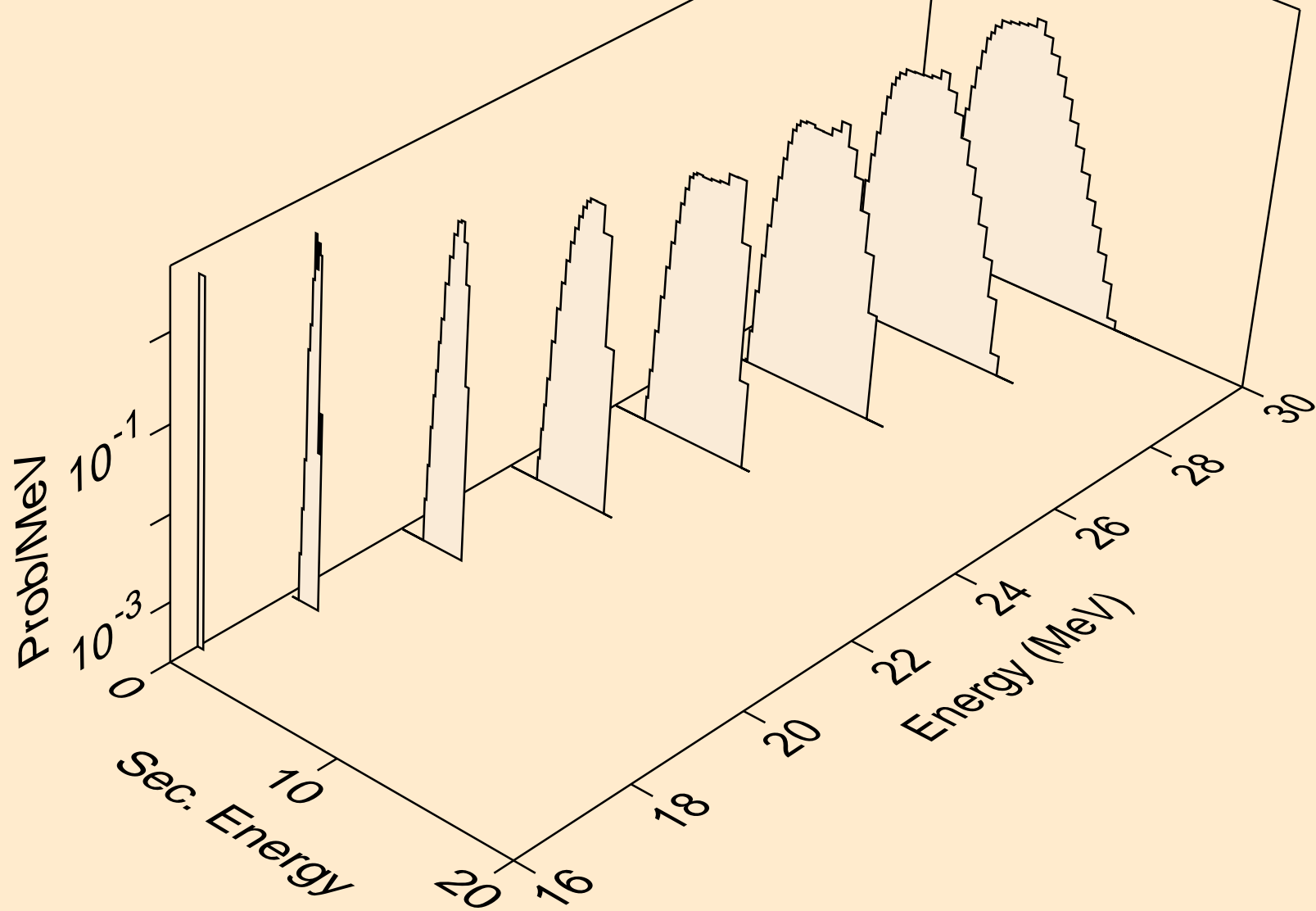

AG095 NEUTRON ACER TENDL-2024 LIBRARY; T=0.K
protons from (n,n2p)

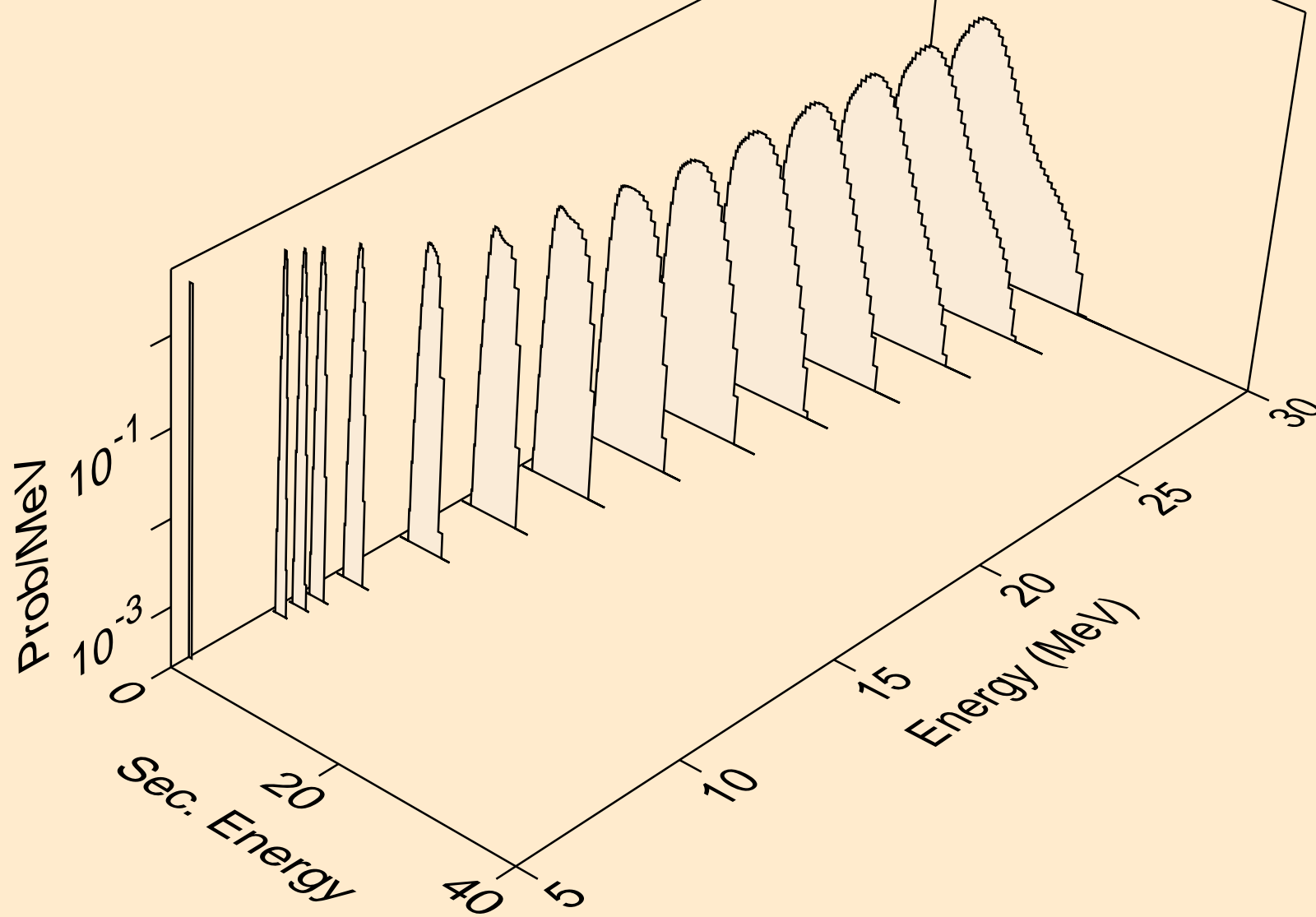

AG095 NEUTRON ACER TENDL-2024 LIBRARY; T=0.K
protons from (n,npa)

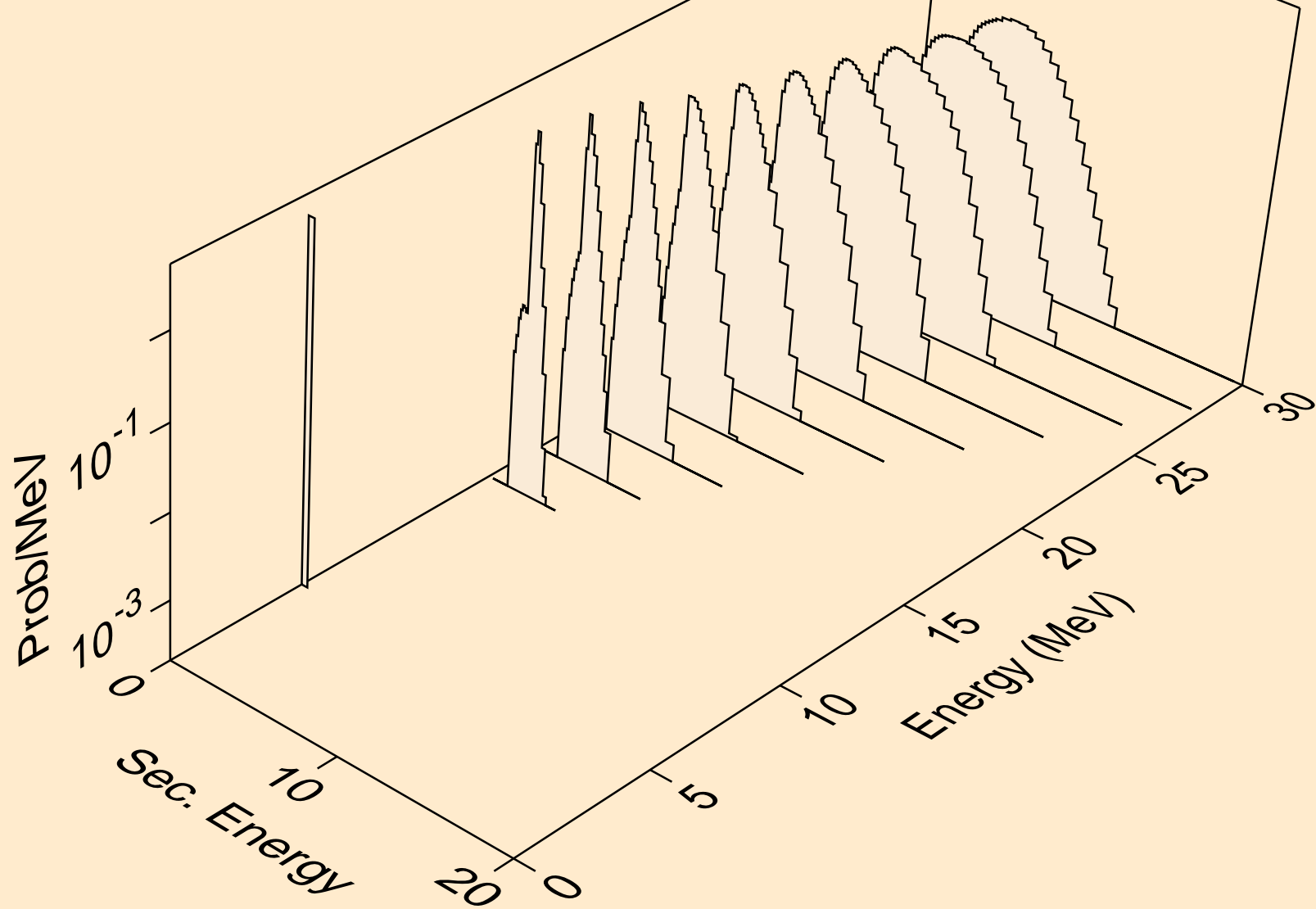

AG095 NEUTRON ACER TENDL-2024 LIBRARY; T=0.K
protons from (n,p)

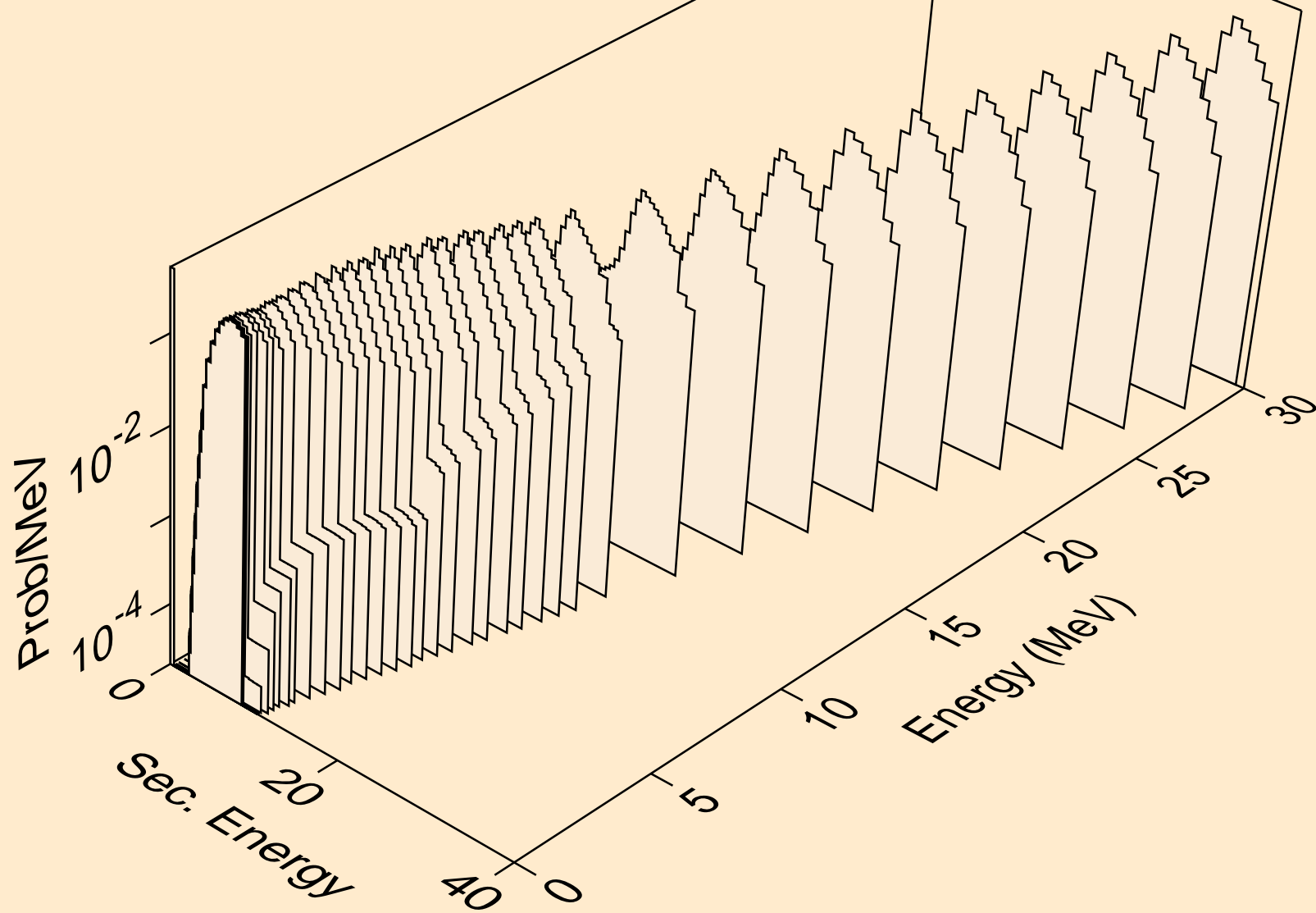

AG095 NEUTRON ACER TENDL-2024 LIBRARY; T=0.K
protons from (n,2p)

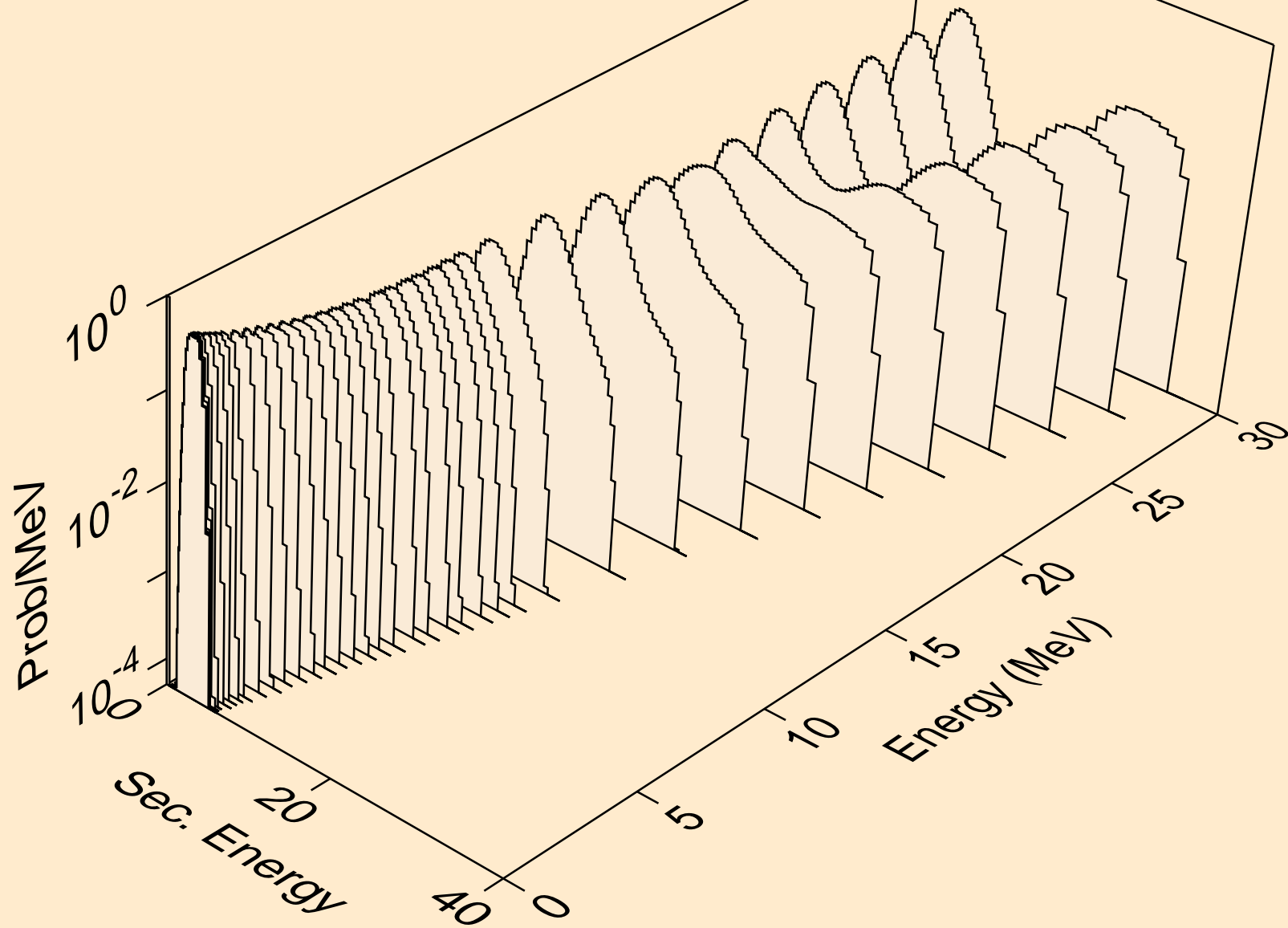

AG095 NEUTRON ACER TENDL-2024 LIBRARY; T=0.K
protons from (n,p)

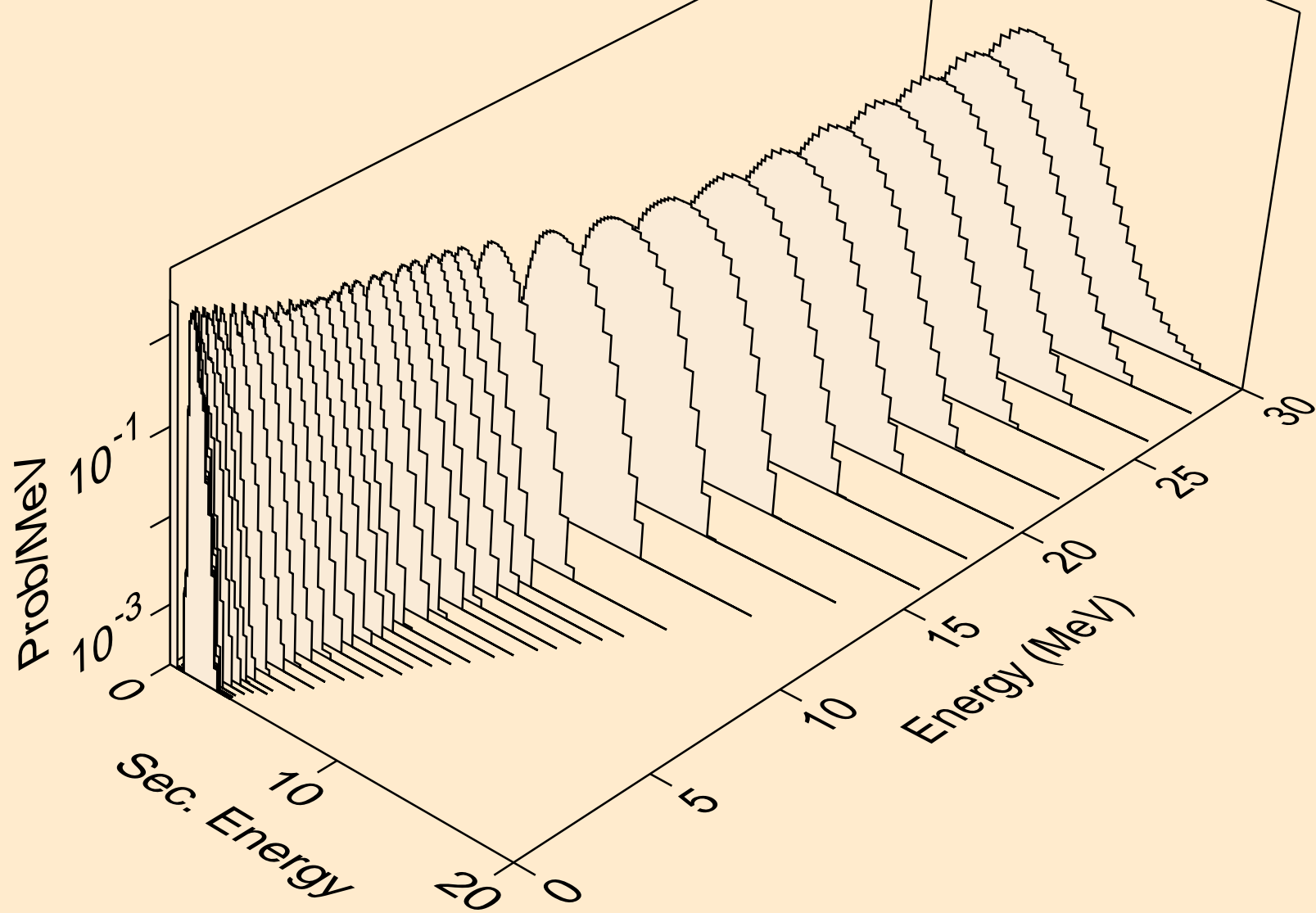

AG095 NEUTRON ACER TENDL-2024 LIBRARY; T=0.K
protons from (n,pd)

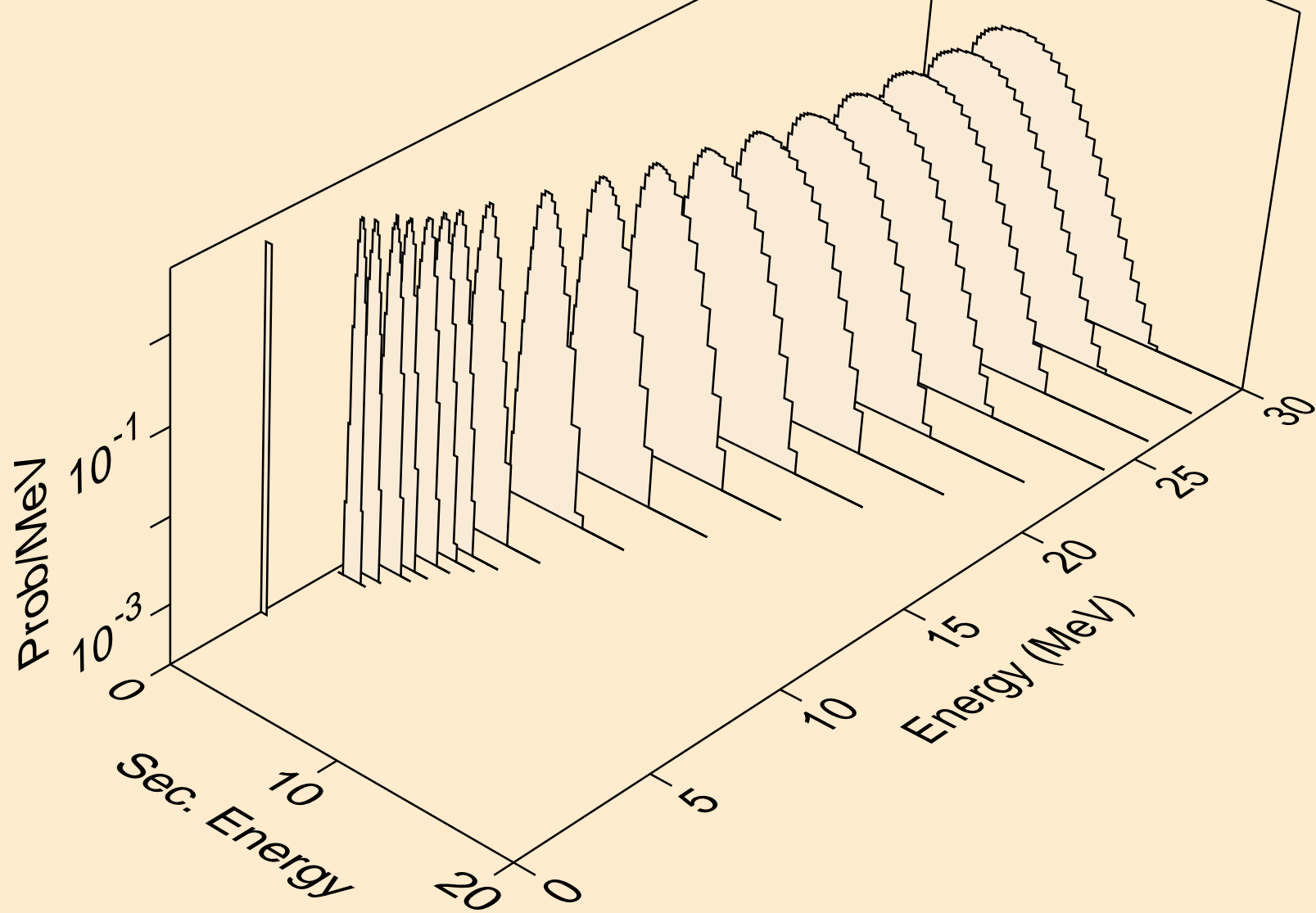

AG095 NEUTRON ACER TENDL-2024 LIBRARY; T=0.K
protons from (n,pt)

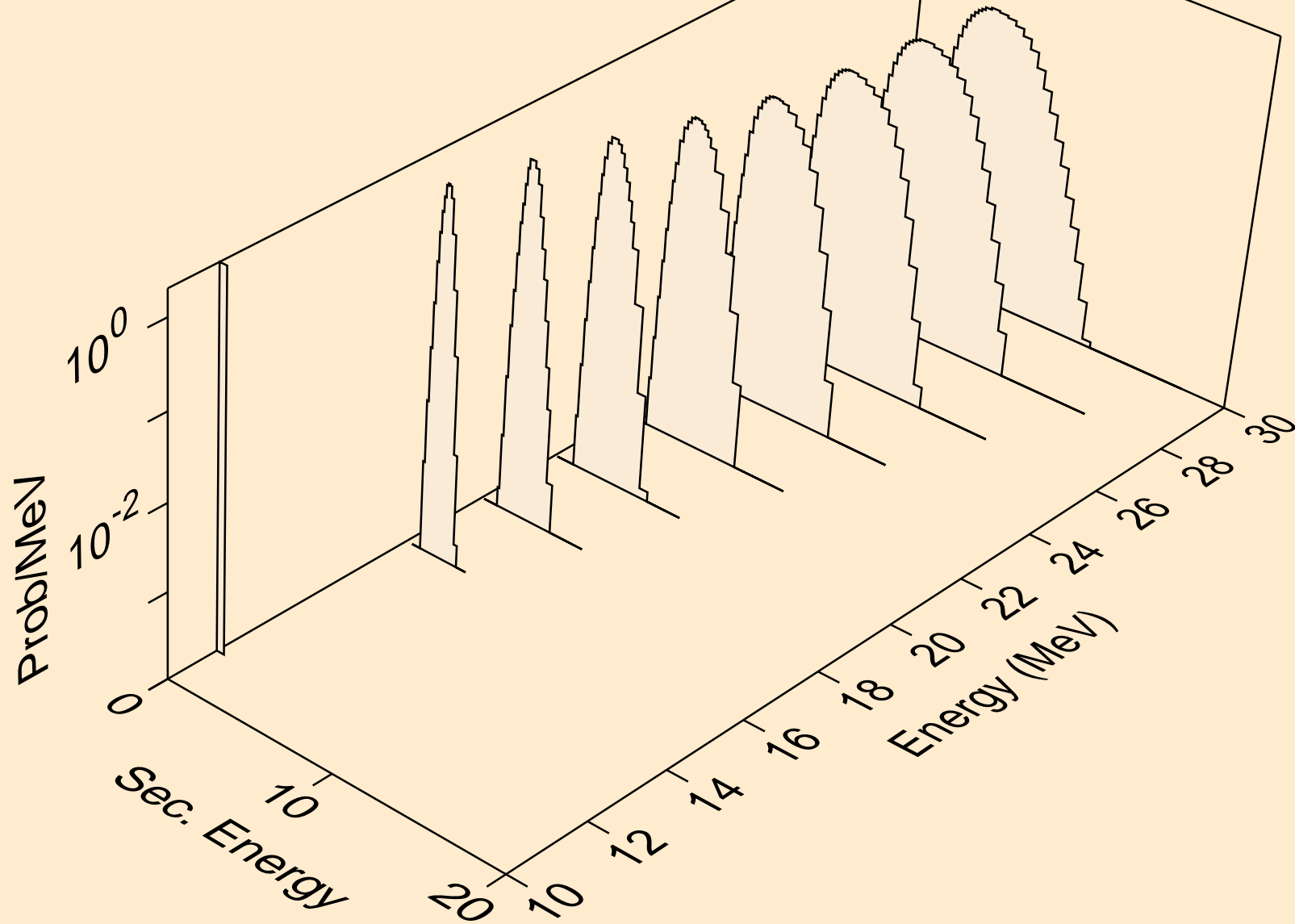

AG095 NEUTRON ACER TENDL-2024 LIBRARY; T=0.K
deuterons from (n,x)

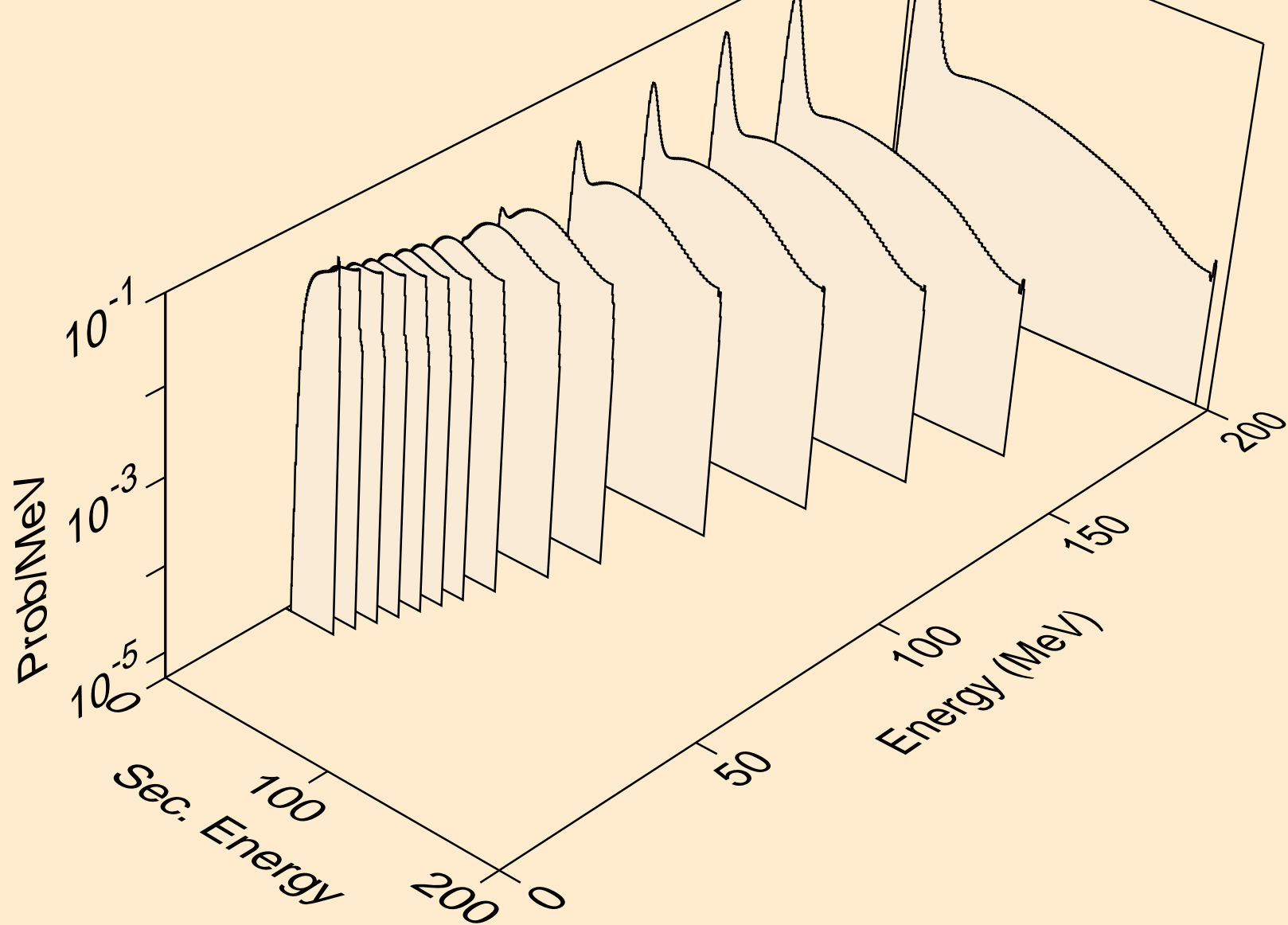

AG095 NEUTRON ACER TENDL-2024 LIBRARY; T=0.K
deuterons from (n,n*)d

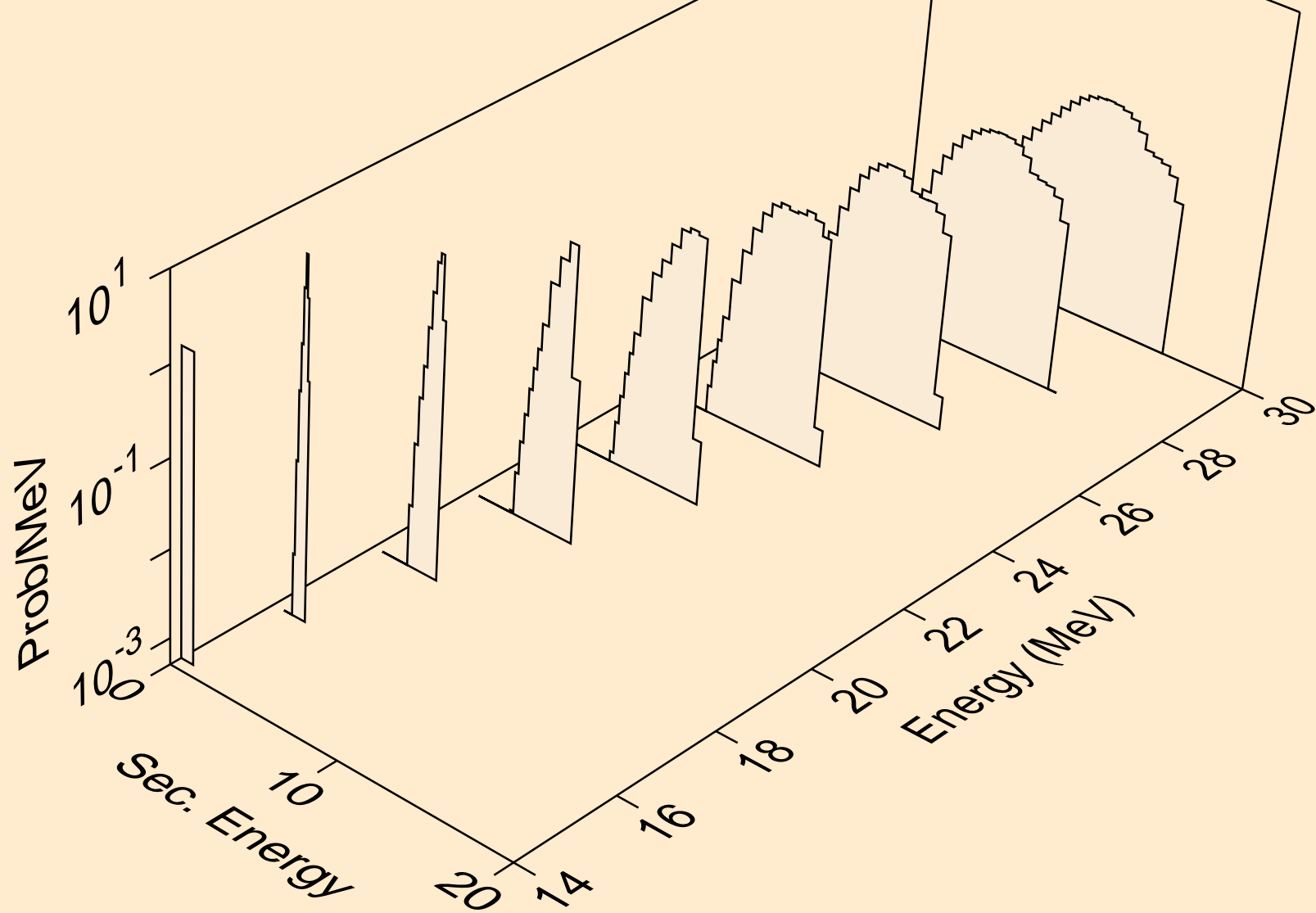

AG095 NEUTRON ACER TENDL-2024 LIBRARY; T=0.K
deuterons from (n,d)

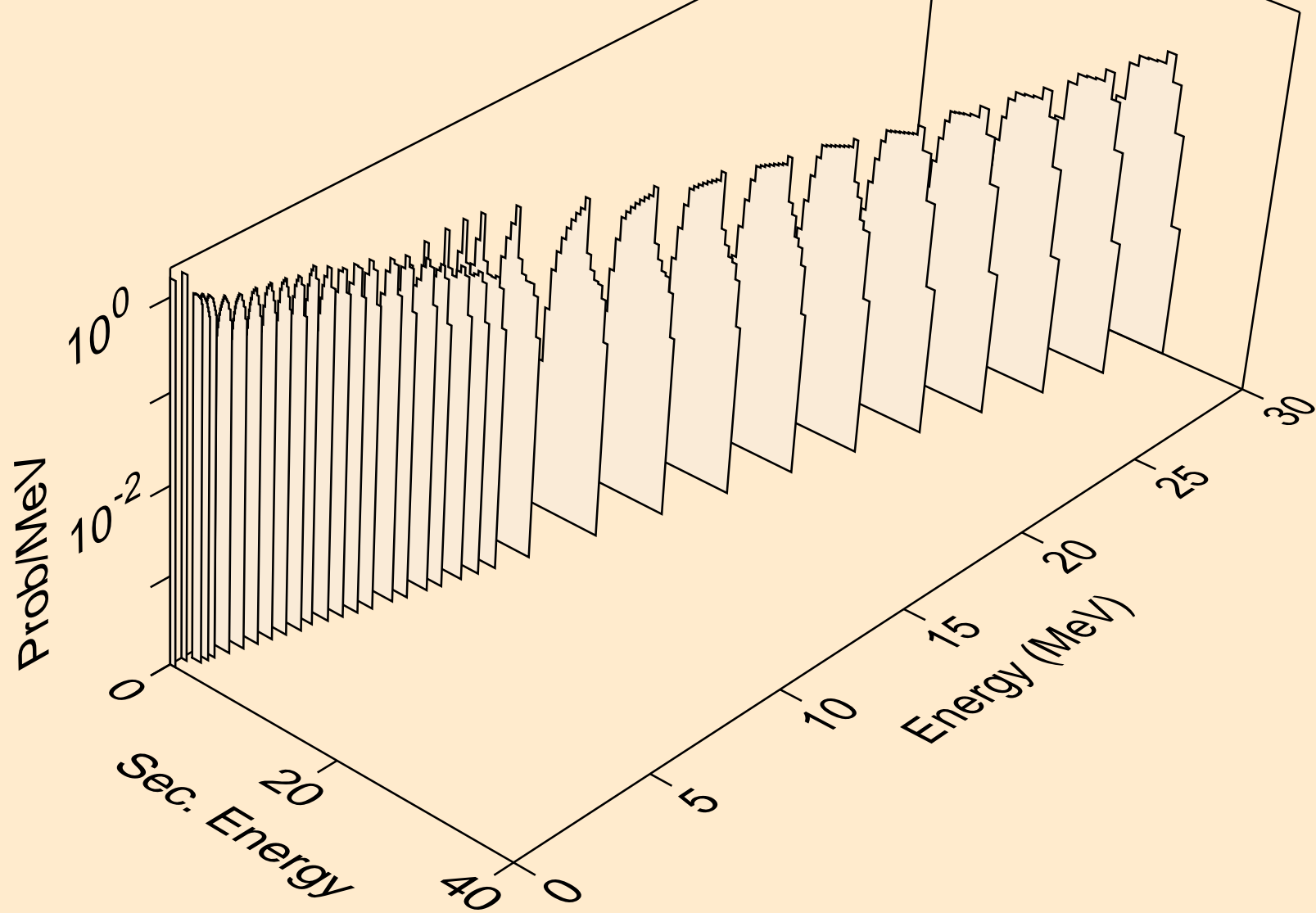

AG095 NEUTRON ACER TENDL-2024 LIBRARY; T=0.K
deuterons from (n,pd)

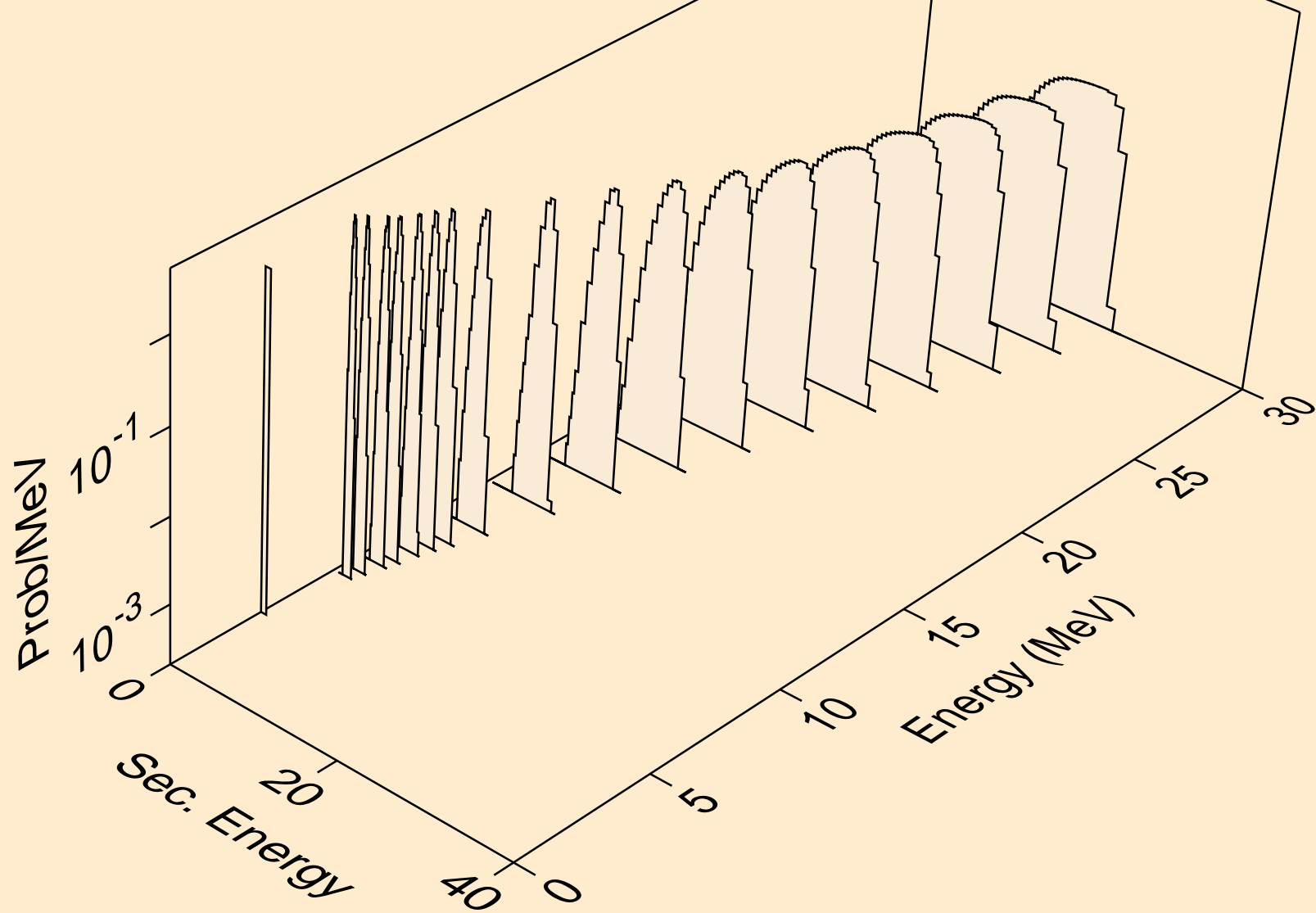

AG095 NEUTRON ACER TENDL-2024 LIBRARY; T=0.K
deuterons from (n,da)

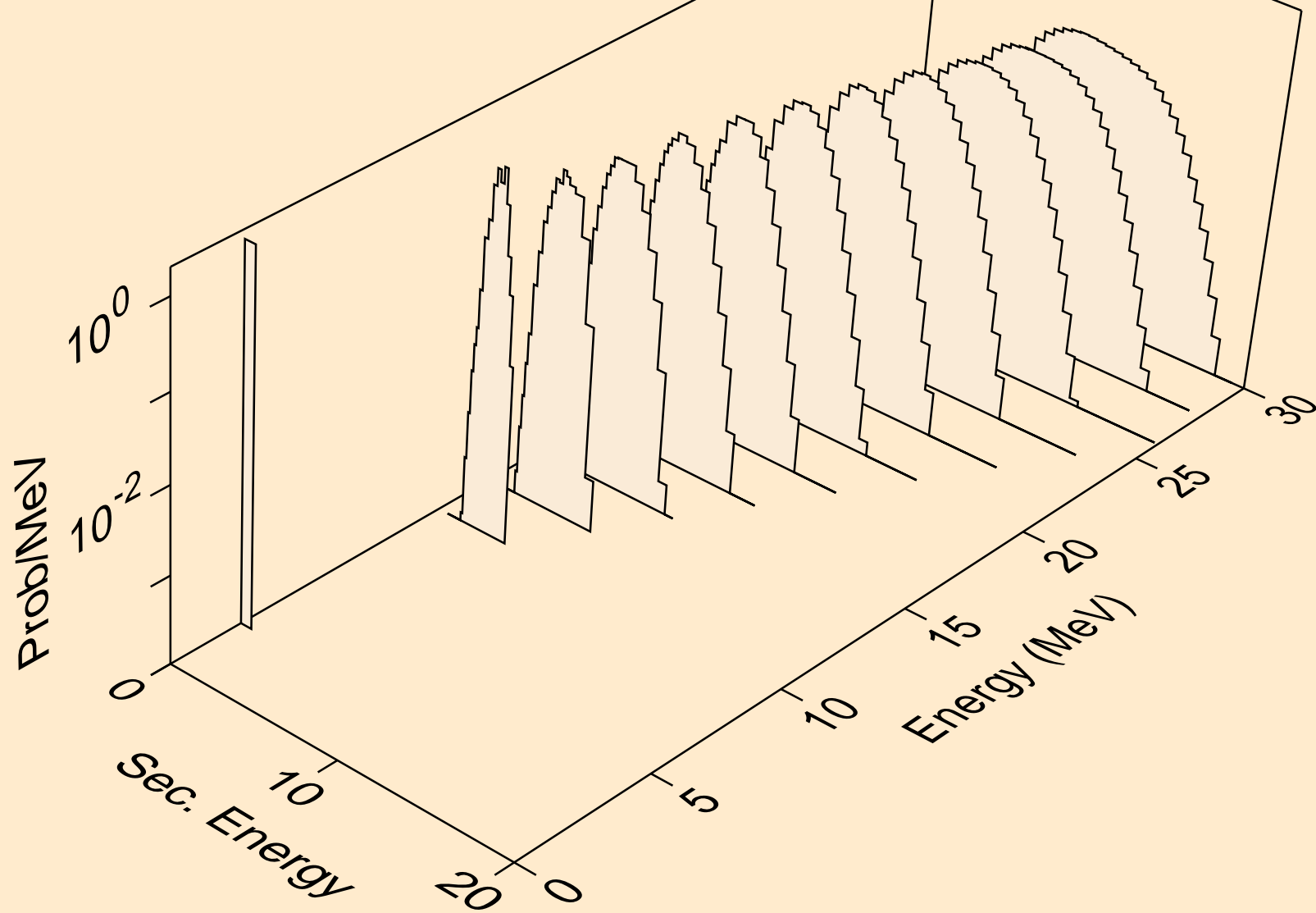

AG095 NEUTRON ACER TENDL-2024 LIBRARY; T=0.K
tritons from (n,x)

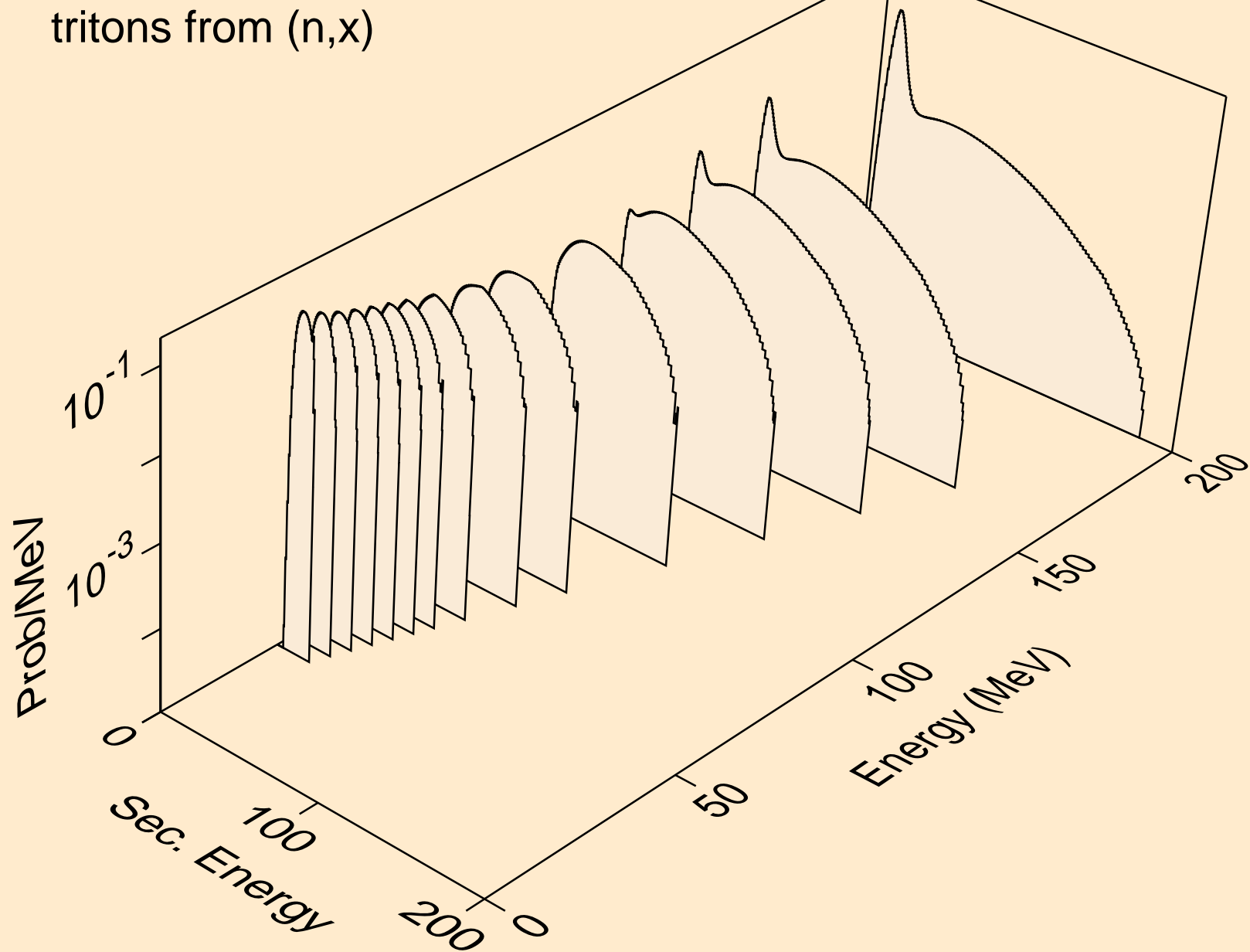

AG095 NEUTRON ACER TENDL-2024 LIBRARY; T=0.K
tritons from (n,n*)t

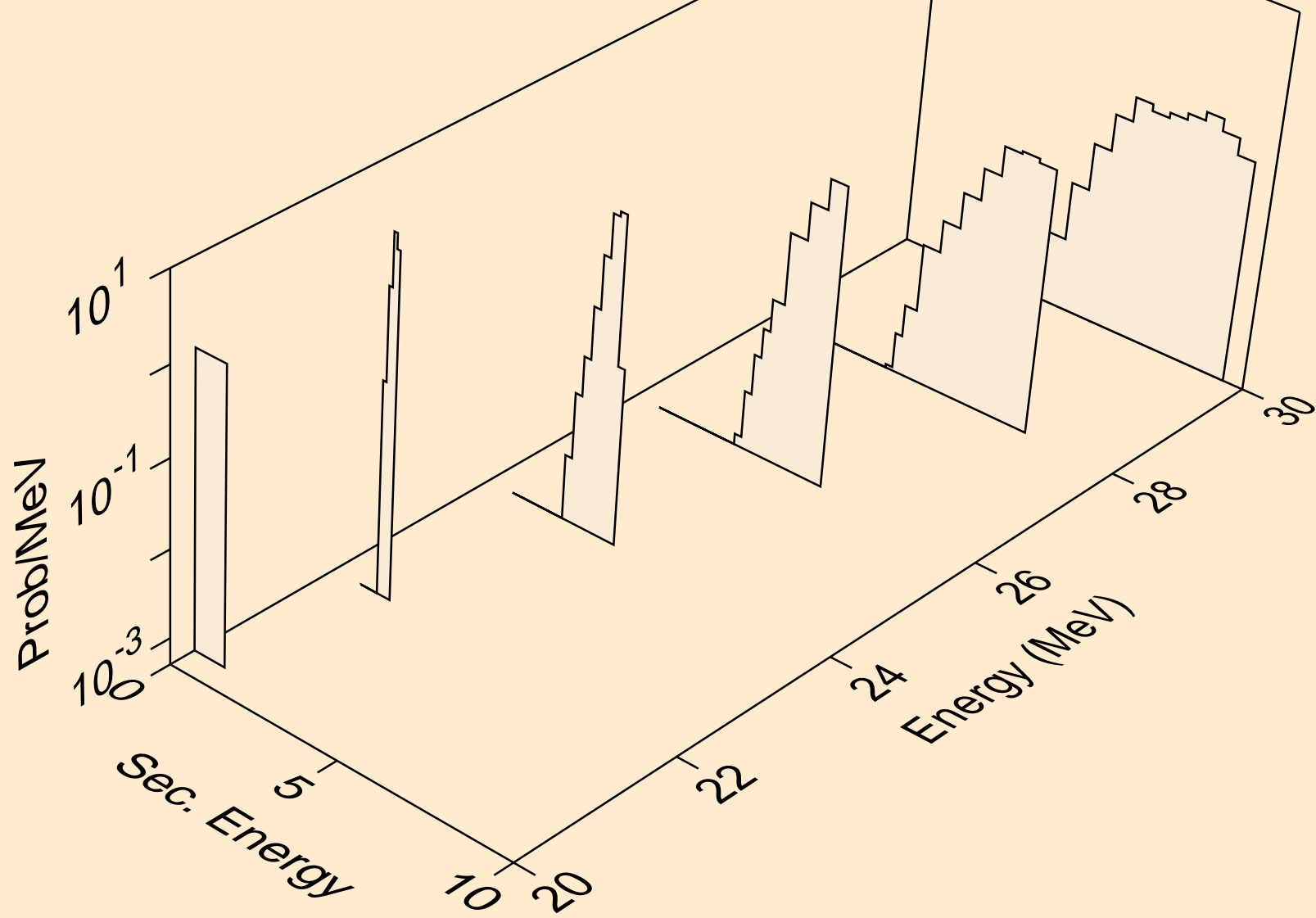

AG095 NEUTRON ACER TENDL-2024 LIBRARY; T=0.K
tritons from (n,t)

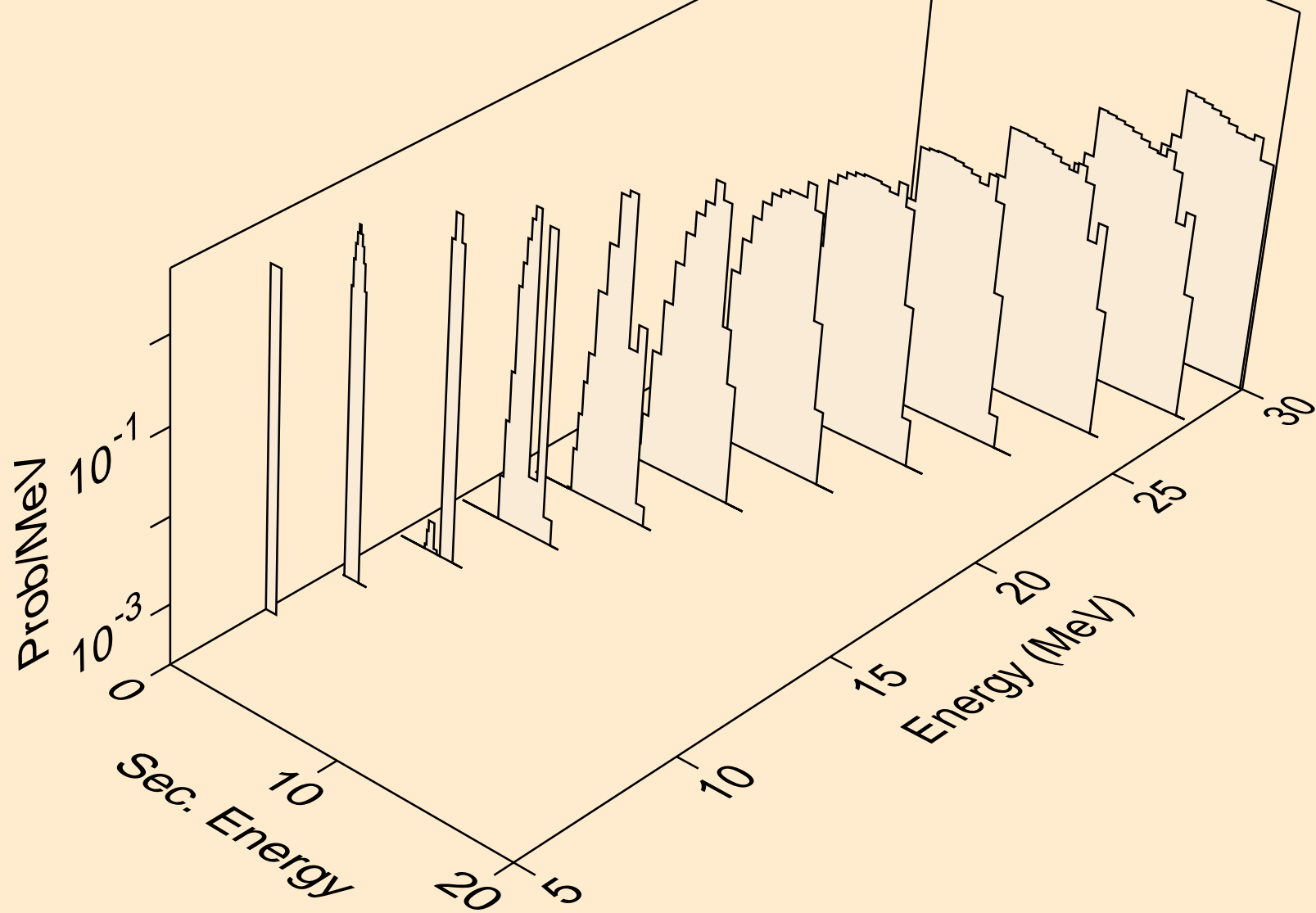

AG095 NEUTRON ACER TENDL-2024 LIBRARY; T=0.K
tritons from (n,pt)

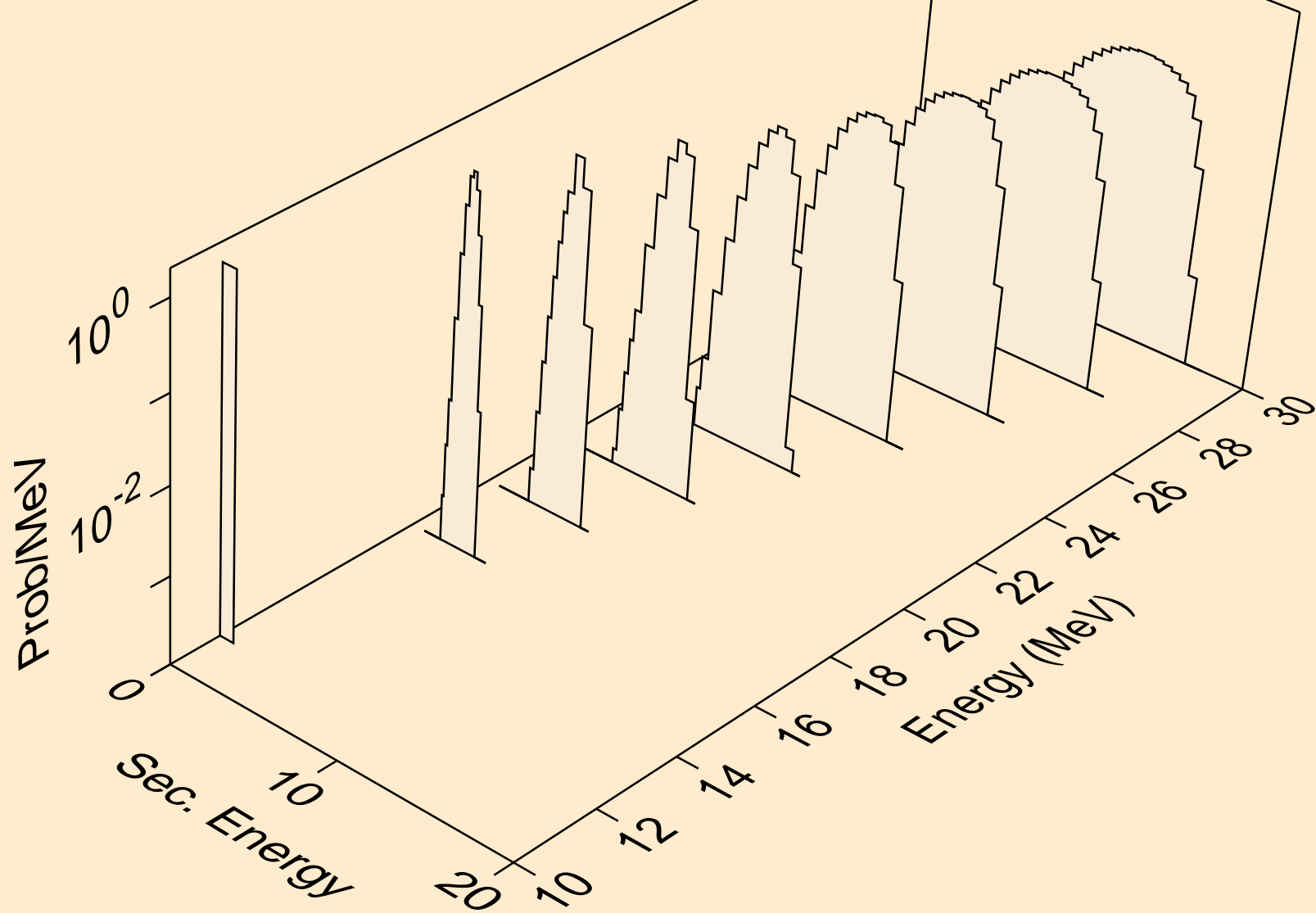

AG095 NEUTRON ACER TENDL-2024 LIBRARY; T=0.K
he3s from (n,x)

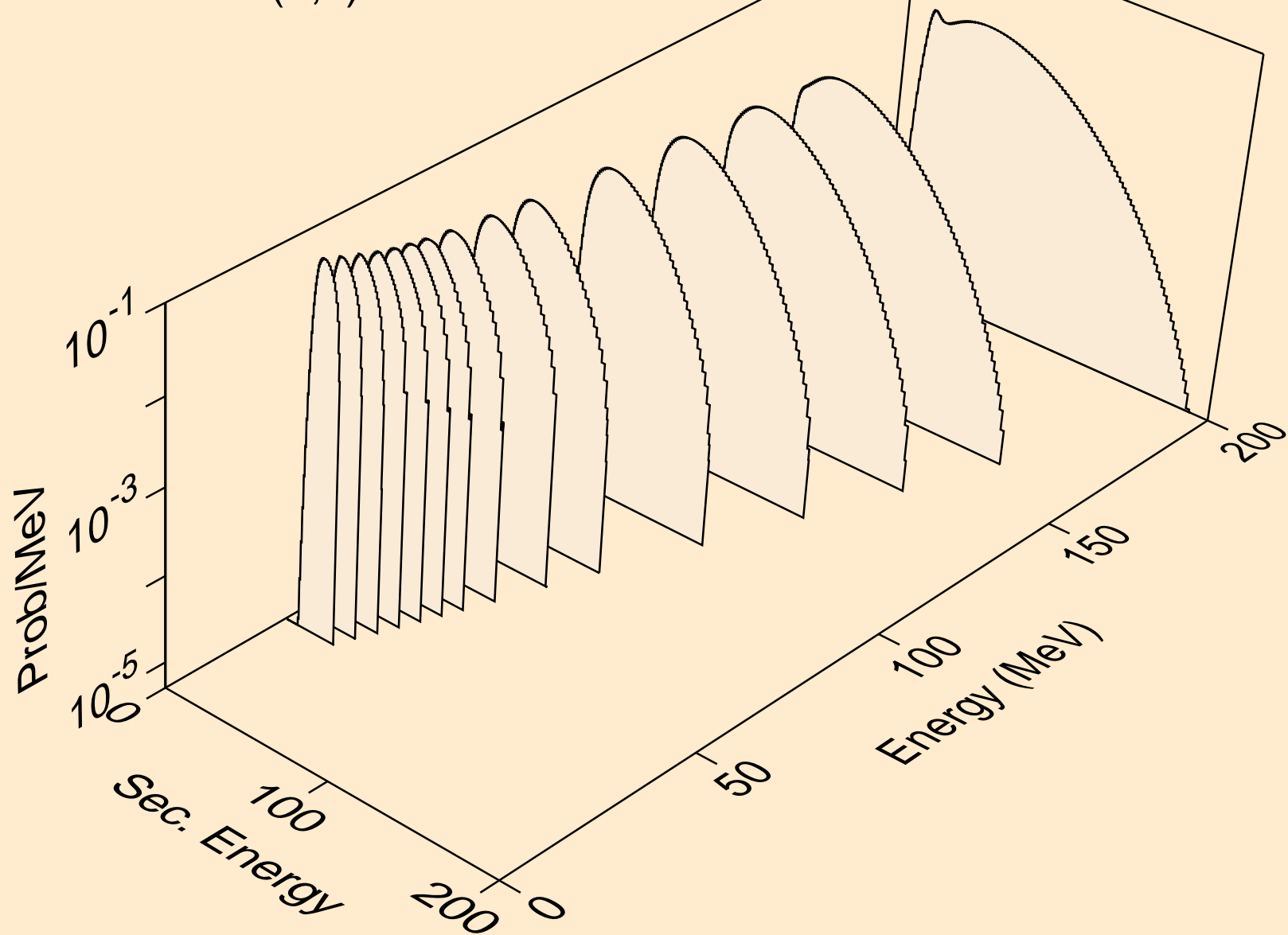

AG095 NEUTRON ACER TENDL-2024 LIBRARY; T=0.K
he3s from (n,n*)he3

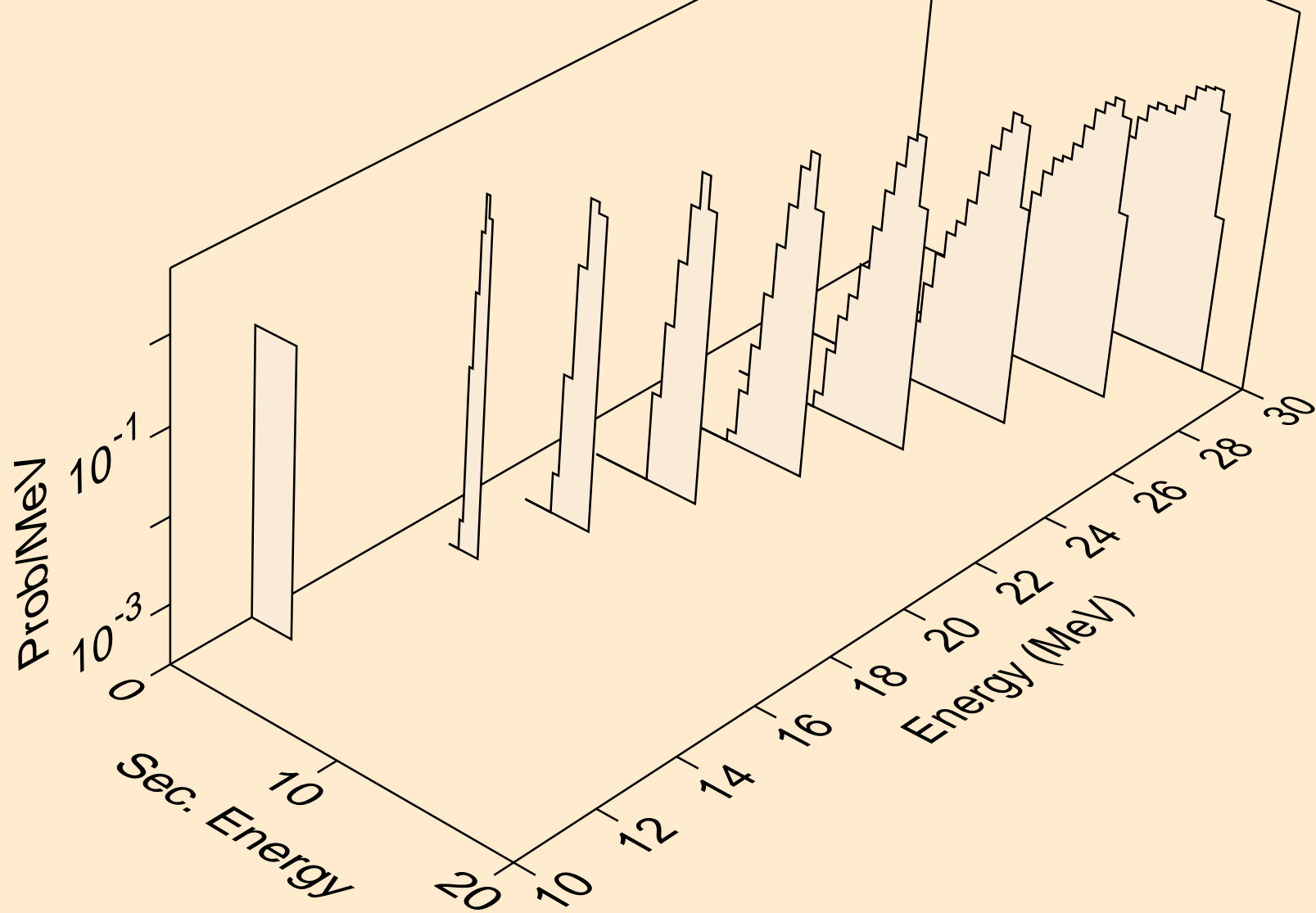

AG095 NEUTRON ACER TENDL-2024 LIBRARY; T=0.K
he3s from (n,he3)

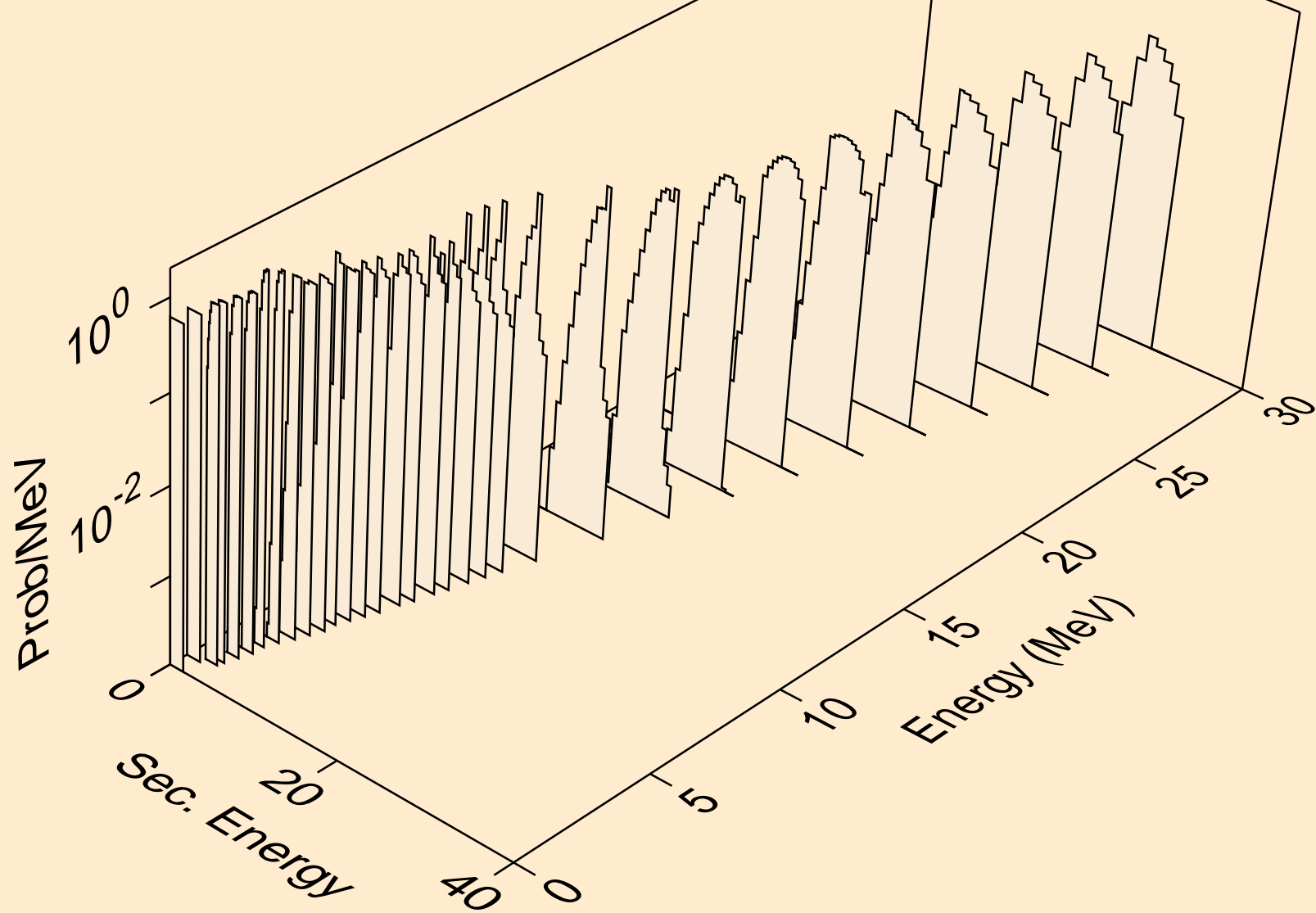

AG095 NEUTRON ACER TENDL-2024 LIBRARY; T=0.K
alphas from (n,x)

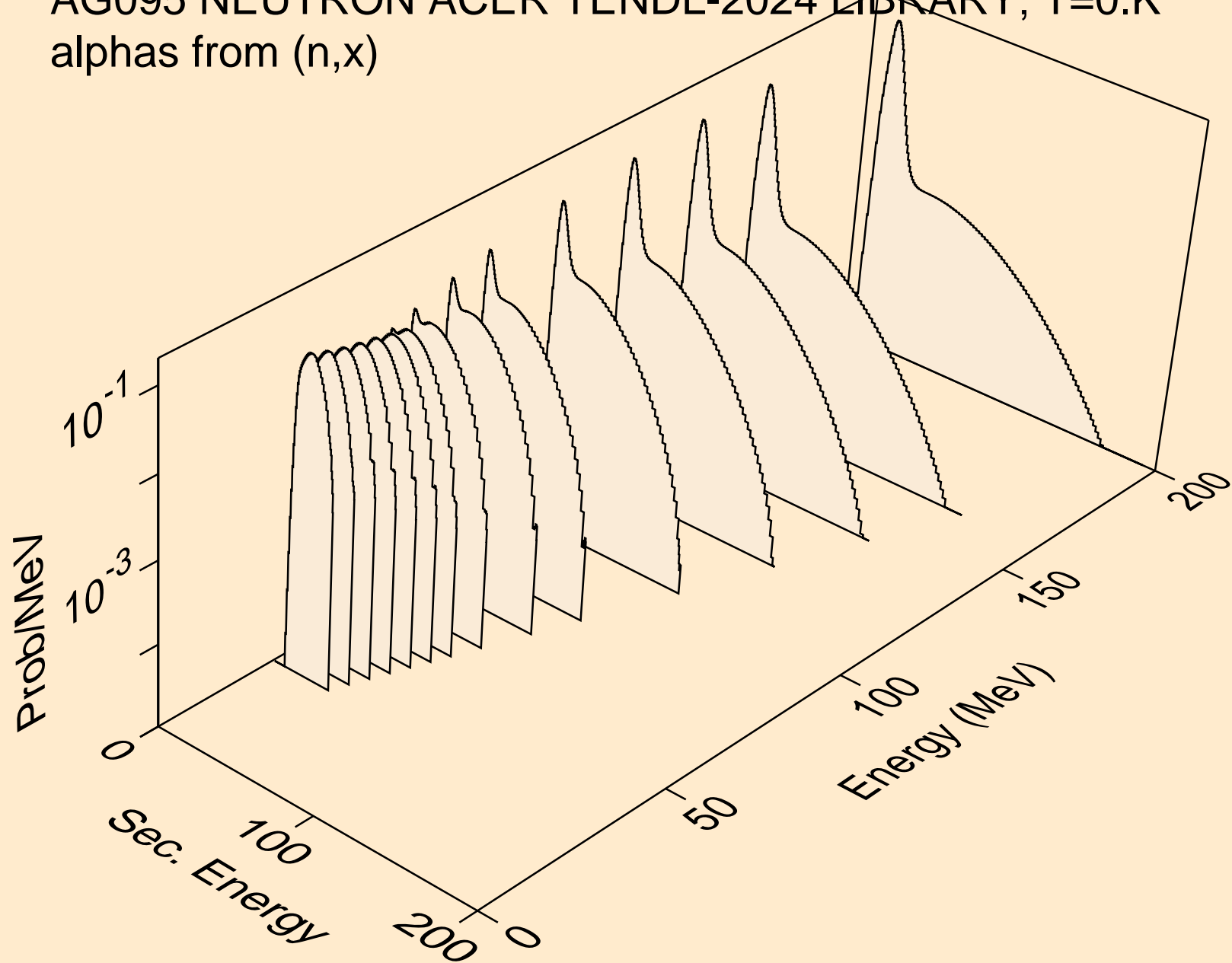

AG095 NEUTRON ACER TENDL-2024 LIBRARY; T=0.K
alphas from (n,n*)a

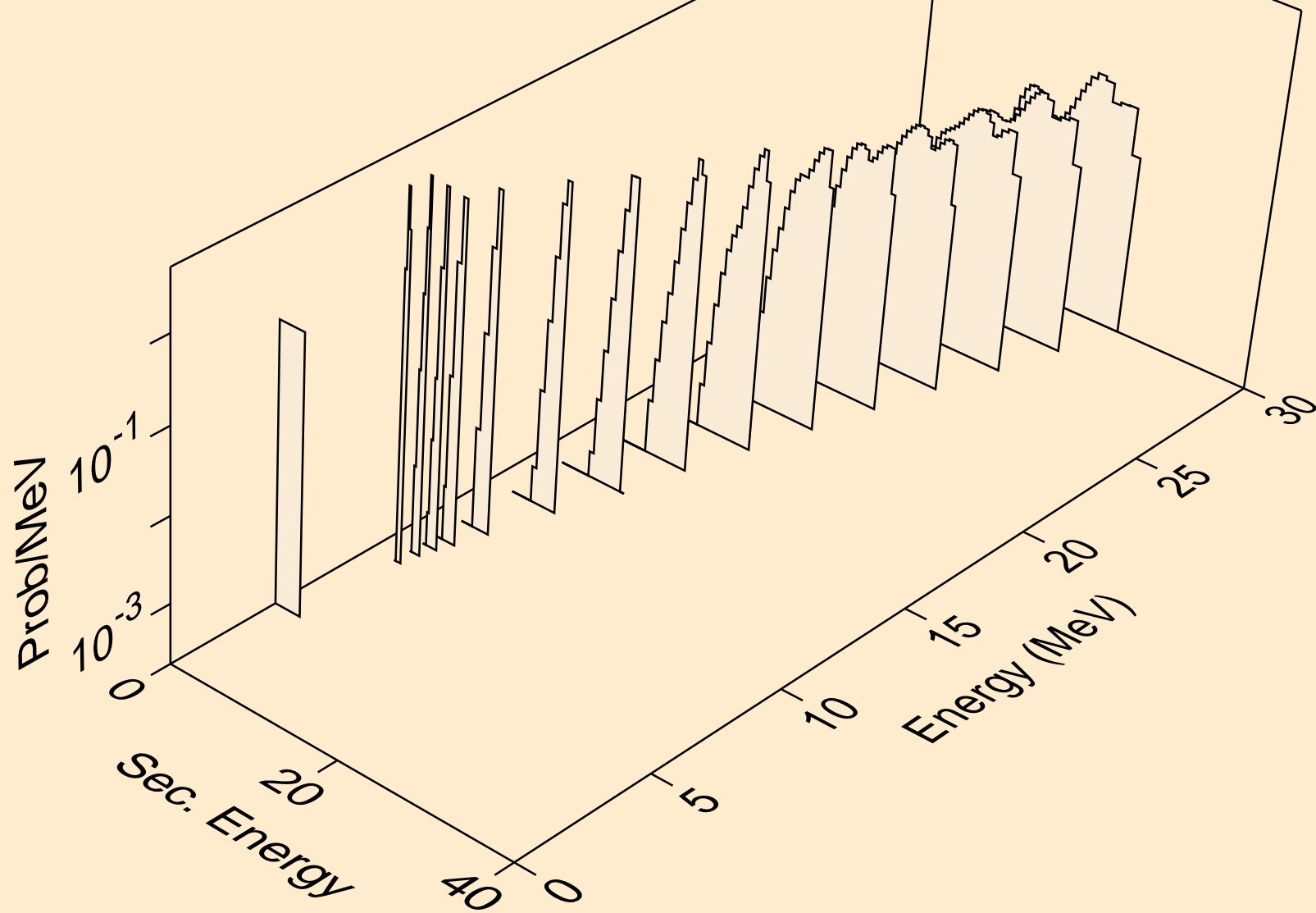

AG095 NEUTRON ACER TENDL-2024 LIBRARY; T=0.K
alphas from (n,2n)a

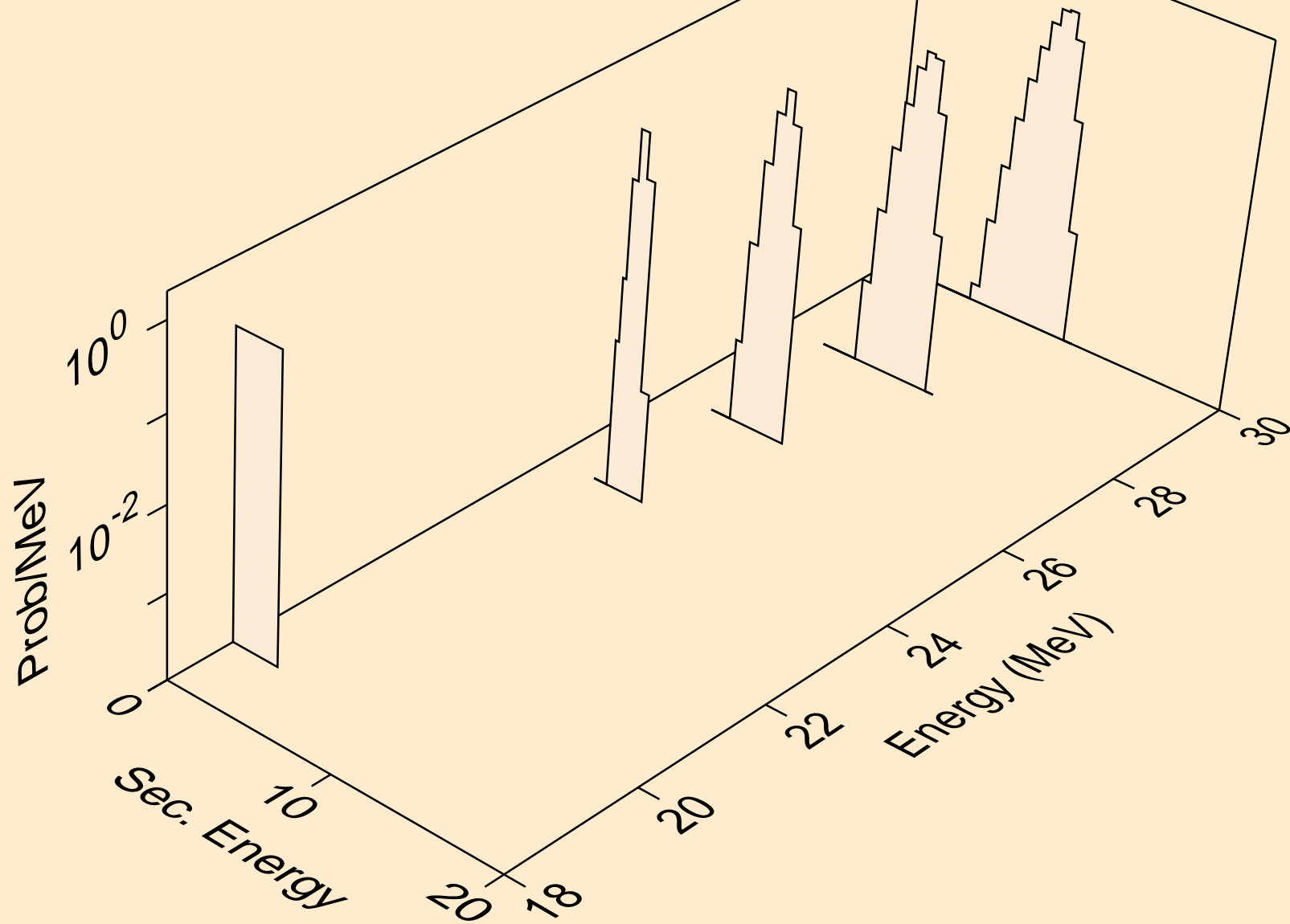

AG095 NEUTRON ACER TENDL-2024 LIBRARY; T=0.K
alphas from (n,n*)2a

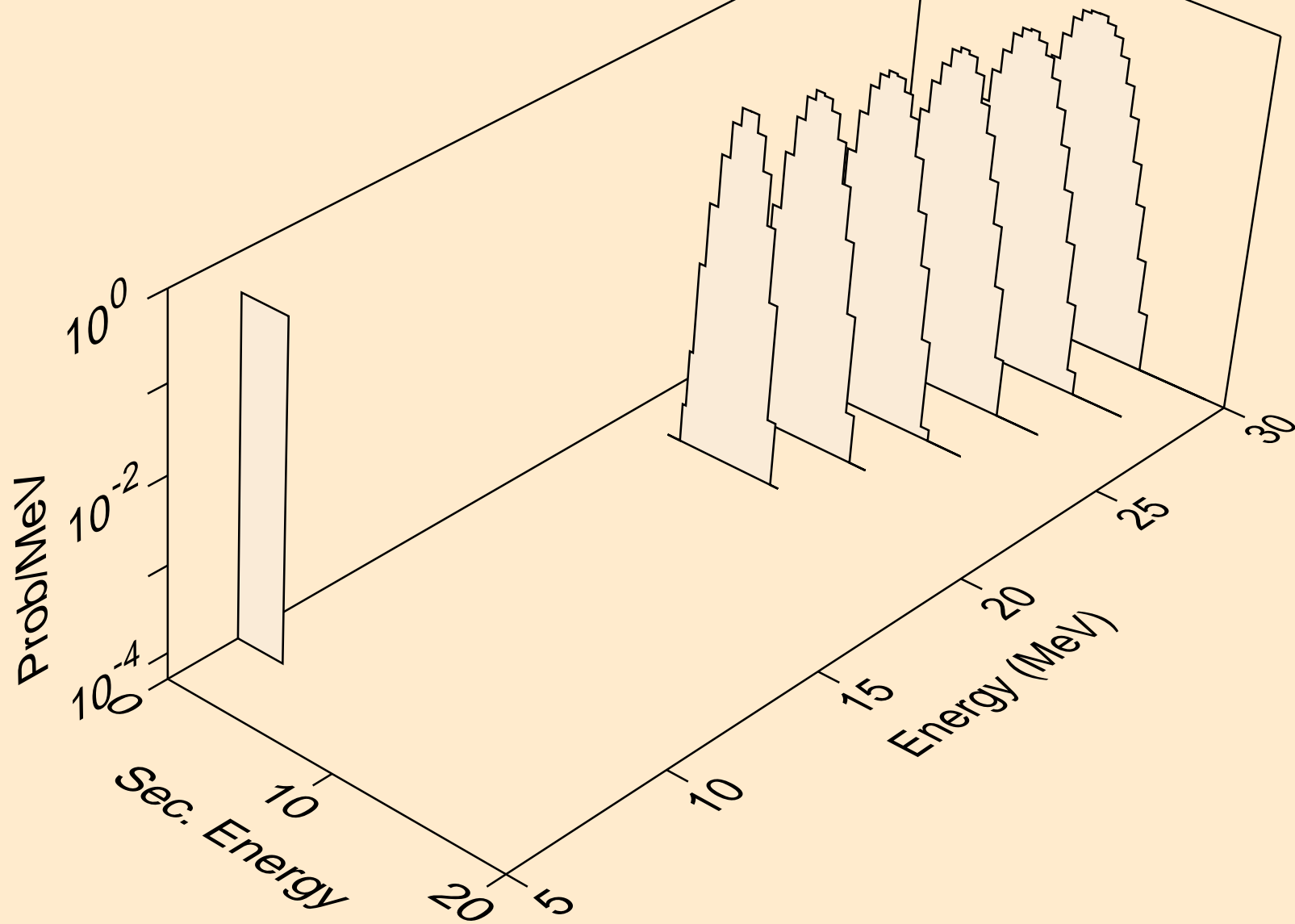

AG095 NEUTRON ACER TENDL-2024 LIBRARY; T=0.K
alphas from (n,npa)

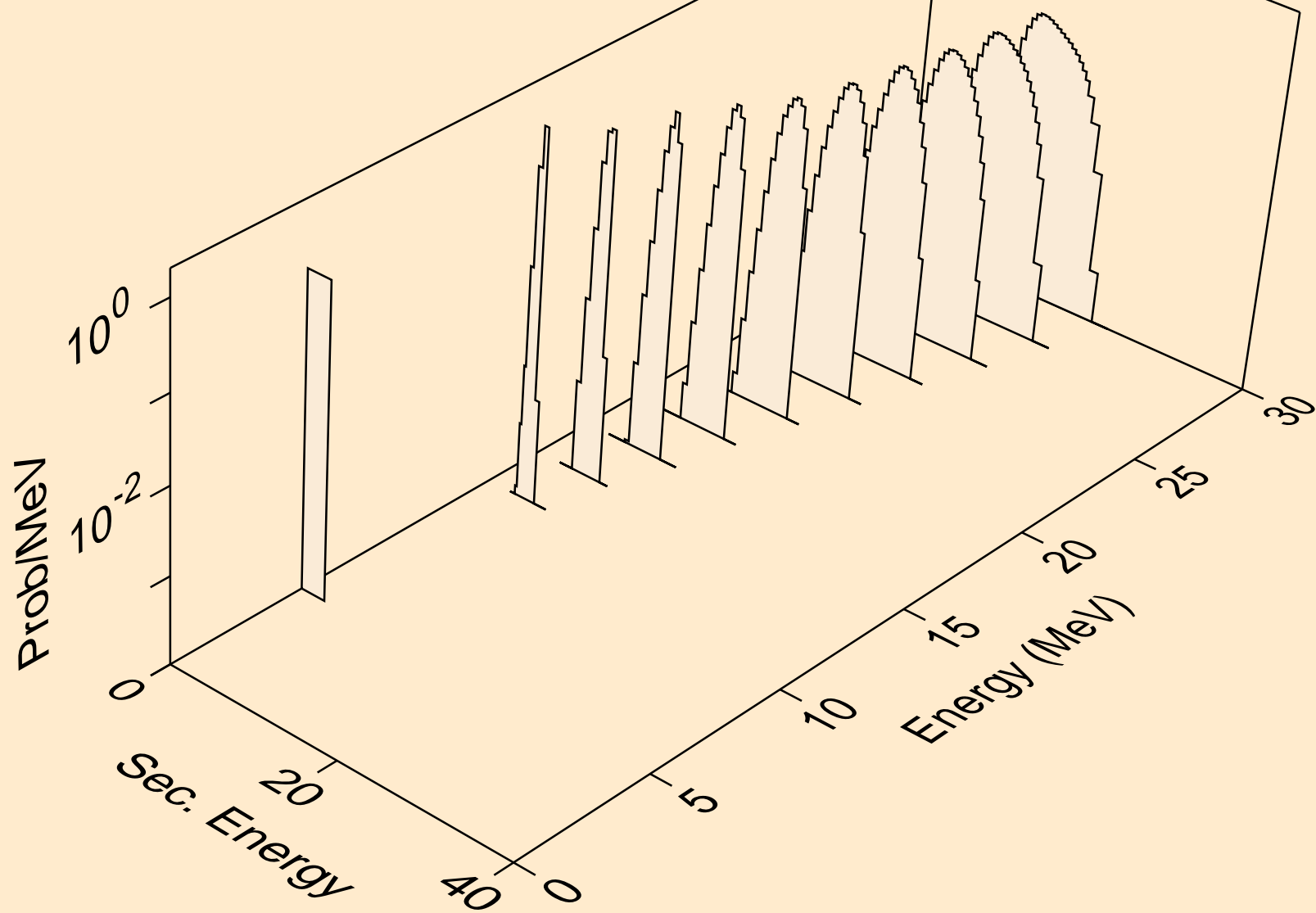

AG095 NEUTRON ACER TENDL-2024 LIBRARY; T=0.K
alphas from (n,a)

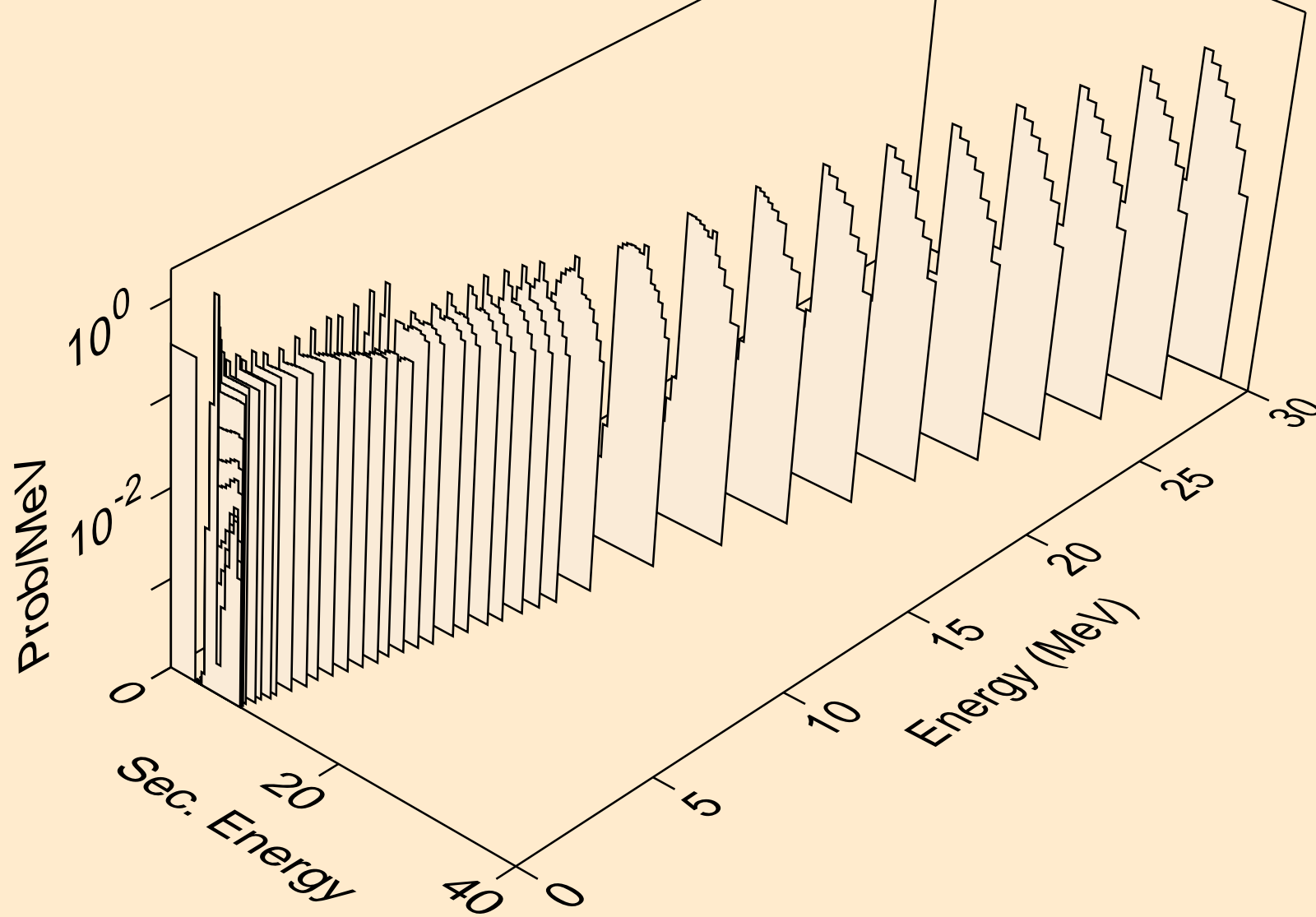

AG095 NEUTRON ACER TENDL-2024 LIBRARY; T=0.K
alphas from (n,2a)

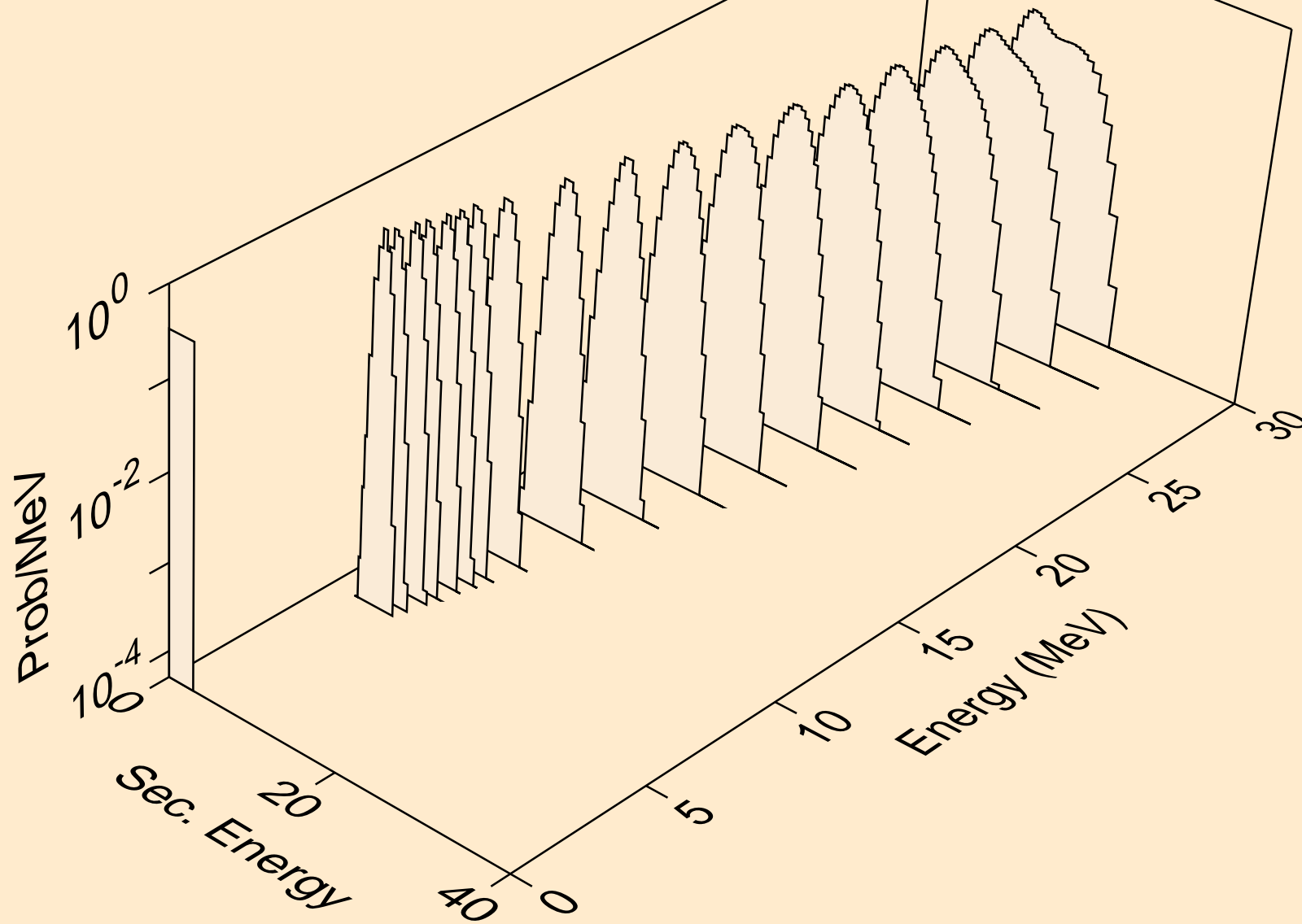

AG095 NEUTRON ACER TENDL-2024 LIBRARY; T=0.K
alphas from (n,pa)

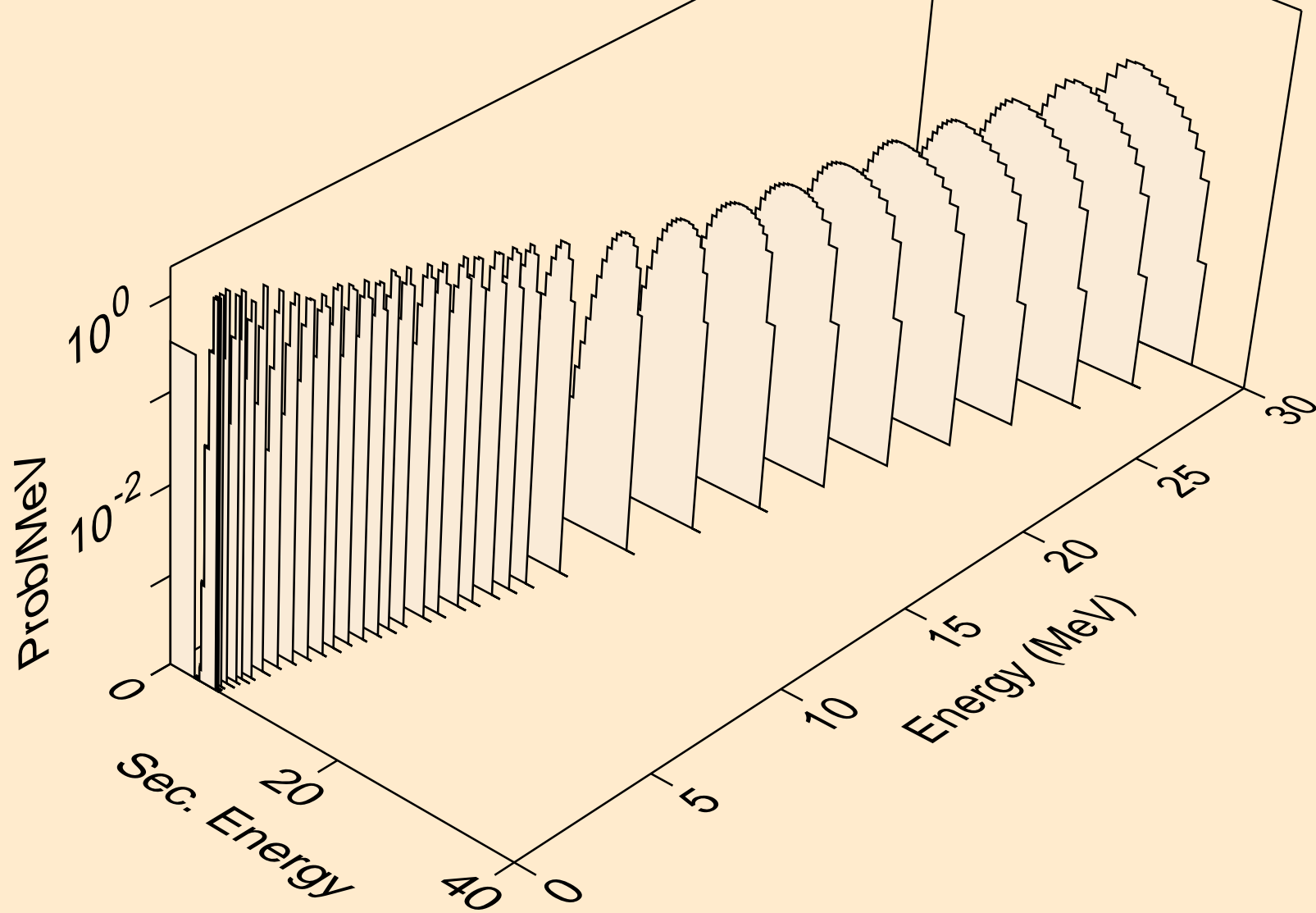

AG095 NEUTRON ACER TENDL-2024 LIBRARY; T=0.K
alphas from (n,da)

