

AG112 NEUTRON ACER TENDL-2024 LIBRARY; T=0.K

Principal cross sections

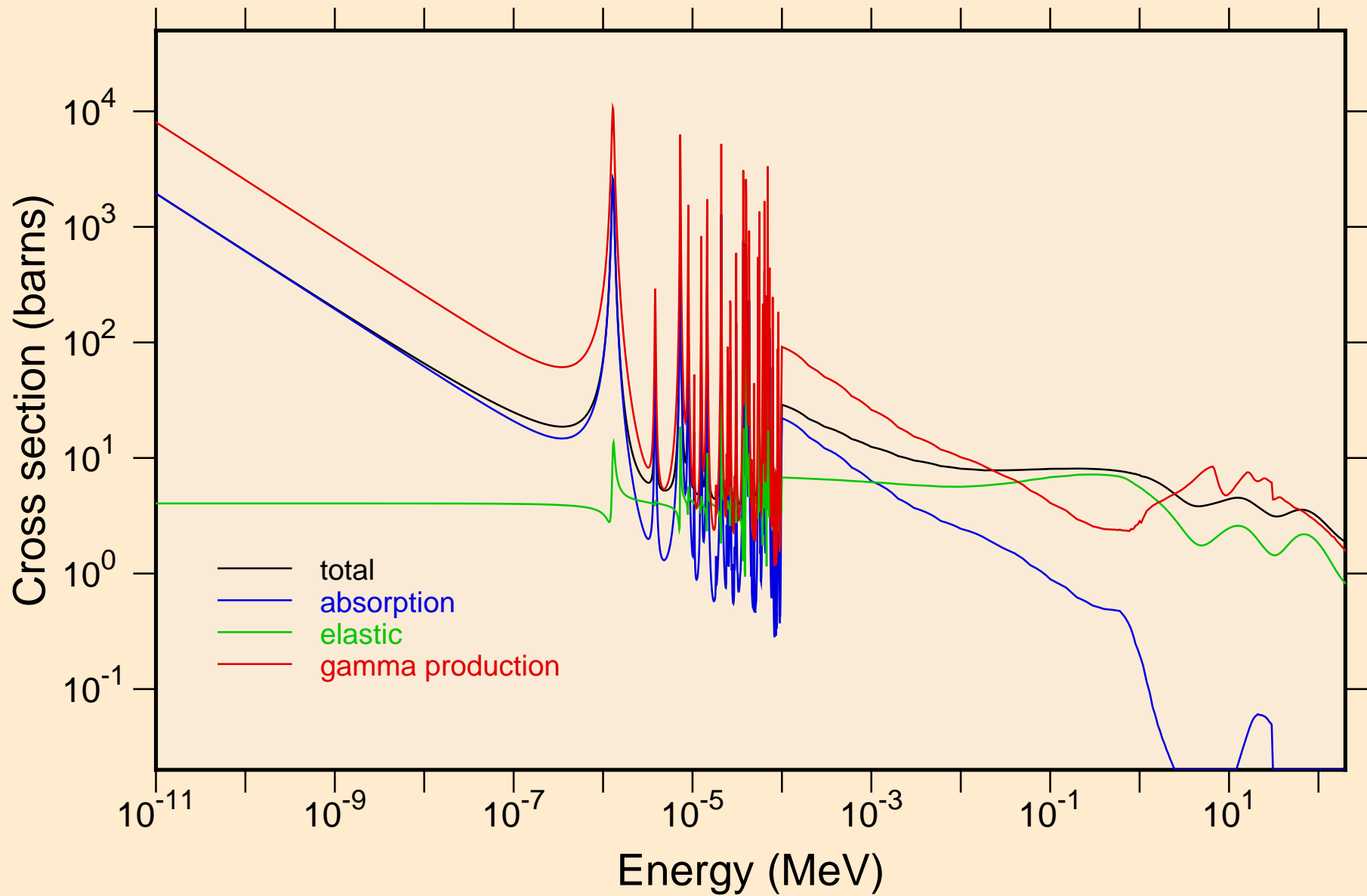

AG112 NEUTRON ACER TENDL-2024 LIBRARY; T=0.K
resonance total cross section

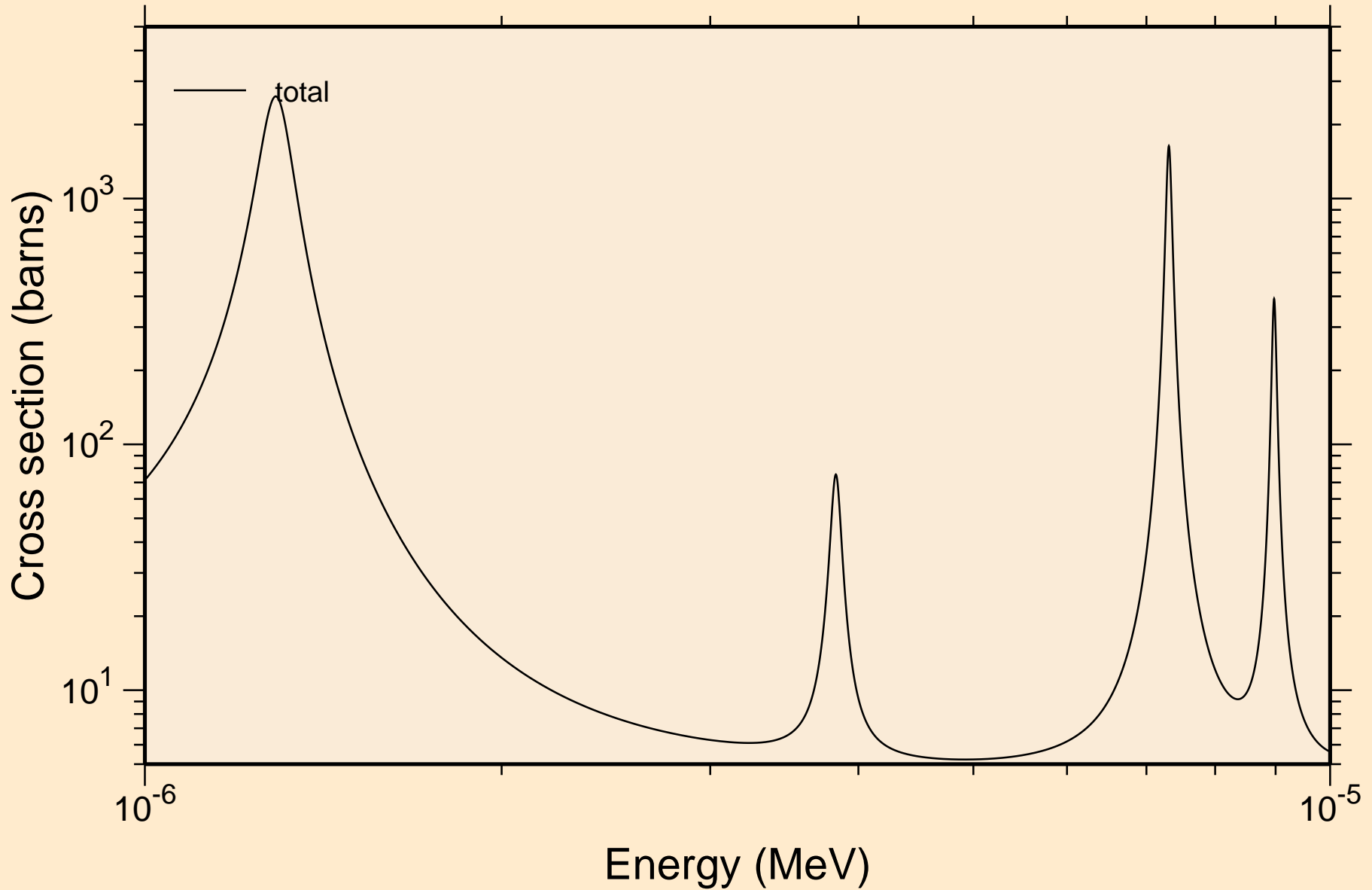

AG112 NEUTRON ACER TENDL-2024 LIBRARY; T=0.K
resonance total cross section

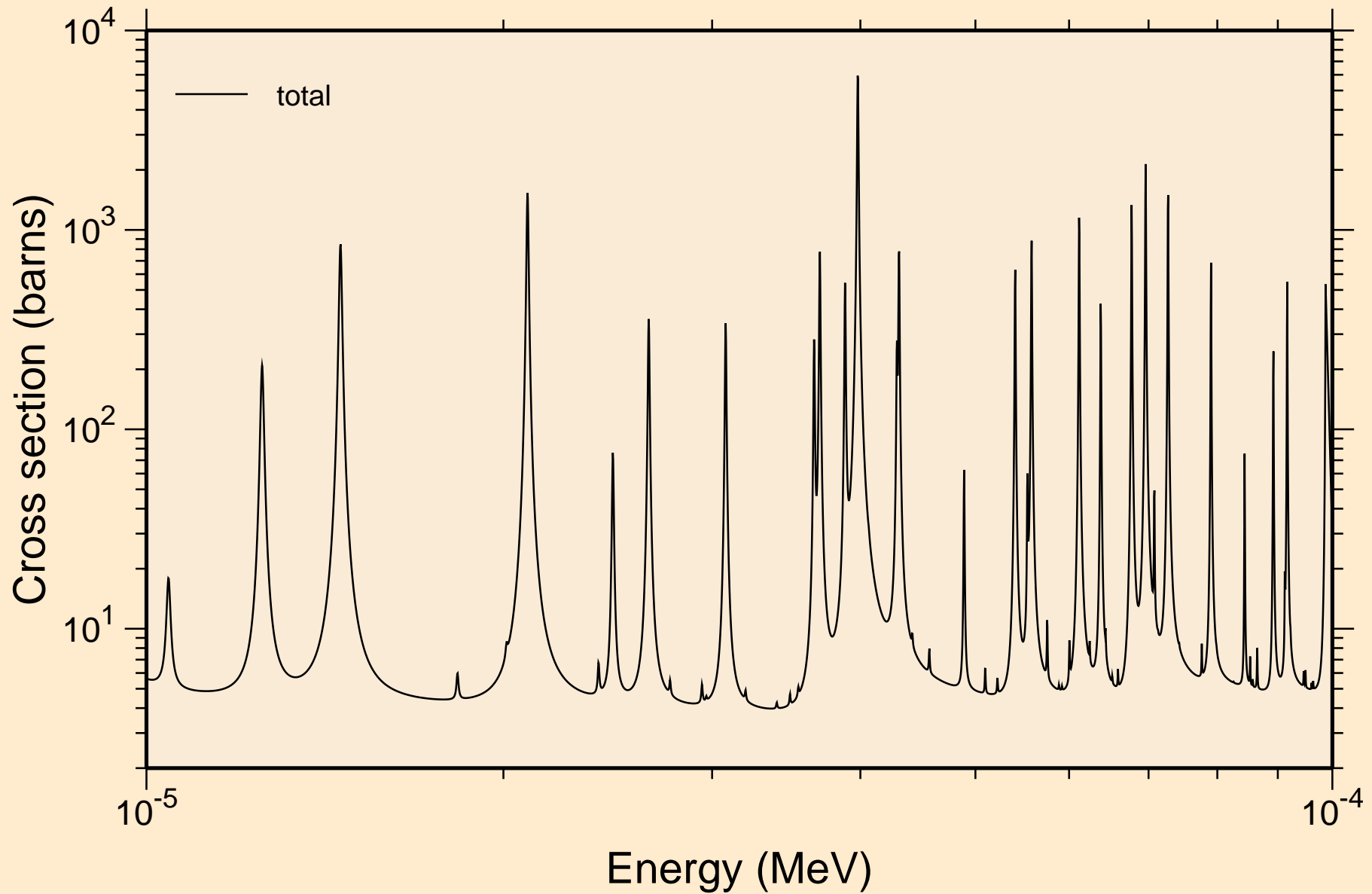

AG112 NEUTRON ACER TENDL-2024 LIBRARY; T=0.K
resonance total cross section

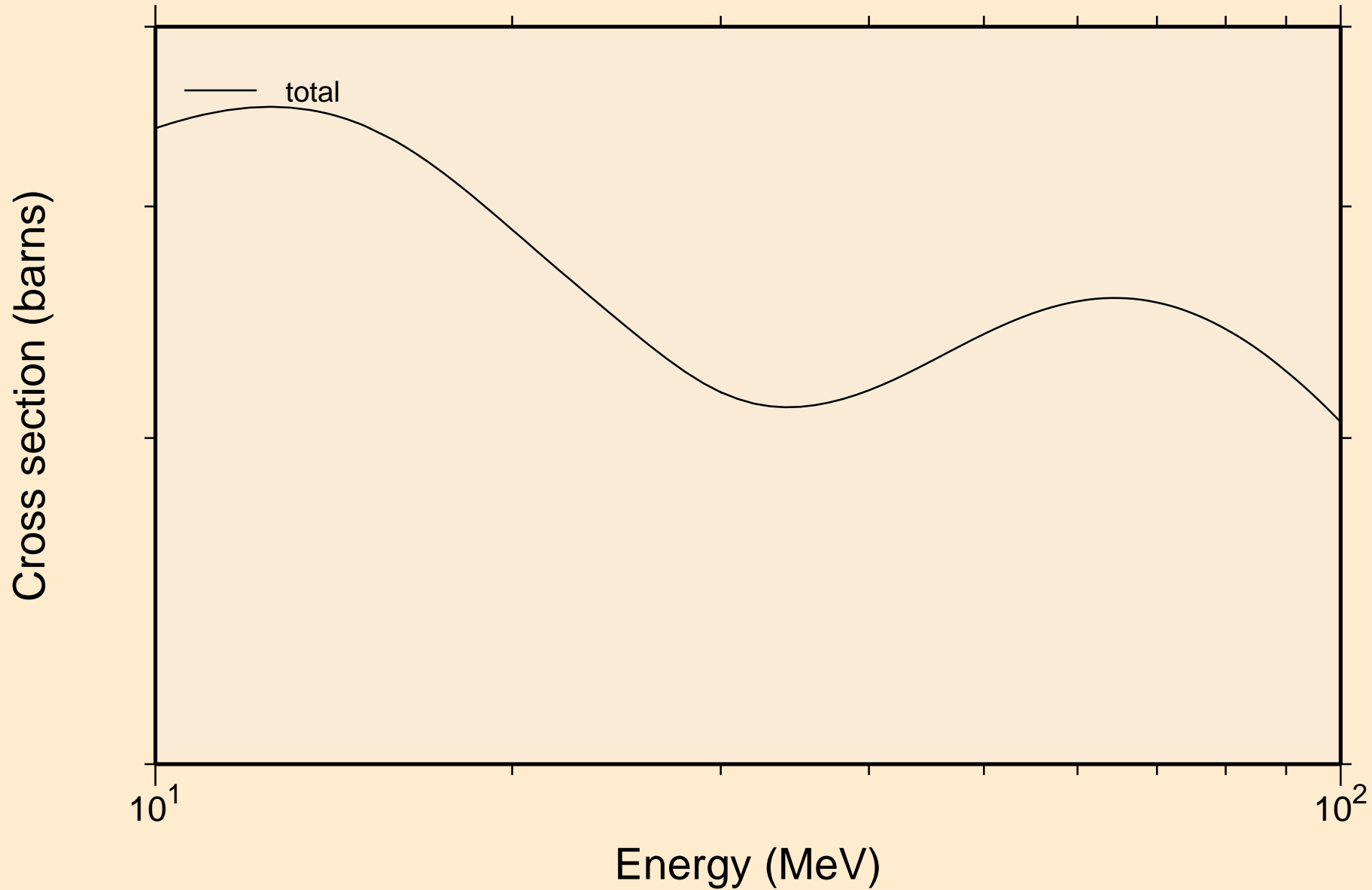

AG112 NEUTRON ACER TENDL-2024 LIBRARY; T=0.K
resonance absorption cross sections

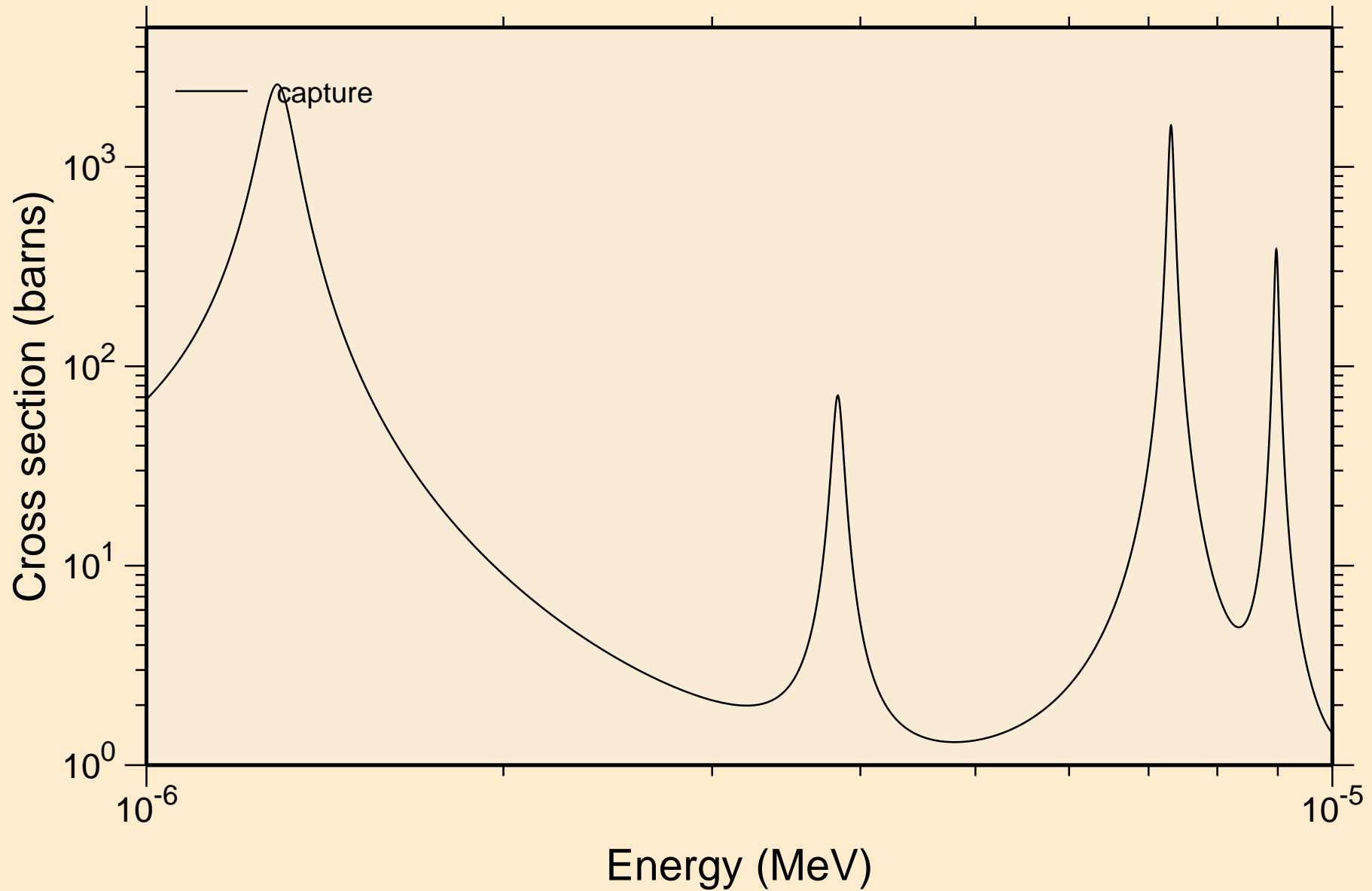

AG112 NEUTRON ACER TENDL-2024 LIBRARY; T=0.K
resonance absorption cross sections

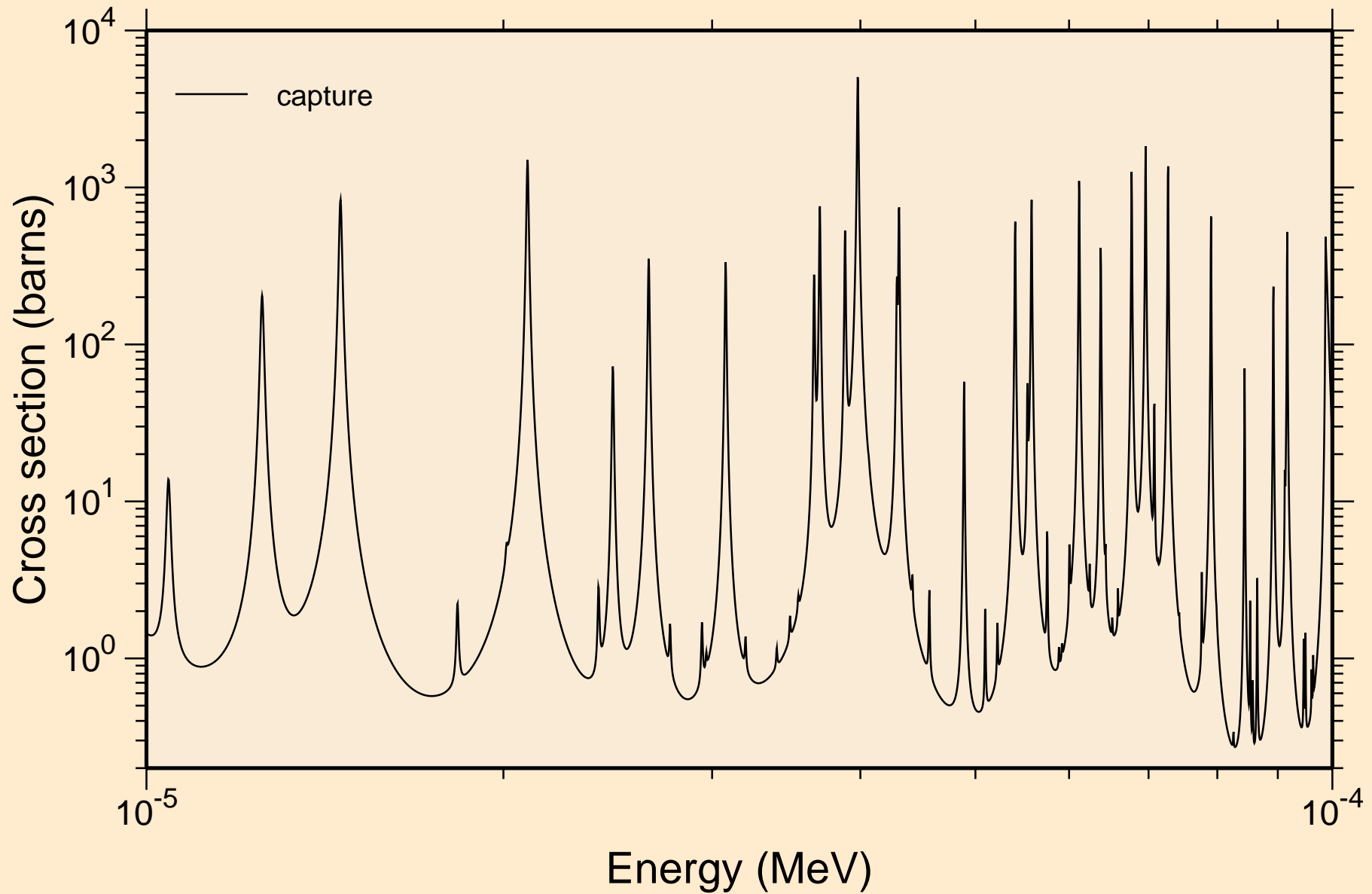

AG112 NEUTRON ACER TENDL-2024 LIBRARY; T=0.K
resonance absorption cross sections

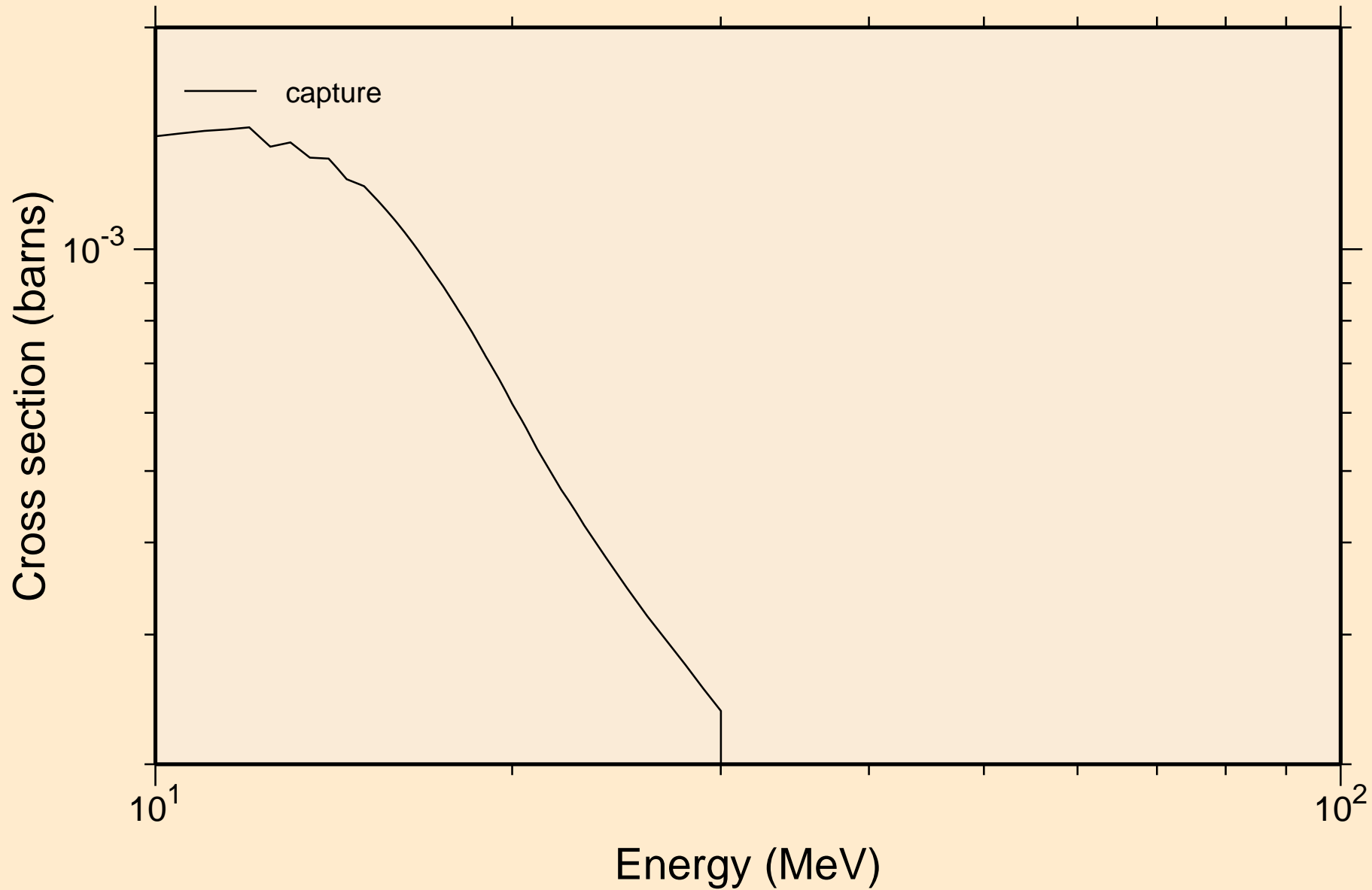

AG112 NEUTRON ACER TENDL-2024 LIBRARY; T=0.K
Heating

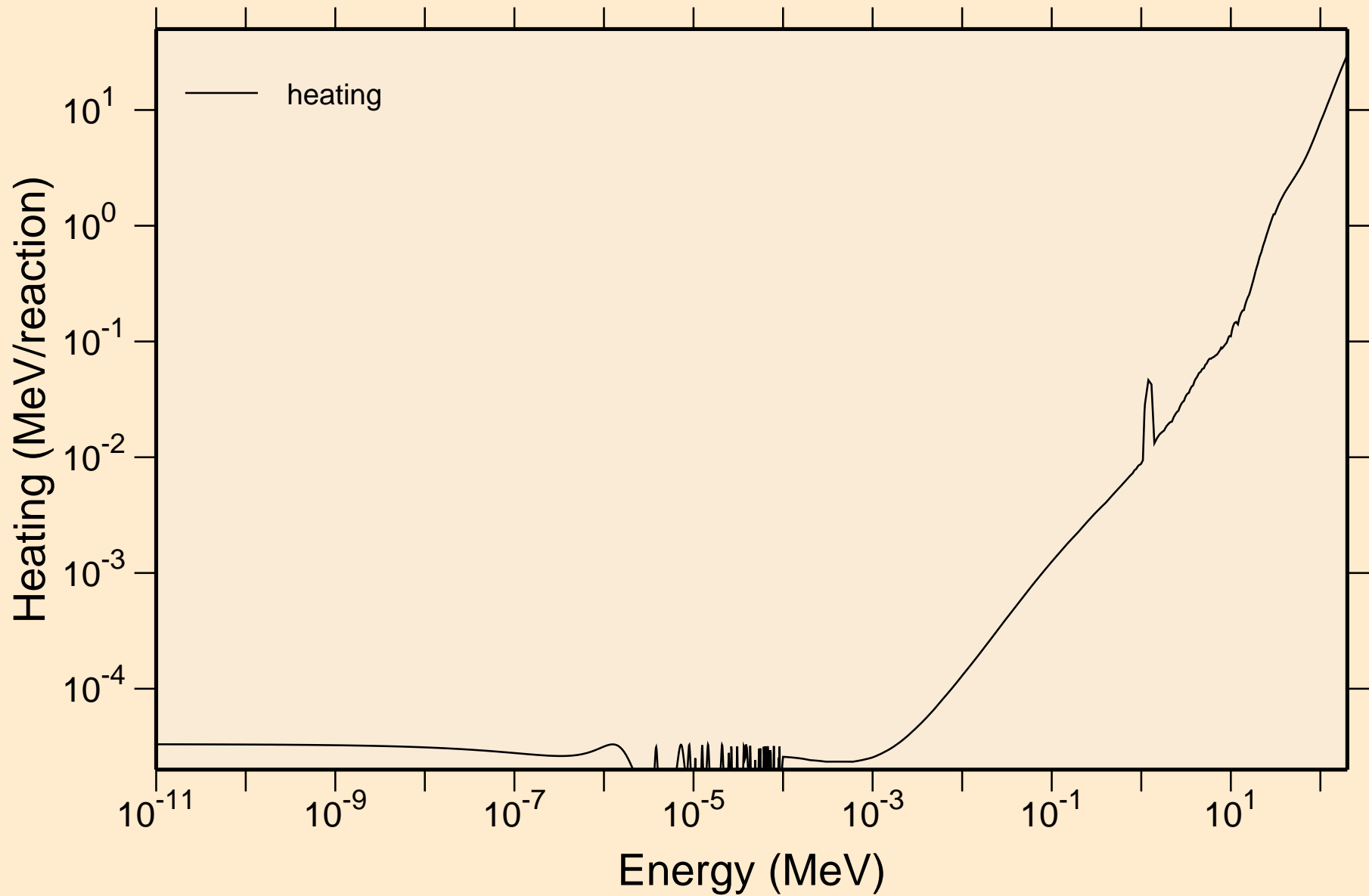

AG112 NEUTRON ACER TENDL-2024 LIBRARY; T=0.K

Damage

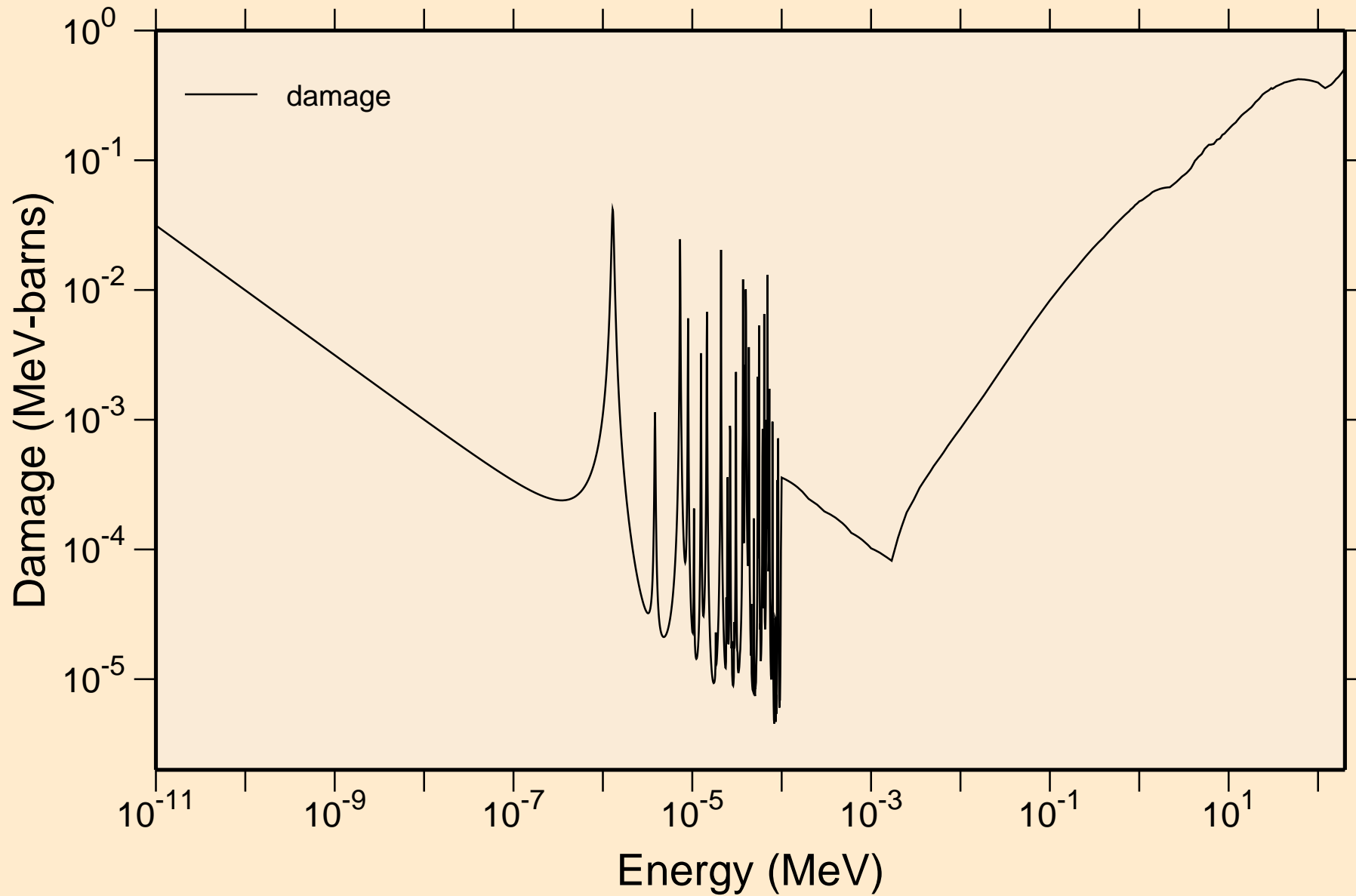

AG112 NEUTRON ACER TENDL-2024 LIBRARY; T=0.K

Non-threshold reactions

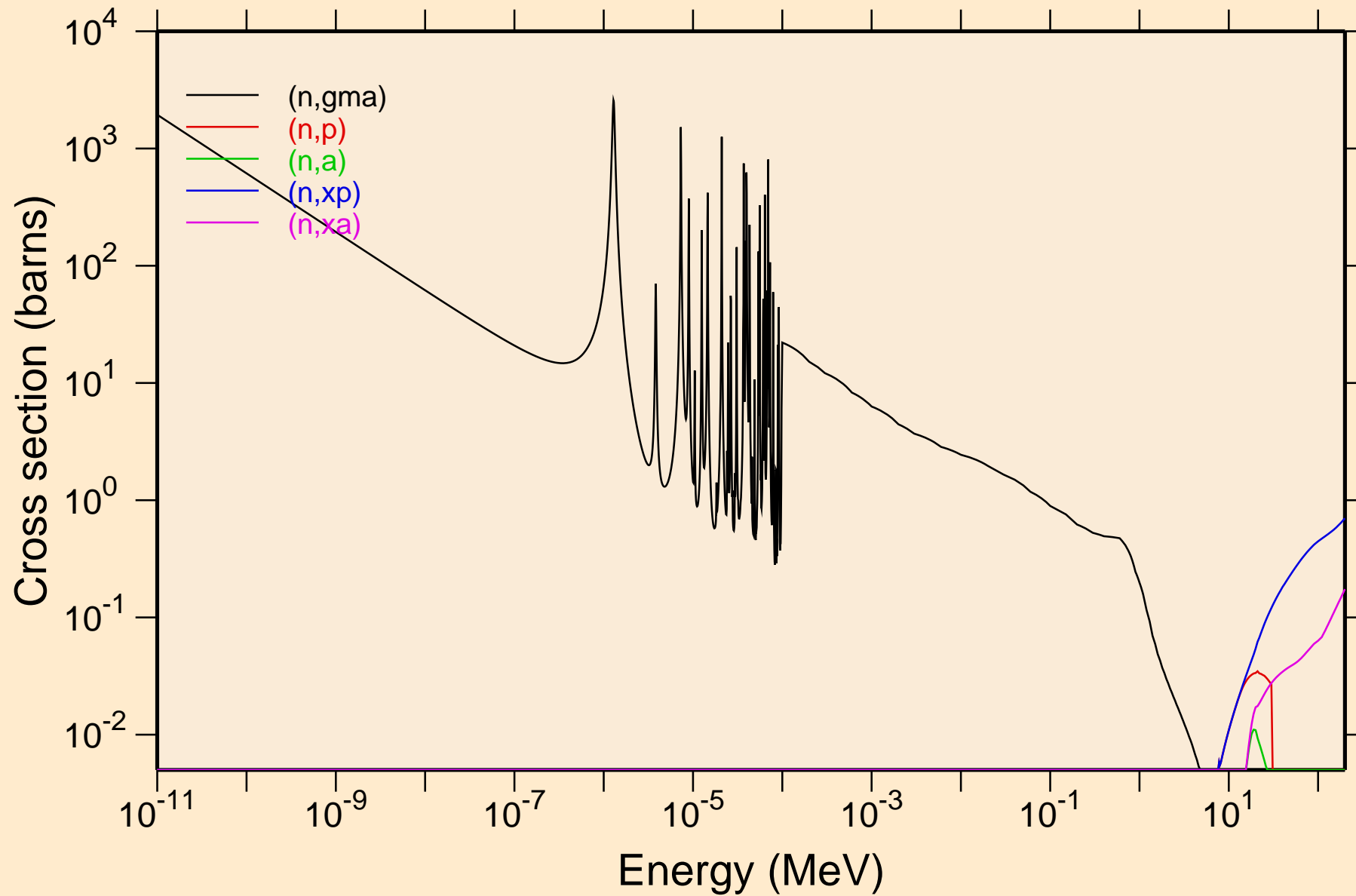

AG112 NEUTRON ACER TENDL-2024 LIBRARY; T=0.K

Principal cross sections

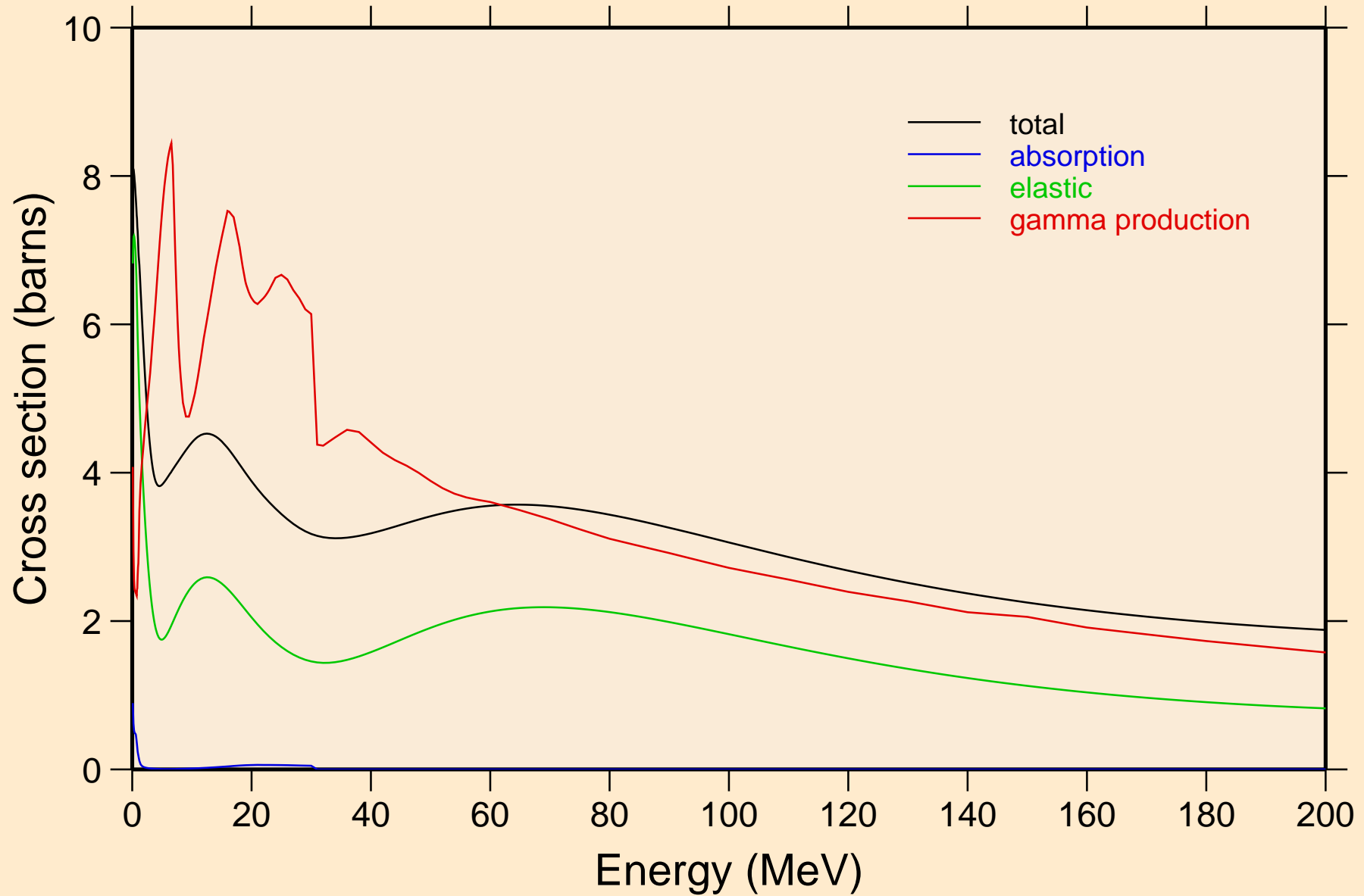

AG112 NEUTRON ACER TENDL-2024 LIBRARY; T=0.K

Heating

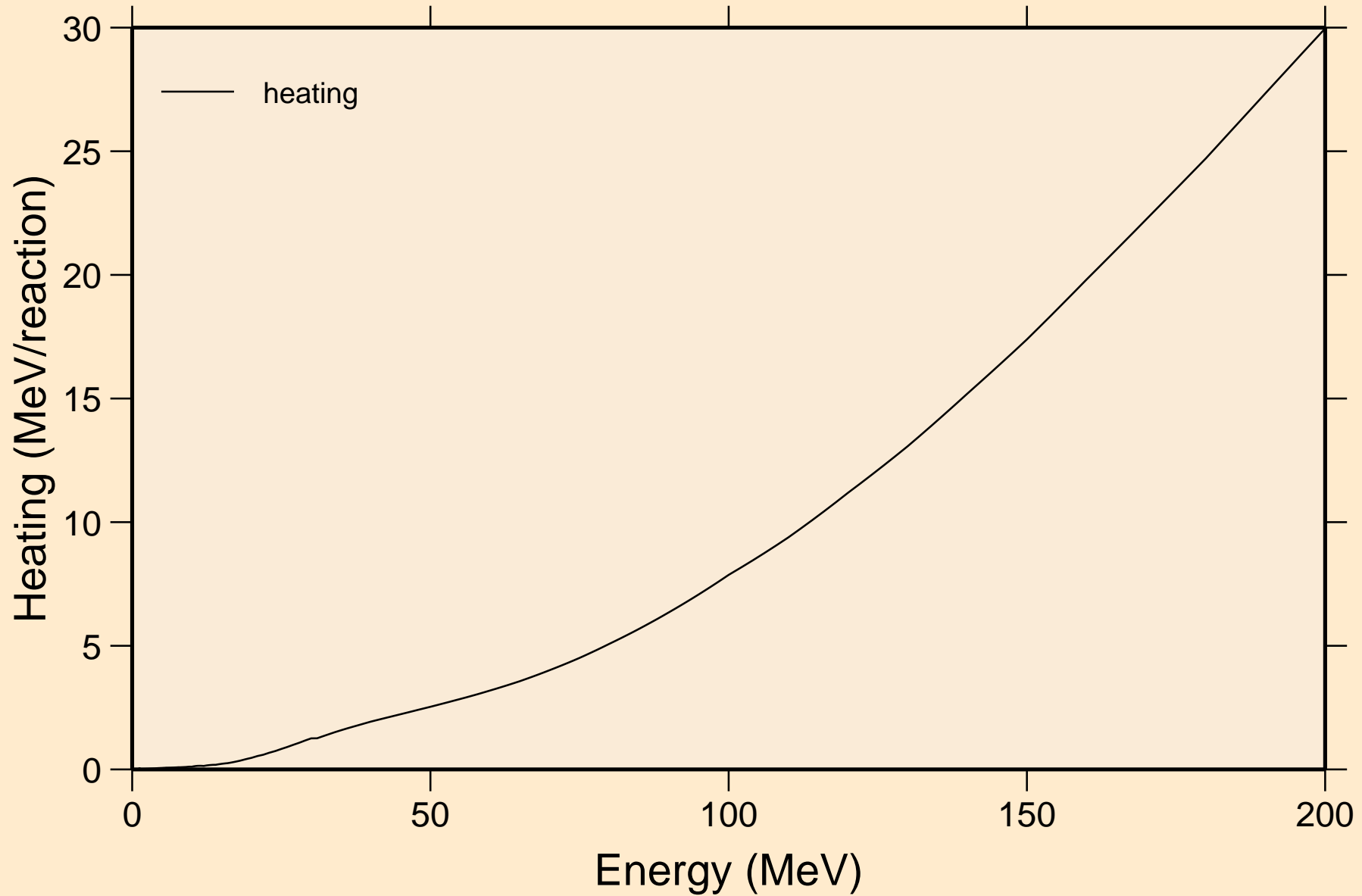

AG112 NEUTRON ACER TENDL-2024 LIBRARY; T=0.K

Damage

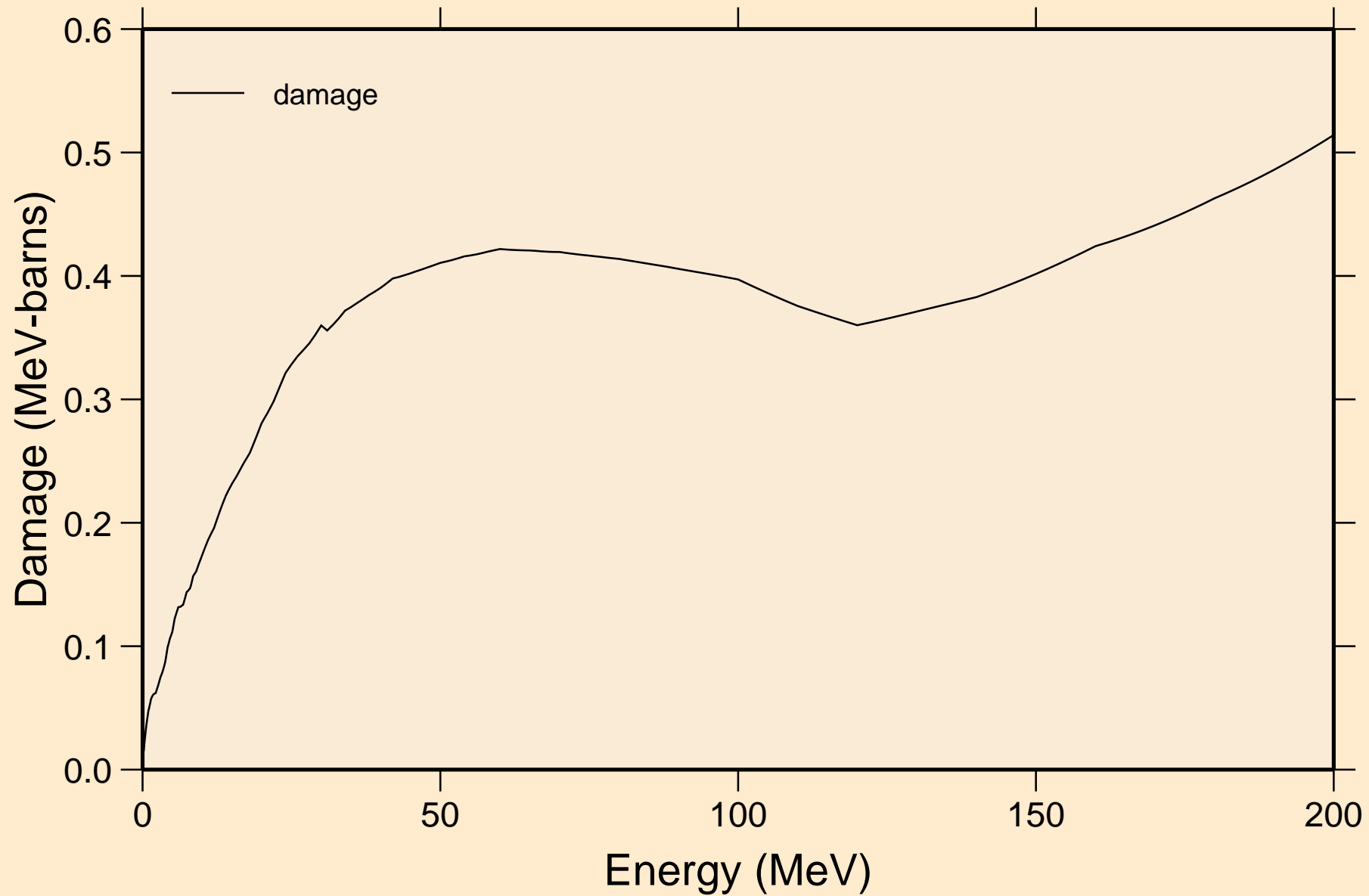

AG112 NEUTRON ACER TENDL-2024 LIBRARY; T=0.K

Non-threshold reactions

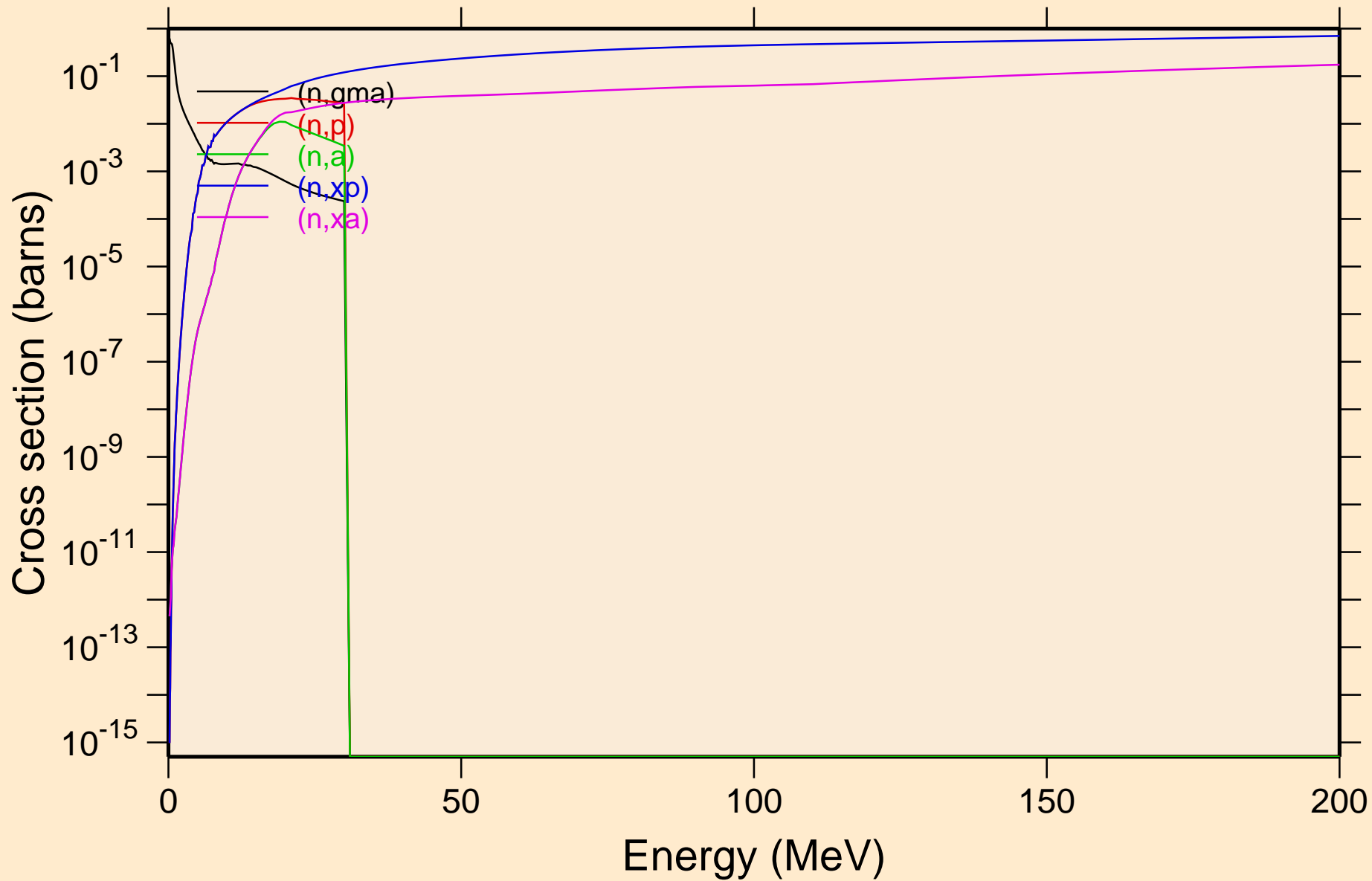

AG112 NEUTRON ACER TENDL-2024 LIBRARY; T=0.K

Inelastic levels

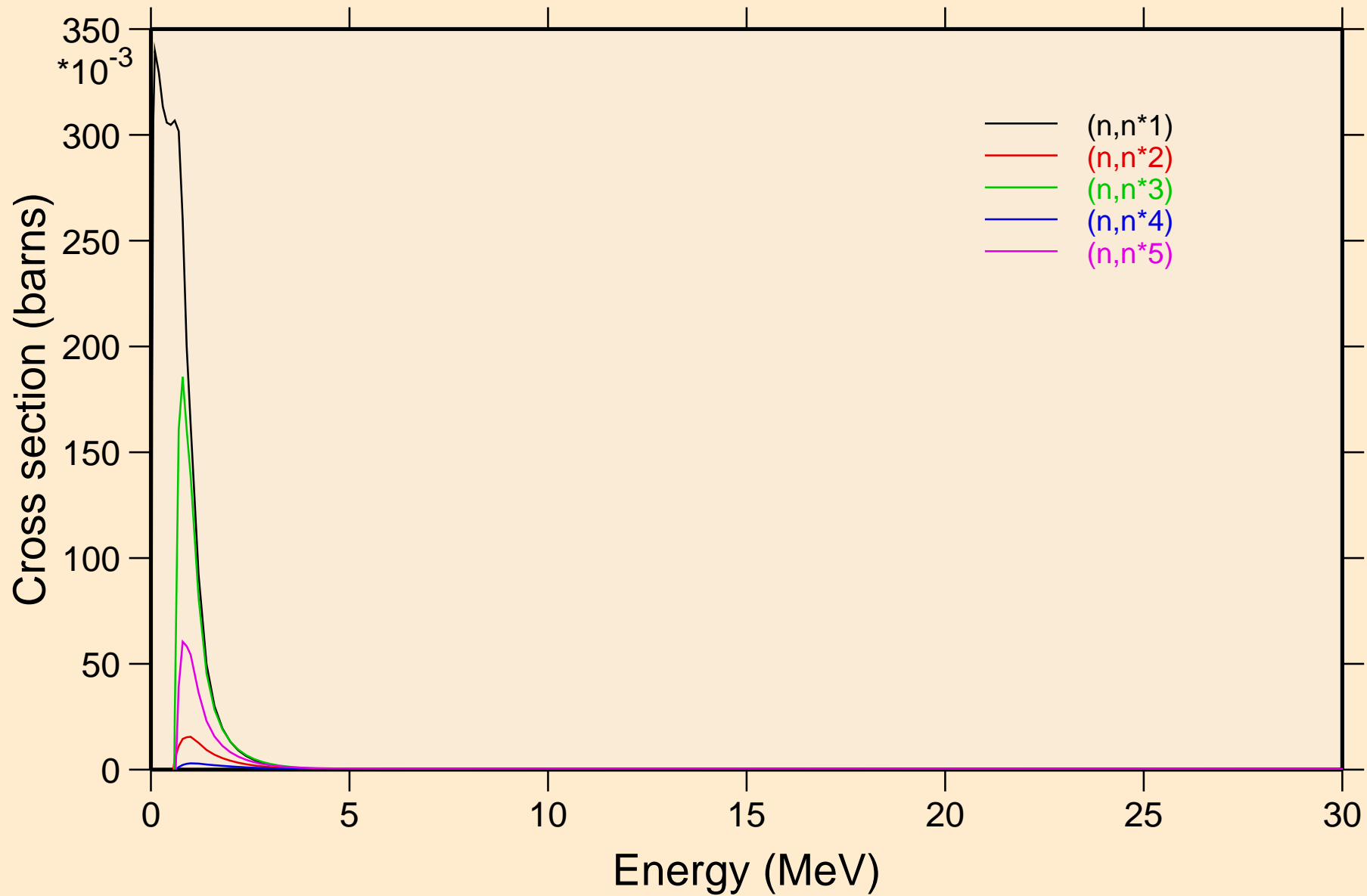

AG112 NEUTRON ACER TENDL-2024 LIBRARY; T=0.K

Inelastic levels

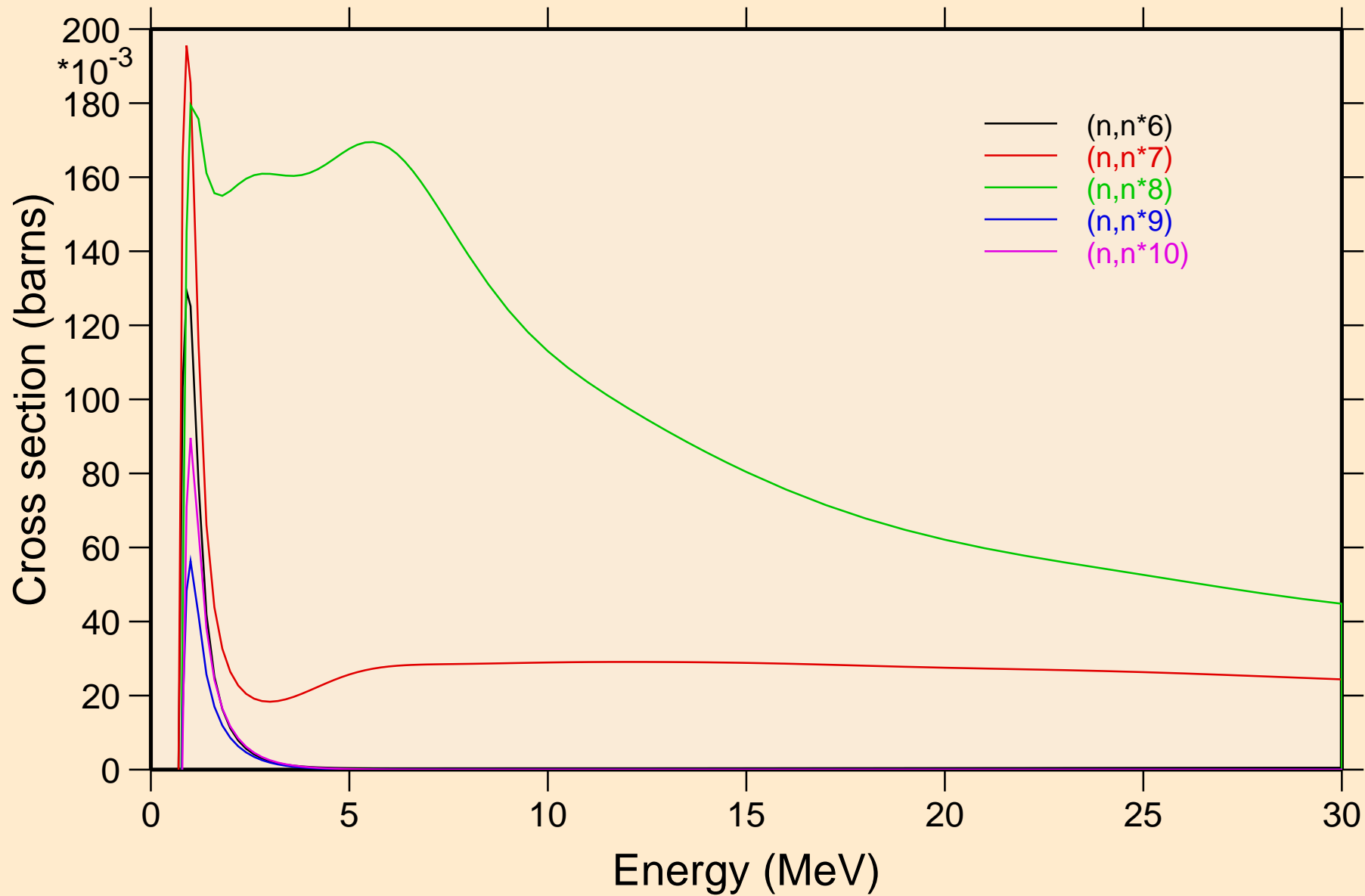

AG112 NEUTRON ACER TENDL-2024 LIBRARY; T=0.K
Inelastic levels

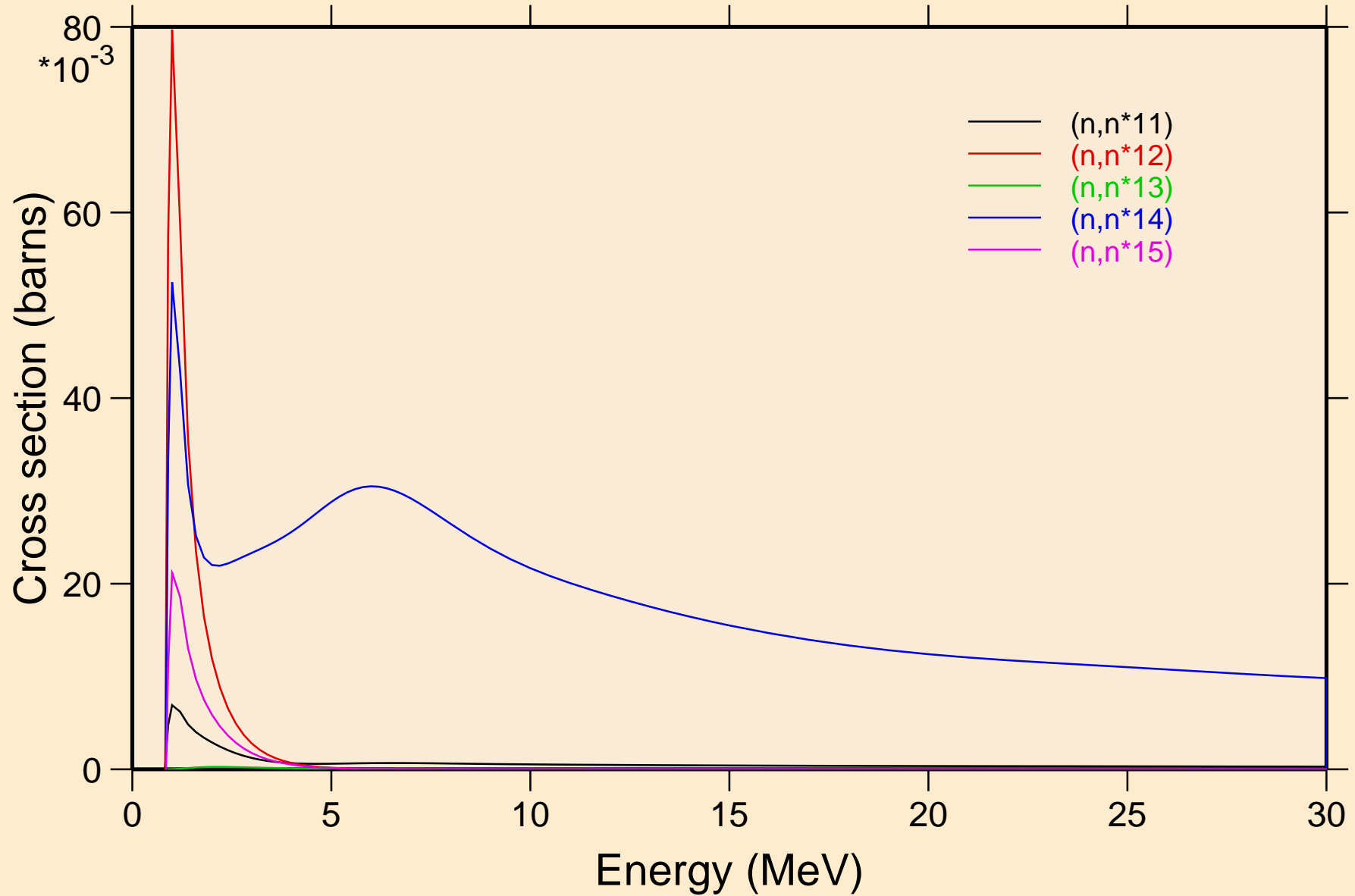

AG112 NEUTRON ACER TENDL-2024 LIBRARY; T=0.K

Inelastic levels

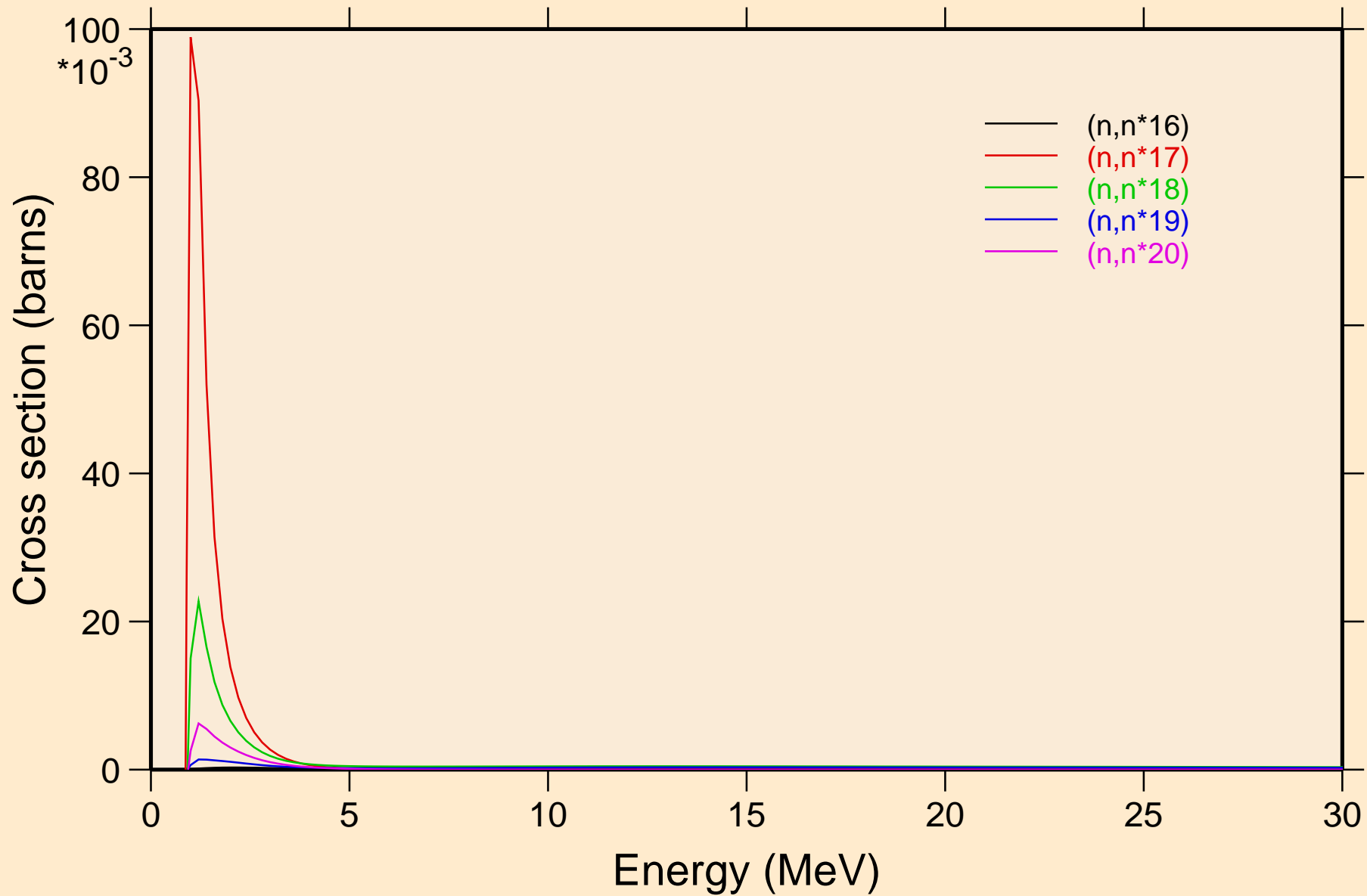

AG112 NEUTRON ACER TENDL-2024 LIBRARY; T=0.K
Inelastic levels

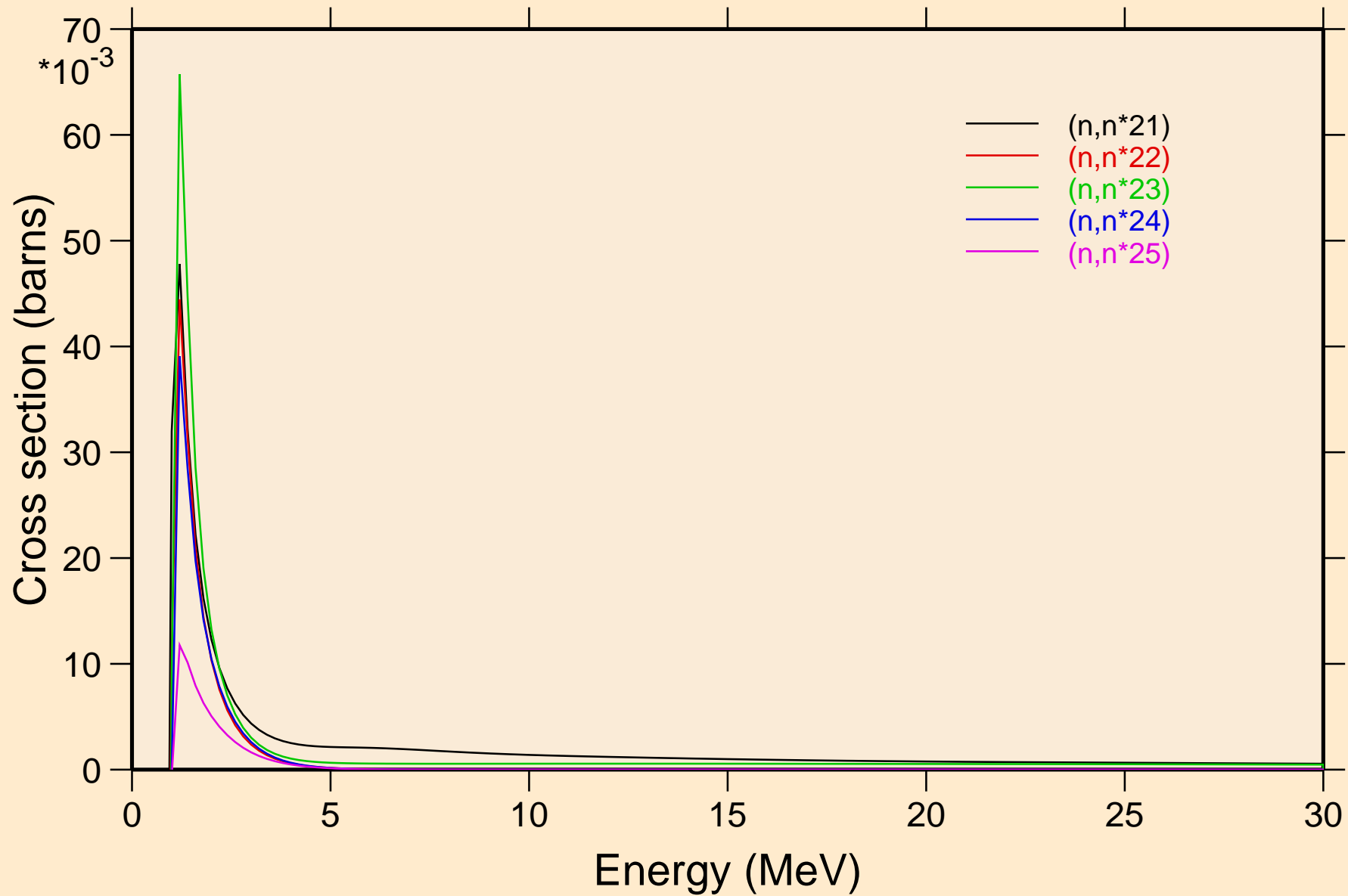

AG112 NEUTRON ACER TENDL-2024 LIBRARY; T=0.K
Inelastic levels

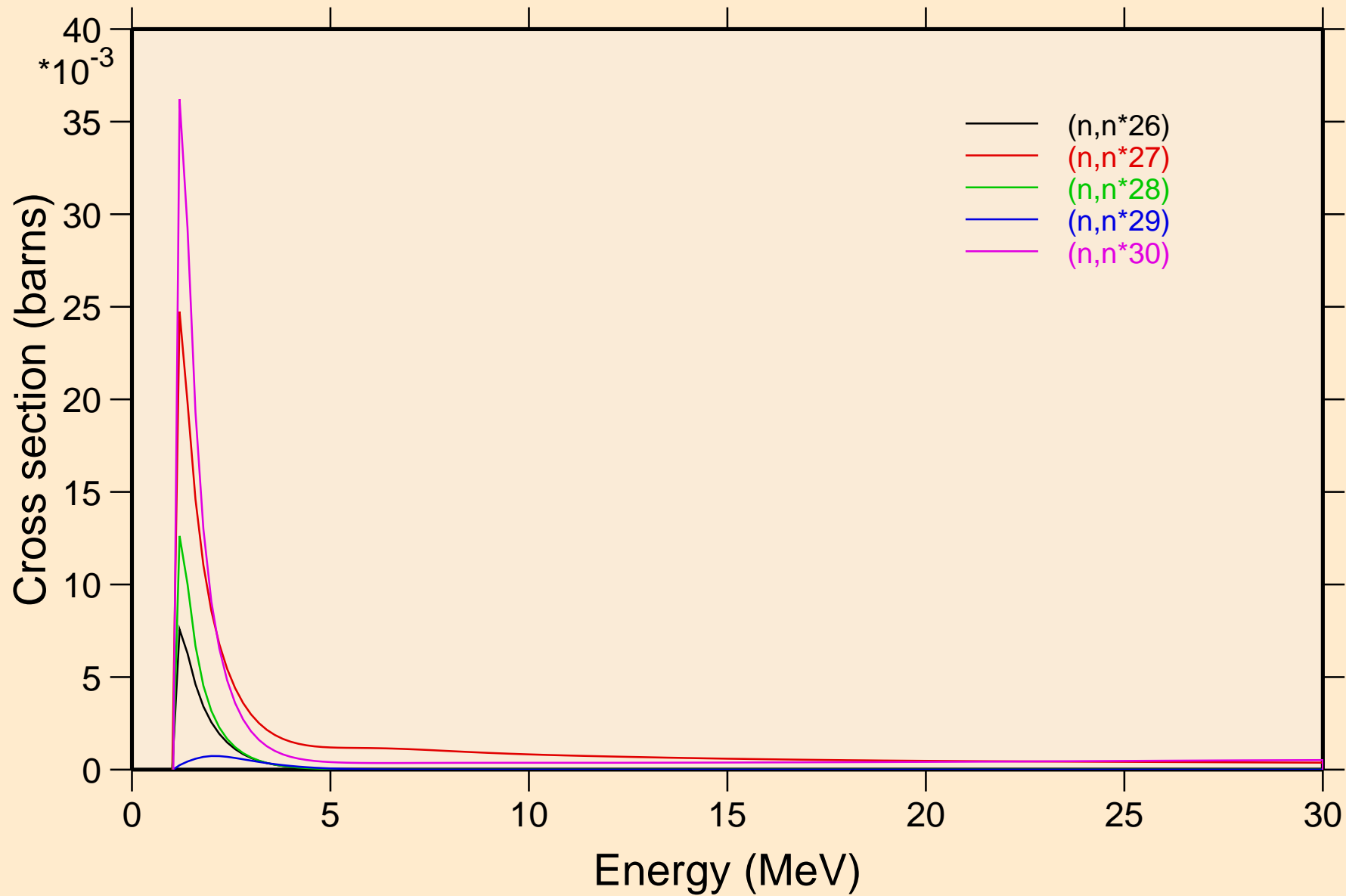

AG112 NEUTRON ACER TENDL-2024 LIBRARY; T=0.K

Threshold reactions

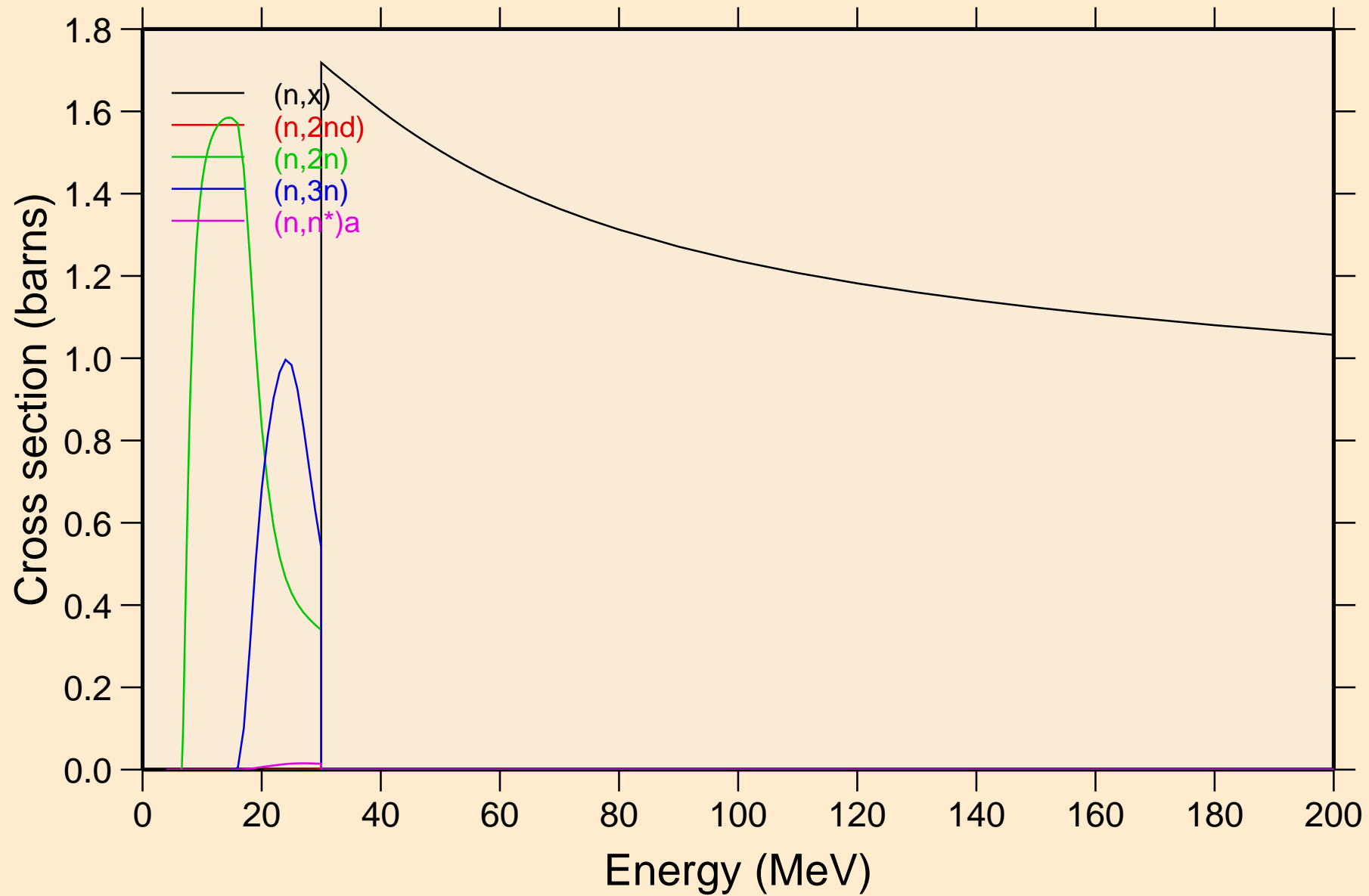

AG112 NEUTRON ACER TENDL-2024 LIBRARY; T=0.K

Threshold reactions

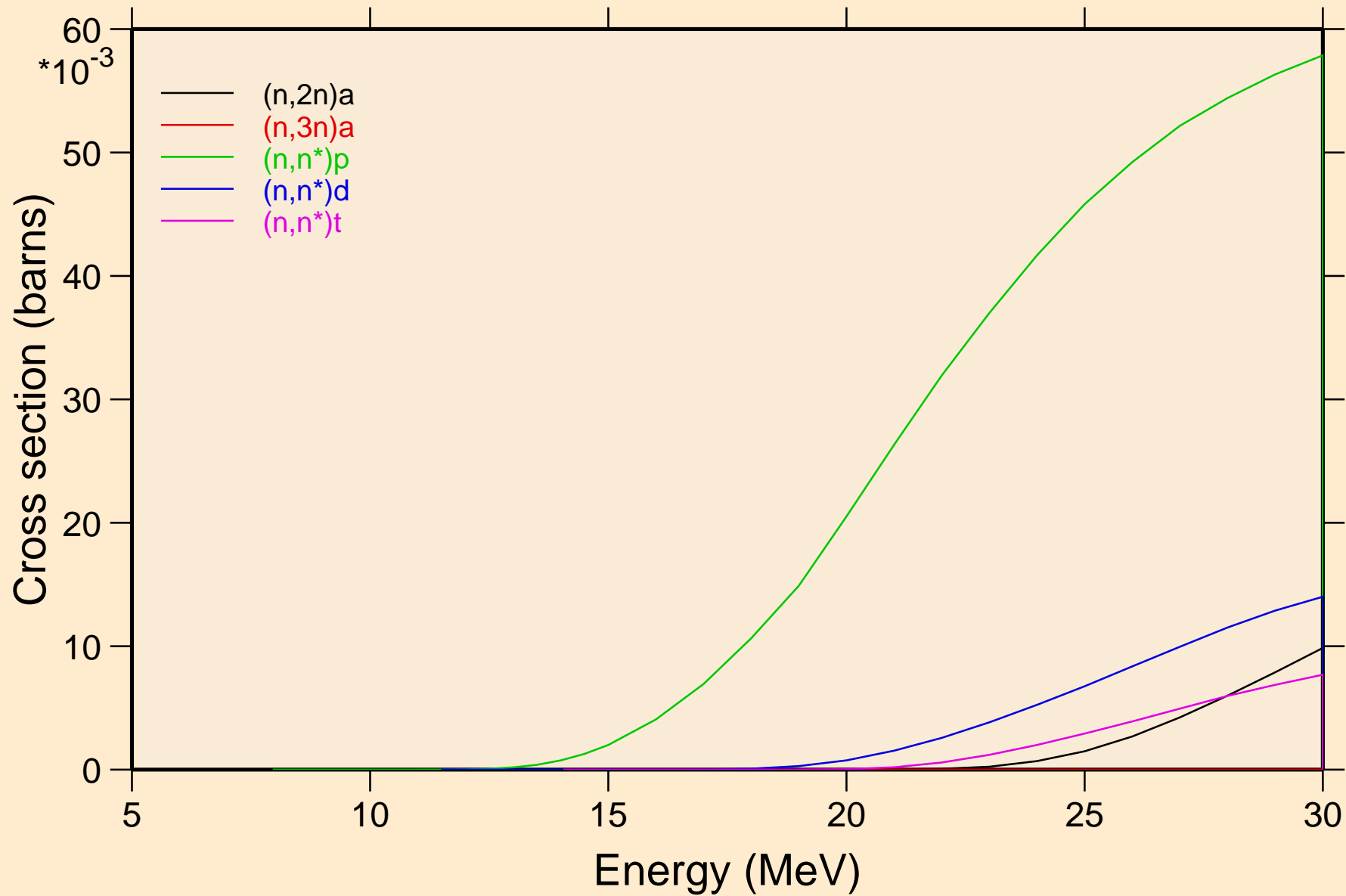

AG112 NEUTRON ACER TENDL-2024 LIBRARY; T=0.K
Threshold reactions

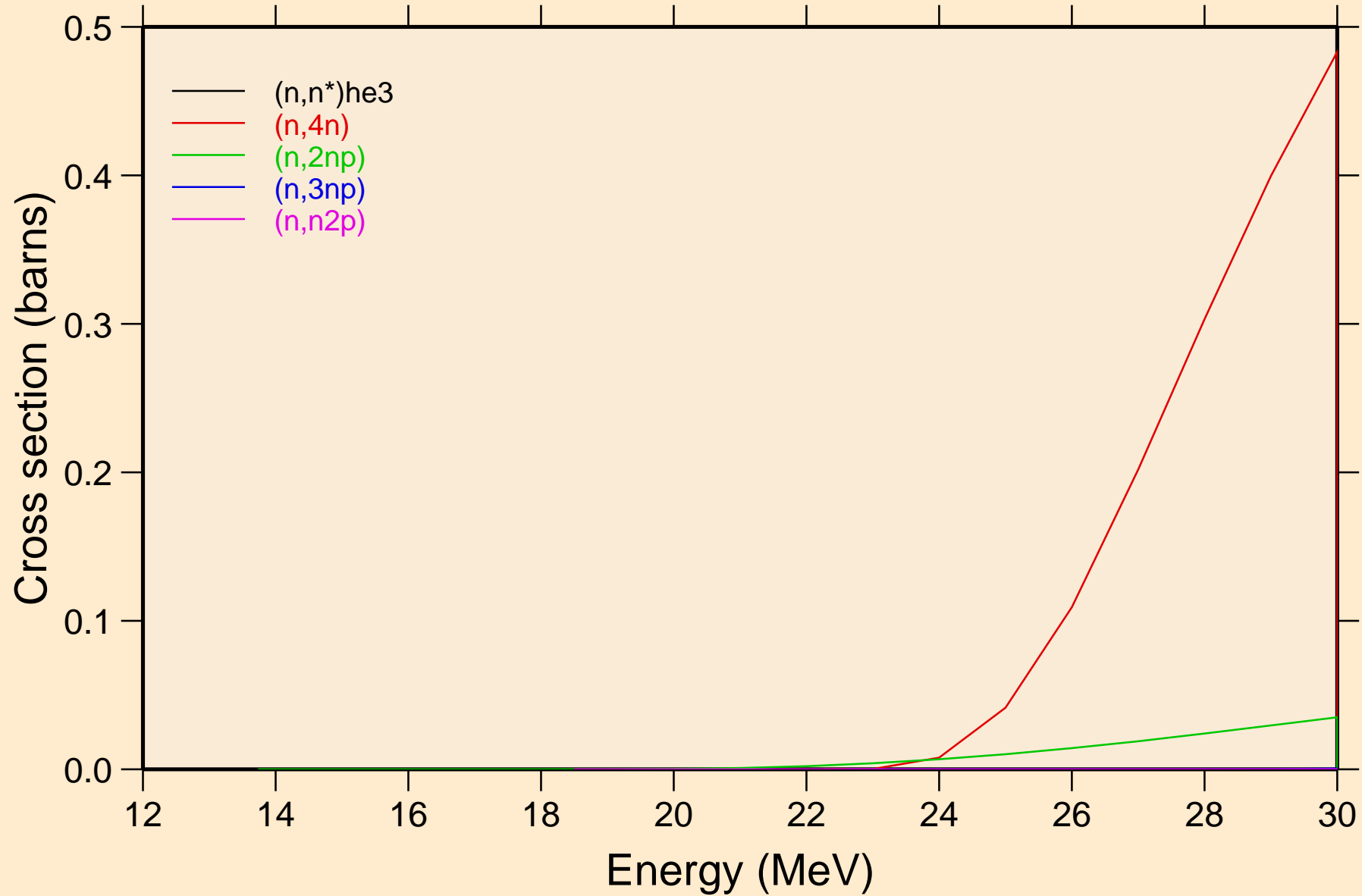

AG112 NEUTRON ACER TENDL-2024 LIBRARY; T=0.K
Threshold reactions

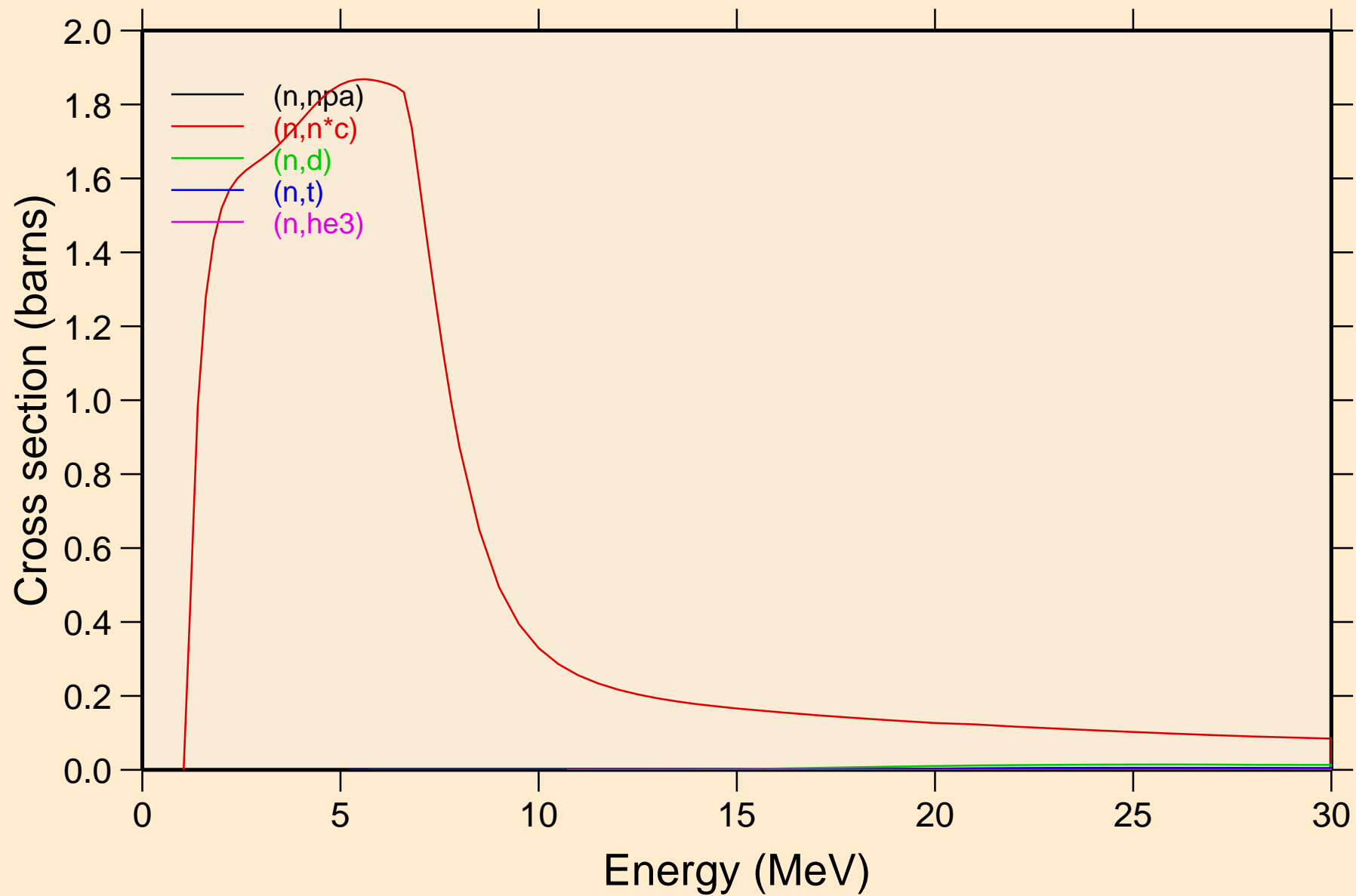

AG112 NEUTRON ACER TENDL-2024 LIBRARY; T=0.K
Threshold reactions

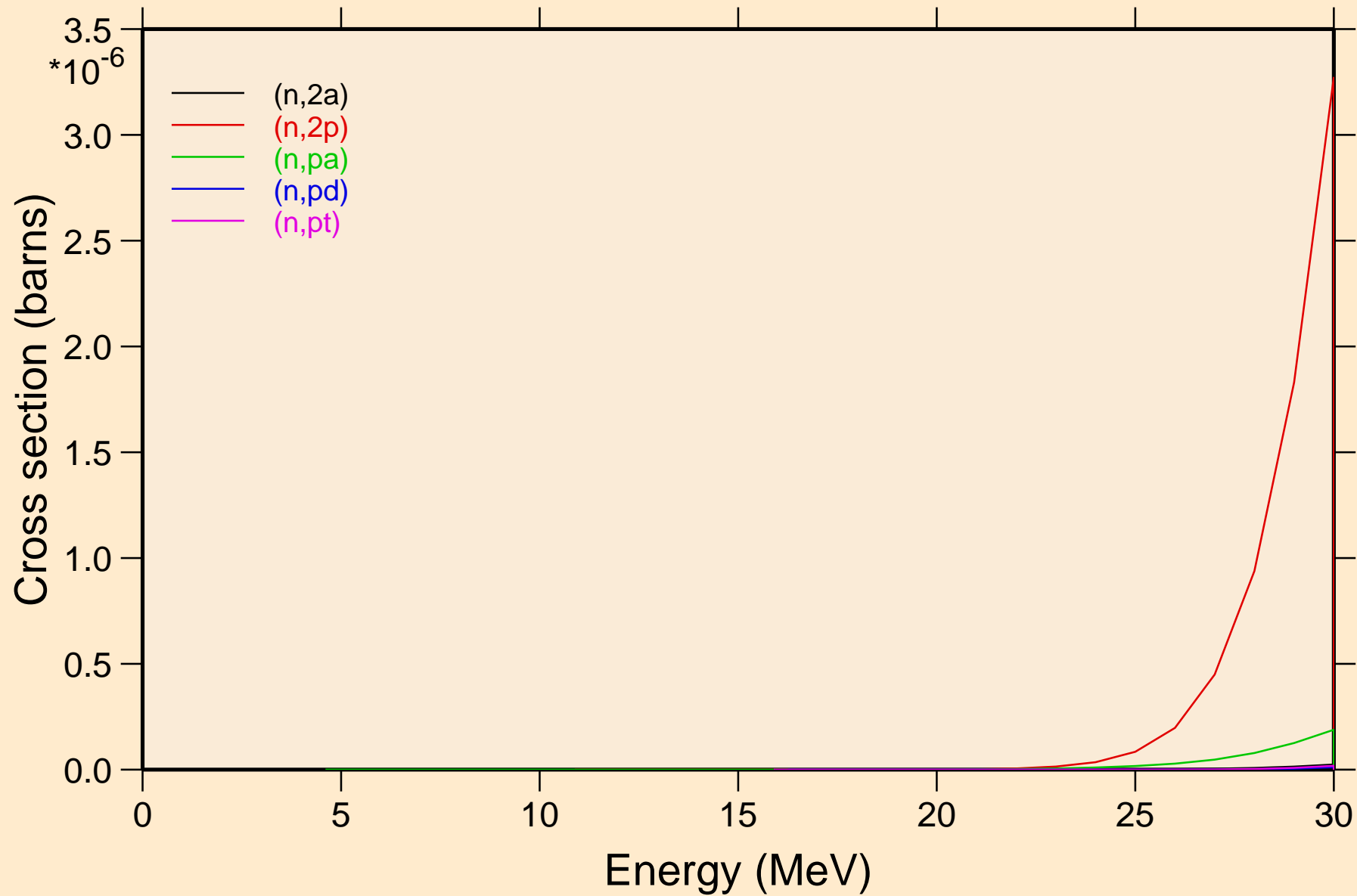

AG112 NEUTRON ACER TENDL-2024 LIBRARY; T=0.K
Threshold reactions

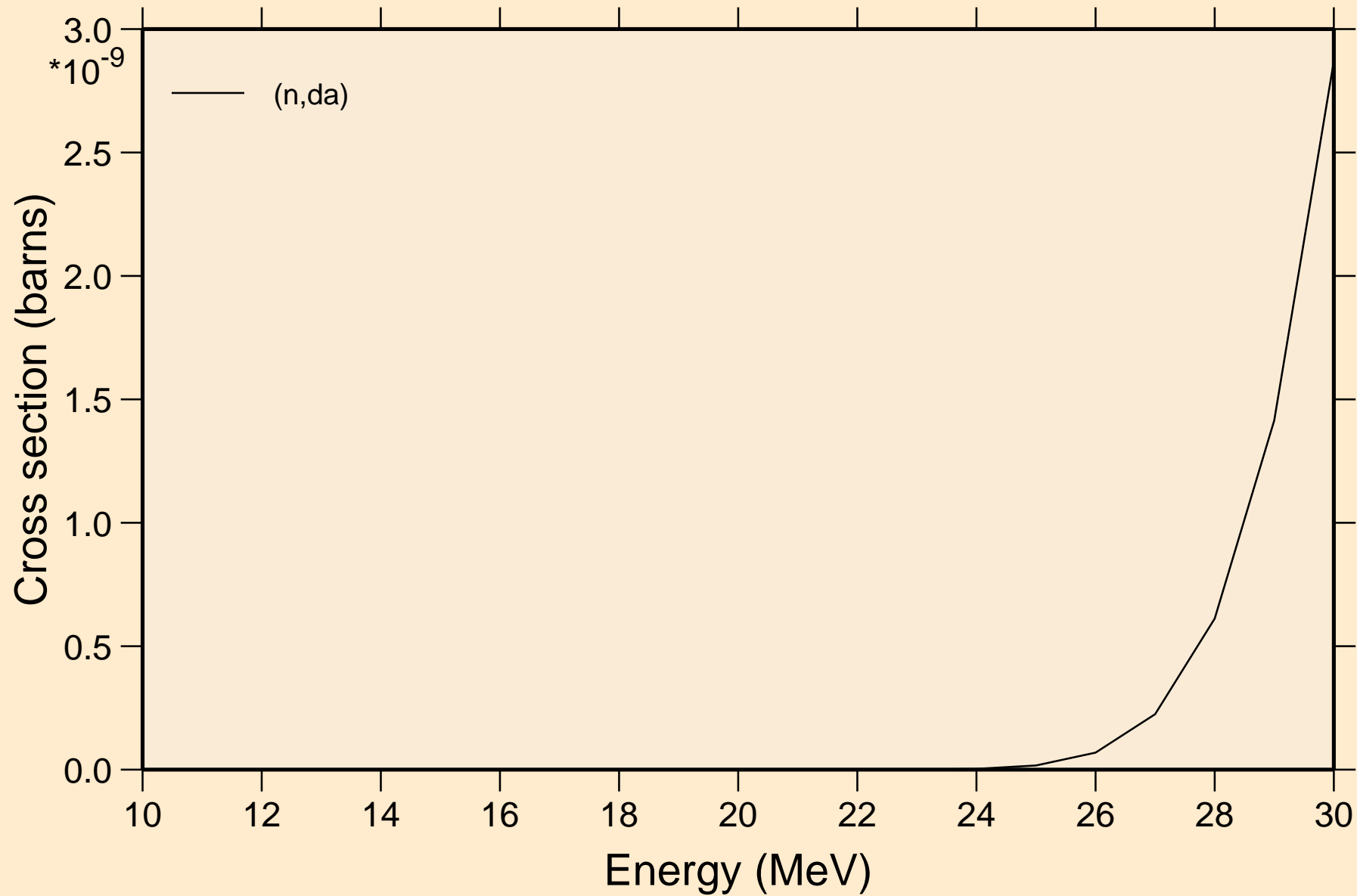

AG112 NEUTRON ACER TENDL-2024 LIBRARY; T=0.K

Threshold reactions

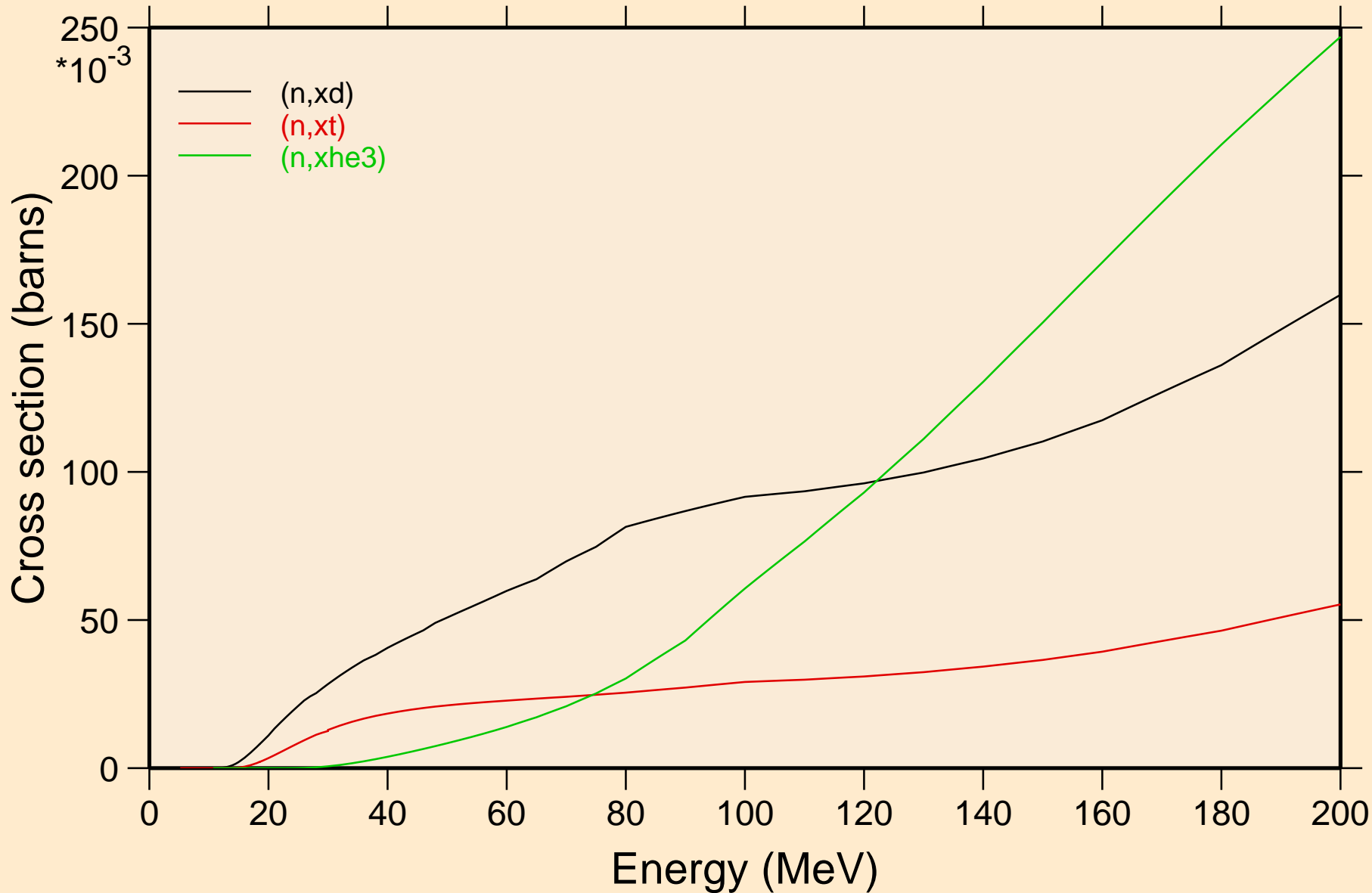

AG112 NEUTRON ACER TENDL-2024 LIBRARY; T=0.K
angular distribution for elastic

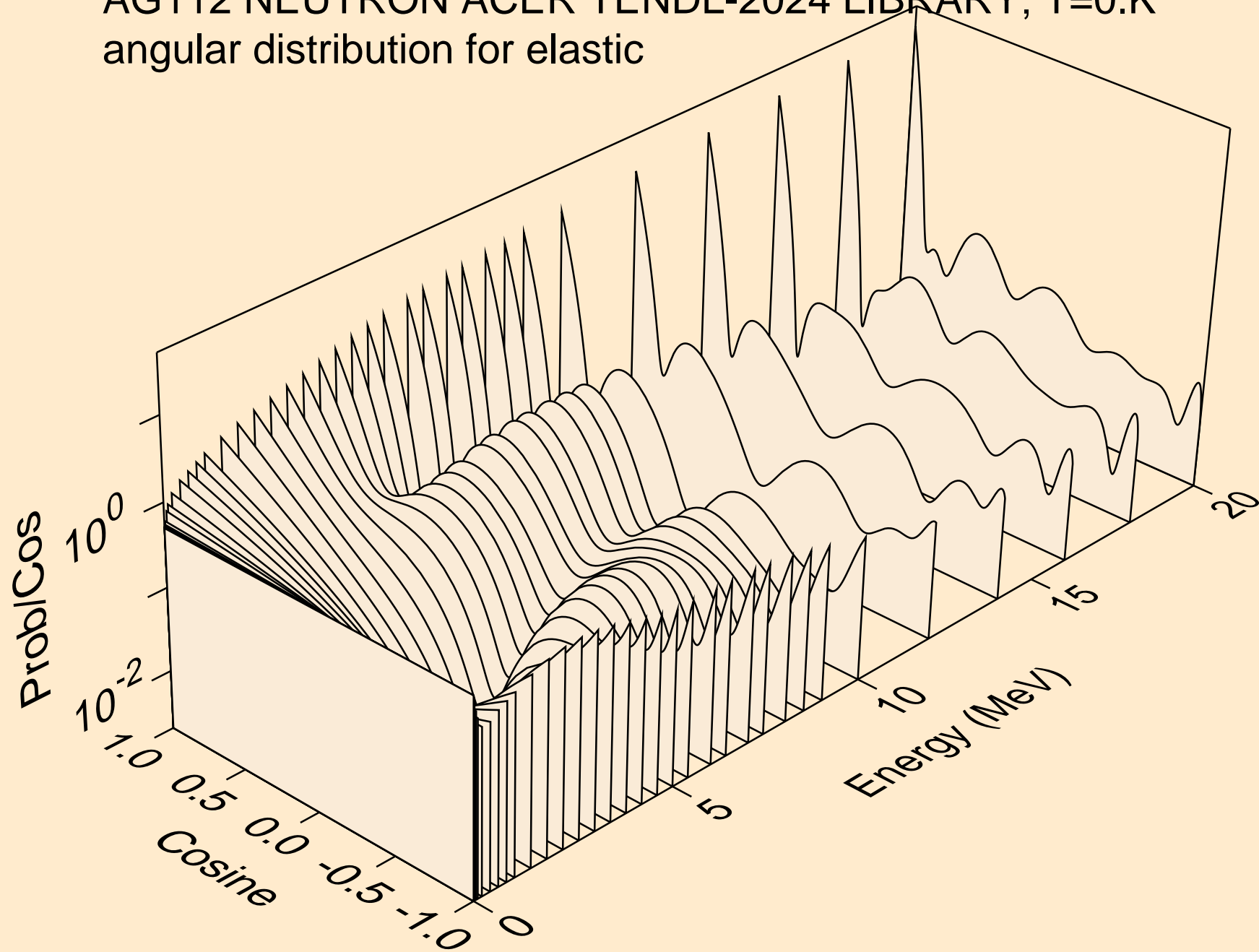

AG112 NEUTRON ACER TENDL-2024 LIBRARY; T=0.K
angular distribution for elastic

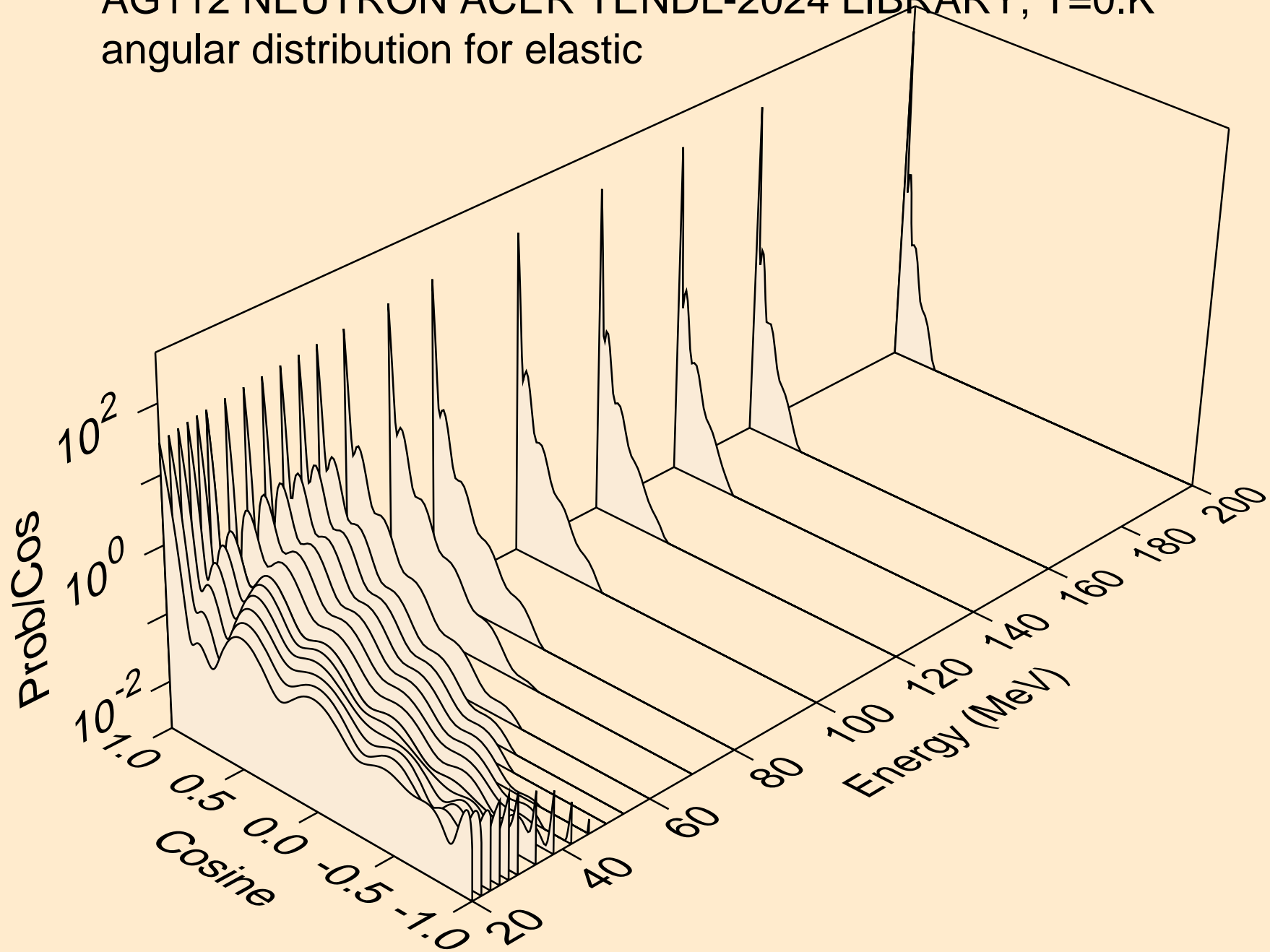

AG112 NEUTRON ACER TENDL-2024 LIBRARY; T=0.K
angular distribution for (n,n*1)

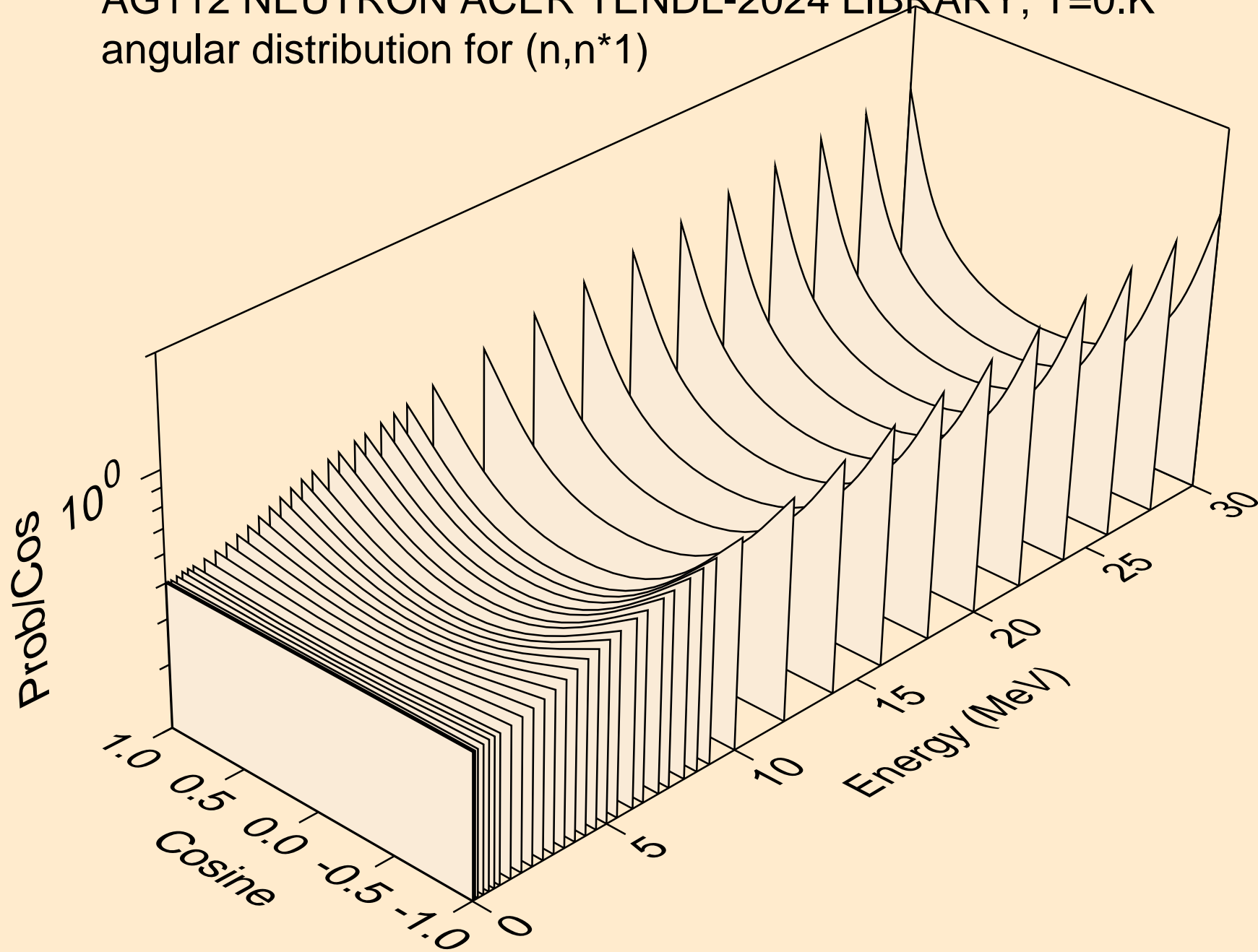

AG112 NEUTRON ACER TENDL-2024 LIBRARY; T=0.K
angular distribution for (n,n*2)

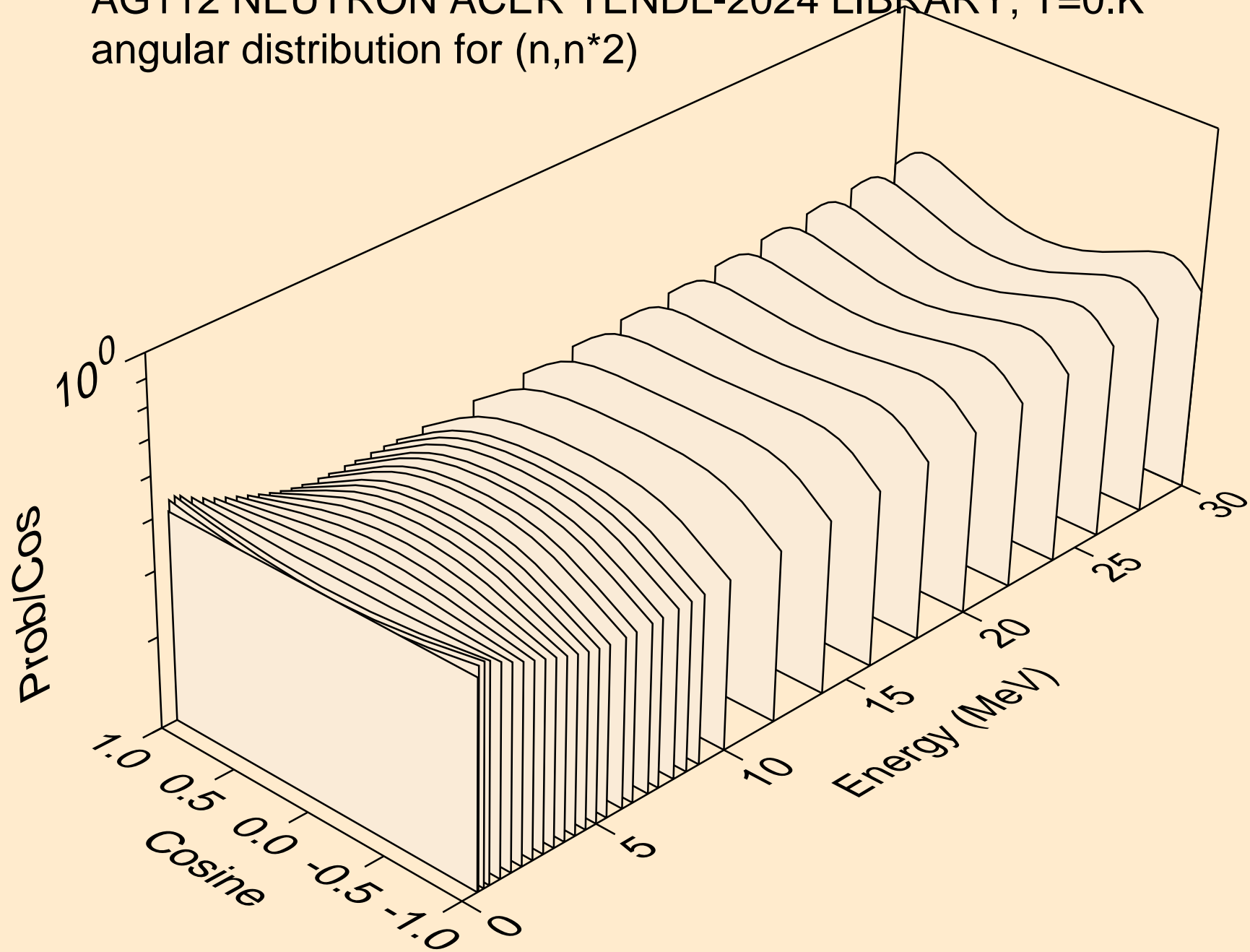

AG112 NEUTRON ACER TENDL-2024 LIBRARY; T=0.K
angular distribution for (n,n*3)

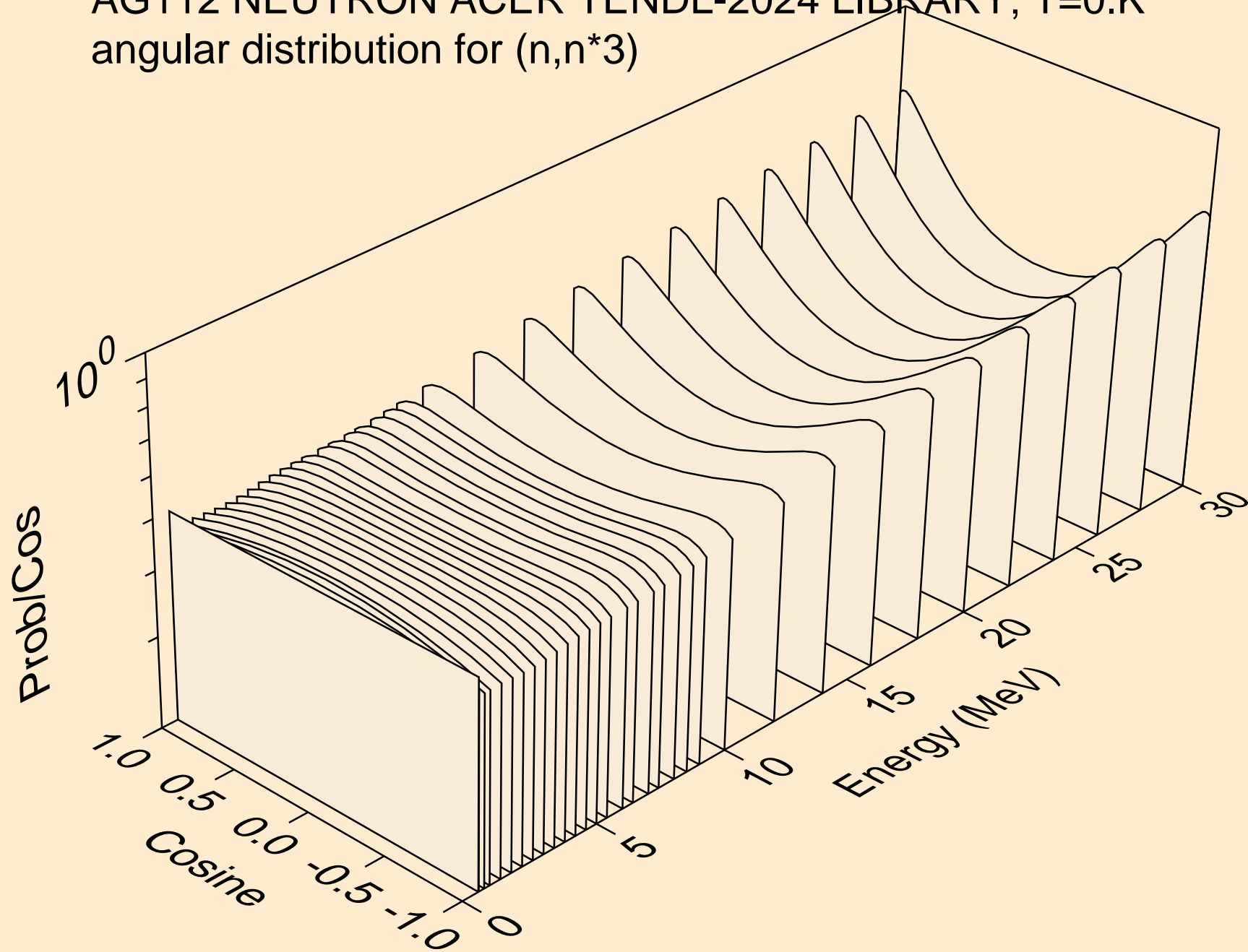

AG112 NEUTRON ACER TENDL-2024 LIBRARY; T=0.K
angular distribution for (n,n*4)

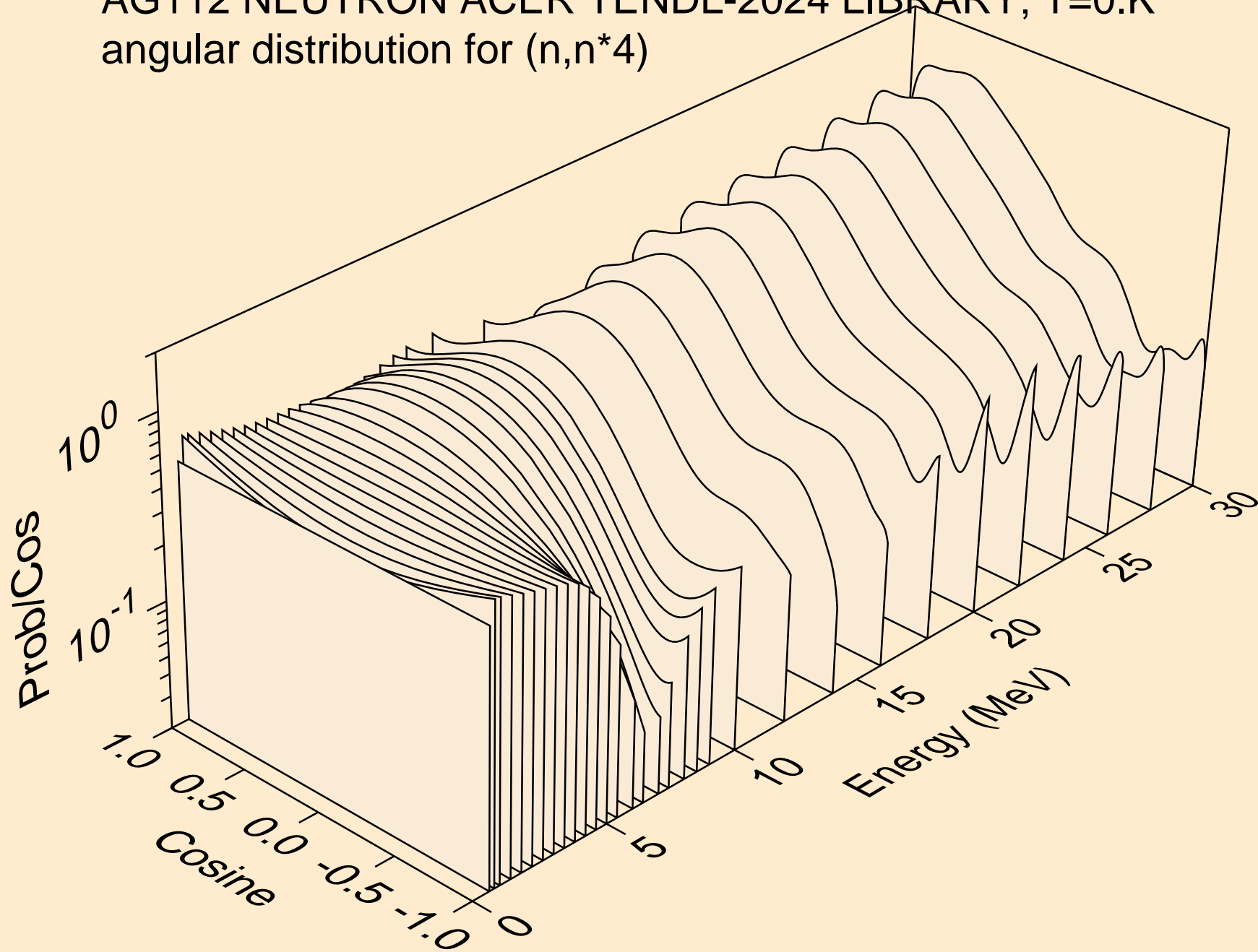

AG112 NEUTRON ACER TENDL-2024 LIBRARY; T=0.K
angular distribution for (n,n*5)

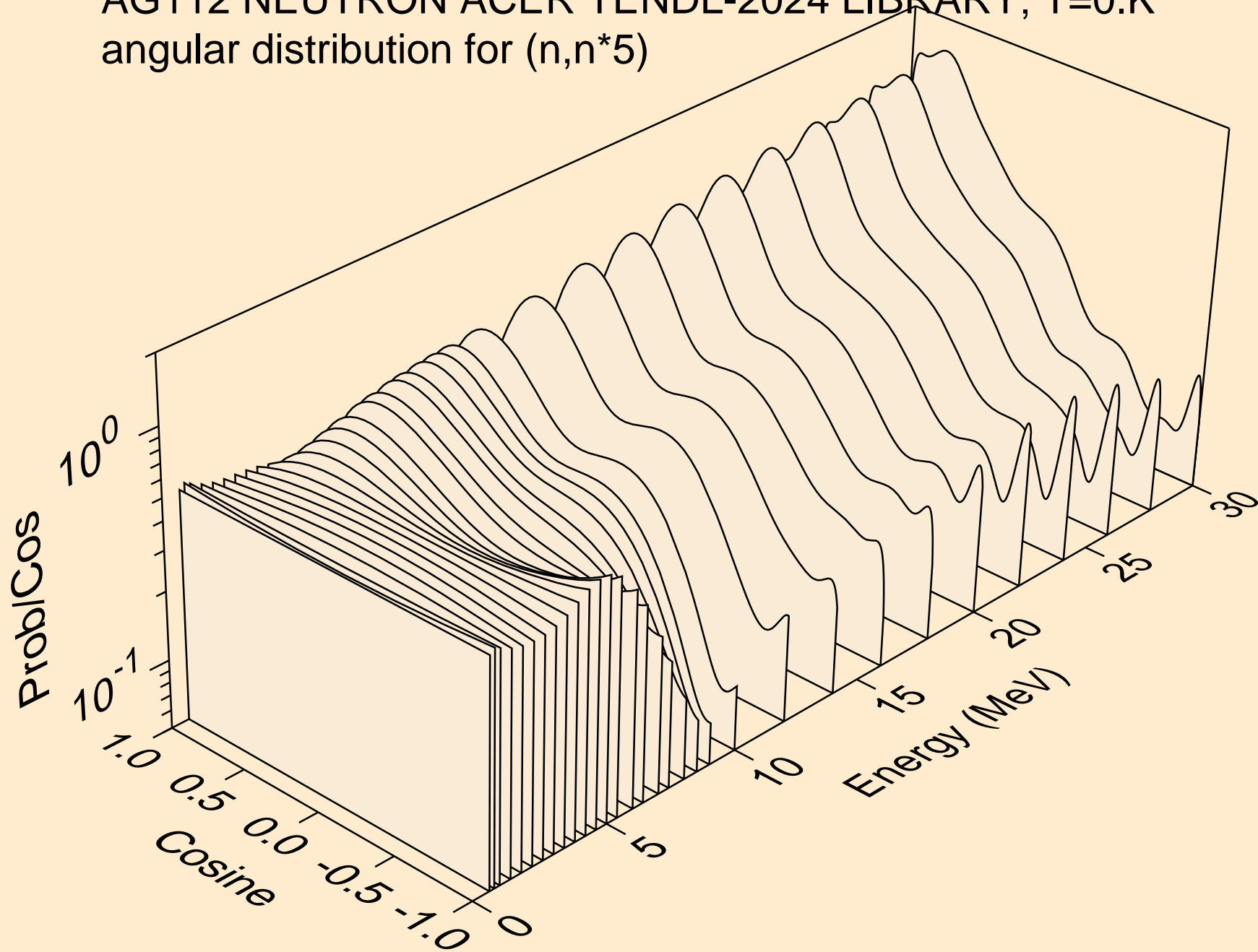

AG112 NEUTRON ACER TENDL-2024 LIBRARY; T=0.K
angular distribution for (n,n*6)

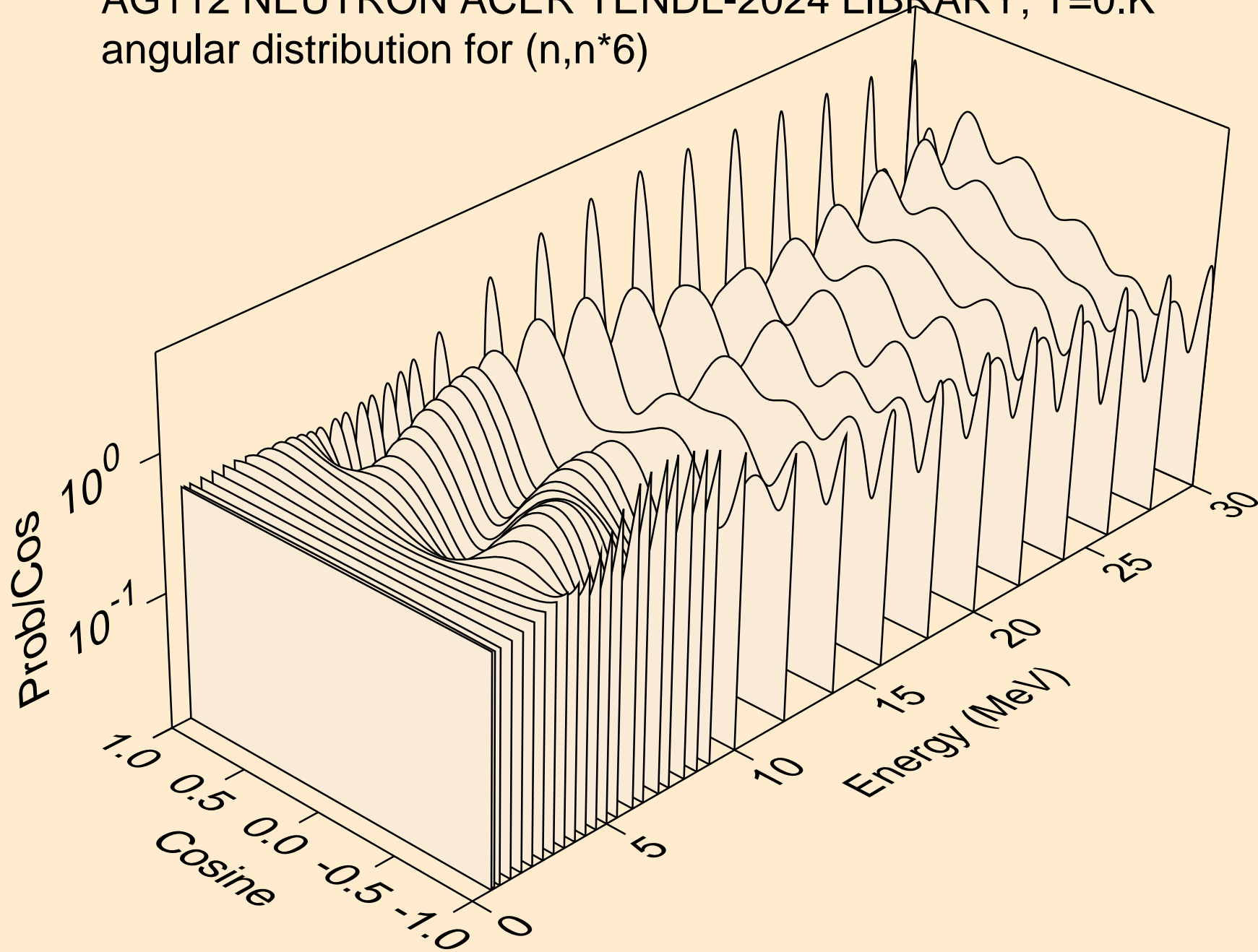

AG112 NEUTRON ACER TENDL-2024 LIBRARY; T=0.K
angular distribution for (n,n*7)

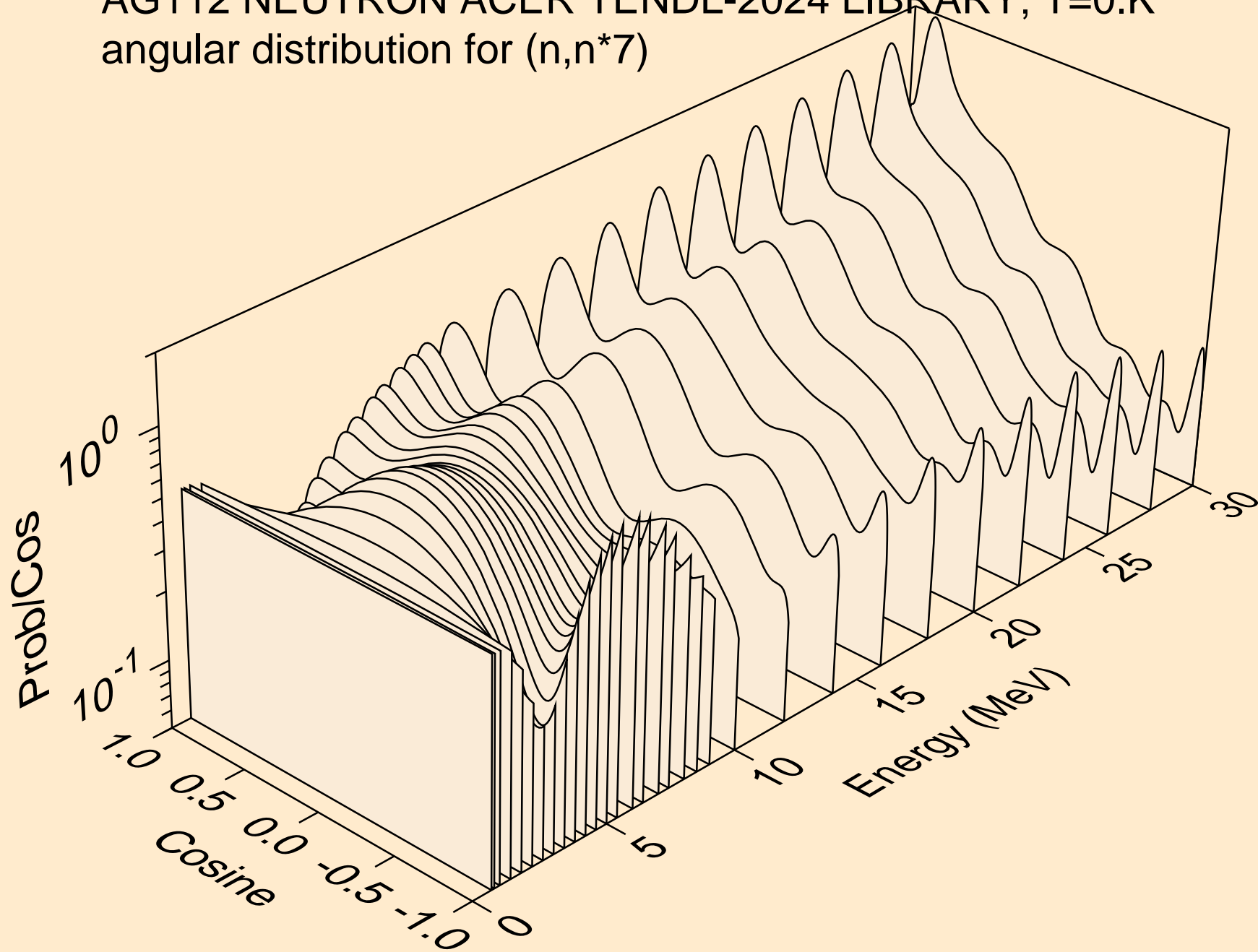

AG112 NEUTRON ACER TENDL-2024 LIBRARY; T=0.K
angular distribution for (n,n*8)

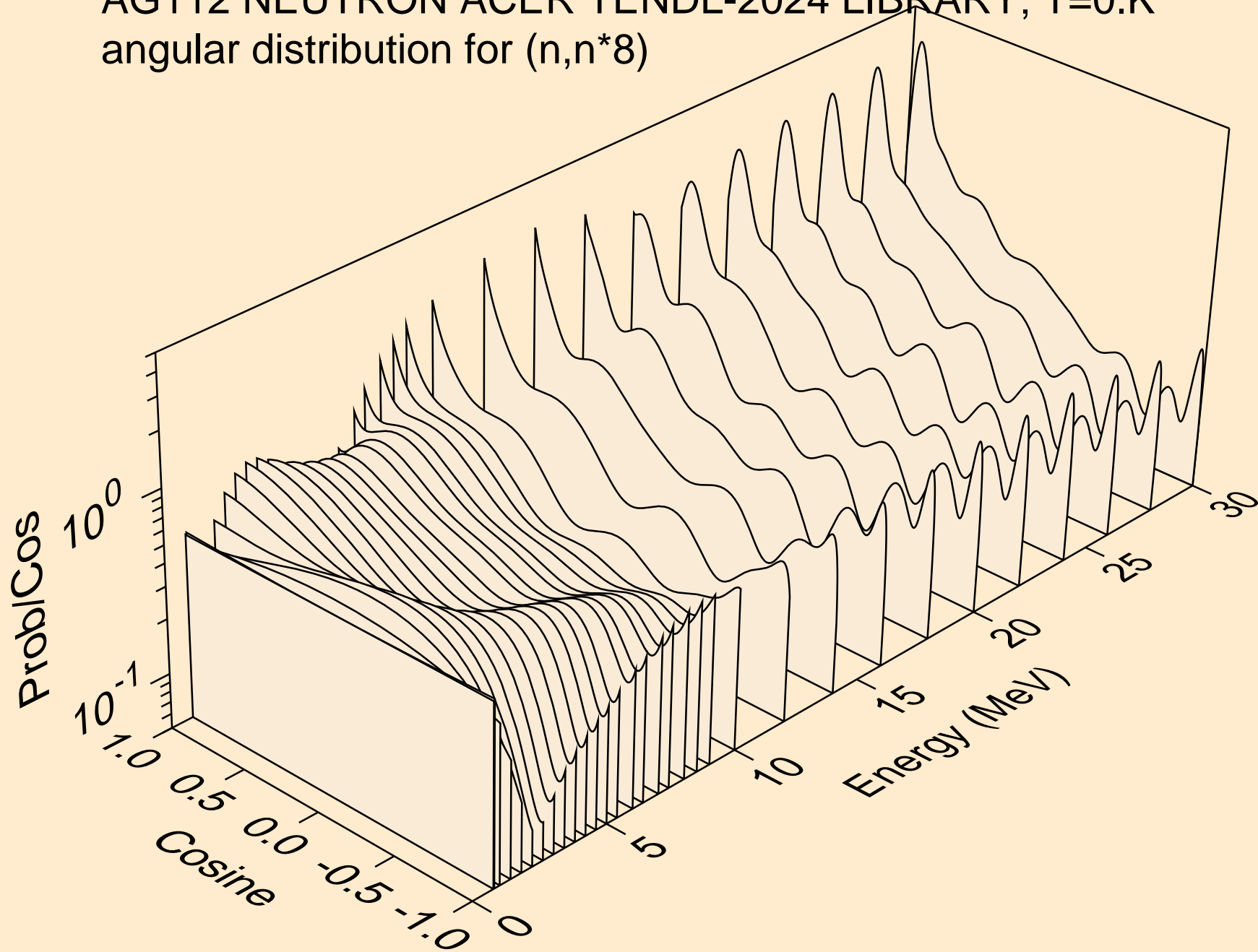

AG112 NEUTRON ACER TENDL-2024 LIBRARY; T=0.K
angular distribution for (n,n*9)

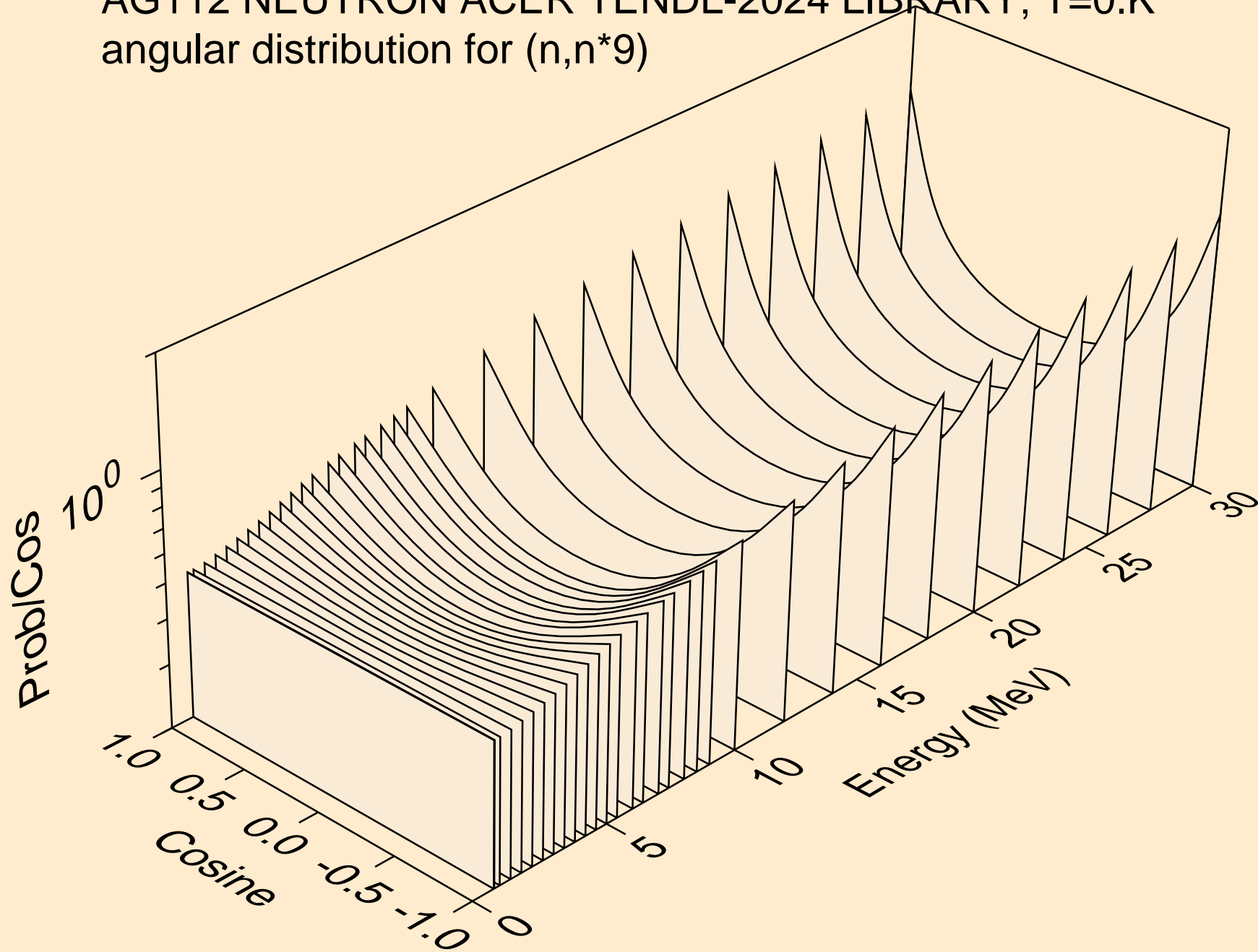

AG112 NEUTRON ACER TENDL-2024 LIBRARY; T=0.K
angular distribution for (n,n*10)

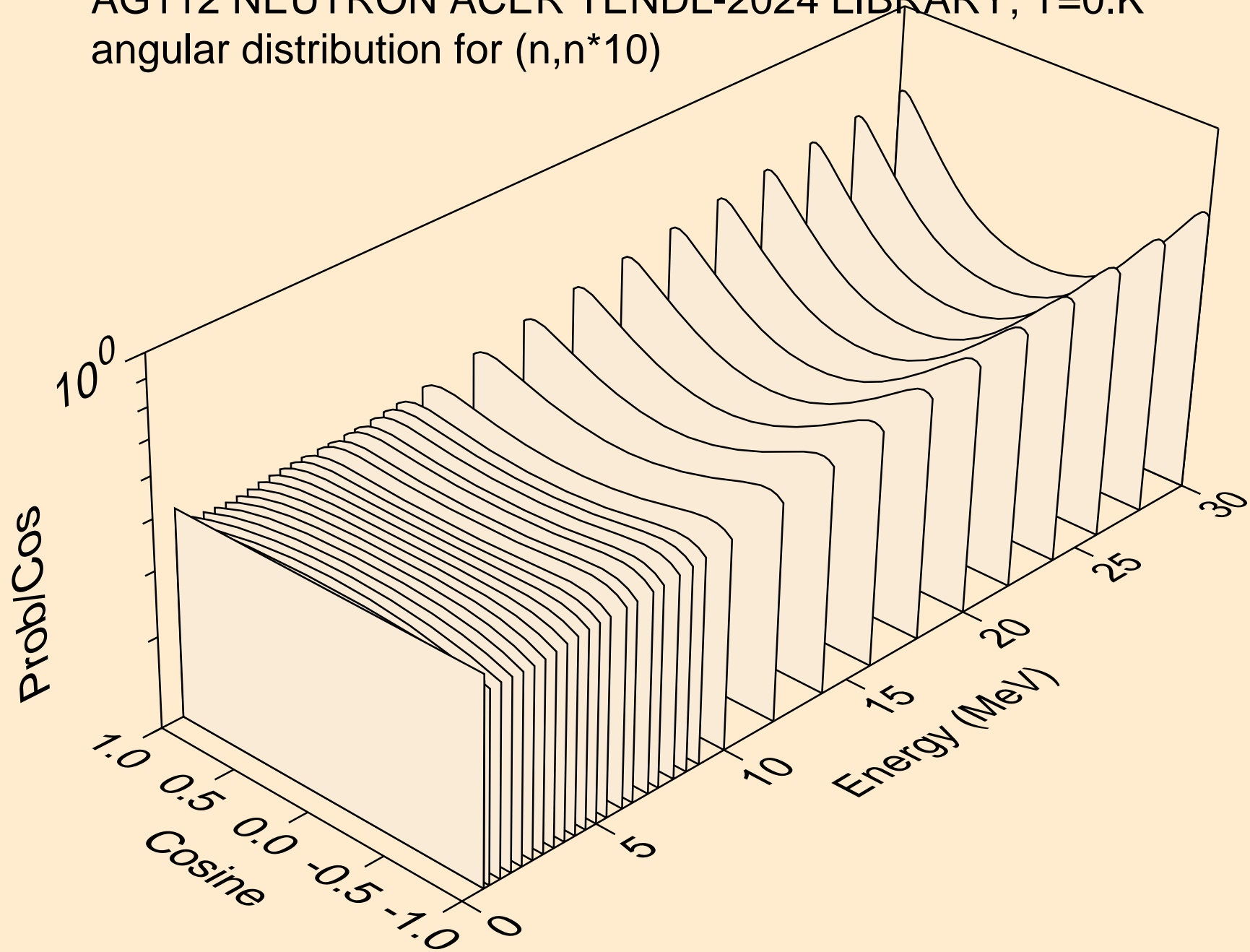

AG112 NEUTRON ACER TENDL-2024 LIBRARY; T=0.K
angular distribution for (n,n*11)

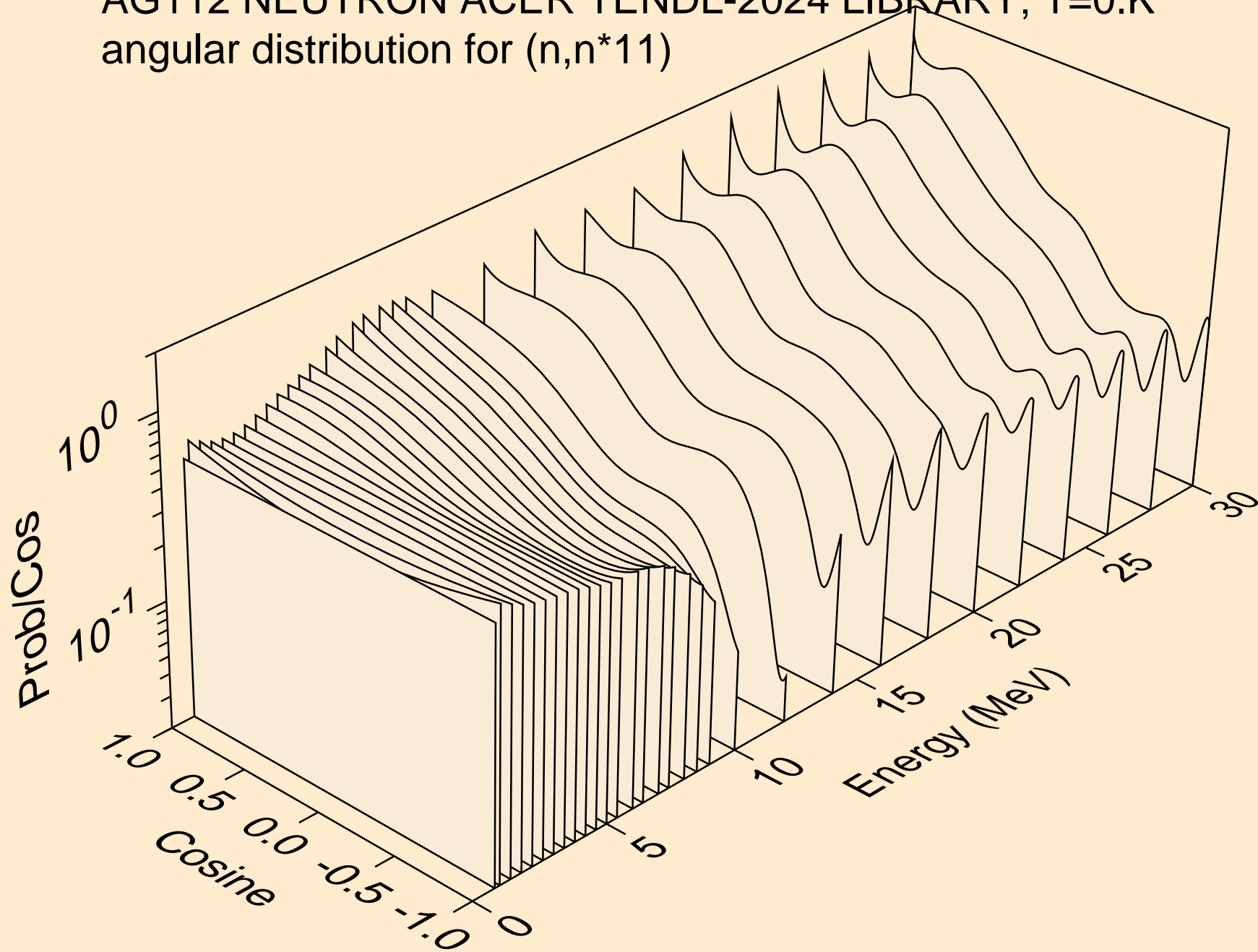

AG112 NEUTRON ACER TENDL-2024 LIBRARY; T=0.K
angular distribution for (n,n*12)

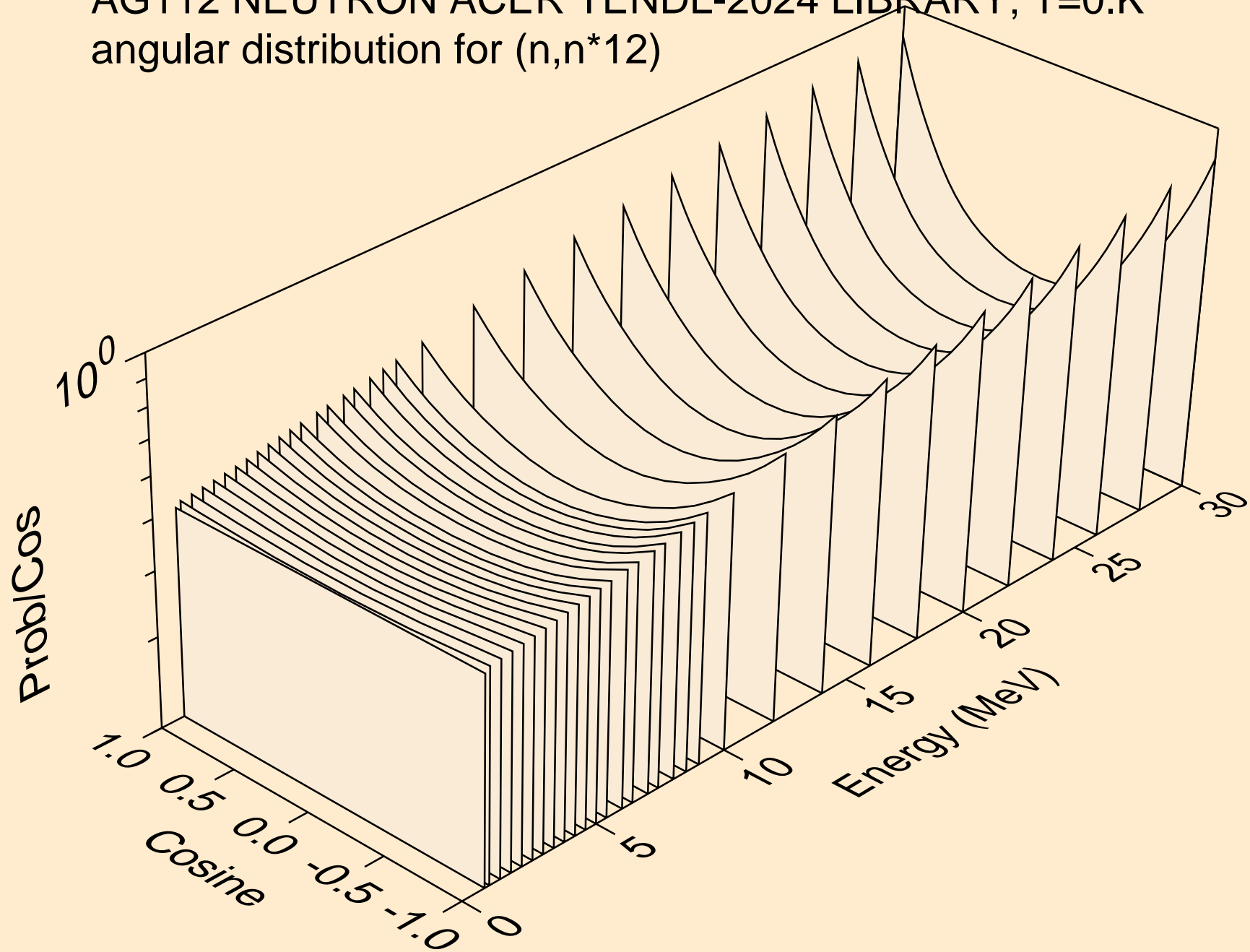

AG112 NEUTRON ACER TENDL-2024 LIBRARY; T=0.K
angular distribution for (n,n*13)

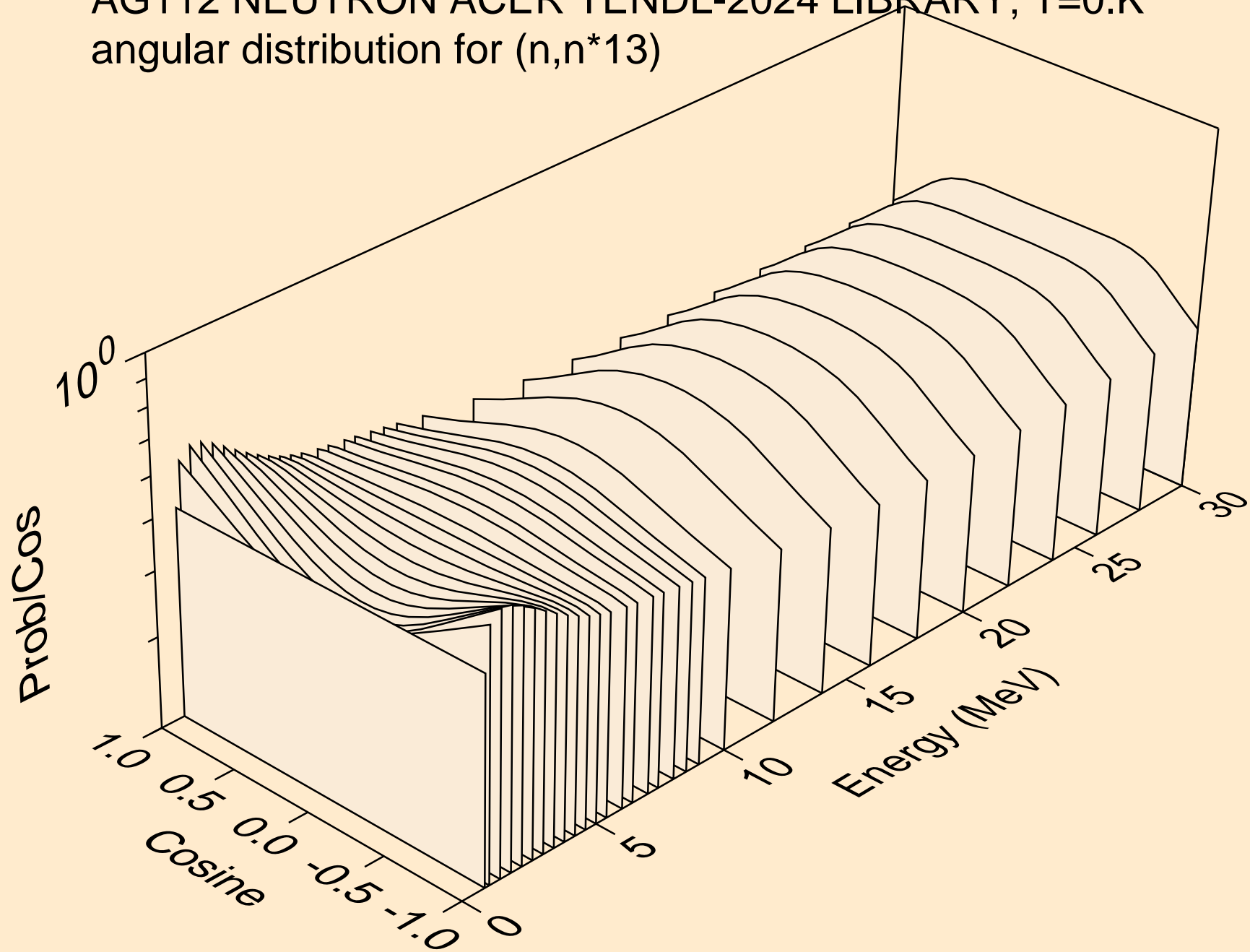

AG112 NEUTRON ACER TENDL-2024 LIBRARY; T=0.K
angular distribution for (n,n*14)

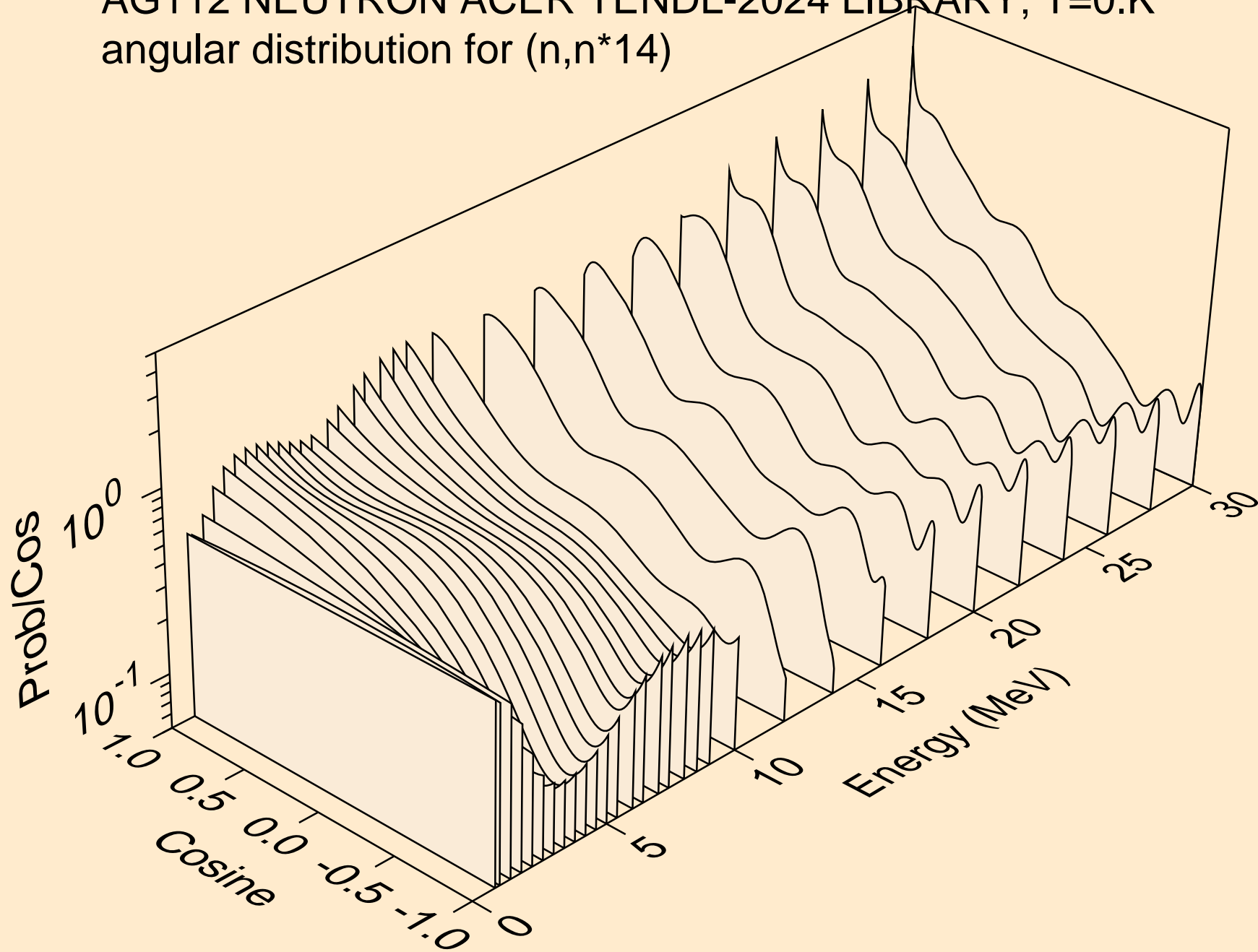

AG112 NEUTRON ACER TENDL-2024 LIBRARY; T=0.K
angular distribution for (n,n*15)

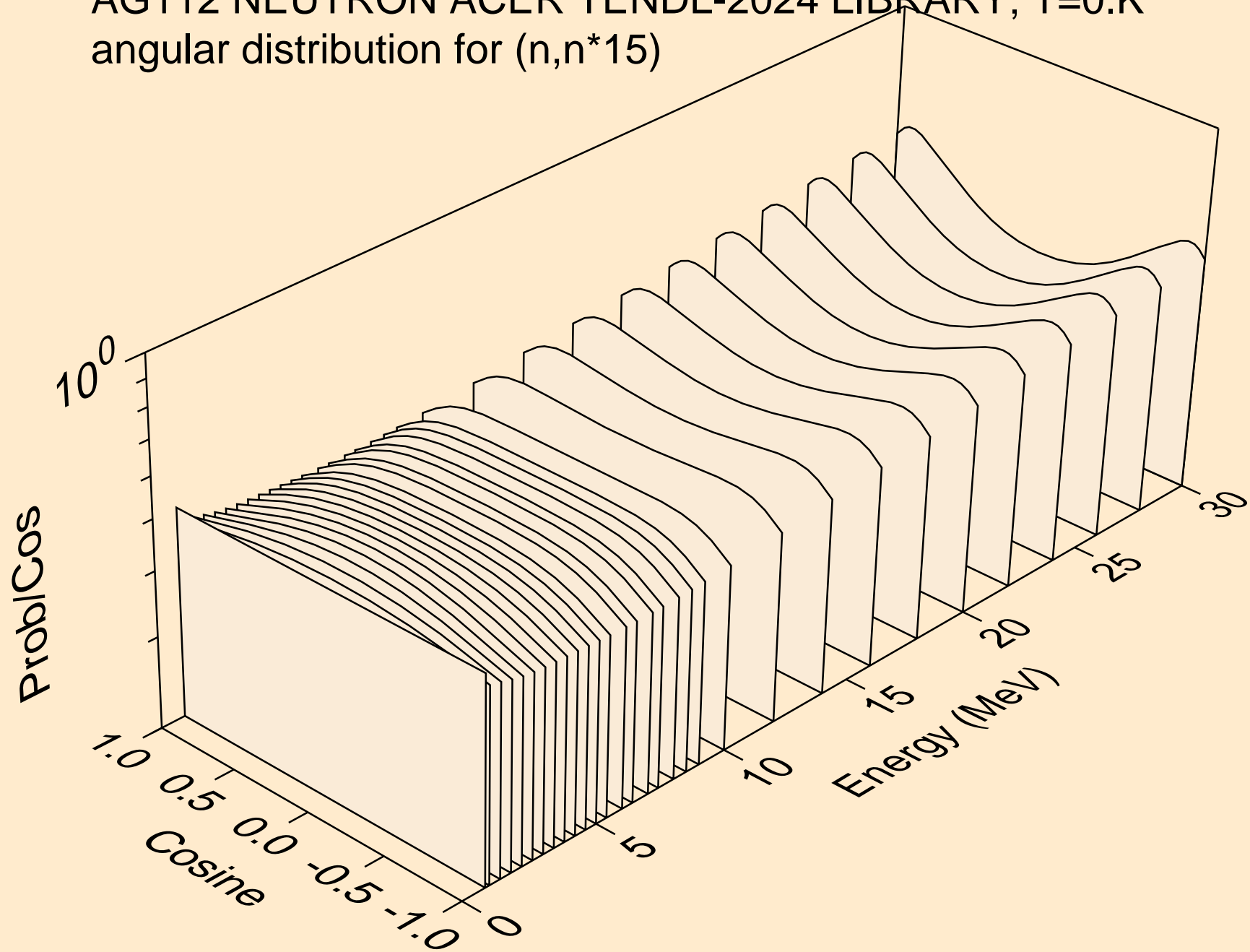

AG112 NEUTRON ACER TENDL-2024 LIBRARY; T=0.K
angular distribution for (n,n*16)

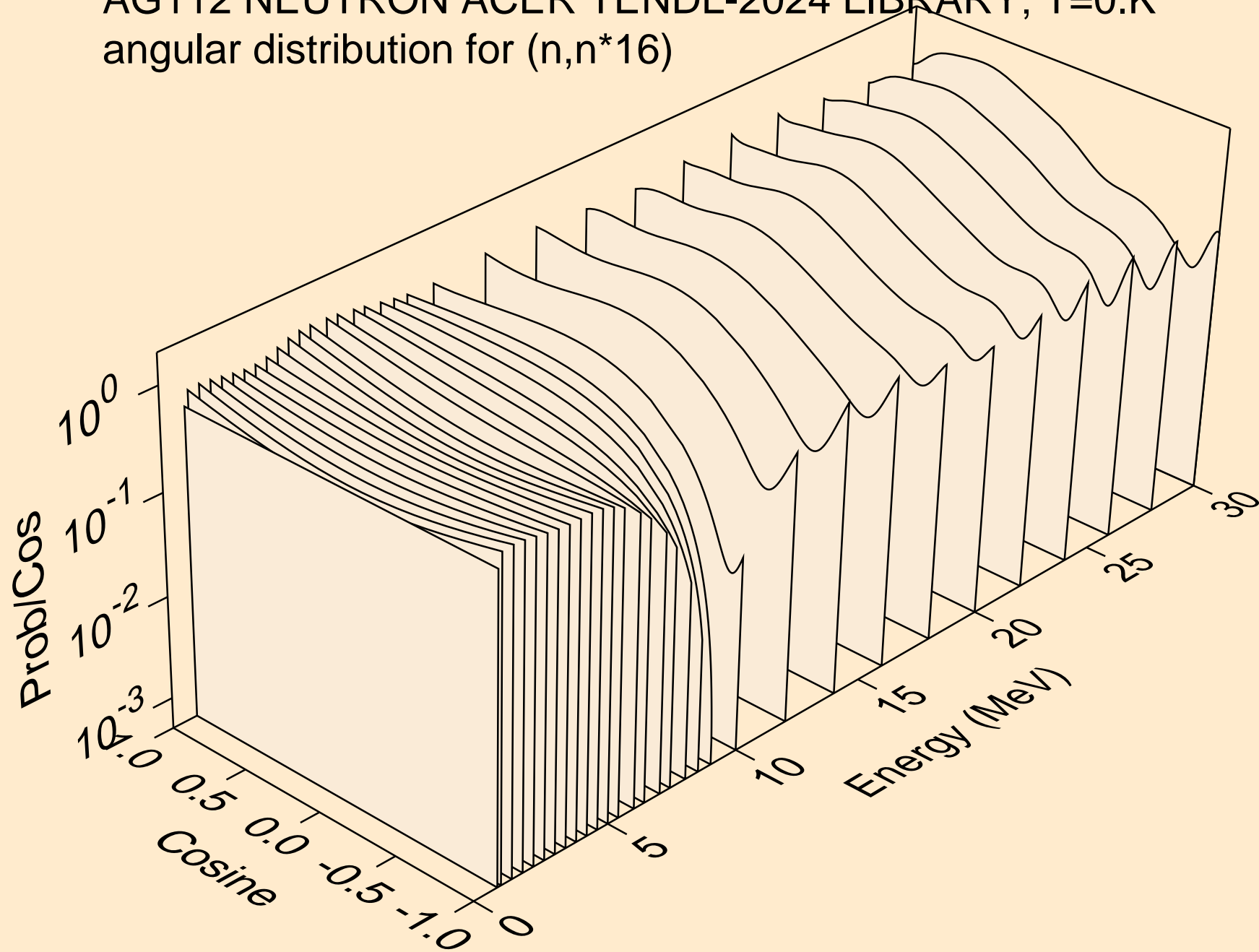

AG112 NEUTRON ACER TENDL-2024 LIBRARY; T=0.K
angular distribution for (n,n*17)

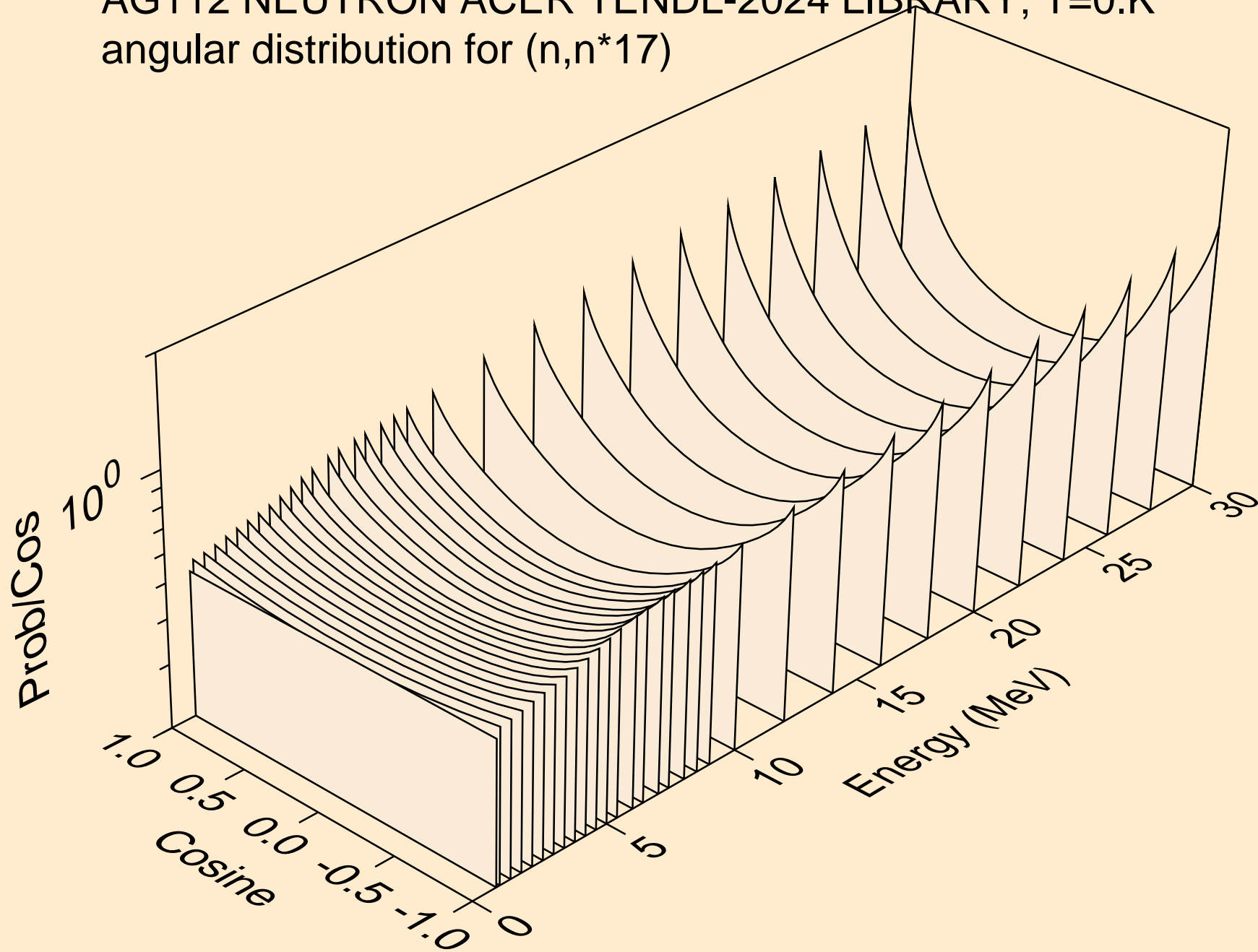

AG112 NEUTRON ACER TENDL-2024 LIBRARY; T=0.K
angular distribution for (n,n*18)

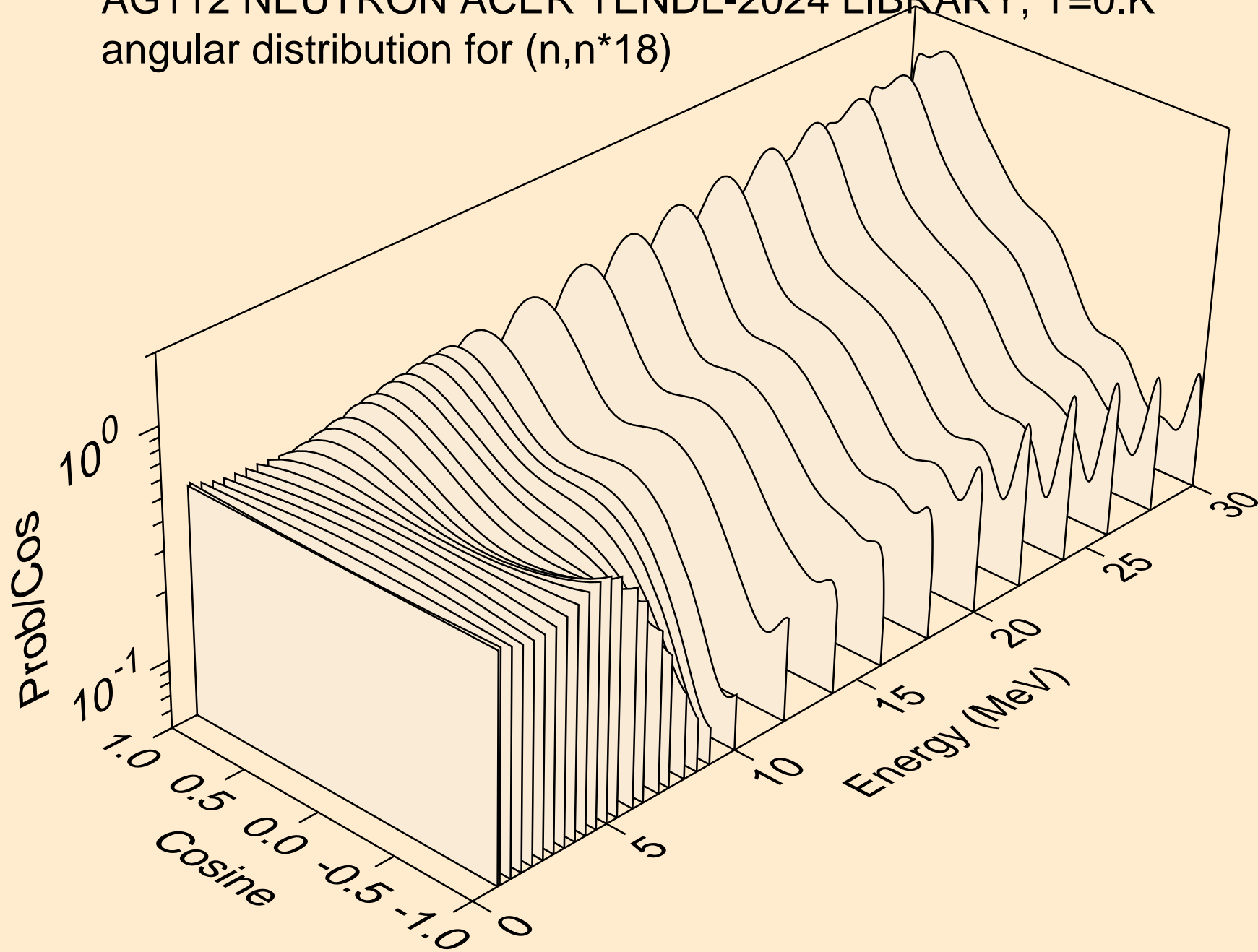

AG112 NEUTRON ACER TENDL-2024 LIBRARY; T=0.K
angular distribution for (n,n*19)

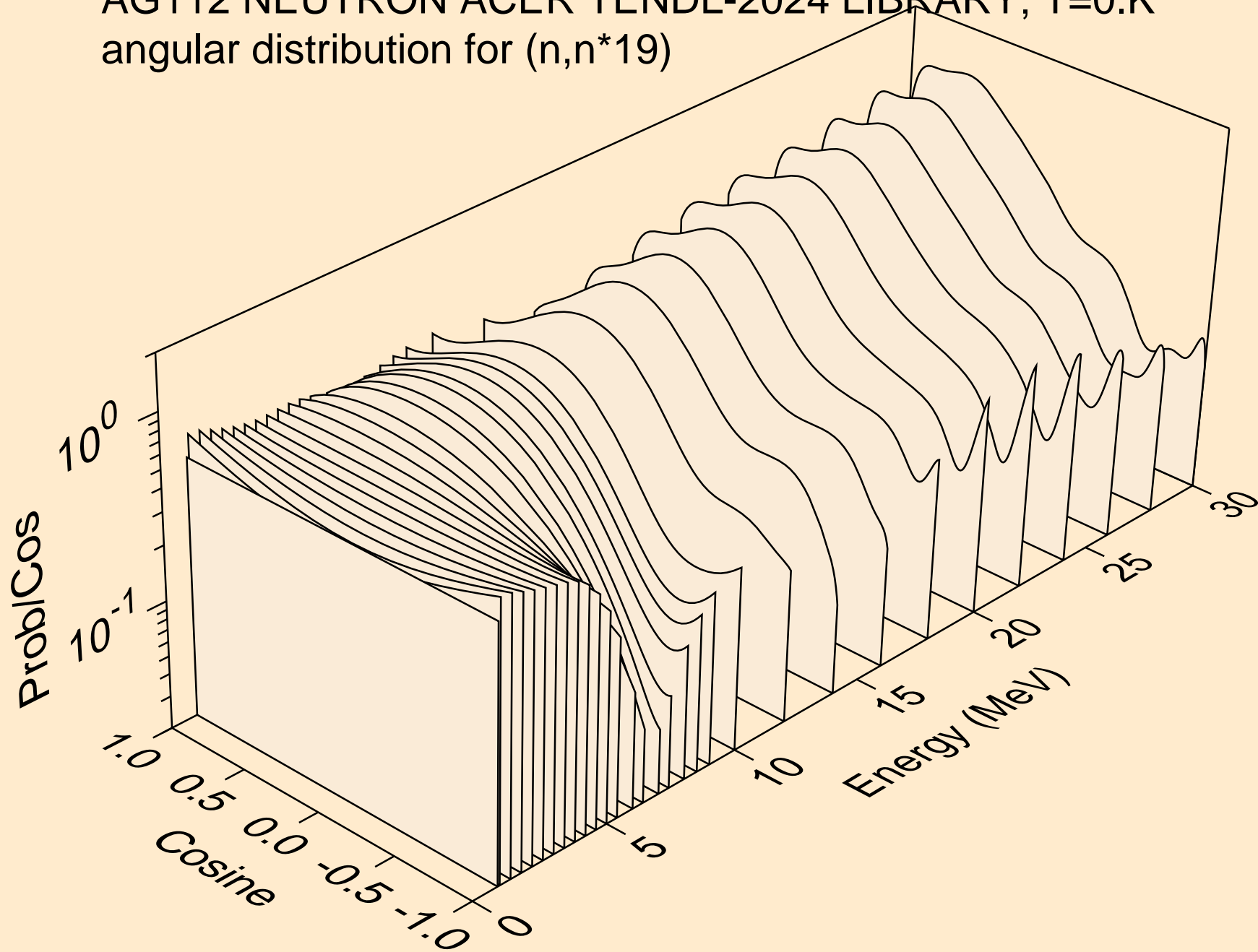

AG112 NEUTRON ACER TENDL-2024 LIBRARY; T=0.K
angular distribution for (n,n*20)

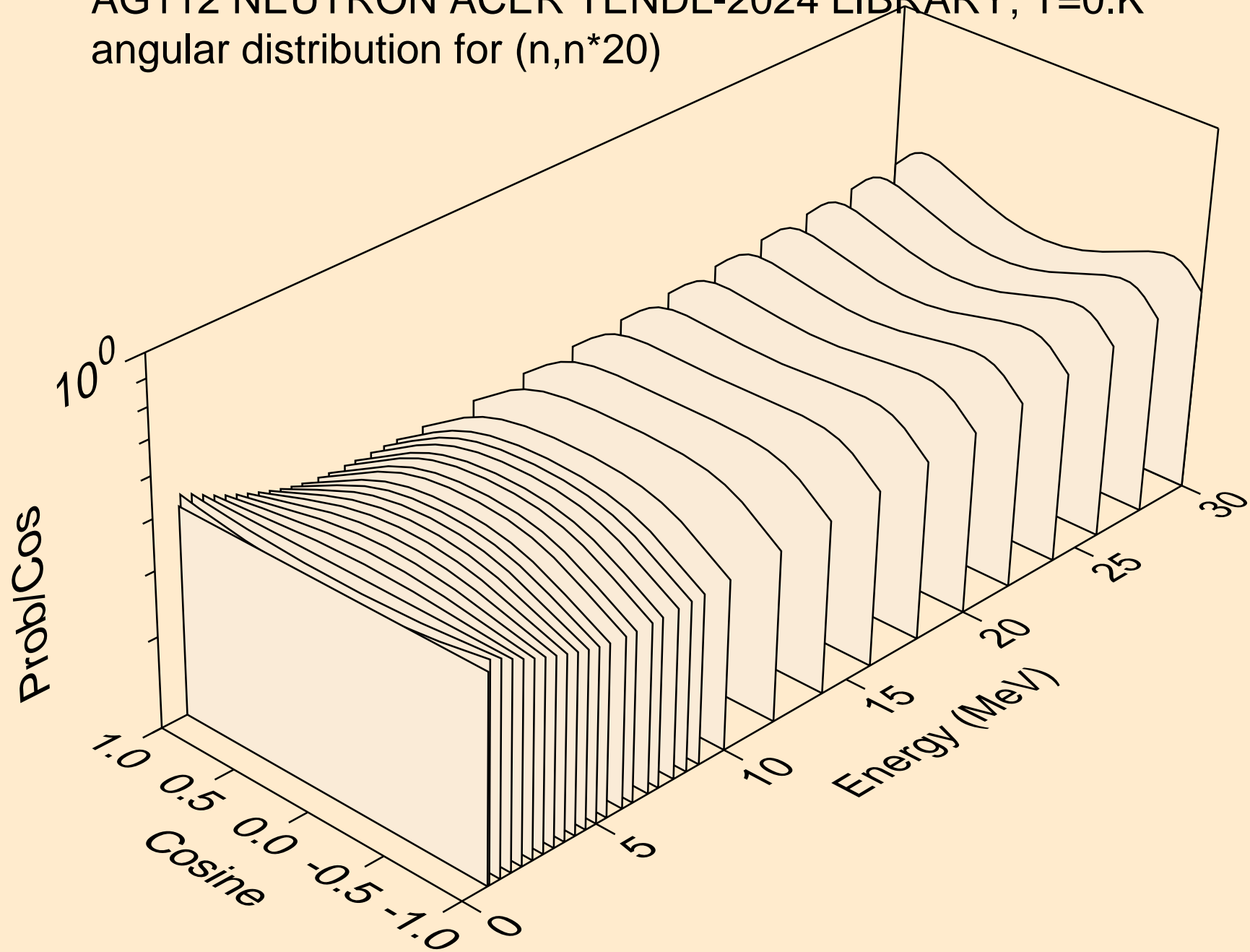

AG112 NEUTRON ACER TENDL-2024 LIBRARY; T=0.K
angular distribution for (n,n*21)

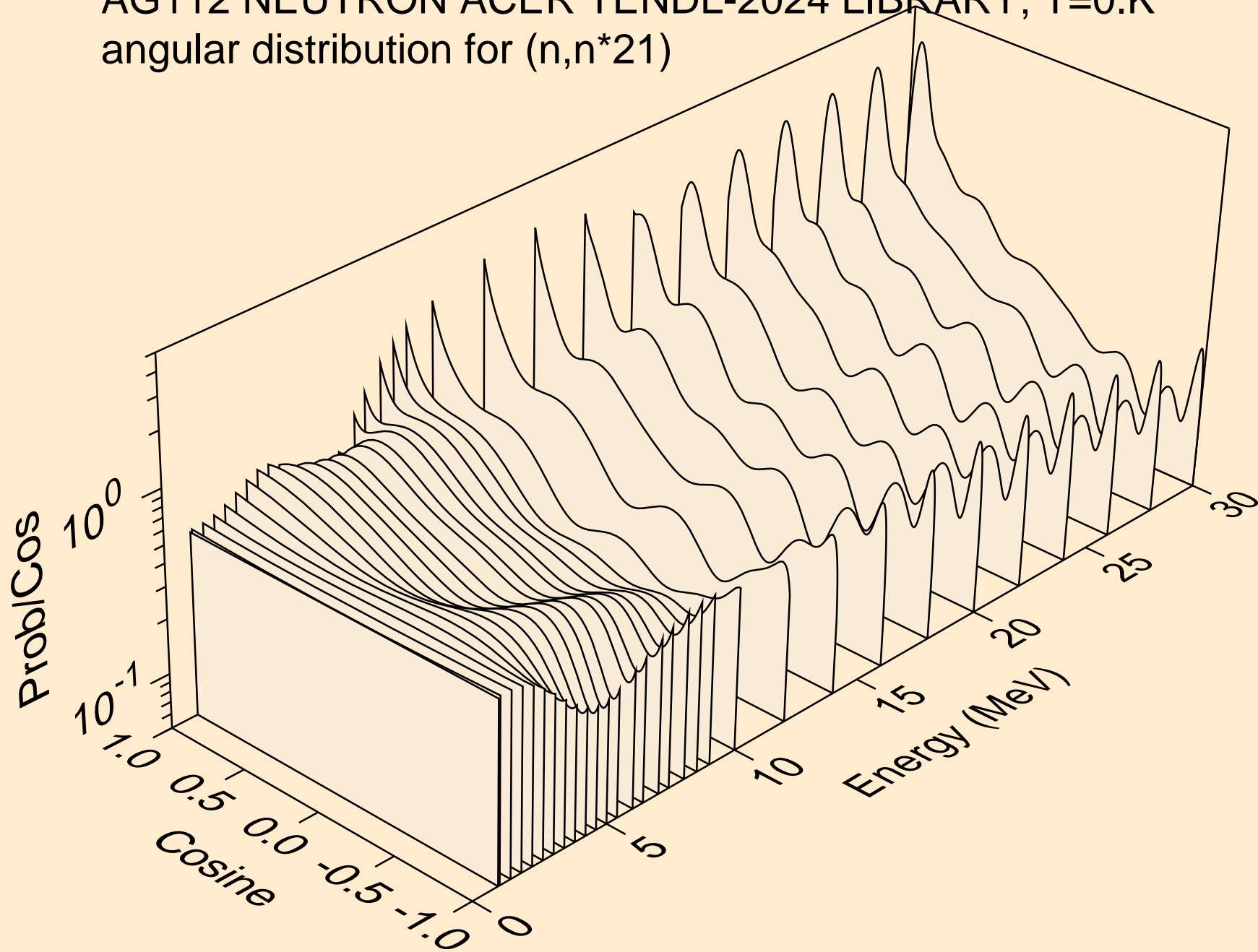

AG112 NEUTRON ACER TENDL-2024 LIBRARY; T=0.K
angular distribution for (n,n*22)

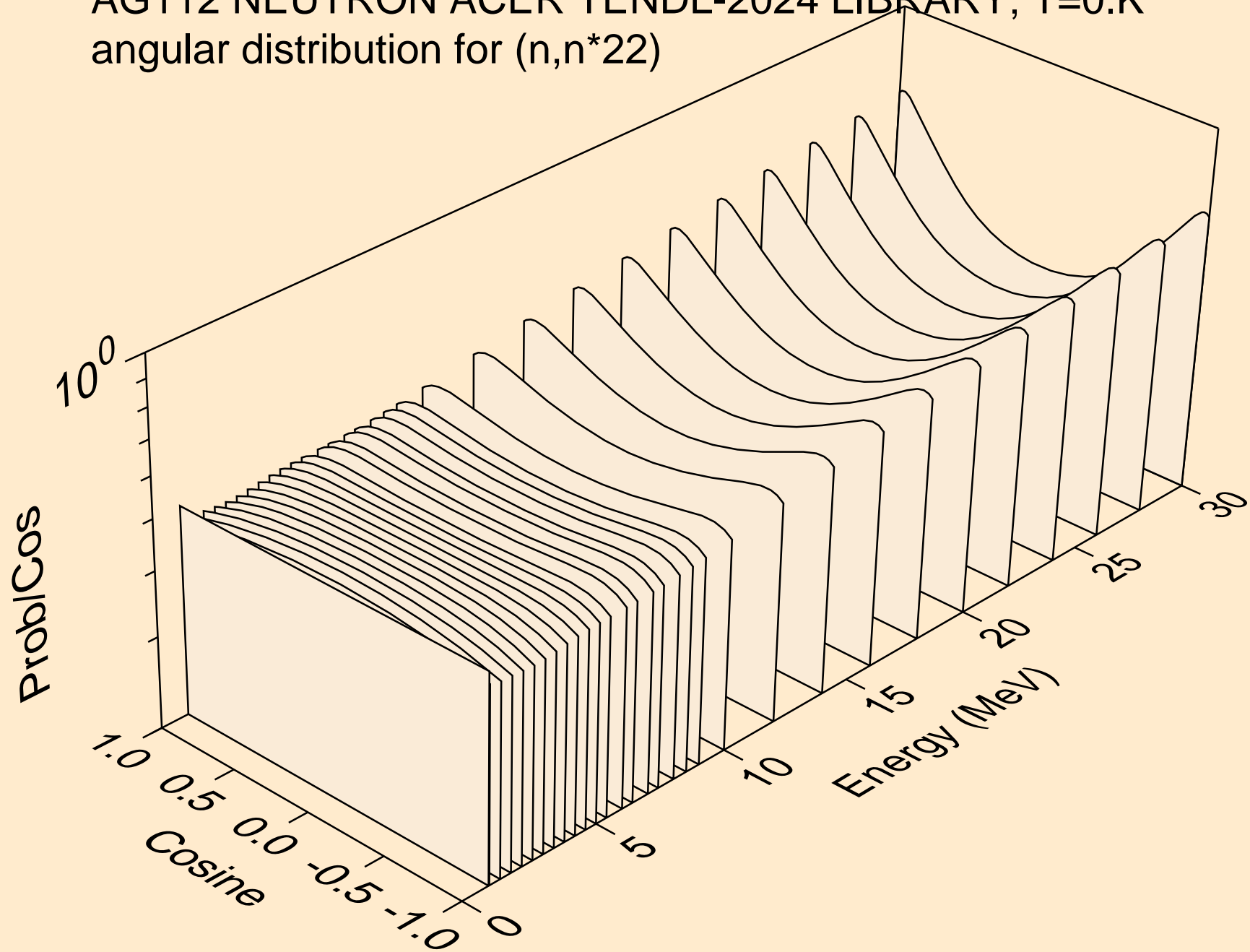

AG112 NEUTRON ACER TENDL-2024 LIBRARY; T=0.K
angular distribution for (n,n*23)

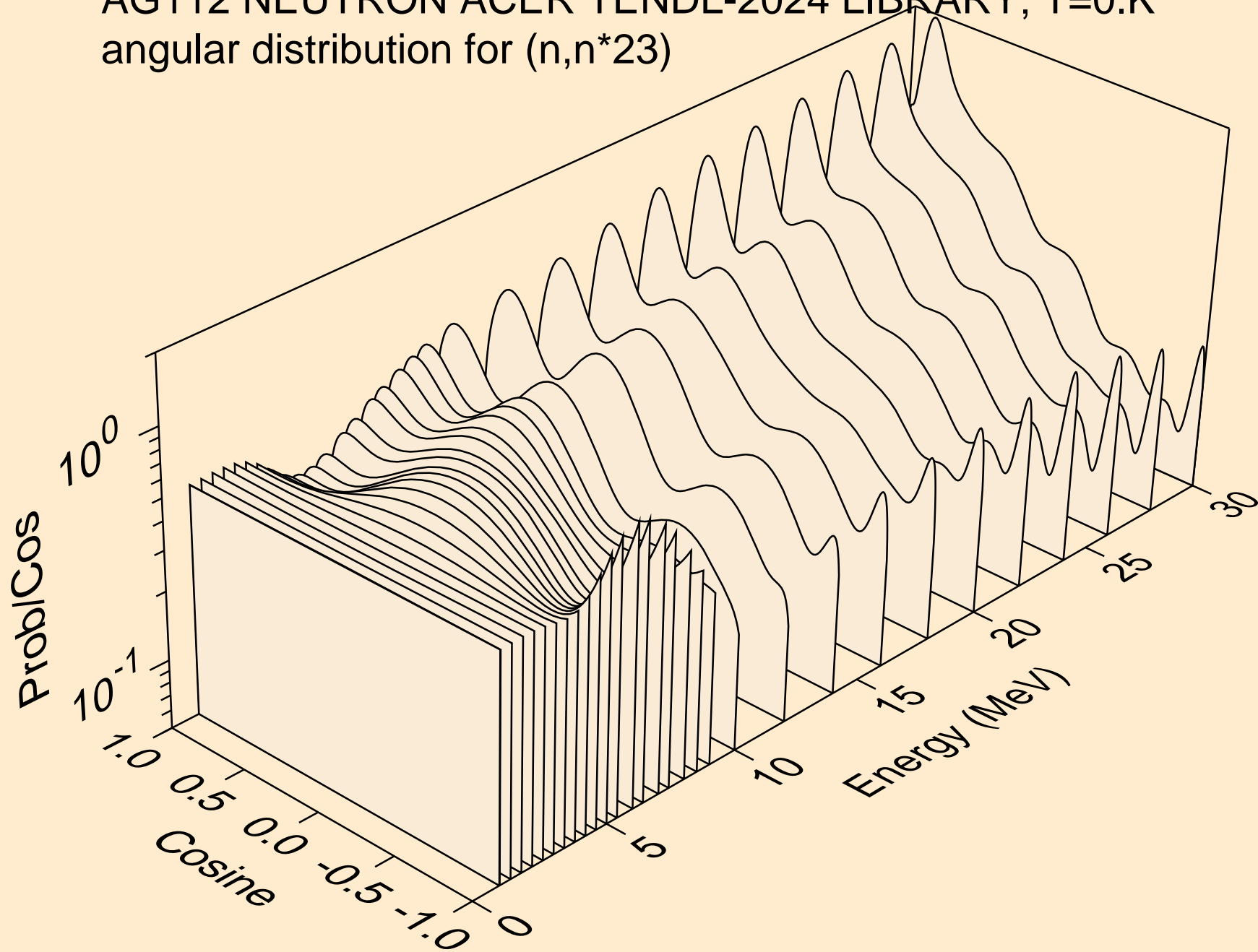

AG112 NEUTRON ACER TENDL-2024 LIBRARY; T=0.K
angular distribution for (n,n*24)

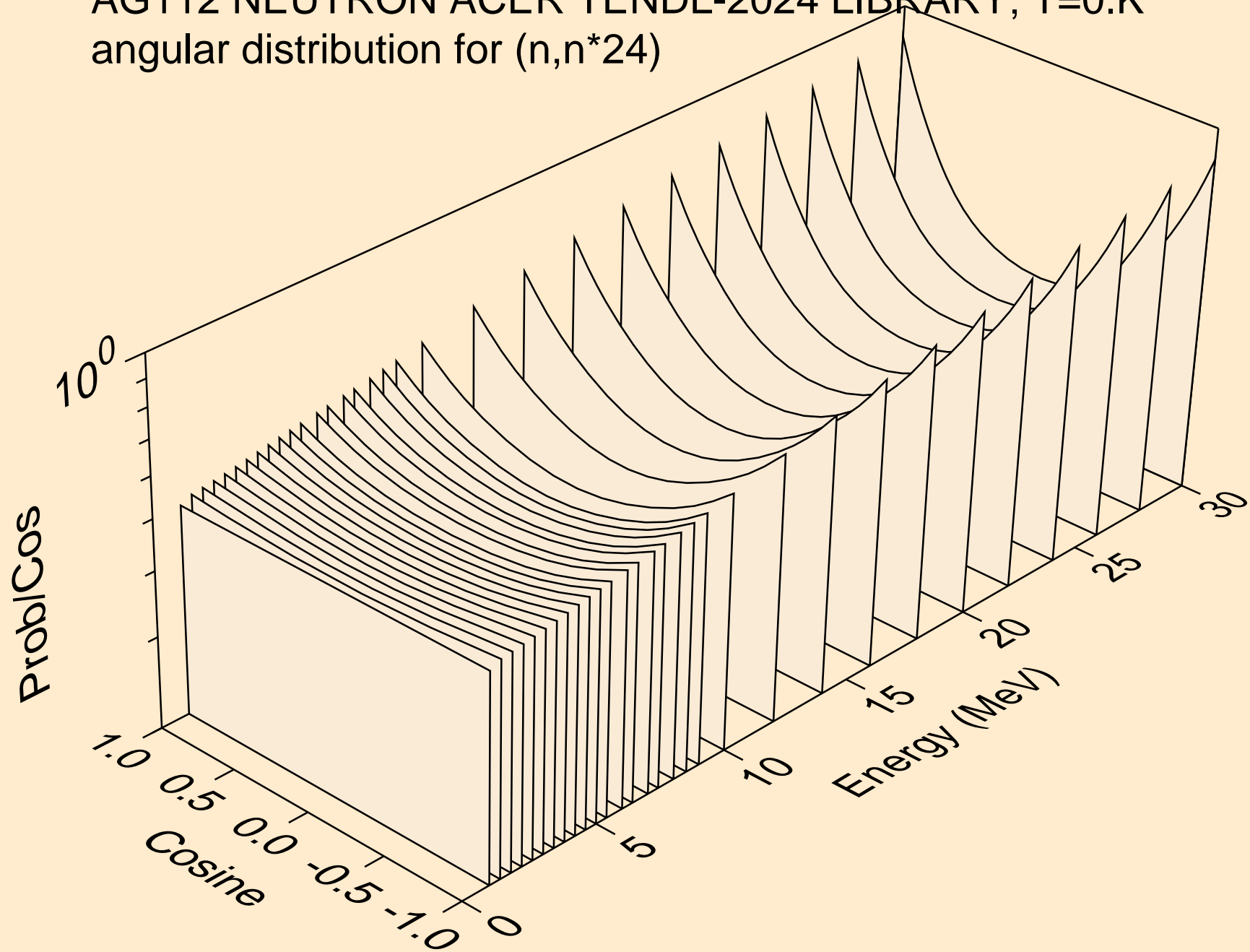

AG112 NEUTRON ACER TENDL-2024 LIBRARY; T=0.K
angular distribution for (n,n*25)

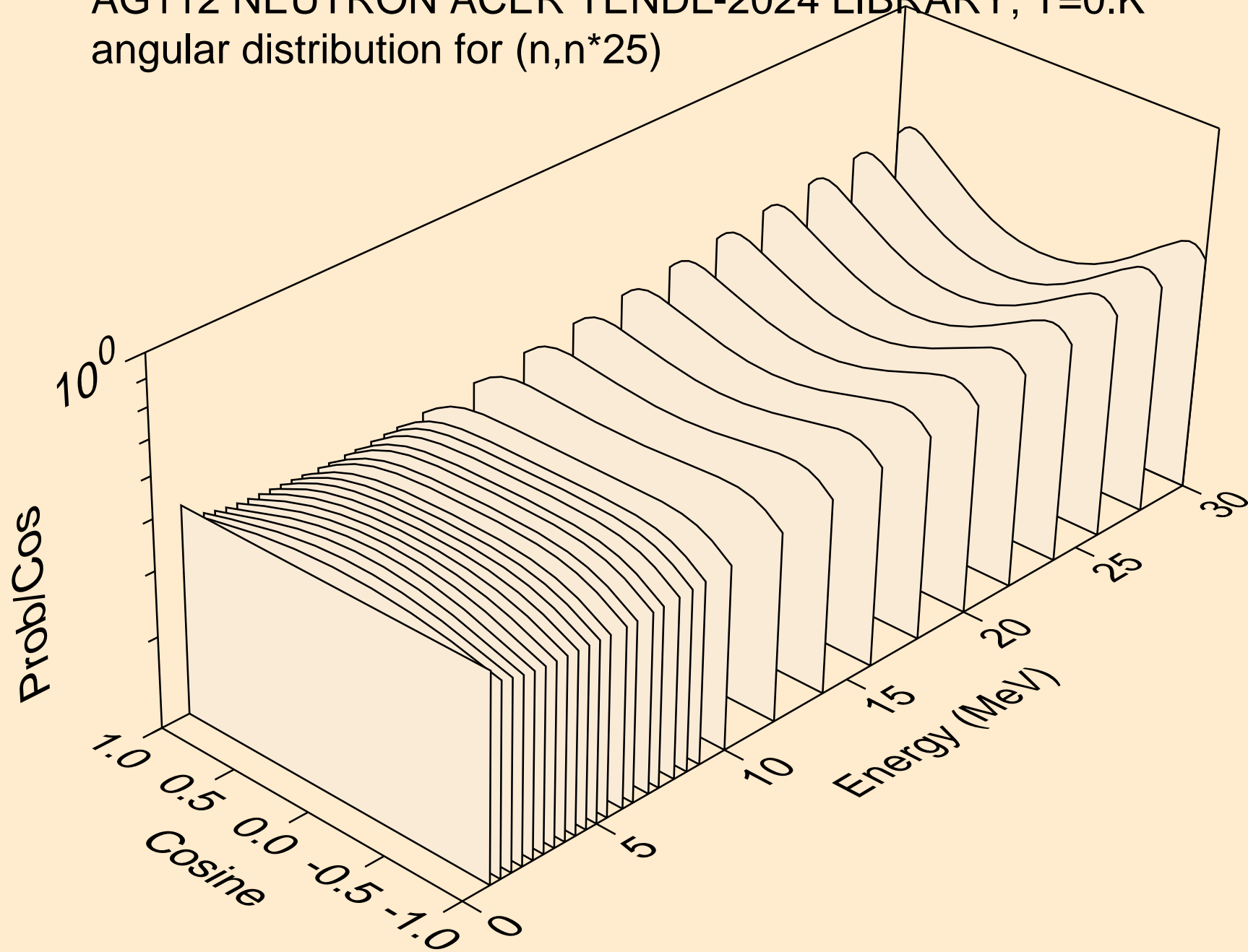

AG112 NEUTRON ACER TENDL-2024 LIBRARY; T=0.K
angular distribution for (n,n*26)

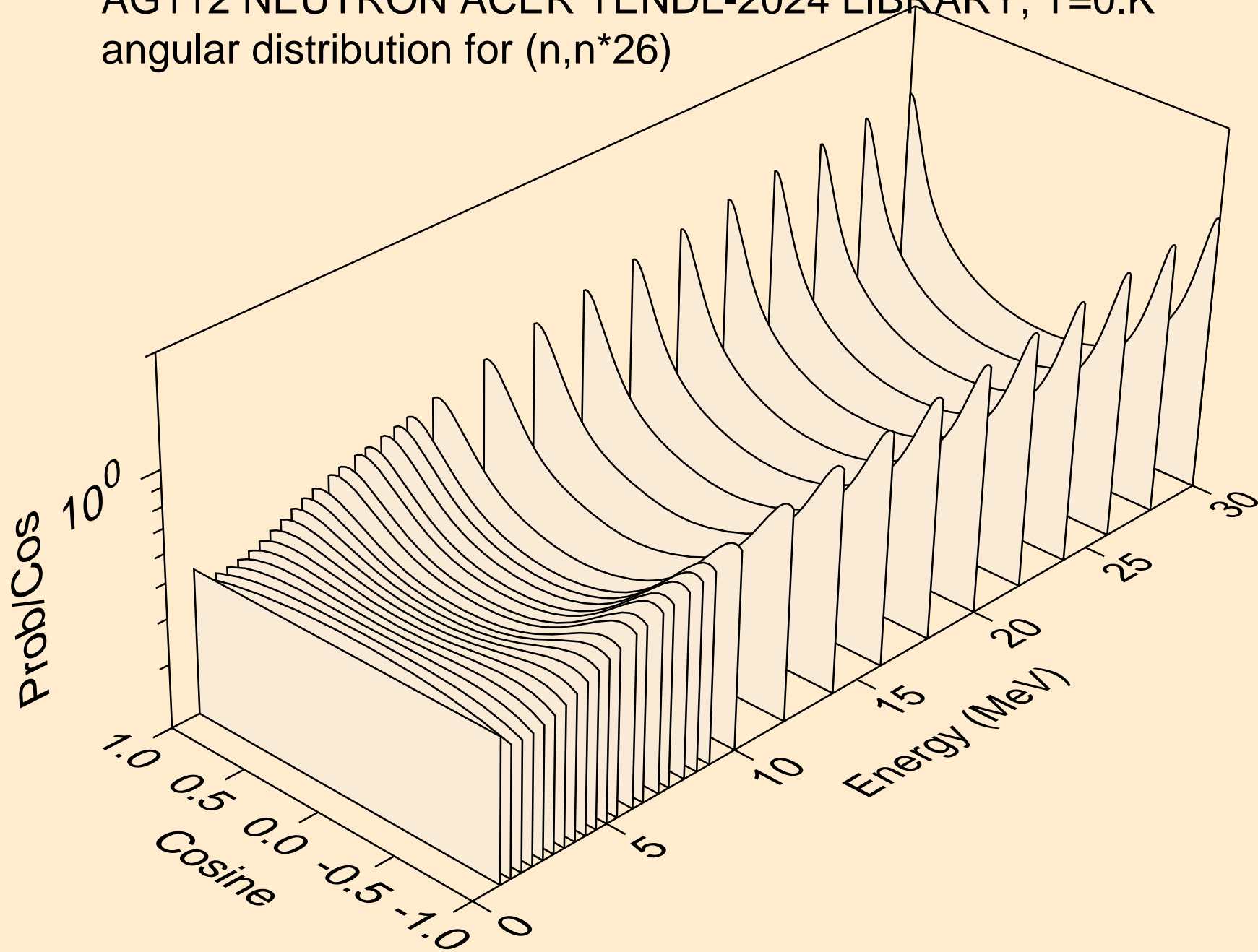

AG112 NEUTRON ACER TENDL-2024 LIBRARY; T=0.K
angular distribution for (n,n*27)

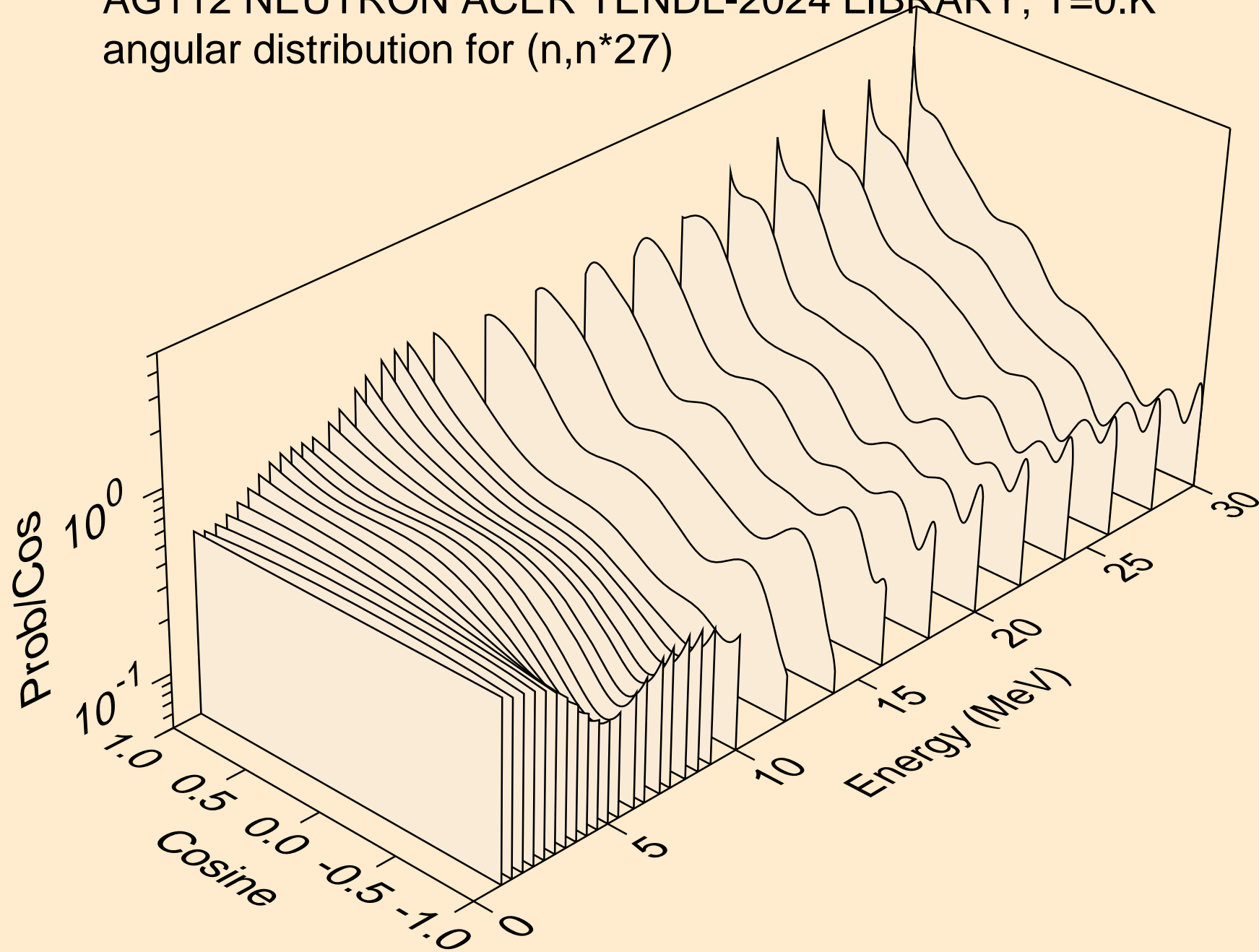

AG112 NEUTRON ACER TENDL-2024 LIBRARY; T=0.K
angular distribution for (n,n*28)

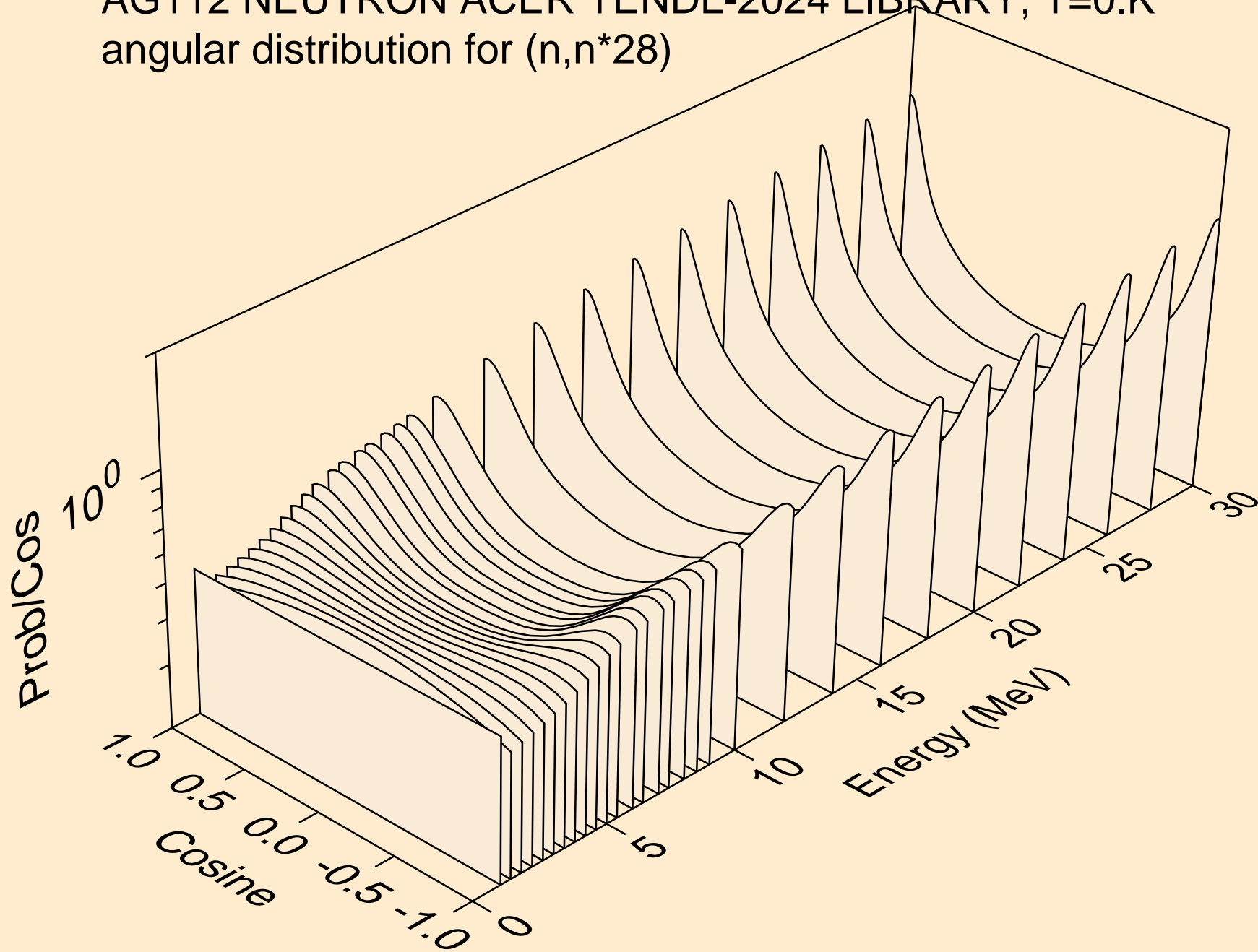

AG112 NEUTRON ACER TENDL-2024 LIBRARY; T=0.K
angular distribution for (n,n*29)

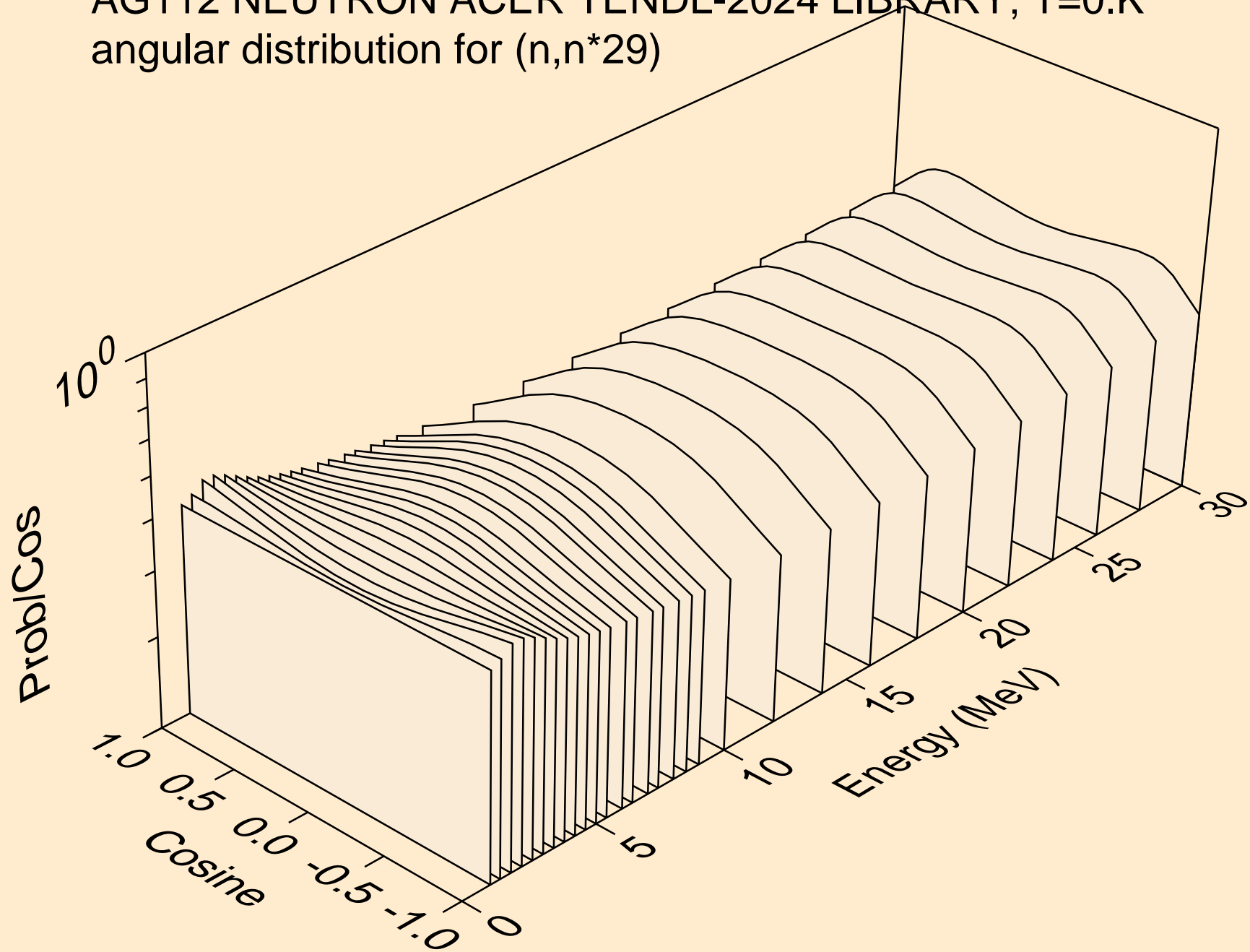

AG112 NEUTRON ACER TENDL-2024 LIBRARY; T=0.K
angular distribution for (n,n*30)

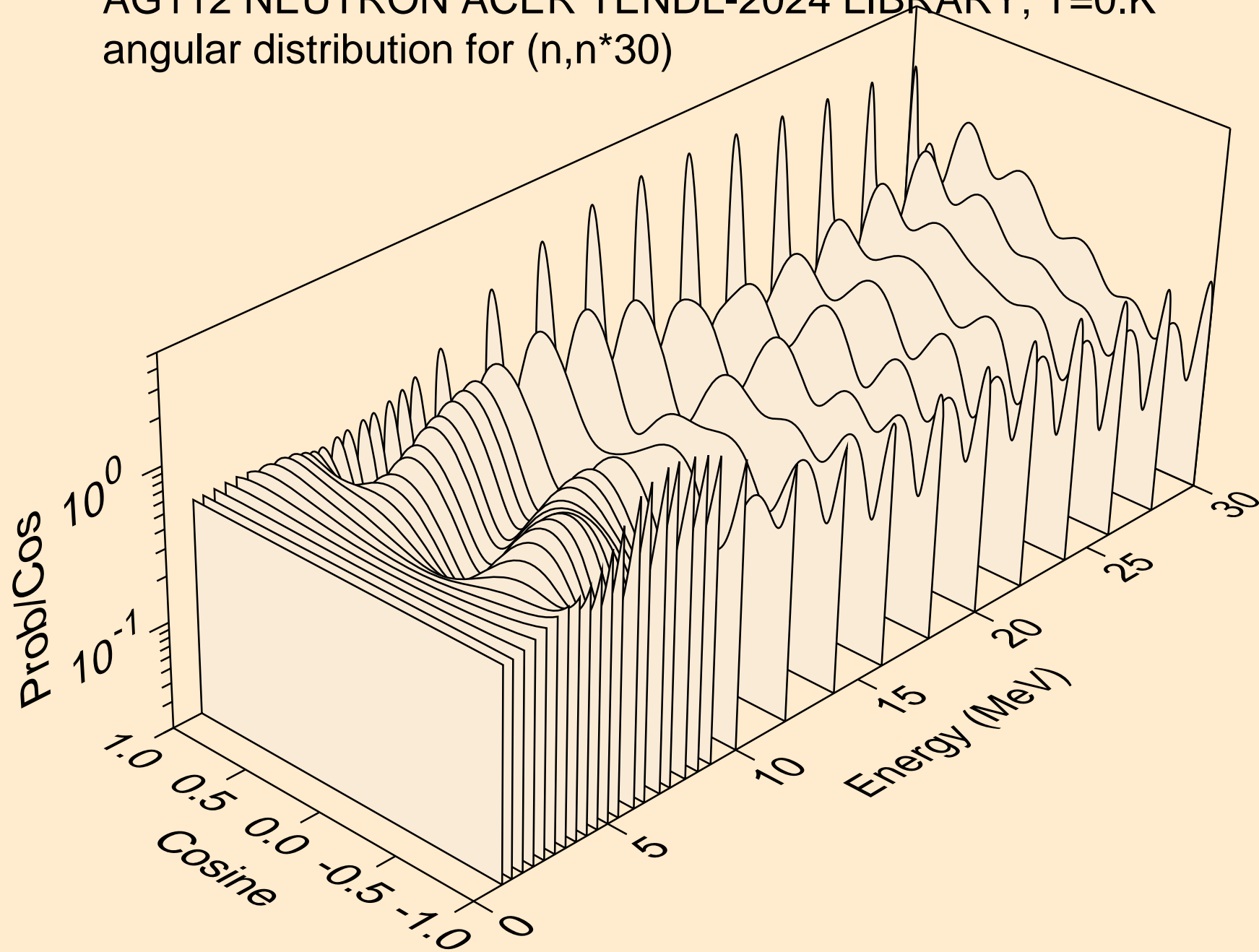

AG112 NEUTRON ACER TENDL-2024 LIBRARY; T=0.K
Neutron emission for (n,x)

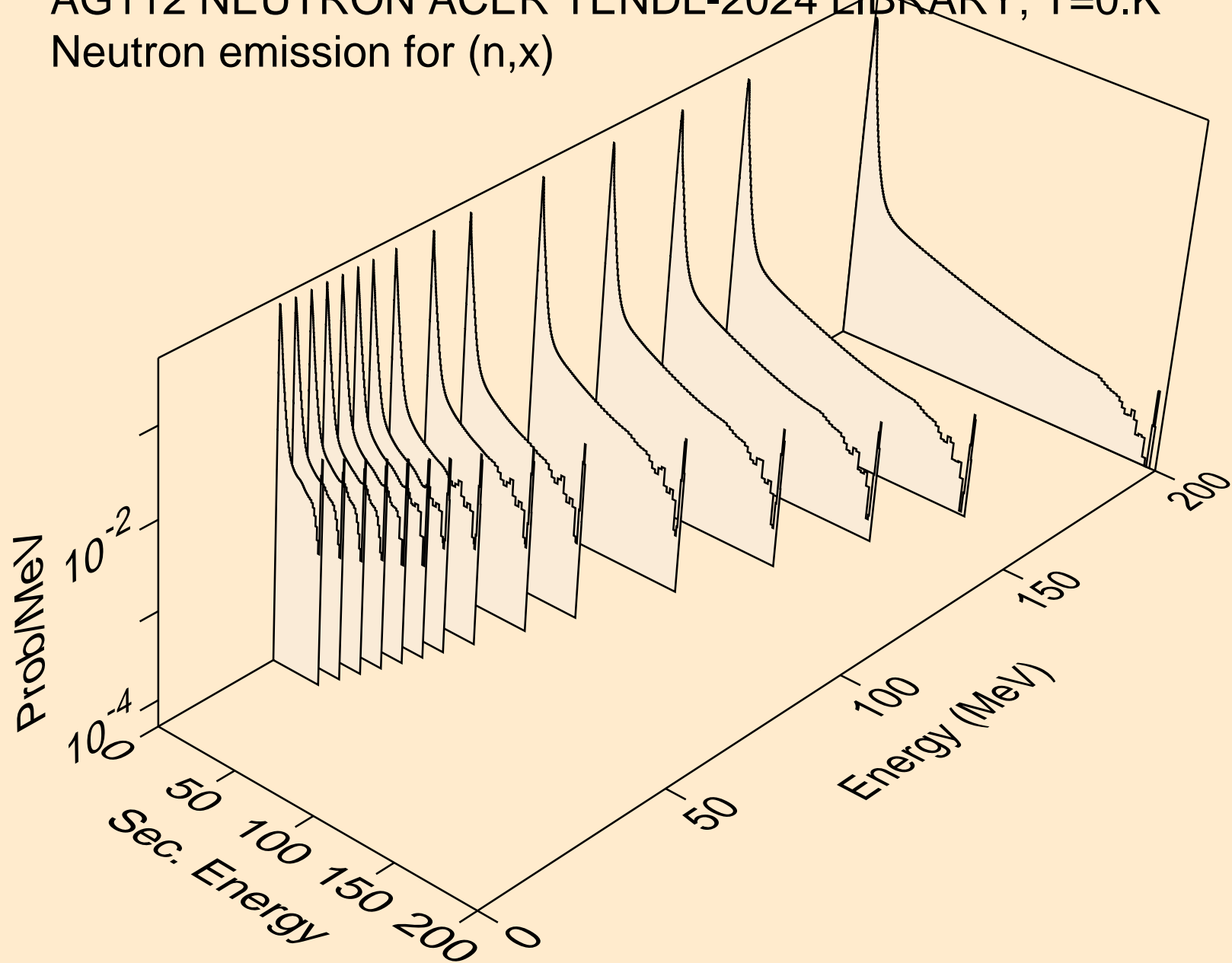

AG112 NEUTRON ACER TENDL-2024 LIBRARY; T=0.K
Neutron emission for (n,2nd)

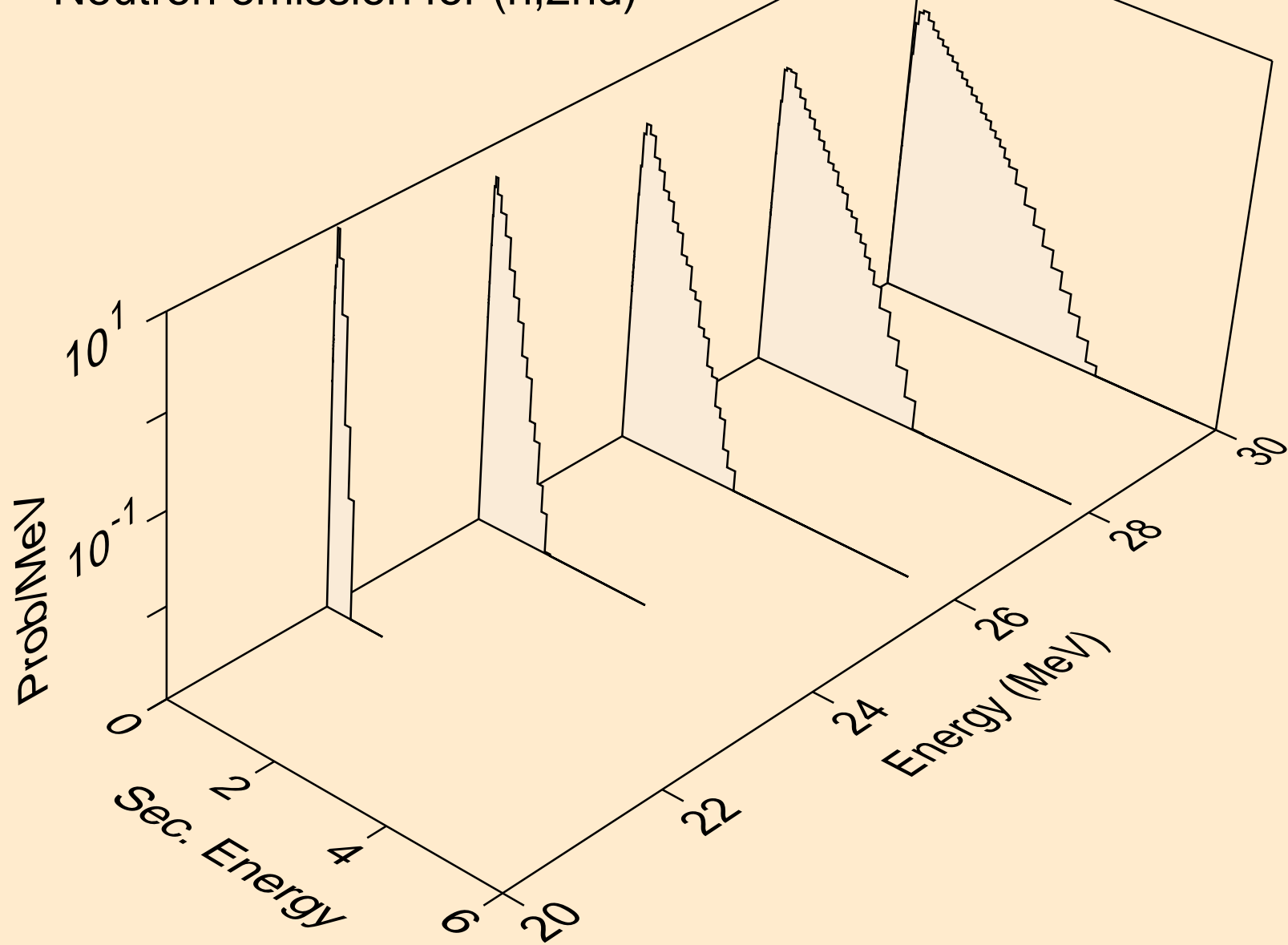

AG112 NEUTRON ACER TENDL-2024 LIBRARY; T=0.K
Neutron emission for (n,2n)

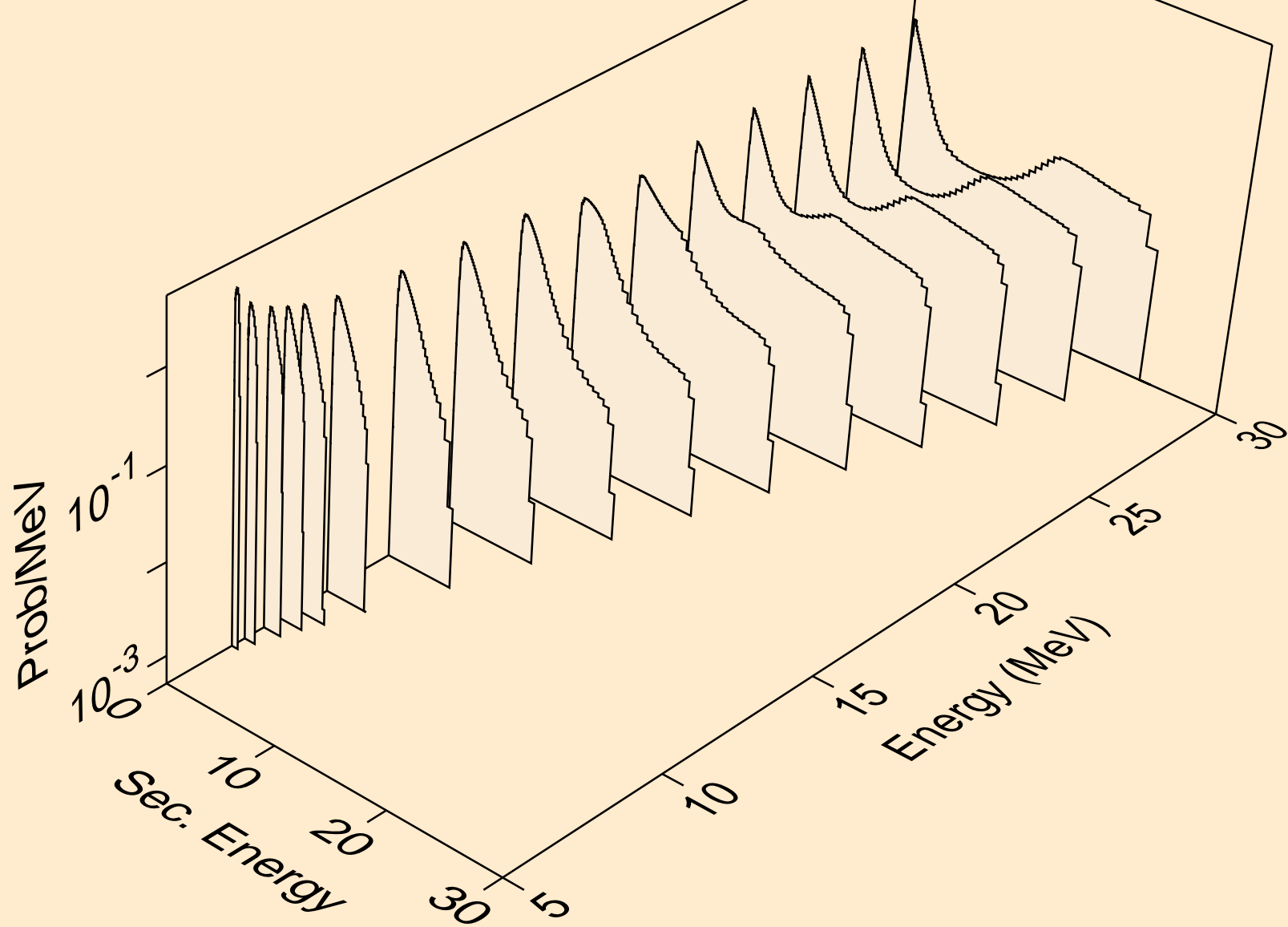

AG112 NEUTRON ACER TENDL-2024 LIBRARY; T=0.K
Neutron emission for (n,3n)

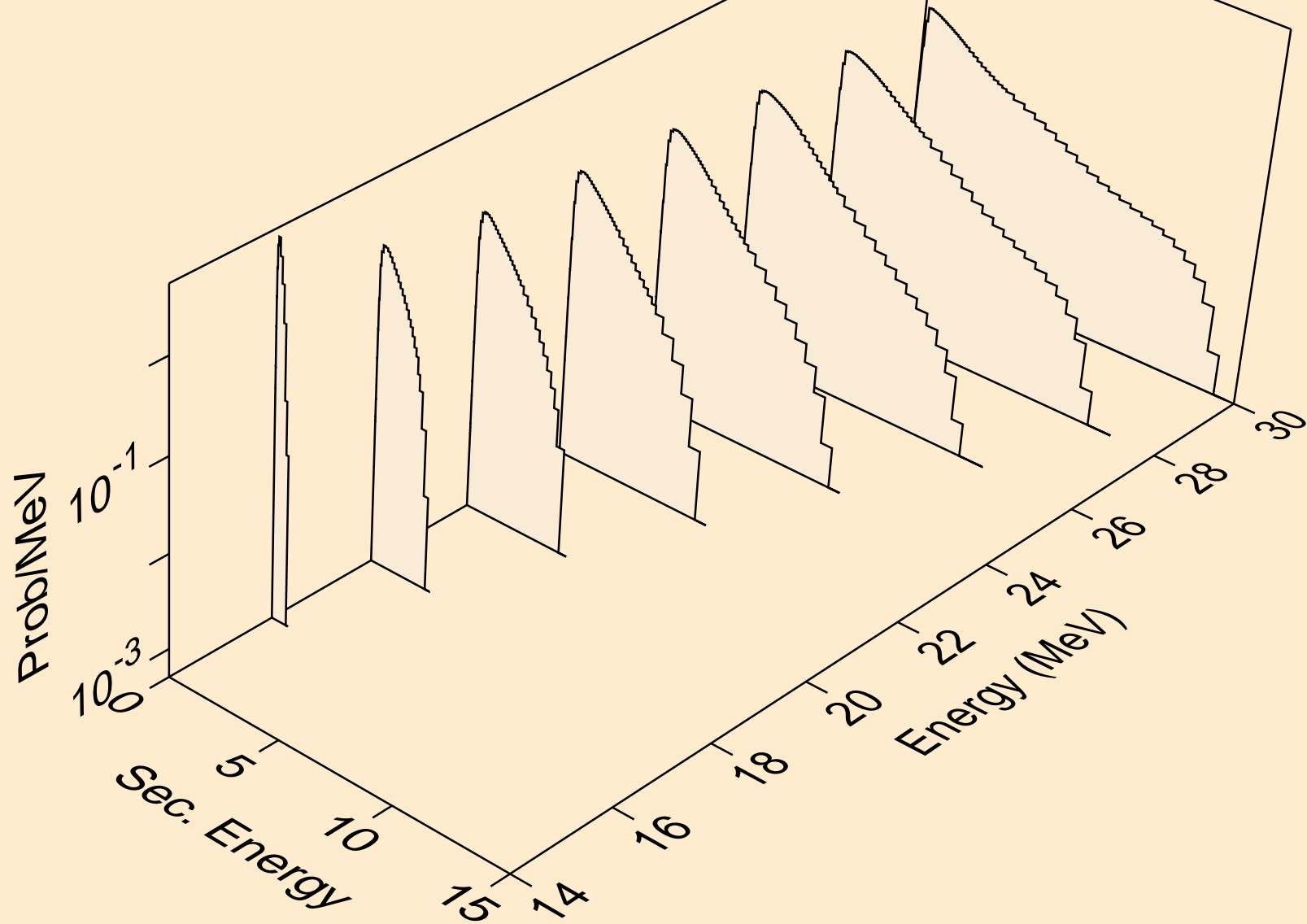

AG112 NEUTRON ACER TENDL-2024 LIBRARY; T=0.K
Neutron emission for (n,n*)a

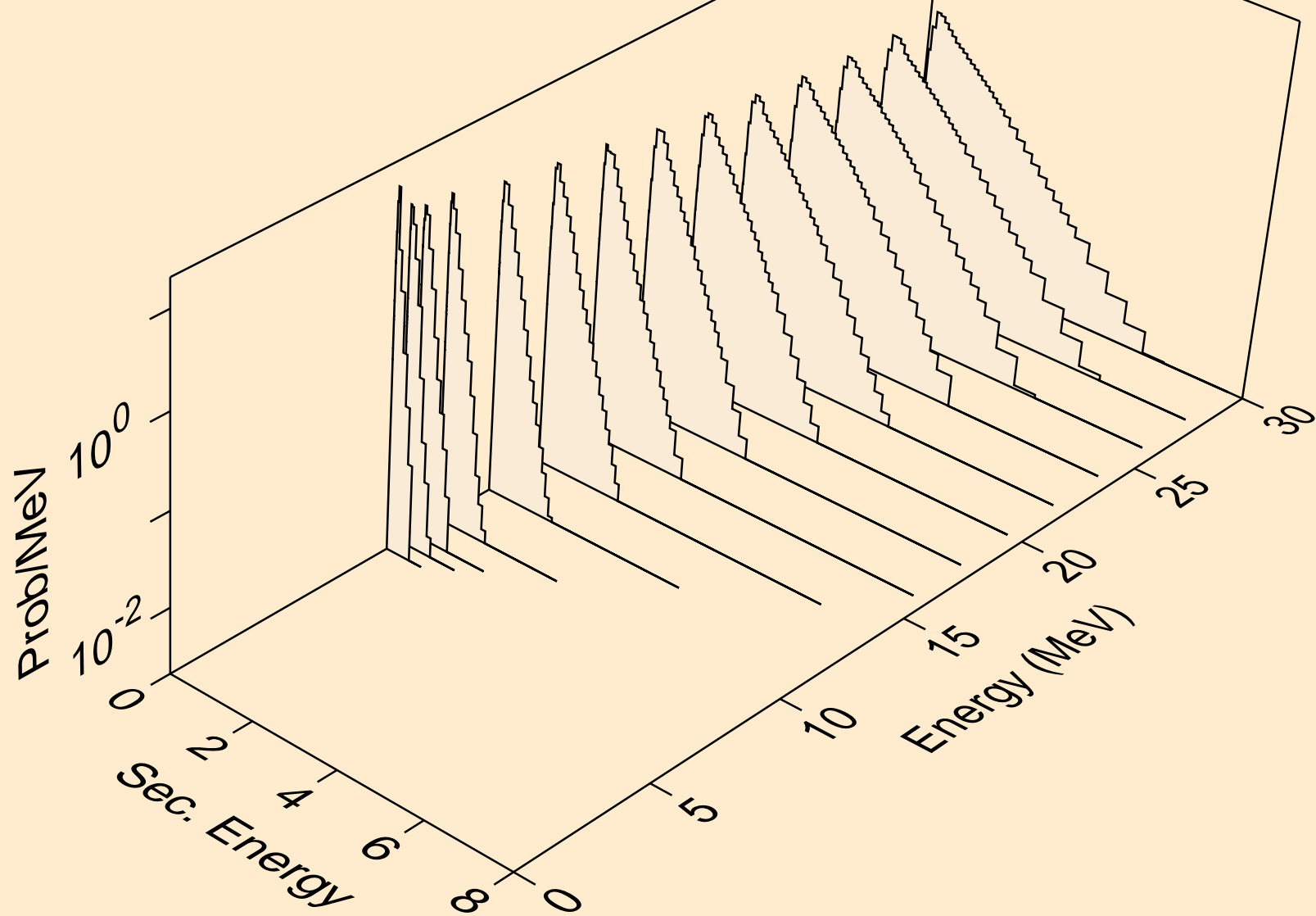

AG112 NEUTRON ACER TENDL-2024 LIBRARY; T=0.K
Neutron emission for (n,2n)a

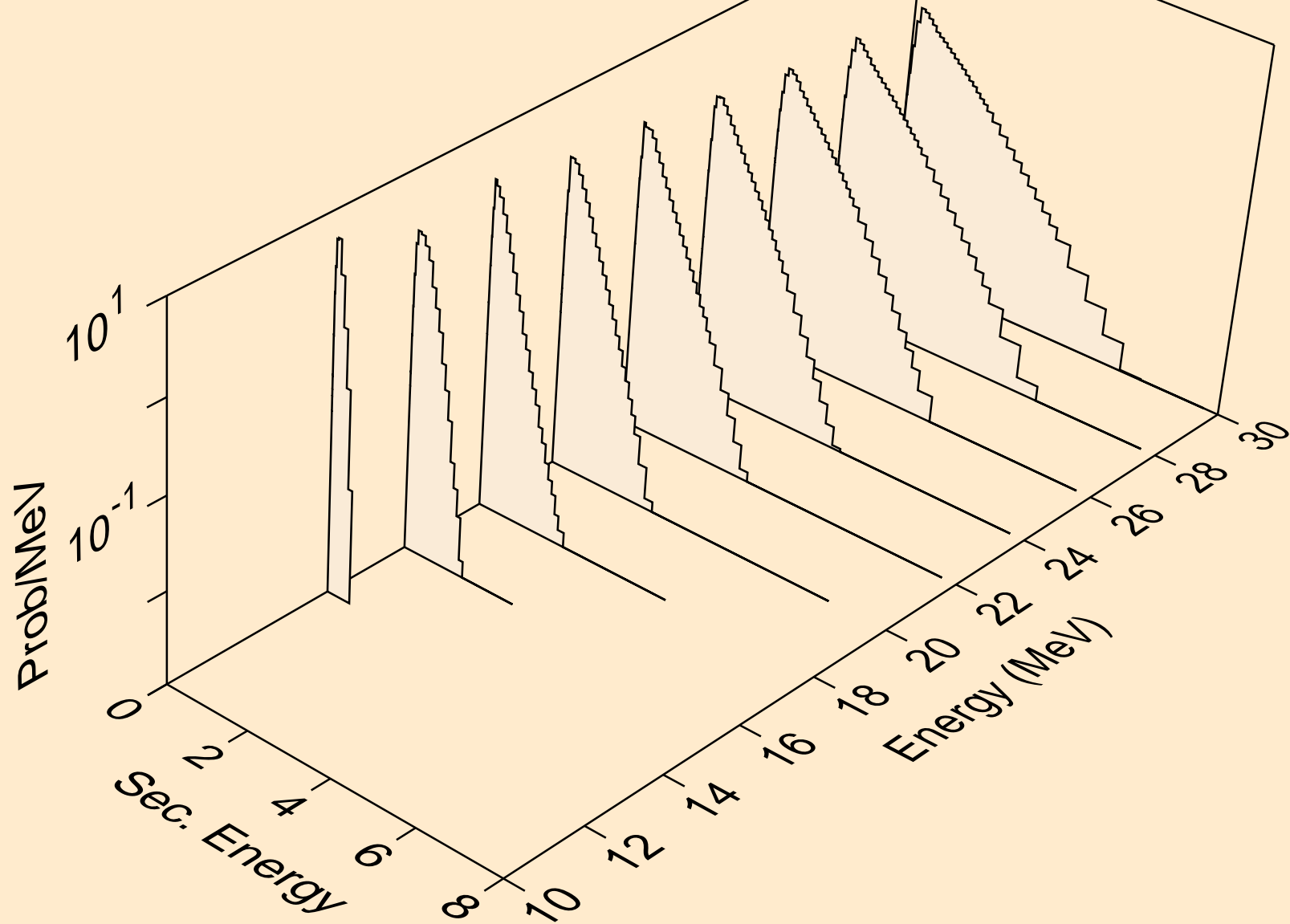

AG112 NEUTRON ACER TENDL-2024 LIBRARY; T=0.K
Neutron emission for (n,3n)a

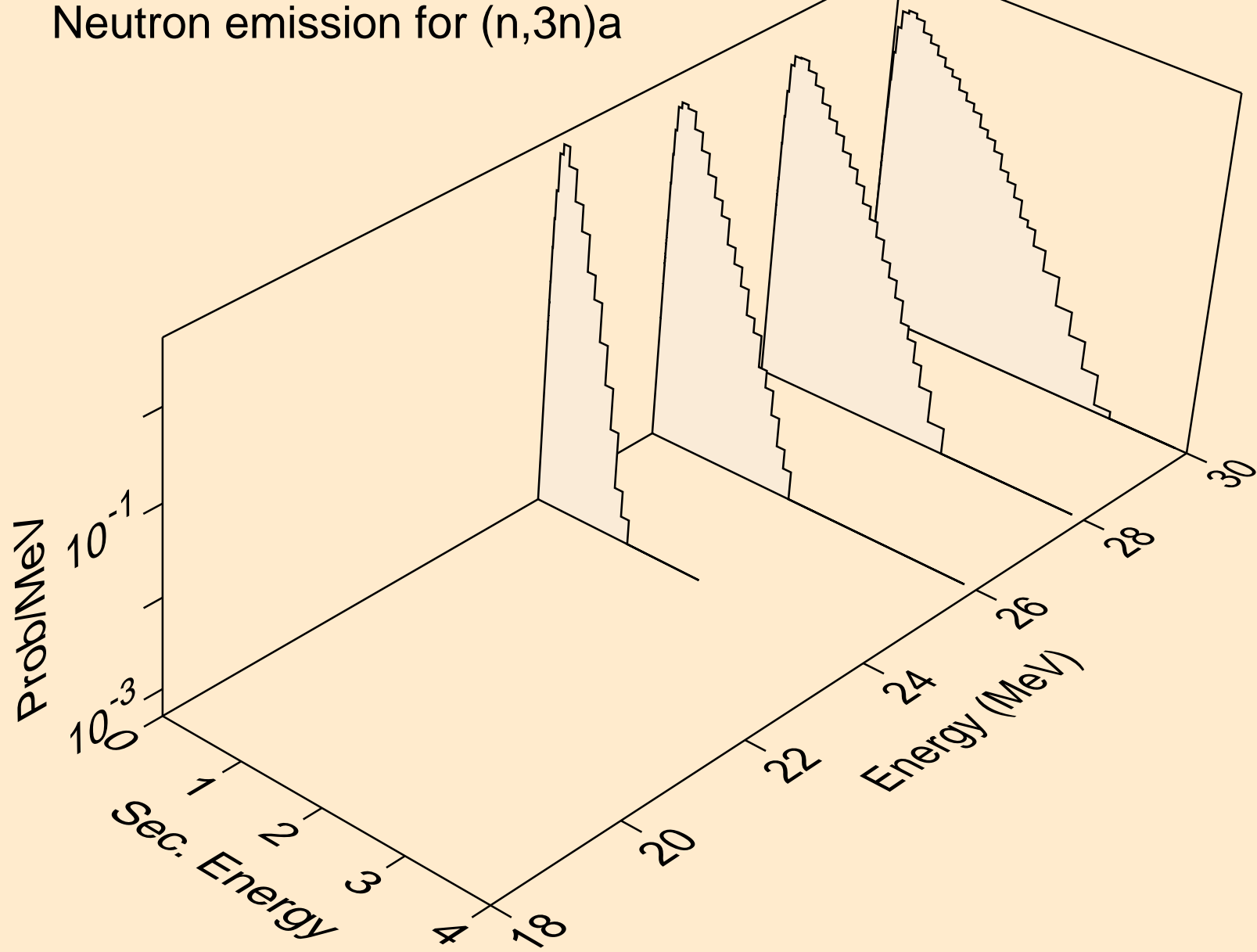

AG112 NEUTRON ACER TENDL-2024 LIBRARY; T=0.K
Neutron emission for (n,n*)p

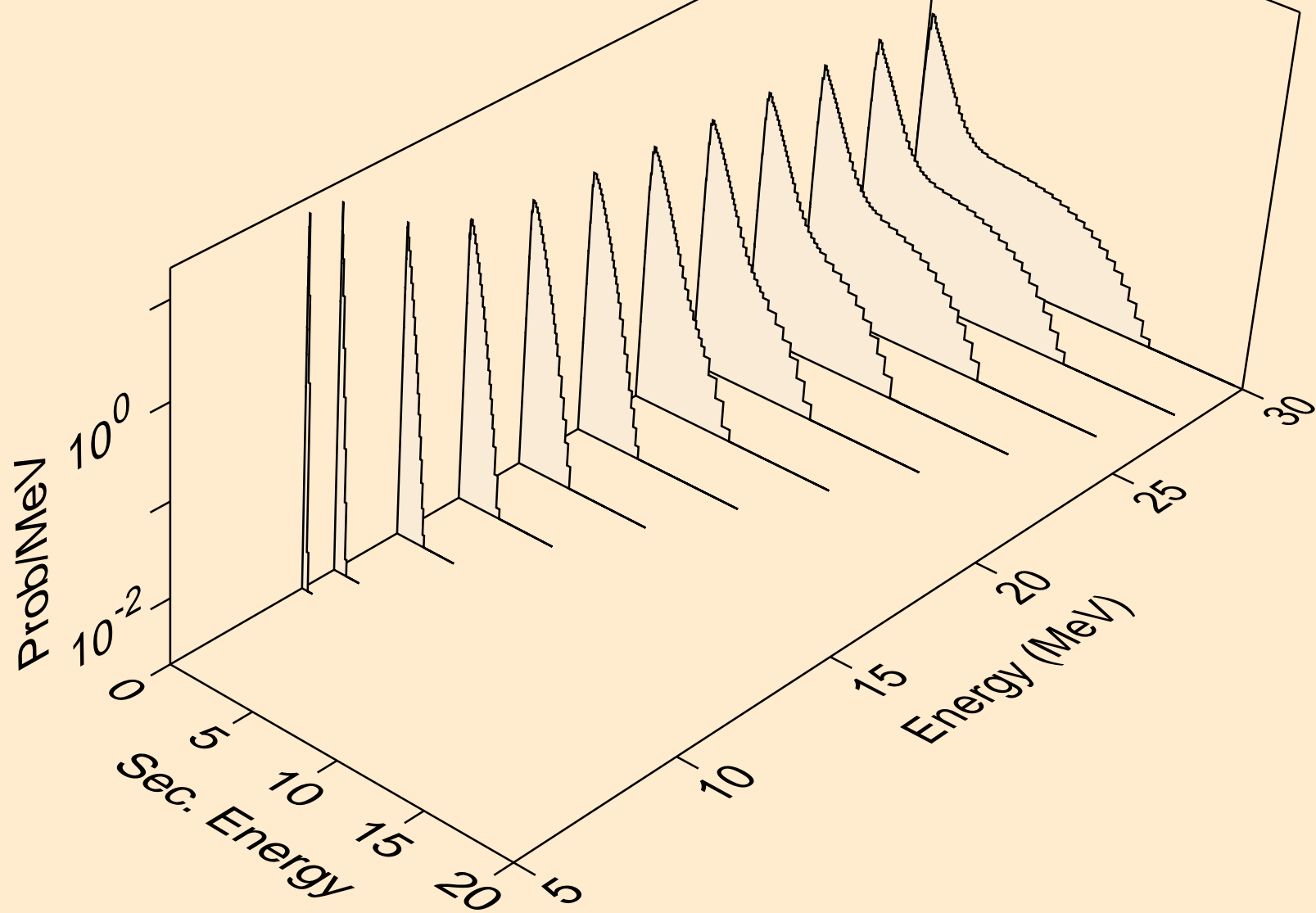

AG112 NEUTRON ACER TENDL-2024 LIBRARY; T=0.K
Neutron emission for (n,n*)d

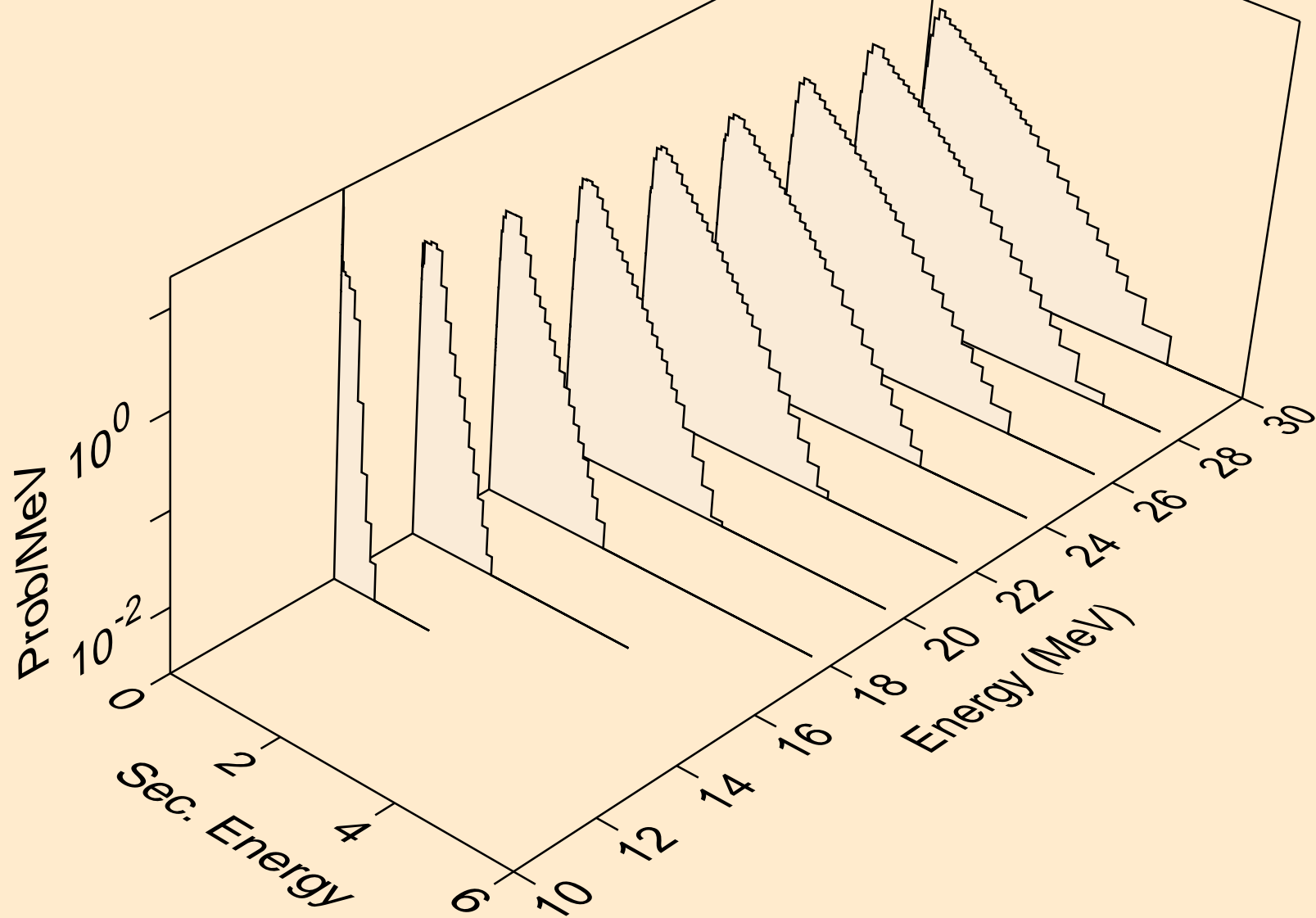

AG112 NEUTRON ACER TENDL-2024 LIBRARY; T=0.K
Neutron emission for (n,n*)t

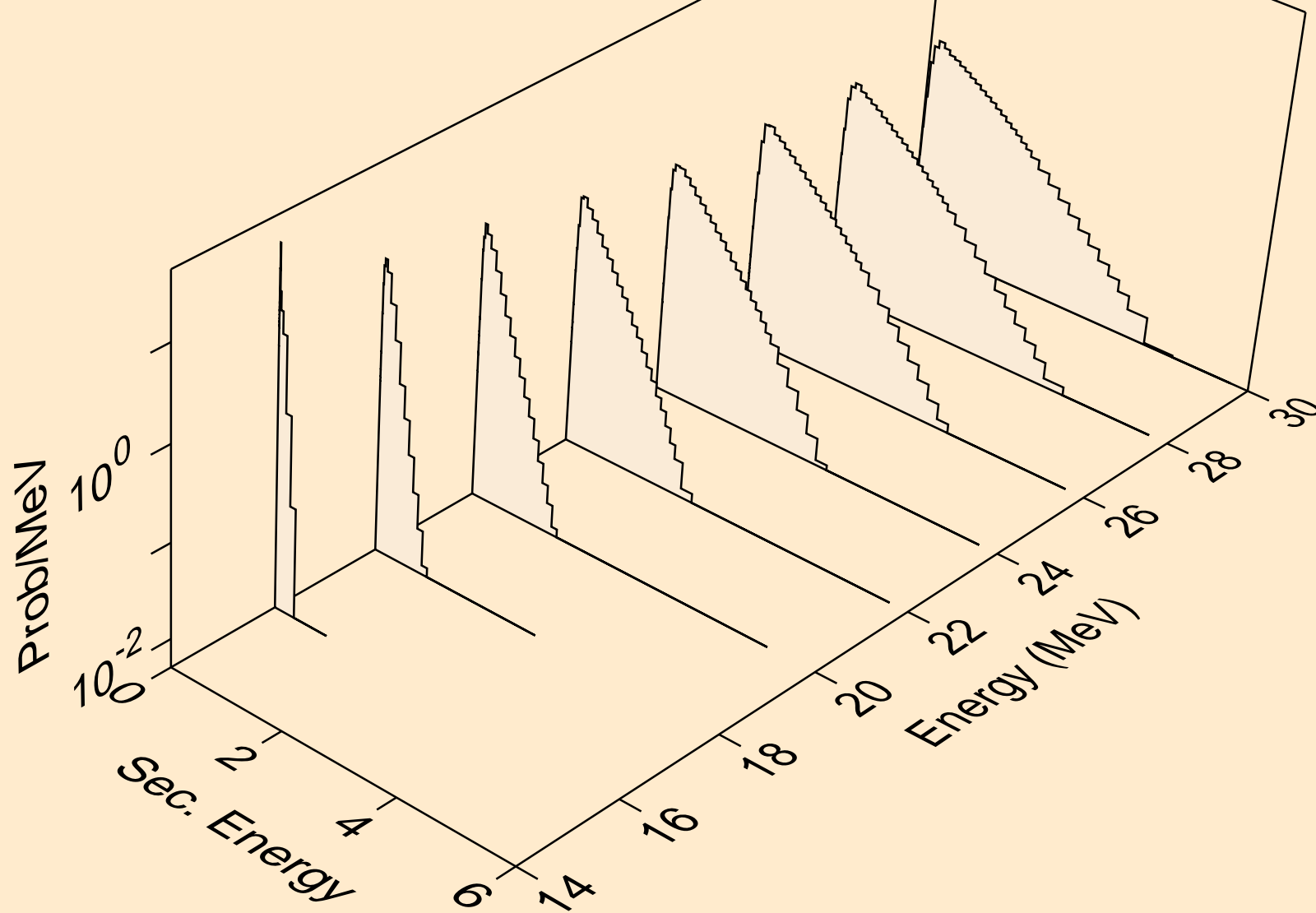

AG112 NEUTRON ACER TENDL-2024 LIBRARY; T=0.K
Neutron emission for (n,n*)he3

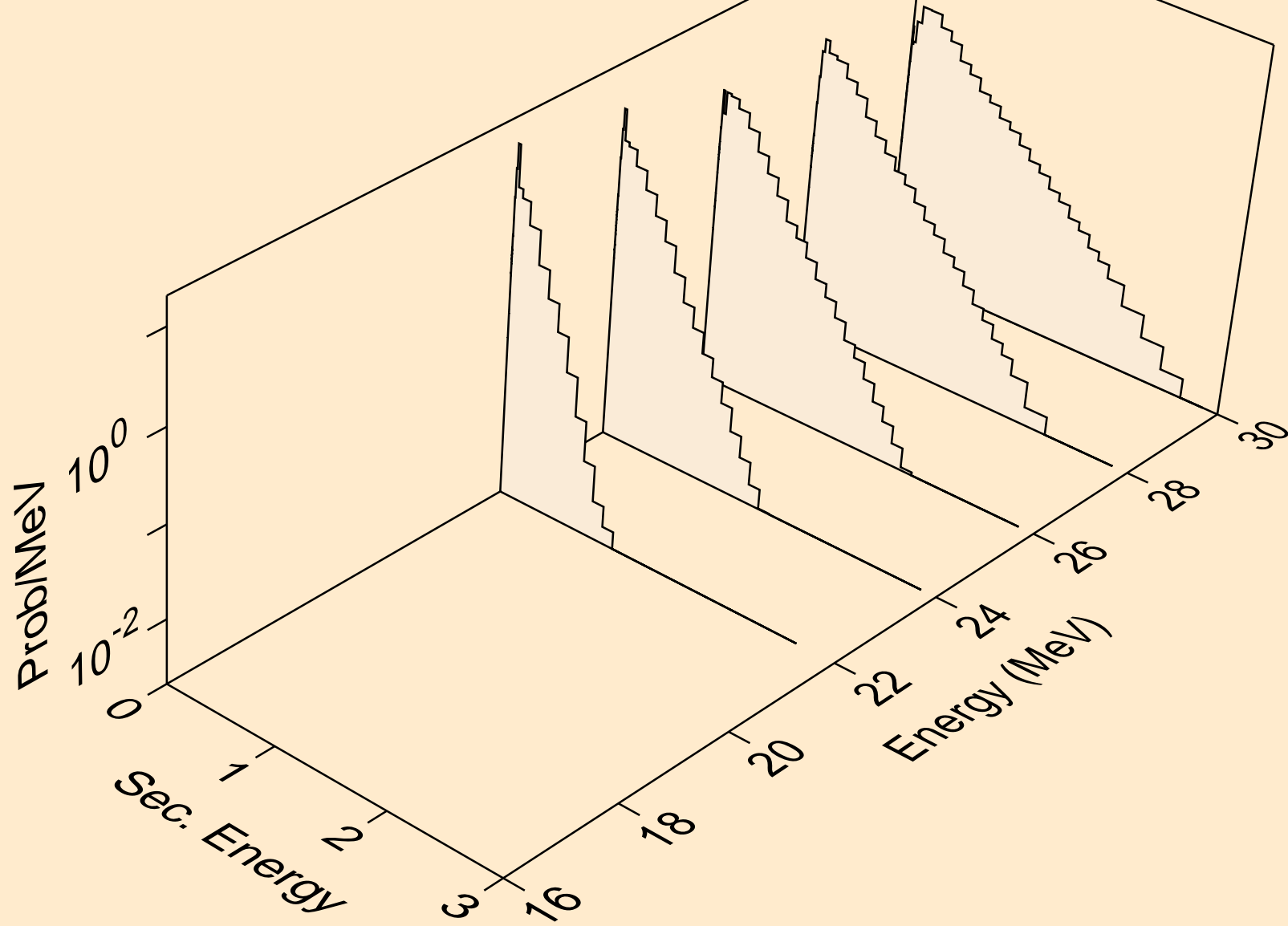

AG112 NEUTRON ACER TENDL-2024 LIBRARY; T=0.K
Neutron emission for (n,4n)

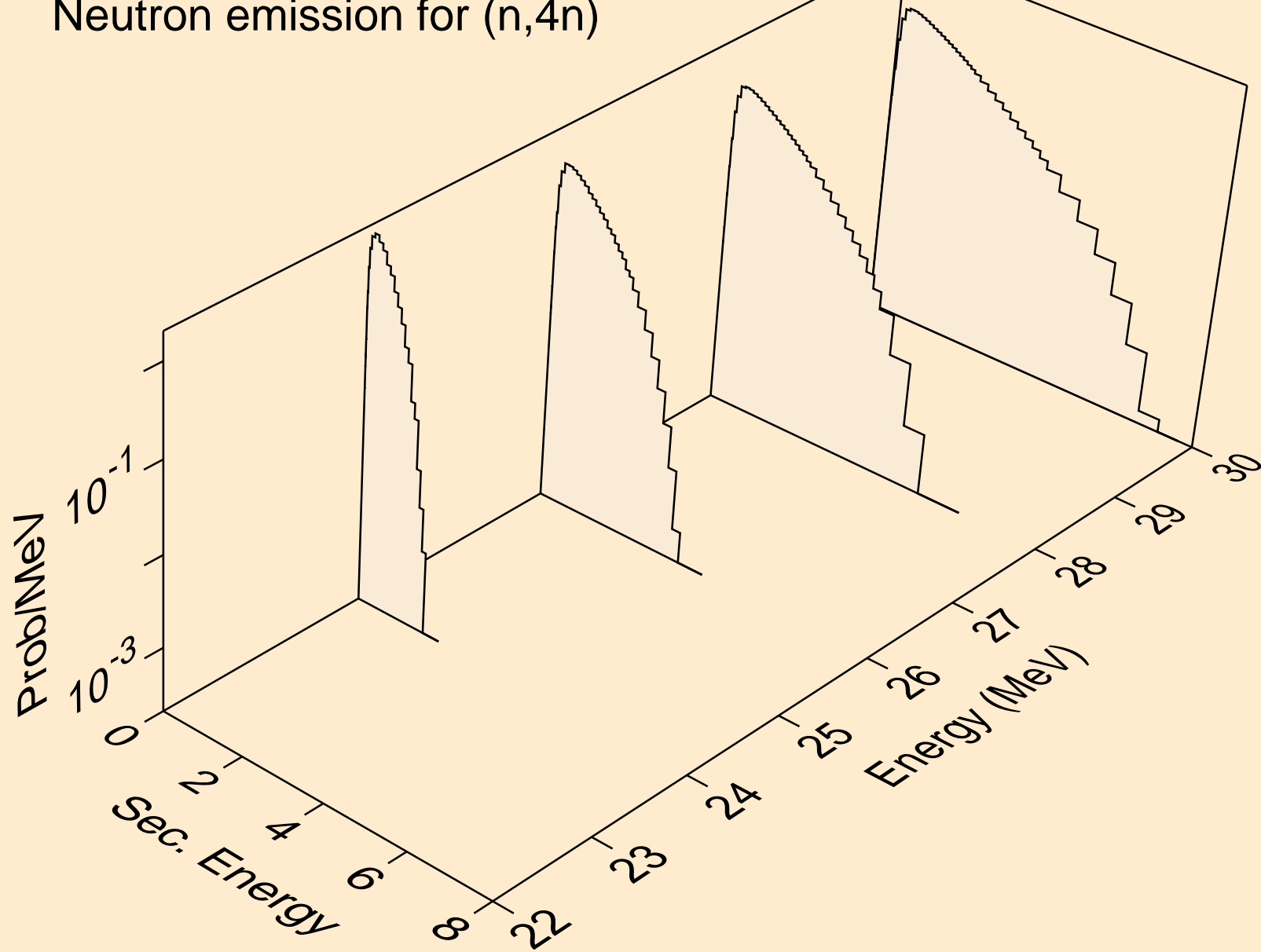

AG112 NEUTRON ACER TENDL-2024 LIBRARY; T=0.K
Neutron emission for (n,2np)

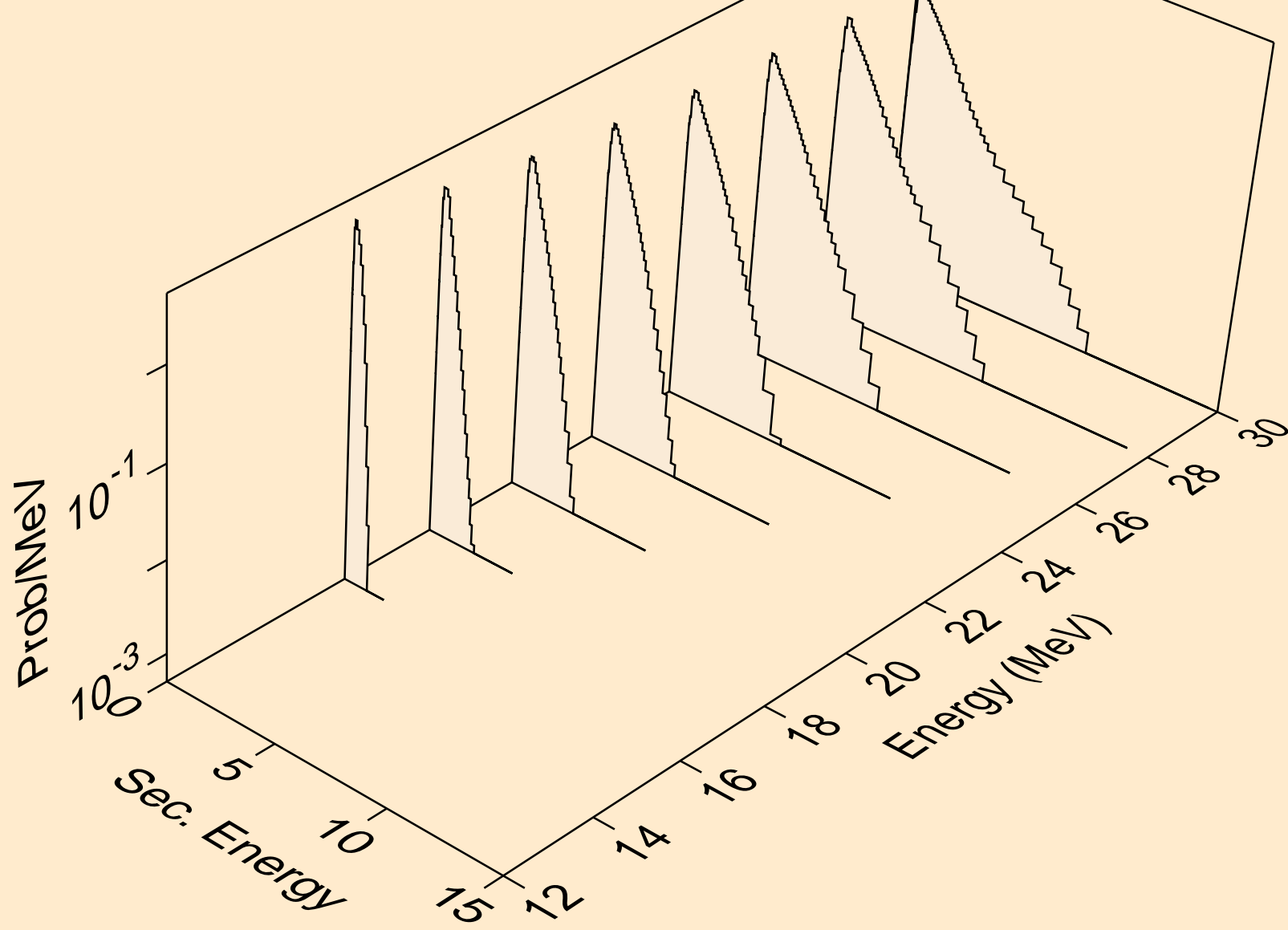

AG112 NEUTRON ACER TENDL-2024 LIBRARY; T=0.K
Neutron emission for (n,3np)

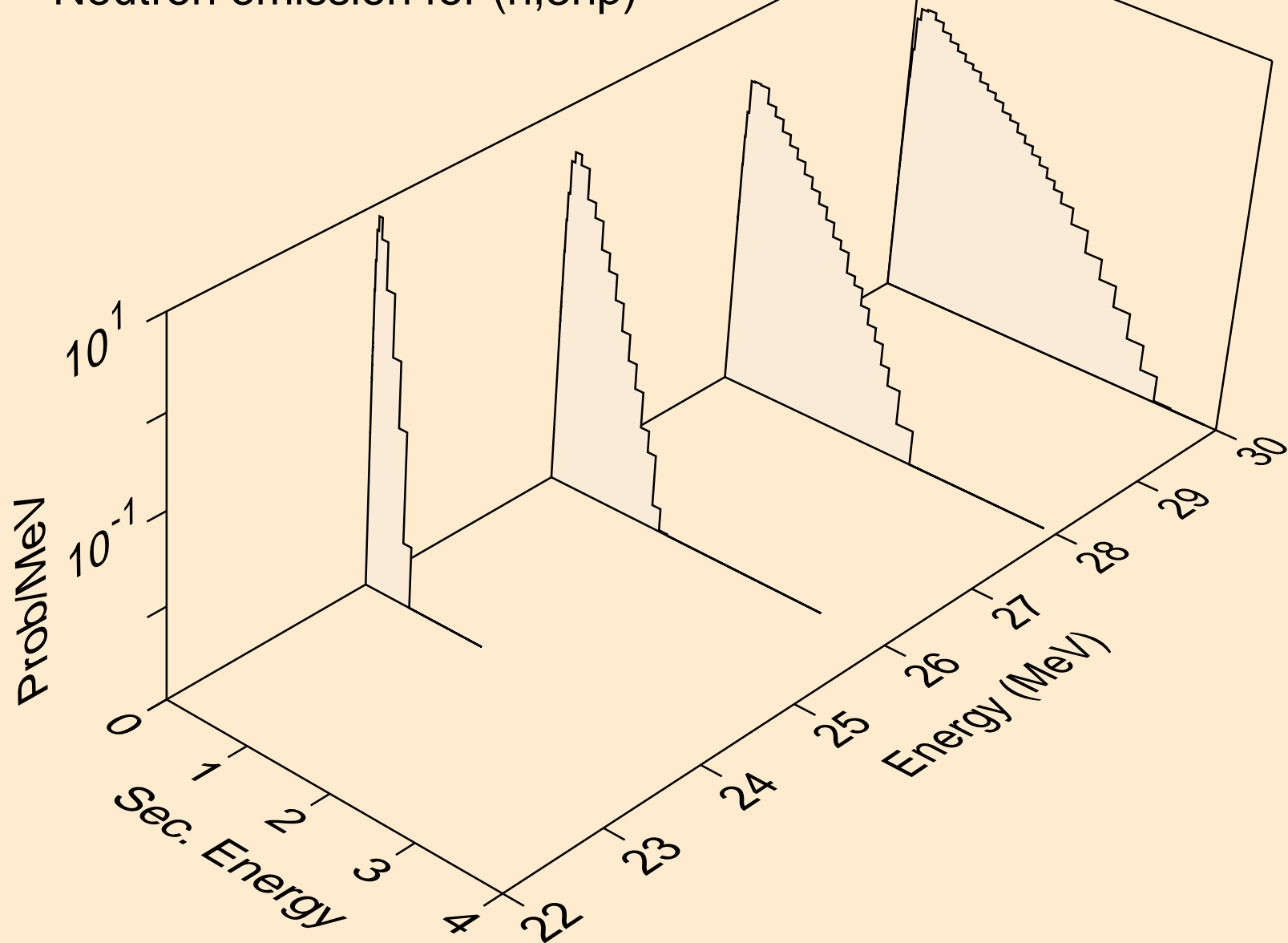

AG112 NEUTRON ACER TENDL-2024 LIBRARY; T=0.K
Neutron emission for (n,n2p)

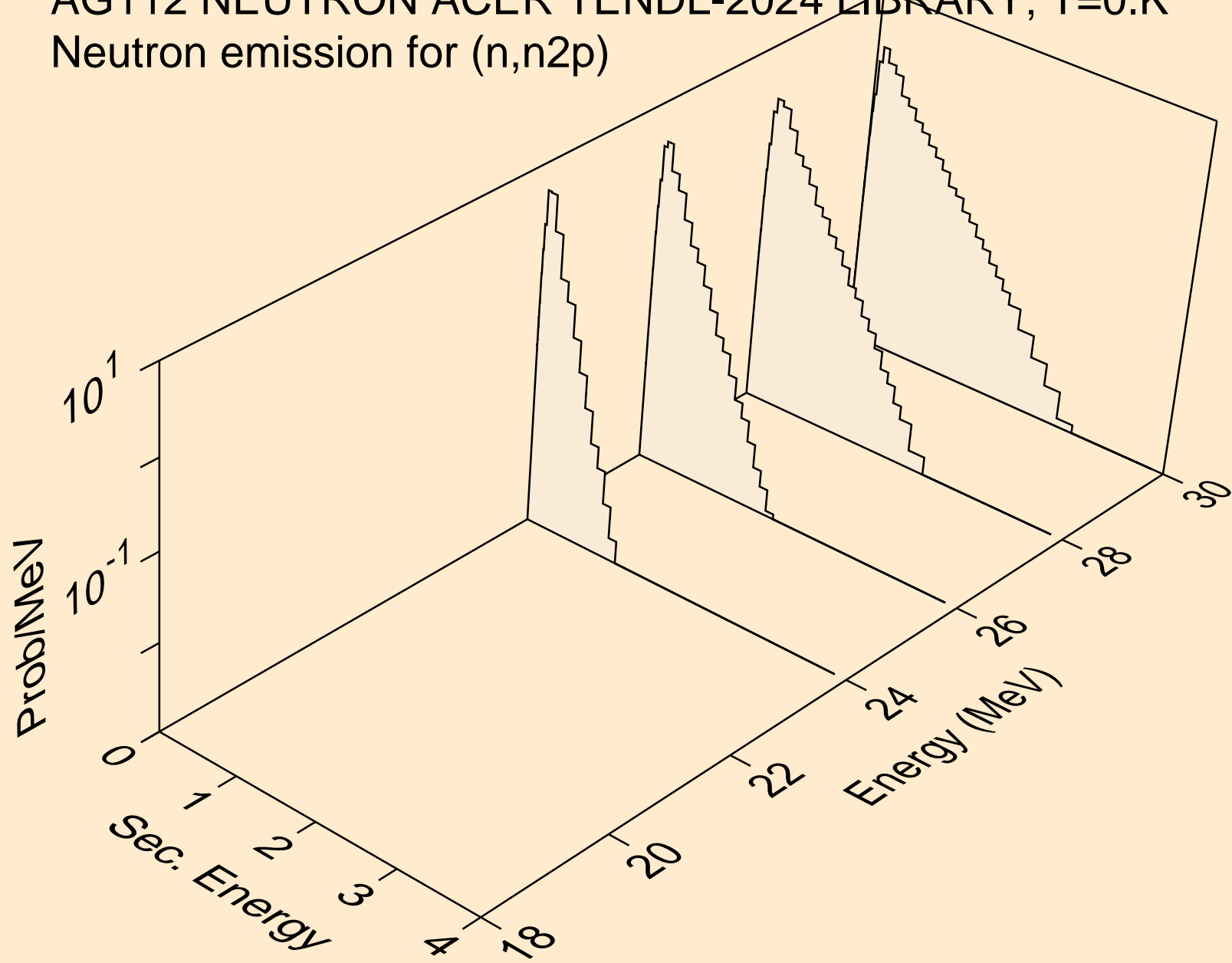

AG112 NEUTRON ACER TENDL-2024 LIBRARY; T=0.K
Neutron emission for (n,npa)

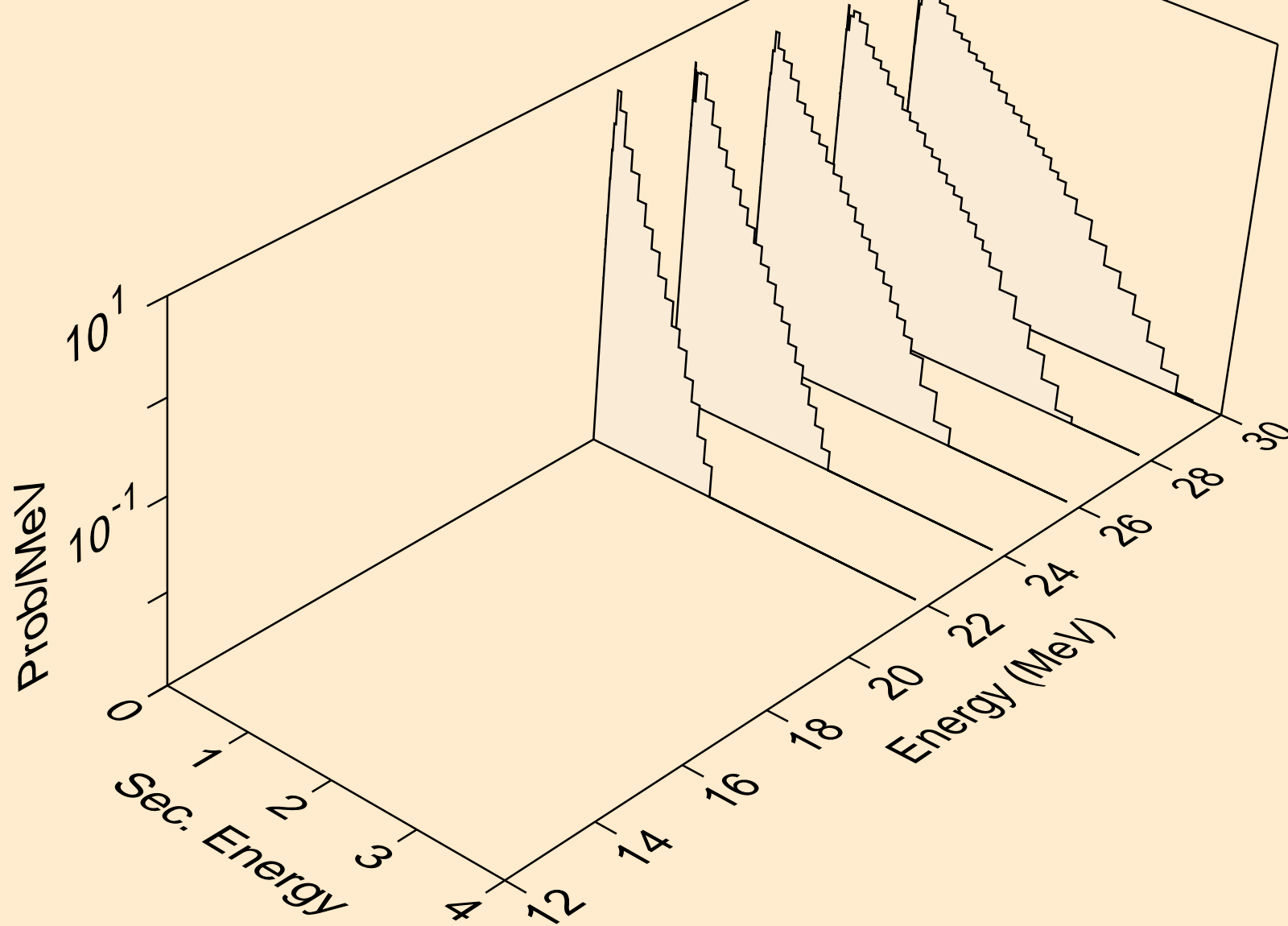

AG112 NEUTRON ACER TENDL-2024 LIBRARY; T=0.K
Neutron emission for (n,n*c)

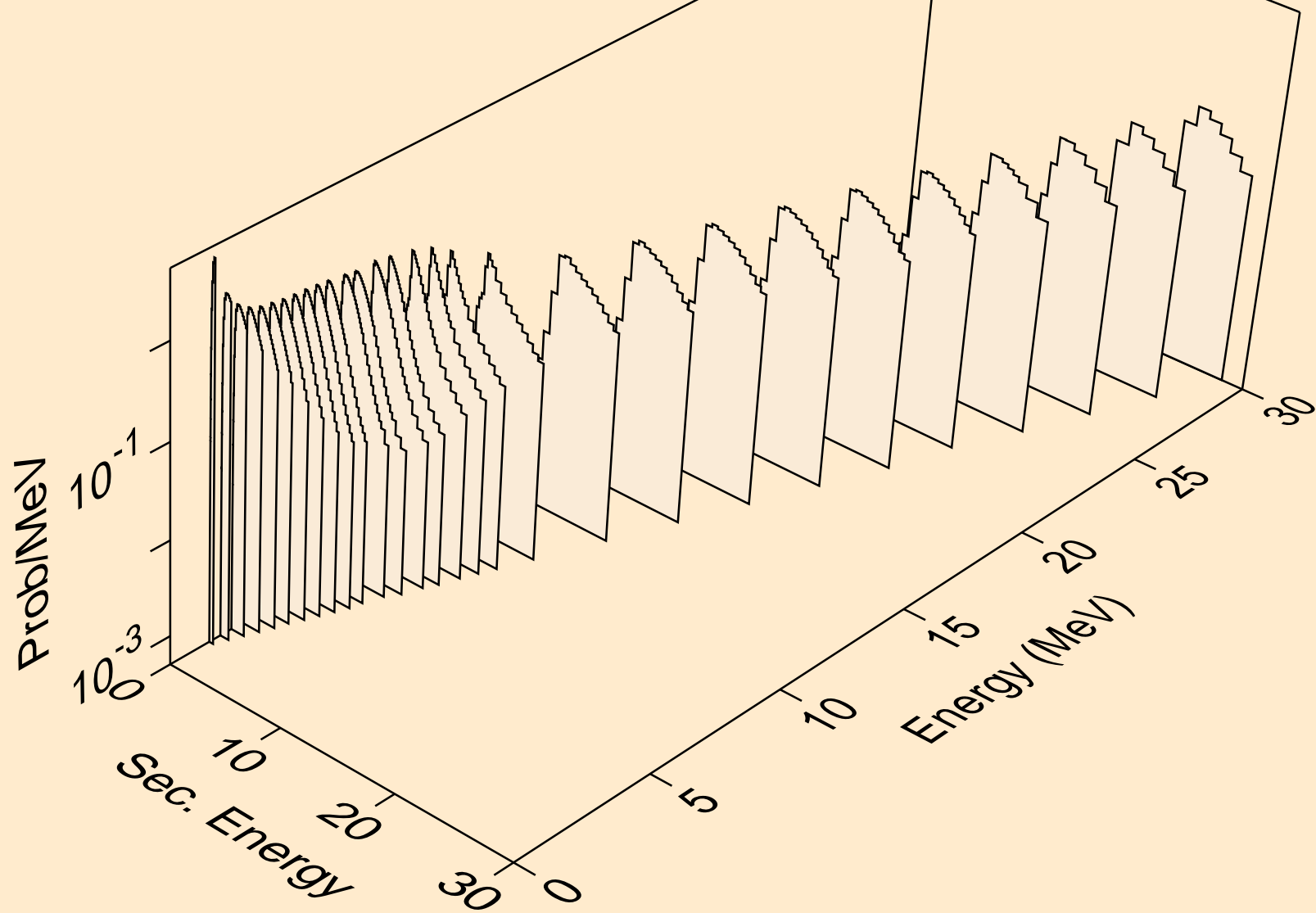

AG112 NEUTRON ACER TENDL-2024 LIBRARY; T=0.K
Photon emission for (n,x)

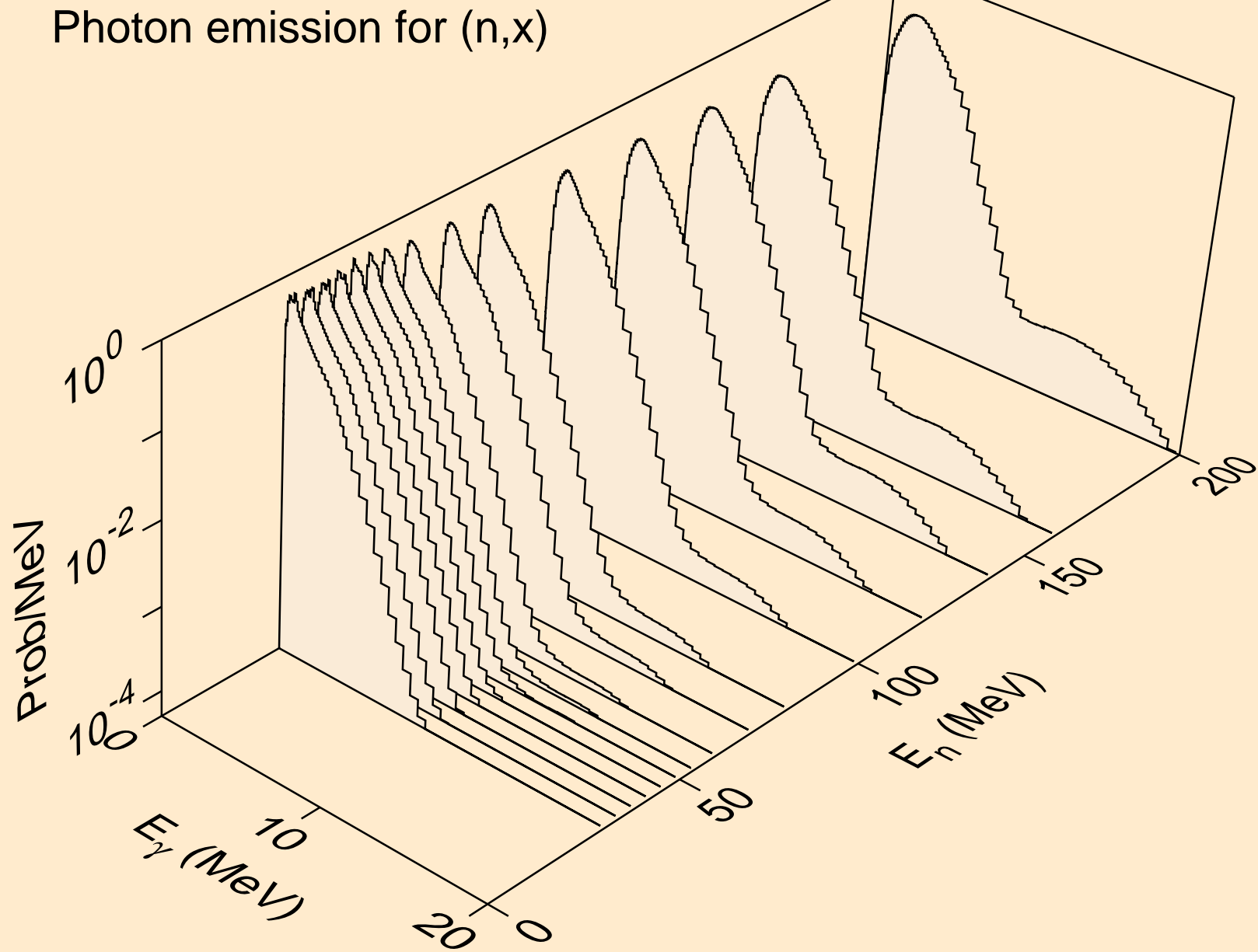

AG112 NEUTRON ACER TENDL-2024 LIBRARY; T=0.K
Photon emission for (n,2nd)

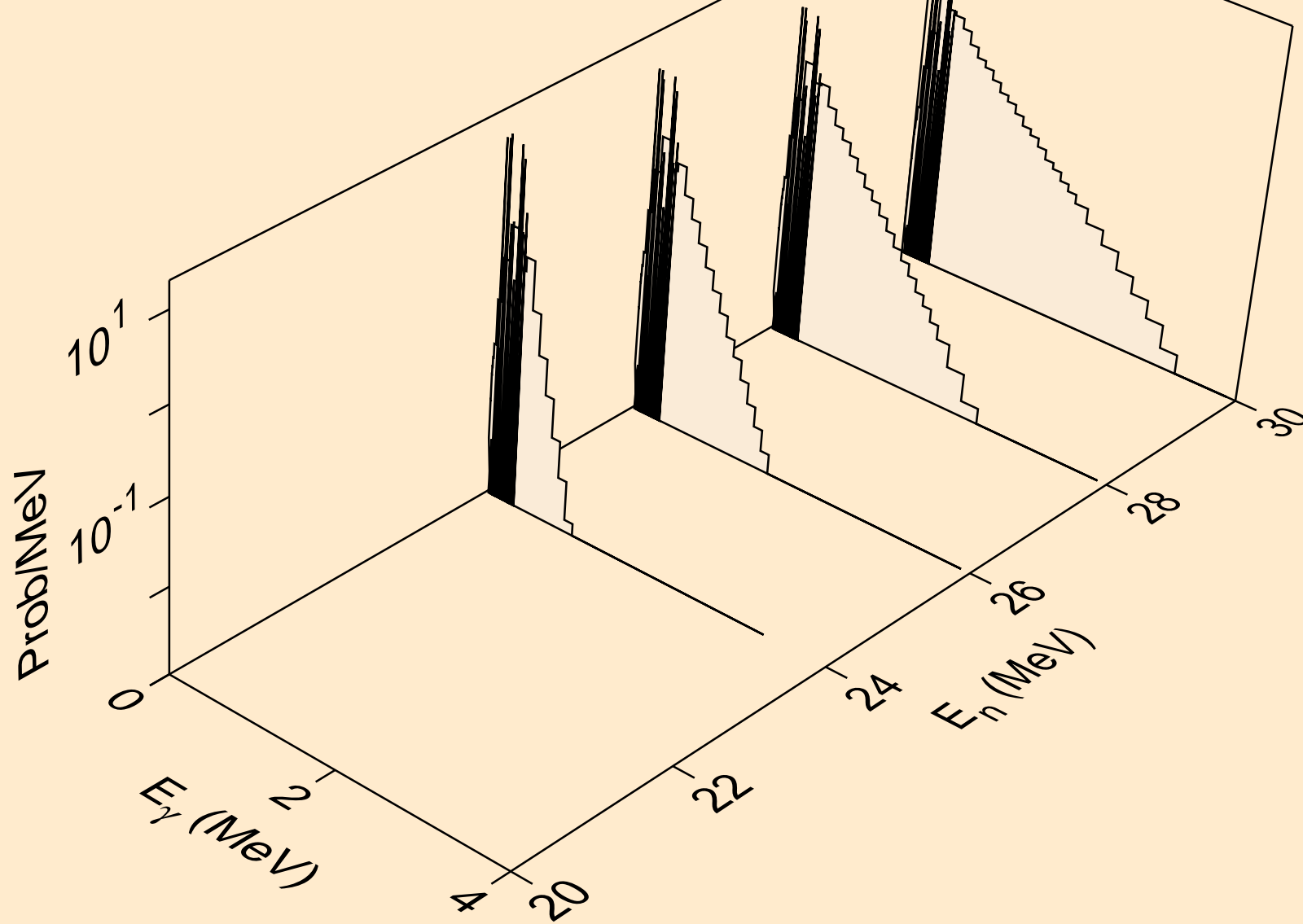

AG112 NEUTRON ACER TENDL-2024 LIBRARY; T=0.K
Photon emission for (n,2n)

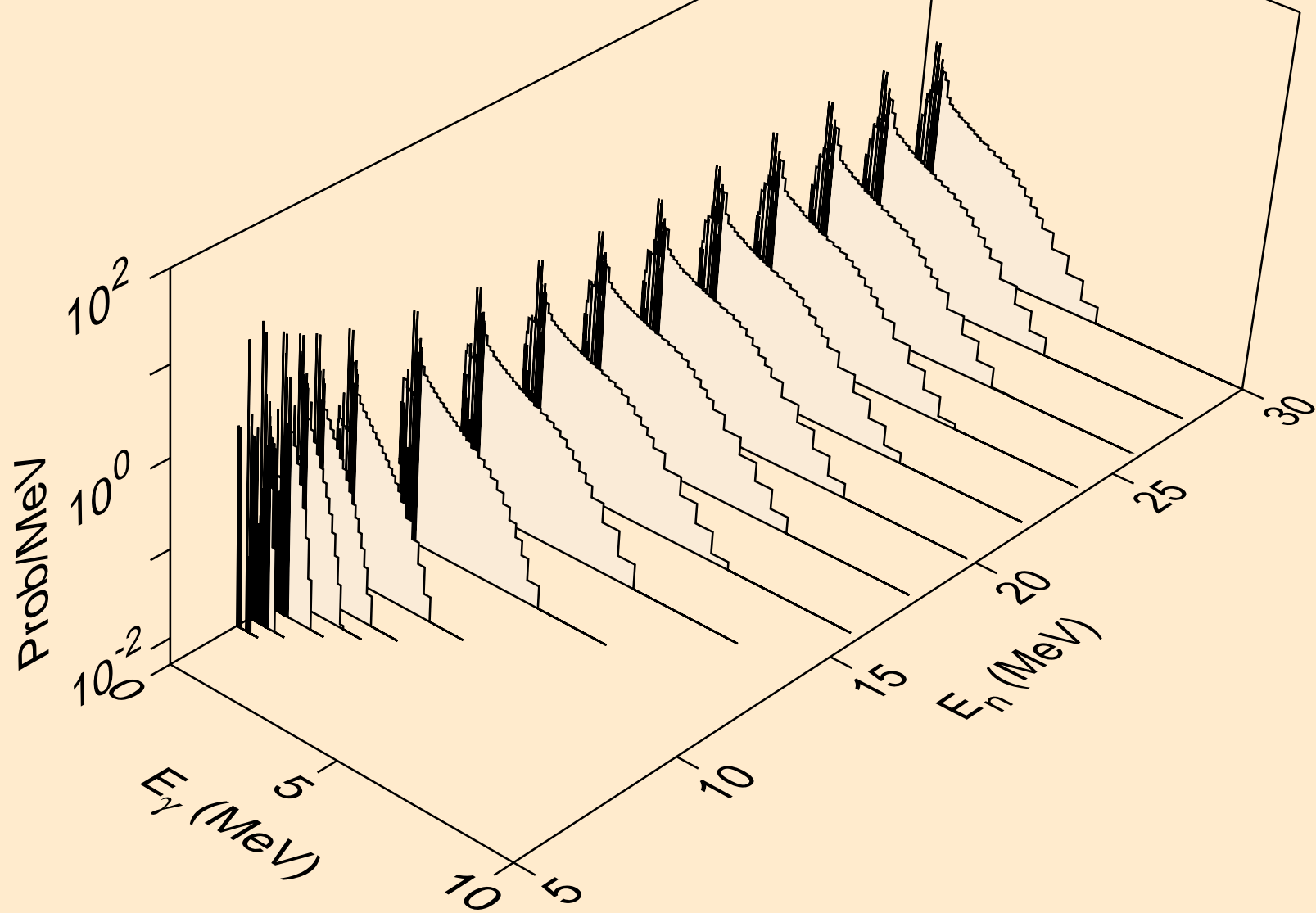

AG112 NEUTRON ACER TENDL-2024 LIBRARY; T=0.K
Photon emission for (n,3n)

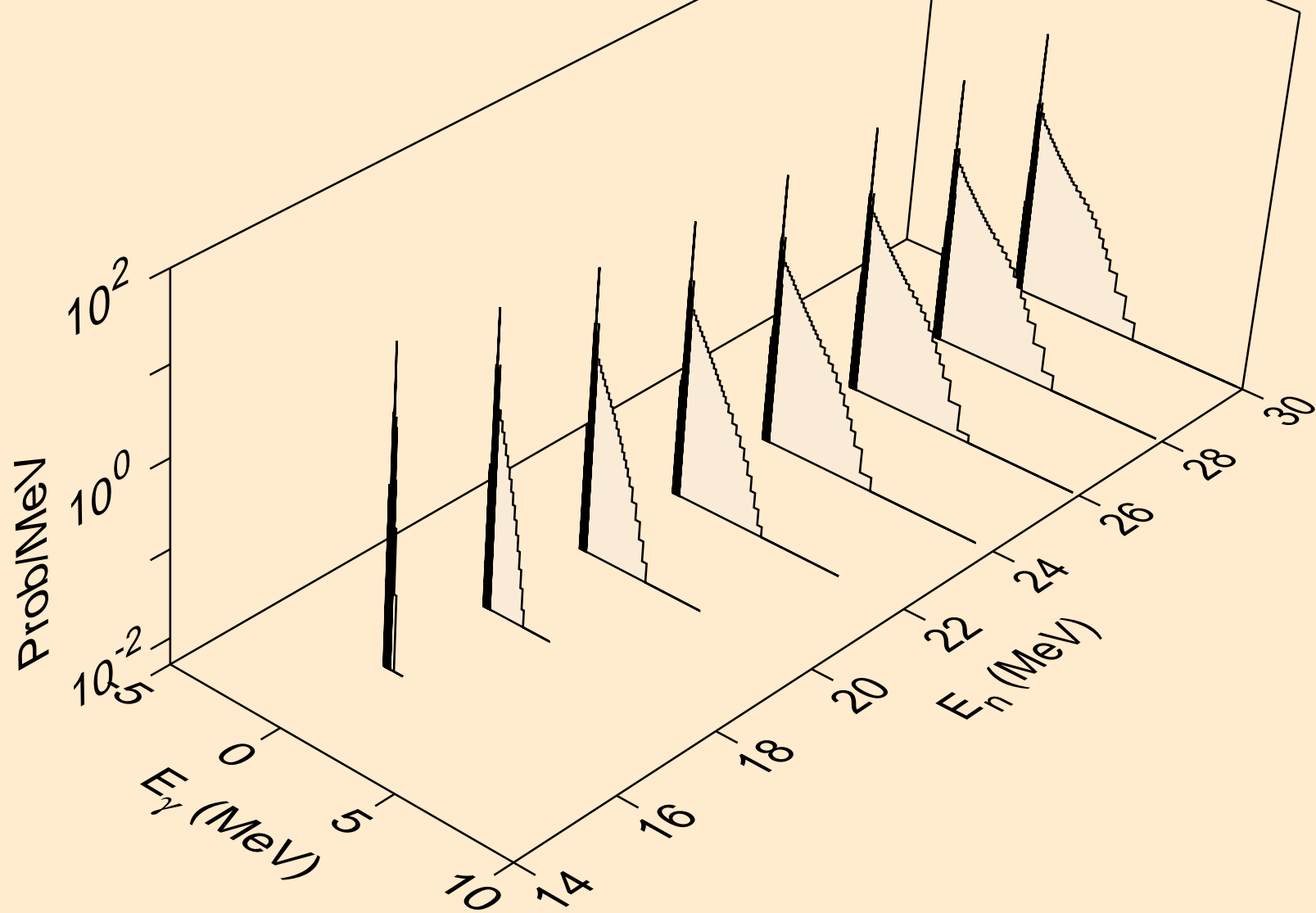

AG112 NEUTRON ACER TENDL-2024 LIBRARY; T=0.K
Photon emission for (n,n*)a

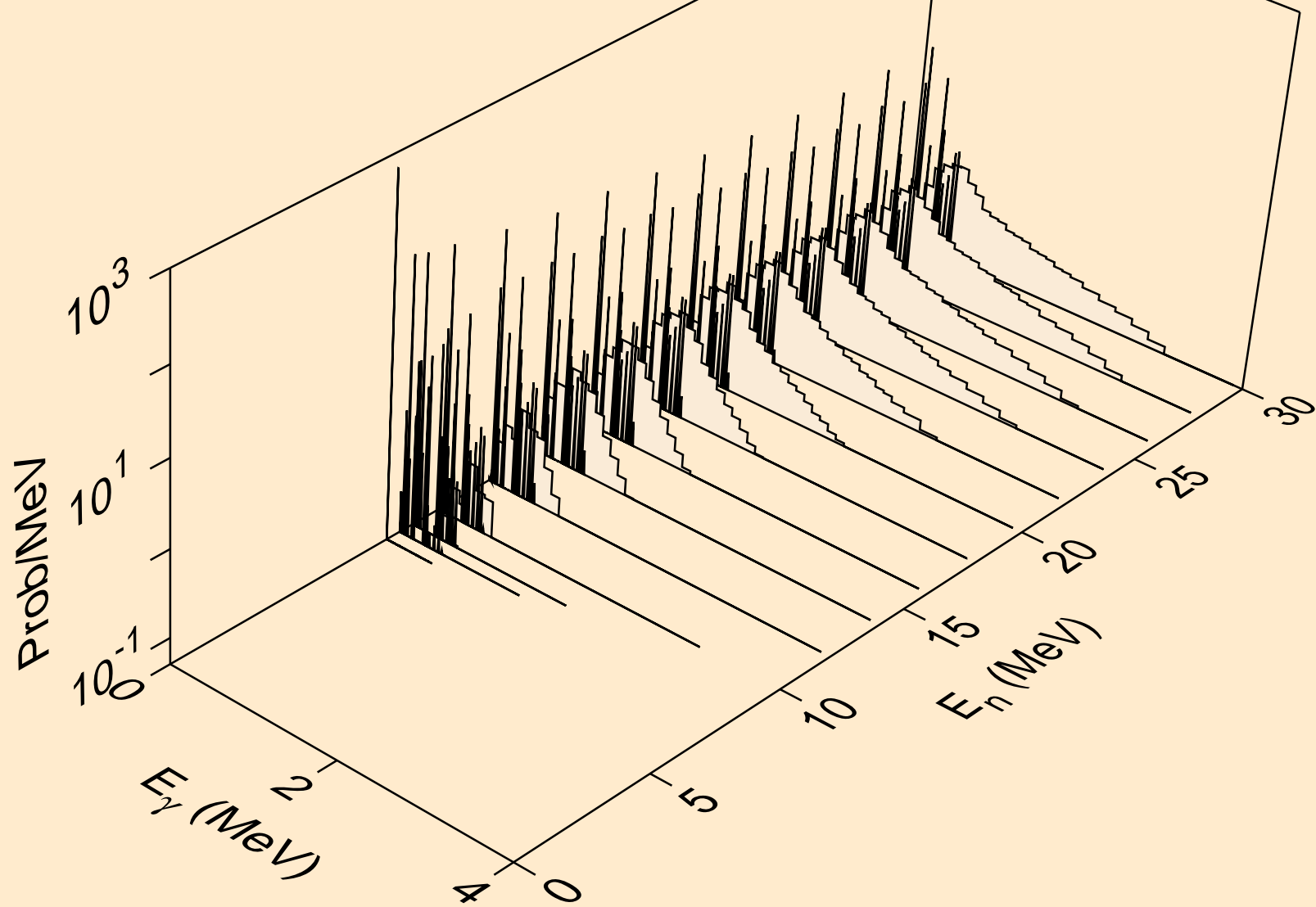

AG112 NEUTRON ACER TENDL-2024 LIBRARY; T=0.K
Photon emission for (n,2n)a

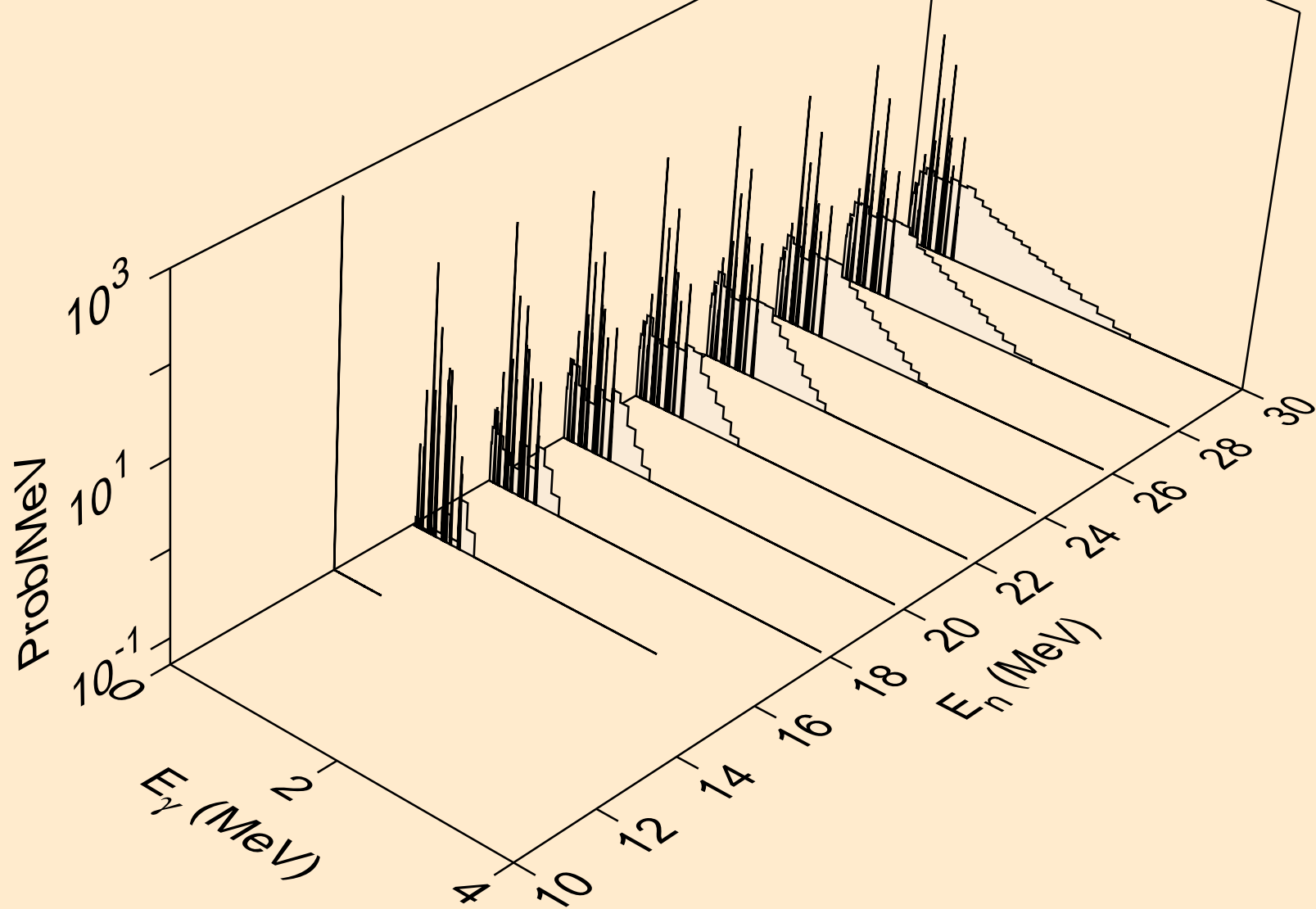

AG112 NEUTRON ACER TENDL-2024 LIBRARY; T=0.K
Photon emission for (n,3n)a

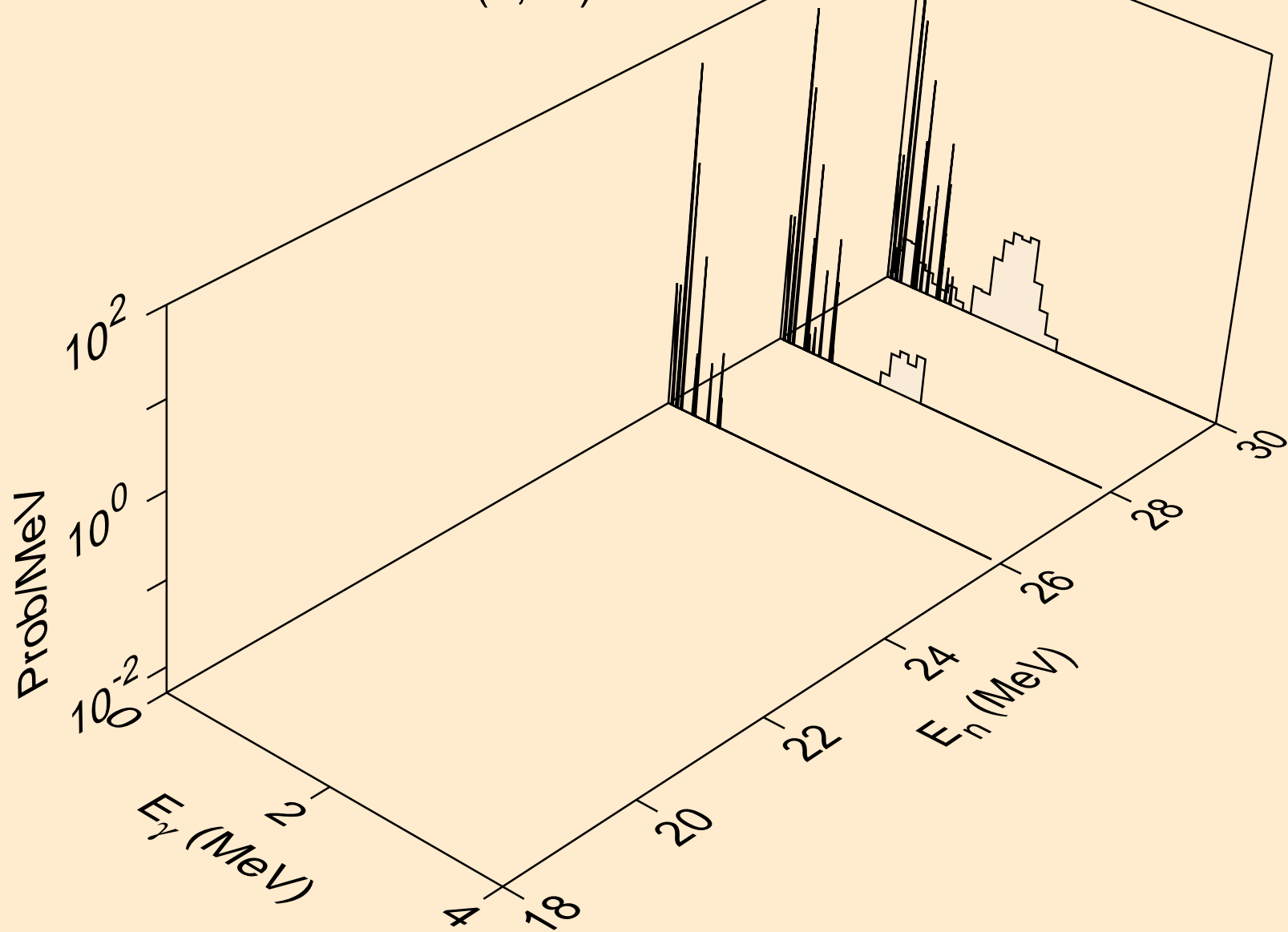

AG112 NEUTRON ACER TENDL-2024 LIBRARY; T=0.K
Photon emission for (n,n*)p

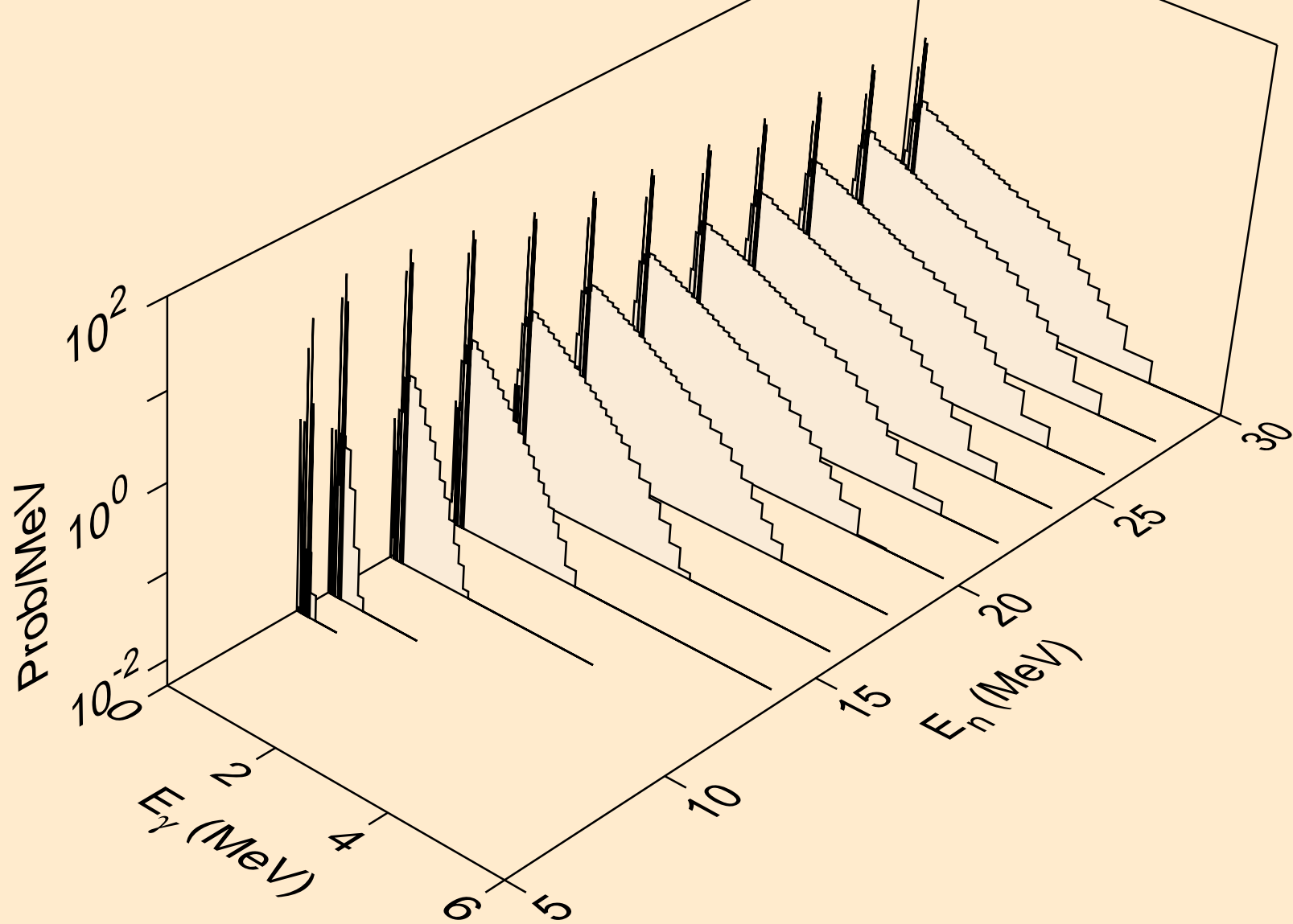

AG112 NEUTRON ACER TENDL-2024 LIBRARY; T=0.K
Photon emission for (n,n*)d

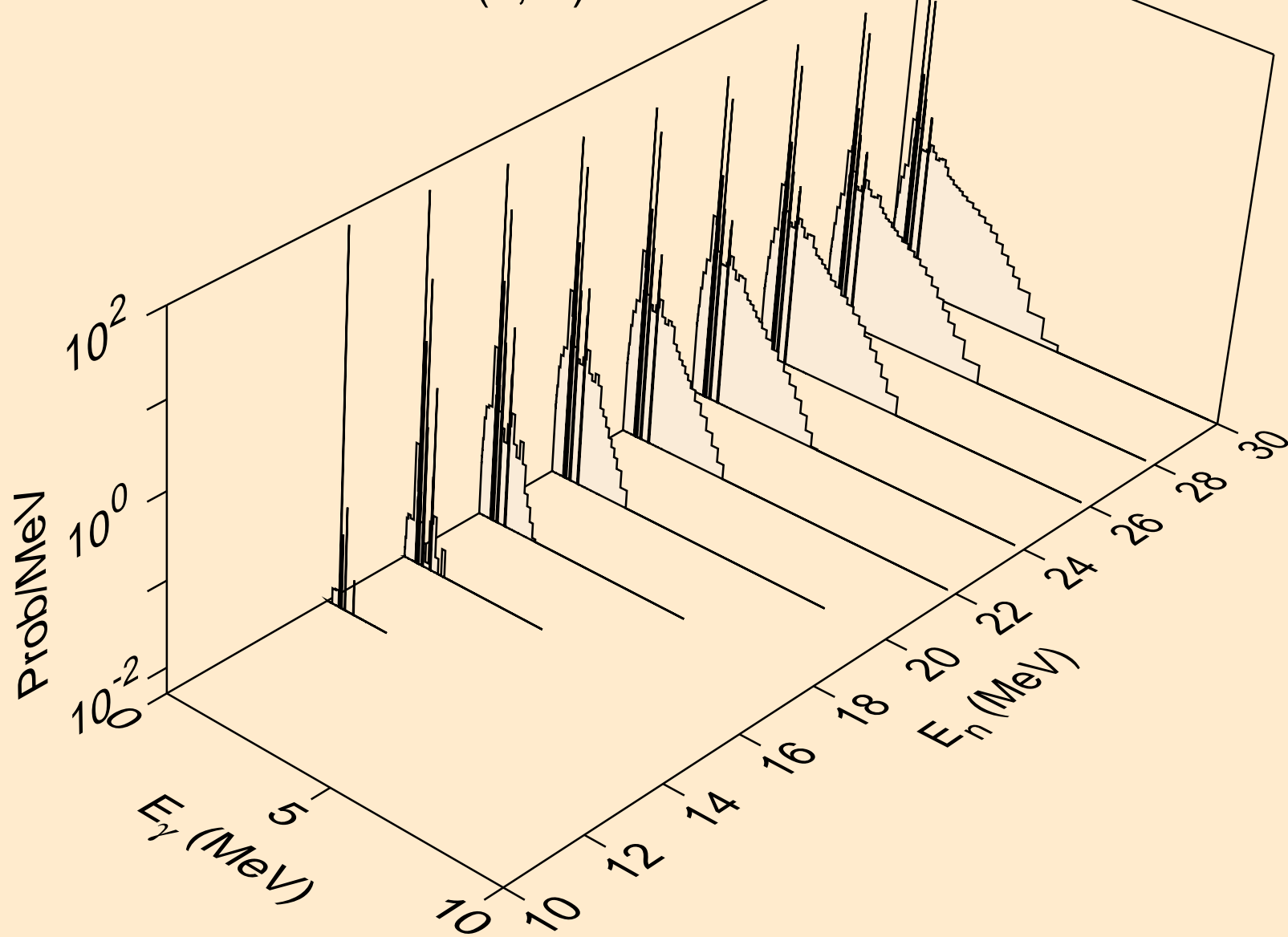

AG112 NEUTRON ACER TENDL-2024 LIBRARY; T=0.K
Photon emission for (n,n*)t

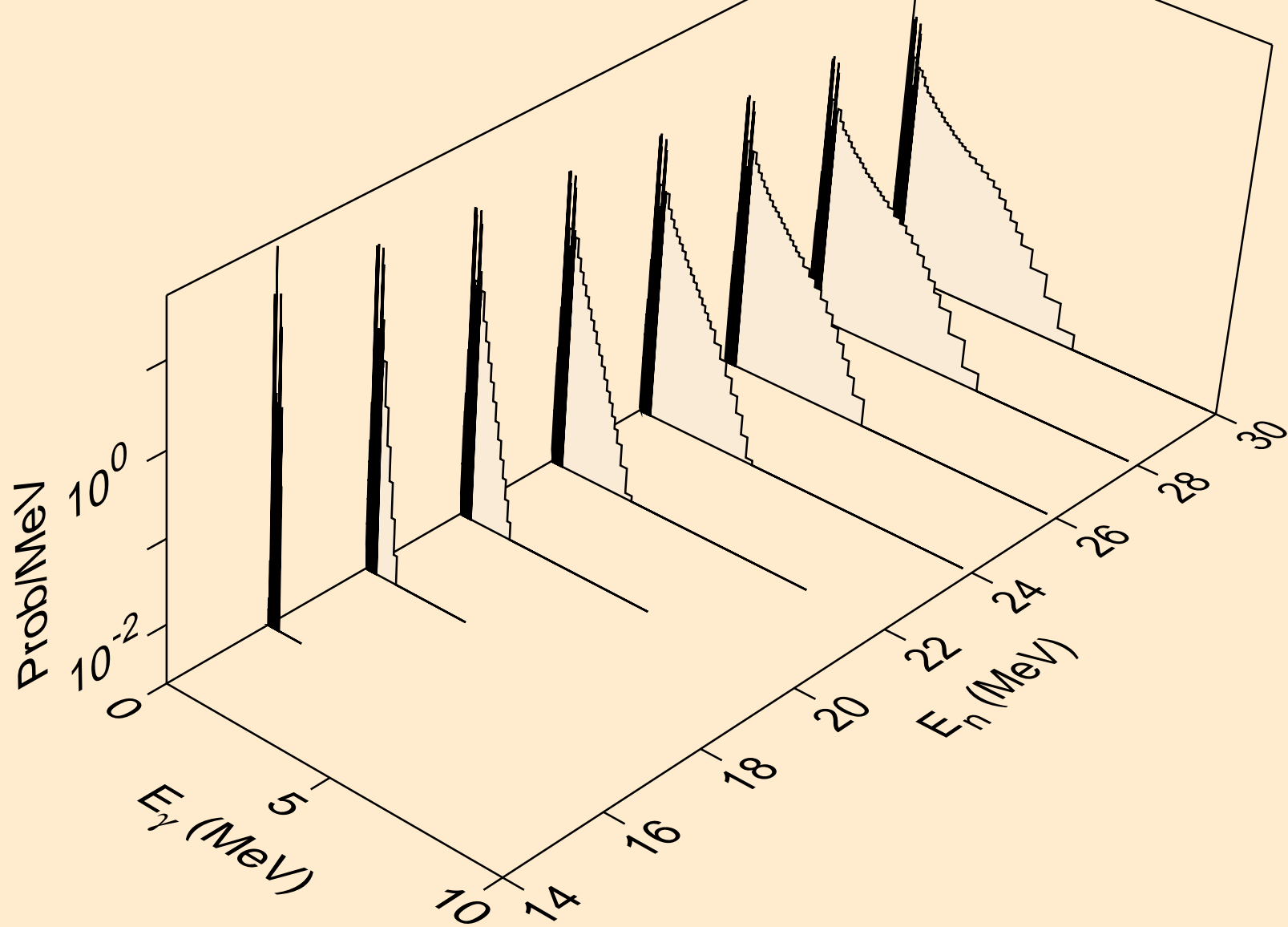

AG112 NEUTRON ACER TENDL-2024 LIBRARY; T=0.K
Photon emission for (n,n*)he3

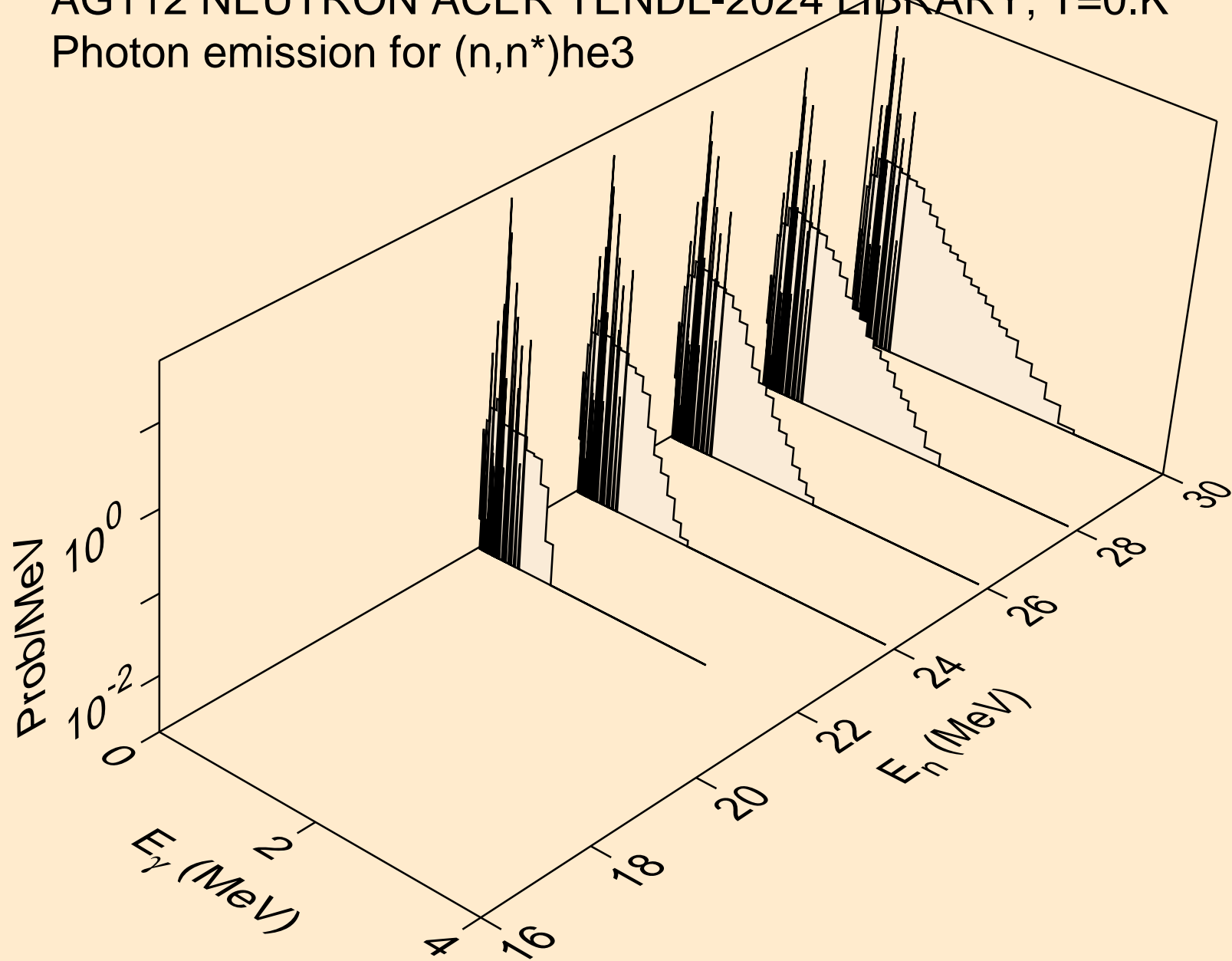

AG112 NEUTRON ACER TENDL-2024 LIBRARY; T=0.K
Photon emission for (n,4n)

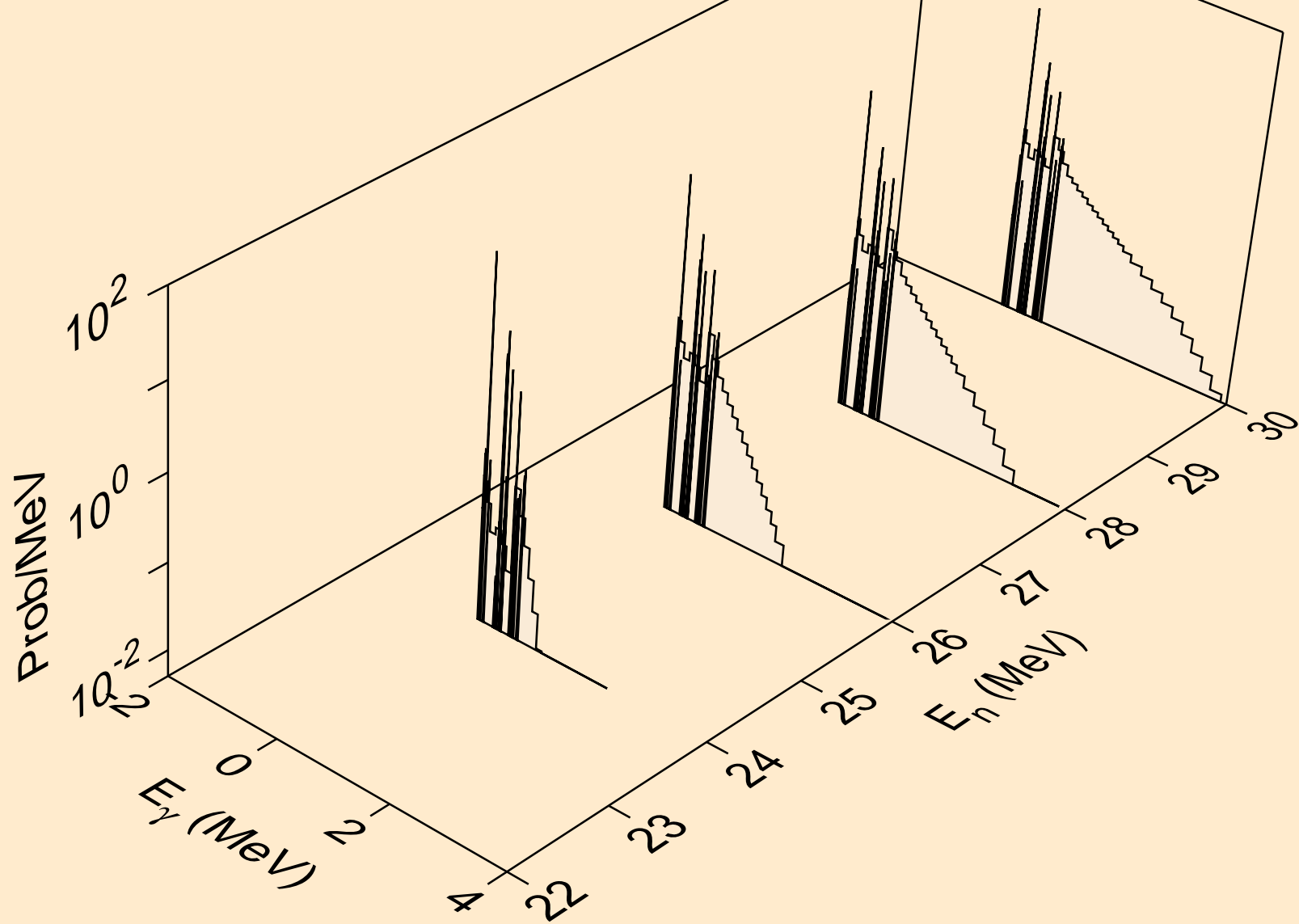

AG112 NEUTRON ACER TENDL-2024 LIBRARY; T=0.K
Photon emission for (n,2np)

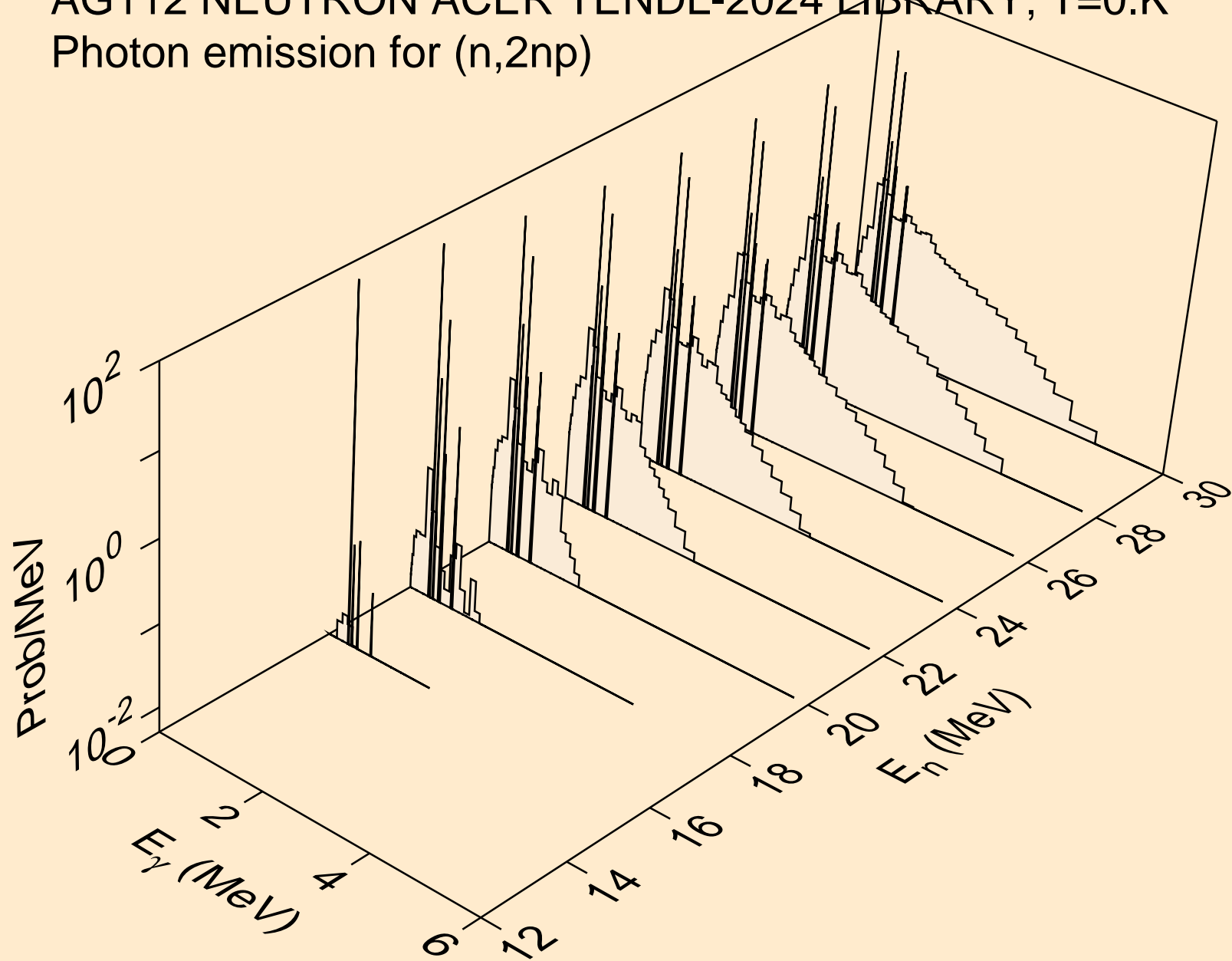

AG112 NEUTRON ACER TENDL-2024 LIBRARY; T=0.K
Photon emission for (n,3np)

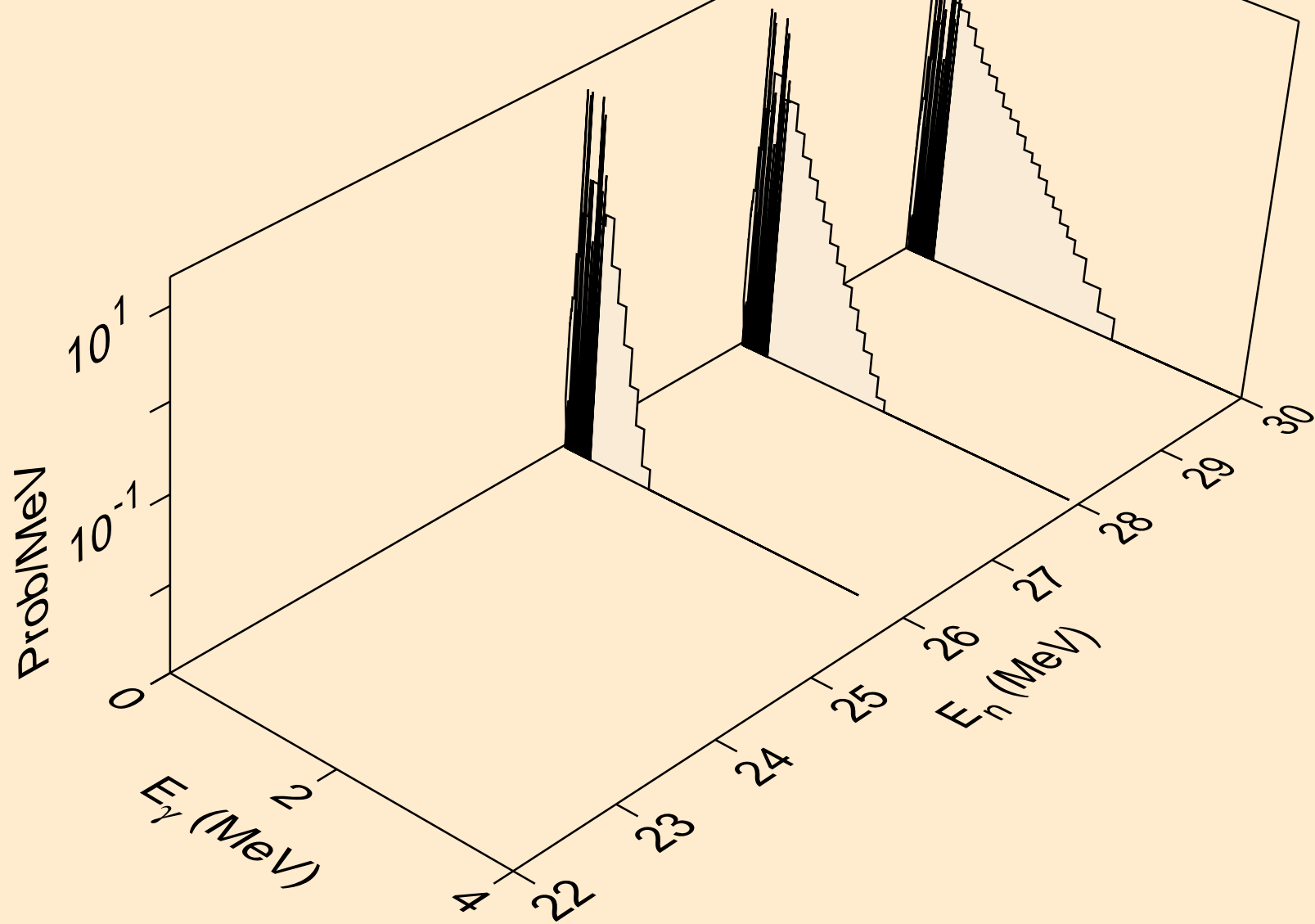

AG112 NEUTRON ACER TENDL-2024 LIBRARY; T=0.K
Photon emission for (n,n2p)

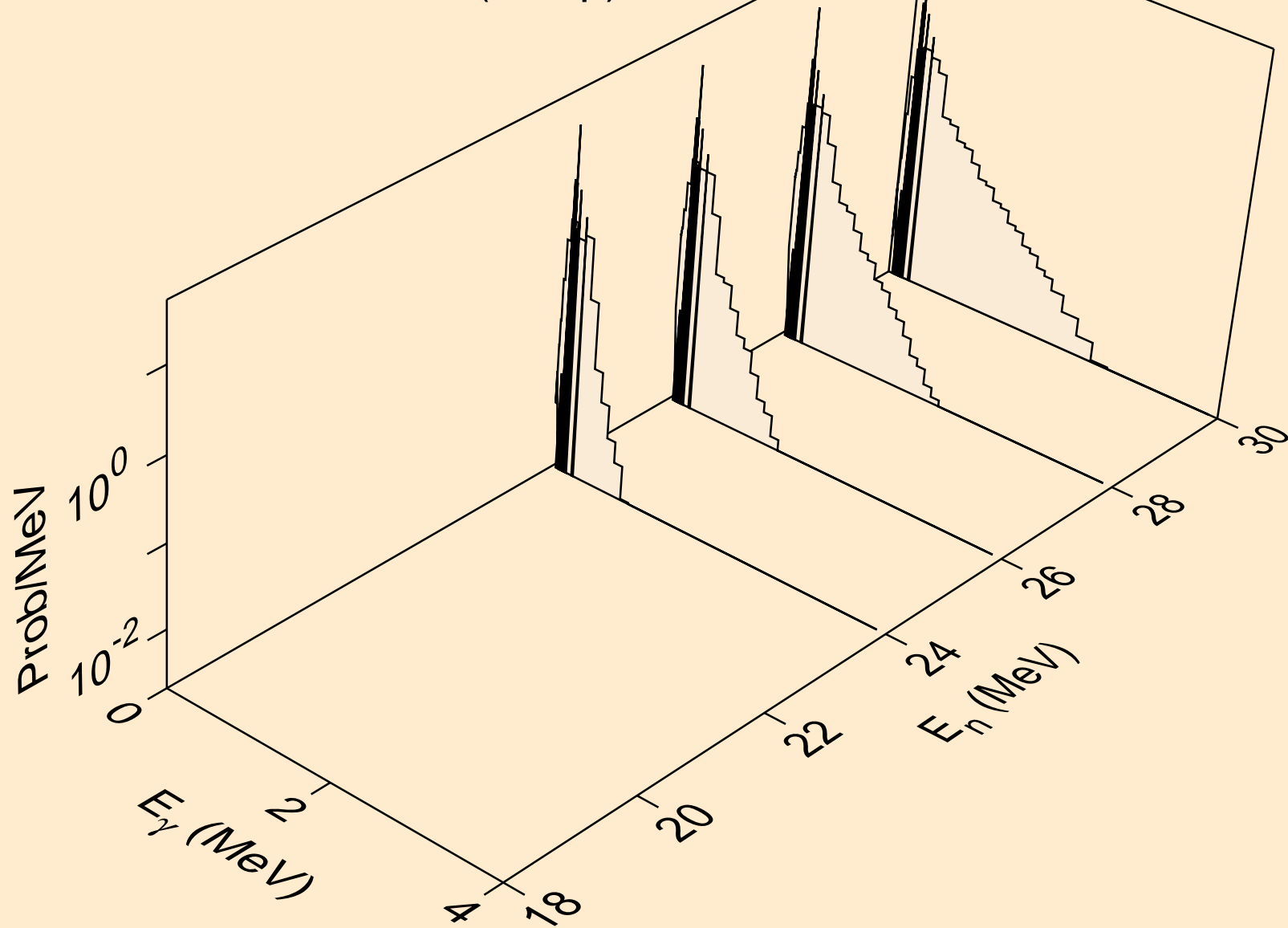

AG112 NEUTRON ACER TENDL-2024 LIBRARY; T=0.K
Photon emission for (n,npa)

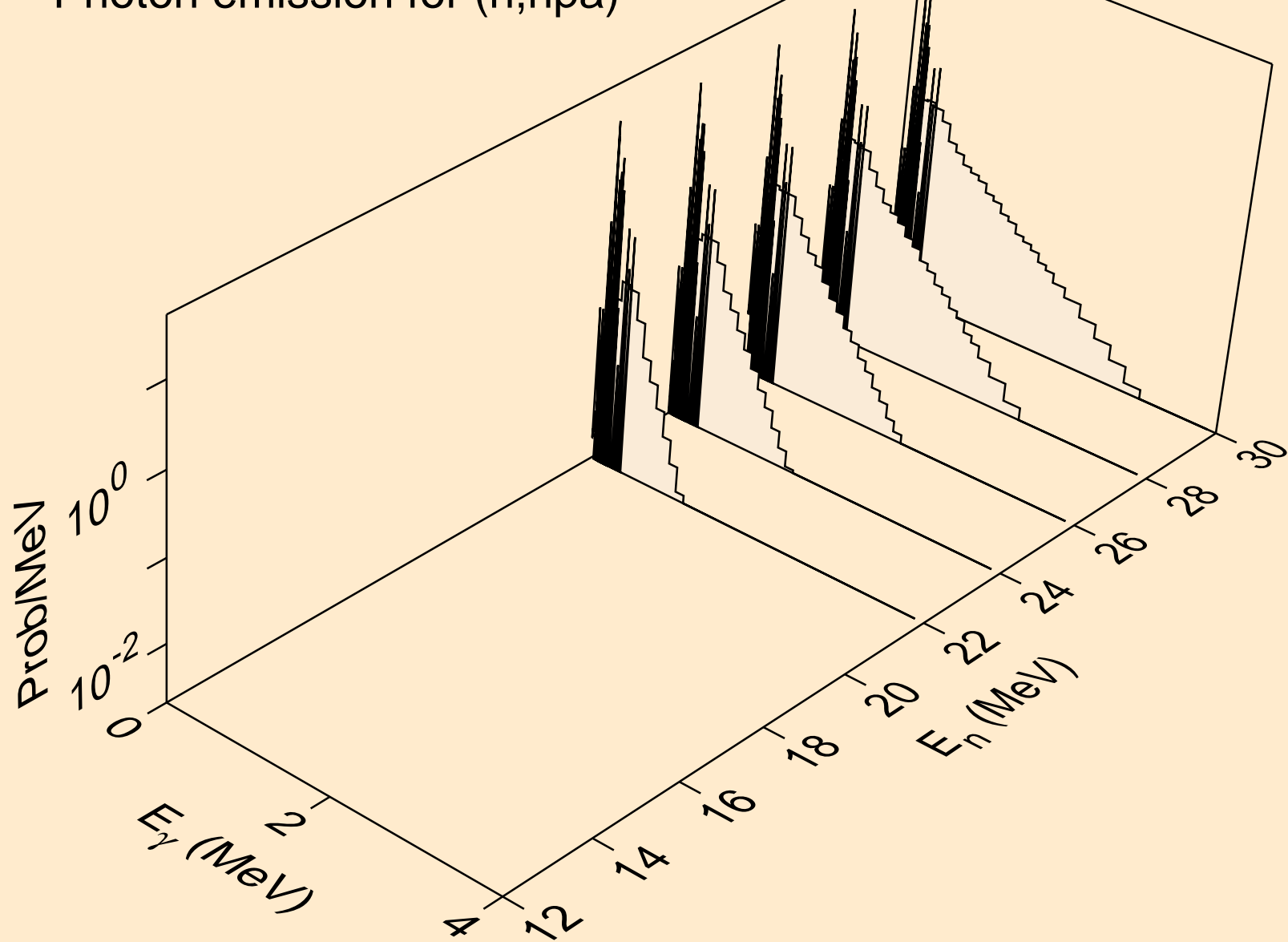

AG112 NEUTRON ACER TENDL-2024 LIBRARY; T=0.K
Photon emission for (n,n*c)

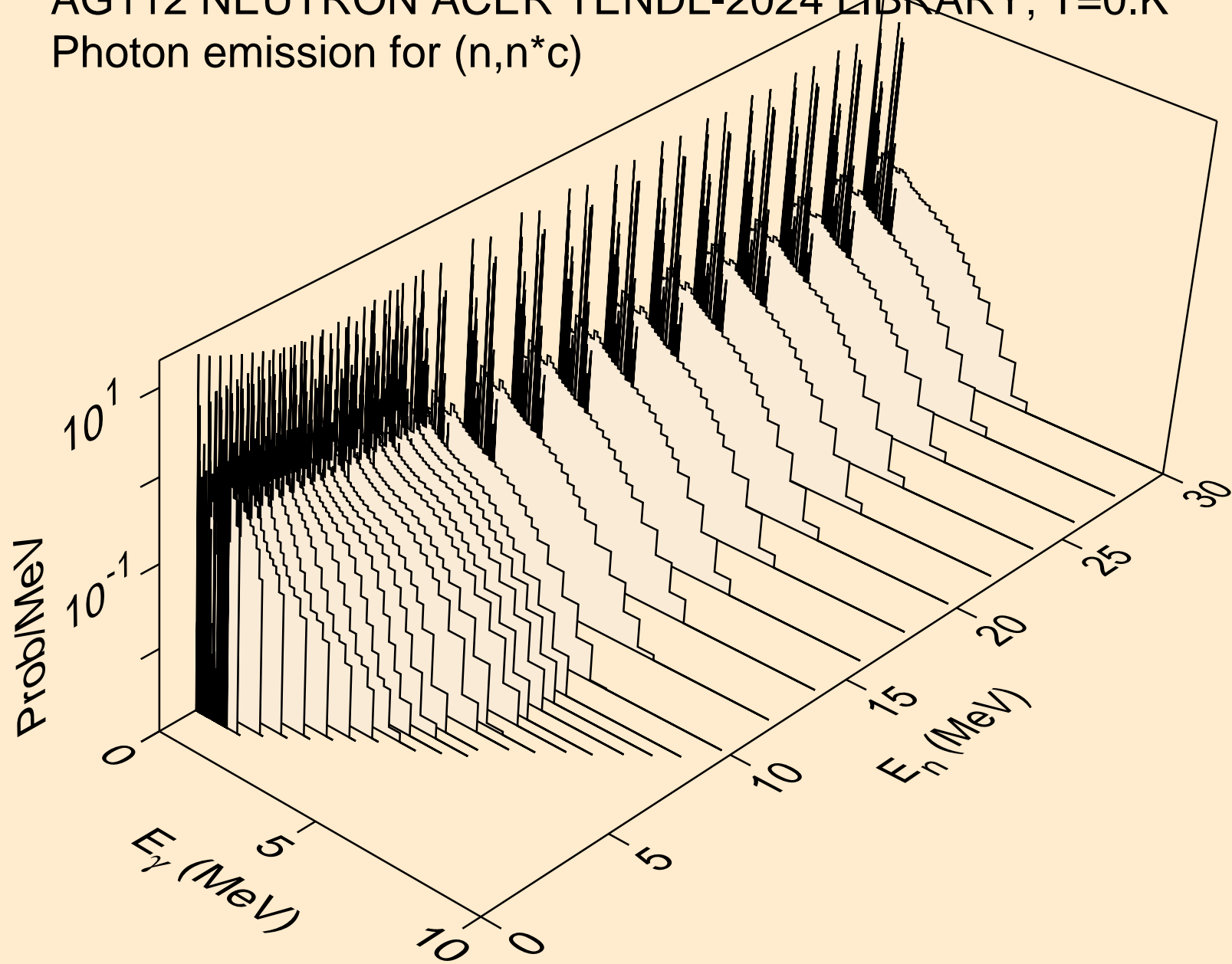

AG112 NEUTRON ACER TENDL-2024 LIBRARY; T=0.K
Photon emission for (n,gma)

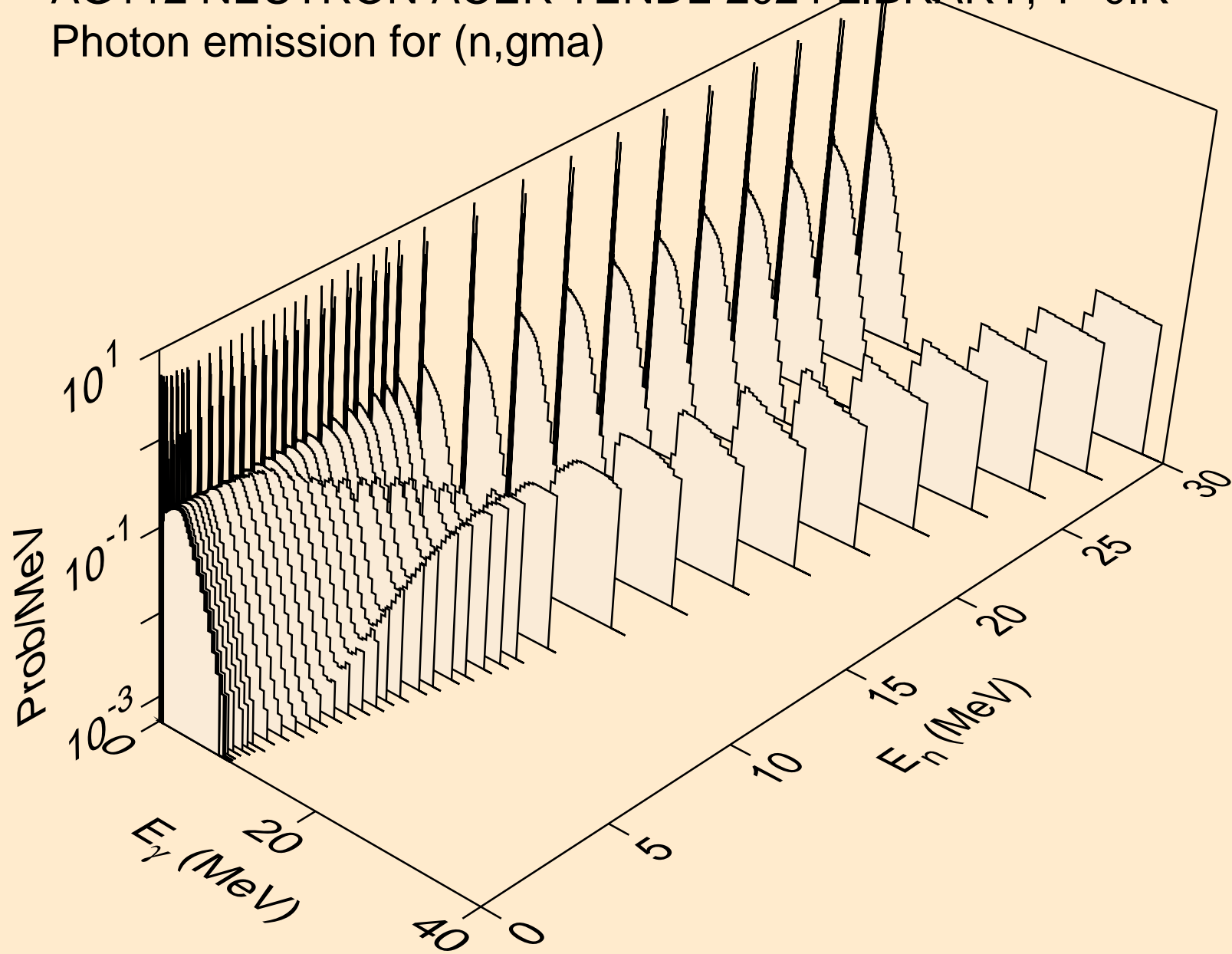

AG112 NEUTRON ACER TENDL-2024 LIBRARY; T=0.K
Photon emission for (n,p)

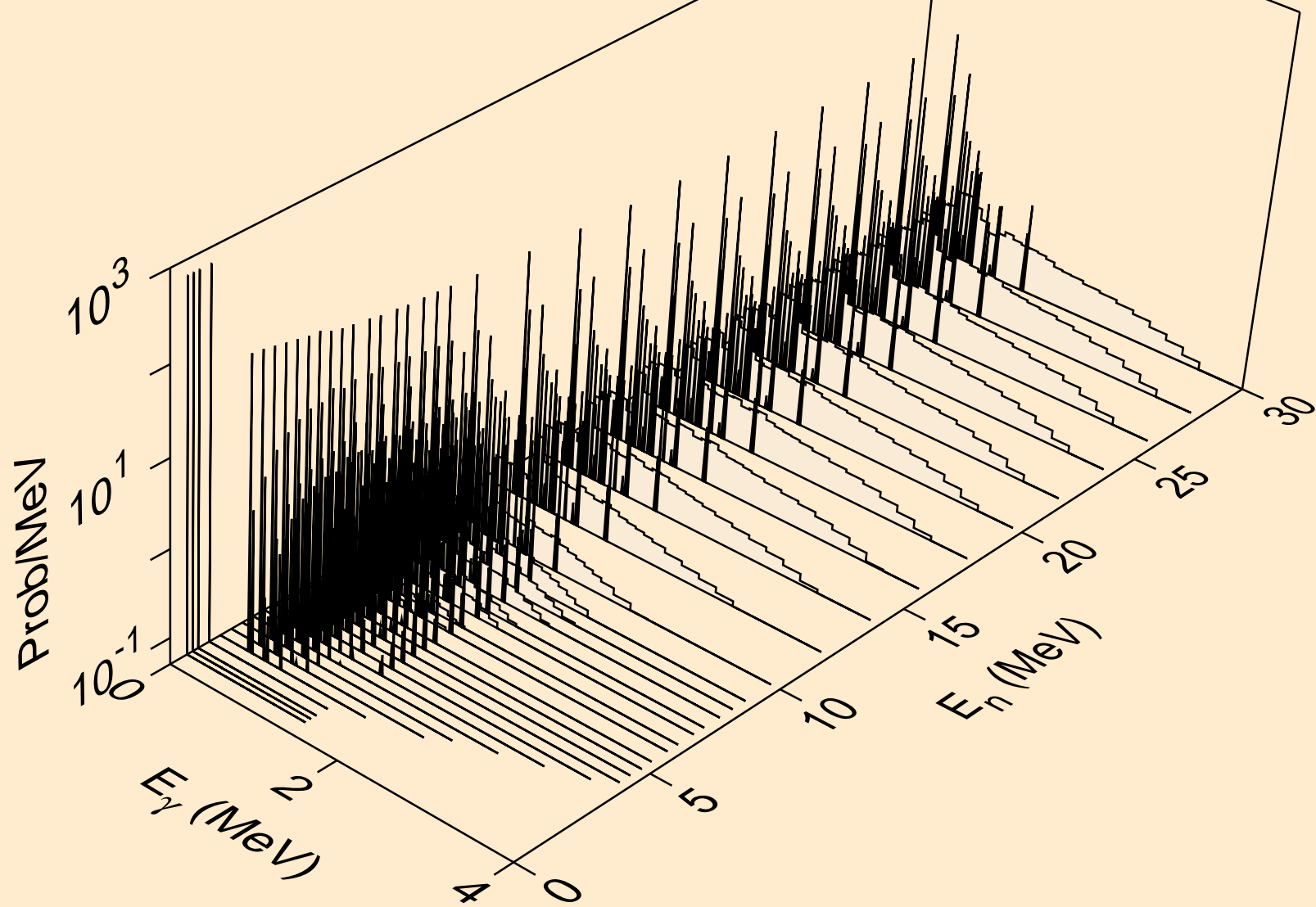

AG112 NEUTRON ACER TENDL-2024 LIBRARY; T=0.K
Photon emission for (n,d)

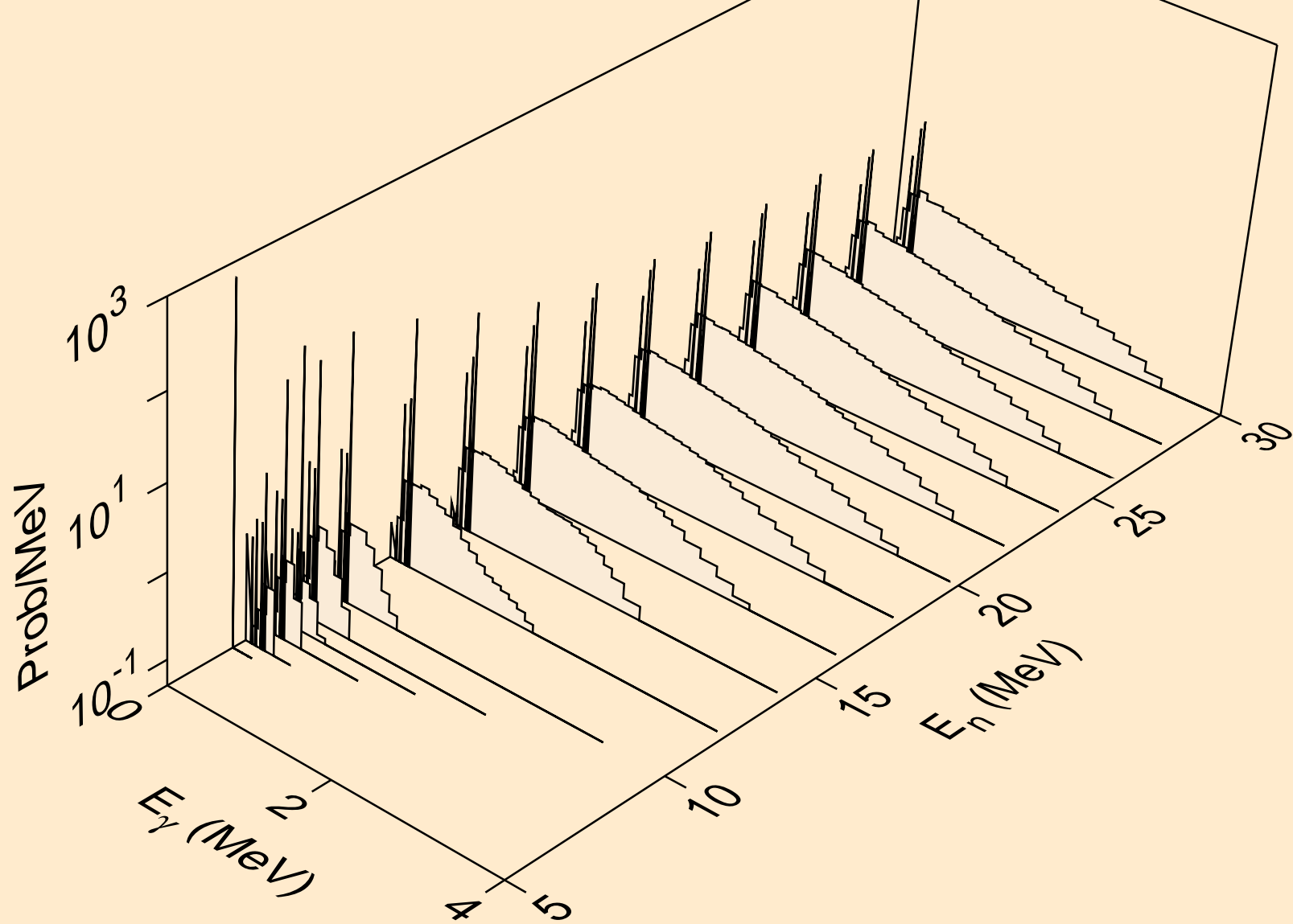

AG112 NEUTRON ACER TENDL-2024 LIBRARY; T=0.K
Photon emission for (n,t)

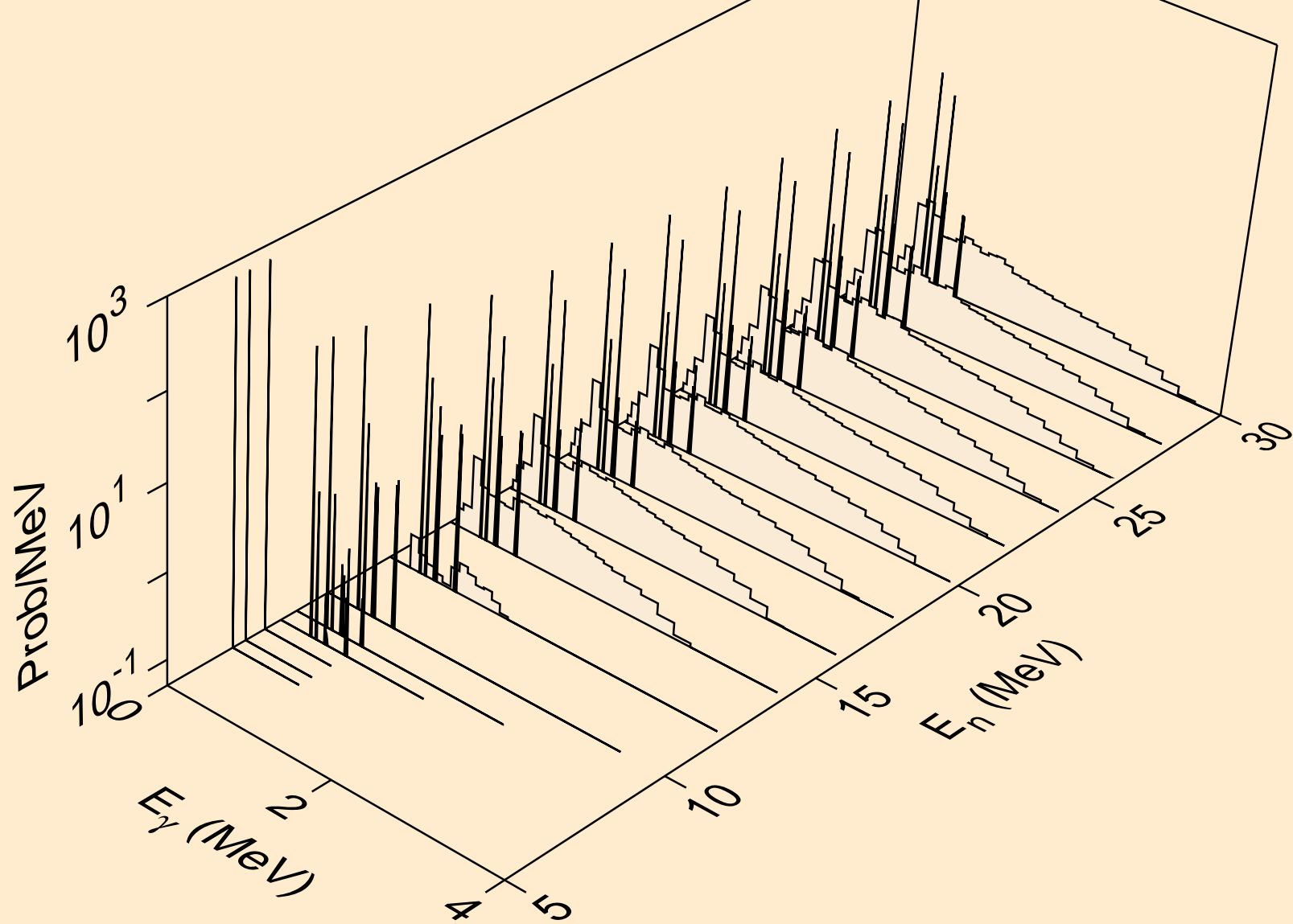

AG112 NEUTRON ACER TENDL-2024 LIBRARY; T=0.K
Photon emission for (n,he3)

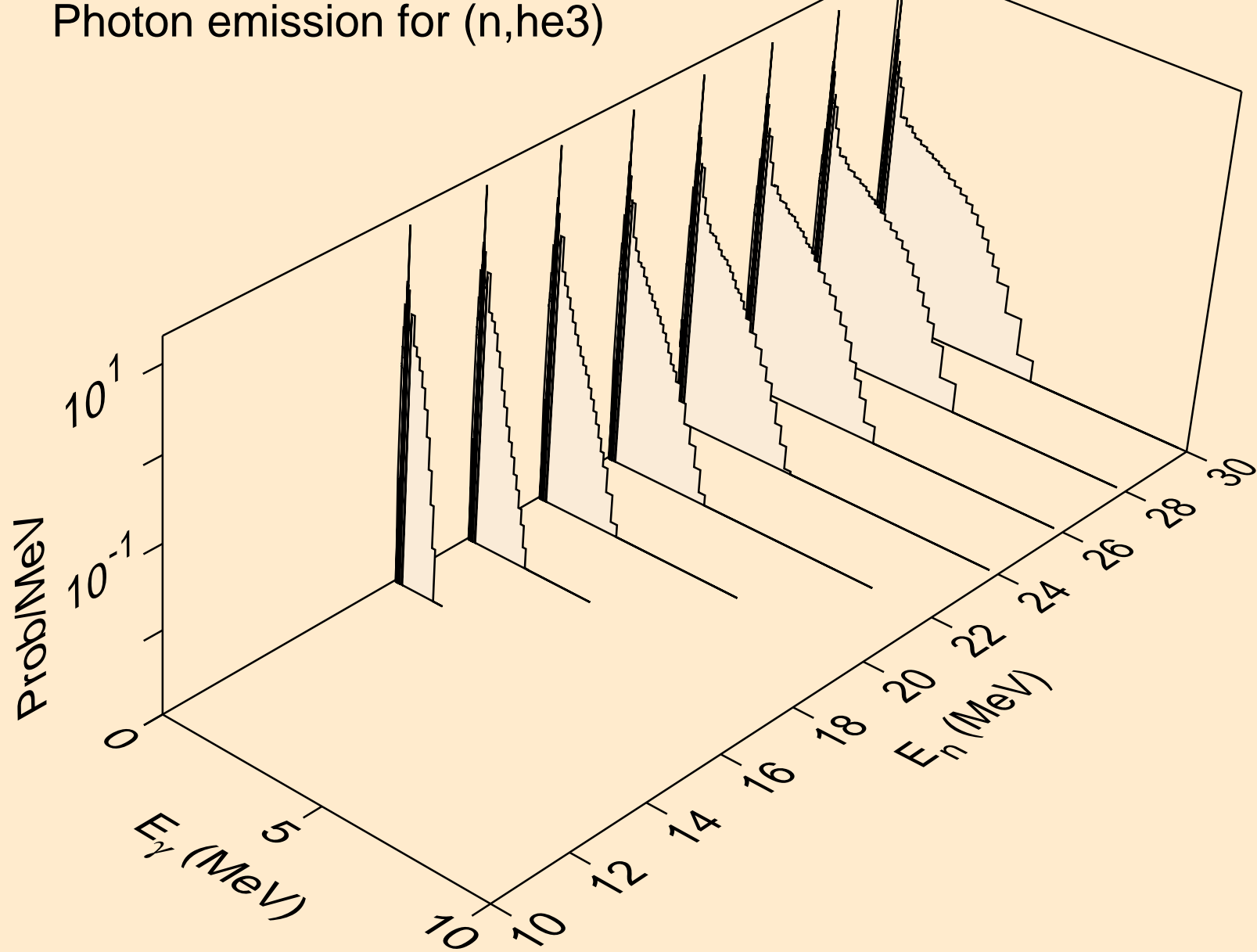

AG112 NEUTRON ACER TENDL-2024 LIBRARY; T=0.K
Photon emission for (n,a)

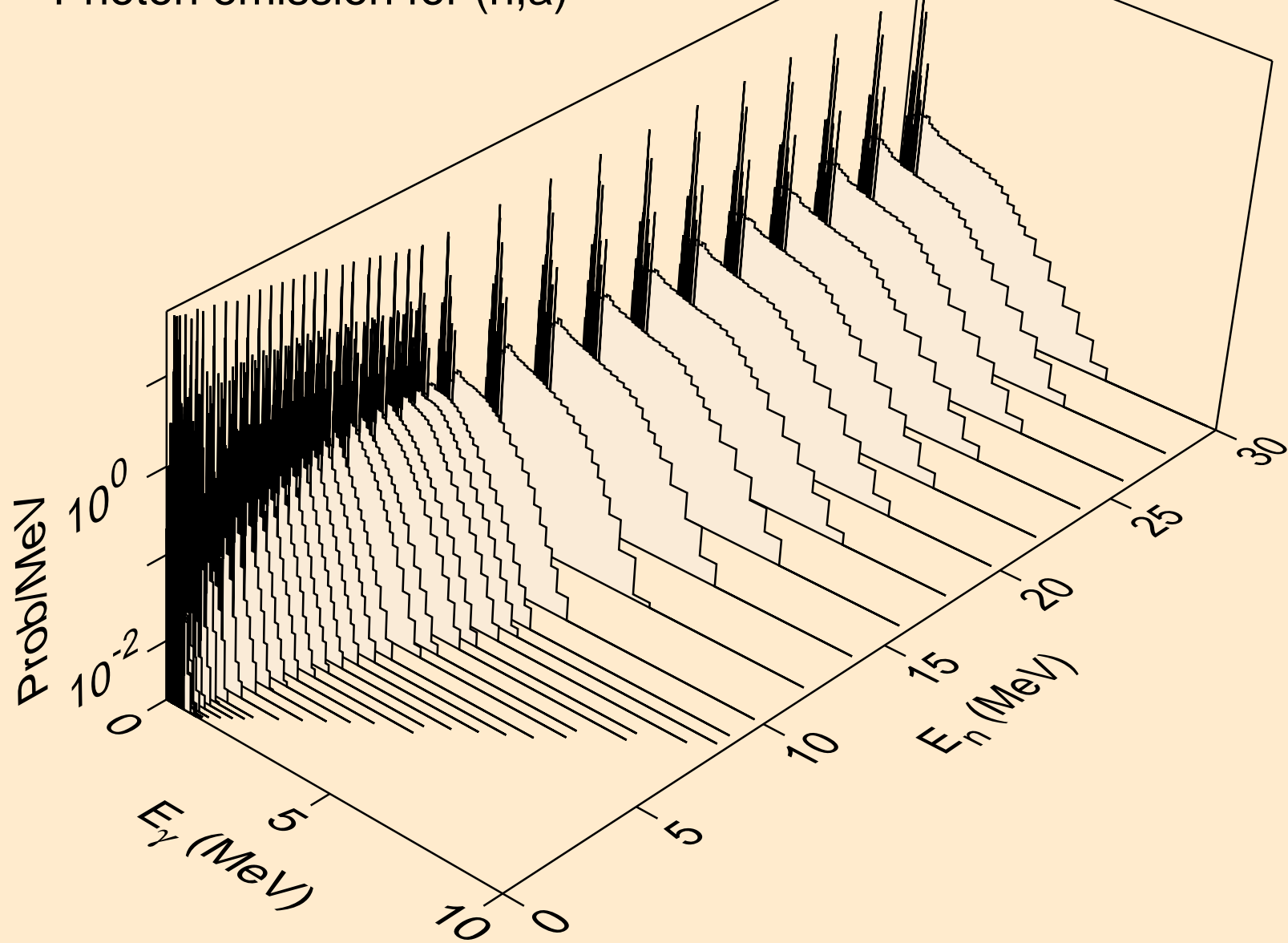

AG112 NEUTRON ACER TENDL-2024 LIBRARY; T=0.K
Photon emission for (n,2a)

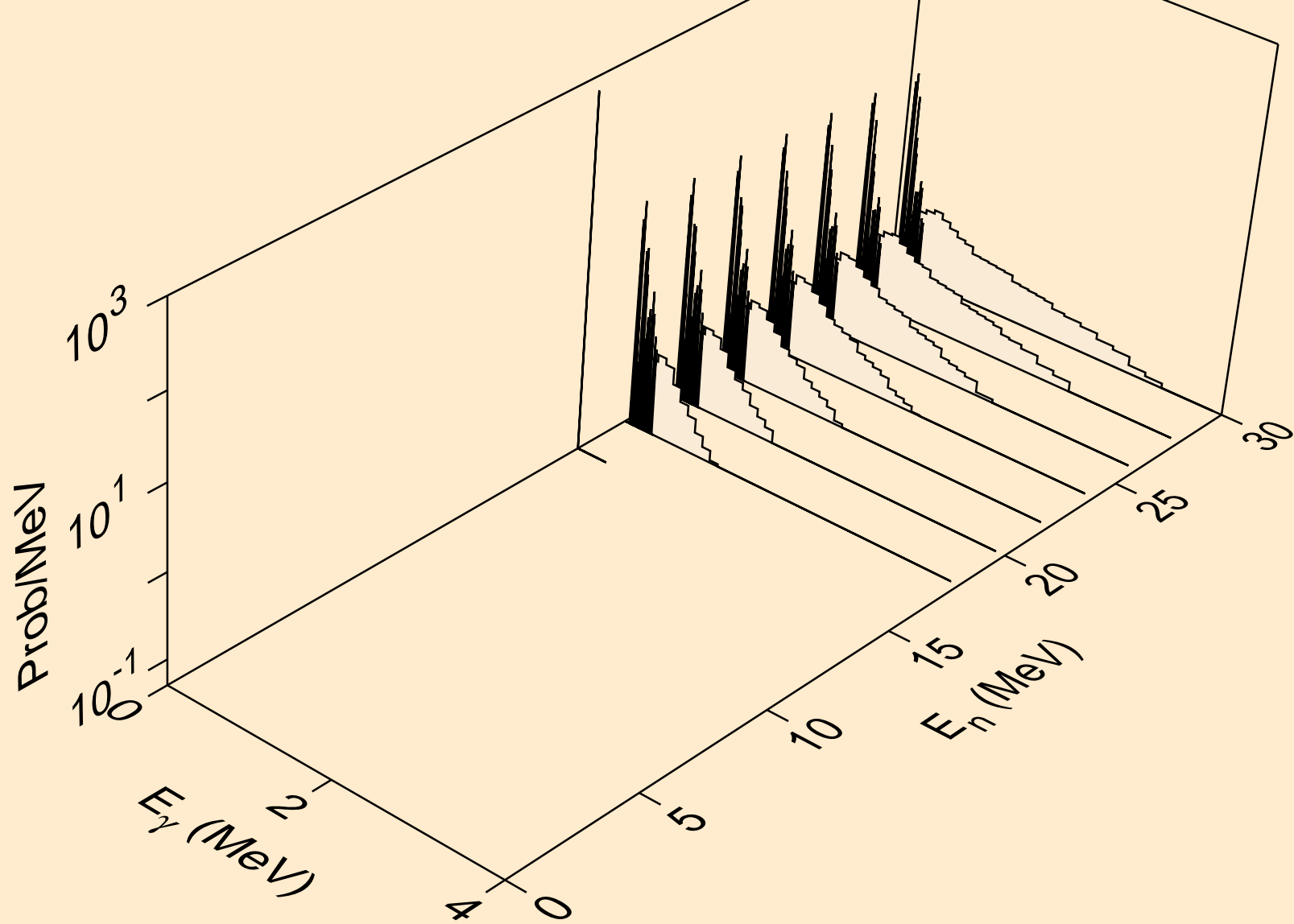

AG112 NEUTRON ACER TENDL-2024 LIBRARY; T=0.K
Photon emission for (n,2p)

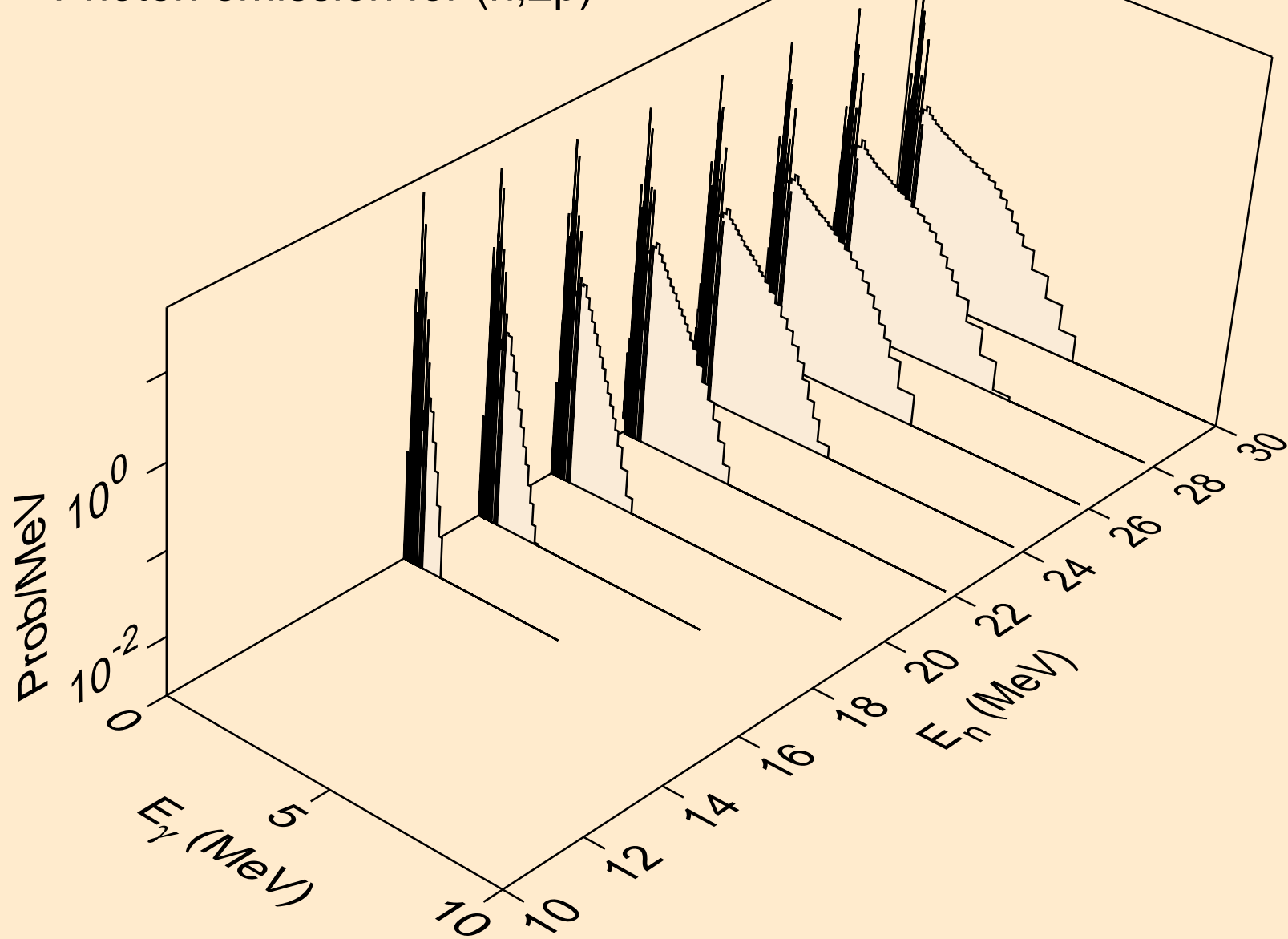

AG112 NEUTRON ACER TENDL-2024 LIBRARY; T=0.K
Photon emission for (n,p α)

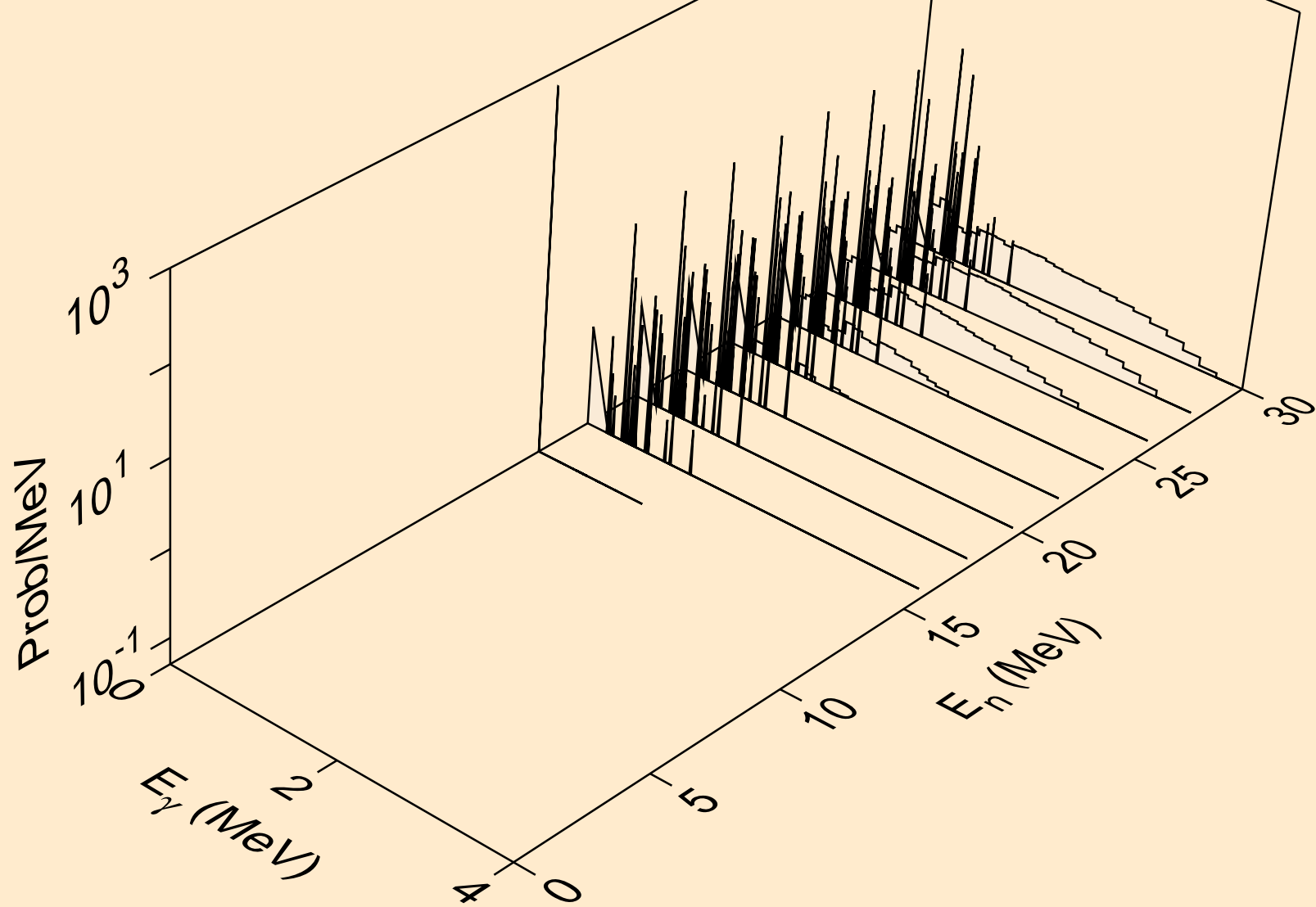

AG112 NEUTRON ACER TENDL-2024 LIBRARY; T=0.K
Photon emission for (n,pd)

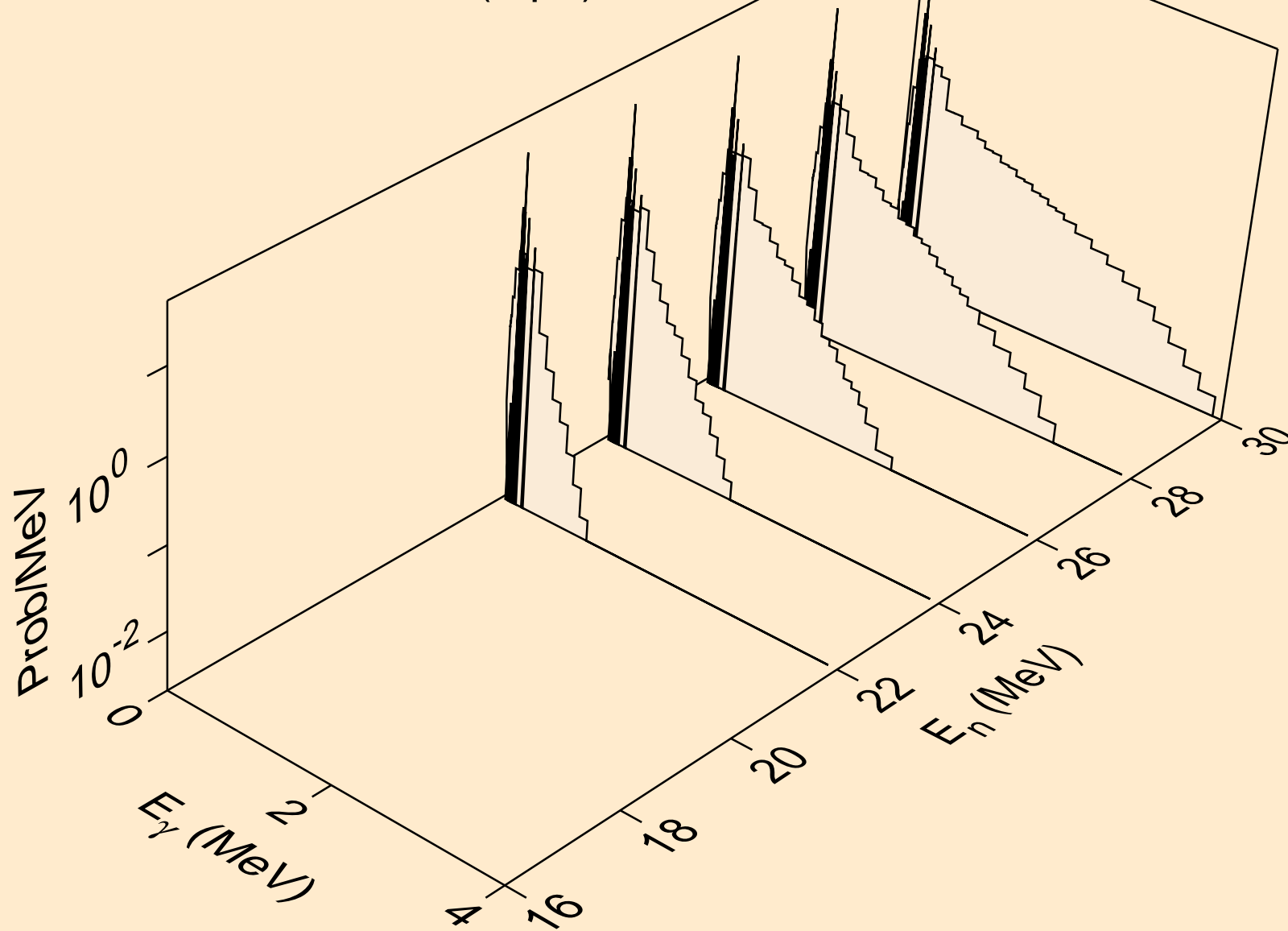

AG112 NEUTRON ACER TENDL-2024 LIBRARY; T=0.K
Photon emission for (n,pt)

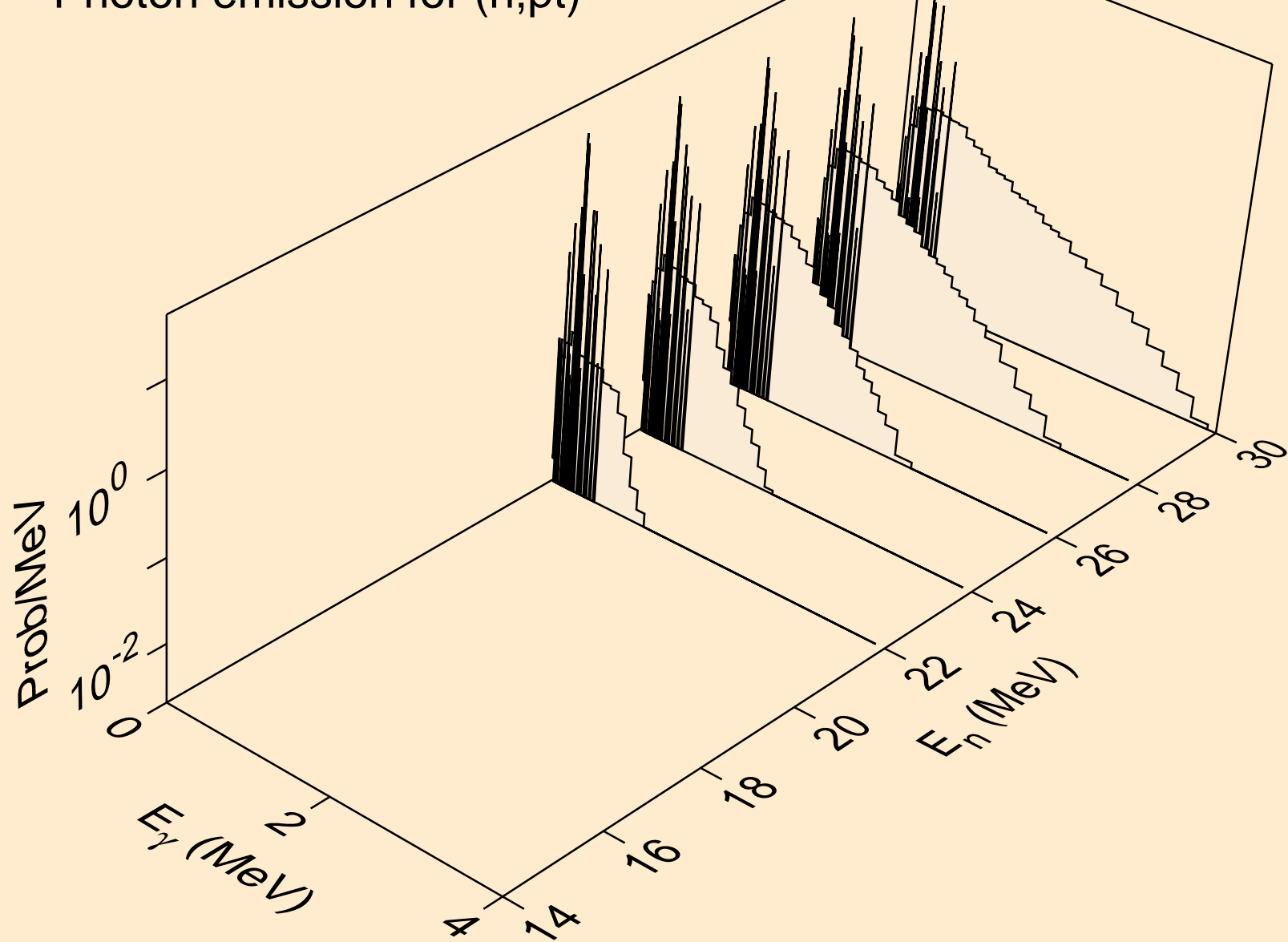

AG112 NEUTRON ACER TENDL-2024 LIBRARY; T=0.K
Photon emission for (n,da)

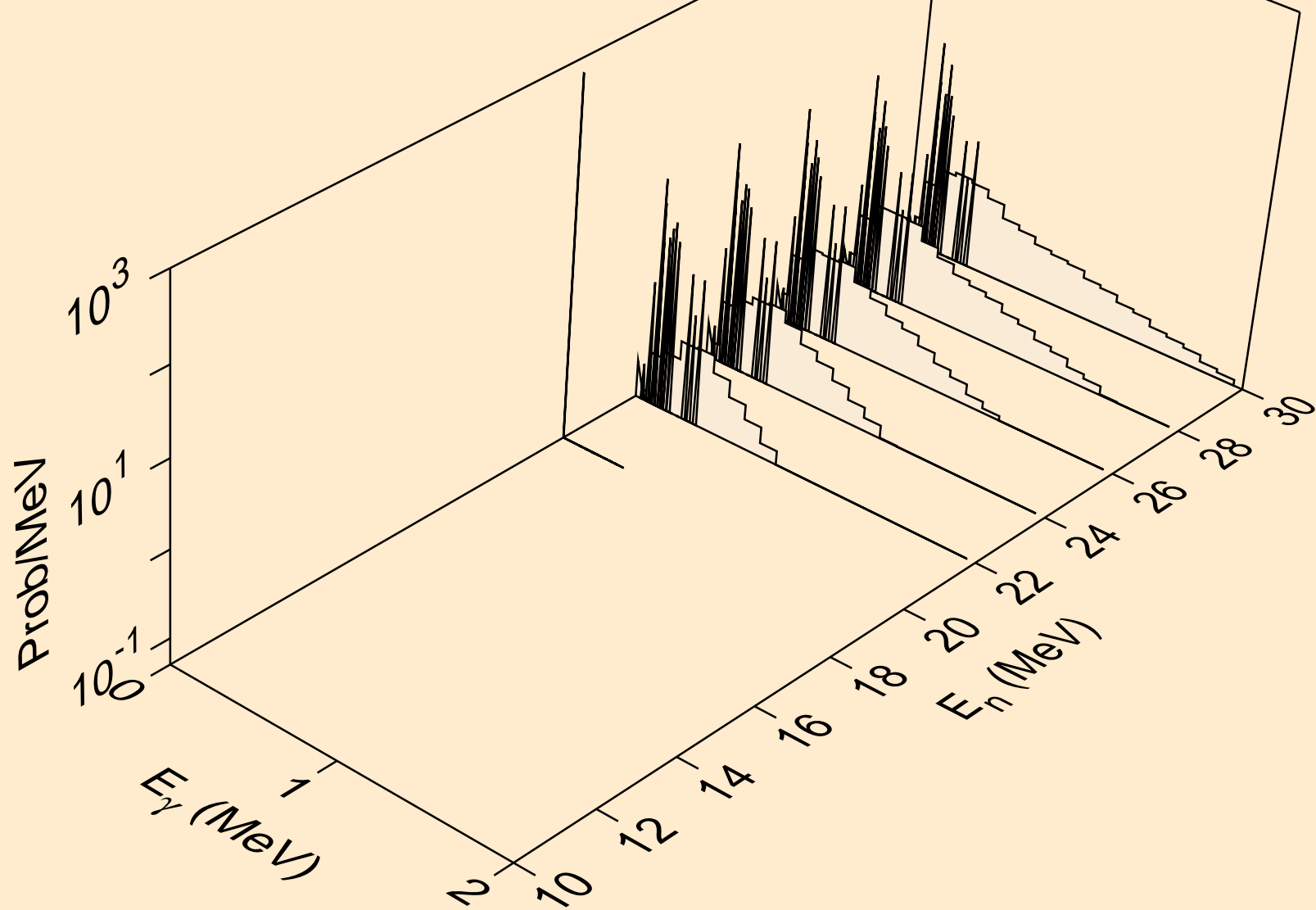

AG112 NEUTRON ACER TENDL-2024 LIBRARY; T=0.K
thermal capture photon spectrum

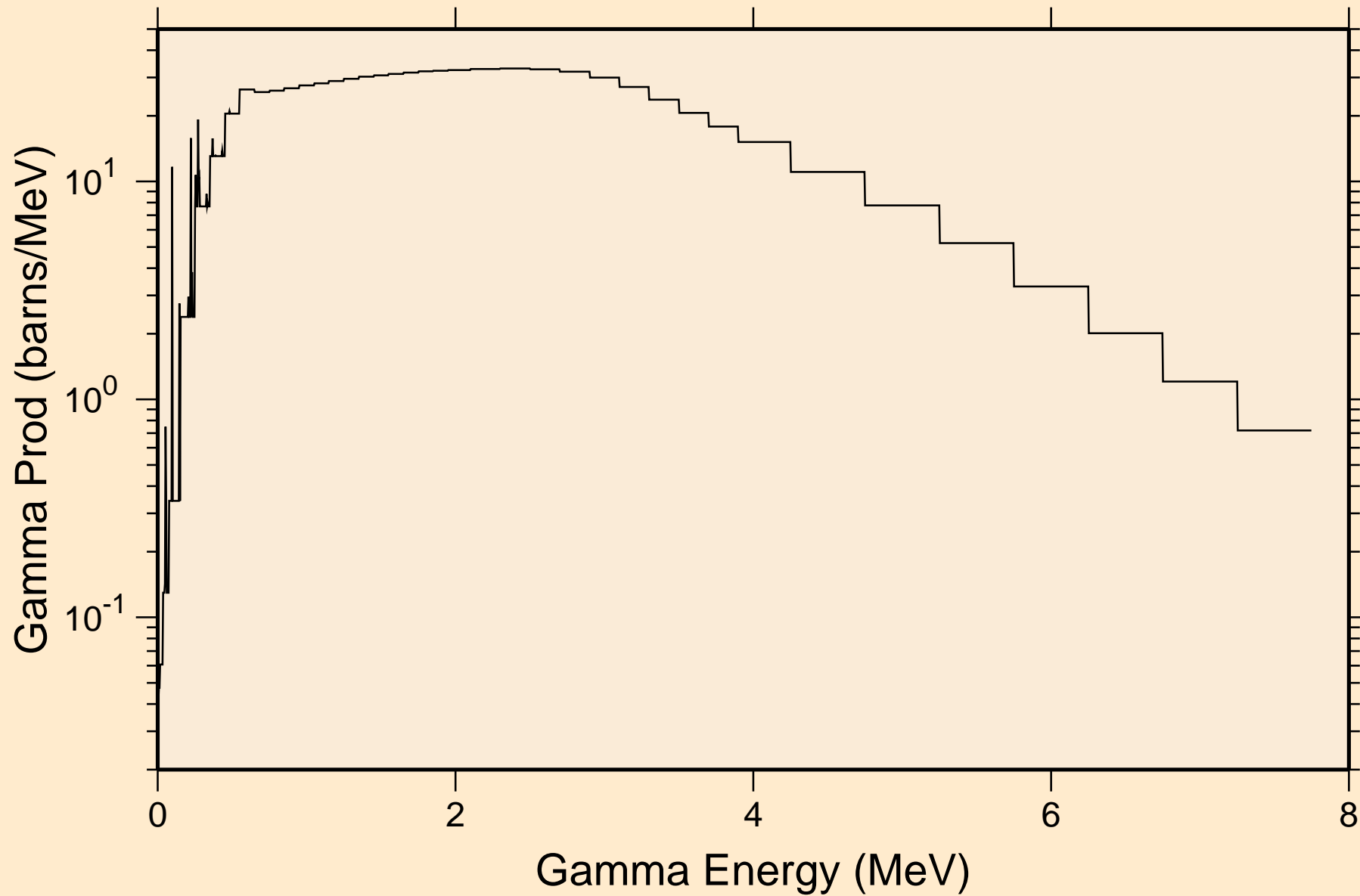

AG112 NEUTRON ACER TENDL-2024 LIBRARY; T=0.K
14 MeV photon spectrum

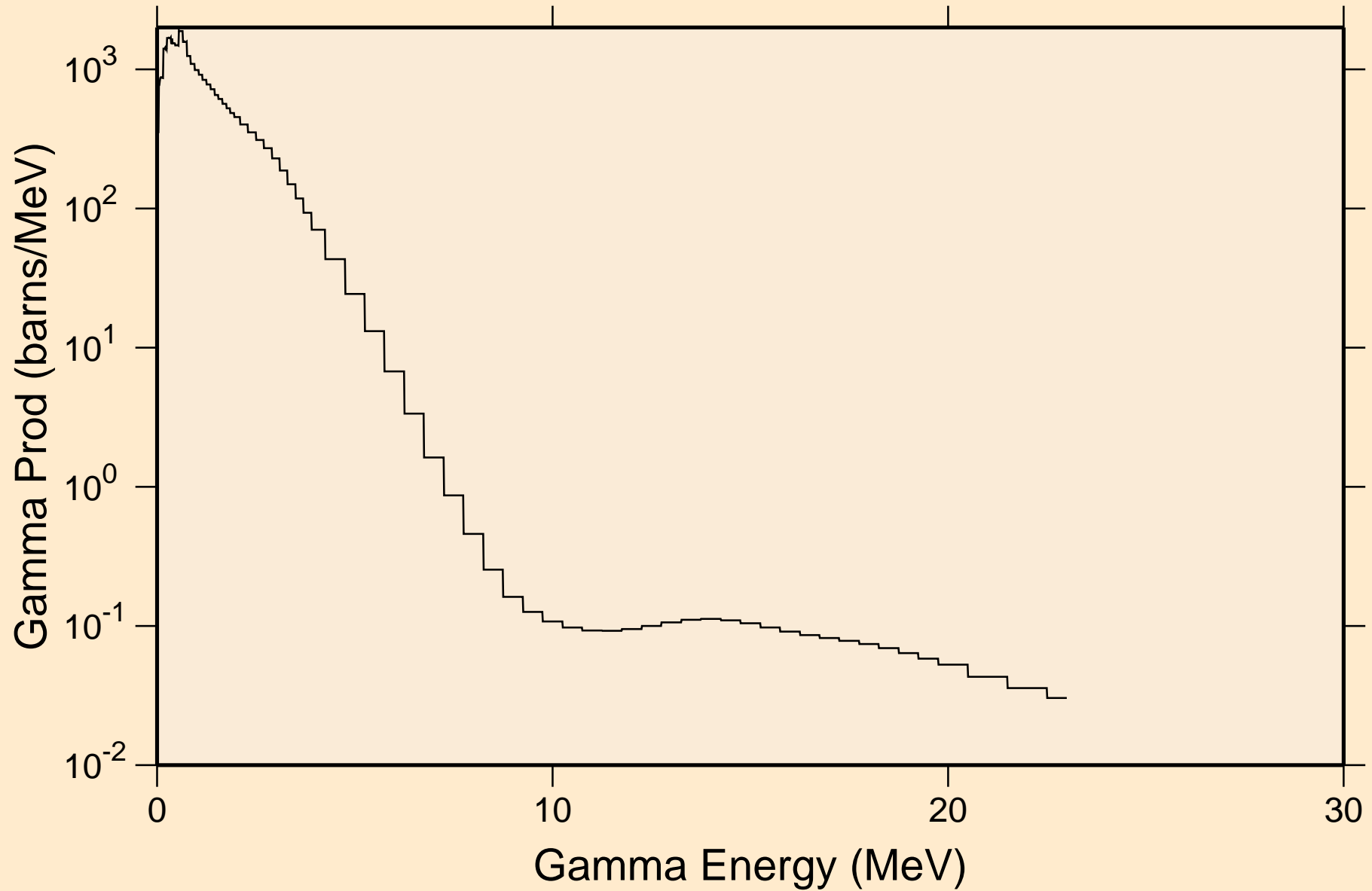

AG112 NEUTRON ACER TENDL-2024 LIBRARY; T=0.K

Particle heating contributions

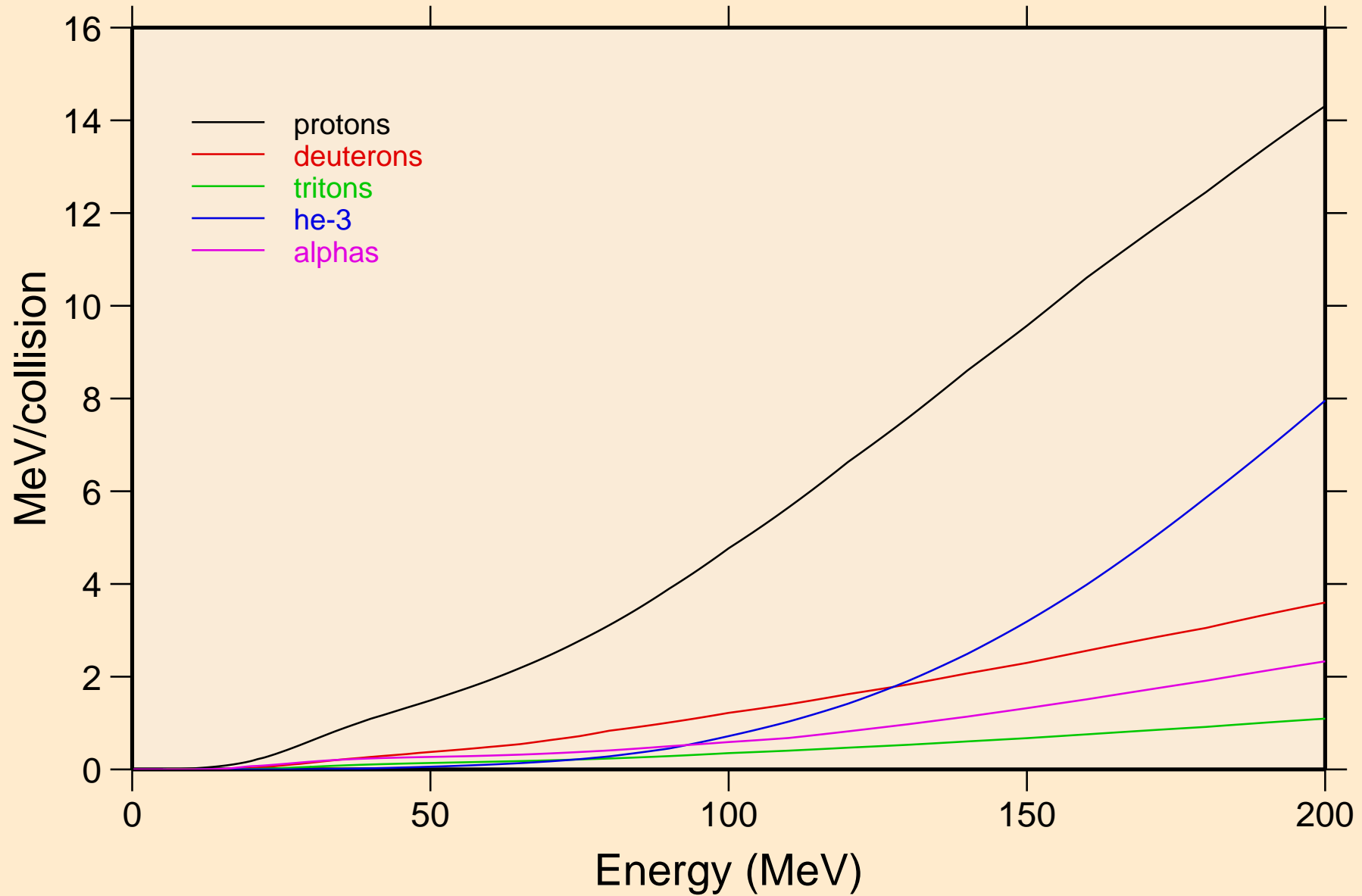

AG112 NEUTRON ACER TENDL-2024 LIBRARY; T=0.K

Recoil Heating

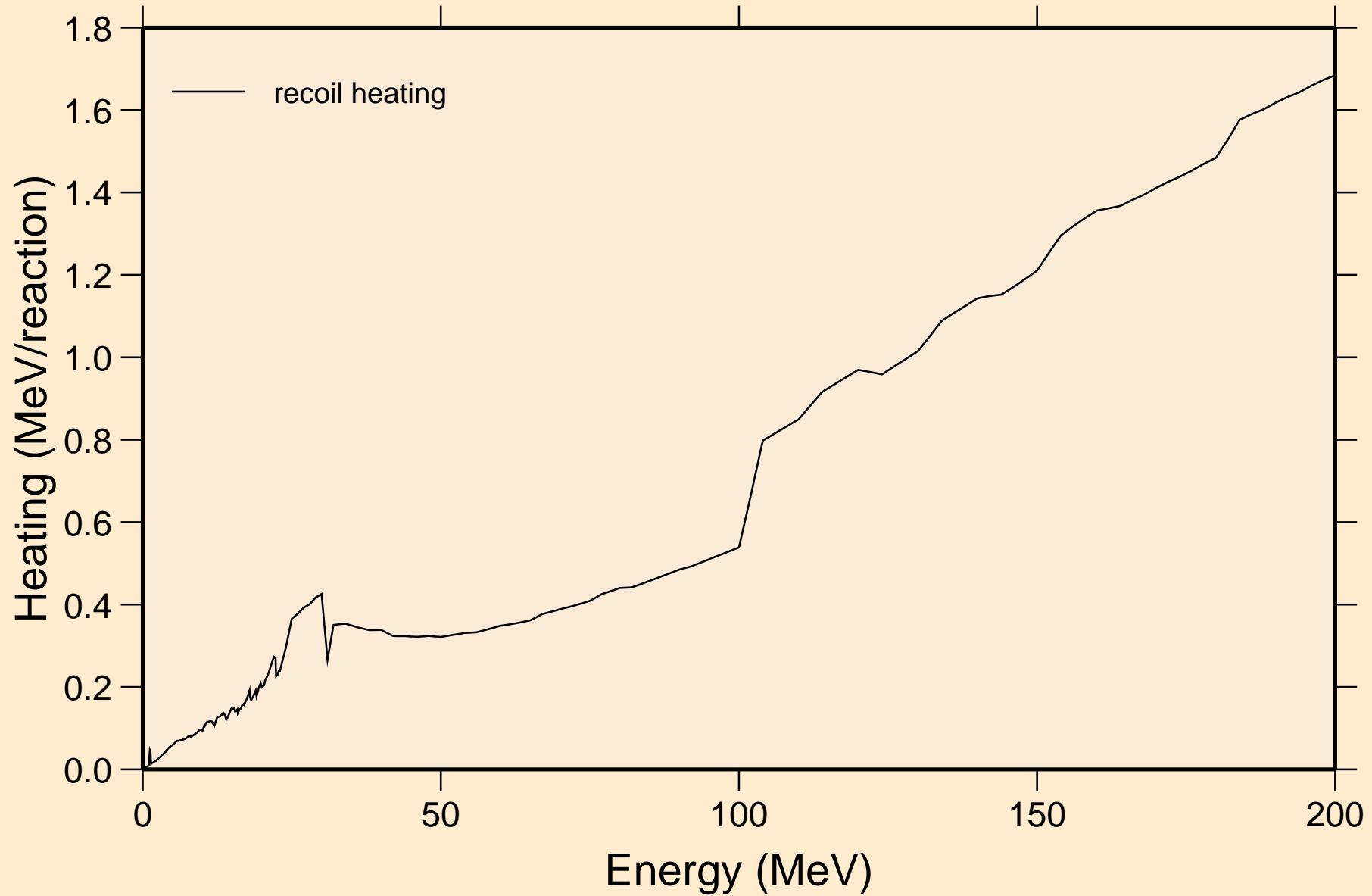

AG112 NEUTRON ACER TENDL-2024 LIBRARY; T=0.K

Particle production cross sections

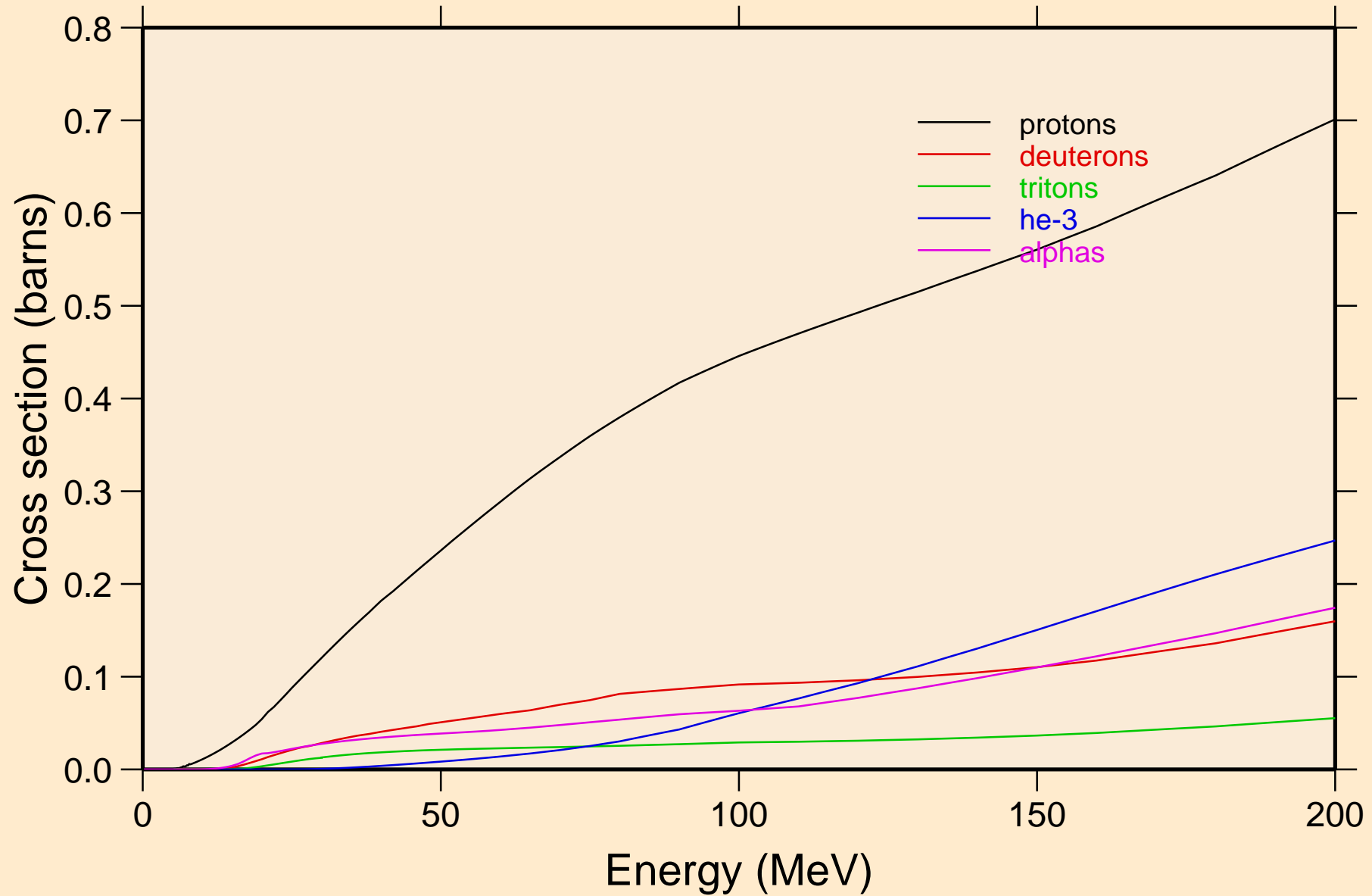

AG112 NEUTRON ACER TENDL-2024 LIBRARY; T=0.K
protons from (n,x)

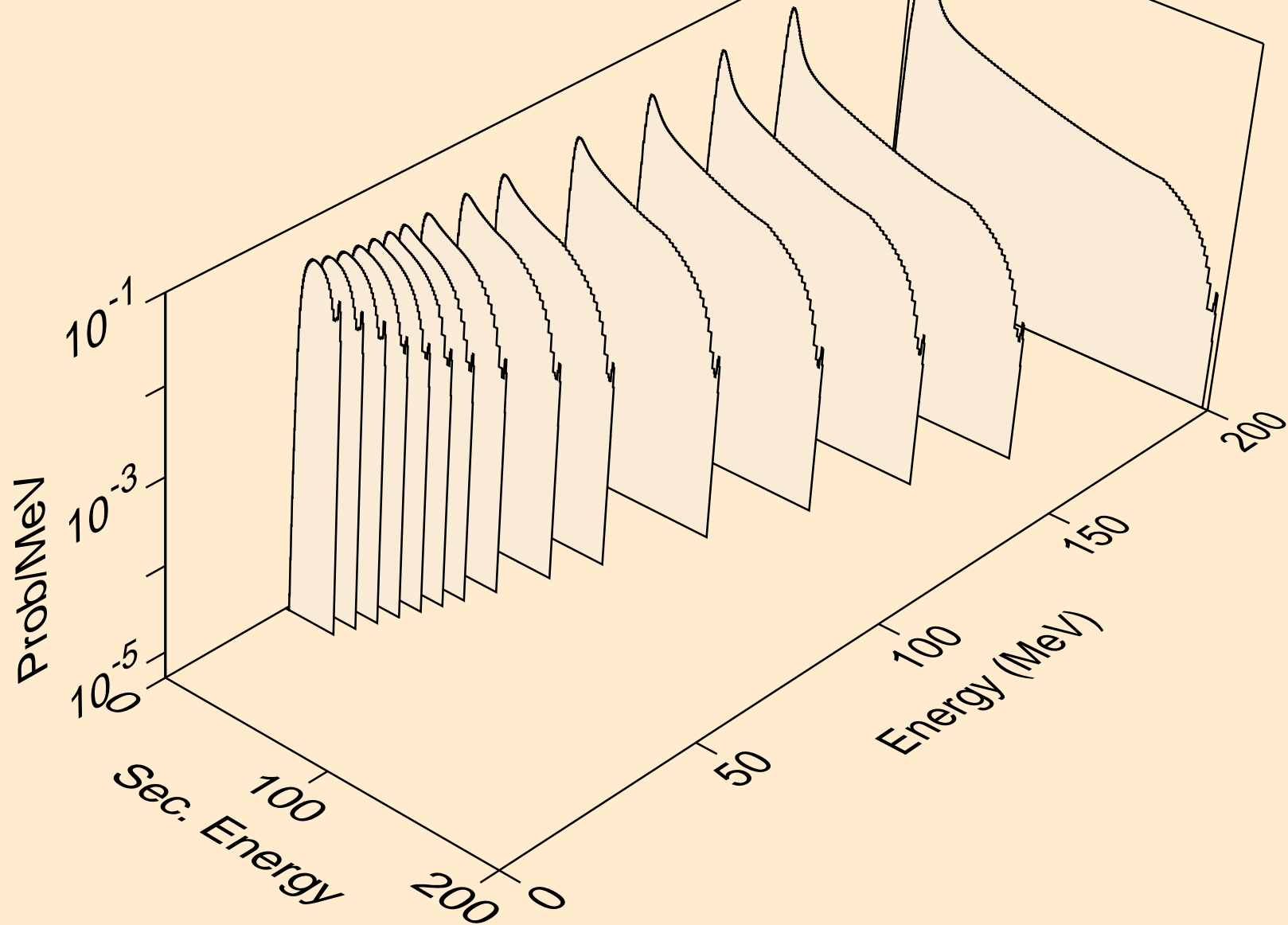

AG112 NEUTRON ACER TENDL-2024 LIBRARY; T=0.K
protons from (n,n*)p

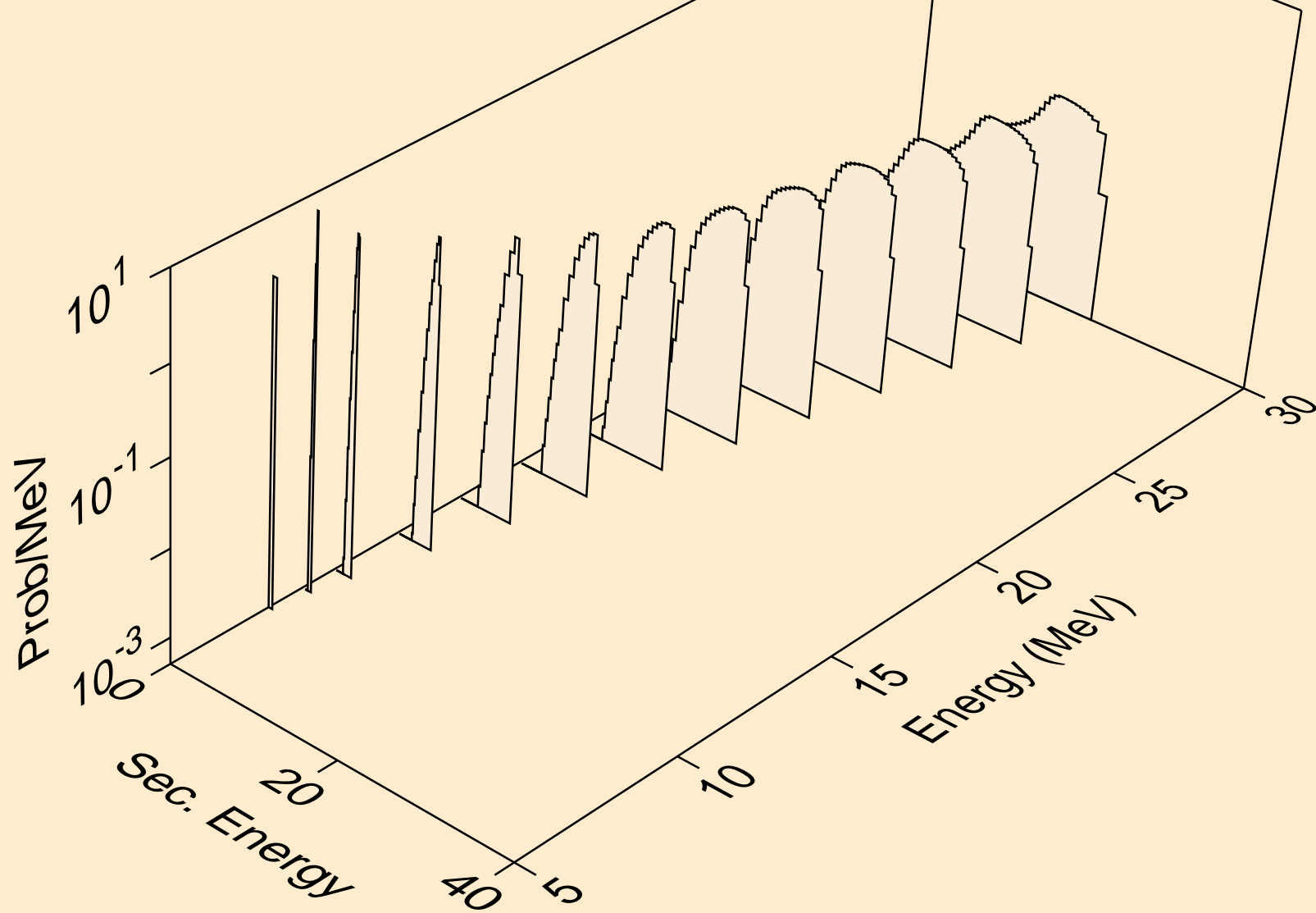

AG112 NEUTRON ACER TENDL-2024 LIBRARY; T=0.K
protons from (n,2np)

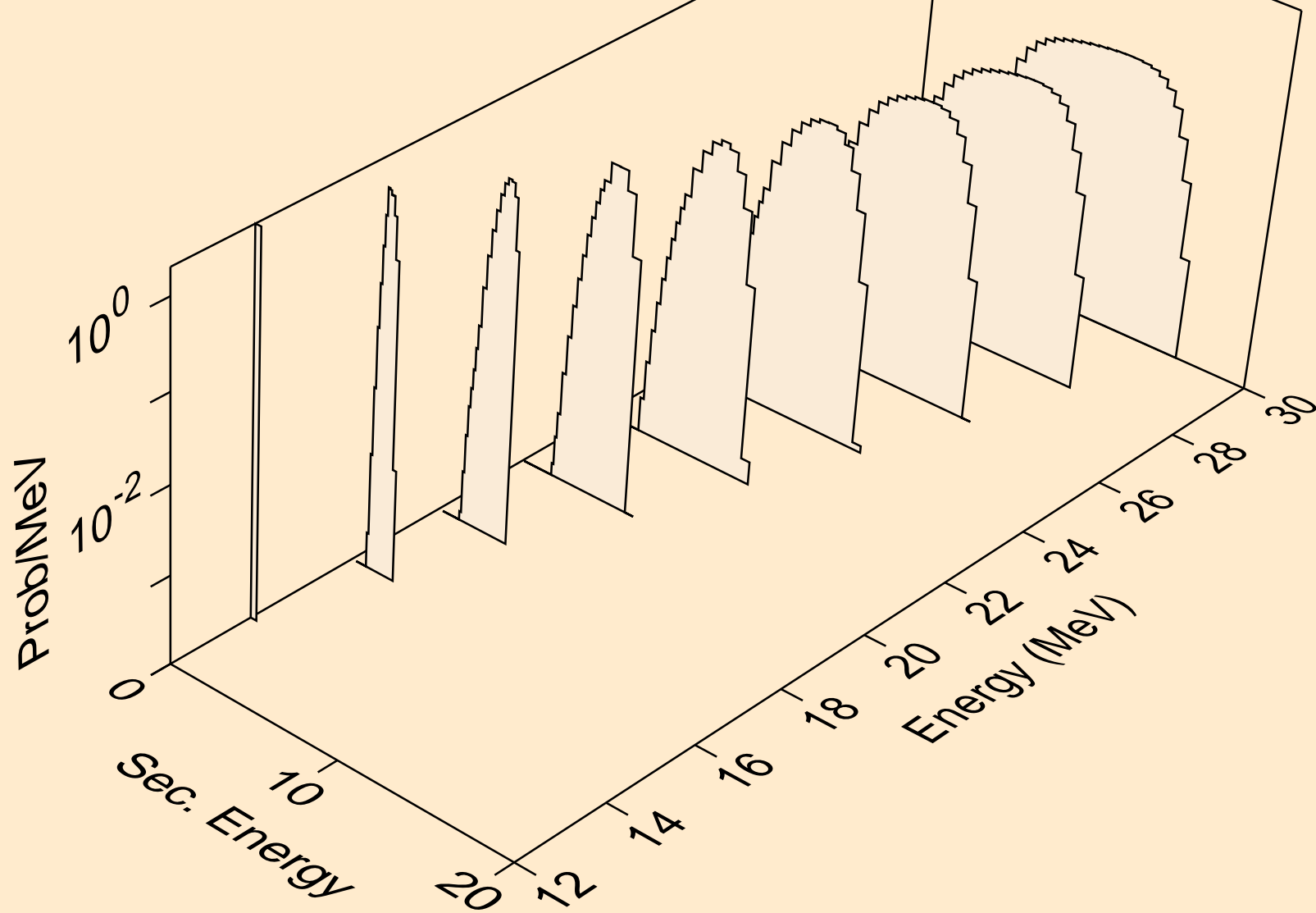

AG112 NEUTRON ACER TENDL-2024 LIBRARY; T=0.K
protons from (n,3np)

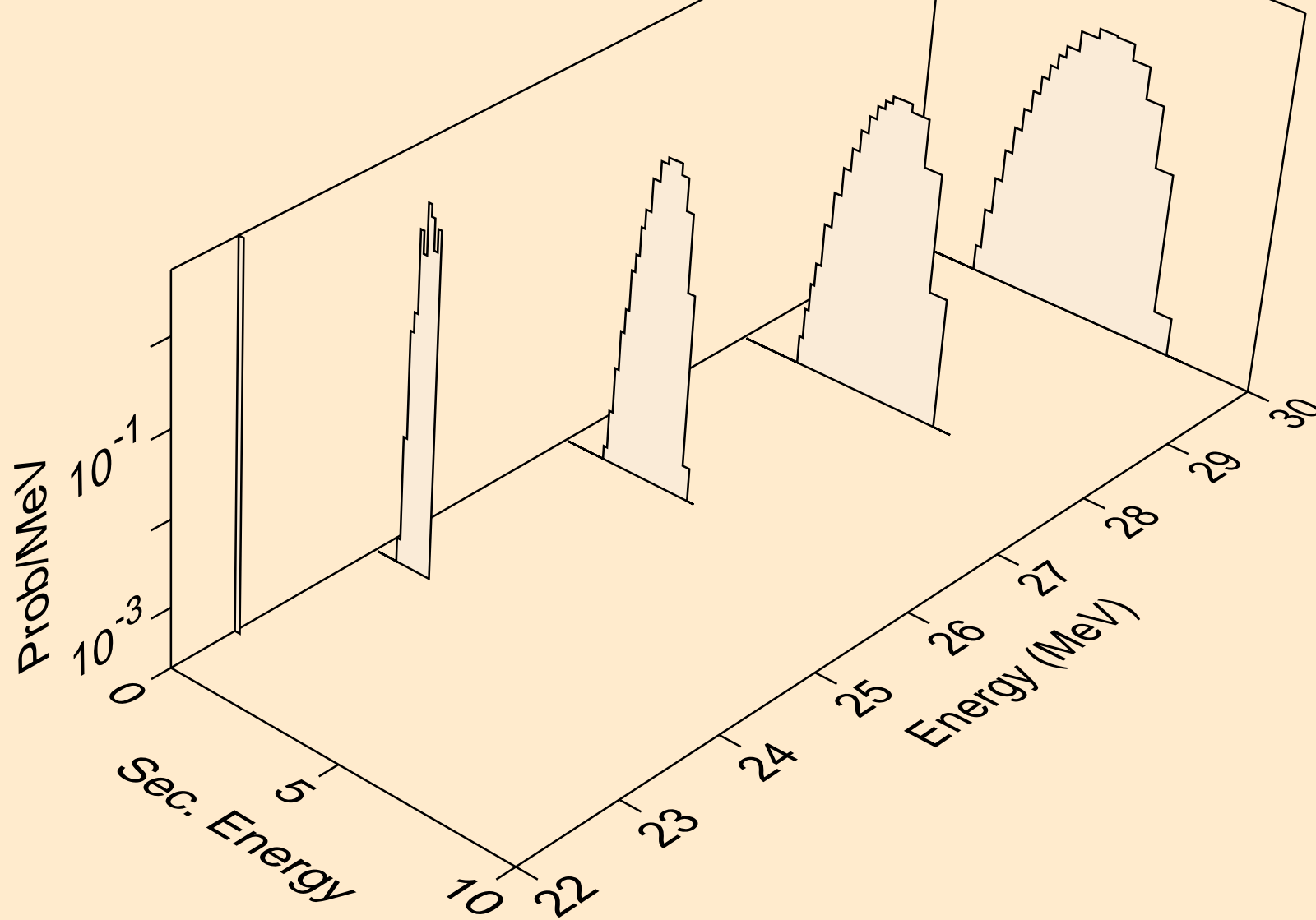

AG112 NEUTRON ACER TENDL-2024 LIBRARY; T=0.K
protons from (n,n2p)

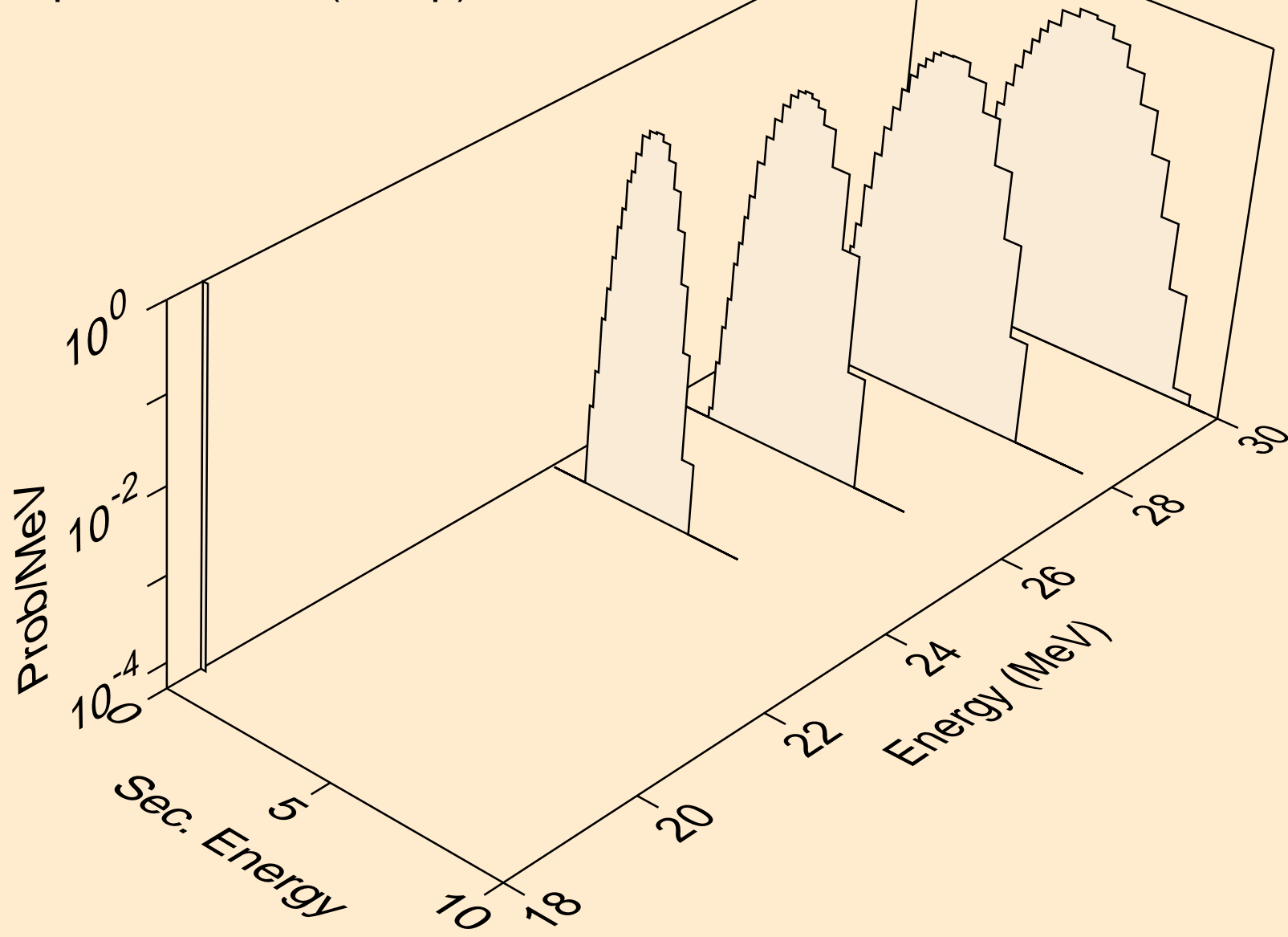

AG112 NEUTRON ACER TENDL-2024 LIBRARY; T=0.K
protons from (n,npa)

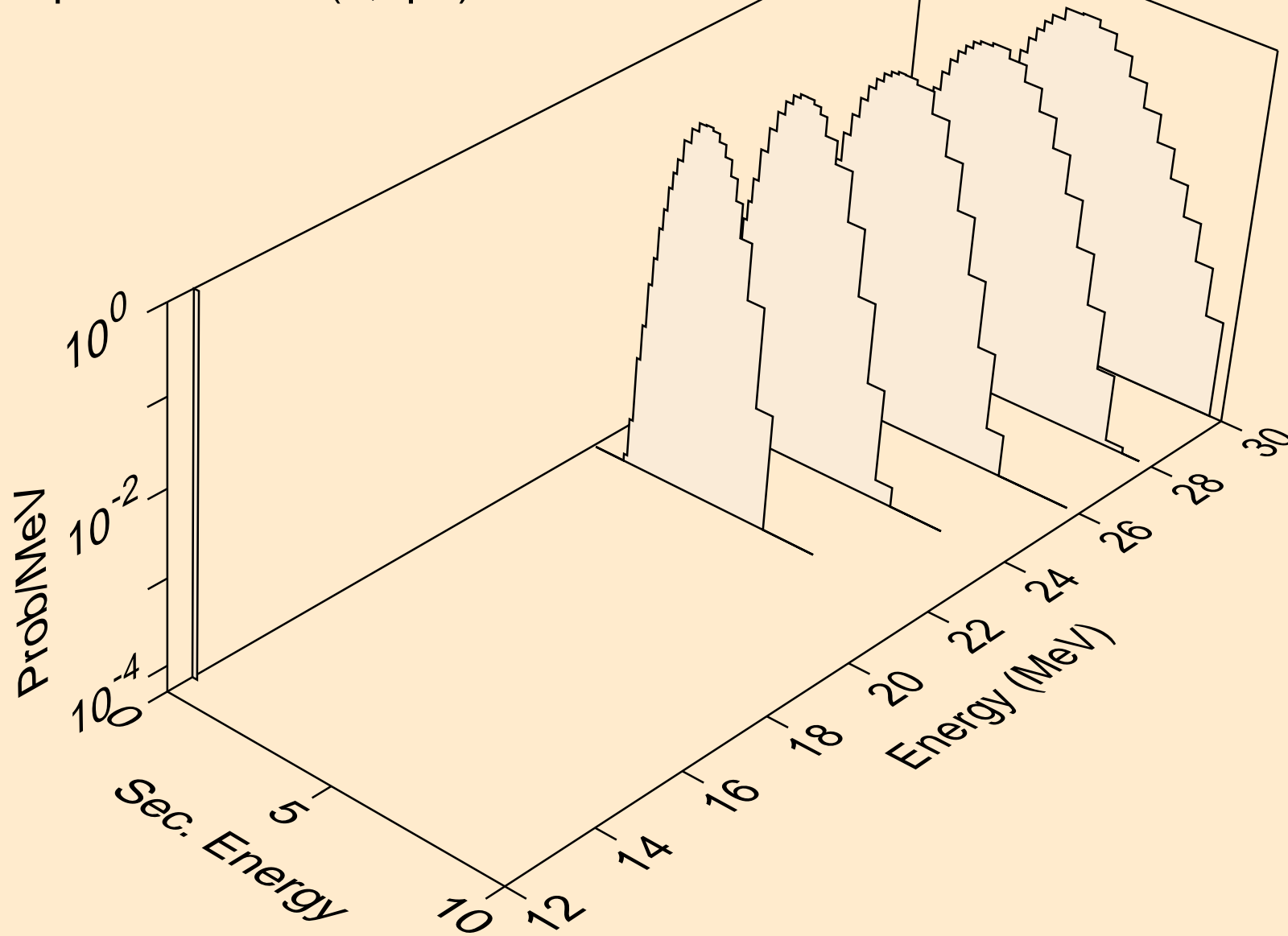

AG112 NEUTRON ACER TENDL-2024 LIBRARY; T=0.K
protons from (n,p)

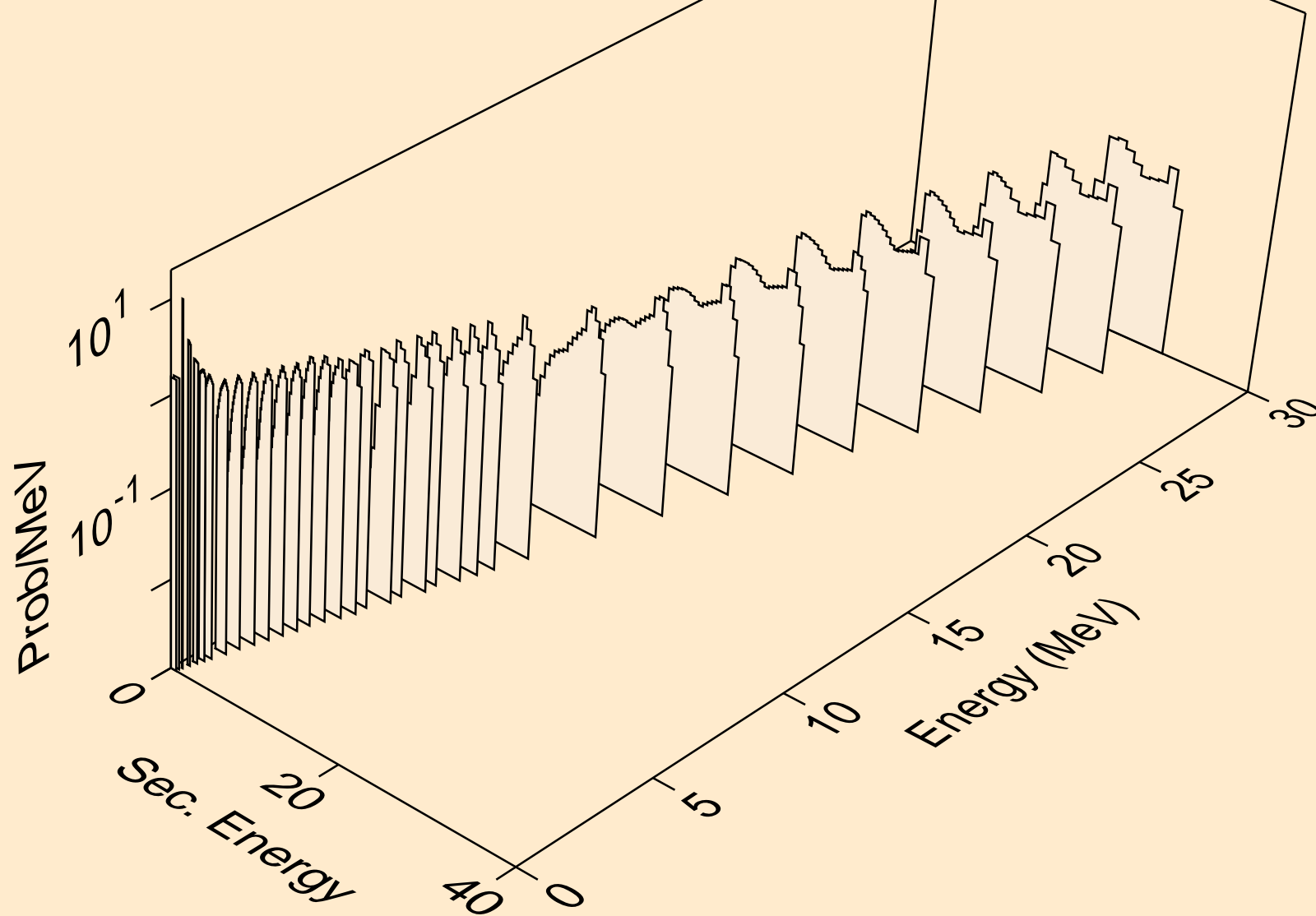

AG112 NEUTRON ACER TENDL-2024 LIBRARY; T=0.K
protons from (n,2p)

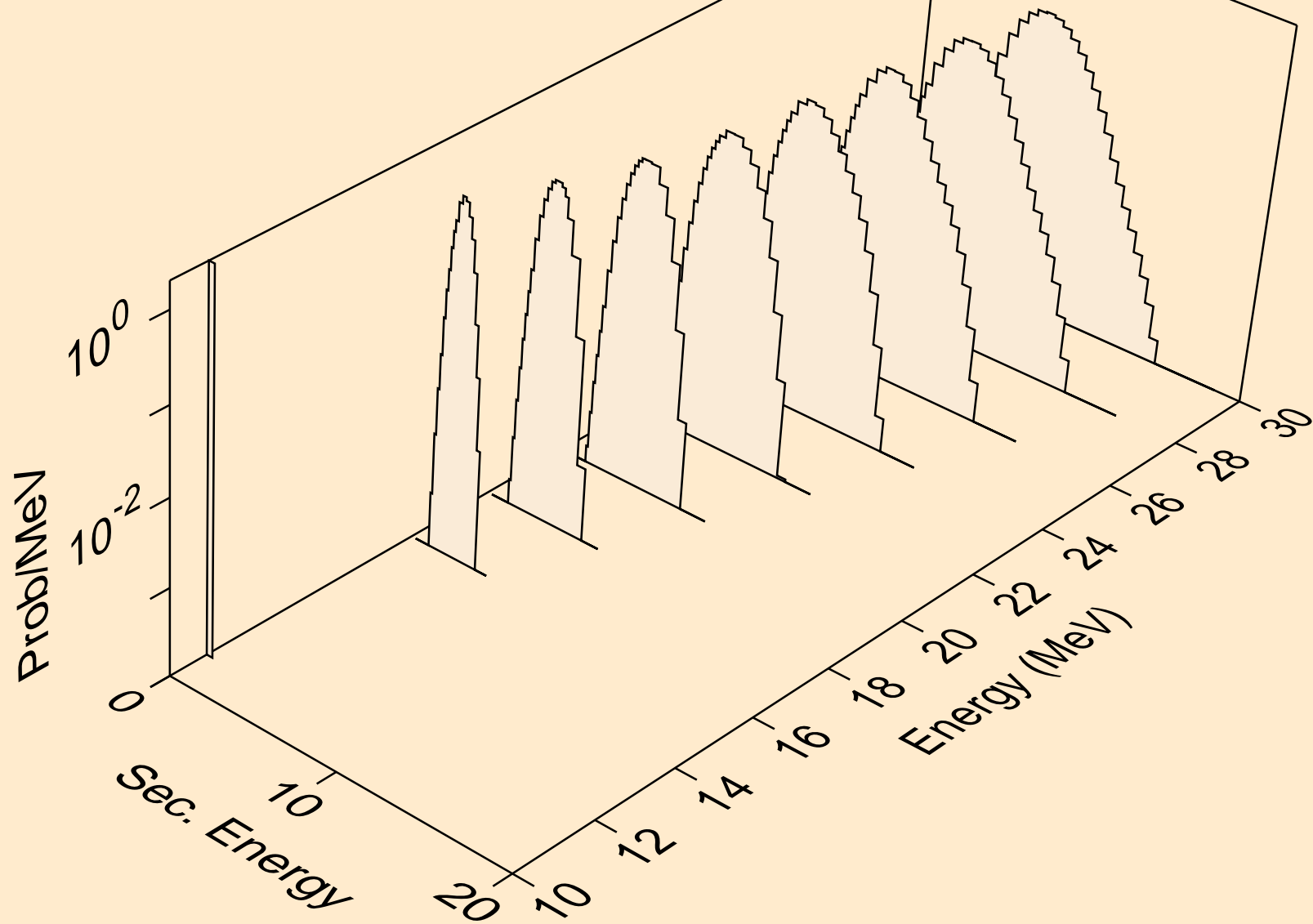

AG112 NEUTRON ACER TENDL-2024 LIBRARY; T=0.K
protons from (n,p)

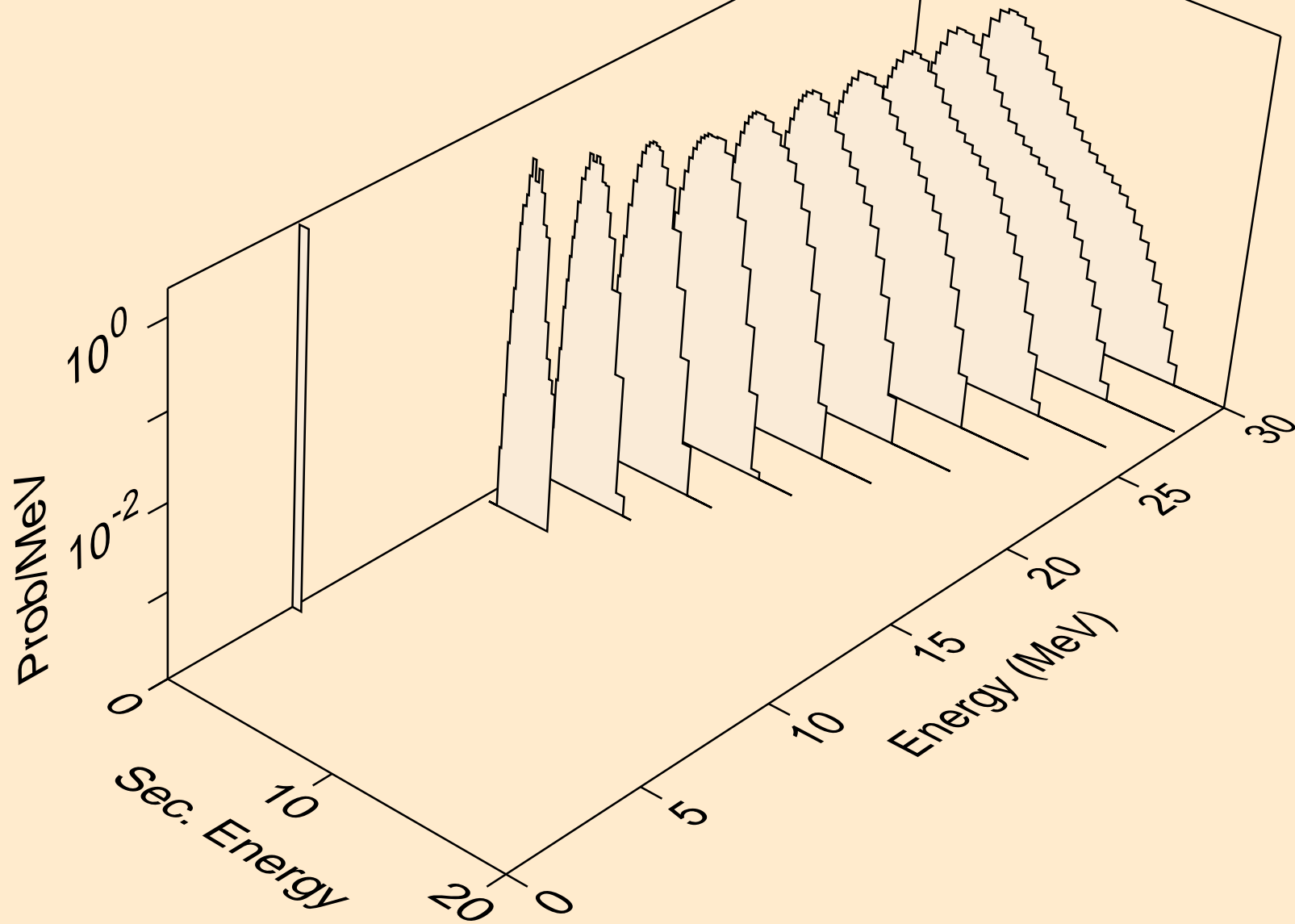

AG112 NEUTRON ACER TENDL-2024 LIBRARY; T=0.K
protons from (n,pd)

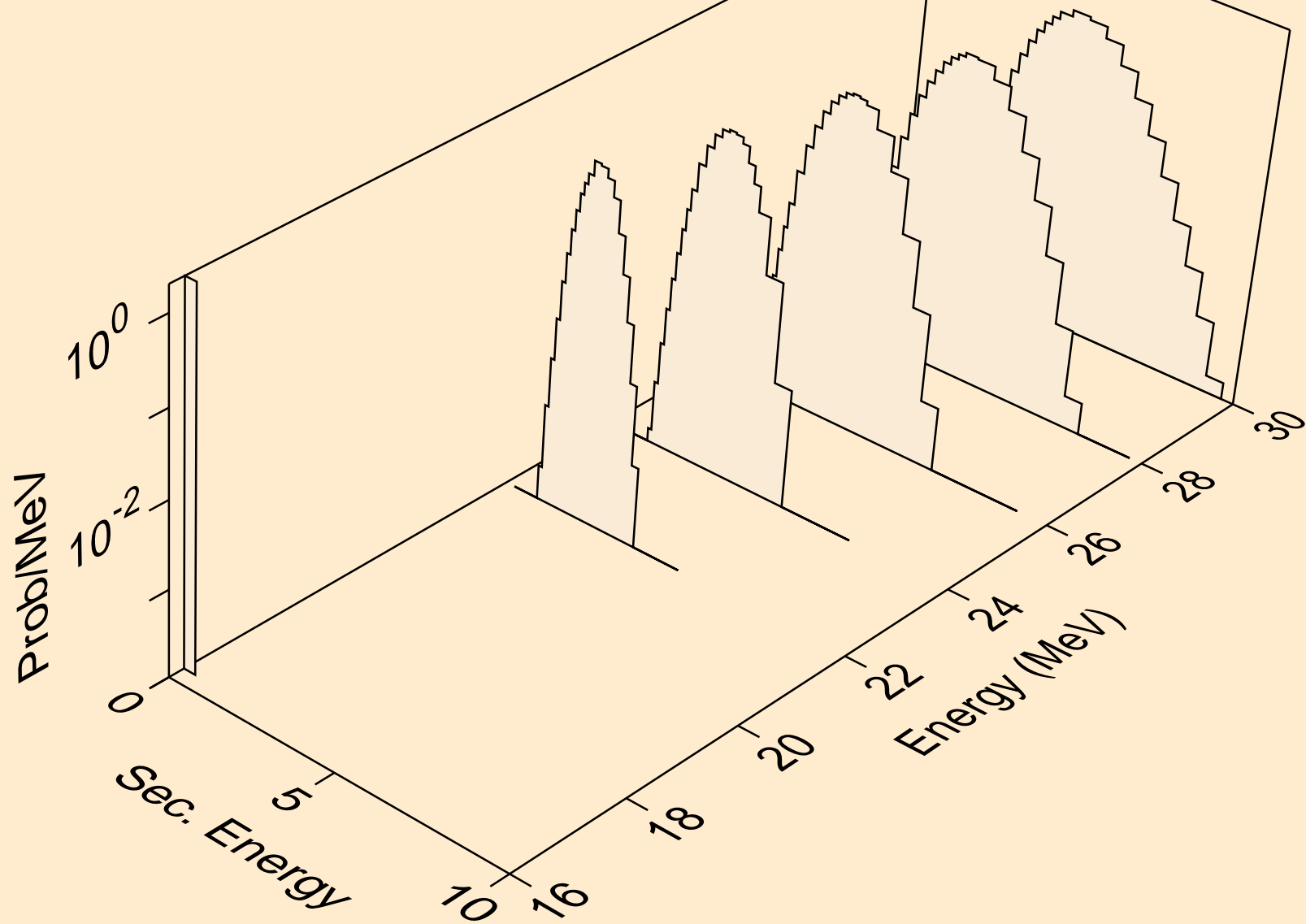

AG112 NEUTRON ACER TENDL-2024 LIBRARY; T=0.K
protons from (n,pt)

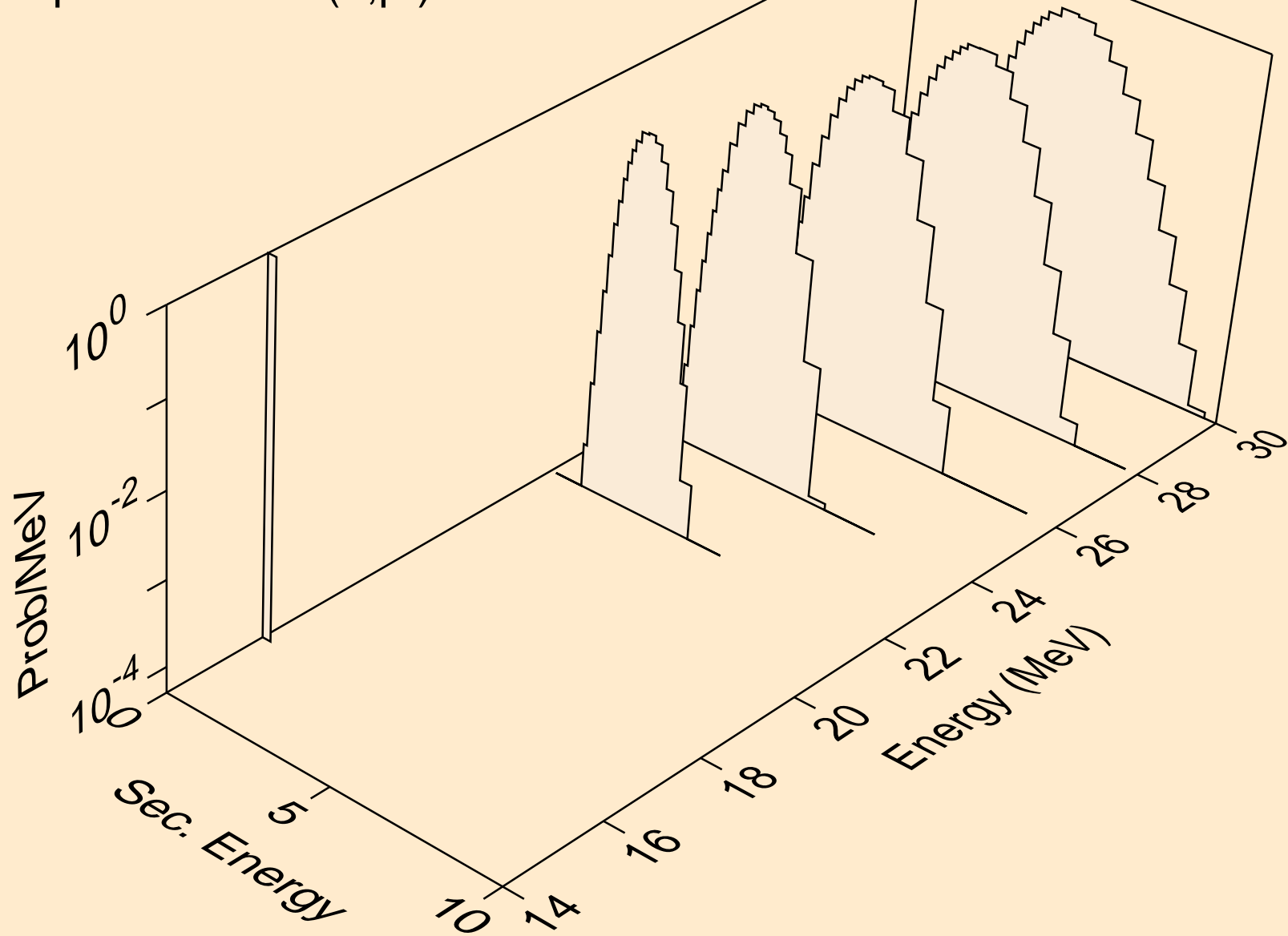

AG112 NEUTRON ACER TENDL-2024 LIBRARY; T=0.K
deuterons from (n,x)

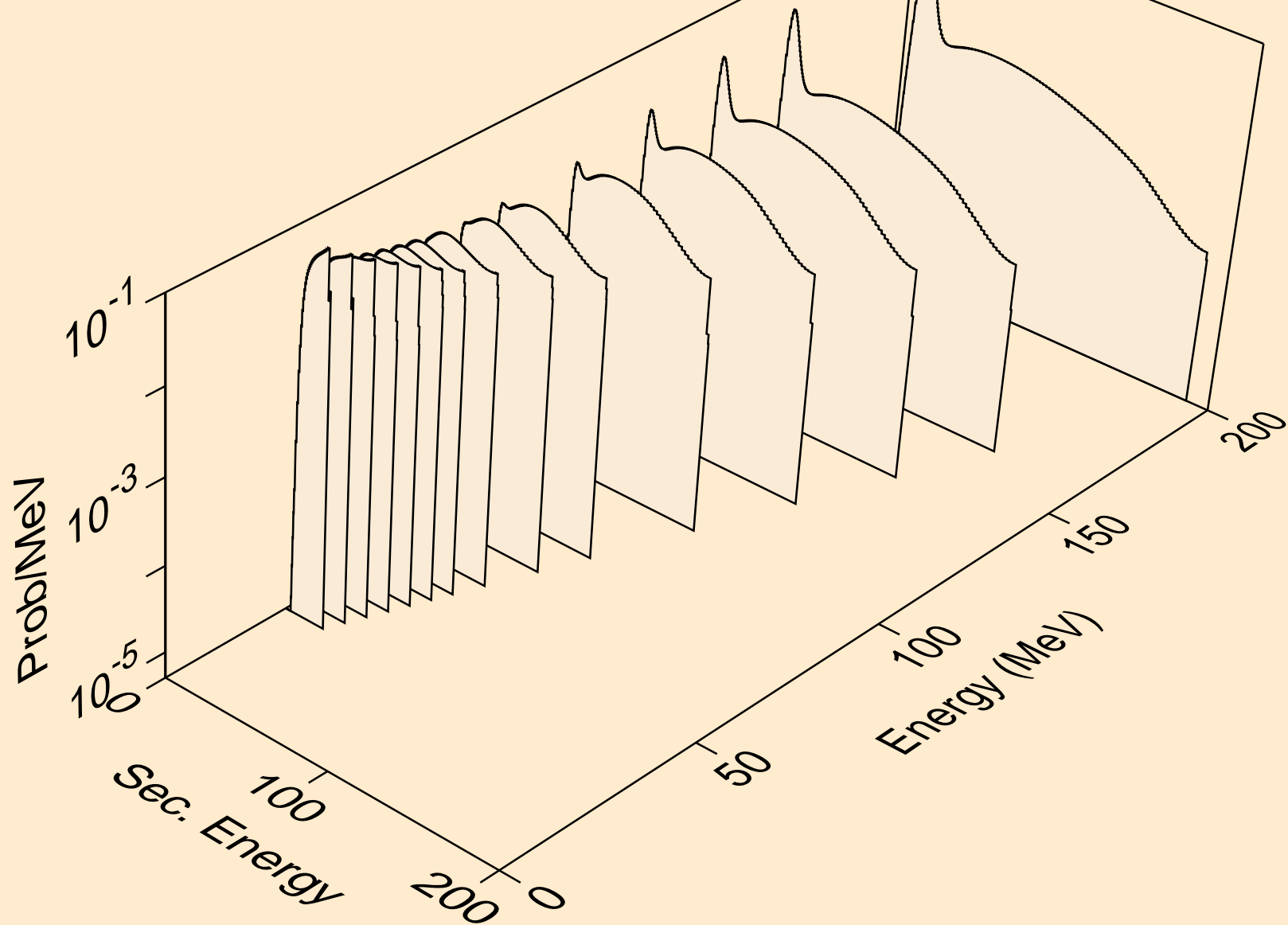

AG112 NEUTRON ACER TENDL-2024 LIBRARY; T=0.K
deuterons from (n,2nd)

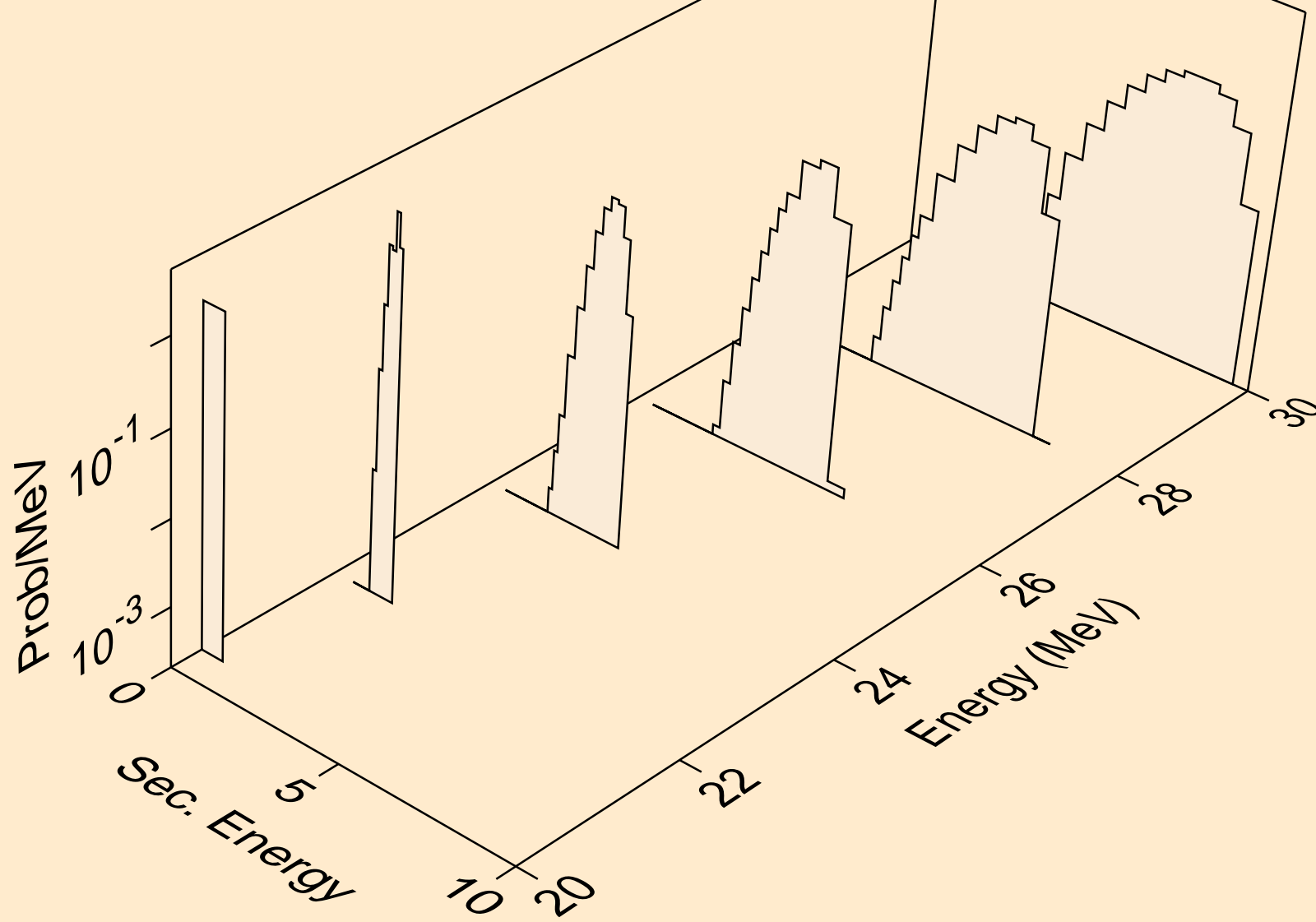

AG112 NEUTRON ACER TENDL-2024 LIBRARY; T=0.K
deuterons from (n,n*)d

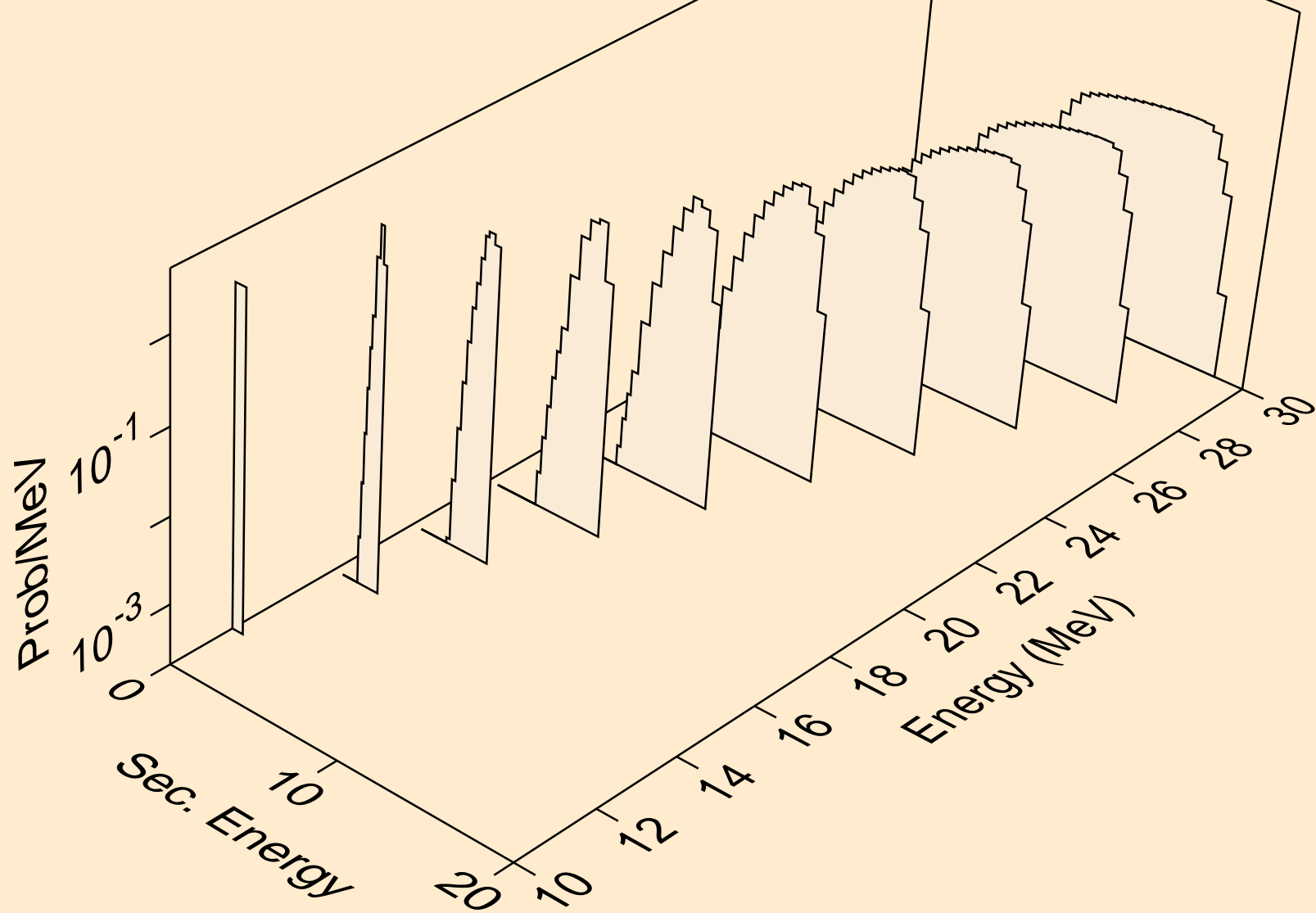

AG112 NEUTRON ACER TENDL-2024 LIBRARY; T=0.K
deuterons from (n,d)

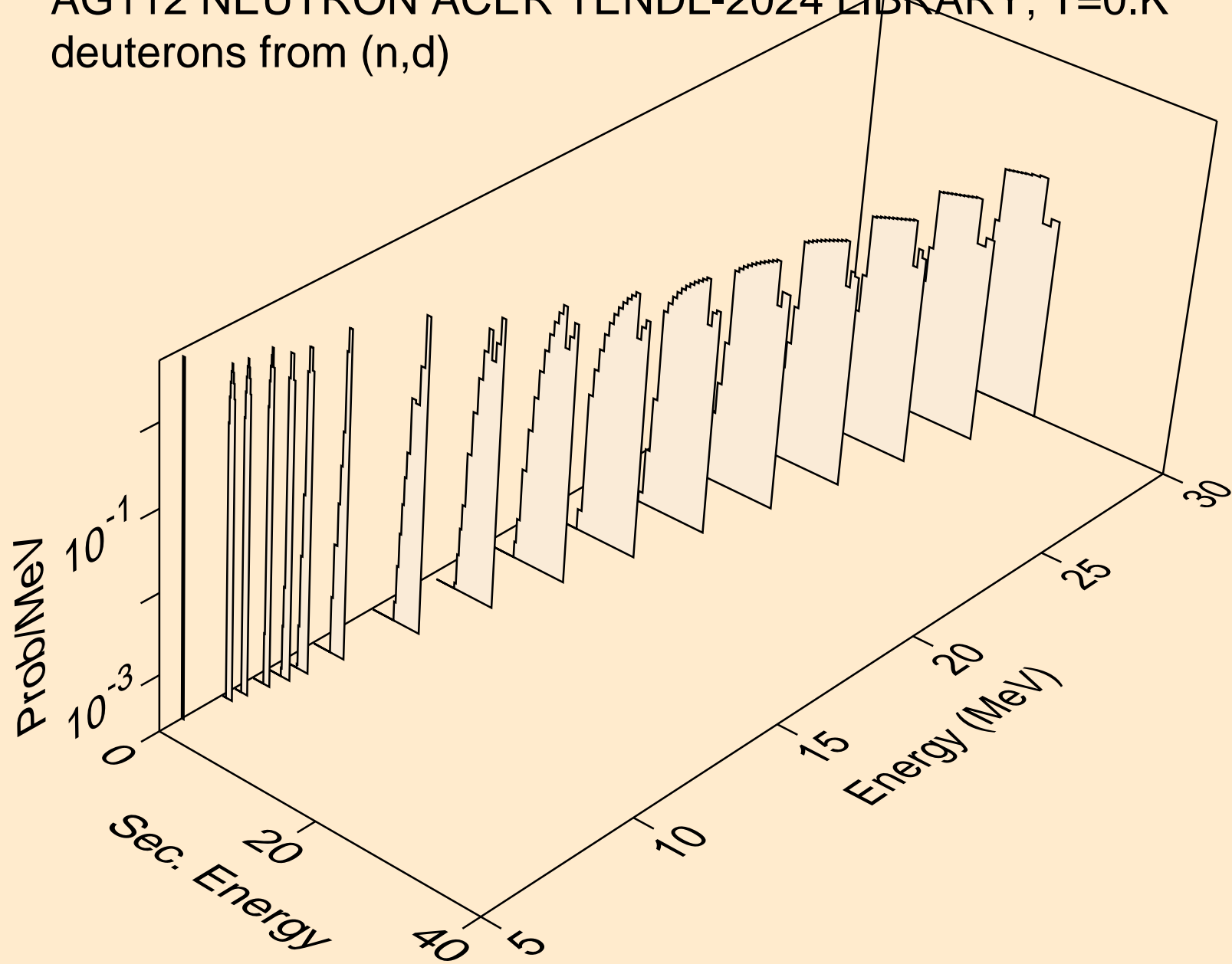

AG112 NEUTRON ACER TENDL-2024 LIBRARY; T=0.K
deuterons from (n,pd)

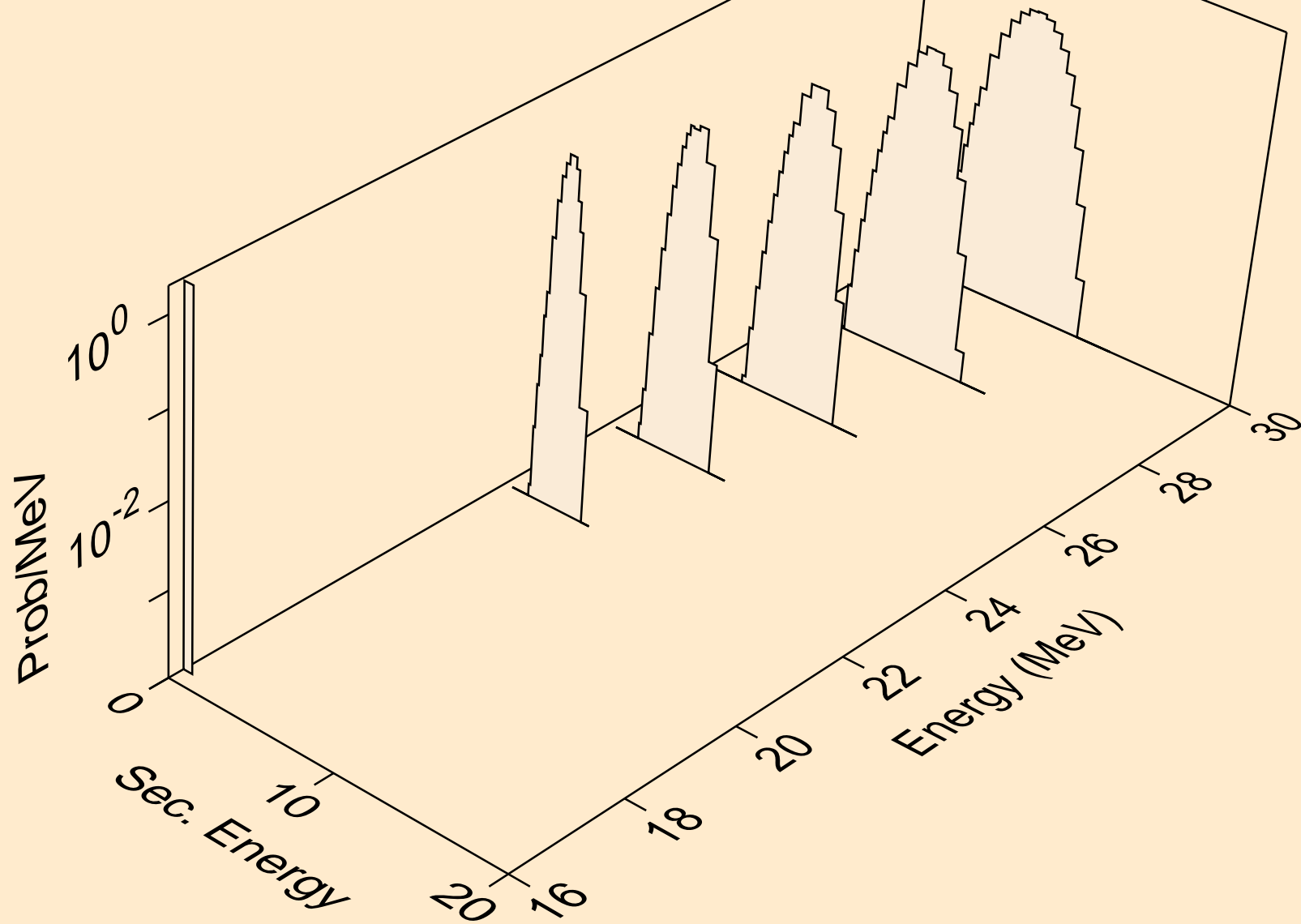

AG112 NEUTRON ACER TENDL-2024 LIBRARY; T=0.K
deuterons from (n,da)

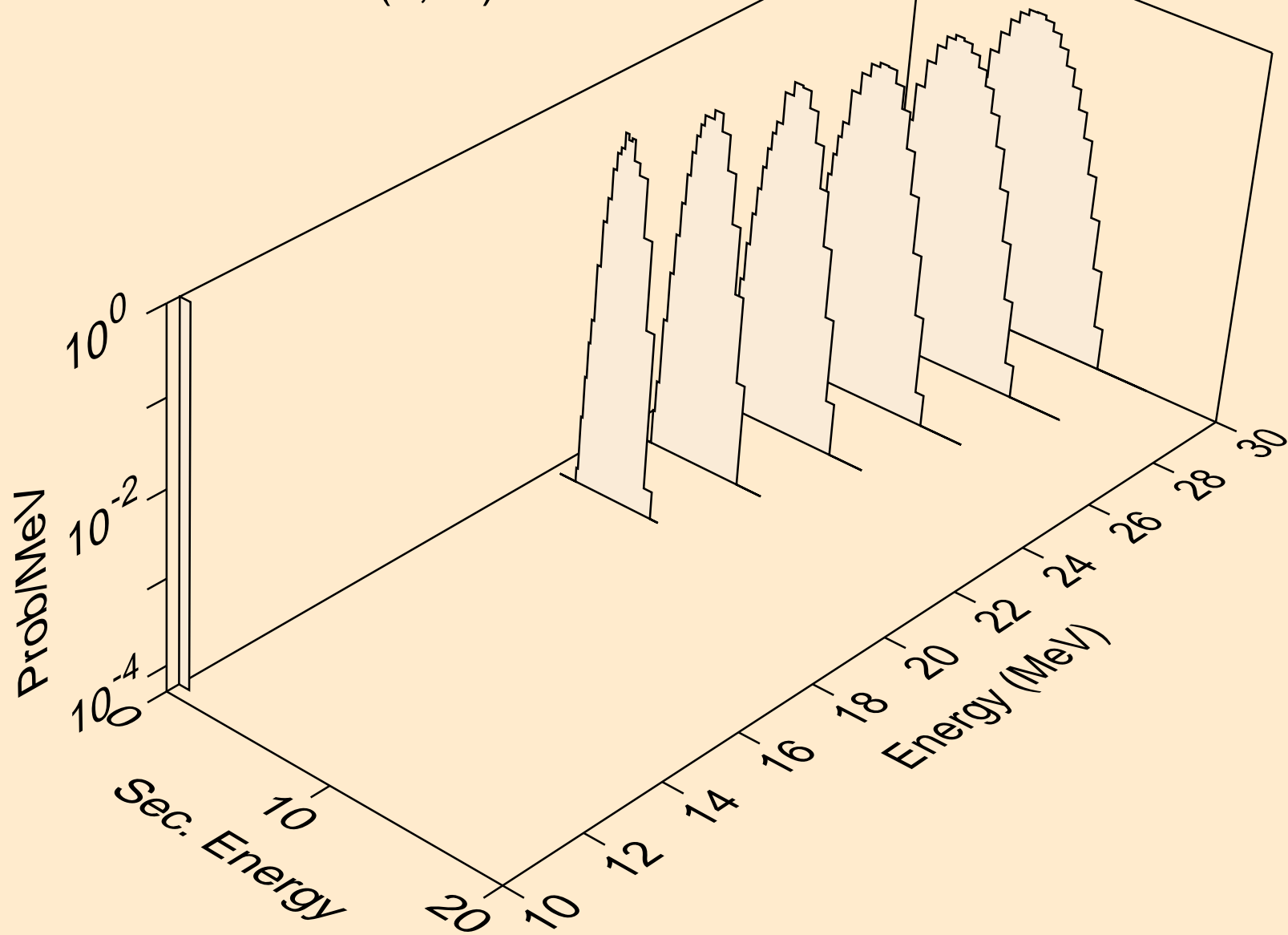

AG112 NEUTRON ACER TENDL-2024 LIBRARY; T=0.K
tritons from (n,x)

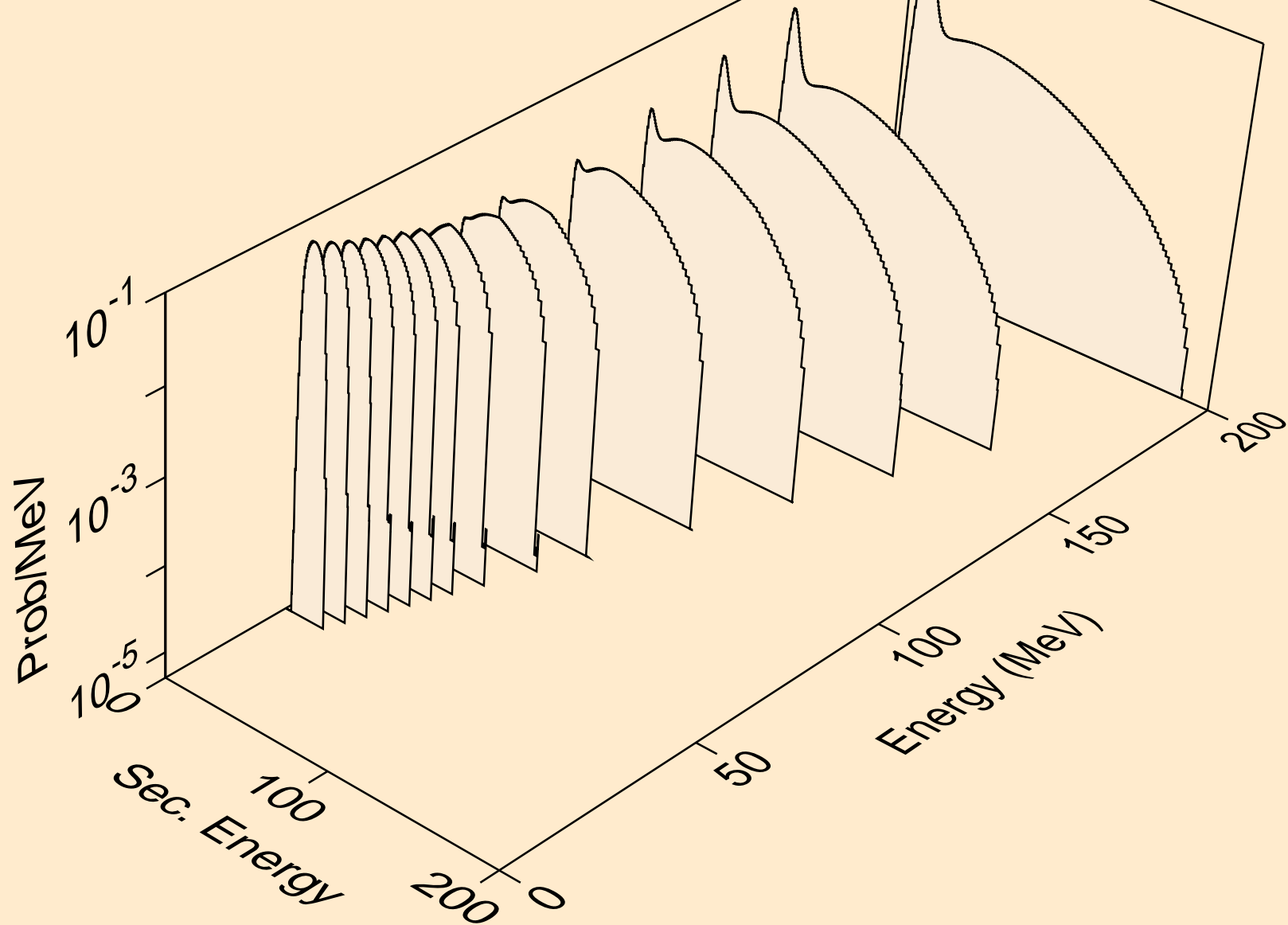

AG112 NEUTRON ACER TENDL-2024 LIBRARY; T=0.K
tritons from (n,n*)t

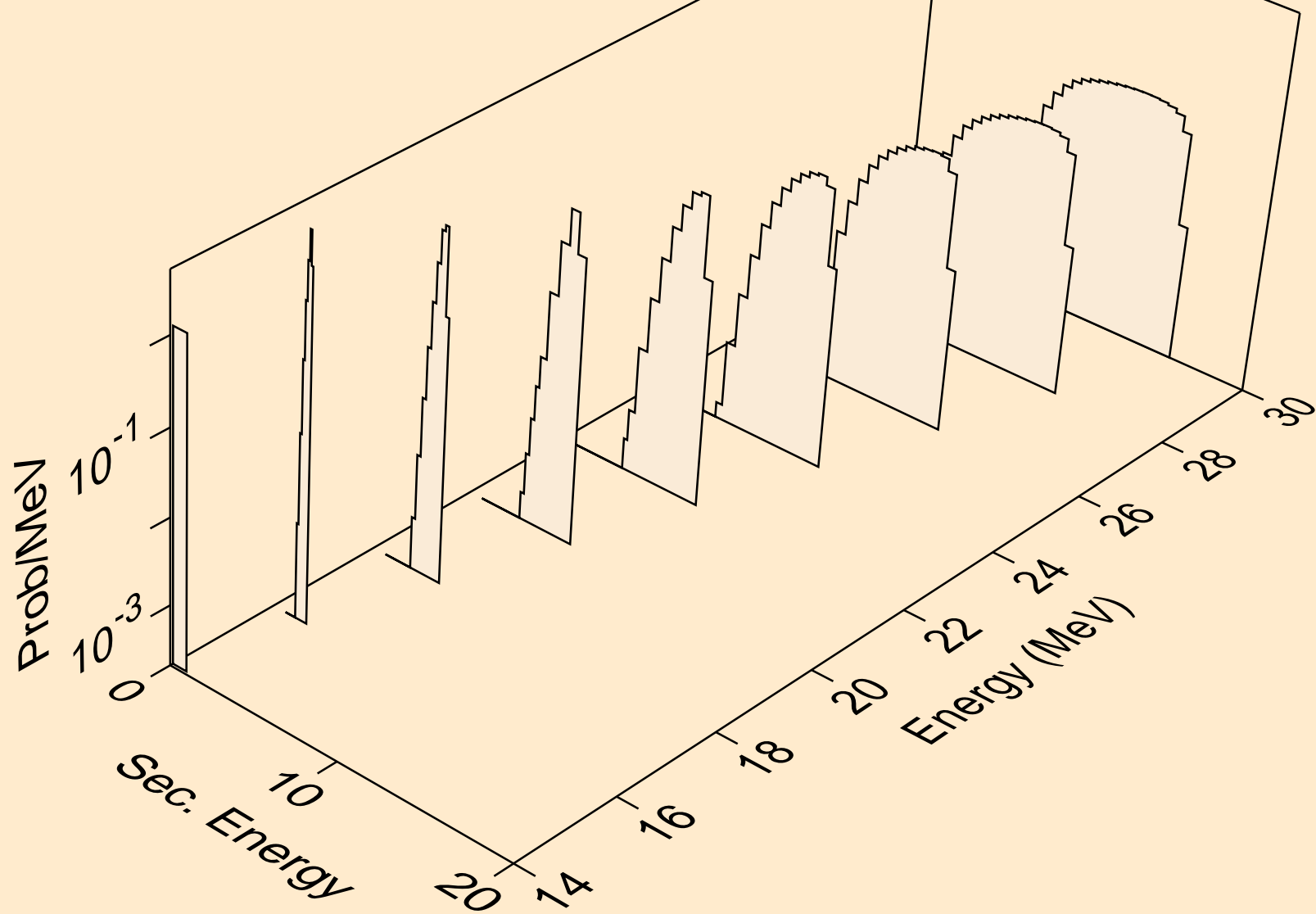

AG112 NEUTRON ACER TENDL-2024 LIBRARY; T=0.K
tritons from (n,t)

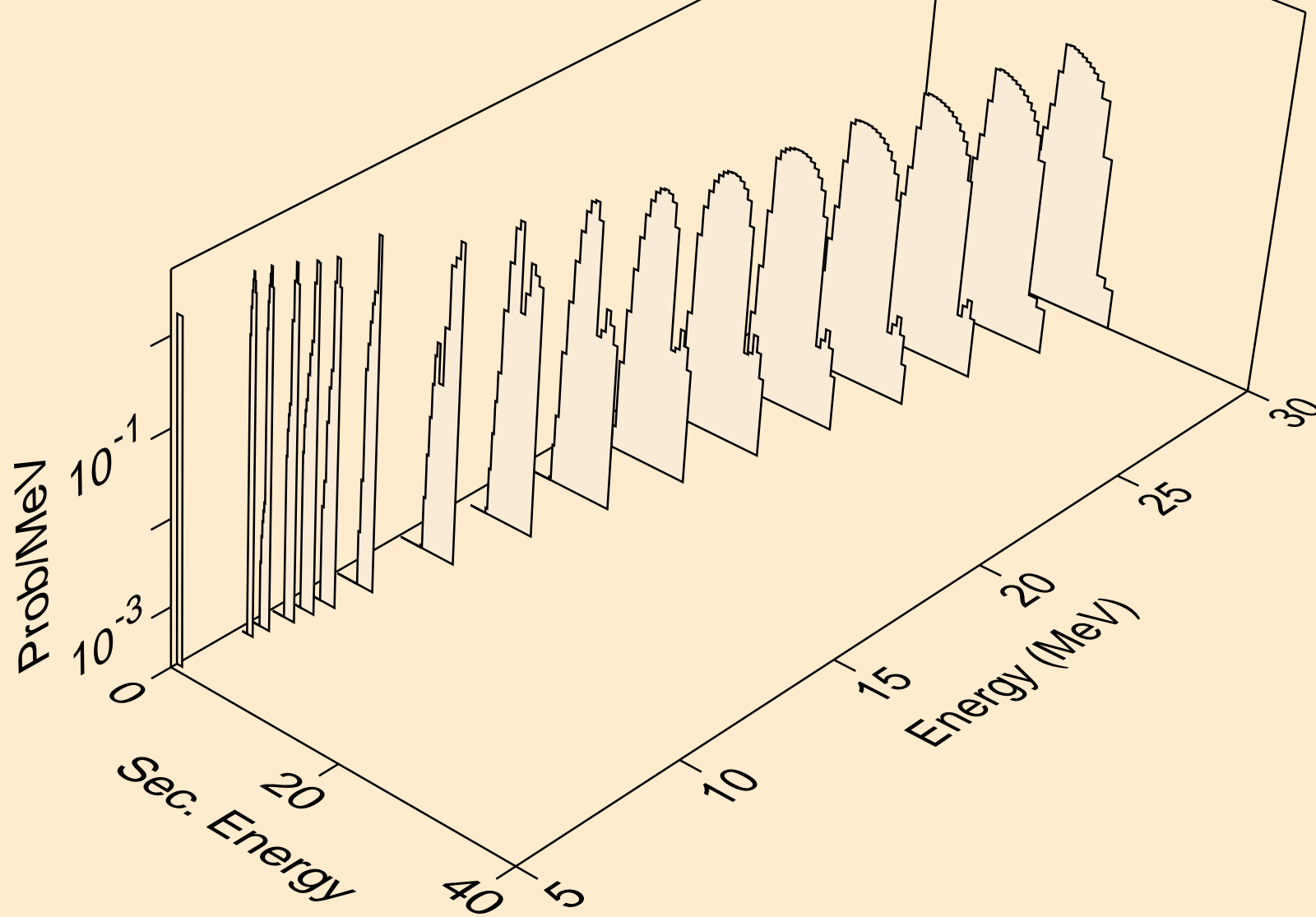

AG112 NEUTRON ACER TENDL-2024 LIBRARY; T=0.K
tritons from (n,pt)

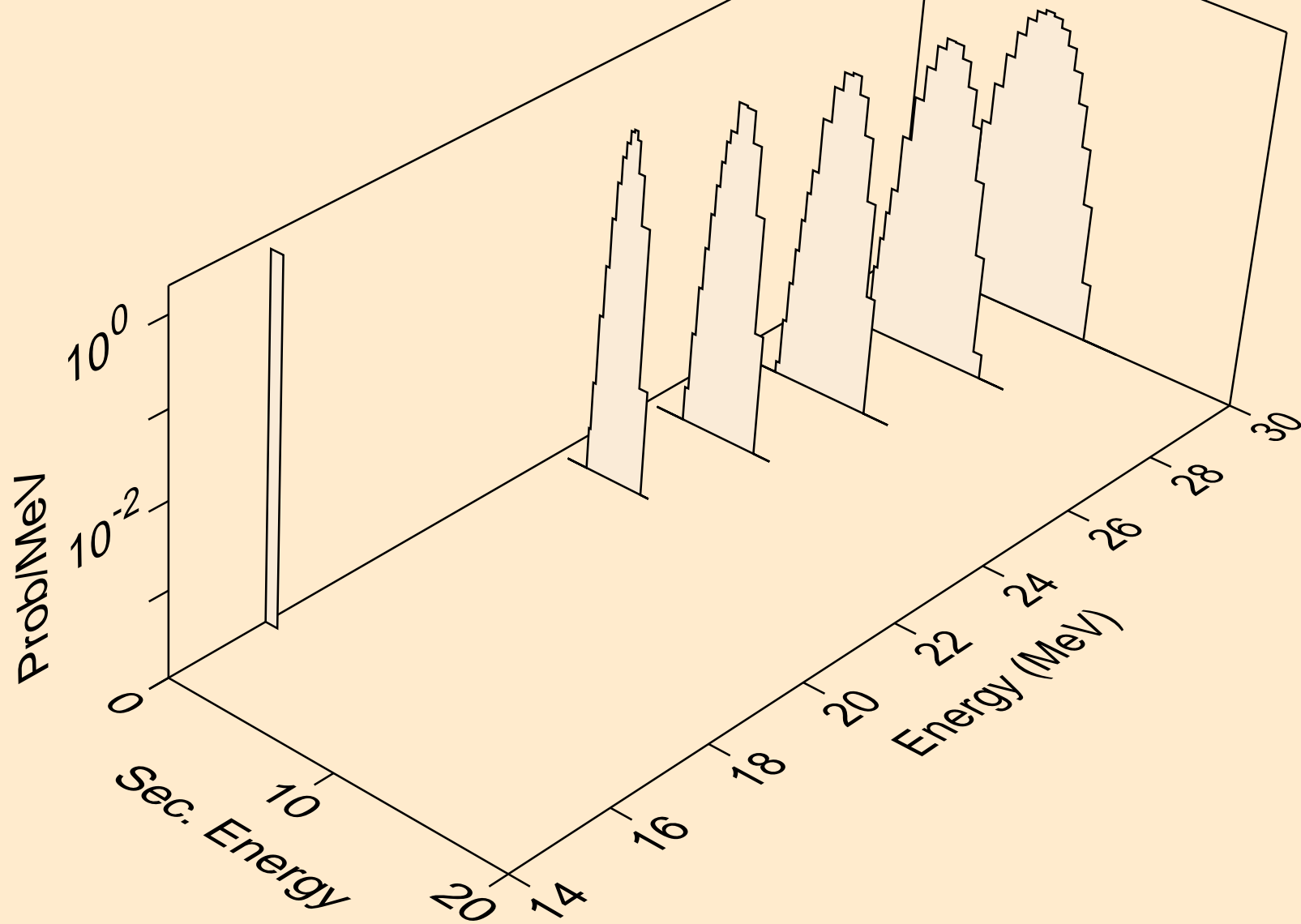

AG112 NEUTRON ACER TENDL-2024 LIBRARY; T=0.K
he3s from (n,x)

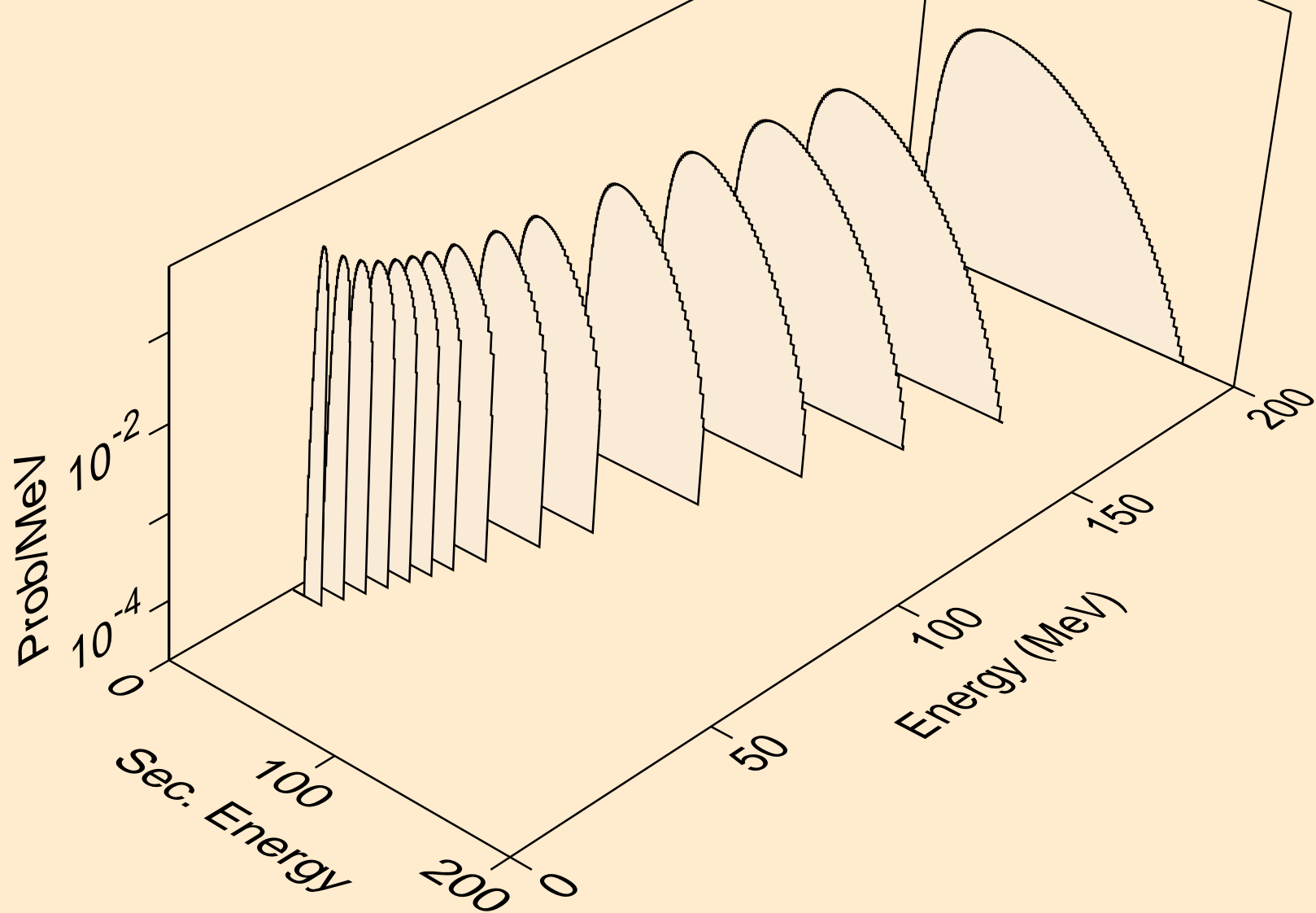

AG112 NEUTRON ACER TENDL-2024 LIBRARY; T=0.K
he3s from (n,n*)he3

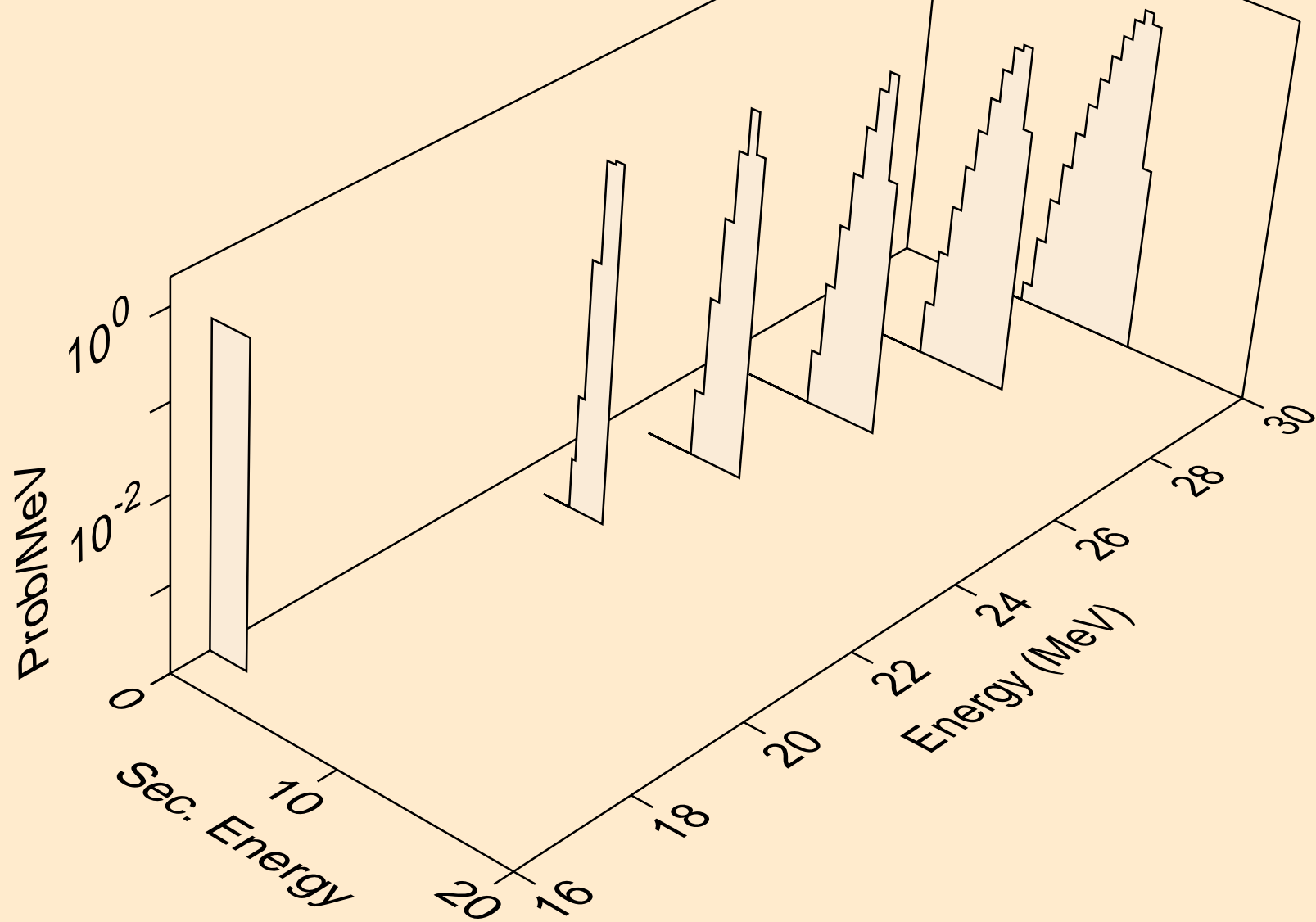

AG112 NEUTRON ACER TENDL-2024 LIBRARY; T=0.K
he3s from (n,he3)

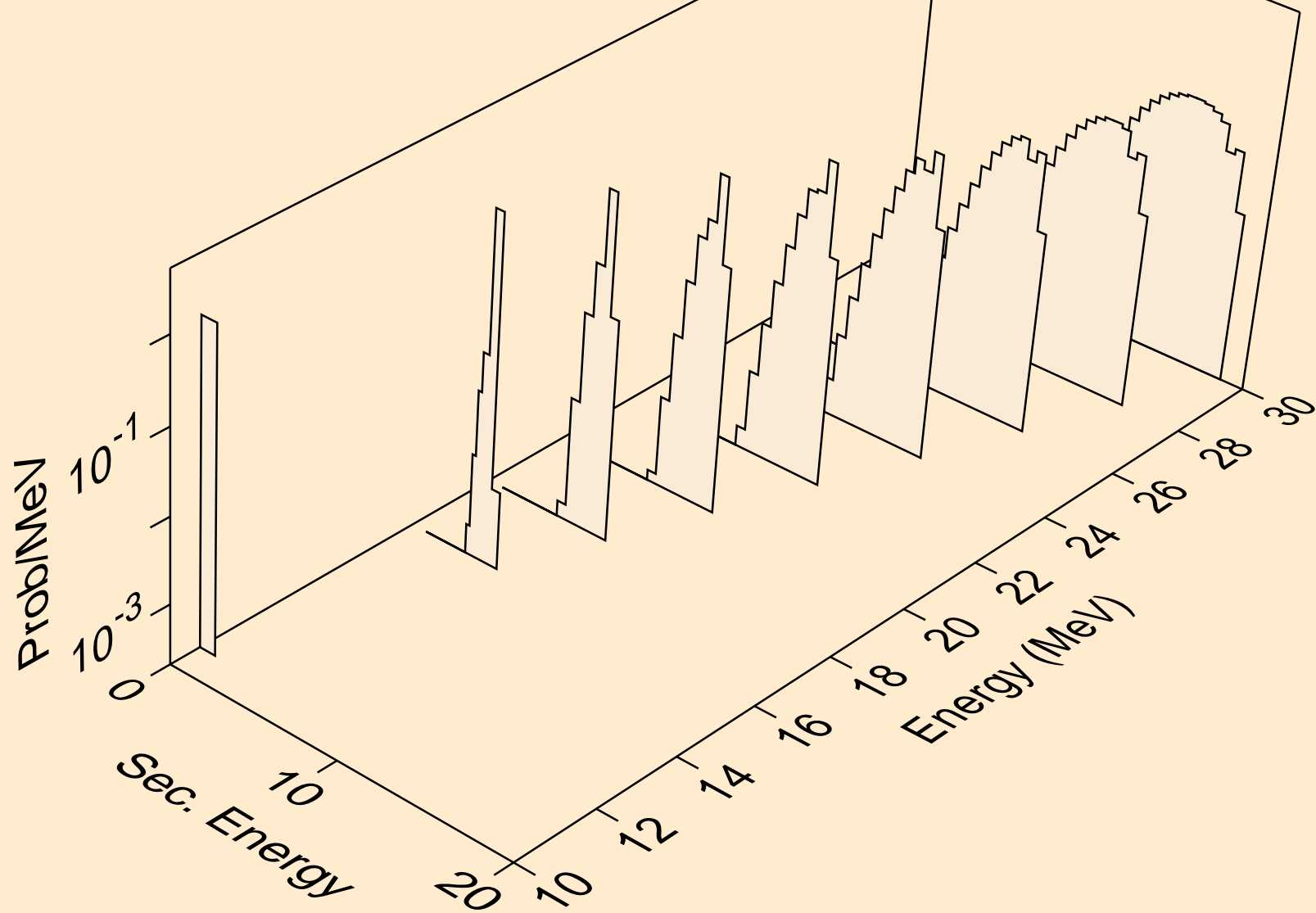

AG112 NEUTRON ACER TENDL-2024 LIBRARY; T=0.K
alphas from (n,x)

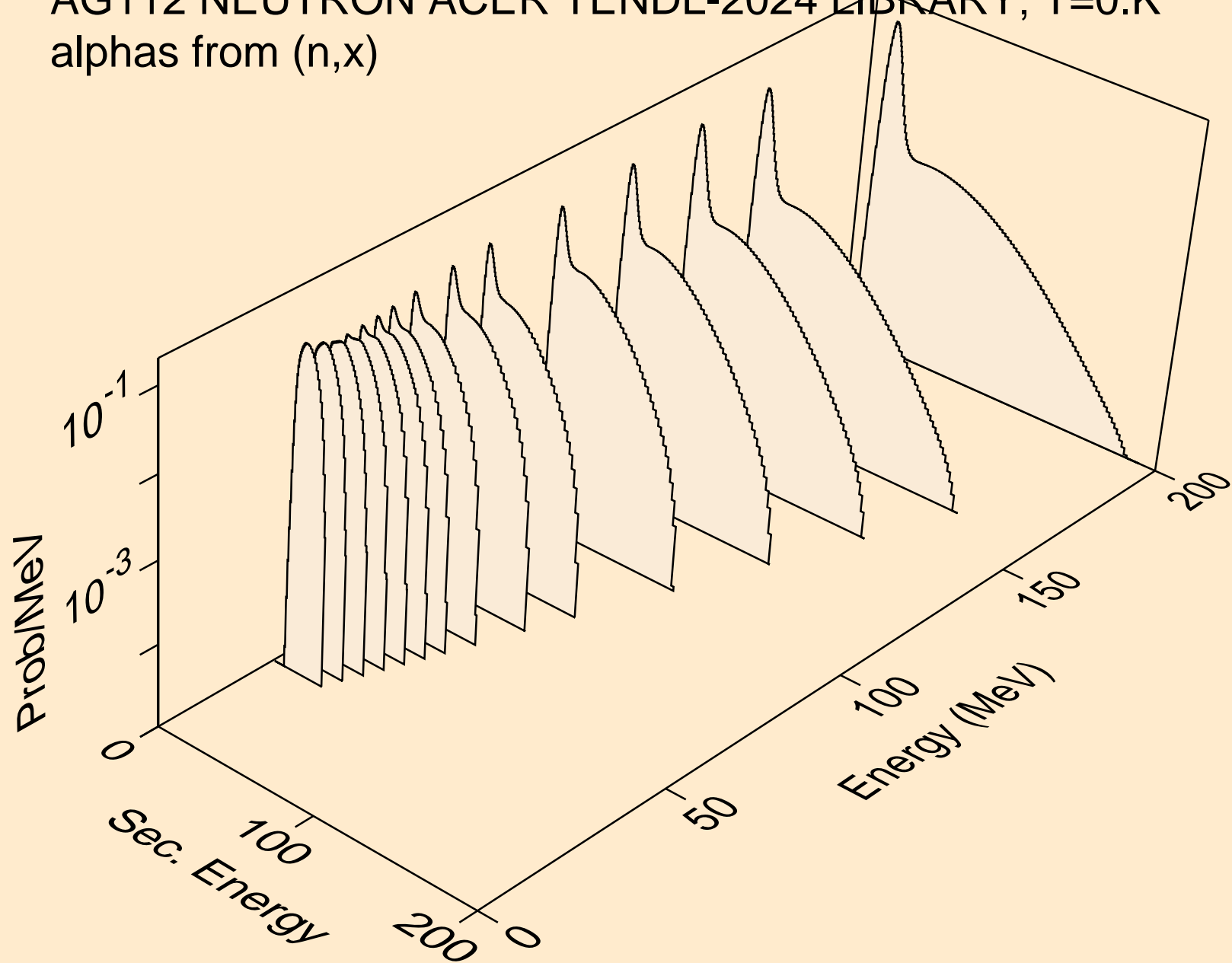

AG112 NEUTRON ACER TENDL-2024 LIBRARY; T=0.K
alphas from (n,n*)a

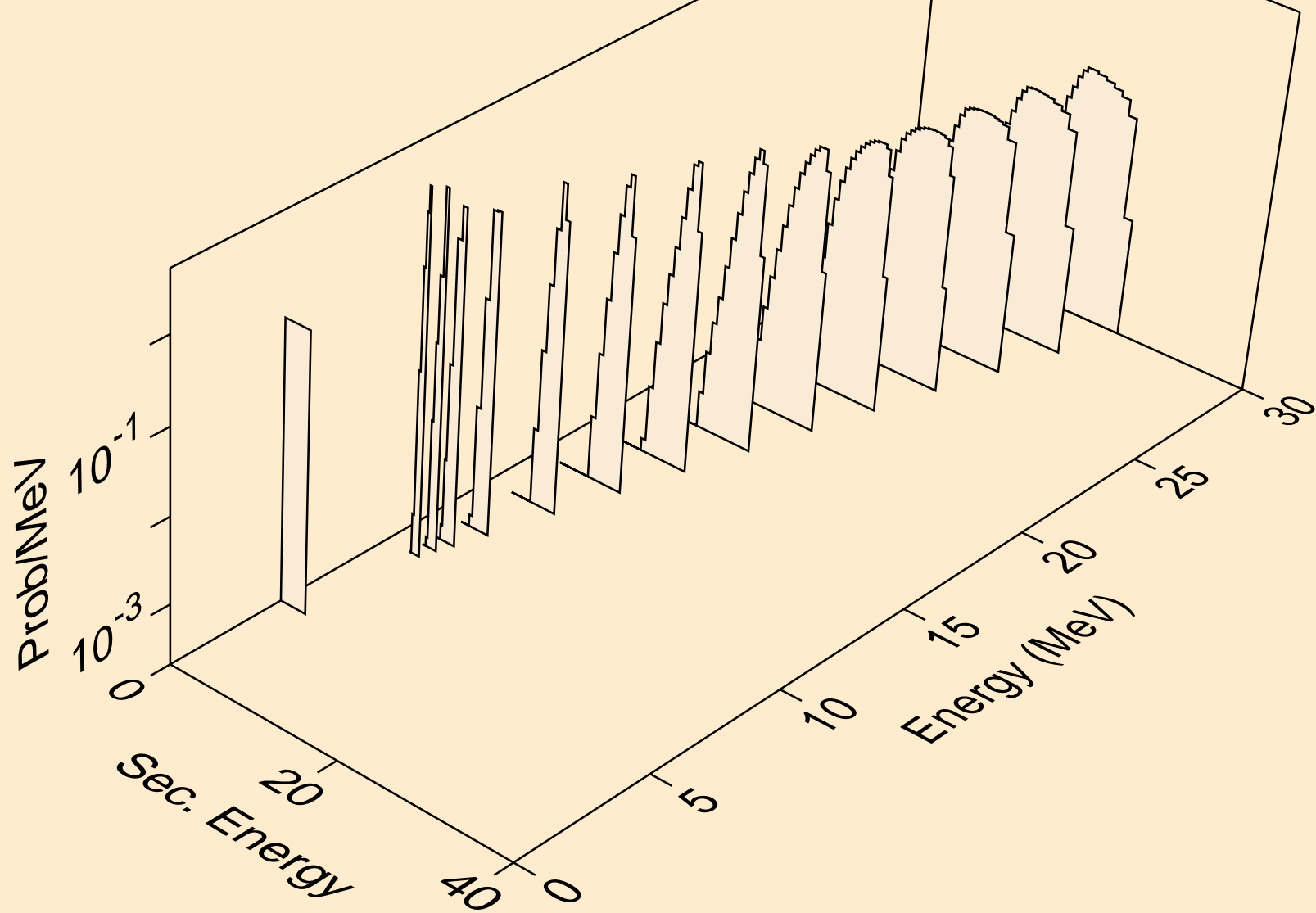

AG112 NEUTRON ACER TENDL-2024 LIBRARY; T=0.K
alphas from (n,2n)a

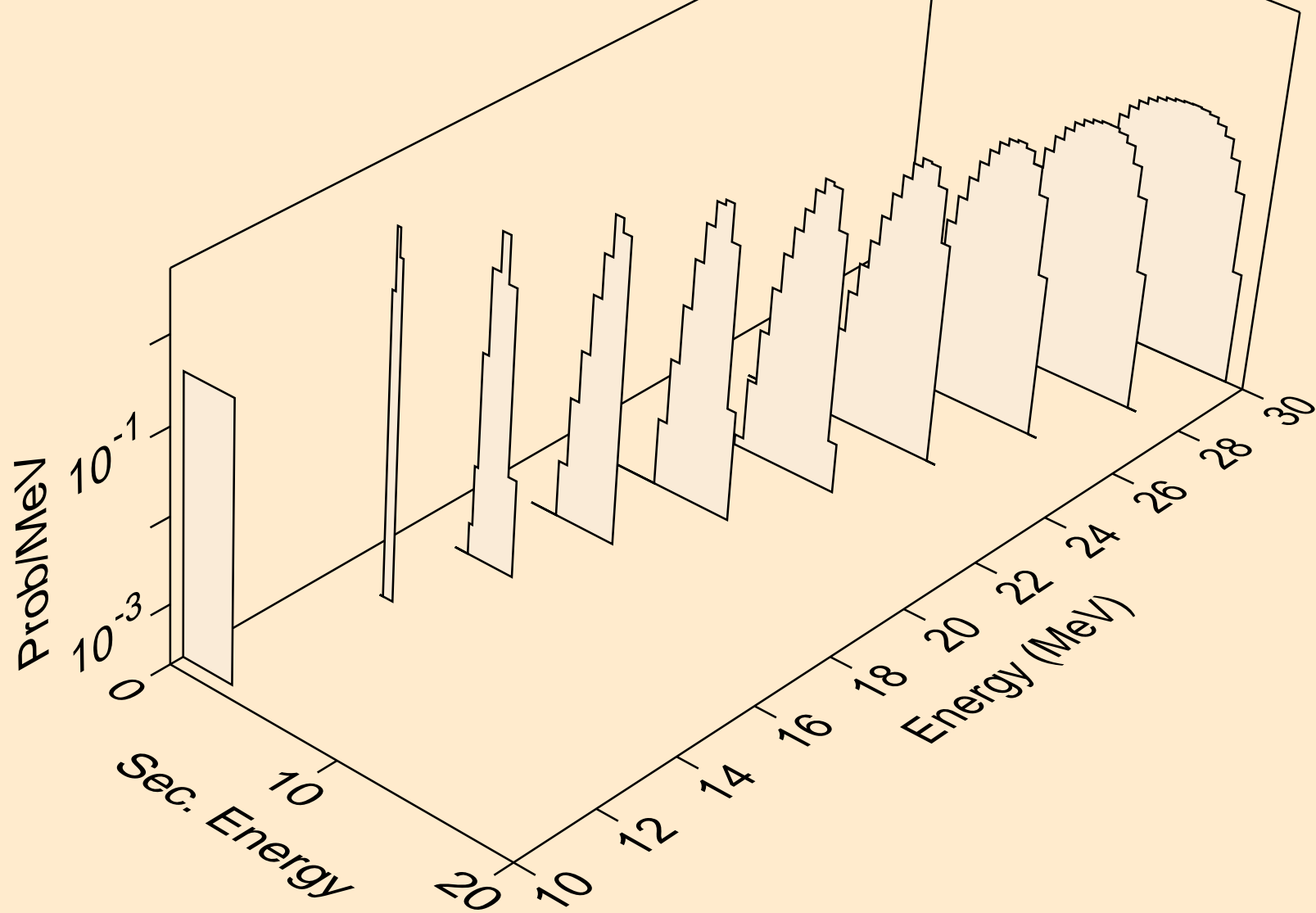

AG112 NEUTRON ACER TENDL-2024 LIBRARY; T=0.K
alphas from (n,3n)a

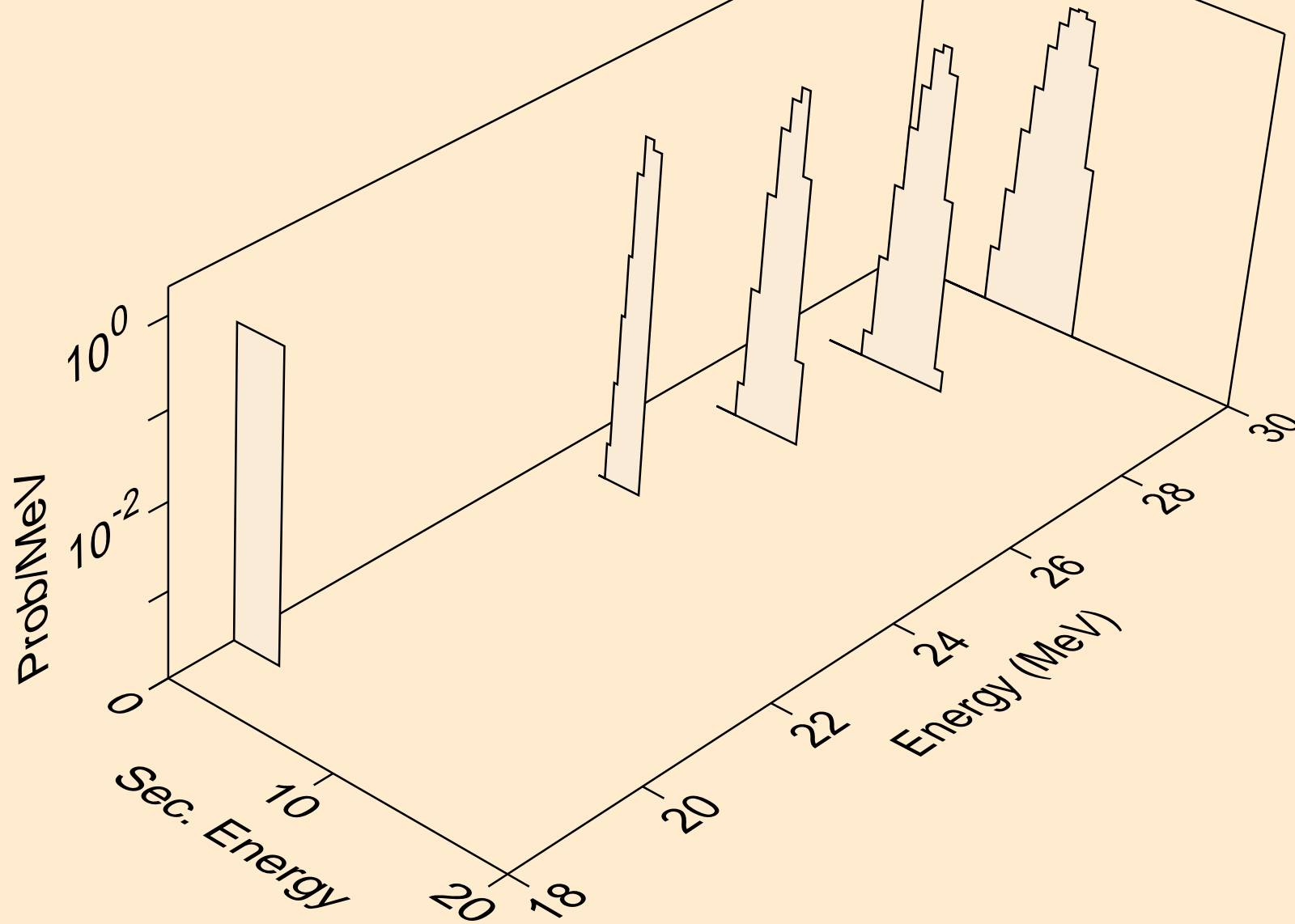

AG112 NEUTRON ACER TENDL-2024 LIBRARY; T=0.K
alphas from (n,npa)

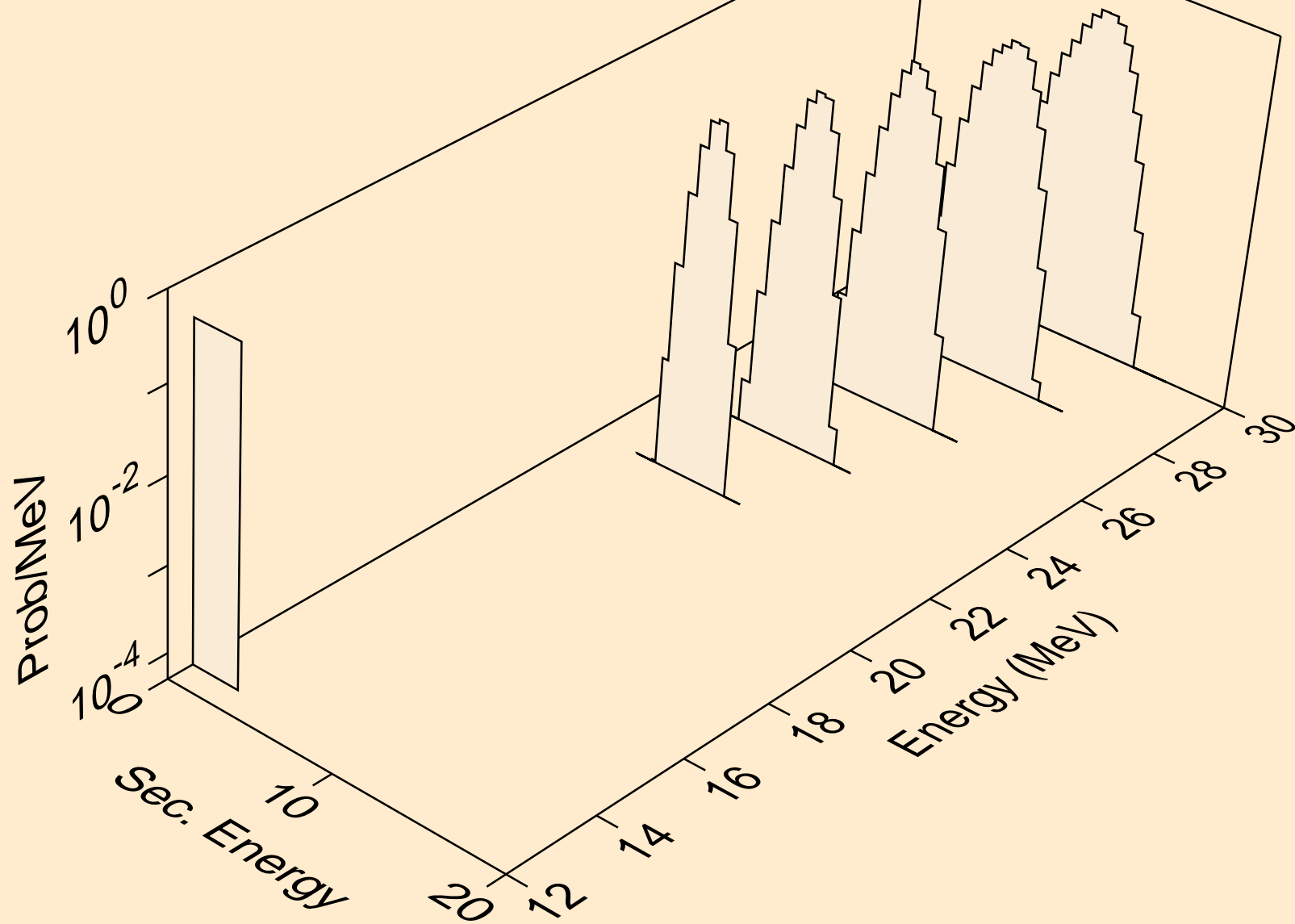

AG112 NEUTRON ACER TENDL-2024 LIBRARY; T=0.K
alphas from (n,a)

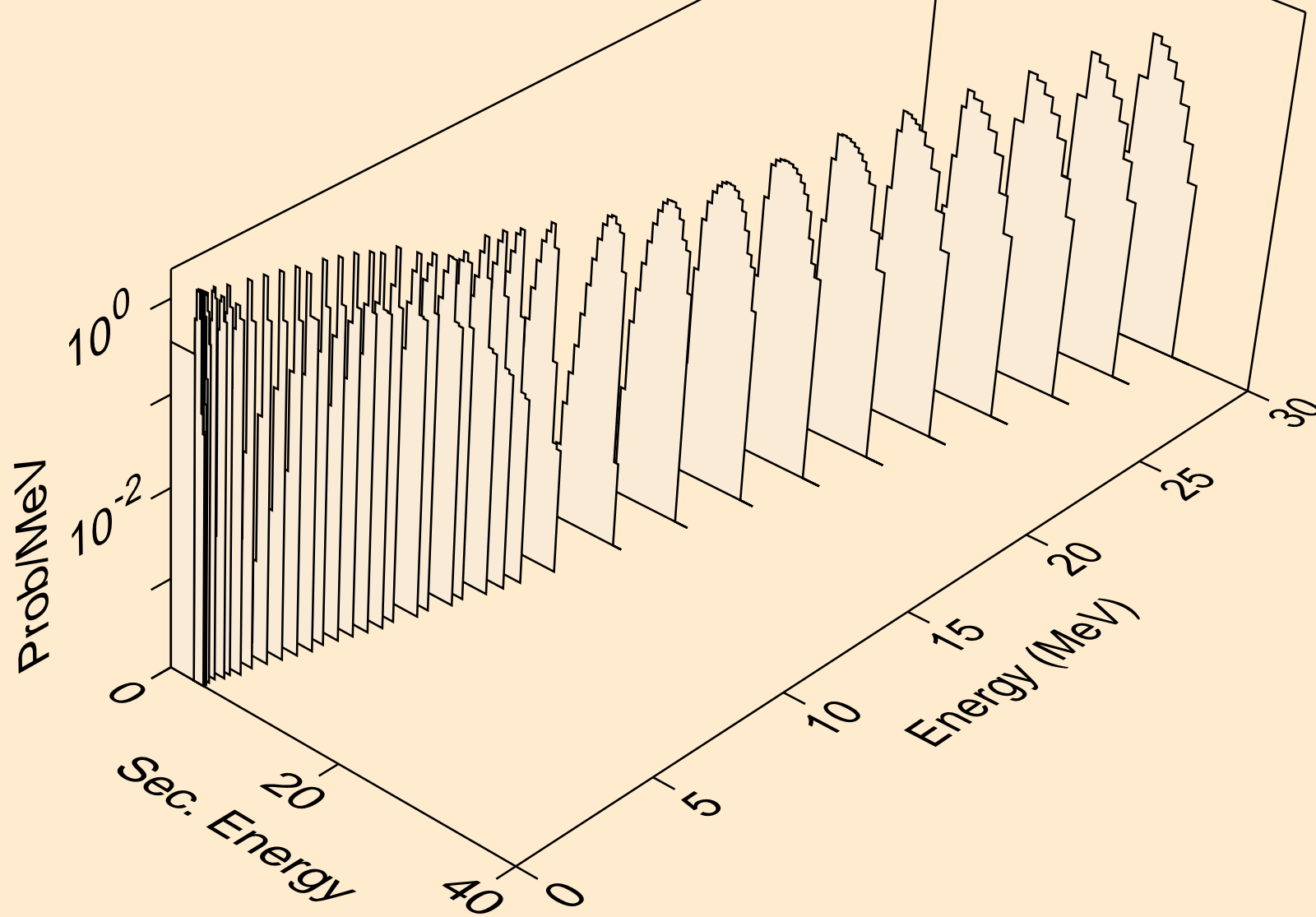

AG112 NEUTRON ACER TENDL-2024 LIBRARY; T=0.K
alphas from (n,2a)

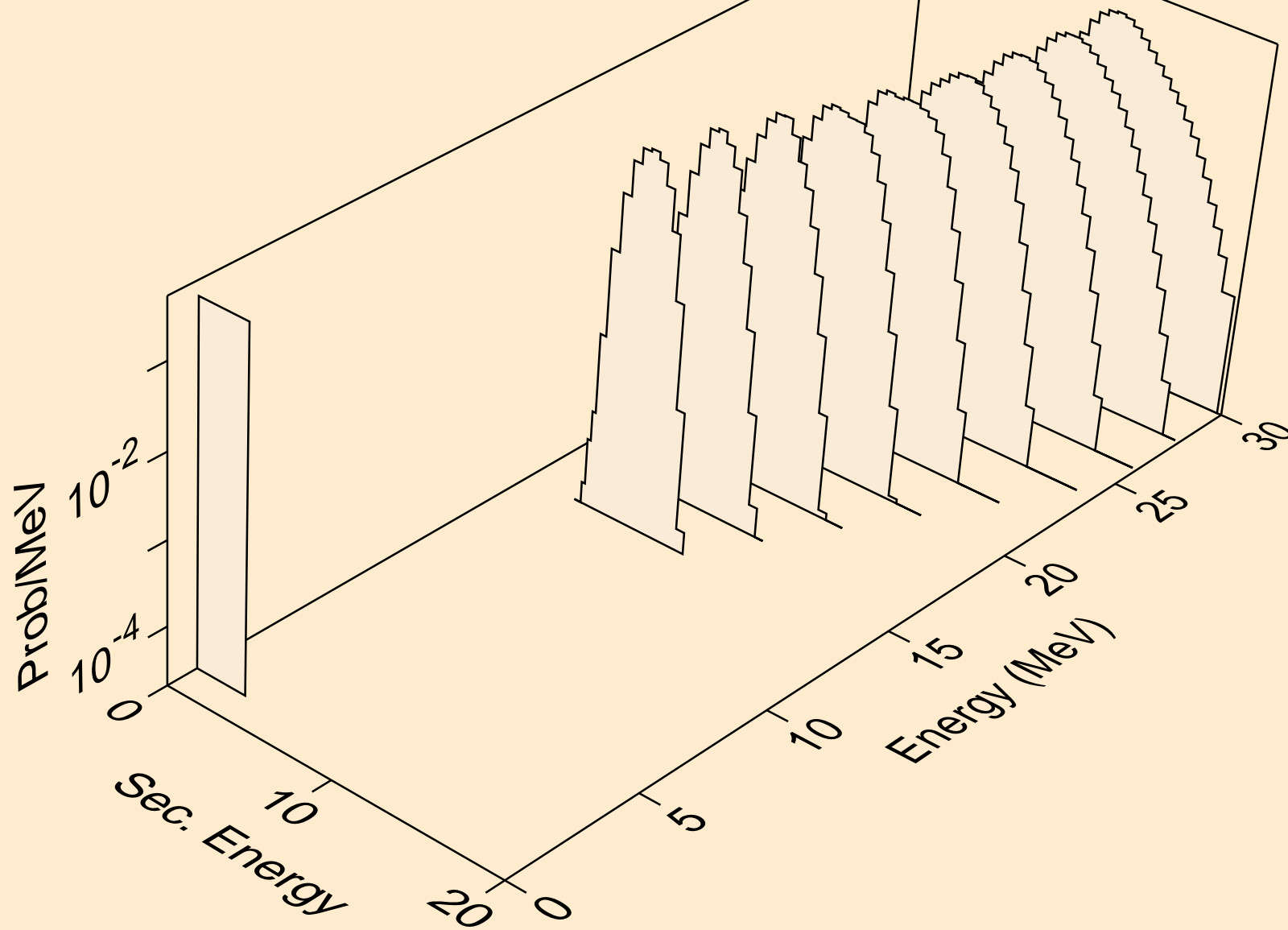

AG112 NEUTRON ACER TENDL-2024 LIBRARY; T=0.K
alphas from (n,pa)

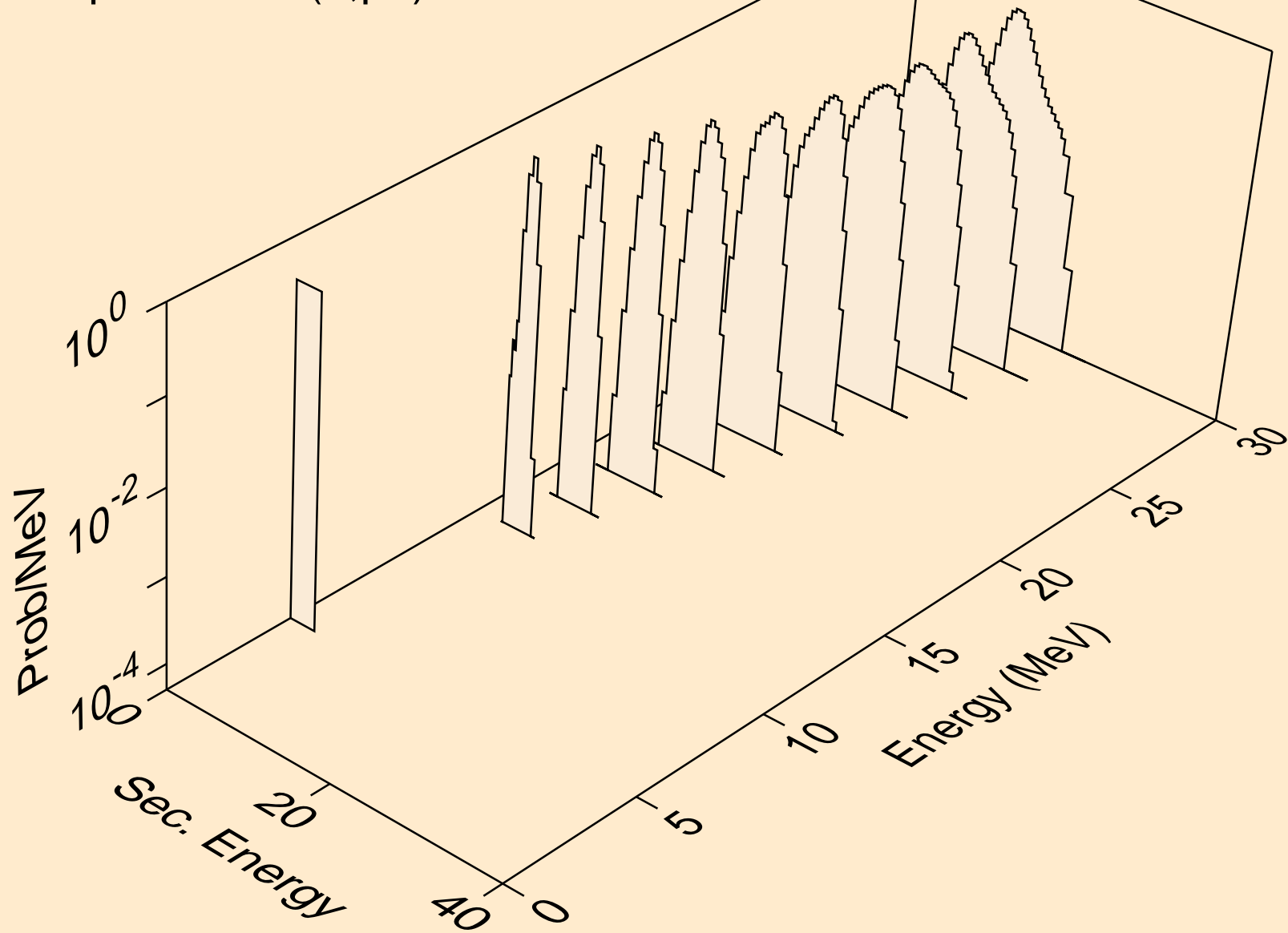

AG112 NEUTRON ACER TENDL-2024 LIBRARY; T=0.K
alphas from (n,da)

