

# AM233 NEUTRON ACER TENDL-2024 LIBRARY; T=0.K

## Principal cross sections

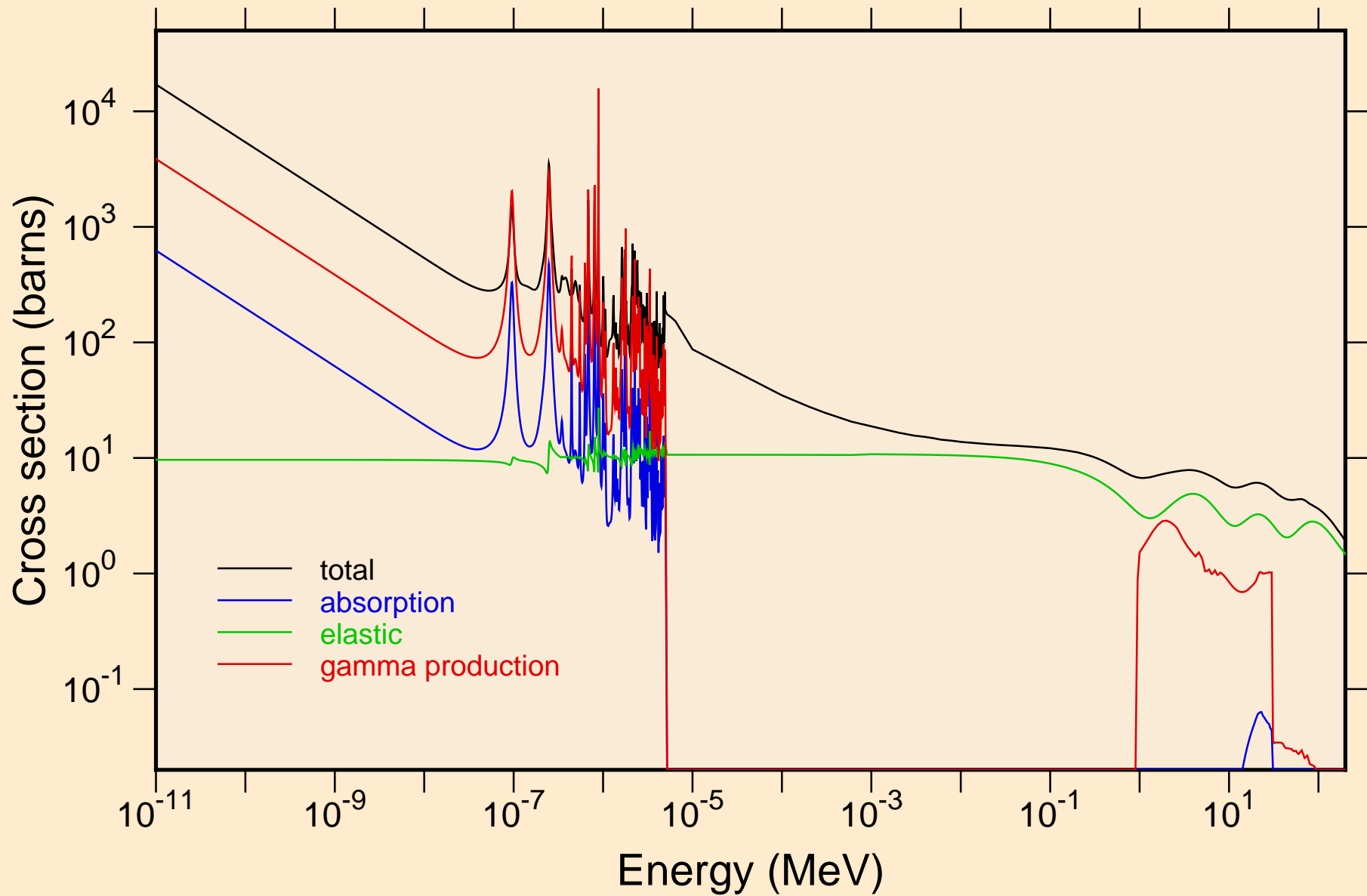

AM233 NEUTRON ACER TENDL-2024 LIBRARY; T=0.K  
resonance total cross section

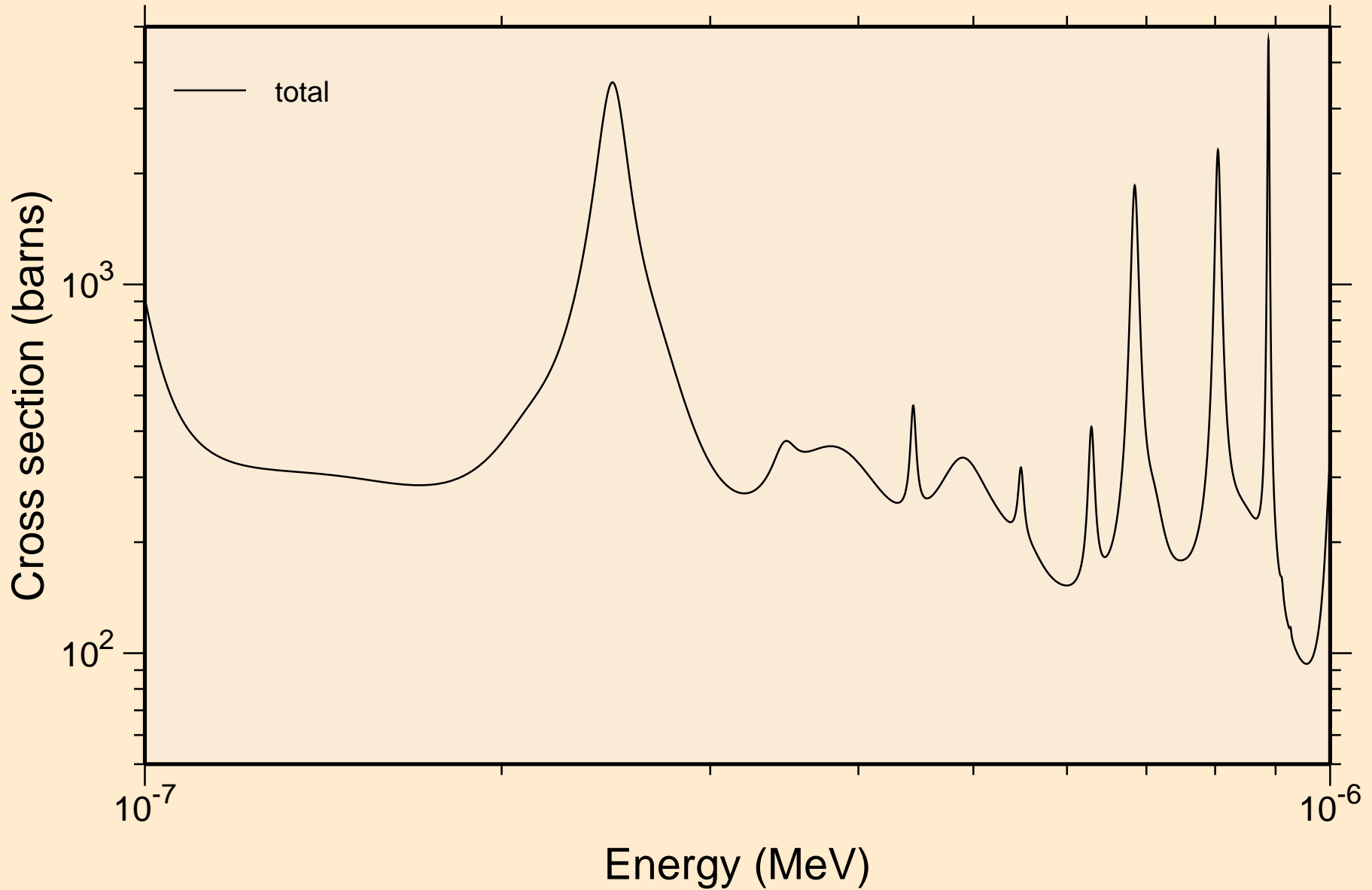

AM233 NEUTRON ACER TENDL-2024 LIBRARY; T=0.K  
resonance total cross section

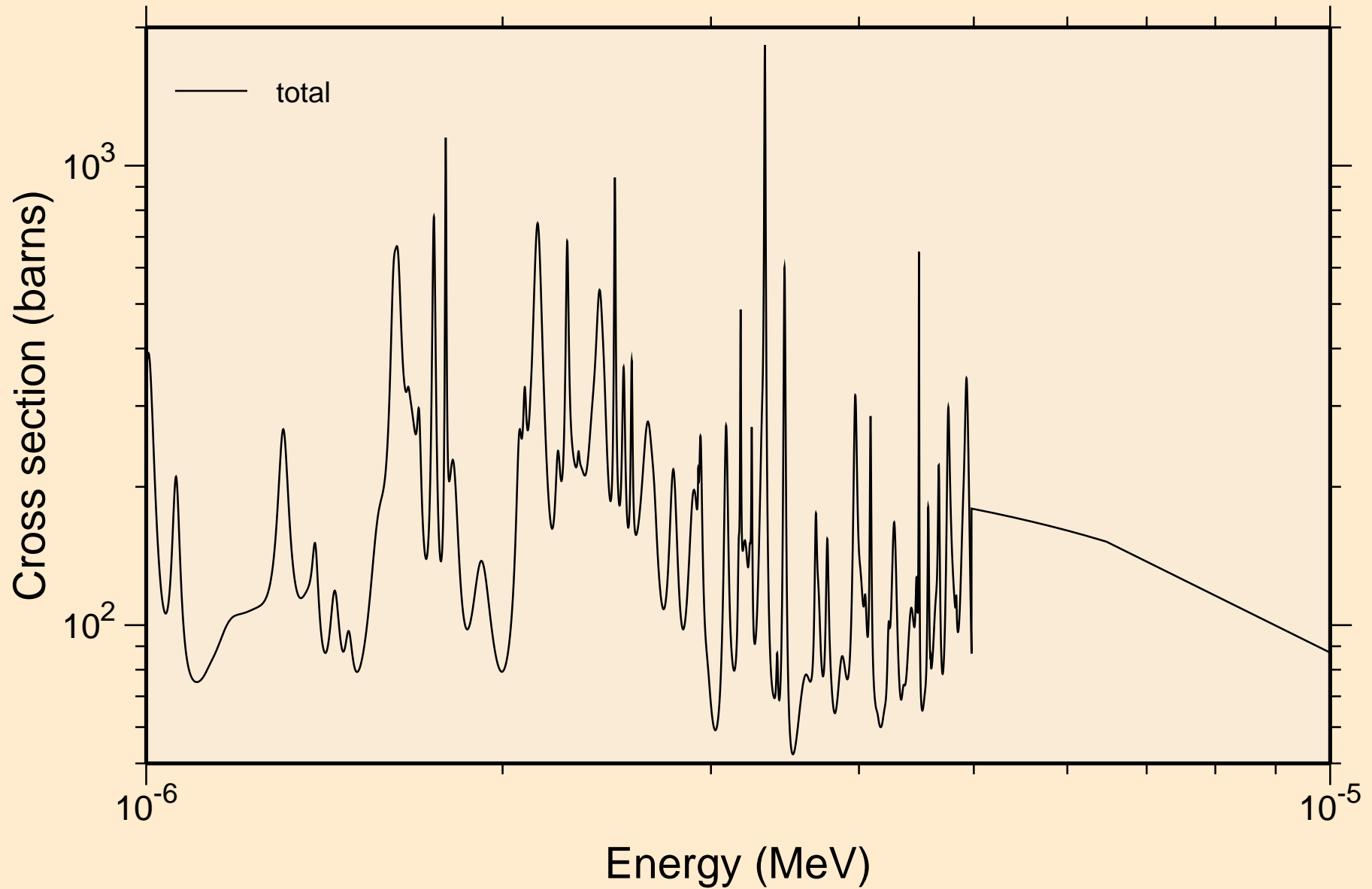

AM233 NEUTRON ACER TENDL-2024 LIBRARY; T=0.K  
resonance total cross section

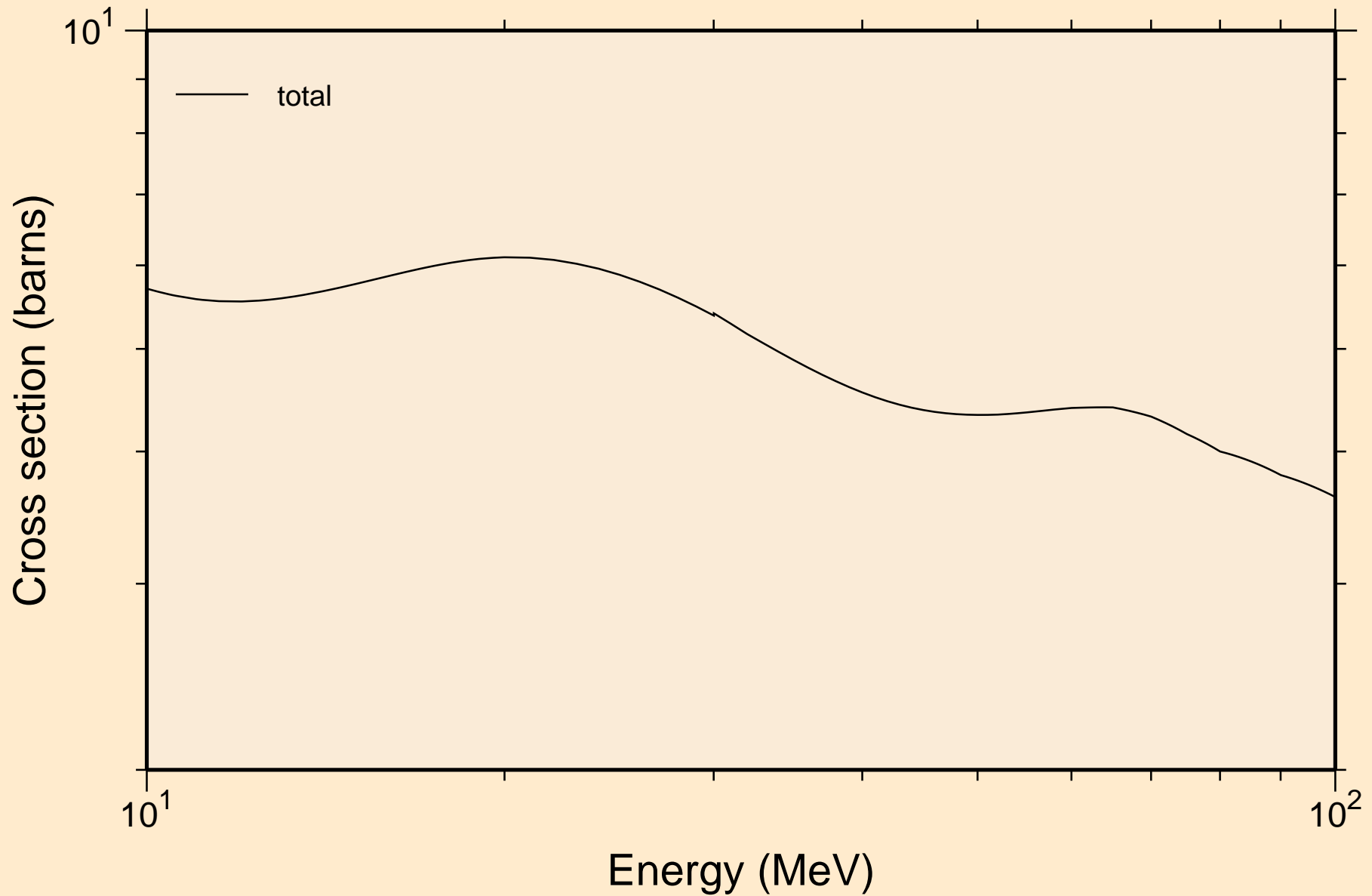

AM233 NEUTRON ACER TENDL-2024 LIBRARY; T=0.K  
resonance absorption cross sections

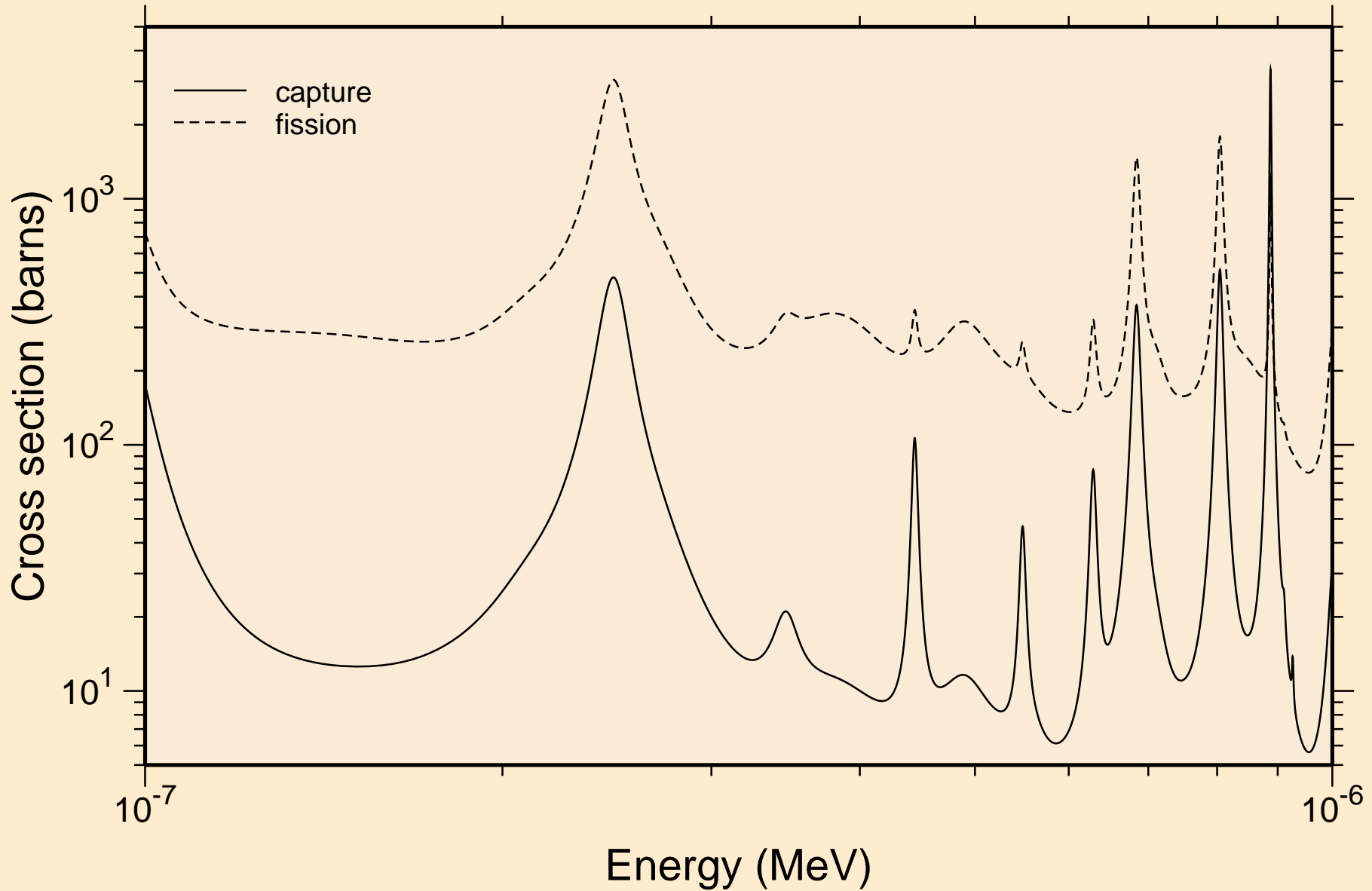

AM233 NEUTRON ACER TENDL-2024 LIBRARY; T=0.K  
resonance absorption cross sections

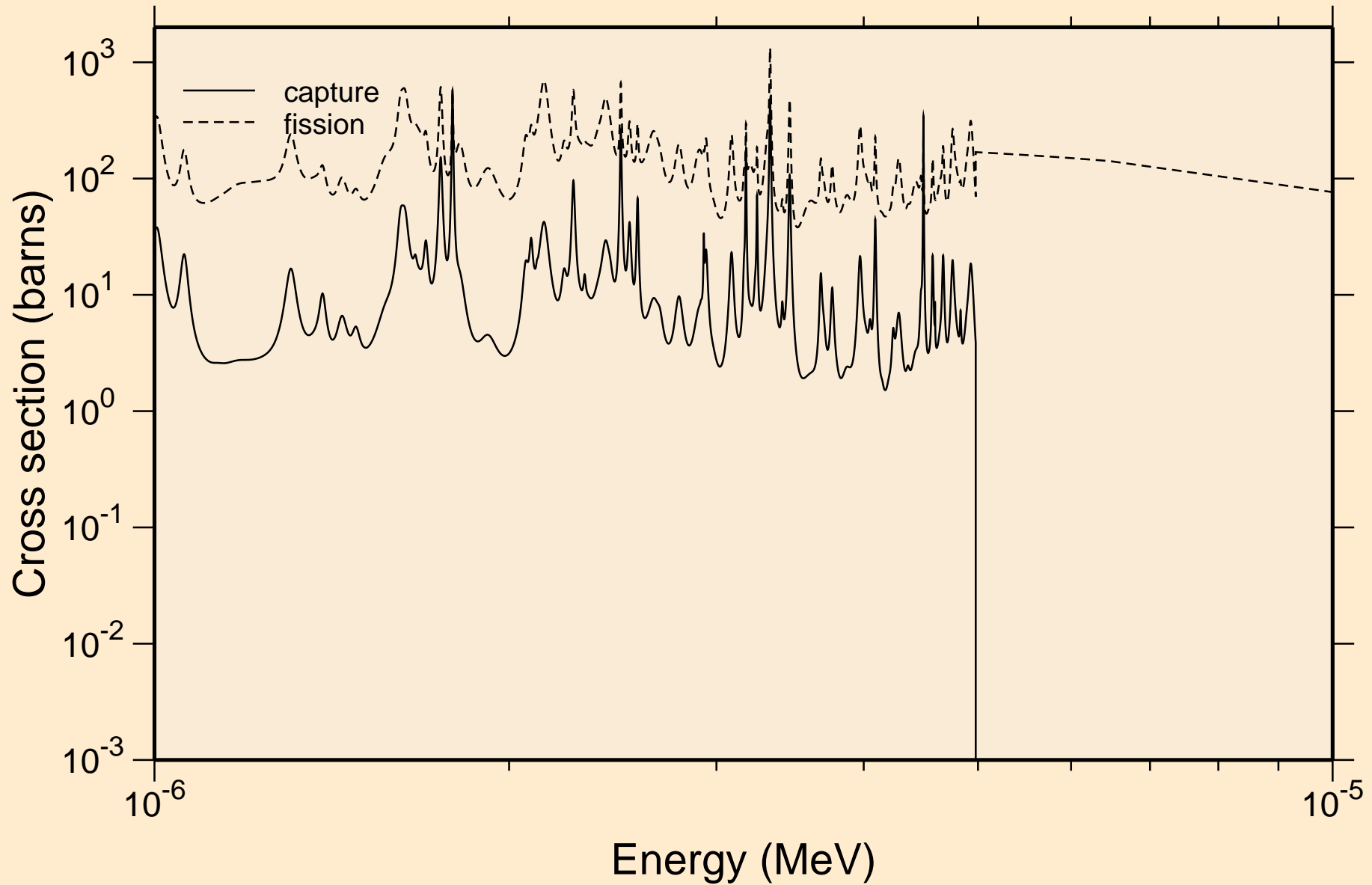

AM233 NEUTRON ACER TENDL-2024 LIBRARY; T=0.K  
resonance absorption cross sections

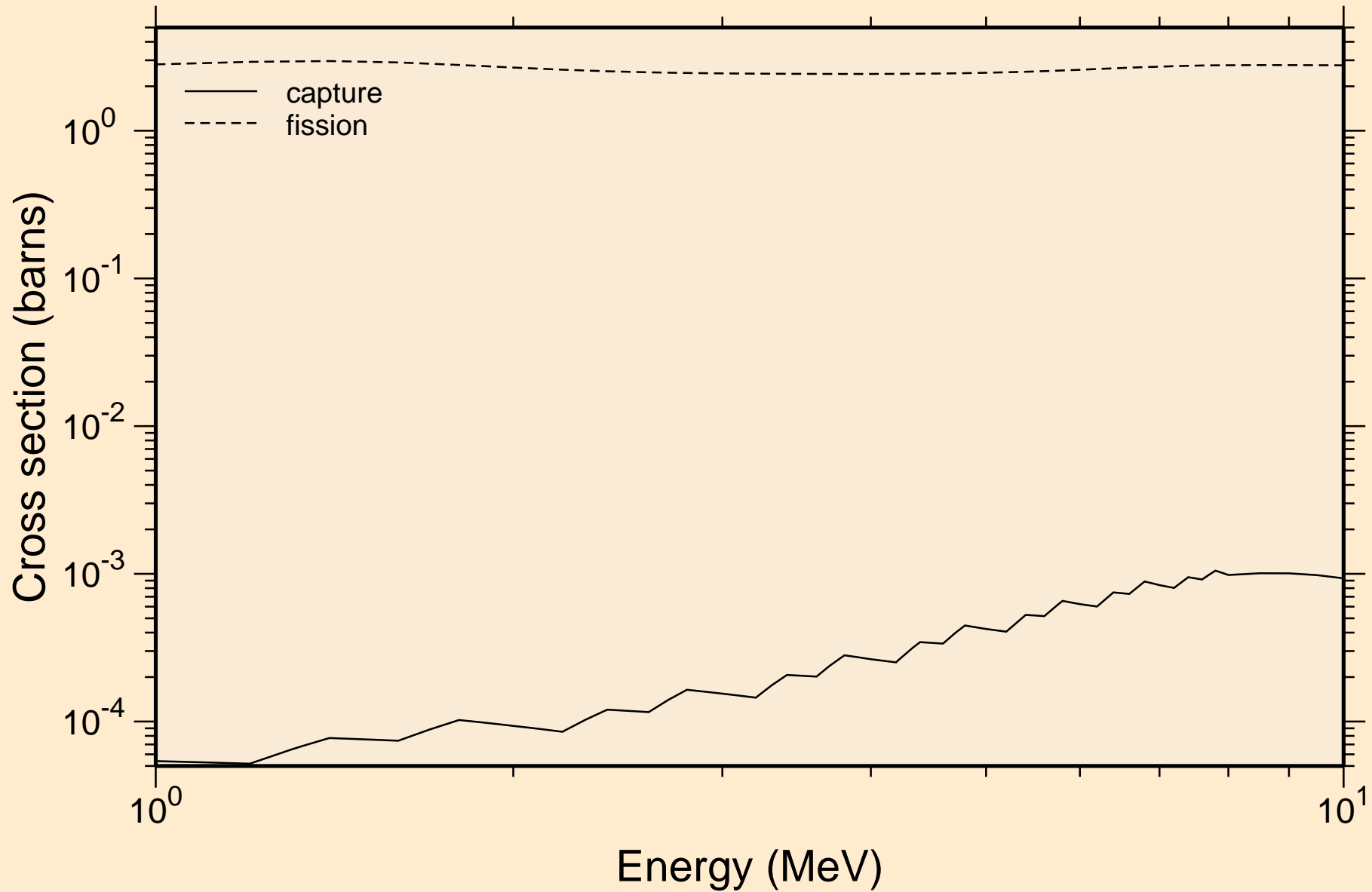

# AM233 NEUTRON ACER TENDL-2024 LIBRARY; T=0.K

## Heating

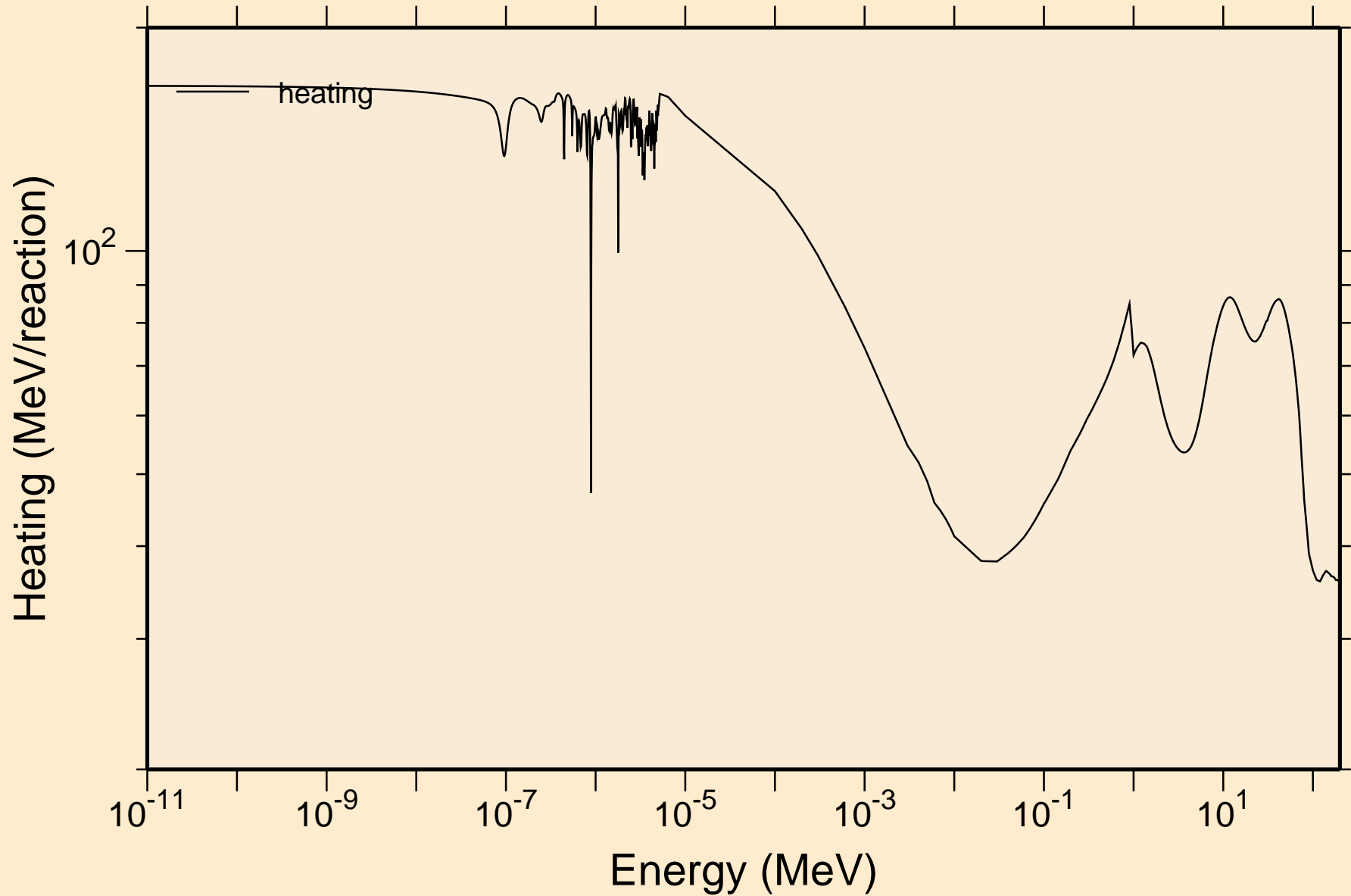



AM233 NEUTRON ACER TENDL-2024 LIBRARY; T=0.K  
Damage

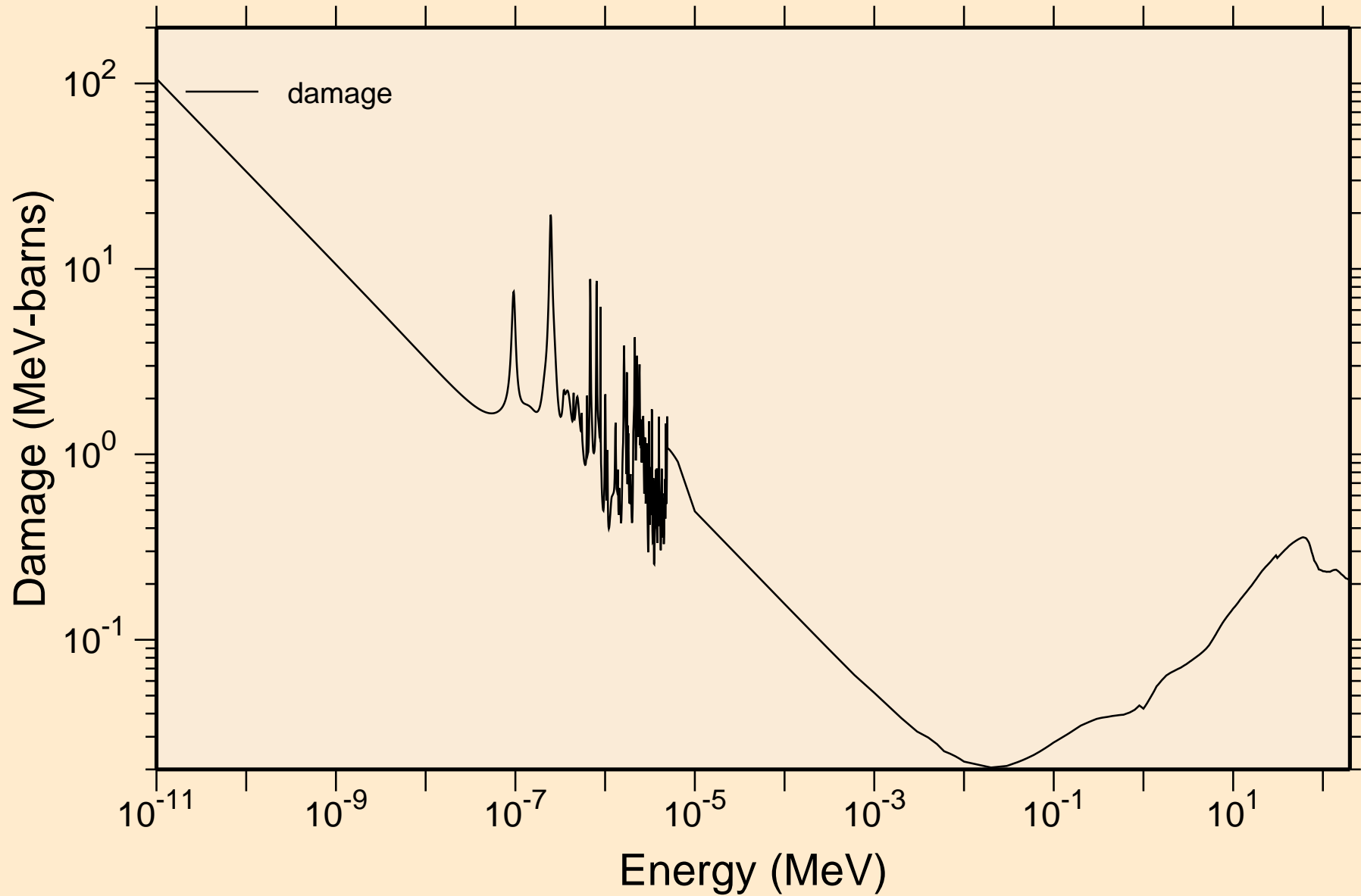

# AM233 NEUTRON ACER TENDL-2024 LIBRARY; T=0.K

## Non-threshold reactions

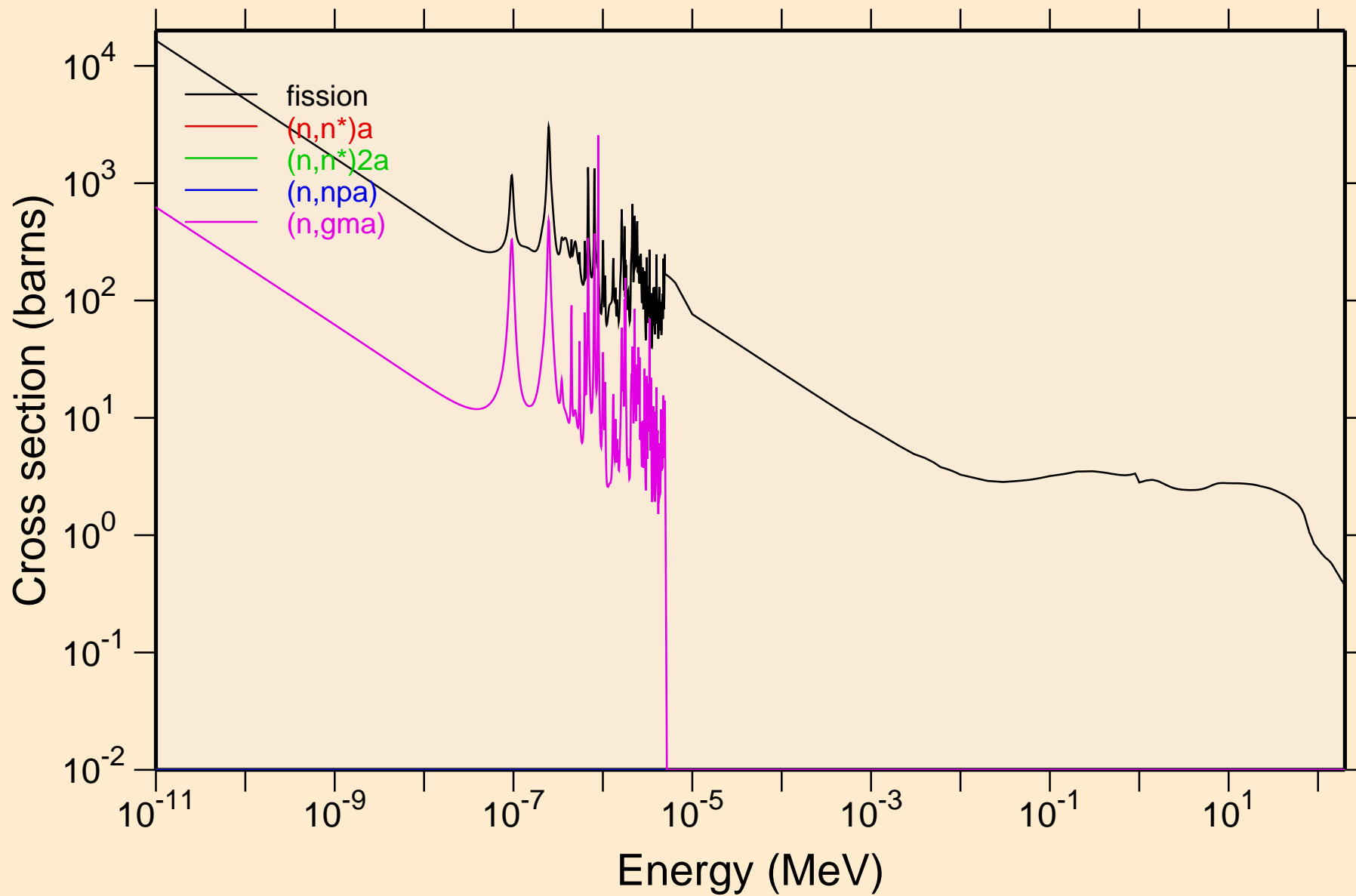

AM233 NEUTRON ACER TENDL-2024 LIBRARY; T=0.K  
Non-threshold reactions

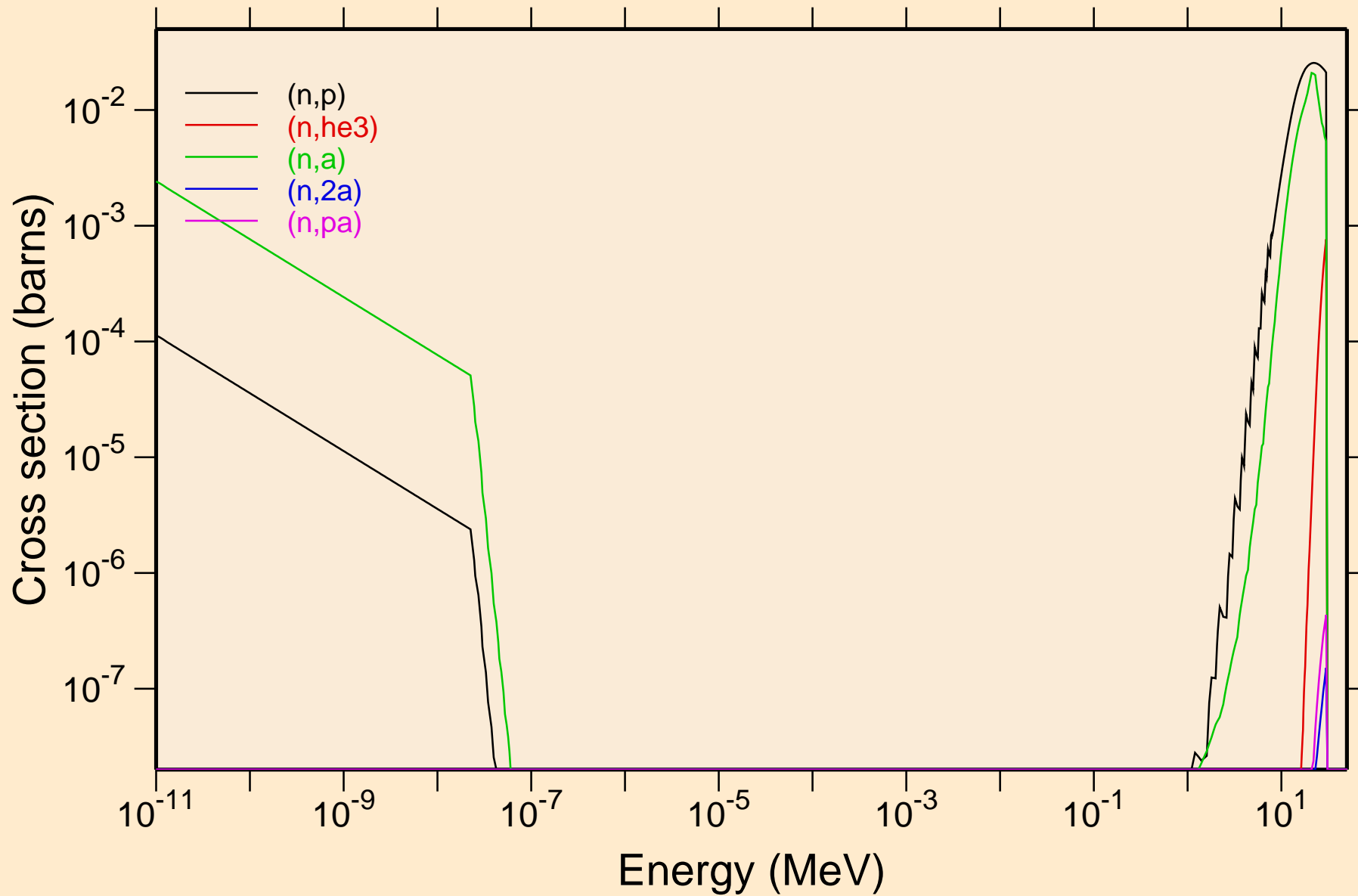

# AM233 NEUTRON ACER TENDL-2024 LIBRARY; T=0.K

## Non-threshold reactions

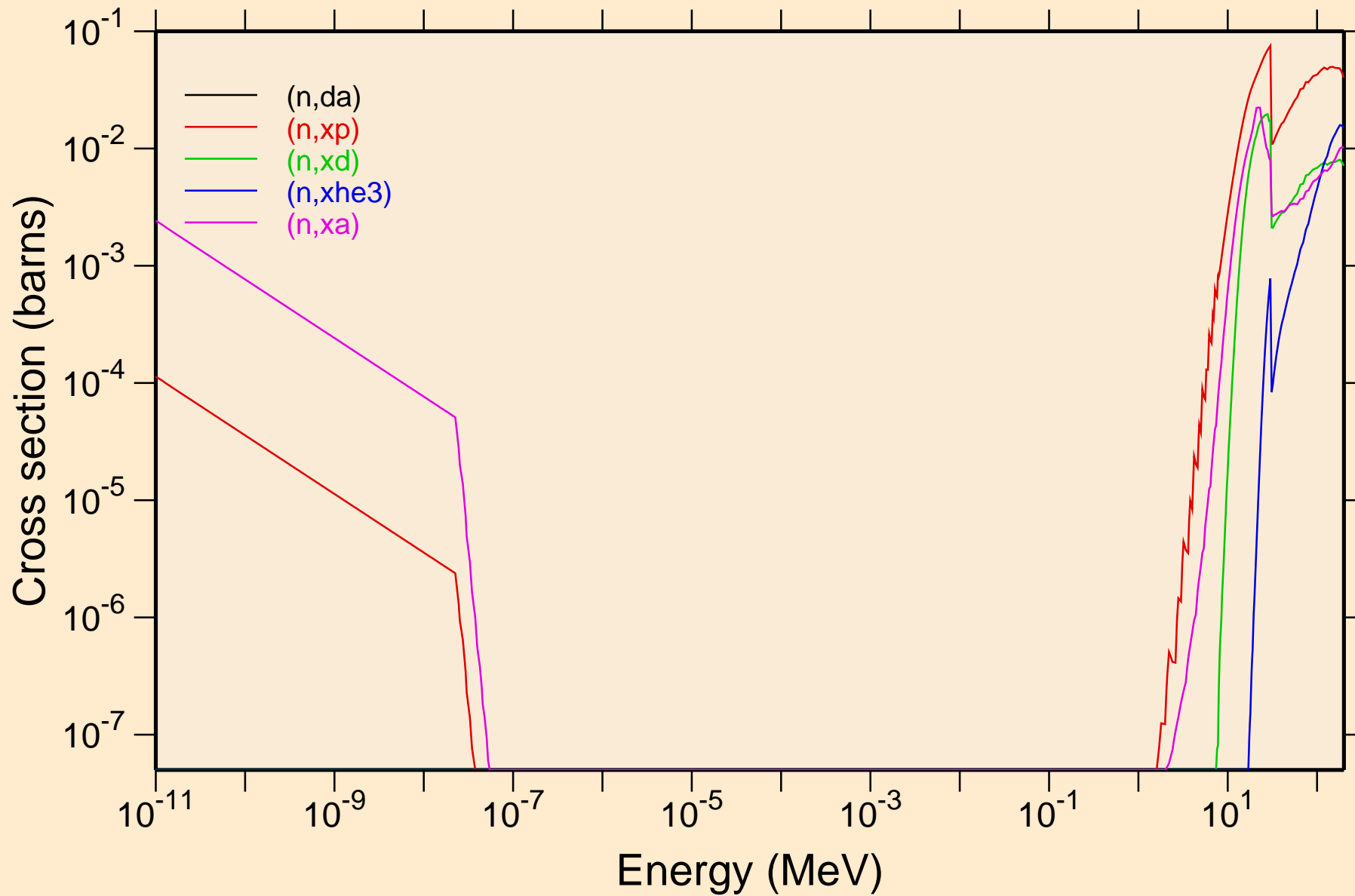

# AM233 NEUTRON ACER TENDL-2024 LIBRARY; T=0.K

## Principal cross sections

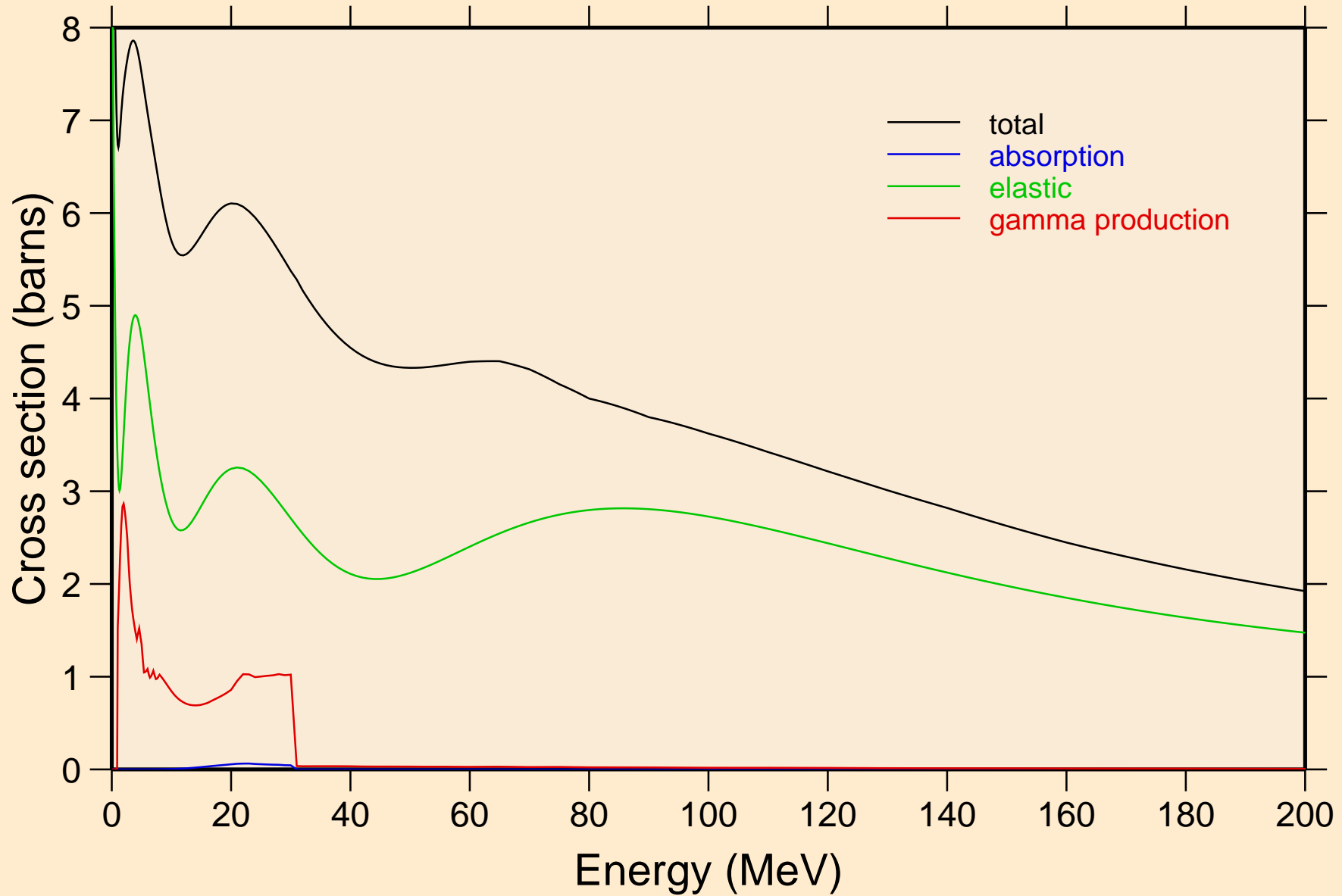

# AM233 NEUTRON ACER TENDL-2024 LIBRARY; T=0.K

## Heating

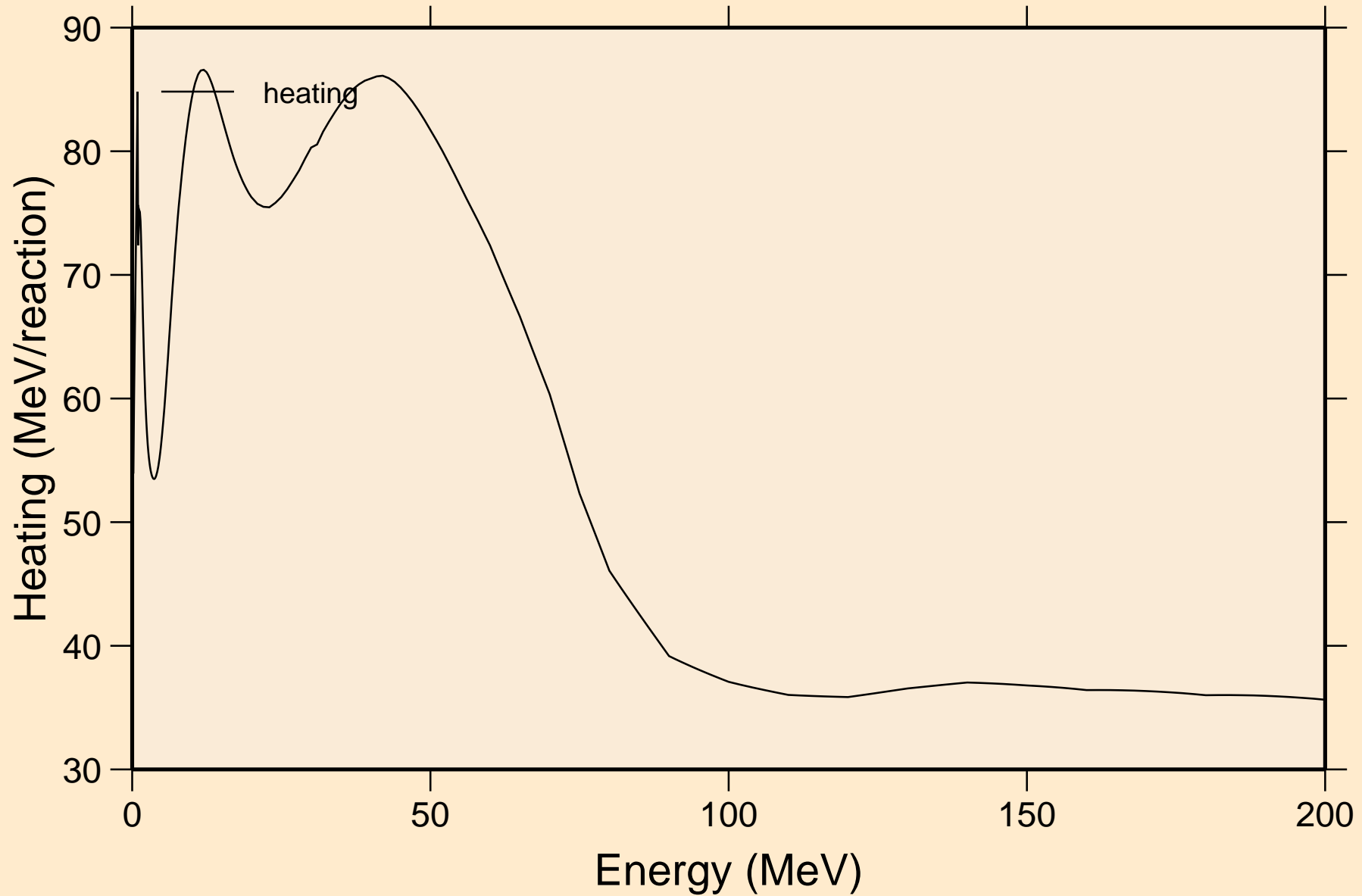

# AM233 NEUTRON ACER TENDL-2024 LIBRARY; T=0.K

## Damage

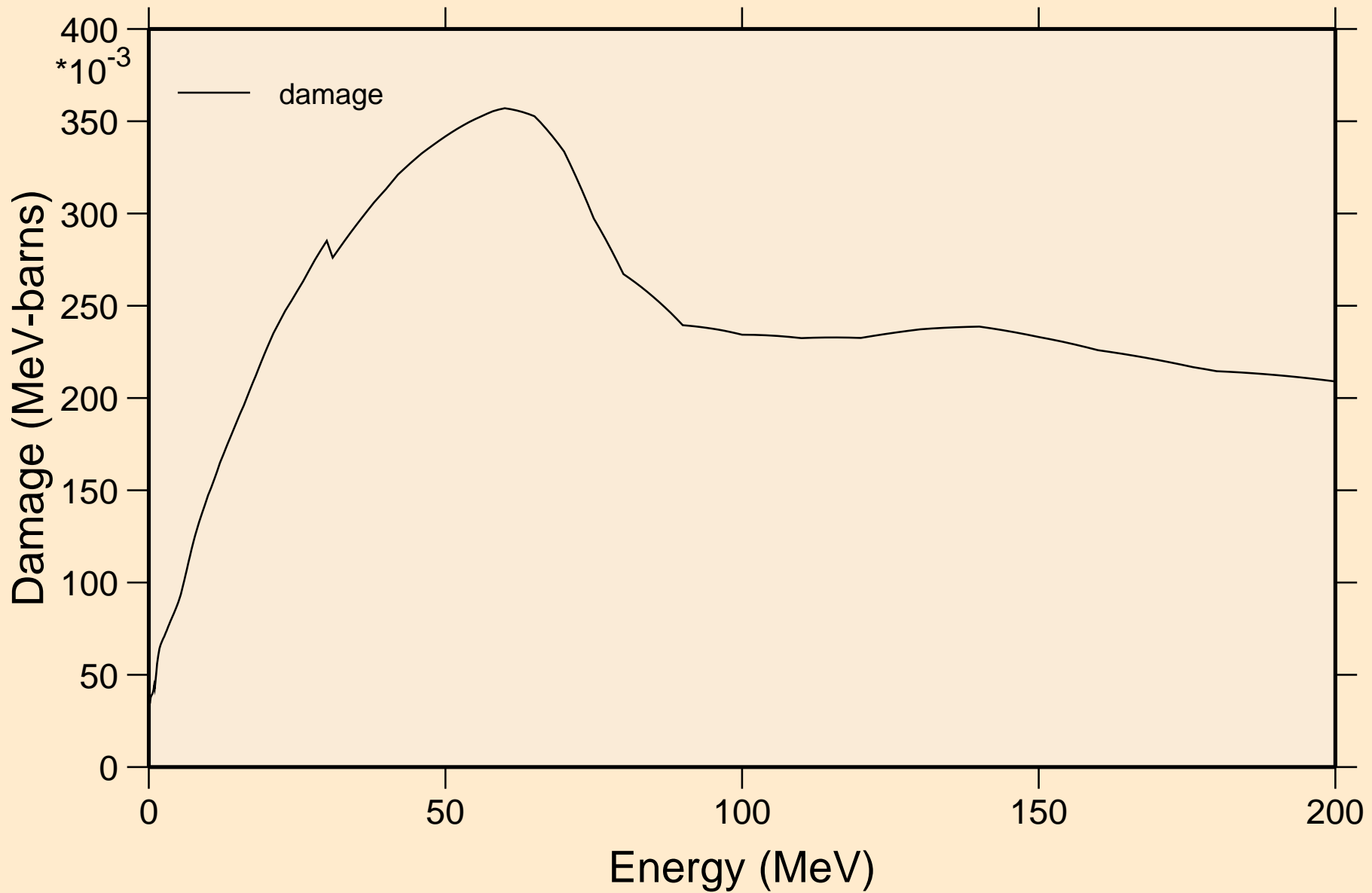

# AM233 NEUTRON ACER TENDL-2024 LIBRARY; T=0.K

## Non-threshold reactions

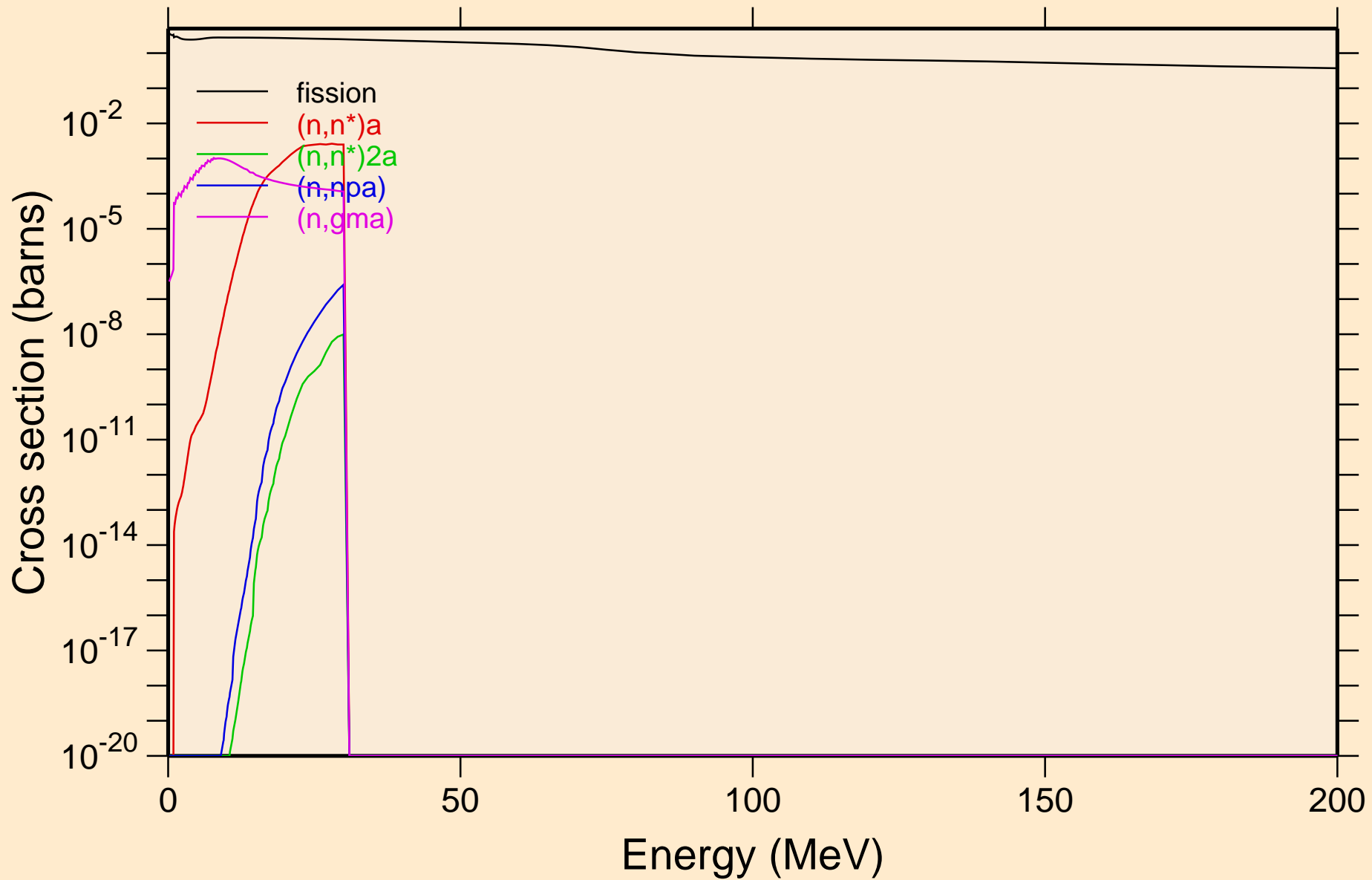



AM233 NEUTRON ACER TENDL-2024 LIBRARY; T=0.K  
Non-threshold reactions

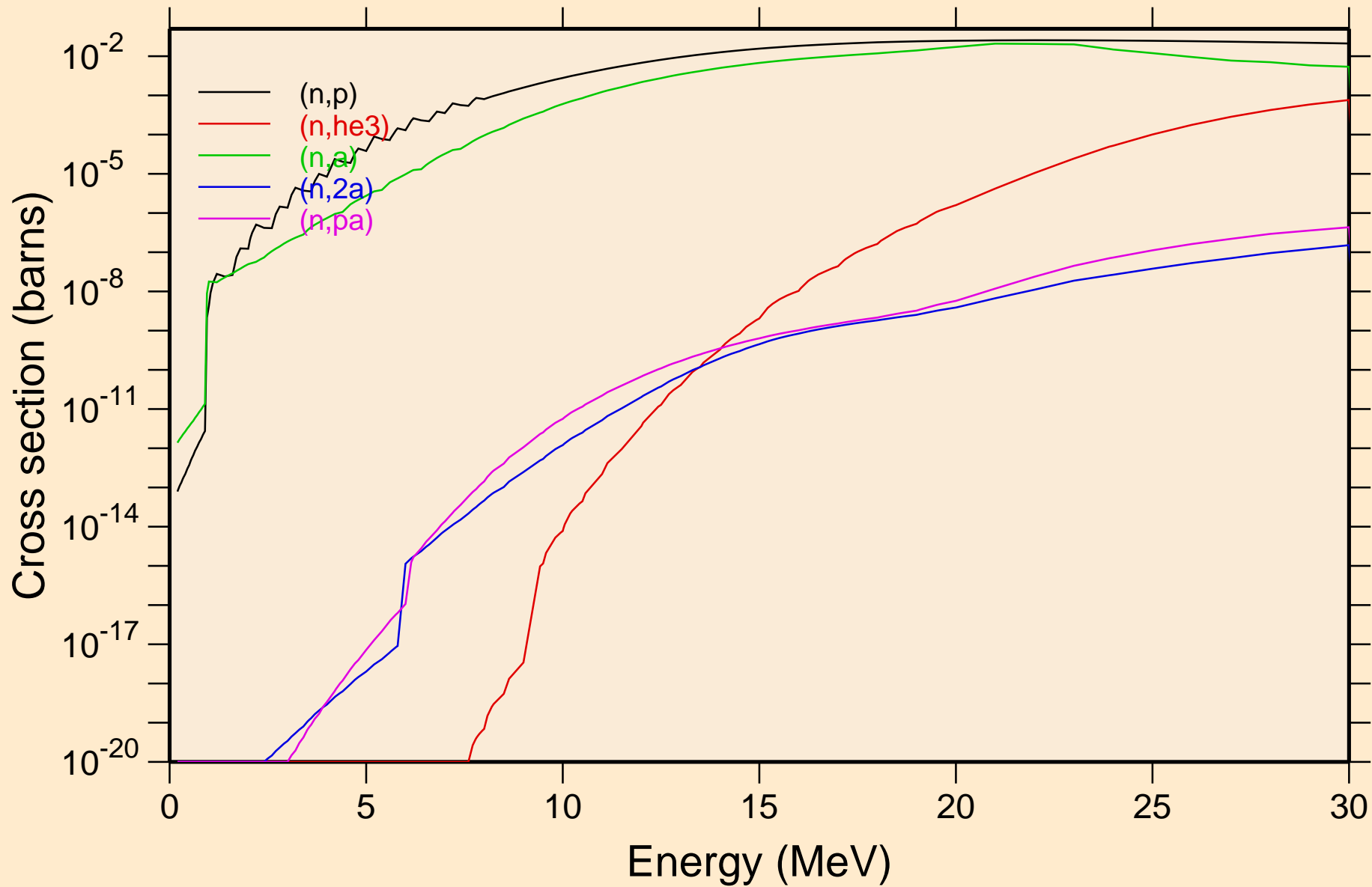

AM233 NEUTRON ACER TENDL-2024 LIBRARY; T=0.K  
Non-threshold reactions

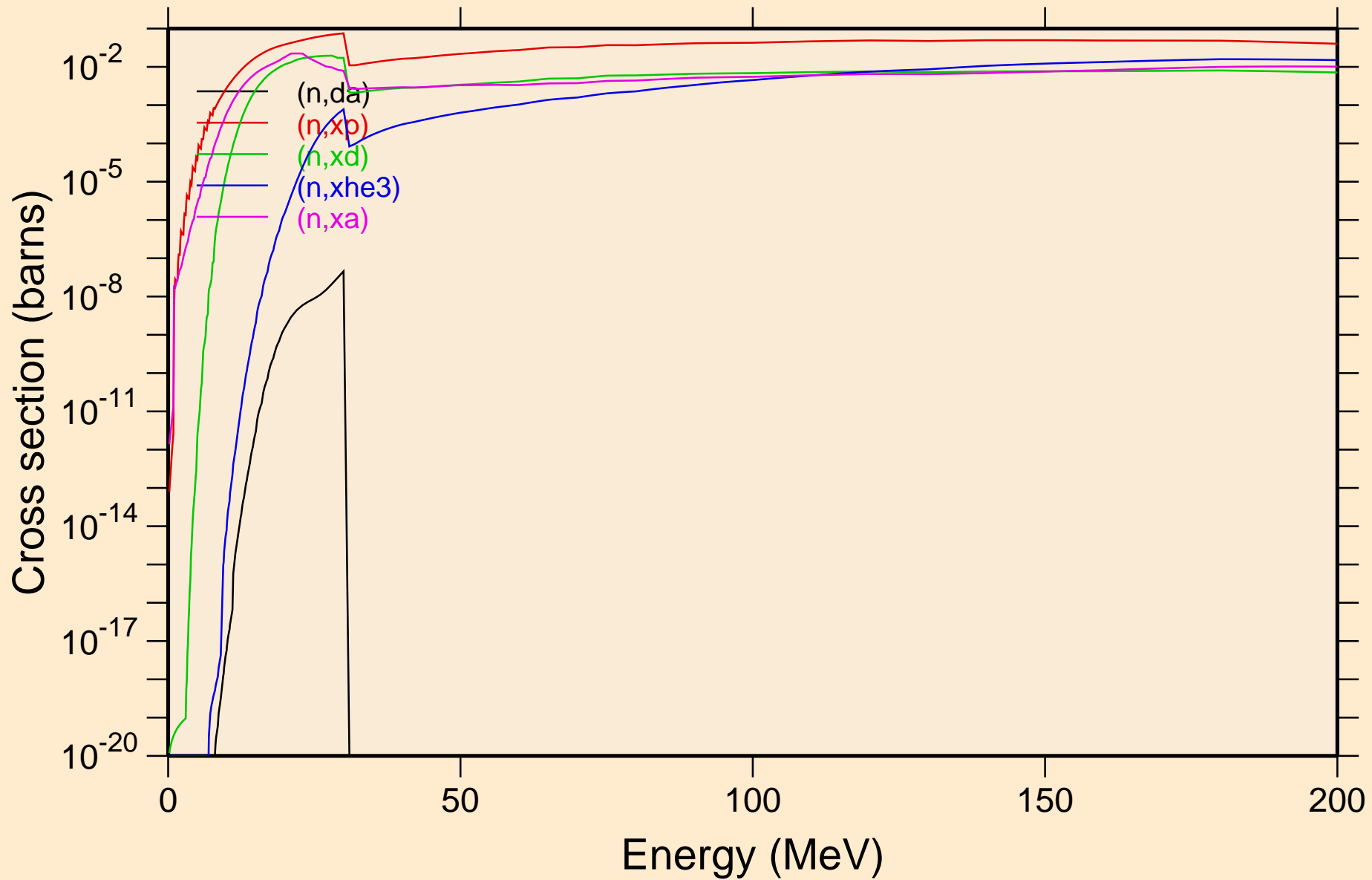

AM233 NEUTRON ACER TENDL-2024 LIBRARY; T=0.K  
Inelastic levels

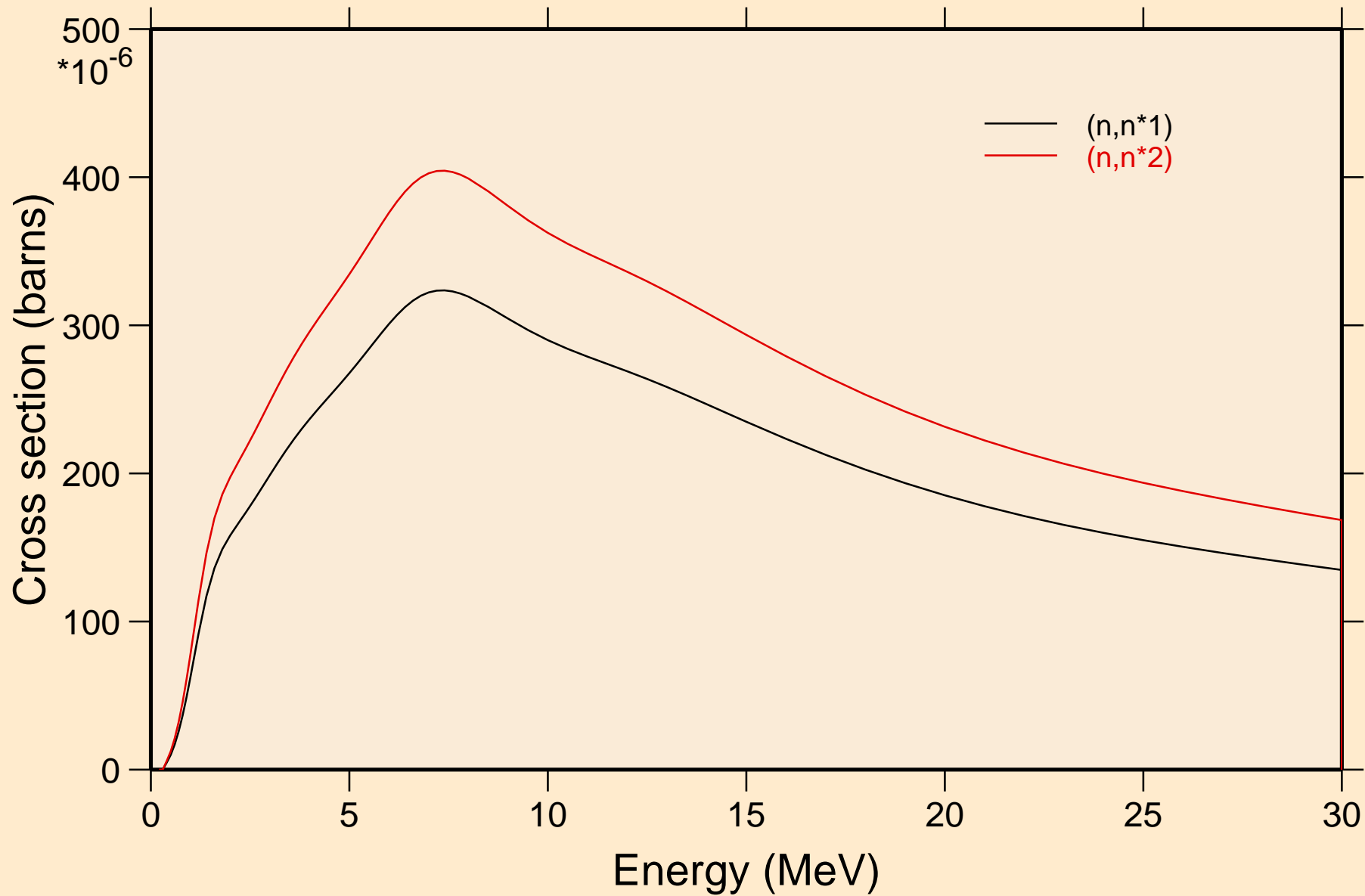

# AM233 NEUTRON ACER TENDL-2024 LIBRARY; T=0.K

## Threshold reactions

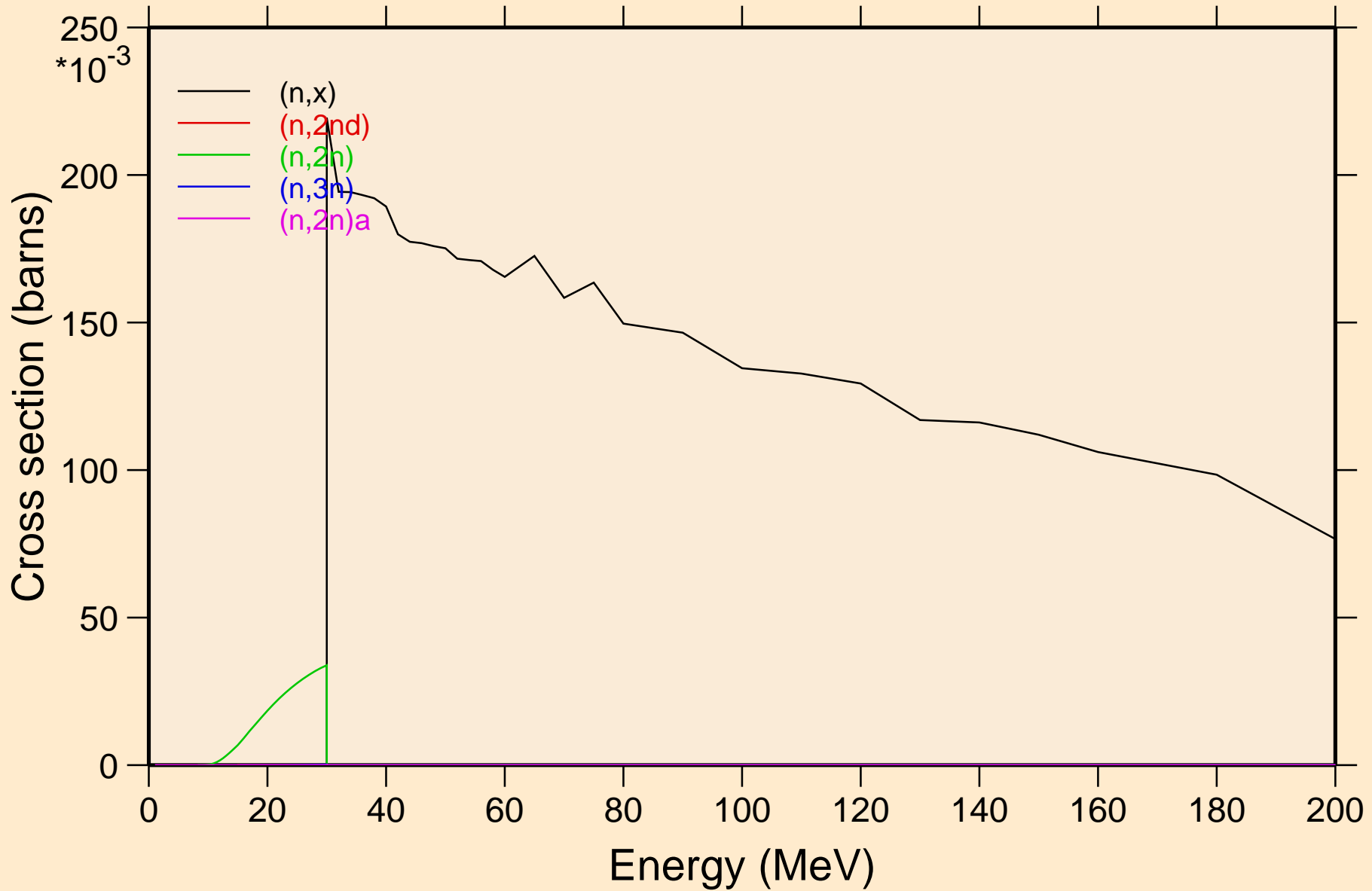

AM233 NEUTRON ACER TENDL-2024 LIBRARY; T=0.K  
Threshold reactions

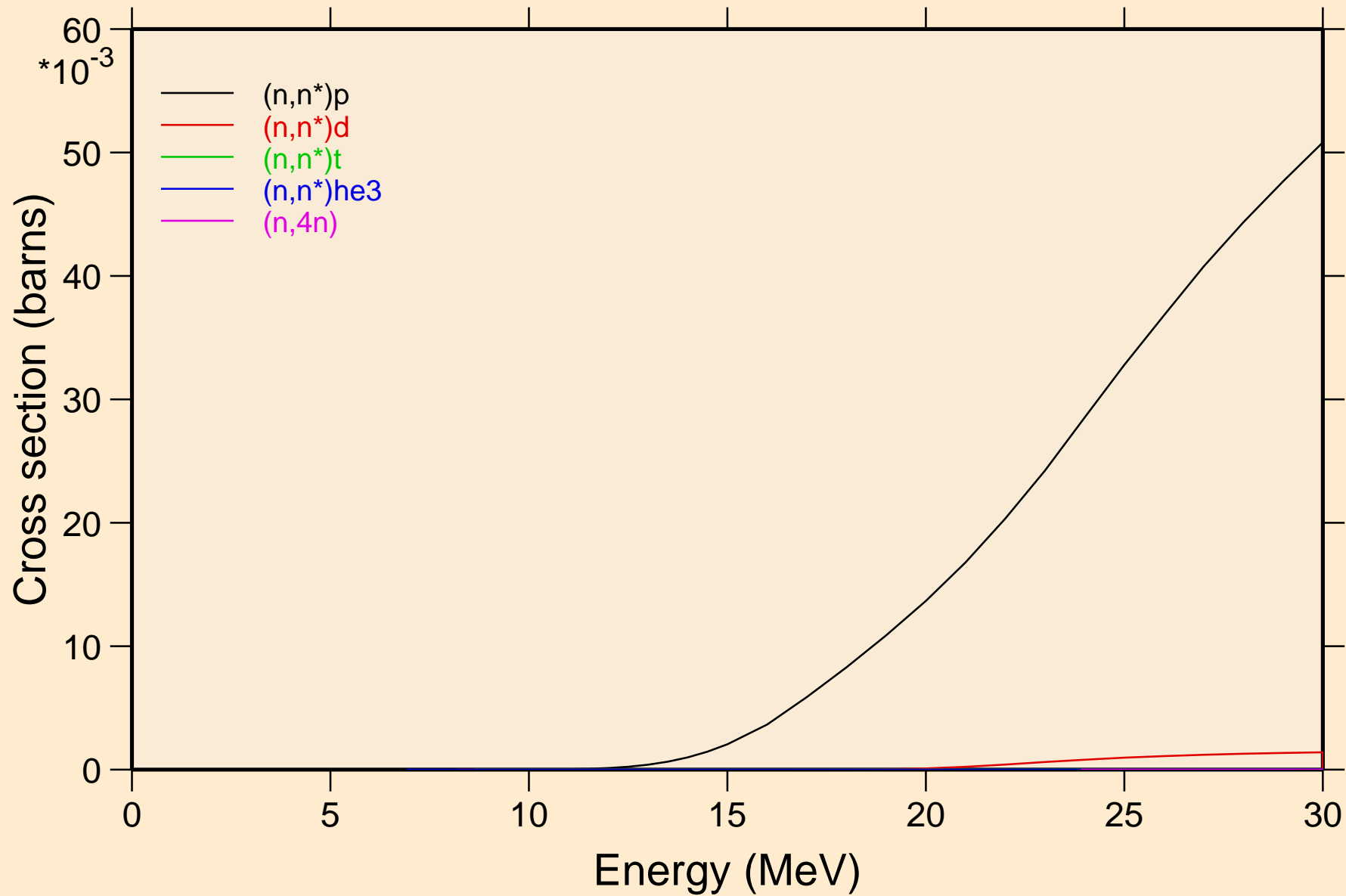

AM233 NEUTRON ACER TENDL-2024 LIBRARY; T=0.K  
Threshold reactions

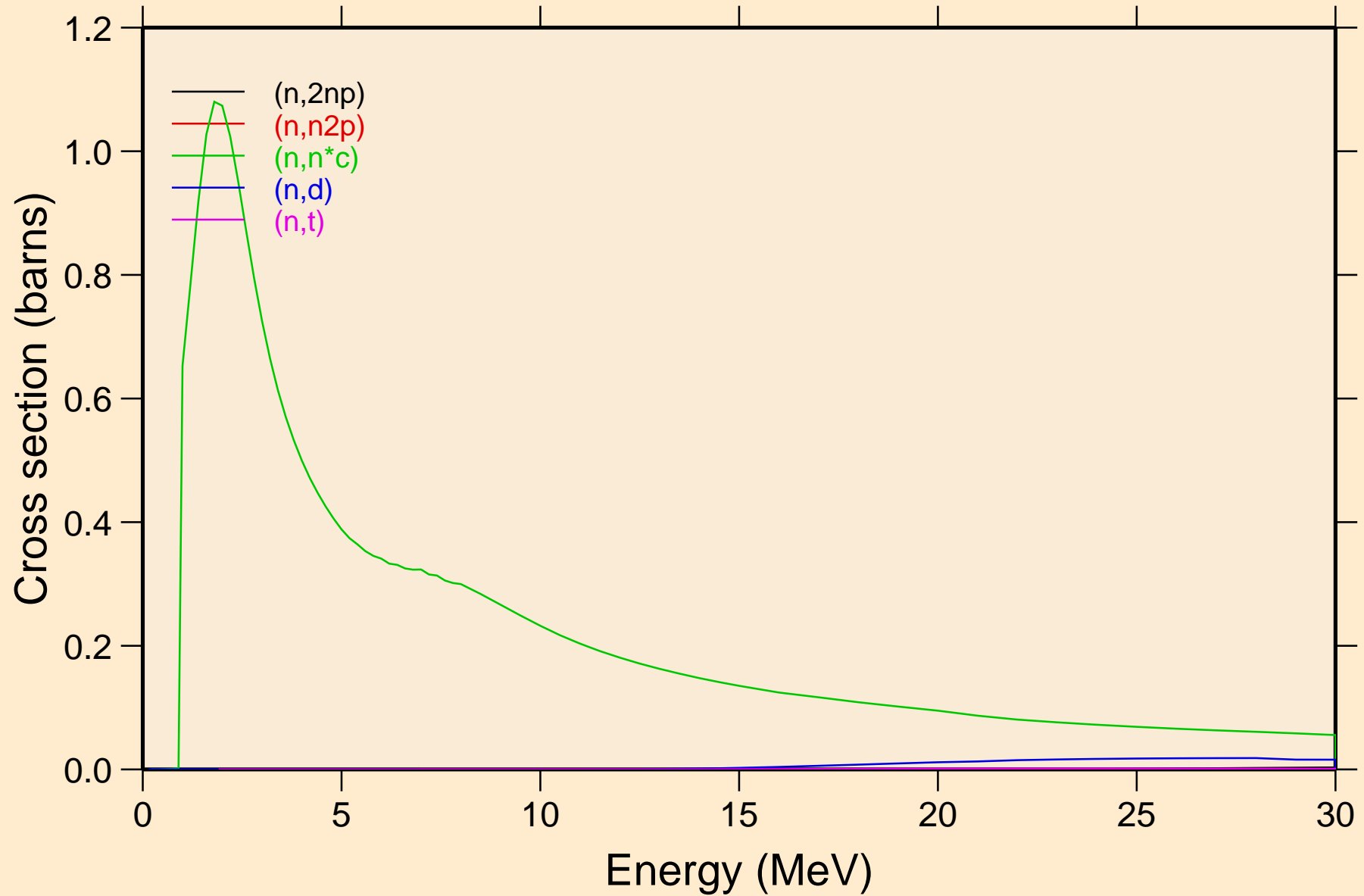

# AM233 NEUTRON ACER TENDL-2024 LIBRARY; T=0.K

## Threshold reactions

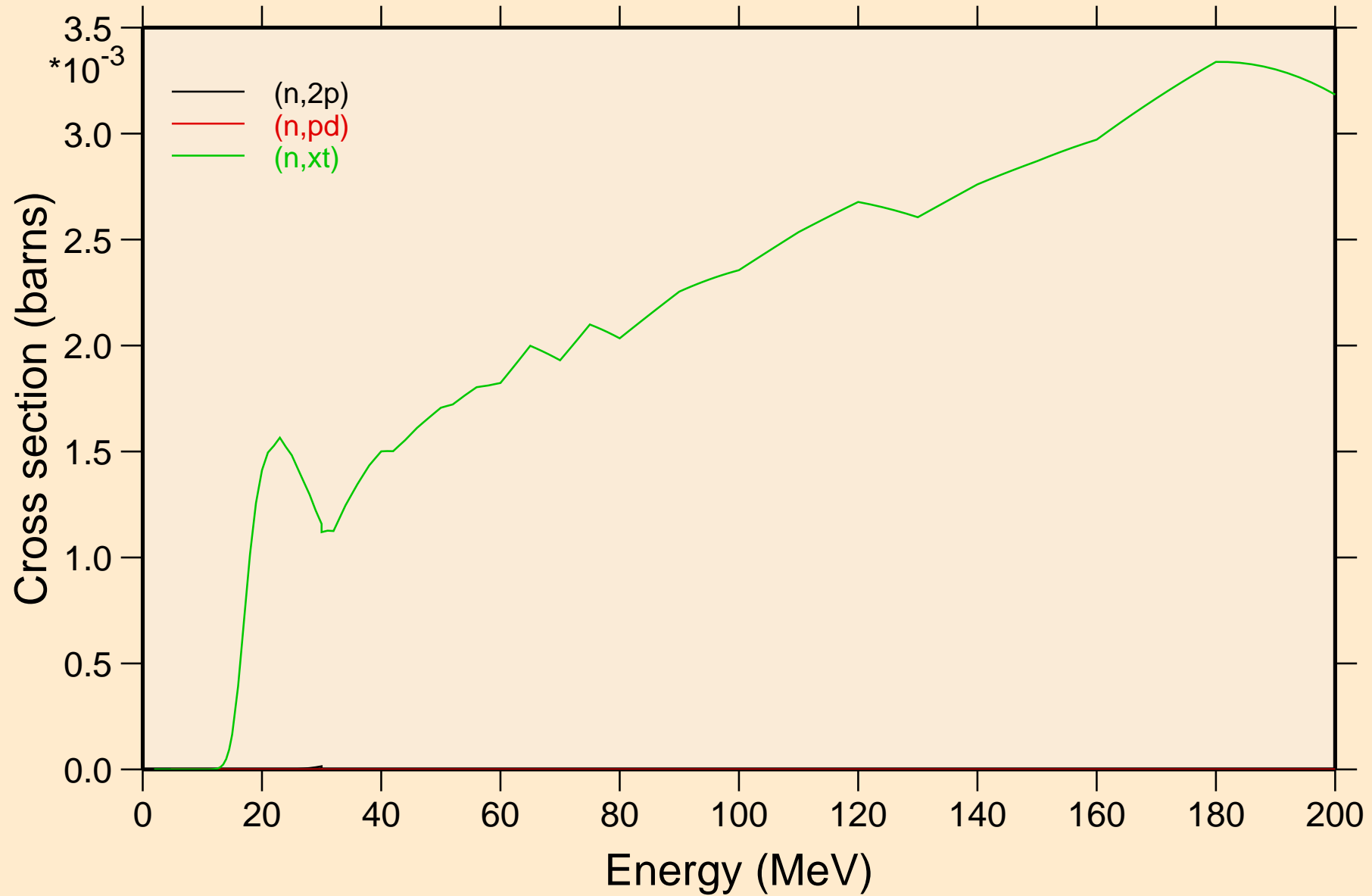

AM233 NEUTRON ACER TENDL-2024 LIBRARY; T=0.K  
angular distribution for elastic

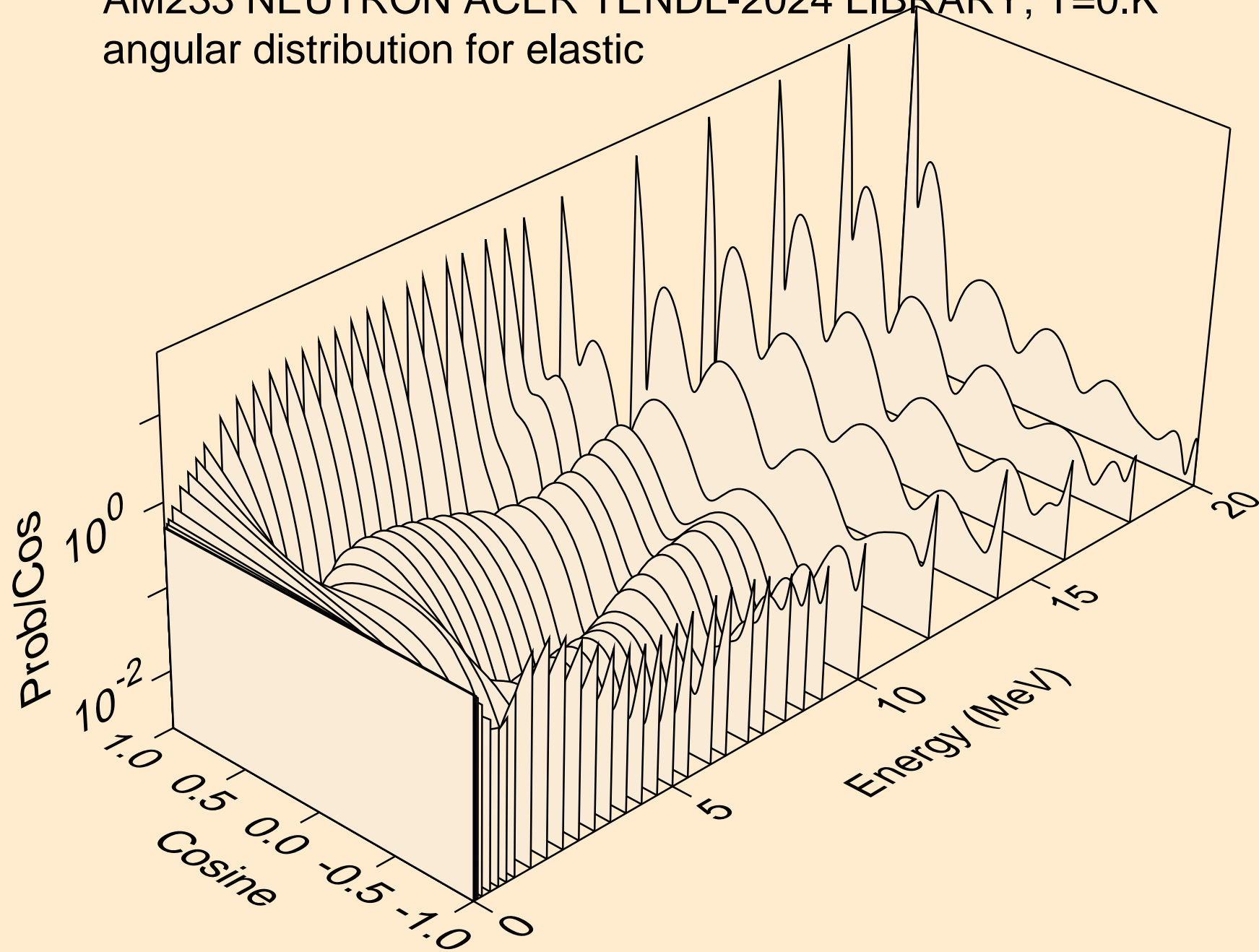



AM233 NEUTRON ACER TENDL-2024 LIBRARY; T=0.K  
angular distribution for elastic

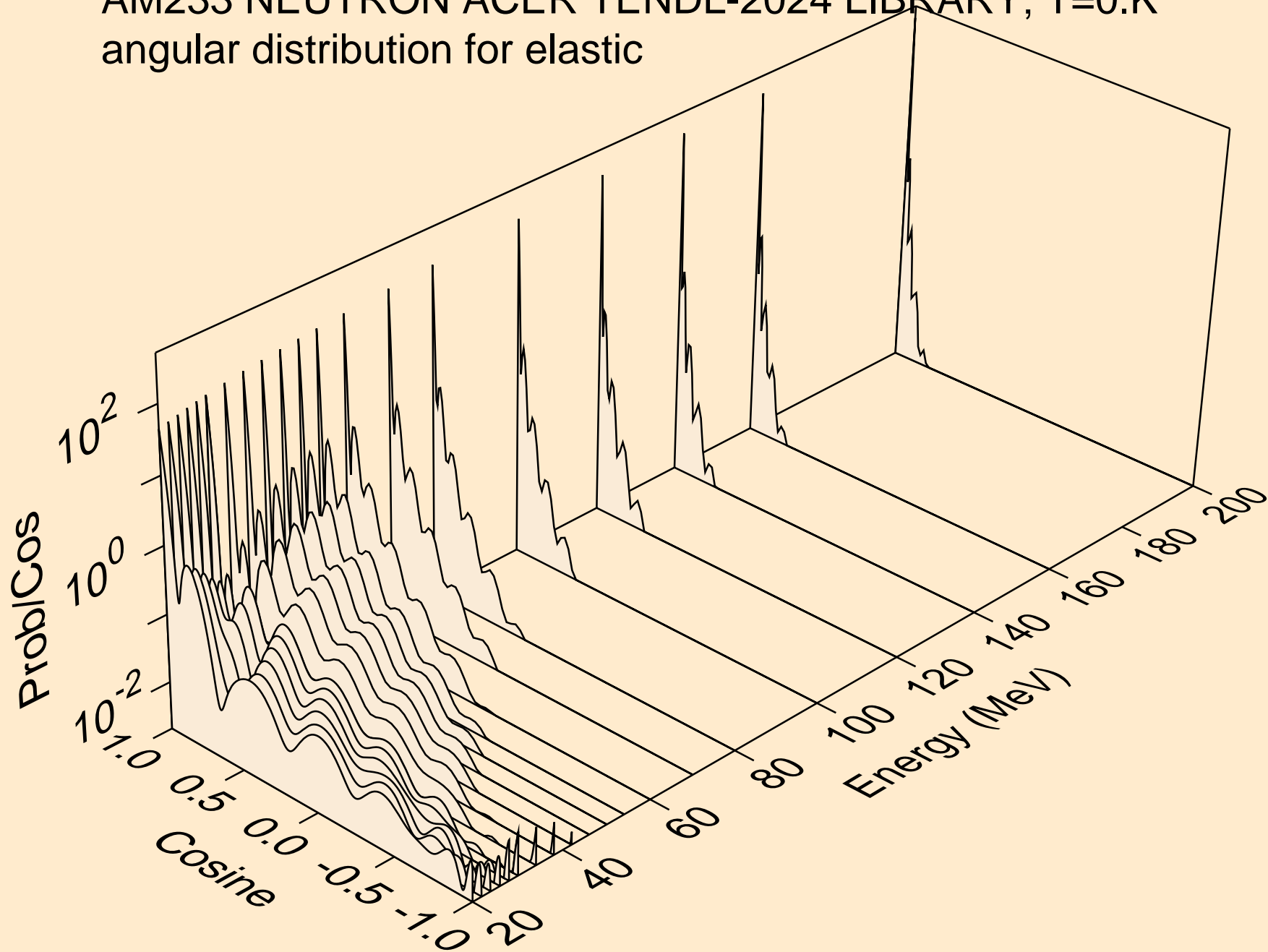

AM233 NEUTRON ACER TENDL-2024 LIBRARY; T=0.K  
angular distribution for (n,n\*1)

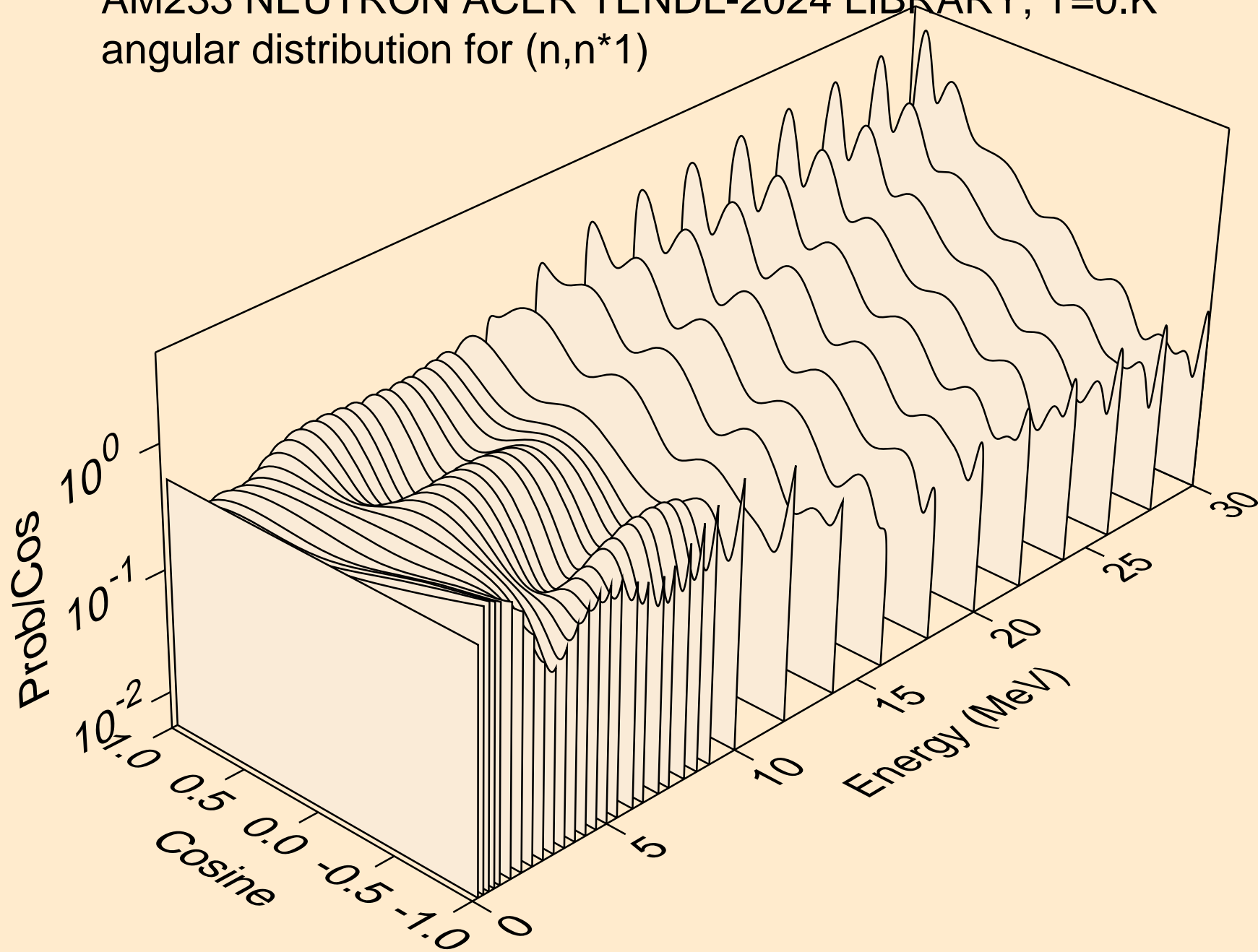

AM233 NEUTRON ACER TENDL-2024 LIBRARY; T=0.K  
angular distribution for (n,n\*2)

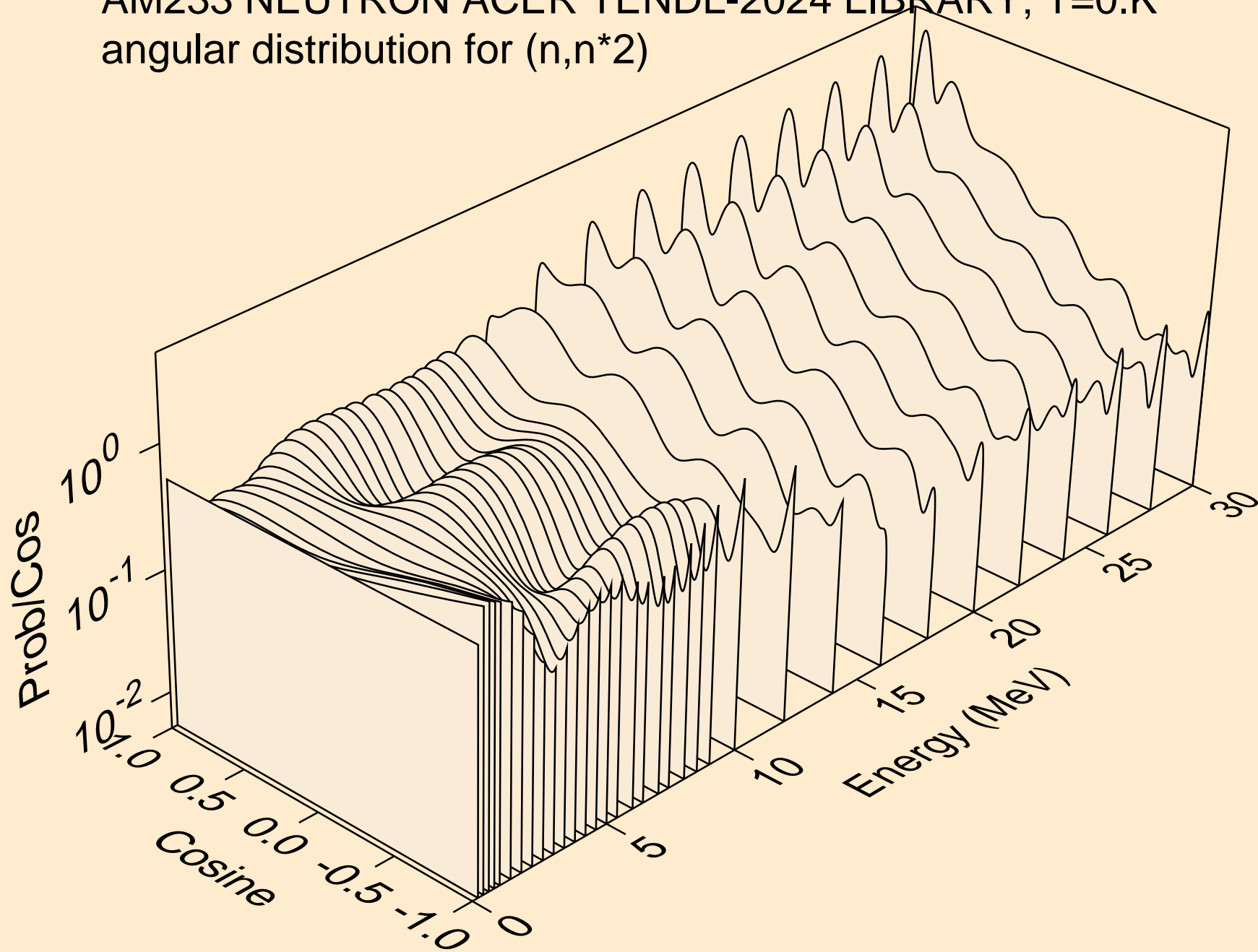

# AM233 NEUTRON ACER TENDL-2024 LIBRARY; T=0.K

## Total fission nubar

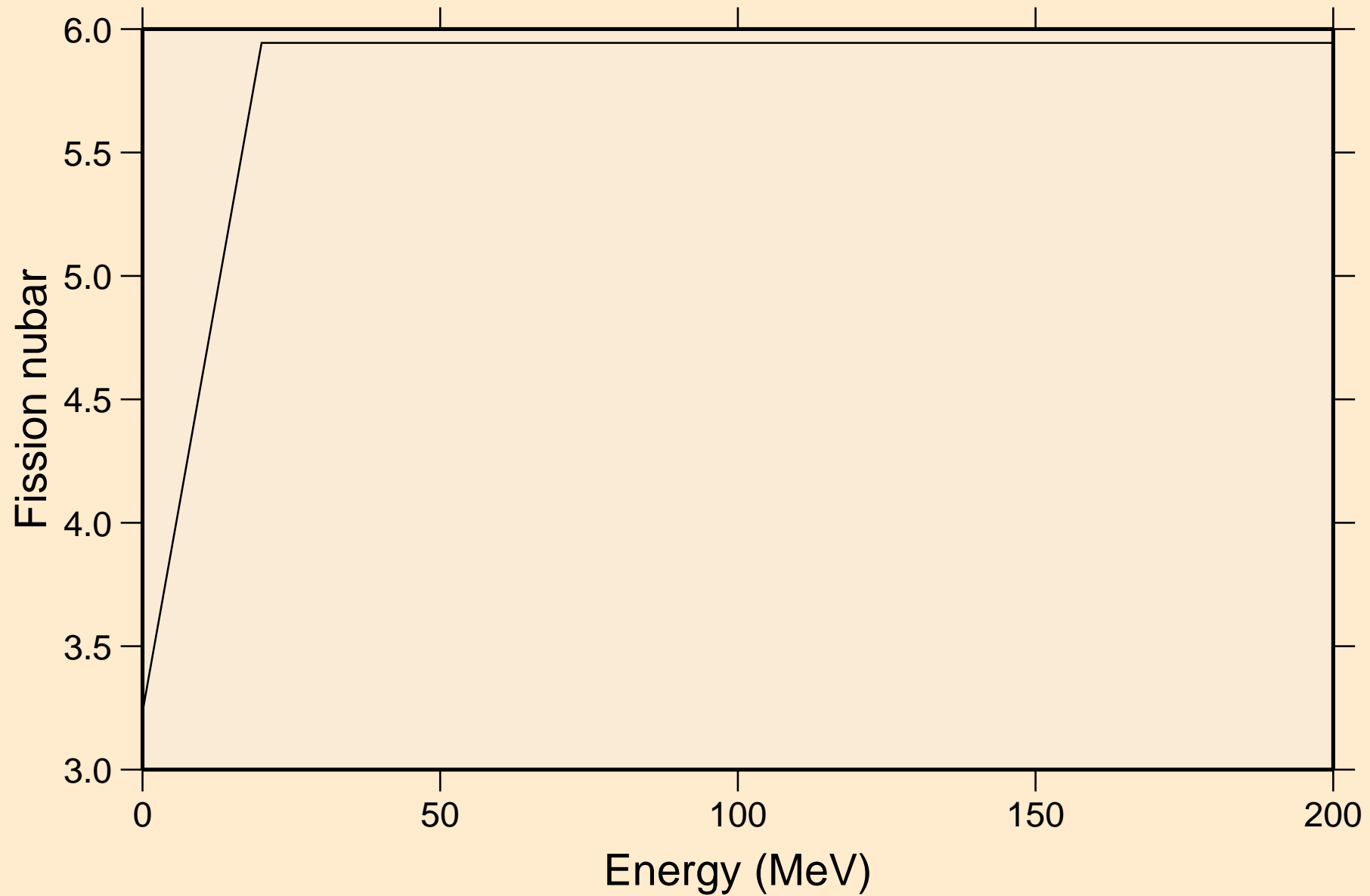

AM233 NEUTRON ACER TENDL-2024 LIBRARY; T=0.K  
Neutron emission for (n,x)

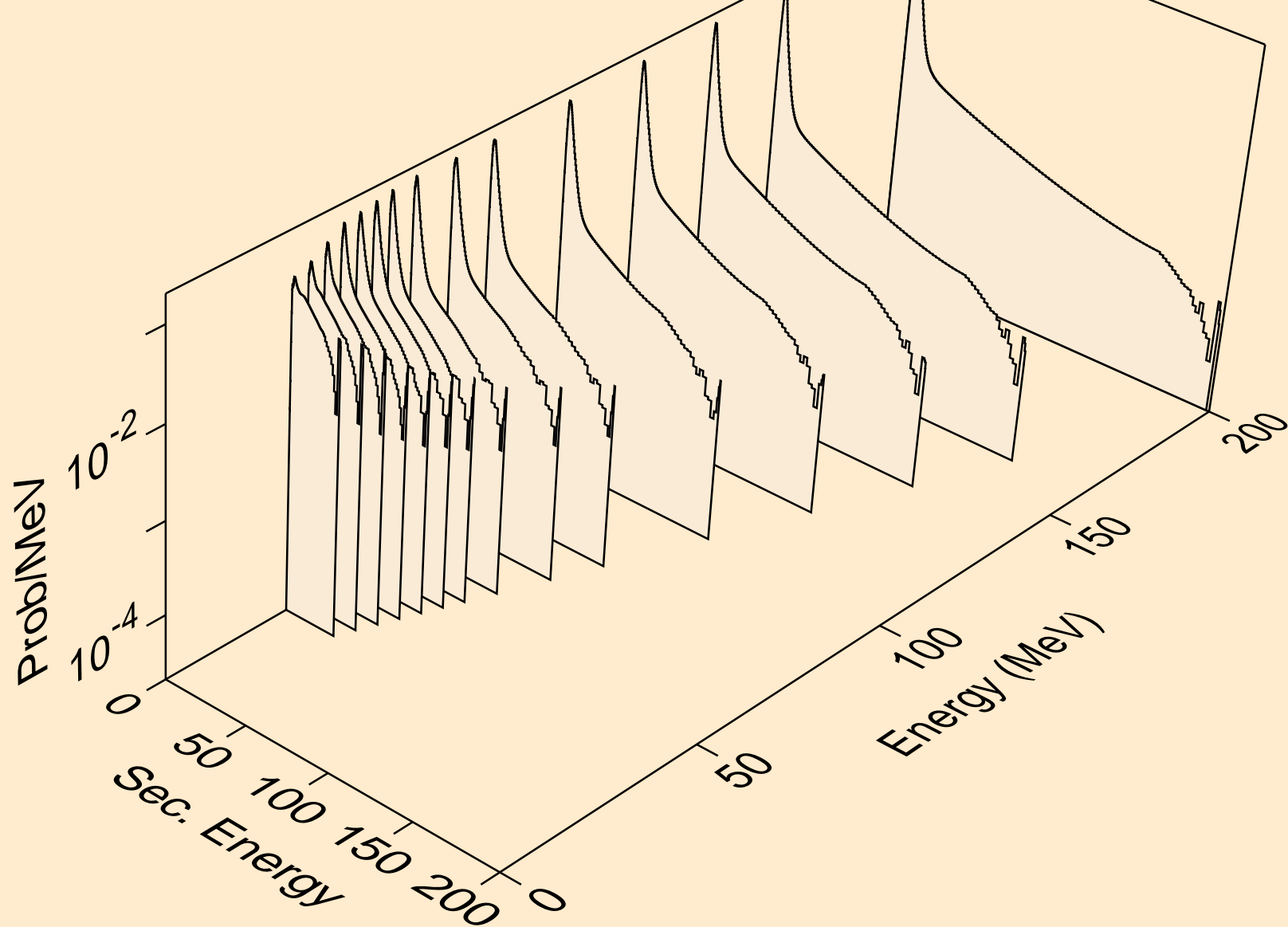

AM233 NEUTRON ACER TENDL-2024 LIBRARY; T=0.K  
Neutron emission for (n,2nd)

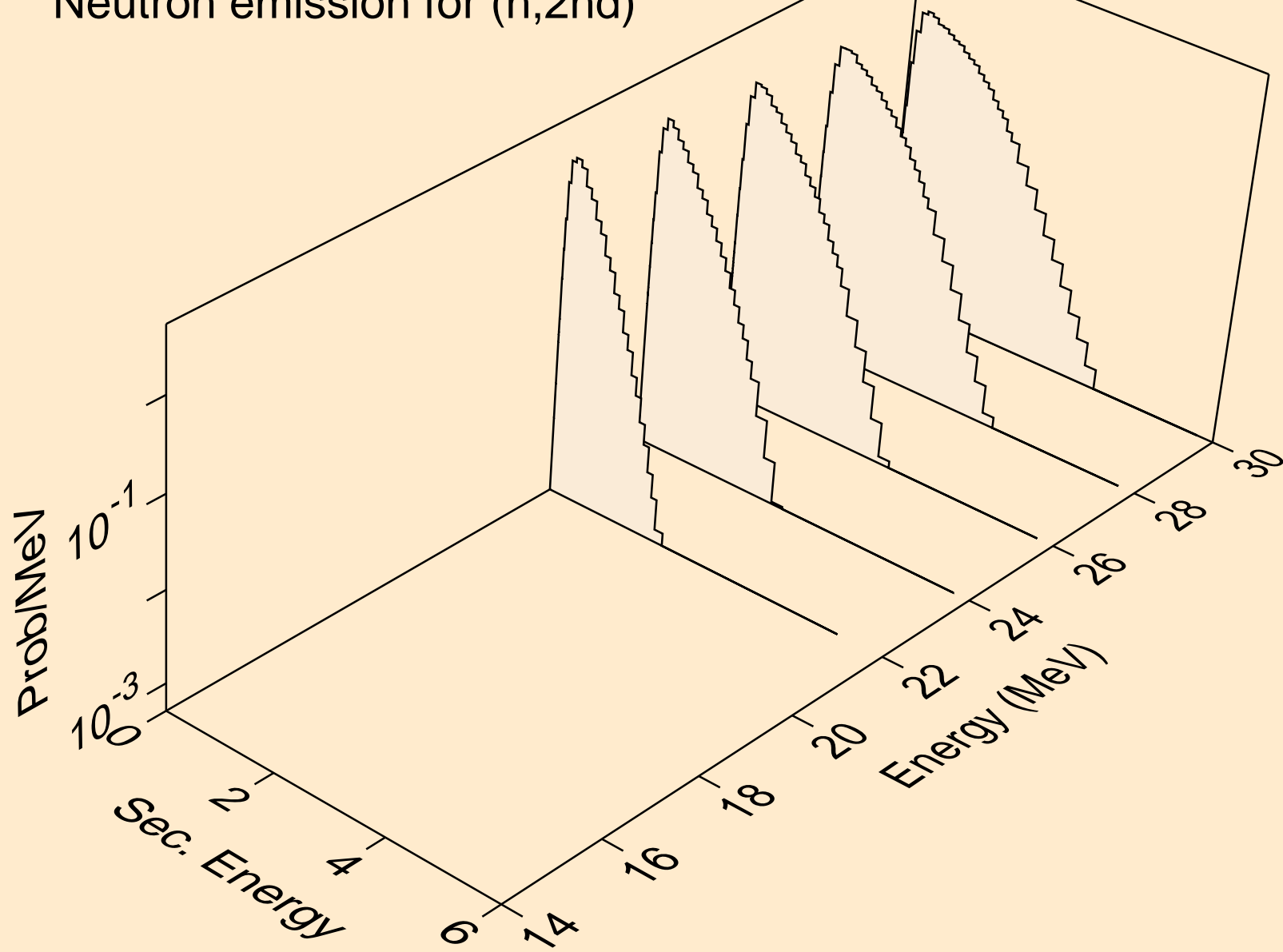

AM233 NEUTRON ACER TENDL-2024 LIBRARY; T=0.K  
Neutron emission for (n,2n)

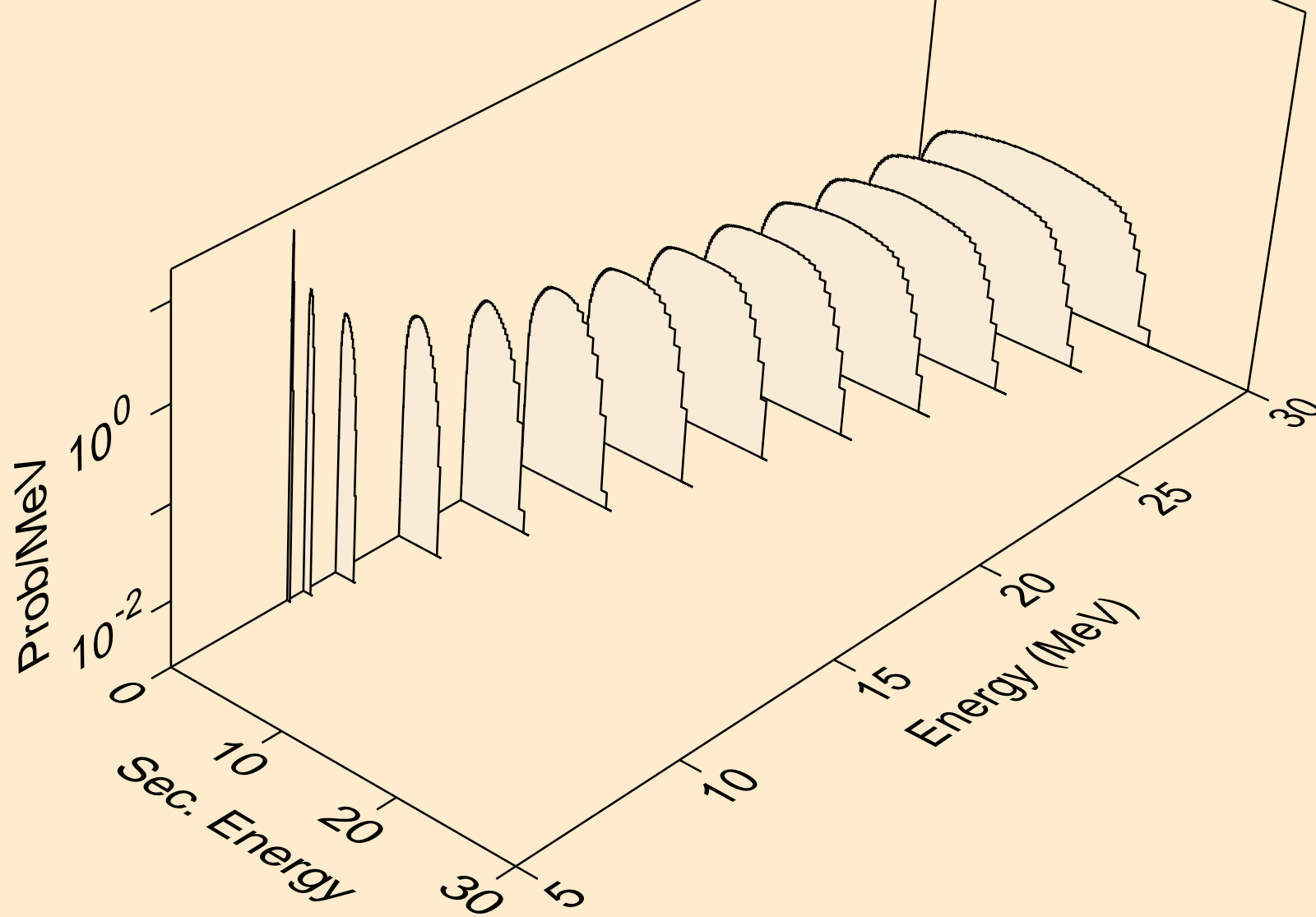

AM233 NEUTRON ACER TENDL-2024 LIBRARY; T=0.K  
Neutron emission for (n,3n)

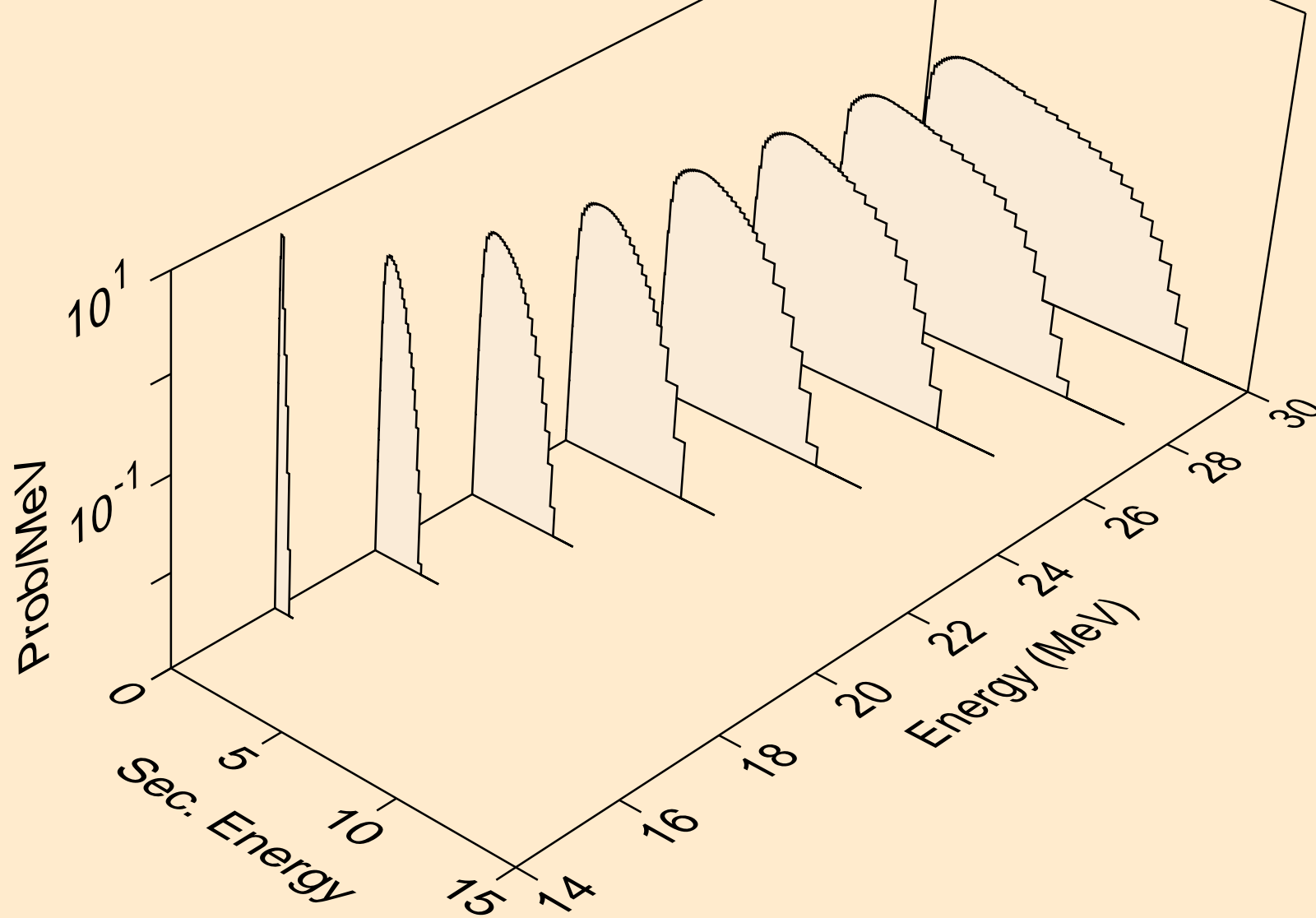



AM233 NEUTRON ACER TENDL-2024 LIBRARY; T=0.K  
Neutron emission for fission

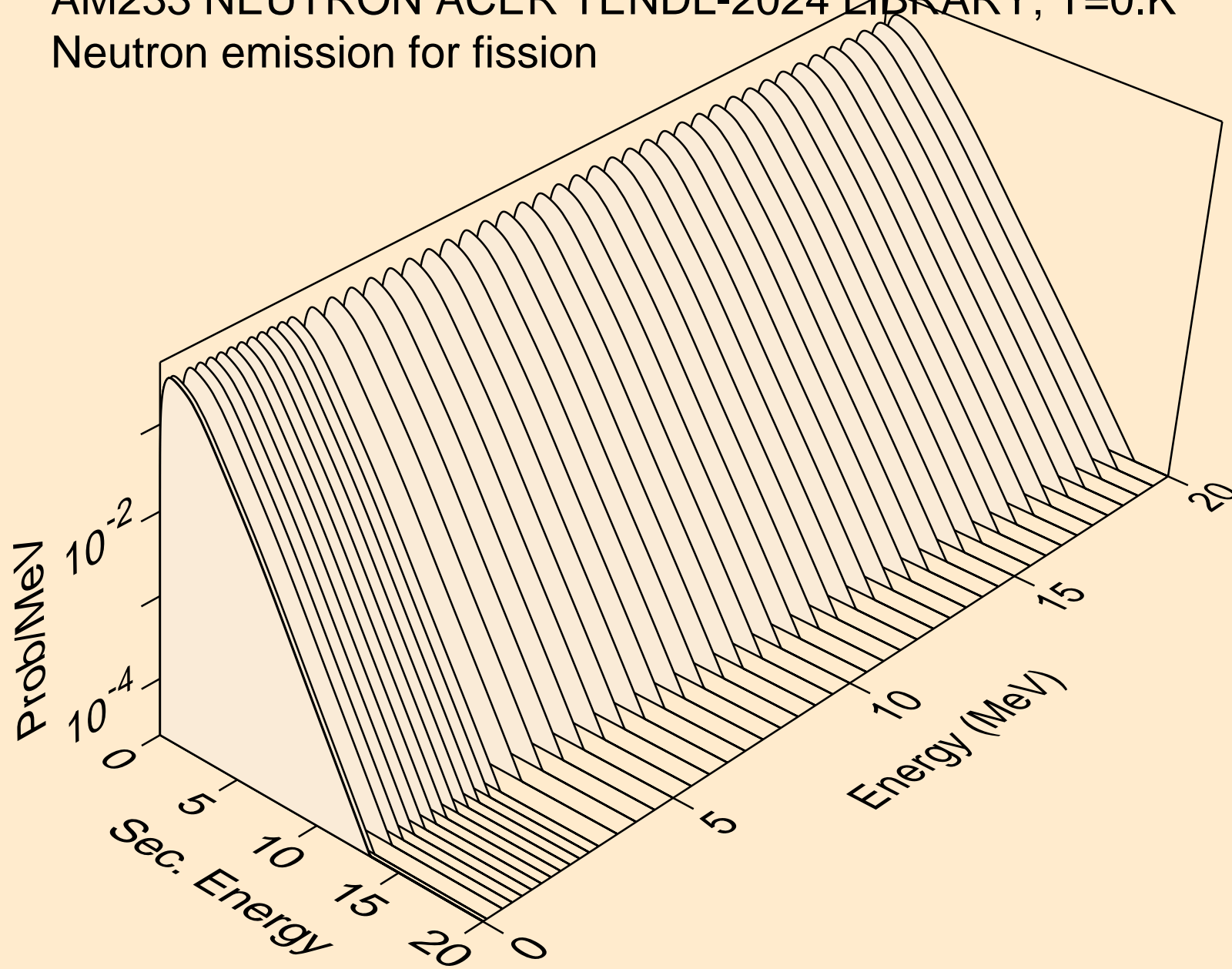

AM233 NEUTRON ACER TENDL-2024 LIBRARY; T=0.K  
Neutron emission for (n,n\*)a

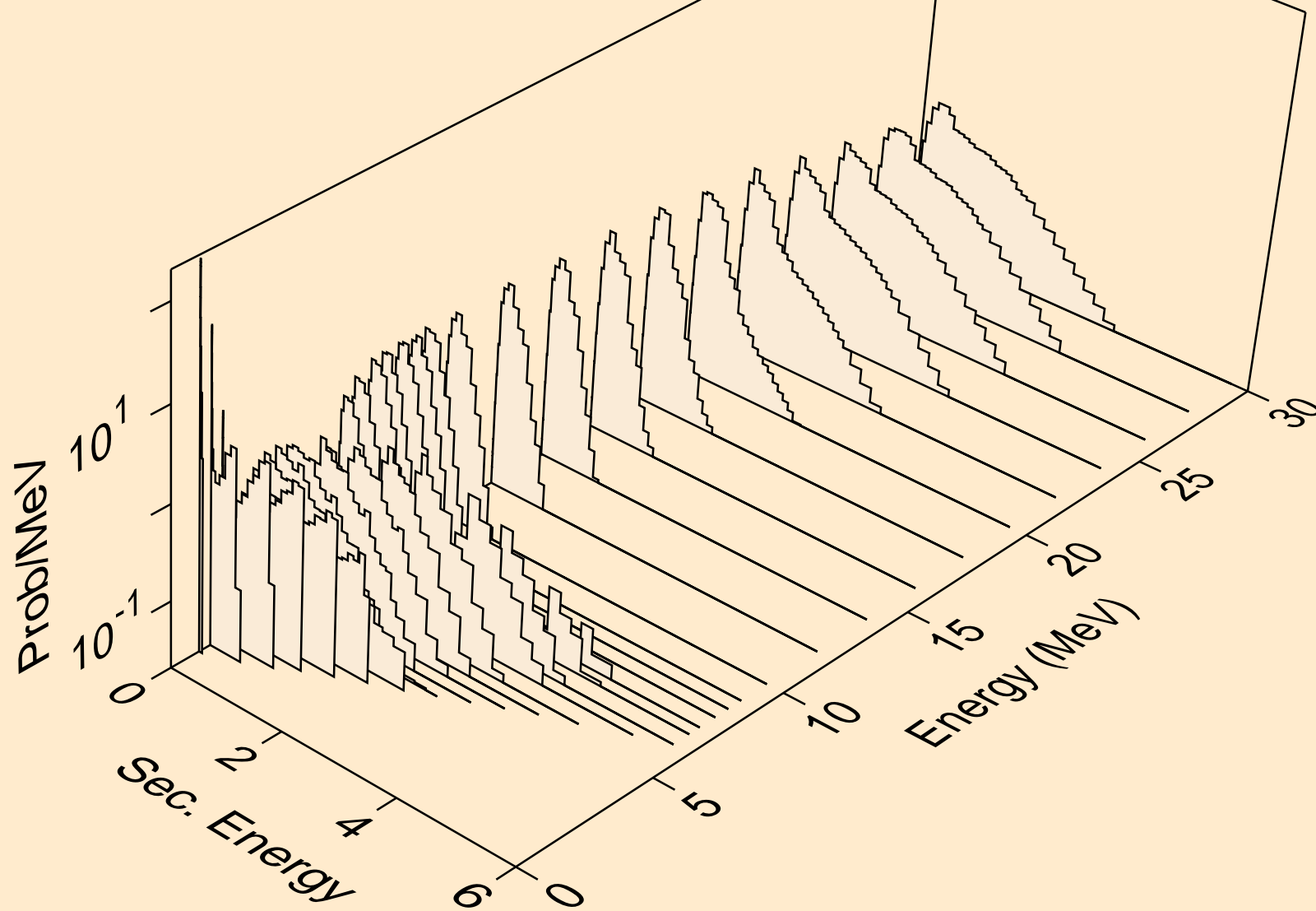

AM233 NEUTRON ACER TENDL-2024 LIBRARY; T=0.K  
Neutron emission for (n,2n)a

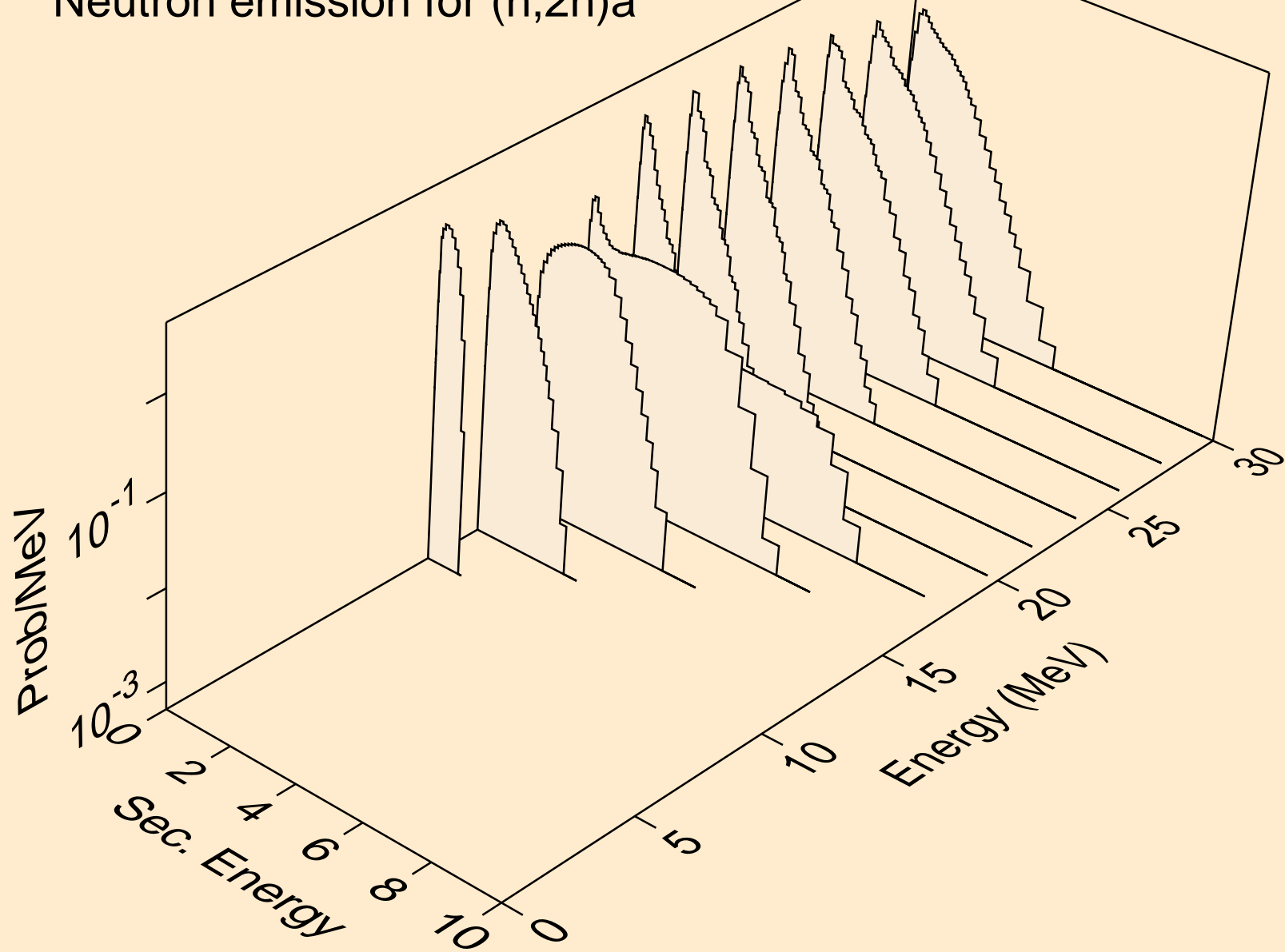

AM233 NEUTRON ACER TENDL-2024 LIBRARY; T=0.K  
Neutron emission for (n,n\*)p

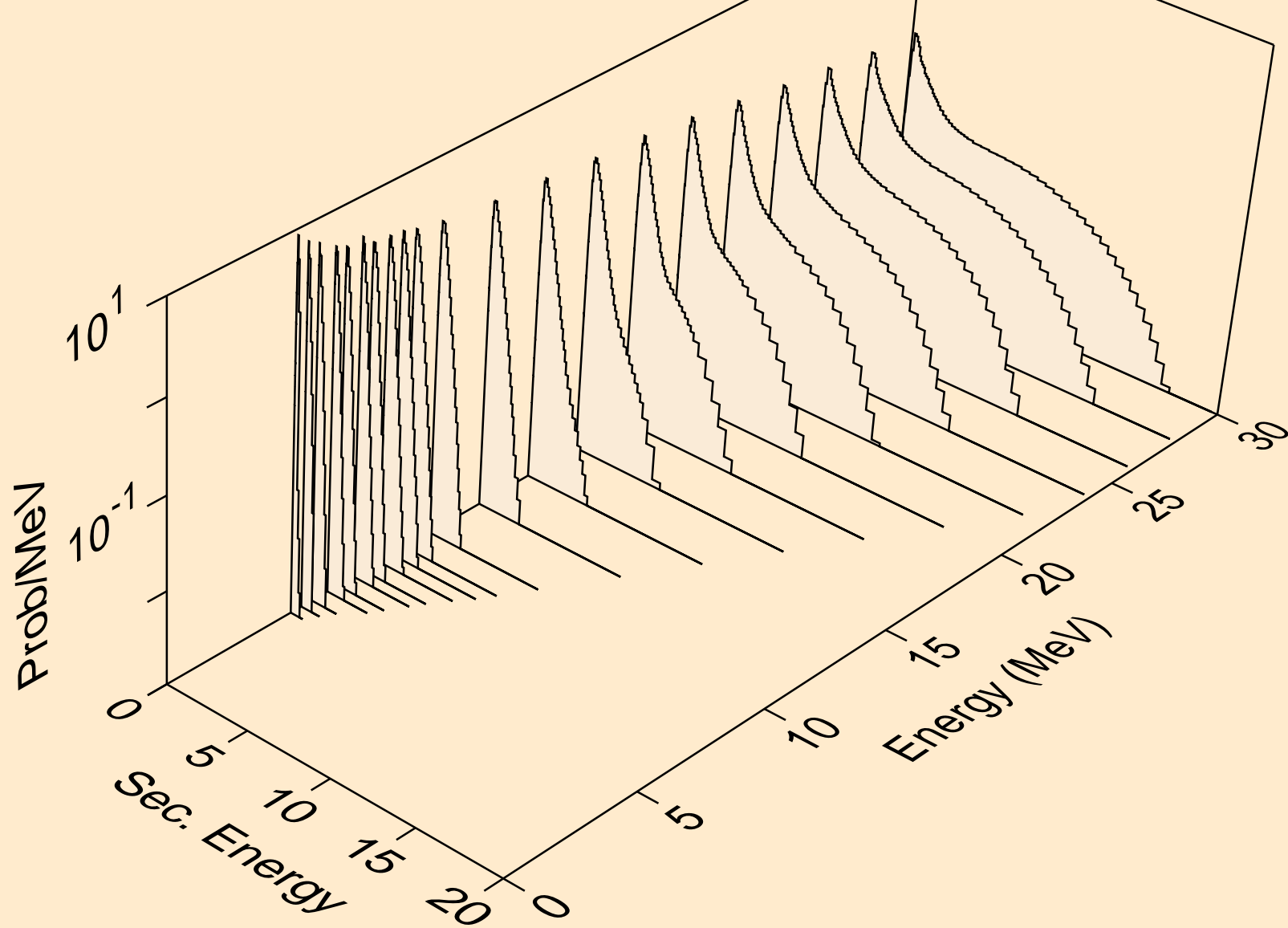

AM233 NEUTRON ACER TENDL-2024 LIBRARY; T=0.K  
Neutron emission for (n,n\*)2a

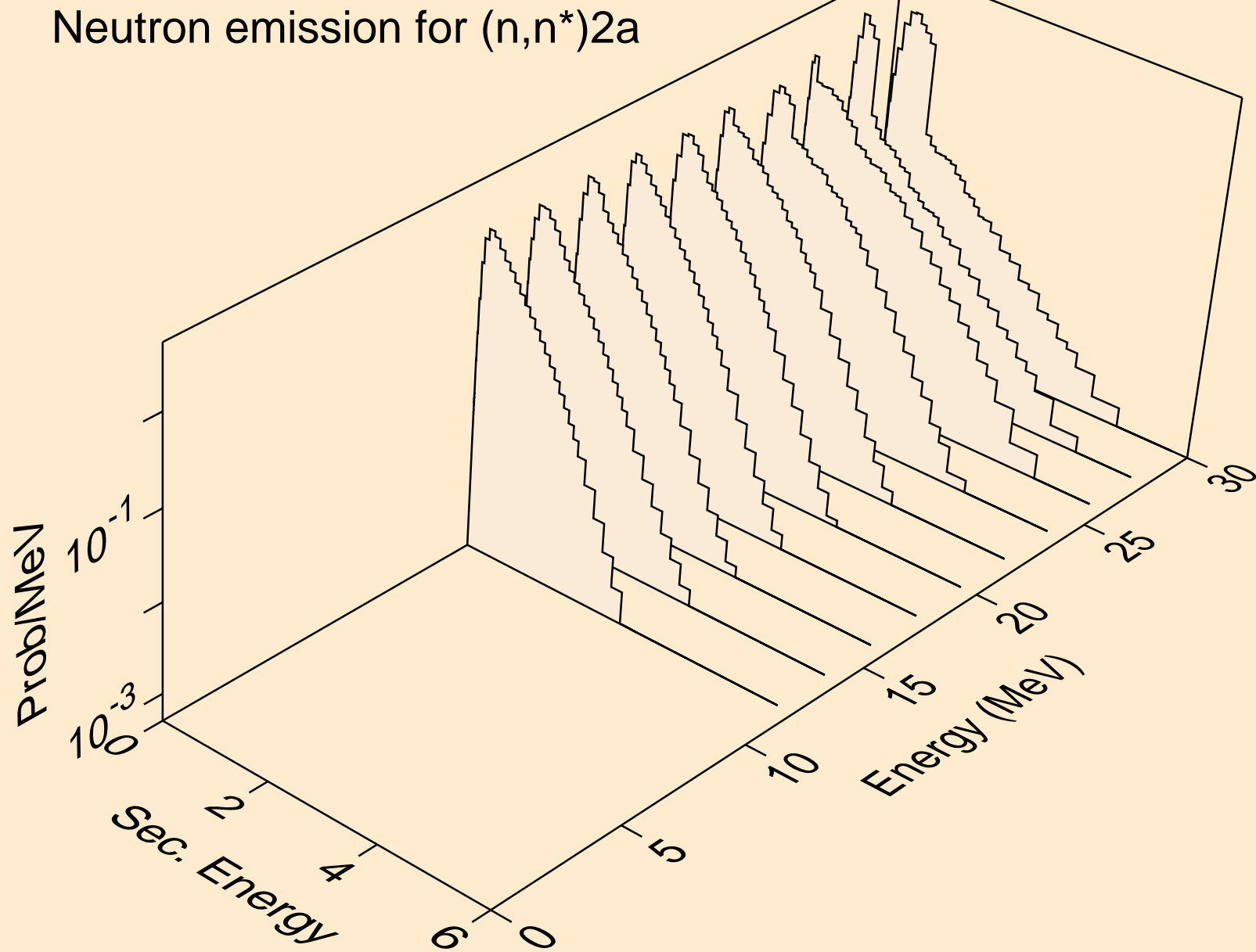

AM233 NEUTRON ACER TENDL-2024 LIBRARY; T=0.K  
Neutron emission for (n,n\*)d

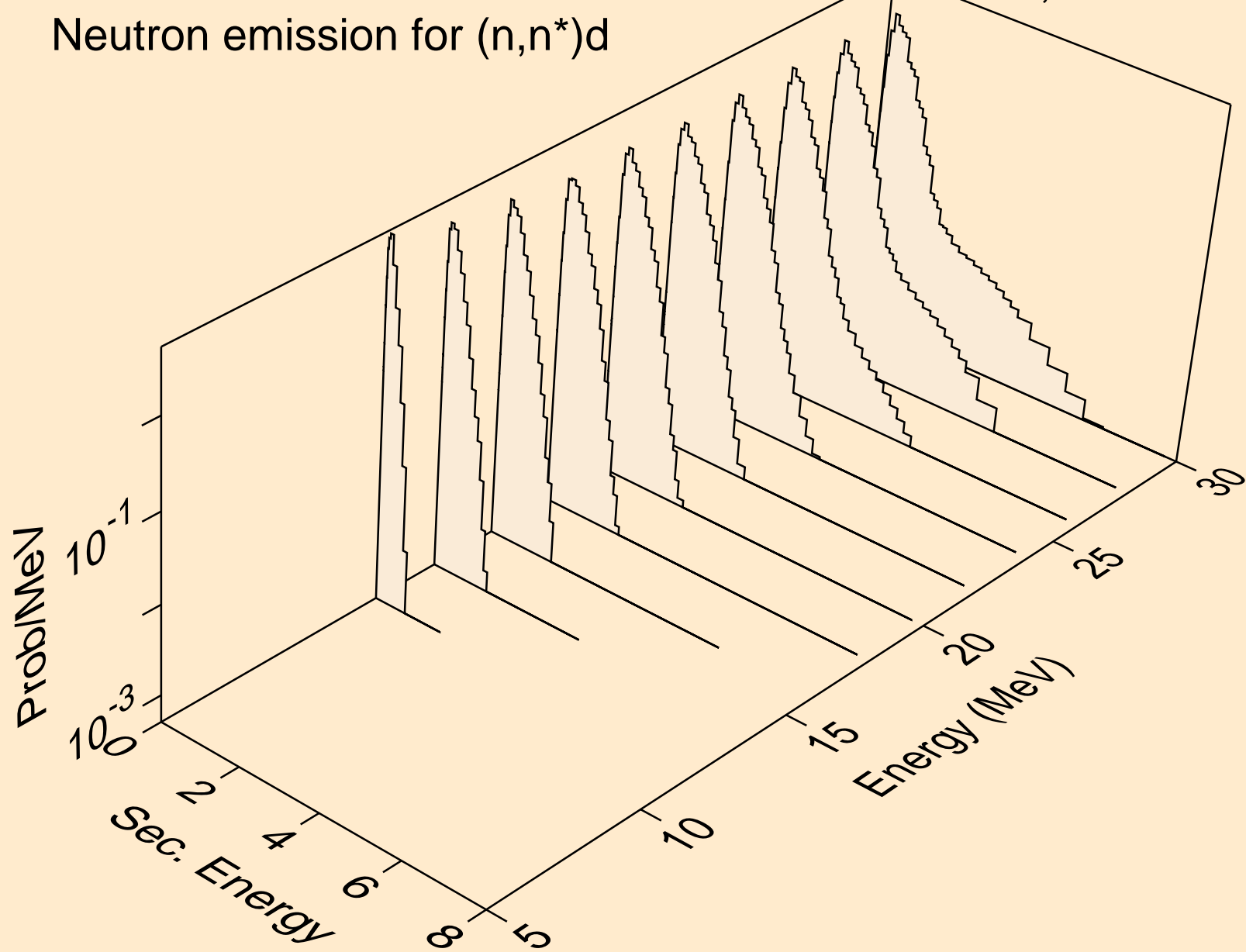

AM233 NEUTRON ACER TENDL-2024 LIBRARY; T=0.K  
Neutron emission for (n,n\*)t

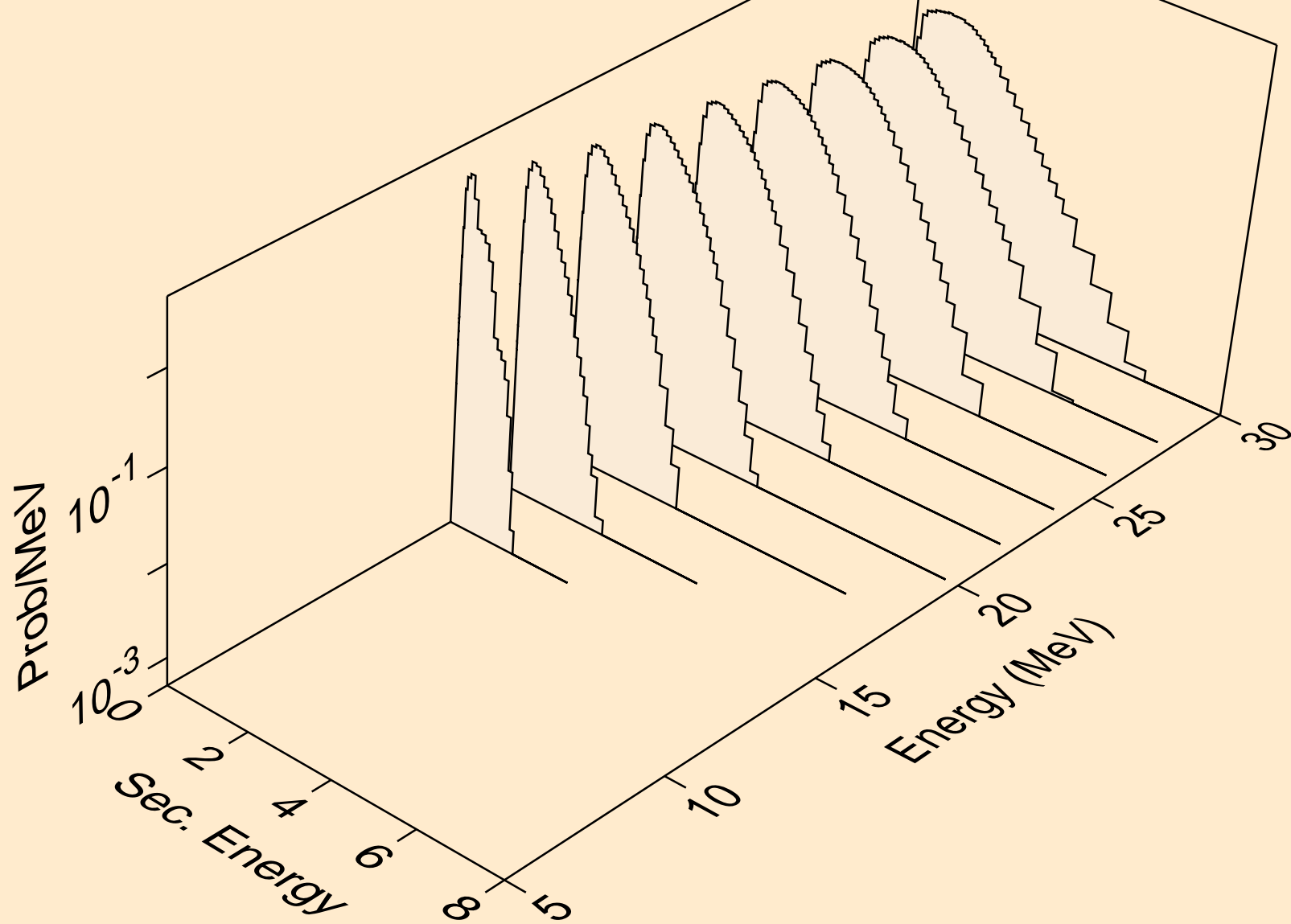

AM233 NEUTRON ACER TENDL-2024 LIBRARY; T=0.K  
Neutron emission for (n,n\*)he3

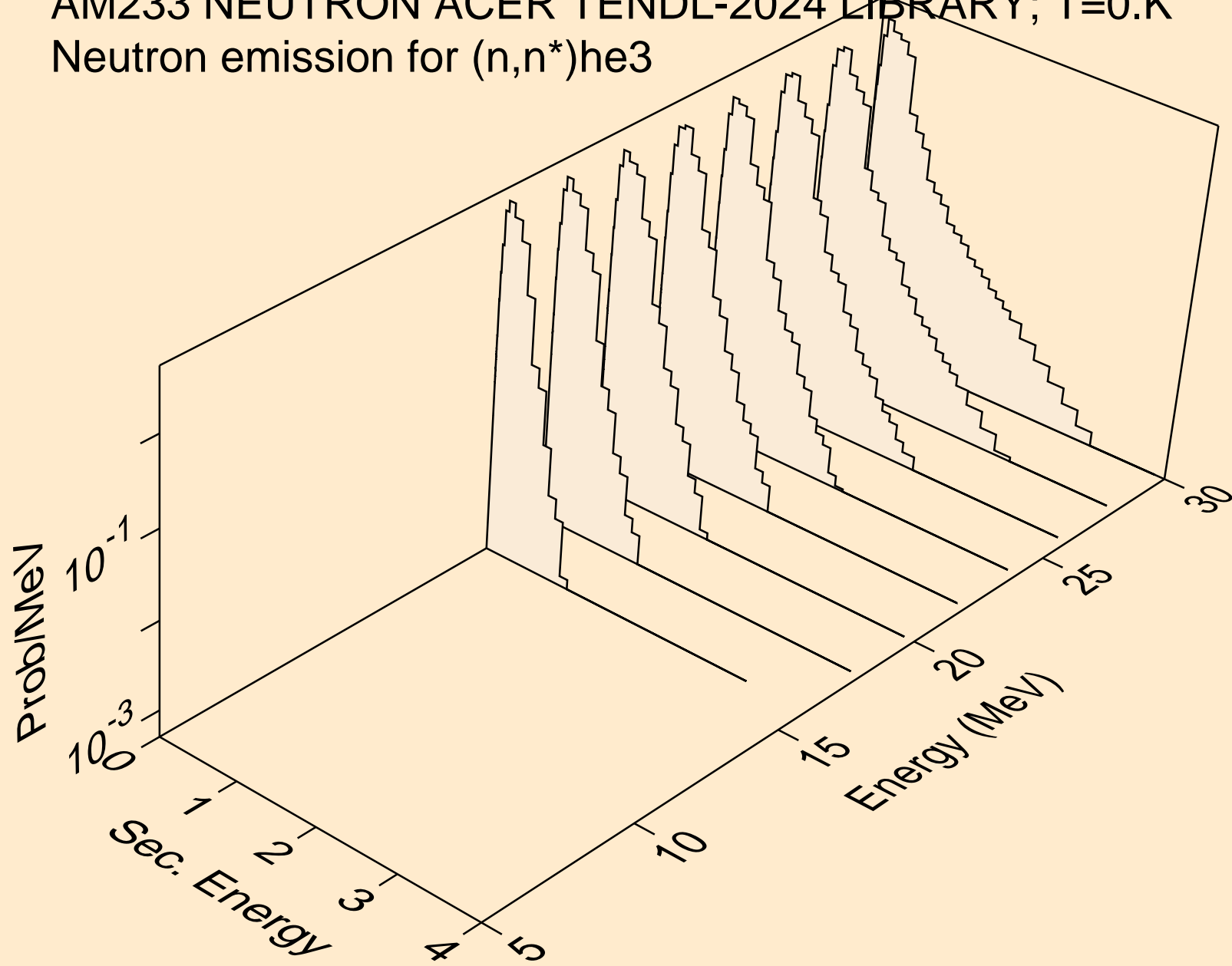



AM233 NEUTRON ACER TENDL-2024 LIBRARY; T=0.K  
Neutron emission for (n,4n)

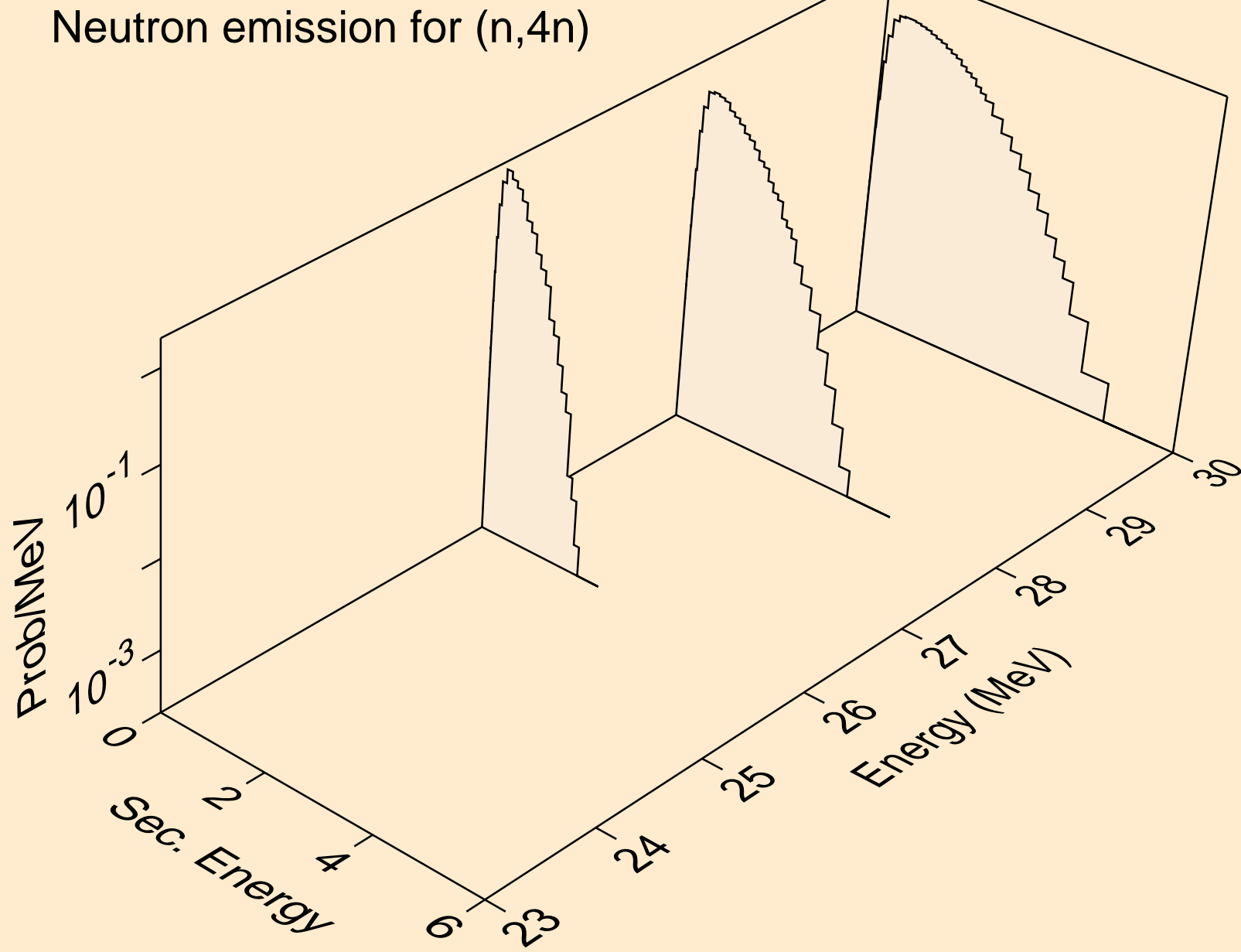

AM233 NEUTRON ACER TENDL-2024 LIBRARY; T=0.K  
Neutron emission for (n,2np)

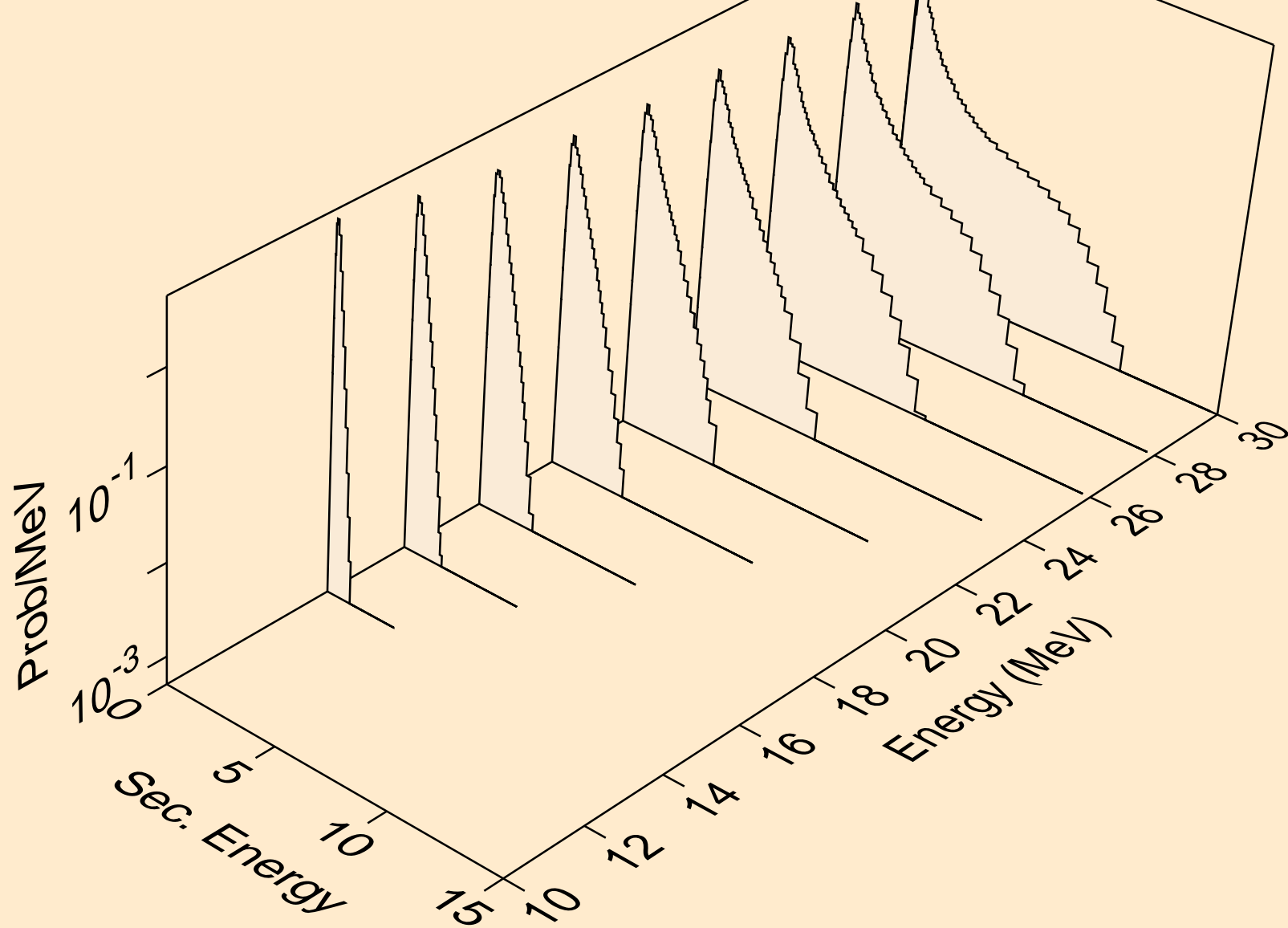

AM233 NEUTRON ACER TENDL-2024 LIBRARY; T=0.K  
Neutron emission for (n,n2p)

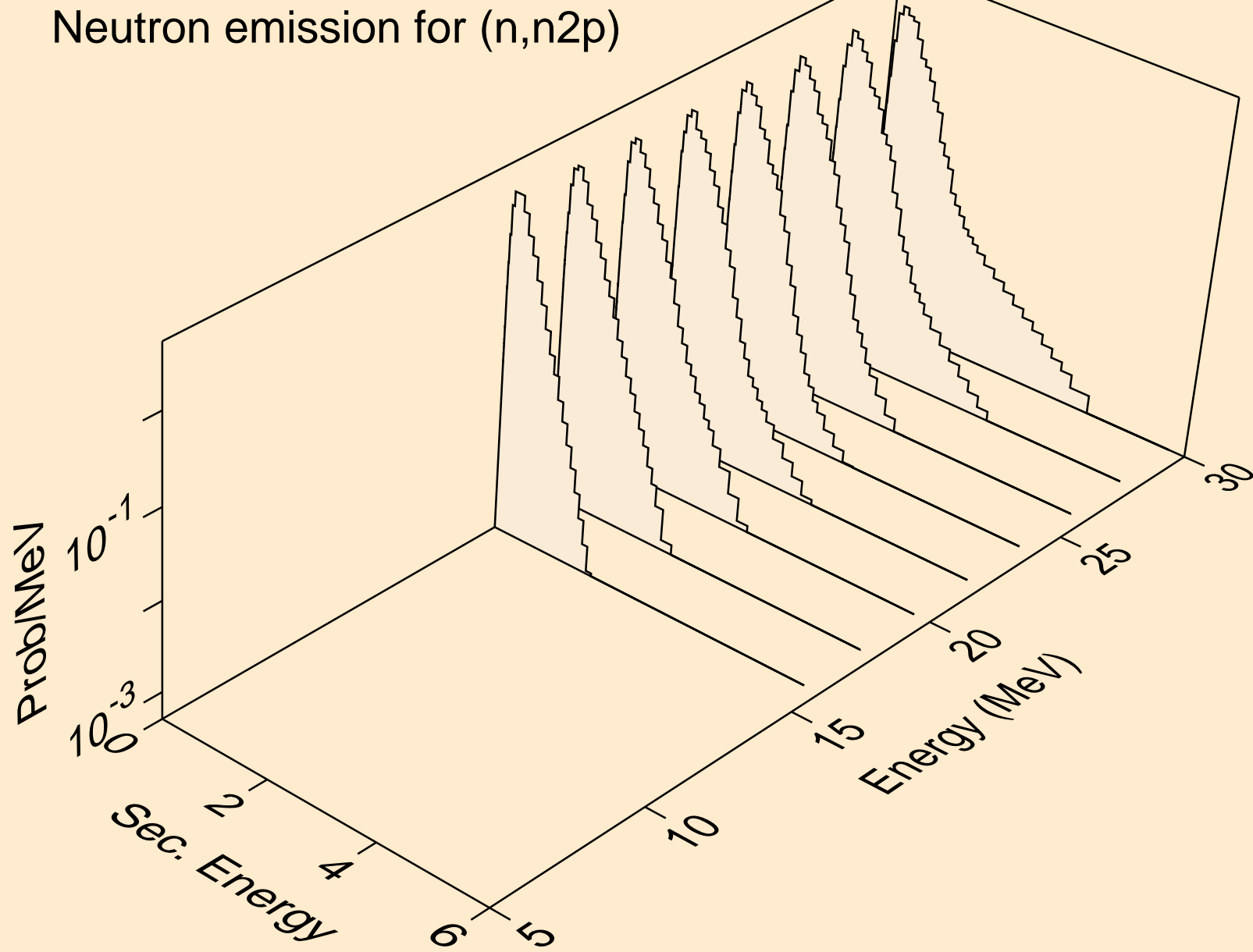

AM233 NEUTRON ACER TENDL-2024 LIBRARY; T=0.K  
Neutron emission for (n,npa)

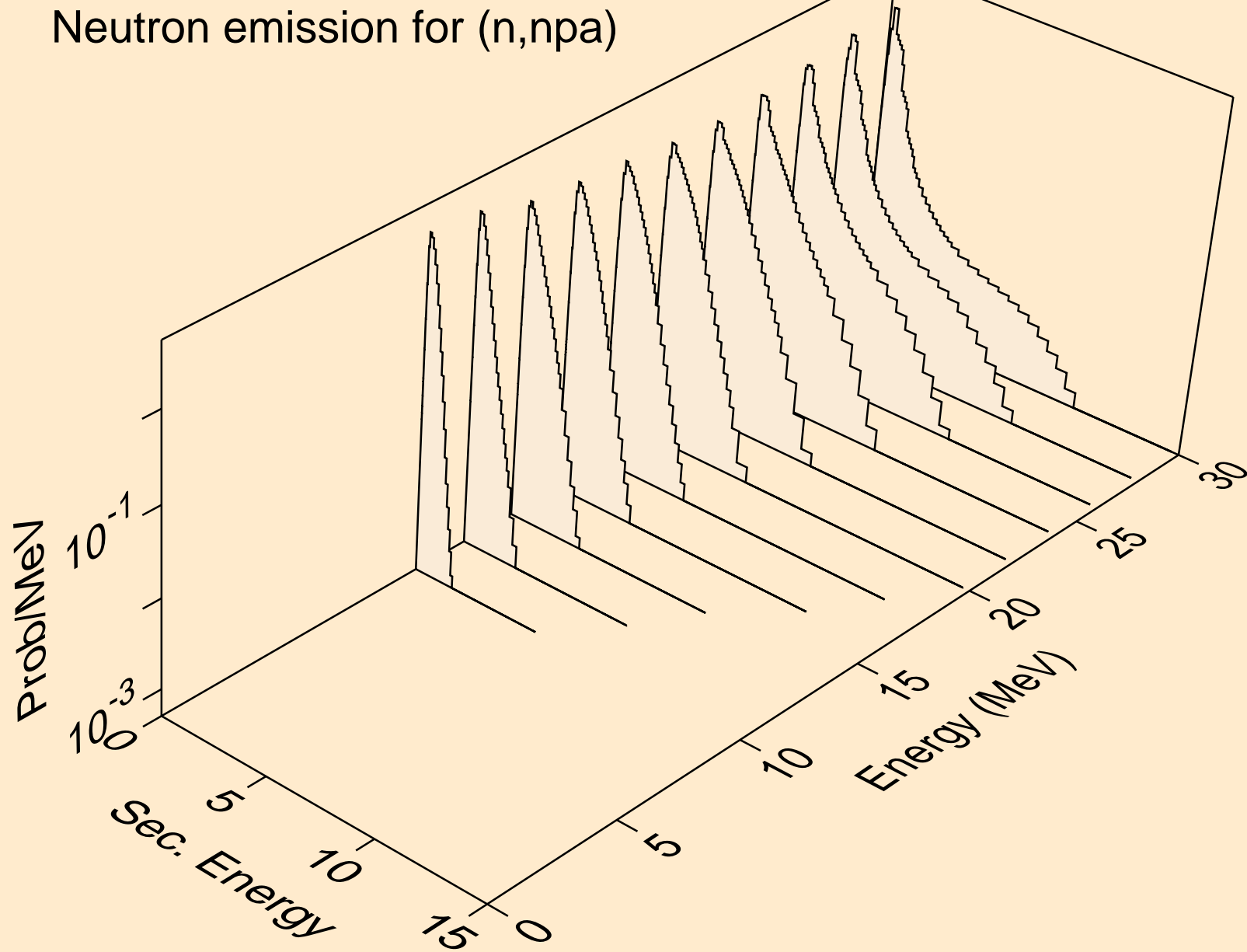

AM233 NEUTRON ACER TENDL-2024 LIBRARY; T=0.K  
Neutron emission for (n,n\*c)

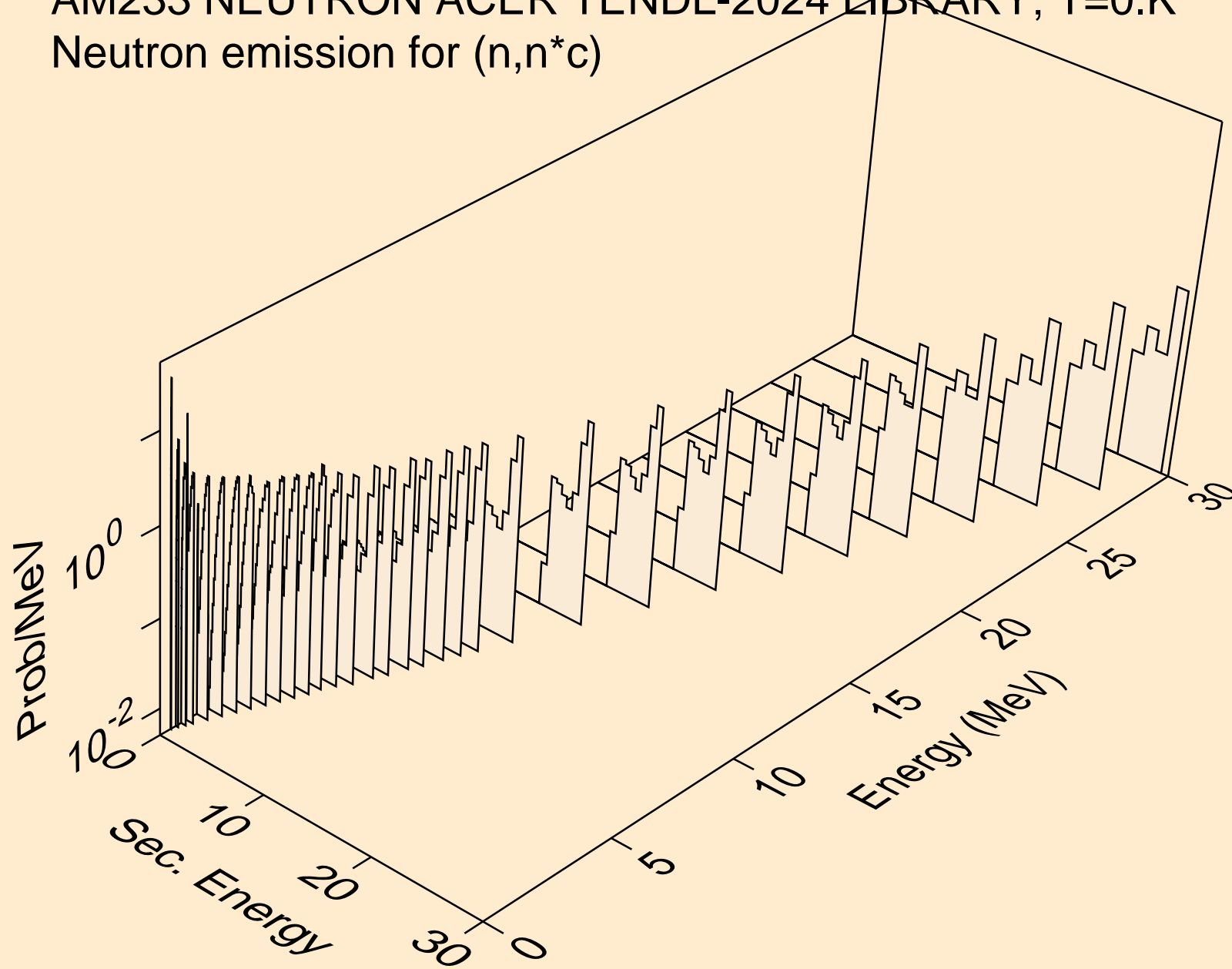

# AM233 NEUTRON ACER TENDL-2024 LIBRARY; T=0.K

Delayed nubar

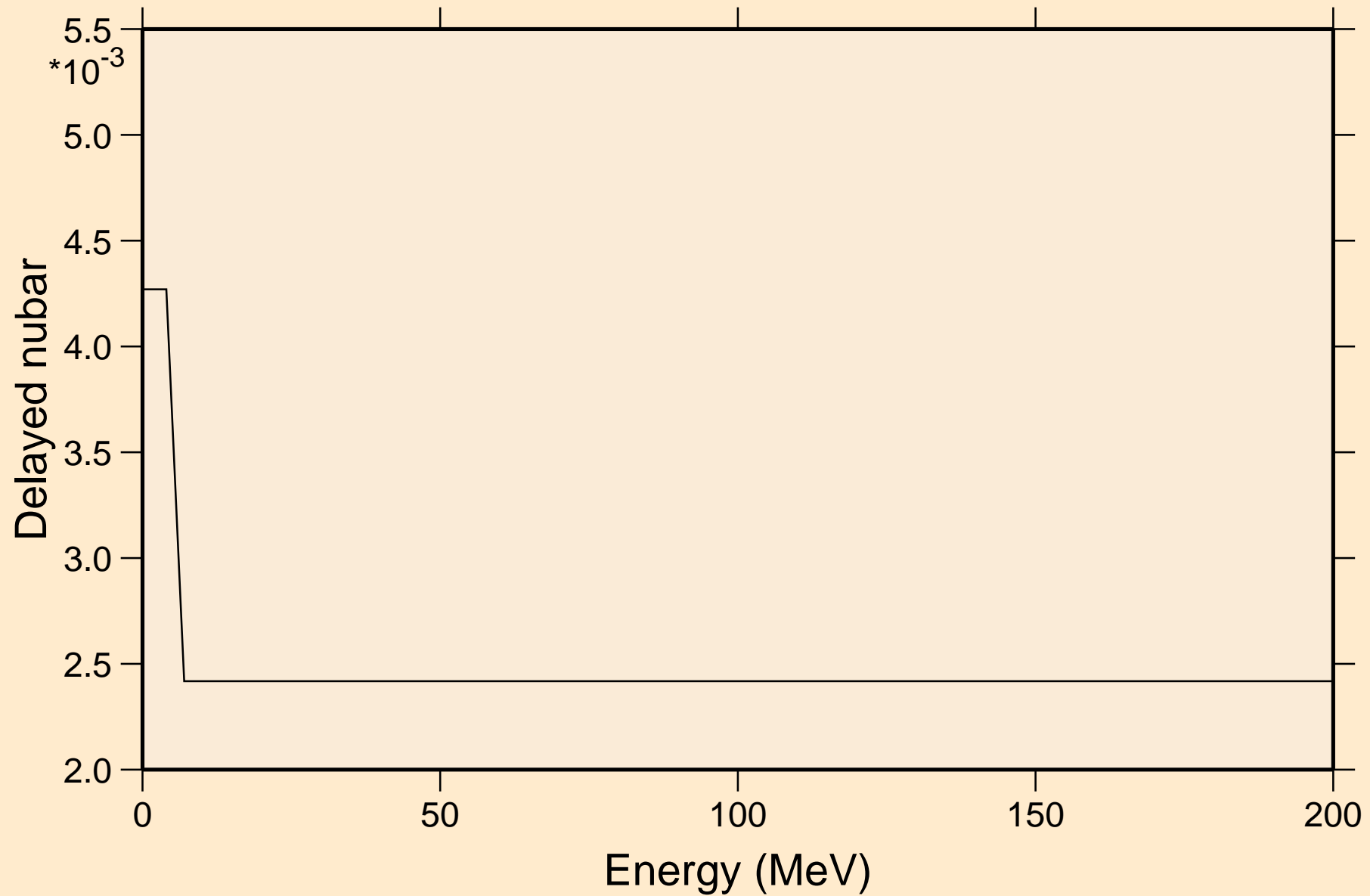

# AM233 NEUTRON ACER TENDL-2024 LIBRARY; T=0.K

## Delayed neutron spectra

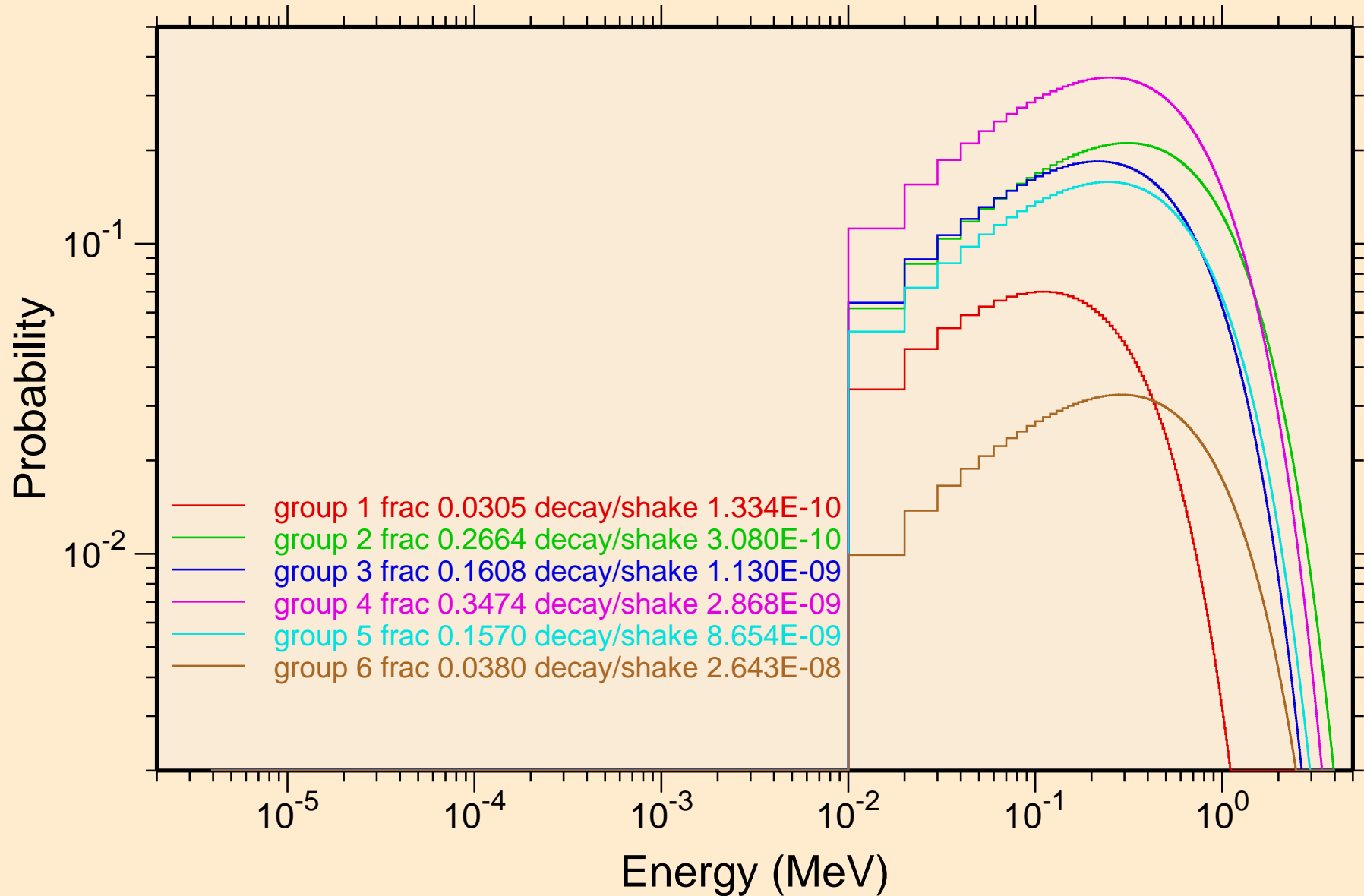

AM233 NEUTRON ACER TENDL-2024 LIBRARY; T=0.K  
Photon emission for (n,x)

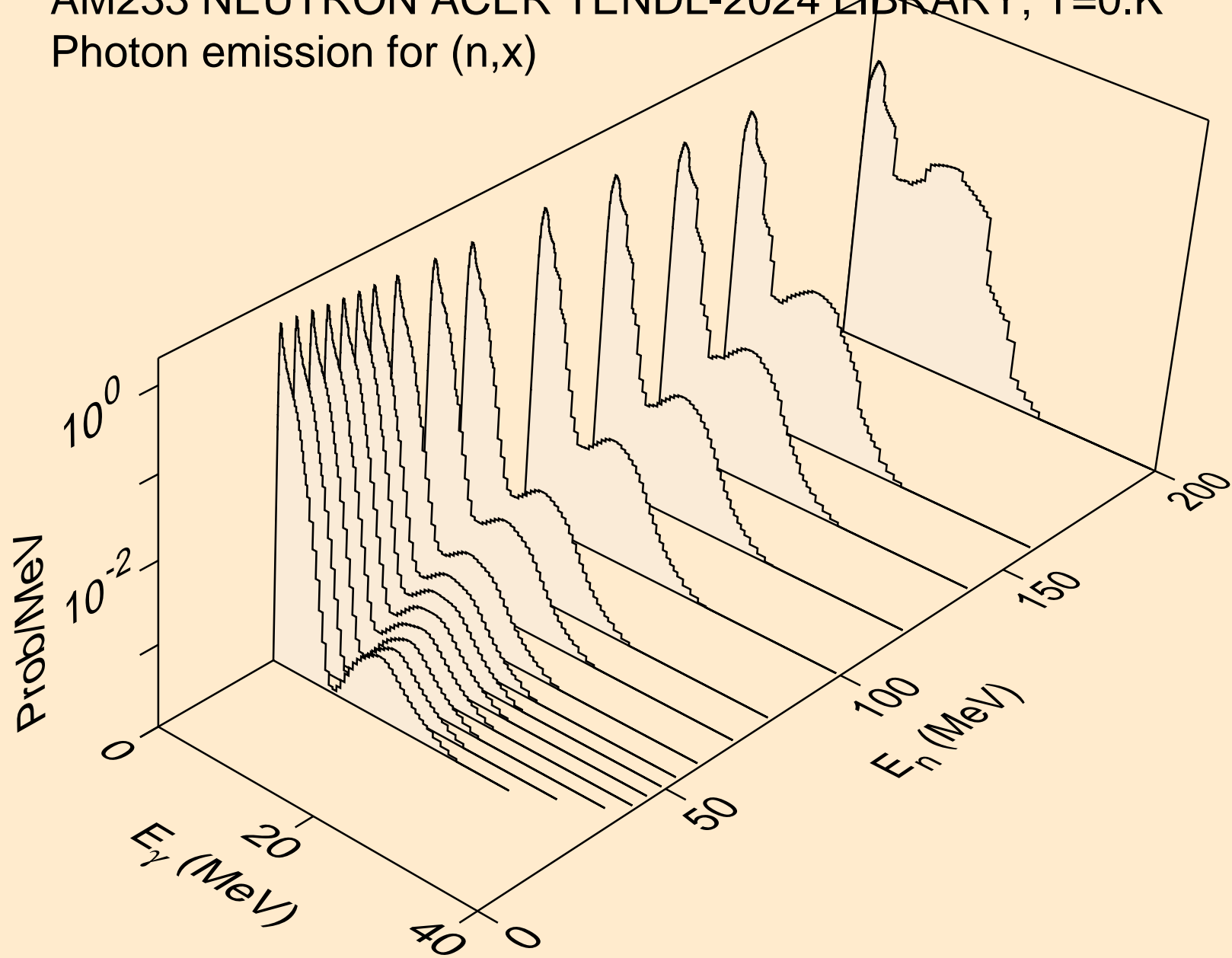



AM233 NEUTRON ACER TENDL-2024 LIBRARY; T=0.K  
Photon emission for (n,2nd)

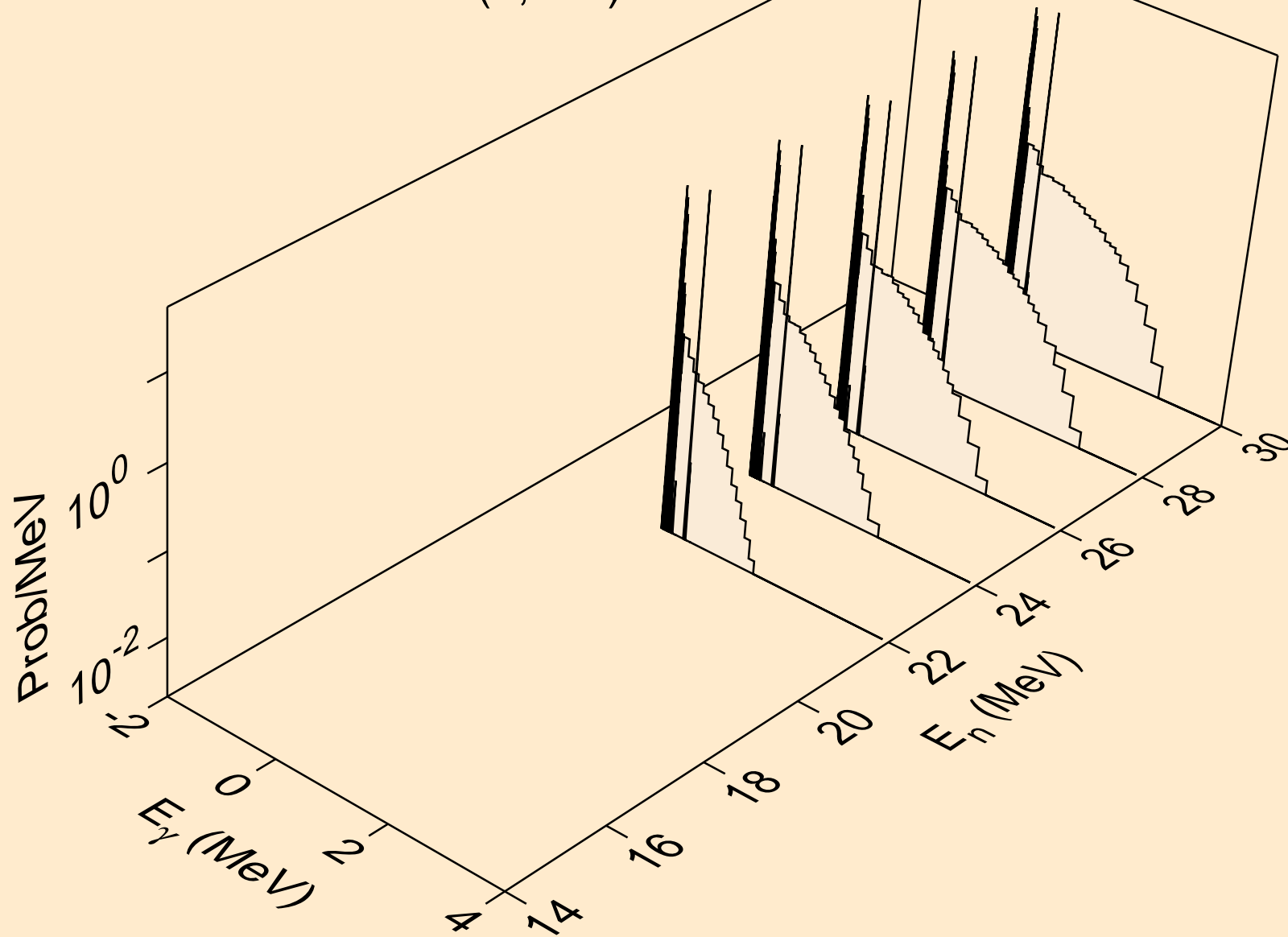

AM233 NEUTRON ACER TENDL-2024 LIBRARY; T=0.K  
Photon emission for (n,2n)

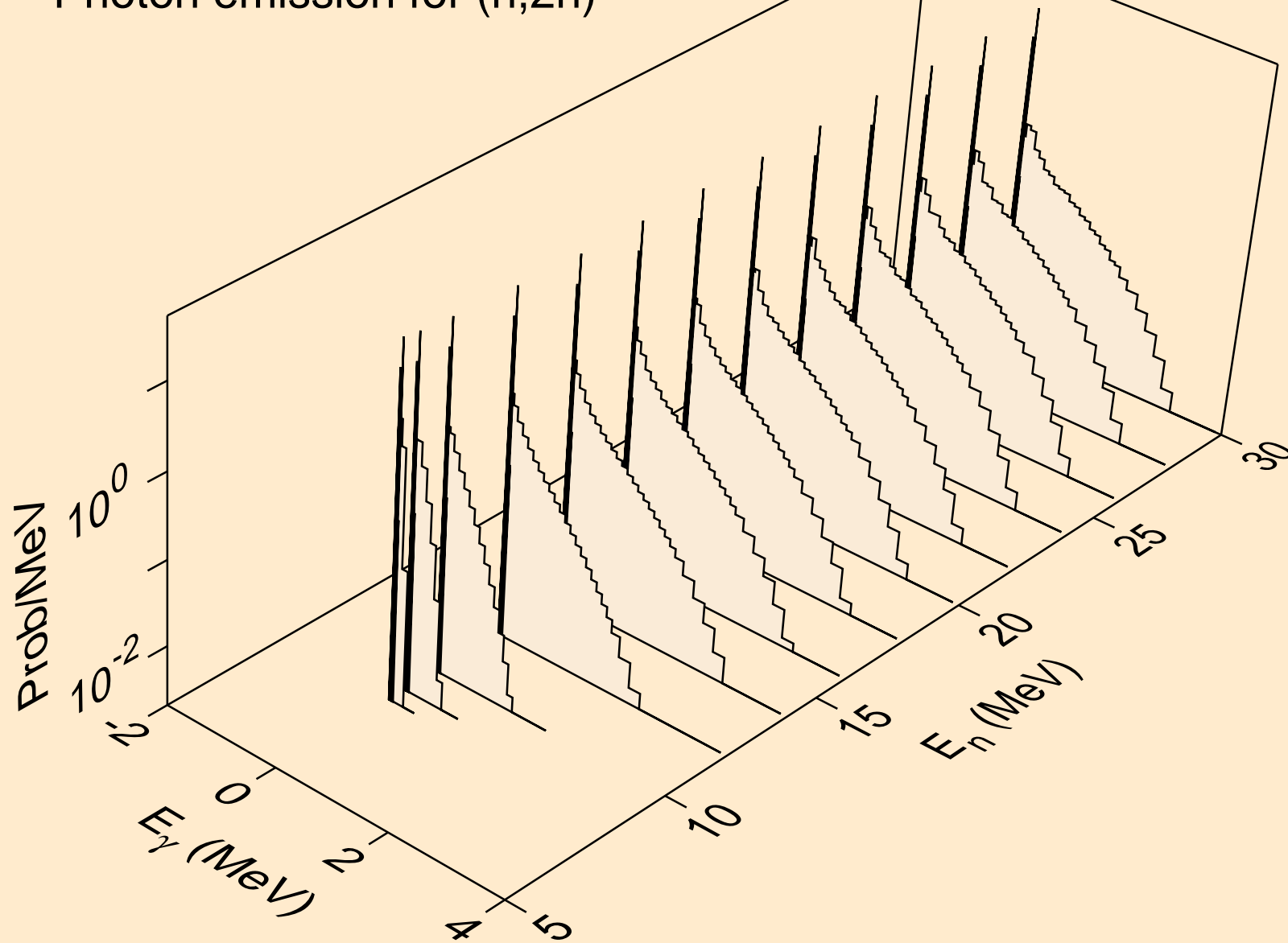

AM233 NEUTRON ACER TENDL-2024 LIBRARY; T=0.K  
Photon emission for (n,3n)

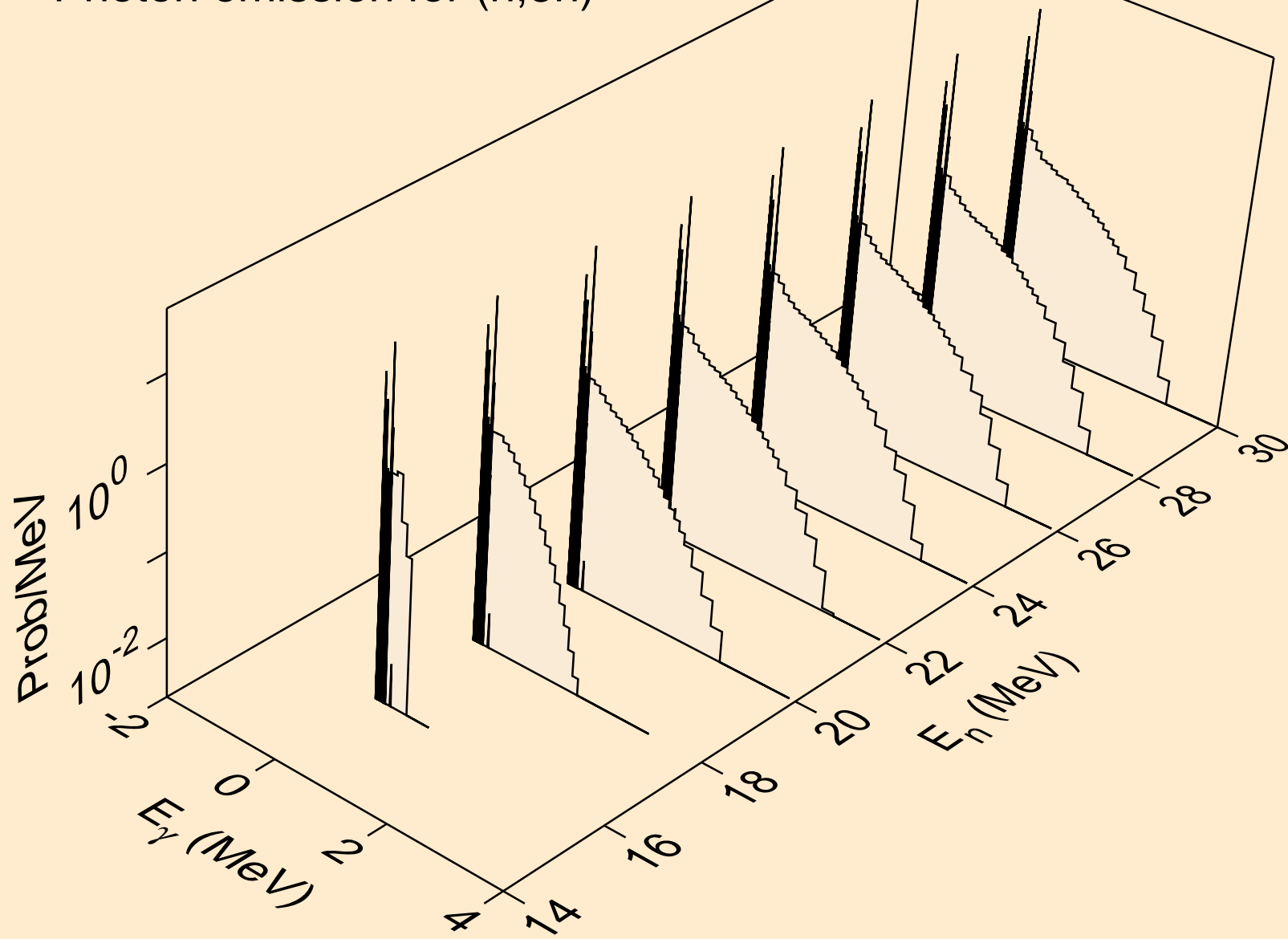

AM233 NEUTRON ACER TENDL-2024 LIBRARY; T=0.K  
Photon emission for (n,n\*)a

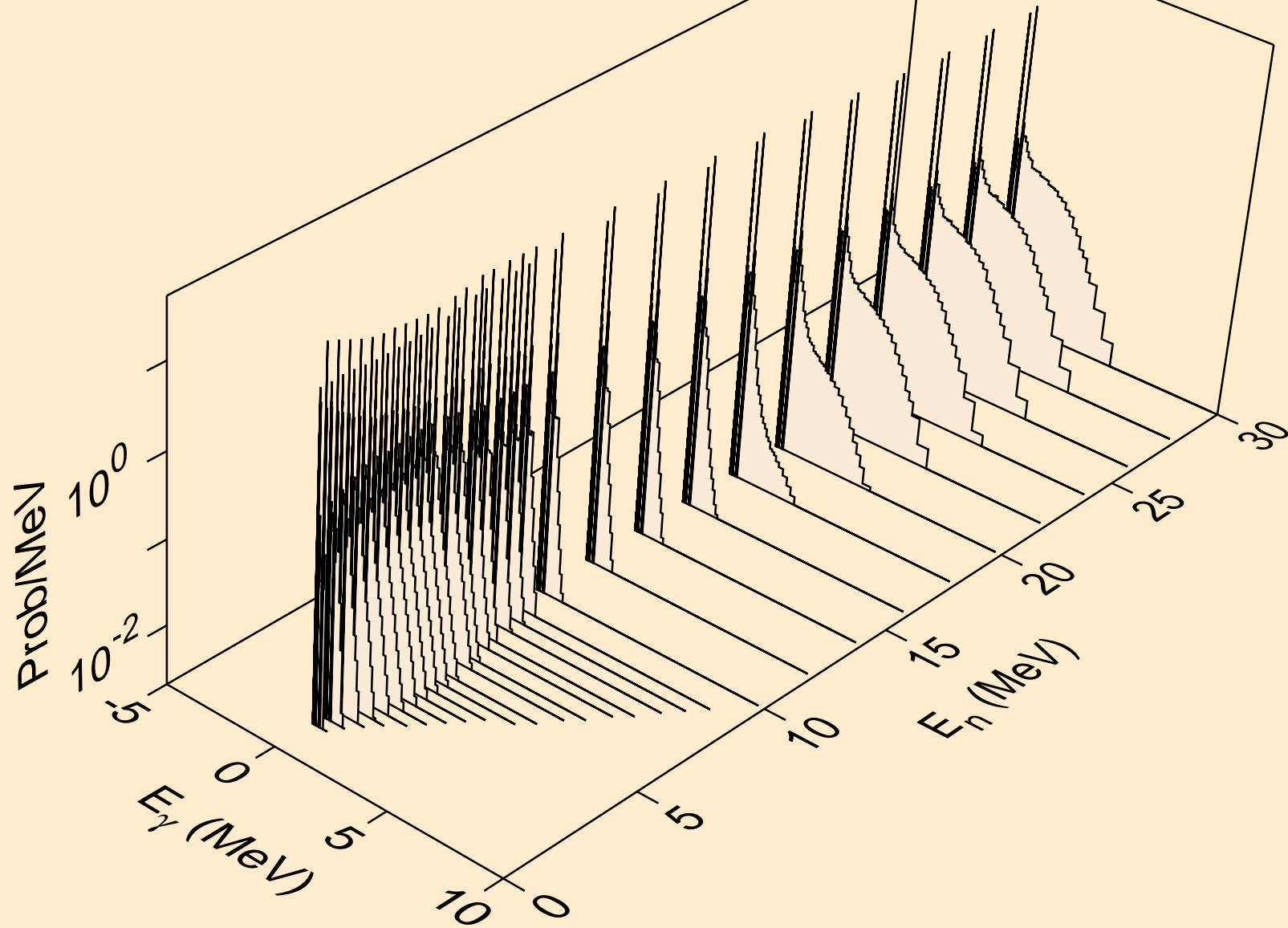

AM233 NEUTRON ACER TENDL-2024 LIBRARY; T=0.K  
Photon emission for (n,2n)a

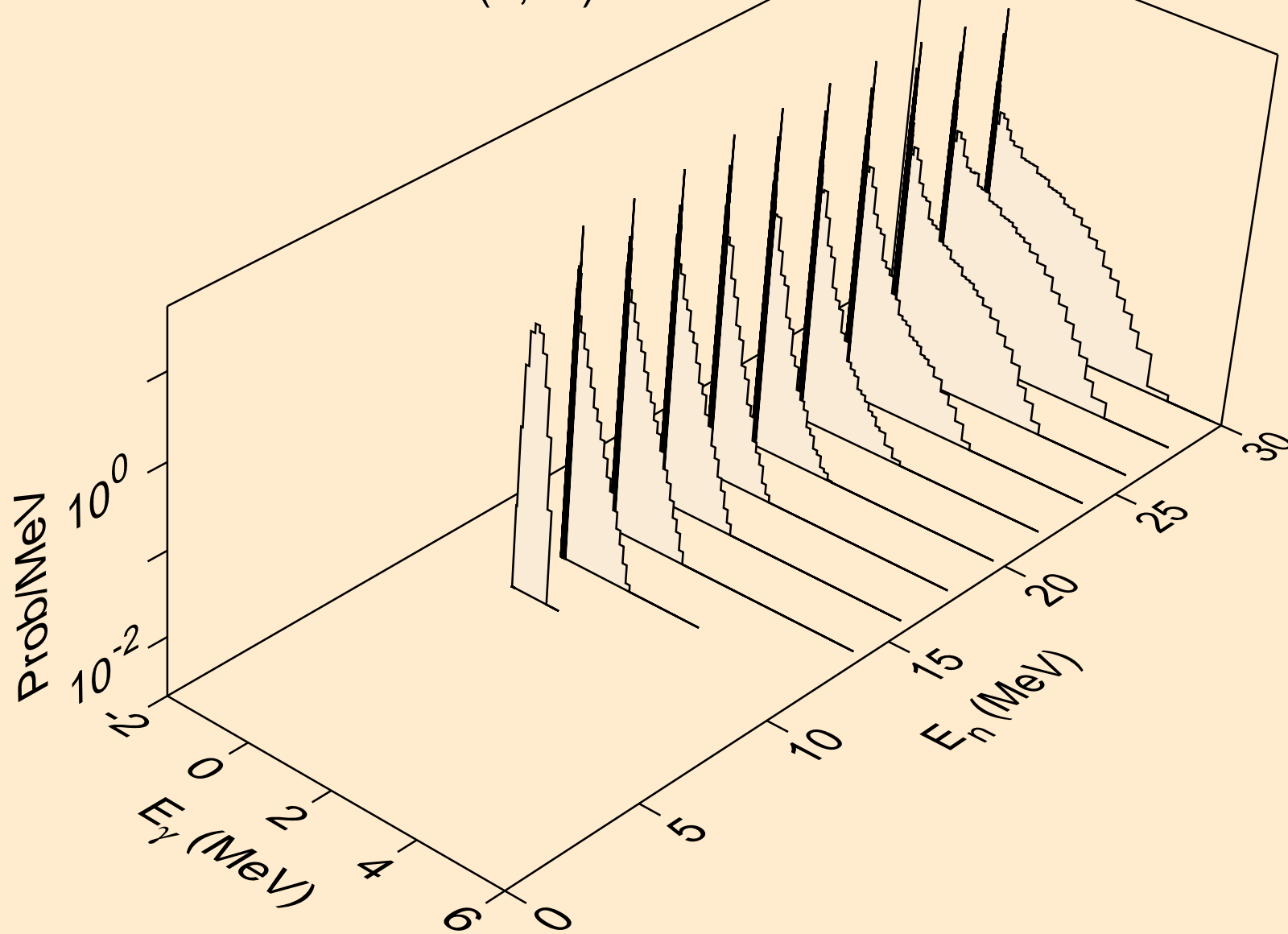

AM233 NEUTRON ACER TENDL-2024 LIBRARY; T=0.K  
Photon emission for (n,n\*)p

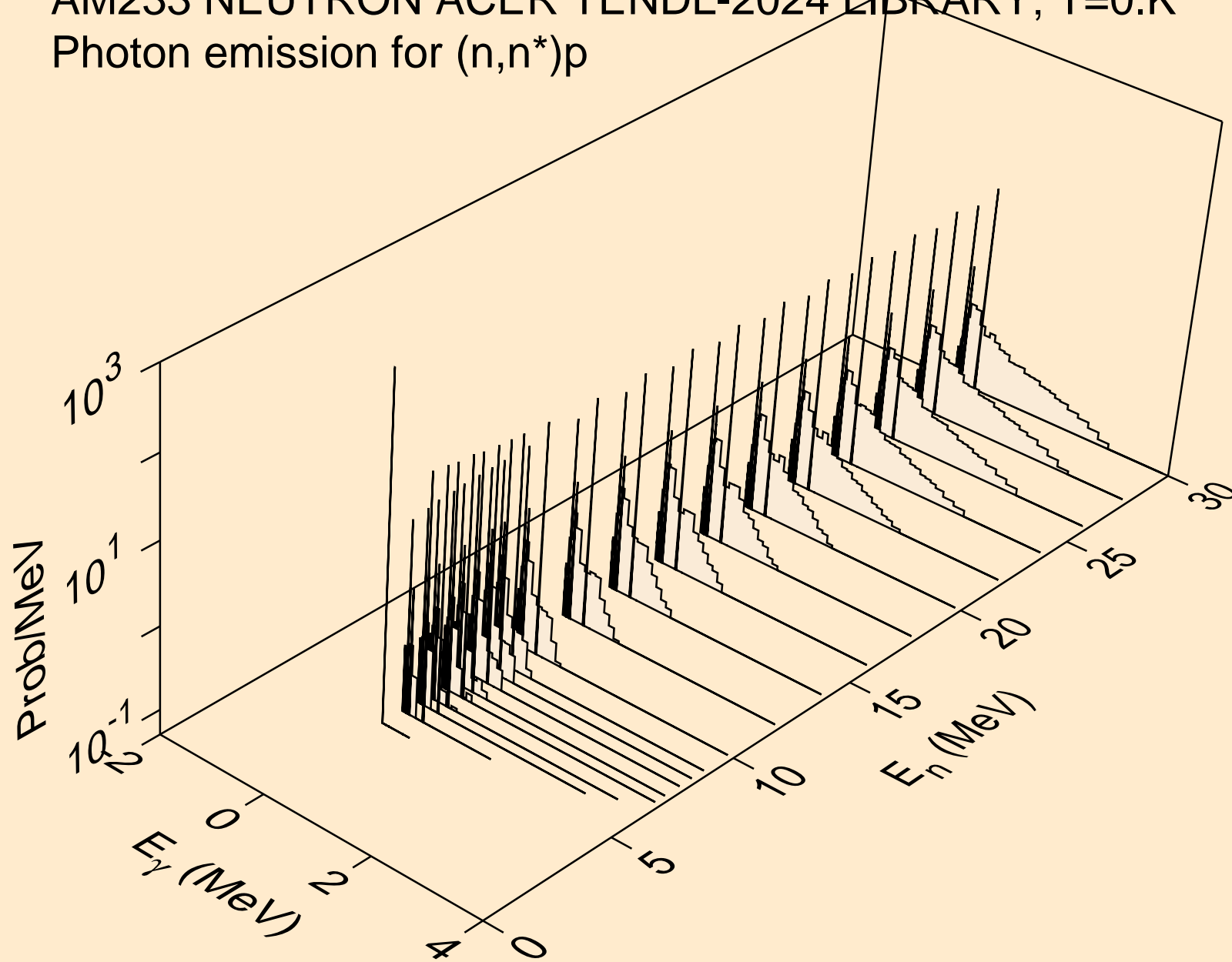

AM233 NEUTRON ACER TENDL-2024 LIBRARY; T=0.K  
Photon emission for (n,n\*)2a

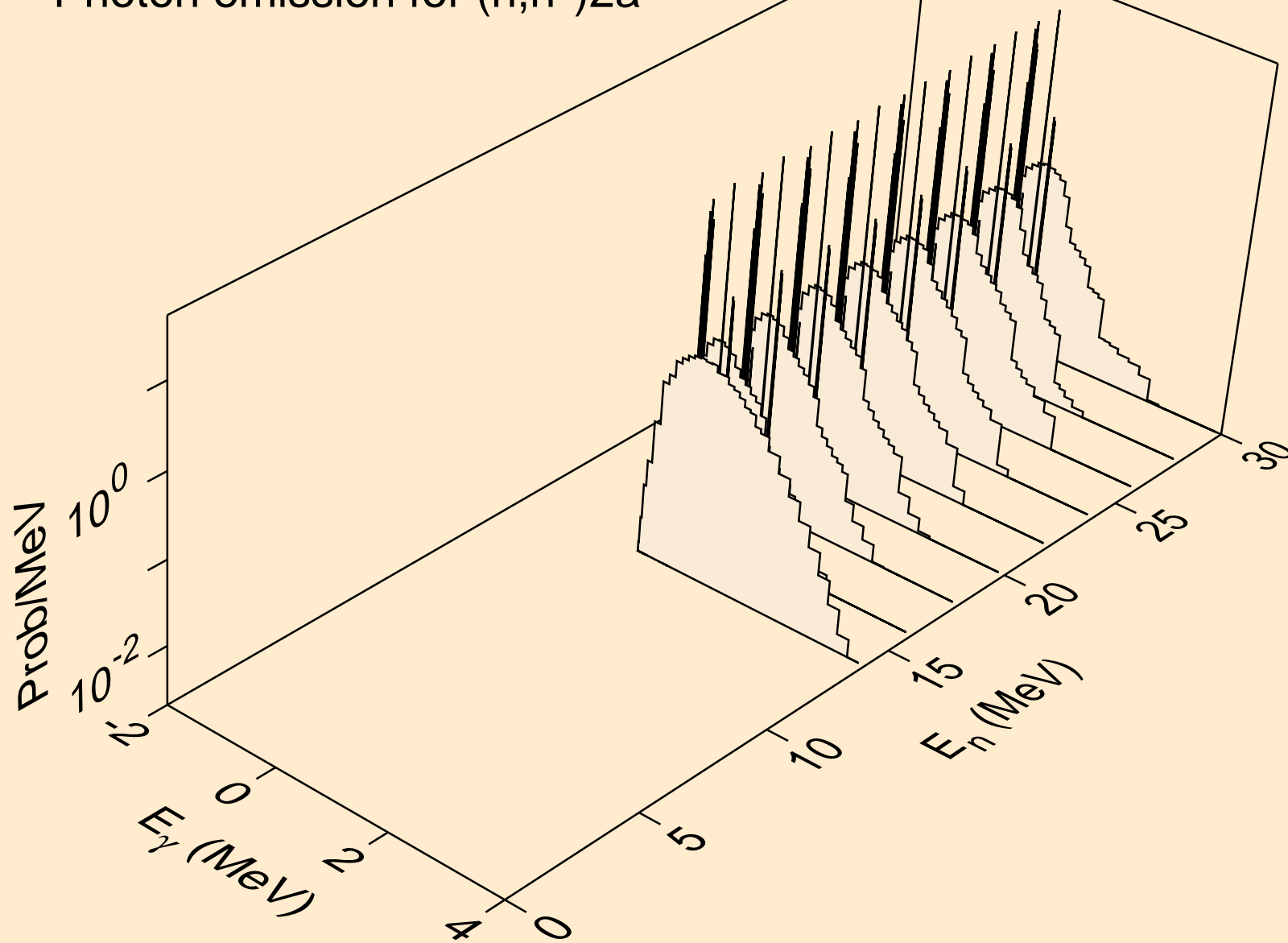

AM233 NEUTRON ACER TENDL-2024 LIBRARY; T=0.K  
Photon emission for (n,n\*)d

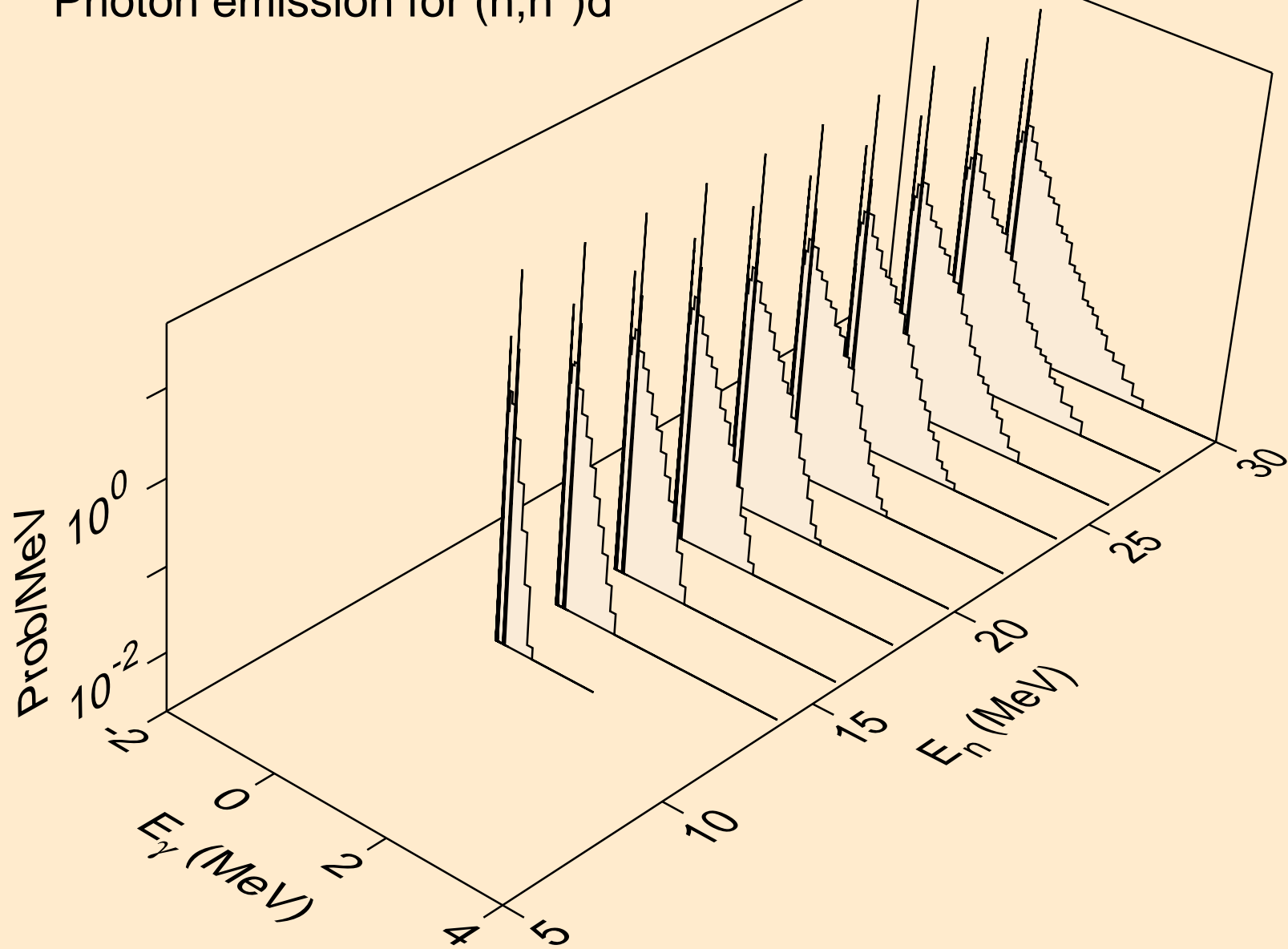



AM233 NEUTRON ACER TENDL-2024 LIBRARY; T=0.K  
Photon emission for (n,n\*)t

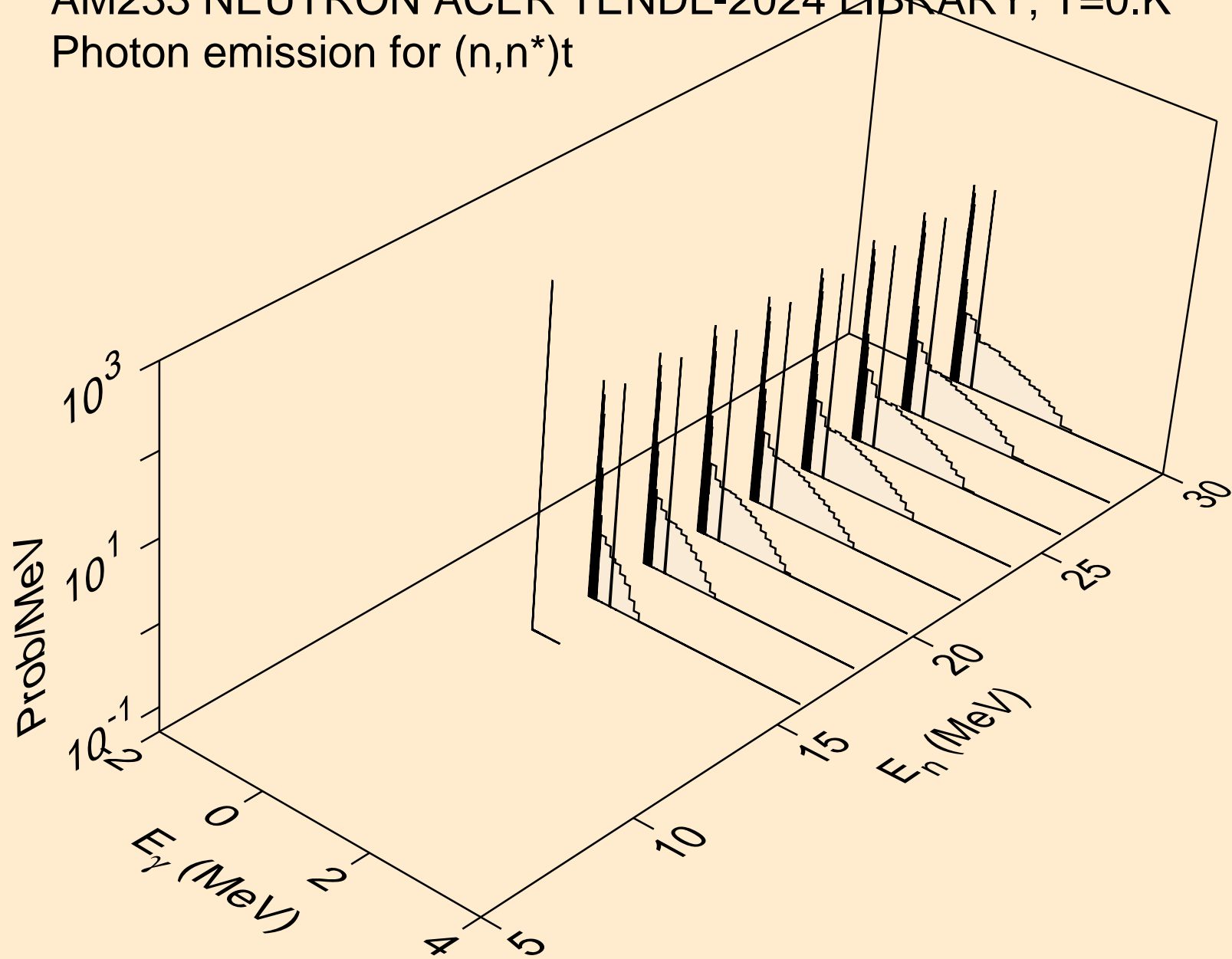

AM233 NEUTRON ACER TENDL-2024 LIBRARY; T=0.K  
Photon emission for (n,n\*)he3

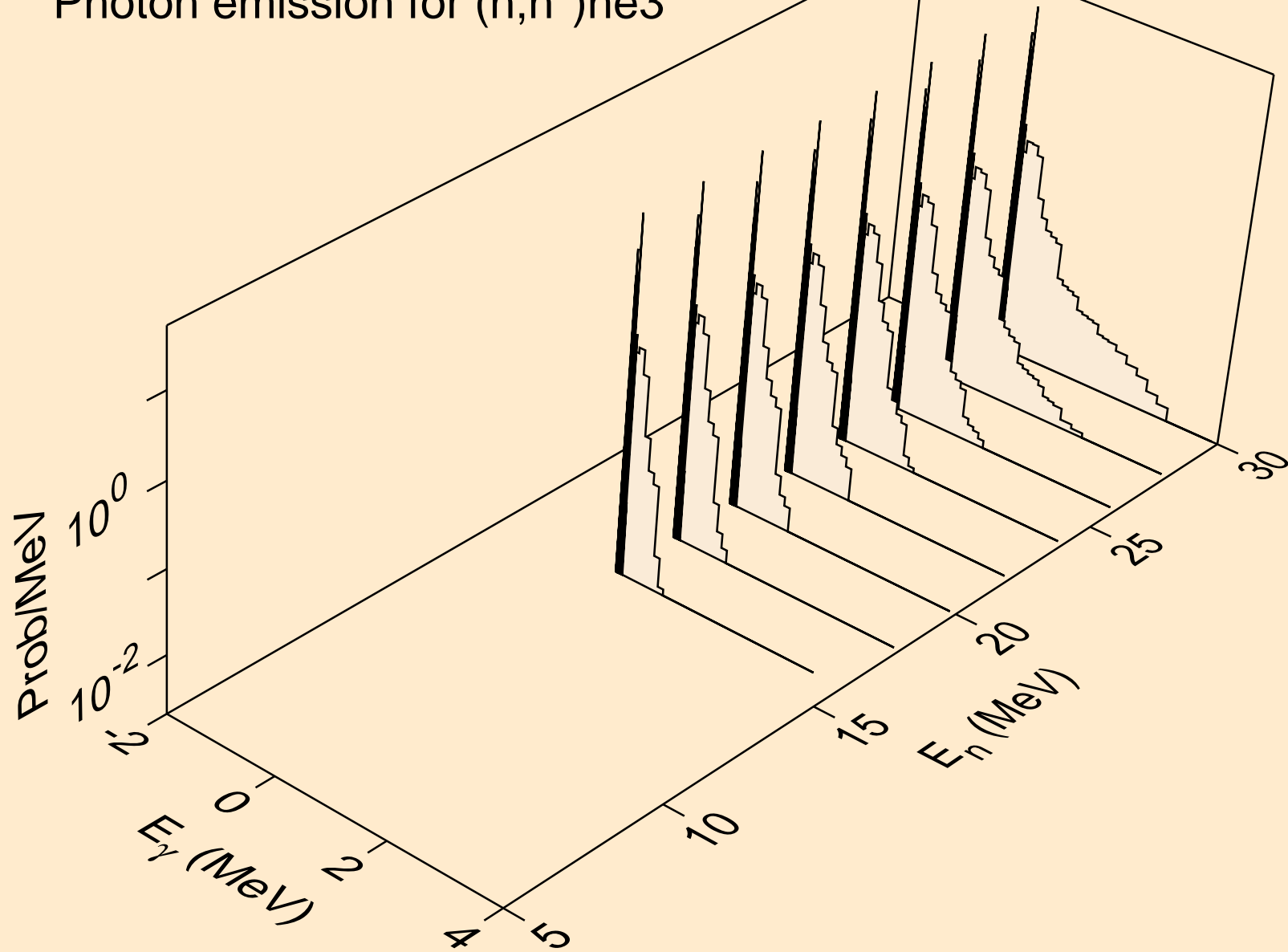

AM233 NEUTRON ACER TENDL-2024 LIBRARY; T=0.K  
Photon emission for (n,4n)

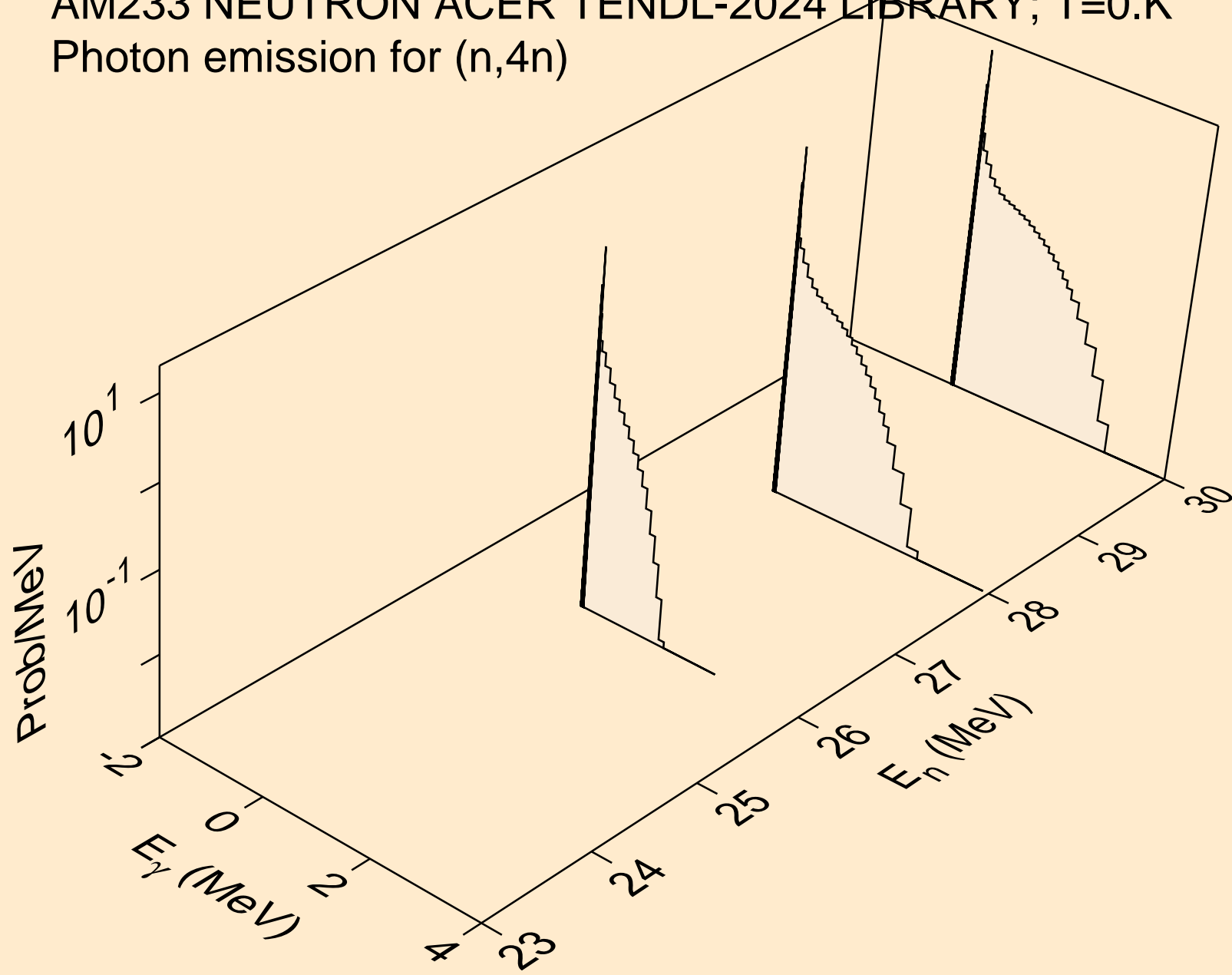

AM233 NEUTRON ACER TENDL-2024 LIBRARY; T=0.K  
Photon emission for (n,2np)

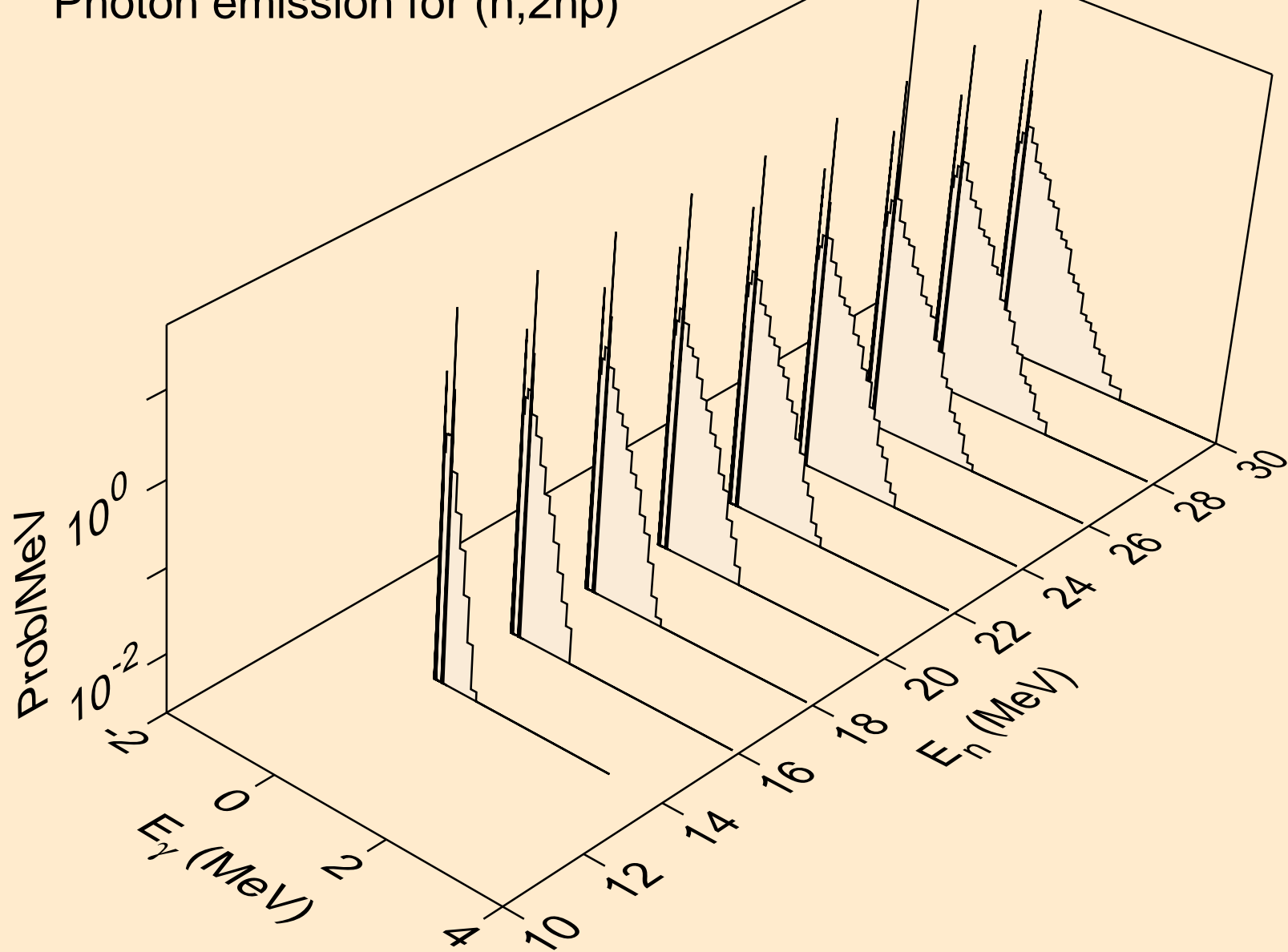

AM233 NEUTRON ACER TENDL-2024 LIBRARY; T=0.K  
Photon emission for (n,n2p)

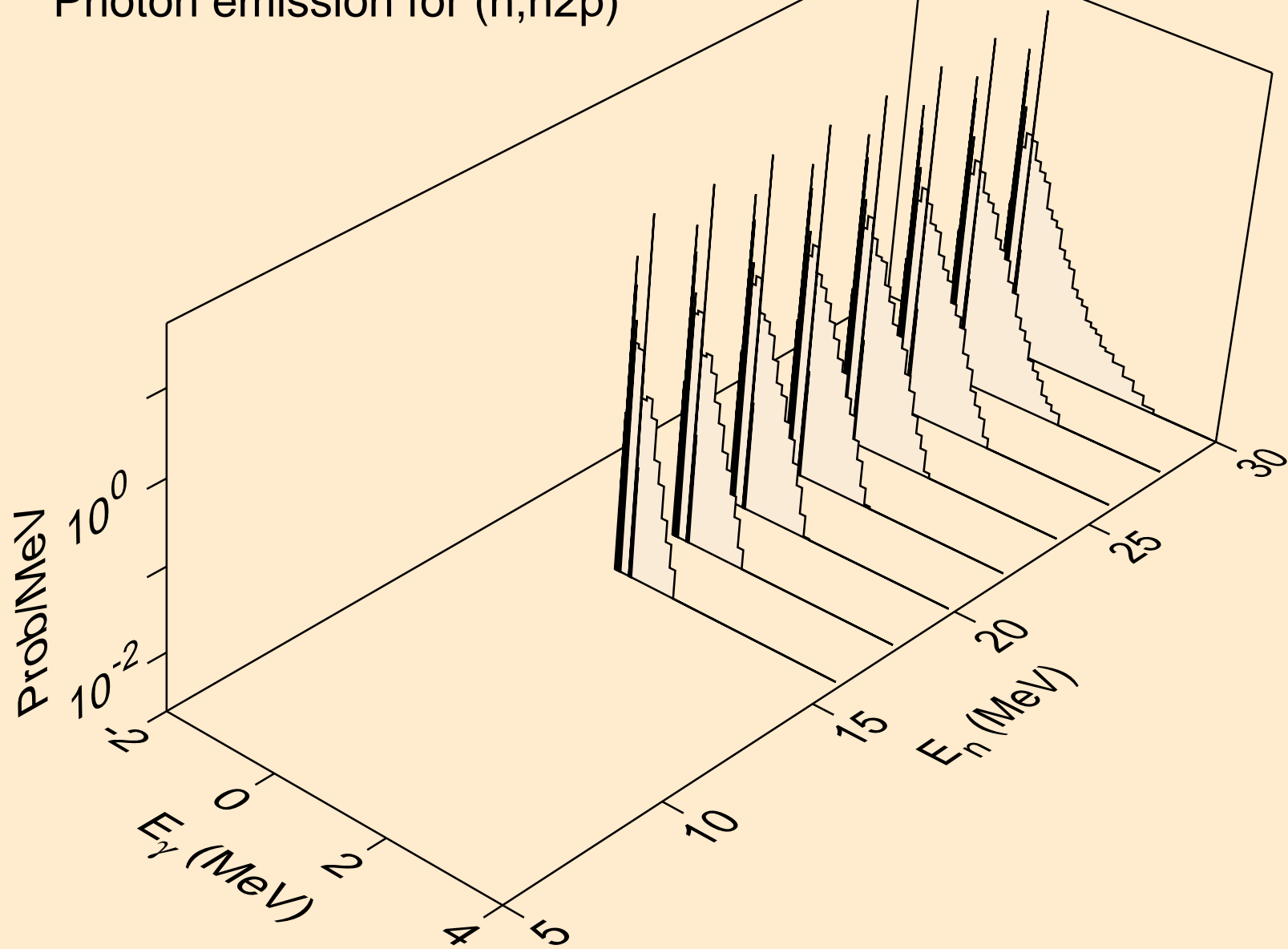

AM233 NEUTRON ACER TENDL-2024 LIBRARY; T=0.K  
Photon emission for (n,npa)

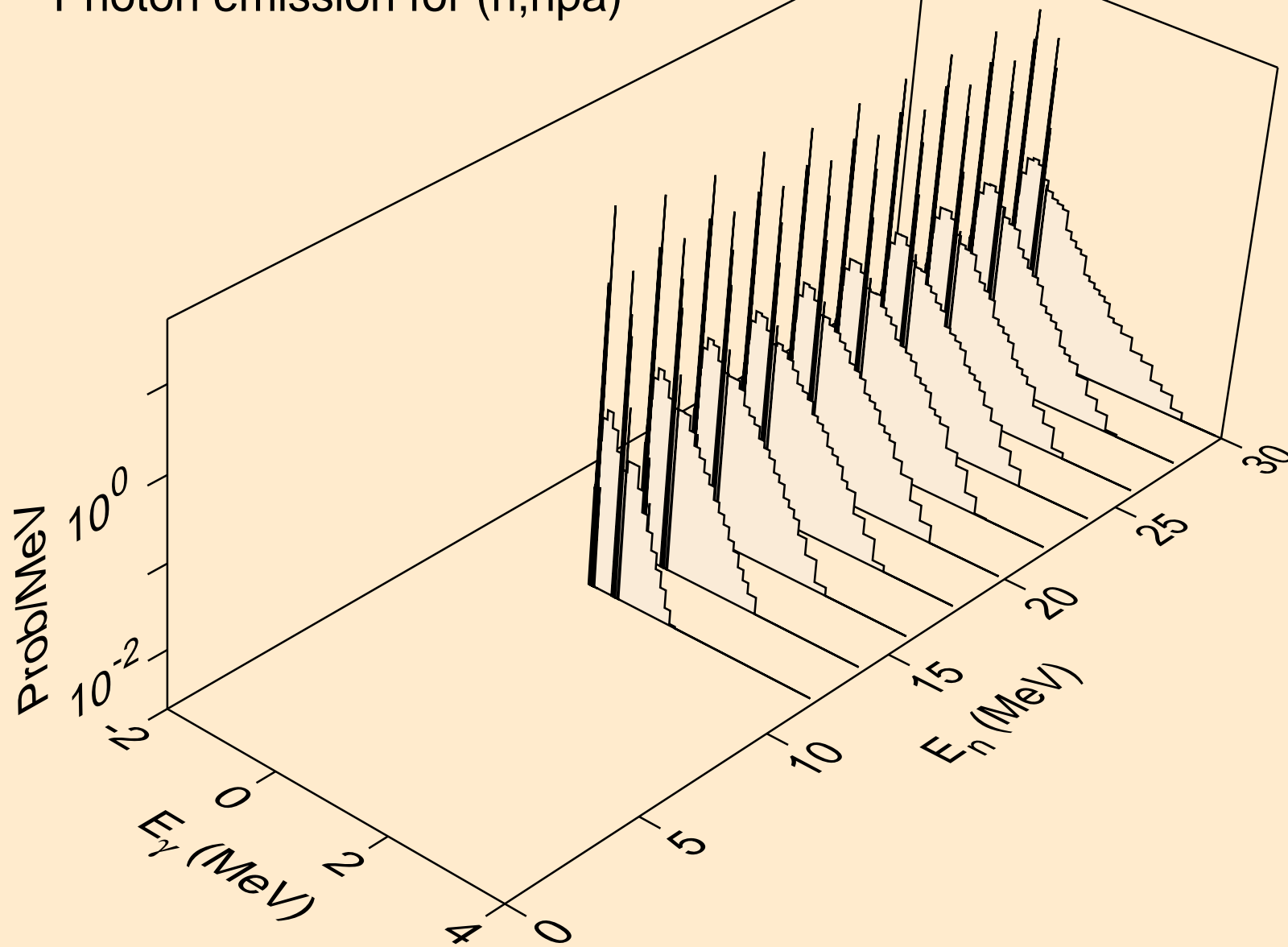

AM233 NEUTRON ACER TENDL-2024 LIBRARY; T=0.K  
Photon emission for (n,n\*c)

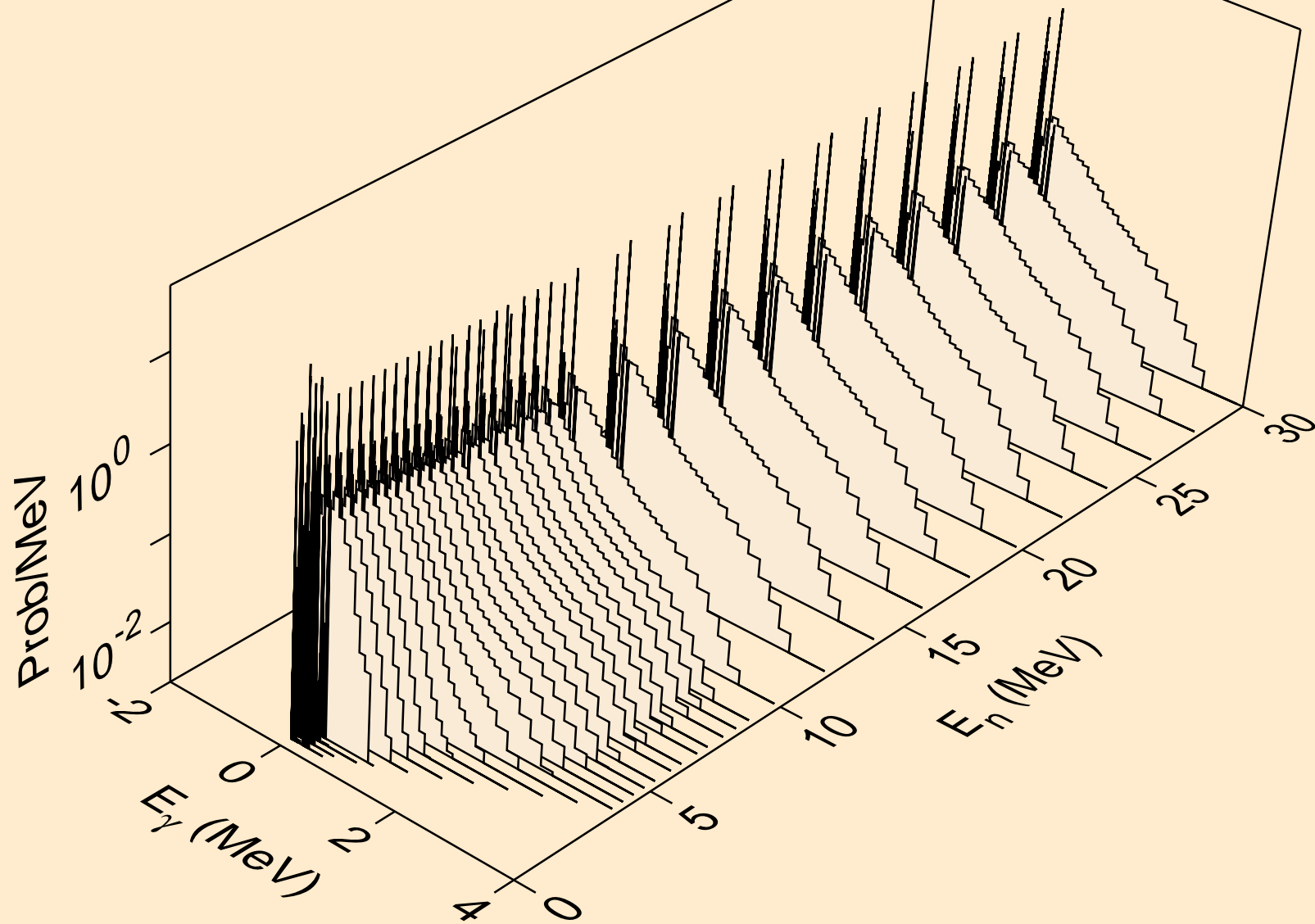

AM233 NEUTRON ACER TENDL-2024 LIBRARY; T=0.K  
Photon emission for (n,gma)

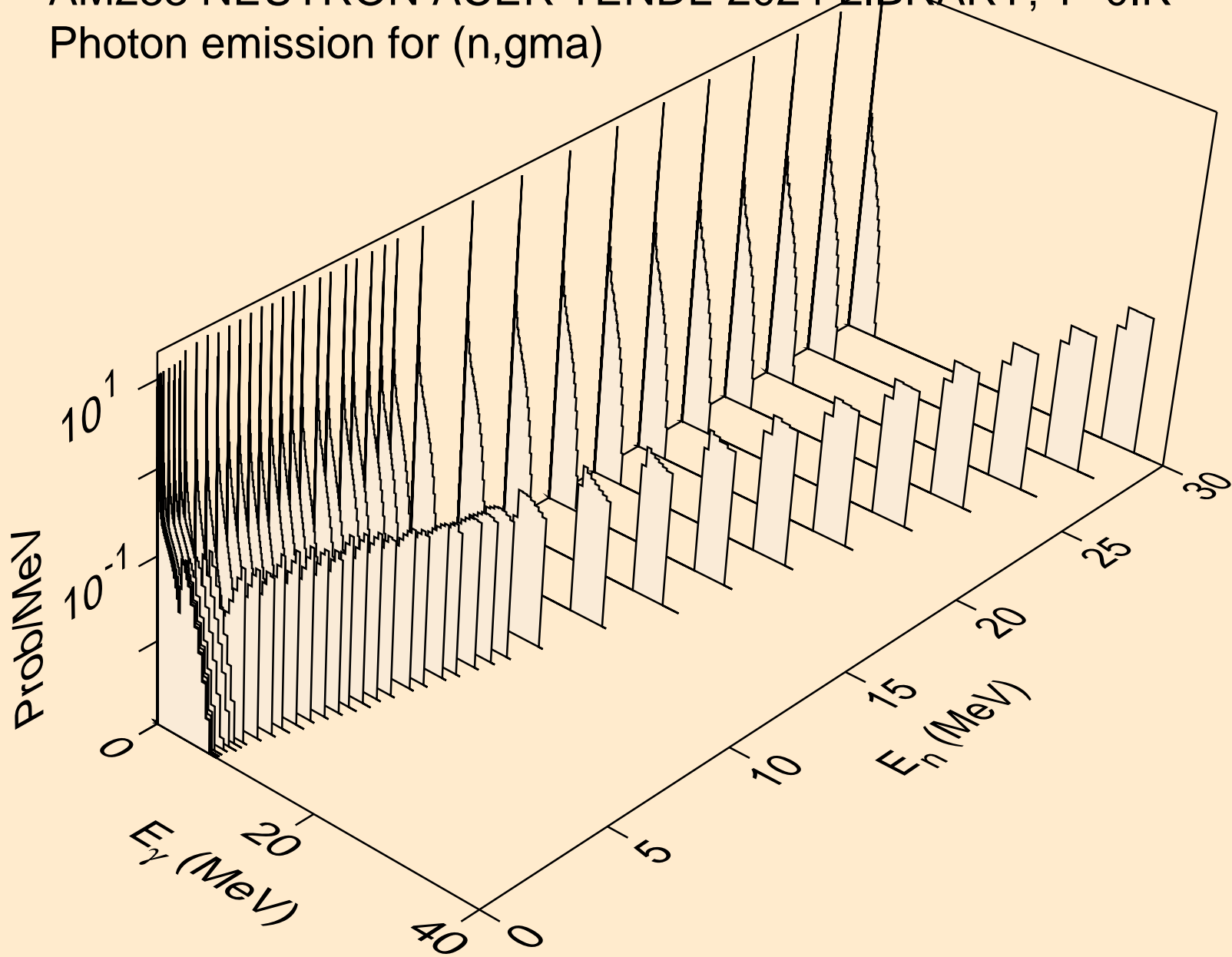



AM233 NEUTRON ACER TENDL-2024 LIBRARY; T=0.K  
Photon emission for (n,p)

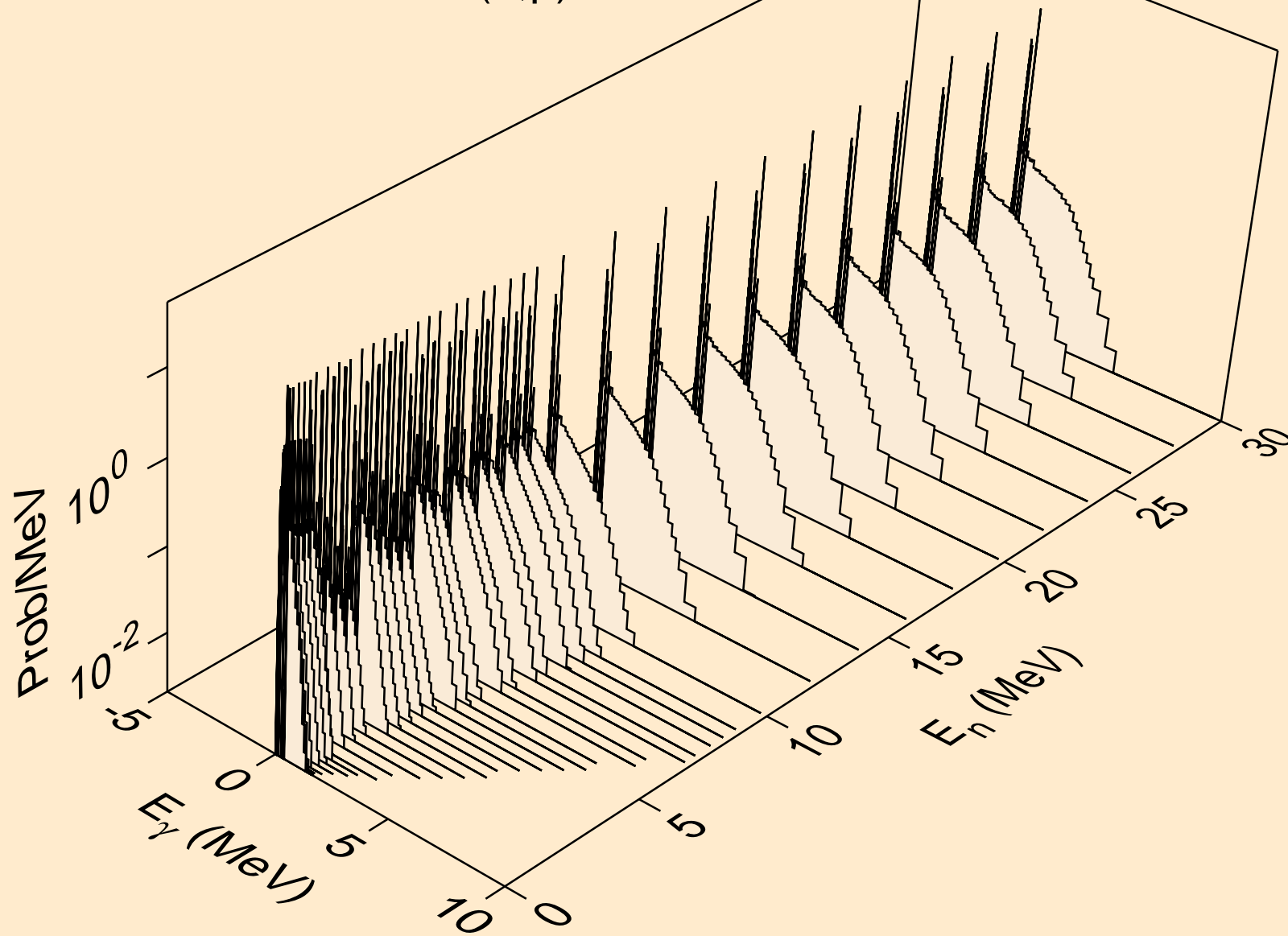

AM233 NEUTRON ACER TENDL-2024 LIBRARY; T=0.K  
Photon emission for (n,d)

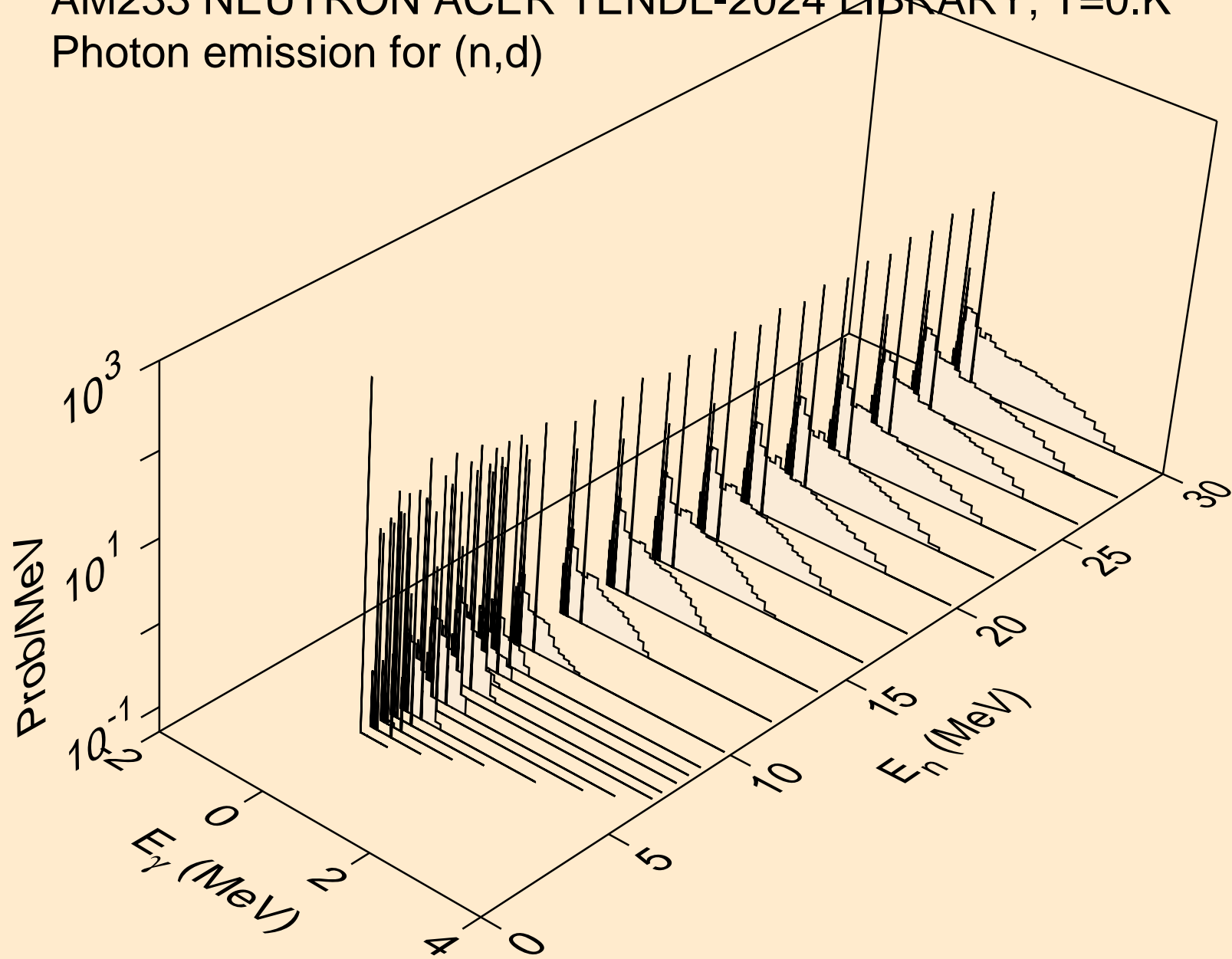

AM233 NEUTRON ACER TENDL-2024 LIBRARY; T=0.K  
Photon emission for (n,t)

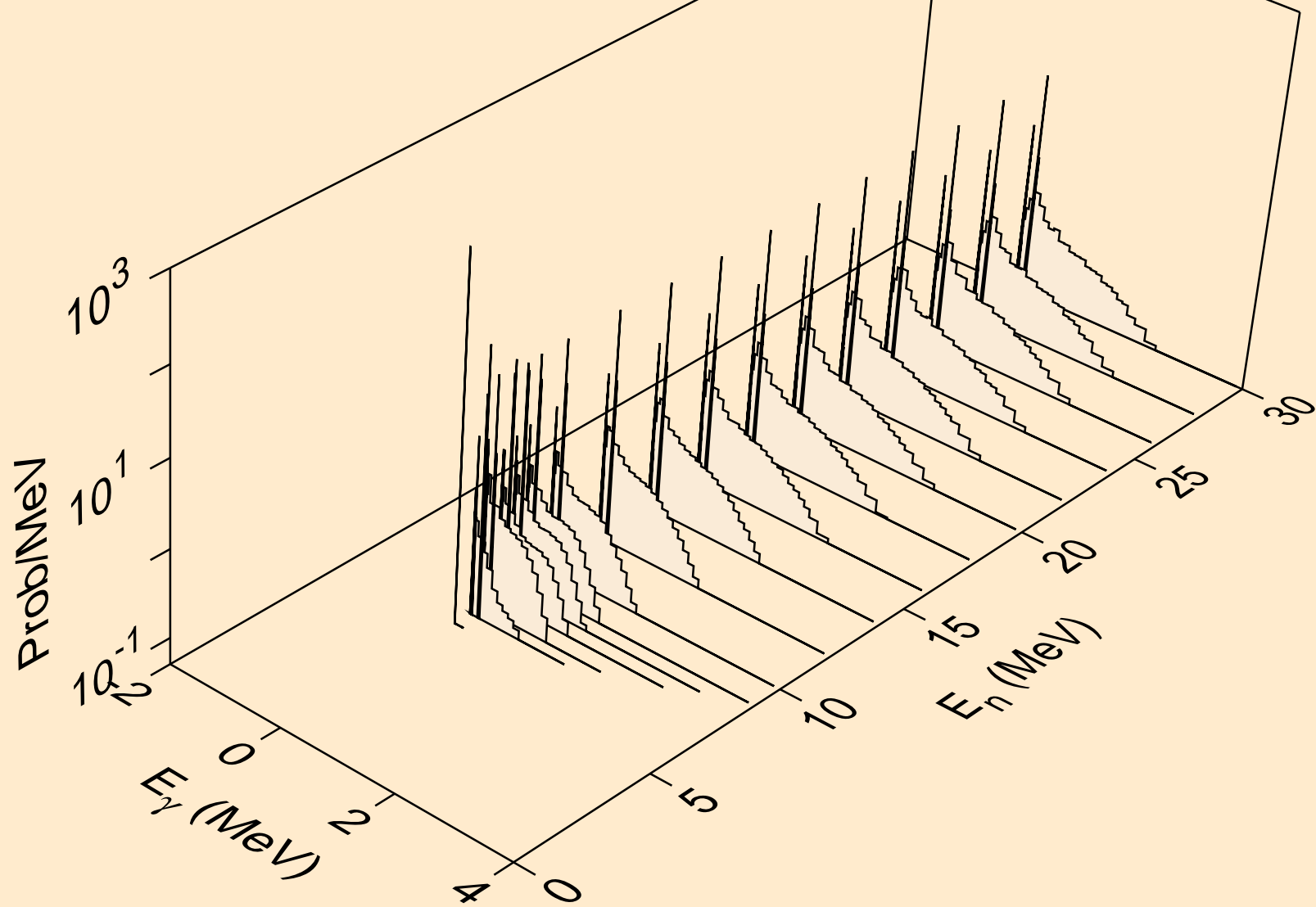

AM233 NEUTRON ACER TENDL-2024 LIBRARY; T=0.K  
Photon emission for (n,he3)

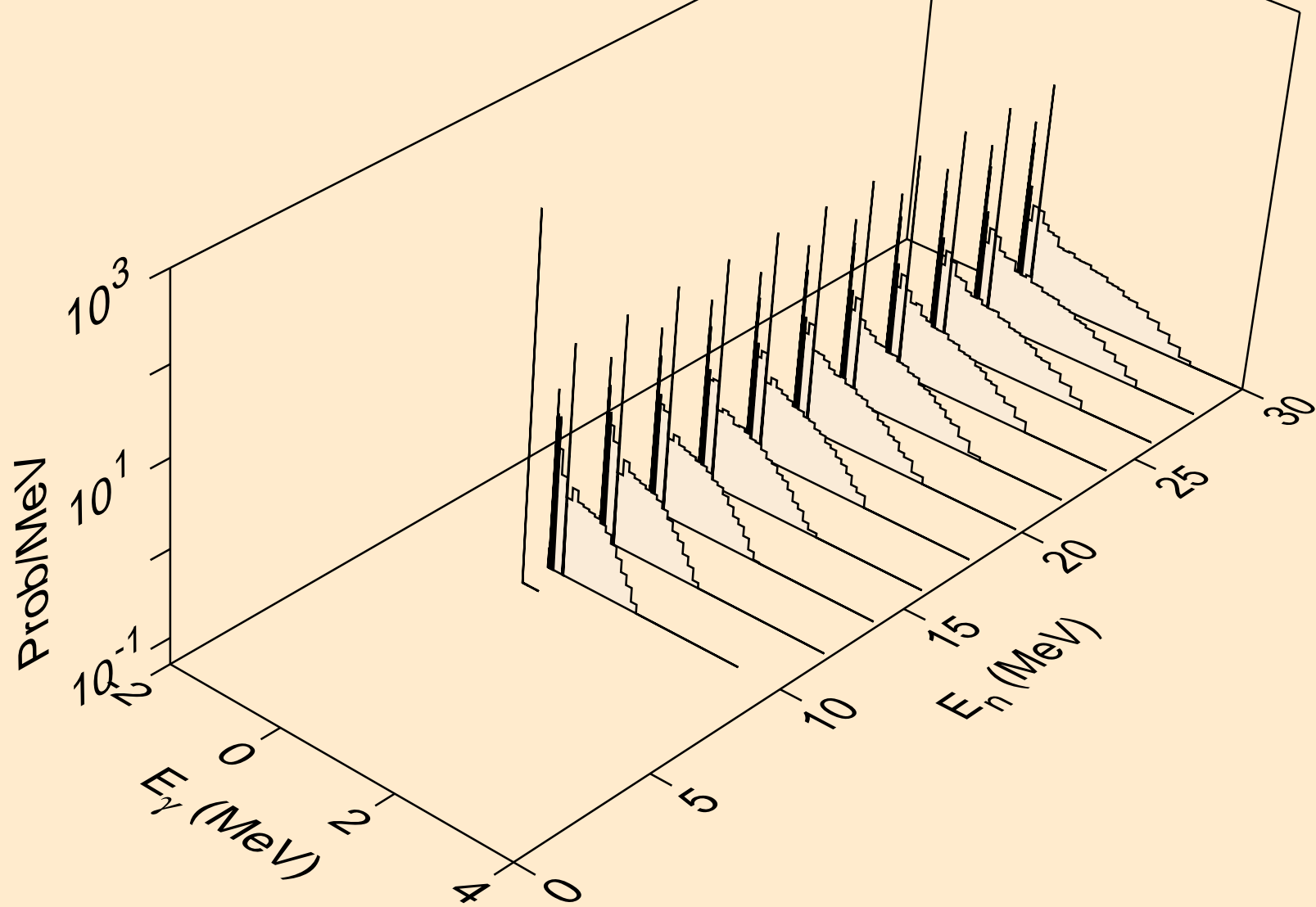

AM233 NEUTRON ACER TENDL-2024 LIBRARY; T=0.K  
Photon emission for (n,a)

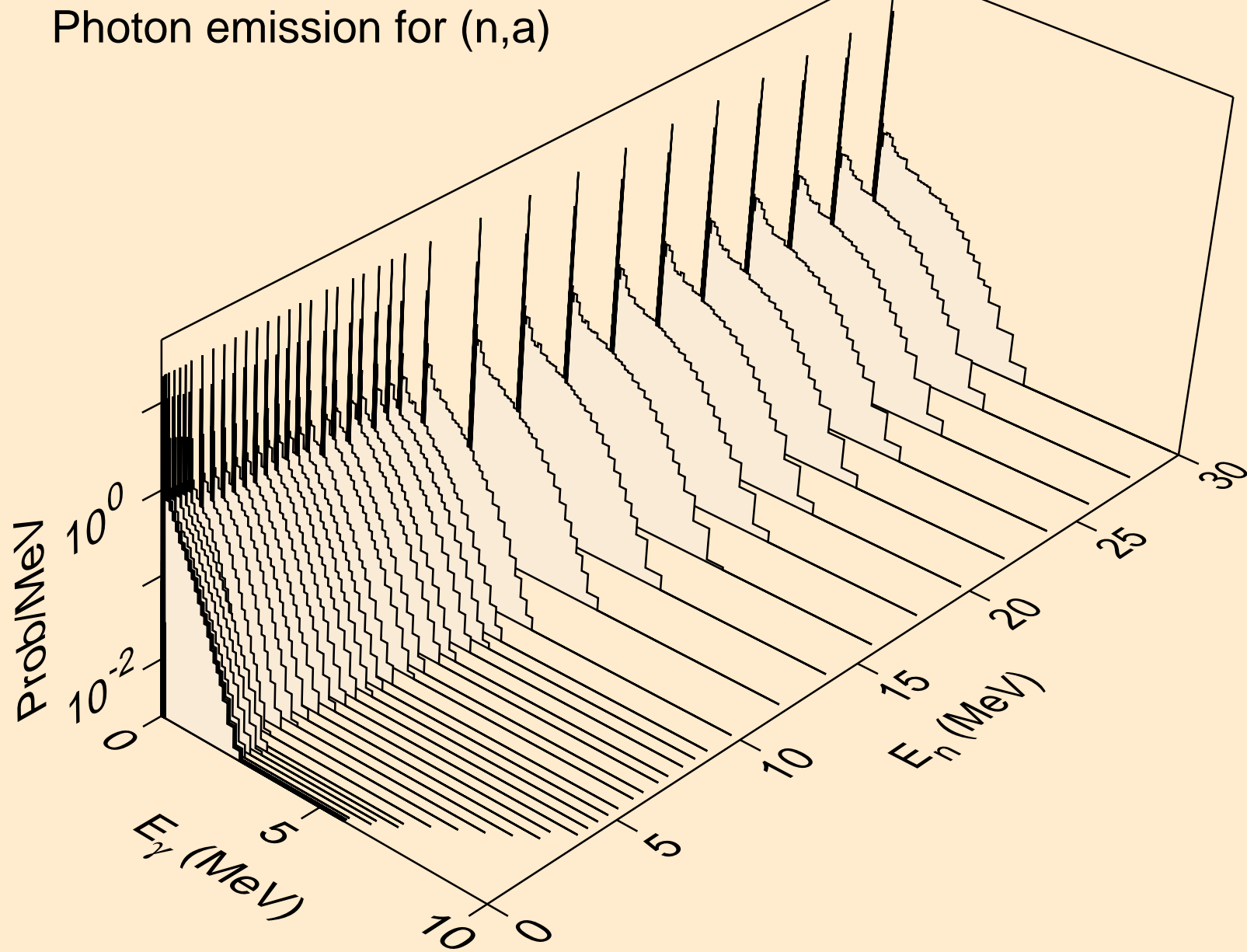

AM233 NEUTRON ACER TENDL-2024 LIBRARY; T=0.K  
Photon emission for (n,2a)

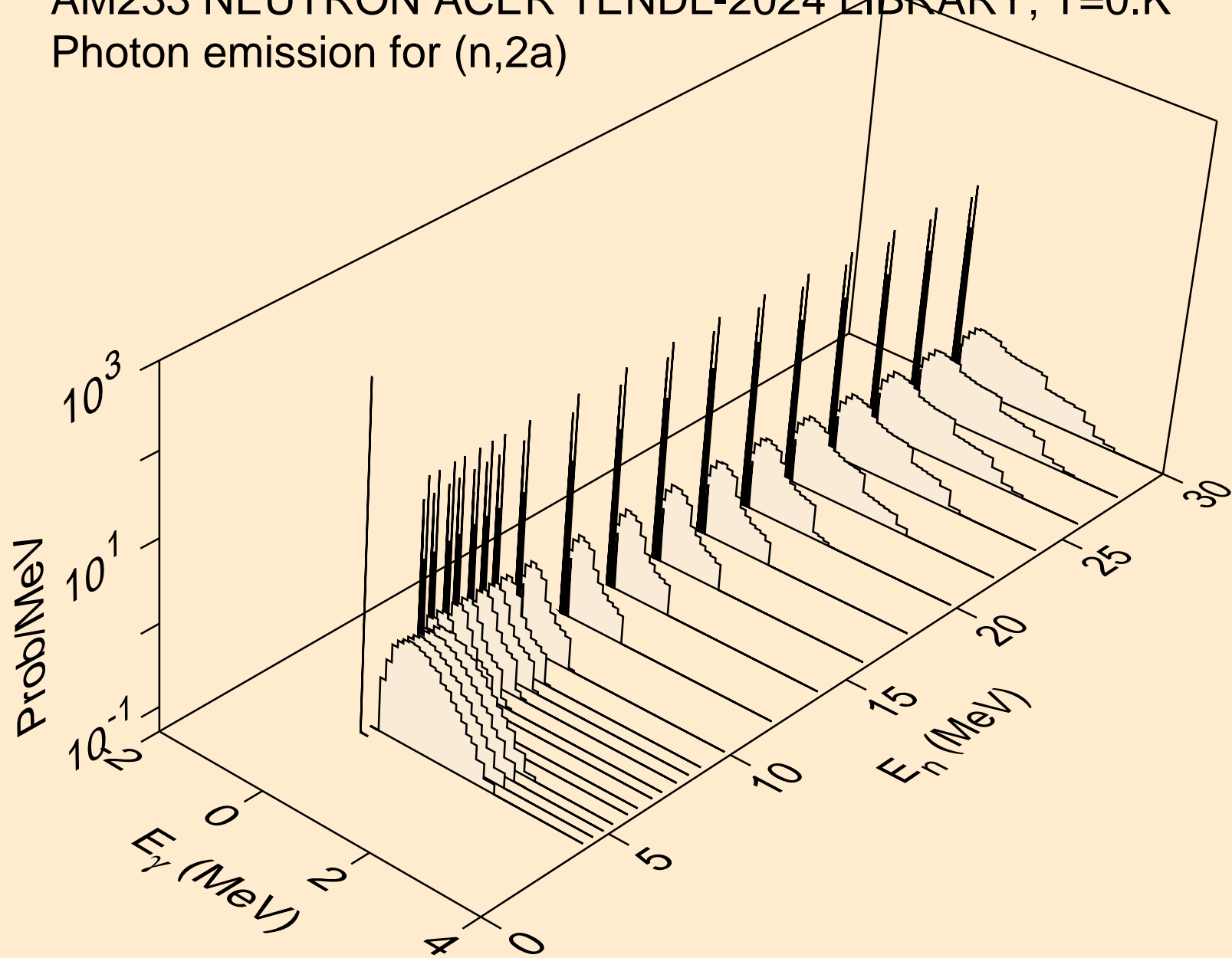

AM233 NEUTRON ACER TENDL-2024 LIBRARY; T=0.K  
Photon emission for (n,2p)

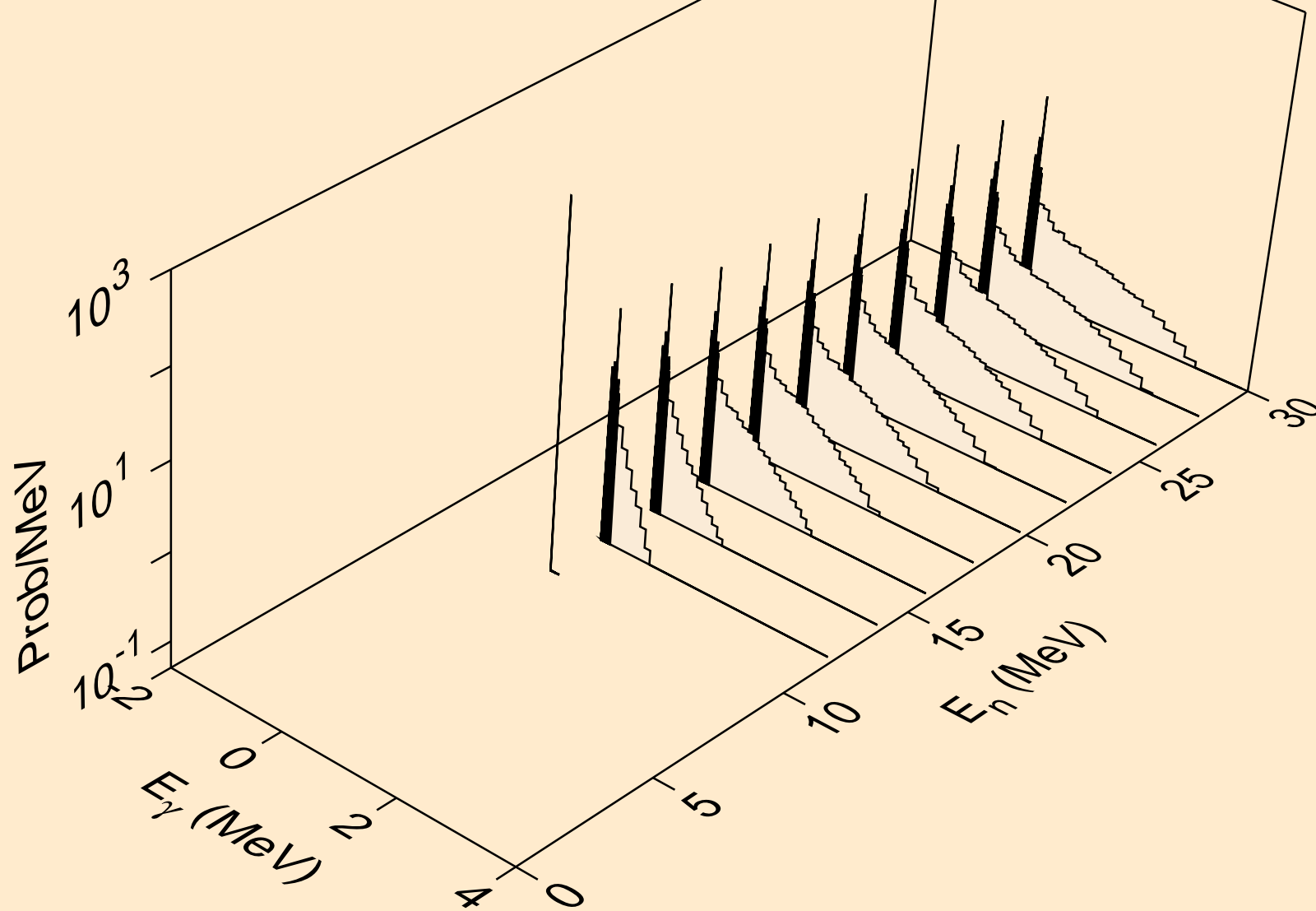

AM233 NEUTRON ACER TENDL-2024 LIBRARY; T=0.K  
Photon emission for (n,p $\alpha$ )

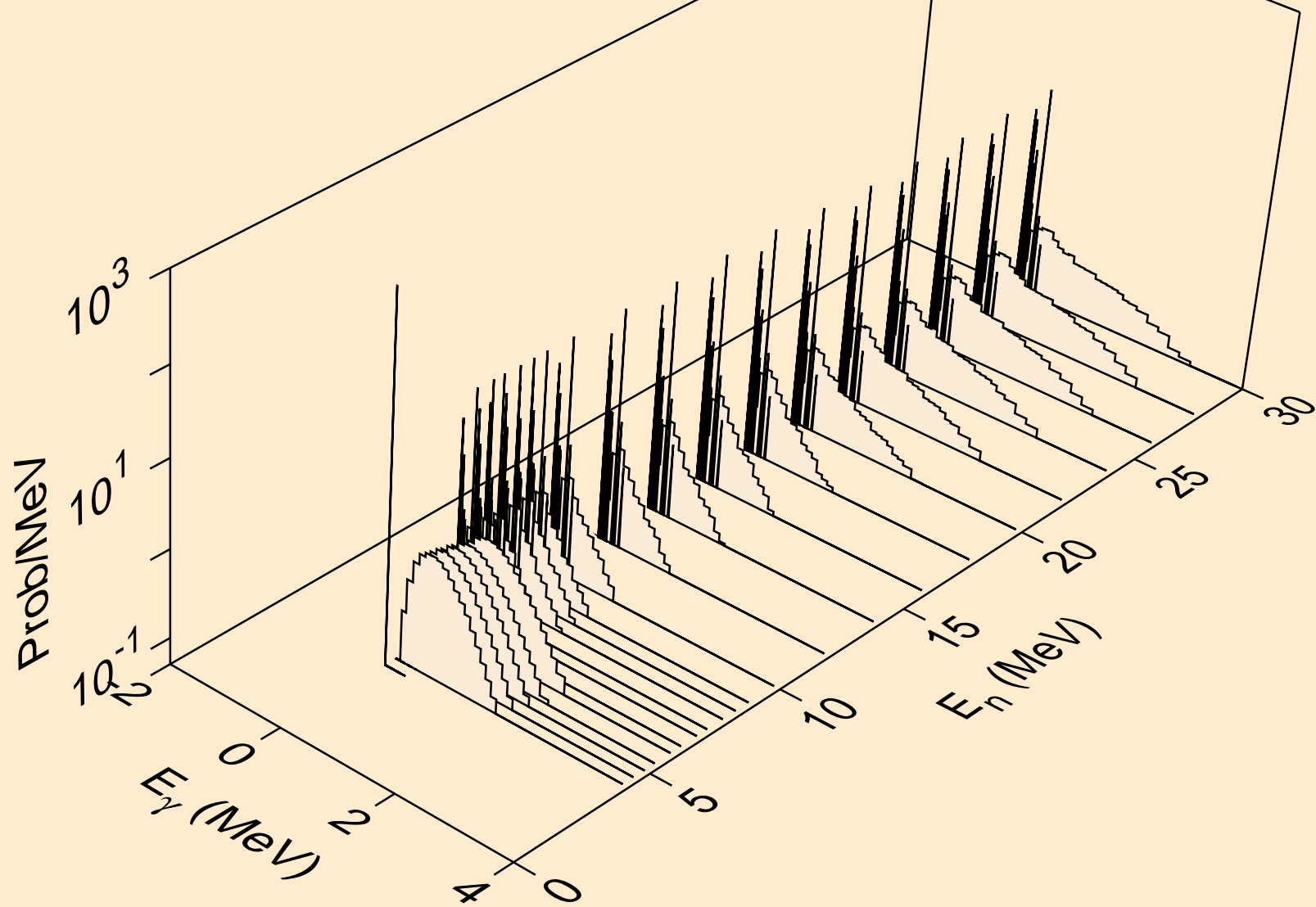



AM233 NEUTRON ACER TENDL-2024 LIBRARY; T=0.K  
Photon emission for (n,pd)

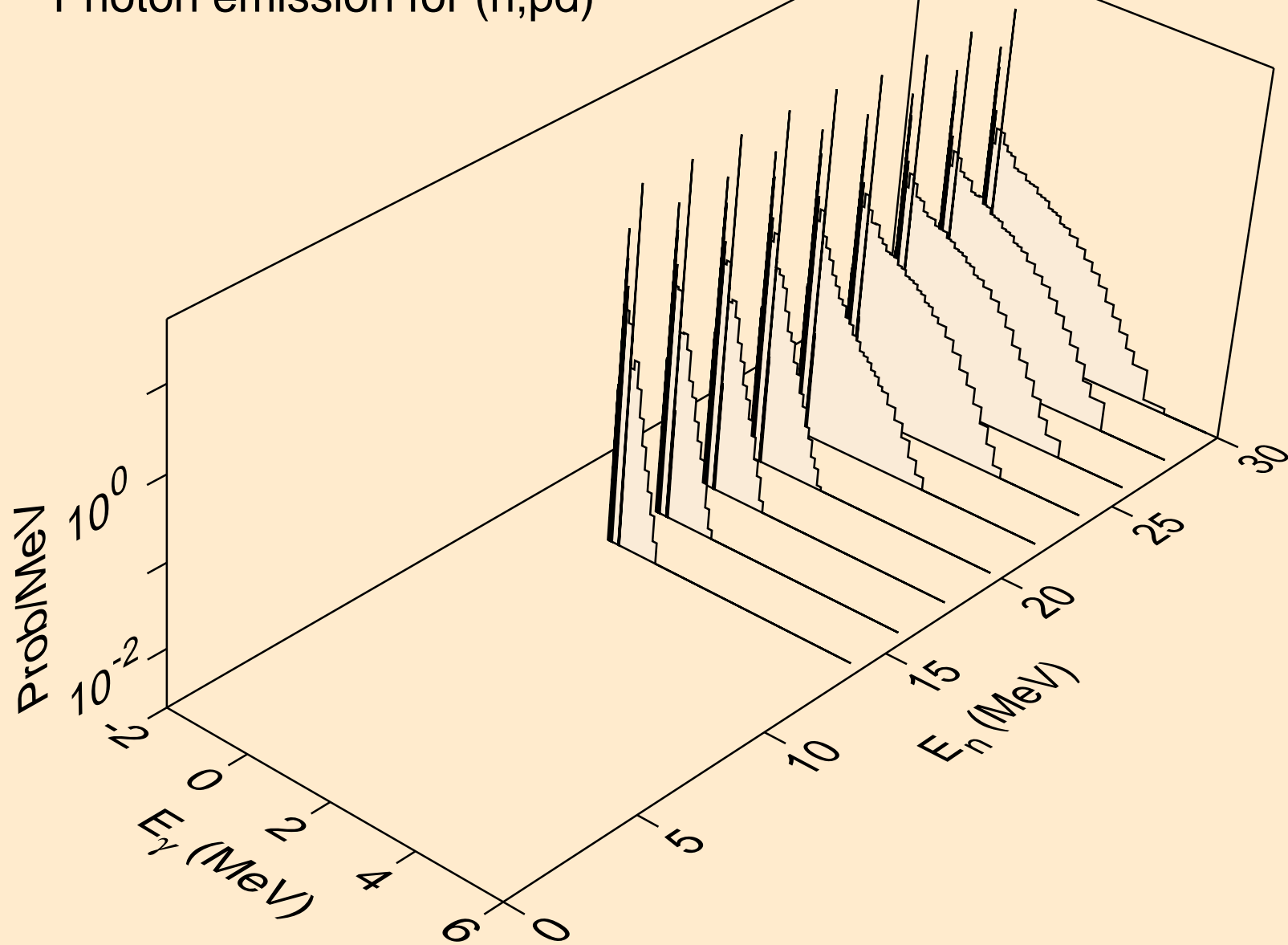

AM233 NEUTRON ACER TENDL-2024 LIBRARY; T=0.K  
Photon emission for (n,da)

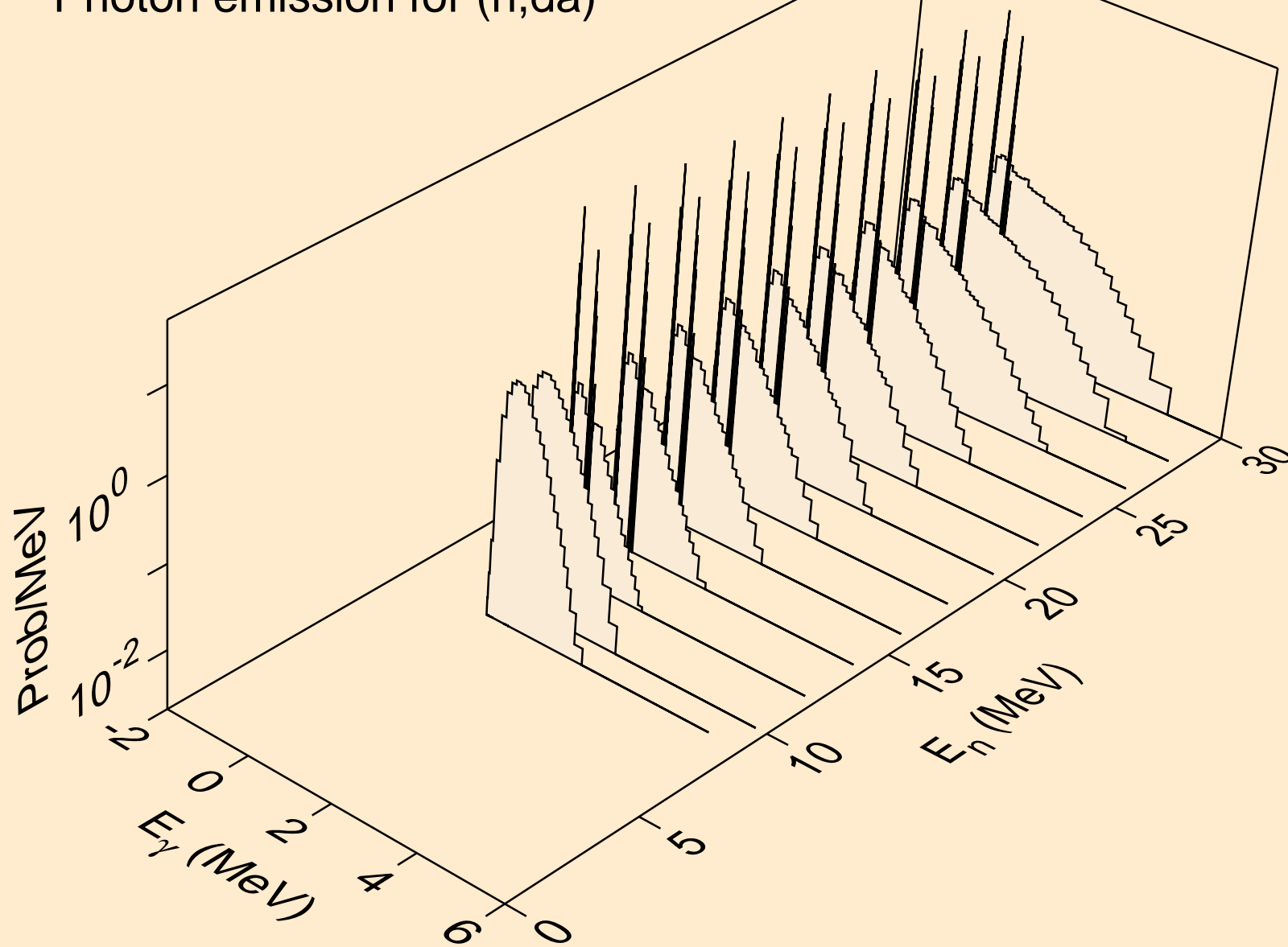

AM233 NEUTRON ACER TENDL-2024 LIBRARY; T=0.K  
thermal capture photon spectrum

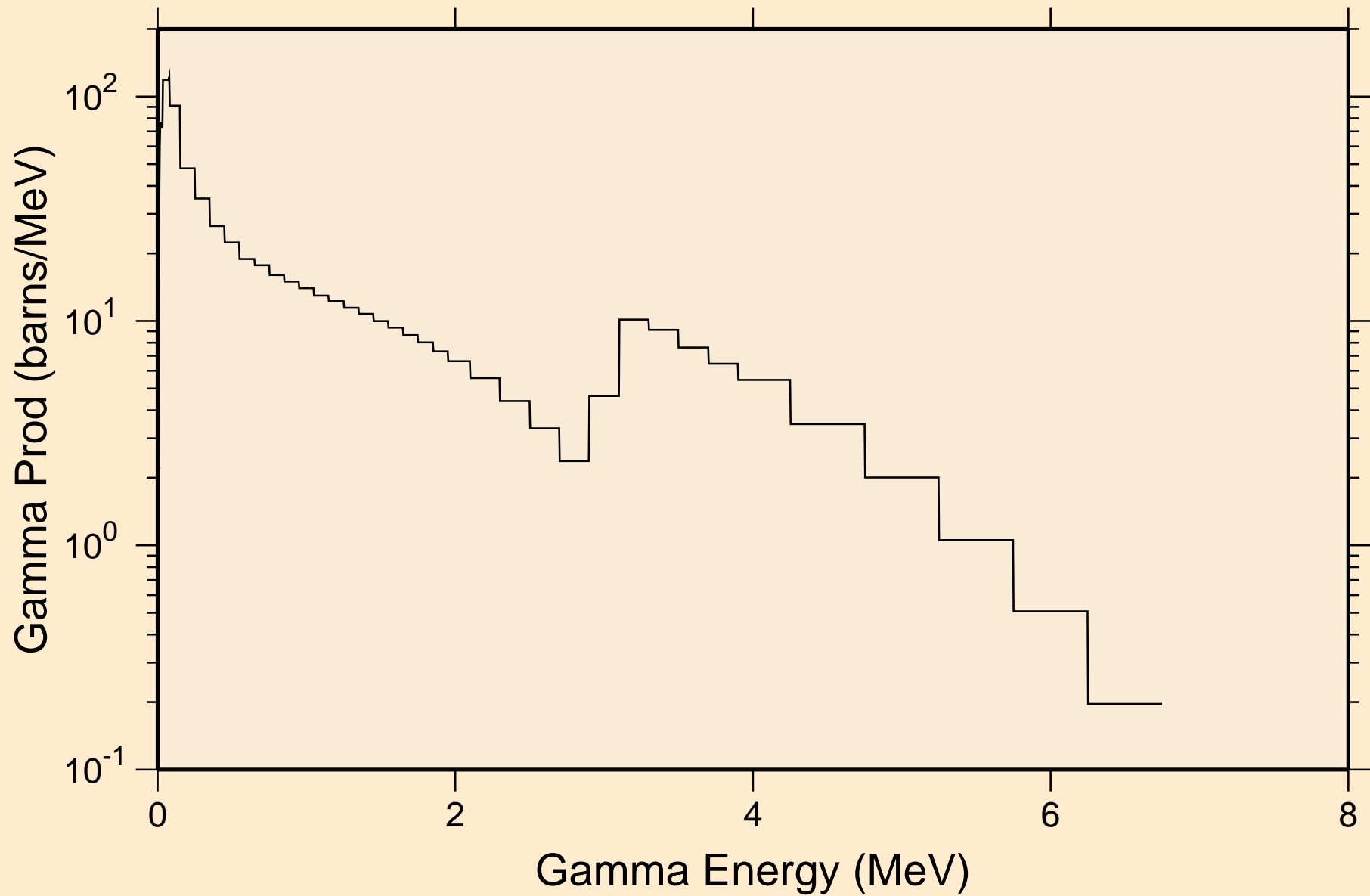

AM233 NEUTRON ACER TENDL-2024 LIBRARY; T=0.K  
14 MeV photon spectrum

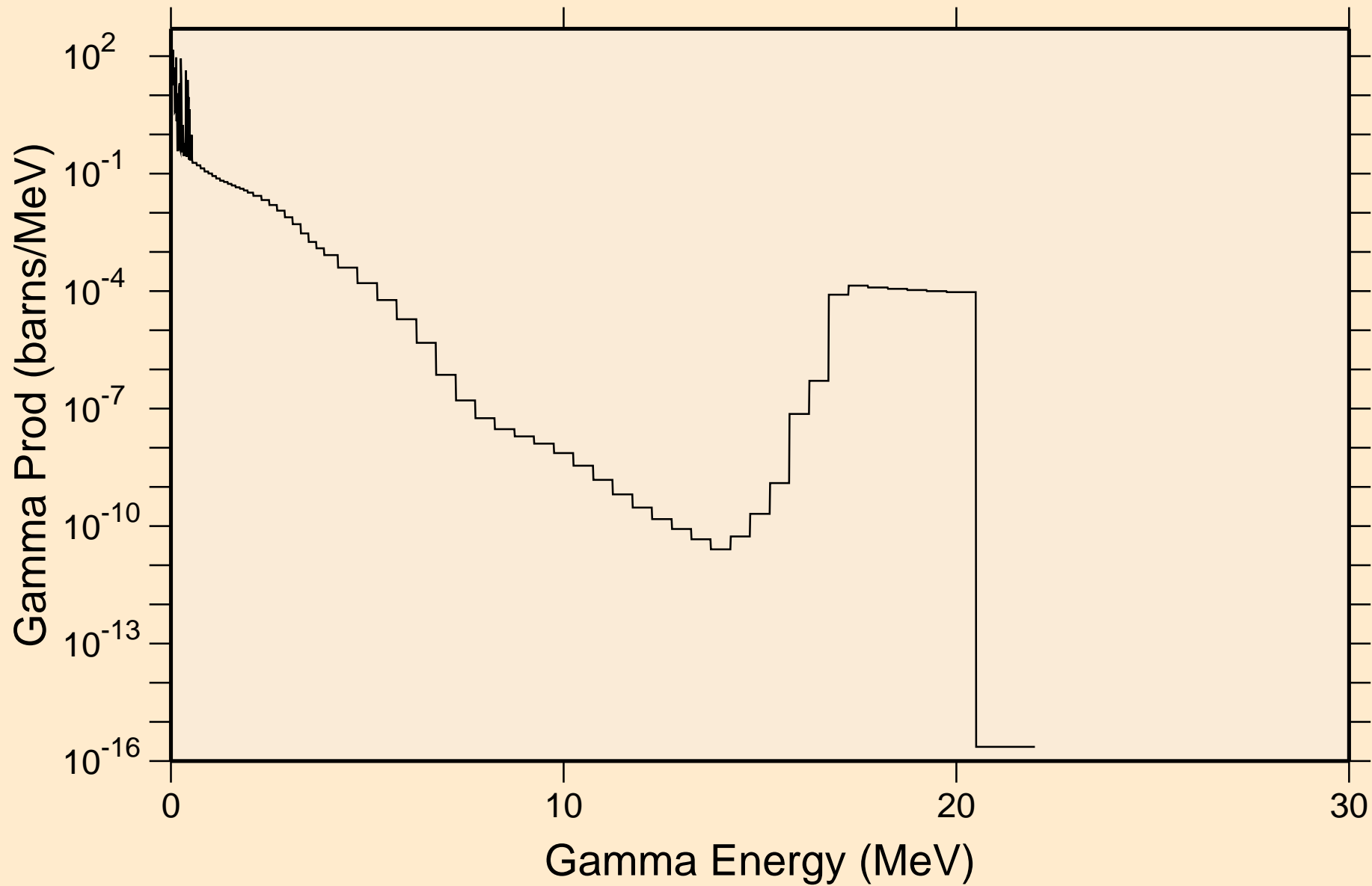

AM233 NEUTRON ACER TENDL-2024 LIBRARY; T=0.K  
Particle heating contributions

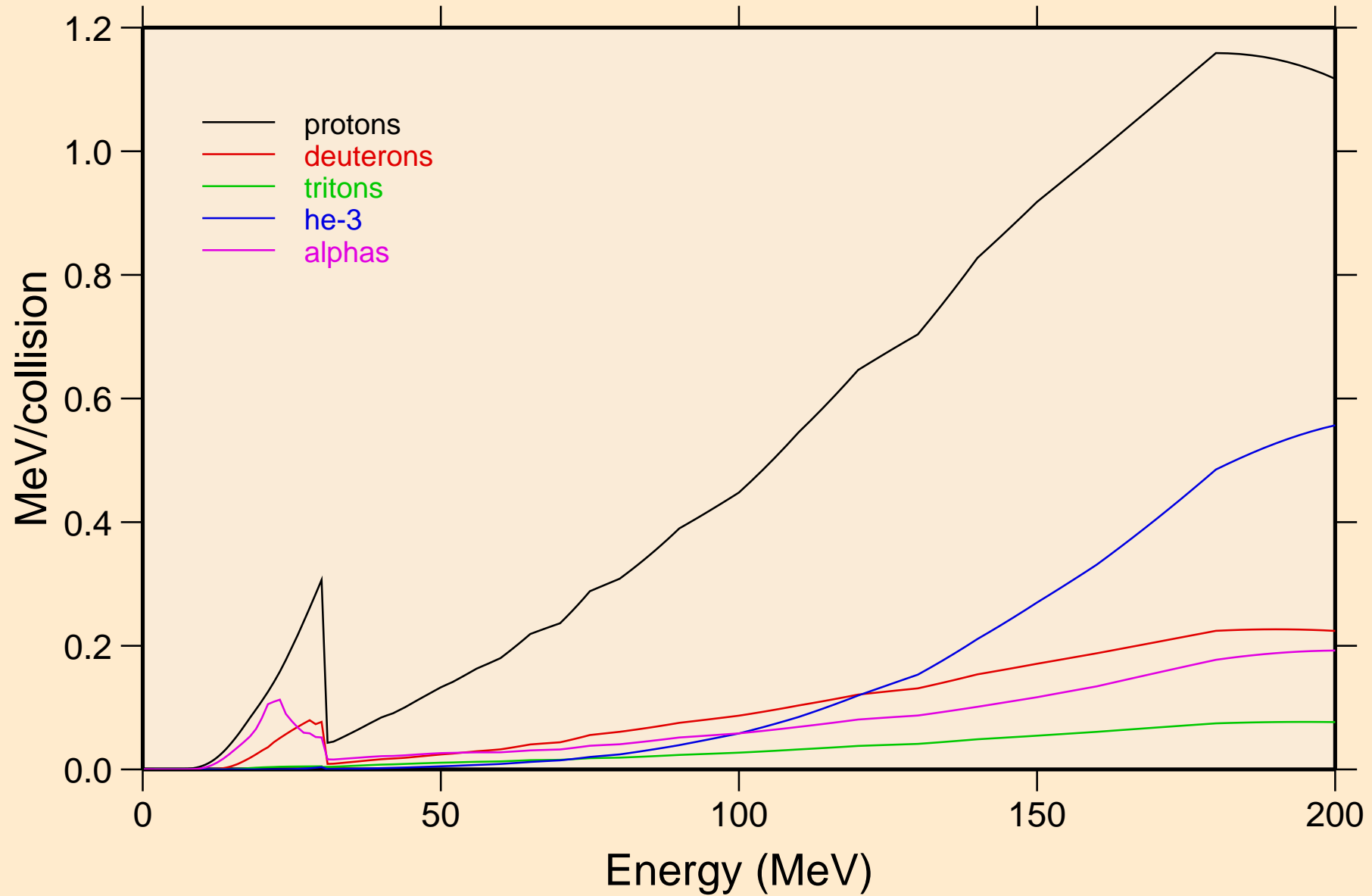

AM233 NEUTRON ACER TENDL-2024 LIBRARY; T=0.K  
Recoil Heating

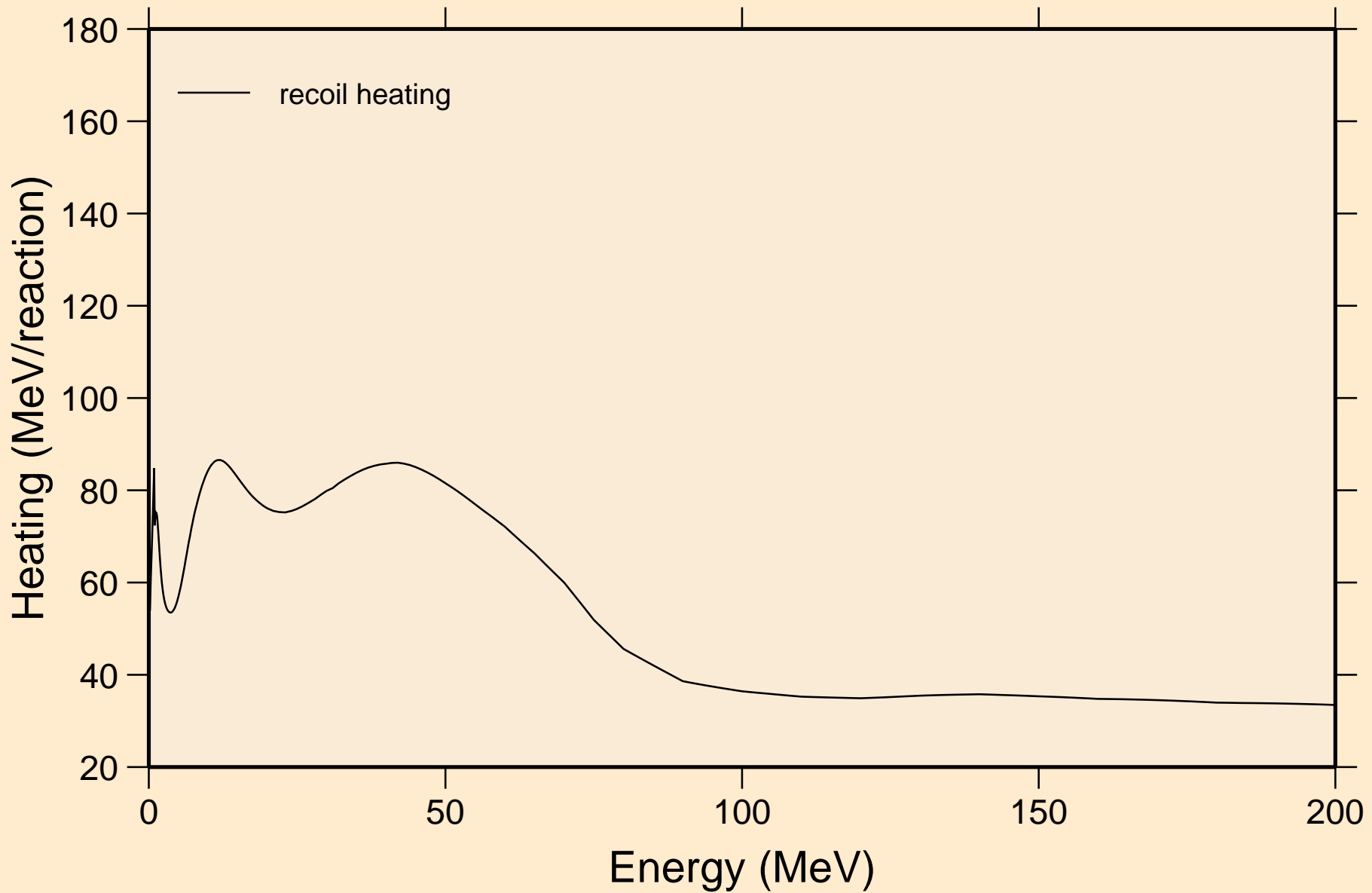

# AM233 NEUTRON ACER TENDL-2024 LIBRARY; T=0.K

## Particle production cross sections

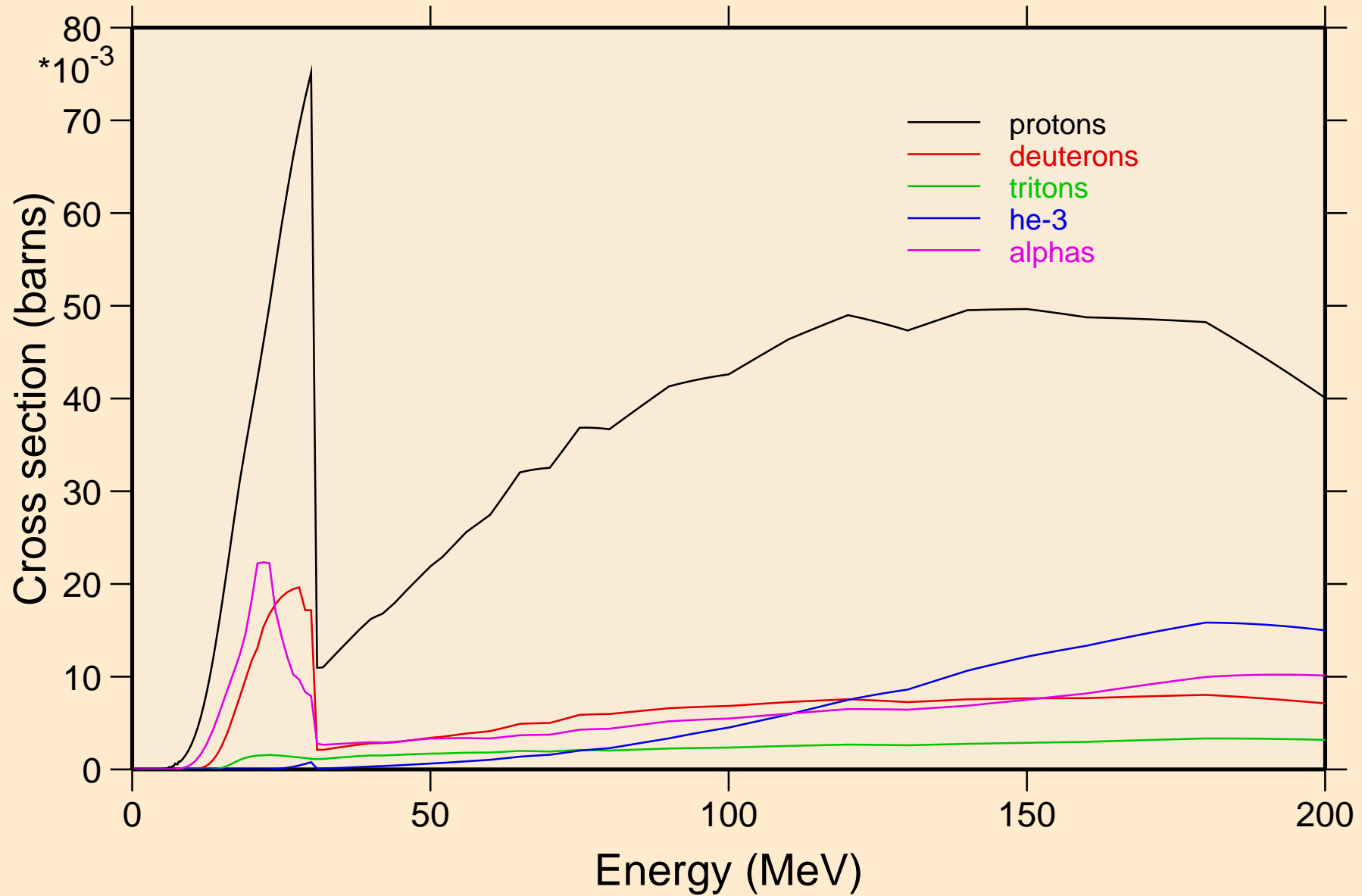

AM233 NEUTRON ACER TENDL-2024 LIBRARY; T=0.K  
protons from (n,x)

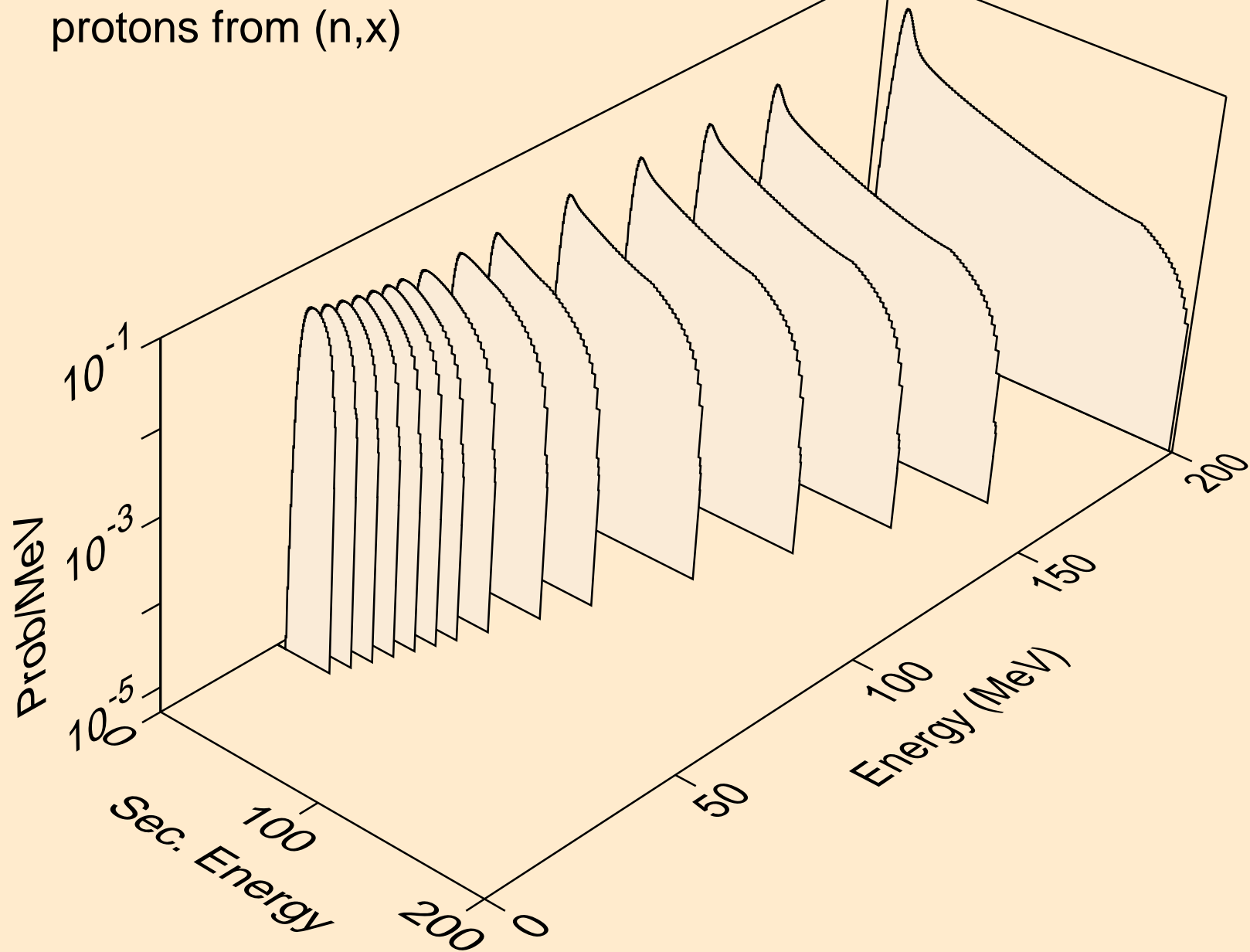



AM233 NEUTRON ACER TENDL-2024 LIBRARY; T=0.K  
protons from (n,n\*)p

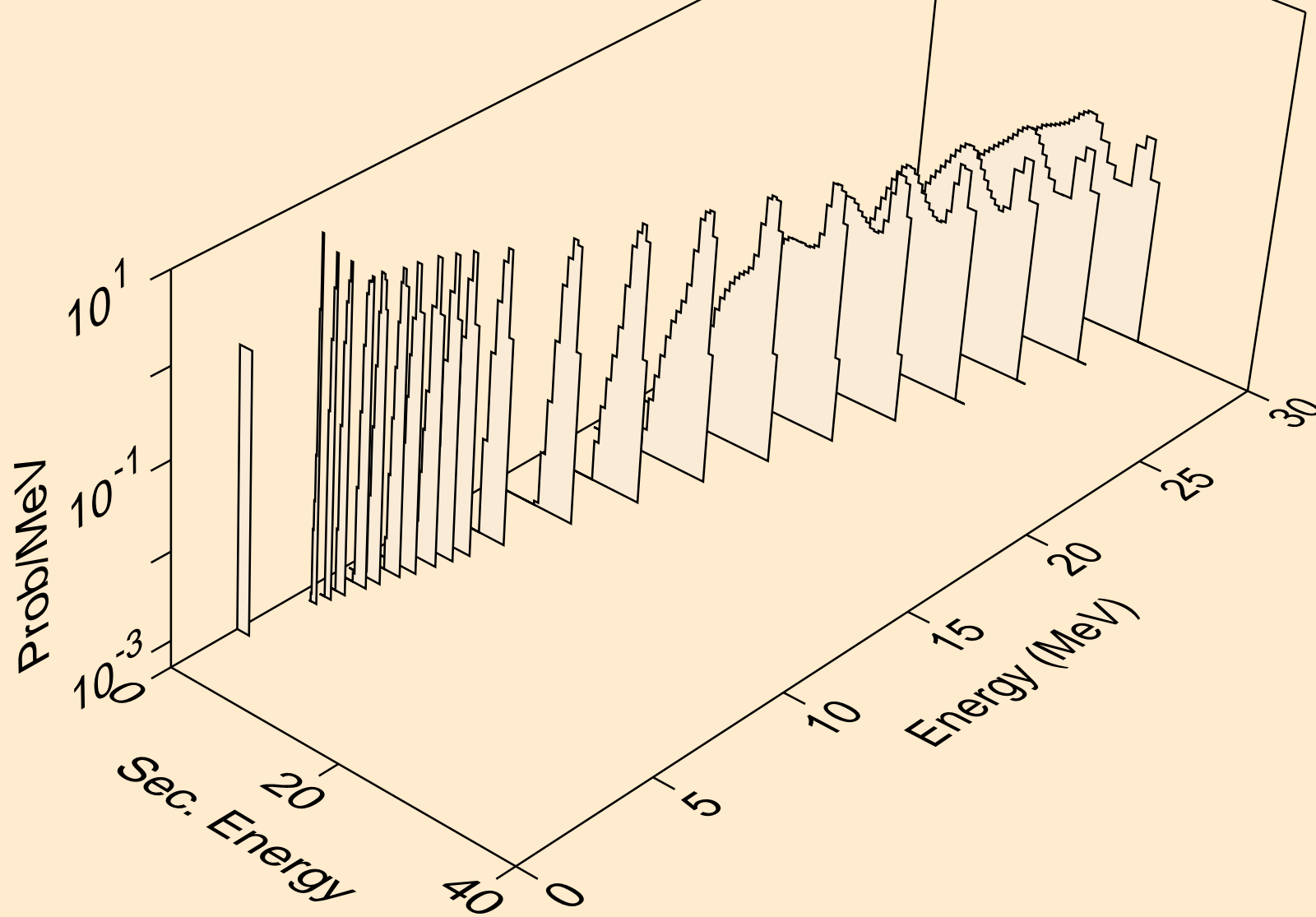

AM233 NEUTRON ACER TENDL-2024 LIBRARY; T=0.K  
protons from (n,2np)

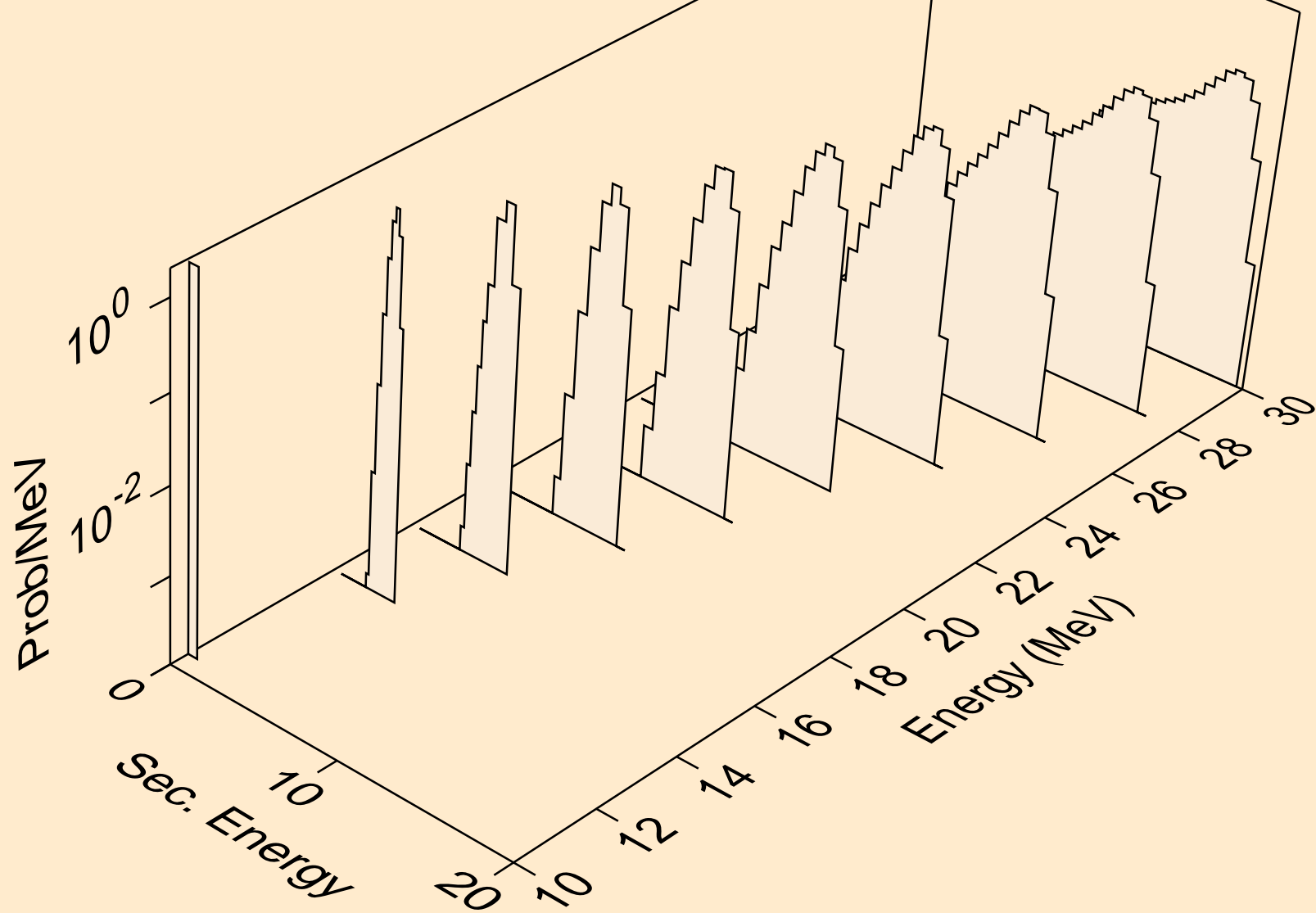

AM233 NEUTRON ACER TENDL-2024 LIBRARY; T=0.K  
protons from (n,n2p)

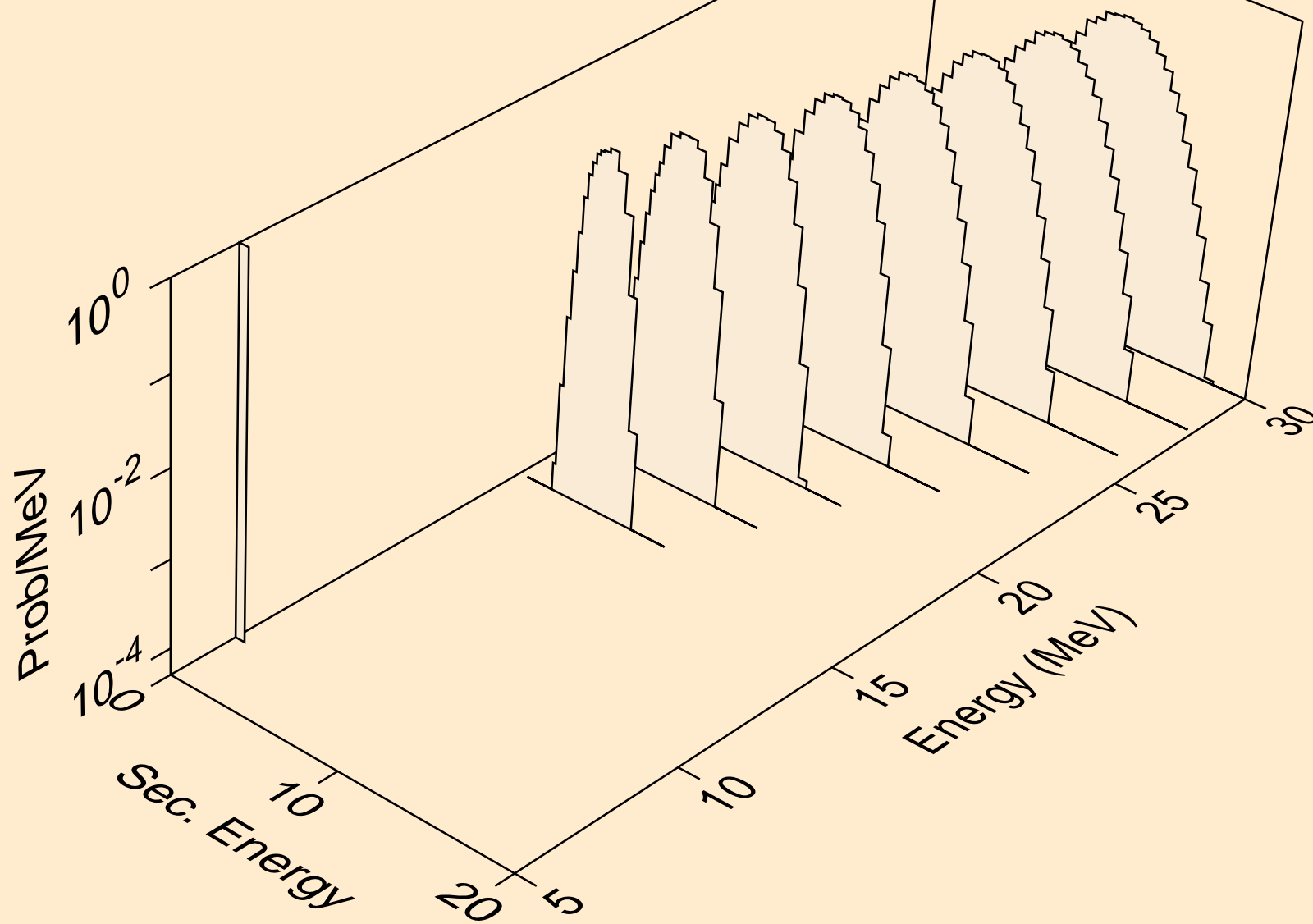

AM233 NEUTRON ACER TENDL-2024 LIBRARY; T=0.K  
protons from (n,npa)

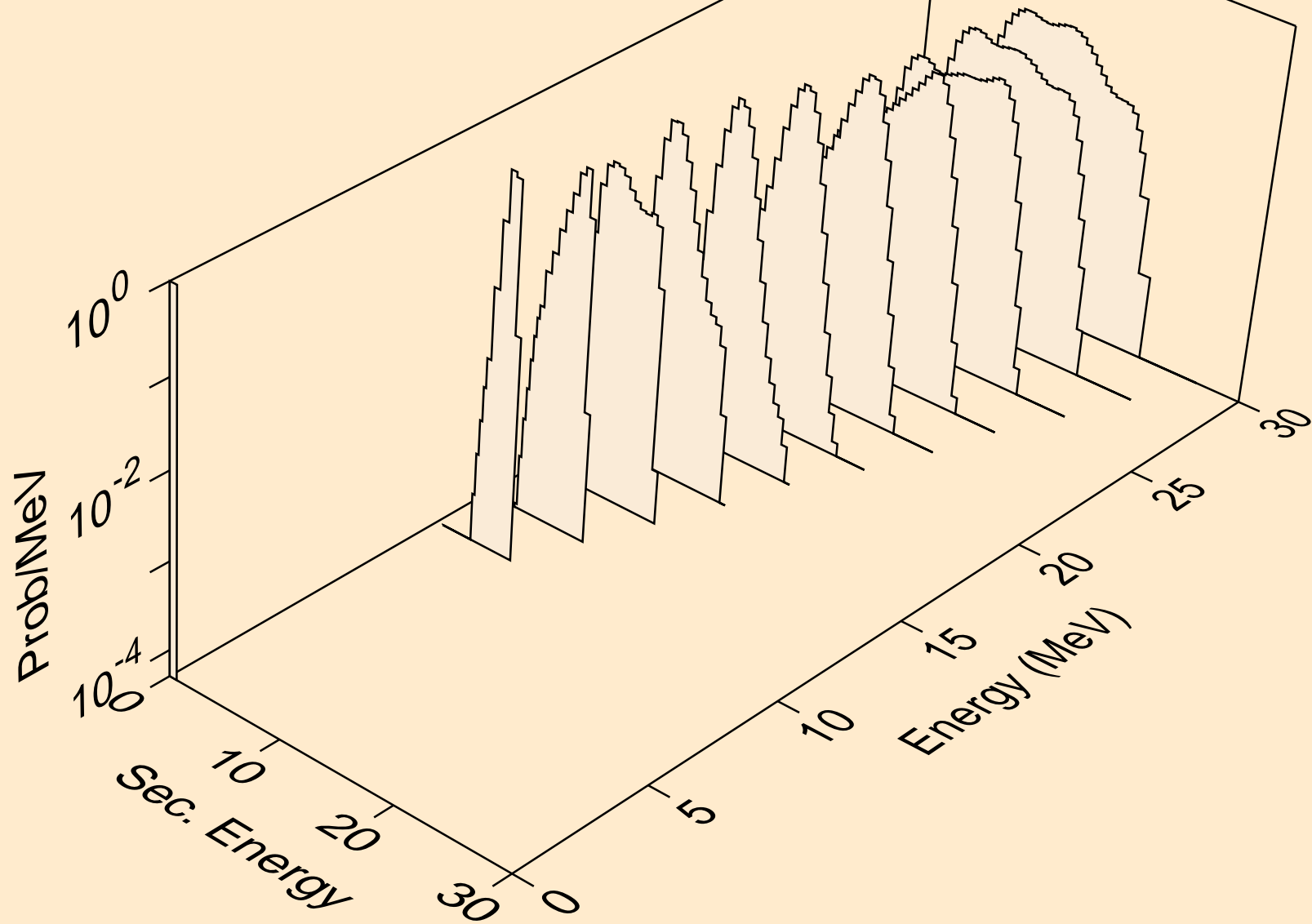

AM233 NEUTRON ACER TENDL-2024 LIBRARY; T=0.K  
protons from (n,p)

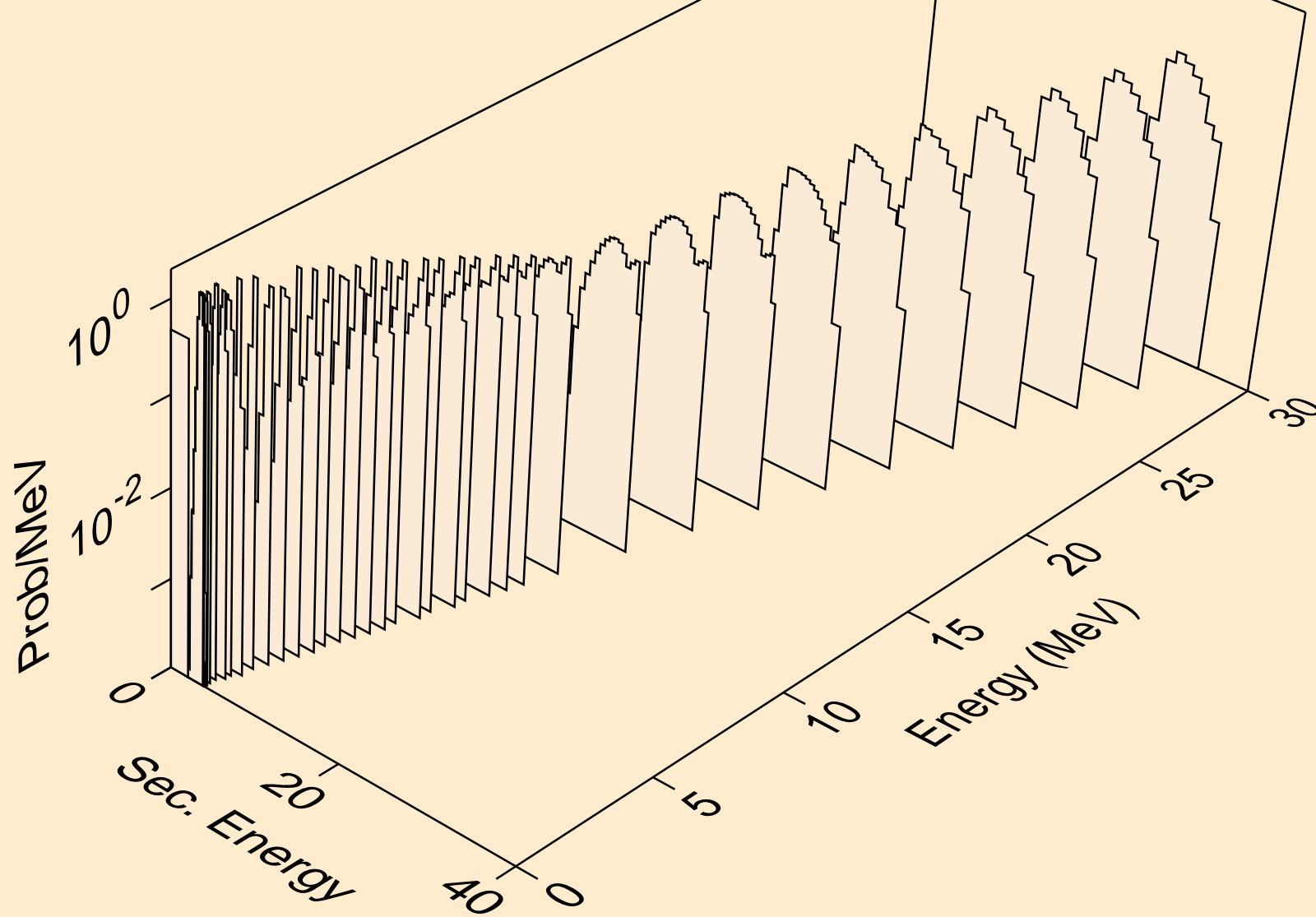

AM233 NEUTRON ACER TENDL-2024 LIBRARY; T=0.K  
protons from (n,2p)

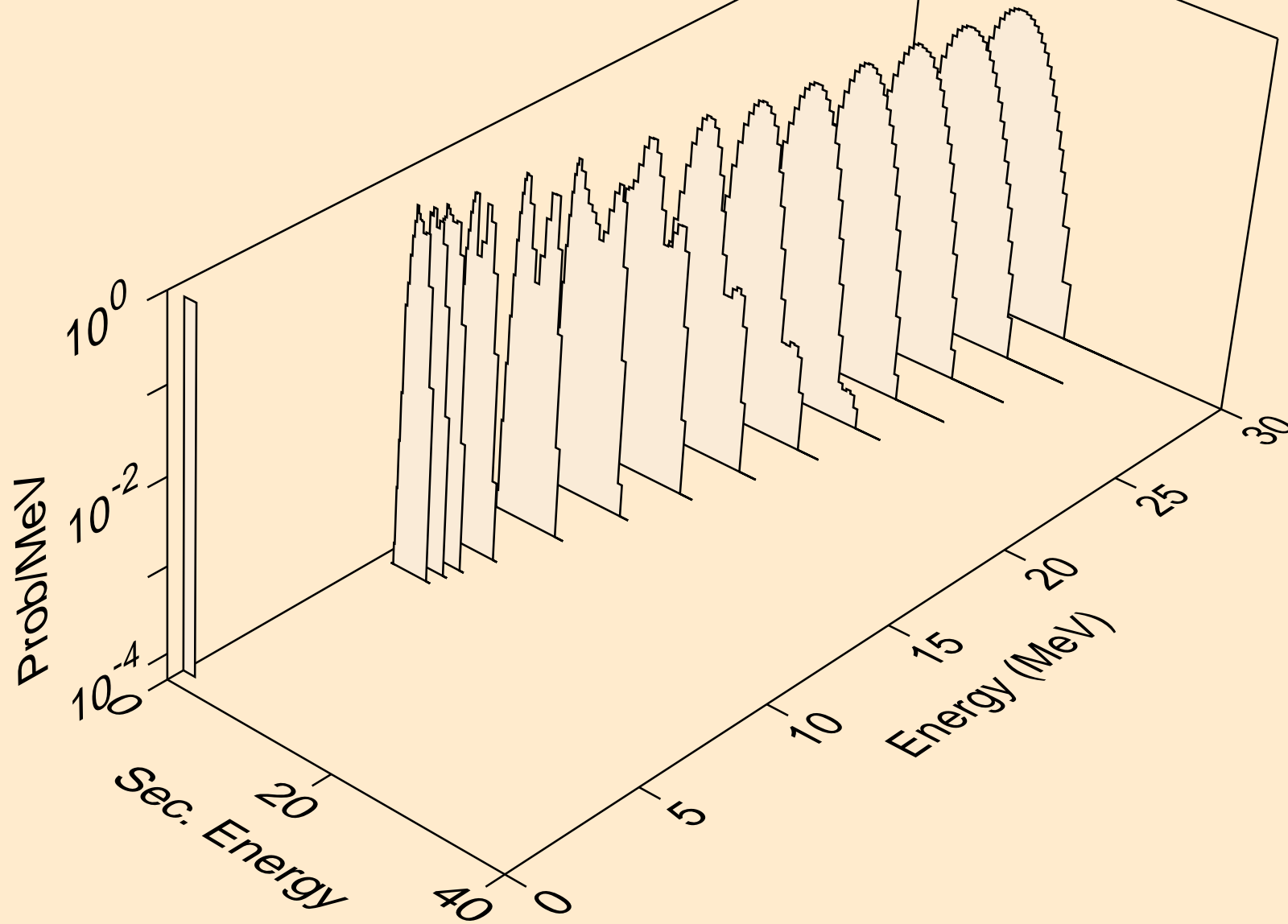

AM233 NEUTRON ACER TENDL-2024 LIBRARY; T=0.K  
protons from (n,pa)

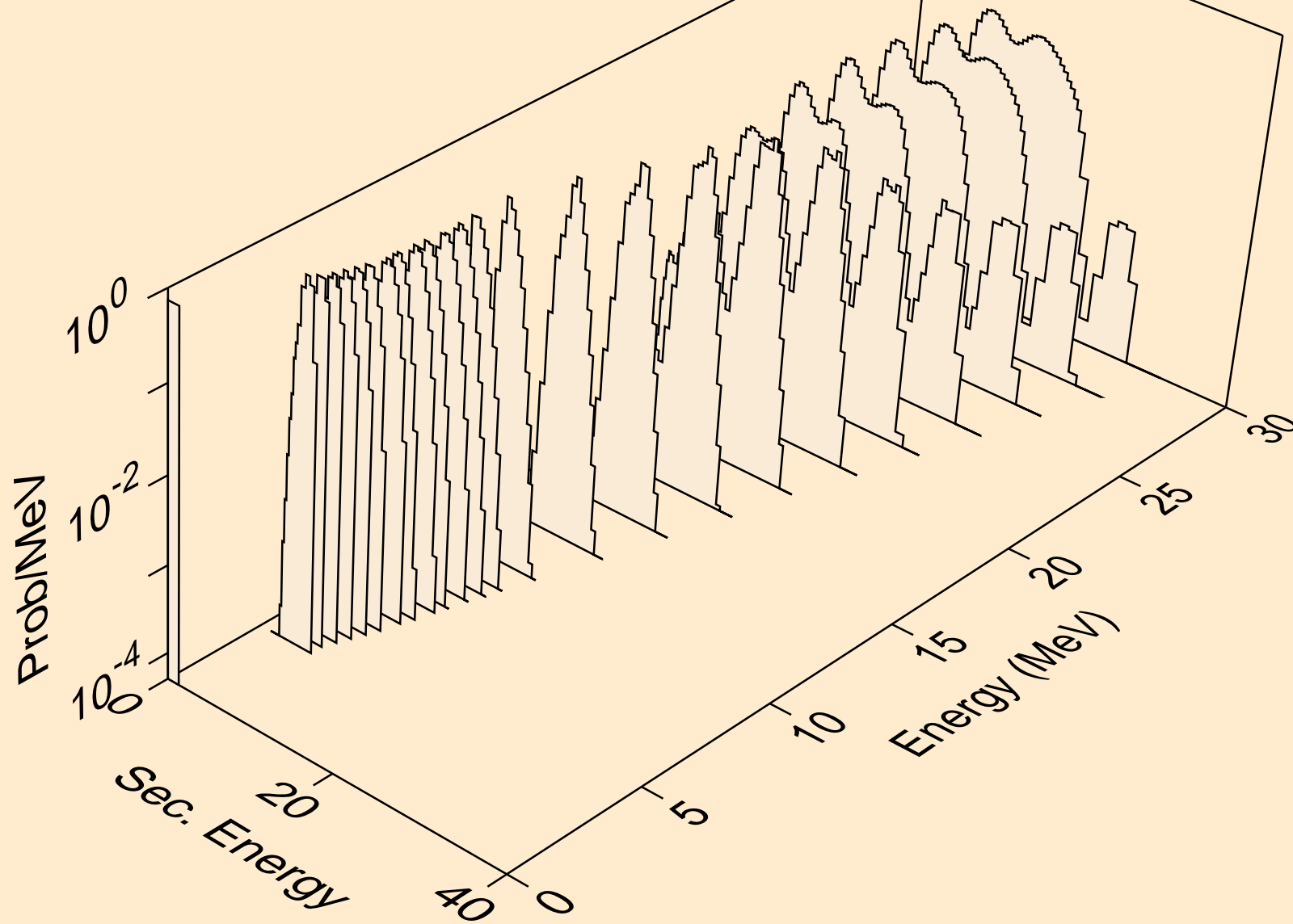

AM233 NEUTRON ACER TENDL-2024 LIBRARY; T=0.K  
protons from (n,pd)

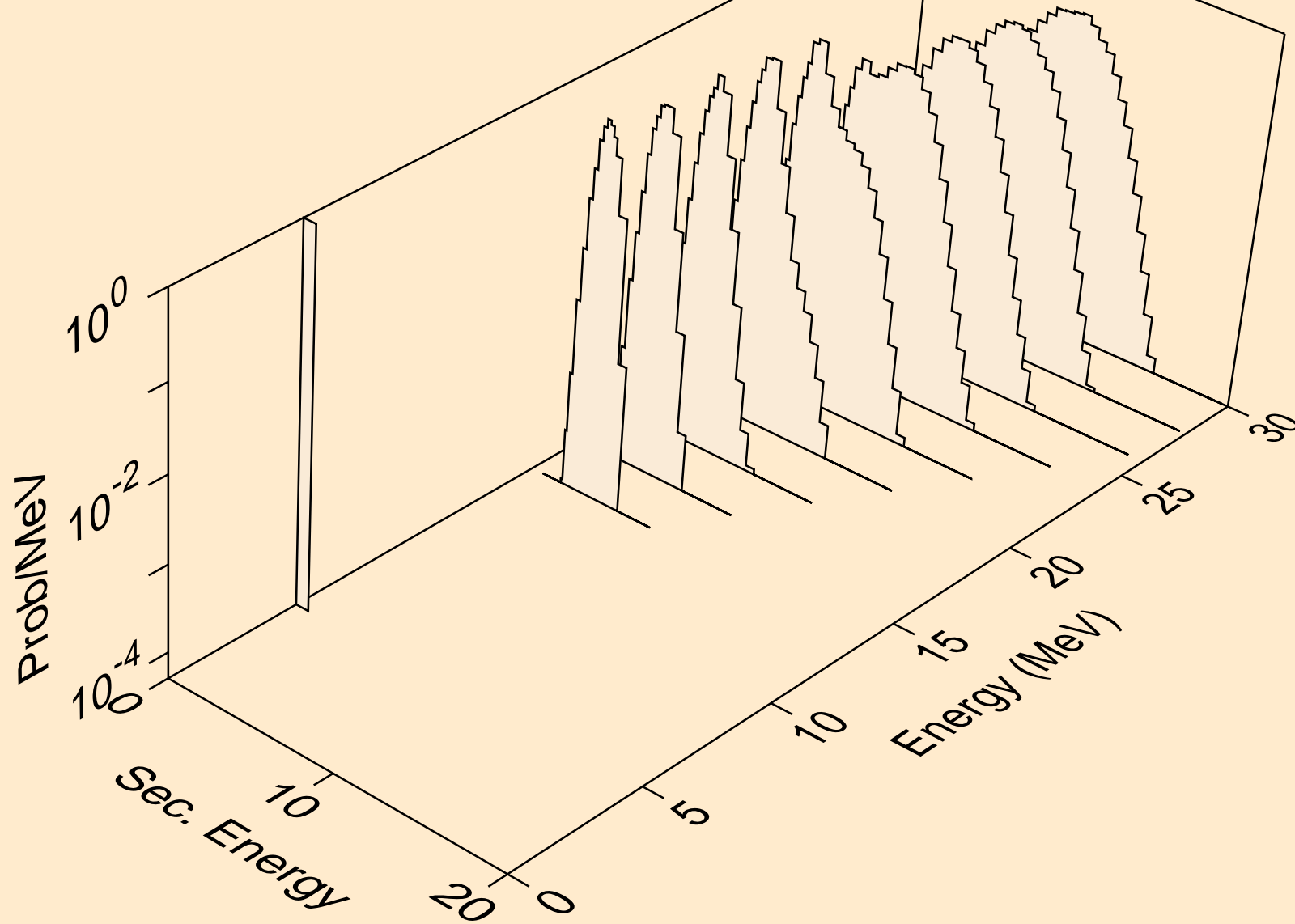



AM233 NEUTRON ACER TENDL-2024 LIBRARY; T=0.K  
deuterons from (n,x)

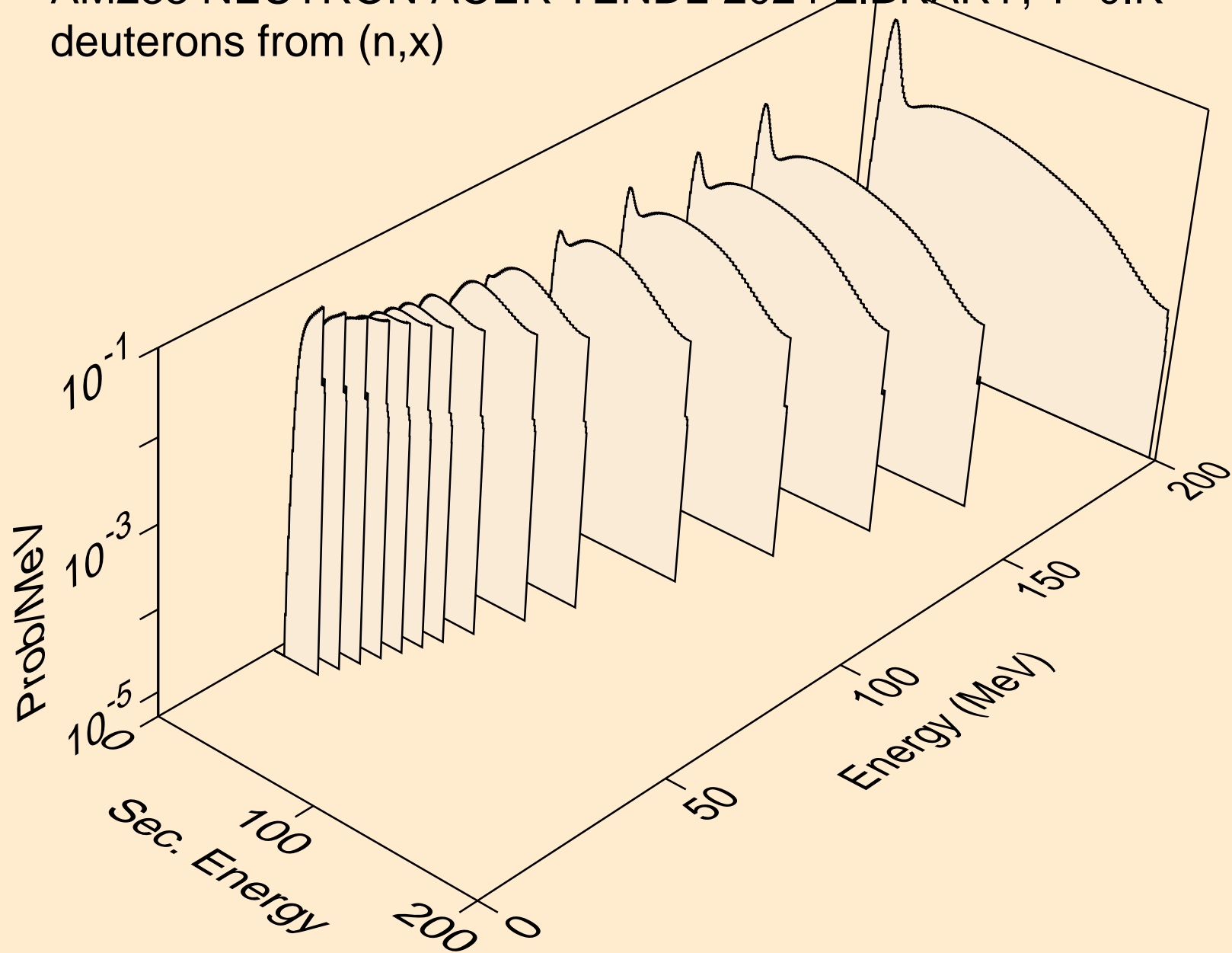

AM233 NEUTRON ACER TENDL-2024 LIBRARY; T=0.K  
deuterons from (n,2nd)

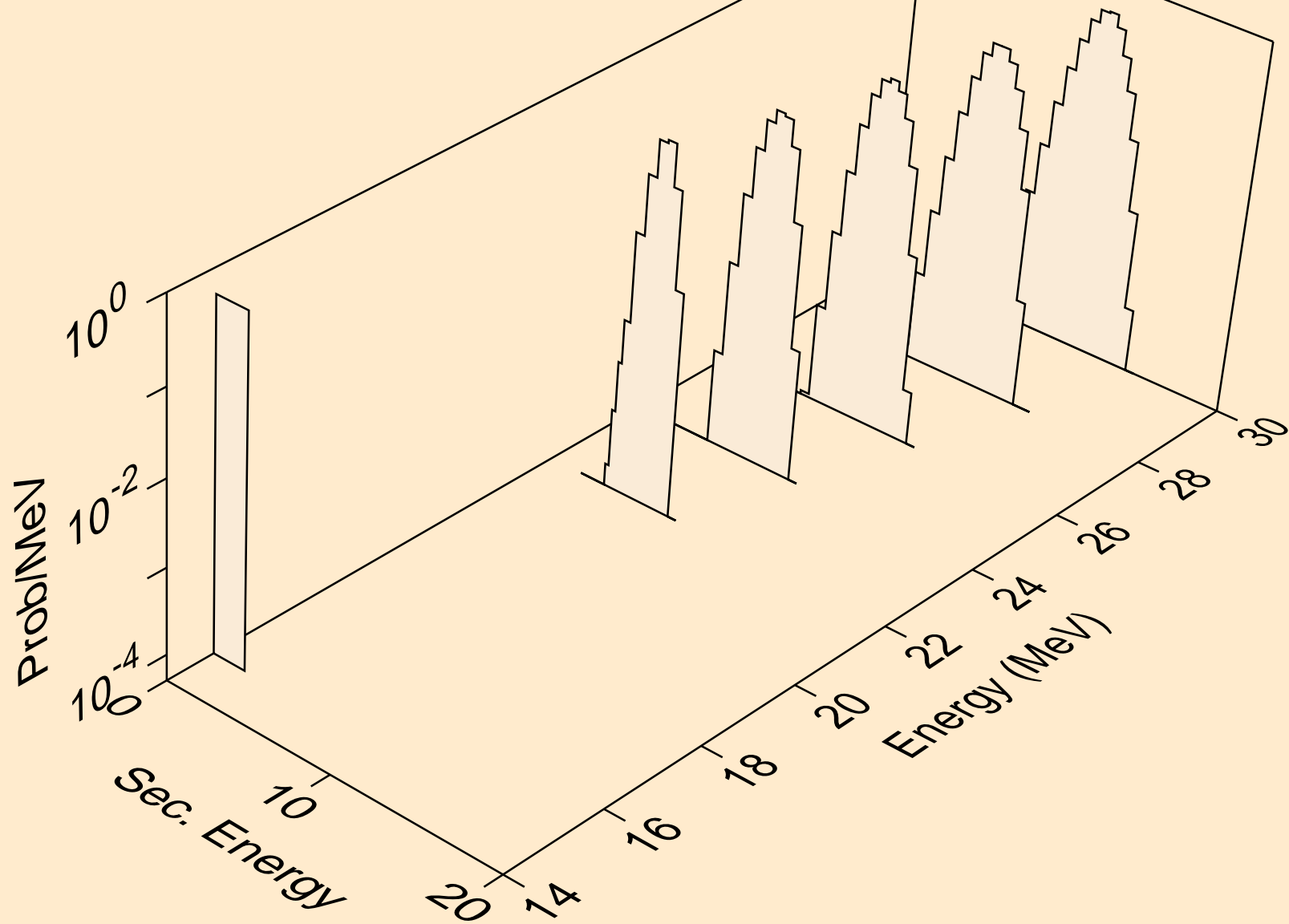

AM233 NEUTRON ACER TENDL-2024 LIBRARY; T=0.K  
deuterons from (n,n\*)d

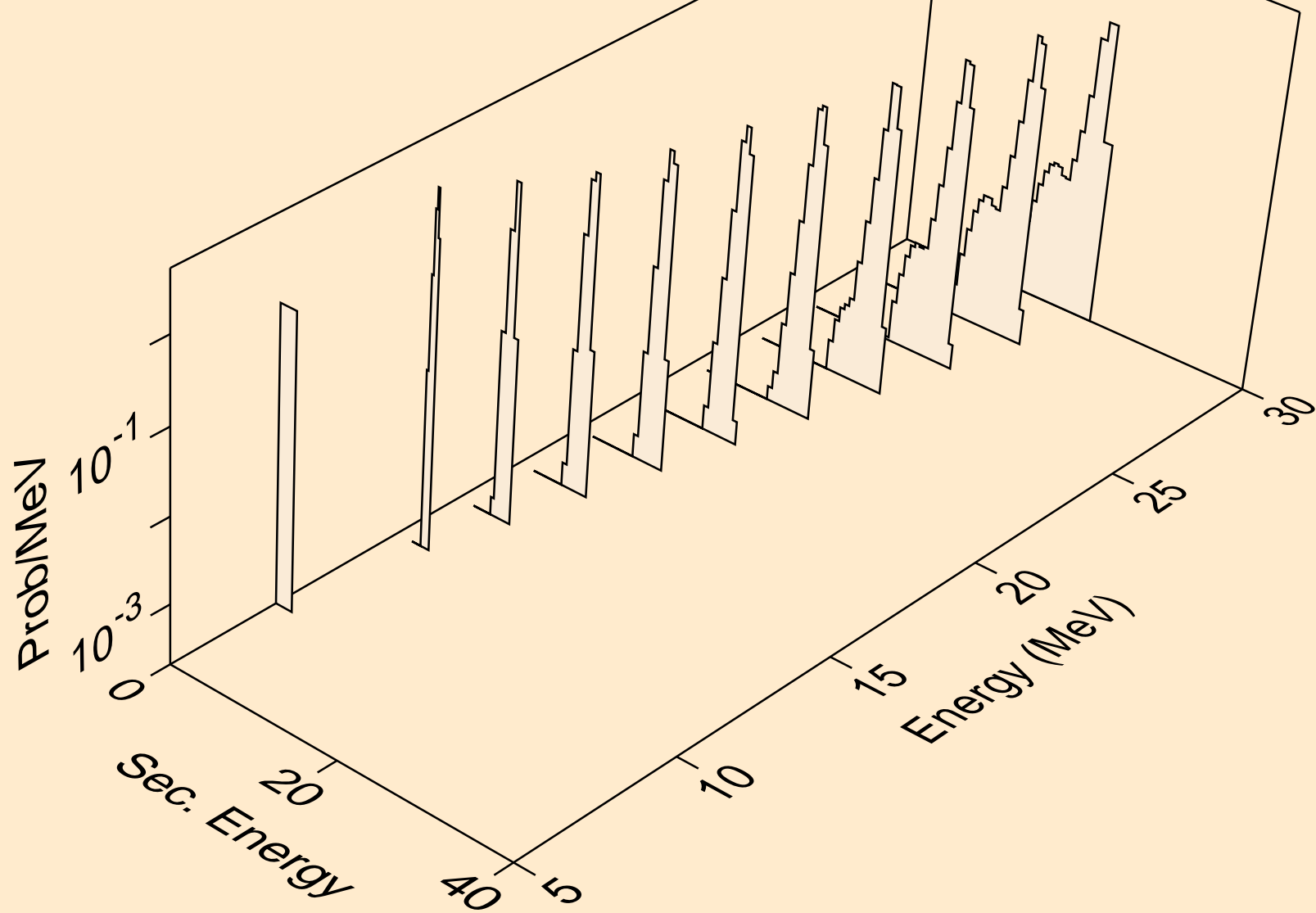

AM233 NEUTRON ACER TENDL-2024 LIBRARY; T=0.K  
deuterons from (n,d)

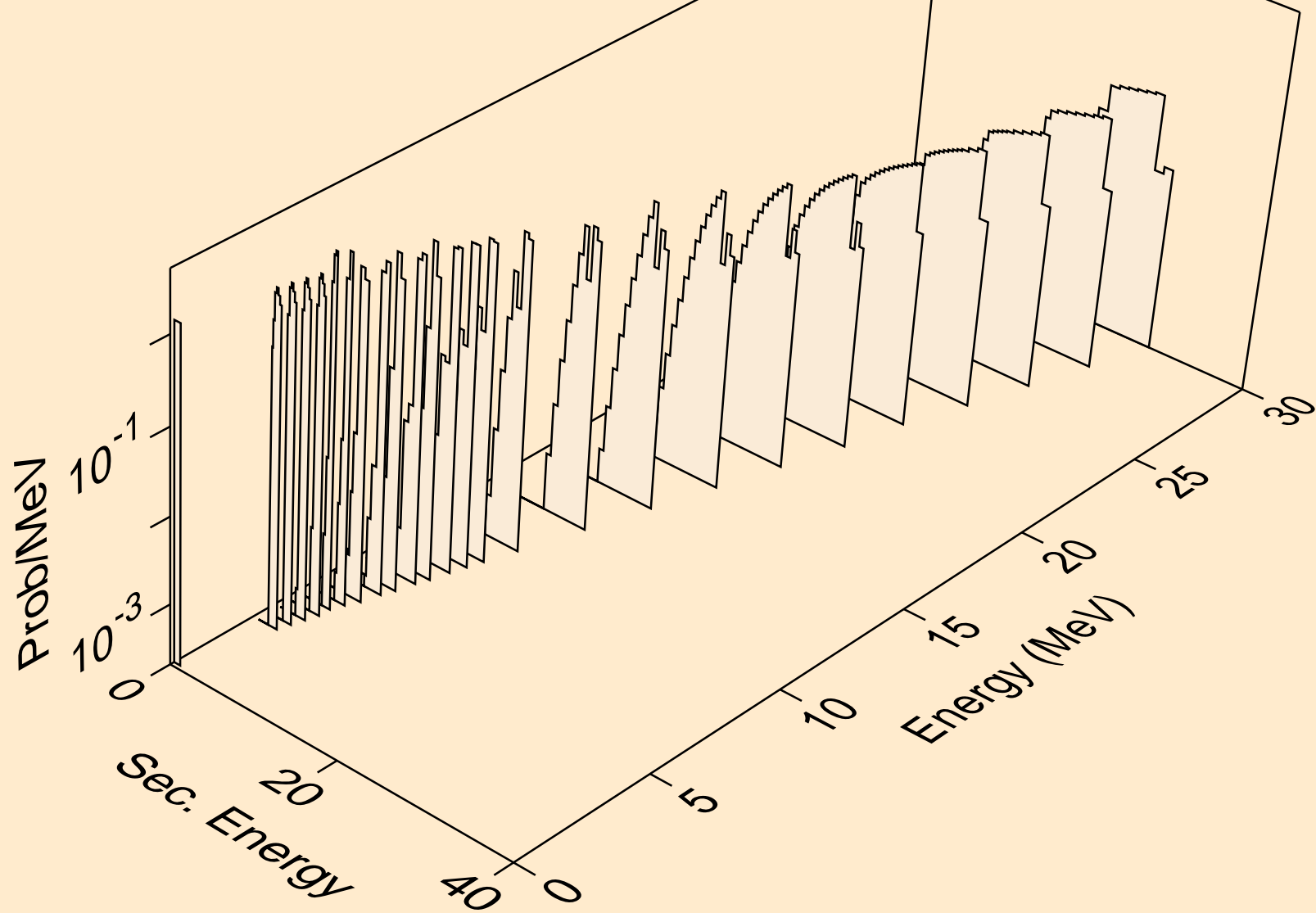

AM233 NEUTRON ACER TENDL-2024 LIBRARY; T=0.K  
deuterons from (n,pd)

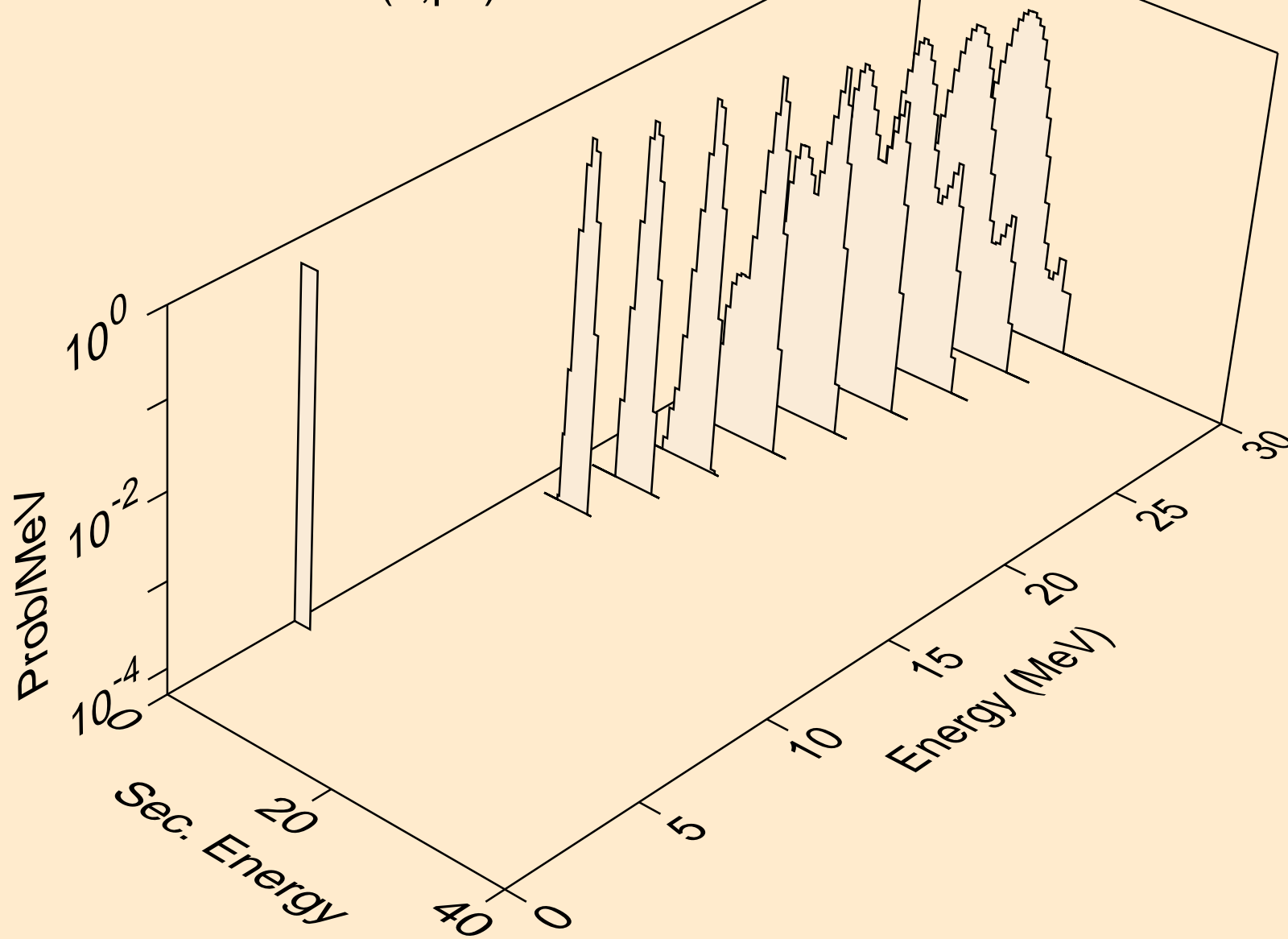

AM233 NEUTRON ACER TENDL-2024 LIBRARY; T=0.K  
deuterons from (n,da)

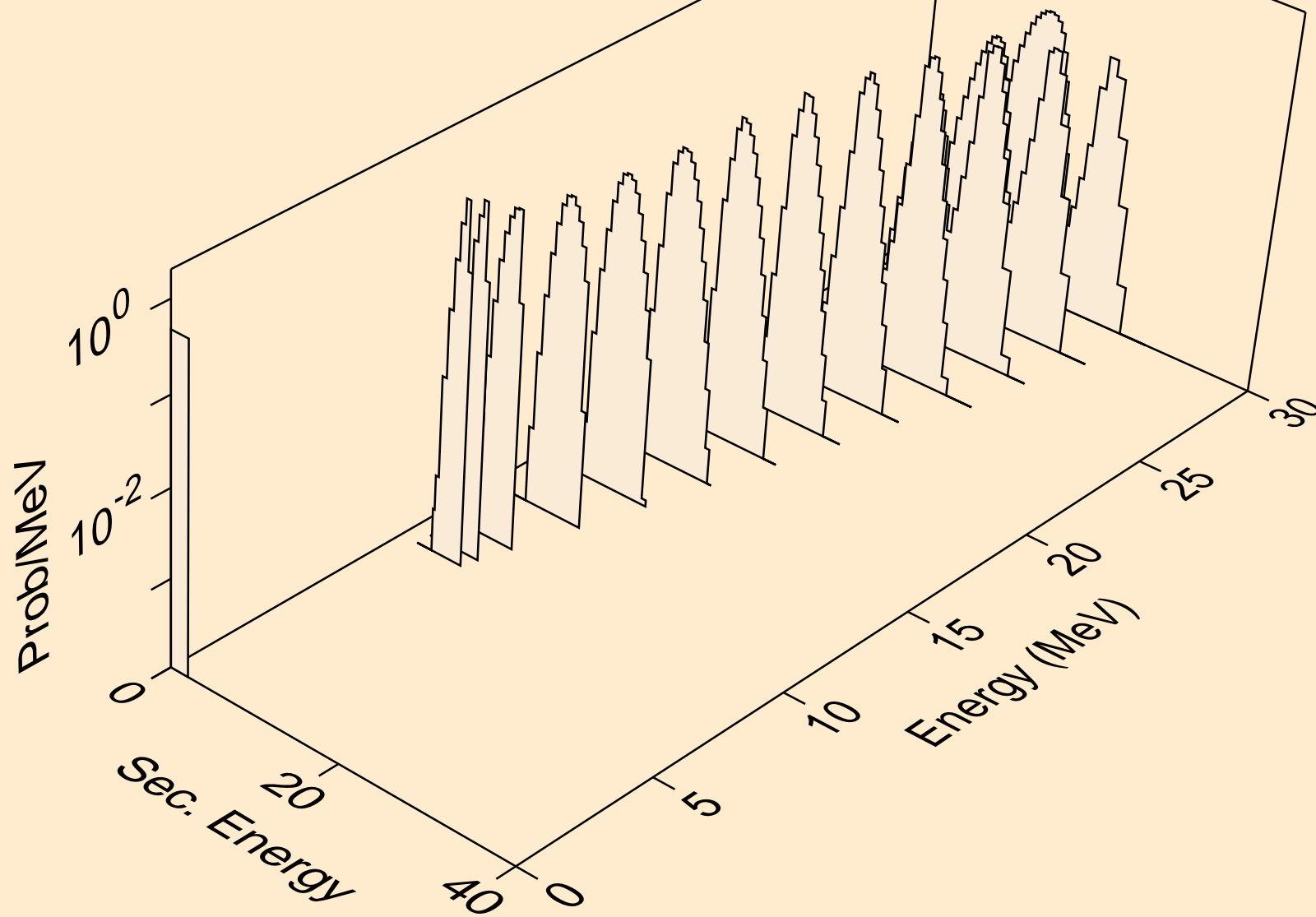

AM233 NEUTRON ACER TENDL-2024 LIBRARY; T=0.K  
tritons from (n,x)

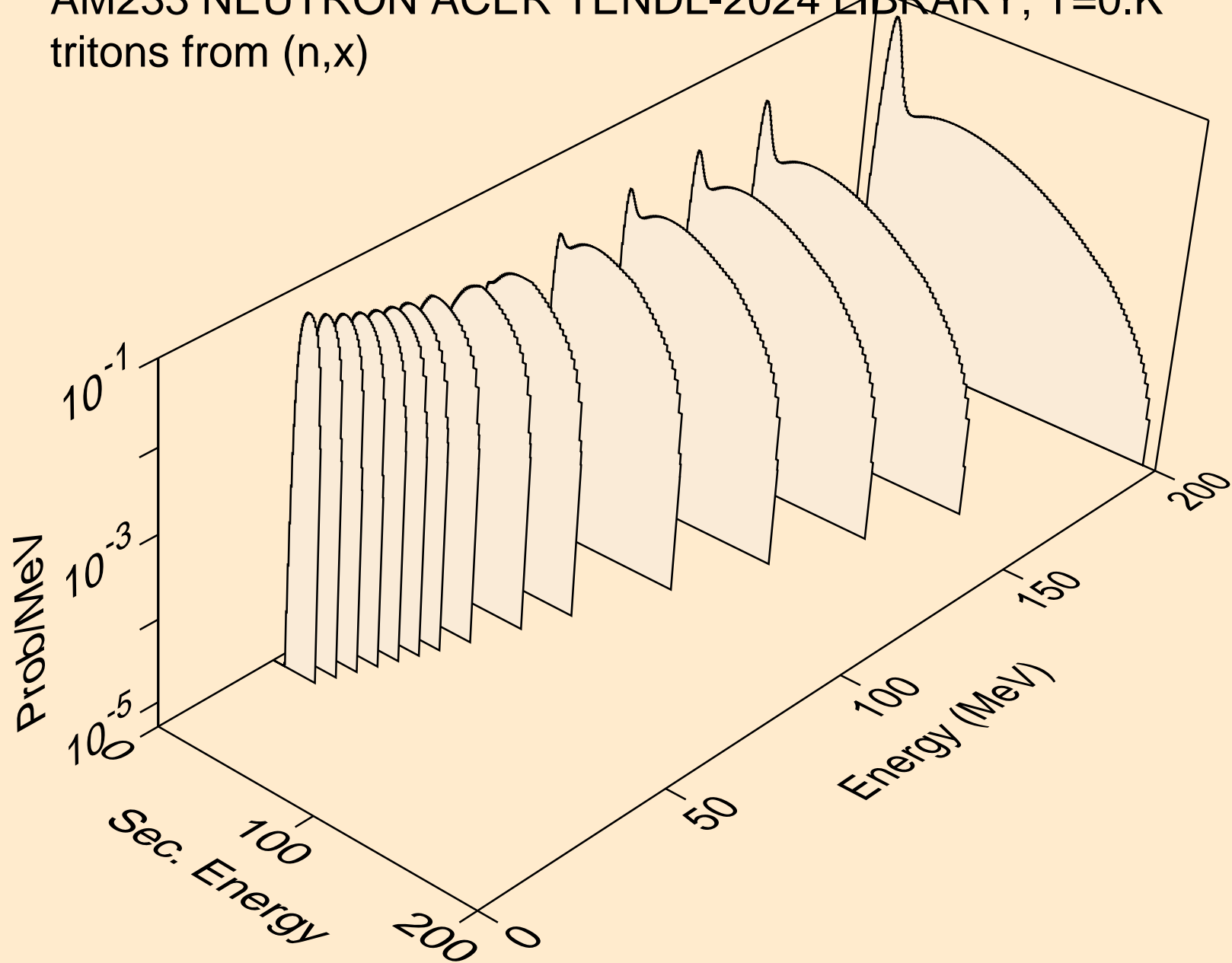

AM233 NEUTRON ACER TENDL-2024 LIBRARY; T=0.K  
tritons from (n,n\*)t

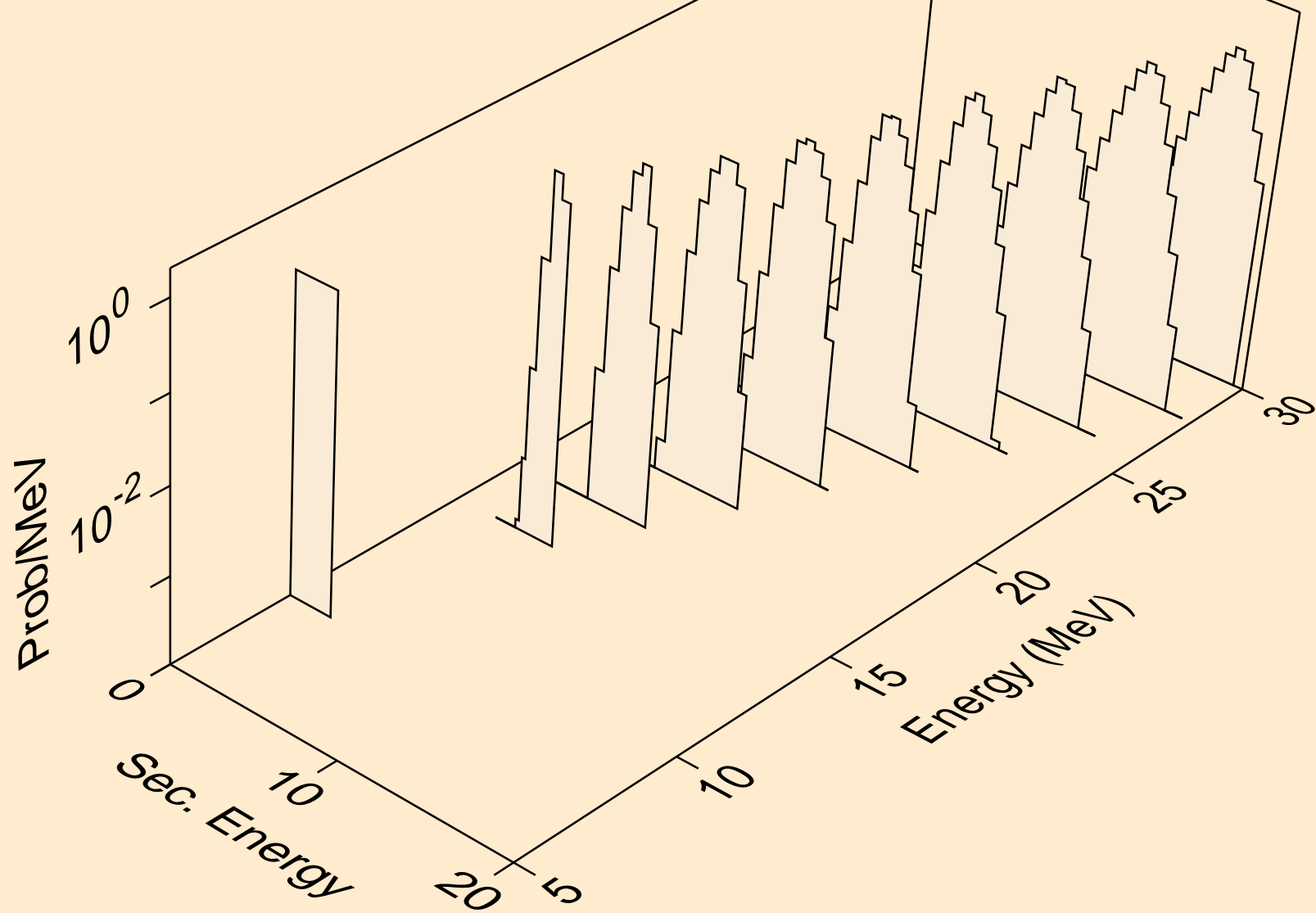



AM233 NEUTRON ACER TENDL-2024 LIBRARY; T=0.K  
tritons from (n,t)

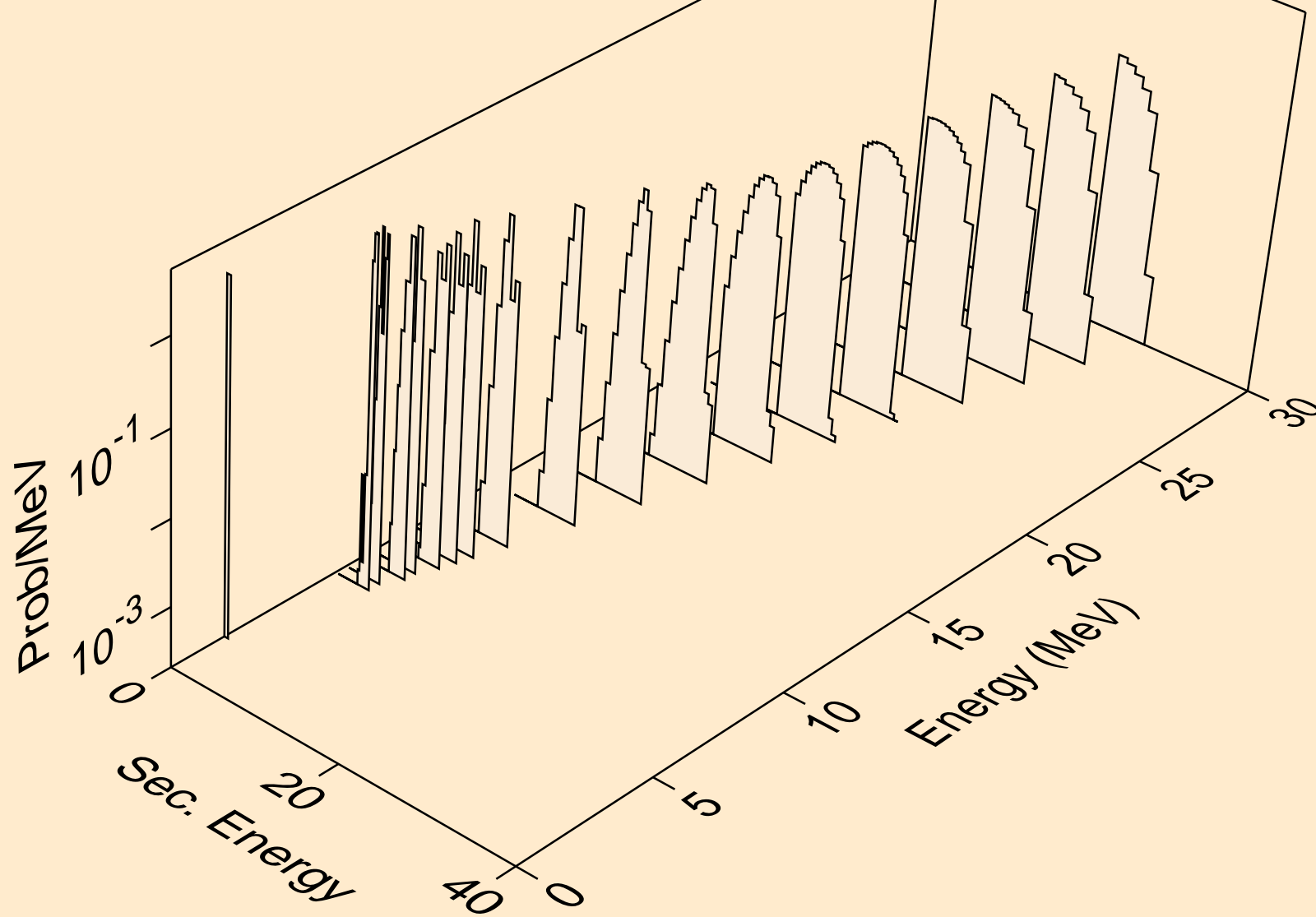

AM233 NEUTRON ACER TENDL-2024 LIBRARY; T=0.K  
he3s from (n,x)

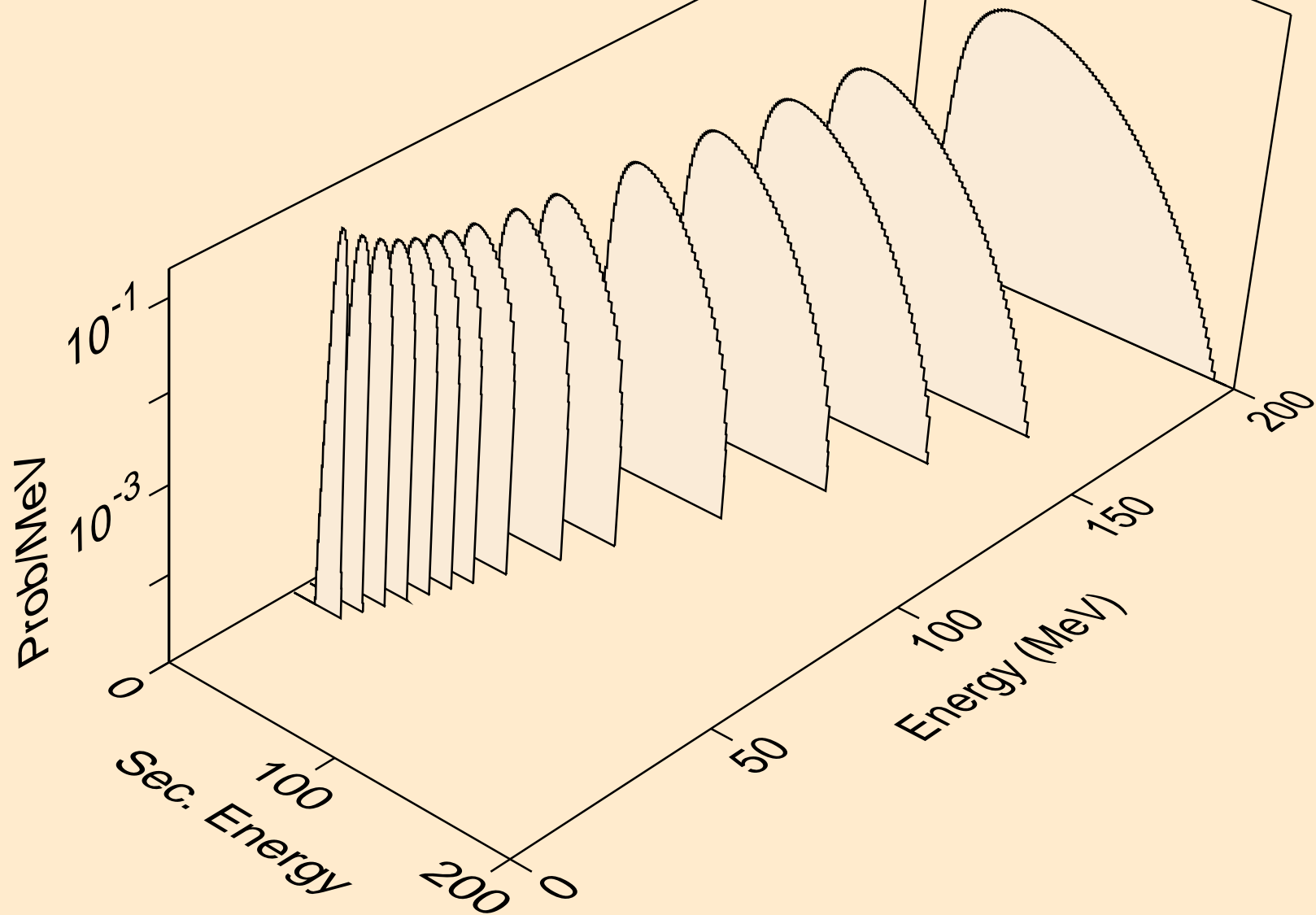

AM233 NEUTRON ACER TENDL-2024 LIBRARY; T=0.K  
he3s from (n,n\*)he3

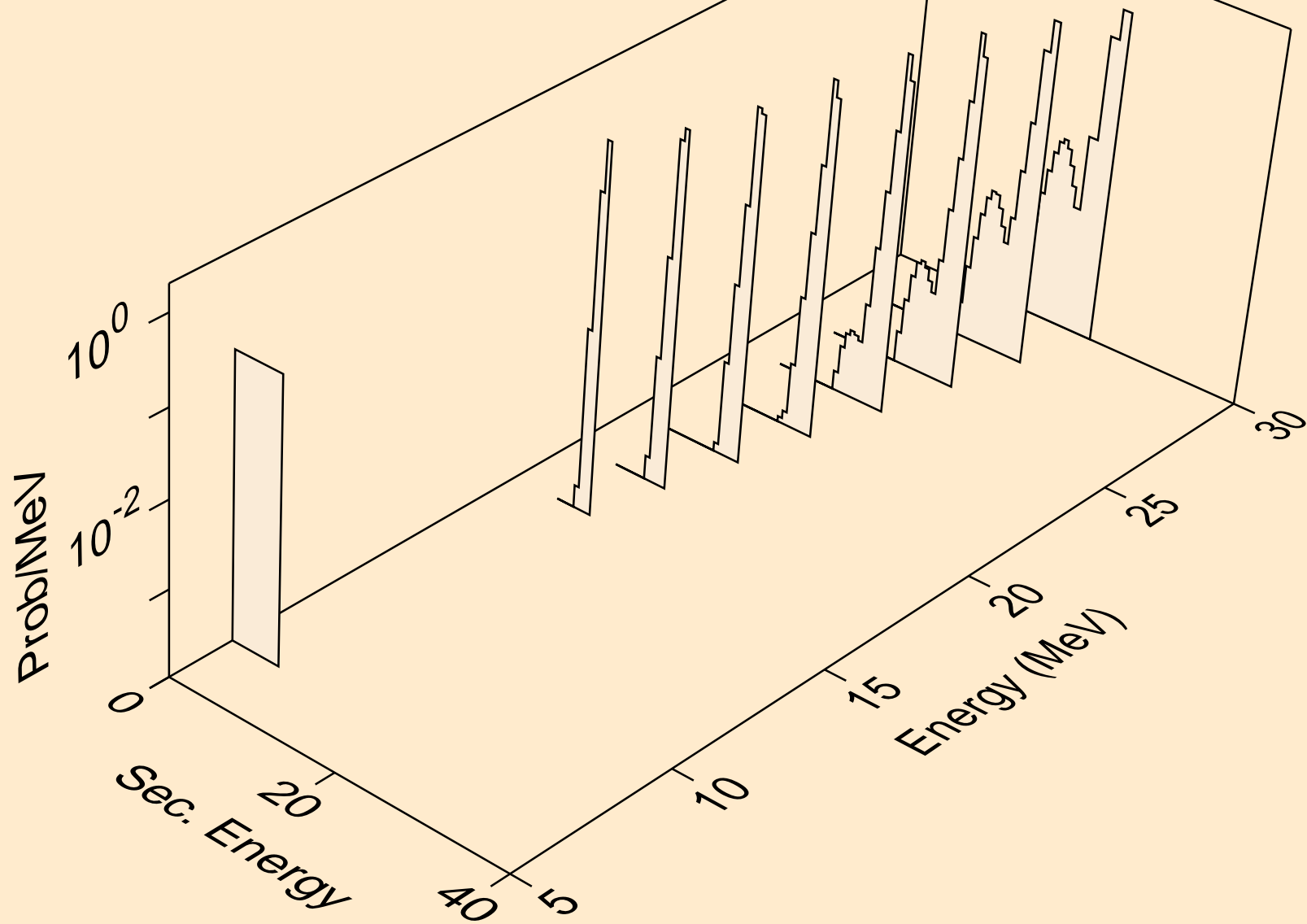

AM233 NEUTRON ACER TENDL-2024 LIBRARY; T=0.K  
he3s from (n,he3)

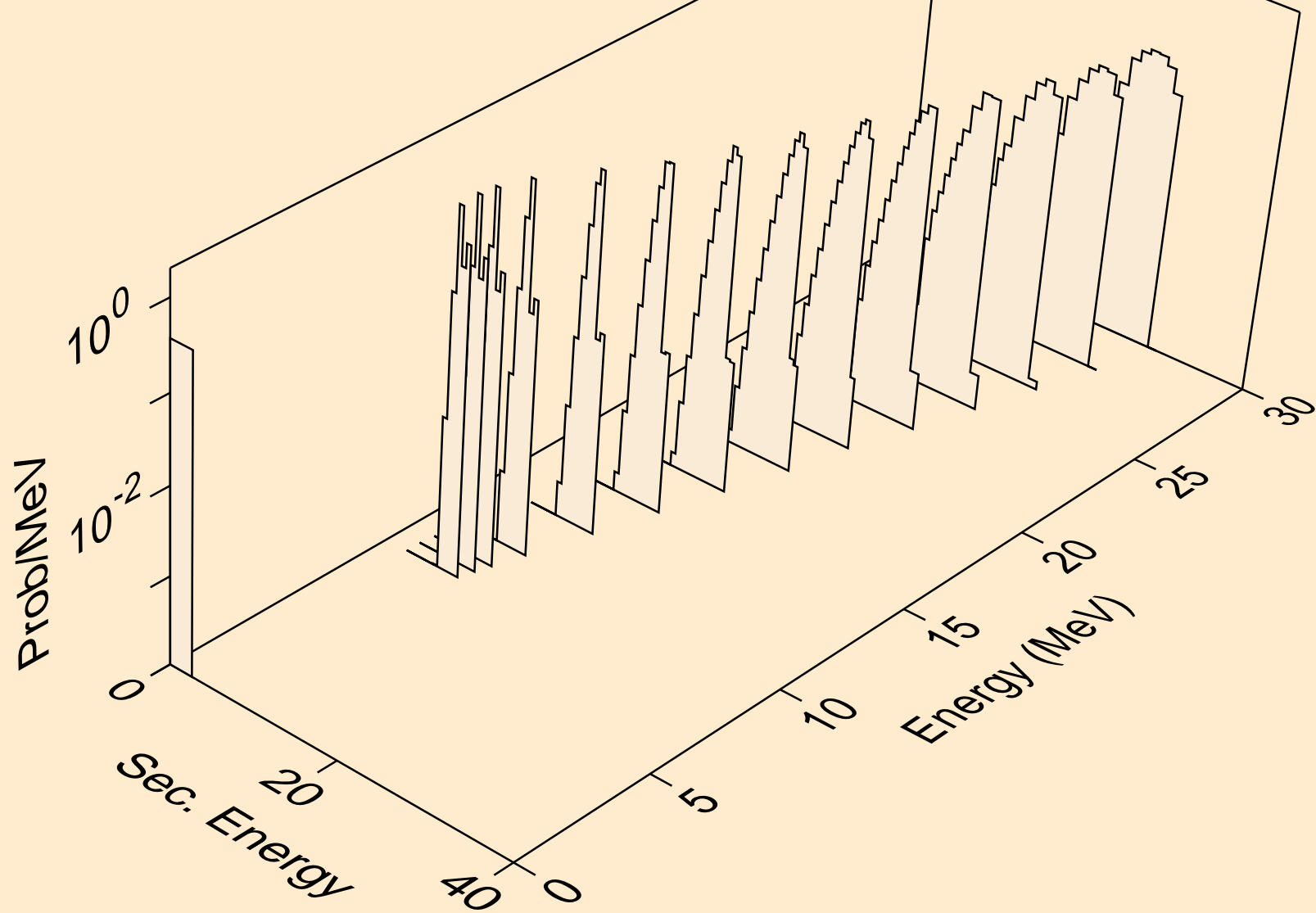

AM233 NEUTRON ACER TENDL-2024 LIBRARY; T=0.K  
alphas from (n,x)

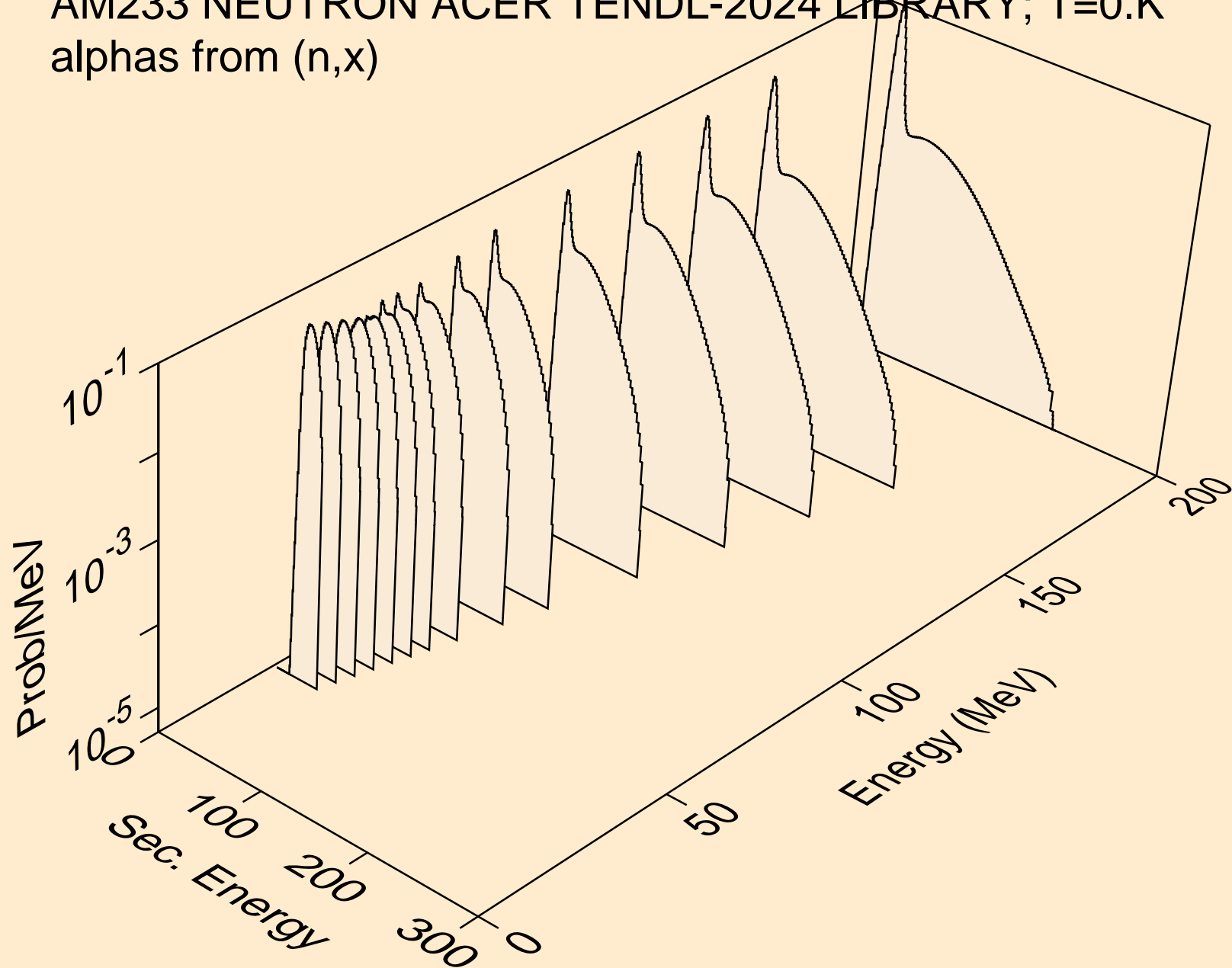

AM233 NEUTRON ACER TENDL-2024 LIBRARY; T=0.K  
alphas from (n,n\*)a

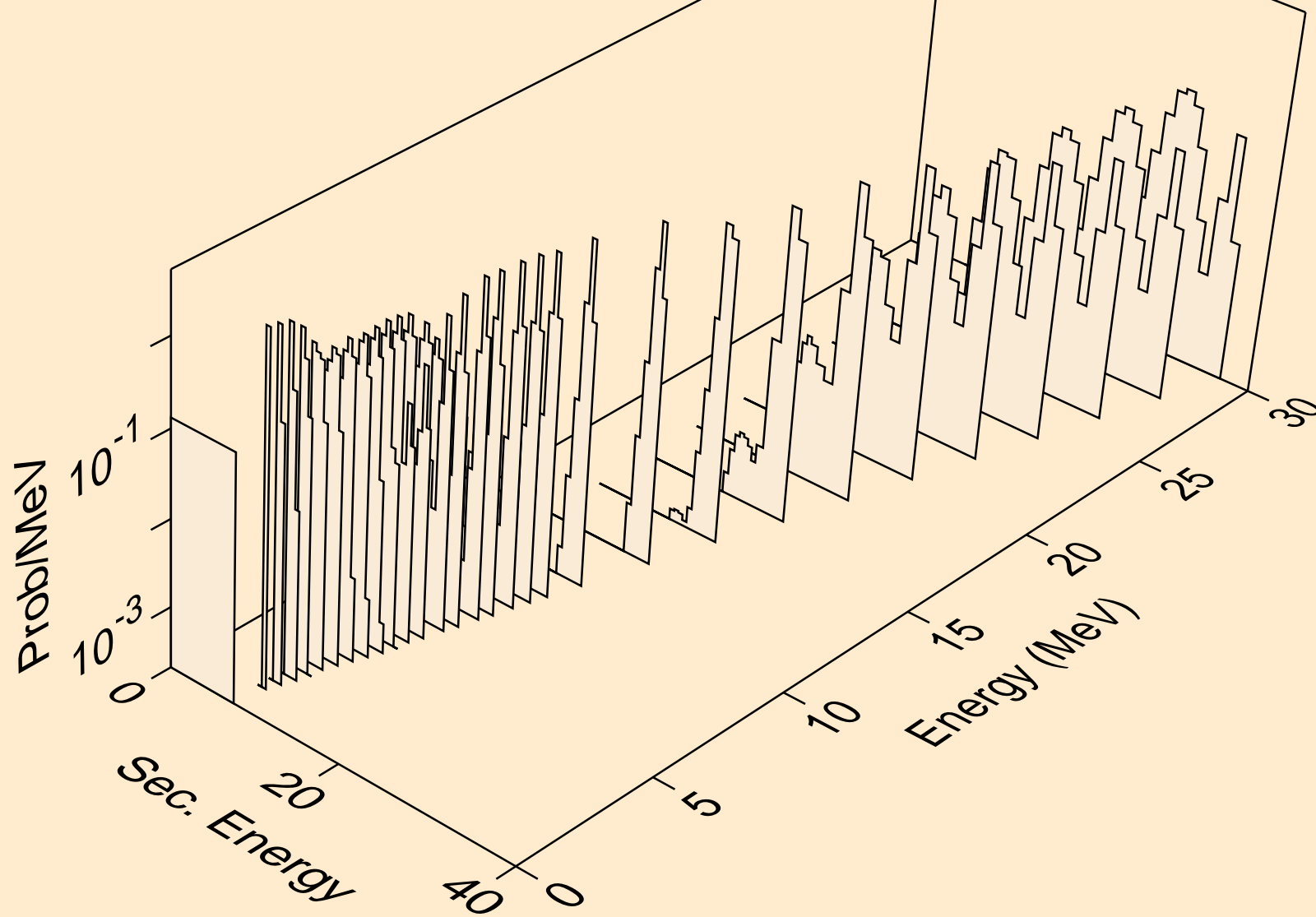

AM233 NEUTRON ACER TENDL-2024 LIBRARY; T=0.K  
alphas from (n,2n)a

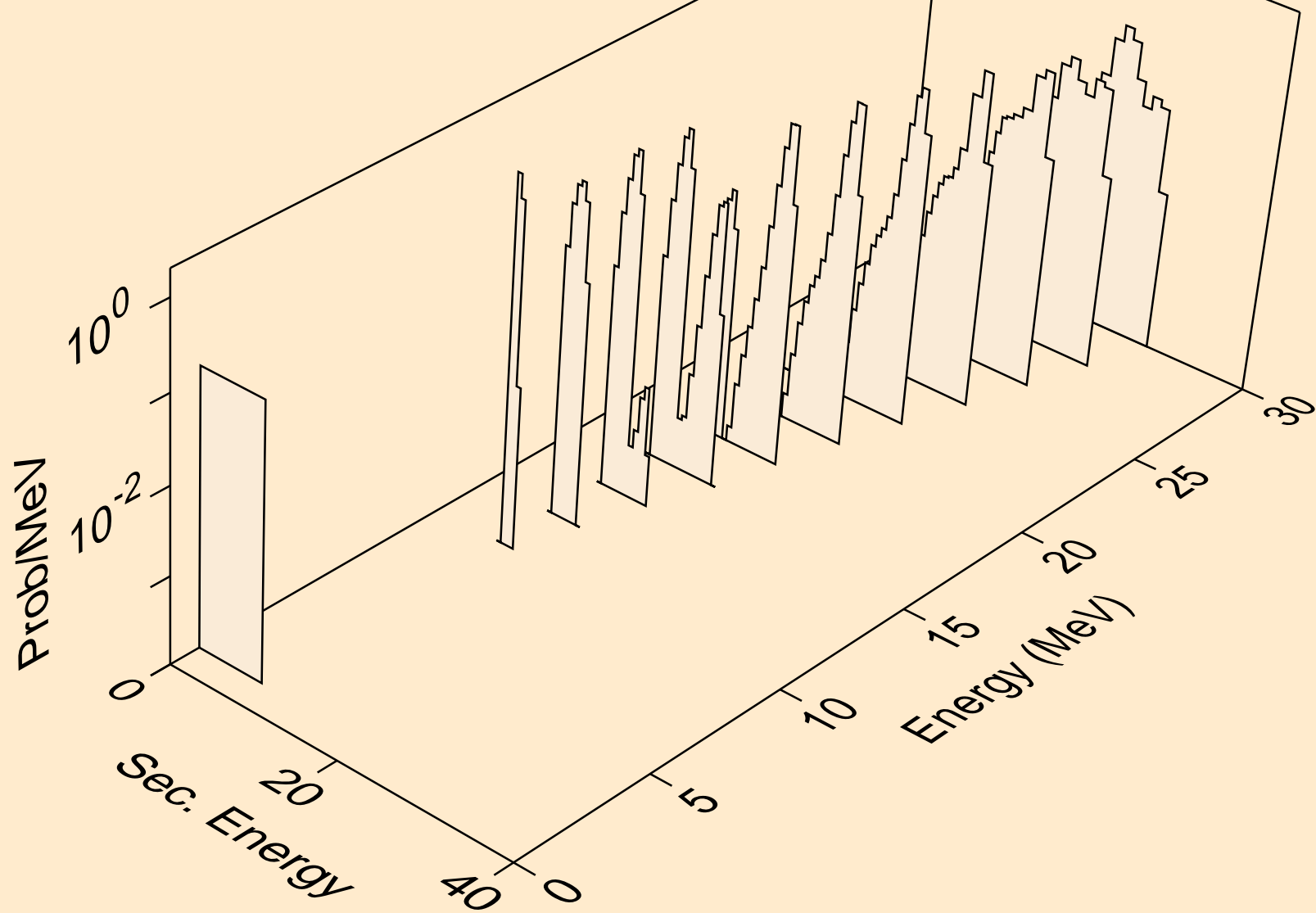

AM233 NEUTRON ACER TENDL-2024 LIBRARY; T=0.K  
alphas from (n,n\*)2a

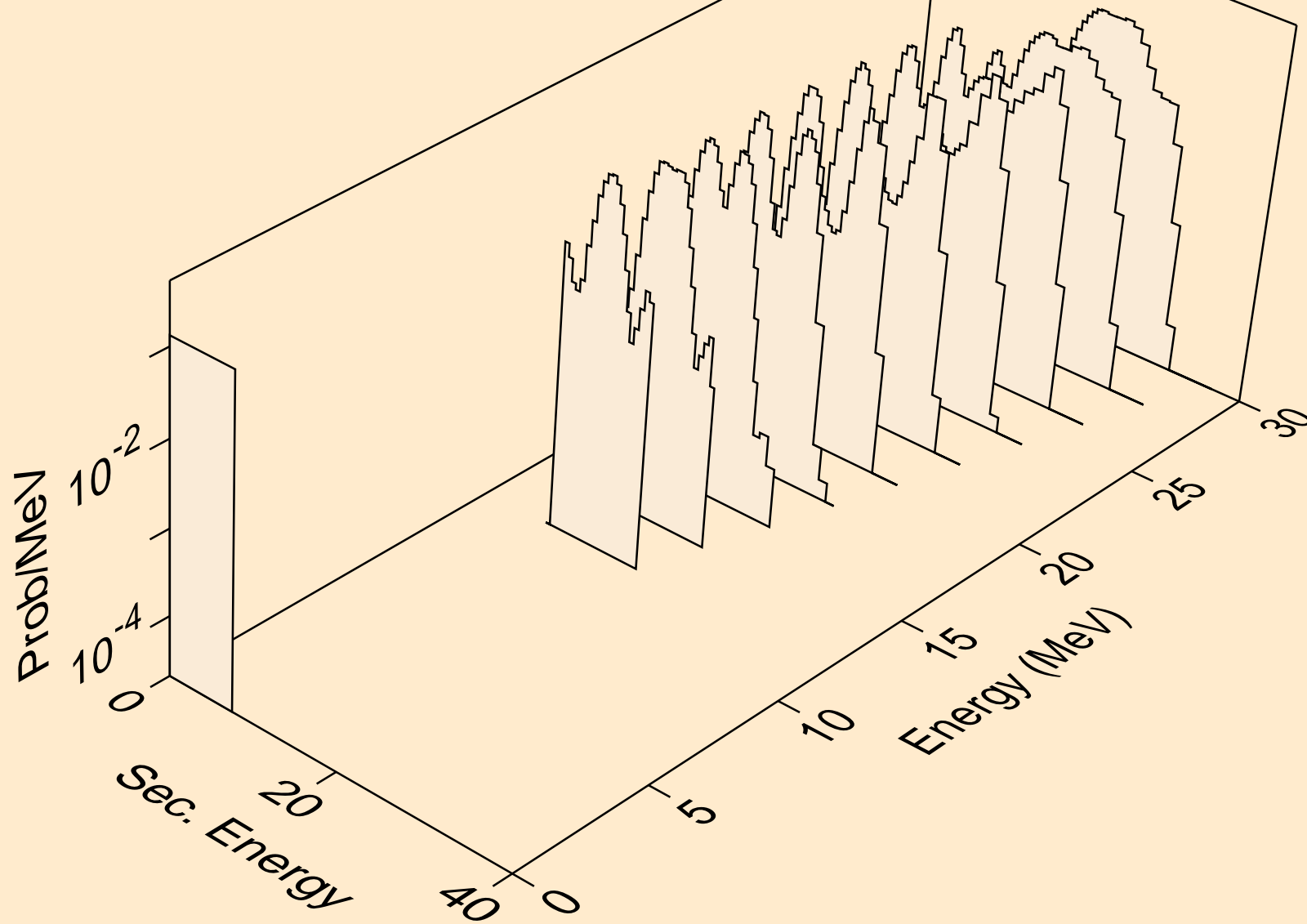



AM233 NEUTRON ACER TENDL-2024 LIBRARY; T=0.K  
alphas from (n,npa)

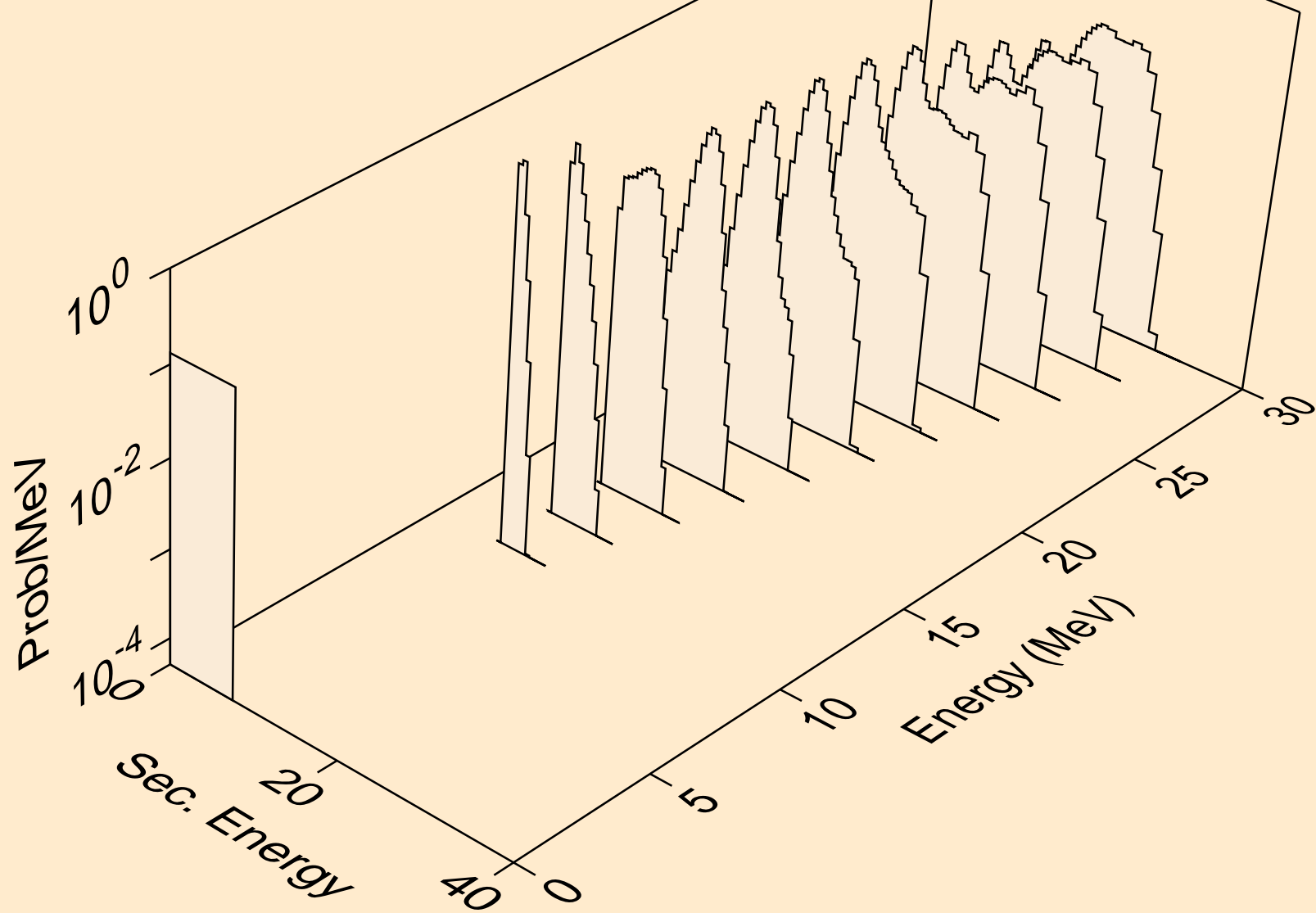

AM233 NEUTRON ACER TENDL-2024 LIBRARY; T=0.K  
alphas from (n,a)

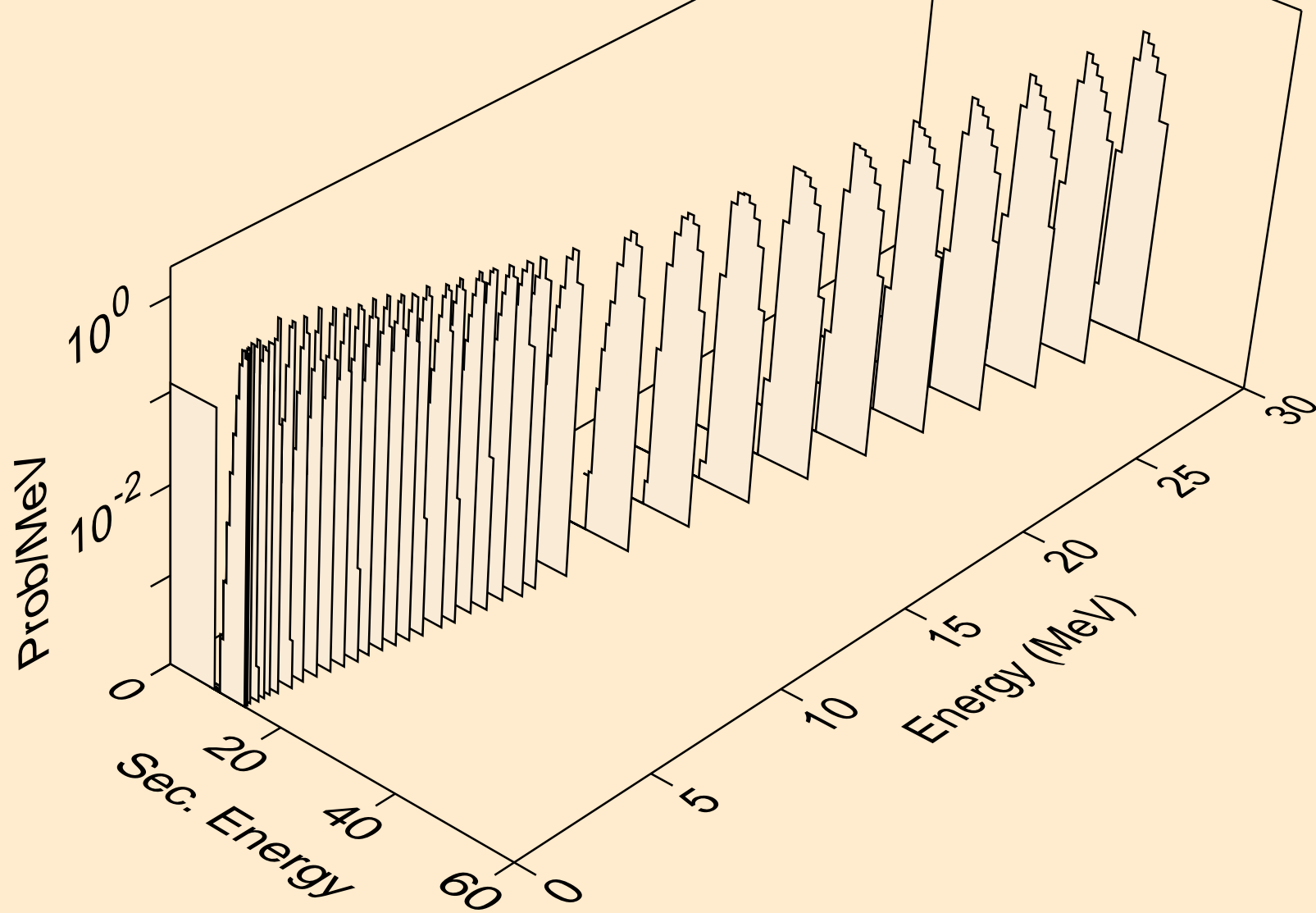

AM233 NEUTRON ACER TENDL-2024 LIBRARY; T=0.K  
alphas from (n,2a)

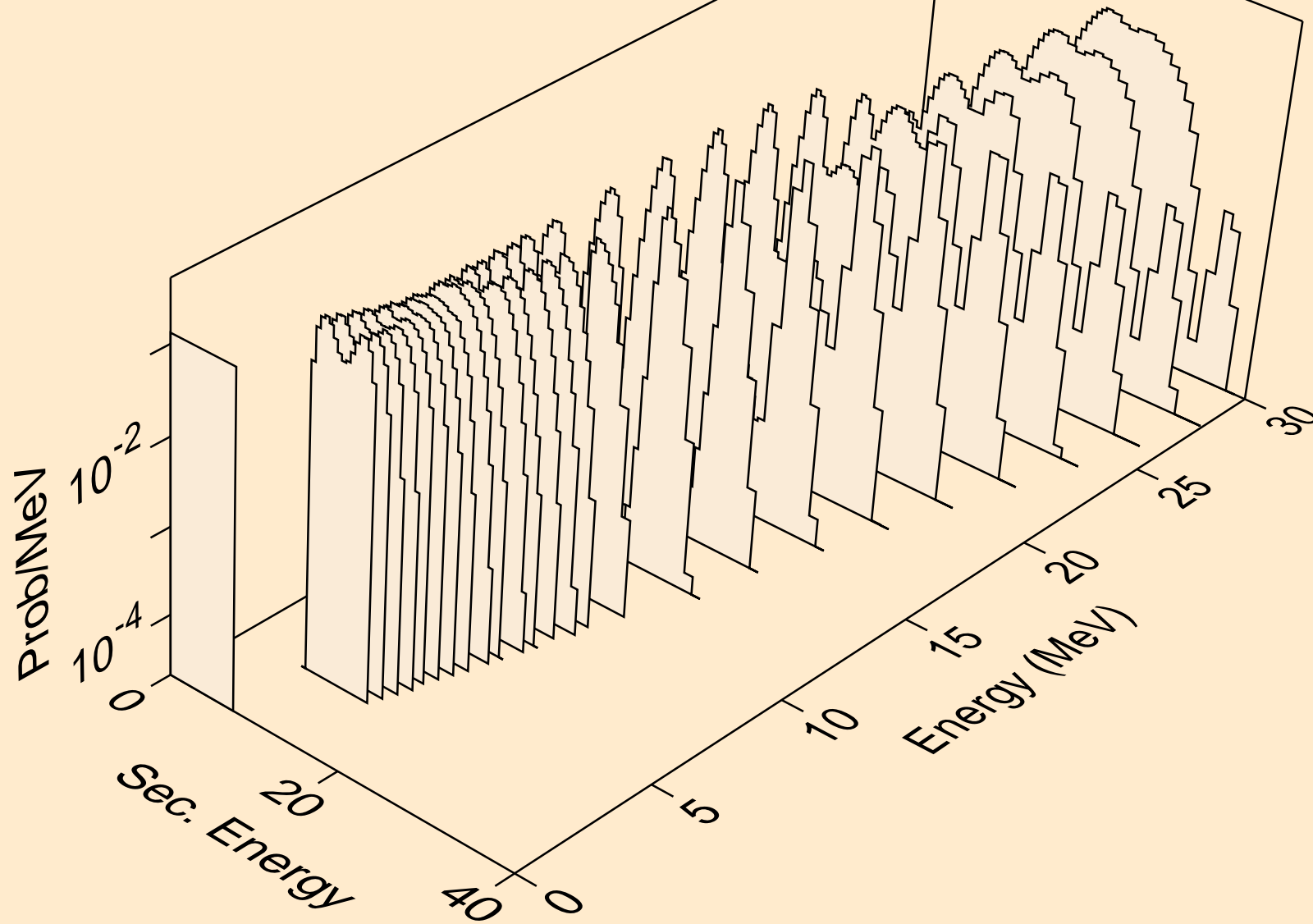

AM233 NEUTRON ACER TENDL-2024 LIBRARY; T=0.K  
alphas from (n,pa)

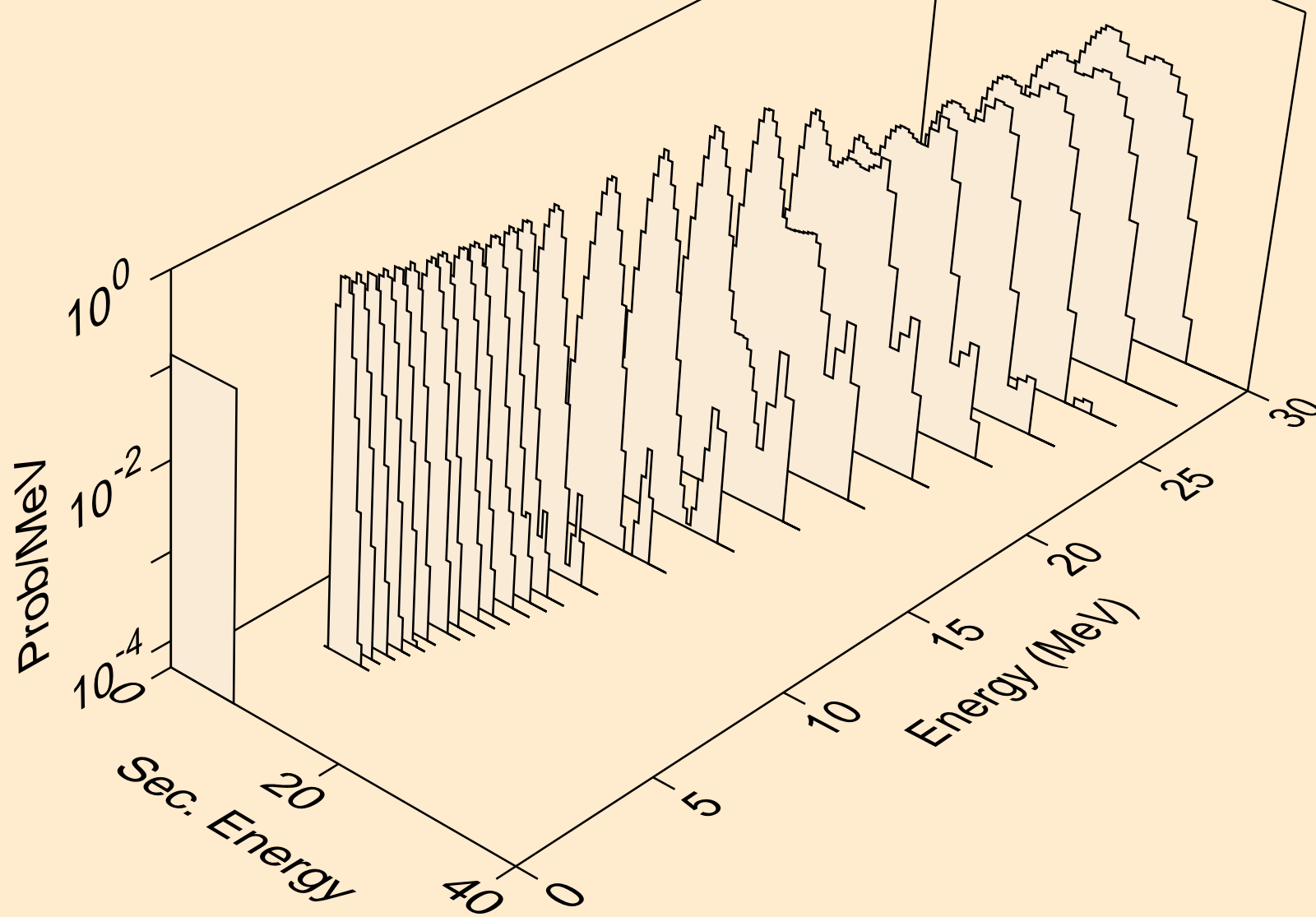

AM233 NEUTRON ACER TENDL-2024 LIBRARY; T=0.K  
alphas from (n,da)

