

AS084 NEUTRON ACER TENDL-2024 LIBRARY; T=0.K

Principal cross sections

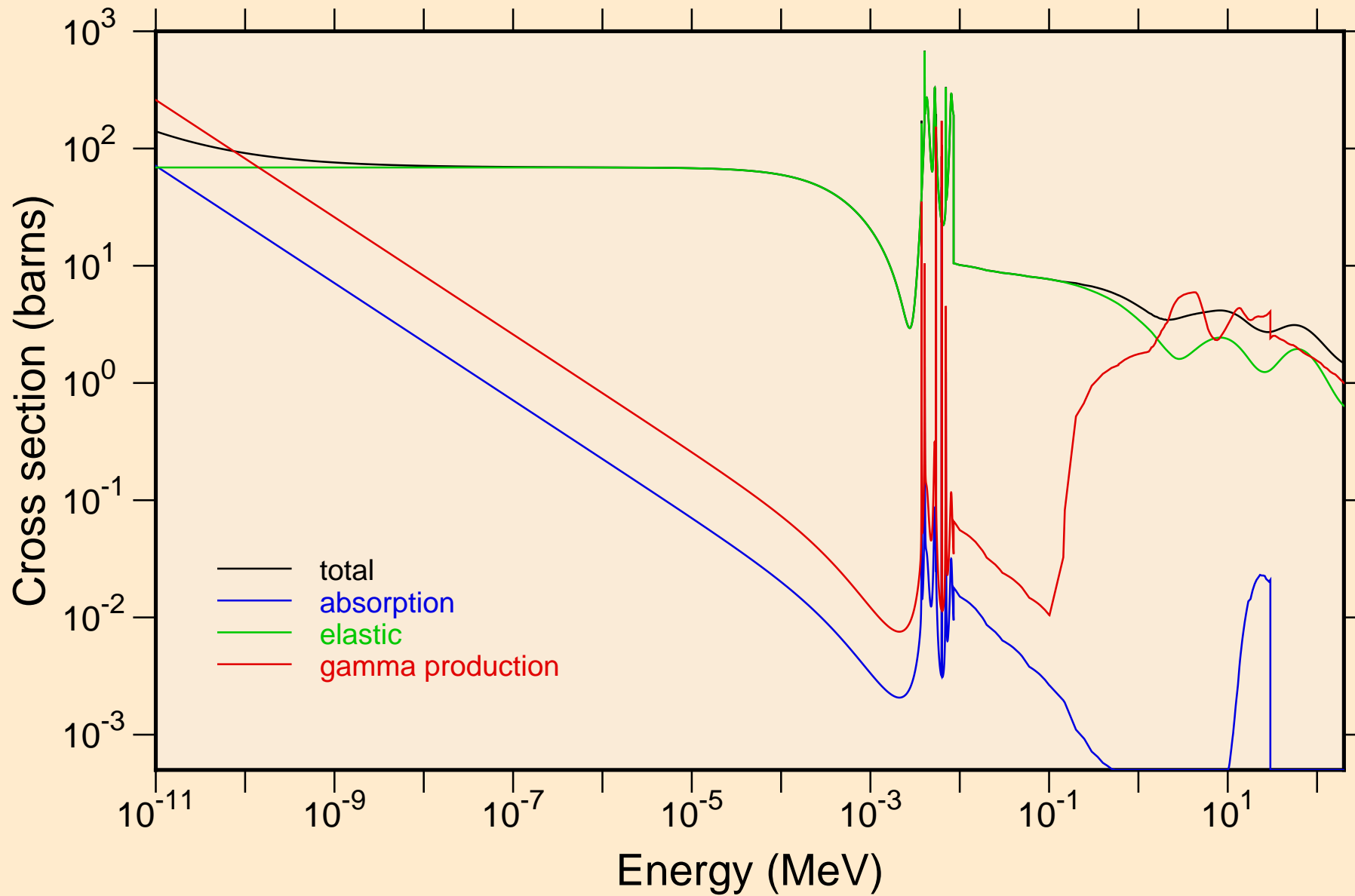

AS084 NEUTRON ACER TENDL-2024 LIBRARY; T=0.K
resonance total cross section

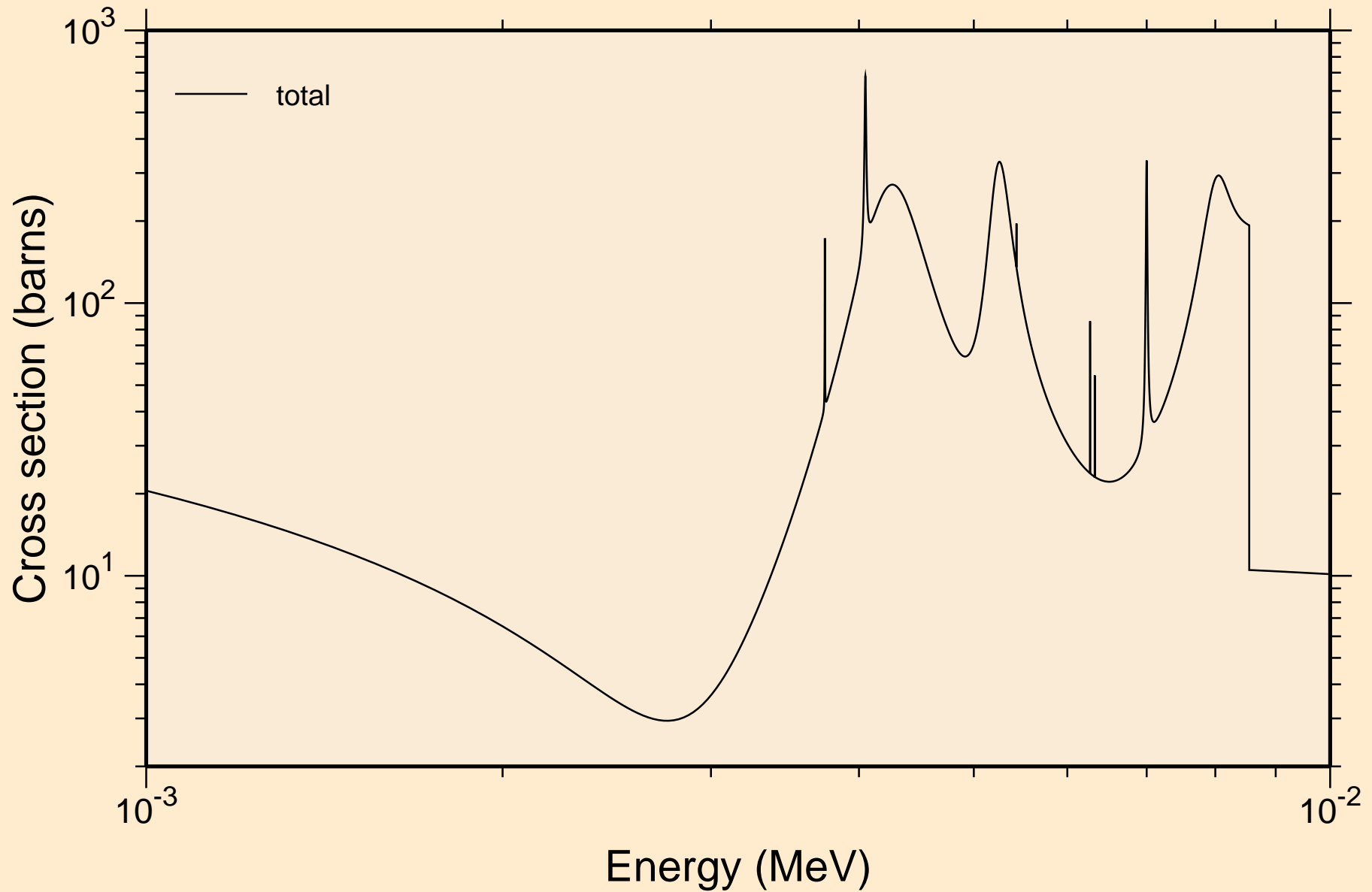

A5084 NEUTRON ACER TENDL-2024 LIBRARY; T=0.K
resonance total cross section

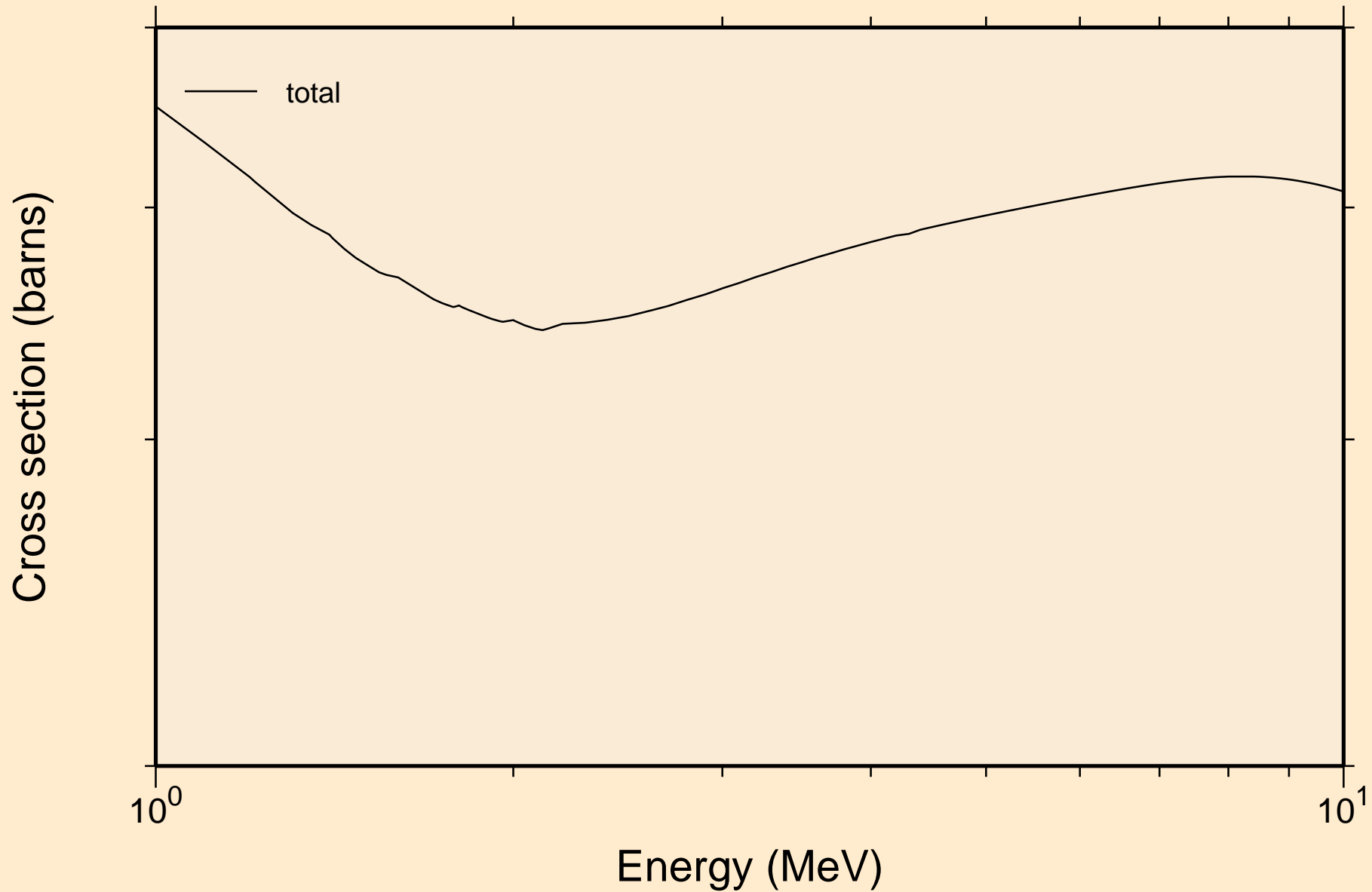

AS084 NEUTRON ACER TENDL-2024 LIBRARY; T=0.K
resonance absorption cross sections

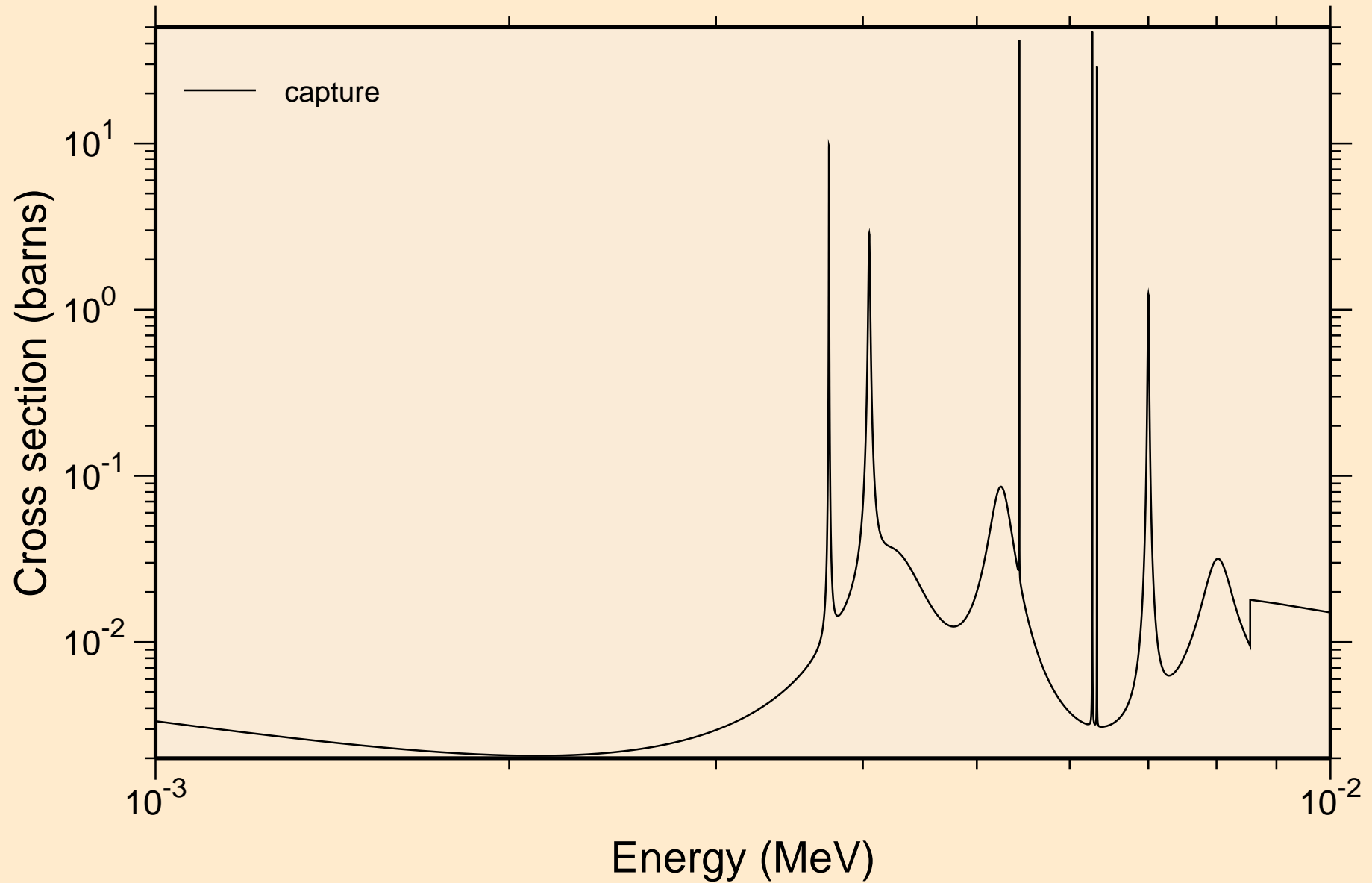

AS084 NEUTRON ACER TENDL-2024 LIBRARY; T=0.K
resonance absorption cross sections

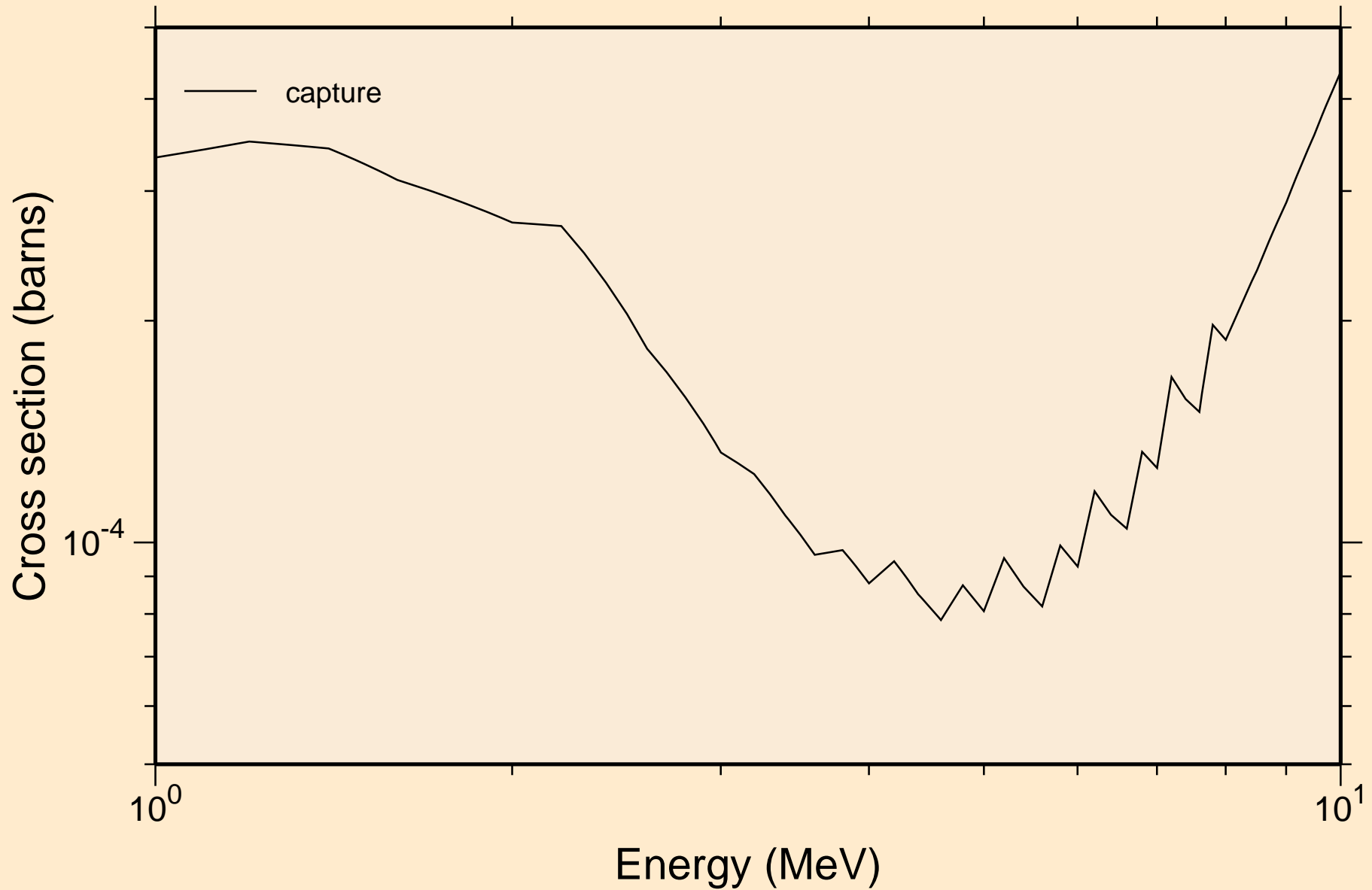

AS084 NEUTRON ACER TENDL-2024 LIBRARY; T=0.K

Heating

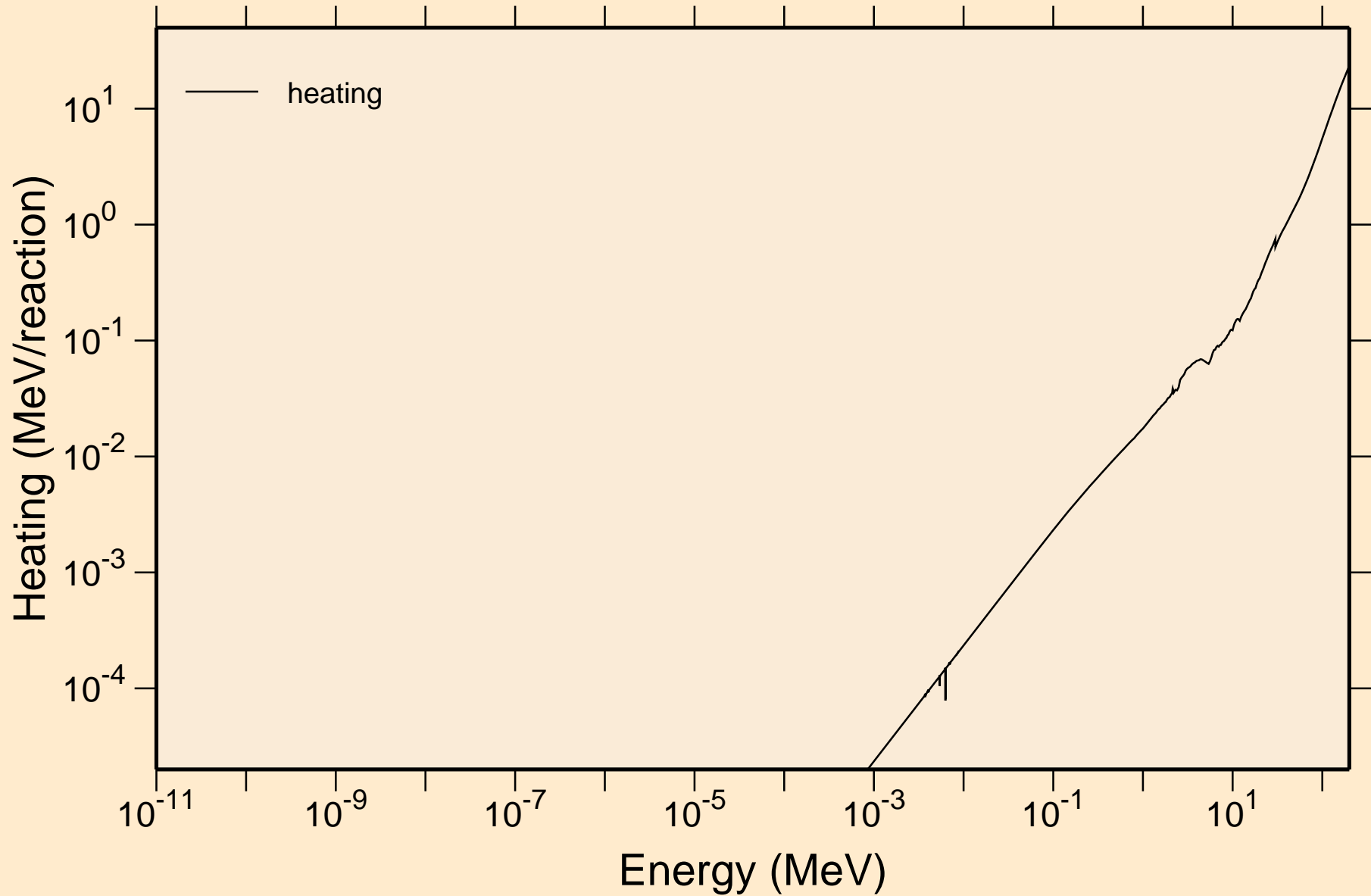

AS084 NEUTRON ACER TENDL-2024 LIBRARY; T=0.K

Damage

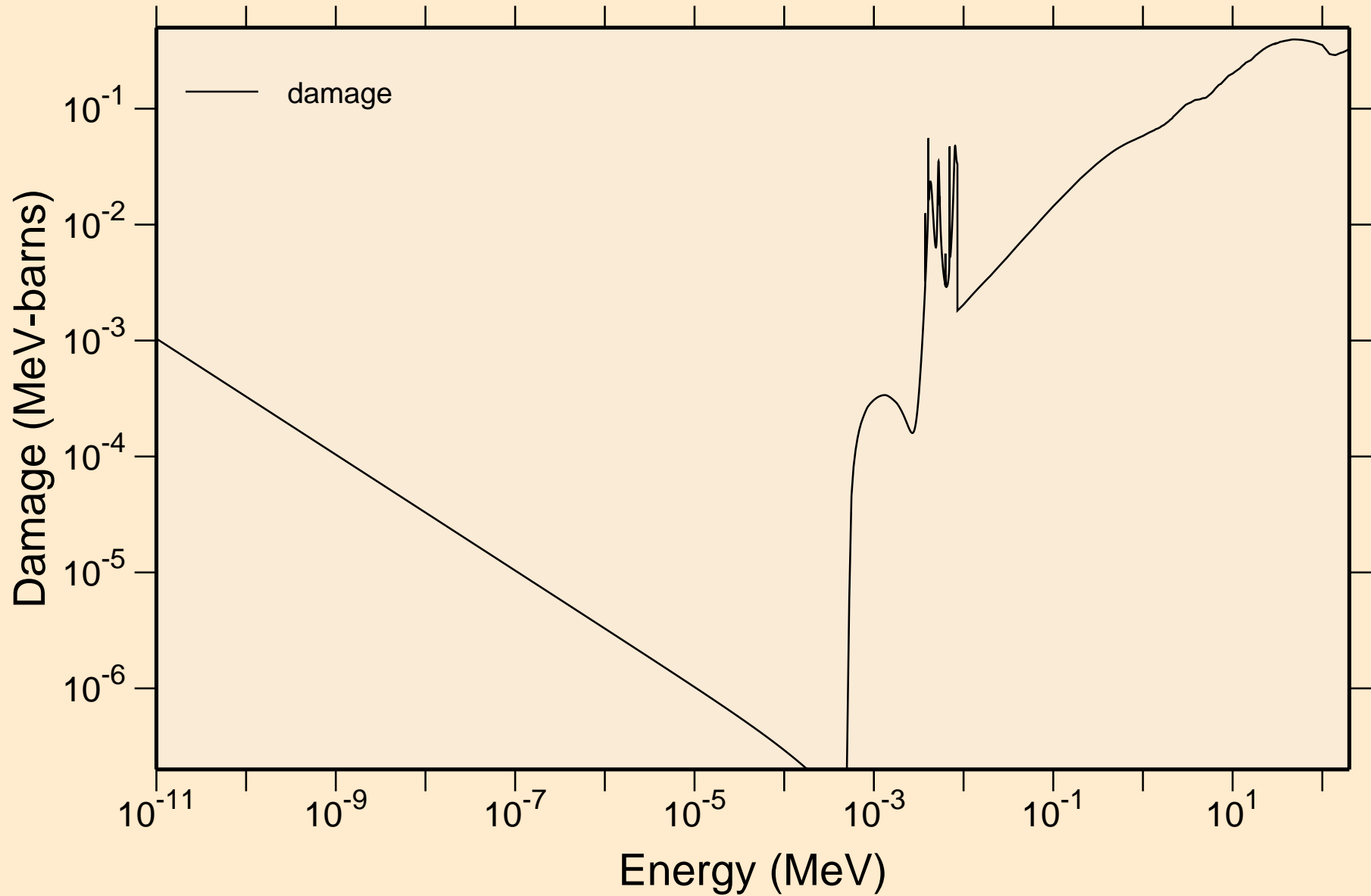

AS084 NEUTRON ACER TENDL-2024 LIBRARY; T=0.K
Non-threshold reactions

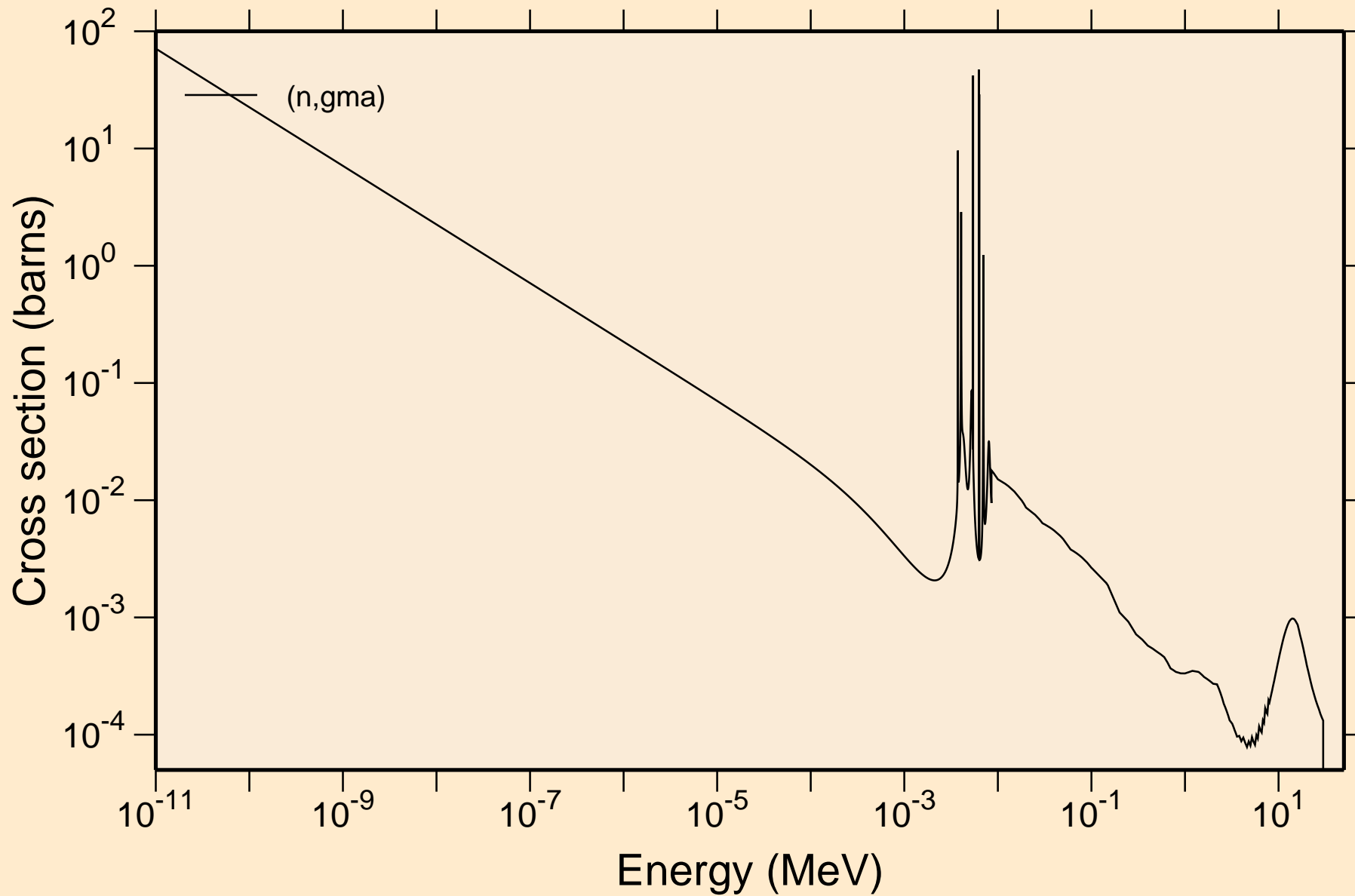

AS084 NEUTRON ACER TENDL-2024 LIBRARY; T=0.K

Principal cross sections

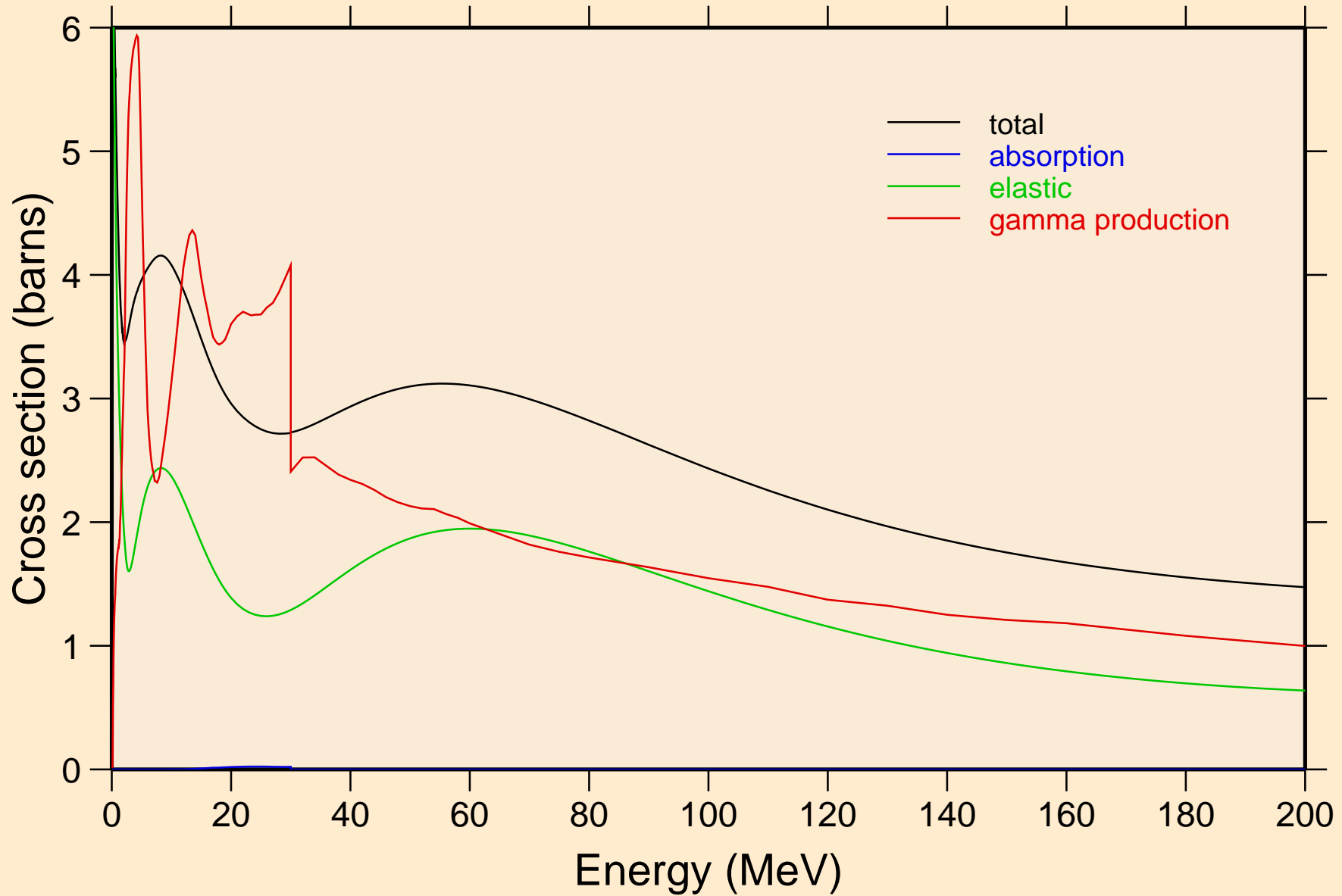

AS084 NEUTRON ACER TENDL-2024 LIBRARY; T=0.K

Heating

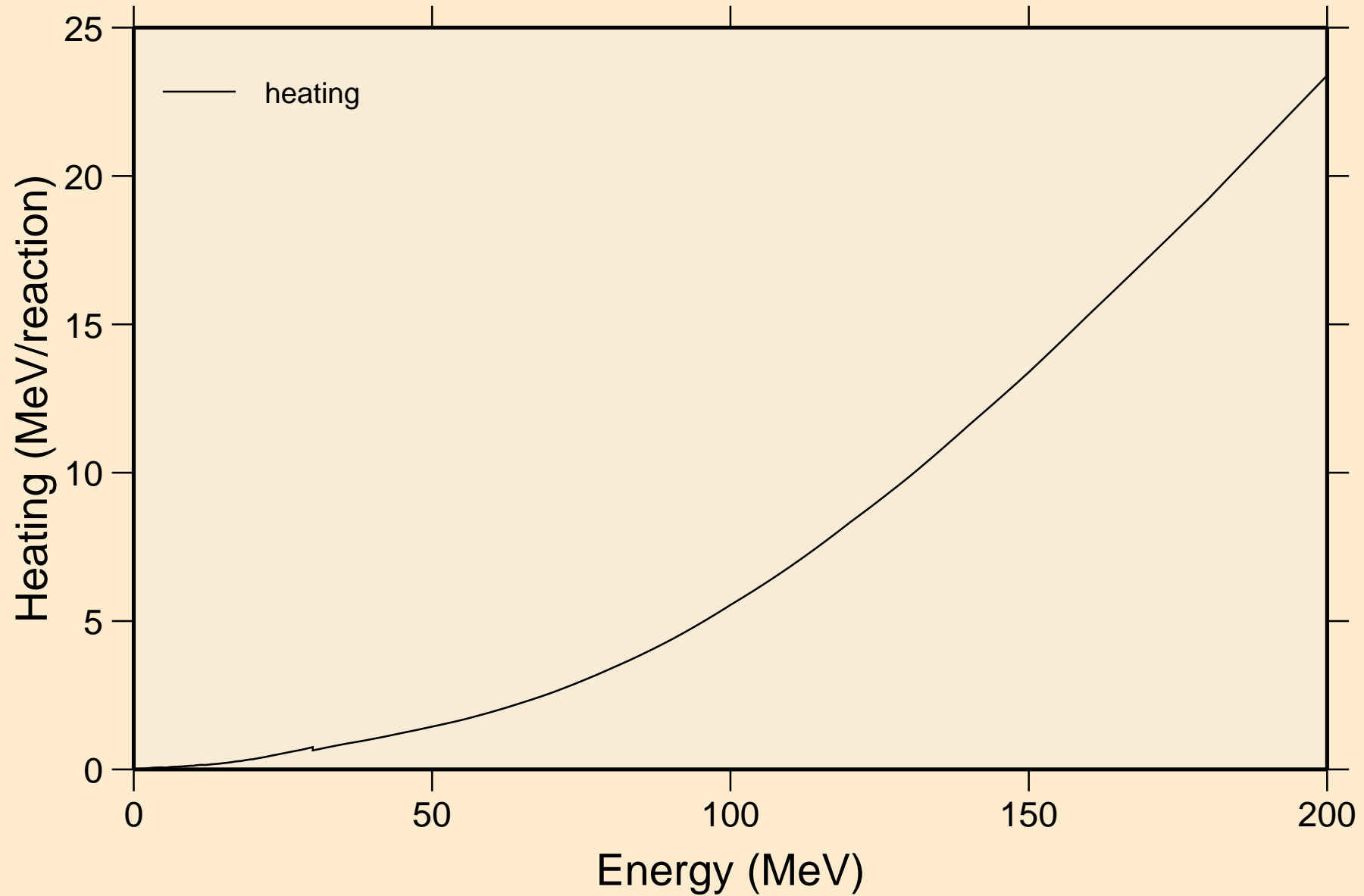

AS084 NEUTRON ACER TENDL-2024 LIBRARY; T=0.K

Damage

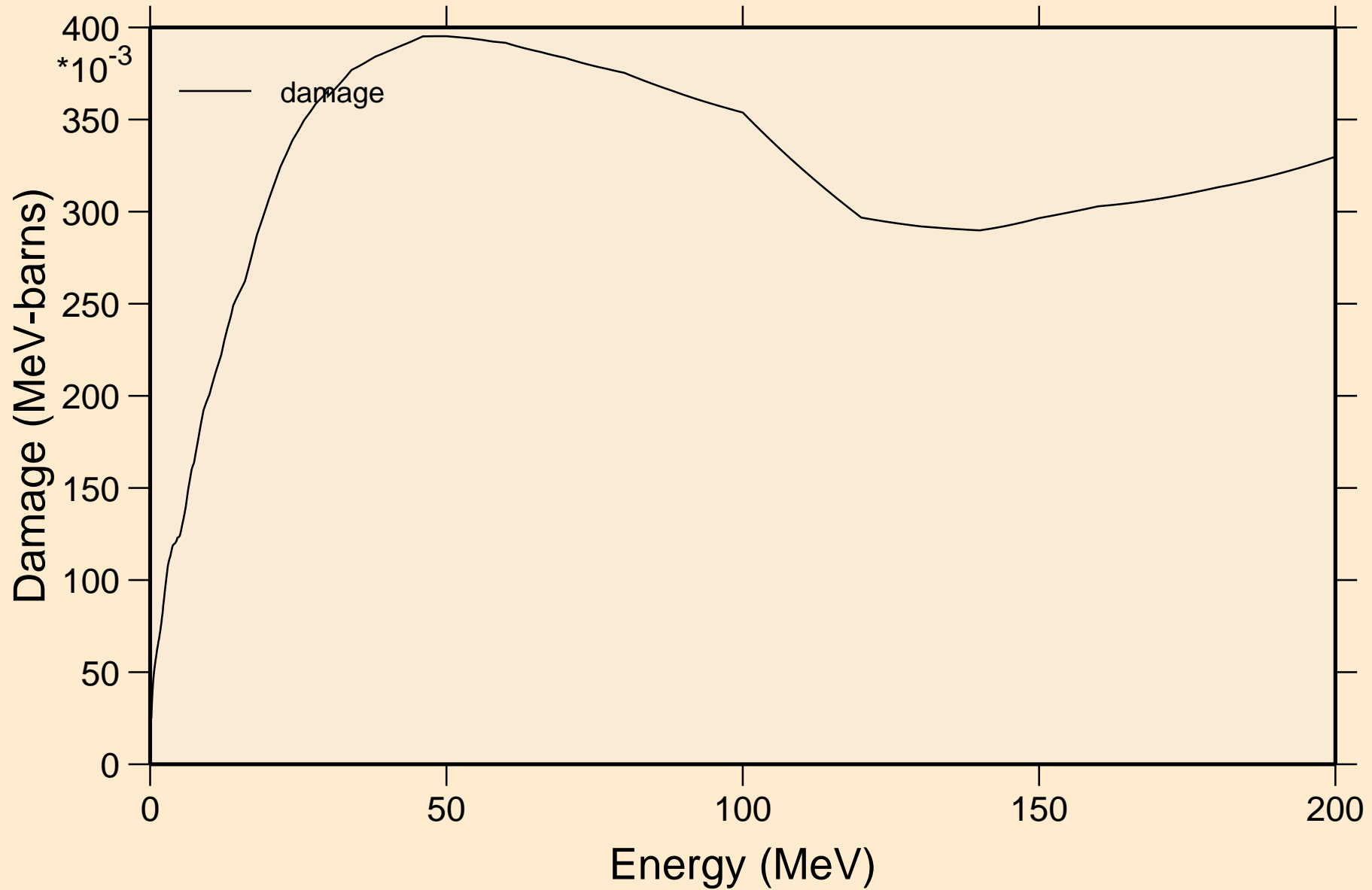

AS084 NEUTRON ACER TENDL-2024 LIBRARY; T=0.K
Non-threshold reactions

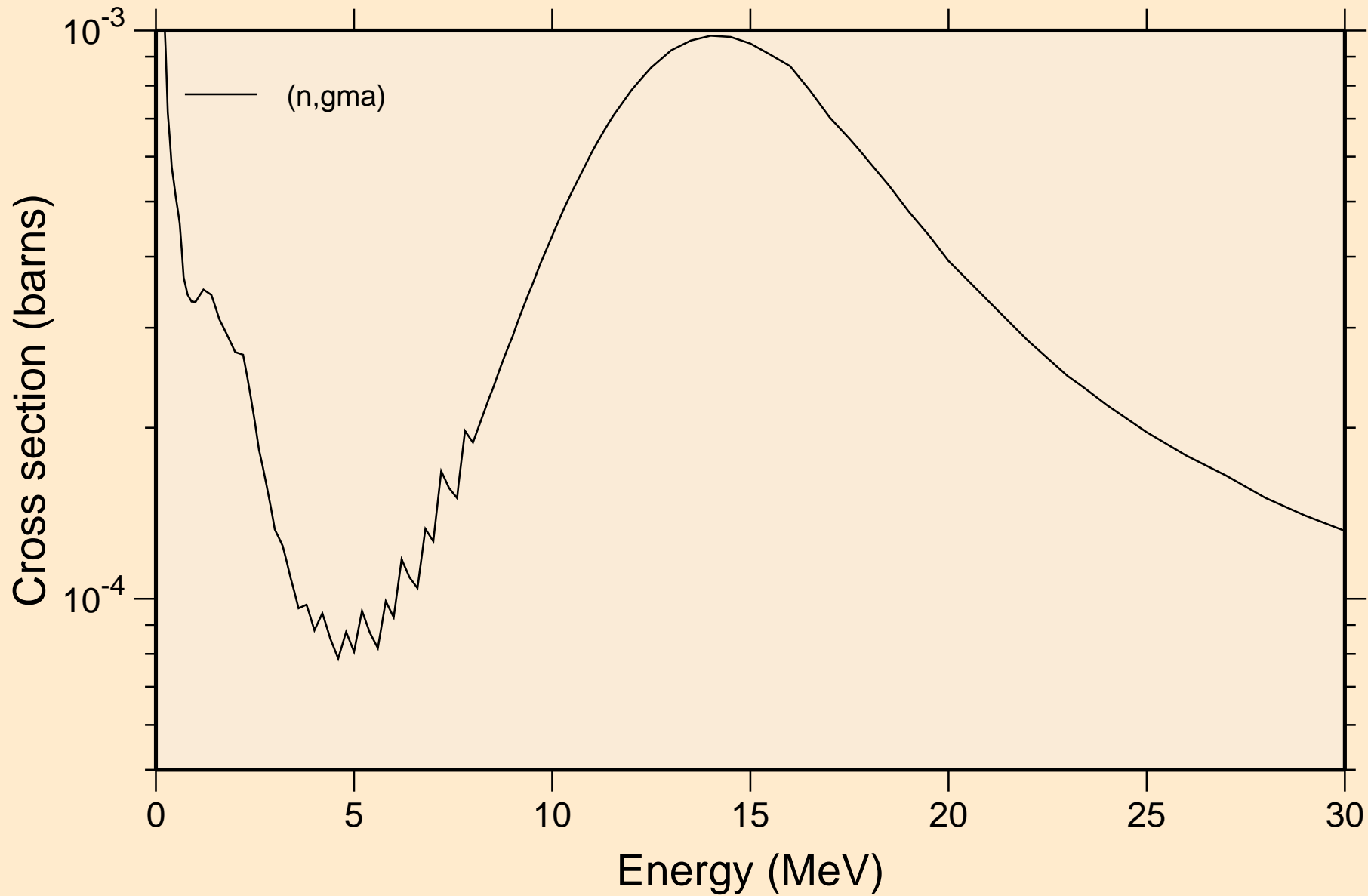

AS084 NEUTRON ACER TENDL-2024 LIBRARY; T=0.K
Inelastic levels

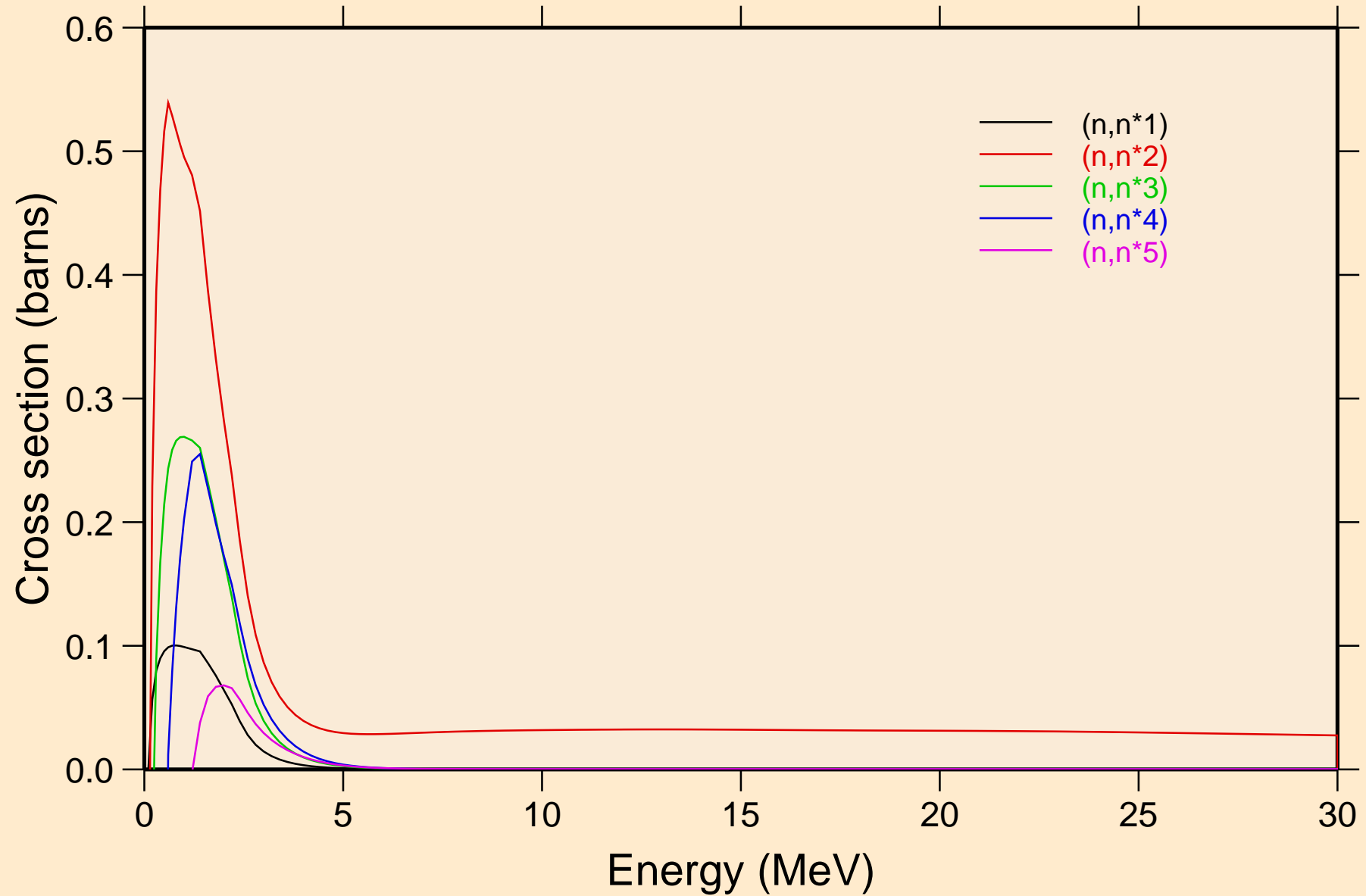

AS084 NEUTRON ACER TENDL-2024 LIBRARY; T=0.K
Inelastic levels

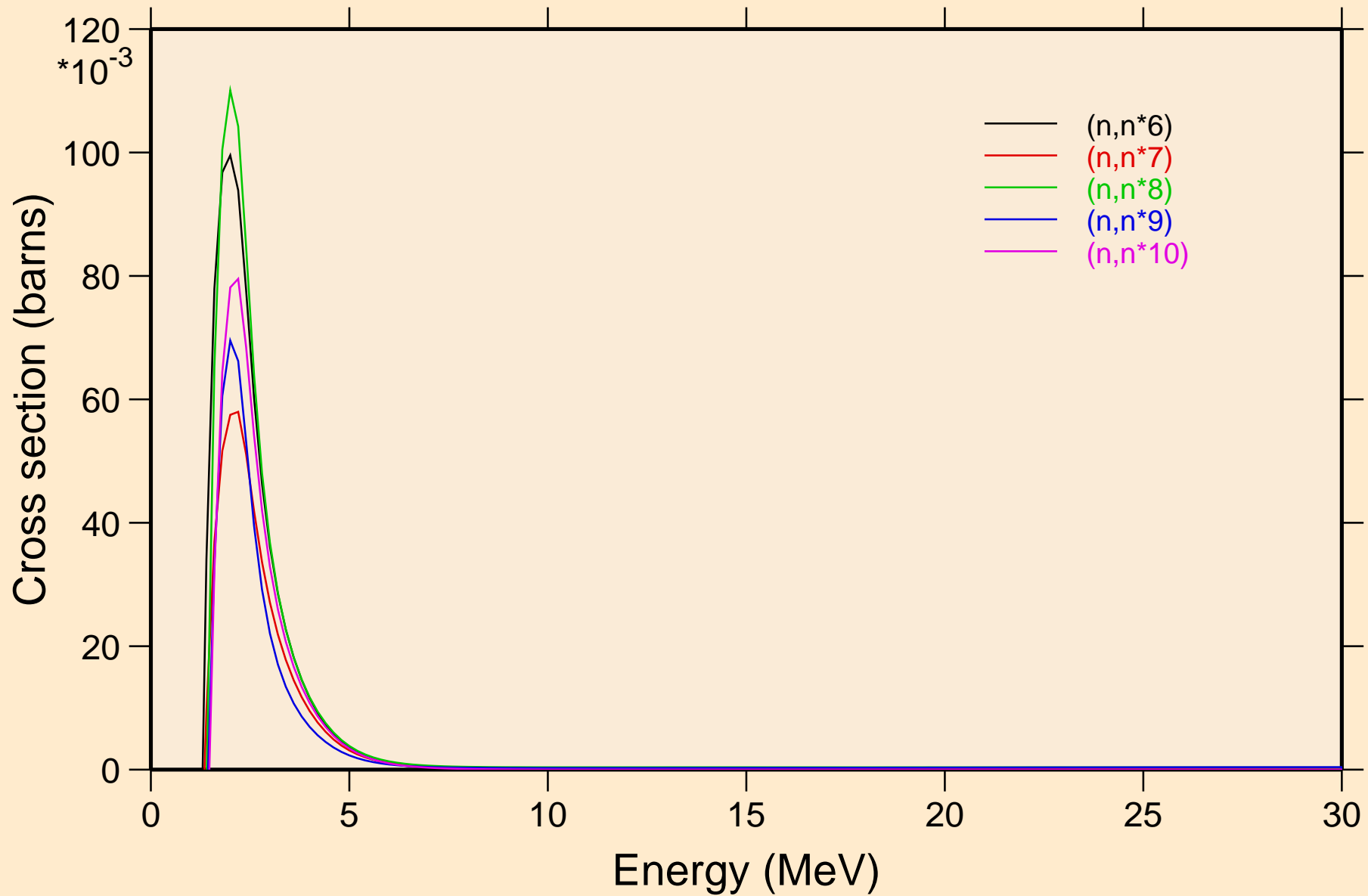

AS084 NEUTRON ACER TENDL-2024 LIBRARY; T=0.K
Inelastic levels

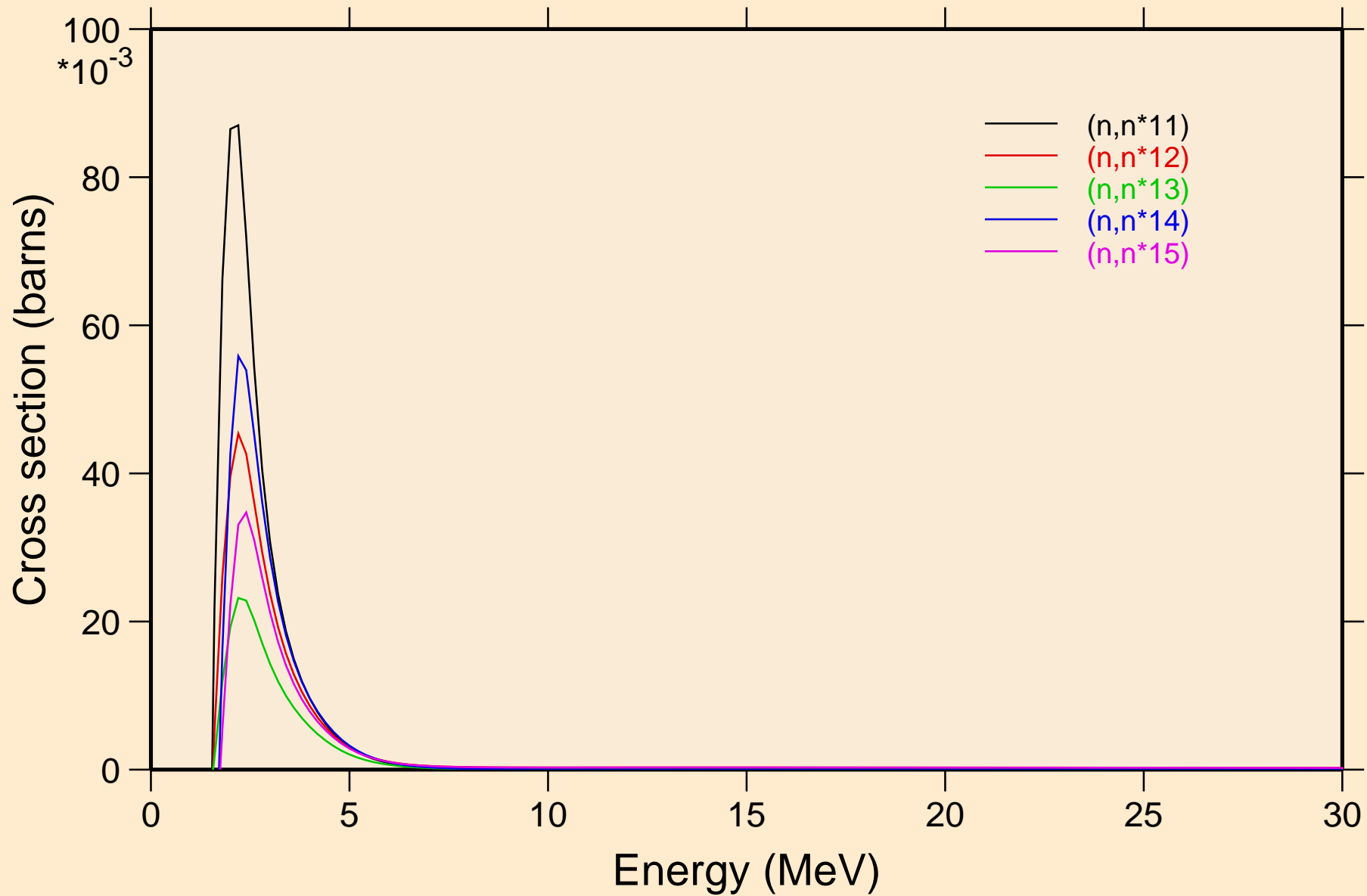

AS084 NEUTRON ACER TENDL-2024 LIBRARY; T=0.K
Inelastic levels

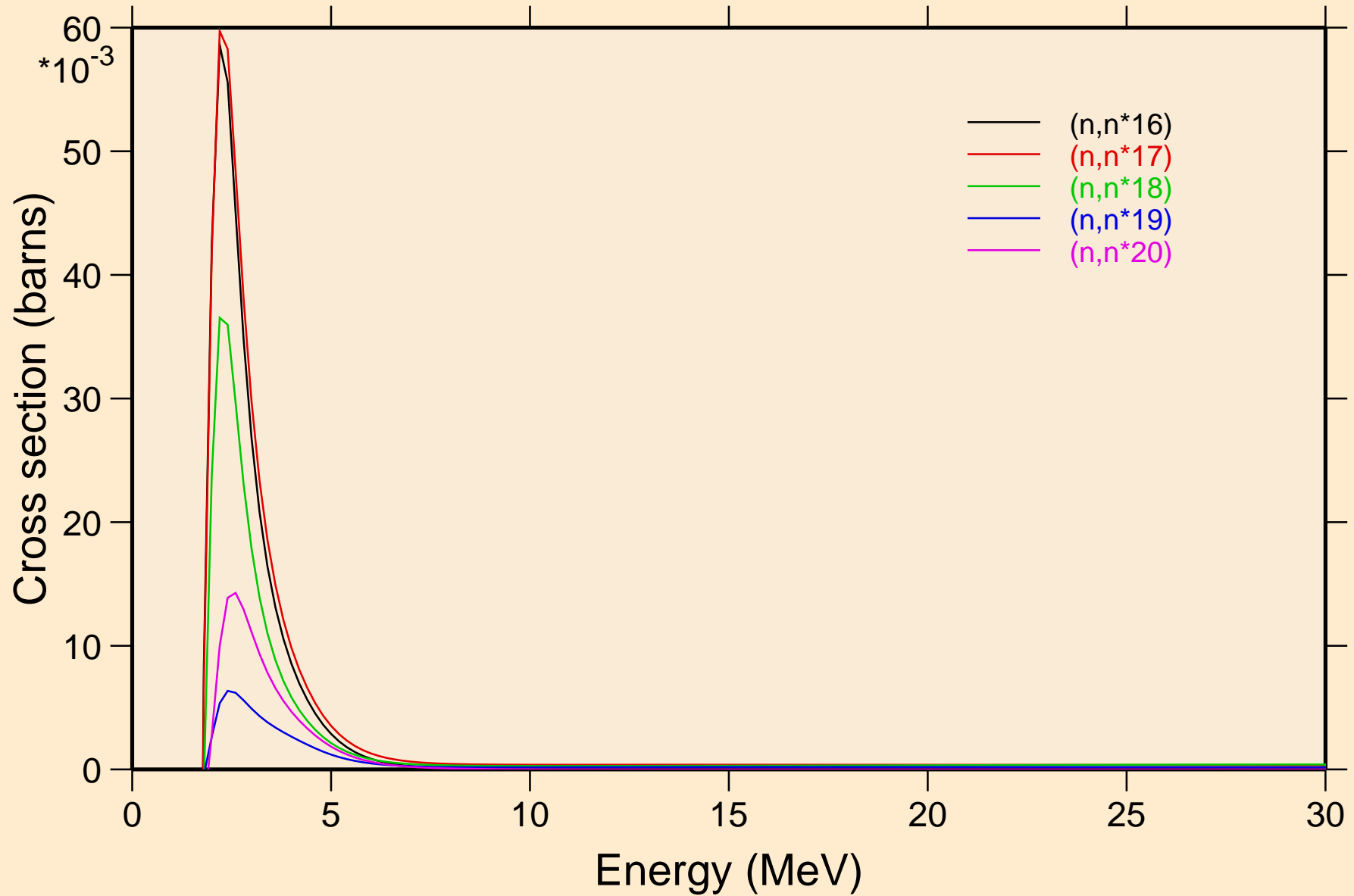

AS084 NEUTRON ACER TENDL-2024 LIBRARY; T=0.K
Inelastic levels

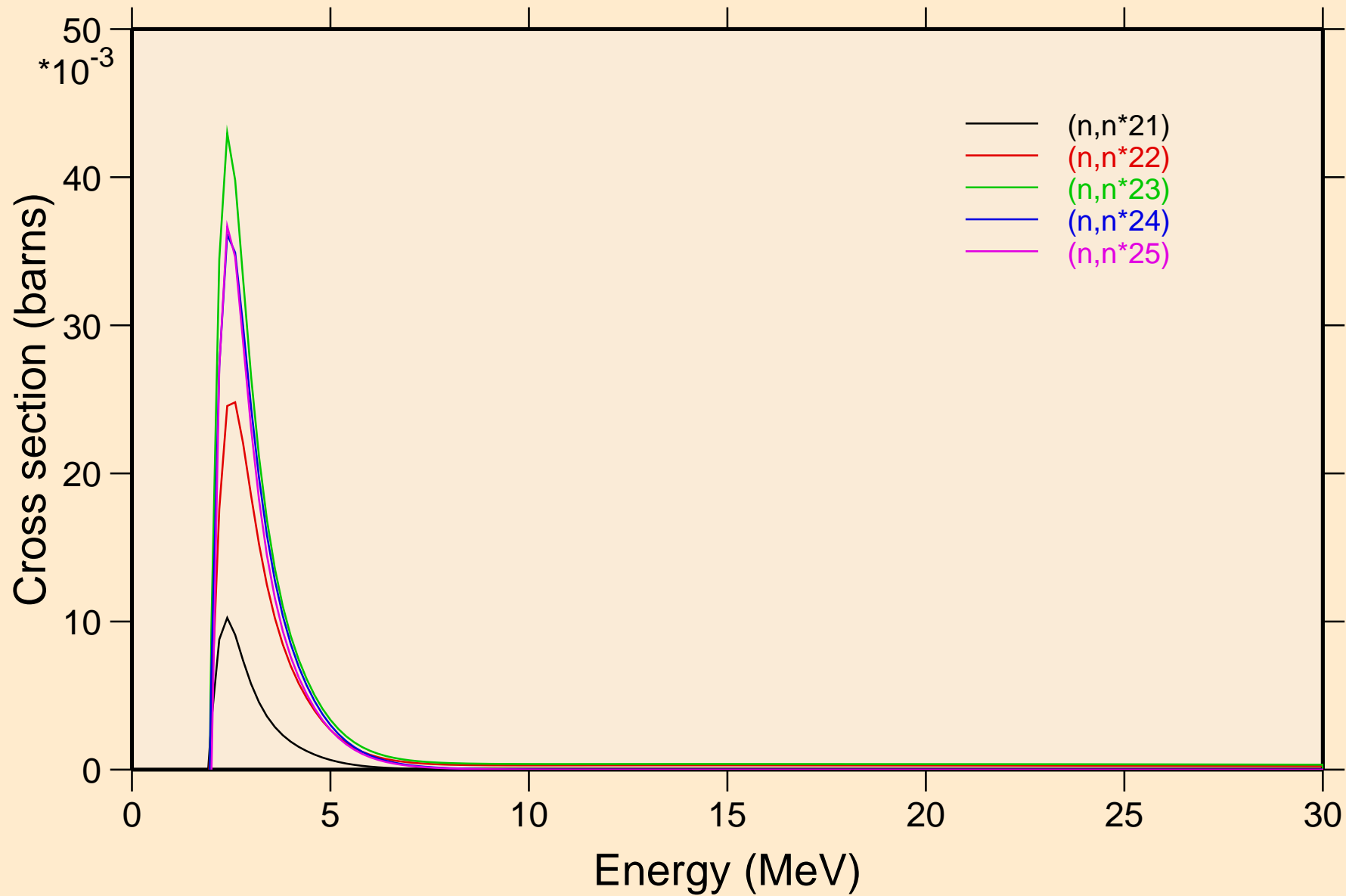

AS084 NEUTRON ACER TENDL-2024 LIBRARY; T=0.K
Inelastic levels

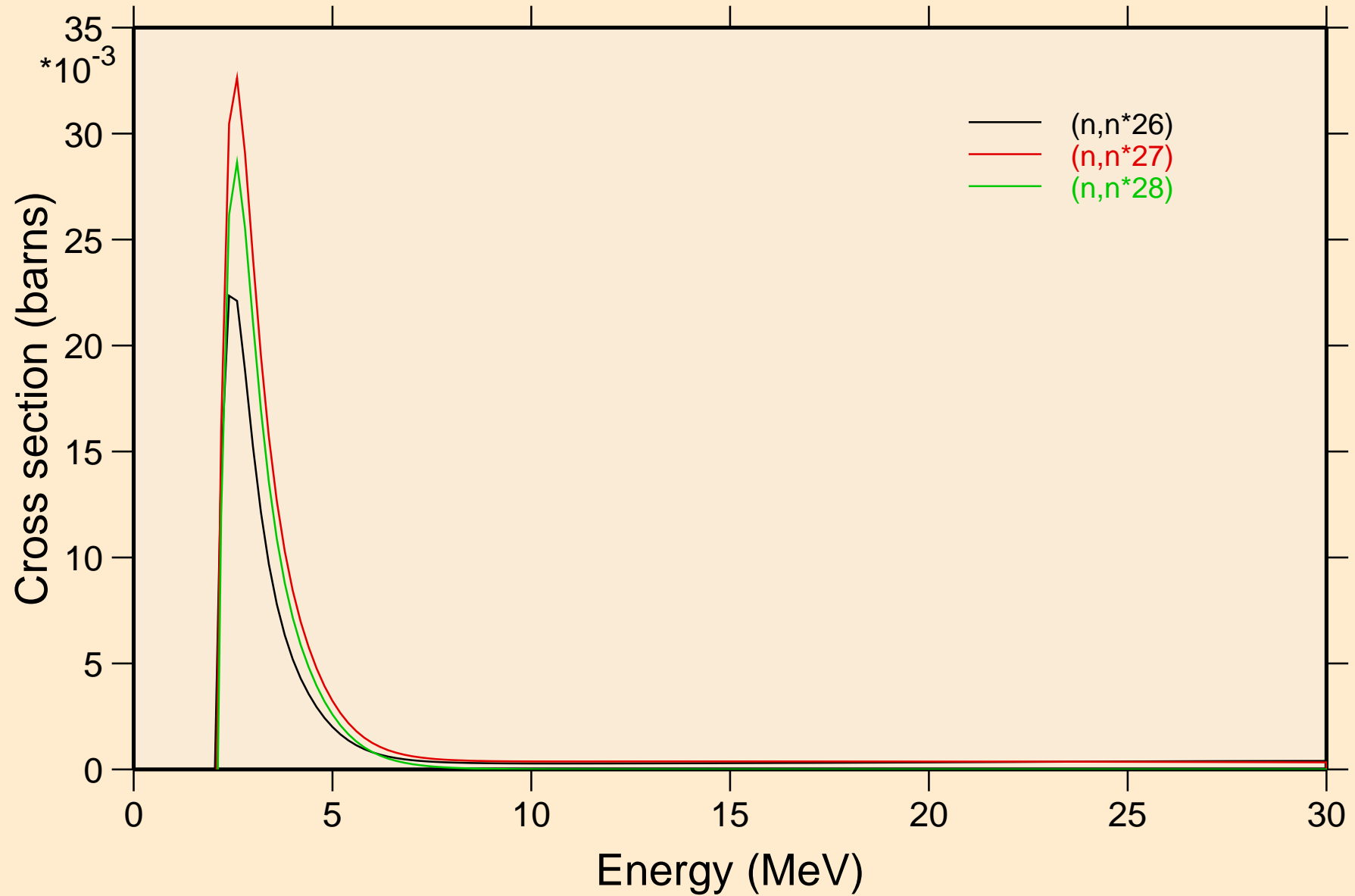

AS084 NEUTRON ACER TENDL-2024 LIBRARY; T=0.K
Threshold reactions

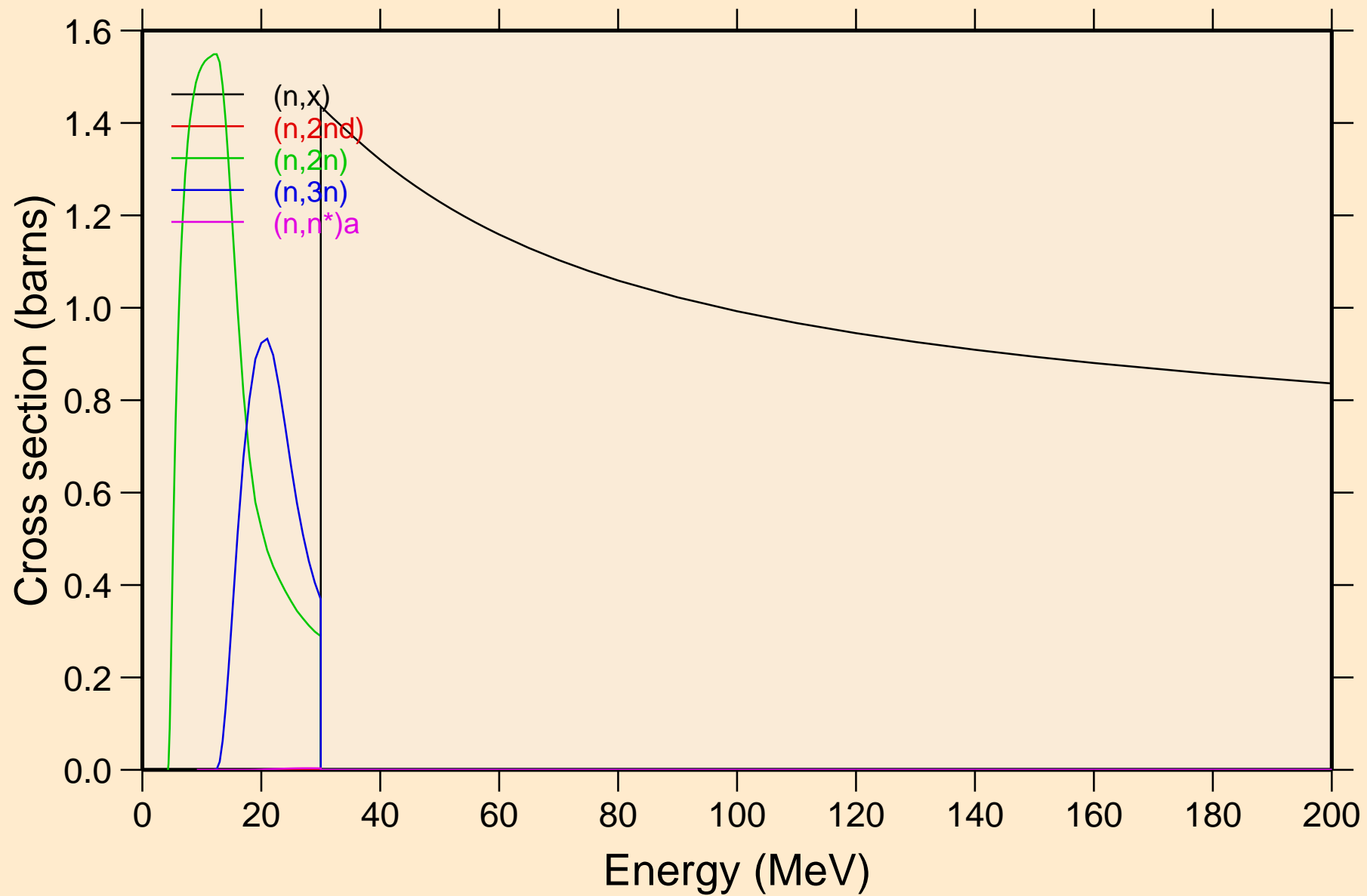

AS084 NEUTRON ACER TENDL-2024 LIBRARY; T=0.K
Threshold reactions

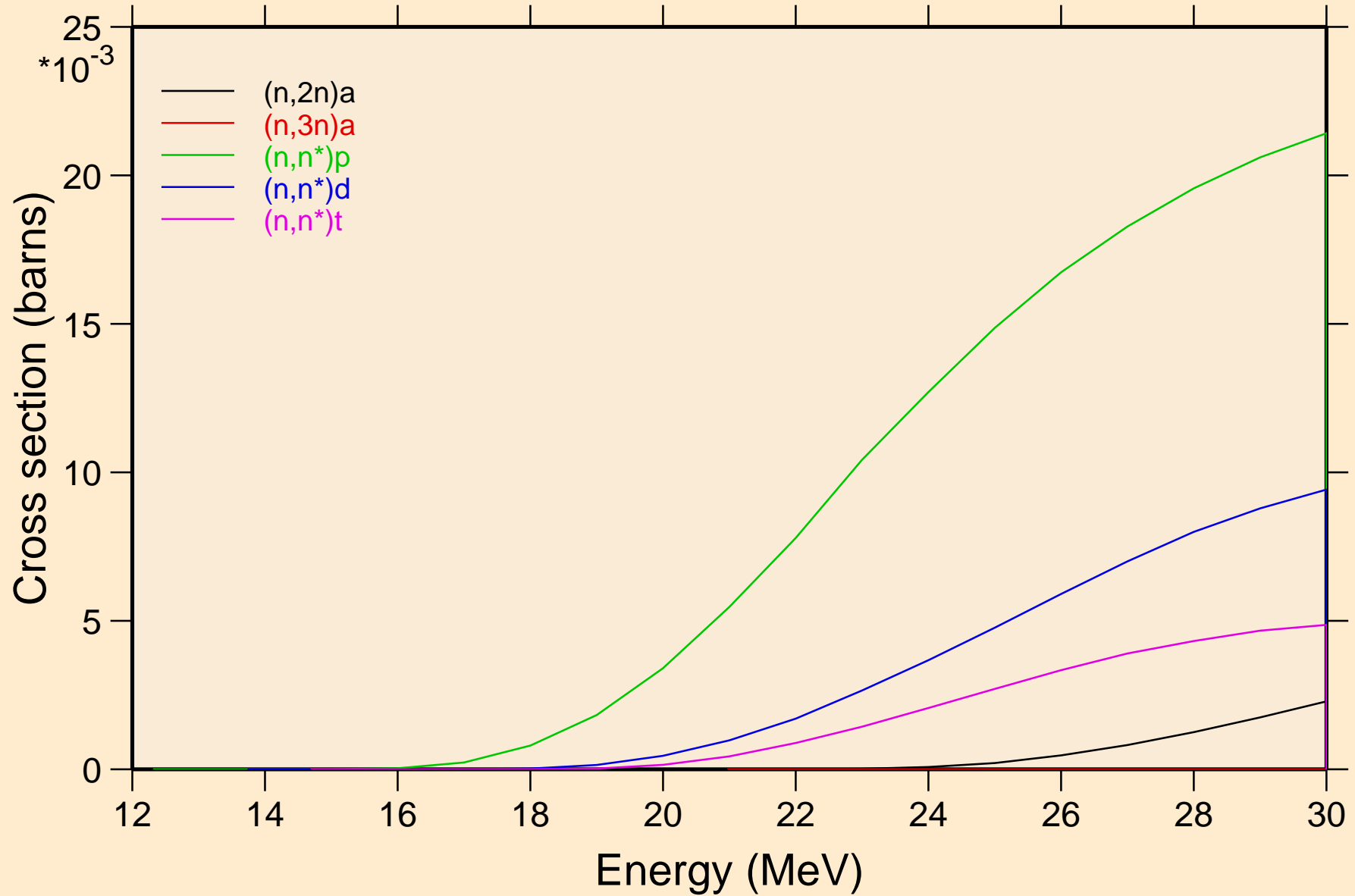

AS084 NEUTRON ACER TENDL-2024 LIBRARY; T=0.K
Threshold reactions

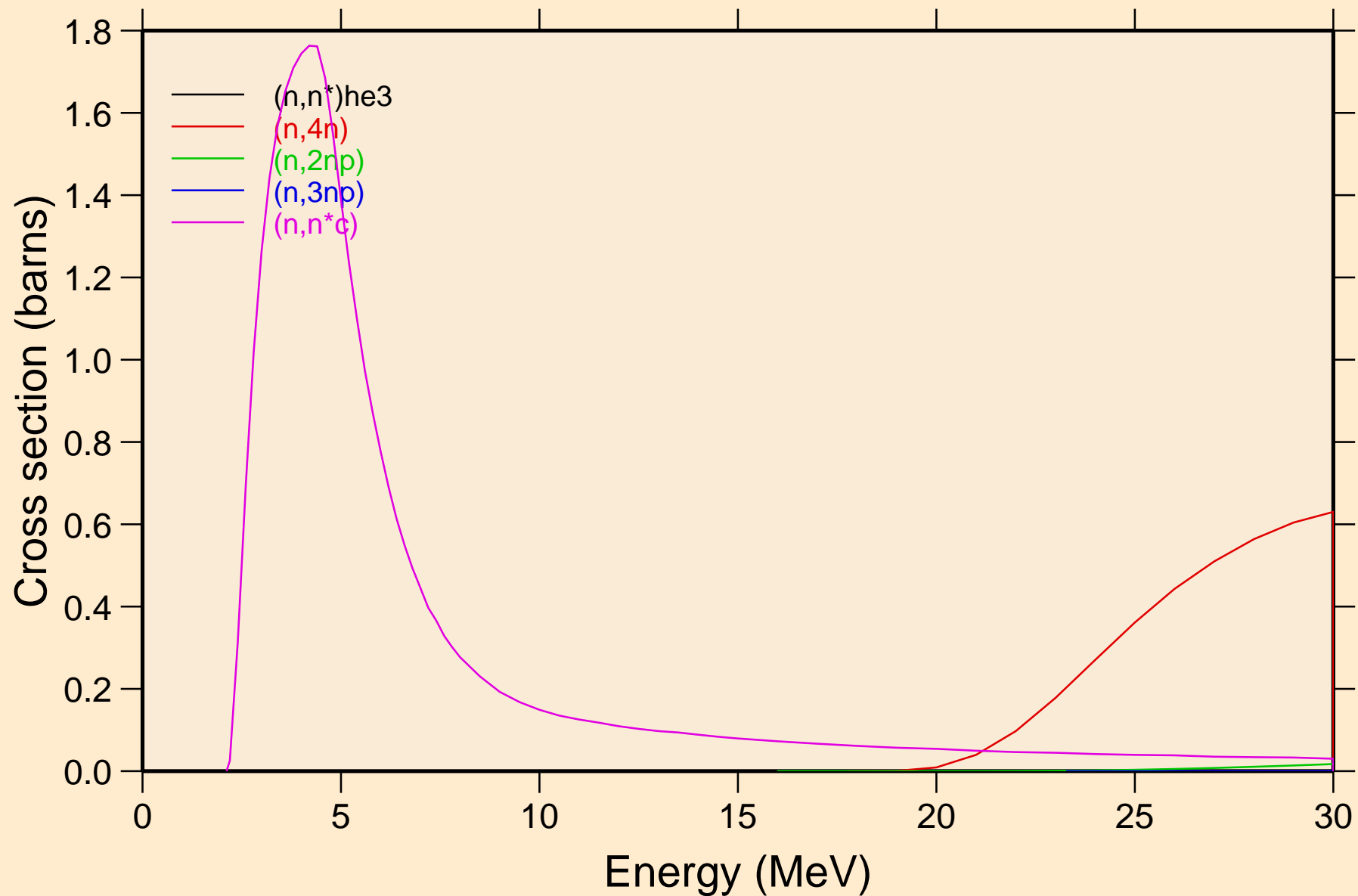

AS084 NEUTRON ACER TENDL-2024 LIBRARY; T=0.K
Threshold reactions

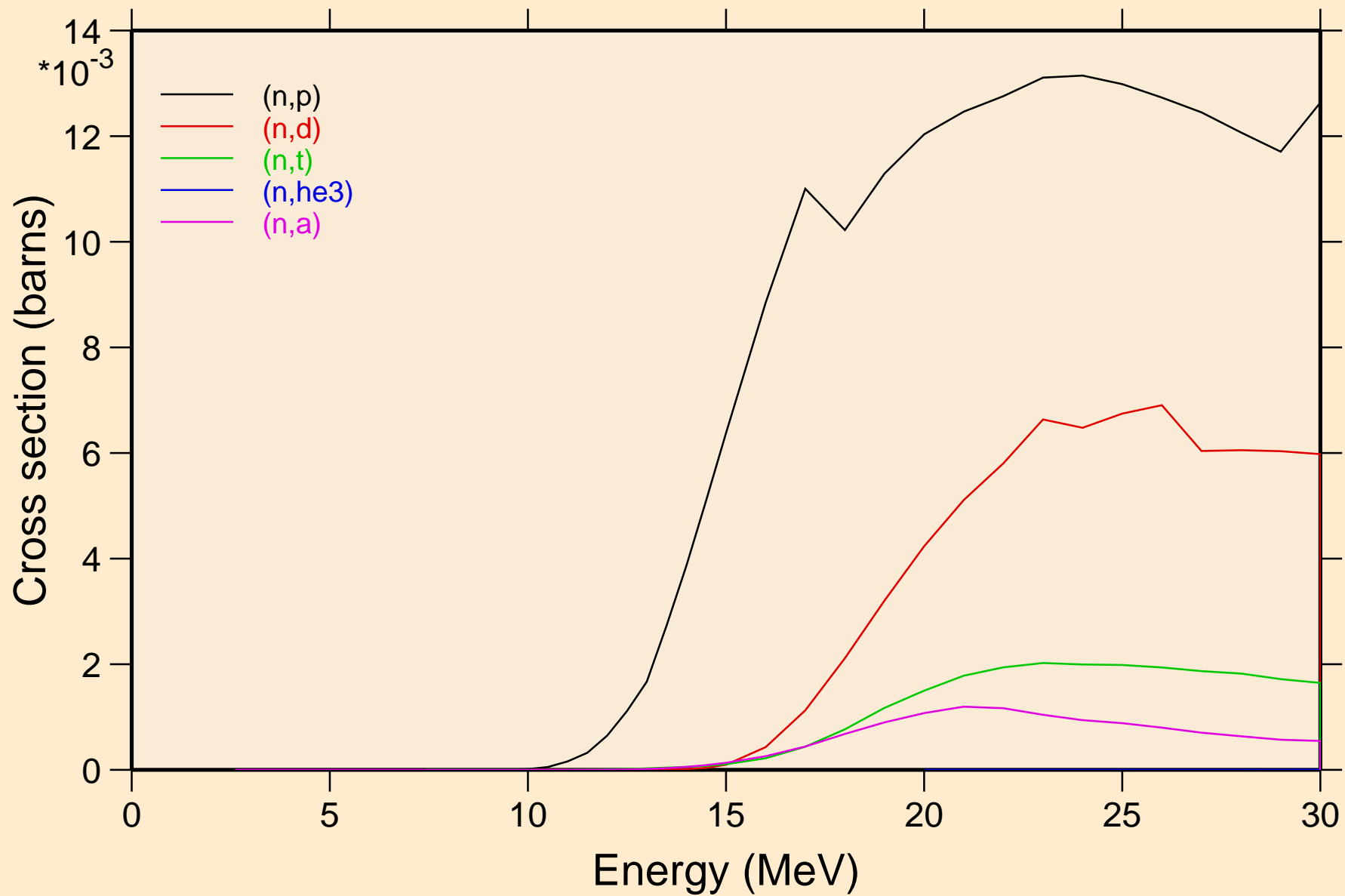

AS084 NEUTRON ACER TENDL-2024 LIBRARY; T=0.K

Threshold reactions

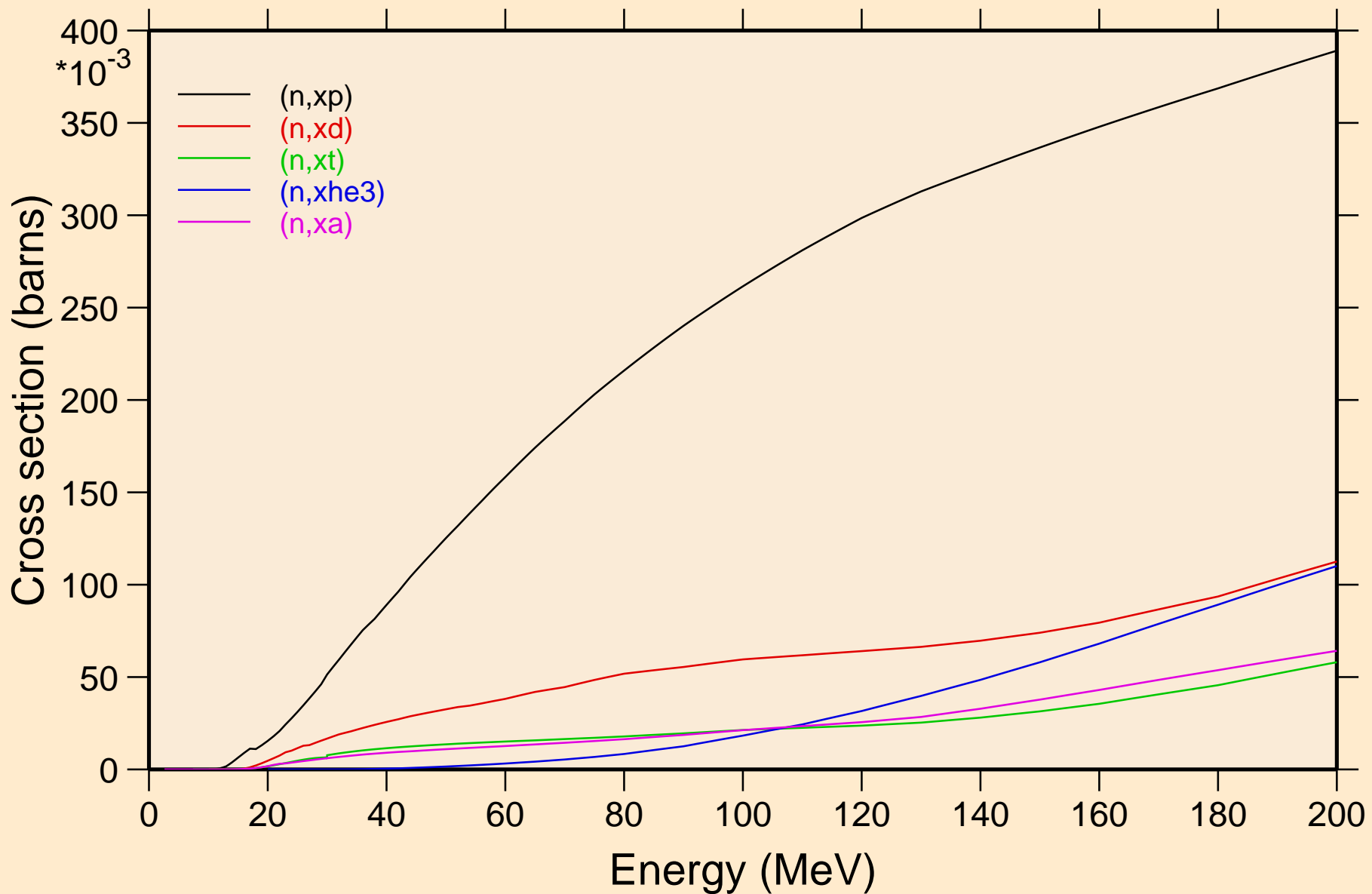

AS084 NEUTRON ACER TENDL-2024 LIBRARY; T=0.K
angular distribution for elastic

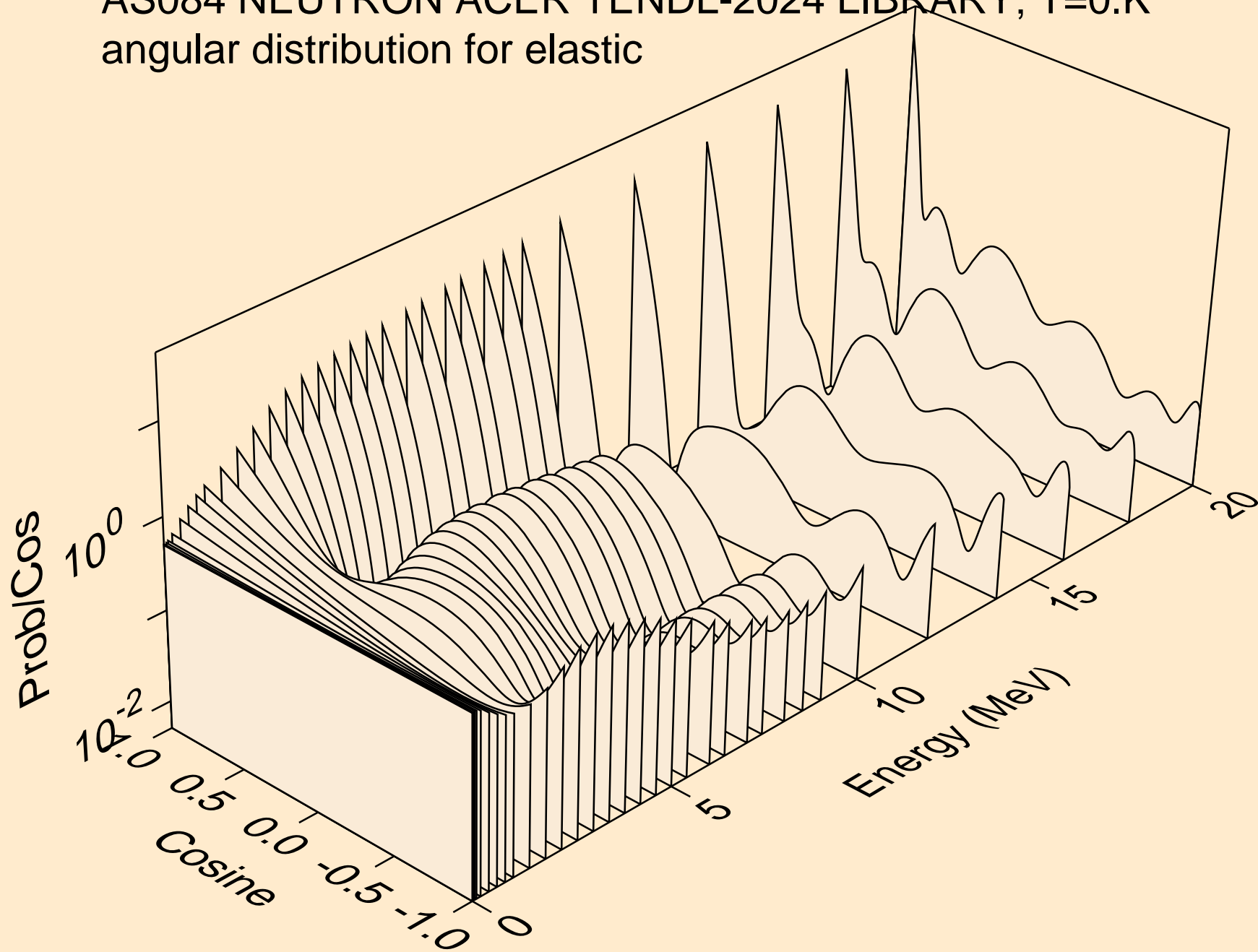

AS084 NEUTRON ACER TENDL-2024 LIBRARY; T=0.K
angular distribution for elastic

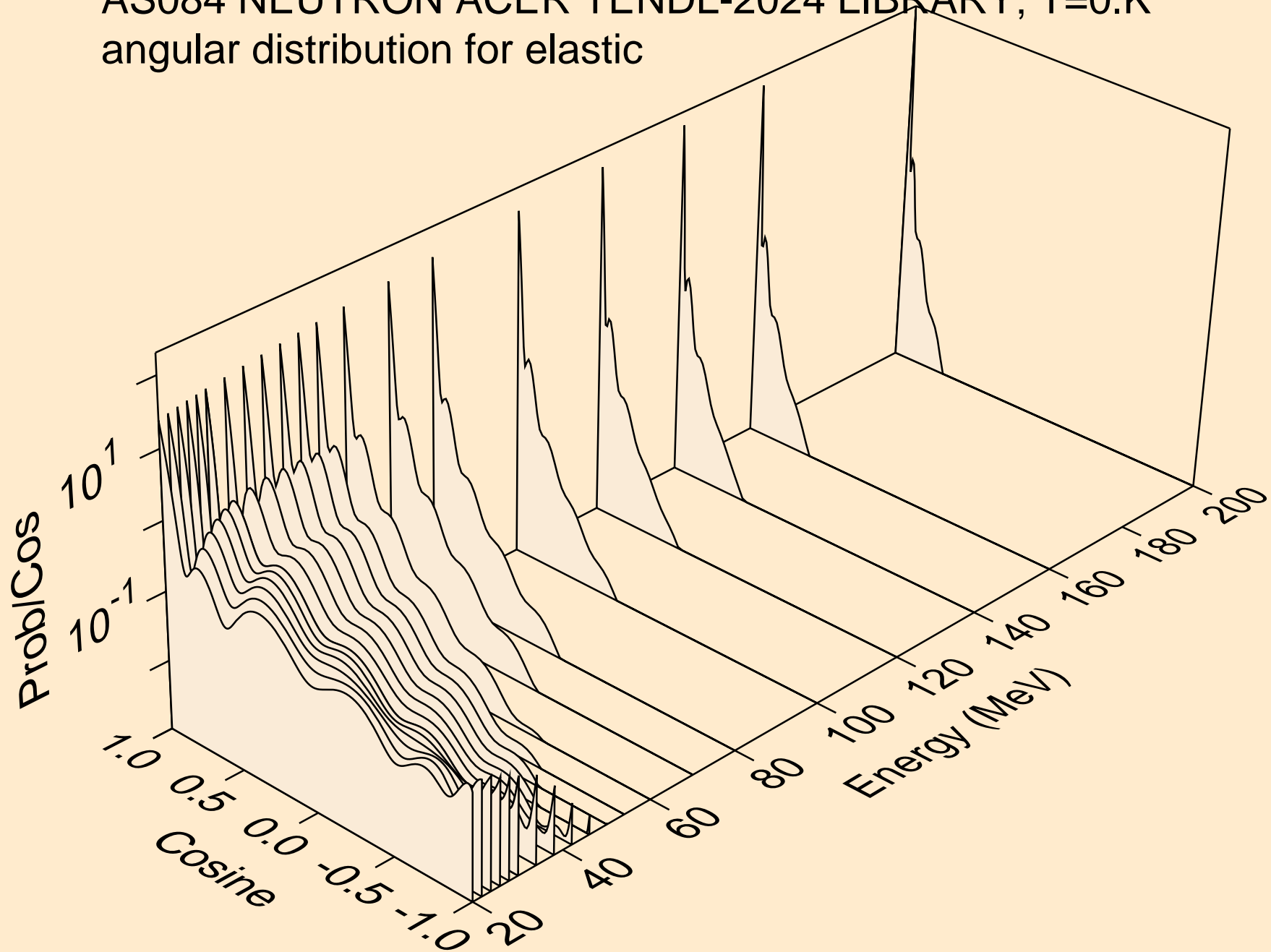

AS084 NEUTRON ACER TENDL-2024 LIBRARY; T=0.K
angular distribution for (n,n*1)

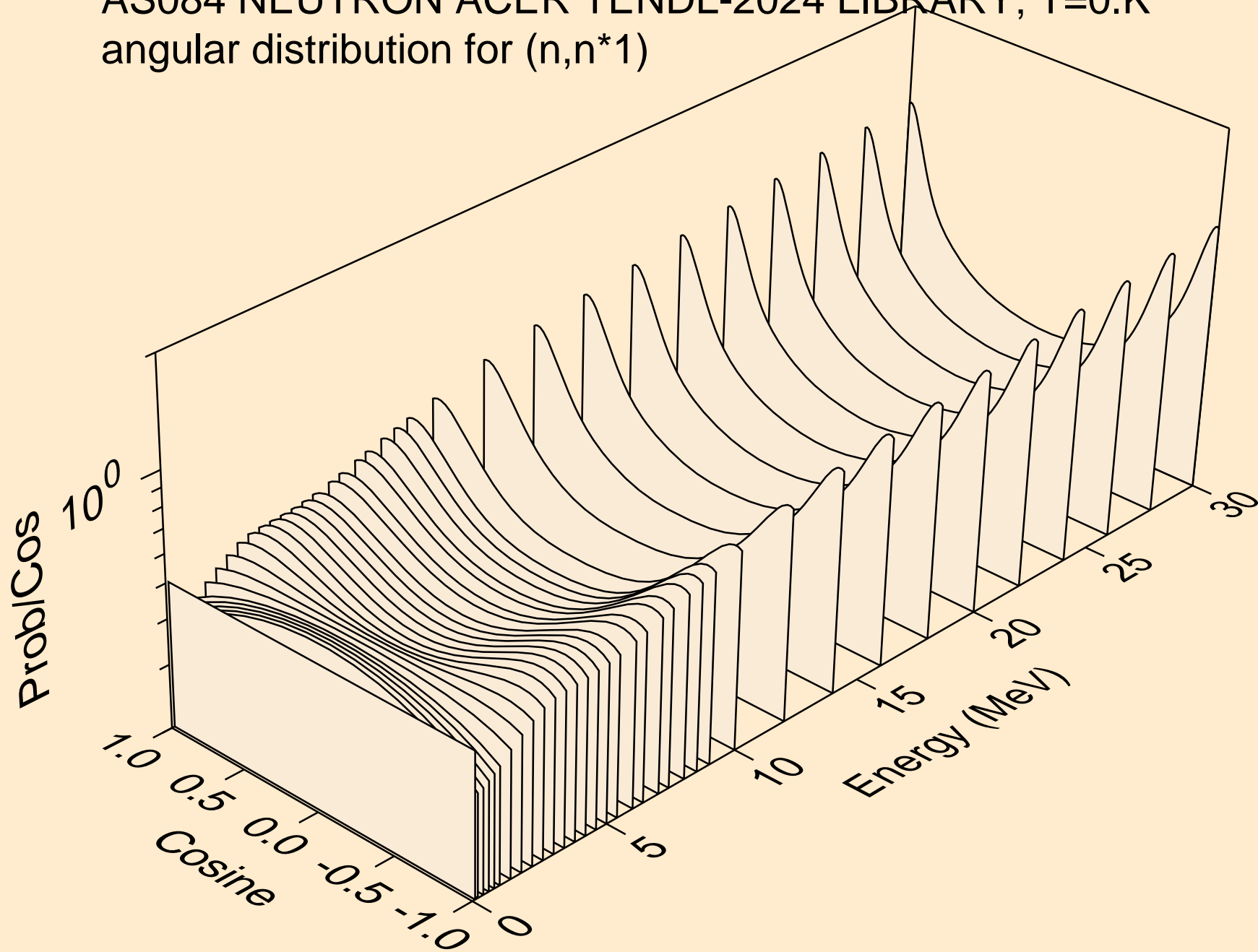

AS084 NEUTRON ACER TENDL-2024 LIBRARY; T=0.K
angular distribution for (n,n*2)

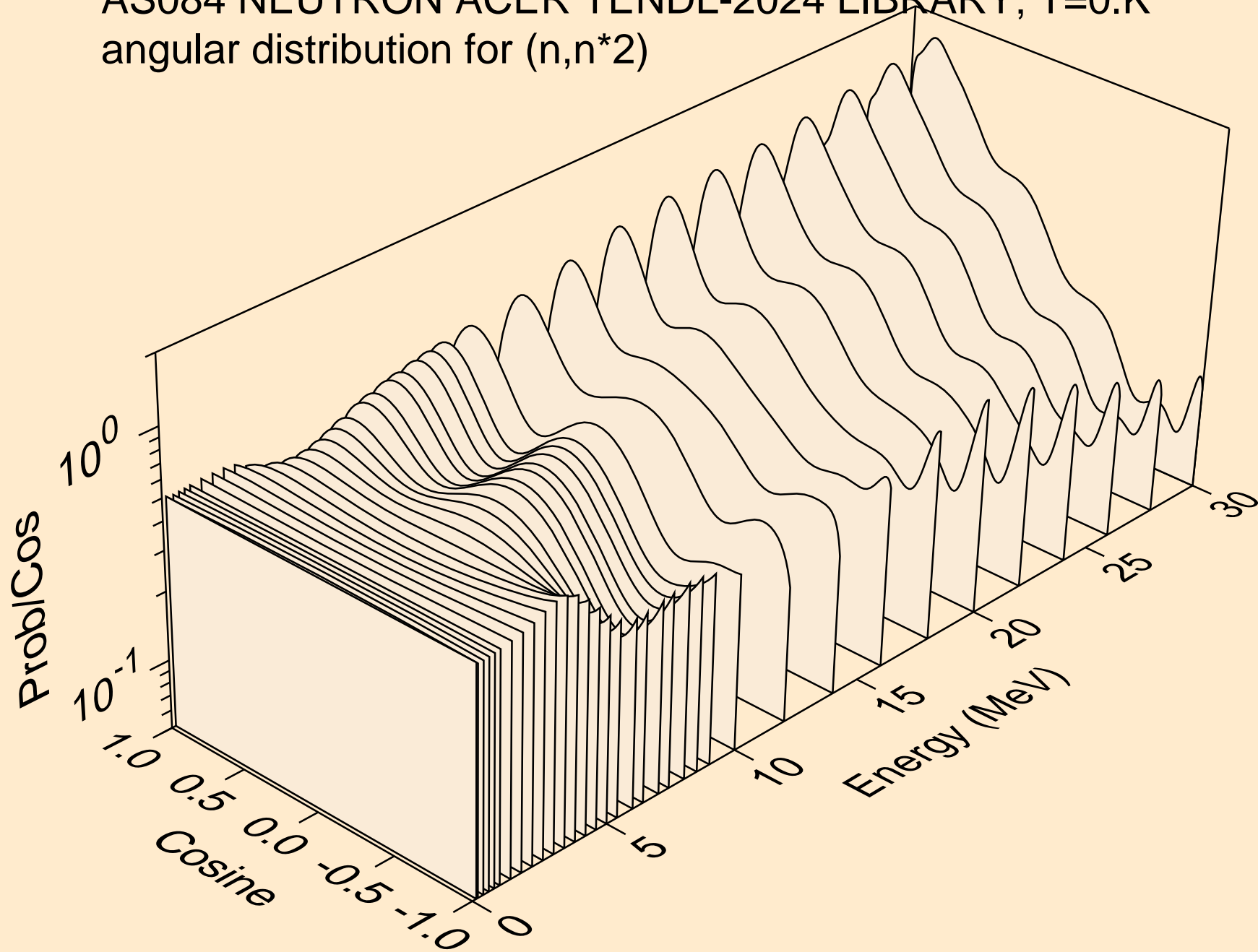

AS084 NEUTRON ACER TENDL-2024 LIBRARY; T=0.K
angular distribution for (n,n*3)

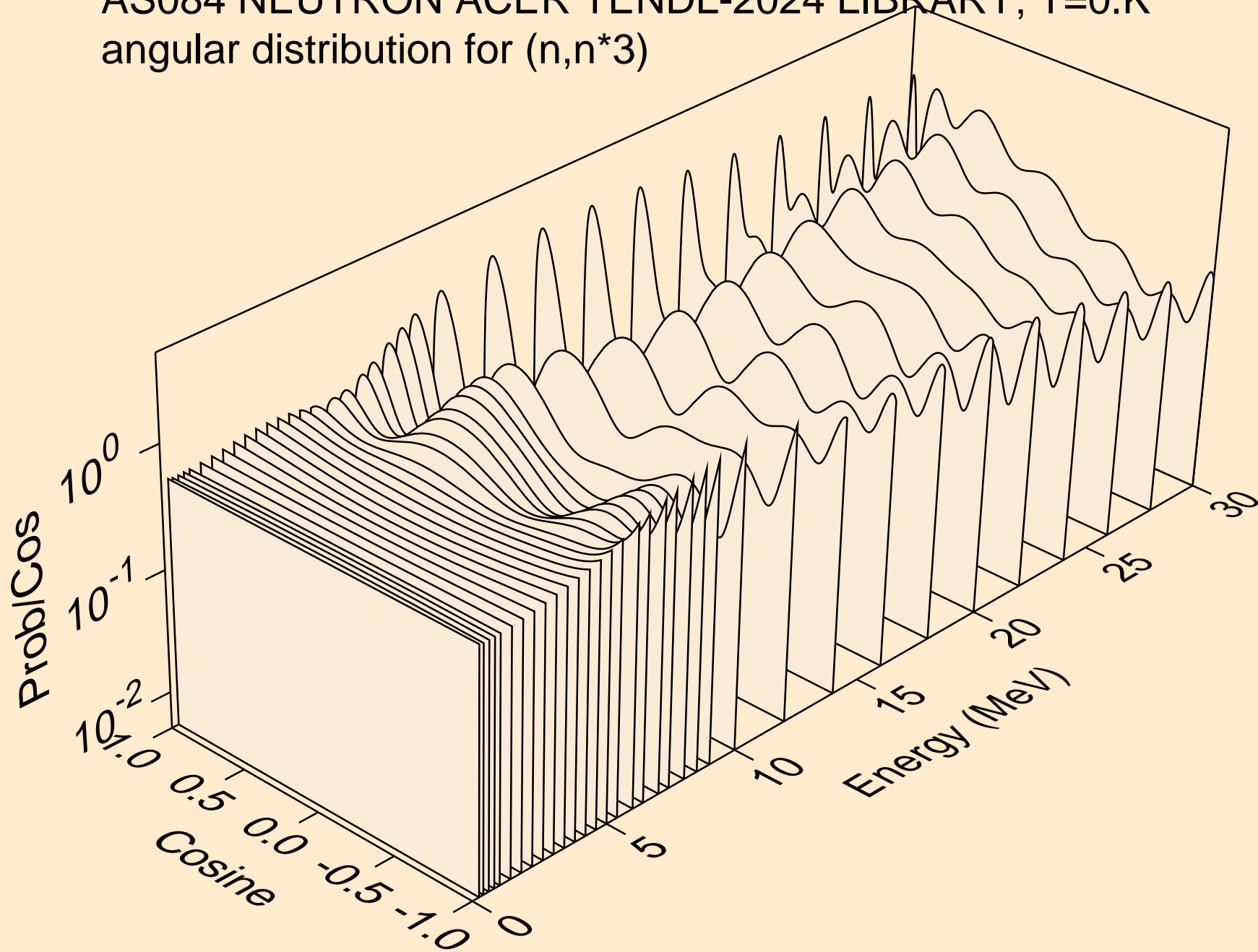

AS084 NEUTRON ACER TENDL-2024 LIBRARY; T=0.K
angular distribution for (n,n*4)

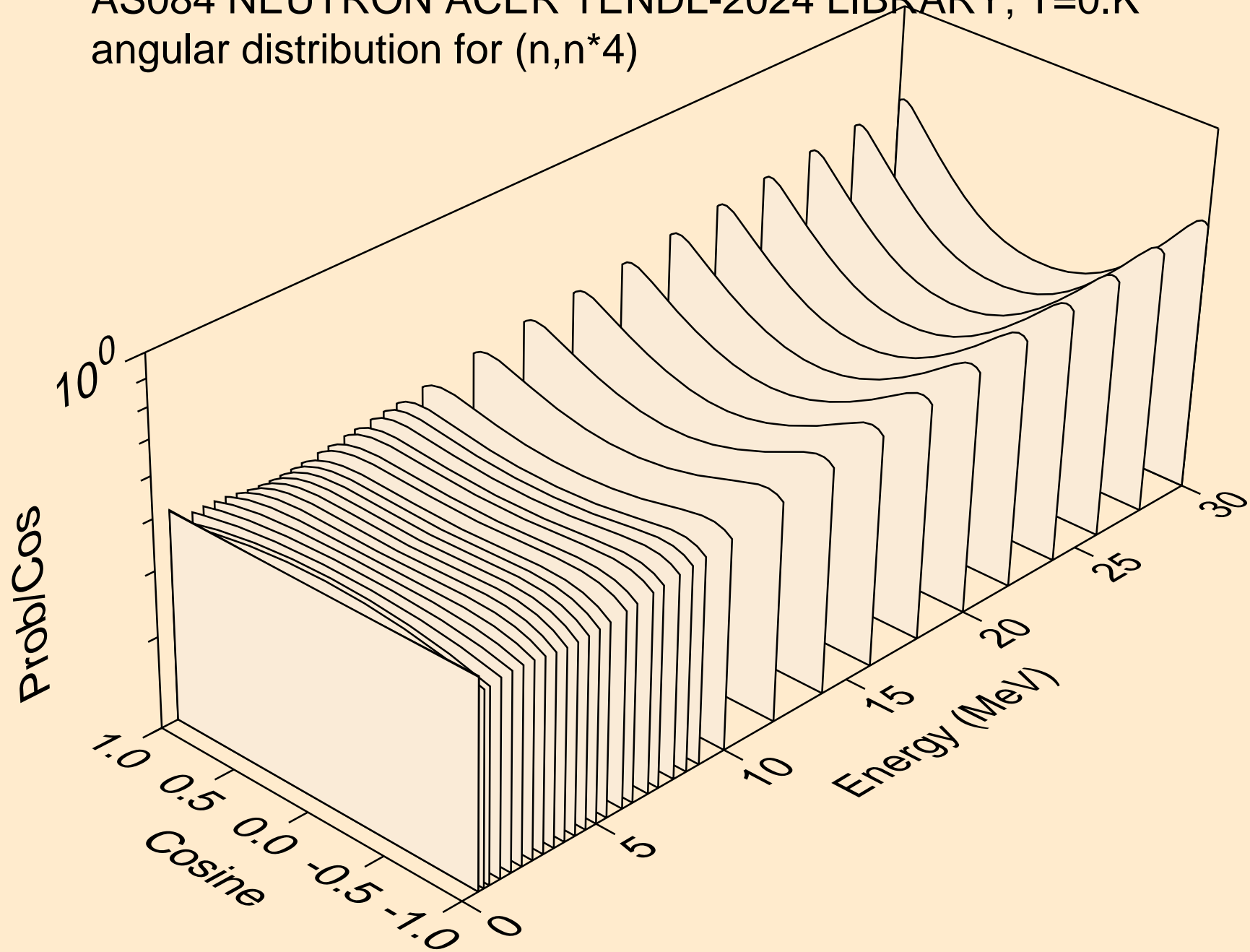

AS084 NEUTRON ACER TENDL-2024 LIBRARY; T=0.K
angular distribution for (n,n*5)

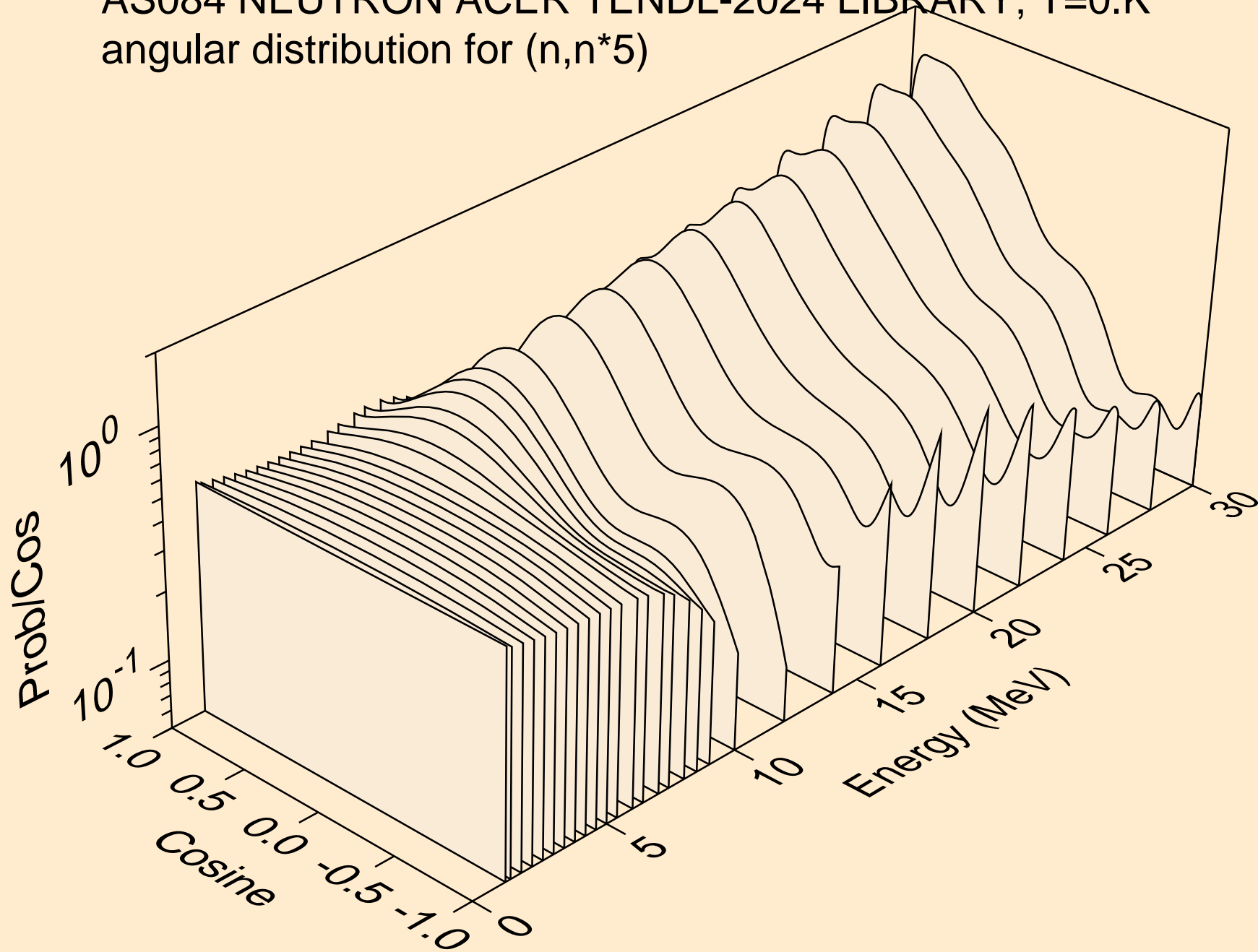

AS084 NEUTRON ACER TENDL-2024 LIBRARY; T=0.K
angular distribution for (n,n*6)

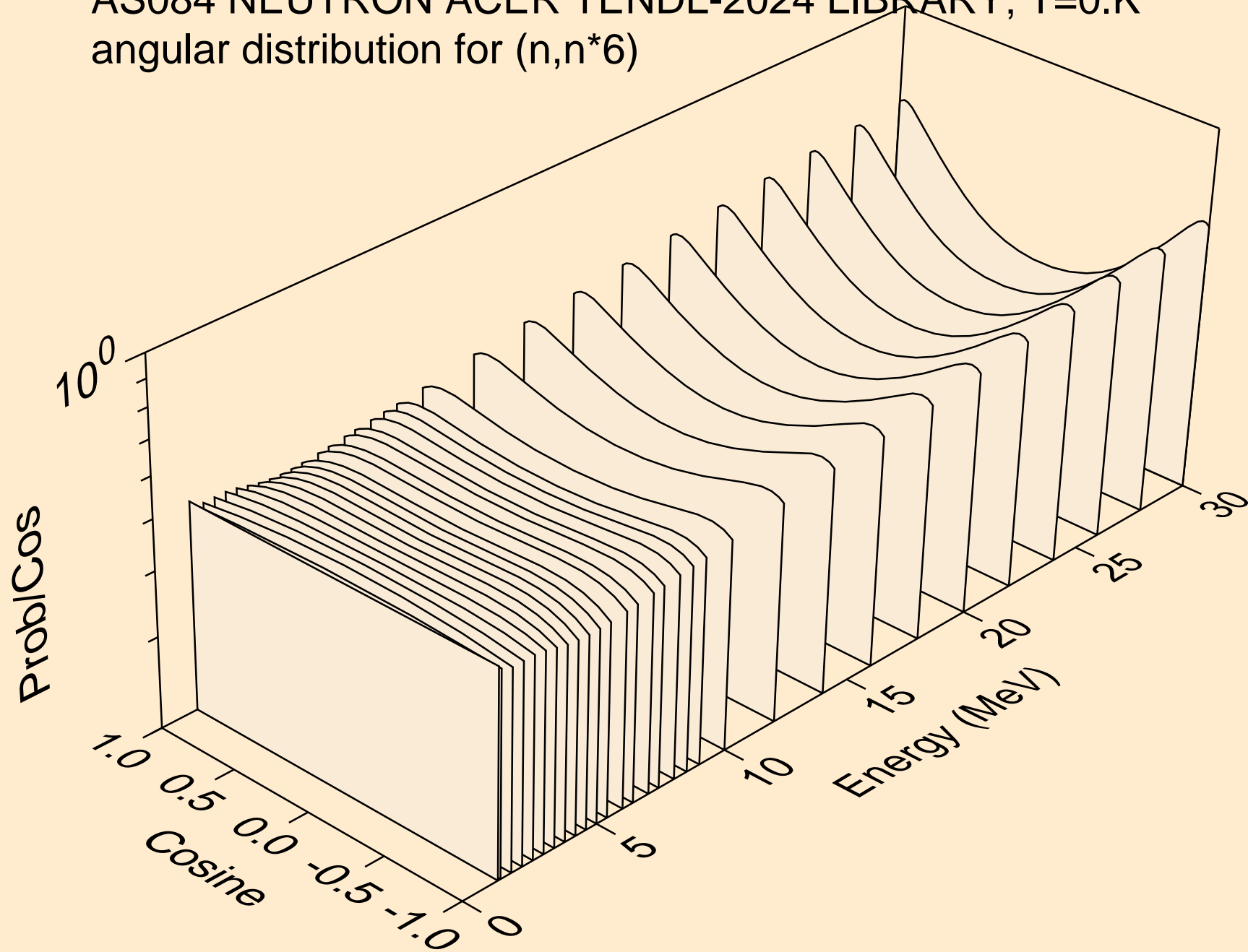

AS084 NEUTRON ACER TENDL-2024 LIBRARY; T=0.K
angular distribution for (n,n*7)

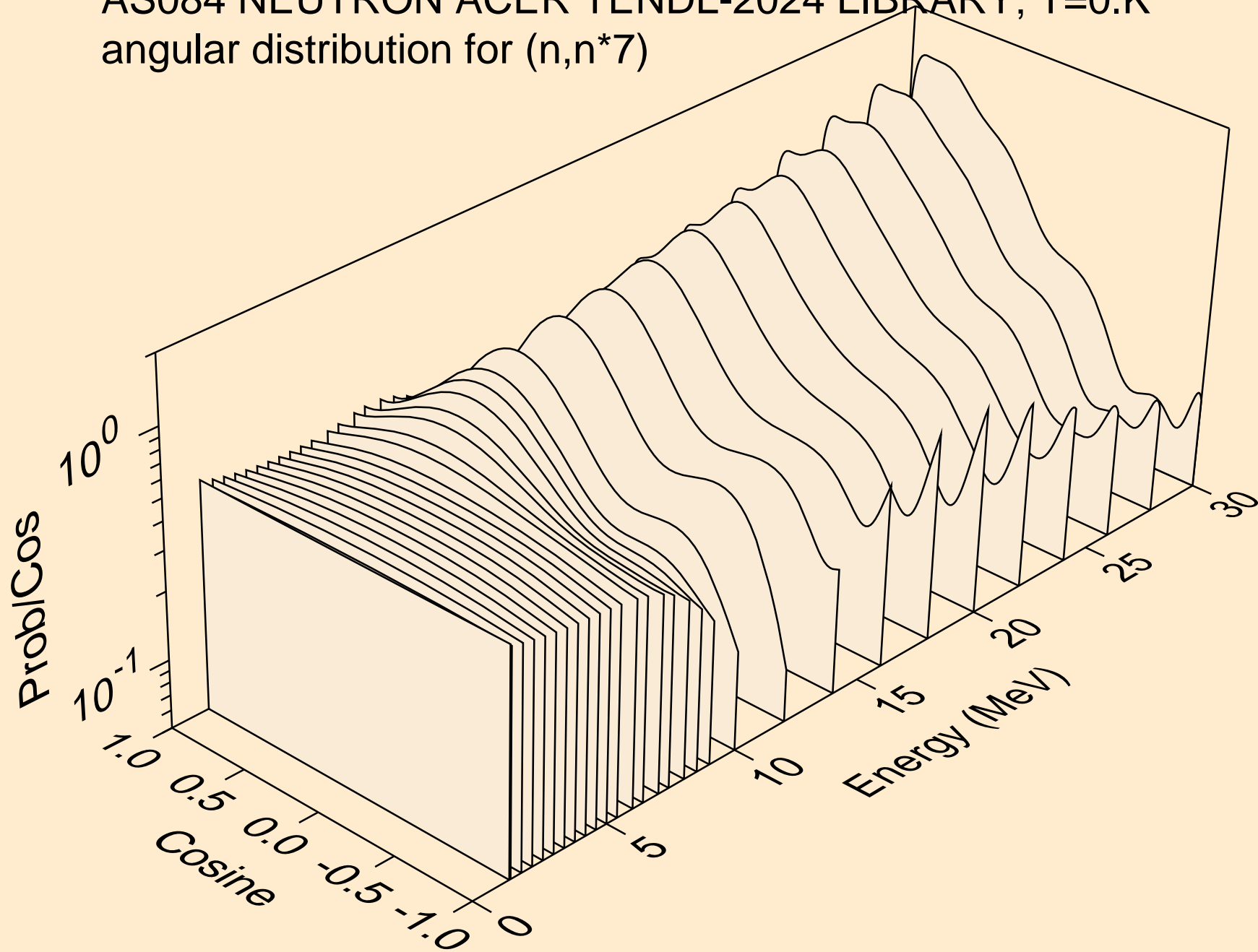

AS084 NEUTRON ACER TENDL-2024 LIBRARY; T=0.K
angular distribution for (n,n*8)

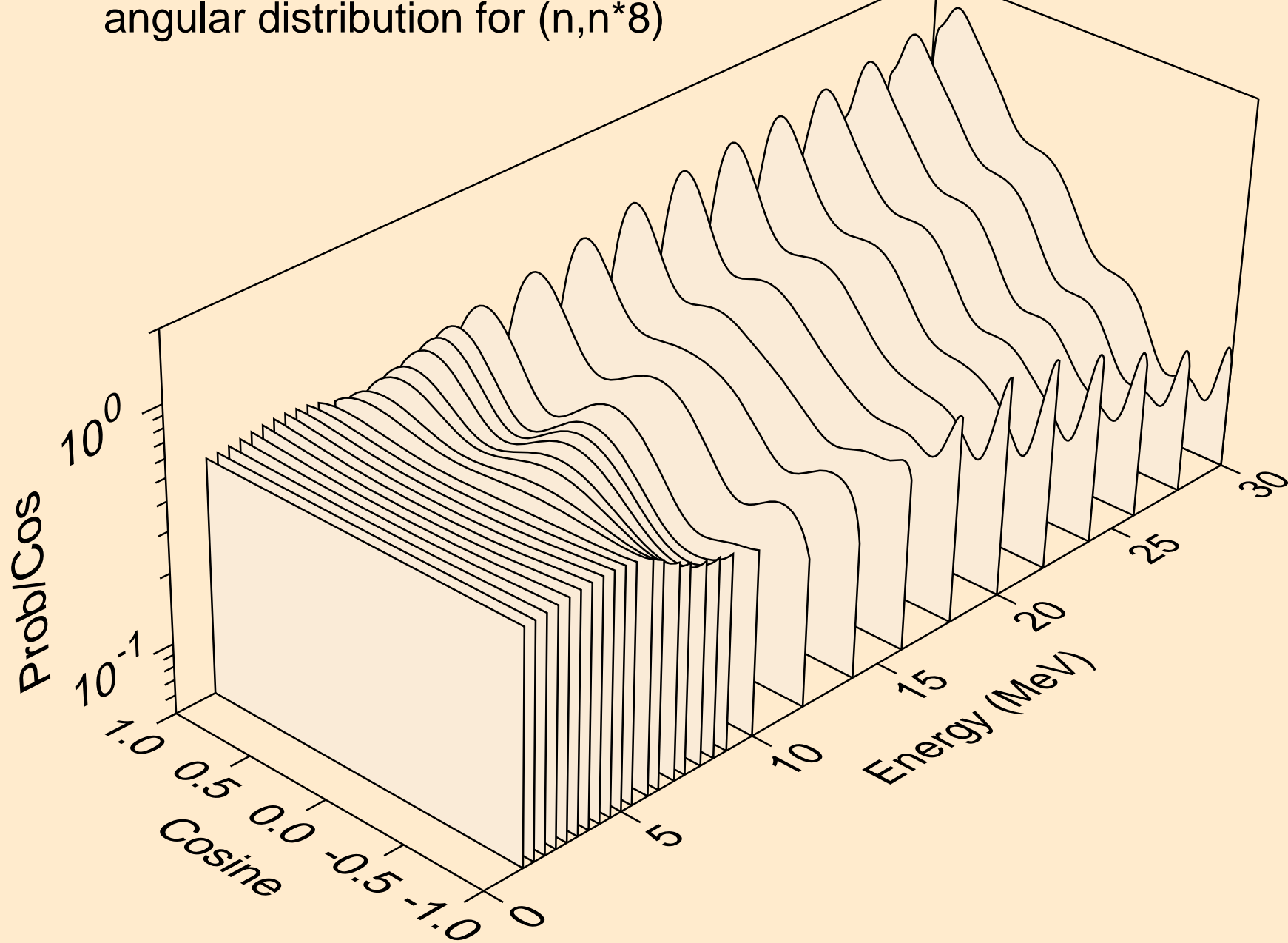

AS084 NEUTRON ACER TENDL-2024 LIBRARY; T=0.K
angular distribution for (n,n*9)

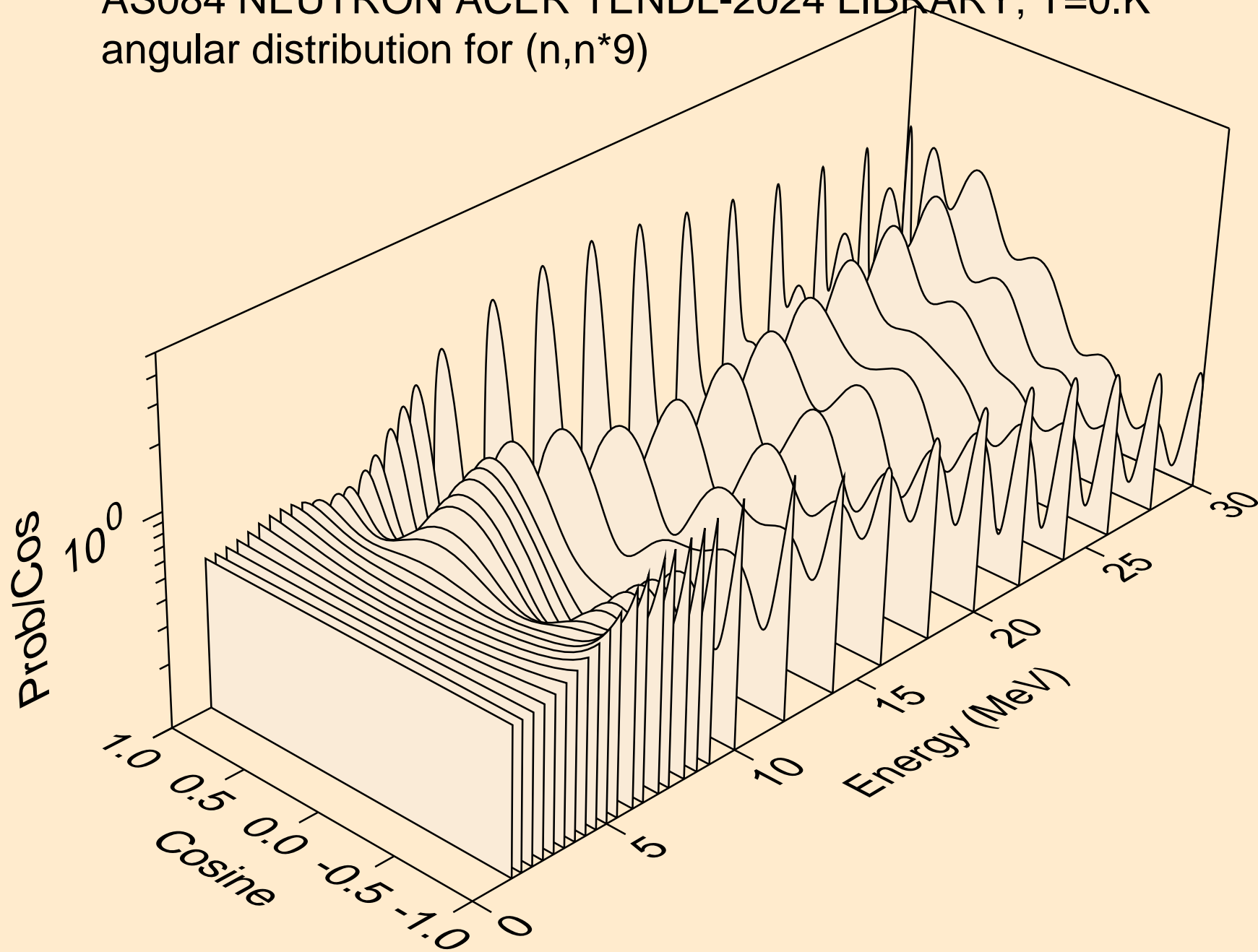

AS084 NEUTRON ACER TENDL-2024 LIBRARY; T=0.K
angular distribution for (n,n*10)

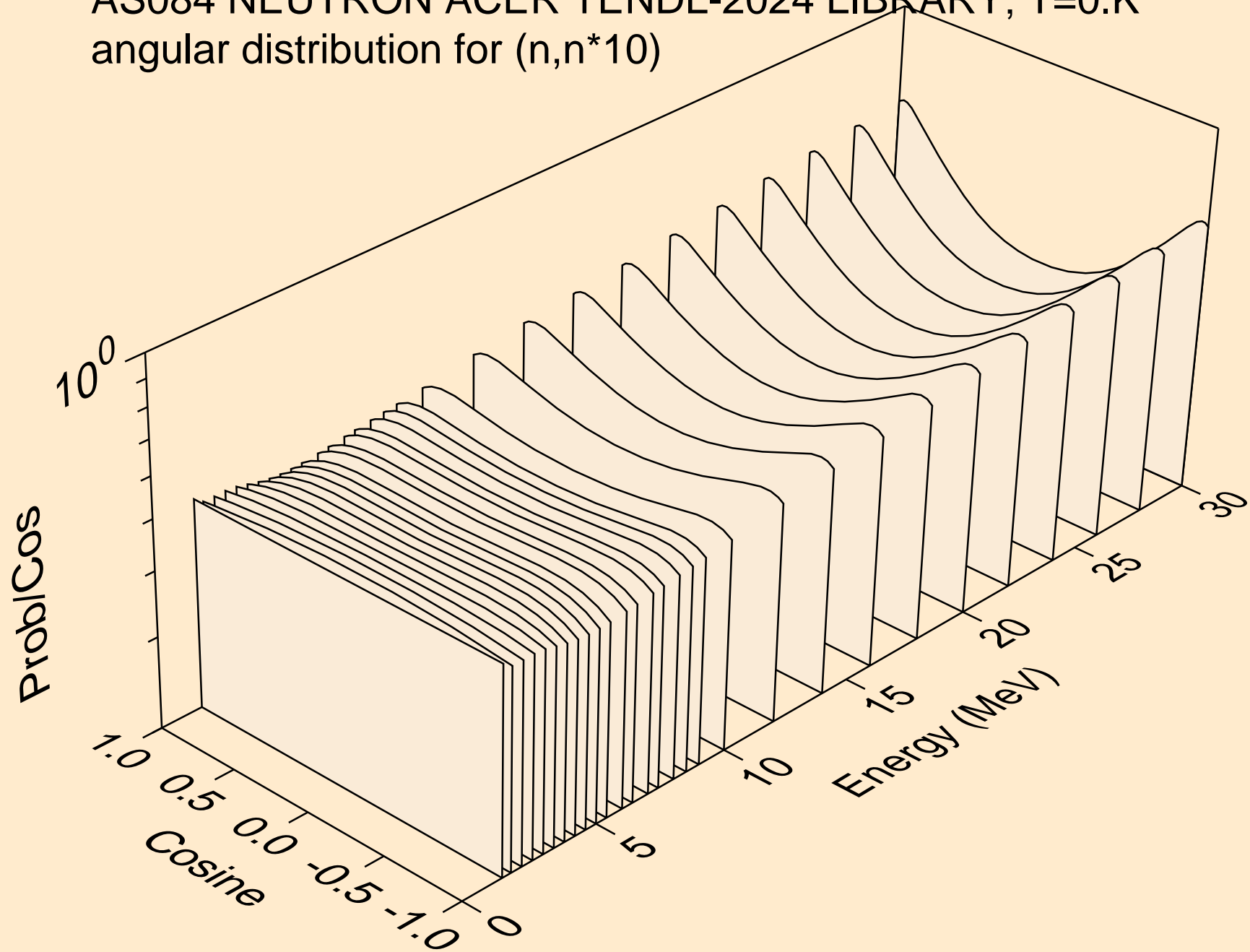

AS084 NEUTRON ACER TENDL-2024 LIBRARY; T=0.K
angular distribution for (n,n*11)

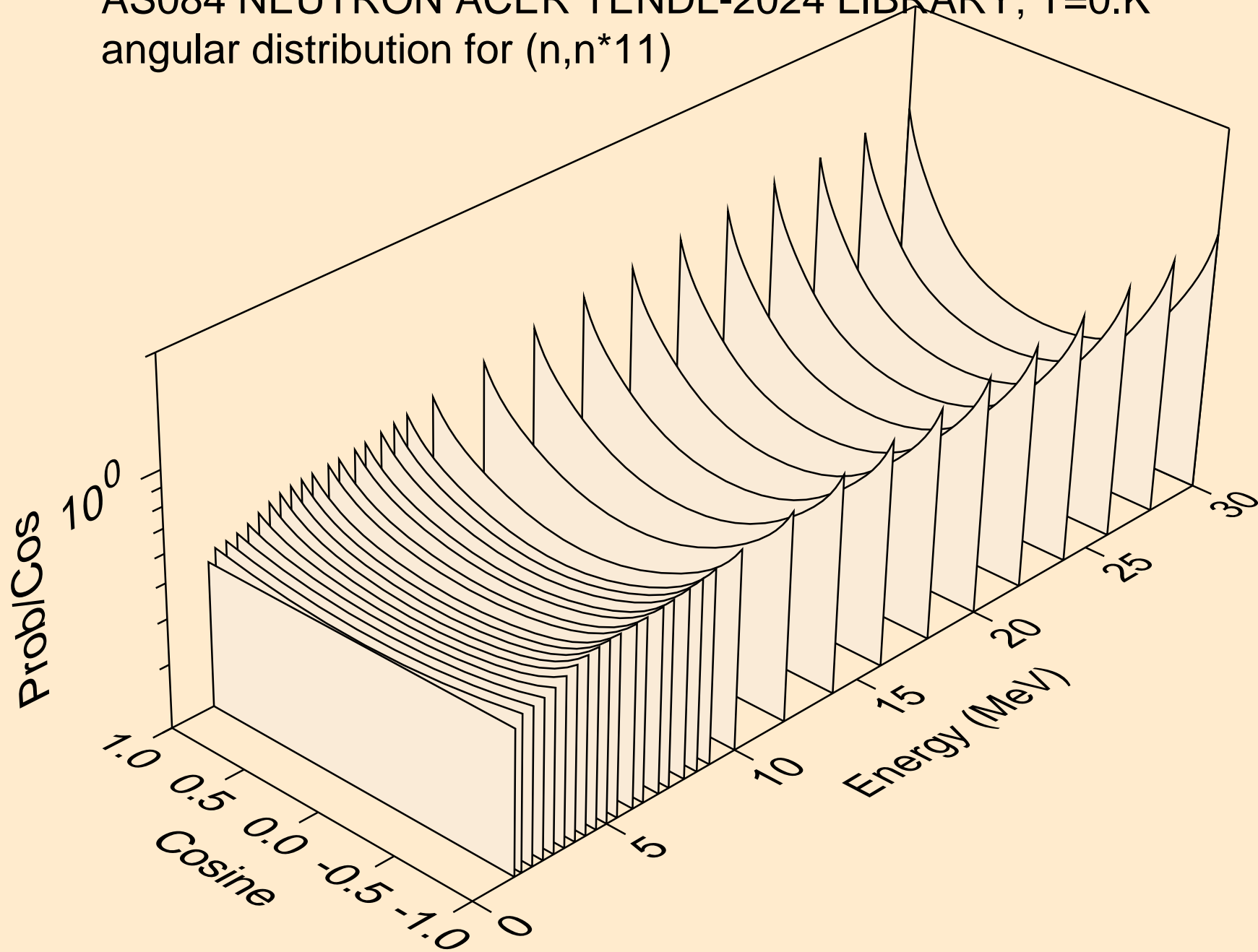

AS084 NEUTRON ACER TENDL-2024 LIBRARY; T=0.K
angular distribution for (n,n*12)

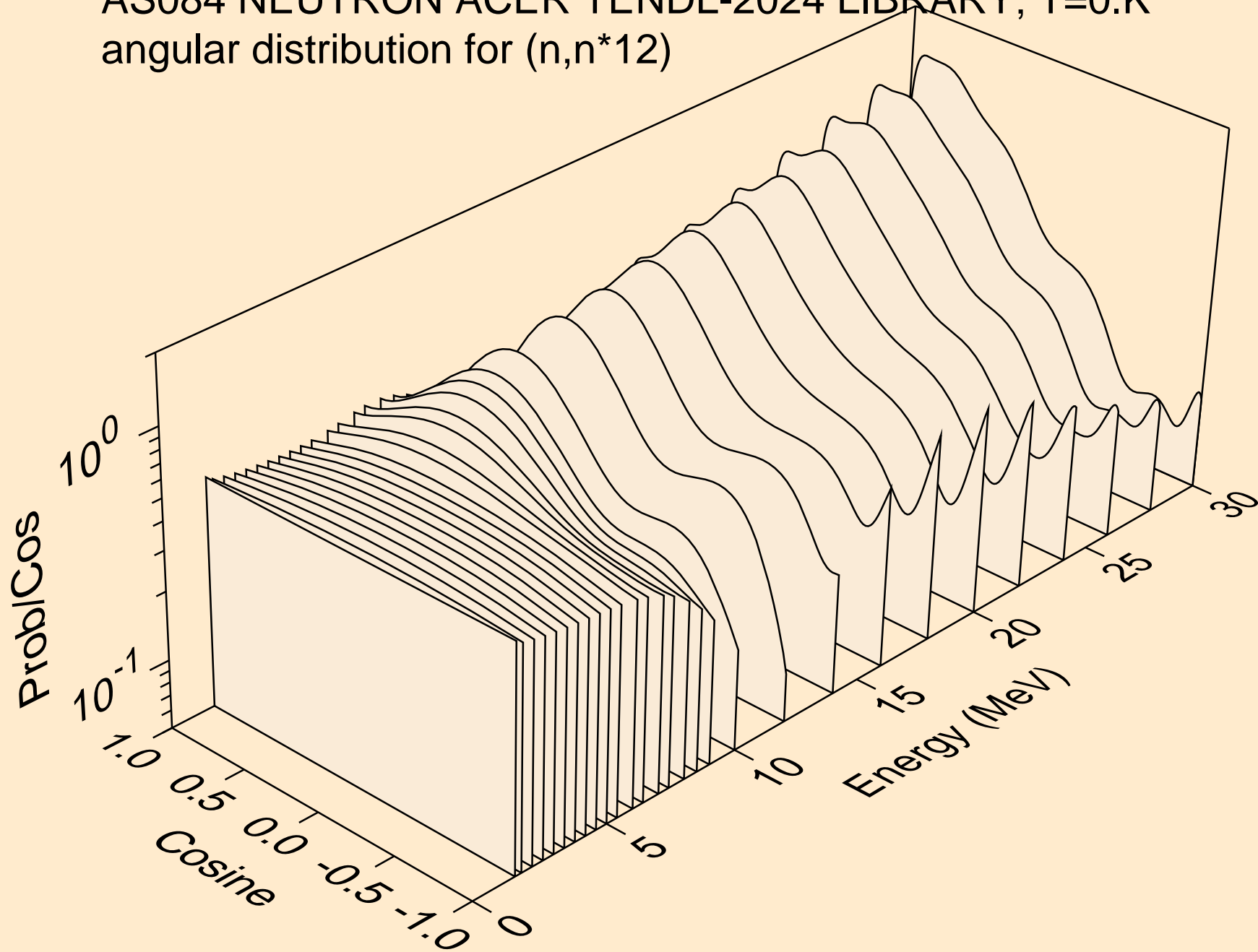

AS084 NEUTRON ACER TENDL-2024 LIBRARY; T=0.K
angular distribution for (n,n*13)

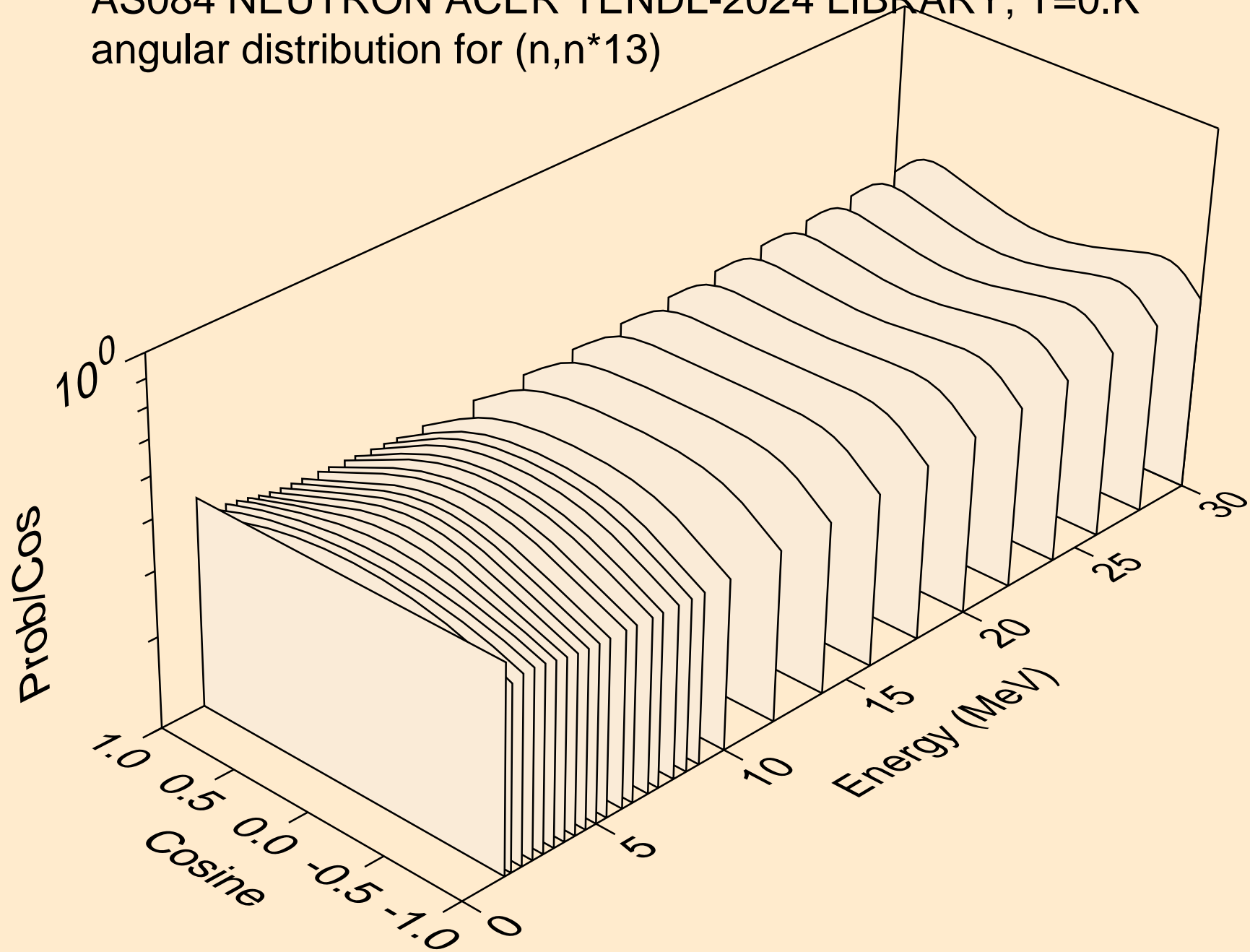

AS084 NEUTRON ACER TENDL-2024 LIBRARY; T=0.K
angular distribution for (n,n*14)

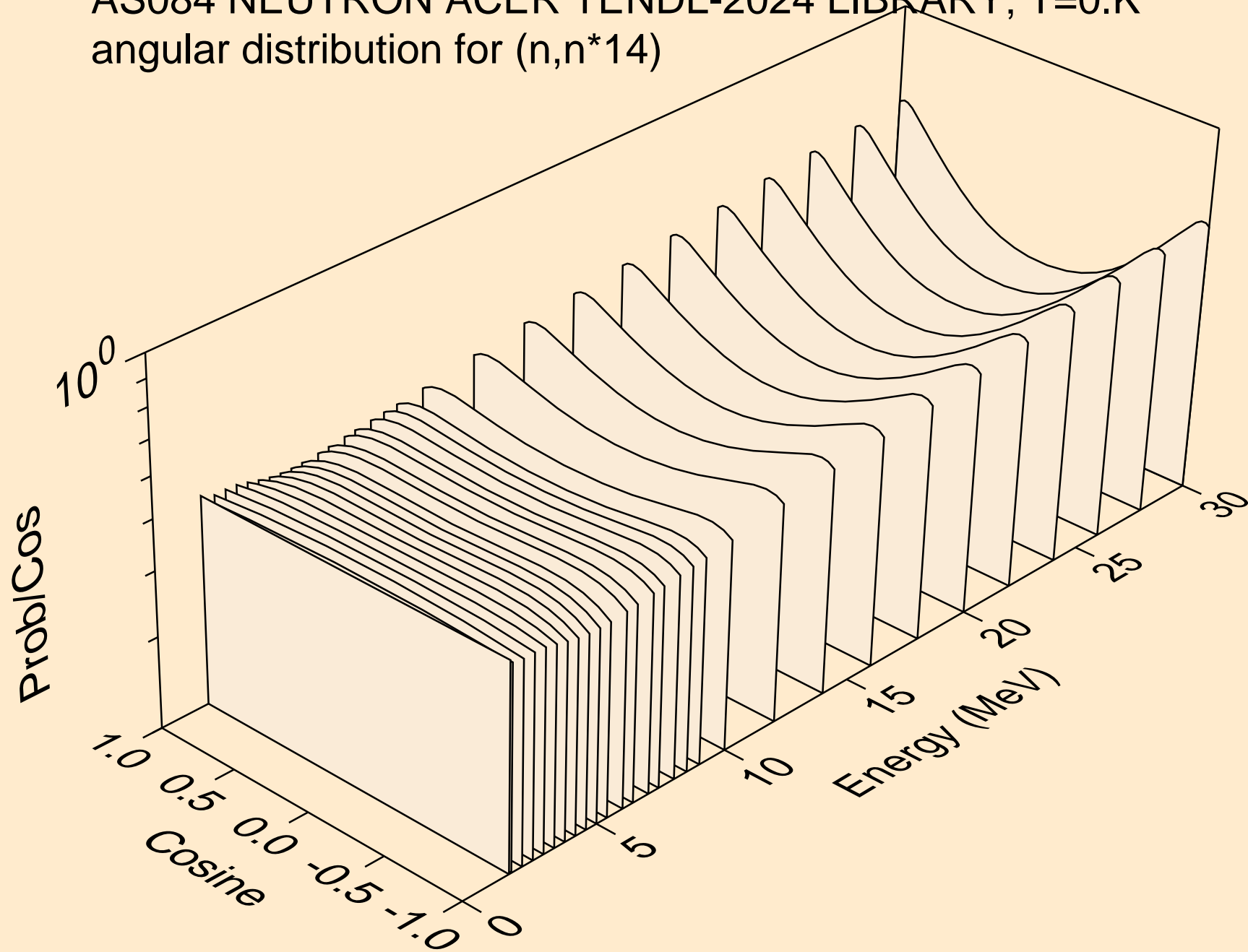

AS084 NEUTRON ACER TENDL-2024 LIBRARY; T=0.K
angular distribution for (n,n*15)

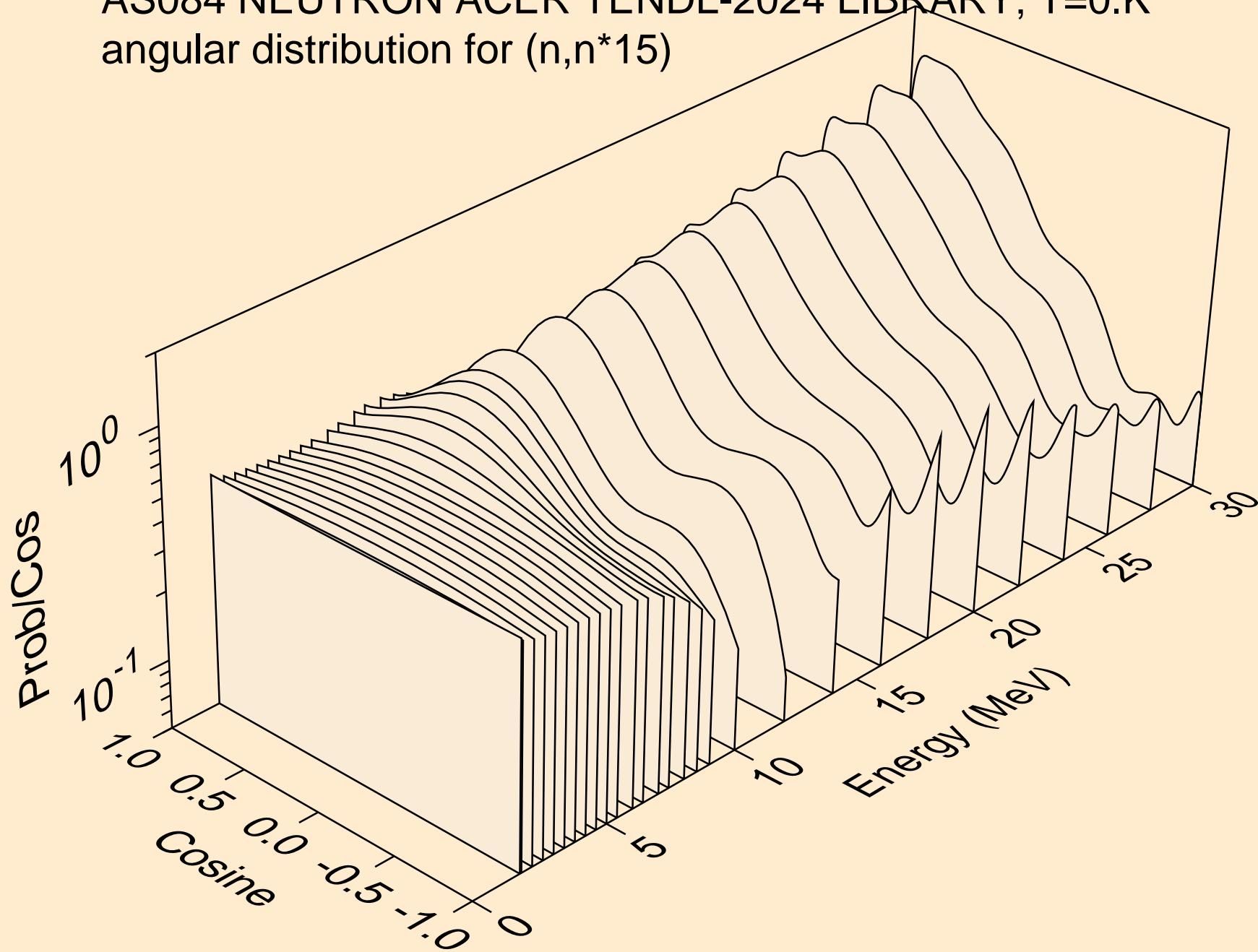

AS084 NEUTRON ACER TENDL-2024 LIBRARY; T=0.K
angular distribution for (n,n*16)

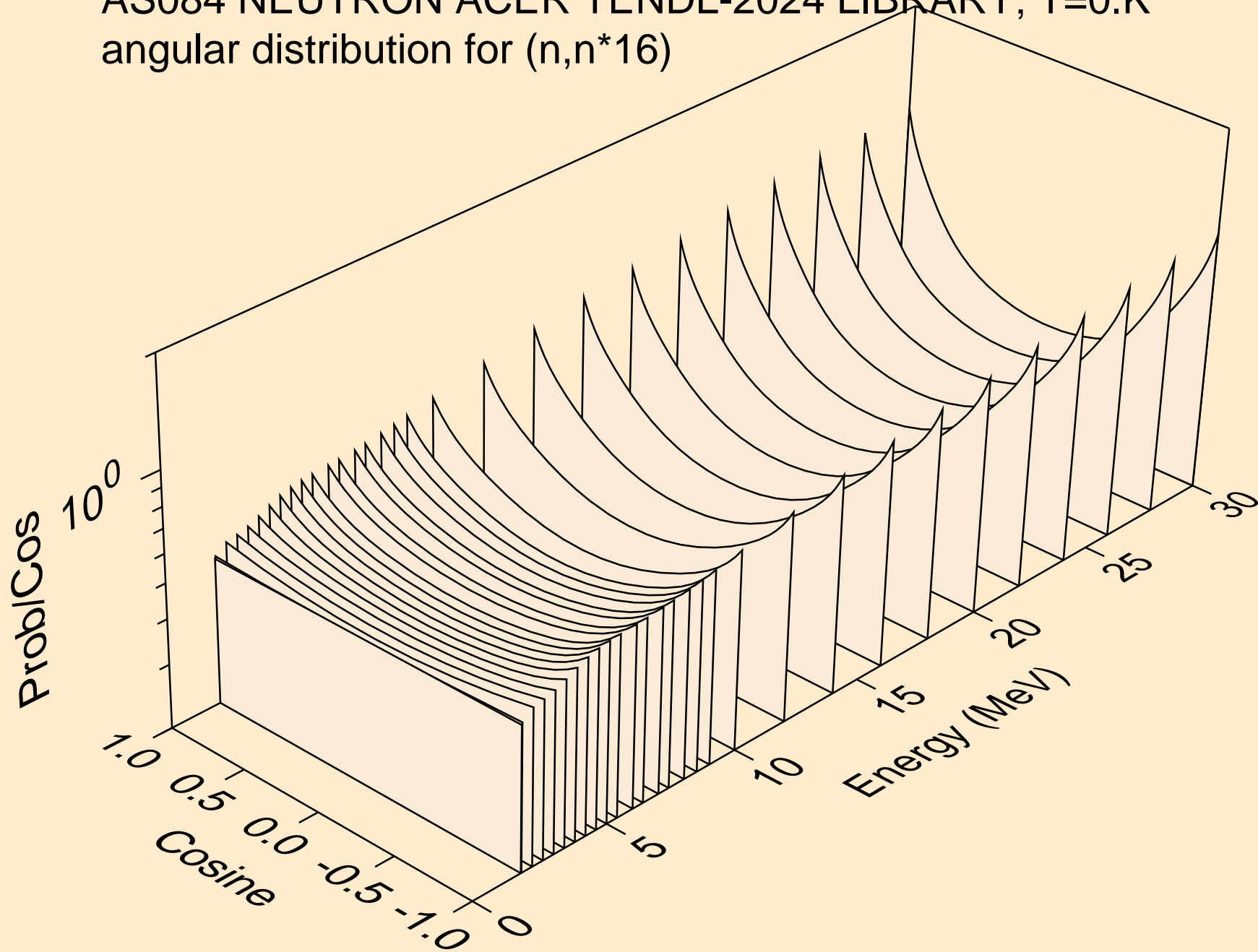

AS084 NEUTRON ACER TENDL-2024 LIBRARY; T=0.K
angular distribution for (n,n*17)

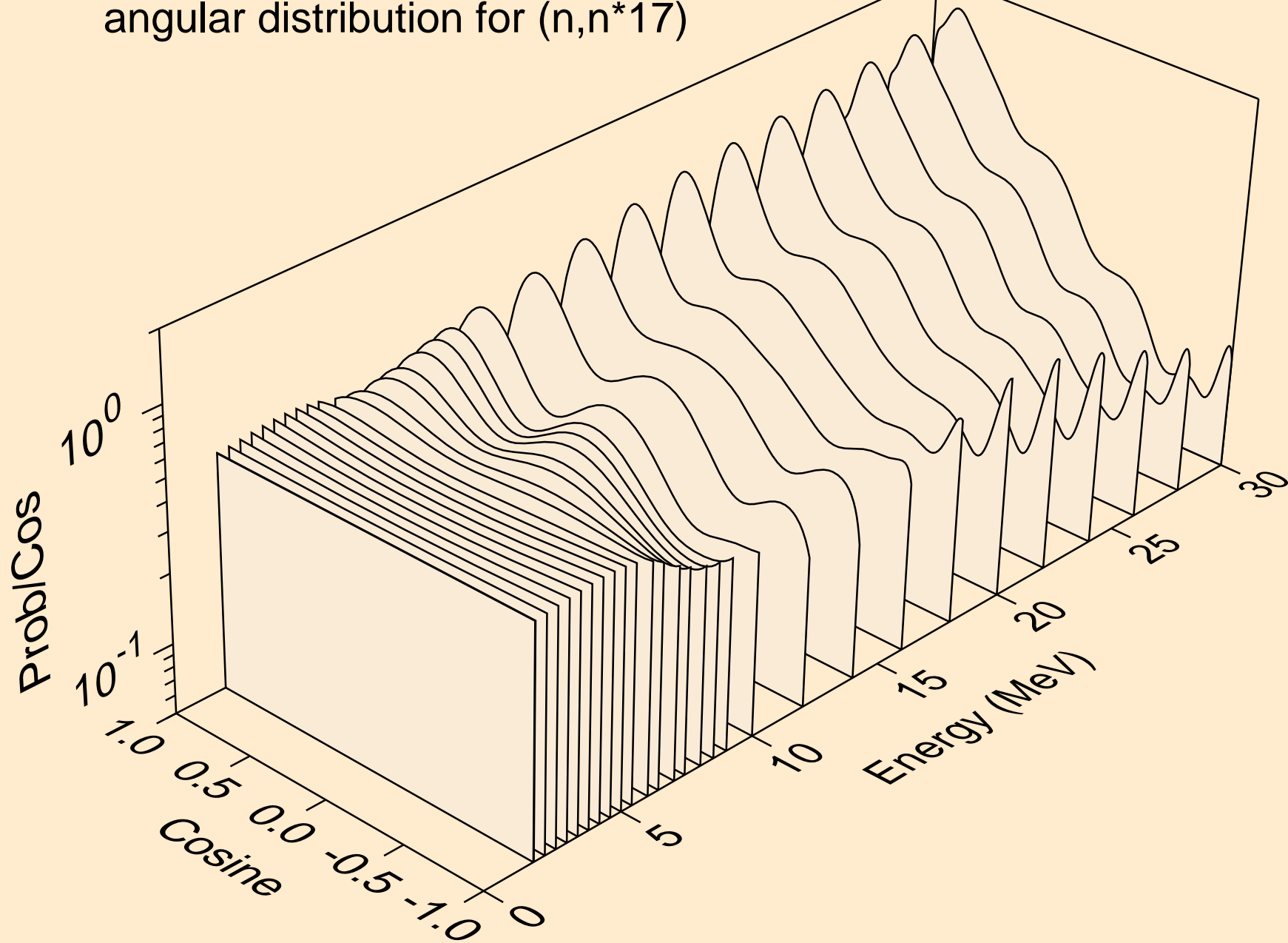

AS084 NEUTRON ACER TENDL-2024 LIBRARY; T=0.K
angular distribution for (n,n*18)

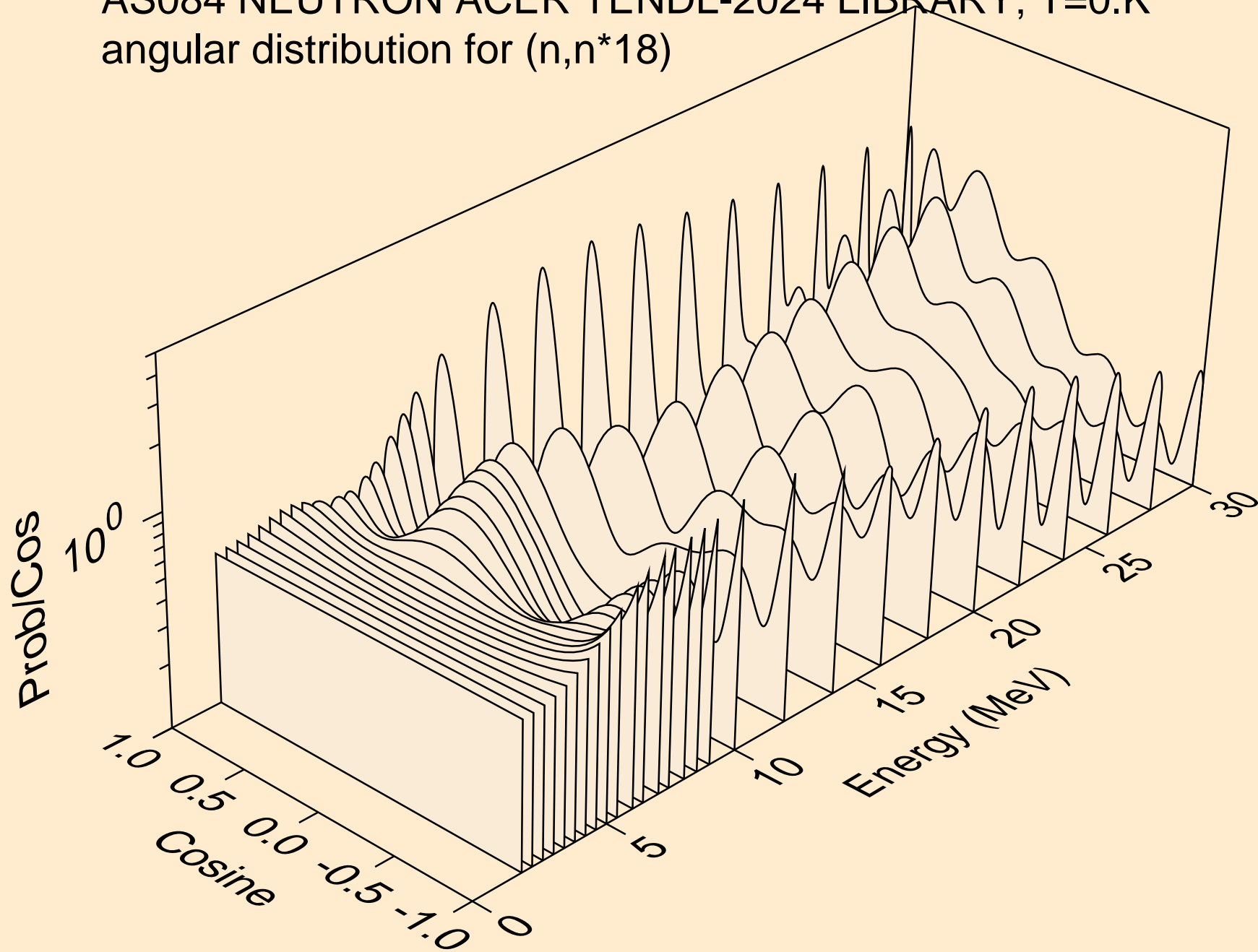

AS084 NEUTRON ACER TENDL-2024 LIBRARY; T=0.K
angular distribution for (n,n*19)

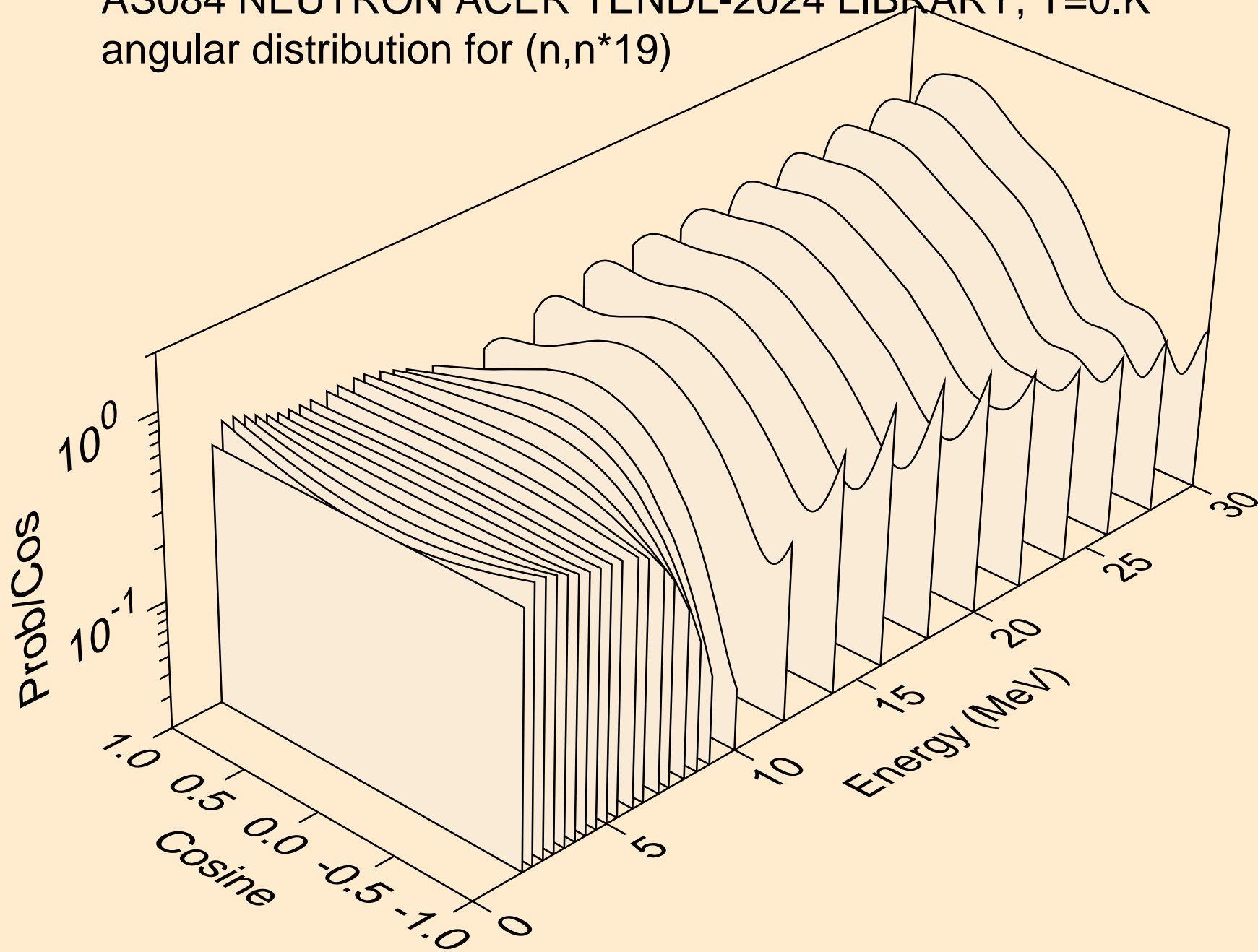

AS084 NEUTRON ACER TENDL-2024 LIBRARY; T=0.K
angular distribution for (n,n*20)

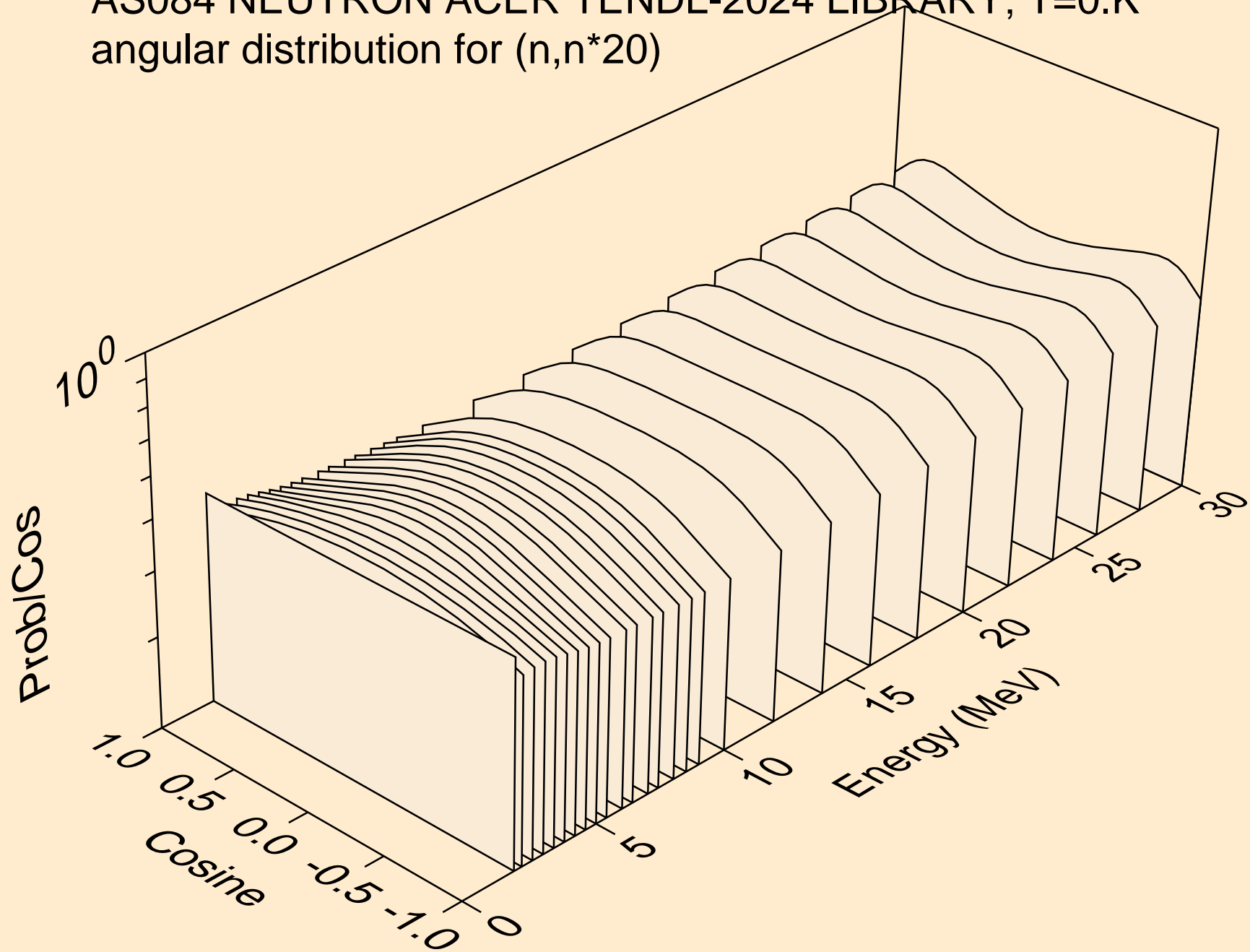

AS084 NEUTRON ACER TENDL-2024 LIBRARY; T=0.K
angular distribution for (n,n*21)

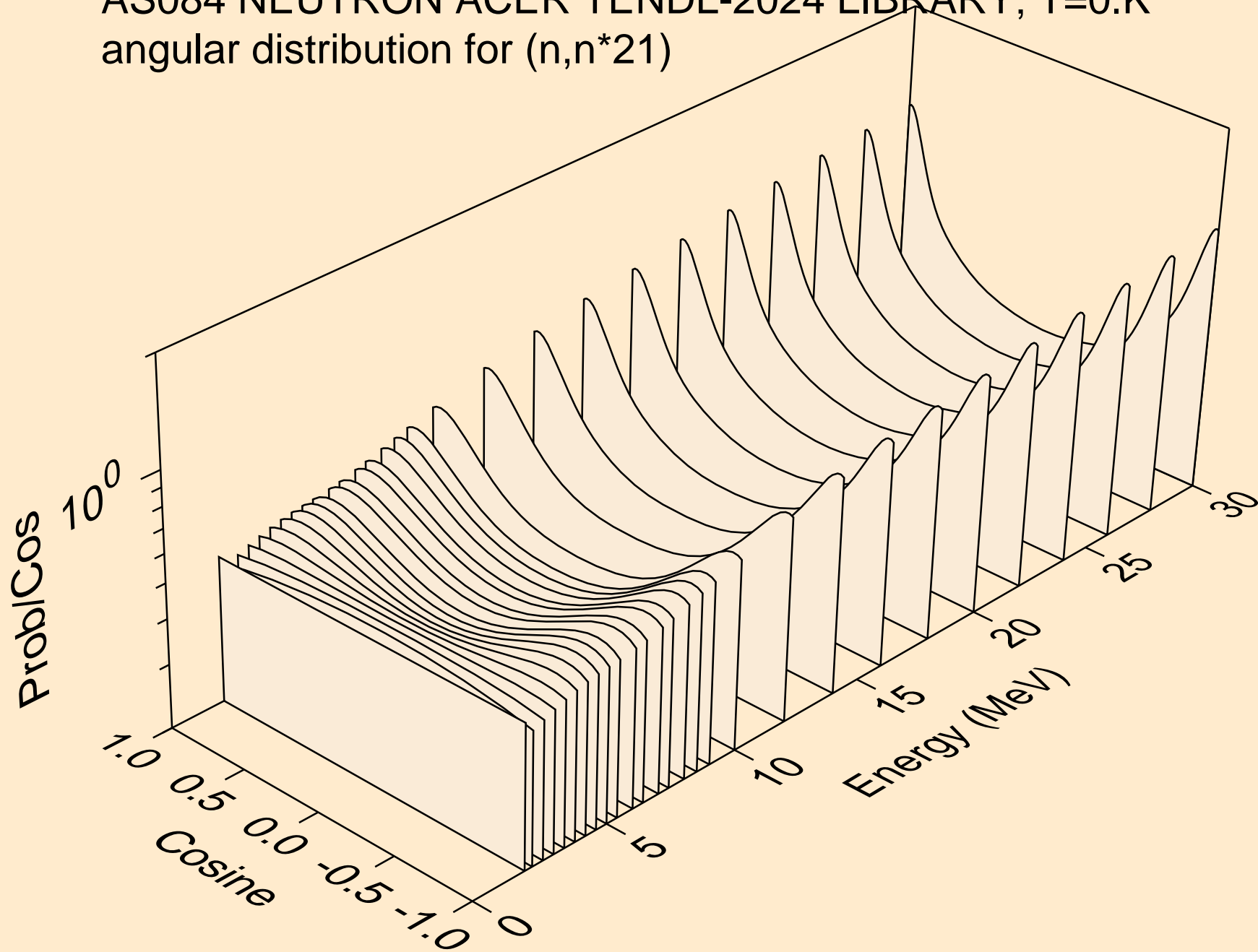

AS084 NEUTRON ACER TENDL-2024 LIBRARY; T=0.K
angular distribution for (n,n*22)

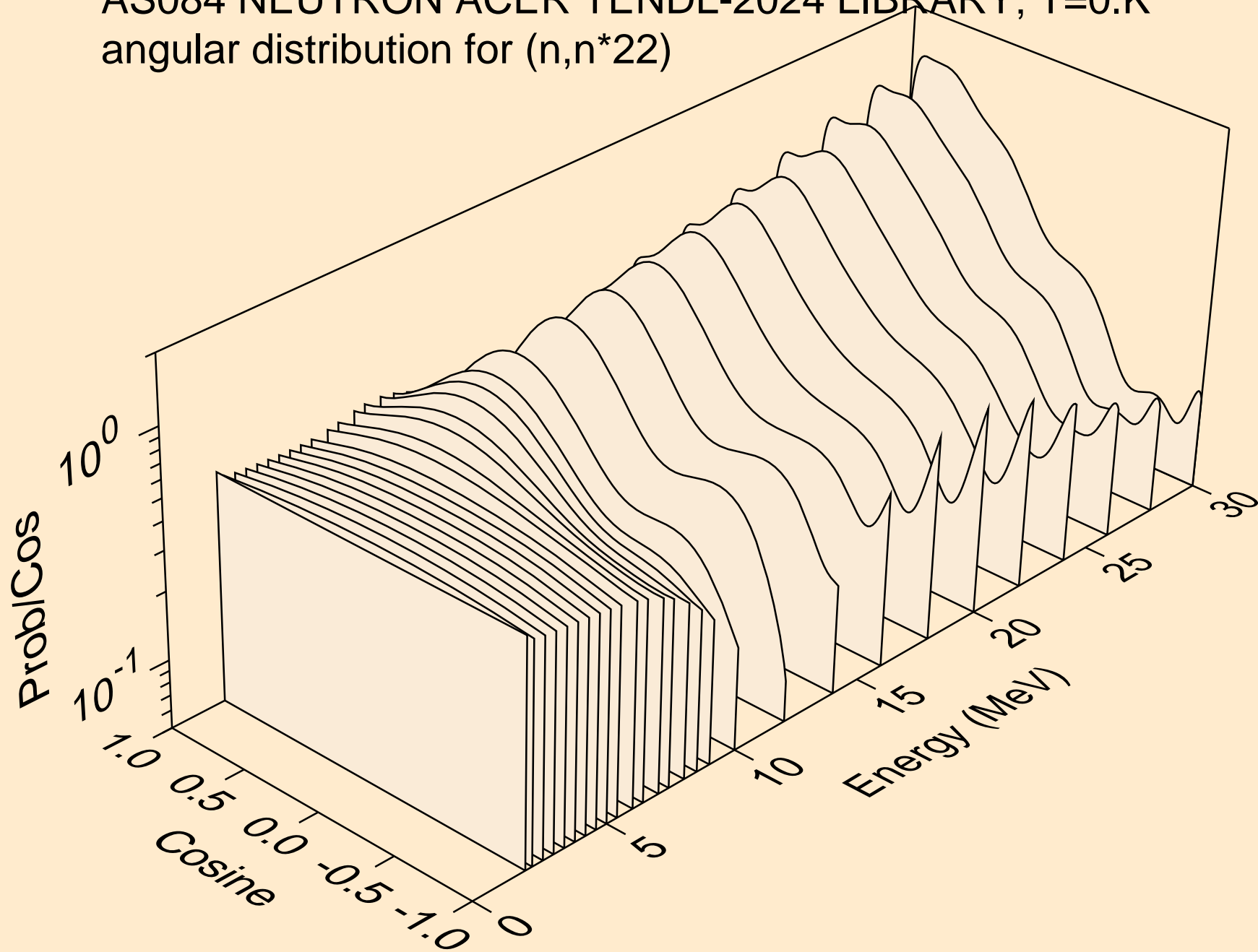

AS084 NEUTRON ACER TENDL-2024 LIBRARY; T=0.K
angular distribution for (n,n*23)

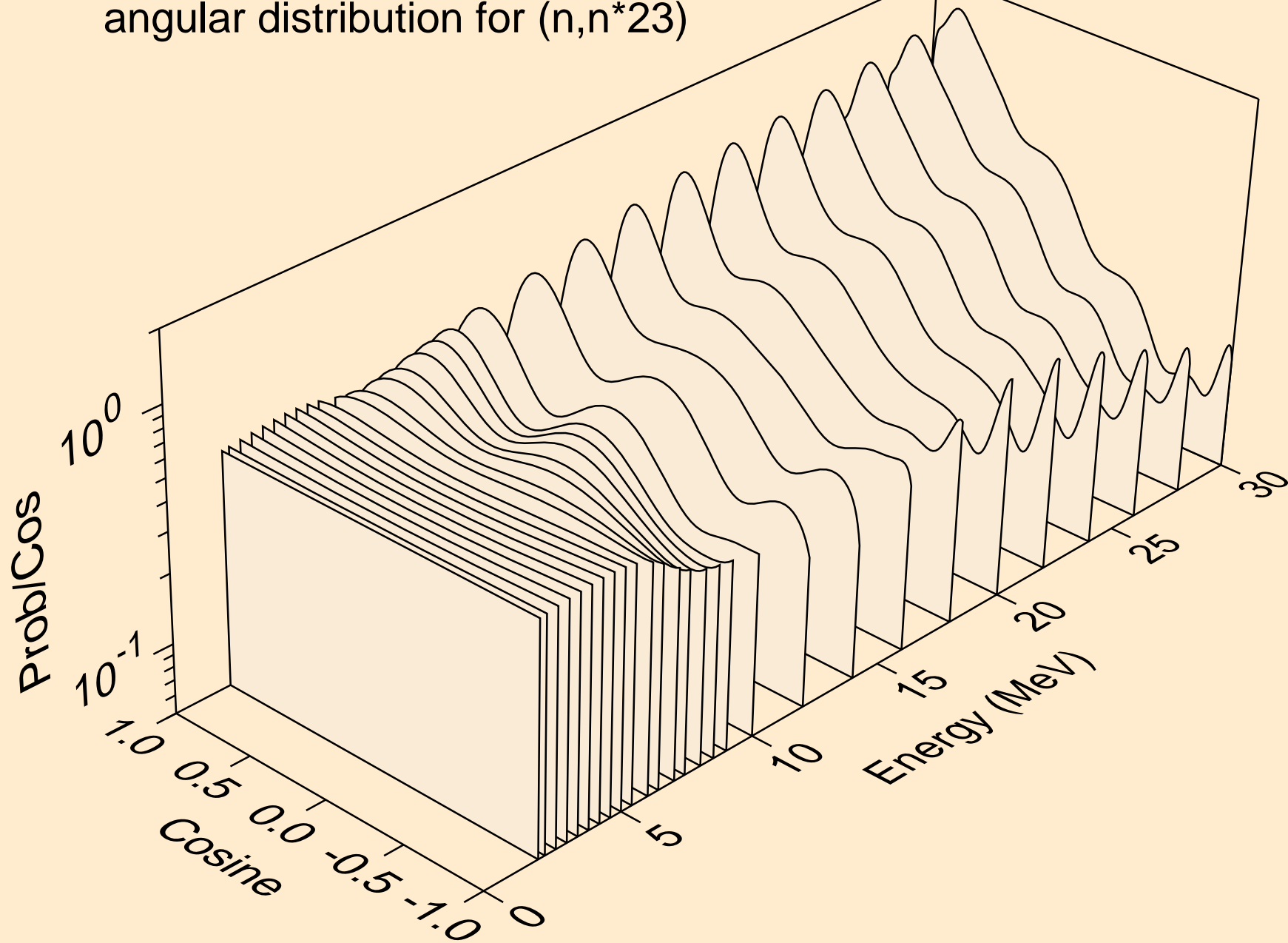

AS084 NEUTRON ACER TENDL-2024 LIBRARY; T=0.K
angular distribution for (n,n*24)

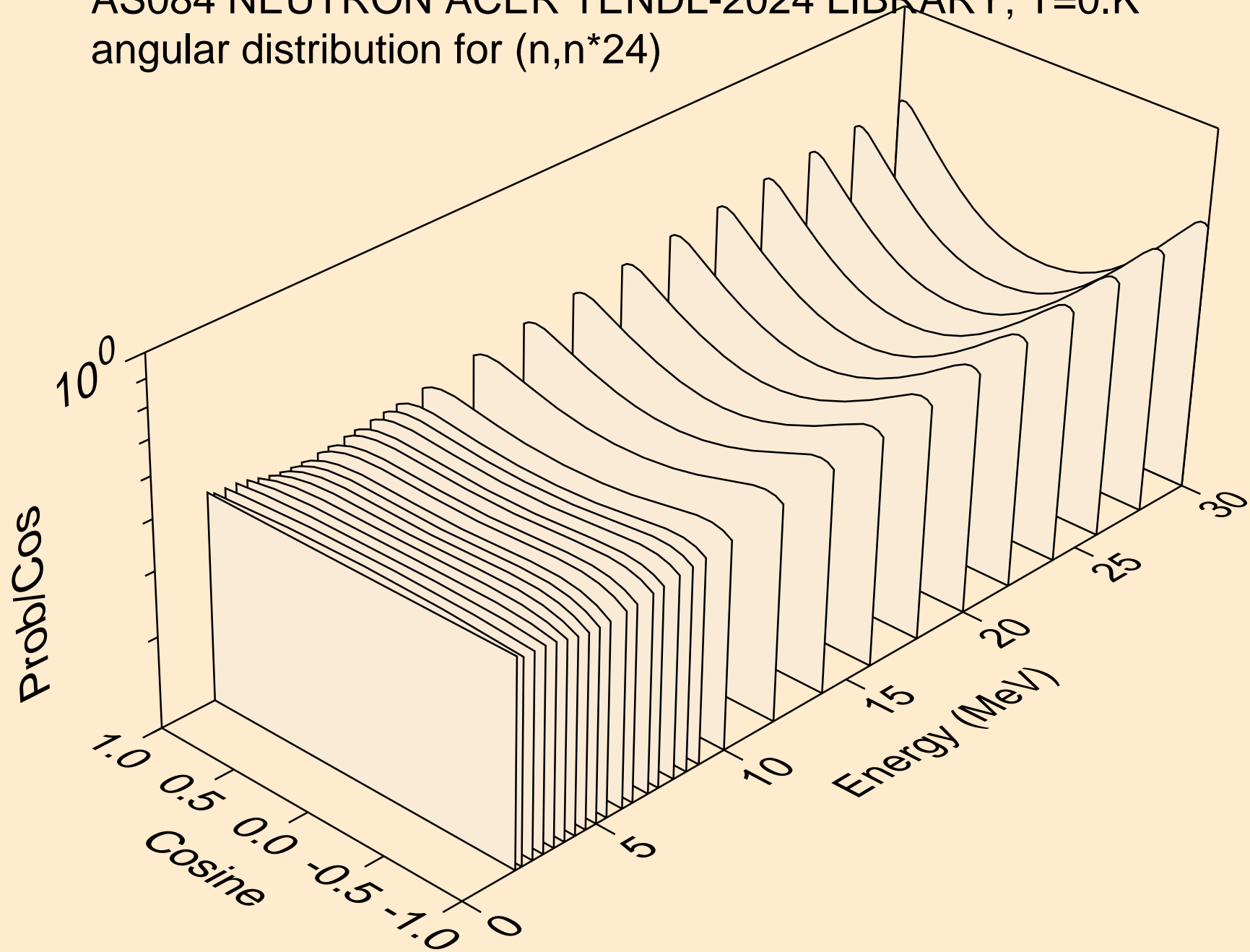

AS084 NEUTRON ACER TENDL-2024 LIBRARY; T=0.K
angular distribution for (n,n*25)

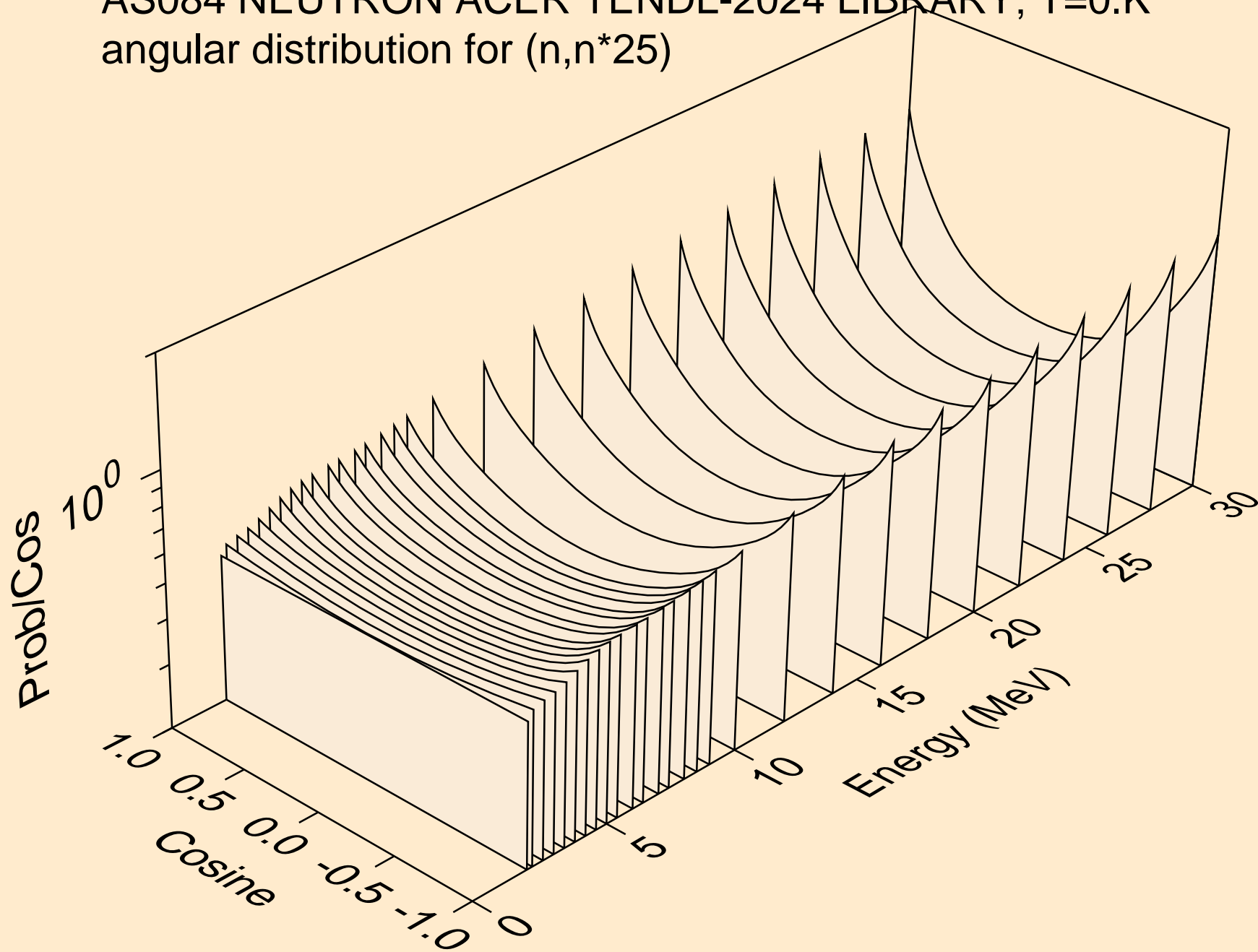

AS084 NEUTRON ACER TENDL-2024 LIBRARY; T=0.K
angular distribution for (n,n*26)

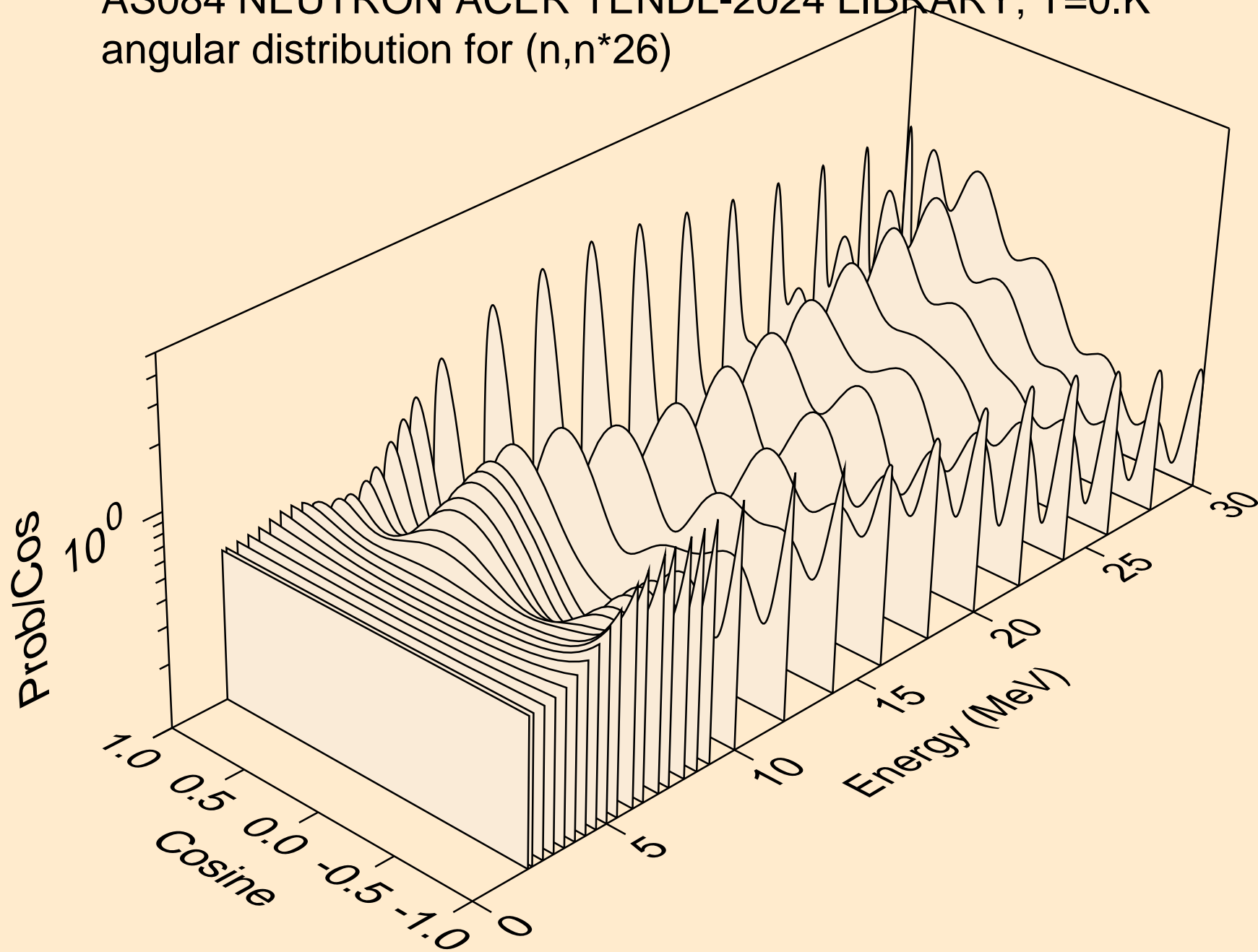

AS084 NEUTRON ACER TENDL-2024 LIBRARY; T=0.K
angular distribution for (n,n*27)

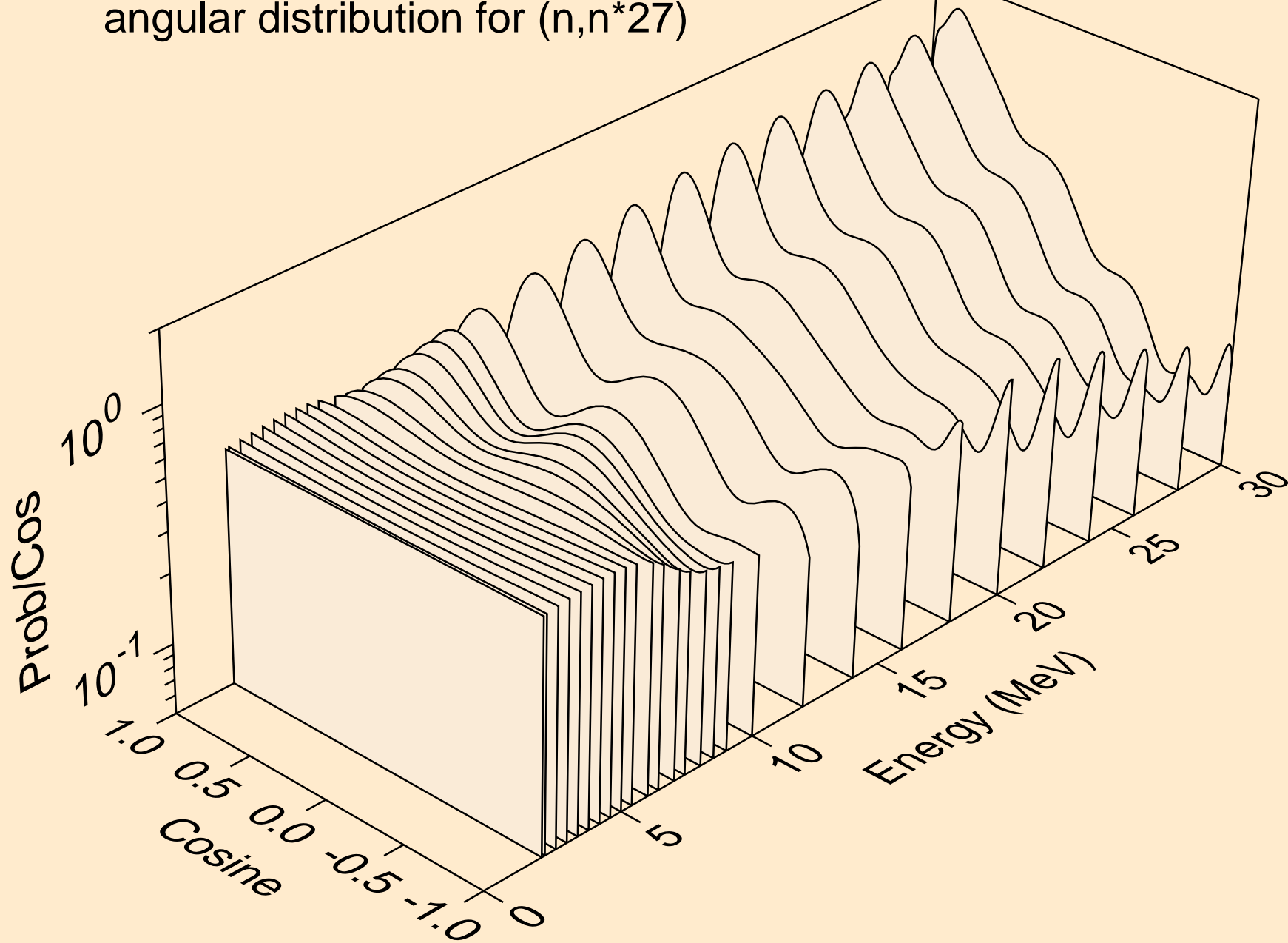

AS084 NEUTRON ACER TENDL-2024 LIBRARY; T=0.K
angular distribution for (n,n*28)

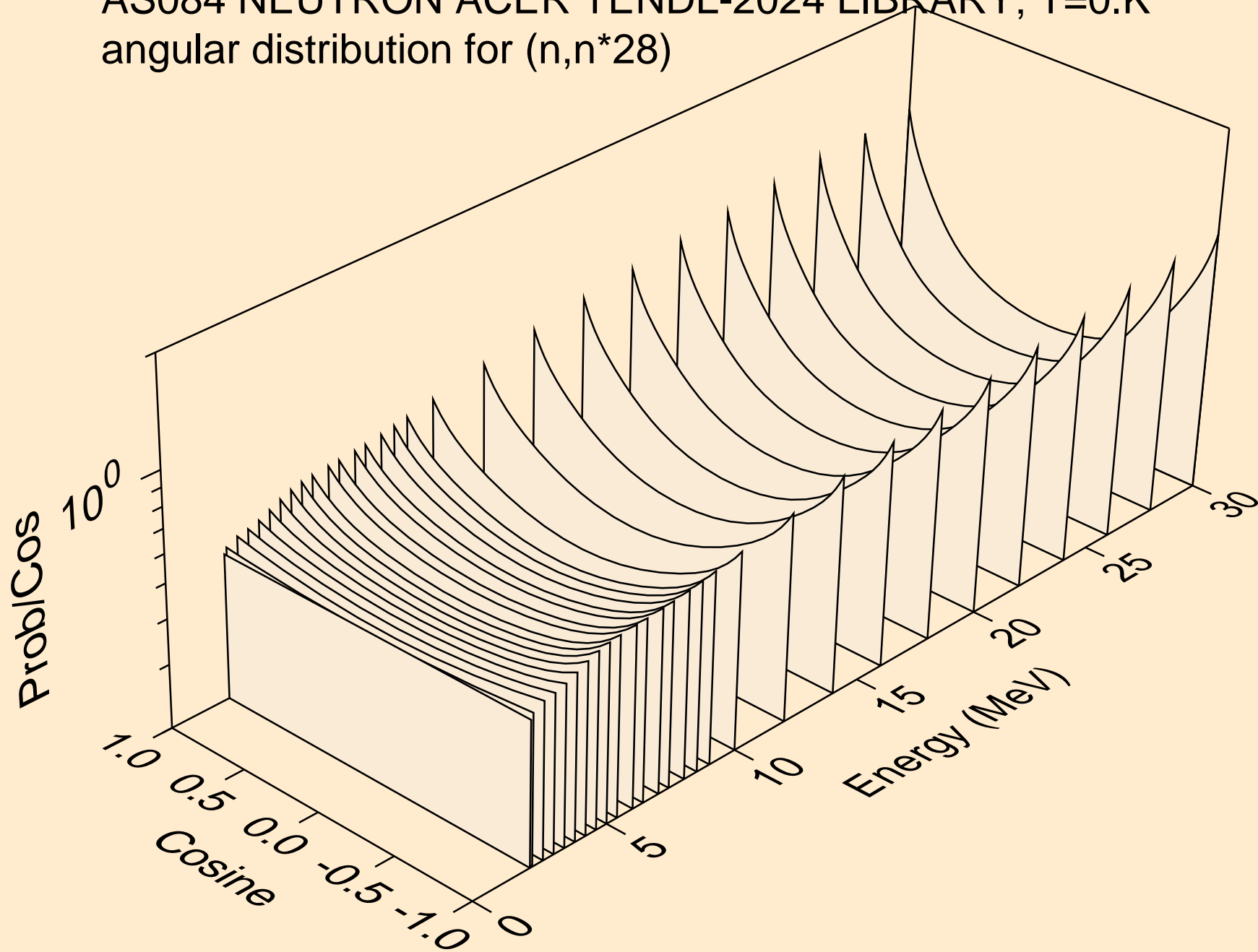

AS084 NEUTRON ACER TENDL-2024 LIBRARY; T=0.K
Neutron emission for (n,x)

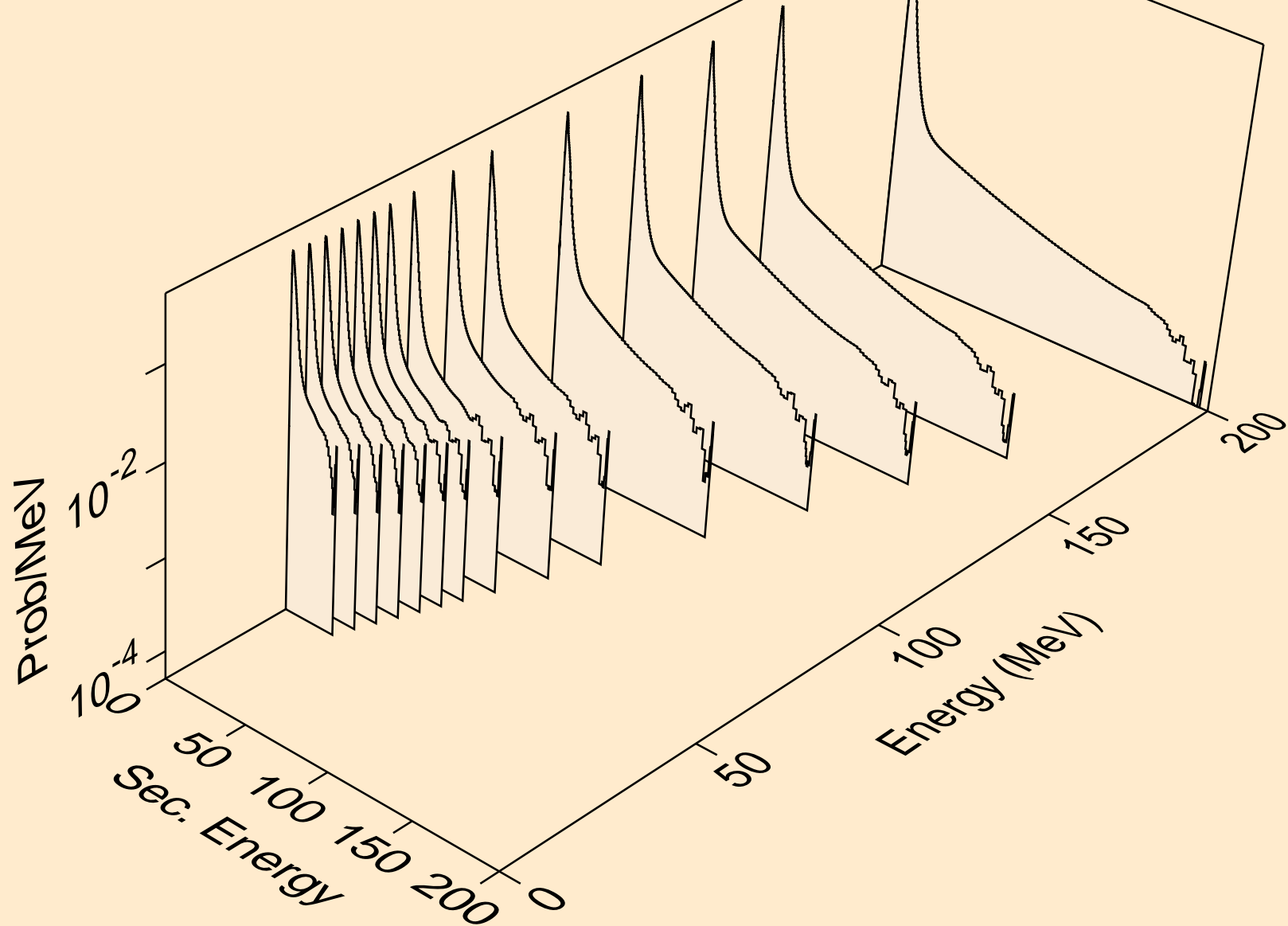

AS084 NEUTRON ACER TENDL-2024 LIBRARY; T=0.K
Neutron emission for (n,2nd)

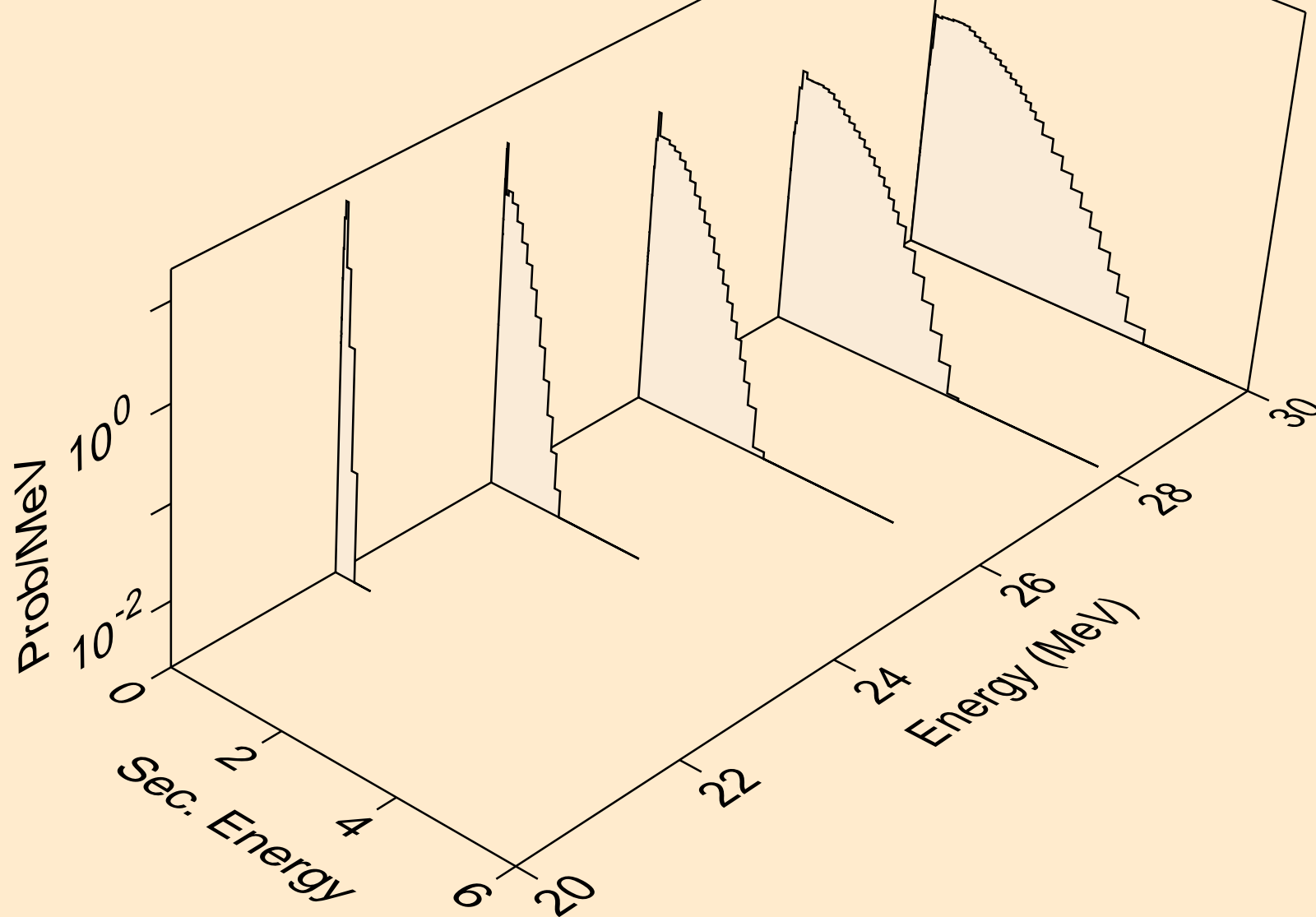

AS084 NEUTRON ACER TENDL-2024 LIBRARY; T=0.K
Neutron emission for (n,2n)

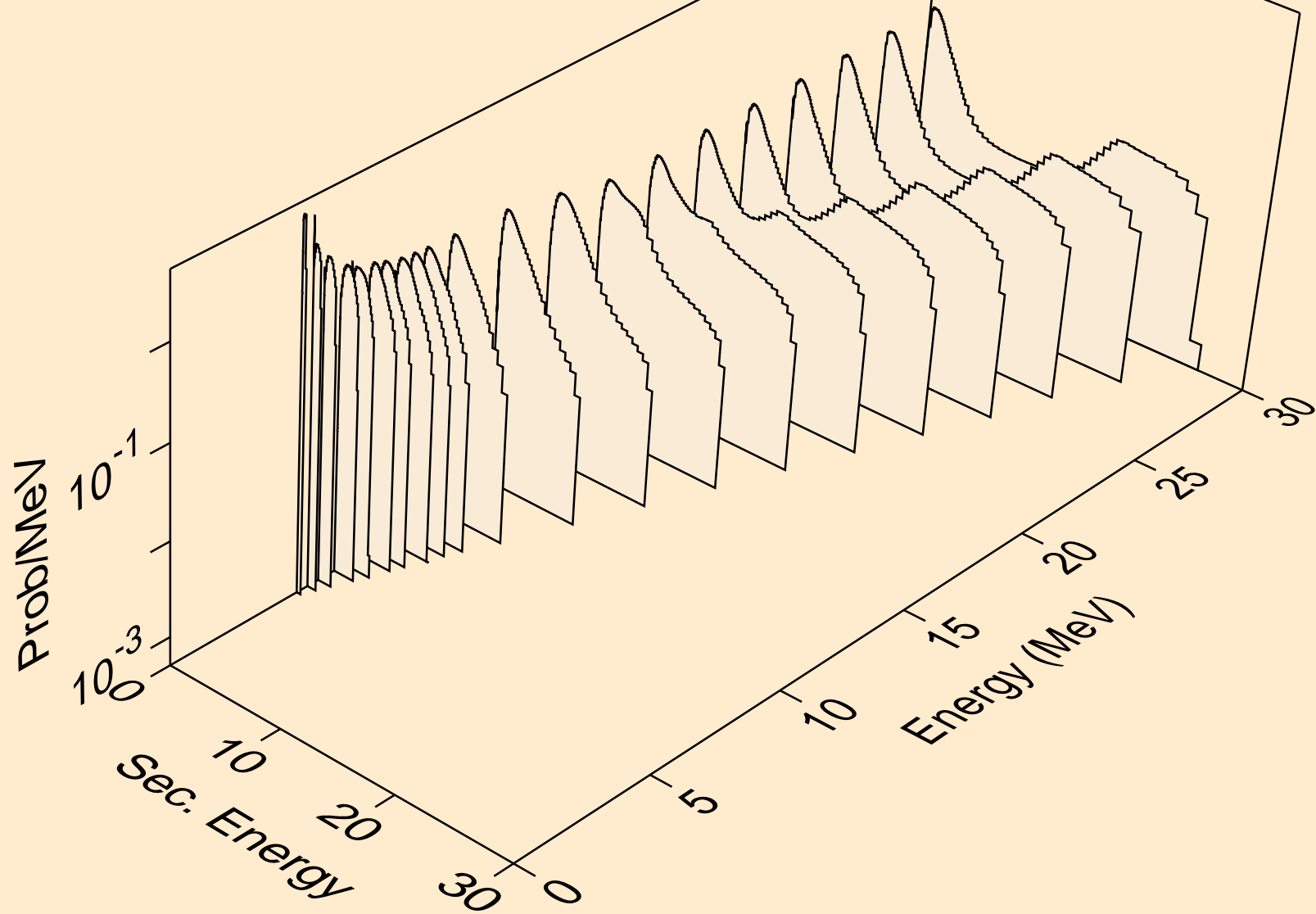

AS084 NEUTRON ACER TENDL-2024 LIBRARY; T=0.K
Neutron emission for (n,3n)

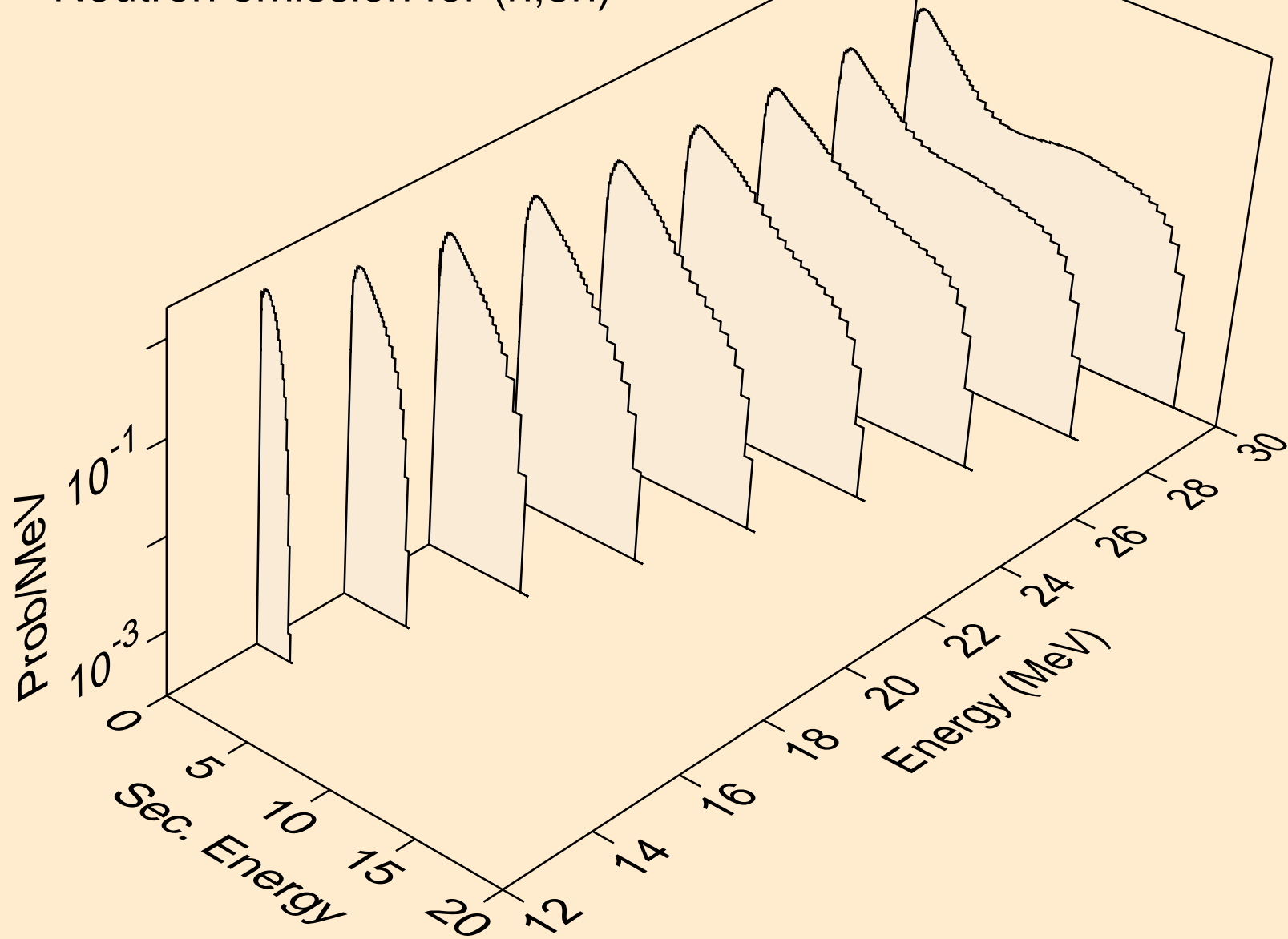

AS084 NEUTRON ACER TENDL-2024 LIBRARY; T=0.K
Neutron emission for (n,n*)a

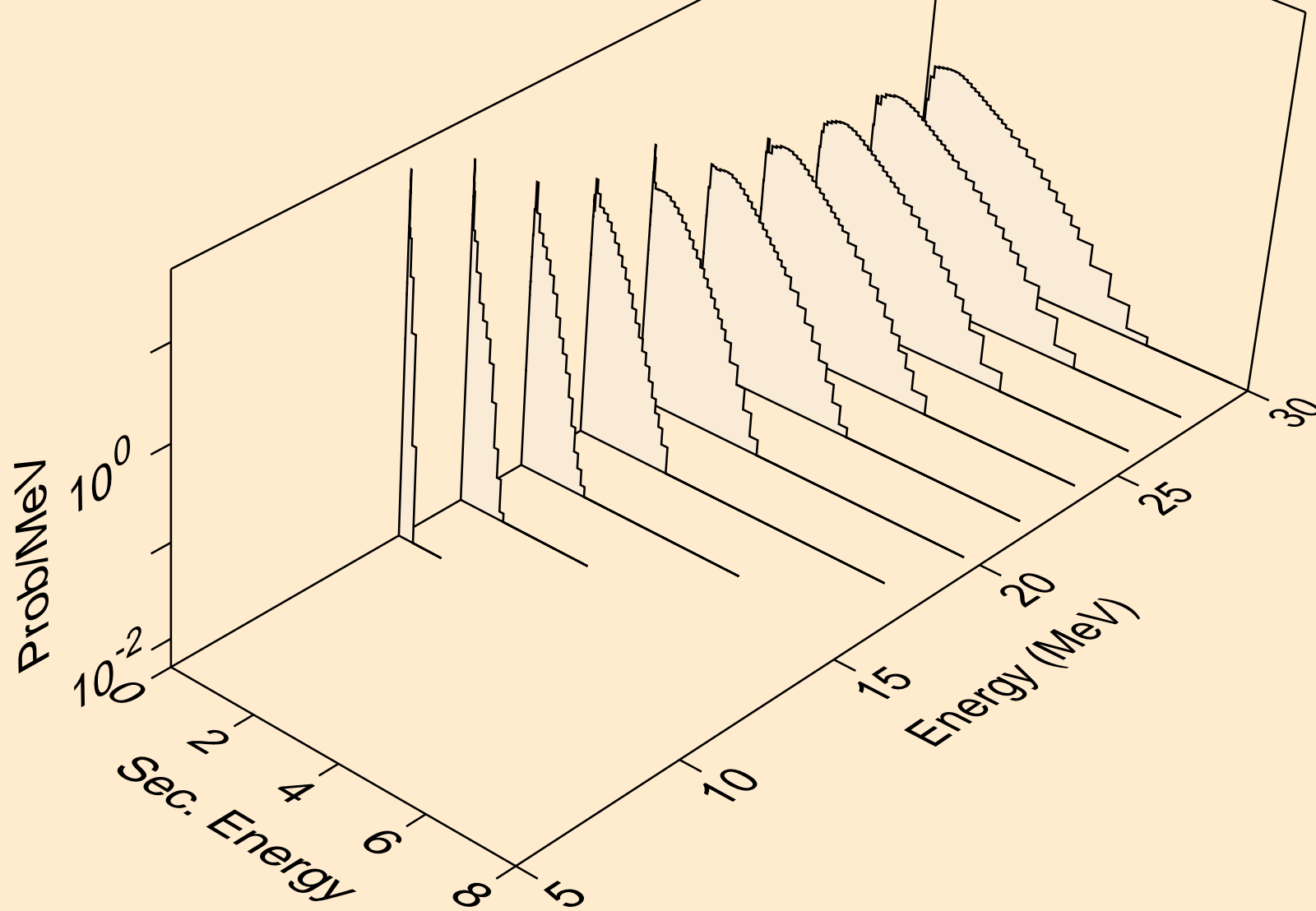

AS084 NEUTRON ACER TENDL-2024 LIBRARY; T=0.K
Neutron emission for (n,2n)a

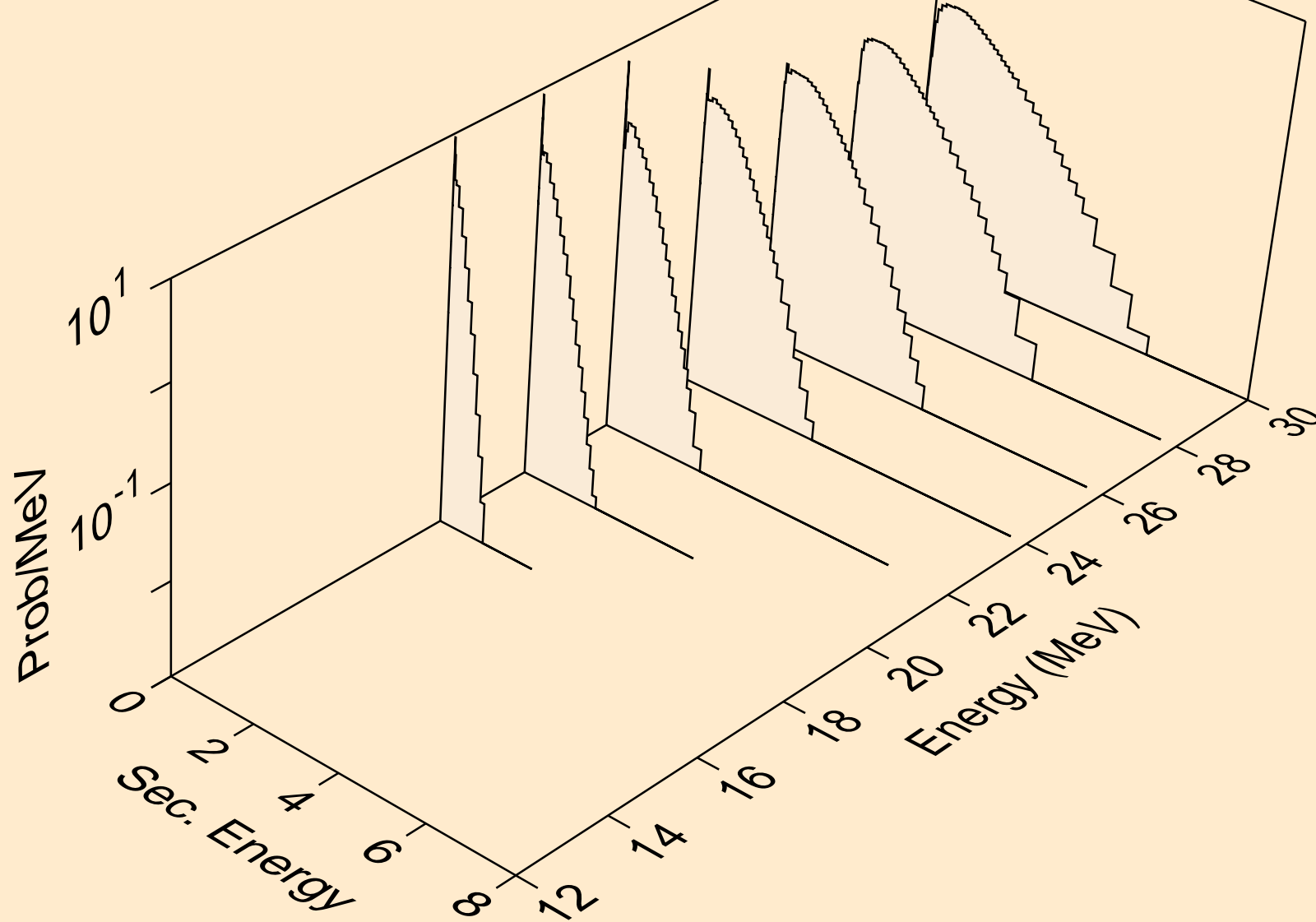

AS084 NEUTRON ACER TENDL-2024 LIBRARY; T=0.K
Neutron emission for (n,3n)a

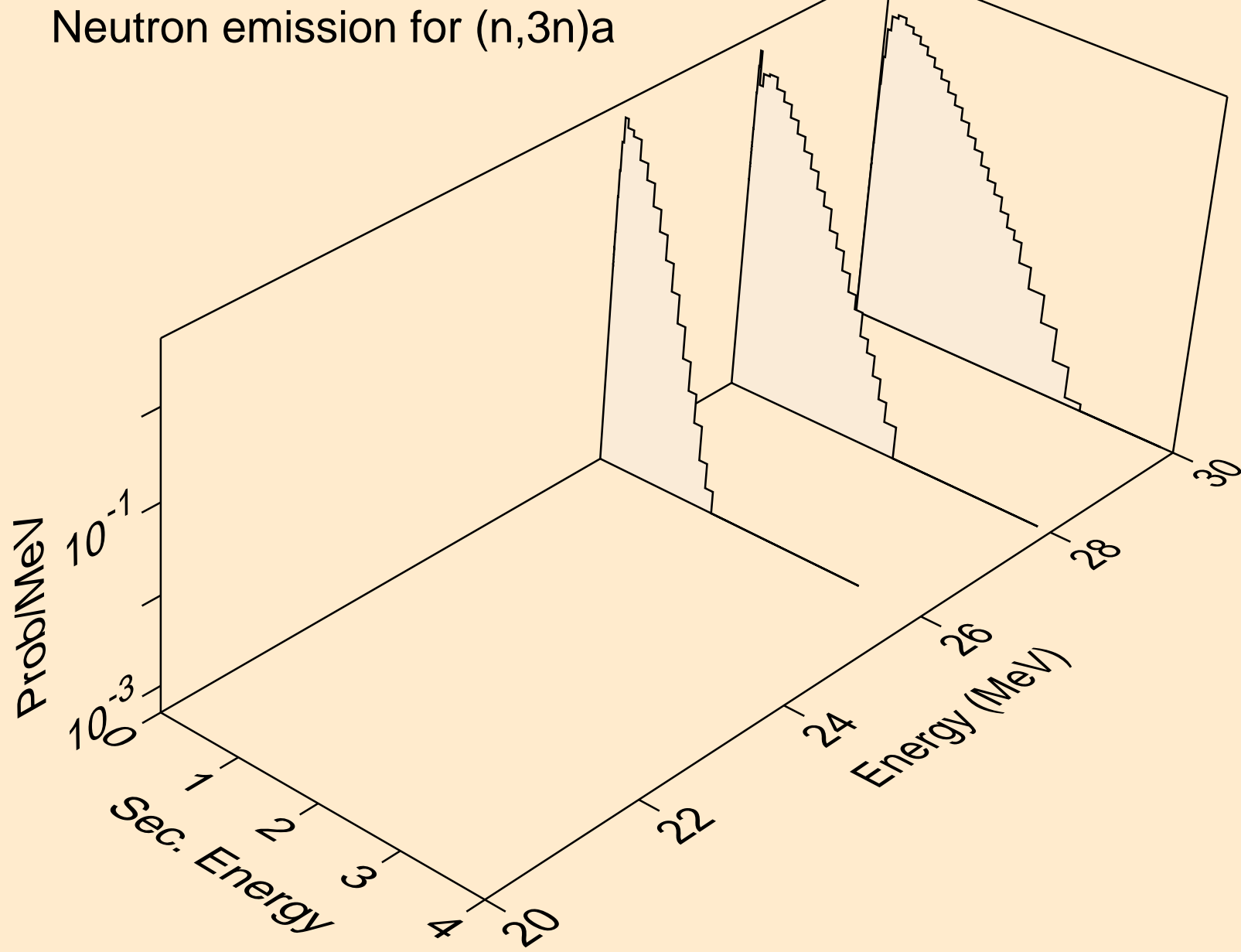

AS084 NEUTRON ACER TENDL-2024 LIBRARY; T=0.K
Neutron emission for (n,n*)p

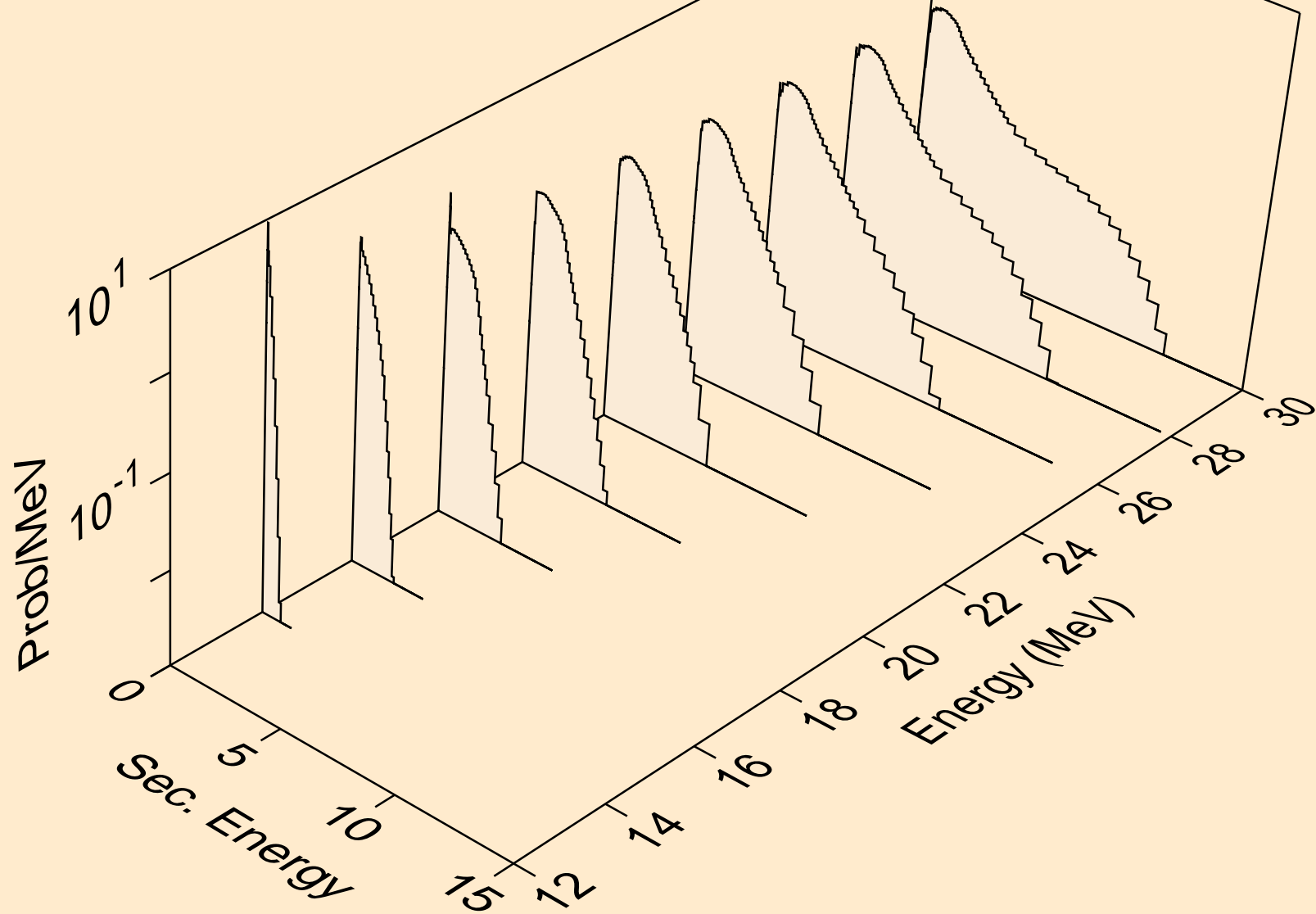

AS084 NEUTRON ACER TENDL-2024 LIBRARY; T=0.K
Neutron emission for (n,n*)d

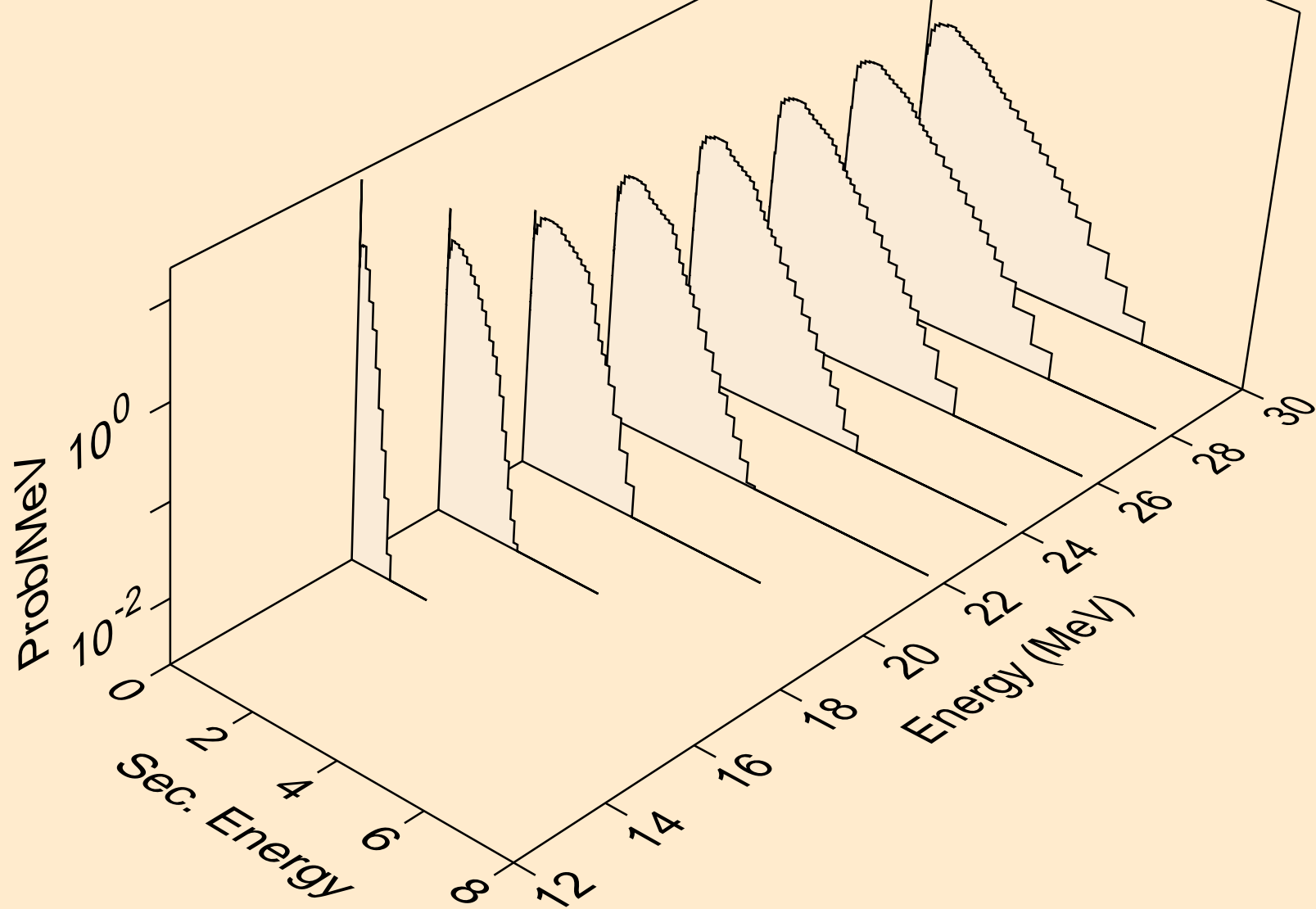

AS084 NEUTRON ACER TENDL-2024 LIBRARY; T=0.K
Neutron emission for (n,n*)t

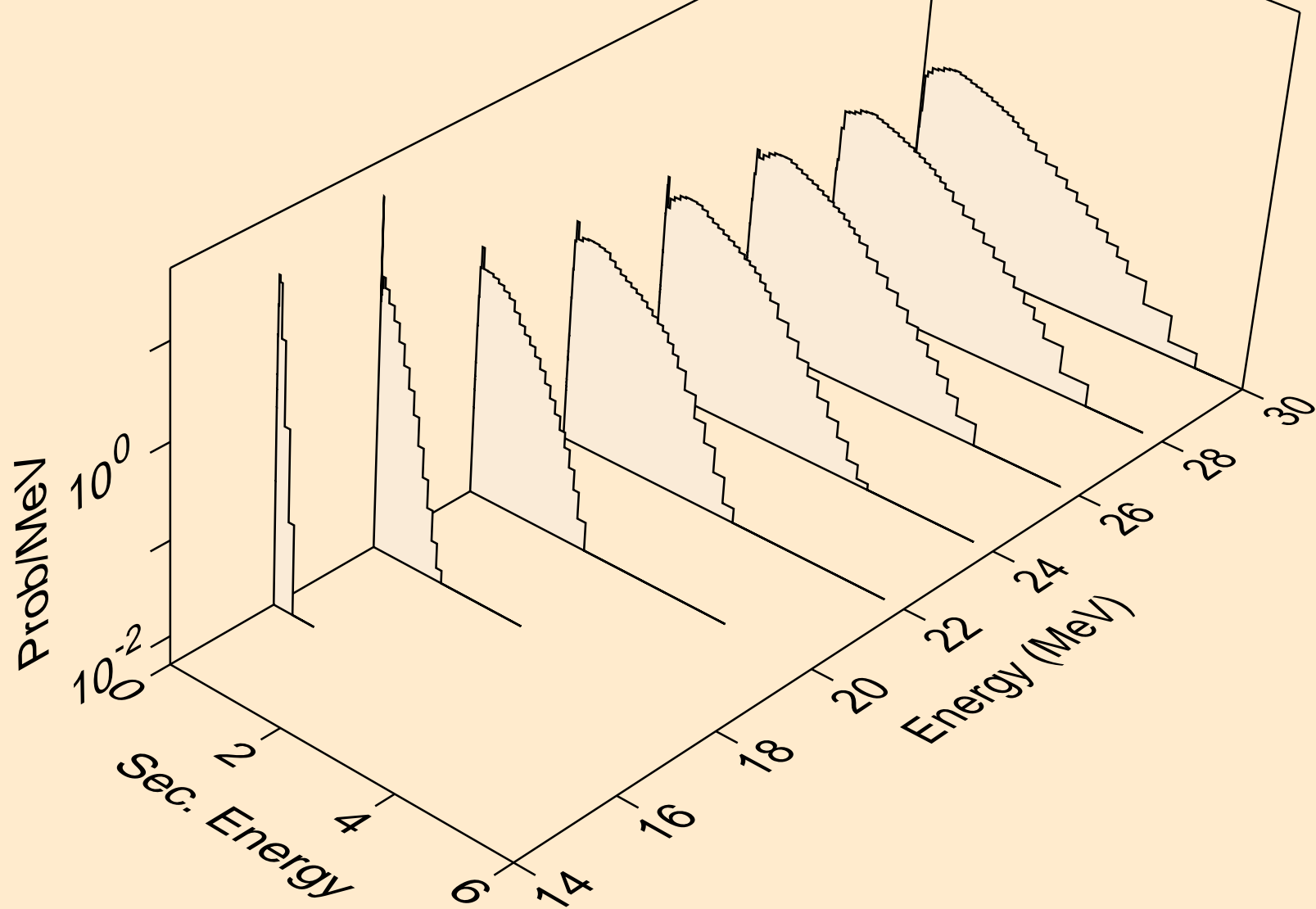

AS084 NEUTRON ACER TENDL-2024 LIBRARY; T=0.K
Neutron emission for (n,n*)he3

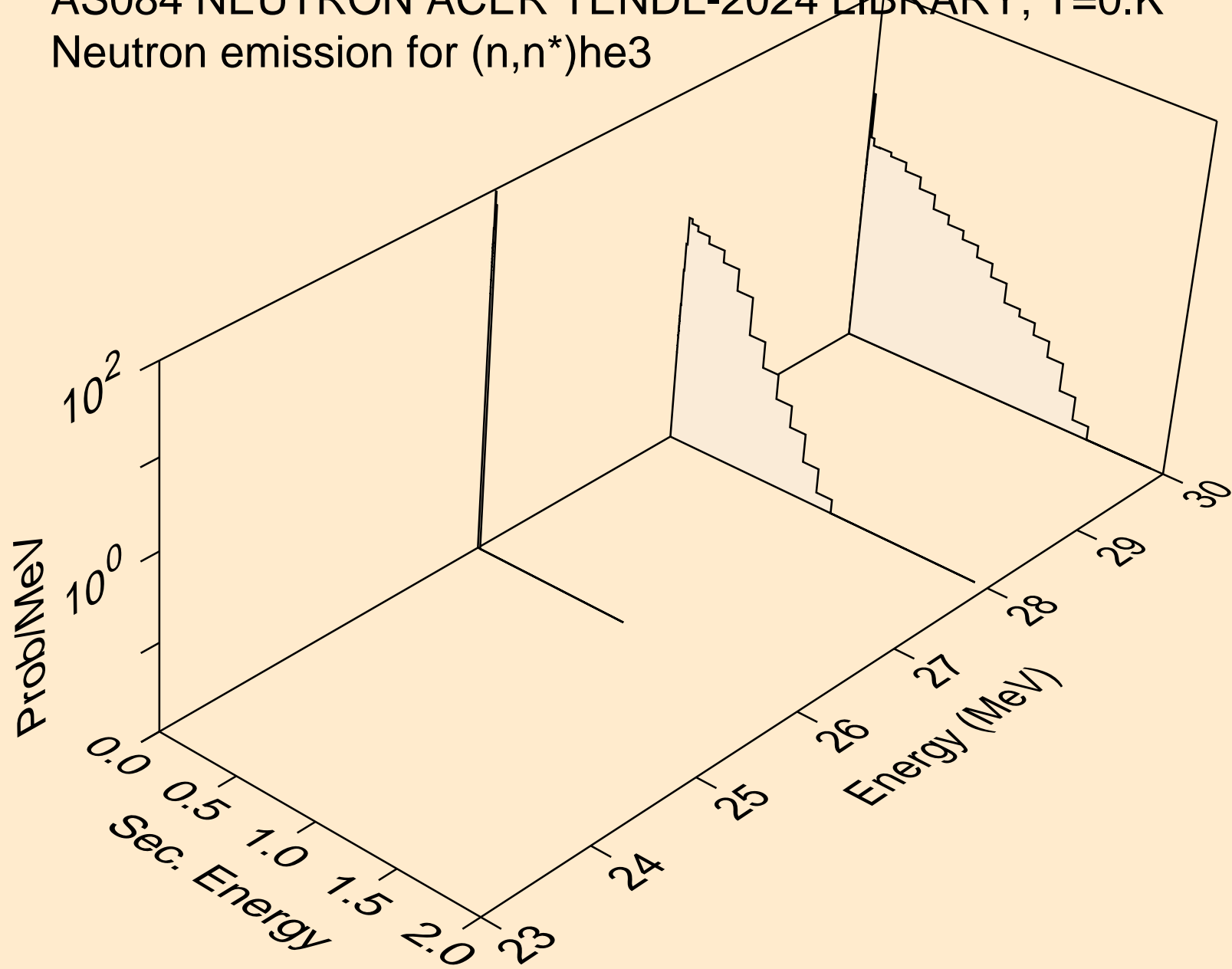

AS084 NEUTRON ACER TENDL-2024 LIBRARY; T=0.K
Neutron emission for (n,4n)

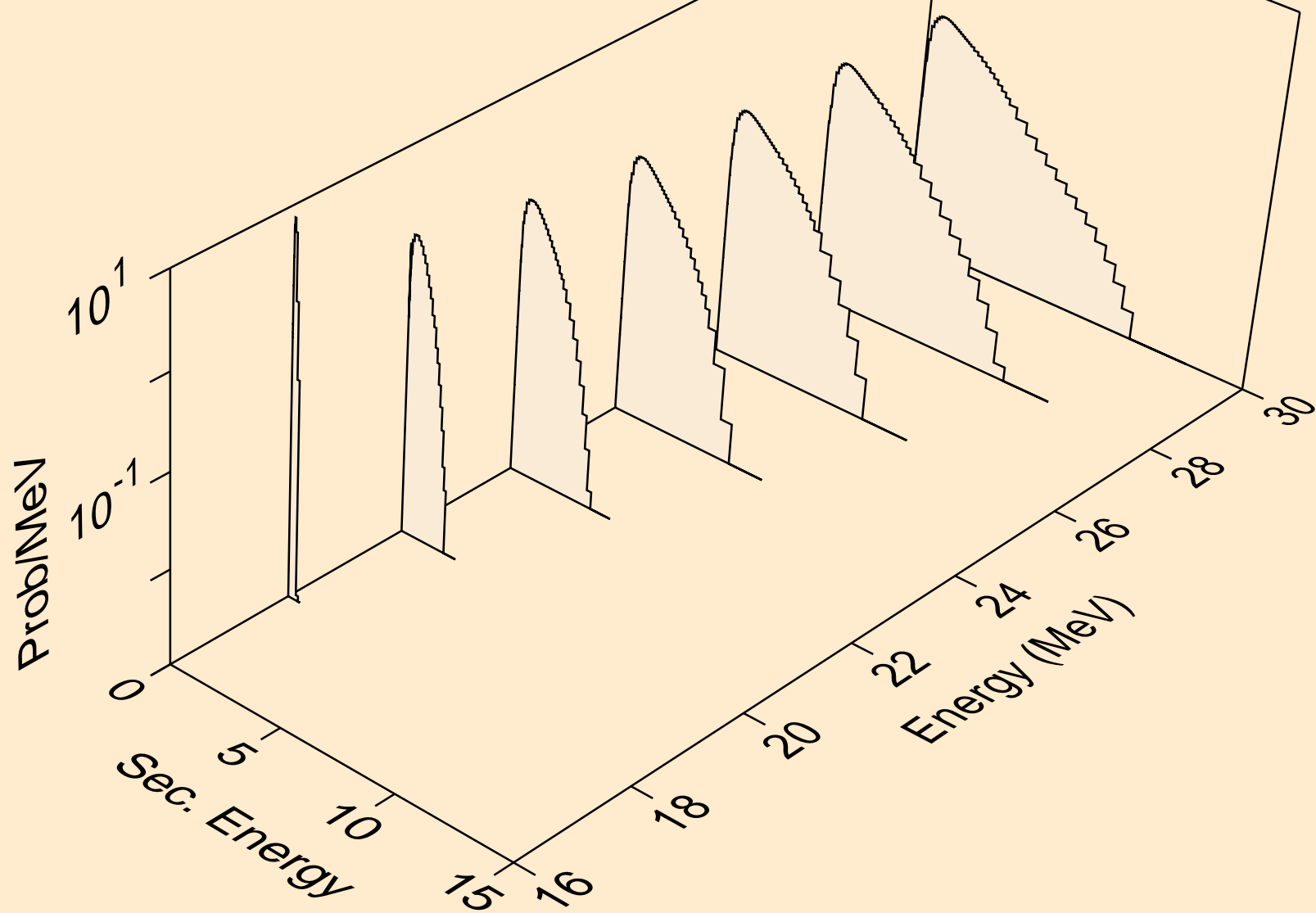

AS084 NEUTRON ACER TENDL-2024 LIBRARY; T=0.K
Neutron emission for (n,2np)

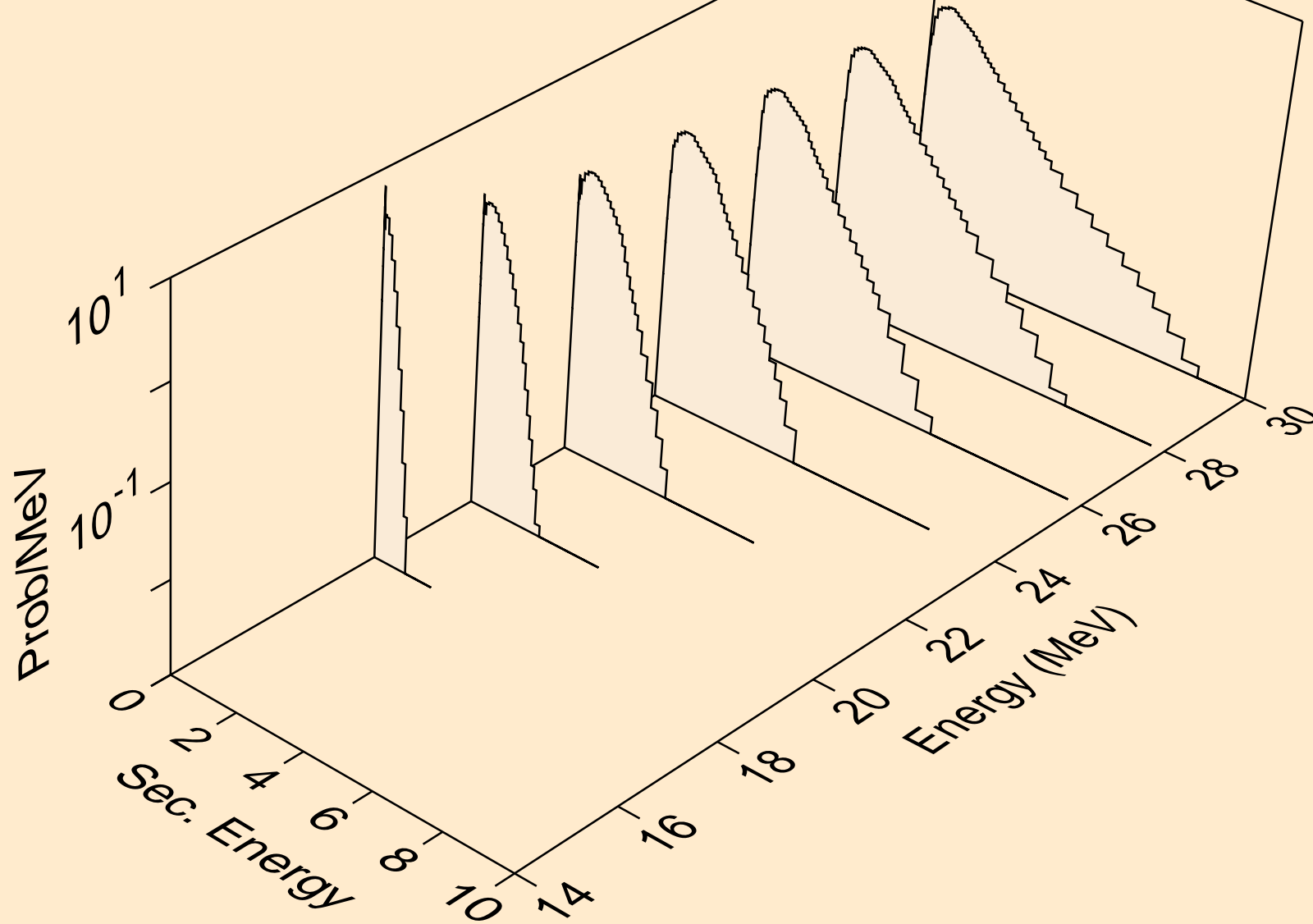

AS084 NEUTRON ACER TENDL-2024 LIBRARY; T=0.K
Neutron emission for (n,3np)

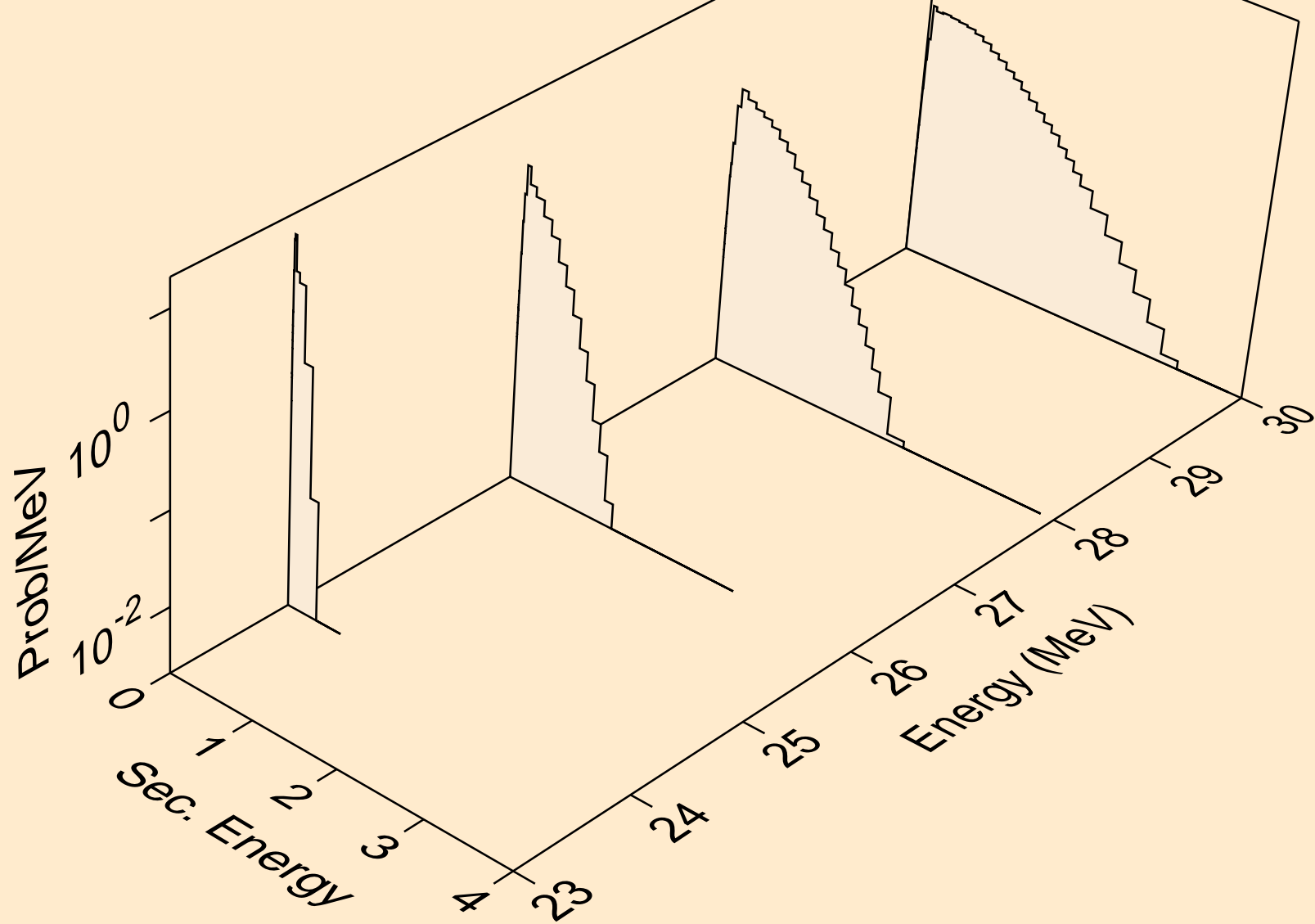

AS084 NEUTRON ACER TENDL-2024 LIBRARY; T=0.K
Neutron emission for (n,n*c)

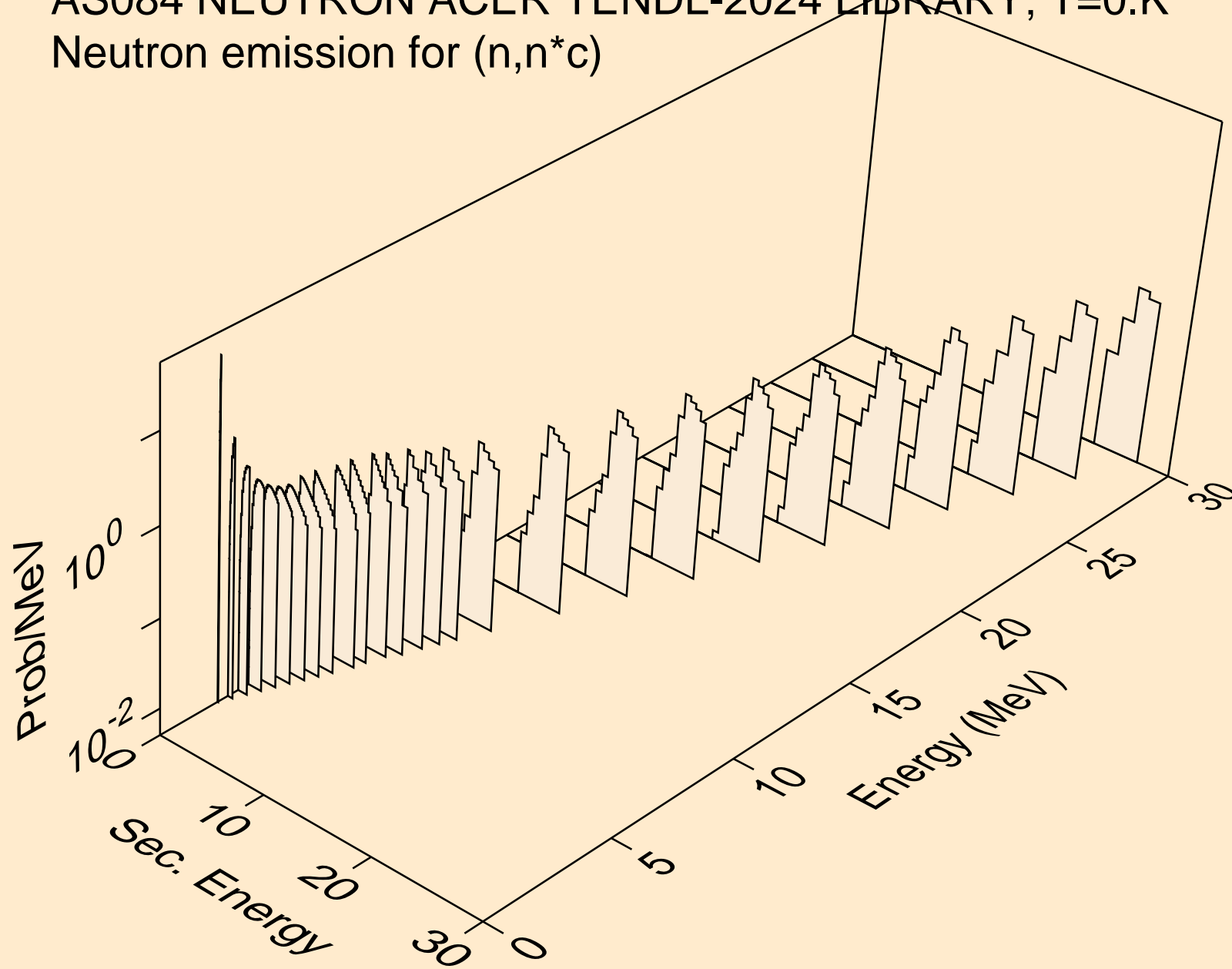

AS084 NEUTRON ACER TENDL-2024 LIBRARY; T=0.K
Photon emission for (n,x)

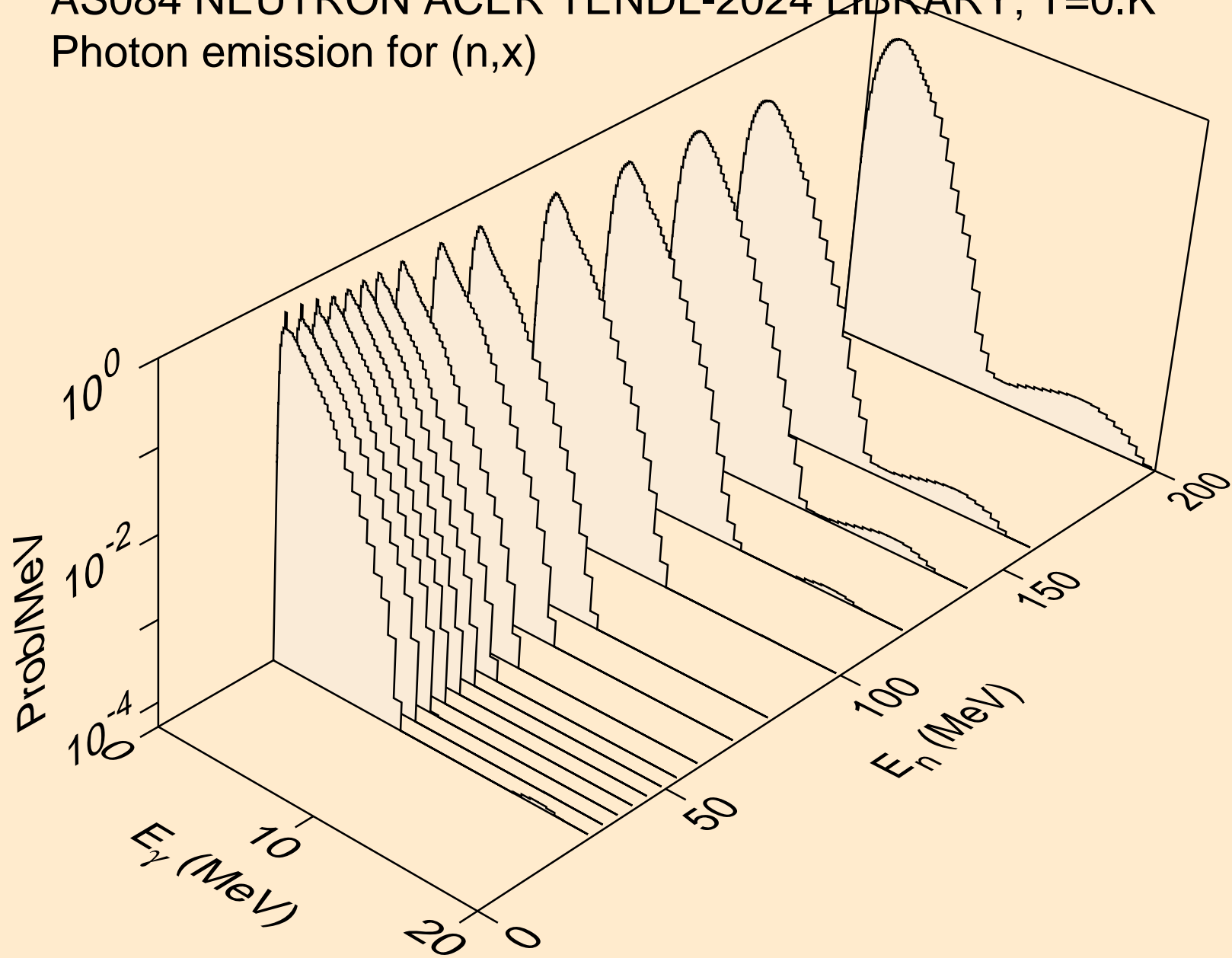

AS084 NEUTRON ACER TENDL-2024 LIBRARY; T=0.K
Photon emission for (n,2nd)

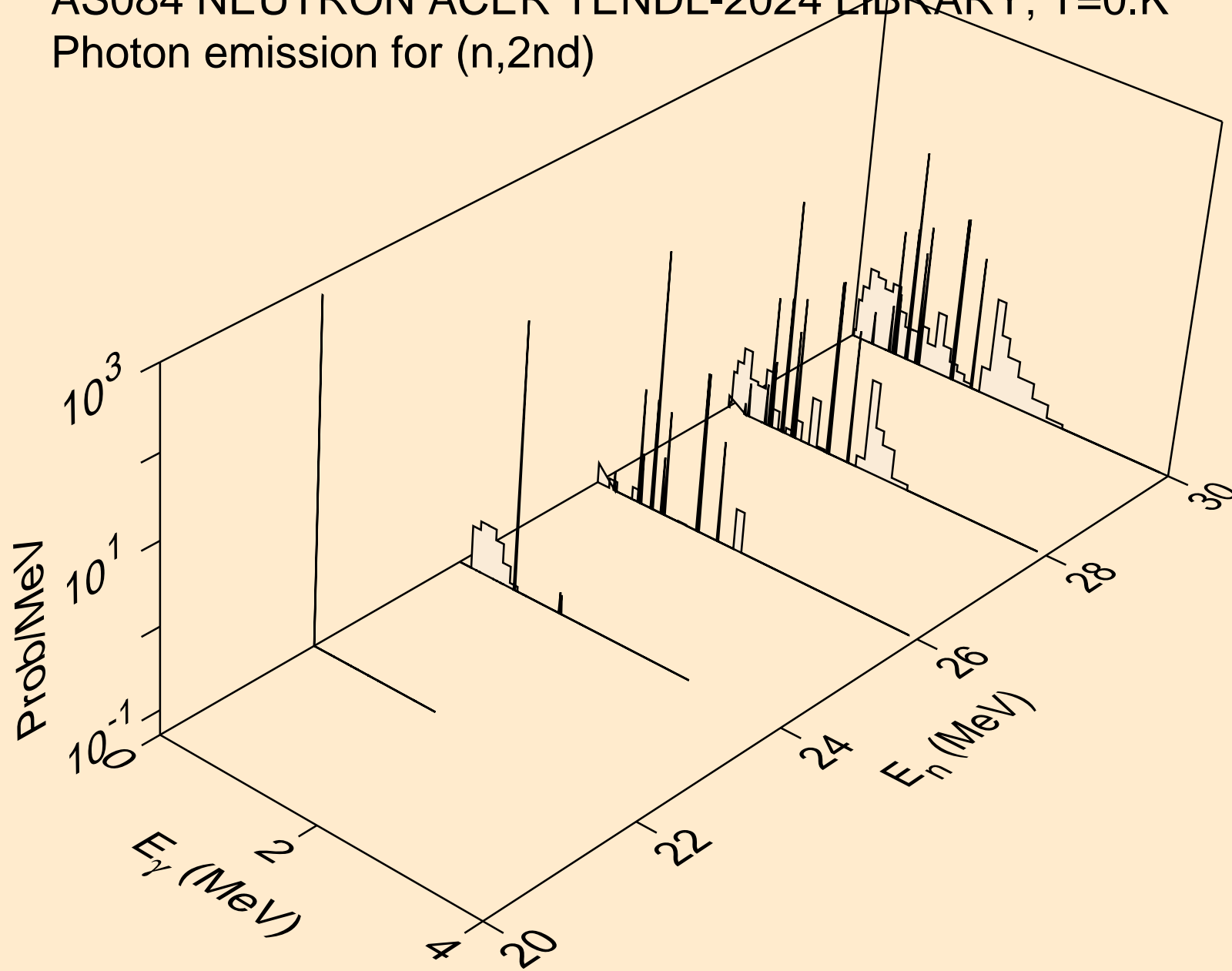

AS084 NEUTRON ACER TENDL-2024 LIBRARY; T=0.K
Photon emission for (n,2n)

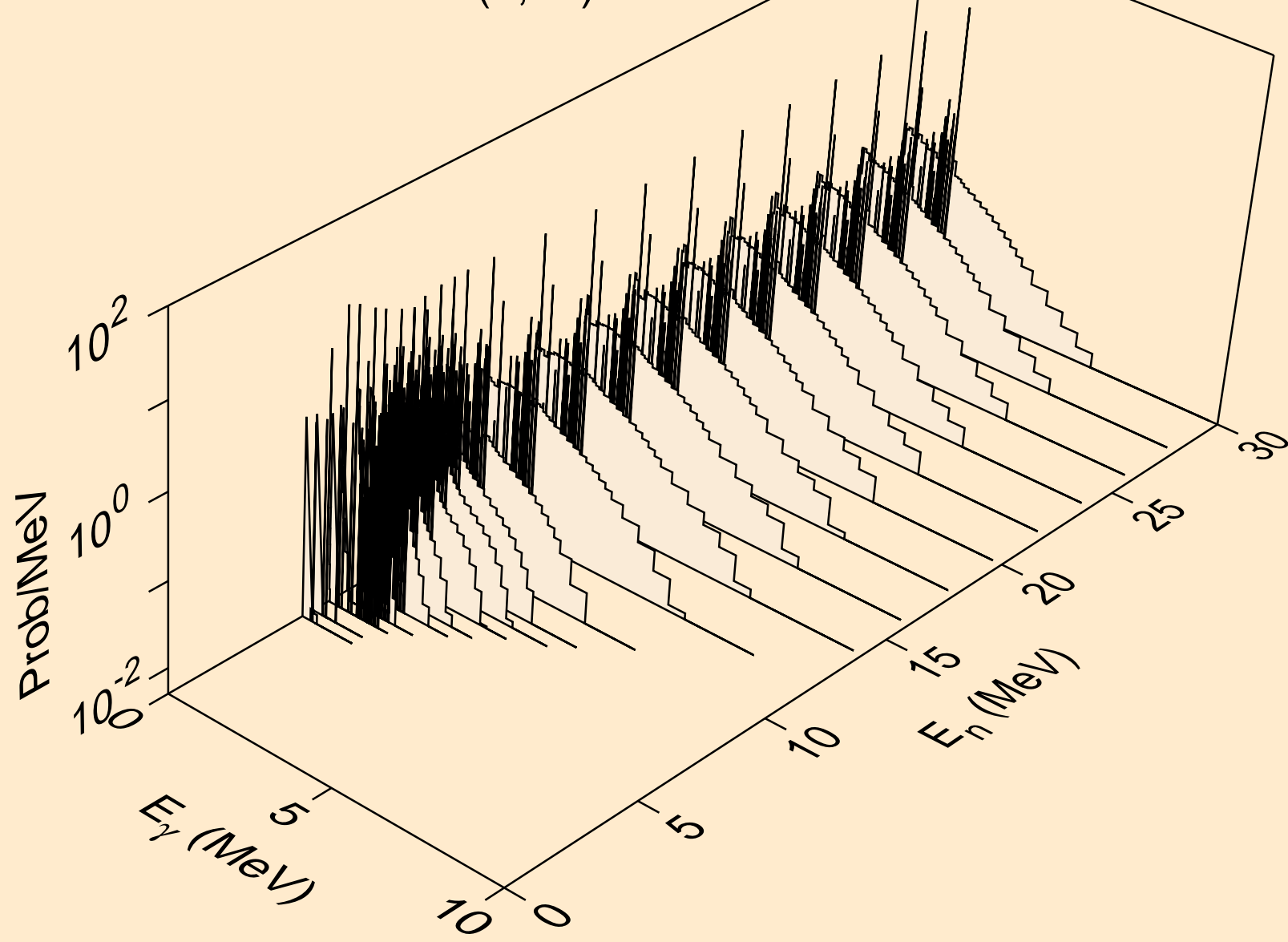

AS084 NEUTRON ACER TENDL-2024 LIBRARY; T=0.K
Photon emission for (n,3n)

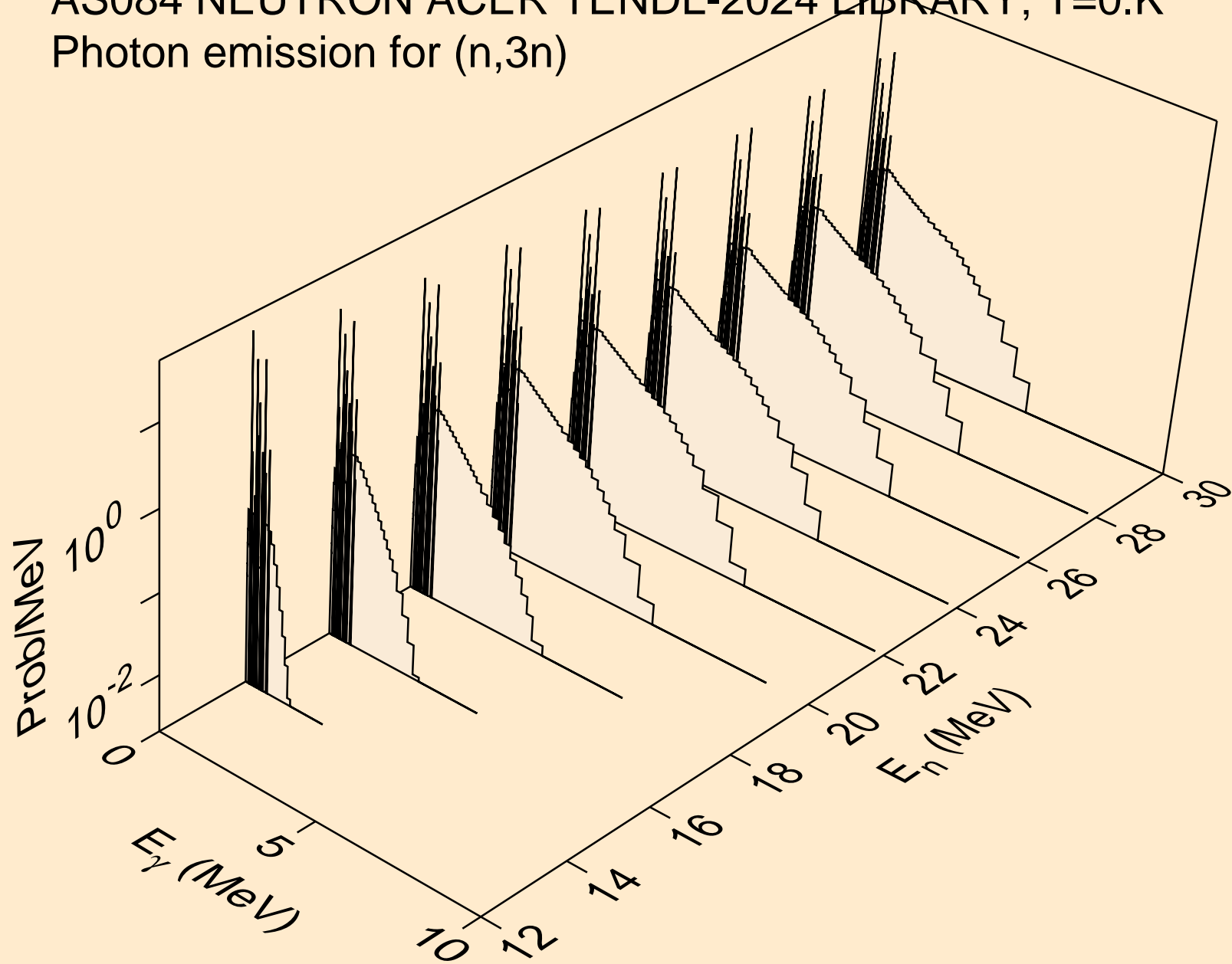

AS084 NEUTRON ACER TENDL-2024 LIBRARY; T=0.K
Photon emission for (n,n*)a

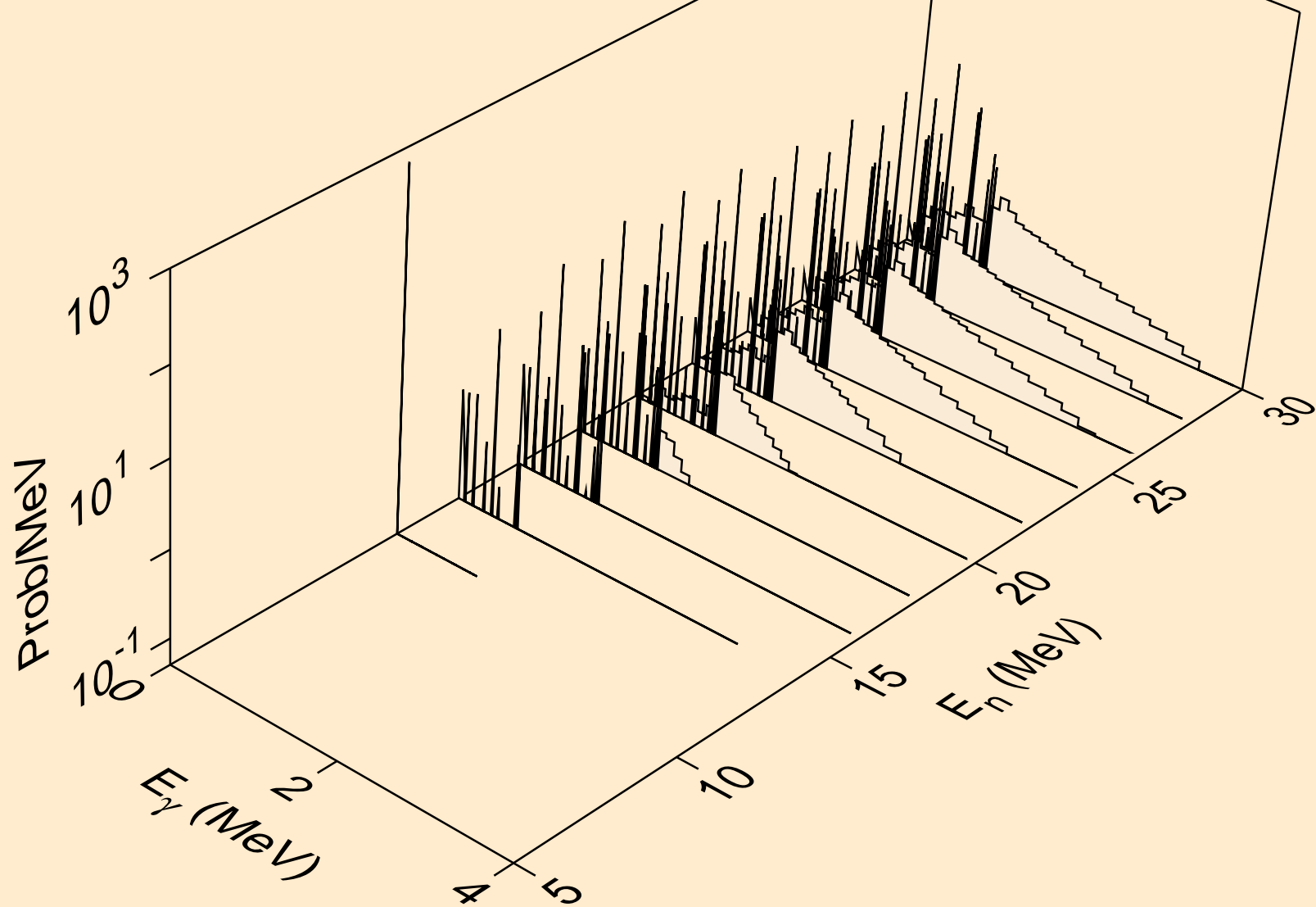

AS084 NEUTRON ACER TENDL-2024 LIBRARY; T=0.K
Photon emission for (n,2n)a

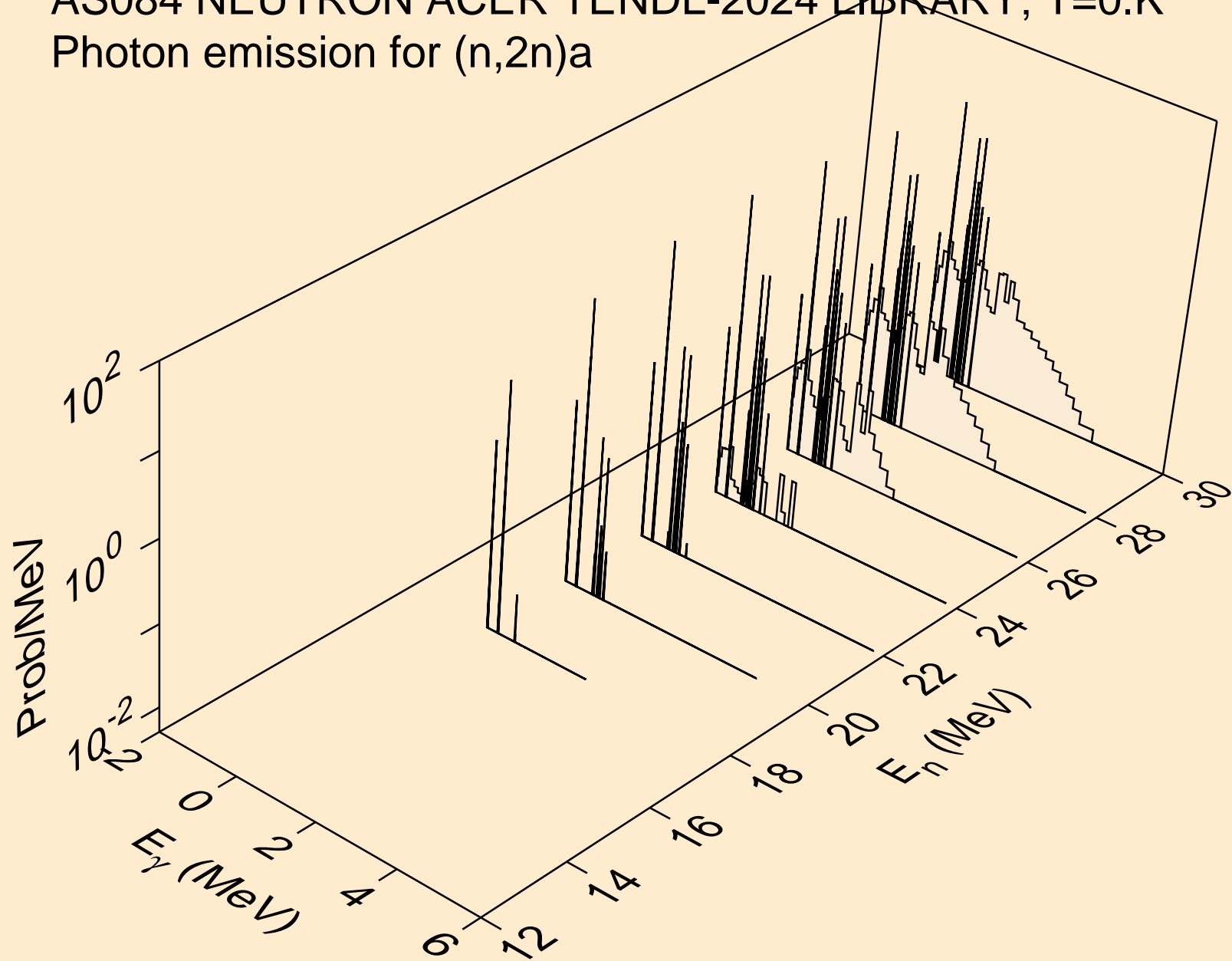

AS084 NEUTRON ACER TENDL-2024 LIBRARY; T=0.K
Photon emission for (n,3n)a

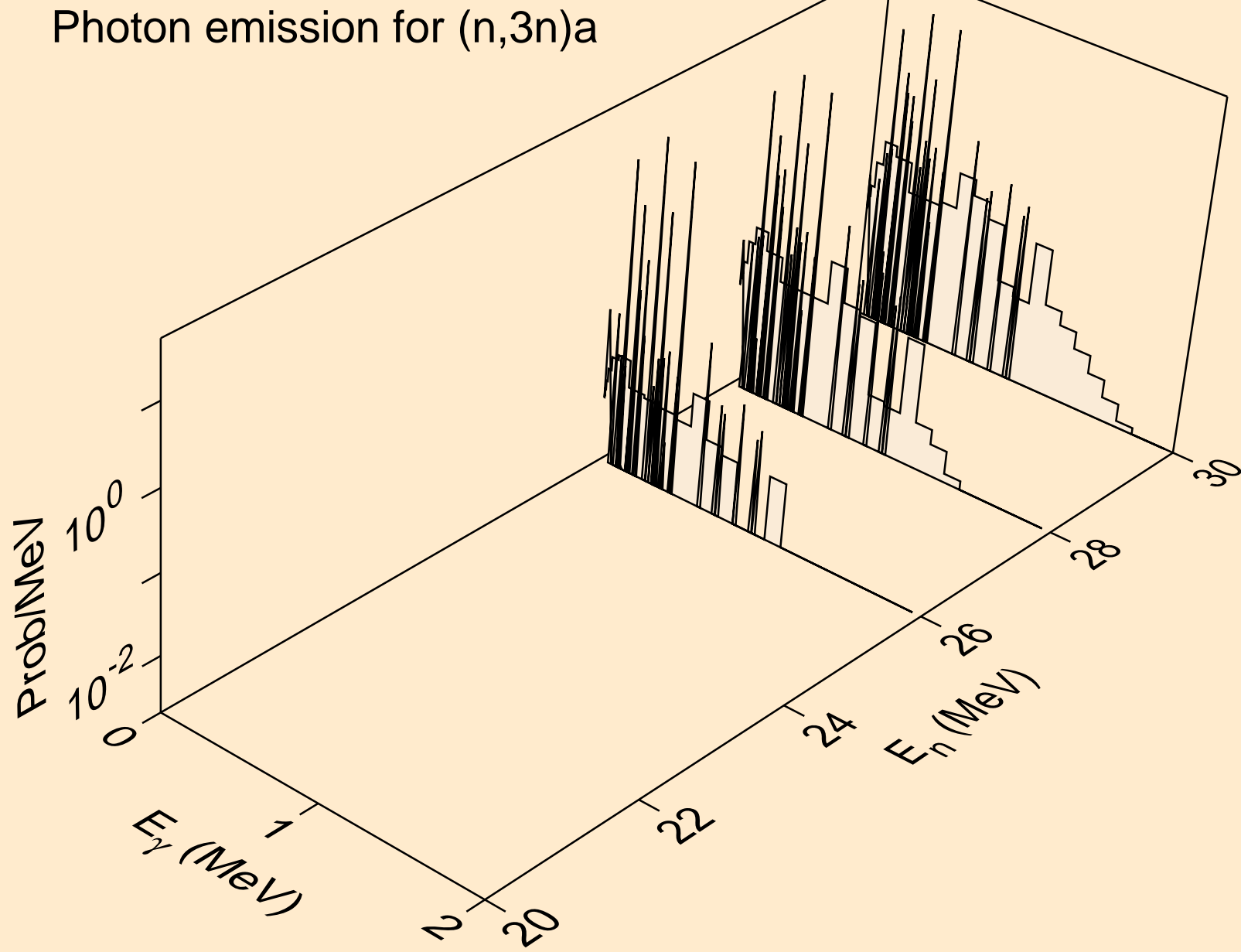

AS084 NEUTRON ACER TENDL-2024 LIBRARY; T=0.K
Photon emission for (n,n*)p

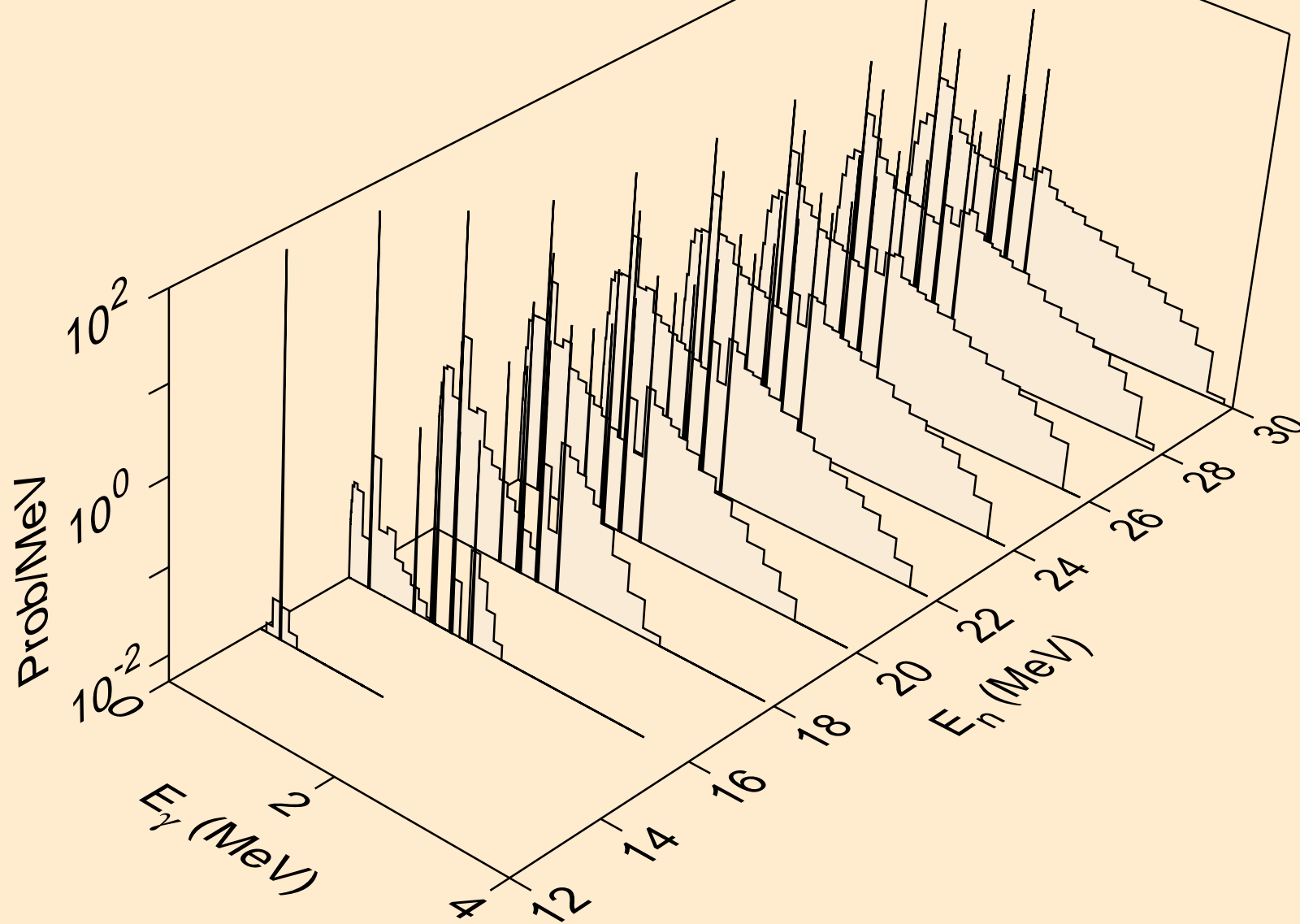

AS084 NEUTRON ACER TENDL-2024 LIBRARY; T=0.K
Photon emission for (n,n*)d

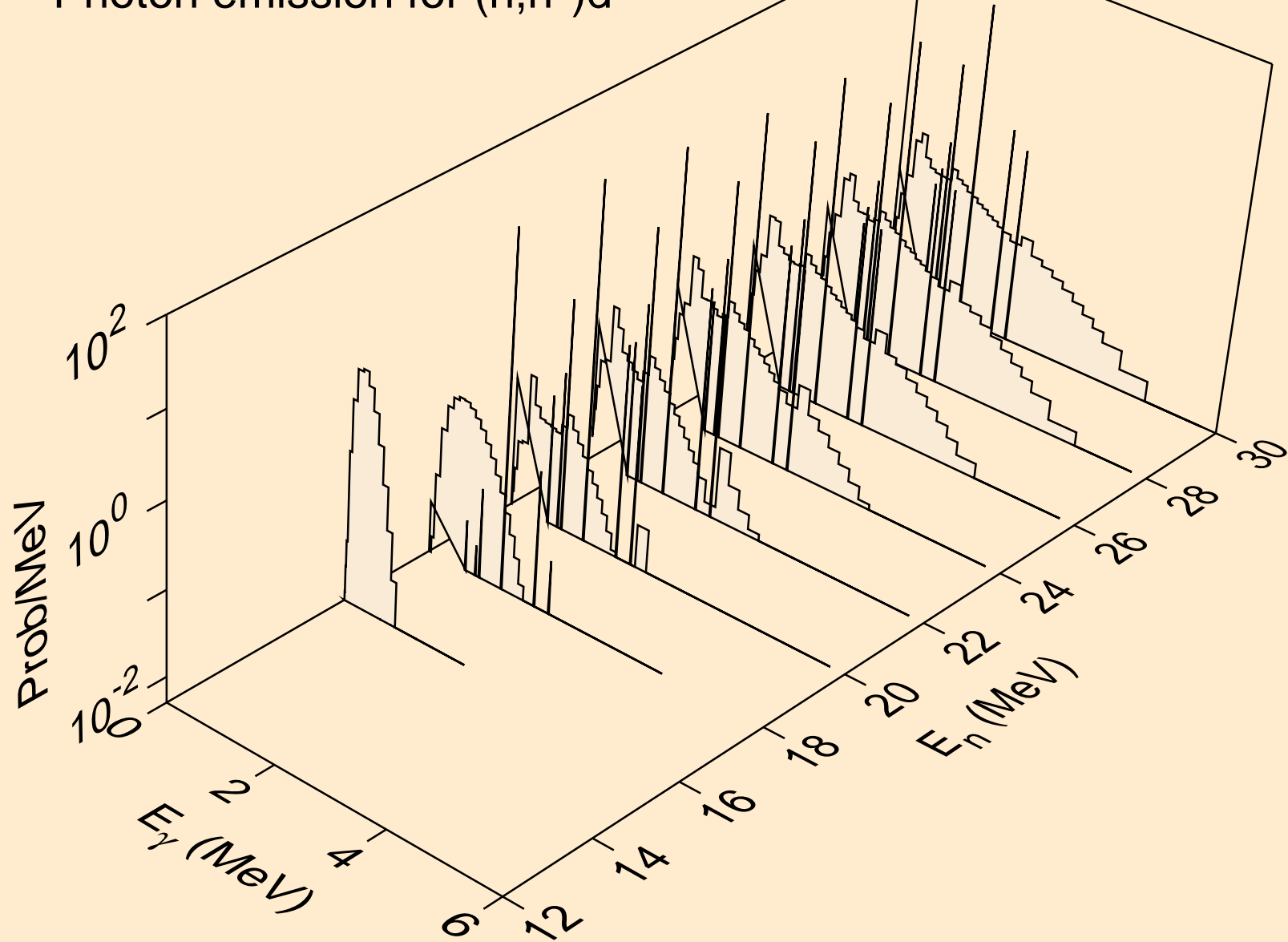

AS084 NEUTRON ACER TENDL-2024 LIBRARY; T=0.K
Photon emission for (n,n*)t

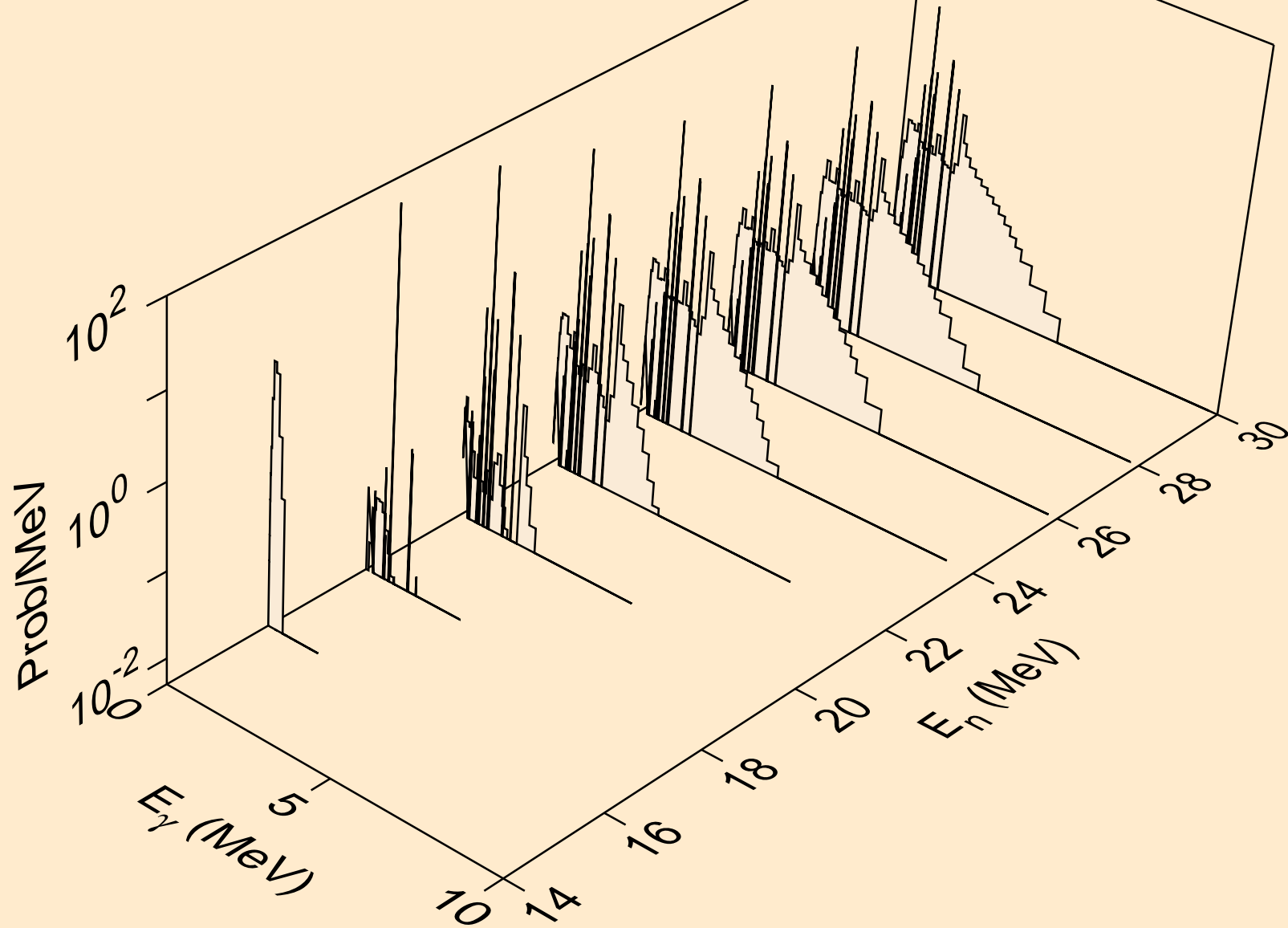

AS084 NEUTRON ACER TENDL-2024 LIBRARY; T=0.K
Photon emission for (n,n*)he3

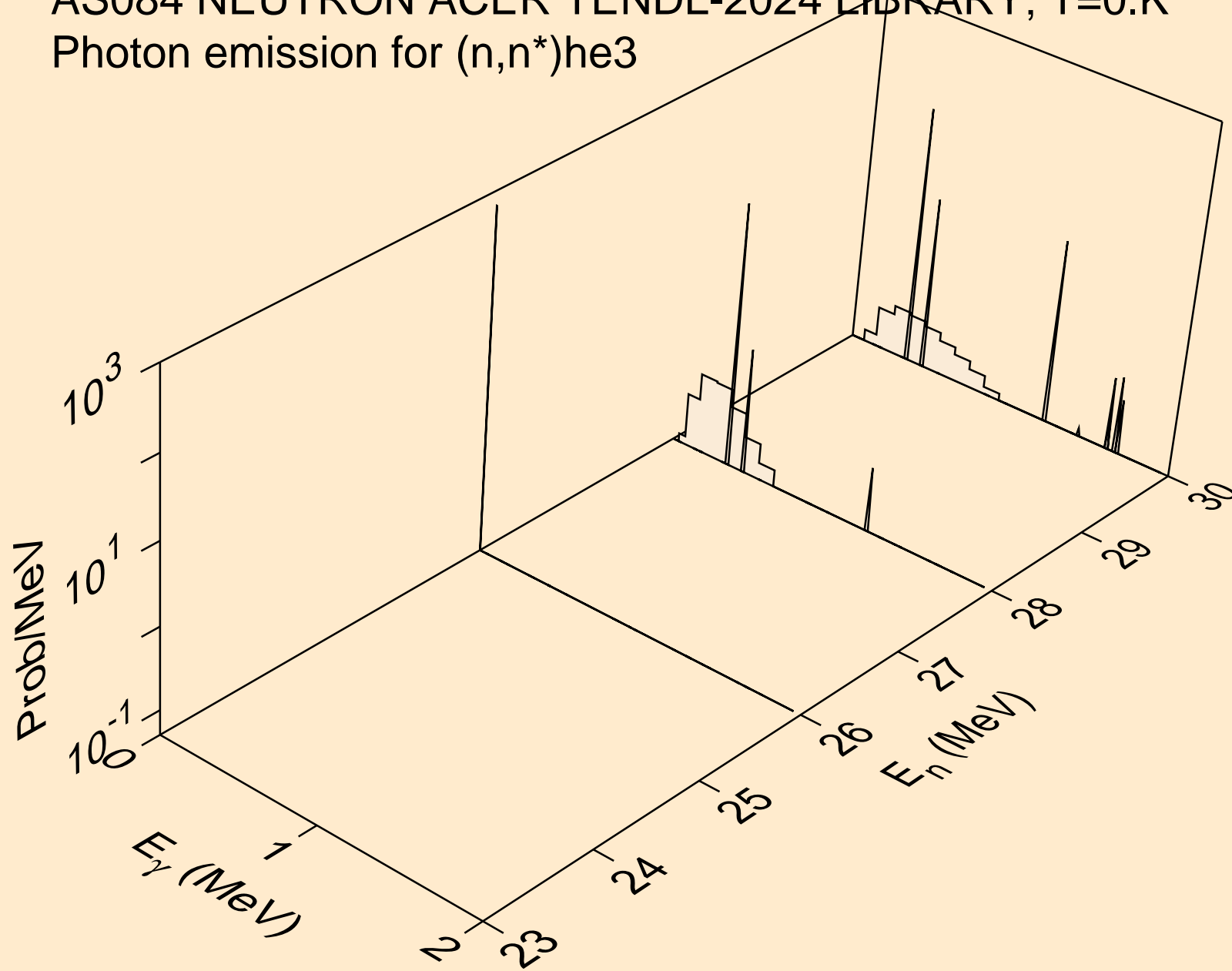

AS084 NEUTRON ACER TENDL-2024 LIBRARY; T=0.K
Photon emission for (n,4n)

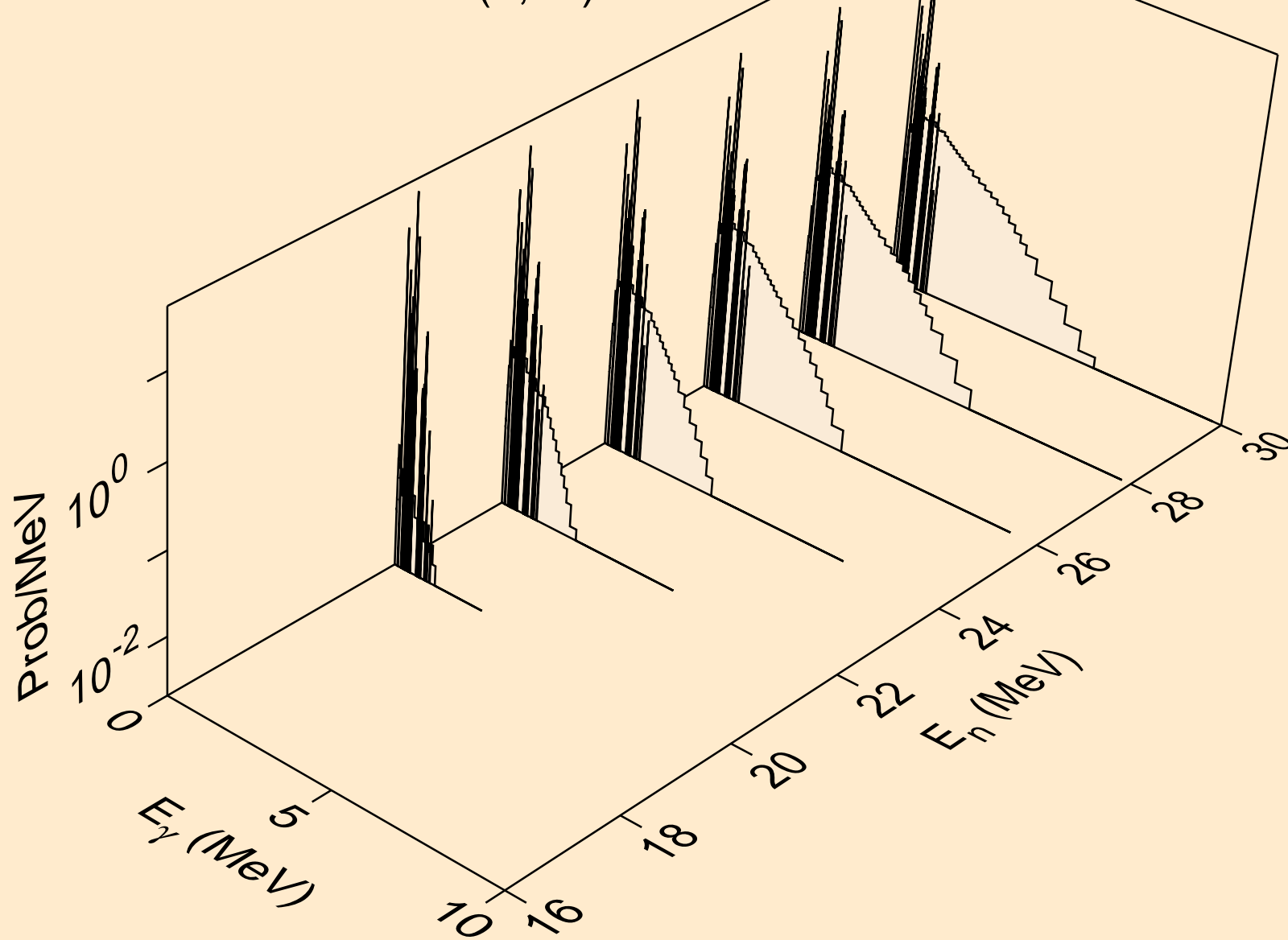

AS084 NEUTRON ACER TENDL-2024 LIBRARY; T=0.K
Photon emission for (n,2np)

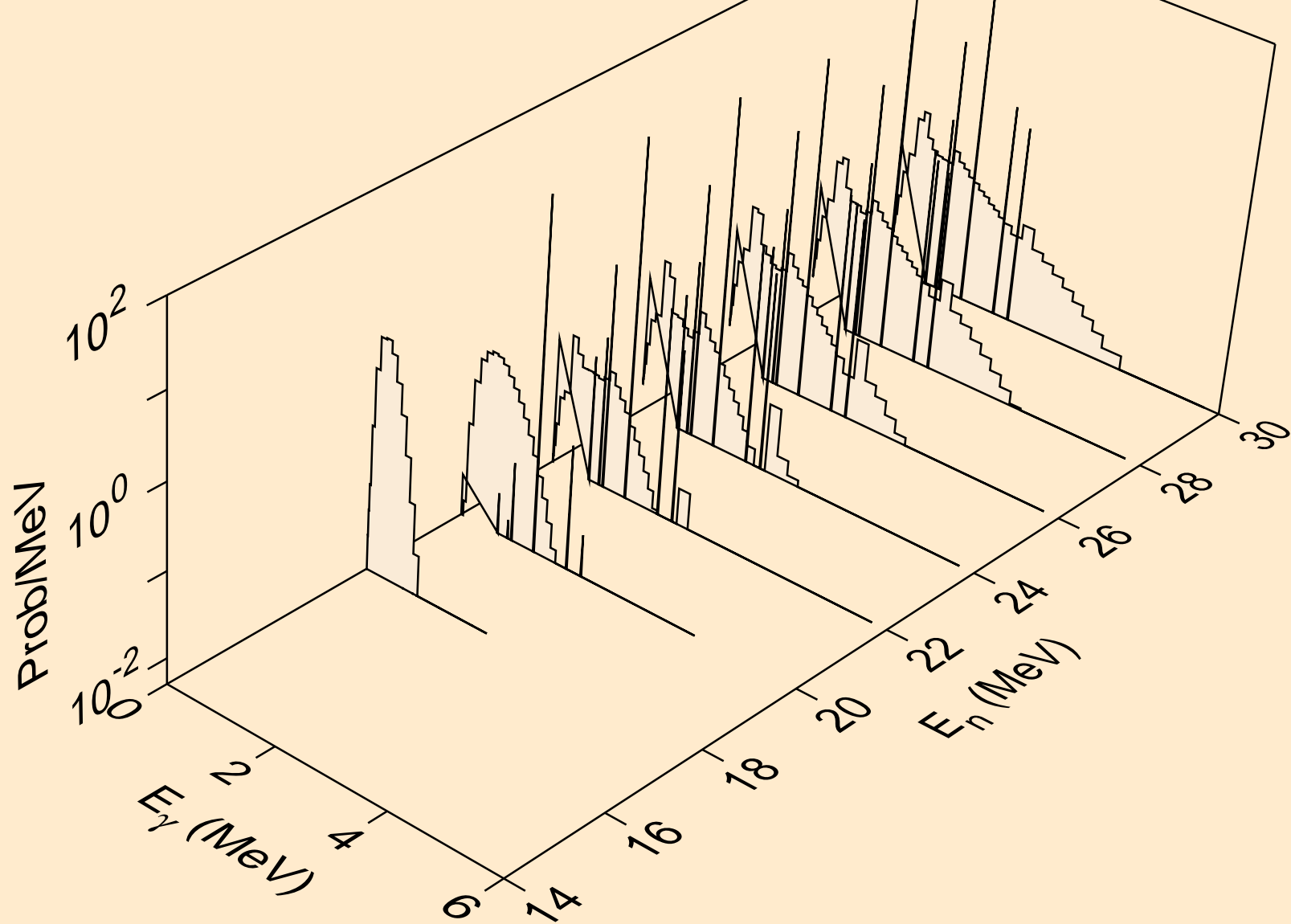

AS084 NEUTRON ACER TENDL-2024 LIBRARY; T=0.K
Photon emission for (n,3np)

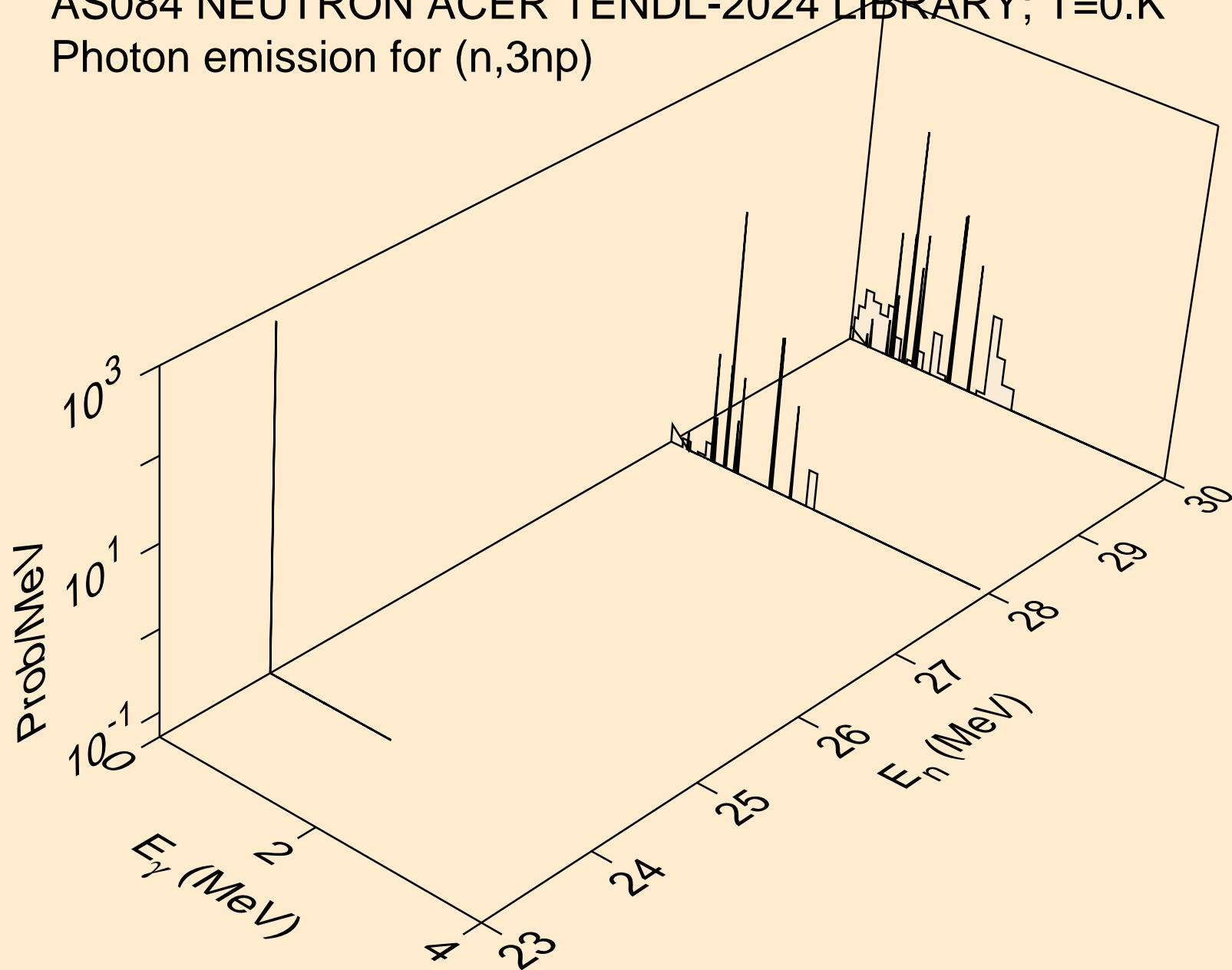

AS084 NEUTRON ACER TENDL-2024 LIBRARY; T=0.K
Photon emission for (n,n*c)

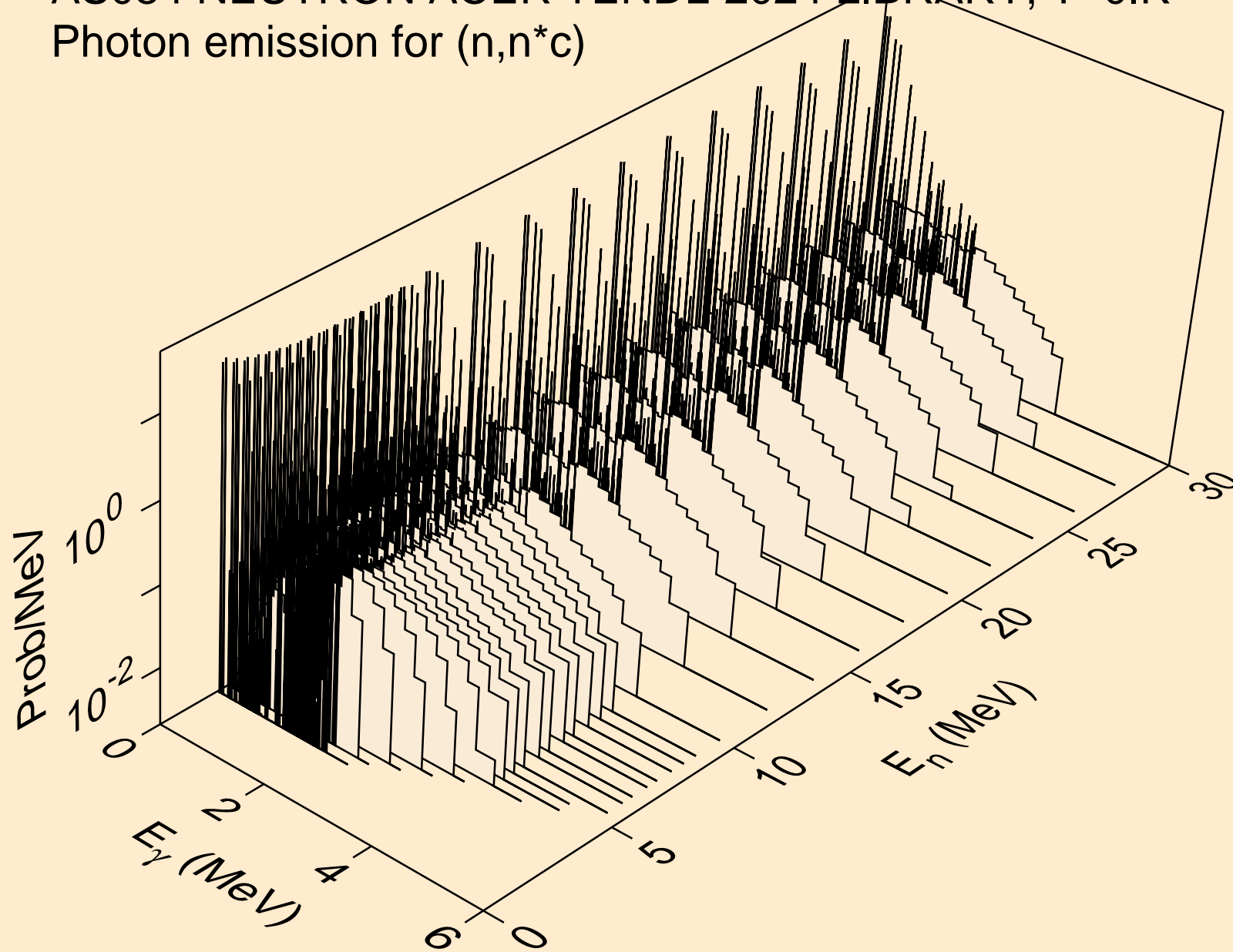

AS084 NEUTRON ACER TENDL-2024 LIBRARY; T=0.K
Photon emission for (n,gma)

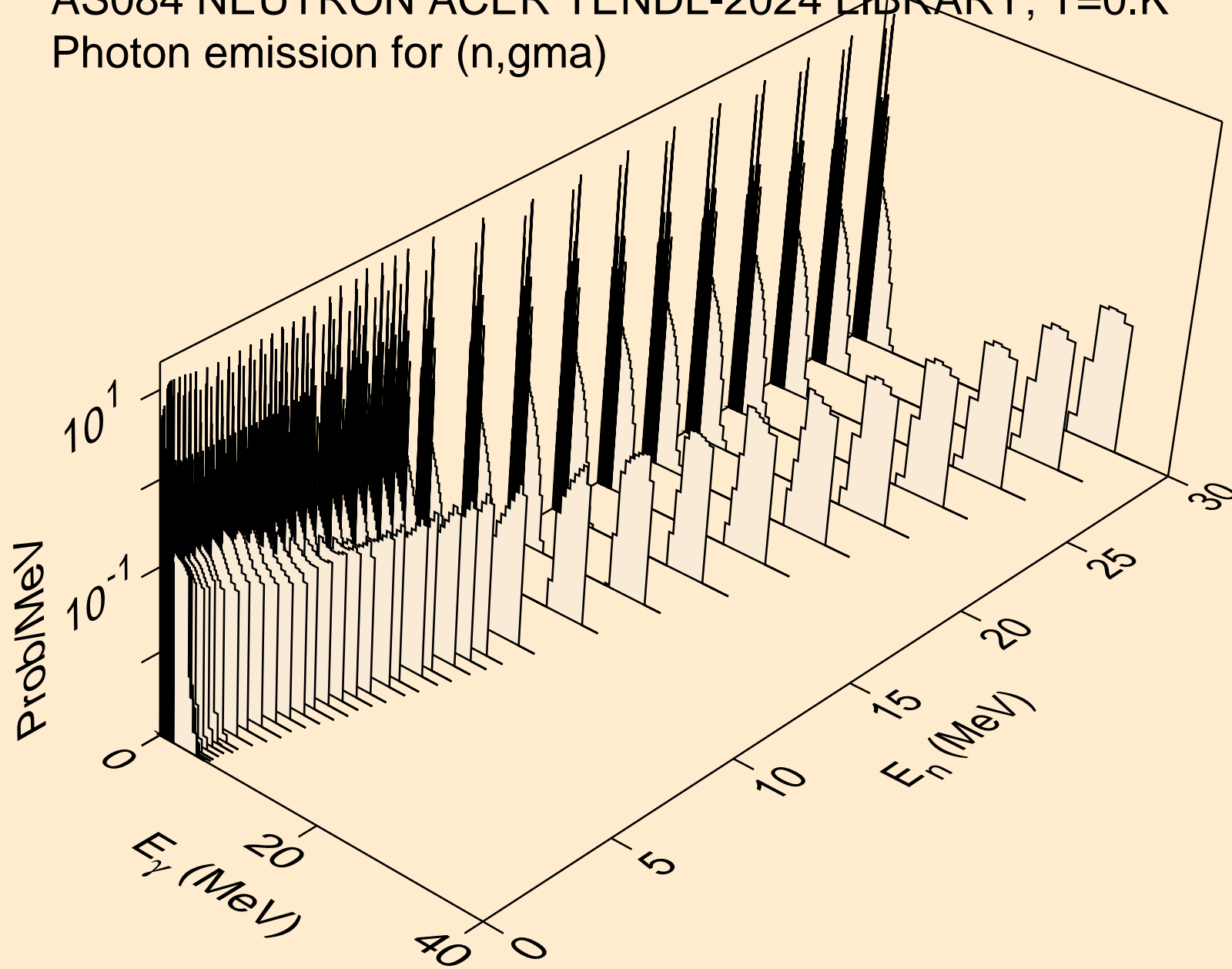

AS084 NEUTRON ACER TENDL-2024 LIBRARY; T=0.K
Photon emission for (n,p)

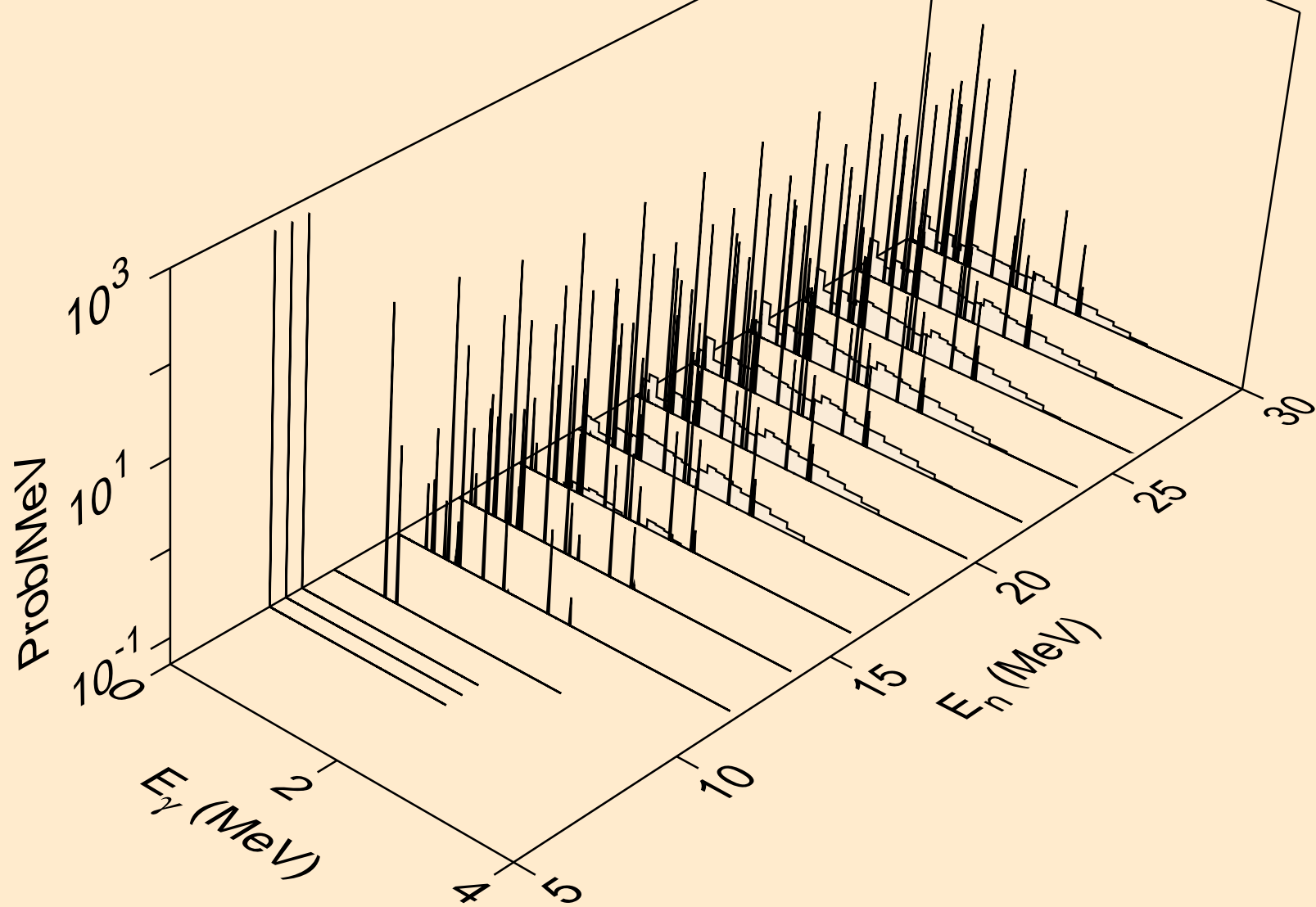

AS084 NEUTRON ACER TENDL-2024 LIBRARY; T=0.K
Photon emission for (n,d)

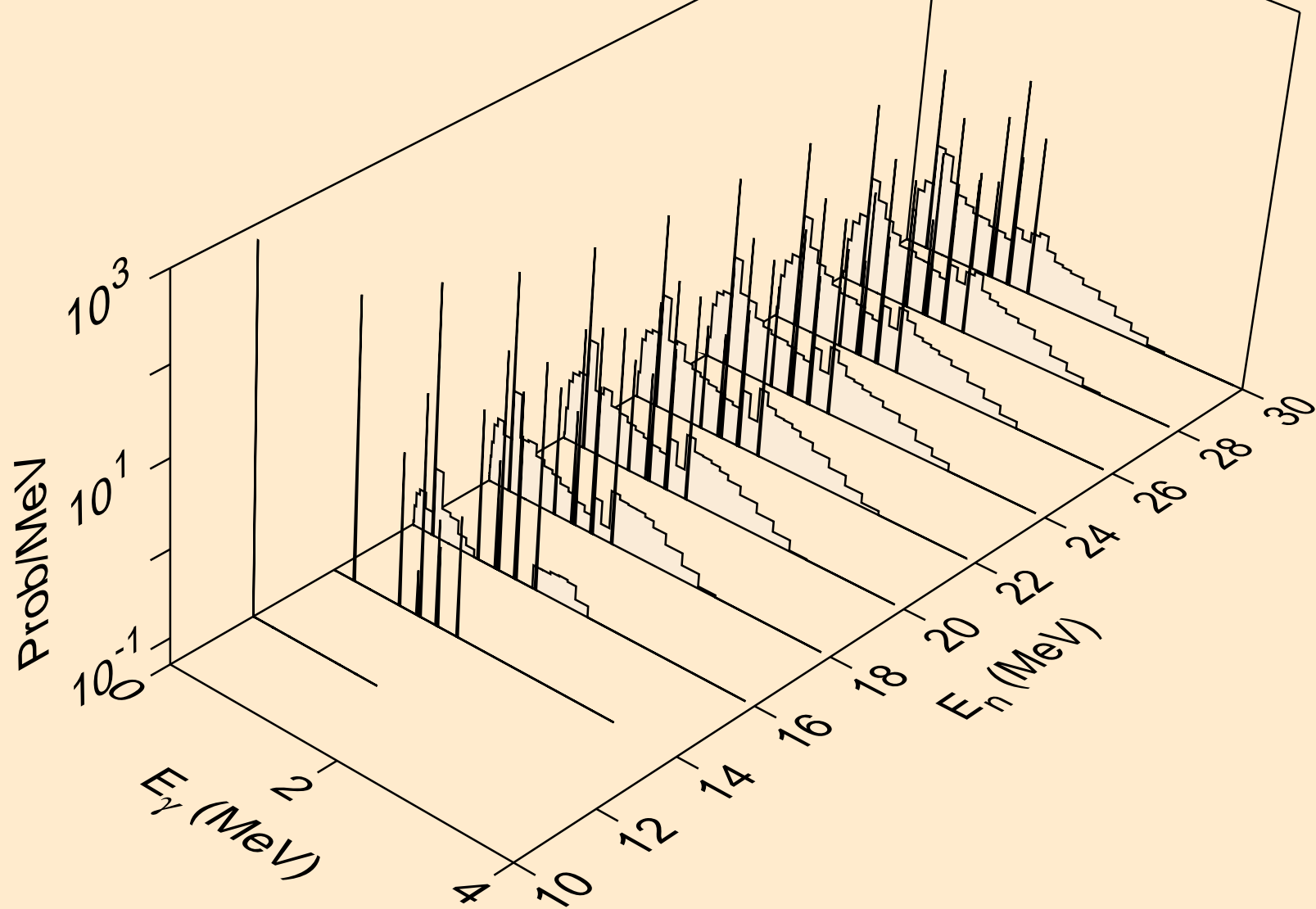

AS084 NEUTRON ACER TENDL-2024 LIBRARY; T=0.K
Photon emission for (n,t)

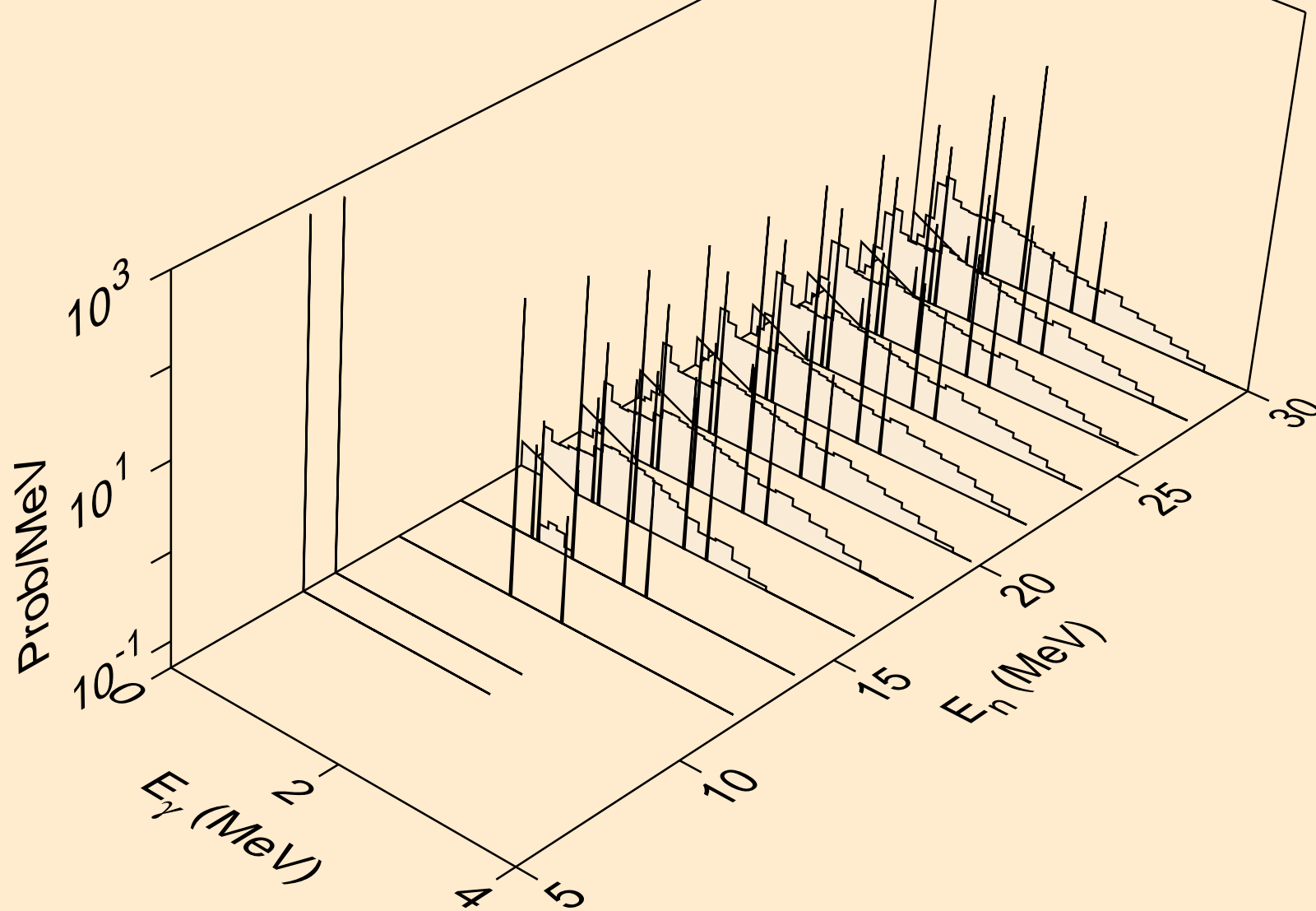

AS084 NEUTRON ACER TENDL-2024 LIBRARY; T=0.K
Photon emission for (n,he3)

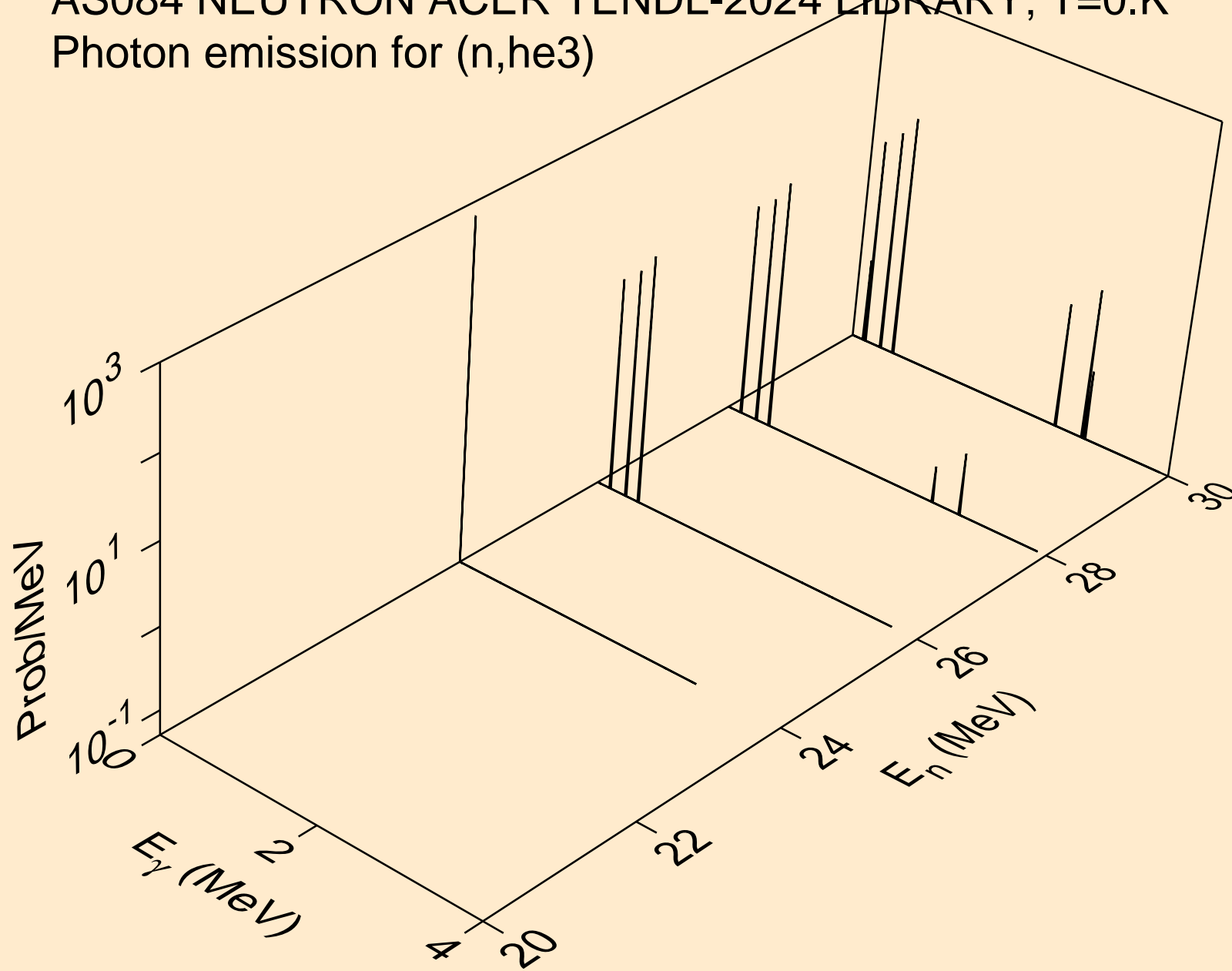

AS084 NEUTRON ACER TENDL-2024 LIBRARY; T=0.K
Photon emission for (n,a)

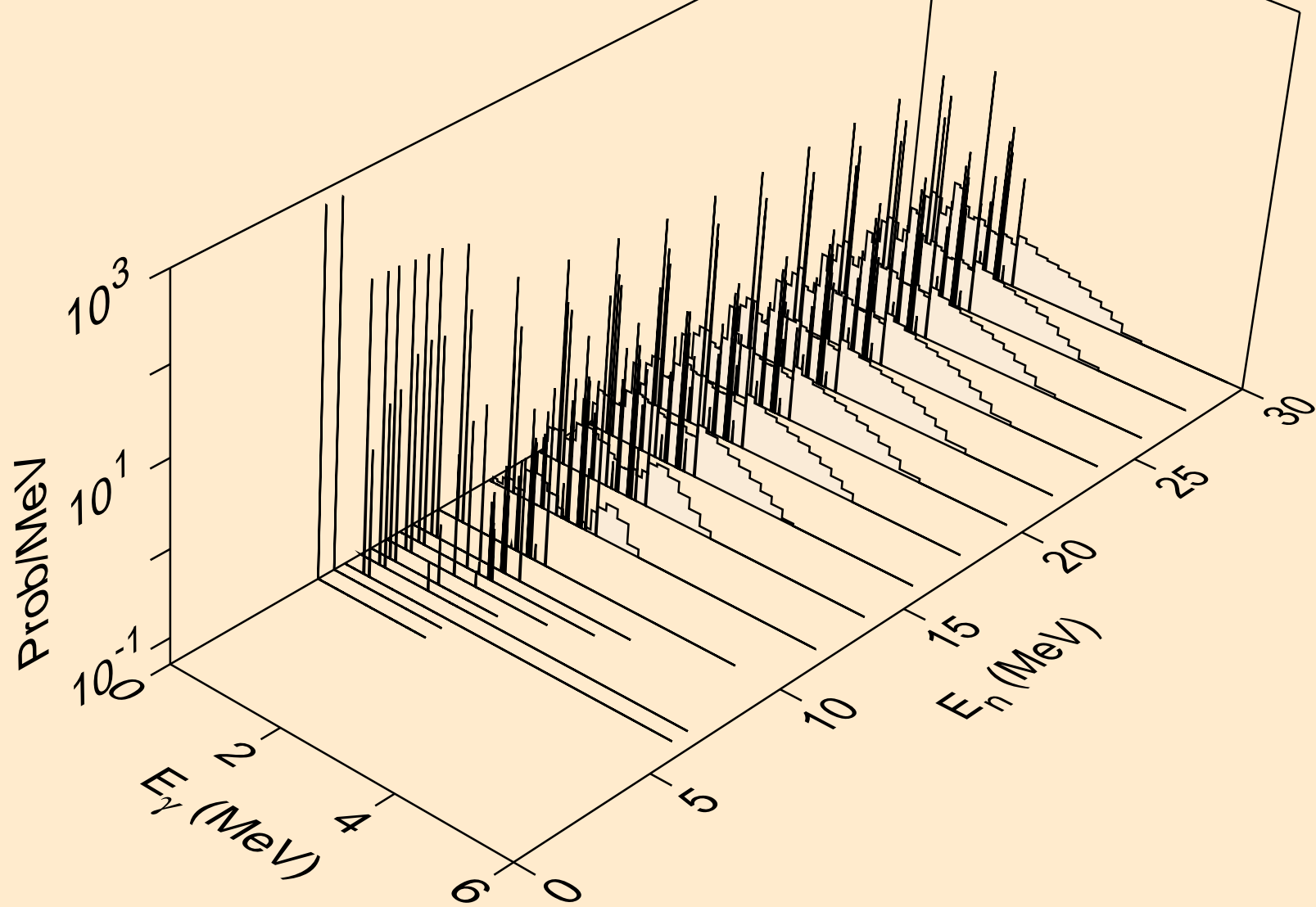

AS084 NEUTRON ACER TENDL-2024 LIBRARY; T=0.K
thermal capture photon spectrum

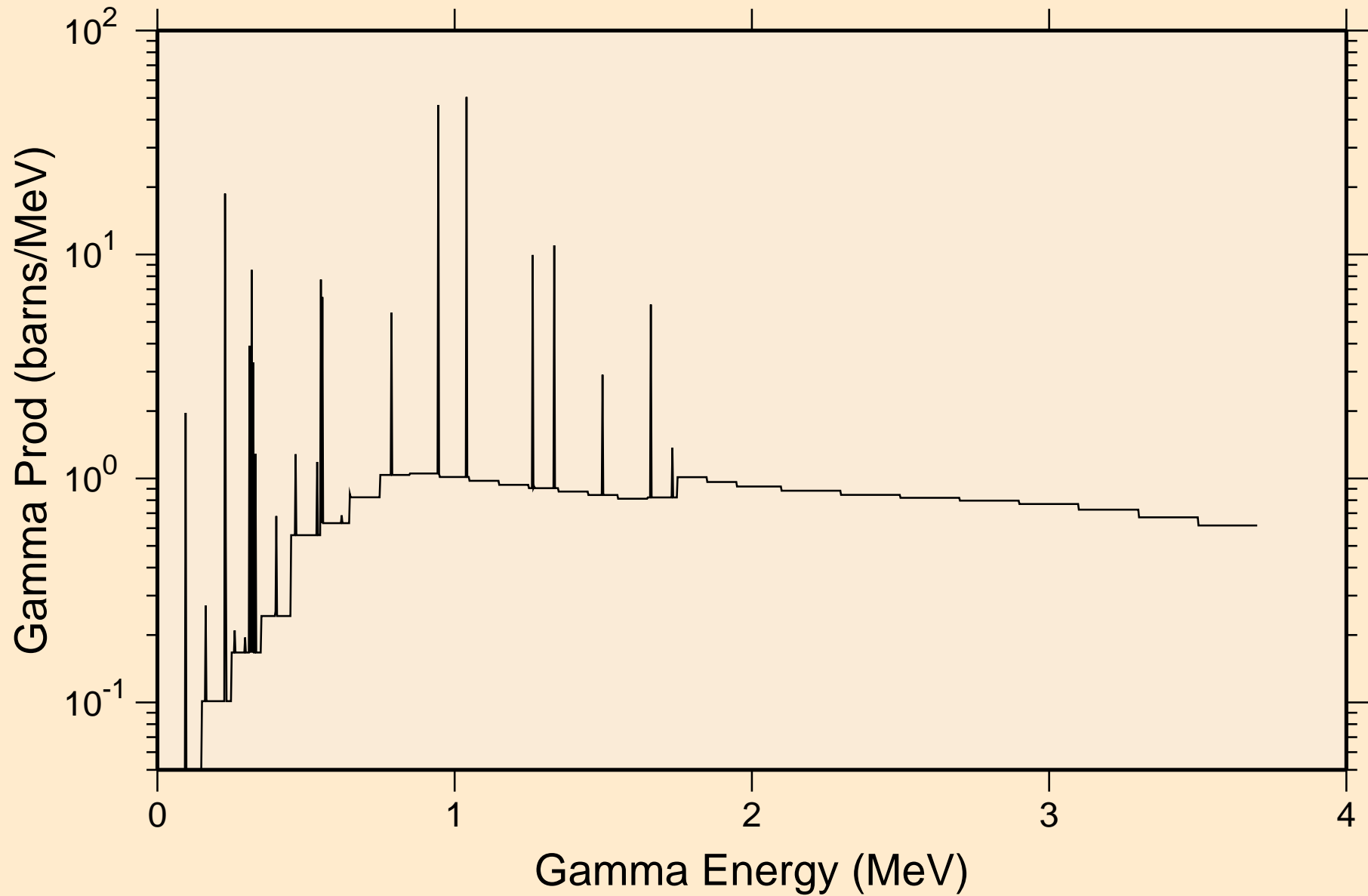

AS084 NEUTRON ACER TENDL-2024 LIBRARY; T=0.K
14 MeV photon spectrum

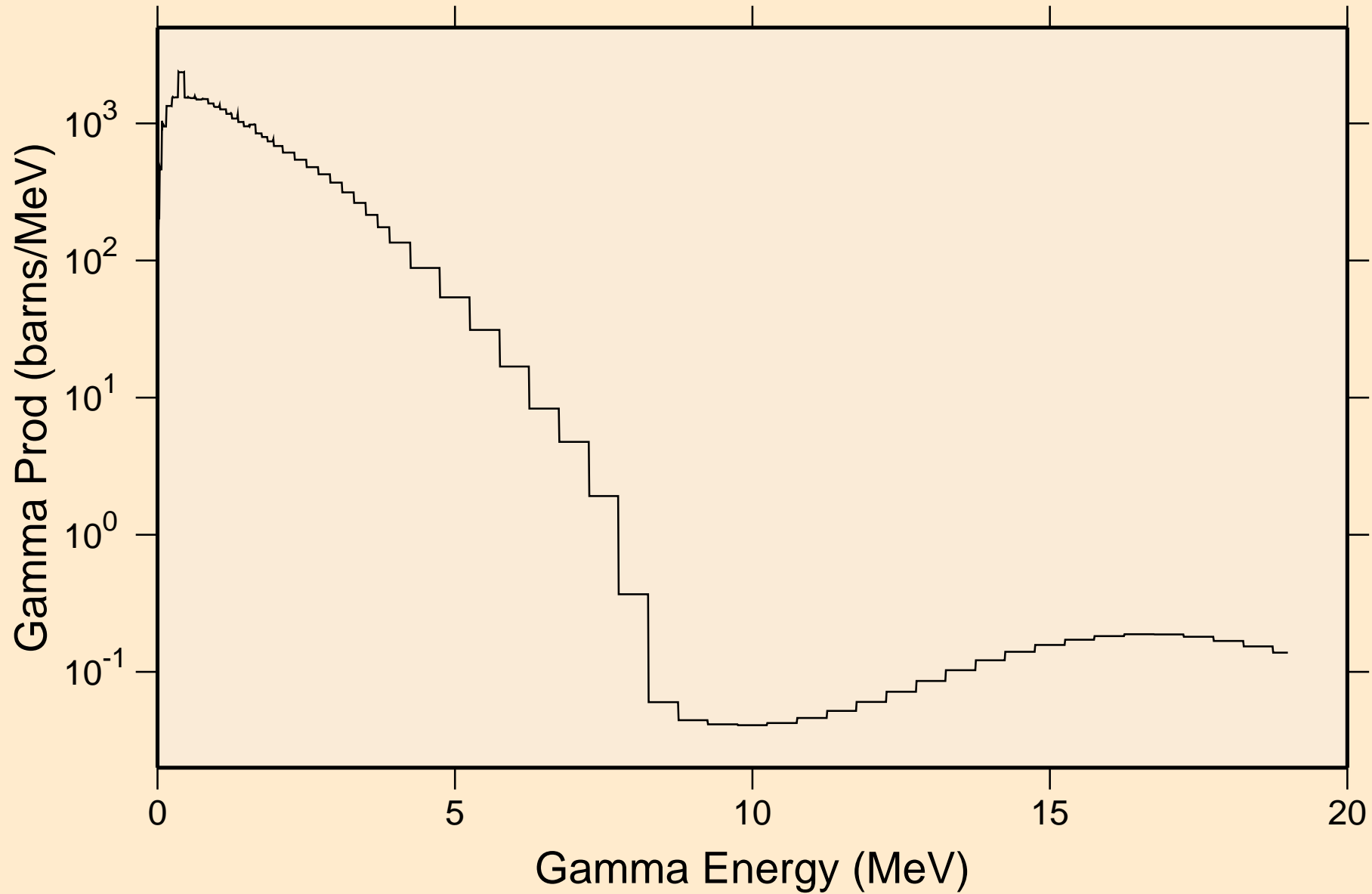

AS084 NEUTRON ACER TENDL-2024 LIBRARY; T=0.K
Particle heating contributions

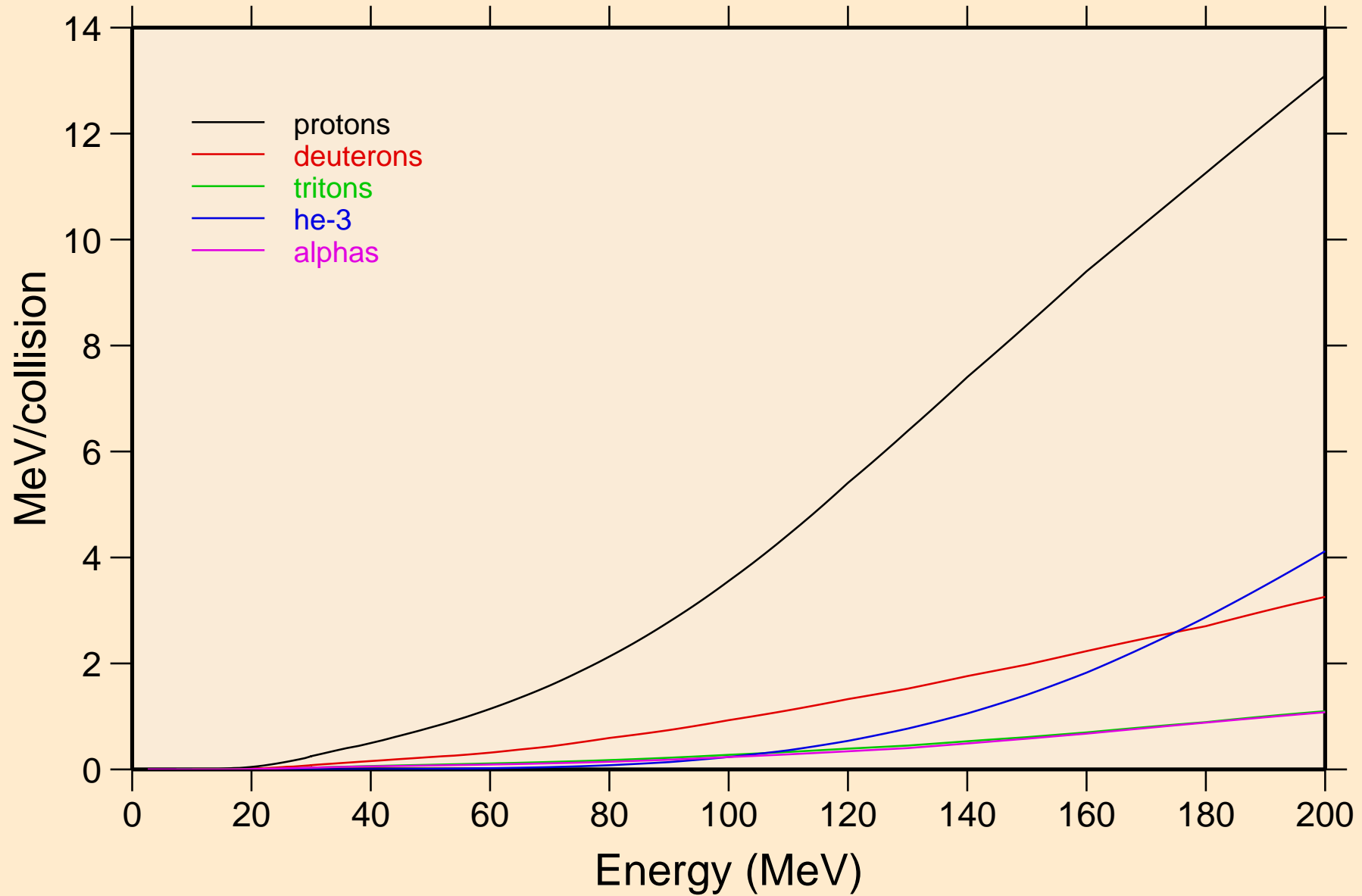

AS084 NEUTRON ACER TENDL-2024 LIBRARY; T=0.K
Recoil Heating

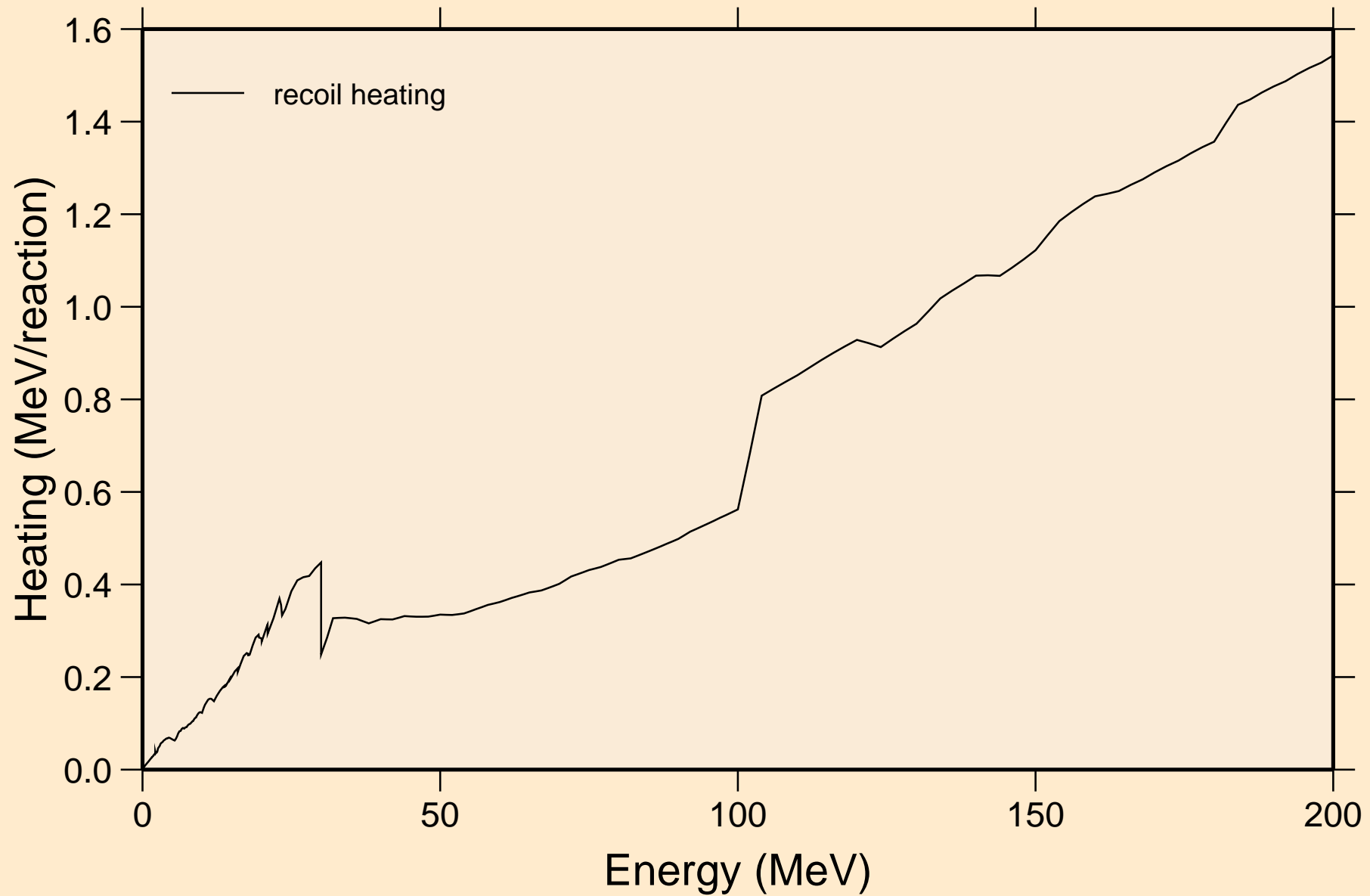

AS084 NEUTRON ACER TENDL-2024 LIBRARY; T=0.K

Particle production cross sections

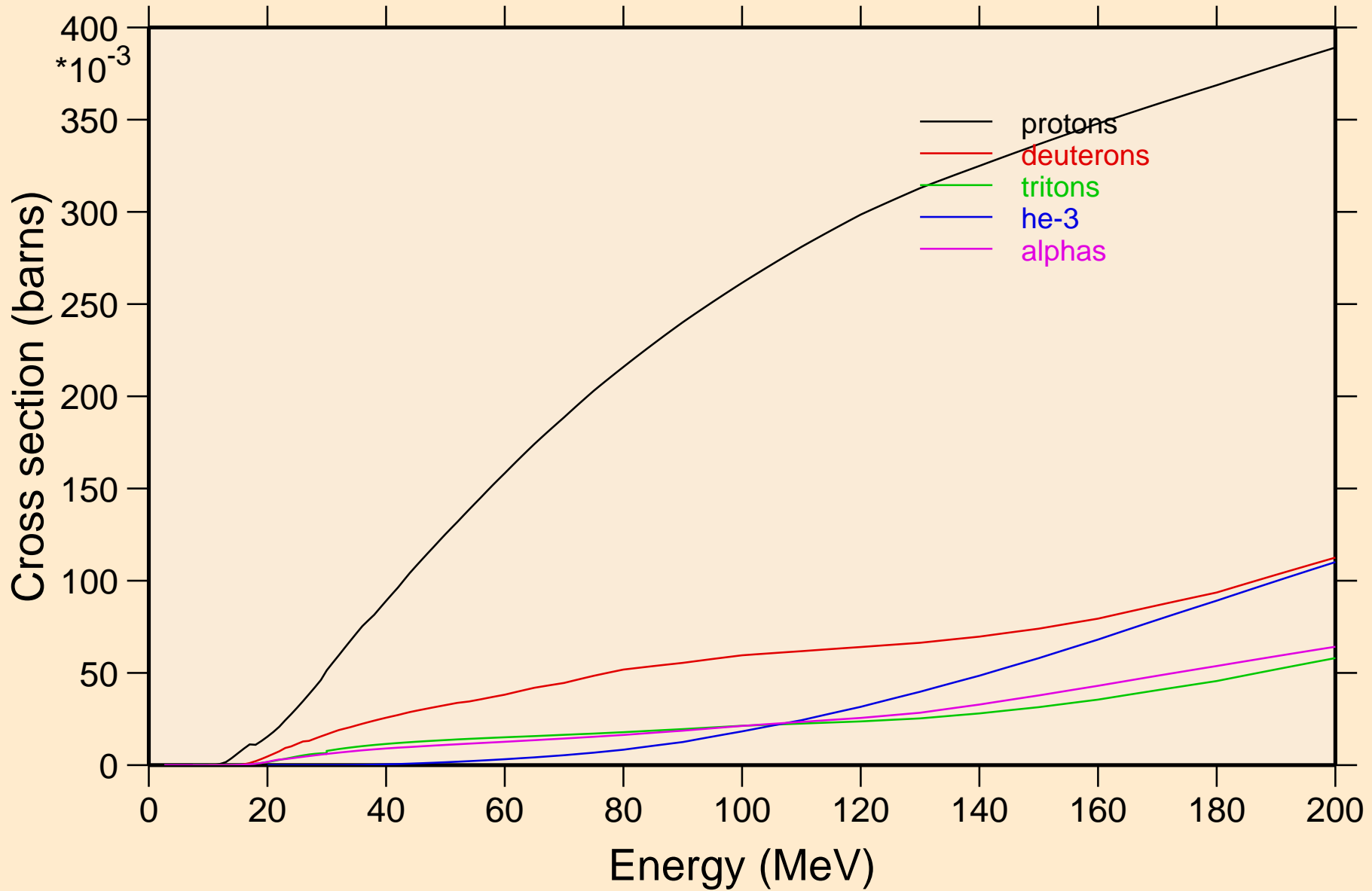

AS084 NEUTRON ACER TENDL-2024 LIBRARY; T=0.K
protons from (n,x)

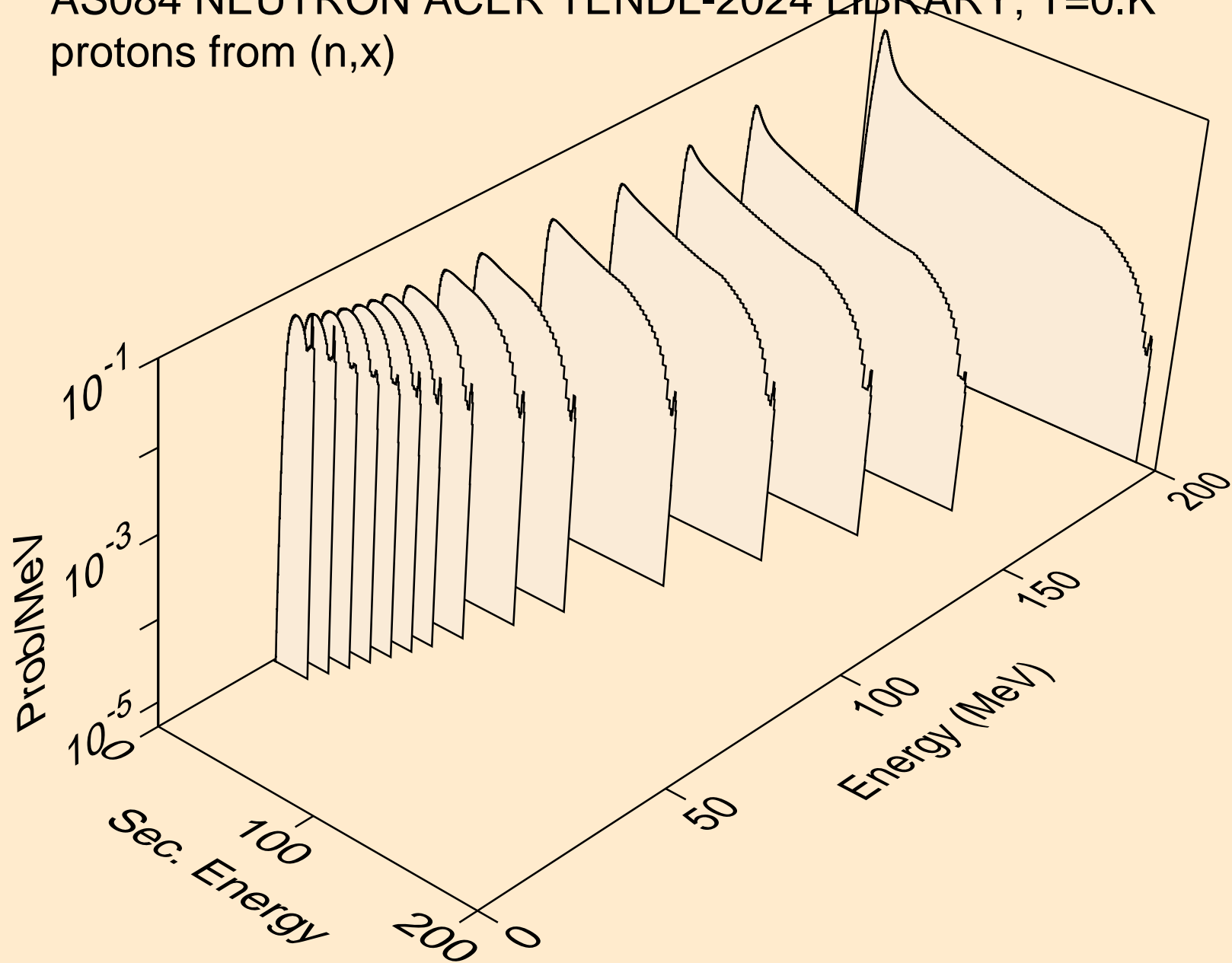

AS084 NEUTRON ACER TENDL-2024 LIBRARY; T=0.K
protons from (n,n*)p

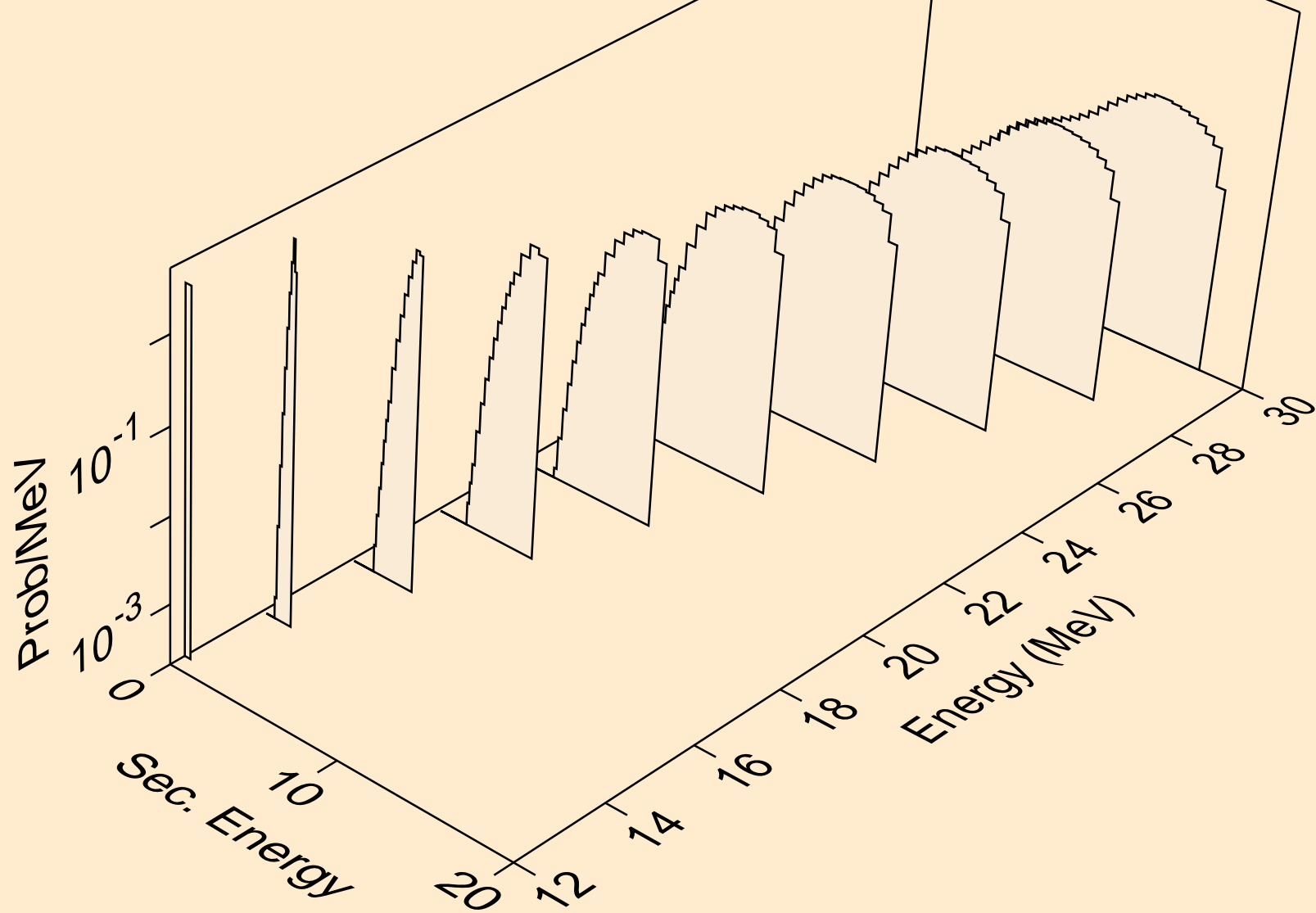

AS084 NEUTRON ACER TENDL-2024 LIBRARY; T=0.K
protons from (n,2np)

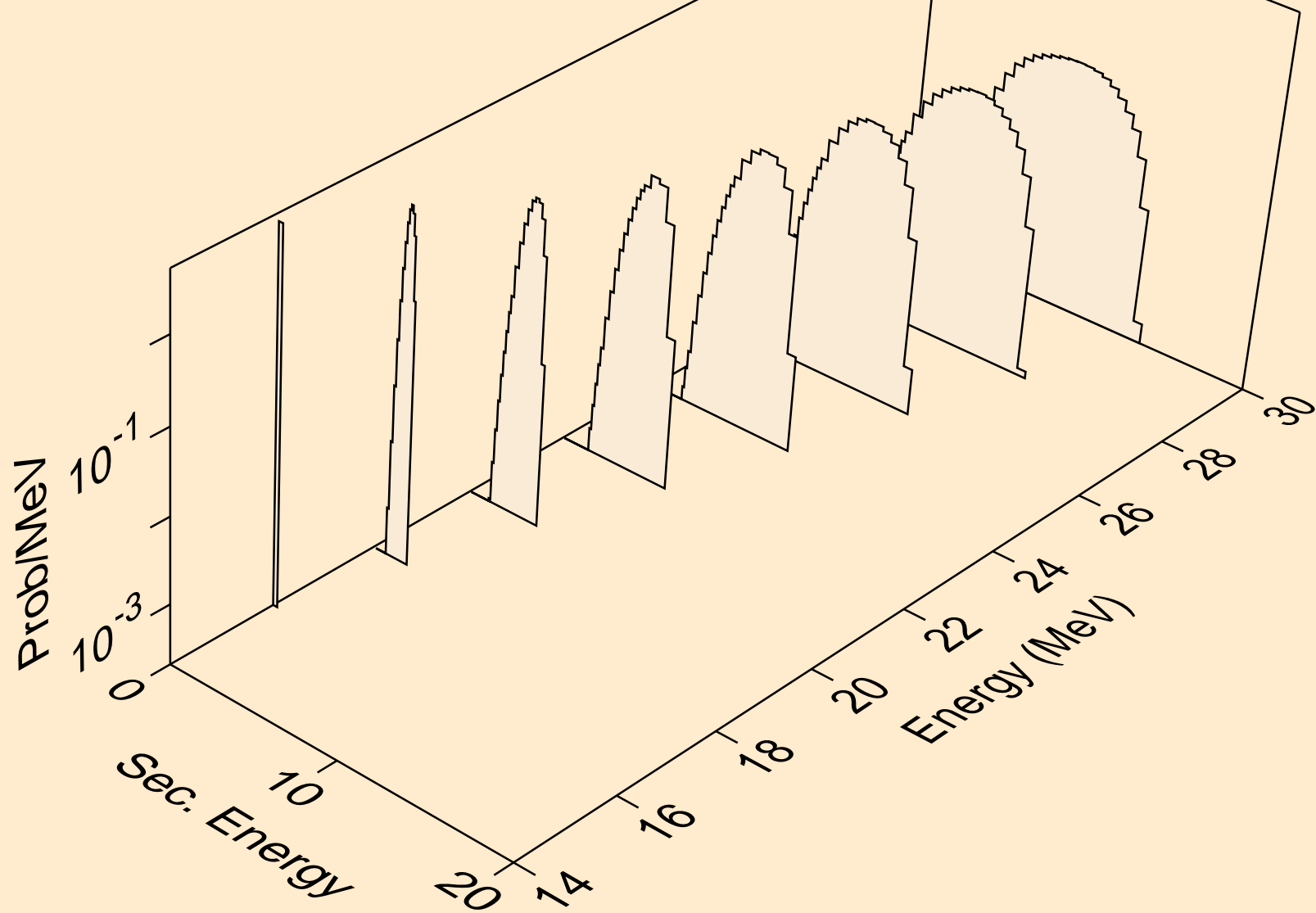

AS084 NEUTRON ACER TENDL-2024 LIBRARY; T=0.K
protons from (n,3np)

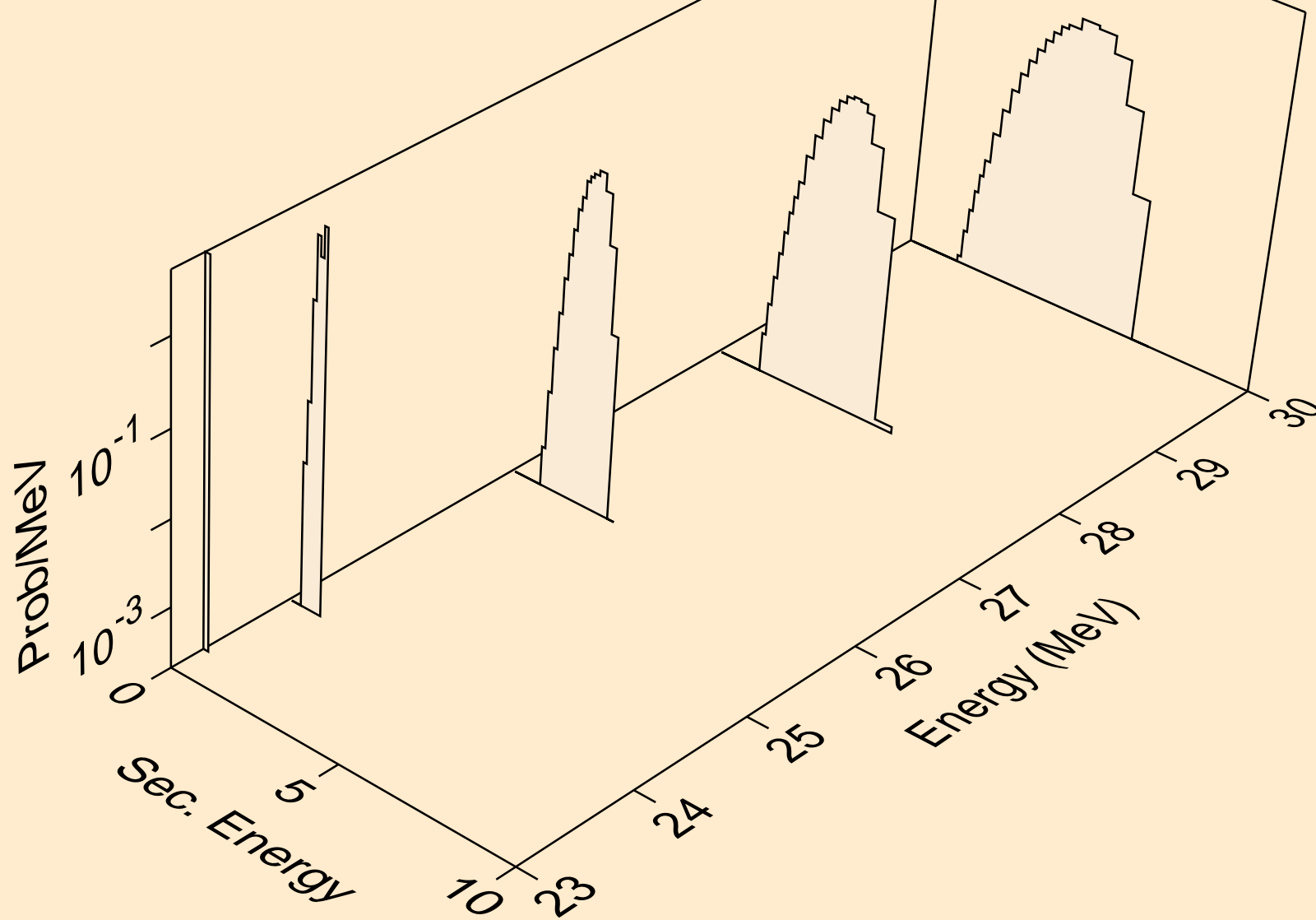

AS084 NEUTRON ACER TENDL-2024 LIBRARY; T=0.K
protons from (n,p)

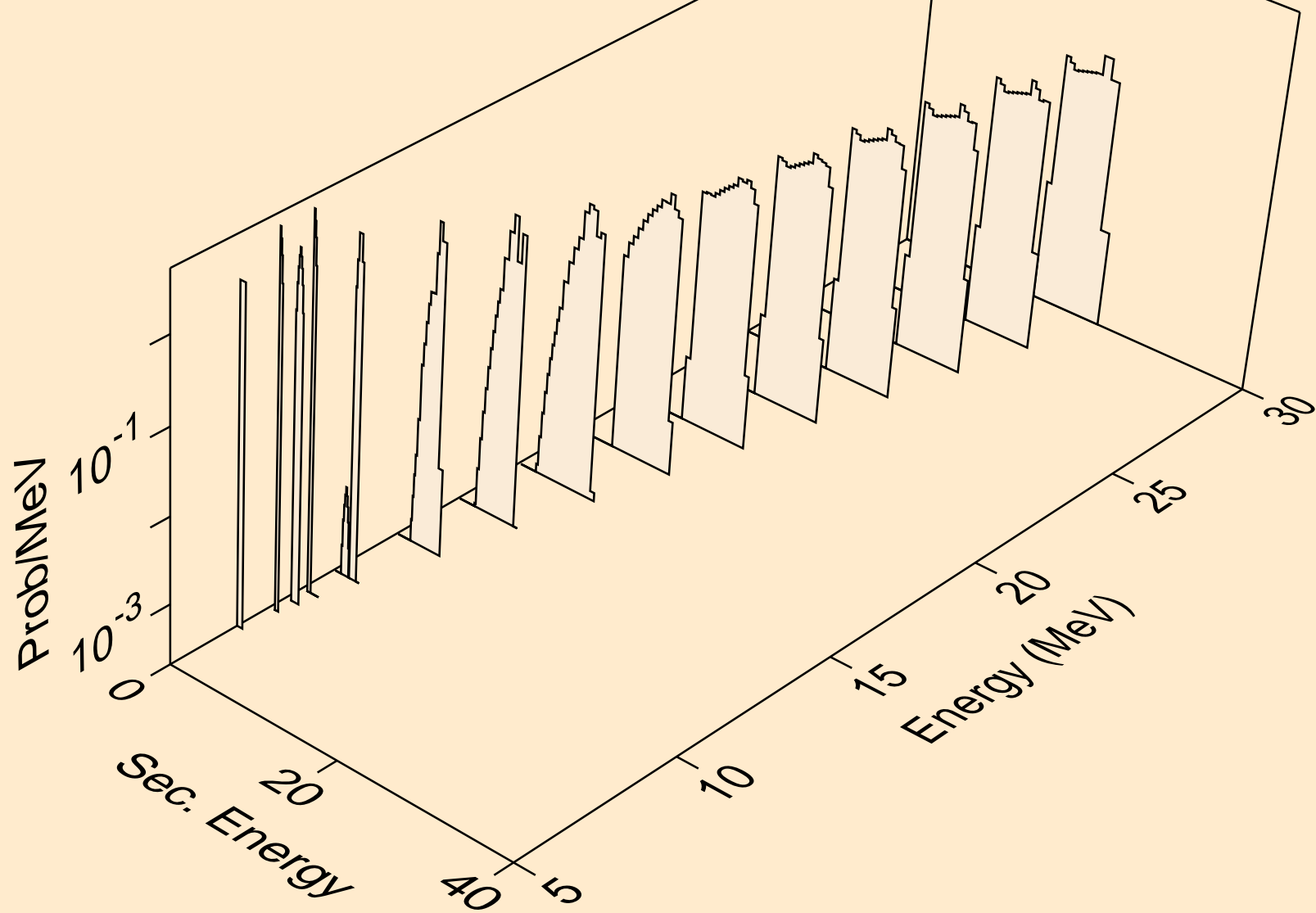

AS084 NEUTRON ACER TENDL-2024 LIBRARY; T=0.K
deuterons from (n,x)

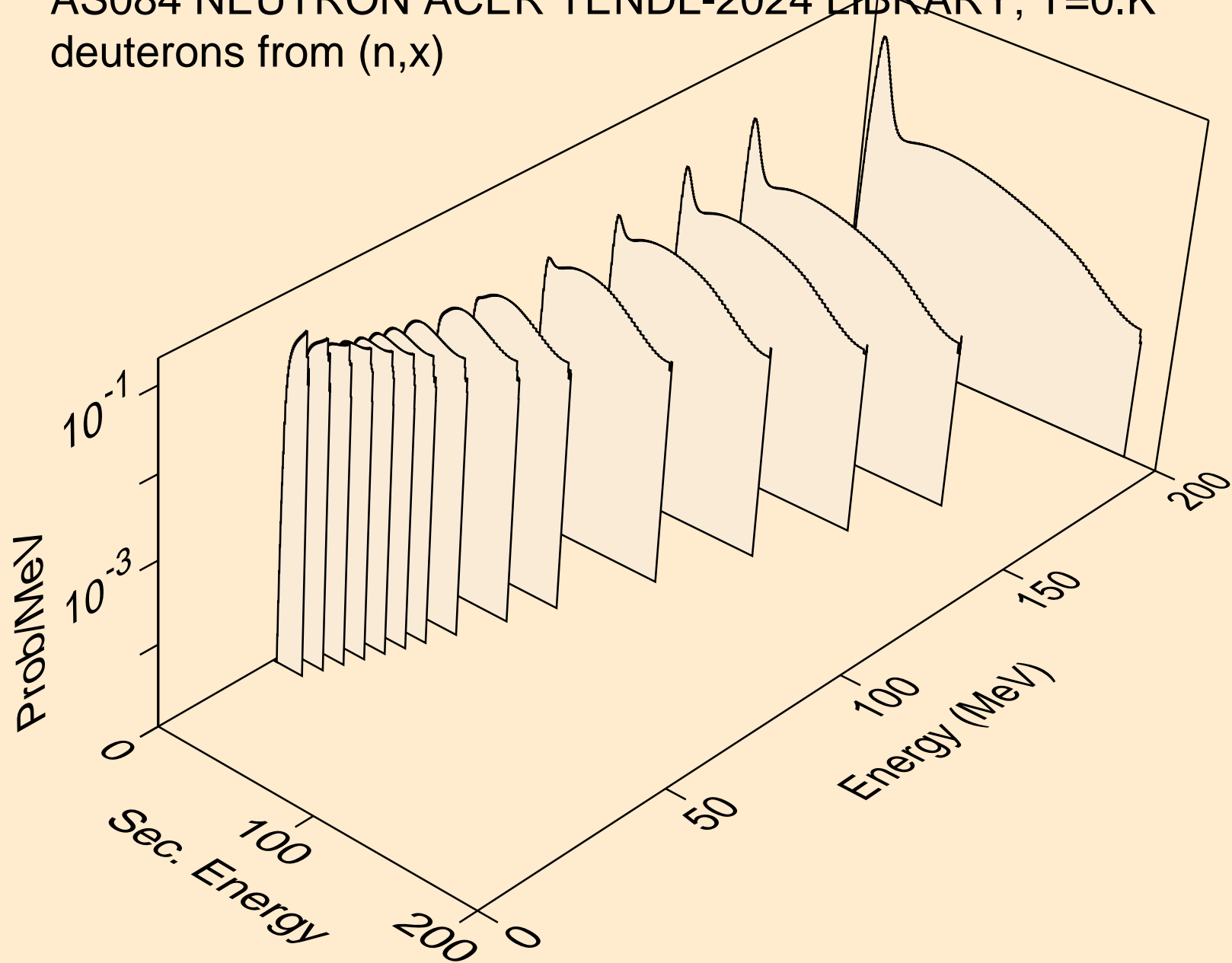

AS084 NEUTRON ACER TENDL-2024 LIBRARY; T=0.K
deuterons from (n,2nd)

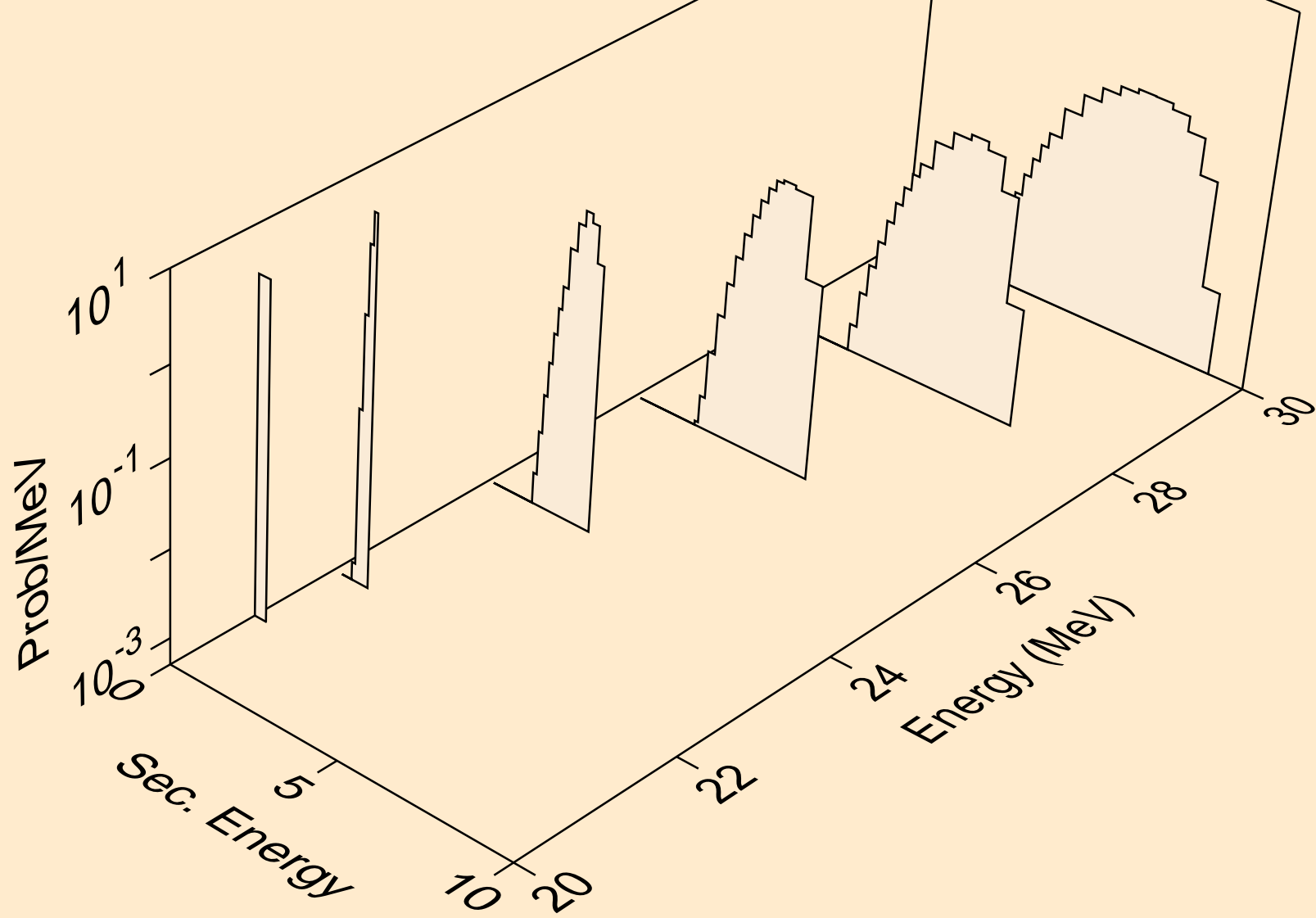

AS084 NEUTRON ACER TENDL-2024 LIBRARY; T=0.K
deuterons from (n,n*)d

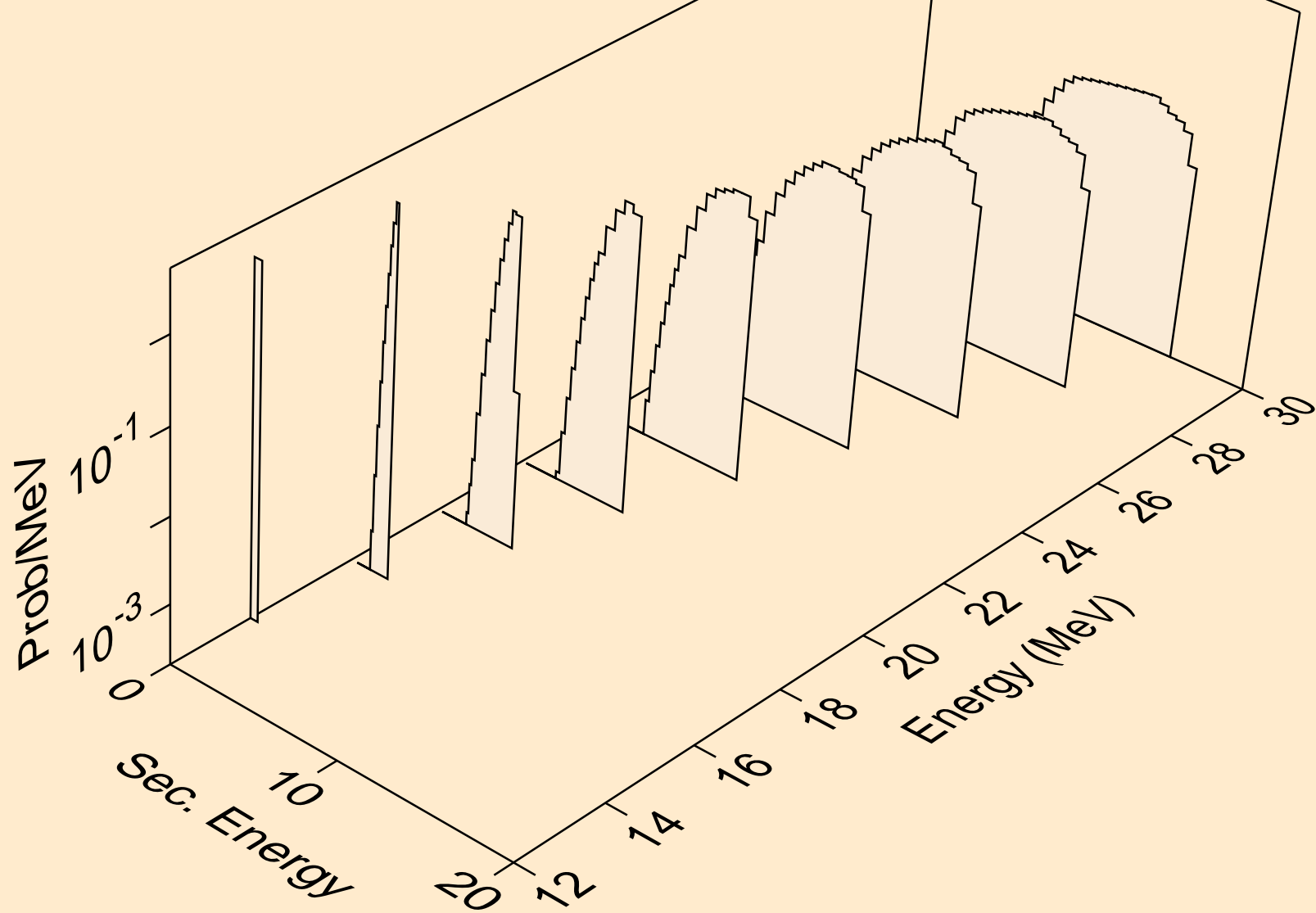

AS084 NEUTRON ACER TENDL-2024 LIBRARY; T=0.K
deuterons from (n,d)

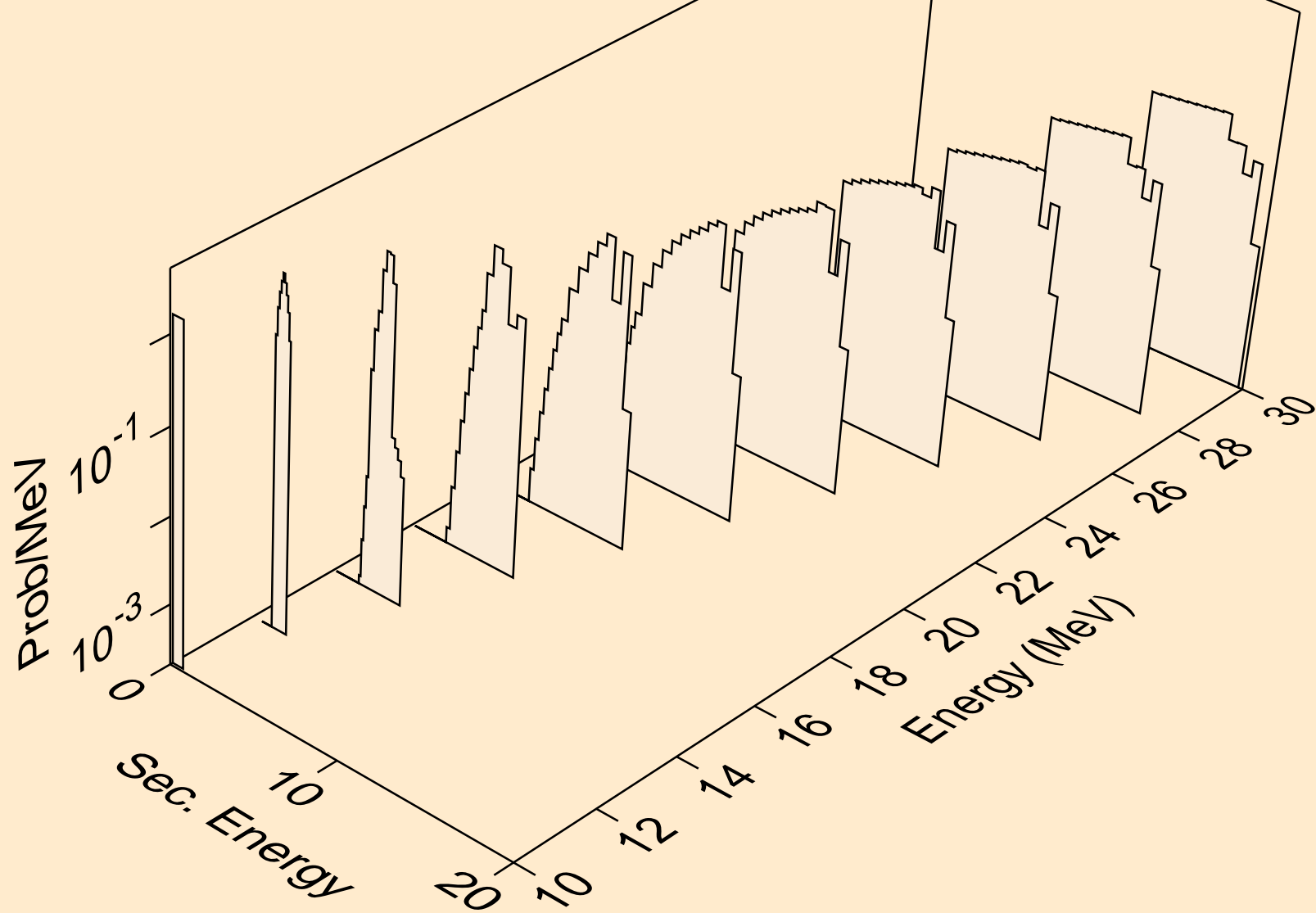

AS084 NEUTRON ACER TENDL-2024 LIBRARY; T=0.K
tritons from (n,x)

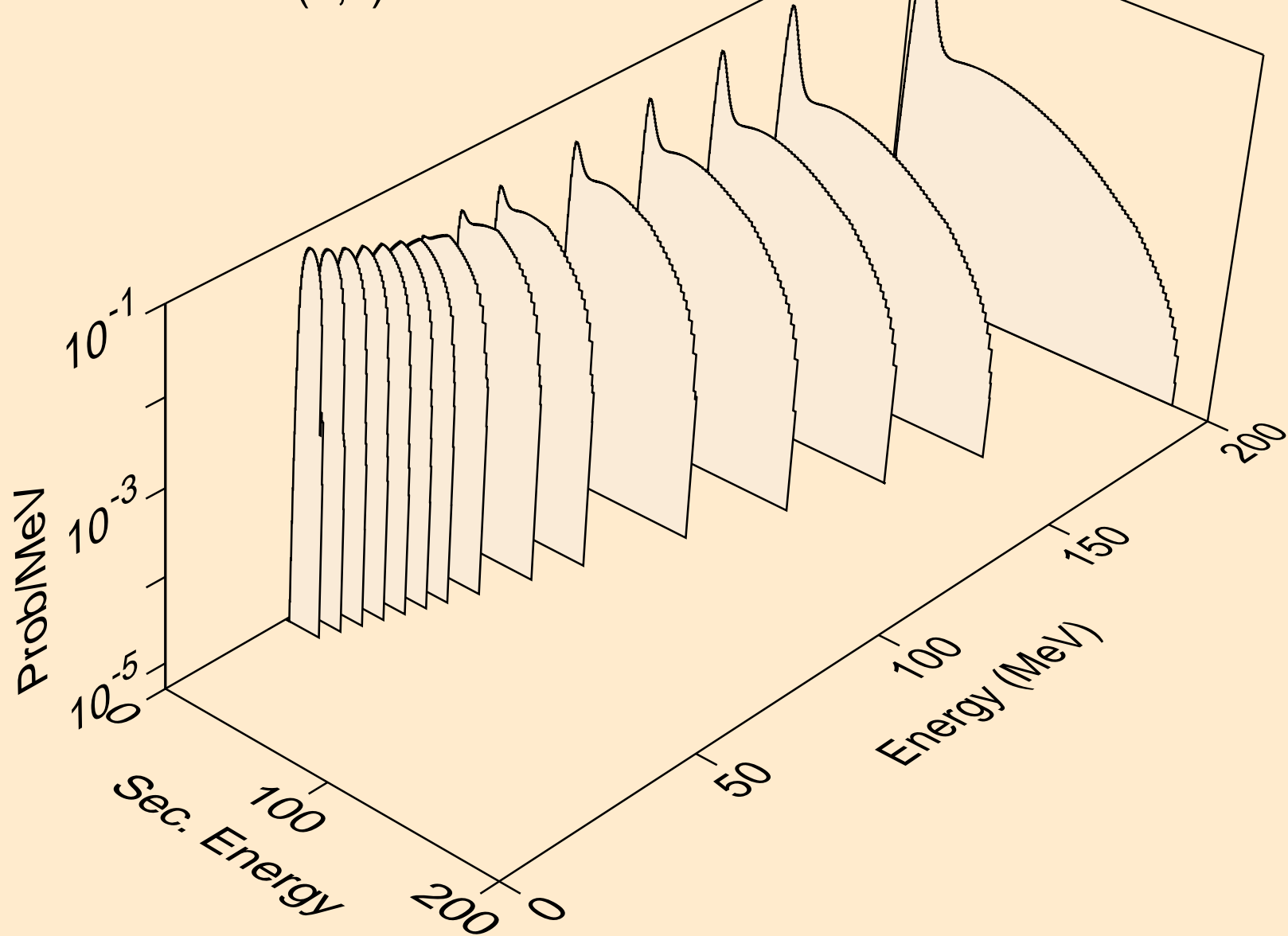

AS084 NEUTRON ACER TENDL-2024 LIBRARY; T=0.K
tritons from (n,n*)t

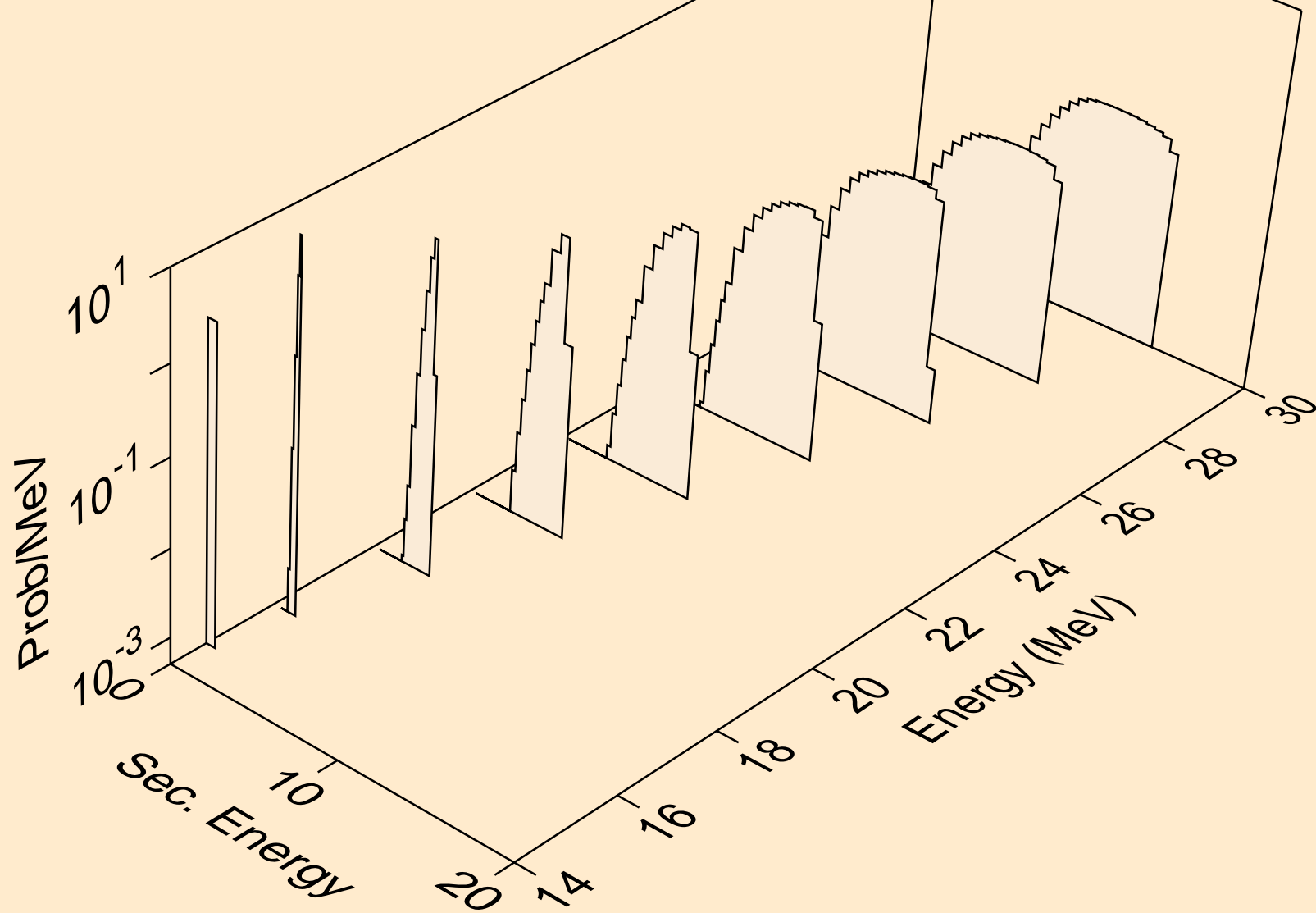

AS084 NEUTRON ACER TENDL-2024 LIBRARY; T=0.K
tritons from (n,t)

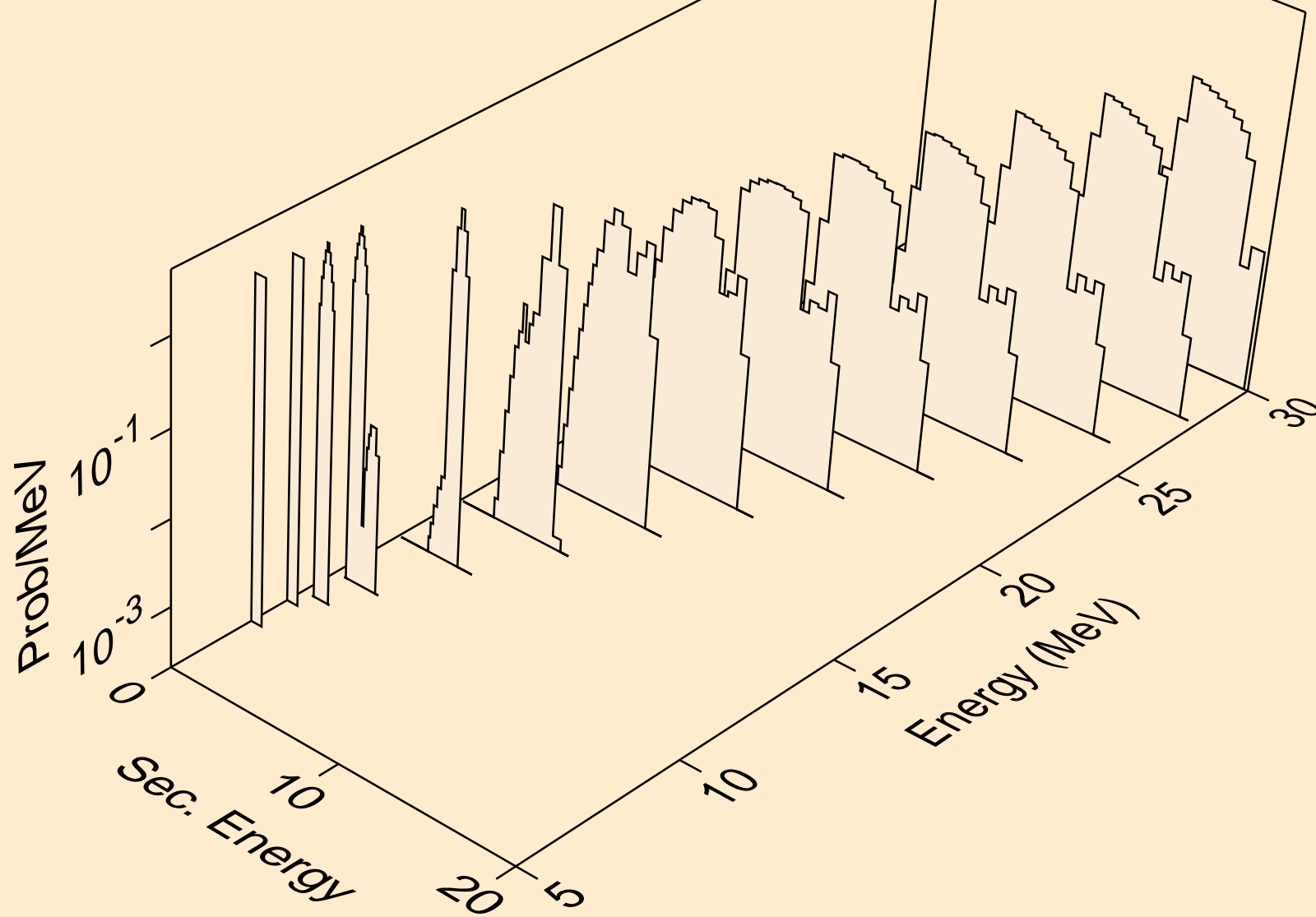

AS084 NEUTRON ACER TENDL-2024 LIBRARY; T=0.K
he3s from (n,x)

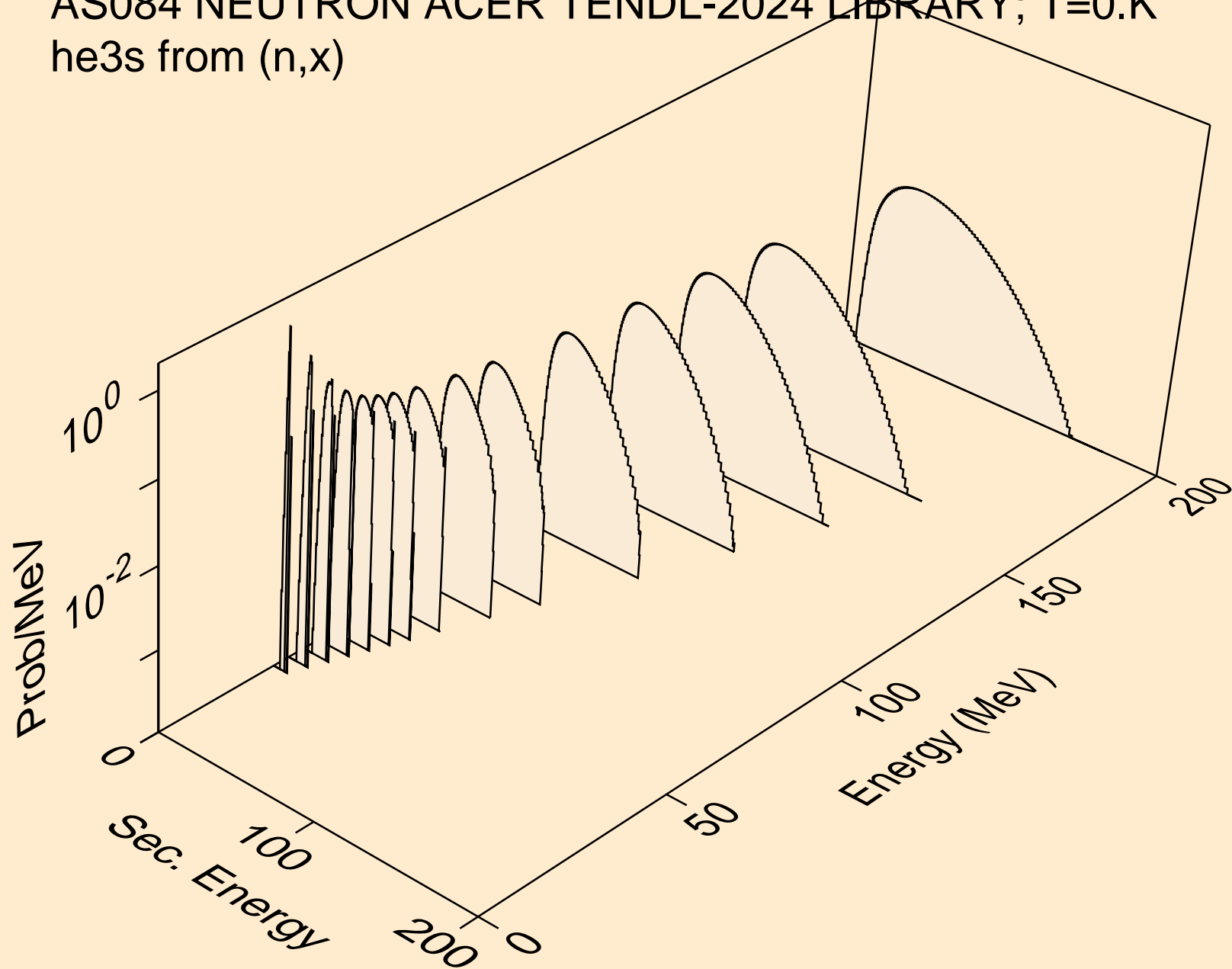

AS084 NEUTRON ACER TENDL-2024 LIBRARY; T=0.K
he3s from (n,n*)he3

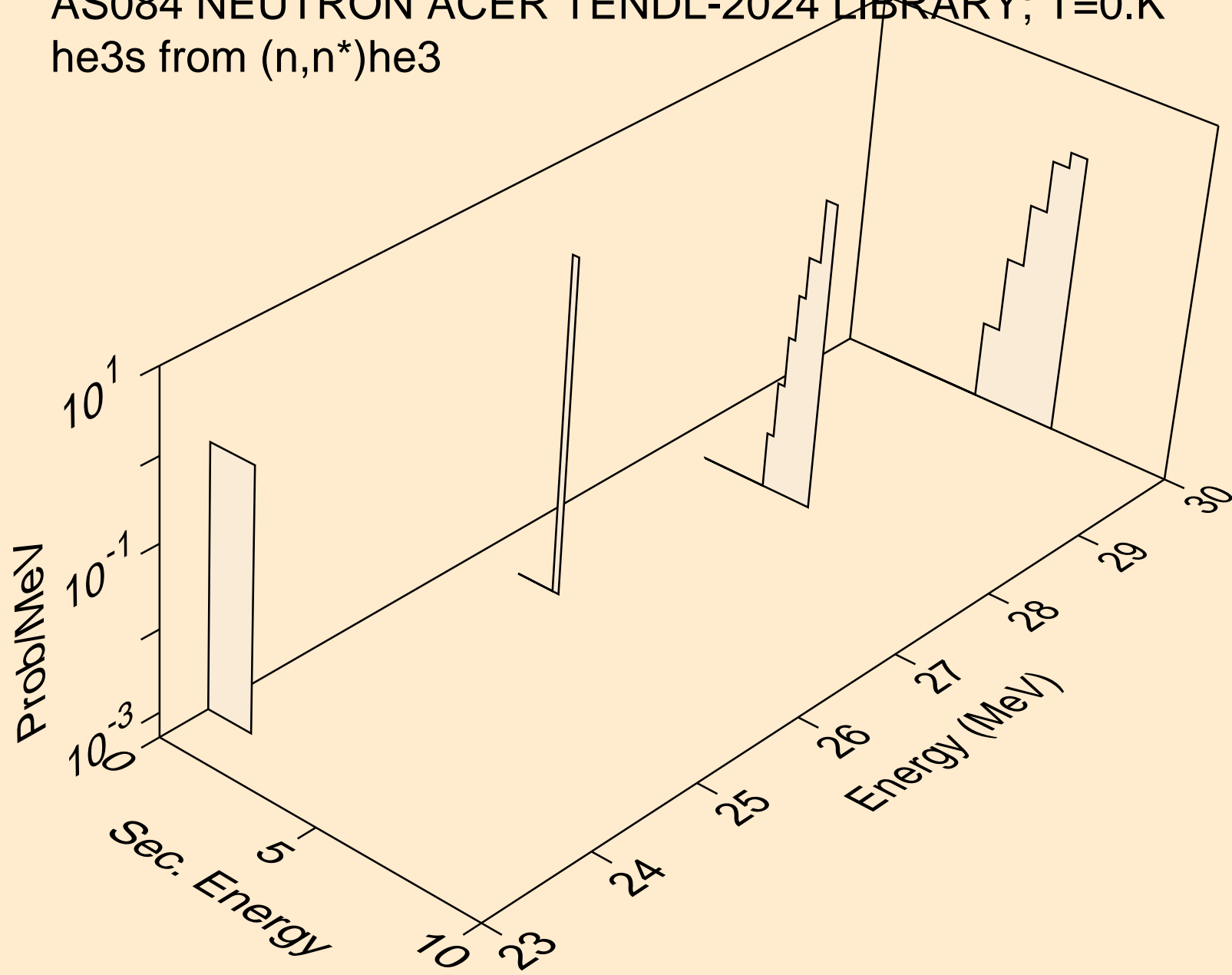

AS084 NEUTRON ACER TENDL-2024 LIBRARY; T=0.K
he3s from (n,he3)

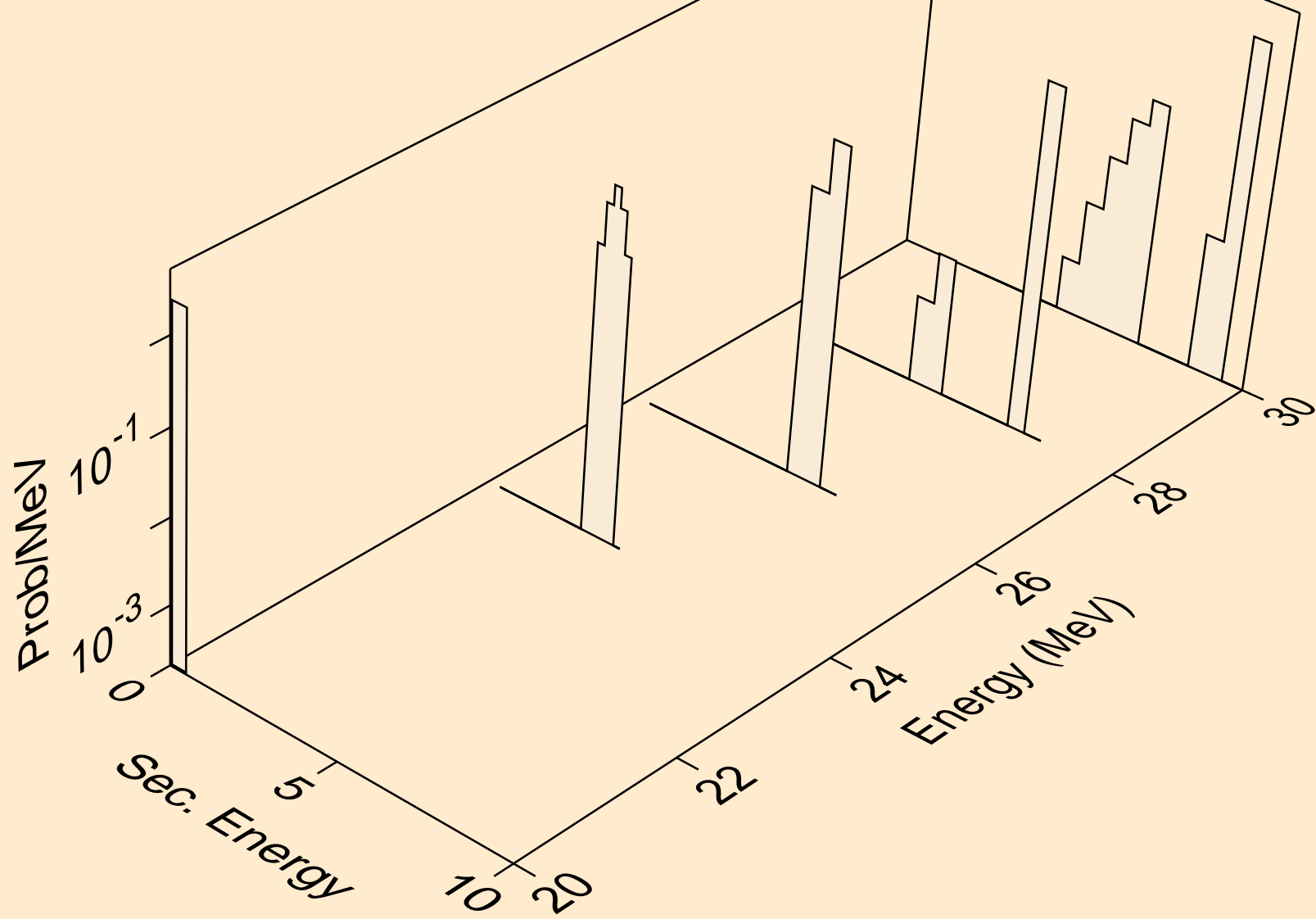

AS084 NEUTRON ACER TENDL-2024 LIBRARY; T=0.K
alphas from (n,x)

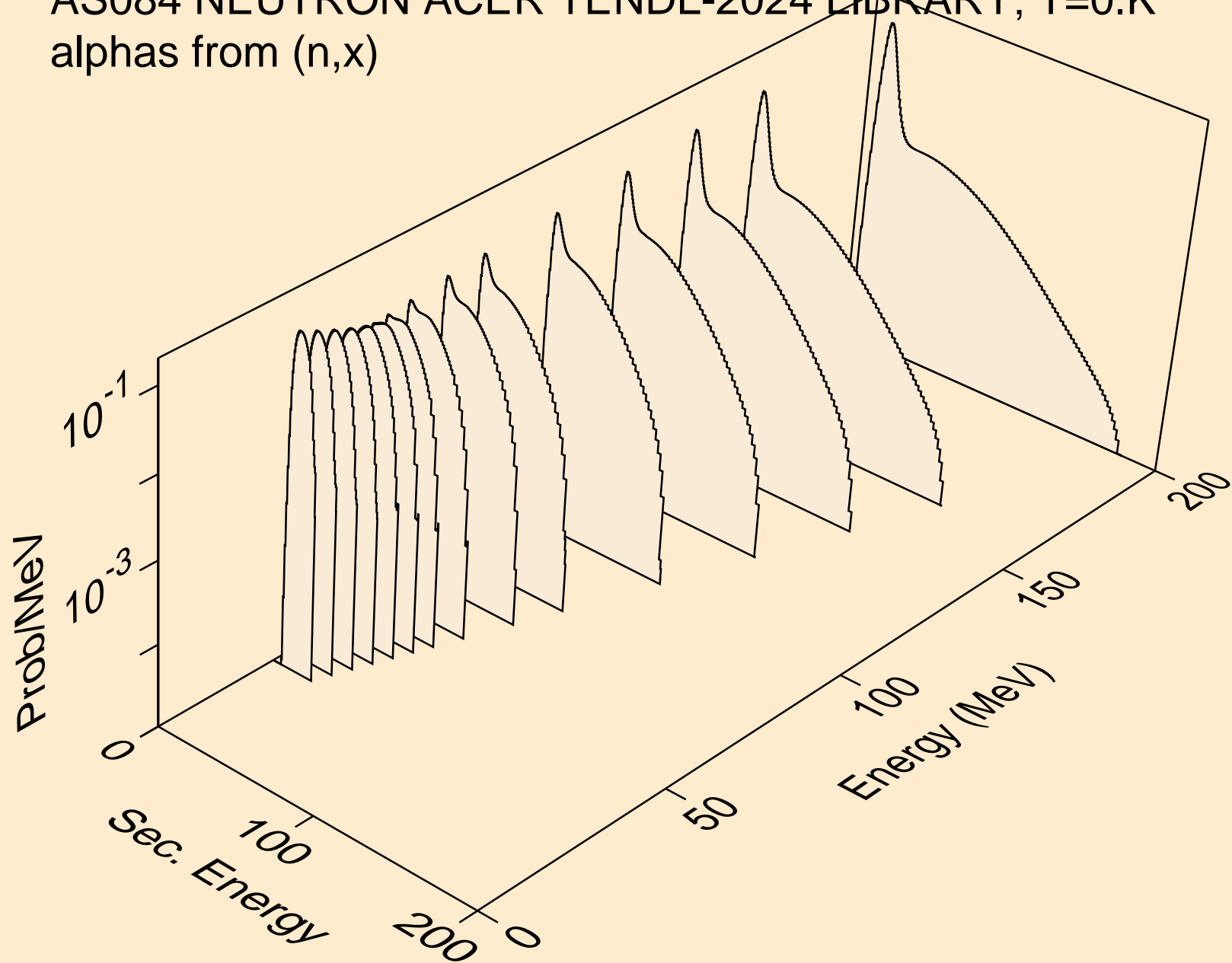

AS084 NEUTRON ACER TENDL-2024 LIBRARY; T=0.K
alphas from (n,n*)a

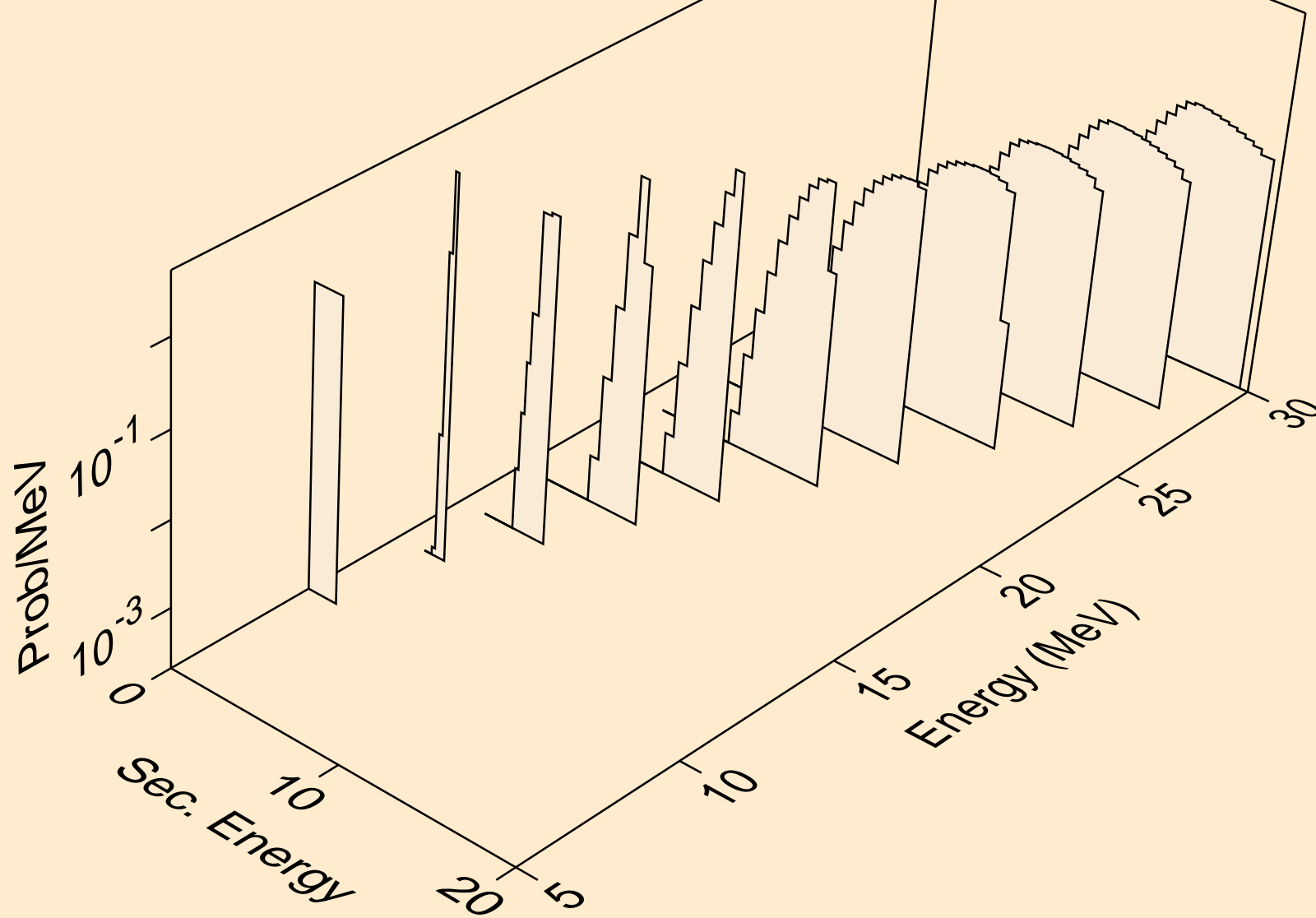

AS084 NEUTRON ACER TENDL-2024 LIBRARY; T=0.K
alphas from (n,2n)a

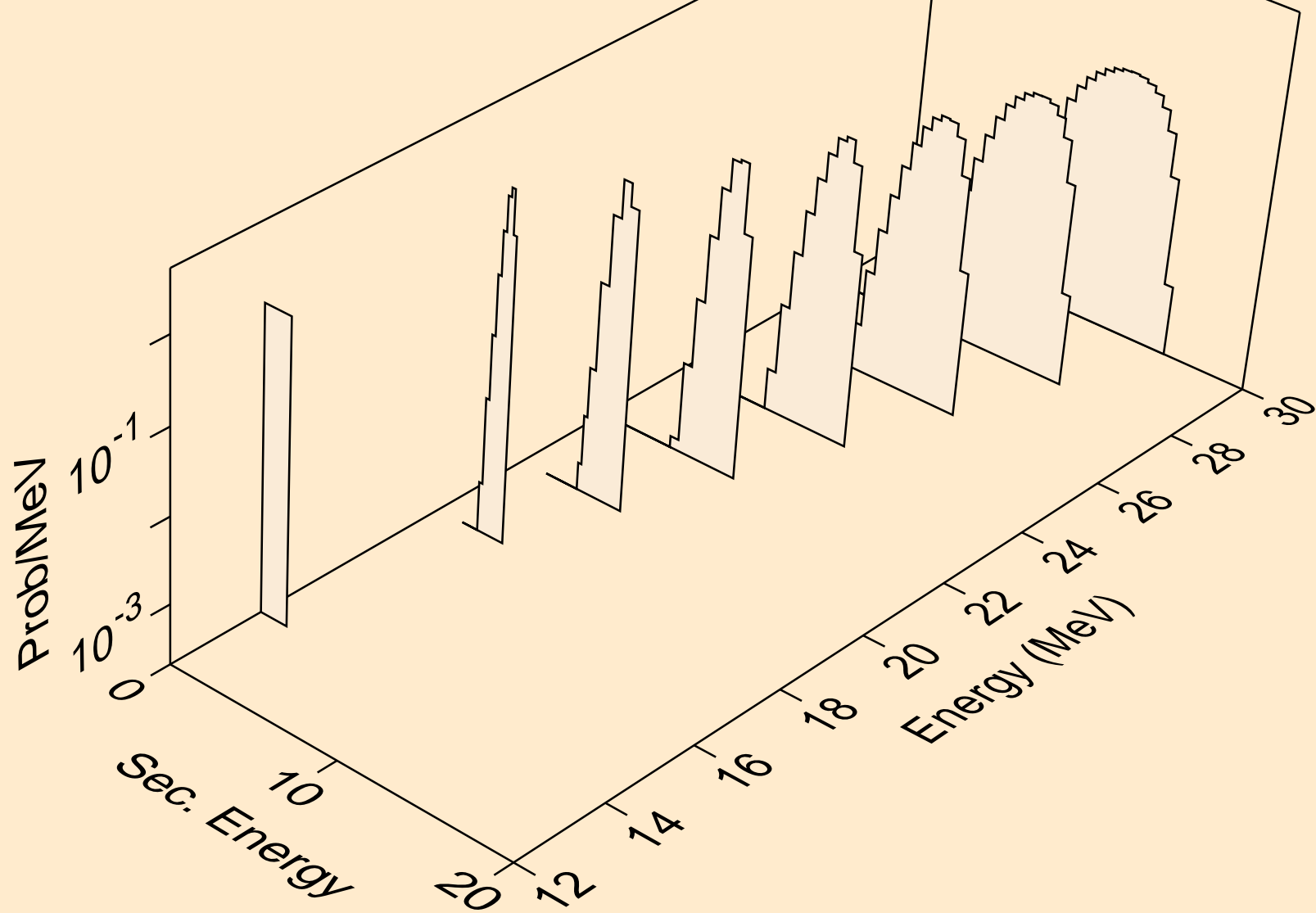

AS084 NEUTRON ACER TENDL-2024 LIBRARY; T=0.K
alphas from (n,3n)a

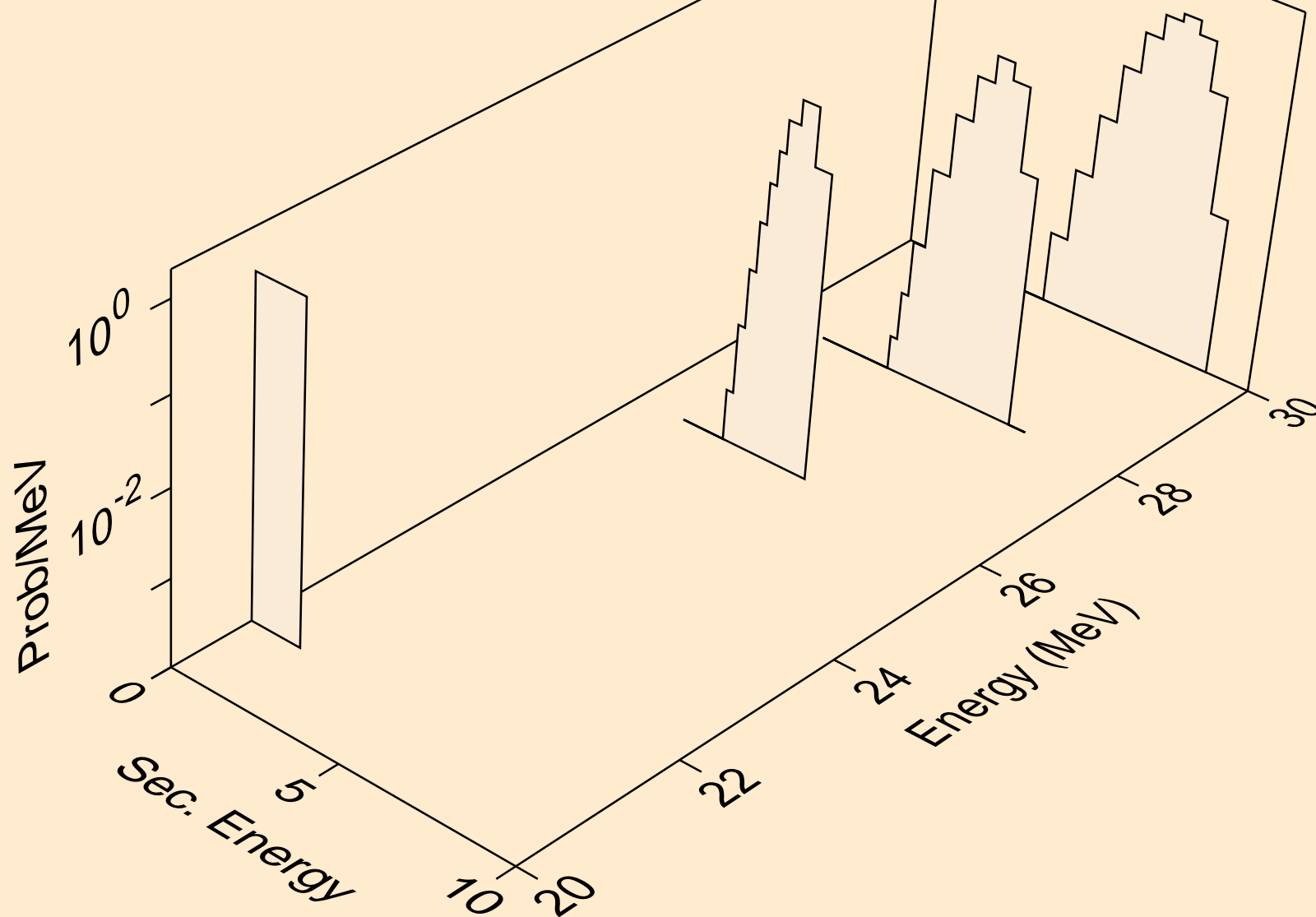

AS084 NEUTRON ACER TENDL-2024 LIBRARY; T=0.K
alphas from (n,a)

