

AT218 NEUTRON ACER TENDL-2024 LIBRARY; T=0.K

Principal cross sections

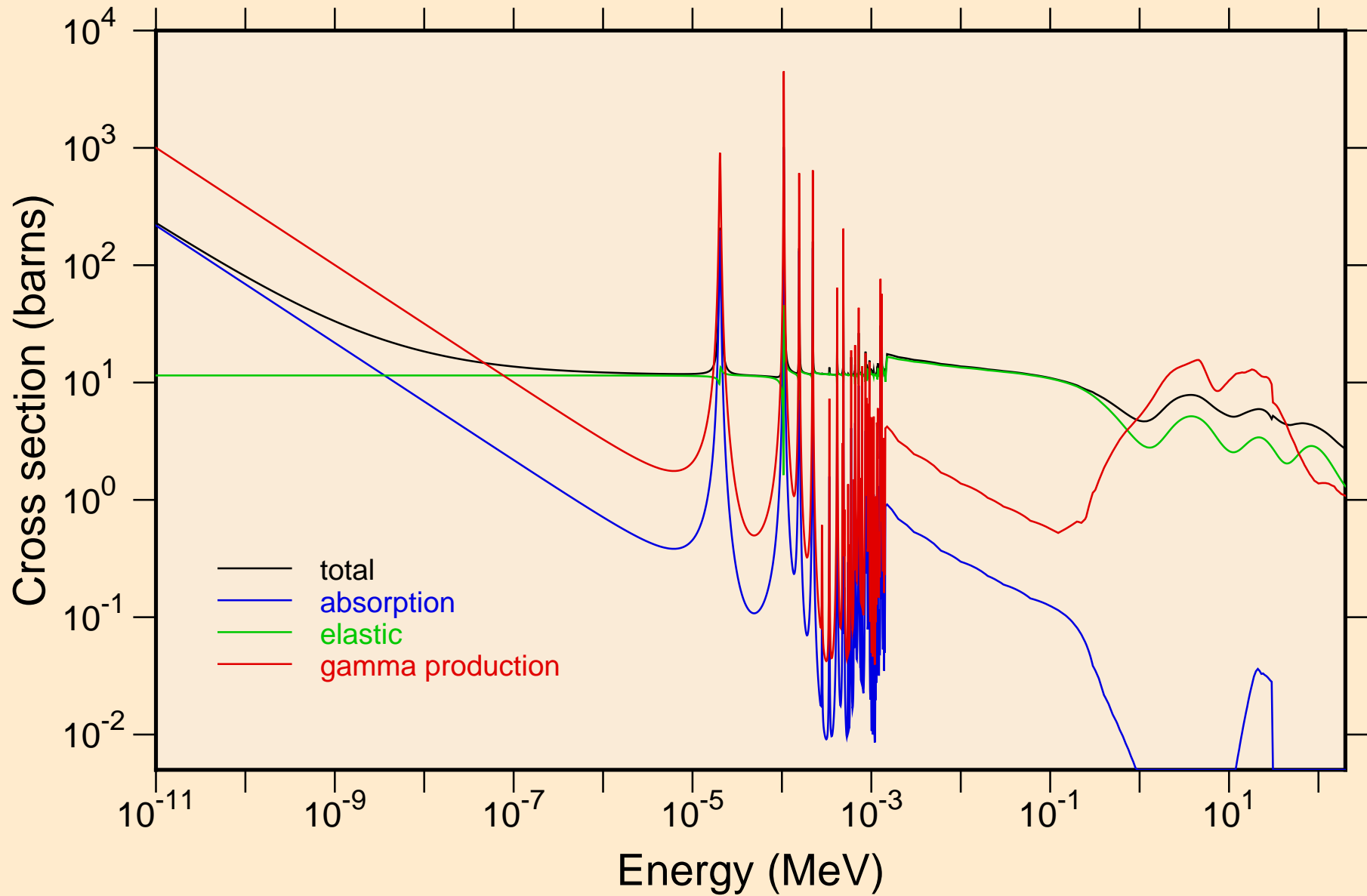

AT218 NEUTRON ACER TENDL-2024 LIBRARY; T=0.K
resonance total cross section

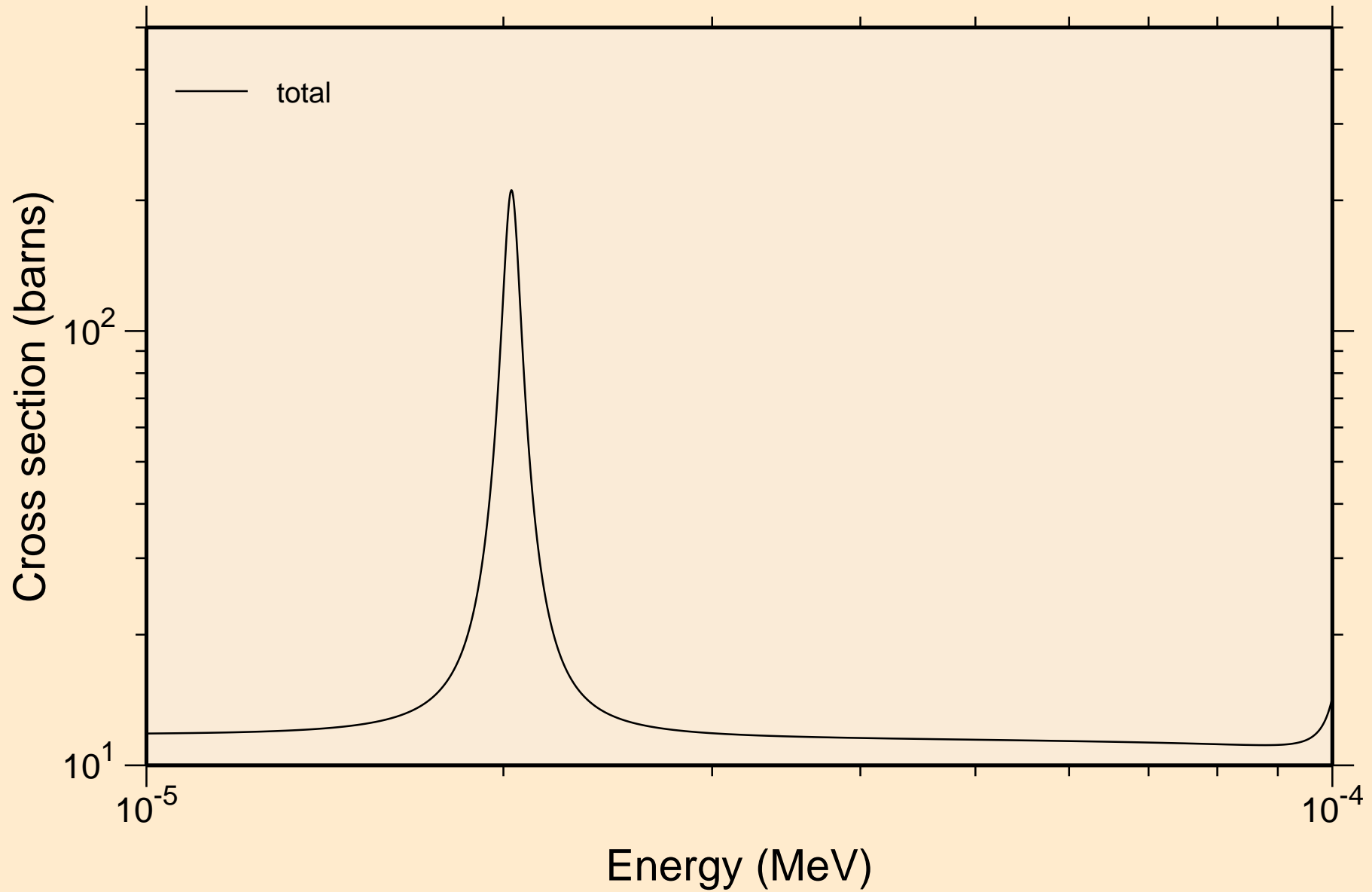

AT218 NEUTRON ACER TENDL-2024 LIBRARY; T=0.K
resonance total cross section

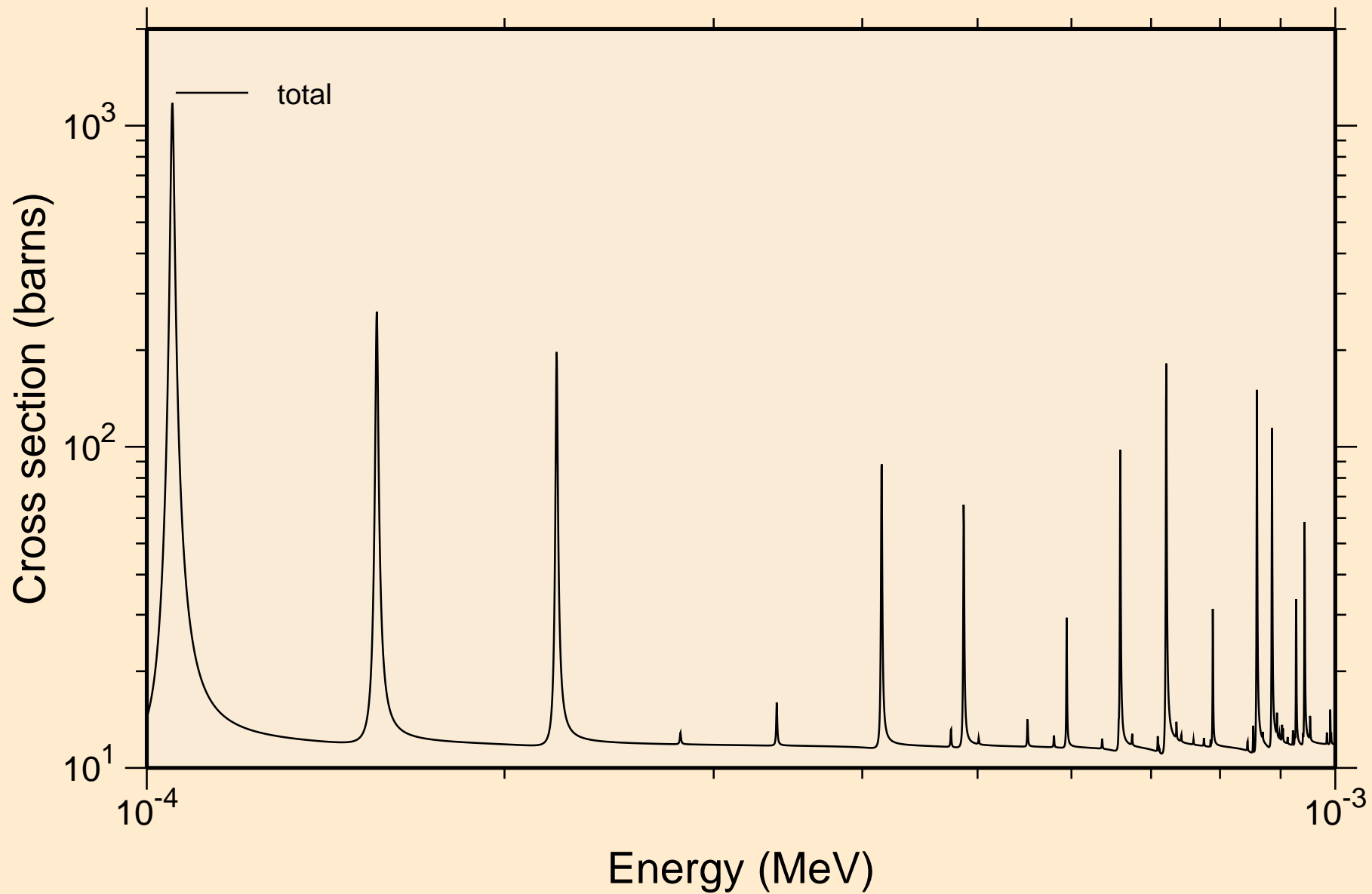

AT218 NEUTRON ACER TENDL-2024 LIBRARY; T=0.K
resonance total cross section

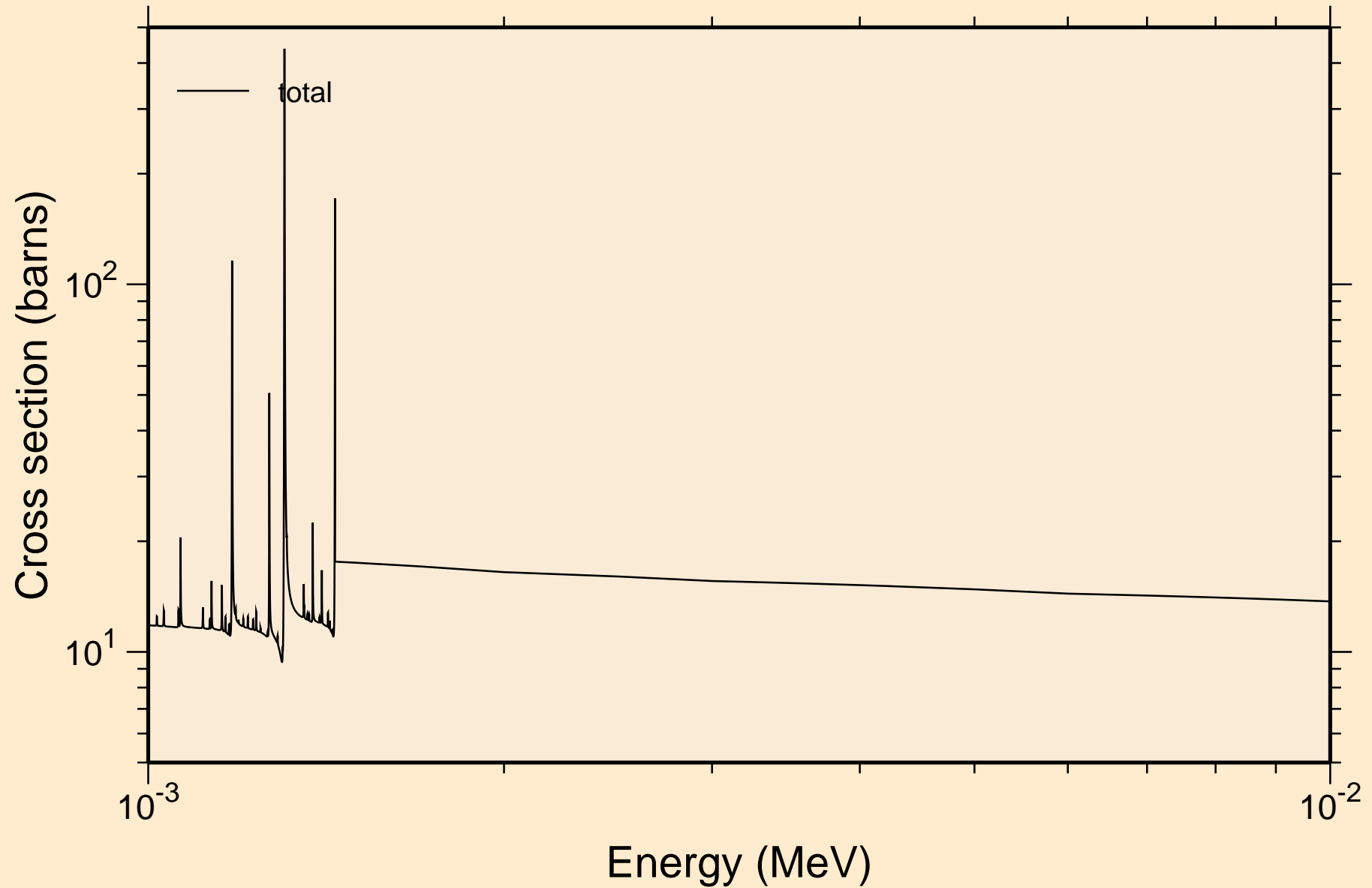

AT218 NEUTRON ACER TENDL-2024 LIBRARY; T=0.K
resonance total cross section

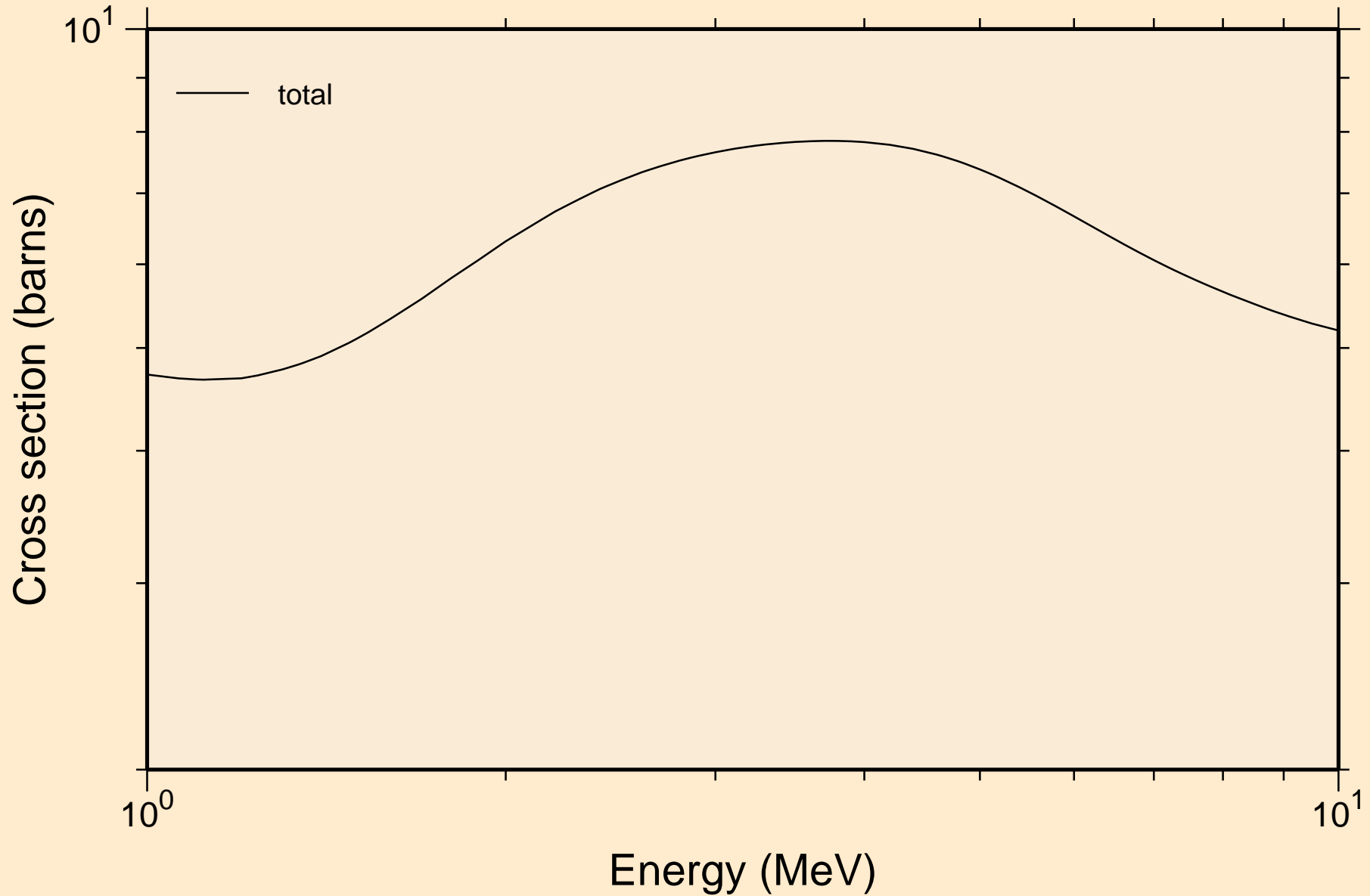

AT218 NEUTRON ACER TENDL-2024 LIBRARY; T=0.K
resonance absorption cross sections

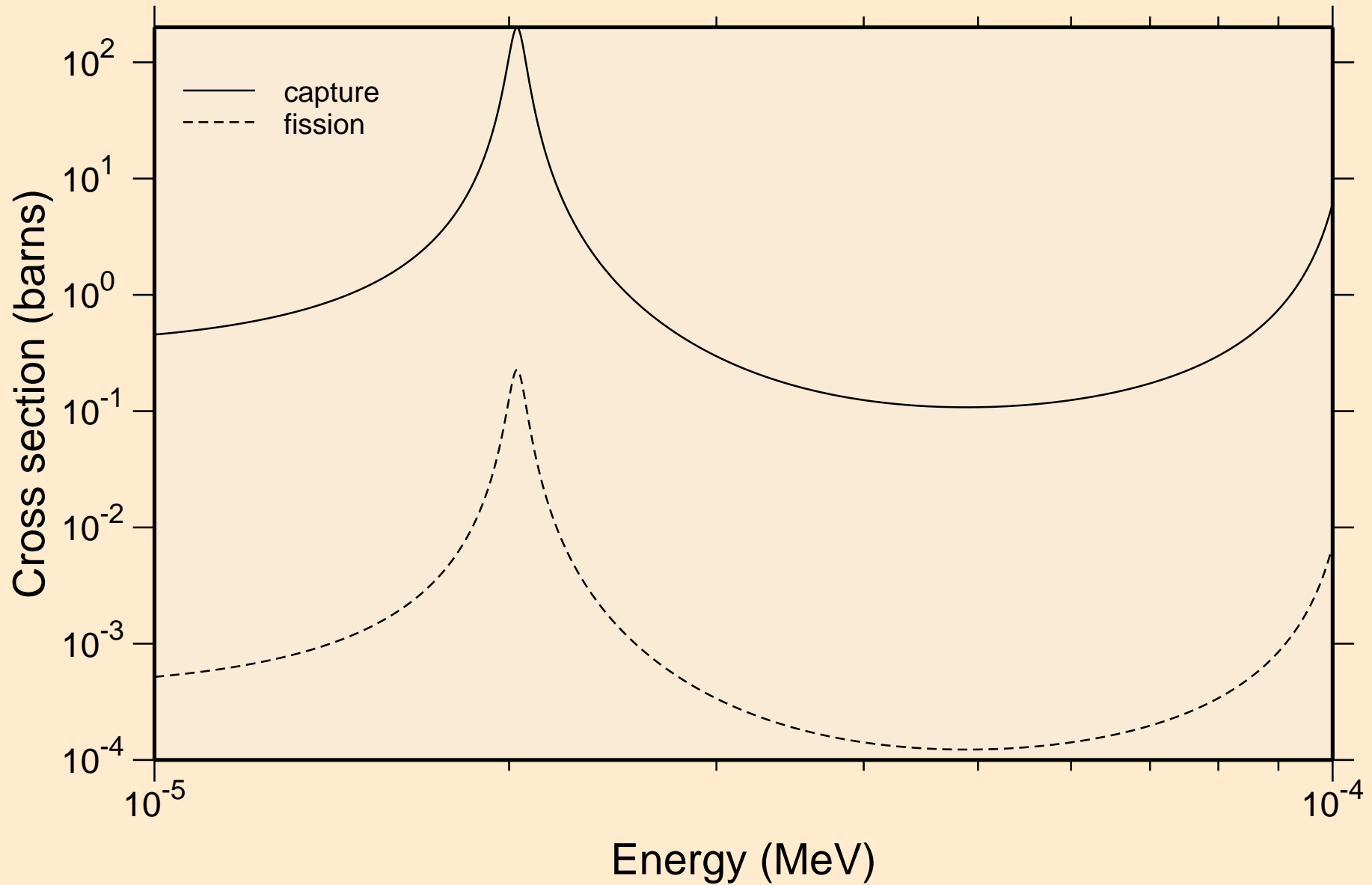

AT218 NEUTRON ACER TENDL-2024 LIBRARY; T=0.K

resonance absorption cross sections

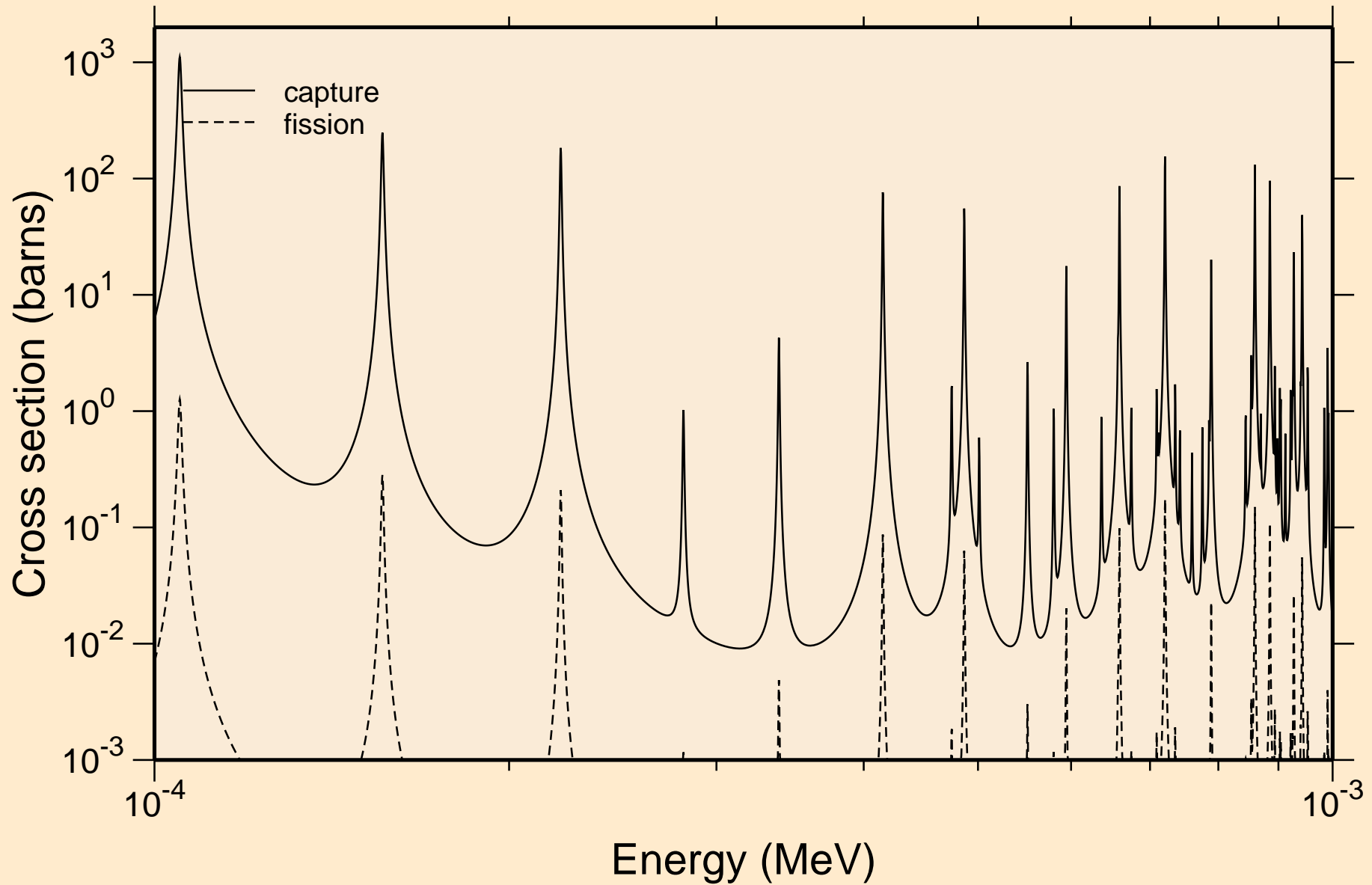

AT218 NEUTRON ACER TENDL-2024 LIBRARY; T=0.K
resonance absorption cross sections

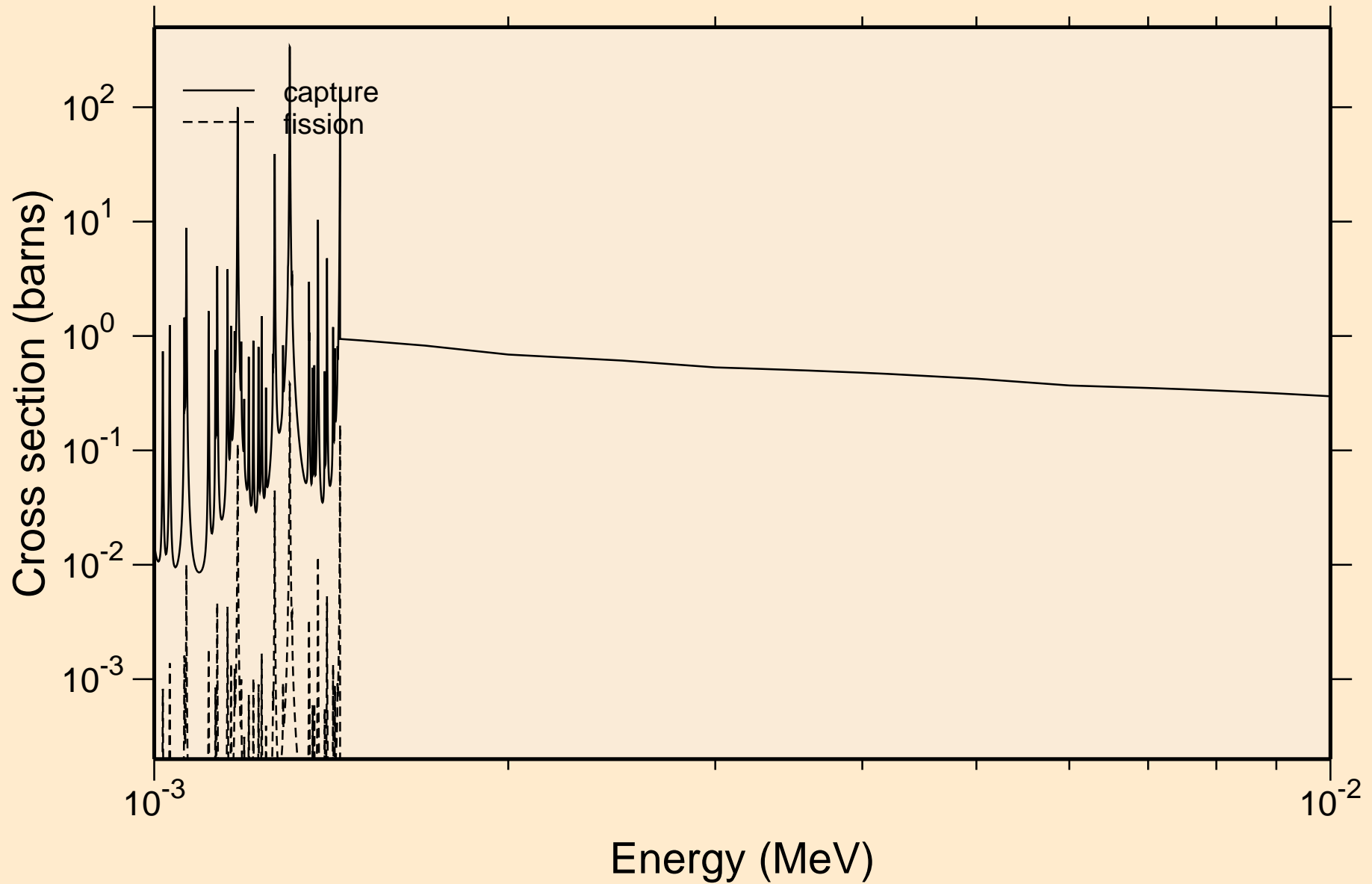

AT218 NEUTRON ACER TENDL-2024 LIBRARY; T=0.K
resonance absorption cross sections

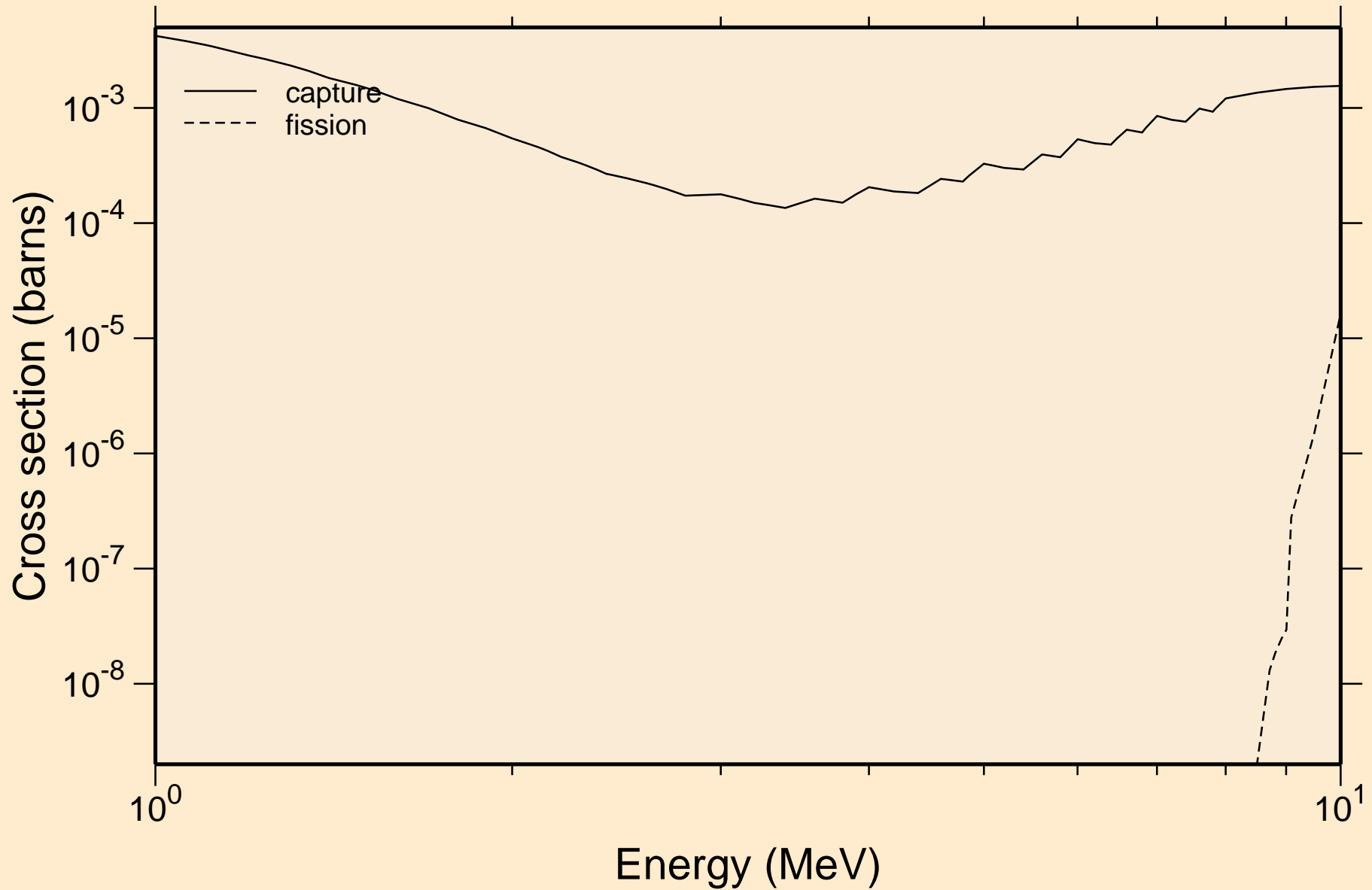

AT218 NEUTRON ACER TENDL-2024 LIBRARY; T=0.K

Heating

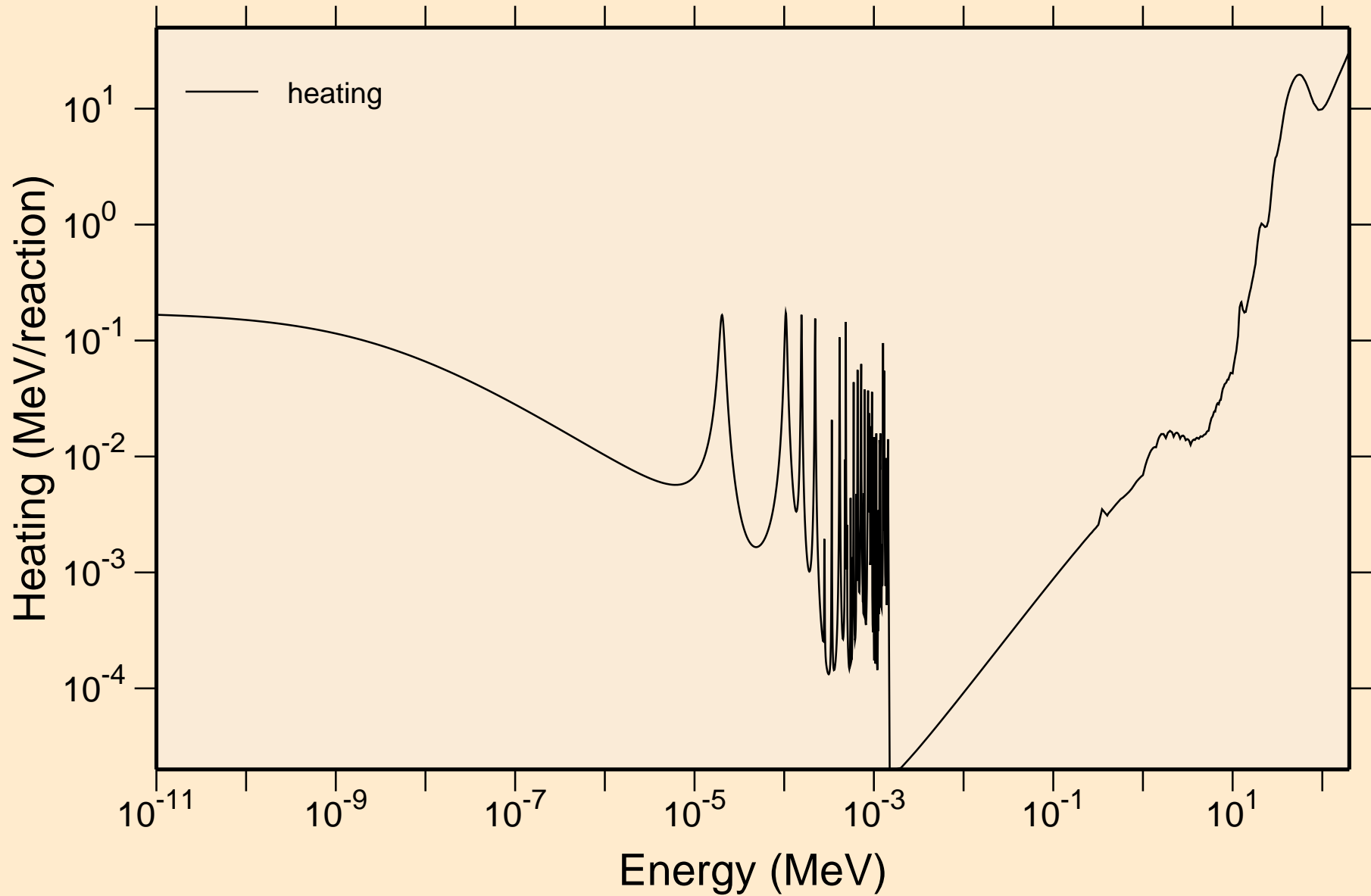

AT218 NEUTRON ACER TENDL-2024 LIBRARY; T=0.K

Damage

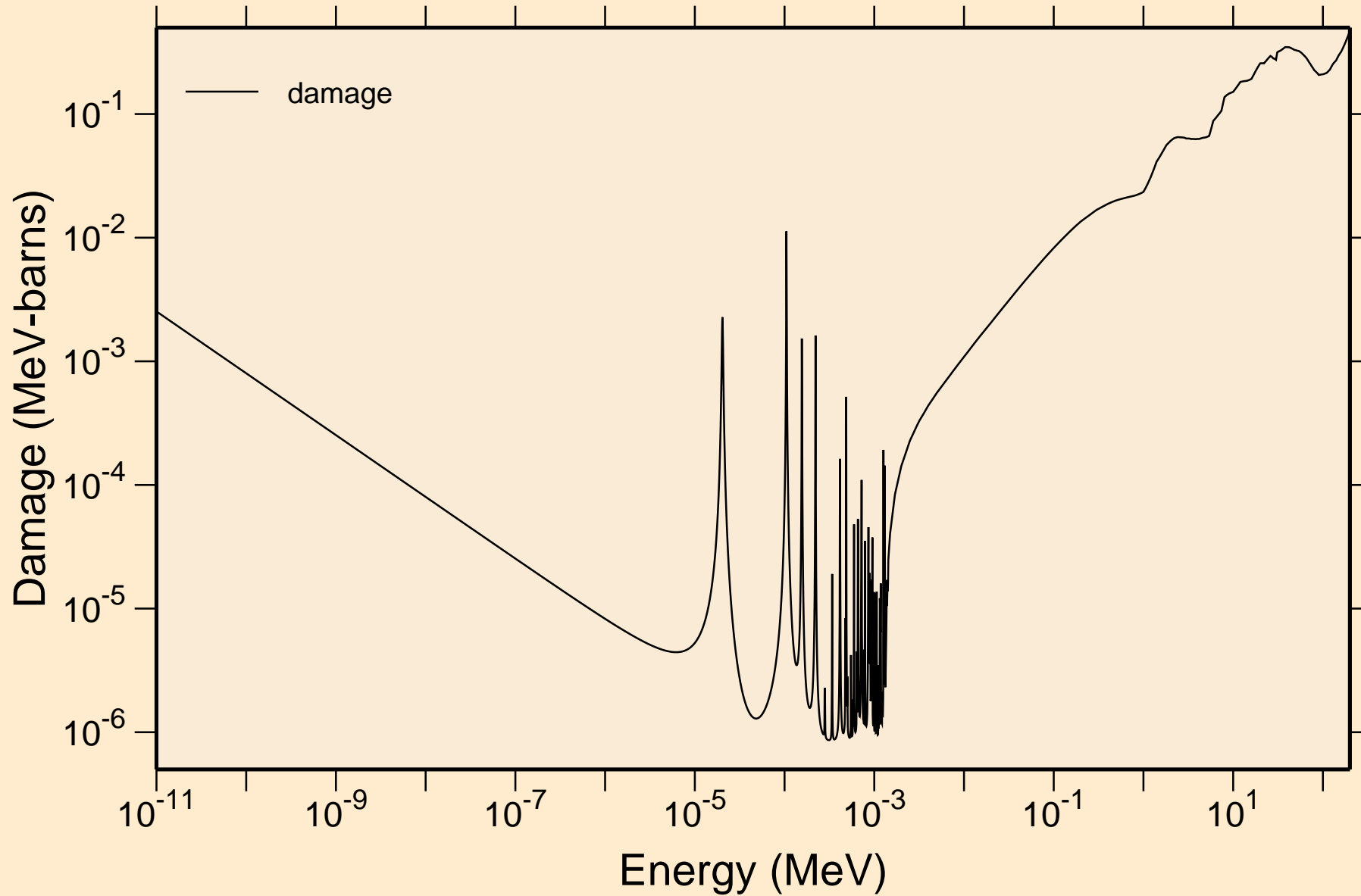

AT218 NEUTRON ACER TENDL-2024 LIBRARY; T=0.K

Non-threshold reactions

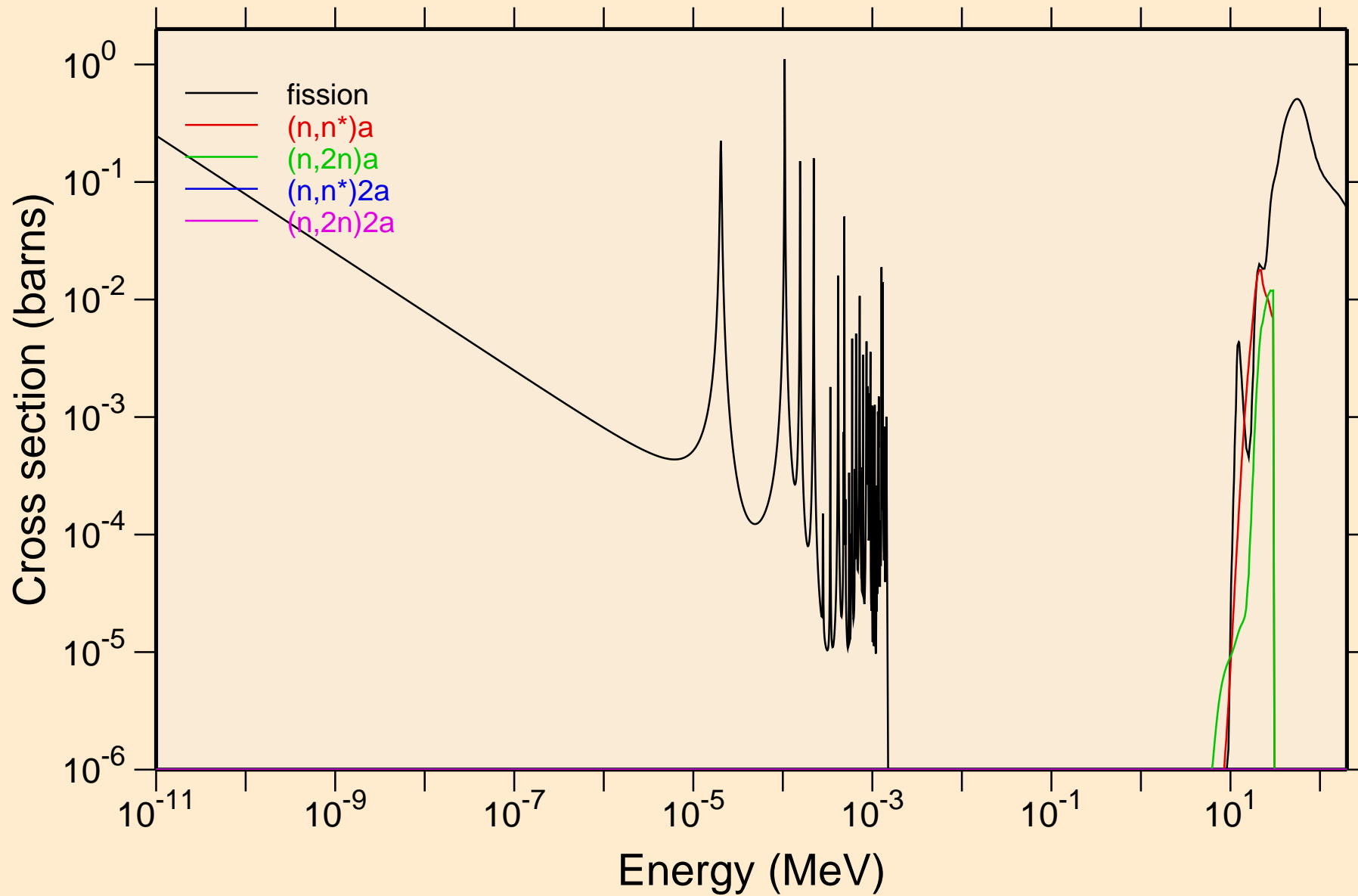

AT218 NEUTRON ACER TENDL-2024 LIBRARY; T=0.K

Non-threshold reactions

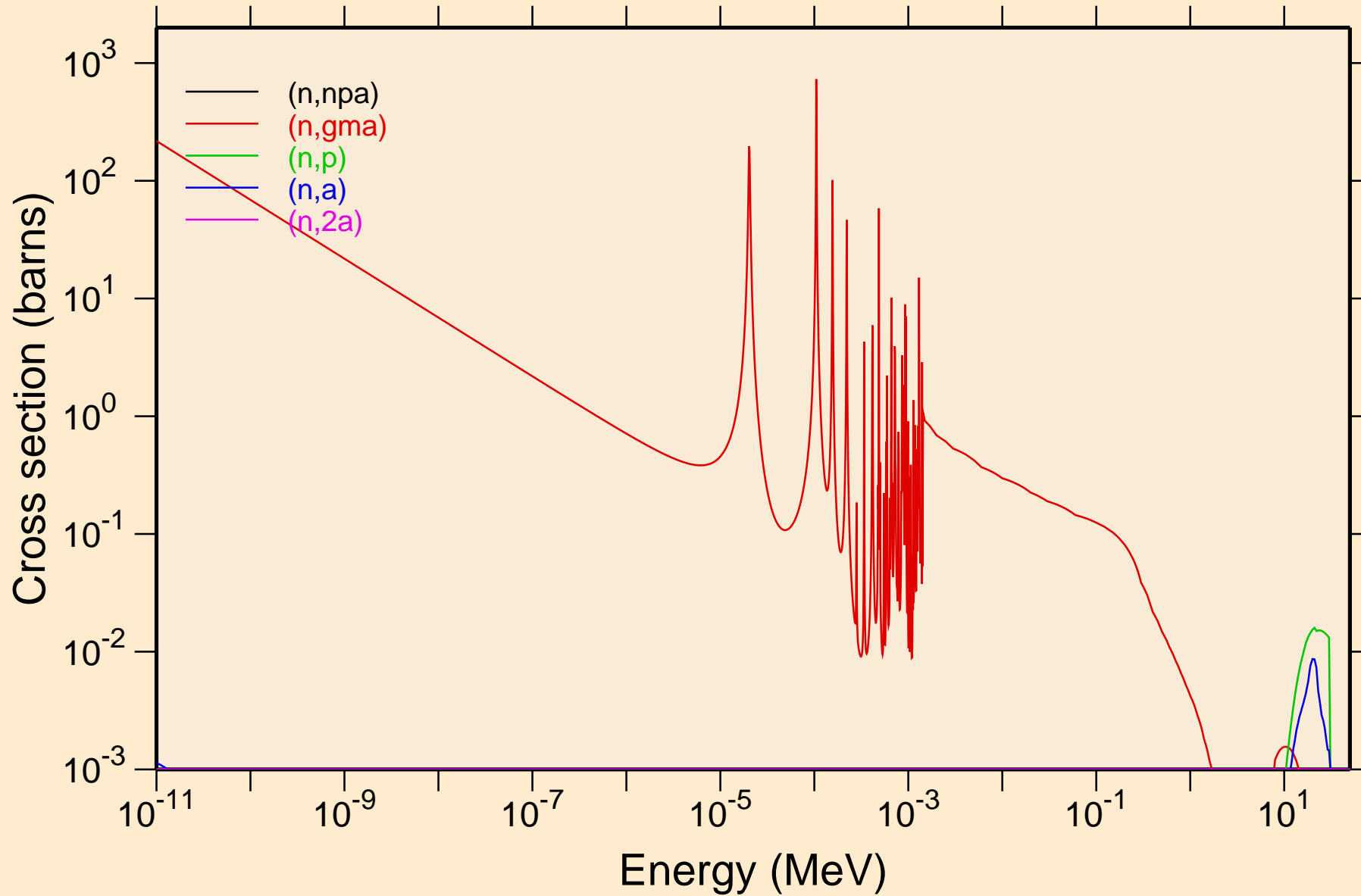

AT218 NEUTRON ACER TENDL-2024 LIBRARY; T=0.K
Non-threshold reactions

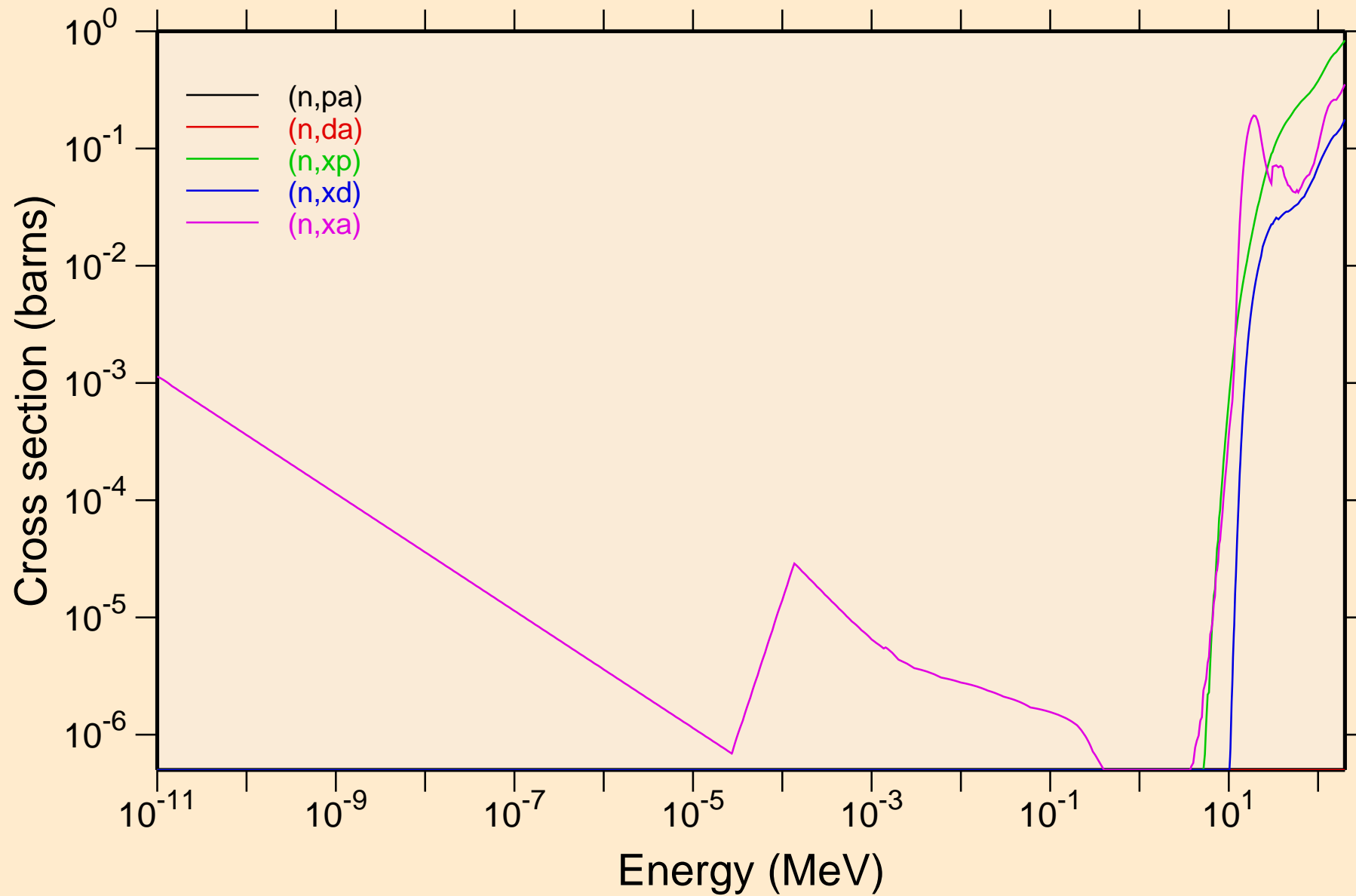

AT218 NEUTRON ACER TENDL-2024 LIBRARY; T=0.K

Principal cross sections

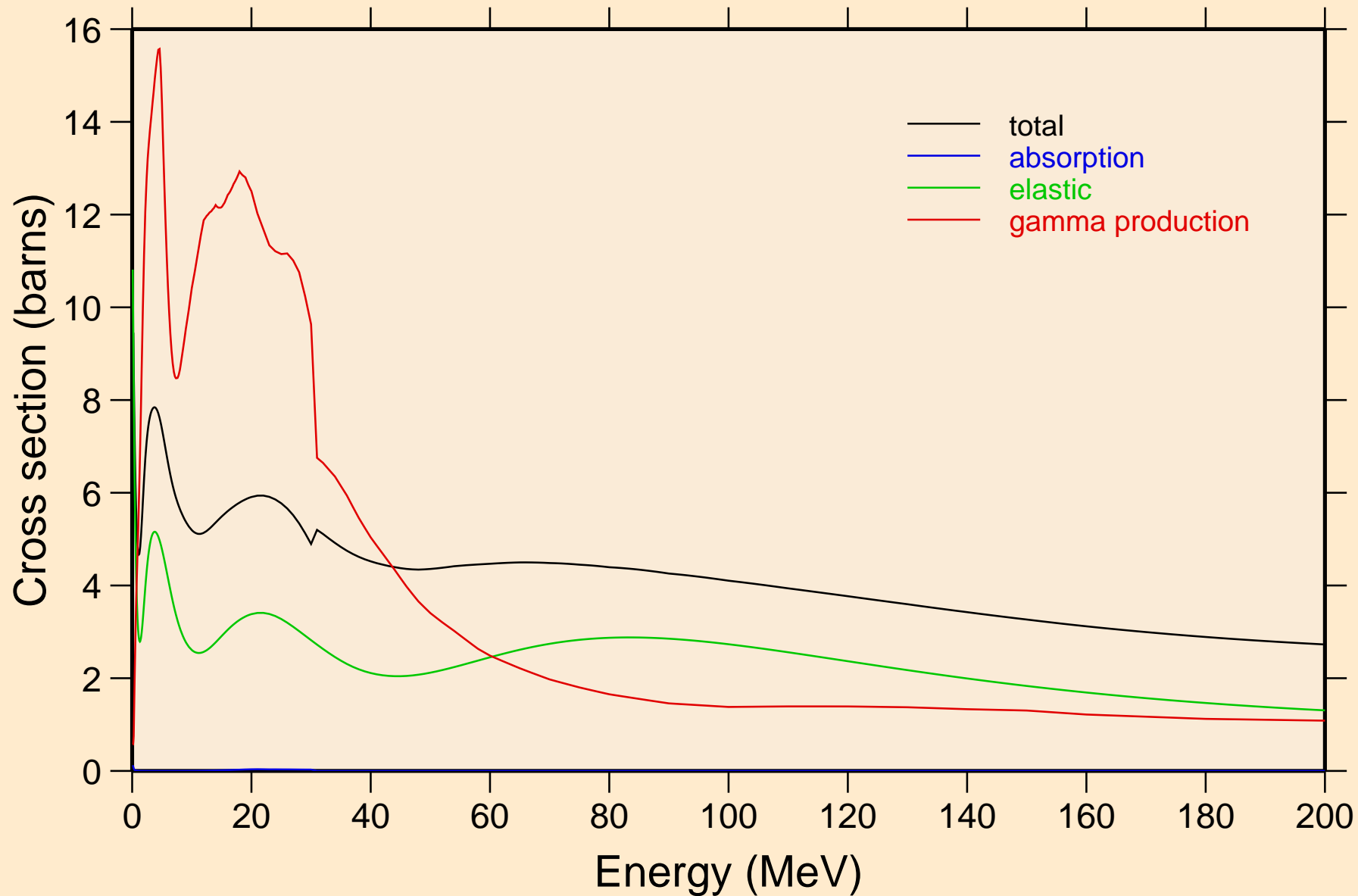

AT218 NEUTRON ACER TENDL-2024 LIBRARY; T=0.K

Heating

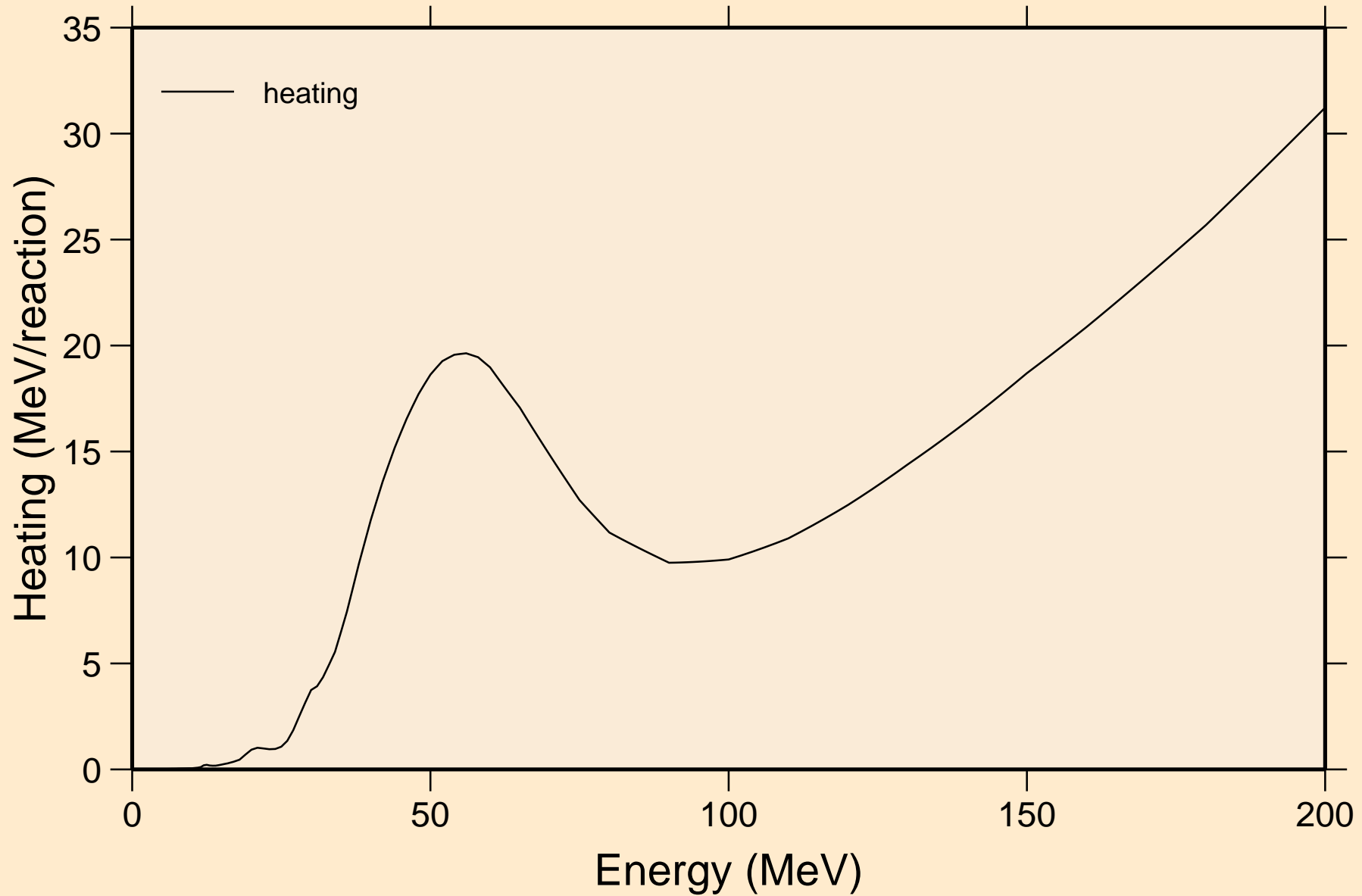

AT218 NEUTRON ACER TENDL-2024 LIBRARY; T=0.K
Damage

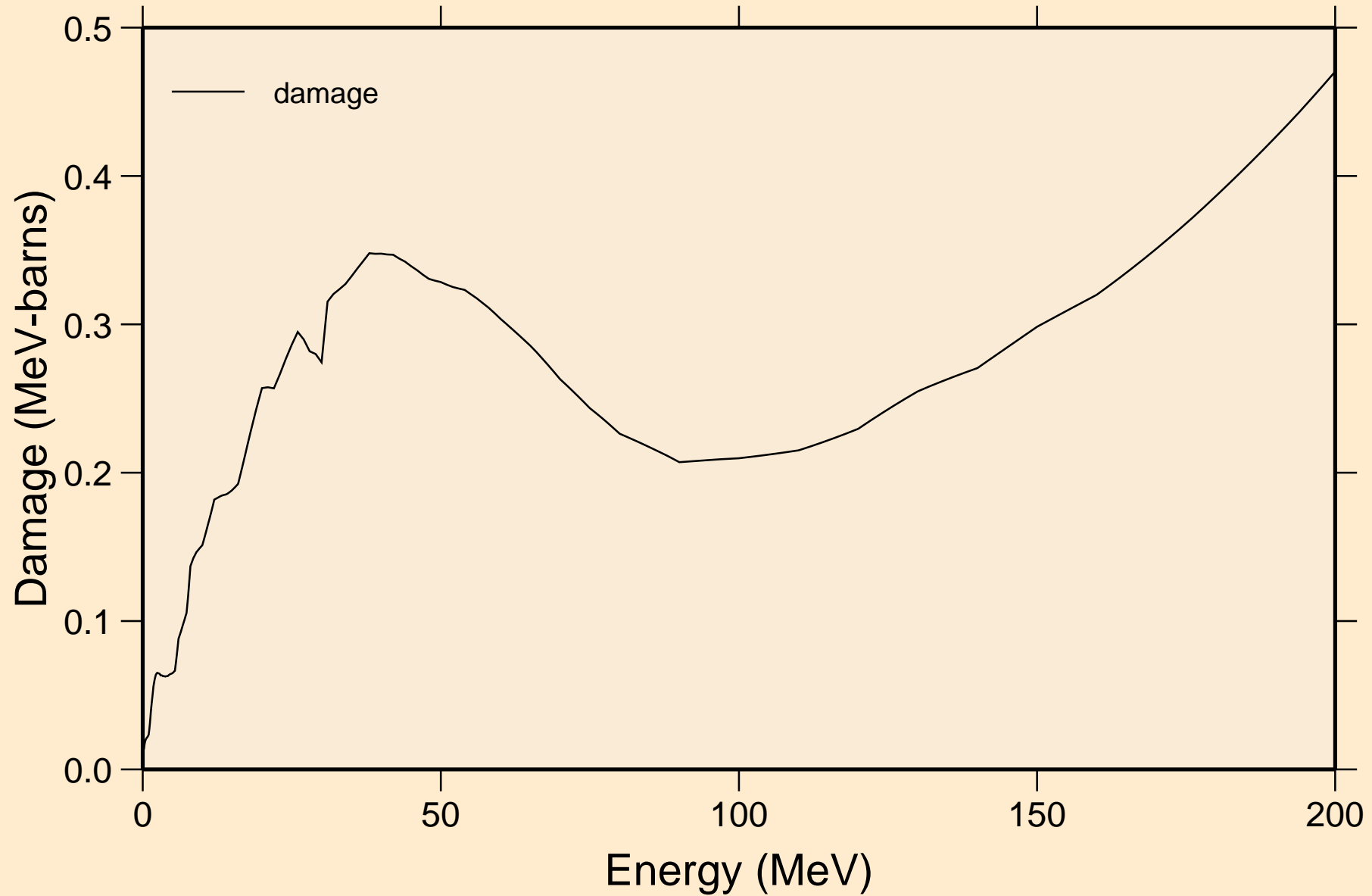

AT218 NEUTRON ACER TENDL-2024 LIBRARY; T=0.K
Non-threshold reactions

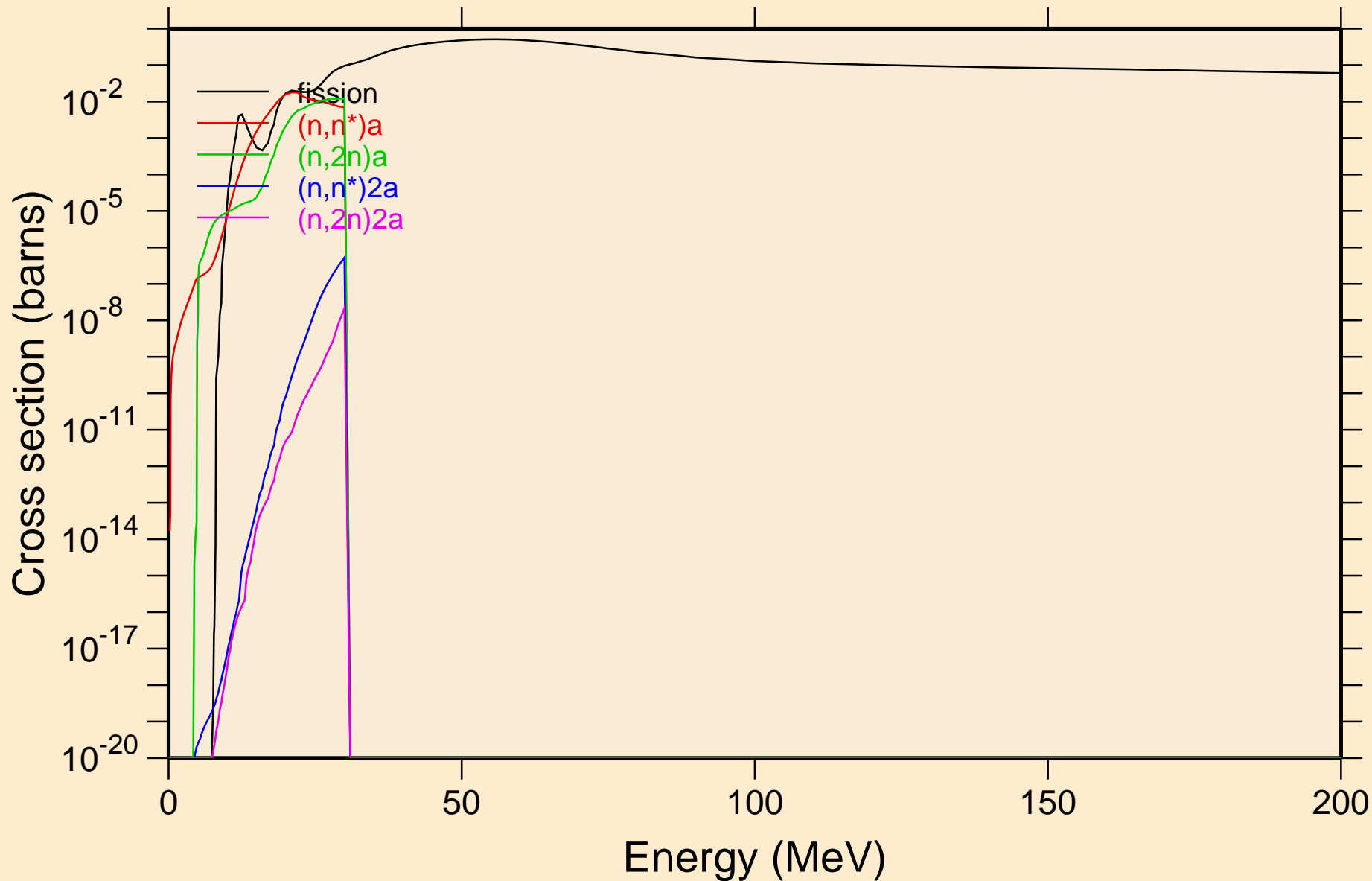

AT218 NEUTRON ACER TENDL-2024 LIBRARY; T=0.K

Non-threshold reactions

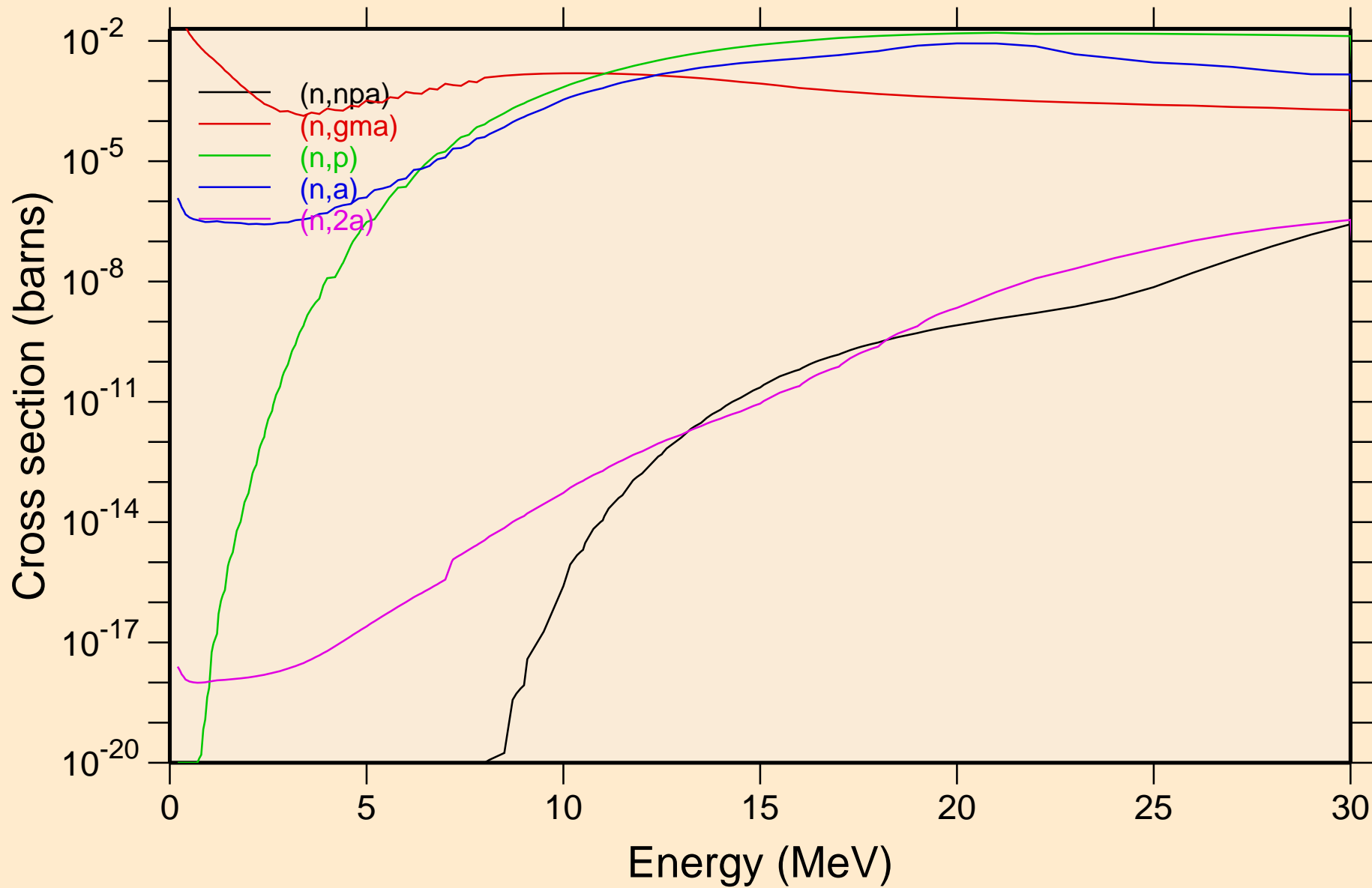

AT218 NEUTRON ACER TENDL-2024 LIBRARY; T=0.K
Non-threshold reactions

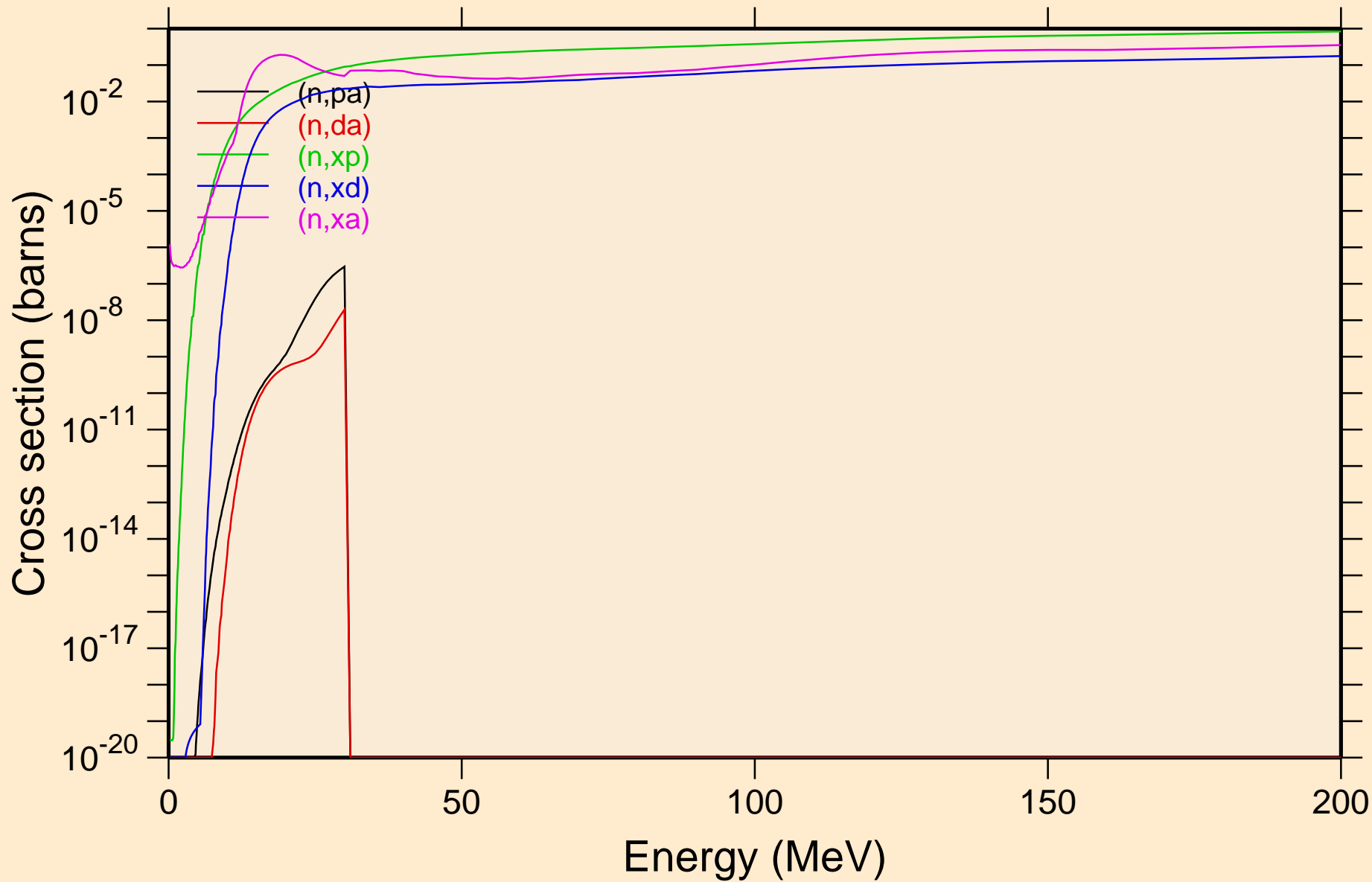

AT218 NEUTRON ACER TENDL-2024 LIBRARY; T=0.K

Inelastic levels

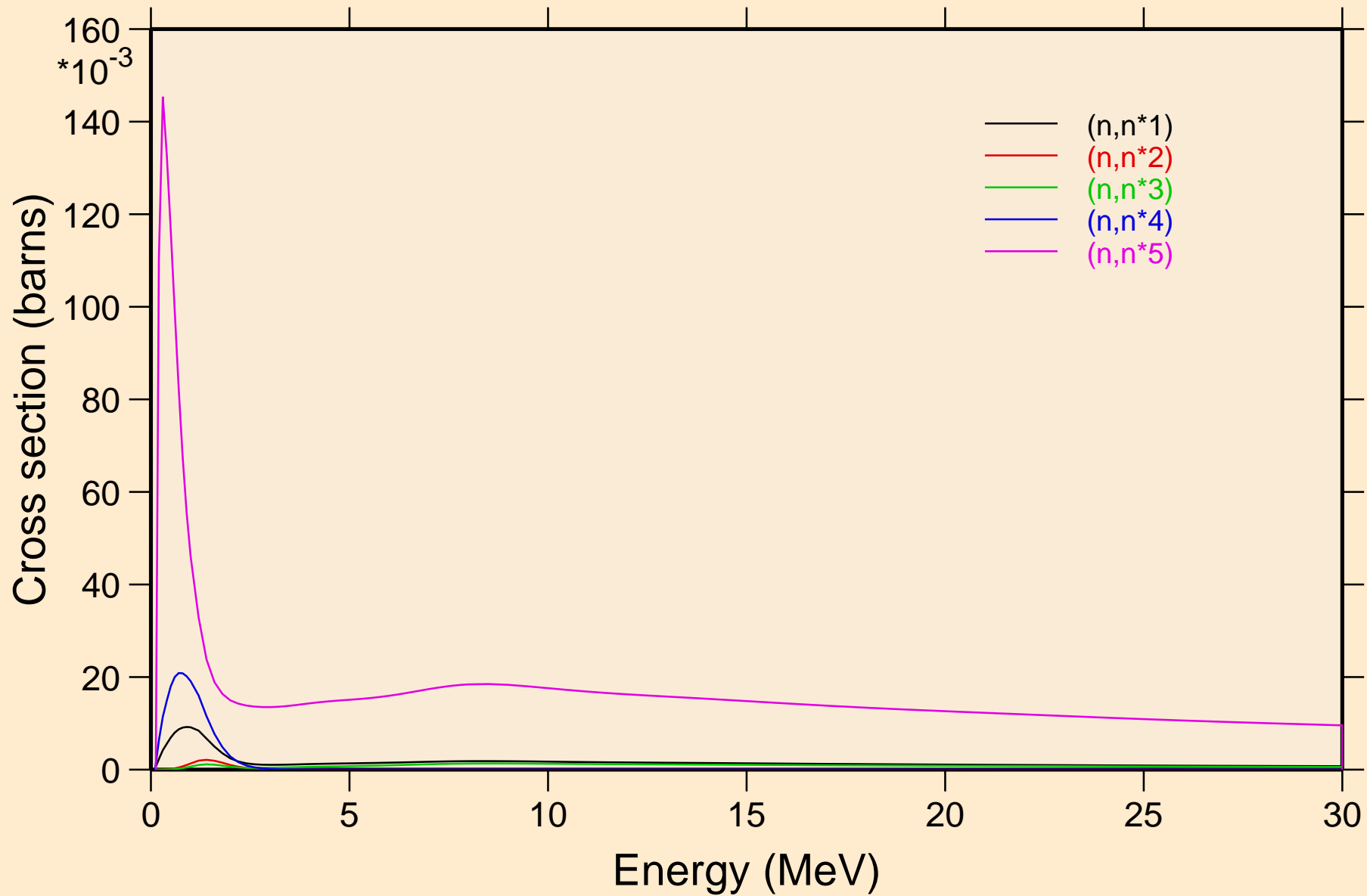

AT218 NEUTRON ACER TENDL-2024 LIBRARY; T=0.K
Inelastic levels

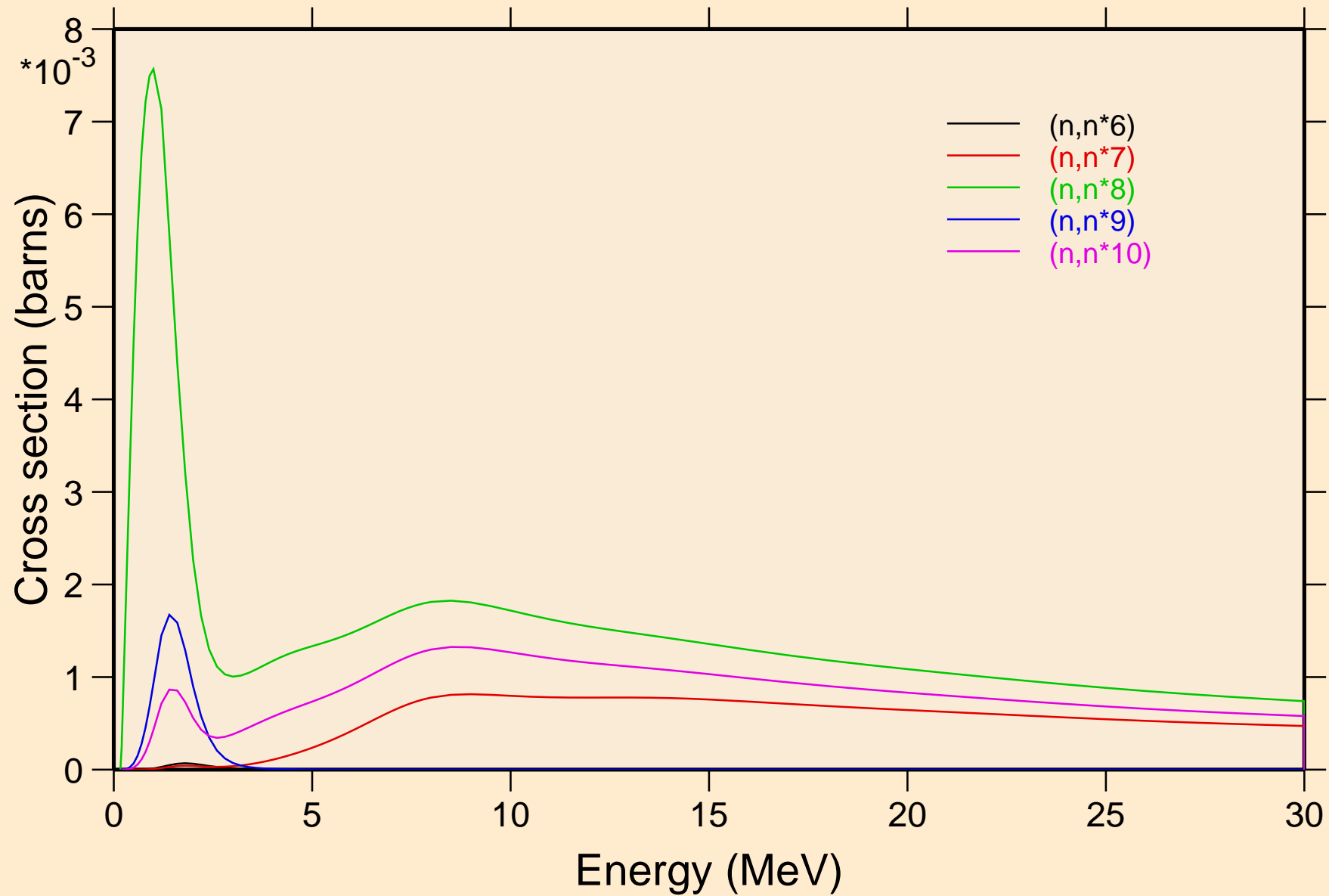

AT218 NEUTRON ACER TENDL-2024 LIBRARY; T=0.K
Inelastic levels

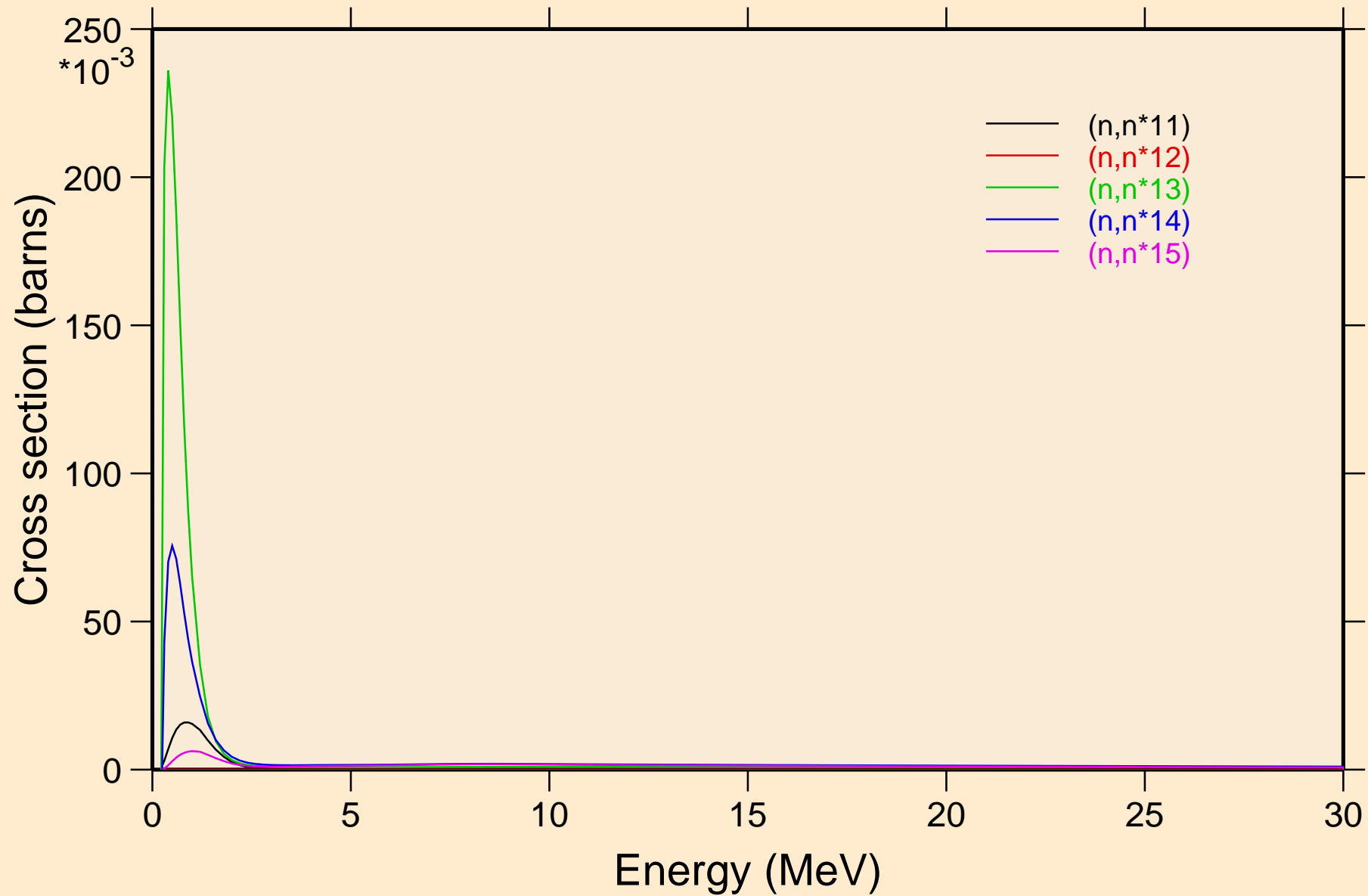

AT218 NEUTRON ACER TENDL-2024 LIBRARY; T=0.K
Inelastic levels

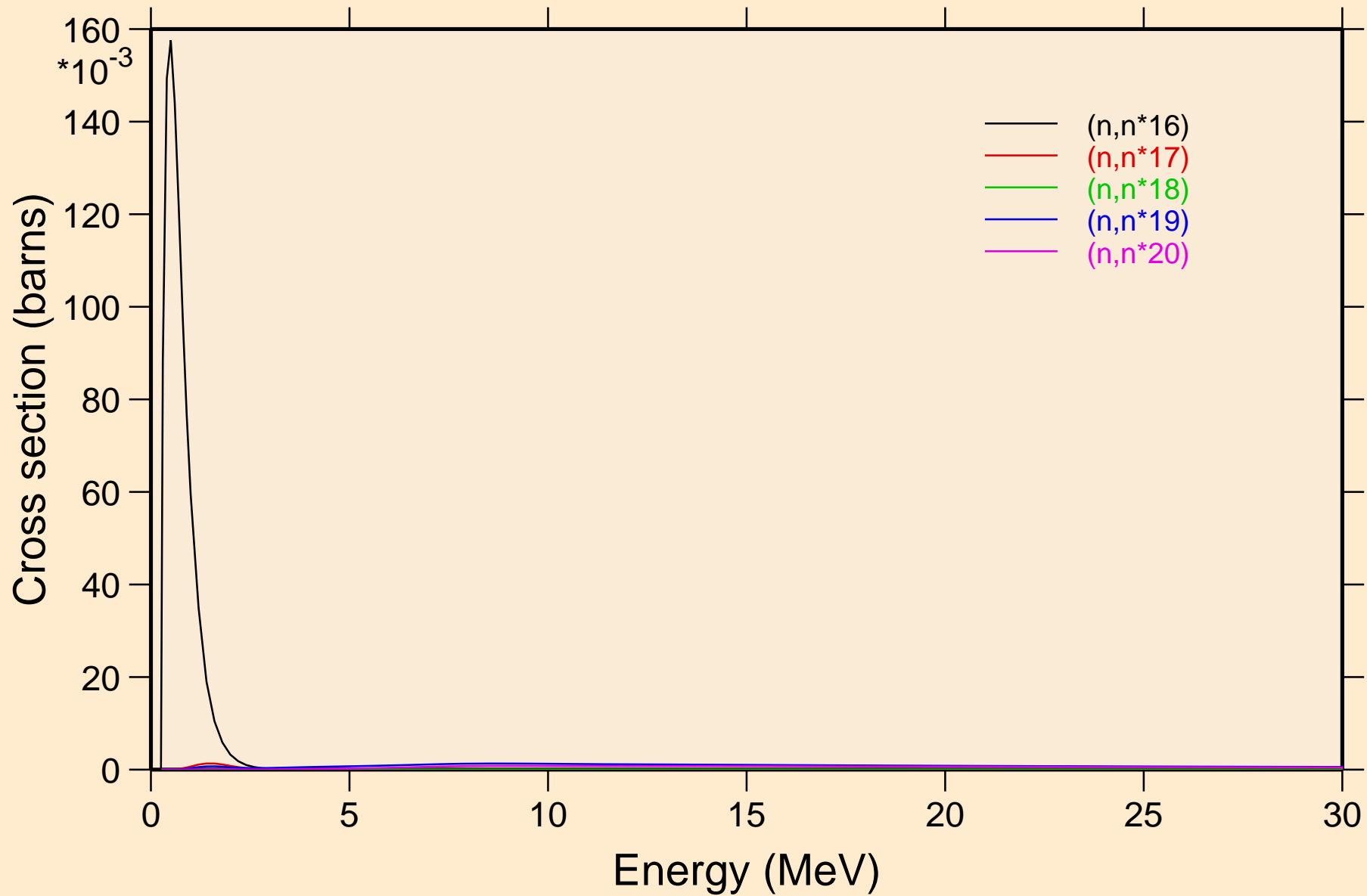

AT218 NEUTRON ACER TENDL-2024 LIBRARY; T=0.K
Inelastic levels

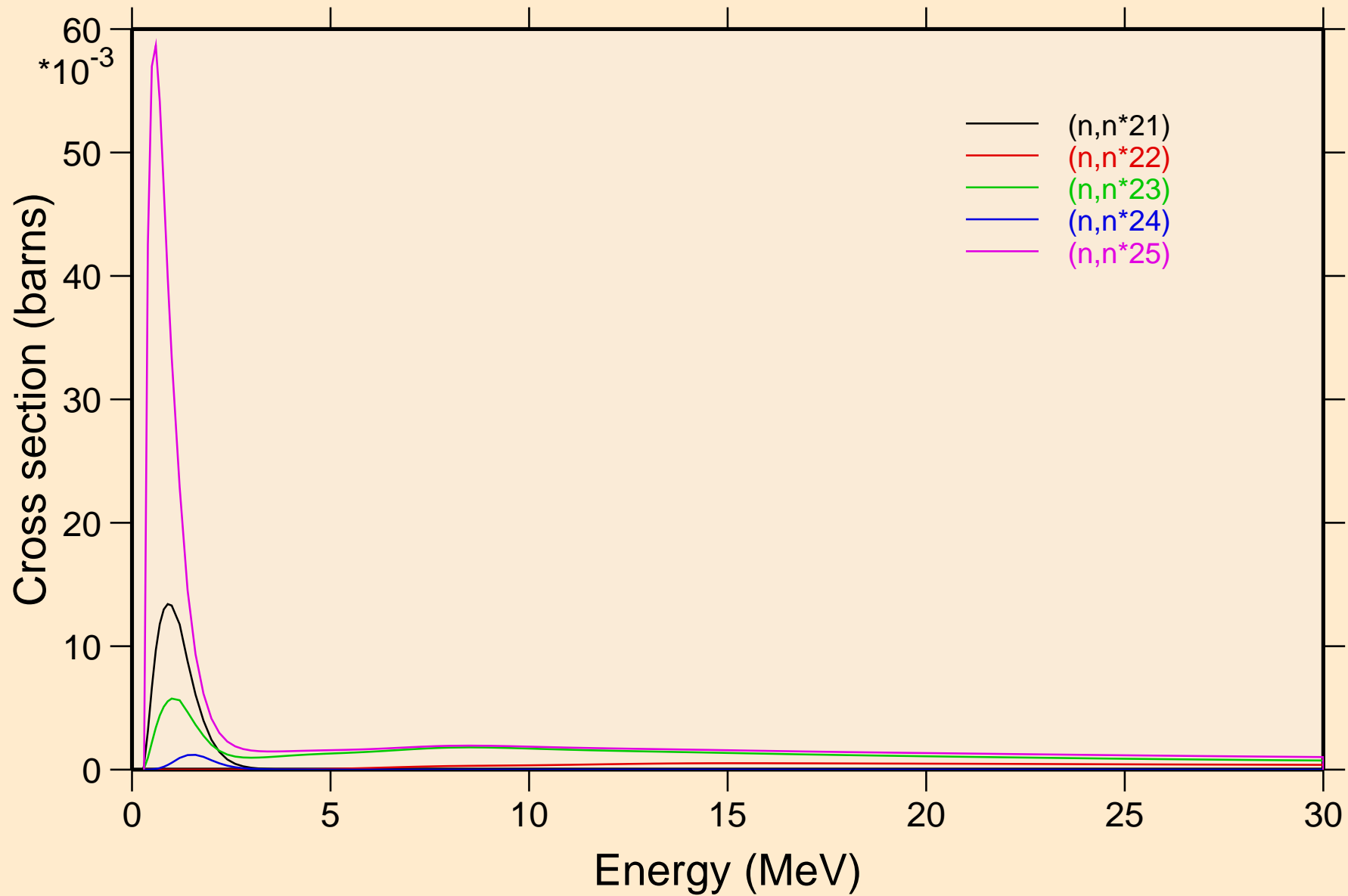

AT218 NEUTRON ACER TENDL-2024 LIBRARY; T=0.K
Inelastic levels

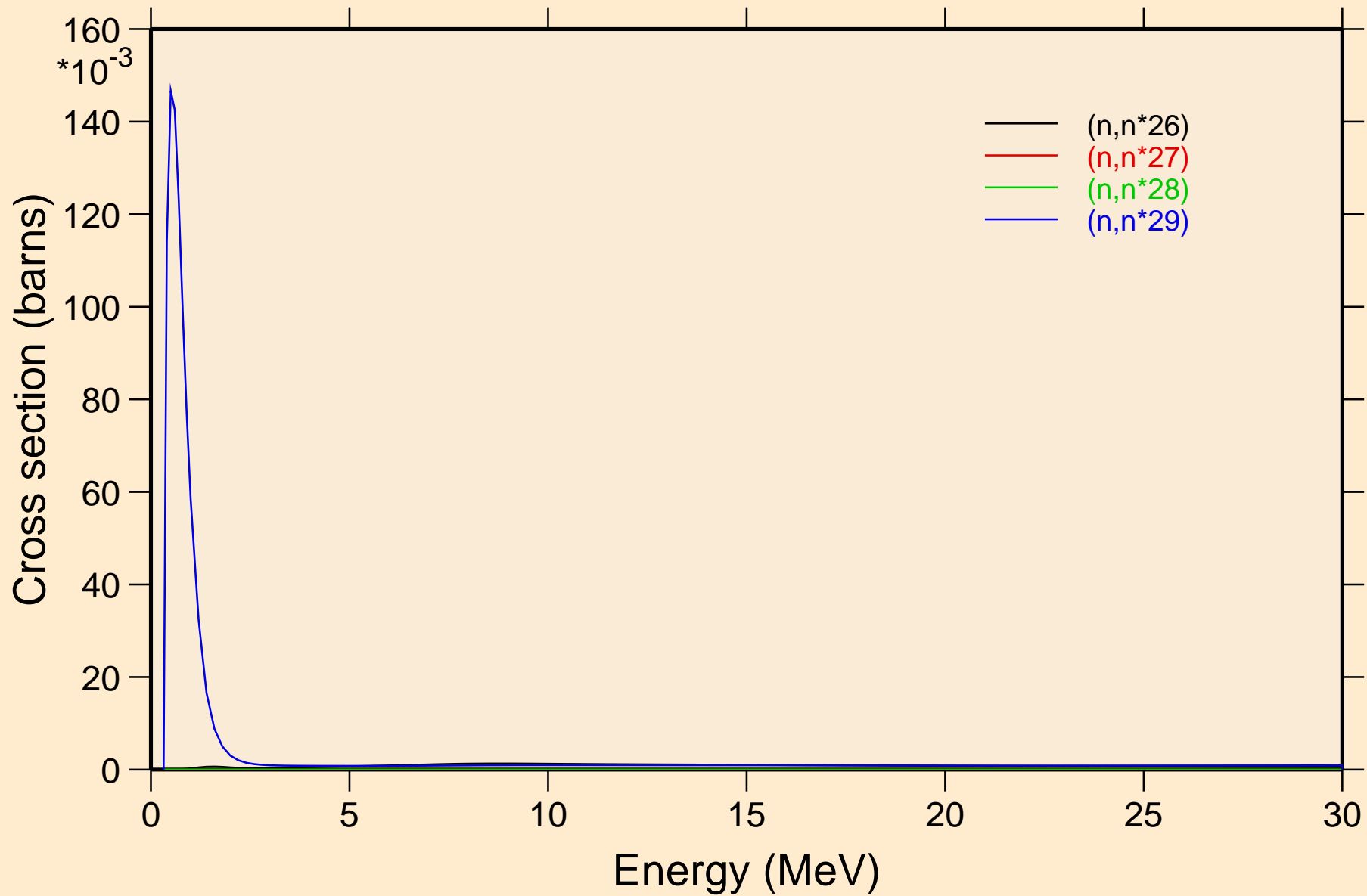

AT218 NEUTRON ACER TENDL-2024 LIBRARY; T=0.K

Threshold reactions

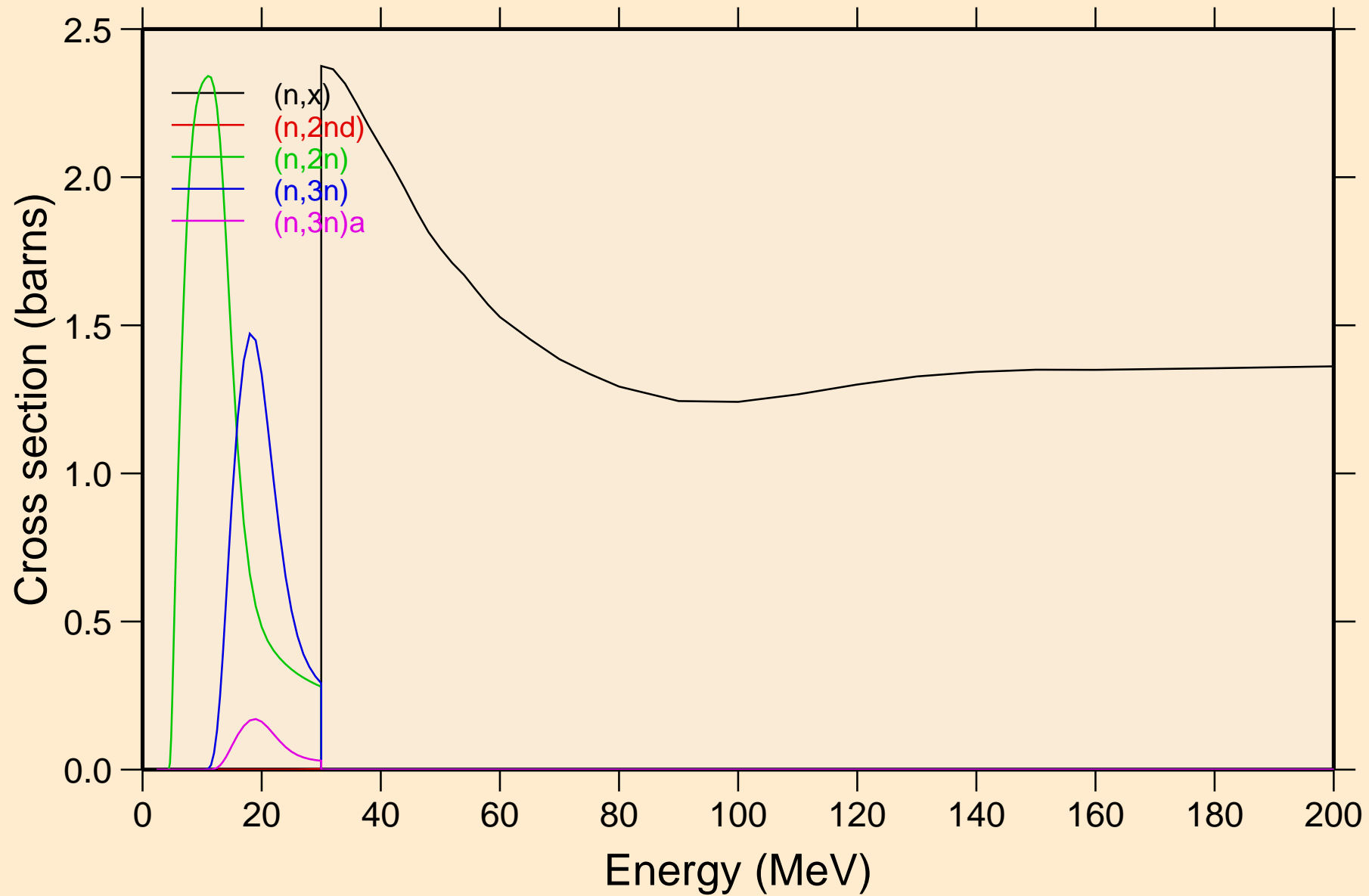

AT218 NEUTRON ACER TENDL-2024 LIBRARY; T=0.K
Threshold reactions

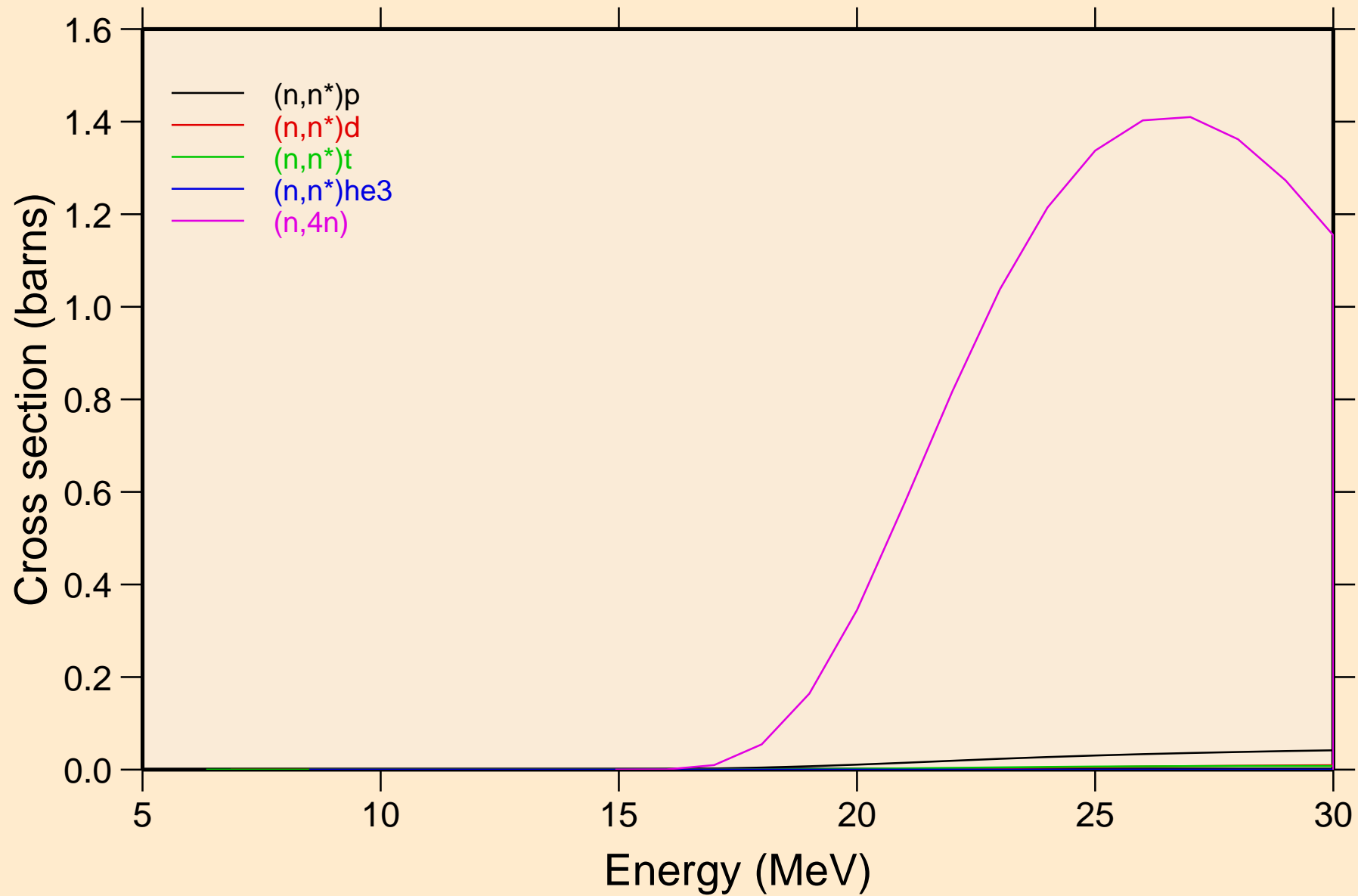

AT218 NEUTRON ACER TENDL-2024 LIBRARY; T=0.K
Threshold reactions

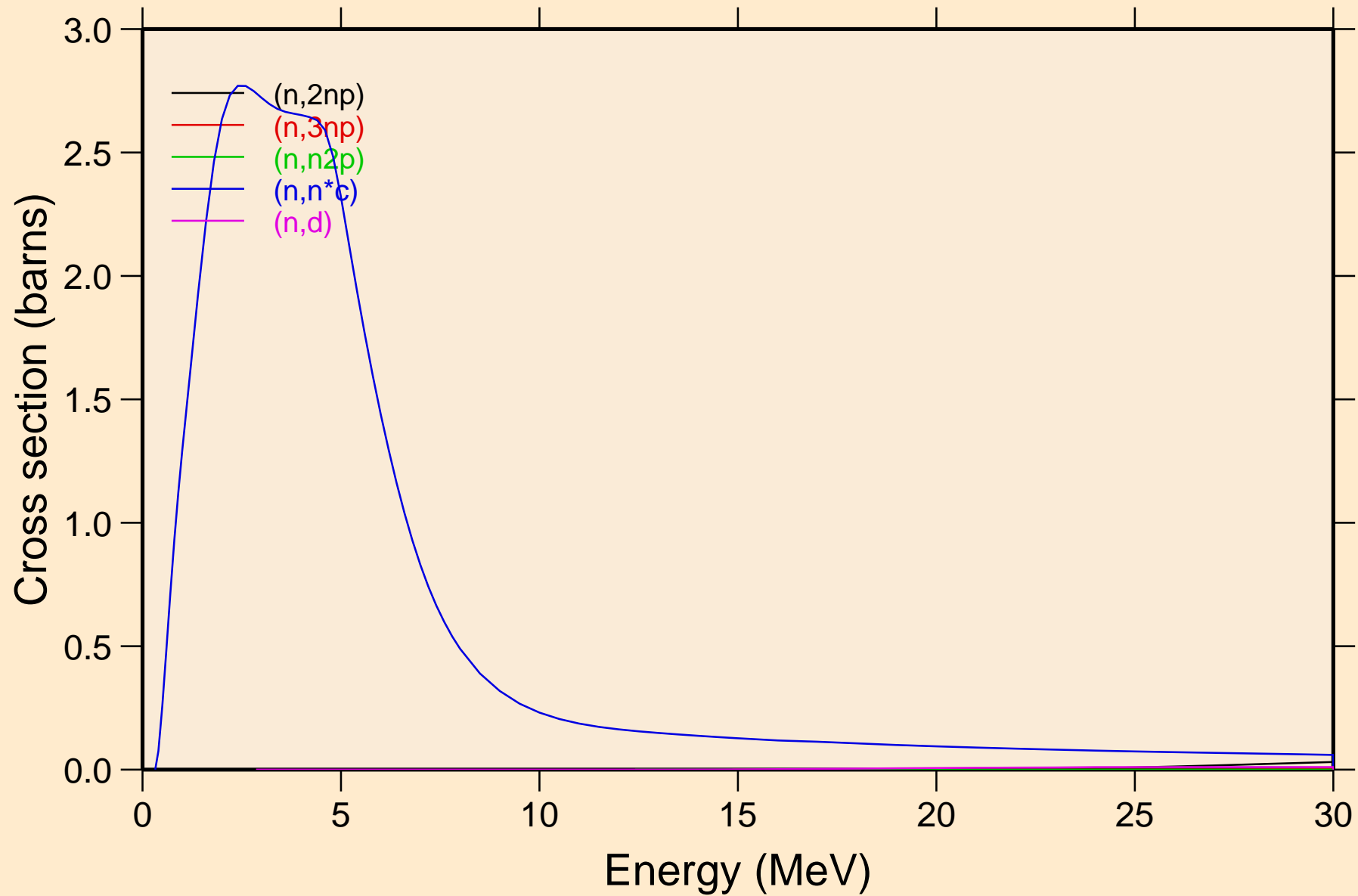

AT218 NEUTRON ACER TENDL-2024 LIBRARY; T=0.K

Threshold reactions

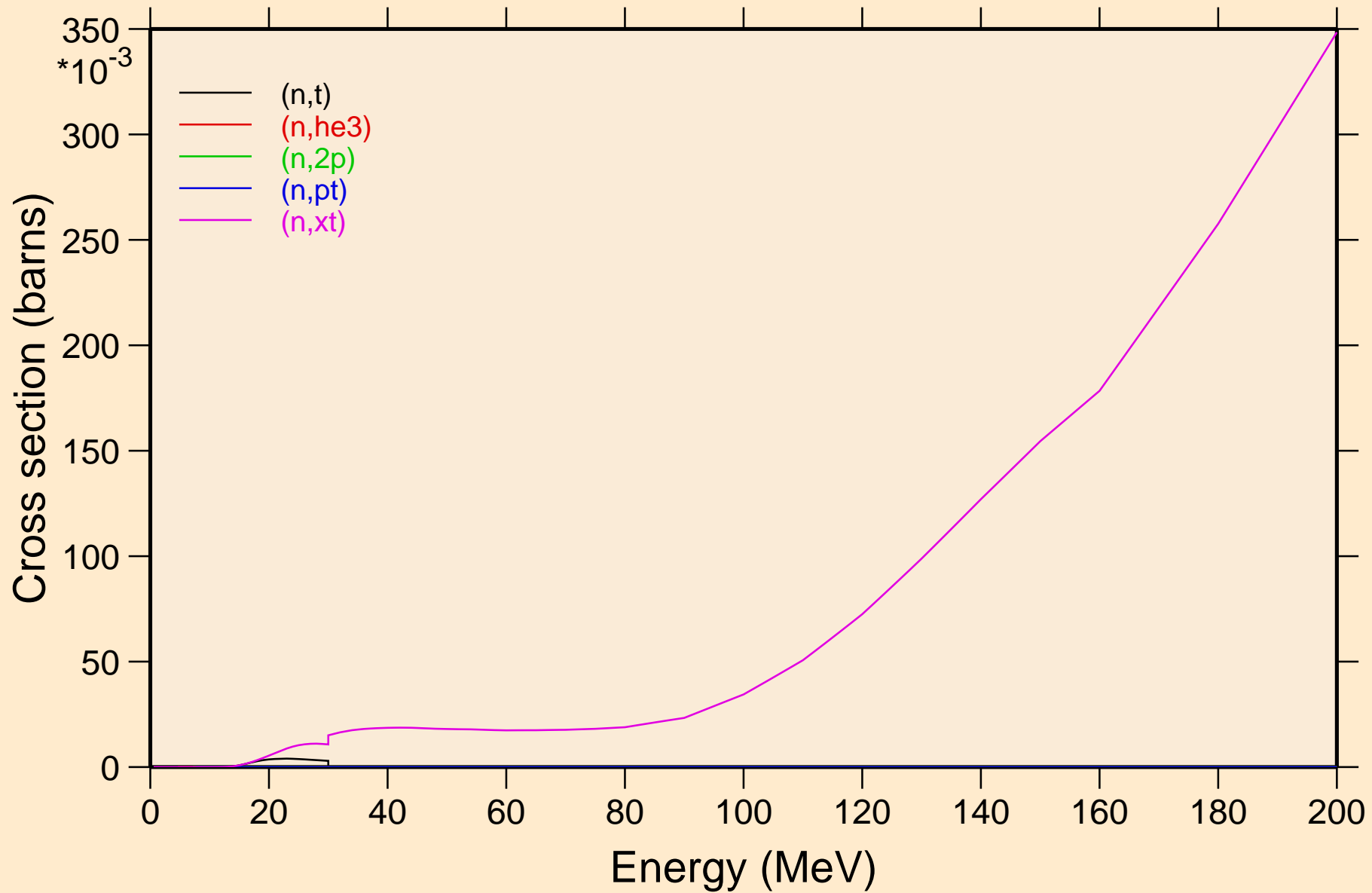

AT218 NEUTRON ACER TENDL-2024 LIBRARY; T=0.K
Threshold reactions

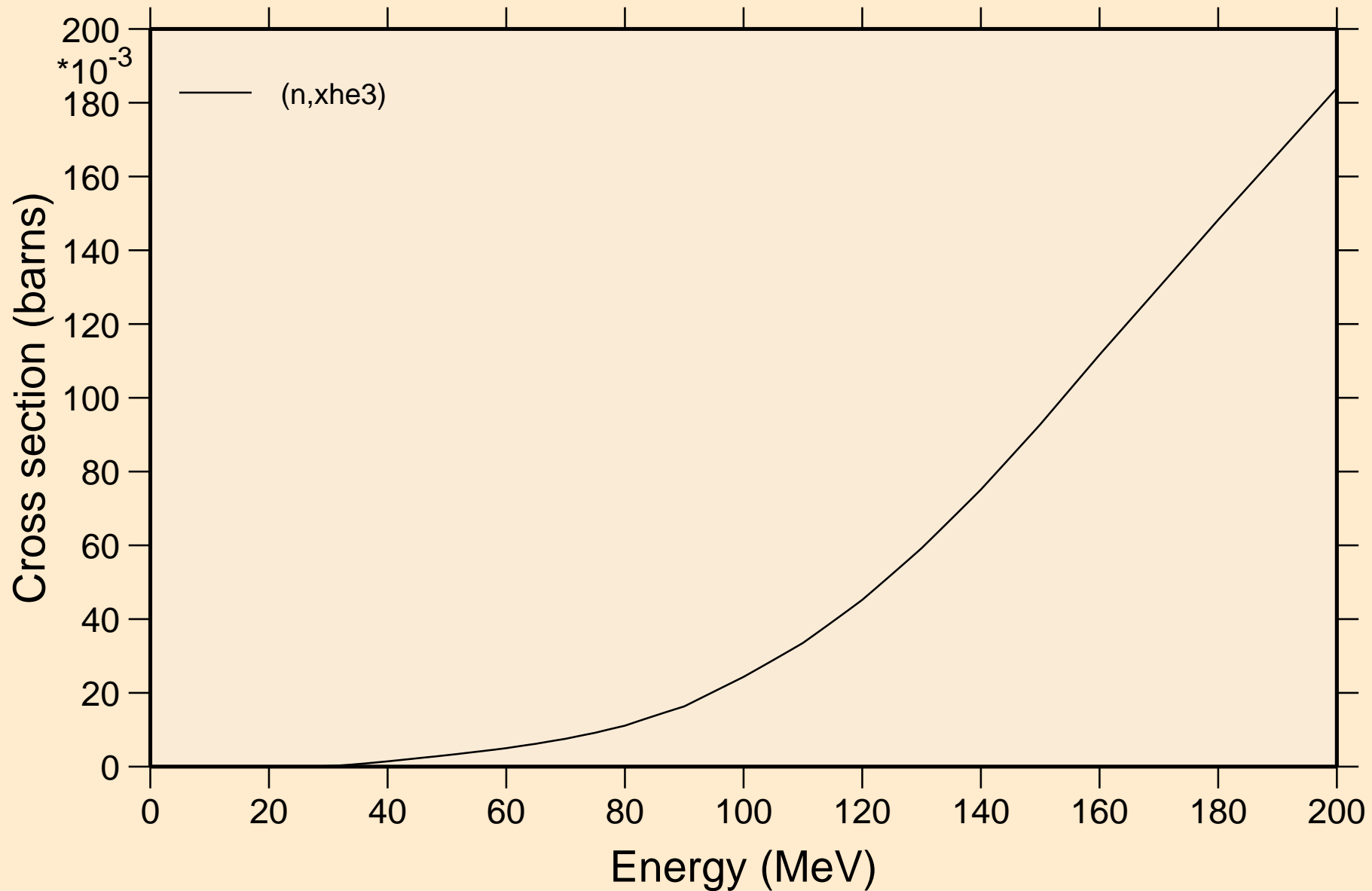

AT218 NEUTRON ACER TENDL-2024 LIBRARY; T=0.K
angular distribution for elastic

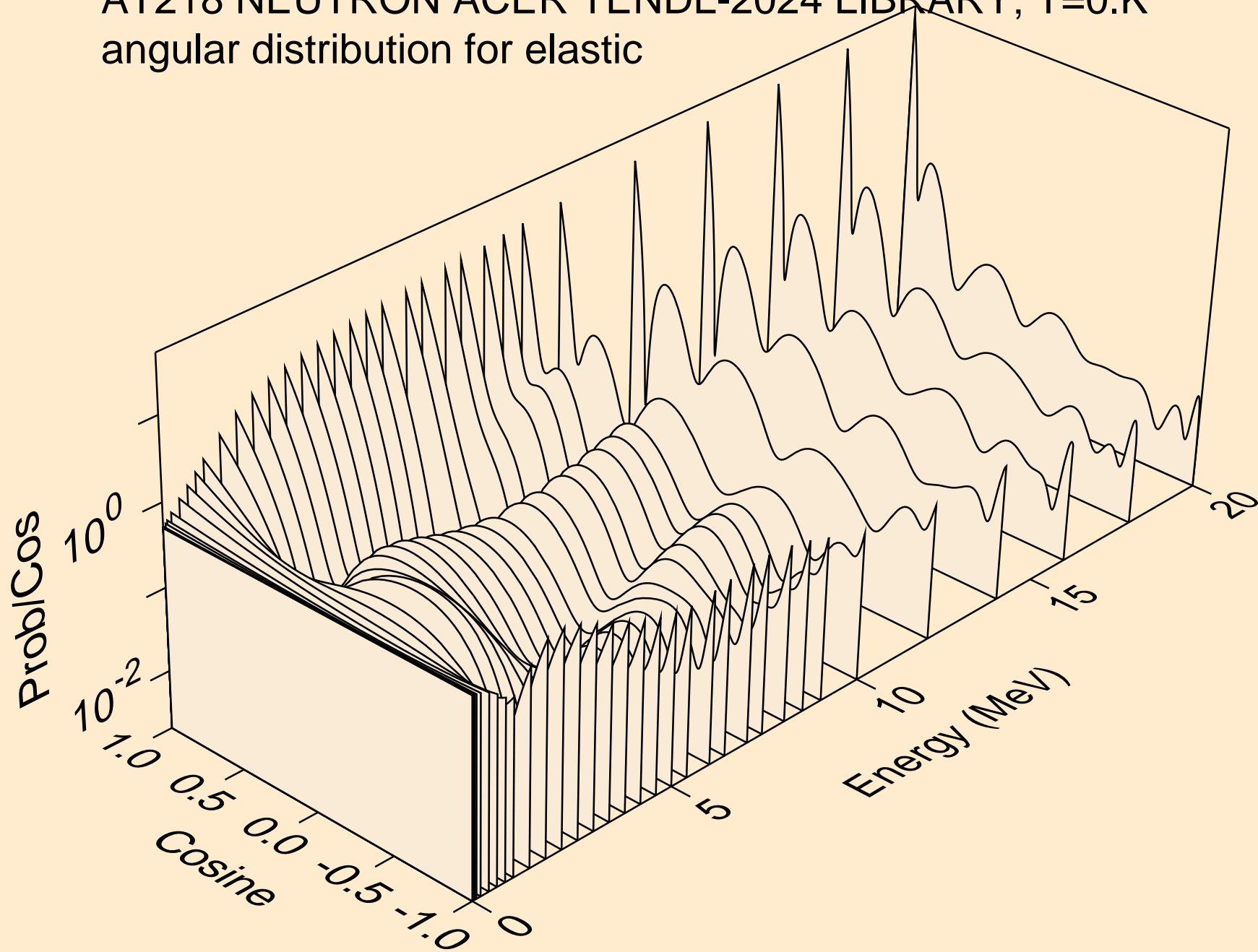

AT218 NEUTRON ACER TENDL-2024 LIBRARY; T=0.K
angular distribution for elastic

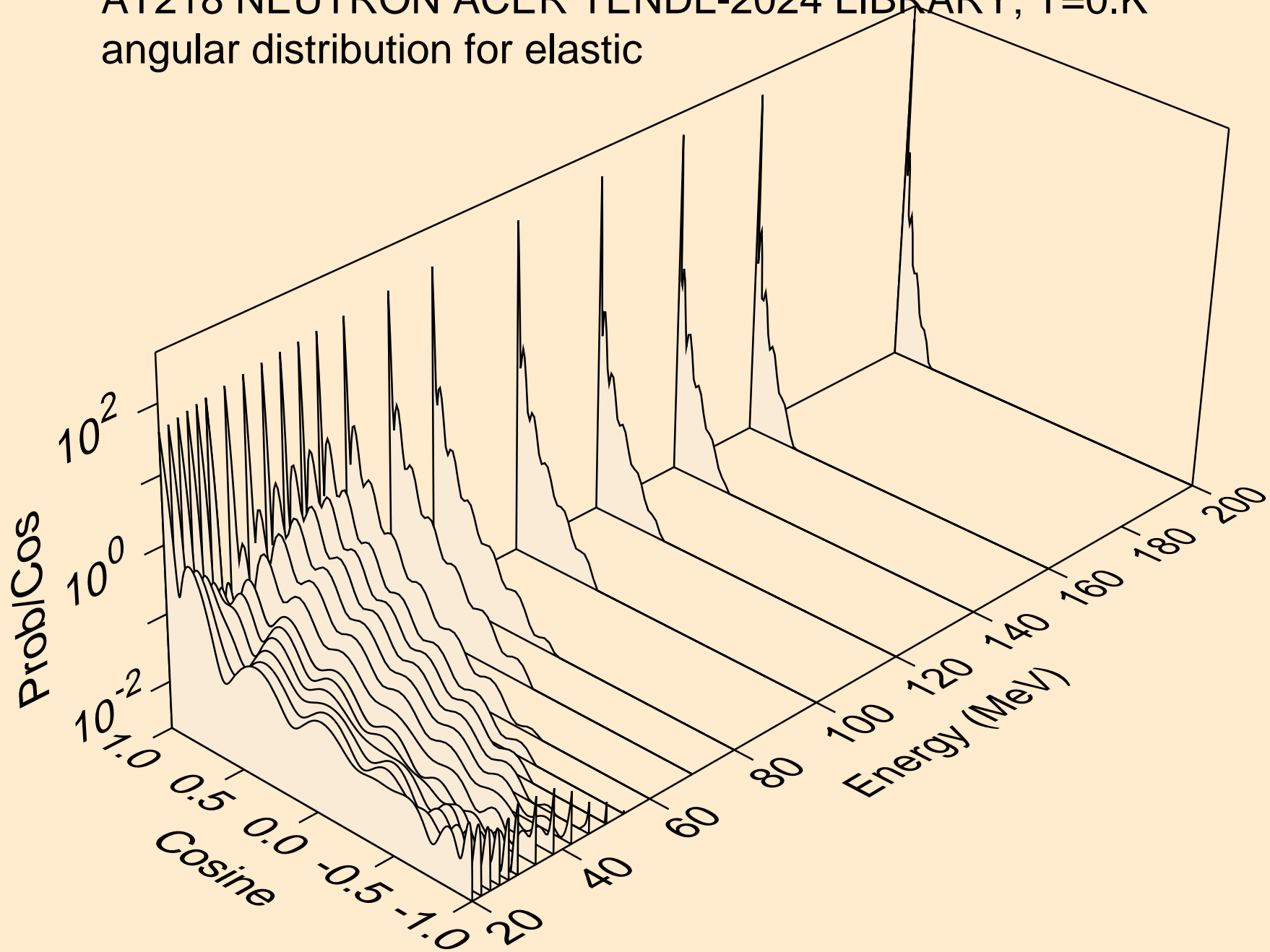

AT218 NEUTRON ACER TENDL-2024 LIBRARY; T=0.K
angular distribution for (n,n*1)

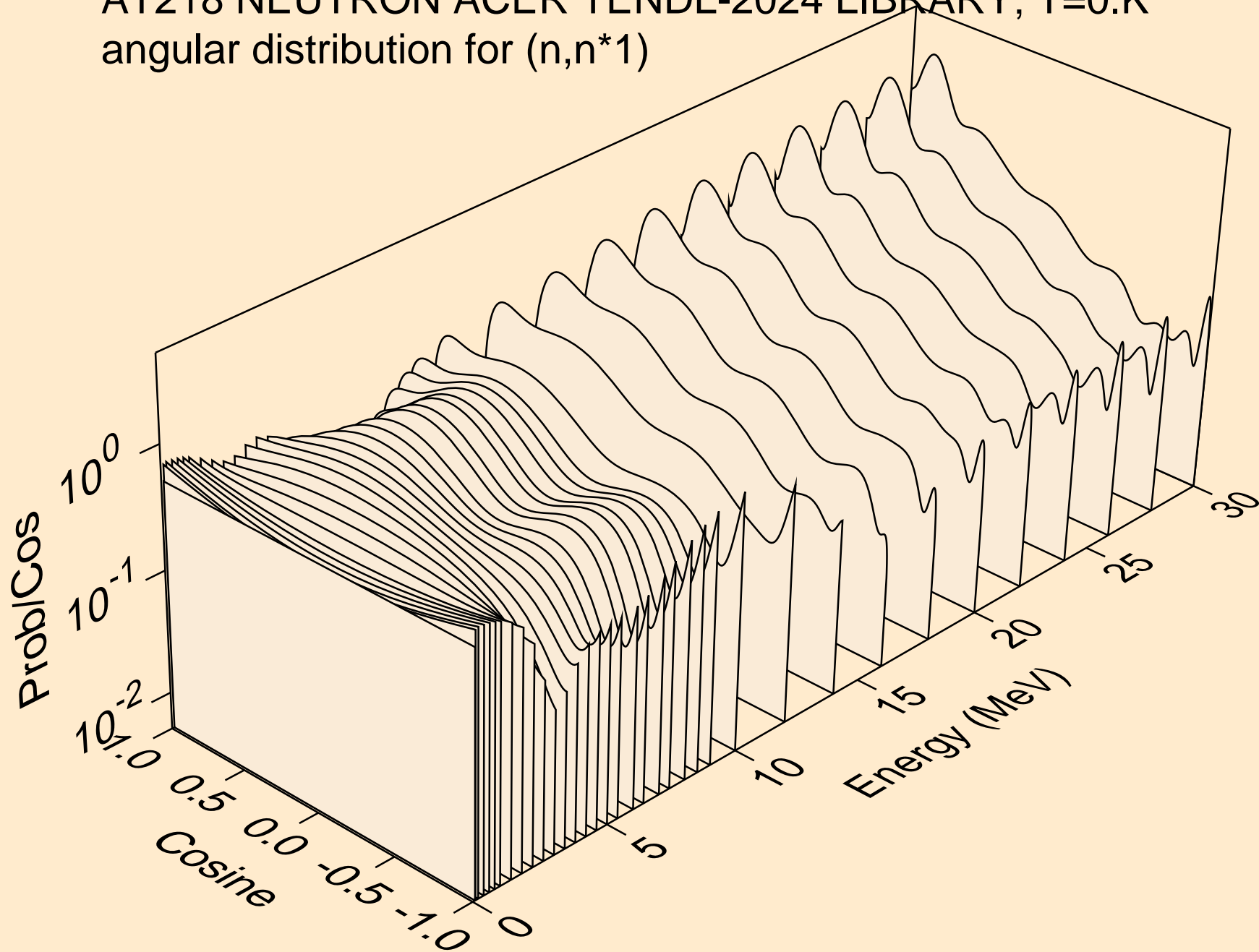

AT218 NEUTRON ACER TENDL-2024 LIBRARY; T=0.K
angular distribution for (n,n*2)

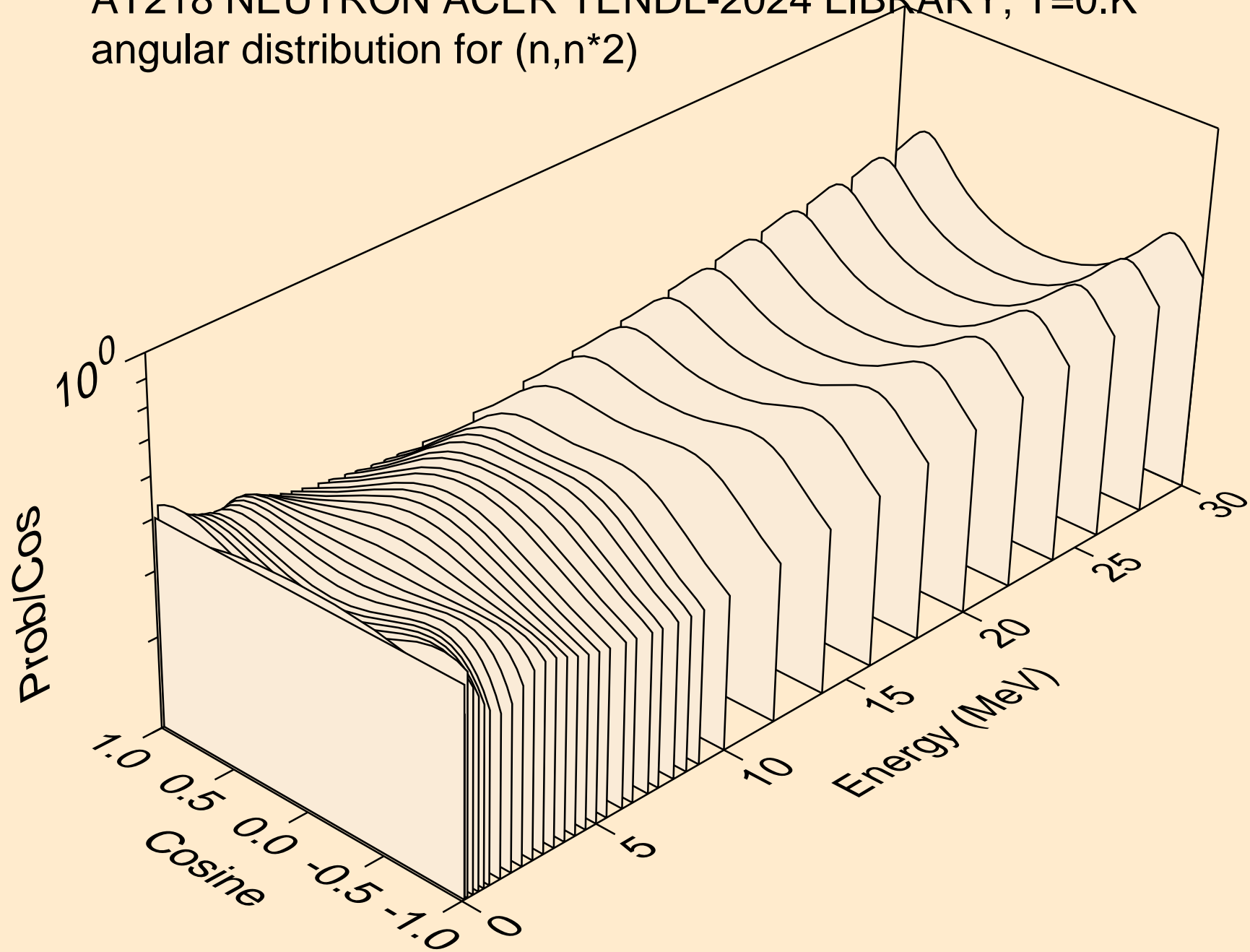

AT218 NEUTRON ACER TENDL-2024 LIBRARY; T=0.K
angular distribution for (n,n*3)

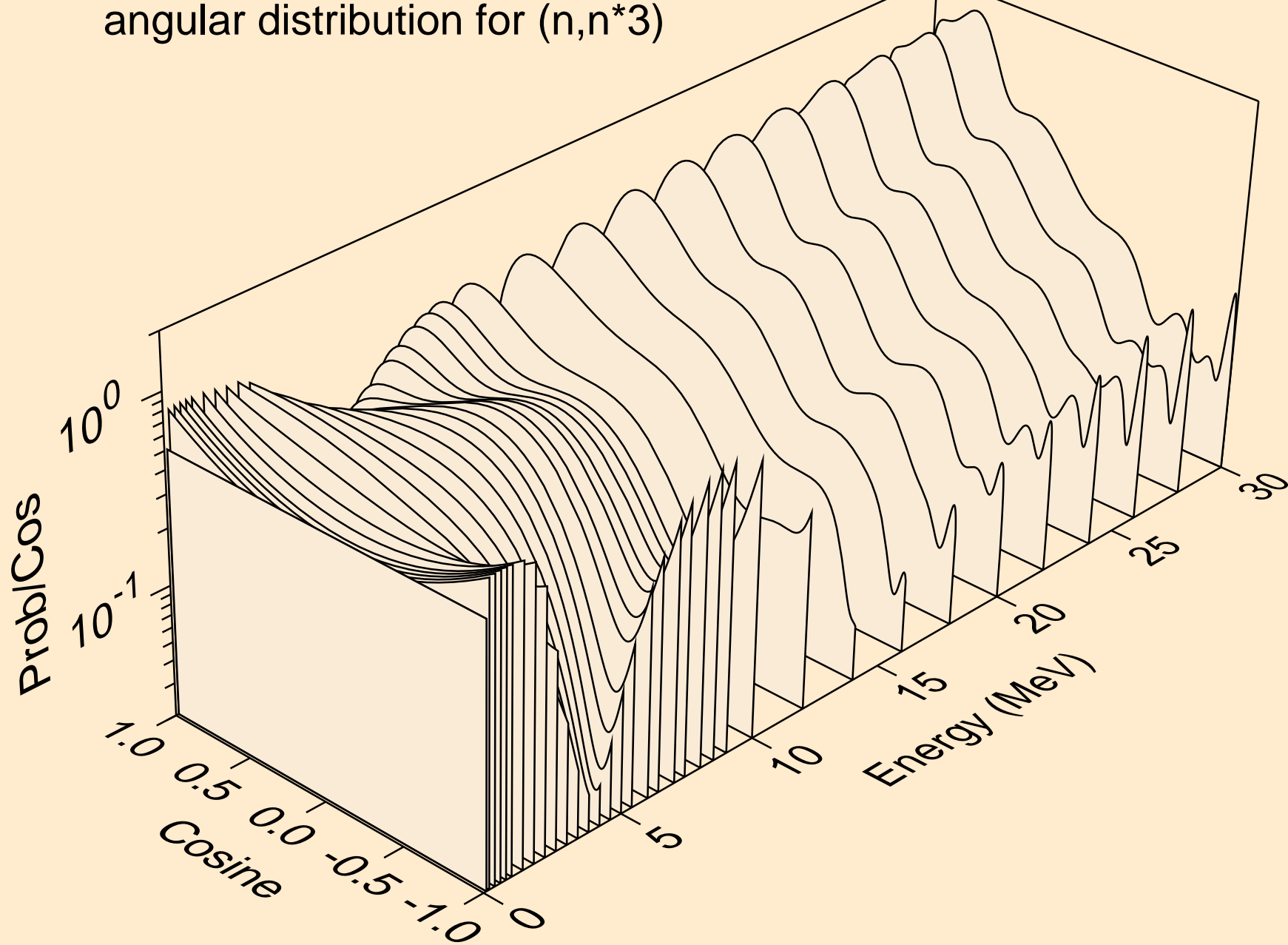

AT218 NEUTRON ACER TENDL-2024 LIBRARY; T=0.K
angular distribution for (n,n*4)

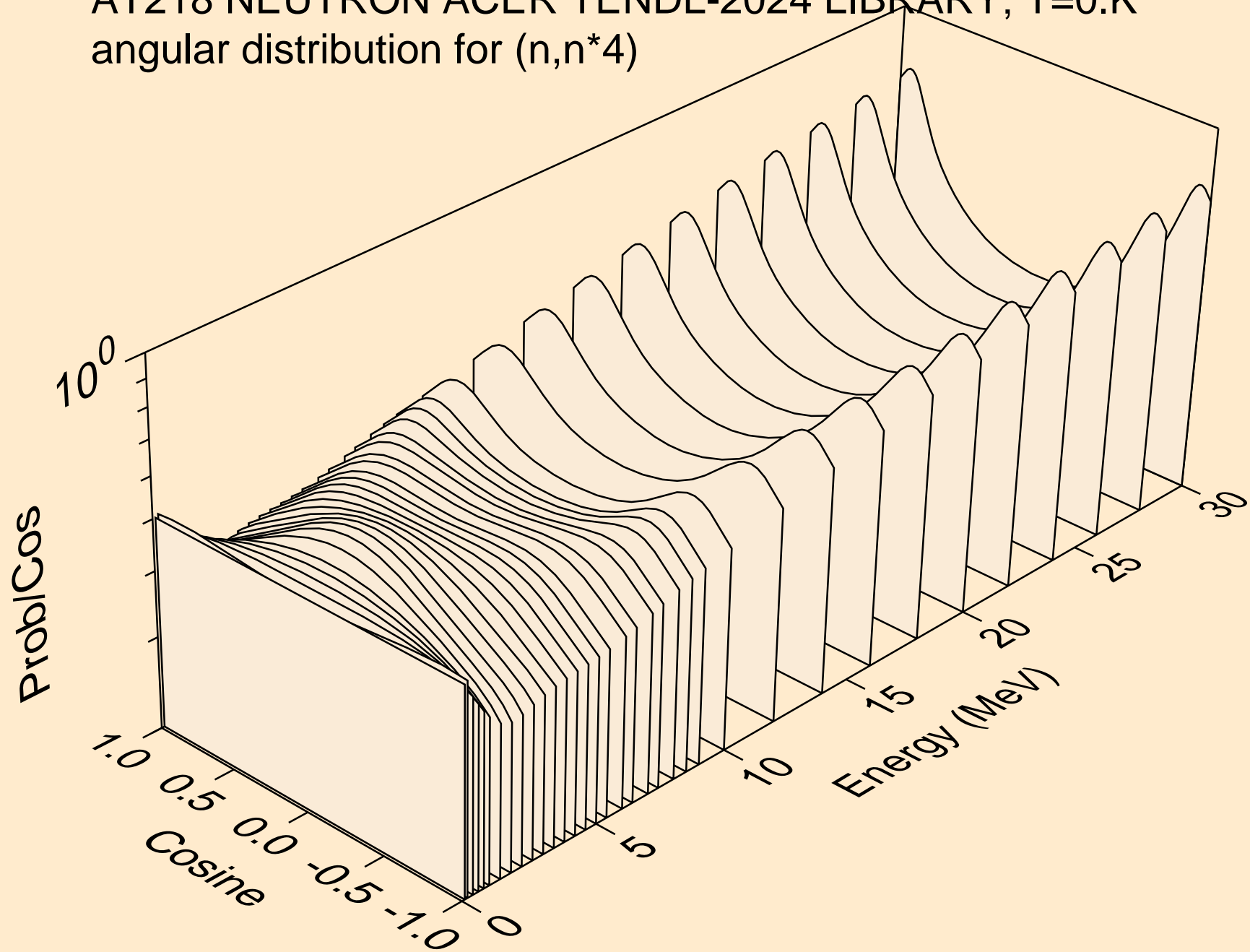

AT218 NEUTRON ACER TENDL-2024 LIBRARY; T=0.K
angular distribution for (n,n*5)

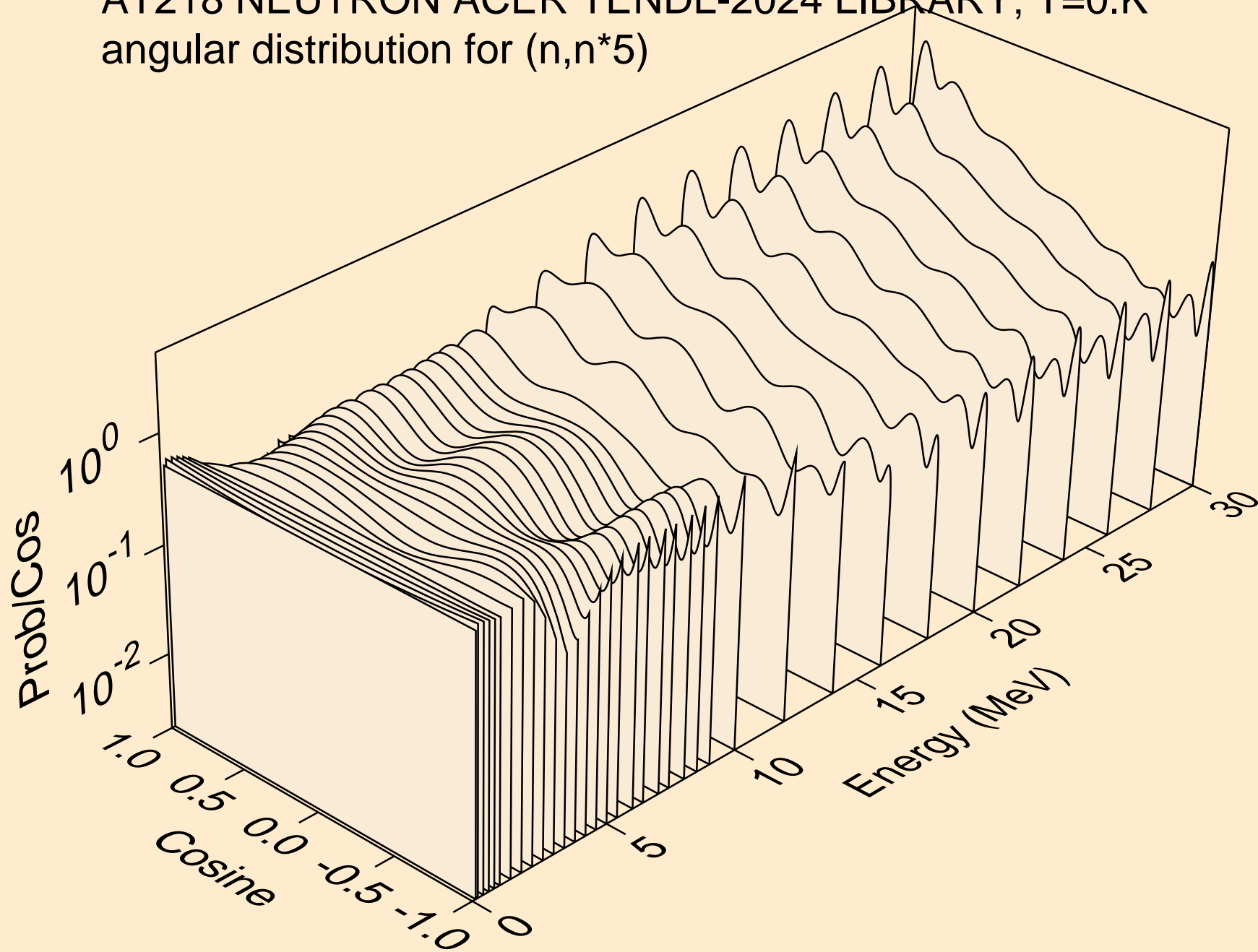

AT218 NEUTRON ACER TENDL-2024 LIBRARY; T=0.K
angular distribution for (n,n*6)

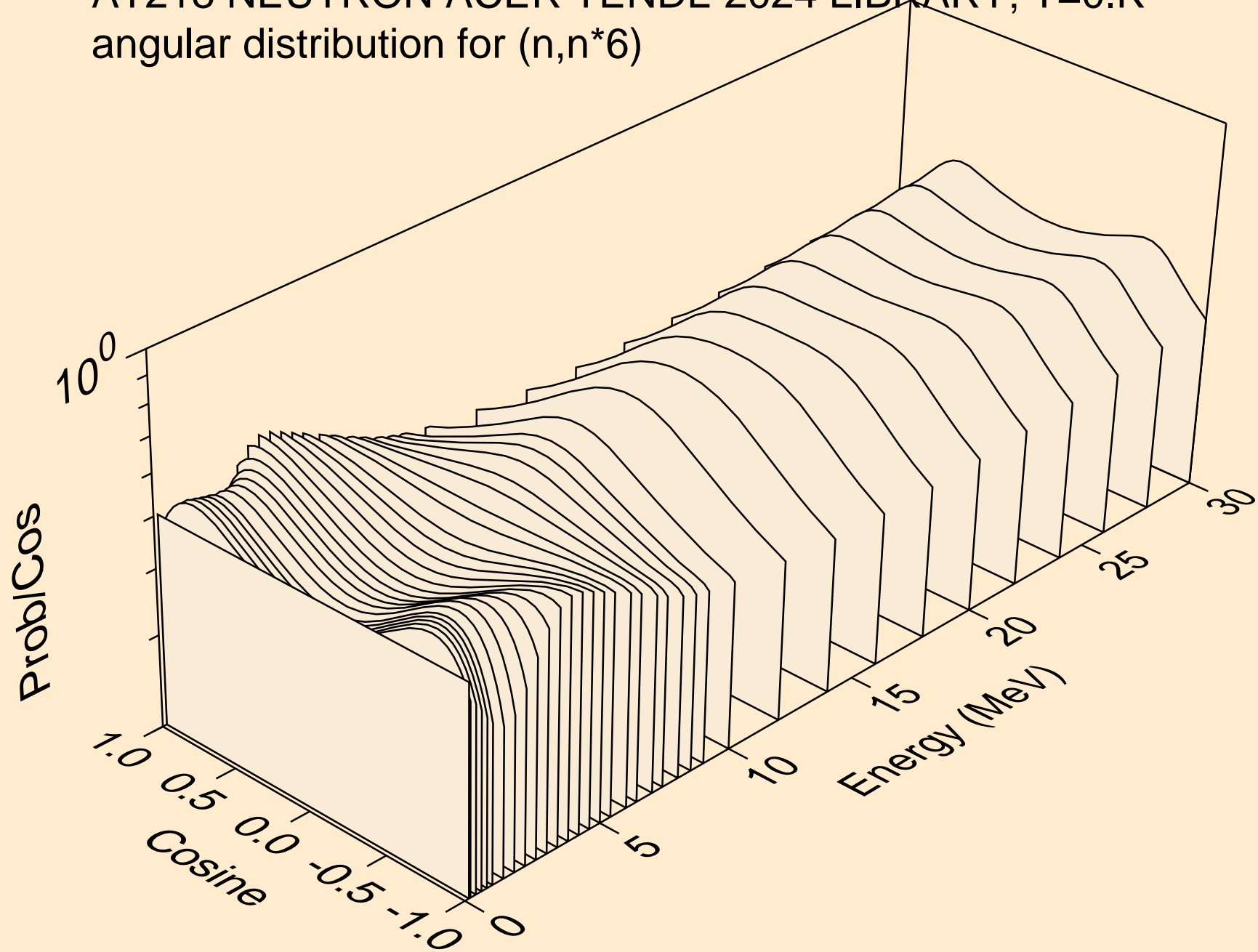

AT218 NEUTRON ACER TENDL-2024 LIBRARY; T=0.K
angular distribution for (n,n*7)

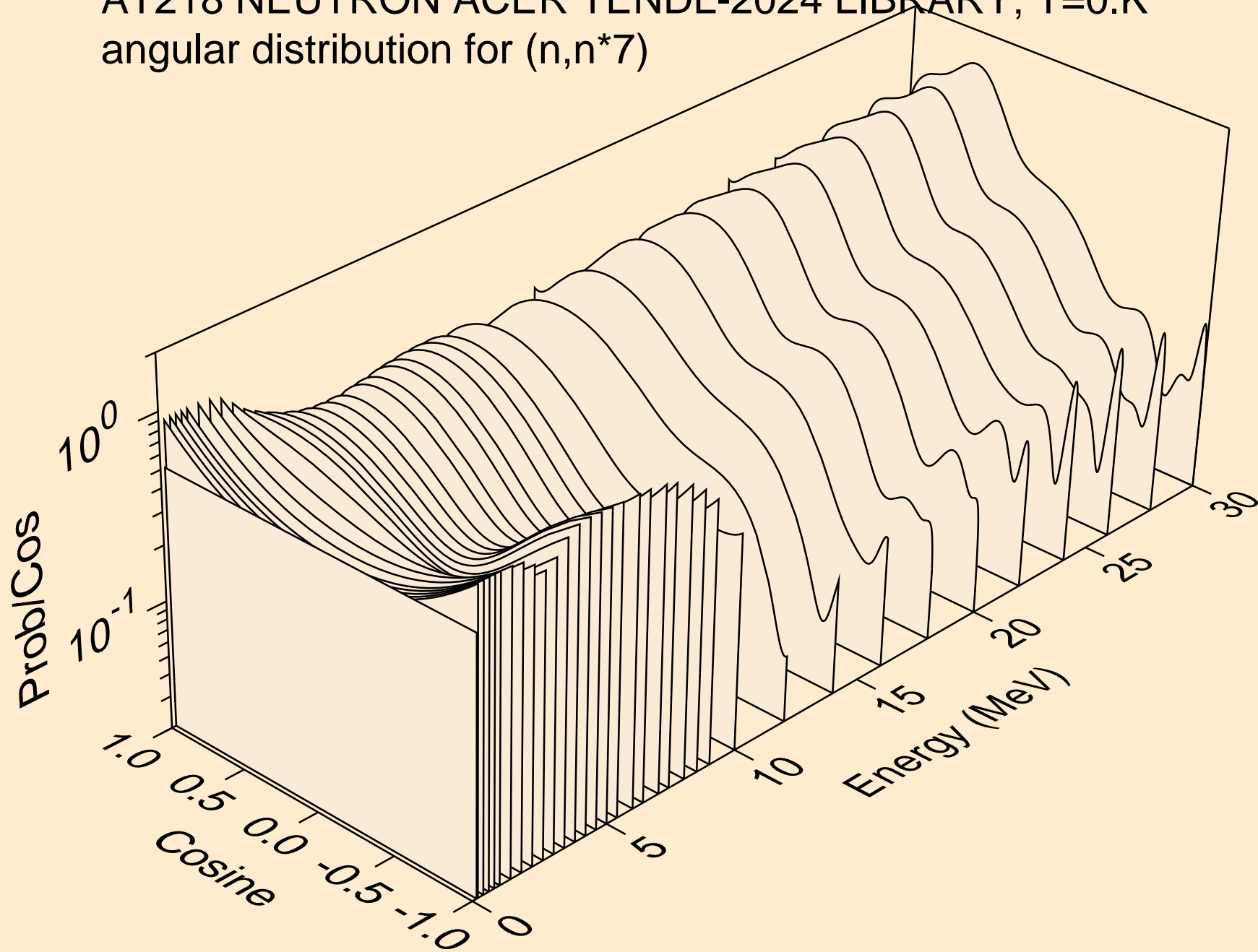

AT218 NEUTRON ACER TENDL-2024 LIBRARY; T=0.K
angular distribution for (n,n*8)

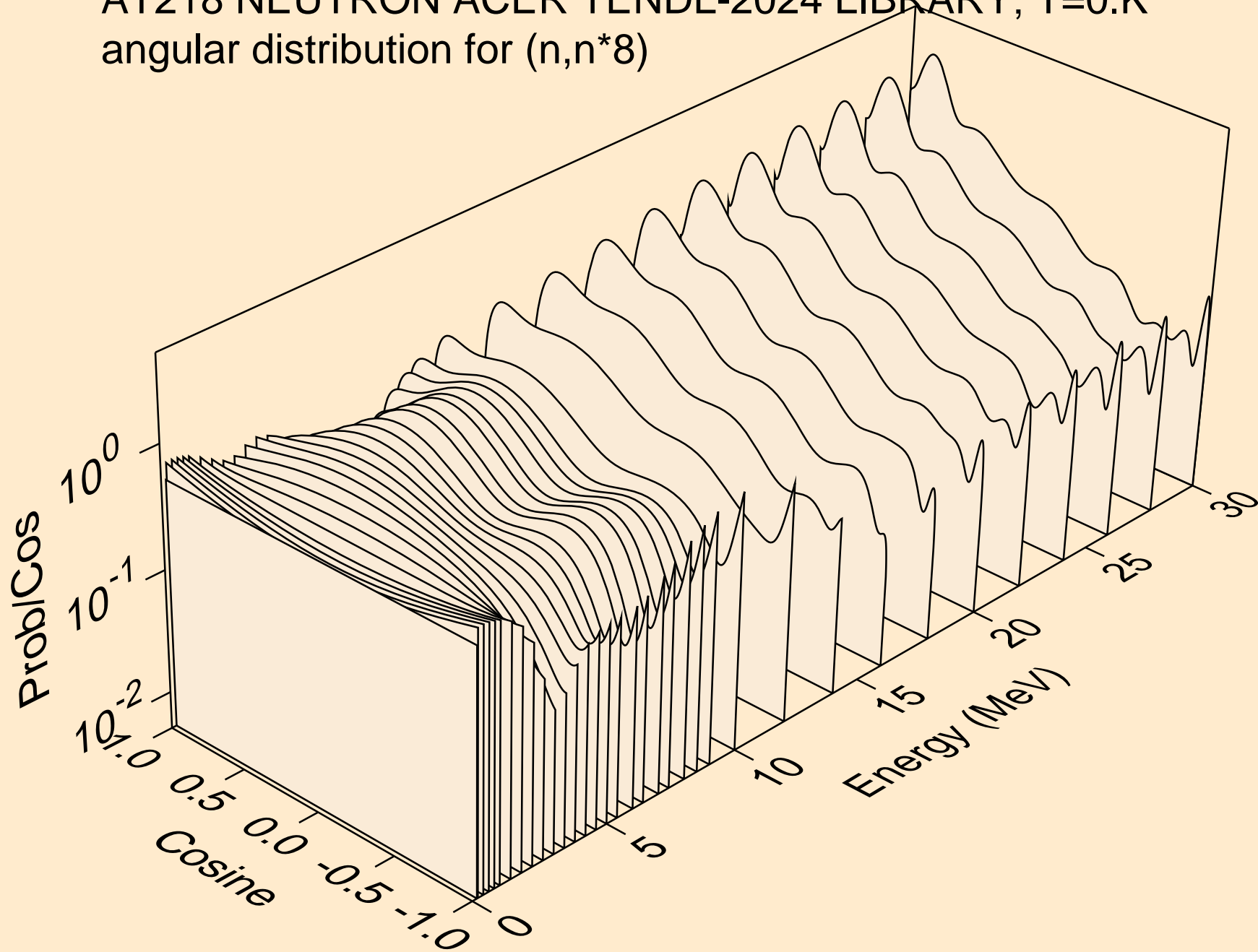

AT218 NEUTRON ACER TENDL-2024 LIBRARY; T=0.K
angular distribution for (n,n*9)

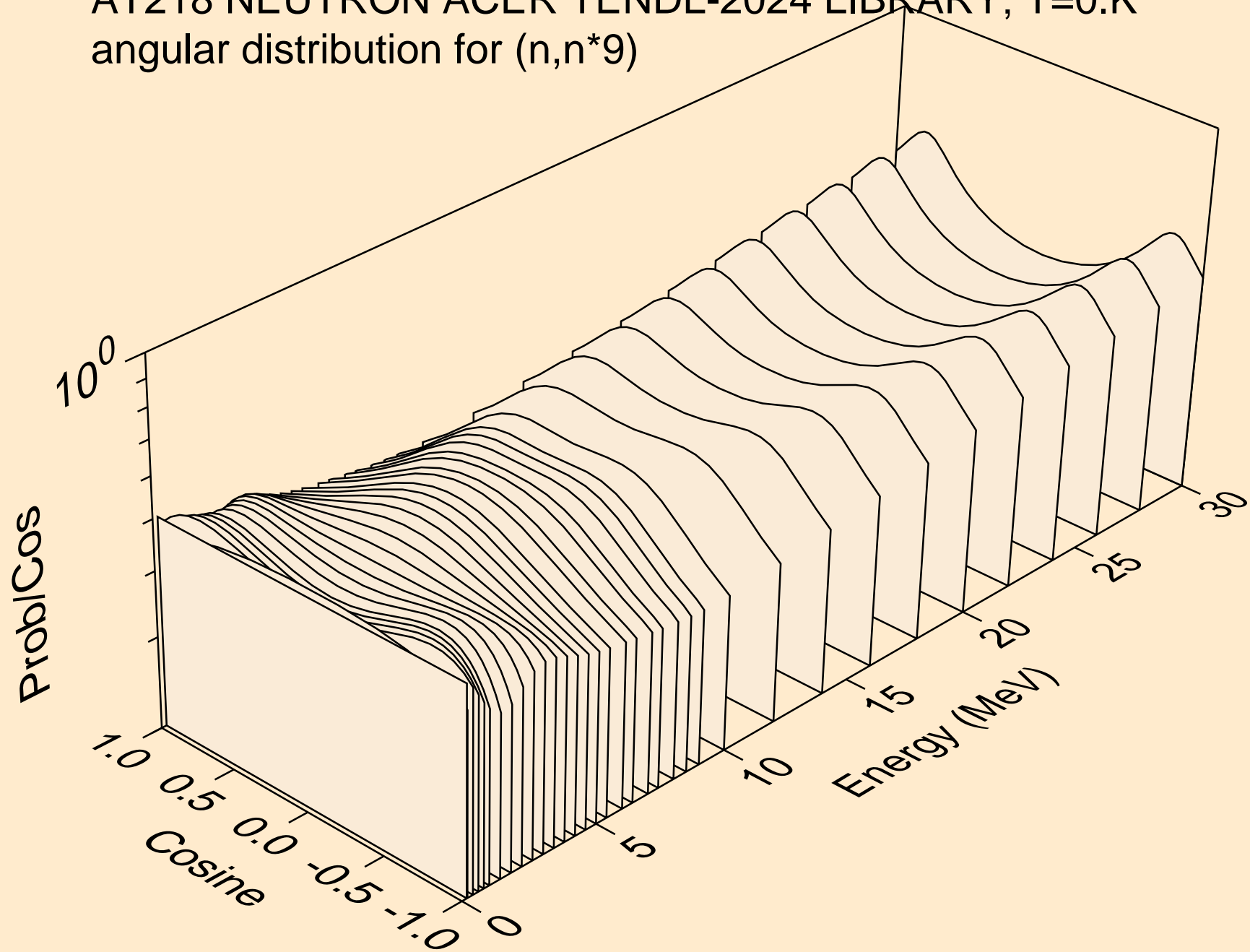

AT218 NEUTRON ACER TENDL-2024 LIBRARY; T=0.K
angular distribution for (n,n*10)

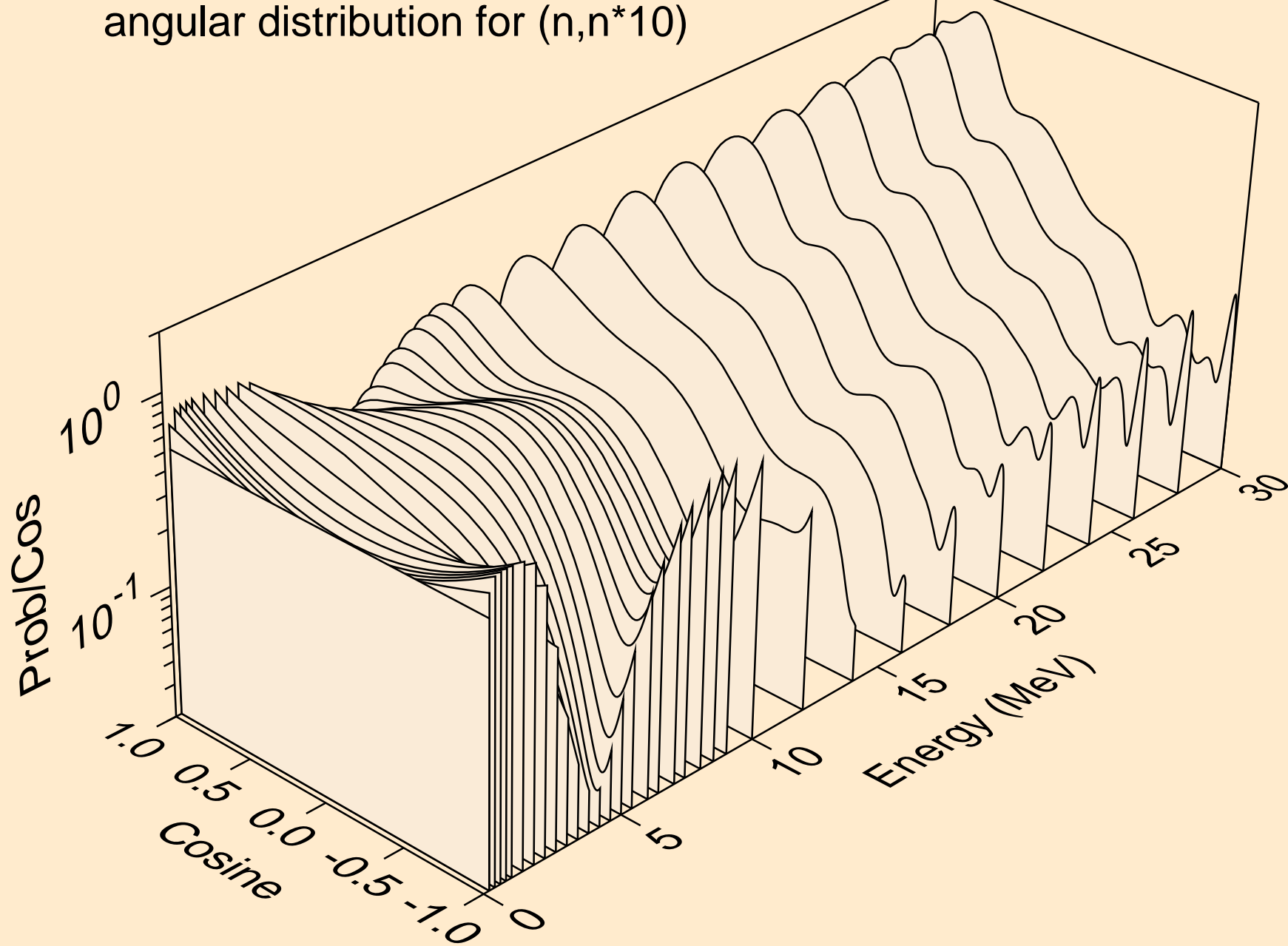

AT218 NEUTRON ACER TENDL-2024 LIBRARY; T=0.K
angular distribution for (n,n*11)

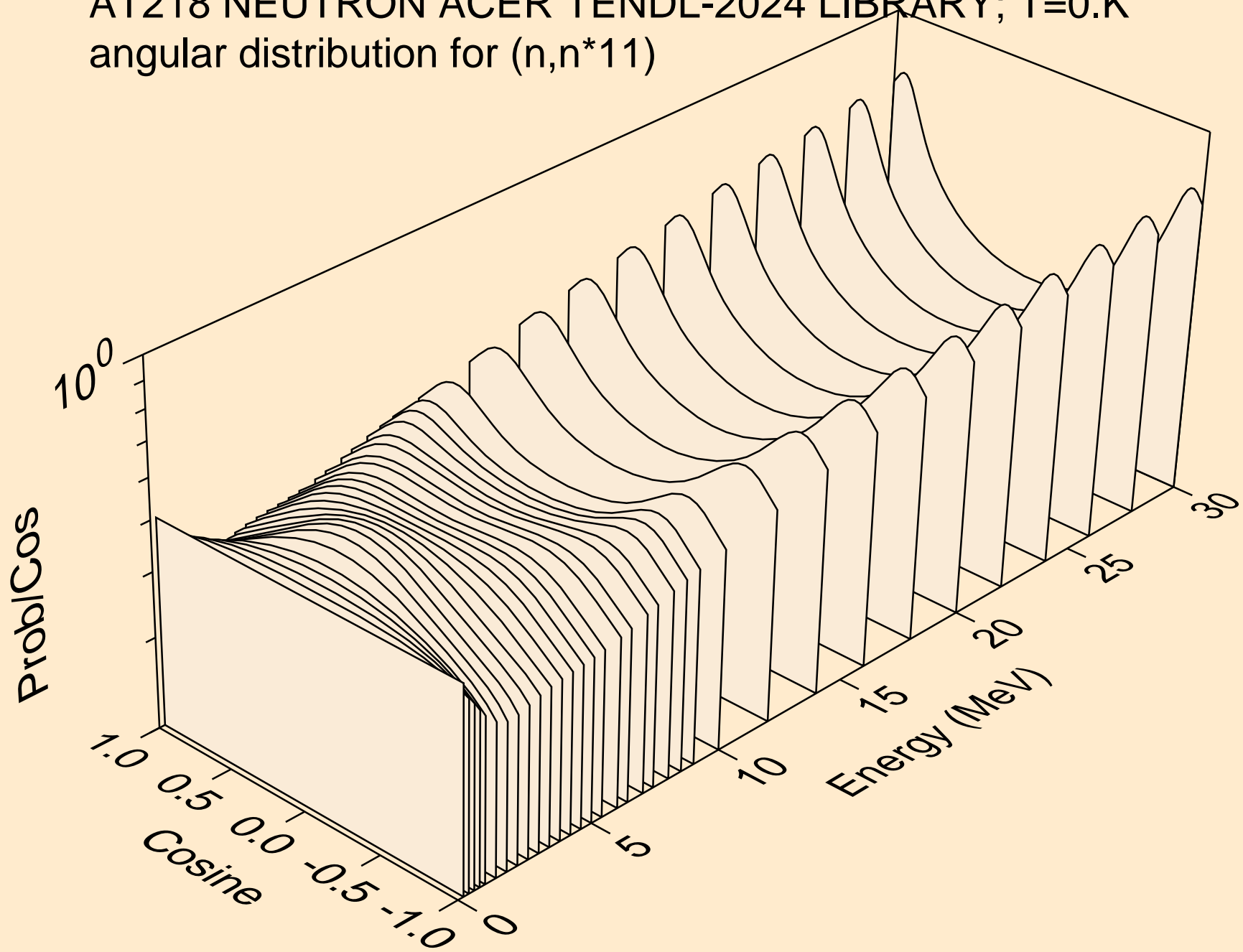

AT218 NEUTRON ACER TENDL-2024 LIBRARY; T=0.K
angular distribution for (n,n*12)

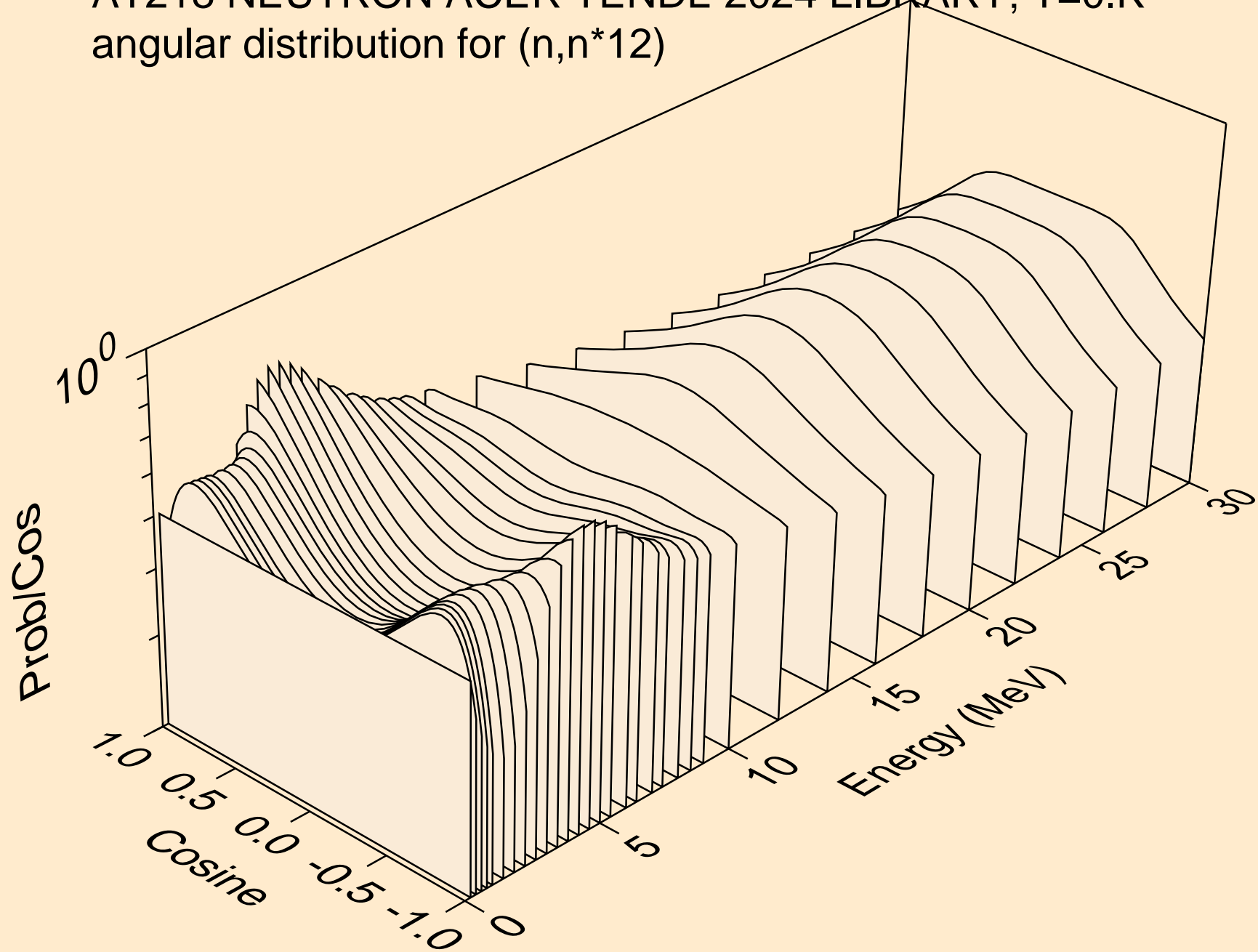

AT218 NEUTRON ACER TENDL-2024 LIBRARY; T=0.K
angular distribution for (n,n*13)

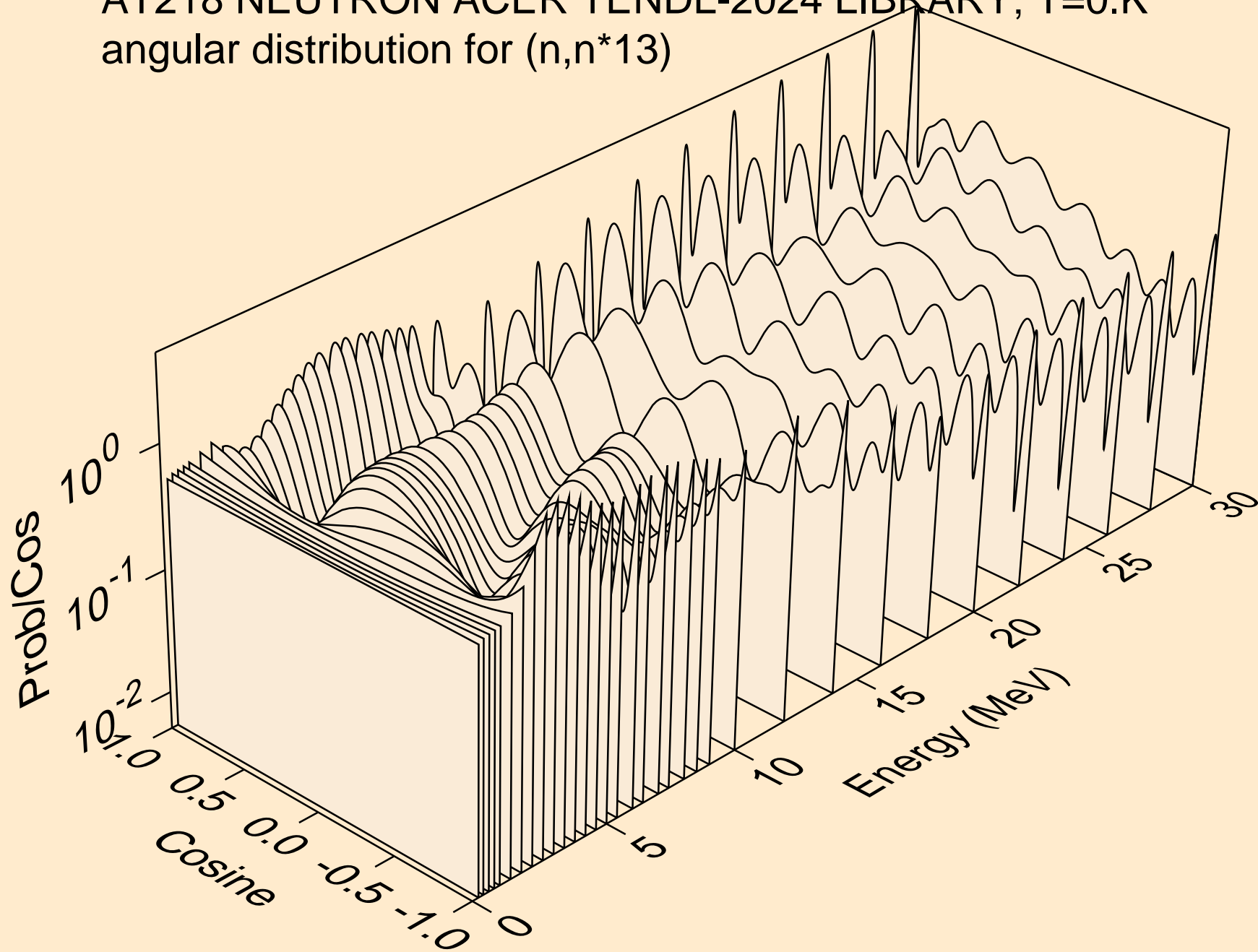

AT218 NEUTRON ACER TENDL-2024 LIBRARY; T=0.K
angular distribution for (n,n*14)

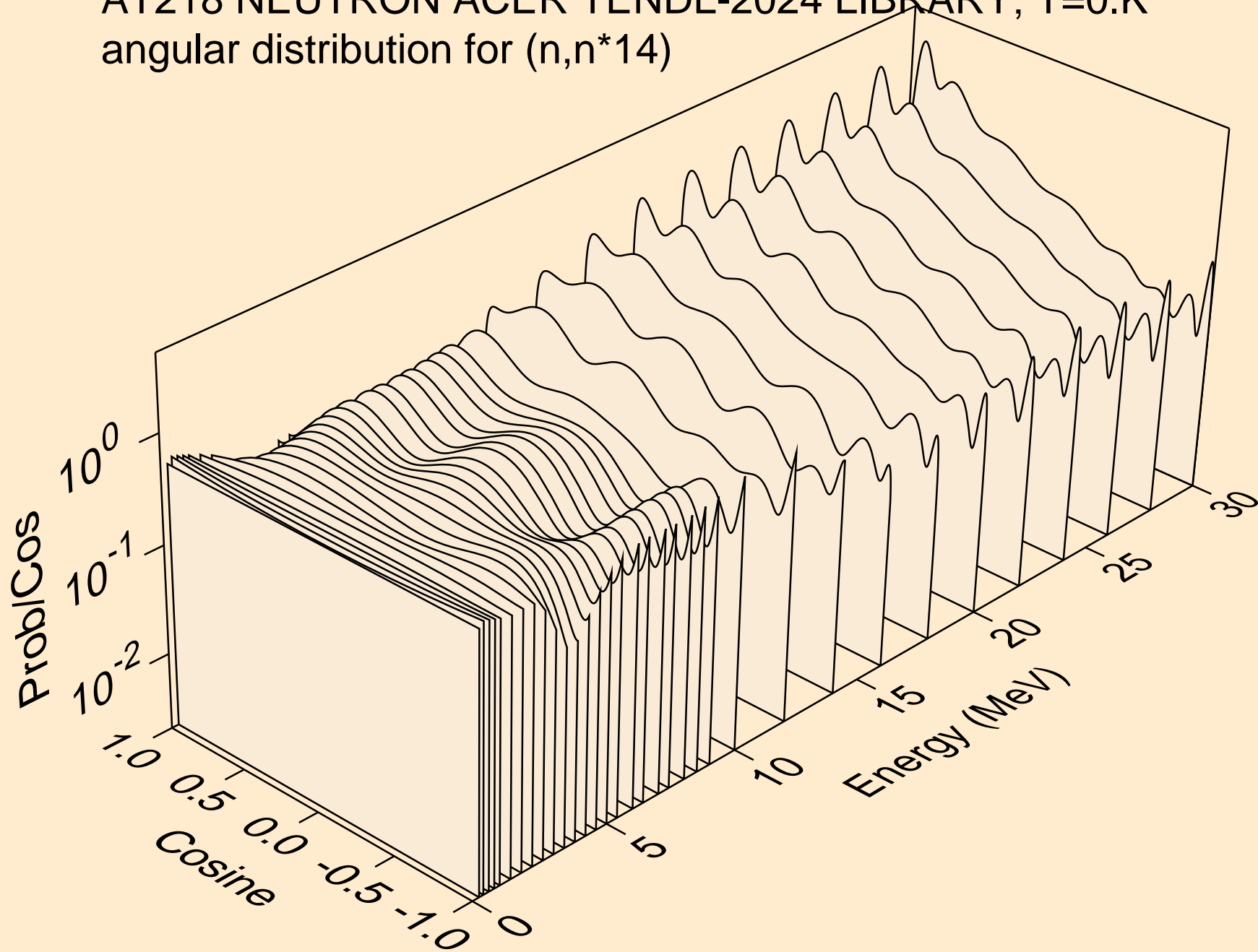

AT218 NEUTRON ACER TENDL-2024 LIBRARY; T=0.K
angular distribution for (n,n*15)

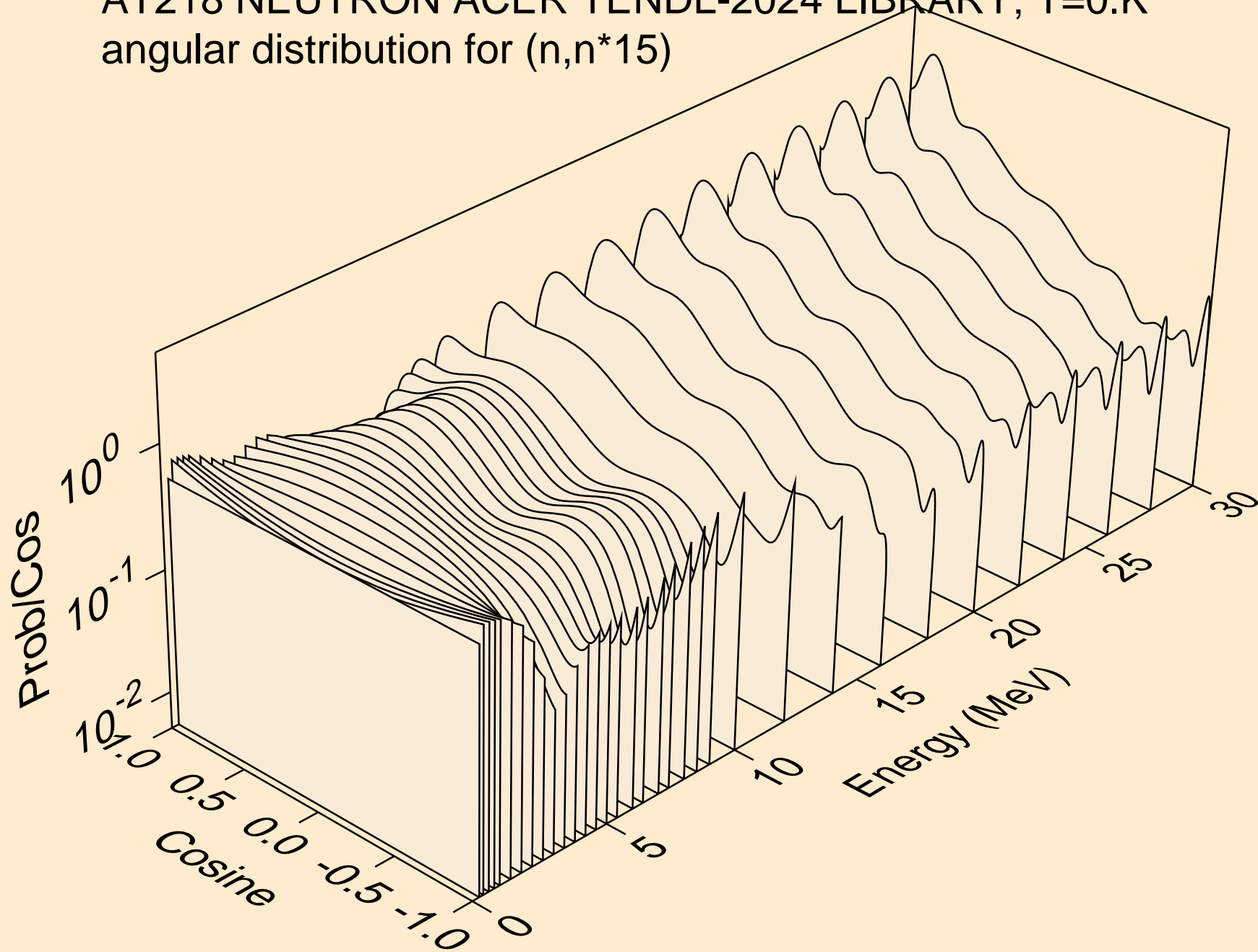

AT218 NEUTRON ACER TENDL-2024 LIBRARY; T=0.K
angular distribution for (n,n*16)

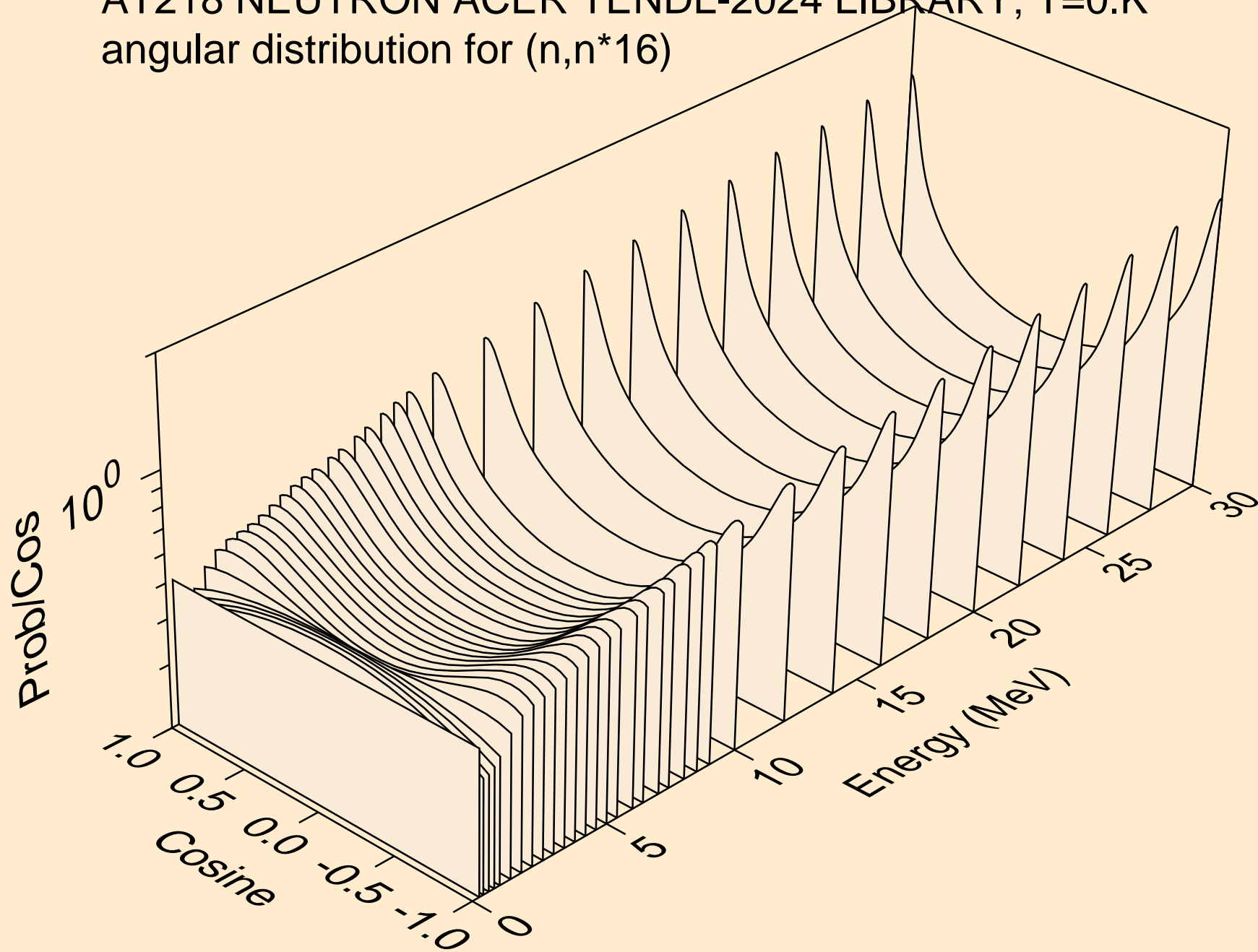

AT218 NEUTRON ACER TENDL-2024 LIBRARY; T=0.K
angular distribution for (n,n*17)

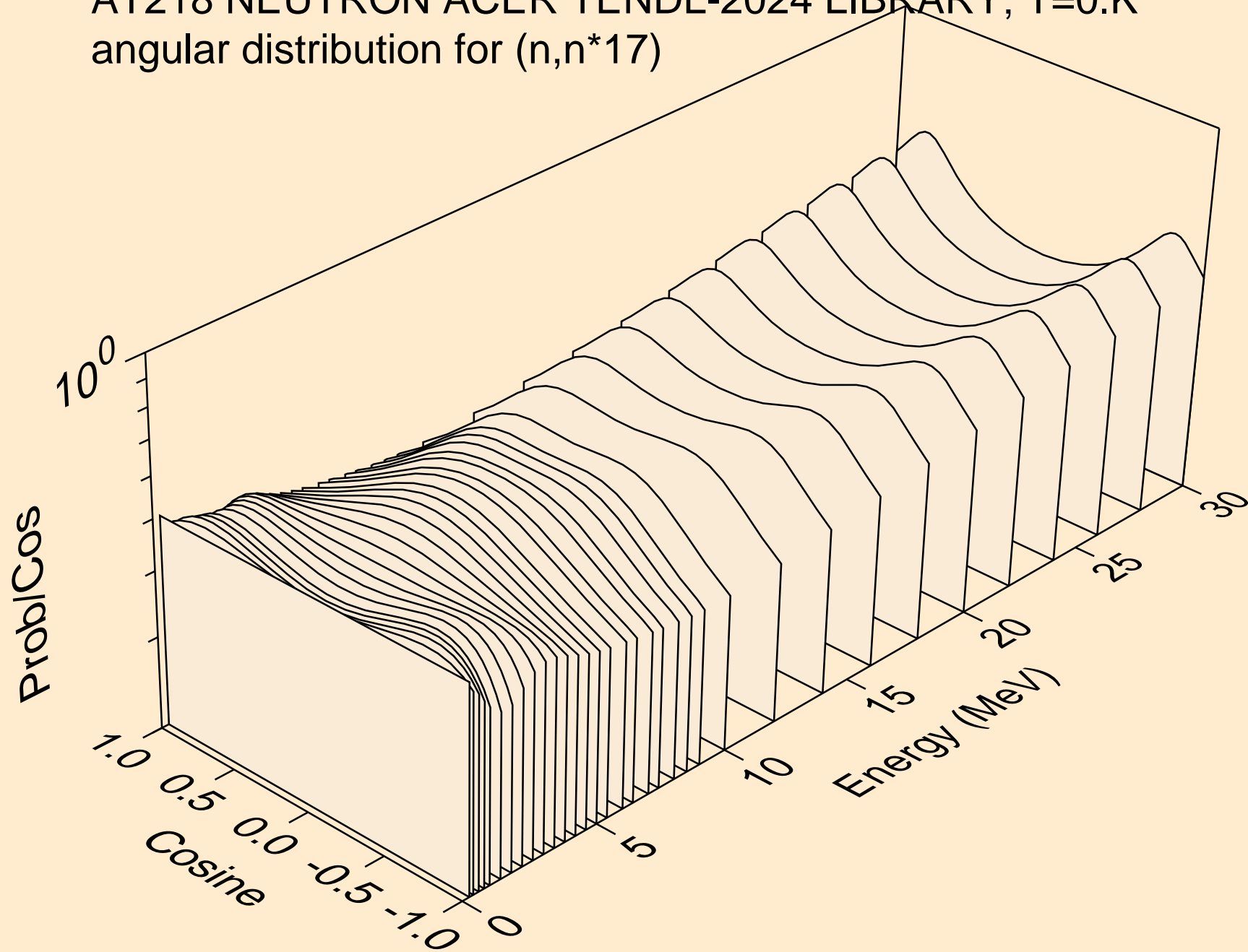

AT218 NEUTRON ACER TENDL-2024 LIBRARY; T=0.K
angular distribution for (n,n*18)

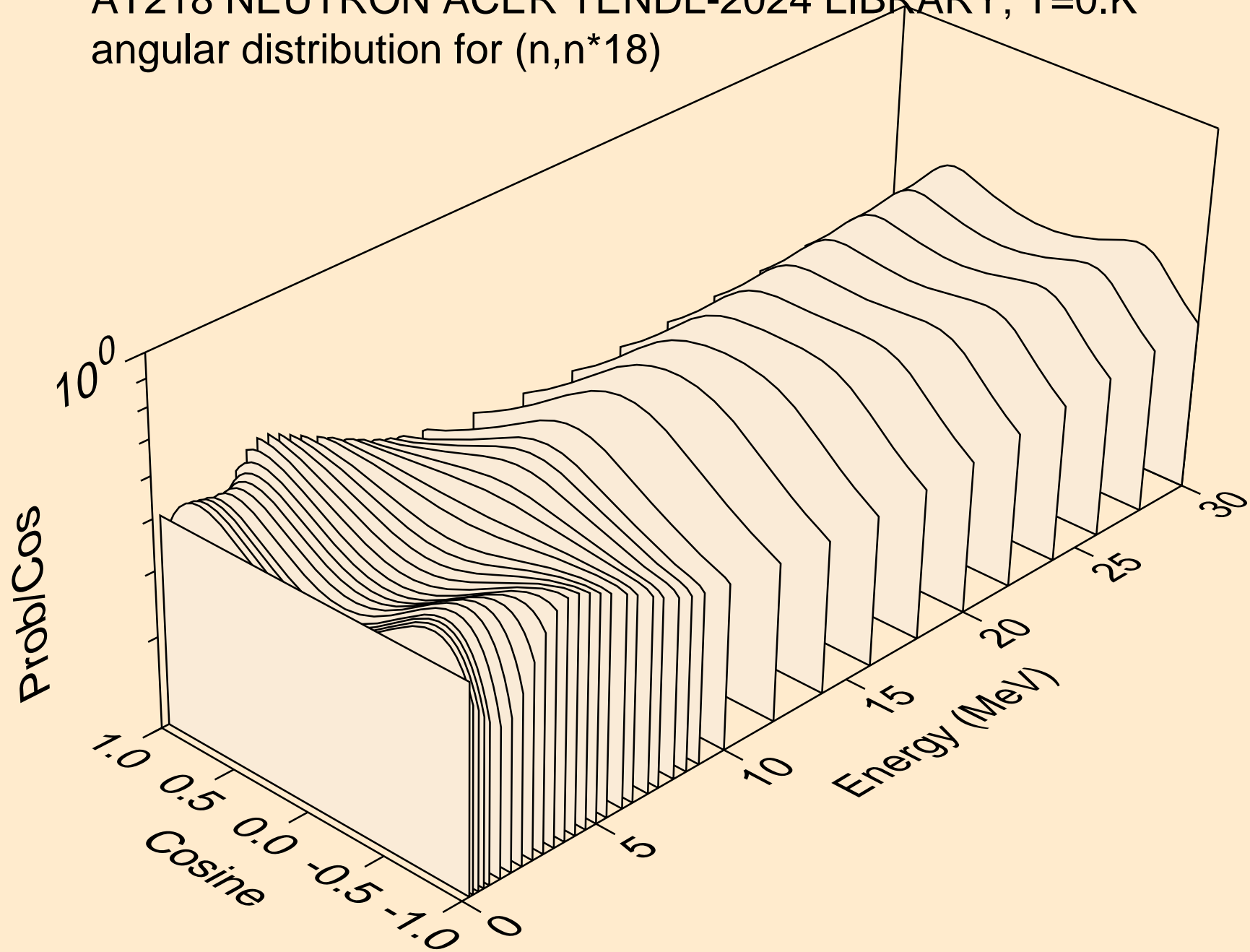

AT218 NEUTRON ACER TENDL-2024 LIBRARY; T=0.K
angular distribution for (n,n*19)

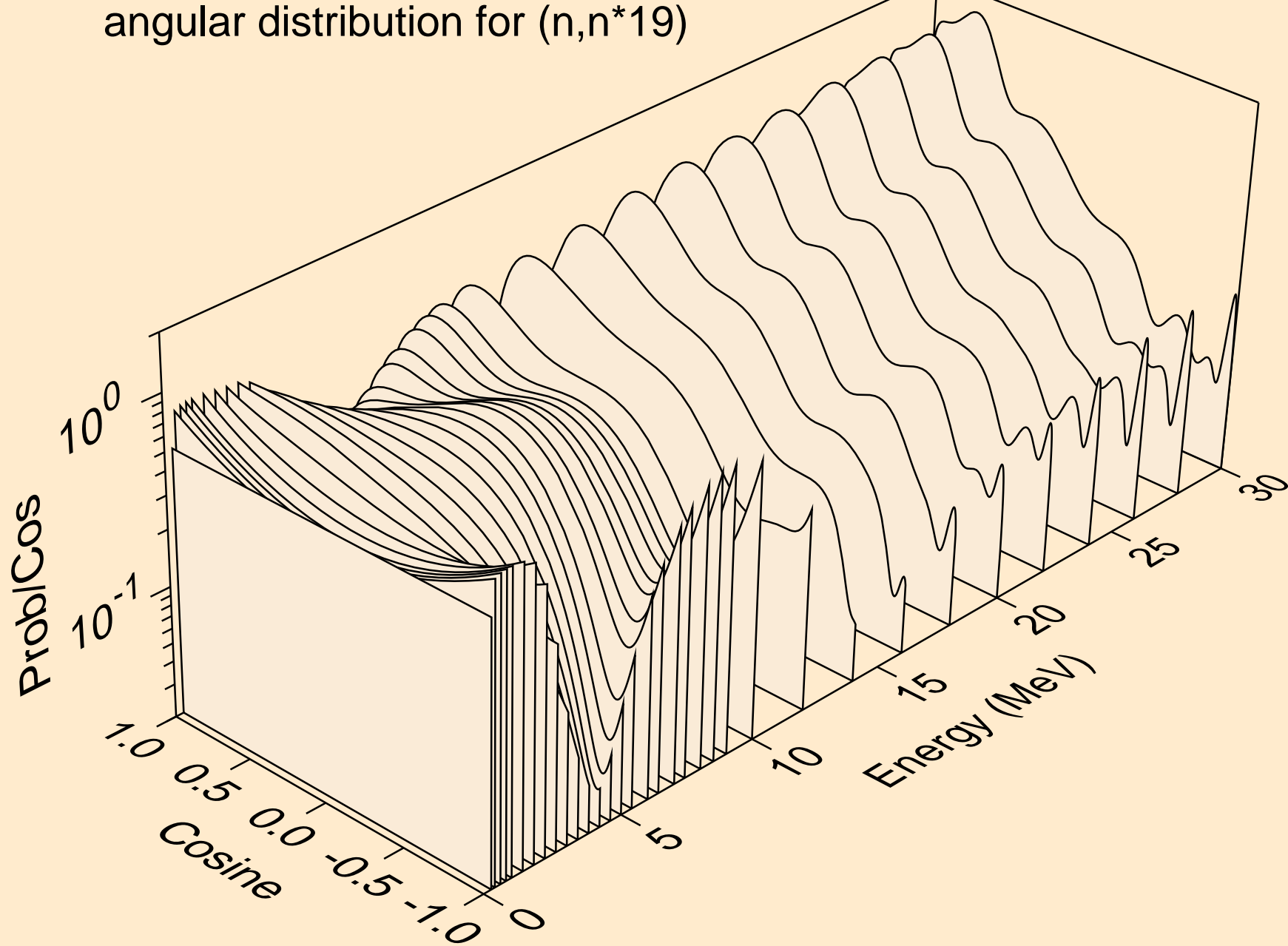

AT218 NEUTRON ACER TENDL-2024 LIBRARY; T=0.K
angular distribution for (n,n*20)

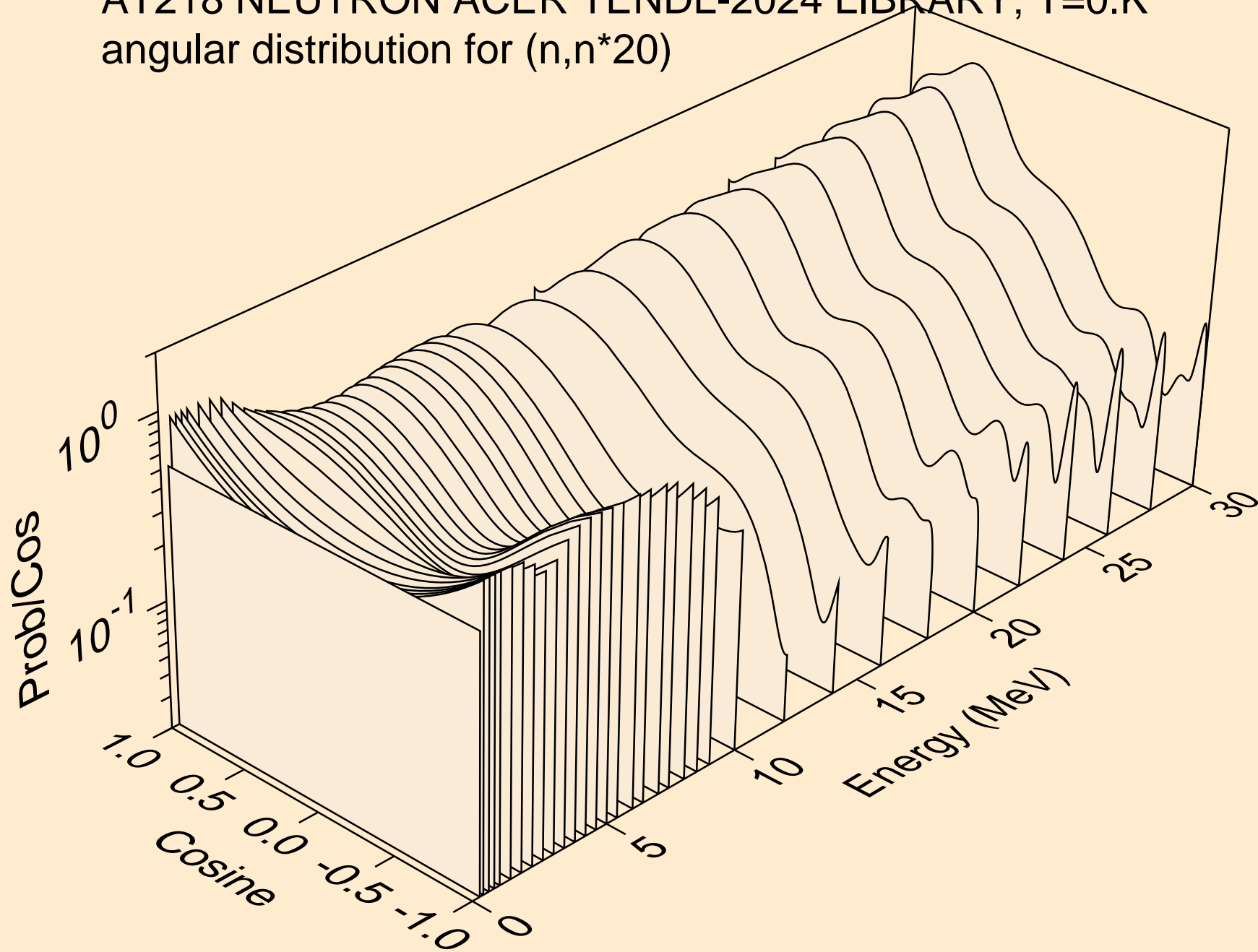

AT218 NEUTRON ACER TENDL-2024 LIBRARY; T=0.K
angular distribution for (n,n*21)

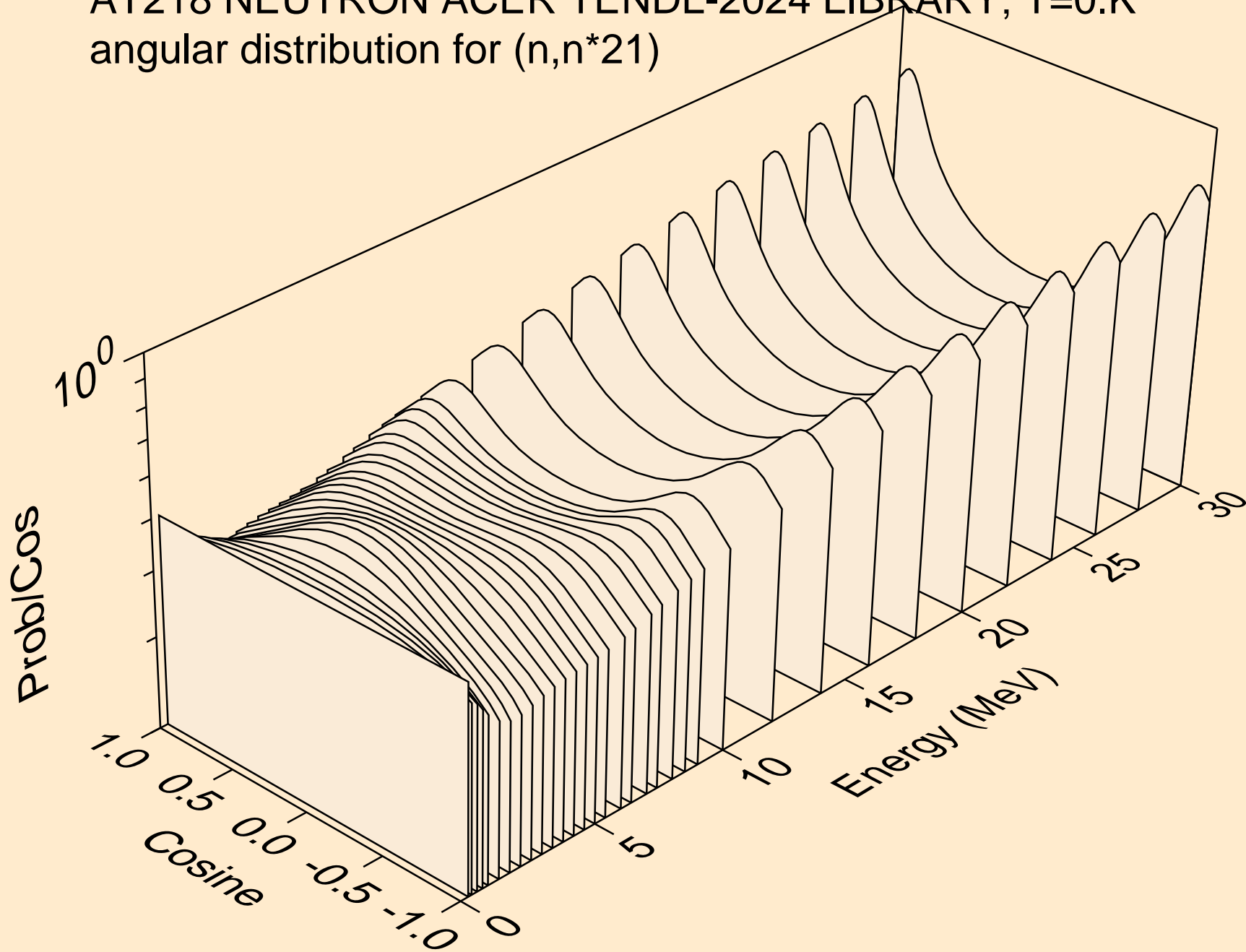

AT218 NEUTRON ACER TENDL-2024 LIBRARY; T=0.K
angular distribution for (n,n*22)

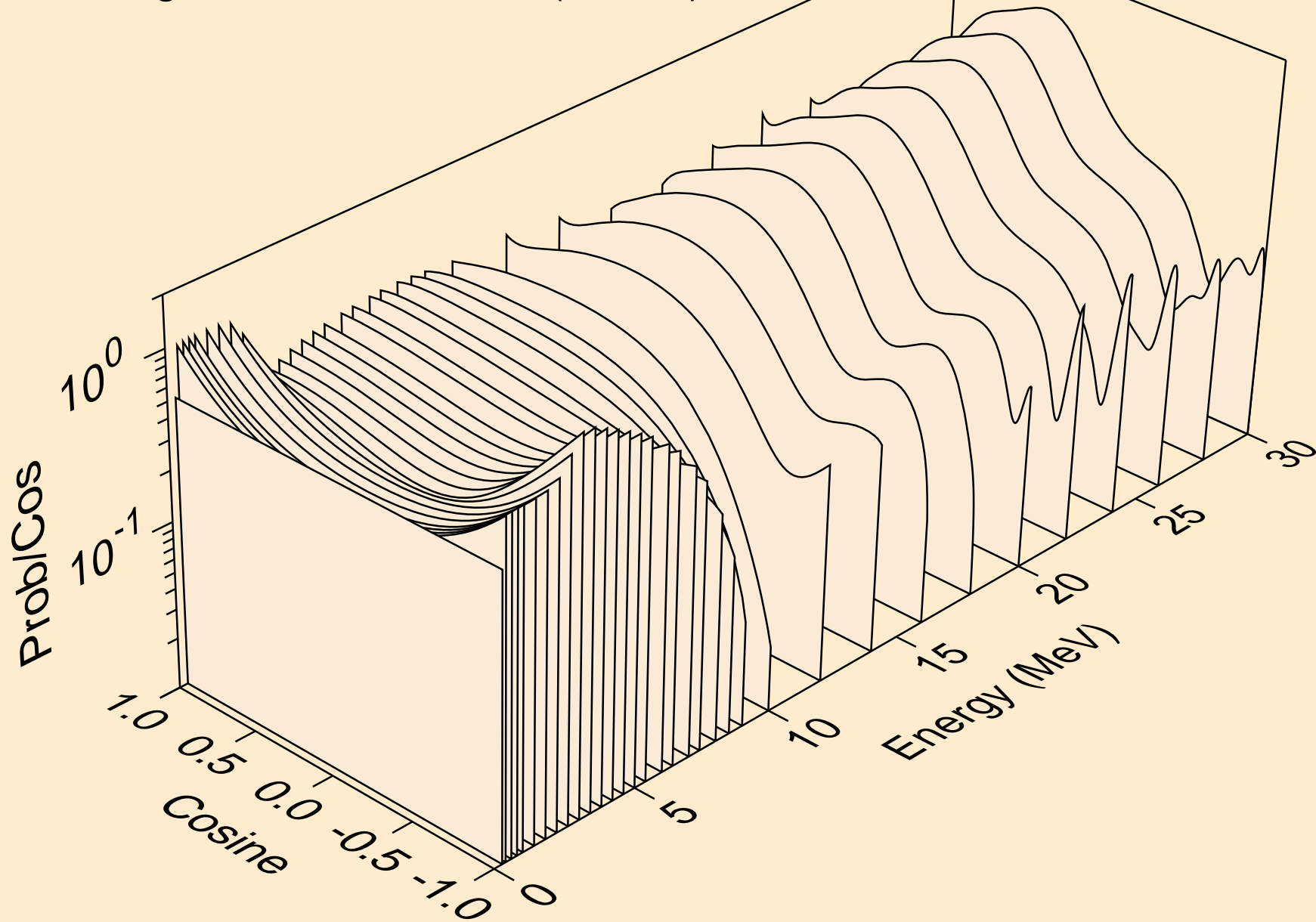

AT218 NEUTRON ACER TENDL-2024 LIBRARY; T=0.K
angular distribution for (n,n*23)

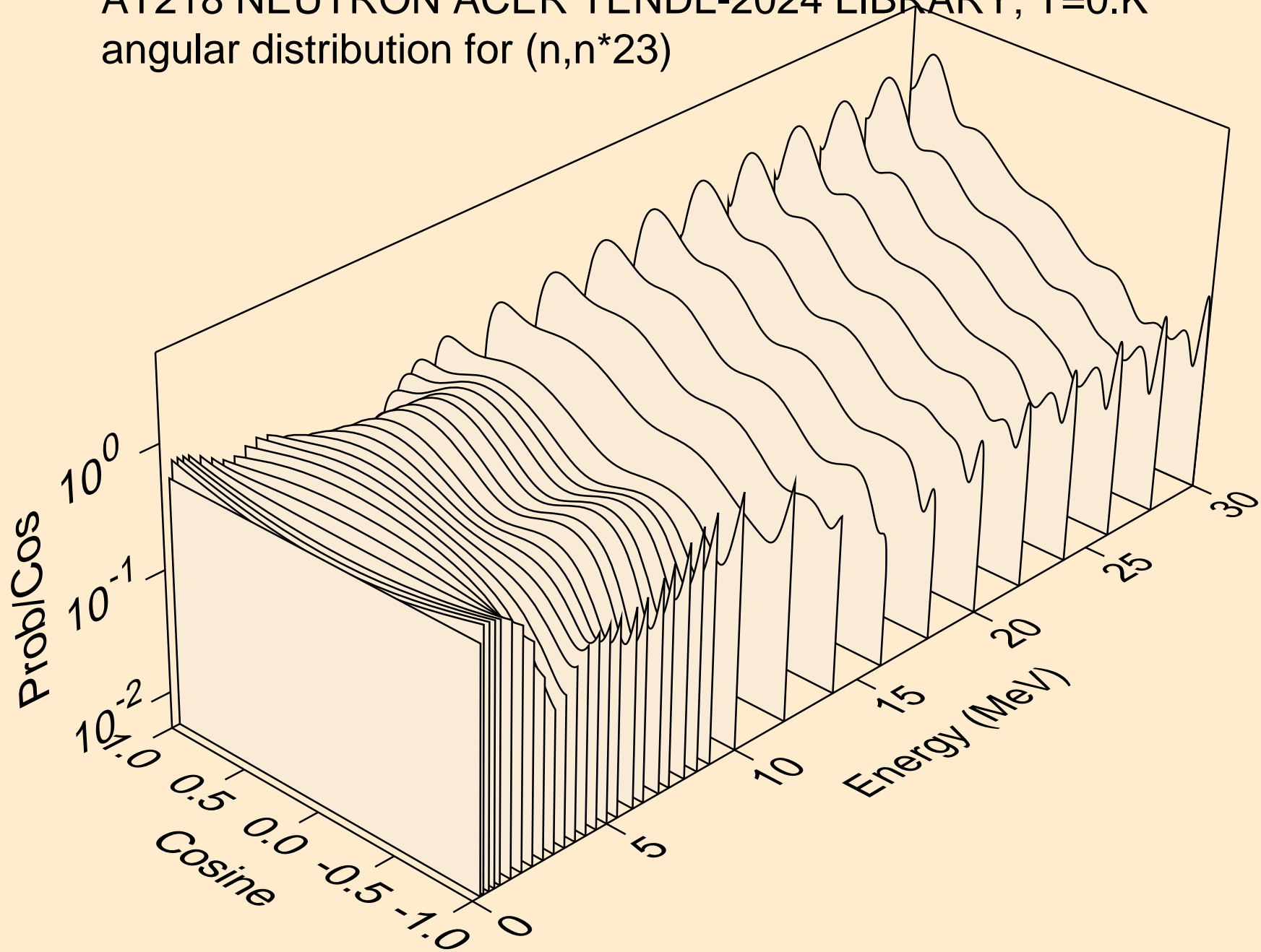

AT218 NEUTRON ACER TENDL-2024 LIBRARY; T=0.K
angular distribution for (n,n*24)

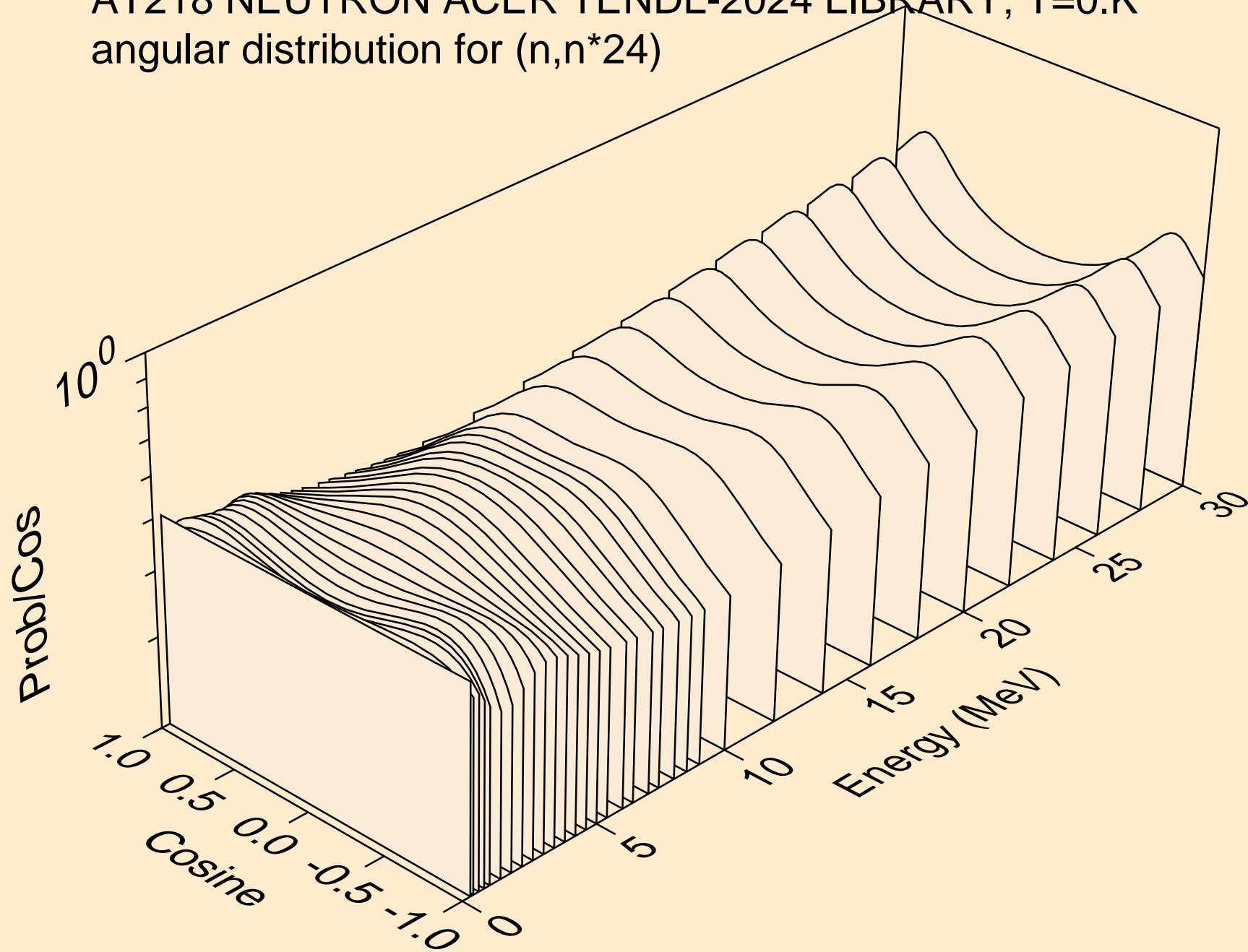

AT218 NEUTRON ACER TENDL-2024 LIBRARY; T=0.K
angular distribution for (n,n*25)

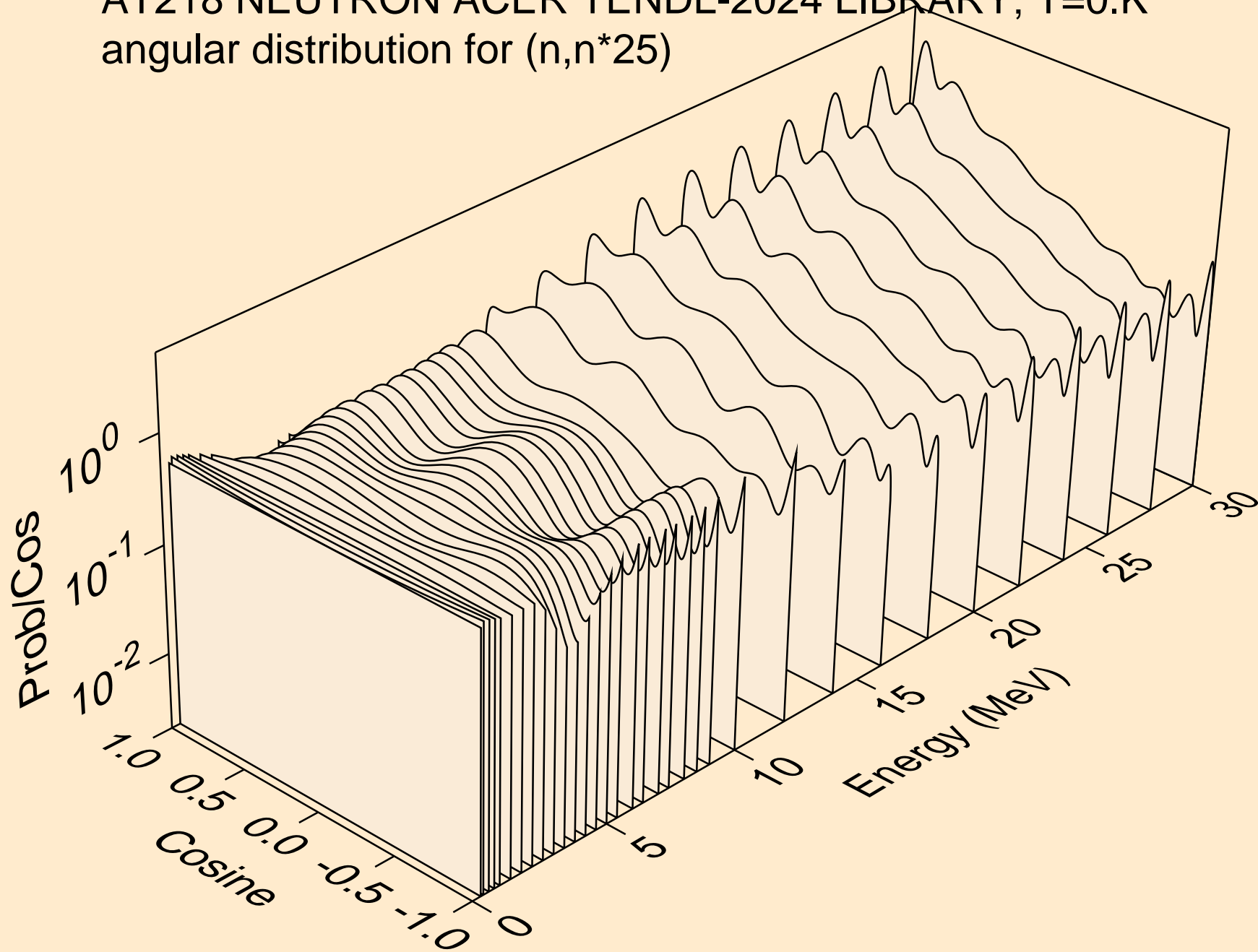

AT218 NEUTRON ACER TENDL-2024 LIBRARY; T=0.K
angular distribution for (n,n*26)

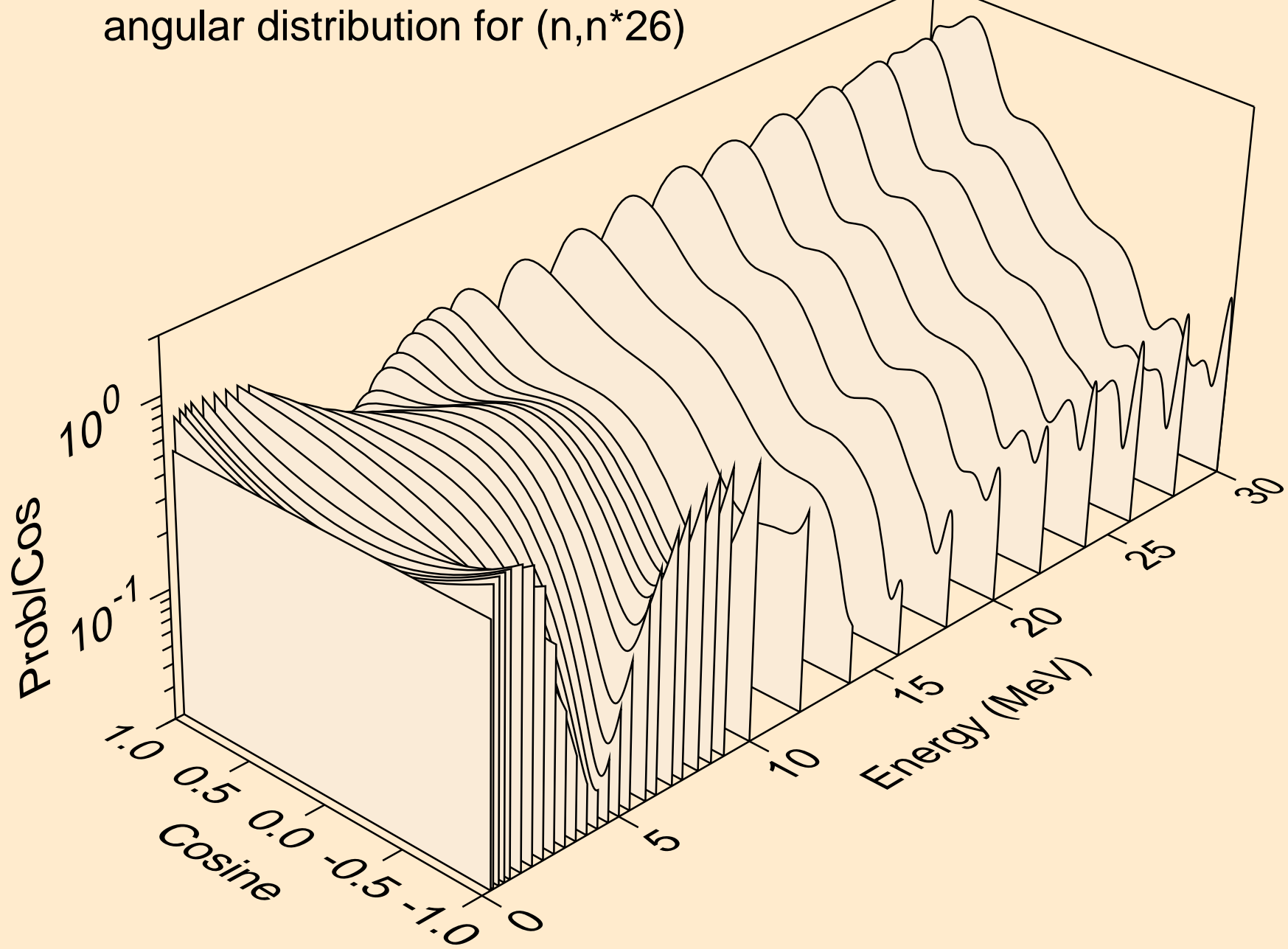

AT218 NEUTRON ACER TENDL-2024 LIBRARY; T=0.K
angular distribution for (n,n*27)

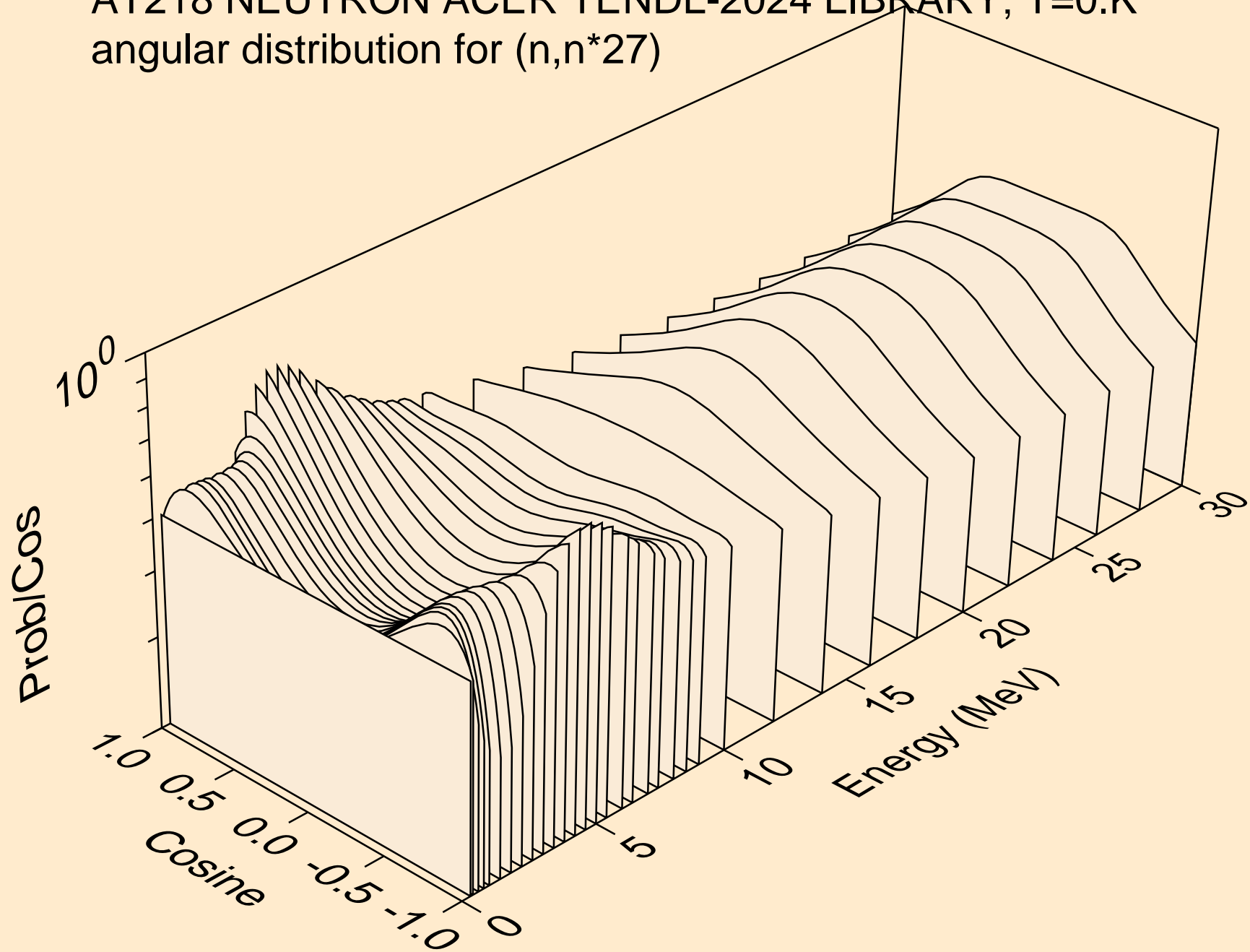

AT218 NEUTRON ACER TENDL-2024 LIBRARY; T=0.K
angular distribution for (n,n*28)

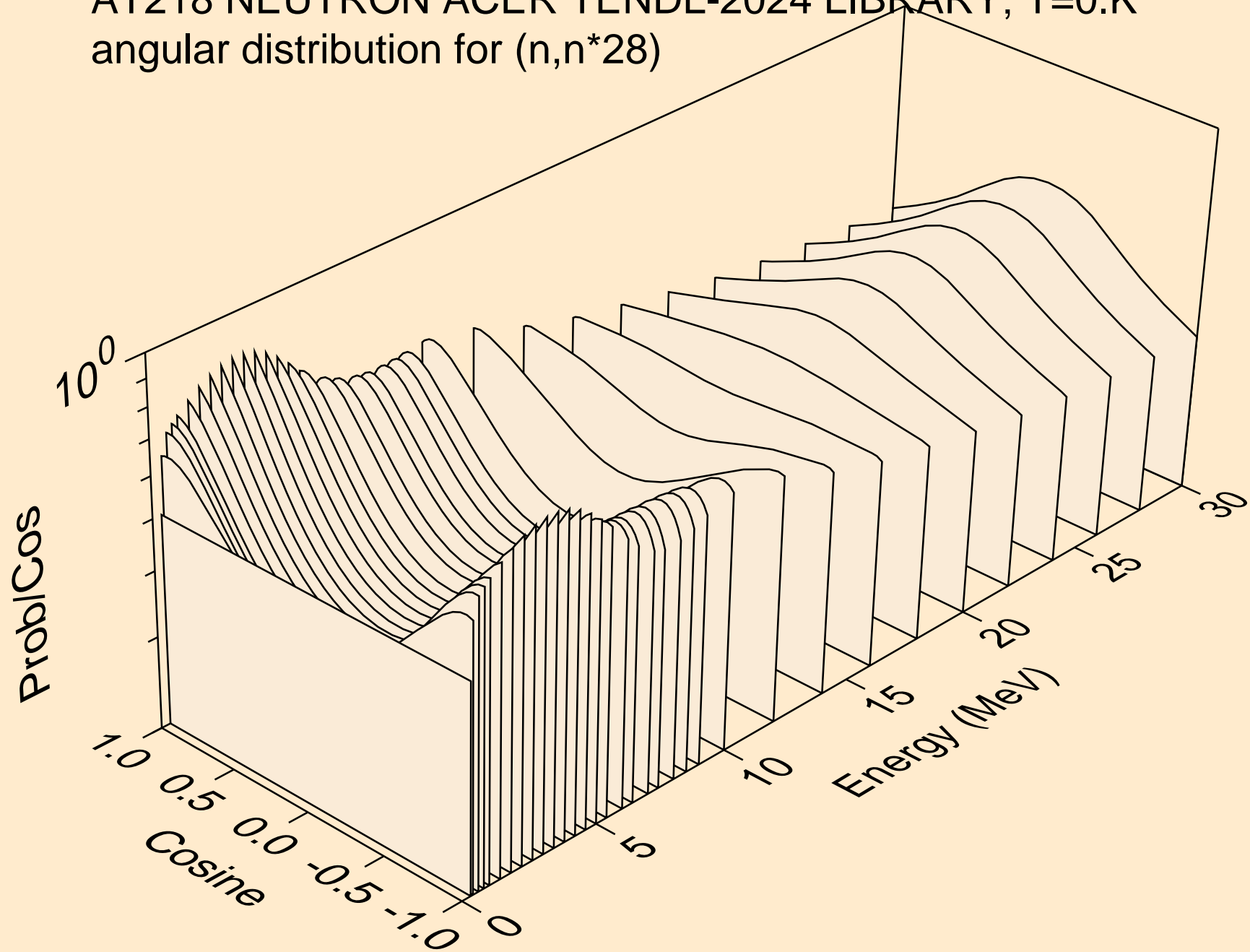

AT218 NEUTRON ACER TENDL-2024 LIBRARY; T=0.K
angular distribution for (n,n*29)

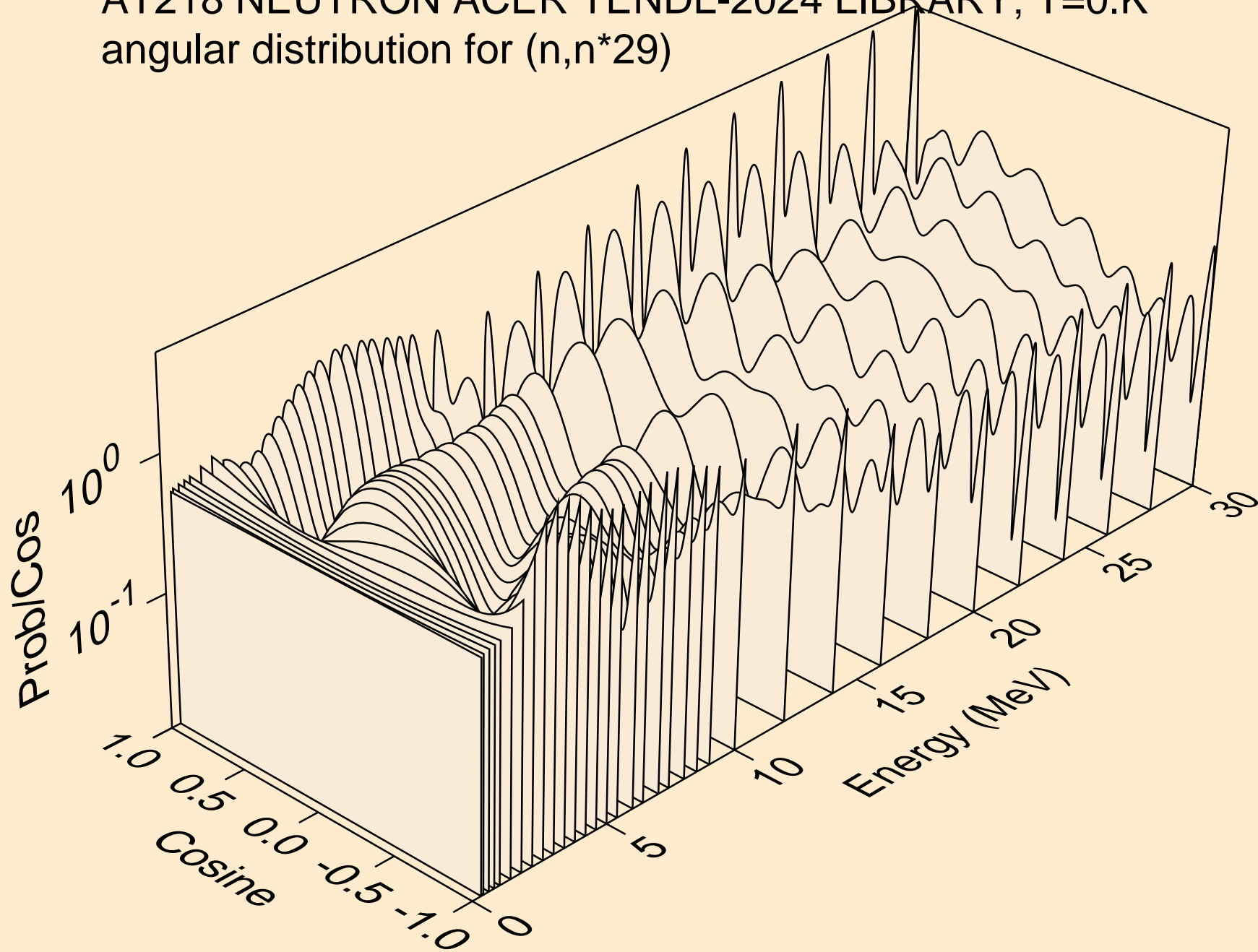

AT218 NEUTRON ACER TENDL-2024 LIBRARY; T=0.K

Total fission nubar

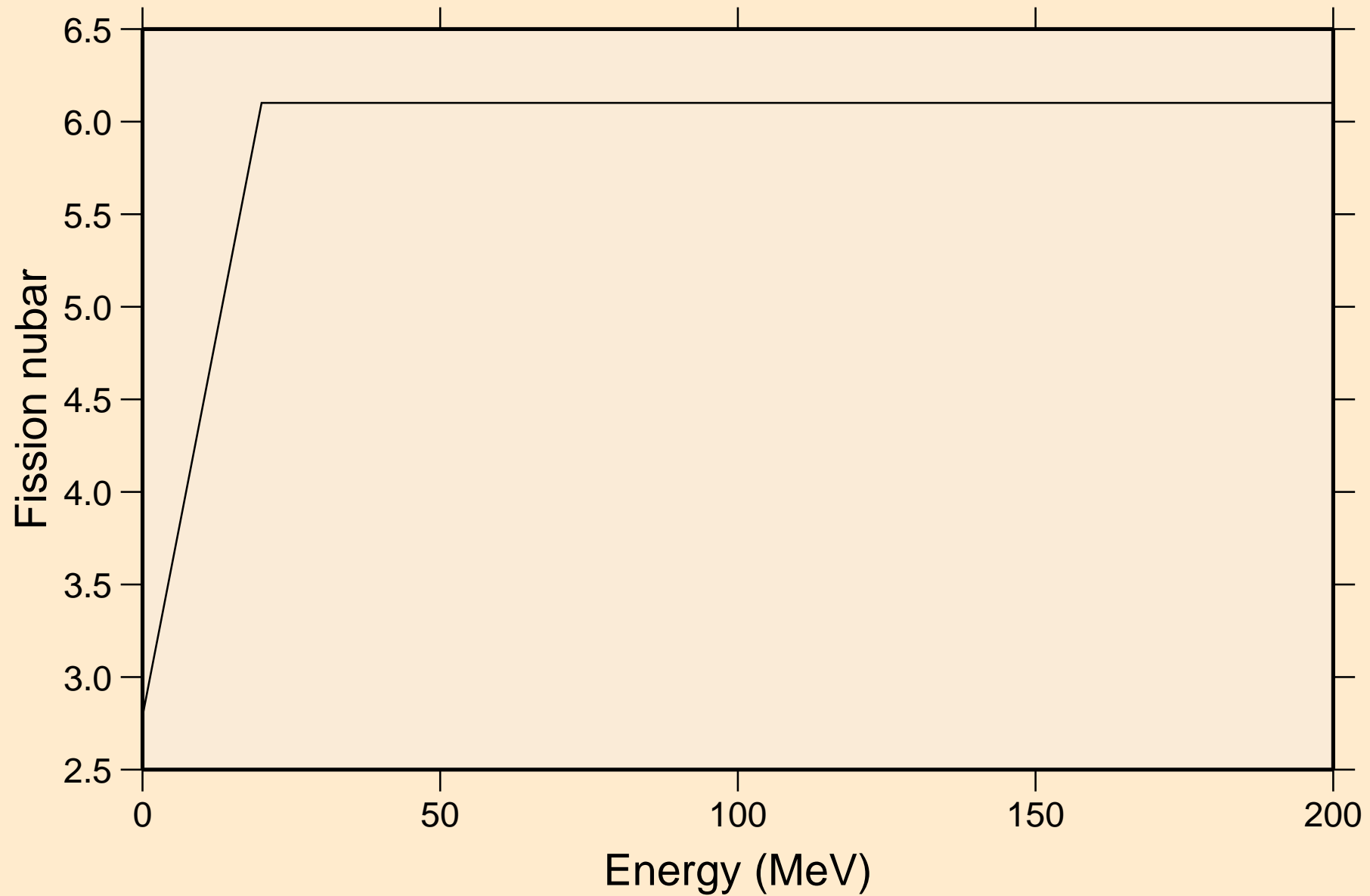

AT218 NEUTRON ACER TENDL-2024 LIBRARY; T=0.K
Neutron emission for (n,x)

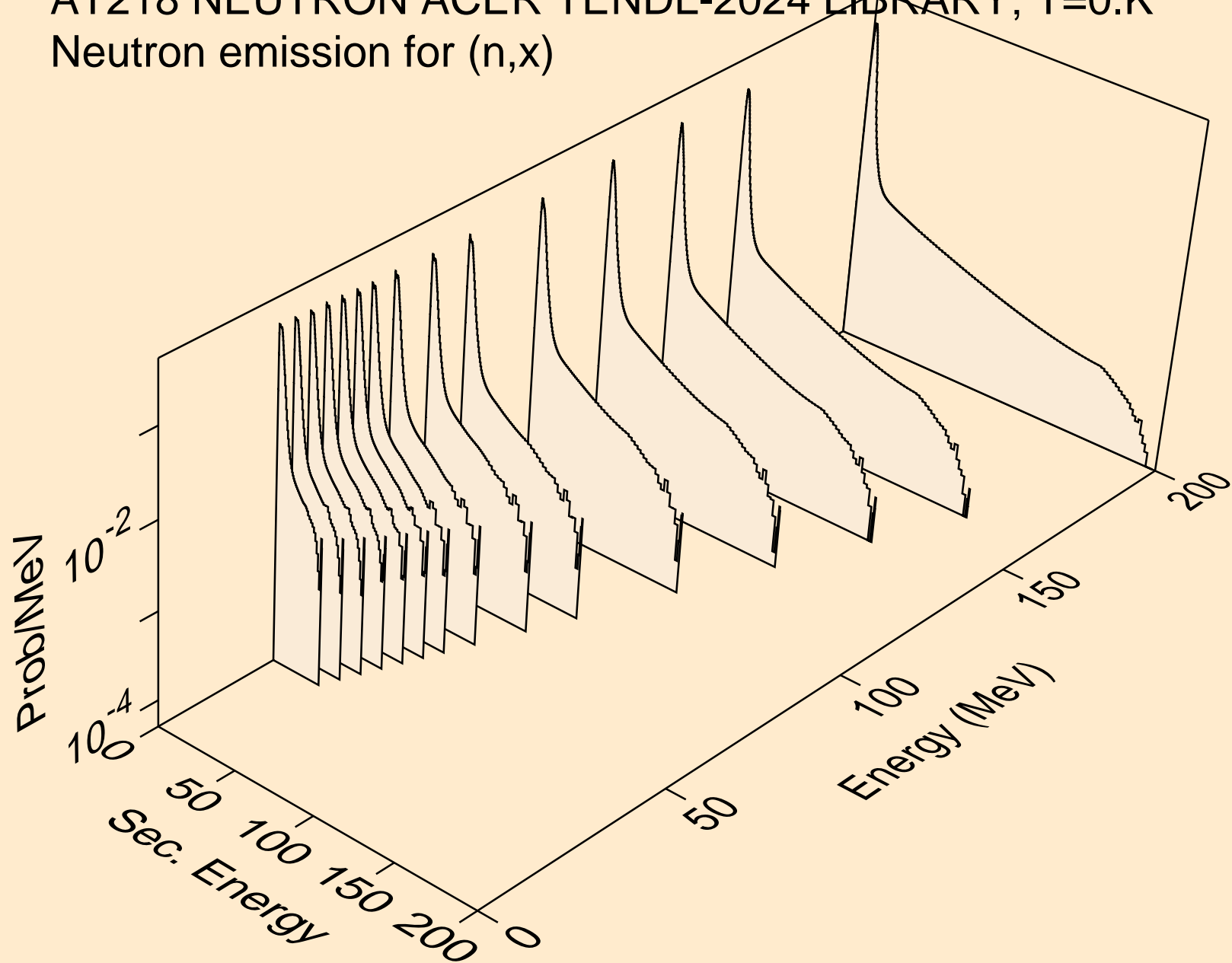

AT218 NEUTRON ACER TENDL-2024 LIBRARY; T=0.K
Neutron emission for (n,2nd)

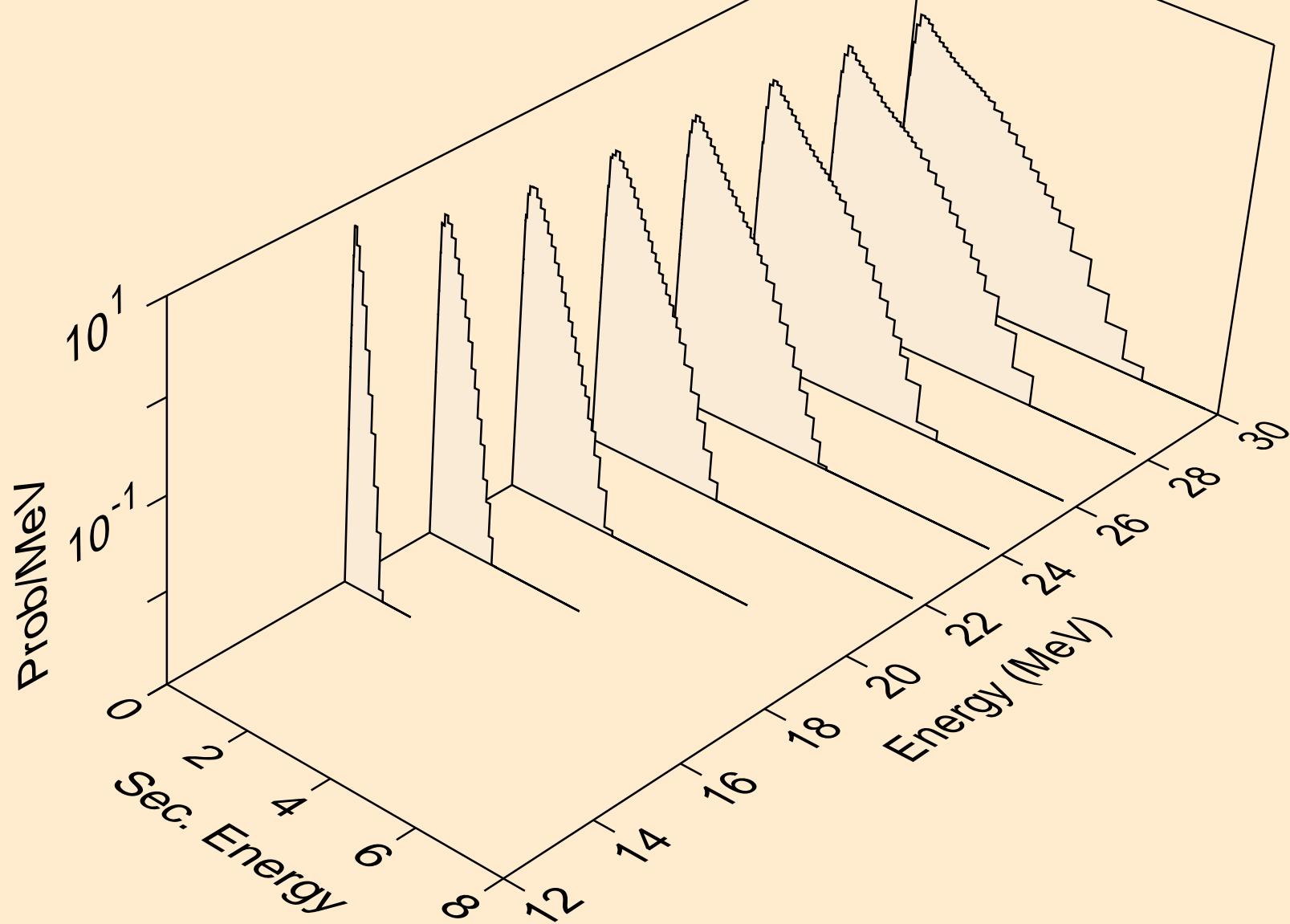

AT218 NEUTRON ACER TENDL-2024 LIBRARY; T=0.K
Neutron emission for (n,2n)

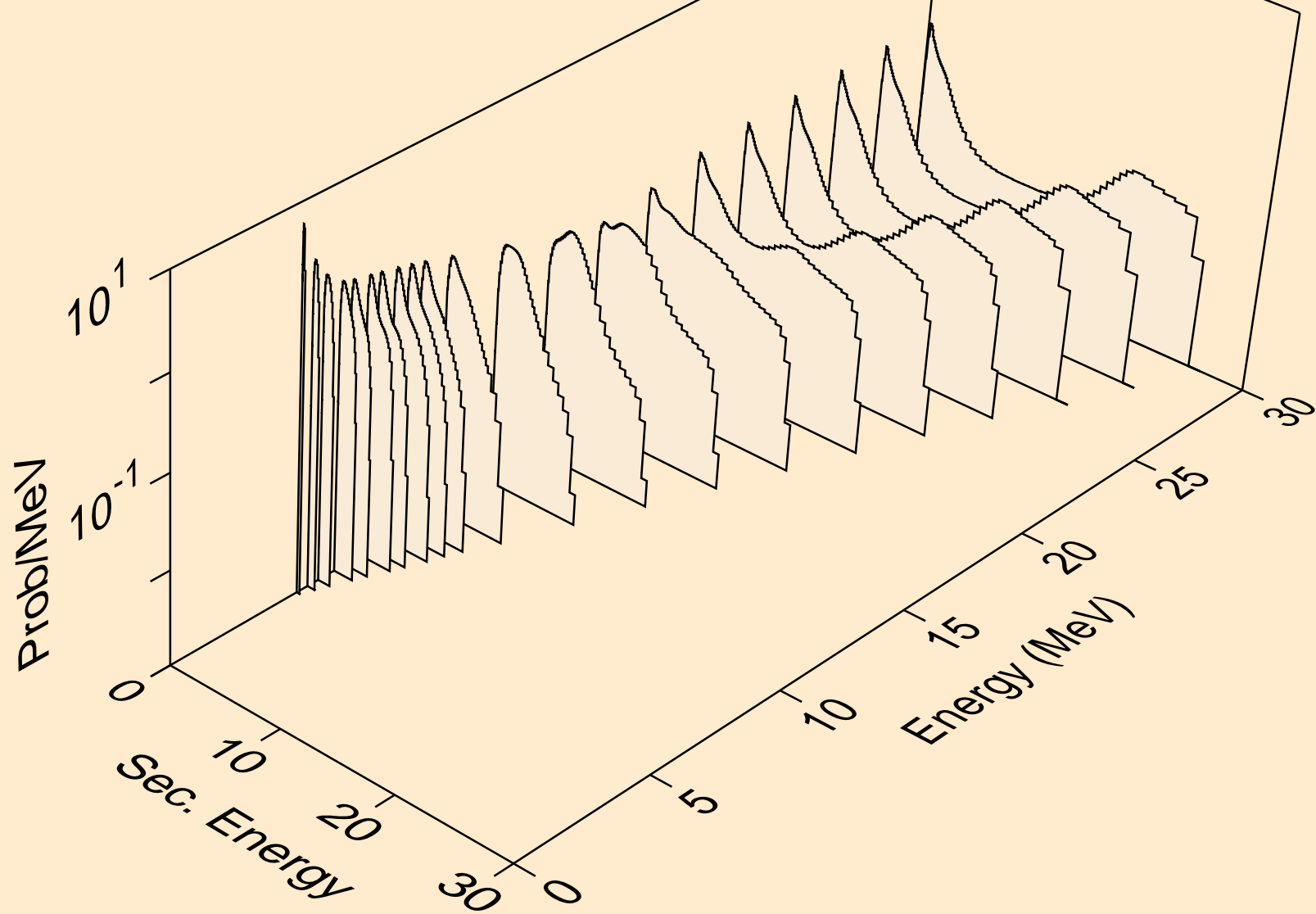

AT218 NEUTRON ACER TENDL-2024 LIBRARY; T=0.K
Neutron emission for (n,3n)

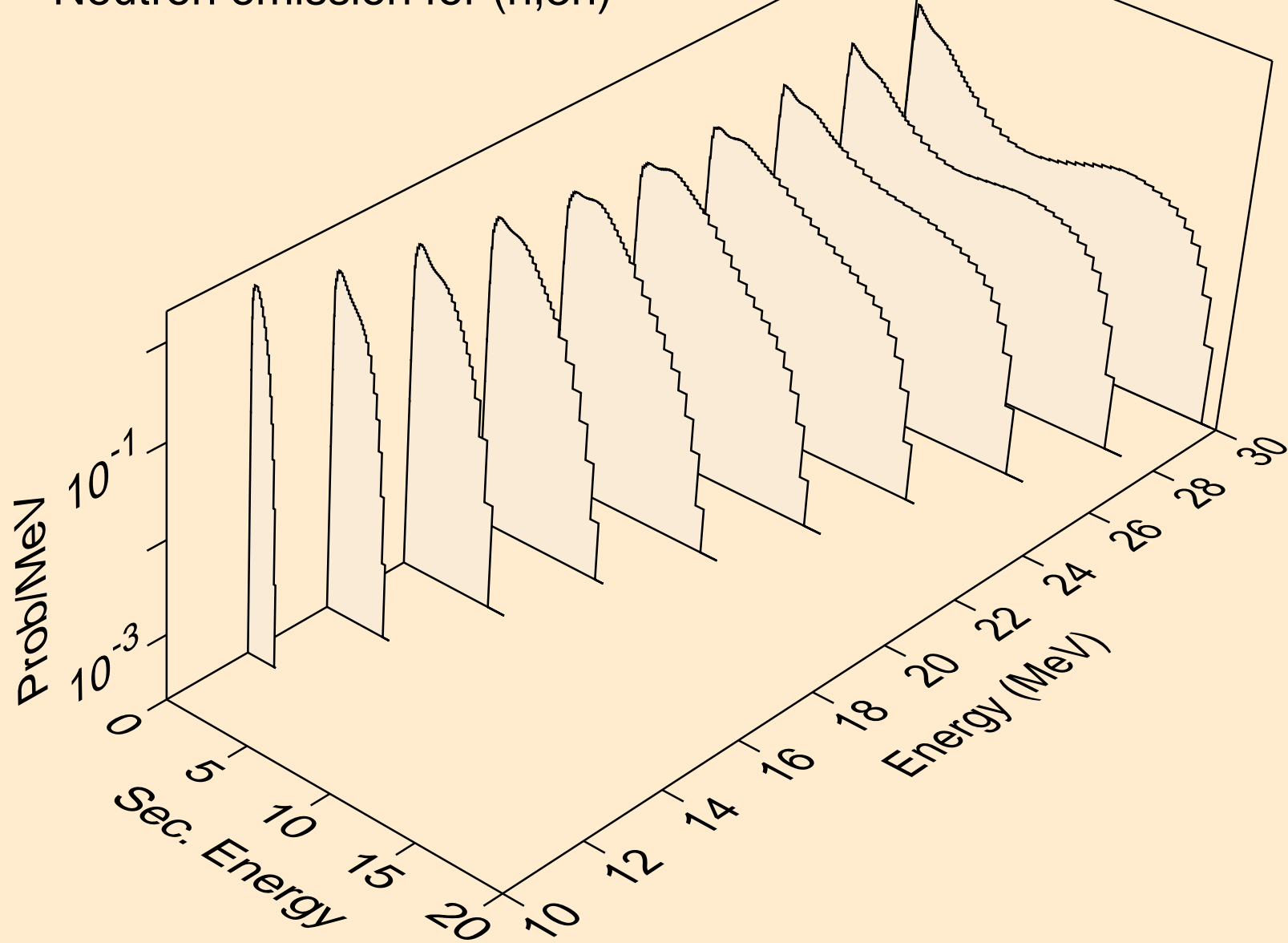

AT218 NEUTRON ACER TENDL-2024 LIBRARY; T=0.K
Neutron emission for fission

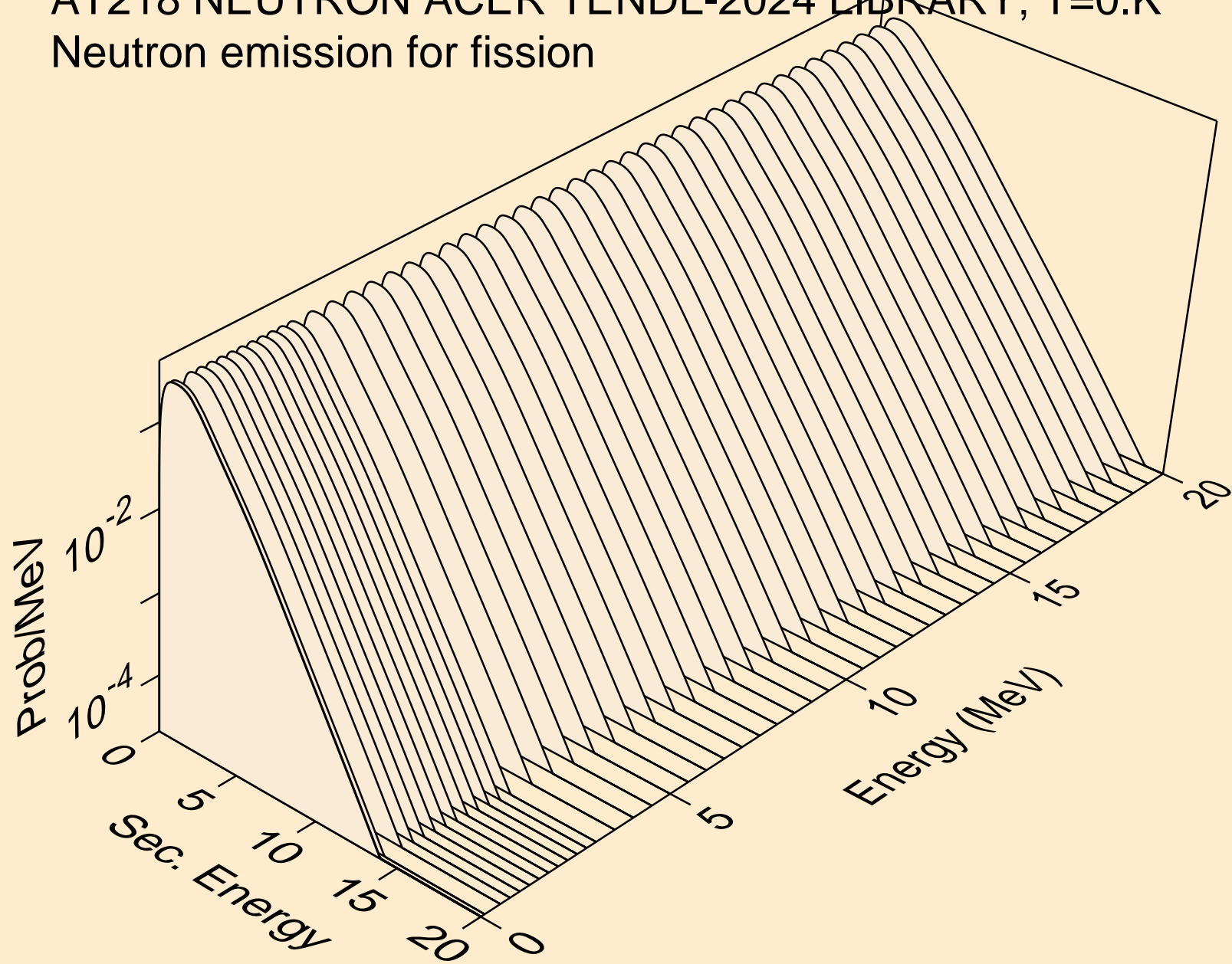

AT218 NEUTRON ACER TENDL-2024 LIBRARY; T=0.K
Neutron emission for (n,n*)a

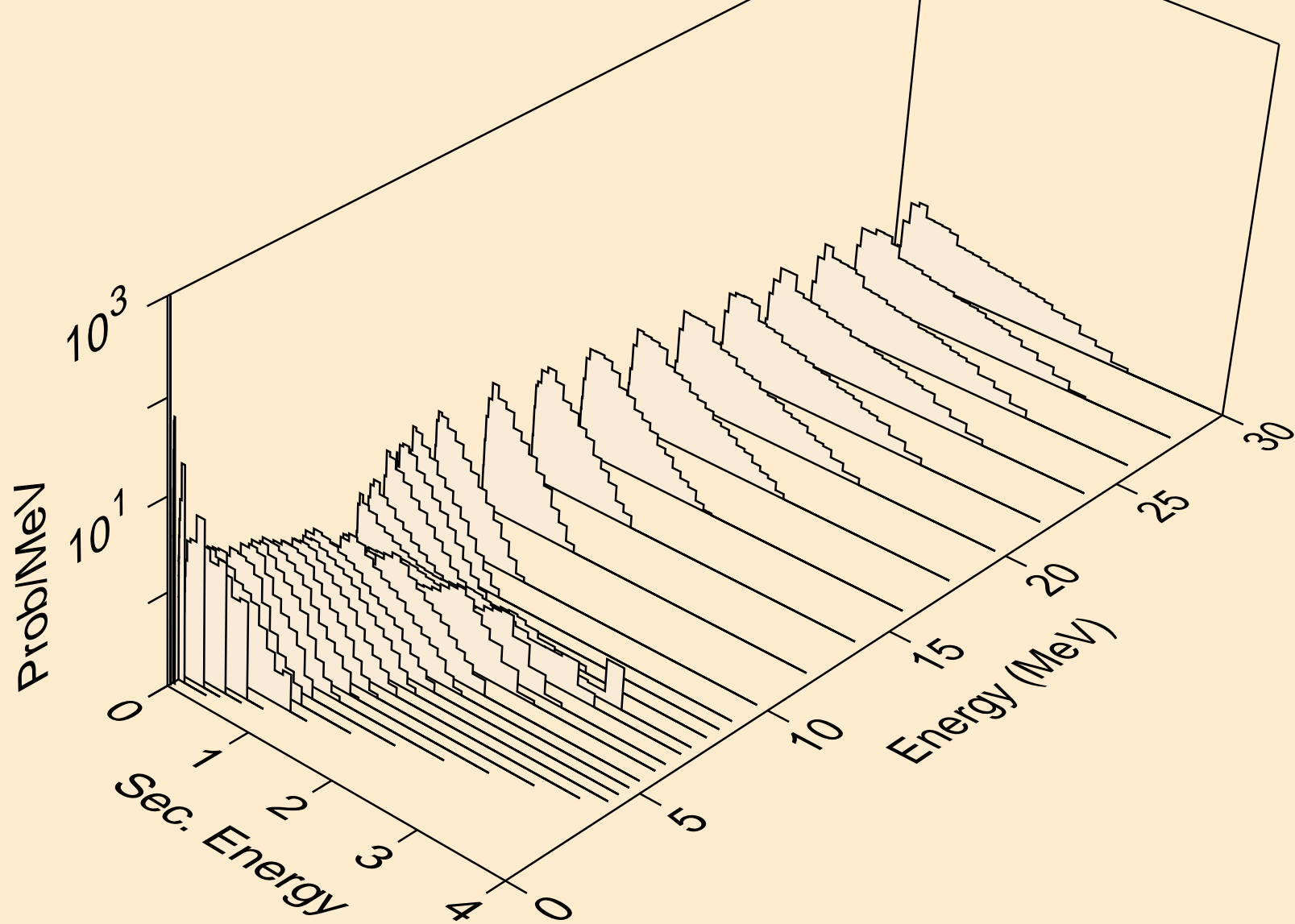

AT218 NEUTRON ACER TENDL-2024 LIBRARY; T=0.K
Neutron emission for (n,2n)a

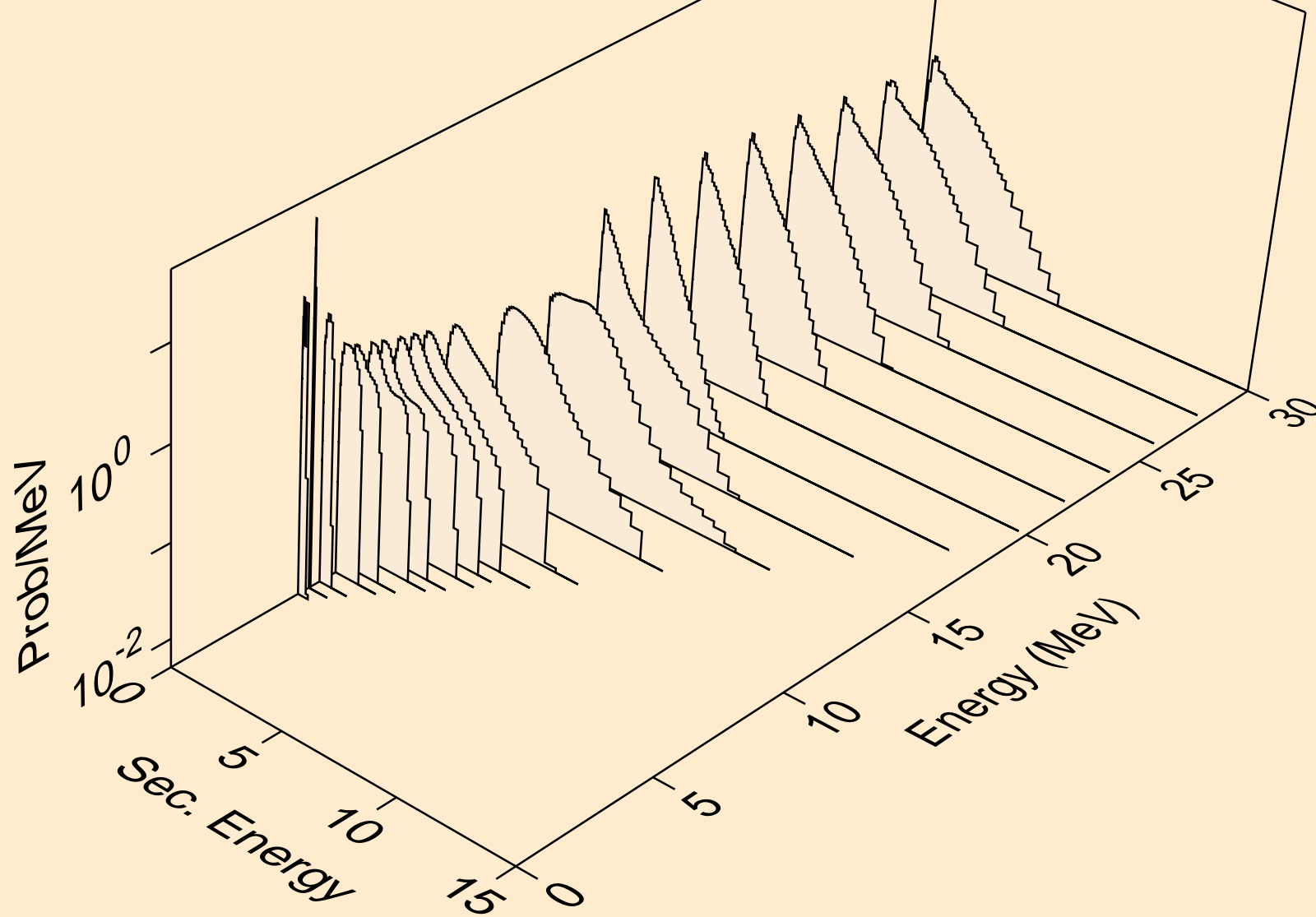

AT218 NEUTRON ACER TENDL-2024 LIBRARY; T=0.K
Neutron emission for (n,3n)a

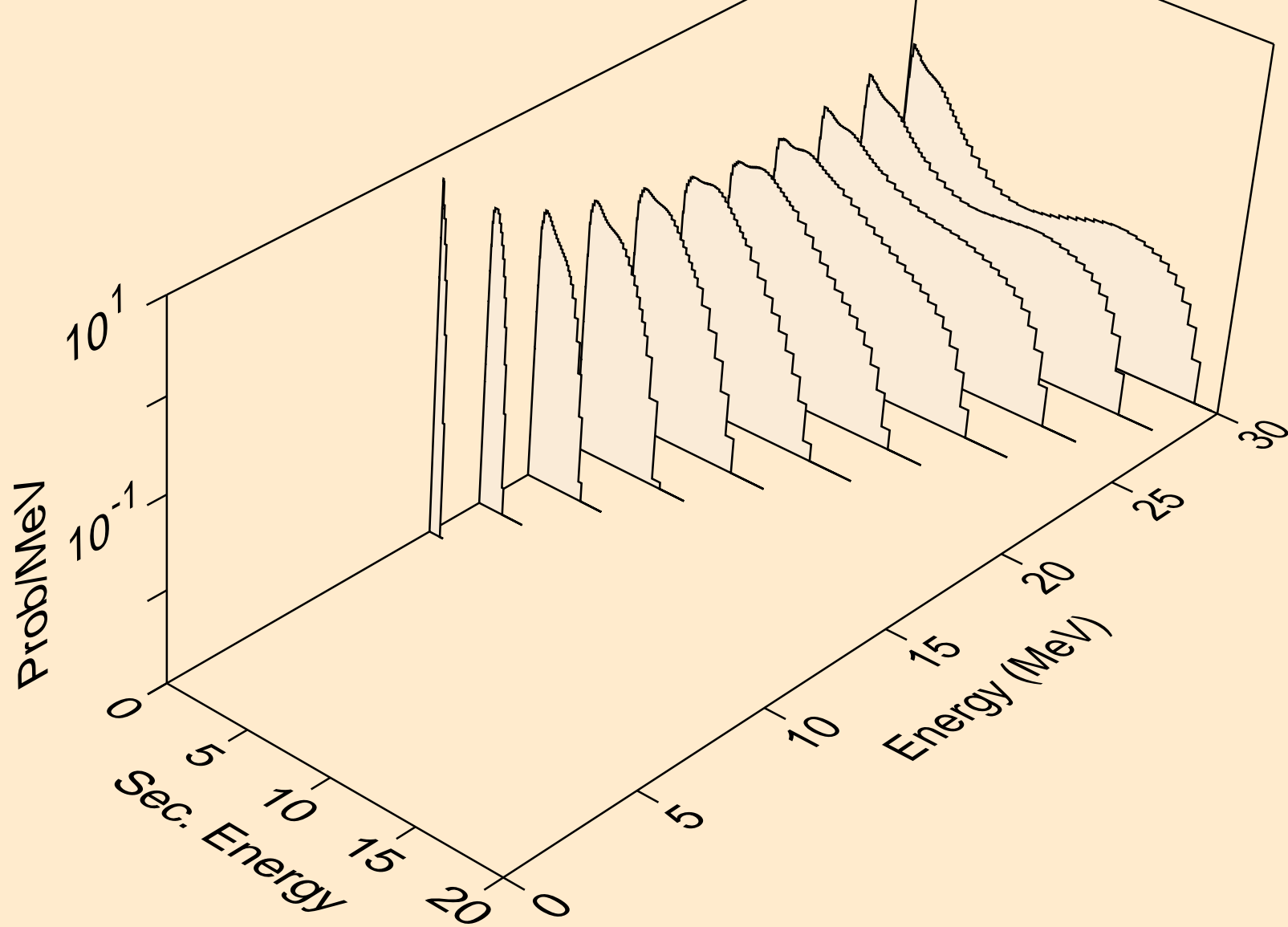

AT218 NEUTRON ACER TENDL-2024 LIBRARY; T=0.K
Neutron emission for (n,n*)p

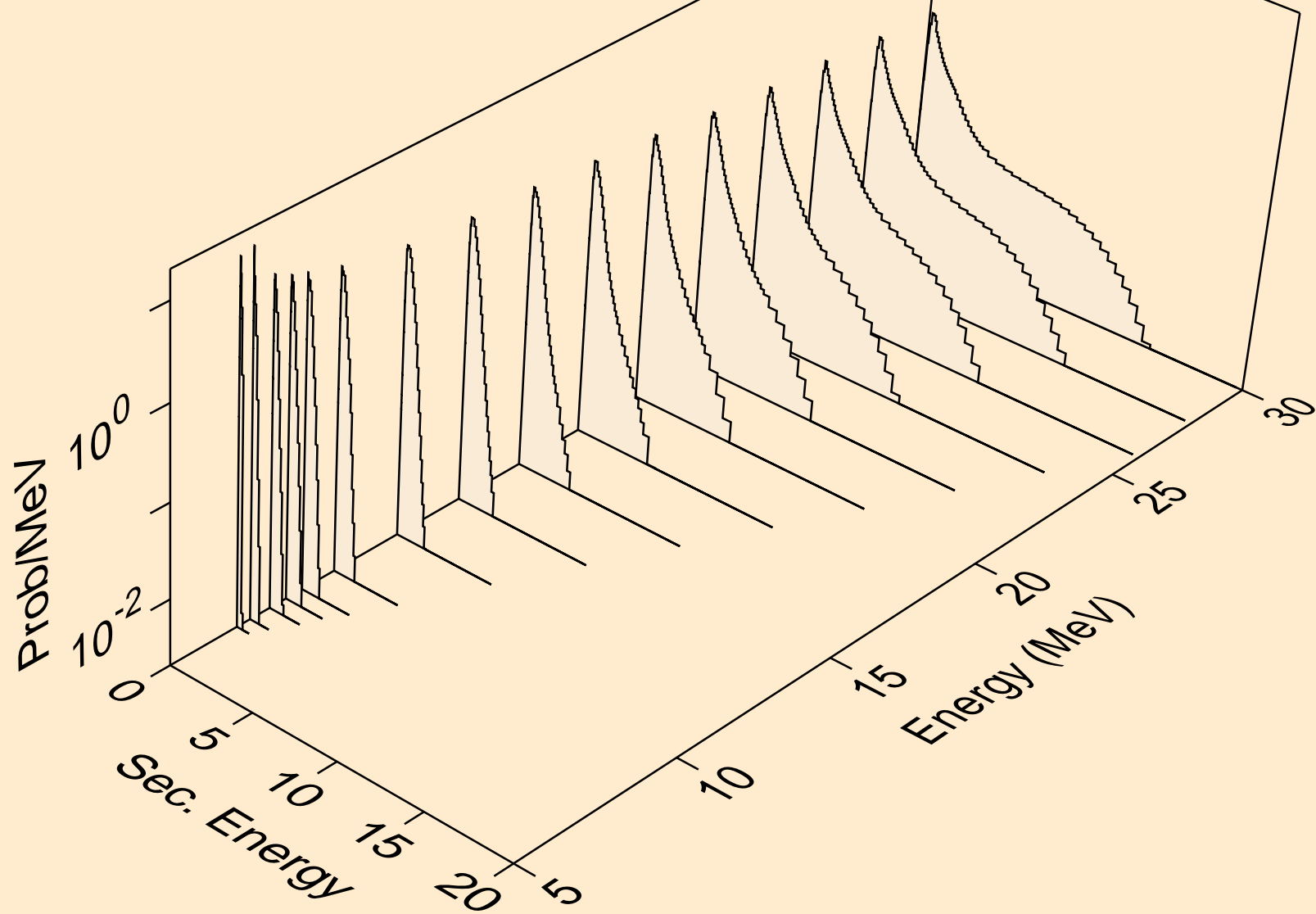

AT218 NEUTRON ACER TENDL-2024 LIBRARY; T=0.K
Neutron emission for (n,n*)2a

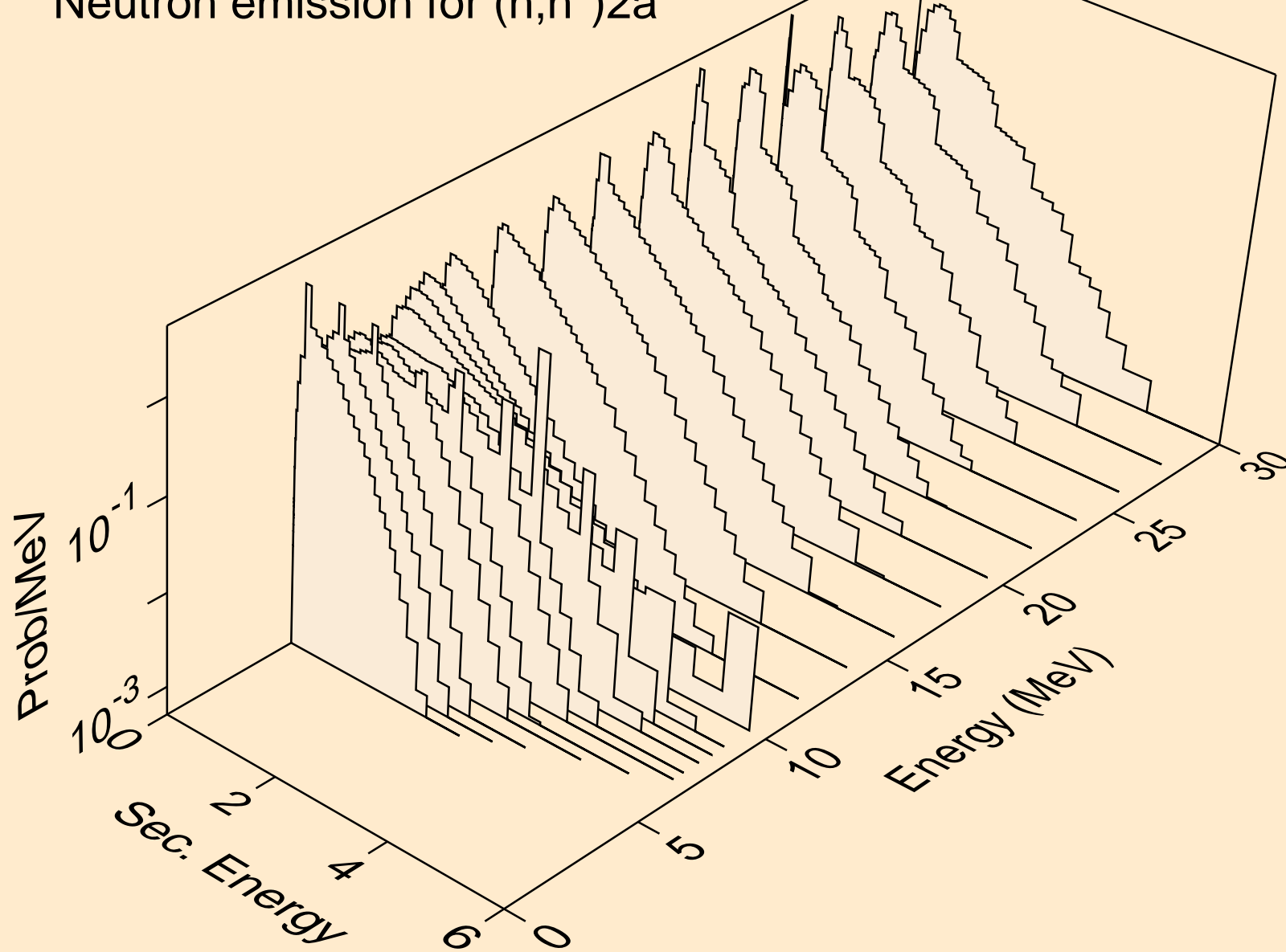

AT218 NEUTRON ACER TENDL-2024 LIBRARY; T=0.K
Neutron emission for (n,2n)2a

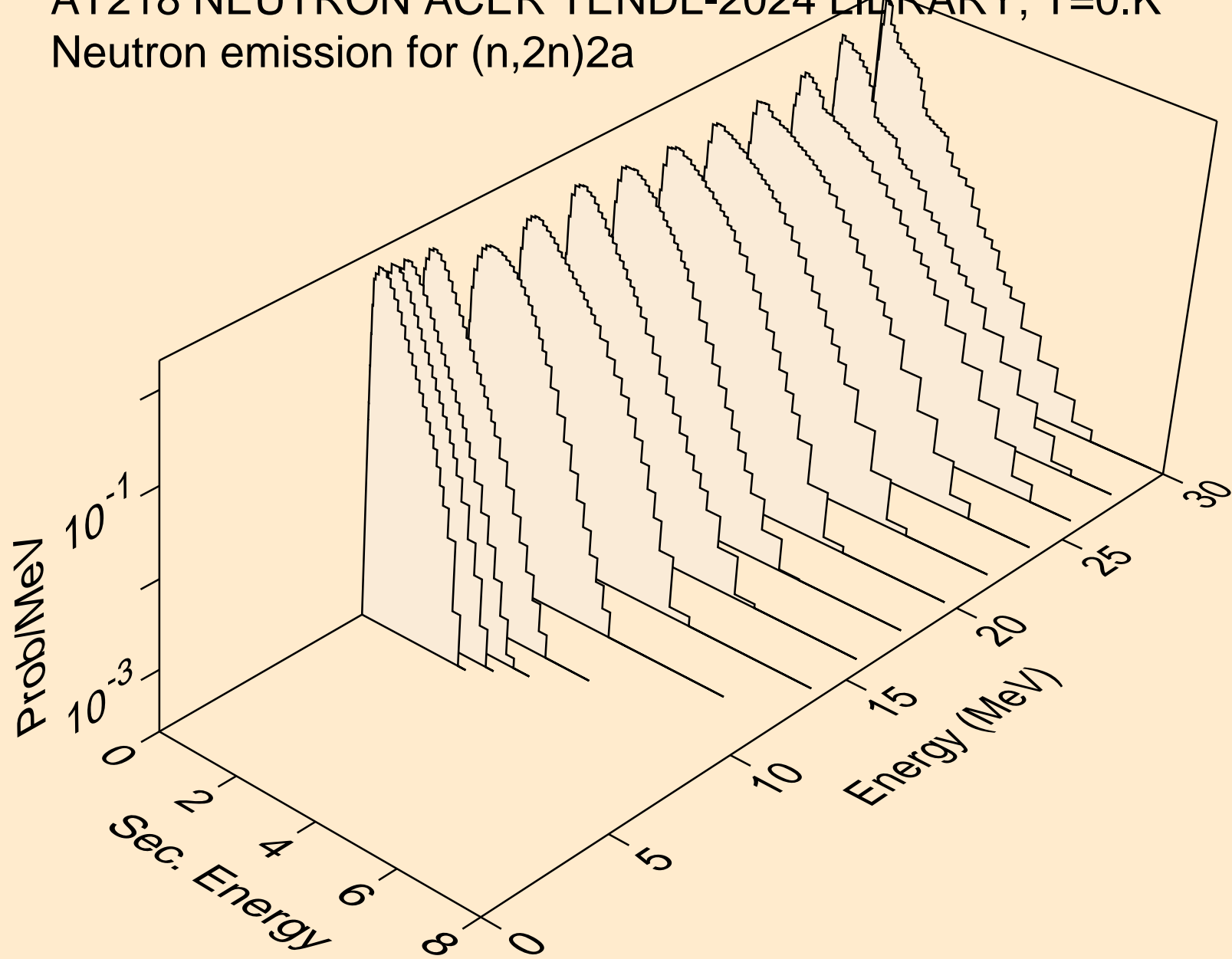

AT218 NEUTRON ACER TENDL-2024 LIBRARY; T=0.K
Neutron emission for (n,n*)d

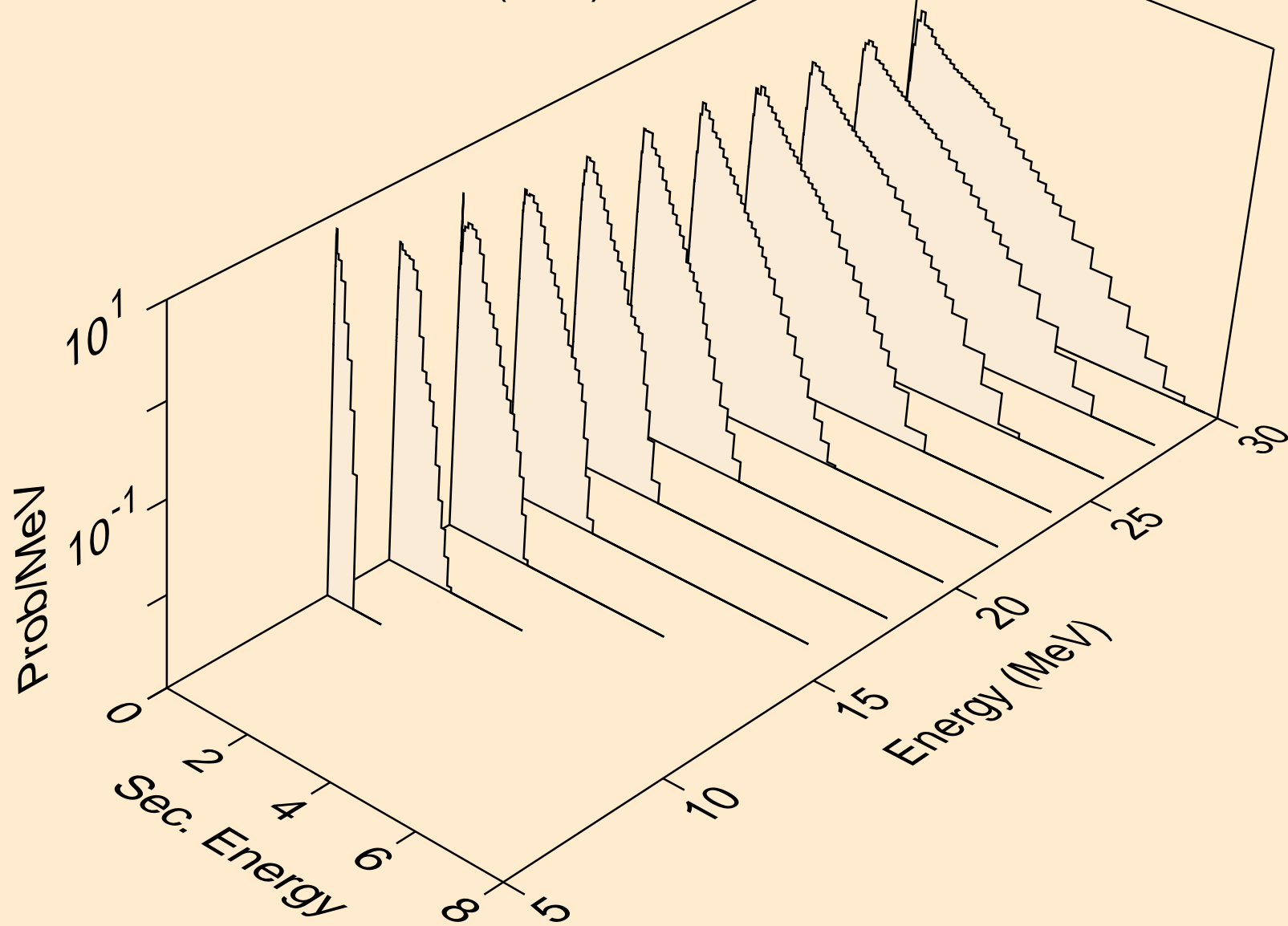

AT218 NEUTRON ACER TENDL-2024 LIBRARY; T=0.K
Neutron emission for (n,n*)t

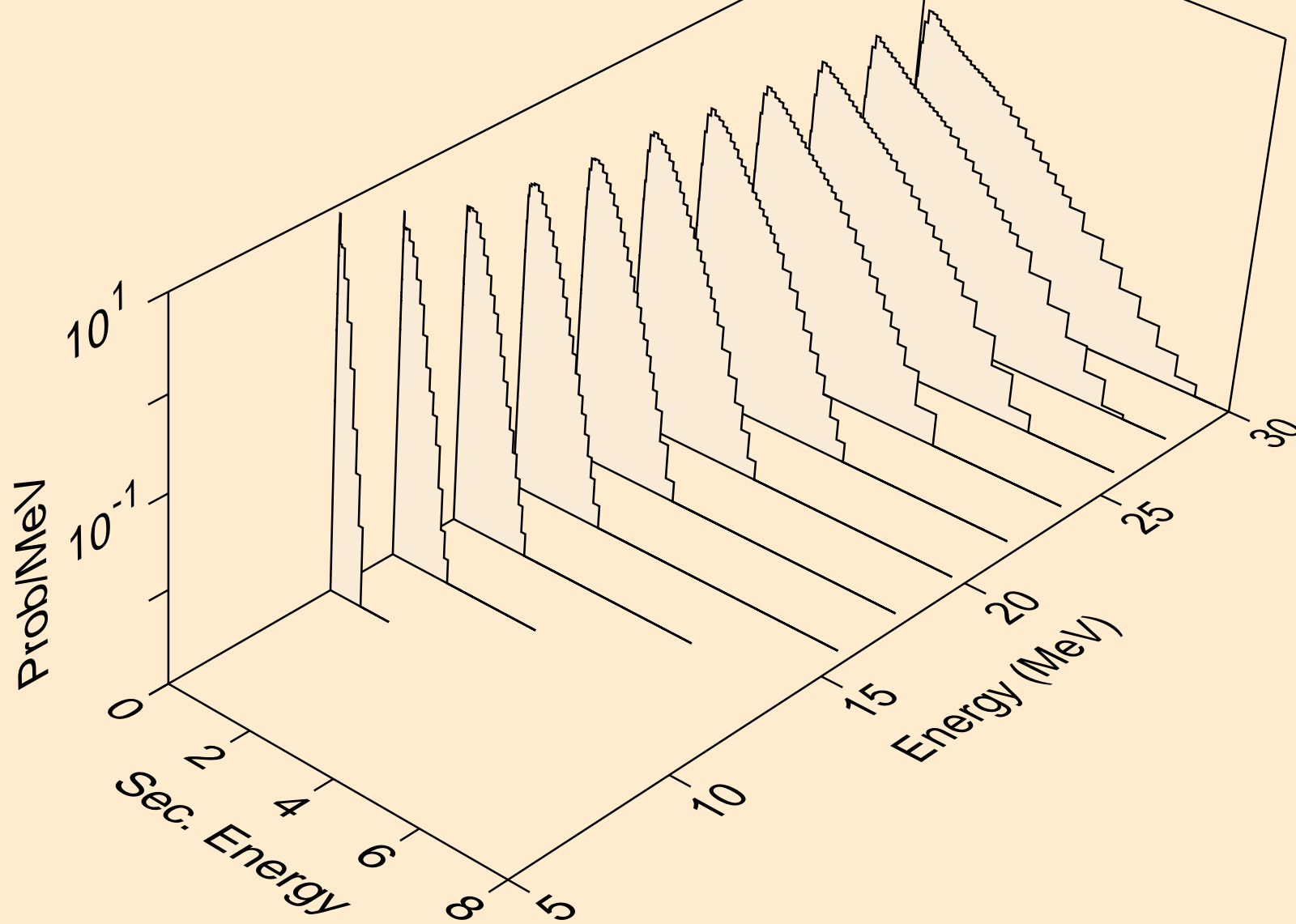

AT218 NEUTRON ACER TENDL-2024 LIBRARY; T=0.K
Neutron emission for (n,n*)he3

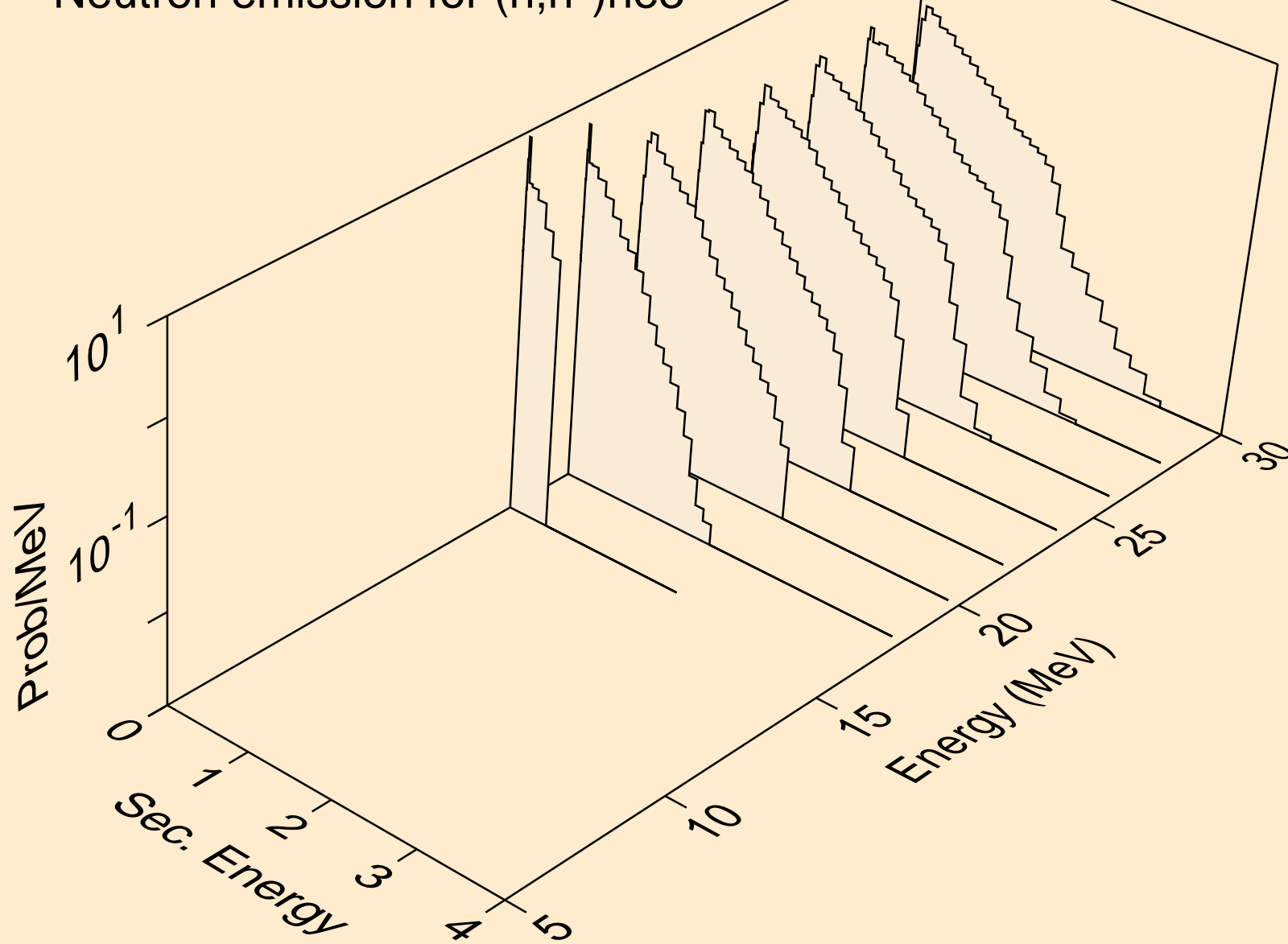

AT218 NEUTRON ACER TENDL-2024 LIBRARY; T=0.K
Neutron emission for (n,4n)

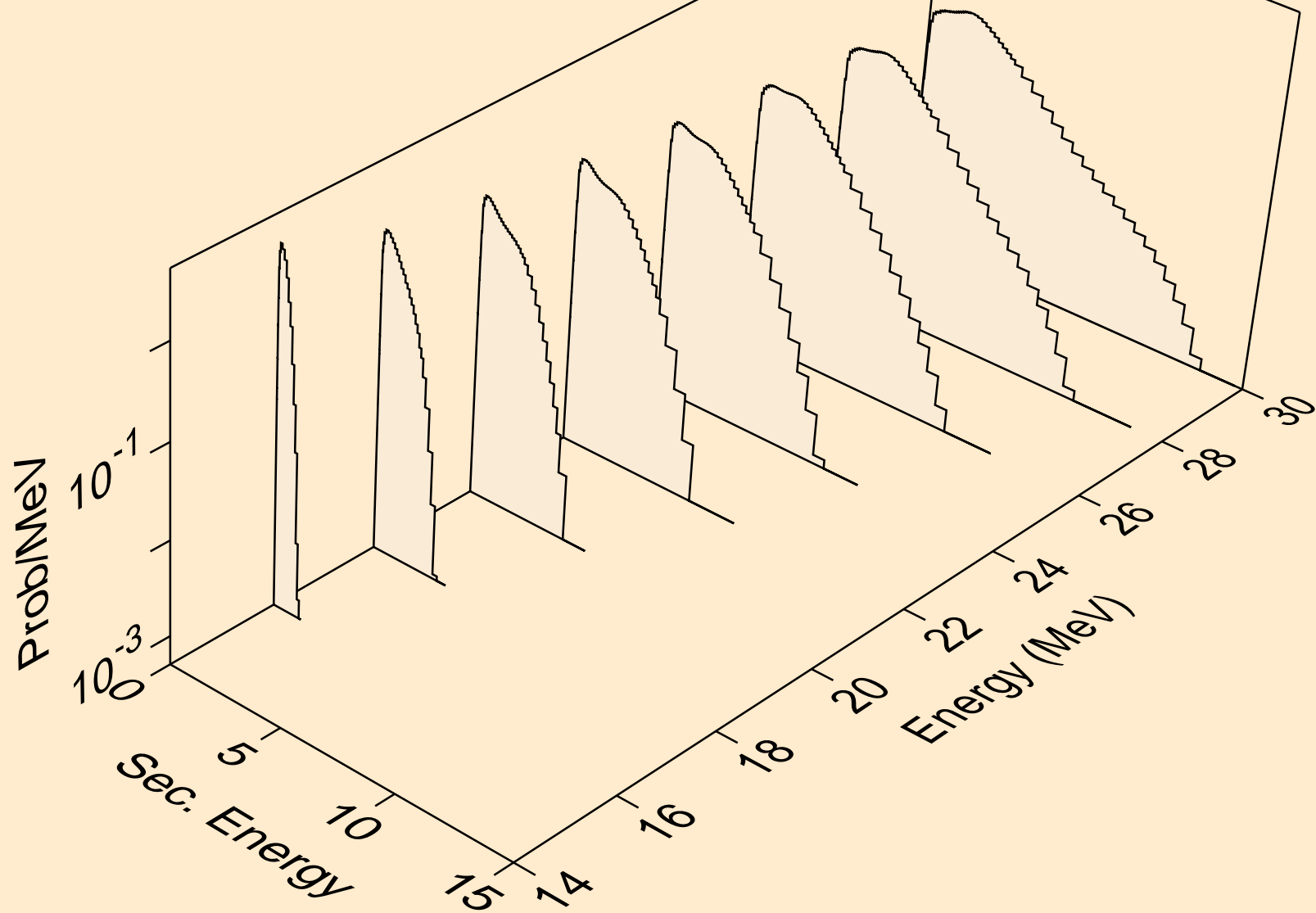

AT218 NEUTRON ACER TENDL-2024 LIBRARY; T=0.K
Neutron emission for (n,2np)

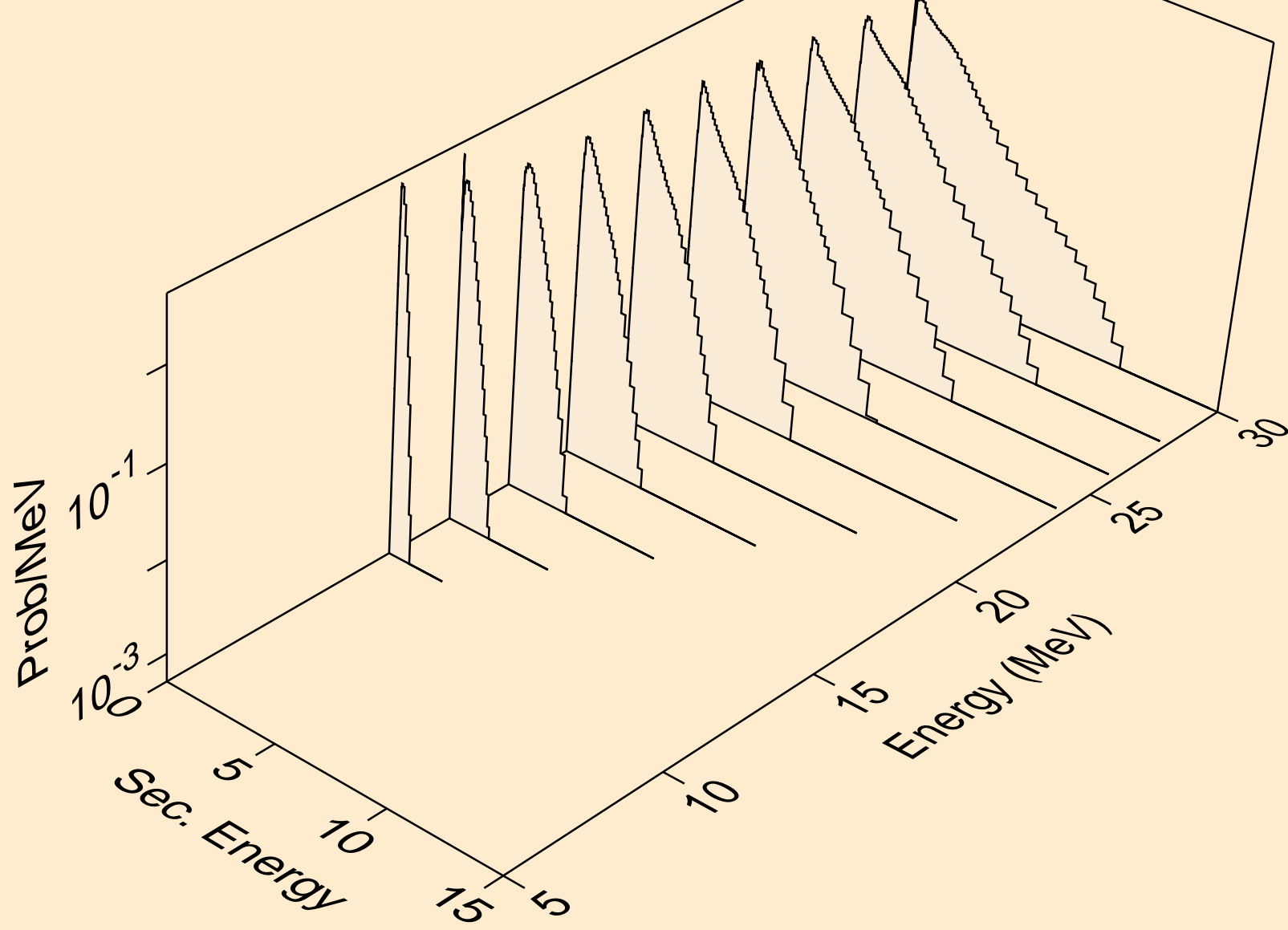

AT218 NEUTRON ACER TENDL-2024 LIBRARY; T=0.K
Neutron emission for (n,3np)

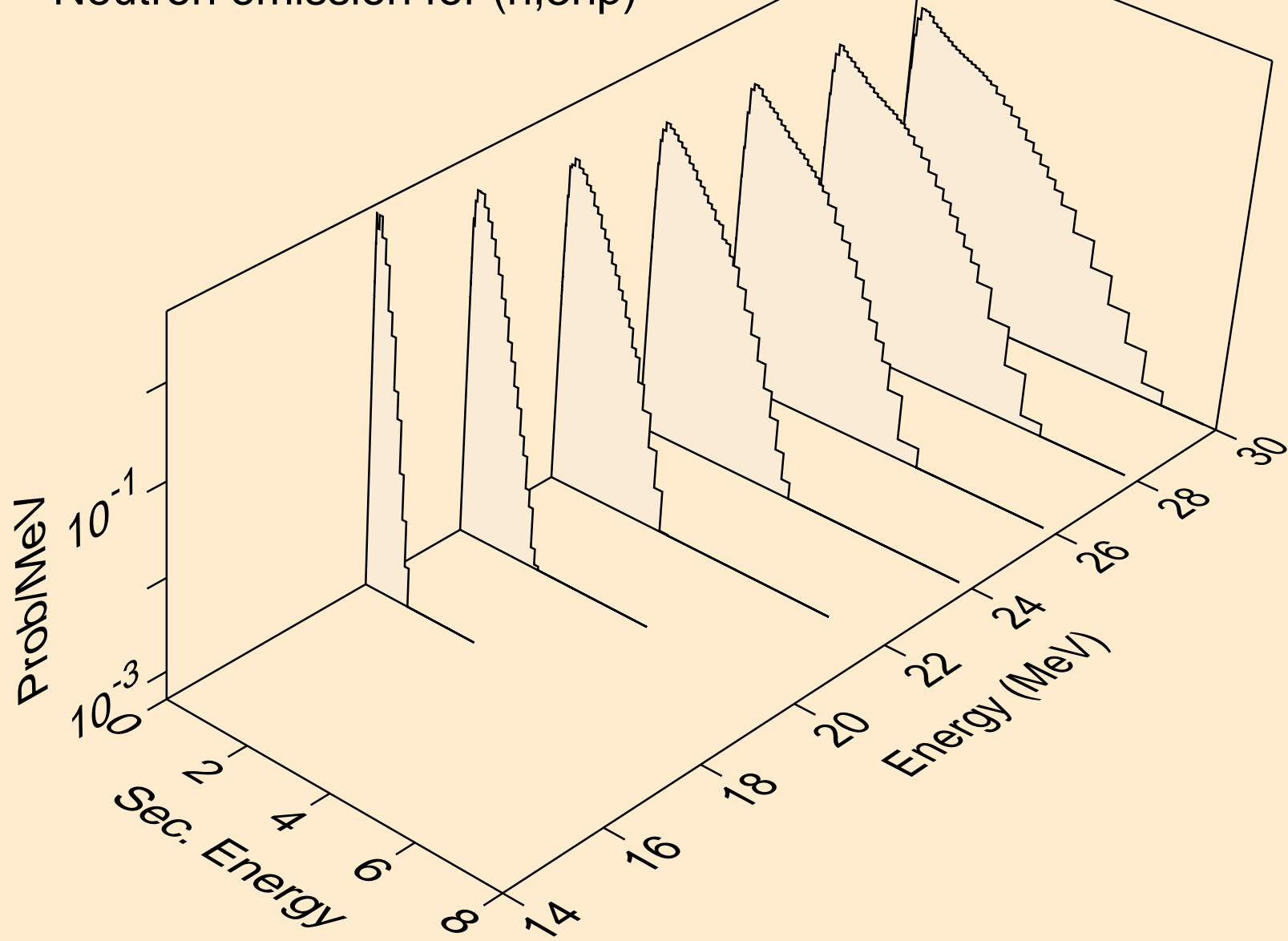

AT218 NEUTRON ACER TENDL-2024 LIBRARY; T=0.K
Neutron emission for (n,n2p)

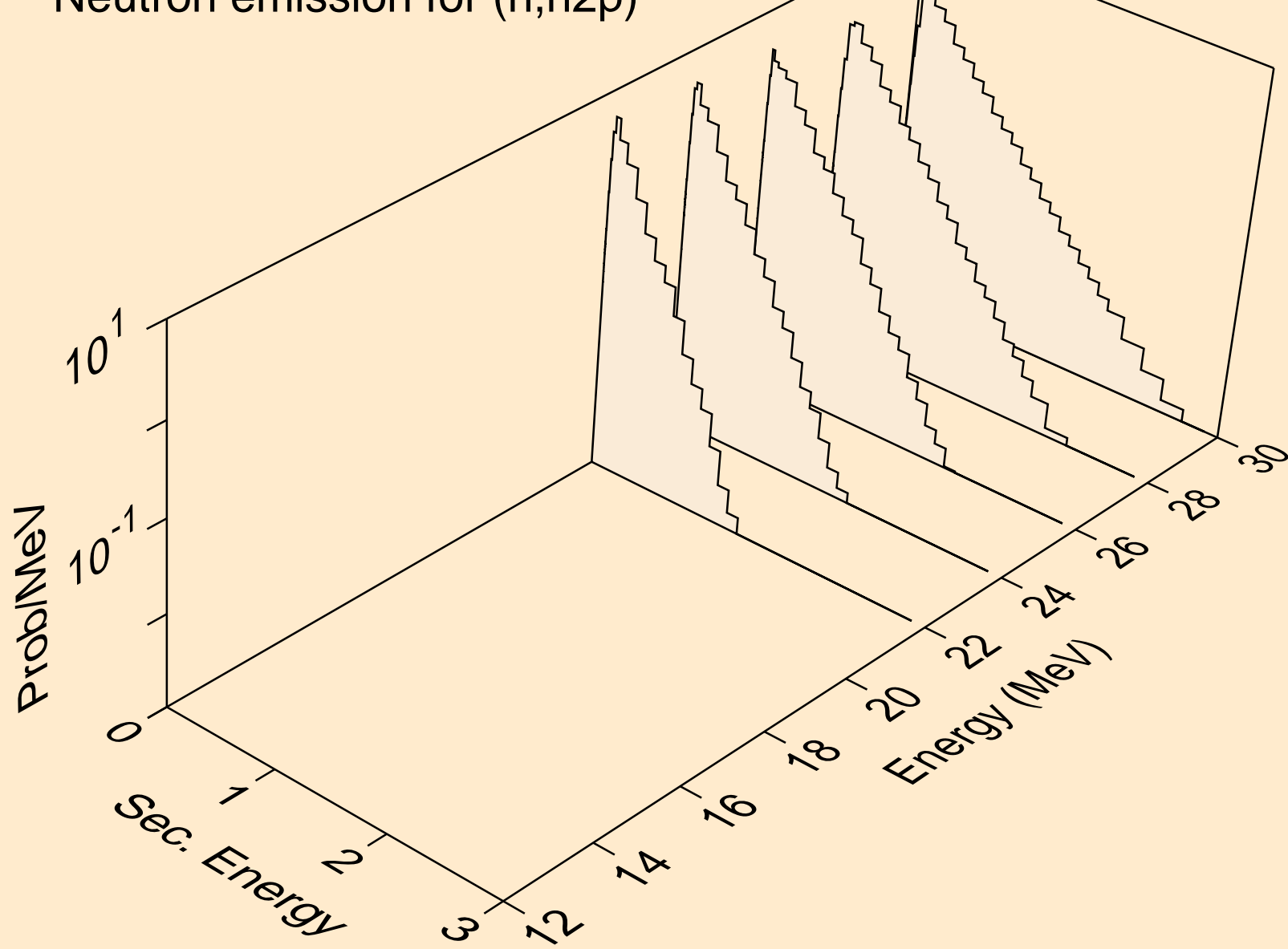

AT218 NEUTRON ACER TENDL-2024 LIBRARY; T=0.K
Neutron emission for (n,npa)

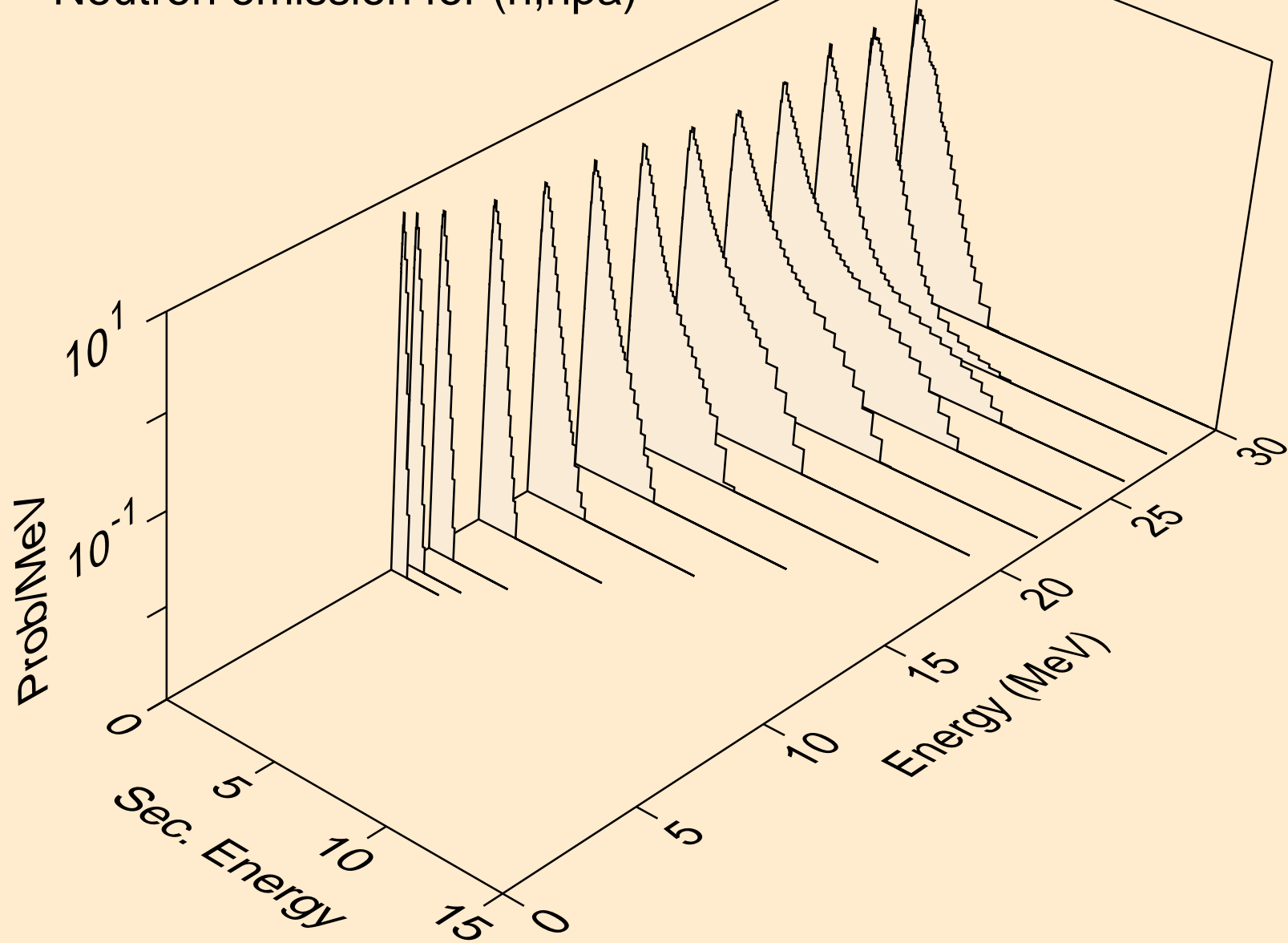

AT218 NEUTRON ACER TENDL-2024 LIBRARY; T=0.K
Neutron emission for (n,n*c)

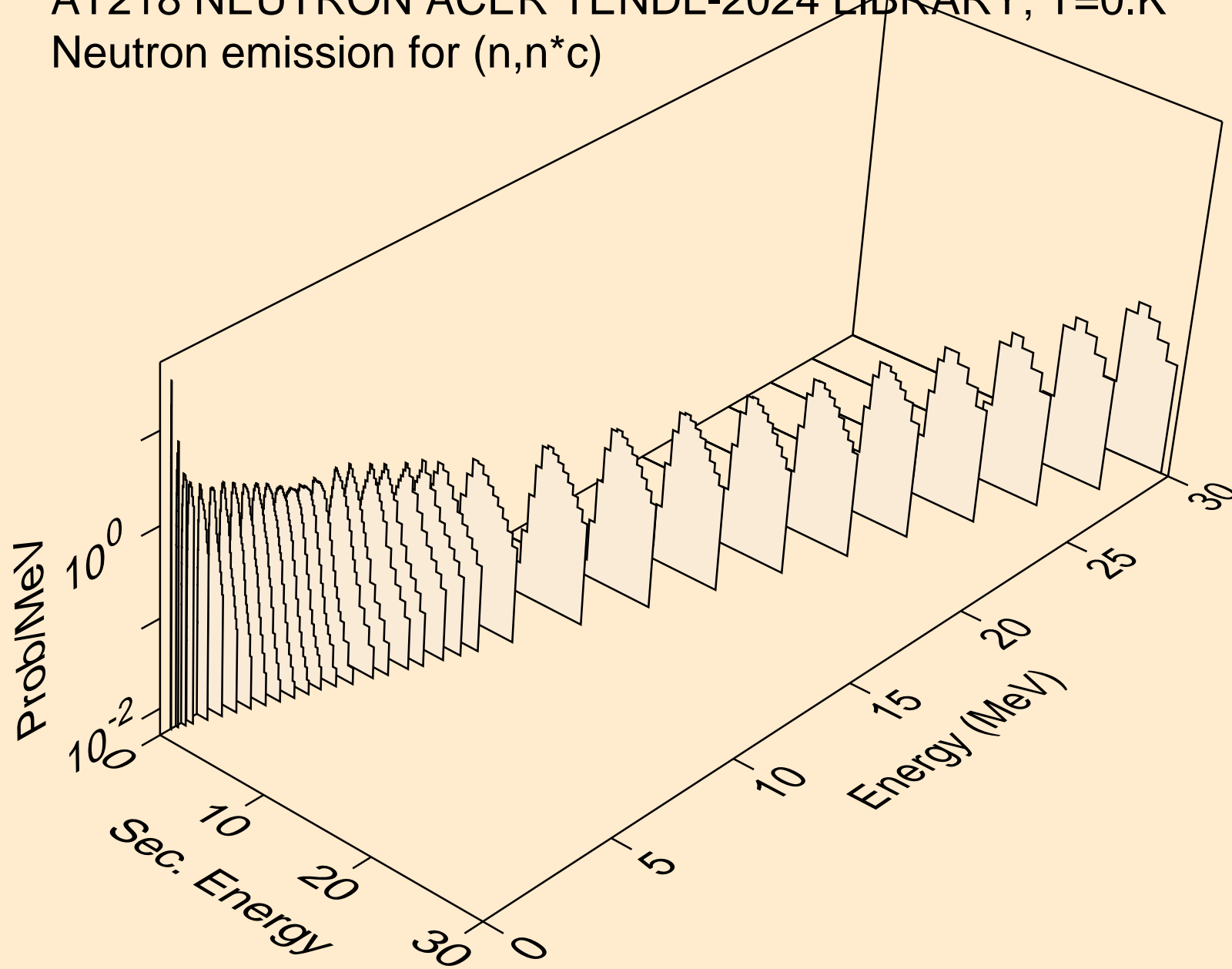

AT218 NEUTRON ACER TENDL-2024 LIBRARY; T=0.K

Delayed nubar

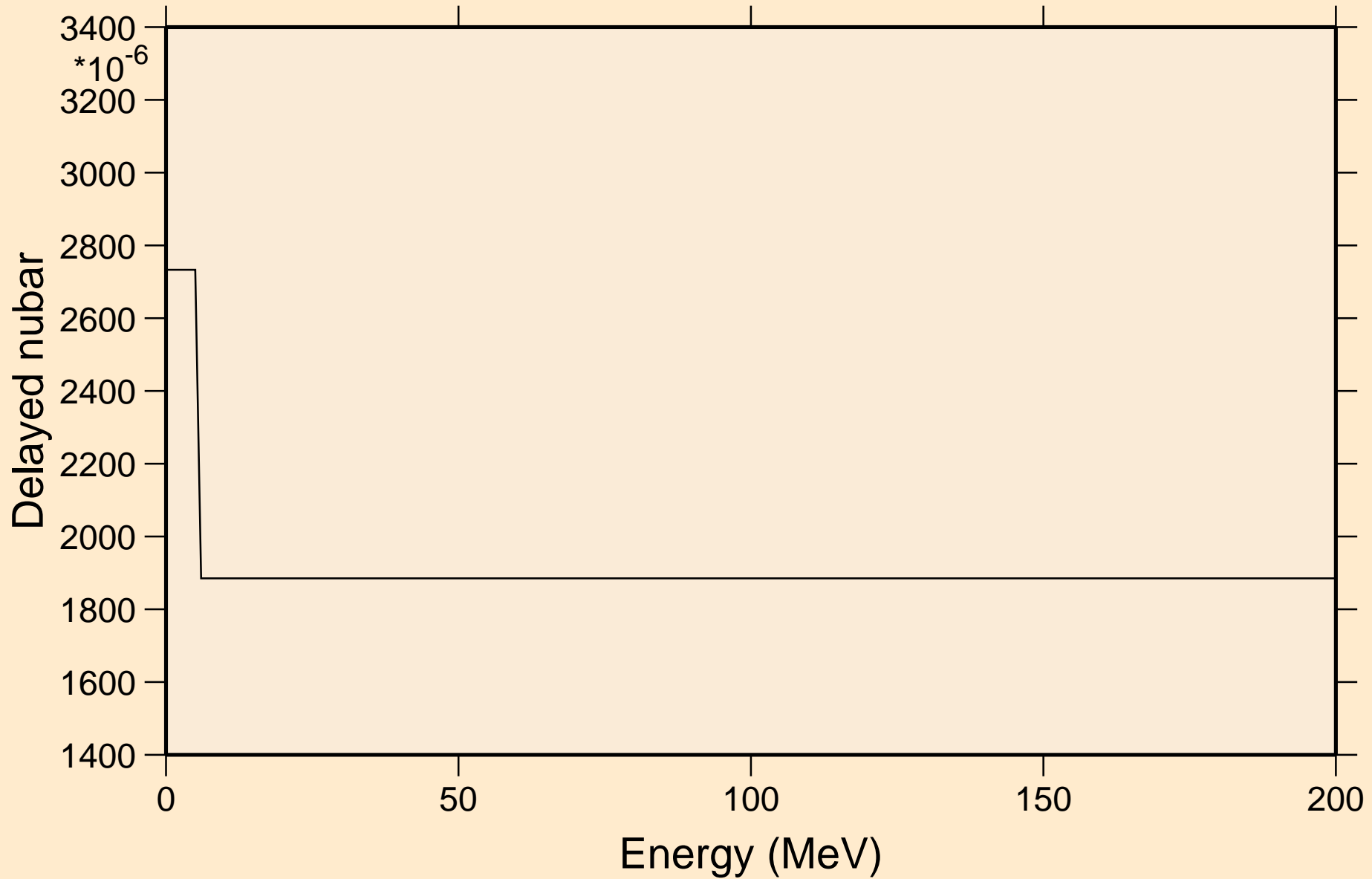

AT218 NEUTRON ACER TENDL-2024 LIBRARY; T=0.K

Delayed neutron spectra

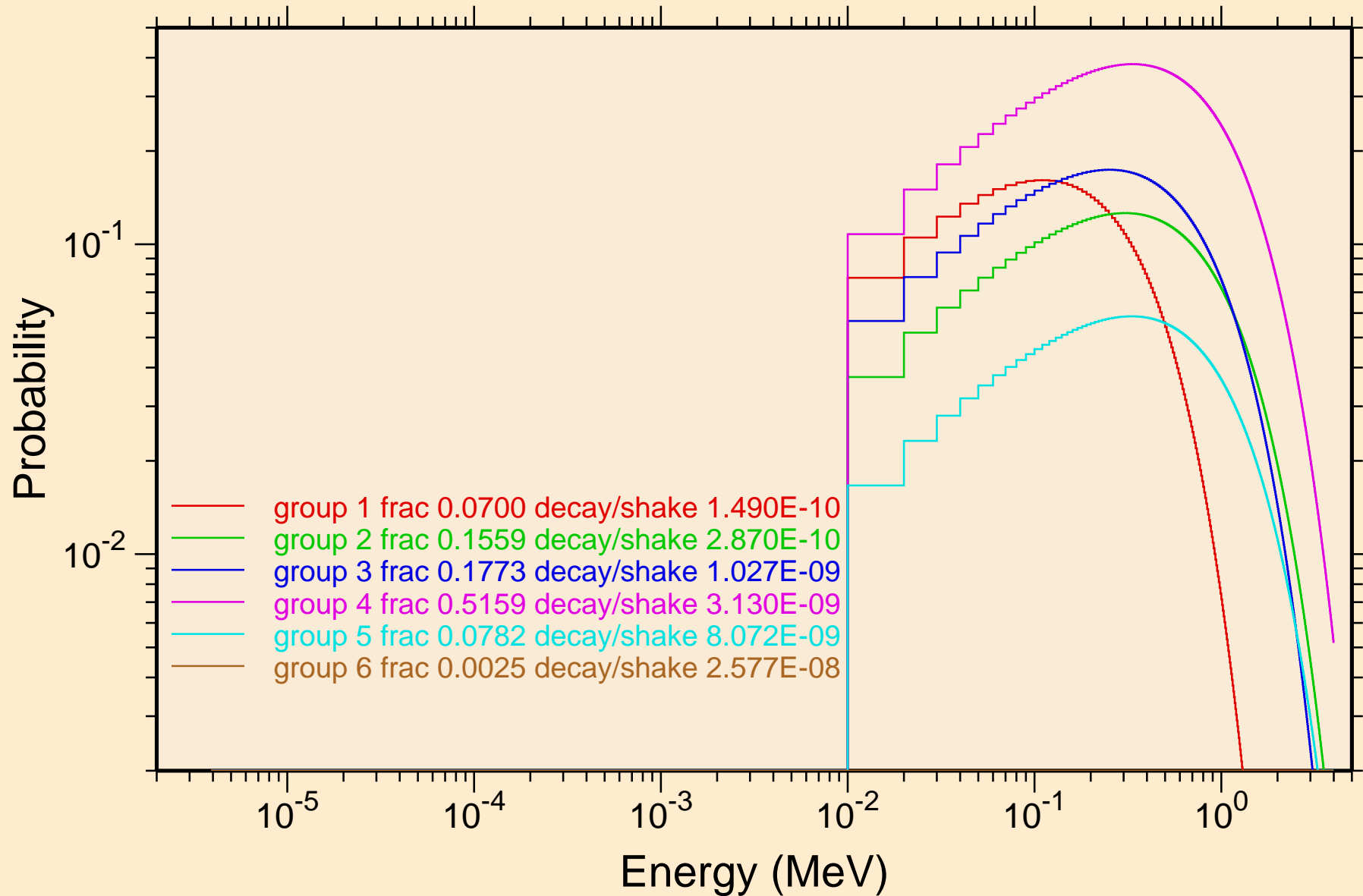

AT218 NEUTRON ACER TENDL-2024 LIBRARY; T=0.K
Photon emission for (n,x)

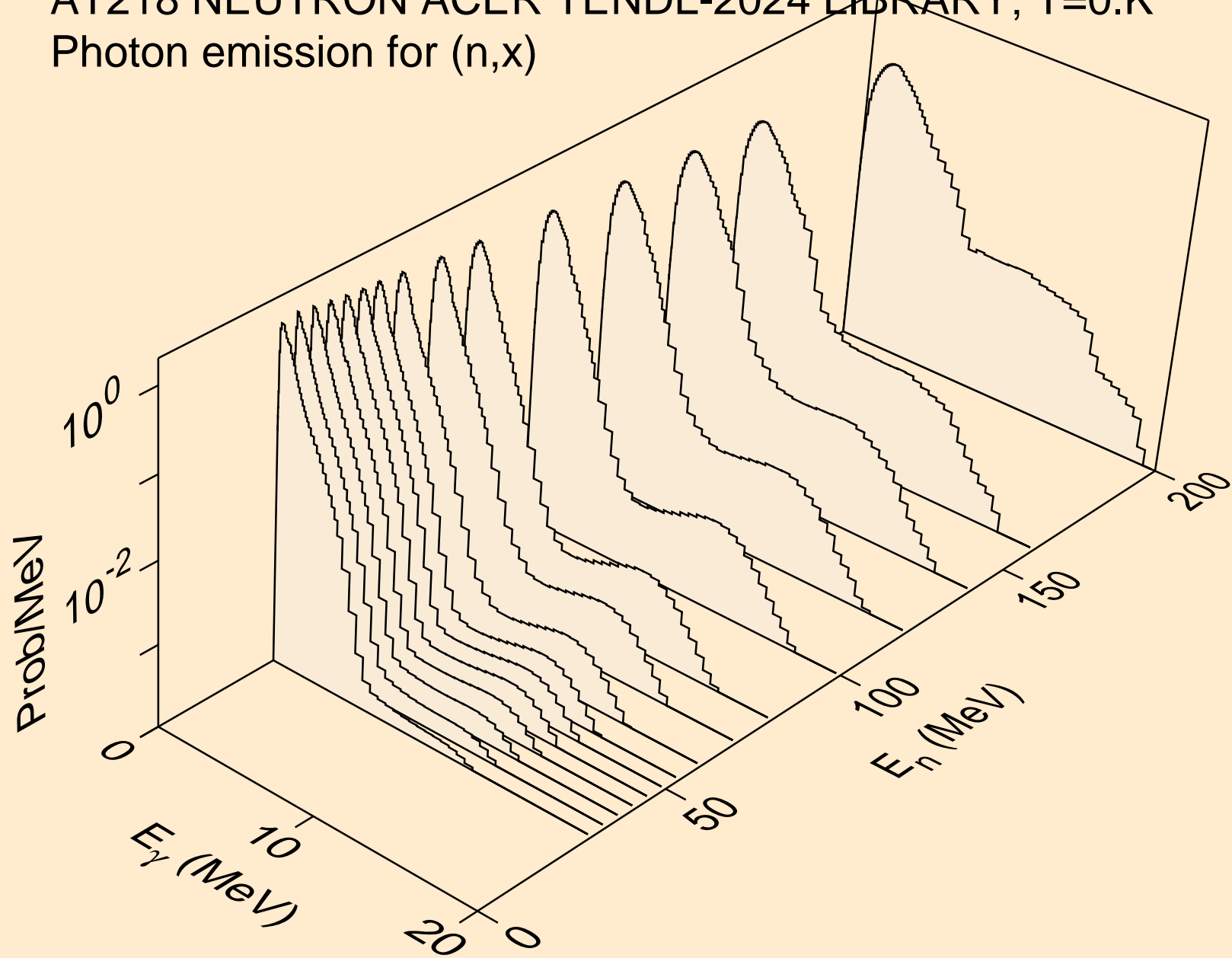

AT218 NEUTRON ACER TENDL-2024 LIBRARY; T=0.K
Photon emission for (n,2nd)

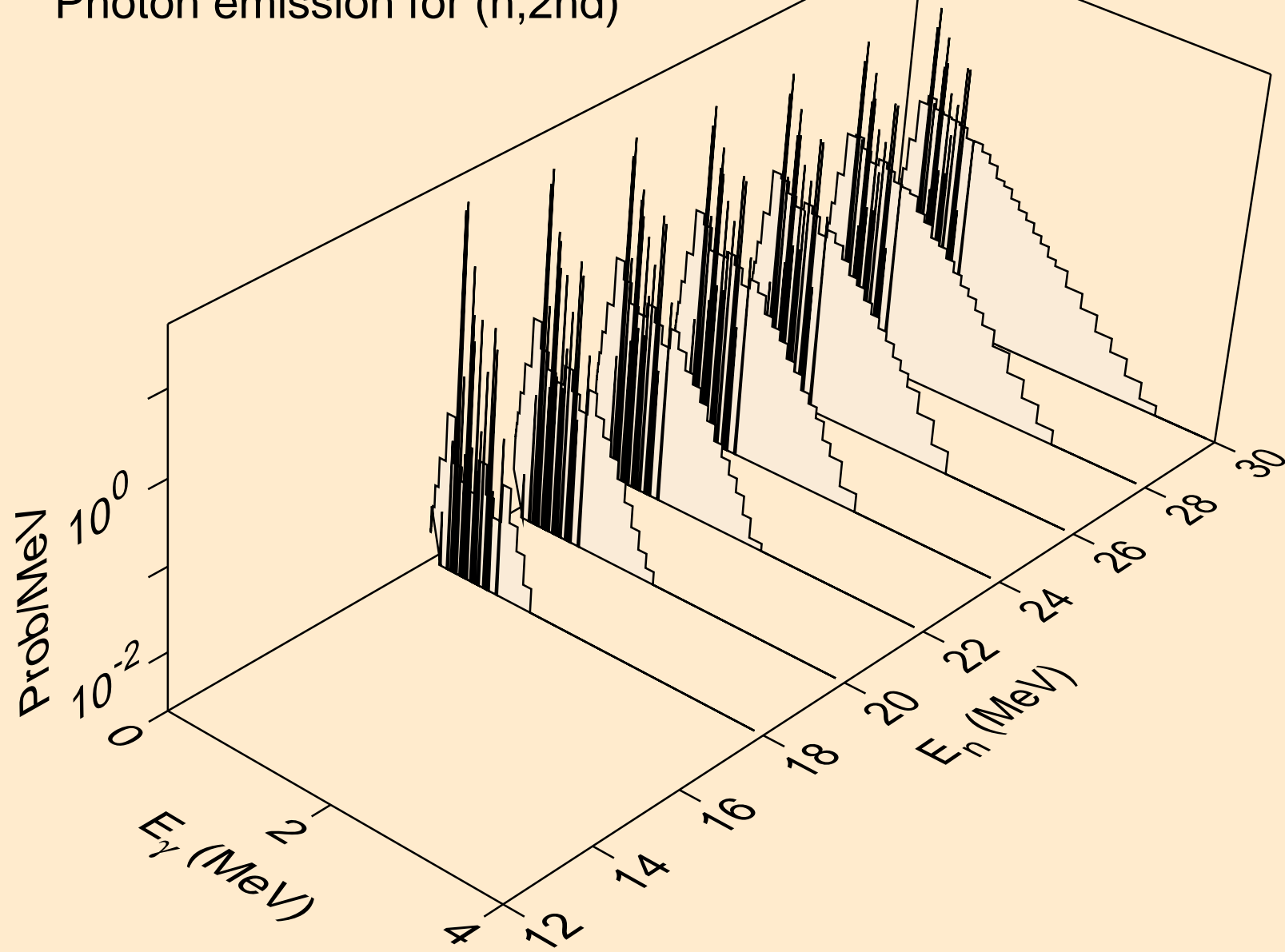

AT218 NEUTRON ACER TENDL-2024 LIBRARY; T=0.K
Photon emission for (n,2n)

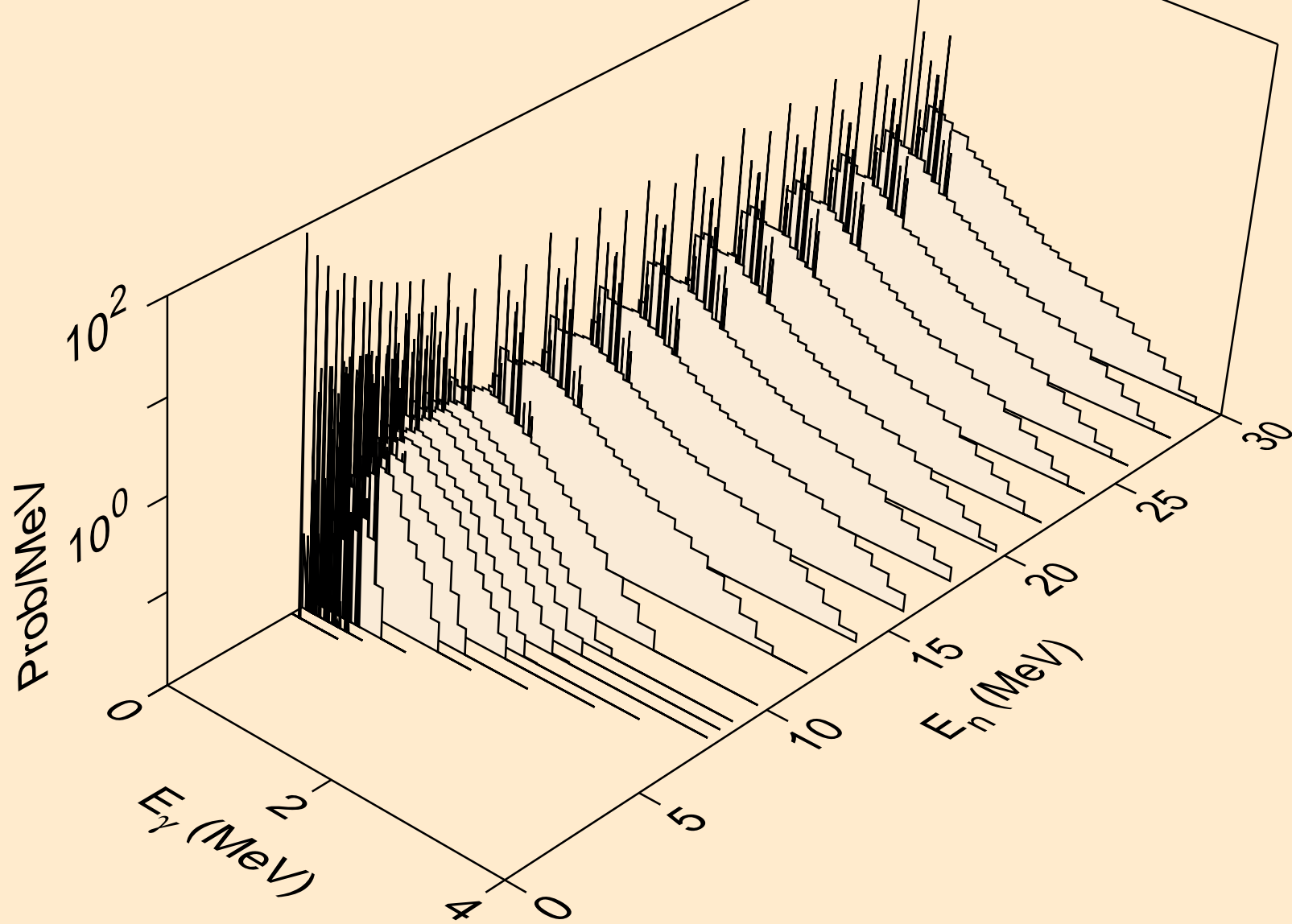

AT218 NEUTRON ACER TENDL-2024 LIBRARY; T=0.K
Photon emission for (n,3n)

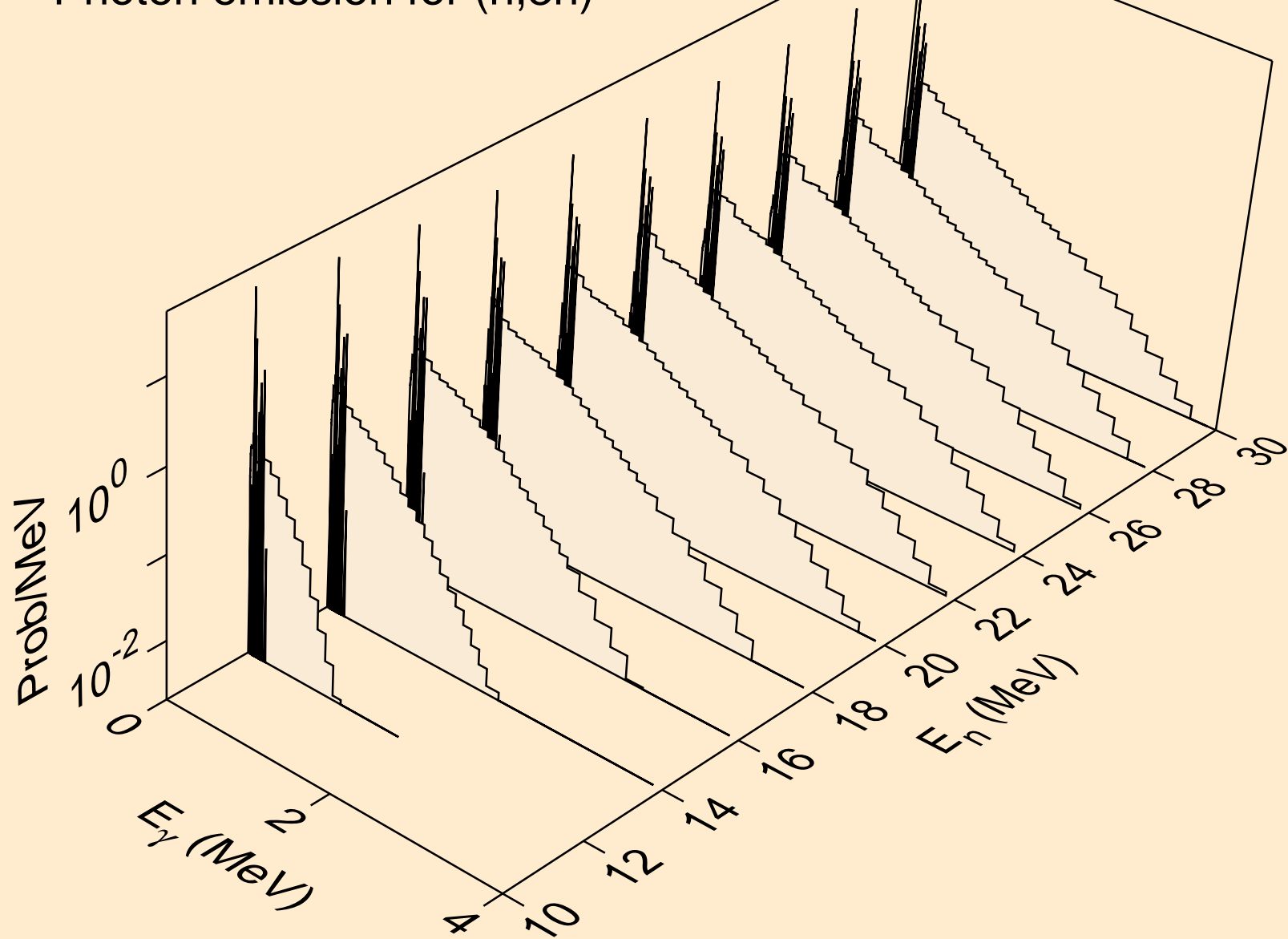

AT218 NEUTRON ACER TENDL-2024 LIBRARY; T=0.K
Photon emission for (n,n*)a

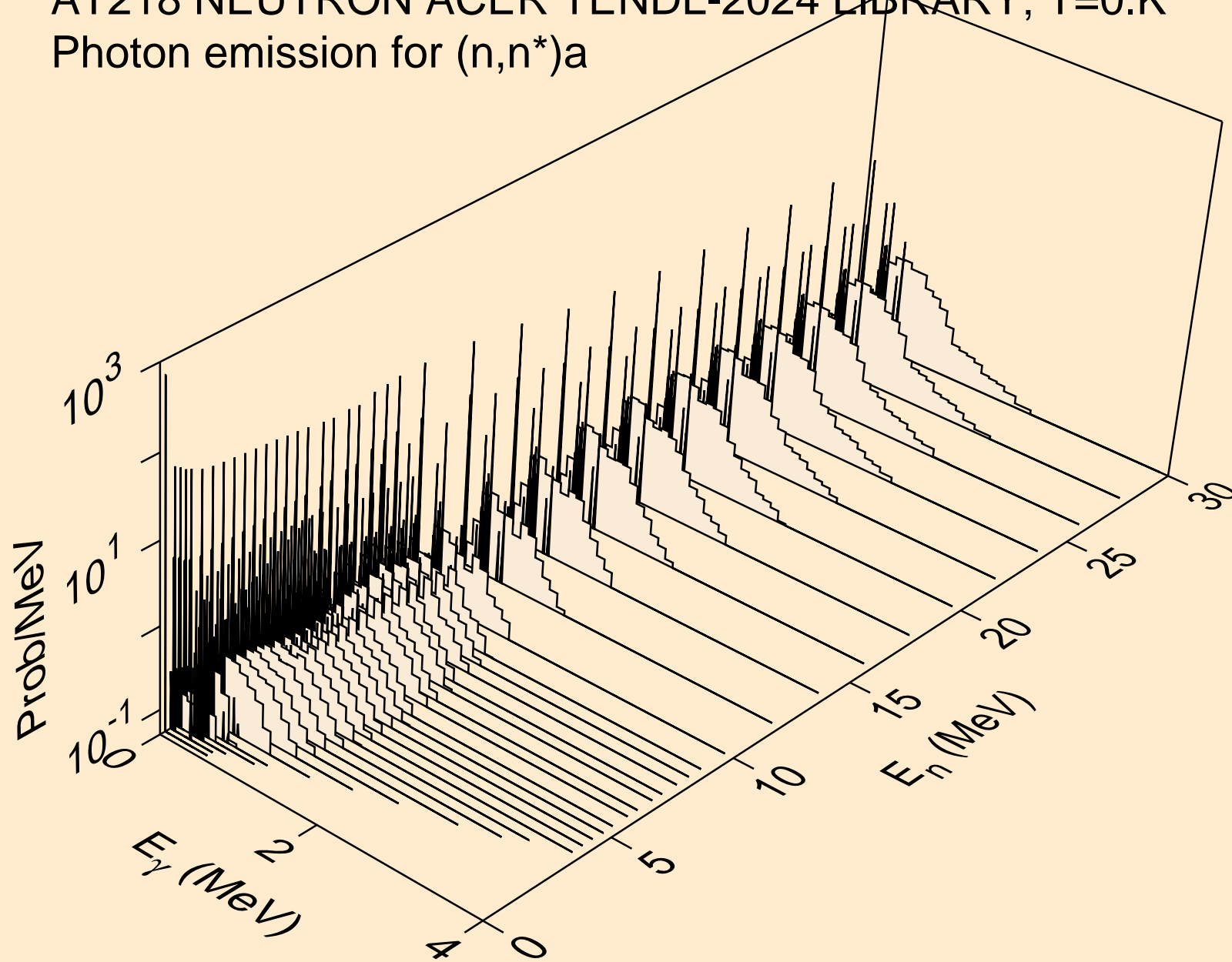

AT218 NEUTRON ACER TENDL-2024 LIBRARY; T=0.K
Photon emission for (n,2n)a

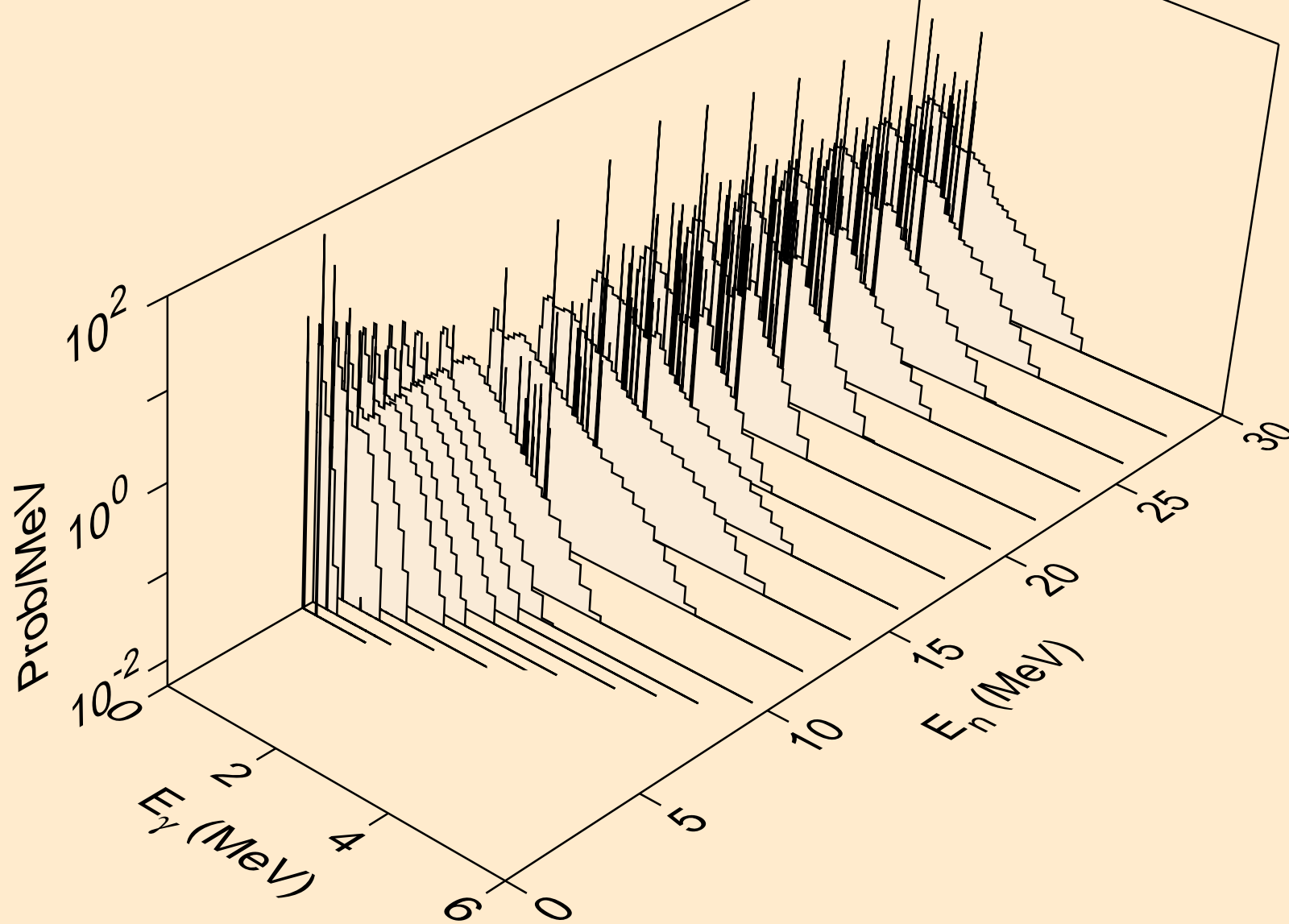

AT218 NEUTRON ACER TENDL-2024 LIBRARY; T=0.K
Photon emission for (n,3n)a

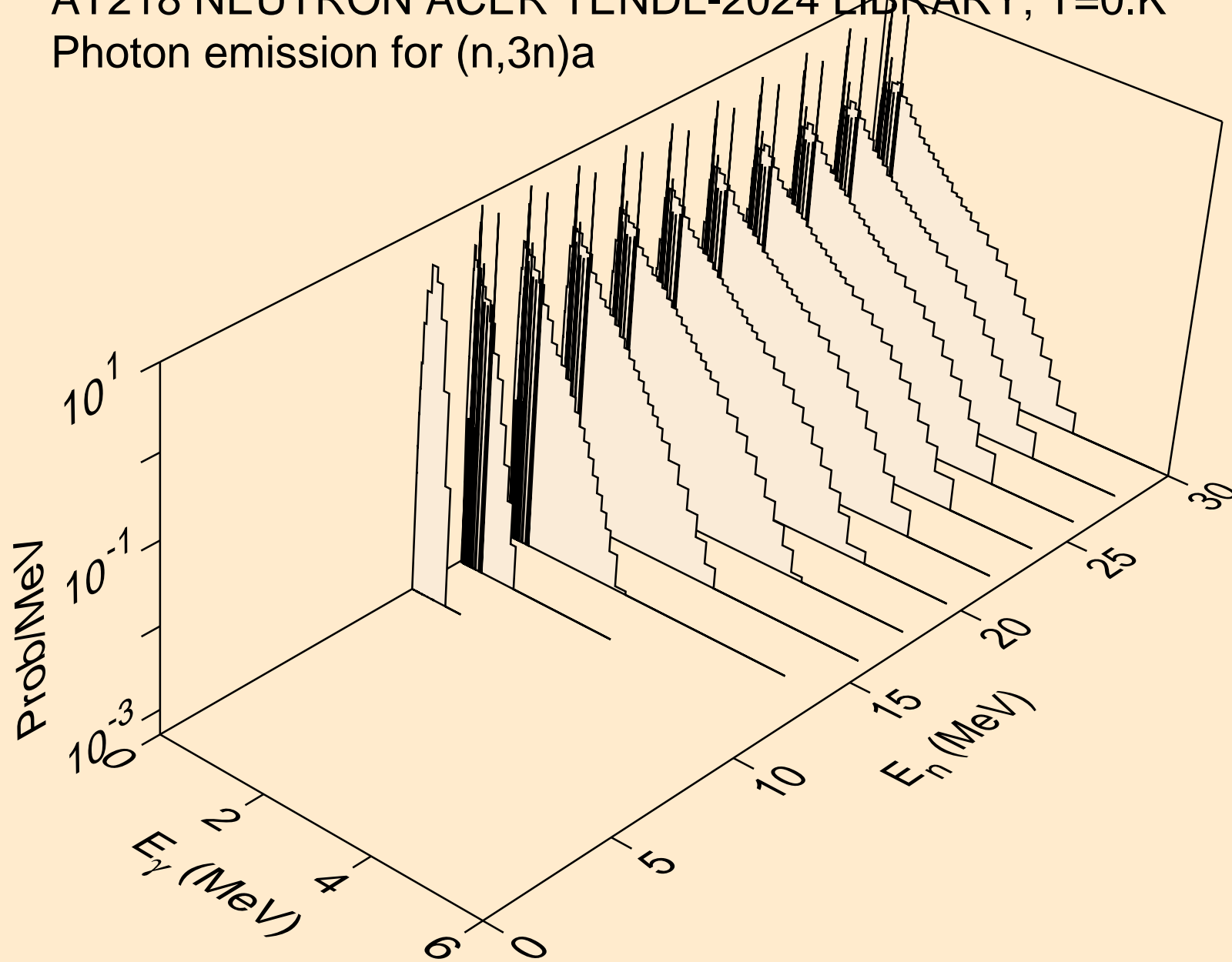

AT218 NEUTRON ACER TENDL-2024 LIBRARY; T=0.K
Photon emission for (n,n*)p

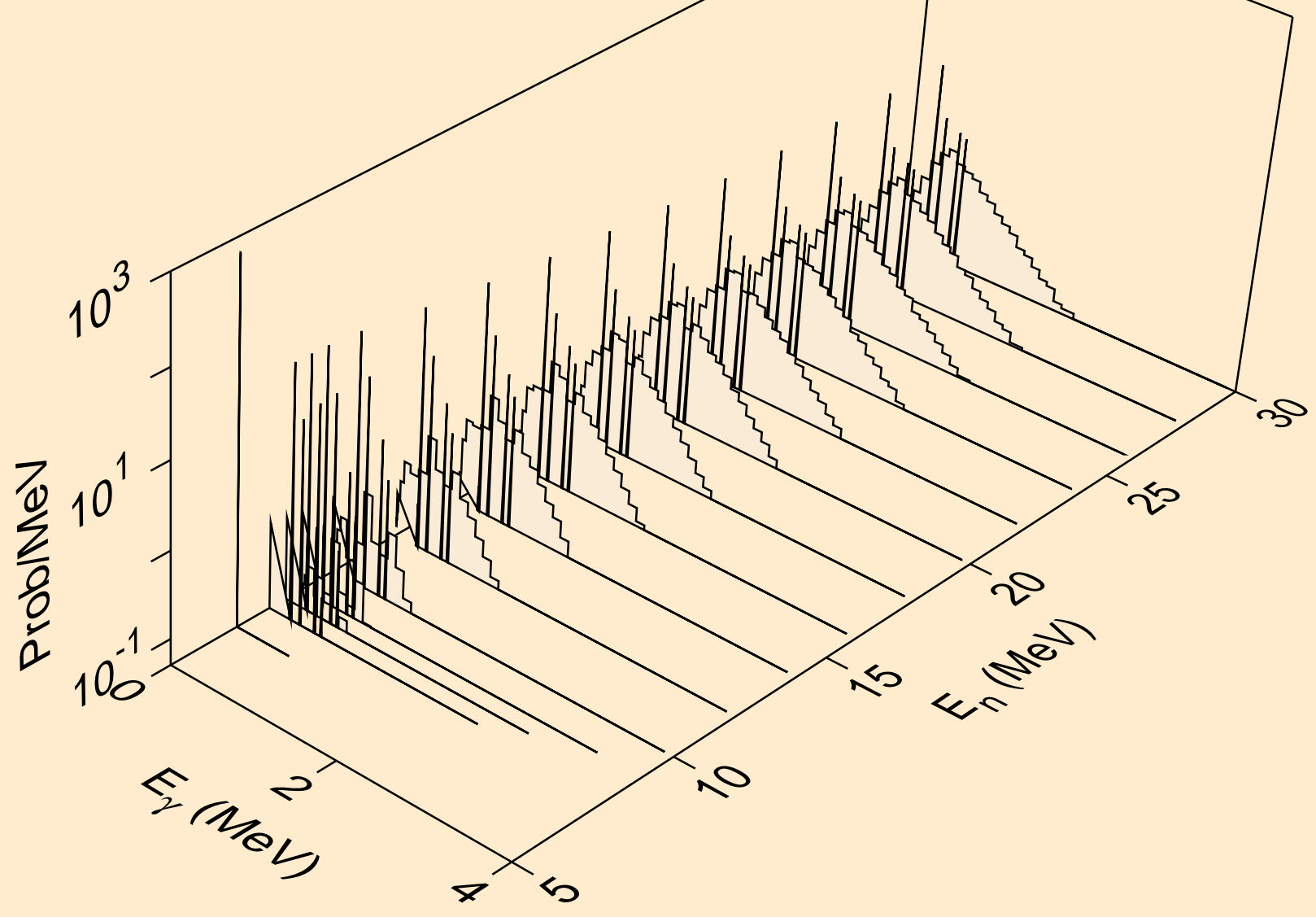

AT218 NEUTRON ACER TENDL-2024 LIBRARY; T=0.K
Photon emission for (n,n*)2a

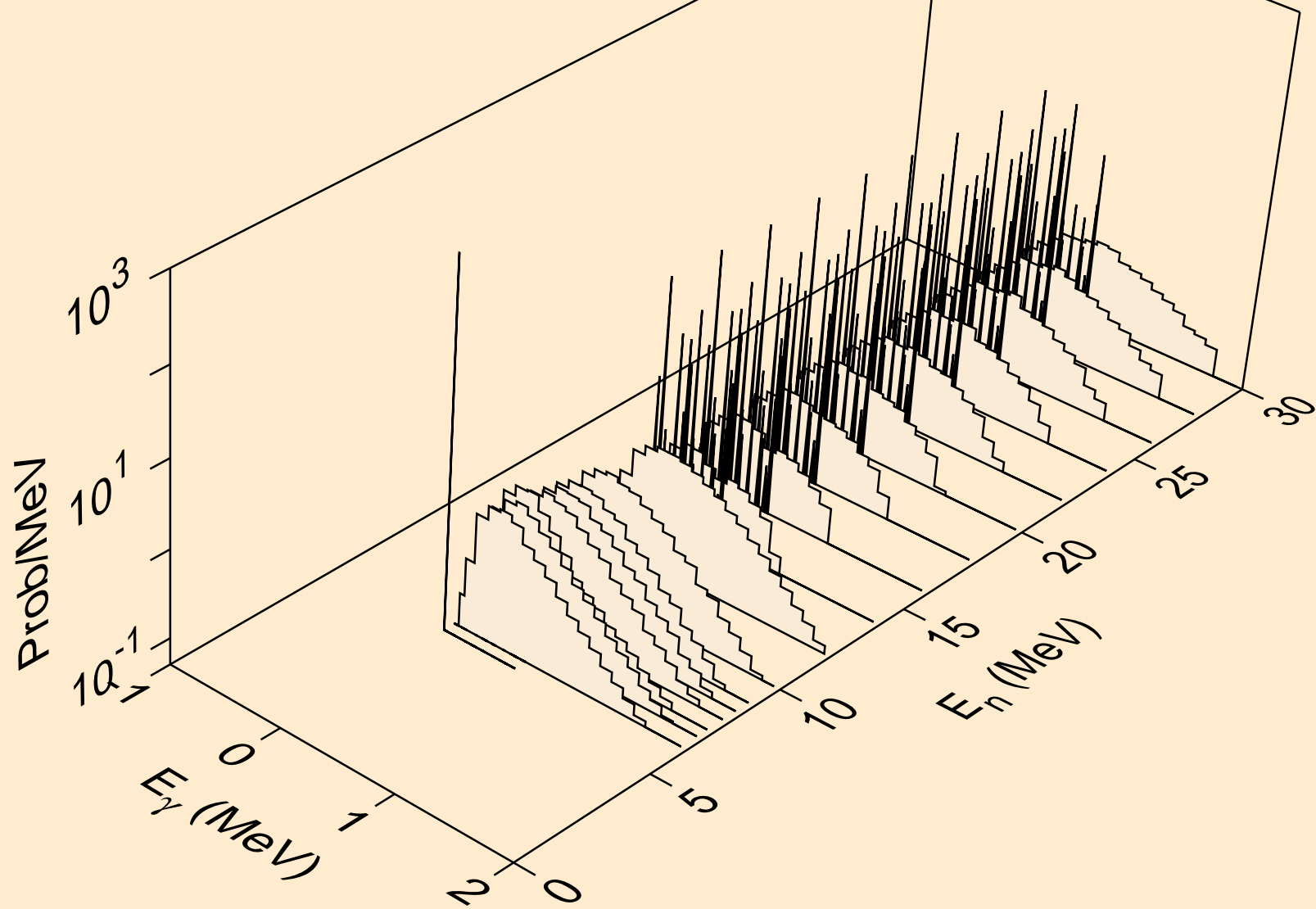

AT218 NEUTRON ACER TENDL-2024 LIBRARY; T=0.K
Photon emission for (n,2n)2a

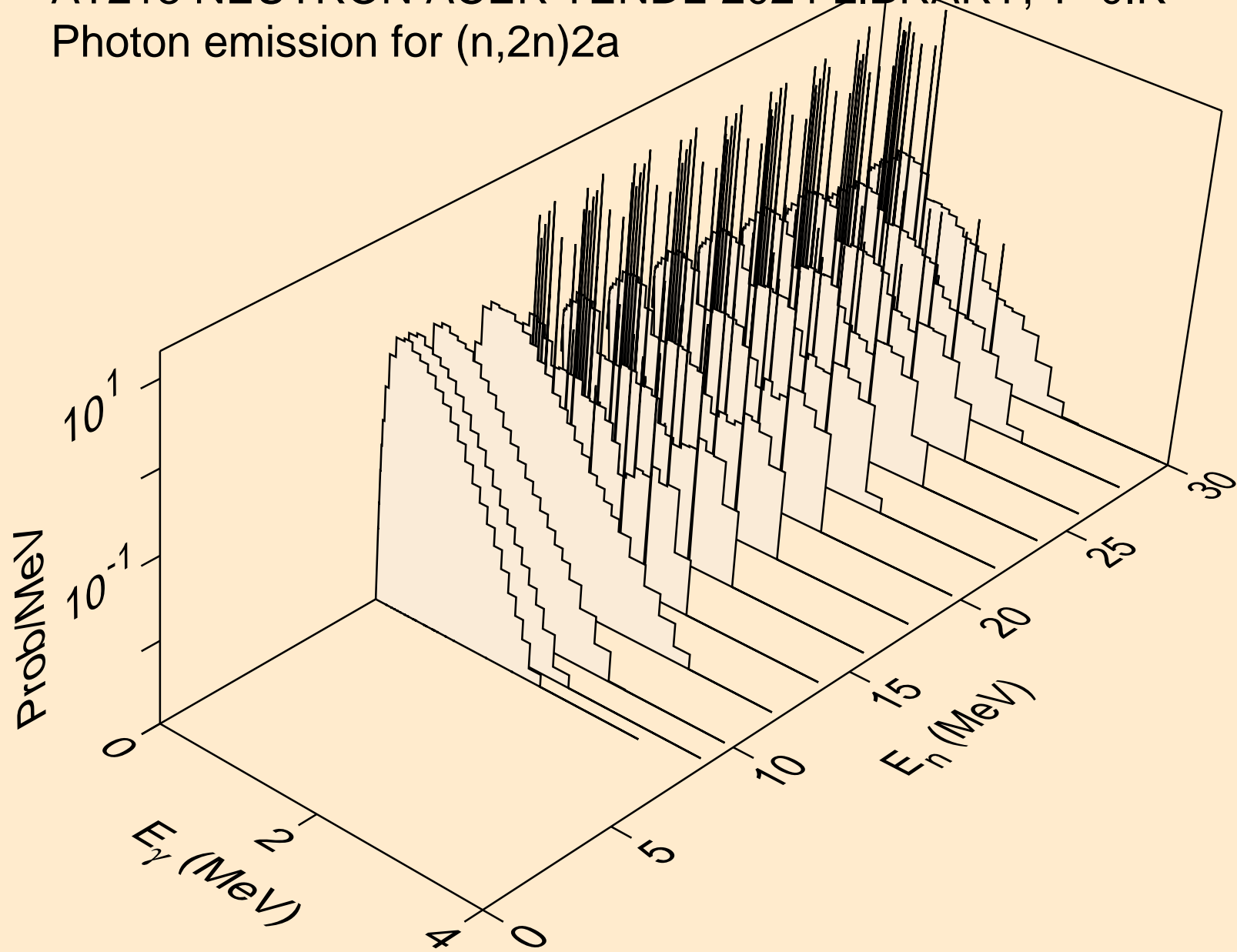

AT218 NEUTRON ACER TENDL-2024 LIBRARY; T=0.K
Photon emission for (n,n*)d

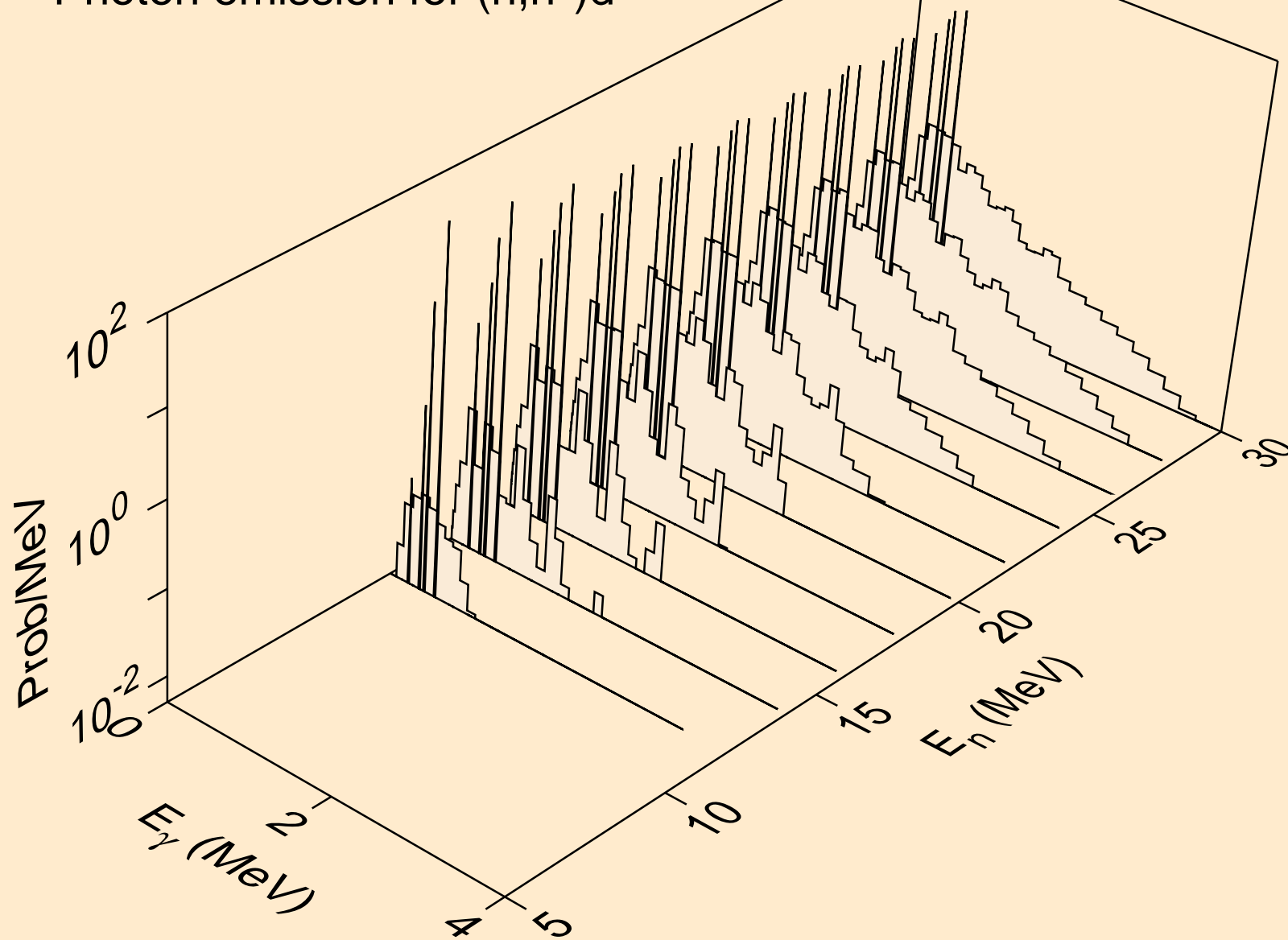

AT218 NEUTRON ACER TENDL-2024 LIBRARY; T=0.K
Photon emission for (n,n*)t

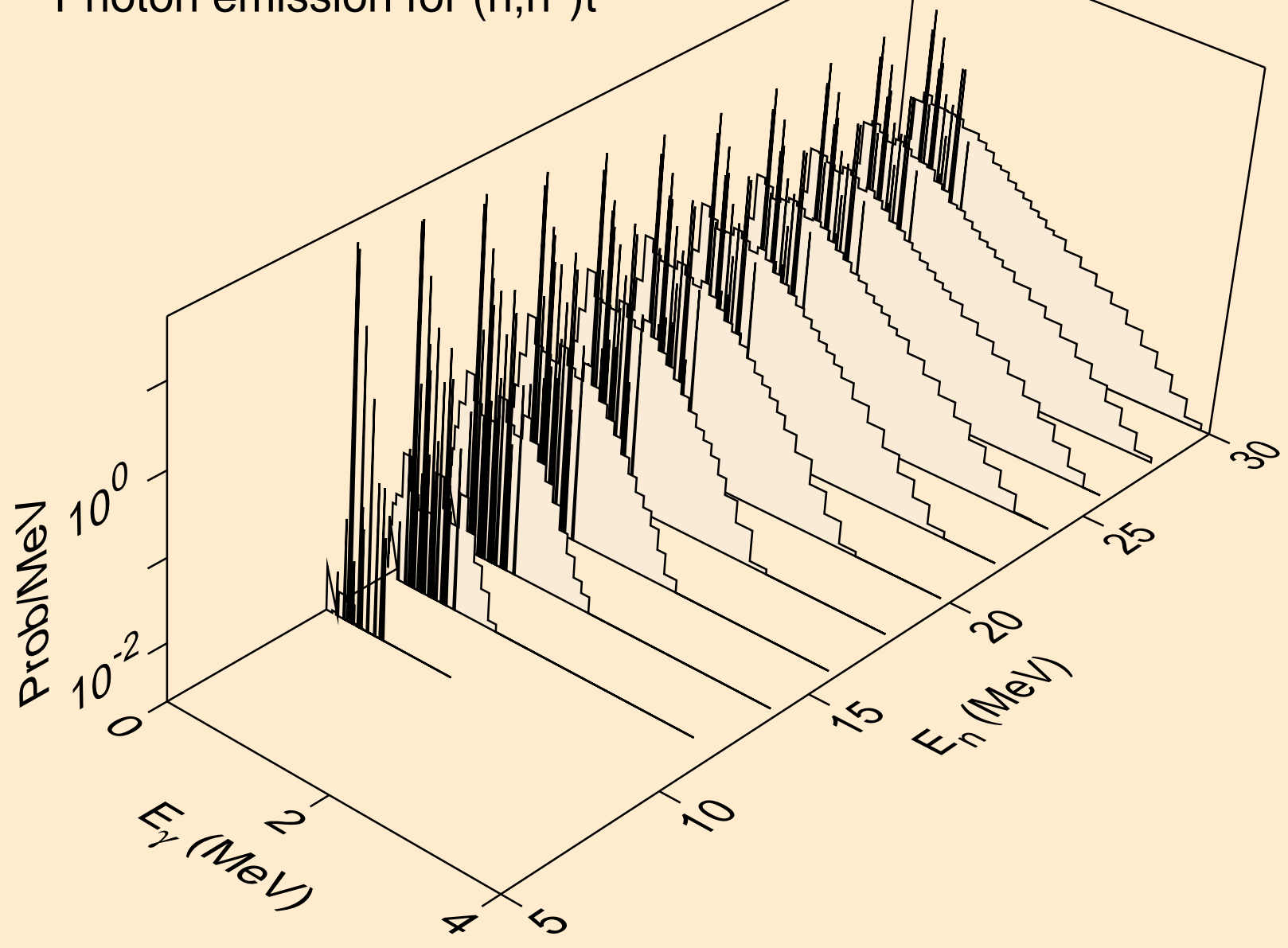

AT218 NEUTRON ACER TENDL-2024 LIBRARY; T=0.K
Photon emission for (n,n*)he3

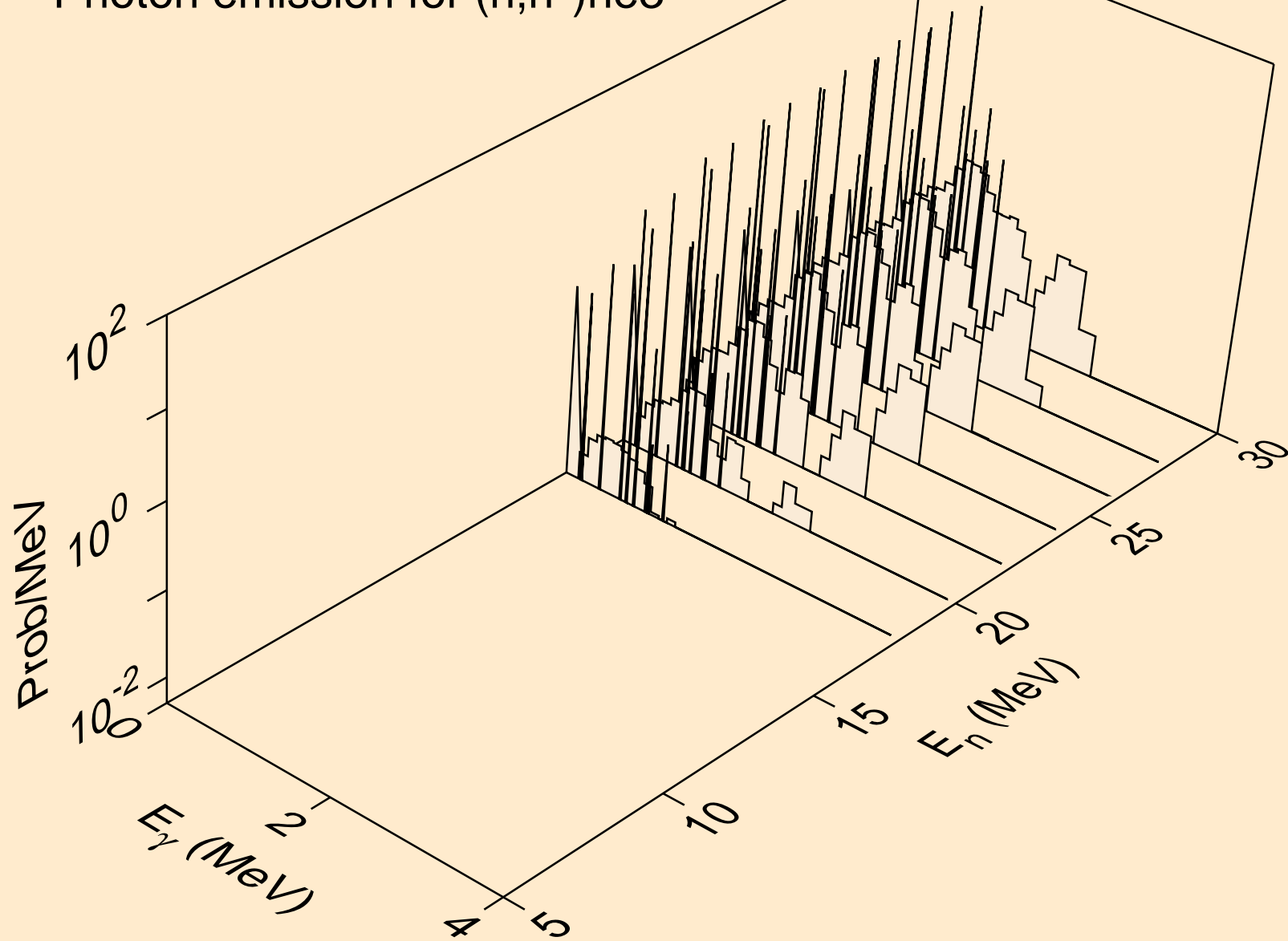

AT218 NEUTRON ACER TENDL-2024 LIBRARY; T=0.K
Photon emission for (n,4n)

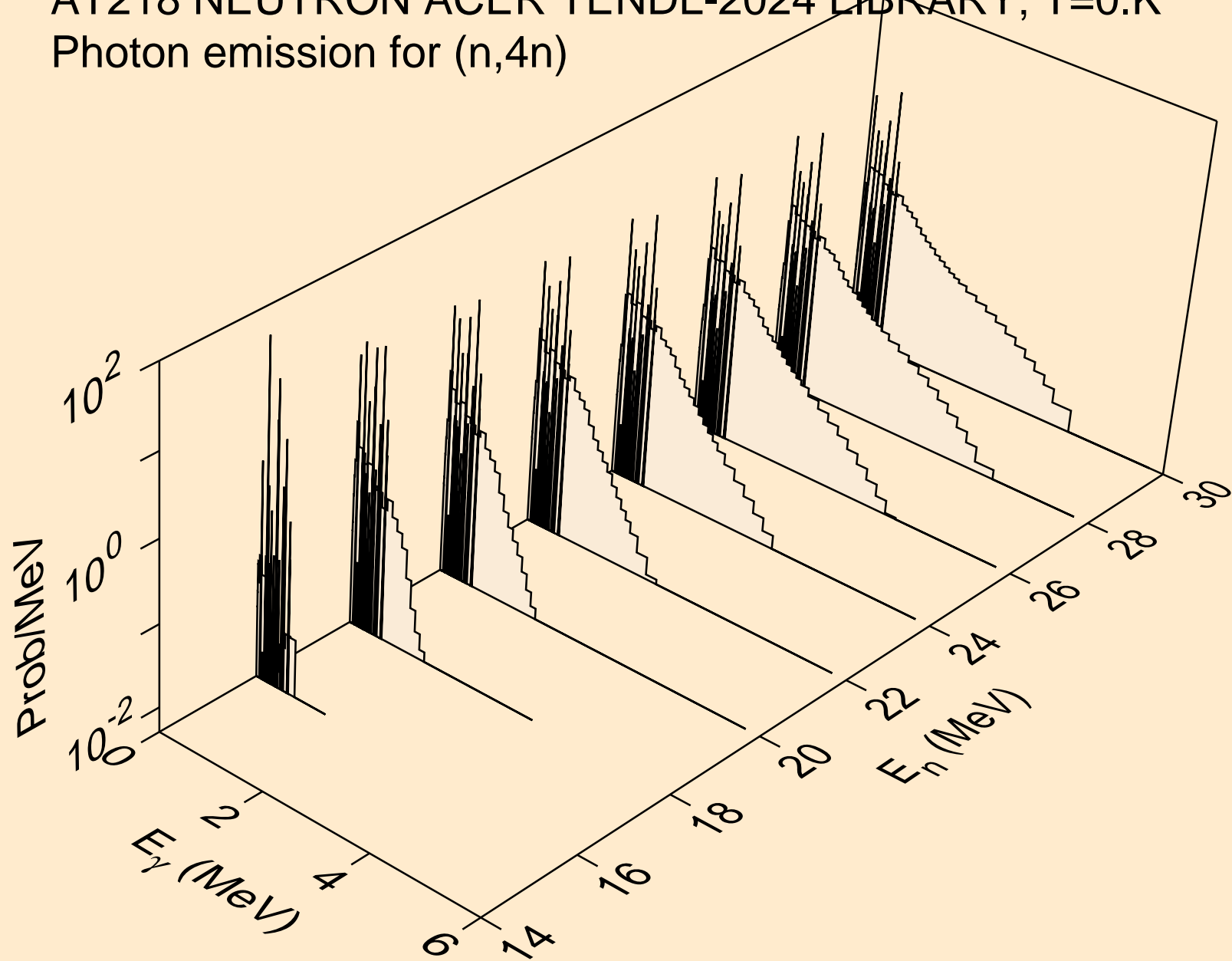

AT218 NEUTRON ACER TENDL-2024 LIBRARY; T=0.K
Photon emission for (n,2np)

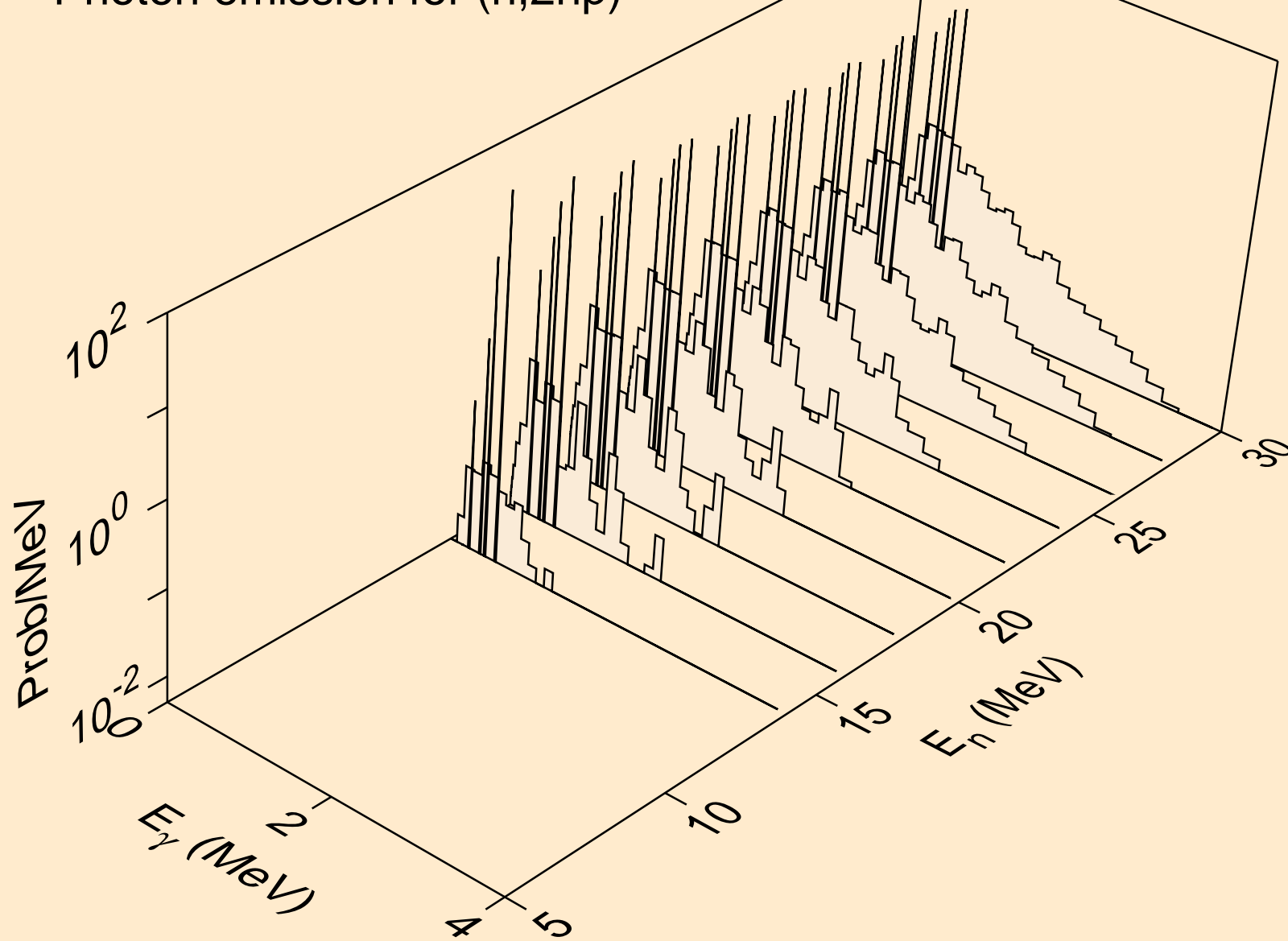

AT218 NEUTRON ACER TENDL-2024 LIBRARY; T=0.K
Photon emission for (n,3np)

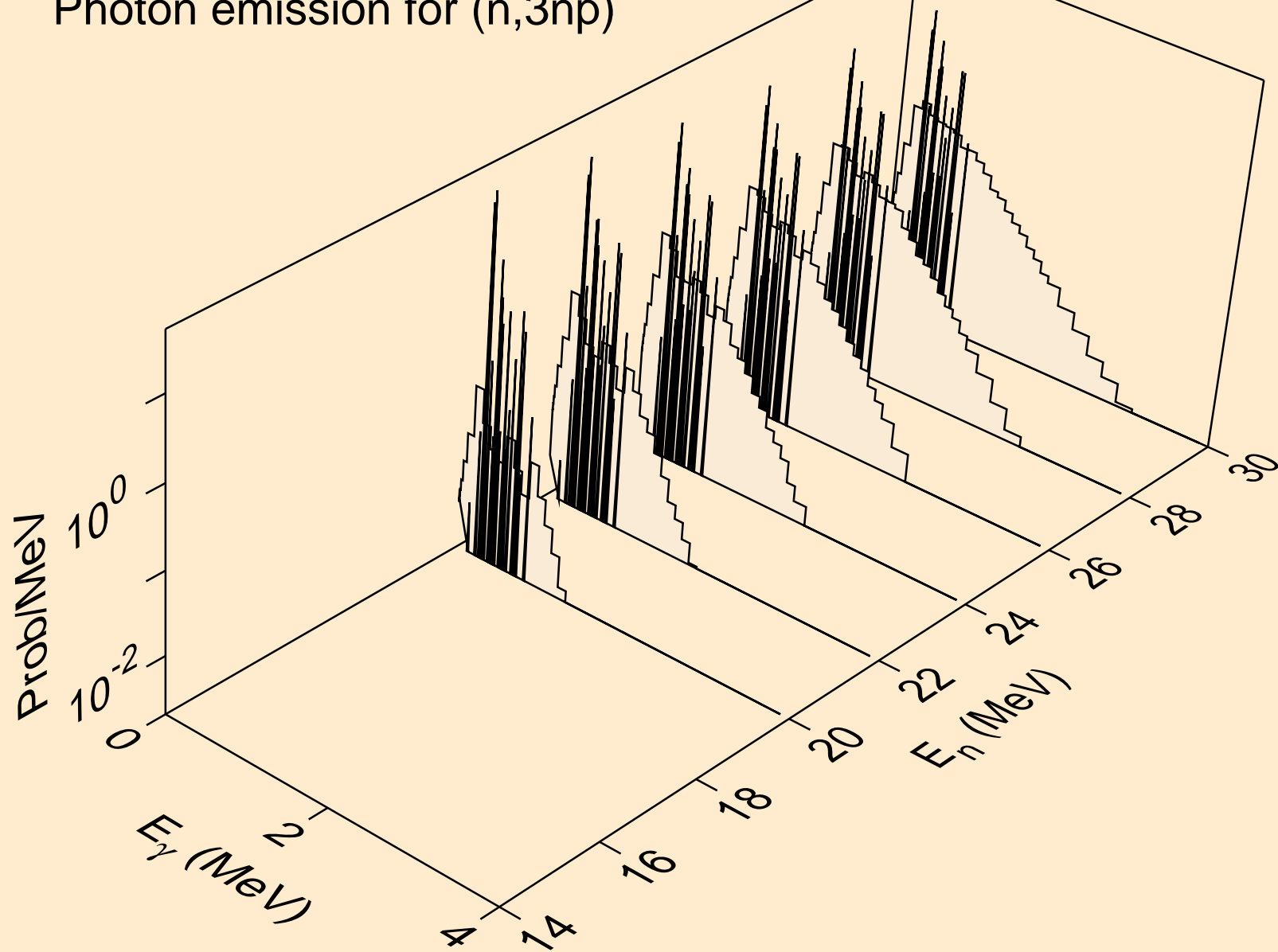

AT218 NEUTRON ACER TENDL-2024 LIBRARY; T=0.K
Photon emission for (n,n2p)

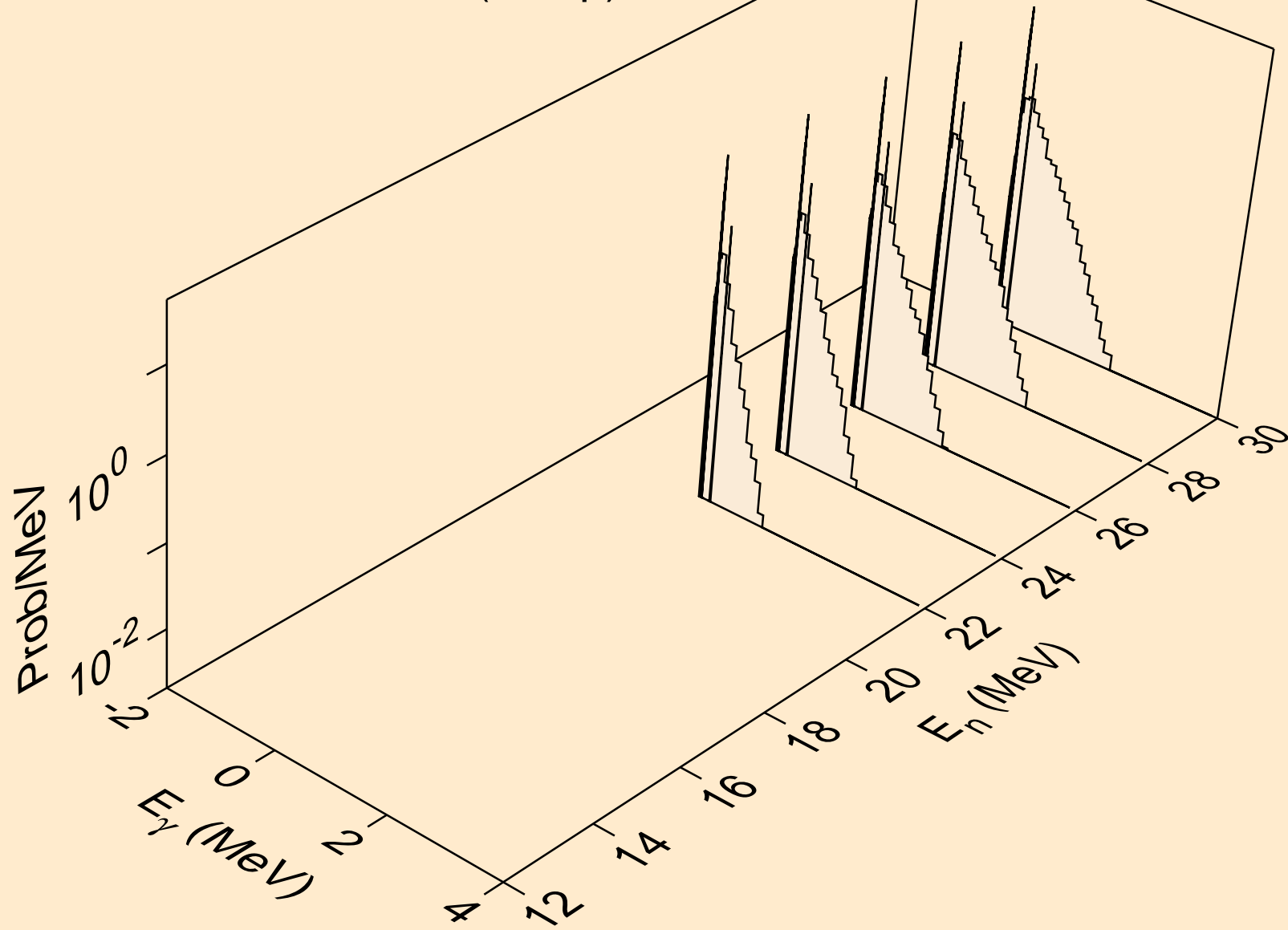

AT218 NEUTRON ACER TENDL-2024 LIBRARY; T=0.K
Photon emission for (n,npa)

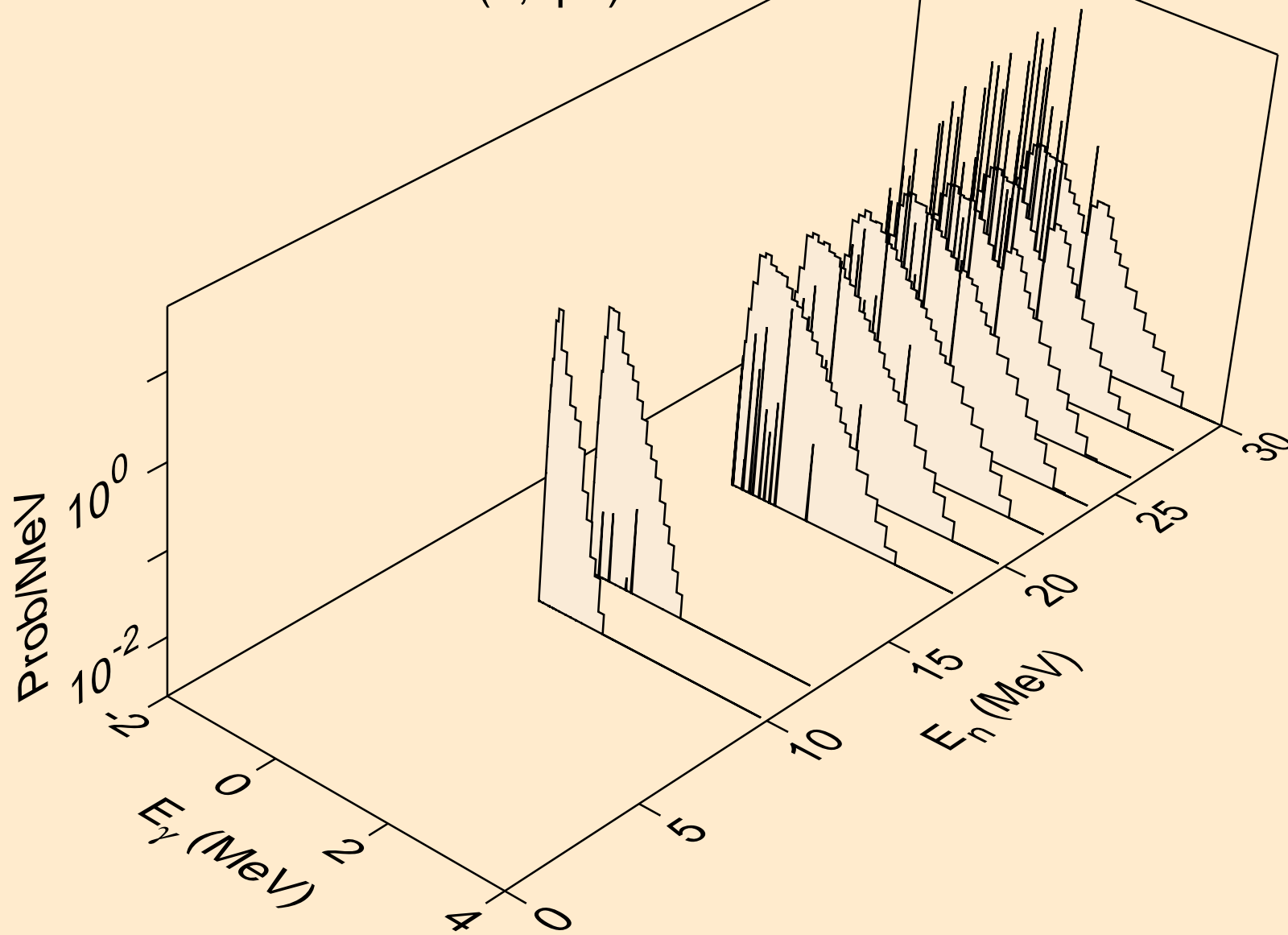

AT218 NEUTRON ACER TENDL-2024 LIBRARY; T=0.K
Photon emission for (n,n*c)

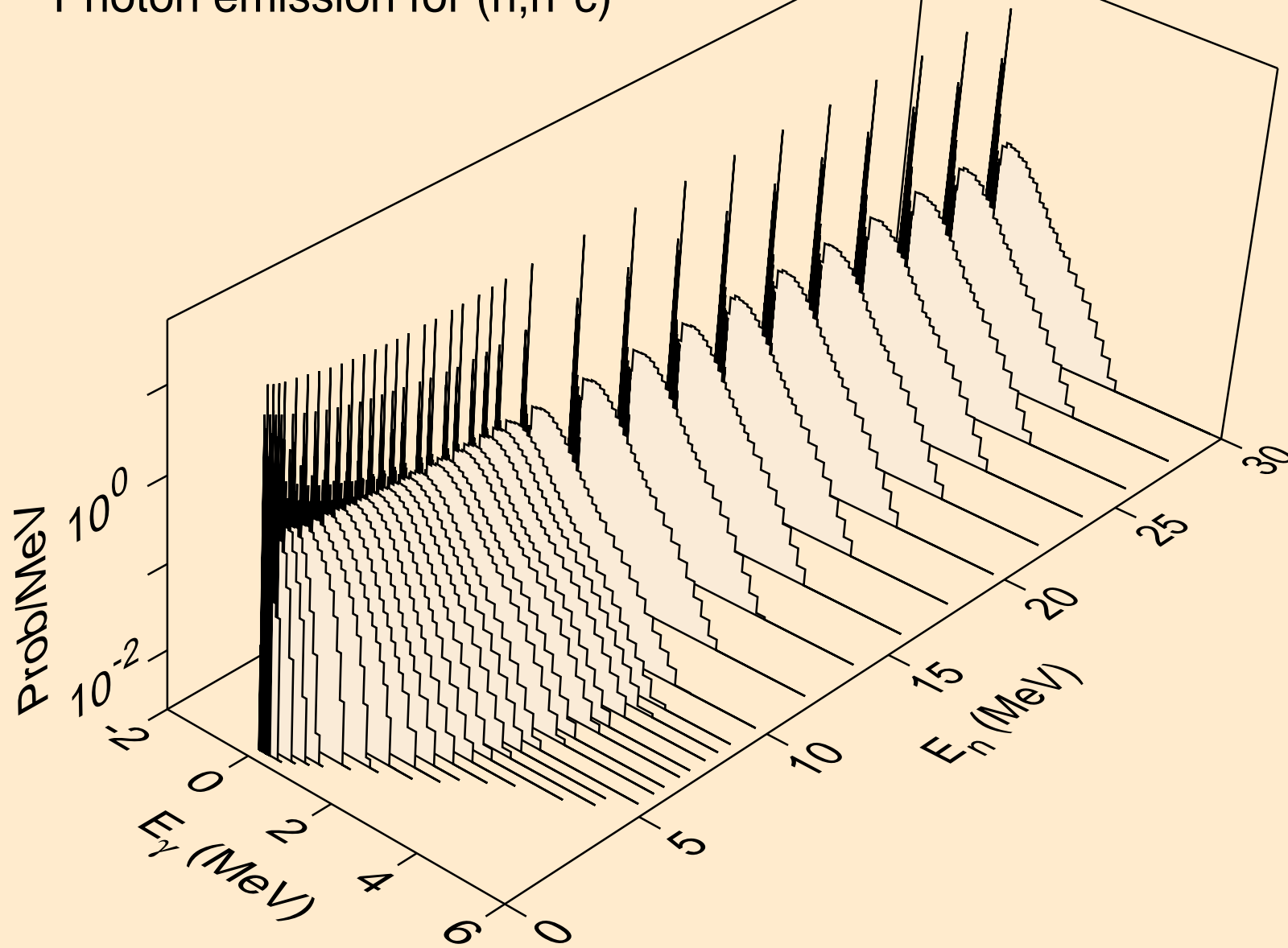

AT218 NEUTRON ACER TENDL-2024 LIBRARY; T=0.K
Photon emission for (n,gma)

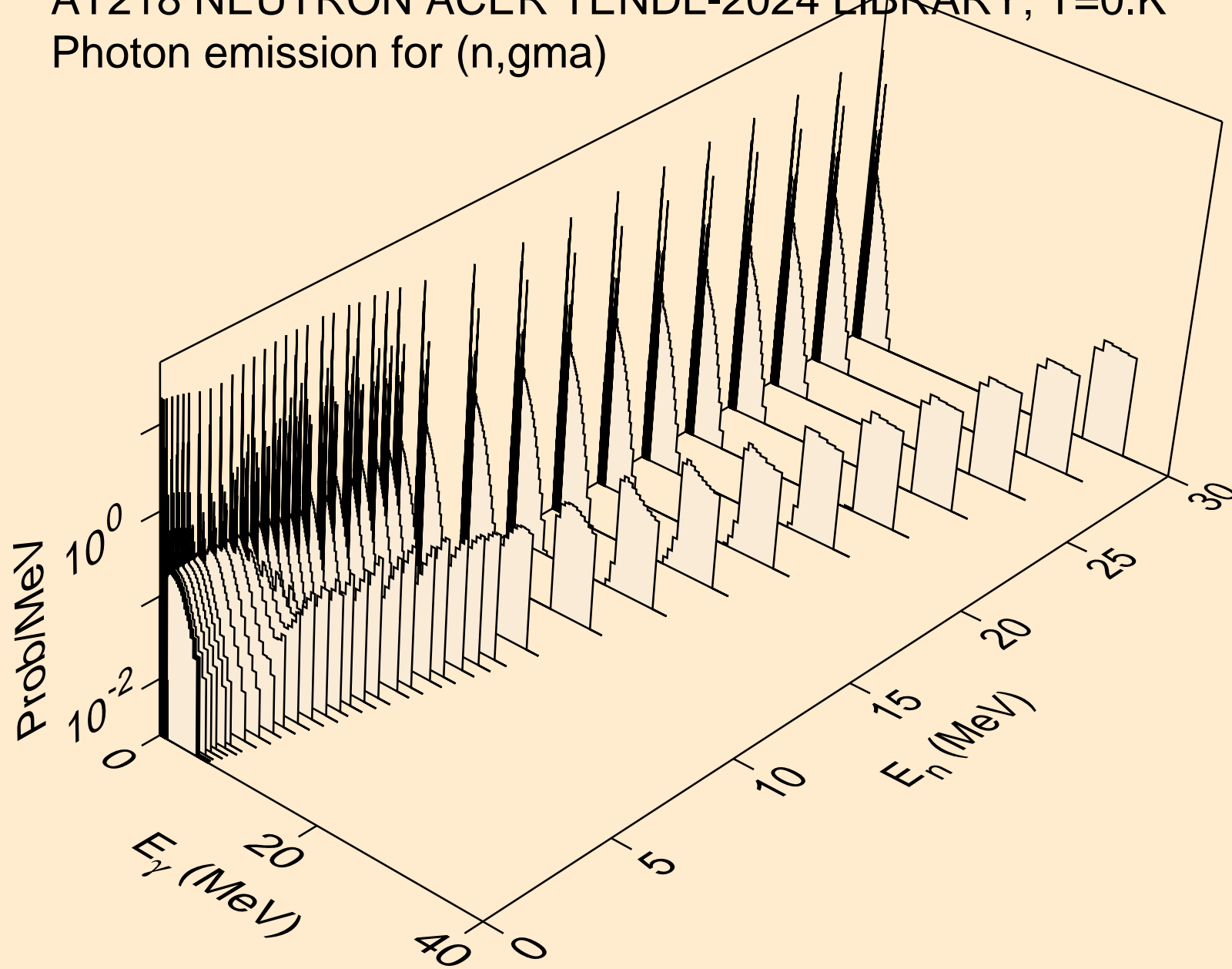

AT218 NEUTRON ACER TENDL-2024 LIBRARY; T=0.K
Photon emission for (n,p)

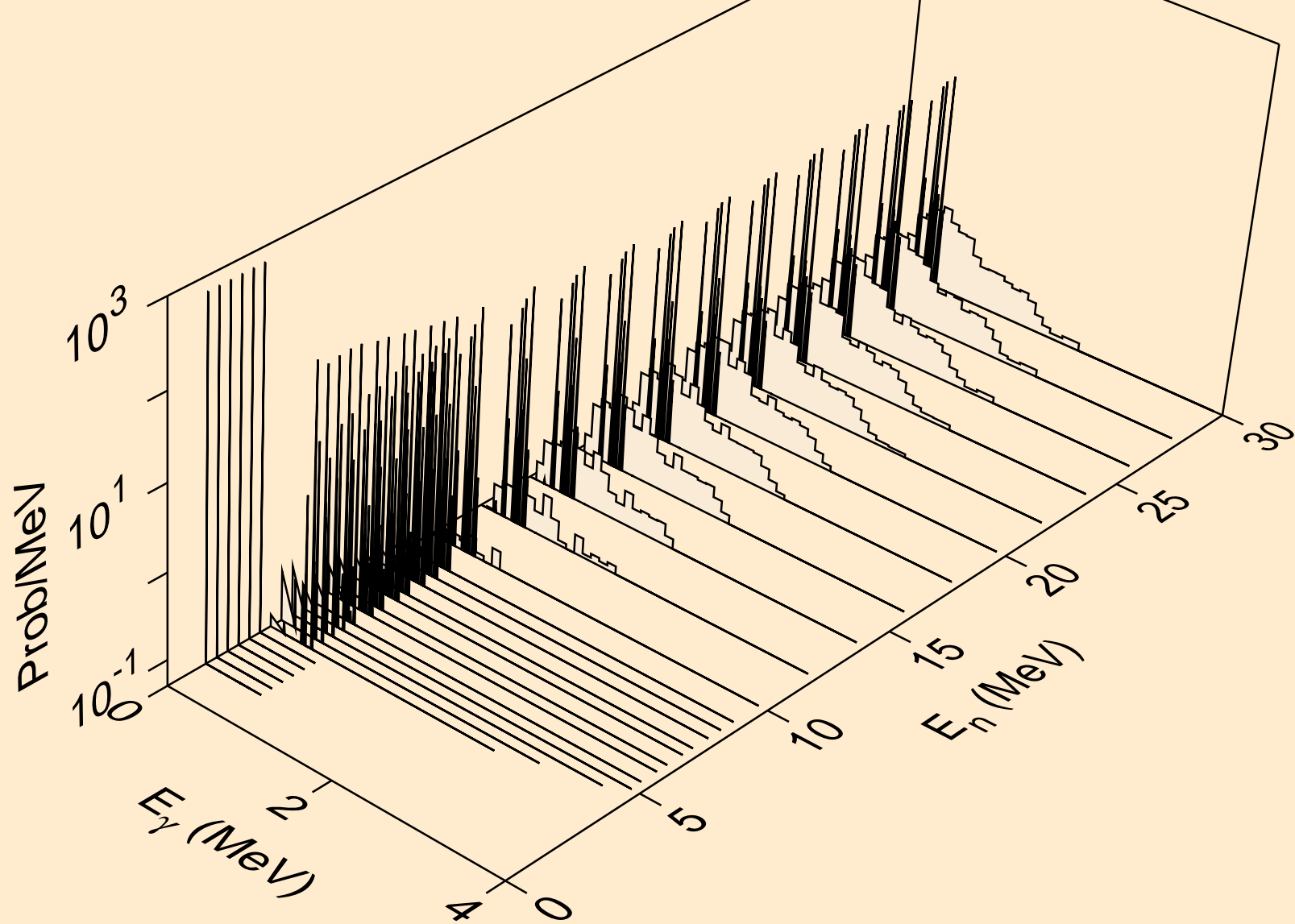

AT218 NEUTRON ACER TENDL-2024 LIBRARY; T=0.K
Photon emission for (n,d)

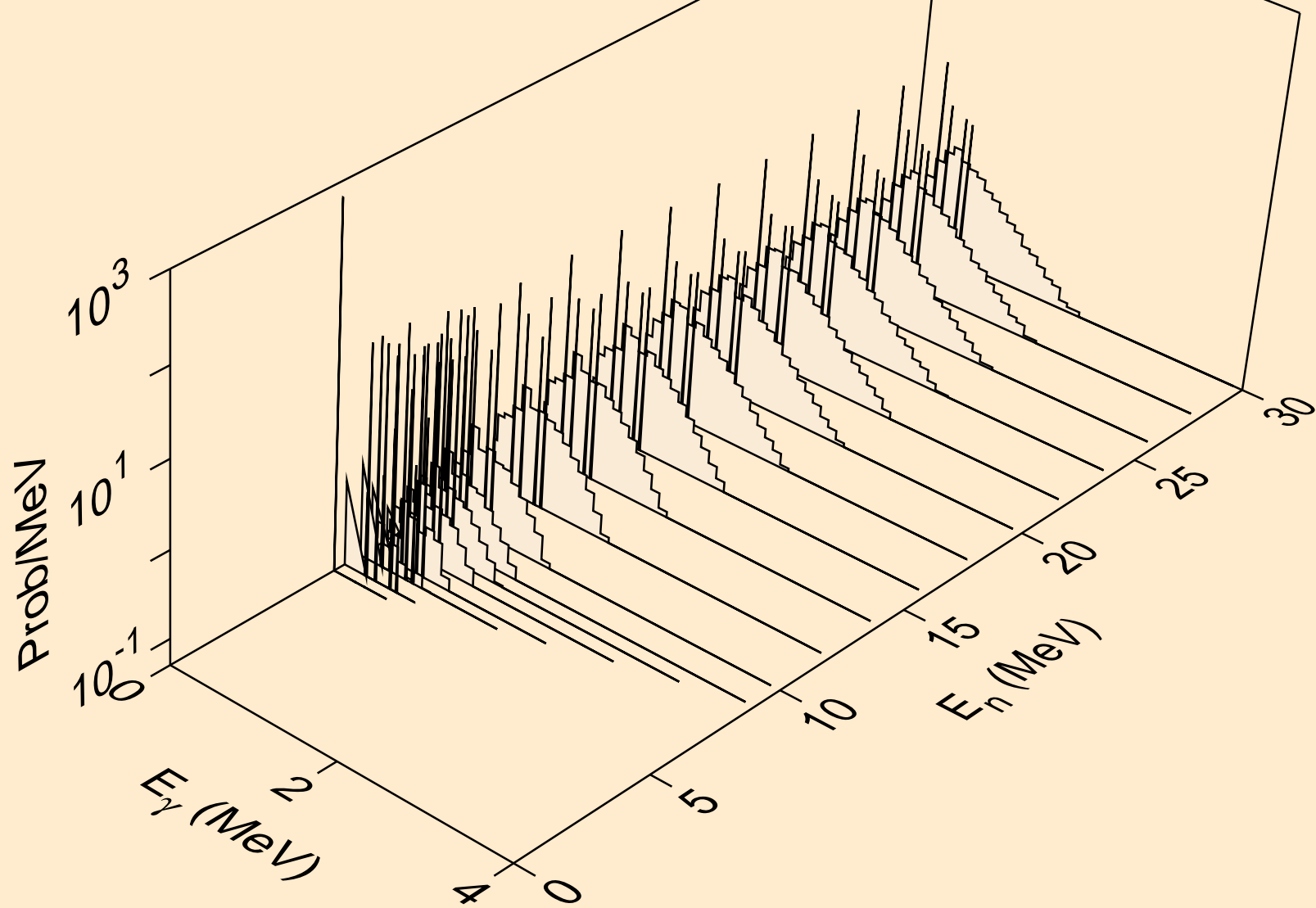

AT218 NEUTRON ACER TENDL-2024 LIBRARY; T=0.K
Photon emission for (n,t)

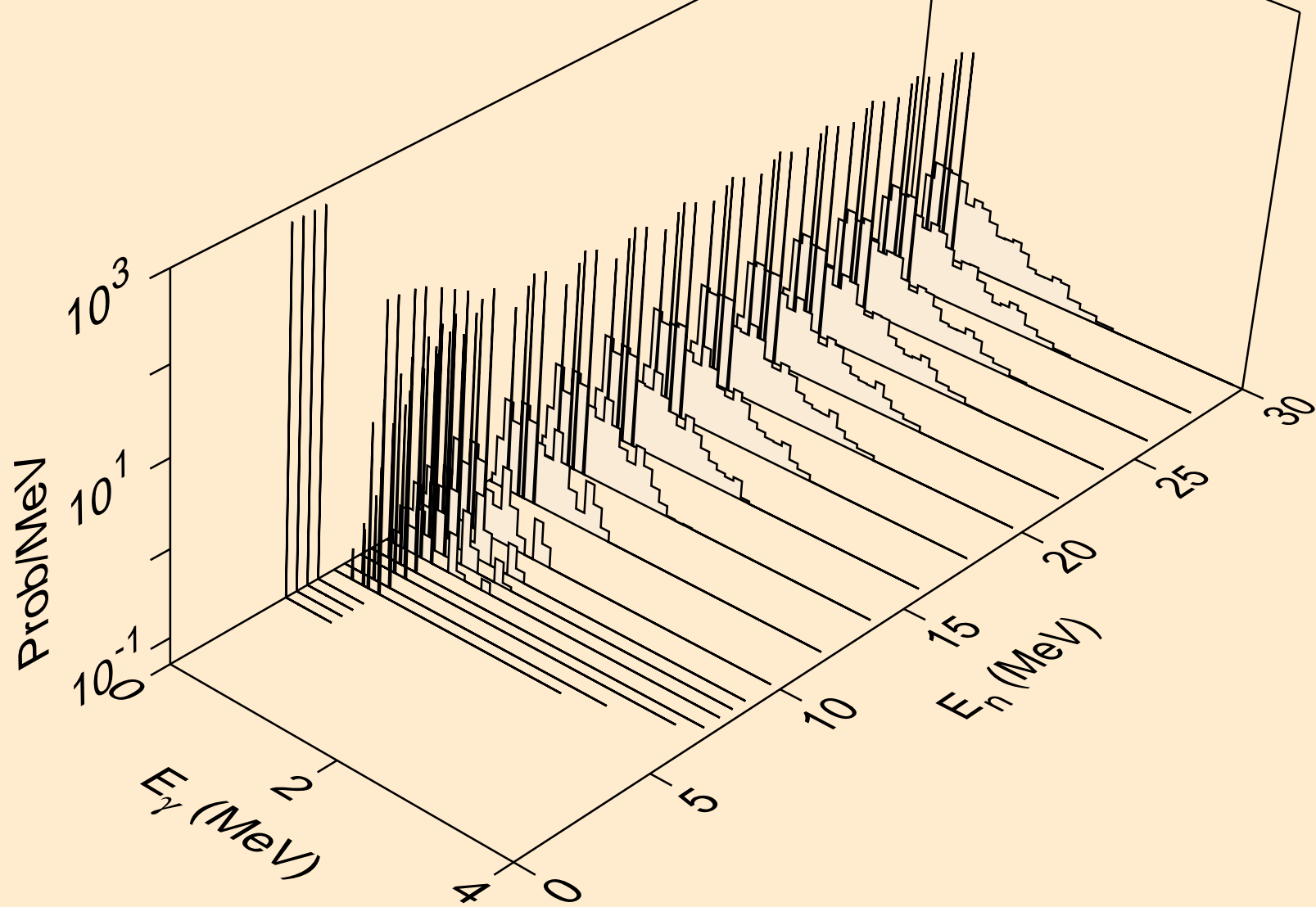

AT218 NEUTRON ACER TENDL-2024 LIBRARY; T=0.K
Photon emission for (n,he3)

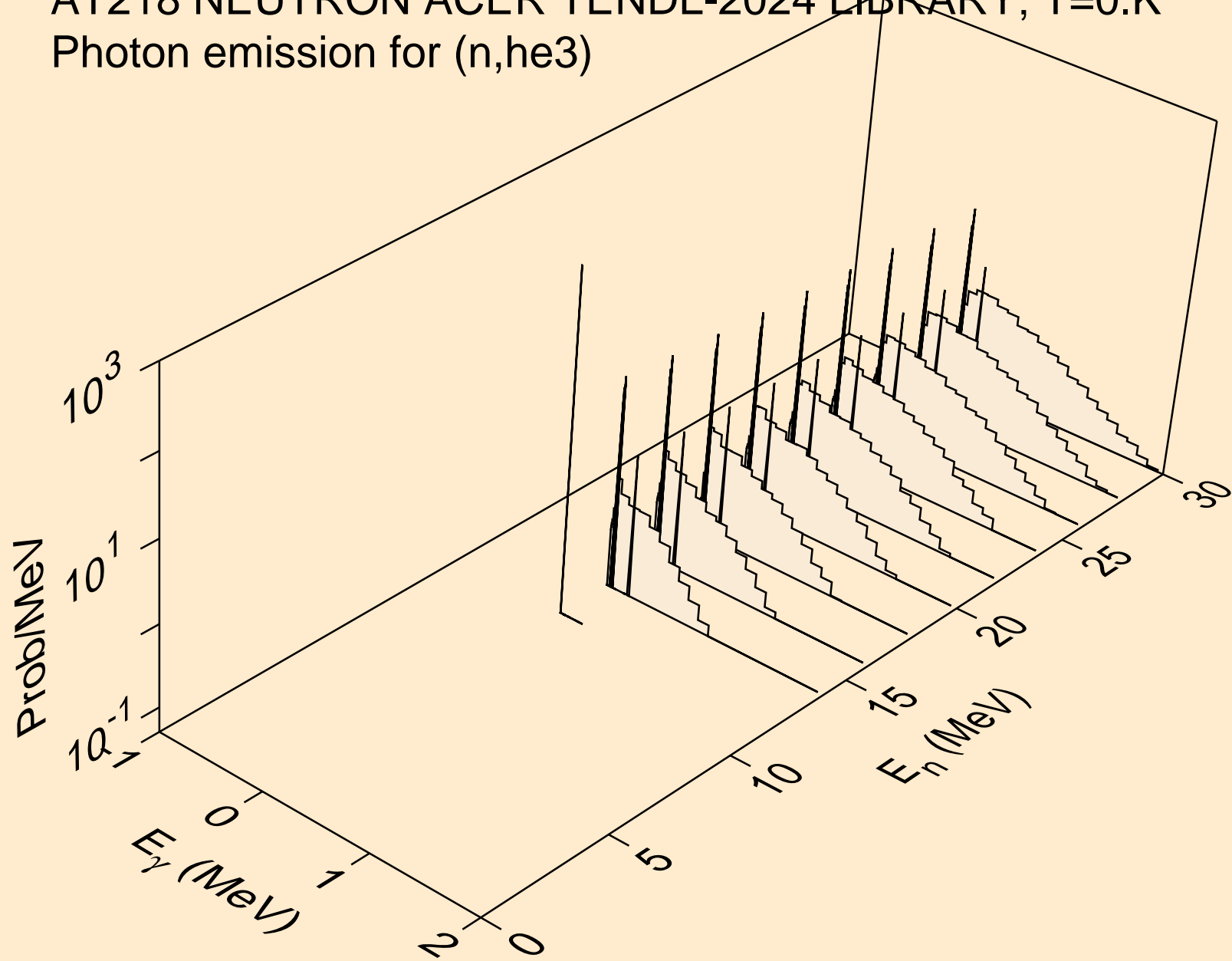

AT218 NEUTRON ACER TENDL-2024 LIBRARY; T=0.K
Photon emission for (n,a)

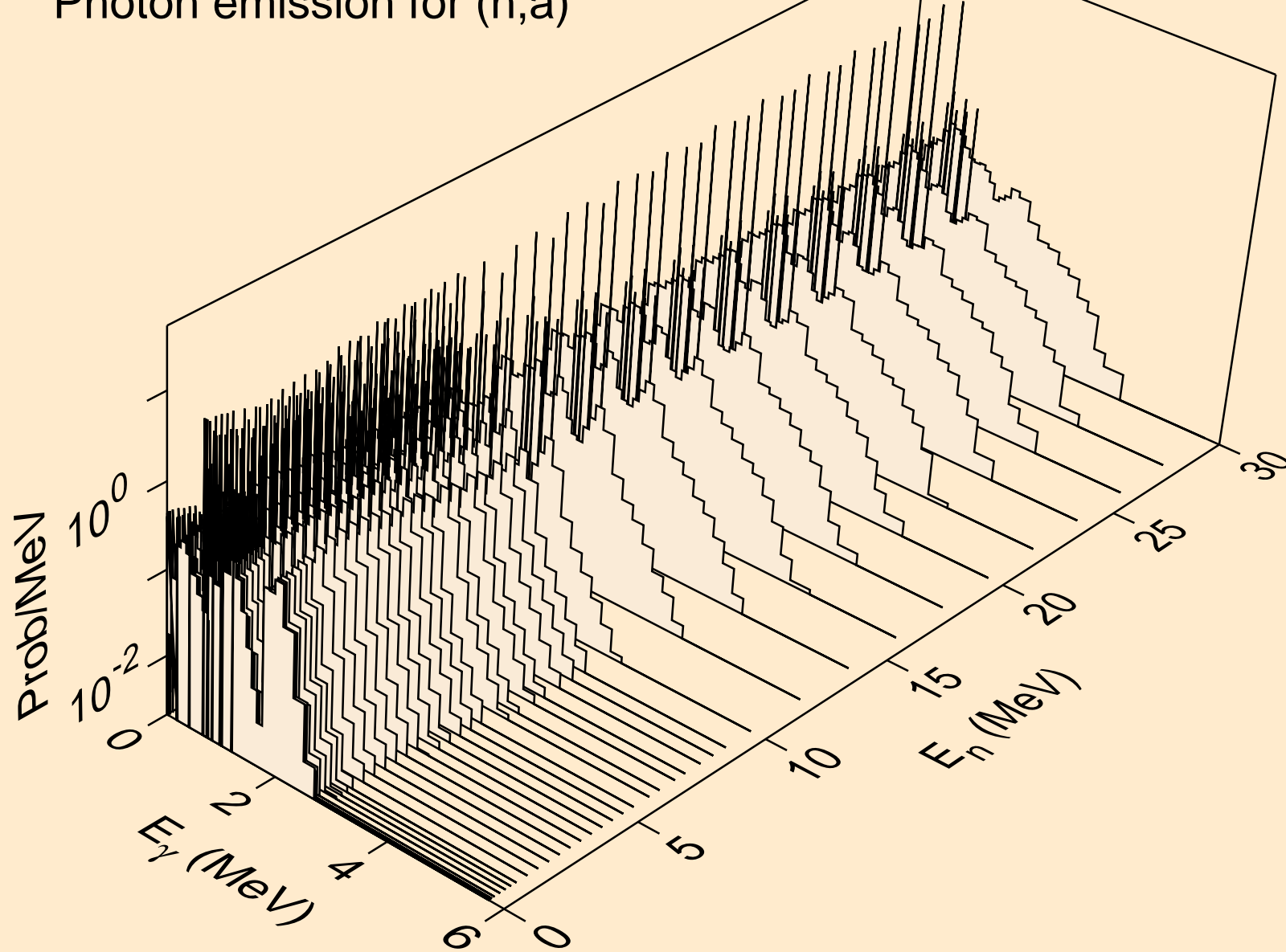

AT218 NEUTRON ACER TENDL-2024 LIBRARY; T=0.K
Photon emission for (n,2a)

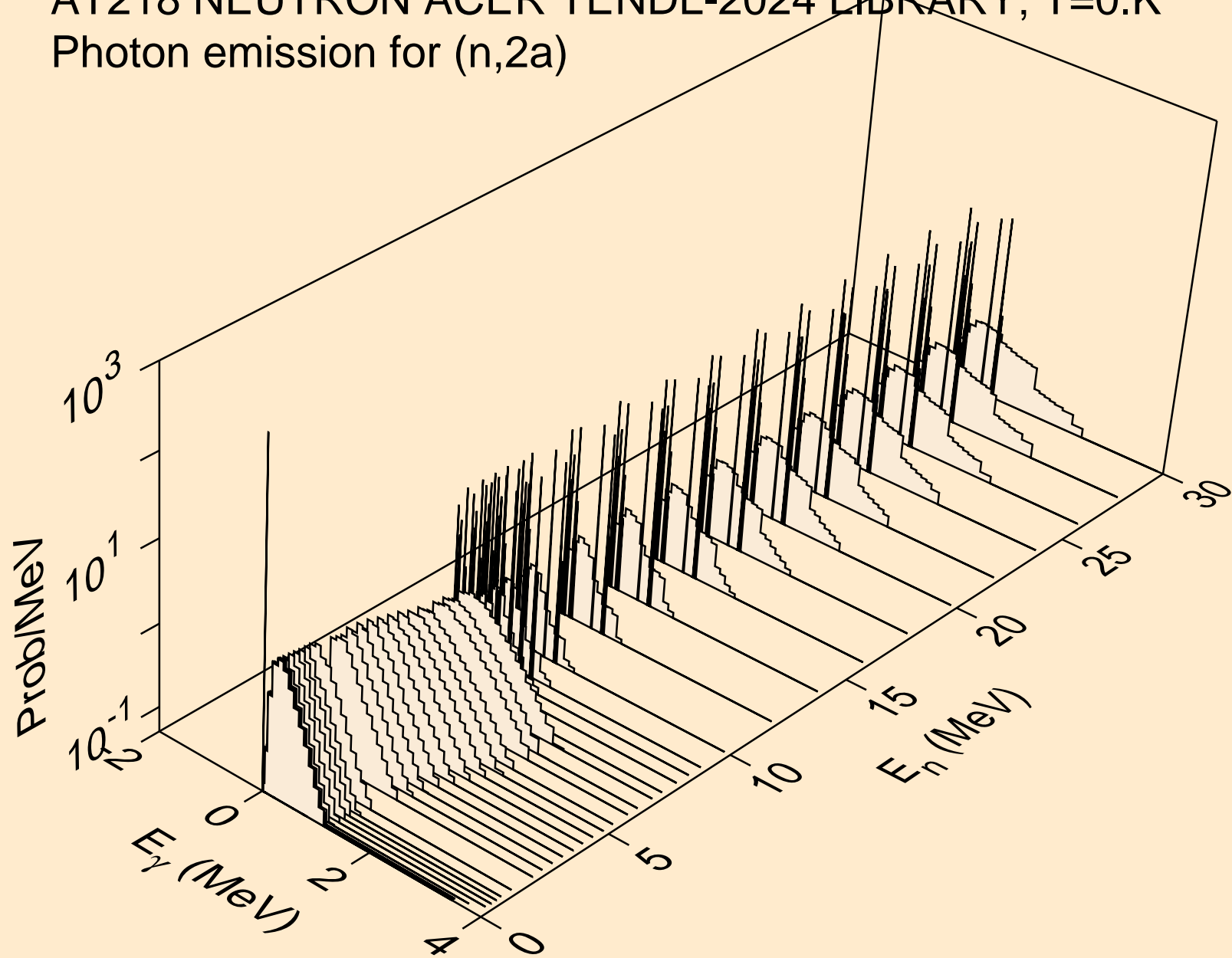

AT218 NEUTRON ACER TENDL-2024 LIBRARY; T=0.K
Photon emission for (n,2p)

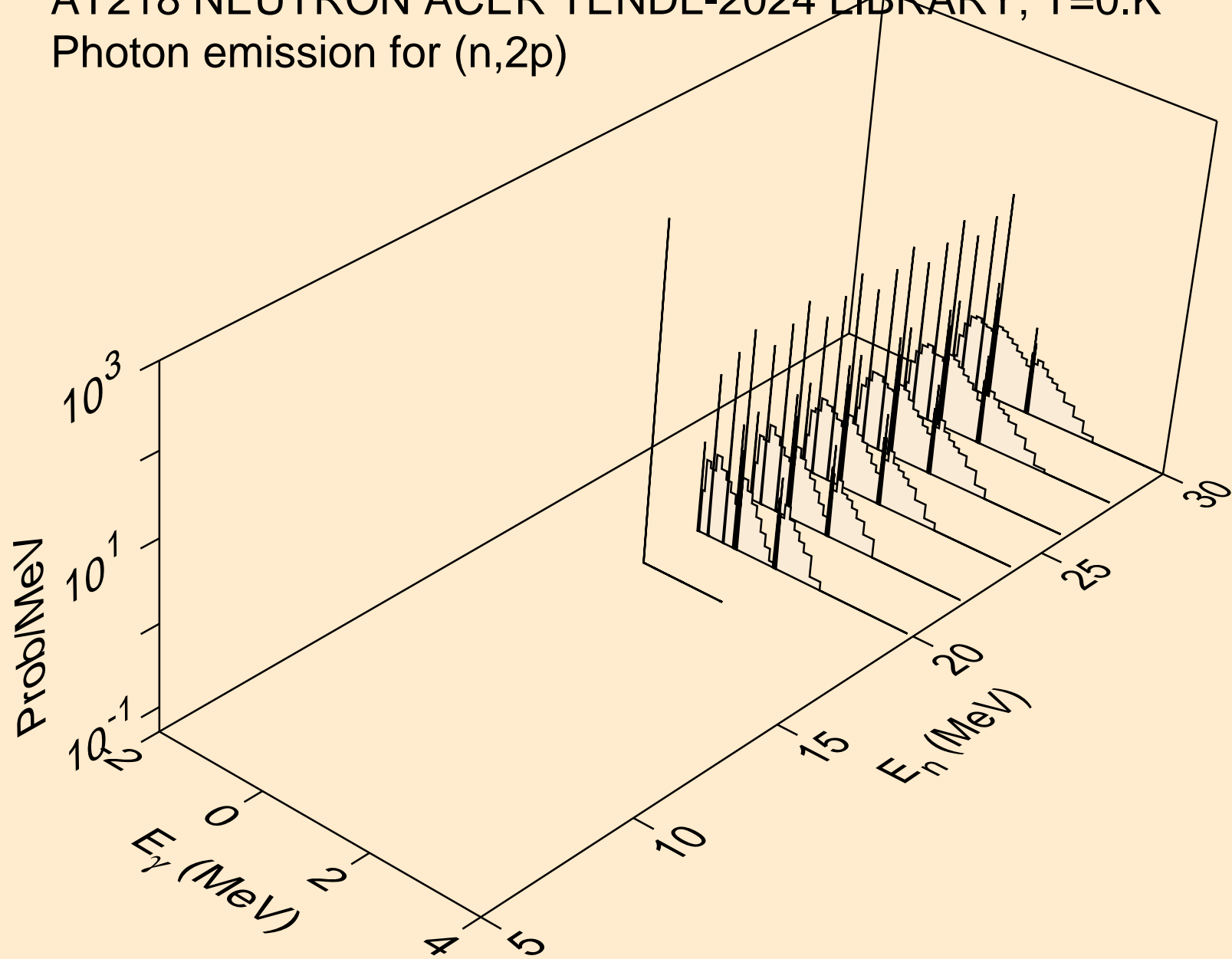

AT218 NEUTRON ACER TENDL-2024 LIBRARY; T=0.K
Photon emission for (n,p α)

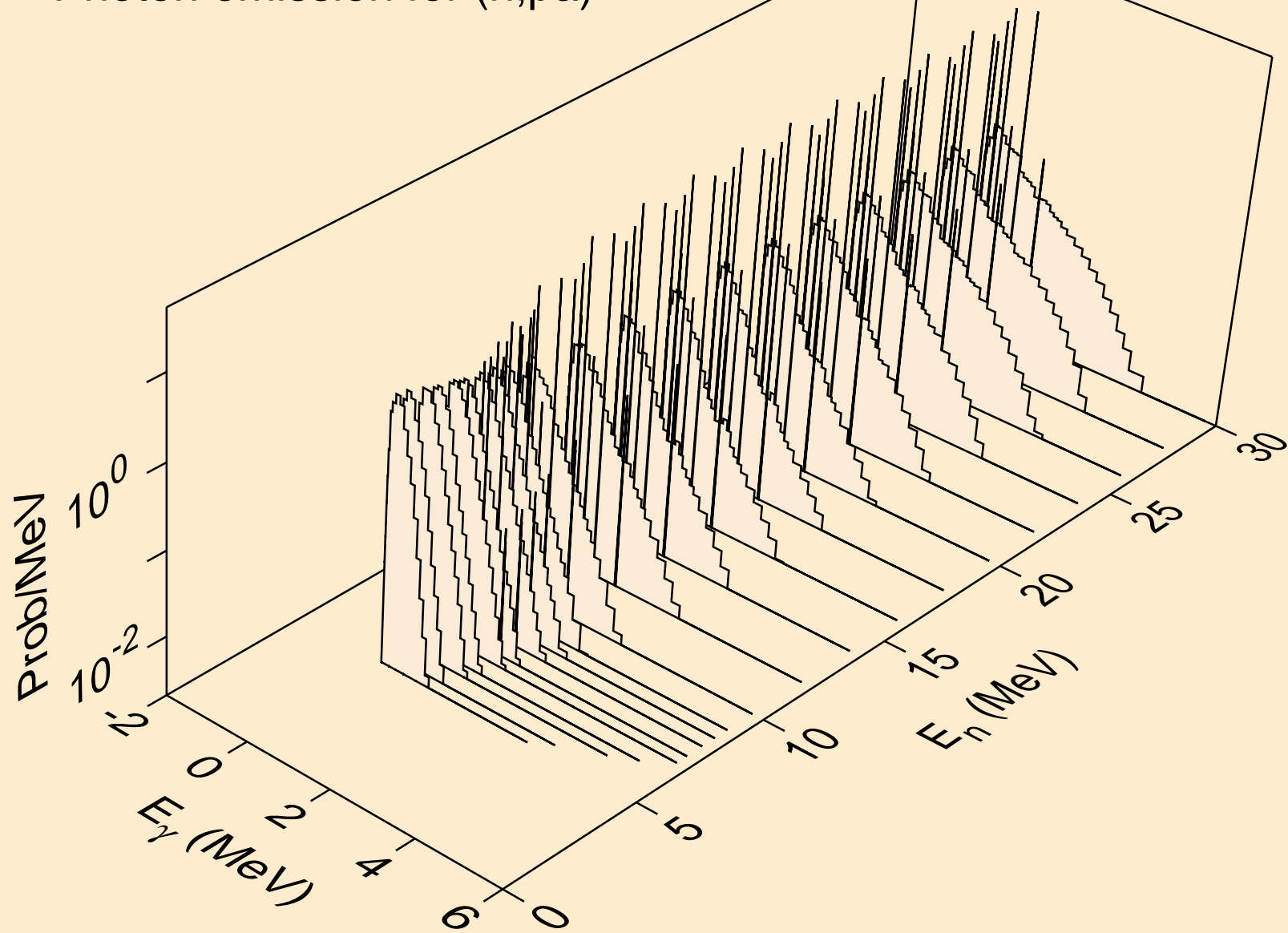

AT218 NEUTRON ACER TENDL-2024 LIBRARY; T=0.K
Photon emission for (n,pt)

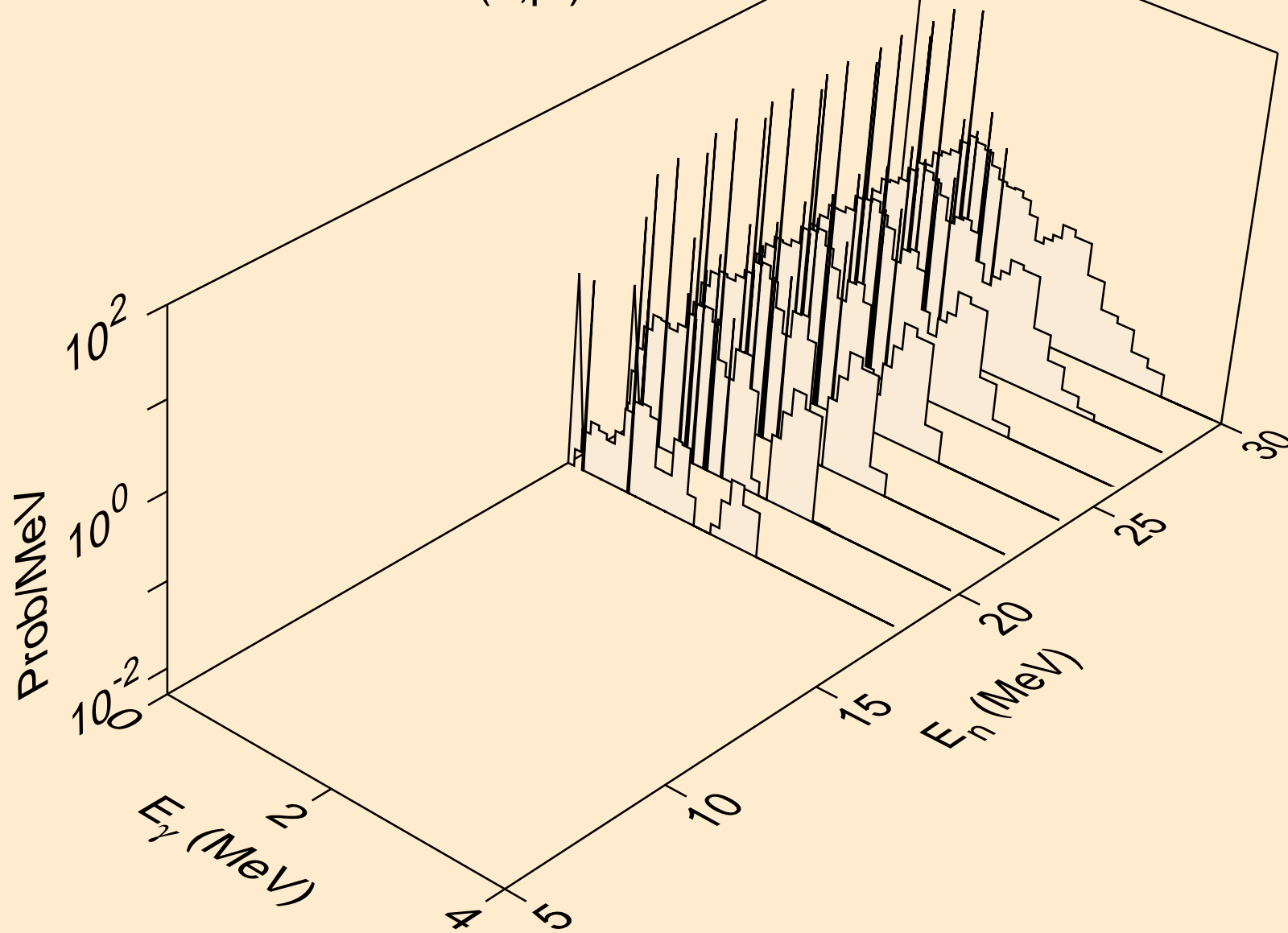

AT218 NEUTRON ACER TENDL-2024 LIBRARY; T=0.K
Photon emission for (n,da)

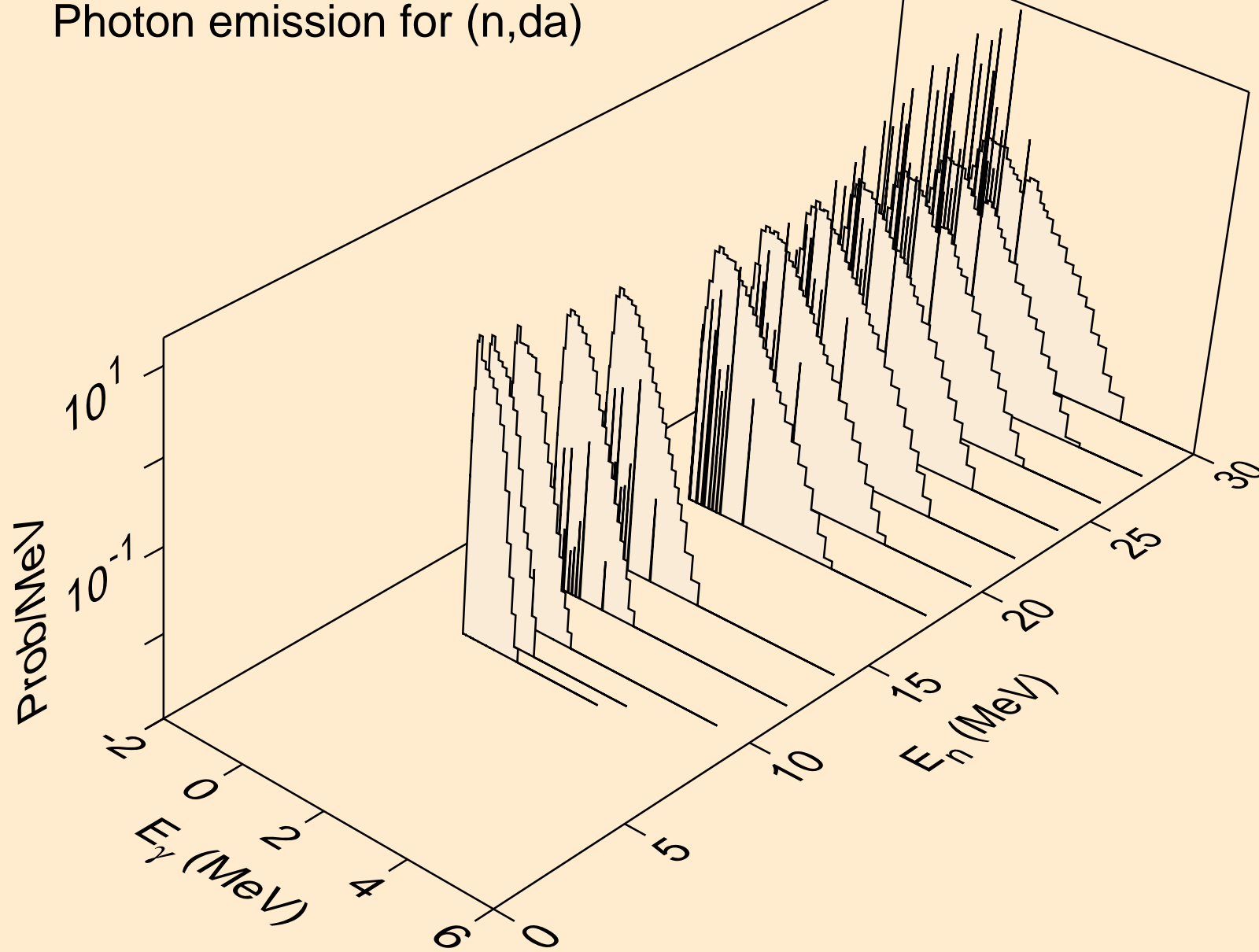

AT218 NEUTRON ACER TENDL-2024 LIBRARY; T=0.K
thermal capture photon spectrum

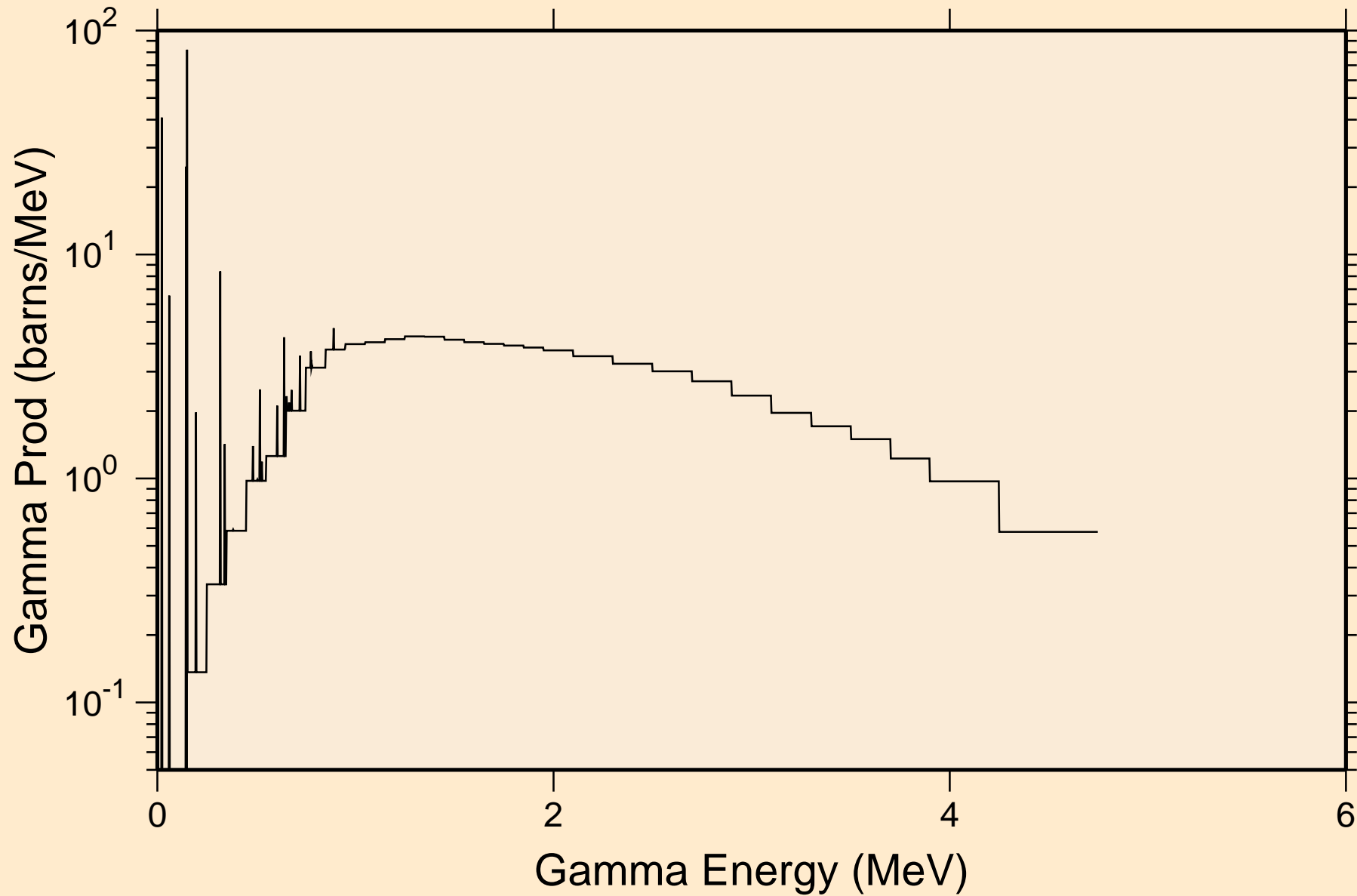

AT218 NEUTRON ACER TENDL-2024 LIBRARY; T=0.K
14 MeV photon spectrum

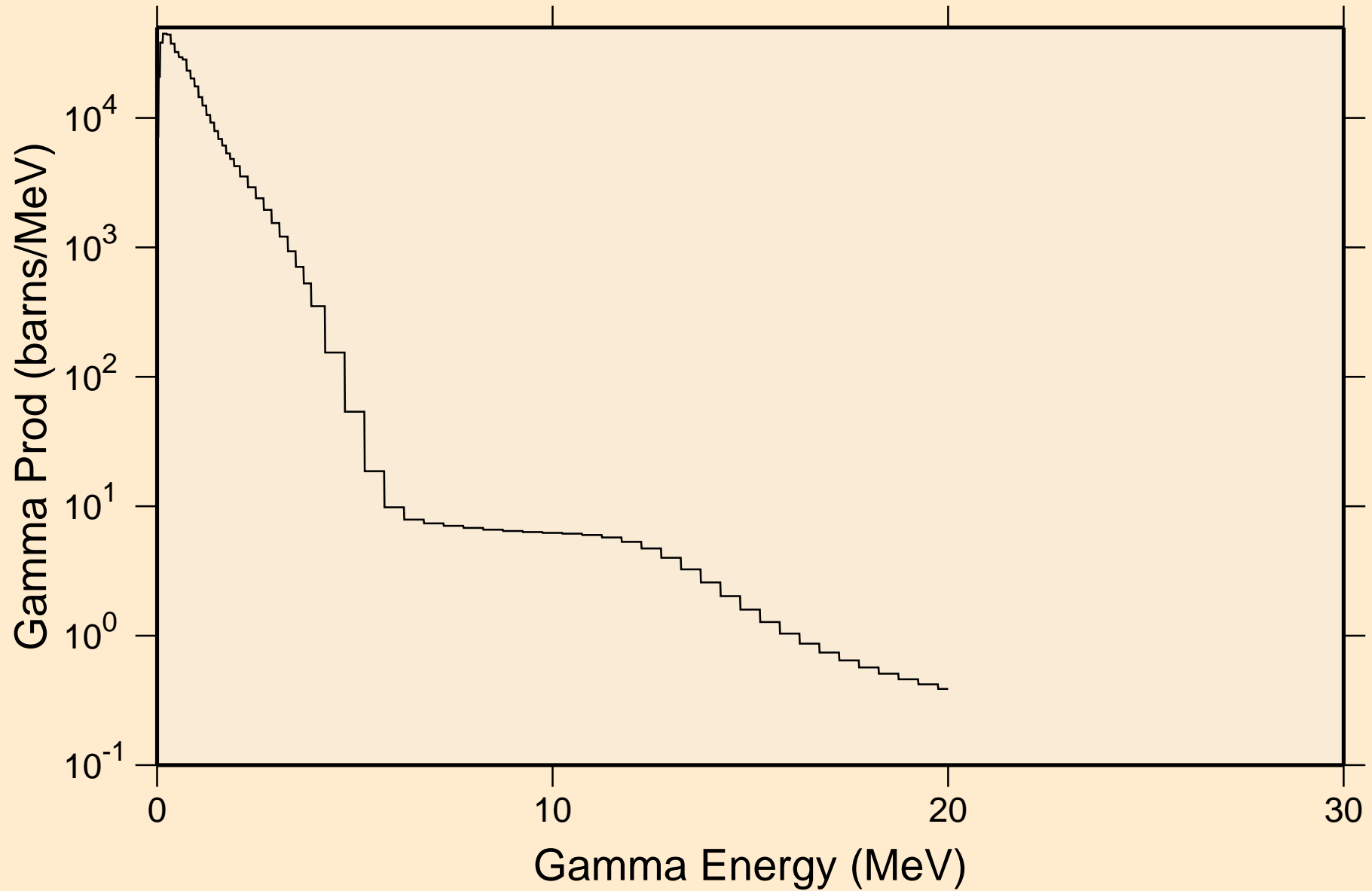

AT218 NEUTRON ACER TENDL-2024 LIBRARY; T=0.K

Particle heating contributions

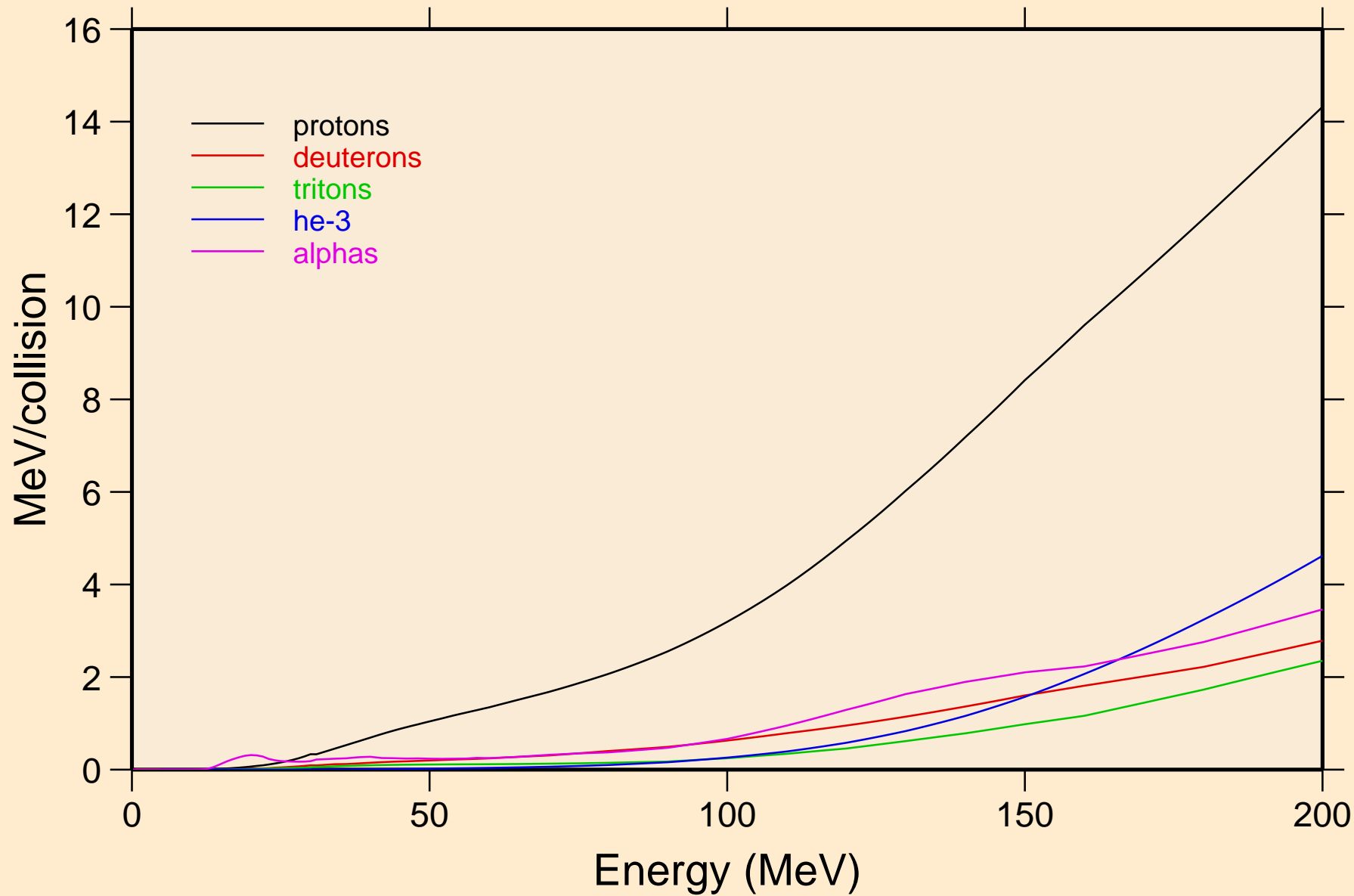

AT218 NEUTRON ACER TENDL-2024 LIBRARY; T=0.K
Recoil Heating

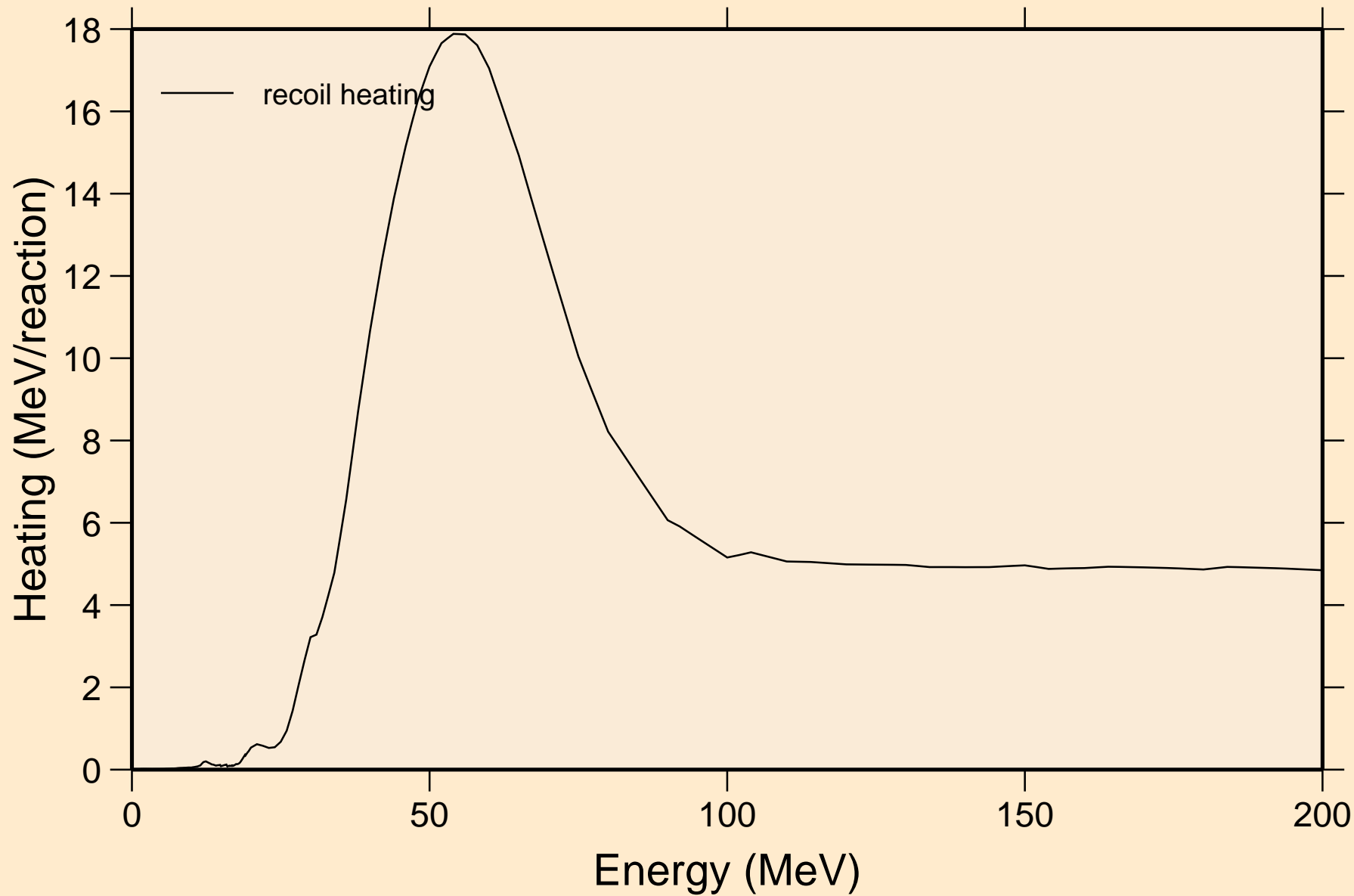

AT218 NEUTRON ACER TENDL-2024 LIBRARY; T=0.K

Particle production cross sections

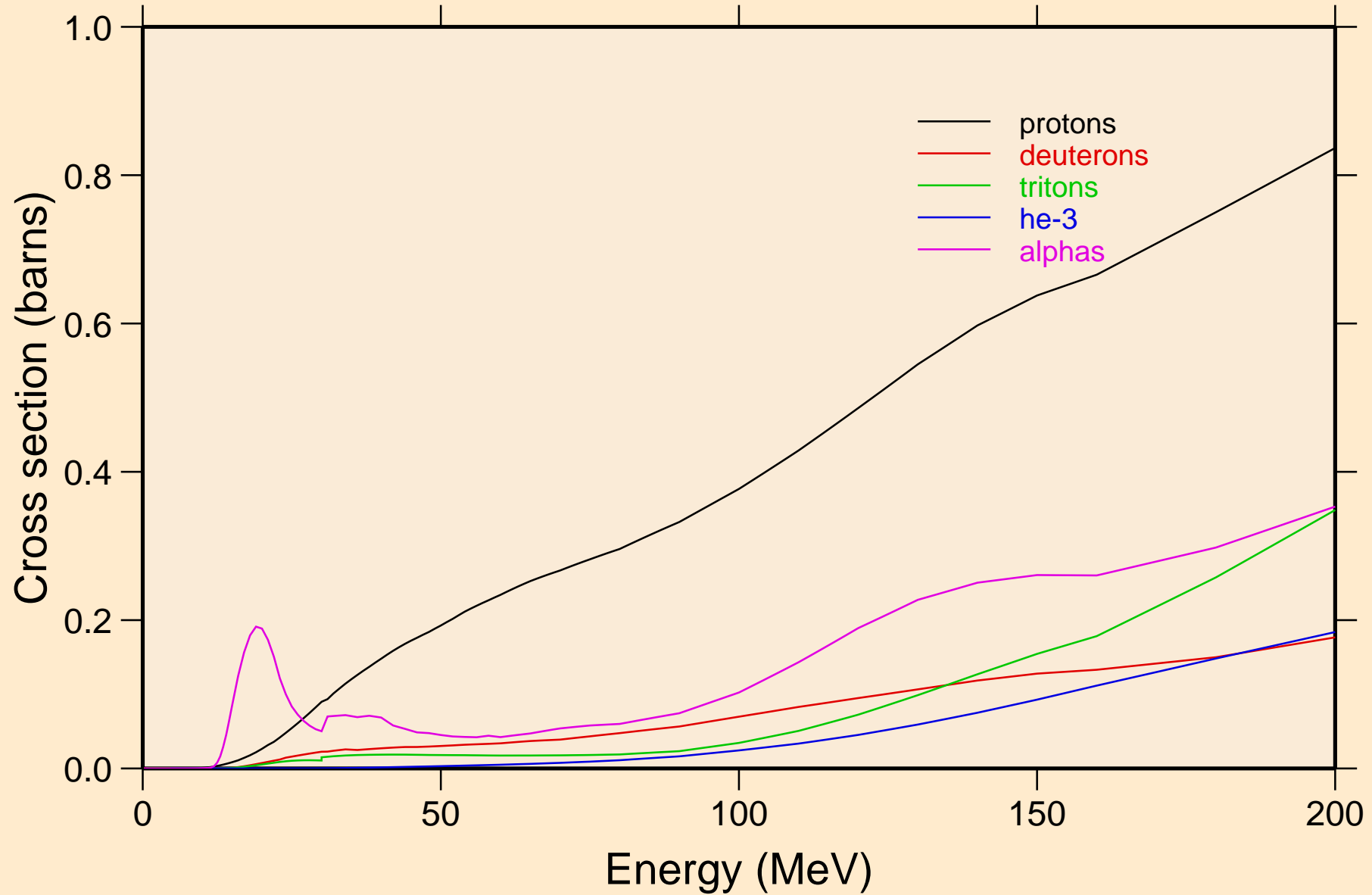

AT218 NEUTRON ACER TENDL-2024 LIBRARY; T=0.K
protons from (n,x)

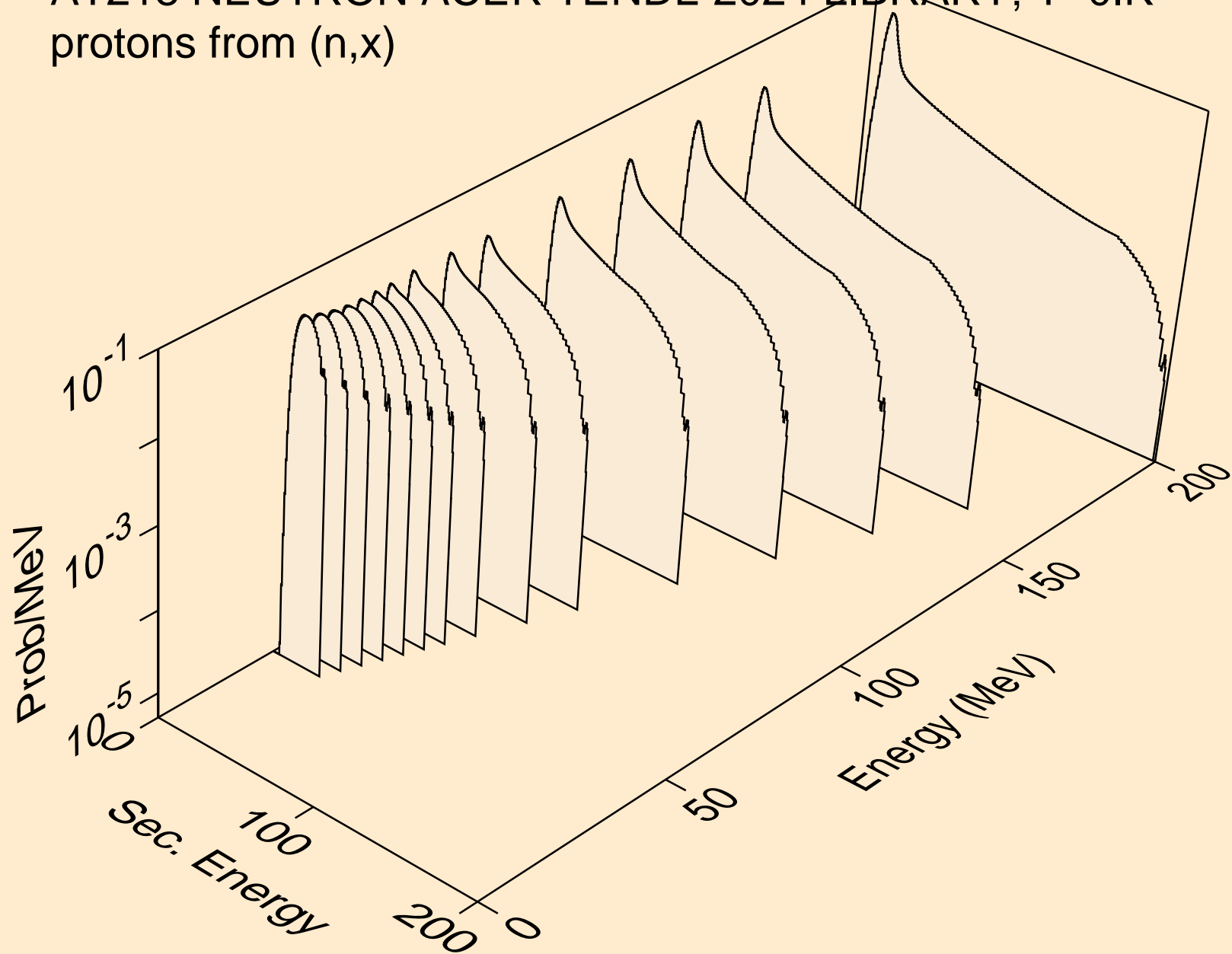

AT218 NEUTRON ACER TENDL-2024 LIBRARY; T=0.K
protons from (n,n*)p

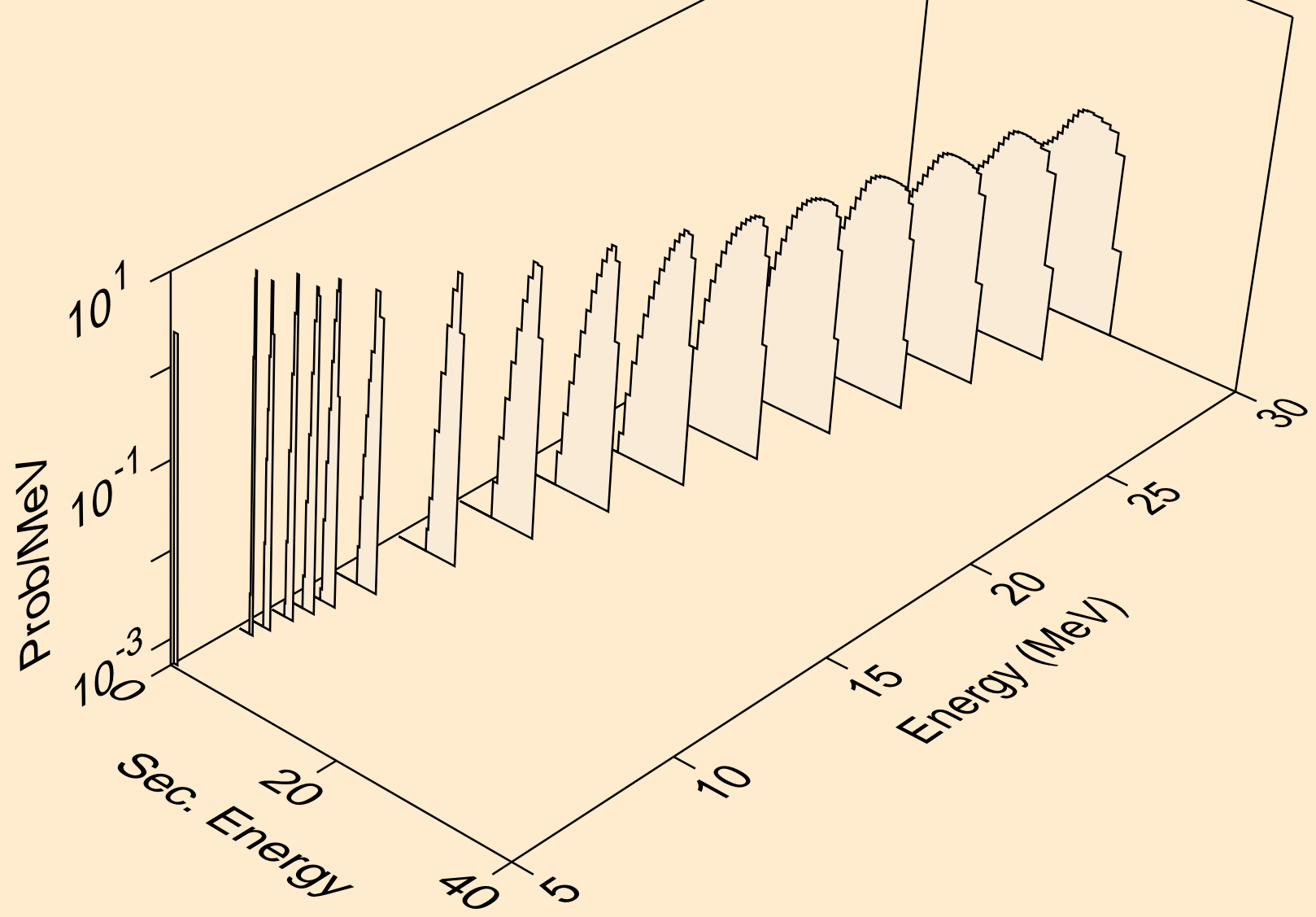

AT218 NEUTRON ACER TENDL-2024 LIBRARY; T=0.K
protons from (n,2np)

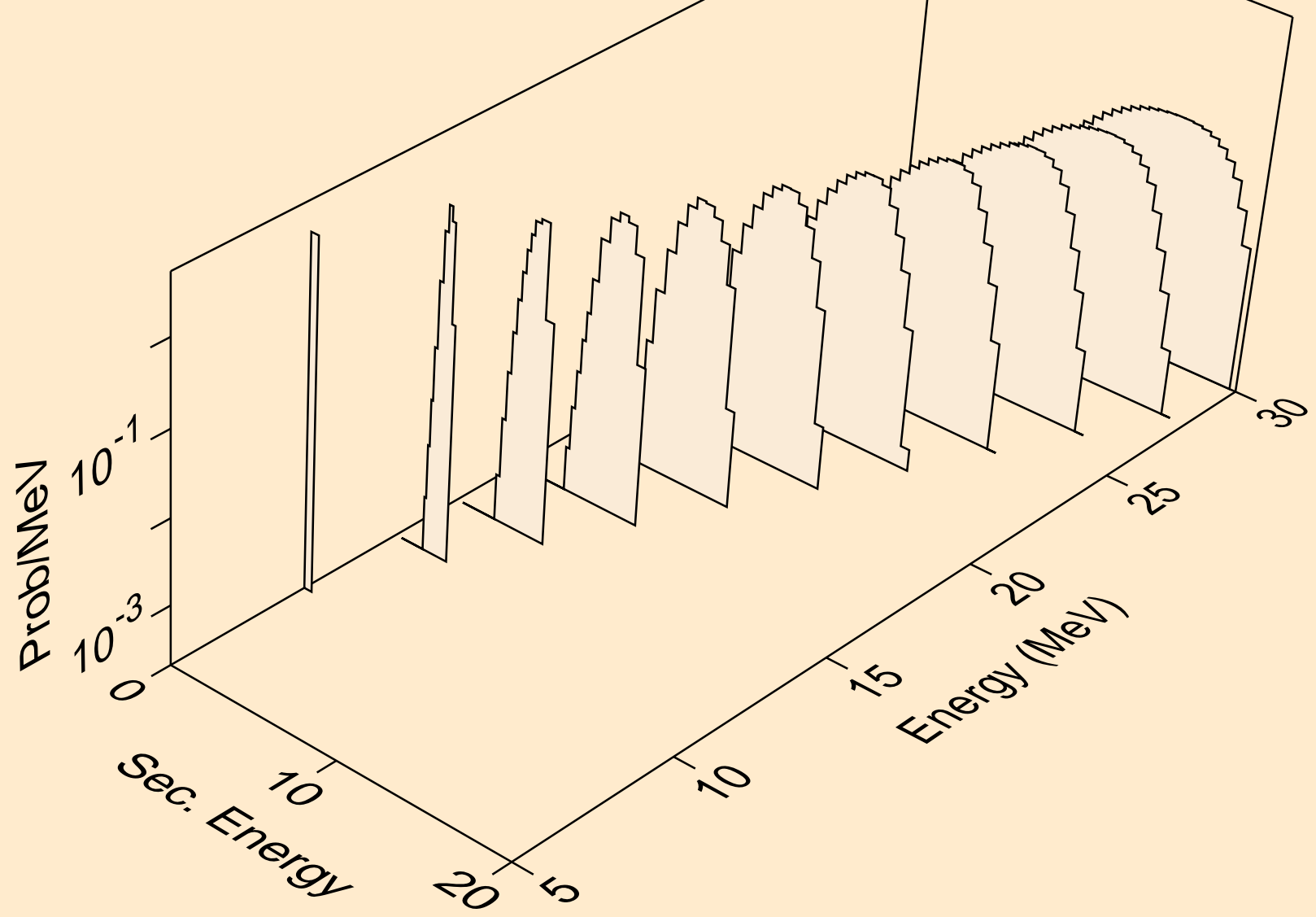

AT218 NEUTRON ACER TENDL-2024 LIBRARY; T=0.K
protons from (n,3np)

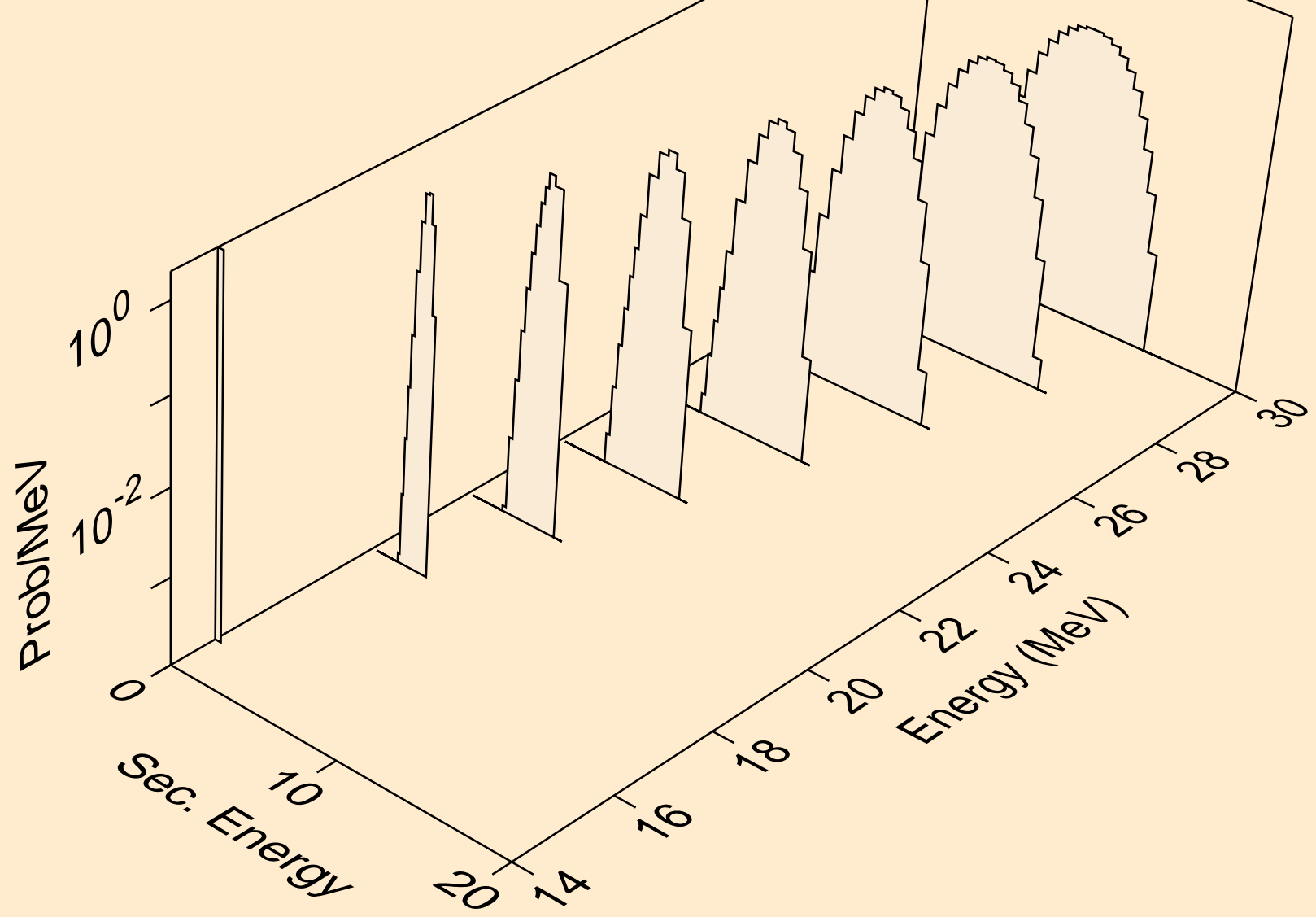

AT218 NEUTRON ACER TENDL-2024 LIBRARY; T=0.K
protons from (n,n2p)

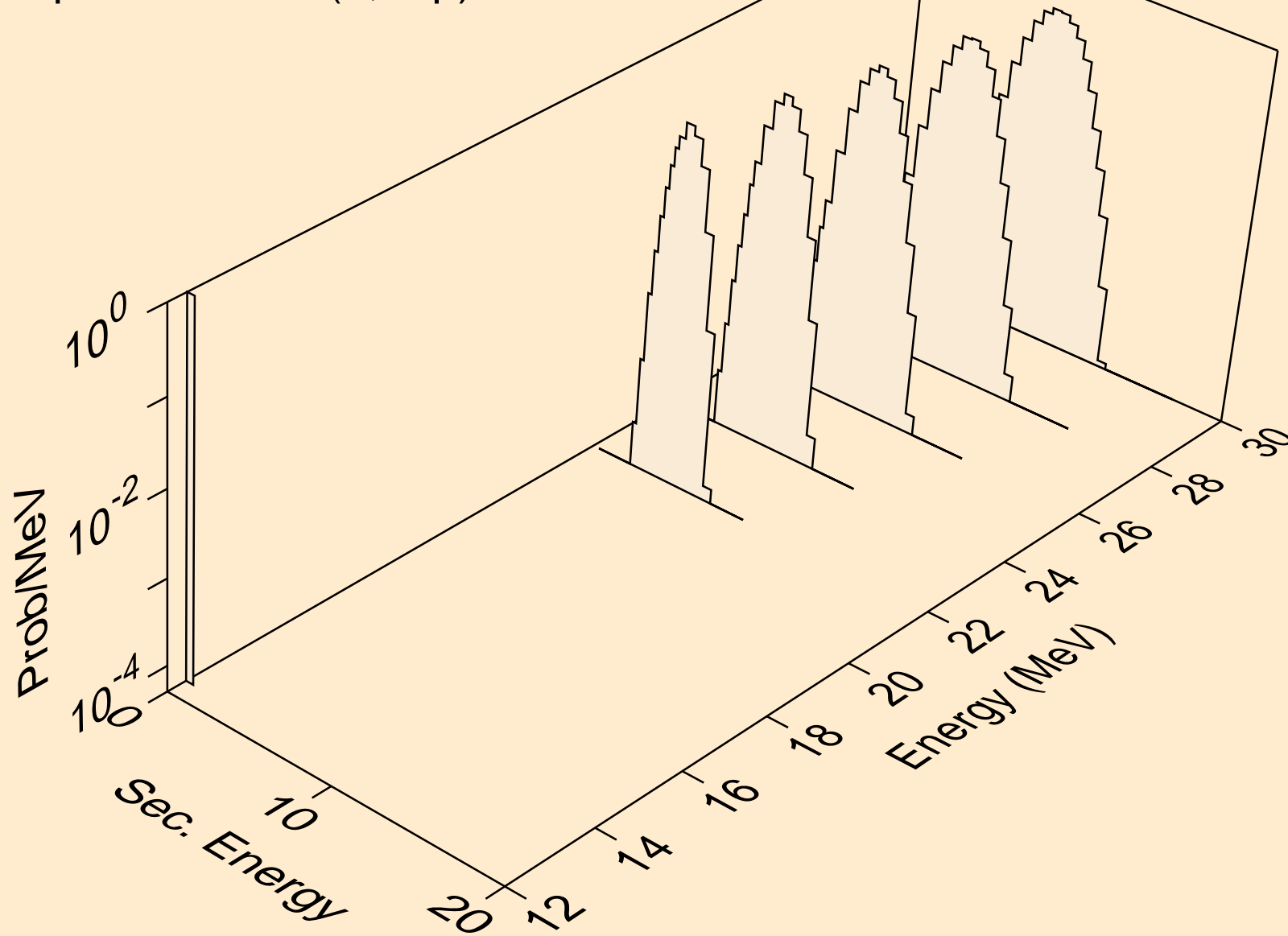

AT218 NEUTRON ACER TENDL-2024 LIBRARY; T=0.K
protons from (n,npa)

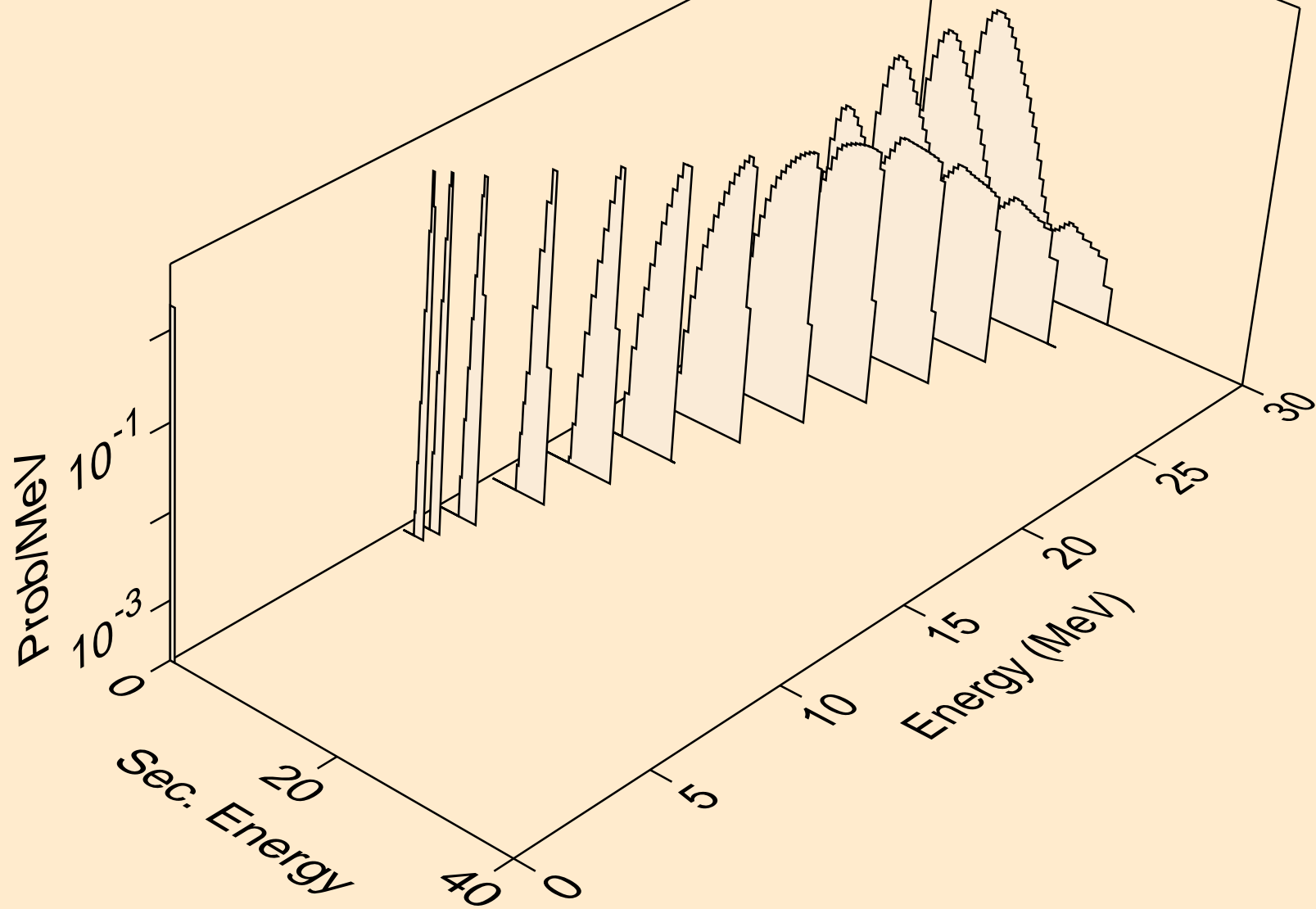

AT218 NEUTRON ACER TENDL-2024 LIBRARY; T=0.K
protons from (n,p)

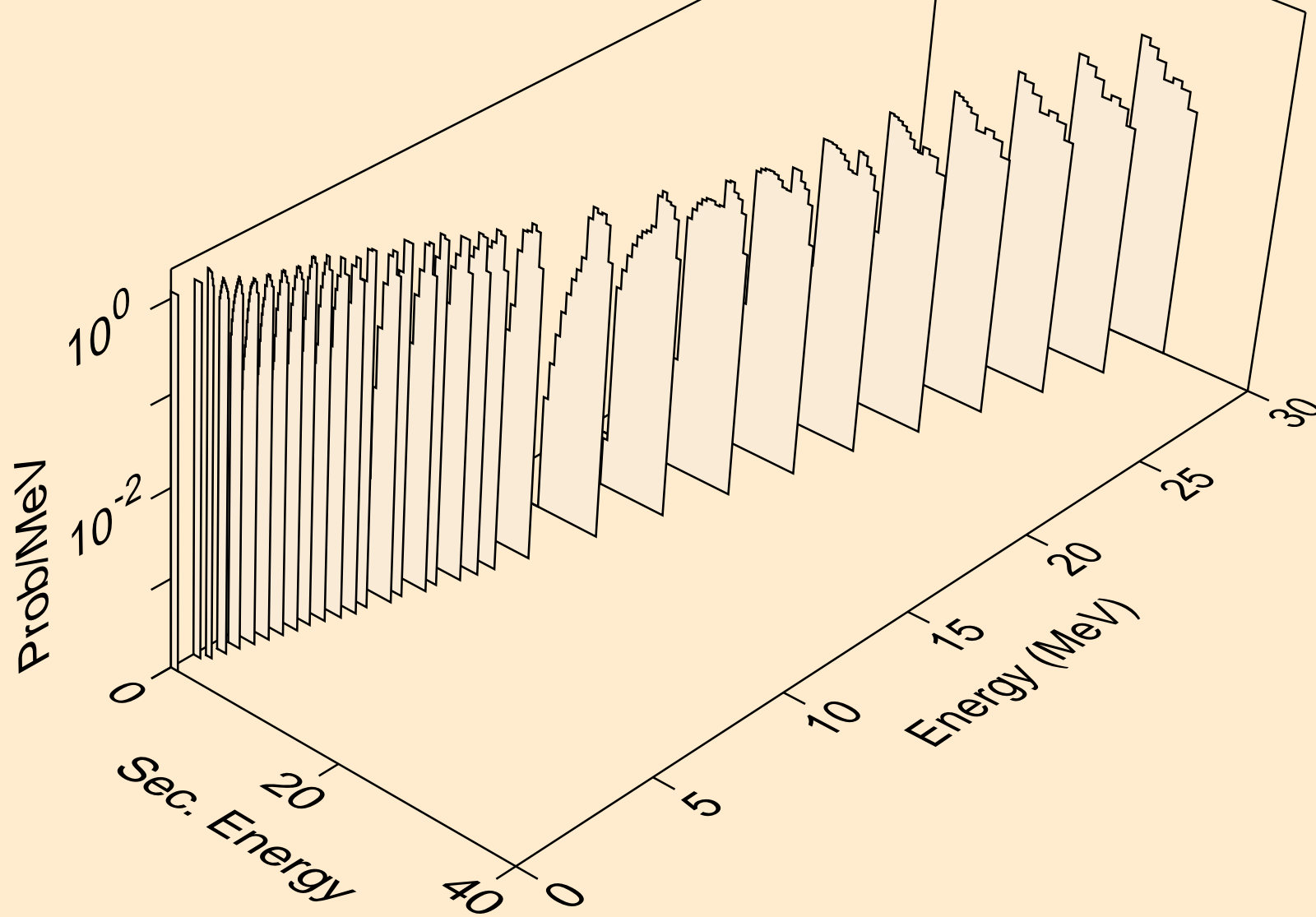

AT218 NEUTRON ACER TENDL-2024 LIBRARY; T=0.K
protons from (n,2p)

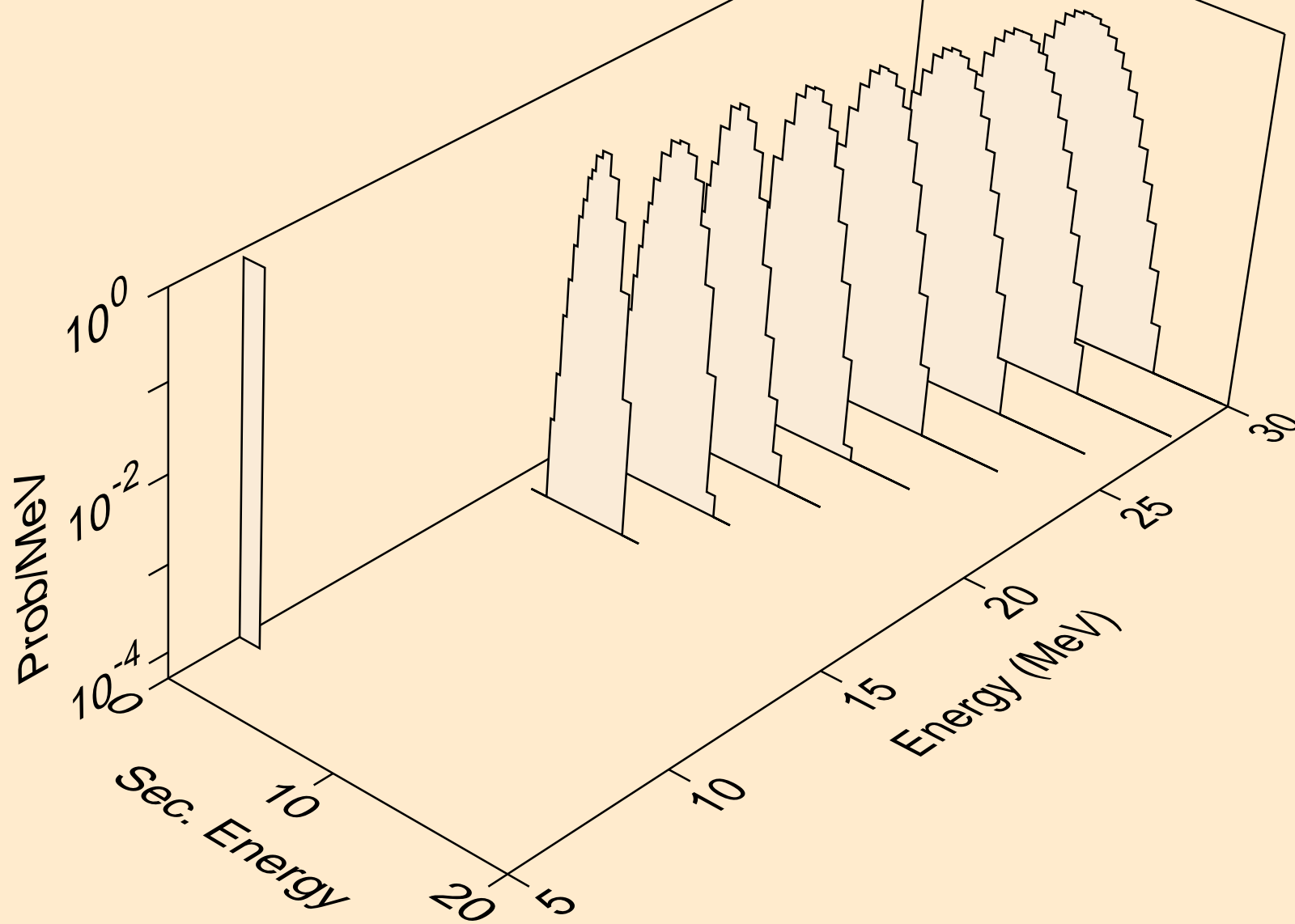

AT218 NEUTRON ACER TENDL-2024 LIBRARY; T=0.K
protons from (n,p)

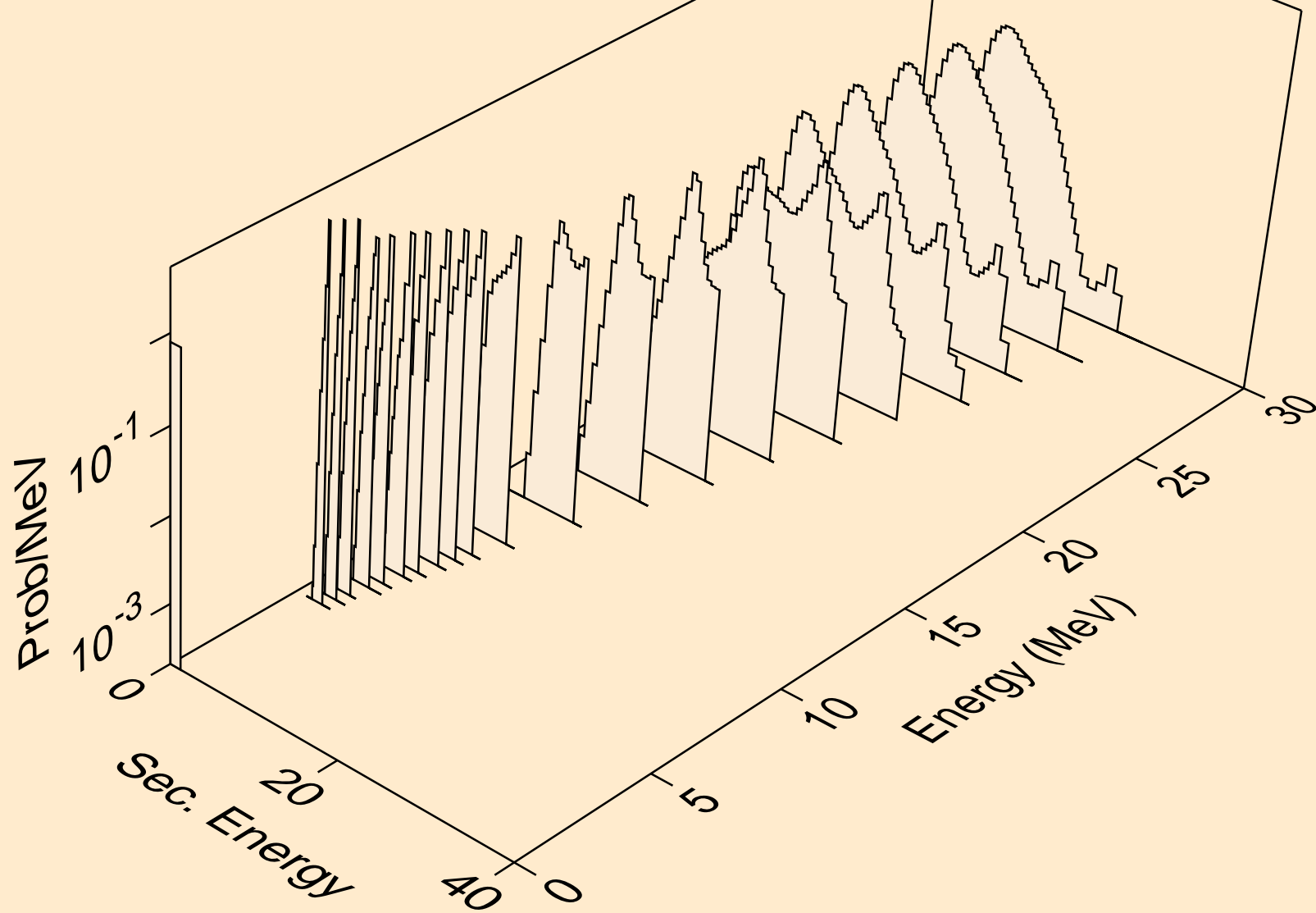

AT218 NEUTRON ACER TENDL-2024 LIBRARY; T=0.K
protons from (n,pt)

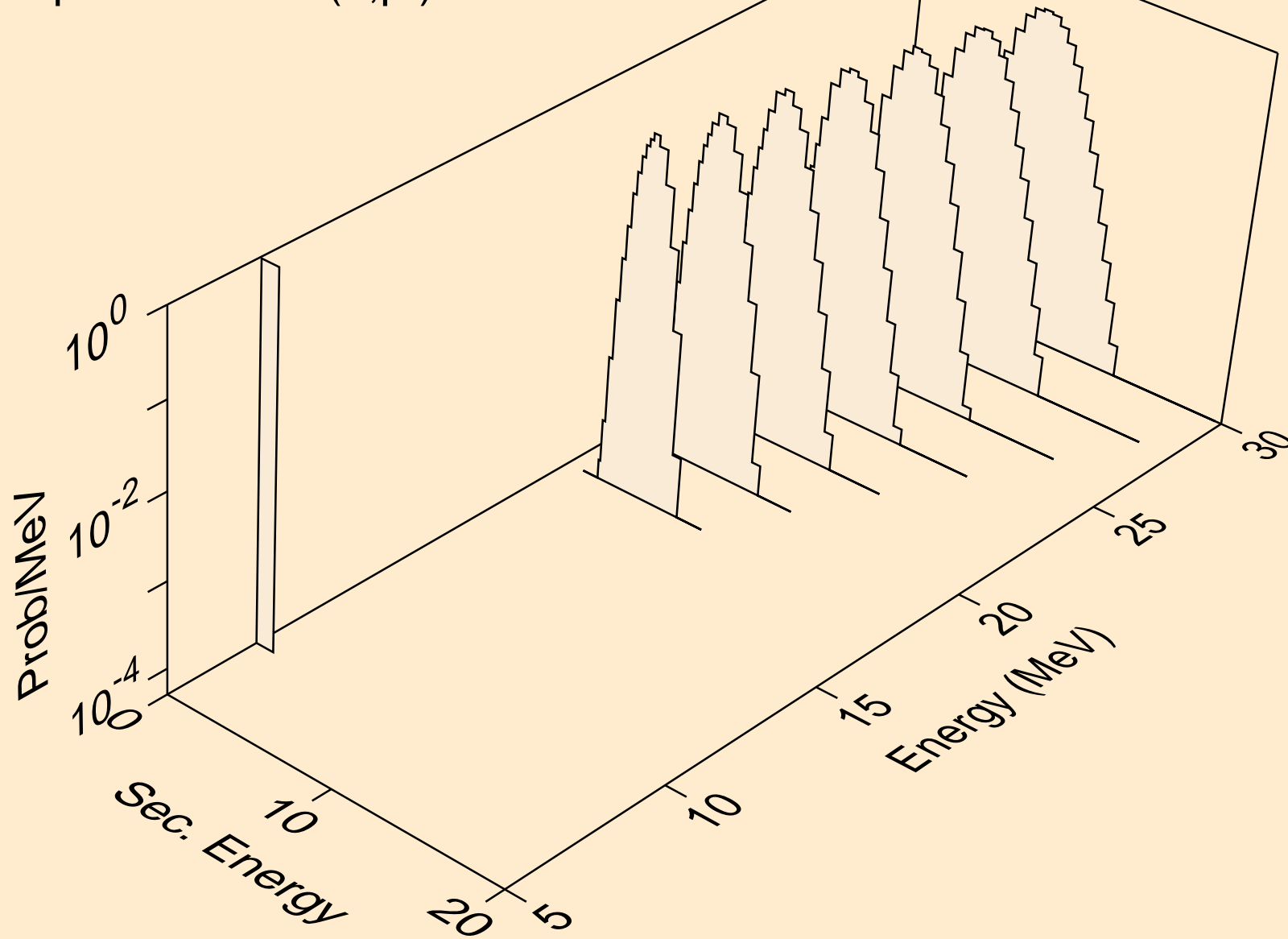

AT218 NEUTRON ACER TENDL-2024 LIBRARY; T=0.K
deuterons from (n,x)

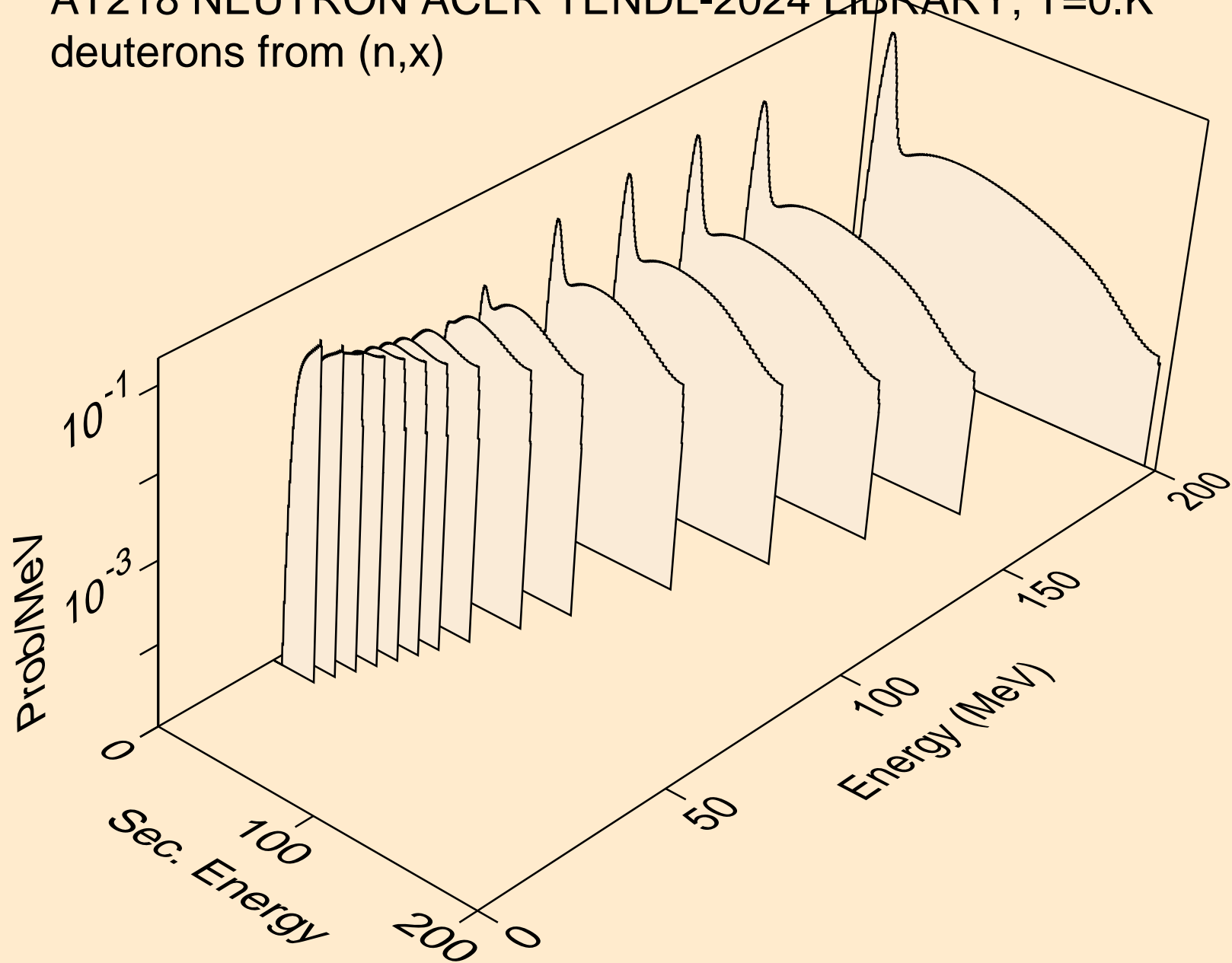

AT218 NEUTRON ACER TENDL-2024 LIBRARY; T=0.K
deuterons from (n,2nd)

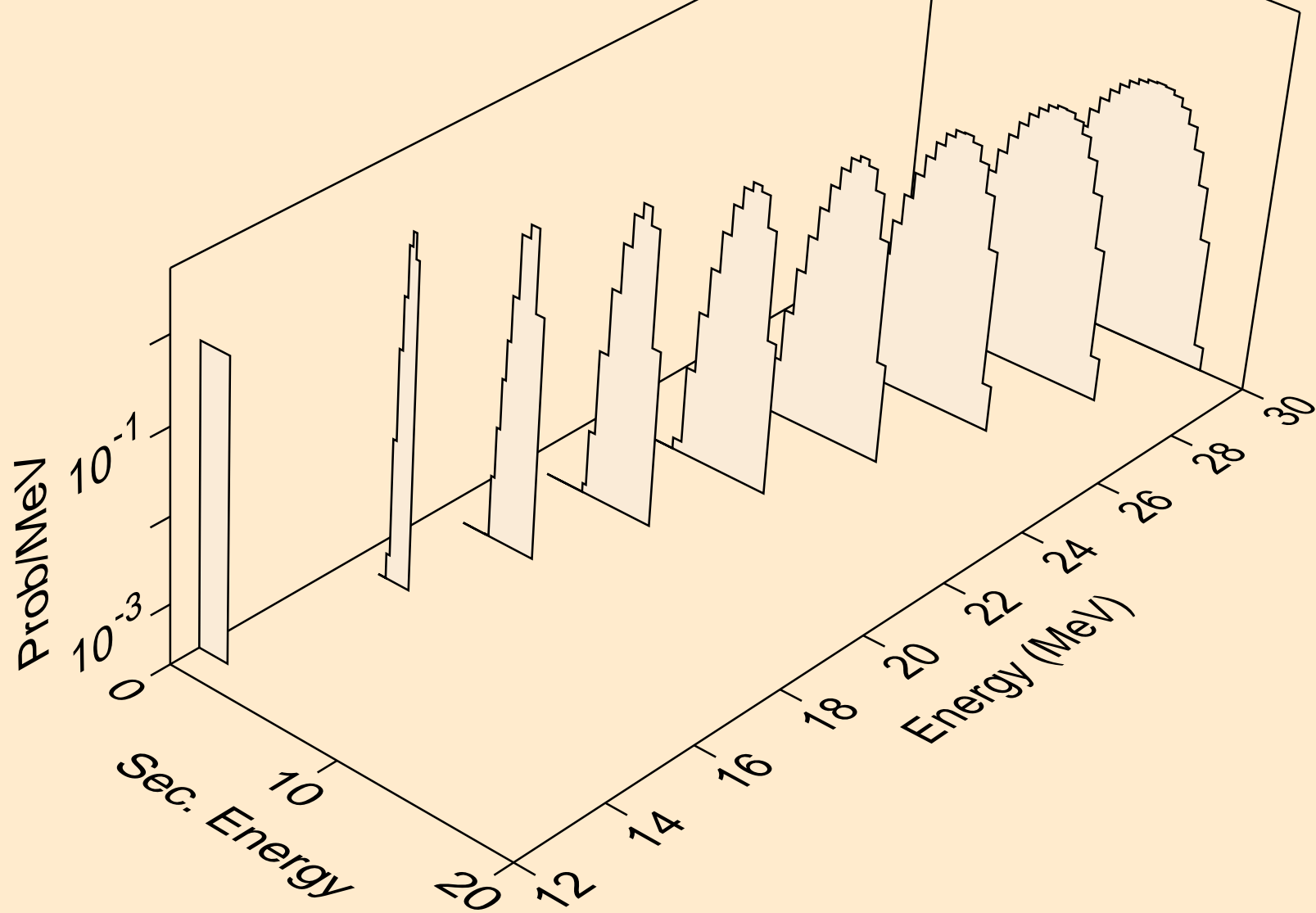

AT218 NEUTRON ACER TENDL-2024 LIBRARY; T=0.K
deuterons from (n,n*)d

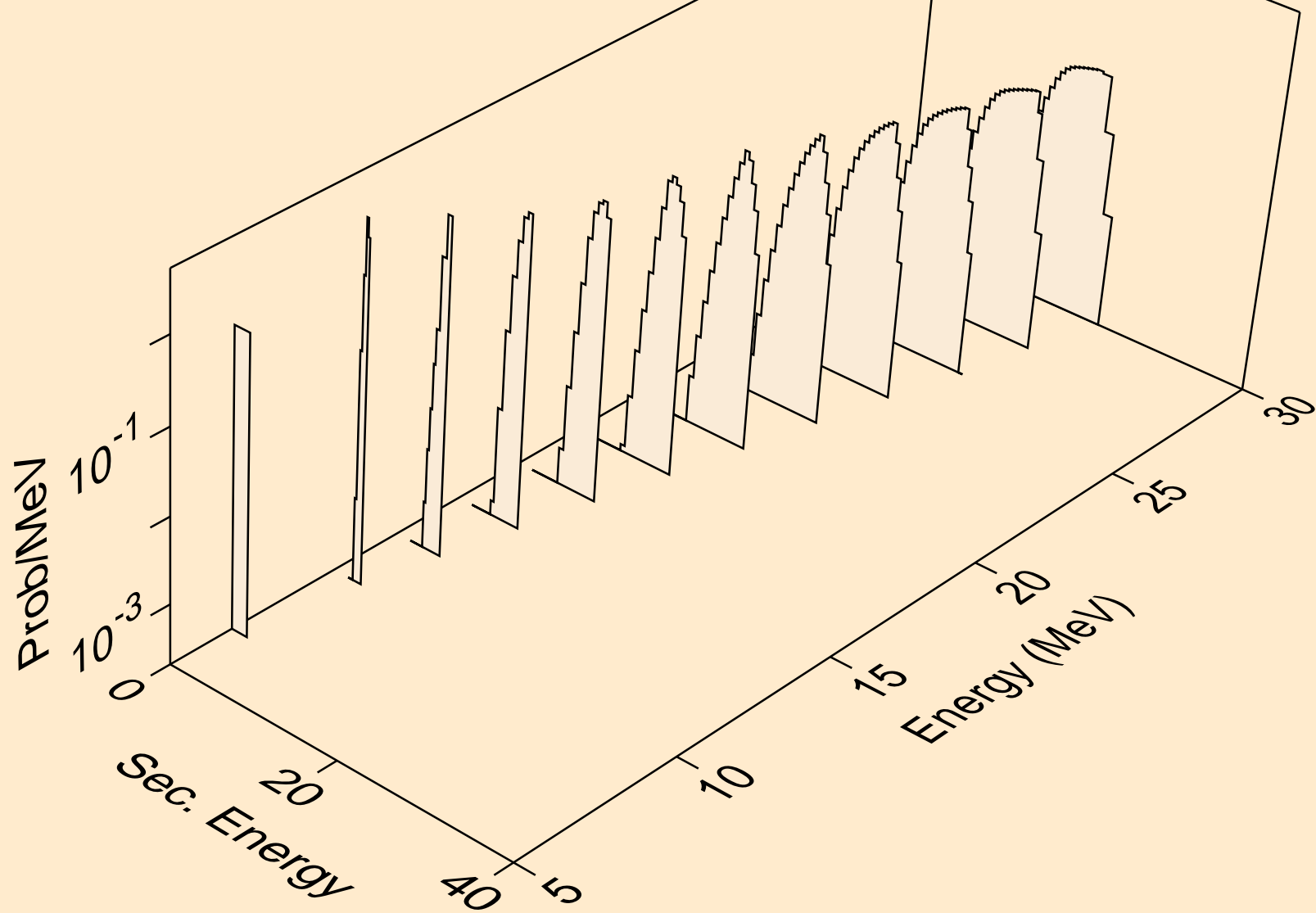

AT218 NEUTRON ACER TENDL-2024 LIBRARY; T=0.K
deuterons from (n,d)

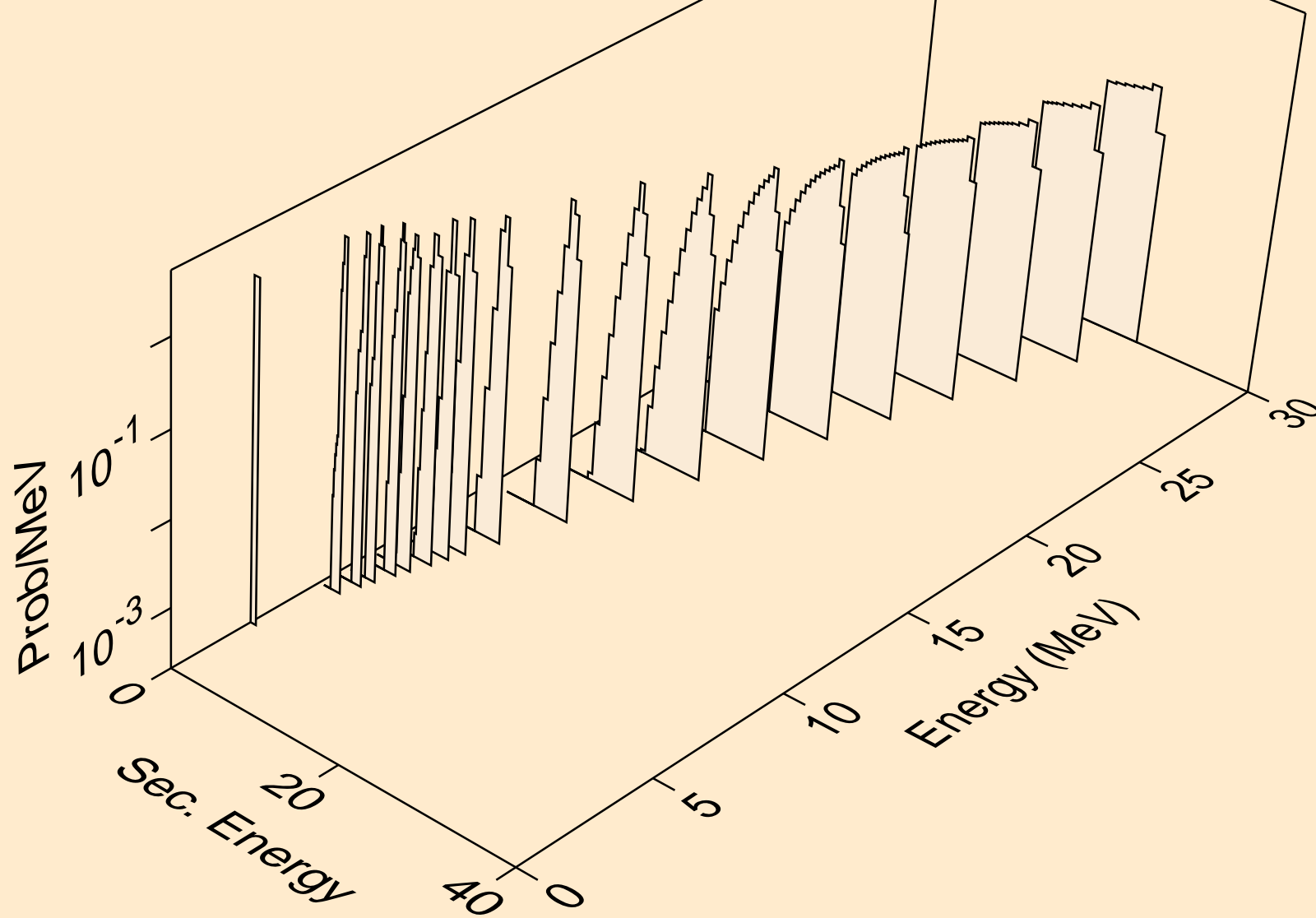

AT218 NEUTRON ACER TENDL-2024 LIBRARY; T=0.K
deuterons from (n,da)

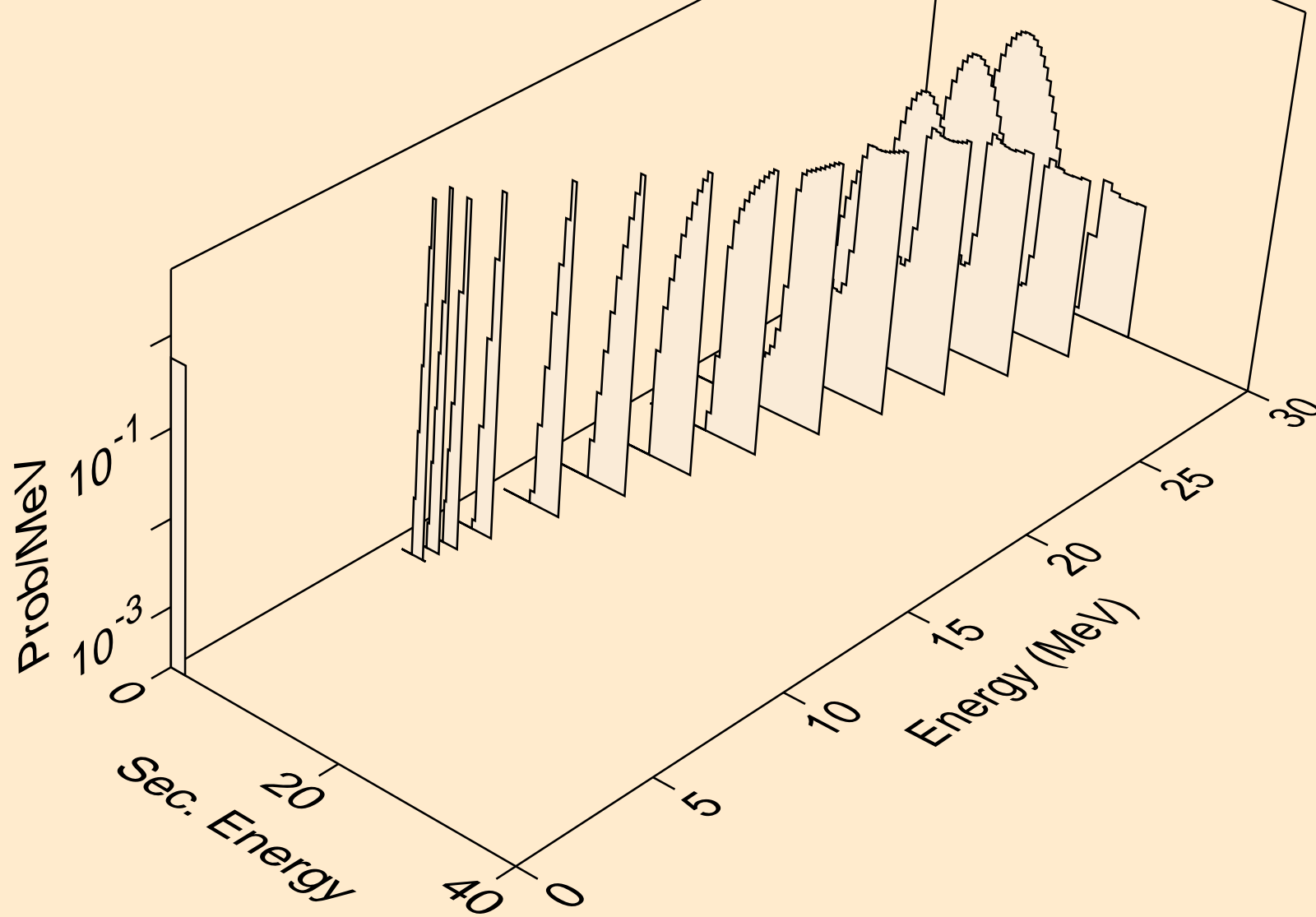

AT218 NEUTRON ACER TENDL-2024 LIBRARY; T=0.K
tritons from (n,x)

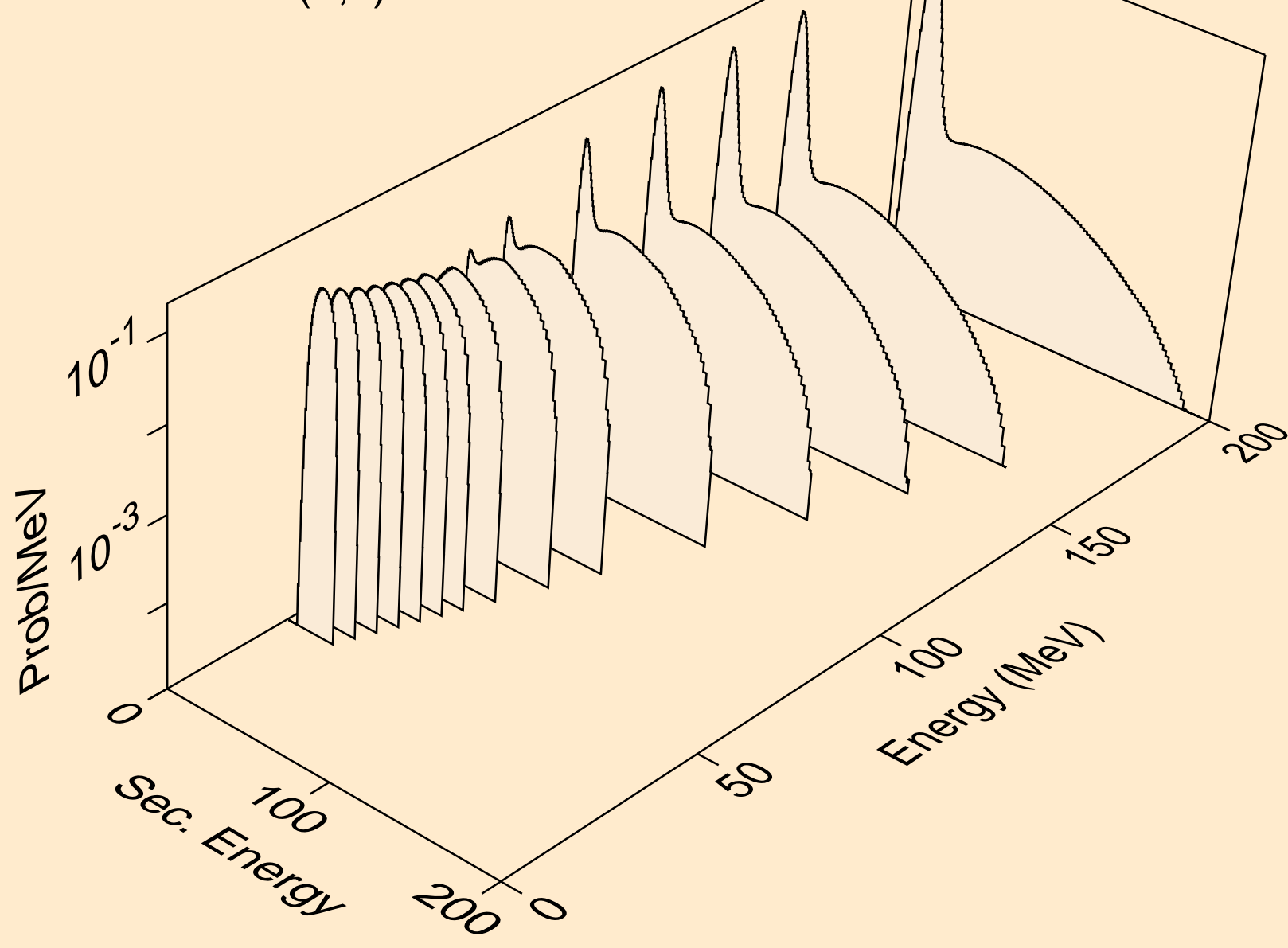

AT218 NEUTRON ACER TENDL-2024 LIBRARY; T=0.K
tritons from (n,n*)t

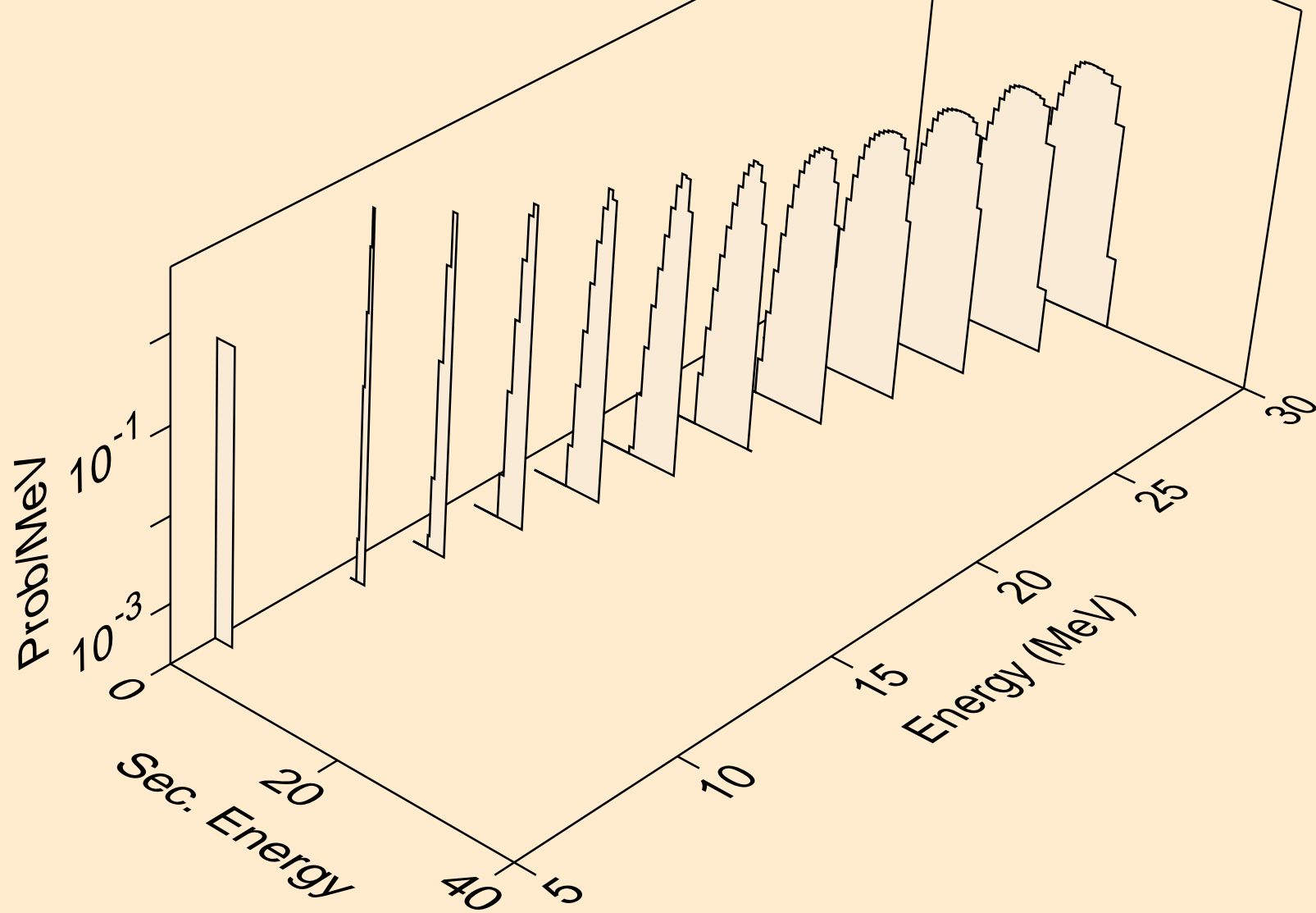

AT218 NEUTRON ACER TENDL-2024 LIBRARY; T=0.K
tritons from (n,t)

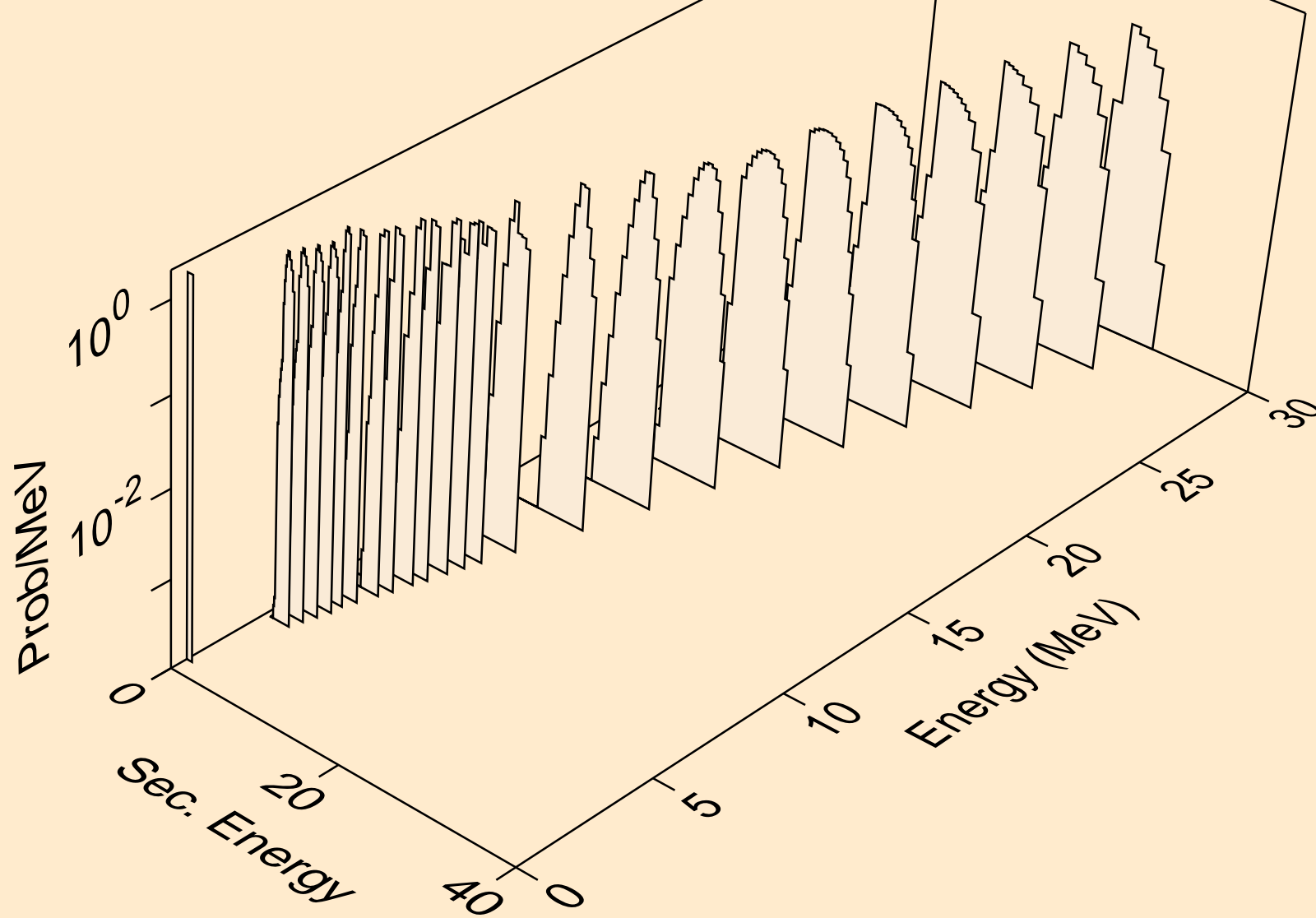

AT218 NEUTRON ACER TENDL-2024 LIBRARY; T=0.K
tritons from (n,pt)

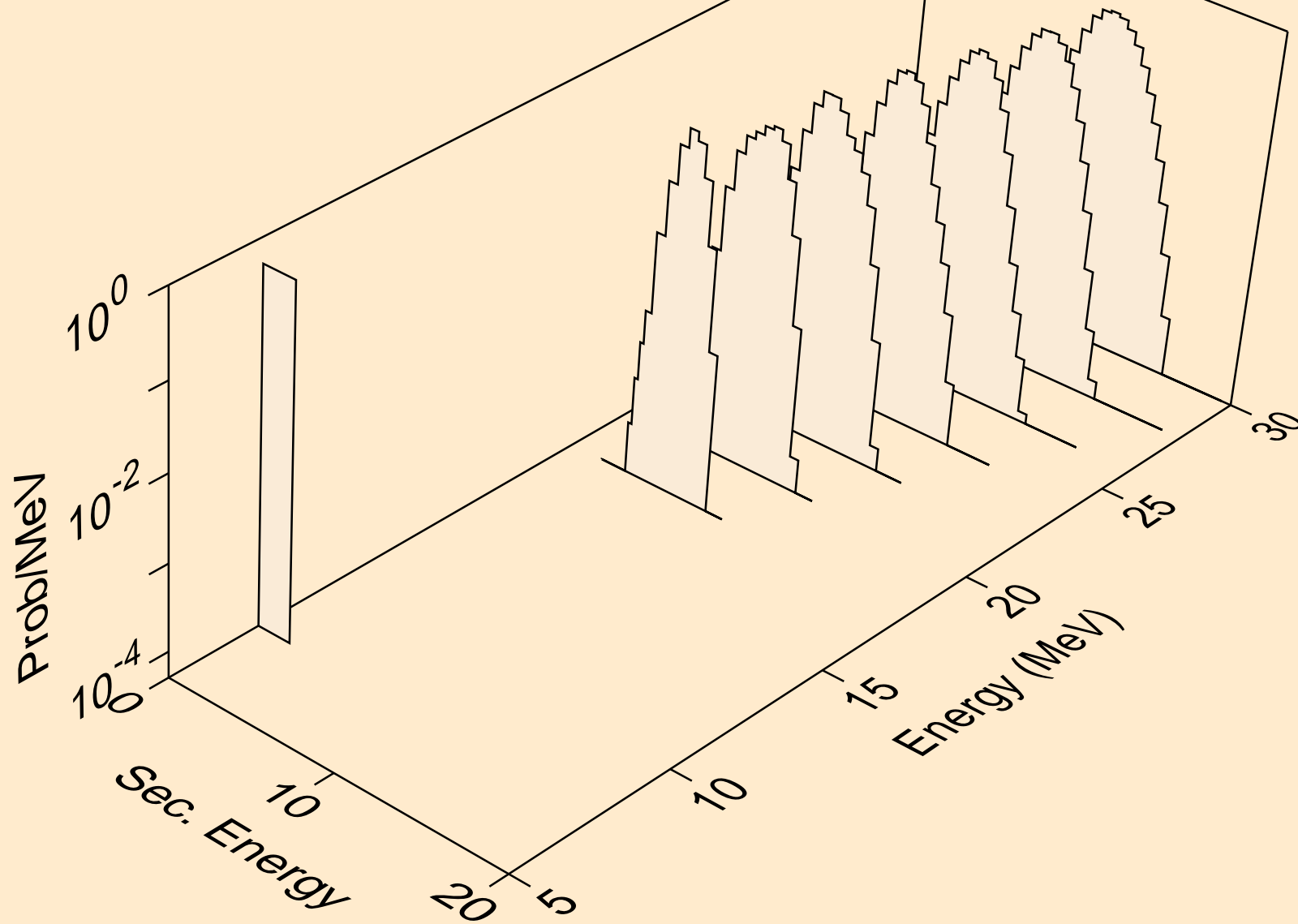

AT218 NEUTRON ACER TENDL-2024 LIBRARY; T=0.K
he3s from (n,x)

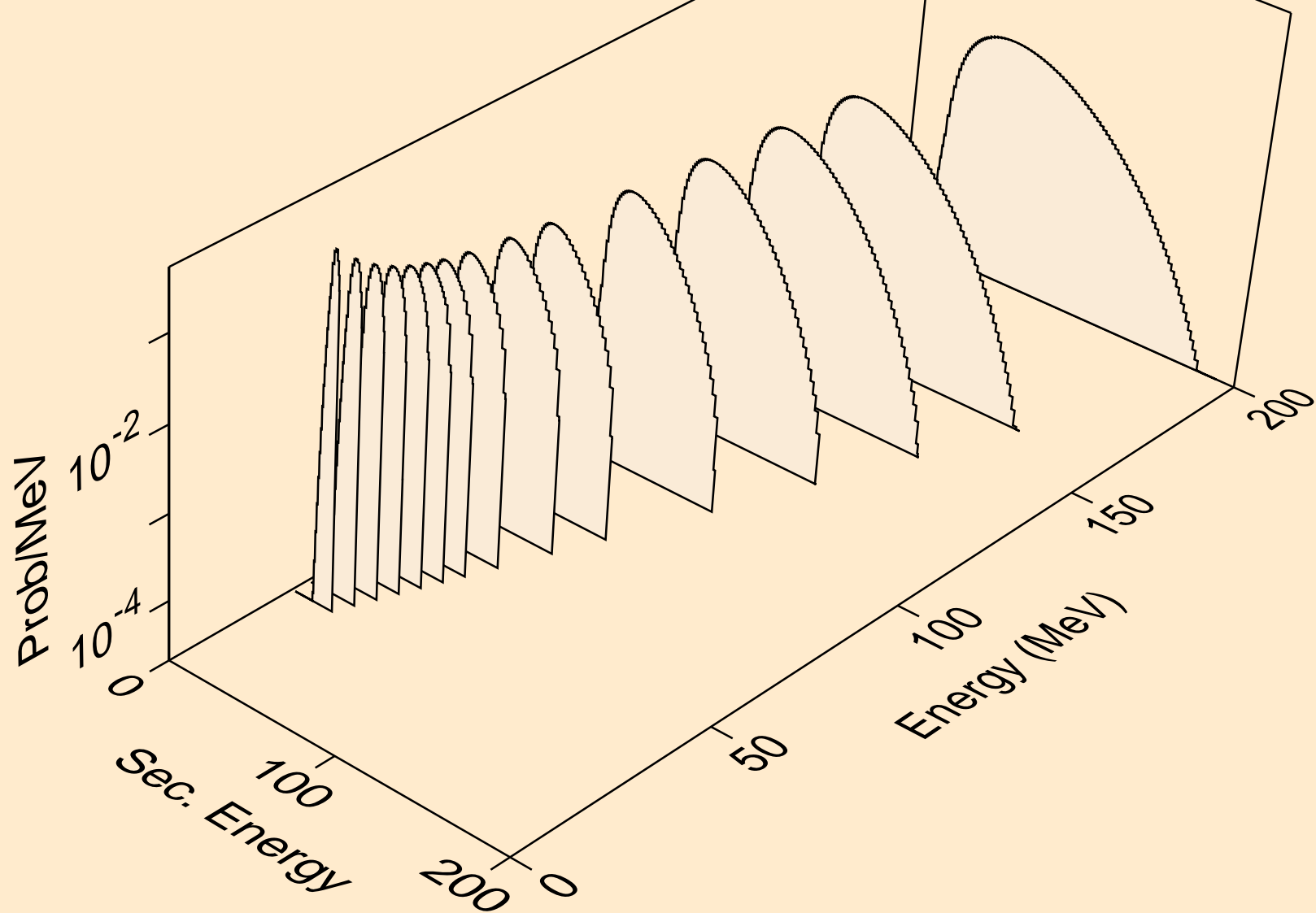

AT218 NEUTRON ACER TENDL-2024 LIBRARY; T=0.K
he3s from (n,n*)he3

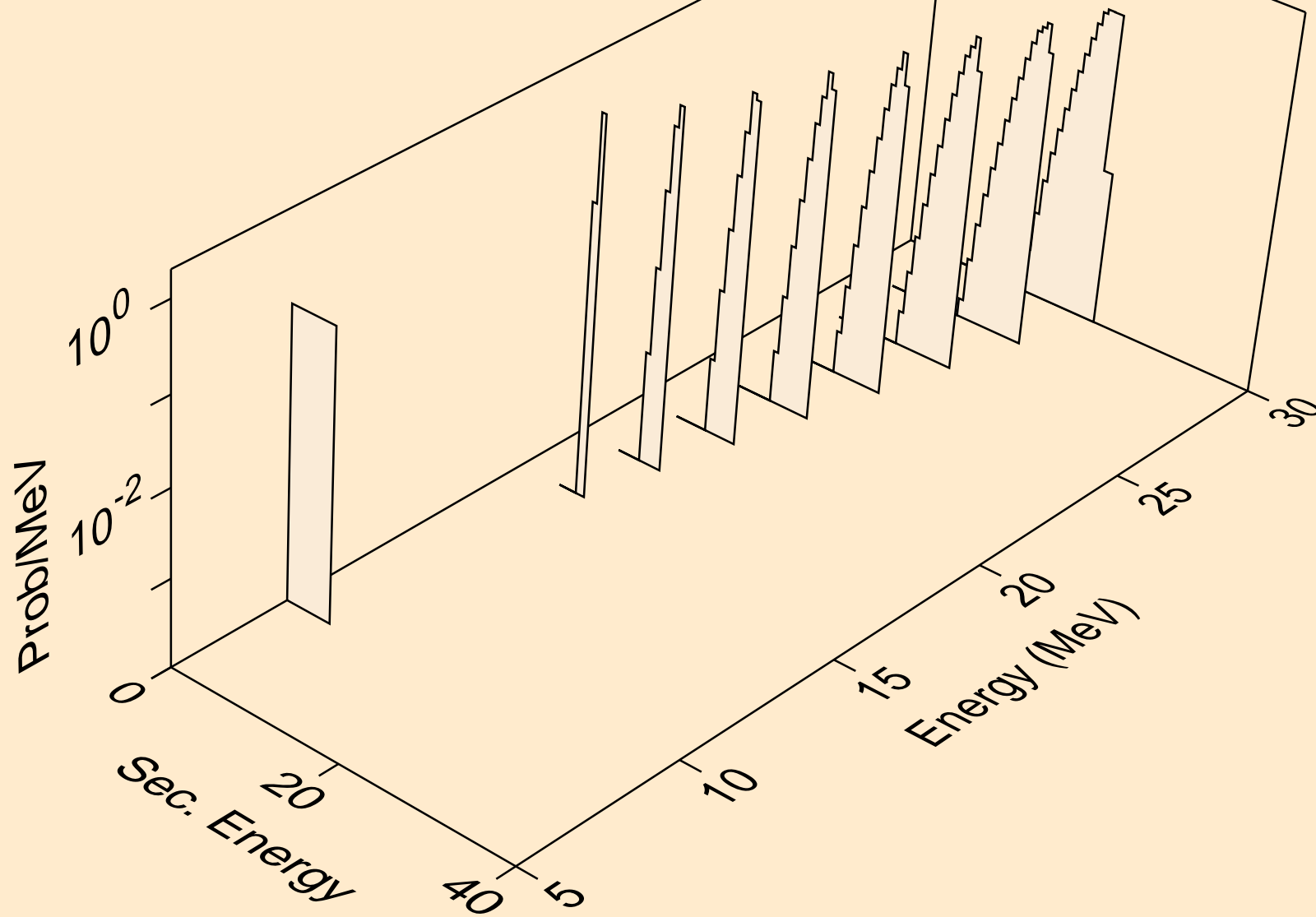

AT218 NEUTRON ACER TENDL-2024 LIBRARY; T=0.K
he3s from (n,he3)

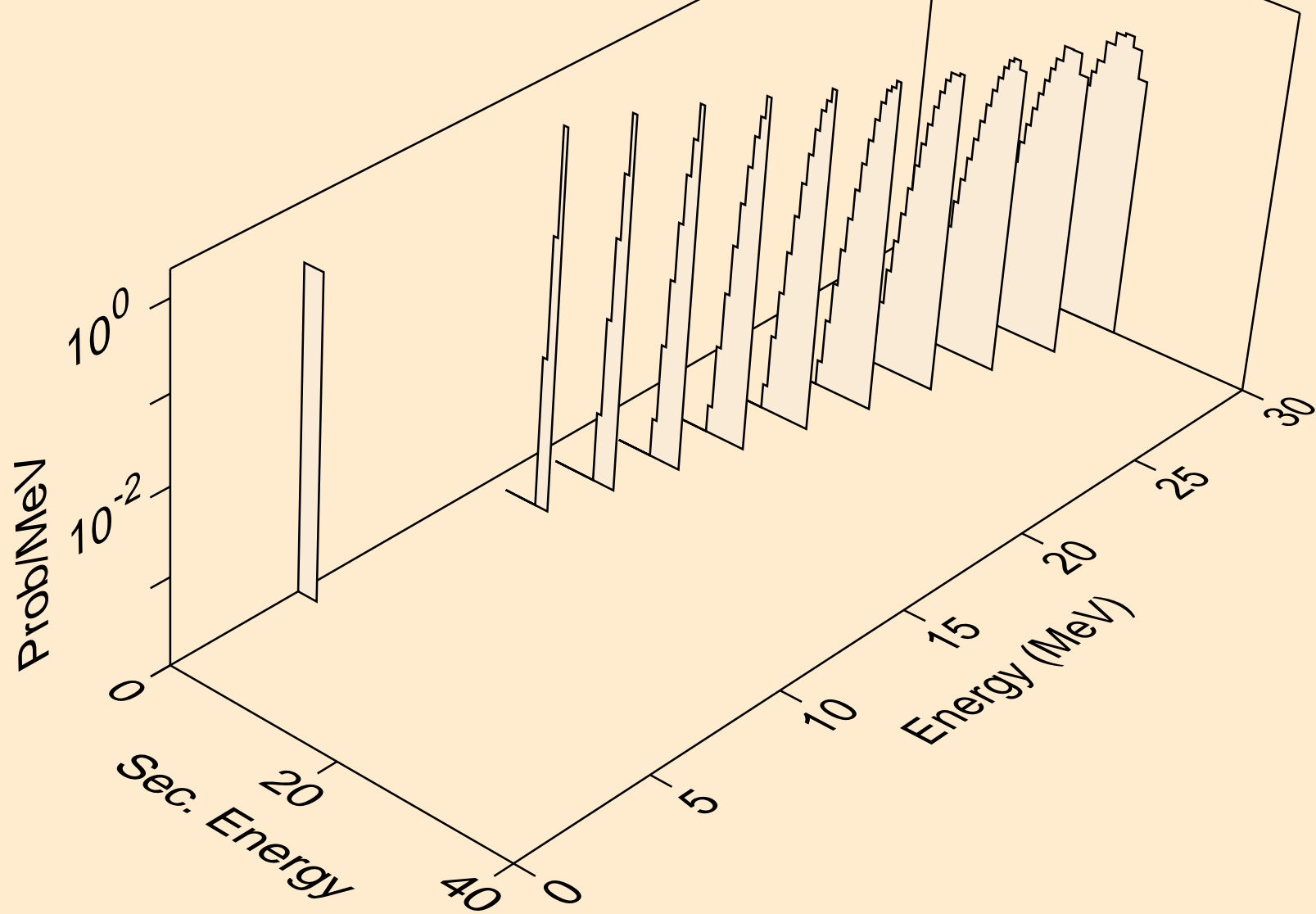

AT218 NEUTRON ACER TENDL-2024 LIBRARY; T=0.K
alphas from (n,x)

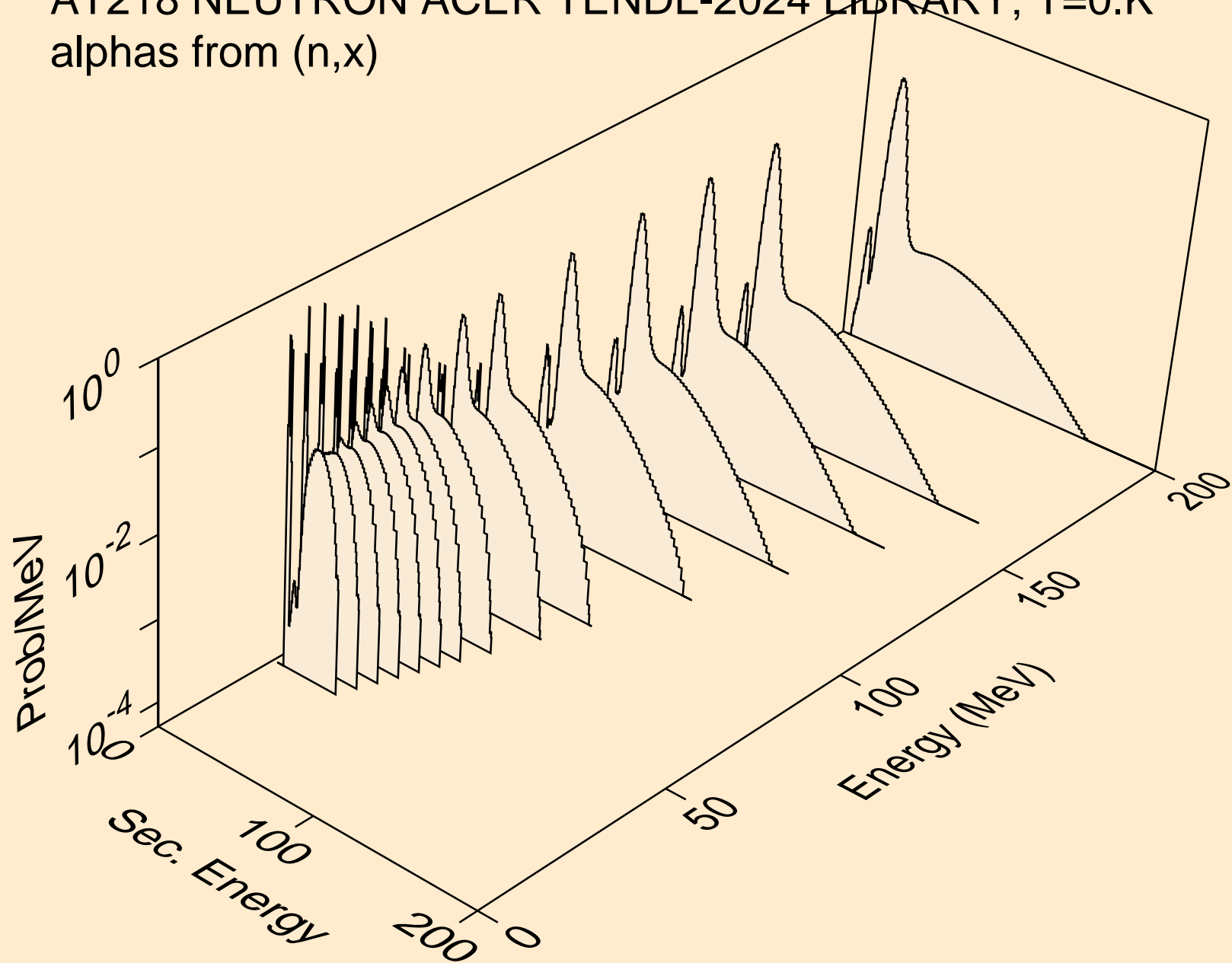

AT218 NEUTRON ACER TENDL-2024 LIBRARY; T=0.K
alphas from (n,n*)a

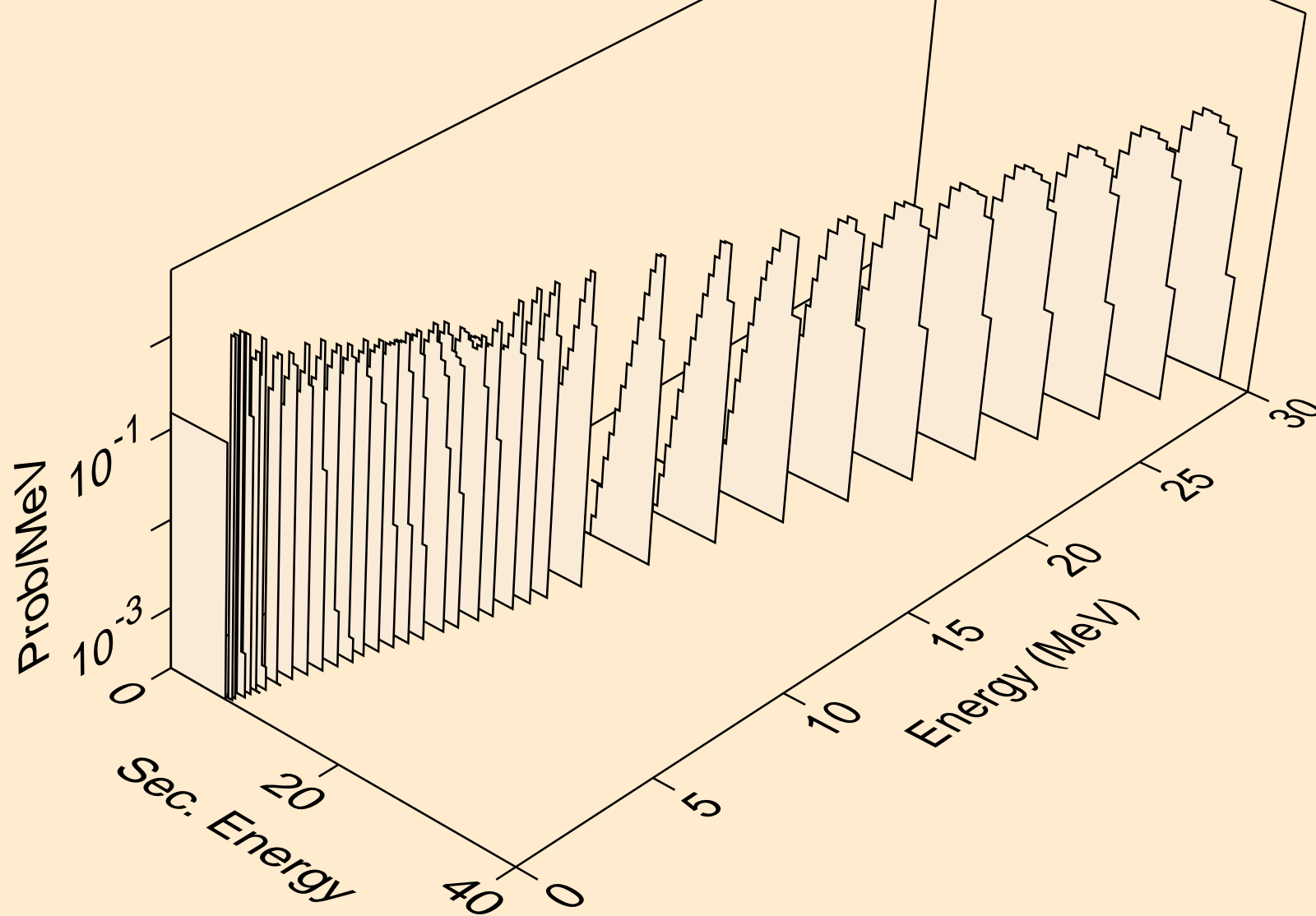

AT218 NEUTRON ACER TENDL-2024 LIBRARY; T=0.K
alphas from (n,2n)a

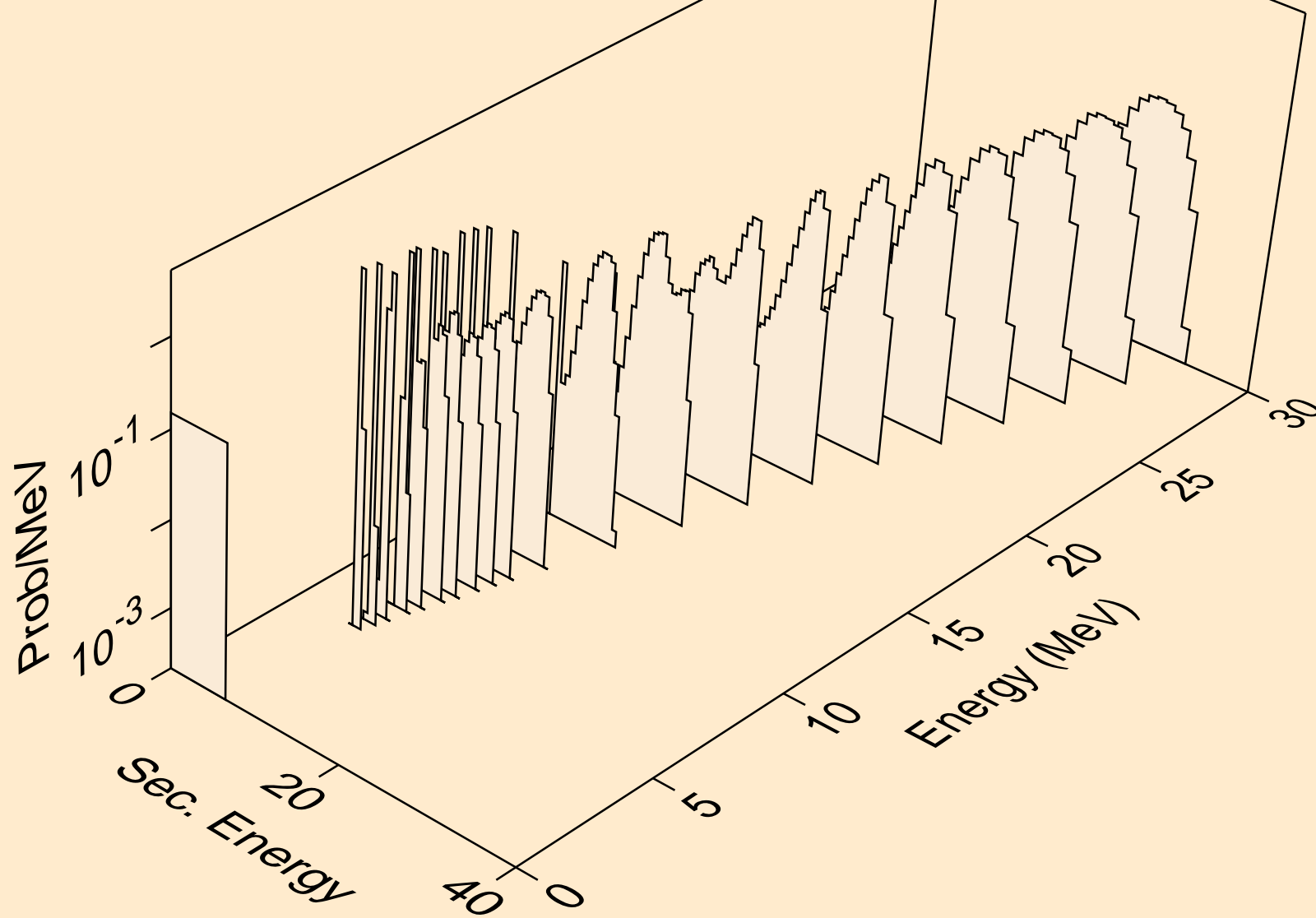

AT218 NEUTRON ACER TENDL-2024 LIBRARY; T=0.K
alphas from (n,3n)a

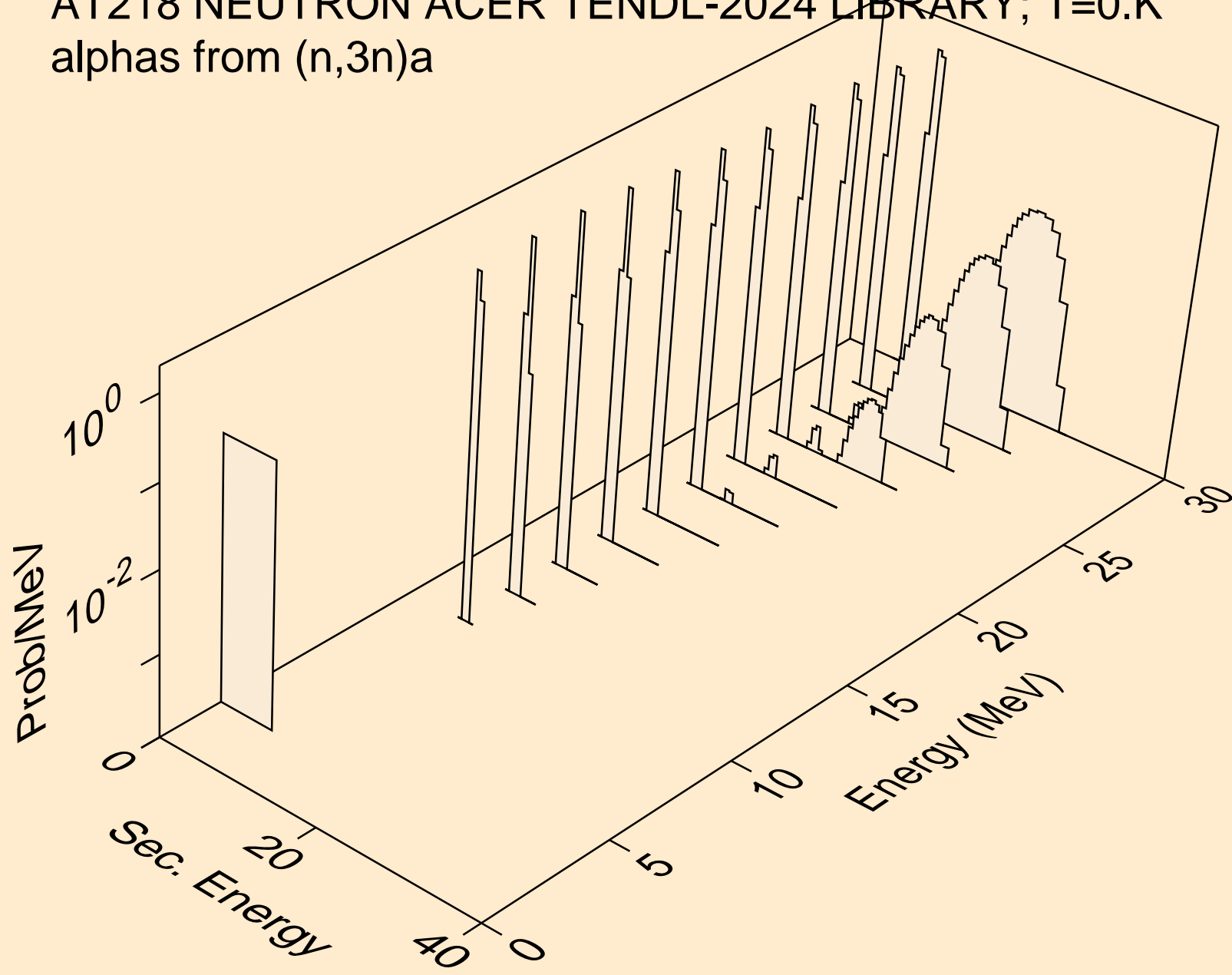

AT218 NEUTRON ACER TENDL-2024 LIBRARY; T=0.K
alphas from (n,n*)2a

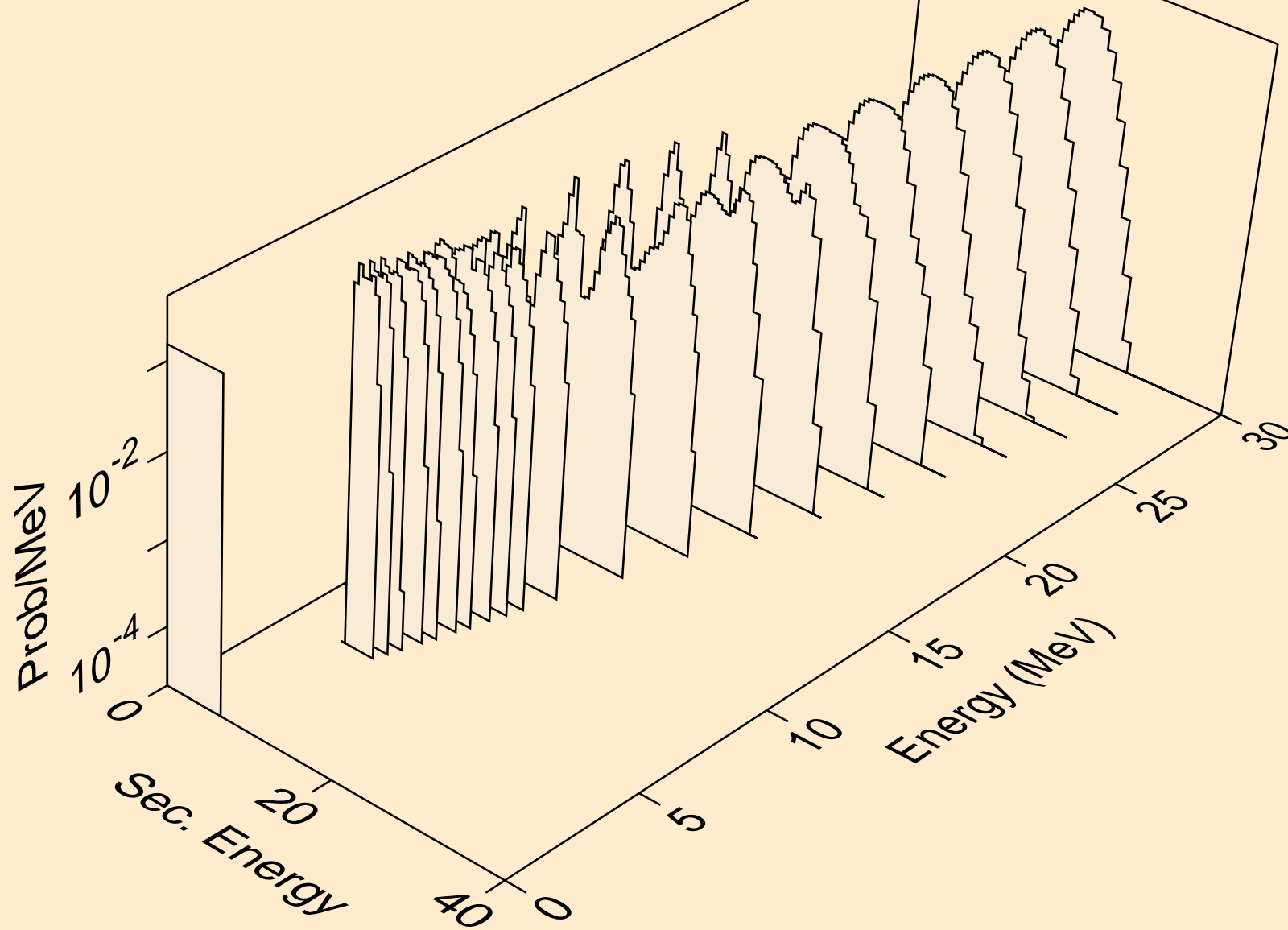

AT218 NEUTRON ACER TENDL-2024 LIBRARY; T=0.K
alphas from (n,2n)2a

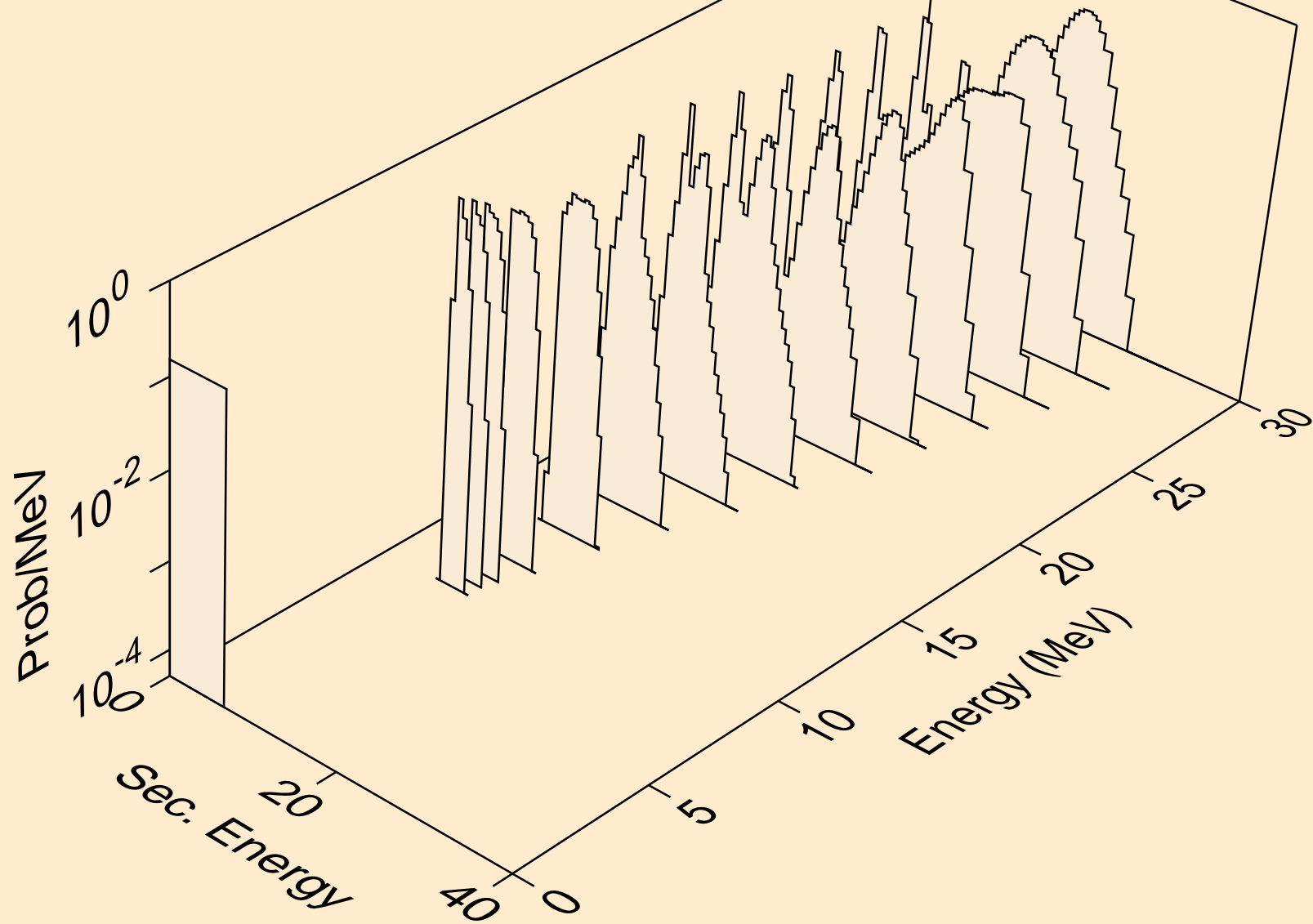

AT218 NEUTRON ACER TENDL-2024 LIBRARY; T=0.K
alphas from (n,npa)

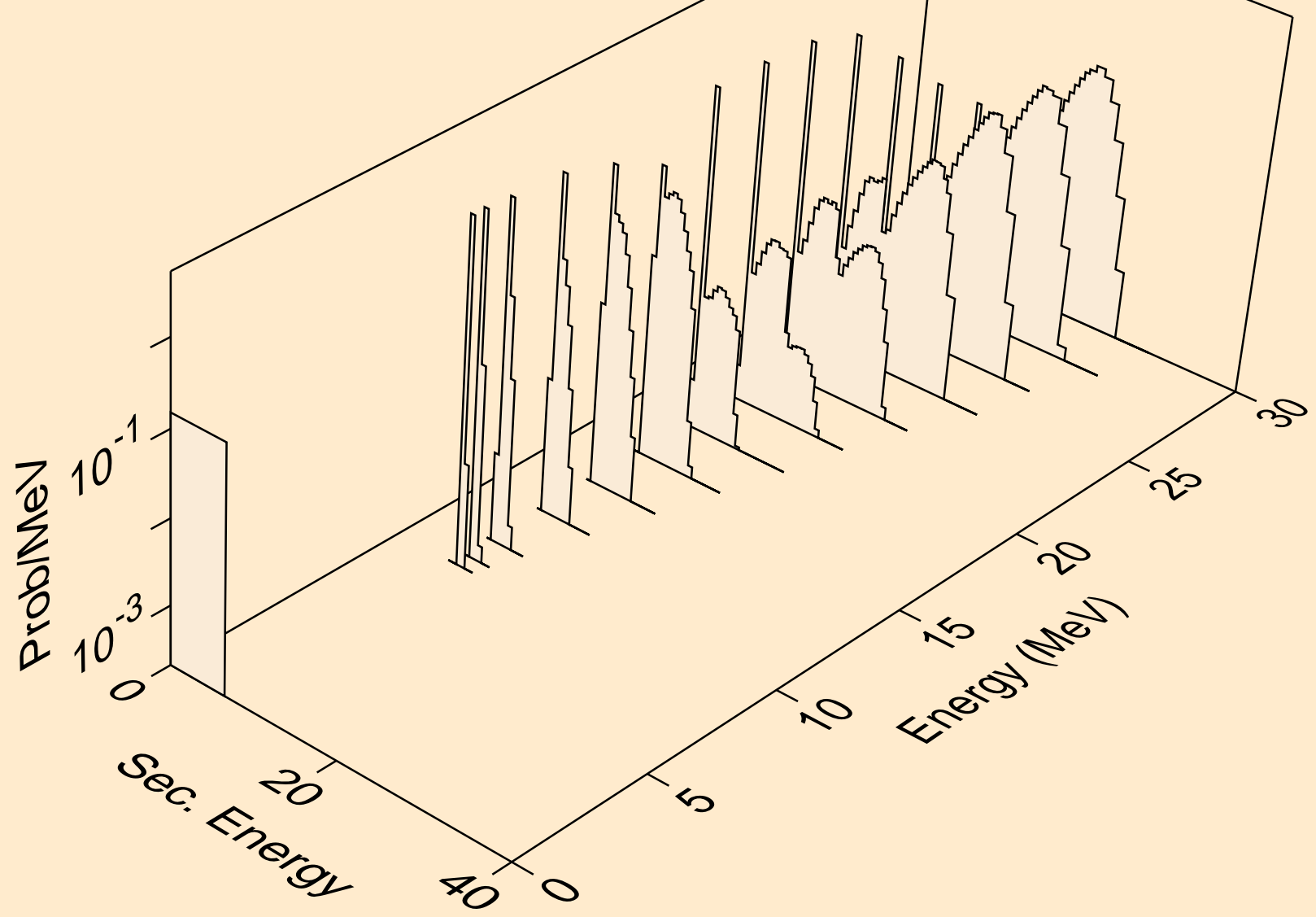

AT218 NEUTRON ACER TENDL-2024 LIBRARY; T=0.K
alphas from (n,a)

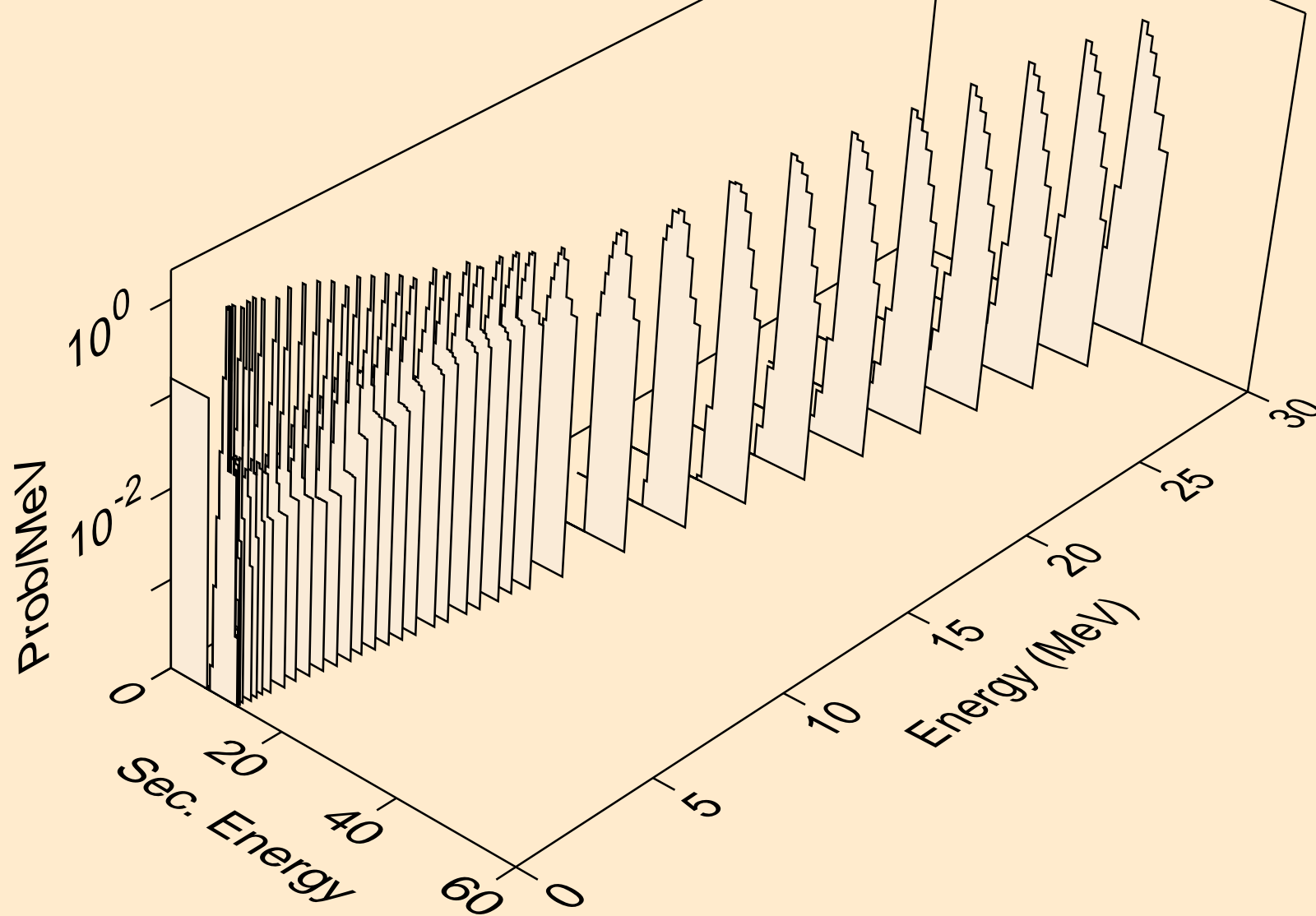

AT218 NEUTRON ACER TENDL-2024 LIBRARY; T=0.K
alphas from (n,2a)

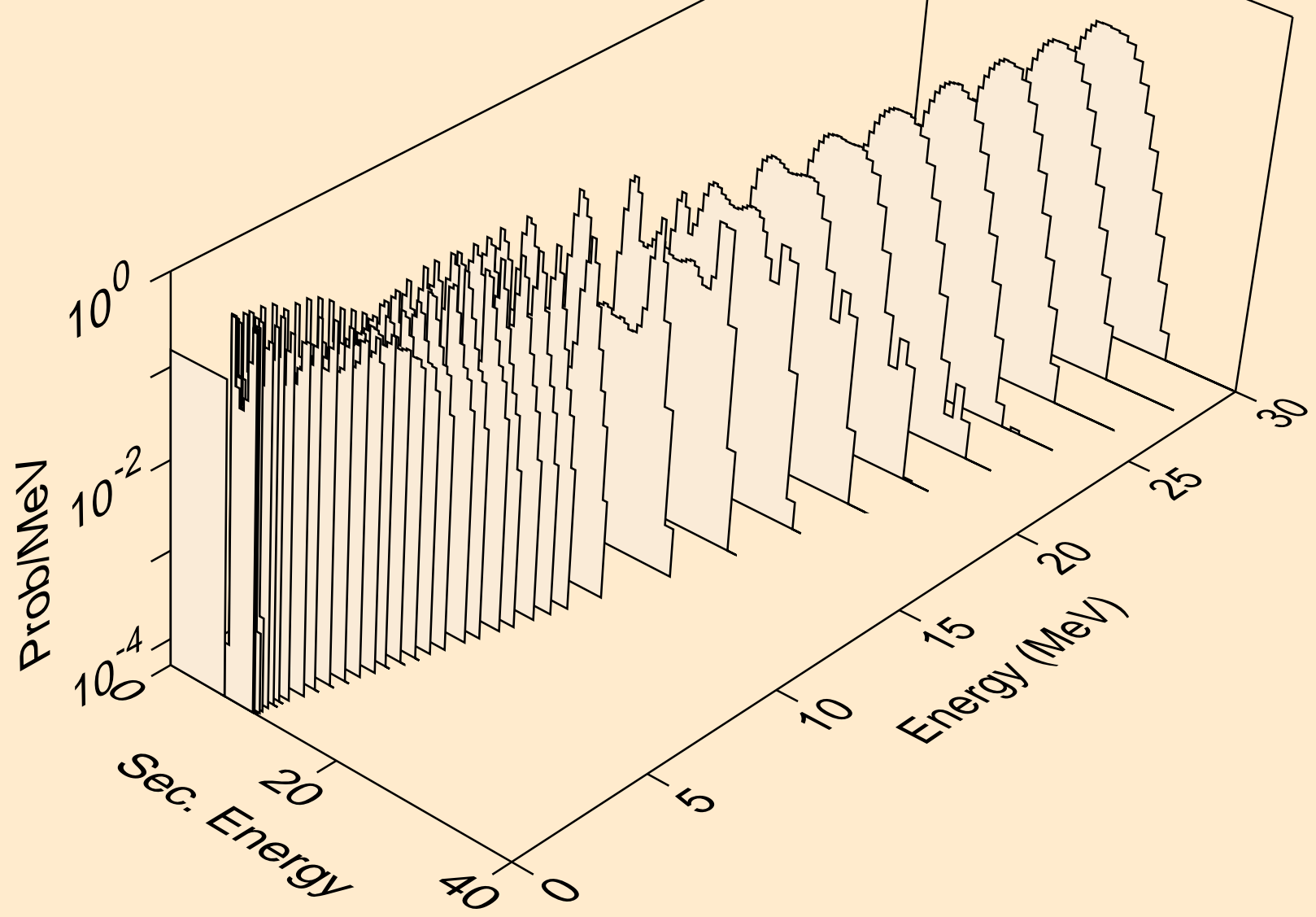

AT218 NEUTRON ACER TENDL-2024 LIBRARY; T=0.K
alphas from (n,pa)

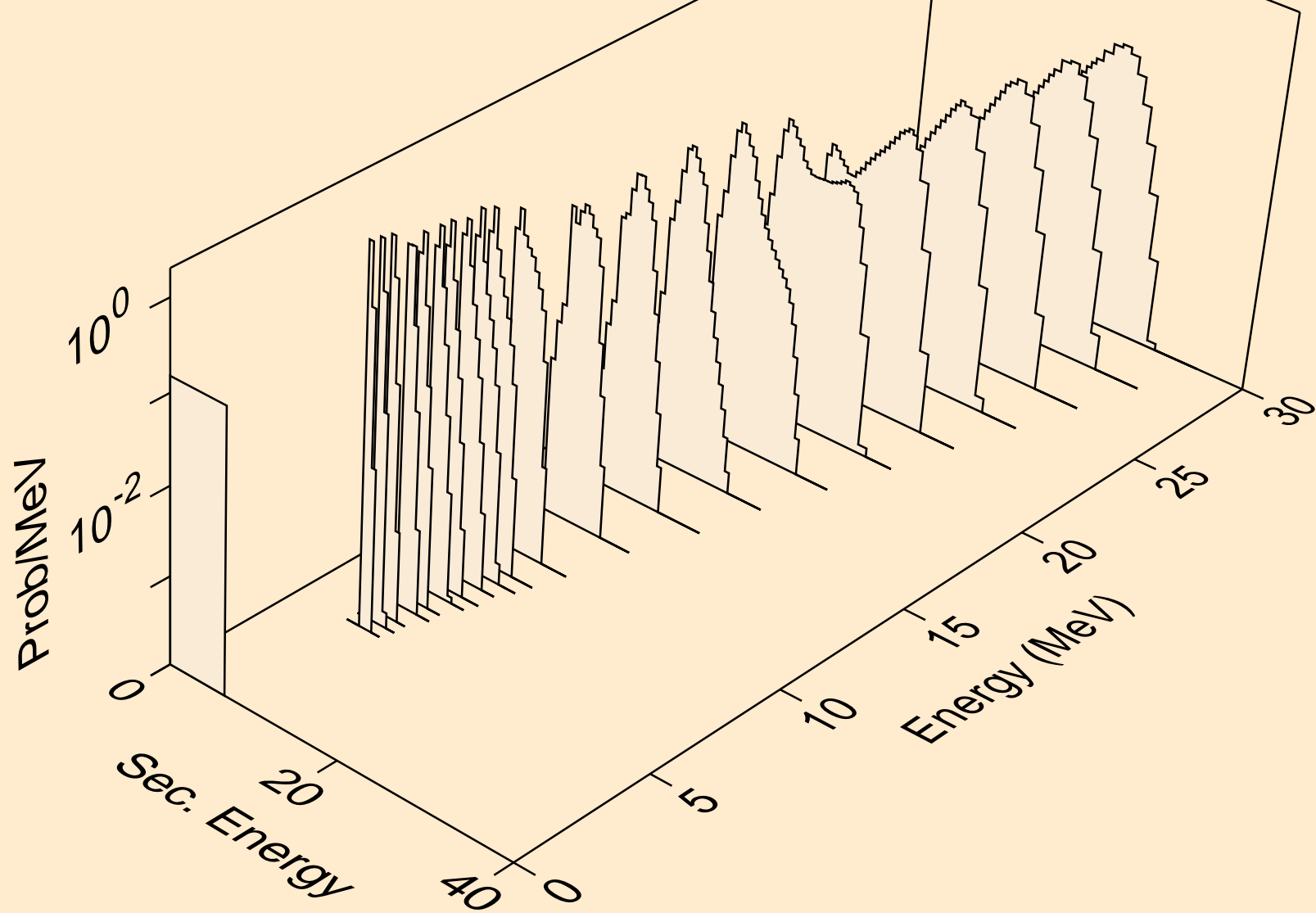

AT218 NEUTRON ACER TENDL-2024 LIBRARY; T=0.K
alphas from (n,da)

