

AU193 NEUTRON ACER TENDL-2024 LIBRARY; T=0.K
Principal cross sections

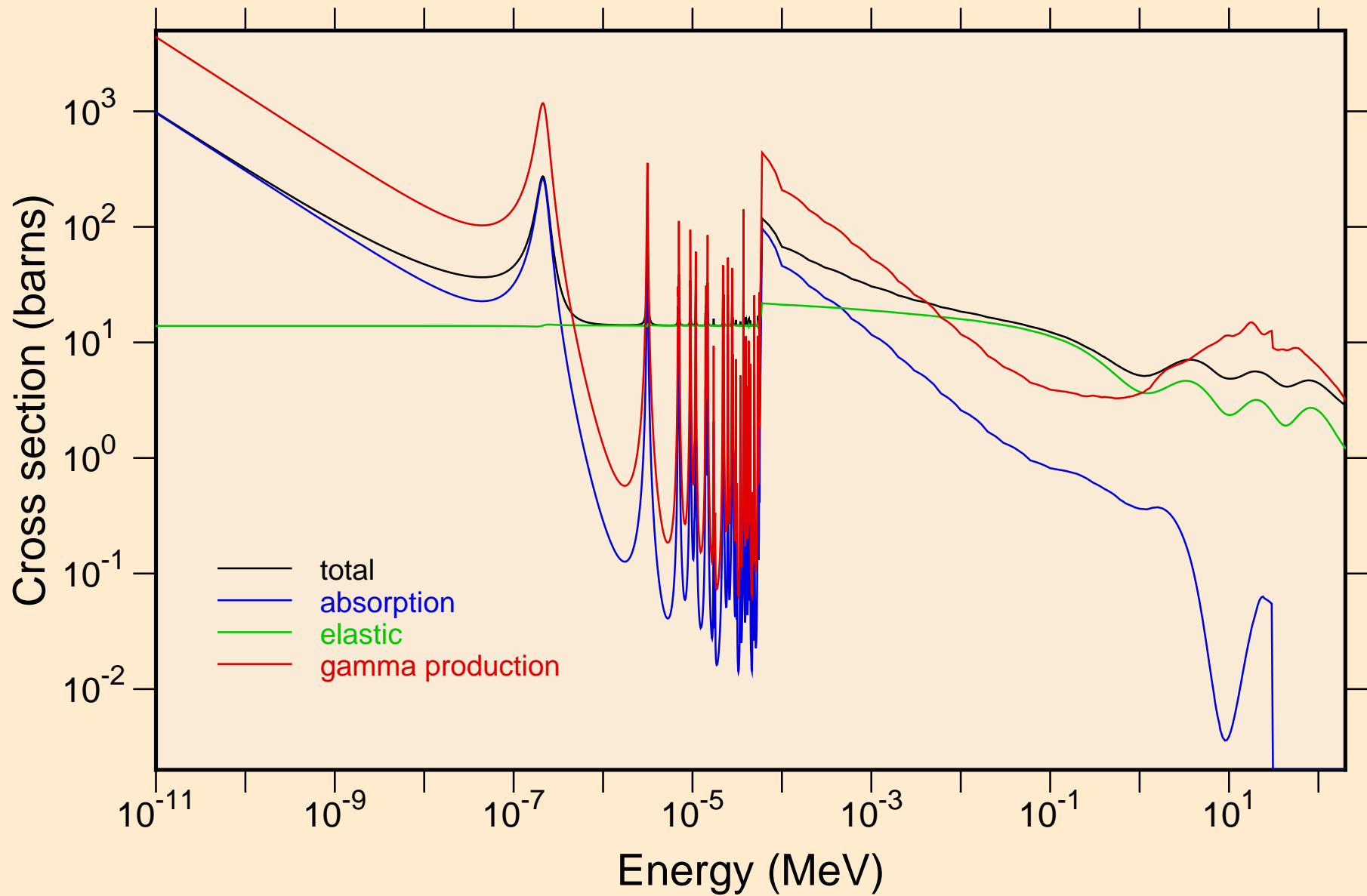

AU193 NEUTRON ACER TENDL-2024 LIBRARY; T=0.K
resonance total cross section

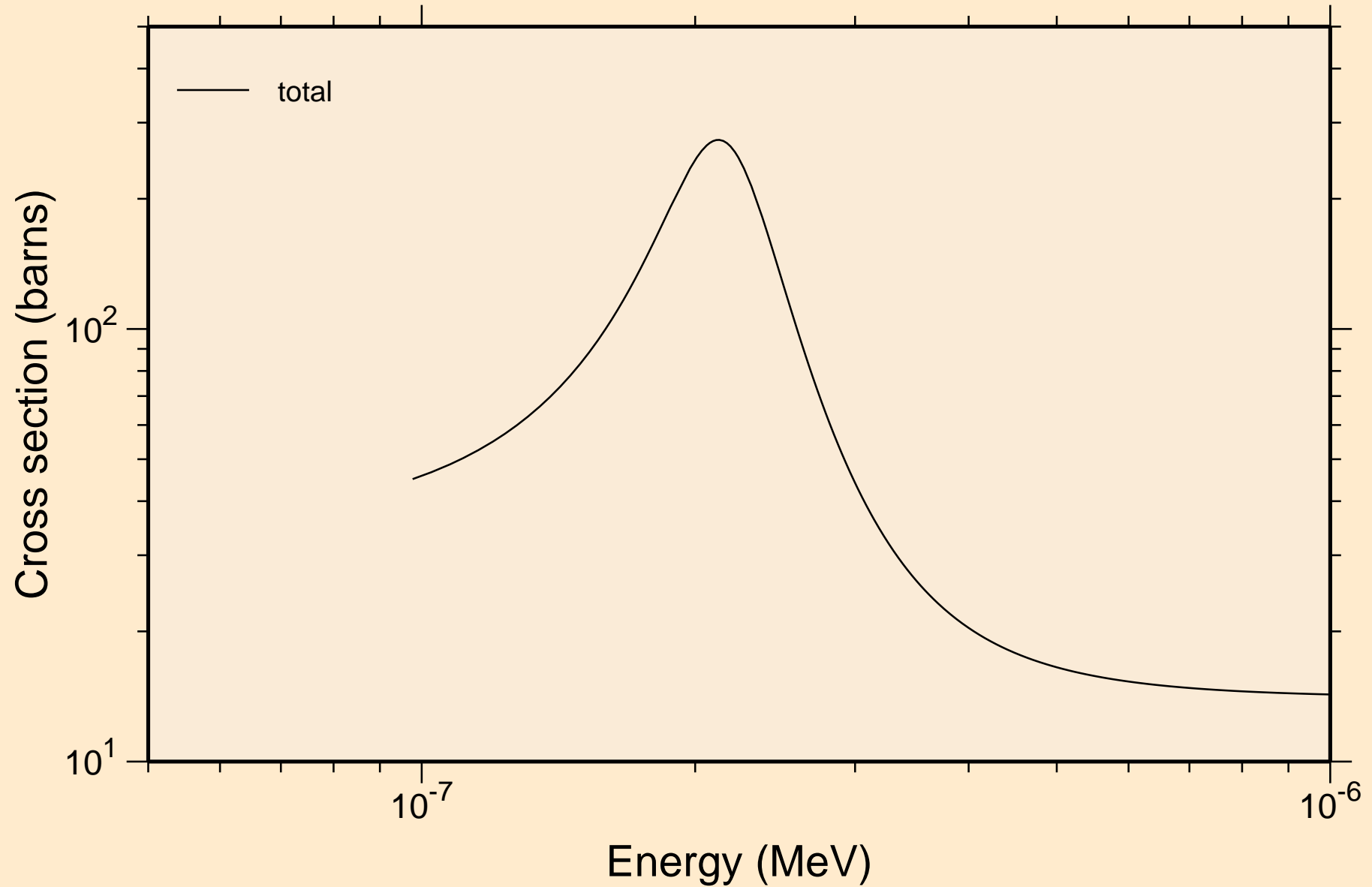

AU193 NEUTRON ACER TENDL-2024 LIBRARY; T=0.K
resonance total cross section

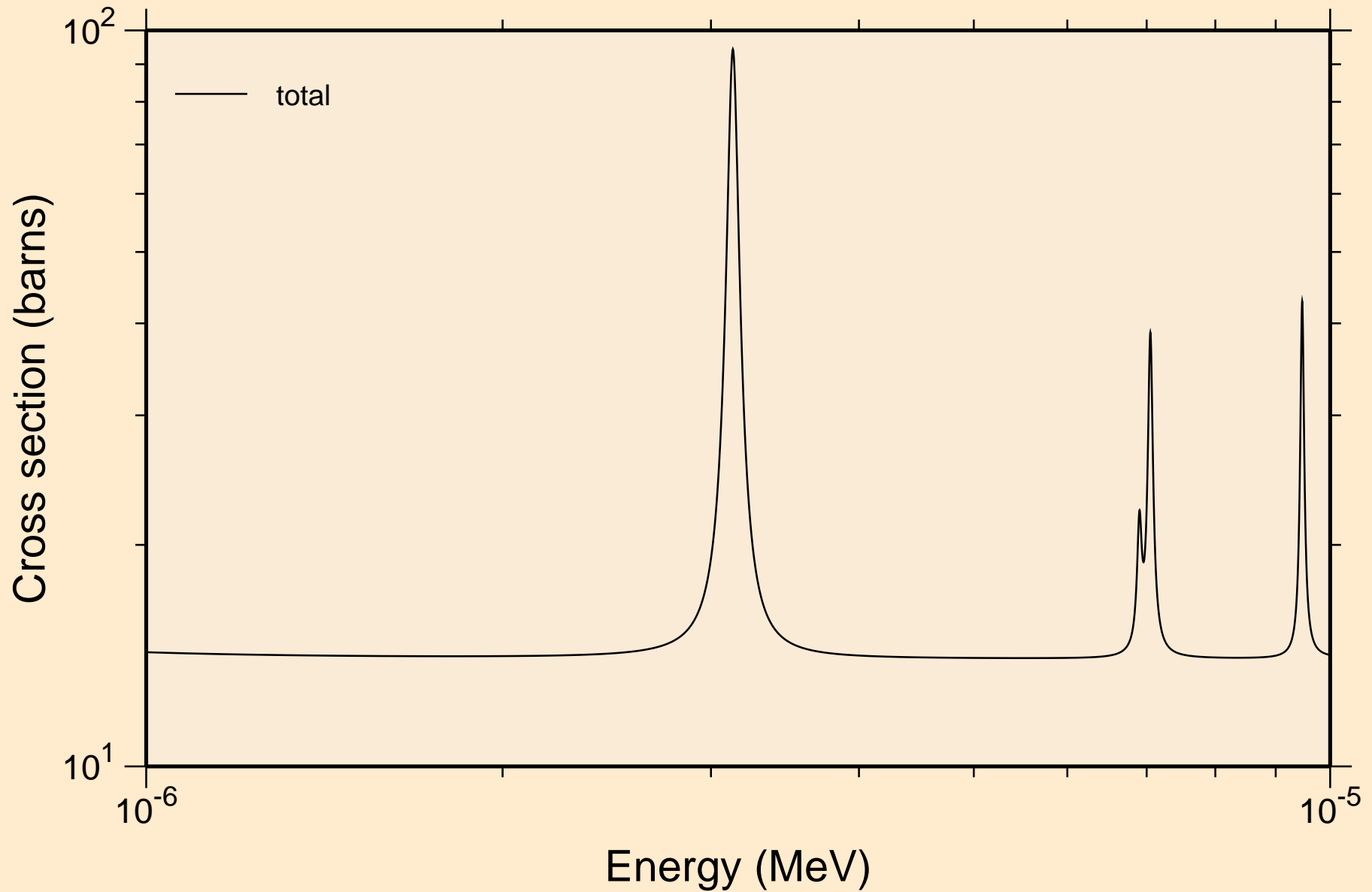

AU193 NEUTRON ACER TENDL-2024 LIBRARY; T=0.K
resonance total cross section

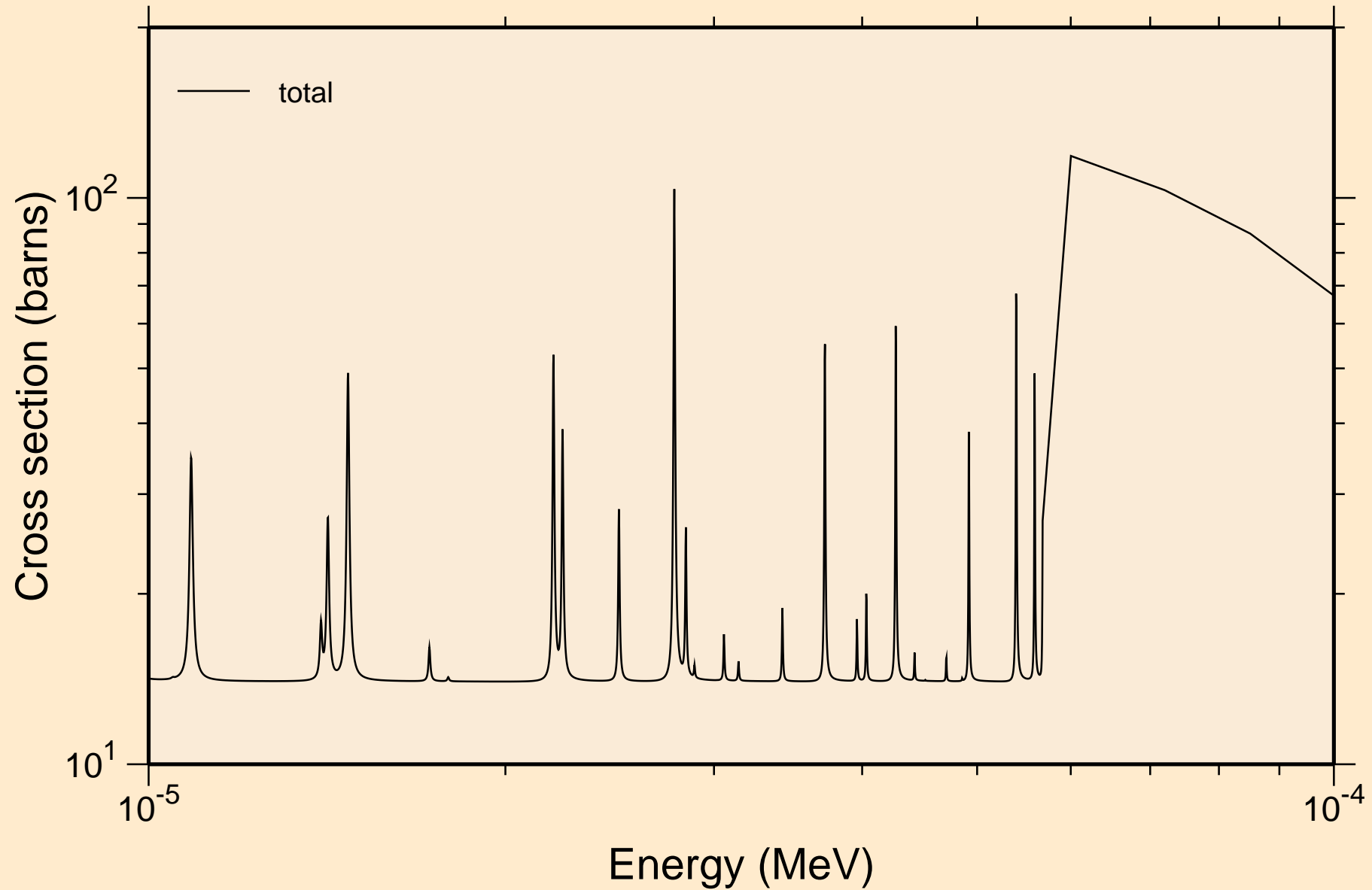

AU193 NEUTRON ACER TENDL-2024 LIBRARY; T=0.K
resonance total cross section

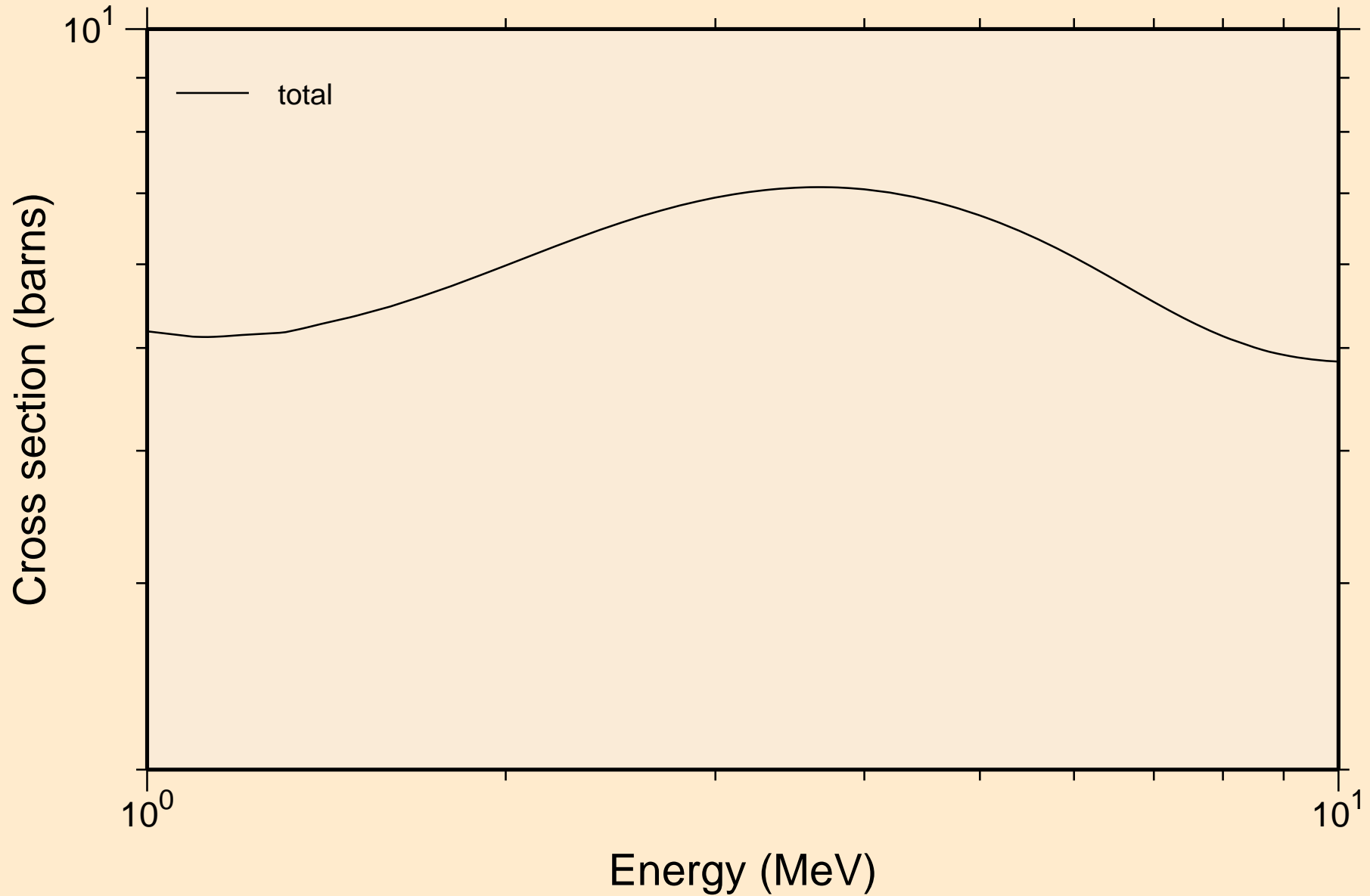

AU193 NEUTRON ACER TENDL-2024 LIBRARY; T=0.K
resonance absorption cross sections

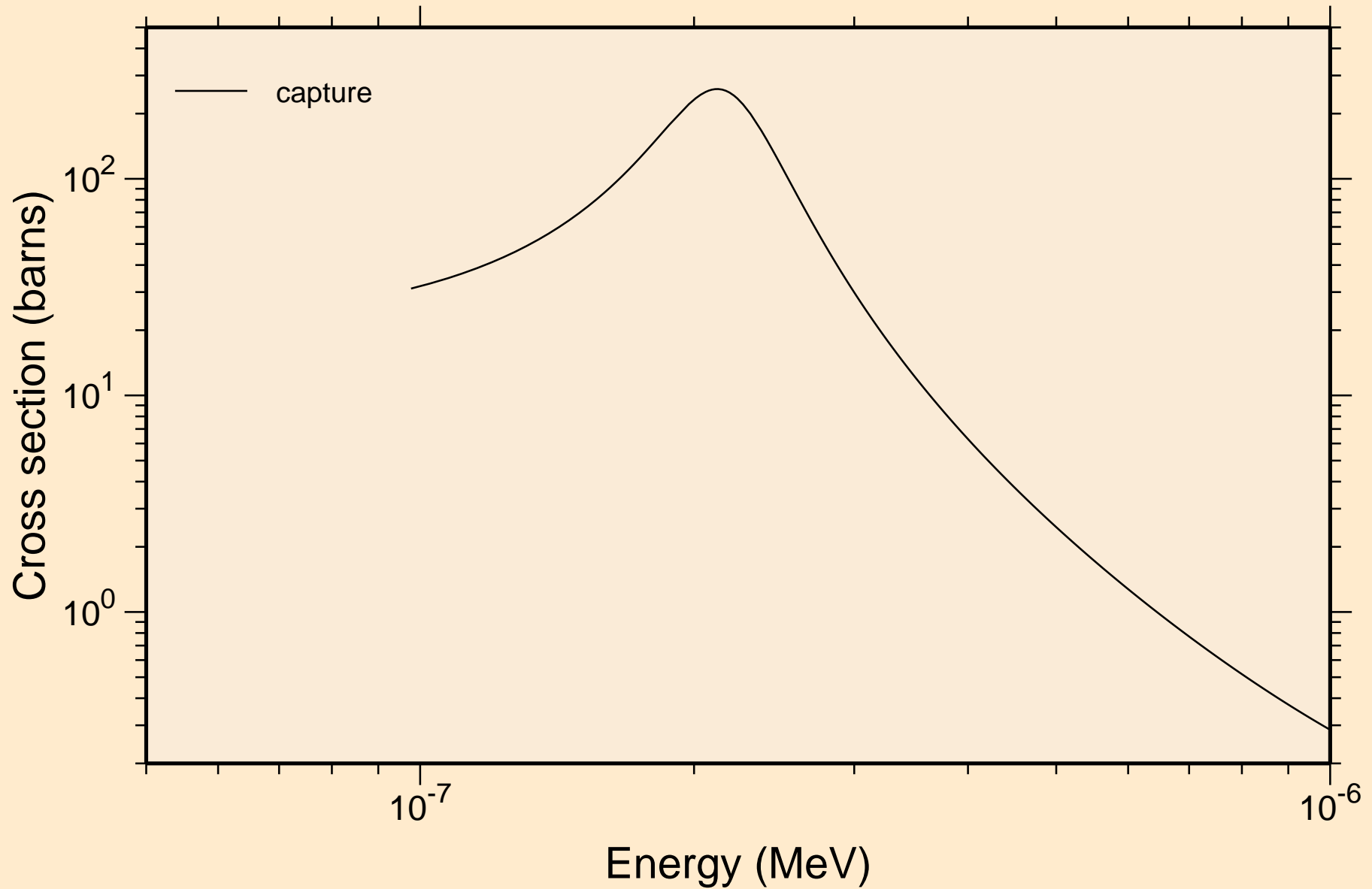

AU193 NEUTRON ACER TENDL-2024 LIBRARY; T=0.K
resonance absorption cross sections

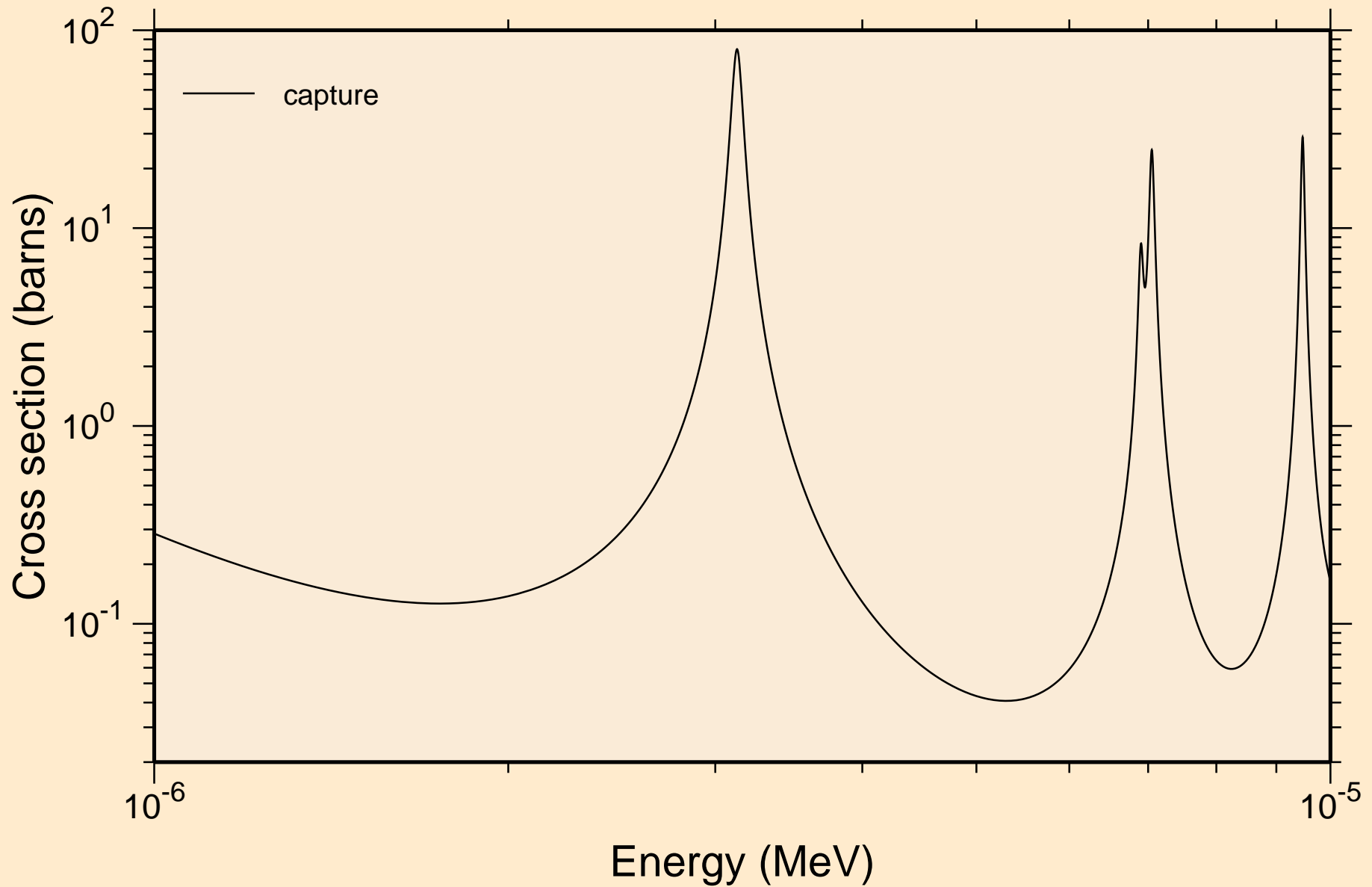

AU193 NEUTRON ACER TENDL-2024 LIBRARY; T=0.K
resonance absorption cross sections

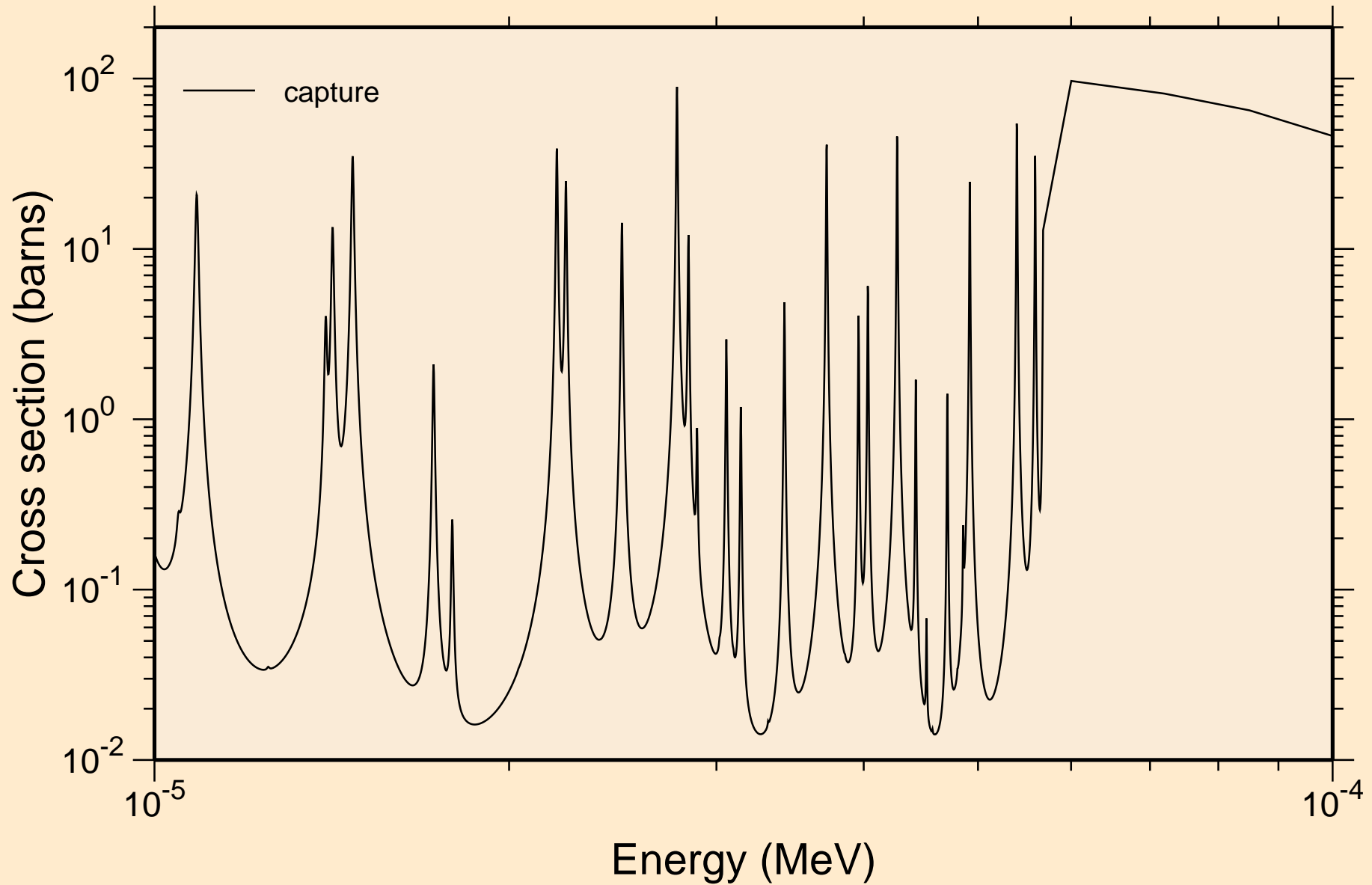

AU193 NEUTRON ACER TENDL-2024 LIBRARY; T=0.K
resonance absorption cross sections

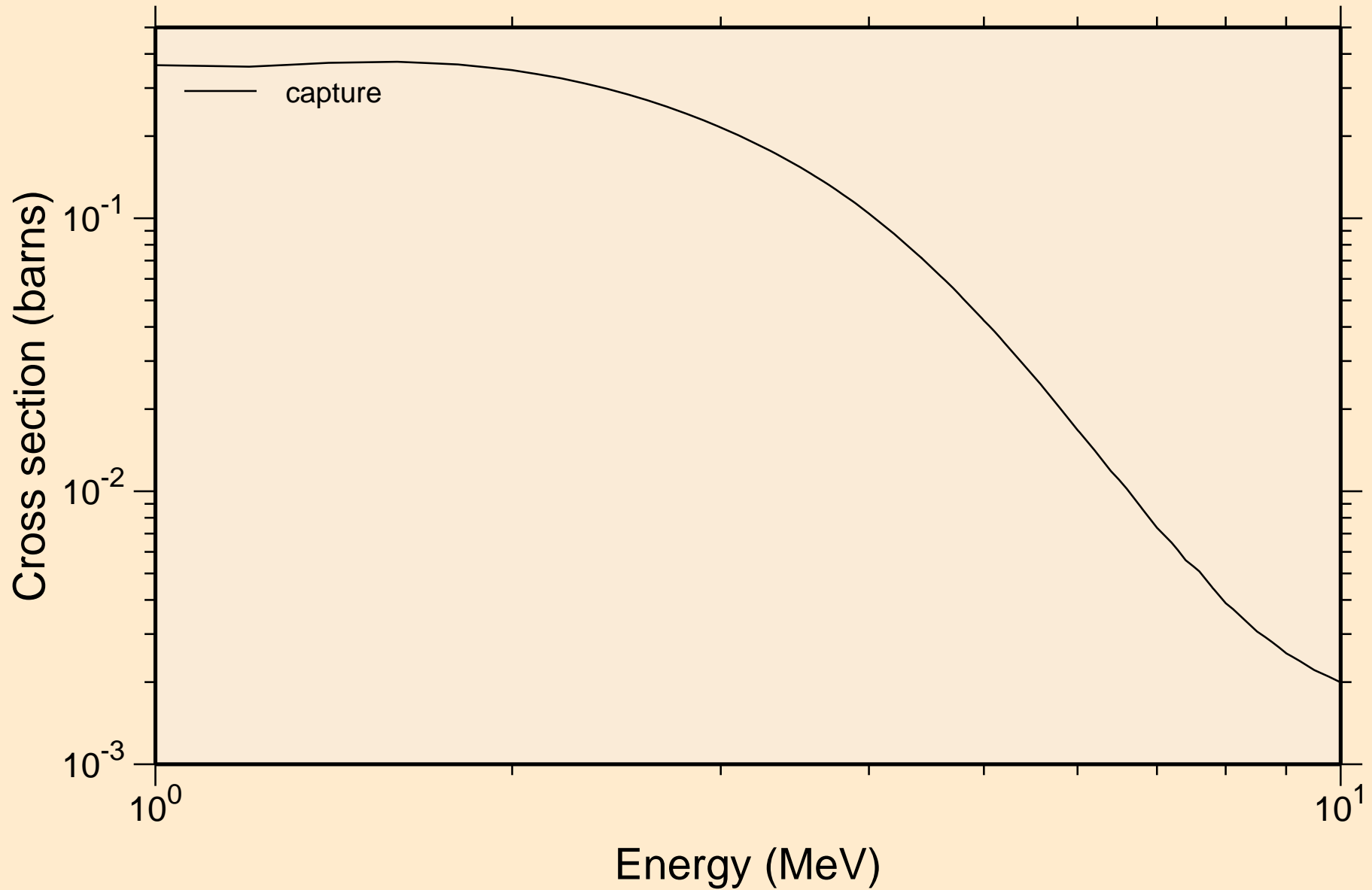

AU193 NEUTRON ACER TENDL-2024 LIBRARY; T=0.K
Heating

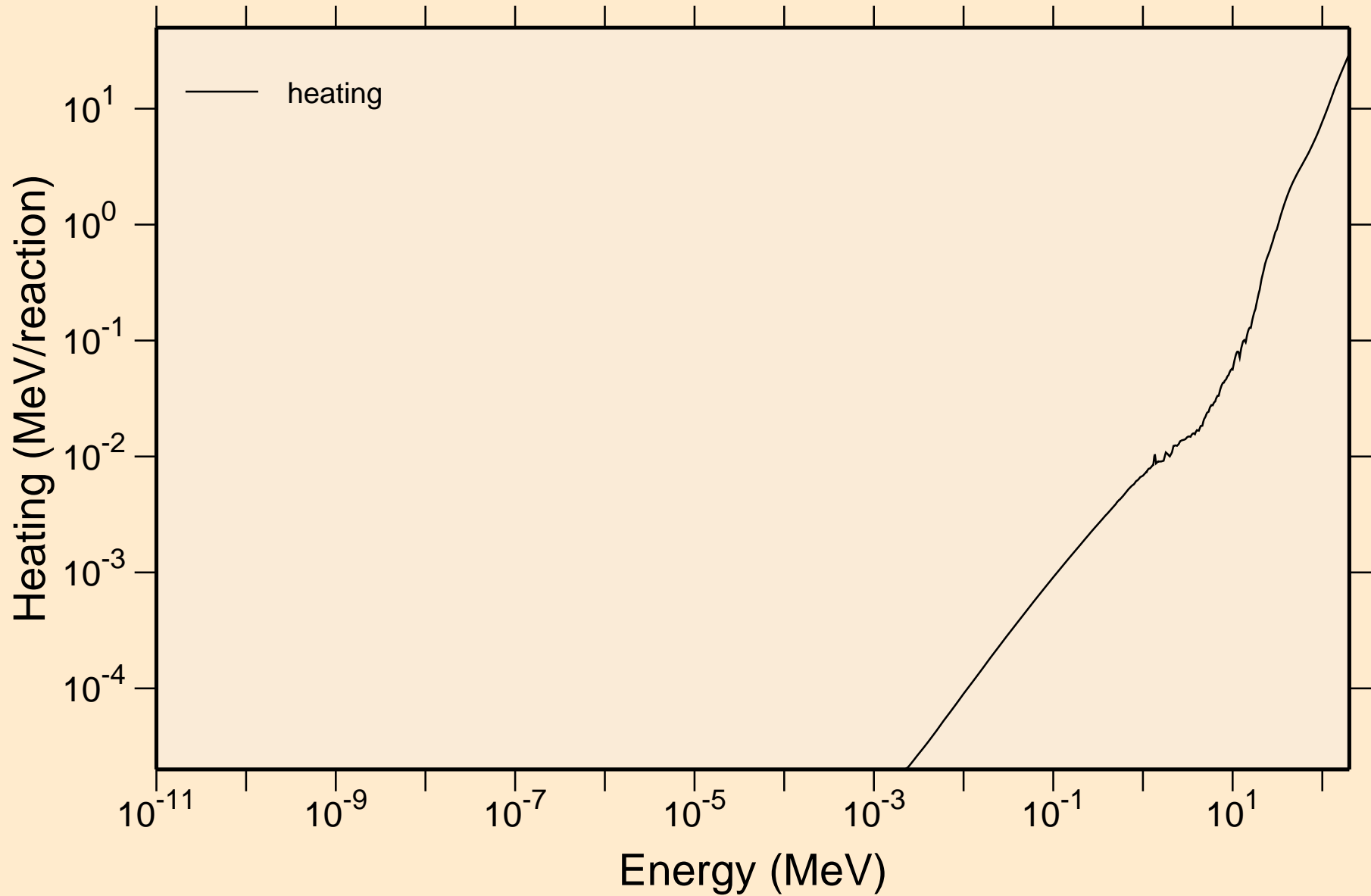

AU193 NEUTRON ACER TENDL-2024 LIBRARY; T=0.K

Damage

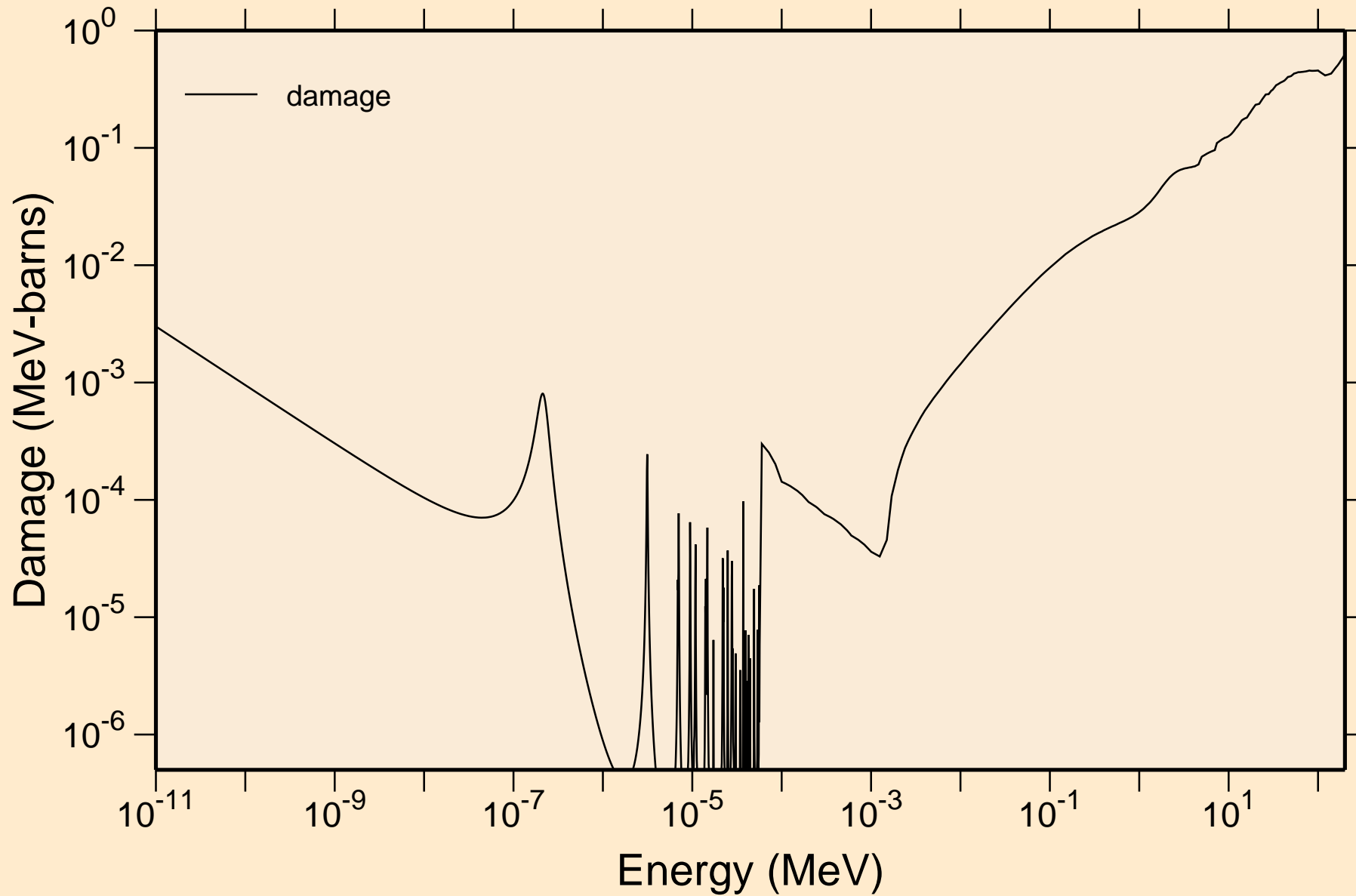

AU193 NEUTRON ACER TENDL-2024 LIBRARY; T=0.K
Non-threshold reactions

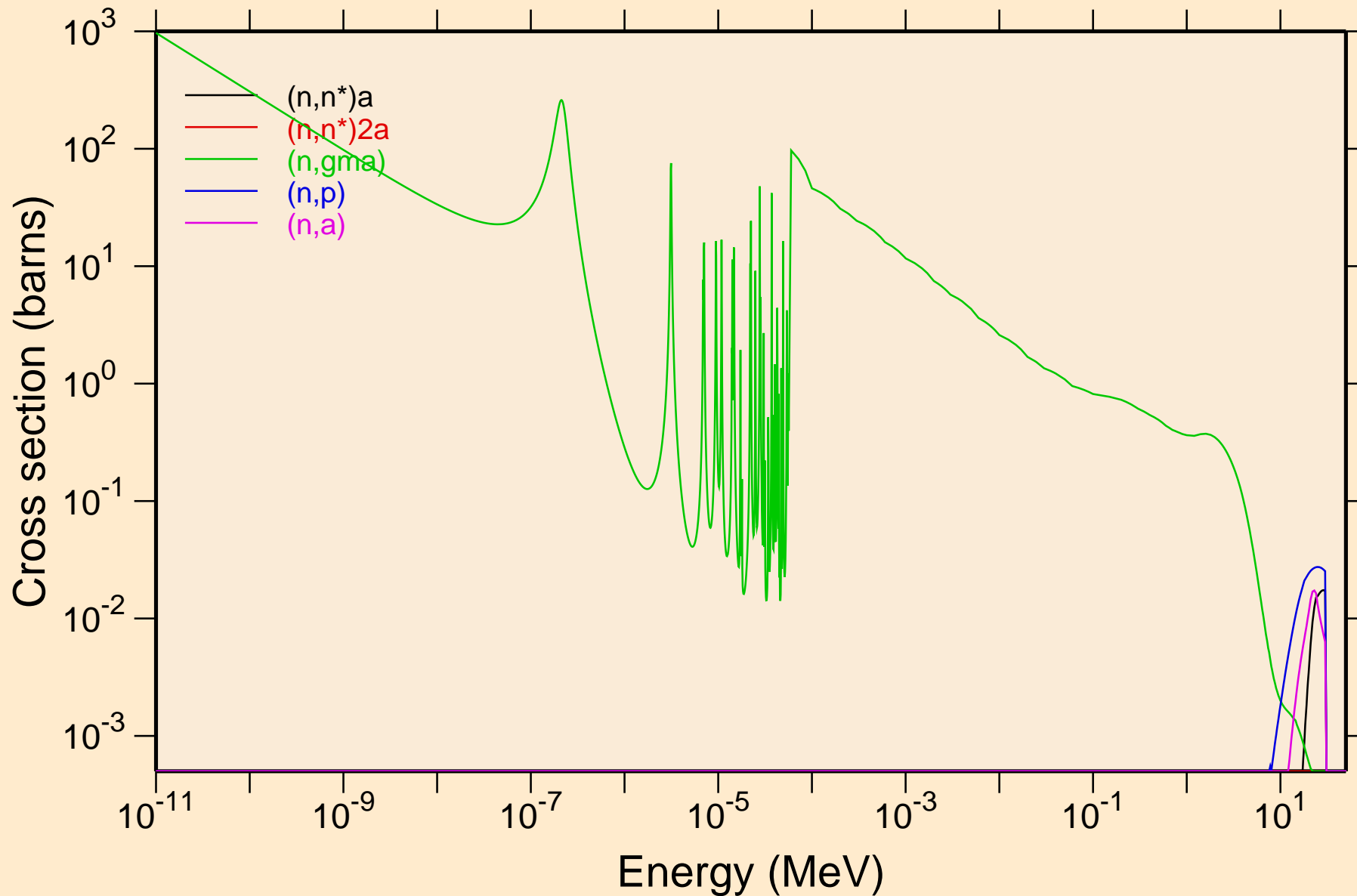

AU193 NEUTRON ACER TENDL-2024 LIBRARY; T=0.K
Non-threshold reactions

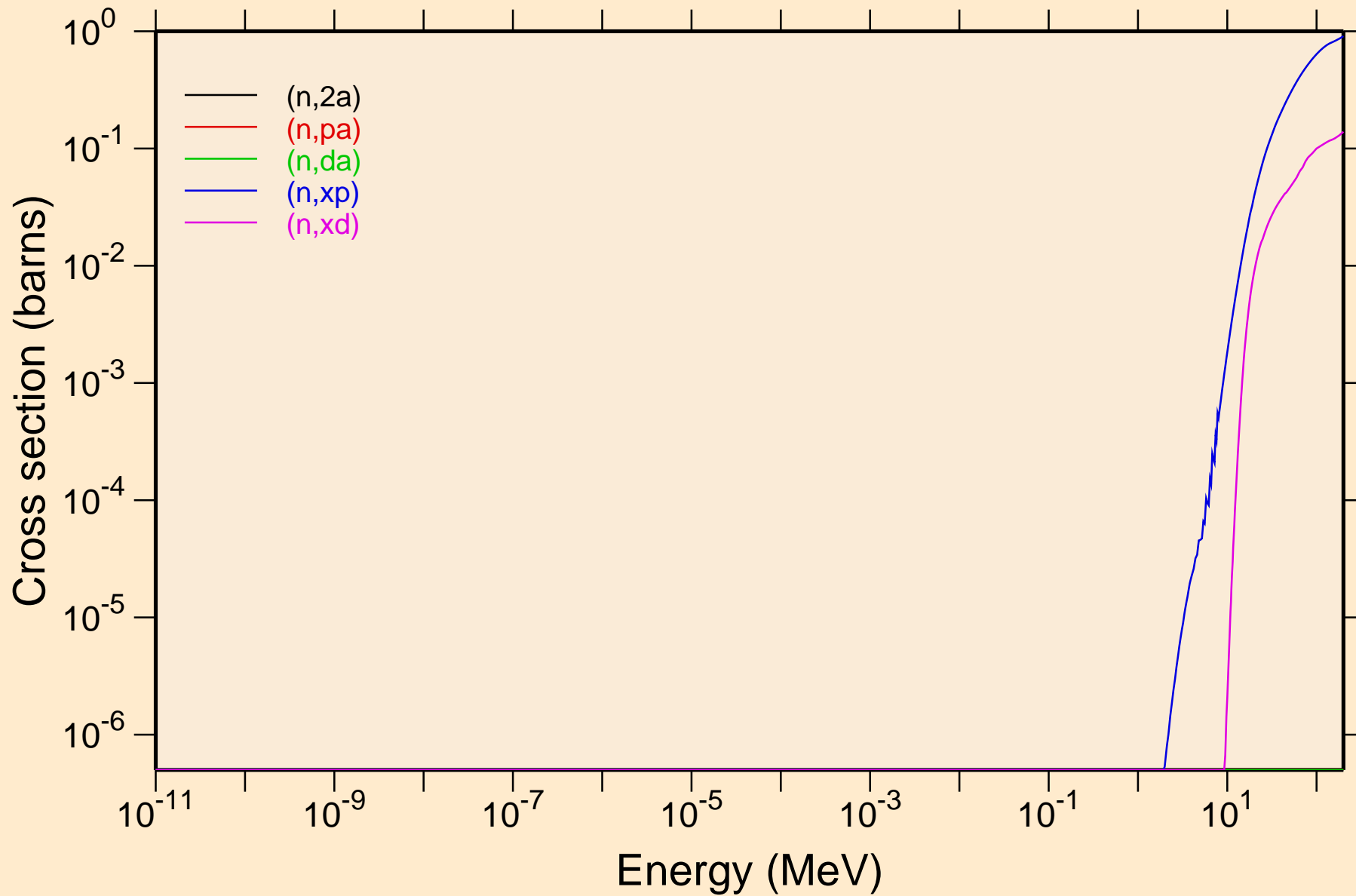

AU193 NEUTRON ACER TENDL-2024 LIBRARY; T=0.K
Non-threshold reactions

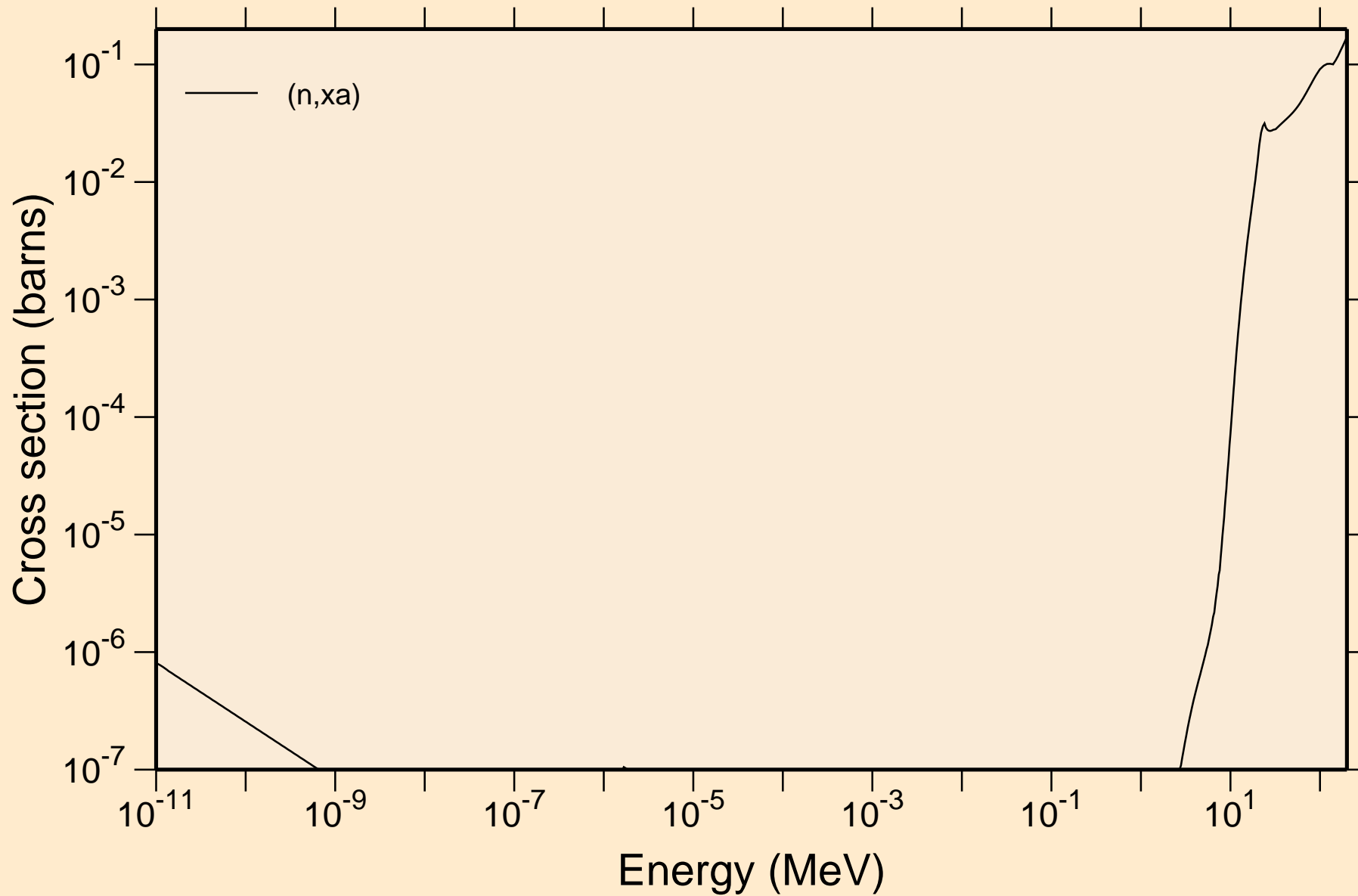

AU193 NEUTRON ACER TENDL-2024 LIBRARY; T=0.K

Principal cross sections

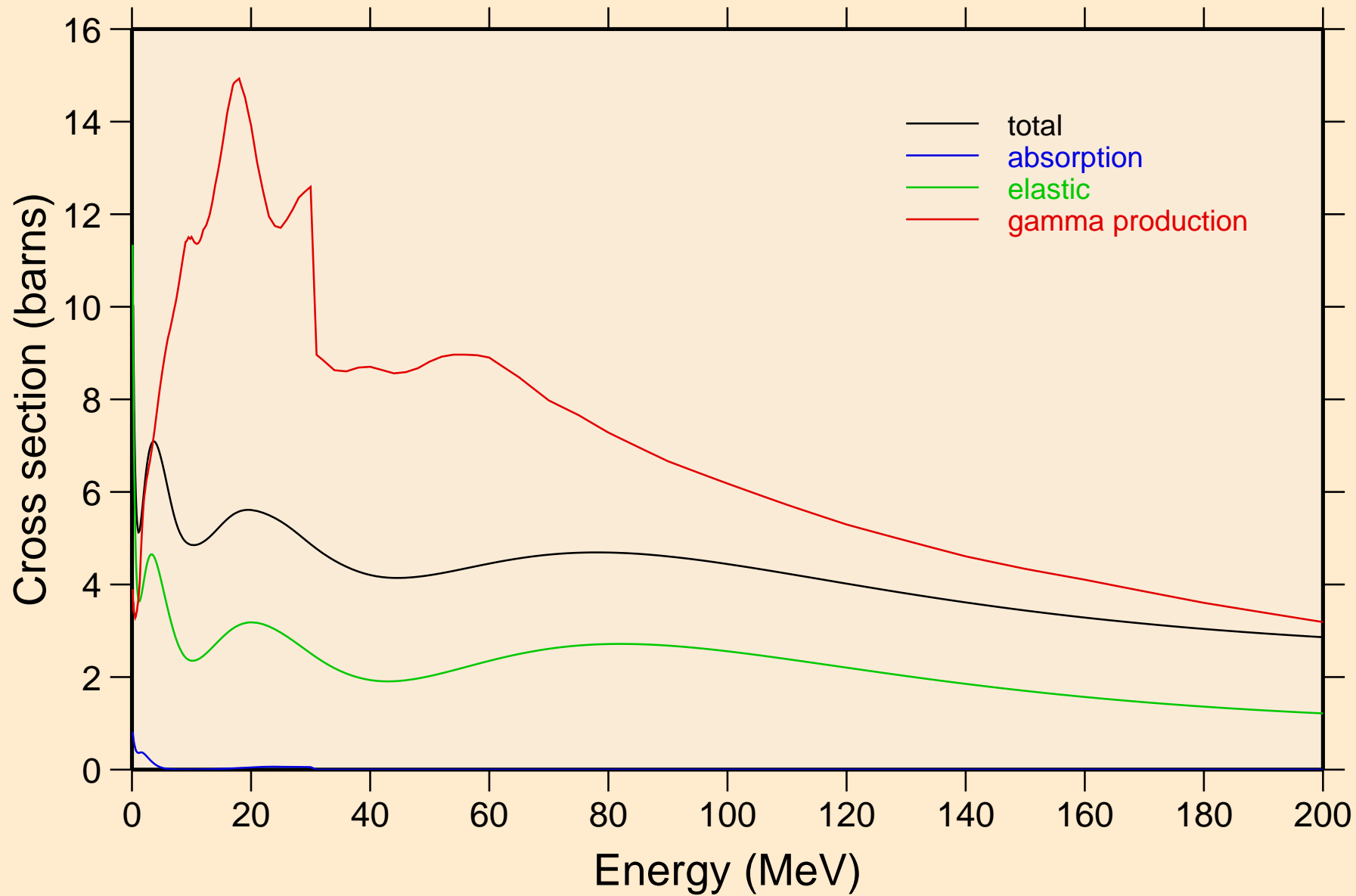

AU193 NEUTRON ACER TENDL-2024 LIBRARY; T=0.K

Heating

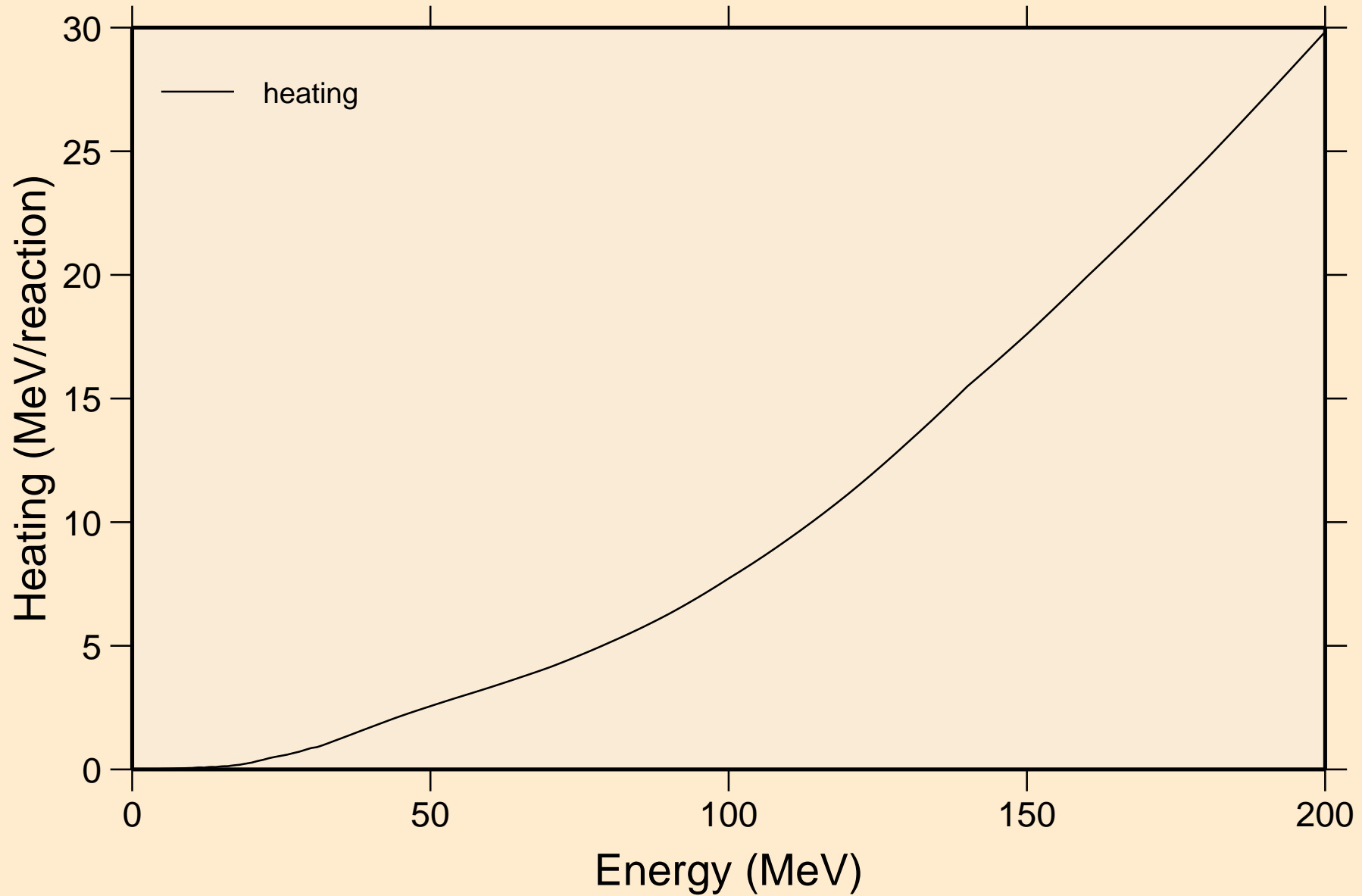

AU193 NEUTRON ACER TENDL-2024 LIBRARY; T=0.K

Damage

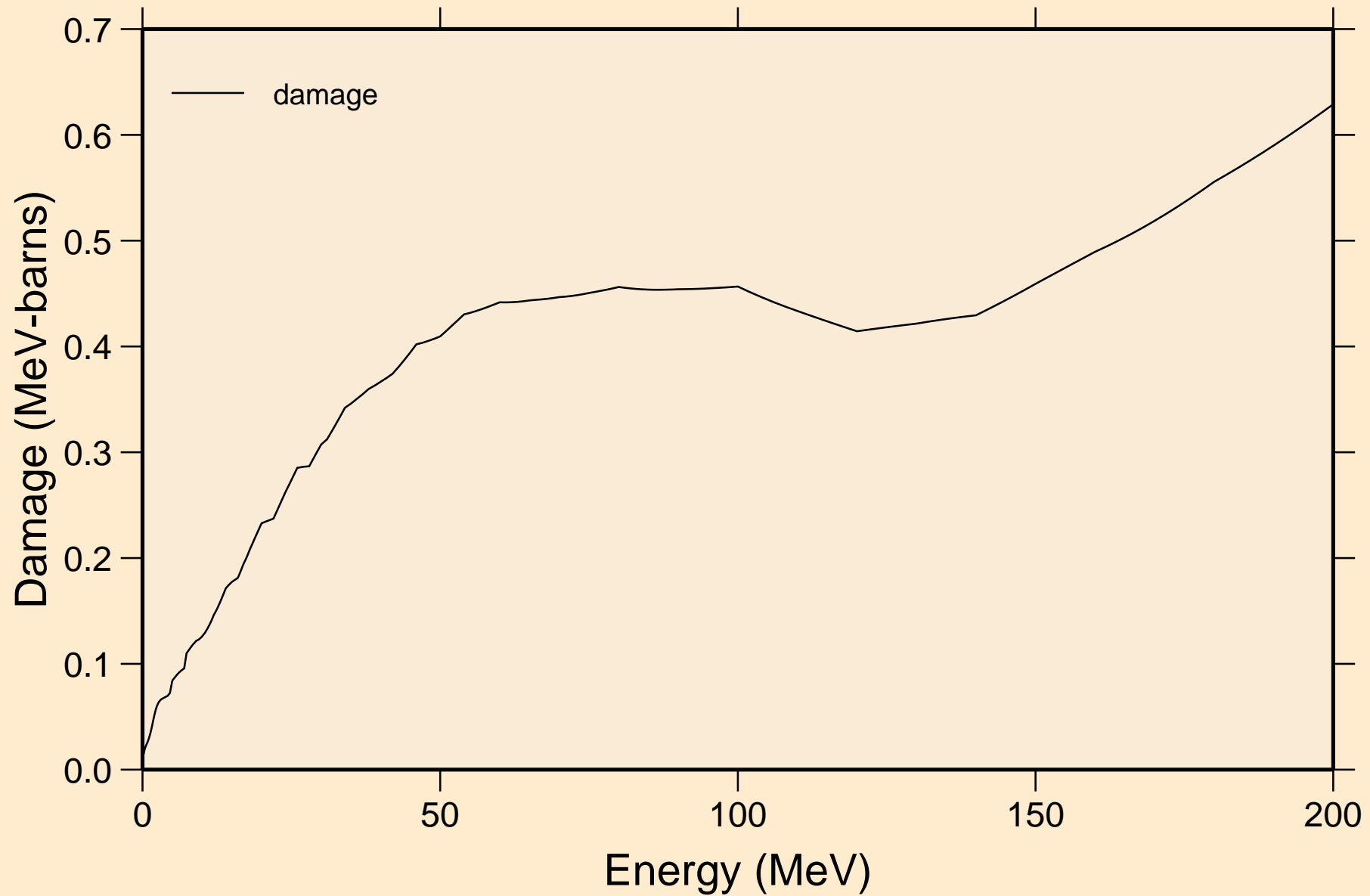

AU193 NEUTRON ACER TENDL-2024 LIBRARY; T=0.K
Non-threshold reactions

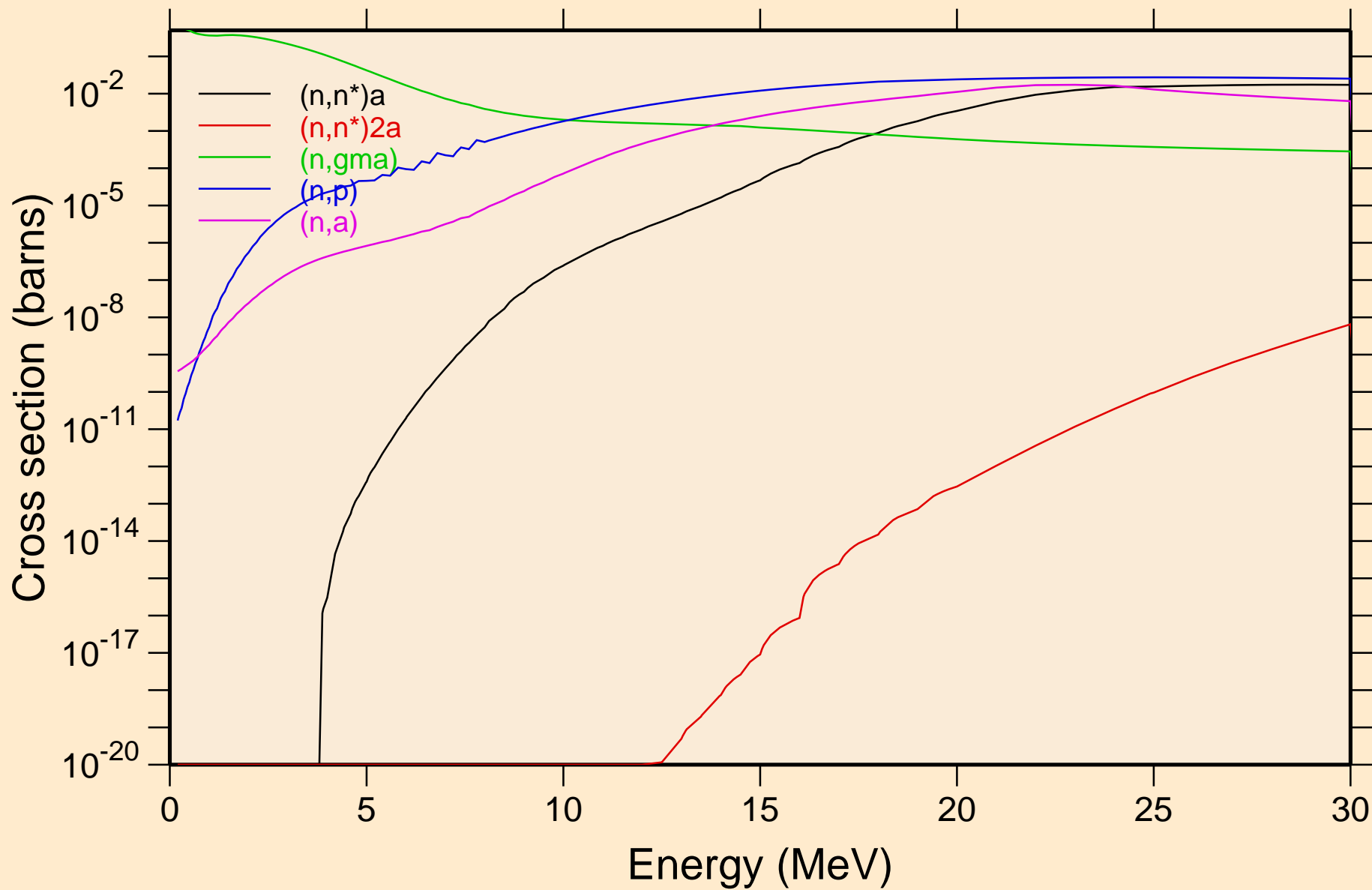

AU193 NEUTRON ACER TENDL-2024 LIBRARY; T=0.K
Non-threshold reactions

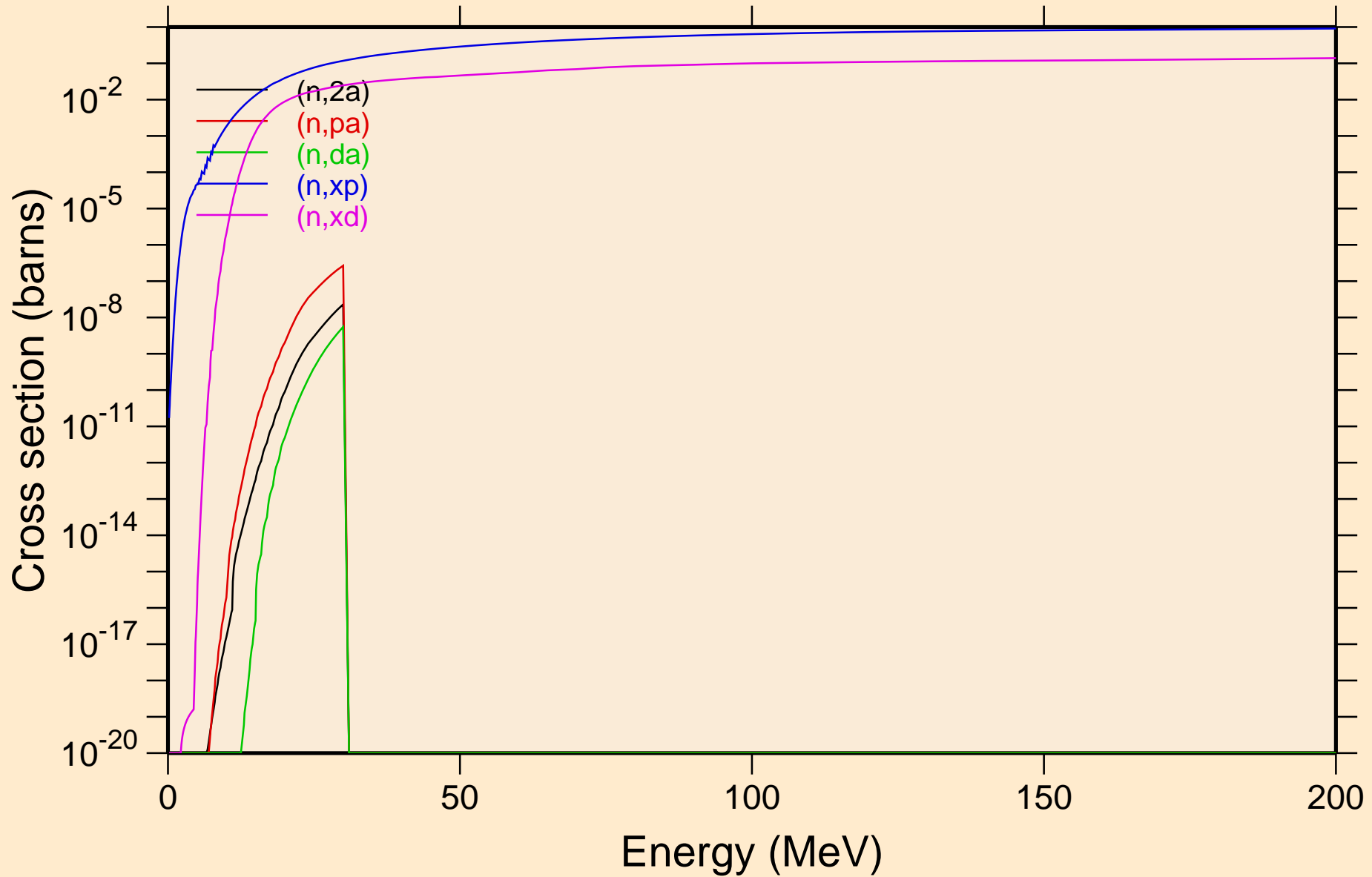

AU193 NEUTRON ACER TENDL-2024 LIBRARY; T=0.K
Non-threshold reactions

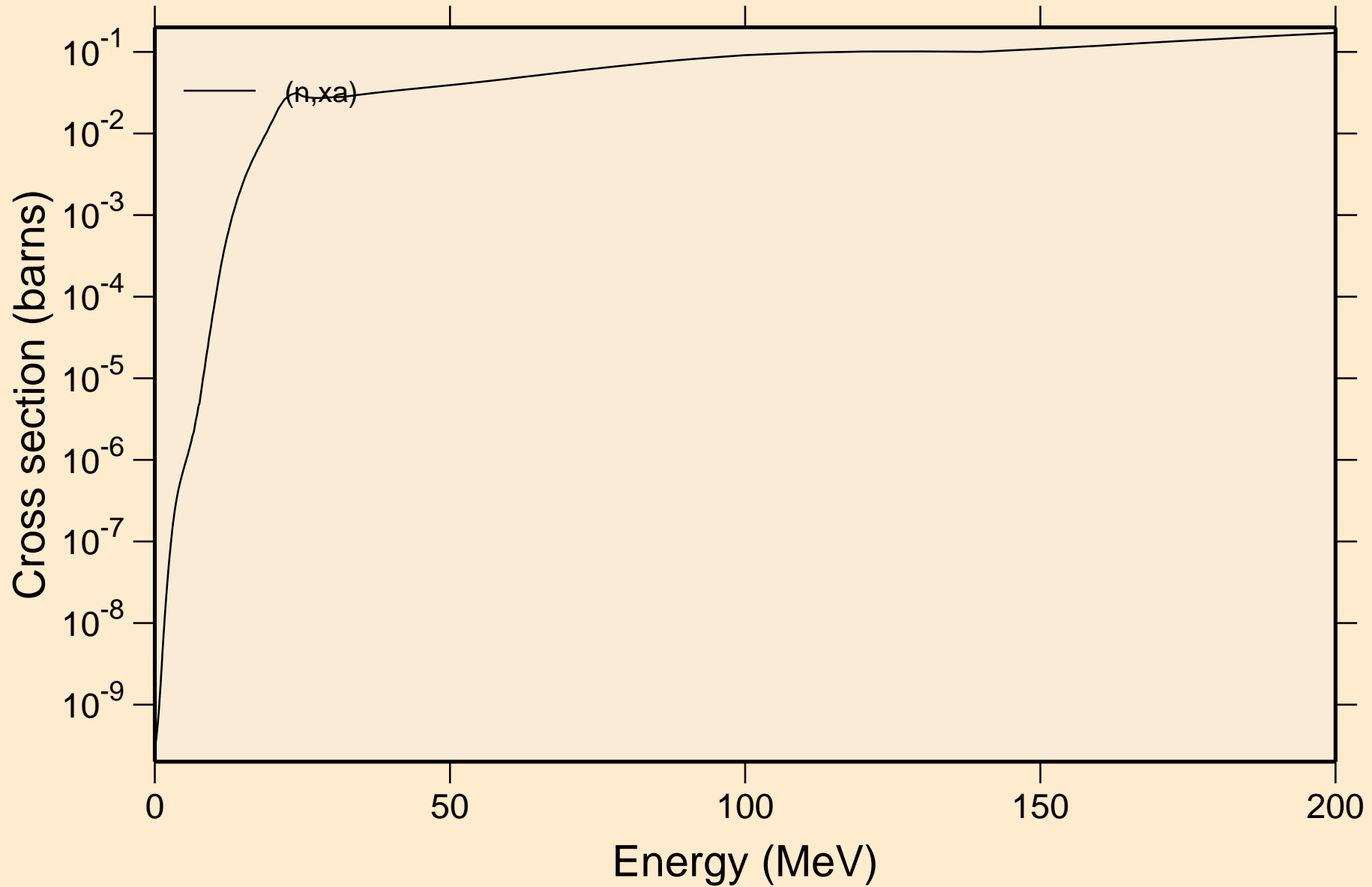

AU193 NEUTRON ACER TENDL-2024 LIBRARY; T=0.K
Inelastic levels

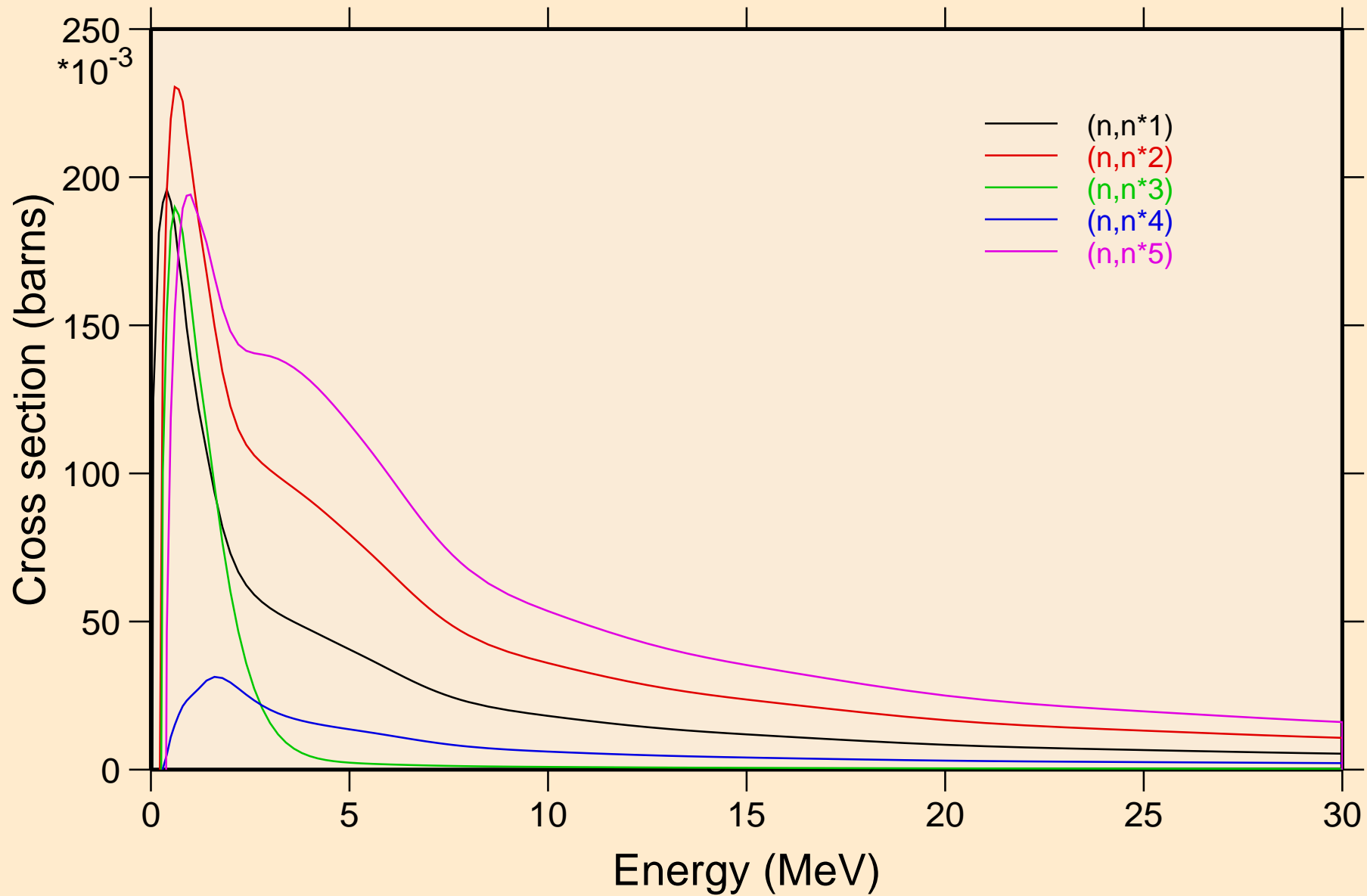

AU193 NEUTRON ACER TENDL-2024 LIBRARY; T=0.K
Inelastic levels

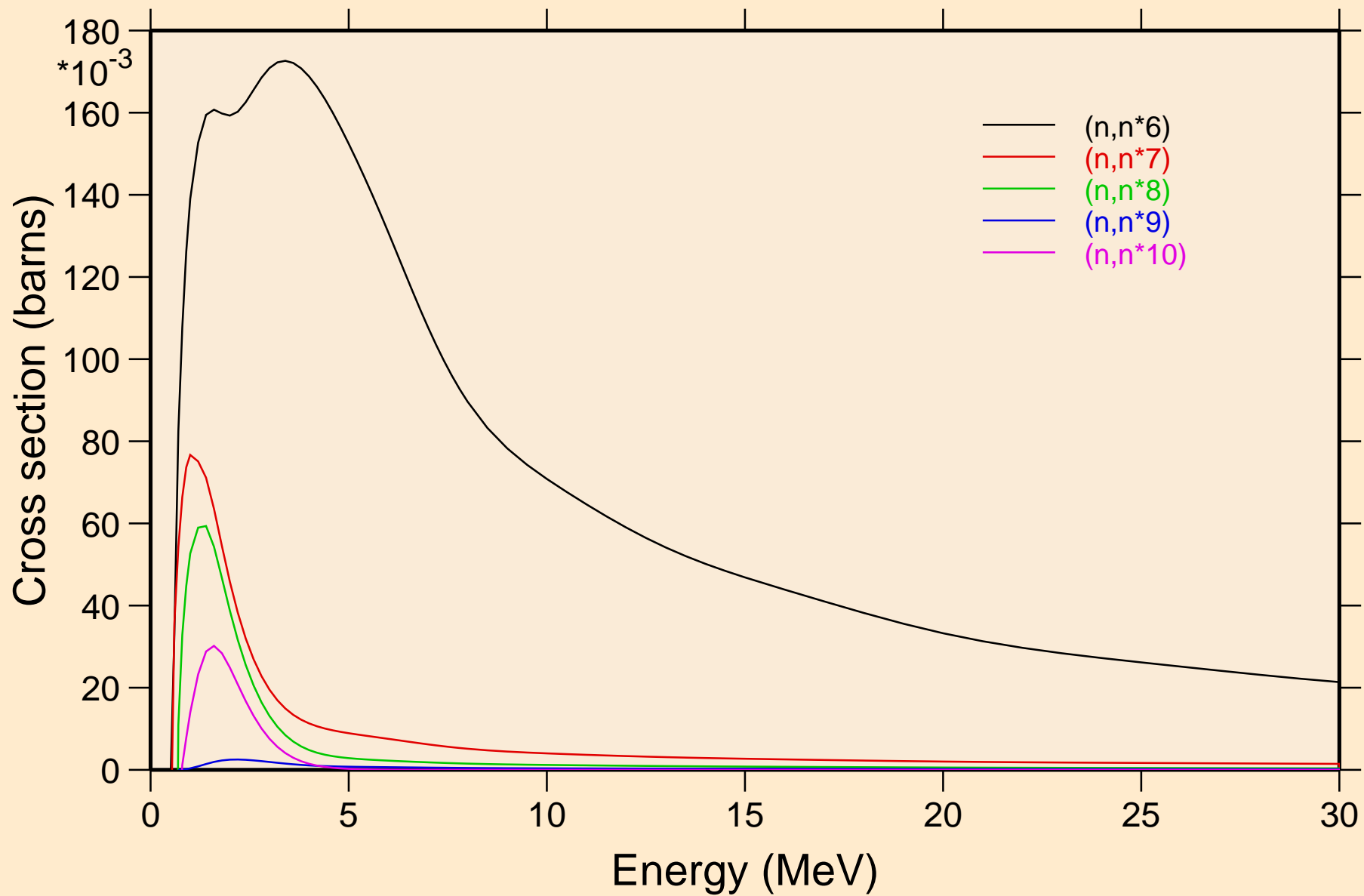

AU193 NEUTRON ACER TENDL-2024 LIBRARY; T=0.K
Inelastic levels

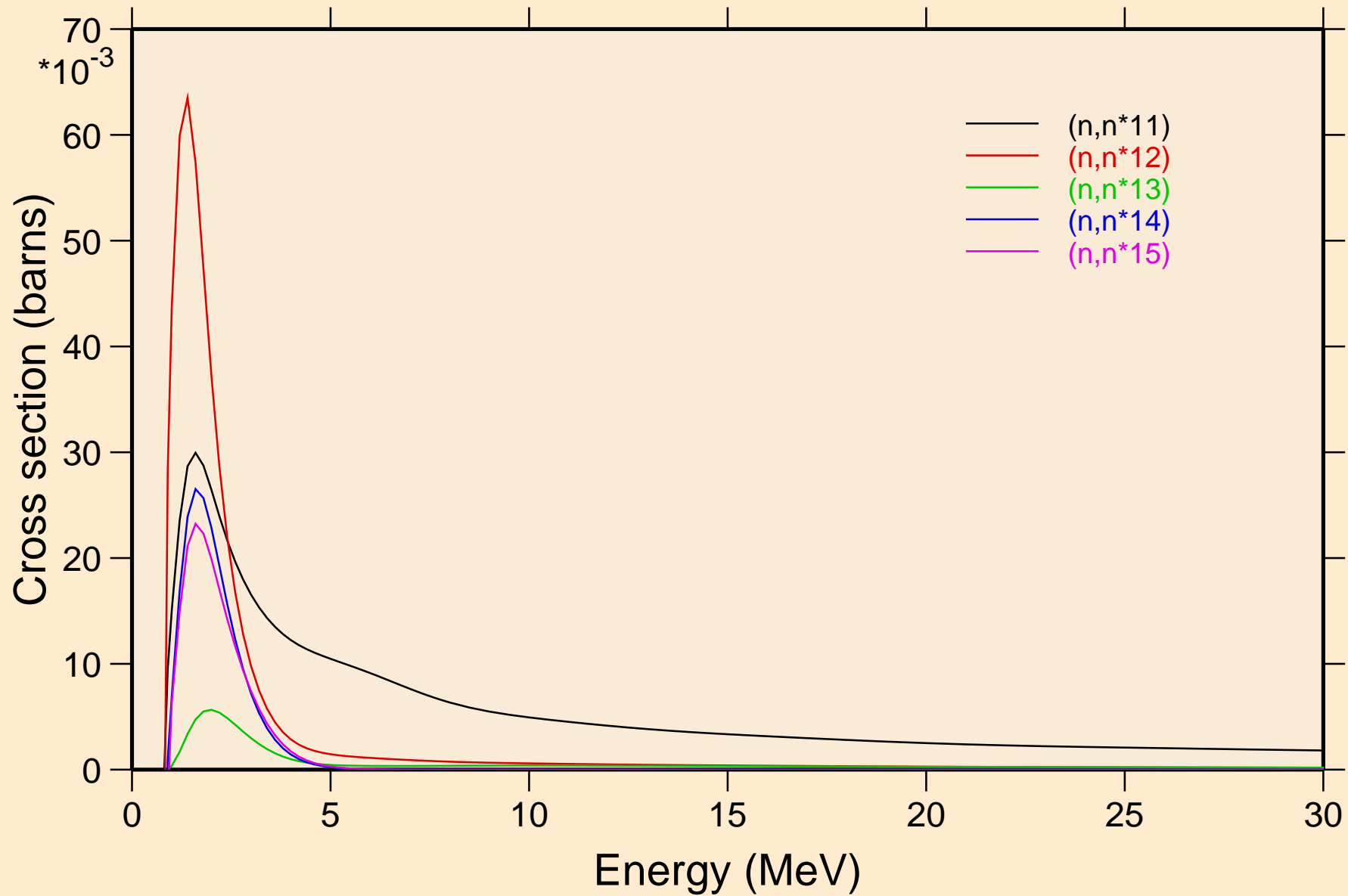

AU193 NEUTRON ACER TENDL-2024 LIBRARY; T=0.K
Inelastic levels

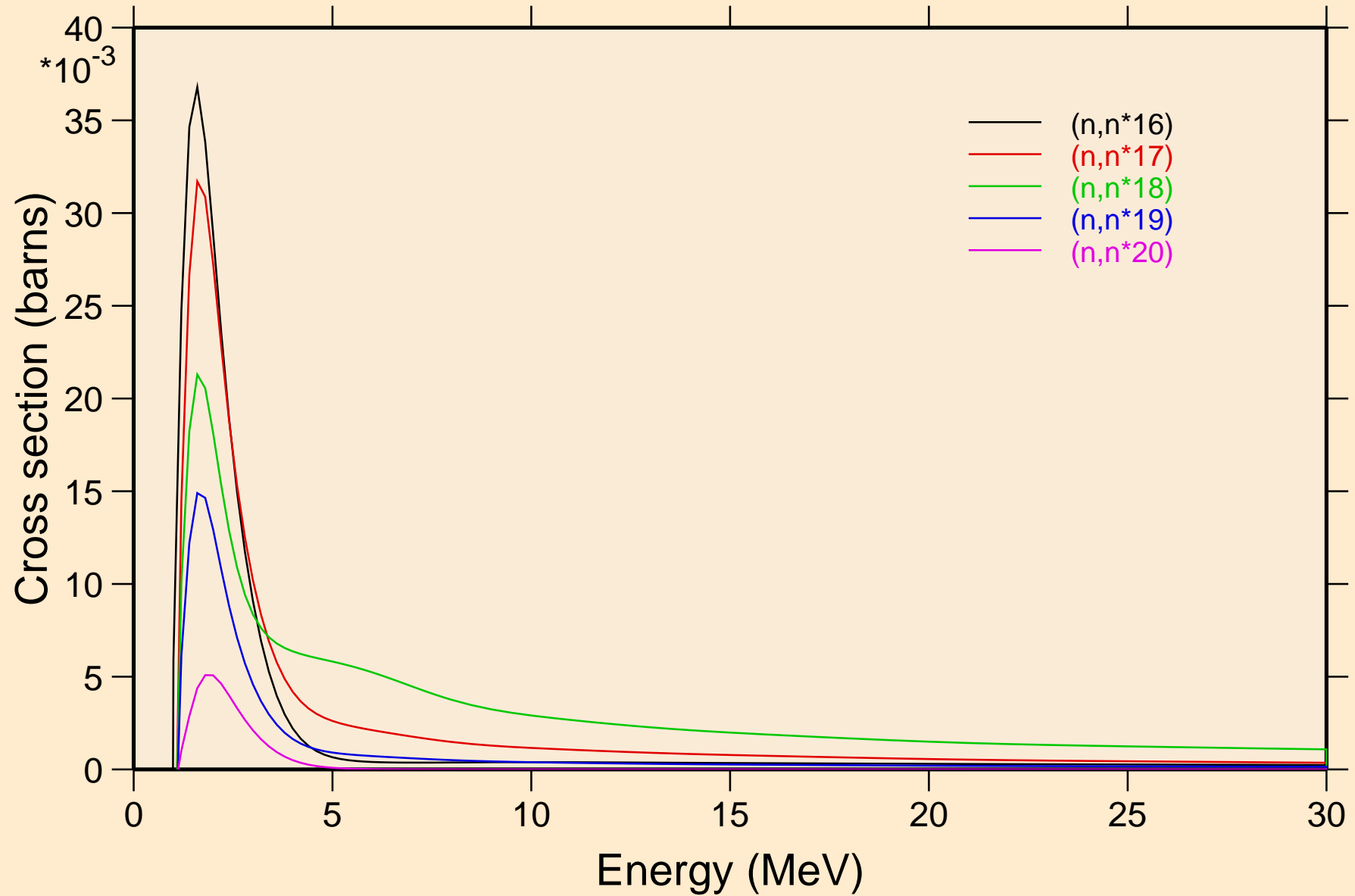

AU193 NEUTRON ACER TENDL-2024 LIBRARY; T=0.K
Inelastic levels

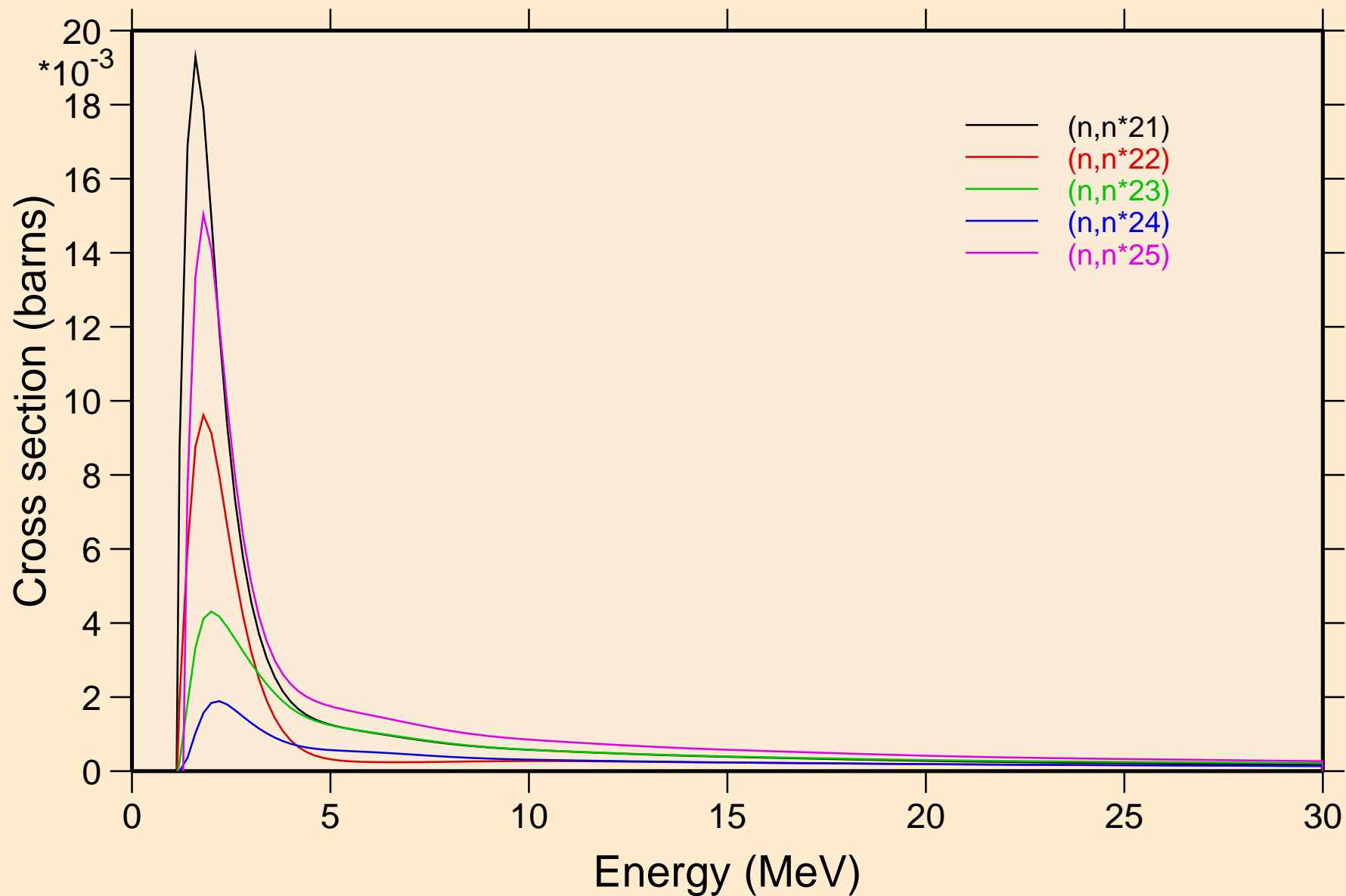

AU193 NEUTRON ACER TENDL-2024 LIBRARY; T=0.K
Inelastic levels

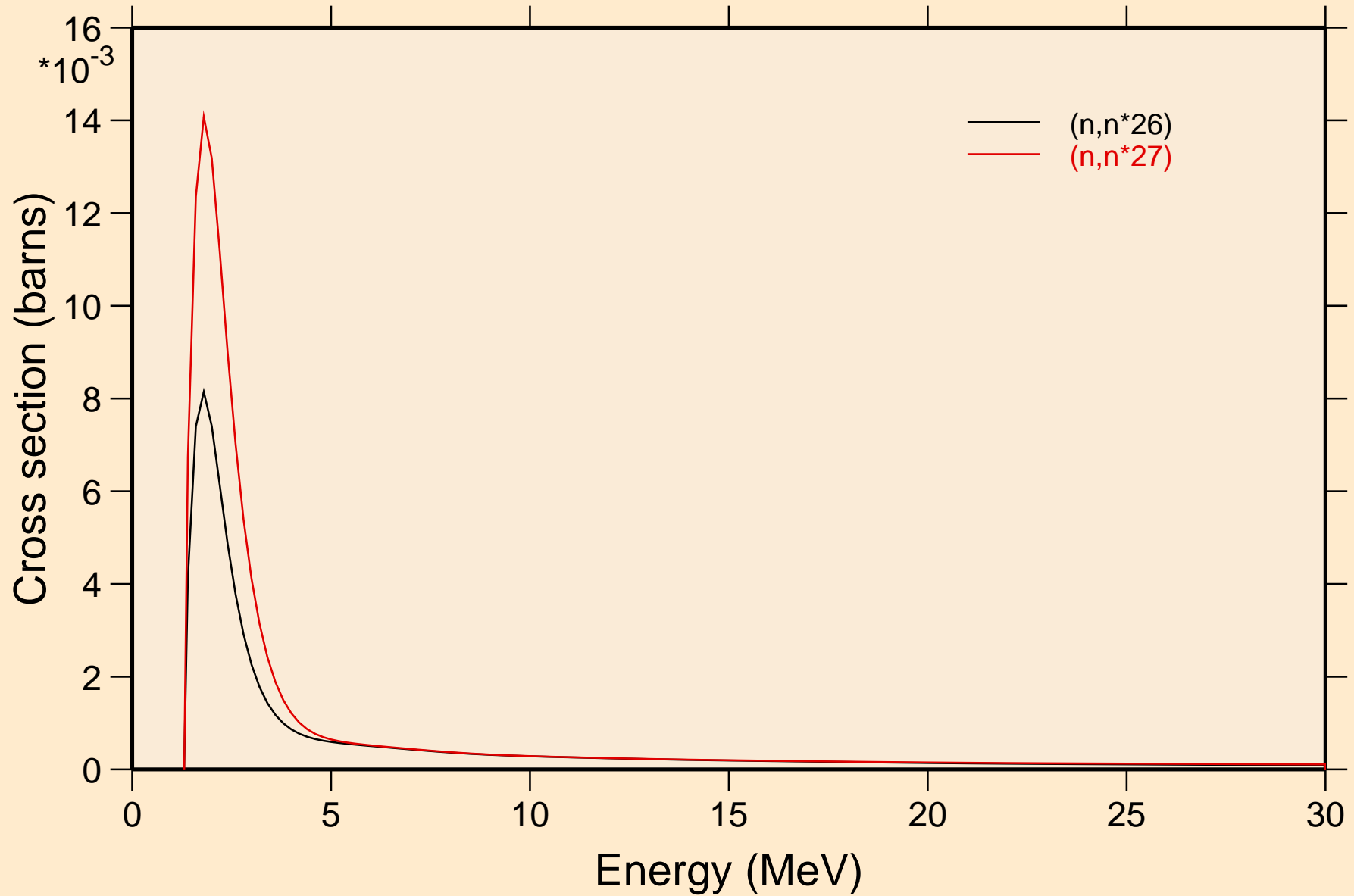

AU193 NEUTRON ACER TENDL-2024 LIBRARY; T=0.K
Threshold reactions

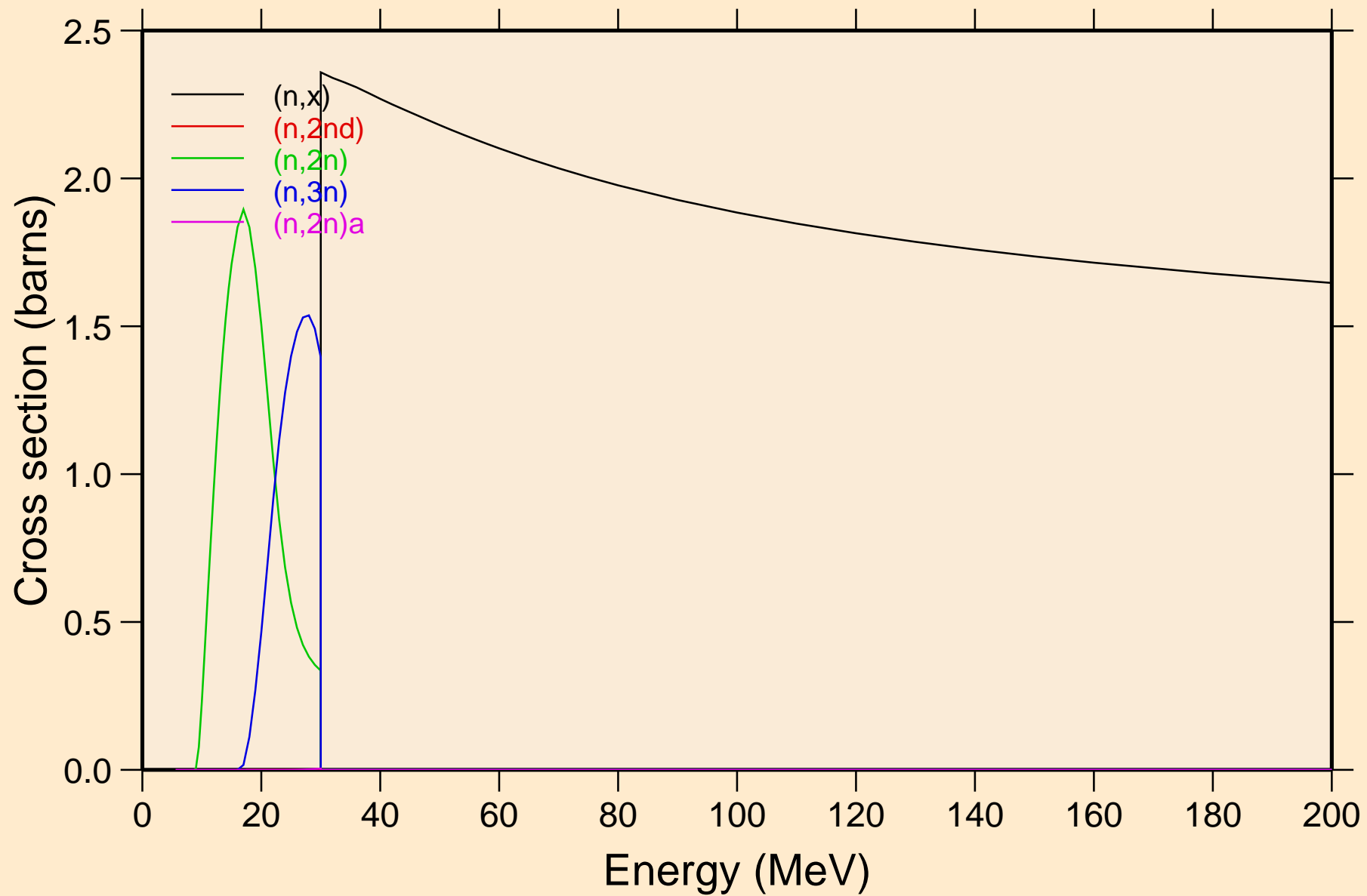

AU193 NEUTRON ACER TENDL-2024 LIBRARY; T=0.K
Threshold reactions

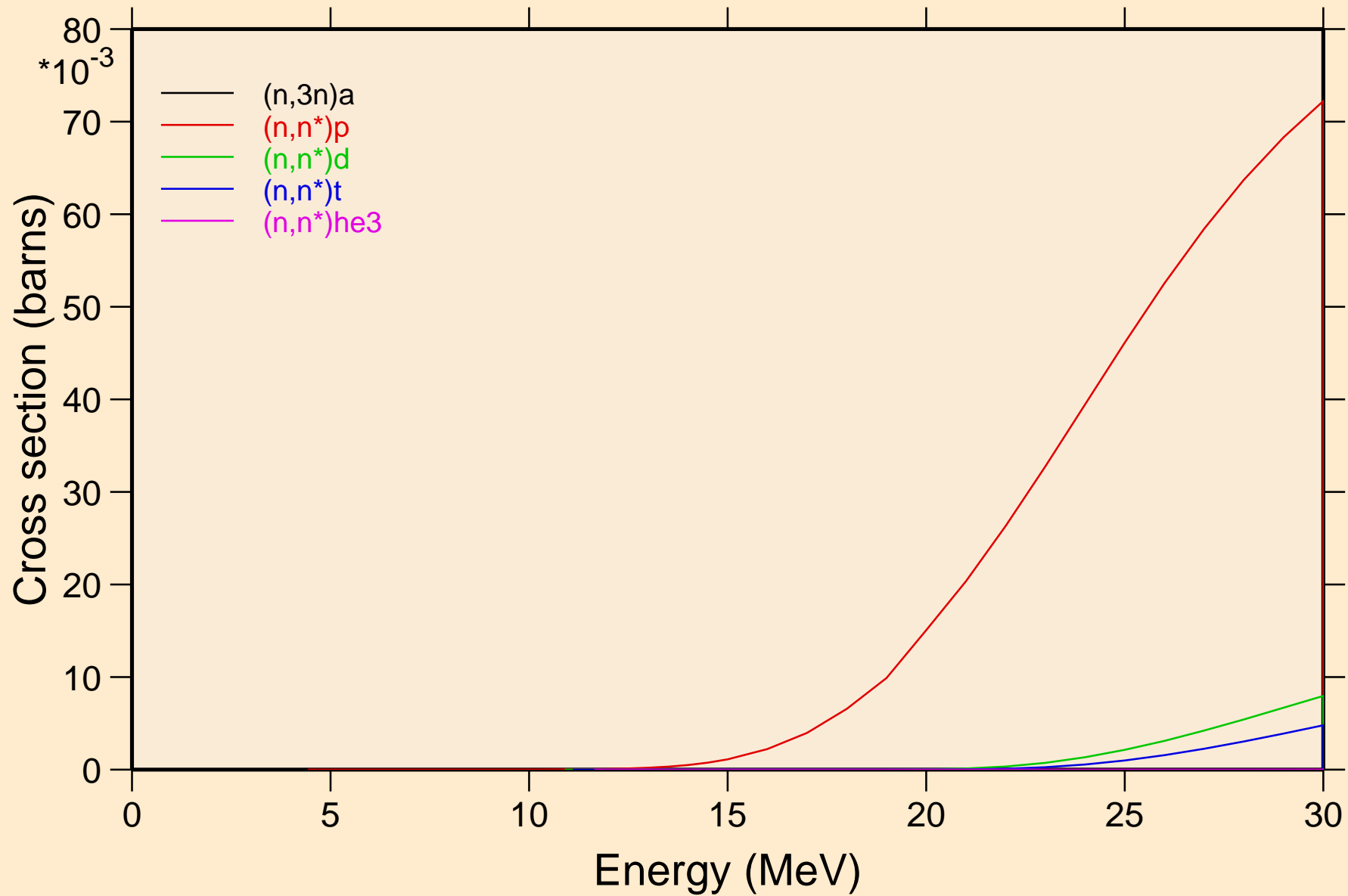

AU193 NEUTRON ACER TENDL-2024 LIBRARY; T=0.K

Threshold reactions

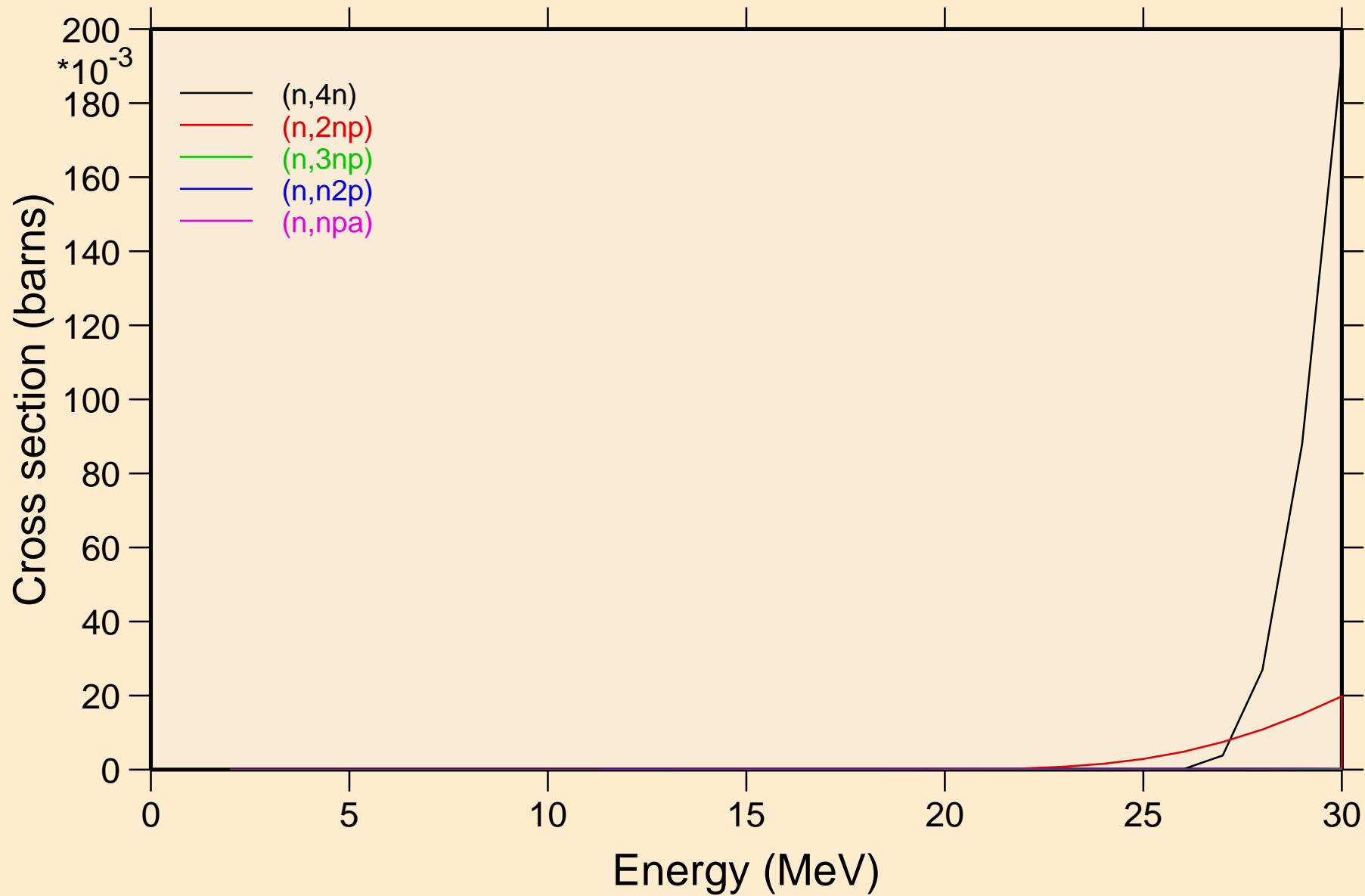

AU193 NEUTRON ACER TENDL-2024 LIBRARY; T=0.K
Threshold reactions

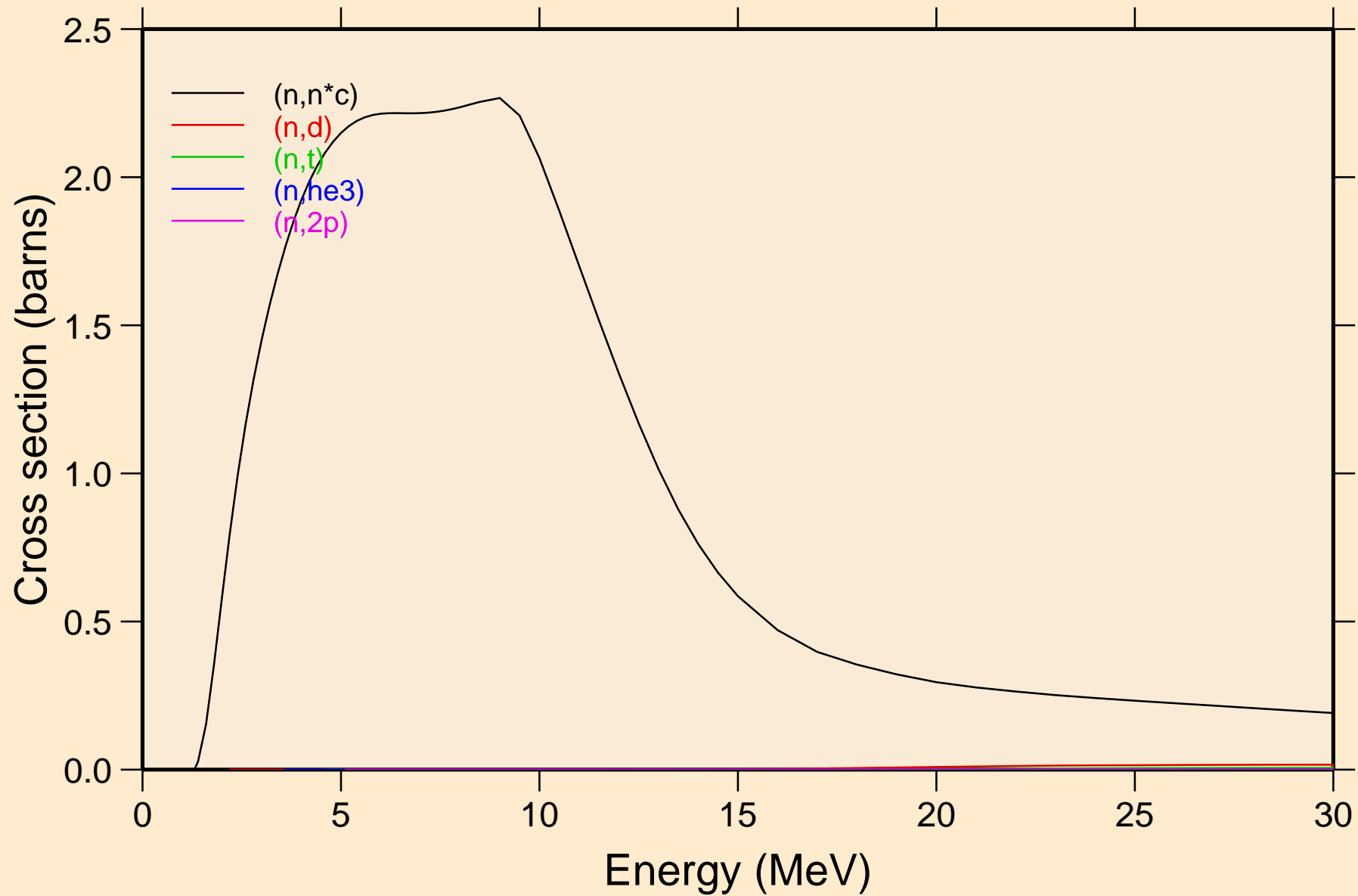

AU193 NEUTRON ACER TENDL-2024 LIBRARY; T=0.K

Threshold reactions

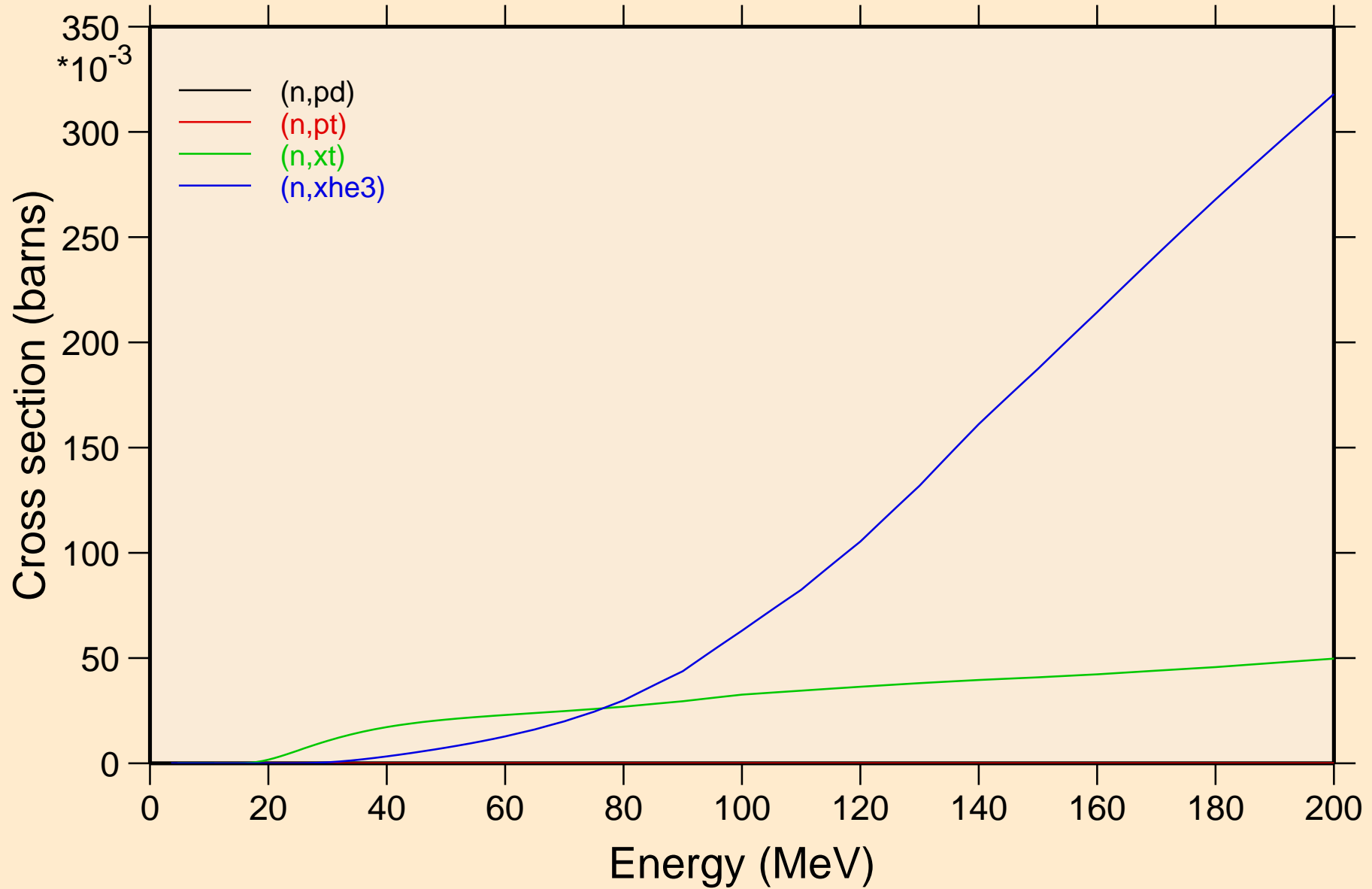

AU193 NEUTRON ACER TENDL-2024 LIBRARY; T=0.K
angular distribution for elastic

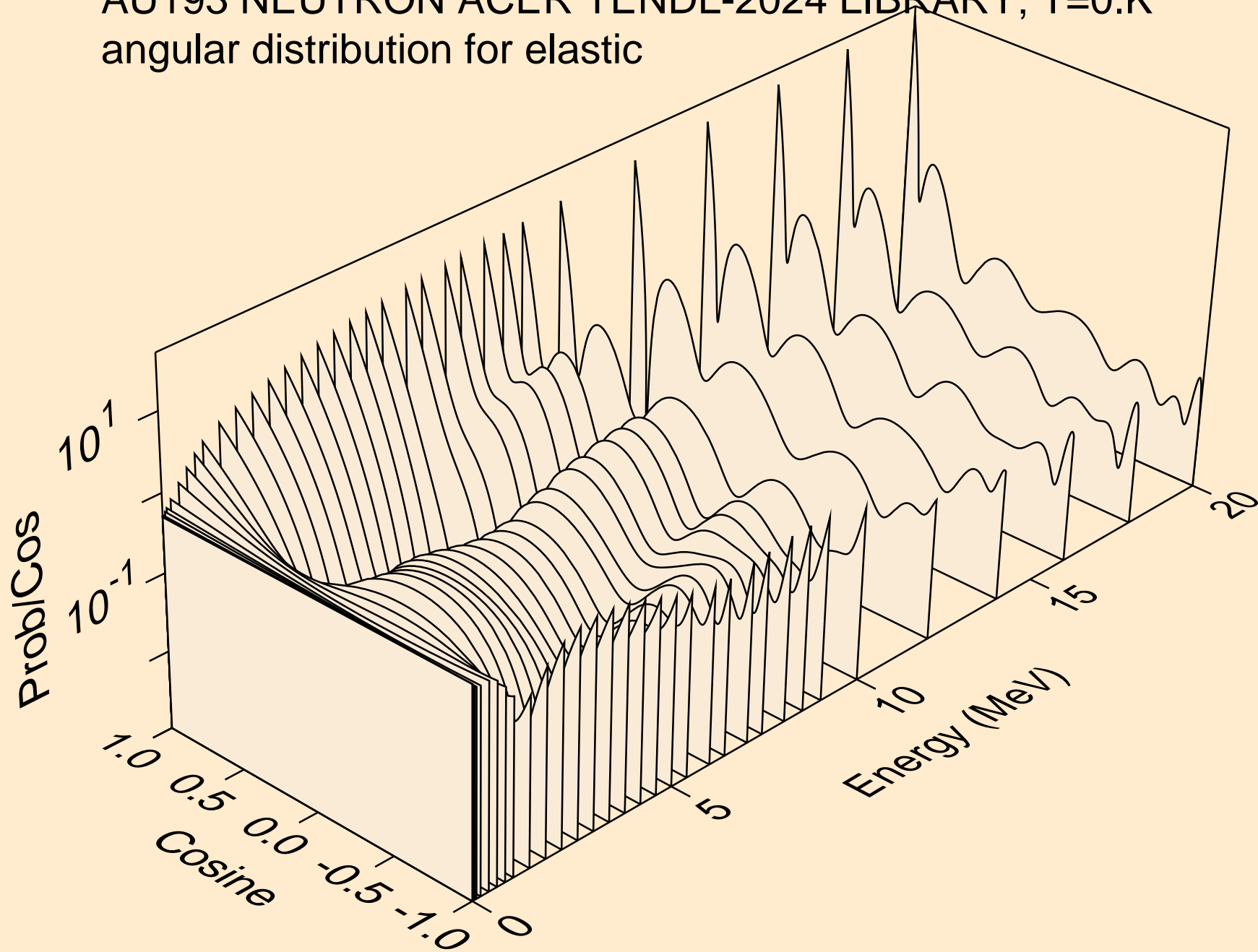

AU193 NEUTRON ACER TENDL-2024 LIBRARY; T=0.K
angular distribution for elastic

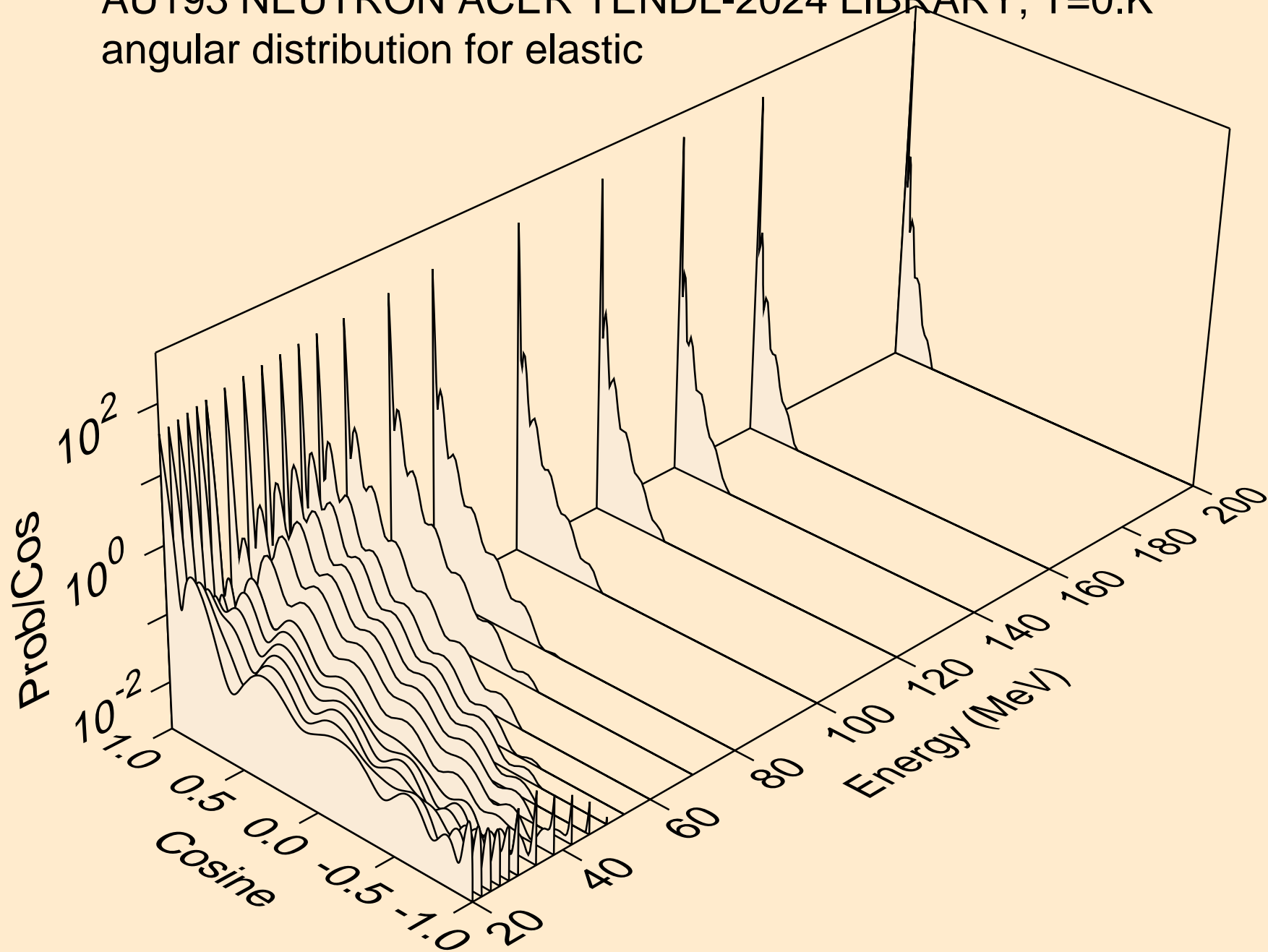

AU193 NEUTRON ACER TENDL-2024 LIBRARY; T=0.K
angular distribution for (n,n*1)

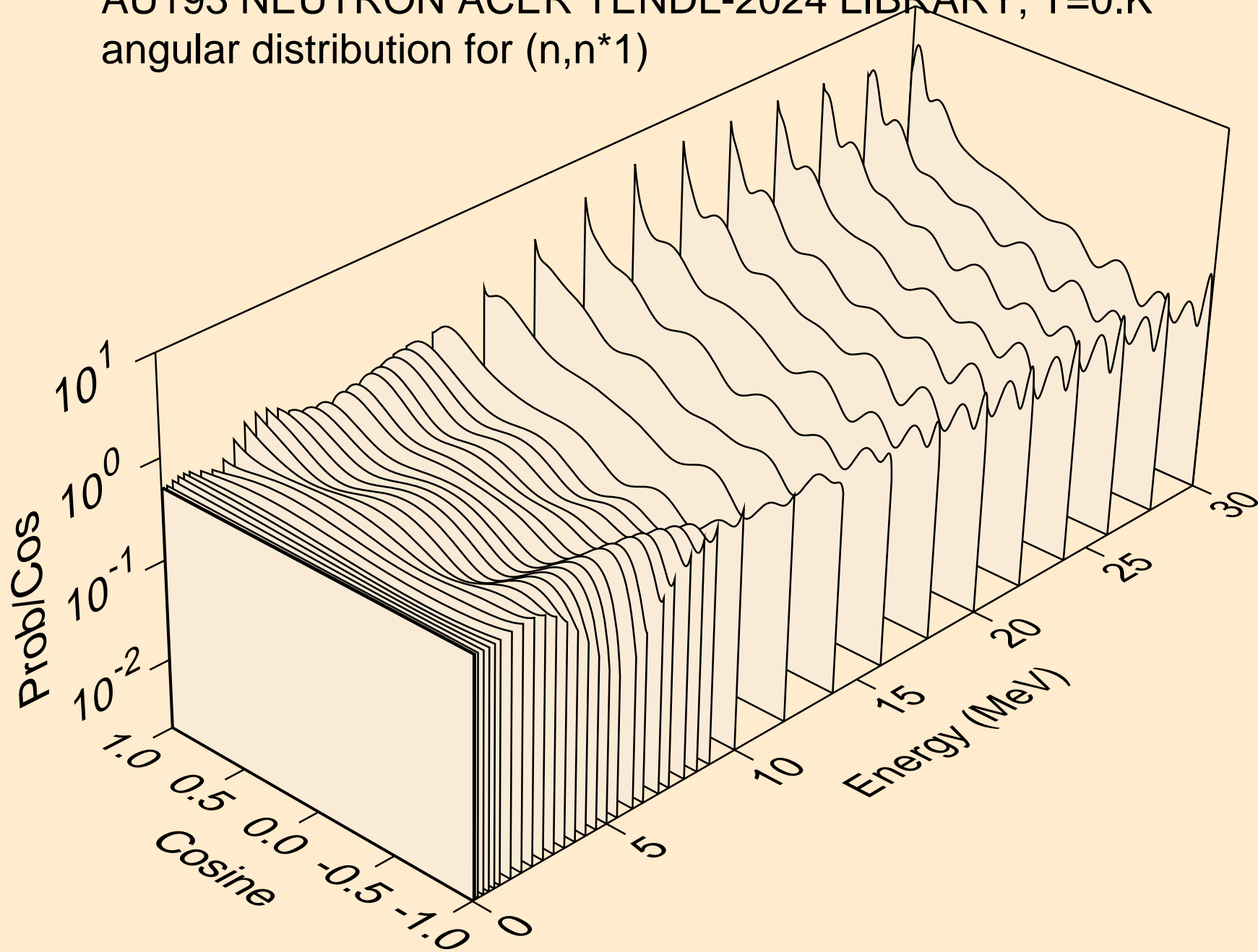

AU193 NEUTRON ACER TENDL-2024 LIBRARY; T=0.K
angular distribution for (n,n*2)

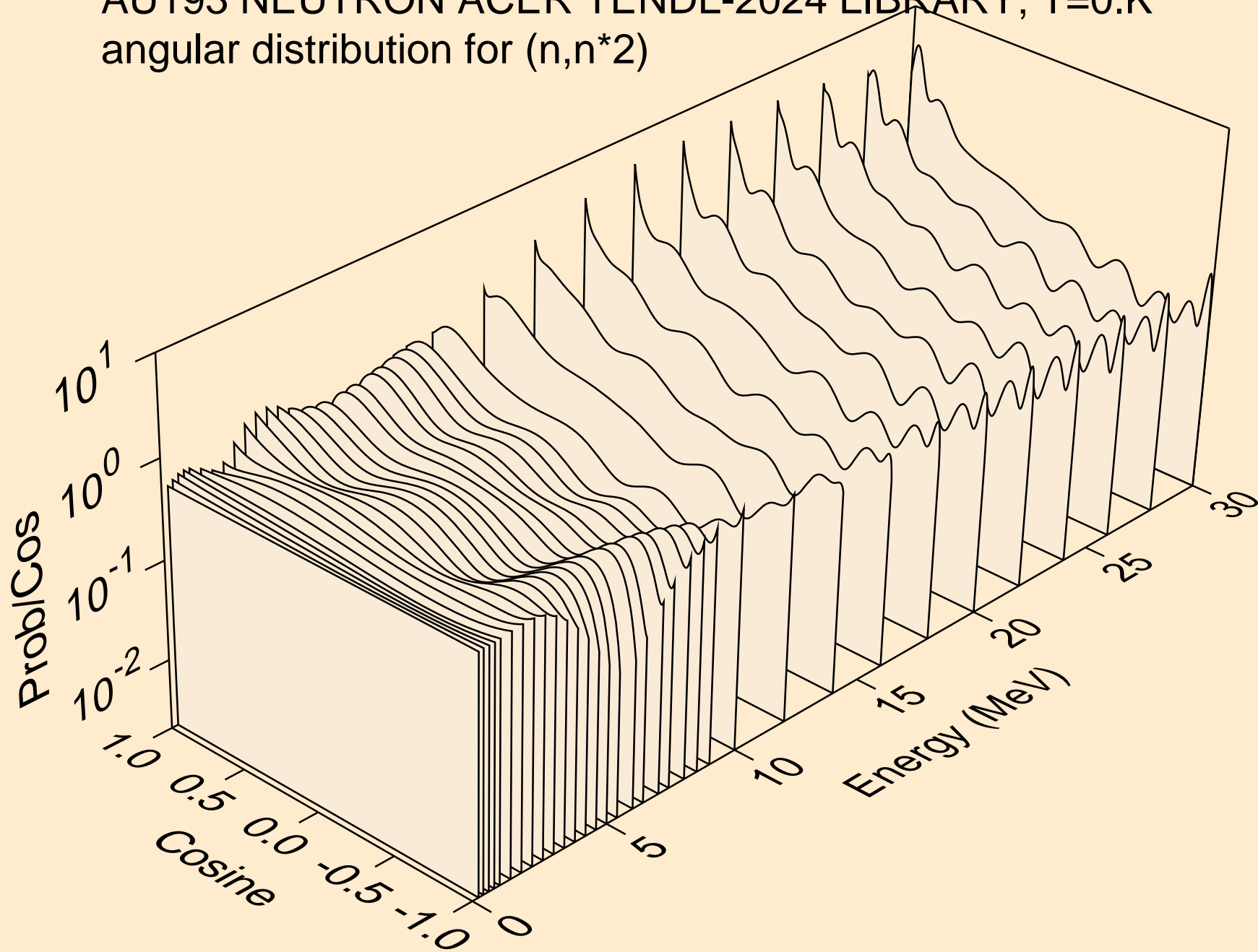

AU193 NEUTRON ACER TENDL-2024 LIBRARY; T=0.K
angular distribution for (n,n*3)

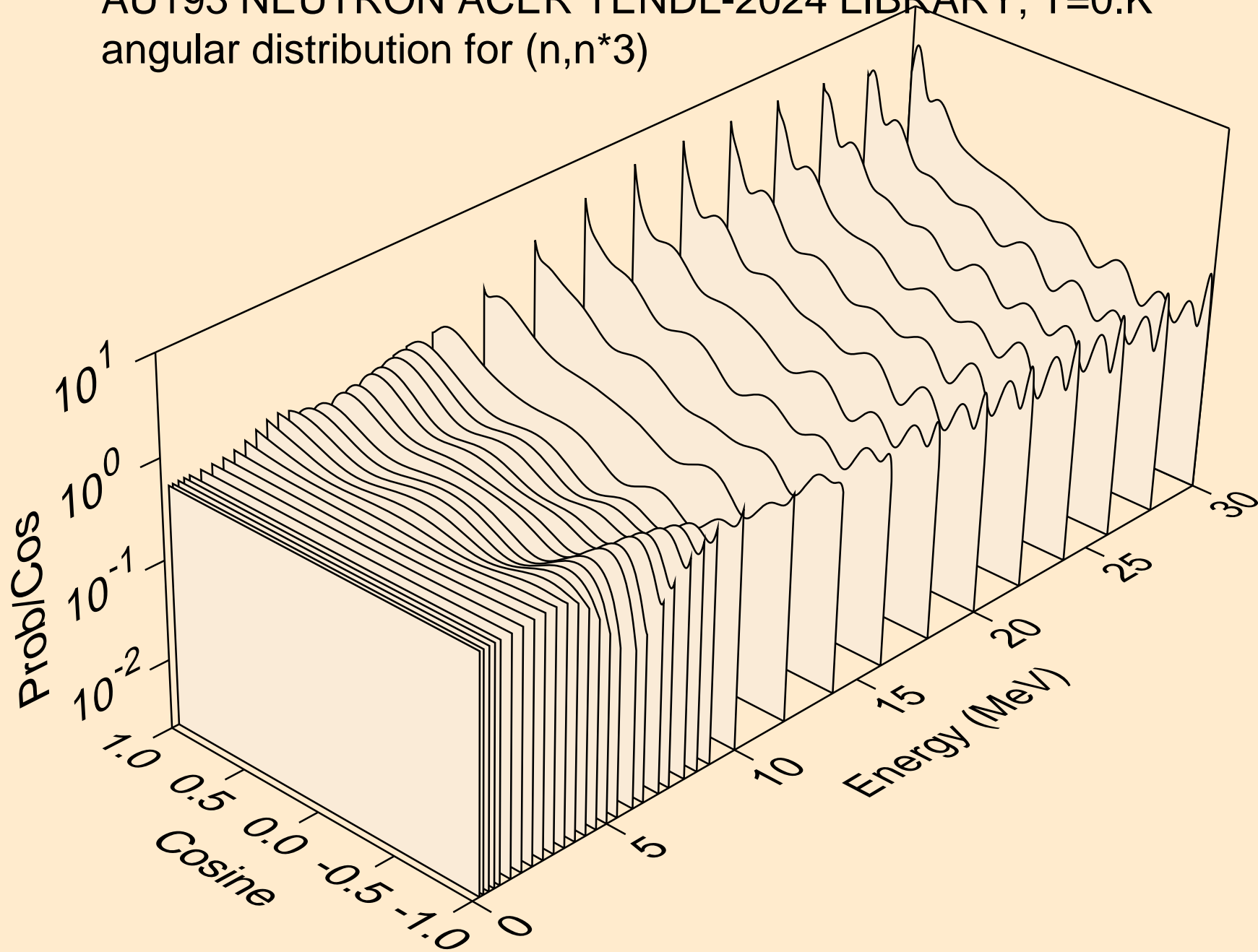

AU193 NEUTRON ACER TENDL-2024 LIBRARY; T=0.K
angular distribution for (n,n*4)

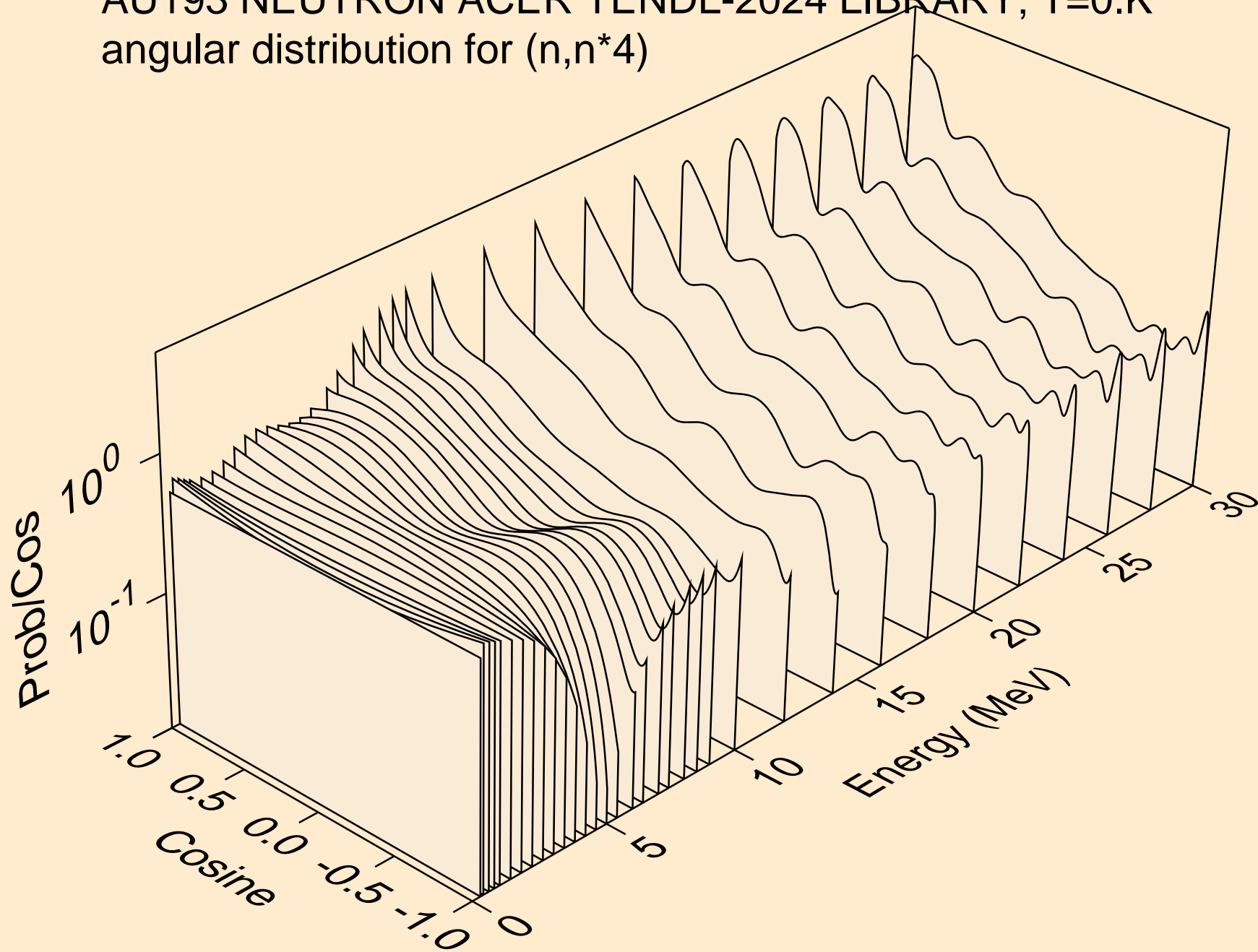

AU193 NEUTRON ACER TENDL-2024 LIBRARY; T=0.K
angular distribution for (n,n*5)

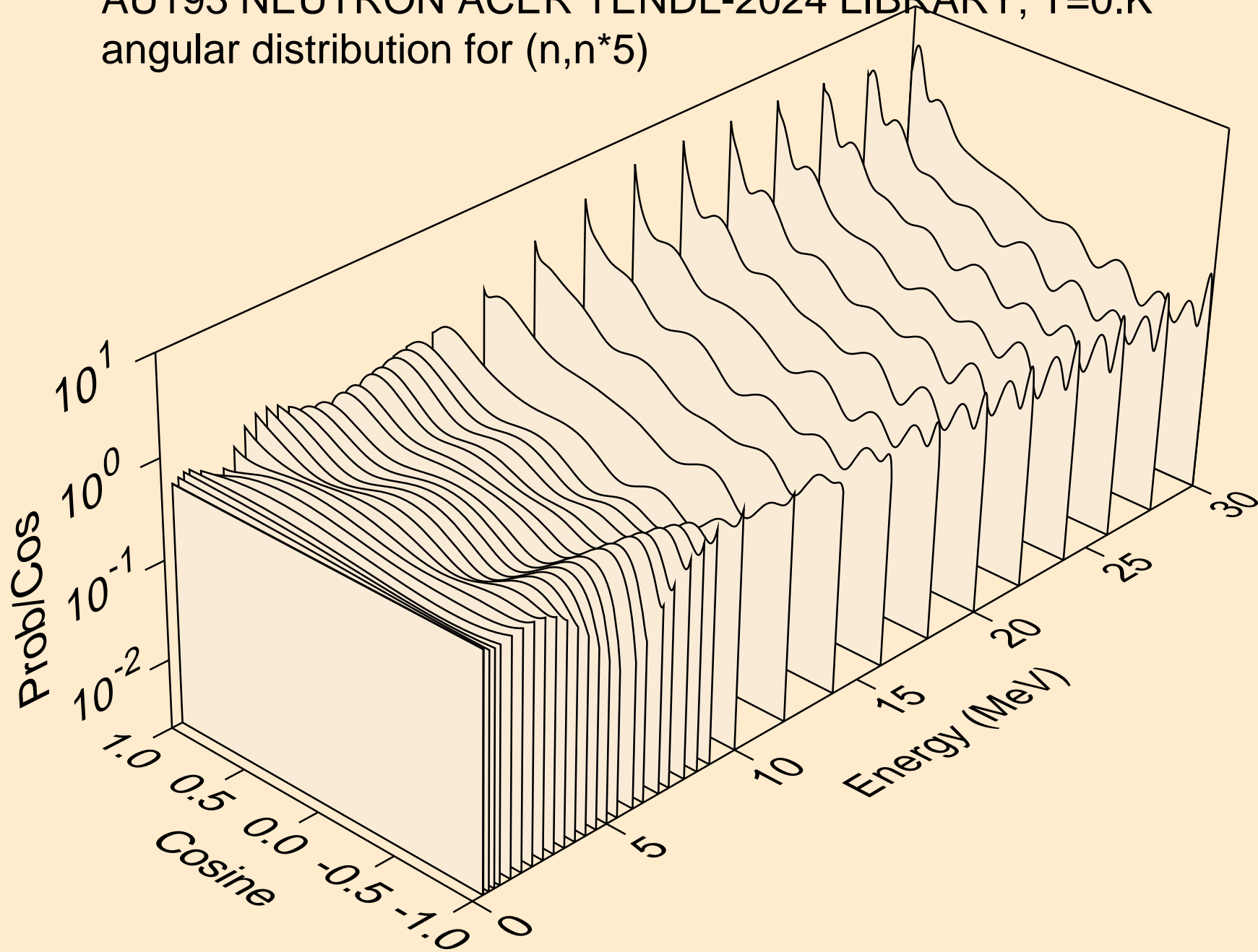

AU193 NEUTRON ACER TENDL-2024 LIBRARY; T=0.K
angular distribution for (n,n*6)

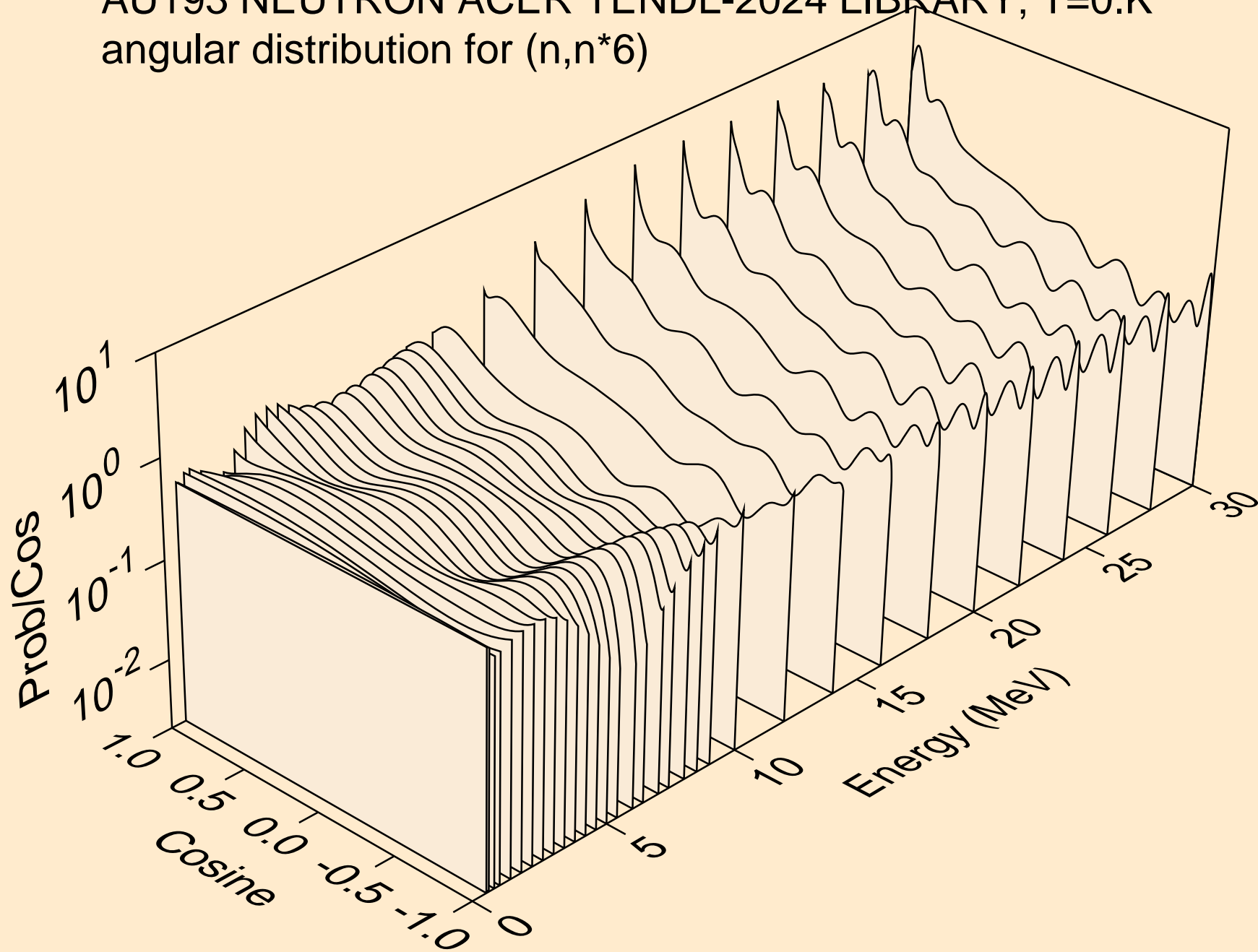

AU193 NEUTRON ACER TENDL-2024 LIBRARY; T=0.K
angular distribution for (n,n*7)

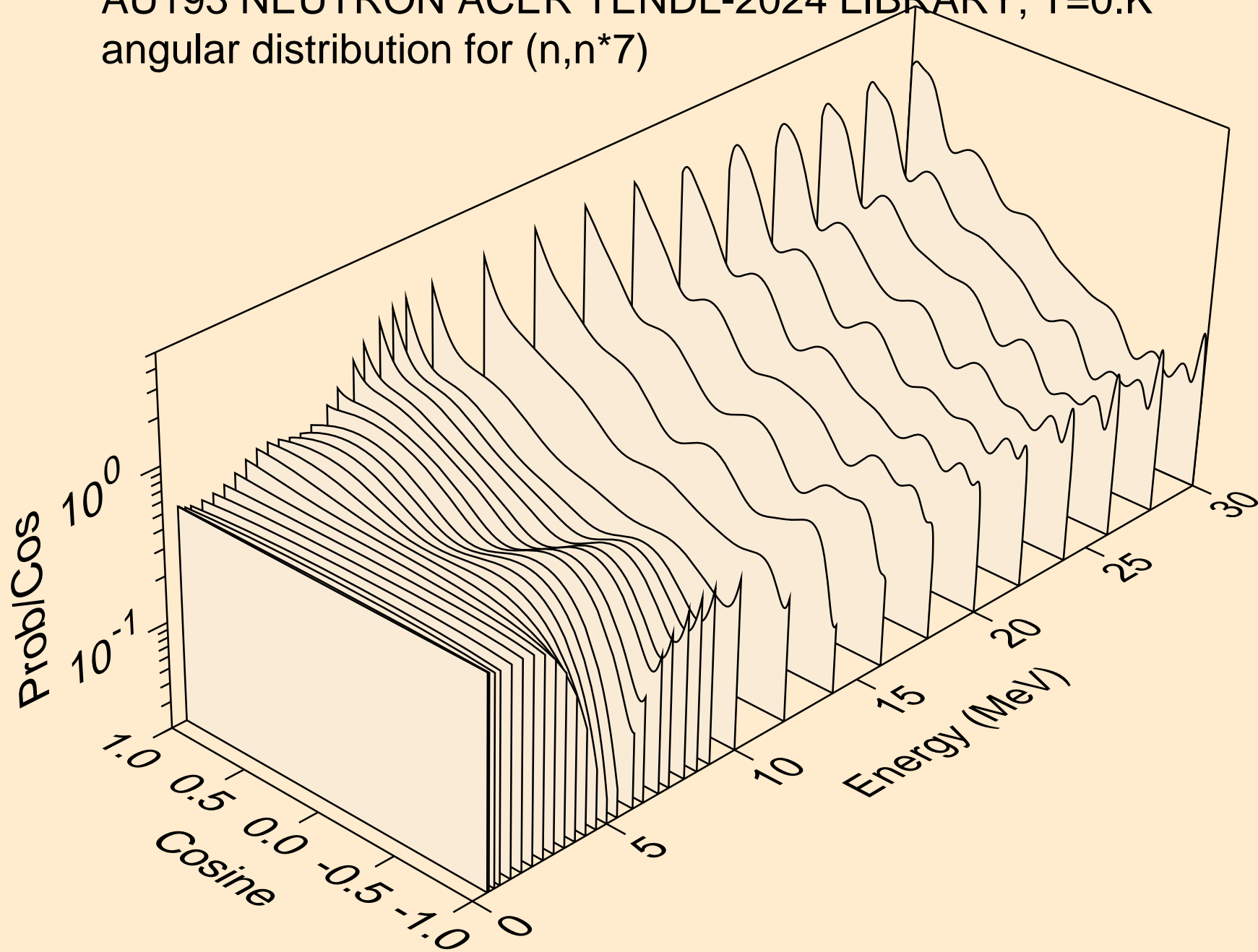

AU193 NEUTRON ACER TENDL-2024 LIBRARY; T=0.K
angular distribution for (n,n*8)

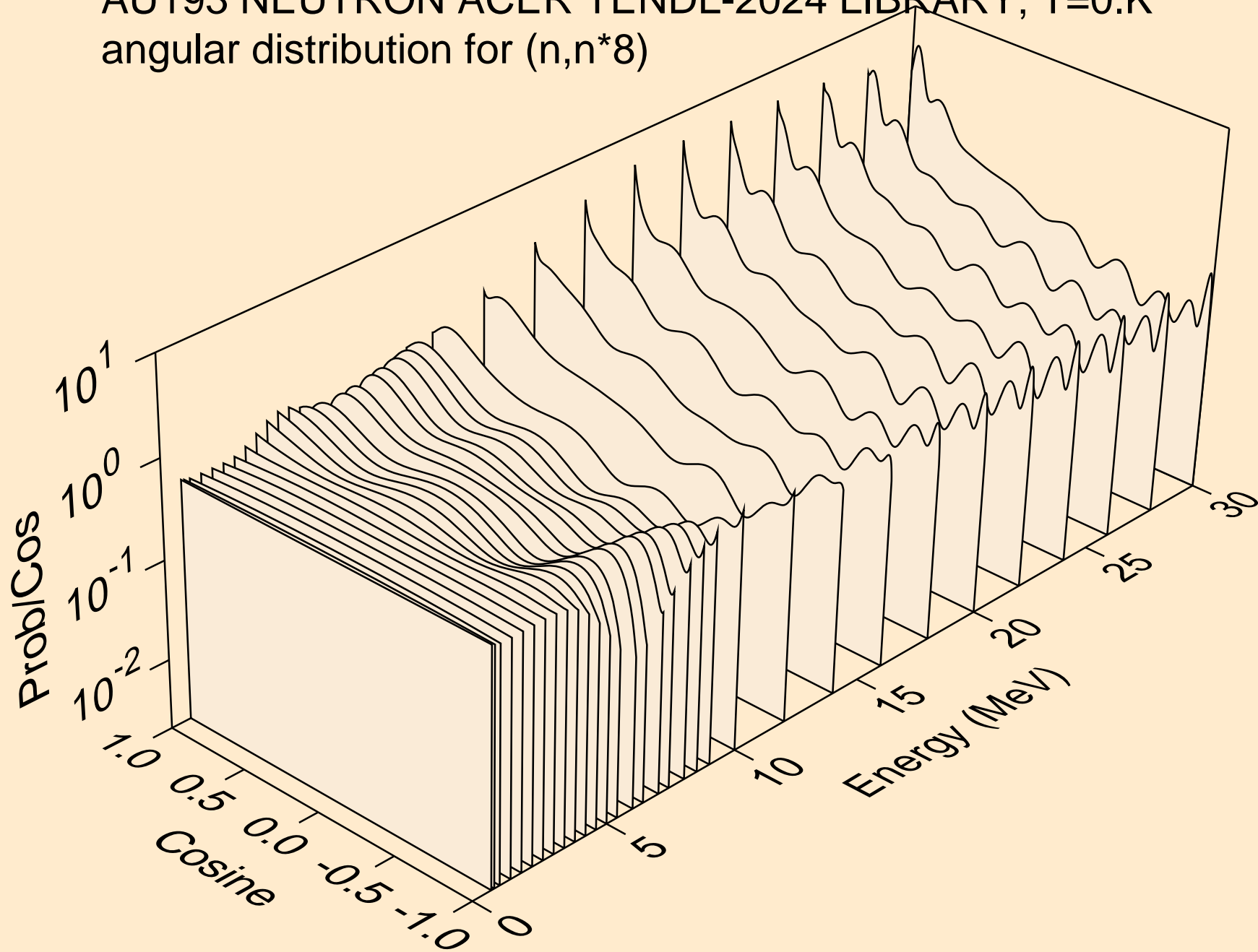

AU193 NEUTRON ACER TENDL-2024 LIBRARY; T=0.K
angular distribution for (n,n*9)

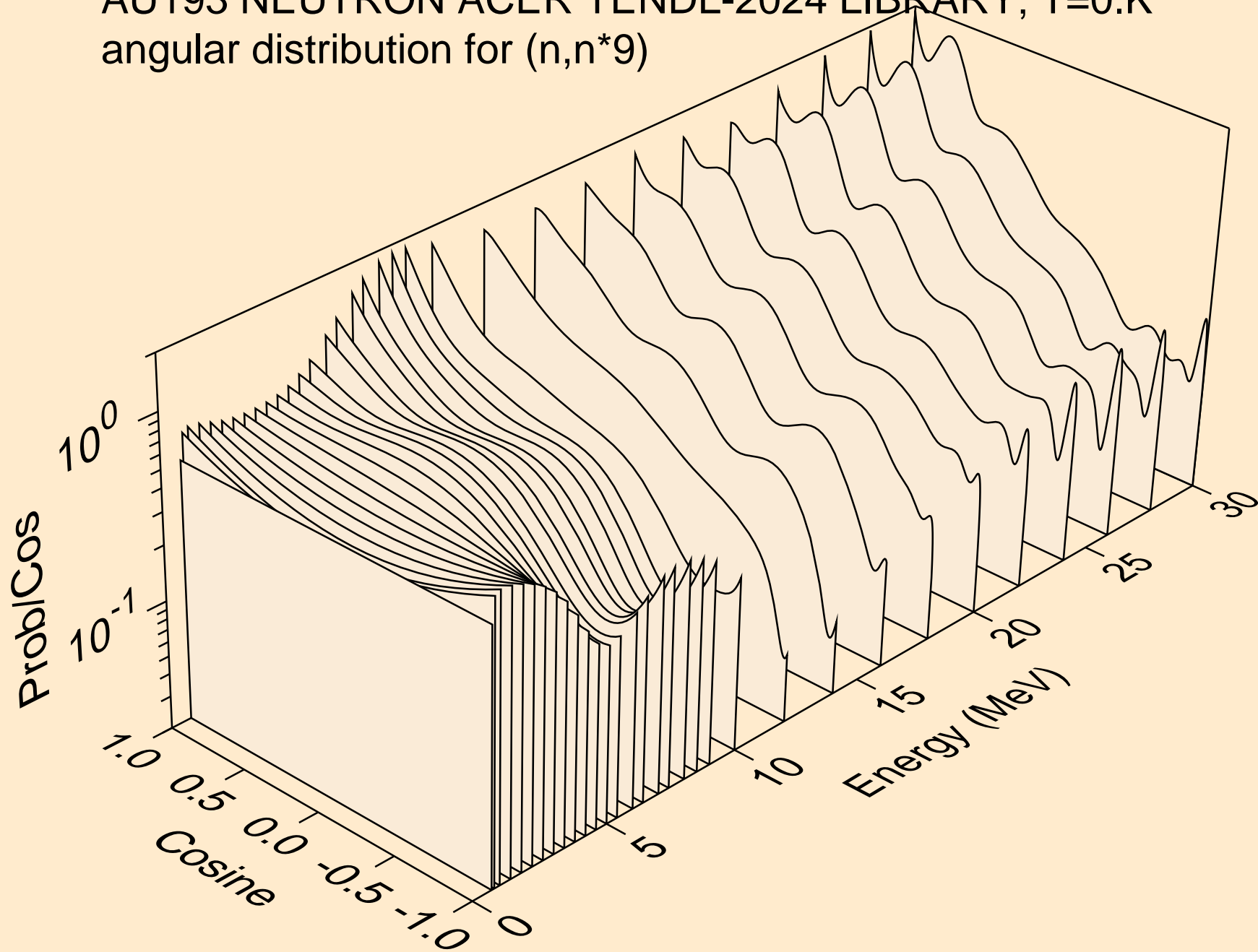

AU193 NEUTRON ACER TENDL-2024 LIBRARY; T=0.K
angular distribution for (n,n*10)

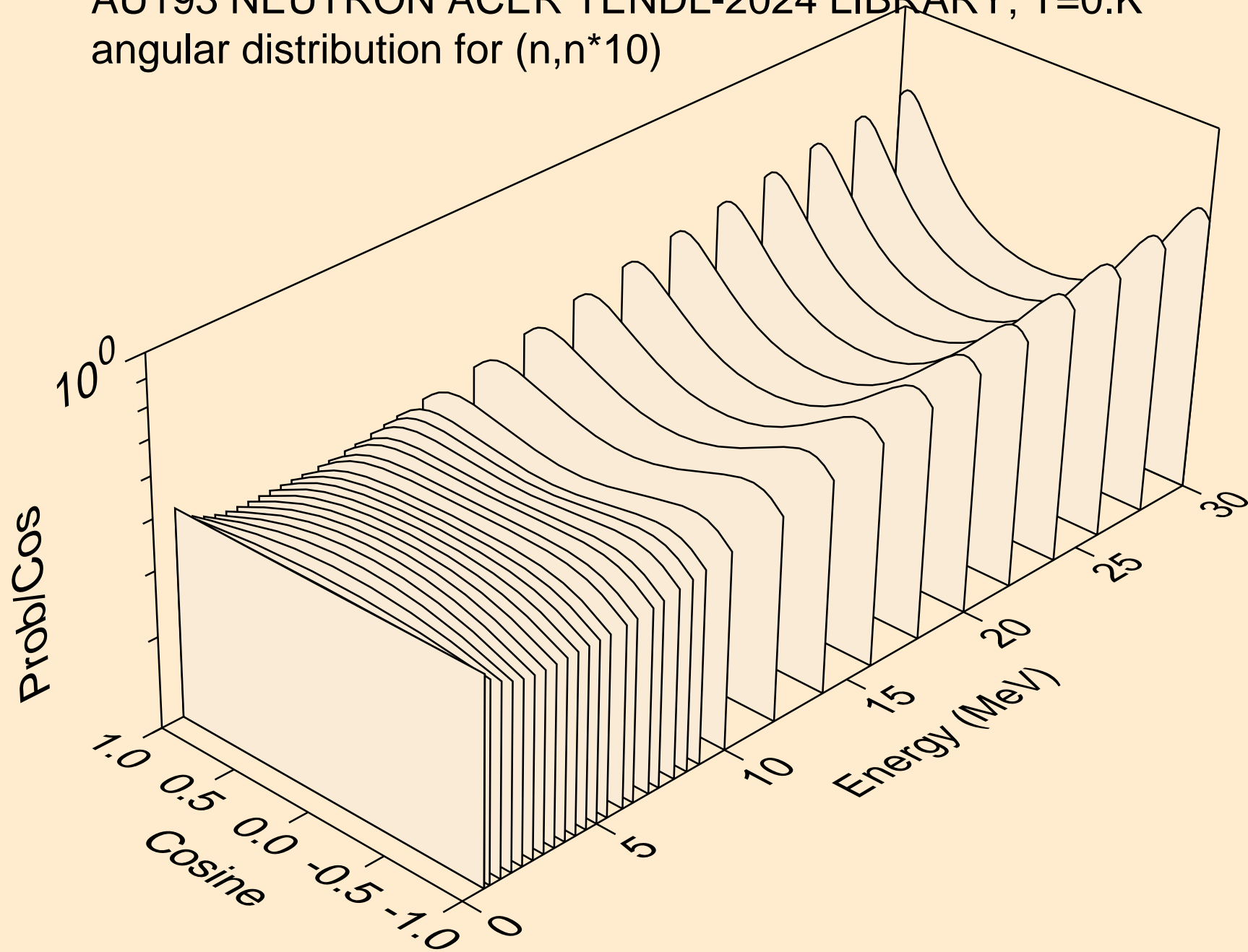

AU193 NEUTRON ACER TENDL-2024 LIBRARY; T=0.K
angular distribution for (n,n*11)

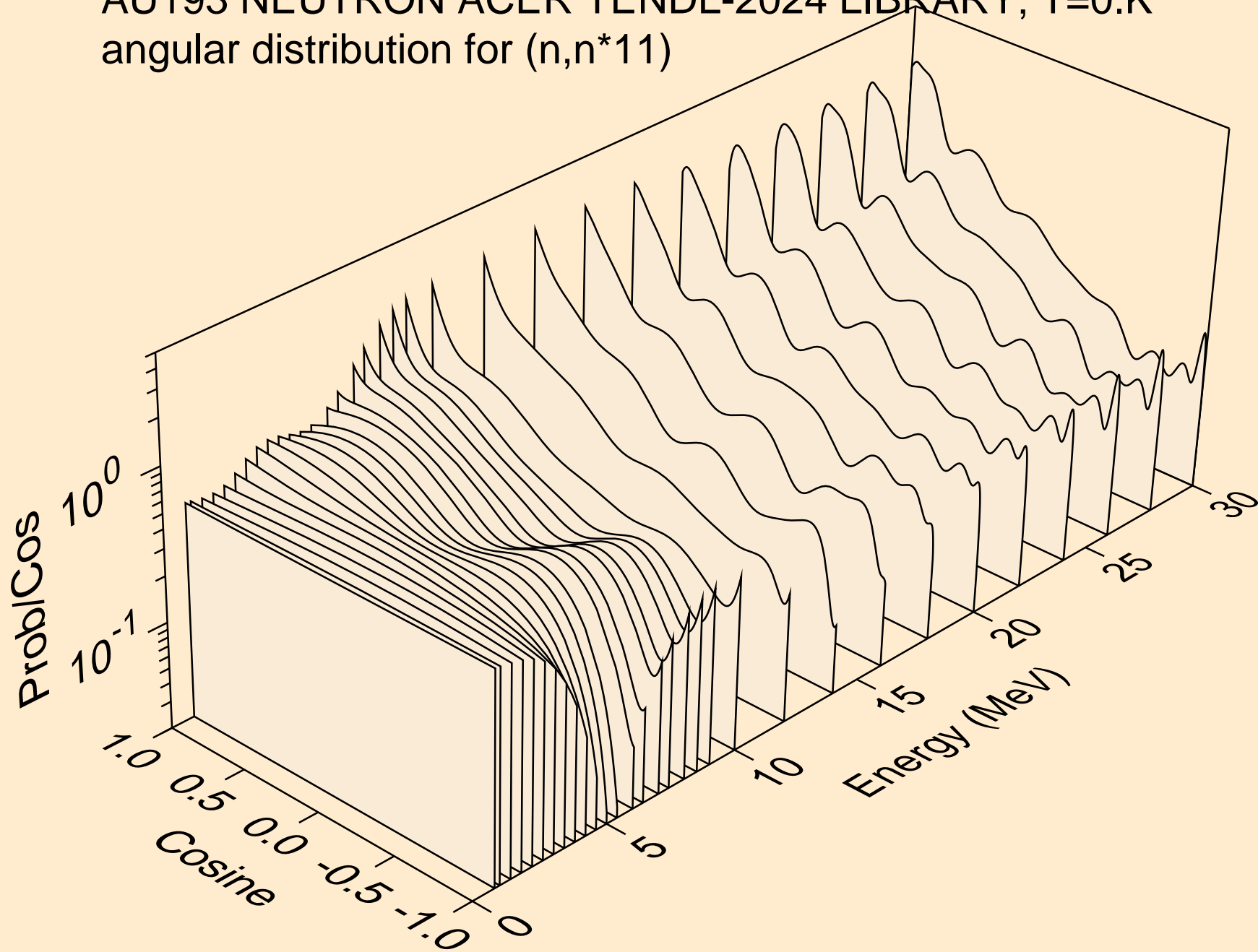

AU193 NEUTRON ACER TENDL-2024 LIBRARY; T=0.K
angular distribution for (n,n*12)

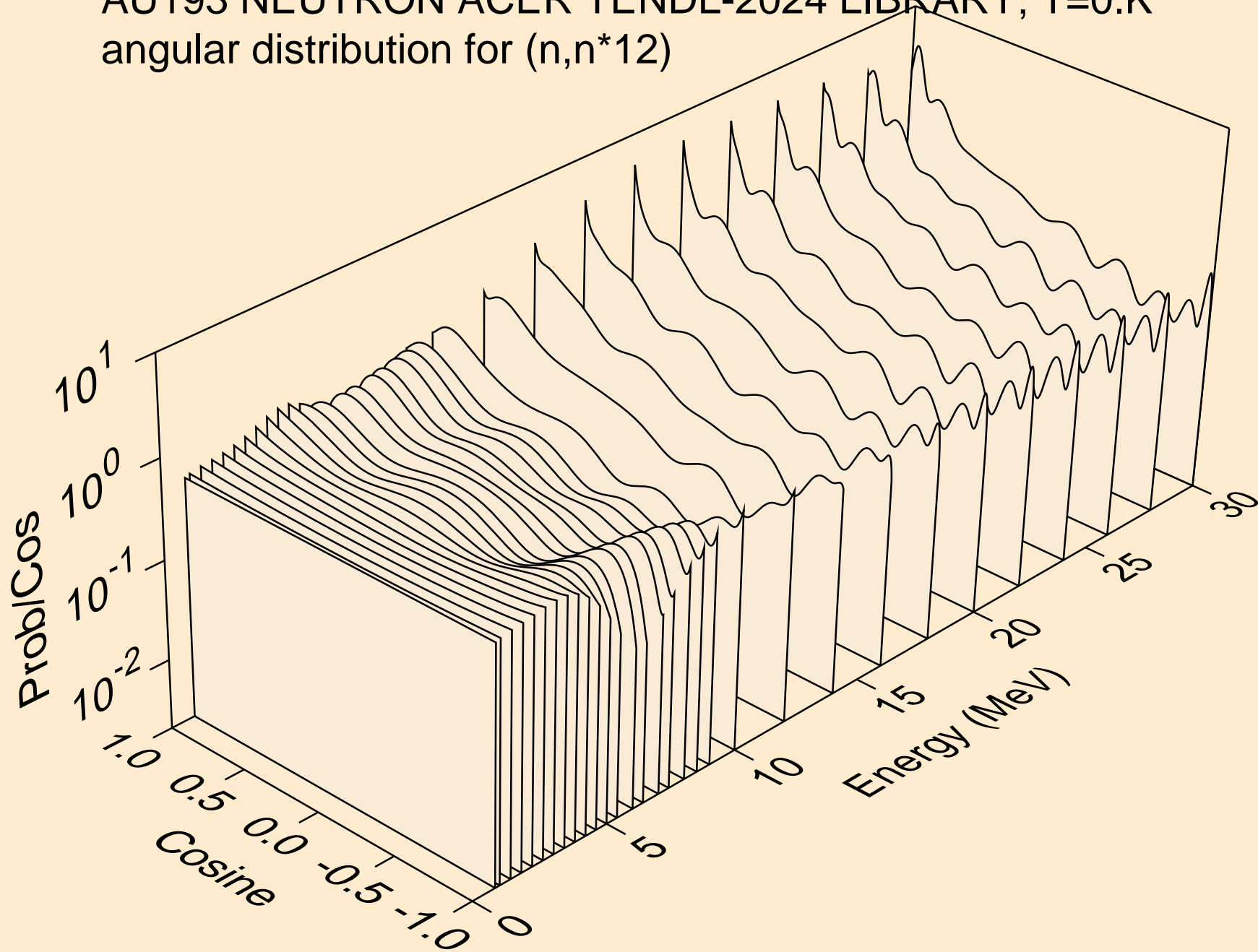

AU193 NEUTRON ACER TENDL-2024 LIBRARY; T=0.K
angular distribution for (n,n*13)

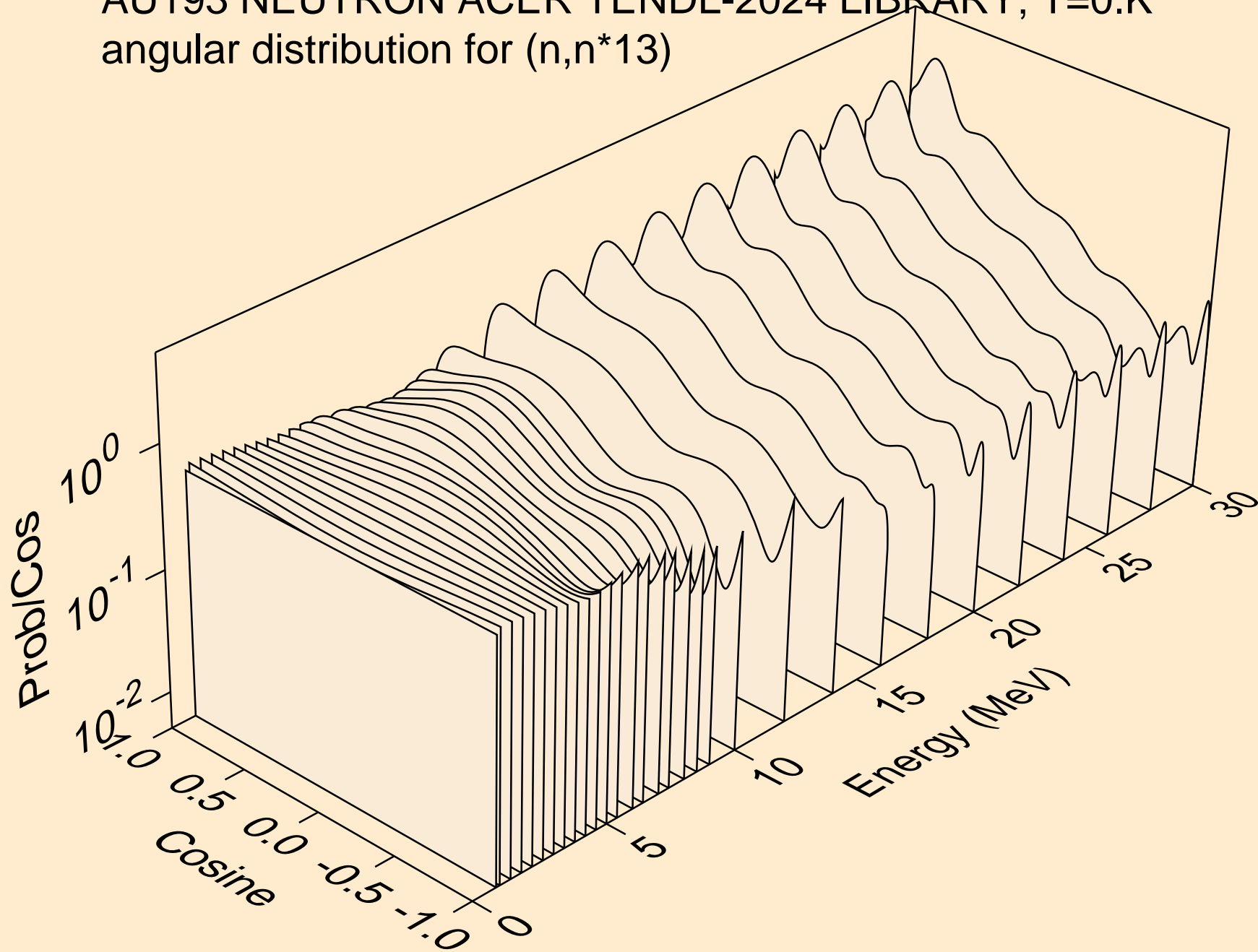

AU193 NEUTRON ACER TENDL-2024 LIBRARY; T=0.K
angular distribution for (n,n*14)

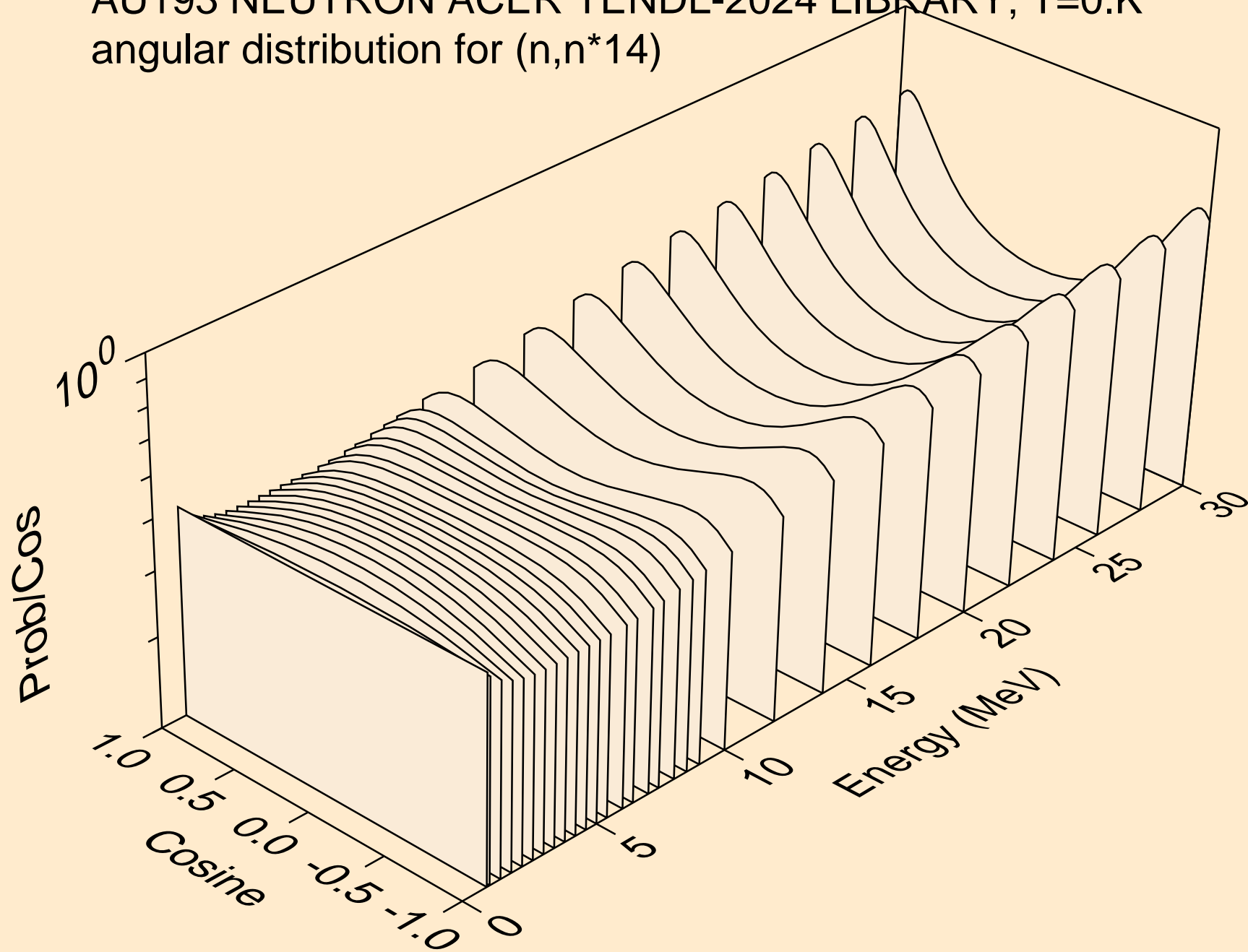

AU193 NEUTRON ACER TENDL-2024 LIBRARY; T=0.K
angular distribution for (n,n*15)

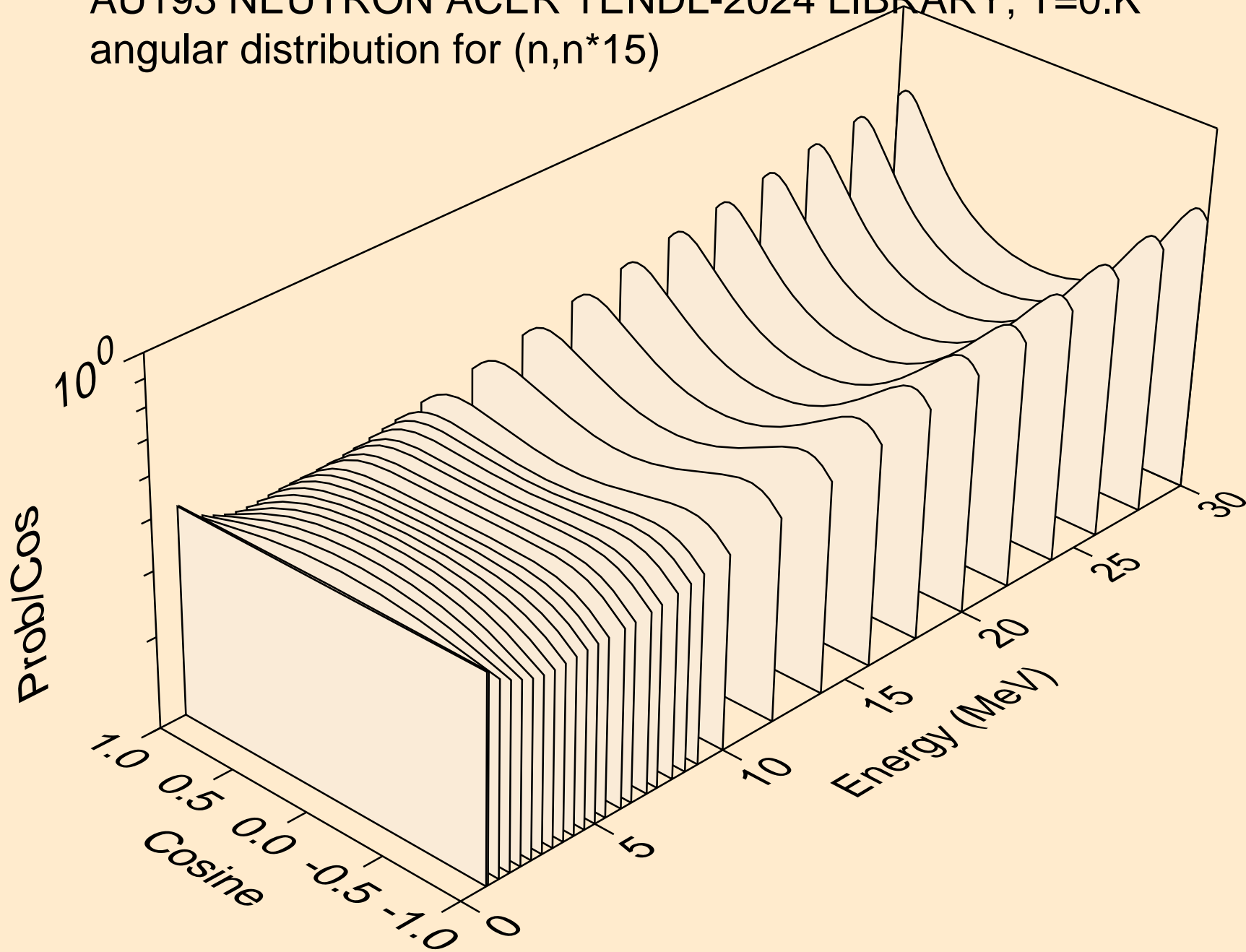

AU193 NEUTRON ACER TENDL-2024 LIBRARY; T=0.K
angular distribution for (n,n*16)

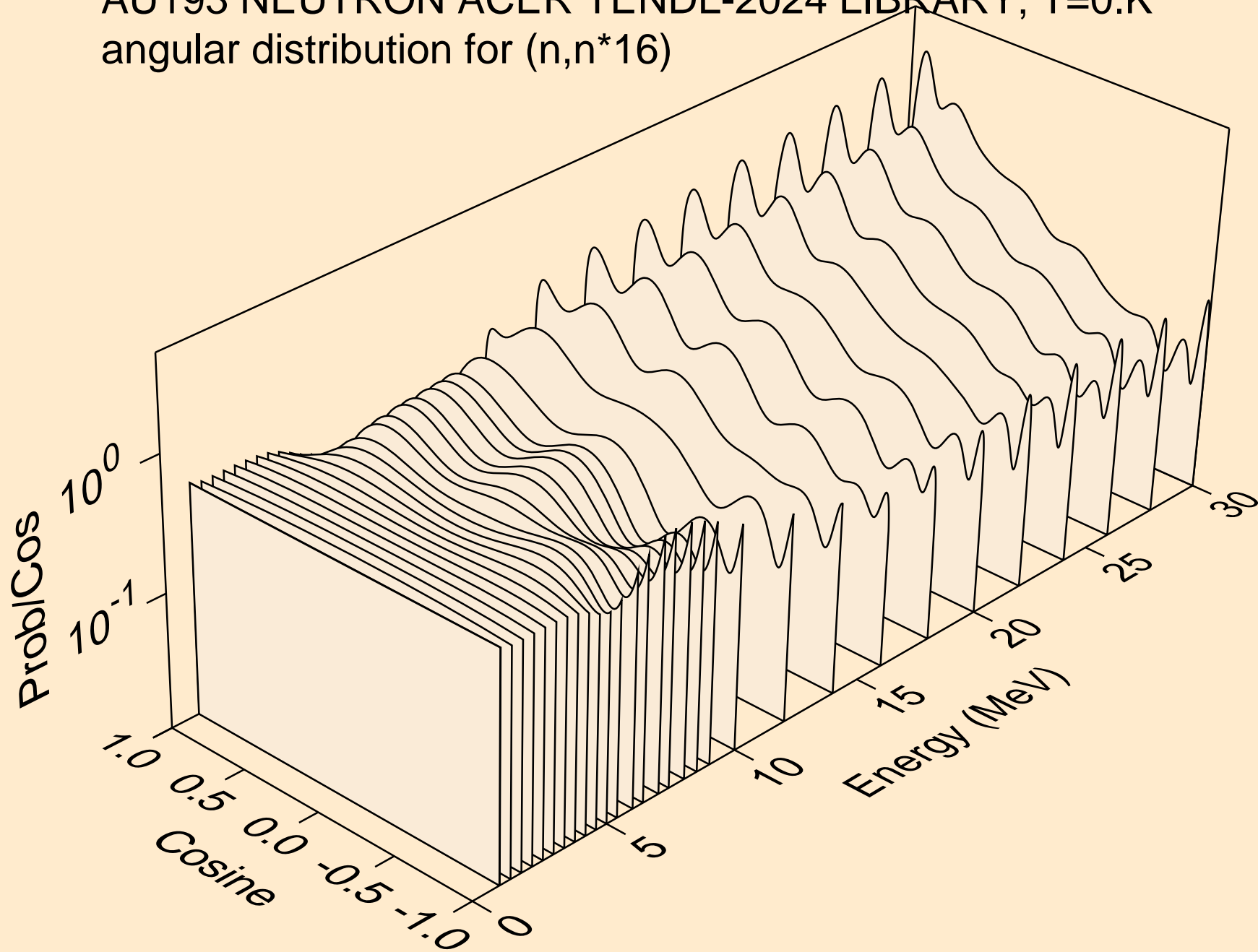

AU193 NEUTRON ACER TENDL-2024 LIBRARY; T=0.K
angular distribution for (n,n*17)

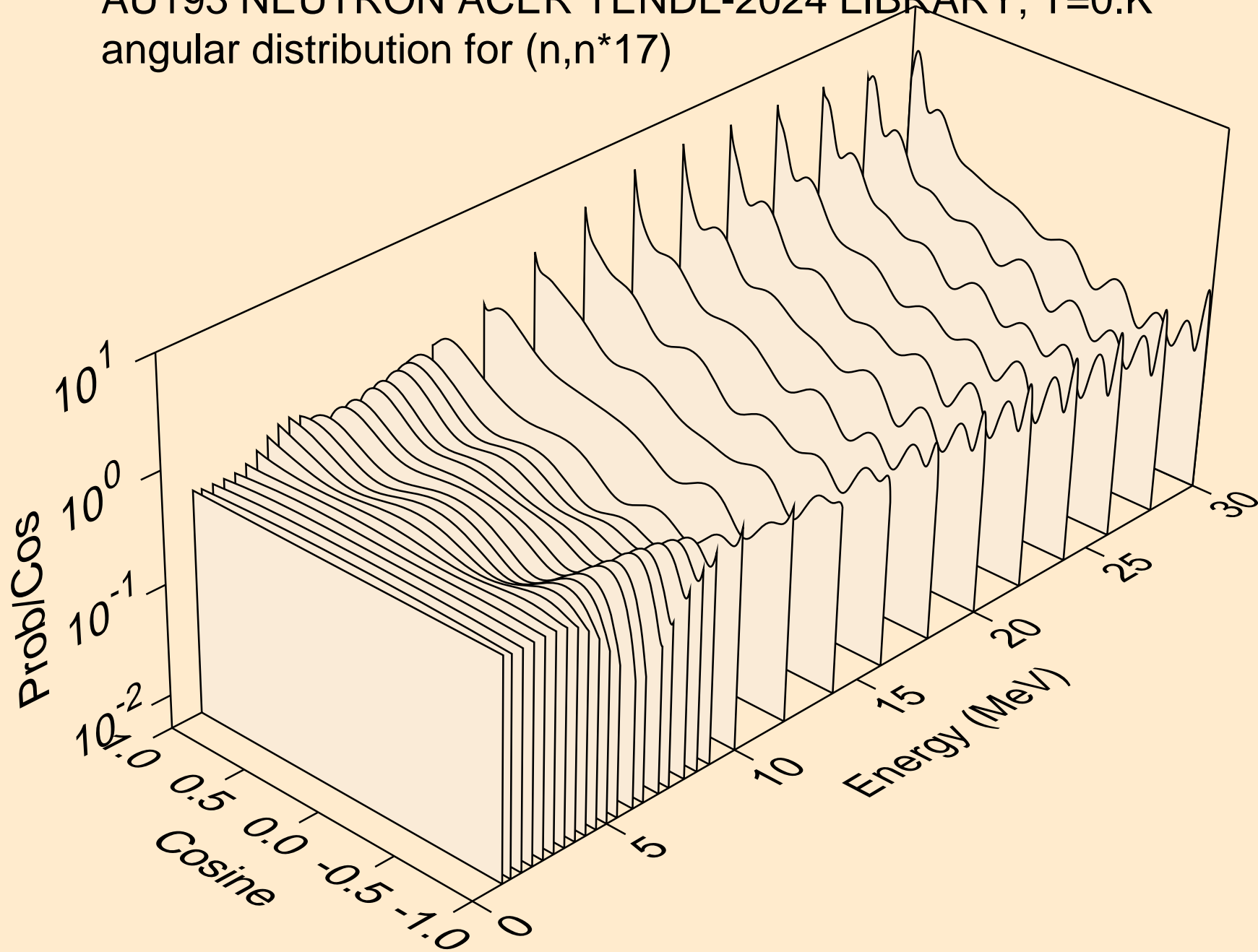

AU193 NEUTRON ACER TENDL-2024 LIBRARY; T=0.K
angular distribution for (n,n*18)

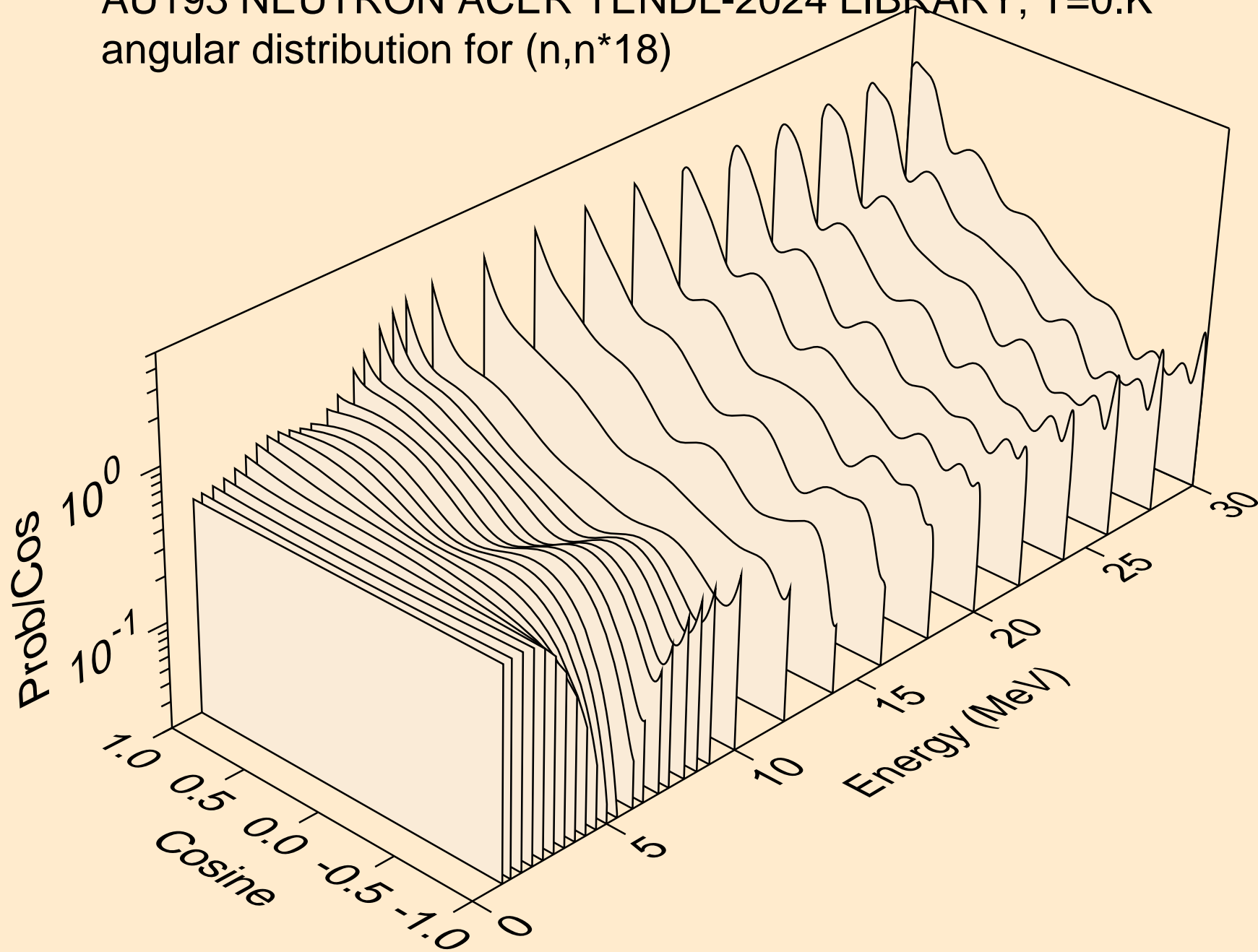

AU193 NEUTRON ACER TENDL-2024 LIBRARY; T=0.K
angular distribution for (n,n*19)

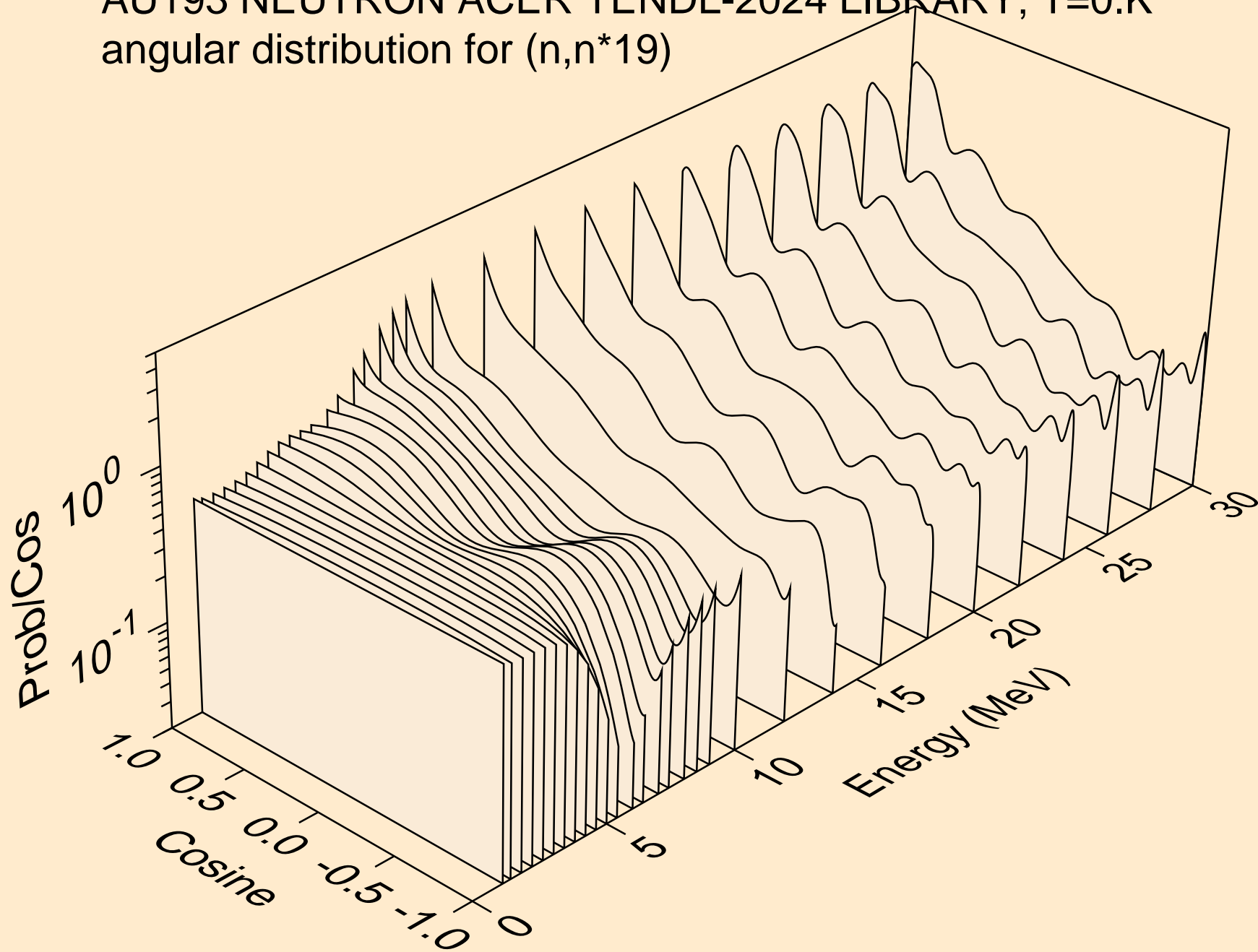

AU193 NEUTRON ACER TENDL-2024 LIBRARY; T=0.K
angular distribution for (n,n*20)

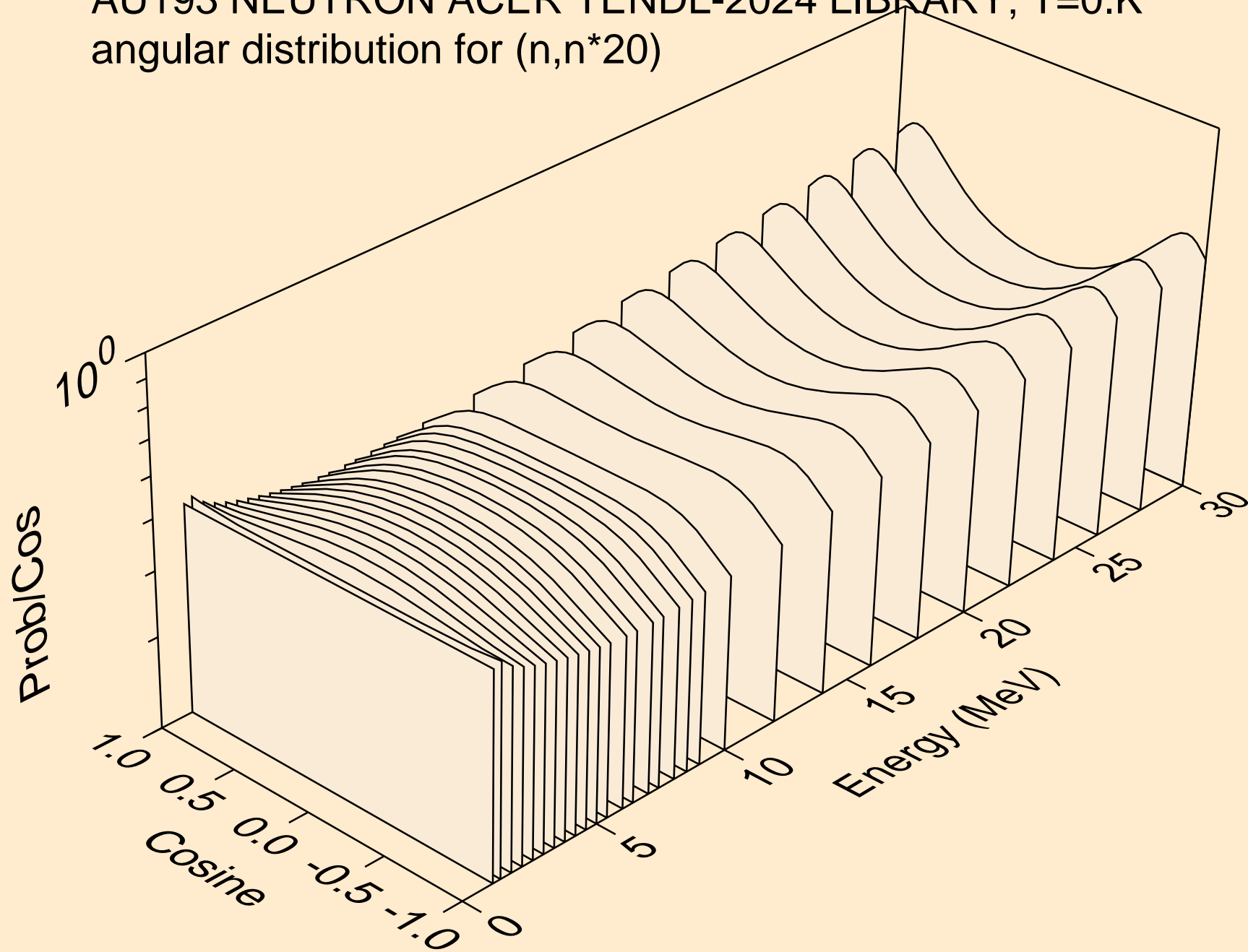

AU193 NEUTRON ACER TENDL-2024 LIBRARY; T=0.K
angular distribution for (n,n*21)

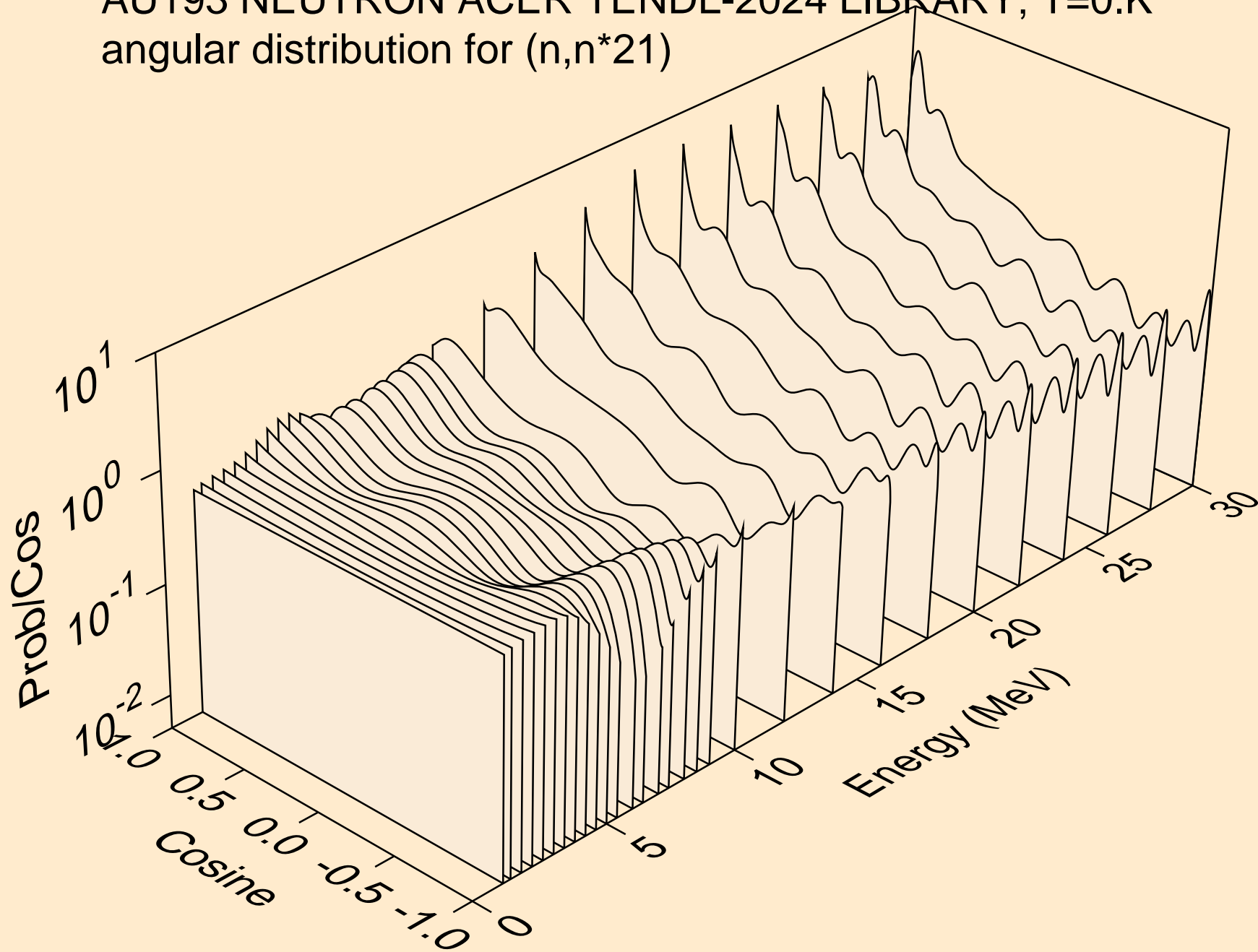

AU193 NEUTRON ACER TENDL-2024 LIBRARY; T=0.K
angular distribution for (n,n*22)

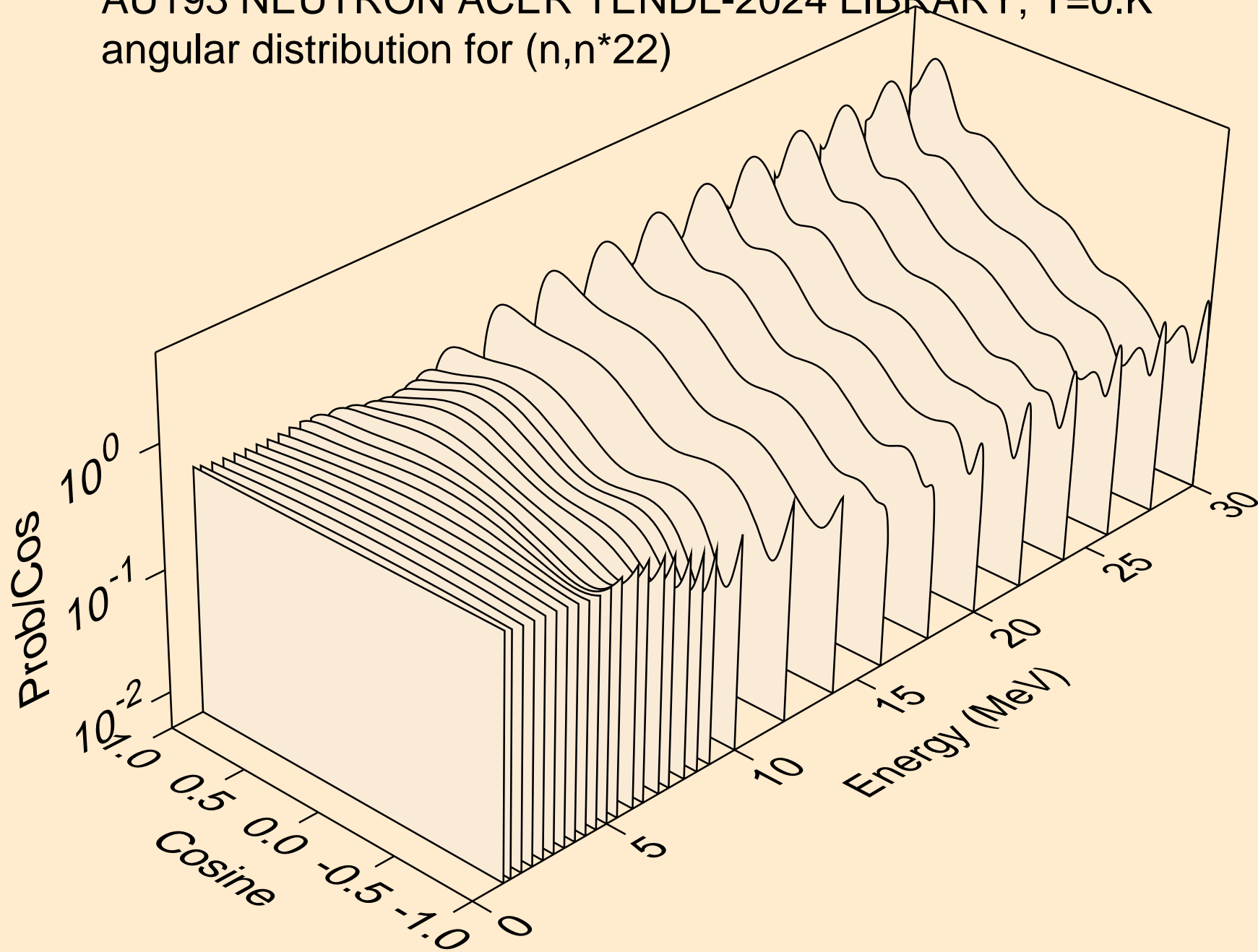

AU193 NEUTRON ACER TENDL-2024 LIBRARY; T=0.K
angular distribution for (n,n*23)

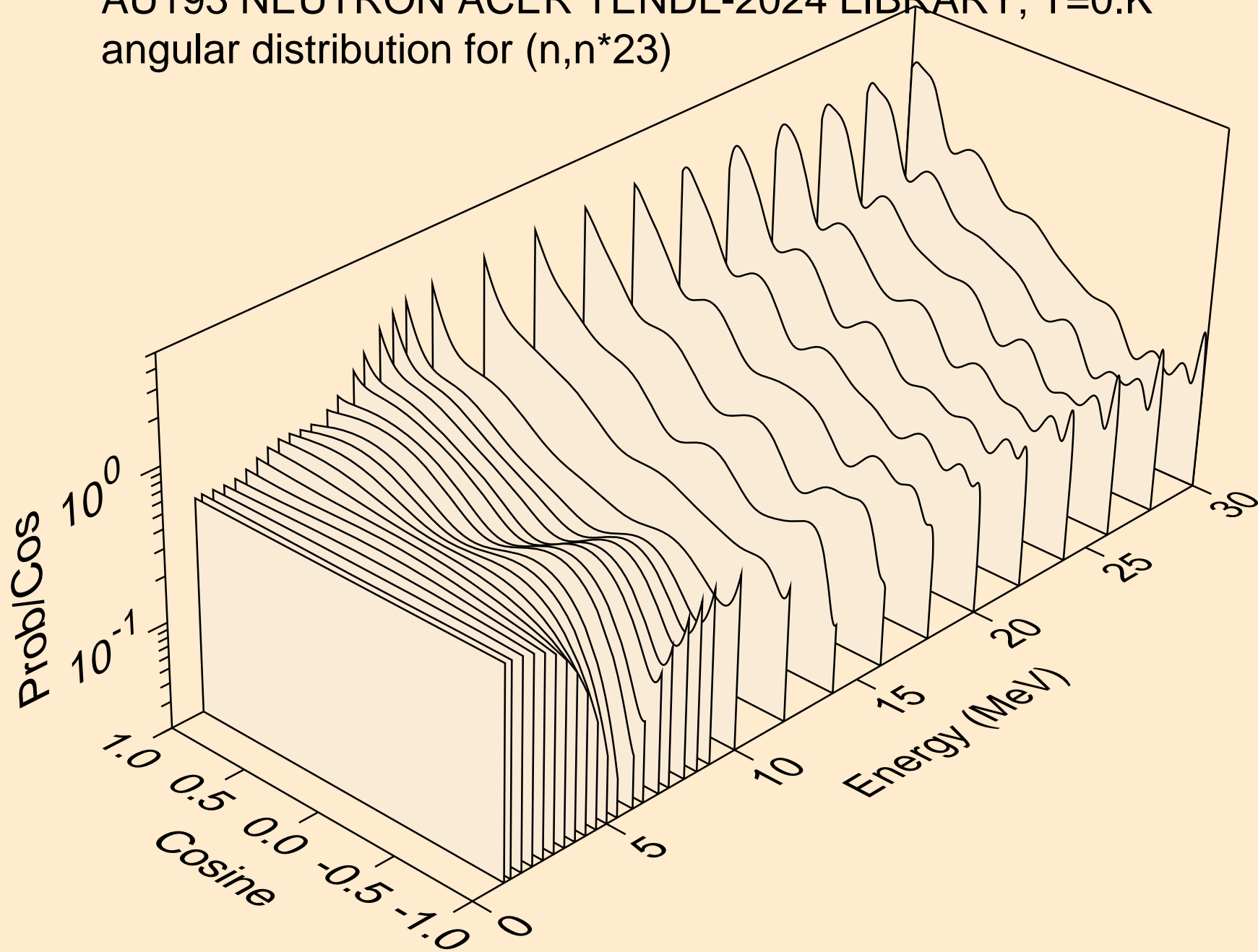

AU193 NEUTRON ACER TENDL-2024 LIBRARY; T=0.K
angular distribution for (n,n*24)

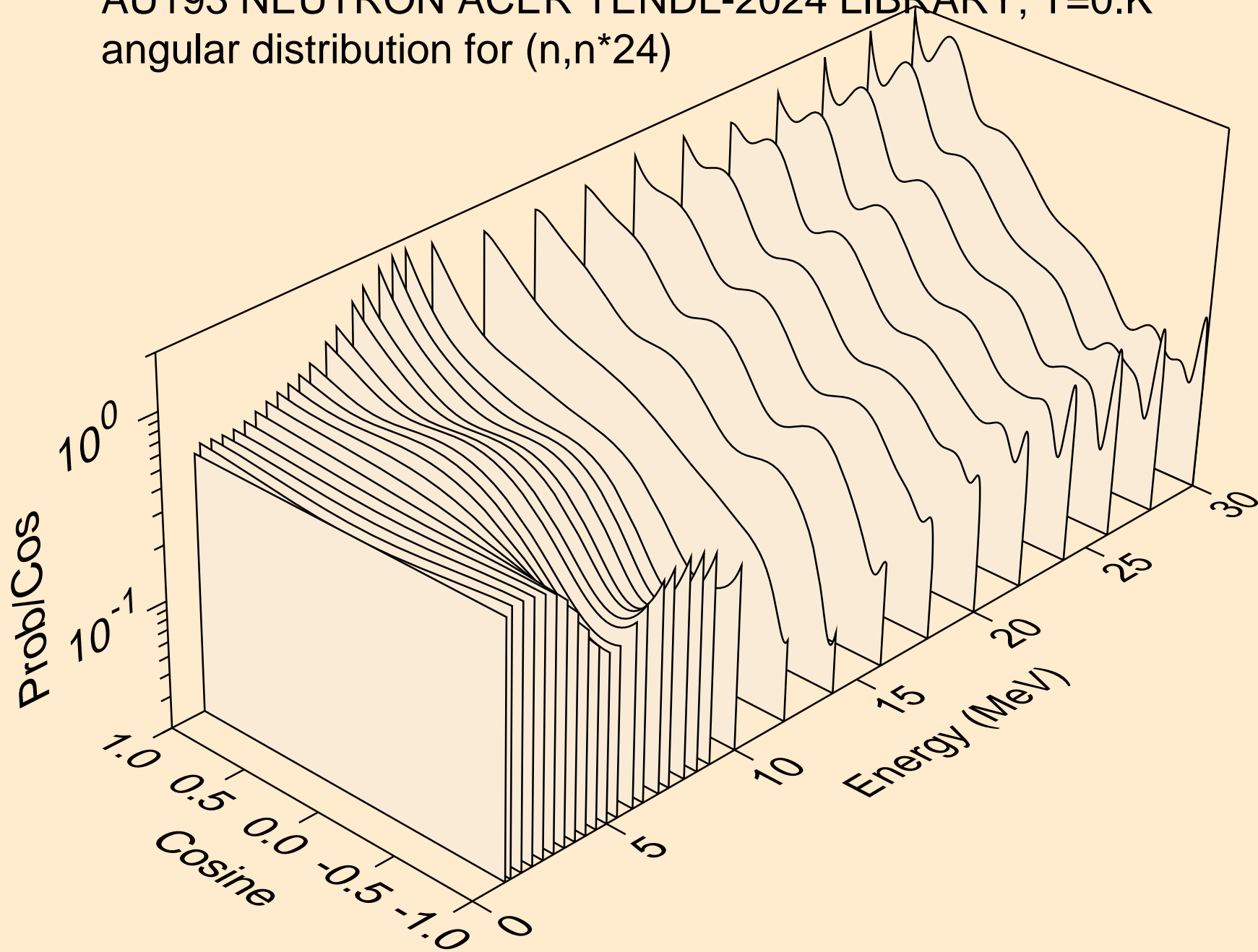

AU193 NEUTRON ACER TENDL-2024 LIBRARY; T=0.K
angular distribution for (n,n*25)

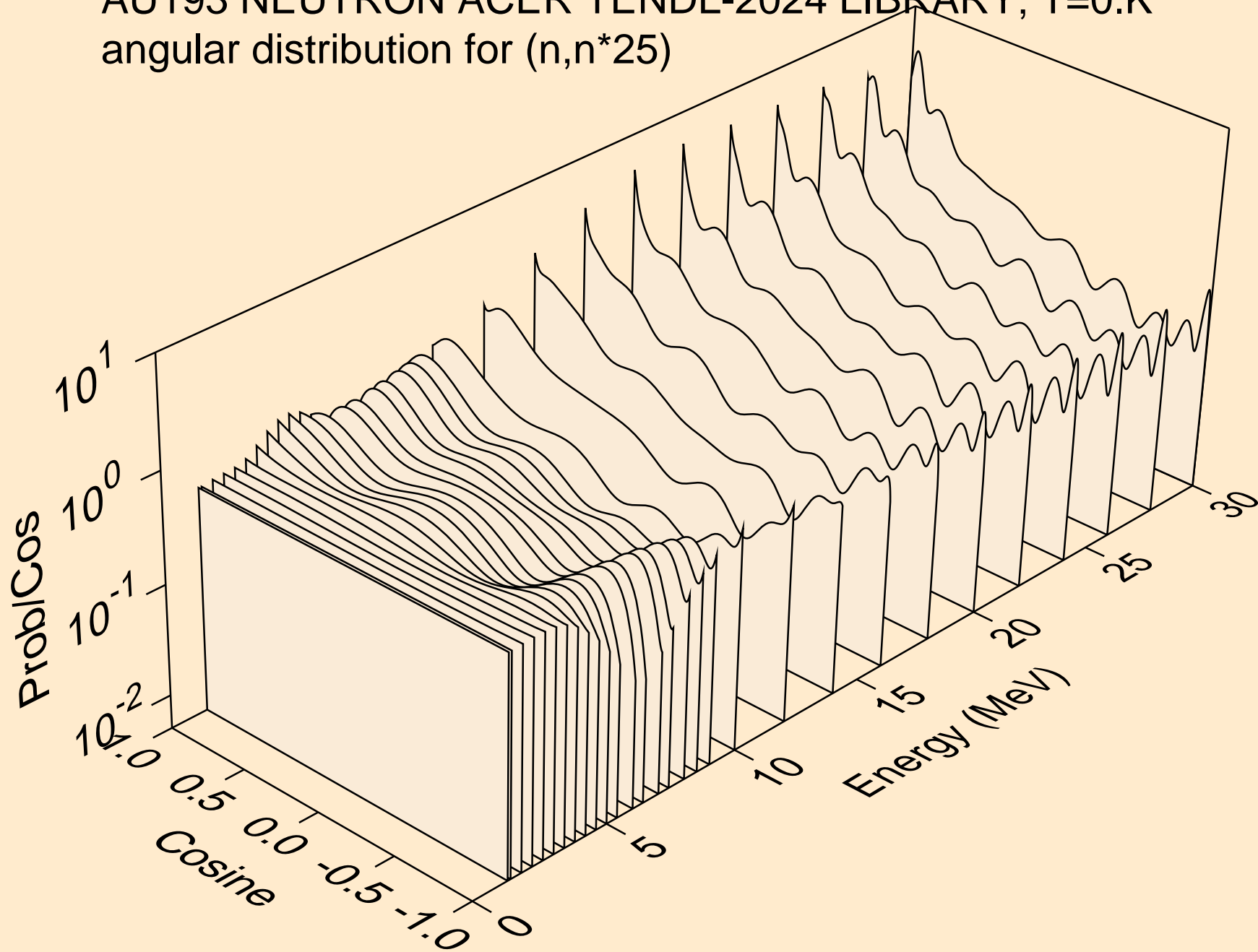

AU193 NEUTRON ACER TENDL-2024 LIBRARY; T=0.K
angular distribution for (n,n*26)

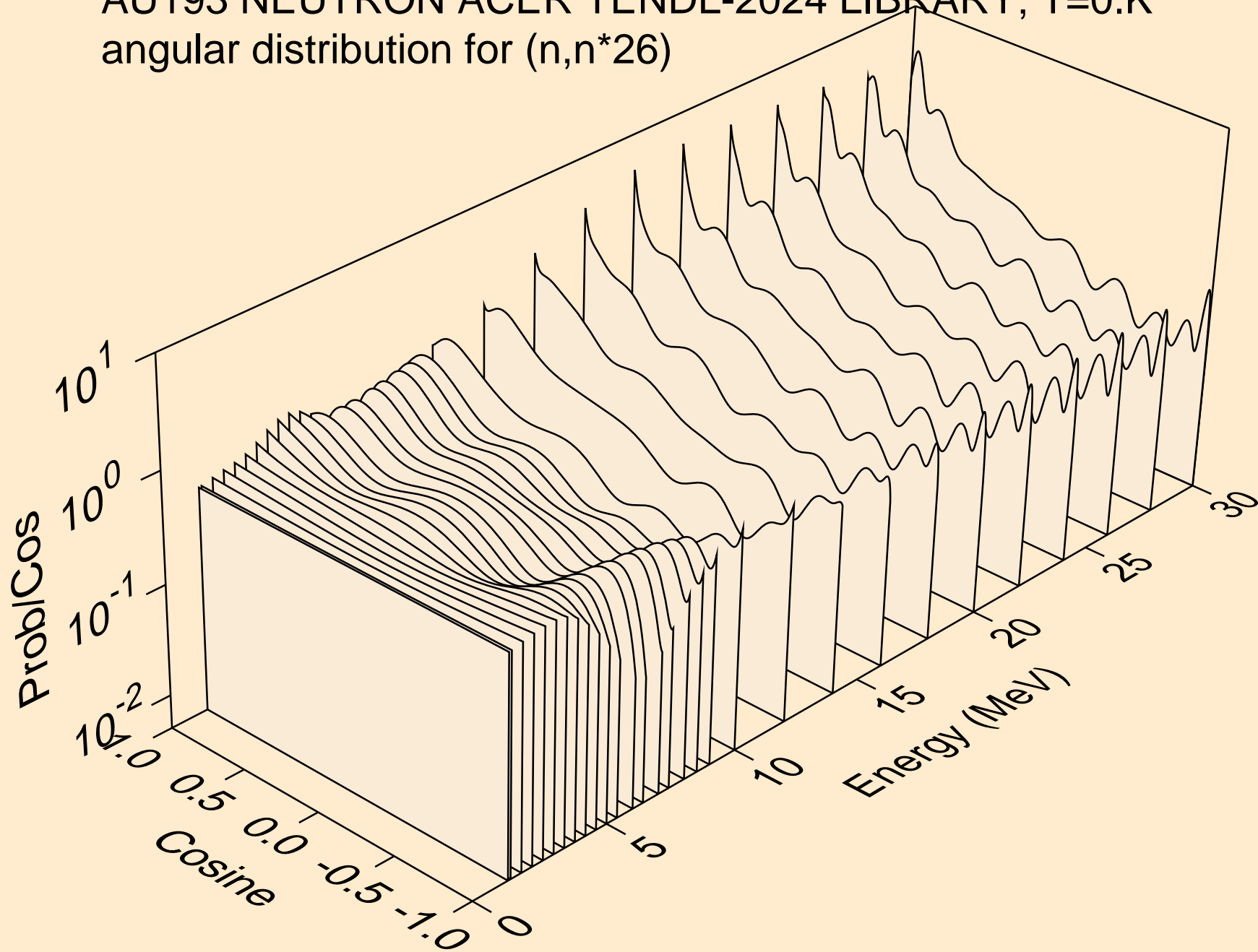

AU193 NEUTRON ACER TENDL-2024 LIBRARY; T=0.K
angular distribution for (n,n*27)

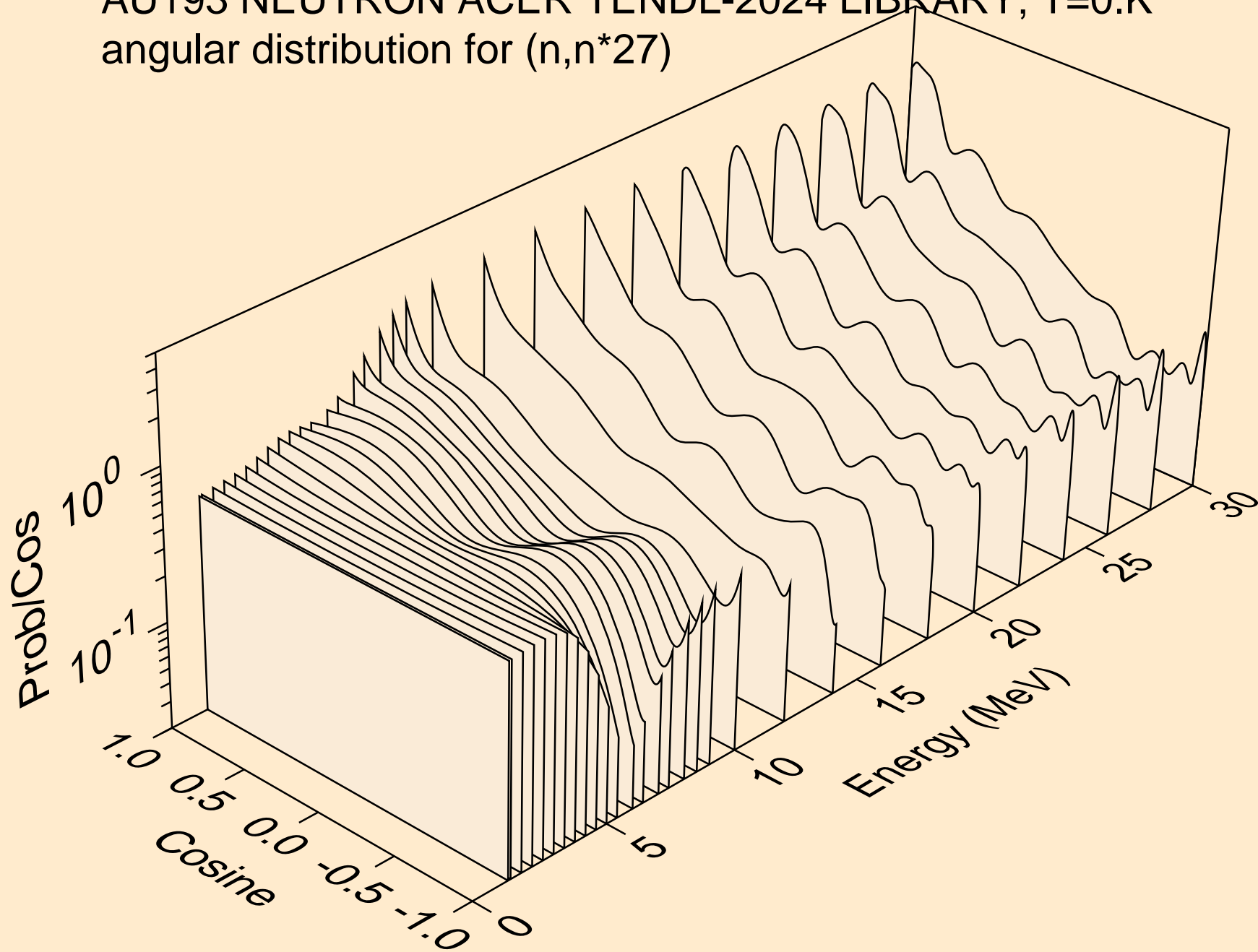

AU193 NEUTRON ACER TENDL-2024 LIBRARY; T=0.K
Neutron emission for (n,x)

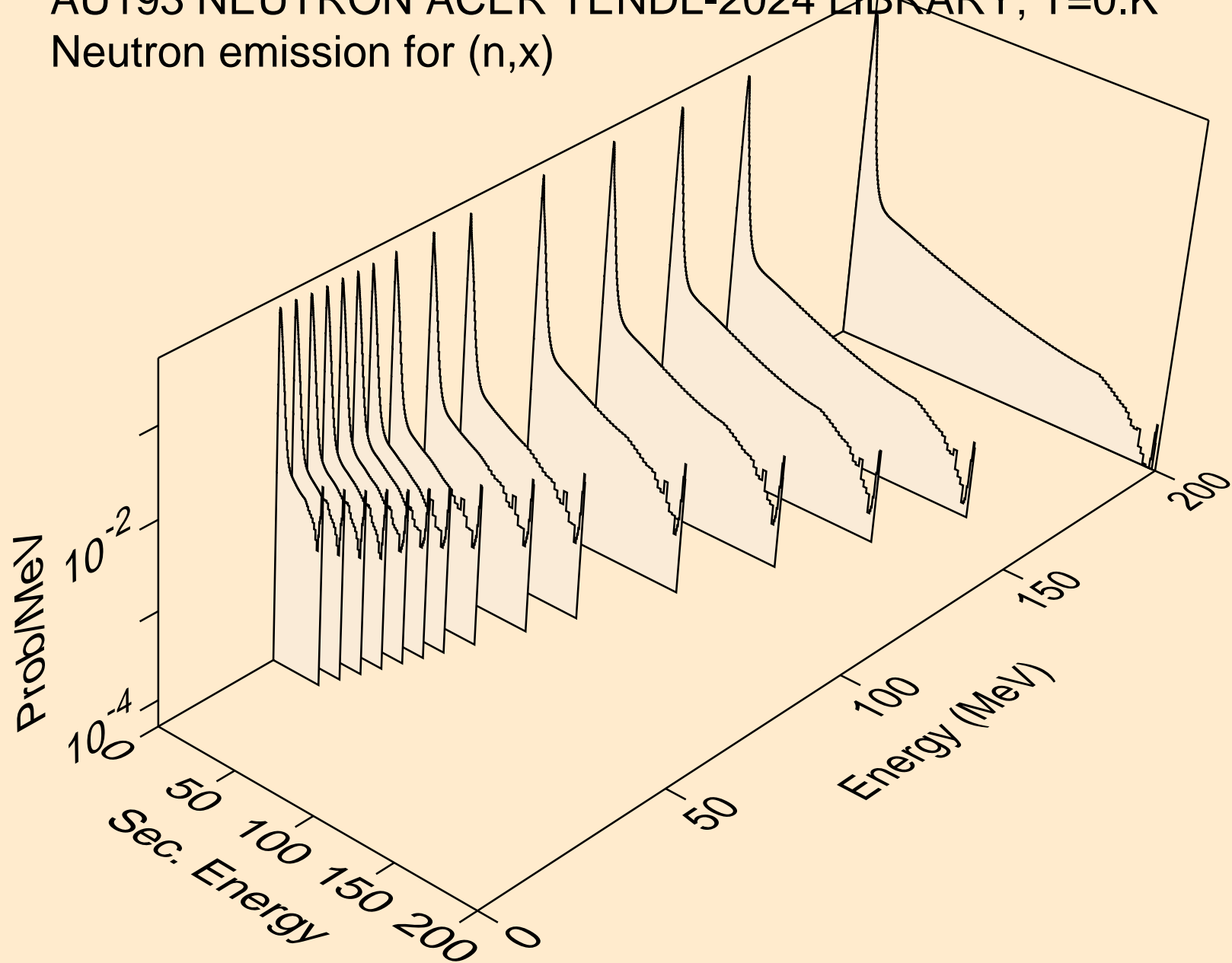

AU193 NEUTRON ACER TENDL-2024 LIBRARY; T=0.K
Neutron emission for (n,2nd)

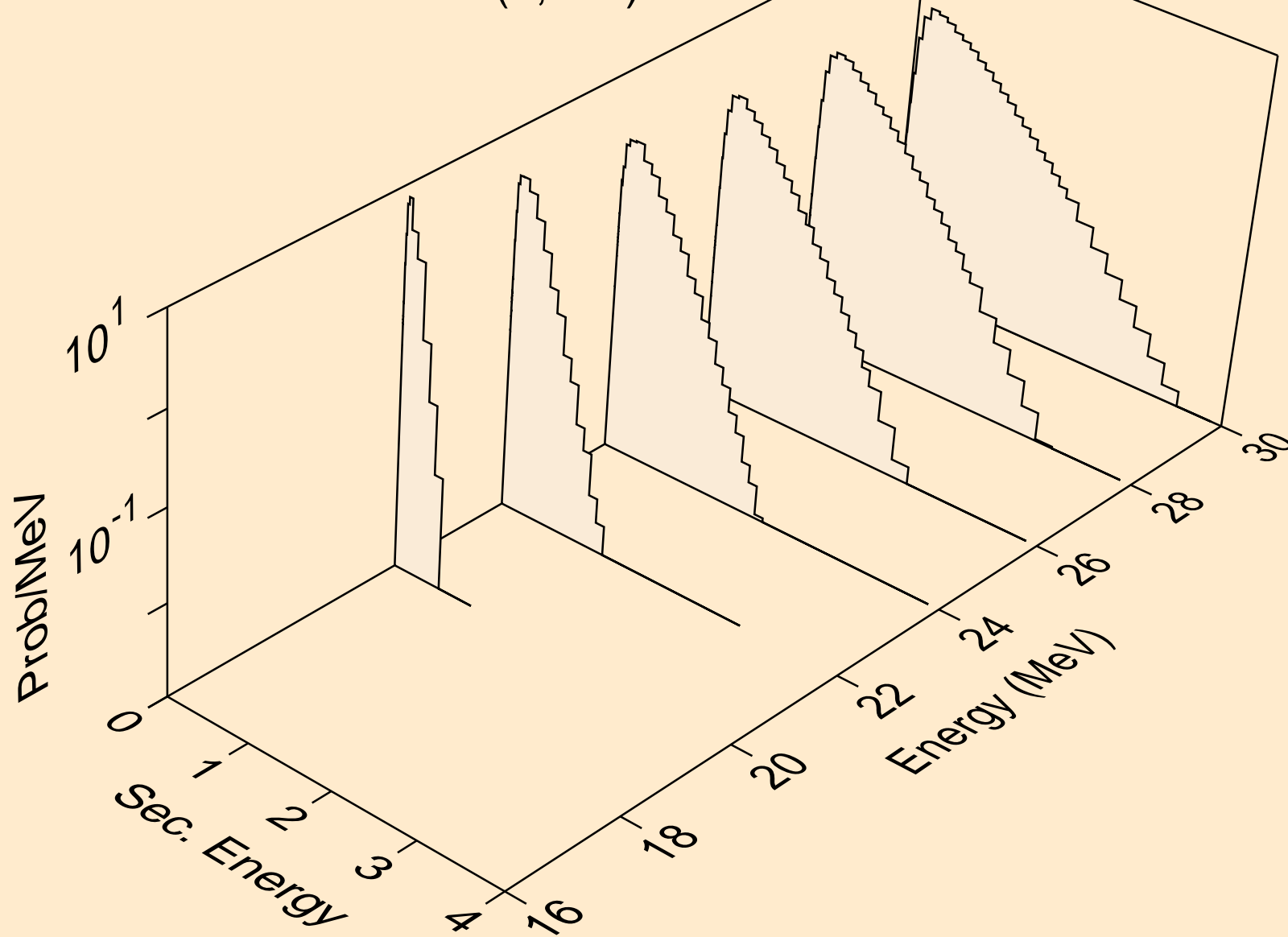

AU193 NEUTRON ACER TENDL-2024 LIBRARY; T=0.K
Neutron emission for (n,2n)

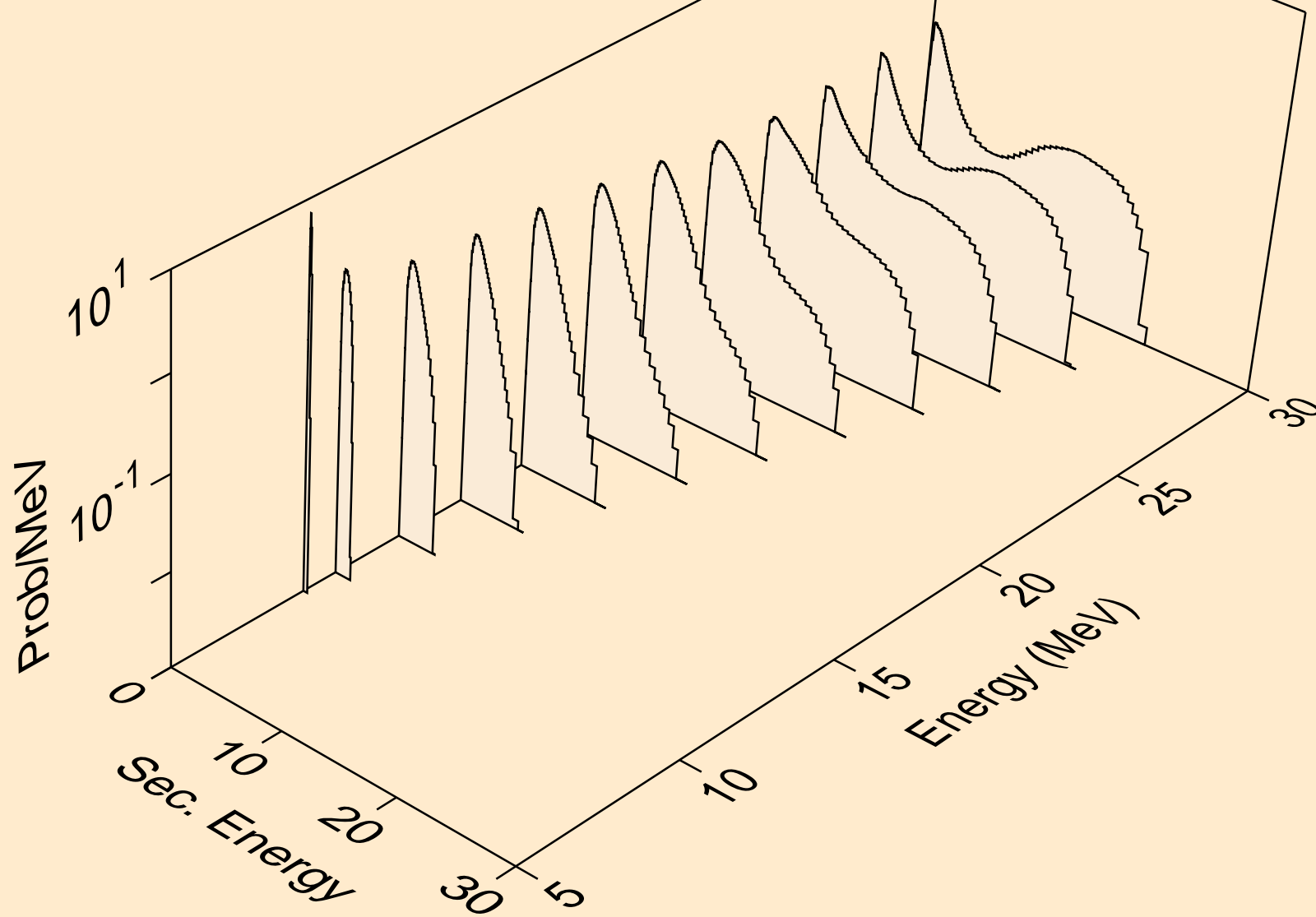

AU193 NEUTRON ACER TENDL-2024 LIBRARY; T=0.K
Neutron emission for (n,3n)

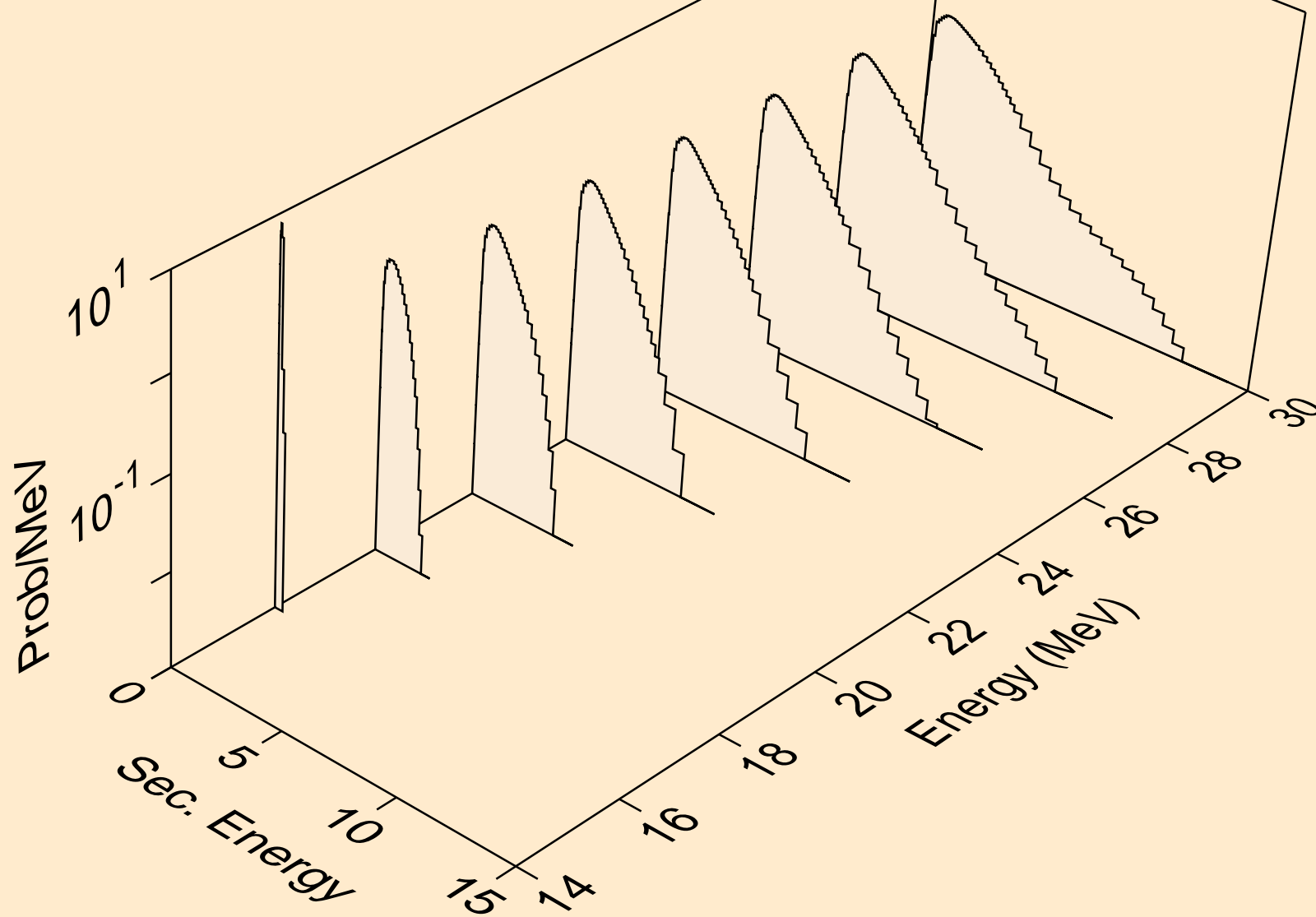

AU193 NEUTRON ACER TENDL-2024 LIBRARY; T=0.K
Neutron emission for (n,n*)a

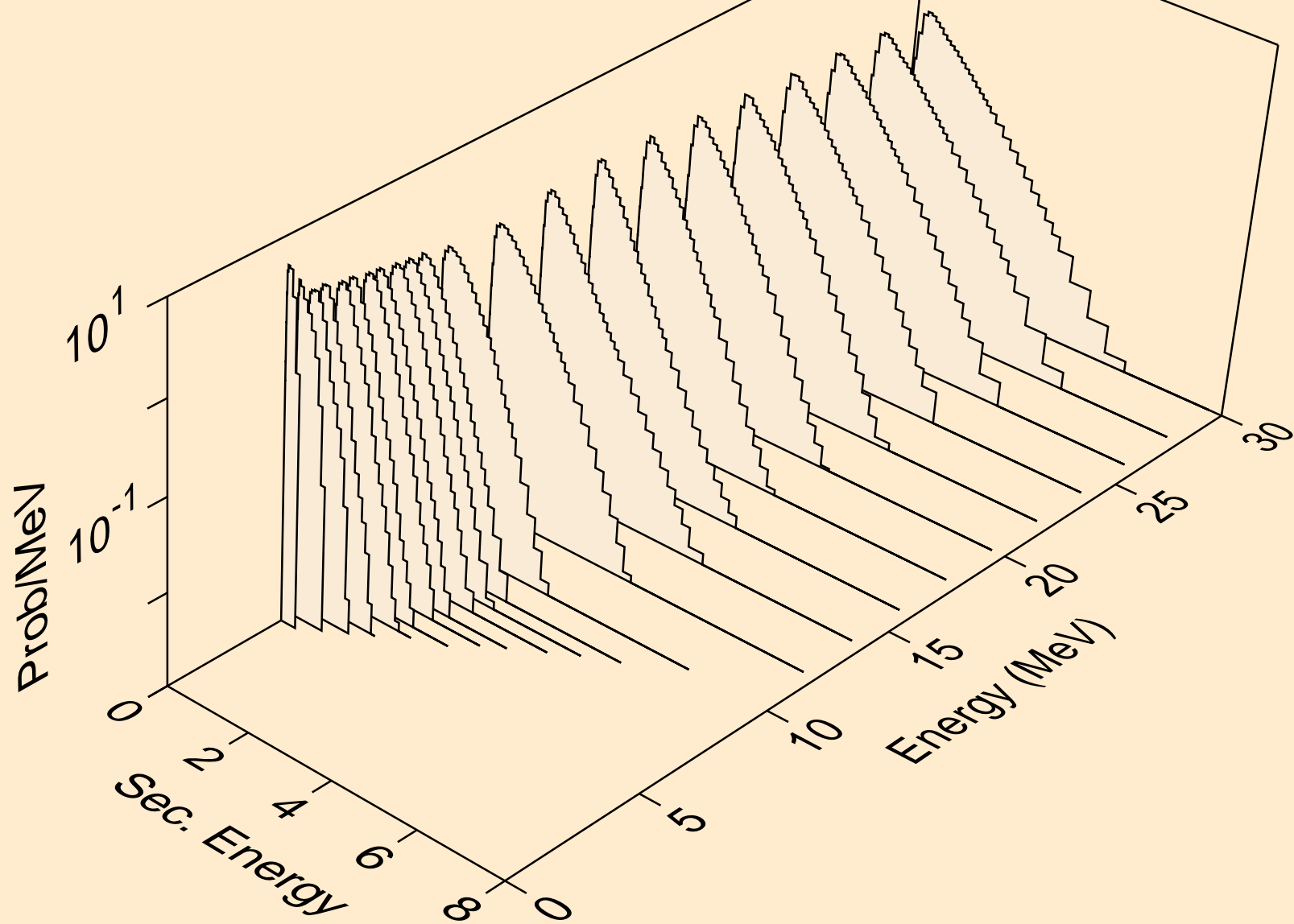

AU193 NEUTRON ACER TENDL-2024 LIBRARY; T=0.K
Neutron emission for (n,2n)a

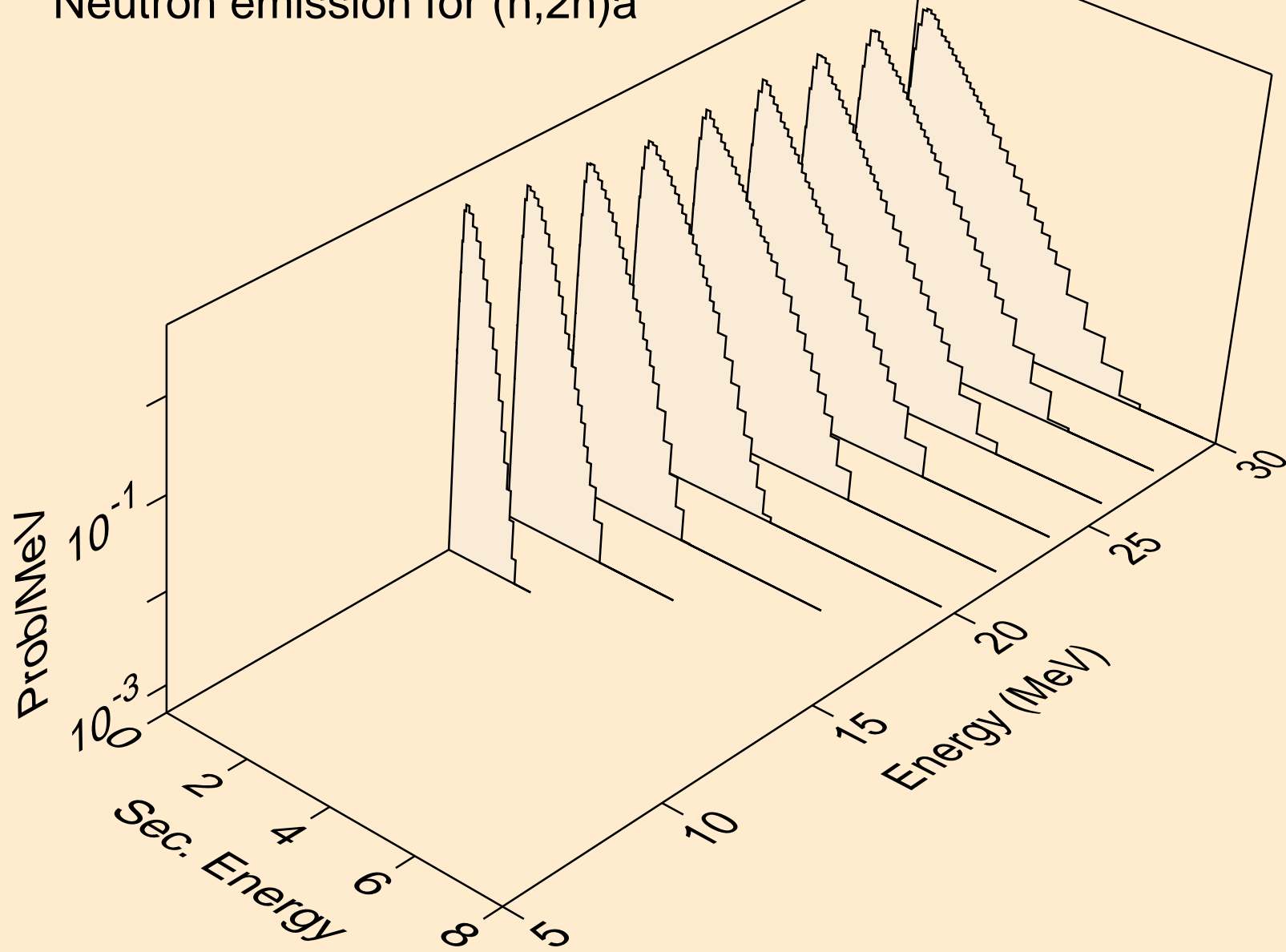

AU193 NEUTRON ACER TENDL-2024 LIBRARY; T=0.K
Neutron emission for (n,3n)a

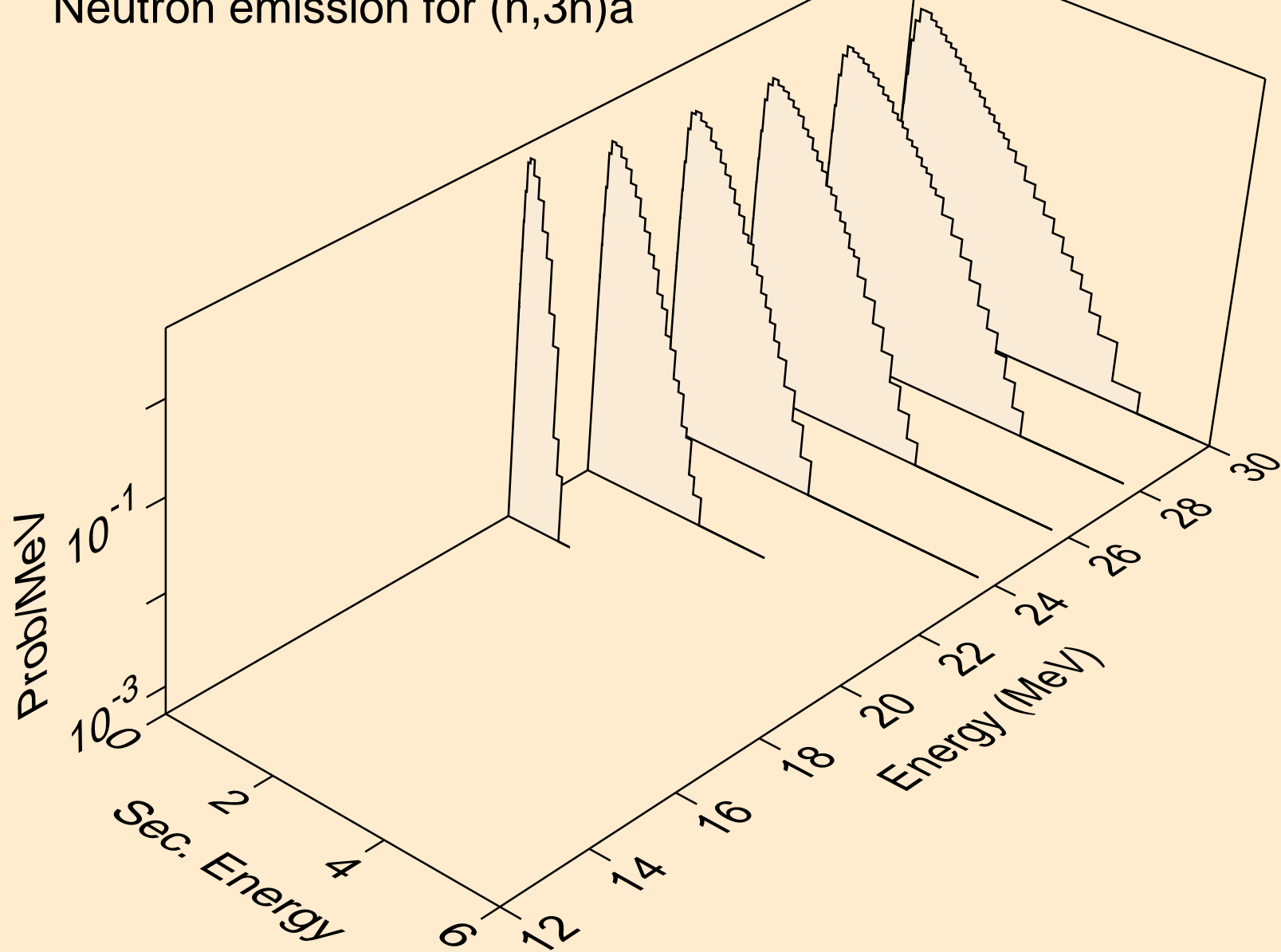

AU193 NEUTRON ACER TENDL-2024 LIBRARY; T=0.K
Neutron emission for (n,n*)p

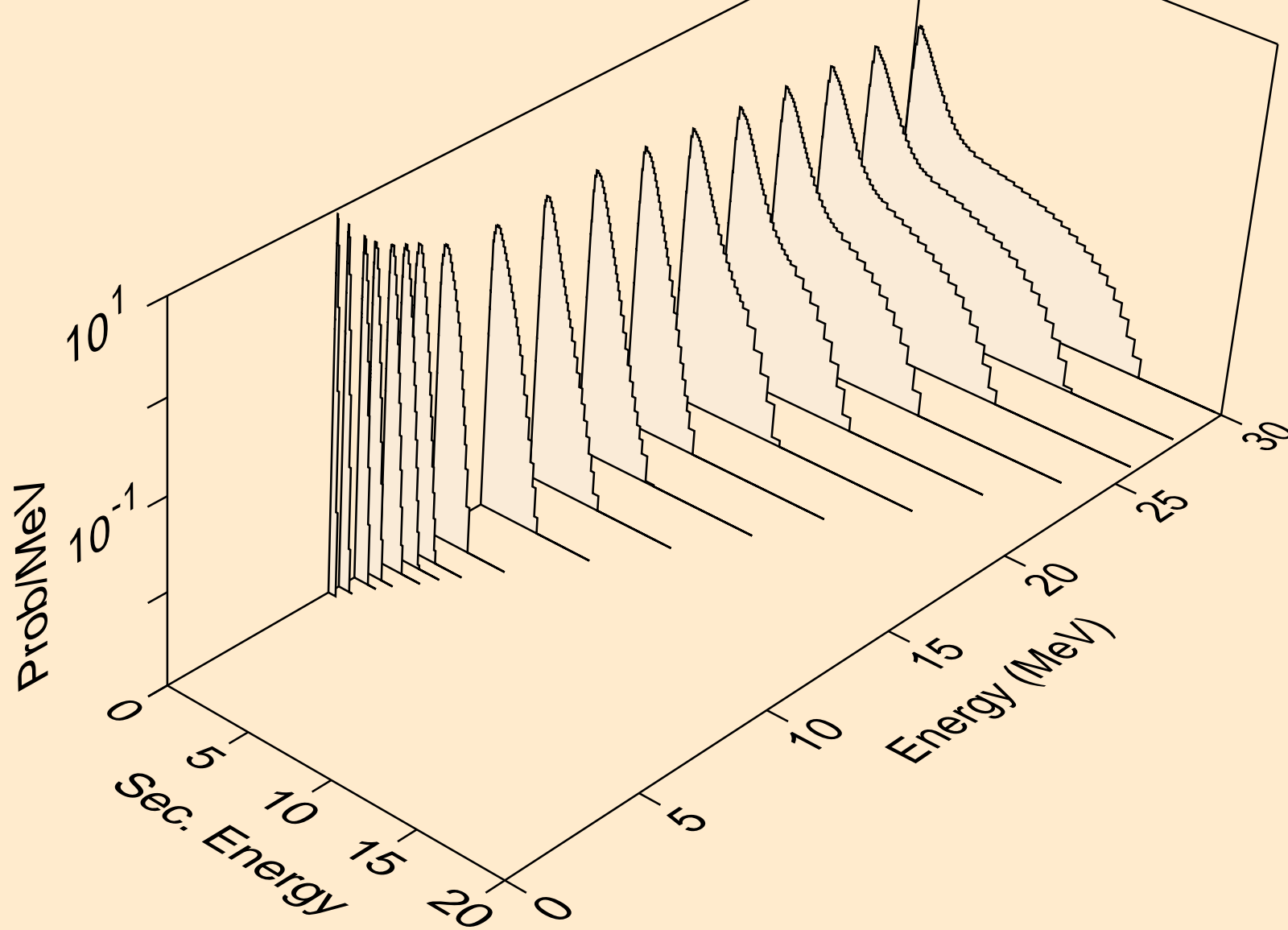

AU193 NEUTRON ACER TENDL-2024 LIBRARY; T=0.K
Neutron emission for (n,n*)2a

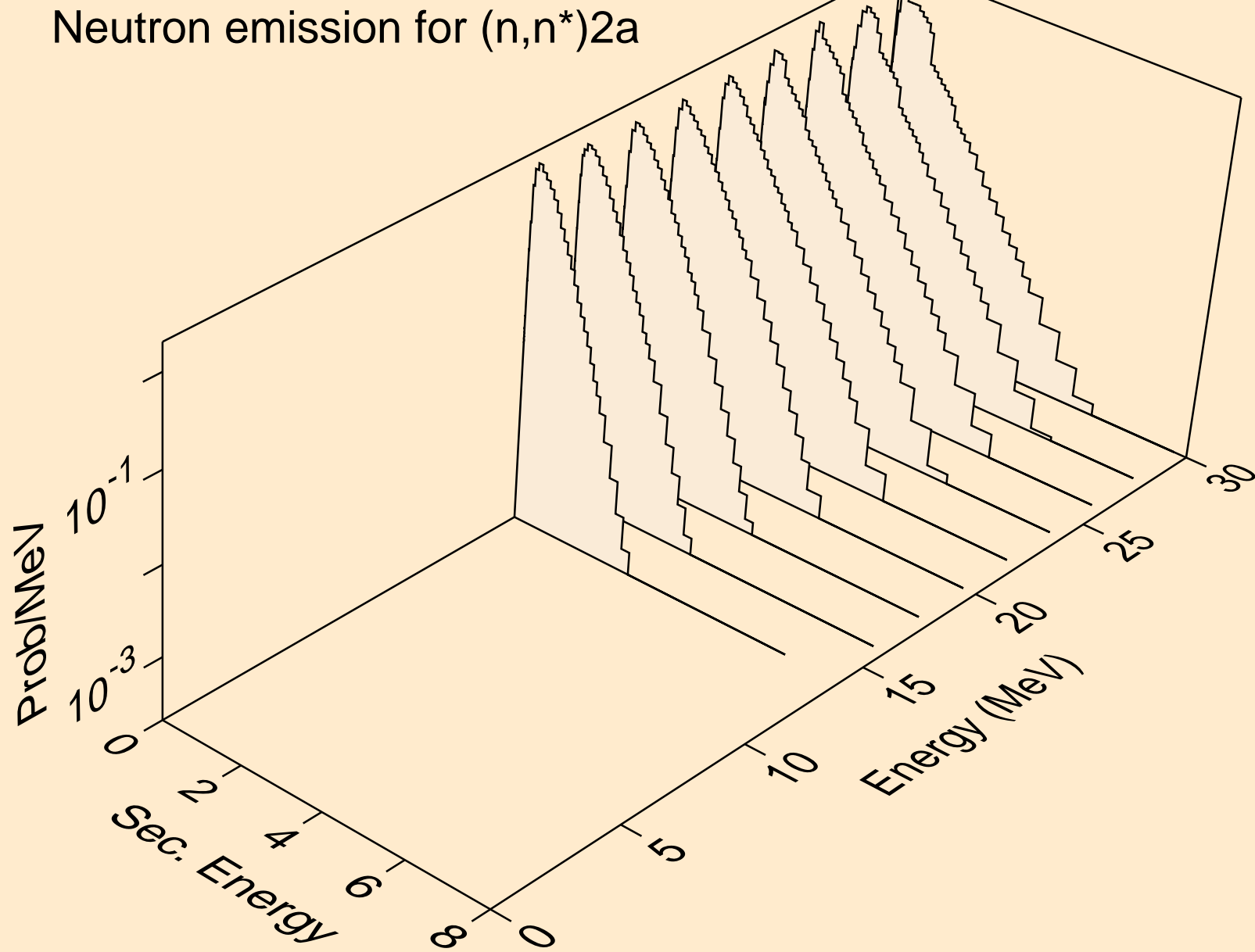

AU193 NEUTRON ACER TENDL-2024 LIBRARY; T=0.K
Neutron emission for (n,n*)d

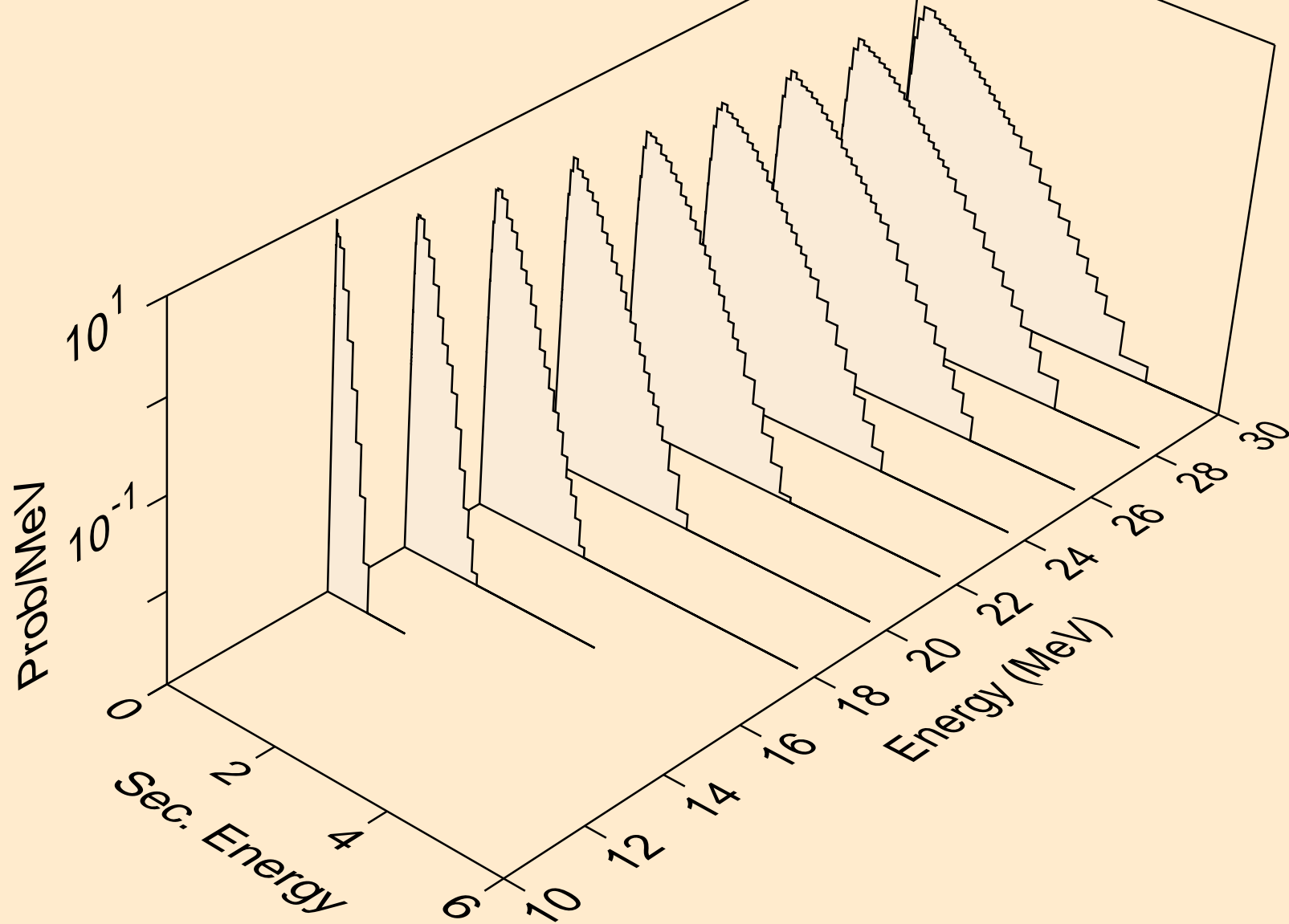

AU193 NEUTRON ACER TENDL-2024 LIBRARY; T=0.K
Neutron emission for (n,n*)t

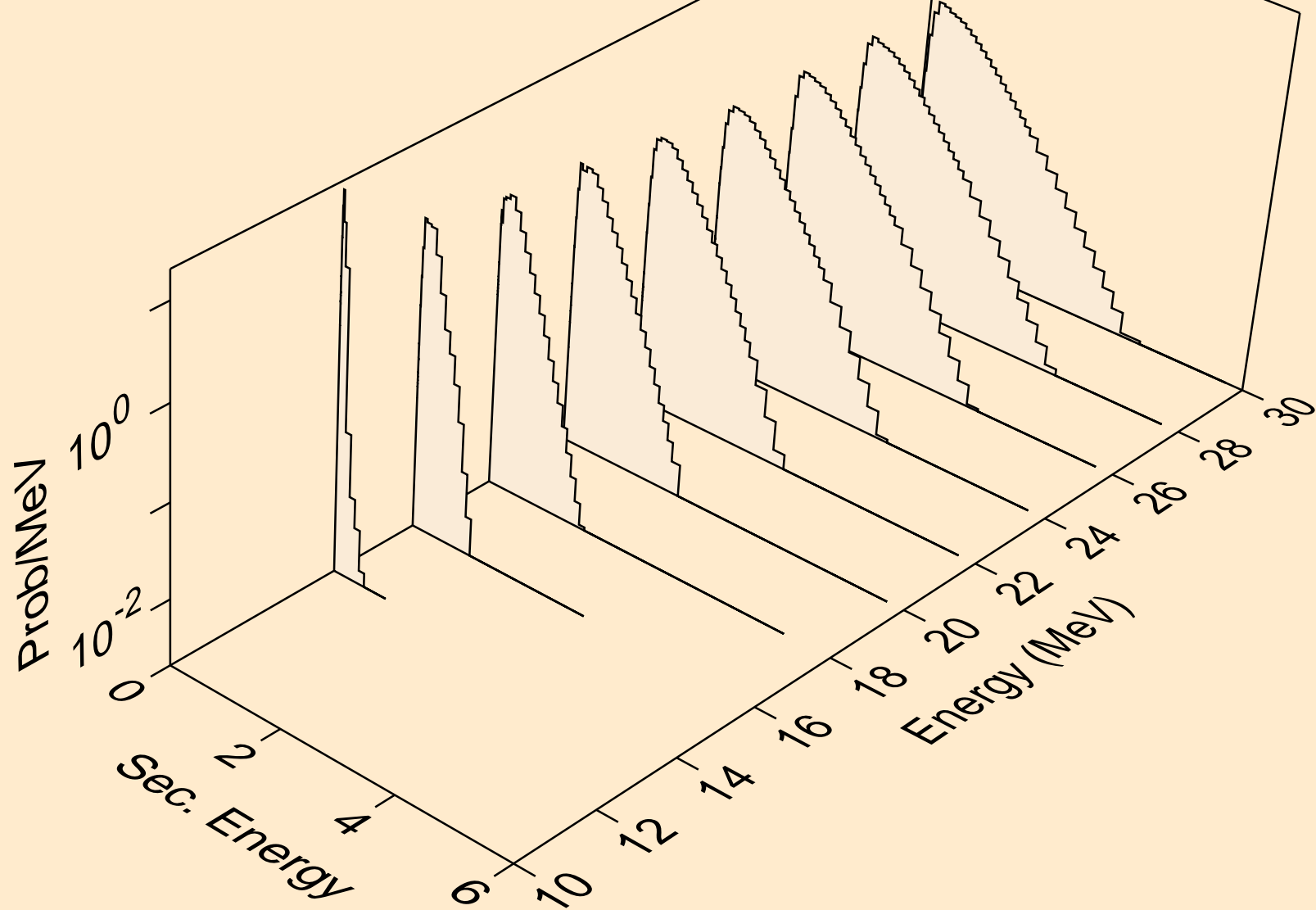

AU193 NEUTRON ACER TENDL-2024 LIBRARY; T=0.K
Neutron emission for (n,n*)he3

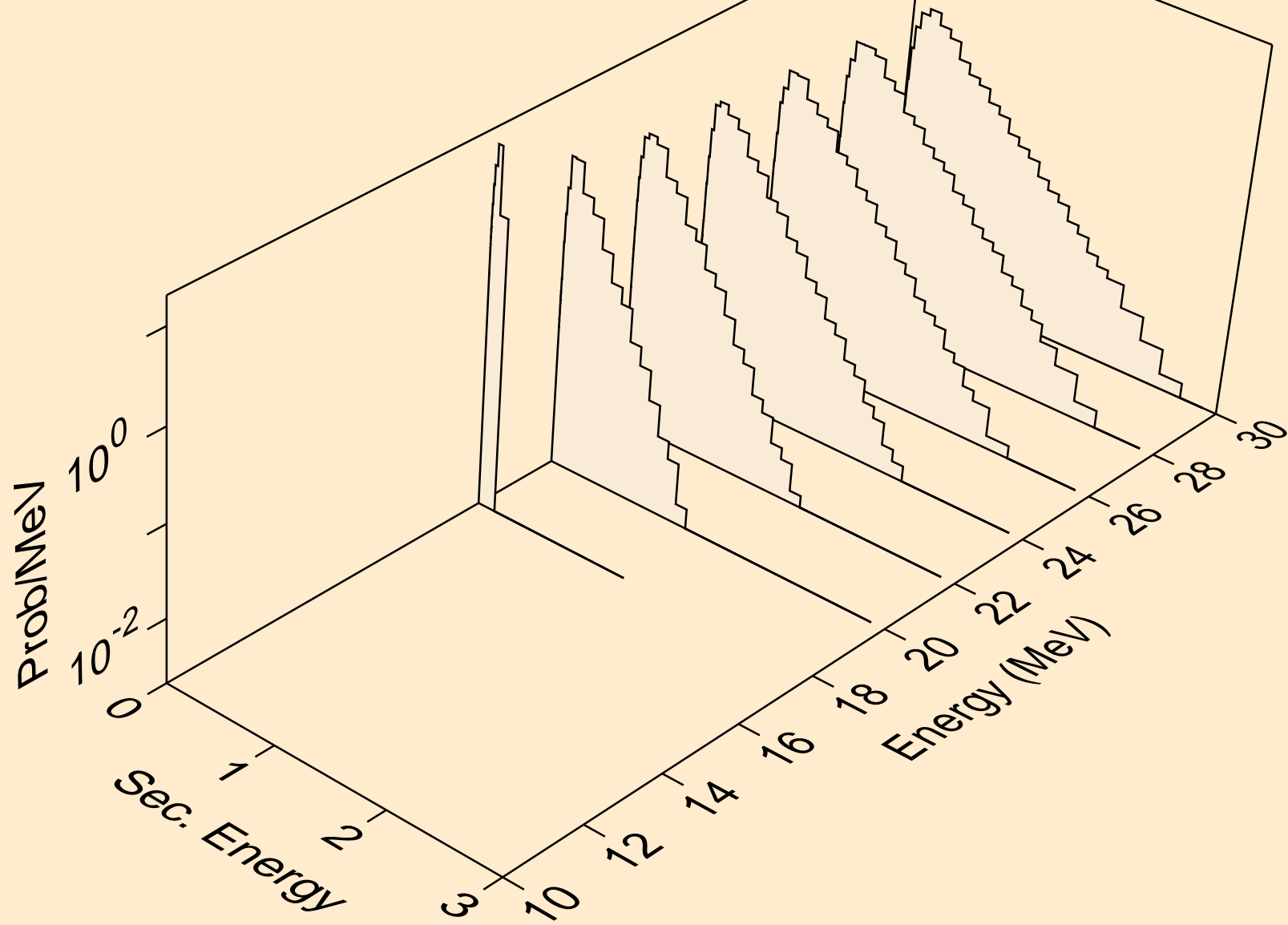

AU193 NEUTRON ACER TENDL-2024 LIBRARY; T=0.K
Neutron emission for (n,4n)

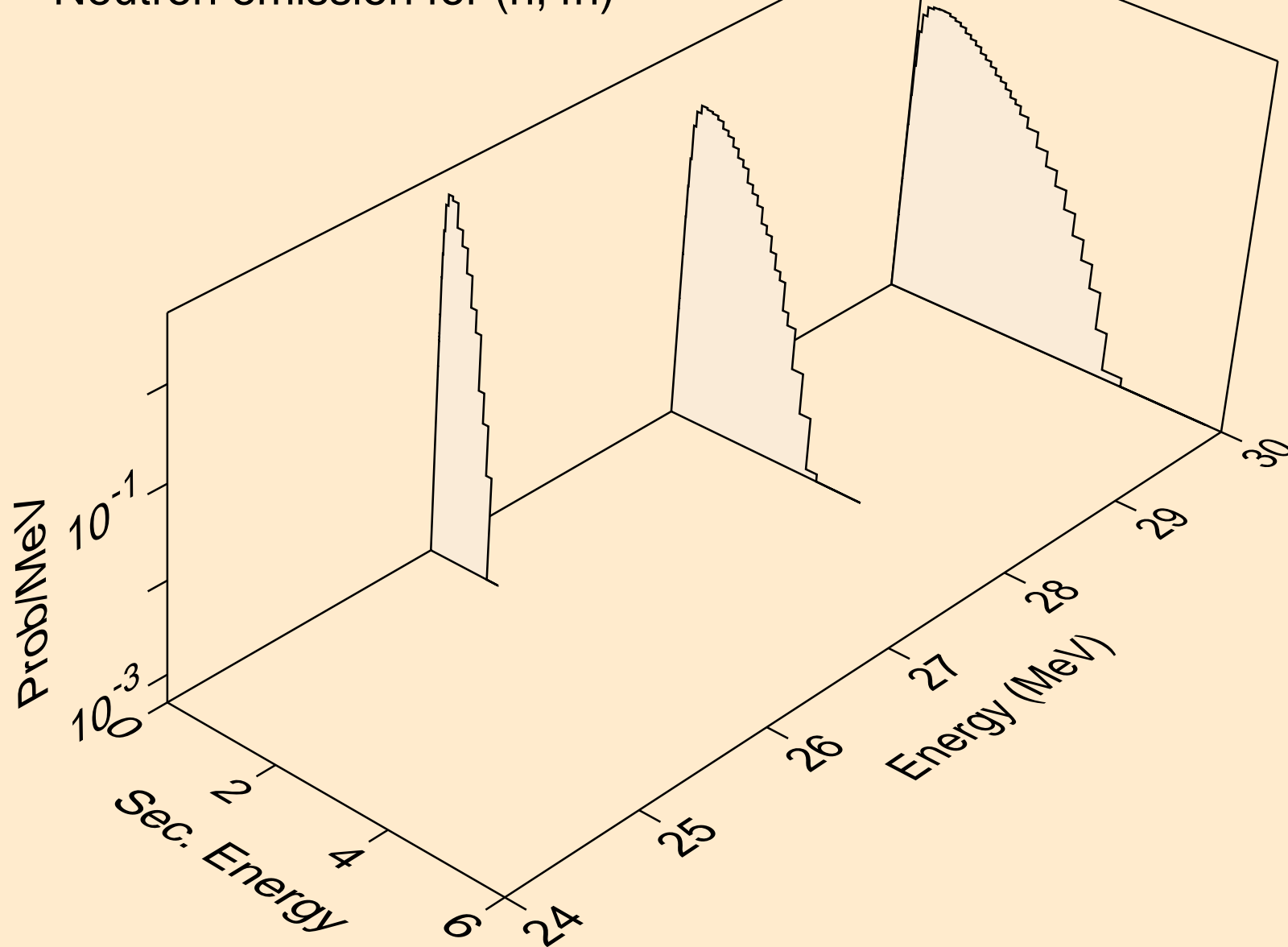

AU193 NEUTRON ACER TENDL-2024 LIBRARY; T=0.K
Neutron emission for (n,2np)

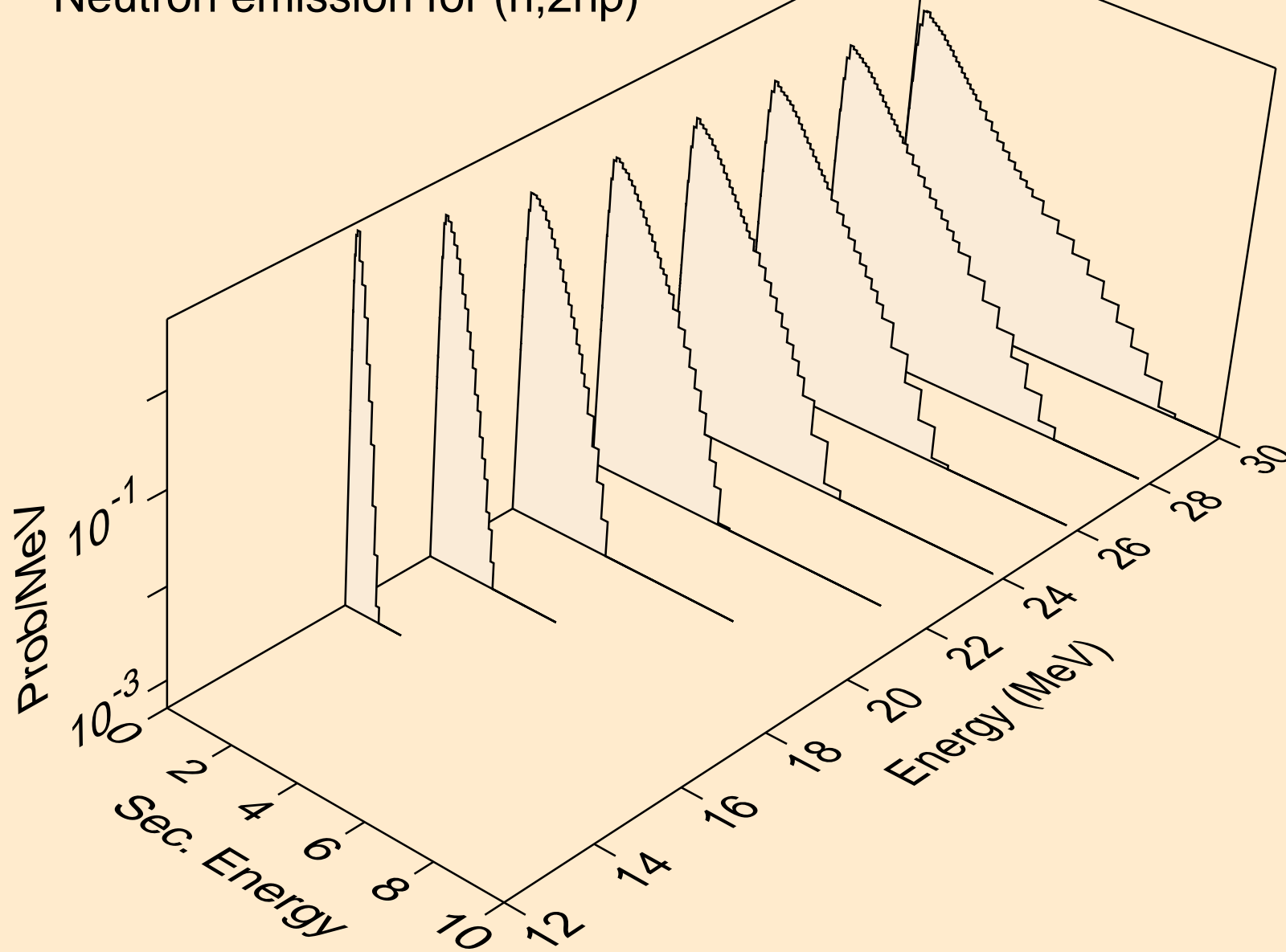

AU193 NEUTRON ACER TENDL-2024 LIBRARY; T=0.K
Neutron emission for (n,3np)

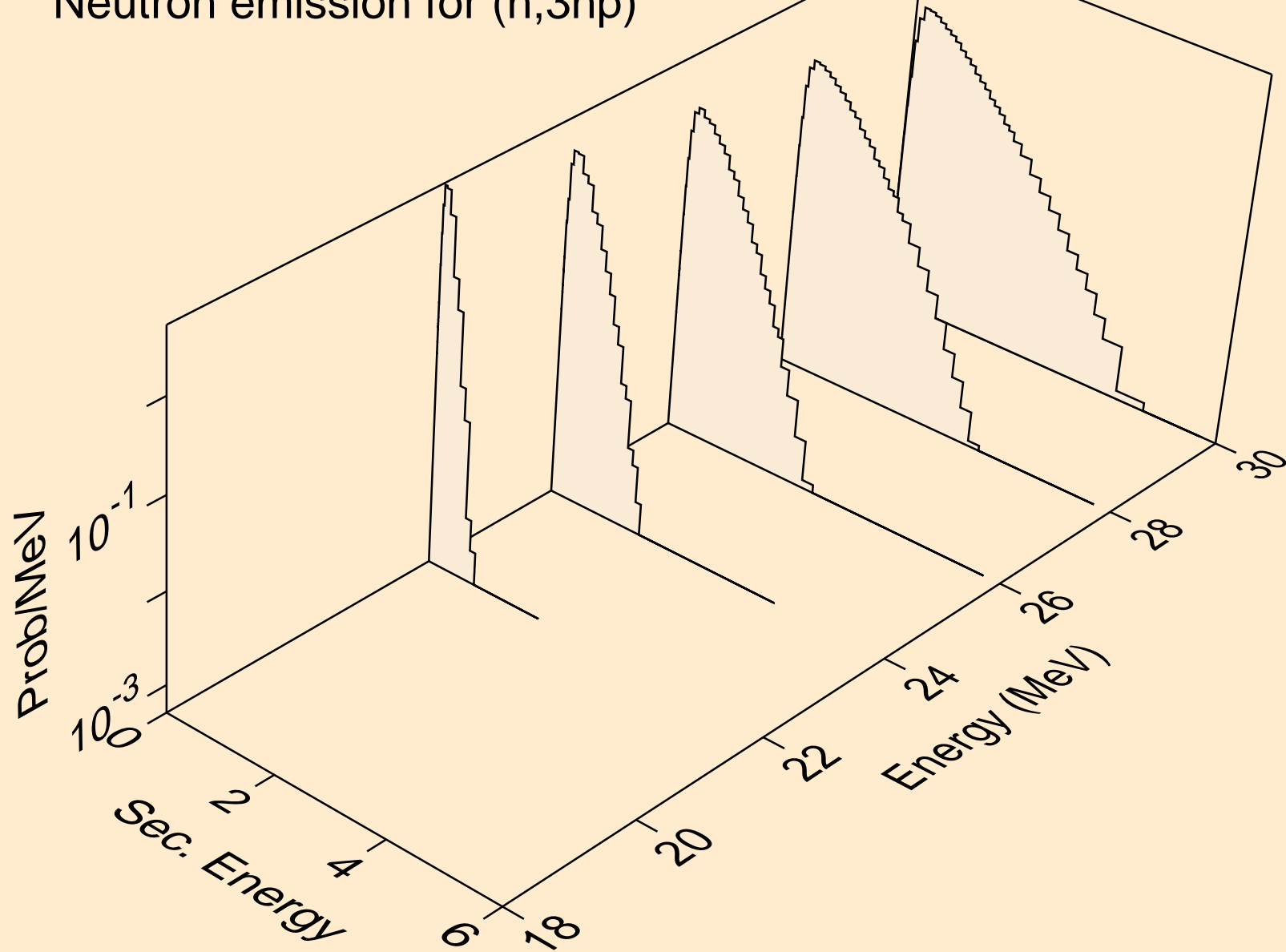

AU193 NEUTRON ACER TENDL-2024 LIBRARY; T=0.K
Neutron emission for (n,n2p)

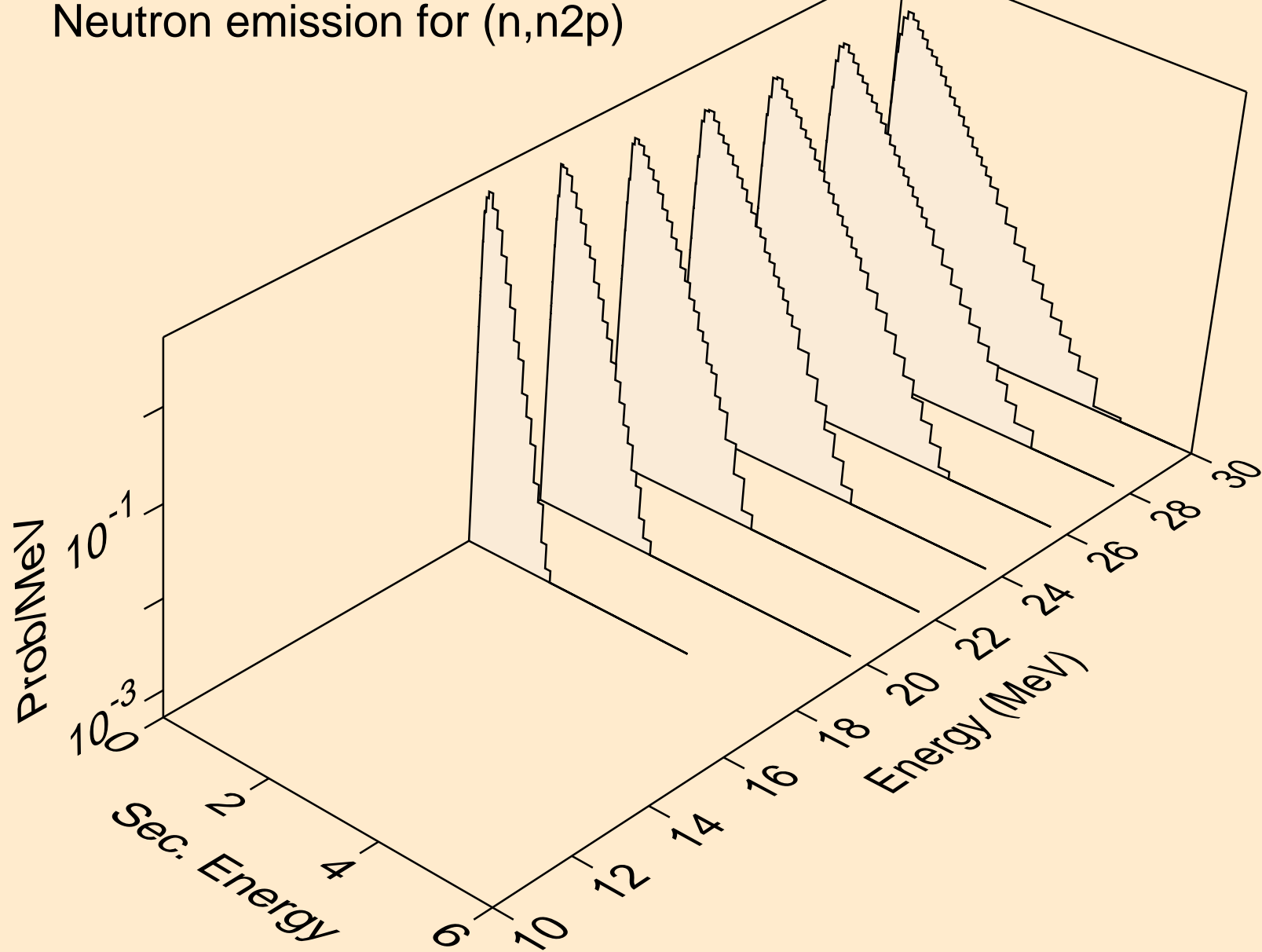

AU193 NEUTRON ACER TENDL-2024 LIBRARY; T=0.K
Neutron emission for (n,npa)

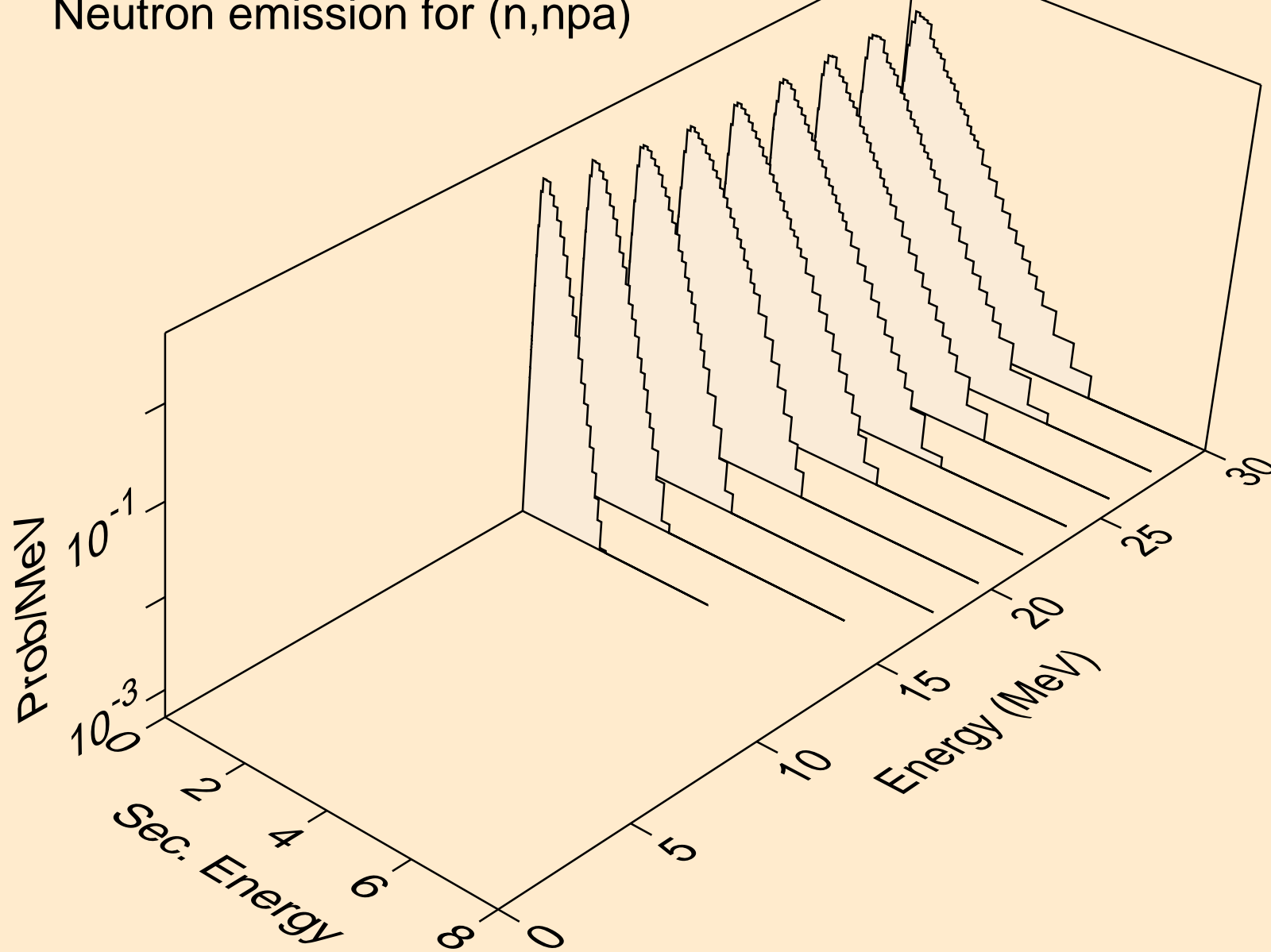

AU193 NEUTRON ACER TENDL-2024 LIBRARY; T=0.K
Neutron emission for (n,n*c)

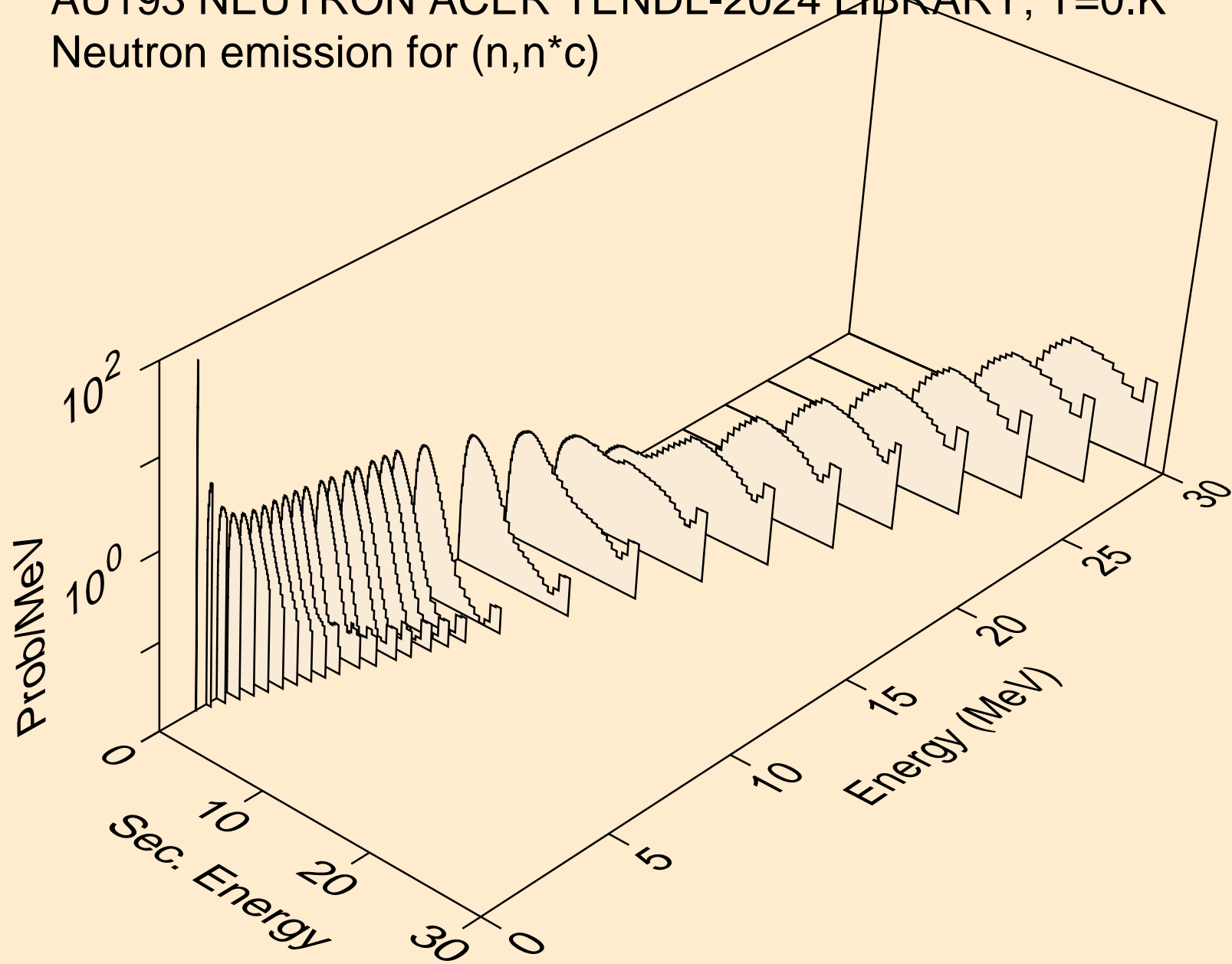

AU193 NEUTRON ACER TENDL-2024 LIBRARY; T=0.K
Photon emission for (n,x)

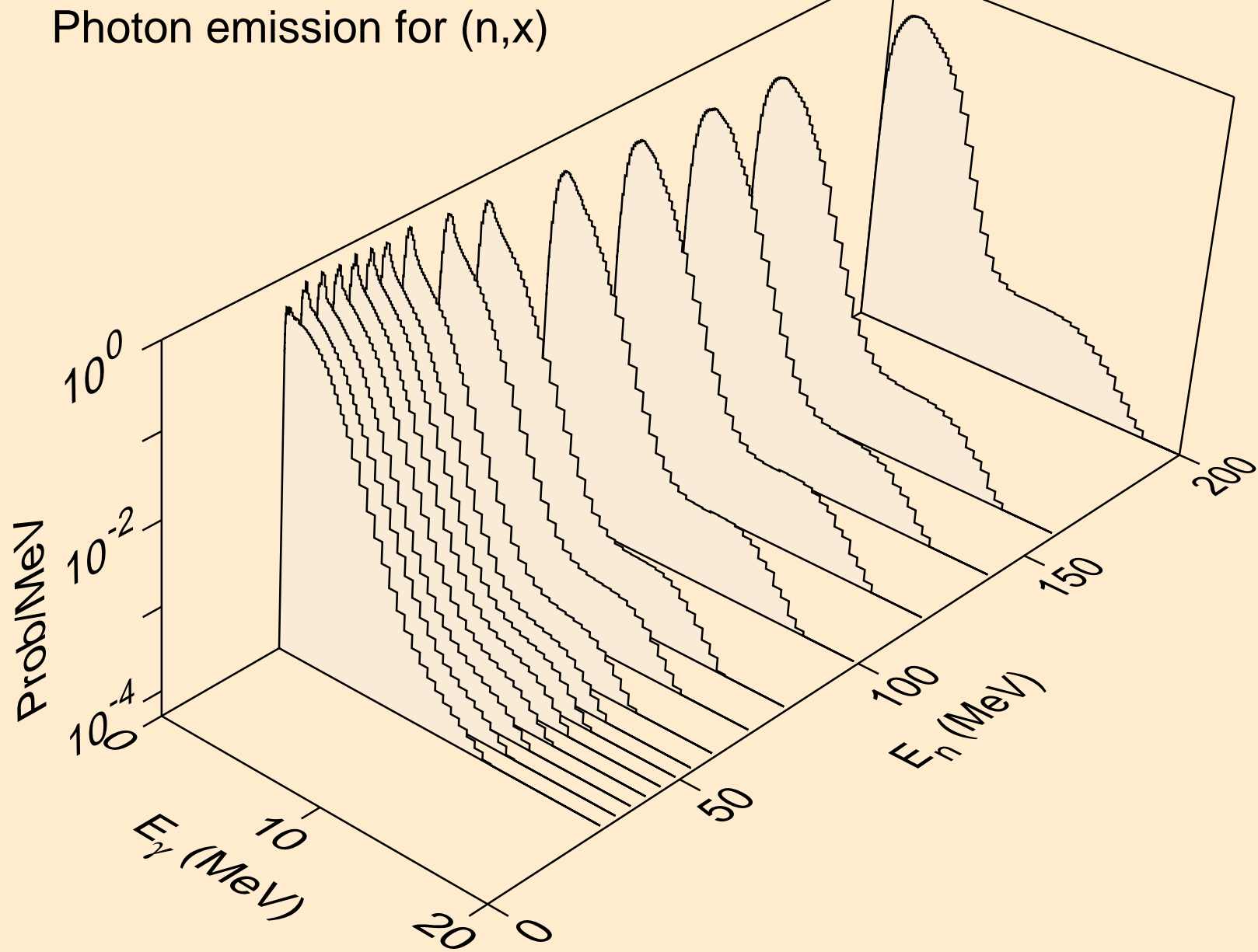

AU193 NEUTRON ACER TENDL-2024 LIBRARY; T=0.K
Photon emission for (n,2nd)

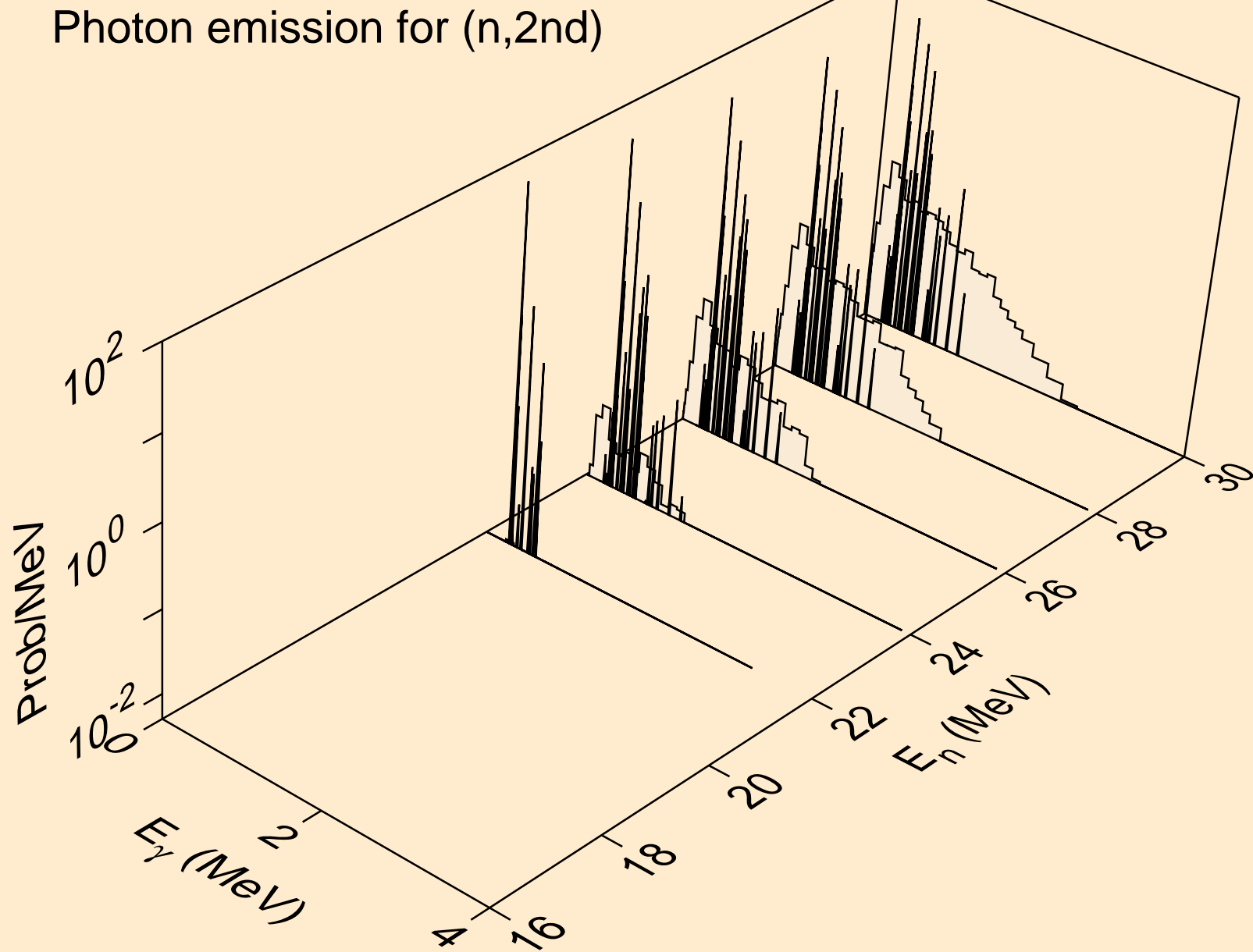

AU193 NEUTRON ACER TENDL-2024 LIBRARY; T=0.K
Photon emission for (n,2n)

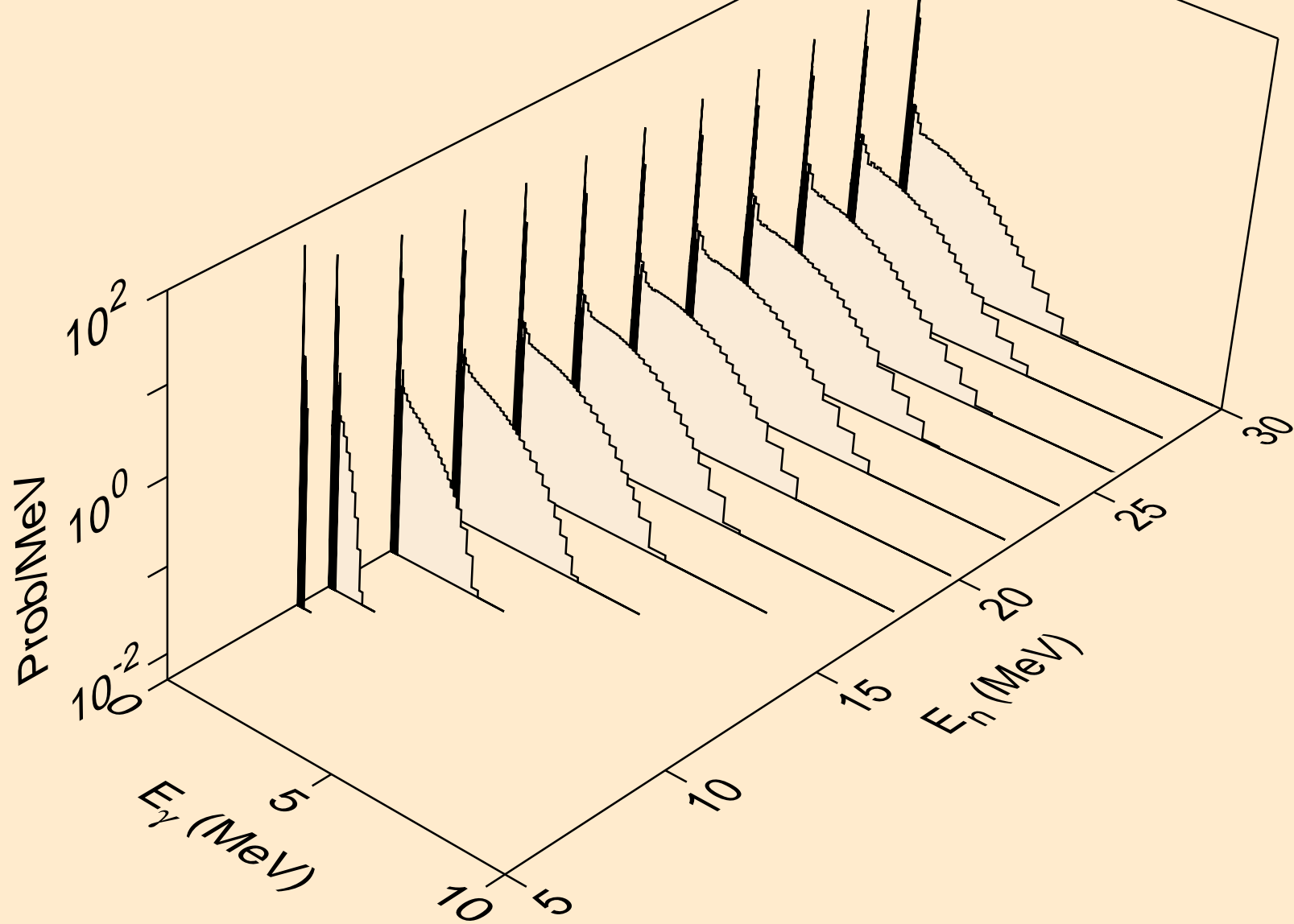

AU193 NEUTRON ACER TENDL-2024 LIBRARY; T=0.K
Photon emission for (n,3n)

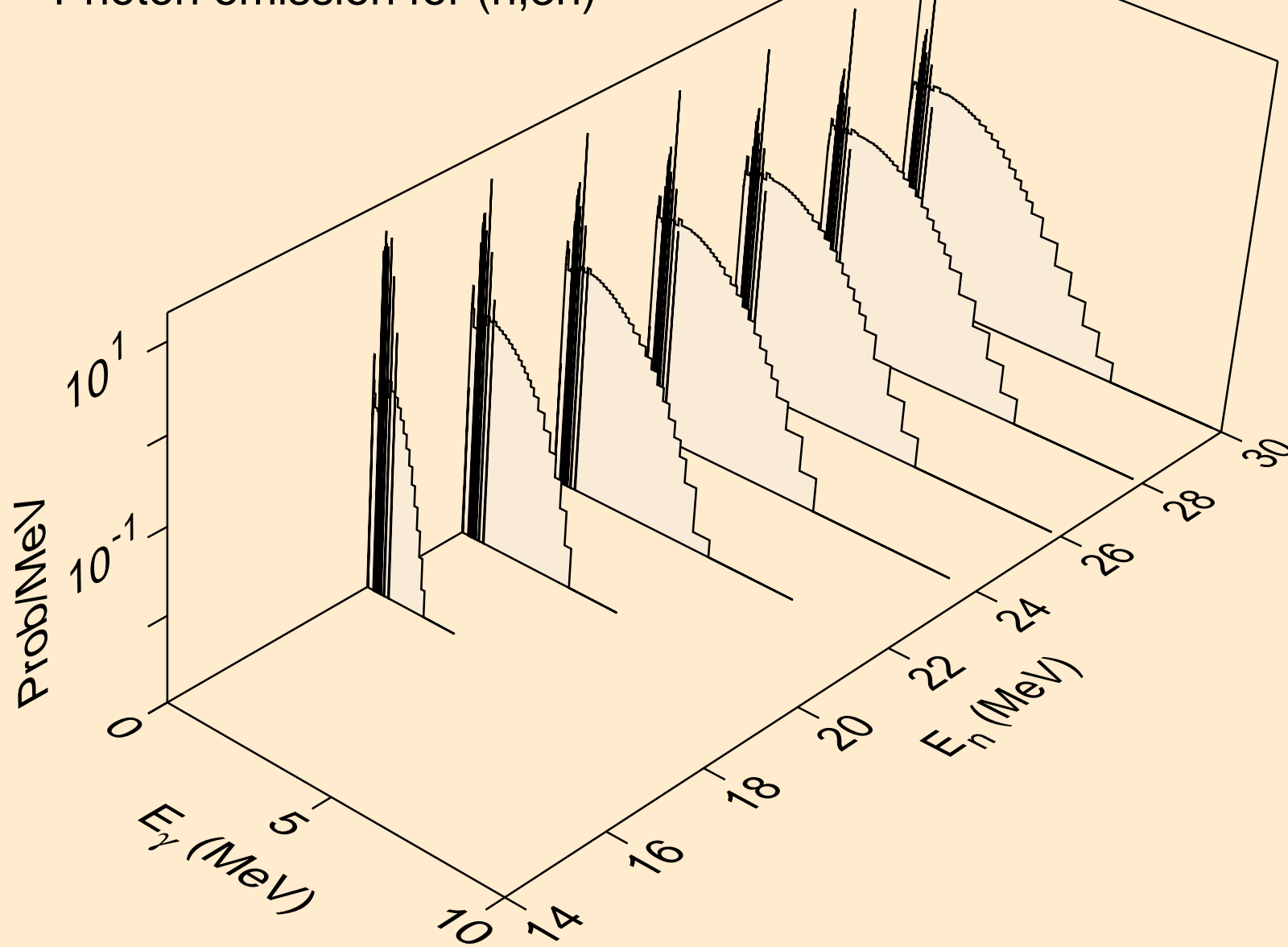

AU193 NEUTRON ACER TENDL-2024 LIBRARY; T=0.K
Photon emission for (n,n*)a

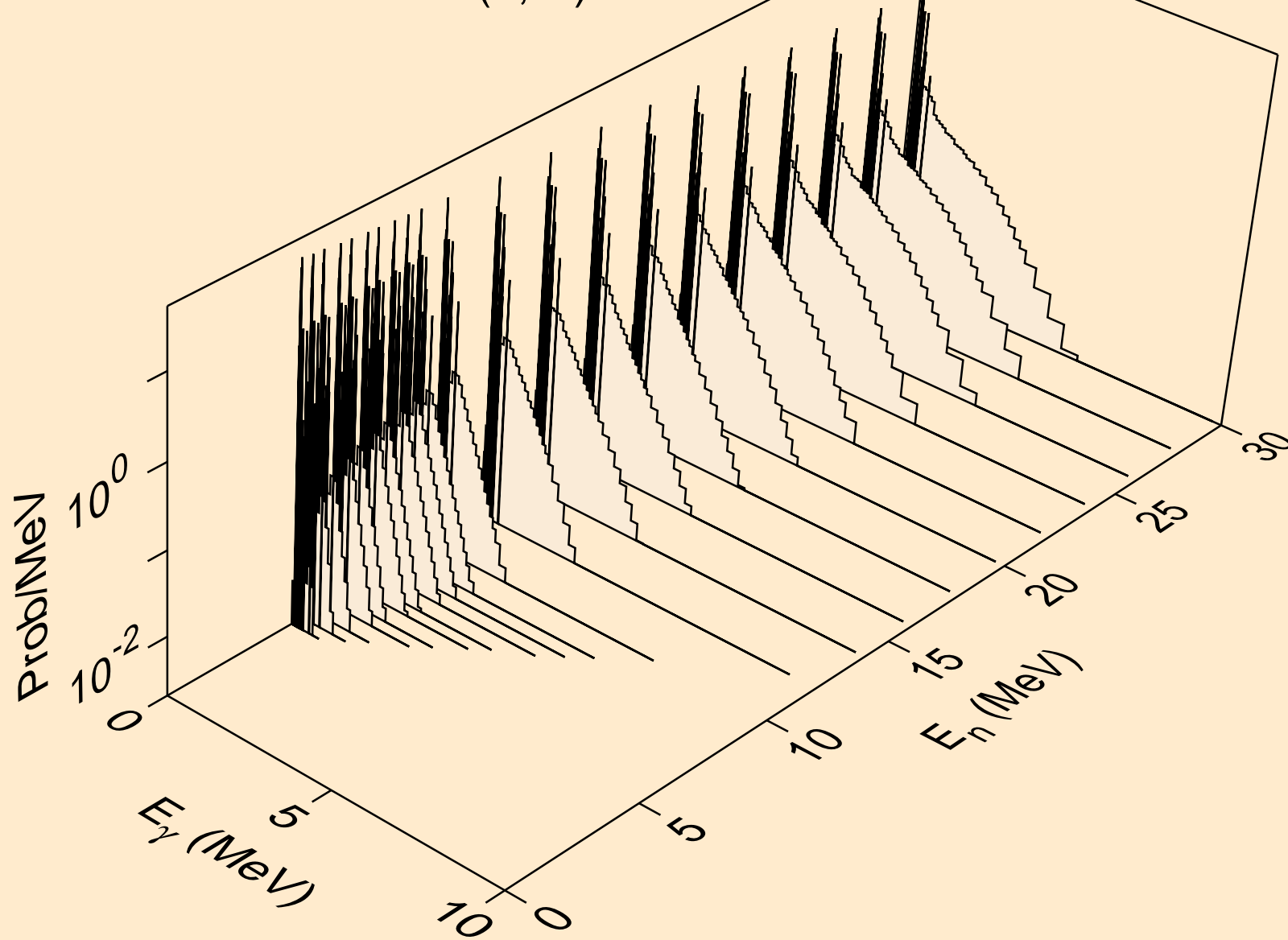

AU193 NEUTRON ACER TENDL-2024 LIBRARY; T=0.K
Photon emission for (n,2n)a

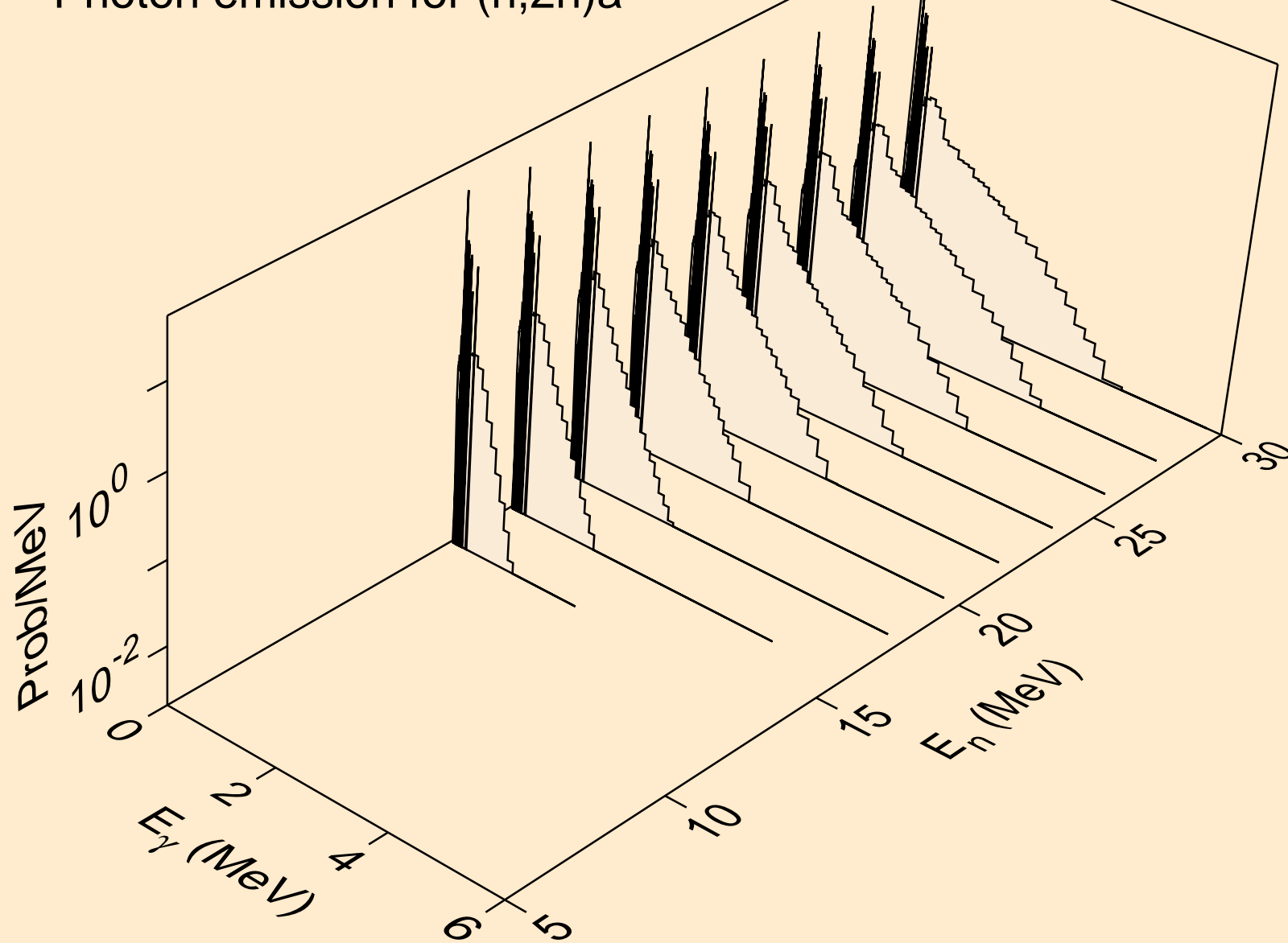

AU193 NEUTRON ACER TENDL-2024 LIBRARY; T=0.K
Photon emission for (n,3n)a

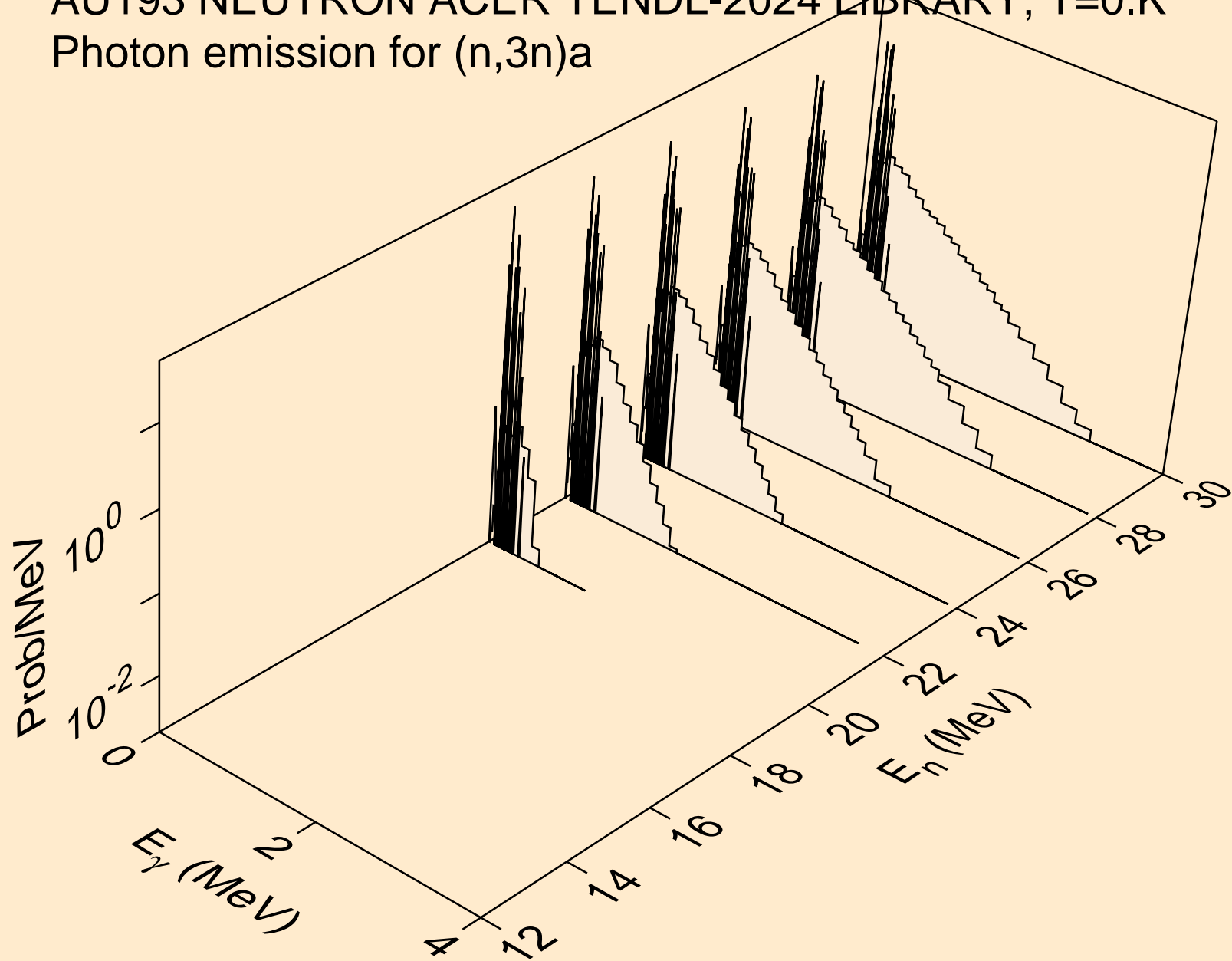

AU193 NEUTRON ACER TENDL-2024 LIBRARY; T=0.K
Photon emission for (n,n*)p

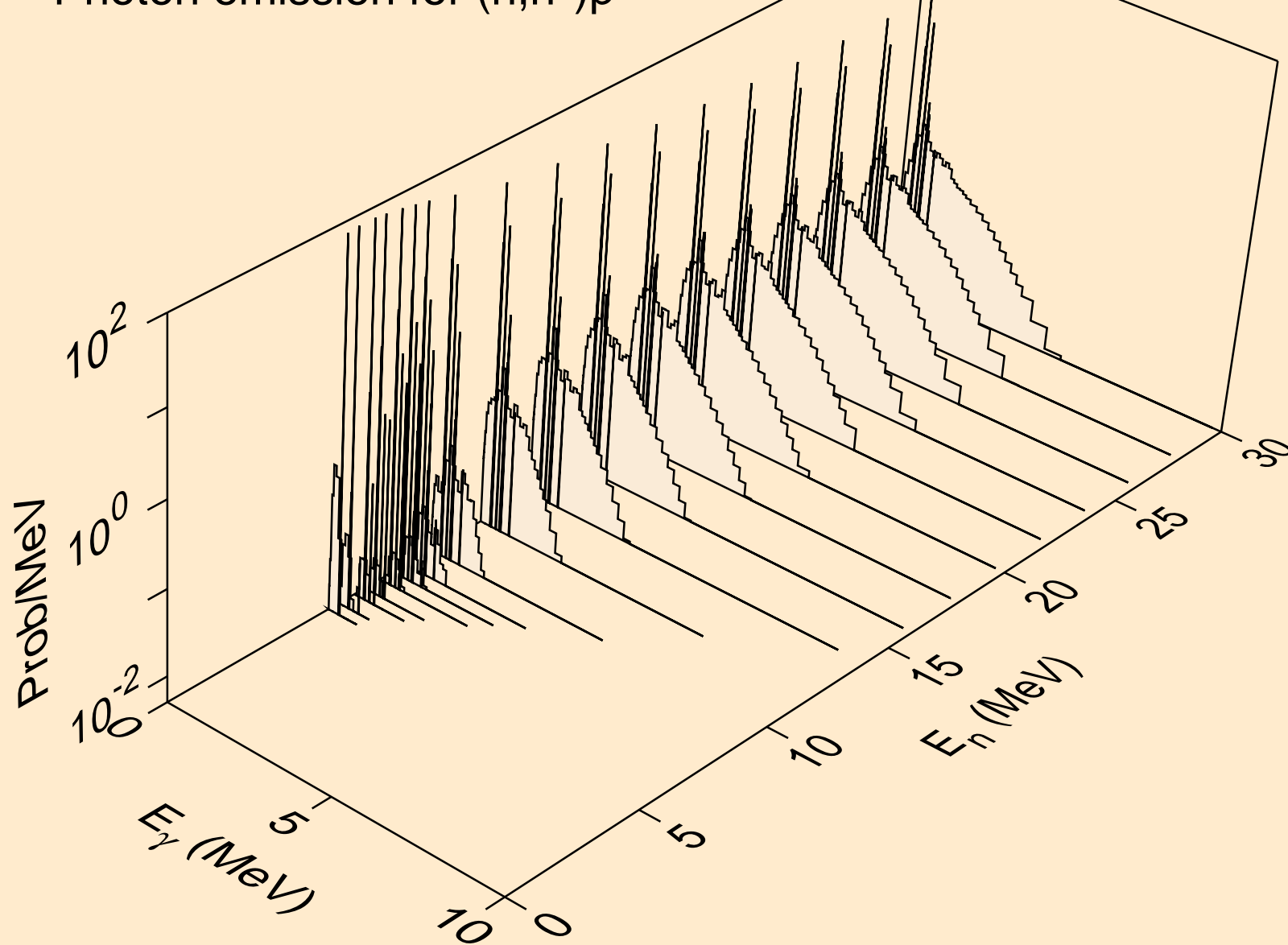

AU193 NEUTRON ACER TENDL-2024 LIBRARY; T=0.K
Photon emission for (n,n*)2a

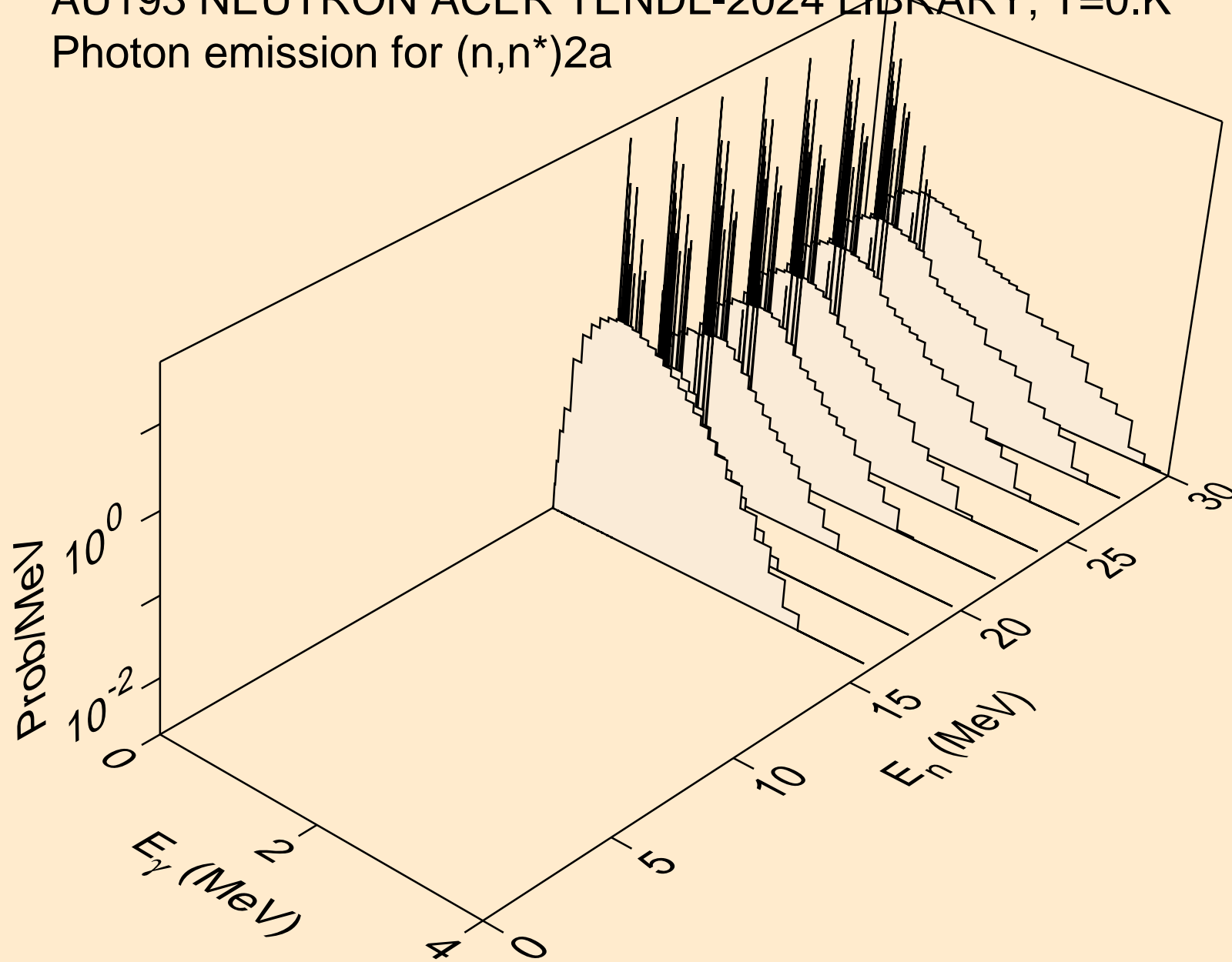

AU193 NEUTRON ACER TENDL-2024 LIBRARY; T=0.K
Photon emission for (n,n*)d

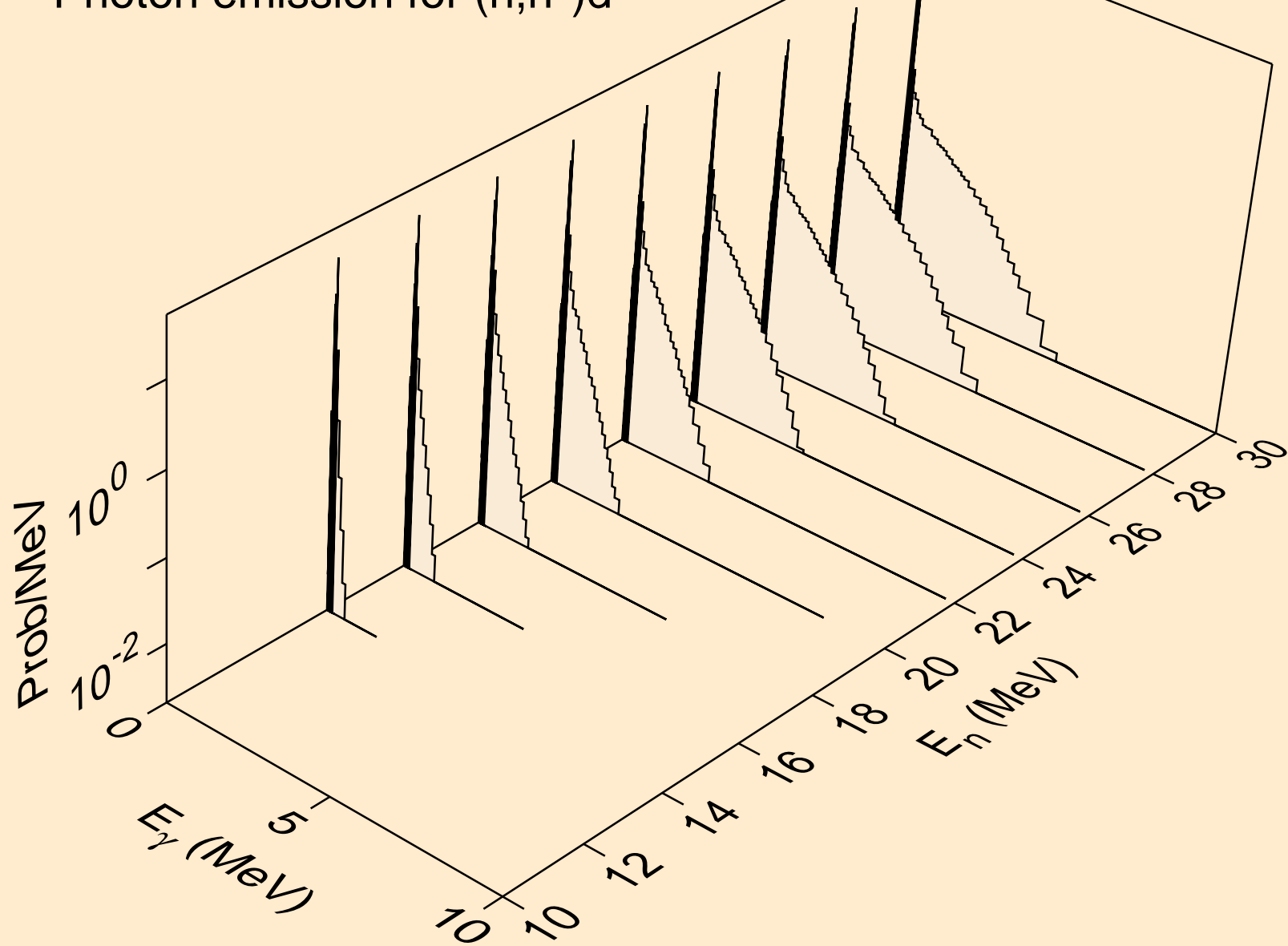

AU193 NEUTRON ACER TENDL-2024 LIBRARY; T=0.K
Photon emission for (n,n*)t

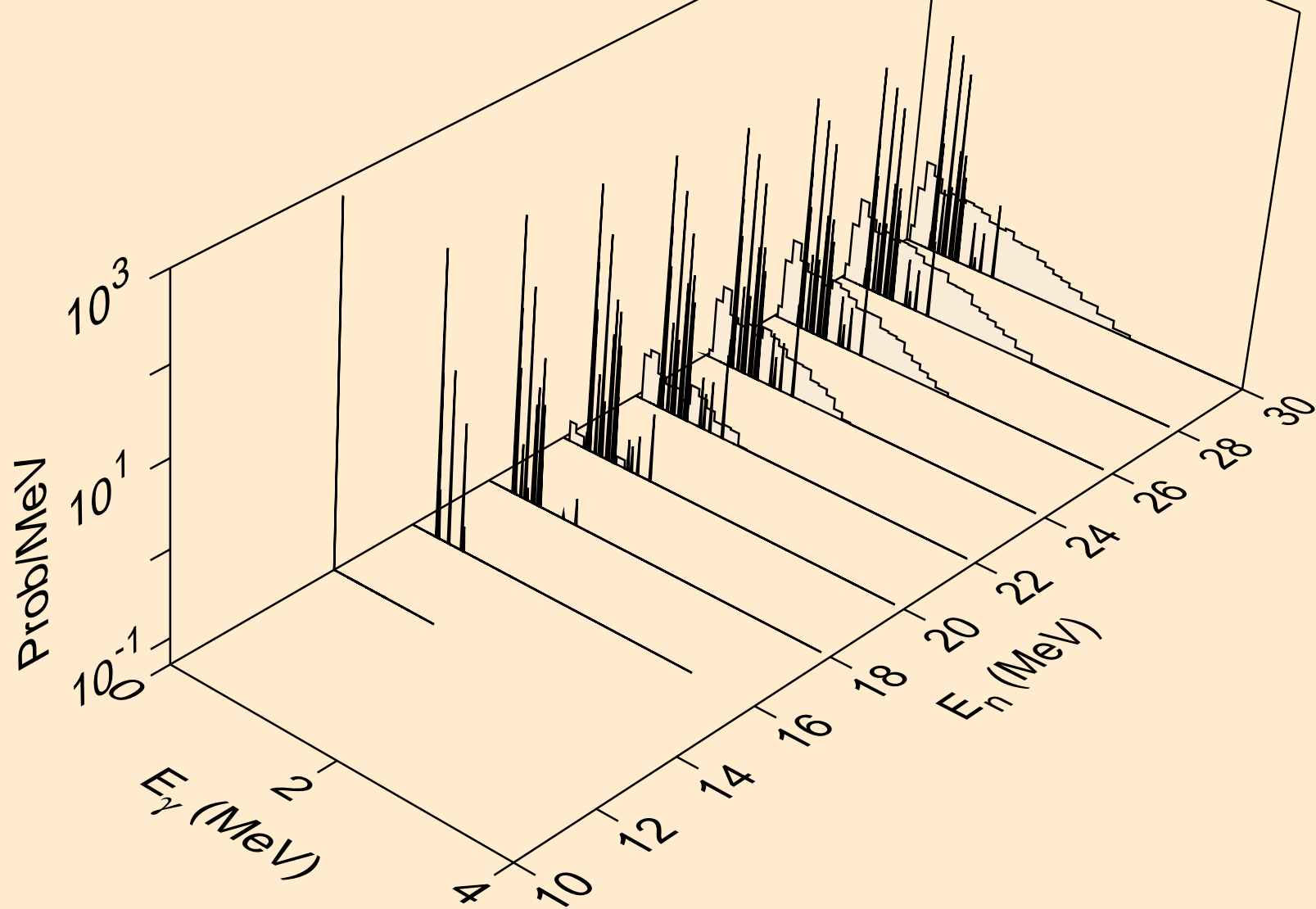

AU193 NEUTRON ACER TENDL-2024 LIBRARY; T=0.K
Photon emission for (n,n*)he3

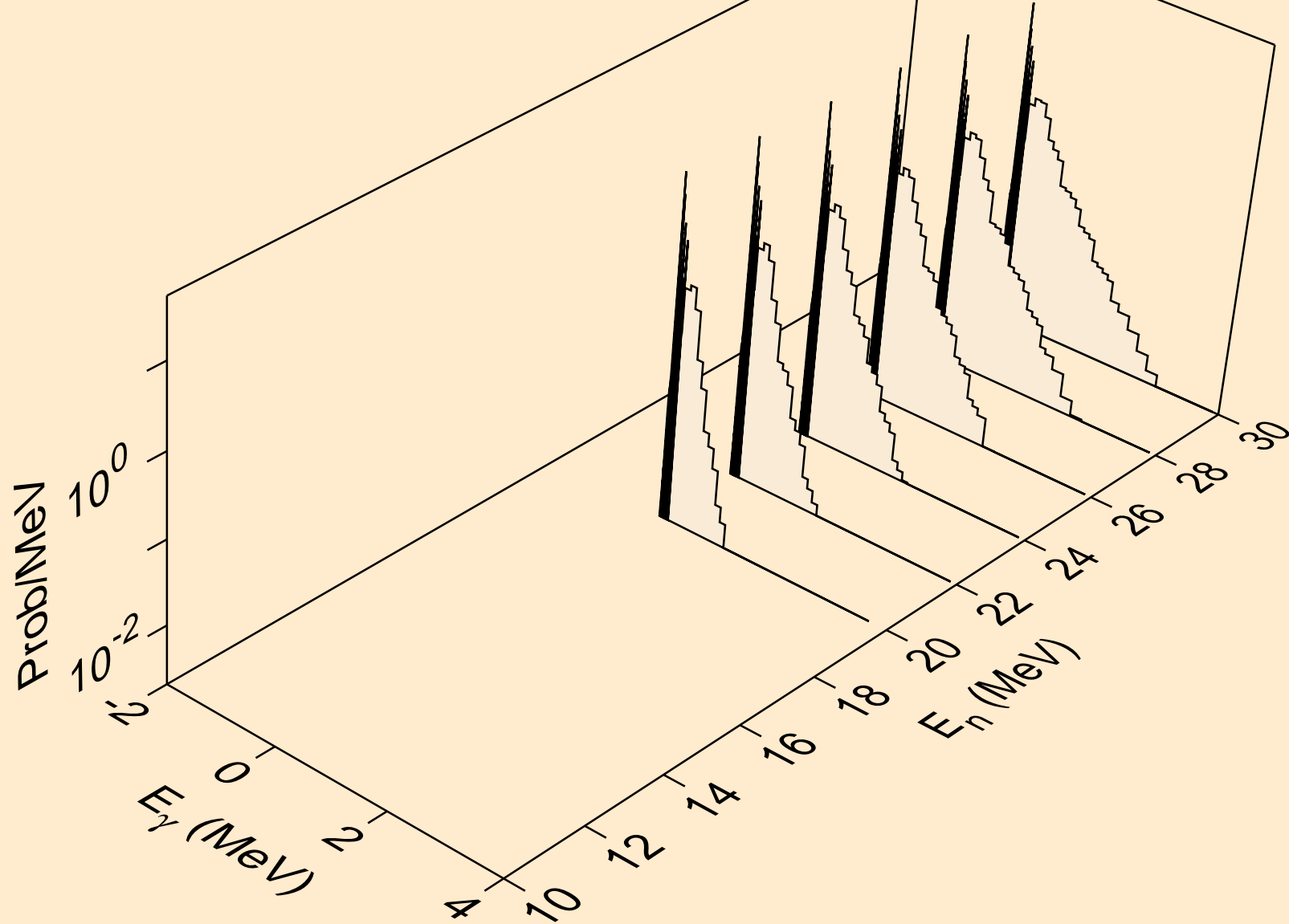

AU193 NEUTRON ACER TENDL-2024 LIBRARY; T=0.K
Photon emission for (n,4n)

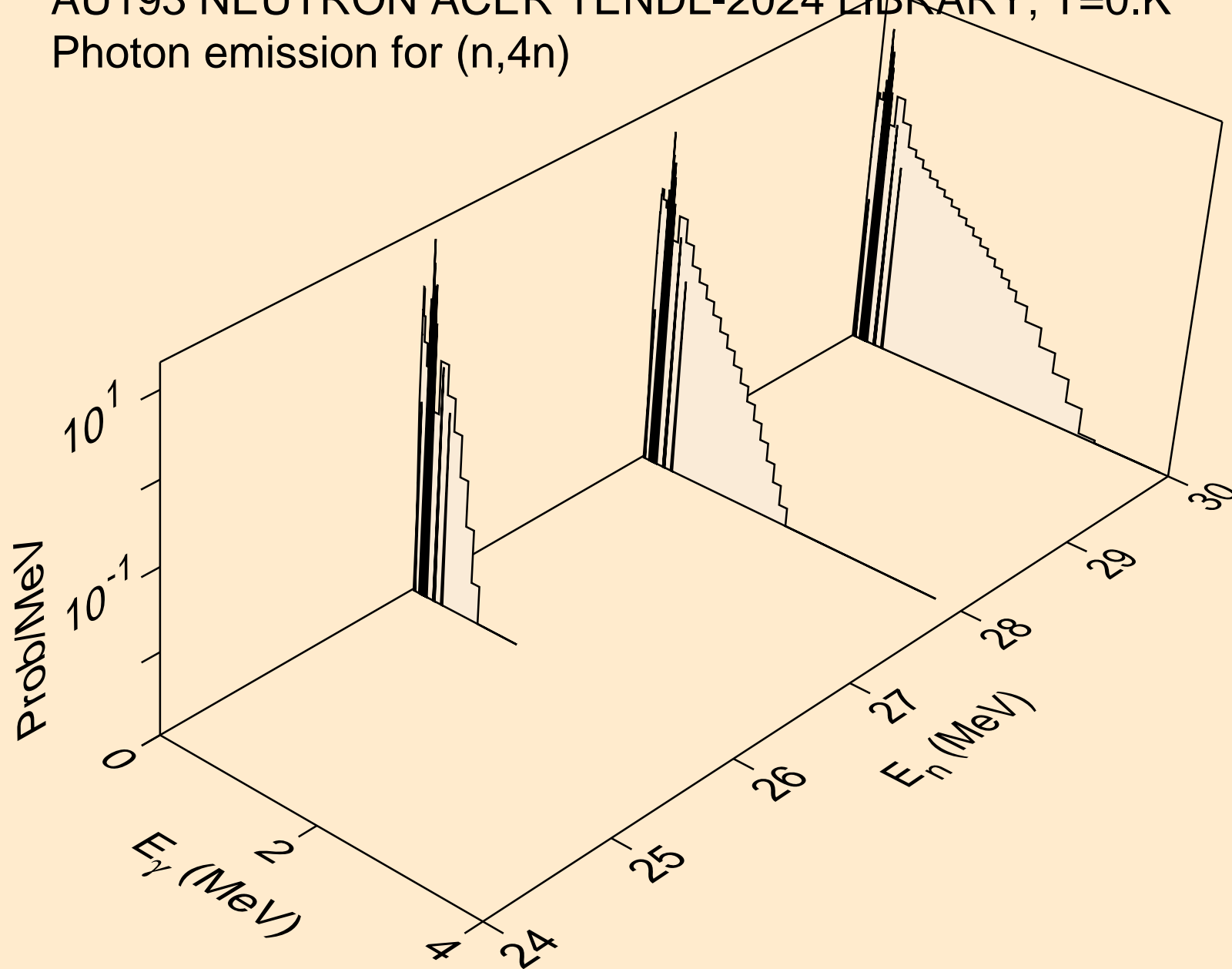

AU193 NEUTRON ACER TENDL-2024 LIBRARY; T=0.K
Photon emission for (n,2np)

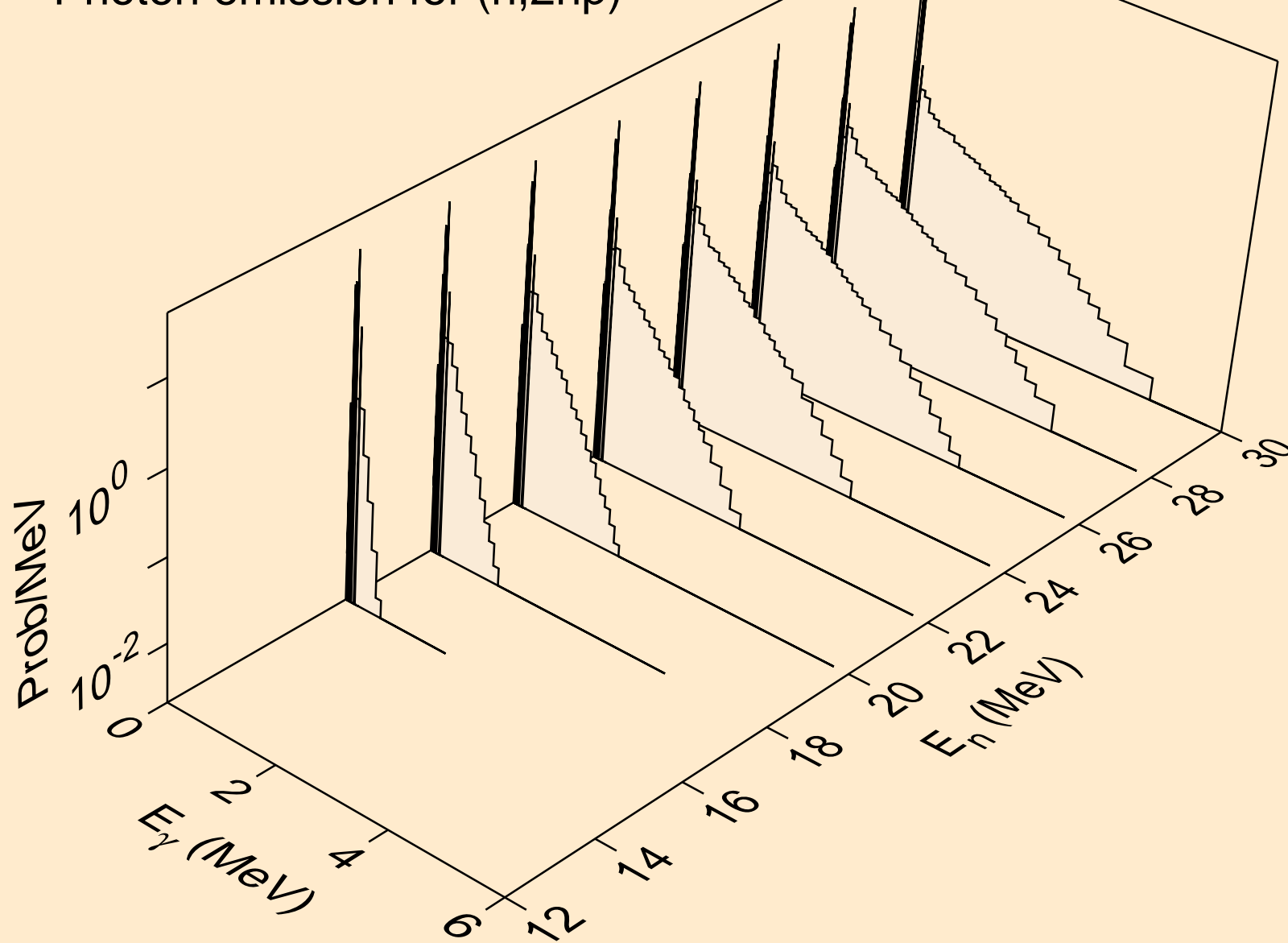

AU193 NEUTRON ACER TENDL-2024 LIBRARY; T=0.K
Photon emission for (n,3np)

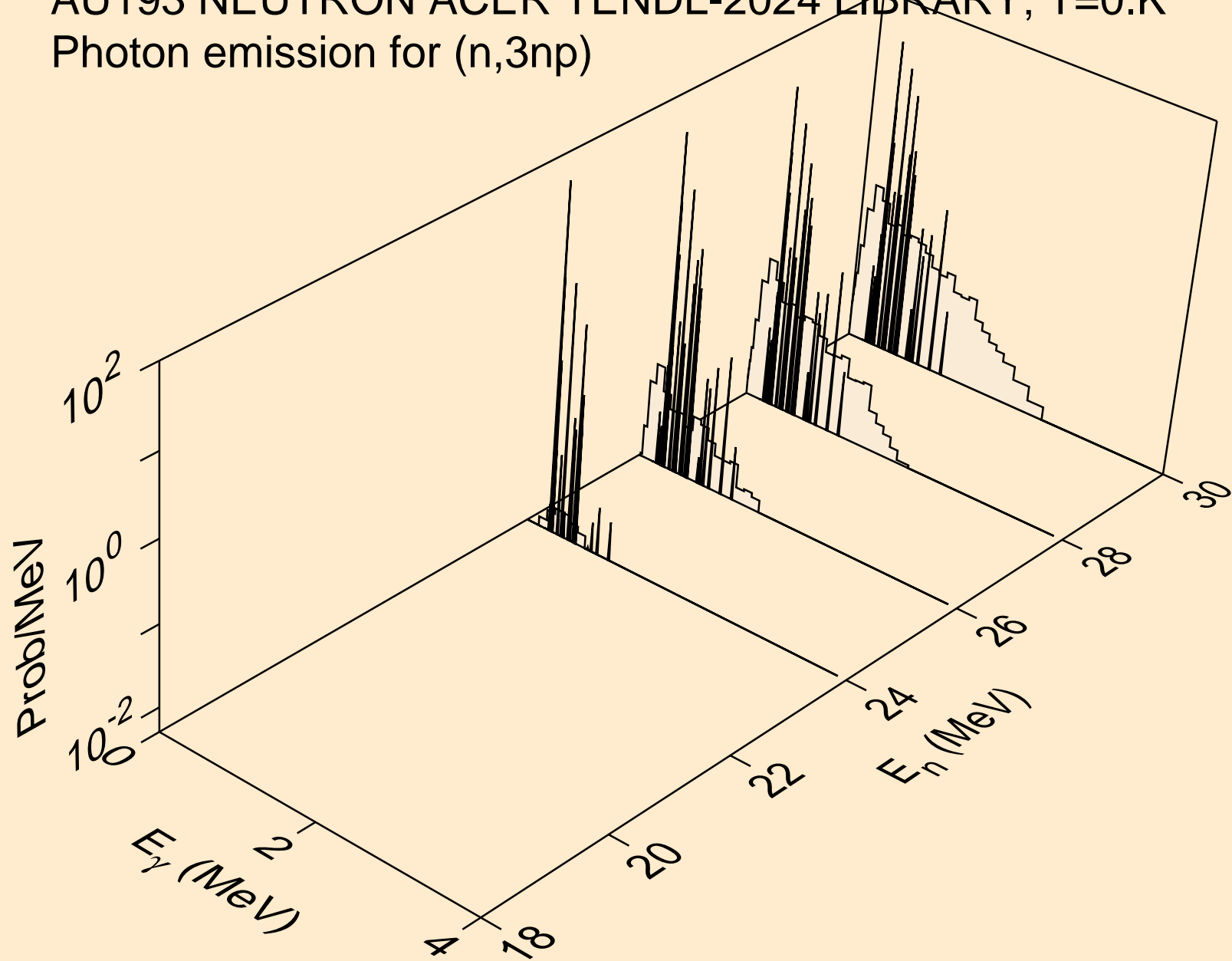

AU193 NEUTRON ACER TENDL-2024 LIBRARY; T=0.K
Photon emission for (n,n2p)

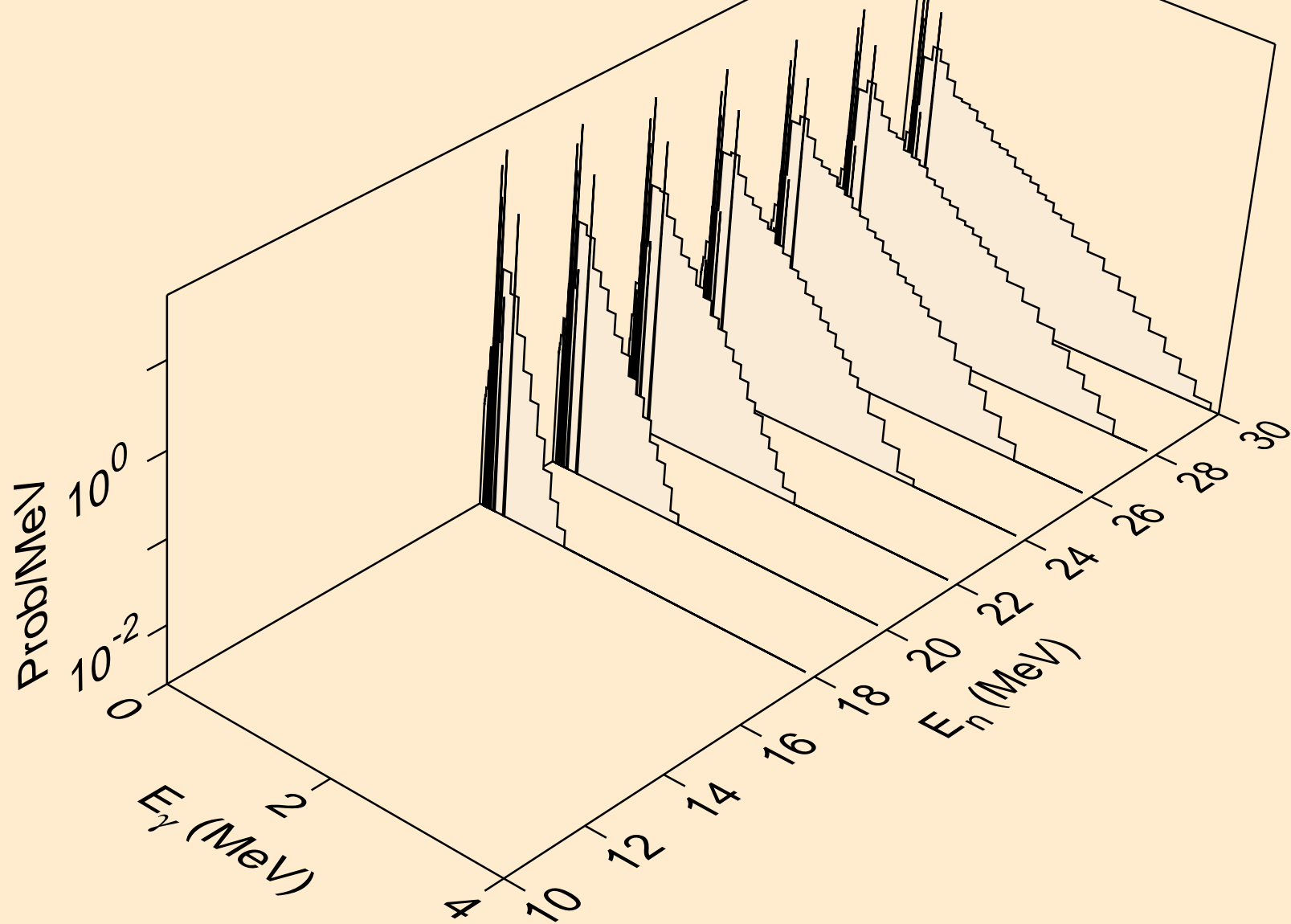

AU193 NEUTRON ACER TENDL-2024 LIBRARY; T=0.K
Photon emission for (n,npa)

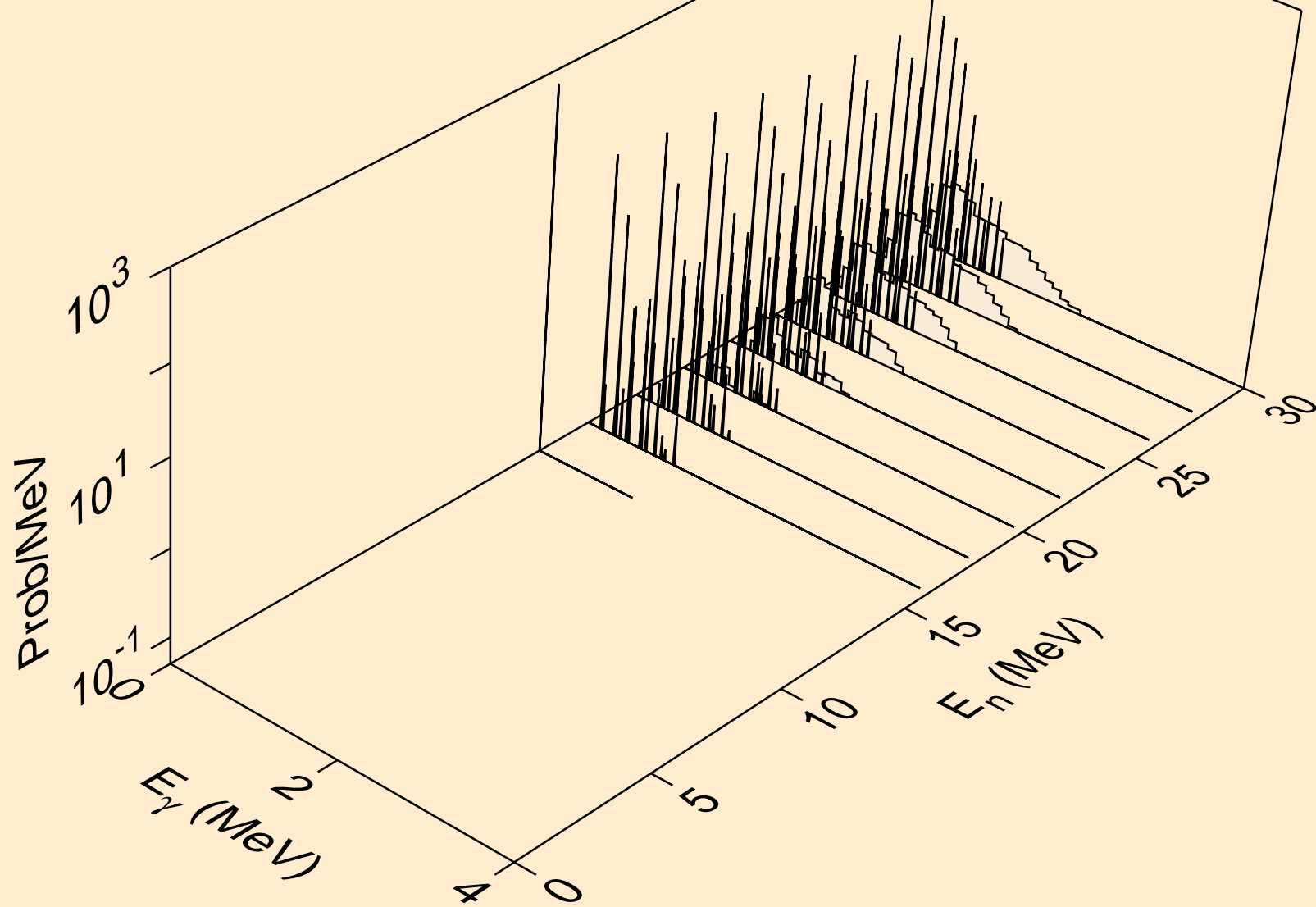

AU193 NEUTRON ACER TENDL-2024 LIBRARY; T=0.K
Photon emission for (n,n*c)

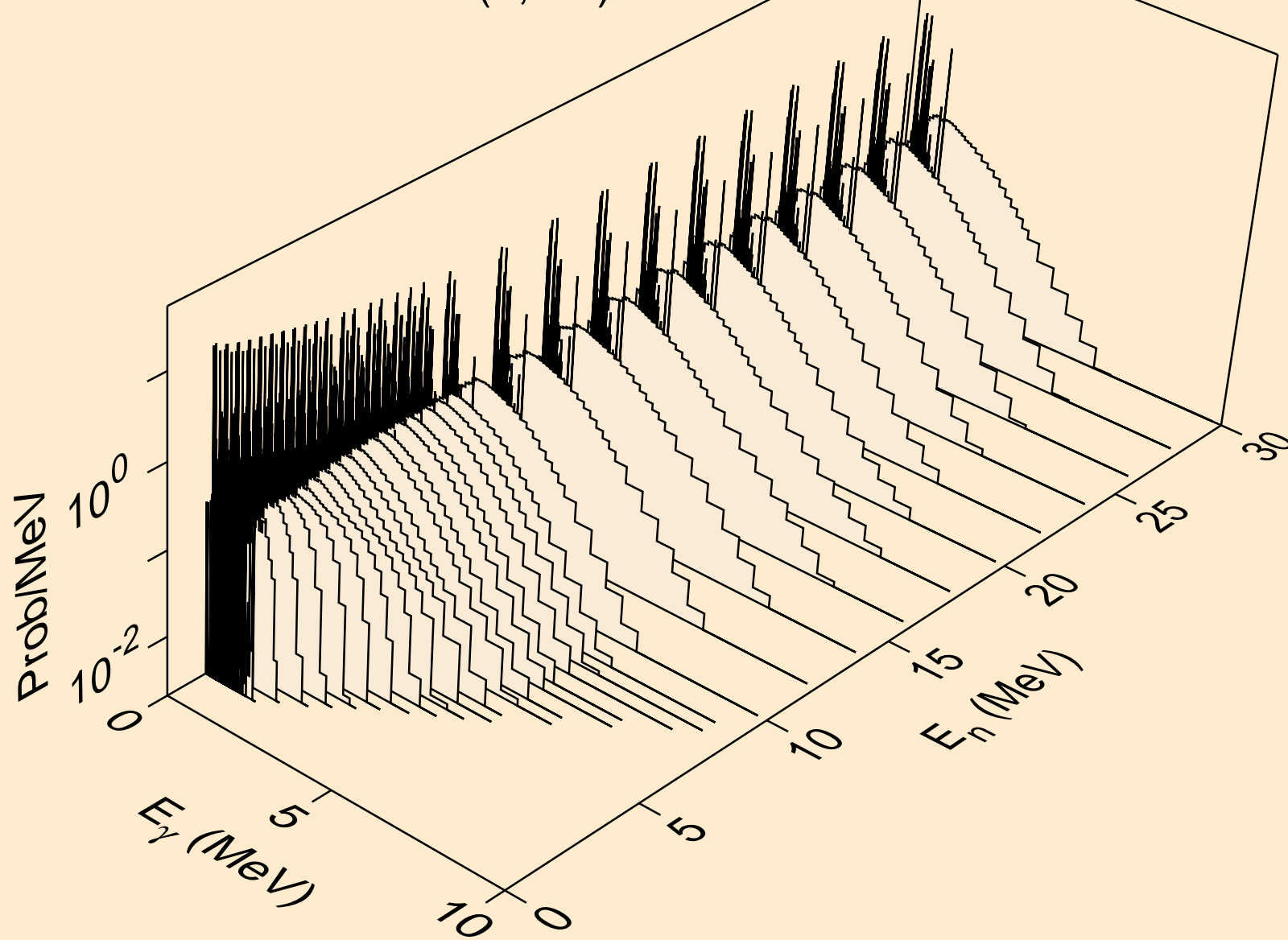

AU193 NEUTRON ACER TENDL-2024 LIBRARY; T=0.K
Photon emission for (n,gma)

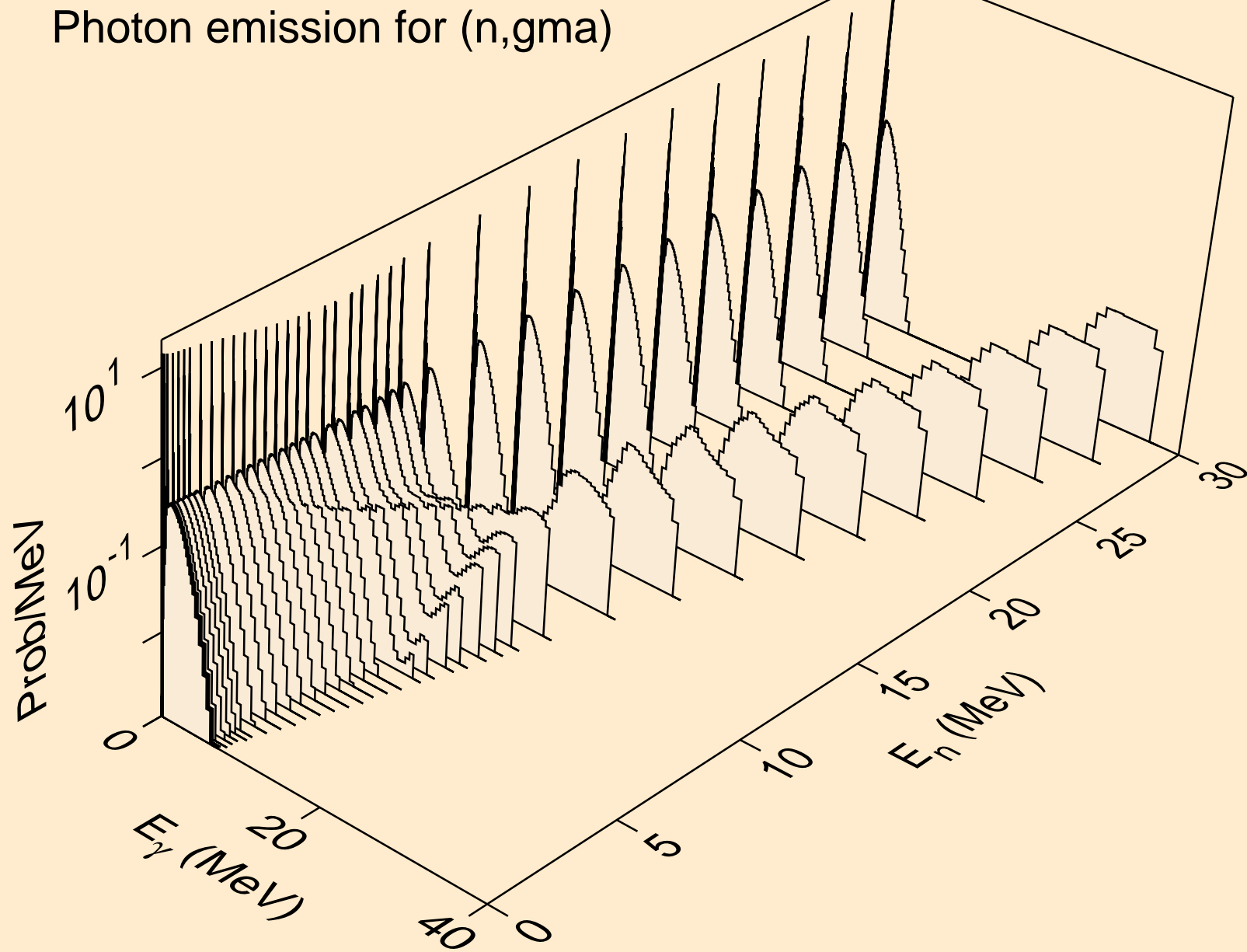

AU193 NEUTRON ACER TENDL-2024 LIBRARY; T=0.K
Photon emission for (n,p)

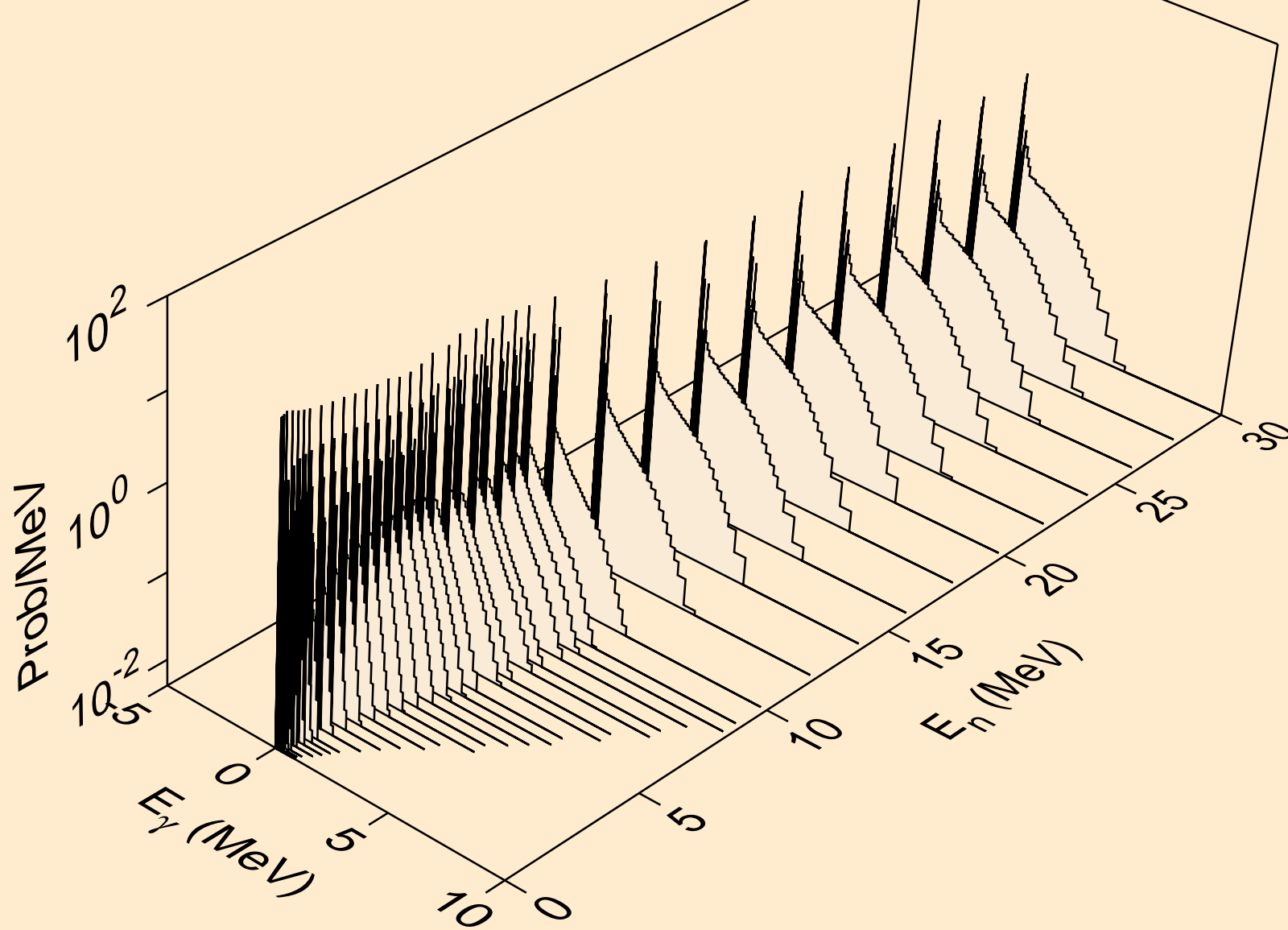

AU193 NEUTRON ACER TENDL-2024 LIBRARY; T=0.K
Photon emission for (n,d)

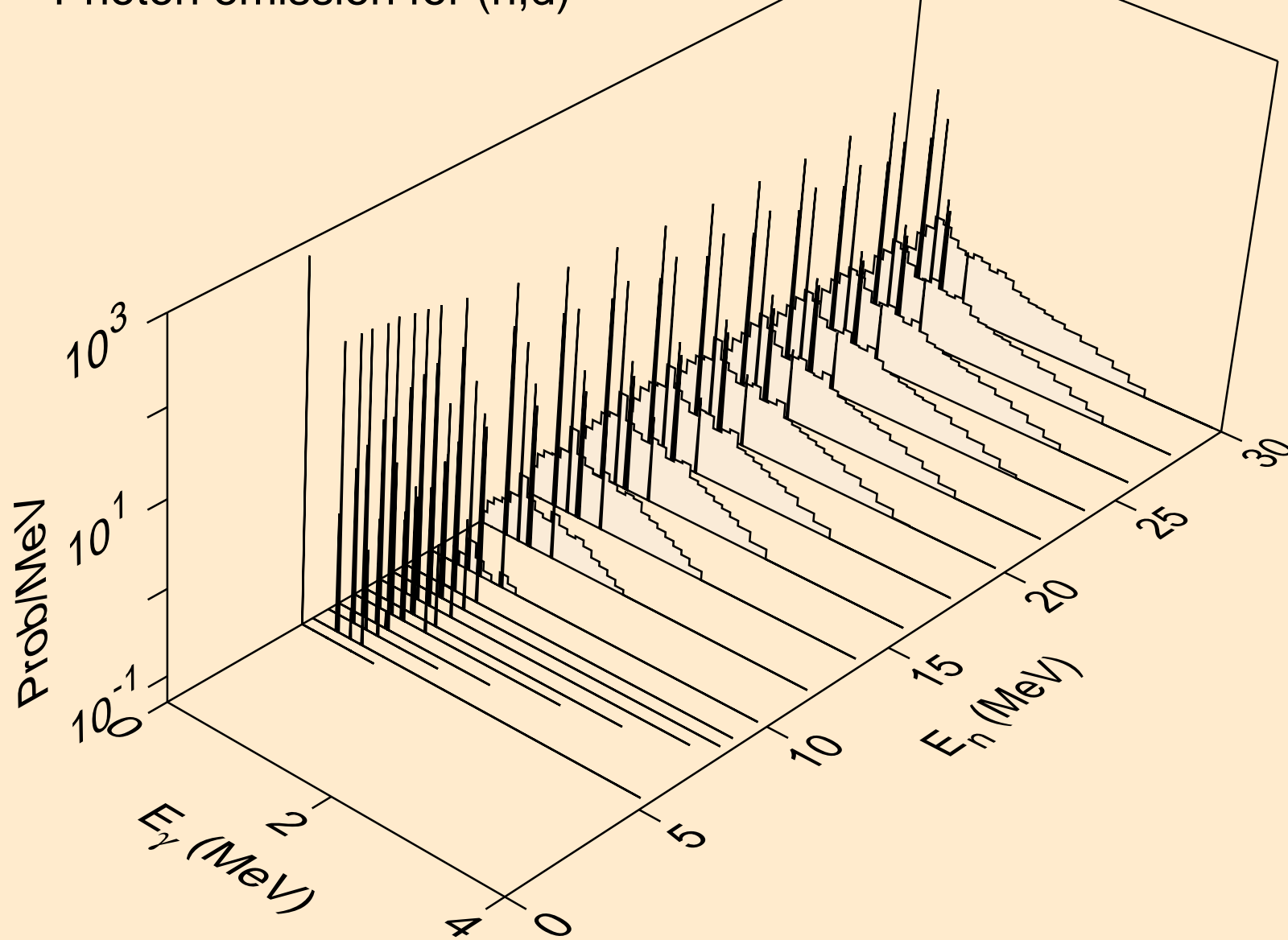

AU193 NEUTRON ACER TENDL-2024 LIBRARY; T=0.K
Photon emission for (n,t)

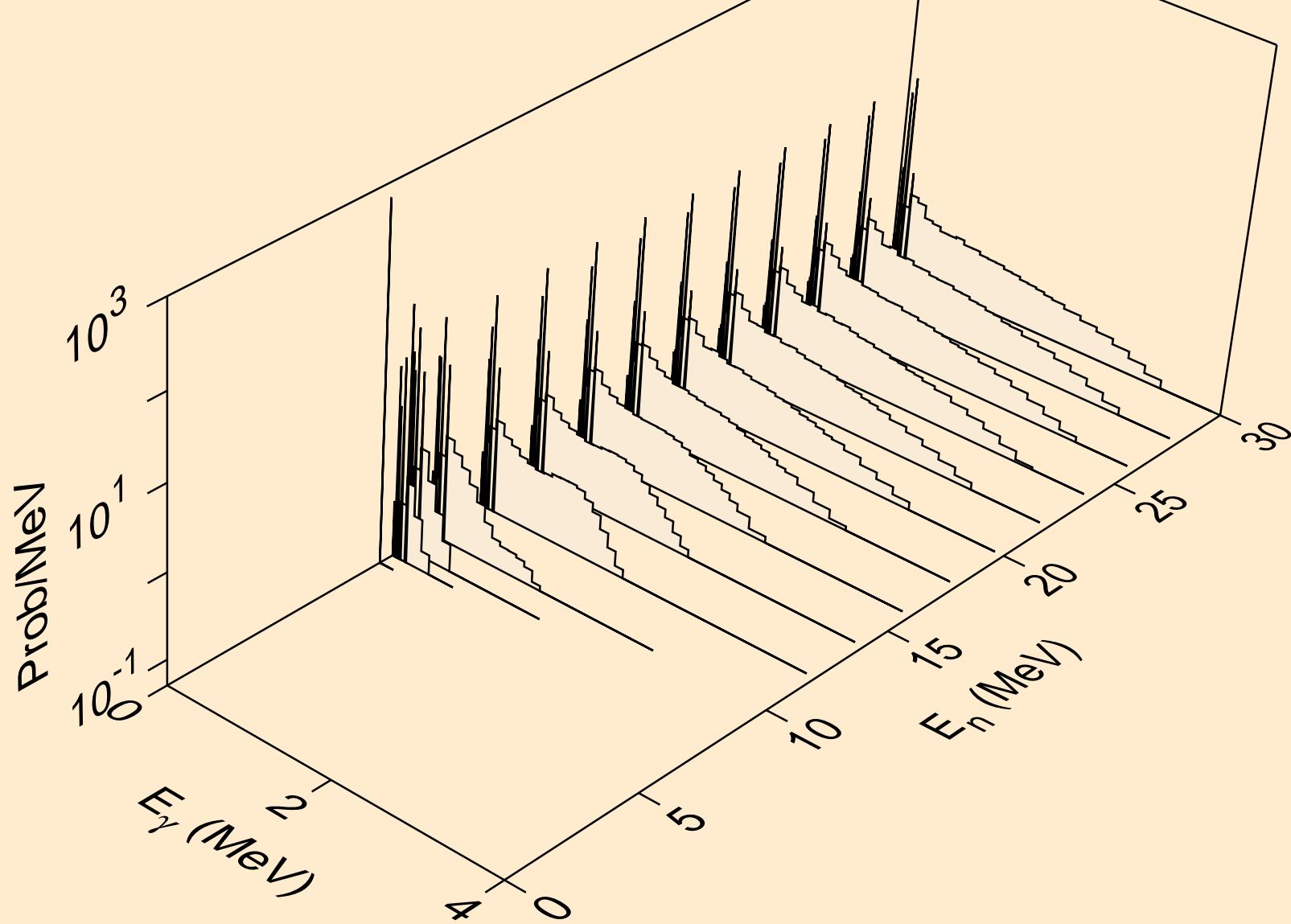

AU193 NEUTRON ACER TENDL-2024 LIBRARY; T=0.K
Photon emission for (n,he3)

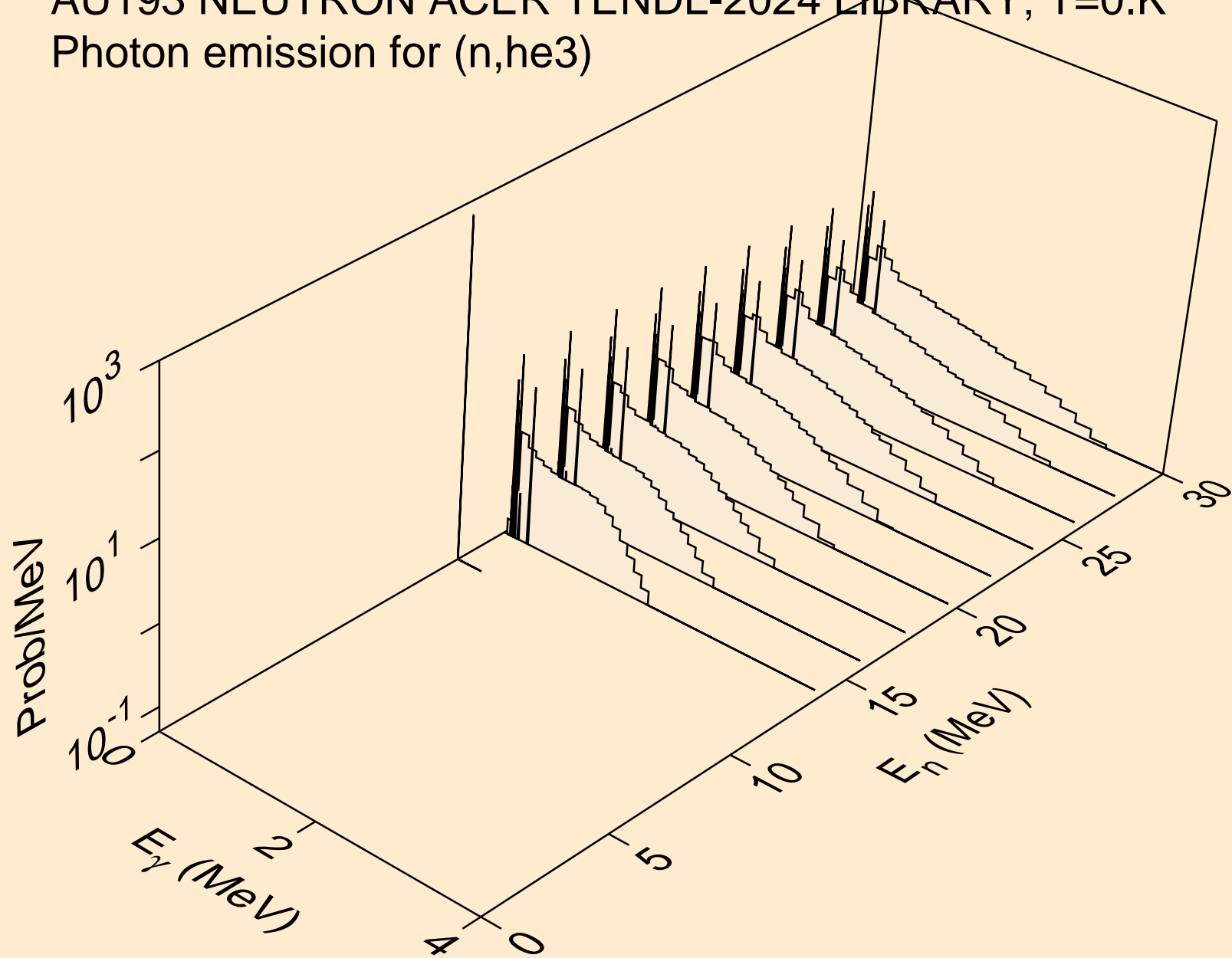

AU193 NEUTRON ACER TENDL-2024 LIBRARY; T=0.K
Photon emission for (n,a)

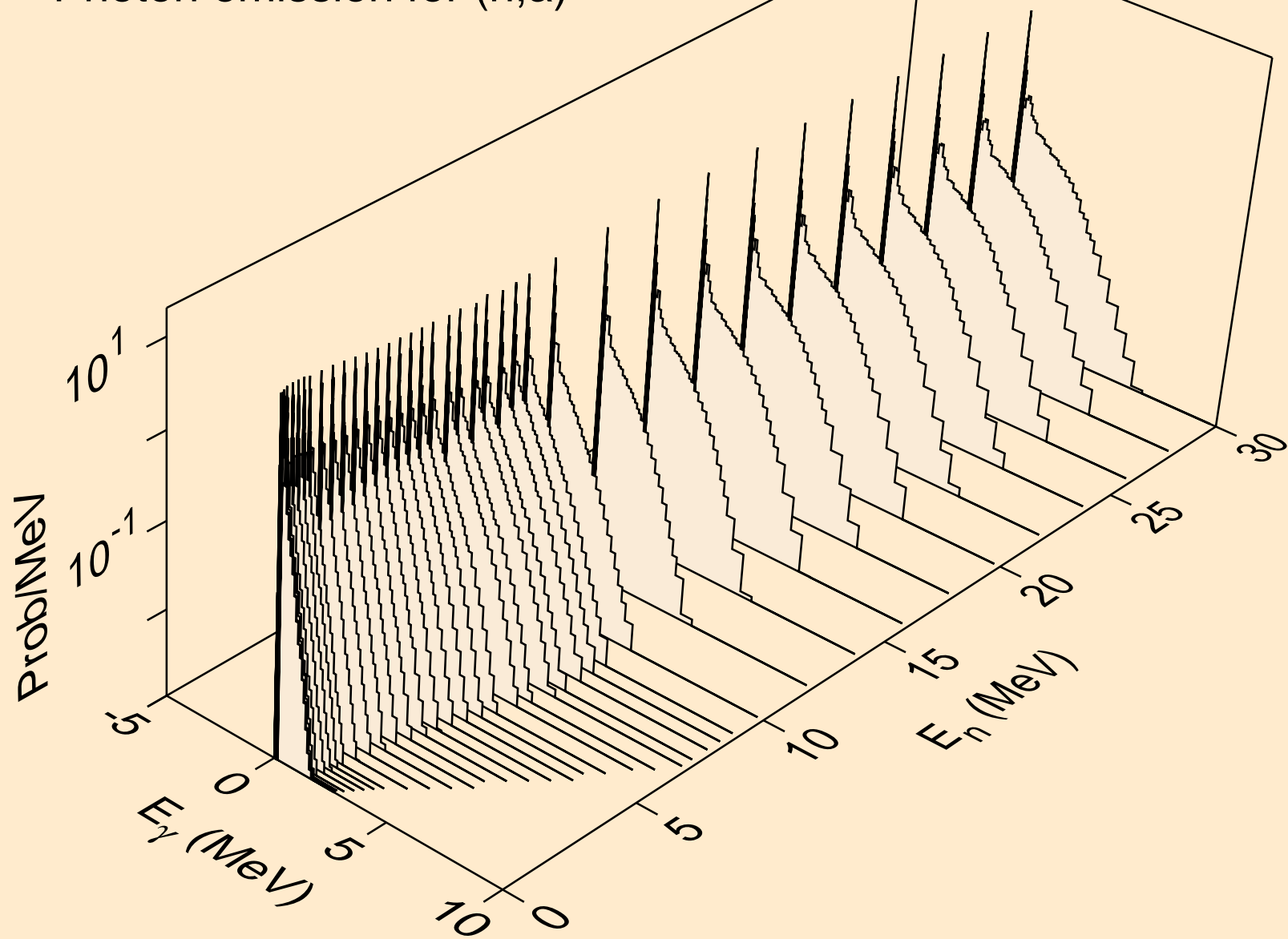

AU193 NEUTRON ACER TENDL-2024 LIBRARY; T=0.K
Photon emission for (n,2a)

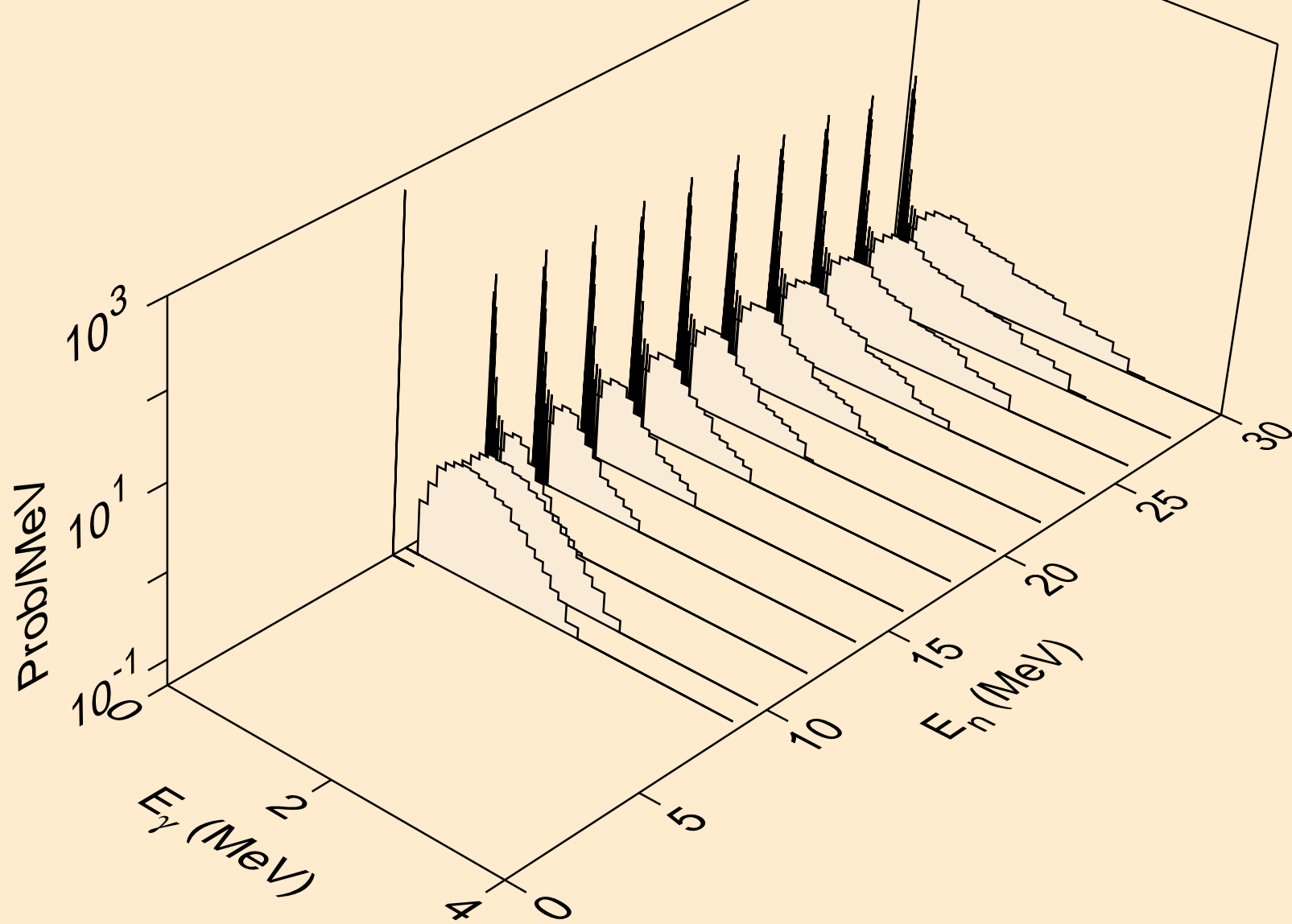

AU193 NEUTRON ACER TENDL-2024 LIBRARY; T=0.K
Photon emission for (n,2p)

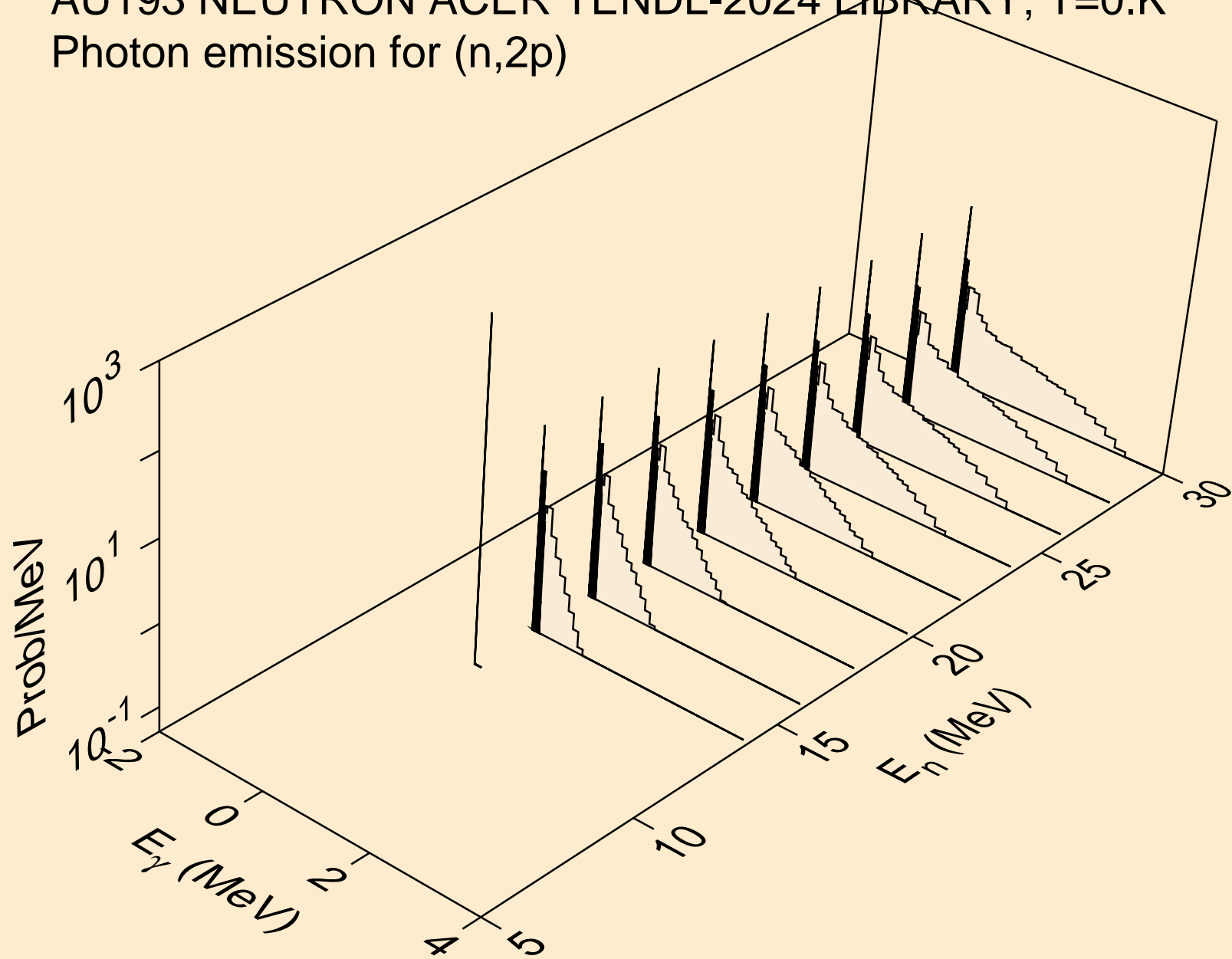

AU193 NEUTRON ACER TENDL-2024 LIBRARY; T=0.K
Photon emission for (n,p α)

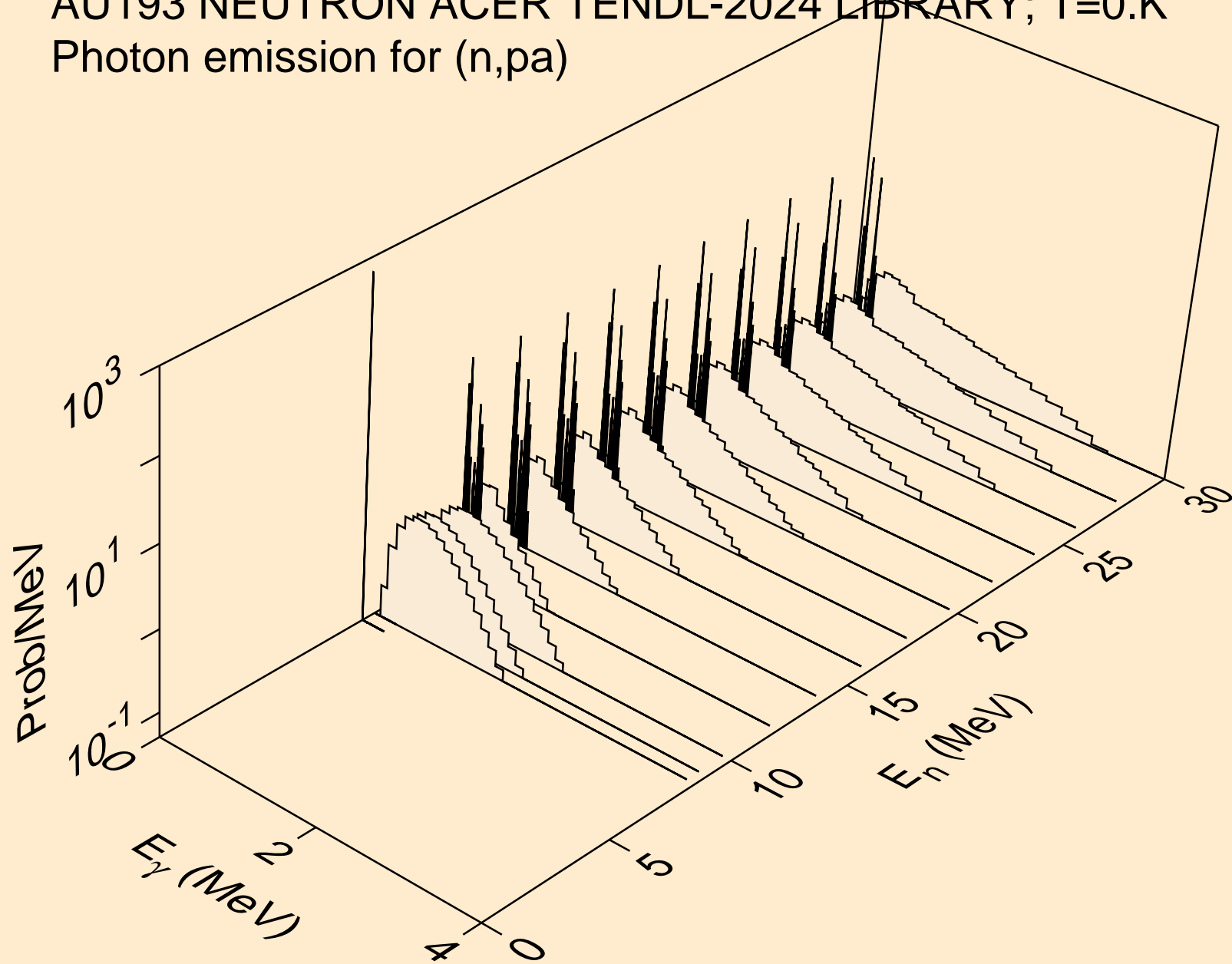

AU193 NEUTRON ACER TENDL-2024 LIBRARY; T=0.K
Photon emission for (n,pd)

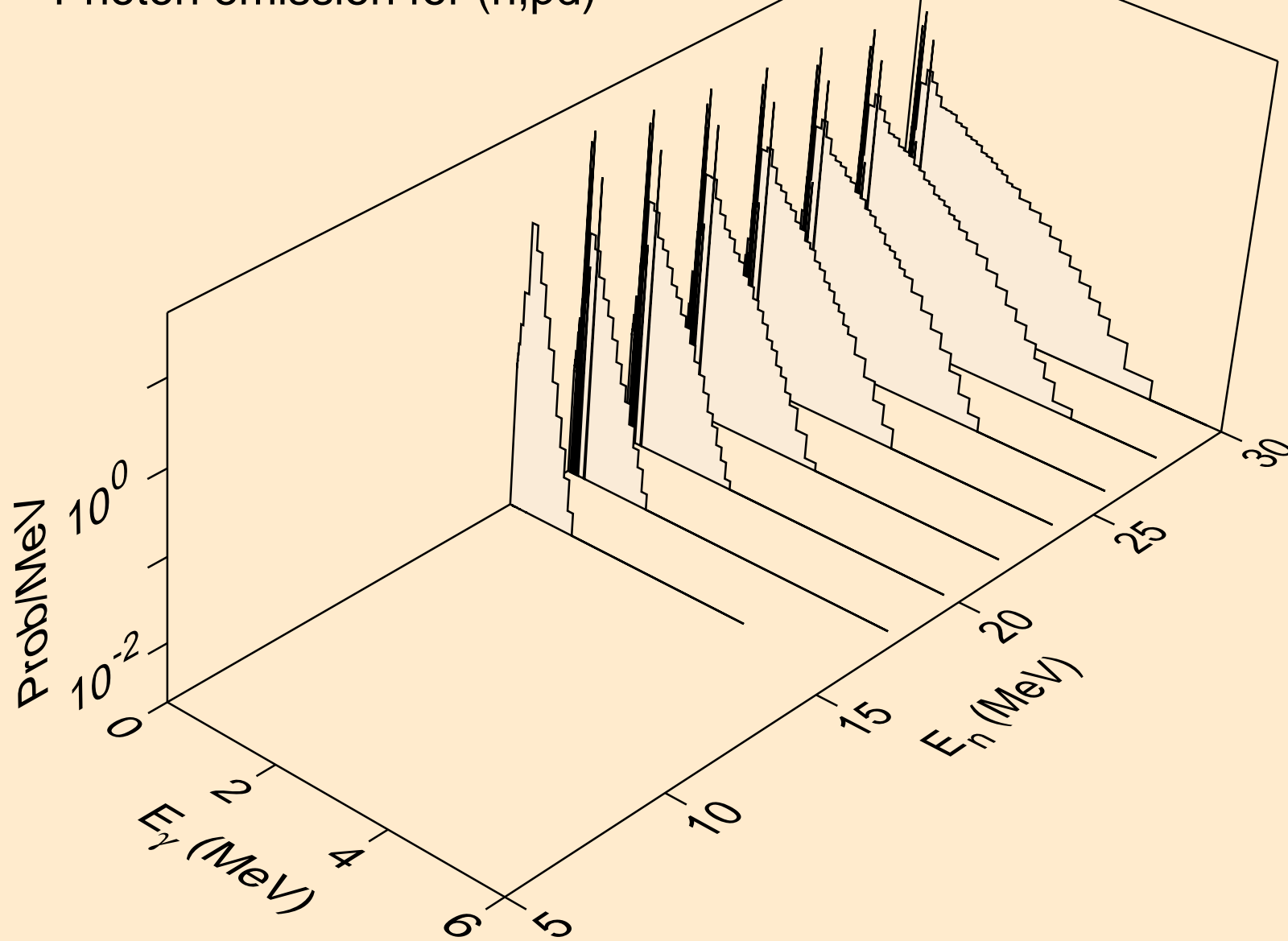

AU193 NEUTRON ACER TENDL-2024 LIBRARY; T=0.K
Photon emission for (n,pt)

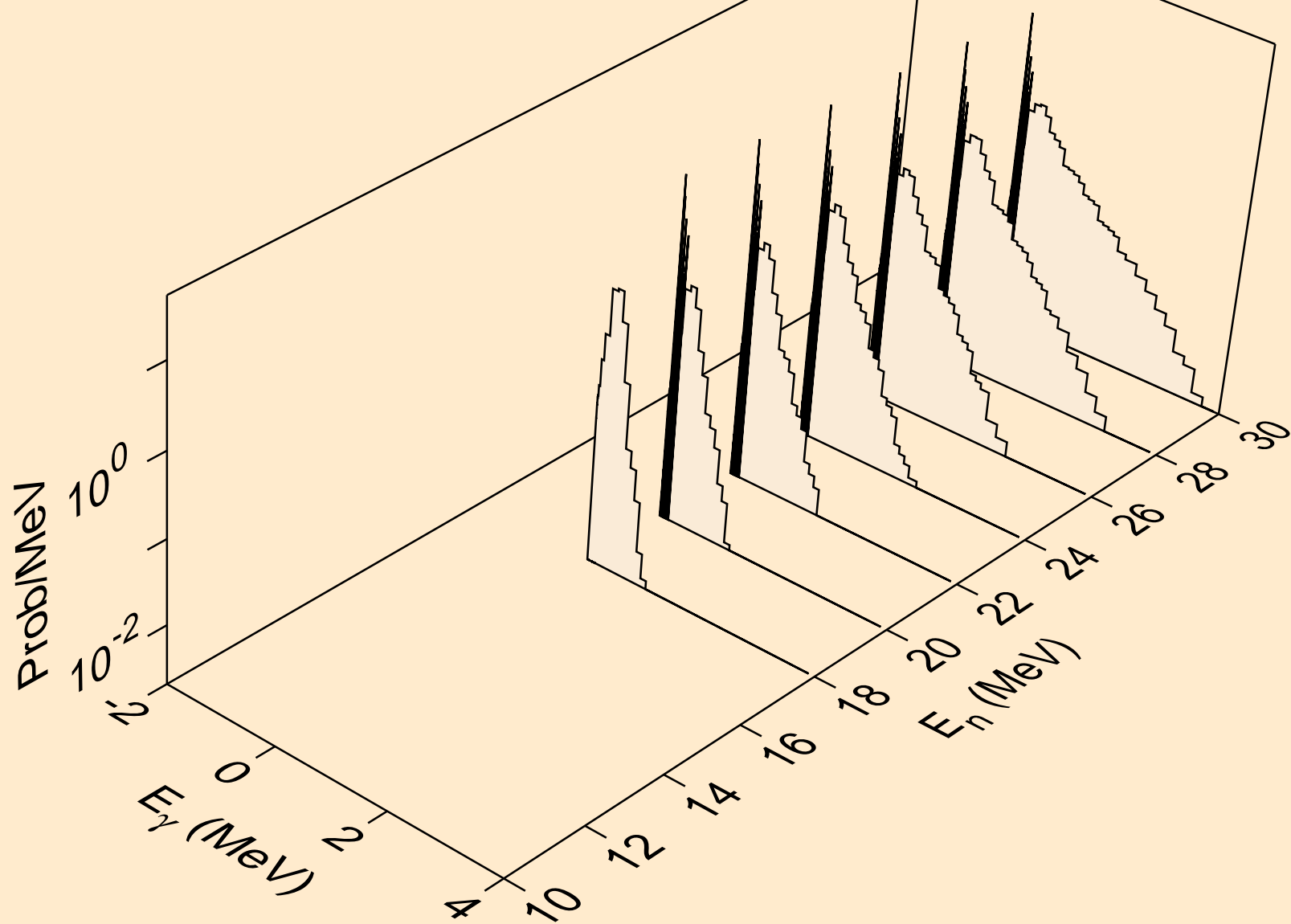

AU193 NEUTRON ACER TENDL-2024 LIBRARY; T=0.K
Photon emission for (n,da)

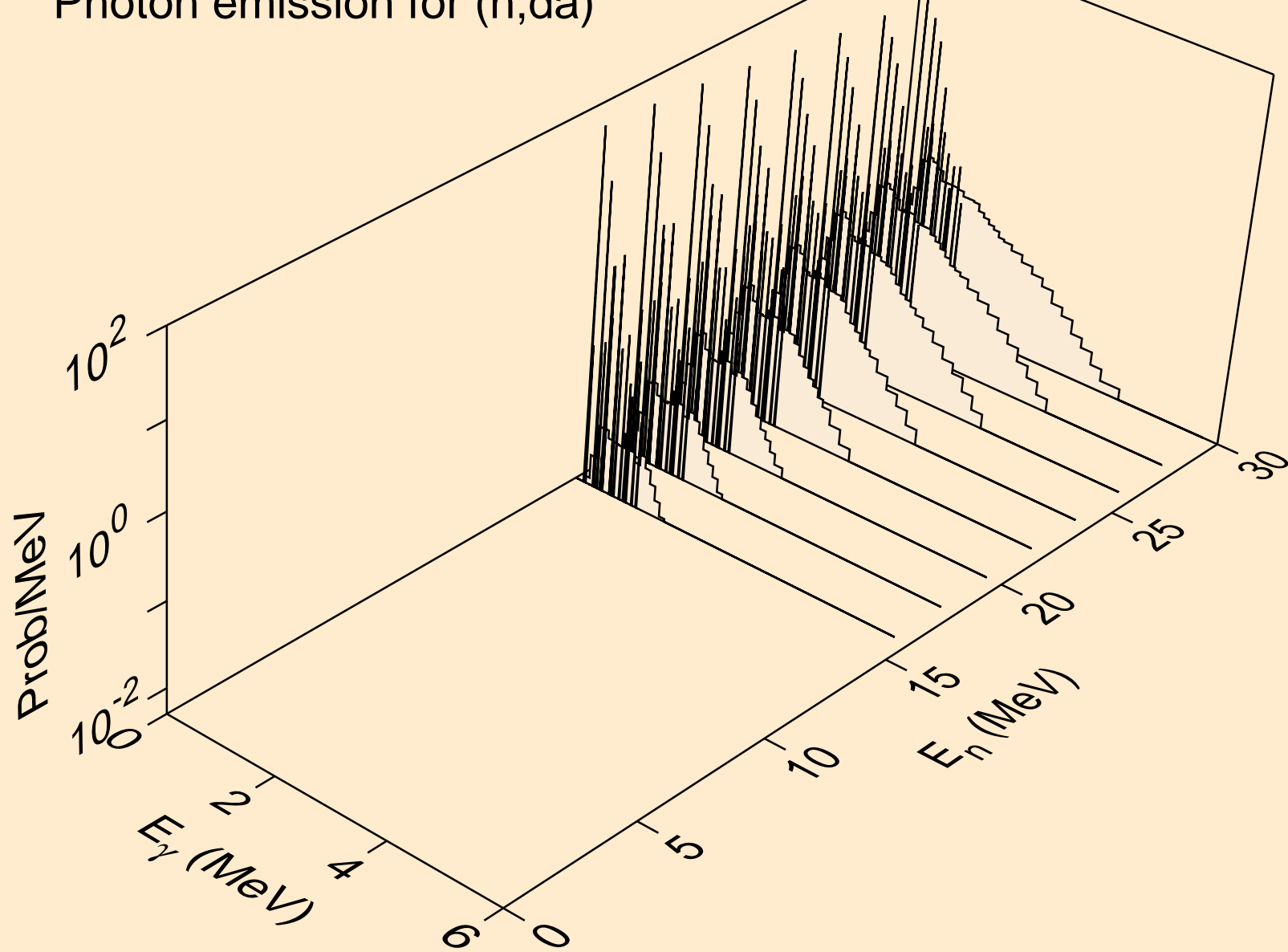

AU193 NEUTRON ACER TENDL-2024 LIBRARY; T=0.K
thermal capture photon spectrum

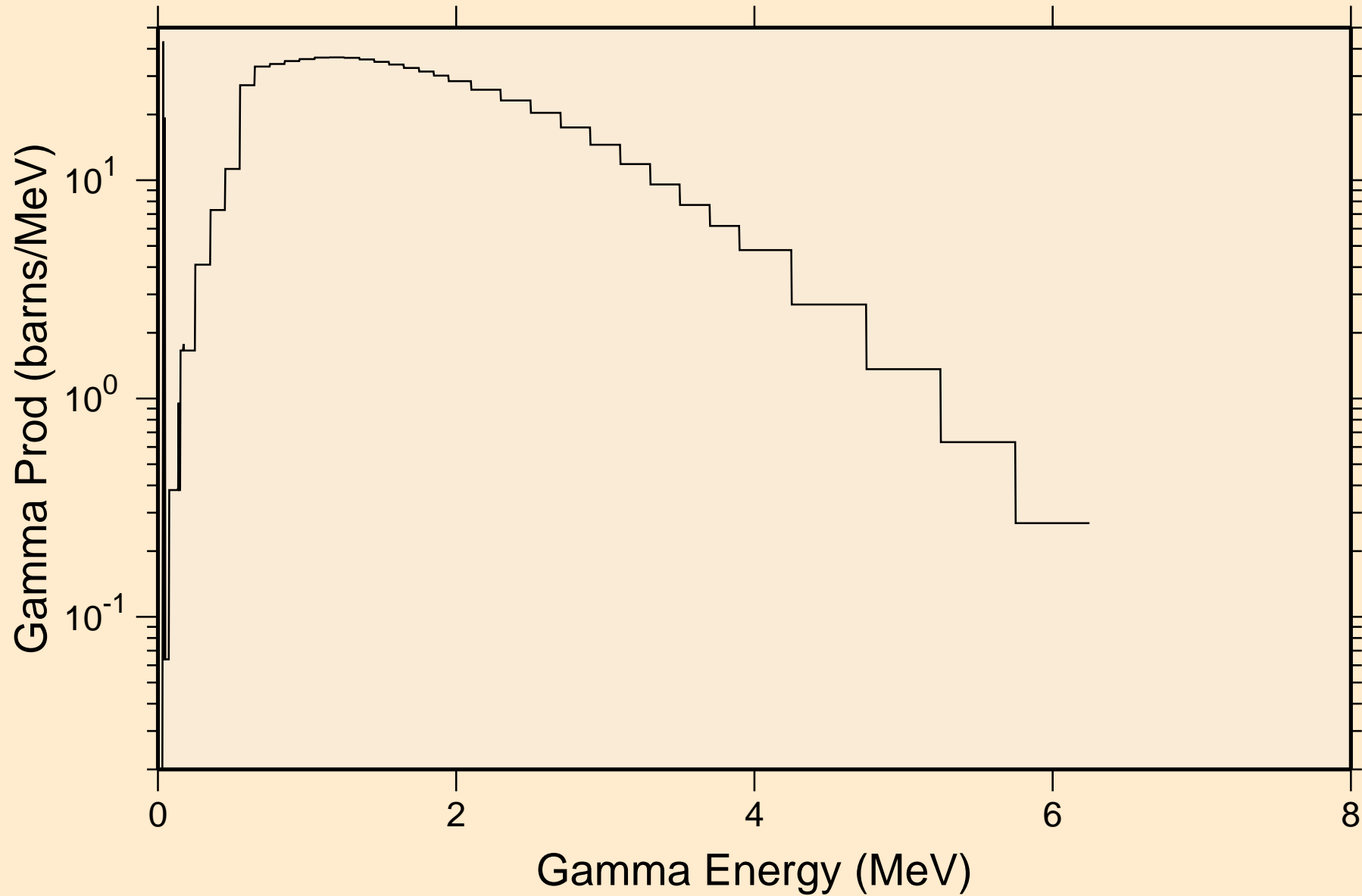

AU193 NEUTRON ACER TENDL-2024 LIBRARY; T=0.K
14 MeV photon spectrum

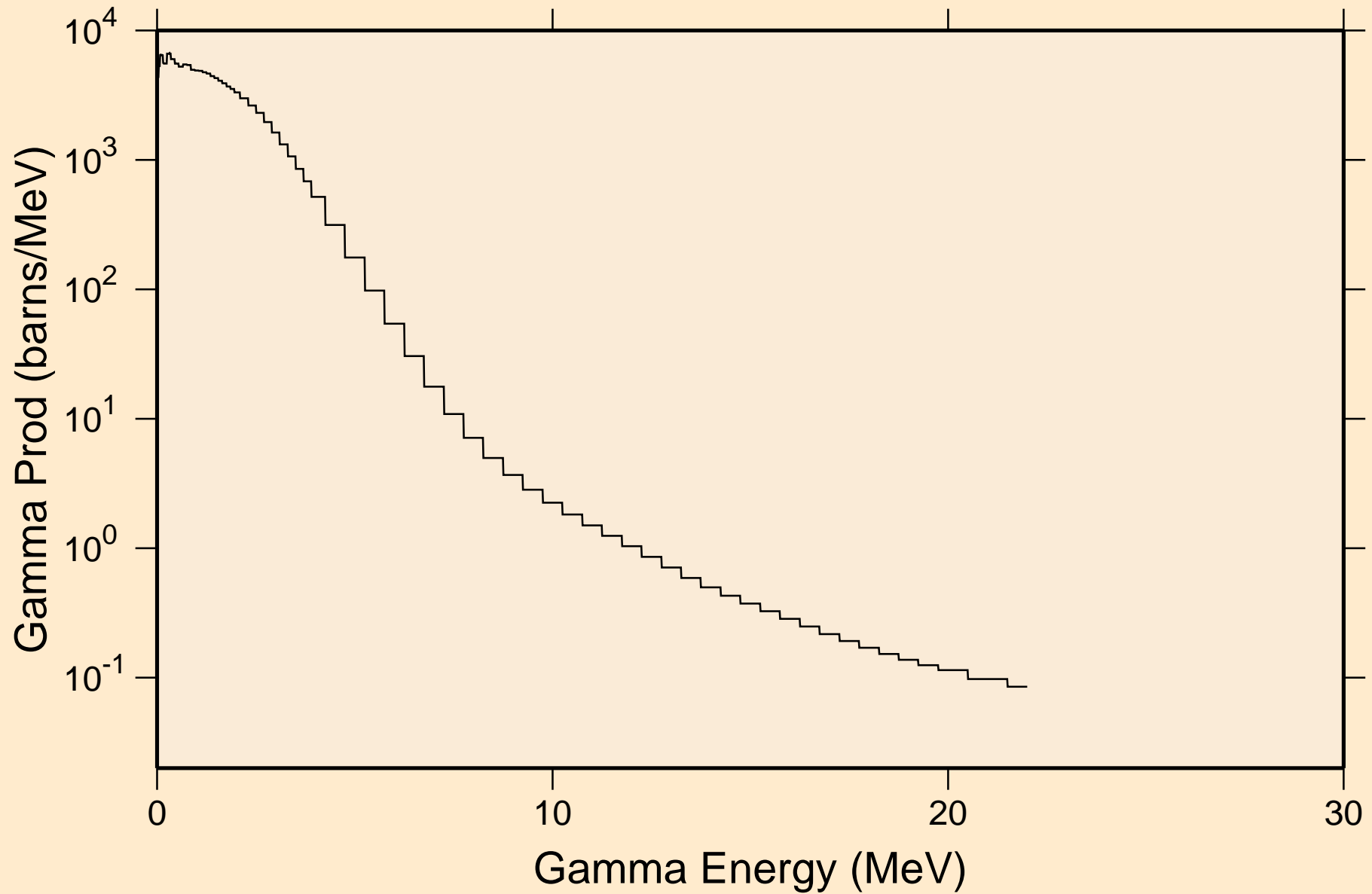

AU193 NEUTRON ACER TENDL-2024 LIBRARY; T=0.K

Particle heating contributions

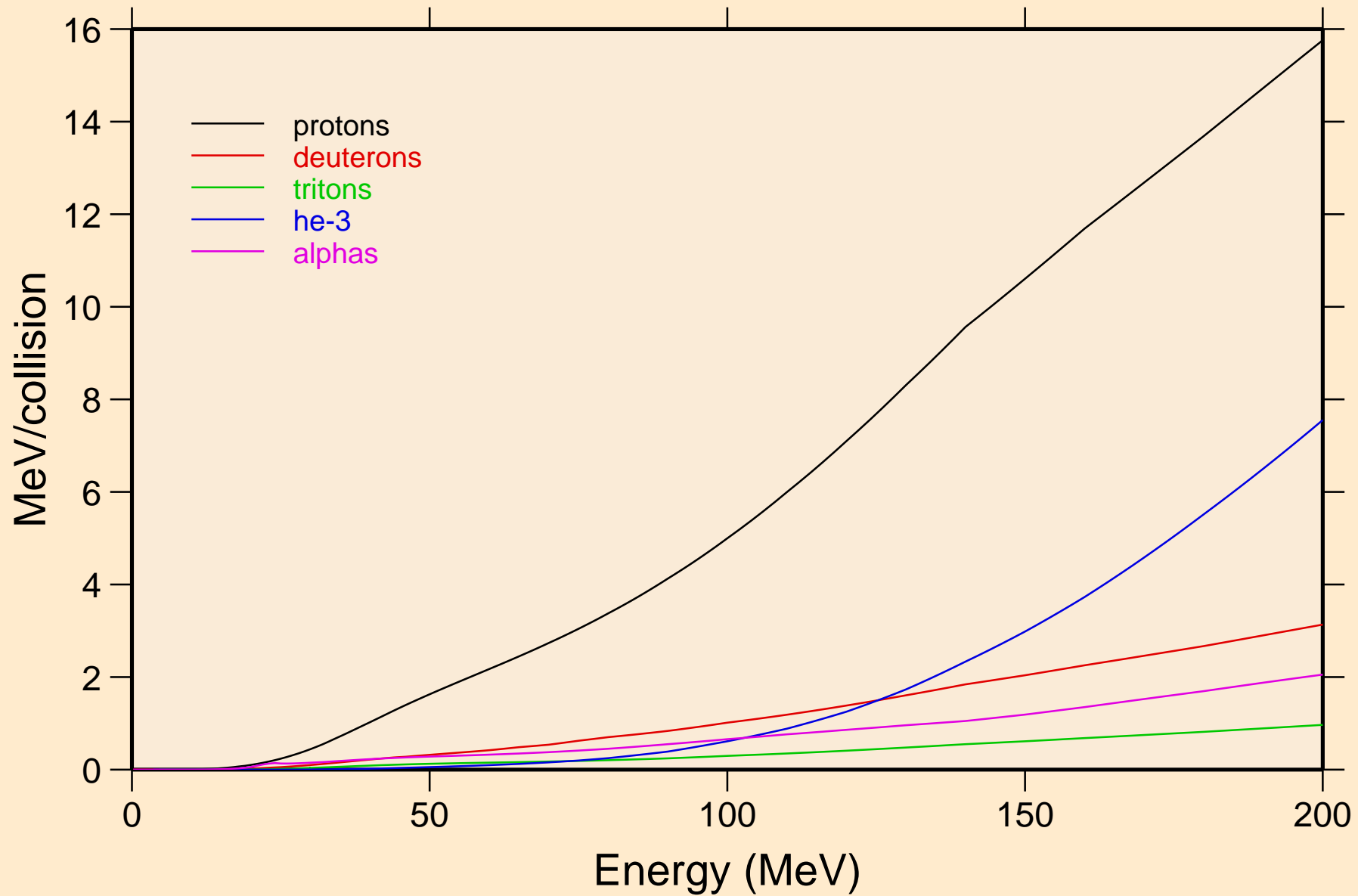

AU193 NEUTRON ACER TENDL-2024 LIBRARY; T=0.K
Recoil Heating

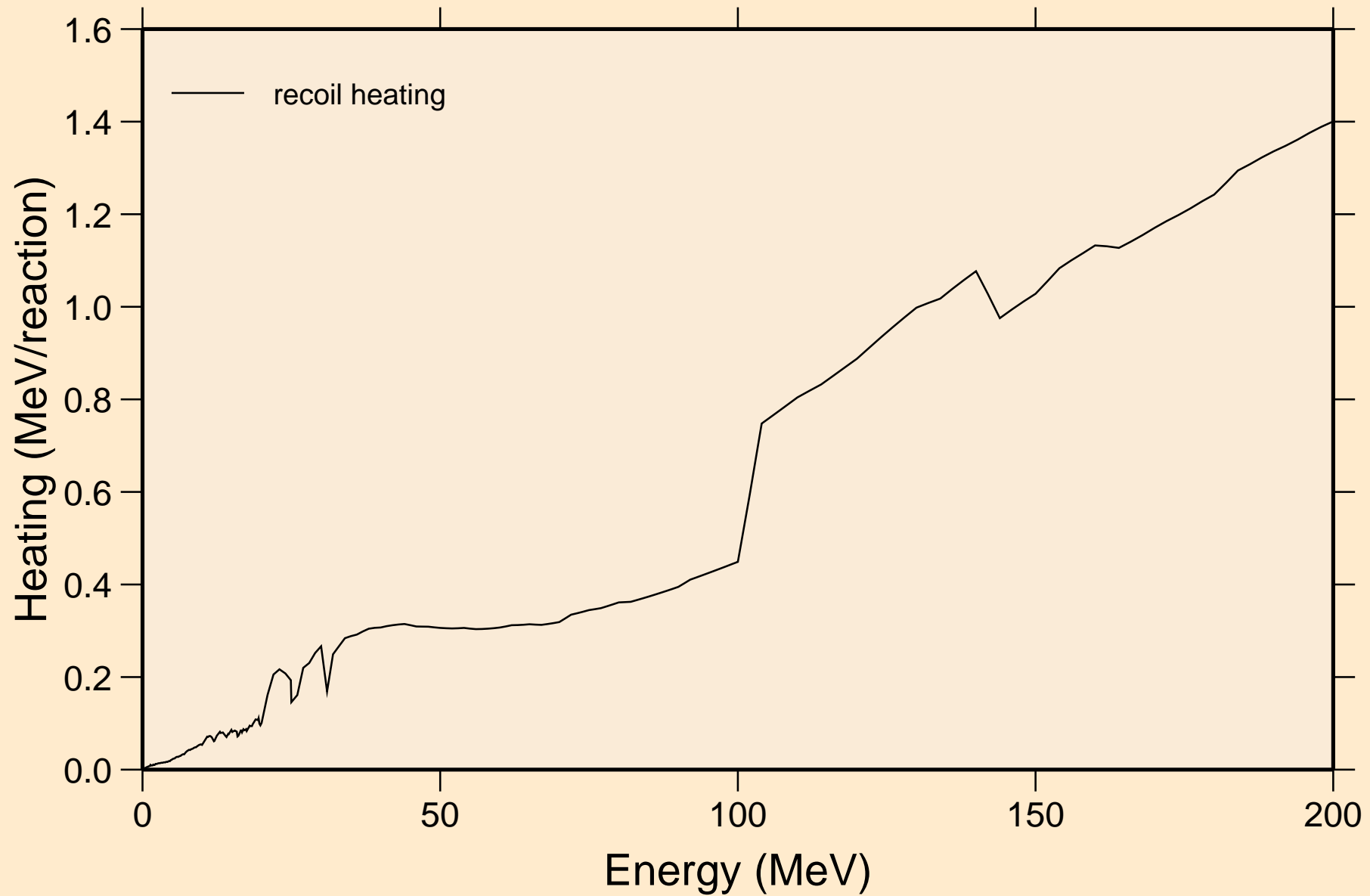

AU193 NEUTRON ACER TENDL-2024 LIBRARY; T=0.K
Particle production cross sections

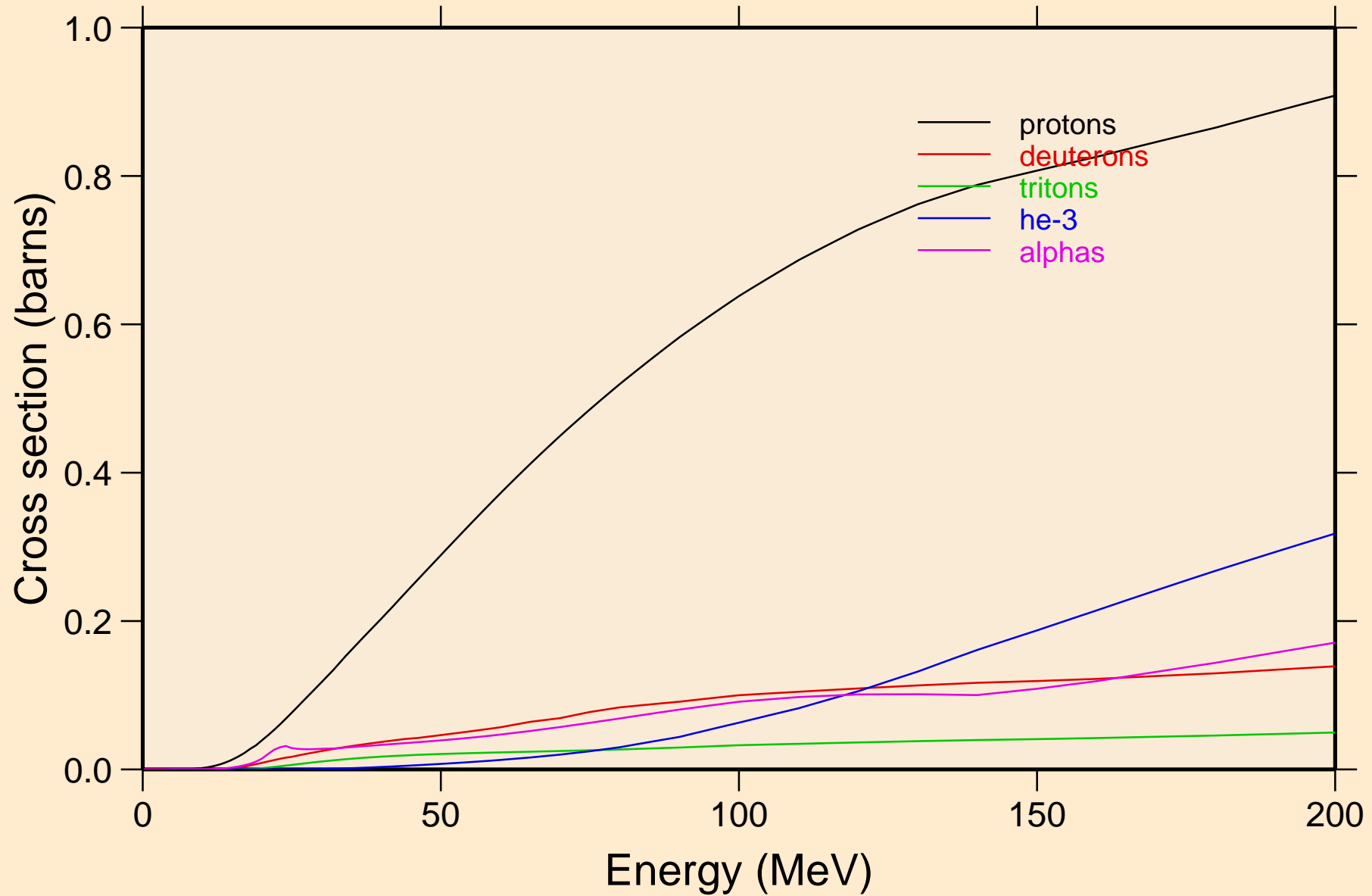

AU193 NEUTRON ACER TENDL-2024 LIBRARY; T=0.K
protons from (n,x)

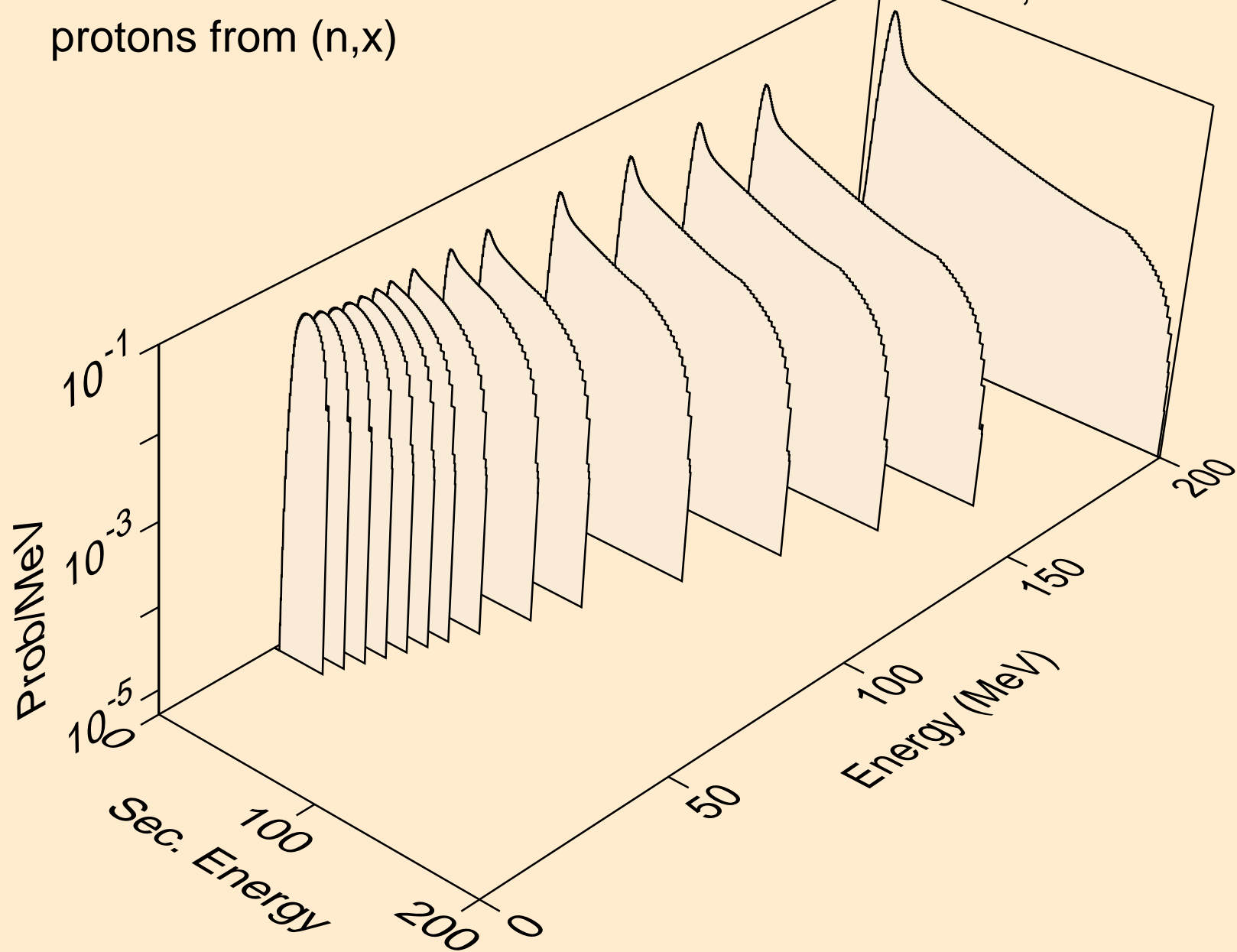

AU193 NEUTRON ACER TENDL-2024 LIBRARY; T=0.K
protons from (n,n*)p

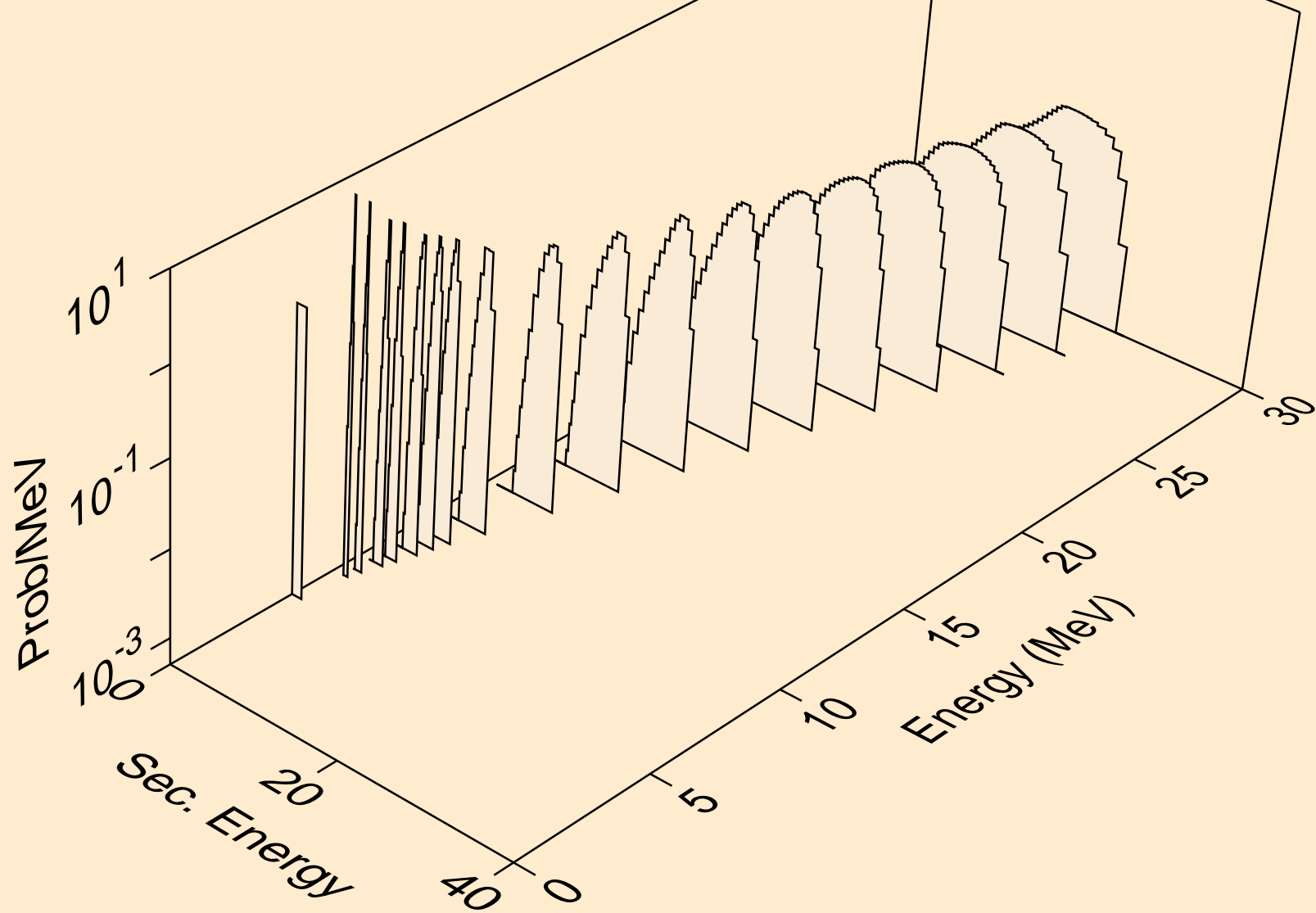

AU193 NEUTRON ACER TENDL-2024 LIBRARY; T=0.K
protons from (n,2np)

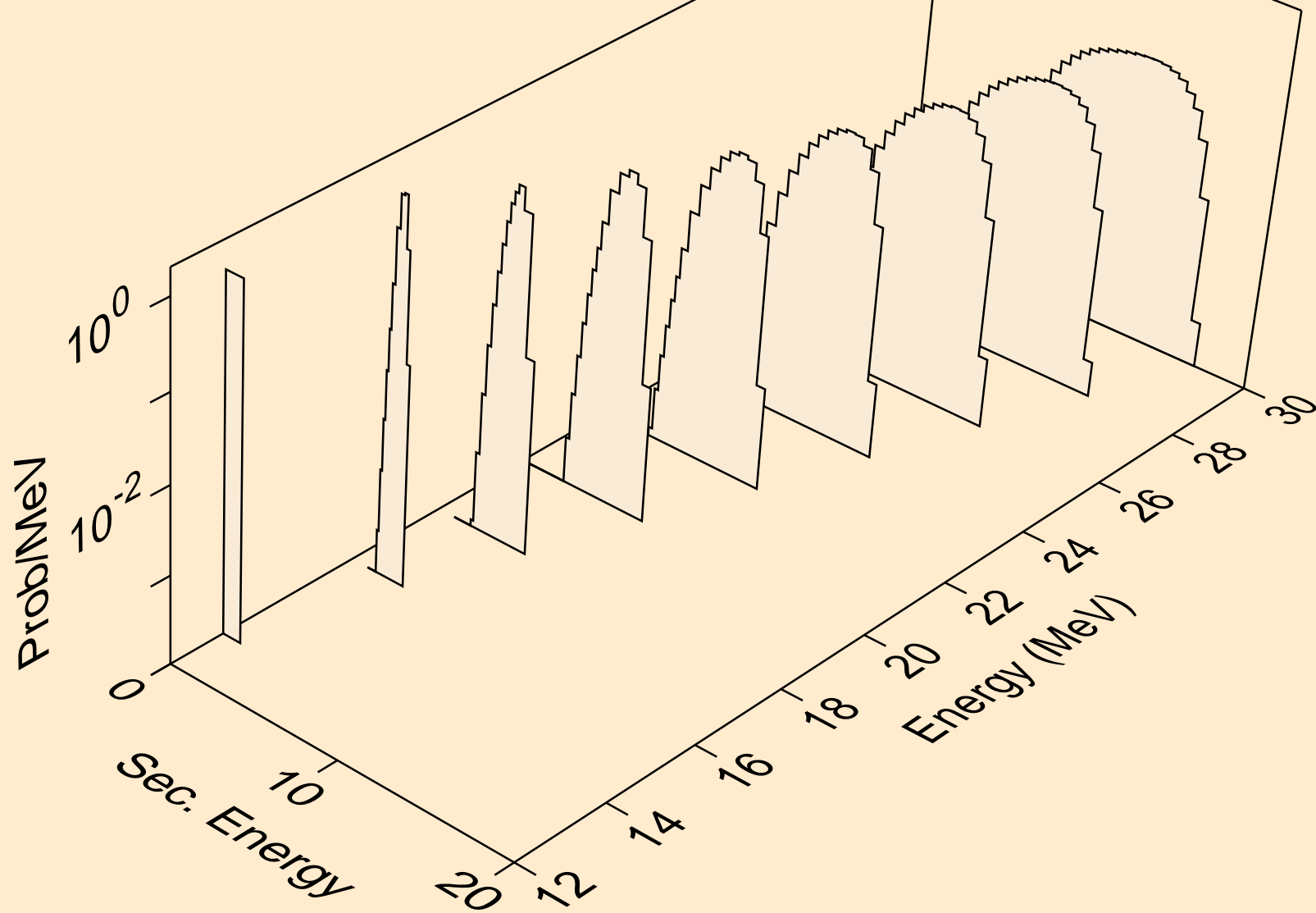

AU193 NEUTRON ACER TENDL-2024 LIBRARY; T=0.K
protons from (n,3np)

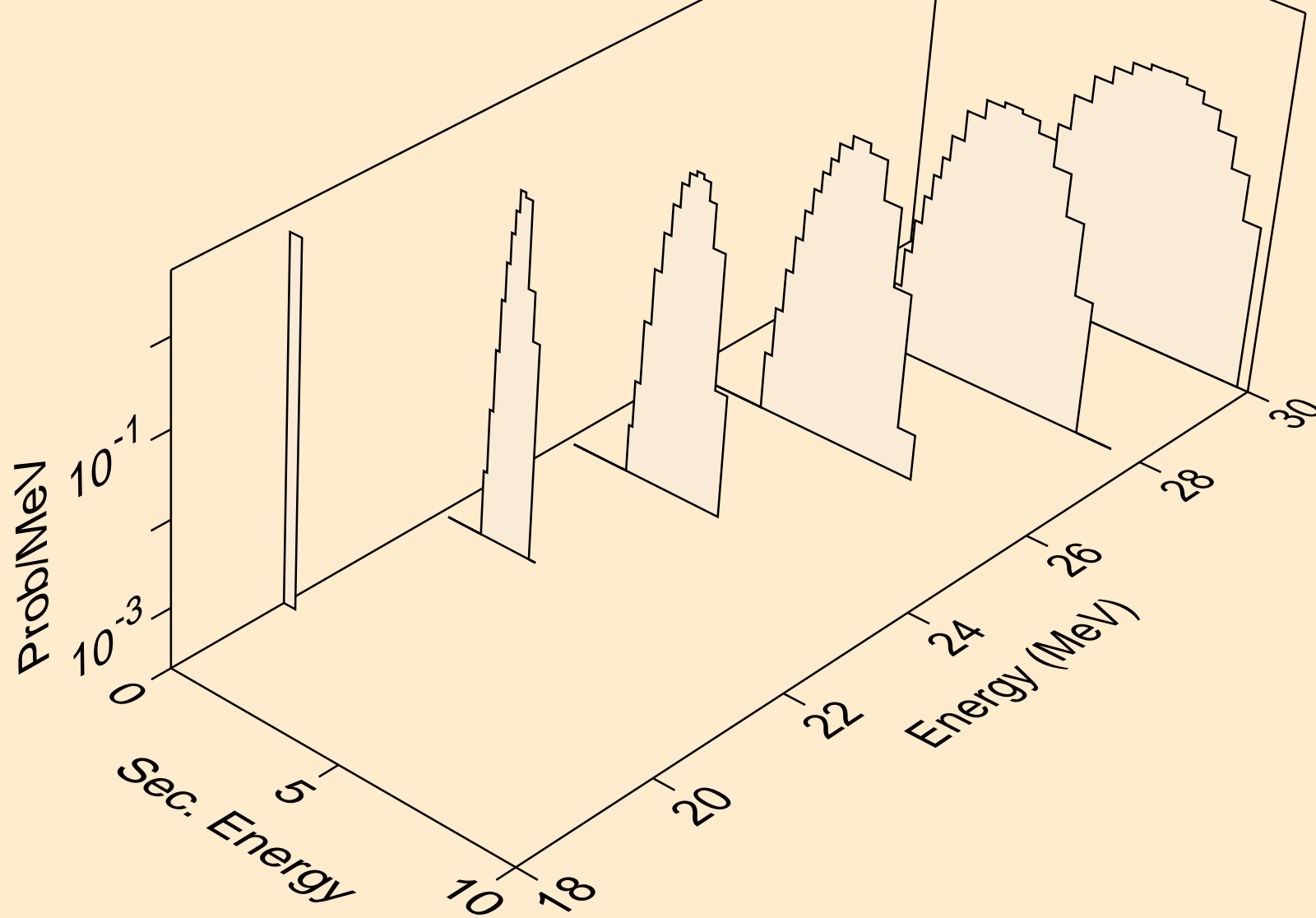

AU193 NEUTRON ACER TENDL-2024 LIBRARY; T=0.K
protons from (n,n2p)

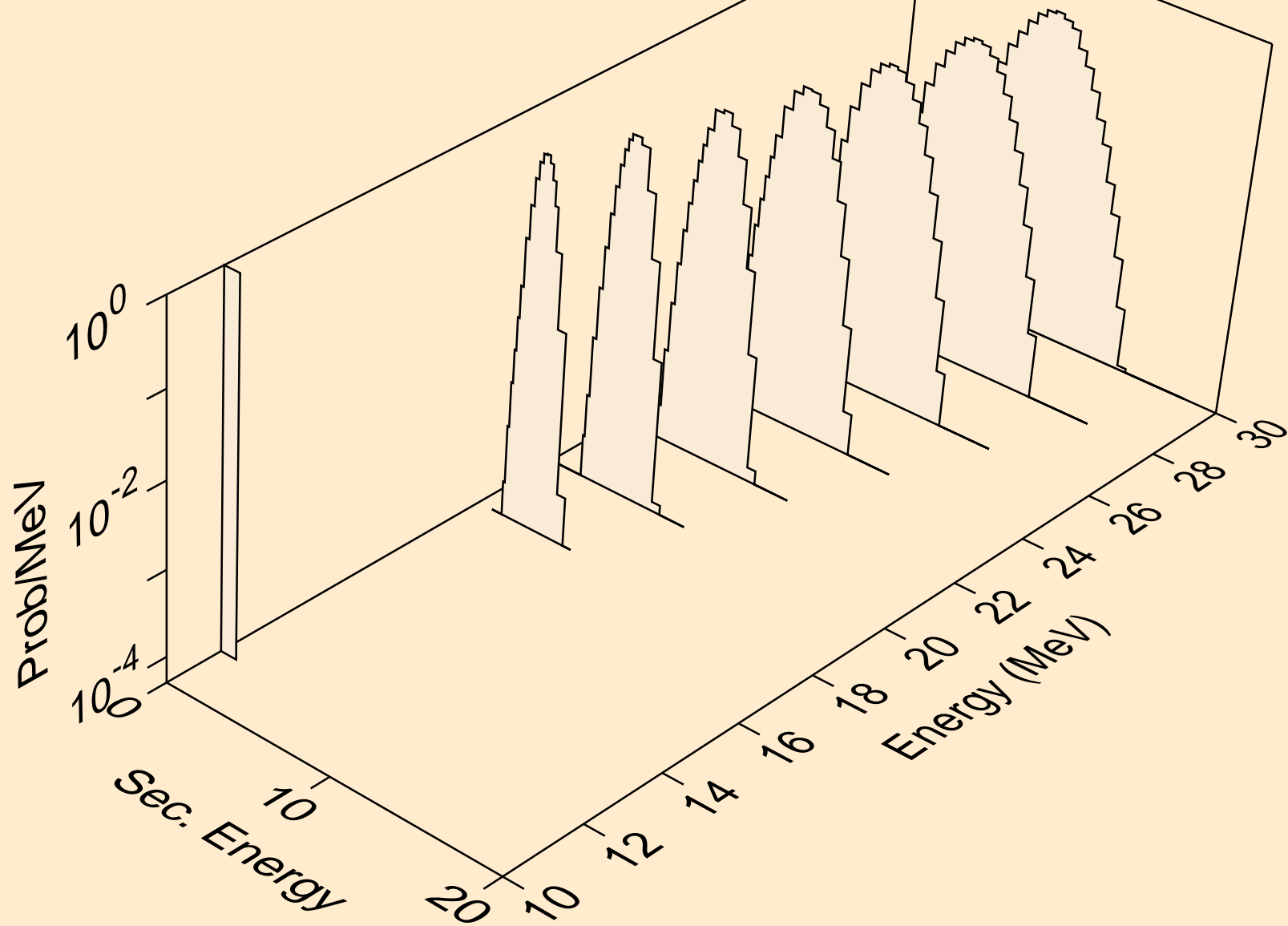

AU193 NEUTRON ACER TENDL-2024 LIBRARY; T=0.K
protons from (n,npa)

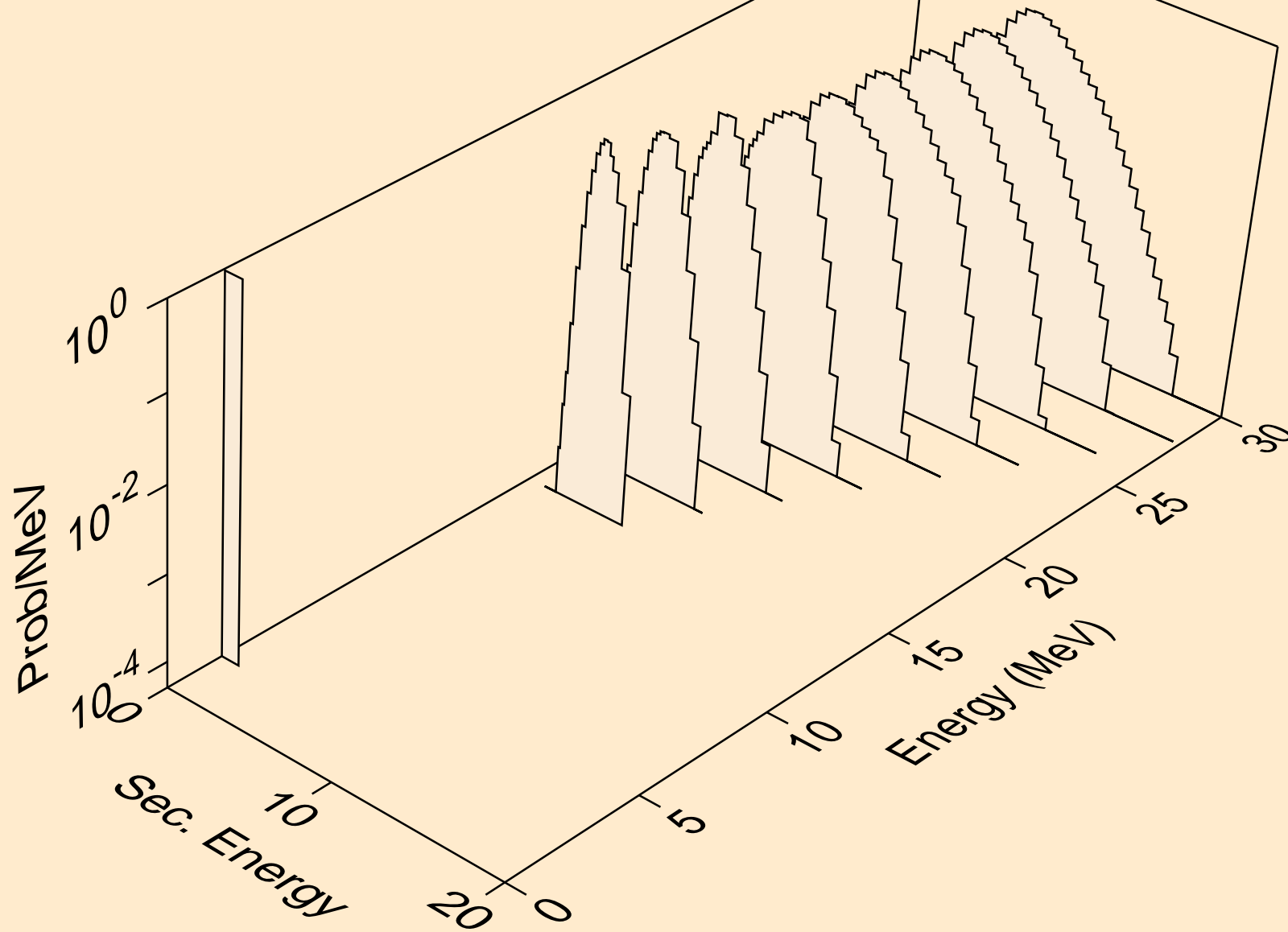

AU193 NEUTRON ACER TENDL-2024 LIBRARY; T=0.K
protons from (n,p)

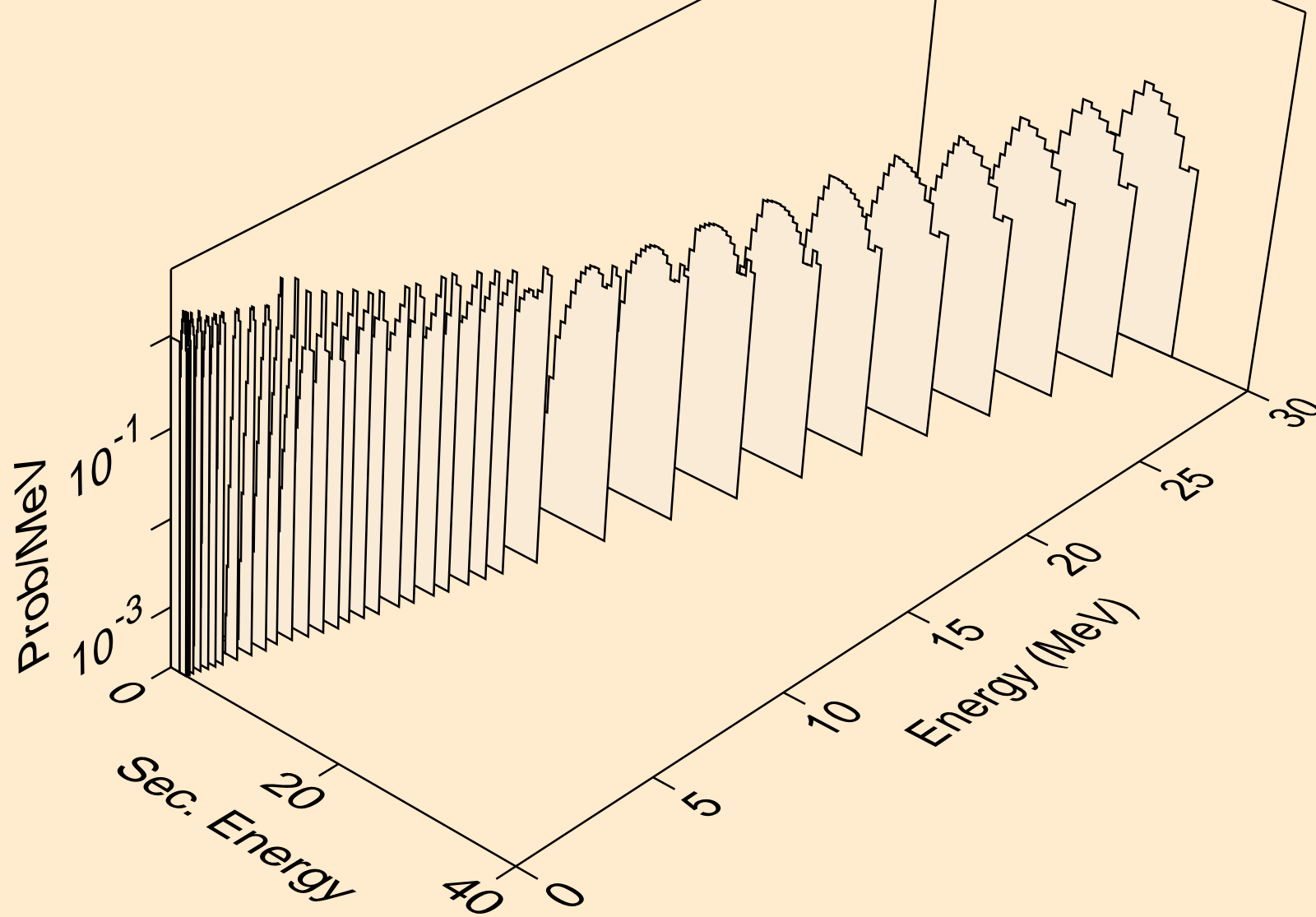

AU193 NEUTRON ACER TENDL-2024 LIBRARY; T=0.K
protons from (n,2p)

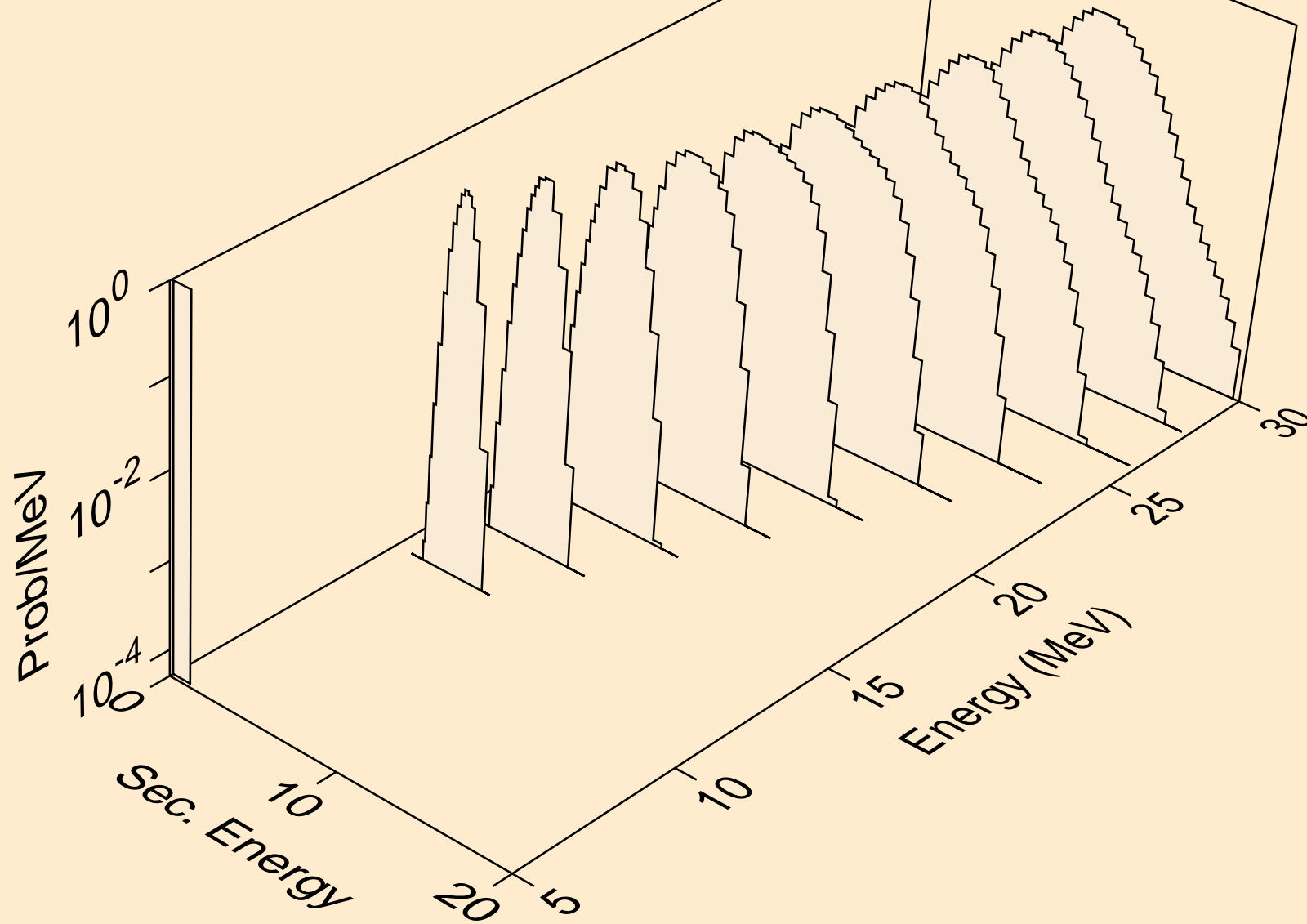

AU193 NEUTRON ACER TENDL-2024 LIBRARY; T=0.K
protons from (n,p)

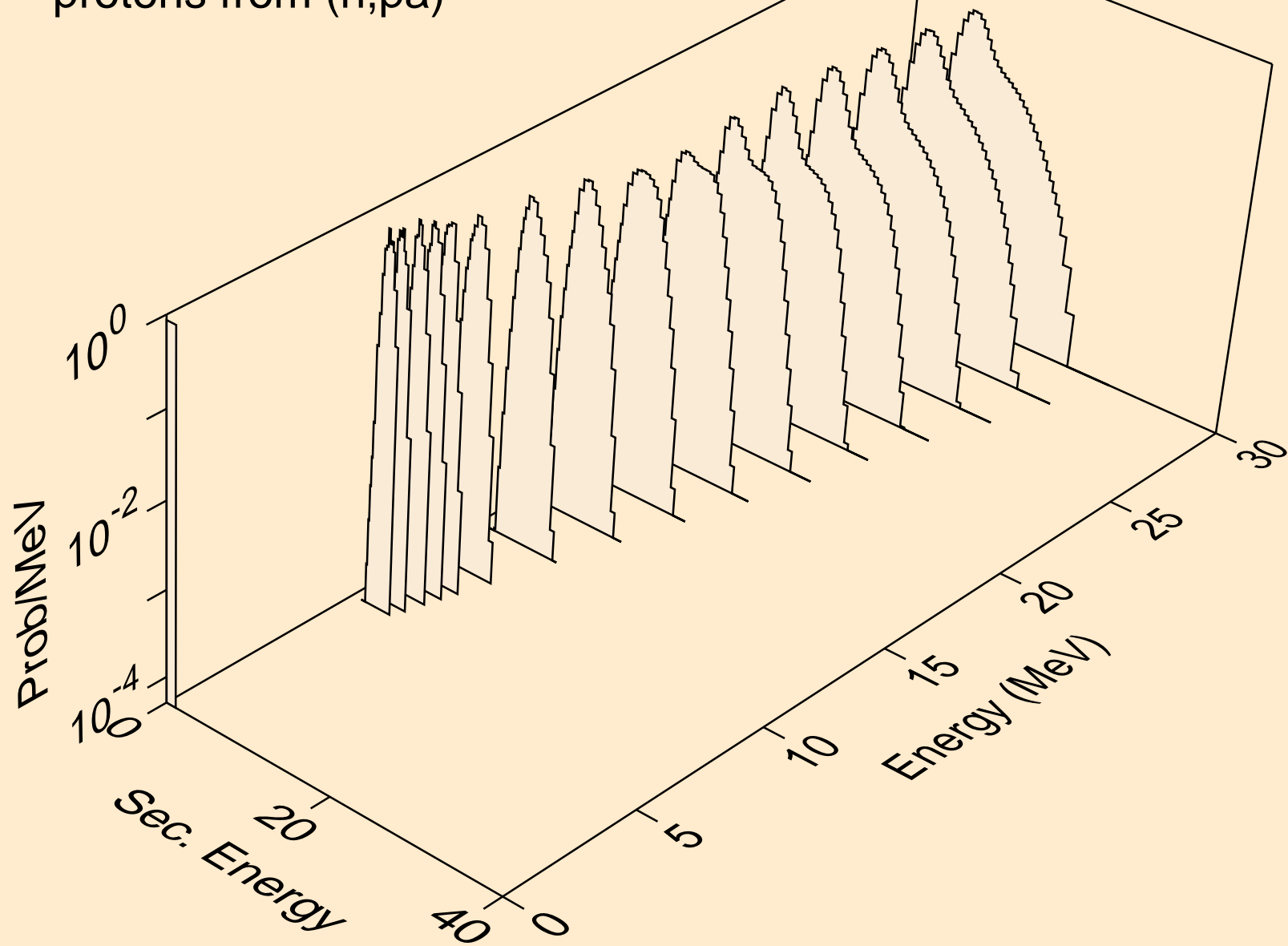

AU193 NEUTRON ACER TENDL-2024 LIBRARY; T=0.K
protons from (n,pd)

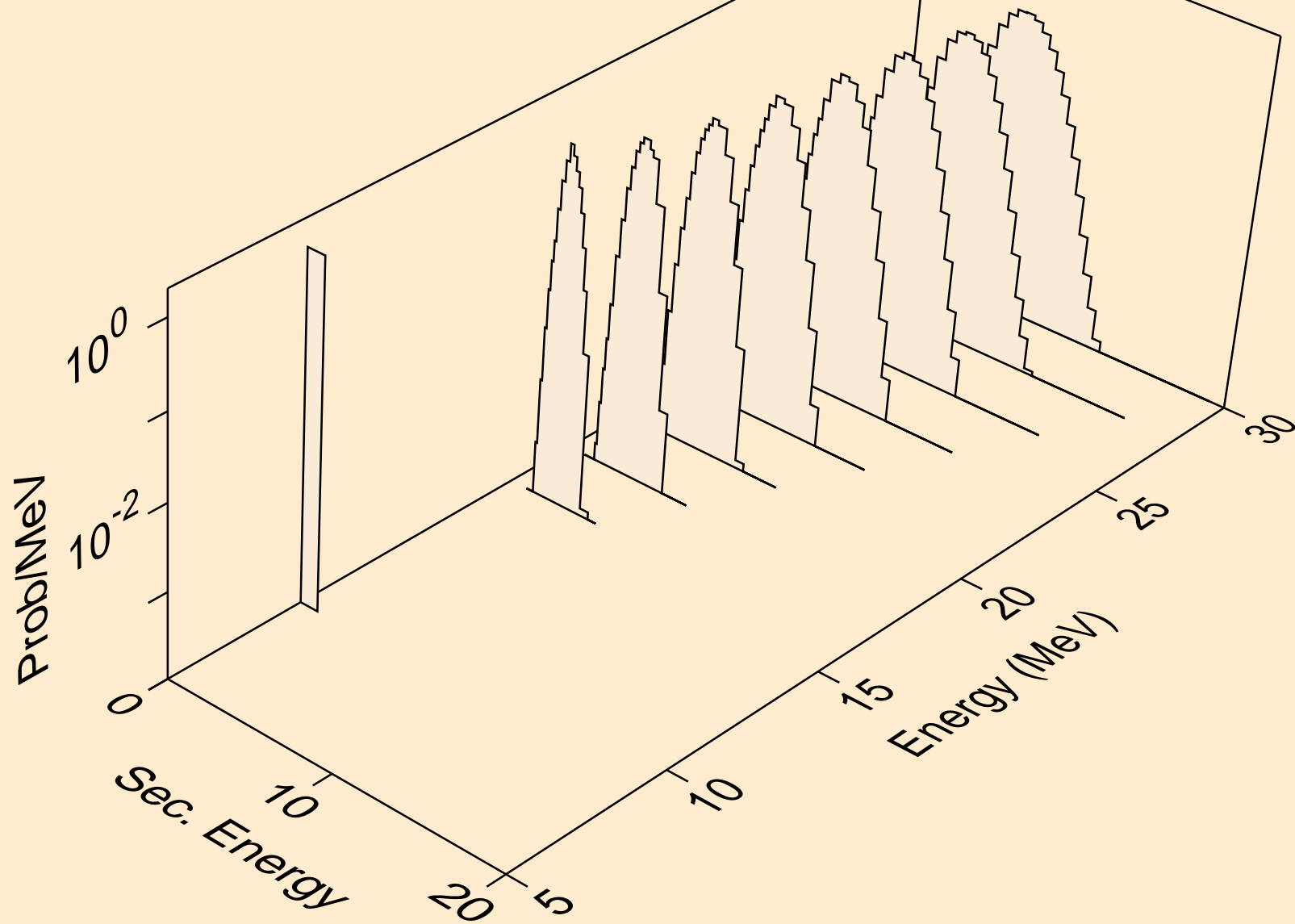

AU193 NEUTRON ACER TENDL-2024 LIBRARY; T=0.K
protons from (n,pt)

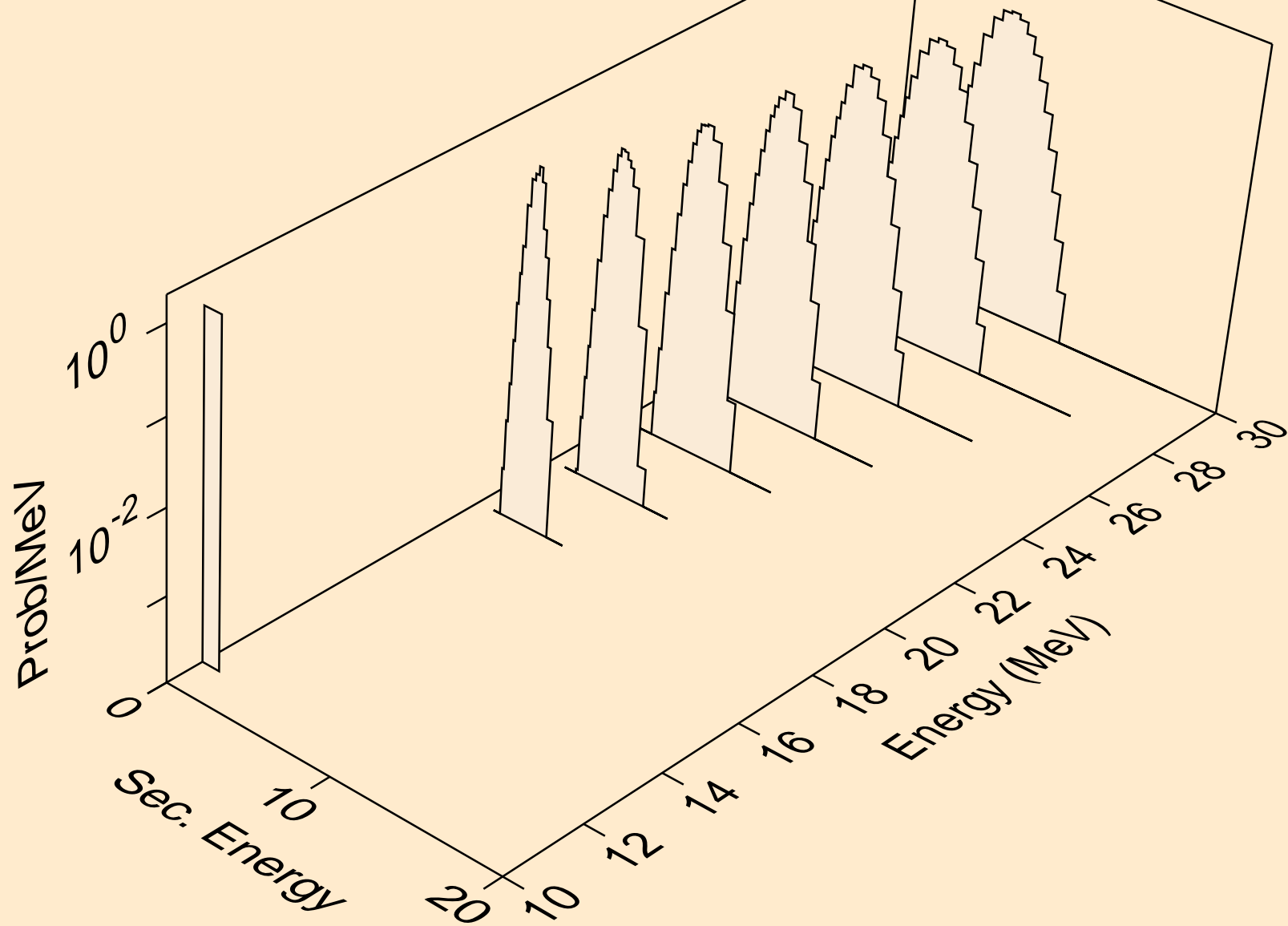

AU193 NEUTRON ACER TENDL-2024 LIBRARY; T=0.K
deuterons from (n,x)

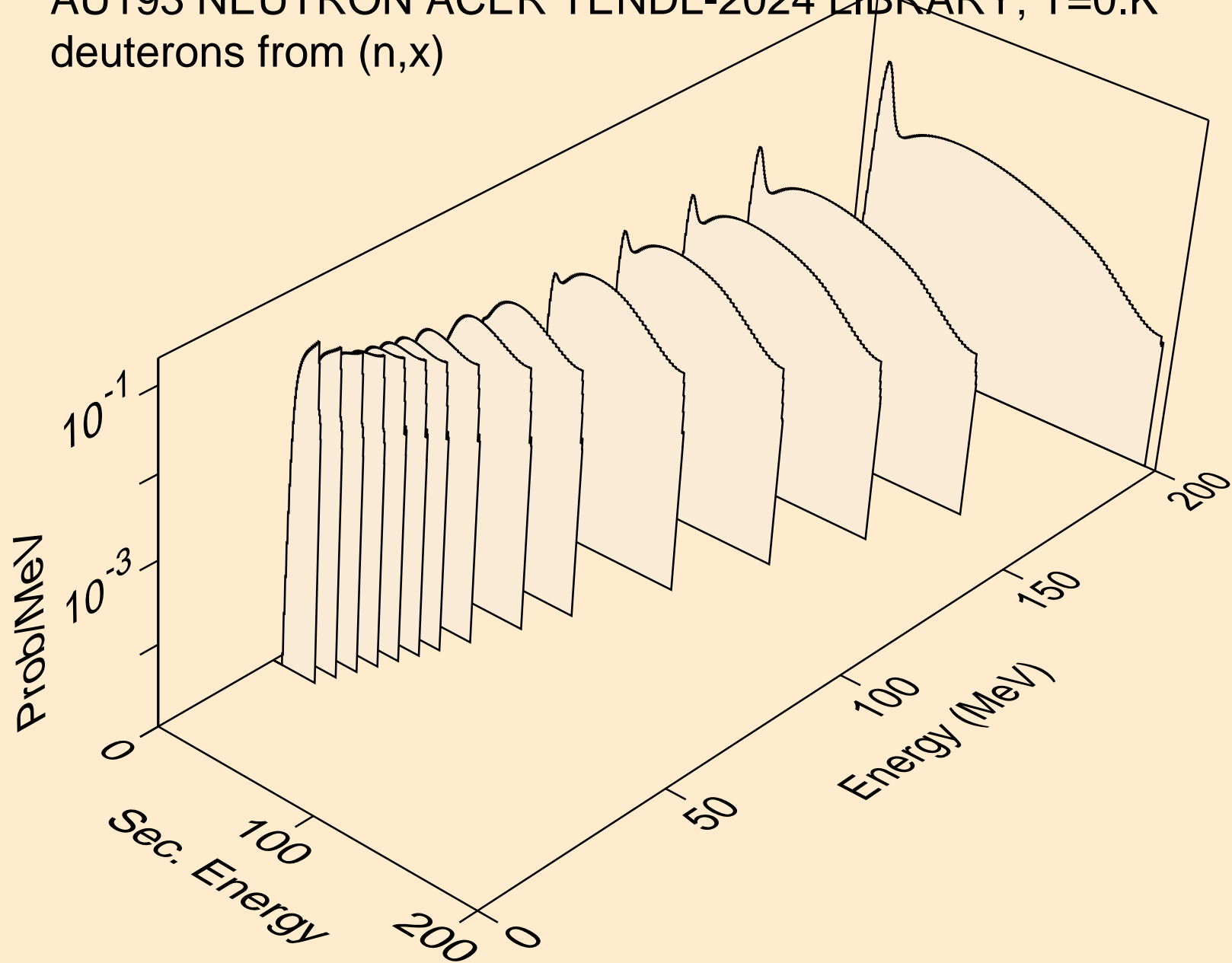

AU193 NEUTRON ACER TENDL-2024 LIBRARY; T=0.K
deuterons from (n,2nd)

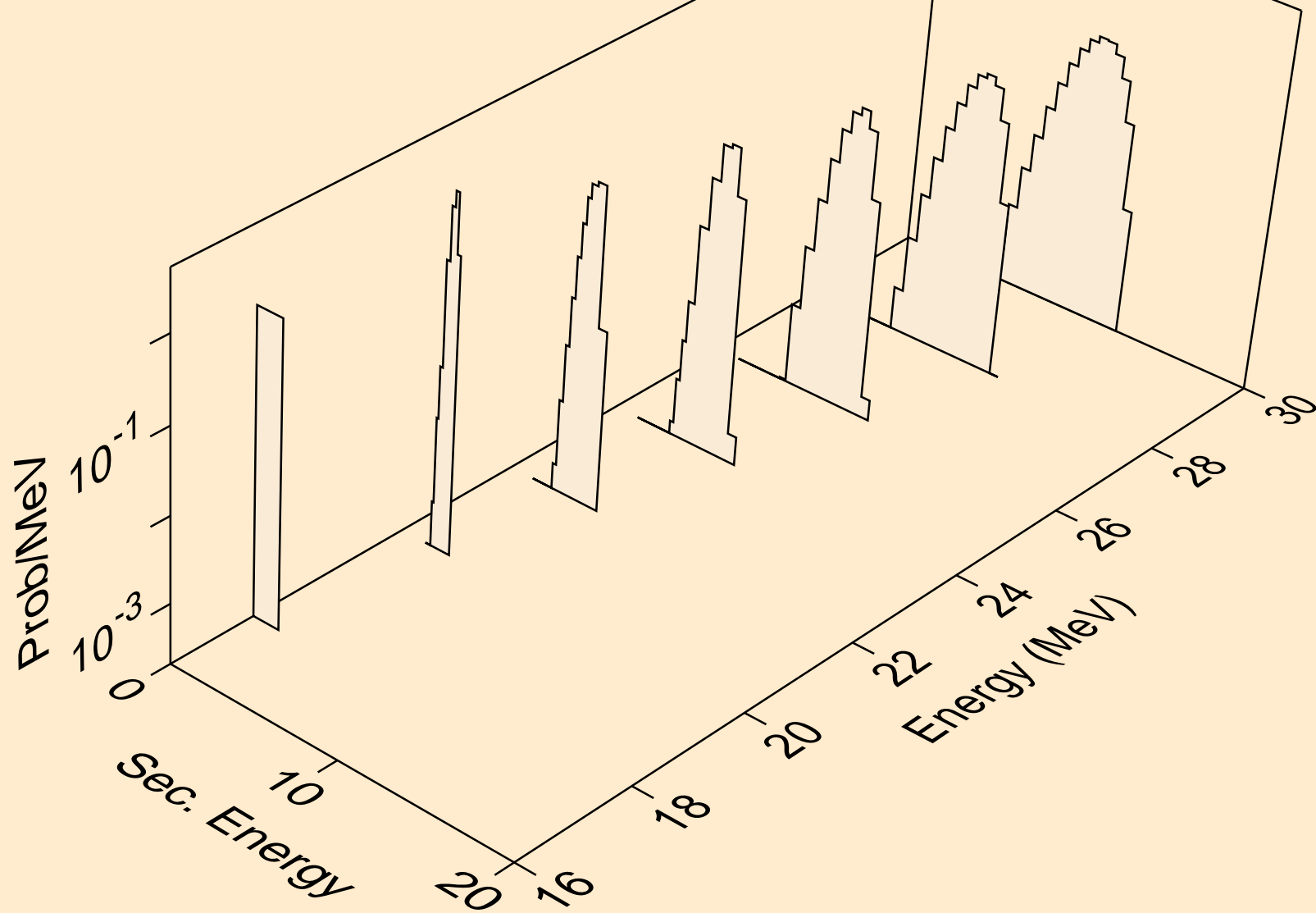

AU193 NEUTRON ACER TENDL-2024 LIBRARY; T=0.K
deuterons from (n,n*)d

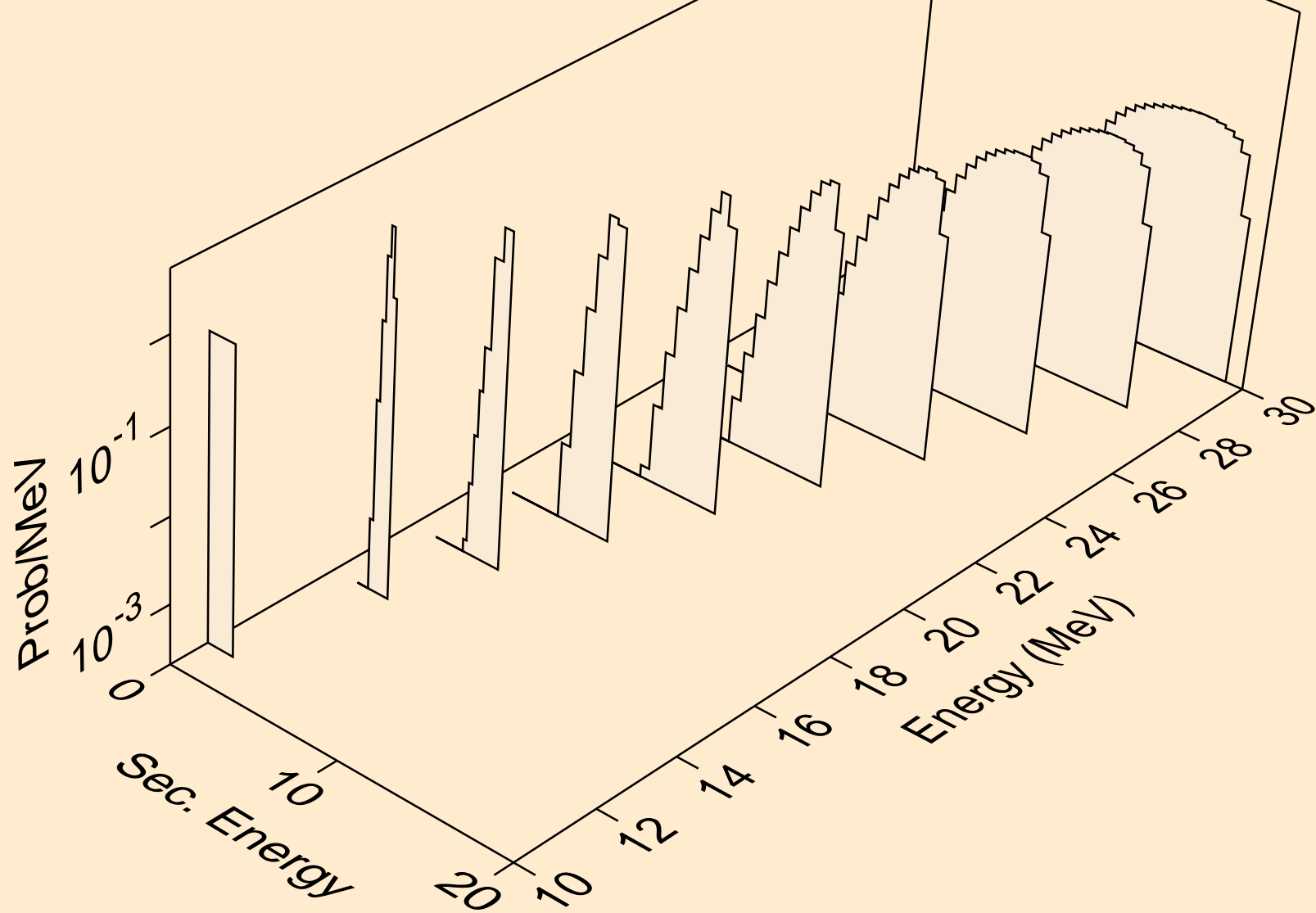

AU193 NEUTRON ACER TENDL-2024 LIBRARY; T=0.K
deuterons from (n,d)

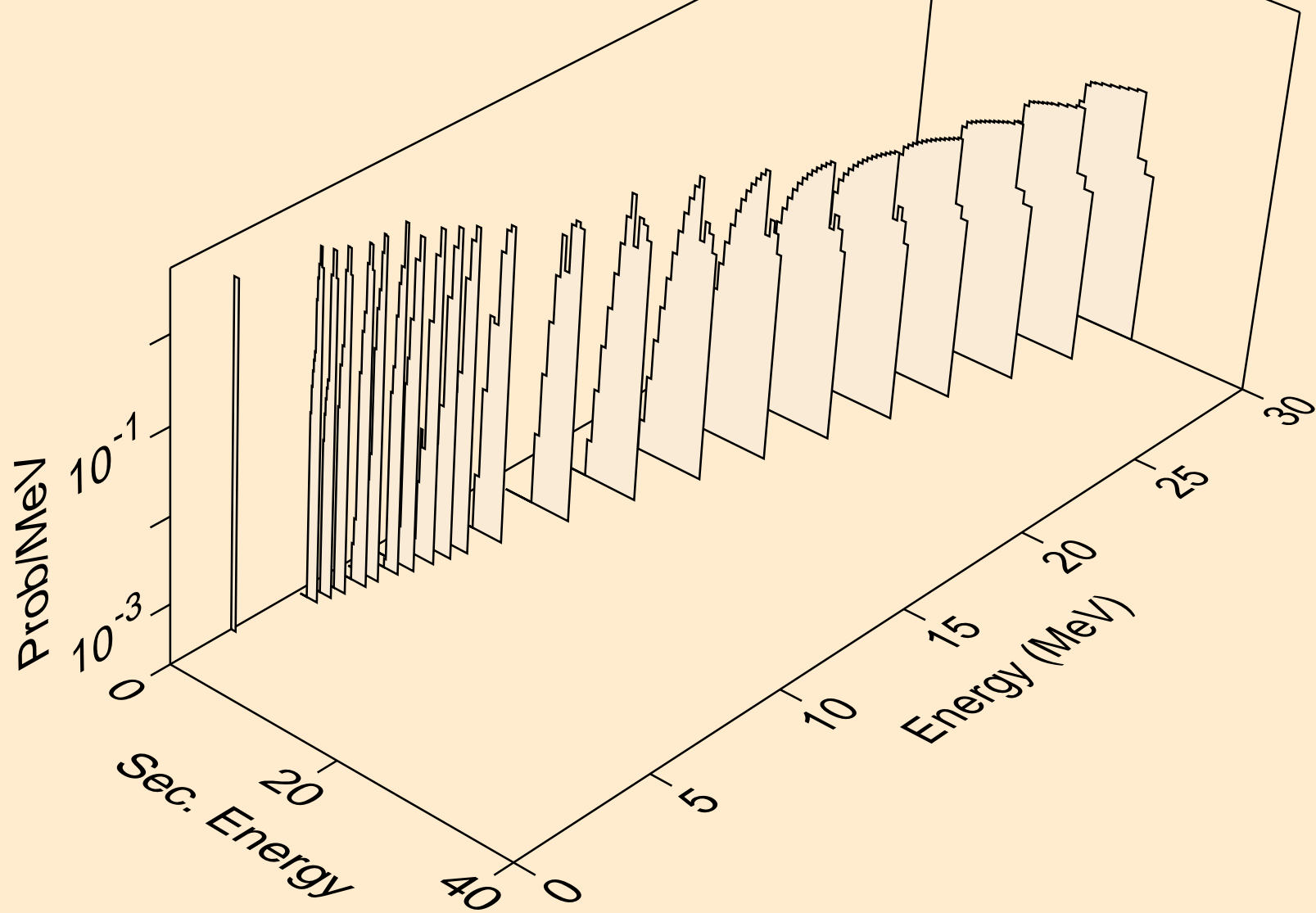

AU193 NEUTRON ACER TENDL-2024 LIBRARY; T=0.K
deuterons from (n,pd)

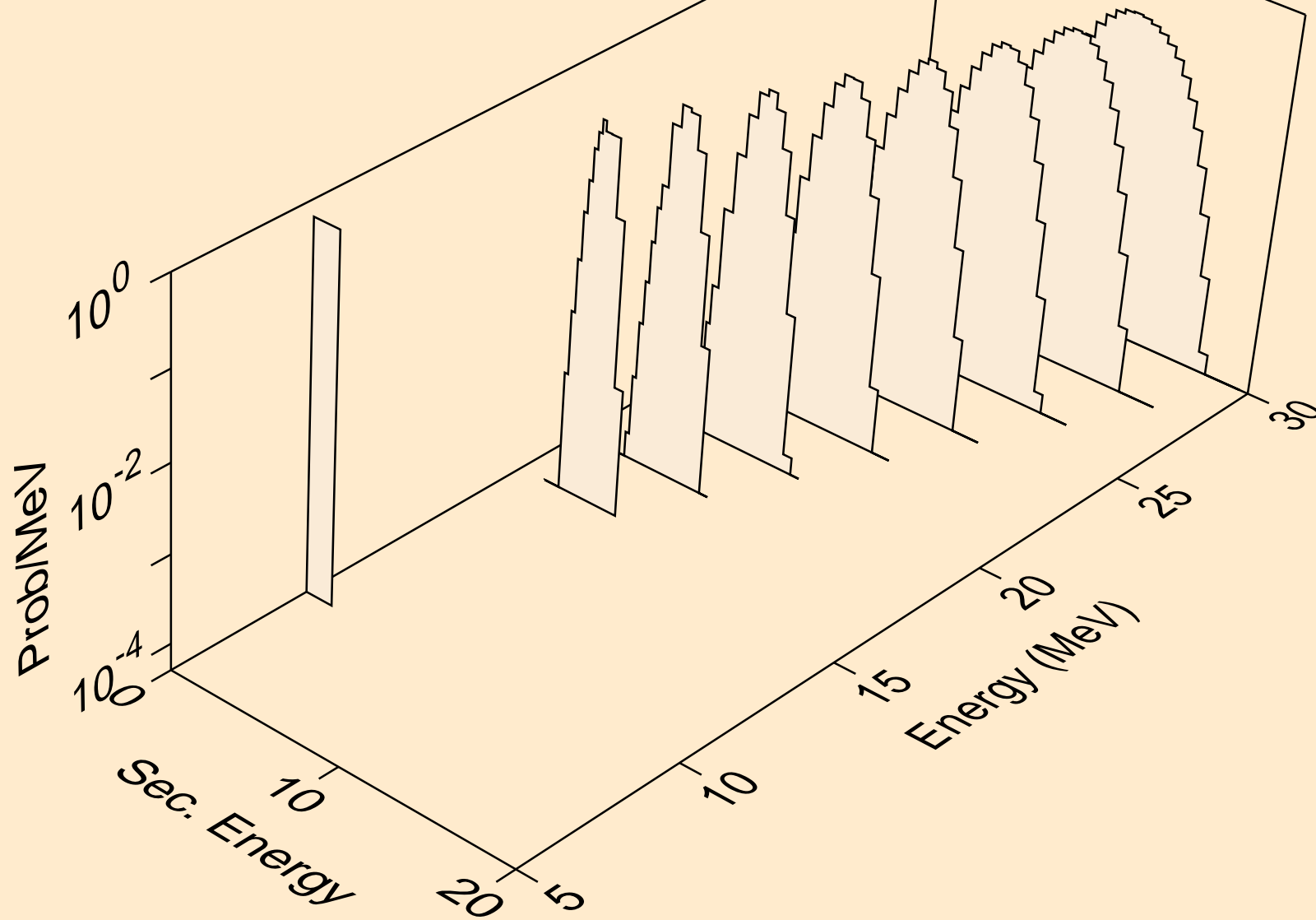

AU193 NEUTRON ACER TENDL-2024 LIBRARY; T=0.K
deuterons from (n,da)

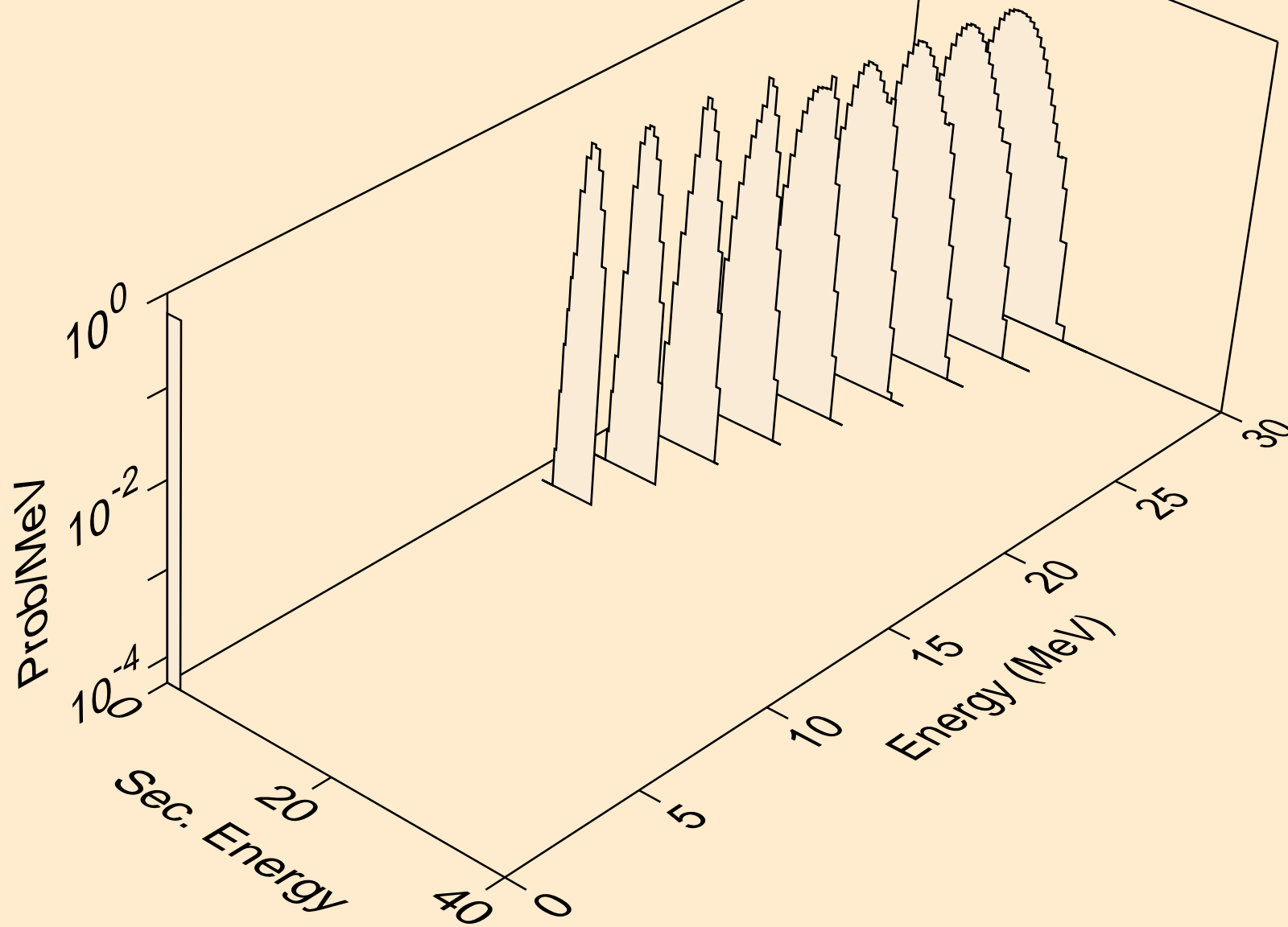

AU193 NEUTRON ACER TENDL-2024 LIBRARY; T=0.K
tritons from (n,x)

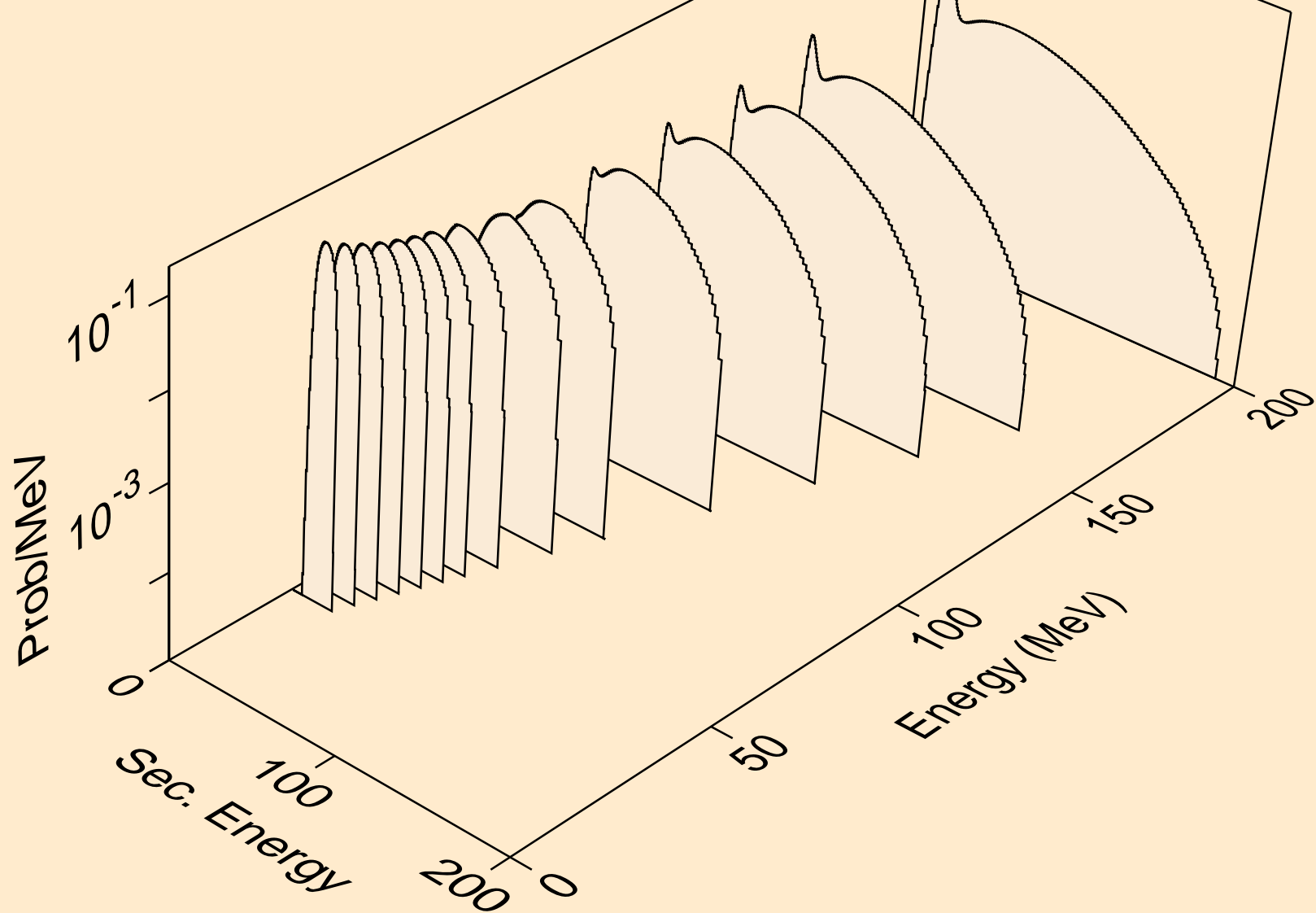

AU193 NEUTRON ACER TENDL-2024 LIBRARY; T=0.K
tritons from (n,n*)t

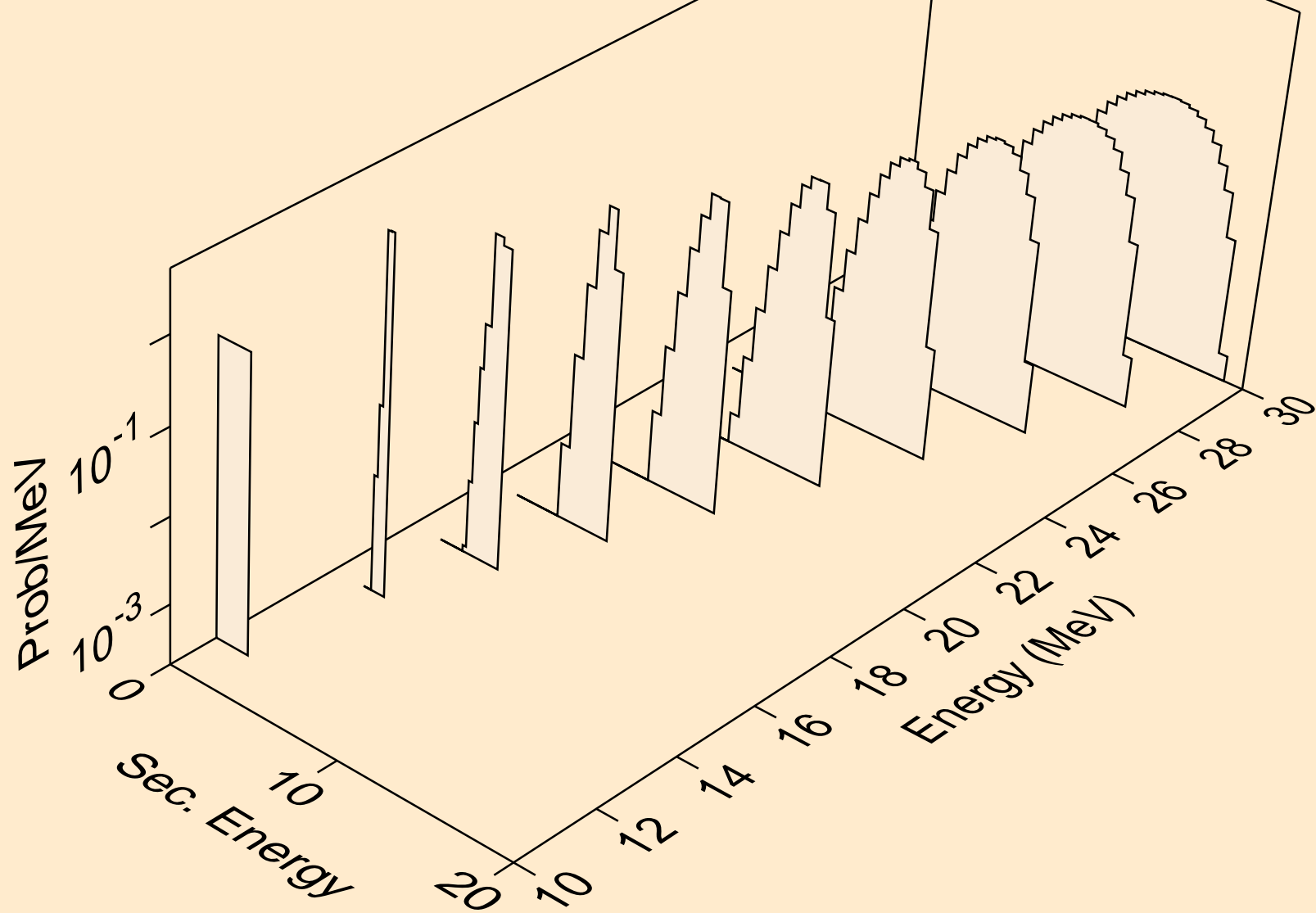

AU193 NEUTRON ACER TENDL-2024 LIBRARY; T=0.K
tritons from (n,t)

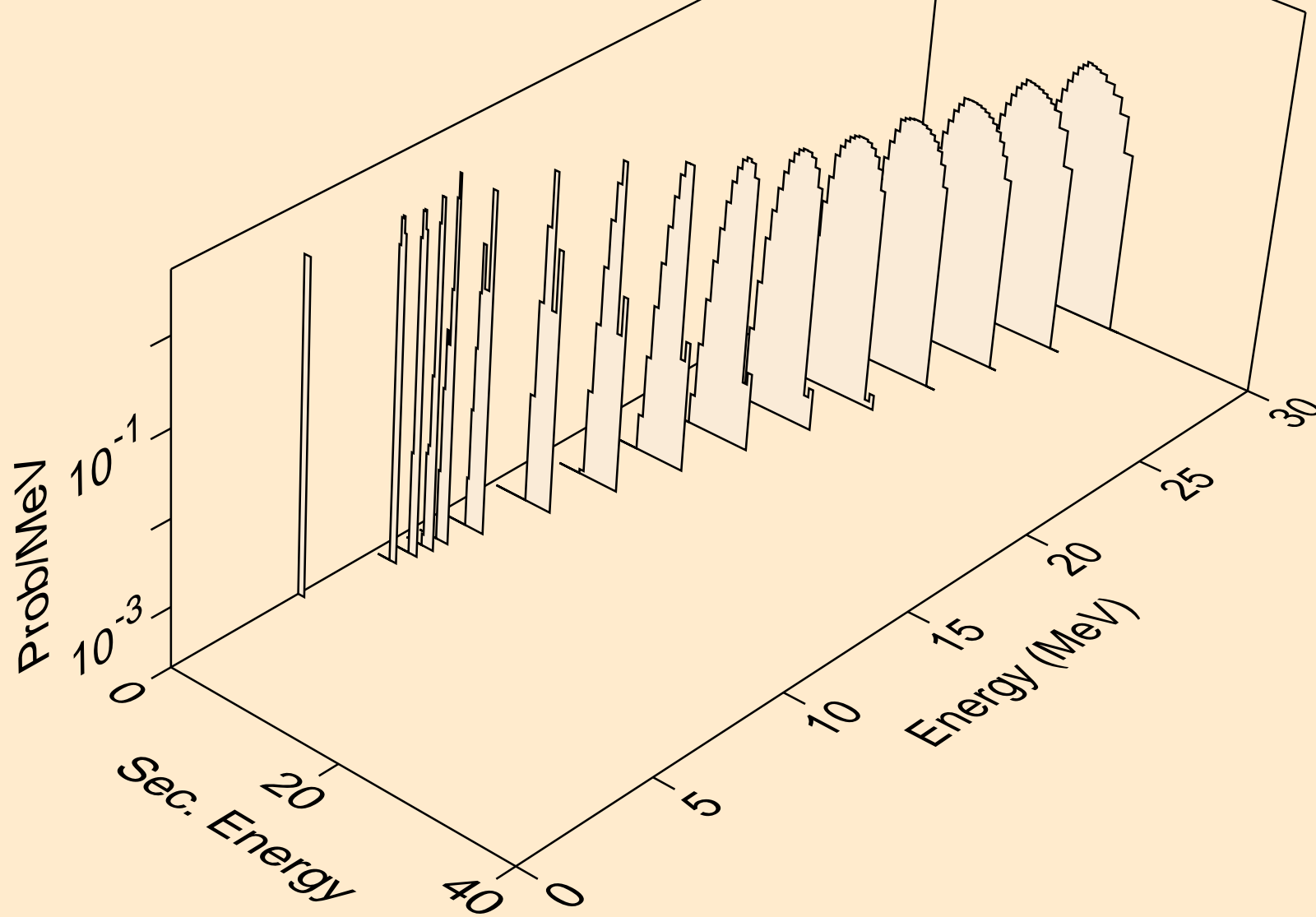

AU193 NEUTRON ACER TENDL-2024 LIBRARY; T=0.K
tritons from (n,pt)

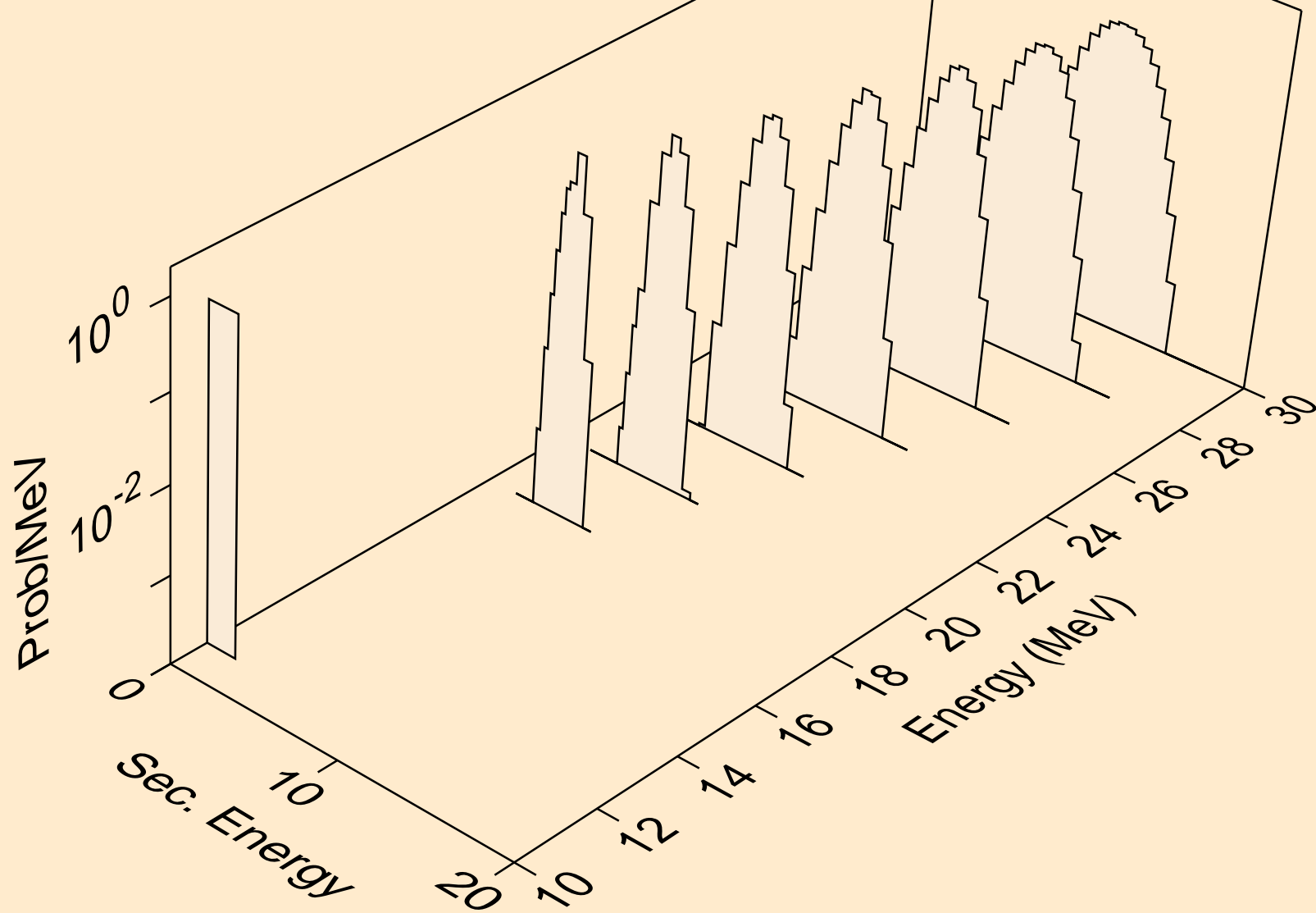

AU193 NEUTRON ACER TENDL-2024 LIBRARY; T=0.K
he3s from (n,x)

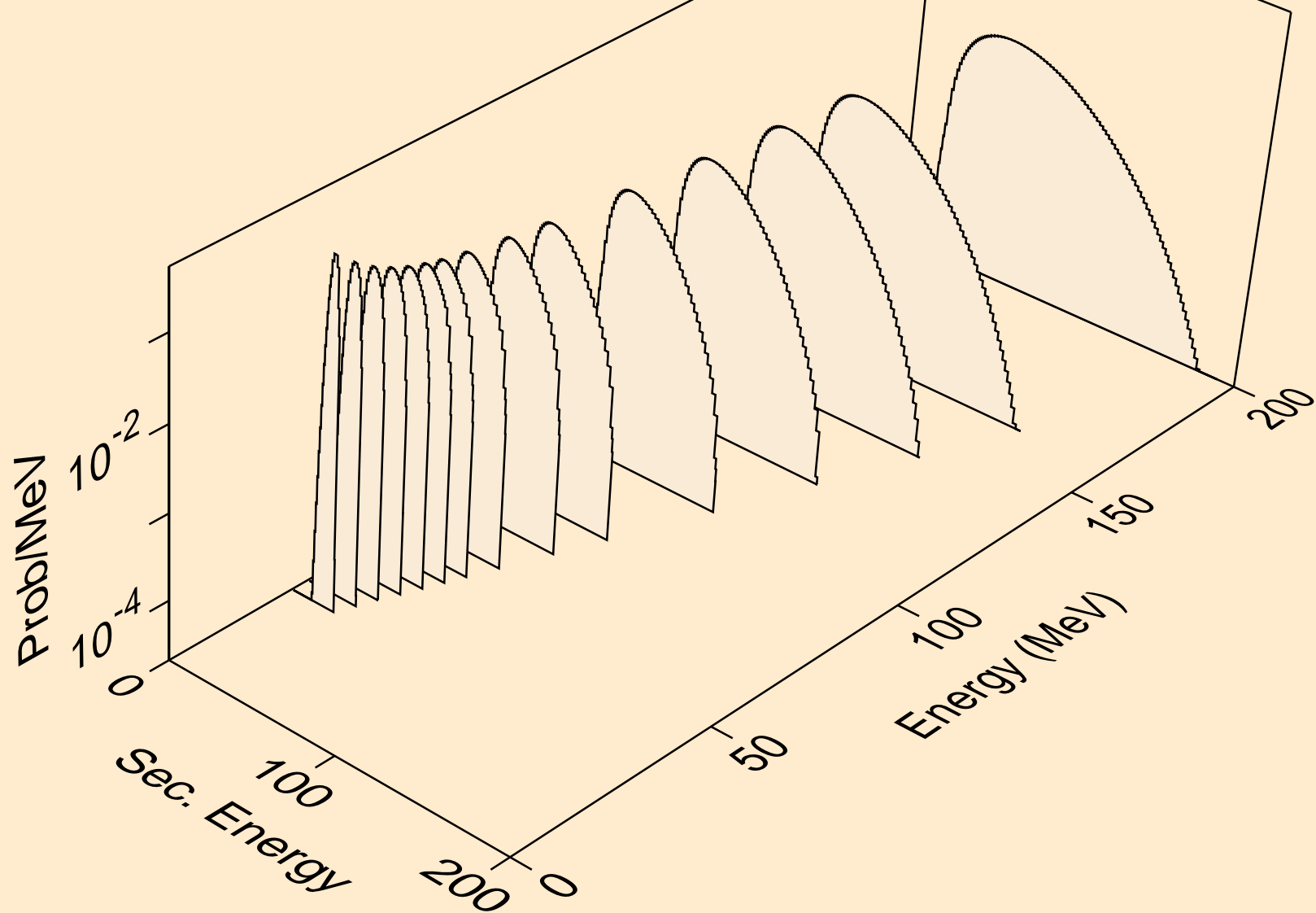

AU193 NEUTRON ACER TENDL-2024 LIBRARY; T=0.K
he3s from (n,n*)he3

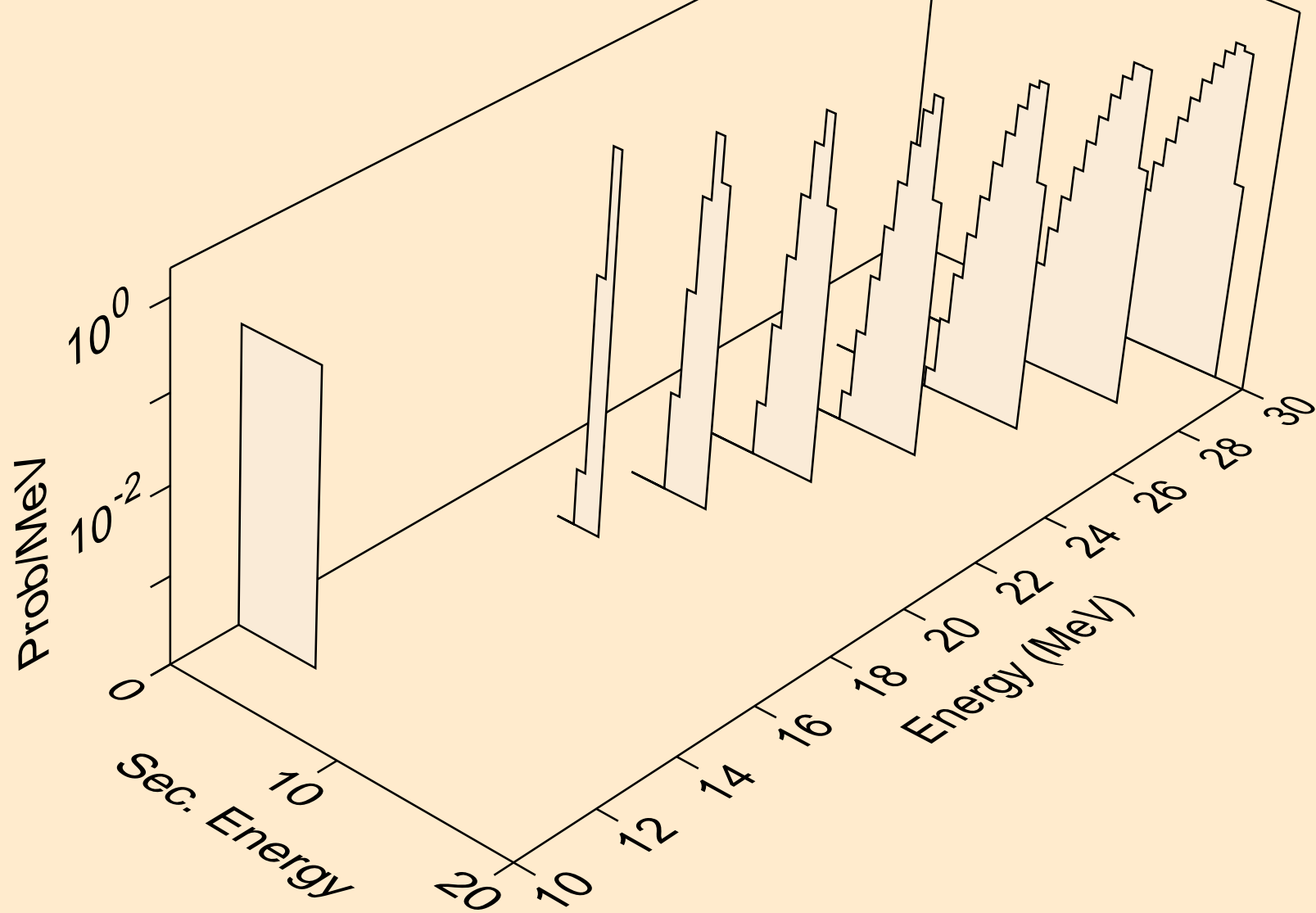

AU193 NEUTRON ACER TENDL-2024 LIBRARY; T=0.K
he3s from (n,he3)

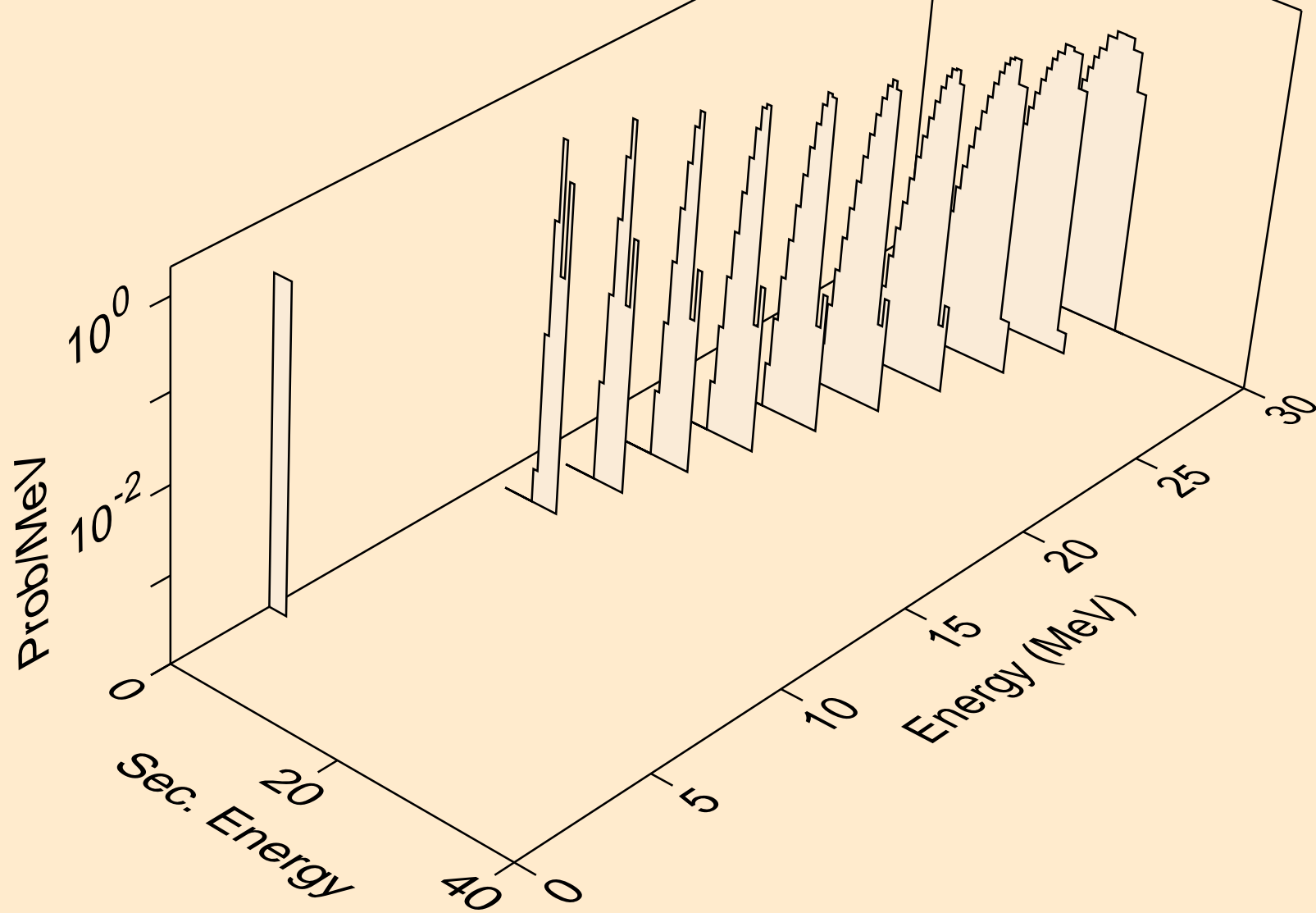

AU193 NEUTRON ACER TENDL-2024 LIBRARY; T=0.K
alphas from (n,x)

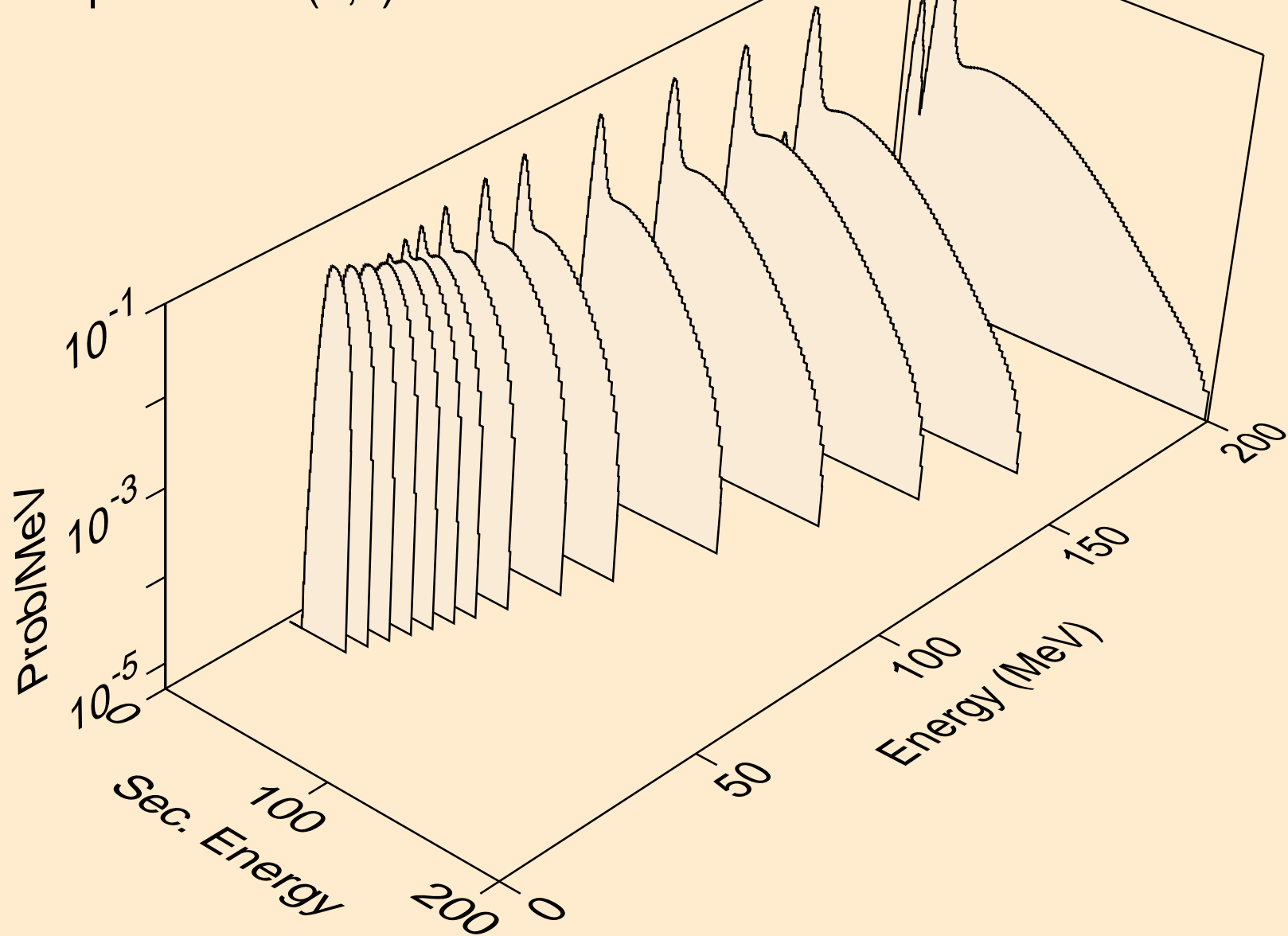

AU193 NEUTRON ACER TENDL-2024 LIBRARY; T=0.K
alphas from (n,n*)a

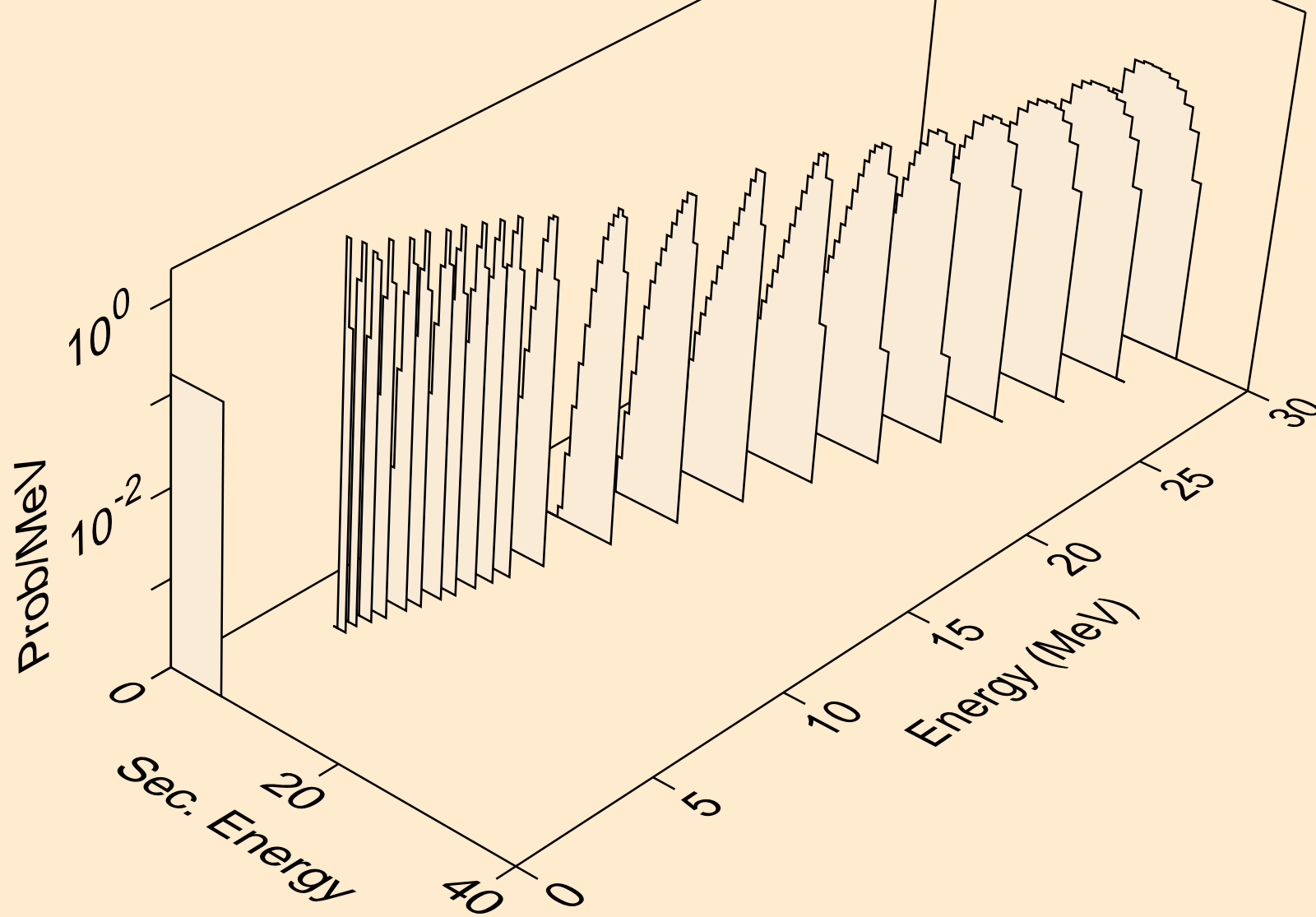

AU193 NEUTRON ACER TENDL-2024 LIBRARY; T=0.K
alphas from (n,2n)a

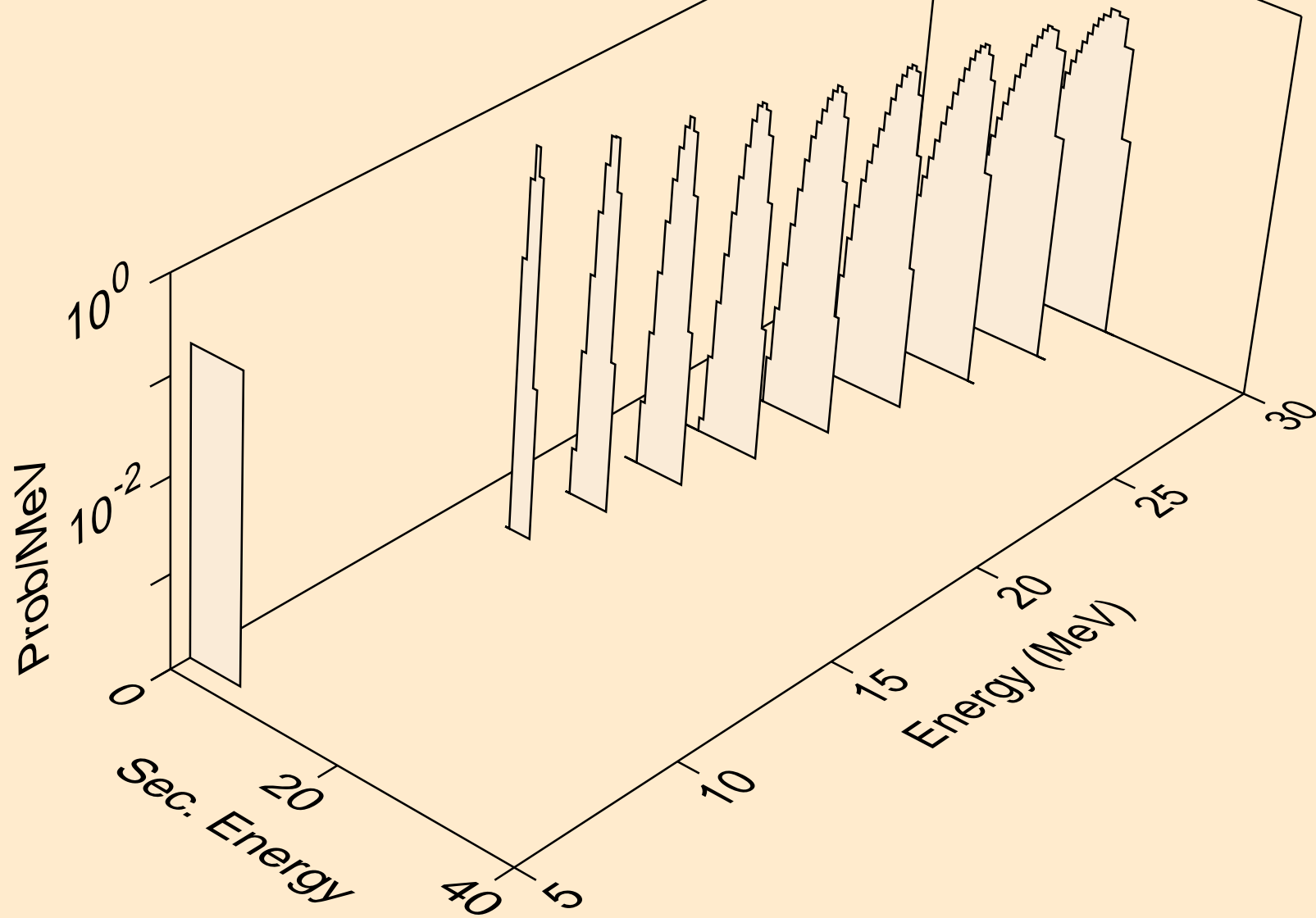

AU193 NEUTRON ACER TENDL-2024 LIBRARY; T=0.K
alphas from (n,3n)a

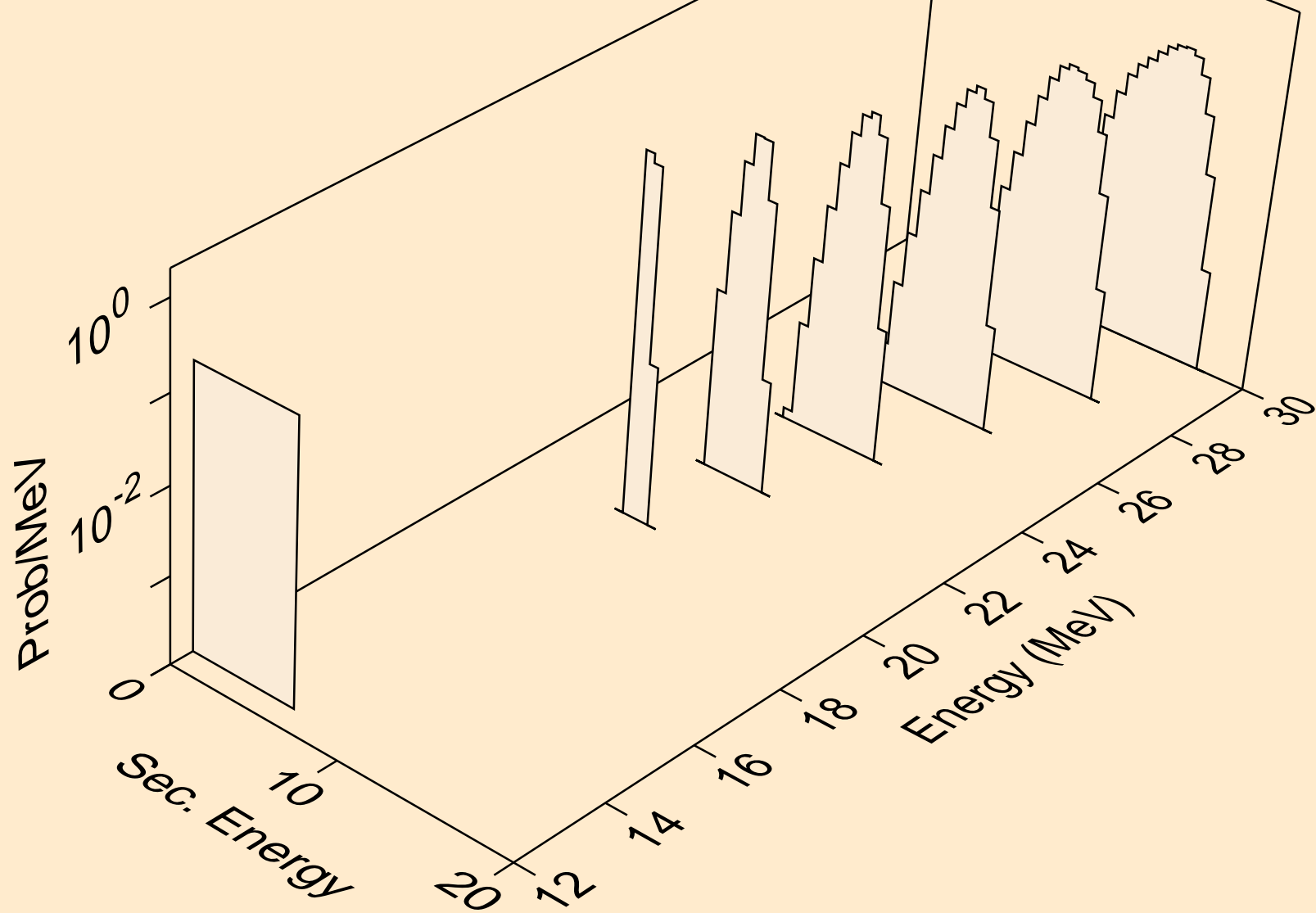

AU193 NEUTRON ACER TENDL-2024 LIBRARY; T=0.K
alphas from (n,n*)2a

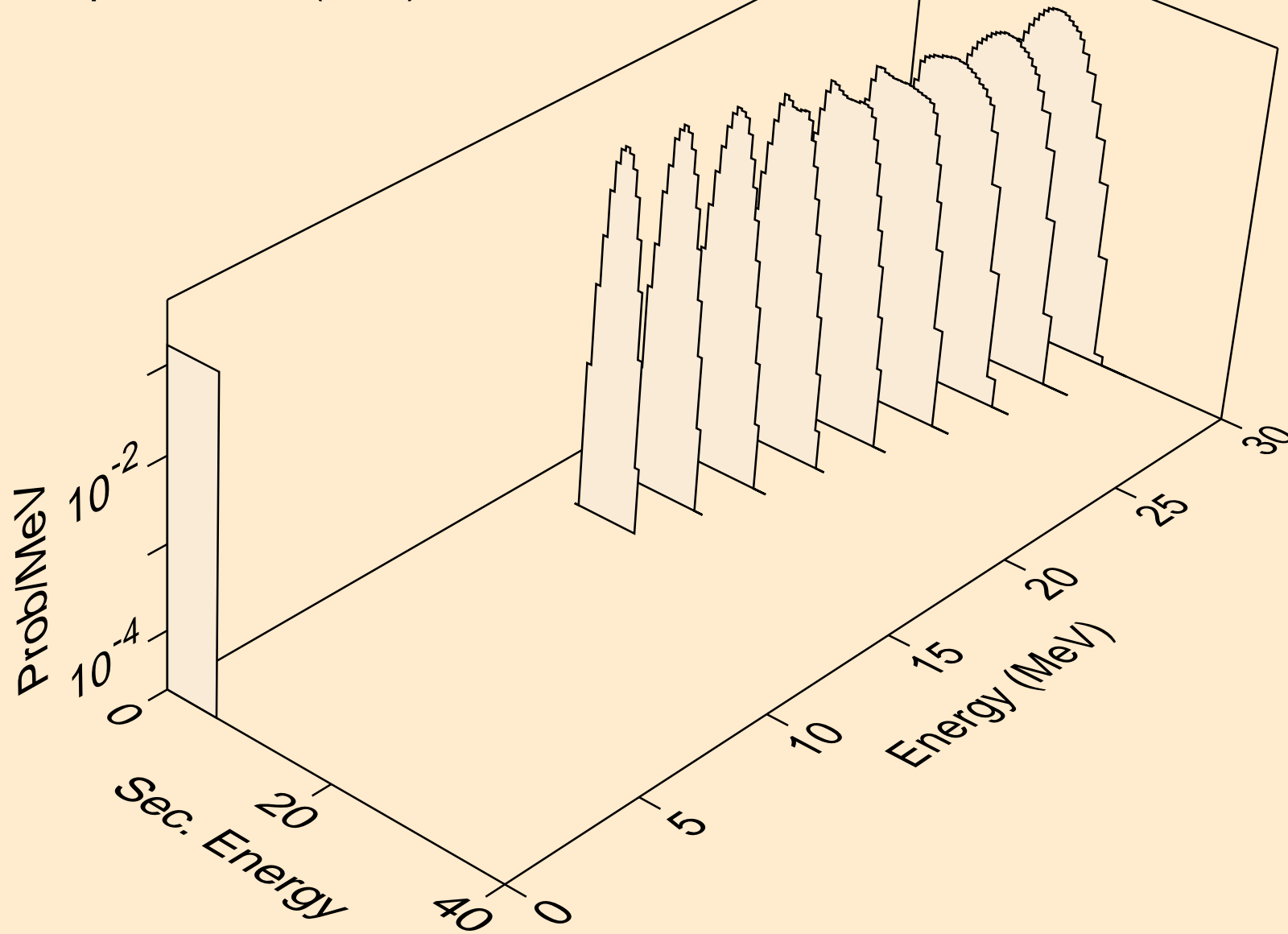

AU193 NEUTRON ACER TENDL-2024 LIBRARY; T=0.K
alphas from (n,npa)

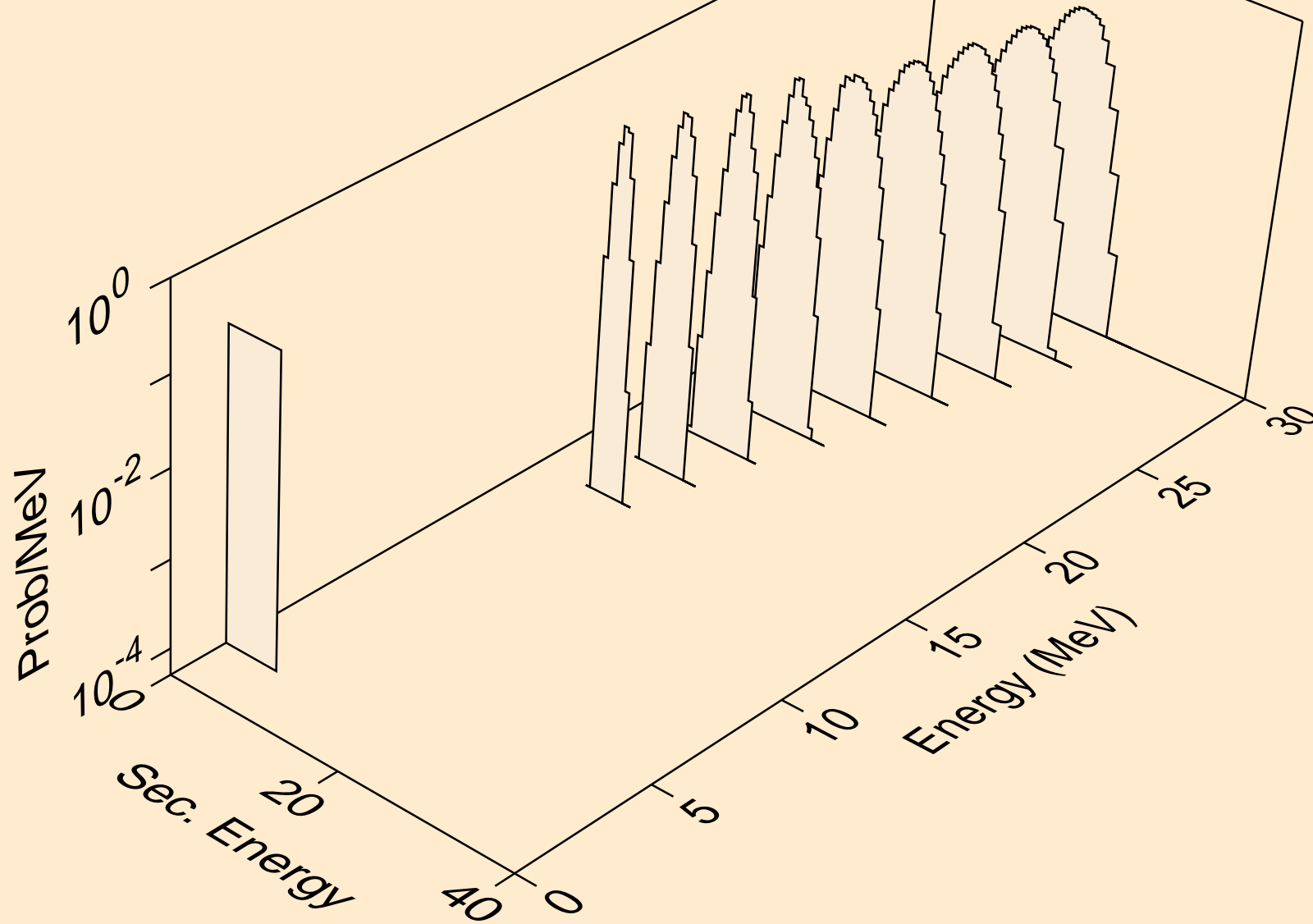

AU193 NEUTRON ACER TENDL-2024 LIBRARY; T=0.K
alphas from (n,a)

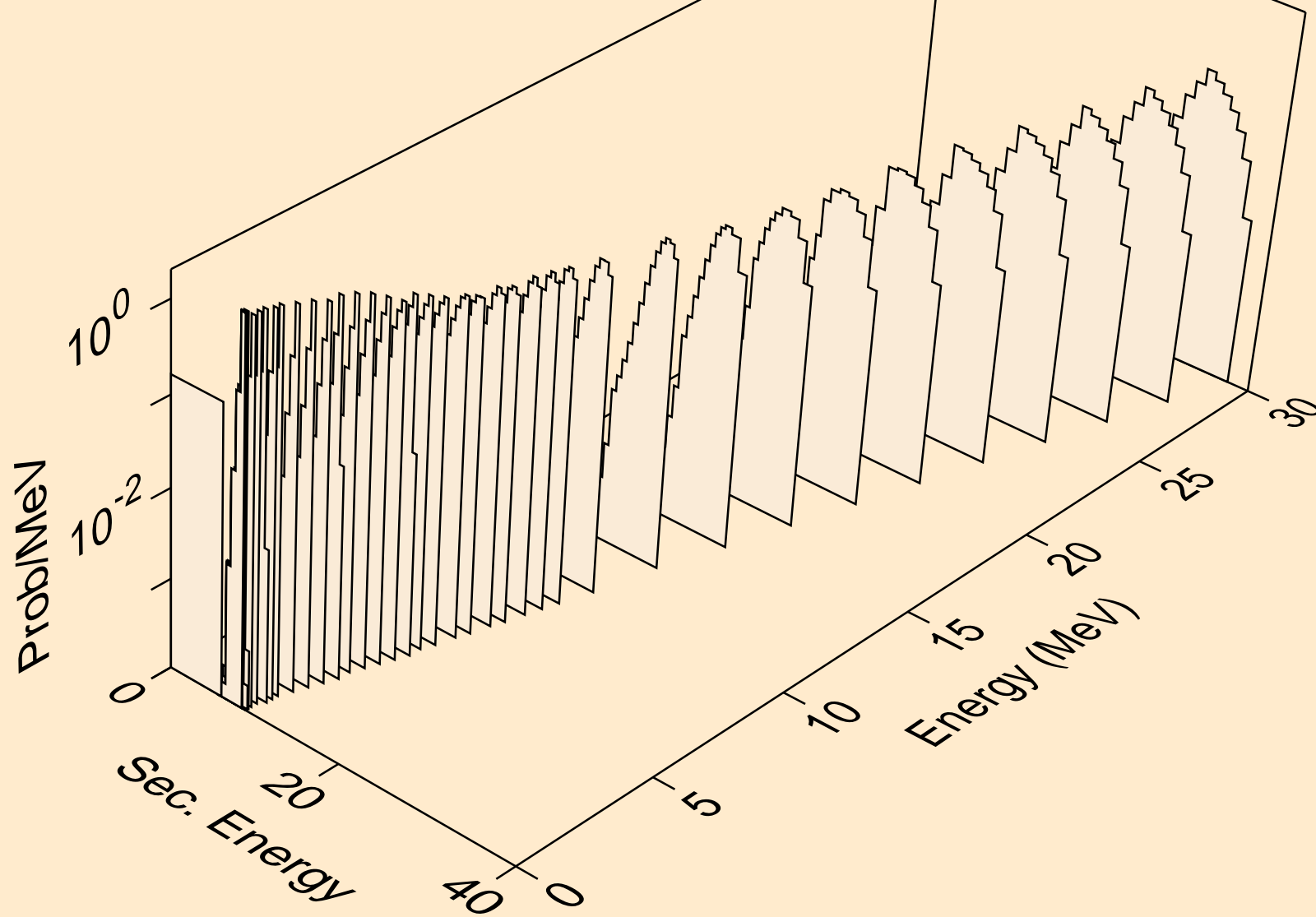

AU193 NEUTRON ACER TENDL-2024 LIBRARY; T=0.K
alphas from (n,2a)

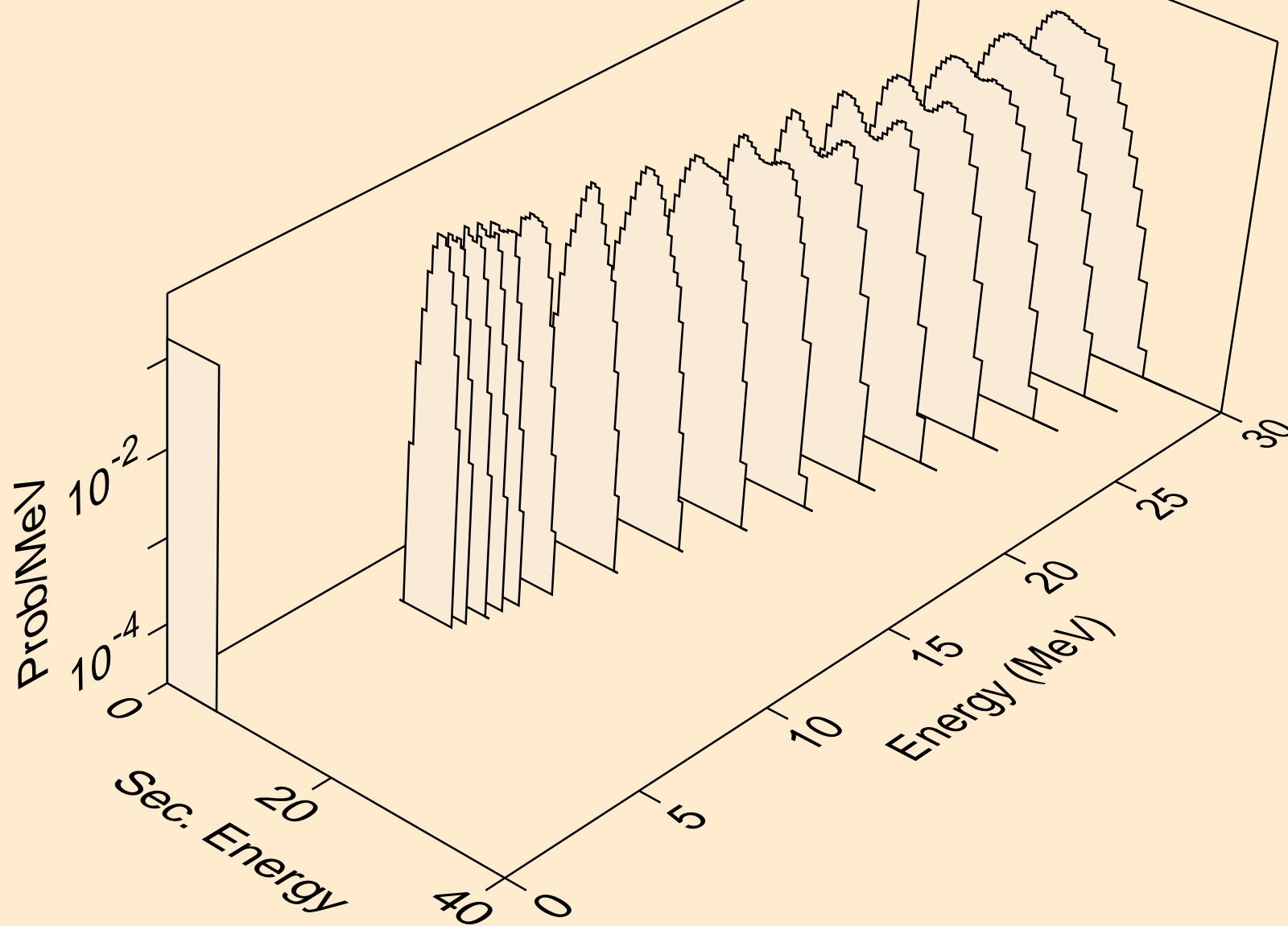

AU193 NEUTRON ACER TENDL-2024 LIBRARY; T=0.K
alphas from (n,pa)

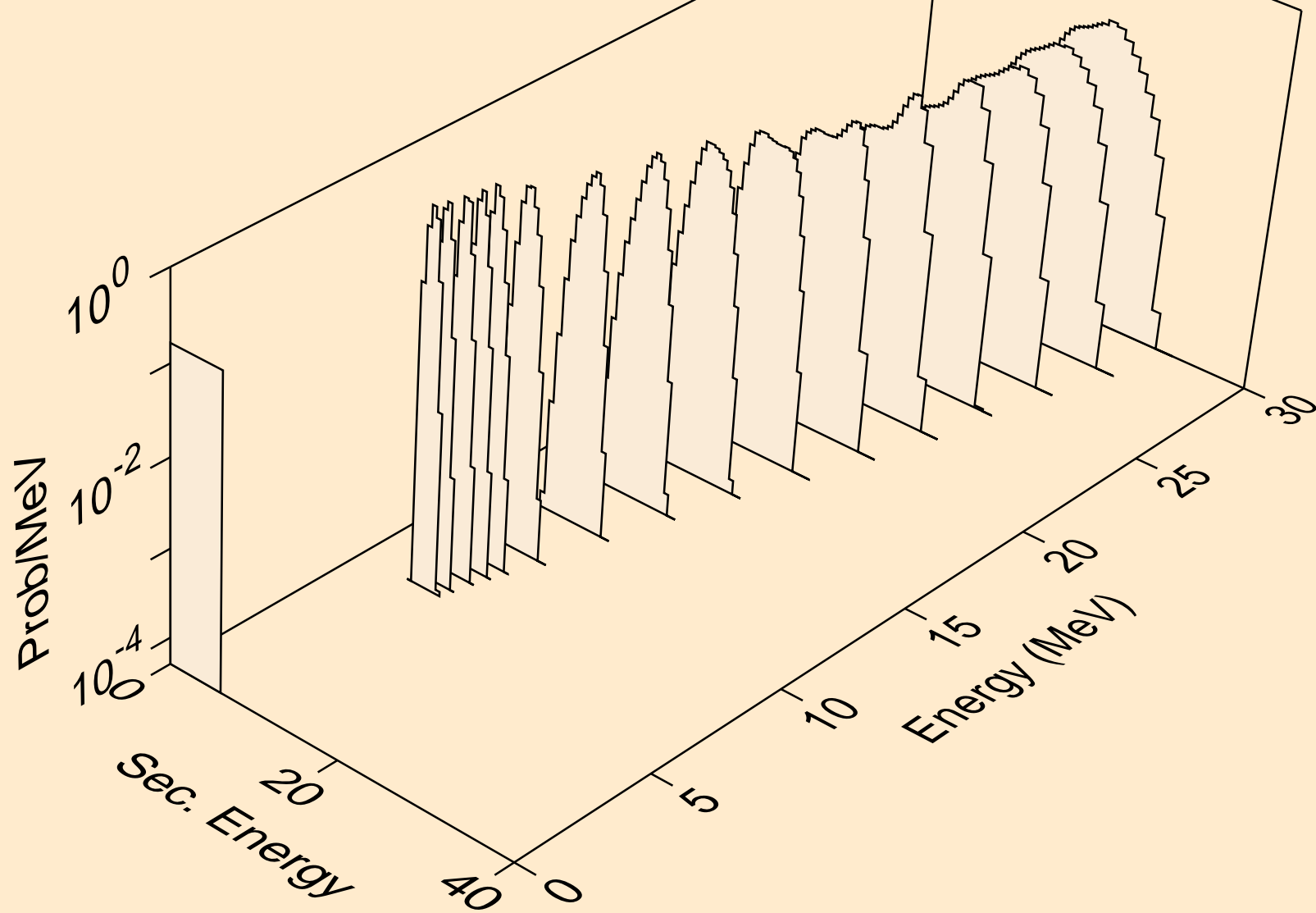

AU193 NEUTRON ACER TENDL-2024 LIBRARY; T=0.K
alphas from (n,da)

