

AU208 NEUTRON ACER TENDL-2024 LIBRARY; T=0.K  
Principal cross sections

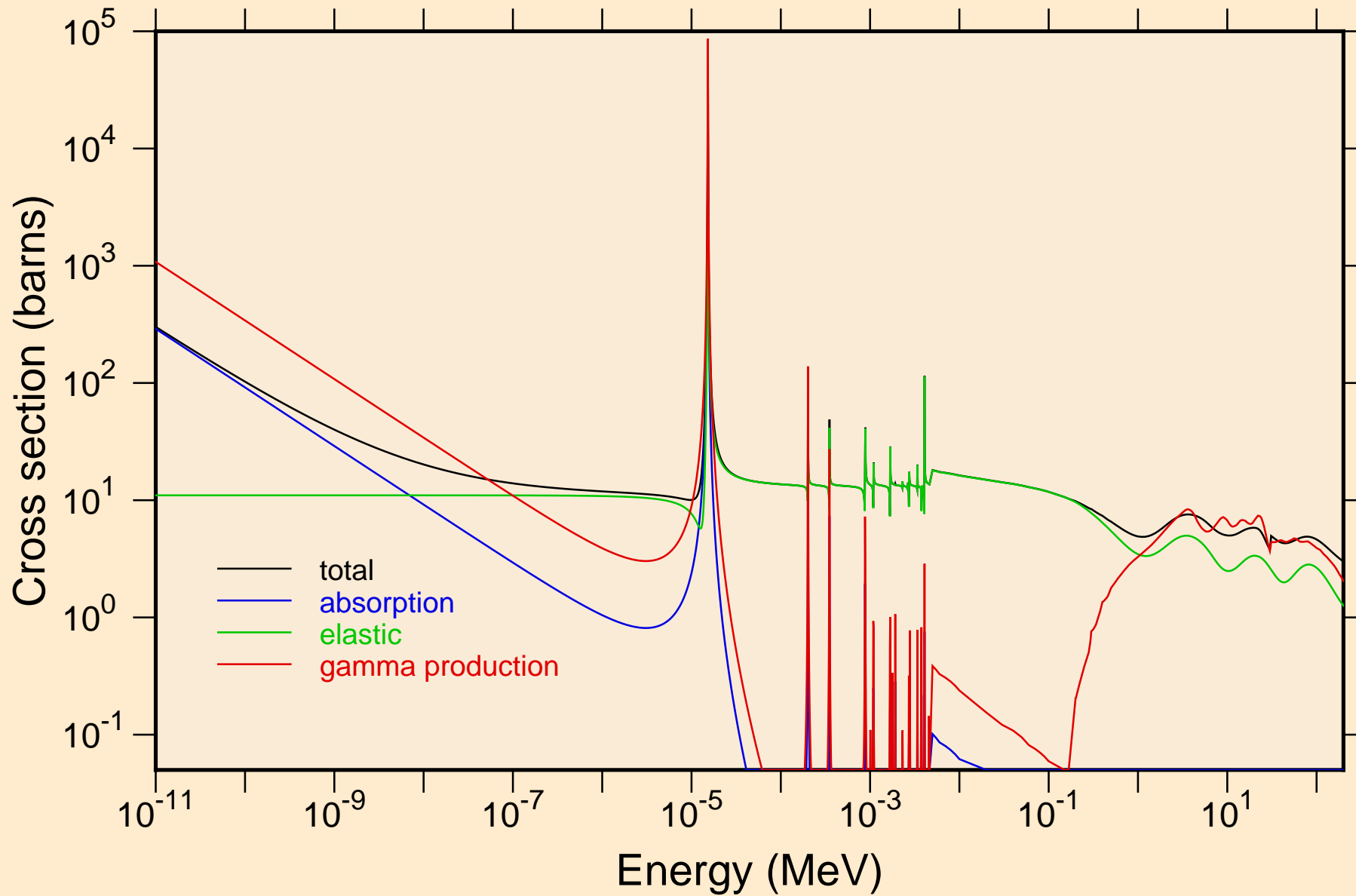

AU208 NEUTRON ACER TENDL-2024 LIBRARY; T=0.K  
resonance total cross section

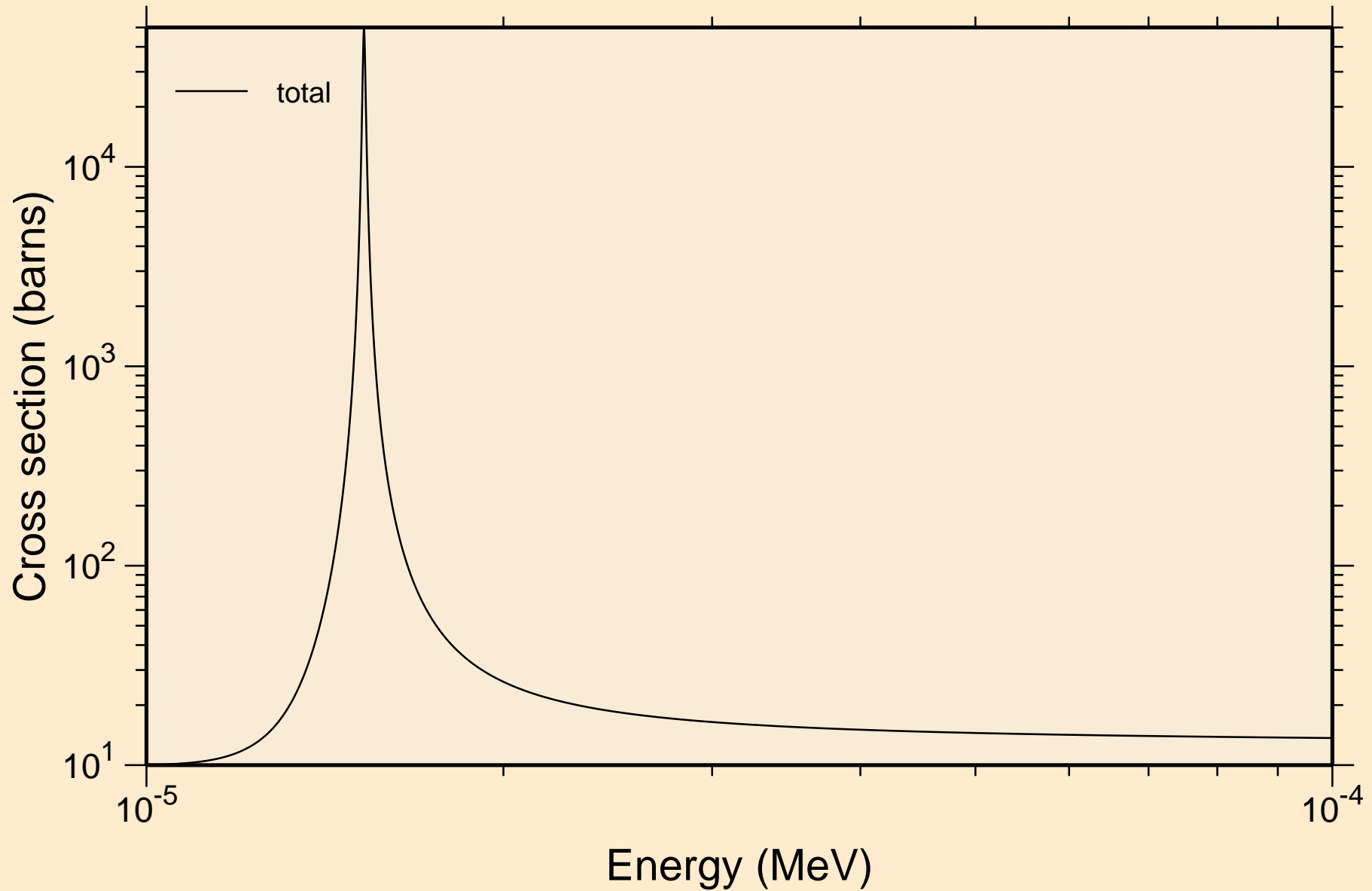

AU208 NEUTRON ACER TENDL-2024 LIBRARY; T=0.K  
resonance total cross section

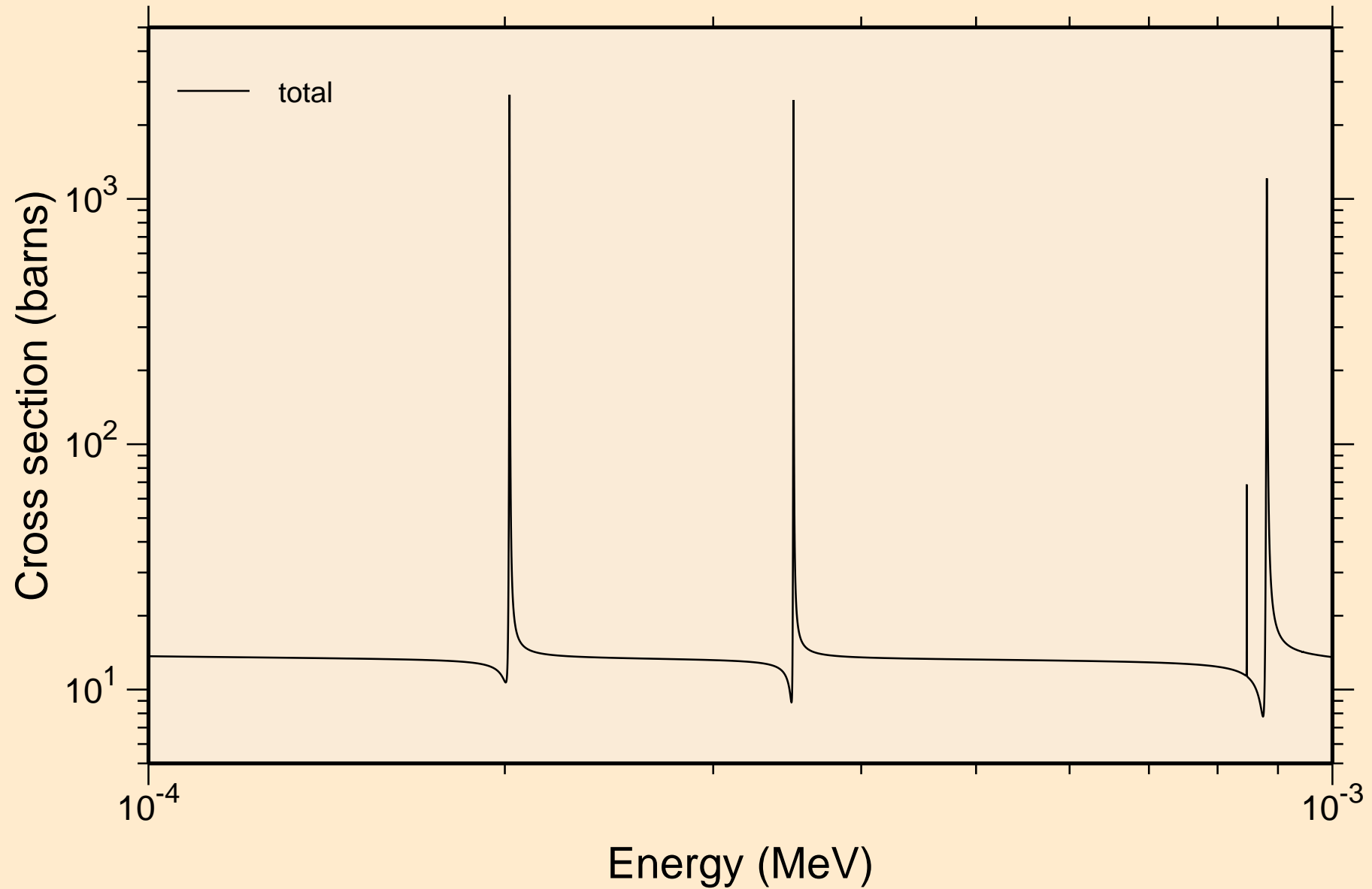

AU208 NEUTRON ACER TENDL-2024 LIBRARY; T=0.K  
resonance total cross section

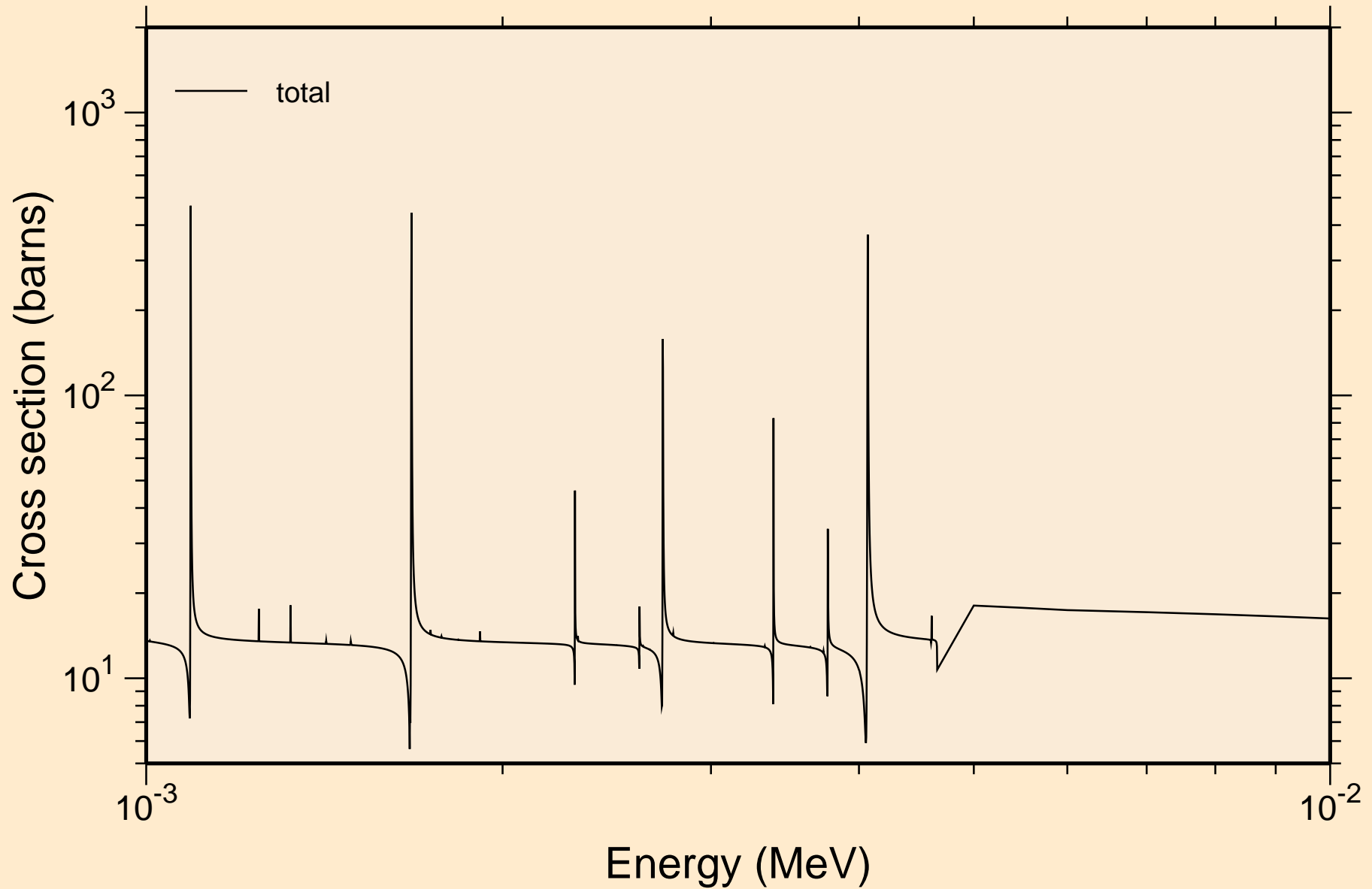

AU208 NEUTRON ACER TENDL-2024 LIBRARY; T=0.K  
resonance total cross section

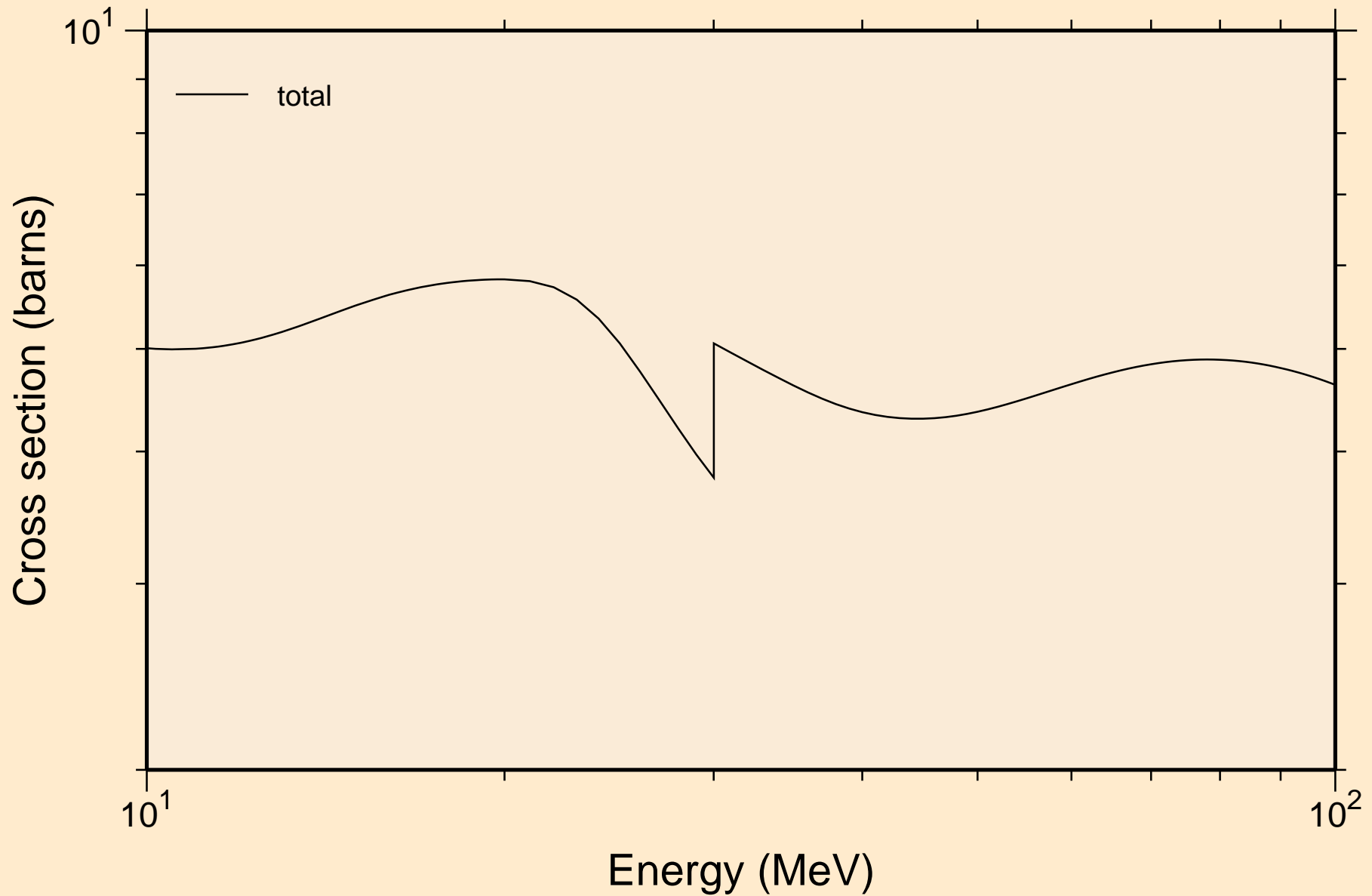

AU208 NEUTRON ACER TENDL-2024 LIBRARY; T=0.K  
resonance absorption cross sections

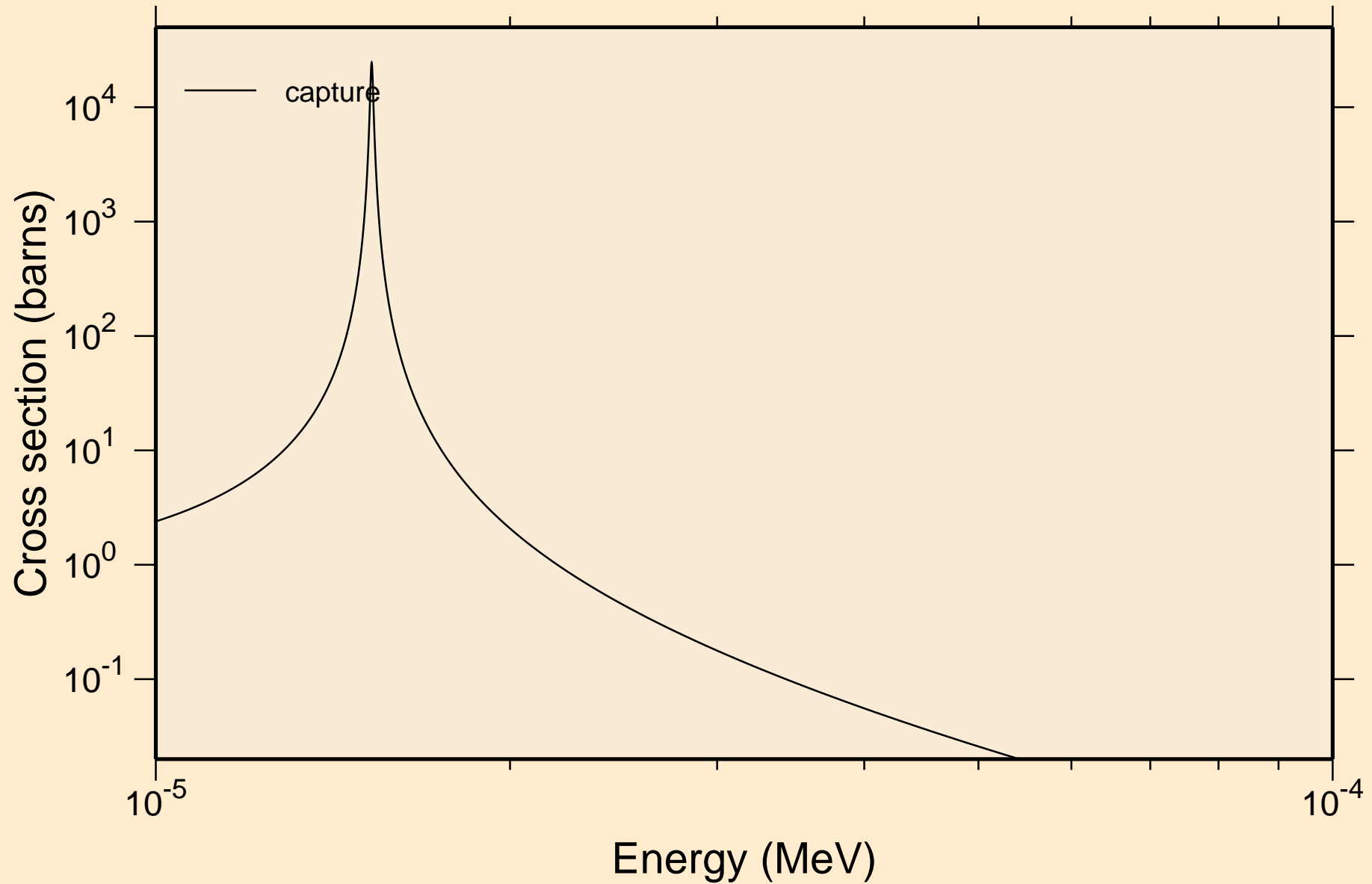

AU208 NEUTRON ACER TENDL-2024 LIBRARY; T=0.K  
resonance absorption cross sections

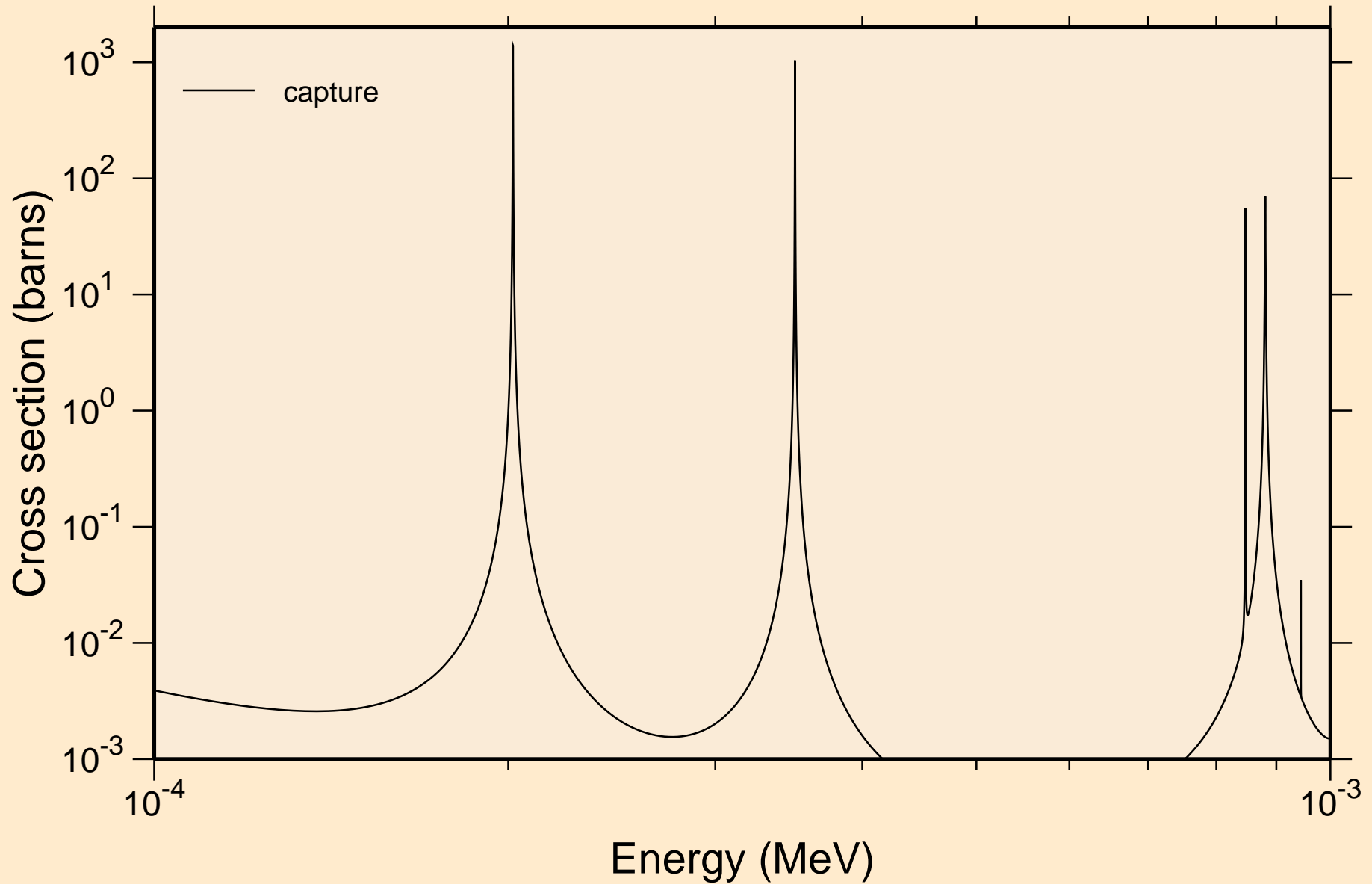

AU208 NEUTRON ACER TENDL-2024 LIBRARY; T=0.K  
resonance absorption cross sections

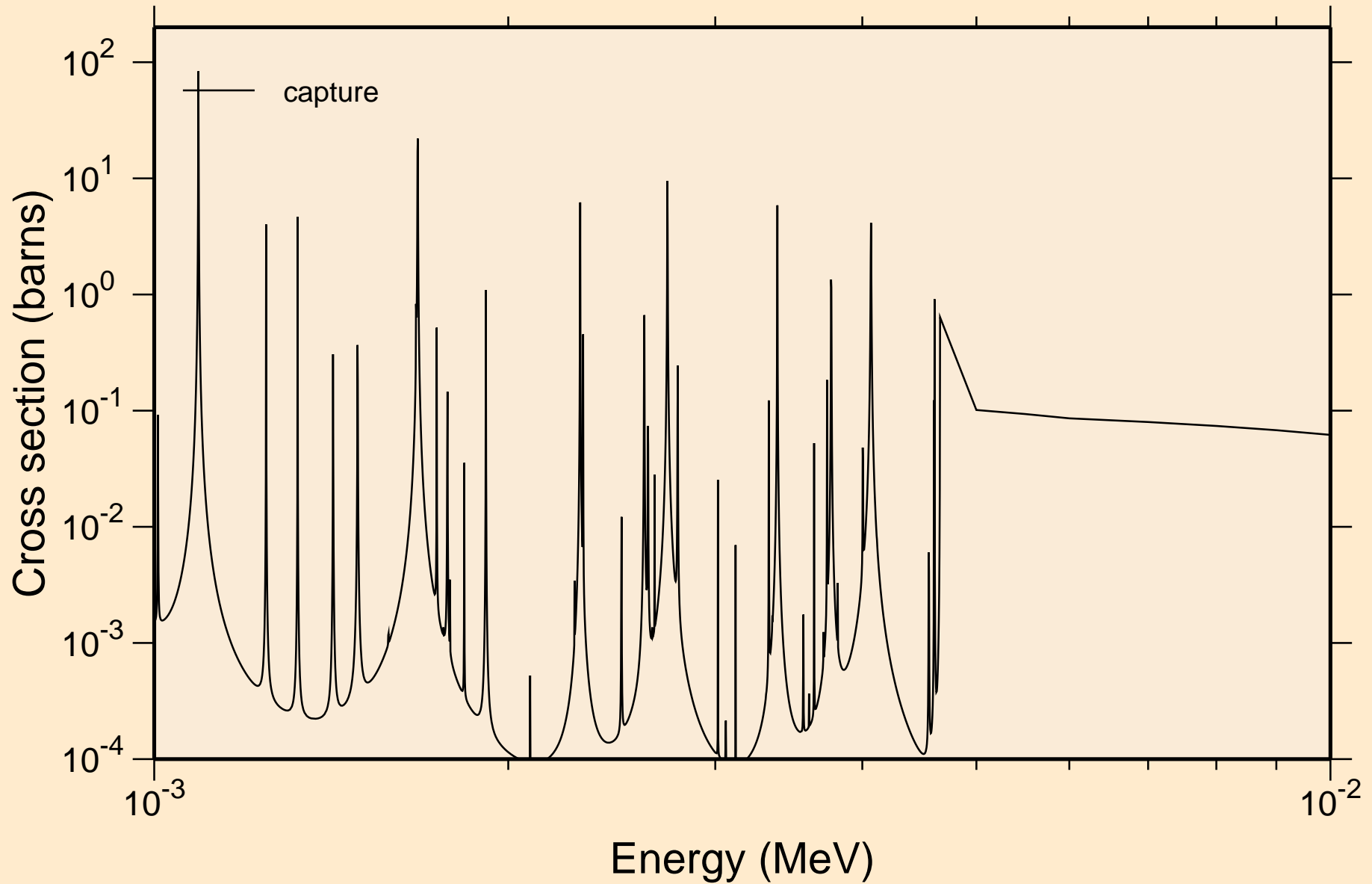



AU208 NEUTRON ACER TENDL-2024 LIBRARY; T=0.K  
resonance absorption cross sections

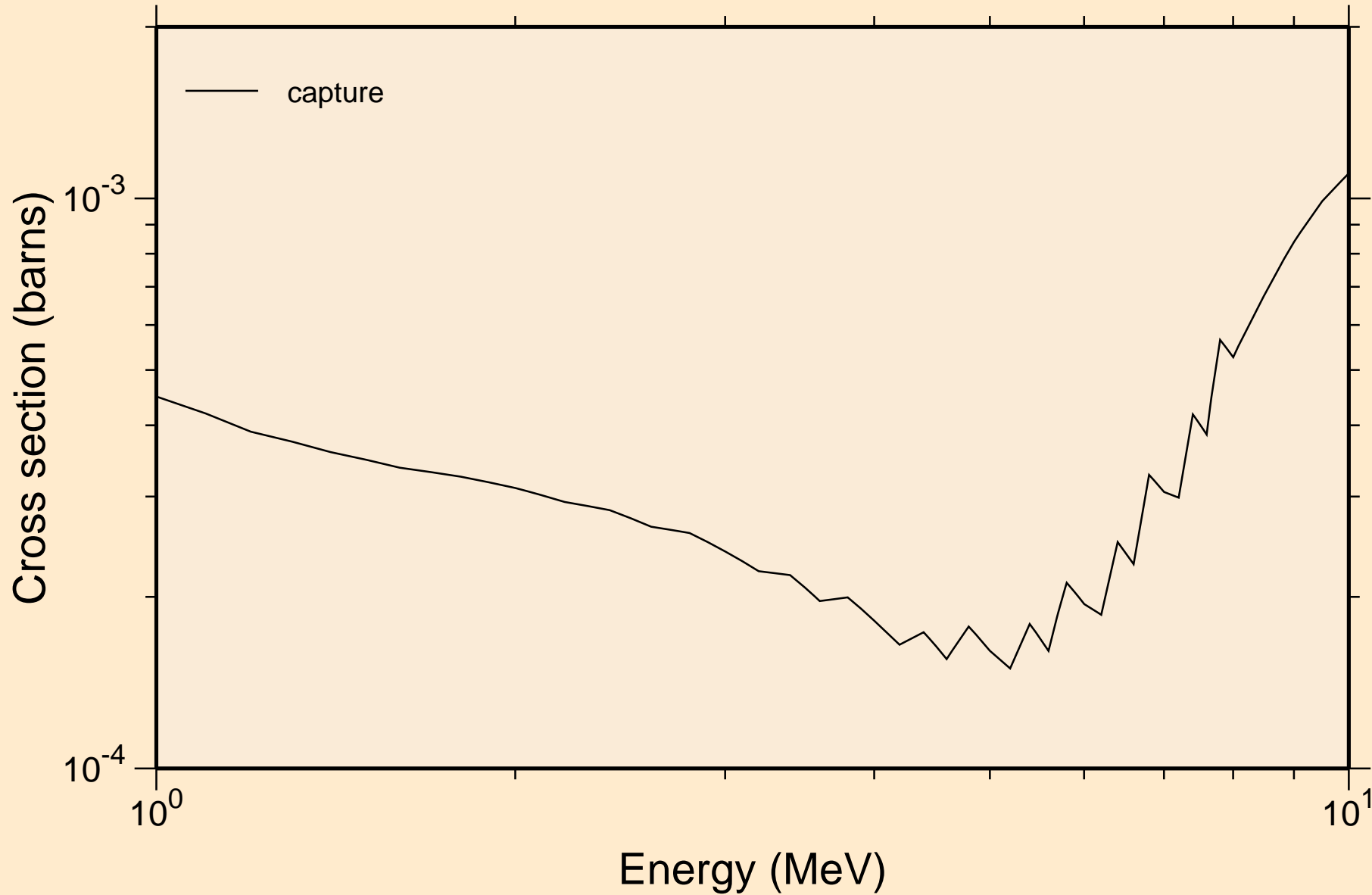

AU208 NEUTRON ACER TENDL-2024 LIBRARY; T=0.K  
Heating

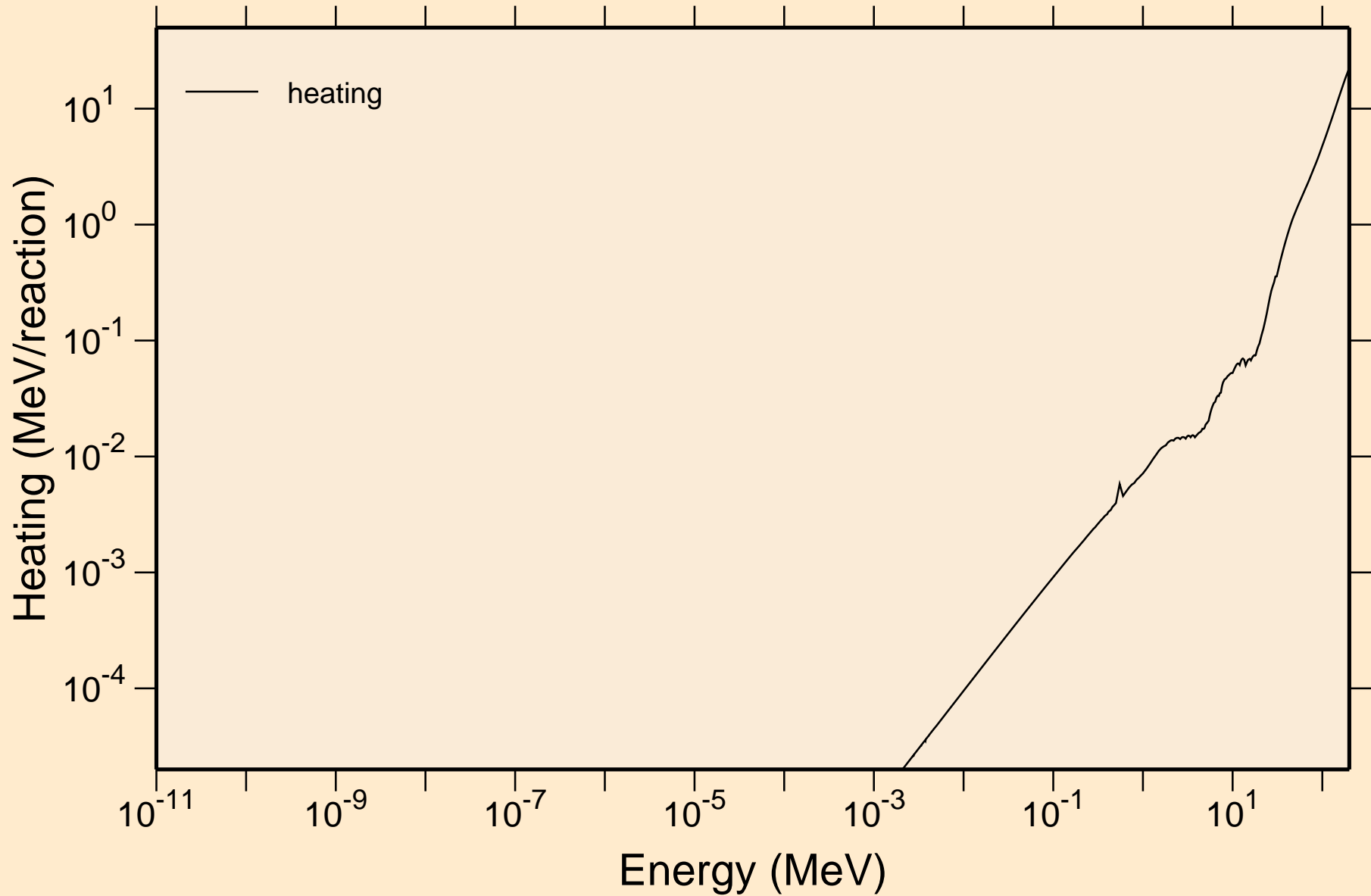

# AU208 NEUTRON ACER TENDL-2024 LIBRARY; T=0.K

## Damage

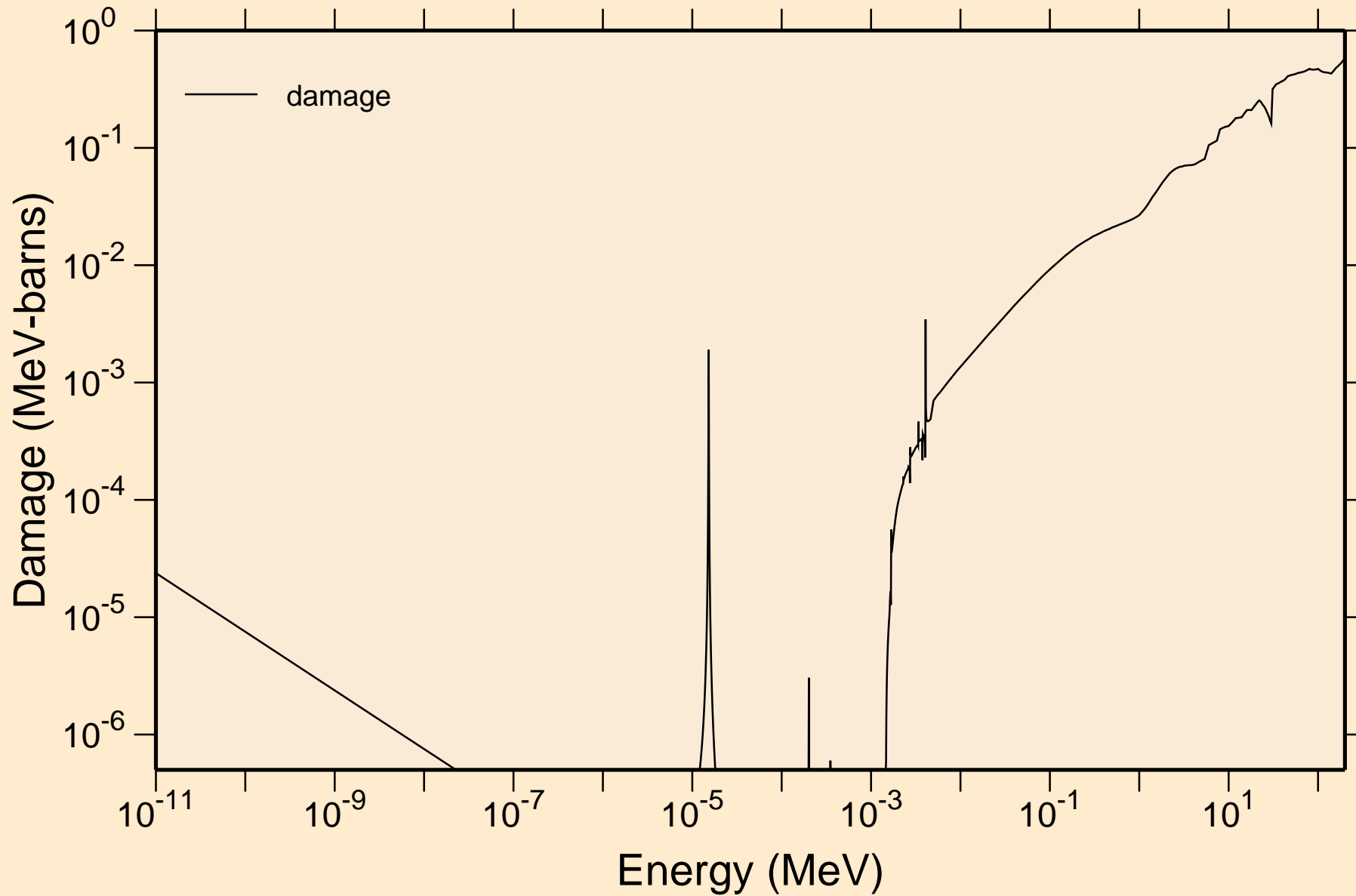

AU208 NEUTRON ACER TENDL-2024 LIBRARY; T=0.K  
Non-threshold reactions

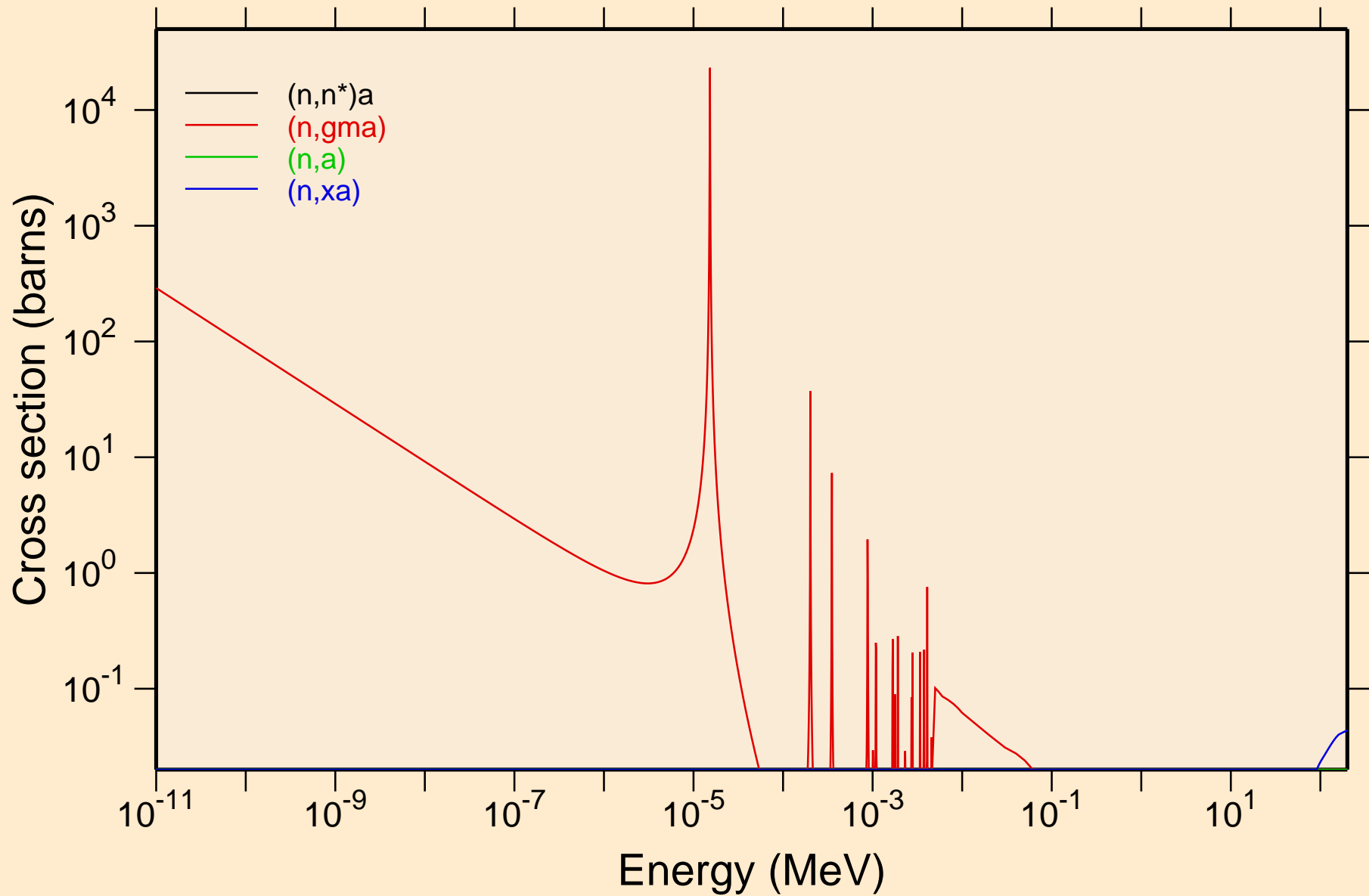

AU208 NEUTRON ACER TENDL-2024 LIBRARY; T=0.K  
Principal cross sections

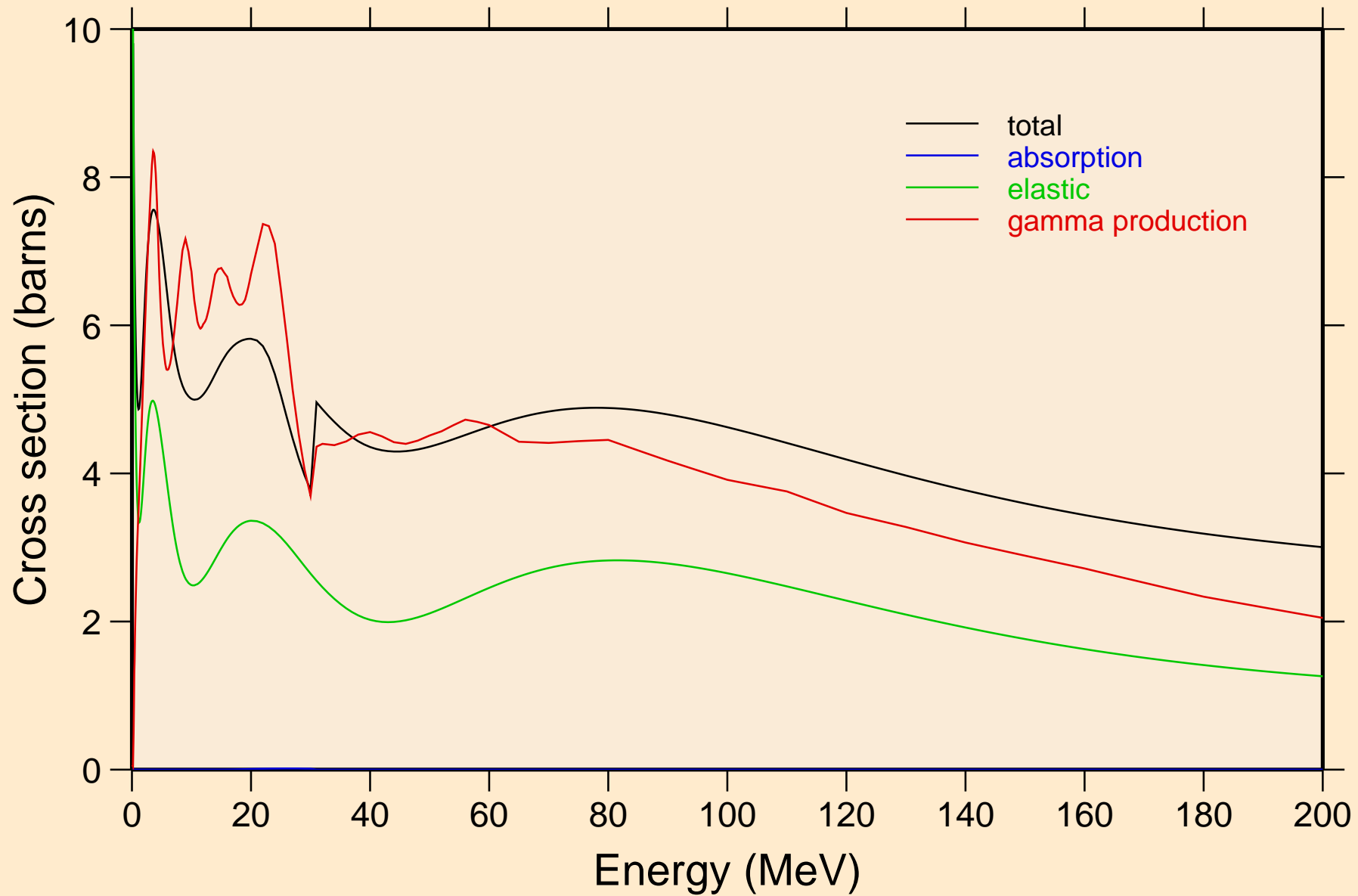

# AU208 NEUTRON ACER TENDL-2024 LIBRARY; T=0.K

## Heating

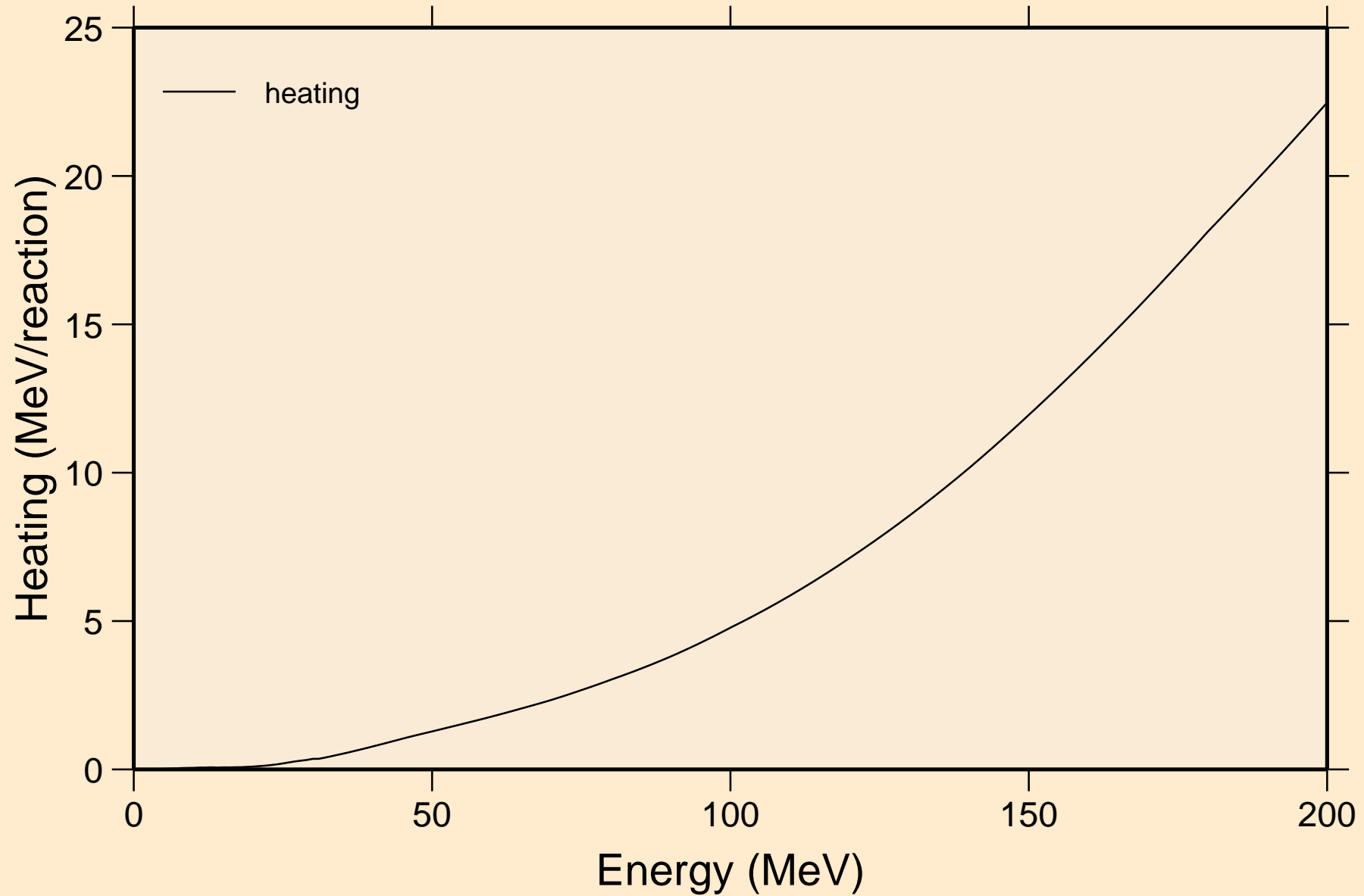

# AU208 NEUTRON ACER TENDL-2024 LIBRARY; T=0.K

## Damage

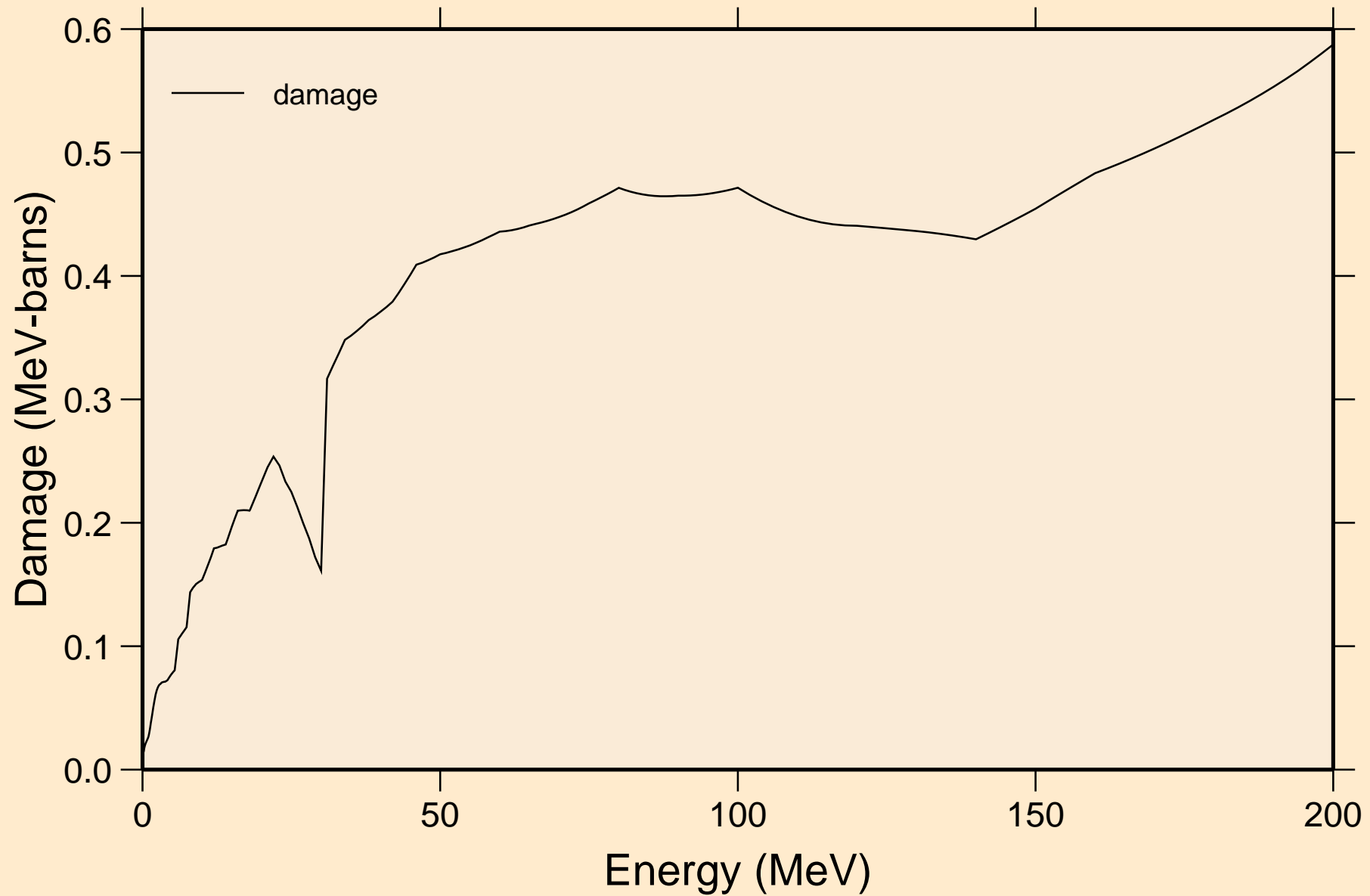

AU208 NEUTRON ACER TENDL-2024 LIBRARY; T=0.K  
Non-threshold reactions

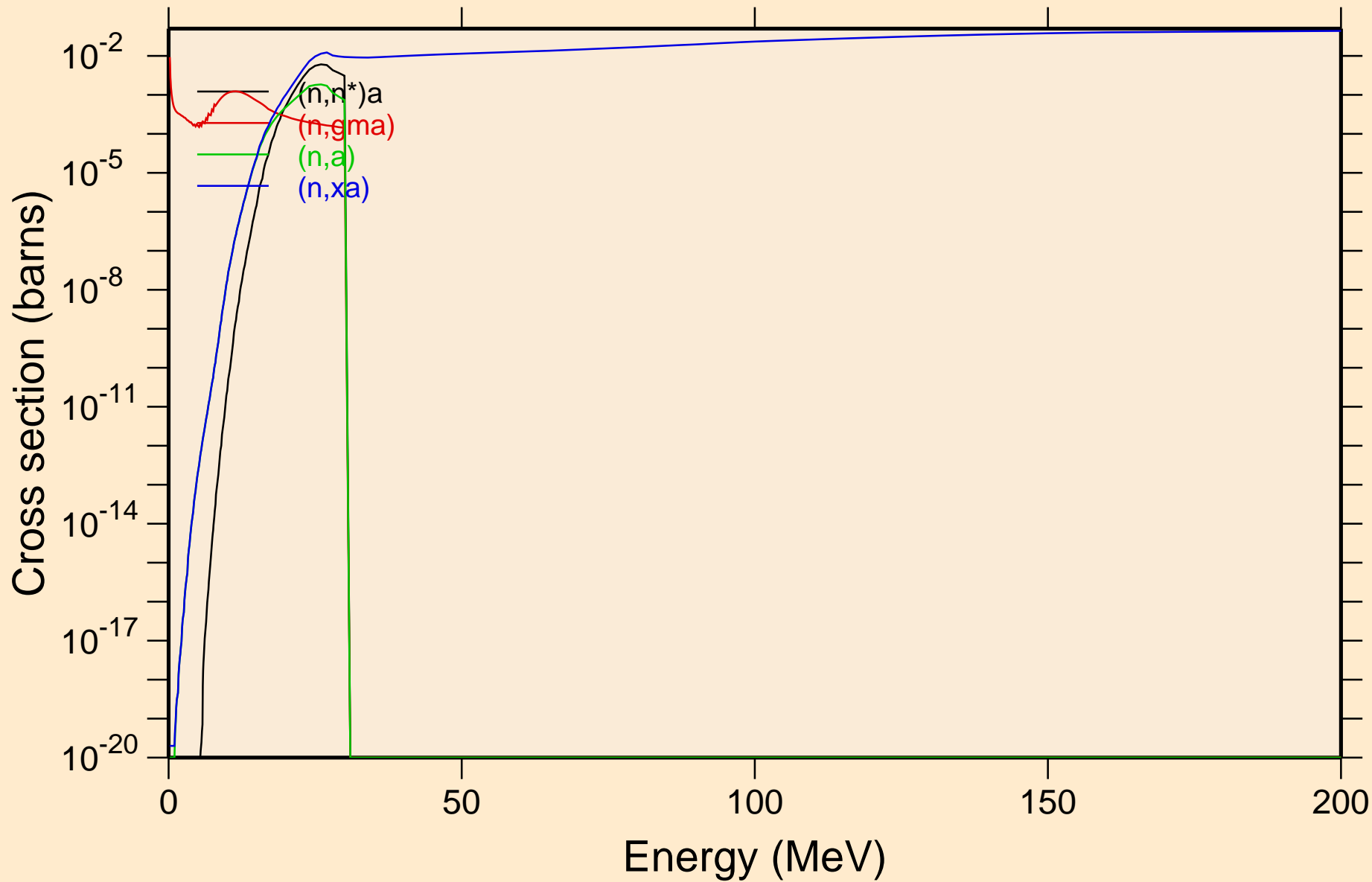



AU208 NEUTRON ACER TENDL-2024 LIBRARY; T=0.K  
Inelastic levels

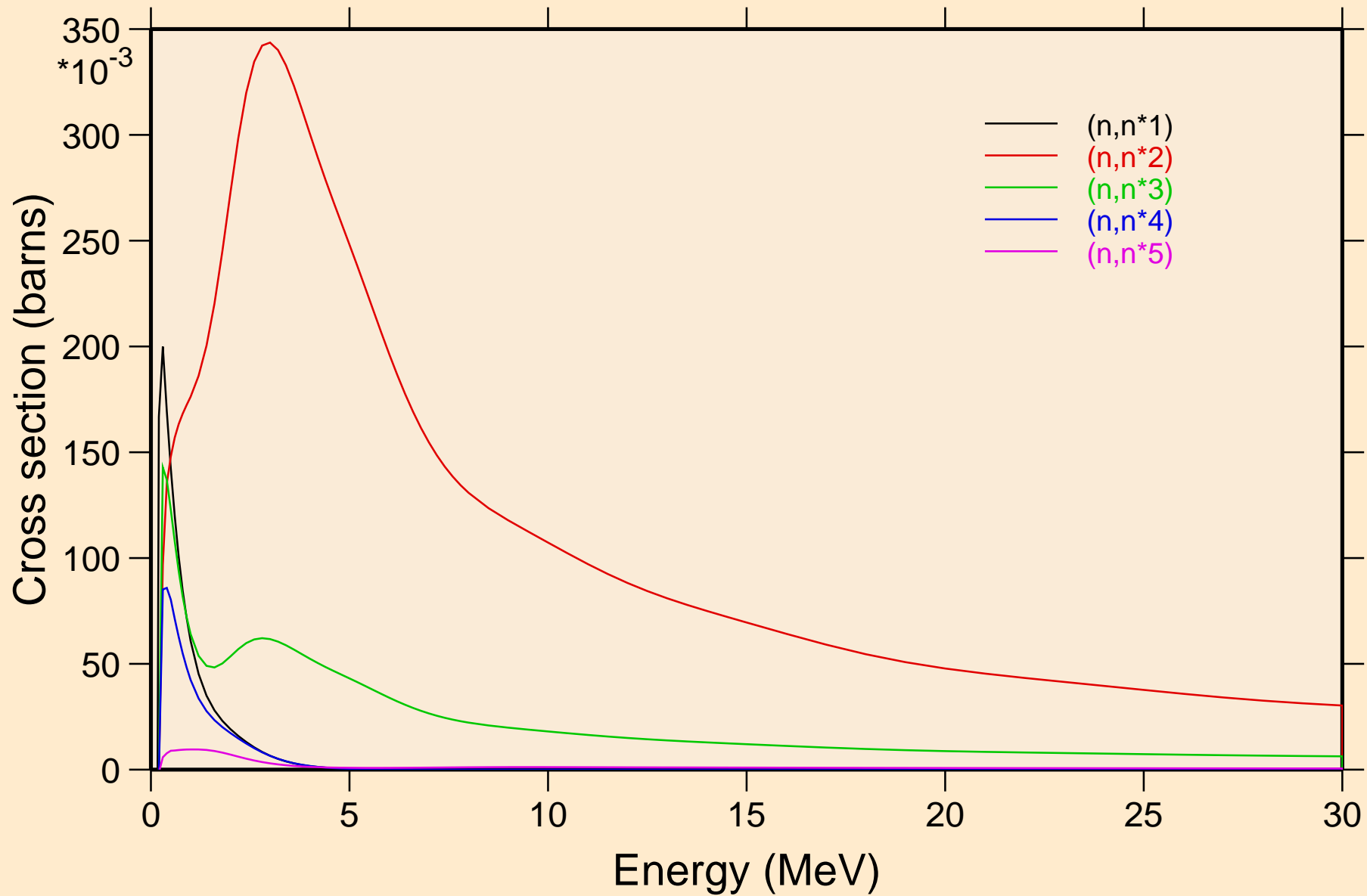

AU208 NEUTRON ACER TENDL-2024 LIBRARY; T=0.K  
Inelastic levels

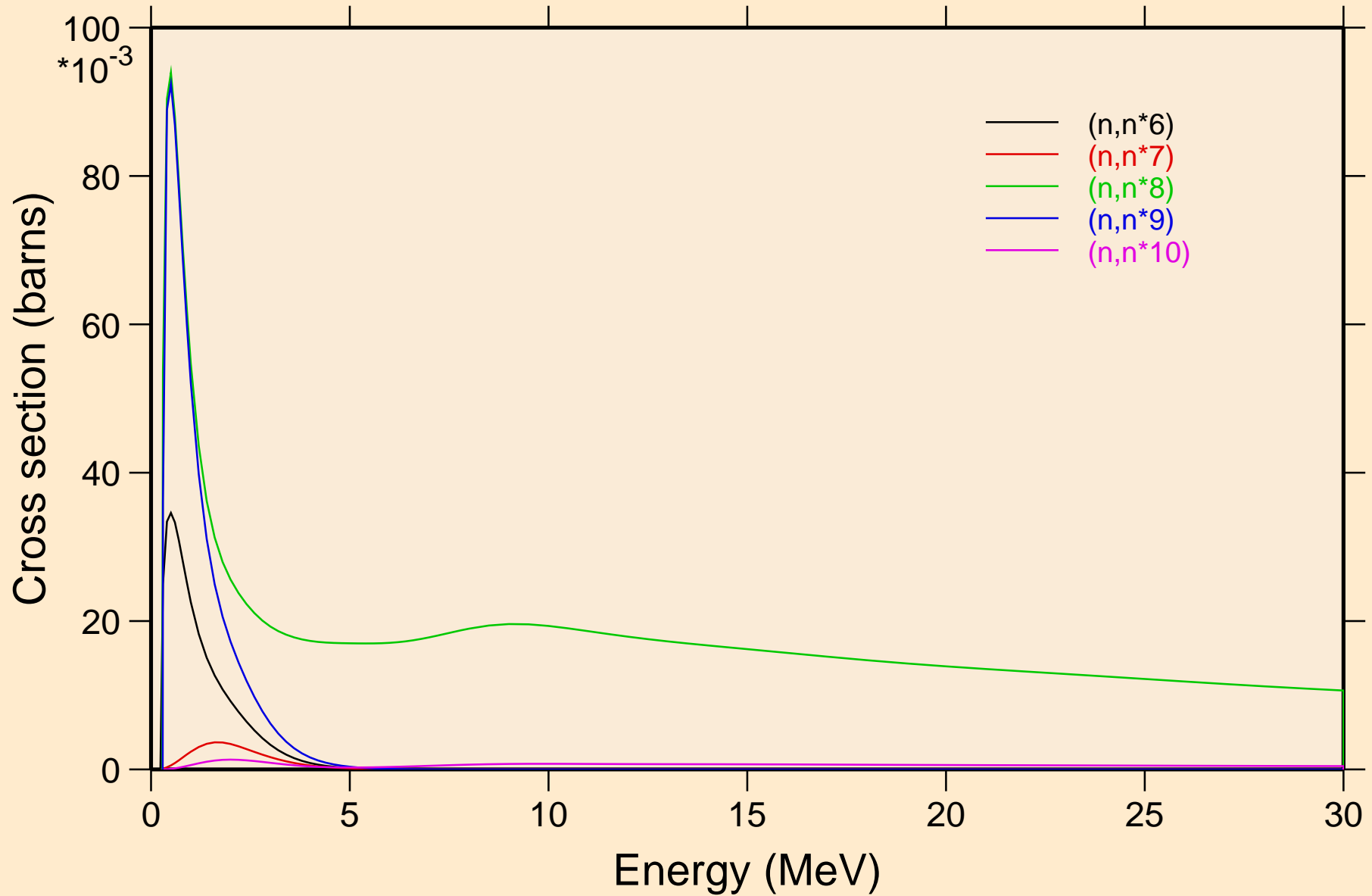

AU208 NEUTRON ACER TENDL-2024 LIBRARY; T=0.K  
Inelastic levels

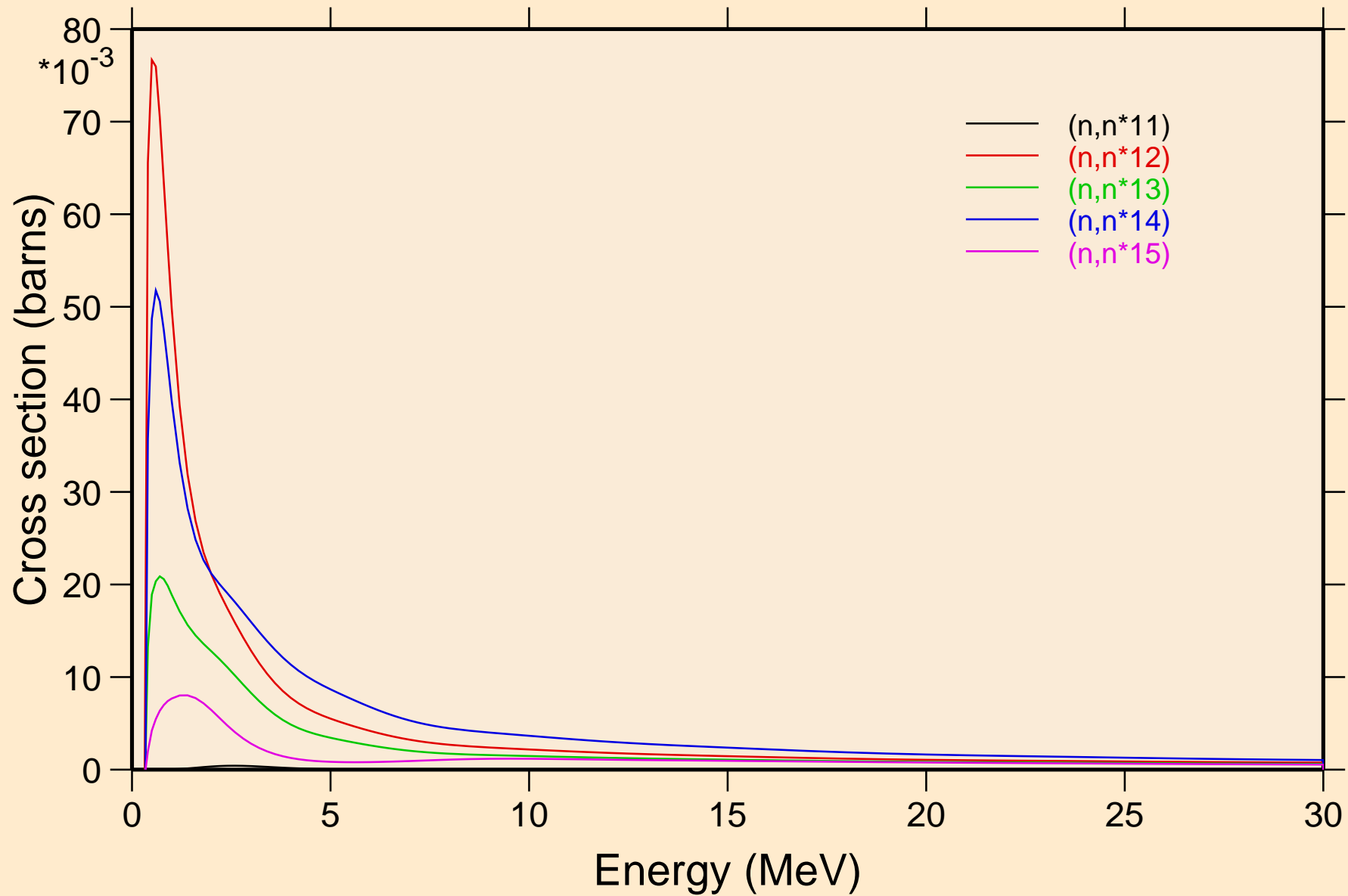

AU208 NEUTRON ACER TENDL-2024 LIBRARY; T=0.K  
Inelastic levels

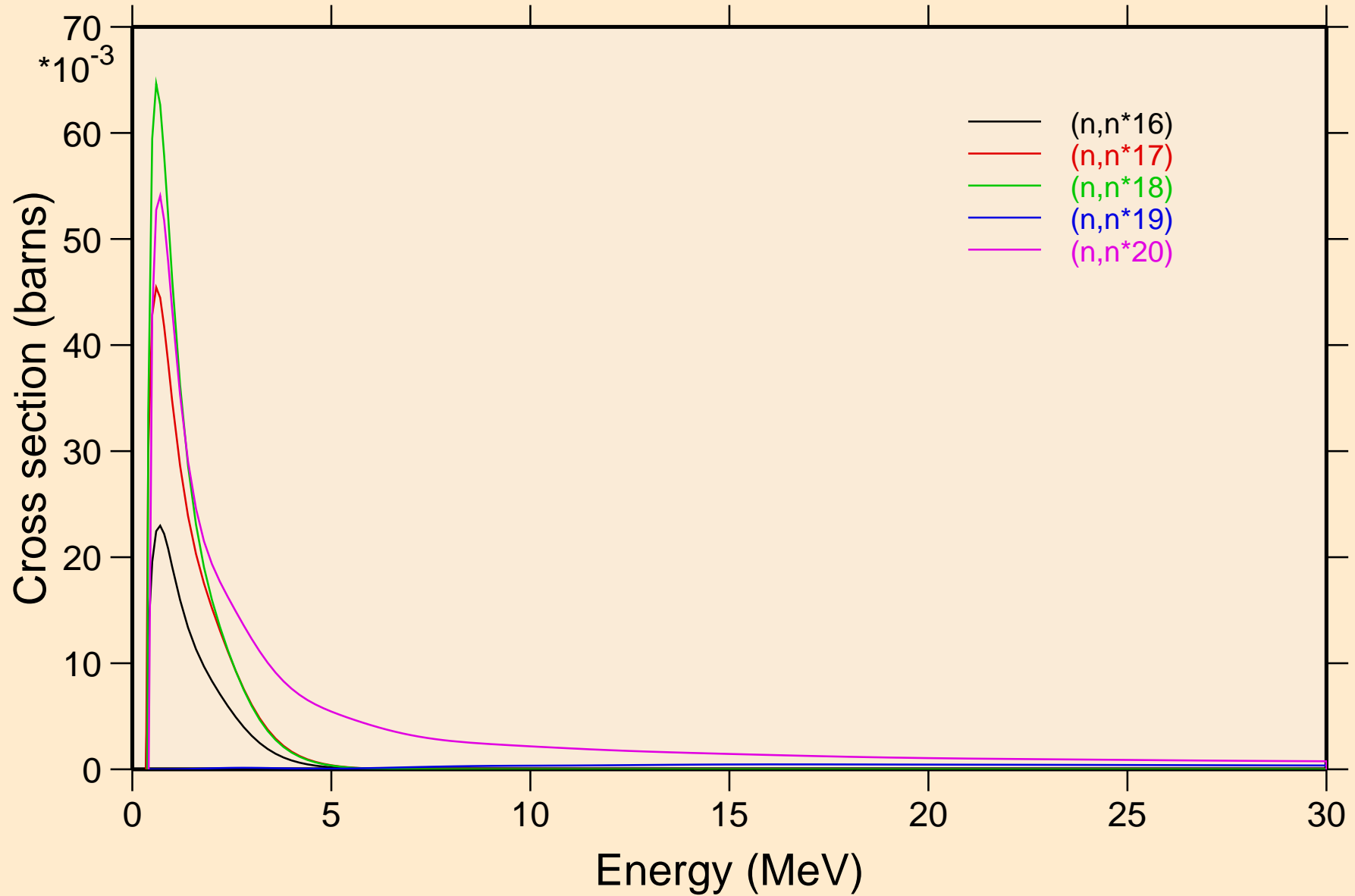

AU208 NEUTRON ACER TENDL-2024 LIBRARY; T=0.K  
Inelastic levels

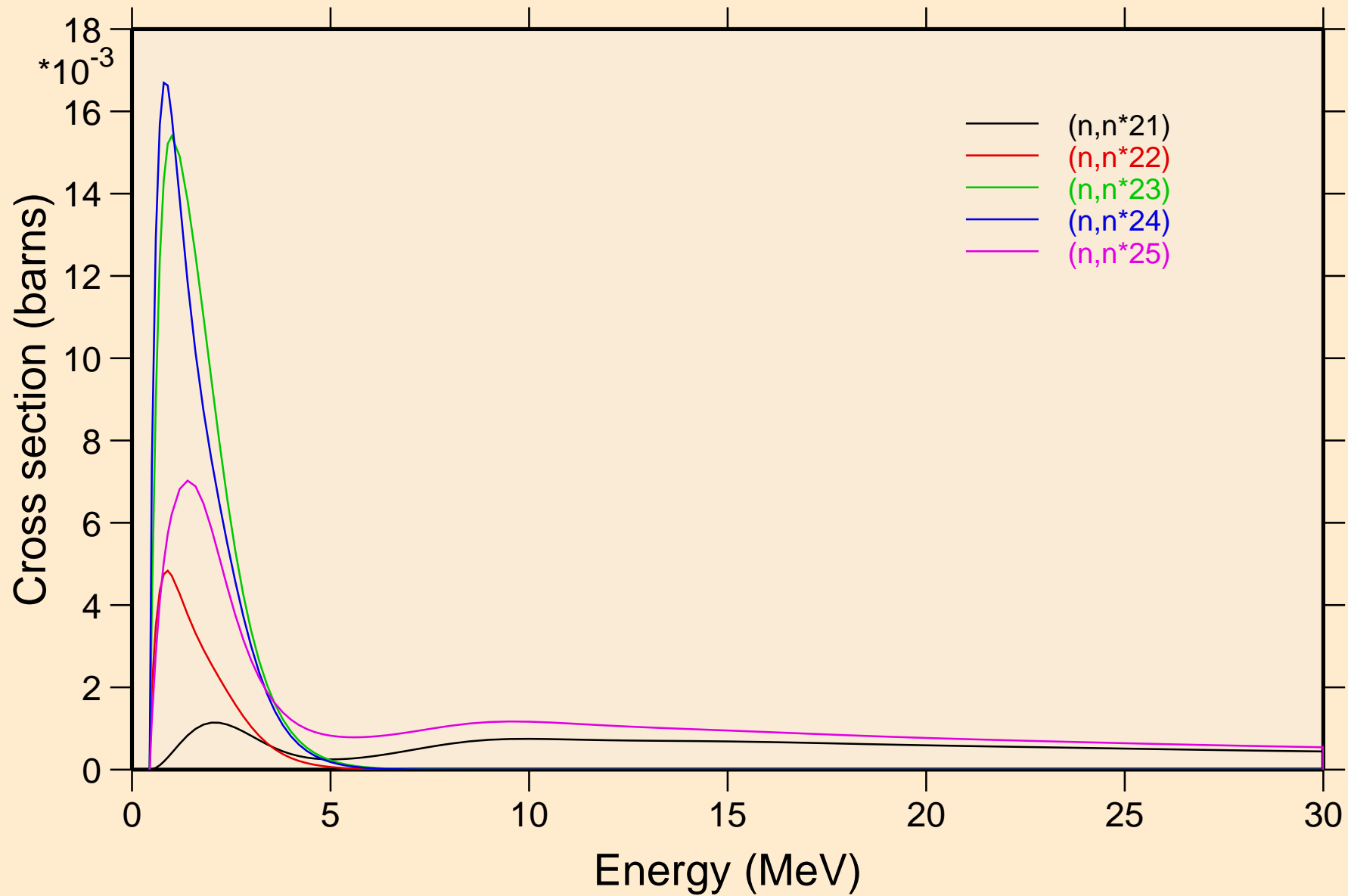

AU208 NEUTRON ACER TENDL-2024 LIBRARY; T=0.K  
Inelastic levels

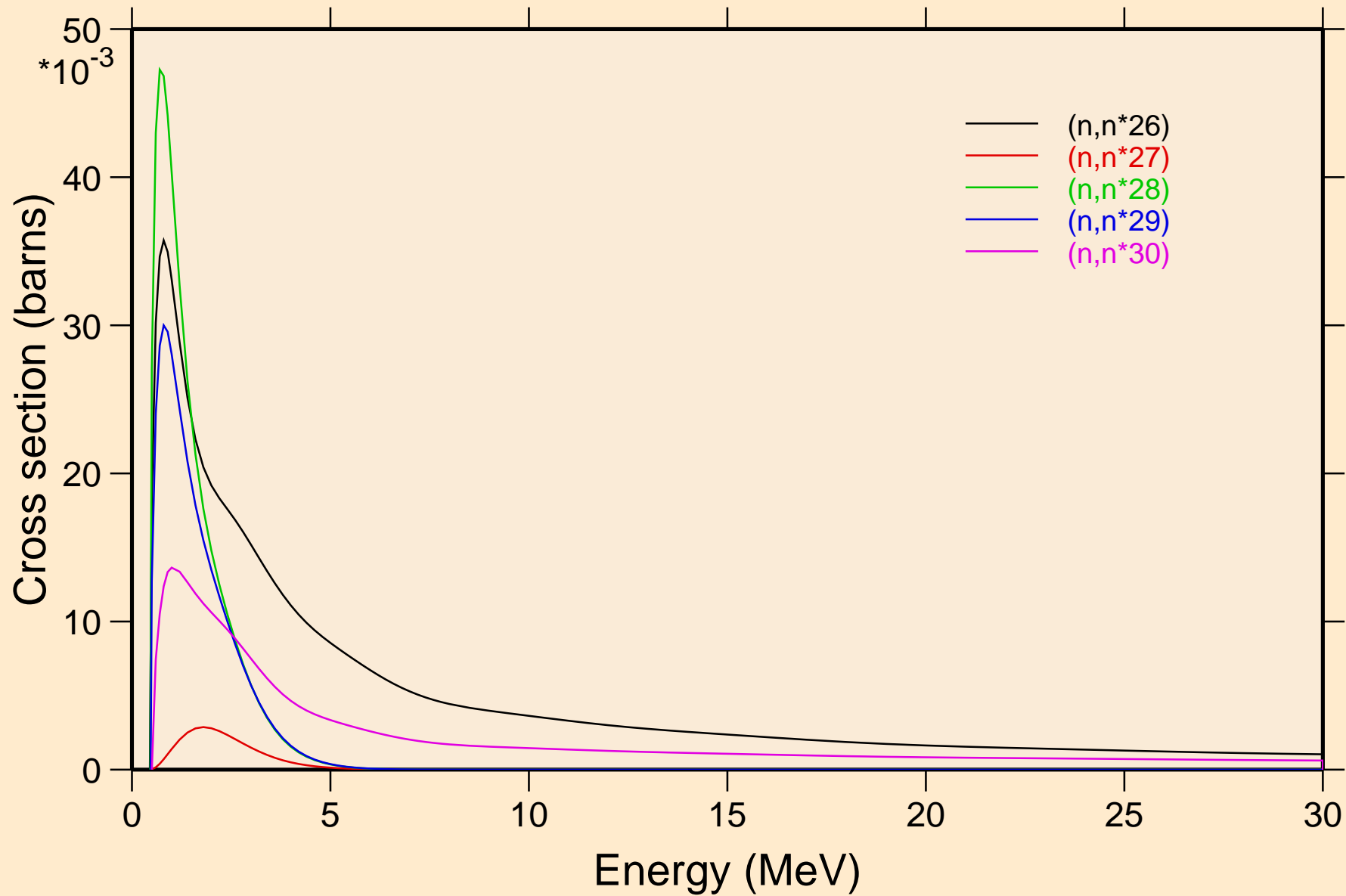

AU208 NEUTRON ACER TENDL-2024 LIBRARY; T=0.K  
Threshold reactions

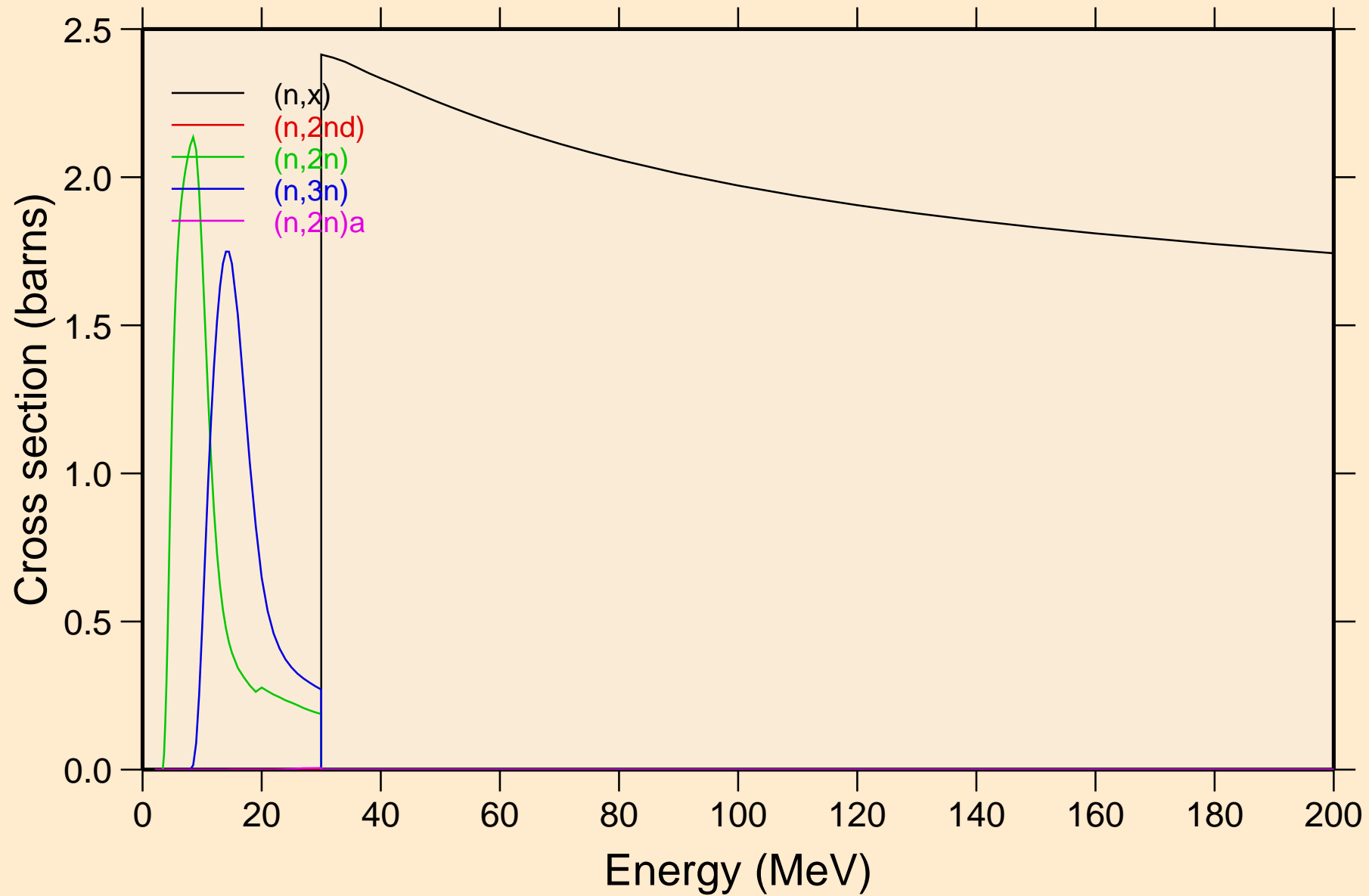

# AU208 NEUTRON ACER TENDL-2024 LIBRARY; T=0.K

## Threshold reactions

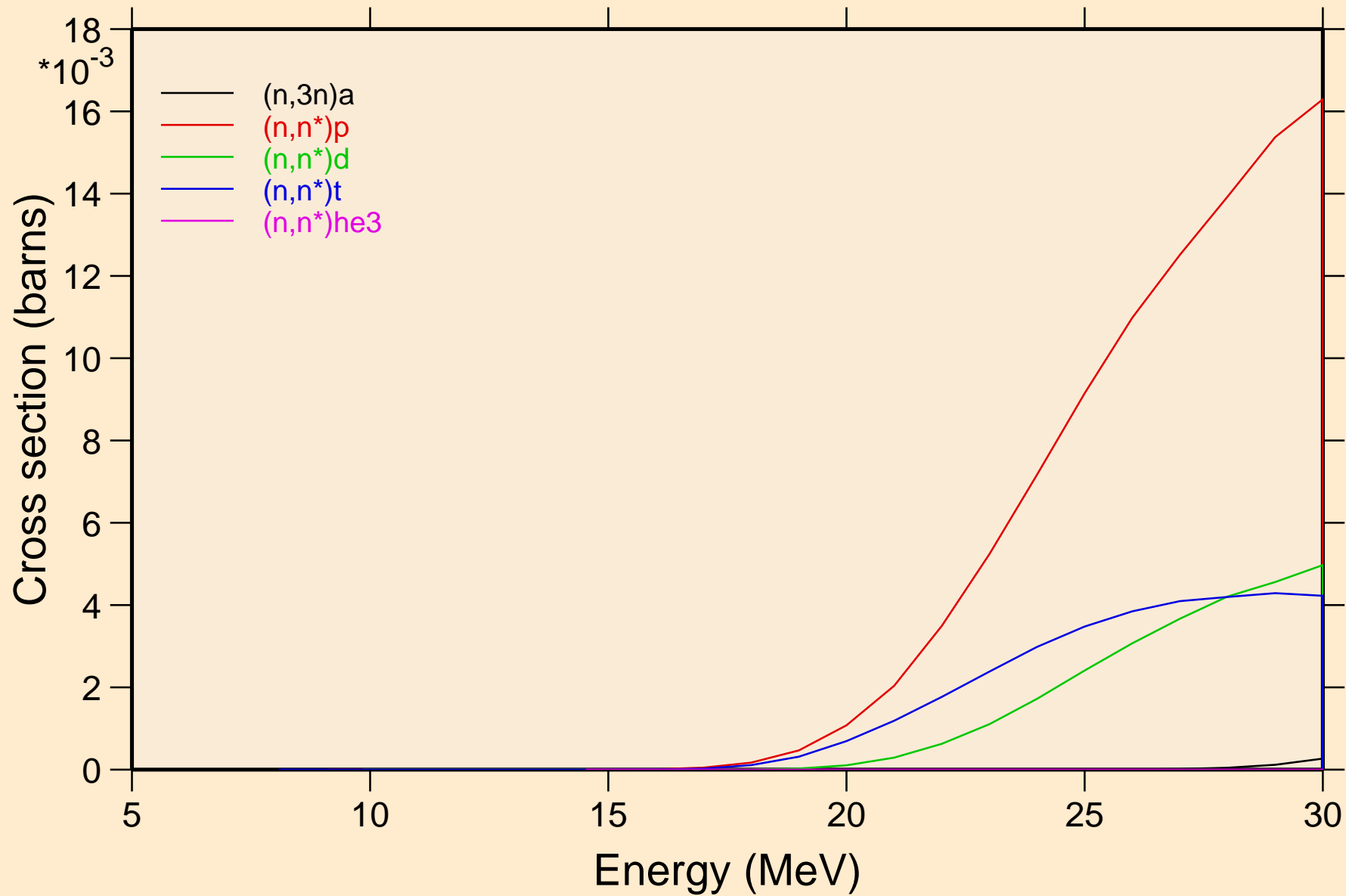



AU208 NEUTRON ACER TENDL-2024 LIBRARY; T=0.K  
Threshold reactions

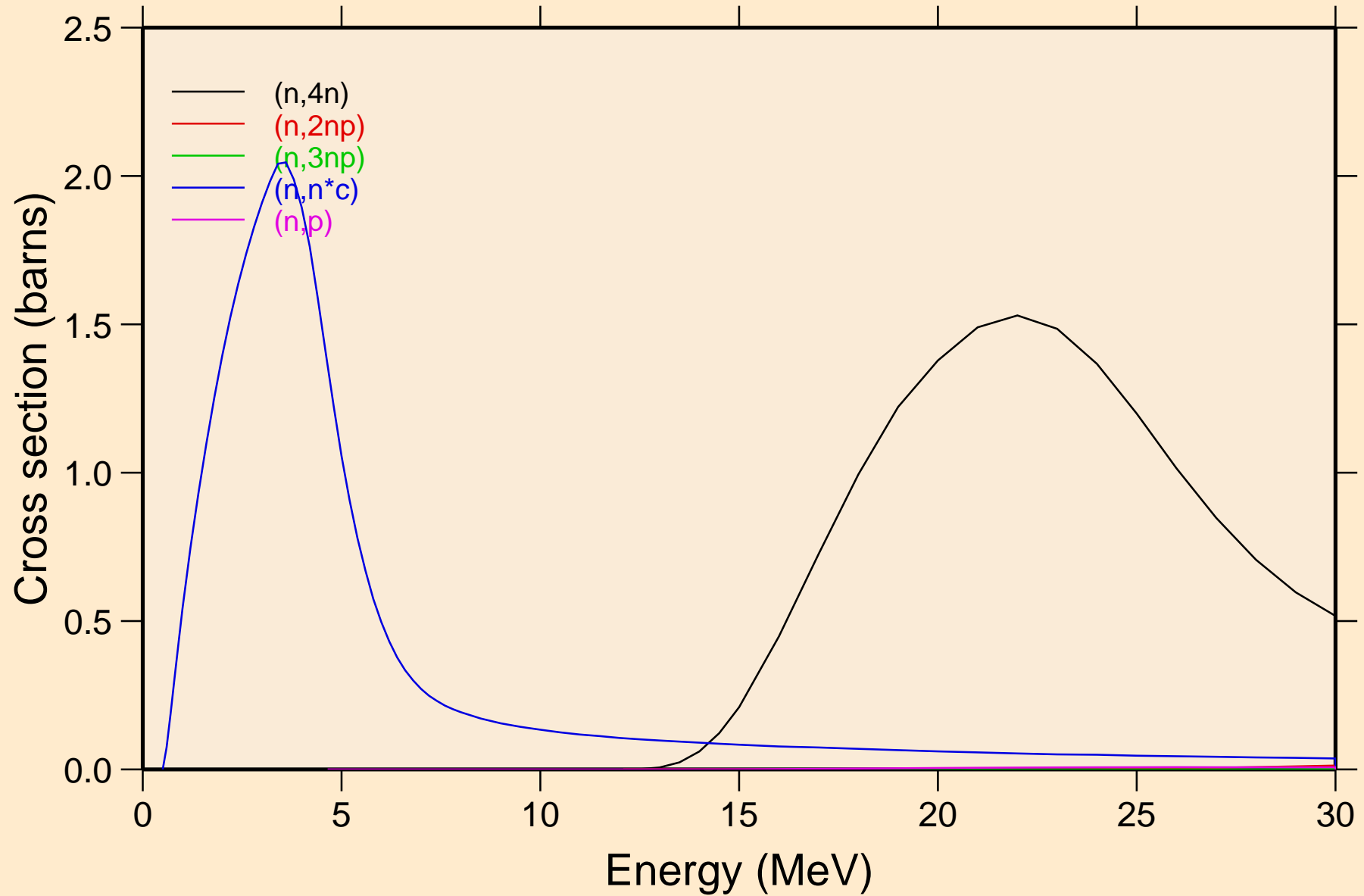

# AU208 NEUTRON ACER TENDL-2024 LIBRARY; T=0.K

## Threshold reactions

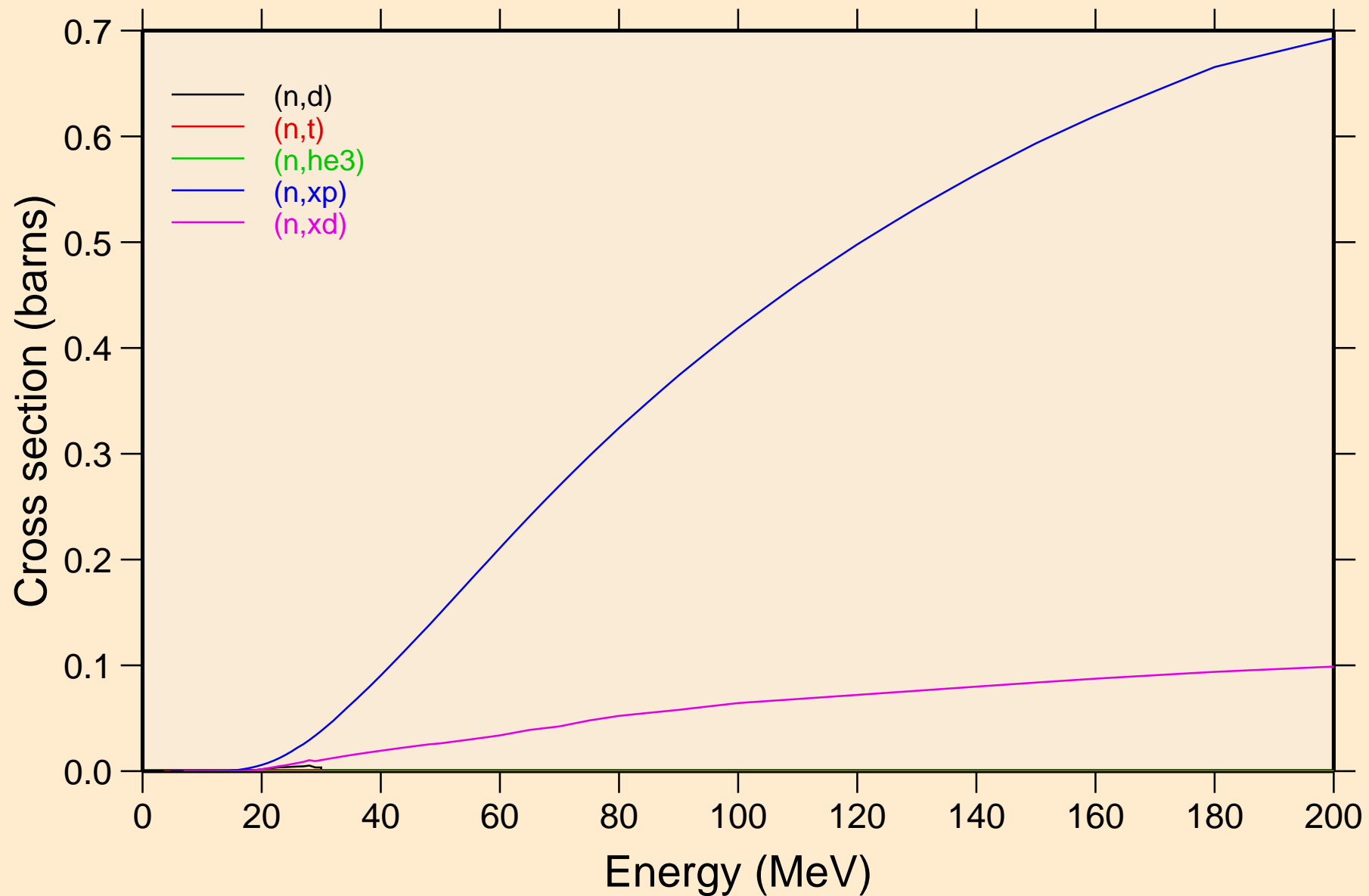

AU208 NEUTRON ACER TENDL-2024 LIBRARY; T=0.K  
Threshold reactions

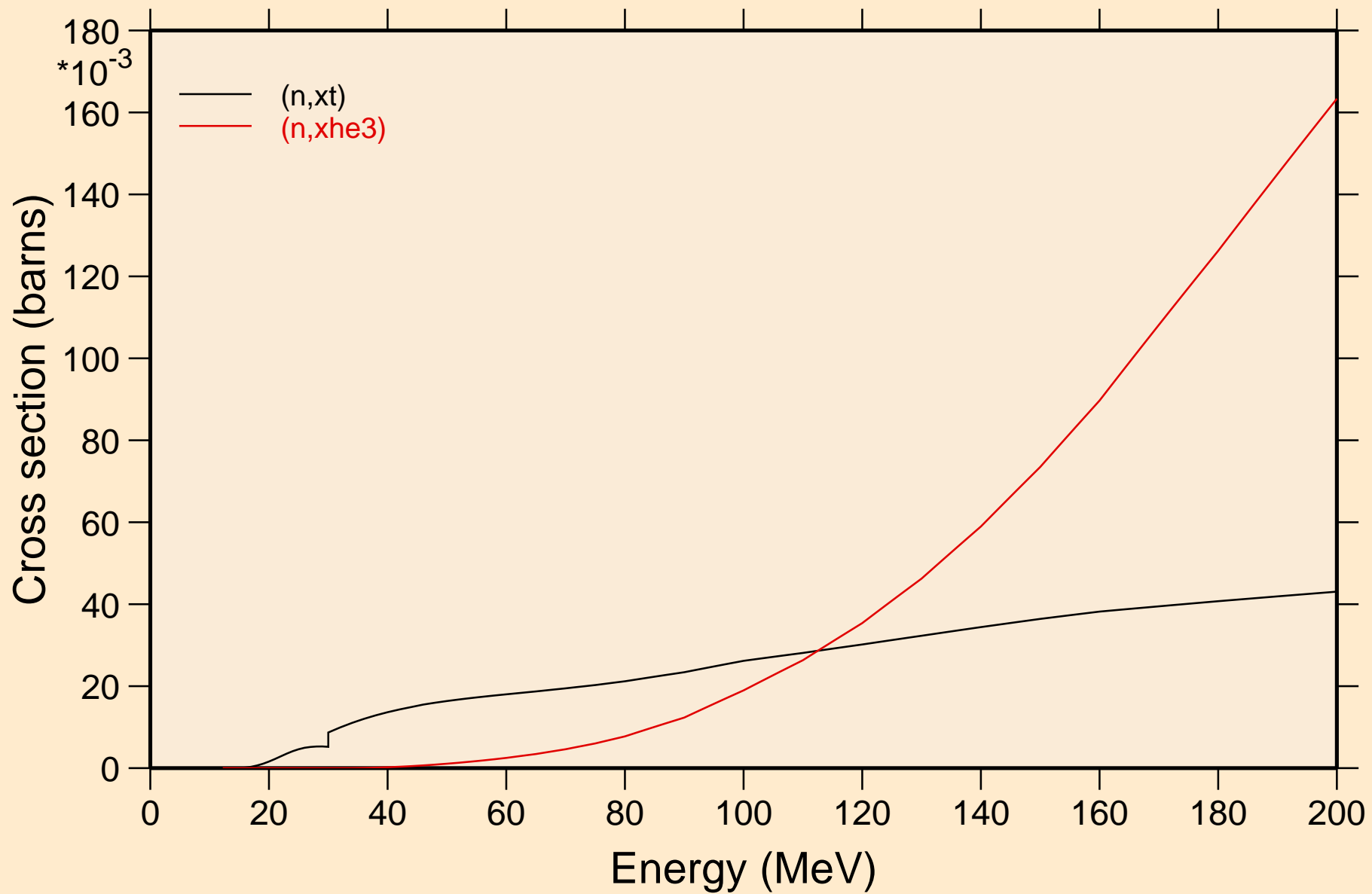

AU208 NEUTRON ACER TENDL-2024 LIBRARY; T=0.K  
angular distribution for elastic

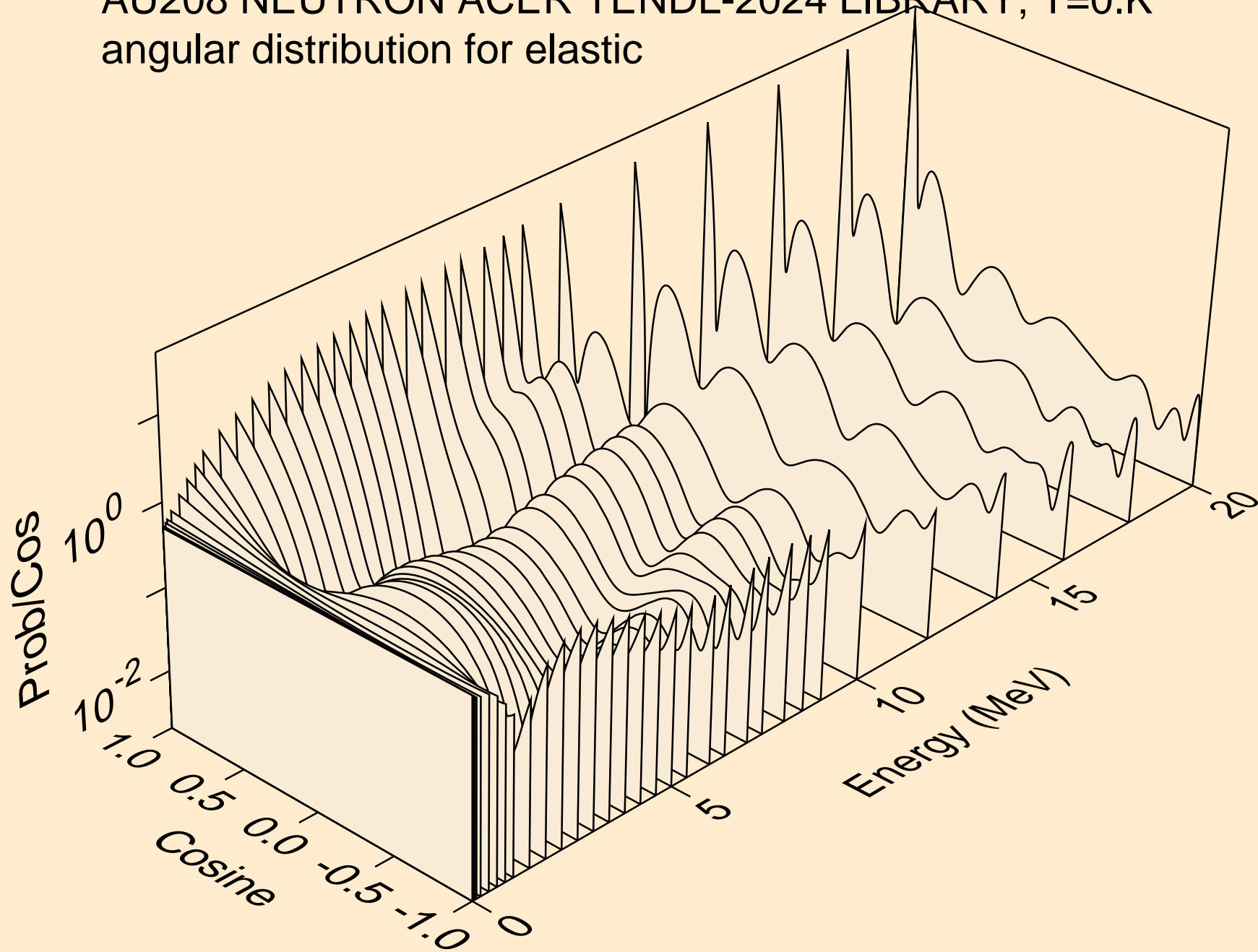

AU208 NEUTRON ACER TENDL-2024 LIBRARY; T=0.K  
angular distribution for elastic

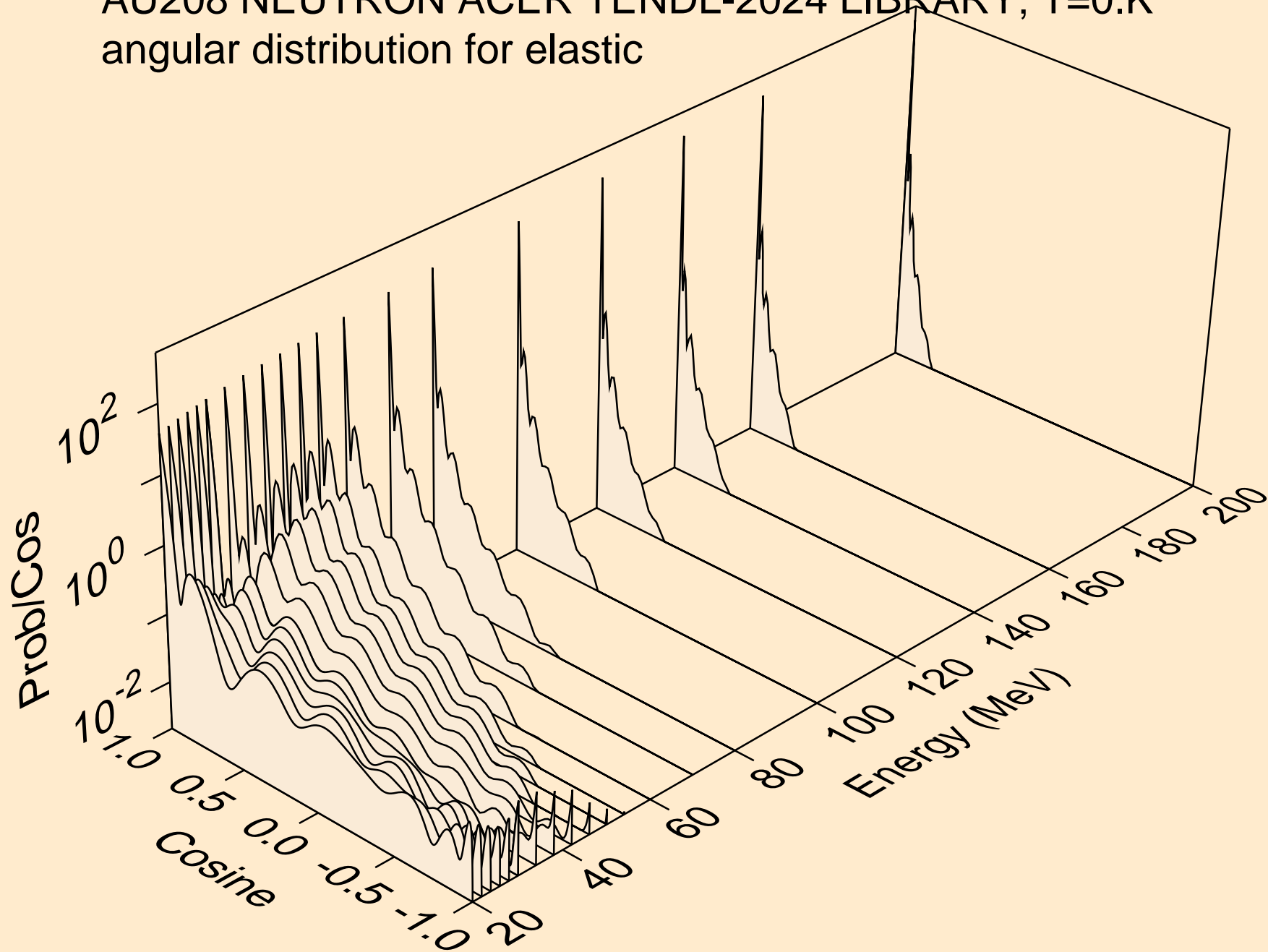

AU208 NEUTRON ACER TENDL-2024 LIBRARY; T=0.K  
angular distribution for (n,n\*1)

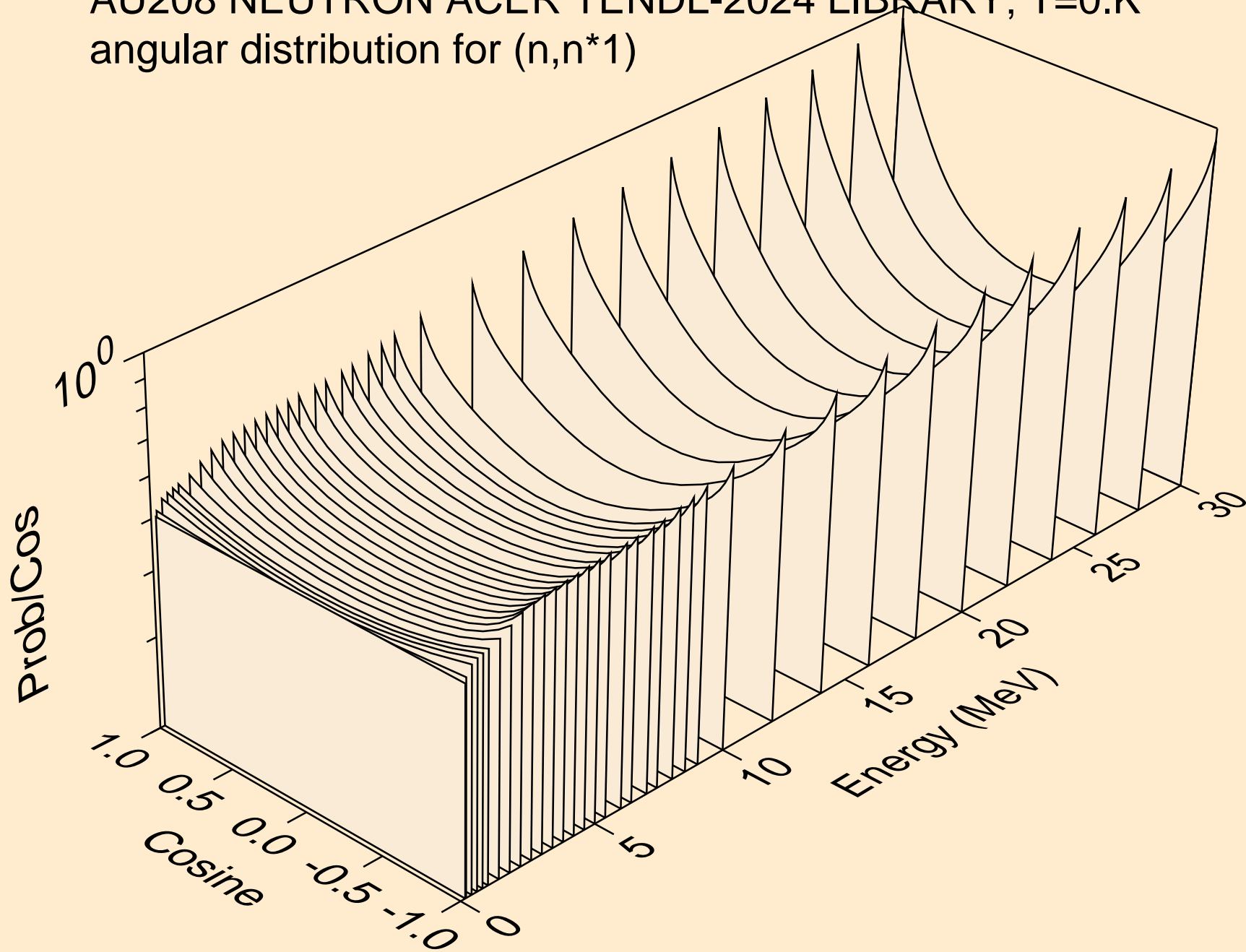

AU208 NEUTRON ACER TENDL-2024 LIBRARY; T=0.K  
angular distribution for (n,n\*2)

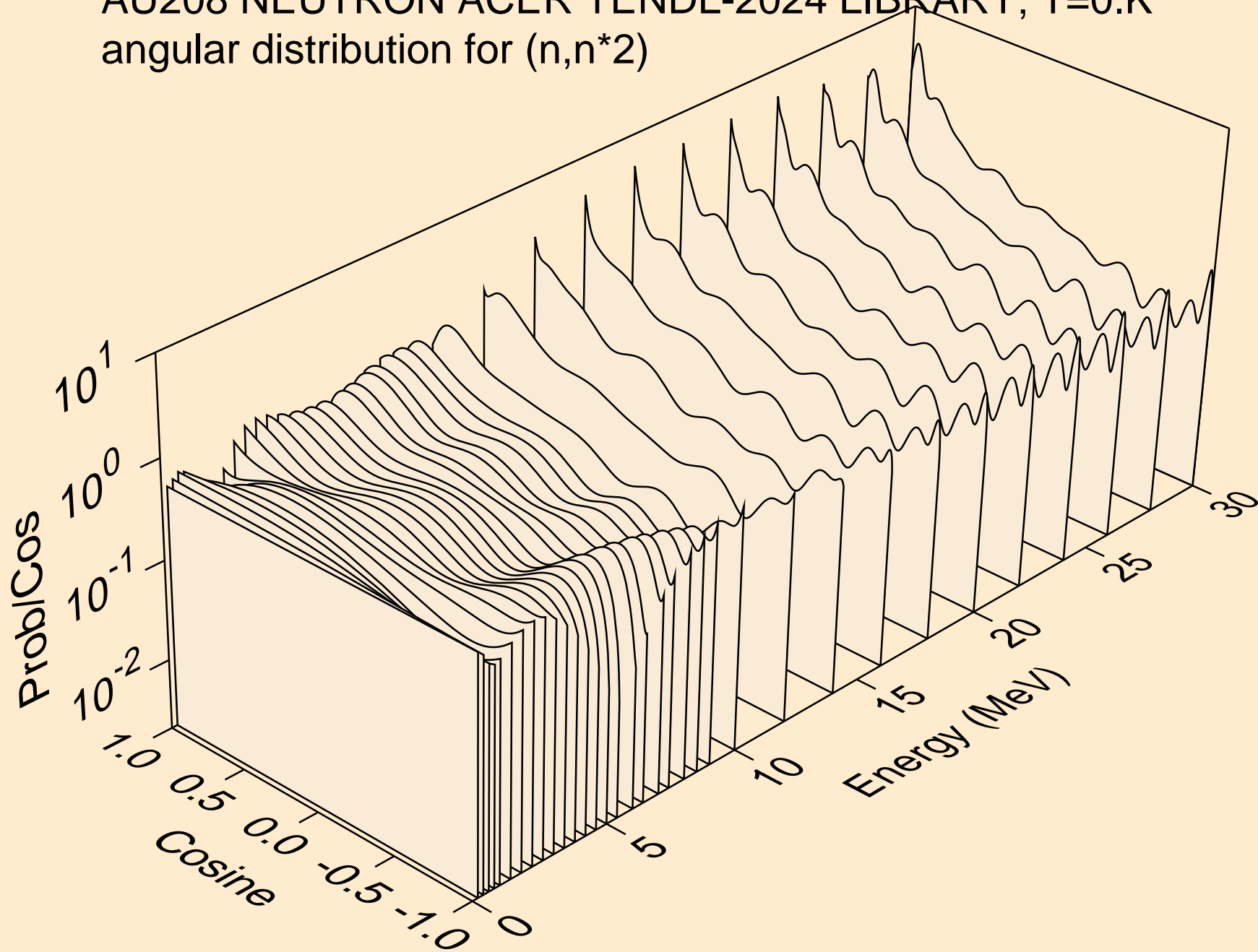

AU208 NEUTRON ACER TENDL-2024 LIBRARY; T=0.K  
angular distribution for (n,n\*3)

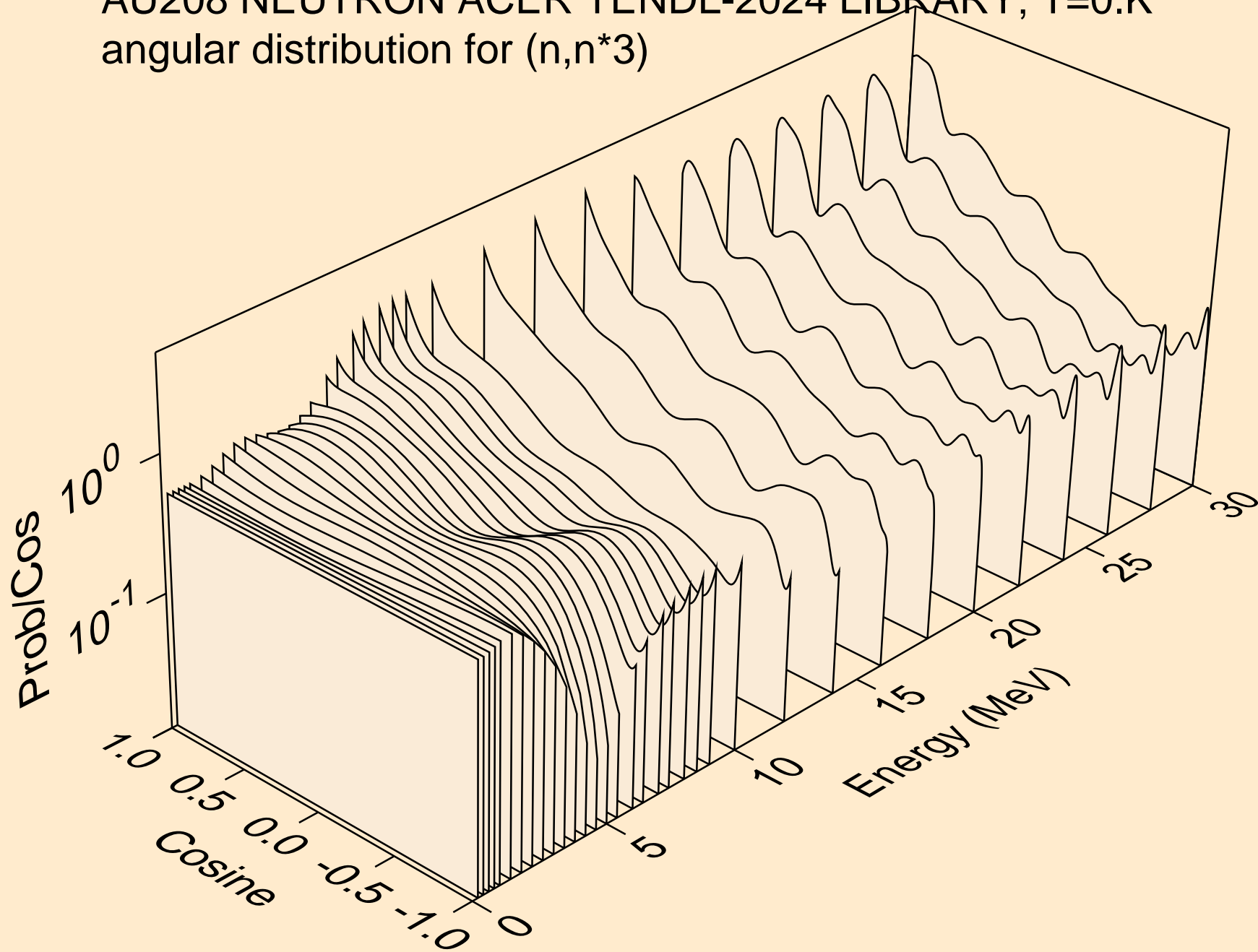



AU208 NEUTRON ACER TENDL-2024 LIBRARY; T=0.K  
angular distribution for (n,n\*4)

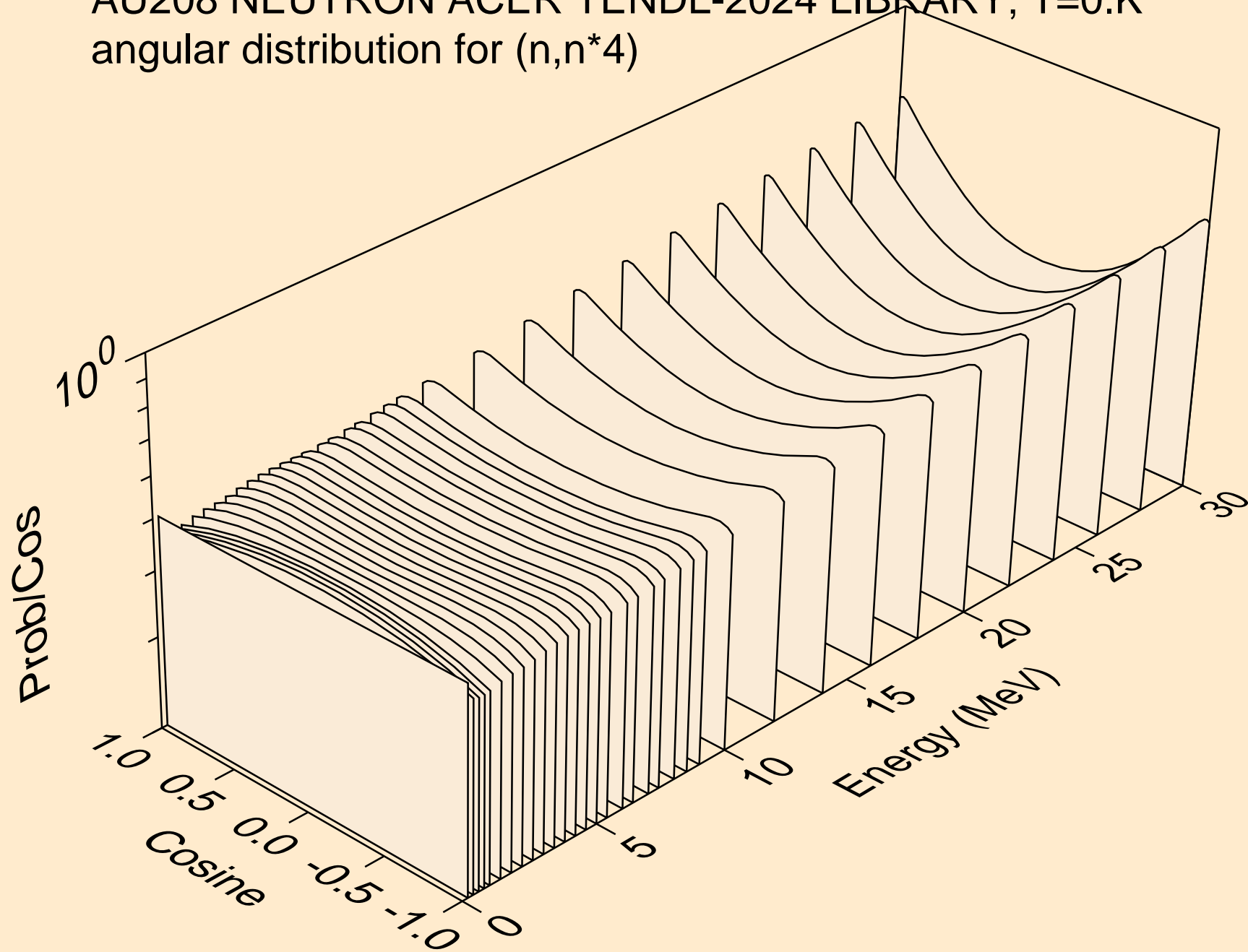

AU208 NEUTRON ACER TENDL-2024 LIBRARY; T=0.K  
angular distribution for (n,n\*5)

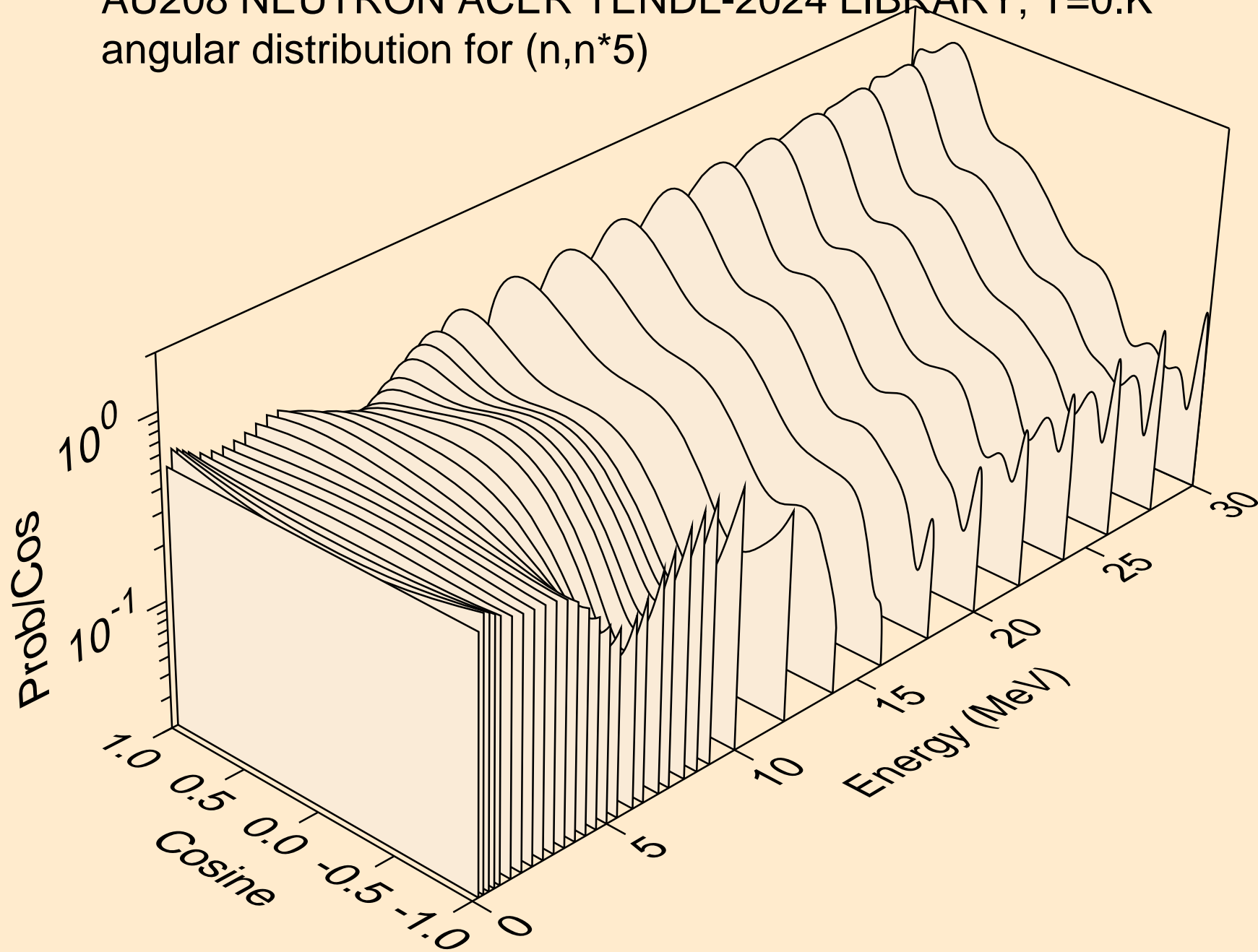

AU208 NEUTRON ACER TENDL-2024 LIBRARY; T=0.K  
angular distribution for (n,n\*6)

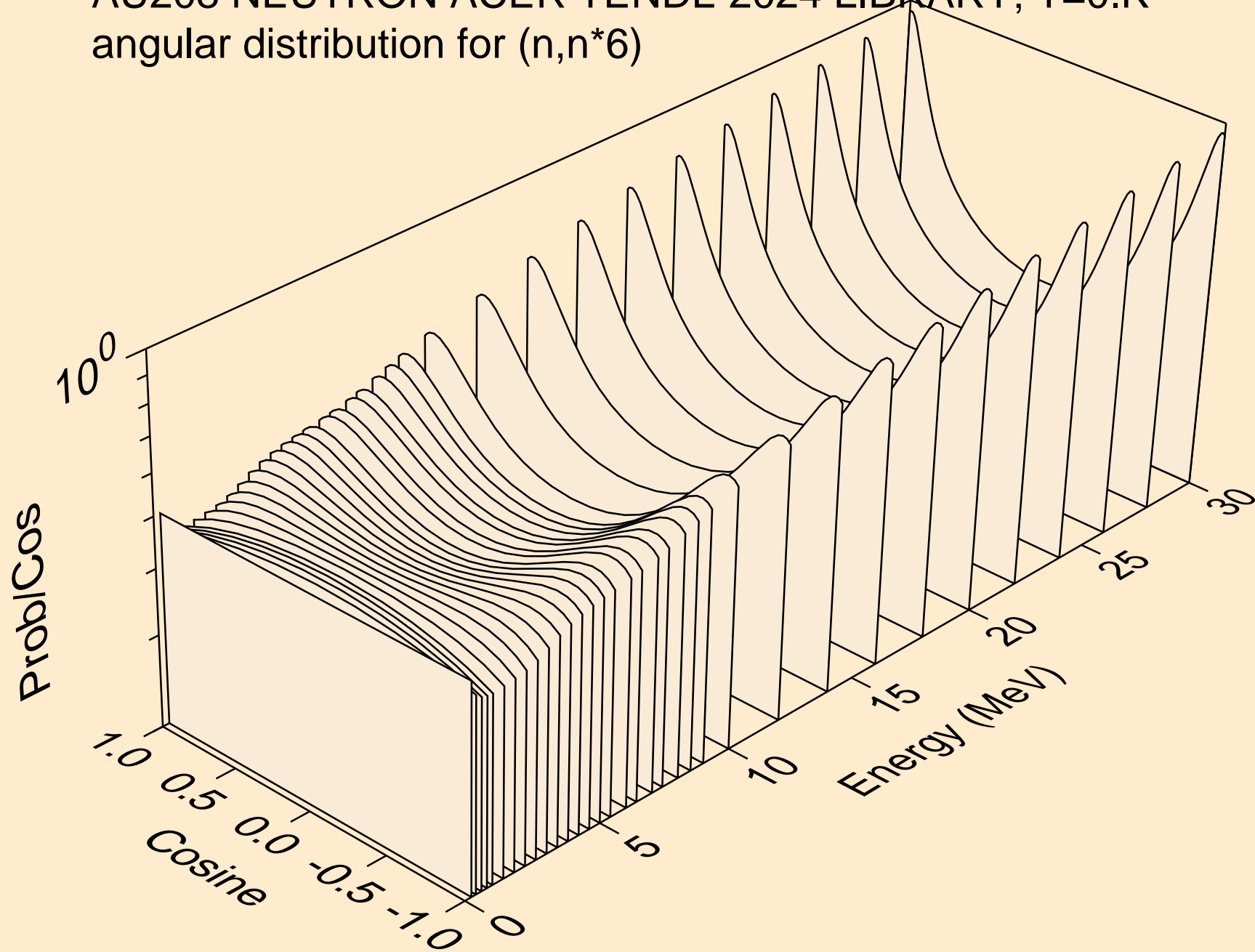

AU208 NEUTRON ACER TENDL-2024 LIBRARY; T=0.K  
angular distribution for (n,n\*7)

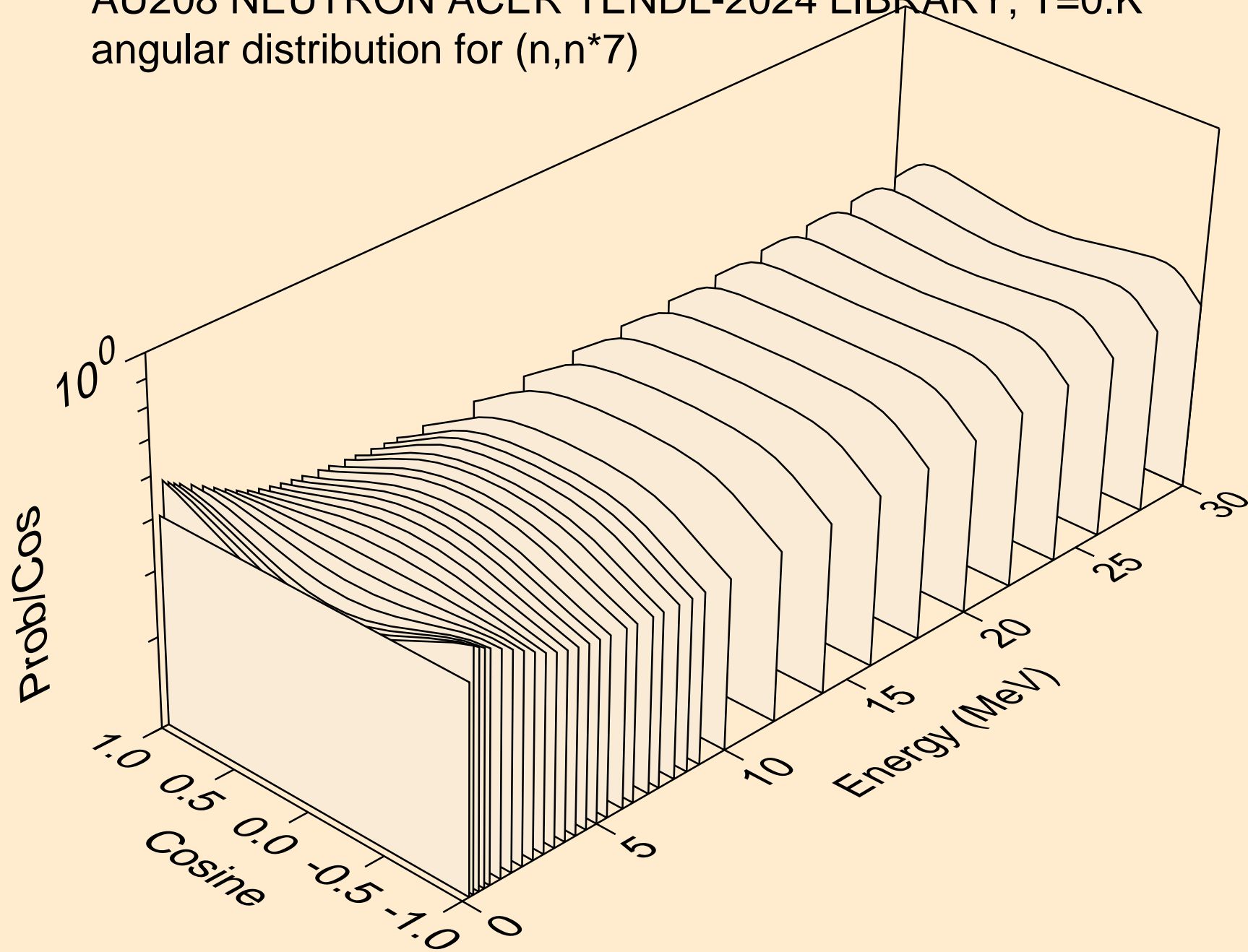

AU208 NEUTRON ACER TENDL-2024 LIBRARY; T=0.K  
angular distribution for (n,n\*8)

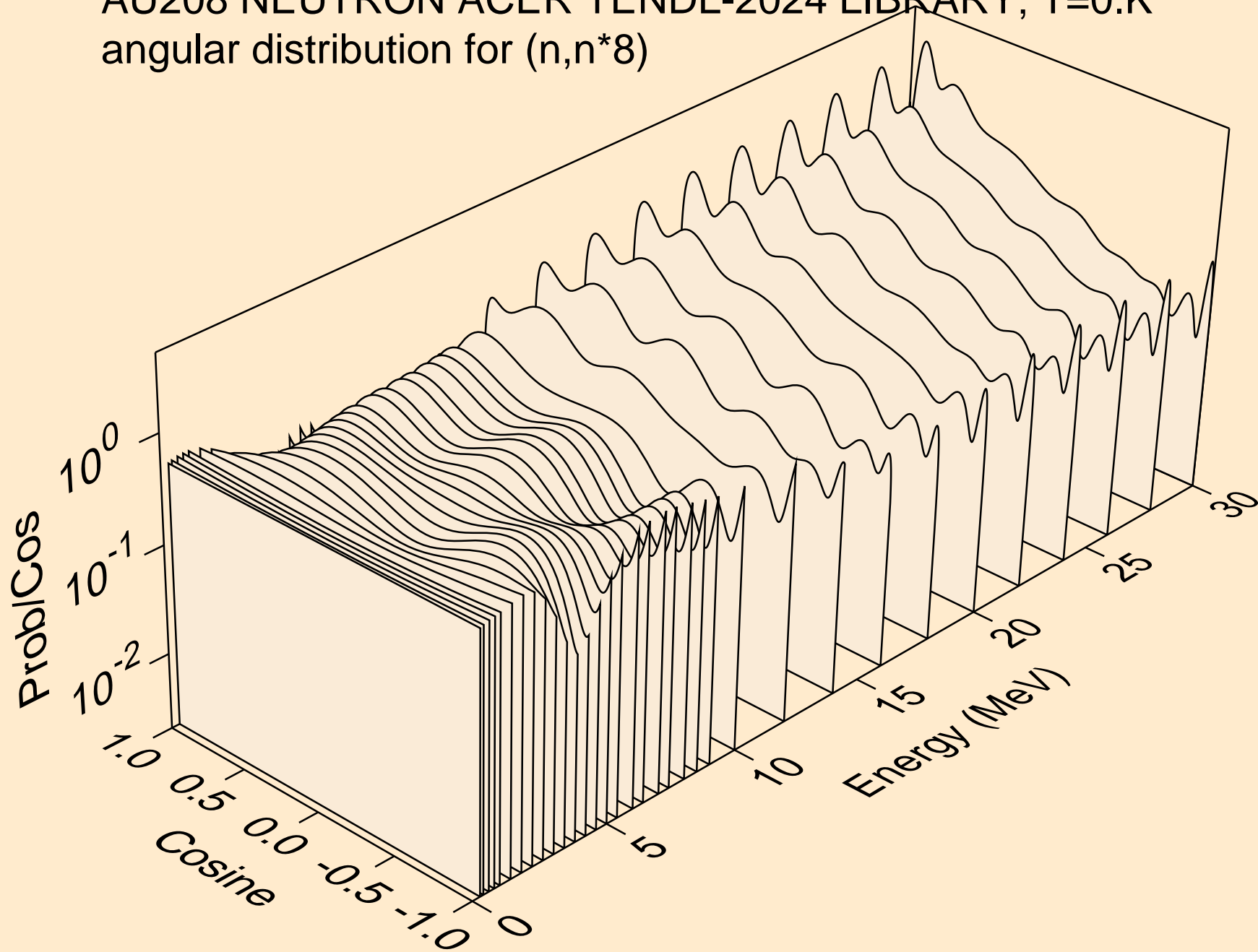

AU208 NEUTRON ACER TENDL-2024 LIBRARY; T=0.K  
angular distribution for (n,n\*9)

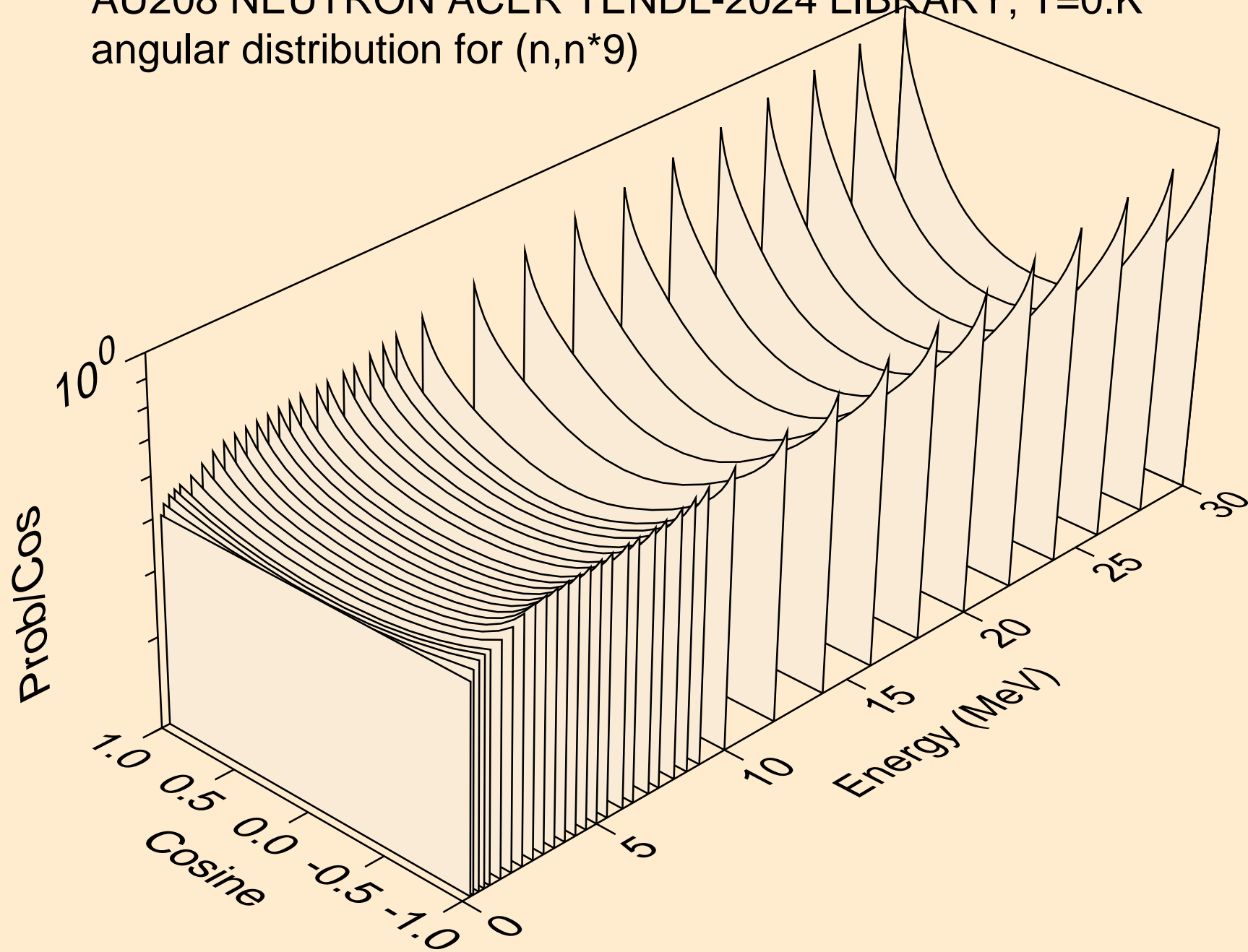

AU208 NEUTRON ACER TENDL-2024 LIBRARY; T=0.K  
angular distribution for (n,n\*10)

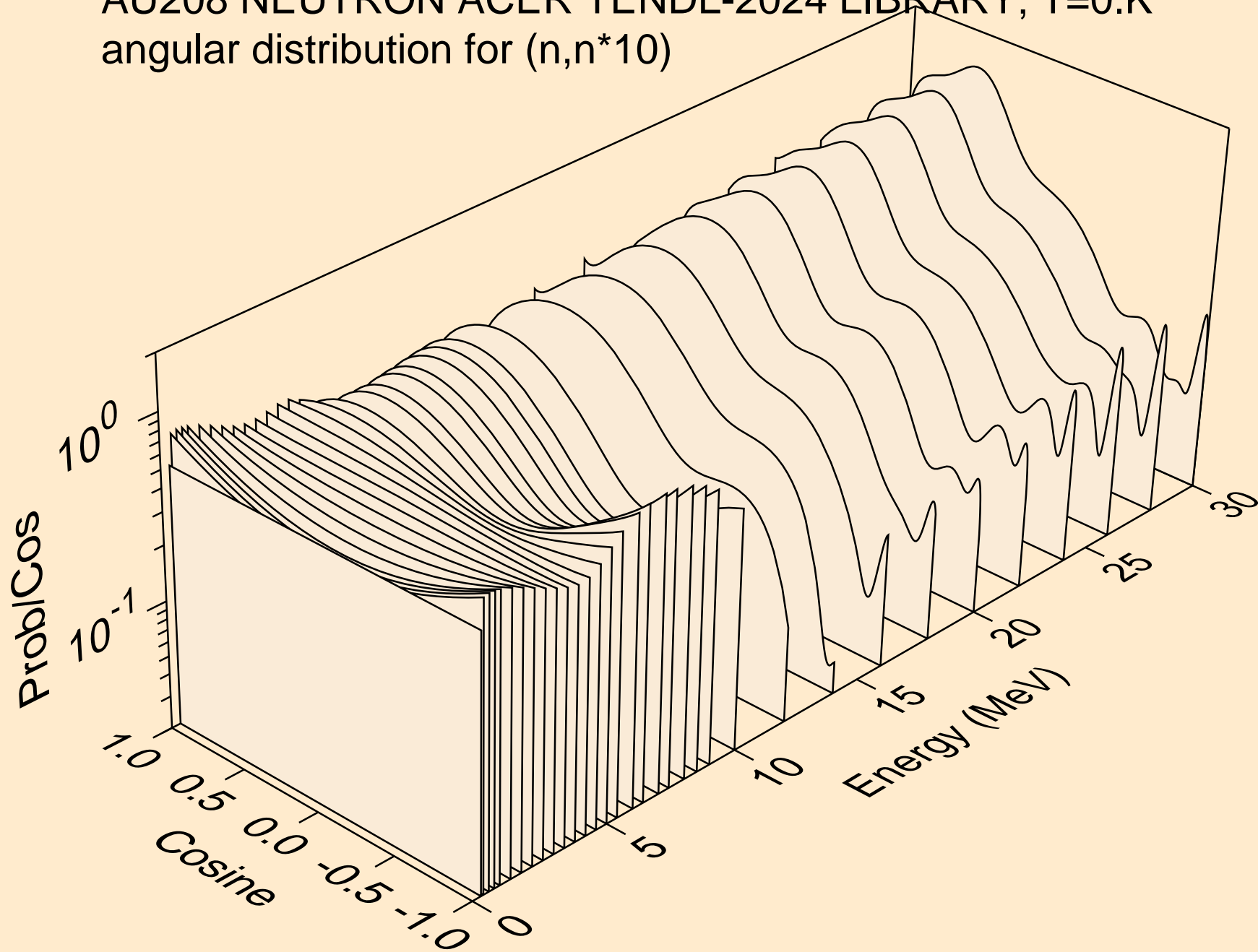

AU208 NEUTRON ACER TENDL-2024 LIBRARY; T=0.K  
angular distribution for (n,n\*11)

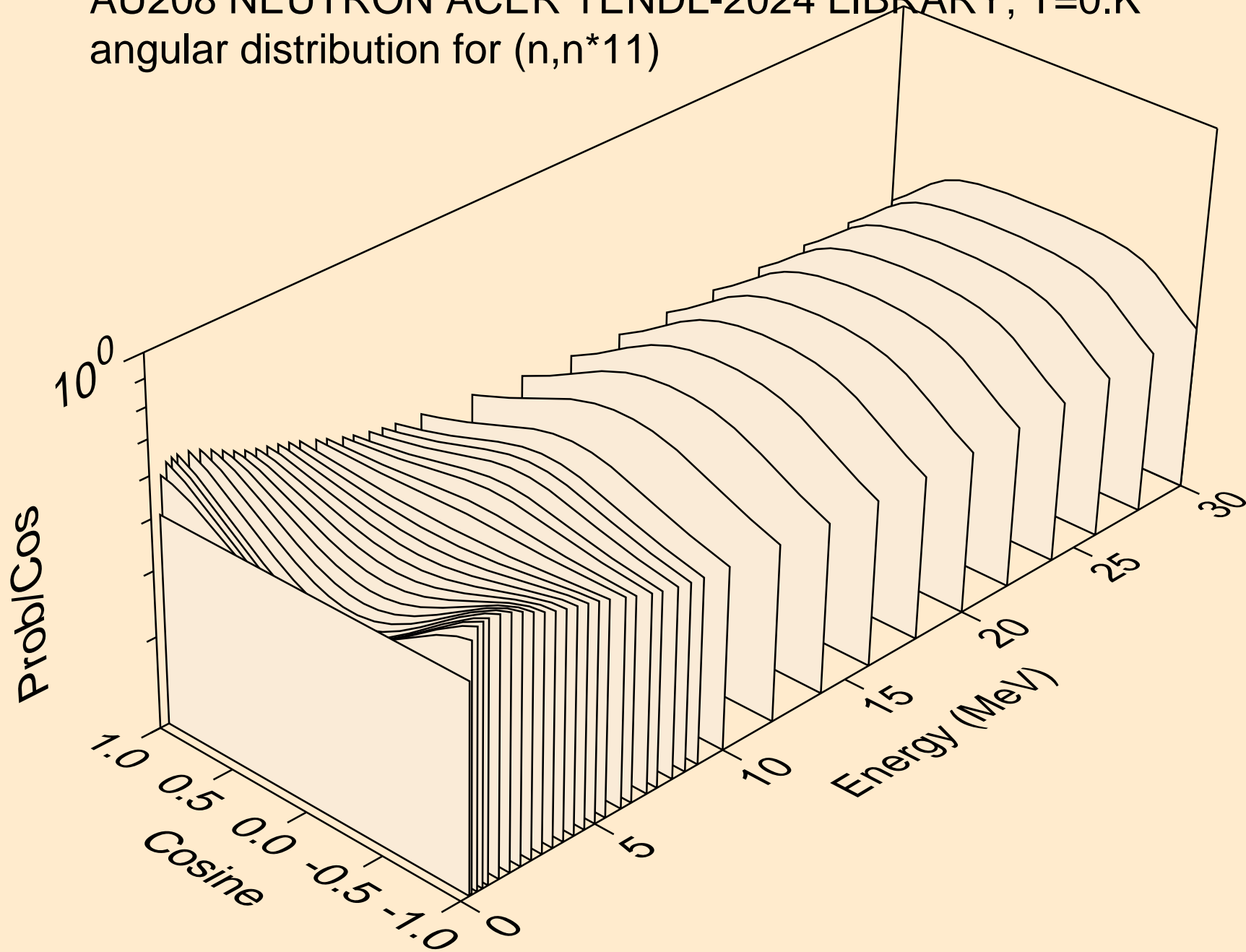



AU208 NEUTRON ACER TENDL-2024 LIBRARY; T=0.K  
angular distribution for (n,n\*12)

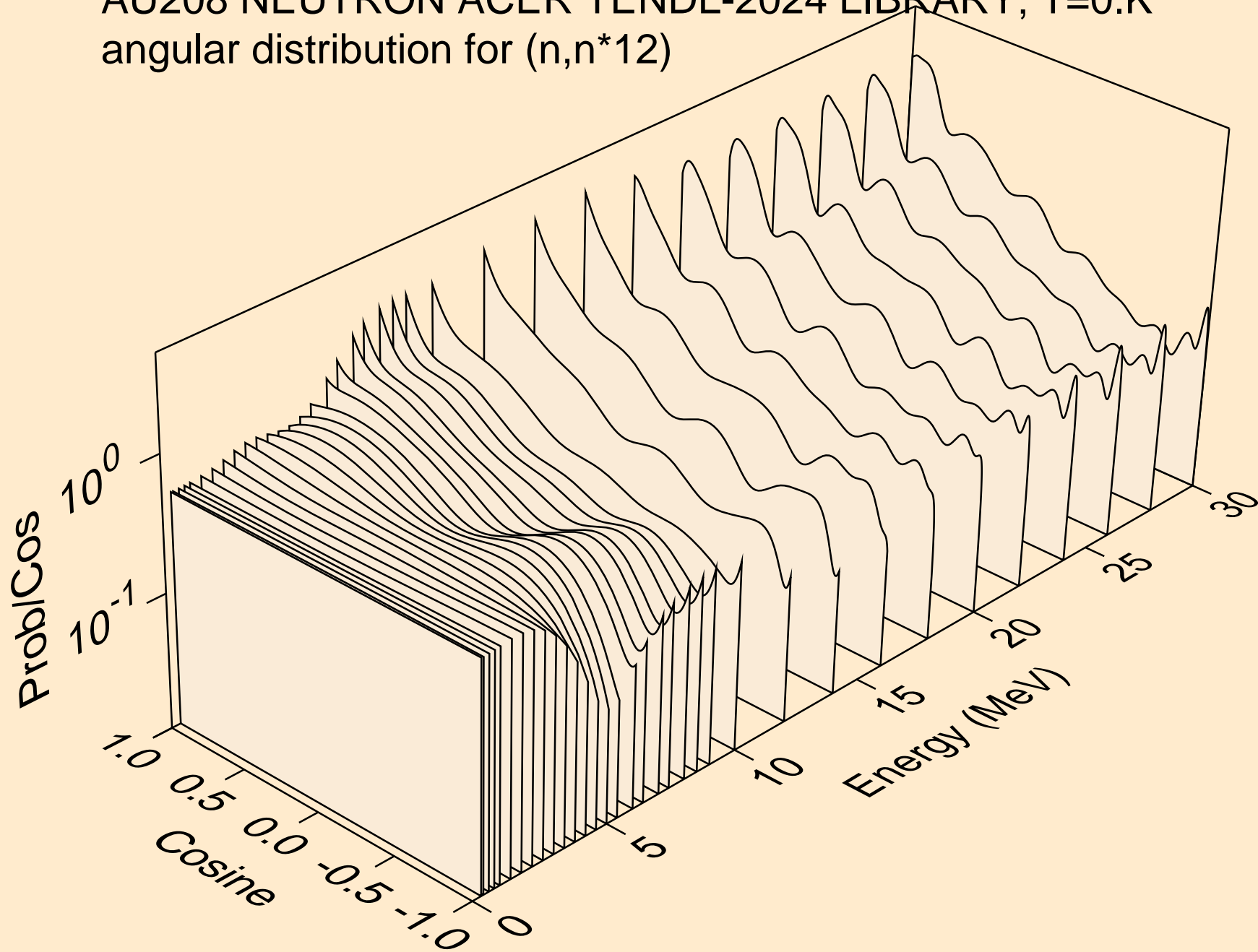

AU208 NEUTRON ACER TENDL-2024 LIBRARY; T=0.K  
angular distribution for (n,n\*13)

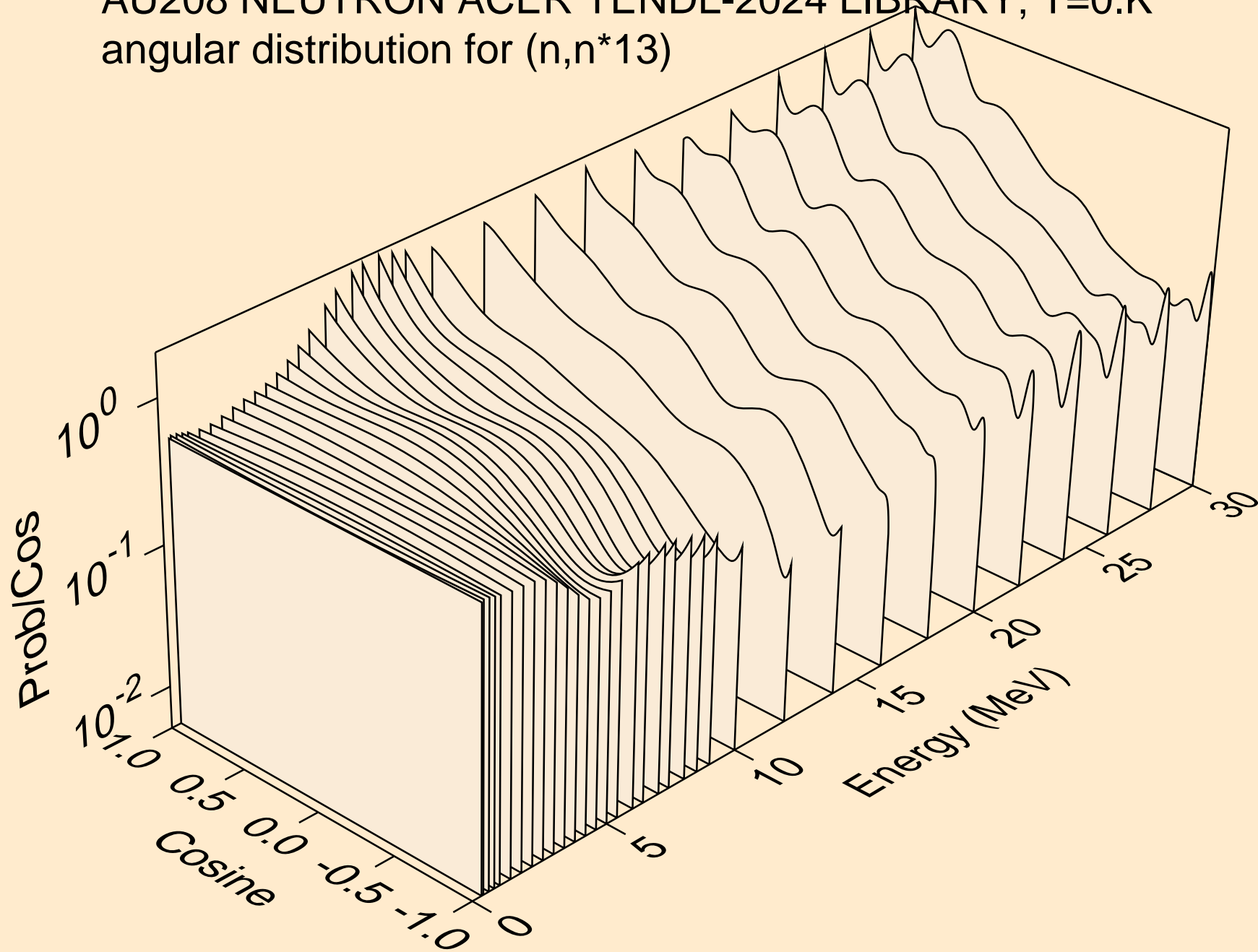

AU208 NEUTRON ACER TENDL-2024 LIBRARY; T=0.K  
angular distribution for (n,n\*14)

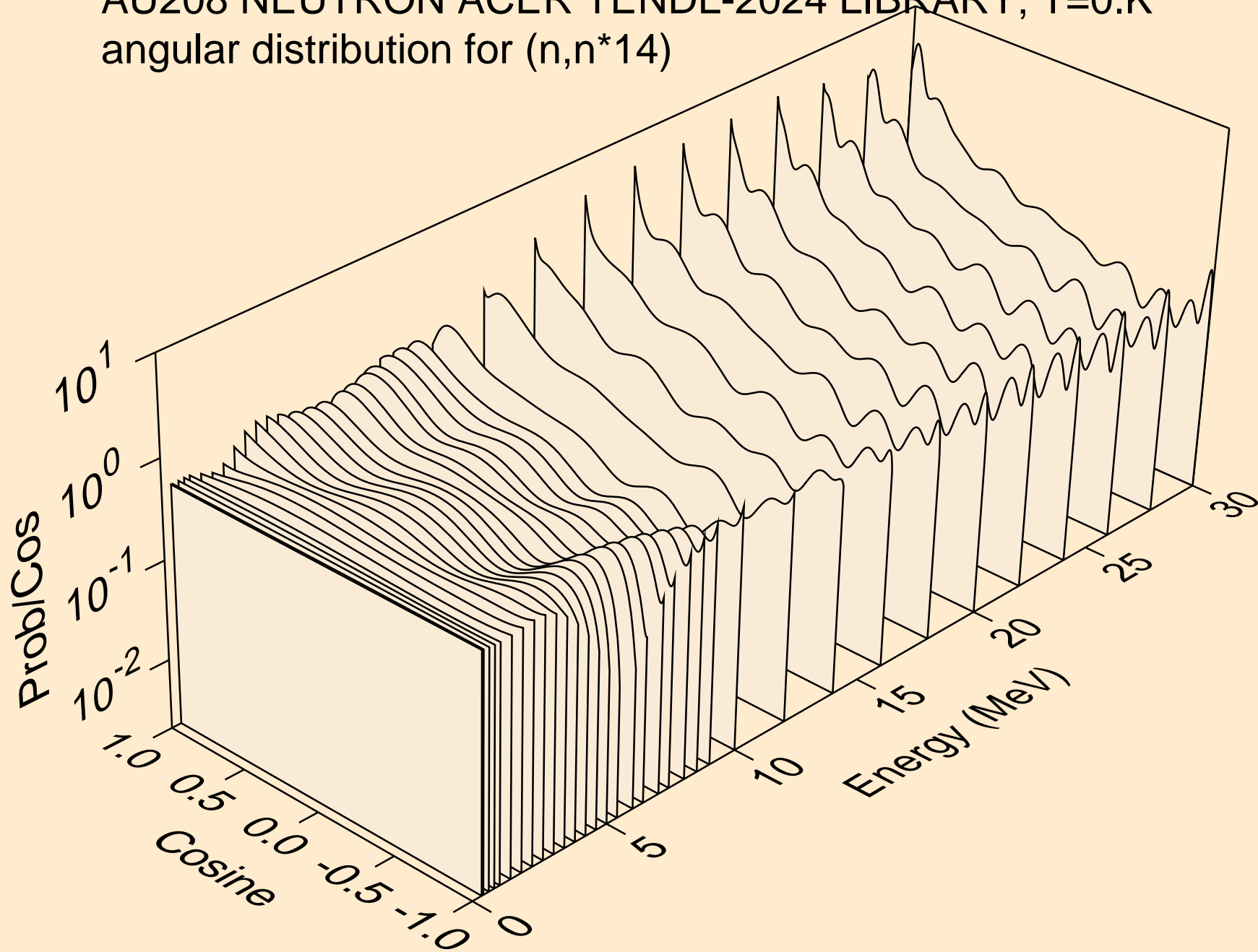

AU208 NEUTRON ACER TENDL-2024 LIBRARY; T=0.K  
angular distribution for (n,n\*15)

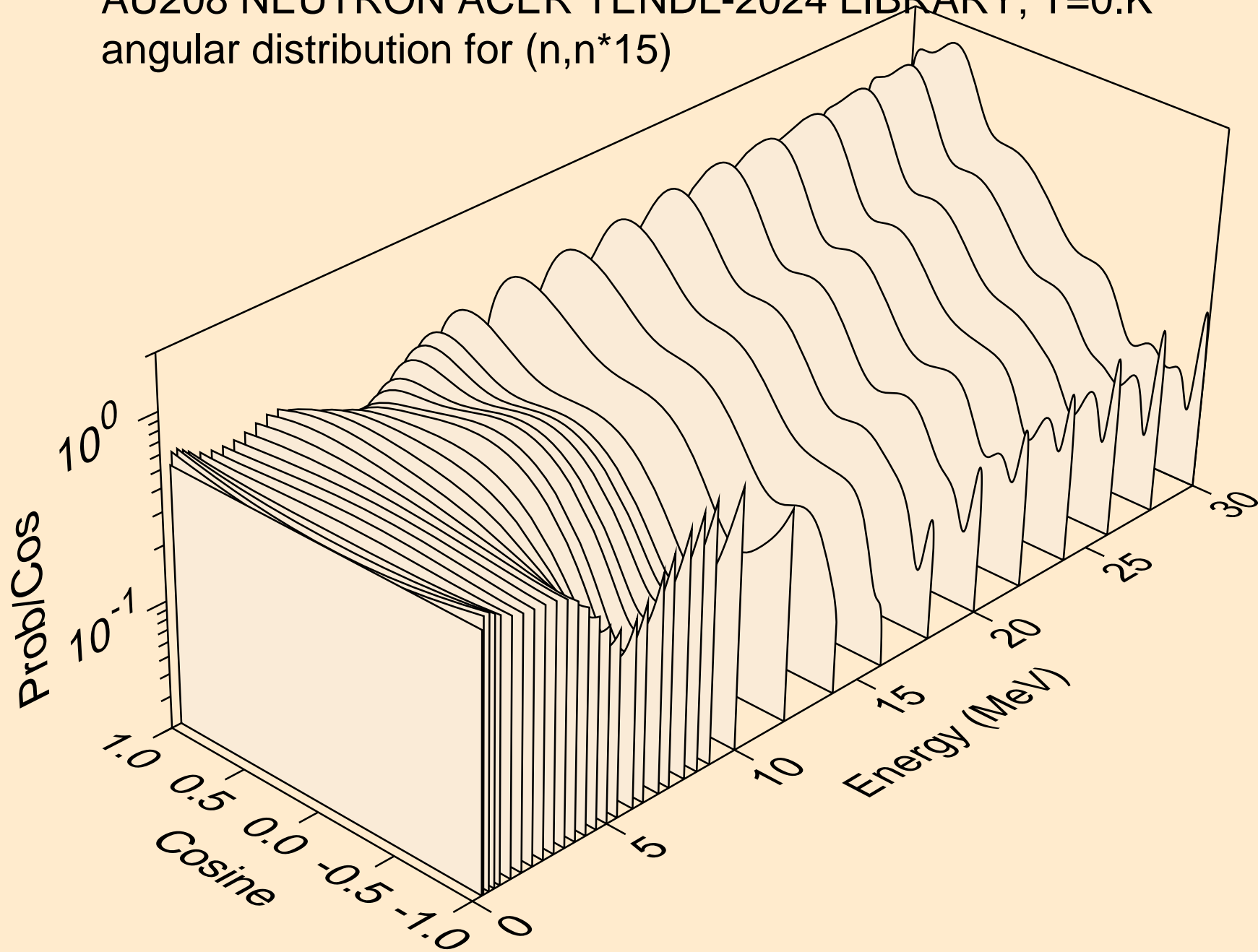

AU208 NEUTRON ACER TENDL-2024 LIBRARY; T=0.K  
angular distribution for (n,n\*16)

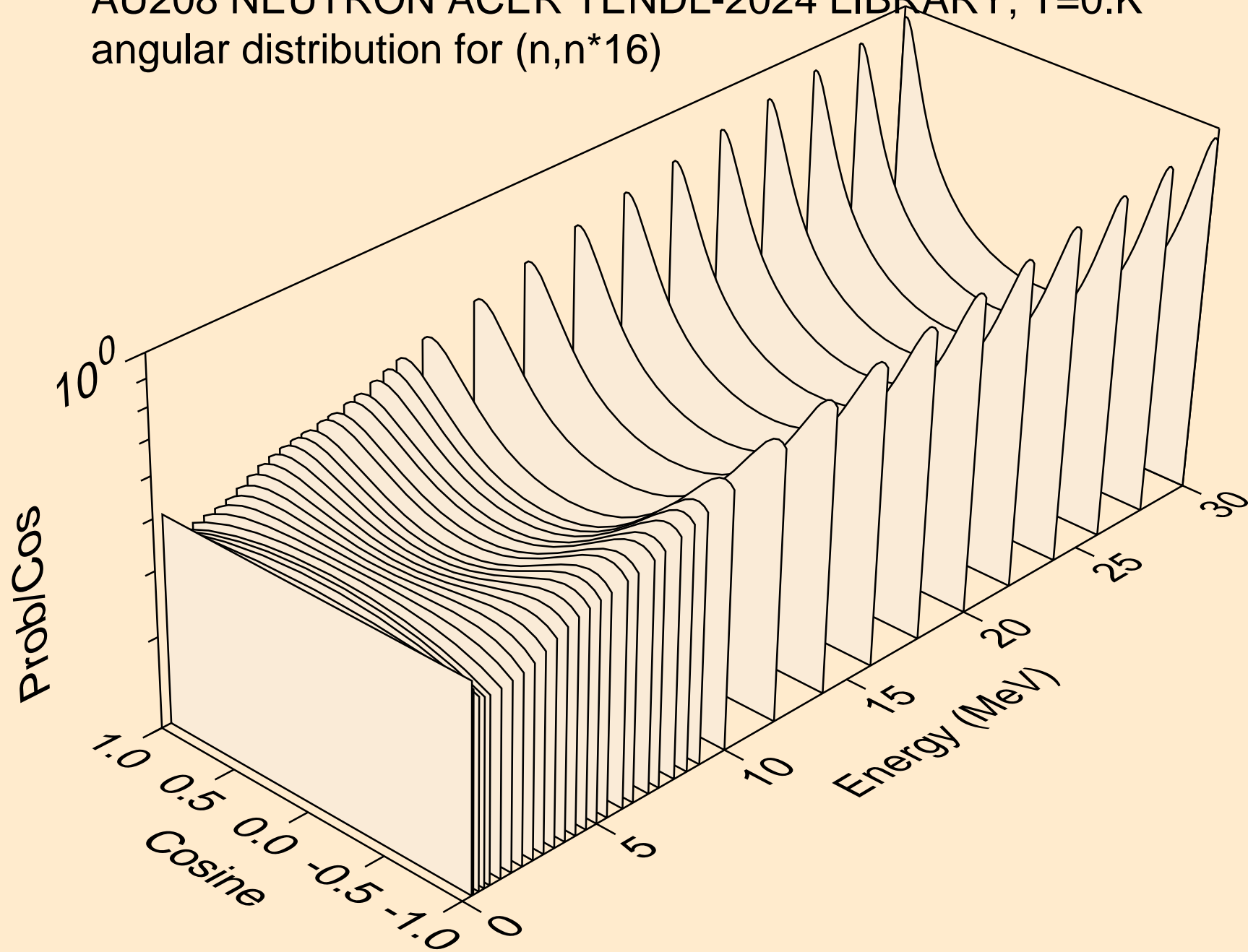

AU208 NEUTRON ACER TENDL-2024 LIBRARY; T=0.K  
angular distribution for (n,n\*17)

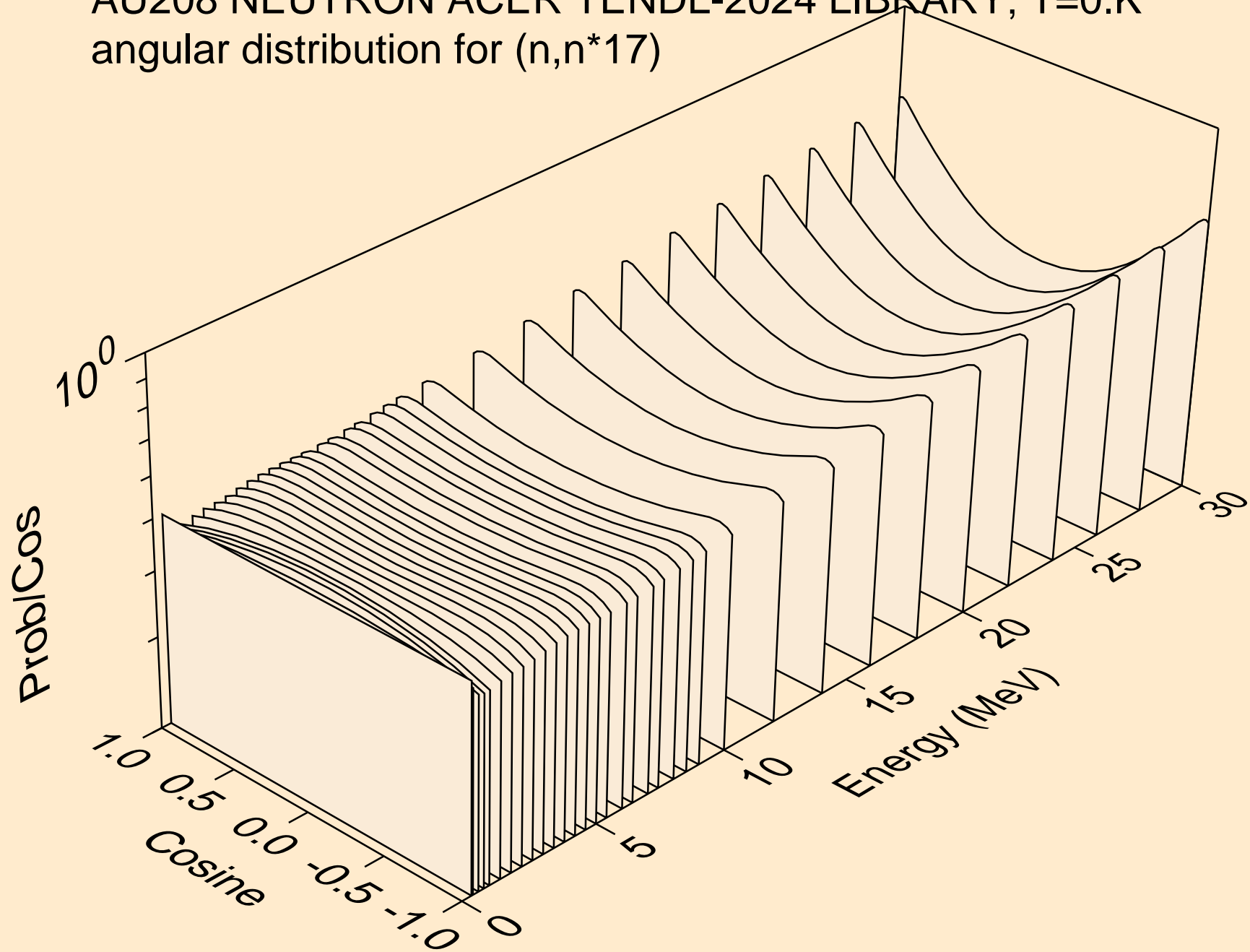

AU208 NEUTRON ACER TENDL-2024 LIBRARY; T=0.K  
angular distribution for (n,n\*18)

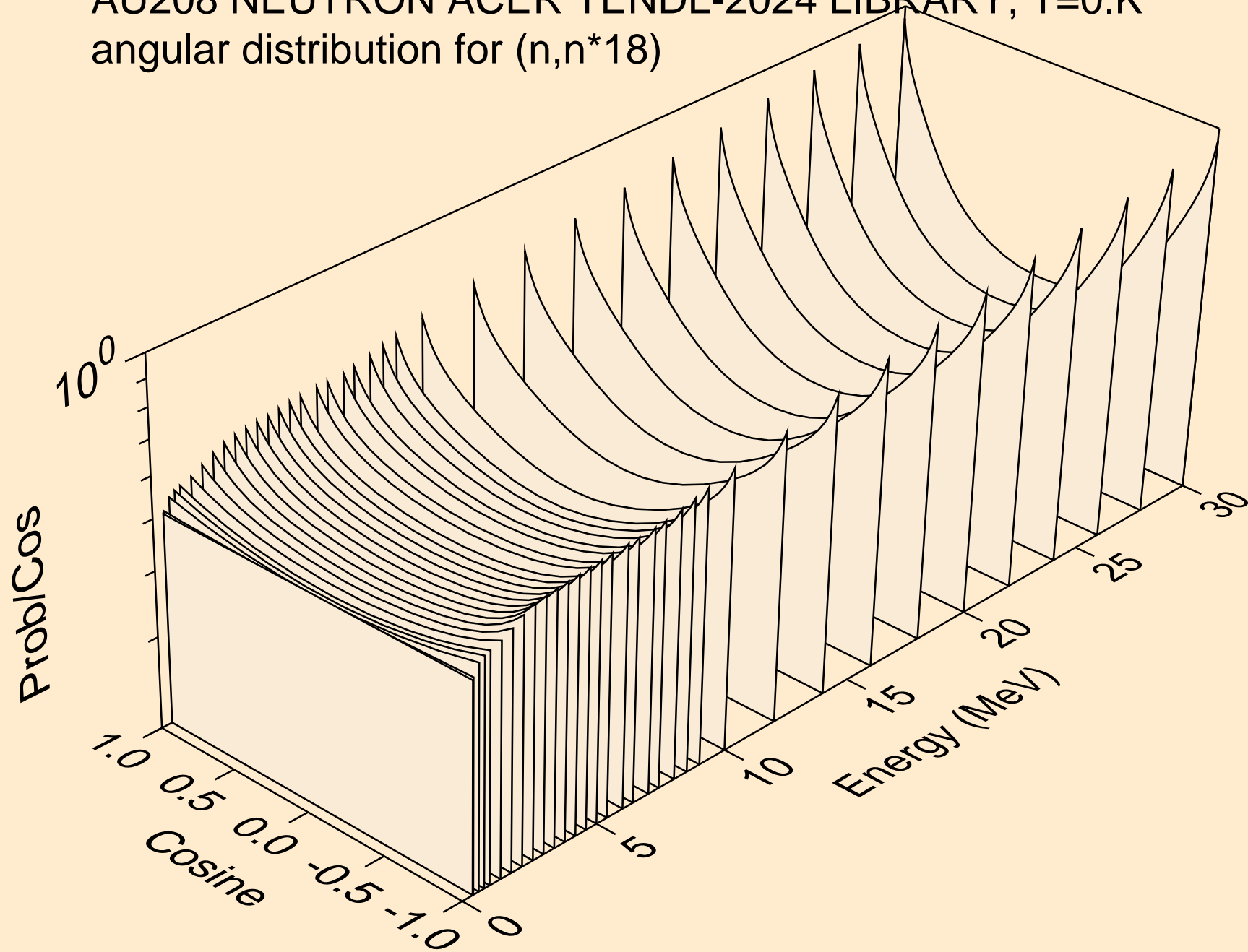

AU208 NEUTRON ACER TENDL-2024 LIBRARY; T=0.K  
angular distribution for (n,n\*19)

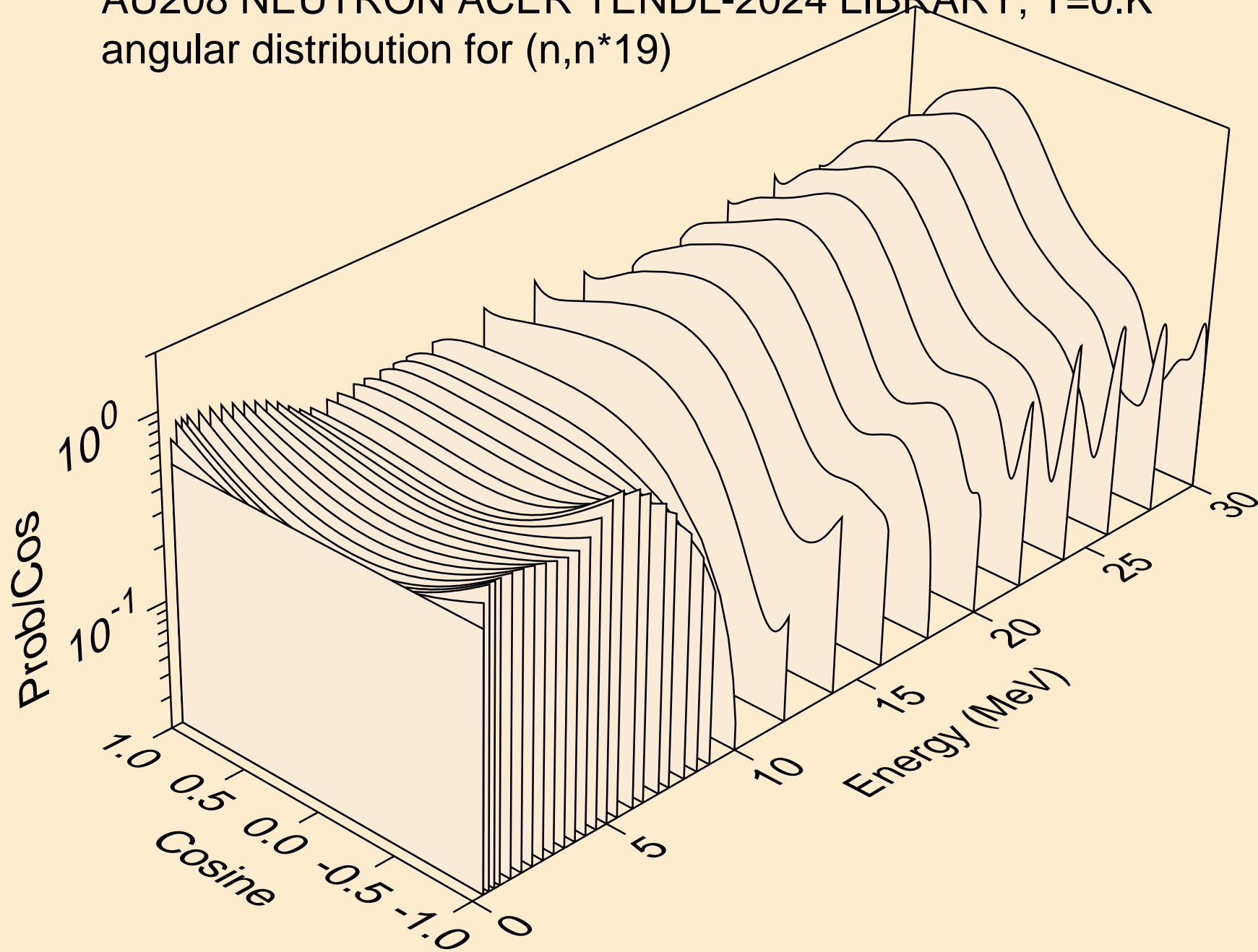



AU208 NEUTRON ACER TENDL-2024 LIBRARY; T=0.K  
angular distribution for (n,n\*20)

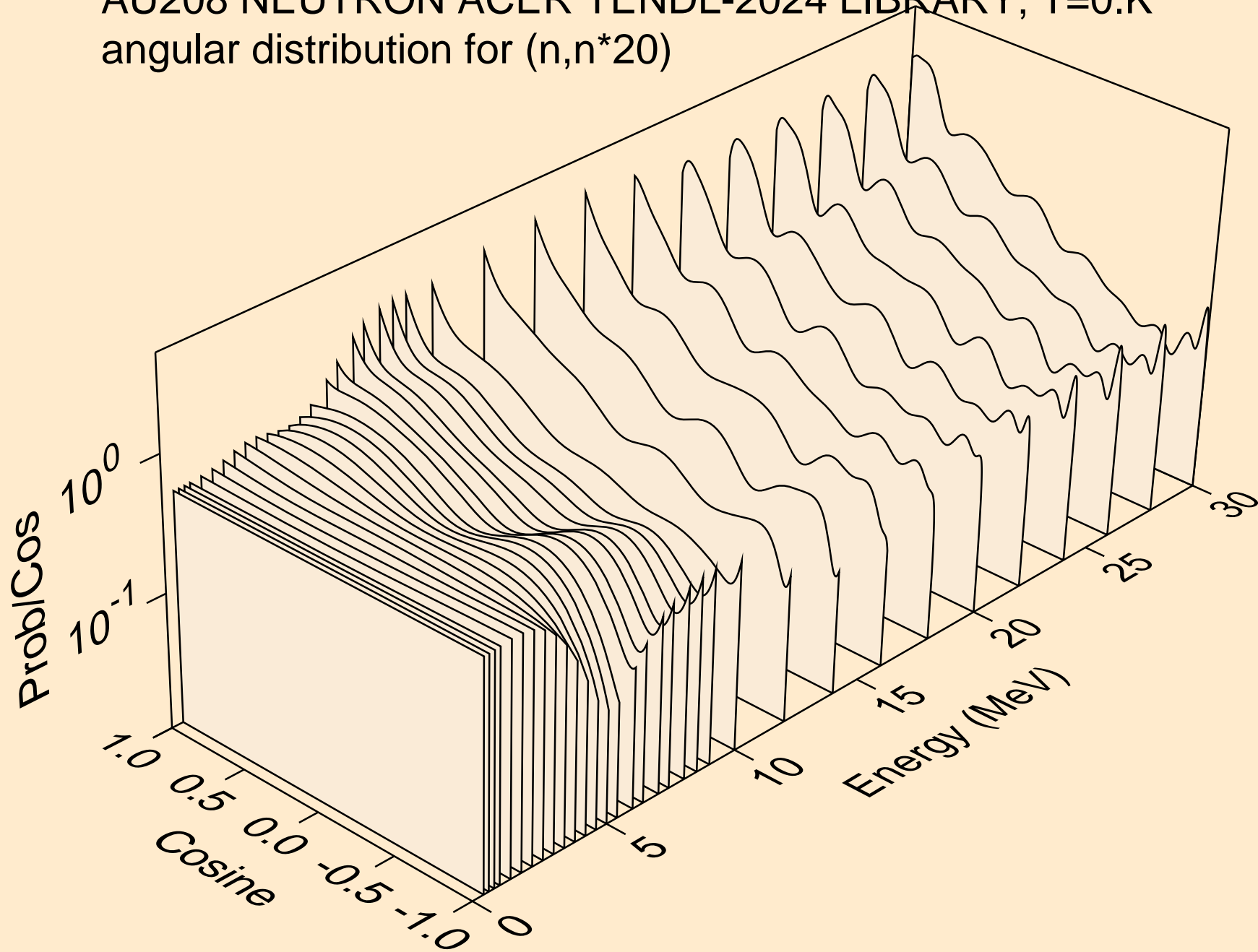

AU208 NEUTRON ACER TENDL-2024 LIBRARY; T=0.K  
angular distribution for (n,n\*21)

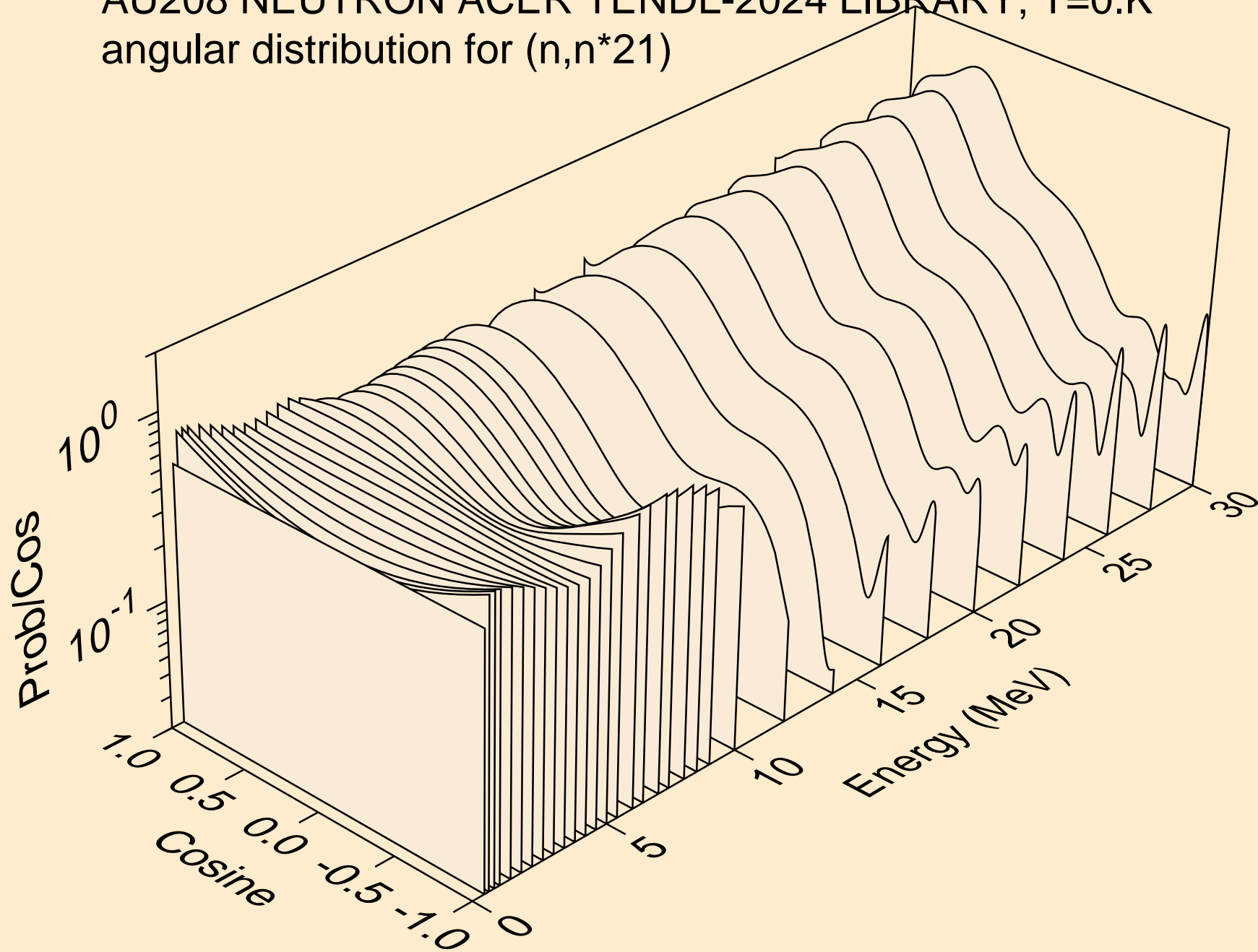

AU208 NEUTRON ACER TENDL-2024 LIBRARY; T=0.K  
angular distribution for (n,n\*22)

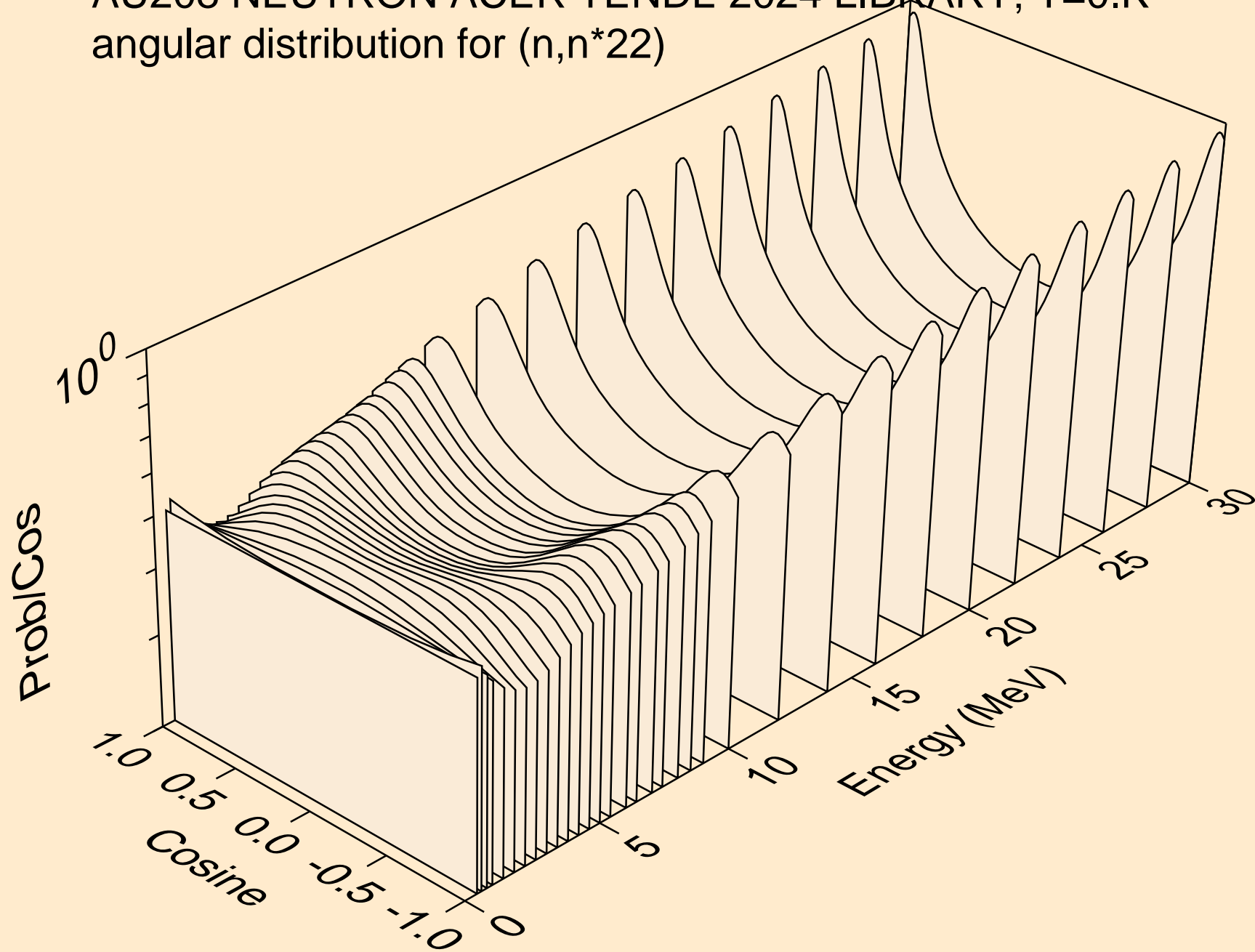

AU208 NEUTRON ACER TENDL-2024 LIBRARY; T=0.K  
angular distribution for (n,n\*23)

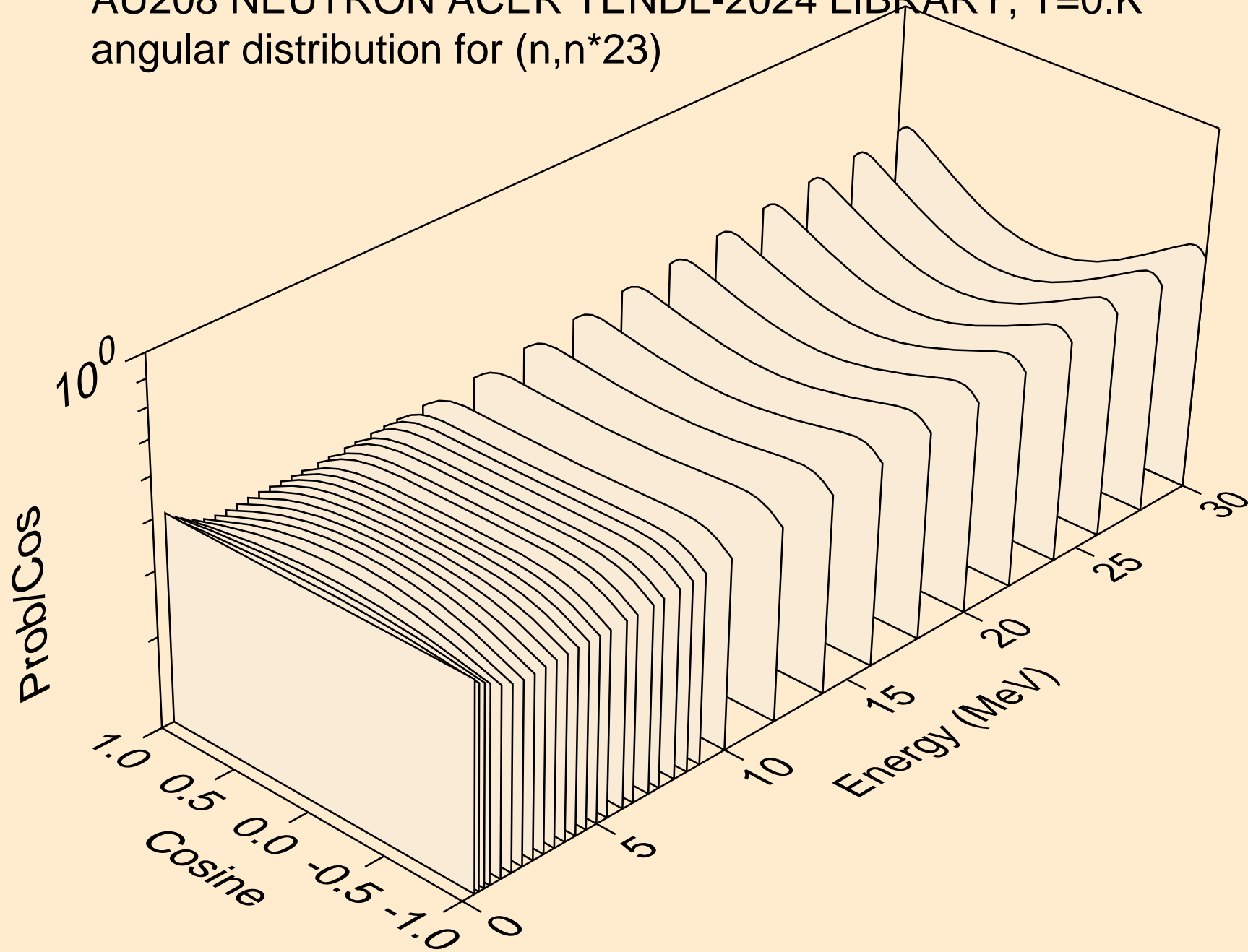

AU208 NEUTRON ACER TENDL-2024 LIBRARY; T=0.K  
angular distribution for (n,n\*24)

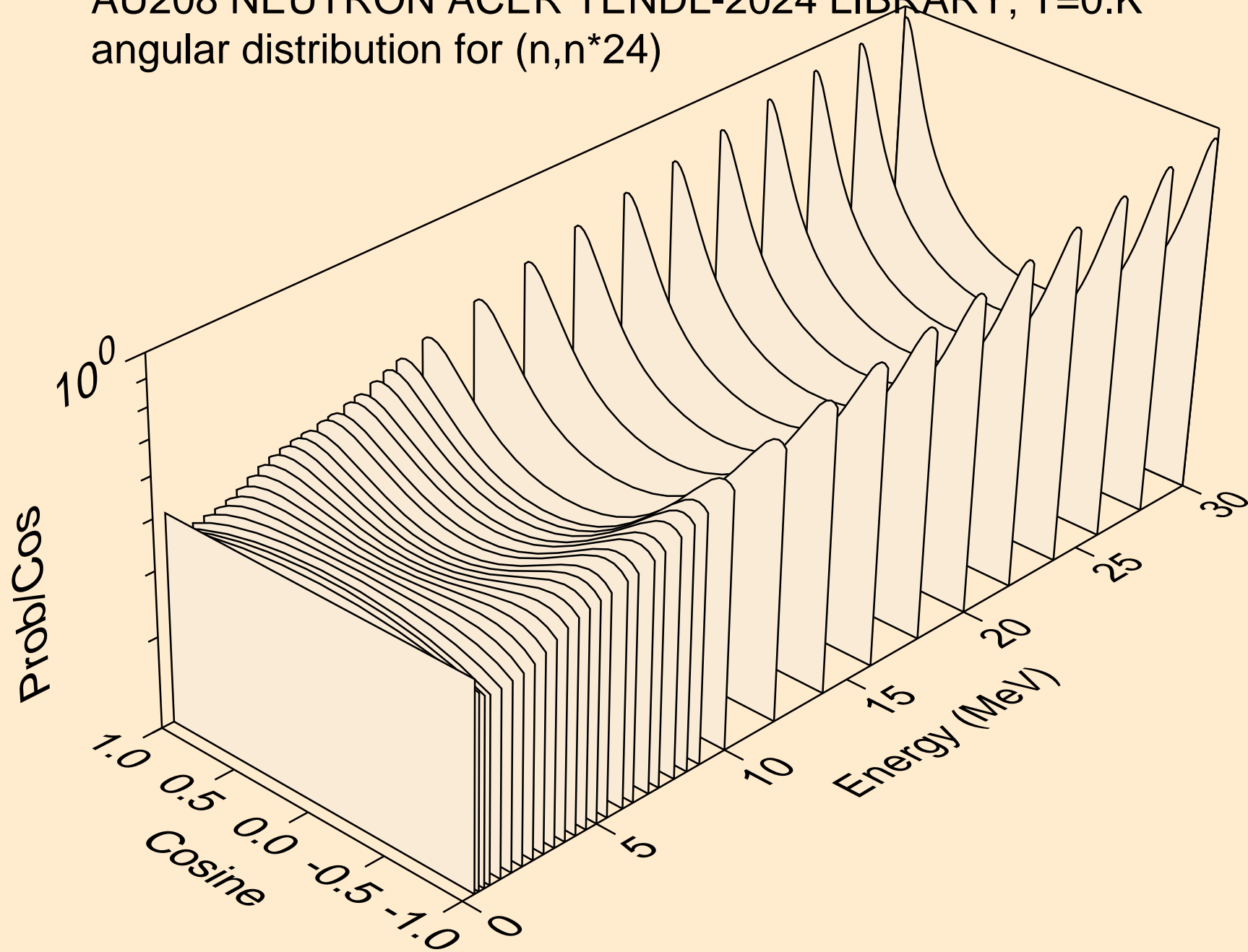

AU208 NEUTRON ACER TENDL-2024 LIBRARY; T=0.K  
angular distribution for (n,n\*25)

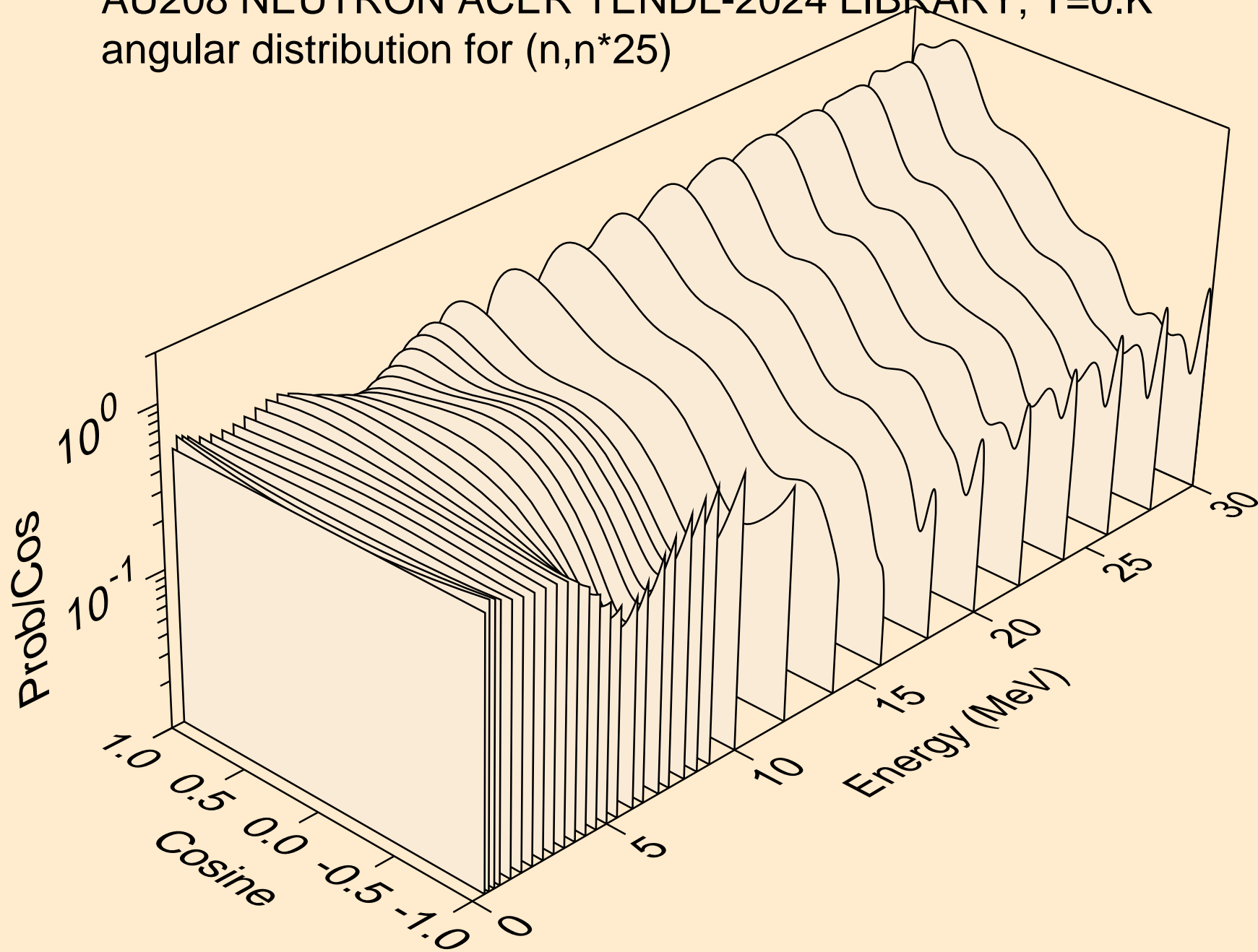

AU208 NEUTRON ACER TENDL-2024 LIBRARY; T=0.K  
angular distribution for (n,n\*26)

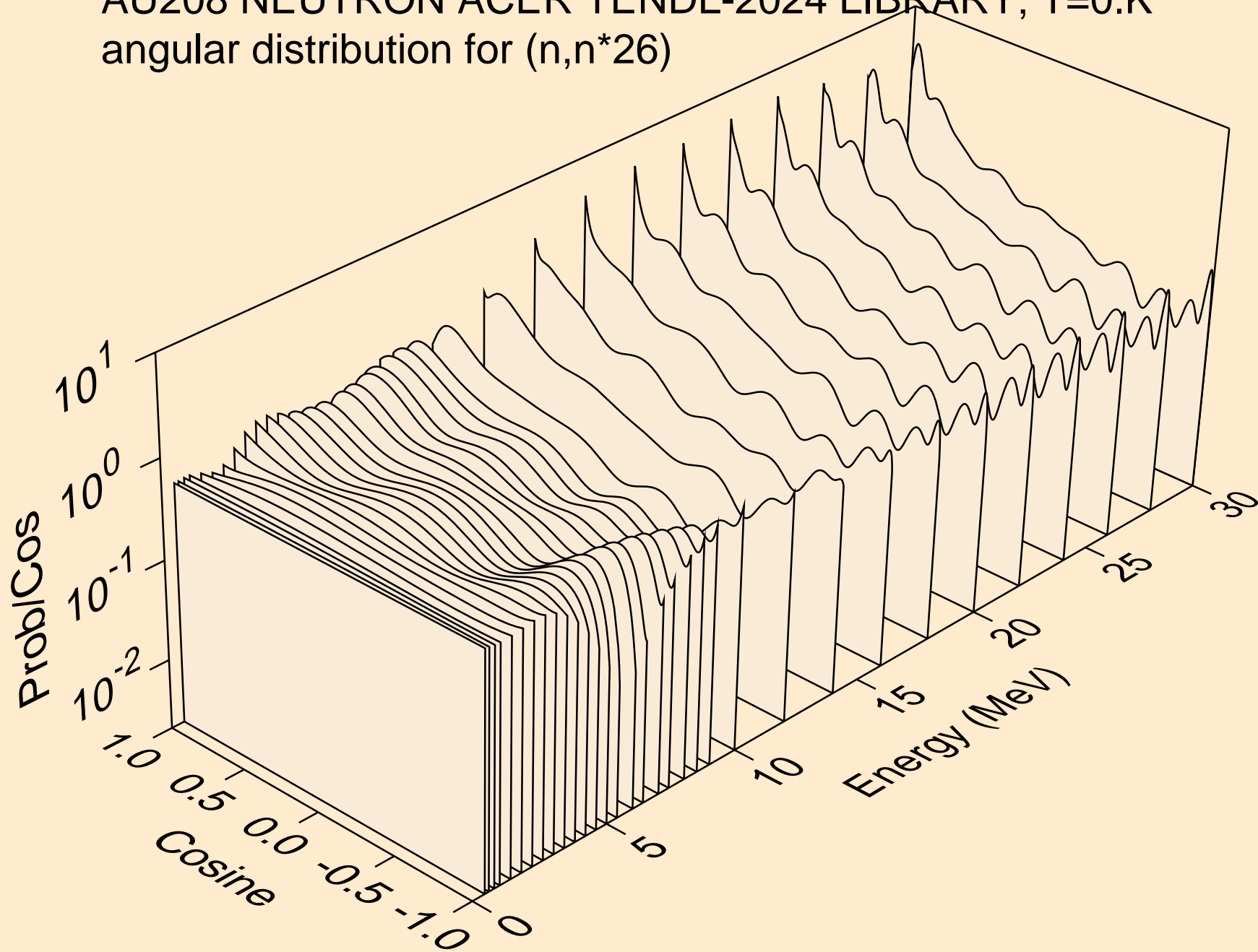

AU208 NEUTRON ACER TENDL-2024 LIBRARY; T=0.K  
angular distribution for (n,n\*27)

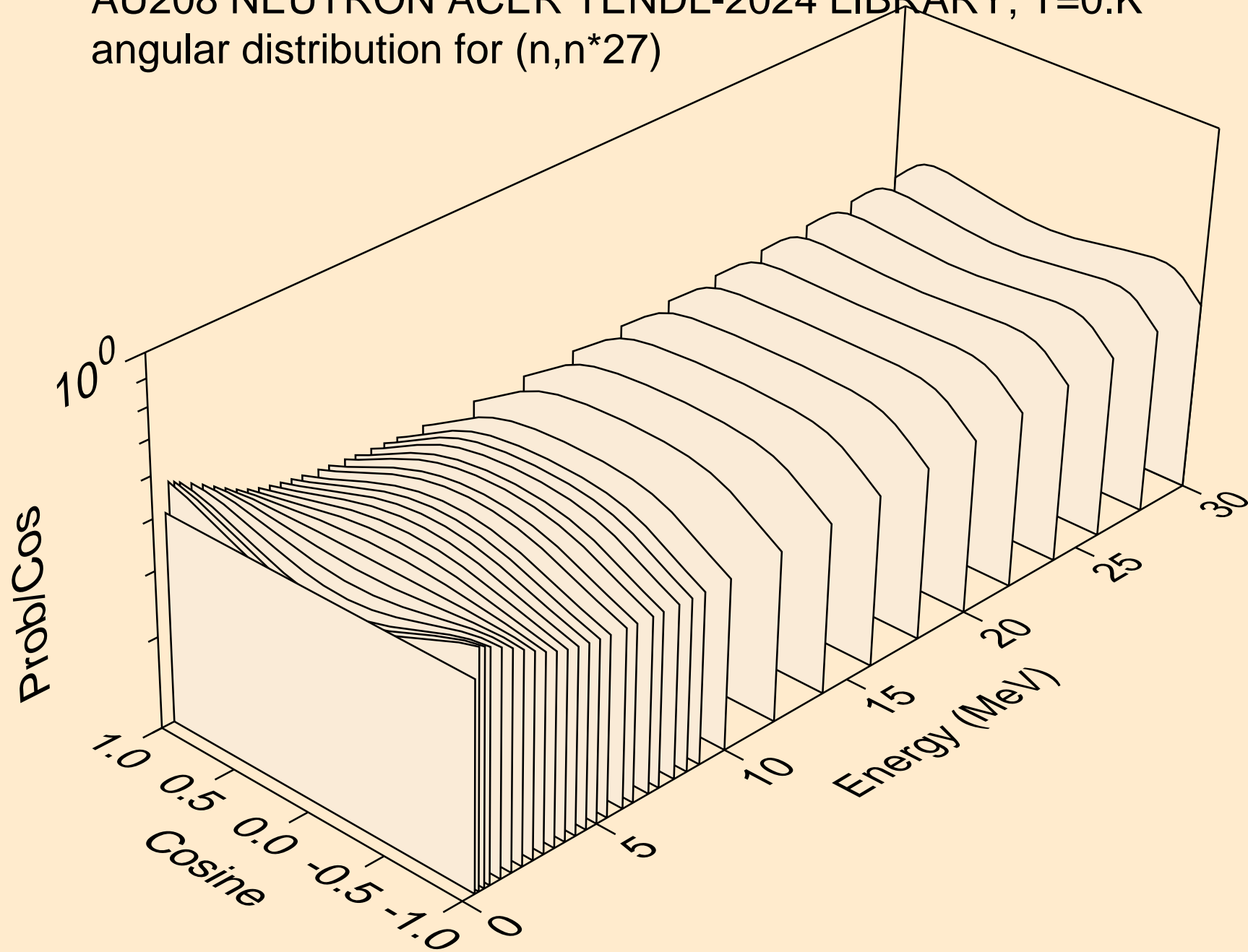



AU208 NEUTRON ACER TENDL-2024 LIBRARY; T=0.K  
angular distribution for (n,n\*28)

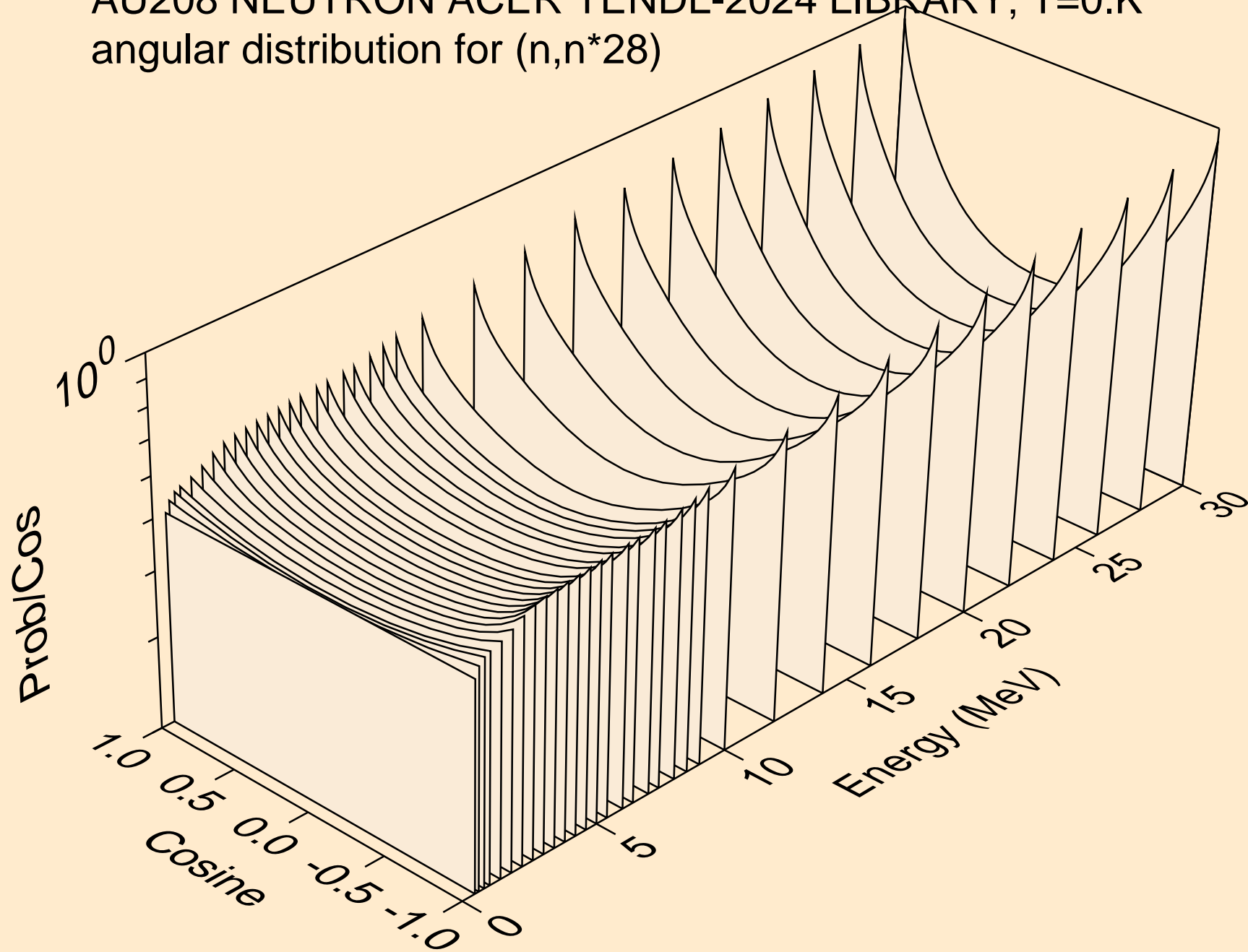

AU208 NEUTRON ACER TENDL-2024 LIBRARY; T=0.K  
angular distribution for (n,n\*29)

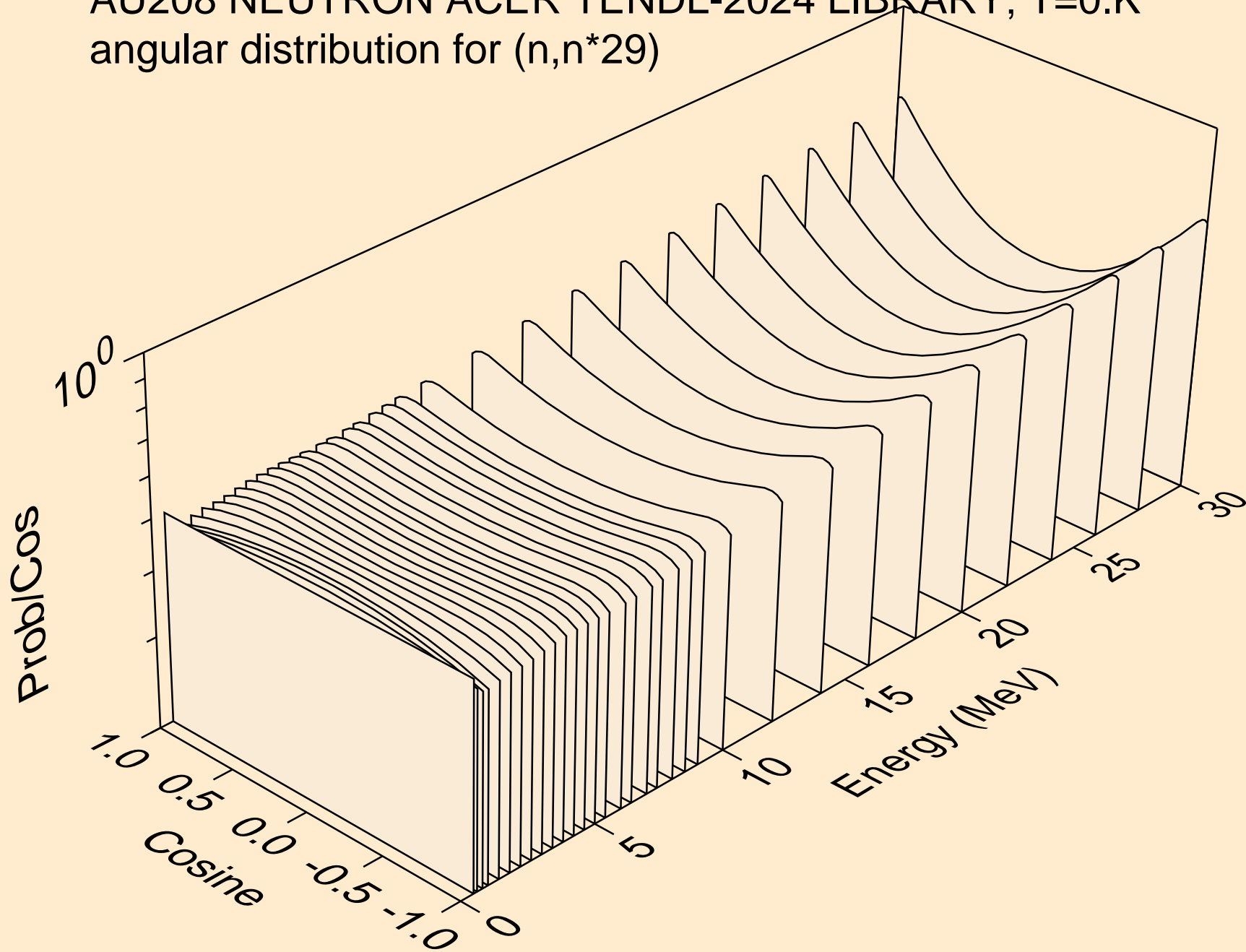

AU208 NEUTRON ACER TENDL-2024 LIBRARY; T=0.K  
angular distribution for (n,n\*30)

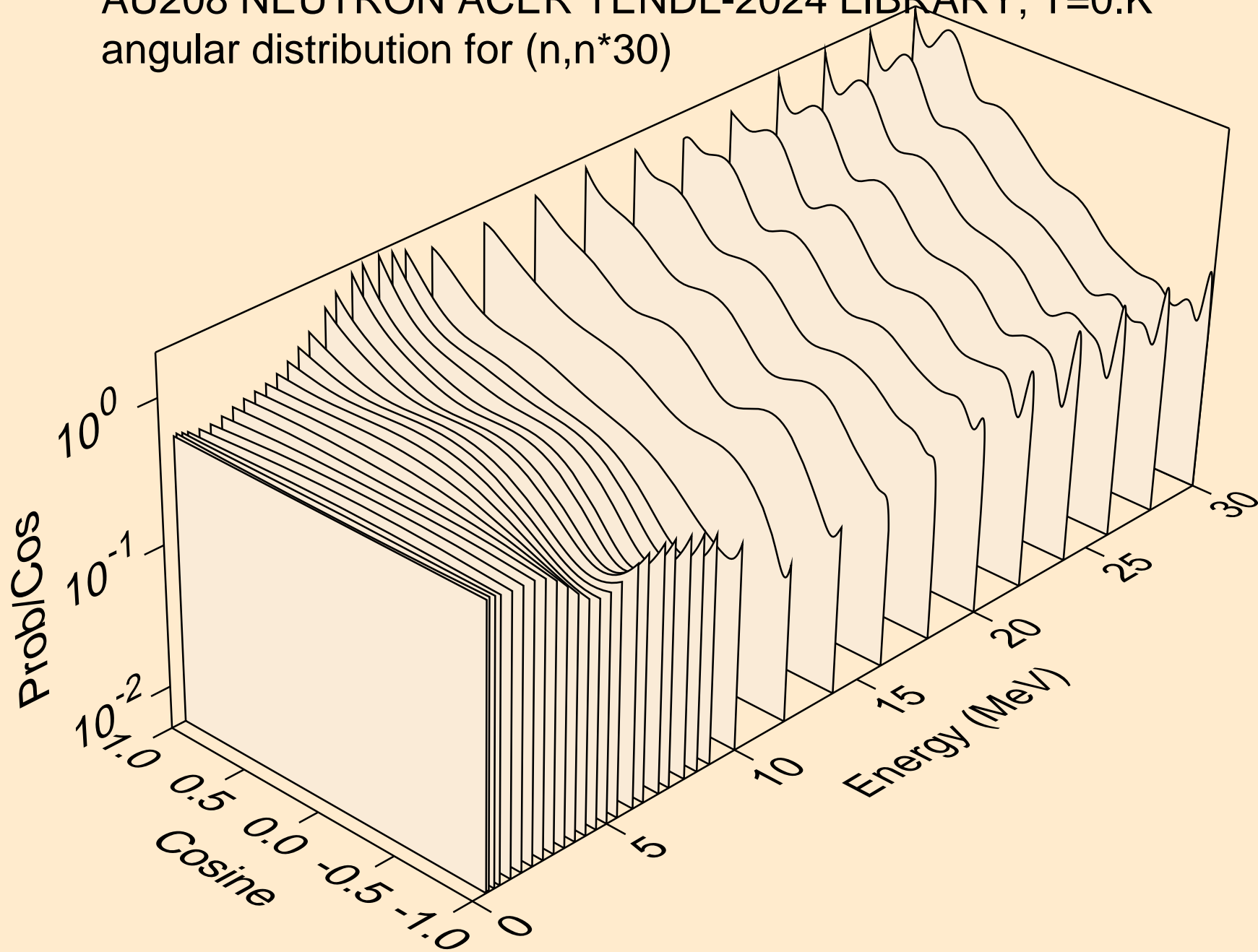

AU208 NEUTRON ACER TENDL-2024 LIBRARY; T=0.K  
Neutron emission for (n,x)

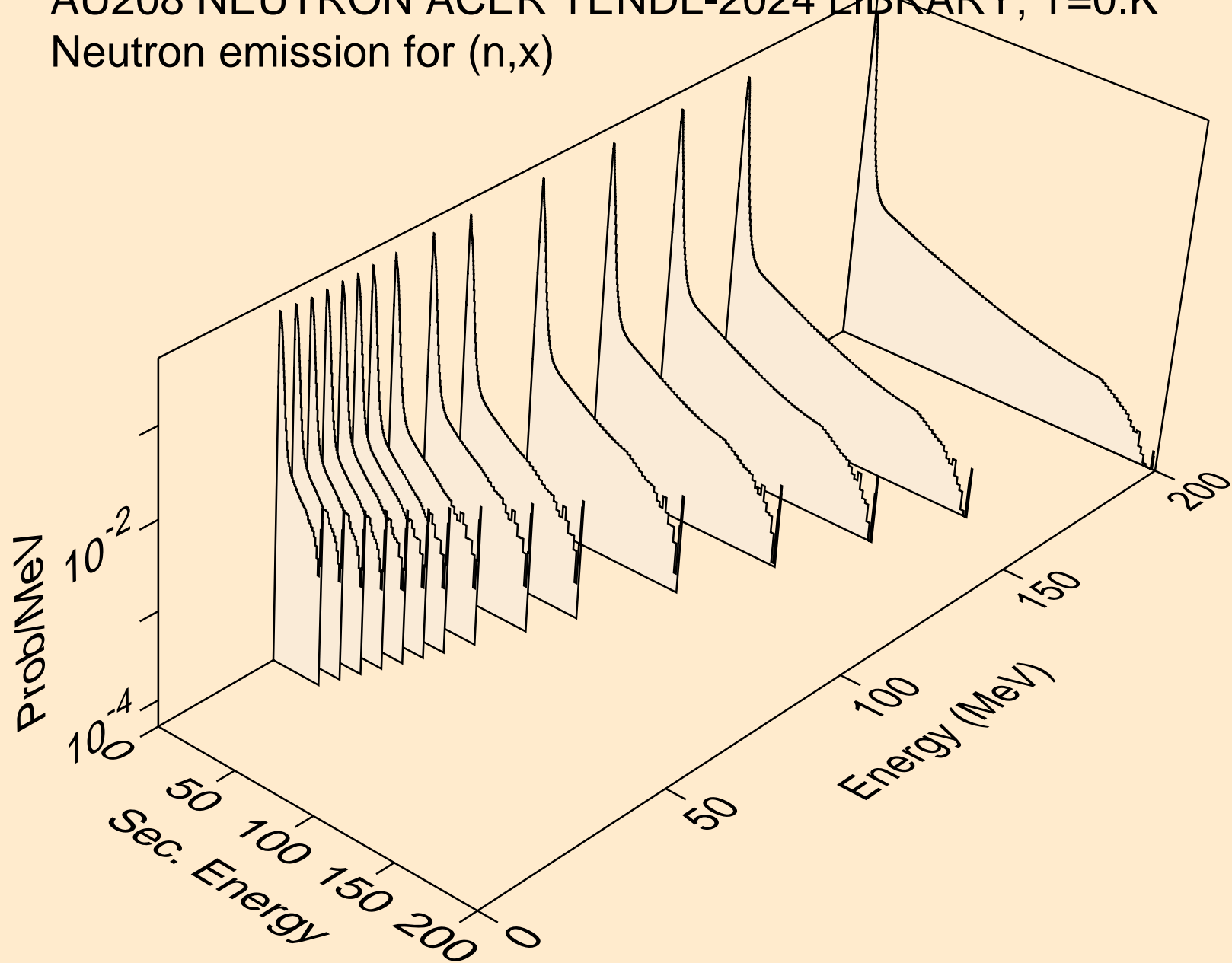

AU208 NEUTRON ACER TENDL-2024 LIBRARY; T=0.K  
Neutron emission for (n,2nd)

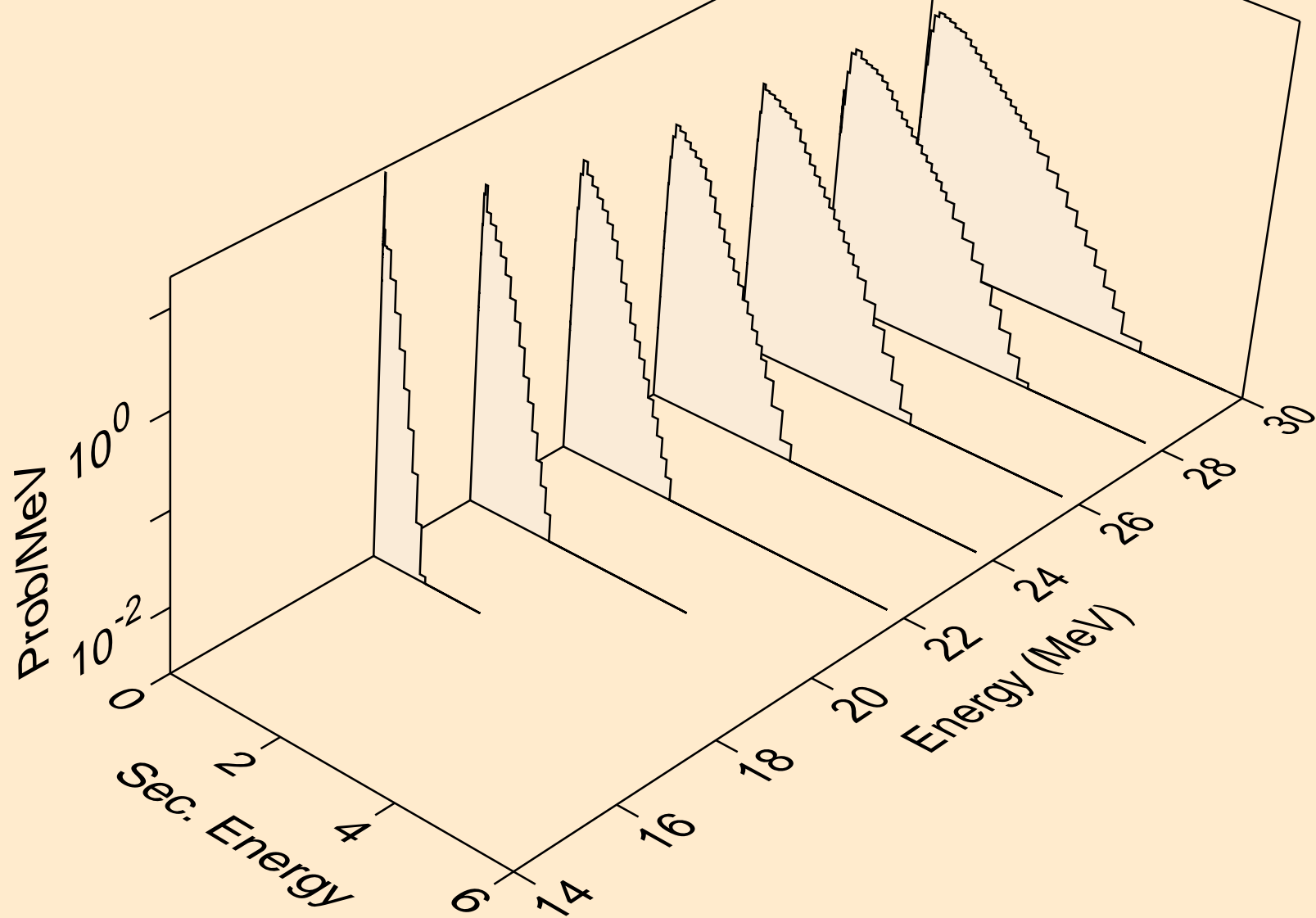

AU208 NEUTRON ACER TENDL-2024 LIBRARY; T=0.K  
Neutron emission for (n,2n)

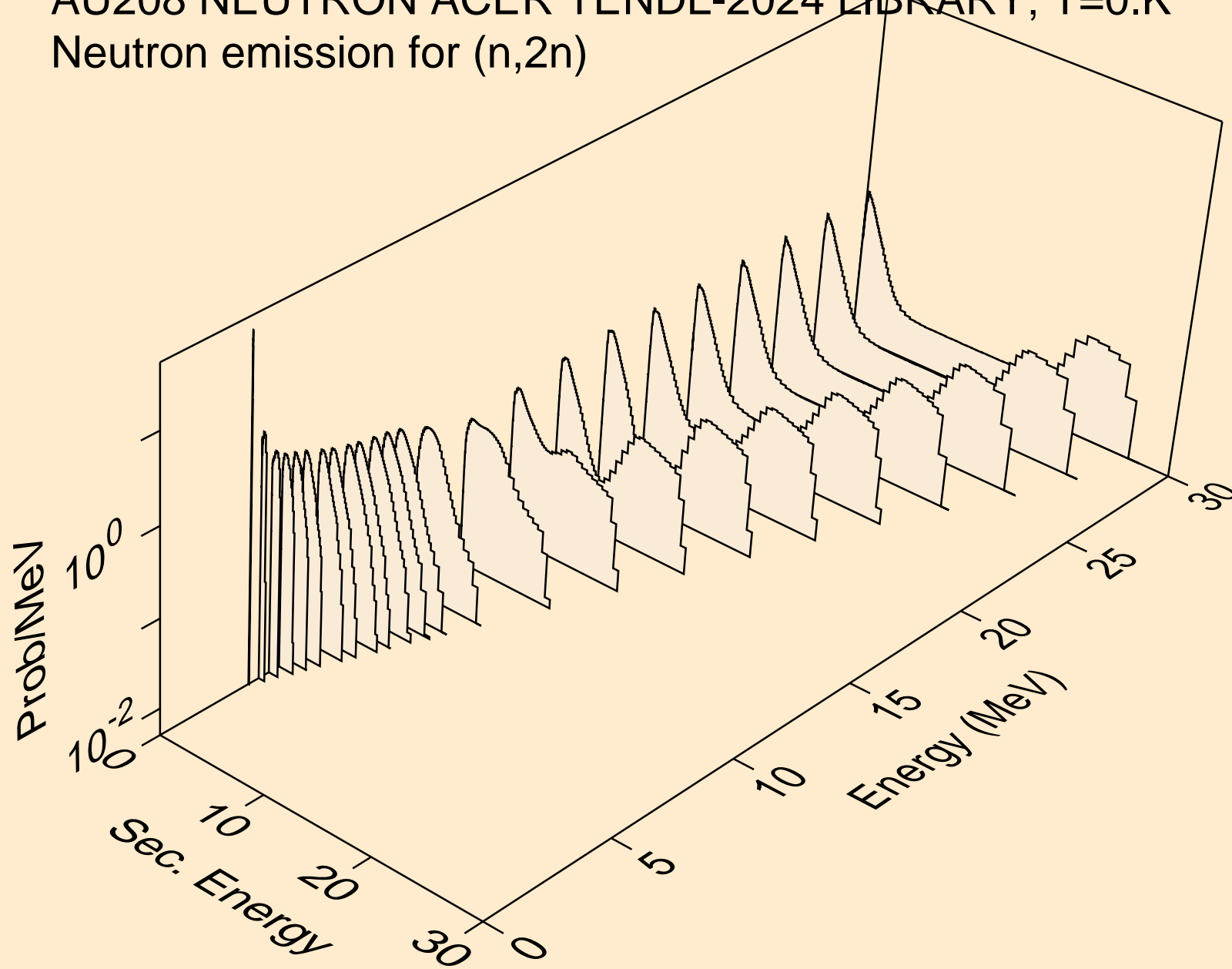

AU208 NEUTRON ACER TENDL-2024 LIBRARY; T=0.K  
Neutron emission for (n,3n)

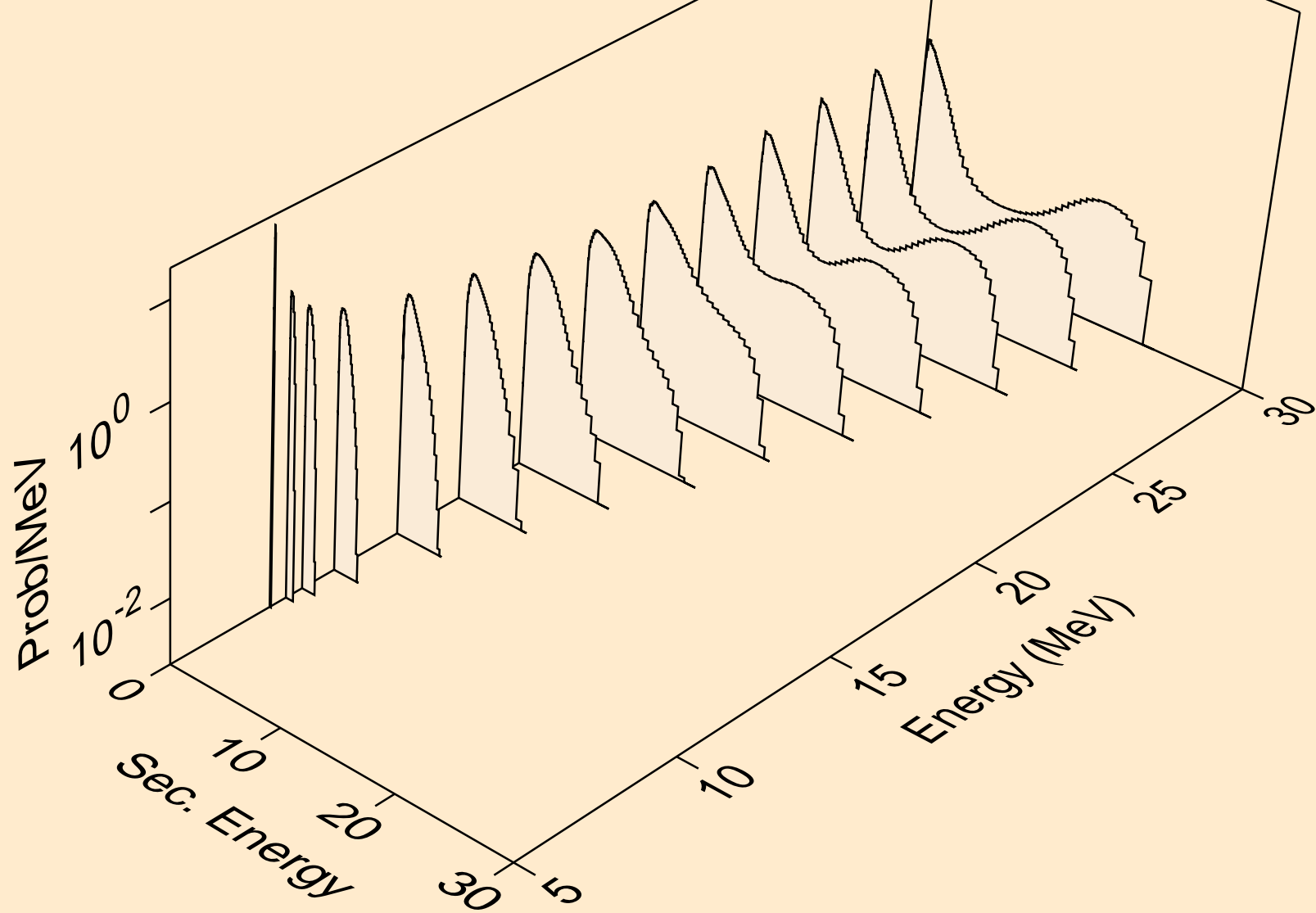

AU208 NEUTRON ACER TENDL-2024 LIBRARY; T=0.K  
Neutron emission for (n,n\*)a

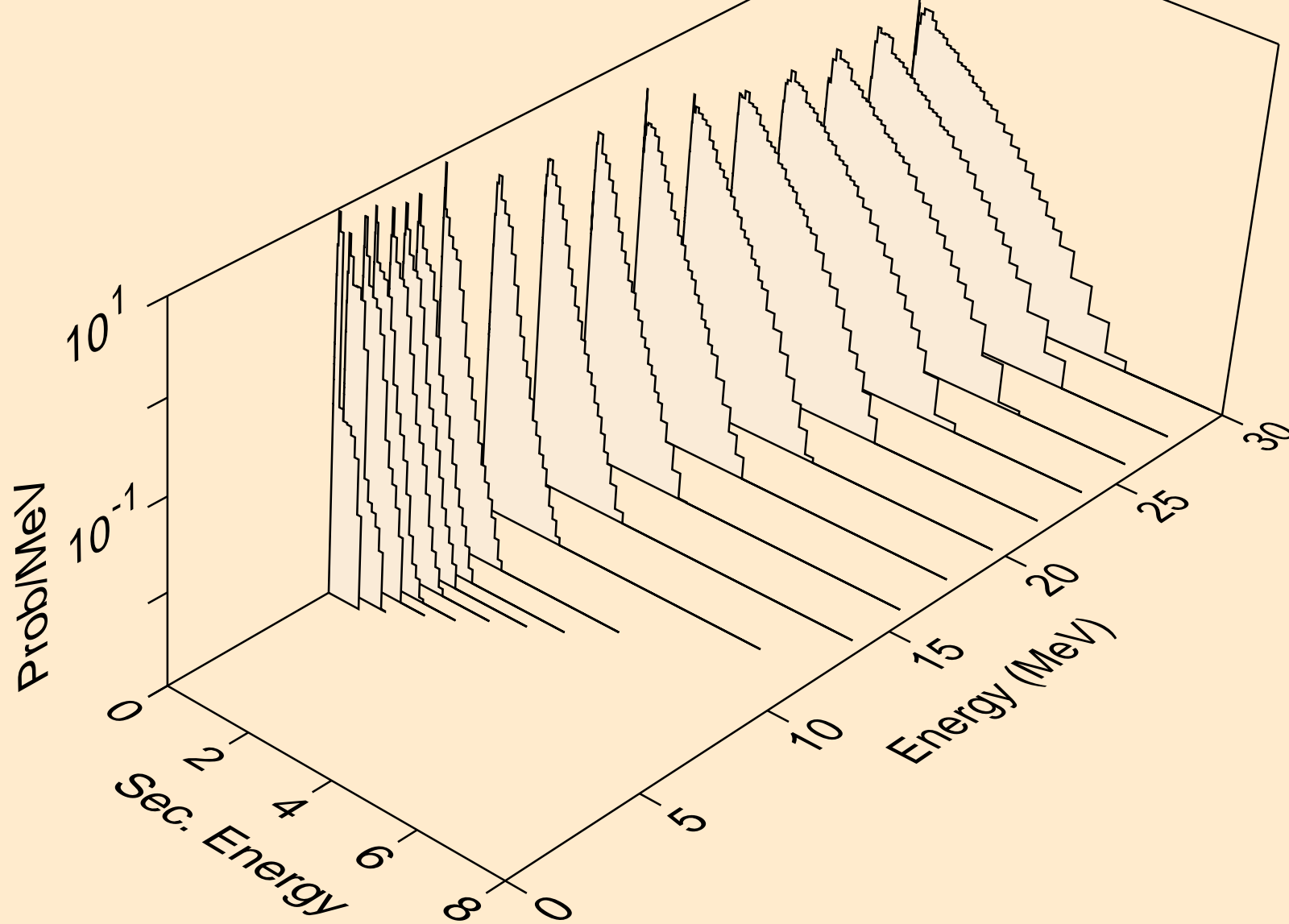



AU208 NEUTRON ACER TENDL-2024 LIBRARY; T=0.K  
Neutron emission for (n,2n)a

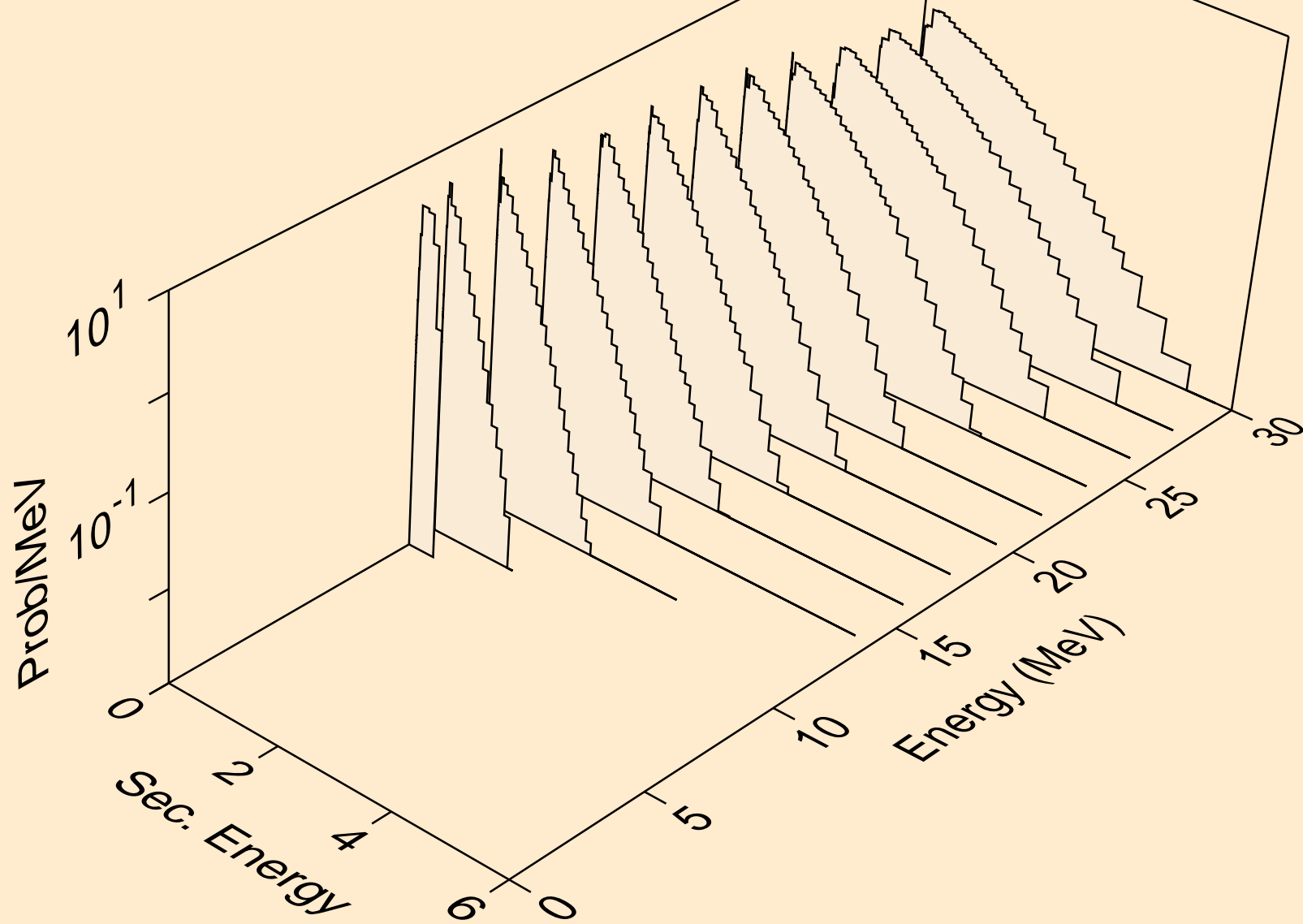

AU208 NEUTRON ACER TENDL-2024 LIBRARY; T=0.K  
Neutron emission for (n,3n)a

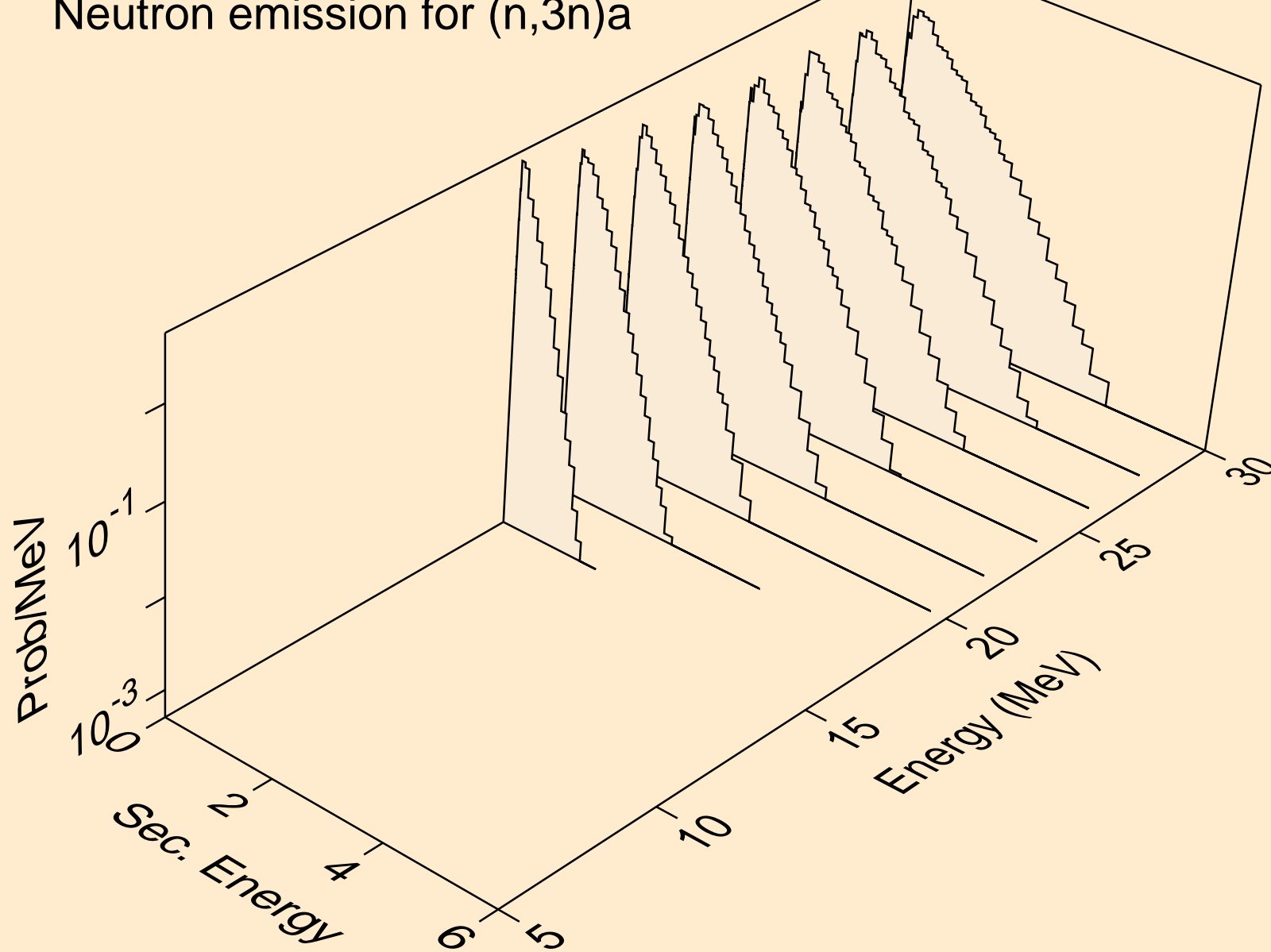

AU208 NEUTRON ACER TENDL-2024 LIBRARY; T=0.K  
Neutron emission for (n,n\*)p

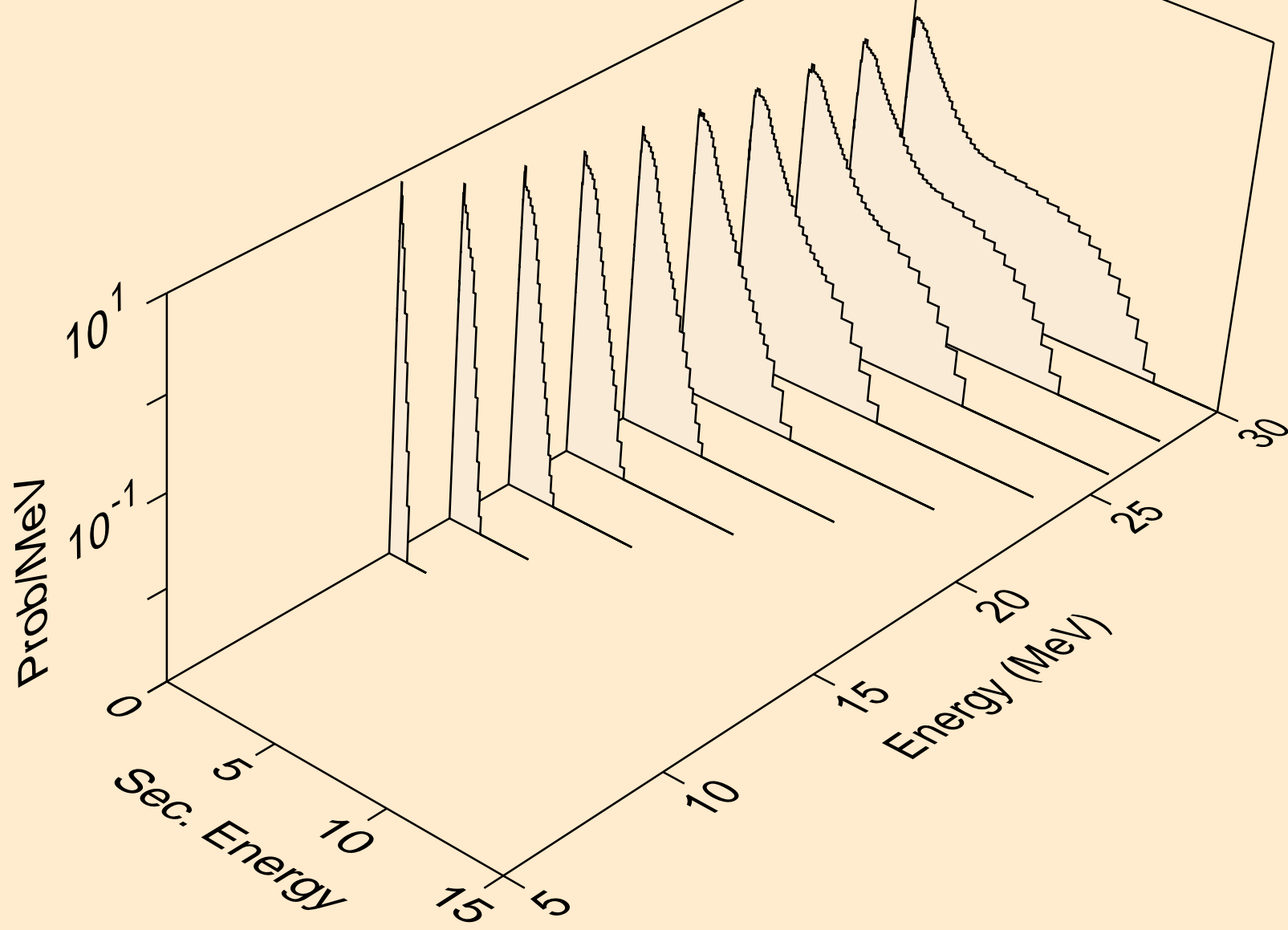

AU208 NEUTRON ACER TENDL-2024 LIBRARY; T=0.K  
Neutron emission for (n,n\*)d

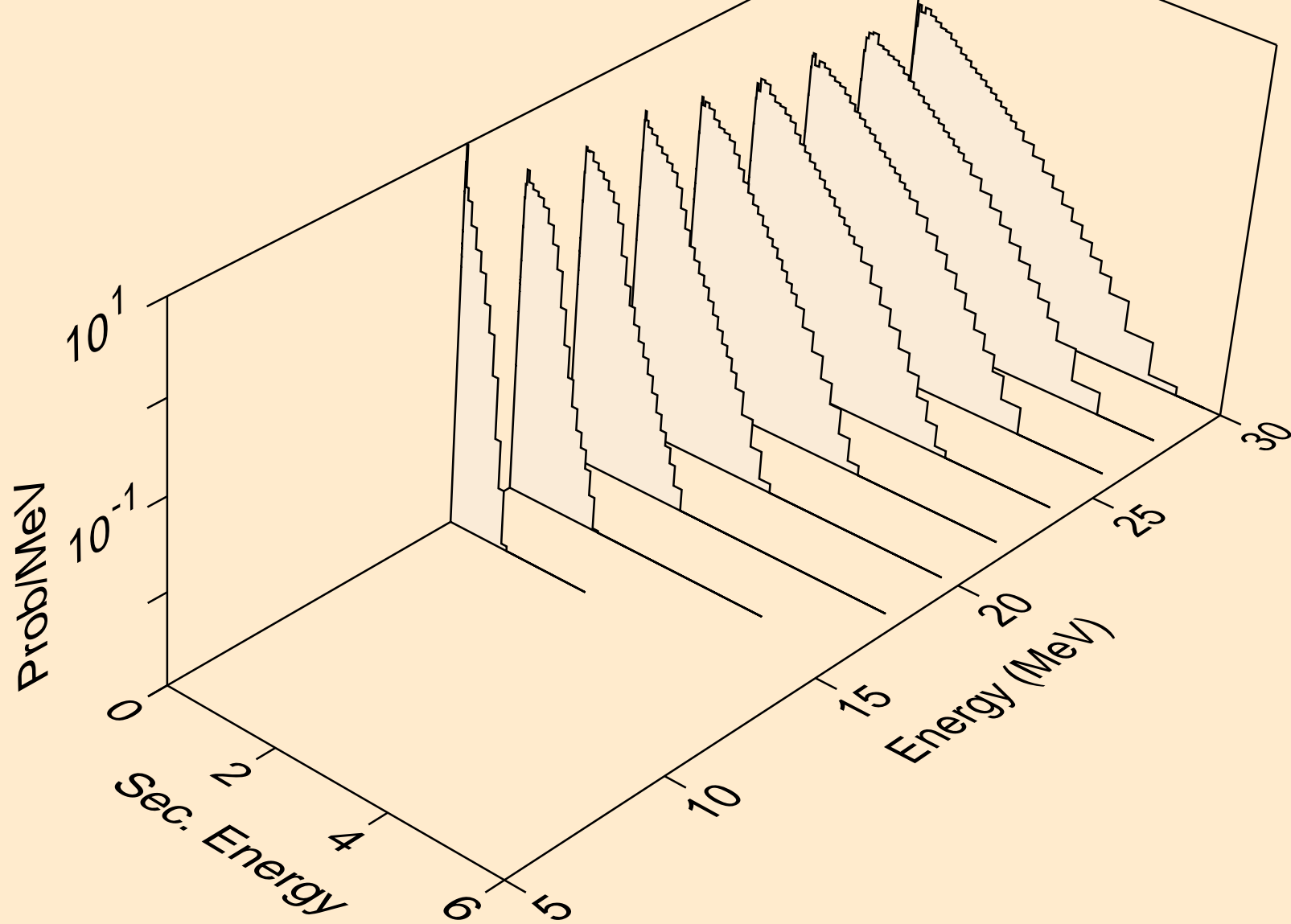

AU208 NEUTRON ACER TENDL-2024 LIBRARY; T=0.K  
Neutron emission for (n,n\*)t

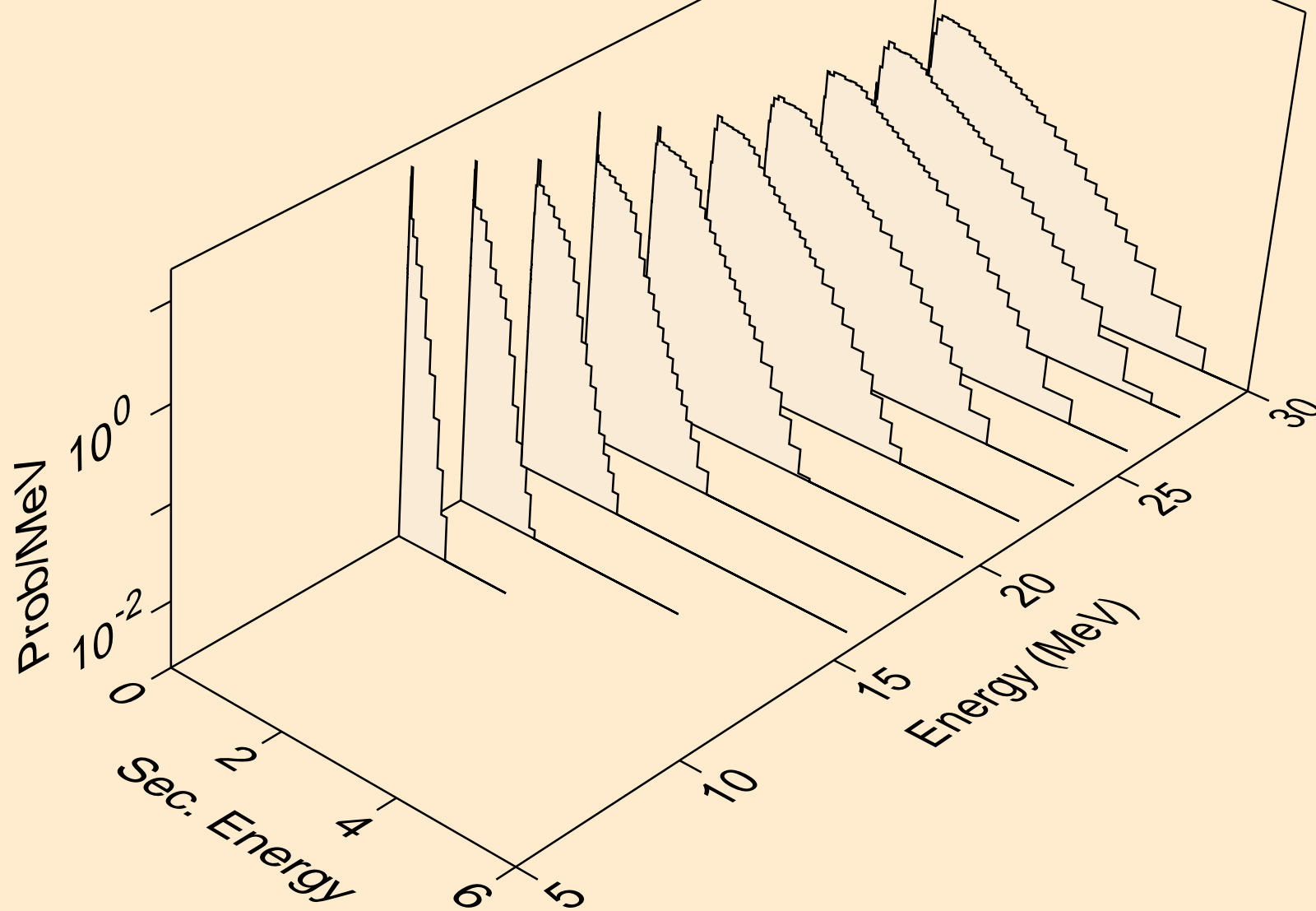

AU208 NEUTRON ACER TENDL-2024 LIBRARY; T=0.K  
Neutron emission for (n,n\*)he3

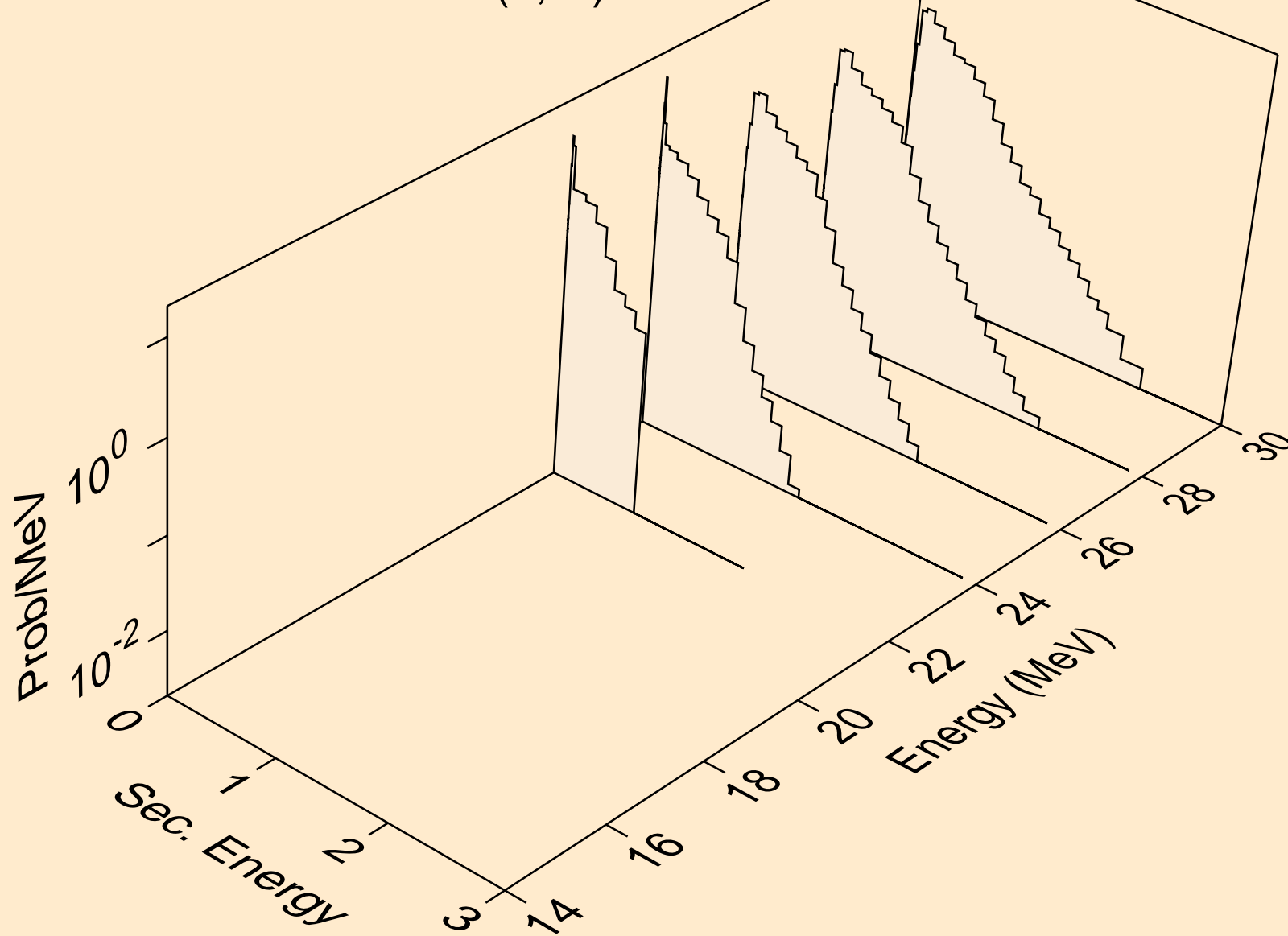

AU208 NEUTRON ACER TENDL-2024 LIBRARY; T=0.K  
Neutron emission for (n,4n)

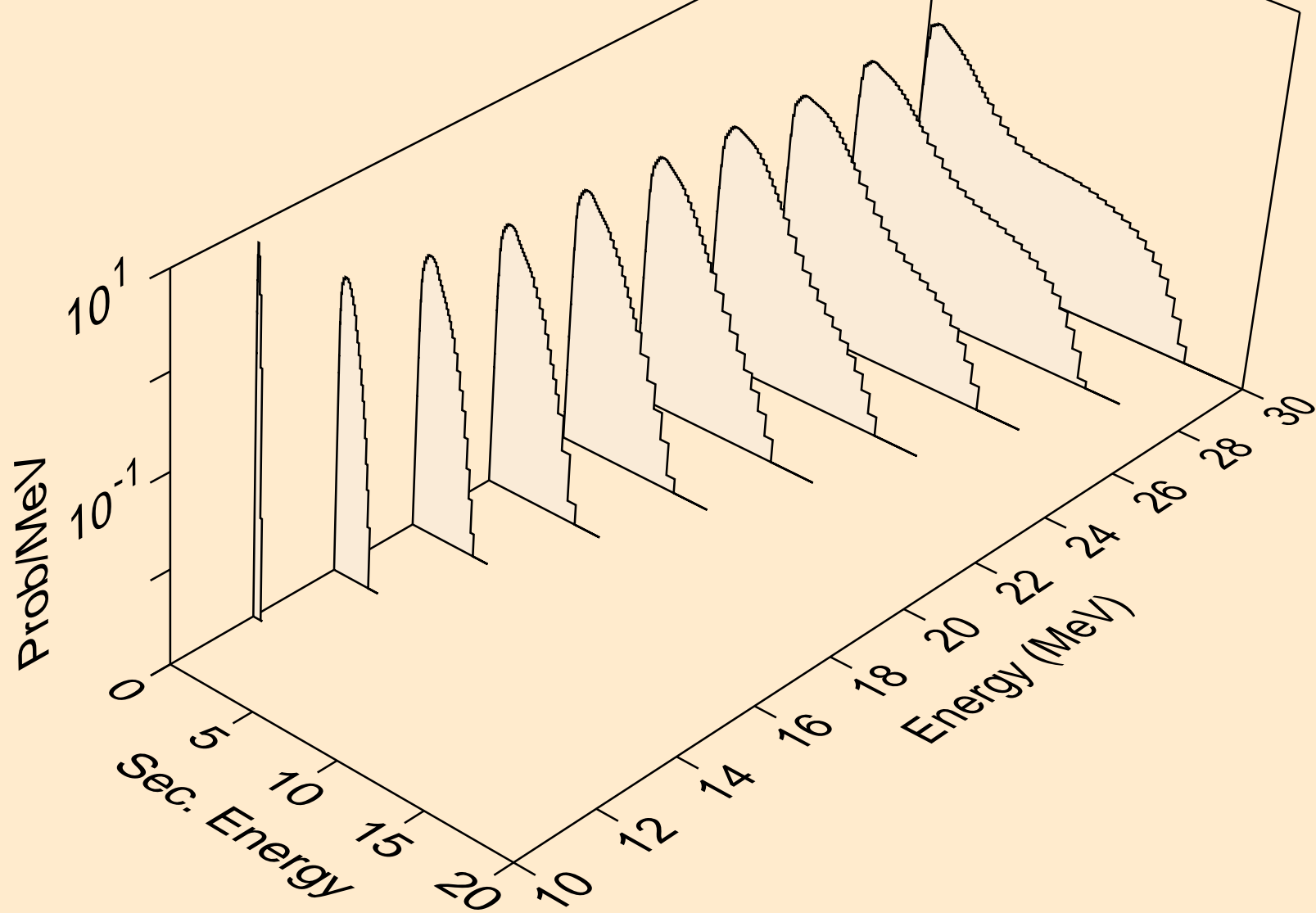

AU208 NEUTRON ACER TENDL-2024 LIBRARY; T=0.K  
Neutron emission for (n,2np)

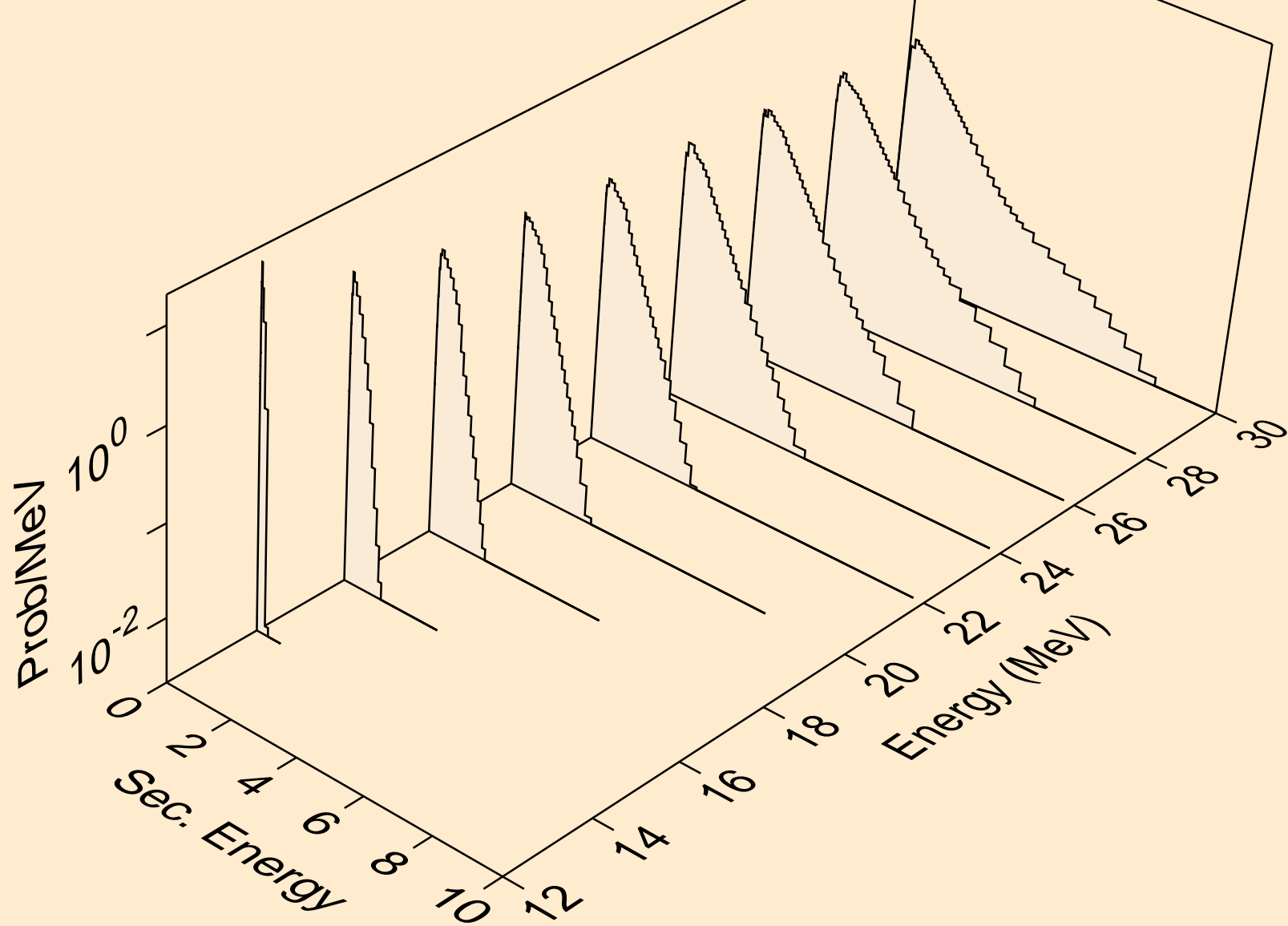



AU208 NEUTRON ACER TENDL-2024 LIBRARY; T=0.K  
Neutron emission for (n,3np)

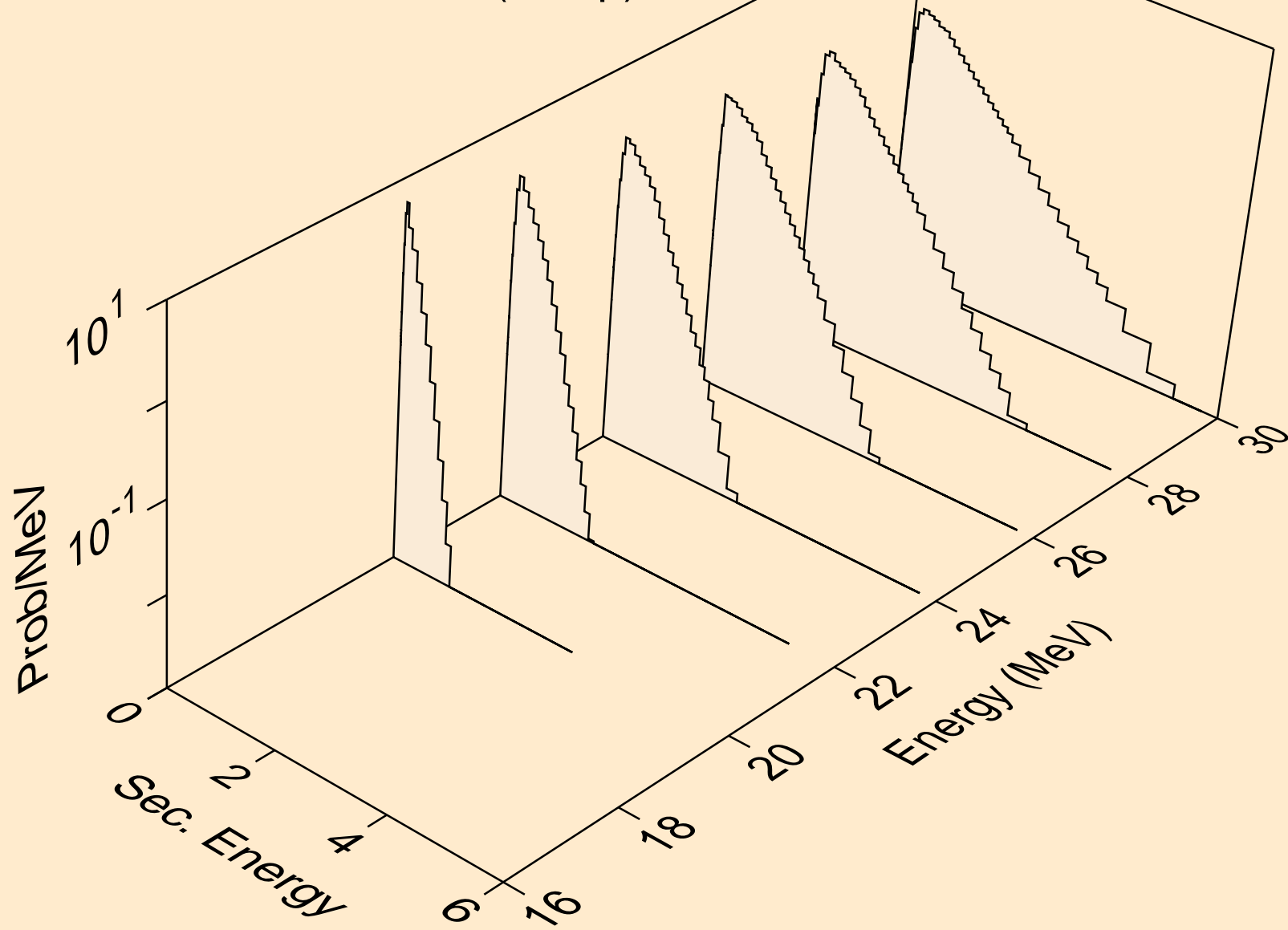

AU208 NEUTRON ACER TENDL-2024 LIBRARY; T=0.K  
Neutron emission for (n,n\*c)

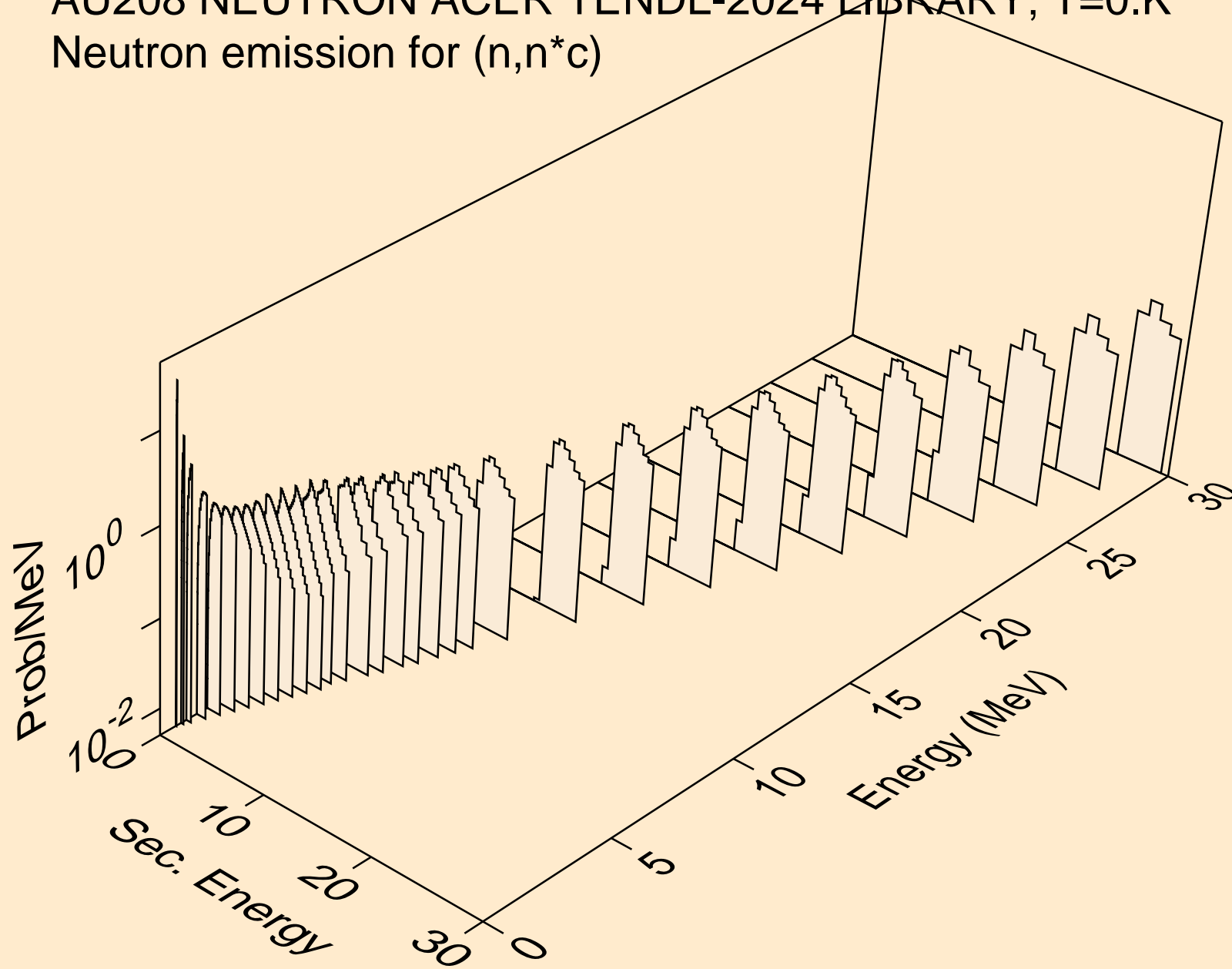

AU208 NEUTRON ACER TENDL-2024 LIBRARY; T=0.K  
Photon emission for (n,x)

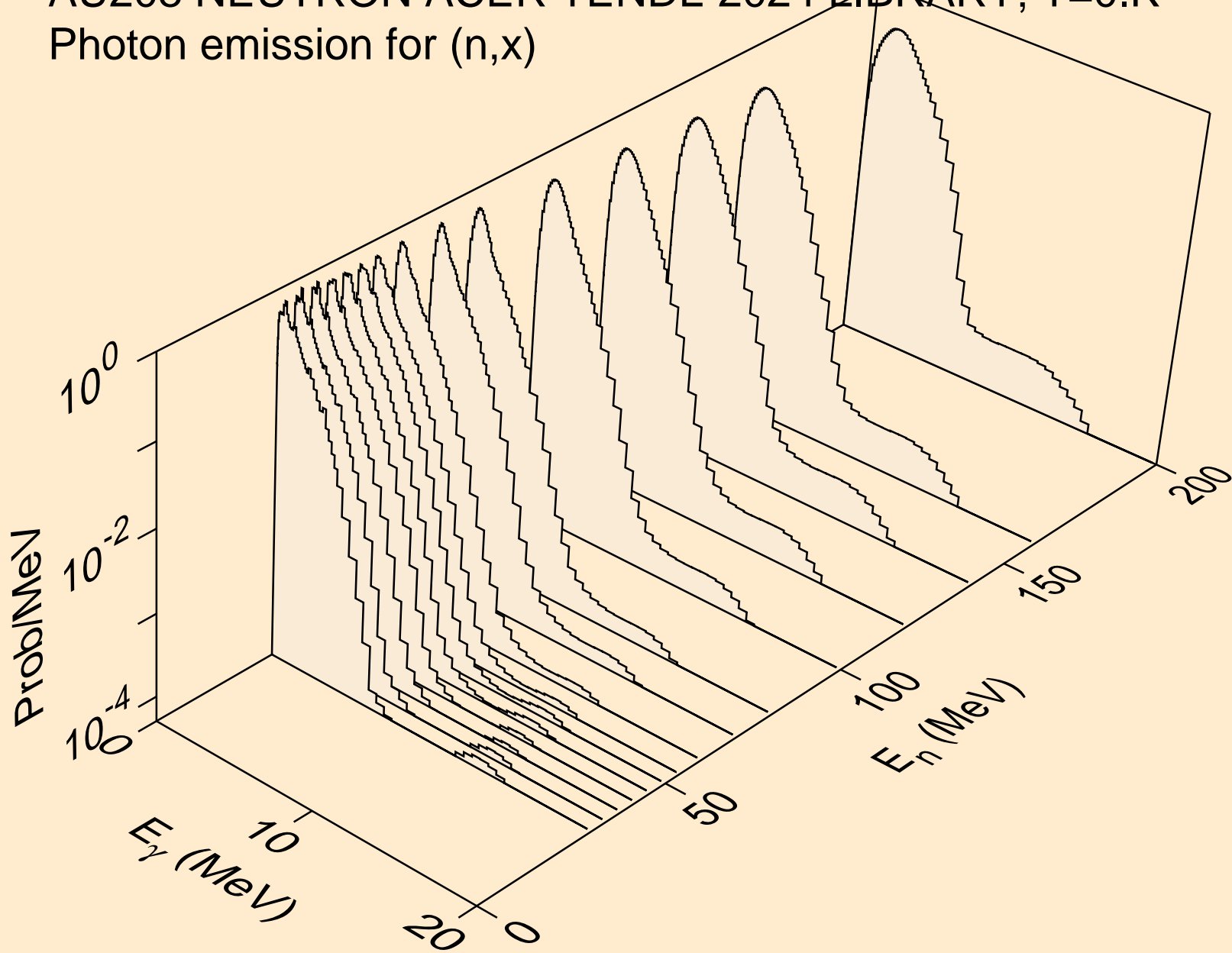

AU208 NEUTRON ACER TENDL-2024 LIBRARY; T=0.K  
Photon emission for (n,2nd)

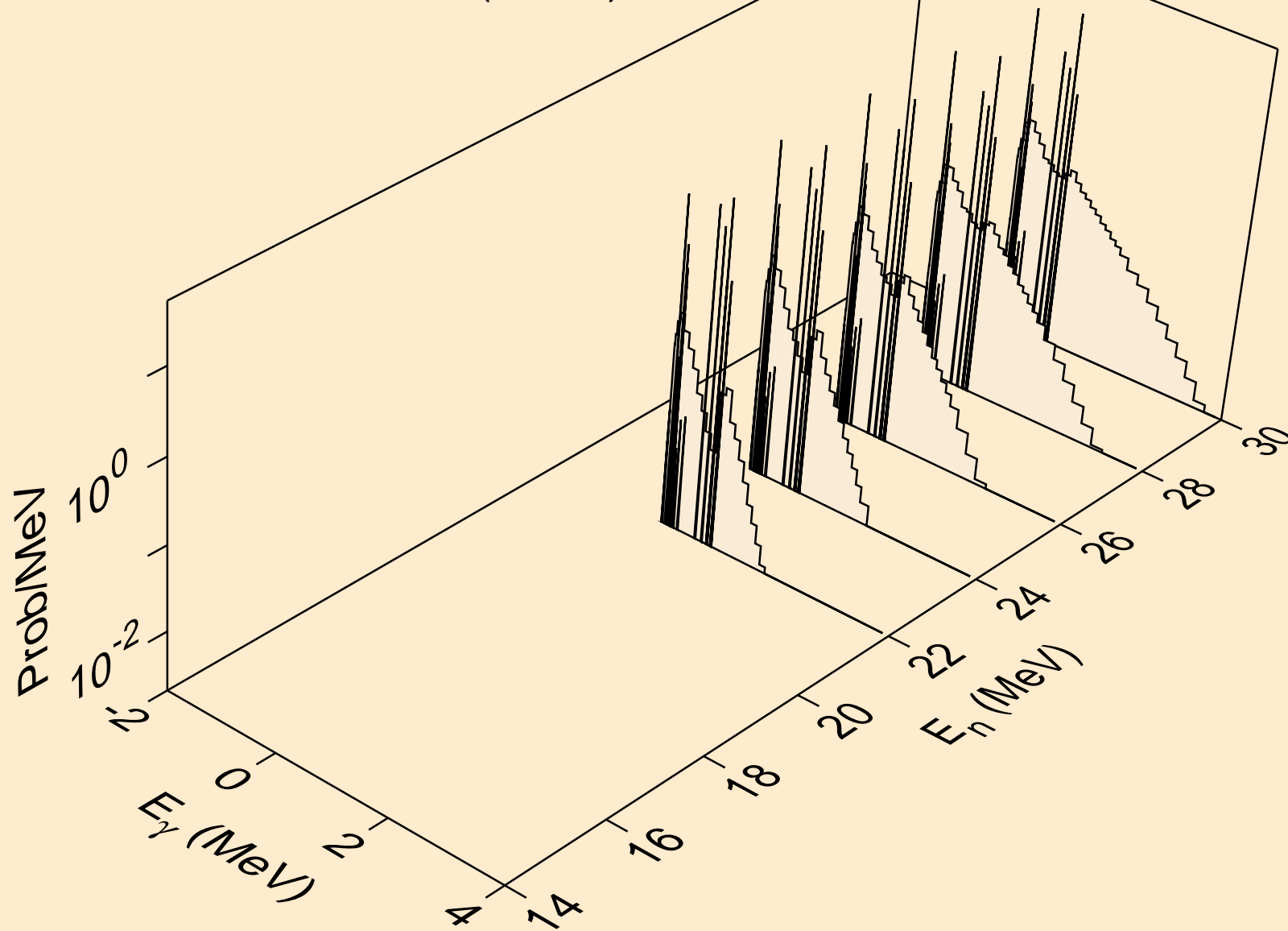

AU208 NEUTRON ACER TENDL-2024 LIBRARY; T=0.K  
Photon emission for (n,2n)

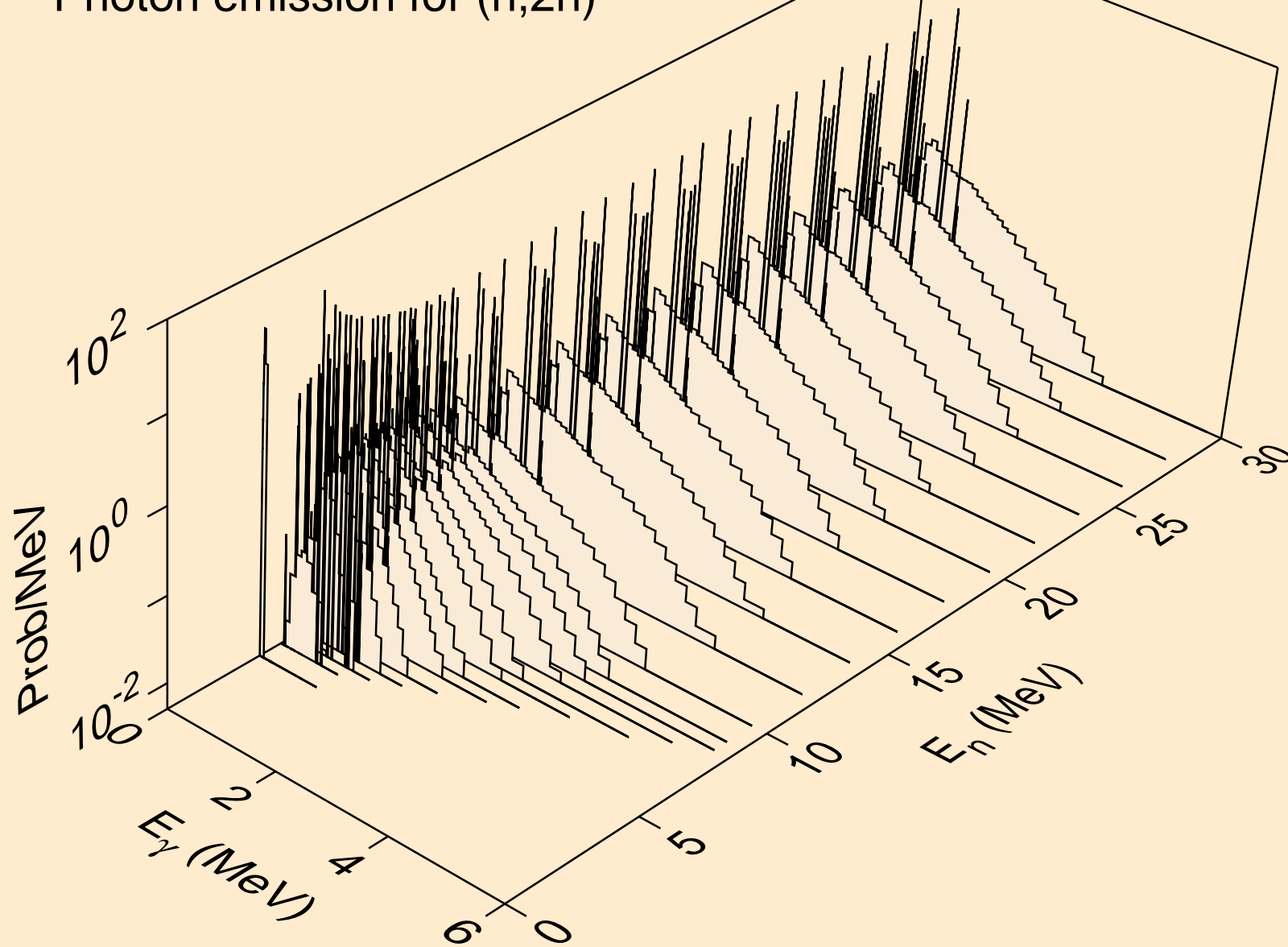

AU208 NEUTRON ACER TENDL-2024 LIBRARY; T=0.K  
Photon emission for (n,3n)

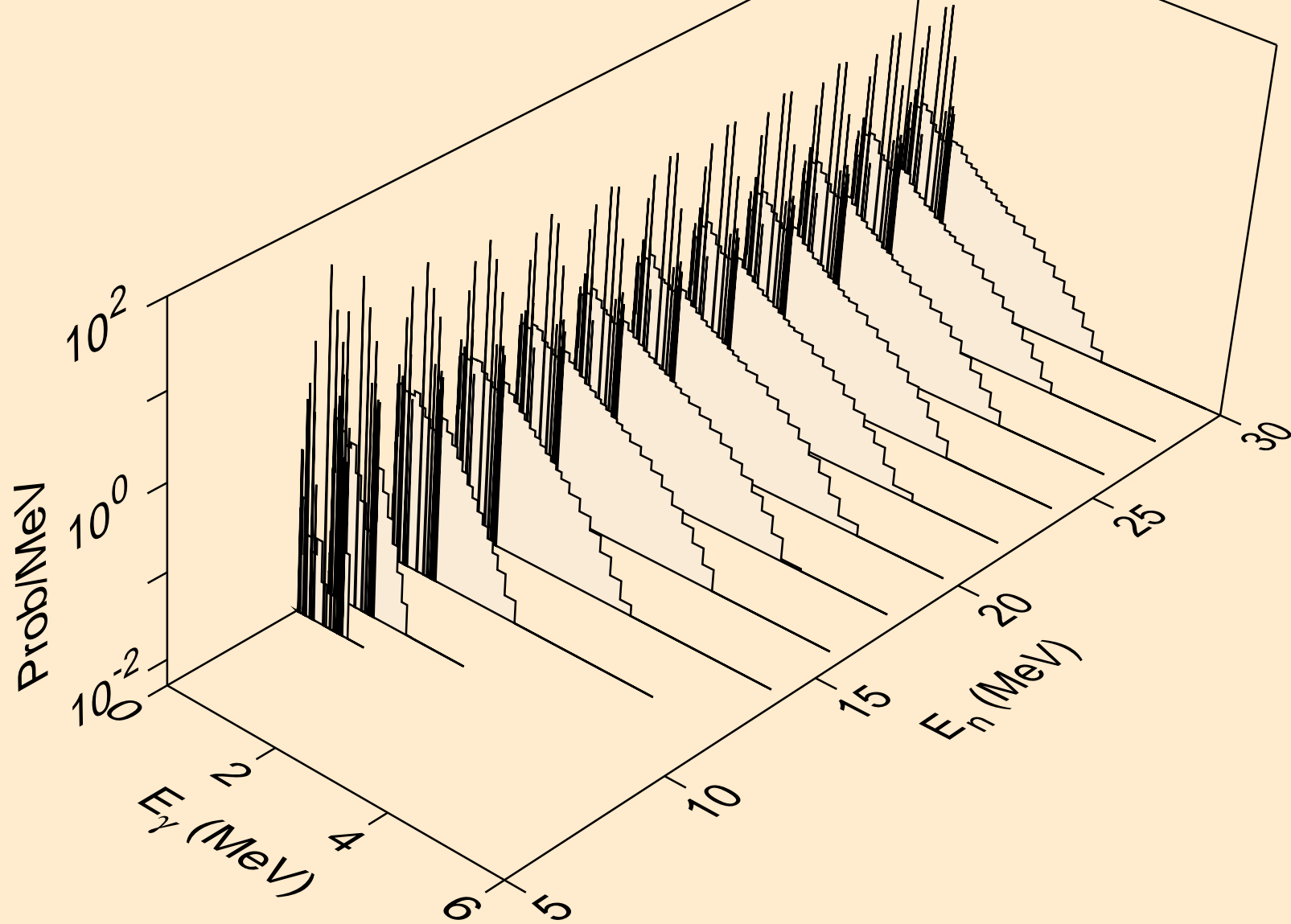

AU208 NEUTRON ACER TENDL-2024 LIBRARY; T=0.K  
Photon emission for (n,n\*)a

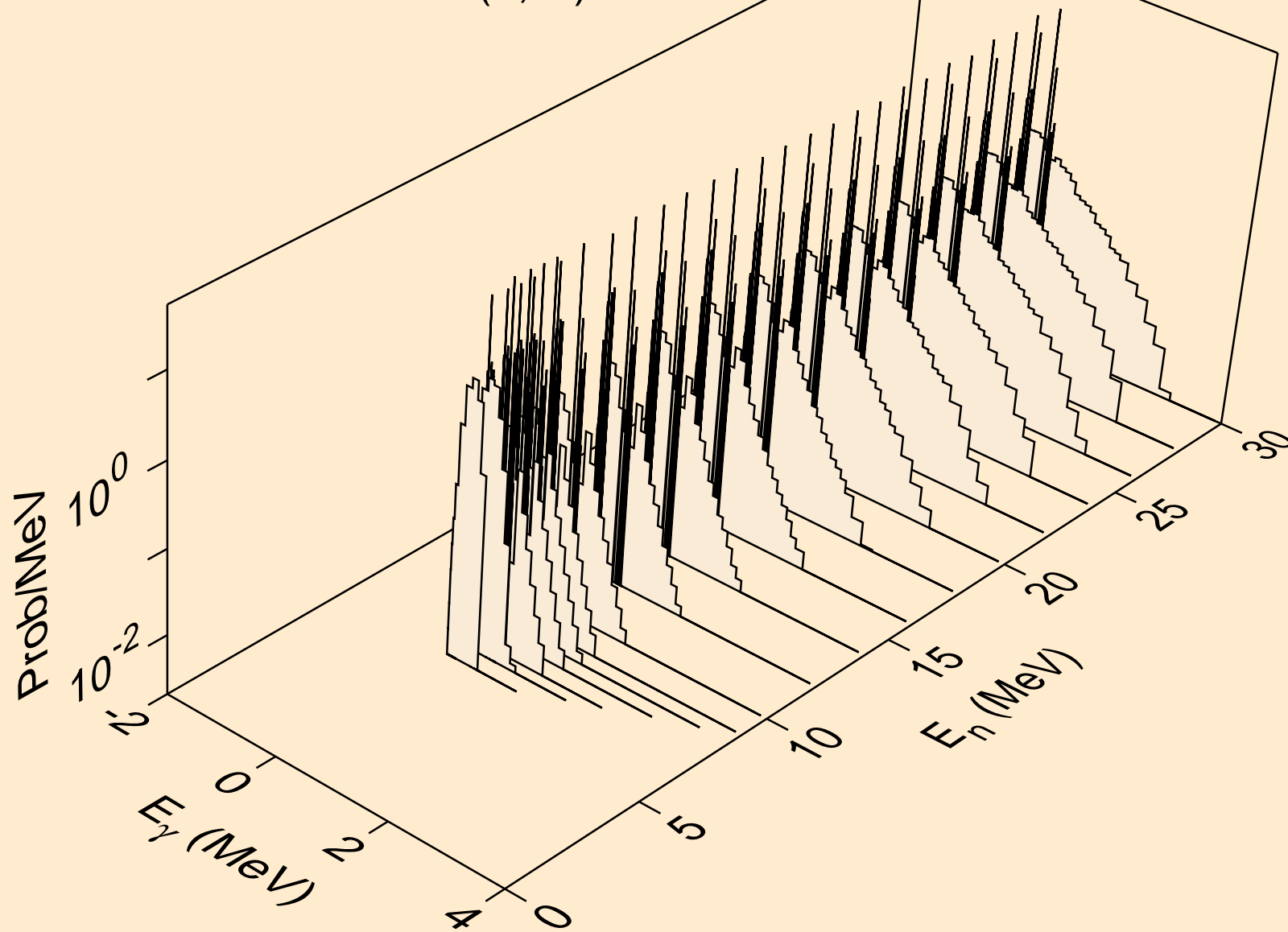

AU208 NEUTRON ACER TENDL-2024 LIBRARY; T=0.K  
Photon emission for (n,2n)a

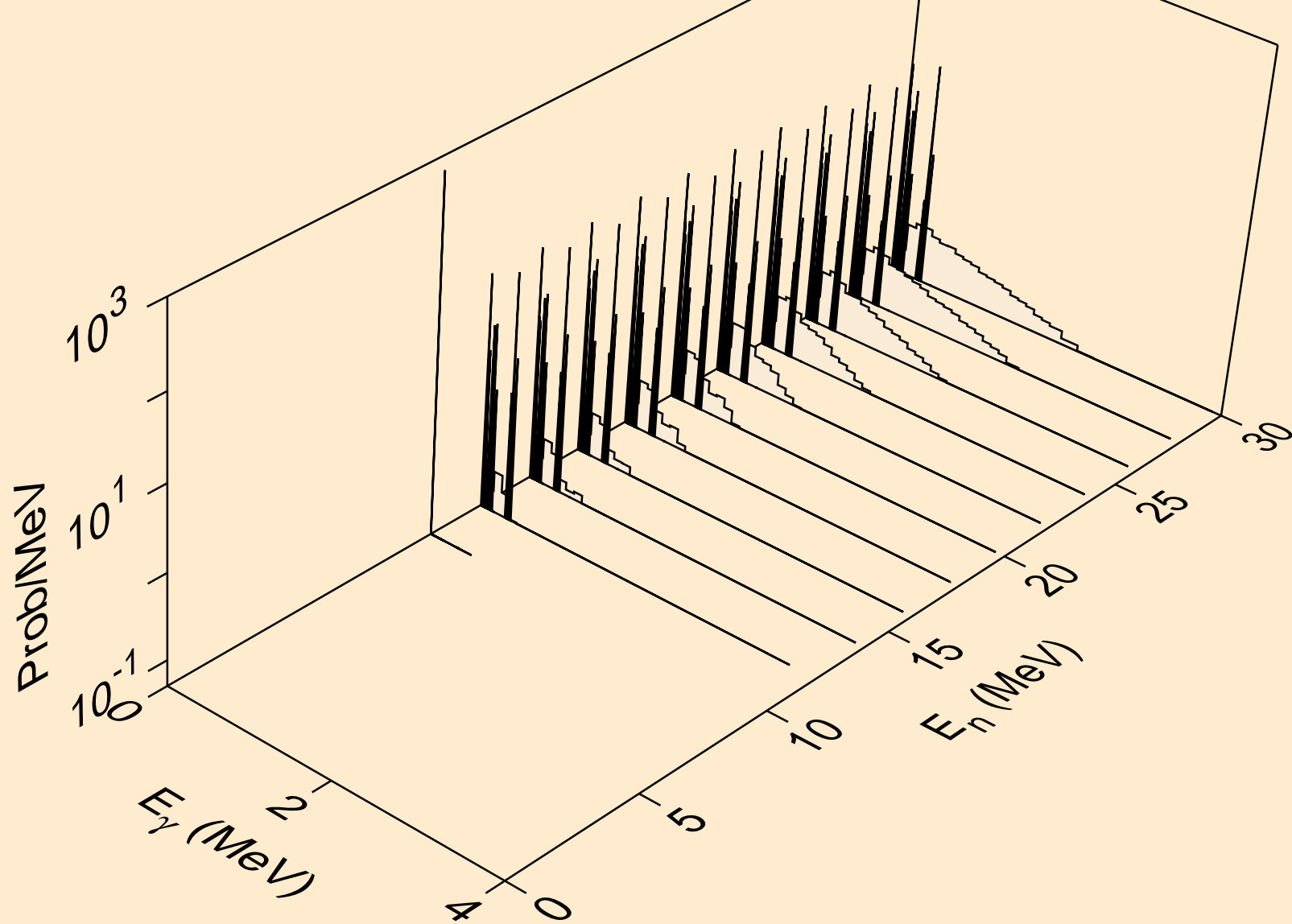



AU208 NEUTRON ACER TENDL-2024 LIBRARY; T=0.K  
Photon emission for (n,3n)a

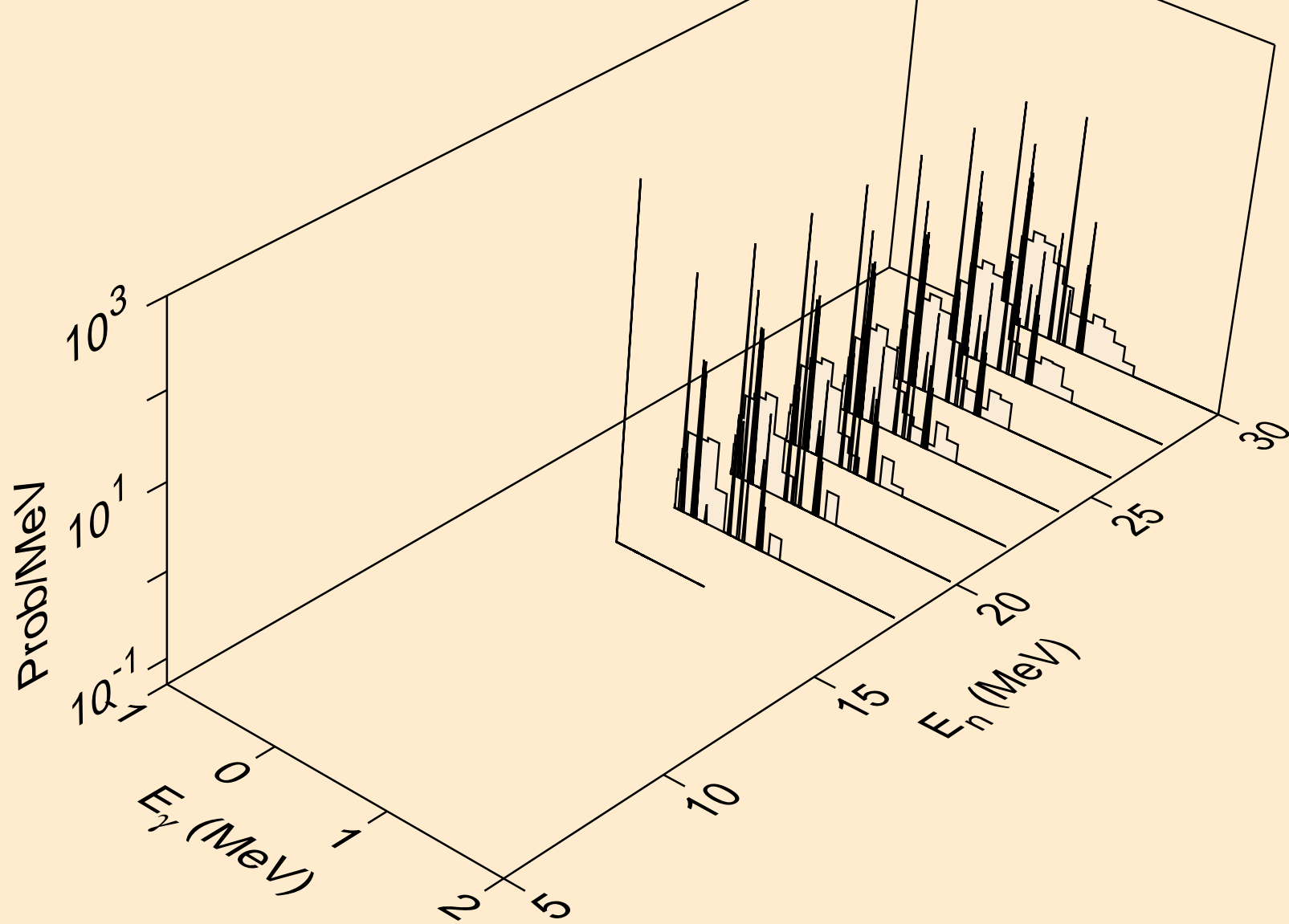

AU208 NEUTRON ACER TENDL-2024 LIBRARY; T=0.K  
Photon emission for (n,n\*)p

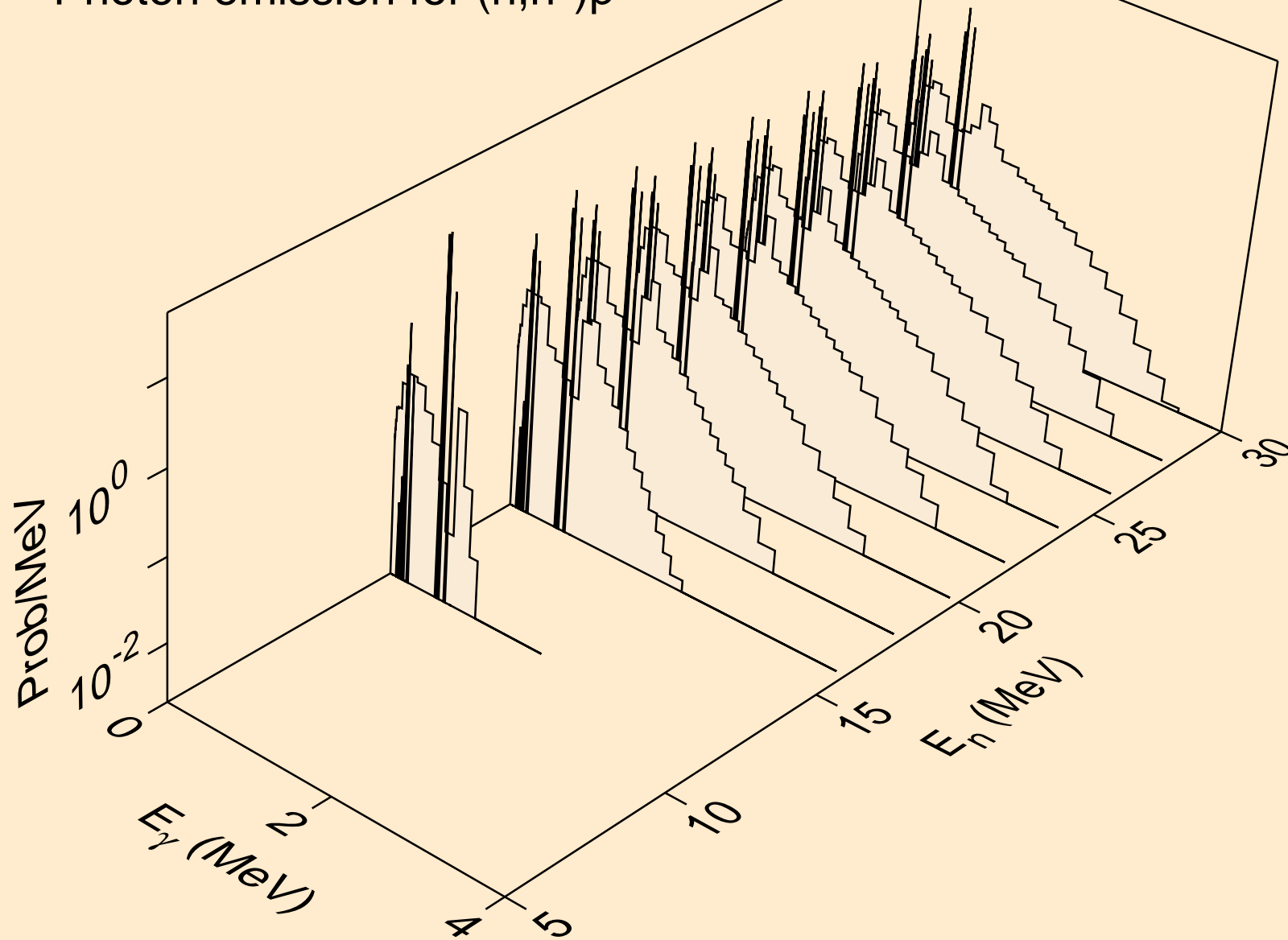

AU208 NEUTRON ACER TENDL-2024 LIBRARY; T=0.K  
Photon emission for (n,n\*)d

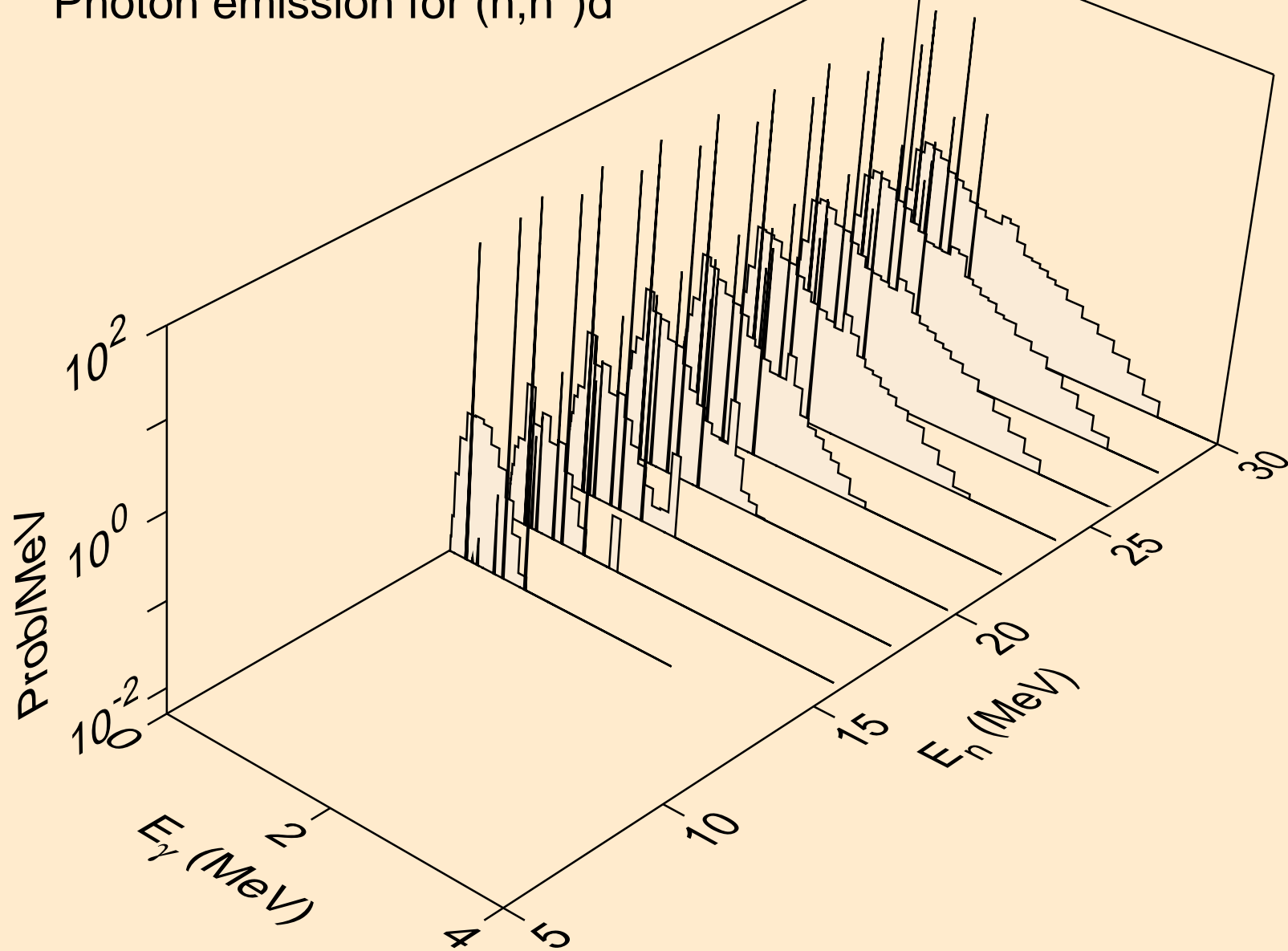

AU208 NEUTRON ACER TENDL-2024 LIBRARY; T=0.K  
Photon emission for (n,n\*)t

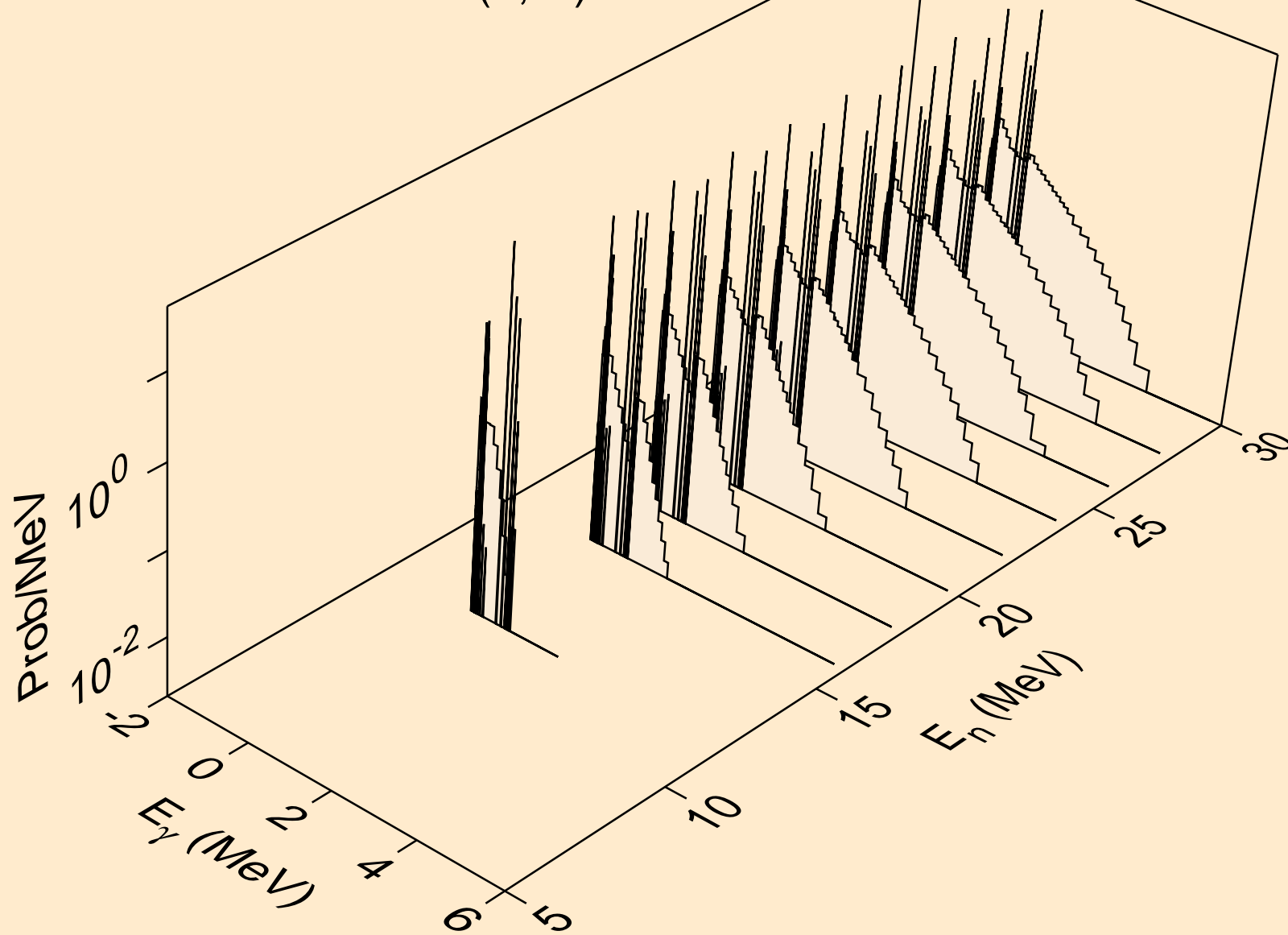

AU208 NEUTRON ACER TENDL-2024 LIBRARY; T=0.K  
Photon emission for (n,n\*)he3

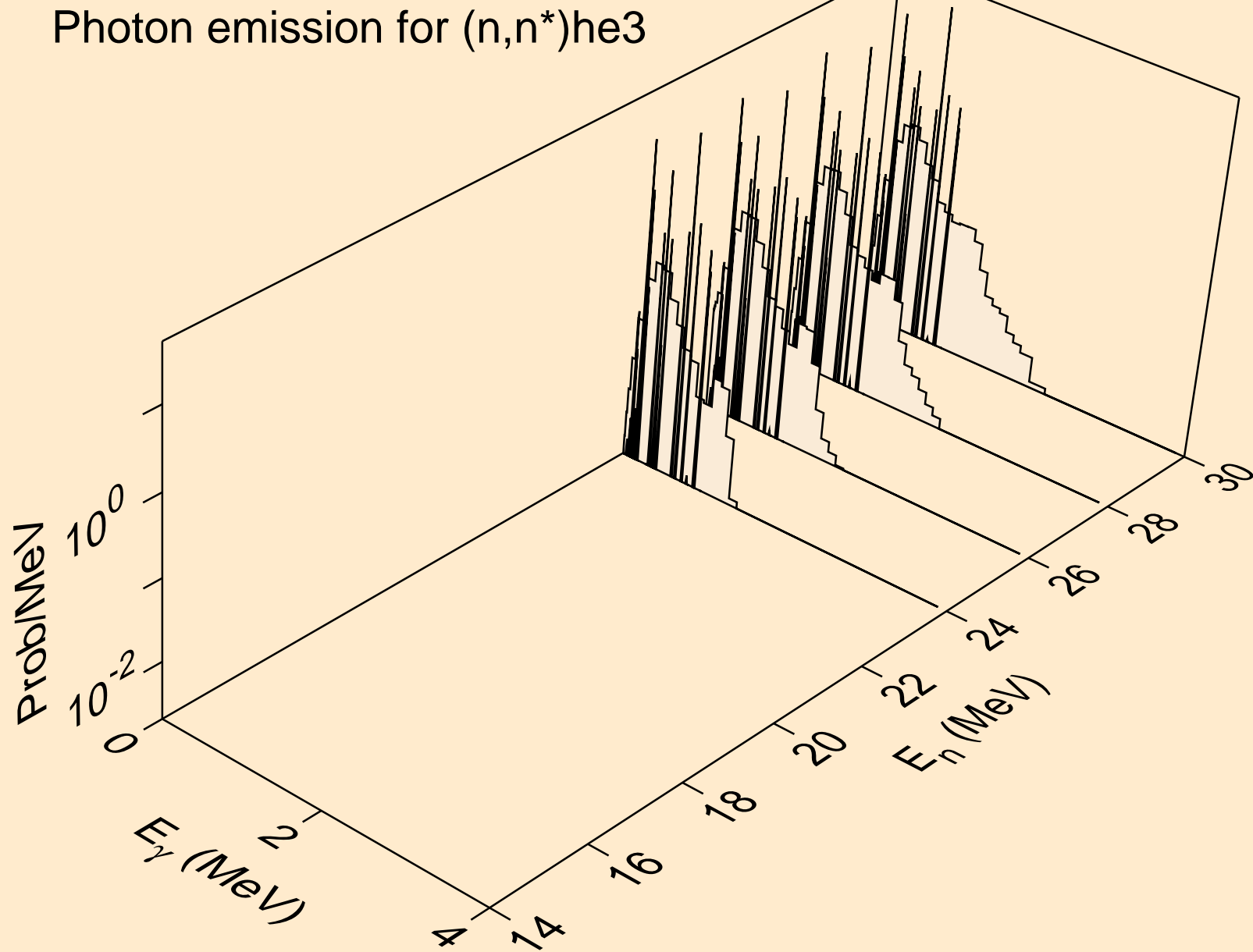

AU208 NEUTRON ACER TENDL-2024 LIBRARY; T=0.K  
Photon emission for (n,4n)

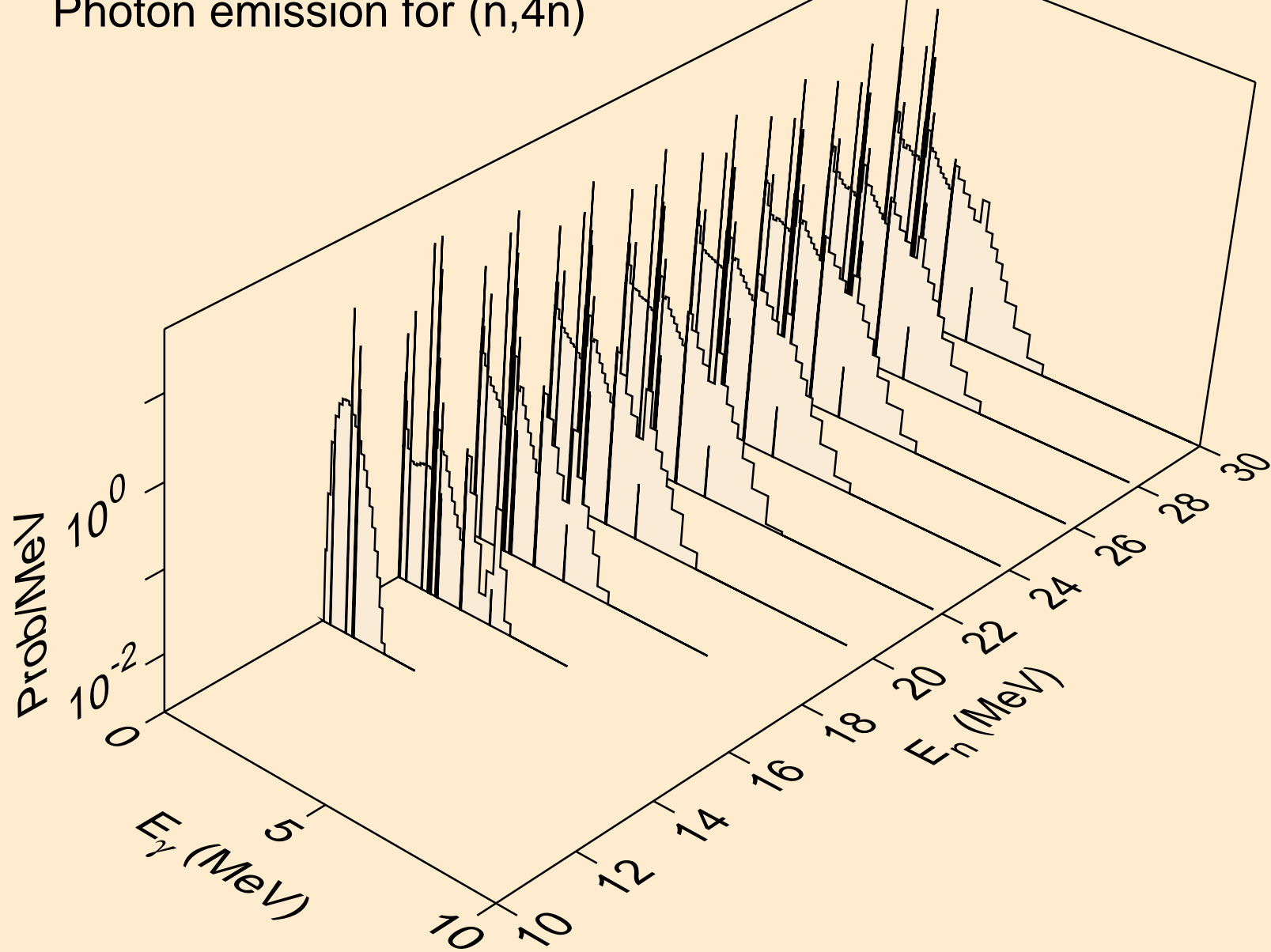

AU208 NEUTRON ACER TENDL-2024 LIBRARY; T=0.K  
Photon emission for (n,2np)

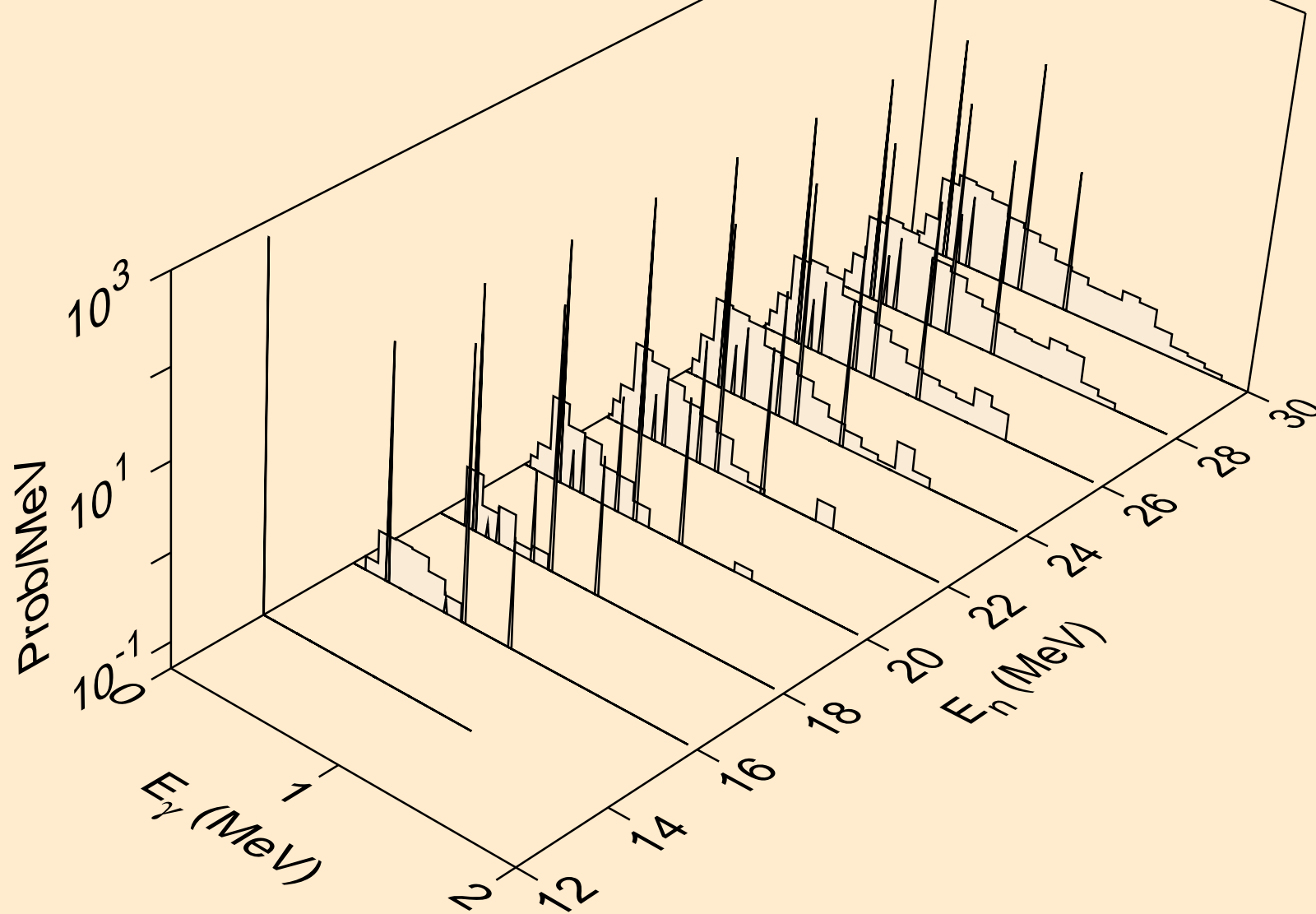

AU208 NEUTRON ACER TENDL-2024 LIBRARY; T=0.K  
Photon emission for (n,3np)

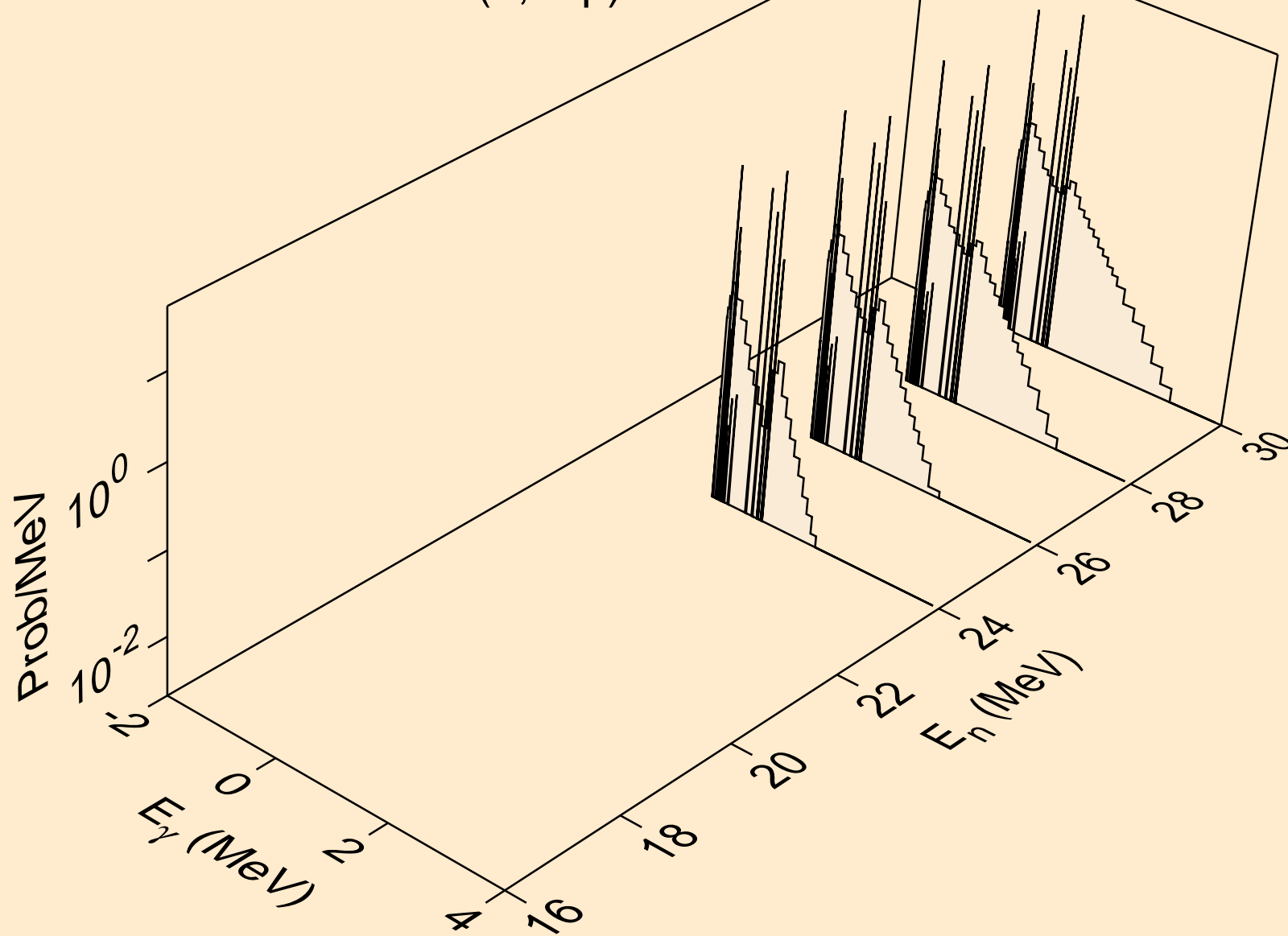



AU208 NEUTRON ACER TENDL-2024 LIBRARY; T=0.K  
Photon emission for (n,n\*c)

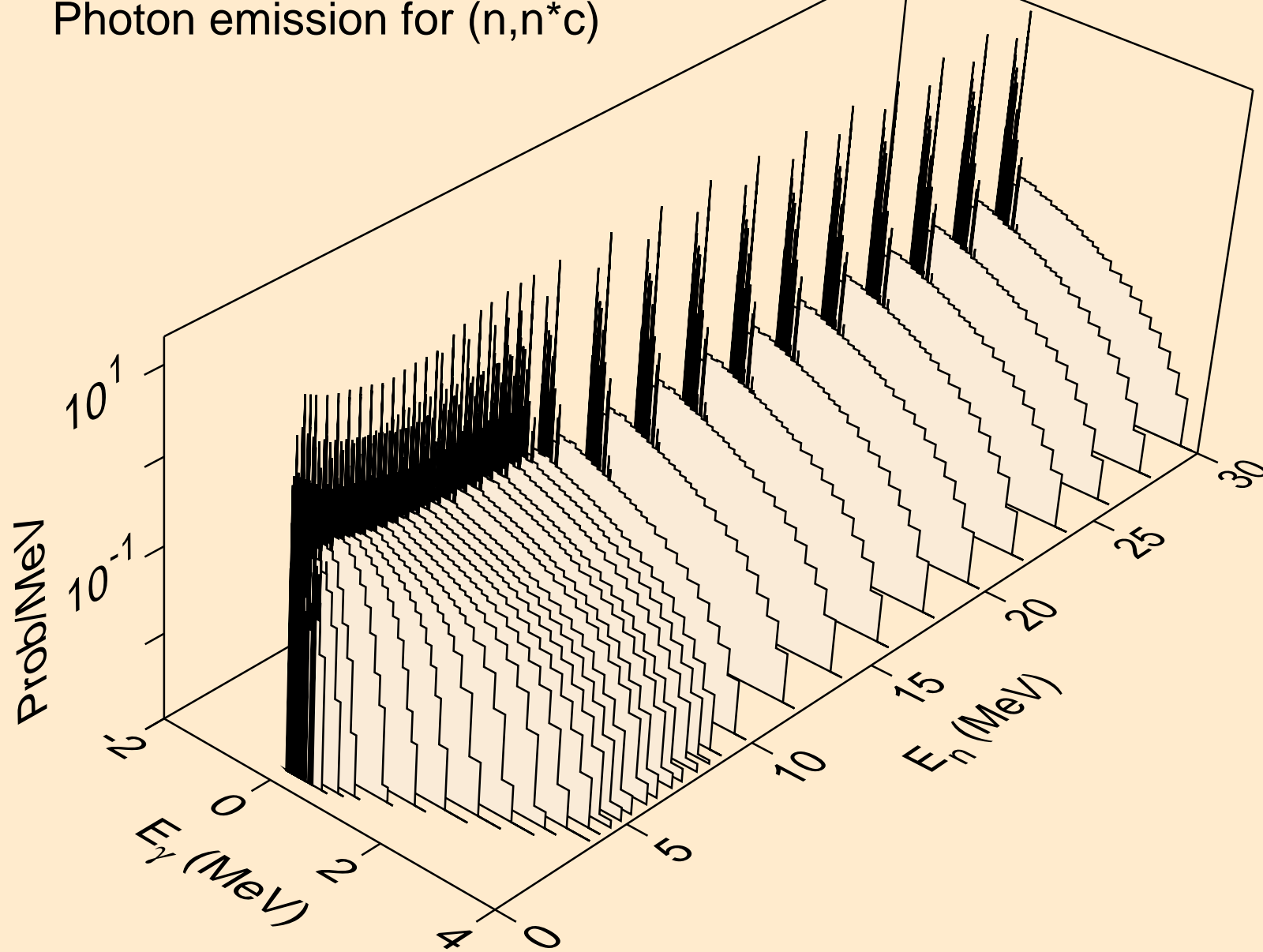

AU208 NEUTRON ACER TENDL-2024 LIBRARY; T=0.K  
Photon emission for (n,gma)

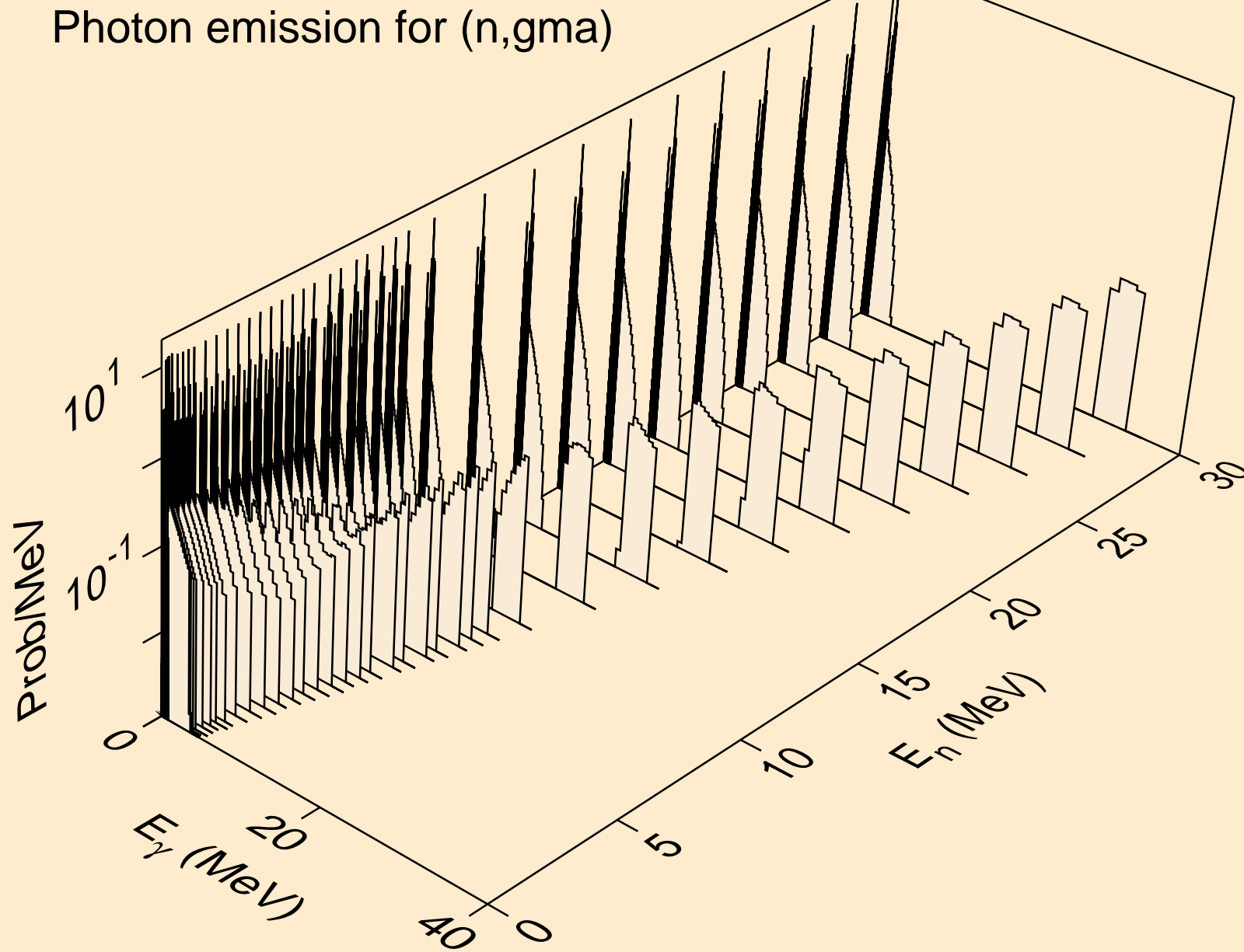

AU208 NEUTRON ACER TENDL-2024 LIBRARY; T=0.K  
Photon emission for (n,p)

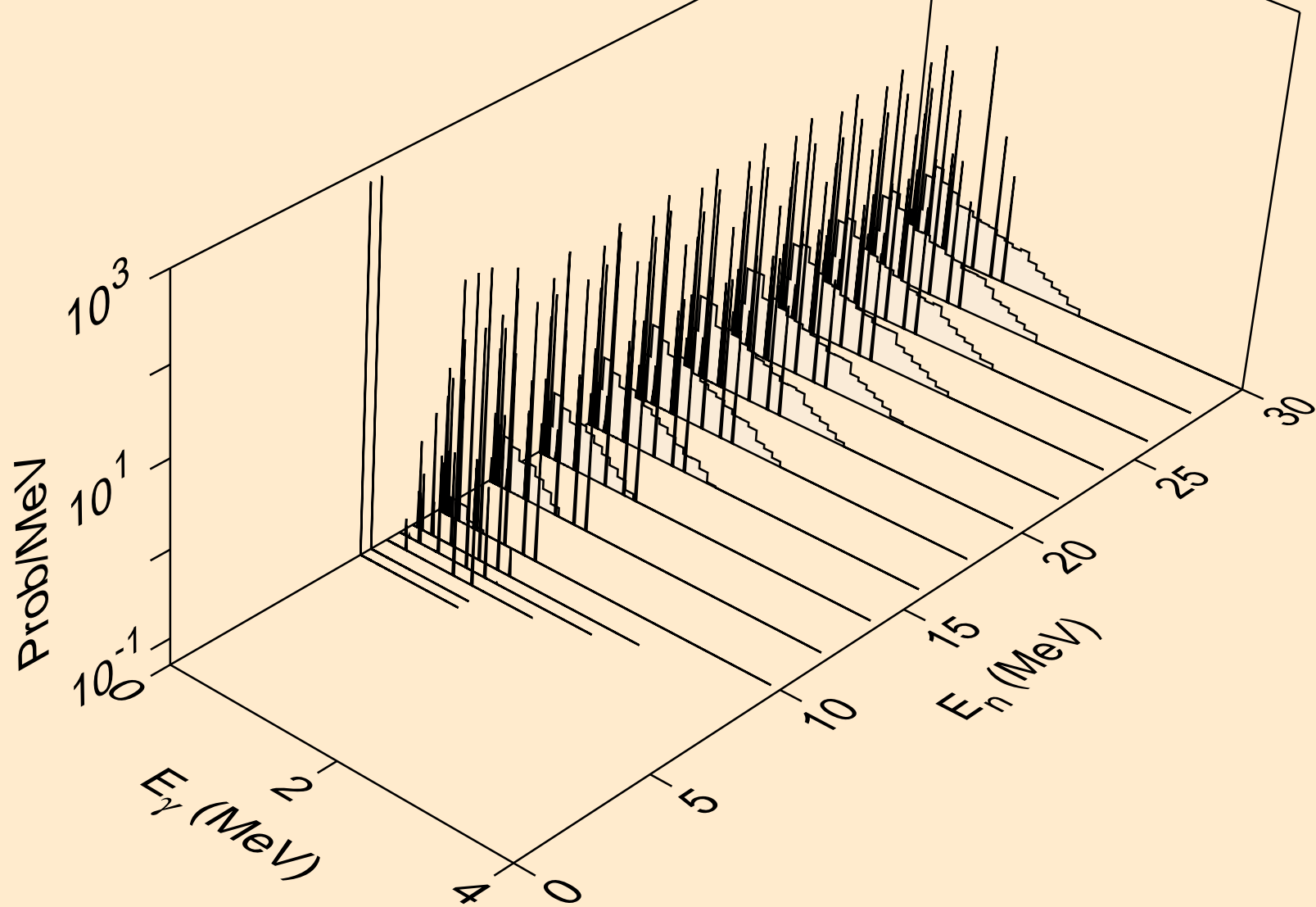

AU208 NEUTRON ACER TENDL-2024 LIBRARY; T=0.K  
Photon emission for (n,d)

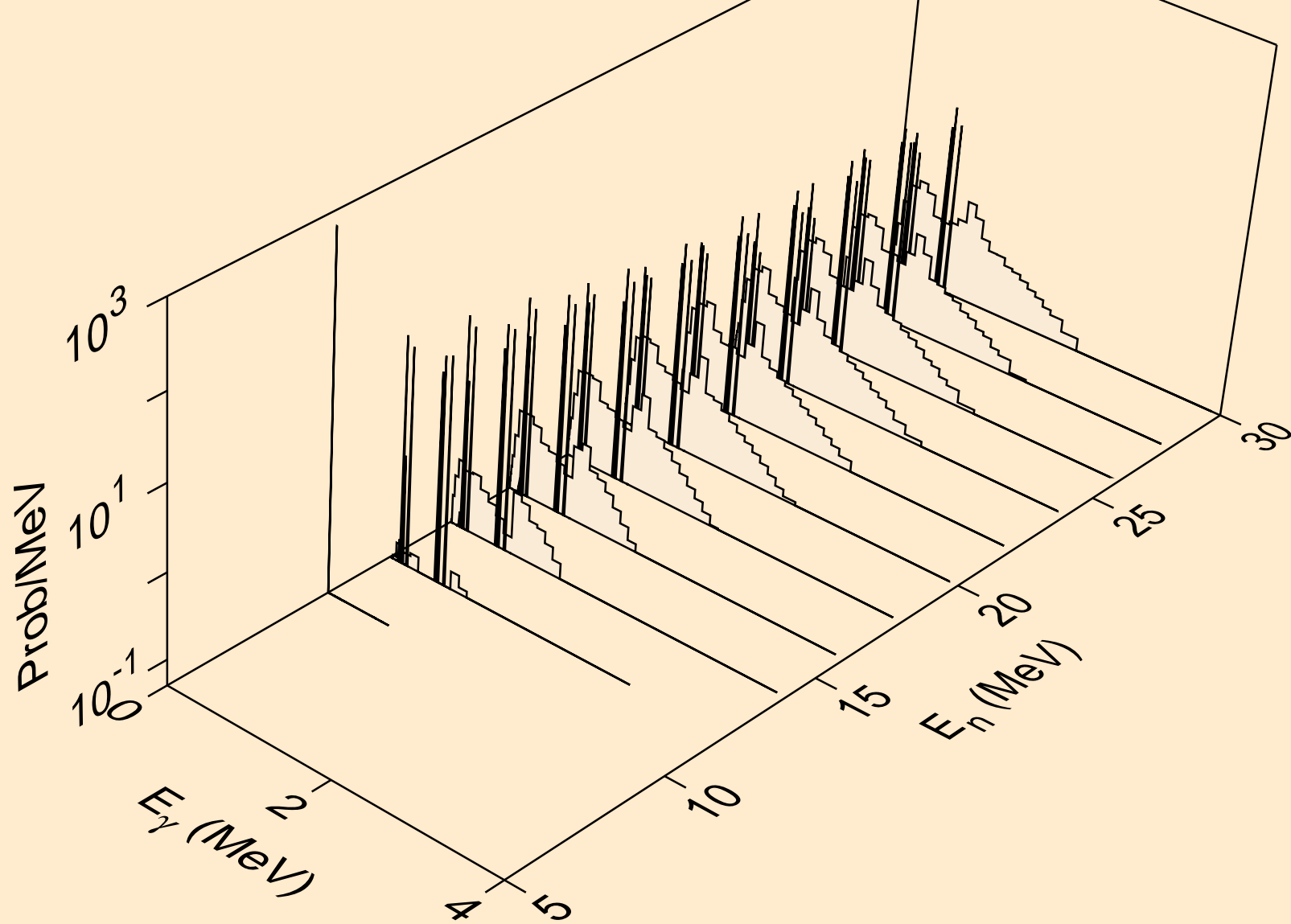

AU208 NEUTRON ACER TENDL-2024 LIBRARY; T=0.K  
Photon emission for (n,t)

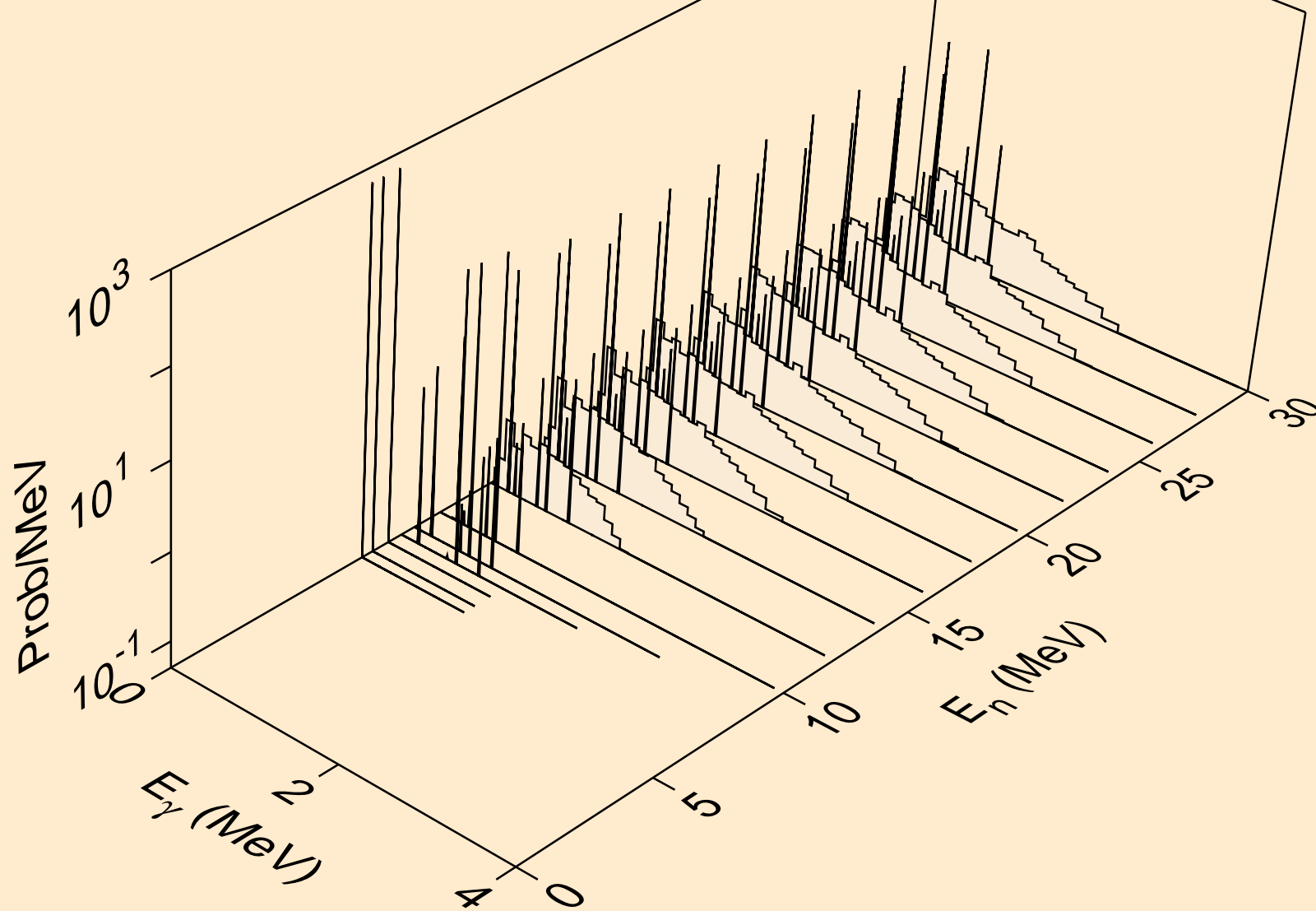

AU208 NEUTRON ACER TENDL-2024 LIBRARY; T=0.K  
Photon emission for (n,he3)

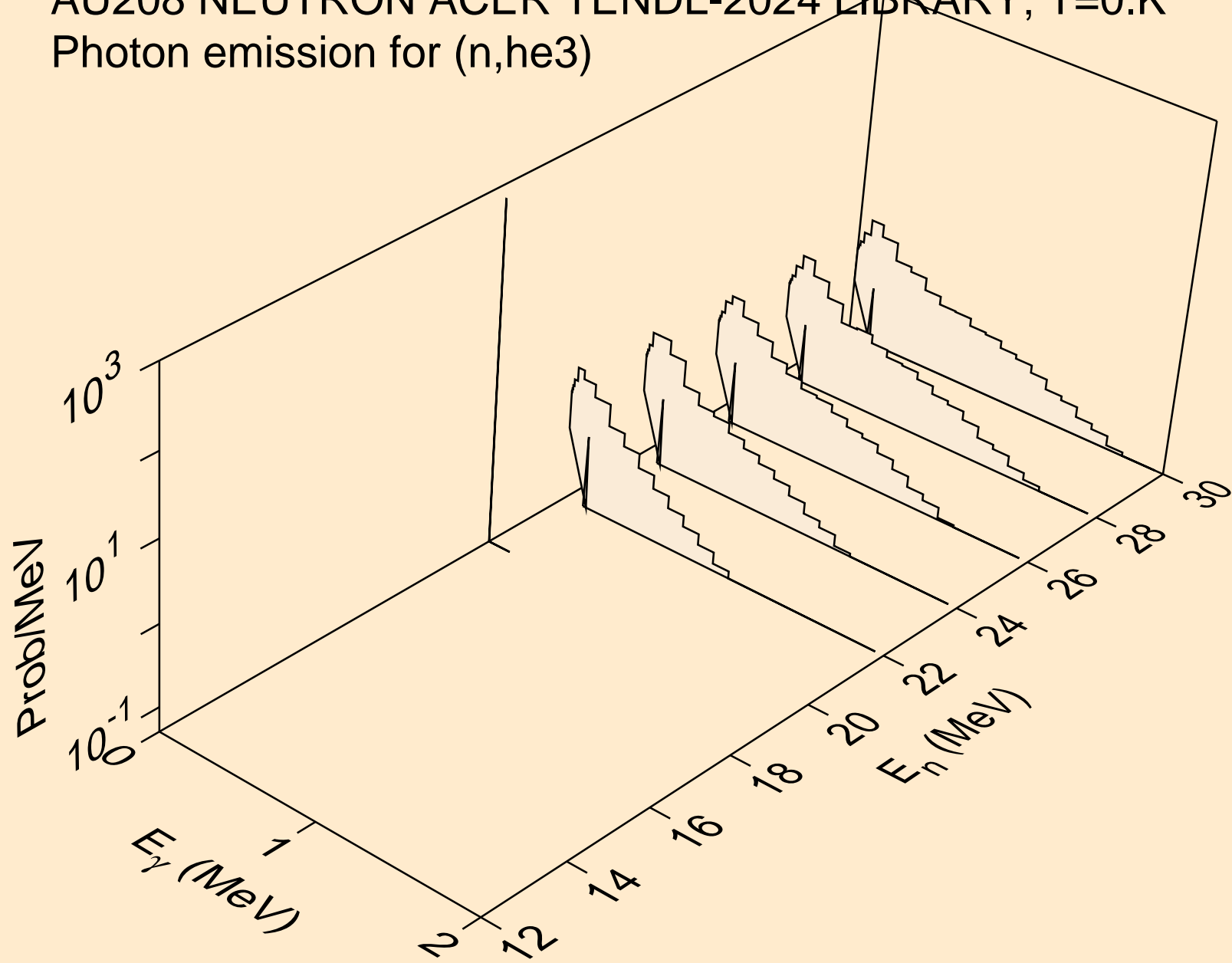

AU208 NEUTRON ACER TENDL-2024 LIBRARY; T=0.K  
Photon emission for (n,a)

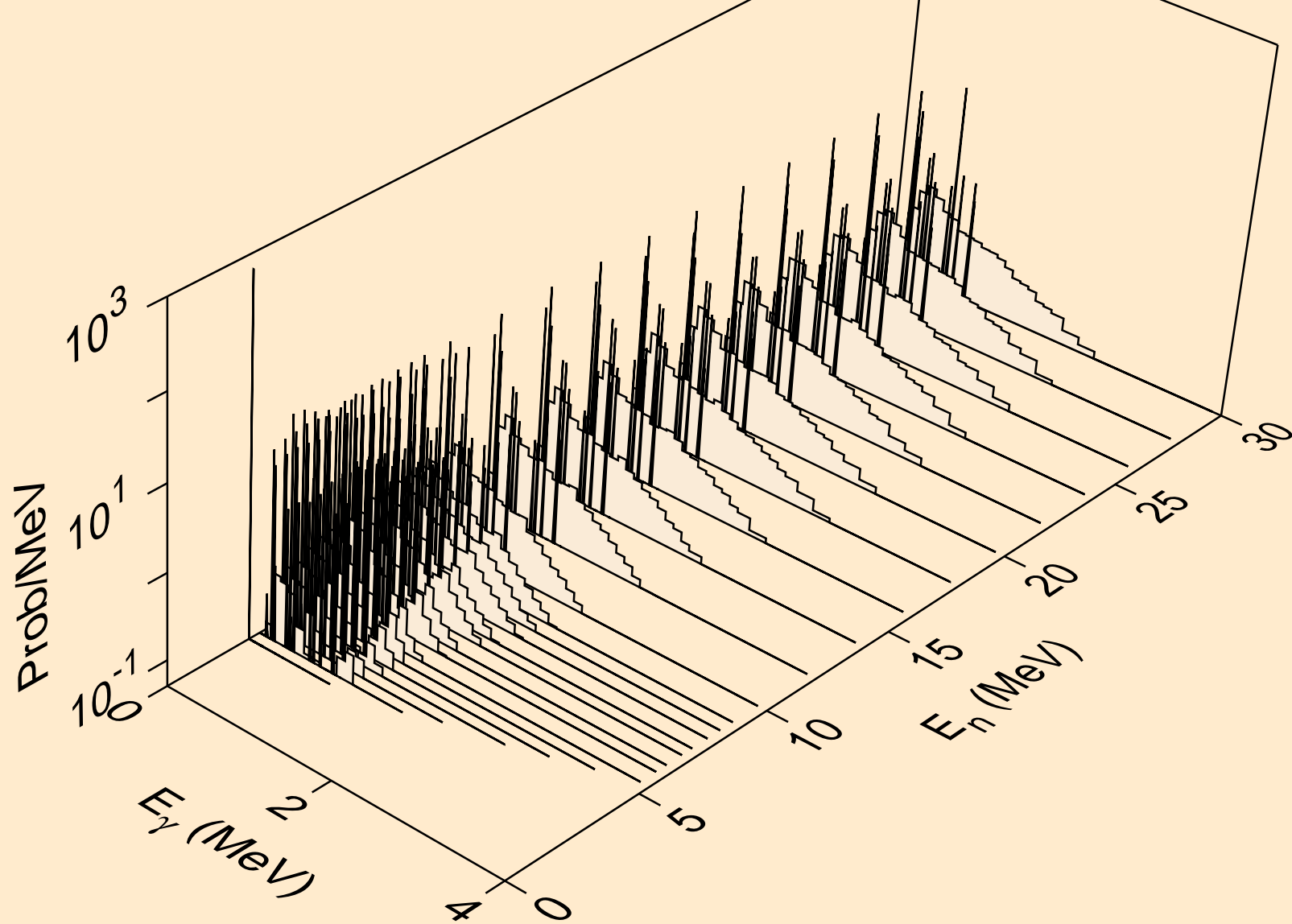

AU208 NEUTRON ACER TENDL-2024 LIBRARY; T=0.K  
thermal capture photon spectrum

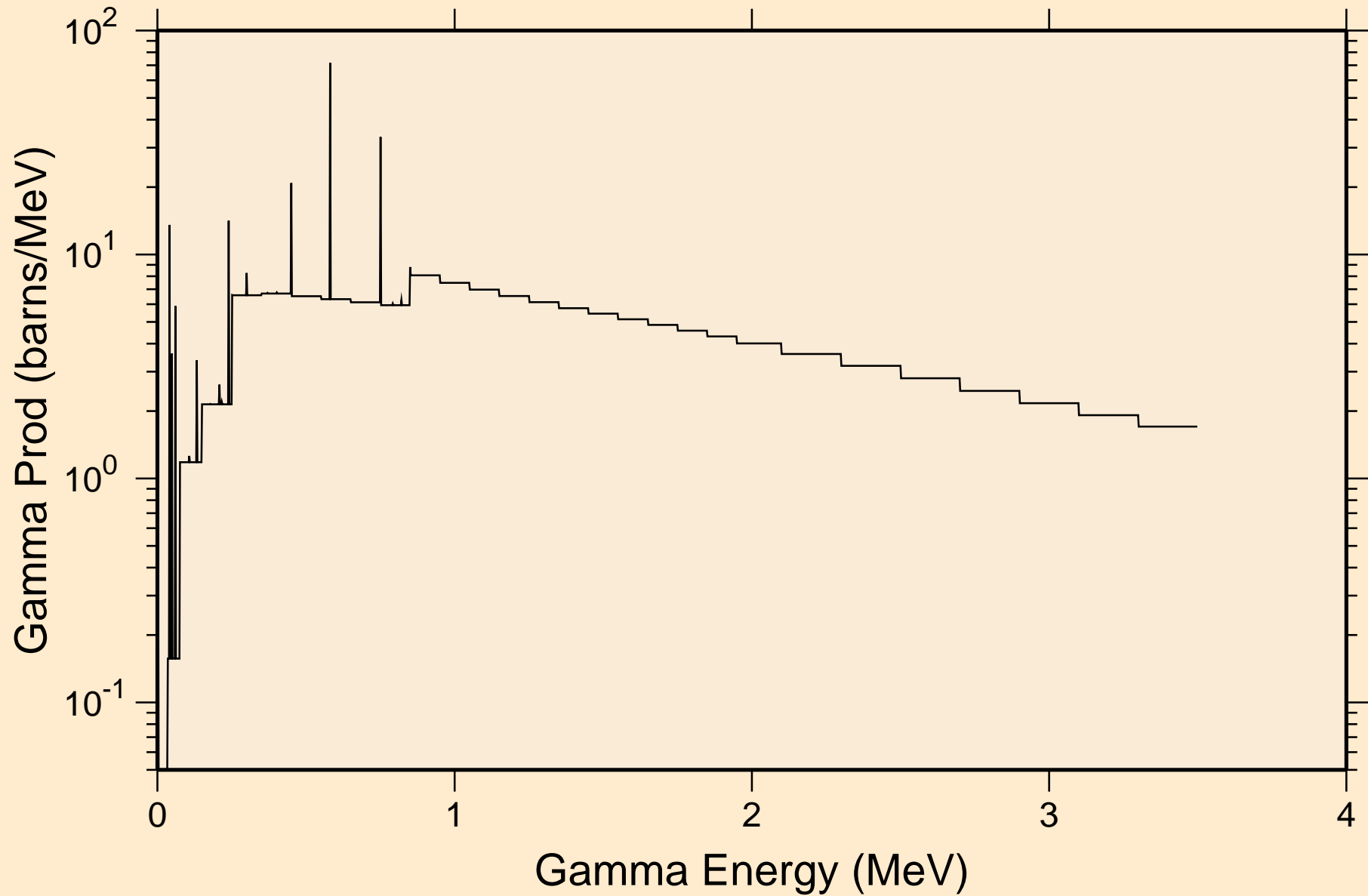



AU208 NEUTRON ACER TENDL-2024 LIBRARY; T=0.K  
14 MeV photon spectrum

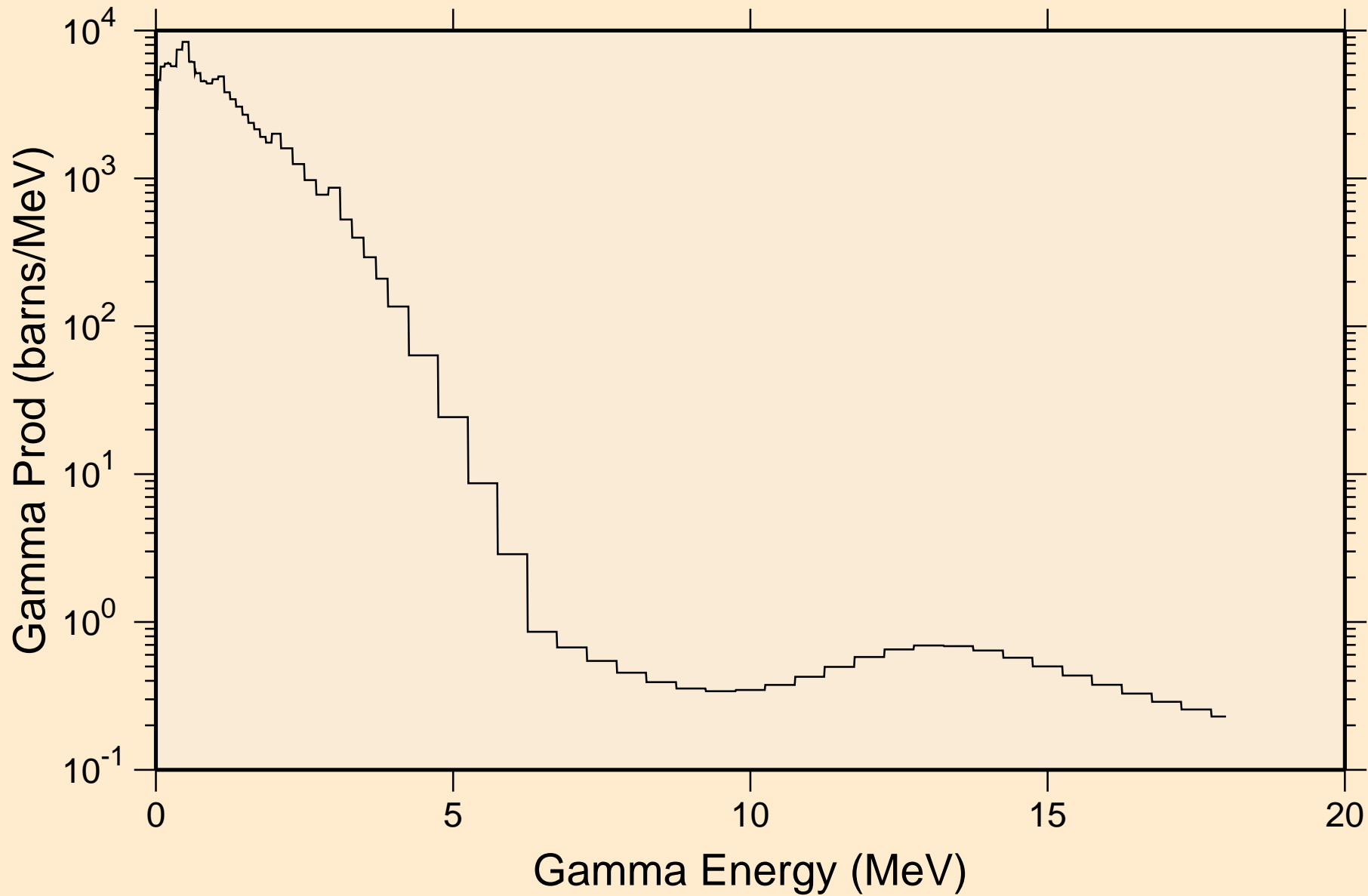

# AU208 NEUTRON ACER TENDL-2024 LIBRARY; T=0.K

## Particle heating contributions

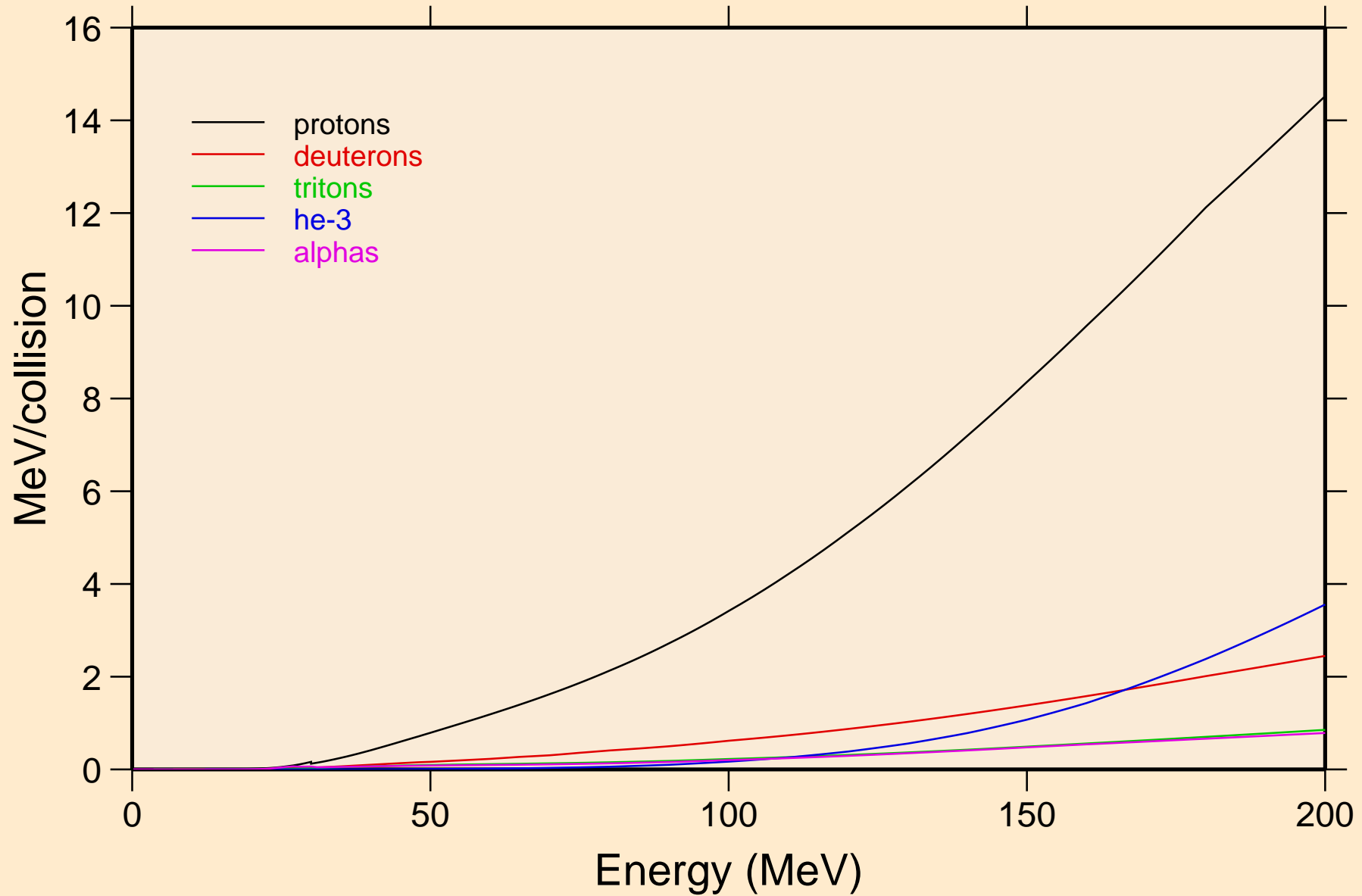

AU208 NEUTRON ACER TENDL-2024 LIBRARY; T=0.K  
Recoil Heating

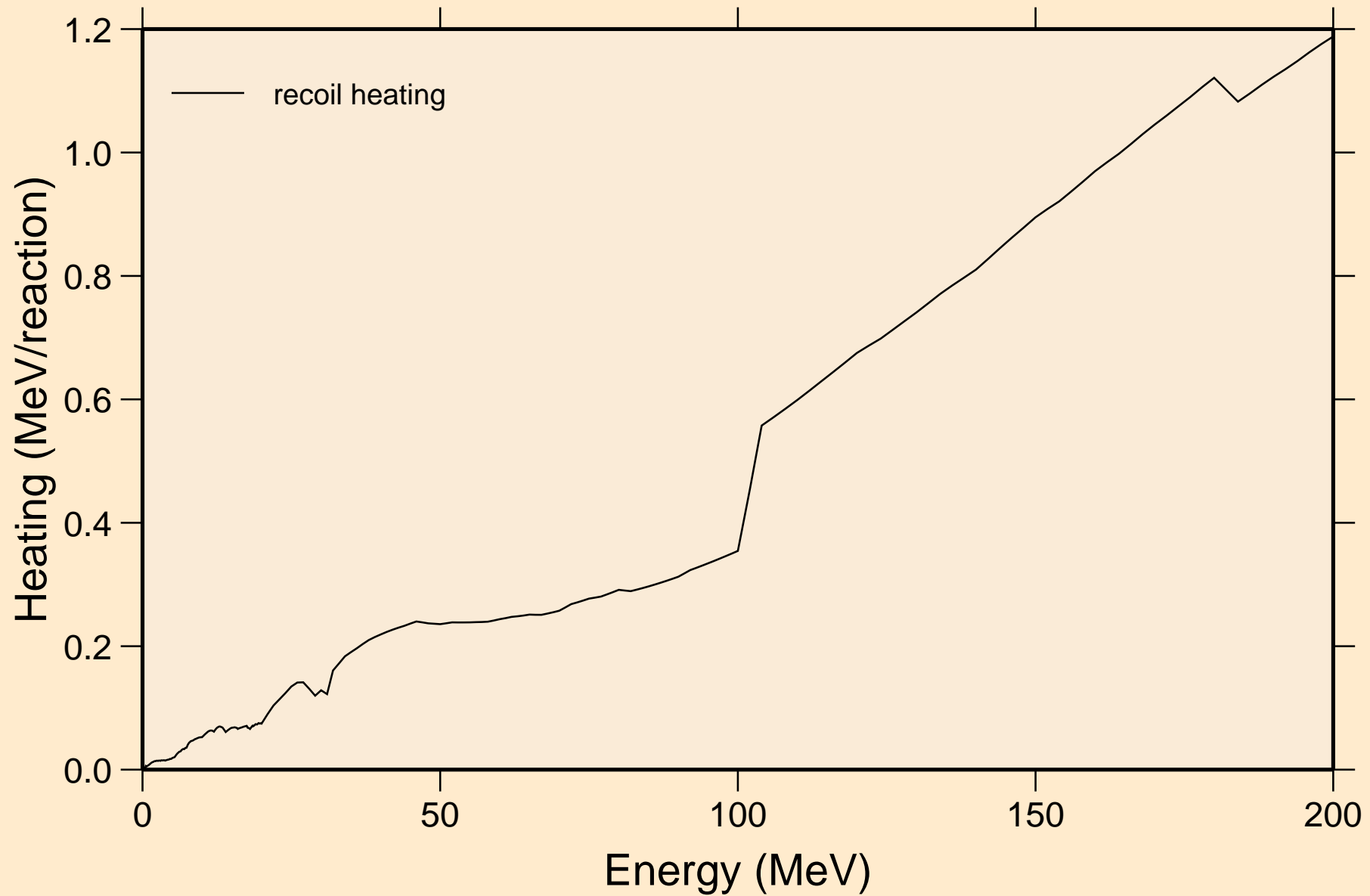

AU208 NEUTRON ACER TENDL-2024 LIBRARY; T=0.K  
Particle production cross sections

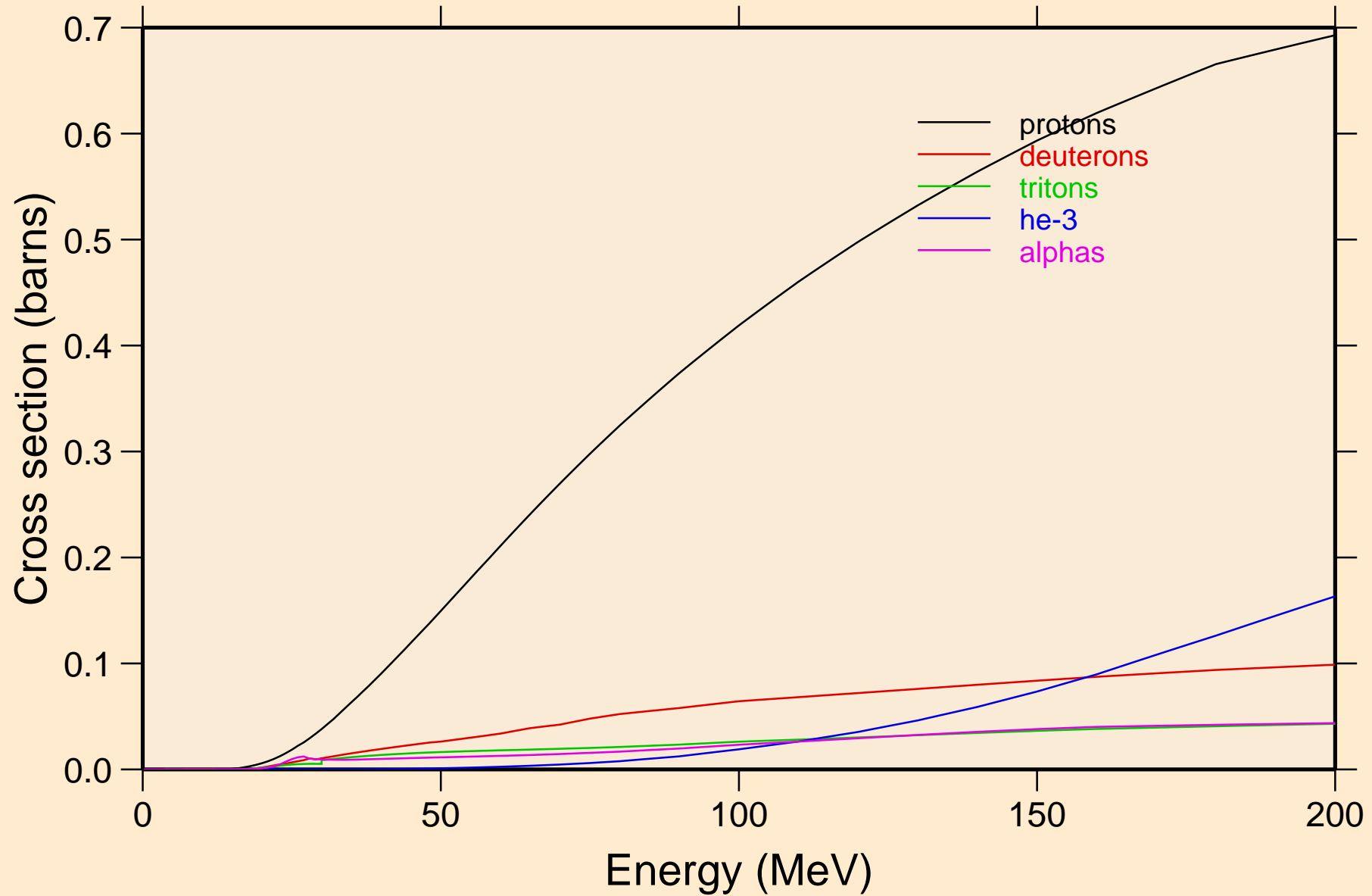

AU208 NEUTRON ACER TENDL-2024 LIBRARY; T=0.K  
protons from (n,x)

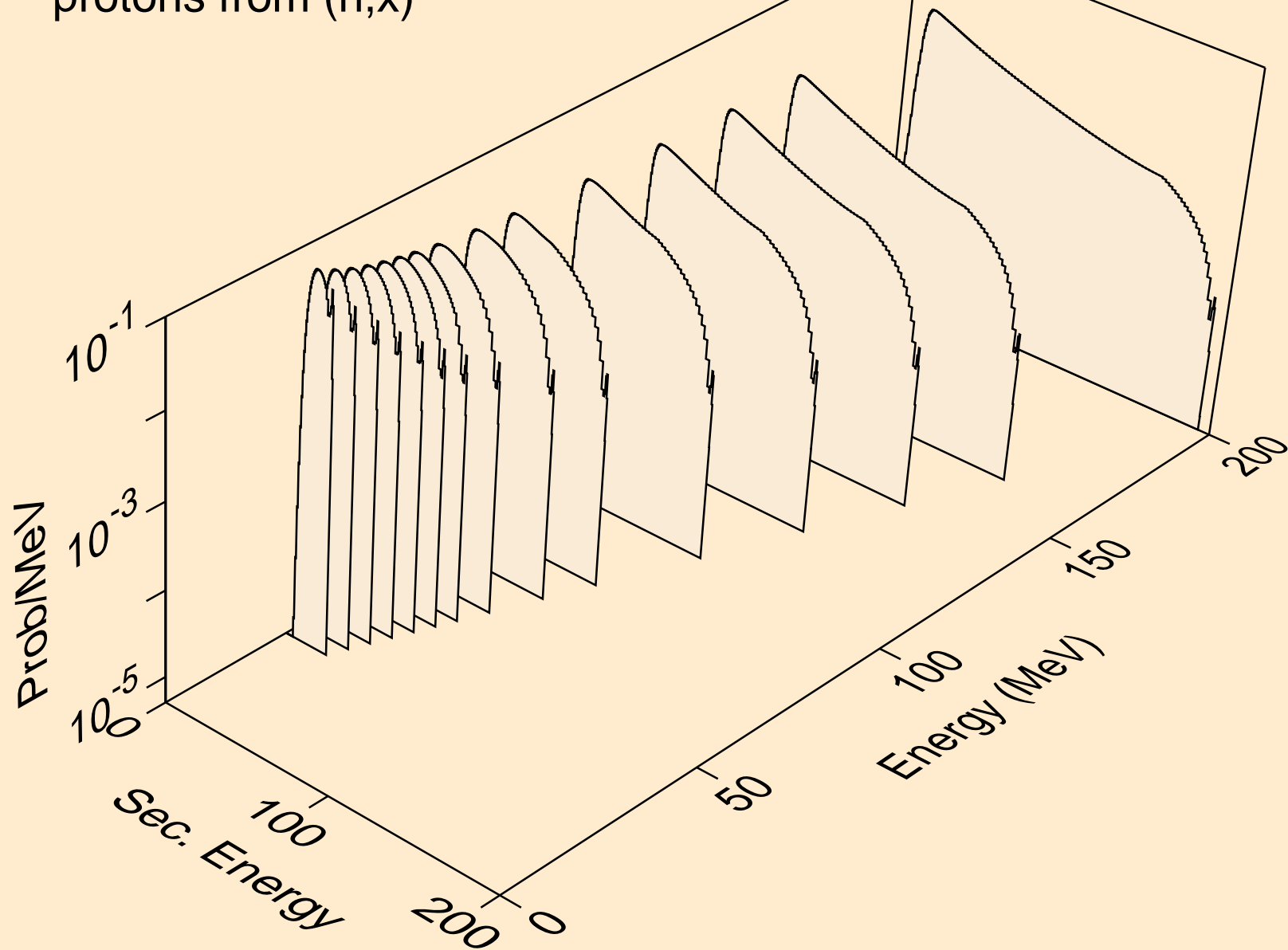

AU208 NEUTRON ACER TENDL-2024 LIBRARY; T=0.K  
protons from (n,n\*)p

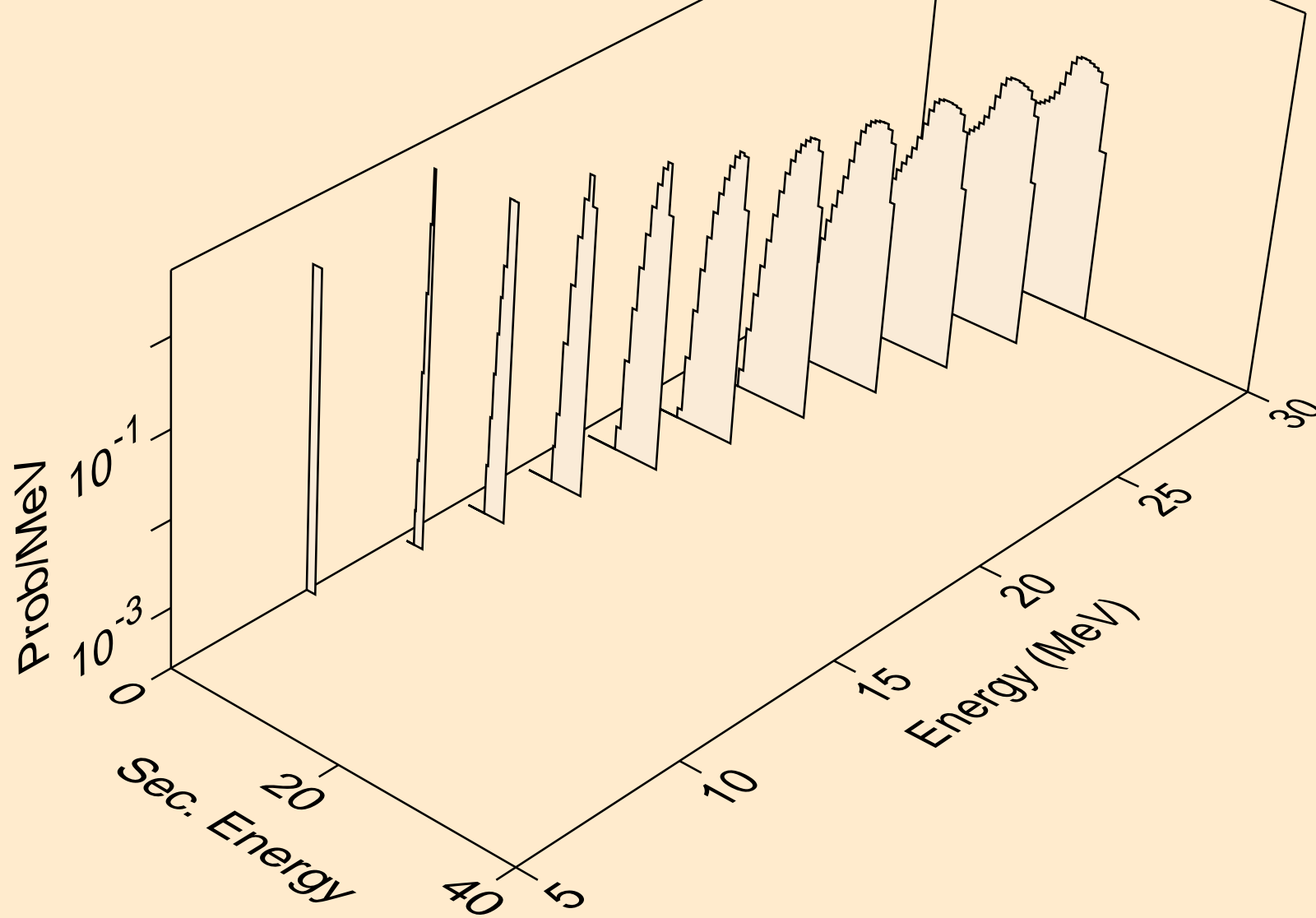

AU208 NEUTRON ACER TENDL-2024 LIBRARY; T=0.K  
protons from (n,2np)

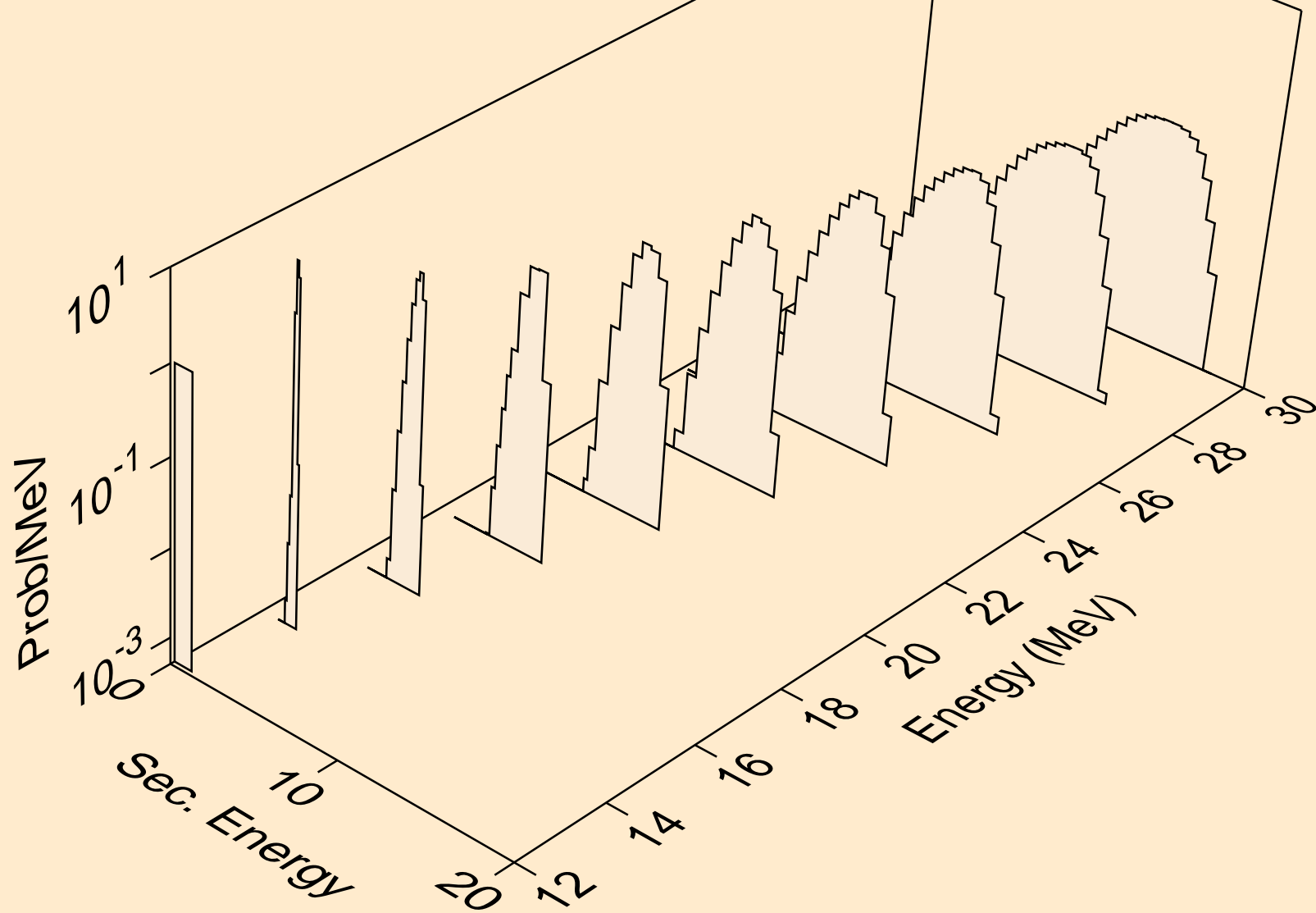

AU208 NEUTRON ACER TENDL-2024 LIBRARY; T=0.K  
protons from (n,3np)

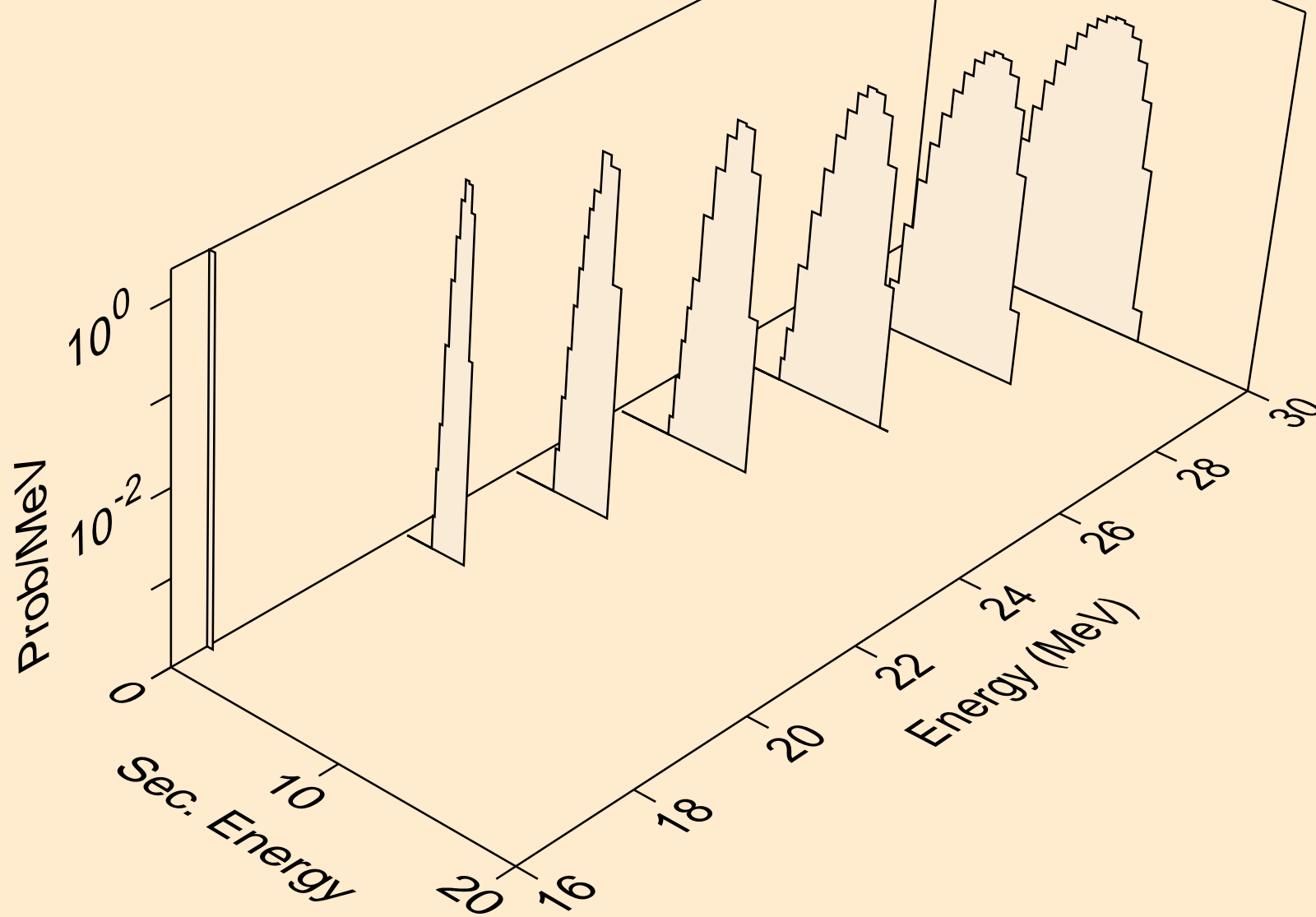



AU208 NEUTRON ACER TENDL-2024 LIBRARY; T=0.K  
protons from (n,p)

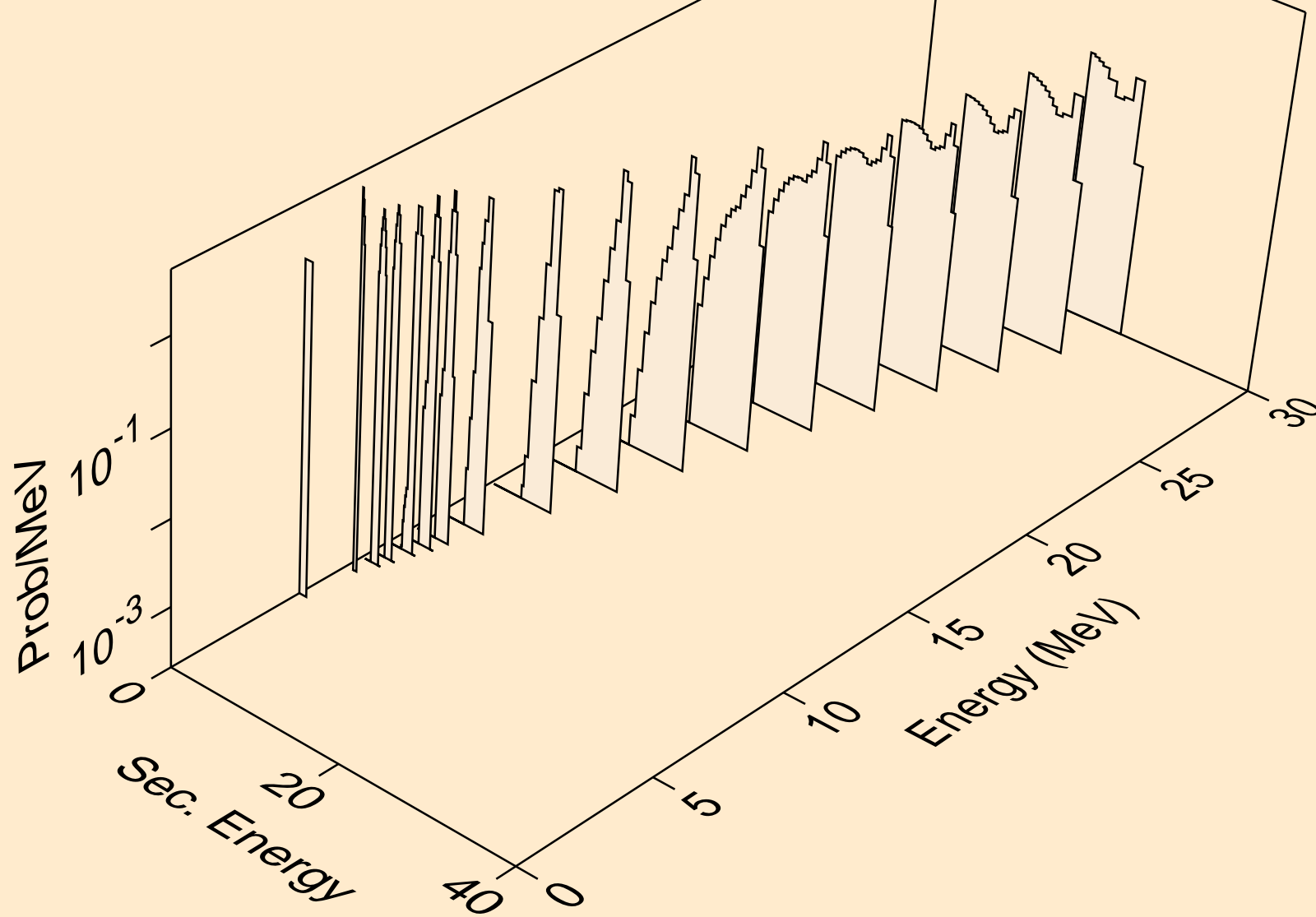

AU208 NEUTRON ACER TENDL-2024 LIBRARY; T=0.K  
deuterons from (n,x)

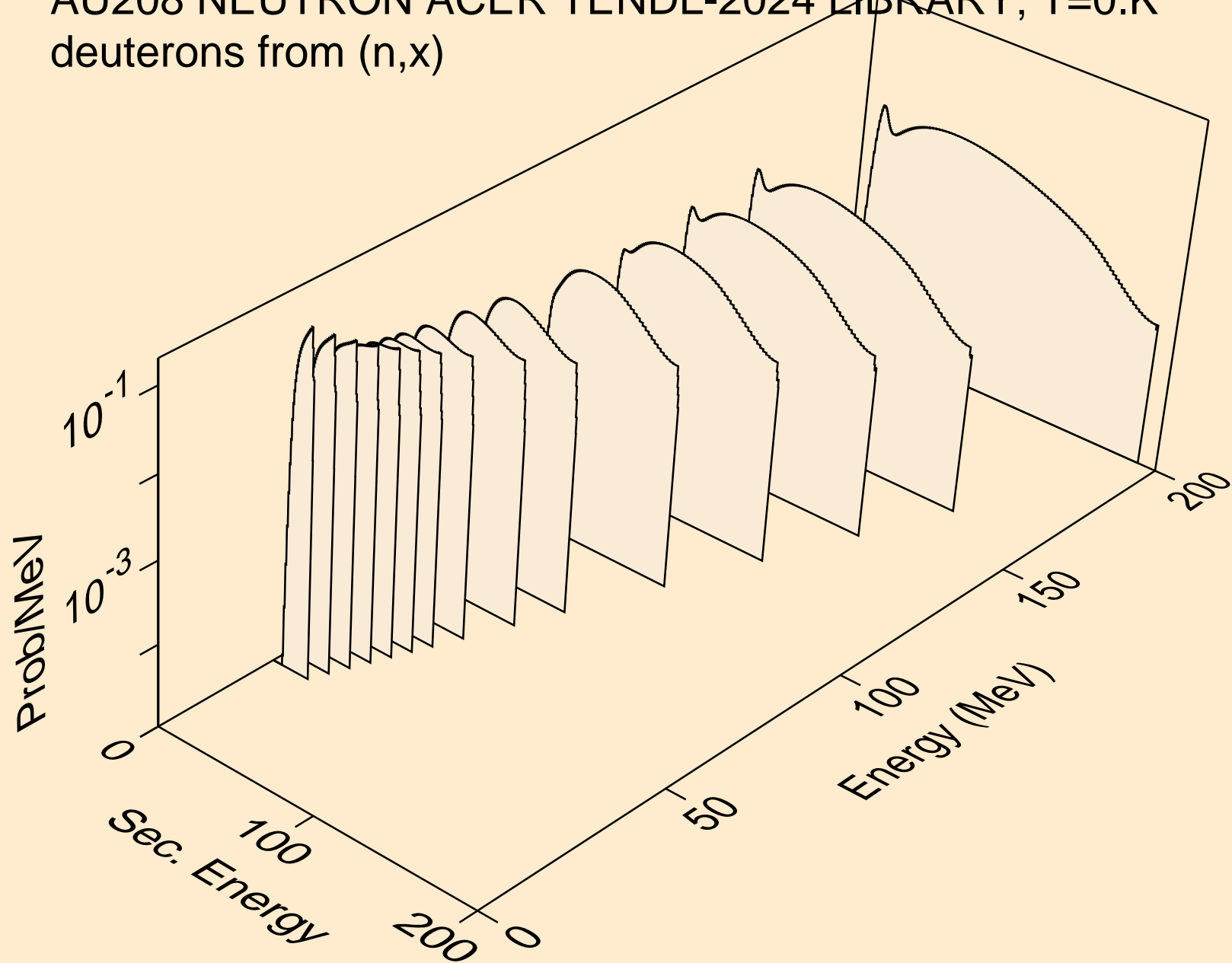

AU208 NEUTRON ACER TENDL-2024 LIBRARY; T=0.K  
deuterons from (n,2nd)

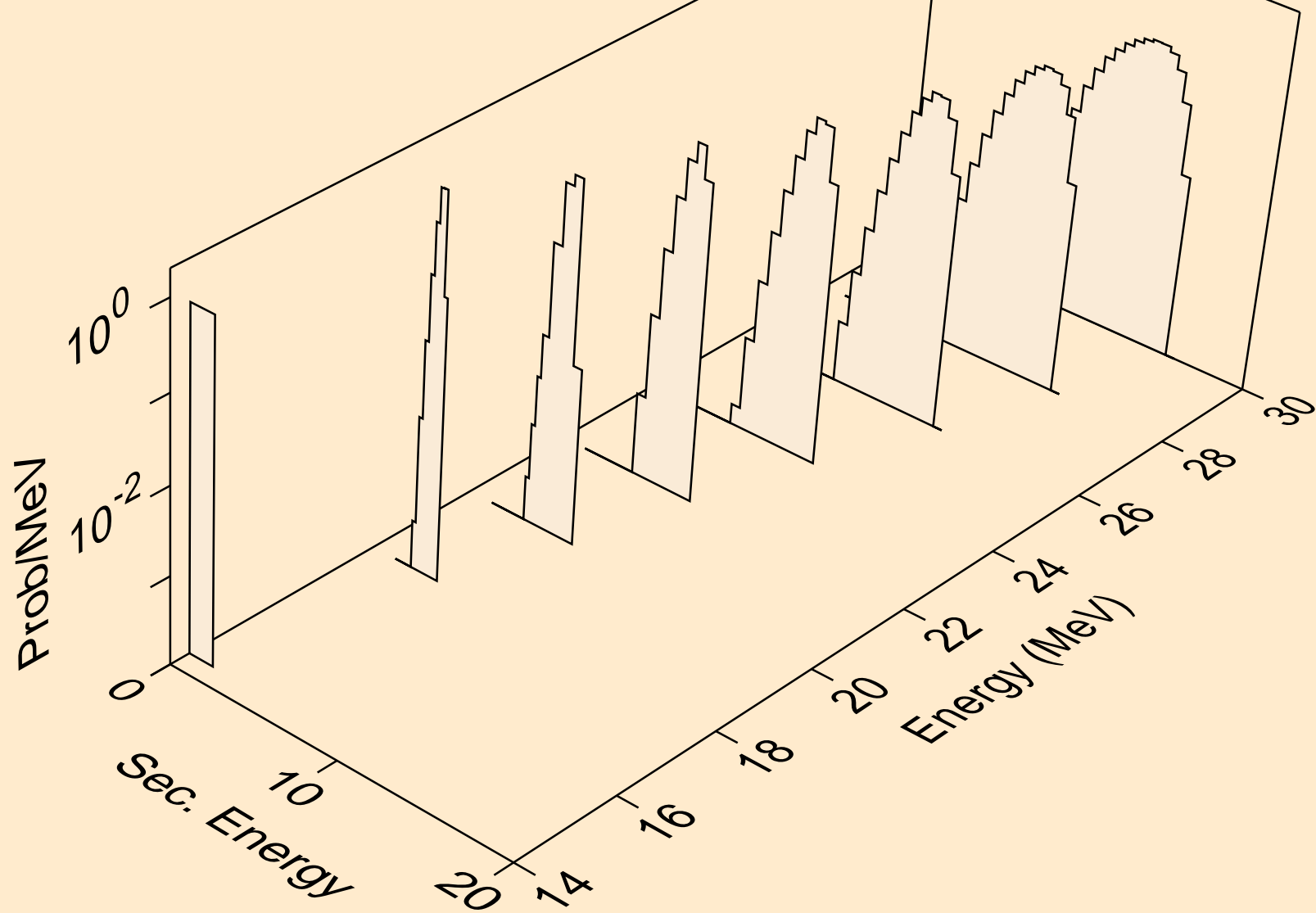

AU208 NEUTRON ACER TENDL-2024 LIBRARY; T=0.K  
deuterons from (n,n\*)d

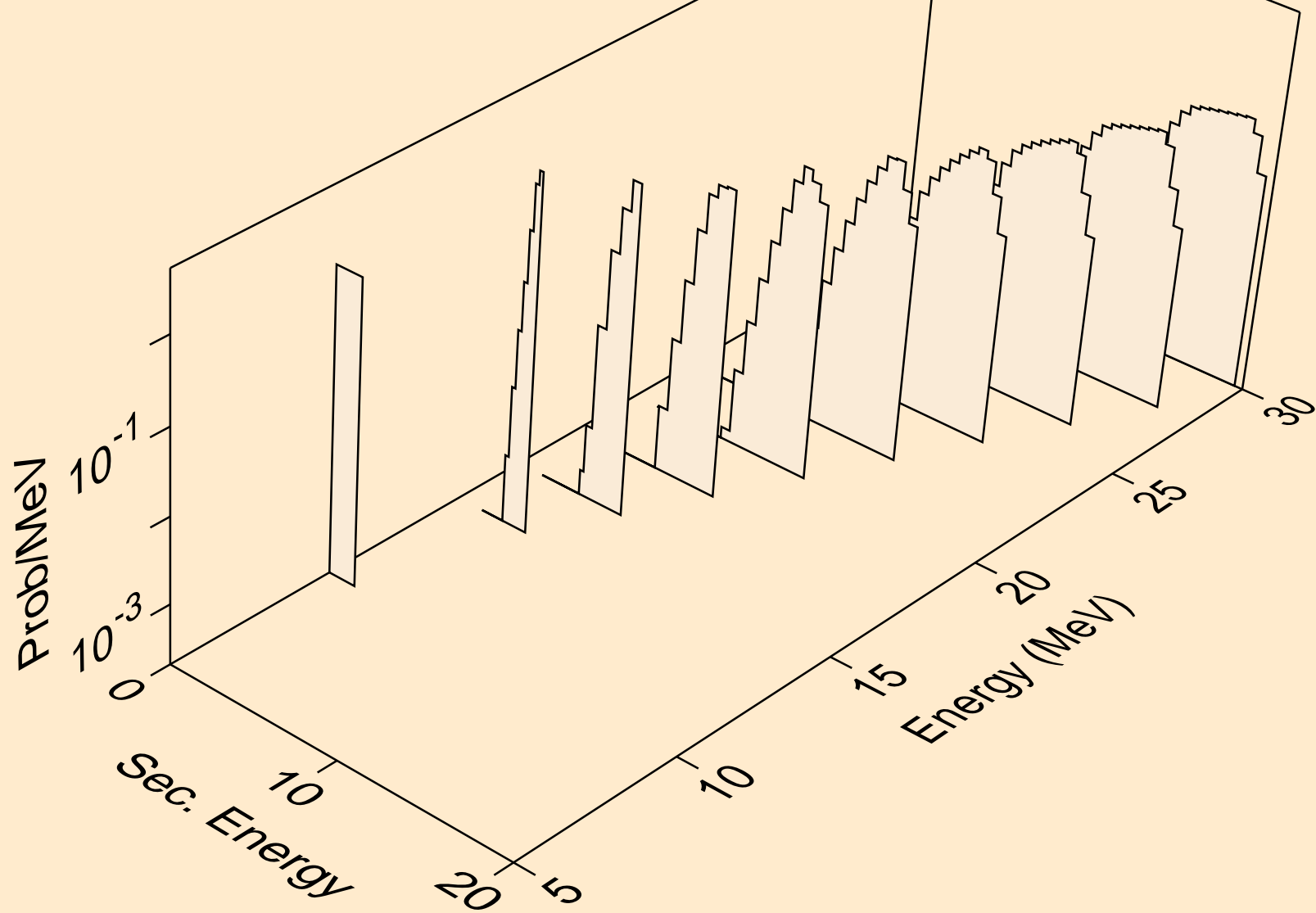

AU208 NEUTRON ACER TENDL-2024 LIBRARY; T=0.K  
deuterons from (n,d)

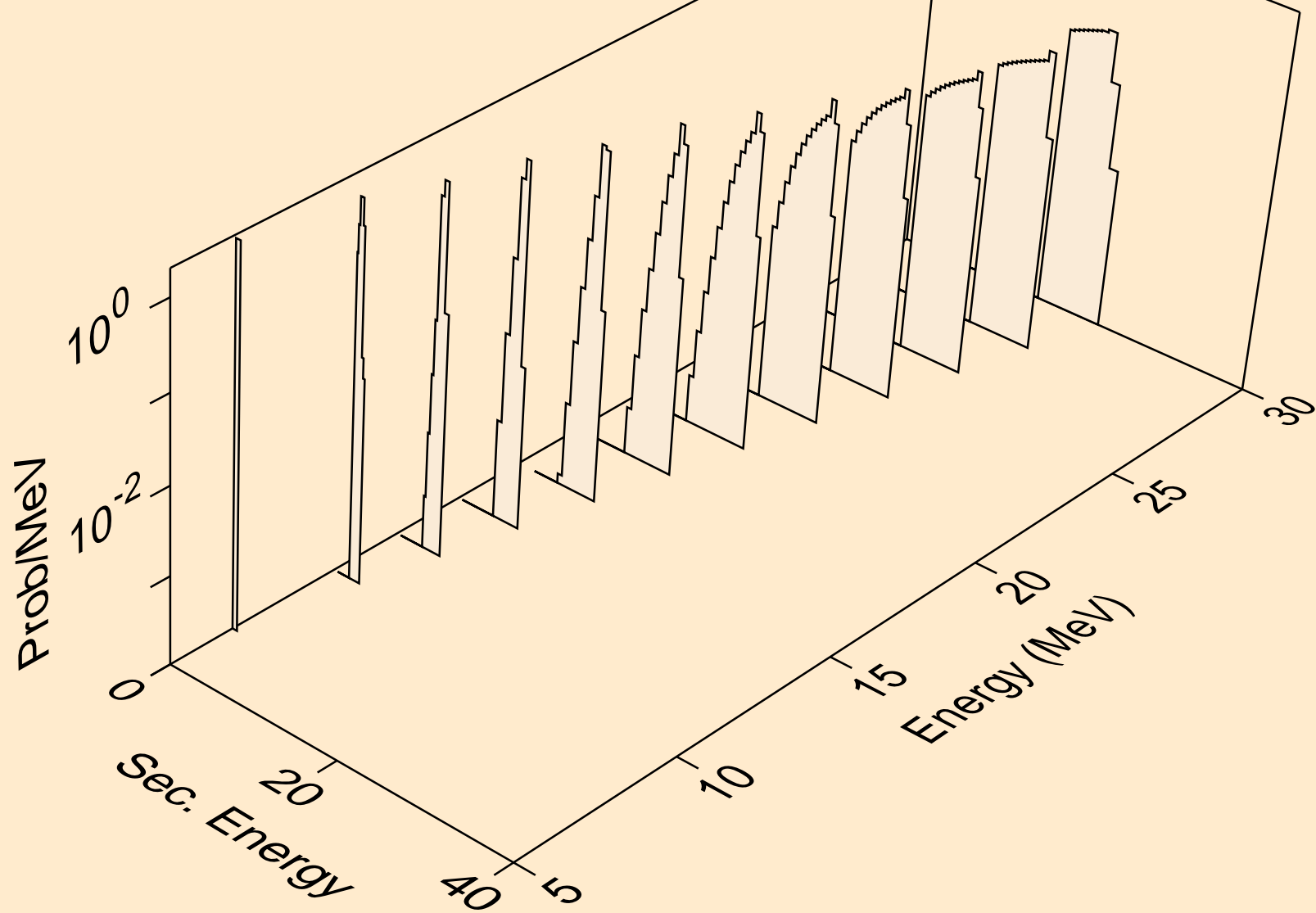

AU208 NEUTRON ACER TENDL-2024 LIBRARY; T=0.K  
tritons from (n,x)

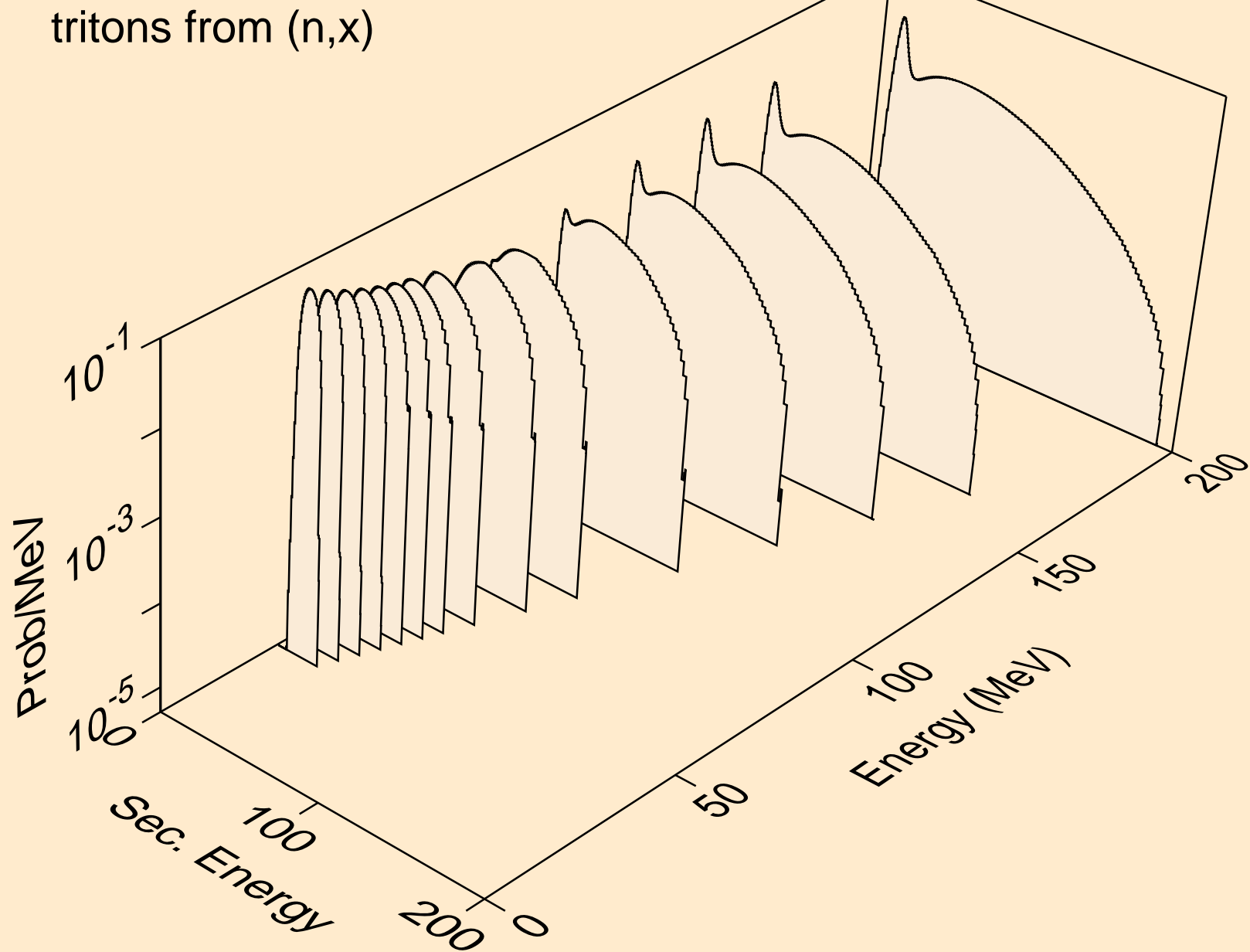

AU208 NEUTRON ACER TENDL-2024 LIBRARY; T=0.K  
tritons from (n,n\*)t

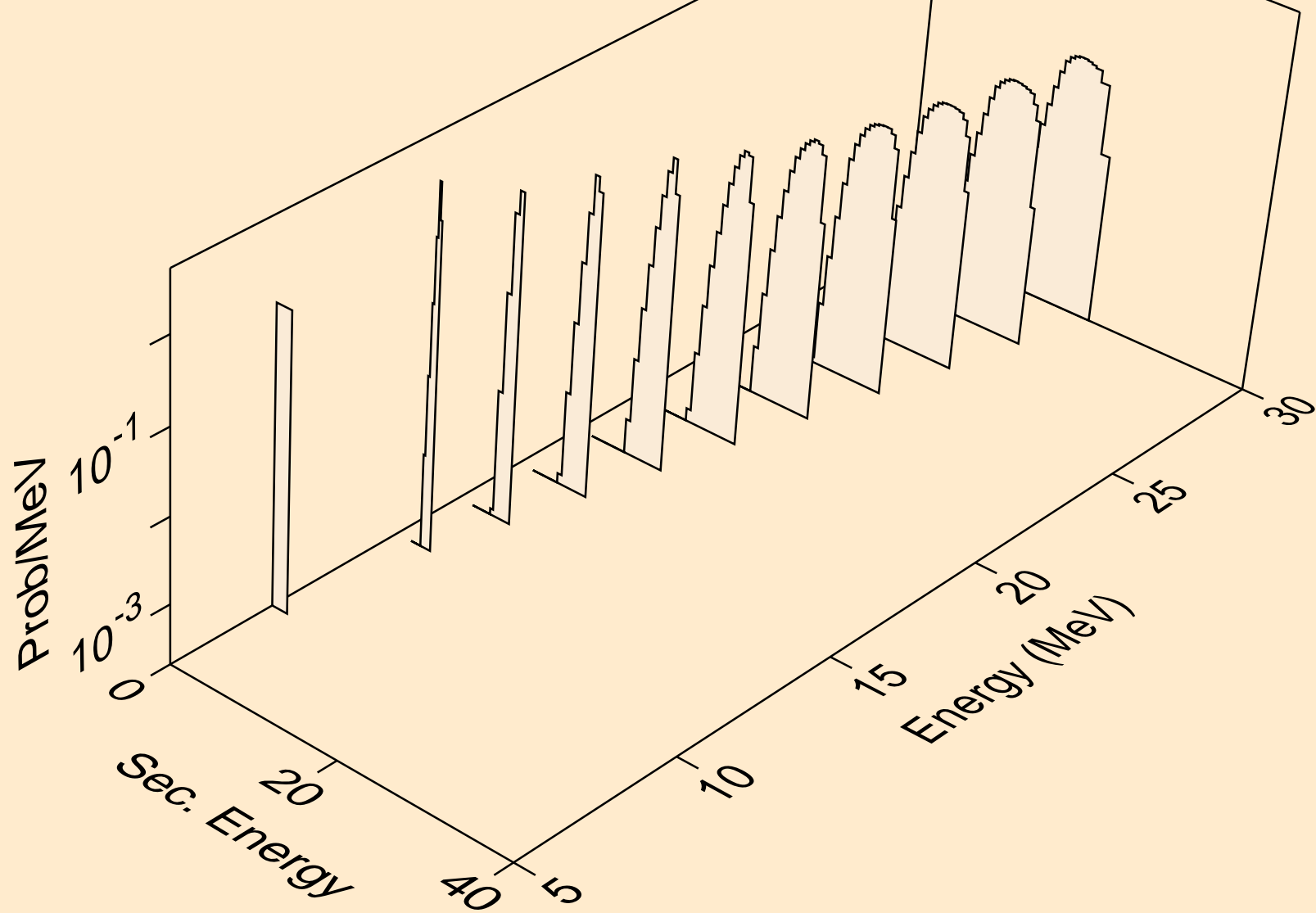

AU208 NEUTRON ACER TENDL-2024 LIBRARY; T=0.K  
tritons from (n,t)

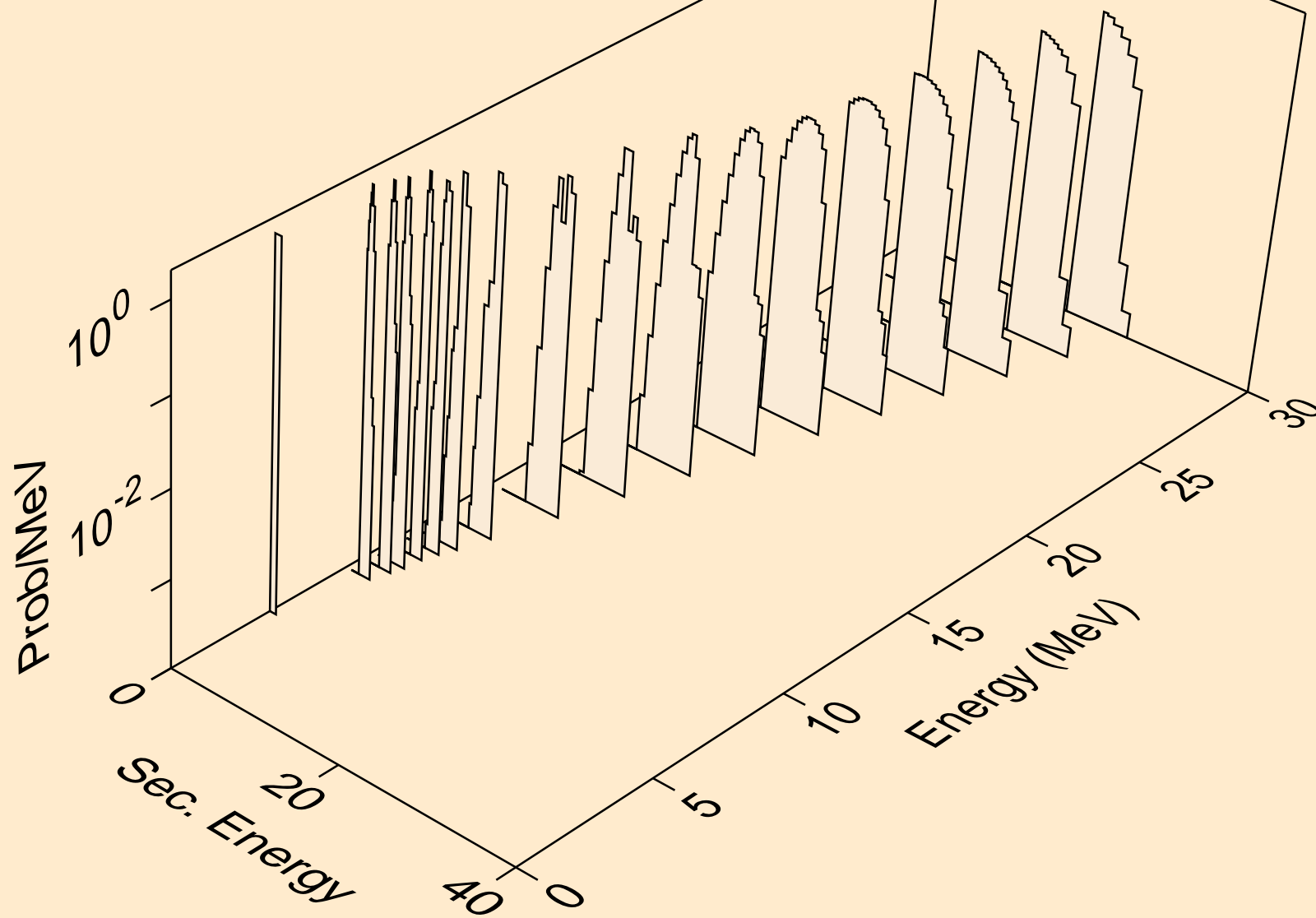



AU208 NEUTRON ACER TENDL-2024 LIBRARY; T=0.K  
he3s from (n,x)

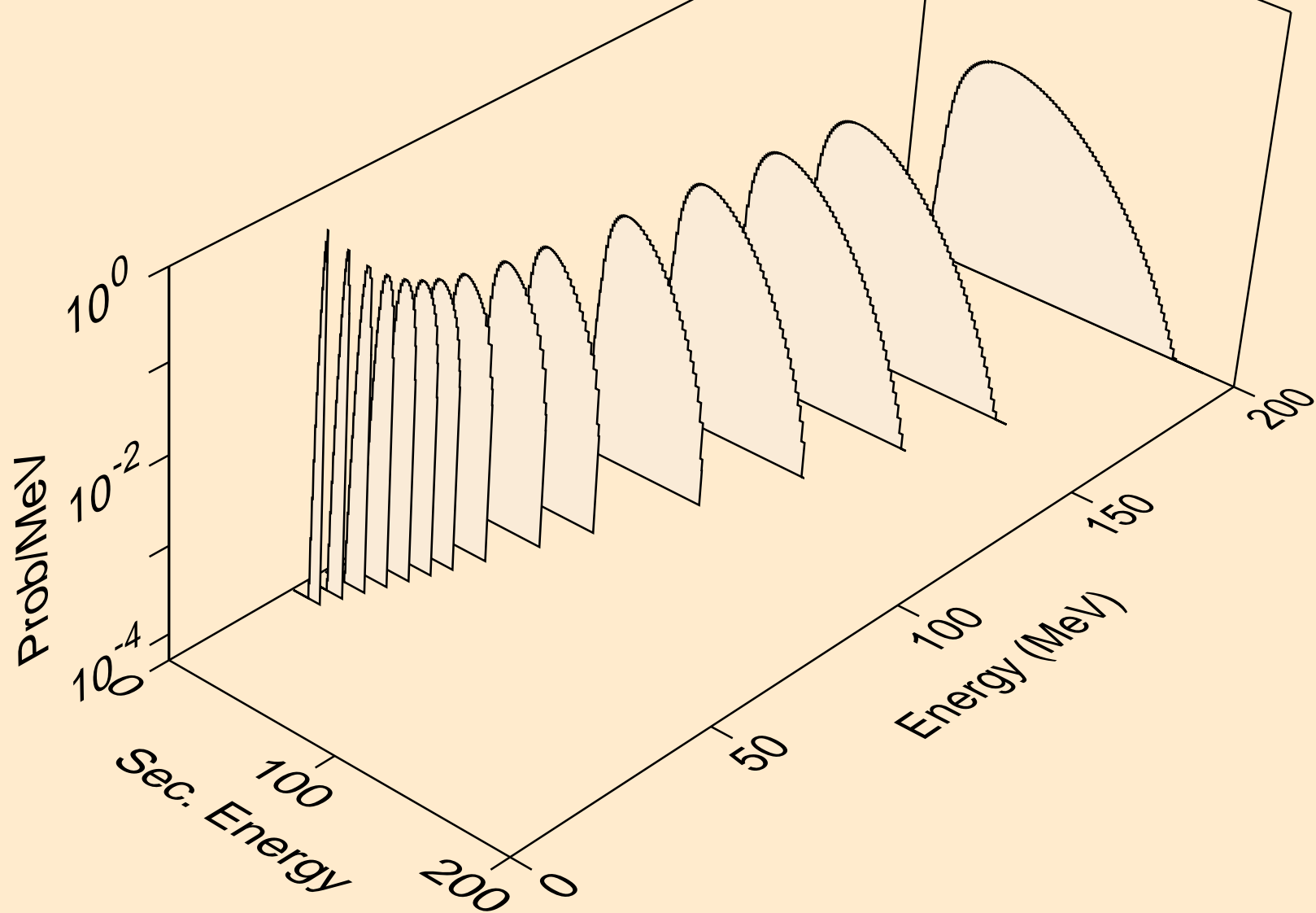

AU208 NEUTRON ACER TENDL-2024 LIBRARY; T=0.K  
he3s from (n,n\*)he3

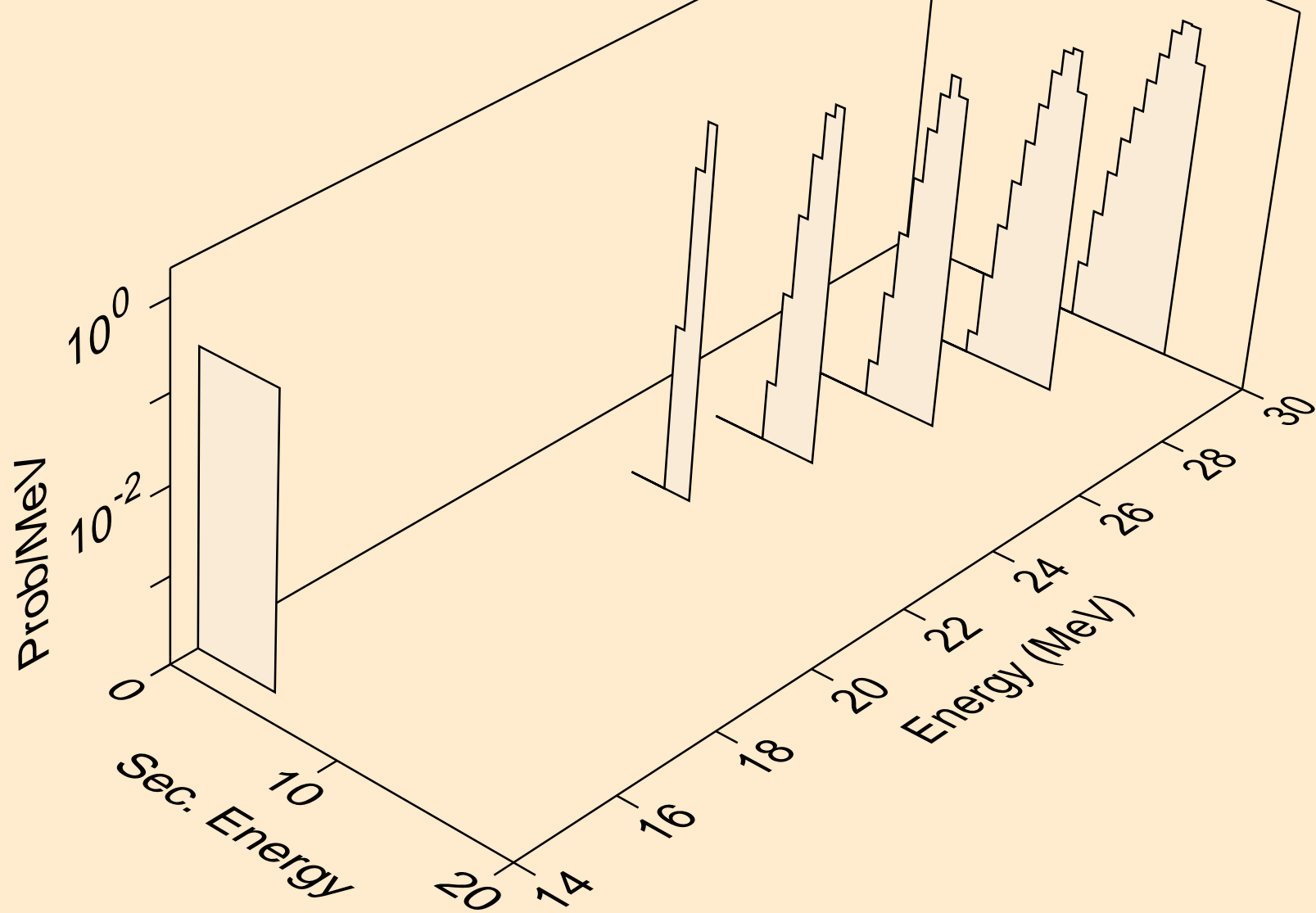

AU208 NEUTRON ACER TENDL-2024 LIBRARY; T=0.K  
he3s from (n,he3)

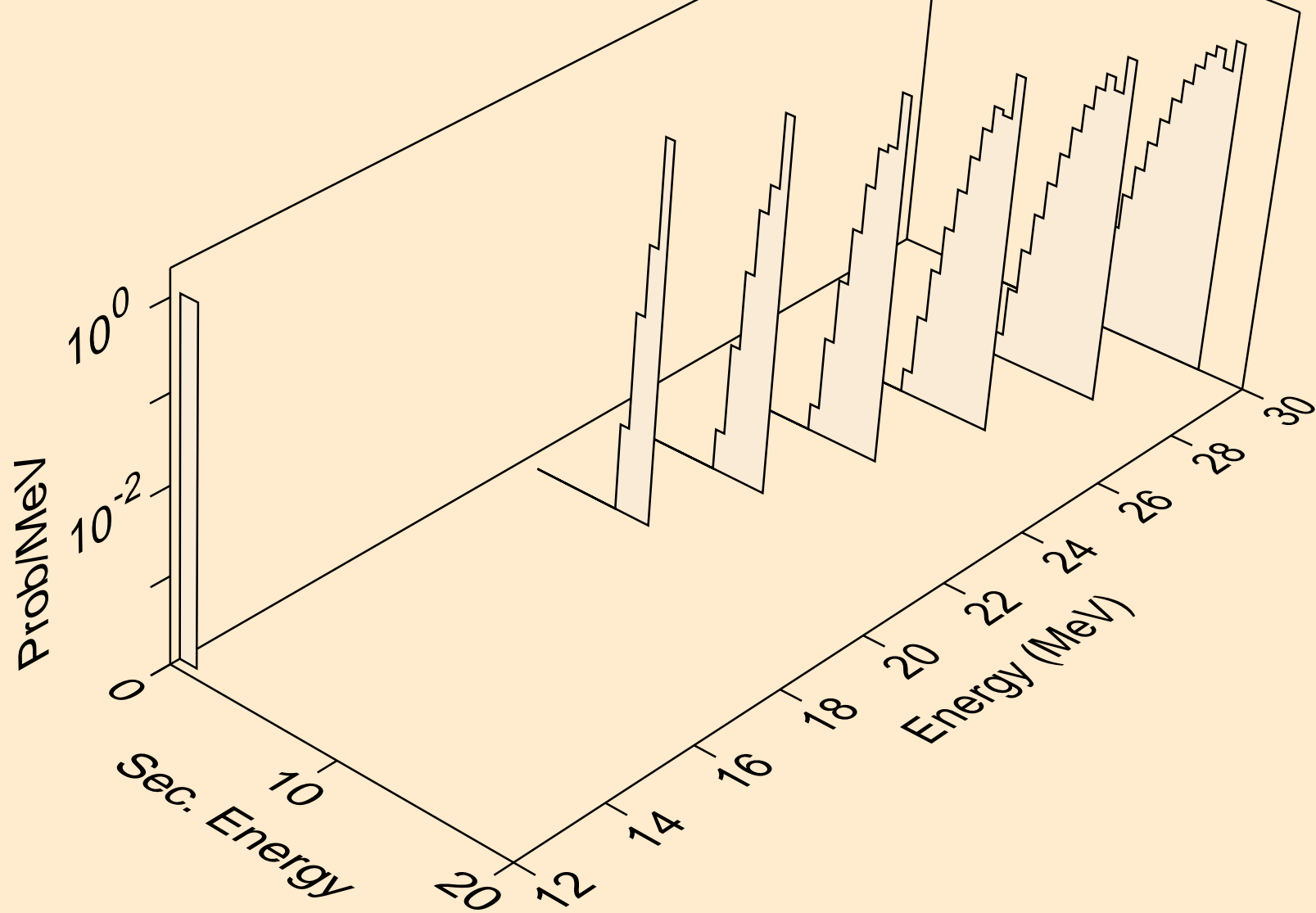

AU208 NEUTRON ACER TENDL-2024 LIBRARY; T=0.K  
alphas from (n,x)

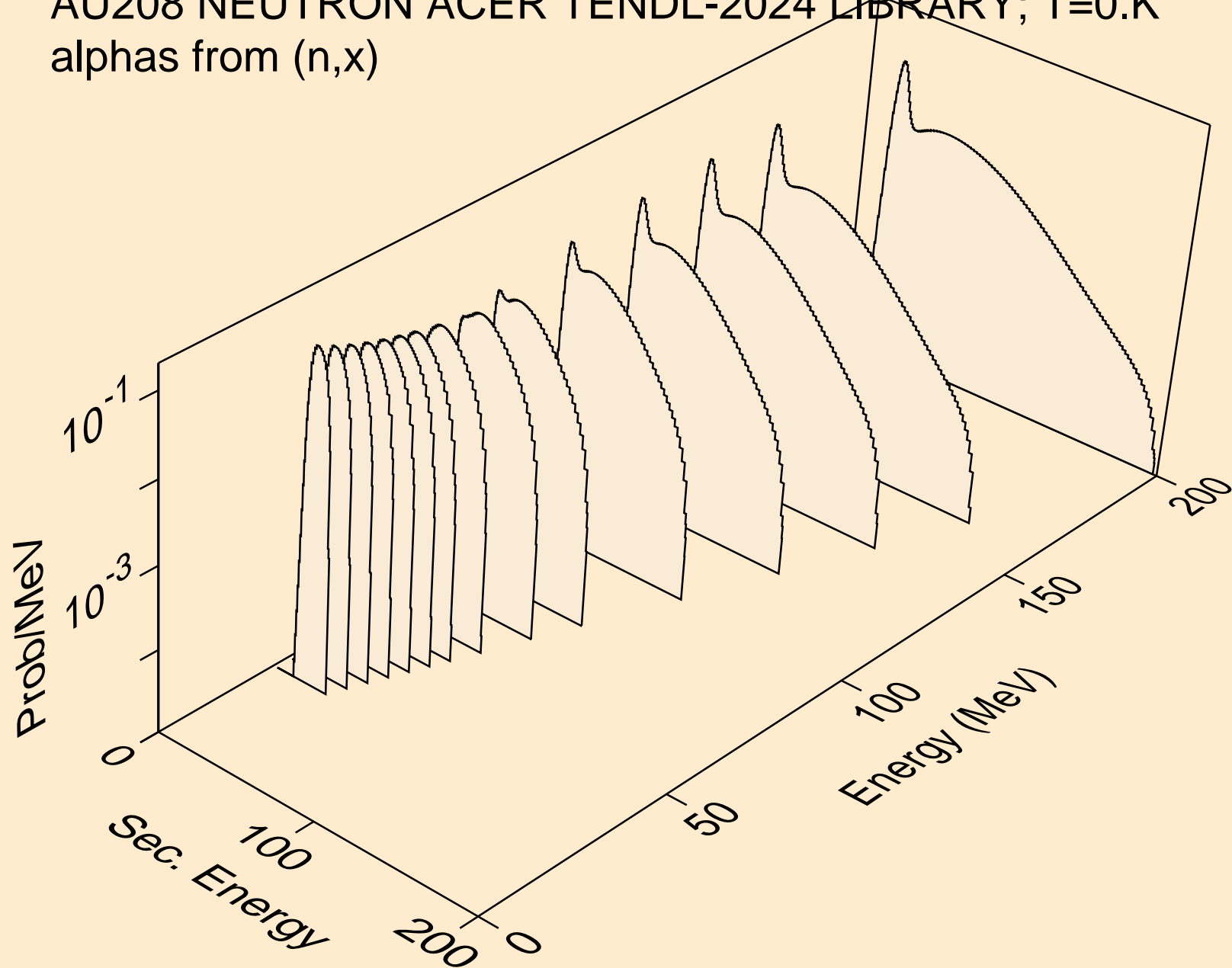

AU208 NEUTRON ACER TENDL-2024 LIBRARY; T=0.K  
alphas from (n,n\*)a

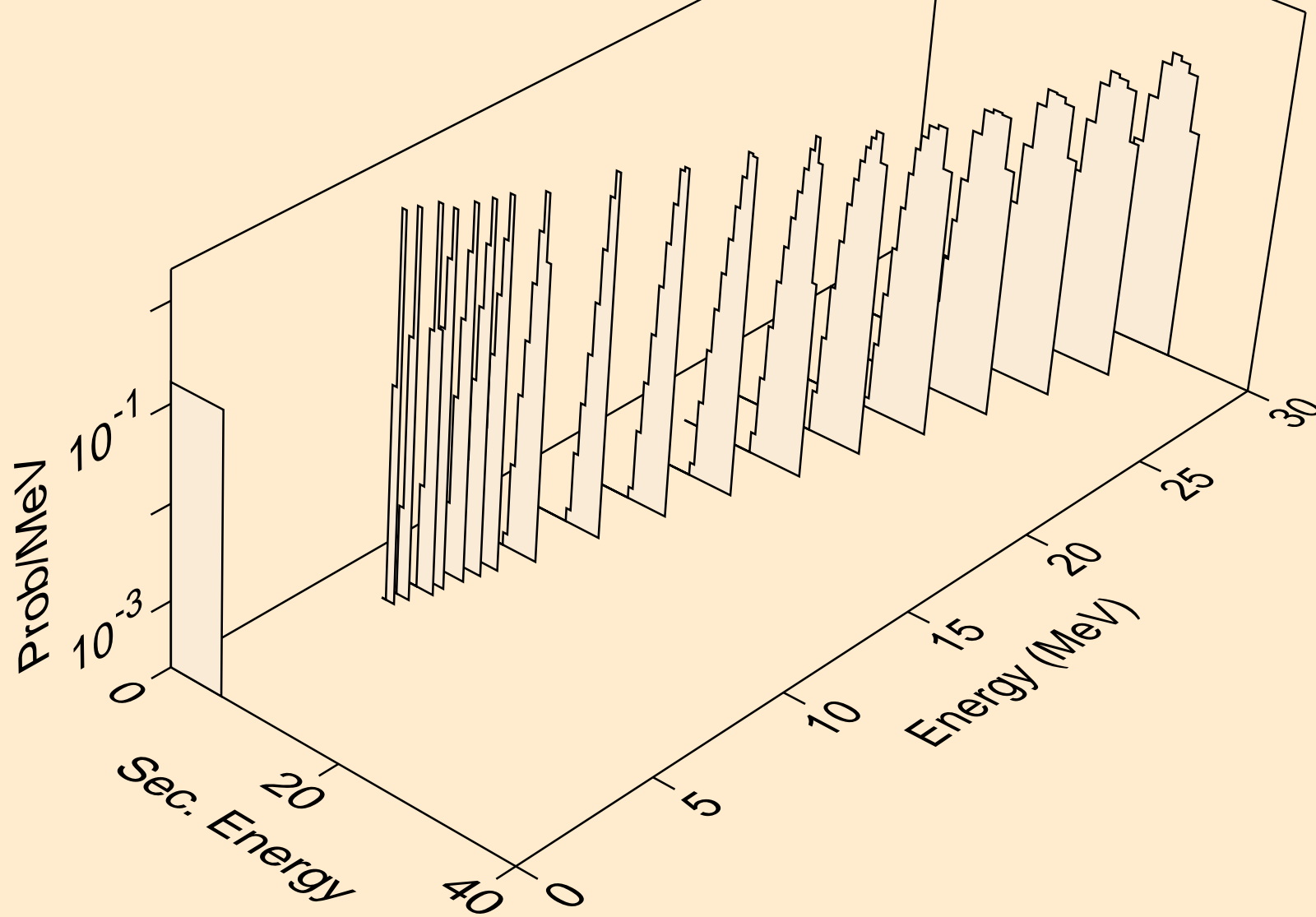

AU208 NEUTRON ACER TENDL-2024 LIBRARY; T=0.K  
alphas from (n,2n)a

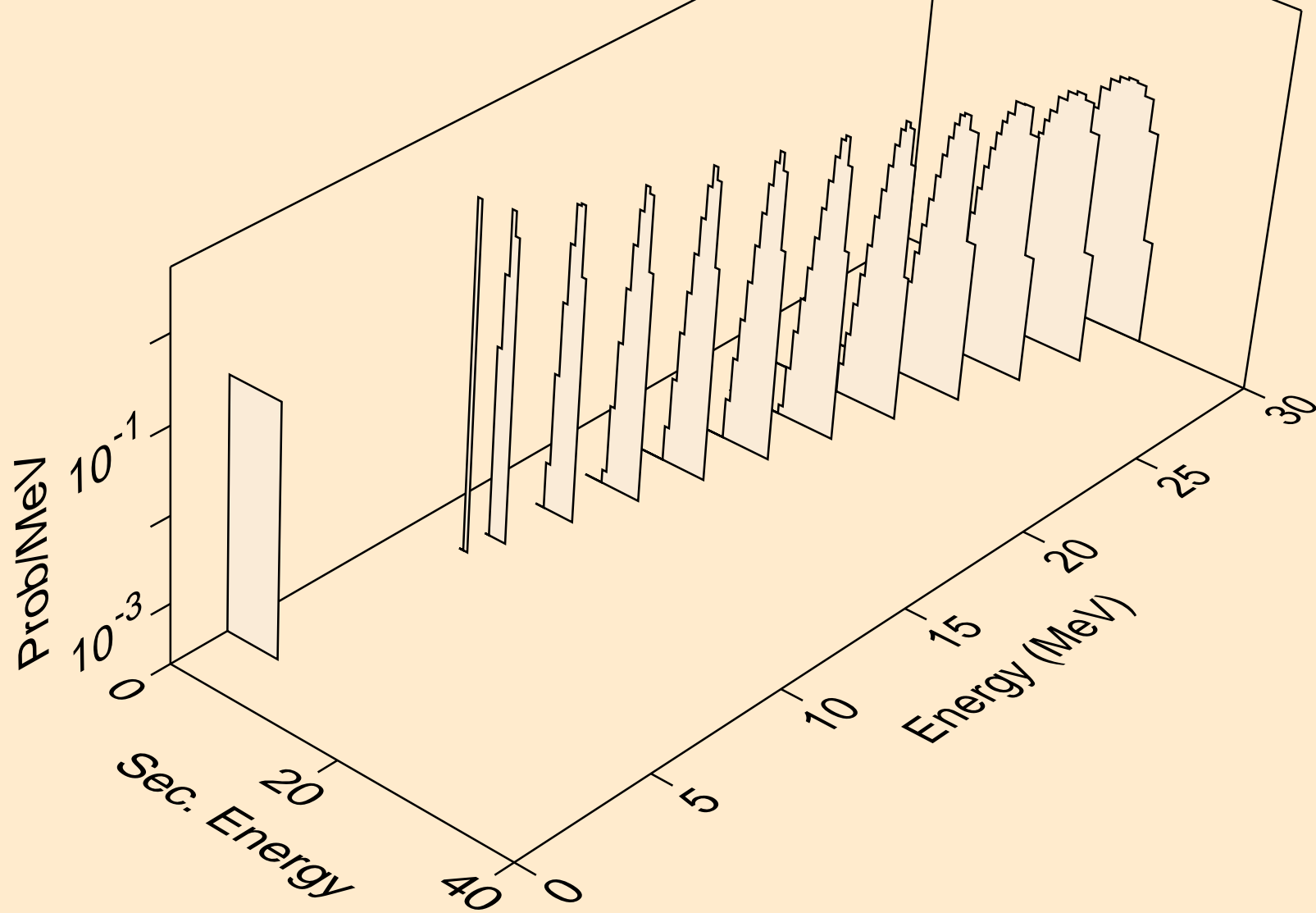

AU208 NEUTRON ACER TENDL-2024 LIBRARY; T=0.K  
alphas from (n,3n)a

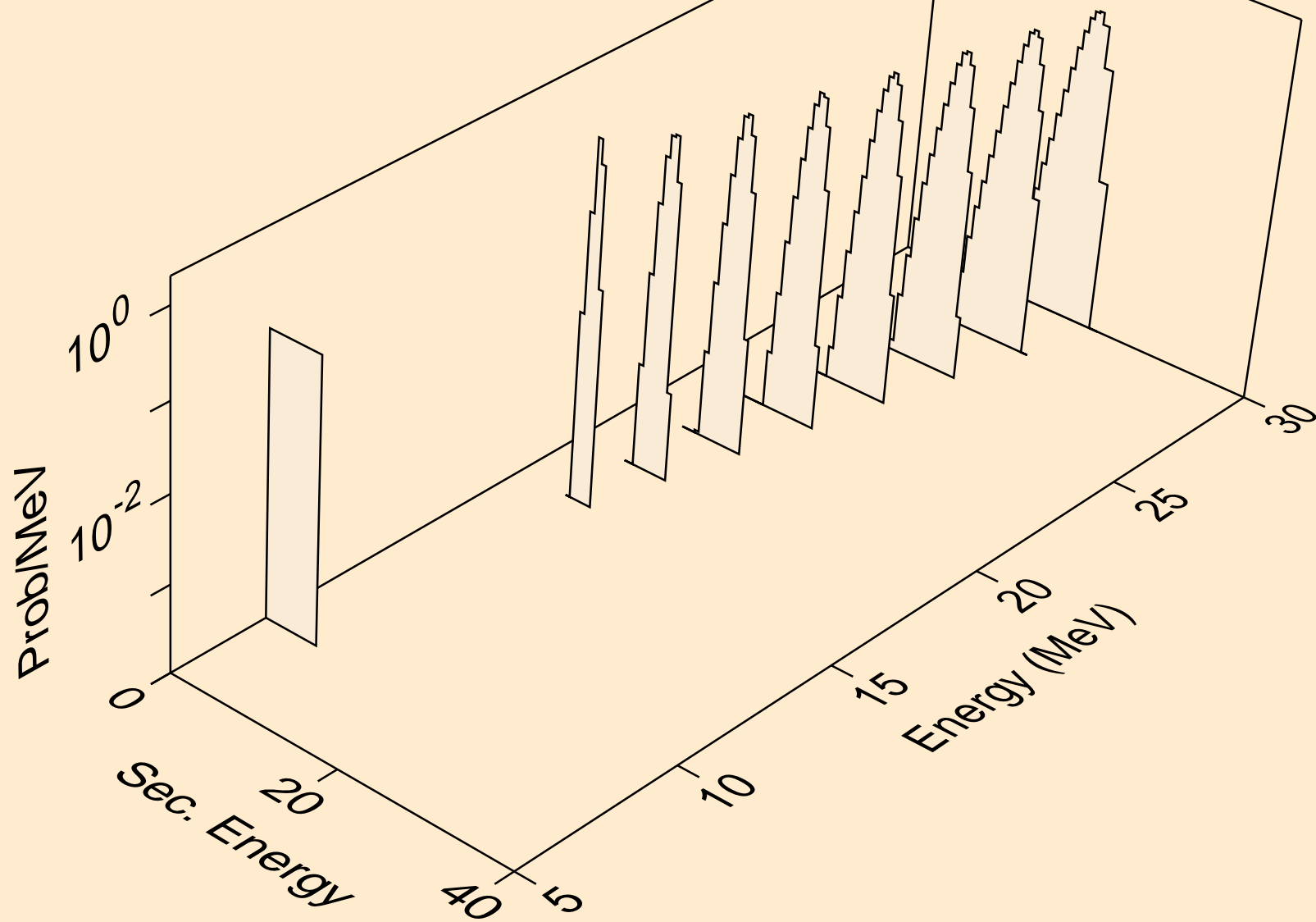

AU208 NEUTRON ACER TENDL-2024 LIBRARY; T=0.K  
alphas from (n,a)

